

SMD-codes

DATABOOK

SMD-codes

Active SMD semiconductor components marking codes

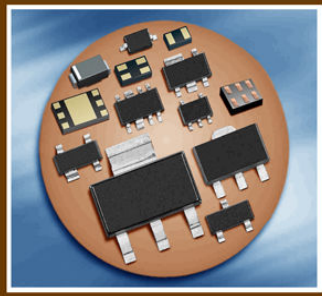

- 170.300 SMD-codes for active semiconductor components:
- Diodes, Transistors, Thyristors, Integrated Circuits
- Conventional case drawings
- Pinouts
- Marking style
- Schematic diagram
- Manufacturers
- Additional SMD info

2011 EDITION

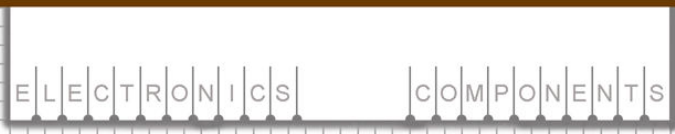

Active SMD components marking codes

databook

INTRODUCTION

1. 2-pin CASES SMD SEMICONDUCTOR COMPONENTS
0 1 2 3 4 5 6 7 8 9 A B C D E F G H I J K L M N O P Q R S T U V W X Y Z
2. SOD-80 CASE SMD SEMICONDUCTOR COMPONENTS
3. 3-pin CASES SMD SEMICONDUCTOR COMPONENTS
0 1 2 3 4 5 6 7 8 9 A B C D E F G H I J K L M N O P Q R S T U V W X Y Z
4. SOT-223 CASE SMD SEMICONDUCTOR COMPONENTS
0 1 2 3 4 5 6 7 8 9 A B C D F G H L N P S T V Z
5. SOT-89 CASE SMD SEMICONDUCTOR COMPONENTS
0 1 2 3 4 5 6 7 8 9 A B C D E F G H I J K L M N O P Q R S T U V W X Y Z
6. 4-pin CASES SMD SEMICONDUCTOR COMPONENTS
0 1 2 3 4 5 6 7 8 9 A B C D E F G H I J K L M N P Q R S T U V W X Y Z
7. 5-pin CASES SMD SEMICONDUCTOR COMPONENTS
0 1 2 3 4 5 6 7 8 9 A B C D E F G H I J K L M N O P Q R S T U V W X Y Z
8. SOT-89-5 CASE SMD SEMICONDUCTOR COMPONENTS
0 1 2 3 4 5 6 7 8 9 A B C D E F G H J K L M N O P Q R S T U V W X
9. 6 and more pin CASES SMD SEMICONDUCTOR COMPONENTS
0 1 2 3 4 5 6 7 8 9 A B C D E F G H I J K L M N O P Q R S T U V W X Y Z
10. BGA, DFN and QFN CASES SMD SEMICONDUCTOR COMPONENTS
0 1 2 3 4 5 6 7 8 9 A B C D E F G H I J K L M N O P Q R S T U V W X Y Z
11. D-PAK CASE SMD SEMICONDUCTOR COMPONENTS
12. CONVENTIONAL CASE DRAWINGS
13. CASES PIN ASSIGNMENTS / PINOUTS
14. PIN / TERMINAL FUNCTION (Table)
15. SMD-CODE MARKING STYLE
16. SAMPLE SCHEMATIC DIAGRAM
17. LOGOS, CONTACT and WEB-ADRESSES OF THE NANUFACTURERS
18. ADITTIONAL SMD INFO

Introduction

At earlier eighties began a trend to replace a traditional through - hole technique with the surface mounted technology (SMT) using surface mounted devices (SMD). The SMT, although intended in principle for automatic manufacturing only expand more and more, even into a hobby world. This trend will continue, because many new components are available in SMD versions only. The SMT technique opens advantages and new applications through miniaturising of the components and increasing of reliability. The industry standard unfortunately allows that most of the SMD components does not have a clear description. Since a tiny size of the components, they are labelled with one, two or more character or graphic SMD code. Thus it is necessary to take into account that the colour and (or) placing of alphanumeric or graphic symbols are also important. Therefore a sure identification of the components is impossible without appropriate technical documentation. Moreover the polarity and pin - outs of different components could be not identified without data sheets.

Identifying the manufacturers type number of an SMD device from the package code can be a difficult task. Unfortunately, each device code is not necessarily unique.

It is possible for various manufacturers to place different devices in the same case with the same SMD-code. For example, with a **6H** SMD-code in a SOT-23 case might be either a npn-transistor **BC818** (CDIL) or a capacitance-diode **FMV2104** (Zetex) or a n-channel JFET transistor **MMBF5486** (Motorola) or a npn-digital transistor **MUN2131** (Motorola) or a npn-digital transistor **UN2117** (Panasonic) or a CMOS-integrated circuit- voltage detector with reset output **R3131N36EA** (Ricoh). Even the same manufacturer may use the same code for different devices.

To identify a particular SMD device, is necessary to identify the manufacturer, package type and note the SMD code printed on the device.

The identification of the manufacturer is possible only if on the case are printed the manufacturer's logos, but it not always happens. Besides, sometimes it is possible to determine the manufacturer with indirect tags. Many recent ON Semiconductor devices have a small superscript letter after the device code, such as **SA^c** (this smaller letter is merely a month of manufacture code). Siemens and Infineon devices usually have a lower case '**s**' (**ATs**, **LOs**). Philips devices usually have a lower case '**p**' (**AHp**, **Z1p**, **pB0**) or '**-**' (**D-Q**, **Z-S**) for the devices made in Hong Kong and '**t**' (**ZtS**, **tT9**, **Y7t**) for the devices made in Malaysia. In section 17 are submitted the logos of the SMD devices manufacturers.

The package type is another problem for the identification of SMD devices. The different manufacturers can designate identical cases according to the various standards (or according to the internal firm system). Besides, the various cases can have an identical kind (form) and differ only by sizes, but this distinction of sizes so it is not enough, that can be as measured only by special measuring devices.

Compliance with the name and type of cases from different manufacturers is solved by applying in the column "Cases" an equivalent type name for equivalent cases.

In addition to SMD-code on cases may be put padding alpha-numeric information (usually by another font or size of characters, also may be by other arrangement). Relationship position of the SMD-code and padding information have defined as style and show in the column "Style"

In the following tables sections the SMD semiconductor components - irrelevant as to whether it is dealing with transistors, diodes, integrated circuits etc. are placed in separate tables according to numbers of terminals and (or) type of cases and are listed in alpha-numeric order by SMD-codes.

Column 1 ("SMD-Code")

...(blue) Color of SMD code

Column 2 ("Type")

The type designations correspond to those of the respective manufacturer documentations.

Column 3 ("Device")

Short definition of the semiconductor component.

Used abbreviations:

BM-IC	Battery Management integrated circuit	Li-IC	Linear integrated circuit
BR	Bridge Rectifier	LVR-IC	Linear voltage regulator integrated circuit
C-diode	Capacitance diode (varactor, varicap)	LVR/Vdet-IC	Linear voltage regulator/Voltage detector combined integrated circuit
CMOS-Logic	CMOS logic integrated circuit	MMC	Monolithic Microwave Integrated Circuit
Comp-IC	Voltage comparator integrated circuit	-MOSFET	Metal-Oxide-Semiconductor FET
DC/DC-IC	DC/DC voltage converter integrated circuit	-MOSFET*	MOSFET, with integrated gate protection diode
ESDP-diode	ElectroStatic Discharge Protection diode	-MOSFETd	MOSFET, depletion type
ESD-Prot	ElectroStatic Discharge Protection thyristor	-MOSFETE	MOSFET, enhancement type
-FET	Field Effect Transistor	-MESFET	MEtal-Semiconductor FET
-FET*	FET with integrated gate protection diode	n-	n-channel junction transistor
-FETd	FET, depletion type	n/p-	n-channel and p-channel transistors area
-FETe	FET, enhancement type	Op-IC	Operational amplifier integrated circuit
HEMT	High electron mobility transistors	p-	p-channel junction transistor
H-IC	Hall-effect sensor integrated circuit	PHEMT	Pseudomorphic high electron mobility transistors
LDR-IC	LED driver integrated circuit	PIN-diode	PIN-diode
		SA-Z-diode	Surge Absorption Zenner diode
		Si-diode	Silicon diode
		Si-Varistor	Silicon voltage depending resistor
		Si-npn	Silicon npn transistor
		Si-n/p	Silicon npn and pnp transistors area
		Si-npn-Darl	Silicon npn Darlington transistor
		Si-npn-Digi	Silicon npn "digital" transistor

Si-npn-Digi+Di	Silicon npn "digital" transistor with internal diode
Si-pnp	Silicon pnp transistor
Si-pnp-Darl	Silicon pnp Darlington transistor
Si-pnp-Digi	Silicon pnp "digital" transistor
Si-npn-Digi+Di	Silicon npn "digital" transistor with internal diode
SiGe-npn	Silicon/Germanium npn transistor
Si-Stab	Silicon stabistor
SVR-IC	Switching Voltage Regulator integrated circuit
Tdet-IC	Thermal detector integrated circuit
Thy-SPD	Thyristor-surge protector device
Triac	Triode for alternating current
TVS	Transient voltage suppressor
Vdet-IC	Voltage Detector integrated circuit
VR-IC	Voltage regulator integrated circuit
Vref-IC	Voltage Reference integrated circuit
Z-diode	Zenner diode

Column 4 ("Short description")

Short data or description of function of each type. Used abbreviations:

Adj.	Adjust, adjustable
AF	Audio Frequency
AGC	Automatic Gain Control
ALC	Automatic Level Control
AM	Amplitude Modulation (AM range)
Amp	Amplifier
Ant	Antenna
Att	Attenuator
Aval	Avalanche
Disc.	Internal CL discharge
BTL	Bridge Tied Loads
Buff	Buffer
CATV	Broad band cable amplifier
+CE	Active HIGH Chip Enable
-CE	Active LOW Chip Enable
Cell	Cellular
CL	Internal CL discharge resistor
Contr	Controlled
Conv	Converter
Cordl	Cordless
Det	Detector
DG	Dual Gate
Diff	Differential
Dr, Drv	Driver
EN	Enable
Ext.	External
FM	Frequency Modulation (FM range)
GaAs	Gallium arsenide
GP	General Purpose Applications
HF	High Frequency
Hi-sp	High-speed
HSST	High-Speed Soft-Start
HV	High Voltage
I2C	I2C interface control
I2S	I2S interface
ICP	Inrush Current Protection
Instrum.	Instrumental
Latch-Pr.	Latch-Protection
LDO	Low drop voltage
LED	Light-emitting diode
LLS	Logic Level Shifter
LN	Low Noise
LogL	Logic Level (Uth > 0,8...2V)
Lo-sat	Low collector-emitter saturation voltage
LSST	Low-Speed Soft-Start
Mix	Mixer
MR	Manual Reset
ODO	Open Drain Output
OCO	Open Collector Output

OVIn	Over Voltage Rest Input (negative)
OVP	Over Voltage Protection
Osc	Oscillator
Out	Output
OV	Latched OverVoltage function
PA	Power Amplifier
PAD	Pico-Amper Diode
PCA	Pulse Current Amplitude modulation
PDR	Internal pull-down resistor
PFM	Pulse-frequency modulation
Pow	Power
PPO	Push-Pull Output
PSM	Pulse-skip modulation
PUR	Internal pull-up resistor
PWM	Pulse-width modulation
Rect.	Rectifier
Reg.	Regulated
Res.	Resistor
Reset-Pr.	Reset-Protection
RF	Radio Frequency applications
Rt	Reset delay time
SBD	Schottky Barrier Diode
SBR	Schottky Barrier Rectifier Diode
SPI	SPI interface
St-dwn	Step-down
Supress.	Supressor
Sw.	Switching
TMBSR	Trench MOS Barrier Schottky Rectifier
T-MOS	Trench-FET MOSFET
Trd	Time Reset Delay
Tun	Tuner
U-Speed	Ultra-speed
UHF	RF applications (>250 MHz)
ULN	Ultra Low-Noise
UV	Latched UperVoltage function
UVLO	Under voltage lock output
Var	Variable
VCO	Voltage controlled oscillator
VDet	Volatge Detector
Vdi	Input volatge detection
Vdo	Output volatge detection
VHF	RF applications (100...250MHz)
VFM	Voltage-Frequency Modulation
Vid	Video output stages
V-MOS	Vertical Metal Oxide Semiconductor
VR	Voltage Regulator
WB	Wide Band
WD	Watch-Dog Timer

Column 5 ("Case")

Manufacturers case designation.

Column 6 ("Pin.")

Related drawing number and pin assignment (section 12, 13, 14).

Column 7 ("Sch.")

Sample schematic connection for some ICs. All drawings are placed in the section 16.

Column 8 ("St.")

"Style" (upercase placement) of the SMD-code and additional infomation drawing. All drawings are placed in the section 15.

Column 9 ("Mnf.")

The names of the manufacturers are abbreviated to save space. The complete name, logos, contact and web-addresses of each manufacurer is listed alphabetically on section 17.

SECTION 1
2-pin CASES SMD SEMICONDUCTOR COMPONENTS

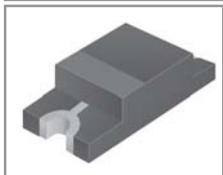
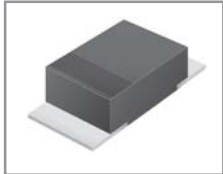
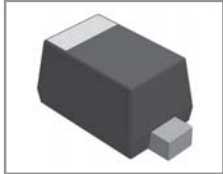
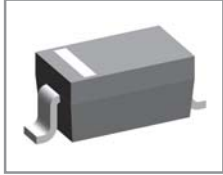

SMD code	Type	Function	Short description	Case	Pinout	St.	Mnf.
Z	MM3Z51VB	Z-diode	49.98 .52.02V, Zzt=169Ω, Izt=2mA, 200mW	SOD-323FL	7d	1a	F
+5	BZX584B3V9	Z-diode	3.82 .3.98V, Izt=5mA, Zzt=90Ω, 200mW	SOD-523FL	7d	1a	Tac
+5	MM5Z3V9B	Z-diode	3.82 .3.98V, Izt=5mA, Zzt=90Ω, 200mW	SOD-523FL	7d	1a	Tac
<5	BZX584B75V	Z-diode	73.50 .76.50V, Izt=2mA, Zzt=255Ω, 200mW	SOD-523FL	7d	1a	Tac
<5	MM5Z75VB	Z-diode	73.50 .76.50V, Izt=2mA, Zzt=255Ω, 200mW	SOD-523FL	7d	1a	Tac
<Z	BZT52-B75S	Z-diode	73.50 .76.50V, Izt=2mA, Zzt=255Ω, 200mW	SOD-323FL	7d	1a	Tsc
<Z	MM3Z75VB	Z-diode	73.5 .76.50V, Zzt=240Ω, Izt=2mA, 200mW	SOD-323FL	7d	1a	F
<Z	MM3Z75VBW	Z-diode	73.50 .76.50V, Izt=2mA, Zzt=255Ω, 200mW	SOD-323FL	7d	1a	Tac
<Z	TCMM3Z75VB	Z-diode	75V±2%, Izt=5mA, Zzt=240Ω, 200mW	SOD-323FL	7d	1a	Tac
=5	BZX584B56V	Z-diode	54.88 .57.12V, Izt=2mA, Zzt=200Ω, 200mW	SOD-523FL	7d	1a	Tac
=5	MM5Z56VB	Z-diode	54.88 .57.12V, Izt=2mA, Zzt=200Ω, 200mW	SOD-523FL	7d	1a	Tac
=Z	BZT52-B56S	Z-diode	54.88 .57.12V, Izt=2mA, Zzt=200Ω, 200mW	SOD-323FL	7d	1a	Tsc
=Z	MM3Z56VB	Z-diode	54.88 .57.12V, Zzt=188Ω, Izt=2mA, 200mW	SOD-323FL	7d	1a	F
=Z	MM3Z56VBW	Z-diode	54.88 .57.12V, Izt=2mA, Zzt=200Ω, 200mW	SOD-323FL	7d	1a	Tac
=Z	TCMM3Z56VB	Z-diode	56V±2%, Izt=5mA, Zzt=188Ω, 200mW	SOD-323FL	7d	1a	Tac
>5	BZX584B68V	Z-diode	66.64 .69.36V, Izt=2mA, Zzt=240Ω, 200mW	SOD-523FL	7d	1a	Tac
>5	MM5Z68VB	Z-diode	66.64 .69.36V, Izt=2mA, Zzt=240Ω, 200mW	SOD-523FL	7d	1a	Tac
>Z	BZT52-B68S	Z-diode	66.64 .69.36V, Izt=2mA, Zzt=240Ω, 200mW	SOD-323FL	7d	1a	Tsc
>Z	MM3Z68VB	Z-diode	66.64 .69.36V, Zzt=226Ω, Izt=2mA, 200mW	SOD-323FL	7d	1a	F
>Z	MM3Z68VBW	Z-diode	66.64 .69.36V, Izt=2mA, Zzt=240Ω, 200mW	SOD-323FL	7d	1a	Tac
>Z	TCMM3Z68VB	Z-diode	68V±2%, Izt=5mA, Zzt=226Ω, 200mW	SOD-323FL	7d	1a	Tac
=5	BZX584B62V	Z-diode	60.76 .63.24V, Izt=2mA, Zzt=215Ω, 200mW	SOD-523FL	7d	1a	Tac
=5	MM5Z62VB	Z-diode	60.76 .63.24V, Izt=2mA, Zzt=215Ω, 200mW	SOD-523FL	7d	1a	Tac
=Z	BZT52-B62S	Z-diode	60.76 .63.24V, Izt=2mA, Zzt=215Ω, 200mW	SOD-323FL	7d	1a	Tsc
=Z	MM3Z62VB	Z-diode	60.76 .63.24V, Zzt=202Ω, Izt=2mA, 200mW	SOD-323FL	7d	1a	F
=Z	MM3Z62VBW	Z-diode	60.76 .63.24V, Izt=2mA, Zzt=215Ω, 200mW	SOD-323FL	7d	1a	Tac
=Z	TCMM3Z62VB	Z-diode	62V±2%, Izt=5mA, Zzt=202Ω, 200mW	SOD-323FL	7d	1a	Tac
0	HVC300A	C-diode	VHF-Tuning, 32V, 2.6/39.5pF(25V..2V/1MHz)	UPF	6d	1b	Ren
0	HVE300A	C-diode	VHF-Tuning, 39.5/47.4pF(2V)	SOD-123	5d	1a	Ren
0	HVU300A	C-diode	VHF-Tuning, 32V, 2.6/39.5pF(25..2V, 1MHz)	SOD-323	5d	1a	Ren
0	MMPZ5221SPT	Z-diode	2.352 .2.448V, Izt=5mA, Zzt=100Ω, 225mW	SOD-323	5d	1a	Chm
0 2	GDZ2V0B-V	Z-diode	2.02 .2.2V, Izt=5mA, Zzt=100Ω, 200mW	SOD-323	5d	1k	Vs
00	FDZ2.4T	Z-diode	2.2 .2.6V, Izt=5mA, Zzt=100Ω, 200mW	SOD-323	5d	1a	Fis
00	MM3Z2V4	Z-diode	2.2 .2.6V, Izt=5mA, Zzt=100Ω, 200mW	SOD-323	5d	1a	Sec
00	MM5Z2V4	Z-diode	2.4V±5%, Izt=5mA, Zzt=100Ω, 100mW	SOD-523	6d	1a	Ons,Wtr
00	MMPZ5221BPT	Z-diode	2.280 .2.520V, Izt=5mA, Zzt=100Ω, 225mW	SOD-323	5d	1a	Chm
00	ZD02V4	Z-diode	2.2..2.6V, 5mA, Zzt=100Ω, 200mW	SOD-322	5d	1a	Cys
01	FDZ2.7T	Z-diode	2.5 .2.9V, Izt=5mA, Zzt=100Ω, 200mW	SOD-323	5d	1a	Fis
01	MM3Z2V7	Z-diode	2.5 .2.9V, Izt=5mA, Zzt=100Ω, 200mW	SOD-323	5d	1a	Sec
01	MM5Z2V7	Z-diode	2.7V±5%, Izt=5mA, Zzt=100Ω, 200mW	SOD-523	6d	1a	Wtr
01	MMPZ5223BPT	Z-diode	2.565 .2.835V, Izt=5mA, Zzt=100Ω, 225mW	SOD-323	5d	1a	Chm
01	ZD02V7	Z-diode	2.5 .2.9V, 5mA, Zzt=100Ω, 200mW	SOD-322	5d	1a	Cys
01C100PH	BZG01-C100	Z-diode	100V±5%, 1.5W	DO-214AC	1d	1a	Phi
01C10PH	BZG01-C10	Z-diode	10V±5%, 1.5W	DO-214AC	1d	1a	Phi
01C110PH	BZG01-C110	Z-diode	110V±5%, 1.5W	DO-214AC	1d	1a	Phi
01C11PH	BZG01-C11	Z-diode	11V±5%, 1.5W	DO-214AC	1d	1a	Phi
01C120PH	BZG01-C120	Z-diode	120V±5%, 1.5W	DO-214AC	1d	1a	Phi
01C12PH	BZG01-C12	Z-diode	12V±5%, 1.5W	DO-214AC	1d	1a	Phi
01C130PH	BZG01-C130	Z-diode	130V±5%, 1.5W	DO-214AC	1d	1a	Phi
01C13PH	BZG01-C13	Z-diode	13V±5%, 1.5W	DO-214AC	1d	1a	Phi
01C150PH	BZG01-C150	Z-diode	150V±5%, 1.5W	DO-214AC	1d	1a	Phi
01C15PH	BZG01-C15	Z-diode	15V±5%, 1.5W	DO-214AC	1d	1a	Phi
01C160PH	BZG01-C160	Z-diode	160V±5%, 1.5W	DO-214AC	1d	1a	Phi
01C16PH	BZG01-C16	Z-diode	16V±5%, 1.5W	DO-214AC	1d	1a	Phi
01C180PH	BZG01-C180	Z-diode	180V±5%, 1.5W	DO-214AC	1d	1a	Phi
01C18PH	BZG01-C18	Z-diode	18V±5%, 1.5W	DO-214AC	1d	1a	Phi
01C200PH	BZG01-C200	Z-diode	200V±5%, 1.5W	DO-214AC	1d	1a	Phi
01C20PH	BZG01-C20	Z-diode	20V±5%, 1.5W	DO-214AC	1d	1a	Phi
01C220PH	BZG01-C220	Z-diode	220V±5%, 1.5W	DO-214AC	1d	1a	Phi
01C22PH	BZG01-C22	Z-diode	22V±5%, 1.5W	DO-214AC	1d	1a	Phi
01C240PH	BZG01-C240	Z-diode	270V±5%, 1.5W	DO-214AC	1d	1a	Phi
01C24PH	BZG01-C24	Z-diode	24V±5%, 1.5W	DO-214AC	1d	1a	Phi
01C270PH	BZG01-C270	Z-diode	270V±5%, 1.5W	DO-214AC	1d	1a	Phi
01C27PH	BZG01-C27	Z-diode	27V±5%, 1.5W	DO-214AC	1d	1a	Phi
01C30PH	BZG01-C30	Z-diode	30V±5%, 1.5W	DO-214AC	1d	1a	Phi
01C33PH	BZG01-C33	Z-diode	33V±5%, 1.5W	DO-214AC	1d	1a	Phi
01C36PH	BZG01-C36	Z-diode	36V±5%, 1.5W	DO-214AC	1d	1a	Phi
01C39PH	BZG01-C39	Z-diode	39V±5%, 1.5W	DO-214AC	1d	1a	Phi
01C43PH	BZG01-C43	Z-diode	43V±5%, 1.5W	DO-214AC	1d	1a	Phi
01C47PH	BZG01-C47	Z-diode	47V±5%, 1.5W	DO-214AC	1d	1a	Phi



SMD code	Type	Function	Short description	Case	Pinout	St.	Mnf.
01C51PH	BZG01-C51	Z-diode	51V±5%, 1.5W	DO-214AC	1d	1a	Phi
01C56PH	BZG01-C56	Z-diode	56V±5%, 1.5W	DO-214AC	1d	1a	Phi
01C62PH	BZG01-C62	Z-diode	62V±5%, 1.5W	DO-214AC	1d	1a	Phi
01C68PH	BZG01-C68	Z-diode	68V±5%, 1.5W	DO-214AC	1d	1a	Phi
01C75PH	BZG01-C75	Z-diode	75V±5%, 1.5W	DO-214AC	1d	1a	Phi
01C82PH	BZG01-C82	Z-diode	82V±5%, 1.5W	DO-214AC	1d	1a	Phi
01C91PH	BZG01-C91	Z-diode	91V±5%, 1.5W	DO-214AC	1d	1a	Phi
02	FDZ2.0VT	Z-diode	2.020..2.200V, Izt=5mA, Zzt=100Ω, 200mW	SOD-323	5d	1a	Fis
02	FDZ3.0T	Z-diode	2.8..3.2V, Izt=5mA, Zzt=100Ω, 200mW	SOD-323	5d	1a	Fis
02	MM3Z3V0	Z-diode	2.8..3.2V, Izt=5mA, Zzt=95Ω, 200mW	SOD-323	5d	1a	Sec
02	MM5Z3V0	Z-diode	3.0V±5%, Izt=5mA, Zzt=100Ω, 200mW	SOD-523	6d	1a,1u	Ons,Wtr
02	MMPZ5225BPT	Z-diode	2.850..3.150V, Izt=5mA, Zzt=95Ω, 225mW	SOD-323	5d	1a	Chm
02	UDZS2.0B	Z-diode	2.02..2.20V, Izt=5mA, Zzt=100Ω, 200mW	SOD-323	5d	1a	Wtr
02	ZD03V0	Z-diode	2.8..3.2V, 5mA, Zzt=100Ω, 200mW	SOD-322	5d	1a	Cys
03C10	BZG03-C10	Z-diode	10V±5%, Izt=50mA, Zzt=2Ω, 1.25W	DO-214AC	1d	1a	Sil
03C100	BZG03-C100	Z-diode	100V±5%, Izt=5mA, Zzt=60Ω, 1.25W	DO-214AC	1d	1a	Sil
03C100PH	BZG03-C100	Z-diode	100V±5%, Izt=5mA, Zzt=60Ω, 1.25W	DO-214AC	1d	1a	Phi
03C10PH	BZG03-C10	Z-diode	10V±5%, Izt=50mA, Zzt=2Ω, 1.25W	DO-214AC	1d	1a	Phi
03C11	BZG03-C11	Z-diode	11V±5%, Izt=50mA, Zzt=4Ω, 1.25W	DO-214AC	1d	1a	Sil
03C110	BZG03-C110	Z-diode	110V±5%, Izt=5mA, Zzt=80Ω, 1.25W	DO-214AC	1d	1a	Sil
03C110PH	BZG03-C110	Z-diode	110V±5%, Izt=5mA, Zzt=80Ω, 1.25W	DO-214AC	1d	1a	Phi
03C11PH	BZG03-C11	Z-diode	11V±5%, Izt=50mA, Zzt=4Ω, 1.25W	DO-214AC	1d	1a	Phi
03C12	BZG03-C12	Z-diode	12V±5%, Izt=50mA, Zzt=4Ω, 1.25W	DO-214AC	1d	1a	Sil
03C120	BZG03-C120	Z-diode	120V±5%, Izt=5mA, Zzt=80Ω, 1.25W	DO-214AC	1d	1a	Sil
03C120PH	BZG03-C120	Z-diode	120V±5%, Izt=5mA, Zzt=80Ω, 1.25W	DO-214AC	1d	1a	Phi
03C12PH	BZG03-C12	Z-diode	12V±5%, Izt=50mA, Zzt=4Ω, 1.25W	DO-214AC	1d	1a	Phi
03C13	BZG03-C13	Z-diode	13V±5%, Izt=50mA, Zzt=5Ω, 1.25W	DO-214AC	1d	1a	Sil
03C130	BZG03-C130	Z-diode	130V±5%, Izt=5mA, Zzt=110Ω, 1.25W	DO-214AC	1d	1a	Sil
03C130PH	BZG03-C130	Z-diode	130V±5%, Izt=5mA, Zzt=110Ω, 1.25W	DO-214AC	1d	1a	Phi
03C13PH	BZG03-C13	Z-diode	13V±5%, Izt=50mA, Zzt=5Ω, 1.25W	DO-214AC	1d	1a	Phi
03C15	BZG03-C15	Z-diode	15V±5%, Izt=50mA, Zzt=5Ω, 1.25W	DO-214AC	1d	1a	Sil
03C150	BZG03-C150	Z-diode	150V±5%, Izt=5mA, Zzt=130Ω, 1.25W	DO-214AC	1d	1a	Sil
03C150PH	BZG03-C150	Z-diode	150V±5%, Izt=5mA, Zzt=130Ω, 1.25W	DO-214AC	1d	1a	Phi
03C15PH	BZG03-C15	Z-diode	15V±5%, Izt=50mA, Zzt=5Ω, 1.25W	DO-214AC	1d	1a	Phi
03C16	BZG03-C16	Z-diode	16V±5%, Izt=25mA, Zzt=6Ω, 1.25W	DO-214AC	1d	1a	Sil
03C160	BZG03-C160	Z-diode	160V±5%, Izt=5mA, Zzt=150Ω, 1.25W	DO-214AC	1d	1a	Sil
03C160PH	BZG03-C160	Z-diode	160V±5%, Izt=5mA, Zzt=150Ω, 1.25W	DO-214AC	1d	1a	Phi
03C16PH	BZG03-C16	Z-diode	16V±5%, Izt=25mA, Zzt=6Ω, 1.25W	DO-214AC	1d	1a	Phi
03C18	BZG03-C18	Z-diode	18V±5%, Izt=25mA, Zzt=6Ω, 1.25W	DO-214AC	1d	1a	Sil
03C180	BZG03-C180	Z-diode	180V±5%, Izt=5mA, Zzt=180Ω, 1.25W	DO-214AC	1d	1a	Sil
03C180PH	BZG03-C180	Z-diode	180V±5%, Izt=5mA, Zzt=180Ω, 1.25W	DO-214AC	1d	1a	Phi
03C18PH	BZG03-C18	Z-diode	18V±5%, Izt=25mA, Zzt=6Ω, 1.25W	DO-214AC	1d	1a	Phi
03C20	BZG03-C20	Z-diode	20V±5%, Izt=25mA, Zzt=6Ω, 1.25W	DO-214AC	1d	1a	Sil
03C200	BZG03-C200	Z-diode	200V±5%, Izt=5mA, Zzt=200Ω, 1.25W	DO-214AC	1d	1a	Sil
03C200PH	BZG03-C200	Z-diode	200V±5%, Izt=5mA, Zzt=200Ω, 1.25W	DO-214AC	1d	1a	Phi
03C20PH	BZG03-C20	Z-diode	20V±5%, Izt=25mA, Zzt=6Ω, 1.25W	DO-214AC	1d	1a	Phi
03C22	BZG03-C22	Z-diode	22V±5%, Izt=25mA, Zzt=6Ω, 1.25W	DO-214AC	1d	1a	Sil
03C220	BZG03-C220	Z-diode	220V±5%, Izt=2mA, Zzt=350Ω, 1.25W	DO-214AC	1d	1a	Sil
03C220PH	BZG03-C220	Z-diode	220V±5%, Izt=2mA, Zzt=350Ω, 1.25W	DO-214AC	1d	1a	Phi
03C22PH	BZG03-C22	Z-diode	22V±5%, Izt=25mA, Zzt=6Ω, 1.25W	DO-214AC	1d	1a	Phi
03C24	BZG03-C24	Z-diode	24V±5%, Izt=25mA, Zzt=7Ω, 1.25W	DO-214AC	1d	1a	Sil
03C240	BZG03-C240	Z-diode	270V±5%, Izt=2mA, Zzt=400Ω, 1.25W	DO-214AC	1d	1a	Sil
03C240PH	BZG03-C240	Z-diode	270V±5%, Izt=2mA, Zzt=400Ω, 1.25W	DO-214AC	1d	1a	Phi
03C24PH	BZG03-C24	Z-diode	24V±5%, Izt=25mA, Zzt=7Ω, 1.25W	DO-214AC	1d	1a	Phi
03C27	BZG03-C27	Z-diode	27V±5%, Izt=25mA, Zzt=7Ω, 1.25W	DO-214AC	1d	1a	Sil
03C270	BZG03-C270	Z-diode	270V±5%, Izt=2mA, Zzt=450Ω, 1.25W	DO-214AC	1d	1a	Sil
03C270PH	BZG03-C270	Z-diode	270V±5%, Izt=2mA, Zzt=450Ω, 1.25W	DO-214AC	1d	1a	Phi
03C27PH	BZG03-C27	Z-diode	27V±5%, Izt=25mA, Zzt=7Ω, 1.25W	DO-214AC	1d	1a	Phi
03C30	BZG03-C30	Z-diode	30V±5%, Izt=25mA, Zzt=8Ω, 1.25W	DO-214AC	1d	1a	Sil
03C30PH	BZG03-C30	Z-diode	30V±5%, Izt=25mA, Zzt=8Ω, 1.25W	DO-214AC	1d	1a	Phi
03C33	BZG03-C33	Z-diode	33V±5%, Izt=25mA, Zzt=8Ω, 1.25W	DO-214AC	1d	1a	Sil
03C33PH	BZG03-C33	Z-diode	33V±5%, Izt=25mA, Zzt=8Ω, 1.25W	DO-214AC	1d	1a	Phi
03C36	BZG03-C36	Z-diode	36V±5%, Izt=10mA, Zzt=21Ω, 1.25W	DO-214AC	1d	1a	Sil
03C36PH	BZG03-C36	Z-diode	36V±5%, Izt=10mA, Zzt=21Ω, 1.25W	DO-214AC	1d	1a	Phi
03C39	BZG03-C39	Z-diode	39V±5%, Izt=10mA, Zzt=21Ω, 1.25W	DO-214AC	1d	1a	Sil
03C39PH	BZG03-C39	Z-diode	39V±5%, Izt=10mA, Zzt=21Ω, 1.25W	DO-214AC	1d	1a	Phi
03C43	BZG03-C43	Z-diode	43V±5%, Izt=10mA, Zzt=24Ω, 1.25W	DO-214AC	1d	1a	Sil
03C43PH	BZG03-C43	Z-diode	43V±5%, Izt=10mA, Zzt=24Ω, 1.25W	DO-214AC	1d	1a	Phi
03C47	BZG03-C47	Z-diode	47V±5%, Izt=10mA, Zzt=24Ω, 1.25W	DO-214AC	1d	1a	Sil
03C47PH	BZG03-C47	Z-diode	47V±5%, Izt=10mA, Zzt=24Ω, 1.25W	DO-214AC	1d	1a	Phi



SMD code	Type	Function	Short description	Case	Pinout	St.	Mnf.
03C51	BZG03-C51	Z-diode	51V±5%, I _Z =10mA, Z _{ZT} =25Ω, 1.25W	DO-214AC	1d	1a	Sil
03C51PH	BZG03-C51	Z-diode	51V±5%, I _Z =10mA, Z _{ZT} =25Ω, 1.25W	DO-214AC	1d	1a	Phi
03C56	BZG03-C56	Z-diode	56V±5%, I _Z =10mA, Z _{ZT} =25Ω, 1.25W	DO-214AC	1d	1a	Sil
03C56PH	BZG03-C56	Z-diode	56V±5%, I _Z =10mA, Z _{ZT} =25Ω, 1.25W	DO-214AC	1d	1a	Phi
03C62	BZG03-C62	Z-diode	62V±5%, I _Z =10mA, Z _{ZT} =25Ω, 1.25W	DO-214AC	1d	1a	Sil
03C62PH	BZG03-C62	Z-diode	62V±5%, I _Z =10mA, Z _{ZT} =25Ω, 1.25W	DO-214AC	1d	1a	Phi
03C68	BZG03-C68	Z-diode	68V±5%, I _Z =10mA, Z _{ZT} =25Ω, 1.25W	DO-214AC	1d	1a	Sil
03C68PH	BZG03-C68	Z-diode	68V±5%, I _Z =10mA, Z _{ZT} =25Ω, 1.25W	DO-214AC	1d	1a	Phi
03C75	BZG03-C75	Z-diode	75V±5%, I _Z =10mA, Z _{ZT} =30Ω, 1.25W	DO-214AC	1d	1a	Sil
03C75PH	BZG03-C75	Z-diode	75V±5%, I _Z =10mA, Z _{ZT} =30Ω, 1.25W	DO-214AC	1d	1a	Phi
03C82	BZG03-C82	Z-diode	82V±5%, I _Z =10mA, Z _{ZT} =30Ω, 1.25W	DO-214AC	1d	1a	Sil
03C82PH	BZG03-C82	Z-diode	82V±5%, I _Z =10mA, Z _{ZT} =30Ω, 1.25W	DO-214AC	1d	1a	Phi
03C91	BZG03-C91	Z-diode	91V±5%, I _Z =5mA, Z _{ZT} =60Ω, 1.25W	DO-214AC	1d	1a	Sil
03C91PH	BZG03-C91	Z-diode	91V±5%, I _Z =5mA, Z _{ZT} =60Ω, 1.25W	DO-214AC	1d	1a	Phi
0410	BZG04-10	TVS	V _{BR} =10V, 17.7A, 300W(10/1000μs)	DO-214AC	1d	1a	Sil
04100	BZG04-100	TVS	V _{BR} =100V, 1.8A, 300W(10/1000μs)	DO-214AC	1d	1a	Sil
04100PH	BZG04-100	TVS	V _{BR} =100V, 1.8A, 300W(10/1000μs)	DO-214AC	1d	1a	Phi
0410PH	BZG04-10	TVS	V _{BR} =10V, 17.7A, 300W(10/1000μs)	DO-214AC	1d	1a	Phi
0411	BZG04-11	TVS	V _{BR} =11V, 15.9A, 300W(10/1000μs)	DO-214AC	1d	1a	Sil
04110	BZG04-110	TVS	V _{BR} =110V, 1.6A, 300W(10/1000μs)	DO-214AC	1d	1a	Sil
04110PH	BZG04-110	TVS	V _{BR} =110V, 1.6A, 300W(10/1000μs)	DO-214AC	1d	1a	Phi
0411PH	BZG04-11	TVS	V _{BR} =11V, 15.9A, 300W(10/1000μs)	DO-214AC	1d	1a	Phi
0412	BZG04-12	TVS	V _{BR} =12V, 14.4A, 300W(10/1000μs)	DO-214AC	1d	1a	Sil
04120	BZG04-120	TVS	V _{BR} =120V, 1.5A, 300W(10/1000μs)	DO-214AC	1d	1a	Sil
04120PH	BZG04-120	TVS	V _{BR} =120V, 1.5A, 300W(10/1000μs)	DO-214AC	1d	1a	Phi
0412PH	BZG04-12	TVS	V _{BR} =12V, 14.4A, 300W(10/1000μs)	DO-214AC	1d	1a	Phi
0413	BZG04-13	TVS	V _{BR} =13V, 13.1A, 300W(10/1000μs)	DO-214AC	1d	1a	Sil
04130	BZG04-130	TVS	V _{BR} =130V, 1.3A, 300W(10/1000μs)	DO-214AC	1d	1a	Sil
04130PH	BZG04-130	TVS	V _{BR} =130V, 1.3A, 300W(10/1000μs)	DO-214AC	1d	1a	Phi
0413PH	BZG04-13	TVS	V _{BR} =13V, 13.1A, 300W(10/1000μs)	DO-214AC	1d	1a	Phi
0415	BZG04-15	TVS	V _{BR} =15V, 11.7A, 300W(10/1000μs)	DO-214AC	1d	1a	Sil
04150	BZG04-150	TVS	V _{BR} =150V, 1.2A, 300W(10/1000μs)	DO-214AC	1d	1a	Sil
04150PH	BZG04-150	TVS	V _{BR} =150V, 1.2A, 300W(10/1000μs)	DO-214AC	1d	1a	Phi
0415PH	BZG04-15	TVS	V _{BR} =15V, 11.7A, 300W(10/1000μs)	DO-214AC	1d	1a	Phi
0416	BZG04-16	TVS	V _{BR} =16V, 10.6A, 300W(10/1000μs)	DO-214AC	1d	1a	Sil
04160	BZG04-160	TVS	V _{BR} =160V, 1.1A, 300W(10/1000μs)	DO-214AC	1d	1a	Sil
04160PH	BZG04-160	TVS	V _{BR} =160V, 1.1A, 300W(10/1000μs)	DO-214AC	1d	1a	Phi
0416PH	BZG04-16	TVS	V _{BR} =16V, 10.6A, 300W(10/1000μs)	DO-214AC	1d	1a	Phi
0418	BZG04-18	TVS	V _{BR} =18V, 9.7A, 300W(10/1000μs)	DO-214AC	1d	1a	Sil
04180	BZG04-180	TVS	V _{BR} =180V, 1A, 300W(10/1000μs)	DO-214AC	1d	1a	Sil
04180PH	BZG04-180	TVS	V _{BR} =180V, 1A, 300W(10/1000μs)	DO-214AC	1d	1a	Phi
0418PH	BZG04-18	TVS	V _{BR} =18V, 9.7A, 300W(10/1000μs)	DO-214AC	1d	1a	Phi
0420	BZG04-20	TVS	V _{BR} =20V, 8.9A, 300W(10/1000μs)	DO-214AC	1d	1a	Sil
04200	BZG04-200	TVS	V _{BR} =200V, 0.9A, 300W(10/1000μs)	DO-214AC	1d	1a	Sil
04200PH	BZG04-200	TVS	V _{BR} =200V, 0.9A, 300W(10/1000μs)	DO-214AC	1d	1a	Phi
0420PH	BZG04-20	TVS	V _{BR} =20V, 8.9A, 300W(10/1000μs)	DO-214AC	1d	1a	Phi
0422	BZG04-22	TVS	V _{BR} =22V, 7.9A, 300W(10/1000μs)	DO-214AC	1d	1a	Sil
04220	BZG04-220	TVS	V _{BR} =220V, 800mA, 300W(10/1000μs)	DO-214AC	1d	1a	Sil
04220PH	BZG04-220	TVS	V _{BR} =220V, 800mA, 300W(10/1000μs)	DO-214AC	1d	1a	Phi
0422PH	BZG04-22	TVS	V _{BR} =22V, 7.9A, 300W(10/1000μs)	DO-214AC	1d	1a	Phi
0424	BZG04-24	TVS	V _{BR} =24V, 7.1A, 300W(10/1000μs)	DO-214AC	1d	1a	Sil
0424PH	BZG04-24	TVS	V _{BR} =24V, 7.1A, 300W(10/1000μs)	DO-214AC	1d	1a	Phi
0427	BZG04-27	TVS	V _{BR} =27V, 6.5A, 300W(10/1000μs)	DO-214AC	1d	1a	Sil
0427PH	BZG04-27	TVS	V _{BR} =27V, 6.5A, 300W(10/1000μs)	DO-214AC	1d	1a	Phi
0430	BZG04-30	TVS	V _{BR} =30V, 6A, 300W(10/1000μs)	DO-214AC	1d	1a	Sil
0430PH	BZG04-30	TVS	V _{BR} =30V, 6A, 300W(10/1000μs)	DO-214AC	1d	1a	Phi
0433	BZG04-33	TVS	V _{BR} =33V, 5.5A, 300W(10/1000μs)	DO-214AC	1d	1a	Sil
0433PH	BZG04-33	TVS	V _{BR} =33V, 5.5A, 300W(10/1000μs)	DO-214AC	1d	1a	Phi
0436	BZG04-36	TVS	V _{BR} =36V, 4.9A, 300W(10/1000μs)	DO-214AC	1d	1a	Sil
0436PH	BZG04-36	TVS	V _{BR} =36V, 4.9A, 300W(10/1000μs)	DO-214AC	1d	1a	Phi
0439	BZG04-39	TVS	V _{BR} =39V, 4.6A, 300W(10/1000μs)	DO-214AC	1d	1a	Sil
0439PH	BZG04-39	TVS	V _{BR} =39V, 4.6A, 300W(10/1000μs)	DO-214AC	1d	1a	Phi
0443	BZG04-43	TVS	V _{BR} =43V, 4.2A, 300W(10/1000μs)	DO-214AC	1d	1a	Sil
0443PH	BZG04-43	TVS	V _{BR} =43V, 4.2A, 300W(10/1000μs)	DO-214AC	1d	1a	Phi
0447	BZG04-47	TVS	V _{BR} =47V, 3.8A, 300W(10/1000μs)	DO-214AC	1d	1a	Sil
0447PH	BZG04-47	TVS	V _{BR} =47V, 3.8A, 300W(10/1000μs)	DO-214AC	1d	1a	Phi
0451	BZG04-51	TVS	V _{BR} =51V, 3.5A, 300W(10/1000μs)	DO-214AC	1d	1a	Sil
0451PH	BZG04-51	TVS	V _{BR} =51V, 3.5A, 300W(10/1000μs)	DO-214AC	1d	1a	Phi
0456	BZG04-56	TVS	V _{BR} =56V, 3.2A, 300W(10/1000μs)	DO-214AC	1d	1a	Sil
0456PH	BZG04-56	TVS	V _{BR} =56V, 3.2A, 300W(10/1000μs)	DO-214AC	1d	1a	Phi



SMD code	Type	Function	Short description	Case	Pinout	St.	Mnf.
0462	BZG04-62	TVS	Vbr=62V, 2.9A, 300W(10/1000µs)	DO-214AC	1d	1a	Sil
0462PH	BZG04-62	TVS	Vbr=62V, 2.9A, 300W(10/1000µs)	DO-214AC	1d	1a	Phi
0468	BZG04-68	TVS	Vbr=68V, 2.6A, 300W(10/1000µs)	DO-214AC	1d	1a	Sil
0468PH	BZG04-68	TVS	Vbr=68V, 2.6A, 300W(10/1000µs)	DO-214AC	1d	1a	Phi
0475	BZG04-75	TVS	Vbr=75V, 2.4A, 300W(10/1000µs)	DO-214AC	1d	1a	Sil
0475PH	BZG04-75	TVS	Vbr=75V, 2.4A, 300W(10/1000µs)	DO-214AC	1d	1a	Phi
0482	BZG04-82	TVS	Vbr=82V, 2.2A, 300W(10/1000µs)	DO-214AC	1d	1a	Sil
0482PH	BZG04-82	TVS	Vbr=82V, 2.2A, 300W(10/1000µs)	DO-214AC	1d	1a	Phi
048V2	BZG04-8V2	TVS	Vbr=8.2V, 20.3A, 300W(10/1000µs)	DO-214AC	1d	1a	Sil
048V2PH	BZG04-8V2	TVS	Vbr=8.2V, 20.3A, 300W(10/1000µs)	DO-214AC	1d	1a	Phi
0491	BZG04-91	TVS	Vbr=9.1V, 2A, 300W(10/1000µs)	DO-214AC	1d	1a	Sil
0491PH	BZG04-91	TVS	Vbr=9.1V, 2A, 300W(10/1000µs)	DO-214AC	1d	1a	Phi
049V1	BZG04-9V1	TVS	Vbr=9.1V, 19.1A, 300W(10/1000µs)	DO-214AC	1d	1a	Sil
049V1PH	BZG04-9V1	TVS	Vbr=9.1V, 19.1A, 300W(10/1000µs)	DO-214AC	1d	1a	Phi
05	BZX584B2V4	Z-diode	2.35..2.45V, Izt=5mA, Zzt=100Ω, 200mW	SOD-523FL	7d	1a	Tac
05	EDZ10B	Z-diode	9.77..10.21V, Izt=5mA, Zzt=30Ω, 150mW	SOD-523	6d	1a	Rhm
05	FDZ10EV	Z-diode	9.770..10.210V, Izt=5mA, Zzt=30Ω, 150mW	SOD-523	7d	1a	Fis
05	FDZ10VT	Z-diode	9.770..10.210V, Izt=5mA, Zzt=30Ω, 200mW	SOD-323	5d	1a	Fis
05	FDZ33T	Z-diode	3.1..3.5V, Izt=5mA, Zzt=95Ω, 200mW	SOD-323	5d	1a	Fis
05	MM3Z3V3	Z-diode	3.1..3.5V, Izt=5mA, Zzt=95Ω, 200mW	SOD-323	5d	1a	Sec
05	MM5Z2V4B	Z-diode	2.35..2.45V, Izt=5mA, Zzt=100Ω, 200mW	SOD-523FL	7d	1a	Tac
05	MM5Z3V3	Z-diode	3.3V±5%, Izt=5mA, Zzt=95Ω, 200mW	SOD-523	6d	1a,1u	Ons,Wtr
05	MMPZ5226BPT	Z-diode	3.135..3.465V, Izt=5mA, Zzt=95Ω, 225mW	SOD-323	5d	1a	Chm
05	TDZ10B	Z-diode	10V±2.5%, 10mA, 500mW	TUMD2	7d	1s	Rhm
05	UDZS10B	Z-diode	10V±2.5%, Izt=5mA, 200mW	SOD-323FL	7d	1s	Rhm
05	UDZS10B	Z-diode	9.77..10.21V, Izt=5mA, Zzt=30Ω, 200mW	SOD-323	5d	1a	Wtr
05	VDZS10B	Z-diode	10V±5%, 5mA, 100mW	VMD2	5d	1z	Rhm
05	ZD03V3	Z-diode	3.1..3.5V, 5mA, Zzt=95Ω, 200mW	SOD-322	5d	1a	Cys
058A	TSP058SA	Thy-SPD	V Of-St=58V, 50A(1ms), Bidirectional	DO-214AA	1ba	1j	Pjt
058B	TSP058SB	Thy-SPD	V Of-St=58V, 80A(1ms), Bidirectional	DO-214AA	1ba	1j	Pjt
058C	TSP058SC	Thy-SPD	V Of-St=58V, 100A(1ms), Bidirectional	DO-214AA	1ba	1j	Pjt
05A	UMA5.0A	TVS	Vrwm=5.0V, Vbr=6.40..9.2V, 54.3A, 500W(1ms)	UltraMite	14d	1v	Msc
05CA	UMA5.0CA	TVS	Vrwm=5.0V, Vbr=6.40..9.2V, 54.3A, 500W(1ms), Bidirectional	UltraMite	14ba	1v	Msc
06	FDZ33.6T	Z-diode	3.4..3.8V, Izt=5mA, Zzt=90Ω, 200mW	SOD-323	5d	1a	Fis
06	MM3Z3V6	Z-diode	3.4..3.8V, Izt=5mA, Zzt=90Ω, 200mW	SOD-323	5d	1a	Sec
06	MM5Z3V6	Z-diode	3.6V±5%, Izt=5mA, Zzt=90Ω, 200mW	SOD-523	6d	1a,1u	Ons,Wtr
06	MMPZ5227BPT	Z-diode	3.420..3.780V, Izt=5mA, Zzt=90Ω, 225mW	SOD-323	5d	1a	Chm
06	ZD03V6	Z-diode	3.4..3.8V, 5mA, Zzt=90Ω, 200mW	SOD-322	5d	1a	Cys
061	HZU6A1L	Z-diode	5.2..5.5V, Izt=0.5mA, Zzt=150Ω, 150mW	URP	5d	1a	Ren
061	HZU6LA1	Z-diode	5.2..5.5V, 150mW	URP	5d	1a	Ren
062	HZU6A2L	Z-diode	5.3..5.6V, Izt=0.5mA, Zzt=150Ω, 150mW	URP	5d	1a	Ren
062	HZU6LA2	Z-diode	5.3..5.6V, 150mW	URP	5d	1a	Ren
063	HZU6A3L	Z-diode	5.4..5.7V, Izt=0.5mA, Zzt=150Ω, 150mW	URP	5d	1a	Ren
063	HZU6LA3	Z-diode	5.4..5.7V, 150mW	URP	5d	1a	Ren
064	HZU6B1L	Z-diode	5.5..5.8V, Izt=0.5mA, Zzt=80Ω, 150mW	URP	5d	1a	Ren
064	HZU6LB1	Z-diode	5.5..5.8V, 150mW	URP	5d	1a	Ren
065	HZU6B2L	Z-diode	5.6..5.9V, Izt=0.5mA, Zzt=80Ω, 150mW	URP	5d	1a	Ren
065	HZU6LB2	Z-diode	5.6..5.9V, 150mW	URP	5d	1a	Ren
065A	TSP065SA	Thy-SPD	V Of-St=65V, 50A(1ms), Bidirectional	DO-214AA	1ba	1j	Pjt
065A	UMA6.5A	TVS	Vrwm=6.5V, Vbr=7.22..11.2V, 44.7A, 500W(1ms)	UltraMite	14d	1v	Msc
065B	TSP065SB	Thy-SPD	V Of-St=65V, 80A(1ms), Bidirectional	DO-214AA	1ba	1j	Pjt
065C	TSP065SC	Thy-SPD	V Of-St=65V, 100A(1ms), Bidirectional	DO-214AA	1ba	1j	Pjt
065CA	UMA6.5CA	TVS	Vrwm=6.5V, Vbr=7.22..11.2V, 44.7A, 500W(1ms), Bidirectional	UltraMite	14ba	1v	Msc
066	HZU6B3L	Z-diode	5.7..6.0V, Izt=0.5mA, Zzt=80Ω, 150mW	URP	5d	1a	Ren
066	HZU6LB3	Z-diode	5.7..6.0V, 150mW	URP	5d	1a	Ren
067	HZU6C1L	Z-diode	5.8..6.1V, Izt=0.5mA, Zzt=60Ω, 150mW	URP	5d	1a	Ren
067	HZU6LC1	Z-diode	5.8..6.1V, 150mW	URP	5d	1a	Ren
068	HZU6C2L	Z-diode	6.0..6.3V, Izt=0.5mA, Zzt=60Ω, 150mW	URP	5d	1a	Ren
068	HZU6LC2	Z-diode	6.0..6.3V, 150mW	URP	5d	1a	Ren
069	HZU6C3L	Z-diode	6.1..6.4V, Izt=0.5mA, Zzt=60Ω, 150mW	URP	5d	1a	Ren
069	HZU6LC3	Z-diode	6.1..6.4V, 150mW	URP	5d	1a	Ren
06A	UMA6.0A	TVS	Vrwm=6.0V, Vbr=6.67..10.3V, 48.5A, 500W(1ms)	UltraMite	14d	1v	Msc
06CA	UMA6.0CA	TVS	Vrwm=6.0V, Vbr=6.67..10.3V, 48.5A, 500W(1ms), Bidirectional	UltraMite	14ba	1v	Msc
07	FDZ33.9T	Z-diode	3.7..4.1V, Izt=5mA, Zzt=90Ω, 200mW	SOD-323	5d	1a	Fis
07	KL3L07	Thy-SPD	V Of-St=65V, Ifsm=30A(1ms), Ih=100mA, Bidirectional	1F	1ba	1l	Shi
07	MM3Z3V9	Z-diode	3.7..4.1V, Izt=5mA, Zzt=90Ω, 200mW	SOD-323	5d	1a	Sec
07	MM5Z3V9	Z-diode	3.9V±5%, Izt=5mA, Zzt=90Ω, 200mW	SOD-523	6d	1a,1u	Ons,Wtr
07	MMPZ5228BPT	Z-diode	3.705..4.095V, Izt=5mA, Zzt=90Ω, 225mW	SOD-323	5d	1a	Chm
07	ZD03V9	Z-diode	3.7..4.1V, 5mA, Zzt=90Ω, 200mW	SOD-322	5d	1a	Cys
071	HZU7A1L	Z-diode	6.3..6.6V, Izt=0.5mA, Zzt=60Ω, 150mW	URP	5d	1a	Ren



SMD
code

Type

Function

Short description

Case

Pinout

St.

Mnf.

SMD code	Type	Function	Short description	Case	Pinout	St.	Mnf.
071	HZU7LA1	Z-diode	6.3..6.6V, 150mW	URP	5d	1a	Ren
072	HZU7A2L	Z-diode	6.4..6.7V, Izt=0.5mA, Zzt=60Ω, 150mW	URP	5d	1a	Ren
072	HZU7LA2	Z-diode	6.4..6.7V, 150mW	URP	5d	1a	Ren
073	HZU7A3L	Z-diode	6.6..6.9V, Izt=0.5mA, Zzt=60Ω, 150mW	URP	5d	1a	Ren
073	HZU7LA3	Z-diode	6.6..6.9V, 150mW	URP	5d	1a	Ren
074	HZU7B1L	Z-diode	6.7..7.0V, Izt=0.5mA, Zzt=60Ω, 150mW	URP	5d	1a	Ren
074	HZU7LB1	Z-diode	6.7..7V, 150mW	URP	5d	1a	Ren
075	HZU7B2L	Z-diode	6.9..7.2V, Izt=0.5mA, Zzt=60Ω, 150mW	URP	5d	1a	Ren
075	HZU7LB2	Z-diode	6.9..7.2V, 150mW	URP	5d	1a	Ren
075A	TSP075SA	Thy-SPD	V Of-St=75V, 50A(1ms), Bidirectional	DO-214AA	1ba	1j	Pjt
075A	UMA7.5A	TVS	Vrwm=7.5V, Vbr=8.33..12.9V, 38.8A, 500W(1ms)	UltraMite	14d	1v	Msc
075B	TSP075SB	Thy-SPD	V Of-St=75V, 80A(1ms), Bidirectional	DO-214AA	1ba	1j	Pjt
075C	TSP075SC	Thy-SPD	V Of-St=75V, 100A(1ms), Bidirectional	DO-214AA	1ba	1j	Pjt
075CA	UMA7.5CA	TVS	Vrwm=7.5V, Vbr=8.33..12.9V, 38.8A, 500W(1ms), Bidirectional	UltraMite	14ba	1v	Msc
076	HZU7B3L	Z-diode	7.0..7.3V, Izt=0.5mA, Zzt=60Ω, 150mW	URP	5d	1a	Ren
076	HZU7LB3	Z-diode	7.7..7.3V, 150mW	URP	5d	1a	Ren
077	HZU7C1L	Z-diode	7.2..7.6V, Izt=0.5mA, Zzt=60Ω, 150mW	URP	5d	1a	Ren
077	HZU7LC1	Z-diode	7.2..7.6V, 150mW	URP	5d	1a	Ren
078	HZU7C2L	Z-diode	7.3..7.7V, Izt=0.5mA, Zzt=60Ω, 150mW	URP	5d	1a	Ren
078	HZU7LC2	Z-diode	7.3..7.7V, 150mW	URP	5d	1a	Ren
079	HZU7C3L	Z-diode	7.5..7.9V, Izt=0.5mA, Zzt=60Ω, 150mW	URP	5d	1a	Ren
079	HZU7LC3	Z-diode	7.5..7.9V, 150mW	URP	5d	1a	Ren
07A	UMA7.0A	TVS	Vrwm=7.0V, Vbr=7.78..12.0V, 41.7A, 500W(1ms)	UltraMite	14d	1v	Msc
07CA	UMA7.0CA	TVS	Vrwm=7.0V, Vbr=7.78..12.0V, 41.7A, 500W(1ms), Bidirectional	UltraMite	14ba	1v	Msc
08	FDZ4.3T	Z-diode	4.0..4.6V, Izt=5mA, Zzt=90Ω, 200mW	SOD-323	5d	1a	Fis
08	MM3Z4V3	Z-diode	4.0..4.6V, Izt=5mA, Zzt=90Ω, 200mW	SOD-323	5d	1a	Sec
08	MM5Z4V3	Z-diode	4.3V±5%, Izt=5mA, Zzt=90Ω, 200mW	SOD-523	6d	1a,1u	Ons,Wtr
08	MMPZ5229BPT	Z-diode	4.085..4.515V, Izt=5mA, Zzt=88Ω, 225mW	SOD-323	5d	1a	Chm
08	ZD04V3	Z-diode	4.0..4.6V, 5mA, Zzt=90Ω, 200mW	SOD-322	5d	1a	Cys
085A	UMA8.5A	TVS	Vrwm=8.5V, Vbr=9.44..14.4V, 34.7A, 500W(1ms)	UltraMite	14d	1v	Msc
085CA	UMA8.5CA	TVS	Vrwm=8.5V, Vbr=9.44..14.4V, 34.7A, 500W(1ms), Bidirectional	UltraMite	14ba	1v	Msc
08A	UMA8.0A	TVS	Vrwm=8.0V, Vbr=8.89..13.6V, 36.7A, 500W(1ms)	UltraMite	14d	1v	Msc
08CA	UMA8.0CA	TVS	Vrwm=8.0V, Vbr=8.89..13.6V, 36.7A, 500W(1ms), Bidirectional	UltraMite	14ba	1v	Msc
09	FDZ4.7T	Z-diode	4.4..5.0V, Izt=5mA, Zzt=80Ω, 200mW	SOD-323	5d	1a	Fis
09	MM3Z4V7	Z-diode	4.4..5.0V, Izt=5mA, Zzt=80Ω, 200mW	SOD-323	5d	1a	Sec
09	MM5Z4V7	Z-diode	4.7V±5%, Izt=5mA, Zzt=80Ω, 200mW	SOD-523	6d	1a,1u	Ons,Wtr
09	MMPZ5230BPT	Z-diode	4.465..4.935V, Izt=5mA, Zzt=70Ω, 225mW	SOD-323	5d	1a	Chm
09	ZD04V7	Z-diode	4.4..5.0V, 5mA, Zzt=80Ω, 200mW	SOD-322	5d	1a	Cys
090A	TSP090SA	Thy-SPD	V Of-St=90V, 50A(1ms), Bidirectional	DO-214AA	1ba	1j	Pjt
090B	TSP090SB	Thy-SPD	V Of-St=90V, 80A(1ms), Bidirectional	DO-214AA	1ba	1j	Pjt
090C	TSP090SC	Thy-SPD	V Of-St=90V, 100A(1ms), Bidirectional	DO-214AA	1ba	1j	Pjt
091	HZU9A1L	Z-diode	7.7..8.1V, Izt=0.5mA, Zzt=60Ω, 150mW	URP	5d	1a	Ren
091	HZU9LA1	Z-diode	7.7..8.1V, 150mW	URP	5d	1a	Ren
092	HZU9A2L	Z-diode	7.9..8.3V, Izt=0.5mA, Zzt=60Ω, 150mW	URP	5d	1a	Ren
092	HZU9LA2	Z-diode	7.9..8.3V, 150mW	URP	5d	1a	Ren
093	HZU9A3L	Z-diode	8.1..8.5V, Izt=0.5mA, Zzt=60Ω, 150mW	URP	5d	1a	Ren
093	HZU9LA3	Z-diode	8.1..8.5V, 150mW	URP	5d	1a	Ren
094	HZU9B1L	Z-diode	8.3..8.7V, Izt=0.5mA, Zzt=60Ω, 150mW	URP	5d	1a	Ren
094	HZU9LB1	Z-diode	8.3..8.7V, 150mW	URP	5d	1a	Ren
095	HZU9B2L	Z-diode	8.5..8.9V, Izt=0.5mA, Zzt=60Ω, 150mW	URP	5d	1a	Ren
095	HZU9LB2	Z-diode	8.5..8.9V, 150mW	URP	5d	1a	Ren
096	HZU9B3L	Z-diode	8.7..9.1V, Izt=0.5mA, Zzt=60Ω, 150mW	URP	5d	1a	Ren
096	HZU9LB3	Z-diode	8.7..9.1V, 150mW	URP	5d	1a	Ren
097	HZU9C1L	Z-diode	8.9..9.3V, Izt=0.5mA, Zzt=60Ω, 150mW	URP	5d	1a	Ren
097	HZU9LC1	Z-diode	8.9..9.3V, 150mW	URP	5d	1a	Ren
098	HZU9C2L	Z-diode	9.1..9.5V, Izt=0.5mA, Zzt=60Ω, 150mW	URP	5d	1a	Ren
098	HZU9LC2	Z-diode	9.1..9.5V, 150mW	URP	5d	1a	Ren
099	HZU9C3L	Z-diode	9.3..9.7V, Izt=0.5mA, Zzt=60Ω, 150mW	URP	5d	1a	Ren
099	HZU9LC3	Z-diode	9.3..9.7V, 150mW	URP	5d	1a	Ren
09A	BAP64-02	PIN-diode	RF, 175V, 100mA, 715mW, 0.35pF, 2Ω(10mA/100MHz)	SOD-523	6d	1a	Phi
09A	HVU359	C-diode	VcxO, 15V, 24.8/29.8pF(1V)	SOD-323	5d	1a	Ren
09A	UMA9.0A	TVS	Vrwm=9.0V, Vbr=10.0..15.4V, 32.6A, 500W(1ms)	UltraMite	14d	1v	Msc
09CA	UMA9.0CA	TVS	Vrwm=9.0V, Vbr=10.0..15.4V, 32.6A, 500W(1ms), Bidirectional	UltraMite	14ba	1v	Msc
0A	FDZ5.1T	Z-diode	4.8..5.4V, Izt=5mA, Zzt=60Ω, 200mW	SOD-323	5d	1a	Fis
0A	MM1Z9V1B	Z-diode	9.1V±2%, Izt=5mA, Zzt=30Ω, 500mW	SOD-123FL	7d	1a	Sme
0A	MM3Z5V1	Z-diode	8.8..5.4V, Izt=5mA, Zzt=60Ω, 200mW	SOD-323	5d	1a	Sec
0A	MM5Z5V1	Z-diode	5.1V±5%, Izt=5mA, Zzt=60Ω, 200mW	SOD-523	6d	1a,1u	Ons,Wtr
0A	MMPZ5231BPT	Z-diode	4.845..5.355V, Izt=5mA, Zzt=50Ω, 225mW	SOD-323	5d	1a	Chm
0A	ZD05V1	Z-diode	4.8..5.4V, 5mA, Zzt=60Ω, 200mW	SOD-322	5d	1a	Cys
0B	MM1Z10B	Z-diode	10V±2%, Izt=5mA, Zzt=30Ω, 500mW	SOD-123FL	7d	1a	Sme



SMD code	Type	Function	Short description	Case	Pinout	St.	Mnf.
0C	FDZ5.6T	Z-diode	5.2..6.0V, Izt=5mA, Zzt=40Q, 200mW	SOD-323	5d	1a	Fis
0C	MM1Z11B	Z-diode	11V±2%, Izt=5mA, Zzt=30Q, 500mW	SOD-123FL	7d	1a	Sme
0C	MM3Z5V6	Z-diode	5.2..6.0V, Izt=5mA, Zzt=40Q, 200mW	SOD-323	5d	1a	Sec
0C	MM5Z5V6	Z-diode	5.6V±5%, Izt=5mA, Zzt=40Q, 200mW	SOD-523	6d	1a,1u	Ons,Wtr
0C	MMPZ5232BPT	Z-diode	5.320..5.880V, Izt=5mA, Zzt=25Q, 225mW	SOD-323	5d	1a	Chm
0C	ZD05V6	Z-diode	5.2..6.0V, 5mA, Zzt=40Q, 200mW	SOD-322	5d	1a	Cys
0D	MM1Z12B	Z-diode	12V±2%, Izt=5mA, Zzt=35Q, 500mW	SOD-123FL	7d	1a	Sme
0E	FDZ6.2T	Z-diode	5.8..6.6V, Izt=5mA, Zzt=10Q, 200mW	SOD-323	5d	1a	Fis
0E	MM1Z13B	Z-diode	13V±2%, Izt=5mA, Zzt=35Q, 500mW	SOD-123FL	7d	1a	Sme
0E	MM3Z6V2	Z-diode	5.8..6.6V, Izt=5mA, Zzt=10Q, 200mW	SOD-323	5d	1a	Sec
0E	MM5Z6V2	Z-diode	6.2V±5%, Izt=5mA, Zzt=10Q, 200mW	SOD-523	6d	1a,1u	Ons,Wtr
0E	MMPZ5234BPT	Z-diode	5.890..6.510V, Izt=5mA, Zzt=10Q, 225mW	SOD-323	5d	1a	Chm
0E	ZD06V2	Z-diode	5.8..6.6V, 5mA, Zzt=10Q, 200mW	SOD-322	5d	1a	Cys
0F	FDZ6.8T	Z-diode	6.4..7.2V, Izt=5mA, Zzt=15Q, 200mW	SOD-323	5d	1a	Fis
0F	MM1Z15B	Z-diode	15V±2%, Izt=5mA, Zzt=40Q, 500mW	SOD-123FL	7d	1a	Sme
0F	MM3Z6V8	Z-diode	6.4..7.2V, Izt=5mA, Zzt=15Q, 200mW	SOD-323	5d	1a	Sec
0F	MM5Z6V8	Z-diode	6.8V±5%, Izt=5mA, Zzt=15Q, 200mW	SOD-523	6d	1a,1u	Ons,Wtr
0F	MMPZ5235BPT	Z-diode	6.460..7.140V, Izt=5mA, Zzt=8Q, 225mW	SOD-323	5d	1a	Chm
0F	ZD06V8	Z-diode	6.4..7.2V, 5mA, Zzt=15Q, 200mW	SOD-322	5d	1a	Cys
0G	FDZ7.5T	Z-diode	7.0..7.9V, Izt=5mA, Zzt=15Q, 200mW	SOD-323	5d	1a	Fis
0G	MM3Z7V5	Z-diode	7.0..7.9V, Izt=5mA, Zzt=15Q, 200mW	SOD-323	5d	1a	Sec
0G	MM5Z7V5	Z-diode	7.5V±5%, Izt=5mA, Zzt=15Q, 200mW	SOD-523	6d	1a,1u	Ons,Wtr
0G	MMPZ5236BPT	Z-diode	7.125..7.875V, Izt=5mA, Zzt=7Q, 225mW	SOD-323	5d	1a	Chm
0G	PD32284C5V1	Z-diode	5.1..5.4V, 5mA, Zzt=60, 500mW	PowDI323	7d	1d	Di
0G	ZD07V5	Z-diode	7.0..7.9V, 5mA, Zzt=15Q, 200mW	SOD-322	5d	1a	Cys
0H	FDZ8.2T	Z-diode	7.7..8.7V, Izt=5mA, Zzt=15Q, 200mW	SOD-323	5d	1a	Fis
0H	MM1Z16B	Z-diode	16V±2%, Izt=5mA, Zzt=40Q, 500mW	SOD-123FL	7d	1a	Sme
0H	MM3Z2V0	Z-diode	1.91..2.09V, Izt=5mA, Zzt=100Q, 200mW	SOD-323	5d	1a	Sec
0H	MM3Z8V2	Z-diode	7.7..8.7V, Izt=5mA, Zzt=15Q, 200mW	SOD-323	5d	1a	Sec
0H	MM5Z8V2	Z-diode	8.2V±5%, Izt=5mA, Zzt=15Q, 200mW	SOD-523	6d	1a,1u	Ons,Wtr
0H	MMPZ5237BPT	Z-diode	7.790..8.610V, Izt=5mA, Zzt=7Q, 225mW	SOD-323	5d	1a	Chm
0H	PD32284C5V6	Z-diode	5.6..6.0V, 5mA, Zzt=40, 500mW	PowDI323	7d	1d	Di
0H	ZD08V2	Z-diode	7.7..8.7V, 5mA, Zzt=15Q, 200mW	SOD-322	5d	1a	Cys
0J	MM1Z18B	Z-diode	18V±2%, Izt=5mA, Zzt=45Q, 500mW	SOD-123FL	7d	1a	Sme
0K	FDZ9.1T	Z-diode	8.5..9.6V, Izt=5mA, Zzt=15Q, 200mW	SOD-323	5d	1a	Fis
0K	MM1Z20B	Z-diode	20V±2%, Izt=5mA, Zzt=50Q, 500mW	SOD-123FL	7d	1a	Sme
0K	MM3Z9V1	Z-diode	8.5..9.6V, Izt=5mA, Zzt=15Q, 200mW	SOD-323	5d	1a	Sec
0K	MM5Z9V1	Z-diode	9.1V±5%, Izt=5mA, Zzt=15Q, 200mW	SOD-523	6d	1a,1u	Ons,Wtr
0K	MMPZ5239BPT	Z-diode	8.645..9.555V, Izt=5mA, Zzt=10Q, 225mW	SOD-323	5d	1a	Chm
0K	PD32284C6V2	Z-diode	6.2..6.6V, 5mA, Zzt=10, 500mW	PowDI323	7d	1d	Di
0K	ZD09V1	Z-diode	8.5..9.6V, 5mA, Zzt=15Q, 200mW	SOD-322	5d	1a	Cys
0L	FDZ10T	Z-diode	9.4..10.6V, Izt=5mA, Zzt=20Q, 200mW	SOD-323	5d	1a	Fis
0L	MM3Z10V	Z-diode	9.4..10.6V, Izt=5mA, Zzt=20Q, 200mW	SOD-323	5d	1a	Sec
0L	MM5Z10V	Z-diode	10V±5%, Izt=5mA, Zzt=20Q, 200mW	SOD-523	6d	1a,1u	Ons,Wtr
0L	MMPZ5240BPT	Z-diode	9.500..10.50V, Izt=5mA, Zzt=15Q, 225mW	SOD-323	5d	1a	Chm
0L	PD32284C6V8	Z-diode	6.8..7.2V, 5mA, Zzt=15, 500mW	PowDI323	7d	1d	Di
0L	ZD10V0	Z-diode	9.4..10.6V, 5mA, Zzt=20Q, 200mW	SOD-322	5d	1a	Cys
0M	FDZ11T	Z-diode	10.4..11.6V, Izt=5mA, Zzt=20Q, 200mW	SOD-323	5d	1a	Fis
0M	MM1Z22B	Z-diode	22V±2%, Izt=5mA, Zzt=55Q, 500mW	SOD-123FL	7d	1a	Sme
0M	MM3Z11V	Z-diode	10.4..11.6V, Izt=5mA, Zzt=20Q, 200mW	SOD-323	5d	1a	Sec
0M	MM5Z11V	Z-diode	11V±5%, Izt=5mA, Zzt=20Q, 200mW	SOD-523	6d	1a,1u	Ons,Wtr
0M	MMPZ5241BPT	Z-diode	10.45..11.55V, Izt=5mA, Zzt=18Q, 225mW	SOD-323	5d	1a	Chm
0M	PD32284C7V5	Z-diode	7.5..7.9V, 5mA, Zzt=10, 500mW	PowDI323	7d	1d	Di
0M	ZD11V0	Z-diode	10.4..11.6V, 5mA, Zzt=20Q, 200mW	SOD-322	5d	1a	Cys
0N	FDZ12T	Z-diode	11.4..12.7V, Izt=5mA, Zzt=25Q, 200mW	SOD-323	5d	1a	Fis
0N	MM1Z24B	Z-diode	24V±2%, Izt=5mA, Zzt=60Q, 500mW	SOD-123FL	7d	1a	Sme
0N	MM3Z12V	Z-diode	11.4..12.7V, Izt=5mA, Zzt=25Q, 200mW	SOD-323	5d	1a	Sec
0N	MM5Z12V	Z-diode	12V±5%, Izt=5mA, Zzt=25Q, 200mW	SOD-523	6d	1a,1u	Ons,Wtr
0N	MMPZ5242BPT	Z-diode	11.40..12.60V, Izt=5mA, Zzt=22Q, 225mW	SOD-323	5d	1a	Chm
0N	PD32284C8V2	Z-diode	8.2..8.7V, 5mA, Zzt=10, 500mW	PowDI323	7d	1d	Di
0N	ZD12V0	Z-diode	11.4..12.7V, 5mA, Zzt=25Q, 200mW	SOD-322	5d	1a	Cys
0P	FDZ13T	Z-diode	12.4..14.1V, Izt=5mA, Zzt=30Q, 200mW	SOD-323	5d	1a	Fis
0P	MM1Z27B	Z-diode	27V±2%, Izt=5mA, Zzt=70Q, 500mW	SOD-123FL	7d	1a	Sme
0P	MM3Z13V	Z-diode	12.4..14.1V, Izt=5mA, Zzt=30Q, 200mW	SOD-323	5d	1a	Sec
0P	MM5Z13V	Z-diode	13V±5%, Izt=5mA, Zzt=30Q, 200mW	SOD-523	6d	1a,1u	Ons,Wtr
0P	MMPZ5243BPT	Z-diode	12.35..13.65V, Izt=5mA, Zzt=25Q, 225mW	SOD-323	5d	1a	Chm
0P	PD32284C9V1	Z-diode	9.1..9.6V, 5mA, Zzt=10, 500mW	PowDI323	7d	1d	Di
0P	ZD13V2	Z-diode	12.4..14.1V, 5mA, Zzt=30Q, 200mW	SOD-322	5d	1a	Cys
0Q	PD32284C10	Z-diode	10..10.6V, 5mA, Zzt=10, 500mW	PowDI323	7d	1d	Di
0R	MM1Z30B	Z-diode	30V±2%, Izt=5mA, Zzt=80Q, 500mW	SOD-123FL	7d	1a	Sme



SMD code	Type	Function	Short description	Case	Pinout	St.	Mnf.
0R	PD3Z284C11	Z-diode	11..11.6V, 5mA, Zzt=10, 500mW	PowD1323	7d	1d	Di
0S	PD3Z284C12	Z-diode	12..12.7V, 5mA, Zzt=10, 500mW	PowD1323	7d	1d	Di
0T	FDZ15T	Z-diode	14.3..15.8V, Izt=5mA, Zzt=30Ω, 200mW	SOD-323	5d	1a	Fis
0T	MM3Z15V	Z-diode	14.3..15.8V, Izt=5mA, Zzt=30Ω, 200mW	SOD-323	5d	1a	Sec
0T	MM5Z15V	Z-diode	15V±5%, Izt=5mA, Zzt=30Ω, 200mW	SOD-523	6d	1a,1u	Ons,Wtr
0T	MMPZ5245BPT	Z-diode	14.25..15.75V, Izt=5mA, Zzt=32Ω, 225mW	SOD-323	5d	1a	Chm
0T	ZD15V0	Z-diode	14.3..15.8V, 5mA, Zzt=30Ω, 200mW	SOD-322	5d	1a	Cys
0U	FDZ16T	Z-diode	15.3..17.1V, Izt=5mA, Zzt=40Ω, 200mW	SOD-323	5d	1a	Fis
0U	MM3Z16V	Z-diode	15.3..17.1V, Izt=5mA, Zzt=40Ω, 200mW	SOD-323	5d	1a	Sec
0U	MM5Z16V	Z-diode	16V±5%, Izt=5mA, Zzt=40Ω, 200mW	SOD-523	6d	1a,1u	Ons,Wtr
0U	MMPZ5246BPT	Z-diode	15.20..16.80V, Izt=5mA, Zzt=36Ω, 225mW	SOD-323	5d	1a	Chm
0U	ZD16V2	Z-diode	15.3..17.1V, 5mA, Zzt=40Ω, 200mW	SOD-322	5d	1a	Cys
0V	FDZ18T	Z-diode	16.8..19.1V, Izt=5mA, Zzt=45Ω, 200mW	SOD-323	5d	1a	Fis
0V	MM3Z18V	Z-diode	16.8..19.1V, Izt=5mA, Zzt=45Ω, 200mW	SOD-323	5d	1a	Sec
0V	MM5Z18V	Z-diode	18V±5%, Izt=5mA, Zzt=45Ω, 200mW	SOD-523	6d	1a,1u	Ons,Wtr
0V	MMPZ5248BPT	Z-diode	17.10..18.90V, Izt=5mA, Zzt=42Ω, 225mW	SOD-323	5d	1a	Chm
0V	ZD18V0	Z-diode	16.8..19.1V, 5mA, Zzt=45Ω, 200mW	SOD-322	5d	1a	Cys
0X	MM1Z33B	Z-diode	33V±2%, Izt=5mA, Zzt=80Ω, 500mW	SOD-123FL	7d	1a	Sme
0Y	KDZ10VYV	Z-diode	9.77..10.21V, Izt=5mA, Zzt=15Ω, 100mW	VSC	7d	1a	Kec
0Y	MM1Z36B	Z-diode	36V±2%, Izt=5mA, Zzt=90Ω, 500mW	SOD-123FL	7d	1a	Sme
0Z	BZT52-B2V4S	Z-diode	2.35..2.45V, Izt=5mA, Zzt=100Ω, 200mW	SOD-323FL	7d	1a	Tsc
0Z	FDZ20T	Z-diode	18.8..21.2V, Izt=5mA, Zzt=55Ω, 200mW	SOD-323	5d	1a	Fis
0Z	MM1Z39B	Z-diode	39V±2%, Izt=2.5mA, Zzt=100Ω, 500mW	SOD-123FL	7d	1a	Sme
0Z	MM3Z20V	Z-diode	18.8..21.2V, Izt=5mA, Zzt=55Ω, 200mW	SOD-323	5d	1a	Sec
0Z	MM3Z2V4B	Z-diode	2.35..2.45V, Zzt=94Ω, Izt=5mA, 200mW	SOD-323FL	7d	1a	F
0Z	MM3Z2V4BW	Z-diode	2.35..2.45V, Izt=5mA, Zzt=100Ω, 200mW	SOD-323FL	7d	1a	Tac
0Z	MM5Z20V	Z-diode	20V±5%, Izt=5mA, Zzt=55Ω, 200mW	SOD-523	6d	1a,1u	Ons,Wtr
0Z	MMPZ5250BPT	Z-diode	19.0..21.0V, Izt=5mA, Zzt=48Ω, 225mW	SOD-323	5d	1a	Chm
0Z	TCMM3Z2V4B	Z-diode	2.4V±2%, Izt=5mA, Zzt=94Ω, 200mW	SOD-323FL	7d	1a	Tac
0Z	ZD20V0	Z-diode	18.8..21.2V, 5mA, Zzt=55Ω, 200mW	SOD-322	5d	1a	Cys
1	BA277	PIN-diode	VHF-band-Sw, 35V, 100mA, 715mW, 1.2pF, 0.7Ω(2mA/100MHz)	SOD-523	6d	1a	Phi
1	BB669	C-diode	VHF-Tuning, Hyperband, 35V, 2.7/56pF(28/1V)	SOD-123	5d	1a	Sie
1	CDZ3.9B	Z-diode	3.9V±2.5%, Izt=40mA, 1W	VMN	7d	1s	Rhm
1	CH501G-40PT	Si-diode	SBD, 45V, 100mA, Vf<0.55V(100mA)	SOD-723	8d	1a	Chm
1	GBLC18	TVS	Vbr=18V, 8A, 350W(1ms), 3pF	SOD-323	5d	1a	Prt
1	MMPZ5222SPT	Z-diode	2.450..2.550V, Izt=5mA, Zzt=100Ω, 225mW	SOD-323	5d	1a	Chm
1	MMSZ5243BPT	Z-diode	12.35..13.65V, Izt=5mA, Zzt=25Ω, 225mW	SOD-523	7d	1a	Chm
1	SPE0511D52RG	ESDP-diode	Vrwm=15V, Vbr=6..8.5V, 7A, 250W(1ms)	SOD-523	7d	1a	Syn
1 2	GDZ2V2B-V	Z-diode	2.22..2.41V, Izt=5mA, Zzt=100Ω, 200mW	SOD-323	5d	1k	Vs
1.	MMSZ5243SPT	Z-diode	12.74..13.26V, Izt=5mA, Zzt=25Ω, 225mW	SOD-523	7d	1a	Chm
10	BZY55-C10	Z-diode	9.50..10.50V, Izt=5mA, Zzt=15Ω, 500mW	0805	70d	2d	Tsc
10	CDZ55C10	Z-diode	9.50..10.50V, Zzt=15Ω, Izt=5mA, 500mW	1206	70d	2d	Crp
10	CDZ55C10S	Z-diode	9.50..10.50V, Zzt=15Ω, Izt=5mA, 500mW	0805	70d	2d	Crp
10	CDZ55C10T	Z-diode	9.50..10.50V, Zzt=15Ω, Izt=5mA, 200mW	0603	70d	2d	Crp
10	FDZ22T	Z-diode	20.8..23.3V, Izt=5mA, Zzt=55Ω, 200mW	SOD-323	5d	1a	Fis
10	HZU10G	Z-diode	9.45..10.55V, 200mW	SOD-323	5d	1a	Ren
10	KDZ10EV	Z-diode	9.4..10.6V, 150mW	SOD-523	6d	1a	Kec
10	KDZ10V	Z-diode	9.4..10.6V, 150mW	SOD-323	5d	1a	Kec
10	KDZ10VV	Z-diode	9.40..10.60V, Izt=5mA, Zzt=15Ω, 100mW	VSC	7d	1a	Kec
10	MAZ5100	Z-diode	9.4..10V, Zzt=8Ω(5mA), 500mW	MP2	11d	1a	Pan
10	MAZ81000H	Z-diode	10.07..10.59V, Zzt=30Ω(5mA), 150mW	SC-76	6d	1a	Pan
10	MAZF100	Z-diode	9.4..10.6V, Zzt=30Ω(5mA), 120mW	S-Mini	7d	1a	Pan
10	MAZN100	Z-diode	9.4..10.6V, Zzt=30Ω(5mA), 120mW	SSMini2	7d	1a	Pan
10	MAZS100	Z-diode	9.4..10.6V, 200mW	SOD-523	6d	1a	Pan
10	MAZY100	Z-diode	9..11V, Zzt=30Ω(10mA), 1W	NMiniP2	1d	1a	Pan
10	MM3Z22V	Z-diode	20.8..23.3V, Izt=5mA, Zzt=55Ω, 200mW	SOD-323	5d	1a	Sec
10	MM5Z22V	Z-diode	22V±5%, Izt=5mA, Zzt=55Ω, 200mW	SOD-523	6d	1a,1u	Ons,Wtr
10	MMPZ5251BPT	Z-diode	20.90..23.10V, Izt=5mA, Zzt=55Ω, 225mW	SOD-323	5d	1a	Chm
10	P4SMA10	TVS	Vbr=9.00..11.0V, Vrwm=8.10V, 28.0A, 400W(1ms)	DO-214AC	1d	1a	Eic
10	P6SMBJ10	TVS	Vbr=9..11V, 40A, 600W(1ms)	DO-214AA	1d	1n	Lif
10	SML4740	Z-diode	10V±5%, Izt=25mA, Zzt=7Ω, 1W	DO-214AC	1d	1k	Vs
10	TZD10WS	Z-diode	9.40..10.60V, Izt=5mA, Zzt=15Ω, 200mW	SOD-323	5d	1a	Ttr
10	TZD10WT	Z-diode	9.40..10.60V, Izt=5mA, Zzt=15Ω, 150mW	SOD-523	6d	1a	Ttr
10	TZD10WU	Z-diode	9.77..10.21V, Izt=5mA, Zzt=30Ω, 100mW	SOD-723	7d	1a	Ttr
10	U1Z10	Z-diode	9..11V, 1W	SOD-6	1d	1a	Tos
10	U1ZB10	Z-diode	9..11V, 1W	I-FLAT	1d	1a	Tos
10	ZD22V0	Z-diode	20.8..23.3V, 5mA, Zzt=55Ω, 200mW	SOD-322	5d	1a	Cys
10-	MAZ81000M	Z-diode	9.75..10.25V, Zzt=30Ω(5mA), 150mW	SC-76	6d	1a	Pan
10-	MAZ8100GML	Z-diode	9.75..10.25V, Zzt=30Ω(5mA), 150mW	SMini2-F3	6d	1a	Pan
10-	MAZS1000M	Z-diode	9.75..10.25V, 200mW	SOD-523	6d	1a	Pan



SMD
code

Type

Function

Short description

Case

Pinout

St.

Mnf.

10	CTZ55C10	Z-diode	9.50..10.50V, Izt=5mA, Zzt=15Ω, 500mW	1206	70d	2d	Ctc
10 ^A	MAZ81000H	Z-diode	10.07..10.59V, Zzt=30Ω(5mA), 150mW	SC-76	6d	1a	Pan
10 ^A	MAZ8100GHL	Z-diode	10.07..10.59V, Zzt=30Ω(5mA), 150mW	SMiMini2-F3	6d	1a	Pan
10 ^A	MAZS1000H	Z-diode	10.07..10.59V, 200mW	SOD-523	6d	1a	Pan
10_	MAZ81000L	Z-diode	9.44..9.92V, Zzt=30Ω(5mA), 150mW	SC-76	6d	1a	Pan
10_	MAZ8100GLL	Z-diode	9.44..9.92V, Zzt=30Ω(5mA), 150mW	SMiMini2-F3	6d	1a	Pan
10_	MAZS1000L	Z-diode	9.44..9.92 5V, 200mW	SOD-523	6d	1a	Pan
10 ⁺	HZC10	Z-diode	10V±10%, 150mW	SOD-523	6d	1a	Ren
10 ⁺	HZU10B1	Z-diode	9.45..9.87V, Izt=5mA, Zzt=30Ω, 200mW	URP	5d	1a	Ren
10 ⁺	HZU10B2	Z-diode	9.77..10.21V, Izt=5mA, Zzt=30Ω, 200mW	URP	5d	1a	Ren
10 ⁺	HZU10B3	Z-diode	10.11..10.55V, Izt=5mA, Zzt=30Ω, 200mW	URP	5d	1a	Ren
10 ⁺	RKZ10B2KG	Z-diode	9.77..10.21V, Izt=5mA, Zzt=30Ω, 200mW	URP	5d	2e	Ren
10 ⁺	RKZ10B2KJ	Z-diode	9.77..10.21V, Izt=5mA, Zzt=30Ω, 150mW	UFP	7d	2e	Ren
10 ⁺	TZD10YWS	Z-diode	9.77..10.21V, Izt=5mA, Zzt=15Ω, 200mW	SOD-323	5d	1a	Tr
10 ⁺	TZD10YWT	Z-diode	9.77..10.21V, Izt=5mA, Zzt=15Ω, 150mW	SOD-523	6d	1a	Tr
100	P4SMA100	TVS	Vbr=90.0..110V, Vrrwm=81.0V, 2.9A, 400W(1ms)	DO-214AC	1d	1a	Eic
100	P6SMBJ100	TVS	Vbr=90..110V, 4.2A, 600W(1ms)	DO-214AA	1d	1n	Lif
100	SML4764	Z-diode	100V±5%, Izt=2.5mA, Zzt=350Ω, 1W	DO-214AC	1d	1k	Vs
100	U1Z100	Z-diode	90..110V, 1W	SOD-6	1d	1a	Tos
100	U1ZB100	Z-diode	90..110V, 1W	I-FLAT	1d	1a	Tos
100A	1.5SMC100A	TVS	Vbr=95.0..105V, Vrrwm=85.5V, 10.9A, 1500W(1ms)	DO-214AB	1d	1k	Vs
100A	1SMC100A	TVS	Vbr=111..123V, Vrrwm=100V, 9.3A, 1500W(1ms)	DO-214AB	1d	1a	Eic
100A	P4SMA100A	TVS	Vbr=95.0..105V, Vrrwm=85.5V, 3.1A, 400W(1ms)	DO-214AC	1d	1k	Vs
100A	P6SMB100A	TVS	Vrrwm=100V, Vbr=95..105V, 4.4A, 600W(1ms)	DO-214AA	1d,3d	1a,1k	Vs,Ons
100A	P6SMBJ100A	TVS	Vbr=95..105V, 4.4A, 600W(1ms)	DO-214AA	1d	1n	Lif
100A	SMAJ100A	TVS	Vrrwm=100V, Vbr=111..123V, 2.5A, 400W(1ms)	DO-214AC	1d	1a	Sus
100A	SMBJ100A	TVS	Vbr=111..123V, Vrrwm=100V, 3.7A, 600W(1ms)	DO-214AA	1d	1a	Sus
100A	SMCJ100A	TVS	Vrrwm=100V, Vbr=111..136V, 8.4A, 1500W(1ms)	DO-214AB	1d	1k	Sus
100A	UMA100A	TVS	Vrrwm=100V, Vbr=111..162V, 3.1A, 500W(1ms)	UltraMite	14ba	1v	Msc
100B	1SMB3EZ100	Z-diode	100V±5%, Zzt=175Ω, Izt=7.5mA, 3W	DO-214AA	1d	1a	Pjt
100C	1.5SMC100CA	TVS	Vbr=95.0..105V, Vrrwm=85.5V, 10.9A, 1500W(1ms), Bidirectional	DO-214AB	1ba	1l	Vs
100C	P4SMA100C	TVS	Vbr=90.0..110V, Vrrwm=81.0V, 2.9A, 400W(1ms), Bidirectional	DO-214AC	1ba	1j	Eic
100C	P4SMA100CA	TVS	Vbr=95.0..105V, 2.2A, 400W(1ms), Bidirectional	DO-214AC	1ba	1l	Vs
100C	P6SMB100CA	TVS	Vbr=95..105V, 4.4A, 600W(1ms), Bidirectional	DO-214AA	1ba	1l	Vs
100C	P6SMBJ100C	TVS	Vbr=90..110V, 4.2A, 600W(1ms), Bidirectional	DO-214AA	1ba	1p	Lif
100CA	1SMC100CA	TVS	Vbr=111..123V, Vrrwm=100V, 9.3A, 1500W(1ms), Bidirectional	DO-214AB	1ba	1j	Eic
100CA	P4SMA100CA	TVS	Vbr=95.0..105V, Vrrwm=85.5V, 3.1A, 400W(1ms), Bidirectional	DO-214AC	1ba	1j	Eic
100CA	P6SMB100CA	TVS	Vbr=95.0..105V, Vrrwm=85.5V, 4.4A, 600W(1ms), Bidirectional	DO-214AA	1ba	1j	Eic
100CA	P6SMBJ100CA	TVS	Vbr=95..105V, 4.4A, 600W(1ms), Bidirectional	DO-214AA	1ba	1p	Lif
100CA	SMAJ100CA	TVS	Vrrwm=100V, Vbr=111..123V, 2.5A, 400W(1ms), Bidirectional	DO-214AC	1ba	1j	Sus
100CA	SMBJ100CA	TVS	Vrrwm=100V, Vbr=111..128V, 3.7A, 600W(1ms), Bidirectional	DO-214AA	1ba	1j	Sus
100CA	SMCJ100CA	TVS	Vrrwm=100V, Vbr=111..136V, 8.4A, 1500W(1ms), Bidirectional	DO-214AB	1ba	1l	Sus
100CA	UMA100CA	TVS	Vrrwm=100V, Vbr=111..162V, 3.1A, 500W(1ms), Bidirectional	UltraMite	14ba	1v	Msc
100V	SMA100	TVS	Vbr=111..136V, Vrrwm=100.0V, 1.7A, 300W(1ms)	DO-214AC	1d	1a	Mic
100V	SMB100	TVS	Vbr=111..136V, Vrrwm=100V, 3.4A, 600W(1ms)	DO-214AA	1d	1a	Mic
100V	SMC100	TVS	Vbr=111..136V, Vrrwm=100V, 8.4A, 1500W(1ms)	DO-214AB	1d	1a	Mic
100VA	SMA100A	TVS	Vbr=111..123V, Vrrwm=100.0V, 1.9A, 300W(1ms)	DO-214AC	1d	1a	Mic
100VA	SMB100A	TVS	Vbr=111..123V, Vrrwm=100V, 3.7A, 600W(1ms)	DO-214AA	1d	1a	Mic
100VA	SMC100A	TVS	Vbr=111..123V, Vrrwm=100V, 9.3A, 1500W(1ms)	DO-214AB	1d	1a	Mic
100VC	SMA100C	TVS	Vbr=111..136V, Vrrwm=100.0V, 1.7A, 300W(1ms), Bidirectional	DO-214AC	1ba	1j	Mic
100VC	SMB100C	TVS	Vbr=111..136V, Vrrwm=100V, 3.4A, 600W(1ms), Bidirectional	DO-214AA	1ba	1j	Mic
100VC	SMC100C	TVS	Vbr=111..136V, Vrrwm=100V, 8.4A, 1500W(1ms), Bidirectional	DO-214AB	1ba	1j	Mic
100VCA	SMA100CA	TVS	Vbr=111..123V, Vrrwm=100.0V, 1.9A, 300W(1ms), Bidirectional	DO-214AC	1ba	1j	Mic
100VCA	SMB100CA	TVS	Vbr=111..123V, Vrrwm=100V, 3.7A, 600W(1ms), Bidirectional	DO-214AA	1ba	1j	Mic
100VCA	SMC100CA	TVS	Vbr=111..123V, Vrrwm=100V, 9.3A, 1500W(1ms), Bidirectional	DO-214AB	1ba	1j	Mic
1010	SZ1010	Z-diode	10V±10%, Zzt=7.0Ω, Izt=91mA, 1W	DO-214AC	1d	1a	Eic
1011	SZ1011	Z-diode	11V±10%, Zzt=8.0Ω, Izt=83mA, 1W	DO-214AC	1d	1a	Eic
1012	SZ1012	Z-diode	12V±10%, Zzt=9.0Ω, Izt=76mA, 1W	DO-214AC	1d	1a	Eic
1013	SZ1013	Z-diode	13V±10%, Zzt=10Ω, Izt=69mA, 1W	DO-214AC	1d	1a	Eic
1015	SZ1015	Z-diode	15V±10%, Zzt=14Ω, Izt=61mA, 1W	DO-214AC	1d	1a	Eic
1016	SZ1016	Z-diode	16V±10%, Zzt=16Ω, Izt=57mA, 1W	DO-214AC	1d	1a	Eic
1018	SZ1018	Z-diode	18V±10%, Zzt=20Ω, Izt=50mA, 1W	DO-214AC	1d	1a	Eic
1020	SZ1020	Z-diode	20V±10%, Zzt=22Ω, Izt=45mA, 1W	DO-214AC	1d	1a	Eic
1022	SZ1022	Z-diode	22V±10%, Zzt=23Ω, Izt=41mA, 1W	DO-214AC	1d	1a	Eic
1024	SZ1024	Z-diode	24V±10%, Zzt=25Ω, Izt=38mA, 1W	DO-214AC	1d	1a	Eic
1027	SZ1027	Z-diode	27V±10%, Zzt=35Ω, Izt=34mA, 1W	DO-214AC	1d	1a	Eic
1030	SZ1030	Z-diode	30V±10%, Zzt=40Ω, Izt=30mA, 1W	DO-214AC	1d	1a	Eic
1033	SZ1033	Z-diode	33V±10%, Zzt=45Ω, Izt=27mA, 1W	DO-214AC	1d	1a	Eic
1036	SZ1036	Z-diode	36V±10%, Zzt=50Ω, Izt=25mA, 1W	DO-214AC	1d	1a	Eic
1039	SZ1039	Z-diode	39V±10%, Zzt=60Ω, Izt=23mA, 1W	DO-214AC	1d	1a	Eic



SMD code	Type	Function	Short description	Case	Pinout	St.	Mnf.
103D	SZ103D	Z-diode	3.3V±10%, Zzt=10Ω, Izt=276mA, 1W	DO-214AC	1d	1a	Eic
103G	SZ103G	Z-diode	3.6V±10%, Zzt=10Ω, Izt=252mA, 1W	DO-214AC	1d	1a	Eic
103J	SZ103J	Z-diode	3.9V±10%, Zzt=9.0Ω, Izt=234mA, 1W	DO-214AC	1d	1a	Eic
1043	SZ1043	Z-diode	43V±10%, Zzt=70Ω, Izt=22mA, 1W	DO-214AC	1d	1a	Eic
1047	SZ1047	Z-diode	47V±10%, Zzt=80Ω, Izt=19mA, 1W	DO-214AC	1d	1a	Eic
104D	SZ104D	Z-diode	4.3V±10%, Zzt=9.0Ω, Izt=217mA, 1W	DO-214AC	1d	1a	Eic
104H	SZ104H	Z-diode	4.7V±10%, Zzt=8.0Ω, Izt=193mA, 1W	DO-214AC	1d	1a	Eic
1051	SZ1051	Z-diode	5.1V±10%, Zzt=95Ω, Izt=18mA, 1W	DO-214AC	1d	1a	Eic
1056	SZ1056	Z-diode	5.6V±10%, Zzt=110Ω, Izt=16mA, 1W	DO-214AC	1d	1a	Eic
105B	SZ105B	Z-diode	5.1V±10%, Zzt=7.0Ω, Izt=178mA, 1W	DO-214AC	1d	1a	Eic
105G	SZ105G	Z-diode	5.6V±10%, Zzt=5.0Ω, Izt=162mA, 1W	DO-214AC	1d	1a	Eic
1062	SZ1062	Z-diode	62V±10%, Zzt=125Ω, Izt=14mA, 1W	DO-214AC	1d	1a	Eic
1068	SZ1068	Z-diode	68V±10%, Zzt=150Ω, Izt=13mA, 1W	DO-214AC	1d	1a	Eic
106C	SZ106C	Z-diode	6.2V±10%, Zzt=2.0Ω, Izt=146mA, 1W	DO-214AC	1d	1a	Eic
106I	SZ106I	Z-diode	6.8V±10%, Zzt=3.5Ω, Izt=133mA, 1W	DO-214AC	1d	1a	Eic
1075	SZ1075	Z-diode	75V±10%, Zzt=175Ω, Izt=12mA, 1W	DO-214AC	1d	1a	Eic
107F	SZ107F	Z-diode	7.5V±10%, Zzt=4.0Ω, Izt=121mA, 1W	DO-214AC	1d	1a	Eic
1082	SZ1082	Z-diode	82V±10%, Zzt=200Ω, Izt=11mA, 1W	DO-214AC	1d	1a	Eic
108C	SZ108C	Z-diode	8.2V±10%, Zzt=4.5Ω, Izt=110mA, 1W	DO-214AC	1d	1a	Eic
1091	SZ1091	Z-diode	91V±10%, Zzt=250Ω, Izt=10mA, 1W	DO-214AC	1d	1a	Eic
109B	SZ109B	Z-diode	9.1V±10%, Zzt=5.0Ω, Izt=100mA, 1W	DO-214AC	1d	1a	Eic
10A	1.5SMC10A	TVS	Vbr=9.50..10.5V, Vrw=8.55V, 103A, 1500W(1ms)	DO-214AB	1d,3d	1a,1k	Vs,Ons
10A	1SMC10A	TVS	Vbr=11.1..12.3V, Vrw=10V, 88.2A, 1500W(1ms)	DO-214AB	1d	1a	Eic
10A	P4SMA10A	TVS	Vbr=9.50..10.5V, Vrw=8.55V, 29.0A, 400W(1ms)	DO-214AC	1d	1k	Vs
10A	P6SMB10A	TVS	Vrw=10V, Vbr=9.5..10.5V, 41.4A, 600W(1ms)	DO-214AA	1d,3d	1k,1a	Vs,Ons
10A	P6SMBJ10A	TVS	Vbr=9.5..10.5V, 41A, 600W(1ms)	DO-214AA	1d	1n	Lif
10A	RKZ10AKU	Z-diode	9.12..9.59V, Izt=20mA, Zzt=30Ω, 500mW	TURP-FM	7d	1a	Ren
10A	SMAJ10A	TVS	Vrw=10V, Vbr=11.1..12.3V, 23.5A, 400W(1ms)	DO-214AC	1d	1j	Sus
10A	SMBJ10A	TVS	Vrw=10V, Vbr=11.1..12.8V, 35.3A, 600W(1ms)	DO-214AA	1d	1a	Sus
10A	SMCJ10A	TVS	Vrw=10V, Vbr=11.1..13.6V, 79.8A, 1500W(1ms)	DO-214AB	1d	1k	Sus
10A	UMA10A	TVS	Vrw=10V, Vbr=11.1..17.0V, 29.4A, 500W(1ms)	UltraMite	14d	1v	Msc
10B	HZF10BP	Z-diode	10V±5%, 900mW	LRP	1d	2f	Ren
10B	PTZ10B	Z-diode	10V±10%, 40mA, 1W	DO-214AC	1d	1a	Rhm
10B	RKZ10BKU	Z-diode	9.41..9.90V, Izt=20mA, Zzt=30Ω, 500mW	TURP-FM	7d	1a	Ren
10B	Z3SMB10B	Z-diode	9.50..10.50V, Izt=75mA, Zzt=4Ω, 3W	DO-214AA	1d	1a	Thr
10B0	SZ10B0	Z-diode	100V±10%, Zzt=350Ω, Izt=9.0mA, 1W	DO-214AC	1d	1a	Eic
10B1	SZ10B1	Z-diode	110V±10%, Zzt=450Ω, Izt=8.6mA, 1W	DO-214AC	1d	1a	Eic
10B2	SZ10B2	Z-diode	120V±10%, Zzt=550Ω, Izt=7.8mA, 1W	DO-214AC	1d	1a	Eic
10B3	SZ10B3	Z-diode	130V±10%, Zzt=700Ω, Izt=7.0mA, 1W	DO-214AC	1d	1a	Eic
10B5	SZ10B5	Z-diode	150V±10%, Zzt=1000Ω, Izt=6.4mA, 1W	DO-214AC	1d	1a	Eic
10B6	SZ10B6	Z-diode	160V±10%, Zzt=1100Ω, Izt=5.8mA, 1W	DO-214AC	1d	1a	Eic
10B8	SZ10B8	Z-diode	180V±10%, Zzt=1200Ω, Izt=5.2mA, 1W	DO-214AC	1d	1a	Eic
10C	1.5SMC10CA	TVS	Vbr=9.50..10.5V, Vrw=8.55V, 103A, 1500W(1ms), Bidirectional	DO-214AB	1ba	1l	Vs
10C	HZF10CP	Z-diode	10V±10%, 900mW	LRP	1d	2f	Ren
10C	P4SMA10C	TVS	Vbr=9.00..11.0V, Vrw=8.10V, 28.0A, 400W(1ms), Bidirectional	DO-214AC	1ba	1j	Eic
10C	P4SMA10CA	TVS	Vbr=9.5..10.5V, 27.6A, 400W(1ms), Bidirectional	DO-214AC	1ba	1l	Vs
10C	P6SMB10CA	TVS	Vbr=9.5..10.5V, 41.4A, 600W(1ms), Bidirectional	DO-214AA	1ba	1l	Vs
10C	P6SMBJ10C	TVS	Vbr=9.5..11V, 40A, 600W(1ms), Bidirectional	DO-214AA	1ba	1p	Lif
10C	RKZ10CKU	Z-diode	9.70..10.20V, Izt=20mA, Zzt=30Ω, 500mW	TURP-FM	7d	1a	Ren
10CA	1SMC10CA	TVS	Vbr=11.1..12.3V, Vrw=10V, 88.2A, 1500W(1ms), Bidirectional	DO-214AB	1ba	1j	Eic
10CA	P4SMA10CA	TVS	Vbr=9.50..10.5V, Vrw=8.55V, 29.0A, 400W(1ms), Bidirectional	DO-214AC	1ba	1j	Eic
10CA	P6SMB10CA	TVS	Vbr=9.50..10.5V, Vrw=8.55V, 41.0A, 600W(1ms), Bidirectional	DO-214AA	1ba	1j	Eic
10CA	P6SMBJ10CA	TVS	Vbr=9.5..10.5V, 41A, 600W(1ms), Bidirectional	DO-214AA	1ba	1p	Lif
10CA	SMAJ10CA	TVS	Vrw=10V, Vbr=11.1..12.3V, 23.5A, 400W(1ms), Bidirectional	DO-214AC	1ba	1j	Sus
10CA	SMBJ10CA	TVS	Vbr=11.1..12.3V, Vrw=10V, 35.3A, 600W(1ms), Bidirectional	DO-214AA	1ba	1j	Sus
10CA	SMCJ10CA	TVS	Vrw=10V, Vbr=11.1..13.6V, 79.8A, 1500W(1ms), Bidirectional	DO-214AB	1ba	1l	Sus
10CA	UMA10CA	TVS	Vrw=10V, Vbr=11.1..17.0V, 29.4A, 500W(1ms), Bidirectional	UltraMite	14ba	1v	Msc
10D	RKZ10DKU	Z-diode	9.94..10.44V, Izt=20mA, Zzt=30Ω, 500mW	TURP-FM	7d	1a	Ren
10D0	SZ10D0	Z-diode	200V±10%, Zzt=1900Ω, Izt=4.7mA, 1W	DO-214AC	1d	1a	Eic
10D2	SZ10D2	Z-diode	220V±10%, Zzt=1600Ω, Izt=4.0mA, 1W	DO-214AC	1d	1a	Eic
10D4	SZ10D4	Z-diode	240V±10%, Zzt=1800Ω, Izt=3.8mA, 1W	DO-214AC	1d	1a	Eic
10D5	SZ10D5	Z-diode	250V±10%, Zzt=2000Ω, Izt=3.6mA, 1W	DO-214AC	1d	1a	Eic
10D7	SZ10D7	Z-diode	270V±10%, Zzt=2100Ω, Izt=3.3mA, 1W	DO-214AC	1d	1a	Eic
10E0	SZ10E0	Z-diode	300V±10%, Zzt=2300Ω, Izt=3.0mA, 1W	DO-214AC	1d	1a	Eic
10L6	KP10L06	Thy-SPD	V Of-St=55V, Ifsm=100A(1ms), Ih=100mA, Bidirectional	2F	1ba	1l	Shi
10L7	KP10L07	Thy-SPD	V Of-St=65V, Ifsm=100A(1ms), Ih=100mA, Bidirectional	2F	1ba	1l	Shi
10L8	KP10L08	Thy-SPD	V Of-St=70V, Ifsm=100A(1ms), Ih=100mA, Bidirectional	2F	1ba	1l	Shi
10LU06	KP10LU06	Thy-SPD	V Of-St=55V, Ifsm=100A(1ms), Ih=100mA, Bidirectional	SOD-123	5ba	1j	Shi
10LU08	KP10LU08	Thy-SPD	V Of-St=70V, Ifsm=100A(1ms), Ih=100mA, Bidirectional	SOD-123	5ba	1j	Shi
10N12	KP10N12	Thy-SPD	V Of-St=110V, Ifsm=100A(1ms), Ih=100mA, Bidirectional	2F	1ba	1l	Shi



SMD code	Type	Function	Short description	Case	Pinout	St.	Mnf.
10N14	KP10N14	Thy-SPD	V Of-St=130V, Ifsm=100A(1ms), Ith=100mA, Bidirectional	2F	1ba	1l	Shi
10P	BZD27C10P	Z-diode	9.50..10.50V, Zzt=4Ω, Izt=50mA, 800mW	SOD-123FL	7d	1a	Pjt
10P	MFPZ10	Z-diode	9.50..10.50V, Izt=50mA, Zzt=4Ω, 800mW	SOD-123FL	7d	1a	Tr
10R25	KP10R25	Thy-SPD	V Of-St=220V, Ifsm=100A(1ms), Ith=100mA, Bidirectional	2F	1ba	1l	Shi
10V	SMA10	TVS	Vbr=11.1..13.6V, Vrrwm=10.0V, 16A, 300W(1ms)	DO-214AC	1d	1a	Mic
10V	SMB10	TVS	Vbr=11.1..13.6V, Vrrwm=10V, 31.9A, 600W(1ms)	DO-214AA	1d	1a	Mic
10V	SMC10	TVS	Vbr=11.1..13.6V, Vrrwm=10V, 79.8A, 1500W(1ms)	DO-214AB	1d	1a	Mic
10VA	SMA10A	TVS	Vbr=11.1..12.3V, Vrrwm=10.0V, 17.6A, 300W(1ms)	DO-214AC	1d	1a	Mic
10VA	SMB10A	TVS	Vbr=11.1..12.3V, Vrrwm=10V, 35.3A, 600W(1ms)	DO-214AA	1d	1a	Mic
10VA	SMC10A	TVS	Vbr=11.1..12.3V, Vrrwm=10V, 88.2A, 1500W(1ms)	DO-214AB	1d	1a	Mic
10VB	BZT52-B10	Z-diode	9.80..10.20V, Izt=5mA, Zzt=20Ω, 500mW	SOD-123FL	7d	1a	Tsc
10VB	MMSZ10VBW	Z-diode	9.80..10.20V, Izt=5mA, Zzt=20Ω, 500mW	SOD-123FL	7d	1a	Tac
10VC	SMA10C	TVS	Vbr=11.1..13.6V, Vrrwm=10.0V, 16A, 300W(1ms), Bidirectional	DO-214AC	1ba	1j	Mic
10VC	SMB10C	TVS	Vbr=11.1..13.6V, Vrrwm=10V, 31.9A, 600W(1ms), Bidirectional	DO-214AA	1ba	1j	Mic
10VC	SMC10C	TVS	Vbr=11.1..13.6V, Vrrwm=10V, 79.8A, 1500W(1ms), Bidirectional	DO-214AB	1ba	1j	Mic
10VCA	SMA10CA	TVS	Vbr=11.1..12.3V, Vrrwm=10.0V, 17.6A, 300W(1ms), Bidirectional	DO-214AC	1ba	1j	Mic
10VCA	SMB10CA	TVS	Vbr=11.1..12.3V, Vrrwm=10V, 35.3A, 600W(1ms), Bidirectional	DO-214AA	1ba	1j	Mic
10VCA	SMC10CA	TVS	Vbr=11.1..12.3V, Vrrwm=10V, 88.2A, 1500W(1ms), Bidirectional	DO-214AB	1ba	1j	Mic
10VZ	BZT52-C10	Z-diode	9.50..10.50V, Izt=5mA, Zzt=20Ω, 500mW	SOD-123FL	7d	1a	Tsc
10VZ	MMSZ10VCW	Z-diode	9.50..10.50V, Izt=5mA, Zzt=20Ω, 500mW	SOD-123FL	7d	1a	Tac
10VZ	TCMMSZ10V	Z-diode	10V±5%, Izt=5mA, Zzt=18Ω, 500mW	SOD-123FL	7d	1a	Tac
10VZ	ZGFM0510C-MH	Z-diode	9.50..10.50V, Izt=5mA, Zzt=18Ω, 500mW	SOD-123	5d	1a	Pic
11	BZY55-C11	Z-diode	10.45..11.55V, Izt=5mA, Zzt=20Ω, 500mW	0805	70d	2d	Tsc
11	CDZ55C11	Z-diode	10.45..11.55V, Zzt=20Ω, Izt=5mA, 500mW	1206	70d	2d	Crp
11	CDZ55C11S	Z-diode	10.45..11.55V, Zzt=20Ω, Izt=5mA, 500mW	0805	70d	2d	Crp
11	CDZ55C11T	Z-diode	10.45..11.55V, Zzt=20Ω, Izt=5mA, 200mW	0603	70d	2d	Crp
11	FDZ24T	Z-diode	22.8..25.6V, Izt=5mA, Zzt=70Ω, 200mW	SOD-323	5d	1a	Fis
11	KDZ11EV	Z-diode	10.4..11.6V, 150mW	SOD-523	6d	1a	Kec
11	KDZ11V	Z-diode	10.4..11.6V, 150mW	SOD-323	5d	1a	Kec
11	KDZ11VV	Z-diode	10.40..11.60V, Izt=5mA, Zzt=15Ω, 100mW	VSC	7d	1a	Kec
11	MAZ5110	Z-diode	10.4..11.6V, Zzt=10Ω(5mA), 500mW	MP2	11d	1a	Pan
11	MAZ81100H	Z-diode	11.05..11.06V, Zzt=30Ω(5mA), 150mW	SC-76	6d	1a	Pan
11	MAZF110	Z-diode	10.40..11.6V, Zzt=30Ω(5mA), 120mW	S-Mini	7d	1a	Pan
11	MAZN110	Z-diode	10.40..11.6V, Zzt=30Ω(5mA), 120mW	SSMini2	7d	1a	Pan
11	MAZS110	Z-diode	10.4..11.6V, 200mW	SOD-523	6d	1a	Pan
11	MAZY110	Z-diode	9.9..12.1V, Zzt=30Ω(10mA), 1W	NMiniP2	1d	1a	Pan
11	MM3Z24V	Z-diode	22.8..25.6V, Izt=5mA, Zzt=70Ω, 200mW	SOD-323	5d	1a	Sec
11	MMSZ24V	Z-diode	24V±5%, Izt=5mA, Zzt=70Ω, 200mW	SOD-523	6d	1a,1u	Ons,Wtr
11	MMPZ5252BPT	Z-diode	22.80..25.20V, Izt=5mA, Zzt=62Ω, 225mW	SOD-323	5d	1a	Chm
11	P4SMA11	TVS	Vbr=9.90..12.1V, Vrrwm=8.92V, 26.0A, 400W(1ms)	DO-214AC	1d	1a	Eic
11	P6SMBJ11	TVS	Vbr=9.9..12.1V, 37A, 600W(1ms)	DO-214AA	1d	1n	Lif
11	SMA3C11	Z-diode	11V±5%, Izt=68mA, Zzt<4Ω, 3W	DO-214AC	1d	1a	Exc
11	SML4741	Z-diode	11V±5%, Izt=23mA, Zzt=8Ω, 1W	DO-214AC	1d	1k	Vs
11	TZD11WS	Z-diode	10.40..11.60V, Izt=5mA, Zzt=15Ω, 200mW	SOD-323	5d	1a	Tr
11	TZD11WT	Z-diode	10.40..11.60V, Izt=5mA, Zzt=15Ω, 150mW	SOD-523	6d	1a	Tr
11	TZD11WU	Z-diode	10.76..11.22V, Izt=5mA, Zzt=30Ω, 100mW	SOD-723	7d	1a	Tr
11	U1Z11	Z-diode	9.9..12.1V, 1W	SOD-6	1d	1a	Tos
11	U1ZB11	Z-diode	9.9..12.1V, 1W	I-FLAT	1d	1a	Tos
11	ZD24V2	Z-diode	22.8..25.6V, 5mA, Zzt=70Ω, 200mW	SOD-322	5d	1a	Cys
11-	MAZ81100M	Z-diode	10.73..11.28V, Zzt=30Ω(5mA), 150mW	SC-76	6d	1a	Pan
11-	MAZ8110GML	Z-diode	10.73..11.28V, Zzt=30Ω(5mA), 150mW	SMini2-F3	6d	1a	Pan
11-	MAZS1100M	Z-diode	10.73..11.28V, 200mW	SOD-523	6d	1a	Pan
11	CTZ55C11	Z-diode	10.45..11.55V, Izt=5mA, Zzt=20Ω, 500mW	1206	70d	2d	Ctc
11A	MAZ81100H	Z-diode	11.05..11.06V, Zzt=30Ω(5mA), 150mW	SC-76	6d	1a	Pan
11A	MAZ8110GHL	Z-diode	11.05..11.06V, Zzt=30Ω(5mA), 150mW	SMini2-F3	6d	1a	Pan
11A	MAZS1100H	Z-diode	11.05..11.6V, 200mW	SOD-523	6d	1a	Pan
11_	MAZ81100L	Z-diode	10.4..10.94V, Zzt=30Ω(5mA), 150mW	SC-76	6d	1a	Pan
11_	MAZ8110GLL	Z-diode	10.4..10.94V, Zzt=30Ω(5mA), 150mW	SMini2-F3	6d	1a	Pan
11_	MAZS1100L	Z-diode	10.4..10.94V, 200mW	SOD-523	6d	1a	Pan
11■	HZC11	Z-diode	11V±10%, 150mW	SOD-523	6d	1a	Ren
11*	HZU11B1	Z-diode	10.44..10.88V, Izt=5mA, Zzt=30Ω, 200mW	URP	5d	1a	Ren
11*	HZU11B2	Z-diode	10.76..11.22V, Izt=5mA, Zzt=30Ω, 200mW	URP	5d	1a	Ren
11*	HZU11B3	Z-diode	11.10..11.56V, Izt=5mA, Zzt=30Ω, 200mW	URP	5d	1a	Ren
11*	RKZ11B2KG	Z-diode	10.76..11.22V, Izt=5mA, Zzt=30Ω, 200mW	URP	5d	2e	Ren
11*	RKZ11B2KJ	Z-diode	10.76..11.22V, Izt=5mA, Zzt=30Ω, 150mW	UFP	7d	2e	Ren
11*	TZD11YWS	Z-diode	10.76..11.22V, Izt=5mA, Zzt=15Ω, 200mW	SOD-323	5d	1a	Tr
11*	TZD11YWT	Z-diode	10.76..11.22V, Izt=5mA, Zzt=15Ω, 150mW	SOD-523	6d	1a	Tr
110	P4SMA110	TVS	Vbr=99.0..121V, Vrrwm=89.2V, 2.7A, 400W(1ms)	DO-214AC	1d	1a	Eic
110	P6SMBJ110	TVS	Vbr=99..121V, 3.8A, 600W(1ms)	DO-214AA	1d	1n	Lif
110	SMD110APT	Si-diode	Rectifier, Schottky, 100V, 1A, Vf<0.8V(1A)	DO-214AC	1d	1a	Chm



SMD code	Type	Function	Short description	Case	Pinout	St.	Mnf.
110	U1Z110	Z-diode	99..121V, 1W	SOD-6	1d	1a	Tos
110	U1ZB110	Z-diode	99..121V, 1W	I-FLAT	1d	1a	Tos
110A	1.5SMC110A	TVS	Vbr=105..116V, Vrwm=94.0V, 9.9A, 1500W(1ms)	DO-214AB	1d	1k	Vs
110A	1SMC110A	TVS	Vbr=122..135V, Vrwm=110V, 8.5A, 1500W(1ms)	DO-214AB	1d	1a	Eic
110A	P4SMA110A	TVS	Vbr=105..116V, Vrwm=94.0V, 2.8A, 400W(1ms)	DO-214AC	1d	1k	Vs
110A	P6SMB110A	TVS	Vrwm=110V, Vbr=105..116V, 3.9A, 600W(1ms)	DO-214AA	1d,3d	1k,1a	Vs,Ons
110A	P6SMBJ110A	TVS	Vbr=105..116V, 4A, 600W(1ms)	DO-214AA	1d	1n	Lif
110A	SMAJ110A	TVS	Vrwm=110V, Vbr=122..135V, 2.3A, 400W(1ms)	DO-214AC	1d	1a	Sus
110A	SMBJ110A	TVS	Vbr=122..135V, Vrwm=110V, 3.4A, 600W(1ms)	DO-214AA	1d	1a	Sus
110A	SMCJ110A	TVS	Vrwm=110V, Vbr=122..140.5V, 7.7A, 1500W(1ms)	DO-214AB	1d	1k	Sus
110A	UMA110A	TVS	Vrwm=110V, Vbr=122..177V, 2.8A, 500W(1ms)	UltraMite	14ba	1v	Msc
110B	1SMB3EZ110	Z-diode	110V±5%, Zzt=225Ω, Izt=6.8mA, 3W	DO-214AA	1d	1a	Pjt
110C	1.5SMC110CA	TVS	Vbr=105..116V, Vrwm=94.0V, 9.9A, 1500W(1ms), Bidirectional	DO-214AB	1ba	1l	Vs
110C	P4SMA110C	TVS	Vbr=99.0..121V, Vrwm=89.2V, 2.7A, 400W(1ms), Bidirectional	DO-214AC	1ba	1j	Eic
110C	P4SMA110CA	TVS	Vbr=105..116V, Vrwm=94.0V, 2.8A, 400W(1ms), Bidirectional	DO-214AC	1ba	1l	Vs
110C	P6SMB110CA	TVS	Vbr=105..116V, 3.9A, 600W(1ms), Bidirectional	DO-214AA	1ba	1l	Vs
110C	P6SMBJ110C	TVS	Vbr=99..121V, 3.8A, 600W(1ms), Bidirectional	DO-214AA	1ba	1p	Lif
110CA	1SMC110CA	TVS	Vbr=122..135V, Vrwm=110V, 8.5A, 1500W(1ms), Bidirectional	DO-214AB	1ba	1j	Eic
110CA	P4SMA110CA	TVS	Vbr=105..116V, Vrwm=94.0V, 2.8A, 400W(1ms), Bidirectional	DO-214AC	1ba	1j	Eic
110CA	P6SMB110CA	TVS	Vbr=105..116V, Vrwm=94.0V, 4.0A, 600W(1ms), Bidirectional	DO-214AA	1ba	1j	Eic
110CA	P6SMBJ110CA	TVS	Vbr=105..116V, 4A, 600W(1ms), Bidirectional	DO-214AA	1ba	1p	Lif
110CA	SMAJ110CA	TVS	Vrwm=110V, Vbr=122..135V, 2.3A, 400W(1ms), Bidirectional	DO-214AC	1ba	1j	Sus
110CA	SMBJ110CA	TVS	Vbr=122..135V, Vrwm=110V, 3.4A, 600W(1ms), Bidirectional	DO-214AA	1ba	1j	Sus
110CA	SMCJ110CA	TVS	Vrwm=110V, Vbr=122..149V, 7.7A, 1500W(1ms), Bidirectional	DO-214AB	1ba	1l	Sus
110CA	UMA110CA	TVS	Vrwm=110V, Vbr=122..177V, 2.8A, 500W(1ms), Bidirectional	UltraMite	14ba	1v	Msc
110V	SMA110	TVS	Vbr=122..149V, Vrwm=110.0V, 1.5A, 300W(1ms)	DO-214AC	1d	1a	Mic
110V	SMB110	TVS	Vbr=122..149V, Vrwm=110V, 3.1A, 600W(1ms)	DO-214AA	1d	1a	Mic
110V	SMC110	TVS	Vbr=122..149V, Vrwm=110V, 7.7A, 1500W(1ms)	DO-214AB	1d	1a	Mic
110VA	SMA110A	TVS	Vbr=122..135V, Vrwm=110.0V, 1.7A, 300W(1ms)	DO-214AC	1d	1a	Mic
110VA	SMB110A	TVS	Vbr=122..135V, Vrwm=110V, 3.4A, 600W(1ms)	DO-214AA	1d	1a	Mic
110VA	SMC110A	TVS	Vbr=122..135V, Vrwm=110V, 8.5A, 1500W(1ms)	DO-214AB	1d	1a	Mic
110VC	SMA110C	TVS	Vbr=122..149V, Vrwm=110.0V, 1.5A, 300W(1ms), Bidirectional	DO-214AC	1ba	1j	Mic
110VC	SMB110C	TVS	Vbr=122..149V, Vrwm=110V, 3.1A, 600W(1ms), Bidirectional	DO-214AA	1ba	1j	Mic
110VC	SMC110C	TVS	Vbr=122..149V, Vrwm=110V, 7.7A, 1500W(1ms), Bidirectional	DO-214AB	1ba	1j	Mic
110VCA	SMA110CA	TVS	Vbr=122..135V, Vrwm=110.0V, 1.7A, 300W(1ms), Bidirectional	DO-214AC	1ba	1j	Mic
110VCA	SMB110CA	TVS	Vbr=122..135V, Vrwm=110V, 3.4A, 600W(1ms), Bidirectional	DO-214AA	1ba	1j	Mic
110VCA	SMC110CA	TVS	Vbr=122..135V, Vrwm=110V, 8.5A, 1500W(1ms), Bidirectional	DO-214AB	1ba	1j	Mic
110Z	1SMA110Z	Z-diode	110V±5%, 1W	DO-214AC	1d	1a	Trs
111	HZU11A1L	Z-diode	9.5..9.9V, Izt=0.5mA, Zzt=80Ω, 150mW	URP	5d	1a	Ren
111	HZU11LA1	Z-diode	9.5..9.9V, 150mW	URP	5d	1a	Ren
112	HZU11A2L	Z-diode	9.7..10.1V, Izt=0.5mA, Zzt=80Ω, 150mW	URP	5d	1a	Ren
112	HZU11LA2	Z-diode	9.7..10.1V, 150mW	URP	5d	1a	Ren
113	HZU11A3L	Z-diode	9.9..10.3V, Izt=0.5mA, Zzt=80Ω, 150mW	URP	5d	1a	Ren
113	HZU11LA3	Z-diode	9.9..10.3V, 150mW	URP	5d	1a	Ren
114	HZU11B1L	Z-diode	10.2..10.6V, Izt=0.5mA, Zzt=80Ω, 150mW	URP	5d	1a	Ren
114	HZU11LB1	Z-diode	10.2..10.6V, 150mW	URP	5d	1a	Ren
115	HZU11B2L	Z-diode	10.4..10.8V, Izt=0.5mA, Zzt=80Ω, 150mW	URP	5d	1a	Ren
115	HZU11LB2	Z-diode	10.4..10.8V, 150mW	URP	5d	1a	Ren
116	HZU11B3L	Z-diode	10.7..11.1V, Izt=0.5mA, Zzt=80Ω, 150mW	URP	5d	1a	Ren
116	HZU11LB3	Z-diode	10.7..11.1V, 150mW	URP	5d	1a	Ren
117	HZU11C1L	Z-diode	10.9..11.3V, Izt=0.5mA, Zzt=80Ω, 150mW	URP	5d	1a	Ren
117	HZU11C1	Z-diode	10.9..11.3V, 150mW	URP	5d	1a	Ren
118	HZU11C2L	Z-diode	11.1..11.6V, Izt=0.5mA, Zzt=80Ω, 150mW	URP	5d	1a	Ren
118	HZU11C2	Z-diode	11.1..11.6V, 150mW	URP	5d	1a	Ren
119	HZU11C3L	Z-diode	11.4..11.9V, Izt=0.5mA, Zzt=80Ω, 150mW	URP	5d	1a	Ren
119	HZU11C3	Z-diode	11.4..11.9V, 150mW	URP	5d	1a	Ren
11A	1.5SMC11A	TVS	Vbr=105..116V, Vrwm=9.40V, 96.2A, 1500W(1ms)	DO-214AB	1d,3d	1a,1k	Vs,Ons
11A	1SMC11A	TVS	Vbr=122..135V, Vrwm=11V, 82.4A, 1500W(1ms)	DO-214AB	1d	1a	Eic
11A	P4SMA11A	TVS	Vbr=105..116V, Vrwm=9.40V, 27.0A, 400W(1ms)	DO-214AC	1d	1k	Vs
11A	P6SMB11A	TVS	Vrwm=11V, Vbr=105..116V, 38.5A, 600W(1ms)	DO-214AA	1d,3d	1k,1a	Vs,Ons
11A	P6SMBJ11A	TVS	Vbr=105..116V, 38A, 600W(1ms)	DO-214AA	1d	1n	Lif
11A	RKZ11AKU	Z-diode	10.18..10.71V, Izt=10mA, Zzt=300Ω, 500mW	TURP-FM	7d	1a	Ren
11A	SMAJ11A	TVS	Vrwm=11V, Vbr=12.2..13.5V, 22A, 400W(1ms)	DO-214AC	1d	1j	Sus
11A	SMBJ11A	TVS	Vbr=12.2..13.5V, Vrwm=11V, 33.0A, 600W(1ms)	DO-214AA	1d	1a	Sus
11A	SMCJ11A	TVS	Vrwm=11V, Vbr=12.2..14V, 74.6A, 1500W(1ms)	DO-214AB	1d	1k	Sus
11A	UMA11A	TVS	Vrwm=11V, Vbr=12.2..18.2V, 27.4A, 500W(1ms)	UltraMite	14d	1v	Msc
11B	1SMB3EZ11	Z-diode	11V±5%, Zzt=40Ω, Izt=68.0mA, 3W	DO-214AA	1d	1a	Pjt
11B	HZF11BP	Z-diode	11V±5%, 900mW	LRP	1d	2f	Ren
11B	PTZ11B	Z-diode	11V±10%, 20mA, 1W	DO-214AC	1d	1a	Rhm
11B	RKZ11BKU	Z-diode	10.50..11.05V, Izt=10mA, Zzt=300Ω, 500mW	TURP-FM	7d	1a	Ren



SMD
code

Type

Function

Short description

Case

Pinout

St.

Mnf.

SMD code	Type	Function	Short description	Case	Pinout	St.	Mnf.
11B	Z3SMB11B	Z-diode	10.45..11.55V, Izt=68mA, Zzt=4Ω, 3W	DO-214AA	1d	1a	Ttr
11C	1.5SMC11CA	TVS	Vbr=10.5..11.6V, Vrw=9.40V, 96.2A, 1500W(1ms), Bidirectional	DO-214AB	1ba	1l	Vs
11C	HZF11CP	Z-diode	11V±10%, 900mW	LRP	1d	2f	Ren
11C	P4SMA11C	TVS	Vbr=9.90..12.1V, Vrw=8.92V, 26.0A, 400W(1ms), Bidirectional	DO-214AC	1ba	1j	Eic
11C	P4SMA11CA	TVS	Vbr=10.5..11.6V, 25.6A, 400W (1ms), Bidirectional	DO-214AC	1ba	1l	Vs
11C	P6SMB11CA	TVS	Vrw=11V, Vbr=10.5..11.6V, 38.5A, 600W(1ms), Bidirectional	DO-214AA	1ba,3ba	1l,1e	Vs,Ons
11C	P6SMBJ11C	TVS	Vbr=9.9..12.1V, 37A, 600W(1ms), Bidirectional	DO-214AA	1ba	1p	Lif
11C	RKZ11CKU	Z-diode	10.82..11.38V, Izt=10mA, Zzt=30Ω, 500mW	TURP-FM	7d	1a	Ren
11CA	1SMC11CA	TVS	Vbr=12.2..13.5V, Vrw=11V, 82.4A, 1500W(1ms), Bidirectional	DO-214AB	1ba	1j	Eic
11CA	P4SMA11CA	TVS	Vbr=10.5..11.6V, Vrw=9.40V, 27.0A, 400W(1ms), Bidirectional	DO-214AC	1ba	1j	Eic
11CA	P6SMB11CA	TVS	Vbr=10.5..11.6V, Vrw=9.40V, 38.0A, 600W(1ms), Bidirectional	DO-214AA	1ba	1j	Eic
11CA	P6SMBJ11CA	TVS	Vbr=10.5..11.6V, 38A, 600W(1ms), Bidirectional	DO-214AA	1ba	1p	Lif
11CA	SMAJ11CA	TVS	Vrw=11V, Vbr=12.2..13.5V, 22A, 400W(1ms), Bidirectional	DO-214AC	1ba	1j	Sus
11CA	SMBJ11CA	TVS	Vbr=12.2..13.5V, Vrw=11V, 33.0A, 600W(1ms), Bidirectional	DO-214AA	1ba	1j	Sus
11CA	SMCJ11CA	TVS	Vrw=11V, Vbr=12.2..14.9V, 74.6A, 600W(1ms), Bidirectional	DO-214AB	1ba	1l	Sus
11CA	UMA11CA	TVS	Vrw=11V, Vbr=12.2..18.2V, 27.4A, 500W(1ms), Bidirectional	UltraMite	14ba	1v	Msc
11P	BZD27C11P	Z-diode	10.45..11.55V, Zzt=7Ω, Izt=50mA, 800mW	SOD-123FL	7d	1a	Pjt
11P	MFPZ11	Z-diode	10.45..11.55V, Izt=50mA, Zzt=7Ω, 800mW	SOD-123FL	7d	1a	Ttr
11V	SMA11	TVS	Vbr=12.2..14.9V, Vrw=11.0V, 14.9A, 300W(1ms)	DO-214AC	1d	1a	Mic
11V	SMB11	TVS	Vbr=12.2..14.9V, Vrw=11V, 29.9A, 600W(1ms)	DO-214AA	1d	1a	Mic
11V	SMC11	TVS	Vbr=12.2..14.9V, Vrw=11V, 74.6A, 1500W(1ms)	DO-214AB	1d	1a	Mic
11VA	SMA11A	TVS	Vbr=12.2..13.5V, Vrw=11.0V, 16.5A, 300W(1ms)	DO-214AC	1d	1a	Mic
11VA	SMB11A	TVS	Vbr=12.2..13.5V, Vrw=11V, 33A, 600W(1ms)	DO-214AA	1d	1a	Mic
11VA	SMC11A	TVS	Vbr=12.2..13.5V, Vrw=11V, 82.4A, 1500W(1ms)	DO-214AB	1d	1a	Mic
11VB	BZT52-B11	Z-diode	10.78..11.22V, Izt=5mA, Zzt=20Ω, 500mW	SOD-123FL	7d	1a	Tsc
11VB	MMSZ11VBW	Z-diode	10.78..11.22V, Izt=5mA, Zzt=20Ω, 500mW	SOD-123FL	7d	1a	Tac
11VC	SMA11C	TVS	Vbr=12.2..14.9V, Vrw=11.0V, 14.9A, 300W(1ms), Bidirectional	DO-214AC	1ba	1j	Mic
11VC	SMB11C	TVS	Vbr=12.2..14.9V, Vrw=11V, 29.9A, 600W(1ms), Bidirectional	DO-214AA	1ba	1j	Mic
11VC	SMC11C	TVS	Vbr=12.2..14.9V, Vrw=11V, 74.6A, 1500W(1ms), Bidirectional	DO-214AB	1ba	1j	Mic
11VCA	SMA11CA	TVS	Vbr=12.2..13.5V, Vrw=11.0V, 16.5A, 300W(1ms), Bidirectional	DO-214AC	1ba	1j	Mic
11VCA	SMB11CA	TVS	Vbr=12.2..13.5V, Vrw=11V, 33A, 600W(1ms), Bidirectional	DO-214AA	1ba	1j	Mic
11VCA	SMC11CA	TVS	Vbr=12.2..13.5V, Vrw=11V, 82.4A, 1500W(1ms), Bidirectional	DO-214AB	1ba	1j	Mic
11VZ	BZT52-C11	Z-diode	10.45..11.55V, Izt=5mA, Zzt=20Ω, 500mW	SOD-123FL	7d	1a	Tsc
11VZ	MMSZ11VCW	Z-diode	10.45..11.55V, Izt=5mA, Zzt=20Ω, 500mW	SOD-123FL	7d	1a	Tac
11VZ	TCMMSZ11V	Z-diode	11V±5%, Izt=5mA, Zzt=18Ω, 500mW	SOD-123FL	7d	1a	Tac
11VZ	ZGFM0511C-MH	Z-diode	10.45..11.55V, Izt=5mA, Zzt=18Ω, 500mW	SOD-123	5d	1a	Pic
12	BZY55-C12	Z-diode	11.40..12.60V, Izt=5mA, Zzt=20Ω, 500mW	0805	70d	2d	Tsc
12	CDZ55C12	Z-diode	11.40..12.60V, Zzt=20Ω, Izt=5mA, 500mW	1206	70d	2d	Crp
12	CDZ55C12S	Z-diode	11.40..12.60V, Zzt=20Ω, Izt=5mA, 500mW	0805	70d	2d	Crp
12	CDZ55C12T	Z-diode	11.40..12.60V, Zzt=20Ω, Izt=5mA, 200mW	0603	70d	2d	Crp
12	CMZ12	Z-diode	12V±5%, 2W	M-Flat	7d	1a	Tos
12	FDZ2.2VT	Z-diode	2.220..2.410V, Izt=5mA, Zzt=100Ω, 200mW	SOD-323	5d	1a	Fis
12	FDZ27T	Z-diode	25.1..28.9V, Izt=2mA, Zzt=80Ω, 200mW	SOD-323	5d	1a	Fis
12	KDZ12EV	Z-diode	11.4..12.6V, 150mW	SOD-523	6d	1a	Kec
12	KDZ12V	Z-diode	11.4..12.6V, 150mW	SOD-323	5d	1a	Kec
12	KDZ12VV	Z-diode	11.40..12.60V, Izt=5mA, Zzt=15Ω, 100mW	VSC	7d	1a	Kec
12	MAZ5120	Z-diode	11.4..12.7V, Zzt=10Ω(5mA), 500mW	MP2	11d	1a	Pan
12	MAZ81200H	Z-diode	12.06..12.68V, Zzt=30Ω(5mA), 150mW	SC-76	6d	1a	Pan
12	MAZF120	Z-diode	11.4..12.7V, Zzt=30Ω(5mA), 120mW	S-Mini	7d	1a	Pan
12	MAZN120	Z-diode	11.4..12.7V, Zzt=30Ω(5mA), 120mW	SSMini2	7d	1a	Pan
12	MAZS120	Z-diode	11.4..12.7V, 200mW	SOD-523	6d	1a	Pan
12	MAZY120	Z-diode	10.8..13.2V, Zzt=30Ω(10mA), 1W	NMiniP2	1d	1a	Pan
12	MM3Z27V	Z-diode	25.1..28.9V, Izt=2mA, Zzt=80Ω, 200mW	SOD-323	5d	1a	Sec
12	MMSZ27V	Z-diode	25.1..28.9V, 2mA, Zzt=80Ω, 100mW	SOD-523	6d	1a	Wtr
12	MMPZ5254BPT	Z-diode	25.65..28.35V, Izt=5mA, Zzt=70Ω, 225mW	SOD-323	5d	1a	Chm
12	P4SMA12	TVS	Vbr=10.8..13.2V, Vrw=9.72V, 24.0A, 400W(1ms)	DO-214AC	1d	1a	Eic
12	P6SMBJ12	TVS	Vbr=10.8..13.2V, 35A, 600W(1ms)	DO-214AA	1d	1n	Lif
12	SMA3C12	Z-diode	12V±5%, Izt=63mA, Zzt<4.5Ω, 3W	DO-214AC	1d	1a	Exc
12	SML4742	Z-diode	12V±5%, Izt=21mA, Zzt=9Ω, 1W	DO-214AC	1d	1k	Vs
12	TZD12WS	Z-diode	11.40..12.60V, Izt=5mA, Zzt=15Ω, 200mW	SOD-323	5d	1a	Ttr
12	TZD12WT	Z-diode	11.40..12.60V, Izt=5mA, Zzt=15Ω, 150mW	SOD-523	6d	1a	Ttr
12	TZD12WU	Z-diode	11.74..12.24V, Izt=5mA, Zzt=30Ω, 100mW	SOD-723	7d	1a	Ttr
12	U1Z12	Z-diode	10.8..13.2V, 1W	SOD-6	1d	1a	Tos
12	U1ZB12	Z-diode	10.8..13.2V, 1W	I-FLAT	1d	1a	Tos
12	UDZS2.2B	Z-diode	2.22..2.41V, Izt=5mA, Zzt=100Ω, 200mW	SOD-323	5d	1a	Wtr
12	ZDZ27V0	Z-diode	25.1..28.9V, 2mA, Zzt=80Ω, 200mW	SOD-322	5d	1a	Cys
12-	MAZ81200M	Z-diode	11.73..12.33V, Zzt=30Ω(5mA), 150mW	SC-76	6d	1a	Pan
12-	MAZ8120GML	Z-diode	11.73..12.33V, Zzt=30Ω(5mA), 150mW	SMini2-F3	6d	1a	Pan
12-	MAZS1200M	Z-diode	11.73..12.33V, 200mW	SOD-523	6d	1a	Pan
12	CTZ55C12	Z-diode	11.40..12.60V, Izt=5mA, Zzt=20Ω, 500mW	1206	70d	2d	Ctc



SMD
code

Type

Function

Short description

Case

Pinout

St.

Mnf.

SMD code	Type	Function	Short description	Case	Pinout	St.	Mnf.
12ZL	SD12C	TVS	Vbr=12V, 15A, 350W(1ms), Bidirectional	SOD-323	5ba	1e	Smt
12A	MAZ81200H	Z-diode	12.06..12.68V, Zzt=30Ω(5mA), 150mW	SC-76	6d	1a	Pan
12A	MAZ8120GHL	Z-diode	12.06..12.68V, Zzt=30Ω(5mA), 150mW	SMini2-F3	6d	1a	Pan
12A	MAZS1200H	Z-diode	12.06..12.68V, Zzt=30Ω(5mA), 200mW	SOD-523	6d	1a	Pan
12_	MAZ81200L	Z-diode	11.4..11.96V, Zzt=30Ω(5mA), 150mW	SC-76	6d	1a	Pan
12_	MAZ8120GLL	Z-diode	11.4..11.96V, Zzt=30Ω(5mA), 150mW	SMini2-F3	6d	1a	Pan
12_	MAZS1200L	Z-diode	11.4..11.96V, Zzt=30Ω(5mA), 200mW	SOD-523	6d	1a	Pan
12#	HZC12	Z-diode	12V±10%, 150mW	SOD-523	6d	1a	Ren
12*	HZU12B1	Z-diode	11.42..11.90V, lzt=5mA, Zzt=35Ω, 200mW	URP	5d	1a	Ren
12*	HZU12B2	Z-diode	11.74..12.24V, lzt=5mA, Zzt=35Ω, 200mW	URP	5d	1a	Ren
12*	HZU12B3	Z-diode	12.08..12.60V, lzt=5mA, Zzt=35Ω, 200mW	URP	5d	1a	Ren
12*	RKZ12B2KG	Z-diode	11.74..12.24V, lzt=5mA, Zzt=35Ω, 200mW	URP	5d	2e	Ren
12*	RKZ12B2KJ	Z-diode	11.74..12.24V, lzt=5mA, Zzt=35Ω, 150mW	UFP	7d	2e	Ren
12*	TZD12YWS	Z-diode	11.74..12.24V, lzt=5mA, Zzt=15Ω, 200mW	SOD-323	5d	1a	Ttr
12*	TZD12YWT	Z-diode	11.74..12.24V, lzt=5mA, Zzt=15Ω, 200mW	SOD-523	6d	1a	Ttr
120	P4SMA120	TVS	Vbr=108..132V, Vrwm=97.2V, 2.4A, 400W(1ms)	DO-214AC	1d	1a	Eic
120	P6SMBJ120	TVS	Vbr=108..132V, 3.5A, 600W(1ms)	DO-214AA	1d	1n	Lif
120	STPS120M	Si-diode	SBR, 20V, 1A, Vf<0.55V(1A)	DO-216-AA	4d	1a	Ste
120A	1.5SMC120A	TVS	Vbr=114..126V, Vrwm=102V, 9.1A, 1500W(1ms)	DO-214AB	1d	1k	Vs
120A	1SMC120A	TVS	Vbr=133..147V, Vrwm=120V, 7.8A, 1500W(1ms)	DO-214AB	1d	1a	Eic
120A	P4SMA120A	TVS	Vbr=114..126V, Vrwm=102V, 2.5A, 400W(1ms)	DO-214AC	1d	1k	Vs
120A	P6SMB120A	TVS	Vrwm=120V, Vbr=114..126V, 3.6A, 600W(1ms)	DO-214AA	1d,3d	1k,1a	Vs,Ons
120A	P6SMBJ120A	TVS	Vbr=114..126V, 3.6A, 600W(1ms)	DO-214AA	1d	1n	Lif
120A	SMAJ120A	TVS	Vrwm=120V, Vbr=133..147V, 2.0A, 400W(1ms)	DO-214AC	1d	1a	Sus
120A	SMBJ120A	TVS	Vbr=133..147V, Vrwm=120V, 3.1A, 600W(1ms)	DO-214AA	1d	1a	Sus
120A	SMCJ120A	TVS	Vrwm=120V, Vbr=133..153V, 7A, 1500W(1ms)	DO-214AB	1d	1k	Sus
120A	TSP120SA	Thy-SPD	V Of-St=120V, 50A(1ms), Bidirectional	DO-214AA	1ba	1j	Pjt
120A	UMA120A	TVS	Vrwm=120V, Vbr=133..193V, 2.6A, 500W(1ms)	UltraMite	14ba	1v	Msc
120B	1SMB3EZ120	Z-diode	120V±5%, Zzt=300Ω, lzt=6.3mA, 3W	DO-214AA	1d	1a	Pjt
120B	TSP120SB	Thy-SPD	V Of-St=120V, 80A(1ms), Bidirectional	DO-214AA	1ba	1j	Pjt
120C	1.5SMC120CA	TVS	Vbr=114..126V, Vrwm=102V, 9.1A, 1500W(1ms), Bidirectional	DO-214AB	1ba	1l	Vs
120C	P4SMA120C	TVS	Vbr=108..132V, Vrwm=97.2V, 2.4A, 400W(1ms), Bidirectional	DO-214AC	1ba	1j	Eic
120C	P4SMA120CA	TVS	Vbr=114..126V, 1.8A, 400W(1ms), Bidirectional	DO-214AC	1ba	1l	Vs
120C	P6SMB120CA	TVS	Vbr=114..126V, 3.6A, 600W(1ms), Bidirectional	DO-214AA	1ba	1l	Vs
120C	P6SMBJ120C	TVS	Vbr=108..132V, 3.5A, 600W(1ms), Bidirectional	DO-214AA	1ba	1p	Lif
120C	TSP120SC	Thy-SPD	V Of-St=120V, 100A(1ms), Bidirectional	DO-214AA	1ba	1j	Pjt
120CA	1SMC120CA	TVS	Vbr=133..147V, Vrwm=120V, 7.8A, 1500W(1ms), Bidirectional	DO-214AB	1ba	1j	Eic
120CA	P4SMA120CA	TVS	Vbr=114..126V, Vrwm=102V, 2.5A, 400W(1ms), Bidirectional	DO-214AC	1ba	1j	Eic
120CA	P6SMB120CA	TVS	Vbr=114..126V, Vrwm=102V, 3.6A, 600W(1ms), Bidirectional	DO-214AA	1ba	1j	Eic
120CA	P6SMBJ120CA	TVS	Vbr=114..126V, 3.6A, 600W(1ms), Bidirectional	DO-214AA	1ba	1p	Lif
120CA	SMAJ120CA	TVS	Vrwm=120V, Vbr=133..147V, 2.0A, 400W(1ms), Bidirectional	DO-214AC	1ba	1j	Sus
120CA	SMBJ120CA	TVS	Vbr=133..147V, Vrwm=120V, 3.1A, 600W(1ms), Bidirectional	DO-214AA	1ba	1j	Sus
120CA	SMCJ120CA	TVS	Vrwm=120V, Vbr=133..163V, 7.0A, 1500W(1ms), Bidirectional	DO-214AB	1ba	1l	Sus
120CA	UMA120CA	TVS	Vrwm=120V, Vbr=133..193V, 2.6A, 500W(1ms), Bidirectional	UltraMite	14ba	1v	Msc
120V	SMA120	TVS	Vbr=133..163V, Vrwm=120.0V, 1.4A, 300W(1ms)	DO-214AC	1d	1a	Mic
120V	SMB120	TVS	Vbr=133..163V, Vrwm=120V, 2.8A, 600W(1ms)	DO-214AA	1d	1a	Mic
120V	SMC120	TVS	Vbr=133..163V, Vrwm=120V, 7A, 1500W(1ms)	DO-214AB	1d	1a	Mic
120VA	SMA120A	TVS	Vbr=133..157V, Vrwm=120.0V, 1.6A, 300W(1ms)	DO-214AC	1d	1a	Mic
120VA	SMB120A	TVS	Vbr=133..157V, Vrwm=120V, 3.1A, 600W(1ms)	DO-214AA	1d	1a	Mic
120VA	SMC120A	TVS	Vbr=133..147V, Vrwm=120V, 7.8A, 1500W(1ms)	DO-214AB	1d	1a	Mic
120VC	SMA120C	TVS	Vbr=133..163V, Vrwm=120.0V, 1.4A, 300W(1ms), Bidirectional	DO-214AC	1ba	1j	Mic
120VC	SMB120C	TVS	Vbr=133..163V, Vrwm=120V, 2.8A, 600W(1ms), Bidirectional	DO-214AA	1ba	1j	Mic
120VC	SMC120C	TVS	Vbr=133..163V, Vrwm=120V, 7A, 1500W(1ms), Bidirectional	DO-214AB	1ba	1j	Mic
120VCA	SMA120CA	TVS	Vbr=133..157V, Vrwm=120.0V, 1.6A, 300W(1ms), Bidirectional	DO-214AC	1ba	1j	Mic
120VCA	SMB120CA	TVS	Vbr=133..157V, Vrwm=120V, 3.1A, 600W(1ms), Bidirectional	DO-214AA	1ba	1j	Mic
120VCA	SMC120CA	TVS	Vbr=133..147V, Vrwm=120V, 7.8A, 1500W(1ms), Bidirectional	DO-214AB	1ba	1j	Mic
120Z	1SMA120Z	Z-diode	120V±5%, 1W	DO-214AC	1d	1a	Trs
121	HZU12A1L	Z-diode	11.6..12.1V, lzt=0.5mA, Zzt=80Ω, 150mW	URP	5d	1a	Ren
121	HZU12LA1	Z-diode	11.6..12.1V, 150mW	URP	5d	1a	Ren
122	HZU12A2L	Z-diode	11.9..12.4V, lzt=0.5mA, Zzt=80Ω, 150mW	URP	5d	1a	Ren
122	HZU12LA2	Z-diode	11.9..12.4V, 150mW	URP	5d	1a	Ren
123	HZU12A3L	Z-diode	12.2..12.7V, lzt=0.5mA, Zzt=80Ω, 150mW	URP	5d	1a	Ren
123	HZU12LA3	Z-diode	12.2..12.7V, 150mW	URP	5d	1a	Ren
124	HZU12B1L	Z-diode	12.4..12.9V, lzt=0.5mA, Zzt=80Ω, 150mW	URP	5d	1a	Ren
124	HZU12LB1	Z-diode	12.4..12.9V, 150mW	URP	5d	1a	Ren
125	HZU12B2L	Z-diode	12.6..13.1V, lzt=0.5mA, Zzt=80Ω, 150mW	URP	5d	1a	Ren
125	HZU12LB2	Z-diode	12.6..13.1V, 150mW	URP	5d	1a	Ren
126	HZU12B3L	Z-diode	12.9..13.4V, lzt=0.5mA, Zzt=80Ω, 150mW	URP	5d	1a	Ren
126	HZU12LB3	Z-diode	12.9..13.4V, 150mW	URP	5d	1a	Ren
127	HZU12C1L	Z-diode	13.2..13.7V, lzt=0.5mA, Zzt=80Ω, 150mW	URP	5d	1a	Ren



SMD code	Type	Function	Short description	Case	Pinout	St.	Mnf.
127	HZU12LC1	Z-diode	13.2..13.7V, 150mW	URP	5d	1a	Ren
127Z	BYD127	Si-diode	U-Fast Rectifier, 200V, 1A, Vf<0.93V(1A), 30ns	1206	14d	1v	Zow
128	HZU12C2L	Z-diode	13.5..14.0V, Izt=0.5mA, Zzt=80Ω, 150mW	URP	5d	1a	Ren
128	HZU12L.C2	Z-diode	13.5..14V, 150mW	URP	5d	1a	Ren
129	HZU12C3L	Z-diode	13.8..14.3V, Izt=0.5mA, Zzt=80Ω, 150mW	URP	5d	1a	Ren
129	HZU12LC3	Z-diode	13.8..14.3V, 150mW	URP	5d	1a	Ren
12A	1.5SMC12A	TVS	Vbr=11.4..12.6V, Vrrwm=10.2V, 89.8A, 1500W(1ms)	DO-214AB	1d,3d	1a,1k	Vs,Ons
12A	1SMC12A	TVS	Vbr=13.3..14.7V, Vrrwm=12V, 75.4A, 1500W(1ms)	DO-214AB	1d	1a	Eic
12A	P4SMA12A	TVS	Vbr=11.4..12.6V, Vrrwm=10.2V, 25.0A, 400W(1ms)	DO-214AC	1d	1k	Vs
12A	P6SMB12A	TVS	Vrrwm=12V, Vbr=11.4..12.6V, 35.9A, 600W(1ms)	DO-214AA	1d,3d	1k,1a	Vs,Ons
12A	P6SMBJ12A	TVS	Vbr=11.4..12.6V, 36A, 600W(1ms)	DO-214AA	1d	1n	Lif
12A	RKZ12AKU	Z-diode	11.13..11.71V, Izt=10mA, Zzt=35Ω, 500mW	TURP-FM	7d	1a	Ren
12A	SMAJ12A	TVS	Vrrwm=12V, Vbr=13.3..14.7V, 20.1A, 400W(1ms)	DO-214AC	1d	1a	Sus
12A	SMBJ12A	TVS	Vbr=13.3..14.7V, Vrrwm=12V, 30.2A, 600W(1ms)	DO-214AA	1d	1a	Sus
12A	SMCJ12A	TVS	Vrrwm=12V, Vbr=13.3..15.3V, 68.2A, 1500W(1ms)	DO-214AB	1d	1k	Sus
12A	SMD12ALPT	Si-diode	Rectifier, Schottky, 20V, 1A, Vf<0.38V(1A)	SOD-123S	8d	1a	Chm
12A	UMA12A	TVS	Vrrwm=12V, Vbr=13.3..19.9V, 25.1A, 500W(1ms)	UltraMite	14d	1v	Msc
12B	1SMB3EZ12	Z-diode	12V±5%, Zzt=5Ω, Izt=63.0mA, 3W	DO-214AA	1d	1a	Pjt
12B	HZF12BP	Z-diode	12V±5%, 900mW	LRP	1d	2f	Ren
12B	PTZ12B	Z-diode	12V±10%, 20mA, 1W	DO-214AC	1d	1a	Rhm
12B	RKZ12BKU	Z-diode	11.44..12.03V, Izt=10mA, Zzt=35Ω, 500mW	TURP-FM	7d	1a	Ren
12B	Z3SMB12B	Z-diode	11.40..12.60V, Izt=63mA, Zzt=5Ω, 3W	DO-214AA	1d	1a	Ttr
12C	1.5SMC12CA	TVS	Vbr=11.4..12.6V, Vrrwm=10.2V, 89.8A, 1500W(1ms), Bidirectional	DO-214AB	1ba	1l	Vs
12C	HZF12CP	Z-diode	12V±10%, 900mW	LRP	1d	2f	Ren
12C	P4SMA12C	TVS	Vbr=10.8..13.2V, Vrrwm=9.72V, 24.0A, 400W(1ms), Bidirectional	DO-214AC	1ba	1j	Eic
12C	P4SMA12CA	TVS	Vbr=11.4..12.6V, 24A, 400W(1ms), Bidirectional	DO-214AC	1ba	1l	Vs
12C	P6SMB12CA	TVS	Vrrwm=12V, Vbr=11.4..12.6V, 35.9A, 600W(1ms), Bidirectional	DO-214AA	1ba,3ba	1l,1e	Vs,Ons
12C	P6SMBJ12C	TVS	Vbr=10.8..13.2V, 35A, 600W(1ms), Bidirectional	DO-214AA	1ba	1p	Lif
12C	RKZ12CKU	Z-diode	11.74..12.35V, Izt=10mA, Zzt=35Ω, 500mW	TURP-FM	7d	1a	Ren
12CA	1SMC12CA	TVS	Vbr=13.3..14.7V, Vrrwm=12V, 75.4A, 1500W(1ms), Bidirectional	DO-214AB	1ba	1j	Eic
12CA	P4SMA12CA	TVS	Vbr=11.4..12.6V, Vrrwm=10.2V, 25.0A, 400W(1ms), Bidirectional	DO-214AC	1ba	1j	Eic
12CA	P6SMB12CA	TVS	Vbr=11.4..12.6V, Vrrwm=10.2V, 36.0A, 600W(1ms), Bidirectional	DO-214AA	1ba	1j	Eic
12CA	P6SMBJ12CA	TVS	Vbr=11.4..12.6V, 36A, 600W(1ms), Bidirectional	DO-214AA	1ba	1p	Lif
12CA	SMAJ12CA	TVS	Vrrwm=12V, Vbr=13.3..14.7V, 20.1A, 400W(1ms), Bidirectional	DO-214AC	1ba	1j	Sus
12CA	SMBJ12CA	TVS	Vbr=13.3..14.7V, Vrrwm=12V, 30.2A, 600W(1ms), Bidirectional	DO-214AA	1ba	1j	Sus
12CA	SMCJ12CA	TVS	Vrrwm=12V, Vbr=13.3..15.3V, 68.2A, 1500W(1ms), Bidirectional	DO-214AB	1ba	1l	Sus
12CA	UMA12CA	TVS	Vrrwm=12V, Vbr=13.3..19.9V, 25.1A, 500W(1ms), Bidirectional	UltraMite	14ba	1v	Msc
12L	MSS1P2L	Si-diode	SBR, 20V, 1A, Vf<0.55V(1A)	MicroSMP	8d	1k	Vs
12L	MSS1P3L	Si-diode	SBR, 30V, 1A, Vf<0.55V(1A)	MicroSMP	8d	1k	Vs
12LL	SSM12LLPT	Si-diode	Rectifier, Schottky, 20V, 1A, Vf<0.27V(1A)	DO-214AC	1d	1a	Chm
12LP	BZD27C12P	Z-diode	11.40..12.60V, Zzt=7Ω, Izt=50mA, 800mW	SOD-123FL	7d	1a	Pjt
12P	MFPZ12	Z-diode	11.40..12.60V, Izt=50mA, Zzt=7Ω, 800mW	SOD-123FL	7d	1a	Ttr
12U	MSS1P2U	Si-diode	SBR, 20V, 1A, Vf<0.40V(1A)	MicroSMP	8d	1k	Vs
12U	MSS1P3U	Si-diode	SBR, 30V, 1A, Vf<0.40V(1A)	MicroSMP	8d	1k	Vs
12V	SMA12	TVS	Vbr=13.3..16.3V, Vrrwm=12.0V, 13.6A, 300W(1ms)	DO-214AC	1d	1a	Mic
12V	SMB12	TVS	Vbr=13.3..16.3V, Vrrwm=12V, 27.3A, 600W(1ms)	DO-214AA	1d	1a	Mic
12V	SMC12	TVS	Vbr=13.3..16.3V, Vrrwm=12V, 68.2A, 1500W(1ms)	DO-214AB	1d	1a	Mic
12VA	SMA12A	TVS	Vbr=13.3..14.7V, Vrrwm=12.0V, 15.1A, 300W(1ms)	DO-214AC	1d	1a	Mic
12VA	SMB12A	TVS	Vbr=13.3..14.7V, Vrrwm=12V, 30.2A, 600W(1ms)	DO-214AA	1d	1a	Mic
12VA	SMC12A	TVS	Vbr=13.3..14.7V, Vrrwm=12V, 75.4A, 1500W(1ms)	DO-214AB	1d	1a	Mic
12VB	BZT52-B12	Z-diode	11.76..12.24V, Izt=5mA, Zzt=25Ω, 500mW	SOD-123FL	7d	1a	Tsc
12VB	MMSZ12VBW	Z-diode	11.76..12.24V, Izt=5mA, Zzt=25Ω, 500mW	SOD-123FL	7d	1a	Tac
12VC	SMA12C	TVS	Vbr=13.3..16.3V, Vrrwm=12.0V, 13.6A, 300W(1ms), Bidirectional	DO-214AC	1ba	1j	Mic
12VC	SMB12C	TVS	Vbr=13.3..16.3V, Vrrwm=12V, 27.3A, 600W(1ms), Bidirectional	DO-214AA	1ba	1j	Mic
12VC	SMC12C	TVS	Vbr=13.3..16.3V, Vrrwm=12V, 68.2A, 1500W(1ms), Bidirectional	DO-214AB	1ba	1j	Mic
12VCA	SMA12CA	TVS	Vbr=13.3..14.7V, Vrrwm=12.0V, 15.1A, 300W(1ms), Bidirectional	DO-214AC	1ba	1j	Mic
12VCA	SMB12CA	TVS	Vbr=13.3..14.7V, Vrrwm=12V, 30.2A, 600W(1ms), Bidirectional	DO-214AA	1ba	1j	Mic
12VCA	SMC12CA	TVS	Vbr=13.3..14.7V, Vrrwm=12V, 75.4A, 1500W(1ms), Bidirectional	DO-214AB	1ba	1j	Mic
12VZ	BZT52-C12	Z-diode	11.40..12.60V, Izt=5mA, Zzt=25Ω, 500mW	SOD-123FL	7d	1a	Tsc
12VZ	MMSZ12VCW	Z-diode	11.40..12.60V, Izt=5mA, Zzt=25Ω, 500mW	SOD-123FL	7d	1a	Tac
12VZ	TCMMSZ12V	Z-diode	12V±5%, Izt=5mA, Zzt=23Ω, 500mW	SOD-123FL	7d	1a	Tac
12VZ	ZGFM0512C-MH	Z-diode	11.40..12.60V, Izt=5mA, Zzt=23Ω, 500mW	SOD-123	5d	1a	Pic
13	BZY55-C13	Z-diode	12.35..13.65V, Izt=5mA, Zzt=26Ω, 500mW	0805	70d	2d	Tsc
13	CDZ55C13	Z-diode	12.35..13.65V, Zzt=26Ω, Izt=5mA, 500mW	1206	70d	2d	Crp
13	CDZ55C13S	Z-diode	12.35..13.65V, Zzt=26Ω, Izt=5mA, 500mW	0805	70d	2d	Crp
13	CDZ55C13T	Z-diode	12.35..13.65V, Zzt=26Ω, Izt=5mA, 200mW	0603	70d	2d	Crp
13	CMZ13	Z-diode	13V±5%, 2W	M-Flat	7d	1a	Tos
13	KDZ13EV	Z-diode	12.4..14.1V, 150mW	SOD-523	6d	1a	Kec
13	KDZ13V	Z-diode	12.4..14.1V, 150mW	SOD-323	5d	1a	Kec
13	KDZ13VV	Z-diode	12.40..14.10V, Izt=5mA, Zzt=15Ω, 100mW	VSC	7d	1a	Kec



SMD code	Type	Function	Short description	Case	Pinout	St.	Mnf.
13	MAZ5130	Z-diode	12.4..14.1V, Zzt=10Q(5mA), 500mW	MP2	11d	1a	Pan
13	MAZ81300H	Z-diode	13.25..14.08V, Zzt=35Q(5mA), 150mW	SC-76	6d	1a	Pan
13	MAZS130	Z-diode	12.4..14.1V, 200mW	SOD-523	6d	1a	Pan
13	MAZY130	Z-diode	11.7..14.3V, Zzt=30Q(10mA), 1W	NMiniP2	1d	1a	Pan
13	MSS1P3	Si-diode	SBR, 30V, 1A, Vf<0.55V(1A)	MicroSMP	8d	1k	Vs
13	MSS2P2	Si-diode	SBR, 20V, 2A, Vf<0.60V(2A)	MicroSMP	8d	1k	Vs
13	P4SMA13	TVS	Vbr=11.7..14.3V, Vrw=10.5V, 22.0A, 400W(1ms)	DO-214AC	1d	1a	Eic
13	P6SMBJ13	TVS	Vbr=11.7..14.3V, 32A, 600W(1ms)	DO-214AA	1d	1n	Lif
13	SMA3C13	Z-diode	13V±5%, Izt=58mA, Zzt<4.5Q, 3W	DO-214AC	1d	1a	Exc
13	SML4743	Z-diode	13V±5%, Izt=19mA, Zzt=10Q, 1W	DO-214AC	1d	1k	Vs
13	SS1P3	Si-diode	SBR, 30V, 1A, Vf<0.53V(1A)	DO-220AA	8d	1k	Vs
13	TZD13WS	Z-diode	12.40..14.10V, Izt=5mA, Zzt=15 Q, 200mW	SOD-323	5d	1a	Ttr
13	TZD13WT	Z-diode	12.40..14.10V, Izt=5mA, Zzt=15Q, 150mW	SOD-523	6d	1a	Ttr
13	TZD13WU	Z-diode	12.91..13.49V, Izt=5mA, Zzt=37Q, 100mW	SOD-723	7d	1a	Ttr
13	U1Z13	Z-diode	11.7..14.3V, 1W	SOD-6	1d	1a	Tos
13	U1ZB13	Z-diode	11.7..14.3V, 1W	I-FLAT	1d	1a	Tos
13-	MAZ81300M	Z-diode	12.73..13.4V, Zzt=35Q(5mA), 150mW	SC-76	6d	1a	Pan
13-	MAZ8130GML	Z-diode	12.73..13.4V, Zzt=35Q(5mA), 150mW	SMini2-F3	6d	1a	Pan
13-	MAZS1300M	Z-diode	12.73..13.4V, 200mW	SOD-523	6d	1a	Pan
13	CTZ55C13	Z-diode	12.35..13.65V, Izt=5mA, Zzt=26Q, 500mW	1206	70d	2d	Ctc
13^	MAZ81300H	Z-diode	13.25..14.08V, Zzt=35Q(5mA), 150mW	SC-76	6d	1a	Pan
13^	MAZ8130GHL	Z-diode	13.25..14.08V, Zzt=35Q(5mA), 150mW	SMini2-F3	6d	1a	Pan
13^	MAZS1300H	Z-diode	13.25..14.08V, 200mW	SOD-523	6d	1a	Pan
13_	MAZ81300L	Z-diode	12.4..12.99V, Zzt=35Q(5mA), 150mW	SC-76	6d	1a	Pan
13_	MAZ8130GLL	Z-diode	12.4..12.99V, Zzt=35Q(5mA), 150mW	SMini2-F3	6d	1a	Pan
13_	MAZS1300L	Z-diode	12.4..12.99V, 200mW	SOD-523	6d	1a	Pan
13=	HZC13	Z-diode	13V±10%, 150mW	SOD-523	6d	1a	Ren
13°	HZU13B1	Z-diode	12.47..13.03V, Izt=5mA, Zzt=35Q, 200mW	URP	5d	1a	Ren
13°	HZU13B2	Z-diode	12.91..13.49V, Izt=5mA, Zzt=35Q, 200mW	URP	5d	1a	Ren
13°	HZU13B3	Z-diode	13.37..13.96V, Izt=5mA, Zzt=35Q, 200mW	URP	5d	1a	Ren
13*	RKZ13B2KG	Z-diode	12.91..13.49V, Izt=5mA, Zzt=35Q, 200mW	URP	5d	2e	Ren
13*	RKZ13B2KJ	Z-diode	12.91..13.49V, Izt=5mA, Zzt=35Q, 150mW	UPF	7d	2e	Ren
13*	TZD13YWS	Z-diode	12.91..13.49V, Izt=5mA, Zzt=15 Q, 200mW	SOD-323	5d	1a	Ttr
13*	TZD13YWT	Z-diode	12.91..13.49V, Izt=5mA, Zzt=15Q, 150mW	SOD-523	6d	1a	Ttr
130	P4SMA130	TVS	Vbr=117..143V, Vrw=105V, 2.2A, 400W(1ms)	DO-214AC	1d	1a	Eic
130	P6SMBJ130	TVS	Vbr=117..143V, 3.2A, 600W(1ms)	DO-214AA	1d	1n	Lif
130A	1.5SMC130A	TVS	Vbr=124..137V, Vrw=111V, 8.4A, 1500W(1ms)	DO-214AB	1d	1k	Vs
130A	1SMC130A	TVS	Vbr=144..159V, Vrw=130V, 7.2A, 1500W(1ms)	DO-214AB	1d	1a	Eic
130A	P4SMA130A	TVS	Vbr=124..137V, Vrw=111V, 2.3A, 400W(1ms)	DO-214AC	1d	1k	Vs
130A	P6SMB130A	TVS	Vrw=130V, Vbr=124..137V, 3.4A, 600W(1ms)	DO-214AA	1d,3d	1k,1a	Vs,Ons
130A	P6SMBJ130A	TVS	Vbr=124..137V, 3.3A, 600W(1ms)	DO-214AA	1d	1n	Lif
130A	SMAJ130A	TVS	Vrw=130V, Vbr=144..159V, 1.9A, 400W(1ms)	DO-214AC	1d	1a	Sus
130A	SMBJ130A	TVS	Vbr=144..159V, Vrw=130V, 2.9A, 600W(1ms)	DO-214AA	1d	1a	Sus
130A	SMCJ130A	TVS	Vrw=130V, Vbr=144..165.5V, 6.5A, 1500W(1ms)	DO-214AB	1d	1k	Sus
130A	UMA130A	TVS	Vrw=130V, Vbr=144.209V, 2.4A, 500W(1ms)	UltraMite	14ba	1v	Msc
130B	1SMB3EZ130	Z-diode	130V±5%, Zzt=375Q, Izt=5.8mA, 3W	DO-214AA	1d	1a	Pjt
130C	1.5SMC130CA	TVS	Vbr=124..137V, Vrw=111V, 8.4A, 1500W(1ms), Bidirectional	DO-214AB	1ba	1l	Vs
130C	P4SMA130C	TVS	Vbr=117..143V, Vrw=105V, 2.2A, 400W(1ms), Bidirectional	DO-214AC	1ba	1j	Eic
130C	P4SMA130CA	TVS	Vbr=124..137V, 1.7A, 400W(1ms), Bidirectional	DO-214AC	1ba	1l	Vs
130C	P6SMB130CA	TVS	Vbr=124..137V, 3.4A, 600W(1ms), Bidirectional	DO-214AA	1ba	1l	Vs
130C	P6SMBJ130C	TVS	Vbr=117..143V, 3.2A, 600W(1ms), Bidirectional	DO-214AA	1ba	1p	Lif
130CA	1SMC130CA	TVS	Vbr=144..159V, Vrw=130V, 7.2A, 1500W(1ms), Bidirectional	DO-214AB	1ba	1j	Eic
130CA	P4SMA130CA	TVS	Vbr=124..137V, Vrw=111V, 2.3A, 400W(1ms), Bidirectional	DO-214AC	1ba	1j	Eic
130CA	P6SMB130CA	TVS	Vbr=124..137V, Vrw=111V, 3.3A, 600W(1ms), Bidirectional	DO-214AA	1ba	1j	Eic
130CA	P6SMBJ130CA	TVS	Vbr=124..137V, 3.3A, 600W(1ms), Bidirectional	DO-214AA	1ba	1p	Lif
130CA	SMAJ130CA	TVS	Vrw=130V, Vbr=144..159V, 1.9A, 400W(1ms), Bidirectional	DO-214AC	1ba	1j	Sus
130CA	SMBJ130CA	TVS	Vbr=144..159V, Vrw=130V, 2.9A, 600W(1ms), Bidirectional	DO-214AA	1ba	1j	Sus
130CA	SMCJ130CA	TVS	Vrw=130V, Vbr=144..176V, 6.5A, 1500W(1ms), Bidirectional	DO-214AB	1ba	1l	Sus
130CA	UMA130CA	TVS	Vrw=130V, Vbr=144.209V, 2.4A, 500W(1ms), Bidirectional	UltraMite	14ba	1v	Msc
130V	SMA130	TVS	Vbr=144..176V, Vrw=130.0V, 1.3A, 300W(1ms)	DO-214AC	1d	1a	Mic
130V	SMB130	TVS	Vbr=144..176V, Vrw=130V, 2.6A, 600W(1ms)	DO-214AA	1d	1a	Mic
130V	SMC130	TVS	Vbr=144..176V, Vrw=130V, 6.5A, 1500W(1ms)	DO-214AB	1d	1a	Mic
130VA	SMA130A	TVS	Vbr=144..159V, Vrw=130.0V, 1.4A, 300W(1ms)	DO-214AC	1d	1a	Mic
130VA	SMB130A	TVS	Vbr=144..159V, Vrw=130V, 2.9A, 600W(1ms)	DO-214AA	1d	1a	Mic
130VA	SMC130A	TVS	Vbr=144..159V, Vrw=130V, 7.2A, 1500W(1ms)	DO-214AB	1d	1a	Mic
130VC	SMA130C	TVS	Vbr=144..176V, Vrw=130.0V, 1.3A, 300W(1ms), Bidirectional	DO-214AC	1ba	1j	Mic
130VC	SMB130C	TVS	Vbr=144..176V, Vrw=130V, 2.6A, 600W(1ms), Bidirectional	DO-214AA	1ba	1j	Mic
130VC	SMC130C	TVS	Vbr=144..176V, Vrw=130V, 6.5A, 1500W(1ms), Bidirectional	DO-214AB	1ba	1j	Mic
130VCA	SMA130CA	TVS	Vbr=144..159V, Vrw=130.0V, 1.4A, 300W(1ms), Bidirectional	DO-214AC	1ba	1j	Mic
130VCA	SMB130CA	TVS	Vbr=144..159V, Vrw=130V, 2.9A, 600W(1ms), Bidirectional	DO-214AA	1ba	1j	Mic



SMD code	Type	Function	Short description	Case	Pinout	St.	Mnf.
130VCA	SMC130CA	TVS	Vbr=144..159V, Vrwmm=130V, 7.2A, 1500W(1ms), Bidirectional	DO-214AB	1ba	1j	Mic
130Z	1SMA130Z	Z-diode	130V±5%, 1W	DO-214AC	1d	1a	Trs
13A	1.5SMC13A	TVS	Vbr=12.4..13.7V, Vrwmm=11.1V, 82.4A, 1500W(1ms)	DO-214AB	1d,3d	1a,1k	Vs,Ons
13A	1SMC13A	TVS	Vbr=14.4..15.9V, Vrwmm=13V, 69.8A, 1500W(1ms)	DO-214AB	1d	1a	Eic
13A	P4SMA13A	TVS	Vbr=12.4..13.7V, Vrwmm=11.1V, 23.0A, 400W(1ms)	DO-214AC	1d	1k	Vs
13A	P6SMB13A	TVS	Vrwmm=13V, Vbr=12.4..13.7V, 33A, 600W(1ms)	DO-214AA	1d,3d	1k,1a	Vs,Ons
13A	P6SMBJ13A	TVS	Vbr=12.4..13.7V, 33A, 600W(1ms)	DO-214AA	1d	1n	Lif
13A	RKZ13AKU	Z-diode	12.11..12.75V, Izt=10mA, Zzt=35Ω, 500mW	TURP-FM	7d	1a	Ren
13A	SMAJ13A	TVS	Vrwmm=13V, Vbr=14.4..15.9V, 18.6A, 400W(1ms)	DO-214AC	1d	1a	Sus
13A	SMBJ13A	TVS	Vbr=14.4..15.9V, Vrwmm=13V, 27.9A, 600W(1ms)	DO-214AA	1d	1a	Sus
13A	SMCJ13A	TVS	Vrwmm=13V, Vbr=14.4..16.5V, 63A, 1500W(1ms)	DO-214AB	1d	1k	Sus
13A	UMA13A	TVS	Vrwmm=13V, Vbr=14.4..21.5V, 23.2A, 500W(1ms)	UltraMite	14d	1v	Misc
13B	1SMB3EZ13	Z-diode	13V±5%, Zzt=5Ω, Izt=58.0mA, 3W	DO-214AA	1d	1a	Pjt
13B	HZF13BP	Z-diode	13V±5%, 900mW	LRP	1d	2f	Ren
13B	PTZ13B	Z-diode	13V±10%, 20mA, 1W	DO-214AC	1d	1a	Rhm
13B	RKZ13BKU	Z-diode	12.55..13.21V, Izt=10mA, Zzt=35Ω, 500mW	TURP-FM	7d	1a	Ren
13B	Z3SMB13B	Z-diode	12.35..13.65V, Izt=58mA, Zzt=5Ω, 3W	DO-214AA	1d	1a	Tr
13C	1.5SMC13CA	TVS	Vbr=12.4..13.7V, Vrwmm=11.1V, 82.4A, 1500W(1ms), Bidirectional	DO-214AB	1ba	1l	Vs
13C	HZF13CP	Z-diode	13V±10%, 900mW	LRP	1d	2f	Ren
13C	P4SMA13C	TVS	Vbr=11.7..14.3V, Vrwmm=10.5V, 22.0A, 400W(1ms), Bidirectional	DO-214AC	1ba	1j	Eic
13C	P4SMA13CA	TVS	Vbr=12.4..13.7V, 22A, 400W(1ms), Bidirectional	DO-214AC	1ba	1l	Vs
13C	P6SMB13CA	TVS	Vrwmm=13V, Vbr=12.4..13.7V, 33A, 600W(1ms), Bidirectional	DO-214AA	1ba,3ba	1l,1e	Vs,Ons
13C	P6SMBJ13C	TVS	Vbr=11.7..14.3V, 32A, 600W(1ms), Bidirectional	DO-214AA	1ba	1p	Lif
13C	RKZ13CKU	Z-diode	12.99..13.66V, Izt=10mA, Zzt=35Ω, 500mW	TURP-FM	7d	1a	Ren
13CA	1SMC13CA	TVS	Vbr=14.4..15.9V, Vrwmm=13V, 69.8A, 1500W(1ms), Bidirectional	DO-214AB	1ba	1j	Eic
13CA	P4SMA13CA	TVS	Vbr=12.4..13.7V, Vrwmm=11.1V, 23.0A, 400W(1ms), Bidirectional	DO-214AC	1ba	1j	Eic
13CA	P6SMB13CA	TVS	Vbr=12.4..13.7V, Vrwmm=11.1V, 33.0A, 600W(1ms), Bidirectional	DO-214AA	1ba	1j	Eic
13CA	P6SMBJ13CA	TVS	Vbr=12.4..13.7V, 33A, 600W(1ms), Bidirectional	DO-214AA	1ba	1p	Lif
13CA	SMAJ13CA	TVS	Vrwmm=13V, Vbr=14.4..15.9V, 18.6A, 400W(1ms), Bidirectional	DO-214AC	1ba	1j	Sus
13CA	SMBJ13CA	TVS	Vbr=14.4..15.9V, Vrwmm=13V, 27.9A, 600W(1ms), Bidirectional	DO-214AA	1ba	1j	Sus
13CA	SMCJ13CA	TVS	Vrwmm=13V, Vbr=14.4..16.5V, 63A, 1500W(1ms), Bidirectional	DO-214AB	1ba	1l	Sus
13CA	UMA13CA	TVS	Vrwmm=13V, Vbr=14.4..21.5V, 23.2A, 500W(1ms), Bidirectional	UltraMite	14ba	1v	Misc
13L	SS1P3L	Si-diode	SBR, 30V, 1A, Vf<0.59V(1A)	DO-220AA	8d	1k	Vs
13P	BZD27C13P	Z-diode	12.35..13.65V, Zzt=10Ω, Izt=50mA, 800mW	SOD-123FL	7d	1a	Pjt
13P	MFPZ13	Z-diode	12.35..13.65V, Izt=50mA, Zzt=10Ω, 800mW	SOD-123FL	7d	1a	Tr
13V	SMA13	TVS	Vbr=14.4..17.6V, Vrwmm=13.0V, 12.5A, 300W(1ms)	DO-214AC	1d	1a	Mic
13V	SMB13	TVS	Vbr=14.4..17.6V, Vrwmm=13V, 25.2A, 600W(1ms)	DO-214AA	1d	1a	Mic
13V	SMC13	TVS	Vbr=14.4..17.6V, Vrwmm=13V, 63A, 1500W(1ms)	DO-214AB	1d	1a	Mic
13VA	SMA13A	TVS	Vbr=14.4..15.9V, Vrwmm=13.0V, 14A, 300W(1ms)	DO-214AC	1d	1a	Mic
13VA	SMB13A	TVS	Vbr=14.4..15.9V, Vrwmm=13V, 27.9A, 600W(1ms)	DO-214AA	1d	1a	Mic
13VA	SMC13A	TVS	Vbr=14.4..15.9V, Vrwmm=13V, 69.8A, 1500W(1ms)	DO-214AB	1d	1a	Mic
13VB	BZT52-B13	Z-diode	12.74..13.26V, Izt=5mA, Zzt=30Ω, 500mW	SOD-123FL	7d	1a	Tsc
13VB	MMSZ13VBW	Z-diode	12.74..13.26V, Izt=5mA, Zzt=30Ω, 500mW	SOD-123FL	7d	1a	Tac
13VC	SMA13C	TVS	Vbr=14.4..17.6V, Vrwmm=13.0V, 12.5A, 300W(1ms), Bidirectional	DO-214AC	1ba	1j	Mic
13VC	SMB13C	TVS	Vbr=14.4..17.6V, Vrwmm=13V, 25.2A, 600W(1ms), Bidirectional	DO-214AA	1ba	1j	Mic
13VC	SMC13C	TVS	Vbr=14.4..17.6V, Vrwmm=13V, 63A, 1500W(1ms), Bidirectional	DO-214AB	1ba	1j	Mic
13VCA	SMA13CA	TVS	Vbr=14.4..15.9V, Vrwmm=13.0V, 14A, 300W(1ms), Bidirectional	DO-214AC	1ba	1j	Mic
13VCA	SMB13CA	TVS	Vbr=14.4..15.9V, Vrwmm=13V, 27.9A, 600W(1ms), Bidirectional	DO-214AA	1ba	1j	Mic
13VCA	SMC13CA	TVS	Vbr=14.4..15.9V, Vrwmm=13V, 69.8A, 1500W(1ms), Bidirectional	DO-214AB	1ba	1j	Mic
13VZ	BZT52-C13	Z-diode	12.35..13.65V, Izt=5mA, Zzt=30Ω, 500mW	SOD-123FL	7d	1a	Tsc
13VZ	MMSZ13VCW	Z-diode	12.35..13.65V, Izt=5mA, Zzt=30Ω, 500mW	SOD-123FL	7d	1a	Tac
13VZ	TCMMSZ13V	Z-diode	13V±5%, Izt=5mA, Zzt=28Ω, 500mW	SOD-123FL	7d	1a	Tac
13VZ	ZGFM0513C-MH	Z-diode	12.35..13.65V, Izt=5mA, Zzt=28Ω, 500mW	SOD-123	5d	1a	Pic
14	1SR154-400	Si-diode	Rectifier, 400V, 1A, Vf<1V(1A)	DO-214AC	1d	1k	Rhm
14	CMZ15	Z-diode	15V±5%, 2W	M-Flat	7d	1a	Tos
14	FDZ30T	Z-diode	28..32V, Izt=2mA, Zzt=80Ω, 200mW	SOD-323	5d	1a	Fis
14	KL3N14	Thy-SPD	V Of-St=130V, Ifsm=30A(1ms), Ih=100mA, Bidirectional	1F	1ba	1l	Shi
14	MMSZ30V	Z-diode	28..32V, 2mA, Zzt=80Ω, 200mW	SOD-323	5d	1a	Sec
14	MMSZ30V	Z-diode	30V±5%, Izt=2mA, Zzt=80Ω, 100mW	SOD-523	6d	1a,1u	Ons,Wtr
14	MMPZ5256BPT	Z-diode	28.50..31.50V, Izt=5mA, Zzt=78Ω, 225mW	SOD-323	5d	1a	Chm
14	MSS1P4	Si-diode	SBR, 40V, 1A, Vf<0.55V(1A)	MicroSMP	8d	1k	Vs
14	MSS2P3	Si-diode	SBR, 30V, 2A, Vf<0.60V(2A)	MicroSMP	8d	1k	Vs
14	SMA3C14	Z-diode	14V±5%, Izt=53mA, Zzt<5Ω, 3W	DO-214AC	1d	1a	Exc
14	SMD14APT	Si-diode	Rectifier, Schottky, 40V, 1A, Vf<0.46V(1A)	SOD-123S	8d	1a	Chm
14	SS1P4	Si-diode	SBR, 40V, 1A, Vf<0.53V(1A)	DO-220AA	8d	1k	Vs
14	ZD30V0	Z-diode	28..32V, 2mA, Zzt=80Ω, 200mW	SOD-322	5d	1a	Cys
14-	MAZ81400M	Z-diode	13.65..14.35V, Zzt=40Ω(5mA), 150mW	SC-76	6d	1a	Pan
14-	MAZ8140GML	Z-diode	13.65..14.35V, Zzt=40Ω(5mA), 150mW	SMiMini2-F3	6d	1a	Pan
140A	TSP140SA	Thy-SPD	V Of-St=140V, 50A(1ms), Bidirectional	DO-214AA	1ba	1j	Pjt
140B	1SMB3EZ140	Z-diode	140V±5%, Zzt=475Ω, Izt=5.3mA, 3W	DO-214AA	1d	1a	Pjt



SMD code	Type	Function	Short description	Case	Pinout	St.	Mnf.
140B	TSP140SB	Thy-SPD	V Of-St=140V, 80A(1ms), Bidirectional	DO-214AA	1ba	1j	Pjt
140C	TSP140SC	Thy-SPD	V Of-St=140V, 100A(1ms), Bidirectional	DO-214AA	1ba	1j	Pjt
147Z	BYD147	Si-diode	U-Fast Rectifier, 400V, 1A, Vf<1.05V(1A), 35ns	1206	14d	1v	Zow
14A	1SMC14A	TVS	Vbr=15.6..17.2V, Vrrwm=14V, 64.7A, 1500W(1ms)	DO-214AB	1d	1a	Eic
14A	SMAJ14A	TVS	Vrrwm=14V, Vbr=15.6..17.2V, 17.2A, 400W(1ms)	DO-214AC	1d	1a	Sus
14A	SMBJ14A	TVS	Vbr=15.6..17.2V, Vrrwm=14V, 25.8A, 600W(1ms)	DO-214AA	1d	1a	Sus
14A	SMCJ14A	TVS	Vrrwm=14V, Vbr=15.6..19.1V, 58.1A, 1500W(1ms)	DO-214AB	1d	1k	Sus
14A	SMD14ALPT	Si-diode	Rectifier, Schottky, 40V, 1A, Vf<0.4V(1A)	SOD-123S	8d	1a	Chm
14A	UMA14A	TVS	Vrrwm=14V, Vbr=15.6..23.2V, 21.5A, 500W(1ms)	UltraMite	14d	1v	Msc
14B	1SMB3EZ14	Z-diode	14V±5%, Zzt=6Ω, lzt=53.0mA, 3W	DO-214AA	1d	1a	Pjt
14B	Z3SMB14B	Z-diode	13.30..14.70V, lzt=53mA, Zzt=5Ω, 3W	DO-214AA	1d	1a	Ttr
14CA	1SMC14CA	TVS	Vbr=15.6..17.2V, Vrrwm=14V, 64.7A, 1500W(1ms), Bidirectional	DO-214AB	1ba	1j	Eic
14CA	SMAJ14CA	TVS	Vrrwm=14V, Vbr=15.6..17.2V, 17.2A, 400W(1ms), Bidirectional	DO-214AC	1ba	1j	Sus
14CA	SMBJ14CA	TVS	Vbr=15.6..17.2V, Vrrwm=14V, 25.8A, 600W(1ms), Bidirectional	DO-214AA	1ba	1j	Sus
14CA	SMCJ14CA	TVS	Vrrwm=14V, Vbr=15.6..19.1V, 58.1A, 1500W(1ms), Bidirectional	DO-214AB	1ba	1l	Sus
14CA	UMA14CA	TVS	Vrrwm=14V, Vbr=15.6..23.2V, 21.5A, 500W(1ms), Bidirectional	UltraMite	14ba	1v	Msc
14L	SS1P4L	Si-diode	SBR, 40V, 1A, Vf<0.59V(1A)	DO-220AA	8d	1k	Vs
14LA	SSM14LAPT	Si-diode	Rectifier, Schottky, 40V, 1A, Vf<0.32V(1A)	DO-214AC	1d	1a	Chm
14LL	SSM14LLPT	Si-diode	Rectifier, Schottky, 40V, 1A, Vf<0.27V(1A)	DO-214AC	1d	1a	Chm
14P	BZD27C14P	Z-diode	13.30..14.70V, Zzt=10Ω, lzt=50mA, 800mW	SOD-123FL	7d	1a	Pjt
14P	MFPZ14	Z-diode	13.30..14.70V, lzt=50mA, Zzt=10Ω, 800mW	SOD-123FL	7d	1a	Ttr
14V	SMA14V	TVS	Vbr=15.6..19.1V, Vrrwm=14.0V, 11.6A, 300W(1ms)	DO-214AC	1d	1a	Mic
14V	SMB14V	TVS	Vbr=15.6..19.1V, Vrrwm=14V, 23.3A, 600W(1ms)	DO-214AA	1d	1a	Mic
14V	SMC14V	TVS	Vbr=15.6..19.1V, Vrrwm=14V, 58.1A, 1500W(1ms)	DO-214AB	1d	1a	Mic
14VA	SMA14VA	TVS	Vbr=15.6..17.2V, Vrrwm=14.0V, 12.9A, 300W(1ms)	DO-214AC	1d	1a	Mic
14VA	SMB14VA	TVS	Vbr=15.6..17.2V, Vrrwm=14V, 25.9A, 600W(1ms)	DO-214AA	1d	1a	Mic
14VA	SMC14VA	TVS	Vbr=15.6..17.2V, Vrrwm=14V, 64.7A, 1500W(1ms)	DO-214AB	1d	1a	Mic
14VC	SMA14VC	TVS	Vbr=15.6..19.1V, Vrrwm=14.0V, 11.6A, 300W(1ms), Bidirectional	DO-214AC	1ba	1j	Mic
14VC	SMB14VC	TVS	Vbr=15.6..19.1V, Vrrwm=14V, 23.3A, 600W(1ms), Bidirectional	DO-214AA	1ba	1j	Mic
14VC	SMC14VC	TVS	Vbr=15.6..19.1V, Vrrwm=14V, 58.1A, 1500W(1ms), Bidirectional	DO-214AB	1ba	1j	Mic
14VCA	SMA14CA	TVS	Vbr=15.6..17.2V, Vrrwm=14.0V, 12.9A, 300W(1ms), Bidirectional	DO-214AC	1ba	1j	Mic
14VCA	SMB14CA	TVS	Vbr=15.6..17.2V, Vrrwm=14V, 25.9A, 600W(1ms), Bidirectional	DO-214AA	1ba	1j	Mic
14VCA	SMC14CA	TVS	Vbr=15.6..17.2V, Vrrwm=14V, 64.7A, 1500W(1ms), Bidirectional	DO-214AB	1ba	1j	Mic
15	BZX584B2V7	Z-diode	2.65..2.75V, lzt=5mA, Zzt=100Ω, 200mW	SOD-523FL	7d	1a	Tac
15	BZY95-C15	Z-diode	14.25..15.75V, lzt=5mA, Zzt=30Ω, 500mW	0805	70d	2d	Tsc
15	CDZ55C15	Z-diode	14.25..15.75V, Zzt=30Ω, lzt=5mA, 500mW	1206	70d	2d	Crp
15	CDZ55C15S	Z-diode	14.25..15.75V, Zzt=30Ω, lzt=5mA, 500mW	0805	70d	2d	Crp
15	CDZ55C15T	Z-diode	14.25..15.75V, Zzt=30Ω, lzt=5mA, 200mW	0603	70d	2d	Crp0m
15	EDZ11B	Z-diode	10.76..11.22V, lzt=5mA, Zzt=30Ω, 150mW	SOD-523	6d	1a	Rhm
15	FDZ11EV	Z-diode	10.760..11.220V, lzt=5mA, Zzt=30Ω, 150mW	SOD-523	7d	1a	Fis
15	FDZ11VT	Z-diode	10.760..11.220V, lzt=5mA, Zzt=30Ω, 200mW	SOD-323	5d	1a	Fis
15	KDZ15EV	Z-diode	13.8..15.6V, 150mW	SOD-523	6d	1a	Kec
15	KDZ15V	Z-diode	13.8..15.6V, 150mW	SOD-323	5d	1a	Kec
15	KDZ15VV	Z-diode	13.80..15.60V, lzt=5mA, Zzt=15Ω, 100mW	VSC	7d	1a	Kec
15	MAZ5150	Z-diode	13.9..15.6V, Zzt=10Ω(5mA), 500mW	MP2	11d	1a	Pan
15	MAZ81500H	Z-diode	14.95..15.6V, Zzt=40Ω(5mA), 150mW	SC-76	6d	1a	Pan
15	MAZS150	Z-diode	13.9..15.6V, 200mW	SOD-523	6d	1a	Pan
15	MAZY150	Z-diode	13.5..16.5V, Zzt=30Ω(10mA), 1W	NMiniP2	1d	1a	Pan
15	MM5Z2V7B	Z-diode	2.65..2.75V, lzt=5mA, Zzt=100Ω, 200mW	SOD-523FL	7d	1a	Tac
15	MSS1P5	Si-diode	SBR, 50V, 1A, Vf<0.68V(1A)	MicroSMP	8d	1k	Vs
15	P4SMA15	TVS	Vbr=13.5..16.5V, Vrrwm=12.1V, 19.0A, 400W(1ms)	DO-214AC	1d	1a	Eic
15	P6SMBJ15	TVS	Vbr=13.5..16.5V, 27A, 600W(1ms)	DO-214AA	1d	1n	Lif
15	SMA3C15	Z-diode	15V±5%, lzt=50mA, Zzt<5.5Ω, 3W	DO-214AC	1d	1a	Exc
15	SML4744	Z-diode	15V±5%, lzt=17mA, Zzt=14Ω, 1W	DO-214AC	1d	1k	Vs
15	TDZ11B	Z-diode	11V±2.5%, 10mA, 500mW	TUMD2	7d	1s	Rhm
15	TZD15WS	Z-diode	13.80..15.60V, lzt=5mA, Zzt=15Ω, 200mW	SOD-323	5d	1a	Ttr
15	TZD15WT	Z-diode	13.80..15.60V, lzt=5mA, Zzt=15Ω, 150mW	SOD-523	6d	1a	Ttr
15	TZD15WU	Z-diode	14.34..14.98V, lzt=5mA, Zzt=42Ω, 100mW	SOD-723	7d	1a	Ttr
15	U1Z15	Z-diode	13.5..16.5V, 1W	SOD-6	1d	1a	Tos
15	U1ZB15	Z-diode	13.5..16.5V, 1W	I-FLAT	1d	1a	Tos
15	UDZS11B	Z-diode	10.76..11.22V, lzt=5mA, Zzt=30Ω, 200mW	SOD-323	5d	1a	Wtr
15	UDZS11B	Z-diode	11V±2.5%, lzt=5mA, 200mW	SOD-323FL	7d	1s	Rhm
15	VDSZ11B	Z-diode	11V±5%, 5mA, 100mW	VMD2	5d	1z	Rhm
15-	MAZ81500M	Z-diode	14.6..15.35V, Zzt=40Ω(5mA), 150mW	SC-76	6d	1a	Pan
15-	MAZ8150GML	Z-diode	14.6..15.35V, Zzt=40Ω(5mA), 150mW	SMini2-F3	6d	1a	Pan
15-	MAZS1500M	Z-diode	14.6..15.35V, 200mW	SOD-523	6d	1a	Pan
15	CTZ55C15	Z-diode	14.25..15.75V, lzt=5mA, Zzt=30Ω, 500mW	1206	70d	2d	Ctc
15S ↓	SD15C	TVS	Vbr=15V, 15A, 350W(1ms), Bidirectional	SOD-323	5ba	1e	Smt
15^	MAZ81500H	Z-diode	14.95..15.6V, Zzt=40Ω(5mA), 150mW	SC-76	6d	1a	Pan
15^	MAZ8150GHL	Z-diode	14.95..15.6V, Zzt=40Ω(5mA), 150mW	SMini2-F3	6d	1a	Pan



SMD code	Type	Function	Short description	Case	Pinout	St.	Mnf.
15A	MAZS1500H	Z-diode	14.95..15.6V, 200mW	SOD-523	6d	1a	Pan
15_	MAZ81500L	Z-diode	13.9..14.76V, Zzt=40Q(5mA), 150mW	SC-76	6d	1a	Pan
15_	MAZ8150GLL	Z-diode	13.9..14.76V, Zzt=40Q(5mA), 150mW	SMini2-F3	6d	1a	Pan
15_	MAZS1500L	Z-diode	13.9..14.76V, 200mW	SOD-523	6d	1a	Pan
15=	HZC15	Z-diode	15V±10%, 150mW	SOD-523	6d	1a	Ren
15°	HZU15B1	Z-diode	13.84..14.46V, lzt=5mA, Zzt=40Q, 200mW	URP	5d	1a	Ren
15°	HZU15B2	Z-diode	14.34..14.98V, lzt=5mA, Zzt=40Q, 200mW	URP	5d	1a	Ren
15•	HZU15B3	Z-diode	14.85..15.52V, lzt=5mA, Zzt=40Q, 200mW	URP	5d	1a	Ren
15•	RKZ15B2KG	Z-diode	14.34..14.98V, lzt=5mA, Zzt=40Q, 200mW	URP	5d	2e	Ren
15•	RKZ15B2KJ	Z-diode	14.34..14.98V, lzt=5mA, Zzt=40Q, 150mW	UFP	7d	2e	Ren
15•	TZD15YWS	Z-diode	14.34..14.98V, lzt=5mA, Zzt=15Q, 200mW	SOD-323	5d	1a	Tr
15•	TZD15YWT	Z-diode	14.34..14.98V, lzt=5mA, Zzt=15Q, 150mW	SOD-523	6d	1a	Tr
150	P4SMA150	TVS	Vbr=135..165V, Vrwm=121V, 2.0A, 400W(1ms)	DO-214AC	1d	1a	Eic
150	P6SMBJ150	TVS	Vbr=135..165V, 2.8A, 600W(1ms)	DO-214AA	1d	1n	Lif
150	U1Z150	Z-diode	135..165V, 1W	SOD-6	1d	1a	Tos
150	U1ZB150	Z-diode	135..165V, 1W	I-FLAT	1d	1a	Tos
150A	1.5SMC150A	TVS	Vbr=143..158V, Vrwm=128V, 7.2A, 1500W(1ms)	DO-214AB	1d	1k	Vs
150A	1SMC150A	TVS	Vbr=167..185V, Vrwm=150V, 6.2A, 1500W(1ms)	DO-214AB	1d	1a	Eic
150A	P4SMA150A	TVS	Vbr=143..158V, Vrwm=128V, 2.0A, 400W(1ms)	DO-214AC	1d	1k	Vs
150A	P6SMB150A	TVS	Vbr=143..158V, Vrwm=128V, 2.9A, 600W(1ms)	DO-214AA	1d	1k	Vs
150A	P6SMBJ150A	TVS	Vbr=143..158V, 2.9A, 600W(1ms)	DO-214AA	1d	1n	Lif
150A	SMAJ150A	TVS	Vrwm=150V, Vbr=167..185V, 1.6A, 400W(1ms)	DO-214AC	1d	1a	Sus
150A	SMBJ150A	TVS	Vbr=167..185V, Vrwm=150V, 2.5A, 600W(1ms)	DO-214AA	1d	1a	Sus
150A	SMCJ150A	TVS	Vrwm=150V, Vbr=167..192.5V, 5.6A, 1500W(1ms)	DO-214AB	1d	1k	Sus
150A	UMA150A	TVS	Vrwm=150V, Vbr=167..243V, 2.1A, 500W(1ms)	UltraMite	14ba	1v	Msc
150B	1SMB3EZ150	Z-diode	150V±5%, Zzt=550Q, lzt=5mA, 3W	DO-214AA	1d	1a	Pjt
150C	1.5SMC150CA	TVS	Vbr=143..158V, Vrwm=128V, 7.2A, 1500W(1ms), Bidirectional	DO-214AB	1ba	1l	Vs
150C	P4SMA150C	TVS	Vbr=135..165V, Vrwm=121V, 2.0A, 400W(1ms), Bidirectional	DO-214AC	1ba	1j	Eic
150C	P4SMA150CA	TVS	Vbr=143..158V, 1.4A, 400W(1ms), Bidirectional	DO-214AC	1ba	1l	Vs
150C	P6SMB150CA	TVS	Vbr=143..158V, 2.9A, 600W(1ms), Bidirectional	DO-214AA	1ba	1l	Vs
150C	P6SMBJ150C	TVS	Vbr=135..165V, 2.8A, 600W(1ms), Bidirectional	DO-214AA	1ba	1p	Lif
150CA	1SMC150CA	TVS	Vbr=167..185V, Vrwm=150V, 6.2A, 1500W(1ms), Bidirectional	DO-214AB	1ba	1j	Eic
150CA	P4SMA150CA	TVS	Vbr=143..158V, Vrwm=128V, 2.0A, 400W(1ms), Bidirectional	DO-214AC	1ba	1j	Eic
150CA	P6SMB150CA	TVS	Vbr=143..158V, Vrwm=128V, 2.9A, 600W(1ms), Bidirectional	DO-214AA	1ba	1j	Eic
150CA	P6SMBJ150CA	TVS	Vbr=143..158V, 2.9A, 600W(1ms), Bidirectional	DO-214AA	1ba	1p	Lif
150CA	SMAJ150CA	TVS	Vrwm=150V, Vbr=167..185V, 1.6A, 400W(1ms), Bidirectional	DO-214AC	1ba	1j	Sus
150CA	SMBJ150CA	TVS	Vbr=167..185V, Vrwm=150V, 2.5A, 600W(1ms), Bidirectional	DO-214AA	1ba	1j	Sus
150CA	SMCJ150CA	TVS	Vrwm=150V, Vbr=167..192.5V, 5.6A, 1500W(1ms), Bidirectional	DO-214AB	1ba	1l	Sus
150CA	UMA150CA	TVS	Vrwm=150V, Vbr=167..243V, 2.1A, 500W(1ms), Bidirectional	UltraMite	14ba	1v	Msc
150V	SMA150	TVS	Vbr=167..204V, Vrwm=150.0V, 1.1A, 300W(1ms)	DO-214AC	1d	1a	Mic
150V	SMB150	TVS	Vbr=167..204V, Vrwm=150V, 2.2A, 600W(1ms)	DO-214AA	1d	1a	Mic
150V	SMC150	TVS	Vbr=167..204V, Vrwm=150V, 5.6A, 1500W(1ms)	DO-214AB	1d	1a	Mic
150VA	SMA150A	TVS	Vbr=167..185V, Vrwm=150.0V, 1.2A, 300W(1ms)	DO-214AC	1d	1a	Mic
150VA	SMB150A	TVS	Vbr=167..185V, Vrwm=150V, 2.5A, 600W(1ms)	DO-214AA	1d	1a	Mic
150VA	SMC150A	TVS	Vbr=167..185V, Vrwm=150V, 6.2A, 1500W(1ms)	DO-214AB	1d	1a	Mic
150VC	SMA150C	TVS	Vbr=167..204V, Vrwm=150.0V, 1.1A, 300W(1ms), Bidirectional	DO-214AC	1ba	1j	Mic
150VC	SMB150C	TVS	Vbr=167..204V, Vrwm=150V, 2.2A, 600W(1ms), Bidirectional	DO-214AA	1ba	1j	Mic
150VC	SMC150C	TVS	Vbr=167..204V, Vrwm=150V, 5.6A, 1500W(1ms), Bidirectional	DO-214AB	1ba	1j	Mic
150VCA	SMA150CA	TVS	Vbr=167..185V, Vrwm=150.0V, 1.2A, 300W(1ms), Bidirectional	DO-214AC	1ba	1j	Mic
150VCA	SMB150CA	TVS	Vbr=167..185V, Vrwm=150V, 2.5A, 600W(1ms), Bidirectional	DO-214AA	1ba	1j	Mic
150VCA	SMC150CA	TVS	Vbr=167..185V, Vrwm=150V, 6.2A, 1500W(1ms), Bidirectional	DO-214AB	1ba	1j	Mic
150Z	1SMA150Z	Z-diode	150V±5%, 1W	DO-214AC	1d	1a	Trs
151	HZU15L-1	Z-diode	14.1..14.7V, 150mW	URP	5d	1a	Ren
1510	SZ1510	Z-diode	10V±5%, Zzt=7.0Q, lzt=91mA, 1W	DO-214AC	1d	1a	Eic
1511	SZ1511	Z-diode	11V±5%, Zzt=8.0Q, lzt=83mA, 1W	DO-214AC	1d	1a	Eic
1512	SZ1512	Z-diode	12V±5%, Zzt=9.0Q, lzt=76mA, 1W	DO-214AC	1d	1a	Eic
1513	SZ1513	Z-diode	13V±5%, Zzt=10Q, lzt=69mA, 1W	DO-214AC	1d	1a	Eic
1515	SZ1515	Z-diode	15V±5%, Zzt=14Q, lzt=61mA, 1W	DO-214AC	1d	1a	Eic
1516	SZ1516	Z-diode	16V±5%, Zzt=16Q, lzt=57mA, 1W	DO-214AC	1d	1a	Eic
1518	SZ1518	Z-diode	18V±5%, Zzt=20Q, lzt=50mA, 1W	DO-214AC	1d	1a	Eic
152	HZU15L-2	Z-diode	14.5..15.1V, 150mW	URP	5d	1a	Ren
1520	SZ1520	Z-diode	20V±5%, Zzt=22Q, lzt=45mA, 1W	DO-214AC	1d	1a	Eic
1522	SZ1522	Z-diode	22V±5%, Zzt=23Q, lzt=41mA, 1W	DO-214AC	1d	1a	Eic
1524	SZ1524	Z-diode	24V±5%, Zzt=25Q, lzt=38mA, 1W	DO-214AC	1d	1a	Eic
1527	SZ1527	Z-diode	27V±5%, Zzt=35Q, lzt=34mA, 1W	DO-214AC	1d	1a	Eic
153	HZU15L-3	Z-diode	14.9..15.5V, 150mW	URP	5d	1a	Ren
1530	SZ1530	Z-diode	30V±5%, Zzt=40Q, lzt=30mA, 1W	DO-214AC	1d	1a	Eic
1533	SZ1533	Z-diode	33V±5%, Zzt=45Q, lzt=27mA, 1W	DO-214AC	1d	1a	Eic
1536	SZ1536	Z-diode	36V±5%, Zzt=50Q, lzt=25mA, 1W	DO-214AC	1d	1a	Eic
1539	SZ1539	Z-diode	39V±5%, Zzt=60Q, lzt=23mA, 1W	DO-214AC	1d	1a	Eic



SMD code	Type	Function	Short description	Case	Pinout	St.	Mnf.
153D	SZ153D	Z-diode	3.3V±5%, Zzt=10Ω, Izt=276mA, 1W	DO-214AC	1d	1a	Eic
153G	SZ153G	Z-diode	3.6V±5%, Zzt=10Ω, Izt=252mA, 1W	DO-214AC	1d	1a	Eic
153J	SZ153J	Z-diode	3.9V±5%, Zzt=9.0Ω, Izt=234mA, 1W	DO-214AC	1d	1a	Eic
1543	SZ1543	Z-diode	43V±5%, Zzt=70Ω, Izt=22mA, 1W	DO-214AC	1d	1a	Eic
1547	SZ1547	Z-diode	47V±5%, Zzt=80Ω, Izt=19mA, 1W	DO-214AC	1d	1a	Eic
154D	SZ154D	Z-diode	4.3V±5%, Zzt=9.0Ω, Izt=217mA, 1W	DO-214AC	1d	1a	Eic
154H	SZ154H	Z-diode	4.7V±5%, Zzt=8.0Ω, Izt=193mA, 1W	DO-214AC	1d	1a	Eic
1551	SZ1551	Z-diode	51V±5%, Zzt=95Ω, Izt=18mA, 1W	DO-214AC	1d	1a	Eic
1556	SZ1556	Z-diode	56V±5%, Zzt=110Ω, Izt=16mA, 1W	DO-214AC	1d	1a	Eic
155B	SZ155B	Z-diode	5.1V±5%, Zzt=7.0Ω, Izt=178mA, 1W	DO-214AC	1d	1a	Eic
155G	SZ155G	Z-diode	5.6V±5%, Zzt=5.0Ω, Izt=162mA, 1W	DO-214AC	1d	1a	Eic
1562	SZ1562	Z-diode	62V±5%, Zzt=125Ω, Izt=14mA, 1W	DO-214AC	1d	1a	Eic
1568	SZ1568	Z-diode	68V±5%, Zzt=150Ω, Izt=13mA, 1W	DO-214AC	1d	1a	Eic
156C	SZ156C	Z-diode	6.2V±5%, Zzt=2.0Ω, Izt=146mA, 1W	DO-214AC	1d	1a	Eic
156I	SZ156I	Z-diode	6.8V±5%, Zzt=3.5Ω, Izt=133mA, 1W	DO-214AC	1d	1a	Eic
1575	SZ1575	Z-diode	75V±5%, Zzt=175Ω, Izt=12mA, 1W	DO-214AC	1d	1a	Eic
157F	SZ157F	Z-diode	7.5V±5%, Zzt=4.0Ω, Izt=121mA, 1W	DO-214AC	1d	1a	Eic
1582	SZ1582	Z-diode	82V±5%, Zzt=200Ω, Izt=11mA, 1W	DO-214AC	1d	1a	Eic
158C	SZ158C	Z-diode	8.2V±5%, Zzt=4.5Ω, Izt=110mA, 1W	DO-214AC	1d	1a	Eic
1591	SZ1591	Z-diode	91V±5%, Zzt=250Ω, Izt=10mA, 1W	DO-214AC	1d	1a	Eic
159B	SZ159B	Z-diode	9.1V±5%, Zzt=5.0Ω, Izt=100mA, 1W	DO-214AC	1d	1a	Eic
15A	15SMC15A	TVS	Vbr=14.3..15.8V, Vrw=12.8V, 70.8A, 1500W(1ms)	DO-214AB	1d,3d	1k,1a	Vs,Ons
15A	15MC15A	TVS	Vbr=16.7..18.5V, Vrw=15V, 61.5A, 1500W(1ms)	DO-214AB	1d	1a	Eic
15A	P4SMA15A	TVS	Vbr=14.3..15.8V, Vrw=12.8V, 20.0A, 400W(1ms)	DO-214AC	1d	1k	Vs
15A	P6SMB15A	TVS	Vrw=15V, Vbr=14.3..15.8V, 28.3A, 600W(1ms)	DO-214AA	1d,3d	1k,1a	Vs,Ons
15A	P6SMBJ15A	TVS	Vbr=14.3..15.8V, 28A, 600W(1ms)	DO-214AA	1d	1n	Lif
15A	RKZ15AKU	Z-diode	13.44..14.13V, Izt=10mA, Zzt=40Ω, 500mW	TURP-FM	7d	1a	Ren
15A	SMAJ15A	TVS	Vrw=15V, Vbr=16.7..18.5V, 16.4A, 400W(1ms)	DO-214AC	1d	1a	Sus
15A	SMBJ15A	TVS	Vbr=16.7..18.5V, Vrw=15V, 24.0A, 600W(1ms)	DO-214AA	1d	1a	Sus
15A	SMCJ15A	TVS	Vrw=15V, Vbr=16.7..19.2V, 55.8A, 1500W(1ms)	DO-214AB	1d	1k	Sus
15A	UMA15A	TVS	Vrw=15V, Vbr=16.7..24.4V, 20.6A, 500W(1ms)	UltraMite	14d	1v	Msc
15B	15MB3EZ15	Z-diode	15V±5%, Zzt=7Ω, Izt=50.0mA, 3W	DO-214AA	1d	1a	Pjt
15B	HZF15BP	Z-diode	15V±5%, 900mW	LRP	1d	2f	Ren
15B	PTZ15B	Z-diode	15V±10%, 20mA, 1W	DO-214AC	1d	1a	Rhm
15B	RKZ15BKU	Z-diode	13.89..14.62V, Izt=10mA, Zzt=40Ω, 500mW	TURP-FM	7d	1a	Ren
15B	Z3SMB15B	Z-diode	14.25..15.75V, Izt=50mA, Zzt=6Ω, 3W	DO-214AA	1d	1a	Tr
15B0	SZ15B0	Z-diode	100V±5%, Zzt=350Ω, Izt=9.0mA, 1W	DO-214AC	1d	1a	Eic
15B1	SZ15B1	Z-diode	110V±5%, Zzt=450Ω, Izt=8.6mA, 1W	DO-214AC	1d	1a	Eic
15B2	SZ15B2	Z-diode	120V±5%, Zzt=550Ω, Izt=7.8mA, 1W	DO-214AC	1d	1a	Eic
15B3	SZ15B3	Z-diode	130V±5%, Zzt=700Ω, Izt=7.0mA, 1W	DO-214AC	1d	1a	Eic
15B5	SZ15B5	Z-diode	150V±5%, Zzt=1000Ω, Izt=6.4mA, 1W	DO-214AC	1d	1a	Eic
15B6	SZ15B6	Z-diode	160V±5%, Zzt=1100Ω, Izt=5.8mA, 1W	DO-214AC	1d	1a	Eic
15B8	SZ15B8	Z-diode	180V±5%, Zzt=1200Ω, Izt=5.2mA, 1W	DO-214AC	1d	1a	Eic
15C	15SMC15CA	TVS	Vbr=14.3..15.8V, Vrw=12.8V, 70.8A, 1500W(1ms), Bidirectional	DO-214AB	1ba	1l	Vs
15C	HZF15CP	Z-diode	15V±10%, 900mW	LRP	1d	2f	Ren
15C	P4SMA15C	TVS	Vbr=13.5..16.5V, Vrw=12.1V, 19.0A, 400W(1ms), Bidirectional	DO-214AC	1ba	1j	Eic
15C	P4SMA15CA	TVS	Vbr=14.3..15.8V, 18.9A, 400W(1ms), Bidirectional	DO-214AC	1ba	1l	Vs
15C	P6SMB15CA	TVS	Vrw=15V, Vbr=14.3..15.8V, 28.3A, 600W(1ms), Bidirectional	DO-214AA	1ba,3ba	1l,1e	Vs,Ons
15C	P6SMBJ15C	TVS	Vbr=13.5..16.5V, 27A, 600W(1ms), Bidirectional	DO-214AA	1ba	1p	Lif
15C	RKZ15CKU	Z-diode	14.35..15.09V, Izt=10mA, Zzt=40Ω, 500mW	TURP-FM	7d	1a	Ren
15CA	15MC15CA	TVS	Vbr=16.7..18.5V, Vrw=15V, 61.5A, 1500W(1ms), Bidirectional	DO-214AB	1ba	1j	Eic
15CA	P4SMA15CA	TVS	Vbr=14.3..15.8V, Vrw=12.8V, 20.0A, 400W(1ms), Bidirectional	DO-214AC	1ba	1j	Eic
15CA	P6SMB15CA	TVS	Vbr=14.3..15.8V, Vrw=12.8V, 28.0A, 600W(1ms), Bidirectional	DO-214AA	1ba	1j	Eic
15CA	P6SMBJ15CA	TVS	Vbr=14.3..15.8V, 28A, 600W(1ms), Bidirectional	DO-214AA	1ba	1p	Lif
15CA	SMAJ15CA	TVS	Vrw=15V, Vbr=16.7..18.5V, 16.4A, 400W(1ms), Bidirectional	DO-214AC	1ba	1j	Sus
15CA	SMBJ15CA	TVS	Vbr=16.7..18.5V, Vrw=15V, 24.0A, 600W(1ms), Bidirectional	DO-214AA	1ba	1j	Sus
15CA	SMCJ15CA	TVS	Vrw=15V, Vbr=16.7..19.2V, 55.8A, 1500W(1ms), Bidirectional	DO-214AB	1ba	1l	Sus
15CA	UMA15CA	TVS	Vrw=15V, Vbr=16.7..24.4V, 20.6A, 500W(1ms), Bidirectional	UltraMite	14ba	1v	Msc
15D0	SZ15D0	Z-diode	200V±5%, Zzt=1900Ω, Izt=4.7mA, 1W	DO-214AC	1d	1a	Eic
15D2	SZ15D2	Z-diode	220V±5%, Zzt=1600Ω, Izt=4.0mA, 1W	DO-214AC	1d	1a	Eic
15D4	SZ15D4	Z-diode	240V±5%, Zzt=1800Ω, Izt=3.8mA, 1W	DO-214AC	1d	1a	Eic
15D5	SZ15D5	Z-diode	250V±5%, Zzt=2000Ω, Izt=3.6mA, 1W	DO-214AC	1d	1a	Eic
15D7	SZ15D7	Z-diode	270V±5%, Zzt=2100Ω, Izt=3.3mA, 1W	DO-214AC	1d	1a	Eic
15E0	SZ15E0	Z-diode	300V±5%, Zzt=2300Ω, Izt=3.0mA, 1W	DO-214AC	1d	1a	Eic
15L	SS1P5L	Si-diode	SBR, 50V, 1A, Vf<0.59V(1A)	DO-220AA	8d	1k	Vs
15L7	KP15L07	Thy-SPD	V Of-St=65V, Ifsm=150A(1ms), Ih=100mA, Bidirectional	2F	1ba	1l	Shi
15L8	KP15L08	Thy-SPD	V Of-St=70V, Ifsm=150A(1ms), Ih=100mA, Bidirectional	2F	1ba	1l	Shi
15N12	KP15N12	Thy-SPD	V Of-St=110V, Ifsm=150A(1ms), Ih=100mA, Bidirectional	2F	1ba	1l	Shi
15N14	KP15N14	Thy-SPD	V Of-St=130V, Ifsm=150A(1ms), Ih=100mA, Bidirectional	2F	1ba	1l	Shi
15P	BZD27C15P	Z-diode	14.25..15.75V, Zzt=10Ω, Izt=50mA, 800mW	SOD-123FL	7d	1a	Pjt



SMD code	Type	Function	Short description	Case	Pinout	St.	Mnf.
15P	MFPZ15	Z-diode	14.25..15.75V, Izt=50mA, Zzt=10Ω, 800mW	SOD-123FL	7d	1a	Ttr
15R25	KP15R25	Thy-SPD	V Of-St=220V, Ifsm=150A(1ms), Ith=100mA, Bidirectional	2F	1ba	1l	Shi
15V	SMA15	TVS	Vbr=16.7..20.4V, Vrrwm=15.0V, 11.2A, 300W(1ms)	DO-214AC	1d	1a	Mic
15V	SMB15	TVS	Vbr=16.7..20.4V, Vrrwm=15V, 22.3A, 600W(1ms)	DO-214AA	1d	1a	Mic
15V	SMC15	TVS	Vbr=16.7..20.4V, Vrrwm=15V, 55.8A, 1500W(1ms)	DO-214AB	1d	1a	Mic
15VA	SMA15A	TVS	Vbr=16.7..18.5V, Vrrwm=15.0V, 12.3A, 300W(1ms)	DO-214AC	1d	1a	Mic
15VA	SMB15A	TVS	Vbr=16.7..18.5V, Vrrwm=15V, 24.6A, 600W(1ms)	DO-214AA	1d	1a	Mic
15VA	SMC15A	TVS	Vbr=16.7..18.5V, Vrrwm=15V, 61.5A, 1500W(1ms)	DO-214AB	1d	1a	Mic
15VB	BZT52-B15	Z-diode	14.70..15.30V, Izt=5mA, Zzt=30Ω, 500mW	SOD-123FL	7d	1a	Tsc
15VB	MMSZ15VBW	Z-diode	14.70..15.30V, Izt=5mA, Zzt=30Ω, 500mW	SOD-123FL	7d	1a	Tac
15VC	SMA15C	TVS	Vbr=16.7..20.4V, Vrrwm=15.0V, 11.2A, 300W(1ms), Bidirectional	DO-214AC	1ba	1j	Mic
15VC	SMB15C	TVS	Vbr=16.7..20.4V, Vrrwm=15V, 22.3A, 600W(1ms), Bidirectional	DO-214AA	1ba	1j	Mic
15VC	SMC15C	TVS	Vbr=16.7..20.4V, Vrrwm=15V, 55.8A, 1500W(1ms), Bidirectional	DO-214AB	1ba	1j	Mic
15VCA	SMA15CA	TVS	Vbr=16.7..18.5V, Vrrwm=15.0V, 12.3A, 300W(1ms), Bidirectional	DO-214AC	1ba	1j	Mic
15VCA	SMB15CA	TVS	Vbr=16.7..18.5V, Vrrwm=15V, 24.6A, 600W(1ms), Bidirectional	DO-214AA	1ba	1j	Mic
15VCA	SMC15CA	TVS	Vbr=16.7..18.5V, Vrrwm=15V, 61.5A, 1500W(1ms), Bidirectional	DO-214AB	1ba	1j	Mic
15VZ	BZT52-C15	Z-diode	14.25..15.75V, Izt=5mA, Zzt=30Ω, 500mW	SOD-123FL	7d	1a	Tsc
15VZ	MMSZ15VCW	Z-diode	14.25..15.75V, Izt=5mA, Zzt=30Ω, 500mW	SOD-123FL	7d	1a	Tac
15VZ	TCMMSZ15V	Z-diode	15V±5%, Izt=5mA, Zzt=28Ω, 500mW	SOD-123FL	7d	1a	Tac
15VZ	ZGFM0515C-MH	Z-diode	14.25..15.75V, Izt=5mA, Zzt=28Ω, 500mW	SOD-123	5d	1a	Pic
16	1SR154-600	Si-diode	Rectifier, 600V, 1A, Vf<1V(1A)	DO-214AC	1d	1k	Rhm
16	BZY55-C16	Z-diode	15.20..16.80V, Izt=5mA, Zzt=40Ω, 500mW	0805	70d	2d	Tsc
16	CDZ55C16	Z-diode	15.20..16.80V, Zzt=40Ω, Izt=5mA, 500mW	1206	70d	2d	Crp
16	CDZ55C16S	Z-diode	15.20..16.80V, Zzt=40Ω, Izt=5mA, 500mW	0805	70d	2d	Crp
16	CDZ55C16T	Z-diode	15.20..16.80V, Zzt=40Ω, Izt=5mA, 200mW	0603	70d	2d	Crp
16	CMZ16	Z-diode	16V±5%, 2W	M-Flat	7d	1a	Tos
16	KDZ16EV	Z-diode	15.3..17.1V, 150mW	SOD-523	6d	1a	Kec
16	KDZ16V	Z-diode	15.3..17.1V, 150mW	SOD-323	5d	1a	Kec
16	KDZ16VV	Z-diode	15.30..17.10V, Izt=5mA, Zzt=18Ω, 100mW	VSC	7d	1a	Kec
16	MAZ5160	Z-diode	15.3..17.1V, Zzt=10Ω(5mA), 500mW	MP2	11d	1a	Pan
16	MAZ81600H	Z-diode	16.26..17.1V, Zzt=50Ω(5mA), 150mW	SC-76	6d	1a	Pan
16	MAZS160	Z-diode	15.3..17.1V, 200mW	SOD-523	6d	1a	Pan
16	MAZY160	Z-diode	14.4..17.6V, Zzt=30Ω(10mA), 1W	NMiniP2	1d	1a	Pan
16	MSS1P6	Si-diode	SBR, 60V, 1A, Vf<0.68V(1A)	MicroSMP	8d	1k	Vs
16	P4SMA16	TVS	Vbr=14.4..17.6V, Vrrwm=12.9V, 18.0A, 400W(1ms)	DO-214AC	1d	1a	Eic
16	P6SMBJ16	TVS	Vbr=14.4..17.6V, 26A, 600W(1ms)	DO-214AA	1d	1n	Lif
16	SMA3C16	Z-diode	16V±5%, Izt=47mA, Zzt<5.5Ω, 3W	DO-214AC	1d	1a	Exc
16	SMD16APT	Si-diode	Rectifier, Schottky, 60V, 1A, Vf<0.65V(1A)	SOD-123S	8d	1a	Chm
16	SML4745	Z-diode	16V±5%, Izt=15.5mA, Zzt=16Ω, 1W	DO-214AC	1d	1k	Vs
16	TZD16WS	Z-diode	15.30..17.10V, Izt=5mA, Zzt=18Ω, 200mW	SOD-323	5d	1a	Ttr
16	TZD16WT	Z-diode	15.30..17.10V, Izt=5mA, Zzt=18Ω, 150mW	SOD-523	6d	1a	Ttr
16	TZD16WU	Z-diode	15.85..16.51V, Izt=5mA, Zzt=50Ω, 100mW	SOD-723	7d	1a	Ttr
16	U1Z16	Z-diode	14.4..17.6V, 1W	SOD-6	1d	1a	Tos
16	U1ZB16	Z-diode	14.4..17.6V, 1W	I-Flat	1d	1a	Tos
16-	MAZ81600L	Z-diode	15.7..16.5V, Zzt=50Ω(5mA), 150mW	SC-76	6d	1a	Pan
16-	MAZ8160GML	Z-diode	15.7..16.5V, Zzt=50Ω(5mA), 150mW	SMini2-F3	6d	1a	Pan
16-	MAZS1600M	Z-diode	15.7..16.5V, 200mW	SOD-523	6d	1a	Pan
16-	CTZ55C16	Z-diode	15.20..16.80V, Izt=5mA, Zzt=40Ω, 500mW	1206	70d	2d	Ctc
16^	MAZ81600H	Z-diode	16.26..17.1V, Zzt=50Ω(5mA), 150mW	SC-76	6d	1a	Pan
16^	MAZ8160GHL	Z-diode	16.26..17.1V, Zzt=50Ω(5mA), 150mW	SMini2-F3	6d	1a	Pan
16^	MAZS1600H	Z-diode	16.26..17.1V, 200mW	SOD-523	6d	1a	Pan
16_	MAZ81600L	Z-diode	15.3..16.09V, Zzt=50Ω(5mA), 150mW	SC-76	6d	1a	Pan
16_	MAZ8160GLL	Z-diode	15.3..16.09V, Zzt=50Ω(5mA), 150mW	SMini2-F3	6d	1a	Pan
16_	MAZS1600L	Z-diode	15.3..16.09V, 200mW	SOD-523	6d	1a	Pan
16=	HZC16	Z-diode	16V±10%, 150mW	SOD-523	6d	1a	Ren
16°	HZU16B1	Z-diode	15.37..16.01V, Izt=5mA, Zzt=40Ω, 200mW	URP	5d	1a	Ren
16°	HZU16B2	Z-diode	15.58..16.51V, Izt=5mA, Zzt=40Ω, 200mW	URP	5d	1a	Ren
16°	HZU16B3	Z-diode	16.35..17.09V, Izt=5mA, Zzt=40Ω, 200mW	URP	5d	1a	Ren
16°	RKZ16B2KG	Z-diode	15.85..16.51V, Izt=5mA, Zzt=40Ω, 200mW	URP	5d	2e	Ren
16°	RKZ16B2KJ	Z-diode	15.85..16.51V, Izt=5mA, Zzt=40Ω, 150mW	UFP	7d	2e	Ren
16°	TZD16YWS	Z-diode	15.85..16.51V, Izt=5mA, Zzt=18Ω, 200mW	SOD-323	5d	1a	Ttr
16°	TZD16YWT	Z-diode	15.85..16.51V, Izt=5mA, Zzt=18Ω, 150mW	SOD-523	6d	1a	Ttr
160	P4SMA160	TVS	Vbr=144..176V, Vrrwm=130V, 1.8A, 400W(1ms)	DO-214AC	1d	1a	Eic
160	P6SMBJ160	TVS	Vbr=144..176V, 2.6A, 600W(1ms)	DO-214AA	1d	1n	Lif
160A	1.5SMC160A	TVS	Vbr=152..168V, Vrrwm=136V, 6.8A, 1500W(1ms)	DO-214AB	1d	1k	Vs
160A	1SMC160A	TVS	Vbr=178..197V, Vrrwm=160V, 5.8A, 1500W(1ms)	DO-214AB	1d	1a	Eic
160A	P4SMA160A	TVS	Vbr=152..168V, Vrrwm=136V, 1.9A, 400W(1ms)	DO-214AC	1d	1k	Vs
160A	P6SMB160A	TVS	Vrrwm=160V, Vbr=152..168V, 2.7A, 600W(1ms)	DO-214AA	1d,3d	1k,1a	Vs,Ons
160A	P6SMBJ160A	TVS	Vbr=152..168V, 2.7A, 600W(1ms)	DO-214AA	1d	1n	Lif
160A	SMAJ160A	TVS	Vrrwm=160V, Vbr=178..197V, 1.5A, 400W(1ms)	DO-214AC	1d	1a	Sus



SMD
code

Type

Function

Short description

Case

Pinout

St.

Mnf.

SMD code	Type	Function	Short description	Case	Pinout	St.	Mnf.
160A	SMBJ160A	TVS	Vbr=178..197V, Vrwm=160V, 2.3A, 600W(1ms)	DO-214AA	1d	1a	Sus
160A	SMCJ160A	TVS	Vrwm=160V, Vbr=178..218V, 5.2A, 1500W(1ms)	DO-214AB	1d	1k	Sus
160A	TSP160SA	Thy-SPD	V Of-St=160V, 50A(1ms), Bidirectional	DO-214AA	1ba	1j	Pjt
160A	UMA160A	TVS	Vrwm=160V, Vbr=178..259V, 1.9A, 500W(1ms)	UltraMite	14ba	1v	Msc
160B	1SMB3EZ160	Z-diode	160V±5%, Zzt=625Ω, lzt=4.7mA, 3W	DO-214AA	1d	1a	Pjt
160B	TSP160SB	Thy-SPD	V Of-St=160V, 80A(1ms), Bidirectional	DO-214AA	1ba	1j	Pjt
160C	1.5SMC160CA	TVS	Vbr=152..168V, Vrwm=136V, 6.8A, 1500W(1ms), Bidirectional	DO-214AB	1ba	1l	Vs
160C	P4SMA160C	TVS	Vbr=144..176V, Vrwm=130V, 1.8A, 400W(1ms), Bidirectional	DO-214AC	1ba	1j	Eic
160C	P4SMA160CA	TVS	Vbr=152..168V, 1.4A, 400W(1ms), Bidirectional	DO-214AC	1ba	1l	Vs
160C	P6SMB160CA	TVS	Vbr=152..168V, 2.7A, 600W(1ms), Bidirectional	DO-214AA	1ba	1l	Vs
160C	P6SMBJ160C	TVS	Vbr=144..176V, 2.6A, 600W(1ms), Bidirectional	DO-214AA	1ba	1p	Lif
160C	TSP160SC	Thy-SPD	V Of-St=160V, 100A(1ms), Bidirectional	DO-214AA	1ba	1j	Pjt
160CA	1SMC160CA	TVS	Vbr=178..197V, Vrwm=160V, 5.8A, 1500W(1ms), Bidirectional	DO-214AB	1ba	1j	Eic
160CA	P4SMA160CA	TVS	Vbr=152..168V, Vrwm=136V, 1.9A, 400W(1ms), Bidirectional	DO-214AC	1ba	1j	Eic
160CA	P6SMB160CA	TVS	Vbr=152..168V, Vrwm=136V, 2.7A, 600W(1ms), Bidirectional	DO-214AA	1ba	1j	Eic
160CA	P6SMBJ160CA	TVS	Vbr=152..168V, 2.7A, 600W(1ms), Bidirectional	DO-214AA	1ba	1p	Lif
160CA	SMAJ160CA	TVS	Vrwm=160V, Vbr=178..197V, 1.5A, 400W(1ms), Bidirectional	DO-214AC	1ba	1j	Sus
160CA	SMBJ160CA	TVS	Vbr=178..197V, Vrwm=160V, 2.3A, 600W(1ms), Bidirectional	DO-214AA	1ba	1j	Sus
160CA	SMCJ160CA	TVS	Vrwm=160V, Vbr=178..205V, 5.2A, 1500W(1ms), Bidirectional	DO-214AB	1ba	1l	Sus
160CA	UMA160CA	TVS	Vrwm=160V, Vbr=178..259V, 1.9A, 500W(1ms), Bidirectional	UltraMite	14ba	1v	Msc
160V	SMA160	TVS	Vbr=178..218V, Vrwm=160.0V, 1A, 300W(1ms)	DO-214AC	1d	1a	Mic
160V	SMB160	TVS	Vbr=178..218V, Vrwm=160V, 2.1A, 600W(1ms)	DO-214AA	1d	1a	Mic
160V	SMC160	TVS	Vbr=178..218V, Vrwm=160V, 5.2A, 1500W(1ms)	DO-214AB	1d	1a	Mic
160VA	SMA160A	TVS	Vbr=178..197V, Vrwm=160.0V, 1.2A, 300W(1ms)	DO-214AC	1d	1a	Mic
160VA	SMB160A	TVS	Vbr=178..197V, Vrwm=160V, 2.3A, 600W(1ms)	DO-214AA	1d	1a	Mic
160VA	SMC160A	TVS	Vbr=178..197V, Vrwm=160V, 5.8A, 1500W(1ms)	DO-214AB	1d	1a	Mic
160VC	SMA160C	TVS	Vbr=178..218V, Vrwm=160.0V, 1A, 300W(1ms), Bidirectional	DO-214AC	1ba	1j	Mic
160VC	SMB160C	TVS	Vbr=178..218V, Vrwm=160V, 2.1A, 600W(1ms), Bidirectional	DO-214AA	1ba	1j	Mic
160VC	SMC160C	TVS	Vbr=178..218V, Vrwm=160V, 5.2A, 1500W(1ms), Bidirectional	DO-214AB	1ba	1j	Mic
160VCA	SMA160CA	TVS	Vbr=178..197V, Vrwm=160.0V, 1.2A, 300W(1ms), Bidirectional	DO-214AC	1ba	1j	Mic
160VCA	SMB160CA	TVS	Vbr=178..197V, Vrwm=160V, 2.3A, 600W(1ms), Bidirectional	DO-214AA	1ba	1j	Mic
160VCA	SMC160CA	TVS	Vbr=178..197V, Vrwm=160V, 5.8A, 1500W(1ms), Bidirectional	DO-214AB	1ba	1j	Mic
160Z	1SMA160Z	Z-diode	160V±5%, 1W	DO-214AC	1d	1a	Trs
161	HZU16L-1	Z-diode	15.3..15.9V, 150mW	URP	5d	1a	Ren
162	HZU16L-2	Z-diode	15.7..16.5V, 150mW	URP	5d	1a	Ren
163	HZU16L-3	Z-diode	16.3..17.1V, 150mW	URP	5d	1a	Ren
167Z	BYD167	Si-diode	U-Fast Rectifier, 600V, 1A, Vf<1.25V(1A), 35ns	1206	14d	1v	Zow
16A	1.5SMC16A	TVS	Vbr=15.2..16.8V, Vrwm=13.6V, 66.7A, 1500W(1ms)	DO-214AB	1d,3d	1a,1k	Vs,Ons
16A	1SMC16A	TVS	Vbr=17.8..19.7V, Vrwm=16V, 57.7A, 1500W(1ms)	DO-214AB	1d	1a	Eic
16A	P4SMA16A	TVS	Vbr=15.2..16.8V, Vrwm=13.6V, 19.0A, 400W(1ms)	DO-214AC	1d	1k	Vs
16A	P6SMB16A	TVS	Vrwm=16V, Vbr=15.2..16.8V, 26.7A, 600W(1ms)	DO-214AA	1d,3d	1k,1a	Vs,Ons
16A	P6SMBJ16A	TVS	Vbr=15.2..16.8V, 27A, 600W(1ms)	DO-214AA	1d	1n	Lif
16A	RKZ16AKU	Z-diode	14.80..15.57V, lzt=10mA, Zzt=40Ω, 500mW	TURP-FM	7d	1a	Ren
16A	SMAJ16A	TVS	Vrwm=16V, Vbr=17.8..19.7V, 15.3A, 400W(1ms)	DO-214AC	1d	1a	Sus
16A	SMBJ16A	TVS	Vbr=17.8..19.7V, Vrwm=16V, 23.1A, 600W(1ms)	DO-214AA	1d	1a	Sus
16A	SMCJ16A	TVS	Vrwm=16V, Vbr=17.8..20.5V, 52.1A, 1500W(1ms)	DO-214AB	1d	1k	Sus
16A	UMA16A	TVS	Vrwm=16V, Vbr=17.8..26.0V, 19.2A, 500W(1ms)	UltraMite	14d	1v	Msc
16B	1SMB3EZ16	Z-diode	16V±5%, Zzt=8Ω, lzt=47.0mA, 3W	DO-214AA	1d	1a	Pjt
16B	HZF16BP	Z-diode	16V±5%, 900mW	LRP	1d	2f	Ren
16B	PTZ16B	Z-diode	16V±10%, 20mA, 1W	DO-214AC	1d	1a	Rhm
16B	RKZ16BKU	Z-diode	15.25..16.04V, lzt=10mA, Zzt=40Ω, 500mW	TURP-FM	7d	1a	Ren
16B	Z3SMB16B	Z-diode	15.20..16.80V, lzt=47mA, Zzt=6Ω, 3W	DO-214AA	1d	1a	Tr
16C	1.5SMC16CA	TVS	Vbr=15.2..16.8V, Vrwm=13.6V, 66.7A, 1500W(1ms), Bidirectional	DO-214AB	1ba	1l	Vs
16C	HZF16CP	Z-diode	16V±10%, 900mW	LRP	1d	2f	Ren
16C	P4SMA16C	TVS	Vbr=14.4..17.6V, Vrwm=12.9V, 18.0A, 400W(1ms), Bidirectional	DO-214AC	1ba	1j	Eic
16C	P4SMA16CA	TVS	Vbr=15.2..16.8V, 17.8A, 400W(1ms), Bidirectional	DO-214AC	1ba	1l	Vs
16C	P6SMB16CA	TVS	Vrwm=16V, Vbr=15.2..16.8V, 26.7A, 600W(1ms), Bidirectional	DO-214AA	1ba,3ba	1l,1e	Vs,Ons
16C	P6SMBJ16C	TVS	Vbr=14.4..17.6V, 26A, 600W(1ms), Bidirectional	DO-214AA	1ba	1p	Lif
16C	RKZ16CKU	Z-diode	15.69..16.51V, lzt=10mA, Zzt=40Ω, 500mW	TURP-FM	7d	1a	Ren
16CA	1SMC16CA	TVS	Vbr=17.8..19.7V, Vrwm=16V, 57.7A, 1500W(1ms), Bidirectional	DO-214AB	1ba	1j	Eic
16CA	P4SMA16CA	TVS	Vbr=15.2..16.8V, Vrwm=13.6V, 19.0A, 400W(1ms), Bidirectional	DO-214AC	1ba	1j	Eic
16CA	P6SMB16CA	TVS	Vbr=15.2..16.8V, Vrwm=13.6V, 27.0A, 600W(1ms), Bidirectional	DO-214AA	1ba	1j	Eic
16CA	P6SMBJ16CA	TVS	Vbr=15.2..16.8V, 27A, 600W(1ms), Bidirectional	DO-214AA	1ba	1p	Lif
16CA	SMAJ16CA	TVS	Vrwm=16V, Vbr=17.8..19.7V, 15.3A, 400W(1ms), Bidirectional	DO-214AC	1ba	1j	Sus
16CA	SMBJ16CA	TVS	Vbr=17.8..19.7V, Vrwm=16V, 23.1A, 600W(1ms), Bidirectional	DO-214AA	1ba	1j	Sus
16CA	SMCJ16CA	TVS	Vrwm=16V, Vbr=17.8..19.7V, 52.1A, 1500W(1ms), Bidirectional	DO-214AB	1ba	1l	Sus
16CA	UMA16CA	TVS	Vrwm=16V, Vbr=17.8..26.0V, 19.2A, 500W(1ms), Bidirectional	UltraMite	14ba	1v	Msc
16L	SS1P6L	Si-diode	SBR, 60V, 1A, Vf<0.59V(1A)	DO-220AA	8d	1k	Vs
16P	BZD27C16P	Z-diode	15.20..16.80V, Zzt=15Ω, lzt=25mA, 800mW	SOD-123FL	7d	1a	Pjt
16P	MFPZ16	Z-diode	15.20..16.80V, lzt=25mA, Zzt=15Ω, 800mW	SOD-123FL	7d	1a	Tr



SMD code	Type	Function	Short description	Case	Pinout	St.	Mnf.
16V	SMA16	TVS	Vbr=17.8..21.8V, Vrwm=16.0V, 10.4A, 300W(1ms)	DO-214AC	1d	1a	Mic
16V	SMB16	TVS	Vbr=17.8..21.8V, Vrwm=16V, 20.8A, 600W(1ms)	DO-214AA	1d	1a	Mic
16V	SMC16	TVS	Vbr=17.8..21.8V, Vrwm=16V, 52.1A, 1500W(1ms)	DO-214AB	1d	1a	Mic
16VA	SMA16A	TVS	Vbr=17.8..19.7V, Vrwm=16.0V, 11.5A, 300W(1ms)	DO-214AC	1d	1a	Mic
16VA	SMB16A	TVS	Vbr=17.8..19.7V, Vrwm=16V, 23.1A, 600W(1ms)	DO-214AA	1d	1a	Mic
16VA	SMC16A	TVS	Vbr=17.8..19.7V, Vrwm=16V, 57.7A, 1500W(1ms)	DO-214AB	1d	1a	Mic
16VB	BZT52-B16	Z-diode	15.68..16.32V, Izt=5mA, Zzt=40Ω, 500mW	SOD-123FL	7d	1a	Tsc
16VB	MMSZ16VBVW	Z-diode	15.68..16.32V, Izt=5mA, Zzt=40Ω, 500mW	SOD-123FL	7d	1a	Tac
16VC	SMA16C	TVS	Vbr=17.8..21.8V, Vrwm=16.0V, 10.4A, 300W(1ms), Bidirectional	DO-214AC	1ba	1j	Mic
16VC	SMB16C	TVS	Vbr=17.8..21.8V, Vrwm=16V, 20.8A, 600W(1ms), Bidirectional	DO-214AA	1ba	1j	Mic
16VC	SMC16C	TVS	Vbr=17.8..21.8V, Vrwm=16V, 52.1A, 1500W(1ms), Bidirectional	DO-214AB	1ba	1j	Mic
16VCA	SMA16CA	TVS	Vbr=17.8..19.7V, Vrwm=16.0V, 11.5A, 300W(1ms), Bidirectional	DO-214AC	1ba	1j	Mic
16VCA	SMB16CA	TVS	Vbr=17.8..19.7V, Vrwm=16V, 23.1A, 600W(1ms), Bidirectional	DO-214AA	1ba	1j	Mic
16VCA	SMC16CA	TVS	Vbr=17.8..19.7V, Vrwm=16V, 57.7A, 1500W(1ms), Bidirectional	DO-214AB	1ba	1j	Mic
16VZ	BZT52-C16	Z-diode	15.20..16.80V, Izt=5mA, Zzt=40Ω, 500mW	SOD-123FL	7d	5A	Tsc
16VZ	MMSZ16VCW	Z-diode	15.20..16.80V, Izt=5mA, Zzt=40Ω, 500mW	SOD-123FL	7d	1a	Tac
16VZ	TCMMSZ16V	Z-diode	16V±5%, Izt=5mA, Zzt=37Ω, 500mW	SOD-123FL	7d	1a	Tac
16VZ	ZGFM0516C-MH	Z-diode	15.20..16.80V, Izt=5mA, Zzt=37Ω, 500mW	SOD-123	5d	1a	Pic
17	P4SMA17	TVS	Vbr=15.3..18.7V, Vrwm=13.7V, 17.0A, 400W(1ms)	DO-214AC	1d	17.0A	Eic
17	SMA3C17	Z-diode	17V±5%, Izt=44mA, Zzt=6Ω, 3W	DO-214AC	1d	1a	Exc
170	P4SMA170	TVS	Vbr=153..187V, Vrwm=138V, 1.7A, 400W(1ms)	DO-214AC	1d	1a	Eic
170	P6SMBJ170	TVS	Vbr=153..187V, 2.5A, 600W(1ms)	DO-214AA	1d	1n	Lif
170A	1.5SMC170A	TVS	Vbr=162..179V, Vrwm=145V, 6.4A, 1500W(1ms)	DO-214AB	1d	1k	Vs
170A	1SMC170A	TVS	Vbr=189..209V, Vrwm=170V, 5.50A, 1500W(1ms)	DO-214AB	1d	1a	Eic
170A	P4SMA170A	TVS	Vbr=162..179V, Vrwm=145V, 1.8A, 400W(1ms)	DO-214AC	1d	1k	Vs
170A	P6SMB170A	TVS	Vrwm=170V, Vbr=162..179V, 2.6A, 600W(1ms)	DO-214AA	1d,3d	1k,1a	Vs,Ons
170A	P6SMBJ170A	TVS	Vbr=162..179V, 2.6A, 600W(1ms)	DO-214AA	1d	1n	Lif
170A	SMAJ170A	TVS	Vrwm=170V, Vbr=189..209V, 1.5A, 400W(1ms)	DO-214AC	1d	1a	Sus
170A	SMBJ170A	TVS	Vbr=189..209V, Vrwm=170V, 2.2A, 600W(1ms)	DO-214AA	1d	1a	Sus
170A	SMCJ170A	TVS	Vrwm=170V, Vbr=189..217V, 4.9A, 1500W(1ms)	DO-214AB	1d	1k	Sus
170A	UMA170A	TVS	Vrwm=170V, Vbr=189..275V, 1.8A, 500W(1ms)	UltraMite	14ba	1v	Msc
170B	1SMB3EZ170	Z-diode	17.0V±5%, Zzt=650Ω, Izt=4.4mA, 3W	DO-214AA	1d	1a	Pjt
170C	1.5SMC170CA	TVS	Vbr=162..179V, Vrwm=145V, 6.4A, 1500W(1ms), Bidirectional	DO-214AB	1ba	1l	Vs
170C	P4SMA170C	TVS	Vbr=153..187V, Vrwm=138V, 1.7A, 400W(1ms), Bidirectional	DO-214AC	1ba	1j	Eic
170C	P4SMA170CA	TVS	Vbr=162..179V, 1.3A, 400W(1ms), Bidirectional	DO-214AC	1ba	1l	Vs
170C	P6SMB170CA	TVS	Vbr=162..179V, 2.6A, 600W(1ms), Bidirectional	DO-214AA	1ba	1l	Vs
170C	P6SMBJ170C	TVS	Vbr=153..187V, 2.5A, 600W(1ms), Bidirectional	DO-214AA	1ba	1p	Lif
170CA	1SMC170CA	TVS	Vbr=189..209V, Vrwm=170V, 5.50A, 1500W(1ms), Bidirectional	DO-214AB	1ba	1j	Eic
170CA	P4SMA170CA	TVS	Vbr=162..179V, Vrwm=145V, 1.8A, 400W(1ms), Bidirectional	DO-214AC	1ba	1j	Eic
170CA	P6SMB170CA	TVS	Vbr=162..179V, Vrwm=145V, 2.6A, 600W(1ms), Bidirectional	DO-214AA	1ba	1j	Eic
170CA	P6SMBJ170CA	TVS	Vbr=162..179V, 2.6A, 600W(1ms), Bidirectional	DO-214AA	1ba	1p	Lif
170CA	SMAJ170CA	TVS	Vrwm=170V, Vbr=189..209V, 1.5A, 400W(1ms), Bidirectional	DO-214AC	1ba	1j	Sus
170CA	SMBJ170CA	TVS	Vbr=189..209V, Vrwm=170V, 2.2A, 600W(1ms), Bidirectional	DO-214AA	1ba	1j	Sus
170CA	SMCJ170CA	TVS	Vrwm=170V, Vbr=189..217V, 4.9A, 1500W(1ms), Bidirectional	DO-214AB	1ba	1l	Sus
170CA	UMA170CA	TVS	Vrwm=170V, Vbr=189..275V, 1.8A, 500W(1ms), Bidirectional	UltraMite	14ba	1v	Msc
170V	SMA170	TVS	Vbr=189..231V, Vrwm=170.0V, 0.99A, 300W(1ms)	DO-214AC	1d	1a	Mic
170V	SMB170	TVS	Vbr=189..231V, Vrwm=170V, 2A, 600W(1ms)	DO-214AA	1d	1a	Mic
170V	SMC170	TVS	Vbr=189..231V, Vrwm=170V, 4.9A, 1500W(1ms)	DO-214AB	1d	1a	Mic
170VA	SMA170A	TVS	Vbr=189..209V, Vrwm=170.0V, 1.09A, 300W(1ms)	DO-214AC	1d	1a	Mic
170VA	SMB170A	TVS	Vbr=189..209V, Vrwm=170V, 2.2A, 600W(1ms)	DO-214AA	1d	1a	Mic
170VA	SMC170A	TVS	Vbr=189..209V, Vrwm=170V, 5.5A, 1500W(1ms)	DO-214AB	1d	1a	Mic
170VC	SMA170C	TVS	Vbr=189..231V, Vrwm=170.0V, 0.99A, 300W(1ms), Bidirectional	DO-214AC	1ba	1j	Mic
170VC	SMB170C	TVS	Vbr=189..231V, Vrwm=170V, 2A, 600W(1ms), Bidirectional	DO-214AA	1ba	1j	Mic
170VC	SMC170C	TVS	Vbr=189..231V, Vrwm=170V, 4.9A, 1500W(1ms), Bidirectional	DO-214AB	1ba	1j	Mic
170VCA	SMA170CA	TVS	Vbr=189..209V, Vrwm=170.0V, 1.09A, 300W(1ms), Bidirectional	DO-214AC	1ba	1j	Mic
170VCA	SMB170CA	TVS	Vbr=189..209V, Vrwm=170V, 2.2A, 600W(1ms), Bidirectional	DO-214AA	1ba	1j	Mic
170VCA	SMC170CA	TVS	Vbr=189..209V, Vrwm=170V, 5.5A, 1500W(1ms), Bidirectional	DO-214AB	1ba	1j	Mic
175A	TSP275SA	Thy-SPD	V Of-St=275V, 50A(1ms), Bidirectional	DO-214AA	1ba	1j	Pjt
175B	TSP275SB	Thy-SPD	V Of-St=275V, 80A(1ms), Bidirectional	DO-214AA	1ba	1j	Pjt
175C	TSP275SC	Thy-SPD	V Of-St=275V, 100A(1ms), Bidirectional	DO-214AA	1ba	1j	Pjt
17A	1SMC17A	TVS	Vbr=18.9..20.9V, Vrwm=17V, 54.3A, 1500W(1ms)	DO-214AB	1d	1a	Eic
17A	P4SMA17A	TVS	Vbr=16.2..17.9V, Vrwm=14.5V, 18.0A, 400W(1ms)	DO-214AC	1d	1a	Eic
17A	SMAJ17A	TVS	Vrwm=17V, Vbr=18.9..20.9V, 14.5A, 400W(1ms)	DO-214AC	1d	1a	Sus
17A	SMBJ17A	TVS	Vbr=18.9..20.9V, Vrwm=17V, 21.7A, 600W(1ms)	DO-214AA	1d	1a	Sus
17A	SMCJ17A	TVS	Vrwm=17V, Vbr=18.9..21.7V, 49.2A, 1500W(1ms)	DO-214AB	1d	1k	Sus
17A	UMA17A	TVS	Vrwm=17V, Vbr=18.9..27.6V, 18.1A, 500W(1ms)	UltraMite	14d	1v	Msc
17B	1SMB3EZ17	Z-diode	17V±5%, Zzt=9Ω, Izt=44.0mA, 3W	DO-214AA	1d	1a	Pjt
17B	Z3SMB17B	Z-diode	16.15..17.85V, Izt=44mA, Zzt=6Ω, 3W	DO-214AA	1d	1a	Ttr
17C	BZT52C-17WT	Z-diode	16.15..17.85V, Izt=5mA, Zzt=40Ω, 200mW	SOD-523	6d	1a	Ttr
17C	P4SMA17C	TVS	Vbr=15.3..18.7V, Vrwm=13.7V, 17.0A, 400W(1ms), Bidirectional	DO-214AC	1ba	1j	Eic



SMD code	Type	Function	Short description	Case	Pinout	St.	Mnf.
17CA	1SMC17CA	TVS	Vbr=18.9..20.9V, Vrw=17V, 54.3A, 1500W(1ms), Bidirectional	DO-214AB	1ba	1j	Eic
17CA	P4SMA17CA	TVS	Vbr=16.2..17.9V, Vrw=14.5V, 18.0A, 400W(1ms), Bidirectional	DO-214AC	1ba	1j	Eic
17CA	SMAJ17CA	TVS	Vrw=17V, Vbr=18.9..20.9V, 14.5A, 400W(1ms), Bidirectional	DO-214AC	1ba	1j	Sus
17CA	SMBJ17CA	TVS	Vbr=18.9..20.9V, Vrw=17V, 21.7A, 600W(1ms), Bidirectional	DO-214AA	1ba	1j	Sus
17CA	SMCJ17CA	TVS	Vrw=17V, Vbr=18.9..21.7V, 49.2A, 1500W(1ms), Bidirectional	DO-214AB	1ba	1l	Sus
17CA	UMA17CA	TVS	Vrw=17V, Vbr=18.9..27.6V, 18.1A, 500W(1ms), Bidirectional	UltraMite	14ba	1v	Msc
17P	BZD27C17P	Z-diode	16.15..17.85V, Zzt=15Ω, Izt=25mA, 800mW	SOD-123FL	7d	1a	Pjt
17P	MFPZ17	Z-diode	16.15..17.85V, Izt=25mA, Zzt=15Ω, 800mW	SOD-123FL	7d	1a	Tr
17V	SMA17	TVS	Vbr=18.9..12.1V, Vrw=17.0V, 9.8A, 300W(1ms)	DO-214AC	1d	1a	Mic
17V	SMB17	TVS	Vbr=18.9..23.1V, Vrw=17V, 19.7A, 600W(1ms)	DO-214AA	1d	1a	Mic
17V	SMC17	TVS	Vbr=18.9..23.1V, Vrw=17V, 49.2A, 1500W(1ms)	DO-214AB	1d	1a	Mic
17VA	SMA17A	TVS	Vbr=18.9..20.9V, Vrw=17.0V, 10.9A, 300W(1ms)	DO-214AC	1d	1a	Mic
17VA	SMB17A	TVS	Vbr=18.9..20.9V, Vrw=17V, 21.7A, 600W(1ms)	DO-214AA	1d	1a	Mic
17VA	SMC17A	TVS	Vbr=18.9..20.9V, Vrw=17V, 54.3A, 1500W(1ms)	DO-214AB	1d	1a	Mic
17VC	SMA17C	TVS	Vbr=18.9..12.1V, Vrw=17.0V, 9.8A, 300W(1ms), Bidirectional	DO-214AC	1ba	1j	Mic
17VC	SMB17C	TVS	Vbr=18.9..23.1V, Vrw=17V, 19.7A, 600W(1ms), Bidirectional	DO-214AA	1ba	1j	Mic
17VC	SMC17C	TVS	Vbr=18.9..23.1V, Vrw=17V, 49.2A, 1500W(1ms), Bidirectional	DO-214AB	1ba	1j	Mic
17VCA	SMA17CA	TVS	Vbr=18.9..20.9V, Vrw=17.0V, 10.9A, 300W(1ms), Bidirectional	DO-214AC	1ba	1j	Mic
17VCA	SMB17CA	TVS	Vbr=18.9..20.9V, Vrw=17V, 21.7A, 600W(1ms), Bidirectional	DO-214AA	1ba	1j	Mic
17VCA	SMC17CA	TVS	Vbr=18.9..20.9V, Vrw=17V, 54.3A, 1500W(1ms), Bidirectional	DO-214AB	1ba	1j	Mic
18	BZY55-C18	Z-diode	17.10..18.90V, Izt=5mA, Zzt=50Ω, 500mW	0805	70d	2d	Tsc
18	CDZ55C18	Z-diode	17.10..18.90V, Zzt=50Ω, Izt=5mA, 500mW	1206	70d	2d	Crp
18	CDZ55C18S	Z-diode	17.10..18.90V, Zzt=50Ω, Izt=5mA, 500mW	0805	70d	2d	Crp
18	CDZ55C18T	Z-diode	17.10..18.90V, Zzt=50Ω, Izt=5mA, 200mW	0603	70d	2d	Crp
18	CMZ18	Z-diode	18V±5%, 2W	M-Flat	7d	1a	Tos
18	FDZ33T	Z-diode	31..35V, Izt=2mA, Zzt=80Ω, 200mW	SOD-323	5d	1a	Fis
18	KDZ18EV	Z-diode	16.8..19.1V, 150mW	SOD-523	6d	1a	Kec
18	KDZ18V	Z-diode	16.80..19.10V, Izt=5mA, Zzt=20Ω, 150mW	SOD-323	5d	1a	Kec
18	KDZ18VV	Z-diode	16.80..19.10V, Izt=5mA, Zzt=20Ω, 100mW	VSC	7d	1a	Kec
18	MAZ5180	Z-diode	16.9..19.1V, Zzt=10Ω(5mA), 500mW	MP2	11d	1a	Pan
18	MAZ81800H	Z-diode	18.2..19.1V, Zzt=60Ω(5mA), 150mW	SC-76	6d	1a	Pan
18	MAZS180	Z-diode	16.9..19.1V, 200mW	SOD-523	6d	1a	Pan
18	MAZY180	Z-diode	16.2..19.8V, Zzt=30Ω(10mA), 1W	NMiniP2	1d	1a	Pan
18	MM3Z33V	Z-diode	31..35V, Izt=2mA, Zzt=80Ω, 200mW	SOD-323	5d	1a	Sec
18	MM5Z33V	Z-diode	33V±5%, Izt=2mA, Zzt=80Ω, 200mW	SOD-523	6d	1a,1u	Ons,Wtr
18	MMPZ5257BPT	Z-diode	31.35..34.65V, Izt=5mA, Zzt=88Ω, 225mW	SOD-323	5d	1a	Chm
18	P4SMA18	TVS	Vbr=16.2..19.8V, Vrw=14.5V, 16.0A, 400W(1ms)	DO-214AC	1d	1a	Eic
18	P6SMBJ18	TVS	Vbr=16.2..19.8V, 23A, 600W(1ms)	DO-214AA	1d	1n	Lif
18	SMA3C18	Z-diode	18V±5%, Izt=42mA, Zzt<6Ω, 3W	DO-214AC	1d	1a	Exc
18	SML4746	Z-diode	18V±5%, Izt=14mA, Zzt=20Ω, 1W	DO-214AC	1d	1k	Vs
18	TZD18WS	Z-diode	16.80..19.10V, Izt=5mA, Zzt=20Ω, 200mW	SOD-323	5d	1a	Tr
18	TZD18WT	Z-diode	16.80..19.10V, Izt=5mA, Zzt=20Ω, 150mW	SOD-523	6d	1a	Tr
18	TZD18WU	Z-diode	17.56..18.35V, Izt=2mA, Zzt=65Ω, 100mW	SOD-723	7d	1a	Tr
18	U1Z18	Z-diode	16.2..19.8V, 1W	SOD-6	1d	1a	Tos
18	U1ZB18	Z-diode	16.2..19.8V, 1W	I-FLAT	1d	1a	Tos
18	ZD33V0	Z-diode	31..35V, 2mA, Zzt=80Ω, 200mW	SOD-322	5d	1a	Cys
18-	MAZ81800M	Z-diode	17.55..18.45V, Zzt=60Ω(5mA), 150mW	SC-76	6d	1a	Pan
18-	MAZ8180GML	Z-diode	17.55..18.45V, Zzt=60Ω(5mA), 150mW	SMini2-F3	6d	1a	Pan
18-	MAZS1800M	Z-diode	17.55..18.45V, 200mW	SOD-523	6d	1a	Pan
18	CTZ55C18	Z-diode	17.10..18.90V, Izt=5mA, Zzt=50Ω, 500mW	1206	70d	2d	Ctc
18^	MAZ81800H	Z-diode	18.2..19.1V, Zzt=60Ω(5mA), 150mW	SC-76	6d	1a	Pan
18^	MAZ8180GHL	Z-diode	18.2..19.1V, Zzt=60Ω(5mA), 150mW	SMini2-F3	6d	1a	Pan
18^	MAZS1800H	Z-diode	18.2..19.1V, 200mW	SOD-523	6d	1a	Pan
18_	MAZ81800M	Z-diode	16.9..17.76V, Zzt=60Ω(5mA), 150mW	SC-76	6d	1a	Pan
18_	MAZ8180GLL	Z-diode	16.9..17.76V, Zzt=60Ω(5mA), 150mW	SMini2-F3	6d	1a	Pan
18_	MAZS1800L	Z-diode	16.9..17.76V, 200mW	SOD-523	6d	1a	Pan
18=	HZC18	Z-diode	18V±10%, 150mW	SOD-523	6d	1a	Ren
18*	HZU18B1	Z-diode	16.94..17.70V, Izt=5mA, Zzt=45Ω, 200mW	URP	5d	1a	Ren
18*	HZU18B2	Z-diode	17.56..18.35V, Izt=5mA, Zzt=45Ω, 200mW	URP	5d	1a	Ren
18*	HZU18B3	Z-diode	18.21..19.03V, Izt=5mA, Zzt=45Ω, 200mW	URP	5d	1a	Ren
18*	RKZ18B2KG	Z-diode	17.56..18.35V, Izt=5mA, Zzt=45Ω, 200mW	URP	5d	2e	Ren
18*	RKZ18B2KJ	Z-diode	17.56..18.35V, Izt=5mA, Zzt=45Ω, 150mW	UPF	7d	2e	Ren
18*	TZD18YWS	Z-diode	17.56..18.35V, Izt=5mA, Zzt=20Ω, 200mW	SOD-323	5d	1a	Tr
18*	TZD18YWT	Z-diode	17.56..18.35V, Izt=5mA, Zzt=20Ω, 150mW	SOD-523	6d	1a	Tr
180	P4SMA180	TVS	Vbr=162..198V, Vrw=146V, 1.6A, 400W(1ms)	DO-214AC	1d	1a	Eic
180	P6SMBJ180	TVS	Vbr=162..198V, 2.3A, 600W(1ms)	DO-214AA	1d	1n	Lif
180	U1Z180	Z-diode	162..198V, 1W	SOD-6	1d	1a	Tos
180	U1ZB180	Z-diode	162..198V, 1W	I-FLAT	1d	1a	Tos
180A	1.5SMC180A	TVS	Vbr=171..189V, Vrw=154V, 6.1A, 1500W(1ms)	DO-214AB	1d	1k	Vs
180A	P4SMA180A	TVS	Vbr=171..189V, Vrw=154V, 1.7A, 400W(1ms)	DO-214AC	1d	1k	Vs



SMD
code

Type

Function

Short description

Case

Pinout

St.

Mnf.

SMD code	Type	Function	Short description	Case	Pinout	St.	Mnf.
180A	P6SMB180A	TVS	Vrwm=180V, Vbr=171 189V, 2.4A, 600W(1ms)	DO-214AA	1d,3d	1k,1a	Vs,Ons
180A	P6SMBJ180A	TVS	Vbr=171..189V, 2.4A, 600W(1ms)	DO-214AA	1d	1n	Lif
180B	1SMB3EZ180	Z-diode	180V±5%, Zzt=700Ω, Izt=4.2mA, 3W	DO-214AA	1d	1a	Pjt
180C	1.5SMC180CA	TVS	Vbr=171..189V, Vrwm=154V, 6.1A, 1500W(1ms), Bidirectional	DO-214AB	1ba	1l	Vs
180C	P4SMA180C	TVS	Vbr=162..198V, Vrwm=146V, 1.6A, 400W(1ms), Bidirectional	DO-214AC	1ba	1j	Eic
180C	P4SMA180CA	TVS	Vbr=171..189V, Vrwm=154V, 1.7A, 400W(1ms), Bidirectional	DO-214AC	1ba	1l	Vs
180C	P6SMB180CA	TVS	Vbr=171 189V, 2.4A, 600W(1ms), Bidirectional	DO-214AA	1ba	1l	Vs
180C	P6SMBJ180C	TVS	Vbr=162..198V, 2.3A, 600W(1ms), Bidirectional	DO-214AA	1ba	1p	Lif
180CA	P4SMA180CA	TVS	Vbr=171..189V, Vrwm=154V, 1.7A, 400W(1ms), Bidirectional	DO-214AC	1ba	1j	Eic
180CA	P6SMB180CA	TVS	Vbr=171..189V, Vrwm=154V, 2.4A, 600W(1ms), Bidirectional	DO-214AA	1ba	1j	Eic
180CA	P6SMBJ180CA	TVS	Vbr=171..189V, 2.4A, 600W(1ms), Bidirectional	DO-214AA	1ba	1p	Lif
180Z	1SMA180Z	Z-diode	180V±5%, 1W	DO-214AC	1d	1a	Trs
181	HZU18L-1	Z-diode	16.9..17.7V, 150mW	URP	5d	1a	Ren
182	HZU18L-2	Z-diode	17.5..18.3V, 150mW	URP	5d	1a	Ren
183	HZU18L-3	Z-diode	18.1..19V, 150mW	URP	5d	1a	Ren
187Z	BYD187	Si-diode	U-Fast Rectifier, 800V, 1A, Vf<2.5V(1A), 35ns	1206	14d	1v	Zow
188A	1SMC188A	TVS	Vbr=209..231V, Vrwm=188V, 4.60A, 1500W(1ms)	DO-214AB	1d	1a	Eic
188A	SMAJ188A	TVS	Vrwm=188V, Vbr=209..231V, 1.4A, 400W(1ms)	DO-214AC	1d	1a	Sus
188A	SMCJ188A	TVS	Vrwm=188V, Vbr=209..231V, 4.6A, 1500W(1ms)	DO-214AB	1d	1k	Sus
188CA	1SMC188CA	TVS	Vbr=209..231V, Vrwm=188V, 4.60A, 1500W(1ms), Bidirectional	DO-214AB	1ba	1j	Eic
188CA	SMAJ188CA	TVS	Vrwm=188V, Vbr=209..231V, 1.4A, 400W(1ms), Bidirectional	DO-214AC	1ba	1j	Sus
188CA	SMCJ188CA	TVS	Vrwm=188V, Vbr=209..231V, 4.6A, 1500W(1ms), Bidirectional	DO-214AB	1ba	1l	Sus
18A	1.5SMC18A	TVS	Vbr=17.1..18.9V, Vrwm=15.3V, 59.5A, 1500W(1ms)	DO-214AB	1d,3d	1a,1k	Vs,Ons
18A	1SMC18A	TVS	Vbr=20.0..22.1V, Vrwm=18V, 51.4A, 1500W(1ms)	DO-214AB	1d	1a	Eic
18A	P4SMA18A	TVS	Vbr=17.1..18.9V, Vrwm=15.3V, 17.0A, 400W(1ms)	DO-214AC	1d	1k	Vs
18A	P6SMB18A	TVS	Vrwm=18V, Vbr=17.1..18.9V, 23.8A, 600W(1ms)	DO-214AA	1d,3d	1k,1a	Vs,Ons
18A	P6SMBJ18A	TVS	Vbr=17.1..18.9V, 24A, 600W(1ms)	DO-214AA	1d	1n	Lif
18A	RKZ18AKU	Z-diode	16.22..17.06V, Izt=10mA, Zzt=45Ω, 500mW	TURP-FM	7d	1a	Ren
18A	SMAJ18A	TVS	Vrwm=18V, Vbr=20.0..22.1V, 13.7A, 400W(1ms)	DO-214AC	1d	1a	Sus
18A	SMBJ18A	TVS	Vbr=20.0..22.1V, Vrwm=18V, 20.5A, 600W(1ms)	DO-214AA	1d	1a	Sus
18A	SMCJ18A	TVS	Vrwm=18V, Vbr=20..23.3V, 46.6A, 1500W(1ms)	DO-214AB	1d	1k	Sus
18A	UMA18A	TVS	Vrwm=18V, Vbr=20.0..29.2V, 17.2A, 500W(1ms)	UltraMite	14d	1v	Msc
18B	1SMB3EZ18	Z-diode	18V±5%, Zzt=10Ω, Izt=42.0mA, 3W	DO-214AA	1d	1a	Pjt
18B	HZF18BP	Z-diode	18V±5%, 900mW	LRP	1d	2f	Ren
18B	PTZ18B	Z-diode	18V±10%, 20mA, 1W	DO-214AC	1d	1a	Rhm
18B	RKZ18BKU	Z-diode	16.82..17.70V, Izt=10mA, Zzt=45Ω, 500mW	TURP-FM	7d	1a	Ren
18B	Z3SMB18B	Z-diode	17.10..18.90V, Izt=42mA, Zzt=6Ω, 3W	DO-214AA	1d	1a	Tr
18C	1.5SMC18CA	TVS	Vbr=17.1..18.9V, Vrwm=15.3V, 59.5A, 1500W(1ms), Bidirectional	DO-214AB	1ba	1l	Vs
18C	HZF18CP	Z-diode	18V±10%, 900mW	LRP	1d	2f	Ren
18C	P4SMA18C	TVS	Vbr=16.2..19.8V, Vrwm=14.5V, 16.0A, 400W(1ms), Bidirectional	DO-214AC	1ba	1j	Eic
18C	P4SMA18CA	TVS	Vbr=17.1..18.9V, 15.9A, 400W(1ms), Bidirectional	DO-214AC	1ba	1l	Vs
18C	P6SMB18CA	TVS	Vrwm=18V, Vbr=17.1..18.9V, 23.8A, 600W(1ms), Bidirectional	DO-214AA	1ba,3ba	1l,1e	Vs,Ons
18C	P6SMBJ18C	TVS	Vbr=16.2..19.8V, 23A, 600W(1ms), Bidirectional	DO-214AA	1ba	1p	Lif
18C	RKZ18CKU	Z-diode	17.42..18.33V, Izt=10mA, Zzt=45Ω, 500mW	TURP-FM	7d	1a	Ren
18CA	1SMC18CA	TVS	Vbr=20.0..22.1V, Vrwm=18V, 51.4A, 1500W(1ms), Bidirectional	DO-214AB	1ba	1j	Eic
18CA	P4SMA18CA	TVS	Vbr=17.1..18.9V, Vrwm=15.3V, 17.0A, 400W(1ms), Bidirectional	DO-214AC	1ba	1j	Eic
18CA	P6SMB18CA	TVS	Vbr=17.1..18.9V, Vrwm=15.3V, 24.0A, 600W(1ms), Bidirectional	DO-214AA	1ba	1j	Eic
18CA	P6SMBJ18CA	TVS	Vbr=17.1..18.9V, 24A, 600W(1ms), Bidirectional	DO-214AA	1ba	1p	Lif
18CA	SMAJ18CA	TVS	Vrwm=18V, Vbr=20.0..22.1V, 13.7A, 400W(1ms), Bidirectional	DO-214AC	1ba	1j	Sus
18CA	SMBJ18CA	TVS	Vbr=20.0..22.1V, Vrwm=18V, 20.5A, 600W(1ms), Bidirectional	DO-214AA	1ba	1j	Sus
18CA	SMCJ18CA	TVS	Vrwm=18V, Vbr=20..23.3V, 46.6A, 1500W(1ms), Bidirectional	DO-214AB	1ba	1l	Sus
18CA	UMA18CA	TVS	Vrwm=18V, Vbr=20.0..29.2V, 17.2A, 500W(1ms), Bidirectional	UltraMite	14ba	1v	Msc
18P	BZD27C18P	Z-diode	17.10..18.90V, Zzt=15Ω, Izt=25mA, 800mW	SOD-123FL	7d	1a	Pjt
18P	MFPZ18	Z-diode	17.10..18.90V, Izt=25mA, Zzt=15Ω, 800mW	SOD-123FL	7d	1a	Tr
18V	SMA18	TVS	Vbr=20..24.4V, Vrwm=18.0V, 9.3A, 300W(1ms)	DO-214AC	1d	1a	Mic
18V	SMB18	TVS	Vbr=20..24.4V, Vrwm=18V, 18.6A, 600W(1ms)	DO-214AA	1d	1a	Mic
18V	SMC18	TVS	Vbr=20..24.4V, Vrwm=18V, 46.6A, 1500W(1ms)	DO-214AB	1d	1a	Mic
18VA	SMA18A	TVS	Vbr=20..22.1V, Vrwm=18.0V, 10.3A, 300W(1ms)	DO-214AC	1d	1a	Mic
18VA	SMB18A	TVS	Vbr=20..22.1V, Vrwm=18V, 20.5A, 600W(1ms)	DO-214AA	1d	1a	Mic
18VA	SMC18A	TVS	Vbr=20..22.1V, Vrwm=18V, 51.4A, 1500W(1ms)	DO-214AB	1d	1a	Mic
18VB	BZT52-B18	Z-diode	17.64..18.36V, Izt=5mA, Zzt=45Ω, 500mW	SOD-123FL	7d	1a	Tsc
18VB	MMSZ18VBW	Z-diode	17.64..18.36V, Izt=5mA, Zzt=45Ω, 500mW	SOD-123FL	7d	1a	Tac
18VC	SMA18C	TVS	Vbr=20..24.4V, Vrwm=18.0V, 9.3A, 300W(1ms), Bidirectional	DO-214AC	1ba	1j	Mic
18VC	SMB18C	TVS	Vbr=20..24.4V, Vrwm=18V, 18.6A, 600W(1ms), Bidirectional	DO-214AA	1ba	1j	Mic
18VC	SMC18C	TVS	Vbr=20..24.4V, Vrwm=18V, 46.6A, 1500W(1ms), Bidirectional	DO-214AB	1ba	1j	Mic
18VCA	SMA18CA	TVS	Vbr=20..22.1V, Vrwm=18.0V, 10.3A, 300W(1ms), Bidirectional	DO-214AC	1ba	1j	Mic
18VCA	SMB18CA	TVS	Vbr=20..22.1V, Vrwm=18V, 20.5A, 600W(1ms), Bidirectional	DO-214AA	1ba	1j	Mic
18VCA	SMC18CA	TVS	Vbr=20..22.1V, Vrwm=18V, 51.4A, 1500W(1ms), Bidirectional	DO-214AB	1ba	1j	Mic
18VZ	BZT52-C18	Z-diode	17.10..18.90V, Izt=5mA, Zzt=45Ω, 500mW	SOD-123FL	7d	1a	Tsc
18VZ	MMSZ18VCW	Z-diode	17.10..18.90V, Izt=5mA, Zzt=45Ω, 500mW	SOD-123FL	7d	1a	Tac



SMD
code

Type

Function

Short description

Case

Pinout

St.

Mnf.

SMD code	Type	Function	Short description	Case	Pinout	St.	Mnf.
18VZ	TCMMSZ18V	Z-diode	18V±5%, Izt=5mA, Zzt=42Ω, 500mW	SOD-123FL	7d	1a	Tac
18VZ	ZGFM0518C-MH	Z-diode	17.10..18.90V, Izt=5mA, Zzt=42Ω, 500mW	SOD-123	5d	1a	Pic
19	FDZ36T	Z-diode	34..38V, Izt=2mA, Zzt=90Ω, 200mW	SOD-323	5d	1a	Fis
19	MM3Z36V	Z-diode	34..38V, Izt=2mA, Zzt=90Ω, 200mW	SOD-323	5d	1a	Sec
19	MM5Z36V	Z-diode	36V±5%, Izt=2mA, Zzt=90Ω, 200mW	SOD-523	6d	1a,1u	Ons,Wtr
19	MMPZ5258BPT	Z-diode	34.20..37.80V, Izt=5mA, Zzt=95Ω, 225mW	SOD-323	5d	1a	Chm
19	SMA3C19	Z-diode	19V±5%, Izt=40mA, Zzt<7Ω, 3W	DO-214AC	1d	1a	Exc
19	ZD36V0	Z-diode	34..38V, 2mA, Zzt=90Ω, 200mW	SOD-322	5d	1a	Cys
190A	TSP190SA	Thy-SPD	V Of-St=190V, 50A(1ms), Bidirectional	DO-214AA	1ba	1j	Pjt
190B	1SMB3EZ190	Z-diode	190V±5%, Zzt=800Ω, Izt=4mA, 3W	DO-214AA	1d	1a	Pjt
190B	TSP190SB	Thy-SPD	V Of-St=190V, 80A(1ms), Bidirectional	DO-214AA	1ba	1j	Pjt
190C	TSP190SC	Thy-SPD	V Of-St=190V, 100A(1ms), Bidirectional	DO-214AA	1ba	1j	Pjt
19B	1SMB3EZ19	Z-diode	19V±5%, Zzt=11Ω, Izt=40.0mA, 3W	DO-214AA	1d	1a	Pjt
19B	Z3SMB19B	Z-diode	18.05..19.95V, Izt=40mA, Zzt=7Ω, 3W	DO-214AA	1d	1a	Ttr
19B	BZD27C19P	Z-diode	18.05..19.95V, Zzt=15Ω, Izt=25mA, 800mW	SOD-123FL	7d	1a	Pjt
19P	MFPZ19	Z-diode	18.05..19.95V, Izt=25mA, Zzt=15Ω, 800mW	SOD-123FL	7d	1a	Ttr
1A	FDZ47T	Z-diode	44..50V, Izt=2mA, Zzt=170Ω, 200mW	SOD-323	5d	1a	Fis
1A	MA110	Si-diode	Fast-Sw, 40V, 100mA, <3ns	SOD-123	5d	1a	Pan
1A	MM3Z47V	Z-diode	44..50V, Izt=2mA, Zzt=170Ω, 200mW	SOD-323	5d	1a	Sec
1A	MM5Z47V	Z-diode	47V±5%, Izt=2mA, Zzt=170Ω, 200mW	SOD-523	6d	1a,1u	Ons,Wtr
1A	MMPZ5261BPT	Z-diode	44.65..49.35V, Izt=2.7mA, Zzt=105Ω, 225mW	SOD-323	5d	1a	Chm
1A	ZD47V0	Z-diode	44..50V, 2mA, Zzt=170Ω, 200mW	SOD-322	5d	1a	Cys
1AD	SMB10J5.0	TVS	Vbr=6.40..7.82V, Vrw=5.0V, 104.2A, 1000W(1ms)	DO-214AC	1d	1k	Vs
1AD	SMB8J5.0C	TVS	Vbr=6.40..7.82V, Vrw=5.0V, 83.3A, 1000W(1ms), Bidirectional	DO-214AA	1ba	1l	Vs
1AE	SMB10J5.0A	TVS	Vbr=6.40..7.07V, Vrw=5.0V, 108.7A, 1000W(1ms)	DO-214AC	1d	1k	Vs
1AE	SMB8J5.0CA	TVS	Vbr=6.40..7.25V, Vrw=5.0V, 87.0A, 1000W(1ms), Bidirectional	DO-214AA	1ba	1l	Vs
1AF	SMB10J6.0	TVS	Vbr=6.67..7.15V, Vrw=6.0V, 87.7A, 1000W(1ms)	DO-214AA	1d	1k	Vs
1AF	SMB8J6.0C	TVS	Vbr=6.67..7.15V, Vrw=6.0V, 70.2A, 1000W(1ms), Bidirectional	DO-214AA	1ba	1l	Vs
1AG	SMB10J6.0A	TVS	Vbr=6.67..7.37V, Vrw=6.0V, 97.1A, 1000W(1ms)	DO-214AA	1d	1k	Vs
1AG	SMB8J6.0CA	TVS	Vbr=6.67..7.37V, Vrw=6.0V, 77.7A, 1000W(1ms), Bidirectional	DO-214AA	1ba	1l	Vs
1AH	SMB10J6.5	TVS	Vbr=7.22..8.82V, Vrw=6.5V, 81.3A, 1000W(1ms)	DO-214AA	1d	1k	Vs
1AH	SMB8J6.5C	TVS	Vbr=7.22..8.82V, Vrw=6.5V, 65.0A, 1000W(1ms), Bidirectional	DO-214AA	1ba	1l	Vs
1AK	SMB10J6.5A	TVS	Vbr=7.22..7.98V, Vrw=6.5V, 89.3A, 1000W(1ms)	DO-214AA	1d	1k	Vs
1AK	SMB8J6.5CA	TVS	Vbr=7.22..7.98V, Vrw=6.5V, 71.4A, 1000W(1ms), Bidirectional	DO-214AA	1ba	1l	Vs
1AL	SMB10J7.0	TVS	Vbr=7.78..9.51V, Vrw=7.0V, 75.2A, 1000W(1ms)	DO-214AA	1d	1k	Vs
1AL	SMB8J7.0C	TVS	Vbr=7.78..9.51V, Vrw=7.0V, 60.2A, 1000W(1ms), Bidirectional	DO-214AA	1ba	1l	Vs
1AM	SMB10J7.0A	TVS	Vbr=7.78..8.60V, Vrw=7.0V, 83.3A, 1000W(1ms)	DO-214AA	1d	1k	Vs
1AM	SMB8J7.0CA	TVS	Vbr=7.78..8.60V, Vrw=7.0V, 66.7A, 1000W(1ms), Bidirectional	DO-214AA	1ba	1l	Vs
1AN	SMB10J7.5	TVS	Vbr=8.33..10.2V, Vrw=7.5V, 69.9A, 1000W(1ms)	DO-214AA	1d	1k	Vs
1AN	SMB8J7.5C	TVS	Vbr=8.33..10.2V, Vrw=7.5V, 55.9A, 1000W(1ms), Bidirectional	DO-214AA	1ba	1l	Vs
1AP	SMB10J7.5A	TVS	Vbr=8.33..9.21V, Vrw=7.5V, 77.5A, 1000W(1ms)	DO-214AA	1d	1k	Vs
1AP	SMB8J7.5CA	TVS	Vbr=8.33..9.21V, Vrw=7.5V, 62.0A, 1000W(1ms), Bidirectional	DO-214AA	1ba	1l	Vs
1AQ	SMB10J8.0	TVS	Vbr=8.89..10.9V, Vrw=8.0V, 66.7A, 1000W(1ms)	DO-214AA	1d	1k	Vs
1AQ	SMB8J8.0C	TVS	Vbr=8.89..10.9V, Vrw=8.0V, 53.3A, 1000W(1ms), Bidirectional	DO-214AA	1ba	1l	Vs
1AR	SMB10J8.0A	TVS	Vbr=8.89..9.83V, Vrw=8.0V, 73.5A, 1000W(1ms)	DO-214AA	1d	1k	Vs
1AR	SMB8J8.0CA	TVS	Vbr=8.89..9.83V, Vrw=8.0V, 58.8A, 1000W(1ms), Bidirectional	DO-214AA	1ba	1l	Vs
1AS	SMB10J8.5	TVS	Vbr=9.44..11.5V, Vrw=8.5V, 62.9A, 1000W(1ms)	DO-214AA	1d	1k	Vs
1AS	SMB8J8.5C	TVS	Vbr=9.44..11.5V, Vrw=8.5V, 50.3A, 1000W(1ms), Bidirectional	DO-214AA	1ba	1l	Vs
1AT	SMB10J8.5A	TVS	Vbr=9.44..10.4V, Vrw=8.5V, 69.4A, 1000W(1ms)	DO-214AA	1d	1k	Vs
1AT	SMB8J8.5CA	TVS	Vbr=9.44..10.4V, Vrw=8.5V, 55.6A, 1000W(1ms), Bidirectional	DO-214AA	1ba	1l	Vs
1AU	SMB10J9.0	TVS	Vbr=10.0..12.2V, Vrw=9.0V, 59.2A, 1000W(1ms)	DO-214AA	1d	1k	Vs
1AU	SMB8J9.0C	TVS	Vbr=10.0..12.2V, Vrw=9.0V, 47.3A, 1000W(1ms), Bidirectional	DO-214AA	1ba	1l	Vs
1AV	SMB10J9.0A	TVS	Vbr=10.0..11.1V, Vrw=9.0V, 64.9A, 1000W(1ms)	DO-214AA	1d	1k	Vs
1AV	SMB8J9.0CA	TVS	Vbr=10.0..11.1V, Vrw=9.0V, 51.9A, 1000W(1ms), Bidirectional	DO-214AA	1ba	1l	Vs
1AW	SMB10J10	TVS	Vbr=11.1..13.6V, Vrw=10V, 53.2A, 1000W(1ms)	DO-214AA	1d	1k	Vs
1AW	SMB8J10C	TVS	Vbr=11.1..13.6V, Vrw=10V, 42.6A, 1000W(1ms), Bidirectional	DO-214AA	1ba	1l	Vs
1AX	SMB10J10A	TVS	Vbr=11.1..12.3V, Vrw=10V, 58.8A, 1000W(1ms)	DO-214AA	1d	1k	Vs
1AX	SMB8J10CA	TVS	Vbr=11.1..12.3V, Vrw=10V, 47.1A, 1000W(1ms), Bidirectional	DO-214AA	1ba	1l	Vs
1AY	SMB10J11	TVS	Vbr=12.2..14.9V, Vrw=11V, 49.8A, 1000W(1ms)	DO-214AA	1d	1k	Vs
1AY	SMB8J11C	TVS	Vbr=12.2..14.9V, Vrw=11V, 39.8A, 1000W(1ms), Bidirectional	DO-214AA	1ba	1l	Vs
1AZ	SMB10J11A	TVS	Vbr=12.2..13.5V, Vrw=11V, 54.9A, 1000W(1ms)	DO-214AA	1d	1k	Vs
1AZ	SMB8J11CA	TVS	Vbr=12.2..13.5V, Vrw=11V, 44.0A, 1000W(1ms), Bidirectional	DO-214AA	1ba	1l	Vs
1B	MAZJ11	Si-diode	Fast, Sw, 80V, 100mA, Vf<1.2V(100mA), <3ns	S-Mini	9d	1j	Pan
1BD	SMB10J12	TVS	Vbr=13.3..16.3V, Vrw=12V, 45.5A, 1000W(1ms)	DO-214AA	1d	1k	Vs
1BD	SMB8J12C	TVS	Vbr=13.3..16.3V, Vrw=12V, 36.4A, 1000W(1ms), Bidirectional	DO-214AA	1ba	1l	Vs
1BE	SMB10J12A	TVS	Vbr=13.3..14.7V, Vrw=12V, 50.3A, 1000W(1ms)	DO-214AA	1d	1k	Vs
1BE	SMB8J12CA	TVS	Vbr=13.3..14.7V, Vrw=12V, 40.2A, 1000W(1ms), Bidirectional	DO-214AA	1ba	1l	Vs
1BF	SMB10J13	TVS	Vbr=14.4..17.6V, Vrw=13V, 42.0A, 1000W(1ms)	DO-214AA	1d	1k	Vs
1BF	SMB8J13C	TVS	Vbr=14.4..17.6V, Vrw=13V, 33.6A, 1000W(1ms), Bidirectional	DO-214AA	1ba	1l	Vs
1BG	SMB10J13A	TVS	Vbr=14.4..15.9V, Vrw=13V, 46.5A, 1000W(1ms)	DO-214AA	1d	1k	Vs



SMD
code

Type

Function

Short description

Case

Pinout

St.

Mnf.

SMD code	Type	Function	Short description	Case	Pinout	St.	Mnf.
1BG	SMB8J13CA	TVS	Vbr=14.4..15.9V, Vrwm=13V, 37.2A, 1000W(1ms), Bidirectional	DO-214AA	1ba	1l	Vs
1BH	SMB10J14	TVS	Vbr=15.6..19.1V, Vrwm=14V, 38.8A, 1000W(1ms)	DO-214AA	1d	1k	Vs
1BH	SMB8J14C	TVS	Vbr=15.6..19.1V, Vrwm=14V, 31.0A, 1000W(1ms), Bidirectional	DO-214AA	1ba	1l	Vs
1BK	SMB10J14A	TVS	Vbr=15.6..17.2V, Vrwm=14V, 43.1A, 1000W(1ms)	DO-214AA	1d	1k	Vs
1BK	SMB8J14CA	TVS	Vbr=15.6..17.2V, Vrwm=14V, 34.5A, 1000W(1ms), Bidirectional	DO-214AA	1ba	1l	Vs
1BL	SMB10J15	TVS	Vbr=16.7..20.4V, Vrwm=15V, 37.2A, 1000W(1ms)	DO-214AA	1d	1k	Vs
1BL	SMB8J15C	TVS	Vbr=16.7..20.4V, Vrwm=15V, 29.7A, 1000W(1ms), Bidirectional	DO-214AA	1ba	1l	Vs
1BL3	MBRS130	Si-diode	SBR, 30V, 1A, Vf=0.55V(1A)	SOD-323	5d	1a	Ons
1BM	SMB10J15A	TVS	Vbr=16.7..18.5V, Vrwm=15V, 41.0A, 1000W(1ms)	DO-214AA	1d	1k	Vs
1BM	SMB8J15CA	TVS	Vbr=16.7..18.5V, Vrwm=15V, 32.8A, 1000W(1ms), Bidirectional	DO-214AA	1ba	1l	Vs
1BN	SMB10J16	TVS	Vbr=17.8..21.8V, Vrwm=16V, 34.7A, 1000W(1ms)	DO-214AA	1d	1k	Vs
1BN	SMB8J16C	TVS	Vbr=17.8..21.8V, Vrwm=16V, 27.8A, 1000W(1ms), Bidirectional	DO-214AA	1ba	1l	Vs
1BP	SMB10J16A	TVS	Vbr=17.8..19.7V, Vrwm=16V, 38.5A, 1000W(1ms)	DO-214AA	1d	1k	Vs
1BP	SMB8J16CA	TVS	Vbr=17.8..19.7V, Vrwm=16V, 30.8A, 1000W(1ms), Bidirectional	DO-214AA	1ba	1l	Vs
1BQ	SMB10J17	TVS	Vbr=18.9..23.1V, Vrwm=17V, 32.8A, 1000W(1ms)	DO-214AA	1d	1k	Vs
1BQ	SMB8J17C	TVS	Vbr=18.9..23.1V, Vrwm=17V, 26.2A, 1000W(1ms), Bidirectional	DO-214AA	1ba	1l	Vs
1BR	SMB10J17A	TVS	Vbr=18.9..20.9V, Vrwm=17V, 36.2A, 1000W(1ms)	DO-214AA	1d	1k	Vs
1BR	SMB8J17CA	TVS	Vbr=18.9..20.9V, Vrwm=17V, 29.0A, 1000W(1ms), Bidirectional	DO-214AA	1ba	1l	Vs
1BS	SMB10J18	TVS	Vbr=20.0..24.4V, Vrwm=18V, 31.1A, 1000W(1ms)	DO-214AA	1d	1k	Vs
1BS	SMB8J18C	TVS	Vbr=20.0..24.4V, Vrwm=18V, 24.8A, 1000W(1ms), Bidirectional	DO-214AA	1ba	1l	Vs
1BT	SMB10J18A	TVS	Vbr=20.0..22.1V, Vrwm=18V, 34.2A, 1000W(1ms)	DO-214AA	1d	1k	Vs
1BT	SMB8J18CA	TVS	Vbr=20.0..22.1V, Vrwm=18V, 27.4A, 1000W(1ms), Bidirectional	DO-214AA	1ba	1l	Vs
1BU	SMB10J20	TVS	Vbr=22.2..27.1V, Vrwm=20V, 27.9A, 1000W(1ms)	DO-214AA	1d	1k	Vs
1BU	SMB8J20C	TVS	Vbr=22.2..27.1V, Vrwm=20V, 22.3A, 1000W(1ms), Bidirectional	DO-214AA	1ba	1l	Vs
1BV	SMB10J20A	TVS	Vbr=22.2..24.5V, Vrwm=20V, 30.9A, 1000W(1ms)	DO-214AA	1d	1k	Vs
1BV	SMB8J20CA	TVS	Vbr=22.2..24.5V, Vrwm=20V, 24.7A, 1000W(1ms), Bidirectional	DO-214AA	1ba	1l	Vs
1BW	SMB10J22	TVS	Vbr=24.4..29.8V, Vrwm=22V, 25.4A, 1000W(1ms)	DO-214AA	1d	1k	Vs
1BW	SMB8J22C	TVS	Vbr=24.4..29.8V, Vrwm=22V, 20.3A, 1000W(1ms), Bidirectional	DO-214AA	1ba	1l	Vs
1BX	SMB10J22A	TVS	Vbr=24.4..26.9V, Vrwm=22V, 28.2A, 1000W(1ms)	DO-214AA	1d	1k	Vs
1BX	SMB8J22CA	TVS	Vbr=24.4..26.9V, Vrwm=22V, 22.5A, 1000W(1ms), Bidirectional	DO-214AA	1ba	1l	Vs
1BY	SMB10J24	TVS	Vbr=26.7..32.6V, Vrwm=24V, 23.3A, 1000W(1ms)	DO-214AA	1d	1k	Vs
1BY	SMB8J24C	TVS	Vbr=26.7..32.6V, Vrwm=24V, 18.6A, 1000W(1ms), Bidirectional	DO-214AA	1ba	1l	Vs
1BZ	SMB10J24A	TVS	Vbr=26.7..29.5V, Vrwm=24V, 25.7A, 1000W(1ms)	DO-214AA	1d	1k	Vs
1BZ	SMB8J24CA	TVS	Vbr=26.7..29.5V, Vrwm=24V, 20.6A, 1000W(1ms), Bidirectional	DO-214AA	1ba	1l	Vs
1C	FDZ51T	Z-diode	48..54V, Izt=2mA, Zzt=180Q, 200mW	SOD-323	5d	1a	Fis
1C	GBLC18C	TVS	Vbr=18V, 8A, 350W(1ms), 3pF, Bidirectional	SOD-323	5ba	1e	Prt
1C	MA112	Si-diode	Fast, Sw, 40V, 200mA, Vf<1.1V(200mA), <10nS	SOD-323	5d	1a	Pan
1C	MM3Z2V4	Z-diode	2.28..2.56V, Izt=5mA, Zzt=100Q, 300mW	SOD-323FL	7d	1a	Lge
1C	MM3Z51V	Z-diode	48..54V, Izt=2mA, Zzt=180Q, 200mW	SOD-323	5d	1a	Sec
1C	MM5Z51V	Z-diode	51V±5%, Izt=2mA, Zzt=180Q, 200mW	SOD-523	6d	1a,1u	Ons,Wtr
1C	MPMPZ5262BPT	Z-diode	48.45..53.35V, Izt=2.5mA, Zzt=125Q, 225mW	SOD-323	5d	1a	Chm
1C	ZD51V0	Z-diode	48..54V, 2mA, Zzt=180Q, 200mW	SOD-322	5d	1a	Cys
1CD	SMB10J26	TVS	Vbr=28.9..35.3V, Vrwm=26V, 21.5A, 1000W(1ms)	DO-214AA	1d	1k	Vs
1CD	SMB8J26C	TVS	Vbr=28.9..35.3V, Vrwm=26V, 17.2A, 1000W(1ms), Bidirectional	DO-214AA	1ba	1l	Vs
1CE	SMB10J26A	TVS	Vbr=28.9..31.9V, Vrwm=26V, 23.8A, 1000W(1ms)	DO-214AA	1d	1k	Vs
1CE	SMB8J26CA	TVS	Vbr=28.9..31.9V, Vrwm=26V, 19.0A, 1000W(1ms), Bidirectional	DO-214AA	1ba	1l	Vs
1CF	SMB10J28	TVS	Vbr=31.1..38.0V, Vrwm=28V, 20.0A, 1000W(1ms)	DO-214AA	1d	1k	Vs
1CF	SMB8J28C	TVS	Vbr=31.1..38.0V, Vrwm=28V, 16.0A, 1000W(1ms), Bidirectional	DO-214AA	1ba	1l	Vs
1CG	SMB10J28A	TVS	Vbr=31.1..34.4V, Vrwm=28V, 22.0A, 1000W(1ms)	DO-214AA	1d	1k	Vs
1CG	SMB8J28CA	TVS	Vbr=31.1..34.4V, Vrwm=28V, 17.6A, 1000W(1ms), Bidirectional	DO-214AA	1ba	1l	Vs
1CH	SMB10J30	TVS	Vbr=33.3..40.7V, Vrwm=30V, 18.7A, 1000W(1ms)	DO-214AA	1d	1k	Vs
1CH	SMB8J30C	TVS	Vbr=33.3..40.7V, Vrwm=30V, 15.0A, 1000W(1ms), Bidirectional	DO-214AA	1ba	1l	Vs
1CK	SMB10J30A	TVS	Vbr=33.3..36.8V, Vrwm=30V, 20.7A, 1000W(1ms)	DO-214AA	1d	1k	Vs
1CK	SMB8J30CA	TVS	Vbr=33.3..36.8V, Vrwm=30V, 16.5A, 1000W(1ms), Bidirectional	DO-214AA	1ba	1l	Vs
1CL	SMB10J33	TVS	Vbr=36.7..44.9V, Vrwm=33V, 16.9A, 1000W(1ms)	DO-214AA	1d	1k	Vs
1CL	SMB8J33C	TVS	Vbr=36.7..44.9V, Vrwm=33V, 13.6A, 1000W(1ms), Bidirectional	DO-214AA	1ba	1l	Vs
1CM	SMB10J33A	TVS	Vbr=36.7..40.6V, Vrwm=33V, 18.8A, 1000W(1ms)	DO-214AA	1d	1k	Vs
1CM	SMB8J33CA	TVS	Vbr=36.7..40.6V, Vrwm=33V, 15.0A, 1000W(1ms), Bidirectional	DO-214AA	1ba	1l	Vs
1CN	SMB10J36	TVS	Vbr=40.0..48.9V, Vrwm=36V, 15.6A, 1000W(1ms)	DO-214AA	1d	1k	Vs
1CN	SMB8J36C	TVS	Vbr=40.0..48.9V, Vrwm=36V, 12.4A, 1000W(1ms), Bidirectional	DO-214AA	1ba	1l	Vs
1CP	SMB10J36A	TVS	Vbr=40.0..44.2V, Vrwm=36V, 17.2A, 1000W(1ms)	DO-214AA	1d	1k	Vs
1CP	SMB8J36CA	TVS	Vbr=40.0..44.2V, Vrwm=36V, 13.8A, 1000W(1ms), Bidirectional	DO-214AA	1ba	1l	Vs
1CQ	SMB10J40	TVS	Vbr=44.4..54.3V, Vrwm=40V, 14.0A, 1000W(1ms)	DO-214AA	1d	1k	Vs
1CQ	SMB8J40C	TVS	Vbr=44.4..54.3V, Vrwm=40V, 11.2A, 1000W(1ms), Bidirectional	DO-214AA	1ba	1l	Vs
1CR	SMB10J40A	TVS	Vbr=44.4..49.1V, Vrwm=40V, 15.5A, 1000W(1ms)	DO-214AA	1d	1k	Vs
1CR	SMB8J40CA	TVS	Vbr=44.4..49.1V, Vrwm=40V, 12.4A, 1000W(1ms), Bidirectional	DO-214AA	1ba	1l	Vs
1D	1S358PT	Si-diode	Sw, 90V, 100mA, Vf<1.2V(100mA), 4ns	SOD-323	5d	1a	Chm
1D	FDZ56T	Z-diode	52..60V, Izt=2mA, Zzt=200Q, 200mW	SOD-323	5d	1a	Fis
1D	MA2J113	Si-diode	Fast, Sw, 80V, 200mA, Vf<1.1V(200mA), <10ns	S-Mini	9d	1j	Pan
1D	MM3Z2V7	Z-diode	2.5..2.9V, Izt=5mA, Zzt=110Q, 300mW	SOD-323FL	7d	1a	Lge



SMD code	Type	Function	Short description	Case	Pinout	St.	Mnf.
1D	MM3Z56V	Z-diode	52.60V, Izt=2mA, Zzt=200Ω, 200mW	SOD-323	5d	1a	Sec
1D	MM5Z56V	Z-diode	56V±5%, Izt=2mA, Zzt=200Ω, 200mW	SOD-523	6d	1a,1u	Ons,Wtr
1D	MMPZ5263BPT	Z-diode	53.20.58.80V, Izt=2.2mA, Zzt=150Ω, 225mW	SOD-323	5d	1a	Chm
1D	ZD56V0	Z-diode	52.60V, 2mA, Zzt=200Ω, 200mW	SOD-322	5d	1a	Cys
1E	FDZ62T	Z-diode	58.66V, Izt=2mA, Zzt=215Ω, 200mW	SOD-323	5d	1a	Fis
1E	MM3Z3V0	Z-diode	2.8.3.2V, Izt=5mA, Zzt=120Ω, 300mW	SOD-323FL	7d	1a	Lge
1E	MM3Z62V	Z-diode	58.66V, Izt=2mA, Zzt=215Ω, 200mW	SOD-323	5d	1a	Sec
1E	MM5Z62V	Z-diode	62V±5%, Izt=2mA, Zzt=215Ω, 200mW	SOD-523	6d	1a,1u	Ons,Wtr
1E	MMPZ5265BPT	Z-diode	58.90.65.10V, Izt=2mA, Zzt=185Ω, 225mW	SOD-323	5d	1a	Chm
1E	ZD62V0	Z-diode	58.66V, 2mA, Zzt=215Ω, 200mW	SOD-322	5d	1a	Cys
1E1	MBRM110E	Si-diode	SBR, 10V, 1A, Vf=0.45V(1A)	DO-216AA	4d	1h	Ons
1F	FDZ68T	Z-diode	64.72V, Izt=2mA, Zzt=240Ω, 200mW	SOD-323	5d	1a	Fis
1F	MAZD024	Z-diode	2.28.2.6V, Zzt=100Ω(5mA), 120mW	SSSMini2	7d	1a	Pan
1F	MM3Z3V3	Z-diode	3.1.3.5V, Izt=5mA, Zzt=130Ω, 300mW	SOD-323FL	7d	1a	Lge
1F	MM3Z68V	Z-diode	64.72V, Izt=2mA, Zzt=240Ω, 200mW	SOD-323	5d	1a	Sec
1F	MM5Z68V	Z-diode	68V±5%, Izt=2mA, Zzt=240Ω, 200mW	SOD-523	6d	1a,1u	Ons,Wtr
1F	MMPZ5266BPT	Z-diode	64.60.71.40V, Izt=1.8mA, Zzt=230Ω, 225mW	SOD-323	5d	1a	Chm
1F	ZD68V0	Z-diode	64.72V, 2mA, Zzt=240Ω, 200mW	SOD-322	5d	1a	Cys
1G	FDZ75T	Z-diode	70.79V, Izt=2mA, Zzt=255Ω, 200mW	SOD-323	5d	1a	Fis
1G	MM3Z75V	Z-diode	70.79V, Izt=2mA, Zzt=255Ω, 200mW	SOD-323	5d	1a	Sec
1G	MM5Z75V	Z-diode	75V±5%, Izt=2mA, Zzt=255Ω, 200mW	SOD-523	6d	1a,1u	Ons,Wtr
1G	MMPZ5267BPT	Z-diode	71.25.78.75V, Izt=1.7mA, Zzt=270Ω, 225mW	SOD-323	5d	1a	Chm
1G	ZD75V0	Z-diode	70.79V, 2mA, Zzt=255Ω, 200mW	SOD-322	5d	1a	Cys
1H	MM3Z3V6	Z-diode	3.4.3.8V, Izt=5mA, Zzt=130Ω, 300mW	SOD-323FL	7d	1a	Lge
1J	MM3Z3V9	Z-diode	3.7.4.1V, Izt=5mA, Zzt=130Ω, 300mW	SOD-323FL	7d	1a	Lge
1K	MM3Z4V3	Z-diode	4.0.4.6V, Izt=5mA, Zzt=130Ω, 300mW	SOD-323FL	7d	1a	Lge
1L1	MBRM110	Si-diode	SBR, 10V, 1A, Vf=0.27V(1A)	DO-216AA	4d	1h	Ons
1M	MM3Z4V7	Z-diode	4.4.5.0V, Izt=5mA, Zzt=130Ω, 300mW	SOD-323FL	7d	1a	Lge
1N	MM3Z5V1	Z-diode	4.8.5.4V, Izt=5mA, Zzt=130Ω, 300mW	SOD-323FL	7d	1a	Lge
1P	CMDZ18L	Z-diode	17.10.18.90V, Izt=0.5mA, Zzt=80Ω, 250mW	SOD-323	5d	1a	Cen
1P	MM3Z5V6	Z-diode	5.2.6.0V, Izt=5mA, Zzt=80Ω, 300mW	SOD-323FL	7d	1a	Lge
1R	MM3Z6V2	Z-diode	5.8.6.6V, Izt=5mA, Zzt=50Ω, 300mW	SOD-323FL	7d	1a	Lge
1W	MM3Z56V	Z-diode	52.60V, Izt=2mA, Zzt=200Ω, 200mW	SOD-323	5d	1a	Sec
1X	MM3Z6V8	Z-diode	6.4.7.2V, Izt=5mA, Zzt=30Ω, 300mW	SOD-323FL	7d	1a	Lge
1Y	KDZ11VVY	Z-diode	10.76.11.22V, Izt=5mA, Zzt=15Ω, 100mW	VSC	7d	1a	Kec
1Y	MM3Z7V5	Z-diode	7.0.7.9V, Izt=5mA, Zzt=30Ω, 300mW	SOD-323FL	7d	1a	Lge
1Z	BZT52-B2V7S	Z-diode	2.65.2.75V, Izt=5mA, Zzt=100Ω, 200mW	SOD-323FL	7d	1a	Tsc
1Z	MM3Z2V7B	Z-diode	2.65.2.75V, Zzt=94Ω, Izt=5mA, 200mW	SOD-323FL	7d	1a	F
1Z	MM3Z2V7BW	Z-diode	2.65.2.75V, Izt=5mA, Zzt=100Ω, 200mW	SOD-323FL	7d	1a	Tac
1Z	MM3Z8V2	Z-diode	7.7.8.7V, Izt=5mA, Zzt=30Ω, 300mW	SOD-323FL	7d	1a	Lge
1Z	TCMM3Z2V7B	Z-diode	2.7V±2%, Izt=5mA, Zzt=94Ω, 200mW	SOD-323FL	7d	1a	Tac
2	1SV200	C-diode	VHF-Tuning, 30V, 2.55/3.16pF(25V)	SOD-123	5d	1a	Hit
2	BB182	C-diode	TV-VHF-Tuning, 32V, 20mA, 52.2.48pF(1.28V), 160MHz	SOD-523	6d	1a	Phi
2	CDZ4.3B	Z-diode	4.3V±2.5%, Izt=40mA, 1W	VMN	7d	1s	Rhm
2	CDZ55C2V0	Z-diode	1.90.2.10V, Zzt=85Ω, Izt=5mA, 500mW	1206	70d	2d	Crp
2	CDZ55C2V0S	Z-diode	1.90.2.10V, Zzt=85Ω, Izt=5mA, 500mW	0805	70d	2d	Crp
2	CDZ55C2V0T	Z-diode	1.90.2.10V, Zzt=85Ω, Izt=5mA, 200mW	0603	70d	2d	Crp
2	CH520G-30PT	Si-diode	SBD, 30V, 200mA, Vf<0.6V(200mA)	SOD-723	8d	1a	Chm
2	CTZ55C2V0	Z-diode	1.90.2.10V, Izt=5mA, Zzt=85Ω, 500mW	1206	70d	2d	Ctc
2	GBLC12	TVS	Vbr=12V, 11A, 350W(1ms), 3pF	SOD-323	5d	1a	Prt
2	HVC200A	C-diode	VHF-Tuning, 32V, 2.67/27.7pF(25V..2V/1MHz)	UFP	6d	1b	Ren
2	HVR100	C-diode	AM-Tuning, 15V, 421.28.2pF(1.8V)	SOD-123	5d	1a	Ren
2	MAZS027	Z-diode	2.5.2.9V, 200mW	SOD-523	6d	1a	Pan
2	MMPZ5223SPT	Z-diode	2.646.2.754V, Izt=5mA, Zzt=100Ω, 225mW	SOD-323	5d	1a	Chm
2	MMSZ5244BPT	Z-diode	13.30.14.70V, Izt=5mA, Zzt=25Ω, 225mW	SOD-523	7d	1a	Chm
2	NZ9F13VST	Z-diode	12.91.13.49V, Izt=5mA, Zzt=37Ω, 200mW	SOD-923	7d	2m	Ons
2	NZ9F2V4ST	Z-diode	2.43.2.63V, Izt=5mA, Zzt=100Ω, 200mW	SOD-923	7d	1n	Ons
2	RB500V-40	Si-diode	SBR, 40V, 100mA, Vf<0.45V(10mA)	SOD-323	5d	1a	Rhm
2	SPE0572D72RG	ESDP-diode	Vrwm=5V, Vbr=6.8.5V, 7A, 250W(1ms), Bidirectional	SOD-723	7d	1a	Syn
2 (blue)	BAR64-03W	PIN-diode	Sw, RF-Att, 150V, 100mA, Vf<1.1V(50mA), <0.35pF	SOD-323	5d	2	Inf
2 (white)	BB419	C-diode	VHF-Tuning, 28V, 20mA, Ir<0.02μA, Cv=26/32pF	SOD-123	5d	2	Sie
2 (white)	BB439	C-diode	VHF-Tuning, 28V, 20mA, Ir<0.02μA, Cv=26/32pF	SOD-323	5d	2	Sie
2.2	GDZ2V4B-V	Z-diode	2.43.2.63V, Izt=5mA, Zzt=100Ω, 200mW	SOD-323	5d	1k	Vs
2.2	MMSZ5244SPT	Z-diode	13.72.14.28V, Izt=5mA, Zzt=25Ω, 225mW	SOD-523	7d	1a	Chm
2.0B	HZF2.0BP	Z-diode	2V±5%, 900mW	LRP	1d	2f	Ren
2.0C	HZF2.0CP	Z-diode	2V±10%, 900mW	LRP	1d	2f	Ren
2.2B	HZF2.2BP	Z-diode	2.2V±5%, 900mW	LRP	1d	2f	Ren
2.2C	HZF2.2CP	Z-diode	2.2V±10%, 900mW	LRP	1d	2f	Ren
2.4	MAZ8024	Z-diode	2.28.2.6V, Zzt=100Ω(5mA), 150mW	SC-76	6d	1a	Pan
2.4	MAZ8024G0L	Z-diode	2.28.2.6V, Zzt=100Ω(5mA), 150mW	SMini2-F3	6d	1a	Pan



SMD code	Type	Function	Short description	Case	Pinout	St.	Mnf.
2.4B	HZF2.4BP	Z-diode	2.4V±5%, 900mW	LRP	1d	2f	Ren
2.4C	HZF2.4CP	Z-diode	2.4V±10%, 900mW	LRP	1d	2f	Ren
2.7	MAZ80270H	Z-diode	2.65..2.9V, Zzt=110Q(5mA), 150mW	SC-76	6d	1a	Pan
2.7B	HZF2.7BP	Z-diode	2.7V±5%, 900mW	LRP	1d	2f	Ren
2.7C	HZF2.7CP	Z-diode	2.7V±10%, 900mW	LRP	1d	2f	Ren
2 ^A	MAZS0270H	Z-diode	2.65..2.9V, 200mW	SOD-523	6d	1a	Pan
2 ^A 7	MAZ80270H	Z-diode	2.65..2.9V, Zzt=110Q(5mA), 150mW	SC-76	6d	1a	Pan
2 ^A 7	MAZ8027GHL	Z-diode	2.65..2.9V, Zzt=110Q(5mA), 150mW	SMini2-F3	6d	1a	Pan
2 ₋	MAZS0270L	Z-diode	2.5..2.75V, 200mW	SOD-523	6d	1a	Pan
2 ₋ 7	MAZ80270L	Z-diode	2.5..2.75V, Zzt=110Q(5mA), 150mW	SC-76	6d	1a	Pan
2 ₋ 7	MAZ8027GLL	Z-diode	2.5..2.75V, Zzt=110Q(5mA), 150mW	SMini2-F3	6d	1a	Pan
2-0	HZU2.0B	Z-diode	1.90..2.20V, lzt=5mA, Zzt=100Q, 200mW	URP	5d	1a	Ren
2-0	RKZ2.0BKG	Z-diode	1.90..2.20V, lzt=5mA, Zzt=100Q, 200mW	URP	5d	2e	Ren
2-0	RKZ2.0BKJ	Z-diode	1.90..2.20V, lzt=5mA, Zzt=100Q, 150mW	UFP	7d	2e	Ren
2-2	HZU2.2B	Z-diode	2.10..2.40V, lzt=5mA, Zzt=100Q, 200mW	URP	5d	1a	Ren
2-2	RKZ2.2BKG	Z-diode	2.10..2.40V, lzt=5mA, Zzt=100Q, 200mW	URP	5d	2e	Ren
2-2	RKZ2.2BKJ	Z-diode	2.10..2.40V, lzt=5mA, Zzt=100Q, 150mW	UFP	7d	2e	Ren
2-4	HZU2.4B	Z-diode	2.30..2.60V, lzt=5mA, Zzt=100Q, 200mW	URP	5d	1a	Ren
2-4	RKZ2.4BKG	Z-diode	2.30..2.60V, lzt=5mA, Zzt=100Q, 200mW	URP	5d	2e	Ren
2-4	RKZ2.4BKJ	Z-diode	2.30..2.60V, lzt=5mA, Zzt=100Q, 150mW	UFP	7d	2e	Ren
2 ⁷	HZU2.7B1	Z-diode	2.50..2.75V, lzt=5mA, Zzt=110Q, 200mW	URP	5d	1a	Ren
2 ⁷	HZU2.7B2	Z-diode	2.65..2.90V, lzt=5mA, Zzt=110Q, 200mW	URP	5d	1a	Ren
2 ⁷	RKZ2.7B2KG	Z-diode	2.65..2.90V, lzt=5mA, Zzt=110Q, 200mW	URP	5d	2e	Ren
2 ⁷	RKZ2.7B2KJ	Z-diode	2.65..2.90V, lzt=5mA, Zzt=110Q, 150mW	UFP	7d	2e	Ren
20	BZY55-C20	Z-diode	19.0..21.0V, lzt=5mA, Zzt=55Q, 500mW	0805	70d	2d	Tsc
20	CDZ55C20	Z-diode	19.0..21.0V, Zzt=55Q, lzt=5mA, 500mW	1206	70d	2d	Crp
20	CDZ55C20S	Z-diode	19.0..21.0V, Zzt=55Q, lzt=5mA, 500mW	0805	70d	2d	Crp
20	CDZ55C20T	Z-diode	19.0..21.0V, Zzt=55Q, lzt=5mA, 200mW	0603	70d	2d	Crp
20	CMZ20	Z-diode	20V±5%, 2W	M-Flat	7d	1a	Tos
20	FDZ39T	Z-diode	37..41V, lzt=2mA, Zzt=130Q, 200mW	SOD-323	5d	1a	Fis
20	HZC2.0	Z-diode	2V±10%, 150mW	SOD-523	6d	1a	Ren
20	KDZ20EV	Z-diode	18.8..21.2V, 150mW	SOD-523	6d	1a	Kec
20	KDZ20V	Z-diode	18.8..21.2V, 150mW	SOD-323	5d	1a	Kec
20	KDZ20VV	Z-diode	18.80..21.20V, lzt=5mA, Zzt=25Q, 100mW	VSC	7d	1a	Kec
20	KL3R20	Thy-SPD	V Of-St=185V, Ifsm=30A(1ms), Ih=100mA, Bidirectional	1F	1ba	1l	Shi
20	MAZ5200	Z-diode	18.8..21.2V, Zzt=15Q(5mA), 500mW	MP2	11d	1a	Pan
20	MAZ82000H	Z-diode	20.15..20.19V, Zzt=80Q(5mA), 150mW	SC-76	6d	1a	Pan
20	MAZS200	Z-diode	18.8..21.2V, 200mW	SOD-523	6d	1a	Pan
20	MAZY200	Z-diode	18..22V, Zzt=30Q(10mA), 1W	NMiniP2	1d	1a	Pan
20	MM3Z39V	Z-diode	37..41V, lzt=2mA, Zzt=130Q, 200mW	SOD-323	5d	1a	Sec
20	MM5Z39V	Z-diode	39V±5%, lzt=2mA, Zzt=130Q, 200mW	SOD-523	6d	1a,1u	Ons Wtr
20	MMPZ5259BPT	Z-diode	37.05..40.95V, lzt=5mA, Zzt=130Q, 225mW	SOD-323	5d	1a	Chm
20	P4SMA20	TVS	Vbr=18.0..22.0V, Vvwm=16.2V, 14.0A, 400W(1ms)	DO-214AC	1d	1a	Eic
20	P6SMBJ20	TVS	Vbr=18..22V, 29.1 21A, 600W(1ms)	DO-214AA	1d	1n	Lif
20	SMA3C20	Z-diode	20V±5%, lzt=37mA, Zzt<7Q, 3W	DO-214AC	1d	1a	Exc
20	SML4747	Z-diode	20V±5%, lzt=12.5mA, Zzt=22Q, 1W	DO-214AC	1d	1k	Vs
20	TZD20WS	Z-diode	18.80..21.20V, lzt=5mA, Zzt=25Q, 200mW	SOD-323	5d	1a	Ttr
20	TZD20WT	Z-diode	18.80..21.20V, lzt=5mA, Zzt=25Q, 150mW	SOD-523	6d	1a	Ttr
20	TZD20WU	Z-diode	19.52..20.39V, lzt=2mA, Zzt=85Q, 100mW	SOD-723	7d	1a	Ttr
20	U1Z20	Z-diode	18..22V, 1W	SOD-6	1d	1a	Tos
20	U1ZB20	Z-diode	18..22V, 1W	I-FLAT	1d	1a	Tos
20	ZD39V0	Z-diode	37..41V, 2mA, Zzt=130Q, 200mW	SOD-322	5d	1a	Cys
20-	MAZ82000M	Z-diode	19.5..20.5V, Zzt=80Q(5mA), 150mW	SC-76	6d	1a	Pan
20-	MAZ8200GML	Z-diode	19.5..20.5V, Zzt=80Q(5mA), 150mW	SMini2-F3	6d	1a	Pan
20-	MAZS2000M	Z-diode	19.5..20.5V, 200mW	SOD-523	6d	1a	Pan
20	CTZ55C20	Z-diode	19.0..21.0V, lzt=5mA, Zzt=55Q, 500mW	1206	70d	2d	Ctc
20 ^A	MAZ82000H	Z-diode	20.15..20.19V, Zzt=80Q(5mA), 150mW	SC-76	6d	1a	Pan
20 ^A	MAZ8200GHL	Z-diode	20.15..20.19V, Zzt=80Q(5mA), 150mW	SMini2-F3	6d	1a	Pan
20 ^A	MAZS2000H	Z-diode	20.15..21.19V, 200mW	SOD-523	6d	1a	Pan
20 ₋	MAZ82000L	Z-diode	18.85..19.81V, Zzt=80Q(5mA), 150mW	SC-76	6d	1a	Pan
20 ₋	MAZ8200GLL	Z-diode	18.85..19.81V, Zzt=80Q(5mA), 150mW	SMini2-F3	6d	1a	Pan
20 ₋	MAZS2000L	Z-diode	18.85..19.81V, 200mW	SOD-523	6d	1a	Pan
20 [•]	HZC20	Z-diode	20V±10%, 150mW	SOD-523	6d	1a	Ren
20 [•]	HZU20B1	Z-diode	18.86..19.70V, lzt=5mA, Zzt=50Q, 200mW	URP	5d	1a	Ren
20 [•]	HZU20B2	Z-diode	19.52..20.39V, lzt=5mA, Zzt=50Q, 200mW	URP	5d	1a	Ren
20 [•]	HZU20B3	Z-diode	20.21..21.08V, lzt=5mA, Zzt=50Q, 200mW	URP	5d	1a	Ren
20 [•]	RKZ20B2KG	Z-diode	19.52..20.39V, lzt=5mA, Zzt=50Q, 200mW	URP	5d	2e	Ren
20 [•]	RKZ20B2KJ	Z-diode	19.52..20.39V, lzt=5mA, Zzt=50Q, 150mW	UFP	7d	2e	Ren
20 [•]	TZD20YWS	Z-diode	19.52..20.39V, lzt=5mA, Zzt=25Q, 200mW	SOD-323	5d	1a	Ttr
20 [•]	TZD20YWT	Z-diode	19.52..20.39V, lzt=5mA, Zzt=25Q, 150mW	SOD-523	6d	1a	Ttr



SMD
code

Type

Function

Short description

Case

Pinout

St.

Mnf.

SMD code	Type	Function	Short description	Case	Pinout	St.	Mnf.
200	MAZX200	Z-diode	180..220V, Zzt=60Q(1.5mA), 1W	NMiniP2	1d	1a	Pan
200	P4SMA200	TVS	Vbr=180..220V, Vrw=162V, 1.5A, 400W(1ms)	DO-214AC	1d	1a	Eic
200	P6SMBJ200	TVS	Vbr=180..220V, 2.1A, 600W(1ms)	DO-214AA	1d	1n	Lif
200	U1Z200	Z-diode	180..220V, 1W	SOD-6	1d	1a	Tos
200	U1ZB200	Z-diode	180..220V, 1W	I-FLAT	1d	1a	Tos
2006	1SMB2EZ6.8	Z-diode	6.46..7.14V, Zzt=2Q, Izt=73.5mA, 2W	DO-214AA	1d	1a	Pjt
2006	Z2SMB6.8B	Z-diode	6.46..7.14V, Izt=73.5mA, Zzt=2Q, 2W	DO-214AA	1d	1a	Tr
2007	1SMB2EZ7.5	Z-diode	7.13..7.88V, Zzt=2Q, Izt=66.5mA, 2W	DO-214AA	1d	1a	Pjt
2007	Z2SMB7.5B	Z-diode	7.13..7.88V, Izt=66.5mA, Zzt=2Q, 2W	DO-214AA	1d	1a	Tr
2008	1SMB2EZ8.2	Z-diode	7.79..8.61V, Zzt=2Q, Izt=61mA, 2W	DO-214AA	1d	1a	Pjt
2008	Z2SMB8.2B	Z-diode	7.79..8.61V, Izt=61mA, Zzt=2Q, 2W	DO-214AA	1d	1a	Tr
2009	1SMB2EZ9.1	Z-diode	8.65..9.56V, Zzt=3Q, Izt=55mA, 2W	DO-214AA	1d	1a	Pjt
2009	Z2SMB9.1B	Z-diode	8.65..9.56V, Izt=55mA, Zzt=3Q, 2W	DO-214AA	1d	1a	Tr
200A	1.5SMC200A	TVS	Vbr=190..210V, Vrw=171V, 5.5A, 1500W(1ms)	DO-214AB	1d	1k	Vs
200A	P4SMA200A	TVS	Vbr=190..210V, Vrw=171V, 1.53A, 400W(1ms)	DO-214AC	1d	1k	Vs
200A	P6SMB200A	TVS	Vrw=200V, Vbr=190..210V, 2.2A, 600W(1ms)	DO-214AA	1d,3d	1k,1a	Vs,Ons
200A	P6SMBJ200A	TVS	Vbr=190..210V, 2.2A, 600W(1ms)	DO-214AA	1d	1n	Lif
200B	1SMB3EZ200	Z-diode	200V±5%, Zzt=875Q, Izt=3.7mA, 3W	DO-214AA	1d	1a	Pjt
200C	1.5SMC200CA	TVS	Vbr=190..210V, Vrw=171V, 5.5A, 1500W(1ms), Bidirectional	DO-214AB	1ba	1l	Vs
200C	P4SMA200C	TVS	Vbr=180..220V, Vrw=162V, 1.5A, 400W(1ms), Bidirectional	DO-214AC	1ba	1j	Eic
200C	P4SMA200CA	TVS	Vbr=190..210V, 1.1A, 400W(1ms), Bidirectional	DO-214AC	1ba	1l	Vs
200C	P6SMB200CA	TVS	Vbr=190..210V, 2.2A, 600W(1ms), Bidirectional	DO-214AA	1ba	1l	Vs
200C	P6SMBJ200C	TVS	Vbr=180..220V, 2.1A, 600W(1ms), Bidirectional	DO-214AA	1ba	1p	Lif
200CA	P4SMA200CA	TVS	Vbr=190..210V, Vrw=171V, 1.53A, 400W(1ms), Bidirectional	DO-214AC	1ba	1j	Eic
200CA	P6SMB200CA	TVS	Vbr=190..210V, Vrw=171V, 2.2A, 600W(1ms), Bidirectional	DO-214AA	1ba	1j	Eic
200CA	P6SMBJ200CA	TVS	Vbr=190..210V, 2.2A, 600W(1ms), Bidirectional	DO-214AA	1ba	1p	Lif
200Y	U1ZB200-Y	Z-diode	190..210V, 1W	I-FLAT	1d	1a	Tos
200Z	1SMA200Z	Z-diode	200V±5%, 1W	DO-214AC	1d	1a	Trs
200Z	U1ZB200-Z	Z-diode	200..220V, 1W	I-FLAT	1d	1a	Tos
201	HZU20L-1	Z-diode	18.8..19.7V, 150mW	URP	5d	1a	Ren
2010	1SMB2EZ10	Z-diode	9.5..10.5V, Zzt=4Q, Izt=50mA, 2W	DO-214AA	1d	1a	Pjt
2010	Z2SMB10B	Z-diode	9.50..10.50V, Izt=50mA, Zzt=4Q, 2W	DO-214AA	1d	1a	Tr
2011	1SMB2EZ11	Z-diode	10.45..11.55V, Zzt=4Q, Izt=45.5mA, 2W	DO-214AA	1d	1a	Pjt
2011	Z2SMB11B	Z-diode	10.45..11.55V, Izt=45.5mA, Zzt=4Q, 2W	DO-214AA	1d	1a	Tr
2012	1SMB2EZ12	Z-diode	11.4..12.6V, Zzt=5Q, Izt=41.5mA, 2W	DO-214AA	1d	1a	Pjt
2012	Z2SMB12B	Z-diode	11.40..12.60V, Izt=41.5mA, Zzt=5Q, 2W	DO-214AA	1d	1a	Tr
2013	1SMB2EZ13	Z-diode	12.35..13.65V, Zzt=5Q, Izt=38.5mA, 2W	DO-214AA	1d	1a	Pjt
2013	Z2SMB13B	Z-diode	12.35..13.65V, Izt=38.5mA, Zzt=5Q, 2W	DO-214AA	1d	1a	Tr
2014	1SMB2EZ14	Z-diode	13.3..14.7V, Zzt=6Q, Izt=35.7mA, 2W	DO-214AA	1d	1a	Pjt
2014	Z2SMB14B	Z-diode	13.30..14.70V, Izt=35.7mA, Zzt=6Q, 2W	DO-214AA	1d	1a	Tr
2015	1SMB2EZ15	Z-diode	14.25..15.75V, Zzt=7Q, Izt=33.4mA, 2W	DO-214AA	1d	1a	Pjt
2015	Z2SMB15B	Z-diode	14.25..15.75V, Izt=33.4mA, Zzt=7Q, 2W	DO-214AA	1d	1a	Tr
2016	1SMB2EZ16	Z-diode	15.2..16.8V, Zzt=8Q, Izt=31.2mA, 2W	DO-214AA	1d	1a	Pjt
2016	Z2SMB16B	Z-diode	15.20..16.80V, Izt=31.2mA, Zzt=8Q, 2W	DO-214AA	1d	1a	Tr
2017	1SMB2EZ17	Z-diode	16.15..17V, Zzt=9Q, Izt=29.4mA, 2W	DO-214AA	1d	1a	Pjt
2017	Z2SMB17B	Z-diode	16.15..17.85V, Izt=29.4mA, Zzt=9Q, 2W	DO-214AA	1d	1a	Tr
2018	1SMB2EZ18	Z-diode	17.1..18.9V, Zzt=10Q, Izt=27.8mA, 2W	DO-214AA	1d	1a	Pjt
2018	Z2SMB18B	Z-diode	17.10..18.90V, Izt=27.8mA, Zzt=10Q, 2W	DO-214AA	1d	1a	Tr
2019	1SMB2EZ19	Z-diode	18.05..19.95V, Zzt=11Q, Izt=26.3mA, 2W	DO-214AA	1d	1a	Pjt
2019	Z2SMB19B	Z-diode	18.05..19.95V, Izt=26.3mA, Zzt=11Q, 2W	DO-214AA	1d	1a	Tr
202	HZU20L-2	Z-diode	19.5..20.4V, 150mW	URP	5d	1a	Ren
2020	1SMB2EZ20	Z-diode	19..21V, Zzt=11Q, Izt=25mA, 2W	DO-214AA	1d	1a	Pjt
2020	Z2SMB20B	Z-diode	19.0..21.0V, Izt=25mA, Zzt=11Q, 2W	DO-214AA	1d	1a	Tr
2022	1SMB2EZ22	Z-diode	20.9..23.1V, Zzt=12Q, Izt=22.8mA, 2W	DO-214AA	1d	1a	Pjt
2022	Z2SMB22B	Z-diode	20.90..23.10V, Izt=22.8mA, Zzt=12Q, 2W	DO-214AA	1d	1a	Tr
2024	1SMB2EZ24	Z-diode	22.8..25.2V, Zzt=13Q, Izt=20.8mA, 2W	DO-214AA	1d	1a	Pjt
2024	Z2SMB24B	Z-diode	22.80..25.20V, Izt=20.8mA, Zzt=13Q, 2W	DO-214AA	1d	1a	Tr
2025	1SMB2EZ25	Z-diode	23.75..26.25V, Zzt=14Q, Izt=20mA, 2W	DO-214AA	1d	1a	Pjt
2025	Z2SMB25B	Z-diode	23.75..26.25V, Izt=20mA, Zzt=14Q, 2W	DO-214AA	1d	1a	Tr
2027	1SMB2EZ27	Z-diode	25.65..28.35V, Zzt=18Q, Izt=18.5mA, 2W	DO-214AA	1d	1a	Pjt
2027	Z2SMB27B	Z-diode	25.65..28.35V, Izt=18.5mA, Zzt=18Q, 2W	DO-214AA	1d	1a	Tr
2028	1SMB2EZ28	Z-diode	26.6..29.4V, Zzt=18Q, Izt=17mA, 2W	DO-214AA	1d	1a	Pjt
2028	Z2SMB28B	Z-diode	26.60..29.40V, Izt=17mA, Zzt=18Q, 2W	DO-214AA	1d	1a	Tr
203	HZU20L-3	Z-diode	20.2..21.1V, 150mW	URP	5d	1a	Ren
2030	1SMB2EZ30	Z-diode	28.5..31.5V, Zzt=20Q, Izt=16.6mA, 2W	DO-214AA	1d	1a	Pjt
2030	Z2SMB30B	Z-diode	28.50..31.50V, Izt=16.6mA, Zzt=20Q, 2W	DO-214AA	1d	1a	Tr
2033	1SMB2EZ33	Z-diode	31.35..34.65V, Zzt=23Q, Izt=15.1mA, 2W	DO-214AA	1d	1a	Pjt
2033	Z2SMB33B	Z-diode	31.35..34.65V, Izt=15.1mA, Zzt=23Q, 2W	DO-214AA	1d	1a	Tr
2036	1SMB2EZ36	Z-diode	34.2..37.8V, Zzt=25Q, Izt=13.9mA, 2W	DO-214AA	1d	1a	Pjt
2036	Z2SMB36B	Z-diode	34.20..37.80V, Izt=13.9mA, Zzt=25Q, 2W	DO-214AA	1d	1a	Tr



SMD
code

Type

Function

Short description

Case

Pinout

St.

Mnf.

SMD code	Type	Function	Short description	Case	Pinout	St.	Mnf.
2039	1SMB2EZ39	Z-diode	37.05. 40.95V, Zzt=30Ω, Izt=12.8mA, 2W	DO-214AA	1d	1a	Pjt
2039	Z2SMB39B	Z-diode	37.05. 40.95V, Izt=12.8mA, Zzt=30Ω, 2W	DO-214AA	1d	1a	Tr
2043	1SMB2EZ43	Z-diode	40.85. 45.15V, Zzt=35Ω, Izt=11.6mA, 2W	DO-214AA	1d	1a	Pjt
2043	Z2SMB43B	Z-diode	40.85. 45.15V, Izt=11.6mA, Zzt=35Ω, 2W	DO-214AA	1d	1a	Tr
2047	1SMB2EZ47	Z-diode	44.65. 49.35V, Zzt=40Ω, Izt=10.6mA, 2W	DO-214AA	1d	1a	Pjt
2047	Z2SMB47B	Z-diode	44.65. 49.35V, Izt=10.6mA, Zzt=40Ω, 2W	DO-214AA	1d	1a	Tr
2051	1SMB2EZ51	Z-diode	48.45. 53.55V, Zzt=48Ω, Izt=9.8mA, 2W	DO-214AA	1d	1a	Pjt
2051	Z2SMB51B	Z-diode	48.45. 53.55V, Izt=9.8mA, Zzt=48Ω, 2W	DO-214AA	1d	1a	Tr
2056	1SMB2EZ56	Z-diode	56V±5%, Zzt=55Ω, Izt=9mA, 2W	DO-214AA	1d	1a	Pjt
2058	1SMB2EZ68	Z-diode	68V±5%, Zzt=75Ω, Izt=4.7mA, 2W	DO-214AA	1d	1a	Pjt
2062	1SMB2EZ62	Z-diode	62V±5%, Zzt=60Ω, Izt=8.1mA, 2W	DO-214AA	1d	1a	Pjt
2075	1SMB2EZ75	Z-diode	75V±5%, Zzt=90Ω, Izt=6.7mA, 2W	DO-214AA	1d	1a	Pjt
2091	1SMB2EZ91	Z-diode	91V±5%, Zzt=125Ω, Izt=5.5mA, 2W	DO-214AA	1d	1a	Pjt
20A	1.5SMC20A	TVS	Vbr=19.0. 21.0V, Vrwm=17.1V, 54.2A, 1500W(1ms)	DO-214AB	1d,3d	1a,1k	Vs,Ons
20A	1SMC20A	TVS	Vbr=22.2. 24.5V, Vrwm=20V, 46.3A, 1500W(1ms)	DO-214AB	1d	1a	Eic
20A	P4SMA20A	TVS	Vbr=19.0. 21.0V, Vrwm=17.1V, 15.0A, 400W(1ms)	DO-214AC	1d	1k	Vs
20A	P6SMB20A	TVS	Vrwm=20V, Vbr=19. 21.0V, 21.7A, 600W(1ms)	DO-214AA	1d,3d	1k,1a	Vs,Ons
20A	P6SMBJ20A	TVS	Vbr=19. 21V, 27.7 22A, 600W(1ms)	DO-214AA	1d	1n	Lif
20A	RKZ20AKU	Z-diode	18.05. 18.96V, Izt=10mA, Zzt=50Ω, 500mW	TURP-FM	7d	1a	Ren
20A	SMAJ20A	TVS	Vrwm=20V, Vbr=22.2. 24.5V, 12.3A, 400W(1ms)	DO-214AC	1d	1a	Sus
20A	SMBJ20A	TVS	Vbr=22.2. 24.5V, Vrwm=20V, 18.5A, 600W(1ms)	DO-214AA	1d	1a	Sus
20A	SMCJ20A	TVS	Vrwm=20V, Vbr=22.2. 25.5V, 41.9A, 1500W(1ms)	DO-214AB	1d	1k	Sus
20A	UMA20A	TVS	Vrwm=20V, Vbr=22.2. 32.4V, 15.4A, 500W(1ms)	UltraMite	14d	1v	Msc
20A8	1SMB2EZ8.7	Z-diode	8.27. 9.14V, Zzt=2Ω, Izt=58mA, 2W	DO-214AA	1d	1a	Pjt
20A8	Z2SMB8.7B	Z-diode	8.27. 9.14V, Izt=58mA, Zzt=2Ω, 2W	DO-214AA	1d	1a	Tr
20B	1PMT5920B	Z-diode	6.2V±5%, 241mA, 2.5W	SOD-323	5d	1a	Ons
20B	1SMB3EZ20	Z-diode	20V±5%, Zzt=11Ω, Izt=37.0mA, 3W	DO-214AA	1d	1a	Pjt
20B	HZF20BP	Z-diode	20V±5%, 900mW	LRP	1d	2f	Ren
20B	PTZ20B	Z-diode	20V±10%, 20mA, 1W	DO-214AC	1d	1a	Rhm
20B	RKZ20BKU	Z-diode	18.63. 19.59V, Izt=10mA, Zzt=50Ω, 500mW	TURP-FM	7d	1a	Ren
20B	Z3SMB20B	Z-diode	19.0. 21.0V, Izt=37mA, Zzt=7Ω, 3W	DO-214AA	1d	1a	Tr
20C	1.5SMC20CA	TVS	Vbr=19.0. 21.0V, Vrwm=17.1V, 54.2A, 1500W(1ms), Bidirectional	DO-214AB	1ba	1l	Vs
20C	HZF20CP	Z-diode	20V±10%, 900mW	LRP	1d	2f	Ren
20C	P4SMA20C	TVS	Vbr=18.0. 22.0V, Vrwm=16.2V, 14.0A, 400W(1ms), Bidirectional	DO-214AC	1ba	1j	Eic
20C	P4SMA20CA	TVS	Vbr=19.0. 21V, 14.4A, 400W(1ms), Bidirectional	DO-214AC	1ba	1l	Vs
20C	P6SMB20CA	TVS	Vrwm=20V, Vbr=19. 21.0V, 21.7A, 600W(1ms), Bidirectional	DO-214AA	1ba,3ba	1l,1e	Vs,Ons
20C	P6SMBJ20C	TVS	Vbr=18. 22V, 29.1 21A, 600W(1ms), Bidirectional	DO-214AA	1ba	1p	Lif
20C	RKZ20CKU	Z-diode	19.23. 20.22V, Izt=10mA, Zzt=50Ω, 500mW	TURP-FM	7d	1a	Ren
20CA	1SMC20CA	TVS	Vbr=22.2. 24.5V, Vrwm=20V, 46.3A, 1500W(1ms), Bidirectional	DO-214AB	1ba	1j	Eic
20CA	P4SMA20CA	TVS	Vbr=19.0. 21.0V, Vrwm=17.1V, 15.0A, 400W(1ms), Bidirectional	DO-214AC	1ba	1j	Eic
20CA	P6SMB20CA	TVS	Vbr=19.0. 21.0V, Vrwm=17.1V, 22.0A, 600W(1ms), Bidirectional	DO-214AA	1ba	1j	Eic
20CA	P6SMBJ20CA	TVS	Vbr=19. 21V, 27.7 22A, 600W(1ms), Bidirectional	DO-214AA	1ba	1p	Lif
20CA	SMAJ20CA	TVS	Vrwm=20V, Vbr=22.2. 24.5V, 12.3A, 400W(1ms), Bidirectional	DO-214AC	1ba	1j	Sus
20CA	SMBJ20CA	TVS	Vbr=22.2. 24.5V, Vrwm=20V, 18.5A, 600W(1ms), Bidirectional	DO-214AA	1ba	1j	Sus
20CA	SMCJ20CA	TVS	Vrwm=20V, Vbr=22.2. 25.5V, 41.9A, 1500W(1ms), Bidirectional	DO-214AB	1ba	1l	Sus
20CA	UMA20CA	TVS	Vrwm=20V, Vbr=22.2. 32.4V, 15.4A, 500W(1ms), Bidirectional	UltraMite	14ba	1v	Msc
20D	RKZ20DKU	Z-diode	19.72. 20.72V, Izt=10mA, Zzt=50Ω, 500mW	TURP-FM	7d	1a	Ren
20P	BZD27C20P	Z-diode	19.0. 21.0V, Zzt=15Ω, Izt=25mA, 800mW	SOD-123FL	7d	1a	Pjt
20P	MFPZ20	Z-diode	19.0. 21.0V, Izt=25mA, Zzt=15Ω, 800mW	SOD-123FL	7d	1a	Tr
20V	SMA20	TVS	Vbr=22.2. 27.1V, Vrwm=20.0V, 8.4A, 300W(1ms)	DO-214AC	1d	1a	Mic
20V	SMB20	TVS	Vbr=22.2. 27.1V, Vrwm=20V, 16.8A, 600W(1ms)	DO-214AA	1d	1a	Mic
20V	SMC20	TVS	Vbr=22.2. 27.1V, Vrwm=20V, 41.9A, 1500W(1ms)	DO-214AB	1d	1a	Mic
20VA	SMA20A	TVS	Vbr=22.2. 24.5V, Vrwm=20.0V, 9.3A, 300W(1ms)	DO-214AC	1d	1a	Mic
20VA	SMB20A	TVS	Vbr=22.2. 24.5V, Vrwm=20V, 18.5A, 600W(1ms)	DO-214AA	1d	1a	Mic
20VA	SMC20A	TVS	Vbr=22.2. 24.5V, Vrwm=20V, 46.3A, 1500W(1ms)	DO-214AB	1d	1a	Mic
20VB	BZT52-B20	Z-diode	19.60. 20.40V, Izt=5mA, Zzt=55Ω, 500mW	SOD-123FL	7d	1a	Tsc
20VB	MMSZ20VBW	Z-diode	19.60. 20.40V, Izt=5mA, Zzt=55Ω, 500mW	SOD-123FL	7d	1a	Tac
20VC	SMA20C	TVS	Vbr=22.2. 27.1V, Vrwm=20.0V, 8.4A, 300W(1ms), Bidirectional	DO-214AC	1ba	1j	Mic
20VC	SMB20C	TVS	Vbr=22.2. 27.1V, Vrwm=20V, 16.8A, 600W(1ms), Bidirectional	DO-214AA	1ba	1j	Mic
20VC	SMC20C	TVS	Vbr=22.2. 27.1V, Vrwm=20V, 41.9A, 1500W(1ms), Bidirectional	DO-214AB	1ba	1j	Mic
20VCA	SMA20CA	TVS	Vbr=22.2. 24.5V, Vrwm=20.0V, 9.3A, 300W(1ms), Bidirectional	DO-214AC	1ba	1j	Mic
20VCA	SMB20CA	TVS	Vbr=22.2. 24.5V, Vrwm=20V, 18.5A, 600W(1ms), Bidirectional	DO-214AA	1ba	1j	Mic
20VCA	SMC20CA	TVS	Vbr=22.2. 24.5V, Vrwm=20V, 46.3A, 1500W(1ms), Bidirectional	DO-214AB	1ba	1j	Mic
20VZ	BZT52-C20	Z-diode	19.0. 21.0V, Izt=5mA, Zzt=55Ω, 500mW	SOD-123FL	7d	1a	Tsc
20VZ	MMSZ20VCW	Z-diode	19.0. 21.00V, Izt=5mA, Zzt=55Ω, 500mW	SOD-123FL	7d	1a	Tac
20VZ	TCMMSZ20V	Z-diode	20V±5%, Izt=5mA, Zzt=51Ω, 500mW	SOD-123FL	7d	1a	Tac
20VZ	ZGFM0520C-MH	Z-diode	19.0. 21.0V, Izt=5mA, Zzt=51Ω, 500mW	SOD-123	5d	1a	Pic
21	FDZ43T	Z-diode	40. 46V, Izt=2mA, Zzt=150Ω, 200mW	SOD-323	5d	1a	Fis
21	HMSZ5221B	Z-diode	2.4V±5%, Izt=20mA, Zzt=30Ω, 225mW	SOD-323	5d	1d	Hsn
21	MM3Z43V	Z-diode	40. 46V, Izt=2mA, Zzt=150Ω, 200mW	SOD-323	5d	1a	Sec



SMD
code

Type

Function

Short description

Case

Pinout

St.

Mnf.

SMD code	Type	Function	Short description	Case	Pinout	St.	Mnf.
21	MMSZ43V	Z-diode	43V±5%, Izt=2mA, Zzt=150Ω, 200mW	SOD-523	6d	1a,1u	Ons,Wtr
21	MMPZ5260BPT	Z-diode	40.85..45.15V, Izt=3.0mA, Zzt=93Ω, 225mW	SOD-323	5d	1a	Chm
21	ZD43V0	Z-diode	40..46V, 2mA, Zzt=150Ω, 200mW	SOD-322	5d	1a	Cys
21	ZD5221BS2	Z-diode	2.4V±5%, 20mA, Zzt=30Ω, 500mW	SOD-323	5d	1a	Cys
210	SMD210APT	Si-diode	Rectifier, Schottky, 100V, 2A, Vf<0.8V(2A)	SOD-123S	8d	1a	Chm
210	SS2PH10	Si-diode	SBR, 100V, 2A, Vf<0.8V(2A)	DO-220AA	8d	1k	Vs
2100	1SMB2EZ100	Z-diode	100V±5%, Zzt=175Ω, Izt=5mA, 2W	DO-214AA	1d	1a	Pjt
2110	1SMB2EZ110	Z-diode	110V±5%, Zzt=250Ω, Izt=4.5mA, 2W	DO-214AA	1d	1a	Pjt
2120	1SMB2EZ120	Z-diode	120V±5%, Zzt=325Ω, Izt=4.2mA, 2W	DO-214AA	1d	1a	Pjt
2130	1SMB2EZ130	Z-diode	130V±5%, Zzt=400Ω, Izt=3.8mA, 2W	DO-214AA	1d	1a	Pjt
2140	1SMB2EZ140	Z-diode	140V±5%, Zzt=500Ω, Izt=3.6mA, 2W	DO-214AA	1d	1a	Pjt
2150	1SMB2EZ150	Z-diode	150V±5%, Zzt=575Ω, Izt=3.3mA, 2W	DO-214AA	1d	1a	Pjt
2160	1SMB2EZ160	Z-diode	160V±5%, Zzt=350Ω, Izt=3.1mA, 2W	DO-214AA	1d	1a	Pjt
2170	1SMB2EZ170	Z-diode	170V±5%, Zzt=675Ω, Izt=2.9mA, 2W	DO-214AA	1d	1a	Pjt
2180	1SMB2EZ180	Z-diode	180V±5%, Zzt=725Ω, Izt=2.8mA, 2W	DO-214AA	1d	1a	Pjt
2182	1SMB2EZ82	Z-diode	82V±5%, Zzt=100Ω, Izt=6.1mA, 2W	DO-214AA	1d	1a	Pjt
2190	1SMB2EZ190	Z-diode	190V±5%, Zzt=825Ω, Izt=2.6mA, 2W	DO-214AA	1d	1a	Pjt
21B	1PMT5921B	Z-diode	6.8V±5%, 220mA, 2.5W	SOD-323	5d	1a	Ons
21B	MMHZ5221BPT	Z-diode	2.280..2.520V, Izt=5mA, Zzt=100Ω, 225mW	SOD-123	5d	1a	Chm
21S	MMHZ5221SPT	Z-diode	2.352..2.448V, Izt=5mA, Zzt=100Ω, 225mW	SOD-123	5d	1a	Chm
22	BZY55-C22	Z-diode	20.90..23.10V, Izt=5mA, Zzt=55Ω, 500mW	0805	70d	2d	Tsc
22	CDZ55C22	Z-diode	20.90..23.10V, Zzt=55Ω, Izt=5mA, 500mW	1206	70d	2d	Crp
22	CDZ55C22S	Z-diode	20.90..23.10V, Zzt=55Ω, Izt=5mA, 500mW	0805	70d	2d	Crp
22	CDZ55C22T	Z-diode	20.90..23.10V, Zzt=55Ω, Izt=5mA, 200mW	0603	70d	2d	Crp
22	CMZ22	Z-diode	22V±5%, 2W	M-Flat	7d	1a	Tos
22	FDZ2.4VT	Z-diode	2.430..2.630V, Izt=5mA, Zzt=100Ω, 200mW	SOD-323	5d	1a	Fis
22	HMSZ5222B	Z-diode	2.5V±5%, Izt=20mA, Zzt=30Ω, 225mW	SOD-323	5d	1d	Hsn
22	HZC2.2	Z-diode	2.2V±10%, 150mW	SOD-523	6d	1a	Ren
22	KDZ22EV	Z-diode	20.8..23.3V, 150mW	SOD-523	6d	1a	Kec
22	KDZ22V	Z-diode	20.8..23.3V, 150mW	SOD-323	5d	1a	Kec
22	KDZ22VV	Z-diode	20.80..23.30V, Izt=5mA, Zzt=30Ω, 100mW	VSC	7d	1a	Kec
22	MAZ5220	Z-diode	20.8..23.3V, Zzt=20Ω(5mA), 500mW	MP2	11d	1a	Pan
22	MAZ82200H	Z-diode	22.1..23.24V, Zzt=80Ω(5mA), 150mW	SC-76	6d	1a	Pan
22	MAZS220	Z-diode	20.8..23.3V, 200mW	SOD-523	6d	1a	Pan
22	MAZY220	Z-diode	19.8..24.2V, Zzt=30Ω(10mA), 1W	NMiniP2	1d	1a	Pan
22	MMPZ5251SPT	Z-diode	21.56..22.44V, Izt=5mA, Zzt=55Ω, 225mW	SOD-323	5d	1a	Chm
22	P4SMA22	TVS	Vbr=19.8..24.2V, Vrrwm=17.8V, 13.0A, 400W(1ms)	DO-214AC	1d	1a	Eic
22	P6SMBJ22	TVS	Vbr=19.8..24.2V, 19A, 600W(1ms)	DO-214AA	1d	1n	Lif
22	SMA3C22	Z-diode	22V±5%, Izt=34mA, Zzt<8Ω, 3W	DO-214AC	1d	1a	Exc
22	SML4748	Z-diode	22V±5%, Izt=11.5mA, Zzt=23Ω, 1W	DO-214AC	1d	1k	Vs
22	SS2P2	Si-diode	SBR, 20V, 2A, Vf<0.54V(2A)	DO-220AA	8d	1k	Vs
22	TZD22WS	Z-diode	20.80..23.30V, Izt=5mA, Zzt=30Ω, 200mW	SOD-323	5d	1a	Ttr
22	TZD22WT	Z-diode	20.80..23.30V, Izt=5mA, Zzt=30Ω, 150mW	SOD-523	6d	1a	Ttr
22	TZD22WU	Z-diode	21.54..22.47V, Izt=2mA, Zzt=100Ω, 100mW	SOD-723	7d	1a	Ttr
22	U1Z22	Z-diode	19.8..24.2V, 1W	SOD-6	1d	1a	Tos
22	U1ZB22	Z-diode	19.8..24.2V, 1W	I-FLAT	1d	1a	Tos
22	UDZS2.4B	Z-diode	2.43..2.63V, Izt=5mA, Zzt=100Ω, 200mW	SOD-323	5d	1a	Wtr
22	ZD5222BS2	Z-diode	2.5V±5%, 20mA, Zzt=30Ω, 500mW	SOD-323	5d	1a	Cys
22-	MAZ82200M	Z-diode	21.45..22.55V, Zzt=80Ω(5mA), 150mW	SC-76	6d	1a	Pan
22-	MAZ8220GML	Z-diode	21.45..22.55V, Zzt=80Ω(5mA), 150mW	SMini2-F3	6d	1a	Pan
22-	MAZS2200M	Z-diode	21.45..22.55V, 200mW	SOD-523	6d	1a	Pan
22	CTZ55C22	Z-diode	20.90..23.10V, Izt=5mA, Zzt=55Ω, 500mW	1206	70d	2d	Ctc
22^	MAZ82200H	Z-diode	22.1..23.24V, Zzt=80Ω(5mA), 150mW	SC-76	6d	1a	Pan
22^	MAZ8220GHL	Z-diode	22.1..23.24V, Zzt=80Ω(5mA), 150mW	SMini2-F3	6d	1a	Pan
22^	MAZS2200H	Z-diode	22.1..23.24V, 200mW	SOD-523	6d	1a	Pan
22_	MAZ82200L	Z-diode	20.8..21.86V, Zzt=80Ω(5mA), 150mW	SC-76	6d	1a	Pan
22_	MAZ8220GLL	Z-diode	20.8..21.86V, Zzt=80Ω(5mA), 150mW	SMini2-F3	6d	1a	Pan
22_	MAZS2200L	Z-diode	20.8..21.86V, 200mW	SOD-523	6d	1a	Pan
22■	HZC22	Z-diode	22V±10%, 150mW	SOD-523	6d	1a	Ren
22*	HZU22B1	Z-diode	20.88..21.77V, Izt=5mA, Zzt=55Ω, 200mW	URP	5d	1a	Ren
22°	HZU22B2	Z-diode	21.54..22.47V, Izt=5mA, Zzt=55Ω, 200mW	URP	5d	1a	Ren
22●	HZU22B3	Z-diode	22.23..23.17V, Izt=5mA, Zzt=55Ω, 200mW	URP	5d	1a	Ren
22•	RKZ22B2KG	Z-diode	21.54..22.47V, Izt=5mA, Zzt=55Ω, 200mW	URP	5d	2e	Ren
22•	RKZ22B2KJ	Z-diode	21.54..22.47V, Izt=5mA, Zzt=55Ω, 150mW	URP	7d	2e	Ren
22•	TZD22YWS	Z-diode	21.54..22.47V, Izt=5mA, Zzt=30Ω, 200mW	SOD-323	5d	1a	Ttr
22•	TZD22YWT	Z-diode	21.54..22.47V, Izt=5mA, Zzt=30Ω, 150mW	SOD-523	6d	1a	Ttr
220	MAZX220	Z-diode	198..242V, Zzt=10Ω(0.5mA), 1W	NMiniP2	1d	1a	Pan
220	P4SMA220	TVS	Vbr=198..242V, Vrrwm=175V, 1.16A, 400W(1ms)	DO-214AC	1d	1a	Eic
220	P6SMBJ220	TVS	Vbr=198..242V, 1.8A, 600W(1ms)	DO-214AA	1d	1n	Lif
220	U1Z220	Z-diode	198..242V, 1W	SOD-6	1d	1a	Tos



SMD
code

Type

Function

Short description

Case

Pinout

St.

Mnf.

SMD code	Type	Function	Short description	Case	Pinout	St.	Mnf.
220	U1ZB220	Z-diode	198..242V, 1W	I-FLAT	1d	1a	Tos
2200	1SMBE2200	Z-diode	200V±5%, Zzt=900Ω, Izt=2.5mA, 2W	DO-214AA	1d	1a	Pjt
220A	1.5SMC220A	TVS	Vbr=209..231V, Vrw=185V, 4.6A, 1500W(1ms)	DO-214AB	1d	1k	Vs
220A	P4SMA220A	TVS	Vbr=209..231V, Vrw=185V, 1.22A, 400W(1ms)	DO-214AC	1d	1k	Vs
220A	P6SMB220A	TVS	Vbr=209..231V, Vrw=185V, 1.83A, 600W(1ms)	DO-214AA	1d	1k	Vs
220A	P6SMBJ220A	TVS	Vbr=209..231V, 1.8A, 600W(1ms)	DO-214AA	1d	1n	Lif
220A	TSP220SA	Thy-SPD	V Of-St=220V, 50A(1ms), Bidirectional	DO-214AA	1ba	1j	Pjt
220B	TSP220SB	Thy-SPD	V Of-St=220V, 80A(1ms), Bidirectional	DO-214AA	1ba	1j	Pjt
220C	1.5SMC220CA	TVS	Vbr=209..231V, Vrw=185V, 4.6A, 1500W(1ms), Bidirectional	DO-214AB	1ba	1l	Vs
220C	P4SMA220C	TVS	Vbr=198..242V, Vrw=175V, 1.16A, 400W(1ms), Bidirectional	DO-214AC	1ba	1j	Eic
220C	P4SMA220CA	TVS	Vbr=209..231V, 0.9A, 400W(1ms), Bidirectional	DO-214AC	1ba	1l	Vs
220C	P6SMB220CA	TVS	Vbr=209..231V, 1.8A, 600W(1ms), Bidirectional	DO-214AA	1ba	1l	Vs
220C	P6SMBJ220C	TVS	Vbr=198..242V, 1.8A, 600W(1ms), Bidirectional	DO-214AA	1ba	1p	Lif
220C	TSP220SC	Thy-SPD	V Of-St=220V, 100A(1ms), Bidirectional	DO-214AA	1ba	1j	Pjt
220CA	P4SMA220CA	TVS	Vbr=209..231V, Vrw=185V, 1.22A, 400W(1ms), Bidirectional	DO-214AC	1ba	1j	Eic
220CA	P6SMB220CA	TVS	Vbr=209..231V, Vrw=185V, 1.83A, 600W(1ms), Bidirectional	DO-214AA	1ba	1j	Eic
220CA	P6SMBJ220CA	TVS	Vbr=209..231V, 1.8A, 600W(1ms), Bidirectional	DO-214AA	1ba	1p	Lif
220Y	U1ZB220-Y	Z-diode	210..230V, 1W	I-FLAT	1d	1a	Tos
220Z	U1ZB220-Z	Z-diode	220..240V, 1W	I-FLAT	1d	1a	Tos
221	HZU22L-1	Z-diode	20.9..21.9V, 150mW	URP	5d	1a	Ren
222	HZU22L-2	Z-diode	21.6..22.6V, 150mW	URP	5d	1a	Ren
223	HZU22L-3	Z-diode	22.3..23.3V, 150mW	URP	5d	1a	Ren
229C	MMSZ5229CW	Z-diode	4.214..4.386V, Izt=20mA, Zzt=22Ω, 500mW	SOD-123FL	7d	1a	Tac
22A	1.5SMC22A	TVS	Vbr=20.9..23.1V, Vrw=18.8V, 49.0A, 1500W(1ms)	DO-214AB	1d,3d	1a,1k	Vs,Ons
22A	1SMC22A	TVS	Vbr=24.4..26.9V, Vrw=22V, 42.3A, 1500W(1ms)	DO-214AB	1d	1a	Eic
22A	P4SMA22A	TVS	Vbr=20.9..23.1V, Vrw=18.8V, 14.0A, 400W(1ms)	DO-214AC	1d	1k	Vs
22A	P6SMB22A	TVS	Vbr=20.9..23.1V, Vrw=18.8V, 20.0A, 600W(1ms)	DO-214AA	1d	1k	Vs
22A	P6SMB-22A	TVS	Vbr=22V, 20A, 600W(1ms)	403A	3d	1S	Ons
22A	P6SMBJ22A	TVS	Vbr=20.9..23.1V, 20A, 600W(1ms)	DO-214AA	1d	1n	Lif
22A	RKZ22AKU	Z-diode	20.15..21.20V, Izt=5mA, Zzt=55Ω, 500mW	TURP-FM	7d	1a	Ren
22A	SMAJ22A	TVS	Vrw=22V, Vbr=24.4..26.9V, 11.2A, 400W(1ms)	DO-214AC	1d	1a	Sus
22A	SMBJ22A	TVS	Vbr=24.4..26.9V, Vrw=22V, 16.9A, 600W(1ms)	DO-214AA	1d	1a	Sus
22A	SMCJ22A	TVS	Vrw=22V, Vbr=24.4..28V, 38.1A, 1500W(1ms)	DO-214AB	1d	1k	Sus
22A	UMA22A	TVS	Vrw=22V, Vbr=24.4..35.5V, 14.1A, 500W(1ms)	UltraMite	14d	1v	Msc
22B	1PMT5922B	Z-diode	7.5V±5%, 200mA, 2.5W	SOD-323	5d	1a	Ons
22B	1SMB3E22	Z-diode	22V±5%, Zzt=12Ω, Izt=34.0mA, 3W	DO-214AA	1d	1a	Pjt
22B	HZF22BP	Z-diode	22V±5%, 900mW	LRP	1d	2f	Ren
22B	MMHZ5222BP	Z-diode	2.375..2.625V, Izt=5mA, Zzt=100Ω, 225mW	SOD-123	5d	1a	Chm
22B	PTZ22B	Z-diode	22V±10%, 10mA, 1W	DO-214AC	1d	1a	Rhm
22B	RKZ22BKU	Z-diode	20.64..21.71V, Izt=5mA, Zzt=55Ω, 500mW	TURP-FM	7d	1a	Ren
22B	Z3SMB22B	Z-diode	20.90..23.10V, Izt=34mA, Zzt=8Ω, 3W	DO-214AA	1d	1a	Ttr
22C	1.5SMC22CA	TVS	Vbr=20.9..23.1V, Vrw=18.8V, 49.0A, 1500W(1ms), Bidirectional	DO-214AB	1ba	1l	Vs
22C	F1C2200	TVS	Vbr=160V, 1A, 500W(1ms)	DO-214AC	1d	1a	Org
22C	HZF22CP	Z-diode	22V±10%, 900mW	LRP	1d	2f	Ren
22C	P4SMA22C	TVS	Vbr=19.8..24.2V, Vrw=17.8V, 13.0A, 400W(1ms), Bidirectional	DO-214AC	1ba	1j	Eic
22C	P4SMA22CA	TVS	Vbr=20.9..23.1V, 13.1A, 400W(1ms), Bidirectional	DO-214AC	1ba	1l	Vs
22C	P6SMB22CA	TVS	Vrw=22V, Vbr=20.9..23.1V, 19.6A, 600W(1ms), Bidirectional	DO-214AA	1ba,3ba	1l,1e	Vs,Ons
22C	P6SMBJ22C	TVS	Vbr=19.8..24.2V, 19A, 600W(1ms), Bidirectional	DO-214AA	1ba	1p	Lif
22C	RKZ22CKU	Z-diode	21.08..22.17V, Izt=5mA, Zzt=55Ω, 500mW	TURP-FM	7d	1a	Ren
22CA	1SMC22CA	TVS	Vbr=24.4..26.9V, Vrw=22V, 42.3A, 1500W(1ms), Bidirectional	DO-214AB	1ba	1j	Eic
22CA	P4SMA22CA	TVS	Vbr=20.9..23.1V, Vrw=18.8V, 14.0A, 400W(1ms), Bidirectional	DO-214AC	1ba	1j	Eic
22CA	P6SMB22CA	TVS	Vbr=20.9..23.1V, Vrw=18.8V, 20.0A, 600W(1ms), Bidirectional	DO-214AA	1ba	1j	Eic
22CA	P6SMBJ22CA	TVS	Vbr=20.9..23.1V, 20A, 600W(1ms), Bidirectional	DO-214AA	1ba	1p	Lif
22CA	SMAJ22CA	TVS	Vrw=22V, Vbr=24.4..26.9V, 11.2A, 400W(1ms), Bidirectional	DO-214AC	1ba	1j	Sus
22CA	SMBJ22CA	TVS	Vbr=24.4..26.9V, Vrw=22V, 16.9A, 600W(1ms), Bidirectional	DO-214AA	1ba	1j	Sus
22CA	SMCJ22CA	TVS	Vrw=22V, Vbr=24.4..28V, 38.1A, 1500W(1ms), Bidirectional	DO-214AB	1ba	1l	Sus
22CA	UMA22CA	TVS	Vrw=22V, Vbr=24.4..35.5V, 14.1A, 500W(1ms), Bidirectional	UltraMite	14ba	1v	Msc
22D	F1C2230	TVS	Vbr=180V, 600mA, 500W(1ms)	DO-214AC	1d	1a	Org
22D	RKZ22DKU	Z-diode	21.52..22.63V, Izt=5mA, Zzt=55Ω, 500mW	TURP-FM	7d	1a	Ren
22D	RKZ33DKU	Z-diode	31.49..33.11V, Izt=5mA, Zzt=80Ω, 500mW	TURP-FM	7d	1a	Ren
22F	F1C2250	TVS	Vbr=200V, 600mA, 500W(1ms)	DO-214AC	1d	1a	Org
22G	F1C2260	TVS	Vbr=208V, 600mA, 500W(1ms)	DO-214AC	1d	1a	Org
22H	F1C2270	TVS	Vbr=216V, 500mA, 500W(1ms)	DO-214AC	1d	1a	Org
22I	F1C2280	TVS	Vbr=224V, 500mA, 500W(1ms)	DO-214AC	1d	1a	Org
22J	F1C2290	TVS	Vbr=232V, 500mA, 500W(1ms)	DO-214AC	1d	1a	Org
22LL	SSM22LLPT	Si-diode	Rectifier, Schottky, 20V, 2A, Vf<0.27V(2A)	DO-214AC	1d	1a	Chm
22P	BZD27C22P	Z-diode	20.90..23.10V, Zzt=15Ω, Izt=25mA, 800mW	SOD-123FL	7d	1a	Pjt
22P	MFPZ22	Z-diode	20.90..23.10V, Izt=25mA, Zzt=15Ω, 800mW	SOD-123FL	7d	1a	Ttr
22S	MMHZ5222SP	Z-diode	2.450..2.550V, Izt=5mA, Zzt=100Ω, 225mW	SOD-123	5d	1a	Chm
22S	SS22S	Si-diode	SBR, 20V, 2A, Vf<0.55V(2A)	DO-214AC	1d	1k	Vs



SMD code	Type	Function	Short description	Case	Pinout	St.	Mnf.
22V	SMA22	TVS	Vbr=24.4..29.8V, Vrwmm=22.2V, 7.6A, 300W(1ms)	DO-214AC	1d	1a	Mic
22V	SMB22	TVS	Vbr=24.4..29.8V, Vrwmm=22V, 15.2A, 600W(1ms)	DO-214AA	1d	1a	Mic
22V	SMC22	TVS	Vbr=24.4..29.8V, Vrwmm=22V, 38.1A, 1500W(1ms)	DO-214AB	1d	1a	Mic
22VA	SMA22A	TVS	Vbr=24.4..26.9V, Vrwmm=22.2V, 8.5A, 300W(1ms)	DO-214AC	1d	1a	Mic
22VA	SMB22A	TVS	Vbr=24.4..26.9V, Vrwmm=22V, 16.9A, 600W(1ms)	DO-214AA	1d	1a	Mic
22VA	SMC22A	TVS	Vbr=24.4..26.9V, Vrwmm=22V, 42.3A, 1500W(1ms)	DO-214AB	1d	1a	Mic
22VB	BZT52-B22	Z-diode	21.56..22.44V, Izt=5mA, Zzt=55Ω, 500mW	SOD-123FL	7d	1a	Tsc
22VB	MMSZ22VBW	Z-diode	21.56..22.44V, Izt=5mA, Zzt=55Ω, 500mW	SOD-123FL	7d	1a	Tac
22VC	SMA22C	TVS	Vbr=24.4..29.8V, Vrwmm=22.2V, 7.6A, 300W(1ms), Bidirectional	DO-214AC	1ba	1j	Mic
22VC	SMB22C	TVS	Vbr=24.4..29.8V, Vrwmm=22V, 15.2A, 600W(1ms), Bidirectional	DO-214AA	1ba	1j	Mic
22VC	SMC22C	TVS	Vbr=24.4..29.8V, Vrwmm=22V, 38.1A, 1500W(1ms), Bidirectional	DO-214AB	1ba	1j	Mic
22VCA	SMA22CA	TVS	Vbr=24.4..26.9V, Vrwmm=22.2V, 8.5A, 300W(1ms), Bidirectional	DO-214AC	1ba	1j	Mic
22VCA	SMB22CA	TVS	Vbr=24.4..26.9V, Vrwmm=22V, 16.9A, 600W(1ms), Bidirectional	DO-214AA	1ba	1j	Mic
22VCA	SMC22CA	TVS	Vbr=24.4..26.9V, Vrwmm=22V, 42.3A, 1500W(1ms), Bidirectional	DO-214AB	1ba	1j	Mic
22VZ	BZT52-C22	Z-diode	20.90..23.10V, Izt=5mA, Zzt=55Ω, 500mW	SOD-123FL	7d	1a	Tsc
22VZ	MMSZ22VCW	Z-diode	20.90..23.10V, Izt=5mA, Zzt=55Ω, 500mW	SOD-123FL	7d	1a	Tac
22VZ	TCMMSZ22V	Z-diode	22V±5%, Izt=5mA, Zzt=51Ω, 500mW	SOD-123FL	7d	1a	Tac
22VZ	ZGFM0522C-MH	Z-diode	20.90..23.1V, Izt=5mA, Zzt=51Ω, 500mW	SOD-123	5d	1a	Pic
23	HMSZ523B	Z-diode	2.7V±5%, Izt=20mA, Zzt=30Ω, 225mW	SOD-323	5d	1d	Hsn
23	SS2P3	Si-diode	SBR, 30V, 2A, Vf<0.54V(2A)	DO-220AA	8d	1k	Vs
23	ZD523BS2	Z-diode	2.7V±5%, 20mA, Zzt=30Ω, 500mW	SOD-323	5d	1a	Cys
230C	MMSZ5230CW	Z-diode	4.606..4.794V, Izt=20mA, Zzt=19Ω, 500mW	SOD-123FL	7d	1a	Tac
231C	MMSZ5231CW	Z-diode	4.998..5.202V, Izt=20mA, Zzt=17Ω, 500mW	SOD-123FL	7d	1a	Tac
232C	MMSZ5232CW	Z-diode	5.488..5.712V, Izt=20mA, Zzt=11Ω, 500mW	SOD-123FL	7d	1a	Tac
233C	MMSZ5233CW	Z-diode	5.88..6.12V, Izt=20mA, Zzt=7Ω, 500mW	SOD-123FL	7d	1a	Tac
234C	MMSZ5234CW	Z-diode	6.076..6.324V, Izt=20mA, Zzt=7Ω, 500mW	SOD-123FL	7d	1a	Tac
235C	MMSZ5235CW	Z-diode	6.664..6.936V, Izt=20mA, Zzt=5Ω, 500mW	SOD-123FL	7d	1a	Tac
236C	MMSZ5236CW	Z-diode	7.35..7.65V, Izt=20mA, Zzt=6Ω, 500mW	SOD-123FL	7d	1a	Tac
237C	MMSZ5237CW	Z-diode	8.036..8.364V, Izt=20mA, Zzt=8Ω, 500mW	SOD-123FL	7d	1a	Tac
238C	MMSZ5238CW	Z-diode	8.526..8.874V, Izt=20mA, Zzt=8Ω, 500mW	SOD-123FL	7d	1a	Tac
239C	MMSZ5239CW	Z-diode	8.918..9.282V, Izt=20mA, Zzt=10Ω, 500mW	SOD-123FL	7d	1a	Tac
23A	F1C2300	TVS	Vbr=240V, 500mA, 500W(1ms)	DO-214AC	1d	1a	Org
23B	1PMT5923B	Z-diode	8.2V±5%, 182mA, 2.5W	SOD-323	5d	1a	Ons
23B	F1C2310	TVS	Vbr=248V, 500mA, 500W(1ms)	DO-214AC	1d	1a	Org
23B	MMHZ5223BPT	Z-diode	2.565..2.835V, Izt=5mA, Zzt=100Ω, 225mW	SOD-123	5d	1a	Chm
23C	F1C2320	TVS	Vbr=256V, 500mA, 500W(1ms)	DO-214AC	1d	1a	Org
23D	F1C2330	TVS	Vbr=264V, 500mA, 500W(1ms)	DO-214AC	1d	1a	Org
23L	SSA23L	Si-diode	SBR, 30V, 2A, Vf<0.49V(2A)	DO-214AC	1d	1k	Vs
23S	MMHZ5223SPT	Z-diode	2.646..2.754V, Izt=5mA, Zzt=100Ω, 225mW	SOD-123	5d	1a	Chm
23S	SS23S	Si-diode	SBR, 30V, 2A, Vf<0.55V(2A)	DO-214AC	1d	1k	Vs
24	1SR156-400	Si-diode	Rectifier, 400V, 1A, Vf<1.3V(800mA)	DO-214AC	1d	1k	Rhm
24	BZY55-C24	Z-diode	22.80..25.20V, Izt=5mA, Zzt=80Ω, 500mW	0805	70d	2d	Tsc
24	CDZ55C24	Z-diode	22.80..25.20V, Zzt=80Ω, Izt=5mA, 500mW	1206	70d	2d	Crp
24	CDZ55C24S	Z-diode	22.80..25.20V, Zzt=80Ω, Izt=5mA, 500mW	0805	70d	2d	Crp
24	CDZ55C24T	Z-diode	22.80..25.20V, Zzt=80Ω, Izt=5mA, 200mW	0603	70d	2d	Crp
24	CMZ24	Z-diode	24V±5%, 2W	M-Flat	7d	1a	Tos
24	HMSZ5224B	Z-diode	2.8V±5%, Izt=20mA, Zzt=30Ω, 225mW	SOD-323	5d	1d	Hsn
24	HZC2.4	Z-diode	2.4V±10%, 150mW	SOD-523	6d	1a	Ren
24	KDZ24EV	Z-diode	22.8..25.6V, 150mW	SOD-523	6d	1a	Kec
24	KDZ24V	Z-diode	22.8..25.6V, 150mW	SOD-323	5d	1a	Kec
24	KDZ24VV	Z-diode	22.80..25.60V, Izt=5mA, Zzt=40Ω, 100mW	VSC	7d	1a	Kec
24	MAZ5240	Z-diode	22.8..25.6V, Zzt=25Ω(5mA), 500mW	MP2	11d	1a	Pan
24	MAZ82400H	Z-diode	24.35..25.6V, Zzt=100Ω(5mA), 150mW	SC-76	6d	1a	Pan
24	MAZS240	Z-diode	22.8..25.6V, 200mW	SOD-523	6d	1a	Pan
24	MAZY240	Z-diode	21.6..26.4V, Zzt=30Ω(10mA), 1W	NMiniP2	1d	1a	Pan
24	MMPZ5252SPT	Z-diode	23.52..24.48V, Izt=5mA, Zzt=62Ω, 225mW	SOD-323	5d	1a	Chm
24	P4SMA24	TVS	Vbr=21.6..26.4V, Vrwmm=19.4V, 12.0A, 400W(1ms)	DO-214AC	1d	1a	Eic
24	P6SMBJ24	TVS	Vbr=21.6..26.4V, 17A, 600W(1ms)	DO-214AA	1d	1n	Lif
24	SMA3C24	Z-diode	24V±5%, Izt=31mA, Zzt=9Ω, 3W	DO-214AC	1d	1a	Exc
24	SML4749	Z-diode	24V±5%, Izt=10.5mA, Zzt=25Ω, 1W	DO-214AC	1d	1k	Vs
24	SS2P4	Si-diode	SBR, 40V, 2A, Vf<0.54V(2A)	DO-220AA	8d	1k	Vs
24	TZD24WS	Z-diode	22.80..25.60V, Izt=5mA, Zzt=40Ω, 200mW	SOD-323	5d	1a	Ttr
24	TZD24WT	Z-diode	22.80..25.60V, Izt=5mA, Zzt=40Ω, 150mW	SOD-523	6d	1a	Ttr
24	TZD24WU	Z-diode	23.72..24.78V, Izt=2mA, Zzt=120Ω, 100mW	SOD-723	7d	1a	Ttr
24	U1Z24	Z-diode	21.6..26.4V, 1W	SOD-6	1d	1a	Tos
24	U1ZB24	Z-diode	21.6..26.4V, 1W	I-FLAT	1d	1a	Tos
24-	MAZ82400M	Z-diode	23.5..24.7V, Zzt=100Ω(5mA), 150mW	SC-76	6d	1a	Pan
24-	MAZ8240GML	Z-diode	23.5..24.7V, Zzt=100Ω(5mA), 150mW	SMini2-F3	6d	1a	Pan
24-	MAZS2400M	Z-diode	23.5..24.7V, 200mW	SOD-523	6d	1a	Pan
24	CTZ55C24	Z-diode	22.80..25.20V, Izt=5mA, Zzt=80Ω, 500mW	1206	70d	2d	Ctc



SMD
code

Type

Function

Short description

Case

Pinout

St.

Mnf.

SMD code	Type	Function	Short description	Case	Pinout	St.	Mnf.
24VZ	SD24C	TVS	Vbr=24V, 8A, 350W(1ms), Bidirectional	SOD-323	5ba	1e	Smt
24A	MAZ82400H	Z-diode	24.35 .25.6V, Zzt=100Ω(5mA), 150mW	SC-76	6d	1a	Pan
24A	MAZ8240GHL	Z-diode	24.35 .25.6V, Zzt=100Ω(5mA), 150mW	SMini2-F3	6d	1a	Pan
24A	MAZS2400H	Z-diode	24.35 .25.6V, 200mW	SOD-523	6d	1a	Pan
24_	MAZ82400L	Z-diode	22.8 .23.97V, Zzt=100Ω(5mA), 150mW	SC-76	6d	1a	Pan
24_	MAZ8240GLL	Z-diode	22.8 .23.97V, Zzt=100Ω(5mA), 150mW	SMini2-F3	6d	1a	Pan
24_	MAZS2400L	Z-diode	22.8 .23.97V, 200mW	SOD-523	6d	1a	Pan
24_	HZC24	Z-diode	24V±10%, 150mW	SOD-523	6d	1a	Ren
24°	HZU24B1	Z-diode	22.93 .23.96V, lzt=5mA, Zzt=60Ω, 200mW	URP	5d	1a	Ren
24°	HZU24B2	Z-diode	23.72 .24.78V, lzt=5mA, Zzt=60Ω, 200mW	URP	5d	1a	Ren
24°	HZU24B3	Z-diode	24.54 .25.57V, lzt=5mA, Zzt=60Ω, 200mW	URP	5d	1a	Ren
24+	RKZ24B2KG	Z-diode	23.72 .24.78V, lzt=5mA, Zzt=60Ω, 200mW	URP	5d	2e	Ren
24+	RKZ24B2KJ	Z-diode	23.72 .24.78V, lzt=5mA, Zzt=60Ω, 150mW	UFP	7d	2e	Ren
24+	TZD24YWS	Z-diode	25.60 .24.78V, lzt=5mA, Zzt=40Ω, 200mW	SOD-323	5d	1a	Ttr
24+	TZD24YWT	Z-diode	23.72 .24.78V, lzt=5mA, Zzt=40Ω, 150mW	SOD-523	6d	1a	Ttr
240	MAZX240	Z-diode	216 .264V, Zzt=10Ω(0.5mA), 1W	NMiniP2	1d	1a	Pan
240	U1Z240	Z-diode	216 .264V, 1W	SOD-6	1d	1a	Tos
240	U1ZB240	Z-diode	216 .264V, 1W	I-FLAT	1d	1a	Tos
240C	MMSZ5240CW	Z-diode	9.8 .10.2V, lzt=20mA, Zzt=17Ω, 500mW	SOD-123FL	7d	1a	Tac
240Y	U1ZB240-Y	Z-diode	230 .250V, 1W	I-FLAT	1d	1a	Tos
240Z	U1ZB240-Z	Z-diode	240 .260V, 1W	I-FLAT	1d	1a	Tos
241	HZU24L-1	Z-diode	22.9 .24V, 150mW	URP	5d	1a	Ren
241C	MMSZ5241CW	Z-diode	10.78 .11.22V, lzt=20mA, Zzt=22Ω, 500mW	SOD-123FL	7d	1a	Tac
242	HZU24L-2	Z-diode	23.6 .24.7V, 150mW	URP	5d	1a	Ren
242C	MMSZ5242CW	Z-diode	11.76 .12.24V, lzt=20mA, Zzt=30Ω, 500mW	SOD-123FL	7d	1a	Tac
243	HZU24L-3	Z-diode	24.3 .25.5V, 150mW	URP	5d	1a	Ren
243C	MMSZ5243CW	Z-diode	12.74 .13.26V, lzt=9.5mA, Zzt=13Ω, 500mW	SOD-123FL	7d	1a	Tac
244C	MMSZ5244CW	Z-diode	13.72 .14.28V, lzt=9mA, Zzt=15Ω, 500mW	SOD-123FL	7d	1a	Tac
245C	MMSZ5245CW	Z-diode	14.7 .15.3V, lzt=8.5mA, Zzt=16Ω, 500mW	SOD-123FL	7d	1a	Tac
246C	MMSZ5246CW	Z-diode	15.68 .16.32V, lzt=7.8mA, Zzt=17Ω, 500mW	SOD-123FL	7d	1a	Tac
247C	MMSZ5247CW	Z-diode	16.66 .17.34V, lzt=7.4mA, Zzt=19Ω, 500mW	SOD-123FL	7d	1a	Tac
248C	MMSZ5248CW	Z-diode	17.64 .18.36V, lzt=7mA, Zzt=21Ω, 500mW	SOD-123FL	7d	1a	Tac
249C	MMSZ5249CW	Z-diode	18.62 .19.38V, lzt=6.6mA, Zzt=23Ω, 500mW	SOD-123FL	7d	1a	Tac
24A	1.5SMC24A	TVS	Vbr=22.8 .25.2V, Vrw=20.5V, 45.2A, 1500W(1ms)	DO-214AB	1d,3d	1a,1k	Vs,Ons
24A	1SMC24A	TVS	Vbr=26.7 .29.5V, Vrw=24V, 38.6A, 1500W(1ms)	DO-214AB	1d	1a	Eic
24A	P4SMA24A	TVS	Vbr=22.8 .25.2V, Vrw=20.5V, 13.0A, 400W(1ms)	DO-214AC	1d	1k	Vs
24A	P6SMB24A	TVS	Vrw=24V, Vbr=22.8 .25.2V, 18.1A, 600W(1ms)	DO-214AA	1d,3d	1k,1a	Vs,Ons
24A	P6SMBJ24A	TVS	Vbr=22.8 .25.2V, 18A, 600W(1ms)	DO-214AA	1d	1n	Lif
24A	RKZ24AKU	Z-diode	22.05 .23.18V, lzt=5mA, Zzt=60Ω, 500mW	TURP-FM	7d	1a	Ren
24A	SMAJ24A	TVS	Vrw=24V, Vbr=26.7 .29.5V, 10.3A, 400W(1ms)	DO-214AC	1d	1a	Sus
24A	SMBJ24A	TVS	Vbr=26.7 .29.5V, Vrw=24V, 15.4A, 600W(1ms)	DO-214AA	1d	1a	Sus
24A	SMCJ24A	TVS	Vrw=24V, Vbr=26.7 .30.7V, 34.9A, 1500W(1ms)	DO-214AB	1d	1k	Sus
24A	UMA24A	TVS	Vrw=24V, Vbr=26.7 .38.9V, 12.8A, 500W(1ms)	UltraMite	14d	1v	Msc
24AL	SSM24LAPT	Si-diode	Rectifier, Schottky, 40V, 2A, Vf<0.37V(2A)	SMA-S	8d	1a	Chm
24B	1PMT5924B	Z-diode	9.1V±5%, 164mA, 2.5W	SOD-323	5d	1a	Ons
24B	1SMB3EZ24	Z-diode	24V±5%, Zzt=13Ω, lzt=31.0mA, 3W	DO-214AA	1d	1a	Pjt
24B	HZF24BP	Z-diode	24V±5%, 900mW	LRP	1d	2f	Ren
24B	MMHZ5224BPT	Z-diode	2.660 .2.940V, lzt=5mA, Zzt=100Ω, 225mW	SOD-123	5d	1a	Chm
24B	PTZ24B	Z-diode	24V±10%, 10mA, 1W	DO-214AC	1d	1a	Rhm
24B	RKZ24BKU	Z-diode	22.61 .23.77V, lzt=5mA, Zzt=60Ω, 500mW	TURP-FM	7d	1a	Ren
24B	Z3SMB24B	Z-diode	22.80 .25.20V, lzt=31mA, Zzt=9Ω, 3W	DO-214AA	1d	1a	Ttr
24C	1.5SMC24CA	TVS	Vbr=22.8 .25.2V, Vrw=20.5V, 45.2A, 1500W(1ms), Bidirectional	DO-214AB	1ba	1l	Vs
24C	HZF24CP	Z-diode	24V±10%, 900mW	LRP	1d	2f	Ren
24C	P4SMA24C	TVS	Vbr=21.6 .26.4V, Vrw=19.4V, 12.0A, 400W(1ms), Bidirectional	DO-214AC	1ba	1j	Eic
24C	P4SMA24CA	TVS	Vbr=22.8 .25.2V, 12A, 400W(1ms), Bidirectional	DO-214AC	1ba	1l	Vs
24C	P6SMB24CA	TVS	Vrw=24V, Vbr=22.8 .25.2V, 18.1A, 600W(1ms), Bidirectional	DO-214AA	1ba,3ba	1l,1e	Vs,Ons
24C	P6SMBJ24C	TVS	Vbr=21.6 .26.4V, 17A, 600W(1ms), Bidirectional	DO-214AA	1ba	1p	Lif
24C	RKZ24CKU	Z-diode	23.12 .24.31V, lzt=5mA, Zzt=60Ω, 500mW	TURP-FM	7d	1a	Ren
24CA	1SMC24CA	TVS	Vbr=26.7 .29.5V, Vrw=24V, 38.6A, 1500W(1ms), Bidirectional	DO-214AB	1ba	1j	Eic
24CA	P4SMA24CA	TVS	Vbr=22.8 .25.2V, Vrw=20.5V, 13.0A, 400W(1ms), Bidirectional	DO-214AC	1ba	1j	Eic
24CA	P6SMB24CA	TVS	Vbr=22.8 .25.2V, Vrw=20.5V, 18.0A, 600W(1ms), Bidirectional	DO-214AA	1ba	1j	Eic
24CA	P6SMBJ24CA	TVS	Vbr=22.8 .25.2V, 18A, 600W(1ms), Bidirectional	DO-214AA	1ba	1p	Lif
24CA	SMAJ24CA	TVS	Vrw=24V, Vbr=26.7 .29.5V, 10.3A, 400W(1ms), Bidirectional	DO-214AC	1ba	1j	Sus
24CA	SMBJ24CA	TVS	Vbr=26.7 .29.5V, Vrw=24V, 15.4A, 600W(1ms), Bidirectional	DO-214AA	1ba	1j	Sus
24CA	SMCJ24CA	TVS	Vrw=24V, Vbr=26.7 .30.7V, 34.9A, 1500W(1ms), Bidirectional	DO-214AB	1ba	1l	Sus
24CA	UMA24CA	TVS	Vrw=24V, Vbr=26.7 .38.9V, 12.8A, 500W(1ms), Bidirectional	UltraMite	14ba	1v	Msc
24D	RKZ24DKU	Z-diode	23.63 .24.85V, lzt=5mA, Zzt=60Ω, 500mW	TURP-FM	7d	1a	Ren
24LA	SSM24LAPT	Si-diode	Rectifier, Schottky, 40V, 2A, Vf<0.35V(2A)	DO-214AC	1d	1a	Chm
24P	BZD27C24P	Z-diode	22.80 .25.20V, Zzt=15Ω, lzt=25mA, 800mW	SOD-123FL	7d	1a	Pjt
24P	MFPZ24	Z-diode	22.80 .25.20V, lzt=25mA, Zzt=15Ω, 800mW	SOD-123FL	7d	1a	Ttr



SMD
code

Type

Function

Short description

Case

Pinout

St.

Mnf.

SMD code	Type	Function	Short description	Case	Pinout	St.	Mnf.
24R	SMD24APT	Si-diode	Rectifier, Schottky, 40V, 2A, Vf<0.5V(2A)	SOD-123S	8d	1a	Chm
24S	MHMZ5224SPT	Z-diode	2.774. 2.856V, Izt=5mA, Zzt=100Ω, 225mW	SOD-123	5d	1a	Chm
24S	SS24S	Si-diode	SBR, 40V, 2A, Vf<0.55V(2A)	DO-214AC	1d	1k	Vs
24V	SMA24	TVS	Vbr=26.7..32.6V, Vrrwm=24.0V, 7A, 300W(1ms)	DO-214AC	1d	1a	Mic
24V	SMB24	TVS	Vbr=26.7..32.6V, Vrrwm=24V, 14A, 600W(1ms)	DO-214AA	1d	1a	Mic
24V	SMC24	TVS	Vbr=26.47..32.6V, Vrrwm=24V, 34.9A, 1500W(1ms)	DO-214AB	1d	1a	Mic
24VA	SMA24A	TVS	Vbr=26.7..29.5V, Vrrwm=24.0V, 7.7A, 300W(1ms)	DO-214AC	1d	1a	Mic
24VA	SMB24A	TVS	Vbr=26.7..29.5V, Vrrwm=24V, 15.4A, 600W(1ms)	DO-214AA	1d	1a	Mic
24VA	SMC24A	TVS	Vbr=26.7..29.5V, Vrrwm=24V, 38.6A, 1500W(1ms)	DO-214AB	1d	1a	Mic
24VB	BZT52-B24	Z-diode	23.52..24.48V, Izt=5mA, Zzt=70Ω, 500mW	SOD-123FL	7d	1a	Tsc
24VB	MMSZ24VBW	Z-diode	23.52..24.48V, Izt=5mA, Zzt=70Ω, 500mW	SOD-123FL	7d	1a	Tac
24VC	SMA24C	TVS	Vbr=26.7..32.6V, Vrrwm=24.0V, 7A, 300W(1ms), Bidirectional	DO-214AC	1ba	1j	Mic
24VC	SMB24C	TVS	Vbr=26.7..32.6V, Vrrwm=24V, 14A, 600W(1ms), Bidirectional	DO-214AA	1ba	1j	Mic
24VC	SMC24C	TVS	Vbr=26.47..32.6V, Vrrwm=24V, 34.9A, 1500W(1ms), Bidirectional	DO-214AB	1ba	1j	Mic
24VCA	SMA24CA	TVS	Vbr=26.7..29.5V, Vrrwm=24.0V, 7.7A, 300W(1ms), Bidirectional	DO-214AC	1ba	1j	Mic
24VCA	SMB24CA	TVS	Vbr=26.7..29.5V, Vrrwm=24V, 15.4A, 600W(1ms), Bidirectional	DO-214AA	1ba	1j	Mic
24VCA	SMC24CA	TVS	Vbr=26.7..29.5V, Vrrwm=24V, 38.6A, 1500W(1ms), Bidirectional	DO-214AB	1ba	1j	Mic
24VZ	BZT52-C24	Z-diode	22.80..25.20V, Izt=5mA, Zzt=70Ω, 500mW	SOD-123FL	7d	1a	Tsc
24VZ	MMSZ24VCW	Z-diode	22.80..25.20V, Izt=5mA, Zzt=70Ω, 500mW	SOD-123FL	7d	1a	Tac
24VZ	TCMMSZ24V	Z-diode	24V±5%, Izt=5mA, Zzt=65Ω, 500mW	SOD-123FL	7d	1a	Tac
24VZ	ZGFM0524C-MH	Z-diode	22.80..25.2V, Izt=5mA, Zzt=65Ω, 500mW	SOD-123	5d	1a	Pic
25	BZX584B3V0	Z-diode	2.94..3.06V, Izt=5mA, Zzt=100Ω, 200mW	SOD-523FL	7d	1a	Tac
25	EDZ12B	Z-diode	11.74..12.24V, Izt=5mA, Zzt=30Ω, 150mW	SOD-523	6d	1a	Rhm
25	FDZ12EV	Z-diode	11.740..12.240V, Izt=5mA, Zzt=30Ω, 150mW	SOD-523	7d	1a	Fis
25	FDZ12VT	Z-diode	11.740..12.240V, Izt=5mA, Zzt=30Ω, 200mW	SOD-323	5d	1a	Fis
25	HMSZ5225B	Z-diode	3V±5%, Izt=20mA, Zzt=29Ω, 225mW	SOD-323	5d	1d	Hsn
25	KL3R25	Thy-SPD	V Of-St=220V, Ifsm=30A(1ms), Iht=100mA, Bidirectional	1F	1ba	1l	Shi
25	MMSZ3V0B	Z-diode	2.94..3.06V, Izt=5mA, Zzt=100Ω, 200mW	SOD-523FL	7d	1a	Tac
25	MMPZ5253SPT	Z-diode	24.50..25.50V, Izt=5mA, Zzt=62Ω, 225mW	SOD-323	5d	1a	Chm
25	SS2P5	Si-diode	SBR, 50V, 2A, Vf<0.7V(2A)	DO-220AA	8d	1k	Vs
25	TDZ12B	Z-diode	12V±2.5%, 10mA, 500mW	TUMD2	7d	1s	Rhm
25	UDZS12B	Z-diode	11.74..12.24V, Izt=5mA, Zzt=30Ω, 200mW	SOD-323	5d	1a	Wtr
25	UDZS12B	Z-diode	12V±2.5%, Izt=5mA, 200mW	SOD-323FL	7d	1s	Rhm
25	VDSZ12B	Z-diode	12V±5%, 5mA, 100mW	VMD2	5d	1z	Rhm
25	ZD5225BS2	Z-diode	3.0V±5%, 20mA, Zzt=29Ω, 500mW	SOD-323	5d	1a	Cys
250	P4SMA250	TVS	Vbr=225..275V, Vrrwm=202V, 1.11A, 400W(1ms)	DO-214AC	1d	1a	Eic
250A	1.5SMC250A	TVS	Vbr=237..263V, Vrrwm=214V, 4.4A, 1500W(1ms)	DO-214AB	1d	1k	Vs
250A	P4SMA250A	TVS	Vbr=237..263V, Vrrwm=214V, 1.16A, 400W(1ms)	DO-214AC	1d	1k	Vs
250A	P6SMB150A	TVS	Vbr=150V, 2.9A, 600W(1ms)	403A	3d	1s	Ons
250A	P6SMB250A	TVS	Vbr=237..263V, Vrrwm=214V, 1.75A, 600W(1ms)	DO-214AA	1d	1k	Vs
250C	1.5SMC250CA	TVS	Vrrwm=214.0V, Vbr=237.0..263.0V, 4.4A, 1500W(1ms), Bidirectional	DO-214AB	1ba	1j	Fee
250C	MMSZ5250CW	Z-diode	19.6..20.4V, Izt=6.2mA, Zzt=25Ω, 500mW	SOD-123FL	7d	1a	Tac
250C	P4SMA250C	TVS	Vbr=225..275V, Vrrwm=202V, 1.11A, 400W(1ms), Bidirectional	DO-214AC	1ba	1j	Eic
250CA	P4SMA250CA	TVS	Vbr=237..263V, Vrrwm=214V, 1.16A, 400W(1ms), Bidirectional	DO-214AC	1ba	1j	Eic
250CA	P6SMB250CA	TVS	Vbr=237..263V, Vrrwm=214V, 1.75A, 600W(1ms), Bidirectional	DO-214AA	1ba	1j	Eic
2510	SZ2510	Z-diode	10V±5%, Izt=25mA, Zzt=7.0Ω, 1.3W	DO-214AC	1d	1a	Eic
2511	SZ2511	Z-diode	11V±5%, Izt=20mA, Zzt=8.0Ω, 1.3W	DO-214AC	1d	1a	Eic
2512	SZ2512	Z-diode	12V±5%, Izt=20mA, Zzt=9.0Ω, 1.3W	DO-214AC	1d	1a	Eic
2513	SZ2513	Z-diode	13V±5%, Izt=20mA, Zzt=10Ω, 1.3W	DO-214AC	1d	1a	Eic
2515	SZ2515	Z-diode	15V±5%, Izt=15mA, Zzt=15Ω, 1.3W	DO-214AC	1d	1a	Eic
2516	SZ2516	Z-diode	16V±5%, Izt=15mA, Zzt=15Ω, 1.3W	DO-214AC	1d	1a	Eic
2518	SZ2518	Z-diode	18V±5%, Izt=15mA, Zzt=20Ω, 1.3W	DO-214AC	1d	1a	Eic
251C	MMSZ5251CW	Z-diode	21.56..22.44V, Izt=5.6mA, Zzt=29Ω, 500mW	SOD-123FL	7d	1a	Tac
2520	SZ2520	Z-diode	20V±5%, Izt=10mA, Zzt=24Ω, 1.3W	DO-214AC	1d	1a	Eic
2522	SZ2522	Z-diode	22V±5%, Izt=10mA, Zzt=25Ω, 1.3W	DO-214AC	1d	1a	Eic
2524	SZ2524	Z-diode	24V±5%, Izt=10mA, Zzt=25Ω, 1.3W	DO-214AC	1d	1a	Eic
2527	SZ2527	Z-diode	27V±5%, Izt=8.0mA, Zzt=30Ω, 1.3W	DO-214AC	1d	1a	Eic
252C	MMSZ5252CW	Z-diode	23.52..24.48V, Izt=5.2mA, Zzt=33Ω, 500mW	SOD-123FL	7d	1a	Tac
252H	SZ252H	Z-diode	2.7V±5%, Izt=80mA, Zzt=20 400Ω, 1.3W	DO-214AC	1d	1a	Eic
2530	SZ2530	Z-diode	30V±5%, Izt=8.0mA, Zzt=30Ω, 1.3W	DO-214AC	1d	1a	Eic
2533	SZ2533	Z-diode	33V±5%, Izt=8.0mA, Zzt=35Ω, 1.3W	DO-214AC	1d	1a	Eic
2536	SZ2536	Z-diode	36V±5%, Izt=8.0mA, Zzt=40Ω, 1.3W	DO-214AC	1d	1a	Eic
2539	SZ2539	Z-diode	39V±5%, Izt=6.0mA, Zzt=50Ω, 1.3W	DO-214AC	1d	1a	Eic
253A	SZ253A	Z-diode	3.0V±5%, Izt=80mA, Zzt=20Ω, 1.3W	DO-214AC	1d	1a	Eic
253C	MMSZ5253CW	Z-diode	24.5..25.5V, Izt=5mA, Zzt=35Ω, 500mW	SOD-123FL	7d	1a	Tac
253D	SZ253D	Z-diode	3.3V±5%, Izt=80mA, Zzt=20Ω, 1.3W	DO-214AC	1d	1a	Eic
253G	SZ253G	Z-diode	3.6V±5%, Izt=70mA, Zzt=20Ω, 1.3W	DO-214AC	1d	1a	Eic
253J	SZ253J	Z-diode	3.9V±5%, Izt=60mA, Zzt=15Ω, 1.3W	DO-214AC	1d	1a	Eic
2543	SZ2543	Z-diode	43V±5%, Izt=6.0mA, Zzt=50Ω, 1.3W	DO-214AC	1d	1a	Eic
2547	SZ2547	Z-diode	47V±5%, Izt=4.0mA, Zzt=90Ω, 1.3W	DO-214AC	1d	1a	Eic



SMD code	Type	Function	Short description	Case	Pinout	St.	Mnf.
254C	MMSZ5254CW	Z-diode	26.46..27.54V, Izt=4.6mA, Zzt=41Ω, 500mW	SOD-123FL	7d	1a	Tac
254D	SZ254D	Z-diode	4.3V±5%, Izt=50mA, Zzt=13Ω, 1.3W	DO-214AC	1d	1a	Eic
254H	SZ254H	Z-diode	4.7V±5%, Izt=45mA, Zzt=13Ω, 1.3W	DO-214AC	1d	1a	Eic
2551	SZ2551	Z-diode	51V±5%, Izt=4.0mA, Zzt=115Ω, 1.3W	DO-214AC	1d	1a	Eic
2556	SZ2556	Z-diode	56V±5%, Izt=4.0mA, Zzt=120Ω, 1.3W	DO-214AC	1d	1a	Eic
255B	SZ255B	Z-diode	5.1V±5%, Izt=45mA, Zzt=10Ω, 1.3W	DO-214AC	1d	1a	Eic
255C	MMSZ5255CW	Z-diode	27.44..28.56V, Izt=4.5mA, Zzt=44Ω, 500mW	SOD-123FL	7d	1a	Tac
255G	SZ255G	Z-diode	5.6V±5%, Izt=45mA, Zzt=7.0Ω, 1.3W	DO-214AC	1d	1a	Eic
2562	SZ2562	Z-diode	62V±5%, Izt=4.0mA, Zzt=125Ω, 1.3W	DO-214AC	1d	1a	Eic
2568	SZ2568	Z-diode	68V±5%, Izt=4.0mA, Zzt=130Ω, 1.3W	DO-214AC	1d	1a	Eic
256C	MMSZ5256CW	Z-diode	29.4..30.6V, Izt=4.2mA, Zzt=49Ω, 500mW	SOD-123FL	7d	1a	Tac
256C	SZ256C	Z-diode	6.2V±5%, Izt=35mA, Zzt=4.0Ω, 1.3W	DO-214AC	1d	1a	Eic
256I	SZ256I	Z-diode	6.8V±5%, Izt=35mA, Zzt=3.5Ω, 1.3W	DO-214AC	1d	1a	Eic
2575	SZ2575	Z-diode	75V±5%, Izt=4.0mA, Zzt=135Ω, 1.3W	DO-214AC	1d	1a	Eic
257C	MMSZ5257CW	Z-diode	32.34..33.66V, Izt=3.8mA, Zzt=58Ω, 500mW	SOD-123FL	7d	1a	Tac
257F	SZ257F	Z-diode	7.5V±5%, Izt=35mA, Zzt=3.0Ω, 1.3W	DO-214AC	1d	1a	Eic
2582	SZ2582	Z-diode	82V±5%, Izt=2.7mA, Zzt=200Ω, 1.3W	DO-214AC	1d	1a	Eic
258C	MMSZ5258CW	Z-diode	35.28..36.72V, Izt=3.4mA, Zzt=70Ω, 500mW	SOD-123FL	7d	1a	Tac
258C	SZ258C	Z-diode	8.2V±5%, Izt=25mA, Zzt=5.0Ω, 1.3W	DO-214AC	1d	1a	Eic
2591	SZ2591	Z-diode	91V±5%, Izt=2.7mA, Zzt=250Ω, 1.3W	DO-214AC	1d	1a	Eic
259B	SZ259B	Z-diode	9.1V±5%, Izt=25mA, Zzt=5.0Ω, 1.3W	DO-214AC	1d	1a	Eic
259C	MMSZ5259CW	Z-diode	38.22..39.78V, Izt=3.2mA, Zzt=80Ω, 500mW	SOD-123FL	7d	1a	Tac
25B	1PMT5925B	Z-diode	10V±5%, 150mA, 2.5W	SOD-323	5d	1a	Ons
25B	MMHZ5225BPT	Z-diode	2.850..3.150V, Izt=5mA, Zzt=95Ω, 225mW	SOD-123	5d	1a	Chm
25B	Z3SMB25B	Z-diode	23.75..26.25V, Izt=30mA, Zzt=10Ω, 3W	DO-214AA	1d	1a	Tr
25B0	SZ25B0	Z-diode	100V±5%, Izt=2.7mA, Zzt=350Ω, 1.3W	DO-214AC	1d	1a	Eic
25B1	SZ25B1	Z-diode	110V±5%, Izt=2.7mA, Zzt=450Ω, 1.3W	DO-214AC	1d	1a	Eic
25B2	SZ25B2	Z-diode	120V±5%, Izt=2.0mA, Zzt=550Ω, 1.3W	DO-214AC	1d	1a	Eic
25B3	SZ25B3	Z-diode	130V±5%, Izt=2.0mA, Zzt=700Ω, 1.3W	DO-214AC	1d	1a	Eic
25B5	SZ25B5	Z-diode	150V±5%, Izt=2.0mA, Zzt=1000Ω, 1.3W	DO-214AC	1d	1a	Eic
25B6	SZ25B6	Z-diode	160V±5%, Izt=1.5mA, Zzt=1100Ω, 1.3W	DO-214AC	1d	1a	Eic
25B8	SZ25B8	Z-diode	180V±5%, Izt=1.5mA, Zzt=1200Ω, 1.3W	DO-214AC	1d	1a	Eic
25D0	SZ25D0	Z-diode	200V±5%, Izt=1.5mA, Zzt=1500Ω, 1.3W	DO-214AC	1d	1a	Eic
25P	BZD27C25P	Z-diode	23.75..26.25V, Zzt=15Ω, Izt=25mA, 800mW	SOD-123FL	7d	1a	Pjt
25P	MFPZ25	Z-diode	23.75..26.25V, Izt=25mA, Zzt=15Ω, 800mW	SOD-123FL	7d	1a	Tr
25S	MMHZ5225SPT	Z-diode	2.940..3.060V, Izt=5mA, Zzt=95Ω, 225mW	SOD-123	5d	1a	Chm
25S	SS25S	Si-diode	SBR, 50V, 2A, Vf<0.75V(2A)	DO-214AC	1d	1k	Vs
26	HMSZ5226B	Z-diode	3.3V±5%, Izt=20mA, Zzt=28Ω, 225mW	SOD-323	5d	1d	Hsn
26	SMD26APT	Si-diode	Rectifier, Schottky, 60V, 2A, Vf<0.65V(2A)	SOD-123S	8d	1a	Chm
26	SS2P6	Si-diode	SBR, 60V, 2A, Vf<0.7V(2A)	DO-220AA	8d	1k	Vs
26	ZD5226BS2	Z-diode	3.3V±5%, 20mA, Zzt=28Ω, 500mW	SOD-323	5d	1a	Cys
260C	MMSZ5260CW	Z-diode	42.14..43.86V, Izt=3mA, Zzt=93Ω, 500mW	SOD-123FL	7d	1a	Tac
261C	MMSZ5261CW	Z-diode	46.06..47.94V, Izt=2.7mA, Zzt=105Ω, 500mW	SOD-123FL	7d	1a	Tac
262C	MMSZ5262CW	Z-diode	49.98..52.02V, Izt=2.5mA, Zzt=125Ω, 500mW	SOD-123FL	7d	1a	Tac
263C	MMSZ5263CW	Z-diode	54.88..57.12V, Izt=2.2mA, Zzt=150Ω, 500mW	SOD-123FL	7d	1a	Tac
264C	MMSZ5264CW	Z-diode	58.8..61.2V, Izt=2.1mA, Zzt=170Ω, 500mW	SOD-123FL	7d	1a	Tac
265C	MMSZ5265CW	Z-diode	60.76..63.24V, Izt=2.0mA, Zzt=185Ω, 500mW	SOD-123FL	7d	1a	Tac
266C	MMSZ5266CW	Z-diode	66.64..69.36V, Izt=1.8mA, Zzt=230Ω, 500mW	SOD-123FL	7d	1a	Tac
267C	MMSZ5267CW	Z-diode	73.5..76.5V, Izt=1.7mA, Zzt=270Ω, 500mW	SOD-123FL	7d	1a	Tac
26A	1SMC26A	TVS	Vbr=28.9..31.9V, Vrw=26V, 35.6A, 1500W(1ms)	DO-214AB	1d	1a	Eic
26A	SMAJ26A	TVS	Vrw=26V, Vbr=28.9..31.9V, 9.5A, 400W(1ms)	DO-214AC	1d	1a	Sus
26A	SMBJ26A	TVS	Vbr=28.9..31.9V, Vrw=26V, 14.2A, 600W(1ms)	DO-214AA	1d	1a	Sus
26A	SMCJ26A	TVS	Vrw=26V, Vbr=28.9..33.2V, 32.2A, 1500W(1ms)	DO-214AB	1d	1k	Sus
26A	UMA26A	TVS	Vrw=26V, Vbr=28.9..42.1V, 11.9A, 500W(1ms)	UltraMite	14d	1v	Msc
26B	MMHZ5226BPT	Z-diode	3.135..3.465V, Izt=5mA, Zzt=95Ω, 225mW	SOD-123	5d	1a	Chm
26CA	1SMC26CA	TVS	Vbr=28.9..31.9V, Vrw=26V, 35.6A, 1500W(1ms), Bidirectional	DO-214AB	1ba	1j	Eic
26CA	SMAJ26CA	TVS	Vrw=26V, Vbr=28.9..31.9V, 9.5A, 400W(1ms), Bidirectional	DO-214AC	1ba	1j	Sus
26CA	SMBJ26CA	TVS	Vbr=28.9..31.9V, Vrw=26V, 14.2A, 600W(1ms), Bidirectional	DO-214AA	1ba	1j	Sus
26CA	SMCJ26CA	TVS	Vrw=26V, Vbr=28.9..33.2V, 32.2A, 1500W(1ms), Bidirectional	DO-214AB	1ba	1l	Sus
26CA	UMA26CA	TVS	Vrw=26V, Vbr=28.9..42.1V, 11.9A, 500W(1ms), Bidirectional	UltraMite	14ba	1v	Msc
26S	MMHZ5226SPT	Z-diode	3.234..3.366V, Izt=5mA, Zzt=95Ω, 225mW	SOD-123	5d	1a	Chm
26S	SS26S	Si-diode	SBR, 60V, 2A, Vf<0.75V(2A)	DO-214AC	1d	1k	Vs
26V	SMA26	TVS	Vbr=28.9..35.3V, Vrw=26.0V, 6.4A, 300W(1ms)	DO-214AC	1d	1a	Mic
26V	SMB26	TVS	Vbr=28.9..35.3V, Vrw=26V, 12.9A, 600W(1ms)	DO-214AA	1d	1a	Mic
26V	SMC26	TVS	Vbr=28.9..35.3V, Vrw=26V, 32.2A, 1500W(1ms)	DO-214AB	1d	1a	Mic
26VA	SMA26A	TVS	Vbr=28.9..31.9V, Vrw=26.0V, 7.1A, 300W(1ms)	DO-214AC	1d	1a	Mic
26VA	SMB26A	TVS	Vbr=28.9..31.9V, Vrw=26V, 14.3A, 600W(1ms)	DO-214AA	1d	1a	Mic
26VA	SMC26A	TVS	Vbr=28.9..31.9V, Vrw=26.5 35.6A, 1500W(1ms)	DO-214AB	1d	1a	Mic
26VC	SMA26C	TVS	Vbr=28.9..35.3V, Vrw=26.0V, 6.4A, 300W(1ms), Bidirectional	DO-214AC	1ba	1j	Mic
26VC	SMB26C	TVS	Vbr=28.9..35.3V, Vrw=26V, 12.9A, 600W(1ms), Bidirectional	DO-214AA	1ba	1j	Mic



SMD code	Type	Function	Short description	Case	Pinout	St.	Mnf.
26VC	SMC26C	TVS	Vbr=28.9..35.3V, Vrw=26V, 32.2A, 1500W(1ms), Bidirectional	DO-214AB	1ba	1j	Mic
26VCA	SMA26CA	TVS	Vbr=28.9..31.9V, Vrw=26.0V, 7.1A, 300W(1ms), Bidirectional	DO-214AC	1ba	1j	Mic
26VCA	SMB26CA	TVS	Vbr=28.9..31.9V, Vrw=26V, 14.3A, 600W(1ms), Bidirectional	DO-214AA	1ba	1j	Mic
26VCA	SMC26CA	TVS	Vbr=28.9..31.9V, Vrw=26.5 35.6A, 1500W(1ms), Bidirectional	DO-214AB	1ba	1j	Mic
27	BZY55-C27	Z-diode	25.65..28.35V, Izt=5mA, Zzt=80Ω, 500mW	0805	70d	2d	Tsc
27	CDZ55C27	Z-diode	25.65..28.35V, Zzt=80Ω, Izt=5mA, 500mW	1206	70d	2d	Crp
27	CDZ55C27S	Z-diode	25.65..28.35V, Zzt=80Ω, Izt=5mA, 500mW	0805	70d	2d	Crp
27	CDZ55C27T	Z-diode	25.65..28.35V, Zzt=80Ω, Izt=5mA, 200mW	0603	70d	2d	Crp
27	CMZ27	Z-diode	27V±5%, 2W	M-Flat	7d	1a	Tos
27	HMSZ5227B	Z-diode	3.6V±5%, Izt=20mA, Zzt=24Ω, 225mW	SOD-323	5d	1d	Hsn
27	HZC2.7	Z-diode	2.7V±10%, 150mW	SOD-523	6d	1a	Ren
27	KDZ27VV	Z-diode	25.10..28.90V, Izt=2mA, Zzt=150Ω, 100mW	VSC	7d	1a	Kec
27	MAZ82700H	Z-diode	27.3..28.7V, Zzt=120Ω(2mA), 150mW	SC-76	6d	1a	Pan
27	MAZS270	Z-diode	25.1..28.9V, 200mW	SOD-523	8d	1a	Pan
27	MAZY270	Z-diode	24.3..29.7V, Zzt=30Ω(10mA), 1W	NMiniP2	1d	1a	Pan
27	MMPZ5254SPT	Z-diode	26.46..27.54V, Izt=5mA, Zzt=70Ω, 225mW	SOD-323	5d	1a	Chm
27	P4SMA27	TVS	Vbr=24.3..29.7V, Vrw=21.8V, 11.0A, 400W(1ms)	DO-214AC	1d	1a	Eic
27	P6SMBJ27	TVS	Vbr=24.3..29.7V, 15A, 600W(1ms)	DO-214AA	1d	1n	Lif
27	SMA3C27	Z-diode	27V±5%, Izt=28mA, Zzt<10Ω, 3W	DO-214AC	1d	1a	Exc
27	SML4750	Z-diode	27V±5%, Izt=9.5mA, Zzt=35Ω, 1W	DO-214AC	1d	1k	Vs
27	TZD27WU	Z-diode	26.19..27.53V, Izt=2mA, Zzt=150Ω, 100mW	SOD-723	7d	1a	Ttr
27	U1Z27	Z-diode	24.3..29.7V, 1W	SOD-6	1d	1a	Tos
27	U1ZB27	Z-diode	24.3..29.7V, 1W	I-FLAT	1d	1a	Tos
27	ZD5227BS2	Z-diode	3.6V±5%, 20mA, Zzt=24Ω, 500mW	SOD-323	5d	1a	Cys
27-	MAZ82700M	Z-diode	26.3..27.7V, Zzt=120Ω(2mA), 150mW	SC-76	6d	1a	Pan
27-	MAZ8270GML	Z-diode	26.3..27.7V, Zzt=120Ω(2mA), 150mW	SMini2-F3	6d	1a	Pan
27-	MAZS2700M	Z-diode	26.3..27.7V, 200mW	SOD-523	6d	1a	Pan
27	CTZ55C27	Z-diode	25.65..28.35V, Izt=5mA, Zzt=80Ω, 500mW	1206	70d	2d	Ctc
27^	MAZ82700H	Z-diode	27.3..28.7V, Zzt=120Ω(2mA), 150mW	SC-76	6d	1a	Pan
27^	MAZ8270GHL	Z-diode	27.3..28.7V, Zzt=120Ω(2mA), 150mW	SMini2-F3	6d	1a	Pan
27^	MAZS2700H	Z-diode	27.3..28.7V, 200mW	SOD-523	6d	1a	Pan
27_	MAZ82700L	Z-diode	25.3..26.7V, Zzt=120Ω(2mA), 150mW	SC-76	6d	1a	Pan
27_	MAZ8270GLL	Z-diode	25.3..26.7V, Zzt=120Ω(2mA), 150mW	SMini2-F3	6d	1a	Pan
27_	MAZS2700L	Z-diode	25.3..26.7V, 200mW	SOD-523	6d	1a	Pan
27■	HZC27	Z-diode	27V±10%, 150mW	SOD-523	6d	1a	Ren
27•	HZU27B	Z-diode	25.10..28.90V, Izt=2mA, Zzt=70Ω, 200mW	URP	5d	1a	Ren
27•	RKZ27BKG	Z-diode	25.10..28.90V, Izt=2mA, Zzt=70Ω, 200mW	URP	5d	2e	Ren
27•	RKZ27BKJ	Z-diode	25.10..28.9V, Izt=2mA, Zzt=70Ω, 150mW	UPF	7d	2e	Ren
270	MAZX270	Z-diode	243..297V, Zzt=5Ω(0.5mA), 1W	NMiniP2	1d	1a	Pan
270	U1Z270	Z-diode	243..297V, 1W	SOD-6	1d	1a	Tos
270	U1ZB270	Z-diode	243..297V, 1W	I-FLAT	1d	1a	Tos
270X	U1ZB270-X	Z-diode	250..270V, 1W	I-FLAT	1d	1a	Tos
270Y	U1ZB270-Y	Z-diode	260..280V, 1W	I-FLAT	1d	1a	Tos
270Z	U1ZB270-Z	Z-diode	270..290V, 1W	I-FLAT	1d	1a	Tos
271	HZU27L-1	Z-diode	25.2..26.6V, 150mW	URP	5d	1a	Ren
272	HZU27L-2	Z-diode	26.2..27.6V, 150mW	URP	5d	1a	Ren
273	HZU27L-3	Z-diode	27.2..28.6V, 150mW	URP	5d	1a	Ren
274	P6SMB27A	TVS	Vbr=27V, 16A, 600W(1ms)	403A	3d	1s	Ons
27A	1.5SMC27A	TVS	Vbr=25.7..28.4V, Vrw=23.1V, 40.0A, 1500W(1ms)	DO-214AB	1d,3d	1a,1k	Vs,Ons
27A	P4SMA27A	TVS	Vbr=25.7..28.4V, Vrw=23.1V, 11.2A, 400W(1ms)	DO-214AC	1d	1k	Vs
27A	P6SMB27A	TVS	Vbr=25.7..28.4V, Vrw=23.1V, 16.0A, 600W(1ms)	DO-214AA	1d	1k	Vs
27A	P6SMBJ27A	TVS	Vbr=25.7..28.4V, 16A, 600W(1ms)	DO-214AA	1d	1n	Lif
27A	RKZ27AKU	Z-diode	24.26..25.52V, Izt=5mA, Zzt=70Ω, 500mW	TURP-FM	7d	1a	Ren
27B	1PMT5927B	Z-diode	12V±5%, 125mA, 2.5W	SOD-323	5d	1a	Ons
27B	1SMB3EZ27	Z-diode	27V±5%, Zzt=18Ω, Izt=28.0mA, 3W	DO-214AA	1d	1a	Pjt
27B	HZF27BP	Z-diode	27V±5%, 900mW	LRP	1d	2f	Ren
27B	MMHZ5227BPT	Z-diode	3.420..3.780V, Izt=5mA, Zzt=90Ω, 225mW	SOD-123	5d	1a	Chm
27B	PTZ27B	Z-diode	27V±10%, 10mA, 1W	DO-214AC	1d	1a	Rhm
27B	RKZ27BKU	Z-diode	24.97..26.26V, Izt=5mA, Zzt=70Ω, 500mW	TURP-FM	7d	1a	Ren
27B	Z3SMB27B	Z-diode	25.65..28.35V, Izt=28mA, Zzt=10Ω, 3W	DO-214AA	1d	1a	Ttr
27C	1.5SMC27CA	TVS	Vbr=25.7..28.4V, Vrw=23.1V, 40.0A, 1500W(1ms), Bidirectional	DO-214AB	1ba	1l	Vs
27C	HZF27CP	Z-diode	27V±10%, 900mW	LRP	1d	2f	Ren
27C	P4SMA27C	TVS	Vbr=24.3..29.7V, Vrw=21.8V, 11.0A, 400W(1ms), Bidirectional	DO-214AC	1ba	1j	Eic
27C	P4SMA27CA	TVS	Vbr=25.7..28.4V, 10.7A, 400W(1ms), Bidirectional	DO-214AC	1ba	1l	Vs
27C	P6SMB27CA	TVS	Vrw=27V, Vbr=25.7..28.4V, 16A, 600W(1ms), Bidirectional	DO-214AA	1ba,3ba	11,e	Vs,Ons
27C	P6SMBJ27C	TVS	Vbr=24.3..29.7V, 15A, 600W(1ms), Bidirectional	DO-214AA	1ba	1p	Lif
27C	RKZ27CKU	Z-diode	25.63..26.95V, Izt=5mA, Zzt=70Ω, 500mW	TURP-FM	7d	1a	Ren
27C	U5ZA27C	Z-diode	24..30V, Zzt=30Ω, 5W	DO-218	8d	1a	Tos
27CA	P4SMA27CA	TVS	Vbr=25.7..28.4V, Vrw=23.1V, 11.2A, 400W(1ms), Bidirectional	DO-214AC	1ba	1j	Eic
27CA	P6SMB27CA	TVS	Vbr=25.7..28.4V, Vrw=23.1V, 16.0A, 600W(1ms), Bidirectional	DO-214AA	1ba	1j	Eic



SMD
code

Type

Function

Short description

Case

Pinout

St.

Mnf.

27CA	P6SMBJ27CA	TVS	Vbr=25.7..28.4V, 16A, 600W(1ms), Bidirectional
27D	RKZ27DKU	Z-diode	26.29..27.64V, Izt=5mA, Zzt=70Ω, 500mW
27P	BZD27C27P	Z-diode	25.65..28.35V, Zzt=15Ω, Izt=25mA, 800mW
27P	MFPZ27	Z-diode	25.65..28.35V, Izt=25mA, Zzt=15Ω, 800mW
27S	MMHZ5227SPT	Z-diode	3.528..3.762V, Izt=5mA, Zzt=90Ω, 225mW
27VB	BZT52-B27	Z-diode	26.46..27.54V, Izt=2mA, Zzt=80Ω, 500mW
27VB	MMSZ27VBW	Z-diode	26.46..27.54V, Izt=2mA, Zzt=80Ω, 500mW
27VZ	BZT52-C27	Z-diode	25.65..28.35V, Izt=2mA, Zzt=80Ω, 500mW
27VZ	MMSZ27VCW	Z-diode	25.65..28.35V, Izt=2mA, Zzt=80Ω, 500mW
27VZ	TCMMSZ27V	Z-diode	27V±5%, Izt=5mA, Zzt=75Ω, 500mW
27VZ	ZGFM0527C-MH	Z-diode	25.65..28.35V, Izt=5mA, Zzt=75Ω, 500mW
28	HMSZ5228B	Z-diode	3.9V±5%, Izt=20mA, Zzt=23Ω, 225mW
28	MMPZ5255SPT	Z-diode	27.44..28.56V, Izt=5mA, Zzt=44Ω, 225mW
28	SMA3C28	Z-diode	28V±5%, Izt=27mA, Zzt=12Ω, 3W
28	ZD5228BS2	Z-diode	3.9V±5%, Izt=20mA, Zzt=23Ω, 500mW
28A	1SMC28A	TVS	Vbr=31.1..34.4V, Vrw=28V, 33.0A, 1500W(1ms)
28A	SMAJ28A	TVS	Vrw=28V, Vbr=31.1..34.4V, 8.8A, 400W(1ms)
28A	SMBJ28A	TVS	Vbr=31.1..34.4V, Vrw=28V, 13.2A, 600W(1ms)
28A	SMCJ28A	TVS	Vrw=28V, Vbr=31.1..35.8V, 30A, 1500W(1ms)
28A	UMA28A	TVS	Vrw=28V, Vbr=31.1..45.4V, 11.0A, 500W(1ms)
28B	1SMB3EZ28	Z-diode	28V±5%, Zzt=18Ω, Izt=27.0mA, 3W
28B	MMHZ5228BPT	Z-diode	3.705..4.095V, Izt=5mA, Zzt=90Ω, 225mW
28B	Z3SMB28B	Z-diode	26.60..29.40V, Izt=27mA, Zzt=12Ω, 3W
28C	BZT52C-28WT	Z-diode	26.60..29.40V, Izt=5mA, Zzt=80Ω, 200mW
28CA	1SMC28CA	TVS	Vbr=31.1..34.4V, Vrw=28V, 33.0A, 1500W(1ms), Bidirectional
28CA	SMAJ28CA	TVS	Vrw=28V, Vbr=31.1..34.4V, 8.8A, 400W(1ms), Bidirectional
28CA	SMBJ28CA	TVS	Vbr=31.1..34.4V, Vrw=28V, 13.2A, 600W(1ms), Bidirectional
28CA	SMCJ28CA	TVS	Vrw=28V, Vbr=31.1..35.8V, 30A, 1500W(1ms), Bidirectional
28CA	UMA28CA	TVS	Vrw=28V, Vbr=31.1..45.4V, 11.0A, 500W(1ms), Bidirectional
28P	BZD27C28P	Z-diode	26.60..29.40V, Zzt=15Ω, Izt=25mA, 800mW
28P	MFPZ28	Z-diode	26.60..29.40V, Izt=25mA, Zzt=15Ω, 800mW
28S	MMHZ5228SPT	Z-diode	3.822..3.987V, Izt=5mA, Zzt=90Ω, 225mW
28V	SMA28	TVS	Vbr=31.1..38V, Vrw=28.0V, 6A, 300W(1ms)
28V	SMB28	TVS	Vbr=31.1..38V, Vrw=28V, 12A, 600W(1ms)
28V	SMC28	TVS	Vbr=31.1..38V, Vrw=28V, 30A, 1500W(1ms)
28VA	SMA28A	TVS	Vbr=31.1..34.4V, Vrw=28.0V, 6.6A, 300W(1ms)
28VA	SMB28A	TVS	Vbr=31.1..34.4V, Vrw=28V, 13.2A, 600W(1ms)
28VA	SMC28A	TVS	Vbr=31.1..34.4V, Vrw=28V, 33A, 1500W(1ms)
28VC	SMA28C	TVS	Vbr=31.1..38V, Vrw=28.0V, 6A, 300W(1ms), Bidirectional
28VC	SMB28C	TVS	Vbr=31.1..38V, Vrw=28V, 12A, 600W(1ms), Bidirectional
28VC	SMC28C	TVS	Vbr=31.1..38V, Vrw=28V, 30A, 1500W(1ms), Bidirectional
28VCA	SMA28CA	TVS	Vbr=31.1..34.4V, Vrw=28.0V, 6.6A, 300W(1ms), Bidirectional
28VCA	SMB28CA	TVS	Vbr=31.1..34.4V, Vrw=28V, 13.2A, 600W(1ms), Bidirectional
28VCA	SMC28CA	TVS	Vbr=31.1..34.4V, Vrw=28V, 33A, 1500W(1ms), Bidirectional
29	HMSZ5229B	Z-diode	4.3V±5%, Izt=20mA, Zzt=22Ω, 225mW
29	SS2PH9	Si-diode	SBR, 90V, 2A, Vf<0.8V(2A)
29	ZD5229BS2	Z-diode	4.3V±5%, 20mA, Zzt=22Ω, 500mW
291	MA2P291	Si-diode	Rectifier, 250V, 300mA, Vf<1V(200mA), 5MHz
29B	1PMT5929B	Z-diode	13V±5%, 115mA, 2.5W
29B	MMHZ5229BPT	Z-diode	4.085..4.515V, Izt=5mA, Zzt=88Ω, 225mW
29S	MMHZ5229SPT	Z-diode	4.214..4.386V, Izt=5mA, Zzt=88Ω, 225mW
2A	HZU2ALL	Z-diode	1.6..2.0V, Izt=0.5mA, Zzt=350Ω, 150mW
2A	MM3Z9V1	Z-diode	8.5..9.6V, Izt=5mA, Zzt=30Ω, 300mW
2A	TZD2.0WS	Z-diode	1.85..2.15V, Izt=5mA, Zzt=100Ω, 200mW
2A	TZD2.0WT	Z-diode	1.85..2.15V, Izt=5mA, Zzt=100Ω, 150mW
2A*	TZD2.0YWS	Z-diode	1.95..2.15V, Izt=5mA, Zzt=100Ω, 200mW
2A*	TZD2.0YWT	Z-diode	1.95..2.15V, Izt=5mA, Zzt=100Ω, 150mW
2A4	RKZ2.4AKU	Z-diode	2.33..2.52V, Izt=20mA, Zzt=100Ω, 500mW
2A7	RKZ2.7AKU	Z-diode	2.54..2.75V, Izt=20mA, Zzt=110Ω, 500mW
2B	CDZ55C2V2T	Z-diode	2.09..2.31V, Zzt=85Ω, Izt=5mA, 200mW
2B	HZU2BLL	Z-diode	1.9..2.3V, Izt=0.5mA, Zzt=350Ω, 150mW
2B	KDZ2.2EV	Z-diode	2.05..2.38V, Izt=5mA, Zzt=100Ω, 150mW
2B	KDZ2.2V	Z-diode	2.05..2.38V, Izt=5mA, Zzt=100Ω, 150mW
2B	MM3Z10	Z-diode	9.4..10.6V, Izt=5mA, Zzt=30Ω, 300mW
2B	MM3Z10V	Z-diode	9.4..10.6V, Izt=5mA, Zzt=20Ω, 200mW
2B	SA2B	Si-diode	Rectifier, 100V, 2A, Vf<1.1V(2A)
2B	TZD2.2WS	Z-diode	2.05..2.38V, Izt=5mA, Zzt=100Ω, 200mW
2B	TZD2.2WT	Z-diode	2.05..2.38V, Izt=5mA, Zzt=100Ω, 150mW
2B*	TZD2.2YWS	Z-diode	2.16..2.38V, Izt=5mA, Zzt=100Ω, 200mW
2B*	TZD2.2YWT	Z-diode	2.16..2.38V, Izt=5mA, Zzt=100Ω, 150mW



SMD code	Type	Function	Short description	Case	Pinout	St.	Mnf.
2B4	RKZ2.4BKU	Z-diode	2.43..2.63V, Izt=20mA, Zzt=100Ω, 500mW	TURP-FM	7d	1a	Ren
2B7	RKZ2.7BKU	Z-diode	2.69..2.91V, Izt=20mA, Zzt=110Ω, 500mW	TURP-FM	7d	1a	Ren
2BL4	MBRS240	Si-diode	SBR, 40V, 2A, Vf=0.5V(4A)	403A-03	3d	1s	Ons
2C	GBLC12C	TVS	Vbr=12V, 11A, 350W(1ms), 3pF, Bidirectional	SOD-323	5ba	1e	Prt
2C	HZU2CLL	Z-diode	2.2..2.6V, Izt=0.5mA, Zzt=350Ω, 150mW	URP	5d	1a	Ren
2C	KDZ2.4EV	Z-diode	2.28..2.6V, 150mW	SOD-523	6d	1a	Kec
2C	KDZ2.4V	Z-diode	2.28..2.6V, 150mW	SOD-323	5d	1a	Kec
2C	MM3Z11	Z-diode	10.4..11.6V, Izt=5mA, Zzt=30Ω, 300mW	SOD-323FL	7d	1a	Lge
2C	MM3Z11V	Z-diode	10.4..11.6V, Izt=5mA, Zzt=20Ω, 200mW	SOD-323FL	7d	1a	Eic
2C	TZD2.4WS	Z-diode	2.28..2.60V, Izt=5mA, Zzt=100Ω, 200mW	SOD-323	5d	1a	Ttr
2C	TZD2.4WT	Z-diode	2.28..2.60V, Izt=5mA, Zzt=100Ω, 150mW	SOD-523	6d	1a	Ttr
2C	USCD032	Si-diode	SBR, 20V, 0.3A, Vf<0.5V(0.3A)	0603	14d	1v	Zow
2C*	TZD2.4YWS	Z-diode	2.40..2.60V, Izt=5mA, Zzt=100Ω, 200mW	SOD-323	5d	1a	Ttr
2C*	TZD2.4YWT	Z-diode	2.40..2.60V, Izt=5mA, Zzt=100Ω, 150mW	SOD-523	6d	1a	Ttr
2D	CDZ55C2V4T	Z-diode	2.28..2.52V, Zzt=85Ω, Izt=5mA, 200mW	0603	70d	2d	Crp
2D	KDZ2.7EV	Z-diode	2.5..2.9V, 150mW	SOD-523	6d	1a	Kec
2D	KDZ2.7V	Z-diode	2.5..2.9V, 150mW	SOD-323	5d	1a	Kec
2D	MM3Z12	Z-diode	11.4..12.7V, Izt=5mA, Zzt=35Ω, 300mW	SOD-323FL	7d	1a	Lge
2D	MM3Z12V	Z-diode	11.4..12.7V, Izt=5mA, Zzt=25Ω, 200mW	SOD-323FL	7d	1a	Eic
2D	SA2D	Si-diode	Rectifier, 200V, 2A, Vf<1.1V(2A)	DO-214AC	1d	1k	Vs
2D	TZD2.7WS	Z-diode	2.50..2.90V, Izt=5mA, Zzt=110Ω, 200mW	SOD-323	5d	1a	Ttr
2D	TZD2.7WT	Z-diode	2.50..2.90V, Izt=5mA, Zzt=110Ω, 150mW	SOD-523	6d	1a	Ttr
2D	USCD022	Si-diode	SBR, 20V, 0.2A, Vf<0.45V(0.2A)	0603	14d	1v	Zow
2D*	TZD2.7YWS	Z-diode	2.65..2.90V, Izt=5mA, Zzt=110Ω, 200mW	SOD-323	5d	1a	Ttr
2D*	TZD2.7YWT	Z-diode	2.65..2.90V, Izt=5mA, Zzt=110Ω, 150mW	SOD-523	6d	1a	Ttr
2E	MM3Z13	Z-diode	12.4..14.1V, Izt=5mA, Zzt=35Ω, 300mW	SOD-323FL	7d	1a	Lge
2E	MM3Z13V	Z-diode	12.4..14.1V, Izt=5mA, Zzt=30Ω, 200mW	SOD-323FL	7d	1a	Eic
2F	KDZ3.6FV	Z-diode	3.40..3.80V, Izt=5mA, Zzt=130Ω, 100mW	TFSC	7d	1a	Kec
2F	MAZD027	Z-diode	2.5..2.9V, Zzt=110Ω(5mA), 120mW	SSSMini2	7d	1a	Pan
2F	MM3Z15	Z-diode	13.8..15.8V, Izt=5mA, Zzt=40Ω, 300mW	SOD-323FL	7d	1a	Lge
2F	MM3Z15V	Z-diode	14.3..15.8V, Izt=5mA, Zzt=30Ω, 200mW	SOD-323FL	7d	1a	Eic
2F	USCD012	Si-diode	SBR, 20V, 0.1A, Vf<0.4V(0.1A)	0603	14d	1v	Zow
2FS4	D2FS4	Si-diode	SBR, 40V, 1.6A, Vf<0.55V(1.6A)	F2	1d	1a	Shi
2FS6	D2FS6	Si-diode	SBR, 60V, 1.5A, Vf<0.58V(1.5A)	F2	1d	1a	Shi
2G	CDZ55C2V7T	Z-diode	2.57..2.84V, Zzt=85Ω, Izt=5mA, 200mW	0603	70d	2d	Crp
2G	SA2G	Si-diode	Rectifier, 400V, 2A, Vf<1.1V(2A)	DO-214AC	1d	1k	Vs
2H	MM3Z16	Z-diode	15.3..17.1V, Izt=5mA, Zzt=40Ω, 300mW	SOD-323FL	7d	1a	Lge
2H	MM3Z16V	Z-diode	15.3..17.1V, Izt=5mA, Zzt=40Ω, 200mW	SOD-323FL	7d	1a	Eic
2J	MM3Z18	Z-diode	16.8..19.1V, Izt=5mA, Zzt=45Ω, 300mW	SOD-323FL	7d	1a	Lge
2J	MM3Z18V	Z-diode	16.8..19.1V, Izt=5mA, Zzt=45Ω, 200mW	SOD-323FL	7d	1a	Eic
2J	SA2J	Si-diode	Rectifier, 600V, 2A, Vf<1.1V(2A)	DO-214AC	1d	1k	Vs
2K	DDZ22D	Z-diode	22V±10%, Izt=5mA, 500mW	SOD-123	5d	1d	Di
2K	DDZ22DS	Z-diode	22V±10%, Izt=5mA, 200mW	SOD-323	5d	1d	Di
2K	MM3Z20	Z-diode	18.8..21.2V, Izt=5mA, Zzt=50Ω, 300mW	SOD-323FL	7d	1a	Lge
2K	MM3Z20V	Z-diode	18.8..21.2V, Izt=5mA, Zzt=55Ω, 200mW	SOD-323FL	7d	1a	Eic
2K	SA2K	Si-diode	Rectifier, 800V, 2A, Vf<1.1V(2A)	DO-214AC	1d	1k	Vs
2M	DDZ27D	Z-diode	27V±10%, Izt=5mA, 500mW	SOD-123	5d	1d	Di
2M	DDZ27DS	Z-diode	27V±10%, Izt=5mA, 200mW	SOD-323	5d	1d	Di
2M	MM3Z22	Z-diode	20.8..23.3V, Izt=5mA, Zzt=55Ω, 300mW	SOD-323FL	7d	1a	Lge
2M	MM3Z22V	Z-diode	20.8..23.3V, Izt=5mA, Zzt=55Ω, 200mW	SOD-323FL	7d	1a	Eic
2M	SA2M	Si-diode	Rectifier, 1000V, 2A, Vf<1.1V(2A)	DO-214AC	1d	1k	Vs
2N	DDZ30D	Z-diode	30V±10%, Izt=5mA, 500mW	SOD-123	5d	1d	Di
2N	DDZ30DS	Z-diode	30V±10%, Izt=5mA, 200mW	SOD-323	5d	1d	Di
2N	MM3Z24	Z-diode	22.8..25.6V, Izt=5mA, Zzt=60Ω, 300mW	SOD-323FL	7d	1a	Lge
2N	MM3Z24V	Z-diode	22.8..25.6V, Izt=5mA, Zzt=70Ω, 200mW	SOD-323FL	7d	1a	Eic
2P	CMDZ20L	Z-diode	19.0..21.0V, Izt=0.5mA, Zzt=100Ω, 250mW	SOD-323	5d	1a	Cen
2P	KDZ3.6FVY	Z-diode	3.60..3.84V, Izt=5mA, Zzt=130Ω, 100mW	TFSC	7d	1a	Kec
2P	MM3Z27	Z-diode	25.1..28.9V, Izt=5mA, Zzt=70Ω, 300mW	SOD-323FL	7d	1a	Lge
2P	MM3Z27V	Z-diode	25.1..28.9V, Izt=2mA, Zzt=80Ω, 200mW	SOD-323FL	7d	1a	Eic
2R	MM3Z30	Z-diode	28..32V, Izt=5mA, Zzt=80Ω, 300mW	SOD-323FL	7d	1a	Lge
2R	MM3Z30V	Z-diode	28..32V, Izt=2mA, Zzt=80Ω, 200mW	SOD-323FL	7d	1a	Eic
2V2	CDZ55C2V2	Z-diode	2.09..2.31V, Zzt=85Ω, Izt=5mA, 500mW	1206	70d	2d	Crp
2V2	CDZ55C2V2S	Z-diode	2.09..2.31V, Zzt=85Ω, Izt=5mA, 500mW	0805	70d	2d	Crp
2V2	CTZ55C2V2	Z-diode	2.09..2.31V, Izt=5mA, Zzt=85Ω, 500mW	1206	70d	2d	Ctc
2V4	BZY55-C2V4	Z-diode	2.28..2.52V, Izt=5mA, Zzt=85Ω, 500mW	0805	70d	2d	Tsc
2V4	CDZ55C2V4	Z-diode	2.28..2.52V, Zzt=85Ω, Izt=5mA, 500mW	1206	70d	2d	Crp
2V4	CDZ55C2V4S	Z-diode	2.28..2.52V, Zzt=85Ω, Izt=5mA, 500mW	0805	70d	2d	Crp
2V4	CTZ55C2V4	Z-diode	2.28..2.52V, Izt=5mA, Zzt=85Ω, 500mW	1206	70d	2d	Ctc
2V4B	BZT52-B2V4	Z-diode	2.35..2.45V, Izt=5mA, Zzt=100Ω, 500mW	SOD-123FL	7d	1a	Tsc
2V4B	MMSZ2V4BW	Z-diode	2.35..2.45V, Izt=5mA, Zzt=100Ω, 500mW	SOD-123FL	7d	1a	Tac



SMD code	Type	Function	Short description	Case	Pinout	St.	Mnf.
2V4Z	BZT52-C2V4	Z-diode	2.28..2.52V, Izt=5mA, Zzt=100Ω, 500mW	SOD-123FL	7d	1a	Tsc
2V4Z	MMSZ2V4CW	Z-diode	2.28..2.52V, Izt=5mA, Zzt=100Ω, 500mW	SOD-123FL	7d	1a	Tac
2V4Z	TCMMSZ2V4	Z-diode	2.4V±5%, Izt=5mA, Zzt=94Ω, 500mW	SOD-123FL	7d	1a	Tac
2V4Z	ZGFM052V4C-MH	Z-diode	2.28..2.52V, Izt=5mA, Zzt=94Ω, 500mW	SOD-123	5d	1a	Pic
2V7	BZY55-C2V7	Z-diode	2.57..2.84V, Izt=5mA, Zzt=85Ω, 500mW	0805	70d	2d	Tsc
2V7	CDZ55C2V7	Z-diode	2.57..2.84V, Zzt=85Ω, Izt=5mA, 500mW	1206	70d	2d	Crp
2V7	CDZ55C2V7S	Z-diode	2.57..2.84V, Zzt=85Ω, Izt=5mA, 500mW	0805	70d	2d	Crp
2V7	CTZ55C2V7	Z-diode	2.57..2.84V, Izt=5mA, Zzt=85Ω, 500mW	1206	70d	2d	Ctc
2V7B	BZT52-B2V7	Z-diode	2.65..2.75V, Izt=5mA, Zzt=100Ω, 500mW	SOD-123FL	7d	1a	Tsc
2V7B	MMSZ2V7BW	Z-diode	2.65..2.75V, Izt=5mA, Zzt=100Ω, 500mW	SOD-123FL	7d	1a	Tac
2V7Z	BZT52-C2V7	Z-diode	2.57..2.84V, Izt=5mA, Zzt=100Ω, 500mW	SOD-123FL	7d	1a	Tsc
2V7Z	MMSZ2V7CW	Z-diode	2.57..2.84V, Izt=5mA, Zzt=100Ω, 500mW	SOD-123FL	7d	1a	Tac
2V7Z	TCMMSZ2V7	Z-diode	2.7V±5%, Izt=5mA, Zzt=94Ω, 500mW	SOD-123FL	7d	1a	Tac
2V7Z	ZGFM052V7C-MH	Z-diode	2.57..2.84V, Izt=5mA, Zzt=94Ω, 500mW	SOD-123	5d	1a	Pic
2VK	P2SMA130A	TVS	Vbr=124..137V, Vrwm=111V, Ipp=1.11A, 200W(1ms)	DO-214AC	1d	1a	Vs
2VL	P2SMA140A	TVS	Vbr=133..147V, Vrwm=119V, Ipp=1.04A, 200W(1ms)	DO-214AC	1d	1a	Vs
2VM	P2SMA150A	TVS	Vbr=143..158V, Vrwm=128V, Ipp=0.97A, 200W(1ms)	DO-214AC	1d	1a	Vs
2VN	P2SMA170A	TVS	Vbr=162..179V, Vrwm=145V, Ipp=0.85A, 200W(1ms)	DO-214AC	1d	1a	Vs
2VP	P2SMA180A	TVS	Vbr=171..189V, Vrwm=154V, Ipp=0.81A, 200W(1ms)	DO-214AC	1d	1a	Vs
2VQ	P2SMA200A	TVS	Vbr=190..210V, Vrwm=171V, Ipp=0.73A, 200W(1ms)	DO-214AC	1d	1a	Vs
2VR	P2SMA220A	TVS	Vbr=209..231V, Vrwm=185V, Ipp=0.61A, 200W(1ms)	DO-214AC	1d	1a	Vs
2W	MM3Z62V	Z-diode	58..66V, Izt=2mA, Zzt=215Ω, 200mW	SOD-323	5d	1a	Sec
2X	MM3Z33	Z-diode	31..35V, Izt=5mA, Zzt=80Ω, 300mW	SOD-323FL	7d	1a	Lge
2X	MM3Z33V	Z-diode	31..35V, Izt=2mA, Zzt=80Ω, 200mW	SOD-323FL	7d	1a	Eic
2Y	KDZ12VVY	Z-diode	11.74..12.24V, Izt=5mA, Zzt=15Ω, 100mW	VSC	7d	1a	Kec
2Y	MM3Z36	Z-diode	34..38V, Izt=5mA, Zzt=90Ω, 300mW	SOD-323FL	7d	1a	Lge
2Y	MM3Z36V	Z-diode	34..38V, Izt=2mA, Zzt=90Ω, 200mW	SOD-323FL	7d	1a	Eic
2Z	BZT52-B3V0S	Z-diode	2.94..3.06V, Izt=5mA, Zzt=100Ω, 200mW	SOD-323FL	7d	1a	Tsc
2Z	MM3Z39	Z-diode	37..41V, Izt=2.5mA, Zzt=100Ω, 300mW	SOD-323FL	7d	1a	Lge
2Z	MM3Z39V	Z-diode	37..41V, Izt=2mA, Zzt=130Ω, 200mW	SOD-323FL	7d	1a	Eic
2Z	MM3Z3V0B	Z-diode	2.94..3.06V, Zzt=89Ω, Izt=5mA, 200mW	SOD-323FL	7d	1a	F
2Z	MM3Z3V0BW	Z-diode	2.94..3.06V, Izt=5mA, Zzt=100Ω, 200mW	SOD-323FL	7d	1a	Tac
2Z	TCMM3Z3V0B	Z-diode	3.0V±2%, Izt=5mA, Zzt=89Ω, 200mW	SOD-323FL	7d	1a	Tac
3	BAS16-02W	Si-diode	Sw, Fast, 80V, 250mA, 100mW, <6ns	SCD-80	6d	1a	Sie
3	CDZ4.7B	Z-diode	4.7V±2.5%, Izt=40mA, 1W	VMN	7d	1s	Rhm
3	CDZ55C3V0	Z-diode	2.85..3.15V, Zzt=85Ω, Izt=5mA, 500mW	1206	70d	2d	Crp
3	CDZ55C3V0S	Z-diode	2.85..3.15V, Zzt=85Ω, Izt=5mA, 500mW	0805	70d	2d	Crp
3	CDZ55C3V0T	Z-diode	2.85..3.15V, Zzt=85Ω, Izt=5mA, 200mW	0603	70d	2d	Crp
3	CH521G-30PT	Si-diode	SBD, 30V, 200mA, Vf<0.5V(200mA)	SOD-723	8d	1a	Chm
3	CTZ55C3V0	Z-diode	2.85..3.15V, Izt=5mA, Zzt=85Ω, 500mW	1206	70d	2d	Ctc
3	GBL C03	TVS	Vbr=3V, 20A, 350W(1ms), 3pF	SOD-323	5d	1a	Prt
3	MA2SV02	C-diode	VCO, 6V, 19..8pF(1..4V)	SOD-523	6d	1a	Pan
3	MAZS030	Z-diode	2.8..3.2V, 200mW	SOD-523	6d	1a	Pan
3	MM9D3V6	Z-diode	3.42..3.78V, Izt=5mA, Zzt=100Ω, 200mW	SOD-923	7d	1b	Wtr
3	MM9D4V7	Z-diode	4.47..4.94V, Izt=5mA, Zzt=100Ω, 200mW	SOD-923	7d	1a	Wtr
3	MMPZ5224SPT	Z-diode	2.774..2.856V, Izt=5mA, Zzt=100Ω, 225mW	SOD-323	5d	1a	Chm
3	MMSZ5245BPT	Z-diode	14.25..15.75V, Izt=5mA, Zzt=32Ω, 225mW	SOD-523	7d	1a	Chm
3	NZ9F15VST	Z-diode	14.34..14.98V, Izt=5mA, Zzt=42Ω, 200mW	SOD-923	7d	2m	Ons
3	NZ9F2V7ST	Z-diode	2.67..2.91V, Izt=5mA, Zzt=100Ω, 200mW	SOD-923	7d	1n	Ons
3	NZ9F3V6T	Z-diode	3.42..3.78V, Izt=5mA, Zzt=100Ω, 200mW	SOD-923	7d	1b	Ons
3	NZ9F4V7T	Z-diode	4.47..4.94V, Izt=5mA, Zzt=100Ω, 200mW	SOD-923	7d	1a	Ons
3 (white)	BAT60A	Si-diode	SBD, Fast-Sw, 10V, 3A, Vf<0.3V(1A), 20pF	SOD-323	5d	2	Inf
3 2	GDZ2V7B-V	Z-diode	2.69..2.91V, Izt=5mA, Zzt=110Ω, 200mW	SOD-323	5d	1k	Vs
3.	MMSZ5245SPT	Z-diode	14.70..15.30V, Izt=5mA, Zzt=32Ω, 225mW	SOD-523	7d	1a	Chm
3.0	MAZ80300H	Z-diode	2.95..3.1V, Zzt=120Ω(5mA), 150mW	SC-76	6d	1a	Pan
3.010	3.0SMCJ100	TVS	Vbr=111..14.1V, Vrwm=10V, 159.6A, 3000W(1ms)	DO-214AB	1d	1a	Eic
3.0100	3.0SMCJ100	TVS	Vbr=111..141.0V, Vrwm=100V, 16.6A, 3000W(1ms)	DO-214AB	1d	1a	Eic
3.0100A	3.0SMCJ100A	TVS	Vbr=111..128.0V, Vrwm=100V, 18.6A, 3000W(1ms)	DO-214AB	1d	1a	Eic
3.0100C	3.0SMCJ100C	TVS	Vbr=111..141.0V, Vrwm=100V, 16.6A, 3000W(1ms), Bidirectional	DO-214AB	1ba	1j	Eic
3.0100CA	3.0SMCJ100CA	TVS	Vbr=111..128.0V, Vrwm=100V, 18.6A, 3000W(1ms), Bidirectional	DO-214AB	1ba	1j	Eic
3.010A	3.0SMCJ10A	TVS	Vbr=111..12.8V, Vrwm=10V, 176.4A, 3000W(1ms)	DO-214AB	1d	1a	Eic
3.010C	3.0SMCJ10C	TVS	Vbr=111..14.1V, Vrwm=10V, 159.6A, 3000W(1ms), Bidirectional	DO-214AB	1ba	1j	Eic
3.010CA	3.0SMCJ10CA	TVS	Vbr=111..12.8V, Vrwm=10V, 176.4A, 3000W(1ms), Bidirectional	DO-214AB	1ba	1j	Eic
3.011	3.0SMCJ11	TVS	Vbr=12.2..15.4V, Vrwm=11V, 149.2A, 3000W(1ms)	DO-214AB	1d	1a	Eic
3.0110	3.0SMCJ10	TVS	Vbr=122..154.5V, Vrwm=110V, 15.4A, 3000W(1ms)	DO-214AB	1d	1a	Eic
3.0110A	3.0SMCJ110A	TVS	Vbr=122..140.5V, Vrwm=110V, 16.8A, 3000W(1ms)	DO-214AB	1d	1a	Eic
3.0110C	3.0SMCJ110C	TVS	Vbr=122..154.5V, Vrwm=110V, 15.4A, 3000W(1ms), Bidirectional	DO-214AB	1ba	1j	Eic
3.0110CA	3.0SMCJ110CA	TVS	Vbr=122..140.5V, Vrwm=110V, 16.8A, 3000W(1ms), Bidirectional	DO-214AB	1ba	1j	Eic
3.011A	3.0SMCJ11A	TVS	Vbr=12.2..14.0V, Vrwm=11V, 184.8A, 3000W(1ms)	DO-214AB	1d	1a	Eic
3.011C	3.0SMCJ11C	TVS	Vbr=12.2..15.4V, Vrwm=11V, 149.2A, 3000W(1ms), Bidirectional	DO-214AB	1ba	1j	Eic



SMD code	Type	Function	Short description	Case	Pinout	St.	Mnf.
3.011CA	3.0SMCJ11CA	TVS	Vbr=12.2..14.0V, Vrwm=11V, 184.8A, 3000W(1ms), Bidirectional	DO-214AB	1ba	1j	Eic
3.012	3.0SMCJ12	TVS	Vbr=13.3..16.9V, Vrwm=12V, 136.4A, 3000W(1ms)	DO-214AB	1d	1a	Eic
3.0120	3.0SMCJ120	TVS	Vbr=133..169.0V, Vrwm=120V, 14.0A, 3000W(1ms)	DO-214AB	1d	1a	Eic
3.0120A	3.0SMCJ120A	TVS	Vbr=133..153.0V, Vrwm=120V, 15.6A, 3000W(1ms)	DO-214AB	1d	1a	Eic
3.0120C	3.0SMCJ120C	TVS	Vbr=133..169.0V, Vrwm=120V, 14.0A, 3000W(1ms), Bidirectional	DO-214AB	1ba	1j	Eic
3.0120CA	3.0SMCJ120CA	TVS	Vbr=133..153.0V, Vrwm=120V, 15.6A, 3000W(1ms), Bidirectional	DO-214AB	1ba	1j	Eic
3.012A	3.0SMCJ12A	TVS	Vbr=13.3..15.3V, Vrwm=12V, 150.6A, 3000W(1ms)	DO-214AB	1d	1a	Eic
3.012C	3.0SMCJ12C	TVS	Vbr=13.3..16.9V, Vrwm=12V, 136.4A, 3000W(1ms), Bidirectional	DO-214AB	1ba	1j	Eic
3.012CA	3.0SMCJ12CA	TVS	Vbr=13.3..15.3V, Vrwm=12V, 150.6A, 3000W(1ms), Bidirectional	DO-214AB	1ba	1j	Eic
3.013	3.0SMCJ13	TVS	Vbr=14.4..18.2V, Vrwm=13V, 126.0A, 3000W(1ms)	DO-214AB	1d	1a	Eic
3.0130	3.0SMCJ130	TVS	Vbr=144..182.5V, Vrwm=130V, 13.0A, 3000W(1ms)	DO-214AB	1d	1a	Eic
3.0130A	3.0SMCJ130A	TVS	Vbr=144..165.5V, Vrwm=130V, 14.4A, 3000W(1ms)	DO-214AB	1d	1a	Eic
3.0130C	3.0SMCJ130C	TVS	Vbr=144..182.5V, Vrwm=130V, 13.0A, 3000W(1ms), Bidirectional	DO-214AB	1ba	1j	Eic
3.0130CA	3.0SMCJ130CA	TVS	Vbr=144..165.5V, Vrwm=130V, 14.4A, 3000W(1ms), Bidirectional	DO-214AB	1ba	1j	Eic
3.013A	3.0SMCJ13A	TVS	Vbr=14.4..16.5V, Vrwm=13V, 139.4A, 3000W(1ms)	DO-214AB	1d	1a	Eic
3.013C	3.0SMCJ13C	TVS	Vbr=14.4..18.2V, Vrwm=13V, 126.0A, 3000W(1ms), Bidirectional	DO-214AB	1ba	1j	Eic
3.013CA	3.0SMCJ13CA	TVS	Vbr=14.4..16.5V, Vrwm=13V, 139.4A, 3000W(1ms), Bidirectional	DO-214AB	1ba	1j	Eic
3.014	3.0SMCJ14	TVS	Vbr=15.6..19.8V, Vrwm=14V, 116.2A, 3000W(1ms)	DO-214AB	1d	1a	Eic
3.014A	3.0SMCJ14A	TVS	Vbr=15.6..17.9V, Vrwm=14V, 129.4A, 3000W(1ms)	DO-214AB	1d	1a	Eic
3.014C	3.0SMCJ14C	TVS	Vbr=15.6..19.8V, Vrwm=14V, 116.2A, 3000W(1ms), Bidirectional	DO-214AB	1ba	1j	Eic
3.014CA	3.0SMCJ14CA	TVS	Vbr=15.6..17.9V, Vrwm=14V, 129.4A, 3000W(1ms), Bidirectional	DO-214AB	1ba	1j	Eic
3.015	3.0SMCJ15	TVS	Vbr=16.7..21.1V, Vrwm=15V, 111.6A, 3000W(1ms)	DO-214AB	1d	1a	Eic
3.0150	3.0SMCJ150	TVS	Vbr=167..211.5V, Vrwm=150V, 11.2A, 3000W(1ms)	DO-214AB	1d	1a	Eic
3.0150A	3.0SMCJ150A	TVS	Vbr=167..192.5V, Vrwm=150V, 12.4A, 3000W(1ms)	DO-214AB	1d	1a	Eic
3.0150C	3.0SMCJ150C	TVS	Vbr=167..211.5V, Vrwm=150V, 11.2A, 3000W(1ms), Bidirectional	DO-214AB	1ba	1j	Eic
3.0150CA	3.0SMCJ150CA	TVS	Vbr=167..192.5V, Vrwm=150V, 12.4A, 3000W(1ms), Bidirectional	DO-214AB	1ba	1j	Eic
3.015A	3.0SMCJ15A	TVS	Vbr=16.7..19.2V, Vrwm=15V, 123.0A, 3000W(1ms)	DO-214AB	1d	1a	Eic
3.015C	3.0SMCJ15C	TVS	Vbr=16.7..21.1V, Vrwm=15V, 111.6A, 3000W(1ms), Bidirectional	DO-214AB	1ba	1j	Eic
3.015CA	3.0SMCJ15CA	TVS	Vbr=16.7..19.2V, Vrwm=15V, 123.0A, 3000W(1ms), Bidirectional	DO-214AB	1ba	1j	Eic
3.016	3.0SMCJ16	TVS	Vbr=17.8..22.6V, Vrwm=16V, 104.2A, 3000W(1ms)	DO-214AB	1d	1a	Eic
3.0160	3.0SMCJ160	TVS	Vbr=178..226.0V, Vrwm=160V, 10.4A, 3000W(1ms)	DO-214AB	1d	1a	Eic
3.0160A	3.0SMCJ160A	TVS	Vbr=178..205.0V, Vrwm=160V, 11.6A, 3000W(1ms)	DO-214AB	1d	1a	Eic
3.0160C	3.0SMCJ160C	TVS	Vbr=178..226.0V, Vrwm=160V, 10.4A, 3000W(1ms), Bidirectional	DO-214AB	1ba	1j	Eic
3.0160CA	3.0SMCJ160CA	TVS	Vbr=178..205.0V, Vrwm=160V, 11.6A, 3000W(1ms), Bidirectional	DO-214AB	1ba	1j	Eic
3.016A	3.0SMCJ16A	TVS	Vbr=17.8..20.5V, Vrwm=16V, 115.4A, 3000W(1ms)	DO-214AB	1d	1a	Eic
3.016C	3.0SMCJ16C	TVS	Vbr=17.8..22.6V, Vrwm=16V, 104.2A, 3000W(1ms), Bidirectional	DO-214AB	1ba	1j	Eic
3.016CA	3.0SMCJ16CA	TVS	Vbr=17.8..20.5V, Vrwm=16V, 115.4A, 3000W(1ms), Bidirectional	DO-214AB	1ba	1j	Eic
3.017	3.0SMCJ17	TVS	Vbr=18.9..23.9V, Vrwm=17V, 98.4A, 3000W(1ms)	DO-214AB	1d	1a	Eic
3.0170	3.0SMCJ170	TVS	Vbr=189..239.5V, Vrwm=170V, 9.8A, 3000W(1ms)	DO-214AB	1d	1a	Eic
3.0170A	3.0SMCJ170A	TVS	Vbr=189..217.5V, Vrwm=170V, 11.0A, 3000W(1ms)	DO-214AB	1d	1a	Eic
3.0170C	3.0SMCJ170C	TVS	Vbr=189..239.5V, Vrwm=170V, 9.8A, 3000W(1ms), Bidirectional	DO-214AB	1ba	1j	Eic
3.0170CA	3.0SMCJ170CA	TVS	Vbr=189..217.5V, Vrwm=170V, 11.0A, 3000W(1ms), Bidirectional	DO-214AB	1ba	1j	Eic
3.017A	3.0SMCJ17A	TVS	Vbr=18.9..21.7V, Vrwm=17V, 106.6A, 3000W(1ms)	DO-214AB	1d	1a	Eic
3.017C	3.0SMCJ17C	TVS	Vbr=18.9..23.9V, Vrwm=17V, 98.4A, 3000W(1ms), Bidirectional	DO-214AB	1ba	1j	Eic
3.017CA	3.0SMCJ17CA	TVS	Vbr=18.9..21.7V, Vrwm=17V, 106.6A, 3000W(1ms), Bidirectional	DO-214AB	1ba	1j	Eic
3.018	3.0SMCJ18	TVS	Vbr=20.0..25.3V, Vrwm=18V, 93.2A, 3000W(1ms)	DO-214AB	1d	1a	Eic
3.0180	3.0SMCJ180	TVS	Vbr=198..253.8V, Vrwm=180V, 9.3A, 3000W(1ms)	DO-214AB	1d	1a	Eic
3.0180A	3.0SMCJ180A	TVS	Vbr=198..230.4V, Vrwm=180V, 10.3A, 3000W(1ms)	DO-214AB	1d	1a	Eic
3.0180C	3.0SMCJ180C	TVS	Vbr=198..253.8V, Vrwm=180V, 9.3A, 3000W(1ms), Bidirectional	DO-214AB	1ba	1j	Eic
3.0180CA	3.0SMCJ180CA	TVS	Vbr=198..230.4V, Vrwm=180V, 10.3A, 3000W(1ms), Bidirectional	DO-214AB	1ba	1j	Eic
3.018A	3.0SMCJ18A	TVS	Vbr=20.0..23.3V, Vrwm=18V, 102.8A, 3000W(1ms)	DO-214AB	1d	1a	Eic
3.018C	3.0SMCJ18C	TVS	Vbr=20.0..25.3V, Vrwm=18V, 93.2A, 3000W(1ms), Bidirectional	DO-214AB	1ba	1j	Eic
3.018CA	3.0SMCJ18CA	TVS	Vbr=20.0..23.3V, Vrwm=18V, 102.8A, 3000W(1ms), Bidirectional	DO-214AB	1ba	1j	Eic
3.0190	3.0SMCJ190	TVS	Vbr=209..267.9V, Vrwm=190V, 8.8A, 3000W(1ms)	DO-214AB	1d	1a	Eic
3.0190A	3.0SMCJ190A	TVS	Vbr=209..243.2V, Vrwm=190V, 9.7A, 3000W(1ms)	DO-214AB	1d	1a	Eic
3.0190C	3.0SMCJ190C	TVS	Vbr=209..267.9V, Vrwm=190V, 8.8A, 3000W(1ms), Bidirectional	DO-214AB	1ba	1j	Eic
3.0190CA	3.0SMCJ190CA	TVS	Vbr=209..243.2V, Vrwm=190V, 9.7A, 3000W(1ms), Bidirectional	DO-214AB	1ba	1j	Eic
3.020	3.0SMCJ20	TVS	Vbr=22.2..28.1V, Vrwm=20V, 83.8A, 3000W(1ms)	DO-214AB	1d	1a	Eic
3.0200	3.0SMCJ200	TVS	Vbr=220..282.0V, Vrwm=200V, 8.4A, 3000W(1ms)	DO-214AB	1d	1a	Eic
3.0200A	3.0SMCJ200A	TVS	Vbr=220..256.0V, Vrwm=200V, 9.3A, 3000W(1ms)	DO-214AB	1d	1a	Eic
3.0200C	3.0SMCJ200C	TVS	Vbr=220..282.0V, Vrwm=200V, 8.4A, 3000W(1ms), Bidirectional	DO-214AB	1ba	1j	Eic
3.0200CA	3.0SMCJ200CA	TVS	Vbr=220..256.0V, Vrwm=200V, 9.3A, 3000W(1ms), Bidirectional	DO-214AB	1ba	1j	Eic
3.020A	3.0SMCJ20A	TVS	Vbr=22.2..25.5V, Vrwm=20V, 92.6A, 3000W(1ms)	DO-214AB	1d	1a	Eic
3.020C	3.0SMCJ20C	TVS	Vbr=22.2..28.1V, Vrwm=20V, 83.8A, 3000W(1ms), Bidirectional	DO-214AB	1ba	1j	Eic
3.020CA	3.0SMCJ20CA	TVS	Vbr=22.2..25.5V, Vrwm=20V, 92.6A, 3000W(1ms), Bidirectional	DO-214AB	1ba	1j	Eic
3.0210	3.0SMCJ210	TVS	Vbr=231..296.1V, Vrwm=210V, 7.8A, 3000W(1ms)	DO-214AB	1d	1a	Eic
3.0210A	3.0SMCJ210A	TVS	Vbr=231..268.8V, Vrwm=210V, 8.8A, 3000W(1ms)	DO-214AB	1d	1a	Eic
3.0210C	3.0SMCJ210C	TVS	Vbr=231..296.1V, Vrwm=210V, 7.8A, 3000W(1ms), Bidirectional	DO-214AB	1ba	1j	Eic
3.0210CA	3.0SMCJ210CA	TVS	Vbr=231..268.8V, Vrwm=210V, 8.8A, 3000W(1ms), Bidirectional	DO-214AB	1ba	1j	Eic
3.022	3.0SMCJ22	TVS	Vbr=24.4..30.9V, Vrwm=22V, 76.2A, 3000W(1ms)	DO-214AB	1d	1a	Eic



SMD code	Type	Function	Short description	Case	Pinout	St.	Mnf.
3.0220	3.0SMCJ220	TVS	Vbr=242..310.2V, Vrwm=220V, 7.6A, 3000W(1ms)	DO-214AB	1d	1a	Eic
3.0220A	3.0SMCJ220A	TVS	Vbr=242..281.6V, Vrwm=220V, 8.4A, 3000W(1ms)	DO-214AB	1d	1a	Eic
3.0220C	3.0SMCJ220C	TVS	Vbr=242..310.2V, Vrwm=220V, 7.6A, 3000W(1ms), Bidirectional	DO-214AB	1ba	1j	Eic
3.0220CA	3.0SMCJ220CA	TVS	Vbr=242..281.6V, Vrwm=220V, 8.4A, 3000W(1ms), Bidirectional	DO-214AB	1ba	1j	Eic
3.022A	3.0SMCJ22A	TVS	Vbr=24.4..28.0V, Vrwm=22V, 84.4A, 3000W(1ms)	DO-214AB	1d	1a	Eic
3.022C	3.0SMCJ22C	TVS	Vbr=24.4..30.9V, Vrwm=22V, 76.2A, 3000W(1ms), Bidirectional	DO-214AB	1ba	1j	Eic
3.022CA	3.0SMCJ22CA	TVS	Vbr=24.4..28.0V, Vrwm=22V, 84.4A, 3000W(1ms), Bidirectional	DO-214AB	1ba	1j	Eic
3.024	3.0SMCJ24	TVS	Vbr=26.7..33.8V, Vrwm=24V, 69.8A, 3000W(1ms)	DO-214AB	1d	1a	Eic
3.024A	3.0SMCJ24A	TVS	Vbr=26.7..30.7V, Vrwm=24V, 77.2A, 3000W(1ms)	DO-214AB	1d	1a	Eic
3.024C	3.0SMCJ24C	TVS	Vbr=26.7..33.8V, Vrwm=24V, 69.8A, 3000W(1ms), Bidirectional	DO-214AB	1ba	1j	Eic
3.024CA	3.0SMCJ24CA	TVS	Vbr=26.7..30.7V, Vrwm=24V, 77.2A, 3000W(1ms), Bidirectional	DO-214AB	1ba	1j	Eic
3.026	3.0SMCJ26	TVS	Vbr=28.9..36.6V, Vrwm=26V, 64.4A, 3000W(1ms)	DO-214AB	1d	1a	Eic
3.026A	3.0SMCJ26A	TVS	Vbr=28.9..33.2V, Vrwm=26V, 71.2A, 3000W(1ms)	DO-214AB	1d	1a	Eic
3.026C	3.0SMCJ26C	TVS	Vbr=28.9..36.6V, Vrwm=26V, 64.4A, 3000W(1ms), Bidirectional	DO-214AB	1ba	1j	Eic
3.026CA	3.0SMCJ26CA	TVS	Vbr=28.9..33.2V, Vrwm=26V, 71.2A, 3000W(1ms), Bidirectional	DO-214AB	1ba	1j	Eic
3.028	3.0SMCJ28	TVS	Vbr=31.1..39.4V, Vrwm=28V, 60.0A, 3000W(1ms)	DO-214AB	1d	1a	Eic
3.028A	3.0SMCJ28A	TVS	Vbr=31.1..35.8V, Vrwm=28V, 66.0A, 3000W(1ms)	DO-214AB	1d	1a	Eic
3.028C	3.0SMCJ28C	TVS	Vbr=31.1..39.4V, Vrwm=28V, 60.0A, 3000W(1ms), Bidirectional	DO-214AB	1ba	1j	Eic
3.028CA	3.0SMCJ28CA	TVS	Vbr=31.1..35.8V, Vrwm=28V, 66.0A, 3000W(1ms), Bidirectional	DO-214AB	1ba	1j	Eic
3.030	3.0SMCJ30	TVS	Vbr=33.3..42.2V, Vrwm=30V, 56.0A, 3000W(1ms)	DO-214AB	1d	1a	Eic
3.030A	3.0SMCJ30A	TVS	Vbr=33.3..38.3V, Vrwm=30V, 62.0A, 3000W(1ms)	DO-214AB	1d	1a	Eic
3.030C	3.0SMCJ30C	TVS	Vbr=33.3..42.2V, Vrwm=30V, 56.0A, 3000W(1ms), Bidirectional	DO-214AB	1ba	1j	Eic
3.030CA	3.0SMCJ30CA	TVS	Vbr=33.3..38.3V, Vrwm=30V, 62.0A, 3000W(1ms), Bidirectional	DO-214AB	1ba	1j	Eic
3.033	3.0SMCJ33	TVS	Vbr=36.7..46.5V, Vrwm=33V, 50.4A, 3000W(1ms)	DO-214AB	1d	1a	Eic
3.033A	3.0SMCJ33A	TVS	Vbr=36.7..42.2V, Vrwm=33V, 56.2A, 3000W(1ms)	DO-214AB	1d	1a	Eic
3.033C	3.0SMCJ33C	TVS	Vbr=36.7..46.5V, Vrwm=33V, 50.4A, 3000W(1ms), Bidirectional	DO-214AB	1ba	1j	Eic
3.033CA	3.0SMCJ33CA	TVS	Vbr=36.7..42.2V, Vrwm=33V, 56.2A, 3000W(1ms), Bidirectional	DO-214AB	1ba	1j	Eic
3.036	3.0SMCJ36	TVS	Vbr=40.0..50.7V, Vrwm=36V, 46.6A, 3000W(1ms)	DO-214AB	1d	1a	Eic
3.036A	3.0SMCJ36A	TVS	Vbr=40.0..46.0V, Vrwm=36V, 51.6A, 3000W(1ms)	DO-214AB	1d	1a	Eic
3.036C	3.0SMCJ36C	TVS	Vbr=40.0..50.7V, Vrwm=36V, 46.6A, 3000W(1ms), Bidirectional	DO-214AB	1ba	1j	Eic
3.036CA	3.0SMCJ36CA	TVS	Vbr=40.0..46.0V, Vrwm=36V, 51.6A, 3000W(1ms), Bidirectional	DO-214AB	1ba	1j	Eic
3.040	3.0SMCJ40	TVS	Vbr=44.4..56.3V, Vrwm=40V, 42.0A, 3000W(1ms)	DO-214AB	1d	1a	Eic
3.040A	3.0SMCJ40A	TVS	Vbr=44.4..51.1V, Vrwm=40V, 46.4A, 3000W(1ms)	DO-214AB	1d	1a	Eic
3.040C	3.0SMCJ40C	TVS	Vbr=44.4..56.3V, Vrwm=40V, 42.0A, 3000W(1ms), Bidirectional	DO-214AB	1ba	1j	Eic
3.040CA	3.0SMCJ40CA	TVS	Vbr=44.4..51.1V, Vrwm=40V, 46.4A, 3000W(1ms), Bidirectional	DO-214AB	1ba	1j	Eic
3.043	3.0SMCJ43	TVS	Vbr=47.8..60.5V, Vrwm=43V, 39.2A, 3000W(1ms)	DO-214AB	1d	1a	Eic
3.043A	3.0SMCJ43A	TVS	Vbr=47.8..54.9V, Vrwm=43V, 43.2A, 3000W(1ms)	DO-214AB	1d	1a	Eic
3.043C	3.0SMCJ43C	TVS	Vbr=47.8..60.5V, Vrwm=43V, 39.2A, 3000W(1ms), Bidirectional	DO-214AB	1ba	1j	Eic
3.043CA	3.0SMCJ43CA	TVS	Vbr=47.8..54.9V, Vrwm=43V, 43.2A, 3000W(1ms), Bidirectional	DO-214AB	1ba	1j	Eic
3.045	3.0SMCJ45	TVS	Vbr=50.0..63.3V, Vrwm=45V, 37.4A, 3000W(1ms)	DO-214AB	1d	1a	Eic
3.045A	3.0SMCJ45A	TVS	Vbr=50.0..57.5V, Vrwm=45V, 41.2A, 3000W(1ms)	DO-214AB	1d	1a	Eic
3.045C	3.0SMCJ45C	TVS	Vbr=50.0..63.3V, Vrwm=45V, 37.4A, 3000W(1ms), Bidirectional	DO-214AB	1ba	1j	Eic
3.045CA	3.0SMCJ45CA	TVS	Vbr=50.0..57.5V, Vrwm=45V, 41.2A, 3000W(1ms), Bidirectional	DO-214AB	1ba	1j	Eic
3.048	3.0SMCJ48	TVS	Vbr=53.3..67.5V, Vrwm=48V, 35.0A, 3000W(1ms)	DO-214AB	1d	1a	Eic
3.048A	3.0SMCJ48A	TVS	Vbr=53.3..61.3V, Vrwm=48V, 38.8A, 3000W(1ms)	DO-214AB	1d	1a	Eic
3.048C	3.0SMCJ48C	TVS	Vbr=53.3..67.5V, Vrwm=48V, 35.0A, 3000W(1ms), Bidirectional	DO-214AB	1ba	1j	Eic
3.048CA	3.0SMCJ48CA	TVS	Vbr=53.3..61.3V, Vrwm=48V, 38.8A, 3000W(1ms), Bidirectional	DO-214AB	1ba	1j	Eic
3.05.0	3.0SMCJ5.0	TVS	Vbr=6.4..7.55V, Vrwm=5.0V, 312.5A, 3000W(1ms)	DO-214AB	1d	1a	Eic
3.05.0A	3.0SMCJ5.0A	TVS	Vbr=6.4..7.25V, Vrwm=5.0V, 9.2.326A, 3000W(1ms)	DO-214AB	1d	1a	Eic
3.05.0C	3.0SMCJ5.0C	TVS	Vbr=6.4..7.55V, Vrwm=5.0V, 312.5A, 3000W(1ms), Bidirectional	DO-214AB	1ba	1j	Eic
3.05.0CA	3.0SMCJ5.0CA	TVS	Vbr=6.4..7.25V, Vrwm=5.0V, 326A, 3000W(1ms), Bidirectional	DO-214AB	1ba	1j	Eic
3.051	3.0SMCJ51	TVS	Vbr=56.7..71.8V, Vrwm=51V, 37.0A, 3000W(1ms)	DO-214AB	1d	1a	Eic
3.051A	3.0SMCJ51A	TVS	Vbr=56.7..65.2V, Vrwm=51V, 36.4A, 3000W(1ms)	DO-214AB	1d	1a	Eic
3.051C	3.0SMCJ51C	TVS	Vbr=56.7..71.8V, Vrwm=51V, 37.0A, 3000W(1ms), Bidirectional	DO-214AB	1ba	1j	Eic
3.051CA	3.0SMCJ51CA	TVS	Vbr=56.7..65.2V, Vrwm=51V, 36.4A, 3000W(1ms), Bidirectional	DO-214AB	1ba	1j	Eic
3.054	3.0SMCJ54	TVS	Vbr=60.0..76.0V, Vrwm=54V, 31.2A, 3000W(1ms)	DO-214AB	1d	1a	Eic
3.054A	3.0SMCJ54A	TVS	Vbr=60.0..69.0V, Vrwm=54V, 34.4A, 3000W(1ms)	DO-214AB	1d	1a	Eic
3.054C	3.0SMCJ54C	TVS	Vbr=60.0..76.0V, Vrwm=54V, 31.2A, 3000W(1ms), Bidirectional	DO-214AB	1ba	1j	Eic
3.054CA	3.0SMCJ54CA	TVS	Vbr=60.0..69.0V, Vrwm=54V, 34.4A, 3000W(1ms), Bidirectional	DO-214AB	1ba	1j	Eic
3.058	3.0SMCJ58	TVS	Vbr=64.4..81.6V, Vrwm=58V, 39.2A, 3000W(1ms)	DO-214AB	1d	1a	Eic
3.058A	3.0SMCJ58A	TVS	Vbr=64.4..74.1V, Vrwm=58V, 32.0A, 3000W(1ms)	DO-214AB	1d	1a	Eic
3.058C	3.0SMCJ58C	TVS	Vbr=64.4..81.6V, Vrwm=58V, 39.2A, 3000W(1ms), Bidirectional	DO-214AB	1ba	1j	Eic
3.058CA	3.0SMCJ58CA	TVS	Vbr=64.4..74.1V, Vrwm=58V, 32.0A, 3000W(1ms), Bidirectional	DO-214AB	1ba	1j	Eic
3.06.0	3.0SMCJ6.0	TVS	Vbr=6.67..8.45V, Vrwm=6.0V, 263.2A, 3000W(1ms)	DO-214AB	1d	1a	Eic
3.06.0A	3.0SMCJ6.0A	TVS	Vbr=6.67..7.67V, Vrwm=6.0V, 291.3A, 3000W(1ms)	DO-214AB	1d	1a	Eic
3.06.0C	3.0SMCJ6.0C	TVS	Vbr=6.67..8.45V, Vrwm=6.0V, 263.2A, 3000W(1ms), Bidirectional	DO-214AB	1ba	1j	Eic
3.06.0CA	3.0SMCJ6.0CA	TVS	Vbr=6.67..7.67V, Vrwm=6.0V, 291.3A, 3000W(1ms), Bidirectional	DO-214AB	1ba	1j	Eic
3.06.5	3.0SMCJ6.5	TVS	Vbr=7.22..9.14V, Vrwm=6.5V, 243.9A, 3000W(1ms)	DO-214AB	1d	1a	Eic
3.06.5A	3.0SMCJ6.5A	TVS	Vbr=7.22..8.30V, Vrwm=6.5V, 267.9A, 3000W(1ms)	DO-214AB	1d	1a	Eic
3.06.5C	3.0SMCJ6.5C	TVS	Vbr=7.22..9.14V, Vrwm=6.5V, 243.9A, 3000W(1ms), Bidirectional	DO-214AB	1ba	1j	Eic



SMD code	Type	Function	Short description	Case	Pinout	St.	Mnf.
3.06.5CA	3.0SMCJ6.5CA	TVS	Vbr=7.22..8.30V, Vrwm=6.5V, 267.9A, 3000W(1ms), Bidirectional	DO-214AB	1ba	1j	Eic
3.060	3.0SMCJ60	TVS	Vbr=66.7..84.5V, Vrwm=60V, 28.0A, 3000W(1ms)	DO-214AB	1d	1a	Eic
3.060A	3.0SMCJ60A	TVS	Vbr=66.7..76.7V, Vrwm=60V, 31.0A, 3000W(1ms)	DO-214AB	1d	1a	Eic
3.060C	3.0SMCJ60C	TVS	Vbr=66.7..84.5V, Vrwm=60V, 28.0A, 3000W(1ms), Bidirectional	DO-214AB	1ba	1j	Eic
3.060CA	3.0SMCJ60CA	TVS	Vbr=66.7..76.7V, Vrwm=60V, 31.0A, 3000W(1ms), Bidirectional	DO-214AB	1ba	1j	Eic
3.064	3.0SMCJ64	TVS	Vbr=71.1..90.1V, Vrwm=64V, 26.4A, 3000W(1ms)	DO-214AB	1d	1a	Eic
3.064A	3.0SMCJ64A	TVS	Vbr=71.1..81.8V, Vrwm=64V, 29.2A, 3000W(1ms)	DO-214AB	1d	1a	Eic
3.064C	3.0SMCJ64C	TVS	Vbr=71.1..90.1V, Vrwm=64V, 26.4A, 3000W(1ms), Bidirectional	DO-214AB	1ba	1j	Eic
3.064CA	3.0SMCJ64CA	TVS	Vbr=71.1..81.8V, Vrwm=64V, 29.2A, 3000W(1ms), Bidirectional	DO-214AB	1ba	1j	Eic
3.07.0	3.0SMCJ7.0	TVS	Vbr=7.78..9.86V, Vrwm=7.0V, 225.6A, 3000W(1ms)	DO-214AB	1d	1a	Eic
3.07.0A	3.0SMCJ7.0A	TVS	Vbr=7.78..8.95V, Vrwm=7.0V, 250A, 3000W(1ms)	DO-214AB	1d	1a	Eic
3.07.0C	3.0SMCJ7.0C	TVS	Vbr=7.78..9.86V, Vrwm=7.0V, 225.6A, 3000W(1ms), Bidirectional	DO-214AB	1ba	1j	Eic
3.07.0CA	3.0SMCJ7.0CA	TVS	Vbr=7.78..8.95V, Vrwm=7.0V, 250A, 3000W(1ms), Bidirectional	DO-214AB	1ba	1j	Eic
3.07.5	3.0SMCJ7.5	TVS	Vbr=8.33..10.67V, Vrwm=7.5V, 209.8A, 3000W(1ms)	DO-214AB	1d	1a	Eic
3.07.5A	3.0SMCJ7.5A	TVS	Vbr=8.33..9.58V, Vrwm=7.5V, 232.6A, 3000W(1ms)	DO-214AB	1d	1a	Eic
3.07.5C	3.0SMCJ7.5C	TVS	Vbr=8.33..10.67V, Vrwm=7.5V, 209.8A, 3000W(1ms), Bidirectional	DO-214AB	1ba	1j	Eic
3.07.5CA	3.0SMCJ7.5CA	TVS	Vbr=8.33..9.58V, Vrwm=7.5V, 232.6A, 3000W(1ms), Bidirectional	DO-214AB	1ba	1j	Eic
3.070	3.0SMCJ70	TVS	Vbr=77.8..98.6V, Vrwm=70V, 24.0A, 3000W(1ms)	DO-214AB	1d	1a	Eic
3.070A	3.0SMCJ70A	TVS	Vbr=77.8..89.5V, Vrwm=70V, 26.6A, 3000W(1ms)	DO-214AB	1d	1a	Eic
3.070C	3.0SMCJ70C	TVS	Vbr=77.8..98.6V, Vrwm=70V, 24.0A, 3000W(1ms), Bidirectional	DO-214AB	1ba	1j	Eic
3.070CA	3.0SMCJ70CA	TVS	Vbr=77.8..89.5V, Vrwm=70V, 26.6A, 3000W(1ms), Bidirectional	DO-214AB	1ba	1j	Eic
3.075	3.0SMCJ75	TVS	Vbr=83.3..105.7V, Vrwm=75V, 22.4A, 3000W(1ms)	DO-214AB	1d	1a	Eic
3.075A	3.0SMCJ75A	TVS	Vbr=83.3..95.8V, Vrwm=75V, 24.8A, 3000W(1ms)	DO-214AB	1d	1a	Eic
3.075C	3.0SMCJ75C	TVS	Vbr=83.3..105.7V, Vrwm=75V, 22.4A, 3000W(1ms), Bidirectional	DO-214AB	1ba	1j	Eic
3.075CA	3.0SMCJ75CA	TVS	Vbr=83.3..95.8V, Vrwm=75V, 24.8A, 3000W(1ms), Bidirectional	DO-214AB	1ba	1j	Eic
3.078	3.0SMCJ78	TVS	Vbr=86.7..109.8V, Vrwm=78V, 21.6A, 3000W(1ms)	DO-214AB	1d	1a	Eic
3.078A	3.0SMCJ78A	TVS	Vbr=86.7..99.7V, Vrwm=78V, 22.8A, 3000W(1ms)	DO-214AB	1d	1a	Eic
3.078C	3.0SMCJ78C	TVS	Vbr=86.7..109.8V, Vrwm=78V, 21.6A, 3000W(1ms), Bidirectional	DO-214AB	1ba	1j	Eic
3.078CA	3.0SMCJ78CA	TVS	Vbr=86.7..99.7V, Vrwm=78V, 22.8A, 3000W(1ms), Bidirectional	DO-214AB	1ba	1j	Eic
3.08.0	3.0SMCJ8.0	TVS	Vbr=8.89..11.30V, Vrwm=8.0V, 200A, 3000W(1ms)	DO-214AB	1d	1a	Eic
3.08.0A	3.0SMCJ8.0A	TVS	Vbr=8.89..10.23V, Vrwm=8.0V, 220.6A, 3000W(1ms)	DO-214AB	1d	1a	Eic
3.08.0C	3.0SMCJ8.0C	TVS	Vbr=8.89..11.30V, Vrwm=8.0V, 200A, 3000W(1ms), Bidirectional	DO-214AB	1ba	1j	Eic
3.08.0CA	3.0SMCJ8.0CA	TVS	Vbr=8.89..10.23V, Vrwm=8.0V, 220.6A, 3000W(1ms), Bidirectional	DO-214AB	1ba	1j	Eic
3.08.5	3.0SMCJ8.5	TVS	Vbr=9.44..11.92V, Vrwm=8.5V, 188.8A, 3000W(1ms)	DO-214AB	1d	1a	Eic
3.08.5A	3.0SMCJ8.5A	TVS	Vbr=9.44..10.82V, Vrwm=8.5V, 208.4A, 3000W(1ms)	DO-214AB	1d	1a	Eic
3.08.5C	3.0SMCJ8.5C	TVS	Vbr=9.44..11.92V, Vrwm=8.5V, 188.8A, 3000W(1ms), Bidirectional	DO-214AB	1ba	1j	Eic
3.08.5CA	3.0SMCJ8.5CA	TVS	Vbr=9.44..10.82V, Vrwm=8.5V, 208.4A, 3000W(1ms), Bidirectional	DO-214AB	1ba	1j	Eic
3.085	3.0SMCJ85	TVS	Vbr=94.4..119.2V, Vrwm=85V, 19.8A, 3000W(1ms)	DO-214AB	1d	1a	Eic
3.085A	3.0SMCJ85A	TVS	Vbr=94.4..108.2V, Vrwm=85V, 20.8A, 3000W(1ms)	DO-214AB	1d	1a	Eic
3.085C	3.0SMCJ85C	TVS	Vbr=94.4..119.2V, Vrwm=85V, 19.8A, 3000W(1ms), Bidirectional	DO-214AB	1ba	1j	Eic
3.085CA	3.0SMCJ85CA	TVS	Vbr=94.4..108.2V, Vrwm=85V, 20.8A, 3000W(1ms), Bidirectional	DO-214AB	1ba	1j	Eic
3.09.0	3.0SMCJ9.0	TVS	Vbr=10.0..12.6V, Vrwm=9.0V, 177.4A, 3000W(1ms)	DO-214AB	1d	1a	Eic
3.09.0A	3.0SMCJ9.0A	TVS	Vbr=10.0..11.5V, Vrwm=9.0V, 194.8A, 3000W(1ms)	DO-214AB	1d	1a	Eic
3.09.0C	3.0SMCJ9.0C	TVS	Vbr=10.0..12.6V, Vrwm=9.0V, 177.4A, 3000W(1ms), Bidirectional	DO-214AB	1ba	1j	Eic
3.09.0CA	3.0SMCJ9.0CA	TVS	Vbr=10.0..11.5V, Vrwm=9.0V, 194.8A, 3000W(1ms), Bidirectional	DO-214AB	1ba	1j	Eic
3.090	3.0SMCJ90	TVS	Vbr=100..126.5V, Vrwm=90V, 18.8A, 3000W(1ms)	DO-214AB	1d	1a	Eic
3.090A	3.0SMCJ90A	TVS	Vbr=100..115.5V, Vrwm=90V, 20.6A, 3000W(1ms)	DO-214AB	1d	1a	Eic
3.090C	3.0SMCJ90C	TVS	Vbr=100..126.5V, Vrwm=90V, 18.8A, 3000W(1ms), Bidirectional	DO-214AB	1ba	1j	Eic
3.090CA	3.0SMCJ90CA	TVS	Vbr=100..115.5V, Vrwm=90V, 20.6A, 3000W(1ms), Bidirectional	DO-214AB	1ba	1j	Eic
3.0B	HZF3.0BP	Z-diode	3V±5%, 900mW	LRP	1d	2f	Ren
3.0C	HZF3.0CP	Z-diode	3V±10%, 900mW	LRP	1d	2f	Ren
3.3	MAZ80330H	Z-diode	3.25..3.5V, Zzt=130Ω(5mA), 150mW	SC-76	6d	1a	Pan
3.3B	HZF3.3BP	Z-diode	3.3V±5%, 900mW	LRP	1d	2f	Ren
3.3C	HZF3.3CP	Z-diode	3.3V±10%, 900mW	LRP	1d	2f	Ren
3.6	MAZ80360H	Z-diode	3.55..3.8V, Zzt=130Ω(5mA), 150mW	SC-76	6d	1a	Pan
3.6B	HZF3.6BP	Z-diode	3.6V±5%, 900mW	LRP	1d	2f	Ren
3.6B	PTZ3.6B	Z-diode	3.6V±10%, 40mA, 1W	DO-214AC	1d	1a	Rhm
3.6C	HZF3.6CP	Z-diode	3.6V±10%, 900mW	LRP	1d	2f	Ren
3.9	MAZ80390H	Z-diode	3.87..4.1V, Zzt=130Ω(5mA), 150mW	SC-76	6d	1a	Pan
3.9B	HZF3.9BP	Z-diode	3.9V±5%, 900mW	LRP	1d	2f	Ren
3.9B	PTZ3.9B	Z-diode	3.9V±10%, 40mA, 1W	DO-214AC	1d	1a	Rhm
3.9C	HZF3.9CP	Z-diode	3.9V±10%, 900mW	LRP	1d	2f	Ren
3A	MAZS0300H	Z-diode	2.95..3.2V, 200mW	SOD-523	6d	1a	Pan
3A0	MAZ80300H	Z-diode	2.95..3.1V, Zzt=120Ω(5mA), 150mW	SC-76	6d	1a	Pan
3A0	MAZ8030GHL	Z-diode	2.95..3.1V, Zzt=120Ω(5mA), 150mW	SMini2-F3	6d	1a	Pan
3A3	MAZ80330H	Z-diode	3.25..3.5V, Zzt=130Ω(5mA), 150mW	SC-76	6d	1a	Pan
3A3	MAZ8033GHL	Z-diode	3.25..3.5V, Zzt=130Ω(5mA), 150mW	SMini2-F3	6d	1a	Pan
3A6	MAZ80360H	Z-diode	3.55..3.8V, Zzt=130Ω(5mA), 150mW	SC-76	6d	1a	Pan
3A6	MAZ8036GHL	Z-diode	3.55..3.8V, Zzt=130Ω(5mA), 150mW	SMini2-F3	6d	1a	Pan
3A9	MAZ80390H	Z-diode	3.87..4.1V, Zzt=130Ω(5mA), 150mW	SC-76	6d	1a	Pan



SMD code	Type	Function	Short description	Case	Pinout	St.	Mnf.
3*9	MAZ8039GHL	Z-diode	3.87..4.1V, Zzt=130Q(5mA), 150mW	SMini2-F3	6d	1a	Pan
3_	MAZS0300L	Z-diode	2.8..3.05V, 200mW	SOD-523	6d	1a	Pan
3_0	MAZ80300L	Z-diode	2.8..3.05V, Zzt=120Q(5mA), 150mW	SC-76	6d	1a	Pan
3_0	MAZ8030GLL	Z-diode	2.8..3.05V, Zzt=120Q(5mA), 150mW	SMini2-F3	6d	1a	Pan
3_3	MAZ80330L	Z-diode	3.1..3.35V, Zzt=130Q(5mA), 150mW	SC-76	6d	1a	Pan
3_3	MAZ8033GLL	Z-diode	3.1..3.35V, Zzt=130Q(5mA), 150mW	SMini2-F3	6d	1a	Pan
3_6	MAZ80360L	Z-diode	3.4..3.65V, Zzt=130Q(5mA), 150mW	SC-76	6d	1a	Pan
3_6	MAZ8036GLL	Z-diode	3.4..3.65V, Zzt=130Q(5mA), 150mW	SMini2-F3	6d	1a	Pan
3_9	MAZ80390L	Z-diode	3.7..3.97V, Zzt=130Q(5mA), 150mW	SC-76	6d	1a	Pan
3_9	MAZ8039GLL	Z-diode	3.7..3.97V, Zzt=130Q(5mA), 150mW	SMini2-F3	6d	1a	Pan
3*0	HZU3.0B1	Z-diode	2.80..3.05V, lzt=5mA, Zzt=120Q, 200mW	URP	5d	1a	Ren
3*0	HZU3.0B2	Z-diode	2.95..3.20V, lzt=5mA, Zzt=120Q, 200mW	URP	5d	1a	Ren
3*0	RKZ3.0B2KG	Z-diode	2.95..3.20V, lzt=5mA, Zzt=120Q, 200mW	URP	5d	2e	Ren
3*0	RKZ3.0B2KJ	Z-diode	2.95..3.20V, lzt=5mA, Zzt=120Q, 150mW	UPF	7d	2e	Ren
3*3	HZU3.3B1	Z-diode	3.10..3.35V, lzt=5mA, Zzt=130Q, 200mW	URP	5d	1a	Ren
3*3	HZU3.3B2	Z-diode	3.25..3.50V, lzt=5mA, Zzt=130Q, 200mW	URP	5d	1a	Ren
3*3	RKZ3.3B2KG	Z-diode	3.25..3.50V, lzt=5mA, Zzt=130Q, 200mW	URP	5d	2e	Ren
3*3	RKZ3.3B2KJ	Z-diode	3.25..3.50V, lzt=5mA, Zzt=130Q, 150mW	UPF	7d	2e	Ren
3*6	HZU3.6B1	Z-diode	3.40..3.65V, lzt=5mA, Zzt=130Q, 200mW	URP	5d	1a	Ren
3*6	HZU3.6B2	Z-diode	3.55..3.80V, lzt=5mA, Zzt=130Q, 200mW	URP	5d	1a	Ren
3*6	RKZ3.6B2KG	Z-diode	3.55..3.80V, lzt=5mA, Zzt=130Q, 200mW	URP	5d	2e	Ren
3*6	RKZ3.6B2KJ	Z-diode	3.55..3.80V, lzt=5mA, Zzt=130Q, 150mW	UPF	7d	2e	Ren
3*9	HZU3.9B1	Z-diode	3.70..3.97V, lzt=5mA, Zzt=130Q, 200mW	URP	5d	1a	Ren
3*9	HZU3.9B2	Z-diode	3.87..4.10V, lzt=5mA, Zzt=130Q, 200mW	URP	5d	1a	Ren
3*9	RKZ3.9B2KG	Z-diode	3.87..4.10V, lzt=5mA, Zzt=130Q, 200mW	URP	5d	2e	Ren
3*9	RKZ3.9B2KJ	Z-diode	3.87..4.10V, lzt=5mA, Zzt=130Q, 150mW	UPF	7d	2e	Ren
30	BZY55-C30	Z-diode	28.50..31.50V, lzt=5mA, Zzt=80Q, 500mW	0805	70d	2d	Tsc
30	CDZ55C30	Z-diode	28.50..31.50V, Zzt=80Q, lzt=5mA, 500mW	1206	70d	2d	Crp
30	CDZ55C30S	Z-diode	28.50..31.50V, Zzt=80Q, lzt=5mA, 500mW	0805	70d	2d	Crp
30	CDZ55C30T	Z-diode	28.50..31.50V, Zzt=80Q, lzt=5mA, 200mW	0603	70d	2d	Crp
30	CMZ30	Z-diode	30V±5%, 2W	M-Flat	7d	1a	Tos
30	HMSZ5230B	Z-diode	4.7V±5%, lzt=20mA, Zzt=19Q, 225mW	SOD-323	5d	1d	Hsn
30	HZC3.0	Z-diode	3V±10%, 150mW	SOD-523	6d	1a	Ren
30	KDZ3.0EV	Z-diode	2.8..3.2V, 150mW	SOD-523	6d	1a	Kec
30	KDZ3.0V	Z-diode	2.8..3.2V, 150mW	SOD-323	5d	1a	Kec
30	KDZ30VV	Z-diode	28.0..32.0V, lzt=2mA, Zzt=200Q, 100mW	VSC	7d	1a	Kec
30	MAZ83000H	Z-diode	30.2..31.8, Zzt=160Q(2mA), 150mW	SC-76	6d	1a	Pan
30	MAZS300	Z-diode	28..32V, 200mW	SOD-523	6d	1a	Pan
30	MAZY300	Z-diode	27..33V, Zzt=30Q(10mA), 1W	NMiniP2	1d	1a	Pan
30	MMPZ5256SPT	Z-diode	29.40..30.60V, lzt=5mA, Zzt=78Q, 225mW	SOD-323	5d	1a	Chm
30	P4SMA30	TVS	Vbr=27.0..33.0V, Vrw=24.3V, 10.0A, 400W(1ms)	DO-214AC	1d	1a	Eic
30	P6SMBJ30	TVS	Vbr=27..33V, 14A, 600W(1ms)	DO-214AA	1d	1n	Lif
30	P6SMBJ33	TVS	Vbr=29.7..36.3V, 12.6A, 600W(1ms)	DO-214AA	1d	1n	Lif
30	SMA3C30	Z-diode	30V±5%, lzt=25mA, Zzt<16Q, 3W	DO-214AC	1d	1a	Exc
30	SML4751	Z-diode	30V±5%, lzt=8.5mA, Zzt=40Q, 1W	DO-214AC	1d	1k	Vs
30	TZD3.0WS	Z-diode	2.80..3.20V, lzt=5mA, Zzt=120Q, 200mW	SOD-323	5d	1a	Ttr
30	TZD3.0WT	Z-diode	2.80..3.20V, lzt=5mA, Zzt=120Q, 150mW	SOD-523	6d	1a	Ttr
30	TZD30WU	Z-diode	29.19..30.69V, lzt=2mA, Zzt=200Q, 100mW	SOD-723	7d	1a	Ttr
30	U1Z30	Z-diode	27..33V, 1W	SOD-6	1d	1a	Tos
30	U1ZB30	Z-diode	27..33V, 1W	I-FLAT	1d	1a	Tos
30	ZD5230BS2	Z-diode	4.7V±5%, 20mA, Zzt=19Q, 500mW	SOD-323	5d	1a	Cys
30-	MAZ83000M	Z-diode	29.3..30.8V, Zzt=160Q(2mA), 150mW	SC-76	6d	1a	Pan
30-	MAZ8300GML	Z-diode	29.3..30.8V, Zzt=160Q(2mA), 150mW	SMini2-F3	6d	1a	Pan
30	CTZ55C30	Z-diode	28.50..31.50V, lzt=5mA, Zzt=80Q, 500mW	1206	70d	2d	Ctc
30-	MAZS3000M	Z-diode	29.3..30.8V, 200mW	SOD-523	6d	1a	Pan
30^	MAZ83000H	Z-diode	30.2..31.8, Zzt=160Q(2mA), 150mW	SC-76	6d	1a	Pan
30^	MAZ8300GHL	Z-diode	30.2..31.8, Zzt=160Q(2mA), 150mW	SMini2-F3	6d	1a	Pan
30^	MAZS3000H	Z-diode	30.2..31.8V, 200mW	SOD-523	6d	1a	Pan
30_	MAZ83000L	Z-diode	28.3..19.7V, Zzt=160Q(2mA), 150mW	SC-76	6d	1a	Pan
30_	MAZ8300GLL	Z-diode	28.3..19.7V, Zzt=160Q(2mA), 150mW	SMini2-F3	6d	1a	Pan
30_	MAZS3000L	Z-diode	28.3..29.7V, 200mW	SOD-523	6d	1a	Pan
30■	HZC30	Z-diode	30V±10%, 150mW	SOD-523	6d	1a	Ren
30•	HZU30B	Z-diode	28.0..32.0V, lzt=2mA, Zzt=80Q, 200mW	URP	5d	1a	Ren
30•	RKZ30BKG	Z-diode	28.0..32.0V, lzt=2mA, Zzt=80Q, 200mW	URP	5d	2e	Ren
30•	RKZ30BKJ	Z-diode	28.0..32.0V, lzt=2mA, Zzt=80Q, 150mW	UPF	7d	2e	Ren
30•	TZD3.0YWS	Z-diode	2.95..3.20V, lzt=5mA, Zzt=120Q, 200mW	SOD-323	5d	1a	Ttr
30•	TZD3.0YWT	Z-diode	2.95..3.20V, lzt=5mA, Zzt=120Q, 150mW	SOD-523	6d	1a	Ttr
300	MAZX300	Z-diode	270..330V, Zzt=5Q(0.5mA), 1W	NMiniP2	1d	1a	Pan
300	P4SMA300	TVS	Vbr=270..330V, Vrw=243V, 0.93A, 400W(1ms)	DO-214AC	1d	1a	Eic
300	U1Z300	Z-diode	270..330V, 1W	SOD-6	1d	1a	Tos



SMD code	Type	Function	Short description	Case	Pinout	St.	Mnf.
300	U1ZB300	Z-diode	270..330V, 1W	I-FLAT	1d	1a	Tos
3006	1SMB3EZ6.8	Z-diode	6.8V±5%, Zzt=2Ω, Izt=110.0mA, 3W	DO-214AA	1d	1a	Pjt
3007	1SMB3EZ7.5	Z-diode	7.5V±5%, Zzt=2Ω, Izt=100.0mA, 3W	DO-214AA	1d	1a	Pjt
3008	1SMB3EZ8.2	Z-diode	8.2V±5%, Zzt=2Ω, Izt=91.0mA, 3W	DO-214AA	1d	1a	Pjt
3009	1SMB3EZ9.1	Z-diode	9.1V±5%, Zzt=3Ω, Izt=82.0mA, 3W	DO-214AA	1d	1a	Pjt
300A	1.5SMC300A	TVS	Vbr=285..315V, Vrw=256V, 3.6A, 1500W(1ms)	DO-214AB	1d	1k	Vs
300A	P4SMA300A	TVS	Vbr=285..315V, Vrw=256V, 0.97A, 400W(1ms)	DO-214AC	1d	1k	Vs
300A	P6SMB300A	TVS	Vbr=285..315V, Vrw=256V, 1.45A, 600W(1ms)	DO-214AA	1d	1k	Vs
300C	1.5SMC300CA	TVS	Vrw=256.0V, Vbr=285.0..315.0V, 3.7A, 1500W(1ms), Bidirectional	DO-214AB	1ba	1j	Fee
300C	P4SMA300C	TVS	Vbr=270..330V, Vrw=243V, 0.93A, 400W(1ms), Bidirectional	DO-214AC	1ba	1j	Eic
300CA	P4SMA300CA	TVS	Vbr=285..315V, Vrw=256V, 0.97A, 400W(1ms), Bidirectional	DO-214AC	1ba	1j	Eic
300CA	P6SMB300CA	TVS	Vbr=285..315V, Vrw=256V, 1.45A, 600W(1ms), Bidirectional	DO-214AA	1ba	1j	Eic
300X	U1ZB300-X	Z-diode	280..300V, 1W	I-FLAT	1d	1a	Tos
300Y	U1ZB300-Y	Z-diode	290..310V, 1W	I-FLAT	1d	1a	Tos
300Z	U1ZB300-Z	Z-diode	300..320V, 1W	I-FLAT	1d	1a	Tos
301	HZU30L-1	Z-diode	28.2..29.6V, 150mW	URP	5d	1a	Ren
3010	1SMB3EZ10	Z-diode	10V±5%, Zzt=4Ω, Izt=75mA, 3W	DO-214AA	1d	1a	Pjt
3010	SZ3010	Z-diode	10V±10%, Izt=37.5mA, Zzt=4.5Ω, 1.5W	DO-214AC	1d	1a	Eic
3011	1SMB3EZ11	Z-diode	11V±5%, Zzt=4Ω, Izt=68.0mA, 3W	DO-214AA	1d	1a	Pjt
3011	SZ3011	Z-diode	11V±10%, Izt=34.1mA, Zzt=5.5Ω, 1.5W	DO-214AC	1d	1a	Eic
3012	1SMB3EZ12	Z-diode	12V±5%, Zzt=5Ω, Izt=63.0mA, 3W	DO-214AA	1d	1a	Pjt
3012	SZ3012	Z-diode	12V±10%, Izt=31.2mA, Zzt=6.5Ω, 1.5W	DO-214AC	1d	1a	Eic
3013	1SMB3EZ13	Z-diode	13V±5%, Zzt=5Ω, Izt=58.0mA, 3W	DO-214AA	1d	1a	Pjt
3013	SZ3013	Z-diode	13V±10%, Izt=28.8mA, Zzt=7.0Ω, 1.5W	DO-214AC	1d	1a	Eic
3014	1SMB3EZ14	Z-diode	14V±5%, Zzt=6Ω, Izt=53.0mA, 3W	DO-214AA	1d	1a	Pjt
3015	1SMB3EZ15	Z-diode	15V±5%, Zzt=7Ω, Izt=50.0mA, 3W	DO-214AA	1d	1a	Pjt
3015	SZ3015	Z-diode	15V±10%, Izt=25.0mA, Zzt=9.0Ω, 1.5W	DO-214AC	1d	1a	Eic
3016	1SMB3EZ16	Z-diode	16V±5%, Zzt=8Ω, Izt=47.0mA, 3W	DO-214AA	1d	1a	Pjt
3016	SZ3016	Z-diode	16V±10%, Izt=23.4mA, Zzt=10Ω, 1.5W	DO-214AC	1d	1a	Eic
3017	1SMB3EZ17	Z-diode	17V±5%, Zzt=9Ω, Izt=44.0mA, 3W	DO-214AA	1d	1a	Pjt
3018	1SMB3EZ18	Z-diode	18V±5%, Zzt=10Ω, Izt=42.0mA, 3W	DO-214AA	1d	1a	Pjt
3018	SZ3018	Z-diode	18V±10%, Izt=20.8mA, Zzt=12Ω, 1.5W	DO-214AC	1d	1a	Eic
3019	1SMB3EZ19	Z-diode	19V±5%, Zzt=11Ω, Izt=40.0mA, 3W	DO-214AA	1d	1a	Pjt
302	HZU30L-2	Z-diode	29.2..30.6V, 150mW	URP	5d	1a	Ren
3020	1SMB3EZ20	Z-diode	20V±5%, Zzt=11Ω, Izt=37.0mA, 3W	DO-214AA	1d	1a	Pjt
3020	SZ3020	Z-diode	20V±10%, Izt=18.7mA, Zzt=14Ω, 1.5W	DO-214AC	1d	1a	Eic
3022	1SMB3EZ22	Z-diode	22V±5%, Zzt=12Ω, Izt=34.0mA, 3W	DO-214AA	1d	1a	Pjt
3022	SZ3022	Z-diode	22V±10%, Izt=17.0mA, Zzt=17.5Ω, 1.5W	DO-214AC	1d	1a	Eic
3024	1SMB3EZ24	Z-diode	24V±5%, Zzt=13Ω, Izt=31.0mA, 3W	DO-214AA	1d	1a	Pjt
3024	SZ3024	Z-diode	24V±10%, Izt=15.6mA, Zzt=19Ω, 1.5W	DO-214AC	1d	1a	Eic
3025	1SMB3EZ25	Z-diode	25V±5%, Zzt=14Ω, Izt=30.0mA, 3W	DO-214AA	1d	1a	Pjt
3027	1SMB3EZ27	Z-diode	27V±5%, Zzt=18Ω, Izt=28.0mA, 3W	DO-214AA	1d	1a	Pjt
3027	SZ3027	Z-diode	27V±10%, Izt=13.9mA, Zzt=23Ω, 1.5W	DO-214AC	1d	1a	Eic
3028	1SMB3EZ28	Z-diode	28V±5%, Zzt=18Ω, Izt=27.0mA, 3W	DO-214AA	1d	1a	Pjt
303	HZU30L-3	Z-diode	30.2..31.6V, 150mW	URP	5d	1a	Ren
3030	1SMB3EZ30	Z-diode	30V±5%, Zzt=20Ω, Izt=25mA, 3W	DO-214AA	1d	1a	Pjt
3030	SZ3030	Z-diode	30V±10%, Izt=12.5mA, Zzt=26Ω, 1.5W	DO-214AC	1d	1a	Eic
3033	1SMB3EZ33	Z-diode	33V±5%, Zzt=23Ω, Izt=23.0mA, 3W	DO-214AA	1d	1a	Pjt
3033	SZ3033	Z-diode	33V±10%, Izt=11.4mA, Zzt=33Ω, 1.5W	DO-214AC	1d	1a	Eic
3036	1SMB3EZ36	Z-diode	36V±5%, Zzt=25Ω, Izt=21.0mA, 3W	DO-214AA	1d	1a	Pjt
3036	SZ3036	Z-diode	36V±10%, Izt=10.4mA, Zzt=38Ω, 1.5W	DO-214AC	1d	1a	Eic
3039	1SMB3EZ39	Z-diode	39V±5%, Zzt=30Ω, Izt=19.0mA, 3W	DO-214AA	1d	1a	Pjt
3039	SZ3039	Z-diode	39V±10%, Izt=9.6mA, Zzt=45Ω, 1.5W	DO-214AC	1d	1a	Eic
303D	SZ303D	Z-diode	3.3V±10%, Izt=113.6mA, Zzt=10Ω, 1.5W	DO-214AC	1d	1a	Eic
303G	SZ303G	Z-diode	3.6V±10%, Izt=104.2mA, Zzt=9.0Ω, 1.5W	DO-214AC	1d	1a	Eic
303J	SZ303J	Z-diode	3.9V±10%, Izt=96.1mA, Zzt=7.5Ω, 1.5W	DO-214AC	1d	1a	Eic
3043	1SMB3EZ43	Z-diode	43V±5%, Zzt=35Ω, Izt=17.0mA, 3W	DO-214AA	1d	1a	Pjt
3043	SZ3043	Z-diode	43V±10%, Izt=8.7mA, Zzt=53Ω, 1.5W	DO-214AC	1d	1a	Eic
3047	1SMB3EZ47	Z-diode	47V±5%, Zzt=40Ω, Izt=16.0mA, 3W	DO-214AA	1d	1a	Pjt
3047	SZ3047	Z-diode	47V±10%, Izt=8.0mA, Zzt=67Ω, 1.5W	DO-214AC	1d	1a	Eic
304D	SZ304D	Z-diode	4.3V±10%, Izt=87.2mA, Zzt=6.0Ω, 1.5W	DO-214AC	1d	1a	Eic
304H	SZ304H	Z-diode	4.7V±10%, Izt=79.8mA, Zzt=5.0Ω, 1.5W	DO-214AC	1d	1a	Eic
3051	1SMB3EZ51	Z-diode	51V±5%, Zzt=48Ω, Izt=15mA, 3W	DO-214AA	1d	1a	Pjt
3051	SZ3051	Z-diode	51V±10%, Izt=7.3mA, Zzt=70Ω, 1.5W	DO-214AC	1d	1a	Eic
3056	1SMB3EZ56	Z-diode	56V±5%, Zzt=55Ω, Izt=13.0mA, 3W	DO-214AA	1d	1a	Pjt
3056	SZ3056	Z-diode	56V±10%, Izt=6.7mA, Zzt=86Ω, 1.5W	DO-214AC	1d	1a	Eic
305B	SZ305B	Z-diode	5.1V±10%, Izt=73.5mA, Zzt=4.0Ω, 1.5W	DO-214AC	1d	1a	Eic
305G	SZ305G	Z-diode	5.6V±10%, Izt=66.9mA, Zzt=2.0Ω, 1.5W	DO-214AC	1d	1a	Eic
3060	1SMB3EZ60	Z-diode	60V±5%, Zzt=58Ω, Izt=12.5mA, 3W	DO-214AA	1d	1a	Pjt
3062	1SMB3EZ62	Z-diode	62V±5%, Zzt=60Ω, Izt=12.0mA, 3W	DO-214AA	1d	1a	Pjt



SMD
code

Type

Function

Short description

Case

Pinout

St.

Mnf.

SMD code	Type	Function	Short description	Case	Pinout	St.	Mnf.
3062	SZ3062	Z-diode	62V±10%, Izt=6.0mA, Zzt=100Ω, 1.5W	DO-214AC	1d	1a	Eic
3068	1SMB3EZ68	Z-diode	68V±5%, Zzt=75Ω, Izt=11.0mA, 3W	DO-214AA	1d	1a	Pjt
3068	SZ3068	Z-diode	68V±10%, Izt=5.5mA, Zzt=120Ω, 1.5W	DO-214AC	1d	1a	Eic
306C	SZ306C	Z-diode	6.2V±10%, Izt=60.5mA, Zzt=2.0Ω, 1.5W	DO-214AC	1d	1a	Eic
306I	SZ306I	Z-diode	6.8V±10%, Izt=55.1mA, Zzt=2.5Ω, 1.5W	DO-214AC	1d	1a	Eic
3075	1SMB3EZ75	Z-diode	75V±5%, Zzt=90Ω, Izt=10.0mA, 3W	DO-214AA	1d	1a	Pjt
3075	SZ3075	Z-diode	75V±10%, Izt=5.0mA, Zzt=140Ω, 1.5W	DO-214AC	1d	1a	Eic
307F	SZ307F	Z-diode	7.5V±10%, Izt=50.0mA, Zzt=3.0Ω, 1.5W	DO-214AC	1d	1a	Eic
3082	1SMB3EZ82	Z-diode	82V±5%, Zzt=100Ω, Izt=9.1mA, 3W	DO-214AA	1d	1a	Pjt
3082	SZ3082	Z-diode	82V±10%, Izt=4.6mA, Zzt=160Ω, 1.5W	DO-214AC	1d	1a	Eic
3087	1SMB3EZ87	Z-diode	87V±5%, Zzt=120Ω, Izt=8.5mA, 3W	DO-214AA	1d	1a	Pjt
308C	SZ308C	Z-diode	8.2V±10%, Izt=45.7mA, Zzt=3.5Ω, 1.5W	DO-214AC	1d	1a	Eic
309I	1SMB3EZ9I	Z-diode	91V±5%, Zzt=125Ω, Izt=8.2mA, 3W	DO-214AA	1d	1a	Pjt
309I	SZ309I	Z-diode	91V±10%, Izt=4.1mA, Zzt=200Ω, 1.5W	DO-214AC	1d	1a	Eic
309B	SZ309B	Z-diode	9.1V±10%, Izt=41.2mA, Zzt=4.0Ω, 1.5W	DO-214AC	1d	1a	Eic
30A	1.5SMC30A	TVS	Vbr=28.5..31.5V, Vrw=25.6V, 36.2A, 1500W(1ms)	DO-214AB	1d,3d	1a,1k	Vs,Ons
30A	1SMC30A	TVS	Vbr=33.3..36.8V, Vrw=30V, 31.0A, 1500W(1ms)	DO-214AB	1d	1a	Eic
30A	P4SMA30A	TVS	Vbr=28.5..31.5V, Vrw=25.6V, 10.0A, 400W(1ms)	DO-214AC	1d	1k	Vs
30A	P6SMB30A	TVS	Vrw=30V, Vbr=28.5..31.5V, 14.5A, 600W(1ms)	DO-214AA	1d,3d	1k,1a	Vs,Ons
30A	P6SMBJ30A	TVS	Vbr=28.5..31.5V, 14.4A, 600W(1ms)	DO-214AA	1d	1n	Lif
30A	RKZ30AKU	Z-diode	26.99..28.39V, Izt=5mA, Zzt=80Ω, 500mW	TURP-FM	7d	1a	Ren
30A	SMAJ30A	TVS	Vrw=30V, Vbr=33.3..36.8V, 8.3A, 400W(1ms)	DO-214AC	1d	1a	Sus
30A	SMBJ30A	TVS	Vbr=33.1..36.8V, Vrw=30V, 12.4A, 600W(1ms)	DO-214AA	1d	1a	Sus
30A	SMCJ30A	TVS	Vrw=30V, Vbr=33.3..38.3V, 28A, 1500W(1ms)	DO-214AB	1d	1k	Sus
30A	UMA30A	TVS	Vrw=30V, Vbr=33.3..48.4V, 10.3A, 500W(1ms)	UltraMite	14d	1v	Msc
30A8	1SMB3EZ8.7	Z-diode	8.7V±5%, Zzt=2Ω, Izt=85mA, 3W	DO-214AA	1d	1a	Pjt
30B	1SMB3EZ30	Z-diode	30V±5%, Zzt=20Ω, Izt=25mA, 3W	DO-214AA	1d	1a	Pjt
30B	HZF30BP	Z-diode	30V±5%, 900mW	LRP	1d	2f	Ren
30B	MMHZ5230BPT	Z-diode	4.465..4.935V, Izt=5mA, Zzt=70Ω, 225mW	SOD-123	5d	1a	Chm
30B	PTZ30B	Z-diode	30V±10%, 10mA, 1W	DO-214AC	1d	1a	Rhm
30B	RKZ30BKU	Z-diode	27.70..29.13V, Izt=5mA, Zzt=80Ω, 500mW	TURP-FM	7d	1a	Ren
30B	Z3SMB30B	Z-diode	28.50..31.50V, Izt=25mA, Zzt=16Ω, 3W	DO-214AA	1d	1a	Ttr
30B0	SZ30B0	Z-diode	100V±10%, Izt=3.7mA, Zzt=250Ω, 1.5W	DO-214AC	1d	1a	Eic
30B1	SZ30B1	Z-diode	110V±10%, Izt=3.4mA, Zzt=300Ω, 1.5W	DO-214AC	1d	1a	Eic
30B2	SZ30B2	Z-diode	120V±10%, Izt=3.1mA, Zzt=380Ω, 1.5W	DO-214AC	1d	1a	Eic
30B3	SZ30B3	Z-diode	130V±10%, Izt=2.9mA, Zzt=450Ω, 1.5W	DO-214AC	1d	1a	Eic
30B5	SZ30B5	Z-diode	150V±10%, Izt=2.5mA, Zzt=600Ω, 1.5W	DO-214AC	1d	1a	Eic
30B6	SZ30B6	Z-diode	160V±10%, Izt=2.3mA, Zzt=700Ω, 1.5W	DO-214AC	1d	1a	Eic
30B8	SZ30B8	Z-diode	180V±10%, Izt=2.1mA, Zzt=900Ω, 1.5W	DO-214AC	1d	1a	Eic
30C	1.5SMC30CA	TVS	Vbr=28.5..31.5V, Vrw=25.6V, 36.2A, 1500W(1ms), Bidirectional	DO-214AB	1ba	1l	Vs
30C	HZF30CP	Z-diode	30V±10%, 900mW	LRP	1d	2f	Ren
30C	P4SMA30C	TVS	Vbr=27.0..33.0V, Vrw=24.3V, 10.0A, 400W(1ms), Bidirectional	DO-214AC	1ba	1j	Eic
30C	P4SMA30CA	TVS	Vbr=28.5..31.5V, 9.7A, 400W(1ms), Bidirectional	DO-214AC	1ba	1l	Vs
30C	P6SMB30CA	TVS	Vrw=30V, Vbr=28.5..31.5V, 14.5A, 600W(1ms), Bidirectional	DO-214AA	1ba,3ba	1l,1e	Vs,Ons
30C	P6SMBJ30C	TVS	Vbr=27..33V, 14A, 600W(1ms), Bidirectional	DO-214AA	1ba	1p	Lif
30C	RKZ30CKU	Z-diode	28.36..29.82V, Izt=5mA, Zzt=80Ω, 500mW	TURP-FM	7d	1a	Ren
30CA	1SMC30CA	TVS	Vbr=33.3..36.8V, Vrw=30V, 31.0A, 1500W(1ms), Bidirectional	DO-214AB	1ba	1j	Eic
30CA	P4SMA30CA	TVS	Vbr=28.5..31.5V, Vrw=25.6V, 10.0A, 400W(1ms), Bidirectional	DO-214AC	1ba	1j	Eic
30CA	P6SMB30CA	TVS	Vbr=28.5..31.5V, Vrw=25.6V, 14.4A, 600W(1ms), Bidirectional	DO-214AA	1ba	1j	Eic
30CA	P6SMBJ30CA	TVS	Vbr=28.5..31.5V, 14.4A, 600W(1ms), Bidirectional	DO-214AA	1ba	1p	Lif
30CA	SMAJ30CA	TVS	Vrw=30V, Vbr=33.3..36.8V, 8.3A, 400W(1ms), Bidirectional	DO-214AC	1ba	1j	Sus
30CA	SMBJ30CA	TVS	Vbr=33.1..36.8V, Vrw=30V, 12.4A, 600W(1ms), Bidirectional	DO-214AA	1ba	1j	Sus
30CA	SMCJ30CA	TVS	Vrw=30V, Vbr=33.3..38.3V, 28A, 1500W(1ms), Bidirectional	DO-214AB	1ba	1l	Sus
30CA	UMA30CA	TVS	Vrw=30V, Vbr=33.3..48.4V, 10.3A, 500W(1ms), Bidirectional	UltraMite	14ba	1v	Msc
30D	RKZ30DKU	Z-diode	29.02..30.51V, Izt=5mA, Zzt=80Ω, 500mW	TURP-FM	7d	1a	Ren
30D0	SZ30D0	Z-diode	200V±10%, Izt=1.9mA, Zzt=1200Ω, 1.5W	DO-214AC	1d	1a	Eic
30P	BZD27C30P	Z-diode	28.50..31.50V, Zzt=15Ω, Izt=25mA, 800mW	SOD-123FL	7d	1a	Pjt
30P	MFPZ30	Z-diode	28.50..31.50V, Izt=25mA, Zzt=15Ω, 800mW	SOD-123FL	7d	1a	Ttr
30S	MMHZ5230SPT	Z-diode	4.606..4.794V, Izt=5mA, Zzt=70Ω, 225mW	SOD-123	5d	1a	Chm
30V	SMA30	TVS	Vbr=33.3..40.7V, Vrw=30.0V, 5.6A, 300W(1ms)	DO-214AC	1d	1a	Mic
30V	SMB30	TVS	Vbr=33.3..40.7V, Vrw=30V, 11.2A, 600W(1ms)	DO-214AA	1d	1a	Mic
30V	SMC30	TVS	Vbr=33.3..40.7V, Vrw=30V, 28A, 1500W(1ms)	DO-214AB	1d	1a	Mic
30VA	SMA30A	TVS	Vbr=33.3..36.8V, Vrw=30.0V, 6.2A, 300W(1ms)	DO-214AC	1d	1a	Mic
30VA	SMB30A	TVS	Vbr=33.3..36.8V, Vrw=30V, 12.4A, 600W(1ms)	DO-214AA	1d	1a	Mic
30VA	SMC30A	TVS	Vbr=33.3..36.8V, Vrw=30V, 31A, 1500W(1ms)	DO-214AB	1d	1a	Mic
30VB	BZT52-B30	Z-diode	29.40..30.60V, Izt=2mA, Zzt=80Ω, 500mW	SOD-123FL	7d	1a	Tsc
30VB	MMSZ30VBW	Z-diode	29.40..30.60V, Izt=2mA, Zzt=80Ω, 500mW	SOD-123FL	7d	1a	Tac
30VC	SMA30C	TVS	Vbr=33.3..40.7V, Vrw=30.0V, 5.6A, 300W(1ms), Bidirectional	DO-214AC	1ba	1j	Mic
30VC	SMB30C	TVS	Vbr=33.3..40.7V, Vrw=30V, 11.2A, 600W(1ms), Bidirectional	DO-214AA	1ba	1j	Mic
30VC	SMC30C	TVS	Vbr=33.3..40.7V, Vrw=30V, 28A, 1500W(1ms), Bidirectional	DO-214AB	1ba	1j	Mic



SMD code	Type	Function	Short description	Case	Pinout	St.	Mnf.
30VCA	SMA30CA	TVS	Vbr=33.3..36.8V, Vnwm=30.0V, 6.2A, 300W(1ms), Bidirectional	DO-214AC	1ba	1j	Mic
30VCA	SMB30CA	TVS	Vbr=33.3..36.8V, Vnwm=30V, 12.4A, 600W(1ms), Bidirectional	DO-214AA	1ba	1j	Mic
30VCA	SMC30CA	TVS	Vbr=33.3..36.8V, Vnwm=30V, 31A, 1500W(1ms), Bidirectional	DO-214AB	1ba	1j	Mic
30VZ	BZT52-C30	Z-diode	28.50..31.50V, Izt=2mA, Zzt=80Ω, 500mW	SOD-123FL	7d	1a	Tsc
30VZ	MMSZ30VCW	Z-diode	28.50..31.50V, Izt=2mA, Zzt=80Ω, 500mW	SOD-123FL	7d	1a	Tac
30VZ	TCMMSZ30V	Z-diode	30V±5%, Izt=5mA, Zzt=75Ω, 500mW	SOD-123FL	7d	1a	Tac
30VZ	ZGFM0530C-MH	Z-diode	28.50..31.5V, Izt=5mA, Zzt=75Ω, 500mW	SOD-123	5d	1a	Pic
31	HMSZ5231B	Z-diode	5..1V±5%, Izt=20mA, Zzt=17Ω, 225mW	SOD-323	5d	1d	Hsn
31	ZD5231BS2	Z-diode	5..1V±5%, 20mA, Zzt=17Ω, 500mW	SOD-323	5d	1a	Cys
3100	1SMB3EZ100	Z-diode	100V±5%, Zzt=175Ω, Izt=7.5mA, 3W	DO-214AA	1d	1a	Pjt
31B	MMHZ5231BPT	Z-diode	4.845..5.355V, Izt=5mA, Zzt=50Ω, 225mW	SOD-123	5d	1a	Chm
31S	MMHZ5231SPT	Z-diode	4.998..5.202V, Izt=5mA, Zzt=50Ω, 225mW	SOD-123	5d	1a	Chm
32	CMZ33	Z-diode	33V±5%, 2W	M-Flat	7d	1a	Tos
32	FDZ2.7VT	Z-diode	2.690..2.910V, Izt=5mA, Zzt=110Ω, 200mW	SOD-323	5d	1a	Fis
32	HMSZ5232B	Z-diode	5.6V±5%, Izt=20mA, Zzt=11Ω, 225mW	SOD-323	5d	1d	Hsn
32	UDZS2.7B	Z-diode	2.69..2.91V, Izt=5mA, Zzt=110Ω, 200mW	SOD-323	5d	1a	Wtr
32	ZD5232BS2	Z-diode	5.6V±5%, 20mA, Zzt=11Ω, 500mW	SOD-323	5d	1a	Cys
320A	TSP320SA	Thy-SPD	V Of-St=320V, 50A(1ms), Bidirectional	DO-214AA	1ba	1j	Pjt
320B	TSP320SB	Thy-SPD	V Of-St=320V, 80A(1ms), Bidirectional	DO-214AA	1ba	1j	Pjt
320C	TSP320SC	Thy-SPD	V Of-St=320V, 100A(1ms), Bidirectional	DO-214AA	1ba	1j	Pjt
32B	MMHZ5232BPT	Z-diode	5.320..5.880V, Izt=5mA, Zzt=25Ω, 225mW	SOD-123	5d	1a	Chm
32LL	SSM32LLPT	Si-diode	Rectifier, Schottky, 20V, 3A, Vf<0.27V(3A)	DO-214AC	1d	1a	Chm
32LS	SSM32LSPT	Si-diode	Rectifier, Schottky, 20V, 3A, Vf<0.4V(3A)	SMA-S	8d	1a	Chm
32S	MMHZ5232SPT	Z-diode	5.488..5.712V, Izt=5mA, Zzt=25Ω, 225mW	SOD-123	5d	1a	Chm
33	BZY55-C33	Z-diode	31.35..34.65V, Izt=5mA, Zzt=80Ω, 500mW	0805	70d	2d	Tsc
33	CDZ55C33	Z-diode	31.35..34.65V, Zzt=80Ω, Izt=5mA, 500mW	1206	70d	2d	Crp
33	CDZ55C33S	Z-diode	31.35..34.65V, Zzt=80Ω, Izt=5mA, 500mW	0805	70d	2d	Crp
33	CDZ55C33T	Z-diode	31.35..34.65V, Zzt=80Ω, Izt=5mA, 200mW	0603	70d	2d	Crp
33	HMSZ5233B	Z-diode	6V±5%, Izt=20mA, Zzt=7Ω, 225mW	SOD-323	5d	1d	Hsn
33	HZC3.3	Z-diode	3.3V±10%, 150mW	SOD-523	6d	1a	Ren
33	KDZ3.3EV	Z-diode	3.1..3.5V, 150mW	SOD-523	6d	1a	Kec
33	KDZ3.3V	Z-diode	3.1..3.5V, 150mW	SOD-323	5d	1a	Kec
33	KDZ33VV	Z-diode	31.0..35.0V, Izt=2mA, Zzt=250Ω, 100mW	VSC	7d	1a	Kec
33	MAZ83300H	Z-diode	33.2..34.9V, Zzt=200Ω(2mA), 150mW	SC-76	6d	1a	Pan
33	MAZS330	Z-diode	31..35V, 200mW	SOD-523	6d	1a	Pan
33	MAZY330	Z-diode	29.7..36.3V, Zzt=30Ω(10mA), 1W	NMiniP2	1d	1a	Pan
33	MMPZ5257SPT	Z-diode	32.34..33.66V, Izt=5mA, Zzt=88Ω, 225mW	SOD-323	5d	1a	Chm
33	P4SMA33	TVS	Vbr=29.7..36.3V, Vnwm=26.8V, 9.0A, 400W(1ms)	DO-214AC	1d	1a	Eic
33	SMA3C33	Z-diode	33V±5%, Izt=23mA, Zzt<20Ω, 3W	DO-214AC	1d	1a	Exc
33	SML4752	Z-diode	33V±5%, Izt=7.5mA, Zzt=45Ω, 1W	DO-214AC	1d	1k	Vs
33	SS3P3	Si-diode	SBR, 30V, 3A, Vf<0.58V(3A)	DO-220AA	8d	1k	Vs
33	TZD3.3WS	Z-diode	3.10..3.50V, Izt=5mA, Zzt=130Ω, 200mW	SOD-323	5d	1a	Ttr
33	TZD3.3WT	Z-diode	3.10..3.50V, Izt=5mA, Zzt=130Ω, 150mW	SOD-523	6d	1a	Ttr
33	TZD33WU	Z-diode	32.15..33.79V, Izt=2mA, Zzt=250Ω, 100mW	SOD-723	7d	1a	Ttr
33	U1Z33	Z-diode	29.7..36.3V, 1W	SOD-6	1d	1a	Tos
33	U1ZB33	Z-diode	29.7..36.3V, 1W	I-FLAT	1d	1a	Tos
33	ZD5233BS2	Z-diode	6.0V±5%, 20mA, Zzt=7.0Ω, 500mW	SOD-323	5d	1a	Cys
33-	MAZ83300M	Z-diode	32.2..33.8V, Zzt=200Ω(2mA), 150mW	SC-76	6d	1a	Pan
33-	MAZ8330GML	Z-diode	32.2..33.8V, Zzt=200Ω(2mA), 150mW	SMini2-F3	6d	1a	Pan
33-	MAZS3300M	Z-diode	32.2..33.8V, 200mW	SOD-523	6d	1a	Pan
33	CTZ55C33	Z-diode	31.35..34.65V, Izt=5mA, Zzt=80Ω, 500mW	1206	70d	2d	Ctc
33^	MAZ83300H	Z-diode	33.2..34.9V, Zzt=200Ω(2mA), 150mW	SC-76	6d	1a	Pan
33^	MAZ8330GHL	Z-diode	33.2..34.9V, Zzt=200Ω(2mA), 150mW	SMini2-F3	6d	1a	Pan
33^	MAZS3300H	Z-diode	33.2..34.9V, 200mW	SOD-523	6d	1a	Pan
33_	MAZ83300L	Z-diode	31.2..32.8V, Zzt=200Ω(2mA), 150mW	SC-76	6d	1a	Pan
33_	MAZ8330GLL	Z-diode	31.2..32.8V, Zzt=200Ω(2mA), 150mW	SMini2-F3	6d	1a	Pan
33_	MAZS3300L	Z-diode	31.2..32.8V, 200mW	SOD-523	6d	1a	Pan
33=	HZC33	Z-diode	33V±10%, 150mW	SOD-523	6d	1a	Ren
33>	HZU33B	Z-diode	31.0..35.0V, Izt=2mA, Zzt=80Ω, 200mW	URP	5d	1a	Ren
33>	RKZ33BKG	Z-diode	31.0..35.0V, Izt=2mA, Zzt=80Ω, 200mW	URP	5d	2e	Ren
33>	RKZ33BKJ	Z-diode	31.0..35.0V, Izt=2mA, Zzt=80Ω, 150mW	UPF	7d	2e	Ren
33>	TZD3.3YWS	Z-diode	3.25..3.50V, Izt=5mA, Zzt=130Ω, 200mW	SOD-323	5d	1a	Ttr
33>	TZD3.3YWT	Z-diode	3.25..3.50V, Izt=5mA, Zzt=130Ω, 150mW	SOD-523	6d	1a	Ttr
330	HZU33L-1	Z-diode	31.2..32.6V, 150mW	URP	5d	1a	Ren
330	MAZX330	Z-diode	297..363V, Zzt=5Ω(0.5mA), 1W	NMiniP2	1d	1a	Pan
330	U1Z330	Z-diode	297..363V, 1W	SOD-6	1d	1a	Tos
330	U1ZB330	Z-diode	297..363V, 1W	I-FLAT	1d	1a	Tos
330X	U1ZB330-X	Z-diode	310..330V, 1W	I-FLAT	1d	1a	Tos
330Y	U1ZB330-Y	Z-diode	320..340V, 1W	I-FLAT	1d	1a	Tos
330Z	U1ZB330-Z	Z-diode	330..350V, 1W	I-FLAT	1d	1a	Tos



SMD code	Type	Function	Short description	Case	Pinout	St.	Mnf.
331	HZU33L-2	Z-diode	32.2..33.6V, 150mW	URP	5d	1a	Ren
332	HZU33L-3	Z-diode	33.2..34.6V, 150mW	URP	5d	1a	Ren
33A	1.5SMC33A	TVS	Vbr=31.4..34.7V, Vrw=28.2V, 32.8A, 1500W(1ms)	DO-214AB	1d,3d	1a,1k	Vs,Ons
33A	1SMC33A	TVS	Vbr=36.7..40.6V, Vrw=33V, 28.1A, 1500W(1ms)	DO-214AB	1d	1a	Eic
33A	P4SMA33A	TVS	Vbr=31.4..34.7V, Vrw=28.2V, 9.0A, 400W(1ms)	DO-214AC	1d	1k	Vs
33A	P6SMB33A	TVS	Vrw=33V, Vbr=31.4..34.7V, 13.1A, 600W(1ms)	DO-214AA	1d,3d	1k,1a	Vs,Ons
33A	P6SMBJ33A	TVS	Vbr=31.4..34.7V, 13.2A, 600W(1ms)	DO-214AA	1d	1n	Lif
33A	RKZ33AKU	Z-diode	29.68..31.22V, Izt=5mA, Zzt=80Ω, 500mW	TURP-FM	7d	1a	Ren
33A	SMAJ33A	TVS	Vrw=33V, Vbr=36.7..40.6V, 7.5A, 400W(1ms)	DO-214AC	1d	1a	Sus
33A	SMBJ33A	TVS	Vbr=36.7..40.6V, Vrw=33V, 11.3A, 600W(1ms)	DO-214AA	1d	1a	Sus
33A	SMCJ33A	TVS	Vrw=33V, Vbr=36.7..44.9V, 25.4A, 1500W(1ms)	DO-214AB	1d	1k	Sus
33A	UMA33A	TVS	Vrw=33V, Vbr=36.7..53.3V, 9.4A, 500W(1ms)	UltraMite	14d	1v	Msc
33B	1SMB3EZ33	Z-diode	33V±5%, Zzt=23Ω, Izt=23.0mA, 3W	DO-214AA	1d	1a	Pjt
33B	HZF33BP	Z-diode	33V±5%, 900mW	LRP	1d	2f	Ren
33B	MMHZ5233BPT	Z-diode	5.700..6.300V, Izt=5mA, Zzt=25Ω, 225mW	SOD-123	5d	1a	Chm
33B	PTZ33B	Z-diode	33V±10%, 10mA, 1W	DO-214AC	1d	1a	Rhm
33B	RKZ33BKU	Z-diode	30.32..31.88V, Izt=5mA, Zzt=80Ω, 500mW	TURP-FM	7d	1a	Ren
33B	Z3SMB33B	Z-diode	31.35..34.65V, Izt=23mA, Zzt=20Ω, 3W	DO-214AA	1d	1a	Ttr
33C	1.5SMC33CA	TVS	Vbr=31.4..34.7V, Vrw=28.2V, 32.8A, 1500W(1ms), Bidirectional	DO-214AB	1ba	1l	Vs
33C	HZF33CP	Z-diode	33V±10%, 900mW	LRP	1d	2f	Ren
33C	P4SMA33C	TVS	Vbr=29.7..36.3V, Vrw=26.8V, 9.0A, 400W(1ms), Bidirectional	DO-214AC	1ba	1j	Eic
33C	P4SMA33CA	TVS	Vbr=31.4..34.7V, 8.8A, 400W(1ms), Bidirectional	DO-214AC	1ba	1l	Vs
33C	P6SMB33CA	TVS	Vrw=33V, Vbr=31.4..34.7V, 13.1A, 600W(1ms), Bidirectional	DO-214AA	1ba,3ba	11,e	Vs,Ons
33C	P6SMBJ33C	TVS	Vbr=29.7..36.3V, 12.6A, 600W(1ms), Bidirectional	DO-214AA	1ba	1p	Lif
33C	RKZ33CKU	Z-diode	30.90..32.50V, Izt=5mA, Zzt=80Ω, 500mW	TURP-FM	7d	1a	Ren
33C	SMB33C	TVS	Vbr=36.7..44.9V, Vrw=33V, 10.2A, 600W(1ms), Bidirectional	DO-214AA	1ba	1j	Mic
33CA	1SMC33CA	TVS	Vbr=36.7..40.6V, Vrw=33V, 28.1A, 1500W(1ms), Bidirectional	DO-214AB	1ba	1j	Eic
33CA	P4SMA33CA	TVS	Vbr=31.4..34.7V, Vrw=28.2V, 9.0A, 400W(1ms), Bidirectional	DO-214AC	1ba	1j	Eic
33CA	P6SMB33CA	TVS	Vbr=31.4..34.7V, Vrw=28.2V, 13.2A, 600W(1ms), Bidirectional	DO-214AA	1ba	1p	Lif
33CA	P6SMBJ33CA	TVS	Vbr=31.4..34.7V, 13.2A, 600W(1ms), Bidirectional	DO-214AA	1ba	1p	Lif
33CA	SMAJ33CA	TVS	Vrw=33V, Vbr=36.7..40.6V, 7.5A, 400W(1ms), Bidirectional	DO-214AC	1ba	1j	Sus
33CA	SMBJ33CA	TVS	Vbr=36.7..40.6V, Vrw=33V, 11.3A, 600W(1ms), Bidirectional	DO-214AA	1ba	1j	Sus
33CA	SMCJ33CA	TVS	Vrw=33V, Vbr=36.7..44.9V, 25.4A, 1500W(1ms), Bidirectional	DO-214AB	1ba	1l	Sus
33CA	UMA33CA	TVS	Vrw=33V, Vbr=36.7..53.3V, 9.4A, 500W(1ms), Bidirectional	UltraMite	14ba	1v	Msc
33L	SSA33L	Si-diode	SBR, 30V, 3A, Vf<0.49V(3A)	DO-214AC	1d	1k	Vs
33LS	SSM33LSPT	Si-diode	Rectifier, Schottky, 30V, 3A, Vf<0.4V(3A)	SMA-S	8d	1a	Chm
33P	BZD27C33P	Z-diode	31.35..34.65V, Zzt=15Ω, Izt=25mA, 800mW	SOD-123FL	7d	1a	Pjt
33P	MFPZ33	Z-diode	31.35..34.65V, Izt=25mA, Zzt=15Ω, 800mW	SOD-123FL	7d	1a	Ttr
33S	MMHZ5233SPT	Z-diode	5.880..6.120V, Izt=5mA, Zzt=25Ω, 225mW	SOD-123	5d	1a	Chm
33V	SMA33	TVS	Vbr=36.7..44.9V, Vrw=33.0V, 5.1A, 300W(1ms)	DO-214AC	1d	1a	Mic
33V	SMB33	TVS	Vbr=36.7..44.9V, Vrw=33V, 10.2A, 600W(1ms)	DO-214AA	1d	1a	Mic
33V	SMC33	TVS	Vbr=36.7..44.9V, Vrw=33V, 25.4A, 1500W(1ms)	DO-214AB	1d	1a	Mic
33VA	SMA33A	TVS	Vbr=36.7..40.6V, Vrw=33.0V, 5.6A, 300W(1ms)	DO-214AC	1d	1a	Mic
33VA	SMB33A	TVS	Vbr=36.7..40.6V, Vrw=33V, 11.3A, 600W(1ms)	DO-214AA	1d	1a	Mic
33VA	SMC33A	TVS	Vbr=36.7..40.6V, Vrw=33V, 28.1A, 1500W(1ms)	DO-214AB	1d	1a	Mic
33VB	BZT52-B33	Z-diode	32.34..33.66V, Izt=2mA, Zzt=80Ω, 500mW	SOD-123FL	7d	1a	Tsc
33VB	MMSZ33VBW	Z-diode	32.34..33.66V, Izt=2mA, Zzt=80Ω, 500mW	SOD-123FL	7d	1a	Tac
33VC	SMA33C	TVS	Vbr=36.7..44.9V, Vrw=33.0V, 5.1A, 300W(1ms), Bidirectional	DO-214AC	1ba	1j	Mic
33VC	SMC33C	TVS	Vbr=36.7..44.9V, Vrw=33V, 25.4A, 1500W(1ms), Bidirectional	DO-214AB	1ba	1j	Mic
33VCA	SMA33CA	TVS	Vbr=36.7..40.6V, Vrw=33.0V, 5.6A, 300W(1ms), Bidirectional	DO-214AC	1ba	1j	Mic
33VCA	SMB33CA	TVS	Vbr=36.7..40.6V, Vrw=33V, 11.3A, 600W(1ms), Bidirectional	DO-214AA	1ba	1j	Mic
33VCA	SMC33CA	TVS	Vbr=36.7..40.6V, Vrw=33V, 28.1A, 1500W(1ms), Bidirectional	DO-214AB	1ba	1j	Mic
33VZ	BZT52-C33	Z-diode	31.35..34.65V, Izt=2mA, Zzt=80Ω, 500mW	SOD-123FL	7d	1a	Tsc
33VZ	MMSZ33VCW	Z-diode	31.35..34.65V, Izt=2mA, Zzt=80Ω, 500mW	SOD-123FL	7d	1a	Tac
33VZ	TCMMSZ33V	Z-diode	33V±5%, Izt=5mA, Zzt=75Ω, 500mW	SOD-123FL	7d	1a	Tac
33VZ	ZGFM0533C-MH	Z-diode	31.35..34.65V, Izt=5mA, Zzt=75Ω, 500mW	SOD-123	5d	1a	Pic
34	HMSZ5234B	Z-diode	6.2V±5%, Izt=20mA, Zzt=7Ω, 225mW	SOD-323	5d	1d	Hsn
34	SS3P4	Si-diode	SBR, 40V, 3A, Vf<0.6V(3A)	DO-220AA	8d	1k	Vs
34	ZD5234BS2	Z-diode	6.2V±5%, 20mA, Zzt=7.0Ω, 500mW	SOD-323	5d	1a	Cys
342B	1SMC5342	Z-diode	6.46..7.14V, Zzt=1Ω, Izt=175mA, 5W	DO-214AB	1d	1a	Pjt
342B	Z5SMC5342B	Z-diode	6.46..7.14V, Izt=175mA, Zzt=1Ω, 5W	DO-214AB	1d	1a	Ttr
343B	1SMC5343	Z-diode	7.13..7.88V, Zzt=2Ω, Izt=175mA, 5W	DO-214AB	1d	1a	Pjt
343B	Z5SMC5343B	Z-diode	7.13..7.88V, Izt=175mA, Zzt=2Ω, 5W	DO-214AB	1d	1a	Ttr
344B	1SMC5344	Z-diode	7.79..8.61V, Zzt=2Ω, Izt=150mA, 5W	DO-214AB	1d	1a	Pjt
344B	Z5SMC5344B	Z-diode	7.79..8.61V, Izt=150mA, Zzt=2Ω, 5W	DO-214AB	1d	1a	Ttr
345B	1SMC5345	Z-diode	8.27..9.14V, Zzt=2Ω, Izt=150mA, 5W	DO-214AB	1d	1a	Pjt
345B	Z5SMC5345B	Z-diode	8.27..9.14V, Izt=150mA, Zzt=2Ω, 5W	DO-214AB	1d	1a	Ttr
346B	1SMC5346	Z-diode	8.65..9.56V, Zzt=2Ω, Izt=150mA, 5W	DO-214AB	1d	1a	Pjt
346B	Z5SMC5346B	Z-diode	8.65..9.56V, Izt=150mA, Zzt=2Ω, 5W	DO-214AB	1d	1a	Ttr
347B	1SMC5347	Z-diode	9.5..10.5V, Zzt=2Ω, Izt=125mA, 5W	DO-214AB	1d	1a	Pjt



SMD
code

Type

Function

Short description

Case

Pinout

St.

Mnf.

SMD code	Type	Function	Short description	Case	Pinout	St.	Mnf.
347B	Z5SMC5347B	Z-diode	9.50..10.50V, Izt=125mA, Zzt=2Ω, 5W	DO-214AB	1d	1a	Ttr
348B	1SMC5348	Z-diode	10.4..11.55V, Zzt=3Ω, Izt=125mA, 5W	DO-214AB	1d	1a	Pjt
348B	Z5SMC5348B	Z-diode	10.45..11.55V, Izt=125mA, Zzt=3Ω, 5W	DO-214AB	1d	1a	Ttr
349B	1SMC5349	Z-diode	11.4..12.6V, Zzt=3Ω, Izt=100mA, 5W	DO-214AB	1d	1a	Pjt
349B	Z5SMC5349B	Z-diode	11.40..12.60V, Izt=100mA, Zzt=3Ω, 5W	DO-214AB	1d	1a	Ttr
34AS	SSM34LASPT	Si-diode	Rectifier, Schottky, 40V, 3A, Vf<0.38V(3A)	SMA-S	8d	1a	Chm
34B	MMHZ5234BPT	Z-diode	5.890..6.510V, Izt=5mA, Zzt=10Ω, 225mW	SOD-123	5d	1a	Chm
34LA	SSM34LAPT	Si-diode	Rectifier, Schottky, 40V, 3A, Vf<0.38V(3A)	DO-214AC	1d	1a	Chm
34LS	SSM34LSPT	Si-diode	Rectifier, Schottky, 40V, 3A, Vf<0.4V(3A)	SMA-S	8d	1a	Chm
34S	MMHZ5234SPT	Z-diode	6.070..6.324V, Izt=5mA, Zzt=10Ω, 225mW	SOD-123	5d	1a	Chm
35	BZX584B3V3	Z-diode	3.23..3.37V, Izt=5mA, Zzt=95Ω, 200mW	SOD-523FL	7d	1a	Tac
35	EDZ13B	Z-diode	12.91..13.49V, Izt=5mA, Zzt=37Ω, 150mW	SOD-523	6d	1a	Rhm
35	FDZ13EV	Z-diode	12.910..13.490V, Izt=5mA, Zzt=37Ω, 150mW	SOD-523	7d	1a	Fis
35	FDZ13VT	Z-diode	12.910..13.490V, Izt=5mA, Zzt=37Ω, 200mW	SOD-323	5d	1a	Fis
35	HMSZ5235B	Z-diode	6.8V±5%, Izt=20mA, Zzt=5Ω, 225mW	SOD-323	5d	1d	Hsn
35	MM5Z3V3B	Z-diode	3.23..3.37V, Izt=5mA, Zzt=95Ω, 200mW	SOD-523FL	7d	1a	Tac
35	SS3P5	Si-diode	SBR, 50V, 3A, Vf<0.78V(3A)	DO-220AA	8d	1k	Vs
35	TDZ13B	Z-diode	13V±2.5%, 10mA, 500mW	TUMD2	7d	1s	Rhm
35	UDZS13B	Z-diode	12.91..13.49V, Izt=5mA, Zzt=37Ω, 200mW	SOD-323	5d	1a	Wtr
35	UDZS13B	Z-diode	13V±2.5%, Izt=5mA, 200mW	SOD-323FL	7d	1s	Rhm
35	VDSZ13B	Z-diode	13V±5%, 5mA, 100mW	VMD2	5d	1z	Rhm
35	ZD5235B52	Z-diode	6.8V±5%, 20mA, Zzt=5.0Ω, 500mW	SOD-323	5d	1a	Chm
350	P4SMA350	TVS	Vbr=315..385V, Vrrm=284V, 0.79A, 400W(1ms)	DO-214AC	1d	1a	Eic
350A	1.5SMC350A	TVS	Vbr=333..368V, Vrrm=300V, 3.1A, 1500W(1ms)	DO-214AB	1d	1k	Vs
350A	P4SMA350A	TVS	Vbr=332..368V, Vrrm=300V, 0.83A, 400W(1ms)	DO-214AC	1d	1k	Vs
350A	P6SMB350A	TVS	Vbr=332..368V, Vrrm=300V, 1.25A, 600W(1ms)	DO-214AA	1d	1k	Vs
350B	1SMC5350	Z-diode	12.35..13.65V, Zzt=3Ω, Izt=100mA, 5W	DO-214AB	1d	1a	Pjt
350B	Z5SMC5350B	Z-diode	12.35..13.65V, Izt=100mA, Zzt=3Ω, 5W	DO-214AB	1d	1a	Ttr
350C	1.5SMC350CA	TVS	Vrrm=300.0V, Vbr=332.0..368.0V, 3.2A, 1500W(1ms), Bidirectional	DO-214AB	1ba	1j	Fee
350C	P4SMA350C	TVS	Vbr=315..385V, Vrrm=284V, 0.79A, 400W(1ms), Bidirectional	DO-214AC	1ba	1j	Eic
350CA	P4SMA350CA	TVS	Vbr=332..368V, Vrrm=300V, 0.83A, 400W(1ms), Bidirectional	DO-214AC	1ba	1j	Eic
350CA	P6SMB350CA	TVS	Vbr=332..368V, Vrrm=300V, 1.25A, 600W(1ms), Bidirectional	DO-214AA	1ba	1j	Eic
3510	SZ3510	Z-diode	10V±5%, Izt=37.5mA, Zzt=4.5Ω, 1.5W	DO-214AC	1d	1a	Eic
3511	SZ3511	Z-diode	11V±5%, Izt=34.1mA, Zzt=5.5Ω, 1.5W	DO-214AC	1d	1a	Eic
3512	SZ3512	Z-diode	12V±5%, Izt=31.2mA, Zzt=6.5Ω, 1.5W	DO-214AC	1d	1a	Eic
3513	SZ3513	Z-diode	13V±5%, Izt=28.8mA, Zzt=7.0Ω, 1.5W	DO-214AC	1d	1a	Eic
3515	SZ3515	Z-diode	15V±5%, Izt=25.0mA, Zzt=9.0Ω, 1.5W	DO-214AC	1d	1a	Eic
3516	SZ3516	Z-diode	16V±5%, Izt=23.4mA, Zzt=10Ω, 1.5W	DO-214AC	1d	1a	Eic
3518	SZ3518	Z-diode	18V±5%, Izt=20.8mA, Zzt=12Ω, 1.5W	DO-214AC	1d	1a	Eic
351B	1SMC5351	Z-diode	13.3..14.7V, Zzt=3Ω, Izt=100mA, 5W	DO-214AB	1d	1a	Pjt
351B	Z5SMC5351B	Z-diode	13.30..14.70V, Izt=100mA, Zzt=3Ω, 5W	DO-214AB	1d	1a	Ttr
3520	SZ3520	Z-diode	20V±5%, Izt=18.7mA, Zzt=14Ω, 1.5W	DO-214AC	1d	1a	Eic
3522	SZ3522	Z-diode	22V±5%, Izt=17.0mA, Zzt=17.5Ω, 1.5W	DO-214AC	1d	1a	Eic
3524	SZ3524	Z-diode	24V±5%, Izt=15.6mA, Zzt=19Ω, 1.5W	DO-214AC	1d	1a	Eic
3527	SZ3527	Z-diode	27V±5%, Izt=13.9mA, Zzt=23Ω, 1.5W	DO-214AC	1d	1a	Eic
352B	1SMC5352	Z-diode	14.25..15.75V, Zzt=3Ω, Izt=75mA, 5W	DO-214AB	1d	1a	Pjt
352B	Z5SMC5352B	Z-diode	14.25..15.75V, Izt=75mA, Zzt=3Ω, 5W	DO-214AB	1d	1a	Ttr
3530	SZ3530	Z-diode	30V±5%, Izt=12.5mA, Zzt=26Ω, 1.5W	DO-214AC	1d	1a	Eic
3533	SZ3533	Z-diode	33V±5%, Izt=11.4mA, Zzt=33Ω, 1.5W	DO-214AC	1d	1a	Eic
3536	SZ3536	Z-diode	36V±5%, Izt=10.4mA, Zzt=38Ω, 1.5W	DO-214AC	1d	1a	Eic
3539	SZ3539	Z-diode	39V±5%, Izt=9.6mA, Zzt=45Ω, 1.5W	DO-214AC	1d	1a	Eic
353B	1SMC5353	Z-diode	15.2..16.8V, Zzt=3Ω, Izt=75mA, 5W	DO-214AB	1d	1a	Pjt
353B	Z5SMC5353B	Z-diode	15.20..16.80V, Izt=75mA, Zzt=3Ω, 5W	DO-214AB	1d	1a	Ttr
353D	SZ353D	Z-diode	3.3V±5%, Izt=113.6mA, Zzt=10Ω, 1.5W	DO-214AC	1d	1a	Eic
353G	SZ353G	Z-diode	3.6V±5%, Izt=104.2mA, Zzt=9.0Ω, 1.5W	DO-214AC	1d	1a	Eic
353J	SZ353J	Z-diode	3.9V±5%, Izt=96.1mA, Zzt=7.5Ω, 1.5W	DO-214AC	1d	1a	Eic
3543	SZ3543	Z-diode	43V±5%, Izt=8.7mA, Zzt=53Ω, 1.5W	DO-214AC	1d	1a	Eic
3547	SZ3547	Z-diode	47V±5%, Izt=8.0mA, Zzt=67Ω, 1.5W	DO-214AC	1d	1a	Eic
354B	1SMC5354	Z-diode	16.15..17.85V, Zzt=3Ω, Izt=70mA, 5W	DO-214AB	1d	1a	Pjt
354B	Z5SMC5354B	Z-diode	16.15..17.85V, Izt=70mA, Zzt=3Ω, 5W	DO-214AB	1d	1a	Ttr
354D	SZ354D	Z-diode	4.3V±5%, Izt=87.2mA, Zzt=6.0Ω, 1.5W	DO-214AC	1d	1a	Eic
354H	SZ354H	Z-diode	4.7V±5%, Izt=79.8mA, Zzt=5.0Ω, 1.5W	DO-214AC	1d	1a	Eic
3551	SZ3551	Z-diode	51V±5%, Izt=7.3mA, Zzt=70Ω, 1.5W	DO-214AC	1d	1a	Eic
3556	SZ3556	Z-diode	56V±5%, Izt=6.7mA, Zzt=86Ω, 1.5W	DO-214AC	1d	1a	Eic
355B	1SMC5355	Z-diode	17.1..18.9V, Zzt=3Ω, Izt=65mA, 5W	DO-214AB	1d	1a	Pjt
355B	Z5SMC5355B	Z-diode	17.10..18.90V, Izt=65mA, Zzt=3Ω, 5W	DO-214AB	1d	1a	Ttr
355B	SZ355B	Z-diode	5.1V±5%, Izt=73.5mA, Zzt=4.0Ω, 1.5W	DO-214AC	1d	1a	Eic
355B	Z5SMC5355B	Z-diode	17.10..18.90V, Izt=65mA, Zzt=3Ω, 5W	DO-214AB	1d	1a	Ttr
355G	SZ355G	Z-diode	5.6V±5%, Izt=66.9mA, Zzt=2.0Ω, 1.5W	DO-214AC	1d	1a	Eic
3562	SZ3562	Z-diode	62V±5%, Izt=6.0mA, Zzt=100Ω, 1.5W	DO-214AC	1d	1a	Eic
3568	SZ3568	Z-diode	68V±5%, Izt=5.5mA, Zzt=120Ω, 1.5W	DO-214AC	1d	1a	Eic



SMD code	Type	Function	Short description	Case	Pinout	St.	Mnf.
356B	1SMC5356	Z-diode	18.05..19.95V, Zzt=3Ω, Izt=65mA, 5W	DO-214AB	1d	1a	Pjt
356B	Z5SMC5356B	Z-diode	18.05..19.95V, Izt=65mA, Zzt=3Ω, 5W	DO-214AB	1d	1a	Ttr
356C	SZ356C	Z-diode	6.2V±5%, Izt=60.5mA, Zzt=2.0Ω, 1.5W	DO-214AC	1d	1a	Eic
356I	SZ356I	Z-diode	6.8V±5%, Izt=55.1mA, Zzt=2.5Ω, 1.5W	DO-214AC	1d	1a	Eic
3575	SZ3575	Z-diode	75V±5%, Izt=5.0mA, Zzt=140Ω, 1.5W	DO-214AC	1d	1a	Eic
357B	1SMC5357	Z-diode	19..21V, Zzt=3Ω, Izt=65.75mA, 5W	DO-214AB	1d	1a	Pjt
357B	Z5SMC5357B	Z-diode	19.0..21.0V, Izt=65mA, Zzt=3Ω, 5W	DO-214AB	1d	1a	Ttr
357F	SZ357F	Z-diode	7.5V±5%, Izt=50.0mA, Zzt=3.0Ω, 1.5W	DO-214AC	1d	1a	Eic
3582	SZ3582	Z-diode	82V±5%, Izt=4.6mA, Zzt=160Ω, 1.5W	DO-214AC	1d	1a	Eic
358B	1SMC5358	Z-diode	20.9..23.1V, Zzt=4Ω, Izt=50mA, 5W	DO-214AB	1d	1a	Pjt
358B	Z5SMC5358B	Z-diode	20.90..23.10V, Izt=50mA, Zzt=4Ω, 5W	DO-214AB	1d	1a	Ttr
358C	SZ358C	Z-diode	8.2V±5%, Izt=45.7mA, Zzt=3.5Ω, 1.5W	DO-214AC	1d	1a	Eic
3591	SZ3591	Z-diode	91V±5%, Izt=4.1mA, Zzt=200Ω, 1.5W	DO-214AC	1d	1a	Eic
359B	1SMC5359	Z-diode	22.8..25.2V, Zzt=4Ω, Izt=50mA, 5W	DO-214AB	1d	1a	Pjt
359B	SZ359B	Z-diode	9.1V±5%, Izt=41.2mA, Zzt=4.0Ω, 1.5W	DO-214AC	1d	1a	Eic
359B	Z5SMC5359B	Z-diode	22.80..25.20V, Izt=50mA, Zzt=4Ω, 5W	DO-214AB	1d	1a	Ttr
35B	MMHZ5235BPT	Z-diode	6.460..7.140V, Izt=5mA, Zzt=8Ω, 225mW	SOD-123	5d	1a	Chm
35B0	SZ35B0	Z-diode	100V±5%, Izt=3.7mA, Zzt=250Ω, 1.5W	DO-214AC	1d	1a	Eic
35B1	SZ35B1	Z-diode	110V±5%, Izt=3.4mA, Zzt=300Ω, 1.5W	DO-214AC	1d	1a	Eic
35B2	SZ35B2	Z-diode	120V±5%, Izt=3.1mA, Zzt=380Ω, 1.5W	DO-214AC	1d	1a	Eic
35B3	SZ35B3	Z-diode	130V±5%, Izt=2.9mA, Zzt=450Ω, 1.5W	DO-214AC	1d	1a	Eic
35B5	SZ35B5	Z-diode	150V±5%, Izt=2.5mA, Zzt=600Ω, 1.5W	DO-214AC	1d	1a	Eic
35B6	SZ35B6	Z-diode	160V±5%, Izt=2.3mA, Zzt=700Ω, 1.5W	DO-214AC	1d	1a	Eic
35B8	SZ35B8	Z-diode	180V±5%, Izt=2.1mA, Zzt=900Ω, 1.5W	DO-214AC	1d	1a	Eic
35D0	SZ35D0	Z-diode	200V±5%, Izt=1.9mA, Zzt=1200Ω, 1.5W	DO-214AC	1d	1a	Eic
35S	MMHZ5235SPT	Z-diode	6.664..6.936V, Izt=5mA, Zzt=8Ω, 225mW	SOD-123	5d	1a	Chm
36	BZY55-C36	Z-diode	34.20..37.80V, Izt=5mA, Zzt=80Ω, 500mW	0805	70d	2d	Tsc
36	CDZ55C36	Z-diode	34.20..37.80V, Zzt=80Ω, Izt=5mA, 500mW	1206	70d	2d	Crp
36	CDZ55C36S	Z-diode	34.20..37.80V, Zzt=80Ω, Izt=5mA, 500mW	0805	70d	2d	Crp
36	CDZ55C36T	Z-diode	34.20..37.80V, Zzt=80Ω, Izt=5mA, 200mW	0603	70d	2d	Crp
36	CMZ36	Z-diode	36V±5%, 2W	M-Flat	7d	1a	Tos
36	HMSZ5236B	Z-diode	7.5V±5%, Izt=20mA, Zzt=6Ω, 225mW	SOD-323	5d	1d	Hsn
36	HZC3.6	Z-diode	3.6V±10%, 150mW	SOD-523	6d	1a	Ren
36	KDZ3.6EV	Z-diode	3.4..3.8V, 150mW	SOD-523	6d	1a	Kec
36	KDZ3.6V	Z-diode	3.4..3.8V, 150mW	SOD-323	5d	1a	Kec
36	KDZ36VV	Z-diode	34.0..38.0V, Izt=2mA, Zzt=300Ω, 100mW	VSC	7d	1a	Kec
36	MAZ83600H	Z-diode	36.1..34.9V, Zzt=250Ω(2mA), 150mW	SC-76	6d	1a	Pan
36	MAZS360	Z-diode	34..38V, 200mW	SOD-523	6d	1a	Pan
36	MAZY360	Z-diode	32.4..39.6V, Zzt=30Ω(5mA), 1W	NMiniP2	1d	1a	Pan
36	MMPZ5258SPT	Z-diode	35.28..36.72V, Izt=5mA, Zzt=95Ω, 225mW	SOD-323	5d	1a	Chm
36	P4SMA36	TVS	Vbr=32.4..39.6V, Vvwm=29.1V, 8.0A, 400W(1ms)	DO-214AC	1d	1a	Eic
36	P6SMBJ36	TVS	Vbr=32.4..39.6V, 11.6A, 600W(1ms)	DO-214AA	1d	1n	Lif
36	SMA3C36	Z-diode	36V±5%, Izt=2.1mA, Zzt=22Ω, 3W	DO-214AC	1d	1a	Exc
36	SML4753	Z-diode	36V±5%, Izt=7mA, Zzt=50Ω, 1W	DO-214AC	1d	1k	Vs
36	SS3P6	Si-diode	SBR, 60V, 3A, Vf<0.78V(3A)	DO-220AA	8d	1k	Vs
36	TZD3.6WS	Z-diode	3.40..3.80V, Izt=5mA, Zzt=113Ω, 200mW	SOD-323	5d	1a	Ttr
36	TZD3.6WT	Z-diode	3.40..3.80V, Izt=5mA, Zzt=113Ω, 150mW	SOD-523	6d	1a	Ttr
36	TZD36WU	Z-diode	35.07..36.87V, Izt=2mA, Zzt=300Ω, 100mW	SOD-723	7d	1a	Ttr
36	U1Z36	Z-diode	32.4..39.6V, 1W	SOD-6	1d	1a	Tos
36	U1ZB36	Z-diode	32.4..39.6V, 1W	I-FLAT	1d	1a	Tos
36	ZD5236BS2	Z-diode	7.5V±5%, 20mA, Zzt=6.0Ω, 500mW	SOD-323	5d	1a	Cys
36-	MAZ83600M	Z-diode	35.1..36.9V, Zzt=250Ω(2mA), 150mW	SC-76	6d	1a	Pan
36-	MAZ8360GML	Z-diode	35.1..36.9V, Zzt=250Ω(2mA), 150mW	SMini2-F3	6d	1a	Pan
36-	MAZS3600M	Z-diode	35.1..36.9V, 200mW	SOD-523	6d	1a	Pan
36	CTZ55C36	Z-diode	34.20..37.80V, Izt=5mA, Zzt=80Ω, 500mW	1206	70d	2d	Ctc
36^	MAZ83600H	Z-diode	36.1..34.9V, Zzt=250Ω(2mA), 150mW	SC-76	6d	1a	Pan
36^	MAZ8360GHL	Z-diode	36.1..34.9V, Zzt=250Ω(2mA), 150mW	SMini2-F3	6d	1a	Pan
36^	MAZS3600H	Z-diode	36.1..37.9V, 200mW	SOD-523	6d	1a	Pan
36_	MAZ83600L	Z-diode	34.1..35.9V, Zzt=250Ω(2mA), 150mW	SC-76	6d	1a	Pan
36_	MAZ8360GLL	Z-diode	34.1..35.9V, Zzt=250Ω(2mA), 150mW	SMini2-F3	6d	1a	Pan
36_	MAZS3600L	Z-diode	34.1..35.9V, 200mW	SOD-523	6d	1a	Pan
36■	HZC36	Z-diode	36V±10%, 150mW	SOD-523	6d	1a	Ren
36*	HZU36B	Z-diode	34.0..38.0V, Izt=2mA, Zzt=90Ω, 200mW	URP	5d	1a	Ren
36*	RKZ36BKG	Z-diode	34.0..38.0V, Izt=2mA, Zzt=90Ω, 200mW	URP	5d	2e	Ren
36*	RKZ36BKJ	Z-diode	34.0..38.0V, Izt=2mA, Zzt=90Ω, 150mW	UFP	7d	2e	Ren
36*	TZD3.6YWS	Z-diode	3.60..3.845V, Izt=5mA, Zzt=113Ω, 200mW	SOD-323	5d	1a	Ttr
36*	TZD3.6YWT	Z-diode	3.60..3.845V, Izt=5mA, Zzt=113Ω, 150mW	SOD-523	6d	1a	Ttr
360B	1SMC5360	Z-diode	23.75..26.25V, Zzt=4Ω, Izt=50mA, 5W	DO-214AB	1d	1a	Pjt
360B	Z5SMC5360B	Z-diode	23.75..26.25V, Izt=50mA, Zzt=4Ω, 5W	DO-214AB	1d	1a	Ttr
361	HZU36L-1	Z-diode	34.2..35.7V, 150mW	URP	5d	1a	Ren



SMD code	Type	Function	Short description	Case	Pinout	St.	Mnf.
361B	1SMC5361	Z-diode	25.65 .28.35V, Zzt=5Ω, Izt=50mA, 5W	DO-214AB	1d	1a	Pjt
361B	Z5SMC5361B	Z-diode	25.65 .28.35V, Izt=50mA, Zzt=5Ω, 5W	DO-214AB	1d	1a	Tr
362	HZU36L-2	Z-diode	35.3 .36.8V, 150mW	URP	5d	1a	Ren
362B	1SMC5362	Z-diode	26.6 .29.4V, Zzt=6Ω, Izt=50mA, 5W	DO-214AB	1d	1a	Pjt
362B	Z5SMC5362B	Z-diode	26.60 .29.40V, Izt=50mA, Zzt=6Ω, 5W	DO-214AB	1d	1a	Tr
363	HZU36L-3	Z-diode	36.4 .38V, 150mW	URP	5d	1a	Ren
363B	1SMC5363	Z-diode	28.5 .31.5V, Zzt=8Ω, Izt=40mA, 5W	DO-214AB	1d	1a	Pjt
363B	Z5SMC5363B	Z-diode	28.50 .31.50V, Izt=40mA, Zzt=8Ω, 5W	DO-214AB	1d	1a	Tr
364B	1SMC5364	Z-diode	31.35 .34.65V, Zzt=10Ω, Izt=40mA, 5W	DO-214AB	1d	1a	Pjt
364B	Z5SMC5364B	Z-diode	31.35 .34.65V, Izt=40mA, Zzt=10Ω, 5W	DO-214AB	1d	1a	Tr
365B	1SMC5365	Z-diode	34.2 .37.8V, Zzt=11Ω, Izt=30mA, 5W	DO-214AB	1d	1a	Pjt
365B	Z5SMC5365B	Z-diode	34.20 .37.80V, Izt=30mA, Zzt=11Ω, 5W	DO-214AB	1d	1a	Tr
366B	1SMC5366	Z-diode	37.05 .40.95V, Zzt=14Ω, Izt=30mA, 5W	DO-214AB	1d	1a	Pjt
366B	Z5SMC5366B	Z-diode	37.05 .40.95V, Izt=30mA, Zzt=14Ω, 5W	DO-214AB	1d	1a	Tr
367B	1SMC5367	Z-diode	40.85 .45.15V, Zzt=20Ω, Izt=30mA, 5W	DO-214AB	1d	1a	Pjt
367B	Z5SMC5367B	Z-diode	40.85 .45.15V, Izt=30mA, Zzt=20Ω, 5W	DO-214AB	1d	1a	Tr
368B	1SMC5368	Z-diode	44.65 .49.35V, Zzt=25Ω, Izt=25mA, 5W	DO-214AB	1d	1a	Pjt
368B	Z5SMC5368B	Z-diode	44.65 .49.35V, Izt=25mA, Zzt=25Ω, 5W	DO-214AB	1d	1a	Tr
369B	1SMC5369	Z-diode	48.45 .53.55V, Zzt=27Ω, Izt=25mA, 5W	DO-214AB	1d	1a	Pjt
369B	Z5SMC5369B	Z-diode	48.45 .53.55V, Izt=25mA, Zzt=27Ω, 5W	DO-214AB	1d	1a	Tr
36A	1.5SMC36A	TVS	Vbr=34.2 .37.8V, Vrw=30.8V, 30.1A, 1500W(1ms)	DO-214AB	1d,3d	1a,1k	Vs,Ons
36A	1SMC36A	TVS	Vbr=40.0 .44.2V, Vrw=36V, 25.8A, 1500W(1ms)	DO-214AB	1d	1a	Eic
36A	P4SMA36A	TVS	Vbr=34.2 .37.8V, Vrw=30.8V, 8.4A, 400W(1ms)	DO-214AC	1d	1k	Vs
36A	P6SMB36A	TVS	Vrw=36V, Vbr=34.2 .37.8V, 12A, 600W(1ms)	DO-214AA	1d,3d	1k,1a	Vs,Ons
36A	P6SMBJ36A	TVS	Vbr=34.2 .37.8V, 12A, 600W(1ms)	DO-214AA	1d	1n	Lif
36A	RKZ36AKU	Z-diode	32.14 .33.79V, Izt=5mA, Zzt=90Ω, 500mW	TURP-FM	7d	1a	Ren
36A	SMAJ36A	TVS	Vrw=36V, Vbr=40.0 .44.2V, 6.9A, 400W(1ms)	DO-214AC	1d	1a	Sus
36A	SMBJ36A	TVS	Vbr=40.0 .44.2V, Vrw=36V, 10.3A, 600W(1ms)	DO-214AA	1d	1a	Sus
36A	SMCJ36A	TVS	Vrw=36V, Vbr= 40. .46V, 23.3A, 1500W(1ms)	DO-214AB	1d	1k	Sus
36A	UMA36A	TVS	Vrw=36V, Vbr=40.0 .58.1V, 8.6A, 500W(1ms)	UltraMite	14d	1v	Msc
36B	1SMB3EZ36	Z-diode	36V±5%, Zzt=25Ω, Izt=21.0mA, 3W	DO-214AA	1d	1a	Pjt
36B	HZF36BP	Z-diode	36V±5%, 900mW	LRP	1d	2f	Ren
36B	MMHZ5236BPT	Z-diode	7.125 .7.875V, Izt=5mA, Zzt=7Ω, 225mW	SOD-123	5d	1a	Chm
36B	PTZ36B	Z-diode	36V±10%, 10mA, 1W	DO-214AC	1d	1a	Rhm
36B	RKZ36BKU	Z-diode	32.79 .34.49V, Izt=5mA, Zzt=90Ω, 500mW	TURP-FM	7d	1a	Ren
36B	Z3SMB36B	Z-diode	34.20 .37.80V, Izt=21mA, Zzt=22Ω, 3W	DO-214AA	1d	1a	Tr
36C	1.5SMC36CA	TVS	Vbr=34.2 .37.8V, Vrw=30.8V, 30.1A, 1500W(1ms), Bidirectional	DO-214AB	1ba	1l	Vs
36C	HZF36CP	Z-diode	36V±10%, 900mW	LRP	1d	2f	Ren
36C	P4SMA36C	TVS	Vbr=32.4 .39.6V, Vrw=29.1V, 8.0A, 400W(1ms), Bidirectional	DO-214AC	1ba	1j	Eic
36C	P4SMA36CA	TVS	Vbr=34.2 .37.8V, 8A, 400W(1ms), Bidirectional	DO-214AC	1ba	1l	Vs
36C	P6SMB36CA	TVS	Vrw=36V, Vbr=34.2 .37.8V, 12A, 600W(1ms), Bidirectional	DO-214AA	1ba,3ba	1l,1e	Vs,Ons
36C	P6SMBJ36C	TVS	Vbr=32.4 .39.6V, 11.6A, 600W(1ms), Bidirectional	DO-214AA	1ba	1p	Lif
36C	RKZ36CKU	Z-diode	33.40 .35.13V, Izt=5mA, Zzt=90Ω, 500mW	TURP-FM	7d	1a	Ren
36CA	1SMC36CA	TVS	Vbr=40.0 .44.2V, Vrw=36V, 25.8A, 1500W(1ms), Bidirectional	DO-214AB	1ba	1j	Eic
36CA	P4SMA36CA	TVS	Vbr=34.2 .37.8V, Vrw=30.8V, 8.4A, 400W(1ms), Bidirectional	DO-214AC	1ba	1j	Eic
36CA	P6SMB36CA	TVS	Vbr=34.2 .37.8V, Vrw=30.8V, 12.0A, 600W(1ms), Bidirectional	DO-214AA	1ba	1j	Eic
36CA	P6SMBJ36CA	TVS	Vbr=34.2 .37.8V, 12A, 600W(1ms), Bidirectional	DO-214AA	1ba	1p	Lif
36CA	SMAJ36CA	TVS	Vrw=36V, Vbr=40.0 .44.2V, 6.9A, 400W(1ms), Bidirectional	DO-214AC	1ba	1j	Sus
36CA	SMBJ36CA	TVS	Vbr=40.0 .44.2V, Vrw=36V, 10.3A, 600W(1ms), Bidirectional	DO-214AA	1ba	1j	Sus
36CA	SMCJ36CA	TVS	Vrw=36V, Vbr= 40. .46V, 23.3A, 1500W(1ms), Bidirectional	DO-214AB	1ba	1l	Sus
36CA	UMA36CA	TVS	Vrw=36V, Vbr=40.0 .58.1V, 8.6A, 500W(1ms), Bidirectional	UltraMite	14ba	1v	Msc
36D	RKZ36DKU	Z-diode	34.01 .35.77V, Izt=5mA, Zzt=90Ω, 500mW	TURP-FM	7d	1a	Ren
36P	BZD27C36P	Z-diode	34.20 .37.80V, Zzt=40Ω, Izt=10mA, 800mW	SOD-123FL	7d	1a	Pjt
36P	MFPZ36	Z-diode	34.20 .37.80V, Izt=10mA, Zzt=40Ω, 800mW	SOD-123FL	7d	1a	Tr
36S	MMHZ5236SPT	Z-diode	7.350 .7.650V, Izt=5mA, Zzt=7Ω, 225mW	SOD-123	5d	1a	Chm
36V	SMA36	TVS	Vbr=40 .48.6V, Vrw=36.0V, 4.7A, 300W(1ms)	DO-214AC	1d	1a	Mic
36V	SMB36	TVS	Vbr=40 .48.9V, Vrw=36V, 9.3A, 600W(1ms)	DO-214AA	1d	1a	Mic
36V	SMC36	TVS	Vbr=40 .48.9V, Vrw=36V, 23.3A, 1500W(1ms)	DO-214AB	1d	1a	Mic
36VA	SMA36A	TVS	Vbr=40 .44.2V, Vrw=36.0V, 5.2A, 300W(1ms)	DO-214AC	1d	1a	Mic
36VA	SMB36A	TVS	Vbr=40 .44.2V, Vrw=36V, 10.3A, 600W(1ms)	DO-214AA	1d	1a	Mic
36VA	SMC36A	TVS	Vbr=40 .44.2V, Vrw=36V, 25.8A, 1500W(1ms),	DO-214AB	1d	1a	Mic
36VB	BZT52-B36	Z-diode	35.28 .36.72V, Izt=2mA, Zzt=90Ω, 500mW	SOD-123FL	7d	1a	Tsc
36VB	MMSZ36VBW	Z-diode	35.28 .36.72V, Izt=2mA, Zzt=90Ω, 500mW	SOD-123FL	7d	1a	Tac
36VC	SMA36C	TVS	Vbr=40 .48.6V, Vrw=36.0V, 4.7A, 300W(1ms), Bidirectional	DO-214AC	1ba	1j	Mic
36VC	SMB36C	TVS	Vbr=40 .48.9V, Vrw=36V, 9.3A, 600W(1ms), Bidirectional	DO-214AA	1ba	1j	Mic
36VC	SMC36C	TVS	Vbr=40 .48.9V, Vrw=36V, 23.3A, 1500W(1ms), Bidirectional	DO-214AB	1ba	1j	Mic
36VCA	SMA36CA	TVS	Vbr=40 .44.2V, Vrw=36.0V, 5.2A, 300W(1ms), Bidirectional	DO-214AC	1ba	1j	Mic
36VCA	SMB36CA	TVS	Vbr=40 .44.2V, Vrw=36V, 10.3A, 600W(1ms), Bidirectional	DO-214AA	1ba	1j	Mic
36VCA	SMC36CA	TVS	Vbr=40 .44.2V, Vrw=36V, 25.8A, 1500W(1ms), Bidirectional	DO-214AB	1ba	1j	Mic
36VZ	BZT52-C36	Z-diode	34.20 .37.80V, Izt=2mA, Zzt=90Ω, 500mW	SOD-123FL	7d	1a	Tsc



SMD
code

Type

Function

Short description

Case

Pinout

St.

Mnf.

SMD code	Type	Function	Short description	Case	Pinout	St.	Mnf.
36VZ	MMSZ36VCW	Z-diode	34.20..37.80V, Izt=2mA, Zzt=90Ω, 500mW	SOD-123FL	7d	1a	Tac
36VZ	TCMMSZ36V	Z-diode	36V±5%, Izt=5mA, Zzt=84Ω, 500mW	SOD-123FL	7d	1a	Tac
36VZ	ZGFM0536C-MH	Z-diode	34.20..37.8V, Izt=5mA, Zzt=84Ω, 500mW	SOD-123	5d	1a	Pic
37	HMSZ5237B	Z-diode	8.2V±5%, Izt=20mA, Zzt=8Ω, 225mW	SOD-323	5d	1d	Hsn
37	ZD5237BS2	Z-diode	8.2V±5%, 20mA, Zzt=8.0Ω, 500mW	SOD-323	5d	1a	Cys
370B	1SMC5370	Z-diode	56V±10%, Zzt=35Ω, Izt=20mA, 5W	DO-214AB	1d	1a	Pjt
371B	1SMC5371	Z-diode	60V±10%, Zzt=40Ω, Izt=20mA, 5W	DO-214AB	1d	1a	Pjt
372B	1SMC5372	Z-diode	62V±10%, Zzt=42Ω, Izt=20mA, 5W	DO-214AB	1d	1a	Pjt
373B	1SMC5373	Z-diode	68V±10%, Zzt=44Ω, Izt=20mA, 5W	DO-214AB	1d	1a	Pjt
374B	1SMC5374	Z-diode	75V±10%, Zzt=45Ω, Izt=20mA, 5W	DO-214AB	1d	1a	Pjt
375B	1SMC5375	Z-diode	82V±10%, Zzt=65Ω, Izt=15mA, 5W	DO-214AB	1d	1a	Pjt
376B	1SMC5376	Z-diode	87V±10%, Zzt=75Ω, Izt=15mA, 5W	DO-214AB	1d	1a	Pjt
377B	1SMC5377	Z-diode	91V±10%, Zzt=75Ω, Izt=15mA, 5W	DO-214AB	1d	1a	Pjt
378B	1SMC5378	Z-diode	100V±10%, Zzt=90Ω, Izt=12mA, 5W	DO-214AB	1d	1a	Pjt
379B	1SMC5379	Z-diode	110V±10%, Zzt=125Ω, Izt=12mA, 5W	DO-214AB	1d	1a	Pjt
37B	MMHZ5237BPT	Z-diode	7.790..8.610V, Izt=5mA, Zzt=7Ω, 225mW	SOD-123	5d	1a	Chm
37S	MMHZ5237SPT	Z-diode	8.036..8.364V, Izt=5mA, Zzt=7Ω, 225mW	SOD-123	5d	1a	Chm
37ZD	BYD37D	Si-diode	Rectifier, Contr.avalanche, 200V, 1A, 250ns, 20pF	1206	14d	1v	Zow
37ZG	BYD37G	Si-diode	Rectifier, Contr.avalanche, 400V, 1A, 250ns, 20pF	1206	14d	1v	Zow
37ZJ	BYD37J	Si-diode	Rectifier, Contr.avalanche, 600V, 1A, 250ns, 20pF	1206	14d	1v	Zow
37ZK	BYD37K	Si-diode	Rectifier, Contr.avalanche, 800V, 1A, 300ns, 20pF	1206	14d	1v	Zow
37ZM	BYD37M	Si-diode	Rectifier, Contr.avalanche, 1000V, 1A, 300ns, 20pF	1206	14d	1v	Zow
38	HMSZ5238B	Z-diode	8.7V±5%, Izt=20mA, Zzt=8Ω, 225mW	SOD-323	5d	1d	Hsn
38	ZD5238BS2	Z-diode	8.7V±5%, 20mA, Zzt=8.0Ω, 500mW	SOD-323	5d	1a	Cys
380B	1SMC5380	Z-diode	120V±10%, Zzt=170Ω, Izt=10mA, 5W	DO-214AB	1d	1a	Pjt
381B	1SMC5381	Z-diode	130V±10%, Zzt=190Ω, Izt=10mA, 5W	DO-214AB	1d	1a	Pjt
382B	1SMC5382	Z-diode	140V±10%, Zzt=230Ω, Izt=8mA, 5W	DO-214AB	1d	1a	Pjt
383B	1SMC5383	Z-diode	150V±10%, Zzt=330Ω, Izt=8mA, 5W	DO-214AB	1d	1a	Pjt
384B	1SMC5384	Z-diode	160V±10%, Zzt=350Ω, Izt=8mA, 5W	DO-214AB	1d	1a	Pjt
385B	1SMC5385	Z-diode	170V±10%, Zzt=380Ω, Izt=8mA, 5W	DO-214AB	1d	1a	Pjt
386B	1SMC5386	Z-diode	180V±10%, Zzt=430Ω, Izt=5mA, 5W	DO-214AB	1d	1a	Pjt
387B	1SMC5387	Z-diode	190V±10%, Zzt=450Ω, Izt=5mA, 5W	DO-214AB	1d	1a	Pjt
388B	1SMC5388	Z-diode	200V±10%, Zzt=480Ω, Izt=5mA, 5W	DO-214AB	1d	1a	Pjt
38B	MMHZ5238BPT	Z-diode	8.265..9.135V, Izt=5mA, Zzt=7Ω, 225mW	SOD-123	5d	1a	Chm
38S	MMHZ5238SPT	Z-diode	8.526..8.874V, Izt=5mA, Zzt=7Ω, 225mW	SOD-123	5d	1a	Chm
39	CDZ55C39	Z-diode	37.05..40.95V, Zzt=90Ω, Izt=5mA, 500mW	1206	70d	2d	Crp
39	CDZ55C39S	Z-diode	37.05..40.95V, Zzt=90Ω, Izt=5mA, 500mW	0805	70d	2d	Crp
39	CDZ55C39T	Z-diode	37.05..40.95V, Zzt=90Ω, Izt=5mA, 200mW	0603	70d	2d	Crp
39	CMZ39	Z-diode	39V±5%, 2W	M-Flat	7d	1a	Tos
39	HMSZ5239B	Z-diode	9.1V±5%, Izt=20mA, Zzt=10Ω, 225mW	SOD-323	5d	1d	Hsn
39	HZC3.9	Z-diode	3.9V±10%, 150mW	SOD-523	6d	1a	Ren
39	KDZ3.9EV	Z-diode	3.7..4.1V, 150mW	SOD-523	6d	1a	Kec
39	KDZ3.9V	Z-diode	3.7..4.1V, 150mW	SOD-323	5d	1a	Kec
39	MAZ83900H	Z-diode	39..41V, Zzt=300Ω(2mA), 150mW	SC-76	6d	1a	Pan
39	MAZS390	Z-diode	37V..41V, 200mW	SOD-523	6d	1a	Pan
39	MAZY390	Z-diode	35.1..42.9V, Zzt=65Ω(5mA), 1W	NMiniP2	1d	1a	Pan
39	MMPZ5259SPT	Z-diode	38.22..39.78V, Izt=5mA, Zzt=130Ω, 225mW	SOD-323	5d	1a	Chm
39	P4SMA39	TVS	Vbr=35.1..42.9V, Vrrm=31.6V, 7.4A, 400W(1ms)	DO-214AC	1d	1a	Eic
39	P6SMBJ39	TVS	Vbr=35.1..42.9V, 10.5A, 600W(1ms)	DO-214AA	1d	1n	Lif
39	SMA3C39	Z-diode	39V±5%, Izt=19mA, Zzt<28Ω, 3W	DO-214AC	1d	1a	Exc
39	SML4754	Z-diode	39V±5%, Izt=6.5mA, Zzt=60Ω, 1W	DO-214AC	1d	1k	Vs
39	TZD3.9WS	Z-diode	3.70..4.10V, Izt=5mA, Zzt=130Ω, 200mW	SOD-323	5d	1a	Ttr
39	TZD3.9WT	Z-diode	3.70..4.10V, Izt=5mA, Zzt=130Ω, 150mW	SOD-523	6d	1a	Ttr
39	ZD5239BS2	Z-diode	9.1V±5%, 20mA, Zzt=10Ω, 500mW	SOD-323	5d	1a	Cys
39-	MAZ83900M	Z-diode	38..40V, Zzt=300Ω(2mA), 150mW	SC-76	6d	1a	Pan
39-	MAZ8390GML	Z-diode	38..40V, Zzt=300Ω(2mA), 150mW	SMini2-F3	6d	1a	Pan
39-	MAZS3900M	Z-diode	38..40V, 200mW	SOD-523	6d	1a	Pan
39^	MAZ83900H	Z-diode	39..41V, Zzt=300Ω(2mA), 150mW	SC-76	6d	1a	Pan
39^	MAZ8390GHL	Z-diode	39..41V, Zzt=300Ω(2mA), 150mW	SMini2-F3	6d	1a	Pan
39^	MAZS3900H	Z-diode	39..40V, 200mW	SOD-523	6d	1a	Pan
39_	MAZ83900L	Z-diode	37.1..39V, Zzt=300Ω(2mA), 150mW	SC-76	6d	1a	Pan
39_	MAZ8390GLL	Z-diode	37.1..39V, Zzt=300Ω(2mA), 150mW	SMini2-F3	6d	1a	Pan
39_	MAZS3900L	Z-diode	37.1..39V, 200mW	SOD-523	6d	1a	Pan
39+	TZD3.9YWS	Z-diode	3.89..4.16V, Izt=5mA, Zzt=130Ω, 200mW	SOD-323	5d	1a	Ttr
39+	TZD3.9YWT	Z-diode	3.89..4.16V, Izt=5mA, Zzt=130Ω, 150mW	SOD-523	6d	1a	Ttr
390	U1ZB390	Z-diode	35.1..42.9V, 1W	I-FLAT	1d	1a	Tos
39A	1.5SMC39A	TVS	Vbr=37.1..41.0V, Vrrm=33.3V, 27.8A, 1500W(1ms)	DO-214AB	1d,3d	1a,1k	Vs,Ons
39A	P4SMA39A	TVS	Vbr=37.1..41.0V, Vrrm=33.3V, 7.8A, 400W(1ms)	DO-214AC	1d	1k	Vs
39A	P6SMB39A	TVS	Vrrm=39V, Vbr=37.1..41V, 11.1A, 600W(1ms)	DO-214AA	1d,3d	1k,1a	Vs,Ons
39A	P6SMBJ39A	TVS	Vbr=37.1..41V, 11.2A, 600W(1ms)	DO-214AA	1d	1n	Lif



SMD
code

Type

Function

Short description

Case

Pinout

St.

Mnf.

39B	1SMB3EZ39	Z-diode	39V±5%, Zzt=30Ω, Izt=19.0mA, 3W	DO-214AA	1d	1a	Pjt
39B	MMHZ5239BPT	Z-diode	8.645..9.555V, Izt=5mA, Zzt=10.0, 225mW	SOD-123	5d	1a	Chm
39B	Z3SMB39B	Z-diode	37.05..40.95V, Izt=19mA, Zzt=28Ω, 3W	DO-214AA	1d	1a	Ttr
39C	1.5SMC39CA	TVS	Vbr=37.1..41.0V, Vrrwm=33.3V, 27.8A, 1500W(1ms), Bidirectional	DO-214AB	1ba	1l	Vs
39C	P4SMA39C	TVS	Vbr=35.1..42.9V, Vrrwm=31.6V, 7.4A, 400W(1ms), Bidirectional	DO-214AC	1ba	1j	Eic
39C	P4SMA39CA	TVS	Vbr=37.1..41V, 7.4A, 400W(1ms), Bidirectional	DO-214AC	1ba	1l	Vs
39C	P6SMB39CA	TVS	Vrrwm=39V, Vbr=37.1..41V, 11.1A, 600W(1ms), Bidirectional	DO-214AA	1ba,3ba	1l,1e	Vs,Ons
39C	P6SMBJ39C	TVS	Vbr=35.1..42.9V, 10.5A, 600W(1ms), Bidirectional	DO-214AA	1ba	1p	Lif
39CA	P4SMA39CA	TVS	Vbr=37.1..41.0V, Vrrwm=33.3V, 7.8A, 400W(1ms), Bidirectional	DO-214AC	1ba	1j	Eic
39CA	P6SMB39CA	TVS	Vbr=37.1..41.0V, Vrrwm=33.3V, 11.2A, 600W(1ms), Bidirectional	DO-214AA	1ba	1j	Eic
39CA	P6SMBJ39CA	TVS	Vbr=37.1..41V, 11.2A, 600W(1ms), Bidirectional	DO-214AA	1ba	1p	Lif
39P	BZD27C39P	Z-diode	37.05..40.95V, Zzt=40Ω, Izt=10mA, 800mW	SOD-123FL	7d	1a	Pjt
39P	MFPZ39	Z-diode	37.05..40.95V, Izt=10mA, Zzt=40Ω, 800mW	SOD-123FL	7d	1a	Ttr
39S	MMHZ5239SPT	Z-diode	8.918..9.282V, Izt=5mA, Zzt=10.0, 225mW	SOD-123	5d	1a	Chm
39VB	BZT52-B39	Z-diode	38.22..39.78V, Izt=2mA, Zzt=130Ω, 500mW	SOD-123FL	7d	1a	Tsc
39VB	MMSZ39VBW	Z-diode	38.22..39.78V, Izt=2mA, Zzt=130Ω, 500mW	SOD-123FL	7d	1a	Tac
39VZ	BZT52-C39	Z-diode	37.05..40.95V, Izt=2mA, Zzt=130Ω, 500mW	SOD-123FL	7d	1a	Tsc
39VZ	MMSZ39VCW	Z-diode	37.05..40.95V, Izt=2mA, Zzt=130Ω, 500mW	SOD-123FL	7d	1a	Tac
39VZ	TCMMSZ39V	Z-diode	39V±5%, Izt=5mA, Zzt=122Ω, 500mW	SOD-123FL	7d	1a	Tac
39VZ	ZGFM0539C-MH	Z-diode	37.05..40.95V, Izt=5mA, Zzt=122Ω, 500mW	SOD-123	5d	1a	Pic
3A	HZU3ALL	Z-diode	2.5..2.9V, Izt=0.5mA, Zzt=360Ω, 150mW	URP	5d	1a	Ren
3A	MM3Z43	Z-diode	40..46V, Izt=2.5mA, Zzt=130Ω, 300mW	SOD-323FL	7d	1a	Lge
3A	MM3Z43V	Z-diode	40..46V, Izt=2mA, Zzt=150Ω, 200mW	SOD-323FL	7d	1a	Eic
3A0	RKZ3.0AKU	Z-diode	2.85..3.07V, Izt=20mA, Zzt=120Ω, 500mW	TURP-FM	7d	1a	Ren
3A0	SMB3EZ6.2D5	Z-diode	6.2V±5%, Izt=121mA, Zzt=1.5Ω, 3W	DO-214AA	1d	1a	Ers
3A1	SMB3EZ6.8D5	Z-diode	6.8V±5%, Izt=110mA, Zzt=2.0Ω, 3W	DO-214AA	1d	1a	Ers
3A2	SMB3EZ7.5D5	Z-diode	7.5V±5%, Izt=100mA, Zzt=2.0Ω, 3W	DO-214AA	1d	1a	Ers
3A3	RKZ3.3AKU	Z-diode	3.16..3.38V, Izt=20mA, Zzt=130Ω, 500mW	TURP-FM	7d	1a	Ren
3A3	SMB3EZ8.2D5	Z-diode	8.2V±5%, Izt=91mA, Zzt=2.3Ω, 3W	DO-214AA	1d	1a	Ers
3A4	SMB3EZ9.1D5	Z-diode	9.1V±5%, Izt=82mA, Zzt=2.5Ω, 3W	DO-214AA	1d	1a	Ers
3A5	SMB3EZ10D5	Z-diode	10V±5%, Izt=75mA, Zzt=3.5Ω, 3W	DO-214AA	1d	1a	Ers
3A6	RKZ3.6AKU	Z-diode	3.45..3.69V, Izt=20 mA, Zzt=130Ω, 500mW	TURP-FM	7d	1a	Ren
3A6	SMB3EZ11D5	Z-diode	11V±5%, Izt=68mA, Zzt=4.0Ω, 3W	DO-214AA	1d	1a	Ers
3A7	SMB3EZ12D5	Z-diode	12V±5%, Izt=63mA, Zzt=4.5Ω, 3W	DO-214AA	1d	1a	Ers
3A8	SMB3EZ13D5	Z-diode	13V±5%, Izt=58mA, Zzt=4.5Ω, 3W	DO-214AA	1d	1a	Ers
3A9	RKZ3.9AKU	Z-diode	3.74..4.01V, Izt=20mA, Zzt=130Ω, 500mW	TURP-FM	7d	1a	Ren
3A9	SMB3EZ14D5	Z-diode	14V±5%, Izt=53mA, Zzt=5.0Ω, 3W	DO-214AA	1d	1a	Ers
3AW	3KASMC10	TVS	Vbr=11.1..13.6V, Vrrwm=10V, 160A, 3000W(1ms)	DO-214AB	1d	1k	Vs
3AX	3KASMC10A	TVS	Vbr=11.1..12.3V, Vrrwm=10V, 177A, 3000W(1ms)	DO-214AB	1d	1k	Vs
3AY	3KASMC11	TVS	Vbr=12.2..14.9V, Vrrwm=11V, 149A, 3000W(1ms)	DO-214AB	1d	1k	Vs
3AZ	3KASMC11A	TVS	Vbr=12.2..13.5V, Vrrwm=11V, 165A, 3000W(1ms)	DO-214AB	1d	1k	Vs
3B	HZU3BLL	Z-diode	2.8..3.2V, Izt=0.5mA, Zzt=360Ω, 150mW	URP	5d	1a	Ren
3B	MM3Z47	Z-diode	44..50V, Izt=2.5mA, Zzt=150Ω, 300mW	SOD-323FL	7d	1a	Lge
3B	MM3Z47V	Z-diode	44..50V, Izt=2mA, Zzt=170Ω, 200mW	SOD-323FL	7d	1a	Eic
3B0	RKZ3.0BKU	Z-diode	3.01..3.22 V, Izt=20mA, Zzt=120Ω, 500mW	TURP-FM	7d	1a	Ren
3B0	SMB3EZ15D5	Z-diode	15V±5%, Izt=50mA, Zzt=5.5Ω, 3W	DO-214AA	1d	1a	Ers
3B1	SMB3EZ16D5	Z-diode	16V±5%, Izt=47mA, Zzt=5.5Ω, 3W	DO-214AA	1d	1a	Ers
3B2	SMB3EZ17D5	Z-diode	17V±5%, Izt=44mA, Zzt=6.0Ω, 3W	DO-214AA	1d	1a	Ers
3B3	RKZ3.3BKU	Z-diode	3.32..3.53V, Izt=20mA, Zzt=130Ω, 500mW	TURP-FM	7d	1a	Ren
3B3	SMB3EZ18D5	Z-diode	18V±5%, Izt=42mA, Zzt=6.0Ω, 3W	DO-214AA	1d	1a	Ers
3B4	SMB3EZ19D5	Z-diode	19V±5%, Izt=40mA, Zzt=7.0Ω, 3W	DO-214AA	1d	1a	Ers
3B5	SMB3EZ20D5	Z-diode	20V±5%, Izt=37mA, Zzt=7.0Ω, 3W	DO-214AA	1d	1a	Ers
3B6	RKZ3.6BKU	Z-diode	3.60..3.84V, Izt=20mA, Zzt=130Ω, 500mW	TURP-FM	7d	1a	Ren
3B6	SMB3EZ22D5	Z-diode	22V±5%, Izt=34mA, Zzt=8.0Ω, 3W	DO-214AA	1d	1a	Ers
3B7	SMB3EZ24D5	Z-diode	24V±5%, Izt=31mA, Zzt=9.0Ω, 3W	DO-214AA	1d	1a	Ers
3B8	SMB3EZ27D5	Z-diode	27V±5%, Izt=28mA, Zzt=10Ω, 3W	DO-214AA	1d	1a	Ers
3B9	RKZ3.9BKU	Z-diode	3.89..4.16V, Izt=20mA, Zzt=130Ω, 500mW	TURP-FM	7d	1a	Ren
3B9	SMB3EZ28D5	Z-diode	28V±5%, Izt=27mA, Zzt=12Ω, 3W	DO-214AA	1d	1a	Ers
3BD	3KASMC12	TVS	Vbr=13.3..16.3V, Vrrwm=12V, 136A, 3000W(1ms)	DO-214AB	1d	1k	Vs
3BE	3KASMC12A	TVS	Vbr=13.3..14.7V, Vrrwm=12V, 151A, 3000W(1ms)	DO-214AB	1d	1k	Vs
3BF	3KASMC13	TVS	Vbr=14.4..17.6V, Vrrwm=13V, 126A, 3000W(1ms)	DO-214AB	1d	1k	Vs
3BG	3KASMC13A	TVS	Vbr=14.4..15.9V, Vrrwm=13V, 140A, 3000W(1ms)	DO-214AB	1d	1k	Vs
3BH	3KASMC14	TVS	Vbr=15.6..19.1V, Vrrwm=14V, 116A, 3000W(1ms)	DO-214AB	1d	1k	Vs
3BK	3KASMC14A	TVS	Vbr=15.6..17.2V, Vrrwm=14V, 129A, 3000W(1ms)	DO-214AB	1d	1k	Vs
3BL	3KASMC15	TVS	Vbr=16.7..20.4V, Vrrwm=15V, 112A, 3000W(1ms)	DO-214AB	1d	1k	Vs
3BM	3KASMC15A	TVS	Vbr=16.7..18.5V, Vrrwm=15V, 123A, 3000W(1ms)	DO-214AB	1d	1k	Vs
3BN	3KASMC16	TVS	Vbr=17.8..21.8V, Vrrwm=16V, 104A, 3000W(1ms)	DO-214AB	1d	1k	Vs
3BP	3KASMC16A	TVS	Vbr=17.8..19.7V, Vrrwm=16V, 115A, 3000W(1ms)	DO-214AB	1d	1k	Vs
3BQ	3KASMC17	TVS	Vbr=18.9..23.1V, Vrrwm=17V, 98.4A, 3000W(1ms)	DO-214AB	1d	1k	Vs
3BR	3KASMC17A	TVS	Vbr=18.9..20.9V, Vrrwm=17V, 109A, 3000W(1ms)	DO-214AB	1d	1k	Vs



SMD code	Type	Function	Short description	Case	Pinout	St.	Mnf.
3BS	3KASMC18	TVS	Vbr=20.0 24.4V, Vrvwm=18V, 93.2A, 3000W(1ms)	DO-214AB	1d	1k	Vs
3BT	3KASMC18A	TVS	Vbr=20.0 22.1V, Vrvwm=18V, 103A, 3000W(1ms)	DO-214AB	1d	1k	Vs
3BU	3KASMC20	TVS	Vbr=22.2 27.1V, Vrvwm=20V, 83.8A, 3000W(1ms)	DO-214AB	1d	1k	Vs
3BV	3KASMC20A	TVS	Vbr=22.2 24.5V, Vrvwm=20V, 92.6A, 3000W(1ms)	DO-214AB	1d	1k	Vs
3BW	3KASMC22	TVS	Vbr=24.4 29.8V, Vrvwm=22V, 76.1A, 3000W(1ms)	DO-214AB	1d	1k	Vs
3BX	3KASMC22A	TVS	Vbr=24.4 26.9V, Vrvwm=22V, 84.5A, 3000W(1ms)	DO-214AB	1d	1k	Vs
3BY	3KASMC24	TVS	Vbr=26.7 32.6V, Vrvwm=24V, 69.8A, 3000W(1ms)	DO-214AB	1d	1k	Vs
3BZ	3KASMC24A	TVS	Vbr=26.7 29.5V, Vrvwm=24V, 77.1A, 3000W(1ms)	DO-214AB	1d	1k	Vs
3C	BZT52C-8V7WU	Z-diode	8.27..9.14V, Izt=5mA, Zzt=15Ω, 200mW	SOD-723	7d	1a	Thr
3C	BZX784C8V7	Z-diode	8.27..9.14V, Zzt=15Ω, Izt=5mA, 200mW	SOD-723	7d	1a	Pjt
3C	CDZ55C3V3T	Z-diode	3.14..3.47V, Zzt=85Ω, Izt=5mA, 200mW	0603	70d	2d	Crp
3C	GBL C03C	TVS	Vbr=3V, 20A, 350W(1ms), 3pF, Bidirectional	SOD-323	5ba	1e	Prt
3C	HZU3CLL	Z-diode	3.1..3.5V, Izt=0.5mA, Zzt=360Ω, 150mW	URP	5d	1a	Ren
3C	MM3Z51	Z-diode	48..54V, Izt=2.5mA, Zzt=180Ω, 300mW	SOD-323FL	7d	1a	Lge
3C	MM3Z51V	Z-diode	48..54V, Izt=2mA, Zzt=180Ω, 200mW	SOD-323FL	7d	1a	Eic
3C0	SMB3EZ30D5	Z-diode	30V±5%, Izt=25mA, Zzt=16Ω, 3W	DO-214AA	1d	1a	Ers
3C1	SMB3EZ33D5	Z-diode	33V±5%, Izt=23mA, Zzt=20Ω, 3W	DO-214AA	1d	1a	Ers
3C2	SMB3EZ36D5	Z-diode	36V±5%, Izt=21mA, Zzt=22Ω, 3W	DO-214AA	1d	1a	Ers
3C3	SMB3EZ39D5	Z-diode	39V±5%, Izt=19mA, Zzt=28Ω, 3W	DO-214AA	1d	1a	Ers
3C4	SMB3EZ43D5	Z-diode	43V±5%, Izt=17mA, Zzt=33Ω, 3W	DO-214AA	1d	1a	Ers
3C5	SMB3EZ47D5	Z-diode	47V±5%, Izt=16mA, Zzt=38Ω, 3W	DO-214AA	1d	1a	Ers
3C6	SMB3EZ51D5	Z-diode	51V±5%, Izt=15mA, Zzt=45Ω, 3W	DO-214AA	1d	1a	Ers
3C7	SMB3EZ56D5	Z-diode	56V±5%, Izt=13mA, Zzt=50Ω, 3W	DO-214AA	1d	1a	Ers
3C8	SMB3EZ62D5	Z-diode	62V±5%, Izt=12mA, Zzt=55Ω, 3W	DO-214AA	1d	1a	Ers
3C9	SMB3EZ68D5	Z-diode	68V±5%, Izt=11mA, Zzt=70Ω, 3W	DO-214AA	1d	1a	Ers
3CD	3KASMC26	TVS	Vbr=28.9 35.3V, Vrvwm=26V, 64.4A, 3000W(1ms)	DO-214AB	1d	1k	Vs
3CE	3KASMC26A	TVS	Vbr=28.9 31.9V, Vrvwm=26V, 71.3A, 3000W(1ms)	DO-214AB	1d	1k	Vs
3CF	3KASMC28	TVS	Vbr=31.1 38.0V, Vrvwm=28V, 60.0A, 3000W(1ms)	DO-214AB	1d	1k	Vs
3CG	3KASMC28A	TVS	Vbr=31.1 34.4V, Vrvwm=28V, 66.1A, 3000W(1ms)	DO-214AB	1d	1k	Vs
3CH	3KASMC30	TVS	Vbr=33.3 40.7V, Vrvwm=30V, 56.1A, 3000W(1ms)	DO-214AB	1d	1k	Vs
3CK	3KASMC30A	TVS	Vbr=33.3 36.8V, Vrvwm=30V, 62.0A, 3000W(1ms)	DO-214AB	1d	1k	Vs
3CL	3KASMC33	TVS	Vbr=36.7 44.9V, Vrvwm=33V, 50.8A, 3000W(1ms)	DO-214AB	1d	1k	Vs
3CM	3KASMC33A	TVS	Vbr=36.7 40.6V, Vrvwm=33V, 56.3A, 3000W(1ms)	DO-214AB	1d	1k	Vs
3CN	3KASMC36	TVS	Vbr=40.0 48.9V, Vrvwm=36V, 46.7A, 3000W(1ms)	DO-214AB	1d	1k	Vs
3CP	3KASMC36A	TVS	Vbr=40.0 44.2V, Vrvwm=36V, 51.6A, 3000W(1ms)	DO-214AB	1d	1k	Vs
3CQ	3KASMC40	TVS	Vbr=44.4 54.3V, Vrvwm=40V, 42.0A, 3000W(1ms)	DO-214AB	1d	1k	Vs
3CR	3KASMC40A	TVS	Vbr=44.4 49.1V, Vrvwm=40V, 46.5A, 3000W(1ms)	DO-214AB	1d	1k	Vs
3CS	3KASMC43	TVS	Vbr=47.8 58.4V, Vrvwm=43V, 39.1A, 3000W(1ms)	DO-214AB	1d	1k	Vs
3CT	3KASMC43A	TVS	Vbr=47.8 52.8V, Vrvwm=43V, 43.2A, 3000W(1ms)	DO-214AB	1d	1k	Vs
3D	MM3Z56	Z-diode	52..60V, Izt=2.5mA, Zzt=180Ω, 300mW	SOD-323FL	7d	1a	Lge
3D	MM3Z56V	Z-diode	52..60V, Izt=2mA, Zzt=200Ω, 200mW	SOD-323FL	7d	1a	Eic
3D	WOSD03	TVS	Vbr=5V, Vcl=7..8.5V, Ipp=12A, 300W(1ms)	SOD-323	5d	1e	Wtr
3E	MM3Z62	Z-diode	58..66V, Izt=2.5mA, Zzt=200Ω, 300mW	SOD-323FL	7d	1a	Lge
3E	MM3Z62V	Z-diode	58..66V, Izt=2mA, Zzt=215Ω, 200mW	SOD-323FL	7d	1a	Eic
3F	CDZ55C3V6T	Z-diode	3.42..3.78V, Zzt=85Ω, Izt=5mA, 200mW	0603	70d	2d	Crp
3F	KDZ3.9FV	Z-diode	3.70..4.10V, Izt=5mA, Zzt=130Ω, 100mW	TFSC	7d	1a	Kec
3F	MAZD030	Z-diode	2.8..3.2V, Zzt=120Ω(5mA), 120mW	SSSMini2	7d	1a	Pan
3F	MM3Z68	Z-diode	64..72V, Izt=2.5mA, Zzt=250Ω, 300mW	SOD-323FL	7d	1a	Lge
3F	MM3Z68V	Z-diode	64..72V, Izt=2mA, Zzt=240Ω, 200mW	SOD-323FL	7d	1a	Eic
3F0	SMB3EZ75D5	Z-diode	75V±5%, Izt=10mA, Zzt=85Ω, 3W	DO-214AA	1d	1a	Ers
3F1	SMB3EZ82D5	Z-diode	82V±5%, Izt=9.1mA, Zzt=95Ω, 3W	DO-214AA	1d	1a	Ers
3F2	SMB3EZ91D5	Z-diode	91V±5%, Izt=8.2mA, Zzt=115Ω, 3W	DO-214AA	1d	1a	Ers
3F3	SMB3EZ100D5	Z-diode	100V±5%, Izt=7.5mA, Zzt=160Ω, 3W	DO-214AA	1d	1a	Ers
3F4	SMB3EZ110D5	Z-diode	110V±5%, Izt=6.8mA, Zzt=225Ω, 3W	DO-214AA	1d	1a	Ers
3F5	SMB3EZ120D5	Z-diode	120V±5%, Izt=6.3mA, Zzt=300Ω, 3W	DO-214AA	1d	1a	Ers
3F6	SMB3EZ130D5	Z-diode	130V±5%, Izt=5.8mA, Zzt=375Ω, 3W	DO-214AA	1d	1a	Ers
3F7	SMB3EZ140D5	Z-diode	140V±5%, Izt=5.3mA, Zzt=475Ω, 3W	DO-214AA	1d	1a	Ers
3F8	SMB3EZ150D5	Z-diode	150V±5%, Izt=5mA, Zzt=550Ω, 3W	DO-214AA	1d	1a	Ers
3F9	SMB3EZ160D5	Z-diode	160V±5%, Izt=4.7mA, Zzt=625Ω, 3W	DO-214AA	1d	1a	Ers
3G1	SMB3EZ170D5	Z-diode	170V±5%, Izt=4.4mA, Zzt=650Ω, 3W	DO-214AA	1d	1a	Ers
3G2	SMB3EZ180D5	Z-diode	180V±5%, Izt=4.2mA, Zzt=700Ω, 3W	DO-214AA	1d	1a	Ers
3G3	SMB3EZ190D5	Z-diode	190V±5%, Izt=4.0mA, Zzt=800Ω, 3W	DO-214AA	1d	1a	Ers
3G4	SMB3EZ200D5	Z-diode	200V±5%, Izt=3.7mA, Zzt=875Ω, 3W	DO-214AA	1d	1a	Ers
3GS	MURS340S	Si-diode	Rectifier, 400V, 3A, Vf<1.2V(3A)	DO-214AA	1d	1k	Vs
3H	MM3Z75	Z-diode	70..79V, Izt=2.5mA, Zzt=300Ω, 300mW	SOD-323FL	7d	1a	Lge
3H	MM3Z75V	Z-diode	70..79V, Izt=2mA, Zzt=255Ω, 200mW	SOD-323FL	7d	1a	Eic
3I	CDZ55C3V9T	Z-diode	3.71..4.10V, Zzt=85Ω, Izt=5mA, 200mW	0603	70d	2d	Crp
3J	MM3Z82	Z-diode	77..87V, Izt=2.5mA, Zzt=300Ω, 300mW	SOD-323FL	7d	1a	Lge
3JS	MURS360S	Si-diode	Rectifier, 600V, 3A, Vf<1.2V(3A)	DO-214AA	1d	1k	Vs
3K	MM3Z91	Z-diode	85..96V, Izt=1mA, Zzt=700Ω, 300mW	SOD-323FL	7d	1a	Lge



SMD code	Type	Function	Short description	Case	Pinout	St.	Mnf.
3M	MM3Z100	Z-diode	94..106V, Izt=1mA, Zzt=700Ω, 300mW	SOD-323FL	7d	1a	Lge
3N	MM3Z110	Z-diode	104..116V, Izt=1mA, Zzt=800Ω, 300mW	SOD-323FL	7d	1a	Lge
3P	CMDZ22L	Z-diode	20.90..23.10V, Izt=0.5mA, Zzt=100Ω, 250mW	SOD-323	5d	1a	Cen
3P	KDZ3.9FVY	Z-diode	3.89..4.16V, Izt=5mA, Zzt=130Ω, 100mW	TFSC	7d	1a	Kec
3P	MM3Z120	Z-diode	114..127V, Izt=1mA, Zzt=900Ω, 300mW	SOD-323FL	7d	1a	Lge
3P3	SML4728	Z-diode	3.3V±5%, Izt=76mA, Zzt=10Ω, 1W	DO-214AC	1d	1k	Vs
3P6	SML4729	Z-diode	3.6V±5%, Izt=69mA, Zzt=10Ω, 1W	DO-214AC	1d	1k	Vs
3P9	SML4730	Z-diode	3.9V±5%, Izt=64mA, Zzt=9Ω, 1W	DO-214AC	1d	1k	Vs
3U3	GBLC24C	Si-diode	24V, 6A, 350W(1ms), 3pF, Bidirectional	SOD-323	5ba	1e	Prt
3U3	SBR3U30P1	Si-diode	SBR, 30V, 3A, Vf<0.35V(3A)	PowD1H23	7d	1d	Di
3V0	BZY55-C3V0	Z-diode	2.85..3.15V, Izt=5mA, Zzt=85Ω, 500mW	0805	70d	2d	Tsc
3V0B	BZT52-B3V0	Z-diode	2.94..3.06V, Izt=5mA, Zzt=100Ω, 500mW	SOD-123FL	7d	1a	Tsc
3V0B	MMSZ3V0BW	Z-diode	2.94..3.06V, Izt=5mA, Zzt=100Ω, 500mW	SOD-123FL	7d	1a	Tac
3V0Z	BZT52-C3V0	Z-diode	2.85..3.15V, Izt=5mA, Zzt=100Ω, 500mW	SOD-123FL	7d	1a	Tsc
3V0Z	MMSZ3V0CW	Z-diode	2.85..3.15V, Izt=5mA, Zzt=100Ω, 500mW	SOD-123FL	7d	1a	Tac
3V0Z	TCMMSZ3V0	Z-diode	3.0V±5%, Izt=5mA, Zzt=89Ω, 500mW	SOD-123FL	7d	1a	Tac
3V0Z	ZGFM053V0C-MH	Z-diode	2.85..3.15V, Izt=5mA, Zzt=89Ω, 500mW	SOD-123	5d	1a	Pic
3V3	BZY55-C3V3	Z-diode	3.14..3.47V, Izt=5mA, Zzt=85Ω, 500mW	0805	70d	2d	Tsc
3V3	CDZ55C3V3	Z-diode	3.14..3.47V, Zzt=85Ω, Izt=5mA, 500mW	1206	70d	2d	Crp
3V3	CDZ55C3V3S	Z-diode	3.14..3.47V, Zzt=85Ω, Izt=5mA, 500mW	0805	70d	2d	Crp
3V3	CTZ55C3V3	Z-diode	3.14..3.47V, Izt=5mA, Zzt=85Ω, 500mW	1206	70d	2d	Ctc
3V3B	BZT52-B3V3	Z-diode	3.23..3.37V, Izt=5mA, Zzt=95Ω, 500mW	SOD-123FL	7d	1a	Tsc
3V3B	MMSZ3V3BW	Z-diode	3.23..3.37V, Izt=5mA, Zzt=95Ω, 500mW	SOD-123FL	7d	1a	Tac
3V3Z	BZT52-C3V3	Z-diode	3.14..3.47V, Izt=5mA, Zzt=95Ω, 500mW	SOD-123FL	7d	1a	Tsc
3V3Z	MMSZ3V3CW	Z-diode	3.14..3.47V, Izt=5mA, Zzt=95Ω, 500mW	SOD-123FL	7d	1a	Tac
3V3Z	TCMMSZ3V3	Z-diode	3.3V±5%, Izt=5mA, Zzt=89Ω, 500mW	SOD-123FL	7d	1a	Tac
3V3Z	ZGFM053V3C-MH	Z-diode	3.14..3.47V, Izt=5mA, Zzt=89Ω, 500mW	SOD-123	5d	1a	Pic
3V6	BZD27C3V6P	Z-diode	3.42..3.78V, Zzt=8Ω, Izt=100mA, 800mW	SOD-123FL	7d	1a	Pjt
3V6	BZY55-C3V6	Z-diode	3.42..3.78V, Izt=5mA, Zzt=85Ω, 500mW	0805	70d	2d	Tsc
3V6	CDZ55C3V6	Z-diode	3.42..3.78V, Zzt=85Ω, Izt=5mA, 500mW	1206	70d	2d	Crp
3V6	CDZ55C3V6S	Z-diode	3.42..3.78V, Zzt=85Ω, Izt=5mA, 500mW	0805	70d	2d	Crp
3V6	CTZ55C3V6	Z-diode	3.42..3.78V, Izt=5mA, Zzt=85Ω, 500mW	1206	70d	2d	Ctc
3V6	MFPZ3V6	Z-diode	3.42..3.78V, Izt=100mA, Zzt=8Ω, 800mW	SOD-123FL	7d	1a	Ttr
3V6B	BZT52-B3V6	Z-diode	3.53..3.67V, Izt=5mA, Zzt=90Ω, 500mW	SOD-123FL	7d	1a	Tsc
3V6B	MMSZ3V6BW	Z-diode	3.53..3.67V, Izt=5mA, Zzt=90Ω, 500mW	SOD-123FL	7d	1a	Tac
3V6Z	BZT52-C3V6	Z-diode	3.42..3.78V, Izt=5mA, Zzt=90Ω, 500mW	SOD-123FL	7d	1a	Tsc
3V6Z	MMSZ3V6CW	Z-diode	3.42..3.78V, Izt=5mA, Zzt=90Ω, 500mW	SOD-123FL	7d	1a	Tac
3V6Z	TCMMSZ3V6	Z-diode	3.6V±5%, Izt=5mA, Zzt=84Ω, 500mW	SOD-123FL	7d	1a	Tac
3V6Z	ZGFM053V6C-MH	Z-diode	3.42..3.78V, Izt=5mA, Zzt=84Ω, 500mW	SOD-123	5d	1a	Pic
3V9	BZD27C3V9P	Z-diode	3.71..4.10V, Zzt=8Ω, Izt=100mA, 800mW	SOD-123FL	7d	1a	Pjt
3V9	BZY55-C3V9	Z-diode	3.71..4.10V, Izt=5mA, Zzt=85Ω, 500mW	0805	70d	2d	Tsc
3V9	CDZ55C3V9	Z-diode	3.71..4.10V, Zzt=85Ω, Izt=5mA, 500mW	1206	70d	2d	Crp
3V9	CDZ55C3V9S	Z-diode	3.71..4.10V, Zzt=85Ω, Izt=5mA, 500mW	0805	70d	2d	Crp
3V9	CTZ55C3V9	Z-diode	3.71..4.10V, Izt=5mA, Zzt=85Ω, 500mW	1206	70d	2d	Ctc
3V9	MFPZ3V9	Z-diode	3.71..4.10V, Izt=100mA, Zzt=8Ω, 800mW	SOD-123FL	7d	1a	Ttr
3V9B	BZT52-B3V9	Z-diode	3.82..3.98V, Izt=5mA, Zzt=90Ω, 500mW	SOD-123FL	7d	1a	Tsc
3V9B	MMSZ3V9BW	Z-diode	3.82..3.98V, Izt=5mA, Zzt=90Ω, 500mW	SOD-123FL	7d	1a	Tac
3V9Z	BZT52-C3V9	Z-diode	3.71..4.10V, Izt=5mA, Zzt=90Ω, 500mW	SOD-123FL	7d	1a	Tsc
3V9Z	MMSZ3V9CW	Z-diode	3.71..4.10V, Izt=5mA, Zzt=90Ω, 500mW	SOD-123FL	7d	1a	Tac
3V9Z	TCMMSZ3V9	Z-diode	3.9V±5%, Izt=5mA, Zzt=84Ω, 500mW	SOD-123FL	7d	1a	Tac
3V9Z	ZGFM053V9C-MH	Z-diode	3.71..4.10V, Izt=5mA, Zzt=84Ω, 500mW	SOD-123	5d	1a	Pic
3W	MM3Z68V	Z-diode	64..72V, Izt=2mA, Zzt=240Ω, 200mW	SOD-323	5d	1a	Sec
3Y	KDZ13VYV	Z-diode	12.91..13.49V, Izt=5mA, Zzt=15Ω, 100mW	VSC	7d	1a	Kec
3Z	BZT52-B3V3S	Z-diode	3.23..3.37V, Izt=5mA, Zzt=95Ω, 200mW	SOD-323FL	7d	1a	Tsc
3Z	MM3Z3V3B	Z-diode	3.23..3.37V, Zzt=89Ω, Izt=5mA, 200mW	SOD-323FL	7d	1a	F
3Z	MM3Z3V3BW	Z-diode	3.23..3.37V, Izt=5mA, Zzt=95Ω, 200mW	SOD-323FL	7d	1a	Tac
3Z	TCMMSZ3V3B	Z-diode	3.3V±2%, Izt=5mA, Zzt=89Ω, 200mW	SOD-323FL	7d	1a	Tac
4	CH601G-70PT	Si-diode	SBD, 70V, 100mA, Vf<0.77V(10mA)	SOD-723	8d	1a	Chm
4	GBLC24	TVS	Vbr=24V, 6A, 350W(1ms), 3pF	SOD-323	5d	1a	Prt
4	KDS160F	Si-diode	Sw, 80V, 100mA, Vf<1.2V(100mA), 4ns	TFSC	7d	1a	Kec
4	MA2SV03	C-diode	VCO, 6V, 5.5..2.35pF(1..4V)	SOD-523	6d	1a	Pan
4	MM9D5V1	Z-diode	4.85..5.36V, Izt=5mA, Zzt=80Ω, 200mW	SOD-923	7d	1a	Wtr
4	MMPZ5225SPT	Z-diode	2.940..3.060V, Izt=5mA, Zzt=95Ω, 225mW	SOD-323	5d	1a	Chm
4	MMSZ5246BPT	Z-diode	15.20..16.80V, Izt=5mA, Zzt=36Ω, 225mW	SOD-523	7d	1a	Chm
4	NZ9F16VST	Z-diode	15.85..16.51V, Izt=5mA, Zzt=50Ω, 200mW	SOD-923	7d	2m	Ons
4	NZ9F3V0ST	Z-diode	2.94..3.26V, Izt=5mA, Zzt=100Ω, 200mW	SOD-923	7d	1n	Ons
4	NZ9F5V1T	Z-diode	4.85..5.36V, Izt=5mA, Zzt=80Ω, 200mW	SOD-923	7d	1a	Ons
4	RB501V-40	Si-diode	SBR, 45V, 100mA, Vf<0.55V(100mA), <6pF	SOD-323	5d	1a	Rhm
4 (white)	BAS140W	Si-diode	Schottky, 40V, 200mA, 200mW, Cd<5pF, <5ns	SOD-323	5d	2	Inf
4 2	GDZ3V0B-V	Z-diode	3.01..3.22V, Izt=5mA, Zzt=120Ω, 200mW	SOD-323	5d	1k	Vs



SMD code	Type	Function	Short description	Case	Pinout	St.	Mnf.
4.	MMSZ5246SPT	Z-diode	15.68..16.32V, Izt=5mA, Zzt=36Ω, 225mW	SOD-523	7d	1a	Chm
4.3	MAZ80430H	Z-diode	4.31..4.54V, Zzt=130Ω(5mA), 150mW	SC-76	6d	1a	Pan
4.3B	HZF4.3BP	Z-diode	4.3V±5%, 900mW	LRP	1d	2f	Ren
4.3B	PTZ4.3B	Z-diode	4.3V±10%, 40mA, 1W	DO-214AC	1d	1a	Rhm
4.3C	HZF4.3CP	Z-diode	4.3V±10%, 900mW	LRP	1d	2f	Ren
4.7	MAZ5047	Z-diode	4.4..5V, Zzt=50Ω(5mA), 500mW	MP2	11d	1a	Pan
4.7	MAZ80470H	Z-diode	4.74..4.99V, Zzt=80Ω(5mA), 150mW	SC-76	6d	1a	Pan
4.7	MAZY047	Z-diode	4.4..5V, Zzt=60Ω(20mA), 1W	NMiniP2	1d	1a	Pan
4.7B	HZF4.7BP	Z-diode	4.7V±5%, 900mW	LRP	1d	2f	Ren
4.7B	PTZ4.7B	Z-diode	4.7V±10%, 40mA, 1W	DO-214AC	1d	1a	Rhm
4.7C	HZF4.7CP	Z-diode	4.7V±10%, 900mW	LRP	1d	2f	Ren
4*3	MAZ80430H	Z-diode	4.31..4.54V, Zzt=130Ω(5mA), 150mW	SC-76	6d	1a	Pan
4*3	MAZ8043GHL	Z-diode	4.31..4.54V, Zzt=130Ω(5mA), 150mW	SMIni2-F3	6d	1a	Pan
4*7	MAZ80470H	Z-diode	4.74..4.99V, Zzt=80Ω(5mA), 150mW	SC-76	6d	1a	Pan
4*7	MAZ8047GHL	Z-diode	4.74..4.99V, Zzt=80Ω(5mA), 150mW	SMIni2-F3	6d	1a	Pan
4_3	MAZ80430L	Z-diode	4.03..4.26V, Zzt=130Ω(5mA), 150mW	SC-76	6d	1a	Pan
4_3	MAZ8043GLL	Z-diode	4.03..4.26V, Zzt=130Ω(5mA), 150mW	SMIni2-F3	6d	1a	Pan
4_7	MAZ80470L	Z-diode	4.45..4.69V, Zzt=80Ω(5mA), 150mW	SC-76	6d	1a	Pan
4_7	MAZ8047GLL	Z-diode	4.45..4.69V, Zzt=80Ω(5mA), 150mW	SMIni2-F3	6d	1a	Pan
4*3	HZU4.3B1	Z-diode	4.01..4.21V, Izt=5mA, Zzt=130Ω, 200mW	URP	5d	1a	Ren
4*3	HZU4.3B2	Z-diode	4.15..4.34V, Izt=5mA, Zzt=130Ω, 200mW	URP	5d	1a	Ren
4.3	HZU4.3B3	Z-diode	4.28..4.48V, Izt=5mA, Zzt=130Ω, 200mW	URP	5d	1a	Ren
4*3	RKZ4.3B2KG	Z-diode	4.15..4.34V, Izt=5mA, Zzt=130Ω, 200mW	URP	5d	2e	Ren
4*3	RKZ4.3B2KJ	Z-diode	4.15..4.34V, Izt=5mA, Zzt=130Ω, 150mW	UFP	7d	2e	Ren
4*7	HZU4.7B1	Z-diode	4.42..4.61V, Izt=5mA, Zzt=130Ω, 200mW	URP	5d	1a	Ren
4*7	HZU4.7B2	Z-diode	4.55..4.75V, Izt=5mA, Zzt=130Ω, 200mW	URP	5d	1a	Ren
4.7	HZU4.7B3	Z-diode	4.69..4.90V, Izt=5mA, Zzt=130Ω, 200mW	URP	5d	1a	Ren
4*7	RKZ4.7B2KG	Z-diode	4.55..4.75V, Izt=5mA, Zzt=130Ω, 200mW	URP	5d	2e	Ren
4*7	RKZ4.7B2KJ	Z-diode	4.55..4.75V, Izt=5mA, Zzt=130Ω, 150mW	UFP	7d	2e	Ren
40	HMSZ5240B	Z-diode	10V±5%, Izt=20mA, Zzt=17Ω, 225mW	SOD-323	5d	1d	Hsn
40	ZD5240BS2	Z-diode	10V±5%, 20mA, Zzt=17Ω, 500mW	SOD-323	5d	1a	Cys
40	ZLS400TA	Si-diode	SBR, 40V, 520mA, 330mW, Vf<0.52V(400mA)	SOD-323	5d	1a	Zx
40	ZLS400TC	Si-diode	SBR, 40V, 520mA, 330mW, Vf<0.52V(400mA)	SOD-323	5d	1a	Zx
400	P4SMA400	TVS	Vbr=360..440V, Vrrm=324V, 0.70A, 400W(1ms)	DO-214AC	1d	1a	Eic
4001	SBM4001PT	Si-diode	Rectifier, 50V, 1A	DO-214AA	1d	1a	Chm
4001	SM4001PT	Si-diode	Rectifier, 50V, 1A	DO-214AC	1d	1a	Chm
4002	SBM4002PT	Si-diode	Rectifier, 100V, 1A	DO-214AA	1d	1a	Chm
4002	SM4002PT	Si-diode	Rectifier, 100V, 1A	DO-214AC	1d	1a	Chm
4003	SBM4003PT	Si-diode	Rectifier, 200V, 1A	DO-214AA	1d	1a	Chm
4003	SM4003PT	Si-diode	Rectifier, 200V, 1A	DO-214AC	1d	1a	Chm
4004	SBM4004PT	Si-diode	Rectifier, 400V, 1A	DO-214AA	1d	1a	Chm
4004	SM4004PT	Si-diode	Rectifier, 400V, 1A	DO-214AC	1d	1a	Chm
4005	SBM4005PT	Si-diode	Rectifier, 600V, 1A	DO-214AA	1d	1a	Chm
4005	SM4005PT	Si-diode	Rectifier, 600V, 1A	DO-214AC	1d	1a	Chm
4006	SBM4006PT	Si-diode	Rectifier, 800V, 1A	DO-214AA	1d	1a	Chm
4006	SM4006PT	Si-diode	Rectifier, 800V, 1A	DO-214AC	1d	1a	Chm
4007	SBM4007PT	Si-diode	Rectifier, 1000V, 1A	DO-214AA	1d	1a	Chm
4007	SM4007PT	Si-diode	Rectifier, 1000V, 1A	DO-214AC	1d	1a	Chm
400A	1.5SMC400A	TVS	Vbr=380..420V, Vrrm=342V, 2.7A, 1500W(1ms)	DO-214AB	1d	1k	Vs
400A	P4SMA400A	TVS	Vbr=380..420V, Vrrm=342V, 0.73A, 400W(1ms)	DO-214AC	1d	1k	Vs
400A	P6SMB400A	TVS	Vbr=380..420V, Vrrm=342V, 1.10A, 600W(1ms)	DO-214AA	1d	1k	Vs
400C	1.5SMC400CA	TVS	Vnrm=342.0V, Vbr=380.0..420.0V, 2.8A, 1500W(1ms), Bidirectional	DO-214AB	1ba	1j	Fee
400C	P4SMA400C	TVS	Vbr=360..440V, Vrrm=324V, 0.70A, 400W(1ms), Bidirectional	DO-214AC	1ba	1j	Eic
400CA	P4SMA400CA	TVS	Vbr=380..420V, Vrrm=342V, 0.73A, 400W(1ms), Bidirectional	DO-214AC	1ba	1j	Eic
400CA	P6SMB400CA	TVS	Vbr=380..420V, Vrrm=342V, 1.10A, 600W(1ms), Bidirectional	DO-214AA	1ba	1j	Eic
4010	SZ4010	Z-diode	10V±10%, Izt=50.0mA, Zzt=3.5Ω, 2W	DO-214AC	1d	1a	Eic
4011	SZ4011	Z-diode	11V±10%, Izt=45.5mA, Zzt=4.0Ω, 2W	DO-214AC	1d	1a	Eic
4012	SZ4012	Z-diode	12V±10%, Izt=41.5mA, Zzt=4.5Ω, 2W	DO-214AC	1d	1a	Eic
4013	SZ4013	Z-diode	13V±10%, Izt=38.5mA, Zzt=5.0Ω, 2W	DO-214AC	1d	1a	Eic
4014	SZ4014	Z-diode	14V±10%, Izt=35.7mA, Zzt=5.5Ω, 2W	DO-214AC	1d	1a	Eic
4015	SZ4015	Z-diode	15V±10%, Izt=33.4mA, Zzt=7.0Ω, 2W	DO-214AC	1d	1a	Eic
4016	SZ4016	Z-diode	16V±10%, Izt=31.2mA, Zzt=8.0Ω, 2W	DO-214AC	1d	1a	Eic
4017	SZ4017	Z-diode	17V±10%, Izt=29.4mA, Zzt=9.0Ω, 2W	DO-214AC	1d	1a	Eic
4018	SZ4018	Z-diode	18V±10%, Izt=27.8mA, Zzt=10Ω, 2W	DO-214AC	1d	1a	Eic
4019	SZ4019	Z-diode	19V±10%, Izt=26.3mA, Zzt=11Ω, 2W	DO-214AC	1d	1a	Eic
4020	SZ4020	Z-diode	20V±10%, Izt=25.0mA, Zzt=11Ω, 2W	DO-214AC	1d	1a	Eic
4022	SZ4022	Z-diode	22V±10%, Izt=22.8mA, Zzt=12Ω, 2W	DO-214AC	1d	1a	Eic
4024	SZ4024	Z-diode	24V±10%, Izt=20.8mA, Zzt=13Ω, 2W	DO-214AC	1d	1a	Eic
4027	SZ4027	Z-diode	27V±10%, Izt=18.5mA, Zzt=18Ω, 2W	DO-214AC	1d	1a	Eic
4030	SZ4030	Z-diode	30V±10%, Izt=16.6mA, Zzt=20Ω, 2W	DO-214AC	1d	1a	Eic



SMD code	Type	Function	Short description	Case	Pinout	St.	Mnf.
4033	SZ4033	Z-diode	33V±10%, Izt=15.1mA, Zzt=23Ω, 2W	DO-214AC	1d	1a	Eic
4036	SZ4036	Z-diode	36V±10%, Izt=13.9mA, Zzt=25Ω, 2W	DO-214AC	1d	1a	Eic
4039	SZ4039	Z-diode	39V±10%, Izt=12.8mA, Zzt=30Ω, 2W	DO-214AC	1d	1a	Eic
403G	SZ403G	Z-diode	3.6V±10%, Izt=139mA, Zzt=5.0Ω, 2W	DO-214AC	1d	1a	Eic
403J	SZ403J	Z-diode	3.9V±10%, Izt=128mA, Zzt=5.0Ω, 2W	DO-214AC	1d	1a	Eic
4043	SZ4043	Z-diode	43V±10%, Izt=11.6mA, Zzt=35Ω, 2W	DO-214AC	1d	1a	Eic
4047	SZ4047	Z-diode	47V±10%, Izt=10.6mA, Zzt=40Ω, 2W	DO-214AC	1d	1a	Eic
404D	SZ404D	Z-diode	4.3V±10%, Izt=116mA, Zzt=4.5Ω, 2W	DO-214AC	1d	1a	Eic
404H	SZ404H	Z-diode	4.7V±10%, Izt=106mA, Zzt=4.5Ω, 2W	DO-214AC	1d	1a	Eic
4051	SZ4051	Z-diode	5.1V±10%, Izt=9.8mA, Zzt=48Ω, 2W	DO-214AC	1d	1a	Eic
4056	SZ4056	Z-diode	5.6V±10%, Izt=9.0mA, Zzt=55Ω, 2W	DO-214AC	1d	1a	Eic
405B	SZ405B	Z-diode	5.1V±10%, Izt=98.0mA, Zzt=3.5Ω, 2W	DO-214AC	1d	1a	Eic
405G	SZ405G	Z-diode	5.6V±10%, Izt=89.5mA, Zzt=2.5Ω, 2W	DO-214AC	1d	1a	Eic
4062	SZ4062	Z-diode	62V±10%, Izt=8.1mA, Zzt=60Ω, 2W	DO-214AC	1d	1a	Eic
4068	SZ4068	Z-diode	68V±10%, Izt=7.4mA, Zzt=75Ω, 2W	DO-214AC	1d	1a	Eic
406C	SZ406C	Z-diode	6.2V±10%, Izt=80.5mA, Zzt=1.5Ω, 2W	DO-214AC	1d	1a	Eic
406I	SZ406I	Z-diode	6.8V±10%, Izt=73.5mA, Zzt=2.0Ω, 2W	DO-214AC	1d	1a	Eic
4075	SZ4075	Z-diode	75V±10%, Izt=6.7mA, Zzt=90Ω, 2W	DO-214AC	1d	1a	Eic
407F	SZ407F	Z-diode	7.5V±10%, Izt=66.5mA, Zzt=2.0Ω, 2W	DO-214AC	1d	1a	Eic
4082	SZ4082	Z-diode	82V±10%, Izt=6.1mA, Zzt=100Ω, 2W	DO-214AC	1d	1a	Eic
408C	SZ408C	Z-diode	8.2V±10%, Izt=61.0mA, Zzt=2.3Ω, 2W	DO-214AC	1d	1a	Eic
4091	SZ4091	Z-diode	91V±10%, Izt=5.5mA, Zzt=125Ω, 2W	DO-214AC	1d	1a	Eic
409B	SZ409B	Z-diode	9.1V±10%, Izt=55.0mA, Zzt=2.5Ω, 2W	DO-214AC	1d	1a	Eic
40A	1SMC40A	TVS	Vbr=44.4.49.1V, Vrw=40V, 23.3A, 1500W(1ms)	DO-214AB	1d	1a	Eic
40A	SMAJ40A	TVS	Vrw=40V, Vbr=44.4.49.1V, 6.2A, 400W(1ms)	DO-214AC	1d	1a	Sus
40A	SMBJ40A	TVS	Vbr=44.4.49.1V, Vrw=40V, 9.3A, 600W(1ms)	DO-214AA	1d	1a	Sus
40A	SMCJ40A	TVS	Vrw=40V, Vbr=44.4.51.1V, 21A, 1500W(1ms)	DO-214AB	1d	1k	Sus
40A	UMA40A	TVS	Vrw=40V, Vbr=44.4.64.5V, 7.8A, 500W(1ms)	UltraMite	14d	1v	Msc
40B	MMHZ5240BPT	Z-diode	9.500..10.50V, Izt=5mA, Zzt=15Ω, 225mW	SOD-123	5d	1a	Chm
40B0	SZ40B0	Z-diode	100V±10%, Izt=5.0mA, Zzt=175Ω, 2W	DO-214AC	1d	1a	Eic
40B1	SZ40B1	Z-diode	110V±10%, Izt=4.5mA, Zzt=250Ω, 2W	DO-214AC	1d	1a	Eic
40B2	SZ40B2	Z-diode	120V±10%, Izt=4.2mA, Zzt=325Ω, 2W	DO-214AC	1d	1a	Eic
40B3	SZ40B3	Z-diode	130V±10%, Izt=3.8mA, Zzt=400Ω, 2W	DO-214AC	1d	1a	Eic
40B4	SZ40B4	Z-diode	140V±10%, Izt=3.6mA, Zzt=500Ω, 2W	DO-214AC	1d	1a	Eic
40B5	SZ40B5	Z-diode	150V±10%, Izt=3.3mA, Zzt=575Ω, 2W	DO-214AC	1d	1a	Eic
40B6	SZ40B6	Z-diode	160V±10%, Izt=3.1mA, Zzt=650Ω, 2W	DO-214AC	1d	1a	Eic
40B7	SZ40B7	Z-diode	170V±10%, Izt=2.9mA, Zzt=675Ω, 2W	DO-214AC	1d	1a	Eic
40B8	SZ40B8	Z-diode	180V±10%, Izt=2.8mA, Zzt=725Ω, 2W	DO-214AC	1d	1a	Eic
40B9	SZ40B9	Z-diode	190V±10%, Izt=2.6mA, Zzt=825Ω, 2W	DO-214AC	1d	1a	Eic
40C	U5ZA40C	Z-diode	36..44V, Zzt=30Ω, 5W	DO-218	8d	1a	Tos
40CA	1SMC40CA	TVS	Vbr=44.4.49.1V, Vrw=40V, 23.3A, 1500W(1ms), Bidirectional	DO-214AB	1ba	1j	Eic
40CA	SMAJ40CA	TVS	Vrw=40V, Vbr=44.4.49.1V, 6.2A, 400W(1ms), Bidirectional	DO-214AC	1ba	1j	Sus
40CA	SMBJ40CA	TVS	Vbr=44.4.49.1V, Vrw=40V, 9.3A, 600W(1ms), Bidirectional	DO-214AA	1ba	1j	Sus
40CA	SMCJ40CA	TVS	Vrw=40V, Vbr=44.4.51.1V, 21A, 1500W(1ms), Bidirectional	DO-214AB	1ba	1l	Sus
40CA	UMA40CA	TVS	Vrw=40V, Vbr=44.4.64.5V, 7.8A, 500W(1ms), Bidirectional	UltraMite	14ba	1v	Msc
40D0	SZ40D0	Z-diode	200V±10%, Izt=2.5mA, Zzt=900Ω, 2W	DO-214AC	1d	1a	Eic
40S	MMHZ5240SPT	Z-diode	9.800..10.20V, Izt=5mA, Zzt=15Ω, 225mW	SOD-123	5d	1a	Chm
40V	SMA40	TVS	Vbr=44.4.54.3V, Vrw=40.0V, 4.2A, 300W(1ms)	DO-214AC	1d	1a	Mic
40V	SMB40	TVS	Vbr=44.4.54.3V, Vrw=40V, 8.4A, 600W(1ms)	DO-214AA	1d	1a	Mic
40V	SMC40	TVS	Vbr=44.4.54.3V, Vrw=40V, 21A, 1500W(1ms)	DO-214AB	1d	1a	Mic
40VA	SMA40A	TVS	Vbr=44.4.49.1V, Vrw=40.0V, 4.7A, 300W(1ms)	DO-214AC	1d	1a	Mic
40VA	SMB40A	TVS	Vbr=44.4.49.1V, Vrw=40V, 9.3A, 600W(1ms)	DO-214AA	1d	1a	Mic
40VA	SMC40A	TVS	Vbr=44.4.49.1V, Vrw=40V, 23.3A, 1500W(1ms)	DO-214AB	1d	1a	Mic
40VC	SMA40C	TVS	Vbr=44.4.54.3V, Vrw=40.0V, 4.2A, 300W(1ms), Bidirectional	DO-214AC	1ba	1j	Mic
40VC	SMB40C	TVS	Vbr=44.4.54.3V, Vrw=40V, 8.4A, 600W(1ms), Bidirectional	DO-214AA	1ba	1j	Mic
40VC	SMC40C	TVS	Vbr=44.4.54.3V, Vrw=40V, 21A, 1500W(1ms), Bidirectional	DO-214AB	1ba	1j	Mic
40VCA	SMA40CA	TVS	Vbr=44.4.49.1V, Vrw=40.0V, 4.7A, 300W(1ms), Bidirectional	DO-214AC	1ba	1j	Mic
40VCA	SMB40CA	TVS	Vbr=44.4.49.1V, Vrw=40V, 9.3A, 600W(1ms), Bidirectional	DO-214AA	1ba	1j	Mic
40VCA	SMC40CA	TVS	Vbr=44.4.49.1V, Vrw=40V, 23.3A, 1500W(1ms), Bidirectional	DO-214AB	1ba	1j	Mic
41	HMSZ5241B	Z-diode	11V±5%, Izt=20mA, Zzt=22Ω, 225mW	SOD-323	5d	1d	Hsn
41	ZD5241BS2	Z-diode	11V±5%, 20mA, Zzt=22Ω, 500mW	SOD-323	5d	1a	Cys
41B	MMHZ5241BPT	Z-diode	10.45..11.55V, Izt=5mA, Zzt=18Ω, 225mW	SOD-123	5d	1a	Chm
41S	MMHZ5241SPT	Z-diode	10.78..11.22V, Izt=5mA, Zzt=18Ω, 225mW	SOD-123	5d	1a	Chm
42	FDZ3.0VT	Z-diode	3.010..3.220V, Izt=5mA, Zzt=120Ω, 200mW	SOD-323	5d	1a	Fis
42	HMSZ5242B	Z-diode	12V±5%, Izt=20mA, Zzt=30Ω, 225mW	SOD-323	5d	1d	Hsn
42	UDZS3.0B	Z-diode	3.01..3.22V, Izt=5mA, Zzt=120Ω, 200mW	SOD-323	5d	1a	Wtr
42	ZD5242BS2	Z-diode	12V±5%, 20mA, Zzt=30Ω, 500mW	SOD-323	5d	1a	Cys
42B	MMHZ5242BPT	Z-diode	11.40..12.60V, Izt=5mA, Zzt=22Ω, 225mW	SOD-123	5d	1a	Chm
42B	SMC5342B	Z-diode	6.8V±5%, Zzt=1.0(175.0mA), Izm=700.0mA, 5W	DO-214AB	1d	1a	Ers
42S	MMHZ5242SPT	Z-diode	11.76..12.24V, Izt=5mA, Zzt=22Ω, 225mW	SOD-123	5d	1a	Chm



SMD
code

Type

Function

Short description

Case

Pinout

St.

Mnf.

SMD code	Type	Function	Short description	Case	Pinout	St.	Mnf.
43	CDZ55C43	Z-diode	40.85..45.15V, Zzt=90Ω, Izt=5mA, 500mW	1206	70d	2d	Crp
43	CDZ55C43S	Z-diode	40.85..45.15V, Zzt=90Ω, Izt=5mA, 500mW	0805	70d	2d	Crp
43	CDZ55C43T	Z-diode	40.85..45.15V, Zzt=90Ω, Izt=5mA, 200mW	0603	70d	2d	Crp
43	CMZ43	Z-diode	43V±5%, 2W	M-Flat	7d	1a	Tos
43	HMSZ5243B	Z-diode	13V±5%, Izt=9.5mA, Zzt=13Ω, 225mW	SOD-323	5d	1d	Hsn
43	HZC4.3	Z-diode	4.3V±10%, 150mW	SOD-523	6d	1a	Ren
43	KDZ4.3EV	Z-diode	4..4.5V, 150mW	SOD-523	6d	1a	Kec
43	KDZ4.3V	Z-diode	4..4.5V, 150mW	SOD-323	5d	1a	Kec
43	MAZY430	Z-diode	38.7..47.3V, Zzt=65Ω(5mA), 1W	NMiniP2	1d	1a	Pan
43	MMPZ5260SPT	Z-diode	42.14..43.86V, Izt=3.0mA, Zzt=93Ω, 225mW	SOD-323	5d	1a	Chm
43	P4SMA43	TVS	Vbr=38.7..47.3V, Vrw=34.8V, 6.8A, 400W(1ms)	DO-214AC	1d	1a	Eic
43	P6SMBJ43	TVS	Vbr=38.7..47.3V, 9.6A, 600W(1ms)	DO-214AA	1d	1n	Lif
43	SML4755	Z-diode	43V±5%, Izt=6mA, Zzt=70Ω, 1W	DO-214AC	1d	1k	Vs
43	TZD4.3WS	Z-diode	4.0..4.50V, Izt=5mA, Zzt=130Ω, 200mW	SOD-323	5d	1a	Ttr
43	TZD4.3WT	Z-diode	4.0..4.50V, Izt=5mA, Zzt=130Ω, 150mW	SOD-523	6d	1a	Ttr
43	U1Z43	Z-diode	38.7..47.3V, 1W	SOD-6	1d	1a	Tos
43	U1ZB43	Z-diode	38.7..47.3V, 1W	I-FLAT	1d	1a	Tos
43	ZD5243BS2	Z-diode	13V±5%, 9.5mA, Zzt=13Ω, 500mW	SOD-323	5d	1a	Cys
4-3	MAZ80430M	Z-diode	4.17..4.40V, Zzt=130Ω(5mA), 150mW	SC-76	6d	1a	Pan
4-3	MAZ8043GML	Z-diode	4.17..4.40V, Zzt=130Ω(5mA), 150mW	SMini2-F3	6d	1a	Pan
43+	TZD4.3YWS	Z-diode	4.17..4.43V, Izt=5mA, Zzt=130Ω, 200mW	SOD-323	5d	1a	Ttr
43+	TZD4.3YWT	Z-diode	4.17..4.43V, Izt=5mA, Zzt=130Ω, 150mW	SOD-523	6d	1a	Ttr
43A	1.5SMC43A	TVS	Vbr=40.9..45.2V, Vrw=36.8V, 25.3A, 1500W(1ms)	DO-214AB	1d,3d	1a,1k	Vs,Ons
43A	1SMC43A	TVS	Vbr=47.8..52.8V, Vrw=43V, 21.6A, 1500W(1ms)	DO-214AB	1d	1a	Eic
43A	P4SMA43A	TVS	Vbr=40.9..45.2V, Vrw=36.8V, 7.1A, 400W(1ms)	DO-214AC	1d	1k	Vs
43A	P6SMB43A	TVS	Vrw=43V, Vbr=40.9..45.2V, 10.1A, 600W(1ms)	DO-214AA	1d,3d	1k,1a	Vs,Ons
43A	P6SMBJ43A	TVS	Vbr=40.9..45.2V, 10.1A, 600W(1ms)	DO-214AA	1d	1n	Lif
43A	SMAJ43A	TVS	Vrw=43V, Vbr=47.8..52.8V, 5.7A, 400W(1ms)	DO-214AC	1d	1a	Sus
43A	SMBJ43A	TVS	Vbr=47.8..52.8V, Vrw=43V, 8.6A, 600W(1ms)	DO-214AA	1d	1a	Sus
43A	SMCJ43A	TVS	Vrw=43V, Vbr=47.8..54.9V, 19.6A, 1500W(1ms)	DO-214AB	1d	1k	Sus
43A	UMA43A	TVS	Vrw=43V, Vbr=47.8..69.4V, 7.2A, 500W(1ms)	UltraMite	14d	1v	Msc
43B	1SMB3EZ43	Z-diode	43V±5%, Zzt=35Ω, Izt=17.0mA, 3W	DO-214AA	1d	1a	Pjt
43B	MMHZ5243BPT	Z-diode	12.35..13.65V, Izt=5mA, Zzt=25Ω, 225mW	SOD-123	5d	1a	Chm
43B	SMC5343B	Z-diode	7.5V±5%, Zzt=1.5(175.0mA), Izm=630.0mA, 5W	DO-214AB	1d	1a	Ers
43B	Z3SMB43B	Z-diode	40.85..45.15V, Izt=17mA, Zzt=33Ω, 3W	DO-214AA	1d	1a	Ttr
43C	1.5SMC43CA	TVS	Vbr=40.9..45.2V, Vrw=36.8V, 25.3A, 1500W(1ms), Bidirectional	DO-214AB	1ba	1l	Vs
43C	P4SMA43C	TVS	Vbr=38.7..47.3V, Vrw=34.8V, 6.8A, 400W(1ms), Bidirectional	DO-214AC	1ba	1j	Eic
43C	P4SMA43CA	TVS	Vbr=40.9..45.2V, 6.7A, 400W(1ms), Bidirectional	DO-214AC	1ba	1l	Vs
43C	P6SMB43CA	TVS	Vrw=43V, Vbr=40.9..45.2V, 10.1A, 600W(1ms), Bidirectional	DO-214AA	1ba,3ba	1l,1e	Vs,Ons
43C	P6SMBJ43C	TVS	Vbr=38.7..47.3V, 9.6A, 600W(1ms), Bidirectional	DO-214AA	1ba	1p	Lif
43CA	1SMC43CA	TVS	Vbr=47.8..52.8V, Vrw=43V, 21.6A, 1500W(1ms), Bidirectional	DO-214AB	1ba	1j	Eic
43CA	P4SMA43CA	TVS	Vbr=40.9..45.2V, Vrw=36.8V, 7.1A, 400W(1ms), Bidirectional	DO-214AC	1ba	1j	Eic
43CA	P6SMB43CA	TVS	Vbr=40.9..45.2V, Vrw=36.8V, 10.1A, 600W(1ms), Bidirectional	DO-214AA	1ba	1j	Eic
43CA	P6SMBJ43CA	TVS	Vbr=40.9..45.2V, 10.1A, 600W(1ms), Bidirectional	DO-214AA	1ba	1p	Lif
43CA	SMAJ43CA	TVS	Vrw=43V, Vbr=47.8..52.8V, 5.7A, 400W(1ms), Bidirectional	DO-214AC	1ba	1j	Sus
43CA	SMBJ43CA	TVS	Vbr=47.8..52.8V, Vrw=43V, 8.6A, 600W(1ms), Bidirectional	DO-214AA	1ba	1j	Sus
43CA	SMCJ43CA	TVS	Vrw=43V, Vbr=47.8..54.9V, 19.6A, 1500W(1ms), Bidirectional	DO-214AB	1ba	1l	Sus
43CA	UMA43CA	TVS	Vrw=43V, Vbr=47.8..69.4V, 7.2A, 500W(1ms), Bidirectional	UltraMite	14ba	1v	Msc
43L	SSB43L	Si-diode	SBR, 30V, 4A, Vf<0.49V(4A)	DO-214AA	1d	1k	Vs
43P	BZD27C43P	Z-diode	40.85..45.15V, Zzt=45Ω, Izt=10mA, 800mW	SOD-123FL	7d	1a	Pjt
43P	MFPZ43	Z-diode	40.85..45.15V, Izt=10mA, Zzt=45Ω, 800mW	SOD-123FL	7d	1a	Ttr
43S	MMHZ5243SPT	Z-diode	12.74..13.26V, Izt=5mA, Zzt=25Ω, 225mW	SOD-123	5d	1a	Chm
43V	SMA43	TVS	Vbr=47.8..58.4V, Vrw=43.0V, 3.9A, 300W(1ms)	DO-214AC	1d	1a	Mic
43V	SMB43	TVS	Vbr=47.8..58.4V, Vrw=43V, 7.8A, 600W(1ms)	DO-214AA	1d	1a	Mic
43V	SMC43	TVS	Vbr=47.8..58.4V, Vrw=43V, 19.6A, 1500W(1ms)	DO-214AB	1d	1a	Mic
43VA	SMA43A	TVS	Vbr=47.8..52.8V, Vrw=43.0V, 4.3A, 300W(1ms)	DO-214AC	1d	1a	Mic
43VA	SMB43A	TVS	Vbr=47.8..52.8V, Vrw=43V, 8.6A, 600W(1ms)	DO-214AA	1d	1a	Mic
43VA	SMC43A	TVS	Vbr=47.8..52.8V, Vrw=43V, 21.6A, 1500W(1ms)	DO-214AB	1d	1a	Mic
43VB	BZT52-B43	Z-diode	42.14..43.86V, Izt=2mA, Zzt=150Ω, 500mW	SOD-123FL	7d	1a	Tsc
43VB	MMSZ43VBW	Z-diode	42.14..43.86V, Izt=2mA, Zzt=150Ω, 500mW	SOD-123FL	7d	1a	Tac
43VC	SMA43C	TVS	Vbr=47.8..58.4V, Vrw=43.0V, 3.9A, 300W(1ms), Bidirectional	DO-214AC	1ba	1j	Mic
43VC	SMB43C	TVS	Vbr=47.8..58.4V, Vrw=43V, 7.8A, 600W(1ms), Bidirectional	DO-214AA	1ba	1j	Mic
43VC	SMC43C	TVS	Vbr=47.8..58.4V, Vrw=43V, 19.6A, 1500W(1ms), Bidirectional	DO-214AB	1ba	1j	Mic
43VCA	SMA43CA	TVS	Vbr=47.8..52.8V, Vrw=43.0V, 4.3A, 300W(1ms), Bidirectional	DO-214AC	1ba	1j	Mic
43VCA	SMB43CA	TVS	Vbr=47.8..52.8V, Vrw=43V, 8.6A, 600W(1ms), Bidirectional	DO-214AA	1ba	1j	Mic
43VCA	SMC43CA	TVS	Vbr=47.8..52.8V, Vrw=43V, 21.6A, 1500W(1ms), Bidirectional	DO-214AB	1ba	1j	Mic
43VZ	BZT52-C43	Z-diode	40.85..45.15V, Izt=2mA, Zzt=150Ω, 500mW	SOD-123FL	7d	1a	Tsc
43VZ	MMSZ43VCW	Z-diode	40.85..45.15V, Izt=2mA, Zzt=150Ω, 500mW	SOD-123FL	7d	1a	Tac
43VZ	TCMMSZ43V	Z-diode	43V±5%, Izt=5mA, Zzt=141Ω, 500mW	SOD-123FL	7d	1a	Tac
43VZ	ZGFM0543C-MH	Z-diode	40.85..45.15V, Izt=5mA, Zzt=141Ω, 500mW	SOD-123	5d	1a	Pic



SMD
code

Type

Function

Short description

Case

Pinout

St.

Mnf.

44	CMDD4448	Si-diode	Sw, 75V, 250mA, 275mW, Vf<1V(100mA), <4pF	SOD-323	5d	1a	Cen
44	HMSZ5244B	Z-diode	14V±5%, Izt=9mA, Zzt=15Ω, 225mW	SOD-323	5d	1d	Hsn
44	ZD5244BS2	Z-diode	14V±5%, 9mA, Zzt=15Ω, 500mW	SOD-323	5d	1a	Cys
440	P4SMA440	TVS	Vbr=396.484V, Vrvwm=356V, 0.95A, 400W(1ms)	DO-214AC	1d	1a	Eic
440A	1.5SMC440A	TVS	Vbr=418.462V, Vrvwm=376V, 2.5A, 1500W(1ms)	DO-214AB	1d	1k	Vs
440A	P4SMA440A	TVS	Vbr=418.462V, Vrvwm=376V, 1.0A, 400W(1ms)	DO-214AC	1d	1k	Vs
440A	P6SMB440A	TVS	Vbr=418.462V, Vrvwm=376V, 1.0A, 600W(1ms)	DO-214AA	1d	1k	Vs
440C	1.5SMC440CA	TVS	Vrvwm=376.0V, Vbr=418.0.462.0V, 2.5A, 1500W(1ms), Bidirectional	DO-214AB	1ba	1j	Fee
440C	P4SMA440C	TVS	Vbr=396.484V, Vrvwm=356V, 0.95A, 400W(1ms), Bidirectional	DO-214AC	1ba	1j	Eic
440CA	P4SMA440CA	TVS	Vbr=418.462V, Vrvwm=376V, 1.0A, 400W(1ms), Bidirectional	DO-214AC	1ba	1j	Eic
440CA	P6SMB440CA	TVS	Vbr=418.462V, Vrvwm=376V, 1.0A, 600W(1ms), Bidirectional	DO-214AA	1ba	1j	Eic
44B	MMHZ5244BPT	Z-diode	13.30..14.70V, Izt=5mA, Zzt=25Ω, 225mW	SOD-123	5d	1a	Chm
44B	SMC5344B	Z-diode	8.2V±5%, Zzt=1.5(150.0mA), Izm=580.0mA, 5W	DO-214AB	1d	1a	Ers
44S	MMHZ5244SPT	Z-diode	13.72..14.28V, Izt=5mA, Zzt=25Ω, 225mW	SOD-123	5d	1a	Chm
445	BZX584B3V6	Z-diode	3.53..3.67V, Izt=5mA, Zzt=90Ω, 200mW	SOD-523FL	7d	1a	Tac
45	EDZ15B	Z-diode	14.34..14.98V, Izt=5mA, Zzt=42Ω, 150mW	SOD-523	6d	1a	Rhm
45	FDZ15EV	Z-diode	14.340..14.980V, Izt=5mA, Zzt=42Ω, 150mW	SOD-523	7d	1a	Fis
45	FDZ15VT	Z-diode	14.340..14.980V, Izt=5mA, Zzt=42Ω, 200mW	SOD-323	5d	1a	Fis
45	HMSZ5245B	Z-diode	15V±5%, Izt=8.5mA, Zzt=16Ω, 225mW	SOD-323	5d	1d	Hsn
45	MM5Z3V6B	Z-diode	3.53..3.67V, Izt=5mA, Zzt=90Ω, 200mW	SOD-523FL	7d	1a	Tac
45	TDZ15B	Z-diode	15V±2.5%, 10mA, 500mW	TUMD2	7d	1s	Rhm
45	UDZS15B	Z-diode	14.34..14.98V, Izt=5mA, Zzt=42Ω, 200mW	SOD-323	5d	1a	Wtr
45	VDZS15B	Z-diode	15V±2.5%, Izt=5mA, 200mW	SOD-323FL	7d	1s	Rhm
45	VDZS15B	Z-diode	15V±5%, 5mA, 100mW	VMD2	5d	1z	Rhm
45	ZD5245BS2	Z-diode	15V±5%, 8.5mA, Zzt=16Ω, 500mW	SOD-323	5d	1a	Cys
4510	SZ4510	Z-diode	10V±5%, Izt=50.0mA, Zzt=3.5Ω, 2W	DO-214AC	1d	1a	Eic
4511	SZ4511	Z-diode	11V±5%, Izt=45.5mA, Zzt=4.0Ω, 2W	DO-214AC	1d	1a	Eic
4512	SZ4512	Z-diode	12V±5%, Izt=41.5mA, Zzt=4.5Ω, 2W	DO-214AC	1d	1a	Eic
4513	SZ4513	Z-diode	13V±5%, Izt=38.5mA, Zzt=5.0Ω, 2W	DO-214AC	1d	1a	Eic
4514	SZ4514	Z-diode	14V±5%, Izt=35.7mA, Zzt=5.5Ω, 2W	DO-214AC	1d	1a	Eic
4515	SZ4515	Z-diode	15V±5%, Izt=33.4mA, Zzt=7.0Ω, 2W	DO-214AC	1d	1a	Eic
4516	SZ4516	Z-diode	16V±5%, Izt=31.2mA, Zzt=8.0Ω, 2W	DO-214AC	1d	1a	Eic
4517	SZ4517	Z-diode	17V±5%, Izt=29.4mA, Zzt=9.0Ω, 2W	DO-214AC	1d	1a	Eic
4518	SZ4518	Z-diode	18V±5%, Izt=27.8mA, Zzt=10Ω, 2W	DO-214AC	1d	1a	Eic
4519	SZ4519	Z-diode	19V±5%, Izt=26.3mA, Zzt=11Ω, 2W	DO-214AC	1d	1a	Eic
4520	SZ4520	Z-diode	20V±5%, Izt=25.0mA, Zzt=11Ω, 2W	DO-214AC	1d	1a	Eic
4522	SZ4522	Z-diode	22V±5%, Izt=22.8mA, Zzt=12Ω, 2W	DO-214AC	1d	1a	Eic
4524	SZ4524	Z-diode	24V±5%, Izt=20.8mA, Zzt=13Ω, 2W	DO-214AC	1d	1a	Eic
4527	SZ4527	Z-diode	27V±5%, Izt=18.5mA, Zzt=18Ω, 2W	DO-214AC	1d	1a	Eic
452H	SZ452H	Z-diode	2.7V±5%, Izt=80mA, Zzt=10Ω, 2W	DO-214AC	1d	1a	Eic
4530	SZ4530	Z-diode	30V±5%, Izt=16.6mA, Zzt=20Ω, 2W	DO-214AC	1d	1a	Eic
4533	SZ4533	Z-diode	33V±5%, Izt=15.1mA, Zzt=23Ω, 2W	DO-214AC	1d	1a	Eic
4536	SZ4536	Z-diode	36V±5%, Izt=13.9mA, Zzt=25Ω, 2W	DO-214AC	1d	1a	Eic
4539	SZ4539	Z-diode	39V±5%, Izt=12.8mA, Zzt=30Ω, 2W	DO-214AC	1d	1a	Eic
453A	SZ453A	Z-diode	3.0V±5%, Izt=160mA, Zzt=8.0Ω, 2W	DO-214AC	1d	1a	Eic
453D	SZ453D	Z-diode	3.3V±5%, Izt=145mA, Zzt=8.0Ω, 2W	DO-214AC	1d	1a	Eic
453G	SZ453G	Z-diode	3.6V±5%, Izt=139mA, Zzt=5.0Ω, 2W	DO-214AC	1d	1a	Eic
453J	SZ453J	Z-diode	3.9V±5%, Izt=128mA, Zzt=5.0Ω, 2W	DO-214AC	1d	1a	Eic
4543	SZ4543	Z-diode	43V±5%, Izt=11.6mA, Zzt=35Ω, 2W	DO-214AC	1d	1a	Eic
4547	SZ4547	Z-diode	47V±5%, Izt=10.6mA, Zzt=40Ω, 2W	DO-214AC	1d	1a	Eic
454D	SZ454D	Z-diode	4.3V±5%, Izt=116mA, Zzt=4.5Ω, 2W	DO-214AC	1d	1a	Eic
454H	SZ454H	Z-diode	4.7V±5%, Izt=106mA, Zzt=4.5Ω, 2W	DO-214AC	1d	1a	Eic
4551	SZ4551	Z-diode	51V±5%, Izt=9.8mA, Zzt=48Ω, 2W	DO-214AC	1d	1a	Eic
4556	SZ4556	Z-diode	56V±5%, Izt=9.0mA, Zzt=55Ω, 2W	DO-214AC	1d	1a	Eic
455B	SZ455B	Z-diode	5.1V±5%, Izt=98.0mA, Zzt=3.5Ω, 2W	DO-214AC	1d	1a	Eic
455G	SZ455G	Z-diode	5.6V±5%, Izt=89.5mA, Zzt=2.5Ω, 2W	DO-214AC	1d	1a	Eic
4562	SZ4562	Z-diode	62V±5%, Izt=8.1mA, Zzt=60Ω, 2W	DO-214AC	1d	1a	Eic
4568	SZ4568	Z-diode	68V±5%, Izt=7.4mA, Zzt=75Ω, 2W	DO-214AC	1d	1a	Eic
456C	SZ456C	Z-diode	6.2V±5%, Izt=80.5mA, Zzt=1.5Ω, 2W	DO-214AC	1d	1a	Eic
456I	SZ456I	Z-diode	6.8V±5%, Izt=73.5mA, Zzt=2.0Ω, 2W	DO-214AC	1d	1a	Eic
4575	SZ4575	Z-diode	75V±5%, Izt=6.7mA, Zzt=90Ω, 2W	DO-214AC	1d	1a	Eic
457F	SZ457F	Z-diode	7.5V±5%, Izt=66.5mA, Zzt=2.0Ω, 2W	DO-214AC	1d	1a	Eic
4582	SZ4582	Z-diode	82V±5%, Izt=6.1mA, Zzt=100Ω, 2W	DO-214AC	1d	1a	Eic
458C	SZ458C	Z-diode	8.2V±5%, Izt=61.0mA, Zzt=2.3Ω, 2W	DO-214AC	1d	1a	Eic
4591	SZ4591	Z-diode	91V±5%, Izt=5.5mA, Zzt=125Ω, 2W	DO-214AC	1d	1a	Eic
459B	SZ459B	Z-diode	9.1V±5%, Izt=55.0mA, Zzt=2.5Ω, 2W	DO-214AC	1d	1a	Eic
45A	1SMC45A	TVS	Vbr=50.0.55.3V, Vrvwm=45V, 20.6A, 1500W(1ms)	DO-214AB	1d	1a	Eic
45A	SMAJ45A	TVS	Vrvwm=45V, Vbr=50.0.55.3V, 5.5A, 400W(1ms)	DO-214AC	1d	1a	Sus
45A	SMBJ45A	TVS	Vbr=50.0.55.3V, Vrvwm=45V, 8.3A, 600W(1ms)	DO-214AA	1d	1a	Sus
45A	SMCJ45A	TVS	Vrvwm=45V, Vbr=50.57.5V, 18.7A, 1500W(1ms)	DO-214AB	1d	1k	Sus



SMD code	Type	Function	Short description	Case	Pinout	St.	Mnf.
45A	UMA45A	TVS	Vrwm=45V, Vbr=50.0..72.7V, 6.9A, 500W(1ms)	UltraMite	14d	1v	Msc
45B	MMHZ5245BPT	Z-diode	14.25..15.75V, Izt=5mA, Zzt=32Ω, 225mW	SOD-123	5d	1a	Chm
45B	SMC5345B	Z-diode	8.7V±5%, Zzt=2.0(150.0mA), Izm=545.0mA, 5W	DO-214AB	1d	1a	Ers
45B0	SZ45B0	Z-diode	100V±5%, Izt=5.0mA, Zzt=175Ω, 2W	DO-214AC	1d	1a	Eic
45B1	SZ45B1	Z-diode	110V±5%, Izt=4.5mA, Zzt=250Ω, 2W	DO-214AC	1d	1a	Eic
45B2	SZ45B2	Z-diode	120V±5%, Izt=4.2mA, Zzt=325Ω, 2W	DO-214AC	1d	1a	Eic
45B3	SZ45B3	Z-diode	130V±5%, Izt=3.8mA, Zzt=400Ω, 2W	DO-214AC	1d	1a	Eic
45B4	SZ45B4	Z-diode	140V±5%, Izt=3.6mA, Zzt=500Ω, 2W	DO-214AC	1d	1a	Eic
45B5	SZ45B5	Z-diode	150V±5%, Izt=3.3mA, Zzt=575Ω, 2W	DO-214AC	1d	1a	Eic
45B6	SZ45B6	Z-diode	160V±5%, Izt=3.1mA, Zzt=650Ω, 2W	DO-214AC	1d	1a	Eic
45B7	SZ45B7	Z-diode	170V±5%, Izt=2.9mA, Zzt=675Ω, 2W	DO-214AC	1d	1a	Eic
45B8	SZ45B8	Z-diode	180V±5%, Izt=2.8mA, Zzt=725Ω, 2W	DO-214AC	1d	1a	Eic
45B9	SZ45B9	Z-diode	190V±5%, Izt=2.6mA, Zzt=825Ω, 2W	DO-214AC	1d	1a	Eic
45CA	1SMC45CA	TVS	Vbr=50.0..55.3V, Vrwm=45V, 20.6A, 1500W(1ms), Bidirectional	DO-214AB	1ba	1j	Eic
45CA	SMAJ45CA	TVS	Vrwm=45V, Vbr=50.0..55.3V, 5.5A, 400W(1ms), Bidirectional	DO-214AC	1ba	1j	Sus
45CA	SMBJ45CA	TVS	Vbr=50.0..55.3V, Vrwm=45V, 8.3A, 600W(1ms), Bidirectional	DO-214AA	1ba	1j	Sus
45CA	SMCJ45CA	TVS	Vrwm=45V, Vbr=50..57.5V, 18.7A, 1500W(1ms), Bidirectional	DO-214AB	1ba	1l	Sus
45CA	UMA45CA	TVS	Vrwm=45V, Vbr=50.0..72.7V, 6.9A, 500W(1ms), Bidirectional	UltraMite	14ba	1v	Msc
45D0	SZ45D0	Z-diode	200V±5%, Izt=2.5mA, Zzt=900Ω, 2W	DO-214AC	1d	1a	Eic
45S	MMHZ5245SPT	Z-diode	14.70..15.30V, Izt=5mA, Zzt=32Ω, 225mW	SOD-123	5d	1a	Chm
45V	SMA45	TVS	Vbr=50..61.1V, Vrwm=43.0V, 3.7A, 300W(1ms)	DO-214AC	1d	1a	Mic
45V	SMB45	TVS	Vbr=50..61.1V, Vrwm=45V, 7.5A, 600W(1ms)	DO-214AA	1d	1a	Mic
45V	SMC45	TVS	Vbr=50..61.1V, Vrwm=45V, 18.7A, 1500W(1ms)	DO-214AB	1d	1a	Mic
45VA	SMA45A	TVS	Vbr=50..55.3V, Vrwm=45.0V, 4.1A, 300W(1ms)	DO-214AC	1d	1a	Mic
45VA	SMB45A	TVS	Vbr=50..55.3V, Vrwm=45V, 8.3A, 600W(1ms)	DO-214AA	1d	1a	Mic
45VA	SMC45A	TVS	Vbr=50..55.3V, Vrwm=45V, 20.6A, 1500W(1ms)	DO-214AB	1d	1a	Mic
45VC	SMA45C	TVS	Vbr=50..61.1V, Vrwm=43.0V, 3.7A, 300W(1ms), Bidirectional	DO-214AC	1ba	1j	Mic
45VC	SMB45C	TVS	Vbr=50..61.1V, Vrwm=45V, 7.5A, 600W(1ms), Bidirectional	DO-214AA	1ba	1j	Mic
45VC	SMC45C	TVS	Vbr=50..61.1V, Vrwm=45V, 18.7A, 1500W(1ms), Bidirectional	DO-214AB	1ba	1j	Mic
45VCA	SMA45CA	TVS	Vbr=50..55.3V, Vrwm=45.0V, 4.1A, 300W(1ms), Bidirectional	DO-214AC	1ba	1j	Mic
45VCA	SMB45CA	TVS	Vbr=50..55.3V, Vrwm=45V, 8.3A, 600W(1ms), Bidirectional	DO-214AA	1ba	1j	Mic
45VCA	SMC45CA	TVS	Vbr=50..55.3V, Vrwm=45V, 20.6A, 1500W(1ms), Bidirectional	DO-214AB	1ba	1j	Mic
46	BAT46J	Si-diode	SBD, 100V, 150mA, Vf<1V(250mA), 6pF	SOD-323	5d	1a	Ste
46	HMSZ5246B	Z-diode	16V±5%, Izt=7.8mA, Zzt=17Ω, 225mW	SOD-323	5d	1d	Hsn
46	ZD5246BS2	Z-diode	16V±5%, 7.8mA, Zzt=17Ω, 600mW	SOD-323	5d	1a	Cys
46B	MMHZ5246BPT	Z-diode	15.20..16.80V, Izt=5mA, Zzt=36Ω, 225mW	SOD-123	5d	1a	Chm
46B	SMC5346B	Z-diode	9.1V±5%, Zzt=2.0(150.0mA), Izm=520.0mA, 5W	DO-214AB	1d	1a	Ers
46S	MMHZ5246SPT	Z-diode	15.68..16.32V, Izt=5mA, Zzt=36Ω, 225mW	SOD-123	5d	1a	Chm
47	CDZ55C47	Z-diode	44.65..49.35V, Zzt=110Ω, Izt=2.25mA, 500mW	1206	70d	2d	Crp
47	CDZ55C47S	Z-diode	44.65..49.35V, Zzt=110Ω, Izt=2.25mA, 500mW	8005	70d	2d	Crp
47	CDZ55C47T	Z-diode	44.65..49.35V, Zzt=110Ω, Izt=2.25mA, 200mW	0603	70d	2d	Crp
47	CMZ47	Z-diode	47V±5%, 2W	M-Flat	7d	1a	Tos
47	HMSZ5247B	Z-diode	17V±5%, Izt=7.4mA, Zzt=19Ω, 225mW	SOD-323	5d	1d	Hsn
47	HZC4.7	Z-diode	4.7V±10%, 150mW	SOD-523	6d	1a	Ren
47	KDZ4.7EV	Z-diode	4.4..4.9V, 150mW	SOD-523	6d	1a	Kec
47	KDZ4.7V	Z-diode	4.4..4.9V, 150mW	SOD-323	5d	1a	Kec
47	MAZY470	Z-diode	42.3..51.7V, Zzt=65Ω(5mA), 1W	NMiniP2	1d	1a	Pan
47	MMPZ5261SPT	Z-diode	46.06..47.94V, Izt=2.7mA, Zzt=105Ω, 225mW	SOD-323	5d	1a	Chm
47	P4SMA47	TVS	Vbr=42.3..51.7V, Vrwm=38.1V, 6.2A, 400W(1ms)	DO-214AC	1d	1a	Eic
47	P6SMBJ47	TVS	Vbr=42.3..51.7V, 8.9A, 600W(1ms)	DO-214AA	1d	1n	Lif
47	SML4756	Z-diode	47V±5%, Izt=5.5mA, Zzt=80Ω, 1W	DO-214AC	1d	1k	Vs
47	TZD4.7WS	Z-diode	4.40..4.90V, Izt=5mA, Zzt=120Ω, 200mW	SOD-323	5d	1a	Ttr
47	TZD4.7WT	Z-diode	4.40..4.90V, Izt=5mA, Zzt=120Ω, 150mW	SOD-523	6d	1a	Ttr
47	U1Z47	Z-diode	42.3..51.7V, 1W	SOD-6	1d	1a	Tos
47	U1ZB47	Z-diode	42.3..51.7V, 1W	I-FLAT	1d	1a	Tos
47	ZD5247BS2	Z-diode	17V±5%, 7.4mA, Zzt=19Ω, 600mW	SOD-323	5d	1a	Cys
4-7	MAZ80470M	Z-diode	4.59..4.83V, Zzt=80Ω(5mA), 150mW	SC-76	6d	1a	Pan
4-7	MAZ8047GML	Z-diode	4.59..4.83V, Zzt=80Ω(5mA), 150mW	SMini2-F3	6d	1a	Pan
47*	TZD4.7YWWS	Z-diode	4.55..4.75V, Izt=5mA, Zzt=120Ω, 200mW	SOD-323	5d	1a	Ttr
47*	TZD4.7YWWT	Z-diode	4.55..4.75V, Izt=5mA, Zzt=120Ω, 150mW	SOD-523	6d	1a	Ttr
4728	SML4728	Z-diode	3.3V±10%, Izt=76mA, Zzt=10Ω, 1W	DO-214AC	1d	1a	Eic
4728A	SMA4728A	Z-diode	3.3V±5%, Izt=76mA, Zzt<10Ω, 1W	DO-214AC	1d	1t	Exc
4728A	SML4728A	Z-diode	3.3V±5%, Izt=76mA, Zzt=10Ω, 1W	DO-214AC	1d	1a	Eic
4729	SML4729	Z-diode	3.6V±10%, Izt=69mA, Zzt=10Ω, 1W	DO-214AC	1d	1a	Eic
4729A	SMA4729A	Z-diode	3.6V±5%, Izt=69mA, Zzt<10Ω, 1W	DO-214AC	1d	1t	Exc
4729A	SML4729A	Z-diode	3.6V±5%, Izt=69mA, Zzt=10Ω, 1W	DO-214AC	1d	1a	Eic
4730	SML4730	Z-diode	3.9V±10%, Izt=64mA, Zzt=9Ω, 1W	DO-214AC	1d	1a	Eic
4730A	SMA4730A	Z-diode	3.9V±5%, Izt=64mA, Zzt<9Ω, 1W	DO-214AC	1d	1t	Exc
4730A	SML4730A	Z-diode	3.9V±5%, Izt=64mA, Zzt=9Ω, 1W	DO-214AC	1d	1a	Eic
4731	SML4731	Z-diode	4.3V±10%, Izt=58mA, Zzt=9Ω, 1W	DO-214AC	1d	1a	Eic



SMD code	Type	Function	Short description	Case	Pinout	St.	Mnf.
4731A	SMA4731A	Z-diode	4.3V±5%, Izt=58mA, Zzt<9Ω, 1W	DO-214AC	1d	1t	Exc
4731A	SML4731A	Z-diode	4.3V±5%, Izt=58mA, Zzt=9Ω, 1W	DO-214AC	1d	1a	Eic
4732	SML4732	Z-diode	4.7V±10%, Izt=53mA, Zzt=8Ω, 1W	DO-214AC	1d	1a	Eic
4732A	SMA4732A	Z-diode	4.7V±5%, Izt=53mA, Zzt<8Ω, 1W	DO-214AC	1d	1t	Exc
4732A	SML4732A	Z-diode	4.7V±5%, Izt=53mA, Zzt=8Ω, 1W	DO-214AC	1d	1a	Eic
4733	SML4733	Z-diode	5.1V±10%, Izt=49mA, Zzt=7Ω, 1W	DO-214AC	1d	1a	Eic
4733A	SMA4733A	Z-diode	5.1V±5%, Izt=49mA, Zzt<7Ω, 1W	DO-214AC	1d	1t	Exc
4733A	SML4733A	Z-diode	5.1V±5%, Izt=49mA, Zzt=7Ω, 1W	DO-214AC	1d	1a	Eic
4734	SML4734	Z-diode	5.6V±10%, Izt=45mA, Zzt=5Ω, 1W	DO-214AC	1d	1a	Eic
4734A	SMA4734A	Z-diode	5.6V±5%, Izt=45mA, Zzt<5Ω, 1W	DO-214AC	1d	1t	Exc
4734A	SML4734A	Z-diode	5.6V±5%, Izt=45mA, Zzt=5Ω, 1W	DO-214AC	1d	1a	Eic
4735	SML4735	Z-diode	6.2V±10%, Izt=41mA, Zzt=2Ω, 1W	DO-214AC	1d	1a	Eic
4735A	SMA4735A	Z-diode	6.2V±5%, Izt=41mA, Zzt<2Ω, 1W	DO-214AC	1d	1t	Exc
4735A	SML4735A	Z-diode	6.2V±5%, Izt=41mA, Zzt=2Ω, 1W	DO-214AC	1d	1a	Eic
4736	SML4736	Z-diode	6.8V±10%, Izt=37mA, Zzt=3.5Ω, 1W	DO-214AC	1d	1a	Eic
4736A	SMA4736A	Z-diode	6.8V±5%, Izt=37mA, Zzt<3.5Ω, 1W	DO-214AC	1d	1t	Exc
4736A	SML4736A	Z-diode	6.8V±5%, Izt=37mA, Zzt=3Ω, 1W	DO-214AC	1d	1a	Eic
4737	SML4737	Z-diode	7.5V±10%, Izt=34mA, Zzt=4Ω, 1W	DO-214AC	1d	1a	Eic
4737A	SMA4737A	Z-diode	7.5V±5%, Izt=34mA, Zzt<4Ω, 1W	DO-214AC	1d	1t	Exc
4737A	SML4737A	Z-diode	7.5V±5%, Izt=34mA, Zzt=4Ω, 1W	DO-214AC	1d	1a	Eic
4738	SML4738	Z-diode	8.2V±10%, Izt=31mA, Zzt=4.5Ω, 1W	DO-214AC	1d	1a	Eic
4738A	SMA4738A	Z-diode	8.2V±5%, Izt=31mA, Zzt<4.5Ω, 1W	DO-214AC	1d	1t	Exc
4738A	SML4738A	Z-diode	8.2V±5%, Izt=31mA, Zzt=4Ω, 1W	DO-214AC	1d	1a	Eic
4739	SML4739	Z-diode	9.1V±10%, Izt=28mA, Zzt=5Ω, 1W	DO-214AC	1d	1a	Eic
4739A	SMA4739A	Z-diode	9.1V±5%, Izt=28mA, Zzt<5Ω, 1W	DO-214AC	1d	1t	Exc
4739A	SML4739A	Z-diode	9.1V±5%, Izt=28mA, Zzt=5Ω, 1W	DO-214AC	1d	1a	Eic
4740	SML4740	Z-diode	10V±10%, Izt=25mA, Zzt=7Ω, 1W	DO-214AC	1d	1a	Eic
4740A	SMA4740A	Z-diode	10V±5%, Izt=25mA, Zzt<7Ω, 1W	DO-214AC	1d	1t	Exc
4740A	SML4740A	Z-diode	10V±5%, Izt=25mA, Zzt=7Ω, 1W	DO-214AC	1d	1a	Eic
4741	SML4741	Z-diode	11V±10%, Izt=23mA, Zzt=8Ω, 1W	DO-214AC	1d	1a	Eic
4741A	SMA4741A	Z-diode	11V±5%, Izt=23mA, Zzt<8Ω, 1W	DO-214AC	1d	1t	Exc
4741A	SML4741A	Z-diode	11V±5%, Izt=23mA, Zzt=8Ω, 1W	DO-214AC	1d	1a	Eic
4742	SML4742	Z-diode	12V±10%, Izt=21mA, Zzt=9Ω, 1W	DO-214AC	1d	1a	Eic
4742A	SMA4742A	Z-diode	12V±5%, Izt=21mA, Zzt<9Ω, 1W	DO-214AC	1d	1t	Exc
4742A	SML4742A	Z-diode	12V±5%, Izt=21mA, Zzt=9Ω, 1W	DO-214AC	1d	1a	Eic
4743	SML4743	Z-diode	13V±10%, Izt=19mA, Zzt=10Ω, 1W	DO-214AC	1d	1a	Eic
4743A	SMA4743A	Z-diode	13V±5%, Izt=19mA, Zzt<10Ω, 1W	DO-214AC	1d	1t	Exc
4743A	SML4743A	Z-diode	13V±5%, Izt=19mA, Zzt=10Ω, 1W	DO-214AC	1d	1a	Eic
4744	SML4744	Z-diode	15V±10%, Izt=17mA, Zzt=14Ω, 1W	DO-214AC	1d	1a	Eic
4744A	SMA4744A	Z-diode	15V±5%, Izt=17mA, Zzt<14Ω, 1W	DO-214AC	1d	1t	Exc
4744A	SML4744A	Z-diode	15V±5%, Izt=17mA, Zzt=14Ω, 1W	DO-214AC	1d	1a	Eic
4745	SML4745	Z-diode	16V±10%, Izt=15.5mA, Zzt=16Ω, 1W	DO-214AC	1d	1a	Eic
4745A	SMA4745A	Z-diode	16V±5%, Izt=15.5mA, Zzt<16Ω, 1W	DO-214AC	1d	1t	Exc
4745A	SML4745A	Z-diode	16V±5%, Izt=15mA, Zzt=16Ω, 1W	DO-214AC	1d	1a	Eic
4746	SML4746	Z-diode	18V±10%, Izt=14mA, Zzt=20Ω, 1W	DO-214AC	1d	1a	Eic
4746A	SMA4746A	Z-diode	18V±5%, Izt=14mA, Zzt<20Ω, 1W	DO-214AC	1d	1t	Exc
4746A	SML4746A	Z-diode	18V±5%, Izt=14mA, Zzt=20Ω, 1W	DO-214AC	1d	1a	Eic
4747	SML4747	Z-diode	20V±10%, Izt=12.5mA, Zzt=22Ω, 1W	DO-214AC	1d	1a	Eic
4747A	SMA4747A	Z-diode	20V±5%, Izt=12.5mA, Zzt<22Ω, 1W	DO-214AC	1d	1t	Exc
4747A	SML4747A	Z-diode	20V±5%, Izt=12.5mA, Zzt=22Ω, 1W	DO-214AC	1d	1a	Eic
4748	SML4748	Z-diode	22V±10%, Izt=11.5mA, Zzt=23Ω, 1W	DO-214AC	1d	1a	Eic
4748A	SMA4748A	Z-diode	22V±5%, Izt=11.5mA, Zzt<23Ω, 1W	DO-214AC	1d	1t	Exc
4748A	SML4748A	Z-diode	22V±5%, Izt=11.5mA, Zzt=23Ω, 1W	DO-214AC	1d	1a	Eic
4749	SML4749	Z-diode	24V±10%, Izt=10.5mA, Zzt=25Ω, 1W	DO-214AC	1d	1a	Eic
4749A	SMA4749A	Z-diode	24V±5%, Izt=10.5mA, Zzt<25Ω, 1W	DO-214AC	1d	1t	Exc
4749A	SML4749A	Z-diode	24V±5%, Izt=10.5mA, Zzt=25Ω, 1W	DO-214AC	1d	1a	Eic
4750	SML4750	Z-diode	27V±10%, Izt=9.5mA, Zzt=35Ω, 1W	DO-214AC	1d	1a	Eic
4750A	SMA4750A	Z-diode	27V±5%, Izt=9.5mA, Zzt<35Ω, 1W	DO-214AC	1d	1t	Exc
4750A	SML4750A	Z-diode	27V±5%, Izt=9.5mA, Zzt=35Ω, 1W	DO-214AC	1d	1a	Eic
4751	SML4751	Z-diode	30V±10%, Izt=8.5mA, Zzt=40Ω, 1W	DO-214AC	1d	1a	Eic
4751A	SMA4751A	Z-diode	30V±5%, Izt=8.5mA, Zzt<40Ω, 1W	DO-214AC	1d	1t	Exc
4751A	SML4751A	Z-diode	30V±5%, Izt=8.5mA, Zzt=40Ω, 1W	DO-214AC	1d	1a	Eic
4752	SML4752	Z-diode	33V±10%, Izt=7.5mA, Zzt=45Ω, 1W	DO-214AC	1d	1a	Eic
4752A	SMA4752A	Z-diode	33V±5%, Izt=7.5mA, Zzt<45Ω, 1W	DO-214AC	1d	1t	Exc
4752A	SML4752A	Z-diode	33V±5%, Izt=7.5mA, Zzt=45Ω, 1W	DO-214AC	1d	1a	Eic
4753	SML4753	Z-diode	36V±10%, Izt=7mA, Zzt=50Ω, 1W	DO-214AC	1d	1a	Eic
4753A	SMA4753A	Z-diode	36V±5%, Izt=7.0mA, Zzt<50Ω, 1W	DO-214AC	1d	1t	Exc
4753A	SML4753A	Z-diode	36V±5%, Izt=7mA, Zzt=50Ω, 1W	DO-214AC	1d	1a	Eic
4754	SML4754	Z-diode	39V±10%, Izt=6.5mA, Zzt=60Ω, 1W	DO-214AC	1d	1a	Eic
4754A	SMA4754A	Z-diode	39V±5%, Izt=6.5mA, Zzt<60Ω, 1W	DO-214AC	1d	1t	Exc



SMD code	Type	Function	Short description	Case	Pinout	St.	Mnf.
4754A	SML4754A	Z-diode	39V±5%, Izt=6.5mA, Zzt=60Ω, 1W	DO-214AC	1d	1a	Eic
4755	SML4755	Z-diode	43V±10%, Izt=6mA, Zzt=70Ω, 1W	DO-214AC	1d	1a	Eic
4755A	SMA4755A	Z-diode	43V±5%, Izt=6.0mA, Zzt<70Ω, 1W	DO-214AC	1d	1t	Exc
4755A	SML4755A	Z-diode	43V±5%, Izt=6mA, Zzt=70Ω, 1W	DO-214AC	1d	1a	Eic
4756	SML4756	Z-diode	47V±10%, Izt=5.5mA, Zzt=80Ω, 1W	DO-214AC	1d	1a	Eic
4756A	SMA4756A	Z-diode	47V±5%, Izt=5.5mA, Zzt<80Ω, 1W	DO-214AC	1d	1t	Exc
4756A	SML4756A	Z-diode	47V±5%, Izt=5.5mA, Zzt=80Ω, 1W	DO-214AC	1d	1a	Eic
4757	SML4757	Z-diode	51V±10%, Izt=5mA, Zzt=95Ω, 1W	DO-214AC	1d	1a	Eic
4757A	SMA4757A	Z-diode	51V±5%, Izt=5mA, Zzt<95Ω, 1W	DO-214AC	1d	1t	Exc
4757A	SML4757A	Z-diode	51V±5%, Izt=5mA, Zzt=95Ω, 1W	DO-214AC	1d	1a	Eic
4758	SML4758	Z-diode	56V±10%, Izt=4.5mA, Zzt=110Ω, 1W	DO-214AC	1d	1a	Eic
4758A	SMA4758A	Z-diode	56V±5%, Izt=4.5mA, Zzt<110Ω, 1W	DO-214AC	1d	1t	Exc
4758A	SML4758A	Z-diode	56V±5%, Izt=4.5mA, Zzt=110Ω, 1W	DO-214AC	1d	1a	Eic
4759	SML4759	Z-diode	62V±10%, Izt=4mA, Zzt=125Ω, 1W	DO-214AC	1d	1a	Eic
4759A	SMA4759A	Z-diode	62V±5%, Izt=4.0mA, Zzt<125Ω, 1W	DO-214AC	1d	1t	Exc
4759A	SML4759A	Z-diode	62V±5%, Izt=4mA, Zzt=125Ω, 1W	DO-214AC	1d	1a	Eic
4760	SML4760	Z-diode	68V±10%, Izt=3.7mA, Zzt=150Ω, 1W	DO-214AC	1d	1a	Eic
4760A	SMA4760A	Z-diode	68V±5%, Izt=3.7mA, Zzt<150Ω, 1W	DO-214AC	1d	1t	Exc
4760A	SML4760A	Z-diode	68V±5%, Izt=3.7mA, Zzt=150Ω, 1W	DO-214AC	1d	1a	Eic
4761	SML4761	Z-diode	75V±10%, Izt=3.3mA, Zzt=175Ω, 1W	DO-214AC	1d	1a	Eic
4761A	SMA4761A	Z-diode	75V±5%, Izt=3.3mA, Zzt<175Ω, 1W	DO-214AC	1d	1t	Exc
4761A	SML4761A	Z-diode	75V±5%, Izt=3.3mA, Zzt=175Ω, 1W	DO-214AC	1d	1a	Eic
4762	SML4762	Z-diode	82V±10%, Izt=3mA, Zzt=200Ω, 1W	DO-214AC	1d	1a	Eic
4762A	SMA4762A	Z-diode	82V±5%, Izt=3.0mA, Zzt<200Ω, 1W	DO-214AC	1d	1t	Exc
4762A	SML4762A	Z-diode	82V±5%, Izt=3mA, Zzt=200Ω, 1W	DO-214AC	1d	1a	Eic
4763	SML4763	Z-diode	91V±10%, Izt=2.8mA, Zzt=250Ω, 1W	DO-214AC	1d	1a	Eic
4763A	SMA4763A	Z-diode	91V±5%, Izt=2.8mA, Zzt<250Ω, 1W	DO-214AC	1d	1t	Exc
4763A	SML4763A	Z-diode	91V±5%, Izt=2.8mA, Zzt=250Ω, 1W	DO-214AC	1d	1a	Eic
4764	SML4764	Z-diode	100V±10%, Izt=2.5mA, Zzt=350Ω, 1W	DO-214AC	1d	1a	Eic
4764A	SMA4764A	Z-diode	100V±5%, Izt=2.5mA, Zzt<350Ω, 1W	DO-214AC	1d	1t	Exc
4764A	SML4764A	Z-diode	100V±5%, Izt=2.5mA, Zzt=350Ω, 1W	DO-214AC	1d	1a	Eic
47A	1.5SMC47A	TVS	Vbr=44.7..49.4V, Vrw=40.2V, 23.1A, 1500W(1ms)	DO-214AB	1d,3d	1a,1k	Vs,Ons
47A	P4SMA47A	TVS	Vbr=44.7..49.4V, Vrw=40.2V, 6.5A, 400W(1ms)	DO-214AC	1d	1k	Vs
47A	P6SMB47A	TVS	Vrw=47V, Vbr=44.7..49.4V, 9.3A, 600W(1ms)	DO-214AA	1d,3d	1k,1a	Vs,Ons
47A	P6SMBJ47A	TVS	Vbr=44.7..49.4V, 9.3A, 600W(1ms)	DO-214AA	1d	1n	Lif
47B	1SMB3EZ47	Z-diode	47V±5%, Zzt=40Ω, Izt=16.0mA, 3W	DO-214AA	1d	1a	Pjt
47B	MMHZ5247BPT	Z-diode	16.15..17.85V, Izt=5mA, Zzt=36Ω, 225mW	SOD-123	5d	1a	Chm
47B	SMC5347B	Z-diode	10.0V±5%, Zzt=2.0(125.0mA), Izm=475.0mA, 5W	DO-214AB	1d	1a	Ers
47B	Z3SMB47B	Z-diode	44.65..49.35V, Izt=16mA, Zzt=38Ω, 3W	DO-214AA	1d	1a	Ttr
47C	1.5SMC47CA	TVS	Vbr=44.7..49.4V, Vrw=40.2V, 23.1A, 1500W(1ms), Bidirectional	DO-214AB	1ba	1l	Vs
47C	P4SMA47C	TVS	Vbr=42.3..51.7V, Vrw=38.1V, 6.2A, 400W(1ms), Bidirectional	DO-214AC	1ba	1j	Eic
47C	P4SMA47CA	TVS	Vbr=44.7..49.4V, 6.2A, 400W(1ms), Bidirectional	DO-214AC	1ba	1l	Vs
47C	P6SMB47CA	TVS	Vrw=47V, Vbr=44.7..49.4V, 9.3A, 600W(1ms), Bidirectional	DO-214AA	1ba,3ba	1l,1e	Vs,Ons
47C	P6SMBJ47C	TVS	Vbr=42.3..51.7V, 8.9A, 600W(1ms), Bidirectional	DO-214AA	1ba	1p	Lif
47CA	P4SMA47CA	TVS	Vbr=44.7..49.4V, Vrw=40.2V, 6.5A, 400W(1ms), Bidirectional	DO-214AC	1ba	1j	Eic
47CA	P6SMB47CA	TVS	Vbr=44.7..49.4V, Vrw=40.2V, 9.3A, 600W(1ms), Bidirectional	DO-214AA	1ba	1j	Eic
47CA	P6SMBJ47CA	TVS	Vbr=44.7..49.4V, 9.3A, 600W(1ms), Bidirectional	DO-214AA	1ba	1p	Lif
47P	BZD27C47P	Z-diode	44.65..49.35V, Zzt=45Ω, Izt=10mA, 800mW	SOD-123FL	7d	1a	Pjt
47P	MFPZ47	Z-diode	44.65..49.35V, Izt=10mA, Zzt=45Ω, 800mW	SOD-123FL	7d	1a	Ttr
47S	MMHZ5247SPT	Z-diode	16.66..17.34V, Izt=5mA, Zzt=36Ω, 225mW	SOD-123	5d	1a	Chm
47VB	BZT52-B47	Z-diode	46.06..47.94V, Izt=2mA, Zzt=170Ω, 500mW	SOD-123FL	7d	1a	Tsc
47VB	MMSZ47VBW	Z-diode	46.06..47.94V, Izt=2mA, Zzt=170Ω, 500mW	SOD-123FL	7d	1a	Tac
47VZ	BZT52-C47	Z-diode	44.65..49.35V, Izt=2mA, Zzt=170Ω, 500mW	SOD-123FL	7d	1a	Tsc
47VZ	MMSZ47VCW	Z-diode	44.65..49.35V, Izt=2mA, Zzt=170Ω, 500mW	SOD-123FL	7d	1a	Tac
47VZ	TCMMSZ47V	Z-diode	47V±5%, Izt=5mA, Zzt=160Ω, 500mW	SOD-123FL	7d	1a	Tac
47VZ	ZGFM0547C-MH	Z-diode	44.65..49.35V, Izt=5mA, Zzt=160Ω, 500mW	SOD-123	5d	1a	Pic
48	HMSZ5248B	Z-diode	18V±5%, Izt=7mA, Zzt=21Ω, 225mW	SOD-323	5d	1d	Hsn
48	ZD5248BS2	Z-diode	18V±5%, 7mA, Zzt=21Ω, 500mW	SOD-323	5d	1a	Cys
480A	1.5SMC480A	TVS	Vbr=456..504V, Vrw=408V, 2.28A, 1500W(1ms)	DO-214AB	1d	1k	Vs
480A	P4SMA480A	TVS	Vbr=456..504V, 0.46A, 400W(1ms)	DO-214AC	1d	1k	Vs
480A	P6SMA480A	TVS	Vbr=456..504V, Vrw=408V, 0.91A, 600W(1ms)	DO-214AC	1d	1a	Eic
480A	P6SMB480A	TVS	Vrw=480V, Vbr=456..504, 0.91A, 600W(1ms)	DO-214AA	1d	1k	Vs
480C	1.5SMC480CA	TVS	Vrw=408.0V, Vbr=456.0..504.0V, 2.3A, 1500W(1ms), Bidirectional	DO-214AB	1ba	1j	Fee
480CA	P6SMA480CA	TVS	Vbr=456..504V, Vrw=408V, 0.91A, 600W(1ms), Bidirectional	DO-214AC	1ba	1j	Eic
48A	1SMC48A	TVS	Vbr=53.3..58.9V, Vrw=48V, 19.4A, 1500W(1ms)	DO-214AB	1d	1a	Eic
48A	SMAJ48A	TVS	Vrw=48V, Vbr=53.3..58.9V, 5.2A, 400W(1ms)	DO-214AC	1d	1a	Sus
48A	SMBJ48A	TVS	Vbr=53.3..58.9V, Vrw=48V, 7.7A, 600W(1ms)	DO-214AA	1d	1a	Sus
48A	SMCJ48A	TVS	Vrw=48V, Vbr=53.3..61.3V, 17.5A, 1500W(1ms)	DO-214AB	1d	1k	Sus
48A	UMA48A	TVS	Vrw=48V, Vbr=53.3..77.4V, 6.5A, 500W(1ms)	UltraMite	14d	1v	Msc
48B	MMHZ5248BPT	Z-diode	17.10..18.90V, Izt=5mA, Zzt=42Ω, 225mW	SOD-123	5d	1a	Chm



SMD code	Type	Function	Short description	Case	Pinout	St.	Mnf.
48B	SMC5348B	Z-diode	11.0V±5%, Zzt=2.5(125.0mA), Izm=430.0mA, 5W	DO-214AB	1d	1a	Ers
48C	U5ZA48C	Z-diode	43.2..52.8V, Zzt=65Ω, 5W	DO-218	8d	1a	Tos
48CA	1SMC48CA	TVS	Vbr=53.3..58.9V, Vrw=48V, 19.4A, 1500W(1ms), Bidirectional	DO-214AB	1ba	1j	Eic
48CA	SMAJ48CA	TVS	Vrw=48V, Vbr=53.3..58.9V, 5.2A, 400W(1ms), Bidirectional	DO-214AC	1ba	1j	Sus
48CA	SMBJ48CA	TVS	Vbr=53.3..58.9V, Vrw=48V, 7.7A, 600W(1ms), Bidirectional	DO-214AA	1ba	1j	Sus
48CA	SMCJ48CA	TVS	Vrw=48V, Vbr=53.3..61.3V, 17.5A, 1500W(1ms), Bidirectional	DO-214AB	1ba	1l	Sus
48CA	UMA48CA	TVS	Vrw=48V, Vbr=53.3..77.4V, 6.5A, 500W(1ms), Bidirectional	UltraMite	14ba	1v	Msc
48S	MMHZ5248SP	Z-diode	17.64..18.36V, Izt=5mA, Zzt=42Ω, 225mW	SOD-123	5d	1a	Chm
48V	SMA48	TVS	Vbr=53.3..65.1V, Vrw=48.0V, 3.5A, 300W(1ms)	DO-214AC	1d	1a	Mic
48V	SMB48	TVS	Vbr=53.3..65.1V, Vrw=48V, 7A, 600W(1ms)	DO-214AA	1d	1a	Mic
48V	SMC48	TVS	Vbr=53.3..65.1V, Vrw=48V, 17.5A, 1500W(1ms),	DO-214AB	1d	1a	Mic
48VA	SMA48A	TVS	Vbr=53.3..58.9V, Vrw=48.0V, 3.6A, 300W(1ms)	DO-214AC	1d	1a	Mic
48VA	SMB48A	TVS	Vbr=53.3..58.9V, Vrw=48V, 7.8A, 600W(1ms)	DO-214AA	1d	1a	Mic
48VA	SMC48A	TVS	Vbr=53.3..58.9V, Vrw=48V, 19.4A, 1500W(1ms),	DO-214AB	1d	1a	Mic
48VC	SMA48C	TVS	Vbr=53.3..65.1V, Vrw=48.0V, 3.5A, 300W(1ms), Bidirectional	DO-214AC	1ba	1j	Mic
48VC	SMB48C	TVS	Vbr=53.3..65.1V, Vrw=48V, 7A, 600W(1ms), Bidirectional	DO-214AA	1ba	1j	Mic
48VC	SMC48C	TVS	Vbr=53.3..65.1V, Vrw=48V, 17.5A, 1500W(1ms), Bidirectional	DO-214AB	1ba	1j	Mic
48VCA	SMA48CA	TVS	Vbr=53.3..58.9V, Vrw=48.0V, 3.6A, 300W(1ms), Bidirectional	DO-214AC	1ba	1j	Mic
48VCA	SMB48CA	TVS	Vbr=53.3..58.9V, Vrw=48V, 7.8A, 600W(1ms), Bidirectional	DO-214AA	1ba	1j	Mic
48VCA	SMC48CA	TVS	Vbr=53.3..58.9V, Vrw=48V, 19.4A, 1500W(1ms), Bidirectional	DO-214AB	1ba	1j	Mic
49	HMSZ5249B	Z-diode	19V±5%, Izt=6.6mA, Zzt=23Ω, 225mW	SOD-323	5d	1d	Hsn
49	ZD5249BS2	Z-diode	19V±5%, 6.6mA, Zzt=23Ω, 500mW	SOD-323	5d	1a	Cys
4933	FSM4933PT	Si-diode	Rectifier, Fast, 50V, 1A	DO-214AC	1d	1a	Chm
4934	FSM4934PT	Si-diode	Rectifier, Fast, 100V, 1A	DO-214AC	1d	1a	Chm
4935	FSM4935PT	Si-diode	Rectifier, Fast, 200V, 1A	DO-214AC	1d	1a	Chm
4936	FSM4936PT	Si-diode	Rectifier, Fast, 400V, 1A	DO-214AC	1d	1a	Chm
4937	FSM4937PT	Si-diode	Rectifier, Fast, 600V, 1A	DO-214AC	1d	1a	Chm
49B	MMHZ5249BPT	Z-diode	18.05..19.95V, Izt=5mA, Zzt=42Ω, 225mW	SOD-123	5d	1a	Chm
49B	SMC5349B	Z-diode	12.0V±5%, Zzt=3.0(100.0mA), Izm=395.0mA, 5W	DO-214AB	1d	1a	Ers
49S	MMHZ5249SP	Z-diode	18.62..19.38V, Izt=5mA, Zzt=42Ω, 225mW	SOD-123	5d	1a	Chm
4A	D3FS4A	Si-diode	SBR, 60V, 2.6A, Vf<0.45V(2.6A)	SOD-15	1d	1a	Shi
4A	HZU4ALL	Z-diode	3.4..3.8V, Izt=0.5mA, Zzt=370Ω, 150mW	URP	5d	1a	Ren
4A	MA72	C-diode	VHF-Band-Sw, 35V, <2pF(6V)	SOD-123	5d	1a	Pan
4A	MM1Z2V0	Z-diode	2.0V±5%, Izt=5mA, Zzt=100Ω, 500mW	SOD-123	5d	1a	Bts
4A	MMVL109	C-diode	VHF-Tuning, 30V, 200mA, 200mW, 26/32pF(3V, 1MHz)	SOD-323	5d	1a	Ons
4A3	RKZ4.3AKU	Z-diode	4.04..4.29V, Izt=20mA, Zzt=130Ω, 500mW	TURP-FM	7d	1a	Ren
4A7	RKZ4.7AKU	Z-diode	4.44..4.68V, Izt=20mA, Zzt=130Ω, 500mW	TURP-FM	7d	1a	Ren
4B	HZU4BL	Z-diode	3.7..4.1V, Izt=0.5mA, Zzt=370Ω, 150mW	URP	5d	1a	Ren
4B	MA2X073	Si-diode	VHF-Band-Sw, 35V, 100mA, <1.2pF(6V)	SOD-123	5d	1a	Pan
4B	MA2Z077	Si-diode	VHF-Band-Sw, 35V, 100mA, Vf<0.92V(100mA), 0.9pF	SOD-123	5d	1a	Pan
4B	MA73	Si-diode	VHF-Band-Sw, 35V, 100mA, <1.2pF(6V)	SOD-123	5d	1a	Pan
4B	MA77	Si-diode	VHF-Band-Sw, 35V, 100mA, Vf<0.92V(100mA), 0.9pF	SOD-123	5d	1a	Pan
4B	MM1Z2V2	Z-diode	2.2V±5%, Izt=5mA, Zzt=100Ω, 500mW	SOD-123	5d	1a	Bts
4B3	RKZ4.3BKU	Z-diode	4.17..4.43V, Izt=20mA, Zzt=130Ω, 500mW	TURP-FM	7d	1a	Ren
4B7	RKZ4.7BKU	Z-diode	4.55..4.80V, Izt=20mA, Zzt=130Ω, 500mW	TURP-FM	7d	1a	Ren
4C	BZT52C-17WU	Z-diode	16.15..17.85V, Izt=5mA, Zzt=40Ω, 200mW	SOD-723	7d	1a	Ttr
4C	BZX784C17	Z-diode	16.15..17.85V, Zzt=40Ω, Izt=5mA, 200mW	SOD-723	7d	1a	Pjt
4C	CDZ55C4V3T	Z-diode	4.09..4.52V, Zzt=80Ω, Izt=5mA, 200mW	0603	70d	2d	Crp
4C	HZU4CLL	Z-diode	4.0..4.4V, Izt=0.5mA, Zzt=370Ω, 150mW	URP	5d	1a	Ren
4C	MA79	Si-diode	VHF-Band-Sw, 25V, <1.5pF(6V)	SOD-123	5d	1a	Pan
4C	MM1Z2V4	Z-diode	2.4V±5%, Izt=5mA, Zzt=100Ω, 500mW	SOD-123FL	7d	1a	Eic
4C	MMSZ2V4	Z-diode	2.4V±5%, Izt=5mA, Zzt=100Ω, 500mW	SOD-123	5d	1a	Eic
4C	MMVL3102	C-diode	FM/VHF-Tuning, 30V, 200mA, 200mW, 20/25pF(3V, 1MHz)	SOD-323	5d	1a	Ons
4C	USCD034	Si-diode	SBR, 40V, 0.3A, Vf<0.5V(0.3A)	0603	14d	1v	Zow
4C3	RKZ4.3CKU	Z-diode	4.30..4.57V, Izt=20mA, Zzt=130Ω, 500mW	TURP-FM	7d	1a	Ren
4C7	RKZ4.7CKU	Z-diode	4.68..4.93V, Izt=20mA, Zzt=130Ω, 500mW	TURP-FM	7d	1a	Ren
4D	MA2Z081	Si-diode	VHF-Band-Sw, 35V, 100mA, Vf<0.96V(100mA), 0.9pF	SOD-123	5d	1a	Pan
4D	MA81	Si-diode	VHF-Band-Sw, 35V, 100mA, Vf<0.96V(100mA), 0.9pF	SOD-123	5d	1a	Pan
4D	MM1Z2V7	Z-diode	2.7V±5%, Izt=5mA, Zzt=110Ω, 500mW	SOD-123FL	5d	1a	Eic
4D	MMBL914HPT	Si-diode	Sw, 100V, 200mA, Vf<1V(10mA), 4ns	SOD-323	5d	1a	Chm
4D	MMSZ2V7	Z-diode	2.7V±5%, Izt=5mA, Zzt=100Ω, 500mW	SOD-123	5d	1a	Eic
4D	MMVL3401	PIN-diode	VHF-Sw, 20V, 20mA, 200mW, <1pF, <0.7Ω(10mA/100MHz)	SOD-323	5d	1a	Ons
4D	USCD024	Si-diode	SBR, 40V, 0.2A, Vf<0.45V(0.2A)	0603	14d	1v	Zow
4D1	USCD024R	Si-diode	SBR, 40V, 0.2A, Vf<0.45V(0.2A)	0603	14d	1v	Zow
4E	MM1Z3V0	Z-diode	3.0V±5%, Izt=5mA, Zzt=120Ω, 500mW	SOD-123FL	7d	1a	Eic
4E	MMSZ3V0	Z-diode	3.0V±5%, Izt=5mA, Zzt=95Ω, 500mW	SOD-123	5d	1a	Eic
4E	MMVL105G	C-diode	VHF-Tuning, 30V, 200mA, 200mW, 1.5/2.8pF(25V, 1MHz)	SOD-323	5d	1a	Ons
4F	KDZ4.3FV	Z-diode	4.0..4.50V, Izt=5mA, Zzt=130Ω, 100mW	TFSC	7d	1a	Kec
4F	MAZD033	Z-diode	3.1..3.5V, Zzt=130Ω(5mA), 120mW	SSSMini2	7d	1a	Pan
4F	MM1Z3V3	Z-diode	3.3V±5%, Izt=5mA, Zzt=130Ω, 500mW	SOD-123FL	7d	1a	Eic



SMD
code

Type

Function

Short description

Case

Pinout

St.

Mnf.

4F	MMSZ3V3	Z-diode	3.3V±5%, Izt=5mA, Zzt=95Ω, 500mW	SOD-123	5d	1a	Eic
4F	USCD014	Si-diode	SBR, 40V, 0.1A, Vf<0.4V(0.1A)	0603	14d	1v	Zow
4G	CDZ55C4V7T	Z-diode	4.47..4.94V, Zzt=70Ω, Izt=5mA, 200mW	0603	70d	2d	Crp
4G	MMVL2101	C-diode	FMV/HF-Tuning, 30V, 200mA, 200mW, 6.1/7.5pF(4V, 1MHz)	SOD-323	5d	1a	Ons
4H	MM1Z3V6	Z-diode	3.6V±5%, Izt=5mA, Zzt=130Ω, 500mW	SOD-123FL	7d	1a	Eic
4H	MMSZ3V6	Z-diode	3.6V±5%, Izt=5mA, Zzt=90Ω, 500mW	SOD-123	5d	1a	Eic
4J	MM1Z3V9	Z-diode	3.9V±5%, Izt=5mA, Zzt=130Ω, 500mW	SOD-123FL	7d	1a	Eic
4J	MMSZ3V9	Z-diode	3.9V±5%, Izt=5mA, Zzt=90Ω, 500mW	SOD-123	5d	1a	Eic
4K	MM1Z4V3	Z-diode	4.3V±5%, Izt=5mA, Zzt=130Ω, 500mW	SOD-123FL	7d	1a	Eic
4K	MMSD1000	Si-diode	Sw, 30V, 200mA, 225mW, Vf<0.95V(10mA), <2pF	SOD-323	5d	1a	Mot
4K	MMSZ4V3	Z-diode	4.3V±5%, Izt=5mA, Zzt=90Ω, 500mW	SOD-123	5d	1a	Eic
4L7	KP4L07	Thy-SPD	V Of-St=65V, Ifsm=40A(1ms), Ih=100mA, Bidirectional	2F	1ba	1l	Shi
4L8	KP4L08	Thy-SPD	V Of-St=70V, Ifsm=40A(1ms), Ih=100mA, Bidirectional	2F	1ba	1l	Shi
4M	MM1Z4V7	Z-diode	4.7V±5%, Izt=5mA, Zzt=130Ω, 500mW	SOD-123FL	7d	1a	Eic
4M	MMDL101	Si-diode	UHF/VHF Det, Schottky Barrier, 7V, 200mW, <0.88pF	SOD-323	5d	1a	Ons
4M	MMSZ4V7	Z-diode	4.7V±5%, Izt=5mA, Zzt=80Ω, 500mW	SOD-123	5d	1a	Eic
4N	MM1Z5V1	Z-diode	5.1V±5%, Izt=5mA, Zzt=130Ω, 500mW	SOD-123FL	7d	1a	Eic
4N	MMSZ5V1	Z-diode	5.1V±5%, Izt=5mA, Zzt=60Ω, 500mW	SOD-123	5d	1a	Eic
4N12	KP4N12	Thy-SPD	V Of-St=110V, Ifsm=40A(1ms), Ih=100mA, Bidirectional	2F	1ba	1l	Shi
4N14	KP4N14	Thy-SPD	V Of-St=130V, Ifsm=40A(1ms), Ih=100mA, Bidirectional	2F	1ba	1l	Shi
4P	CMDZ24L	Z-diode	22.80..25.20V, Izt=0.5mA, Zzt=120Ω, 250mW	SOD-323	5d	1a	Cen
4P	KDZ4.3FVY	Z-diode	4.17..4.43V, Izt=5mA, Zzt=130Ω, 100mW	TFSC	7d	1a	Kec
4P	MM1Z5V6	Z-diode	5.6V±5%, Izt=5mA, Zzt=80Ω, 500mW	SOD-123FL	7d	1a	Eic
4P	MMSZ5V6	Z-diode	5.6V±5%, Izt=5mA, Zzt=40Ω, 500mW	SOD-123	5d	1a	Eic
4P3	SML4731	Z-diode	4.3V±5%, Izt=58mA, Zzt=9Ω, 1W	DO-214AC	1d	1k	Vs
4P7	SML4732	Z-diode	4.7V±5%, Izt=53mA, Zzt=8Ω, 1W	DO-214AC	1d	1k	Vs
4R	MM1Z6V2	Z-diode	6.2V±5%, Izt=5mA, Zzt=50Ω, 500mW	SOD-123FL	7d	1a	Eic
4R	MMSZ6V2	Z-diode	6.2V±5%, Izt=5mA, Zzt=10Ω, 500mW	SOD-123	5d	1a	Eic
4R	MMVL3700	PIN-diode	VHF-Sw, 200V, 20mA, 200mW, <1pF, <1Q(10mA/100MHz)	SOD-323	5d	1a	Ons
4R25	KP4R25	Thy-SPD	V Of-St=220V, Ifsm=40A(1ms), Ih=100mA, Bidirectional	2F	1ba	1l	Shi
4T	MMDL301	Si-diode	UHF/VHF Det, Schottky Barrier, 30V, 200mW, <0.9pF	SOD-323	5d	1a	Ons
4U	MMVL2105	C-diode	VHF-Tuning, 30V, 200mA, 200mW, 13.5/16.5pF(4V, 1MHz)	SOD-323	5d	1a	Ons
4V3	BZD27C4V3P	Z-diode	4.09..4.52V, Zzt=7Ω, Izt=100mA, 800mW	SOD-123FL	7d	1a	Pjt
4V3	BZY55-C4V3	Z-diode	4.09..4.52V, Izt=5mA, Zzt=80Ω, 500mW	0805	70d	2d	Tsc
4V3	CDZ55C4V3	Z-diode	4.09..4.52V, Zzt=80Ω, Izt=5mA, 500mW	1206	70d	2d	Crp
4V3	CDZ55C4V3S	Z-diode	4.09..4.52V, Zzt=80Ω, Izt=5mA, 500mW	0805	70d	2d	Crp
4V3	CTZ55C4V3	Z-diode	4.09..4.52V, Izt=5mA, Zzt=80Ω, 500mW	1206	70d	2d	Ctc
4V3	MFPZ4V3	Z-diode	4.09..4.52V, Izt=100mA, Zzt=7Ω, 800mW	SOD-123FL	7d	1a	Ttr
4V3B	BZT52-B4V3	Z-diode	4.21..4.39V, Izt=5mA, Zzt=90Ω, 500mW	SOD-123FL	7d	1a	Tsc
4V3B	MMSZ4V3BW	Z-diode	4.21..4.39V, Izt=5mA, Zzt=90Ω, 500mW	SOD-123FL	7d	1a	Tac
4V3Z	BZT52-C4V3	Z-diode	4.09..4.52V, Izt=5mA, Zzt=90Ω, 500mW	SOD-123FL	7d	1a	Tsc
4V3Z	MMSZ4V3CW	Z-diode	4.09..4.52V, Izt=5mA, Zzt=90Ω, 500mW	SOD-123FL	7d	1a	Tac
4V3Z	TCMMSZ4V3	Z-diode	4.3V±5%, Izt=5mA, Zzt=84Ω, 500mW	SOD-123FL	7d	1a	Tac
4V3Z	ZGFM054V3C-MH	Z-diode	4.09..4.52V, Izt=5mA, Zzt=84Ω, 500mW	SOD-123	5d	1a	Pic
4V4Z	ZGFM054V7C-MH	Z-diode	4.47..4.94V, Izt=5mA, Zzt=75Ω, 500mW	SOD-123	5d	1a	Pic
4V7	BZD27C4V7P	Z-diode	4.47..4.94V, Zzt=7Ω, Izt=100mA, 800mW	SOD-123FL	7d	1a	Pjt
4V7	BZY55-C4V7	Z-diode	4.47..4.94V, Izt=5mA, Zzt=70Ω, 500mW	0805	70d	2d	Tsc
4V7	CDZ55C4V7	Z-diode	4.47..4.94V, Zzt=70Ω, Izt=5mA, 500mW	1206	70d	2d	Crp
4V7	CDZ55C4V7S	Z-diode	4.47..4.94V, Zzt=70Ω, Izt=5mA, 500mW	0805	70d	2d	Crp
4V7	CTZ55C4V7	Z-diode	4.47..4.94V, Izt=5mA, Zzt=70Ω, 500mW	1206	70d	2d	Ctc
4V7	MFPZ4V7	Z-diode	4.47..4.94V, Izt=100mA, Zzt=7Ω, 800mW	SOD-123FL	7d	1a	Ttr
4V7B	BZT52-B4V7	Z-diode	4.61..4.79V, Izt=5mA, Zzt=80Ω, 500mW	SOD-123FL	7d	1a	Tsc
4V7B	MMSZ4V7BW	Z-diode	4.61..4.79V, Izt=5mA, Zzt=80Ω, 500mW	SOD-123FL	7d	1a	Tac
4V7Z	BZT52-C4V7	Z-diode	4.47..4.94V, Izt=5mA, Zzt=80Ω, 500mW	SOD-123FL	7d	1a	Tsc
4V7Z	MMSZ4V7CW	Z-diode	4.47..4.94V, Izt=5mA, Zzt=80Ω, 500mW	SOD-123FL	7d	1a	Tac
4V7Z	TCMMSZ4V7	Z-diode	4.7V±5%, Izt=5mA, Zzt=75Ω, 500mW	SOD-123FL	7d	1a	Tac
4W	MM3Z75V	Z-diode	70..79V, Izt=2mA, Zzt=255Ω, 200mW	SOD-323	5d	1a	Sec
4X	MM1Z6V8	Z-diode	6.8V±5%, Izt=5mA, Zzt=30Ω, 500mW	SOD-123FL	7d	1a	Eic
4X	MMSZ6V8	Z-diode	6.8V±5%, Izt=5mA, Zzt=15Ω, 500mW	SOD-123	5d	1a	Eic
4Y	KDZ20VVY	Z-diode	19.52..20.39V, Izt=5mA, Zzt=25Ω, 100mW	VSC	7d	1a	Kec
4Y	MM1Z7V5	Z-diode	7.5V±5%, Izt=5mA, Zzt=30Ω, 500mW	SOD-123FL	7d	1a	Eic
4Y	MMSZ7V5	Z-diode	7.5V±5%, Izt=5mA, Zzt=15Ω, 500mW	SOD-123	5d	1a	Eic
4Z	BZT52-B3V6S	Z-diode	3.53..3.67V, Izt=5mA, Zzt=90Ω, 200mW	SOD-323FL	7d	1a	Tsc
4Z	MM1Z8V2	Z-diode	8.2V±5%, Izt=5mA, Zzt=30Ω, 500mW	SOD-123FL	7d	1a	Eic
4Z	MM3Z3V6B	Z-diode	3.53..3.67V, Zzt=84Ω, Izt=5mA, 200mW	SOD-323FL	7d	1a	F
4Z	MM3Z3V6BW	Z-diode	3.53..3.67V, Izt=5mA, Zzt=90Ω, 200mW	SOD-323FL	7d	1a	Tac
4Z	MMSZ8V2	Z-diode	8.2V±5%, Izt=5mA, Zzt=15Ω, 500mW	SOD-123	5d	1a	Eic
4Z	TCMM3Z3V6B	Z-diode	3.6V±2%, Izt=5mA, Zzt=84Ω, 200mW	SOD-323FL	7d	1a	Tac
5	1SV202	C-diode	UHF-Tuning, 30V, 2.1/2.39pF(25V)	SOD-123	5d	1a	Hit
5	BA892	PIN-diode	VHF, TV-Band-Sw, 35V, 100mA, 715mW, Vf<1V(10mA), <1.4pF	SOD-523	6d	1a	Phi



SMD
code

Type

Function

Short description

Case

Pinout

St.

Mnf.

SMD code	Type	Function	Short description	Case	Pinout	St.	Mnf.
5	BBY57-02V	C-diode	VCO-Tuning, 10V, 20mA, 16.5..18.6pF(4..1V)	SC-79	6d	1u	Inf
5	CDZ5.1B	Z-diode	5.1V±2.5%, Izt=40mA, 1W	VMN	7d	1s	Rhm
5	CH751G-40PT	Si-diode	SBD, 40V, 30mA, Vf<0.37V(1mA)	SOD-723	8d	1a	Chm
5	GBLC05	TVS	Vbr=5V, 17A, 350W(1ms), 3pF	SOD-323	5d	1a	Prt
5	HVR300	C-diode	VHF-Tuning, 38.5/46.1pF(2V)	SOD-123	5d	1a	Ren
5	HVU202	C-diode	UHF-Tuning, 30V, 14/16.3pF(2V)	SOD-323	5d	1a	Ren
5	MA2SV04	C-diode	VCO, 6V, 10.5..6.1pF(1..3V)	SOD-523	6d	1a	Pan
5	MAZS051	Z-diode	4.8..5.4V, 200mW	SOD-523	6d	1a	Pan
5	MM9D5V6	Z-diode	5.32..5.88V, Izt=5mA, Zzt=60Ω, 200mW	SOD-923	7d	1a	Wtr
5	MMPZ5226SPT	Z-diode	3.234..3.366V, Izt=5mA, Zzt=95Ω, 225mW	SOD-323	5d	1a	Chm
5	MMSZ5247BPT	Z-diode	16.15..17.85V, Izt=5mA, Zzt=36Ω, 225mW	SOD-523	7d	1a	Chm
5	NZ9F18VST	Z-diode	17.56..18.35V, Izt=5mA, Zzt=50Ω, 200mW	SOD-923	7d	2m	Ons
5	NZ9F3V3ST	Z-diode	3.32..3.53V, Izt=5mA, Zzt=100Ω, 200mW	SOD-923	7d	1n	Ons
5	NZ9F5V6T	Z-diode	5.32..5.88V, Izt=5mA, Zzt=60Ω, 200mW	SOD-923	7d	1a	Ons
5	RB751G-40	Si-diode	SBR, 30V, 30mA, Vf<0.37V(1mA), 2pF	SOD-723	5d	1a	Rhm
5	RB751S-40	Si-diode	SBR, 30V, 30mA, Vf<0.37V(1mA), 2pF	SOD-523	6d	1a	Rhm
5	RB751V-40	Si-diode	SBR, 30V, 30mA, Vf<0.37V(1mA), 2pF	SOD-323	5d	1a	Rhm
5-	MMSZ51V	Z-diode	48..54V, Zzt=180Ω, Izt=2mA, 200mW	SOD-523FL	7d	1a	F
5-	TCBZX584C51V	Z-diode	48..54V, Izt=2mA, Zzt=180Ω, 200mW	SOD-523FL	7d	1a	Tac
5-	TCMMSZ51V	Z-diode	48..54V, Izt=2mA, Zzt=180Ω, 200mW	SOD-523FL	7d	1a	Tac
5-	MAZS0510M	Z-diode	5..5.26V, 200mW	SOD-523	6d	1a	Pan
-5	BZX584B51V	Z-diode	49.98..52.02V, Izt=2mA, Zzt=180Ω, 200mW	SOD-523FL	7d	1a	Tac
-5	MMSZ51VB	Z-diode	49.98..52.02V, Izt=2mA, Zzt=180Ω, 200mW	SOD-523FL	7d	1a	Tac
5 (white)	BAT60B	Si-diode	SBD, Fast-Sw, 10V, 3A, Vf<0.3V(1A), 20pF	SOD-323	5d	2	Inf
5 (white)	BBY53-03W	C-diode	VCO-Tuning, 6V, 20mA, 3.1..5.8pF(3..1V)	SOD-323	5d	1a	Sie
5 2	GDZ3V3B-V	Z-diode	3.32..3.53V, Izt=5mA, Zzt=120Ω, 200mW	SOD-323	5d	1k	Vs
5.	MMSZ5247SPT	Z-diode	16.66..17.34V, Izt=5mA, Zzt=36Ω, 225mW	SOD-523	7d	1a	Chm
5.0A	1SMC5.0A	TVS	Vbr=6.40..7.07V, Vvwm=5.0V, 163.0A, 1500W(1ms)	DO-214AB	1d	1a	Eic
5.0A	SMAJ5.0A	TVS	Vvwm=5.0V, Vbr=6.40..7.0V, 43.5A, 400W(1ms)	DO-214AC	1d	1a	Sus
5.0A	SMBJ5.0A	TVS	Vbr=6.40..7.07V, Vvwm=5.0V, 65.2A, 600W(1ms)	DO-214AA	1d	1a	Sus
5.0A	SMCJ5.0A	TVS	Vvwm=5V, Vbr=6.4..7.25V, 156.3A, 1500W(1ms)	DO-214AB	1d	1k	Sus
5.0CA	1SMC5.0CA	TVS	Vbr=6.40..7.07V, Vvwm=5.0V, 163.0A, 1500W(1ms), Bidirectional	DO-214AB	1ba	1j	Eic
5.0CA	SMAJ5.0CA	TVS	Vvwm=5.0V, Vbr=6.40..7.0V, 43.5A, 400W(1ms), Bidirectional	DO-214AC	1ba	1j	Sus
5.0CA	SMBJ5.0CA	TVS	Vbr=6.40..7.07V, Vvwm=5.0V, 65.2A, 600W(1ms), Bidirectional	DO-214AA	1ba	1j	Sus
5.0CA	SMCJ5.0CA	TVS	Vvwm=5V, Vbr=6.4..7.25V, 156.3A, 1500W(1ms), Bidirectional	DO-214AB	1ba	1l	Sus
5.1	MAZ5051	Z-diode	4.8..5.4V, Zzt=40Q(5mA), 500mW	MP2	11d	1a	Pan
5.1	MAZ80510H	Z-diode	5.14..5.4V, Zzt=60Q(5mA), 150mW	SC-76	6d	1a	Pan
5.1	MAZY051	Z-diode	4.8..5.4V, Zzt=60Q(20mA), 1W	NMiniP2	1d	1a	Pan
5.1B	HZF5.1BP	Z-diode	5.1V±5%, 900mW	LRP	1d	2f	Ren
5.1B	PTZ5.1B	Z-diode	5.1V±10%, 40mA, 1W	DO-214AC	1d	1a	Rhm
5.1C	HZF5.1CP	Z-diode	5.1V±10%, 900mW	LRP	1d	2f	Ren
5.6	MAZ5056	Z-diode	5.3..6V, Zzt=15Q(5mA), 500mW	MP2	11d	1a	Pan
5.6	MAZ80560H	Z-diode	5.66..5.95V, Zzt=40Q(5mA), 150mW	SC-76	6d	1a	Pan
5.6	MAZY056	Z-diode	5.2..6V, Zzt=50Q(20mA), 1W	NMiniP2	1d	1a	Pan
5.6B	HZF5.6BP	Z-diode	5.6V±5%, 900mW	LRP	1d	2f	Ren
5.6B	PTZ5.6B	Z-diode	5.6V±10%, 40mA, 1W	DO-214AC	1d	1a	Rhm
5.6C	HZF5.6CP	Z-diode	5.6V±10%, 900mW	LRP	1d	2f	Ren
5/G	SD05C	TVS	Vbr=5V, 24A, 350W(1ms), Bidirectional	SOD-323	5ba	1e	Smt
5A	MAZS0510H	Z-diode	5.14..5.4V, 200mW	SOD-523	6d	1a	Pan
5A1	MAZ80510H	Z-diode	5.14..5.4V, Zzt=60Q(5mA), 150mW	SC-76	6d	1a	Pan
5A1	MAZ8051GHL	Z-diode	5.14..5.4V, Zzt=60Q(5mA), 150mW	SMini2-F3	6d	1a	Pan
5A6	MAZ80560H	Z-diode	5.66..5.95V, Zzt=40Q(5mA), 150mW	SC-76	6d	1a	Pan
5A6	MAZ8056GHL	Z-diode	5.66..5.95V, Zzt=40Q(5mA), 150mW	SMini2-F3	6d	1a	Pan
5	MAZS0510L	Z-diode	4.87..5.12V, 200mW	SOD-523	6d	1a	Pan
5_1	MAZ80510L	Z-diode	4.87..5.12V, Zzt=60Q(5mA), 150mW	SC-76	6d	1a	Pan
5_1	MAZ8051GLL	Z-diode	4.87..5.12V, Zzt=60Q(5mA), 150mW	SMini2-F3	6d	1a	Pan
5_6	MAZ80560L	Z-diode	5.3..5.58V, Zzt=40Q(5mA), 150mW	SC-76	6d	1a	Pan
5_6	MAZ8056GLL	Z-diode	5.3..5.58V, Zzt=40Q(5mA), 150mW	SMini2-F3	6d	1a	Pan
5<	MMSZ75V	Z-diode	70..79V, Zzt=255Ω, Izt=2mA, 200mW	SOD-523FL	7d	1a	F
5<	TCBZX584C75V	Z-diode	70..79V, Izt=2mA, Zzt=255Ω, 200mW	SOD-523FL	7d	1a	Tac
5<	TCMMSZ75V	Z-diode	70..79V, Izt=2mA, Zzt=255Ω, 200mW	SOD-523FL	7d	1a	Tac
5=	MMSZ56V	Z-diode	52..60V, Zzt=200Ω, Izt=2mA, 200mW	SOD-523FL	7d	1a	F
5=	TCBZX584C56V	Z-diode	52..60V, Izt=2mA, Zzt=200Ω, 200mW	SOD-523FL	7d	1a	Tac
5=	TCMMSZ56V	Z-diode	52..60V, Izt=2mA, Zzt=200Ω, 200mW	SOD-523FL	7d	1a	Tac
5>	MMSZ68V	Z-diode	64..72V, Zzt=240Ω, Izt=2mA, 200mW	SOD-523FL	7d	1a	F
5>	TCBZX584C68V	Z-diode	64..72V, Izt=2mA, Zzt=240Ω, 200mW	SOD-523FL	7d	1a	Tac
5>	TCMMSZ68V	Z-diode	64..72V, Izt=2mA, Zzt=240Ω, 200mW	SOD-523FL	7d	1a	Tac
5≡	MMSZ62V	Z-diode	58..66V, Zzt=215Ω, Izt=2mA, 200mW	SOD-523FL	7d	1a	F
5≡	TCBZX584C62V	Z-diode	58..66V, Izt=2mA, Zzt=215Ω, 200mW	SOD-523FL	7d	1a	Tac
5≡	TCMMSZ62V	Z-diode	58..66V, Izt=2mA, Zzt=215Ω, 200mW	SOD-523FL	7d	1a	Tac



SMD code	Type	Function	Short description	Case	Pinout	St.	Mnf.
5*1	HZU5.1B1	Z-diode	4.84..5.04V, Izt=5mA, Zzt=130Ω, 200mW	URP	5d	1a	Ren
5*1	HZU5.1B2	Z-diode	4.98..5.20V, Izt=5mA, Zzt=130Ω, 200mW	URP	5d	1a	Ren
5*1	HZU5.1B3	Z-diode	5.14..5.37V, Izt=5mA, Zzt=130Ω, 200mW	URP	5d	1a	Ren
5*1	RKZ5.1B2KG	Z-diode	4.98..5.20V, Izt=5mA, Zzt=130Ω, 200mW	URP	5d	2e	Ren
5*1	RKZ5.1B2KJ	Z-diode	4.98..5.20V, Izt=5mA, Zzt=130Ω, 150mW	UFP	7d	2e	Ren
5*6	HZU5.6B1	Z-diode	5.31..5.55V, Izt=5mA, Zzt=80Ω, 200mW	URP	5d	1a	Ren
5*6	HZU5.6B2	Z-diode	5.49..5.73V, Izt=5mA, Zzt=80Ω, 200mW	URP	5d	1a	Ren
5*6	HZU5.6B3	Z-diode	5.67..5.92V, Izt=5mA, Zzt=80Ω, 200mW	URP	5d	1a	Ren
5*6	RKZ5.6B2KG	Z-diode	5.49..5.73V, Izt=5mA, Zzt=80Ω, 200mW	URP	5d	2e	Ren
5*6	RKZ5.6B2KJ	Z-diode	5.49..5.73V, Izt=5mA, Zzt=80Ω, 150mW	UFP	7d	2e	Ren
50	HMSZ5250B	Z-diode	20V±5%, Izt=6.2mA, Zzt=25Ω, 225mW	SOD-323	5d	1d	Hsn
50	MM5Z2V4	Z-diode	2.2..2.6V, Zzt=100Ω, Izt=5mA, 200mW	SOD-523FL	7d	1a	F
50	TCBZX584C2V4	Z-diode	2.2..2.6V, Izt=5mA, Zzt=100Ω, 200mW	SOD-523FL	7d	1a	Tac
50	TCMMSZ2V4	Z-diode	2.2..2.6V, Izt=5mA, Zzt=100Ω, 200mW	SOD-523FL	7d	1a	Tac
50	ZD5250BS2	Z-diode	20V±5%, 6.2mA, Zzt=25Ω, 500mW	SOD-323	5d	1a	Cys
50	ZV950V2TA	C-diode	Hyperabrupt varicap, 12V, 100mA, 9.5..7.8pF(0.5..1.5V)	SOD-523	6d	1a	Zx
5010	SZ5010	Z-diode	10V±10%, Izt=75mA, Zzt=3.5Ω, 3W	DO-214AC	1d	1a	Eic
5011	SZ5011	Z-diode	11V±10%, Izt=68mA, Zzt=4Ω, 3W	DO-214AC	1d	1a	Eic
5012	SZ5012	Z-diode	12V±10%, Izt=63mA, Zzt=4.5Ω, 3W	DO-214AC	1d	1a	Eic
5013	SZ5013	Z-diode	13V±10%, Izt=58mA, Zzt=4.5Ω, 3W	DO-214AC	1d	1a	Eic
5014	SZ5014	Z-diode	14V±10%, Izt=53mA, Zzt=5Ω, 3W	DO-214AC	1d	1a	Eic
5015	SZ5015	Z-diode	15V±10%, Izt=50mA, Zzt=5.5Ω, 3W	DO-214AC	1d	1a	Eic
5016	SZ5016	Z-diode	16V±10%, Izt=47mA, Zzt=5.5Ω, 3W	DO-214AC	1d	1a	Eic
5017	SZ5017	Z-diode	17V±10%, Izt=44mA, Zzt=6Ω, 3W	DO-214AC	1d	1a	Eic
5018	SZ5018	Z-diode	18V±10%, Izt=42mA, Zzt=6Ω, 3W	DO-214AC	1d	1a	Eic
5019	SZ5019	Z-diode	19V±10%, Izt=40mA, Zzt=7Ω, 3W	DO-214AC	1d	1a	Eic
5020	SZ5020	Z-diode	20V±10%, Izt=37mA, Zzt=7Ω, 3W	DO-214AC	1d	1a	Eic
5022	SZ5022	Z-diode	22V±10%, Izt=34mA, Zzt=8Ω, 3W	DO-214AC	1d	1a	Eic
5024	SZ5024	Z-diode	24V±10%, Izt=31mA, Zzt=9Ω, 3W	DO-214AC	1d	1a	Eic
5027	SZ5027	Z-diode	27V±10%, Izt=28mA, Zzt=10Ω, 3W	DO-214AC	1d	1a	Eic
5028	SZ5028	Z-diode	28V±10%, Izt=27mA, Zzt=12Ω, 3W	DO-214AC	1d	1a	Eic
5030	SZ5030	Z-diode	30V±10%, Izt=25mA, Zzt=16Ω, 3W	DO-214AC	1d	1a	Eic
5033	SZ5033	Z-diode	33V±10%, Izt=23mA, Zzt=20Ω, 3W	DO-214AC	1d	1a	Eic
5036	SZ5036	Z-diode	36V±10%, Izt=21mA, Zzt=22Ω, 3W	DO-214AC	1d	1a	Eic
5039	SZ5039	Z-diode	39V±10%, Izt=19mA, Zzt=28Ω, 3W	DO-214AC	1d	1a	Eic
503J	SZ503J	Z-diode	3.9V±10%, Izt=192mA, Zzt=4.5Ω, 3W	DO-214AC	1d	1a	Eic
5043	SZ5043	Z-diode	43V±10%, Izt=17mA, Zzt=33Ω, 3W	DO-214AC	1d	1a	Eic
5047	SZ5047	Z-diode	47V±10%, Izt=16mA, Zzt=38Ω, 3W	DO-214AC	1d	1a	Eic
504D	SZ504D	Z-diode	4.3V±10%, Izt=174mA, Zzt=4.5Ω, 3W	DO-214AC	1d	1a	Eic
504H	SZ504H	Z-diode	4.7V±10%, Izt=160mA, Zzt=4Ω, 3W	DO-214AC	1d	1a	Eic
5051	SZ5051	Z-diode	51V±10%, Izt=15mA, Zzt=45Ω, 3W	DO-214AC	1d	1a	Eic
5056	SZ5056	Z-diode	56V±10%, Izt=13mA, Zzt=50Ω, 3W	DO-214AC	1d	1a	Eic
505B	SZ505B	Z-diode	5.1V±10%, Izt=147mA, Zzt=3.5Ω, 3W	DO-214AC	1d	1a	Eic
505G	SZ505G	Z-diode	5.6V±10%, Izt=134mA, Zzt=2.5Ω, 3W	DO-214AC	1d	1a	Eic
5062	SZ5062	Z-diode	62V±10%, Izt=12mA, Zzt=55Ω, 3W	DO-214AC	1d	1a	Eic
5068	SZ5068	Z-diode	68V±10%, Izt=11mA, Zzt=70Ω, 3W	DO-214AC	1d	1a	Eic
506C	SZ506C	Z-diode	6.2V±10%, Izt=121mA, Zzt=1.5Ω, 3W	DO-214AC	1d	1a	Eic
506I	SZ506I	Z-diode	6.8V±10%, Izt=110mA, Zzt=2Ω, 3W	DO-214AC	1d	1a	Eic
5075	SZ5075	Z-diode	75V±10%, Izt=10mA, Zzt=85Ω, 3W	DO-214AC	1d	1a	Eic
507F	SZ507F	Z-diode	7.5V±10%, Izt=100mA, Zzt=2Ω, 3W	DO-214AC	1d	1a	Eic
5082	SZ5082	Z-diode	82V±10%, Izt=9.1mA, Zzt=95Ω, 3W	DO-214AC	1d	1a	Eic
508C	SZ508C	Z-diode	8.2V±10%, Izt=91mA, Zzt=2.3Ω, 3W	DO-214AC	1d	1a	Eic
5091	SZ5091	Z-diode	91V±10%, Izt=8.2mA, Zzt=115Ω, 3W	DO-214AC	1d	1a	Eic
509B	SZ509B	Z-diode	9.1V±10%, Izt=82mA, Zzt=2.5Ω, 3W	DO-214AC	1d	1a	Eic
50B	MMHZ5250BPT	Z-diode	19.0..21.0V, Izt=5mA, Zzt=48Ω, 225mW	SOD-123	5d	1a	Chm
50B	SMC5350B	Z-diode	13.0V±5%, Zzt=3.0(100.0mA), Izm=365.0mA, 5W	DO-214AB	1d	1a	Ers
50B0	SZ50B0	Z-diode	100V±10%, Izt=7.5mA, Zzt=160Ω, 3W	DO-214AC	1d	1a	Eic
50B1	SZ50B1	Z-diode	110V±10%, Izt=6.8mA, Zzt=225Ω, 3W	DO-214AC	1d	1a	Eic
50B2	SZ50B2	Z-diode	120V±10%, Izt=6.3mA, Zzt=300Ω, 3W	DO-214AC	1d	1a	Eic
50B3	SZ50B3	Z-diode	130V±10%, Izt=5.8mA, Zzt=375Ω, 3W	DO-214AC	1d	1a	Eic
50B4	SZ50B4	Z-diode	140V±10%, Izt=5.3mA, Zzt=475Ω, 3W	DO-214AC	1d	1a	Eic
50B5	SZ50B5	Z-diode	150V±10%, Izt=5mA, Zzt=550Ω, 3W	DO-214AC	1d	1a	Eic
50B6	SZ50B6	Z-diode	160V±10%, Izt=4.7mA, Zzt=625Ω, 3W	DO-214AC	1d	1a	Eic
50B7	SZ50B7	Z-diode	170V±10%, Izt=4.4mA, Zzt=650Ω, 3W	DO-214AC	1d	1a	Eic
50B8	SZ50B8	Z-diode	180V±10%, Izt=4.2mA, Zzt=700Ω, 3W	DO-214AC	1d	1a	Eic
50B9	SZ50B9	Z-diode	190V±10%, Izt=4mA, Zzt=800Ω, 3W	DO-214AC	1d	1a	Eic
50D0	SZ50D0	Z-diode	200V±10%, Izt=3.7mA, Zzt=875Ω, 3W	DO-214AC	1d	1a	Eic
50DPH	BYG50D	Si-diode	Controlled Avalanche Rectifier, 200V, 1A, Vf<0.85V(1A), 2μs	DO-214AC	1d	1a	Phi
50GPH	BYG50G	Si-diode	Controlled Avalanche Rectifier, 400V, 1A, Vf<0.85V(1A), 2μs	DO-214AC	1d	1a	Phi
50JPH	BYG50J	Si-diode	Controlled Avalanche Rectifier, 600V, 1A, Vf<0.85V(1A), 2μs	DO-214AC	1d	1a	Phi



SMD
code

Type

Function

Short description

Case

Pinout

St.

Mnf.

SMD code	Type	Function	Short description	Case	Pinout	St.	Mnf.
50KPH	BYG50K	Si-diode	Controlled Avalanche Rectifier, 800V, 1A, Vf<0.85V(1A), 2μs	DO-214AC	1d	1a	Phi
50MPH	BYG50M	Si-diode	Controlled Avalanche Rectifier, 1000V, 1A, Vf<0.85V(1A), 2μs	DO-214AC	1d	1a	Phi
50S	MMHZ5250SPT	Z-diode	19.60..20.40V, Izt=5mA, Zzt=48Ω, 225mW	SOD-123	5d	1a	Chm
51	CDZ55C51	Z-diode	48.45..53.55V, Zzt=125Ω, Izt=2.25mA, 500mW	1206	70d	2d	Crp
51	CDZ55C51S	Z-diode	48.45..53.55V, Zzt=125Ω, Izt=2.25mA, 500mW	0805	70d	2d	Crp
51	CDZ55C51T	Z-diode	48.45..53.55V, Zzt=125Ω, Izt=2.25mA, 200mW	0603	70d	2d	Crp
51	CMZ51	Z-diode	51V±5%, 2W	M-Flat	7d	1a	Tos
51	HMSZ5251B	Z-diode	22V±5%, Izt=5.6mA, Zzt=29Ω, 225mW	SOD-323	5d	1d	Hsn
51	HZC5.1	Z-diode	5.1V±10%, 150mW	SOD-523	6d	1a	Ren
51	HZU5.1G	Z-diode	4.84..5.37V, 200mW	SOD-323	5d	1a	Ren
51	KDZ5.1EV	Z-diode	4.8..5.4V, 150mW	SOD-523	6d	1a	Kec
51	KDZ5.1V	Z-diode	4.8..5.4V, 150mW	SOD-323	5d	1a	Kec
51	MAZY510	Z-diode	45.9..56.1V, Zzt=65Ω(5mA), 1W	NMiniP2	1d	1a	Pan
51	MM5Z2V7	Z-diode	2.5..2.9V, Zzt=100Ω, Izt=5mA, 200mW	SOD-523FL	7d	1a	F
51	MMPZ5262SPT	Z-diode	49.98..52.02V, Izt=2.5mA, Zzt=125Ω, 225mW	SOD-323	5d	1a	Chm
51	P4SMA51	TVS	Vbr=45.9..56.1V, Vrrwm=41.3V, 5.7A, 400W(1ms)	DO-214AC	1d	1a	Eic
51	P6SMBJ51	TVS	Vbr=45.9..56.1V, 8.2A, 600W(1ms)	DO-214AA	1d	1n	Lif
51	SML4757	Z-diode	51V±5%, Izt=5mA, Zzt=95Ω, 1W	DO-214AC	1d	1k	Vs
51	TCBZX584C2V7	Z-diode	2.5..2.9V, Izt=5mA, Zzt=100Ω, 200mW	SOD-523FL	7d	1a	Tac
51	TCMM5Z2V7	Z-diode	2.5..2.9V, Izt=5mA, Zzt=100Ω, 200mW	SOD-523FL	7d	1a	Tac
51	TZD5.1WS	Z-diode	4.80..5.40V, Izt=5mA, Zzt=70Ω, 200mW	SOD-323	5d	1a	Ttr
51	TZD5.1WT	Z-diode	4.80..5.40V, Izt=5mA, Zzt=70Ω, 150mW	SOD-523	6d	1a	Ttr
51	U1Z51	Z-diode	45.9..56.1, 1W	SOD-6	1d	1a	Tos
51	U1ZB51	Z-diode	45.9..56.1, 1W	I-FLAT	1d	1a	Tos
51	ZD5251BS2	Z-diode	22V±5%, 5.6mA, Zzt=29Ω, 500mW	SOD-323	5d	1a	Cys
5-1	MAZ80510M	Z-diode	5..5.26V, Zzt=60Ω(5mA), 150mW	SC-76	6d	1a	Pan
5-1	MAZ8051GML	Z-diode	5..5.26V, Zzt=60Ω(5mA), 150mW	SMini2-F3	6d	1a	Pan
51+	TZD5.1YWS	Z-diode	4.98..5.20V, Izt=5mA, Zzt=70Ω, 200mW	SOD-323	5d	1a	Ttr
51+	TZD5.1YWT	Z-diode	4.98..5.20V, Izt=5mA, Zzt=70Ω, 150mW	SOD-523	6d	1a	Ttr
510	F1C510	TVS	Vbr=8V, 35A, 500W(1ms)	DO-214AC	1d	1a	Org
510A	1.5SMC510A	TVS	Vbr=485..535V, Vrrwm=434V, 2.15A, 1500W(1ms)	DO-214AB	1d	1k	Vs
510A	P4SMA510A	TVS	Vbr=485..535V, 0.43A, 400W(1ms)	DO-214AC	1d	1k	Vs
510A	P6SMA510A	TVS	Vbr=485..535V, Vrrwm=434V, 0.86A, 600W(1ms)	DO-214AC	1d	1a	Eic
510A	P6SMB510A	TVS	Vrrwm=510V, Vbr=485..535, 0.86A, 600W(1ms)	DO-214AA	1d	1k	Vs
510C	1.5SMC510CA	TVS	Vrrwm=434.0V, Vbr=485.0..535.0V, 2.1A, 1500W(1ms), Bidirectional	DO-214AB	1ba	1j	Fee
510CA	P6SMA510CA	TVS	Vbr=485..535V, Vrrwm=434V, 0.86A, 600W(1ms), Bidirectional	DO-214AC	1ba	1j	Eic
512	F1C512	TVS	Vbr=9.6V, 30A, 500W(1ms)	DO-214AC	1d	1a	Org
516	F1C516	TVS	Vbr=12.5V, 22A, 500W(1ms)	DO-214AC	1d	1a	Org
518	F1C518	TVS	Vbr=14.5V, 20A, 500W(1ms)	DO-214AC	1d	1a	Org
51A	1.5SMC51A	TVS	Vbr=48.5..53.6V, Vrrwm=43.6V, 21.4A, 1500W(1ms)	DO-214AB	1d,3d	1a,1k	Vs,Ons
51A	1SMC51A	TVS	Vbr=56.7..62.7V, Vrrwm=51V, 18.2A, 1500W(1ms)	DO-214AB	1d	1a	Eic
51A	P4SMA51A	TVS	Vbr=48.5..53.6V, Vrrwm=43.6V, 6.0A, 400W(1ms)	DO-214AC	1d	1k	Vs
51A	P6SMB51A	TVS	Vrrwm=51V, Vbr=48.5..53.6V, 8.6A, 600W(1ms)	DO-214AA	1d,3d	1k,1a	Vs,Ons
51A	P6SMBJ51A	TVS	Vbr=48.5..53.6V, 8.6A, 600W(1ms)	DO-214AA	1d	1n	Lif
51A	SMAJ51A	TVS	Vrrwm=51V, Vbr=56.7..62.7V, 4.9A, 400W(1ms)	DO-214AC	1d	1a	Sus
51A	SMBJ51A	TVS	Vbr=56.7..62.7V, Vrrwm=51V, 7.3A, 600W(1ms)	DO-214AA	1d	1a	Sus
51A	SMCJ51A	TVS	Vrrwm=51V, Vbr=56.7..65.2V, 16.5A, 1500W(1ms)	DO-214AB	1d	1k	Sus
51A	UMA51A	TVS	Vrrwm=51V, Vbr=56.7..82.4V, 6.1A, 500W(1ms)	UltraMite	14d	1v	Msc
51B	1SMB3EZ51	Z-diode	51V±5%, Zzt=48Ω, Izt=15mA, 3W	DO-214AA	1d	1a	Pjt
51B	MMHZ5251BPT	Z-diode	20.90..23.10V, Izt=5mA, Zzt=55Ω, 225mW	SOD-123	5d	1a	Chm
51B	SMC5351B	Z-diode	14.0V±5%, Zzt=3.0(100.0mA), Izm=340.0mA, 5W	DO-214AB	1d	1a	Ers
51B	Z3SMB51B	Z-diode	48.45..53.55V, Izt=15mA, Zzt=45Ω, 3W	DO-214AA	1d	1a	Ttr
51C	1.5SMC51CA	TVS	Vbr=48.5..53.6V, Vrrwm=43.6V, 21.4A, 1500W(1ms), Bidirectional	DO-214AB	1ba	1l	Vs
51C	F1C5120	TVS	Vbr=96V, 3A, 500W(1ms)	DO-214AC	1d	1a	Org
51C	P4SMA51C	TVS	Vbr=45.9..56.1V, Vrrwm=41.3V, 5.7A, 400W(1ms), Bidirectional	DO-214AC	1ba	1j	Eic
51C	P4SMA51CA	TVS	Vbr=48.5..53.6V, 5.7A, 400W(1ms), Bidirectional	DO-214AC	1ba	1l	Vs
51C	P6SMB51CA	TVS	Vrrwm=51V, Vbr=48.5..53.6V, 8.6A, 600W(1ms), Bidirectional	DO-214AA	1ba,3ba	1l,1e	Vs,Ons
51C	P6SMBJ51C	TVS	Vbr=45.9..56.1V, 8.2A, 600W(1ms), Bidirectional	DO-214AA	1ba	1p	Lif
51CA	1SMC51CA	TVS	Vbr=56.7..62.7V, Vrrwm=51V, 18.2A, 1500W(1ms), Bidirectional	DO-214AB	1ba	1j	Eic
51CA	P4SMA51CA	TVS	Vbr=48.5..53.6V, Vrrwm=43.6V, 6.0A, 400W(1ms), Bidirectional	DO-214AC	1ba	1j	Eic
51CA	P6SMB51CA	TVS	Vbr=48.5..53.6V, Vrrwm=43.6V, 8.6A, 600W(1ms), Bidirectional	DO-214AA	1ba	1j	Eic
51CA	P6SMBJ51CA	TVS	Vbr=48.5..53.6V, 8.6A, 600W(1ms), Bidirectional	DO-214AA	1ba	1p	Lif
51CA	SMAJ51CA	TVS	Vrrwm=51V, Vbr=56.7..62.7V, 4.9A, 400W(1ms), Bidirectional	DO-214AC	1ba	1j	Sus
51CA	SMBJ51CA	TVS	Vbr=56.7..62.7V, Vrrwm=51V, 7.3A, 600W(1ms), Bidirectional	DO-214AA	1ba	1j	Sus
51CA	SMCJ51CA	TVS	Vrrwm=51V, Vbr=56.7..65.2V, 16.5A, 1500W(1ms), Bidirectional	DO-214AB	1d	1k	Sus
51CA	UMA51CA	TVS	Vrrwm=51V, Vbr=56.7..82.4V, 6.1A, 500W(1ms), Bidirectional	UltraMite	14ba	1v	Msc
51P	BZD27C51P	Z-diode	48.45..53.55V, Zzt=60Ω, Izt=10mA, 800mW	SOD-123FL	7d	1a	Pjt
51P	MFPZ51	Z-diode	48.45..53.55V, Izt=10mA, Zzt=60Ω, 800mW	SOD-123FL	7d	1a	Ttr
51S	MMHZ5251SPT	Z-diode	21.56..22.44V, Izt=5mA, Zzt=55Ω, 225mW	SOD-123	5d	1a	Chm
51V	SMA51	TVS	Vbr=56.7..69.3V, Vrrwm=51.0V, 3.3A, 300W(1ms)	DO-214AC	1d	1a	Mic



SMD
code

Type

Function

Short description

Case

Pinout

St.

Mnf.

SMD code	Type	Function	Short description	Case	Pinout	St.	Mnf.
51V	SMB51	TVS	Vbr=56.7..69.3V, Vrvwm=51V, 6.6A, 600W(1ms)	DO-214AA	1d	1a	Mic
51V	SMC51	TVS	Vbr=56.7..69.3V, Vrvwm=51V, 16.5A, 1500W(1ms)	DO-214AB	1d	1a	Mic
51VA	SMA51A	TVS	Vbr=56.7..62.7V, Vrvwm=51.0V, 3.6A, 300W(1ms)	DO-214AC	1d	1a	Mic
51VA	SMB51A	TVS	Vbr=56.7..62.7V, Vrvwm=51V, 7.3A, 600W(1ms)	DO-214AA	1d	1a	Mic
51VA	SMC51A	TVS	Vbr=56.7..62.7V, Vrvwm=51V, 18.2A, 1500W(1ms)	DO-214AB	1d	1a	Mic
51VB	BZT52-B51	Z-diode	49.98..52.02V, Izt=2mA, Zzt=180Ω, 500mW	SOD-123FL	7d	1a	Tsc
51VB	MMSZ51VBW	Z-diode	49.98..52.02V, Izt=2mA, Zzt=180Ω, 500mW	SOD-123FL	7d	1a	Tac
51VC	SMA51C	TVS	Vbr=56.7..69.3V, Vrvwm=51.0V, 3.3A, 300W(1ms), Bidirectional	DO-214AC	1ba	1j	Mic
51VC	SMB51C	TVS	Vbr=56.7..69.3V, Vrvwm=51V, 6.6A, 600W(1ms), Bidirectional	DO-214AA	1ba	1j	Mic
51VC	SMC51C	TVS	Vbr=56.7..69.3V, Vrvwm=51V, 16.5A, 1500W(1ms), Bidirectional	DO-214AB	1ba	1j	Mic
51VCA	SMA51CA	TVS	Vbr=56.7..62.7V, Vrvwm=51.0V, 3.6A, 300W(1ms), Bidirectional	DO-214AC	1ba	1j	Mic
51VCA	SMB51CA	TVS	Vbr=56.7..62.7V, Vrvwm=51V, 7.3A, 600W(1ms), Bidirectional	DO-214AA	1ba	1j	Mic
51VCA	SMC51CA	TVS	Vbr=56.7..62.7V, Vrvwm=51V, 18.2A, 1500W(1ms), Bidirectional	DO-214AB	1ba	1j	Mic
51VZ	BZT52-C51	Z-diode	48.45..53.55V, Izt=2mA, Zzt=180Ω, 500mW	SOD-123FL	7d	1a	Tsc
51VZ	MMSZ51VGV	Z-diode	48.45..53.55V, Izt=2mA, Zzt=180Ω, 500mW	SOD-123FL	7d	1a	Tac
51VZ	TCMMSZ51V	Z-diode	51V±5%, Izt=5mA, Zzt=169Ω, 500mW	SOD-123FL	7d	1a	Tac
51VZ	ZGFM0551C-MH	Z-diode	48.45..53.55V, Izt=5mA, Zzt=169Ω, 500mW	SOD-123	5d	1a	Pic
52	FDZ3.3VT	Z-diode	3.320..3.530V, Izt=5mA, Zzt=120Ω, 200mW	SOD-323	5d	1a	Fis
52	HMSZ5252B	Z-diode	24V±5%, Izt=5.2mA, Zzt=33Ω, 225mW	SOD-323	5d	1d	Hsn
52	MMSZ3V0	Z-diode	2.8..3.2V, Zzt=100Ω, Izt=5mA, 200mW	SOD-523FL	7d	1a	F
52	TCBZX584C3V0	Z-diode	2.8..3.2V, Izt=5mA, Zzt=100Ω, 200mW	SOD-523FL	7d	1a	Tac
52	TCMMSZ3V0	Z-diode	2.8..3.2V, Izt=5mA, Zzt=100Ω, 200mW	SOD-523FL	7d	1a	Tac
52	UDZS3.3B	Z-diode	3.32..3.53V, Izt=5mA, Zzt=120Ω, 200mW	SOD-323	5d	1a	Wtr
52	ZD5252S2	Z-diode	24V±5%, 5.2mA, Zzt=33Ω, 500mW	SOD-323	5d	1a	Cys
52	ZV952V2A	C-diode	Hyperabrupt varicap, 12V, 100mA, 19...15.7pF(0.5..1.5V)	SOD-523	6d	1a	Zx
527	F1C527	TVS	Vbr=21.6V, 13A, 500W(1ms)	DO-214AC	1d	1a	Org
52B	MMHZ5252BPT	Z-diode	22.80..25.20V, Izt=5mA, Zzt=62Ω, 225mW	SOD-123	5d	1a	Chm
52B	SMC5352B	Z-diode	15.0V±5%, Izt=3.0(75.0mA), Izm=315.0mA, 5W	DO-214AB	1d	1a	Ers
52S	MMHZ5252SPT	Z-diode	23.52..24.48V, Izt=5mA, Zzt=62Ω, 225mW	SOD-123	5d	1a	Chm
53	CMZ53	Z-diode	53V±5%, 2W	M-Flat	7d	1a	Tos
53	HMSZ5253B	Z-diode	25V±5%, Izt=5mA, Zzt=35Ω, 225mW	SOD-323	5d	1d	Hsn
53	MMSZ3V3	Z-diode	3.1..3.5V, Zzt=95Ω, Izt=5mA, 200mW	SOD-523FL	7d	1a	F
53	TCBZX584C3V3	Z-diode	3.1..3.5V, Izt=5mA, Zzt=95Ω, 200mW	SOD-523FL	7d	1a	Tac
53	TCMMSZ3V3	Z-diode	3.1..3.5V, Izt=5mA, Zzt=95Ω, 200mW	SOD-523FL	7d	1a	Tac
53	ZD5253BS2	Z-diode	25V±5%, 5mA, Zzt=35Ω, 500mW	SOD-323	5d	1a	Cys
53	ZV953V2A	C-diode	Hyperabrupt varicap, 12V, 100mA, 45...37pF(0.5..1.5V)	SOD-523	6d	1a	Zx
530A	1.5SMC530A	TVS	Vrvwm=477.0V, Vbr=503.5..556.5V, 2.1A, 1500W(1ms)	DO-214AB	1d	1a	Fee
530C	1.5SMC530CA	TVS	Vrvwm=477.0V, Vbr=503.5..556.5V, 2.1A, 1500W(1ms), Bidirectional	DO-214AB	1ba	1j	Fee
5333A	SMBJ5333A	Z-diode	3.3V±10%, Izt=380mA, Zzt=3Ω, 5W	DO-214AA	1d	1a	Eic
5333B	SMBJ5333B	Z-diode	3.3V±5%, Izt=380mA, Zzt=3Ω, 5W	DO-214AA	1d	1a	Eic
5334A	SMBJ5334A	Z-diode	3.6V±10%, Izt=350mA, Zzt=2Ω, 5W	DO-214AA	1d	1a	Eic
5334B	SMBJ5334B	Z-diode	3.6V±5%, Izt=350mA, Zzt=2.5Ω, 5W	DO-214AA	1d	1a	Eic
5335A	SMBJ5335A	Z-diode	3.9V±10%, Izt=320mA, Zzt=2Ω, 5W	DO-214AA	1d	1a	Eic
5335B	SMBJ5335B	Z-diode	3.9V±5%, Izt=320mA, Zzt=2Ω, 5W	DO-214AA	1d	1a	Eic
5336A	SMBJ5336A	Z-diode	4.3V±10%, Izt=290mA, Zzt=2Ω, 5W	DO-214AA	1d	1a	Eic
5336B	SMBJ5336B	Z-diode	4.3V±5%, Izt=290mA, Zzt=2Ω, 5W	DO-214AA	1d	1a	Eic
5337A	SMBJ5337A	Z-diode	4.7V±10%, Izt=260mA, Zzt=2Ω, 5W	DO-214AA	1d	1a	Eic
5337B	SMBJ5337B	Z-diode	4.7V±5%, Izt=260mA, Zzt=2Ω, 5W	DO-214AA	1d	1a	Eic
5338A	SMBJ5338A	Z-diode	5.1V±10%, Izt=240mA, Zzt=1.5Ω, 5W	DO-214AA	1d	1a	Eic
5338B	SMBJ5338B	Z-diode	5.1V±5%, 240mA, Zzt=1.5Ω, 5W	DO-214AA	1d	1t	Exc
5338B	SMBJ5338B	Z-diode	5.1V±5%, Izt=240mA, Zzt=1Ω, 5W	DO-214AA	1d	1a	Eic
5339A	SMBJ5339A	Z-diode	5.6V±10%, Izt=220mA, Zzt=1Ω, 5W	DO-214AA	1d	1a	Eic
5339B	SMBJ5339B	Z-diode	5.6V±5%, 220mA, Zzt=1Ω, 5W	DO-214AA	1d	1t	Exc
5339B	SMBJ5339B	Z-diode	5.6V±5%, Izt=220mA, Zzt=1Ω, 5W	DO-214AA	1d	1a	Eic
5340A	SMBJ5340A	Z-diode	6.0V±10%, Izt=200mA, Zzt=1Ω, 5W	DO-214AA	1d	1a	Eic
5340B	SMBJ5340B	Z-diode	6.0V±5%, 200mA, Zzt=1Ω, 5W	DO-214AA	1d	1t	Exc
5340B	SMBJ5340B	Z-diode	6.0V±5%, Izt=200mA, Zzt=1Ω, 5W	DO-214AA	1d	1a	Eic
5341A	SMBJ5341A	Z-diode	6.2V±10%, Izt=200mA, Zzt=1Ω, 5W	DO-214AA	1d	1a	Eic
5341B	SMBJ5341B	Z-diode	6.2V±5%, 200mA, Zzt=1Ω, 5W	DO-214AA	1d	1t	Exc
5341B	SMBJ5341B	Z-diode	6.2V±5%, Izt=200mA, Zzt=1Ω, 5W	DO-214AA	1d	1a	Eic
5342A	SMBJ5342A	Z-diode	6.8V±10%, Izt=175mA, Zzt=1Ω, 5W	DO-214AA	1d	1a	Eic
5342B	SMBJ5342B	Z-diode	6.8V±5%, 175mA, Zzt=1Ω, 5W	DO-214AA	1d	1t	Exc
5342B	SMBJ5342B	Z-diode	6.8V±5%, Izt=175mA, Zzt=1Ω, 5W	DO-214AA	1d	1a	Eic
5343A	SMBJ5343A	Z-diode	7.5V±10%, Izt=175mA, Zzt=1.5Ω, 5W	DO-214AA	1d	1a	Eic
5343B	SMBJ5343B	Z-diode	7.5V±5%, 175mA, Zzt=1.5Ω, 5W	DO-214AA	1d	1t	Exc
5343B	SMBJ5343B	Z-diode	7.5V±5%, Izt=175mA, Zzt=1.5Ω, 5W	DO-214AA	1d	1a	Eic
5344A	SMBJ5344A	Z-diode	8.2V±10%, Izt=150mA, Zzt=1.5Ω, 5W	DO-214AA	1d	1a	Eic
5344B	SMBJ5344B	Z-diode	8.2V±5%, 150mA, Zzt=1.5Ω, 5W	DO-214AA	1d	1t	Exc
5344B	SMBJ5344B	Z-diode	8.2V±5%, Izt=150mA, Zzt=1.5Ω, 5W	DO-214AA	1d	1a	Eic
5345A	SMBJ5345A	Z-diode	8.7V±10%, Izt=150mA, Zzt=2Ω, 5W	DO-214AA	1d	1a	Eic



SMD code	Type	Function	Short description	Case	Pinout	St.	Mnf.
5345B	SMB5345B	Z-diode	8.7V±5%, 150mA, Zzt=2Ω, 5W	DO-214AA	1d	1t	Exc
5345B	SMBJ5345B	Z-diode	8.7V±5%, Izt=150mA, Zzt=2Ω, 5W	DO-214AA	1d	1a	Eic
5346A	SMBJ5346A	Z-diode	9.1V±10%, Izt=150mA, Zzt=2Ω, 5W	DO-214AA	1d	1a	Eic
5346B	SMB5346B	Z-diode	9.1V±5%, 150mA, Zzt=2Ω, 5W	DO-214AA	1d	1t	Exc
5346B	SMBJ5346B	Z-diode	9.1V±5%, Izt=150mA, Zzt=2Ω, 5W	DO-214AA	1d	1a	Eic
5347A	SMBJ5347A	Z-diode	10V±10%, Izt=125mA, Zzt=2Ω, 5W	DO-214AA	1d	1a	Eic
5347B	SMB5347B	Z-diode	10V±5%, 125mA, Zzt=2Ω, 5W	DO-214AA	1d	1t	Exc
5347B	SMBJ5347B	Z-diode	10V±5%, Izt=125mA, Zzt=2Ω, 5W	DO-214AA	1d	1a	Eic
5348A	SMBJ5348A	Z-diode	11V±10%, Izt=125mA, Zzt=2.5Ω, 5W	DO-214AA	1d	1a	Eic
5348B	SMB5348B	Z-diode	11V±5%, 125mA, Zzt=2.5Ω, 5W	DO-214AA	1d	1t	Exc
5348B	SMBJ5348B	Z-diode	11V±5%, Izt=125mA, Zzt=2.5Ω, 5W	DO-214AA	1d	1a	Eic
5349A	SMBJ5349A	Z-diode	12V±10%, Izt=100mA, Zzt=2.5Ω, 5W	DO-214AA	1d	1a	Eic
5349B	SMB5349B	Z-diode	12V±5%, 100mA, Zzt=2.5Ω, 5W	DO-214AA	1d	1t	Exc
5349B	SMBJ5349B	Z-diode	12V±5%, Izt=100mA, Zzt=2.5Ω, 5W	DO-214AA	1d	1a	Eic
5350A	SMBJ5350A	Z-diode	13V±10%, Izt=100mA, Zzt=2.5Ω, 5W	DO-214AA	1d	1a	Eic
5350B	SMB5350B	Z-diode	13V±5%, 100mA, Zzt=2.5Ω, 5W	DO-214AA	1d	1t	Exc
5350B	SMBJ5350B	Z-diode	13V±5%, Izt=100mA, Zzt=2.5Ω, 5W	DO-214AA	1d	1a	Eic
5351A	SMBJ5351A	Z-diode	14V±10%, Izt=100mA, Zzt=2.5Ω, 5W	DO-214AA	1d	1a	Eic
5351B	SMB5351B	Z-diode	14V±5%, 100mA, Zzt=2.5Ω, 5W	DO-214AA	1d	1t	Exc
5351B	SMBJ5351B	Z-diode	14V±5%, Izt=100mA, Zzt=2.5Ω, 5W	DO-214AA	1d	1a	Eic
5352A	SMBJ5352A	Z-diode	15V±10%, Izt=75mA, Zzt=2.5Ω, 5W	DO-214AA	1d	1a	Eic
5352B	SMB5352B	Z-diode	15V±5%, 75mA, Zzt=2.5Ω, 5W	DO-214AA	1d	1t	Exc
5352B	SMBJ5352B	Z-diode	15V±5%, Izt=75mA, Zzt=2.5Ω, 5W	DO-214AA	1d	1a	Eic
5353A	SMBJ5353A	Z-diode	16V±10%, Izt=75mA, Zzt=2.5Ω, 5W	DO-214AA	1d	1a	Eic
5353B	SMB5353B	Z-diode	16V±5%, 75mA, Zzt=2.5Ω, 5W	DO-214AA	1d	1t	Exc
5353B	SMBJ5353B	Z-diode	16V±5%, Izt=75mA, Zzt=2.5Ω, 5W	DO-214AA	1d	1a	Eic
5354A	SMBJ5354A	Z-diode	17V±10%, Izt=70mA, Zzt=2.5Ω, 5W	DO-214AA	1d	1a	Eic
5354B	SMB5354B	Z-diode	17V±5%, 70mA, Zzt=2.5Ω, 5W	DO-214AA	1d	1t	Exc
5354B	SMBJ5354B	Z-diode	17V±5%, Izt=70mA, Zzt=2.5Ω, 5W	DO-214AA	1d	1a	Eic
5355A	SMBJ5355A	Z-diode	18V±10%, Izt=65mA, Zzt=2.5Ω, 5W	DO-214AA	1d	1a	Eic
5355B	SMB5355B	Z-diode	18V±5%, 65mA, Zzt=2.5Ω, 5W	DO-214AA	1d	1t	Exc
5355B	SMBJ5355B	Z-diode	18V±5%, Izt=65mA, Zzt=2.5Ω, 5W	DO-214AA	1d	1a	Eic
5356A	SMBJ5356A	Z-diode	19V±10%, Izt=65mA, Zzt=3Ω, 5W	DO-214AA	1d	1a	Eic
5356B	SMB5356B	Z-diode	19V±5%, 65mA, Zzt=3Ω, 5W	DO-214AA	1d	1t	Exc
5356B	SMBJ5356B	Z-diode	19V±5%, Izt=65mA, Zzt=3Ω, 5W	DO-214AA	1d	1a	Eic
5357A	SMBJ5357A	Z-diode	20V±10%, Izt=65mA, Zzt=3Ω, 5W	DO-214AA	1d	1a	Eic
5357B	SMB5357B	Z-diode	20V±5%, 65mA, Zzt=3Ω, 5W	DO-214AA	1d	1t	Exc
5357B	SMBJ5357B	Z-diode	20V±5%, Izt=65mA, Zzt=3Ω, 5W	DO-214AA	1d	1a	Eic
5358A	SMBJ5358A	Z-diode	22V±10%, Izt=50mA, Zzt=3.5Ω, 5W	DO-214AA	1d	1a	Eic
5358B	SMB5358B	Z-diode	22V±5%, 50mA, Zzt=3.5Ω, 5W	DO-214AA	1d	1t	Exc
5358B	SMBJ5358B	Z-diode	22V±5%, Izt=50mA, Zzt=3.5Ω, 5W	DO-214AA	1d	1a	Eic
5359A	SMBJ5359A	Z-diode	24V±10%, Izt=50mA, Zzt=3.5Ω, 5W	DO-214AA	1d	1a	Eic
5359B	SMB5359B	Z-diode	24V±5%, 50mA, Zzt=3.5Ω, 5W	DO-214AA	1d	1t	Exc
5359B	SMBJ5359B	Z-diode	24V±5%, Izt=50mA, Zzt=3.5Ω, 5W	DO-214AA	1d	1a	Eic
5360A	SMBJ5360A	Z-diode	25V±10%, Izt=50mA, Zzt=4Ω, 5W	DO-214AA	1d	1a	Eic
5360B	SMB5360B	Z-diode	25V±5%, 50mA, Zzt=4Ω, 5W	DO-214AA	1d	1t	Exc
5360B	SMBJ5360B	Z-diode	25V±5%, Izt=50mA, Zzt=4Ω, 5W	DO-214AA	1d	1a	Eic
5361A	SMBJ5361A	Z-diode	27V±10%, Izt=50mA, Zzt=5Ω, 5W	DO-214AA	1d	1a	Eic
5361B	SMB5361B	Z-diode	27V±5%, 50mA, Zzt=5Ω, 5W	DO-214AA	1d	1t	Exc
5361B	SMBJ5361B	Z-diode	27V±5%, Izt=50mA, Zzt=5Ω, 5W	DO-214AA	1d	1a	Eic
5362A	SMBJ5362A	Z-diode	28V±10%, Izt=50mA, Zzt=6Ω, 5W	DO-214AA	1d	1a	Eic
5362B	SMB5362B	Z-diode	28V±5%, 50mA, Zzt=6Ω, 5W	DO-214AA	1d	1t	Exc
5362B	SMBJ5362B	Z-diode	28V±5%, Izt=50mA, Zzt=6Ω, 5W	DO-214AA	1d	1a	Eic
5363A	SMBJ5363A	Z-diode	30V±10%, Izt=40mA, Zzt=8Ω, 5W	DO-214AA	1d	1a	Eic
5363B	SMB5363B	Z-diode	30V±5%, 40mA, Zzt=8Ω, 5W	DO-214AA	1d	1t	Exc
5363B	SMBJ5363B	Z-diode	30V±5%, Izt=40mA, Zzt=8Ω, 5W	DO-214AA	1d	1a	Eic
5364A	SMBJ5364A	Z-diode	33V±10%, Izt=40mA, Zzt=10Ω, 5W	DO-214AA	1d	1a	Eic
5364B	SMB5364B	Z-diode	33V±5%, 40mA, Zzt=10Ω, 5W	DO-214AA	1d	1t	Exc
5364B	SMBJ5364B	Z-diode	33V±5%, Izt=40mA, Zzt=10Ω, 5W	DO-214AA	1d	1a	Eic
5365A	SMBJ5365A	Z-diode	36V±10%, Izt=30mA, Zzt=11Ω, 5W	DO-214AA	1d	1a	Eic
5365B	SMB5365B	Z-diode	36V±5%, 30mA, Zzt=11Ω, 5W	DO-214AA	1d	1t	Exc
5365B	SMBJ5365B	Z-diode	36V±5%, Izt=30mA, Zzt=11Ω, 5W	DO-214AA	1d	1a	Eic
5366A	SMBJ5366A	Z-diode	39V±10%, Izt=30mA, Zzt=14Ω, 5W	DO-214AA	1d	1a	Eic
5366B	SMB5366B	Z-diode	39V±5%, 30mA, Zzt=14Ω, 5W	DO-214AA	1d	1t	Exc
5366B	SMBJ5366B	Z-diode	39V±5%, Izt=30mA, Zzt=14Ω, 5W	DO-214AA	1d	1a	Eic
5367A	SMBJ5367A	Z-diode	43V±10%, Izt=30mA, Zzt=20Ω, 5W	DO-214AA	1d	1a	Eic
5367B	SMB5367B	Z-diode	43V±5%, 30mA, Zzt=20Ω, 5W	DO-214AA	1d	1t	Exc
5367B	SMBJ5367B	Z-diode	43V±5%, Izt=30mA, Zzt=20Ω, 5W	DO-214AA	1d	1a	Eic
5368A	SMBJ5368A	Z-diode	47V±10%, Izt=25mA, Zzt=25Ω, 5W	DO-214AA	1d	1a	Eic
5368B	SMB5368B	Z-diode	47V±5%, 25mA, Zzt=25Ω, 5W	DO-214AA	1d	1t	Exc



SMD code	Type	Function	Short description	Case	Pinout	St.	Mnf.
5368B	SMBJ5368B	Z-diode	47V±5%, Izt=25mA, Zzt=25Ω, 5W	DO-214AA	1d	1a	Eic
5369A	SMBJ5369A	Z-diode	51V±10%, Izt=25mA, Zzt=27Ω, 5W	DO-214AA	1d	1a	Eic
5369B	SMBJ5369B	Z-diode	51V±5%, Izt=25mA, Zzt=27Ω, 5W	DO-214AA	1d	1t	Exc
5369B	SMBJ5369B	Z-diode	51V±5%, Izt=25mA, Zzt=27Ω, 5W	DO-214AA	1d	1a	Eic
5370A	SMBJ5370A	Z-diode	56V±10%, Izt=20mA, Zzt=35Ω, 5W	DO-214AA	1d	1a	Eic
5370B	SMBJ5370B	Z-diode	56V±5%, Izt=20mA, Zzt=35Ω, 5W	DO-214AA	1d	1a	Eic
5371A	SMBJ5371A	Z-diode	60V±10%, Izt=20mA, Zzt=40Ω, 5W	DO-214AA	1d	1a	Eic
5371B	SMBJ5371B	Z-diode	60V±5%, Izt=20mA, Zzt=40Ω, 5W	DO-214AA	1d	1a	Eic
5372A	SMBJ5372A	Z-diode	62V±10%, Izt=20mA, Zzt=42Ω, 5W	DO-214AA	1d	1a	Eic
5372B	SMBJ5372B	Z-diode	62V±5%, Izt=20mA, Zzt=42Ω, 5W	DO-214AA	1d	1a	Eic
5373A	SMBJ5373A	Z-diode	68V±10%, Izt=20mA, Zzt=44Ω, 5W	DO-214AA	1d	1a	Eic
5373B	SMBJ5373B	Z-diode	68V±5%, Izt=20mA, Zzt=44Ω, 5W	DO-214AA	1d	1a	Eic
5374A	SMBJ5374A	Z-diode	75V±10%, Izt=20mA, Zzt=45Ω, 5W	DO-214AA	1d	1a	Eic
5374B	SMBJ5374B	Z-diode	75V±5%, Izt=20mA, Zzt=45Ω, 5W	DO-214AA	1d	1a	Eic
5375A	SMBJ5375A	Z-diode	82V±10%, Izt=15mA, Zzt=65Ω, 5W	DO-214AA	1d	1a	Eic
5375B	SMBJ5375B	Z-diode	82V±5%, Izt=15mA, Zzt=65Ω, 5W	DO-214AA	1d	1a	Eic
5376A	SMBJ5376A	Z-diode	87V±10%, Izt=15mA, Zzt=75Ω, 5W	DO-214AA	1d	1a	Eic
5376B	SMBJ5376B	Z-diode	87V±5%, Izt=15mA, Zzt=75Ω, 5W	DO-214AA	1d	1a	Eic
5377A	SMBJ5377A	Z-diode	91V±10%, Izt=15mA, Zzt=75Ω, 5W	DO-214AA	1d	1a	Eic
5377B	SMBJ5377B	Z-diode	91V±5%, Izt=15mA, Zzt=75Ω, 5W	DO-214AA	1d	1a	Eic
5378A	SMBJ5378A	Z-diode	100V±10%, Izt=12mA, Zzt=90Ω, 5W	DO-214AA	1d	1a	Eic
5378B	SMBJ5378B	Z-diode	100V±5%, Izt=12mA, Zzt=90Ω, 5W	DO-214AA	1d	1a	Eic
5379A	SMBJ5379A	Z-diode	110V±10%, Izt=12mA, Zzt=125Ω, 5W	DO-214AA	1d	1a	Eic
5379B	SMBJ5379B	Z-diode	110V±5%, Izt=12mA, Zzt=125Ω, 5W	DO-214AA	1d	1a	Eic
5380A	SMBJ5380A	Z-diode	120V±10%, Izt=10mA, Zzt=170Ω, 5W	DO-214AA	1d	1a	Eic
5380B	SMBJ5380B	Z-diode	120V±5%, Izt=10mA, Zzt=170Ω, 5W	DO-214AA	1d	1a	Eic
5381A	SMBJ5381A	Z-diode	130V±10%, Izt=10mA, Zzt=190Ω, 5W	DO-214AA	1d	1a	Eic
5381B	SMBJ5381B	Z-diode	130V±5%, Izt=10mA, Zzt=190Ω, 5W	DO-214AA	1d	1a	Eic
5382A	SMBJ5382A	Z-diode	140V±10%, Izt=8mA, Zzt=230Ω, 5W	DO-214AA	1d	1a	Eic
5382B	SMBJ5382B	Z-diode	140V±5%, Izt=8mA, Zzt=230Ω, 5W	DO-214AA	1d	1a	Eic
5383A	SMBJ5383A	Z-diode	150V±10%, Izt=8mA, Zzt=330Ω, 5W	DO-214AA	1d	1a	Eic
5383B	SMBJ5383B	Z-diode	150V±5%, Izt=8mA, Zzt=330Ω, 5W	DO-214AA	1d	1a	Eic
5384A	SMBJ5384A	Z-diode	160V±10%, Izt=8mA, Zzt=350Ω, 5W	DO-214AA	1d	1a	Eic
5384B	SMBJ5384B	Z-diode	160V±5%, Izt=8mA, Zzt=350Ω, 5W	DO-214AA	1d	1a	Eic
5385A	SMBJ5385A	Z-diode	170V±10%, Izt=8mA, Zzt=380Ω, 5W	DO-214AA	1d	1a	Eic
5385B	SMBJ5385B	Z-diode	170V±5%, Izt=8mA, Zzt=380Ω, 5W	DO-214AA	1d	1a	Eic
5386A	SMBJ5386A	Z-diode	180V±10%, Izt=5mA, Zzt=430Ω, 5W	DO-214AA	1d	1a	Eic
5386B	SMBJ5386B	Z-diode	180V±5%, Izt=5mA, Zzt=430Ω, 5W	DO-214AA	1d	1a	Eic
5387A	SMBJ5387A	Z-diode	190V±10%, Izt=5mA, Zzt=450Ω, 5W	DO-214AA	1d	1a	Eic
5387B	SMBJ5387B	Z-diode	190V±5%, Izt=5mA, Zzt=450Ω, 5W	DO-214AA	1d	1a	Eic
5388A	SMBJ5388A	Z-diode	200V±10%, Izt=5mA, Zzt=480Ω, 5W	DO-214AA	1d	1a	Eic
5388B	SMBJ5388B	Z-diode	200V±5%, Izt=5mA, Zzt=480Ω, 5W	DO-214AA	1d	1a	Eic
53B	MMHZ5253BPT	Z-diode	23.75..26.25V, Izt=5mA, Zzt=62Ω, 225mW	SOD-123	5d	1a	Chm
53B	SMC5353B	Z-diode	16.0V±5%, Zzt=3.0(75.0mA), Izm=295.0mA, 5W	DO-214AB	1d	1a	Ers
53C	U5ZA53C	Z-diode	47.7..58.3V, Zzt=65Ω, 5W	DO-218	8d	1a	Tos
53L	SSC53L	Si-diode	SBR, 30V, 5A, Vf<0.49V(5A)	DO-214AB	1d	1k	Vs
53S	MMHZ5253SPT	Z-diode	24.50..25.50V, Izt=5mA, Zzt=62Ω, 225mW	SOD-123	5d	1a	Chm
54	HMSZ5254B	Z-diode	27V±5%, Izt=4.6mA, Zzt=41Ω, 225mW	SOD-323	5d	1d	Hsn
54	MM5Z3V6	Z-diode	3.4..3.8V, Zzt=90Ω, Izt=5mA, 200mW	SOD-523FL	7d	1a	F
54	TCBZ584C3V6	Z-diode	3.4..3.8V, Izt=5mA, Zzt=90Ω, 200mW	SOD-523FL	7d	1a	Tac
54	TCMM5Z3V6	Z-diode	3.4..3.8V, Izt=5mA, Zzt=90Ω, 200mW	SOD-523FL	7d	1a	Tac
54	ZD5254BS2	Z-diode	27V±5%, 4.6mA, Zzt=41Ω, 500mW	SOD-323	5d	1a	Cys
540	F1C540	TVS	Vbr=32V, 9A, 500W(1ms)	DO-214AC	1d	1a	Org
540A	1.5SMC540A	TVS	Vbr=513..567V, Vrwm=459V, 2.03A, 1500W(1ms)	DO-214AB	1d	1k	Vs
540A	P4SMA540A	TVS	Vbr=513..567V, 0.41A, 400W(1ms)	DO-214AC	1d	1k	Vs
540A	P6SMA540A	TVS	Vbr=513..567V, Vrwm=459V, 0.81A, 600W(1ms)	DO-214AC	1d	1a	Eic
540A	P6SMB540A	TVS	Vrwm=540V, Vbr=513..567, 0.81A, 600W(1ms)	DO-214AA	1d	1k	Vs
540C	1.5SMC540CA	TVS	Vrwm=459.0V, Vbr=513.0..567.0V, 2.0A, 1500W(1ms), Bidirectional	DO-214AB	1ba	1j	Fee
540CA	P6SMA540CA	TVS	Vbr=513..567V, Vrwm=459V, 0.81A, 600W(1ms), Bidirectional	DO-214AC	1ba	1j	Eic
54A	1SMC54A	TVS	Vbr=60.0..66.3V, Vrwm=54V, 17.2A, 1500W(1ms)	DO-214AB	1d	1a	Eic
54A	SMAJ54A	TVS	Vrwm=54V, Vbr=60.0..66.3V, 4.6A, 400W(1ms)	DO-214AC	1d	1a	Sus
54A	SMBJ54A	TVS	Vbr=60.0..66.3V, Vrwm=54V, 6.9A, 600W(1ms)	DO-214AA	1d	1a	Sus
54A	SMCJ54A	TVS	Vrwm=54V, Vbr=60..69V, 15.6A, 1500W(1ms)	DO-214AB	1d	1k	Sus
54A	UMA54A	TVS	Vrwm=54V, Vbr=60.0..87.1V, 5.7A, 500W(1ms)	UltraMite	14d	1v	Msc
54B	MMHZ5254BPT	Z-diode	25.65..28.35V, Izt=5mA, Zzt=70Ω, 225mW	SOD-123	5d	1a	Chm
54B	SMC5354B	Z-diode	17.0V±5%, Zzt=3.0(70.0mA), Izm=280.0mA, 5W	DO-214AB	1d	1a	Ers
54CA	1SMC54CA	TVS	Vbr=60.0..66.3V, Vrwm=54V, 17.2A, 1500W(1ms), Bidirectional	DO-214AB	1ba	1j	Eic
54CA	SMAJ54CA	TVS	Vrwm=54V, Vbr=60.0..66.3V, 4.6A, 400W(1ms), Bidirectional	DO-214AC	1ba	1j	Sus
54CA	SMBJ54CA	TVS	Vbr=60.0..66.3V, Vrwm=54V, 6.9A, 600W(1ms), Bidirectional	DO-214AA	1ba	1j	Sus
54CA	SMCJ54CA	TVS	Vrwm=54V, Vbr=60..69V, 15.6A, 1500W(1ms), Bidirectional	DO-214AB	1ba	1l	Sus



SMD code	Type	Function	Short description	Case	Pinout	St.	Mnf.
54CA	UMA54CA	TVS	Vrwm=54V, Vbr=60.0..87.1V, 5.7A, 500W(1ms), Bidirectional	UltraMite	14ba	1v	Msc
54S	MMHZ5254SPT	Z-diode	26.46..27.54V, Izt=5mA, Zzt=70Ω, 225mW	SOD-123	5d	1a	Chm
54V	SMA54	TVS	Vbr=60..73.3V, Vrwm=54.0V, 3.1A, 300W(1ms)	DO-214AC	1d	1a	Mic
54V	SMB54	TVS	Vbr=60..73.3V, Vrwm=54V, 6.2A, 600W(1ms)	DO-214AA	1d	1a	Mic
54V	SMC54	TVS	Vbr=60..73.3V, Vrwm=54V, 15.6A, 1500W(1ms),	DO-214AB	1d	1a	Mic
54VA	SMA54A	TVS	Vbr=60..66.3V, Vrwm=54.0V, 3.4A, 300W(1ms)	DO-214AC	1d	1a	Mic
54VA	SMB54A	TVS	Vbr=60..66.3V, Vrwm=54V, 6.9A, 600W(1ms)	DO-214AA	1d	1a	Mic
54VA	SMC54A	TVS	Vbr=60..66.3V, Vrwm=54V, 17.2A, 1500W(1ms),	DO-214AB	1d	1a	Mic
54VC	SMA54C	TVS	Vbr=60..73.3V, Vrwm=54.0V, 3.1A, 300W(1ms), Bidirectional	DO-214AC	1ba	1j	Mic
54VC	SMB54C	TVS	Vbr=60..73.3V, Vrwm=54V, 6.2A, 600W(1ms), Bidirectional	DO-214AA	1ba	1j	Mic
54VC	SMC54C	TVS	Vbr=60..73.3V, Vrwm=54V, 15.6A, 1500W(1ms), Bidirectional	DO-214AB	1ba	1j	Mic
54VCA	SMA54CA	TVS	Vbr=60..66.3V, Vrwm=54.0V, 3.4A, 300W(1ms), Bidirectional	DO-214AC	1ba	1j	Mic
54VCA	SMB54CA	TVS	Vbr=60..66.3V, Vrwm=54V, 6.9A, 600W(1ms), Bidirectional	DO-214AA	1ba	1j	Mic
54VCA	SMC54CA	TVS	Vbr=60..66.3V, Vrwm=54V, 17.2A, 1500W(1ms), Bidirectional	DO-214AB	1ba	1j	Mic
55	BBY57-02L	C-diode	VCO-Tuning, 10V, 20mA, 16.5..18.6pF(4..1V)	TSLP-2-1	13d	2b	Inf
55	BBY57-02W	C-diode	VCO-Tuning, 10V, 20mA, 16.5..18.6pF(4..1V)	SCD-80	6d	1u	Inf
55	EDZ16B	Z-diode	15.85..16.51V, Izt=5mA, Zzt=50Ω, 150mW	SOD-523	6d	1a	Rhm
55	FDZ16EV	Z-diode	15.850..16.510V, Izt=5mA, Zzt=50Ω, 150mW	SOD-523	7d	1a	Fis
55	FDZ16VT	Z-diode	15.850..16.510V, Izt=5mA, Zzt=50Ω, 200mW	SOD-323	5d	1a	Fis
55	HMSZ5255B	Z-diode	28V±5%, Izt=4.5mA, Zzt=44Ω, 225mW	SOD-323	5d	1d	Hsn
55	MMSZ3V9	Z-diode	3.7..4.1V, Zzt=90Ω, Izt=5mA, 200mW	SOD-523FL	7d	1a	F
55	TCBZ584C3V9	Z-diode	3.7..4.1V, Izt=5mA, Zzt=90Ω, 200mW	SOD-523FL	7d	1a	Tac
55	TCMM5Z3V9	Z-diode	3.7..4.1V, Izt=5mA, Zzt=90Ω, 200mW	SOD-523FL	7d	1a	Tac
55	TDZ16B	Z-diode	16V±2.5%, 10mA, 500mW	TUMD2	7d	1s	Rhm
55	UDZS16B	Z-diode	15.85..16.51V, Izt=5mA, Zzt=50Ω, 200mW	SOD-323	5d	1a	Wtr
55	UDZS16B	Z-diode	16V±2.5%, Izt=5mA, 200mW	SOD-323FL	7d	1s	Rhm
55	VDZS16B	Z-diode	16V±5%, 5mA, 100mW	VMD2	5d	1z	Rhm
55	ZD5255BS2	Z-diode	28V±5%, 4.5mA, Zzt=44Ω, 500mW	SOD-323	5d	1a	Cys
550	F1C550	TVS	Vbr=40V, 7A, 500W(1ms)	DO-214AC	1d	1a	Org
550A	1.5SMC550A	TVS	Vrwm=495.0V, Vbr=522.5..577.5V, 2.0A, 1500W(1ms)	DO-214AB	1d	1a	Fee
550C	1.5SMC550CA	TVS	Vrwm=495.0V, Vbr=522.5..577.5V, 2.0A, 1500W(1ms), Bidirectional	DO-214AB	1ba	1j	Fee
5510	SZ5510	Z-diode	10V±5%, Izt=75, Zzt=3.5Ω, 3W	DO-214AC	1d	1a	Eic
5511	SZ5511	Z-diode	11V±5%, Izt=68mA, Zzt=4Ω, 3W	DO-214AC	1d	1a	Eic
5512	SZ5512	Z-diode	12V±5%, Izt=63mA, Zzt=4.5Ω, 3W	DO-214AC	1d	1a	Eic
5513	SZ5513	Z-diode	13V±5%, Izt=58mA, Zzt=4.5Ω, 3W	DO-214AC	1d	1a	Eic
5514	SZ5514	Z-diode	14V±5%, Izt=53mA, Zzt=5Ω, 3W	DO-214AC	1d	1a	Eic
5515	SZ5515	Z-diode	15V±5%, Izt=50mA, Zzt=5.5Ω, 3W	DO-214AC	1d	1a	Eic
5516	SZ5516	Z-diode	16V±5%, Izt=47mA, Zzt=5.5Ω, 3W	DO-214AC	1d	1a	Eic
5517	SZ5517	Z-diode	17V±5%, Izt=44mA, Zzt=6Ω, 3W	DO-214AC	1d	1a	Eic
5518	SZ5518	Z-diode	18V±5%, Izt=42mA, Zzt=6Ω, 3W	DO-214AC	1d	1a	Eic
5519	SZ5519	Z-diode	19V±5%, Izt=40mA, Zzt=7Ω, 3W	DO-214AC	1d	1a	Eic
5520	SZ5520	Z-diode	20V±5%, Izt=37mA, Zzt=7Ω, 3W	DO-214AC	1d	1a	Eic
5522	SZ5522	Z-diode	22V±5%, Izt=34mA, Zzt=8Ω, 3W	DO-214AC	1d	1a	Eic
5524	SZ5524	Z-diode	24V±5%, Izt=31mA, Zzt=9Ω, 3W	DO-214AC	1d	1a	Eic
5527	SZ5527	Z-diode	27V±5%, Izt=28mA, Zzt=10Ω, 3W	DO-214AC	1d	1a	Eic
5528	SZ5528	Z-diode	28V±5%, Izt=27mA, Zzt=12Ω, 3W	DO-214AC	1d	1a	Eic
5530	SZ5530	Z-diode	30V±5%, Izt=25mA, Zzt=16Ω, 3W	DO-214AC	1d	1a	Eic
5533	SZ5533	Z-diode	33V±5%, Izt=23mA, Zzt=20Ω, 3W	DO-214AC	1d	1a	Eic
5536	SZ5536	Z-diode	36V±5%, Izt=21mA, Zzt=22Ω, 3W	DO-214AC	1d	1a	Eic
5539	SZ5539	Z-diode	39V±5%, Izt=19mA, Zzt=28Ω, 3W	DO-214AC	1d	1a	Eic
553J	SZ553J	Z-diode	3.9V±5%, Izt=192mA, Zzt=4.5Ω, 3W	DO-214AC	1d	1a	Eic
5543	SZ5543	Z-diode	43V±5%, Izt=17mA, Zzt=33Ω, 3W	DO-214AC	1d	1a	Eic
5547	SZ5547	Z-diode	47V±5%, Izt=16mA, Zzt=38Ω, 3W	DO-214AC	1d	1a	Eic
554D	SZ554D	Z-diode	4.3V±5%, Izt=174mA, Zzt=4.5Ω, 3W	DO-214AC	1d	1a	Eic
554H	SZ554H	Z-diode	4.7V±5%, Izt=160mA, Zzt=4Ω, 3W	DO-214AC	1d	1a	Eic
5551	SZ5551	Z-diode	51V±5%, Izt=15mA, Zzt=45Ω, 3W	DO-214AC	1d	1a	Eic
5556	SZ5556	Z-diode	56V±5%, Izt=13mA, Zzt=50Ω, 3W	DO-214AC	1d	1a	Eic
555B	SZ555B	Z-diode	5.1V±5%, Izt=147mA, Zzt=3.5Ω, 3W	DO-214AC	1d	1a	Eic
555G	SZ555G	Z-diode	5.6V±5%, Izt=134mA, Zzt=2.5Ω, 3W	DO-214AC	1d	1a	Eic
5562	SZ5562	Z-diode	62V±5%, Izt=12mA, Zzt=55Ω, 3W	DO-214AC	1d	1a	Eic
5568	SZ5568	Z-diode	68V±5%, Izt=11mA, Zzt=70Ω, 3W	DO-214AC	1d	1a	Eic
556C	SZ556C	Z-diode	6.2V±5%, Izt=121mA, Zzt=1.5Ω, 3W	DO-214AC	1d	1a	Eic
556I	SZ556I	Z-diode	6.8V±5%, Izt=110mA, Zzt=2Ω, 3W	DO-214AC	1d	1a	Eic
5575	SZ5575	Z-diode	75V±5%, Izt=10mA, Zzt=85Ω, 3W	DO-214AC	1d	1a	Eic
557F	SZ557F	Z-diode	7.5V±5%, Izt=100mA, Zzt=2Ω, 3W	DO-214AC	1d	1a	Eic
5582	SZ5582	Z-diode	82V±5%, Izt=9.1mA, Zzt=95Ω, 3W	DO-214AC	1d	1a	Eic
558C	SZ558C	Z-diode	8.2V±5%, Izt=91mA, Zzt=2.3Ω, 3W	DO-214AC	1d	1a	Eic
5591	SZ5591	Z-diode	91V±5%, Izt=8.2mA, Zzt=115Ω, 3W	DO-214AC	1d	1a	Eic
559B	SZ559B	Z-diode	9.1V±5%, Izt=82mA, Zzt=2.5Ω, 3W	DO-214AC	1d	1a	Eic
55B	MMHZ5255BPT	Z-diode	26.60..29.40V, Izt=5mA, Zzt=44Ω, 225mW	SOD-123	5d	1a	Chm



SMD
code

Type

Function

Short description

Case

Pinout

St.

Mnf.

55B	SMC5355B	Z-diode	18.0V±5%, Zzt=3.0(65.0mA), Izm=265.0mA, 5W	DO-214AB	1d	1a	Ers
55B0	SZ55B0	Z-diode	100V±5%, Izt=7.5mA, Zzt=160Ω, 3W	DO-214AC	1d	1a	Eic
55B1	SZ55B1	Z-diode	110V±5%, Izt=6.8mA, Zzt=225Ω, 3W	DO-214AC	1d	1a	Eic
55B2	SZ55B2	Z-diode	120V±5%, Izt=6.3mA, Zzt=300Ω, 3W	DO-214AC	1d	1a	Eic
55B3	SZ55B3	Z-diode	130V±5%, Izt=5.8mA, Zzt=375Ω, 3W	DO-214AC	1d	1a	Eic
55B4	SZ55B4	Z-diode	140V±5%, Izt=5.3mA, Zzt=475Ω, 3W	DO-214AC	1d	1a	Eic
55B5	SZ55B5	Z-diode	150V±5%, Izt=5mA, Zzt=550Ω, 3W	DO-214AC	1d	1a	Eic
55B6	SZ55B6	Z-diode	160V±5%, Izt=4.7mA, Zzt=625Ω, 3W	DO-214AC	1d	1a	Eic
55B7	SZ55B7	Z-diode	170V±5%, Izt=4.4mA, Zzt=650Ω, 3W	DO-214AC	1d	1a	Eic
55B8	SZ55B8	Z-diode	180V±5%, Izt=4.2mA, Zzt=700Ω, 3W	DO-214AC	1d	1a	Eic
55B9	SZ55B9	Z-diode	190V±5%, Izt=4mA, Zzt=800Ω, 3W	DO-214AC	1d	1a	Eic
55D0	SZ55D0	Z-diode	200V±5%, Izt=3.7mA, Zzt=875Ω, 3W	DO-214AC	1d	1a	Eic
55S	MMHZ5255SPT	Z-diode	27.44..28.56V, Izt=5mA, Zzt=44Ω, 225mW	SOD-123	5d	1a	Chm
56	CDZ55C56	Z-diode	53.20..58.80V, Zzt=135Ω, Izt=2.25mA, 500mW	1206	70d	2d	Crp
56	CDZ55C56S	Z-diode	53.20..58.80V, Zzt=135Ω, Izt=2.25mA, 500mW	0805	70d	2d	Crp
56	CDZ55C56T	Z-diode	53.20..58.80V, Zzt=135Ω, Izt=2.25mA, 200mW	0603	70d	2d	Crp
56	HMSZ5256B	Z-diode	30V±5%, Izt=4.2mA, Zzt=49Ω, 225mW	SOD-323	5d	1d	Hsn
56	HZC5.6	Z-diode	5.6V±10%, 150mW	SOD-523	6d	1a	Ren
56	HZU5.6G	Z-diode	5.31..5.92V, 200mW	SOD-323	5d	1a	Ren
56	KDZ5.6EV	Z-diode	5.3..6V, 150mW	SOD-523	6d	1a	Kec
56	KDZ5.6V	Z-diode	5.3..6V, 150mW	SOD-323	5d	1a	Kec
56	MMSZ4V3	Z-diode	4.0..4.6V, Zzt=90Ω, Izt=5mA, 200mW	SOD-523FL	7d	1a	F
56	MMPZ5263SPT	Z-diode	54.88..57.12V, Izt=2.2mA, Zzt=150Ω, 225mW	SOD-323	5d	1a	Chm
56	P4SMA56	TVS	Vbr=50.4..61.6V, Vrw=45.4V, 5.2A, 400W(1ms)	DO-214AC	1d	1a	Eic
56	P6SMBJ56	TVS	Vbr=50.4..61.6V, 7.4A, 600W(1ms)	DO-214AA	1d	1n	Lif
56	SML4758	Z-diode	56V±5%, Izt=4.5mA, Zzt=110Ω, 1W	DO-214AC	1d	1k	Vs
56	TCBZX584C4V3	Z-diode	4.0..4.6V, Izt=5mA, Zzt=90Ω, 200mW	SOD-523FL	7d	1a	Tac
56	TCMMSZ4V3	Z-diode	4.0..4.6V, Izt=5mA, Zzt=90Ω, 200mW	SOD-523FL	7d	1a	Tac
56	TZD5.6WS	Z-diode	5.30..6.0V, Izt=5mA, Zzt=40Ω, 200mW	SOD-323	5d	1a	Ttr
56	TZD5.6WT	Z-diode	5.30..6.0V, Izt=5mA, Zzt=40Ω, 150mW	SOD-523	6d	1a	Ttr
56	USFZ5.6V	Z-diode	5.6V, 200mW	USF	8d	1c	Kec
56	ZD5256BS2	Z-diode	30V±5%, 4.2mA, Zzt=49Ω, 500mW	SOD-323	5d	1a	Cys
5-6	MAZ80560M	Z-diode	5.48..5.76V, Zzt=40Ω(5mA), 150mW	SC-76	6d	1a	Pan
5-6	MAZ8056GML	Z-diode	5.48..5.76V, Zzt=40Ω(5mA), 150mW	SMini2-F3	6d	1a	Pan
56*	TZD5.6YWS	Z-diode	5.49..5.73V, Izt=5mA, Zzt=40Ω, 200mW	SOD-323	5d	1a	Ttr
56*	TZD5.6YWT	Z-diode	5.49..5.73V, Izt=5mA, Zzt=40Ω, 150mW	SOD-523	6d	1a	Ttr
560	F1C560	TVS	Vbr=48V, 6A, 500W(1ms)	DO-214AC	1d	1a	Org
56A	1.5SMC56A	TVS	Vbr=53.2..58.8V, Vrw=47.8V, 19.5A, 1500W(1ms)	DO-214AB	1d,3d	1a,1k	Vs,Ons
56A	P4SMA56A	TVS	Vbr=53.2..58.8V, Vrw=47.8V, 5.5A, 400W(1ms)	DO-214AC	1d	1k	Vs
56A	P6SMB56A	TVS	Vrw=56V, Vbr=53.2..58.8V, 7.8A, 600W(1ms)	DO-214AA	1d,3d	1k,1a	Vs,Ons
56A	P6SMBJ56A	TVS	Vbr=53.2..58.8V, 7.8A, 600W(1ms)	DO-214AA	1d	1n	Lif
56B	1SMB3EZ56	Z-diode	56V±5%, Zzt=55Ω, Izt=13.0mA, 3W	DO-214AA	1d	1n	Pjt
56B	MMHZ5256BPT	Z-diode	28.50..31.50V, Izt=5mA, Zzt=78Ω, 225mW	SOD-123	5d	1a	Chm
56B	SMC5356B	Z-diode	19.0V±5%, Zzt=3.0(65.0mA), Izm=250.0mA, 5W	DO-214AB	1d	1a	Ers
56C	1.5SMC56CA	TVS	Vbr=53.2..58.8V, Vrw=47.8V, 19.5A, 1500W(1ms), Bidirectional	DO-214AB	1ba	1l	Vs
56C	P4SMA56C	TVS	Vbr=50.4..61.6V, Vrw=45.4V, 5.2A, 400W(1ms), Bidirectional	DO-214AC	1ba	1j	Eic
56C	P4SMA56CA	TVS	Vbr=53.2..58.8V, 5.2A, 400W(1ms), Bidirectional	DO-214AC	1ba	1l	Vs
56C	P6SMB56CA	TVS	Vrw=56V, Vbr=53.2..58.8V, 7.8A, 600W(1ms), Bidirectional	DO-214AA	1ba,3ba	1l,1e	Vs,Ons
56C	P6SMBJ56C	TVS	Vbr=50.4..61.6V, 7.4A, 600W(1ms), Bidirectional	DO-214AA	1ba	1p	Lif
56CA	P4SMA56CA	TVS	Vbr=53.2..58.8V, Vrw=47.8V, 5.5A, 400W(1ms), Bidirectional	DO-214AC	1ba	1j	Eic
56CA	P6SMB56CA	TVS	Vbr=53.2..58.8V, Vrw=47.8V, 7.8A, 600W(1ms), Bidirectional	DO-214AA	1ba	1j	Eic
56CA	P6SMBJ56CA	TVS	Vbr=53.2..58.8V, 7.8A, 600W(1ms), Bidirectional	DO-214AA	1ba	1p	Lif
56P	BZD27C56P	Z-diode	53.2..58.8V, Zzt=60Ω, Izt=10mA, 800mW	SOD-123FL	7d	1a	Pjt
56P	MFPZ56	Z-diode	53.20..58.80V, Izt=10mA, Zzt=60Ω, 800mW	SOD-123FL	7d	1a	Ttr
56S	MMHZ5256SPT	Z-diode	29.40..30.60V, Izt=5mA, Zzt=78Ω, 225mW	SOD-123	5d	1a	Chm
56VB	BZT52-B56	Z-diode	54.88..57.12V, Izt=2mA, Zzt=200Ω, 500mW	SOD-123FL	7d	1a	Tsc
56VB	MMSZ56VBW	Z-diode	54.88..57.12V, Izt=2mA, Zzt=200Ω, 500mW	SOD-123FL	7d	1a	Tac
56VZ	BZT52-C56	Z-diode	53.20..58.80V, Izt=2mA, Zzt=200Ω, 500mW	SOD-123FL	7d	1a	Tsc
56VZ	MMSZ56VCW	Z-diode	53.20..58.80V, Izt=2mA, Zzt=200Ω, 500mW	SOD-123FL	7d	1a	Tac
56VZ	TCMMSZ56V	Z-diode	56V±5%, Izt=5mA, Zzt=188Ω, 500mW	SOD-123FL	7d	1a	Tac
56VZ	ZGFM056C-MH	Z-diode	53.20..58.8V, Izt=5mA, Zzt=188Ω, 500mW	SOD-123	5d	1a	Pic
56Z	HZU5.6Z	Z-diode	5.31..5.92V, 200mW	SOD-323	5d	1a	Ren
57	F1C57	TVS	Vbr=60V, 40A, 500W(1ms)	DO-214AC	1d	1a	Org
57	HMSZ5257B	Z-diode	33V±5%, Izt=3.8mA, Zzt=58Ω, 225mW	SOD-323	5d	1d	Hsn
57	MMSZ4V7	Z-diode	4.4..5.0V, Zzt=80Ω, Izt=5mA, 200mW	SOD-523FL	7d	1a	F
57	TCBZX584C4V7	Z-diode	4.4..5.0V, Izt=5mA, Zzt=80Ω, 200mW	SOD-523FL	7d	1a	Tac
57	TCMMSZ4V7	Z-diode	4.4..5.0V, Izt=5mA, Zzt=80Ω, 200mW	SOD-523FL	7d	1a	Tac
57	ZD5257BS2	Z-diode	33V±5%, 3.8mA, Zzt=58Ω, 500mW	SOD-323	5d	1a	Cys
57S	F1C57S	TVS	Vbr=60V, 5A, 500W(1ms)	DO-214AC	1d	1a	Org
57B	MMHZ5257BPT	Z-diode	31.35..34.65V, Izt=5mA, Zzt=88Ω, 225mW	SOD-123	5d	1a	Chm



SMD code	Type	Function	Short description	Case	Pinout	St.	Mnf.
57B	SMC5357B	Z-diode	20.0V±5%, Zzt=3.0(65.0mA), Izm=237.0mA, 5W	DO-214AB	1d	1a	Ers
57S	MMHZ5257SPT	Z-diode	32.34..33.66V, Izt=5mA, Zzt=88Ω, 225mW	SOD-123	5d	1a	Chm
57ZD	BYD57D	Si-diode	U-Fast Recovery , Contr.av., 200V, 1A, Vf<1.7V(1A), 50ns	1206	14d	1v	Zow
57ZG	BYD57G	Si-diode	U-Fast Recovery , Contr.av., 400V, 1A, Vf<1.7V(1A), 50ns	1206	14d	1v	Zow
57ZJ	BYD57J	Si-diode	U-Fast Recovery , Contr.av., 600V, 1A, Vf<1.7V(1A), 50ns	1206	14d	1v	Zow
57ZK	BYD57K	Si-diode	U-Fast Recovery , Contr.av., 800V, 1A, Vf<1.7V(1A), 75ns	1206	14d	1v	Zow
57ZM	BYD57M	Si-diode	U-Fast Recovery , Contr.av., 1000V, 1A, Vf<1.7V(1A), 75ns	1206	14d	1v	Zow
58	HMSZ5258B	Z-diode	36V±5%, Izt=3.4mA, Zzt=70Ω, 225mW	SOD-323	5d	1d	Hsn
58	MM5Z5V1	Z-diode	4.8..5.4V, Zzt=60Ω, Izt=5mA, 200mW	SOD-523FL	7d	1a	F
58	TCBZX584C5V1	Z-diode	4.8..5.4V, Izt=5mA, Zzt=60Ω, 200mW	SOD-523FL	7d	1a	Tac
58	TCM5Z5V1	Z-diode	4.8..5.4V, Izt=5mA, Zzt=60Ω, 200mW	SOD-523FL	7d	1a	Tac
58A	1SMC58A	TVS	Vbr=64.4..71.2V, Vrw=58V, 16.0A, 1500W(1ms)	DO-214AB	1d	1a	Eic
58A	SMAJ58A	TVS	Vrw=58V, Vbr=64.4..71.2V, 4.3A, 400W(1ms)	DO-214AC	1d	1a	Sus
58A	SMBJ58A	TVS	Vbr=64.4..71.2V, Vrw=58V, 6.4A, 600W(1ms)	DO-214AA	1d	1a	Sus
58A	SMCJ58A	TVS	Vrw=58V, Vbr=64.4..74.1V, 14.6A, 1500W(1ms)	DO-214AB	1d	1k	Sus
58A	UMA58A	TVS	Vrw=58V, Vbr=64.4..93.6V, 5.3A, 500W(1ms)	UltraMite	14d	1v	Msc
58B	MMHZ5258BPT	Z-diode	34.20..37.80V, Izt=5mA, Zzt=95Ω, 225mW	SOD-123	5d	1a	Chm
58B	SMC5358B	Z-diode	22.0V±5%, Zzt=4.0(50.0mA), Izm=216.0mA, 5W	DO-214AB	1d	1a	Ers
58CA	1SMC58CA	TVS	Vbr=64.4..71.2V, Vrw=58V, 16.0A, 1500W(1ms), Bidirectional	DO-214AB	1ba	1j	Eic
58CA	SMAJ58CA	TVS	Vrw=58V, Vbr=64.4..71.2V, 4.3A, 400W(1ms), Bidirectional	DO-214AC	1ba	1j	Sus
58CA	SMBJ58CA	TVS	Vbr=64.4..71.2V, Vrw=58V, 6.4A, 600W(1ms), Bidirectional	DO-214AA	1ba	1j	Sus
58CA	SMCJ58CA	TVS	Vrw=58V, Vbr=64.4..74.1V, 14.6A, 1500W(1ms), Bidirectional	DO-214AB	1ba	1l	Sus
58CA	UMA58CA	TVS	Vrw=58V, Vbr=64.4..93.6V, 5.3A, 500W(1ms), Bidirectional	UltraMite	14ba	1v	Msc
58S	MMHZ5258SPT	Z-diode	35.28..36.72V, Izt=5mA, Zzt=95Ω, 225mW	SOD-123	5d	1a	Chm
58V	SMA58	TVS	Vbr=64.4..78.7V, Vrw=58.0V, 2.9A, 300W(1ms)	DO-214AC	1d	1a	Mic
58V	SMB58	TVS	Vbr=64.4..78.7V, Vrw=58V, 5.8A, 600W(1ms)	DO-214AA	1d	1a	Mic
58V	SMC58	TVS	Vbr=64.4..78.7V, Vrw=58V, 14.6A, 1500W(1ms),	DO-214AB	1d	1a	Mic
58VA	SMA58A	TVS	Vbr=64.4..71.2V, Vrw=58.0V, 3.2A, 300W(1ms)	DO-214AC	1d	1a	Mic
58VA	SMB58A	TVS	Vbr=64.4..71.2V, Vrw=58V, 6.4A, 600W(1ms)	DO-214AA	1d	1a	Mic
58VA	SMC58A	TVS	Vbr=64.4..71.2V, Vrw=58V, 16A, 1500W(1ms),	DO-214AB	1d	1a	Mic
58VC	SMA58C	TVS	Vbr=64.4..78.7V, Vrw=58.0V, 2.9A, 300W(1ms), Bidirectional	DO-214AC	1ba	1j	Mic
58VC	SMB58C	TVS	Vbr=64.4..78.7V, Vrw=58V, 5.8A, 600W(1ms), Bidirectional	DO-214AA	1ba	1j	Mic
58VC	SMC58C	TVS	Vbr=64.4..78.7V, Vrw=58V, 14.6A, 1500W(1ms), Bidirectional	DO-214AB	1ba	1j	Mic
58VCA	SMA58CA	TVS	Vbr=64.4..71.2V, Vrw=58.0V, 3.2A, 300W(1ms), Bidirectional	DO-214AC	1ba	1j	Mic
58VCA	SMB58CA	TVS	Vbr=64.4..71.2V, Vrw=58V, 6.4A, 600W(1ms), Bidirectional	DO-214AA	1ba	1j	Mic
58VCA	SMC58CA	TVS	Vbr=64.4..71.2V, Vrw=58V, 16A, 1500W(1ms), Bidirectional	DO-214AB	1ba	1j	Mic
59	HMSZ5259B	Z-diode	39V±5%, Izt=3.2mA, Zzt=80Ω, 225mW	SOD-323	5d	1d	Hsn
59	MM5Z5V6	Z-diode	5.2..6.0V, Zzt=40Ω, Izt=5mA, 200mW	SOD-523FL	7d	1a	F
59	TCBZX584C5V6	Z-diode	5.2..6.0V, Izt=5mA, Zzt=40Ω, 200mW	SOD-523FL	7d	1a	Tac
59	TCM5Z5V6	Z-diode	5.2..6.0V, Izt=5mA, Zzt=40Ω, 200mW	SOD-523FL	7d	1a	Tac
5913A	1SMA5913A	Z-diode	3.3V±10%, Zzt=10Ω, Izm<455mA, 1.5W	DO-214AC	1d	1a	Eic
5913B	1SMA5913B	Z-diode	3.3V±5%, Zzt=10Ω, Izm<455mA, 1.5W	DO-214AC	1d	1a	Eic
5913B	SMA5913B	Z-diode	3.3V±5%, Izt=113.6mA, Zzt<10Ω, 1.5W	DO-214AC	1d	1t	Exc
5913B	SMB5913B	Z-diode	3.3V±5%, 113.6mA, Zzt<10Ω, 1.5W	DO-214AA	1d	1t	Exc
5913B3	SMB5913B3	Z-diode	3.3V±5%, 113.6mA, Zzt<10Ω, 3W	DO-214AA	1d	1t	Exc
5914A	1SMA5914A	Z-diode	3.6V±10%, Zzt=9Ω, Izm<417mA, 1.5W	DO-214AC	1d	1a	Eic
5914B	1SMA5914B	Z-diode	3.6V±5%, Zzt=9Ω, Izm<417mA, 1.5W	DO-214AC	1d	1a	Eic
5914B	SMA5914B	Z-diode	3.6V±5%, Izt=104.2mA, Zzt<9Ω, 1.5W	DO-214AC	1d	1t	Exc
5914B	SMB5914B	Z-diode	3.6V±5%, 104.2mA, Zzt<9Ω, 1.5W	DO-214AA	1d	1t	Exc
5914B3	SMB5914B3	Z-diode	3.6V±5%, 104.2mA, Zzt<9Ω, 3W	DO-214AA	1d	1t	Exc
5915A	1SMA5915A	Z-diode	3.9V±10%, Zzt=7.5Ω, Izm<385mA, 1.5W	DO-214AC	1d	1a	Eic
5915B	1SMA5915B	Z-diode	3.9V±5%, Zzt=7.5Ω, Izm<385mA, 1.5W	DO-214AC	1d	1a	Eic
5915B	SMA5915B	Z-diode	3.9V±5%, Izt=96.1mA, Zzt<7.5Ω, 1.5W	DO-214AC	1d	1t	Exc
5915B	SMB5915B	Z-diode	3.9V±5%, 96.1mA, Zzt<7.5Ω, 1.5W	DO-214AA	1d	1t	Exc
5915B3	SMB5915B3	Z-diode	3.9V±5%, 96.1mA, Zzt<7.5Ω, 3W	DO-214AA	1d	1t	Exc
5916A	1SMA5916A	Z-diode	4.3V±10%, Zzt=6Ω, Izm<349mA, 1.5W	DO-214AC	1d	1a	Eic
5916B	1SMA5916B	Z-diode	4.3V±5%, Zzt=6Ω, Izm<349mA, 1.5W	DO-214AC	1d	1a	Eic
5916B	SMA5916B	Z-diode	4.3V±5%, Izt=87.2mA, Zzt<6Ω, 1.5W	DO-214AC	1d	1t	Exc
5916B	SMB5916B	Z-diode	4.3V±5%, 87.2mA, Zzt<6Ω, 1.5W	DO-214AA	1d	1t	Exc
5916B3	SMB5916B3	Z-diode	4.3V±5%, 87.2mA, Zzt<6Ω, 3W	DO-214AA	1d	1t	Exc
5917A	1SMA5917A	Z-diode	4.7V±10%, Zzt=5Ω, Izm<319mA, 1.5W	DO-214AC	1d	1a	Eic
5917B	1SMA5917B	Z-diode	4.7V±5%, Zzt=5Ω, Izm<319mA, 1.5W	DO-214AC	1d	1a	Eic
5917B	SMA5917B	Z-diode	4.7V±5%, Izt=79.8mA, Zzt<5Ω, 1.5W	DO-214AC	1d	1t	Exc
5917B	SMB5917B	Z-diode	4.7V±5%, 79.8mA, Zzt<5Ω, 1.5W	DO-214AA	1d	1t	Exc
5917B3	SMB5917B3	Z-diode	4.7V±5%, 79.8mA, Zzt<5Ω, 3W	DO-214AA	1d	1t	Exc
5918A	1SMA5918A	Z-diode	5.1V±10%, Zzt=4Ω, Izm<294mA, 1.5W	DO-214AC	1d	1a	Eic
5918B	1SMA5918B	Z-diode	5.1V±5%, Zzt=4Ω, Izm<294mA, 1.5W	DO-214AC	1d	1a	Eic
5918B	SMA5918B	Z-diode	5.1V±5%, Izt=73.5mA, Zzt<4Ω, 1.5W	DO-214AC	1d	1t	Exc
5918B	SMB5918B	Z-diode	5.1V±5%, 73.5mA, Zzt<4Ω, 1.5W	DO-214AA	1d	1t	Exc
5918B3	SMB5918B3	Z-diode	5.1V±5%, 73.5mA, Zzt<4Ω, 3W	DO-214AA	1d	1t	Exc



SMD
code

Type

Function

Short description

Case

Pinout

St.

Mnf.

SMD code	Type	Function	Short description	Case	Pinout	St.	Mnf.
5919A	1SMA5919A	Z-diode	5.6V±10%, Zzt=2Ω, Izm<268mA, 1.5W	DO-214AC	1d	1a	Eic
5919B	1SMA5919B	Z-diode	5.6V±5%, Zzt=2Ω, Izm<268mA, 1.5W	DO-214AC	1d	1a	Eic
5919B	SMA5919B	Z-diode	5.6V±5%, Izt=66.9mA, Zzt<2Ω, 1.5W	DO-214AC	1d	1t	Exc
5919B	SMB5919B	Z-diode	5.6V±5%, 66.9mA, Zzt<2Ω, 1.5W	DO-214AA	1d	1t	Exc
5919B3	SMB5919B3	Z-diode	5.6V±5%, 66.9mA, Zzt<2Ω, 3W	DO-214AA	1d	1t	Exc
5920A	1SMA5920A	Z-diode	6.2V±10%, Zzt=2Ω, Izm<242mA, 1.5W	DO-214AC	1d	1a	Eic
5920B	1SMA5920B	Z-diode	6.2V±5%, Zzt=2Ω, Izm<242mA, 1.5W	DO-214AC	1d	1a	Eic
5920B	SMA5920B	Z-diode	6.2V±5%, Izt=60.5mA, Zzt<2Ω, 1.5W	DO-214AC	1d	1t	Exc
5920B	SMB5920B	Z-diode	6.2V±5%, 60.5mA, Zzt<2Ω, 1.5W	DO-214AA	1d	1t	Exc
5920B3	SMB5920B3	Z-diode	6.2V±5%, 60.5mA, Zzt<2Ω, 3W	DO-214AA	1d	1t	Exc
5921A	1SMA5921A	Z-diode	6.8V±10%, Zzt=2.5Ω, Izm<221mA, 1.5W	DO-214AC	1d	1a	Eic
5921B	1SMA5921B	Z-diode	6.8V±5%, Zzt=2.5Ω, Izm<221mA, 1.5W	DO-214AC	1d	1a	Eic
5921B	SMA5921B	Z-diode	6.8V±5%, Izt=55.1mA, Zzt<2.5Ω, 1.5W	DO-214AC	1d	1t	Exc
5921B	SMB5921B	Z-diode	6.8V±5%, 55.1mA, Zzt<2.5Ω, 1.5W	DO-214AA	1d	1t	Exc
5921B3	SMB5921B3	Z-diode	6.8V±5%, 55.1mA, Zzt<2.5Ω, 3W	DO-214AA	1d	1t	Exc
5922A	1SMA5922A	Z-diode	7.5V±10%, Zzt=3Ω, Izm<200mA, 1.5W	DO-214AC	1d	1a	Eic
5922B	1SMA5922B	Z-diode	7.5V±5%, Zzt=3Ω, Izm<200mA, 1.5W	DO-214AC	1d	1a	Eic
5922B	SMA5922B	Z-diode	7.5V±5%, Izt=50mA, Zzt<3Ω, 1.5W	DO-214AC	1d	1t	Exc
5922B	SMB5922B	Z-diode	7.5V±5%, 50mA, Zzt<3Ω, 1.5W	DO-214AA	1d	1t	Exc
5922B3	SMB5922B3	Z-diode	7.5V±5%, 50mA, Zzt<3Ω, 3W	DO-214AA	1d	1t	Exc
5923A	1SMA5923A	Z-diode	8.2V±10%, Zzt=3.5Ω, Izm<183mA, 1.5W	DO-214AC	1d	1a	Eic
5923B	1SMA5923B	Z-diode	8.2V±5%, Zzt=3.5Ω, Izm<183mA, 1.5W	DO-214AC	1d	1a	Eic
5923B	SMA5923B	Z-diode	8.2V±5%, Izt=45.7mA, Zzt<3.5Ω, 1.5W	DO-214AC	1d	1t	Exc
5923B	SMB5923B	Z-diode	8.2V±5%, 45.7mA, Zzt<3.5Ω, 1.5W	DO-214AA	1d	1t	Exc
5923B3	SMB5923B3	Z-diode	8.2V±5%, 45.7mA, Zzt<3.5Ω, 3W	DO-214AA	1d	1t	Exc
5924A	1SMA5924A	Z-diode	9.1V±10%, Zzt=4Ω, Izm<165mA, 1.5W	DO-214AC	1d	1a	Eic
5924B	1SMA5924B	Z-diode	9.1V±5%, Zzt=4Ω, Izm<165mA, 1.5W	DO-214AC	1d	1a	Eic
5924B	SMA5924B	Z-diode	9.1V±5%, Izt=41.2mA, Zzt<4Ω, 1.5W	DO-214AC	1d	1t	Exc
5924B	SMB5924B	Z-diode	9.1V±5%, 41.2mA, Zzt<4Ω, 1.5W	DO-214AA	1d	1t	Exc
5924B3	SMB5924B3	Z-diode	9.1V±5%, 41.2mA, Zzt<4Ω, 3W	DO-214AA	1d	1t	Exc
5925A	1SMA5925A	Z-diode	10V±10%, Zzt=4.5Ω, Izm<150mA, 1.5W	DO-214AC	1d	1a	Eic
5925B	1SMA5925B	Z-diode	10V±5%, Zzt=4.5Ω, Izm<150mA, 1.5W	DO-214AC	1d	1a	Eic
5925B	SMA5925B	Z-diode	10V±5%, Izt=37.5mA, Zzt<4.5Ω, 1.5W	DO-214AC	1d	1t	Exc
5925B	SMB5925B	Z-diode	10V±5%, 37.5mA, Zzt<4.5Ω, 1.5W	DO-214AA	1d	1t	Exc
5925B3	SMB5925B3	Z-diode	10V±5%, 37.5mA, Zzt<4.5Ω, 3W	DO-214AA	1d	1t	Exc
5926A	1SMA5926A	Z-diode	11V±10%, Zzt=5.5Ω, Izm<136mA, 1.5W	DO-214AC	1d	1a	Eic
5926B	1SMA5926B	Z-diode	11V±5%, Zzt=5.5Ω, Izm<136mA, 1.5W	DO-214AC	1d	1a	Eic
5926B	SMA5926B	Z-diode	11V±5%, Izt=34.1mA, Zzt<5.5Ω, 1.5W	DO-214AC	1d	1t	Exc
5926B	SMB5926B	Z-diode	11V±5%, 34.1mA, Zzt<5.5Ω, 1.5W	DO-214AA	1d	1t	Exc
5926B3	SMB5926B3	Z-diode	11V±5%, 34.1mA, Zzt<5.5Ω, 3W	DO-214AA	1d	1t	Exc
5927A	1SMA5927A	Z-diode	12V±10%, Zzt=6.5Ω, Izm<125mA, 1.5W	DO-214AC	1d	1a	Eic
5927B	1SMA5927B	Z-diode	12V±5%, Zzt=6.5Ω, Izm<125mA, 1.5W	DO-214AC	1d	1a	Eic
5927B	SMA5927B	Z-diode	12V±5%, Izt=31.2mA, Zzt<6.5Ω, 1.5W	DO-214AC	1d	1t	Exc
5927B	SMB5927B	Z-diode	12V±5%, 31.2mA, Zzt<6.5Ω, 1.5W	DO-214AA	1d	1t	Exc
5927B3	SMB5927B3	Z-diode	12V±5%, 31.2mA, Zzt<6.5Ω, 3W	DO-214AA	1d	1t	Exc
5928A	1SMA5928A	Z-diode	13V±10%, Zzt=7Ω, Izm<115mA, 1.5W	DO-214AC	1d	1a	Eic
5928B	1SMA5928B	Z-diode	13V±5%, Zzt=7Ω, Izm<115mA, 1.5W	DO-214AC	1d	1a	Eic
5928B	SMA5928B	Z-diode	13V±5%, Izt=28.8mA, Zzt<7Ω, 1.5W	DO-214AC	1d	1t	Exc
5928B	SMB5928B	Z-diode	13V±5%, 28.8mA, Zzt<7Ω, 1.5W	DO-214AA	1d	1t	Exc
5928B3	SMB5928B3	Z-diode	13V±5%, 28.8mA, Zzt<7Ω, 3W	DO-214AA	1d	1t	Exc
5929A	1SMA5929A	Z-diode	15V±10%, Zzt=9Ω, Izm<100mA, 1.5W	DO-214AC	1d	1a	Eic
5929B	1SMA5929B	Z-diode	15V±5%, Zzt=9Ω, Izm<100mA, 1.5W	DO-214AC	1d	1a	Eic
5929B	SMA5929B	Z-diode	15V±5%, Izt=25mA, Zzt<9Ω, 1.5W	DO-214AC	1d	1t	Exc
5929B	SMB5929B	Z-diode	15V±5%, 25mA, Zzt<9Ω, 1.5W	DO-214AA	1d	1t	Exc
5929B3	SMB5929B3	Z-diode	15V±5%, 25mA, Zzt<9Ω, 3W	DO-214AA	1d	1t	Exc
5930A	1SMA5930A	Z-diode	16V±10%, Zzt=10Ω, Izm<94mA, 1.5W	DO-214AC	1d	1a	Eic
5930B	1SMA5930B	Z-diode	16V±5%, Zzt=10Ω, Izm<94mA, 1.5W	DO-214AC	1d	1a	Eic
5930B	SMA5930B	Z-diode	16V±5%, Izt=23.4mA, Zzt<10Ω, 1.5W	DO-214AC	1d	1t	Exc
5930B	SMB5930B	Z-diode	16V±5%, 23.4mA, Zzt<10Ω, 1.5W	DO-214AA	1d	1t	Exc
5930B3	SMB5930B3	Z-diode	16V±5%, 23.4mA, Zzt<10Ω, 3W	DO-214AA	1d	1t	Exc
5931A	1SMA5931A	Z-diode	18V±10%, Zzt=12Ω, Izm<83mA, 1.5W	DO-214AC	1d	1a	Eic
5931B	1SMA5931B	Z-diode	18V±5%, Zzt=12Ω, Izm<83mA, 1.5W	DO-214AC	1d	1a	Eic
5931B	SMA5931B	Z-diode	18V±5%, Izt=20.8mA, Zzt<12Ω, 1.5W	DO-214AC	1d	1t	Exc
5931B	SMB5931B	Z-diode	18V±5%, 20.8mA, Zzt<12Ω, 1.5W	DO-214AA	1d	1t	Exc
5931B3	SMB5931B3	Z-diode	18V±5%, 20.8mA, Zzt<12Ω, 3W	DO-214AA	1d	1t	Exc
5932A	1SMA5932A	Z-diode	20V±10%, Zzt=14Ω, Izm<75mA, 1.5W	DO-214AC	1d	1a	Eic
5932B	1SMA5932B	Z-diode	20V±5%, Zzt=14Ω, Izm<75mA, 1.5W	DO-214AC	1d	1a	Eic
5932B	SMA5932B	Z-diode	20V±5%, Izt=18.7mA, Zzt<14Ω, 1.5W	DO-214AC	1d	1t	Exc
5932B	SMB5932B	Z-diode	20V±5%, 18.7mA, Zzt<14Ω, 1.5W	DO-214AA	1d	1t	Exc
5932B3	SMB5932B3	Z-diode	20V±5%, 18.7mA, Zzt<14Ω, 3W	DO-214AA	1d	1t	Exc



SMD code	Type	Function	Short description	Case	Pinout	St.	Mnf.
5933A	1SMA5933A	Z-diode	22V±10%, Zzt=17.5Ω, Izm<68mA, 1.5W	DO-214AC	1d	1a	Eic
5933B	1SMA5933B	Z-diode	22V±5%, Zzt=17.5Ω, Izm<68mA, 1.5W	DO-214AC	1d	1a	Eic
5933B	SMA5933B	Z-diode	22V±5%, Izt=17mA, Zzt<17.5Ω, 1.5W	DO-214AC	1d	1t	Exc
5933B	SMB5933B	Z-diode	22V±5%, 17mA, Zzt<17.5Ω, 1.5W	DO-214AA	1d	1t	Exc
5933B3	SMB5933B3	Z-diode	22V±5%, 17mA, Zzt<17.5Ω, 3W	DO-214AA	1d	1t	Exc
5934A	1SMA5934A	Z-diode	24V±10%, Zzt=19Ω, Izm<63mA, 1.5W	DO-214AC	1d	1a	Eic
5934B	1SMA5934B	Z-diode	24V±5%, Zzt=19Ω, Izm<63mA, 1.5W	DO-214AC	1d	1a	Eic
5934B	SMA5934B	Z-diode	24V±5%, Izt=15.6mA, Zzt<19Ω, 1.5W	DO-214AC	1d	1t	Exc
5934B	SMB5934B	Z-diode	24V±5%, 15.6mA, Zzt<19Ω, 1.5W	DO-214AA	1d	1t	Exc
5934B3	SMB5934B3	Z-diode	24V±5%, 15.6mA, Zzt<19Ω, 3W	DO-214AA	1d	1t	Exc
5935A	1SMA5935A	Z-diode	27V±10%, Zzt=23Ω, Izm<56mA, 1.5W	DO-214AC	1d	1a	Eic
5935B	1SMA5935B	Z-diode	27V±5%, Zzt=23Ω, Izm<56mA, 1.5W	DO-214AC	1d	1a	Eic
5935B	SMA5935B	Z-diode	27V±5%, Izt=13.9mA, Zzt<23Ω, 1.5W	DO-214AC	1d	1t	Exc
5935B	SMB5935B	Z-diode	27V±5%, 13.9mA, Zzt<23Ω, 1.5W	DO-214AA	1d	1t	Exc
5935B3	SMB5935B3	Z-diode	27V±5%, 13.9mA, Zzt<23Ω, 3W	DO-214AA	1d	1t	Exc
5936A	1SMA5936A	Z-diode	30V±10%, Zzt=26Ω, Izm<50mA, 1.5W	DO-214AC	1d	1a	Eic
5936B	1SMA5936B	Z-diode	30V±5%, Zzt=26Ω, Izm<50mA, 1.5W	DO-214AC	1d	1a	Eic
5936B	SMA5936B	Z-diode	30V±5%, Izt=12.5mA, Zzt<26Ω, 1.5W	DO-214AC	1d	1t	Exc
5936B	SMB5936B	Z-diode	30V±5%, 12.5mA, Zzt<26Ω, 1.5W	DO-214AA	1d	1t	Exc
5936B3	SMB5936B3	Z-diode	30V±5%, 12.5mA, Zzt<26Ω, 3W	DO-214AA	1d	1t	Exc
5937A	1SMA5937A	Z-diode	33V±10%, Zzt=33Ω, Izm<45mA, 1.5W	DO-214AC	1d	1a	Eic
5937B	1SMA5937B	Z-diode	33V±5%, Zzt=33Ω, Izm<45mA, 1.5W	DO-214AC	1d	1a	Eic
5937B	SMA5937B	Z-diode	33V±5%, Izt=11.4mA, Zzt<33Ω, 1.5W	DO-214AC	1d	1t	Exc
5937B	SMB5937B	Z-diode	33V±5%, 11.4mA, Zzt<33Ω, 1.5W	DO-214AA	1d	1t	Exc
5937B3	SMB5937B3	Z-diode	33V±5%, 11.4mA, Zzt<33Ω, 3W	DO-214AA	1d	1t	Exc
5938A	1SMA5938A	Z-diode	36V±10%, Zzt=38Ω, Izm<42mA, 1.5W	DO-214AC	1d	1a	Eic
5938B	1SMA5938B	Z-diode	36V±5%, Zzt=38Ω, Izm<42mA, 1.5W	DO-214AC	1d	1a	Eic
5938B	SMA5938B	Z-diode	36V±5%, Izt=10.4mA, Zzt<38Ω, 1.5W	DO-214AC	1d	1t	Exc
5938B	SMB5938B	Z-diode	36V±5%, 10.4mA, Zzt<38Ω, 1.5W	DO-214AA	1d	1t	Exc
5938B3	SMB5938B3	Z-diode	36V±5%, 10.4mA, Zzt<38Ω, 3W	DO-214AA	1d	1t	Exc
5939A	1SMA5939A	Z-diode	39V±10%, Zzt=45Ω, Izm<38mA, 1.5W	DO-214AC	1d	1a	Eic
5939B	1SMA5939B	Z-diode	39V±5%, Zzt=45Ω, Izm<38mA, 1.5W	DO-214AC	1d	1a	Eic
5939B	SMA5939B	Z-diode	39V±5%, Izt=9.6mA, Zzt<45Ω, 1.5W	DO-214AC	1d	1t	Exc
5939B	SMB5939B	Z-diode	39V±5%, 9.6mA, Zzt<45Ω, 1.5W	DO-214AA	1d	1t	Exc
5939B3	SMB5939B3	Z-diode	39V±5%, 9.6mA, Zzt<45Ω, 3W	DO-214AA	1d	1t	Exc
5940A	1SMA5940A	Z-diode	43V±10%, Zzt=53Ω, Izm<35mA, 1.5W	DO-214AC	1d	1a	Eic
5940B	1SMA5940B	Z-diode	43V±5%, Zzt=53Ω, Izm<35mA, 1.5W	DO-214AC	1d	1a	Eic
5940B	SMA5940B	Z-diode	43V±5%, Izt=8.7mA, Zzt<53Ω, 1.5W	DO-214AC	1d	1t	Exc
5940B	SMB5940B	Z-diode	43V±5%, 8.7mA, Zzt<53Ω, 1.5W	DO-214AA	1d	1t	Exc
5940B3	SMB5940B3	Z-diode	43V±5%, 8.7mA, Zzt<53Ω, 3W	DO-214AA	1d	1t	Exc
5941A	1SMA5941A	Z-diode	47V±10%, Zzt=67Ω, Izm<32mA, 1.5W	DO-214AC	1d	1a	Eic
5941B	1SMA5941B	Z-diode	47V±5%, Zzt=67Ω, Izm<32mA, 1.5W	DO-214AC	1d	1a	Eic
5941B	SMA5941B	Z-diode	47V±5%, Izt=8mA, Zzt<67Ω, 1.5W	DO-214AC	1d	1t	Exc
5941B	SMB5941B	Z-diode	47V±5%, 8mA, Zzt<67Ω, 1.5W	DO-214AA	1d	1t	Exc
5941B3	SMB5941B3	Z-diode	47V±5%, 8mA, Zzt<67Ω, 3W	DO-214AA	1d	1t	Exc
5942A	1SMA5942A	Z-diode	51V±10%, Zzt=70Ω, Izm<29mA, 1.5W	DO-214AC	1d	1a	Eic
5942B	1SMA5942B	Z-diode	51V±5%, Zzt=70Ω, Izm<29mA, 1.5W	DO-214AC	1d	1a	Eic
5942B	SMA5942B	Z-diode	51V±5%, Izt=7.3mA, Zzt<70Ω, 1.5W	DO-214AC	1d	1t	Exc
5942B	SMB5942B	Z-diode	51V±5%, 7.3mA, Zzt<70Ω, 1.5W	DO-214AA	1d	1t	Exc
5942B3	SMB5942B3	Z-diode	51V±5%, 7.3mA, Zzt<70Ω, 3W	DO-214AA	1d	1t	Exc
5943A	1SMA5943A	Z-diode	56V±10%, Zzt=86Ω, Izm<27mA, 1.5W	DO-214AC	1d	1a	Eic
5943B	1SMA5943B	Z-diode	56V±5%, Zzt=86Ω, Izm<27mA, 1.5W	DO-214AC	1d	1a	Eic
5944A	1SMA5944A	Z-diode	62V±10%, Zzt=100Ω, Izm<24mA, 1.5W	DO-214AC	1d	1a	Eic
5944B	1SMA5944B	Z-diode	62V±5%, Zzt=100Ω, Izm<24mA, 1.5W	DO-214AC	1d	1a	Eic
5945A	1SMA5945A	Z-diode	68V±10%, Zzt=120Ω, Izm<22mA, 1.5W	DO-214AC	1d	1a	Eic
5945B	1SMA5945B	Z-diode	68V±5%, Zzt=120Ω, Izm<22mA, 1.5W	DO-214AC	1d	1a	Eic
5946A	1SMA5946A	Z-diode	75V±10%, Zzt=140Ω, Izm<20mA, 1.5W	DO-214AC	1d	1a	Eic
5946B	1SMA5946B	Z-diode	75V±5%, Zzt=140Ω, Izm<20mA, 1.5W	DO-214AC	1d	1a	Eic
5947A	1SMA5947A	Z-diode	82V±10%, Zzt=160Ω, Izm<18mA, 1.5W	DO-214AC	1d	1a	Eic
5947B	1SMA5947B	Z-diode	82V±5%, Zzt=160Ω, Izm<18mA, 1.5W	DO-214AC	1d	1a	Eic
5948A	1SMA5948A	Z-diode	91V±10%, Zzt=200Ω, Izm<16mA, 1.5W	DO-214AC	1d	1a	Eic
5948B	1SMA5948B	Z-diode	91V±5%, Zzt=200Ω, Izm<16mA, 1.5W	DO-214AC	1d	1a	Eic
5949A	1SMA5949A	Z-diode	100V±10%, Zzt=250Ω, Izm<15mA, 1.5W	DO-214AC	1d	1a	Eic
5949B	1SMA5949B	Z-diode	100V±5%, Zzt=250Ω, Izm<15mA, 1.5W	DO-214AC	1d	1a	Eic
5950A	1SMA5950A	Z-diode	110V±10%, Zzt=300Ω, Izm<13mA, 1.5W	DO-214AC	1d	1a	Eic
5950B	1SMA5950B	Z-diode	110V±5%, Zzt=300Ω, Izm<13mA, 1.5W	DO-214AC	1d	1a	Eic
5951A	1SMA5951A	Z-diode	120V±10%, Zzt=380Ω, Izm<12mA, 1.5W	DO-214AC	1d	1a	Eic
5951B	1SMA5951B	Z-diode	120V±5%, Zzt=380Ω, Izm<12mA, 1.5W	DO-214AC	1d	1a	Eic
5952A	1SMA5952A	Z-diode	130V±10%, Zzt=450Ω, Izm<11mA, 1.5W	DO-214AC	1d	1a	Eic
5952B	1SMA5952B	Z-diode	130V±5%, Zzt=450Ω, Izm<11mA, 1.5W	DO-214AC	1d	1a	Eic



SMD
code

Type

Function

Short description

Case

Pinout

St.

Mnf.

SMD code	Type	Function	Short description	Case	Pinout	St.	Mnf.
5953A	1SMA5953A	Z-diode	150V±10%, Zzt=600Ω, Izm<10mA, 1.5W	DO-214AC	1d	1a	Eic
5953B	1SMA5953B	Z-diode	150V±5%, Zzt=600Ω, Izm<10mA, 1.5W	DO-214AC	1d	1a	Eic
5954A	1SMA5954A	Z-diode	160V±10%, Zzt=700Ω, Izm<9mA, 1.5W	DO-214AC	1d	1a	Eic
5954B	1SMA5954B	Z-diode	160V±5%, Zzt=700Ω, Izm<9mA, 1.5W	DO-214AC	1d	1a	Eic
5955A	1SMA5955A	Z-diode	180V±10%, Zzt=900Ω, Izm<8mA, 1.5W	DO-214AC	1d	1a	Eic
5955B	1SMA5955B	Z-diode	180V±5%, Zzt=900Ω, Izm<8mA, 1.5W	DO-214AC	1d	1a	Eic
5956A	1SMA5956A	Z-diode	200V±10%, Zzt=1200Ω, Izm<7mA, 1.5W	DO-214AC	1d	1a	Eic
5956B	1SMA5956B	Z-diode	200V±5%, Zzt=1200Ω, Izm<7mA, 1.5W	DO-214AC	1d	1a	Eic
5957A	1SMA5957A	Z-diode	240V±10%, Zzt=1600Ω, Izm<6mA, 1.5W	DO-214AC	1d	1a	Eic
5957B	1SMA5957B	Z-diode	240V±5%, Zzt=1600Ω, Izm<6mA, 1.5W	DO-214AC	1d	1a	Eic
59B	MMHZ5259BPT	Z-diode	37.05..40.95V, Izt=5mA, Zzt=130Ω, 225mW	SOD-123	5d	1a	Chm
59B	SMC5359B	Z-diode	24.0V±5%, Zzt=4.0(0mA), Izm=198.0mA, 5W	DO-214AB	1d	1a	Ers
59S	MMHZ5259SPT	Z-diode	38.22..39.78V, Izt=5mA, Zzt=130Ω, 225mW	SOD-123	5d	1a	Chm
5A	CDZ525CV1T	Z-diode	4.85..5.36V, Zzt=50Ω, Izt=5mA, 200mW	0603	70d	2d	Crp
5A	CH601H-90PT	Si-diode	SBD, 90V, 100mA, Vf<0.77V(100mA)	SOD-323	5d	1a	Chm
5A	HZU5ALL	Z-diode	4.3..4.7V, Izt=0.5mA, Zzt=380Ω, 150mW	URP	5d	1a	Ren
5A	MM1Z9V1	Z-diode	9.1V±5%, Izt=5mA, Zzt=30Ω, 500mW	SOD-123FL	7d	1a	Eic
5A	MM5Z6V2	Z-diode	5.8..6.6V, Zzt=10Ω, Izt=5mA, 200mW	SOD-523FL	7d	1a	F
5A	MMDL6050	Si-diode	Sw, 70V, 200mA, 200mW, Vf<1.1V(100mA), <4ns	SOD-323	5d	1a	Ons
5A	MMSZ9V1	Z-diode	9.1V±5%, Izt=5mA, Zzt=15Ω, 500mW	SOD-123	5d	1a	Eic
5A	S5A	Si-diode	Rectifier, 50V, 5A, Vf<1.15V(5A)	DO-214AB	1d	1k	Vs
5A	TCBZX584C6V2	Z-diode	5.8..6.6V, Izt=5mA, Zzt=10Ω, 200mW	SOD-523FL	7d	1a	Tac
5A	TCMM5Z6V2	Z-diode	5.8..6.6V, Izt=5mA, Zzt=10Ω, 200mW	SOD-523FL	7d	1a	Tac
5A1	RKZ5.1AKU	Z-diode	4.81..5.07V, Izt=20mA, Zzt=130Ω, 500mW	TURP-FM	7d	1a	Ren
5A6	RKZ5.6AKU	Z-diode	5.28..5.55V, Izt=20mA, Zzt=80Ω, 500mW	TURP-FM	7d	1a	Ren
5AD	SMA5J5.0	TVS	Vbr=6.40..7.82V, Vrrwm=5.0V, 52.1A, 500W(1ms)	DO-214AC	1d	1k	Vs
5AD	SMA5J5.0C	TVS	Vbr=6.40..7.82V, Vrrwm=5.0V, 52.1A, 500W(1ms), Bidirectional	DO-214AC	1ba	1l	Vs
5AE	SMA5J5.0A	TVS	Vbr=6.40..7.07V, Vrrwm=5.0V, 54.3A, 500W(1ms)	DO-214AC	1d	1k	Vs
5AE	SMA5J5.0CA	TVS	Vbr=6.40..7.07V, Vrrwm=5.0V, 54.3A, 500W(1ms), Bidirectional	DO-214AC	1ba	1l	Vs
5AF	SMA5J6.0	TVS	Vbr=6.67..8.15V, Vrrwm=6.0V, 43.9A, 500W(1ms)	DO-214AC	1d	1k	Vs
5AF	SMA5J6.0C	TVS	Vbr=6.67..8.15V, Vrrwm=6.0V, 43.9A, 500W(1ms), Bidirectional	DO-214AC	1ba	1l	Vs
5AG	SMA5J6.0A	TVS	Vbr=6.67..7.37V, Vrrwm=6.0V, 48.5A, 500W(1ms)	DO-214AC	1d	1k	Vs
5AG	SMA5J6.0CA	TVS	Vbr=6.67..7.37V, Vrrwm=6.0V, 48.5A, 500W(1ms), Bidirectional	DO-214AC	1ba	1l	Vs
5AH	SMA5J6.5	TVS	Vbr=7.22..8.82V, Vrrwm=6.5V, 40.7A, 500W(1ms)	DO-214AC	1d	1k	Vs
5AH	SMA5J6.5C	TVS	Vbr=7.22..8.82V, Vrrwm=6.5V, 40.7A, 500W(1ms), Bidirectional	DO-214AC	1ba	1l	Vs
5AK	SMA5J6.5A	TVS	Vbr=7.22..7.98V, Vrrwm=6.5V, 44.6A, 500W(1ms)	DO-214AC	1d	1k	Vs
5AK	SMA5J6.5CA	TVS	Vbr=7.22..7.98V, Vrrwm=6.5V, 44.6A, 500W(1ms), Bidirectional	DO-214AC	1ba	1l	Vs
5AL	SMA5J7.0	TVS	Vbr=7.78..9.51V, Vrrwm=7.0V, 37.6A, 500W(1ms)	DO-214AC	1d	1k	Vs
5AL	SMA5J7.0C	TVS	Vbr=7.78..9.51V, Vrrwm=7.0V, 37.6A, 500W(1ms), Bidirectional	DO-214AC	1ba	1l	Vs
5AM	SMA5J7.0A	TVS	Vbr=7.78..8.60V, Vrrwm=7.0V, 41.7A, 500W(1ms)	DO-214AC	1d	1k	Vs
5AM	SMA5J7.0CA	TVS	Vbr=7.78..8.6V, Vrrwm=7.0V, 41.7A, 500W(1ms), Bidirectional	DO-214AC	1ba	1l	Vs
5AN	SMA5J7.5	TVS	Vbr=8.33..10.2V, Vrrwm=7.5V, 35.0A, 500W(1ms)	DO-214AC	1d	1k	Vs
5AN	SMA5J7.5C	TVS	Vbr=8.33..10.2V, Vrrwm=7.5V, 35.0A, 500W(1ms), Bidirectional	DO-214AC	1ba	1l	Vs
5AP	SMA5J7.5A	TVS	Vbr=8.33..9.21V, Vrrwm=7.5V, 38.8A, 500W(1ms)	DO-214AC	1d	1k	Vs
5AP	SMA5J7.5CA	TVS	Vbr=8.33..9.21V, Vrrwm=7.5V, 38.8A, 500W(1ms), Bidirectional	DO-214AC	1ba	1l	Vs
5AQ	SMA5J8.0	TVS	Vbr=8.89..10.9V, Vrrwm=8.0V, 33.3A, 500W(1ms)	DO-214AC	1d	1k	Vs
5AQ	SMA5J8.0C	TVS	Vbr=8.89..10.9V, Vrrwm=8.0V, 33.3A, 500W(1ms), Bidirectional	DO-214AC	1ba	1l	Vs
5AR	SMA5J8.0A	TVS	Vbr=8.89..9.83V, Vrrwm=8.0V, 36.8A, 500W(1ms)	DO-214AC	1d	1k	Vs
5AR	SMA5J8.0CA	TVS	Vbr=8.89..9.83V, Vrrwm=8.0V, 36.8A, 500W(1ms), Bidirectional	DO-214AC	1ba	1l	Vs
5AS	SMA5J8.5	TVS	Vbr=9.44..11.5V, Vrrwm=8.5V, 31.4A, 500W(1ms)	DO-214AC	1d	1k	Vs
5AS	SMA5J8.5C	TVS	Vbr=9.44..11.5V, Vrrwm=8.5V, 31.4A, 500W(1ms), Bidirectional	DO-214AC	1ba	1l	Vs
5AT	SMA5J8.5A	TVS	Vbr=9.44..10.4V, Vrrwm=8.5V, 34.7A, 500W(1ms)	DO-214AC	1d	1k	Vs
5AT	SMA5J8.5CA	TVS	Vbr=9.44..10.4V, Vrrwm=8.5V, 34.7A, 500W(1ms), Bidirectional	DO-214AC	1ba	1l	Vs
5AU	SMA5J9.0	TVS	Vbr=10.0..12.2V, Vrrwm=9.0V, 29.6A, 500W(1ms)	DO-214AC	1d	1k	Vs
5AU	SMA5J9.0C	TVS	Vbr=10.0..12.2V, Vrrwm=9.0V, 29.6A, 500W(1ms), Bidirectional	DO-214AC	1ba	1l	Vs
5AV	SMA5J9.0A	TVS	Vbr=10.0..11.1V, Vrrwm=9.0V, 32.5A, 500W(1ms)	DO-214AC	1d	1k	Vs
5AV	SMA5J9.0CA	TVS	Vbr=10.0..11.1V, Vrrwm=9.0V, 32.5A, 500W(1ms), Bidirectional	DO-214AC	1ba	1l	Vs
5AW	SMA5J10	TVS	Vbr=11.1..13.6V, Vrrwm=10V, 26.6A, 500W(1ms)	DO-214AC	1d	1k	Vs
5AW	SMA5J10C	TVS	Vbr=11.1..13.6V, Vrrwm=10V, 26.6A, 500W(1ms), Bidirectional	DO-214AC	1ba	1l	Vs
5AX	SMA5J10A	TVS	Vbr=11.1..12.3V, Vrrwm=10V, 29.4A, 500W(1ms)	DO-214AC	1d	1k	Vs
5AX	SMA5J10CA	TVS	Vbr=11.1..12.3V, Vrrwm=10V, 29.4A, 500W(1ms), Bidirectional	DO-214AC	1ba	1l	Vs
5AY	SMA5J11	TVS	Vbr=12.2..14.9V, Vrrwm=11V, 24.9A, 500W(1ms)	DO-214AC	1d	1k	Vs
5AY	SMA5J11C	TVS	Vbr=12.2..14.9V, Vrrwm=11V, 24.9A, 500W(1ms), Bidirectional	DO-214AC	1ba	1l	Vs
5AZ	SMA5J11A	TVS	Vbr=12.2..13.5V, Vrrwm=11V, 27.5A, 500W(1ms)	DO-214AC	1d	1k	Vs
5AZ	SMA5J11CA	TVS	Vbr=12.2..13.5V, Vrrwm=11V, 27.5A, 500W(1ms), Bidirectional	DO-214AC	1ba	1l	Vs
5B	CH601H-70APT	Si-diode	SBD, 70V, 100mA, Vf<0.77V(10mA)	SOD-323	5d	1a	Chm
5B	HZU5BLL	Z-diode	4.6..5.0V, Izt=0.5mA, Zzt=380Ω, 150mW	URP	5d	1a	Ren
5B	MA2X707	Si-diode	SBD, UHF-mix, 5V, 100mA, Vf<0.25V(2mA), 0.85pF	SOD-123	5d	1a	Pan
5B	MM1Z10	Z-diode	10V±5%, Izt=5mA, Zzt=30Ω, 500mW	SOD-123FL	7d	1a	Eic
5B	MM5Z6V8	Z-diode	6.4..7.2V, Zzt=15Ω, Izt=5mA, 200mW	SOD-523FL	7d	1a	F



SMD
code

Type

Function

Short description

Case

Pinout

St.

Mnf.

5B	MMSZ10	Z-diode	10V±5%, Izt=5mA, Zzt=20Ω, 500mW	SOD-123	5d	1a	Eic
5B	S5B	Si-diode	Rectifier, 100V, 5A, Vf<1.15V(5A)	DO-214AB	1d	1k	Vs
5B	TCBZX584C6V8	Z-diode	6.4..7.2V, Izt=5mA, Zzt=15Ω, 200mW	SOD-523FL	7d	1a	Tac
5B	TCMMSZ6V8	Z-diode	6.4..7.2V, Izt=5mA, Zzt=15Ω, 200mW	SOD-523FL	7d	1a	Tac
5B1	RKZ5.1BKU	Z-diode	4.94..5.20V, Izt=20mA, Zzt=130Ω, 500mW	TURP-FM	7d	1a	Ren
5B6	RKZ5.6BKU	Z-diode	5.45..5.73V, Izt=20mA, Zzt=80Ω, 500mW	TURP-FM	7d	1a	Ren
5BD	SMA5J12	TVS	Vbr=13.3..16.3V, Vrw=12V, 22.7A, 500W(1ms)	DO-214AC	1d	1k	Vs
5BD	SMA5J12C	TVS	Vbr=13.3..16.3V, Vrw=12V, 22.7A, 500W(1ms), Bidirectional	DO-214AC	1ba	1l	Vs
5BDW	5.0SMDJ11C	TVS	Vbr=12.2..14.9V, Vrw=11V, 251.2A, 5000W(1ms), Bidirectional	DO-214AB	1ba	1j	Ksm
5BDW	TV50C110KB-G	TVS	Vrw=11.0V, Vbr=12.20..14.90V, Ipp=251.24A, 5000W(1ms), Bidirectional	DO-214AB	1ba	1j	Cmc
5BDX	5.0SMDJ11CA	TVS	Vbr=12.2..13.5V, Vrw=11V, 277.5A, 5000W(1ms), Bidirectional	DO-214AB	1ba	1j	Ksm
5BDX	TV50C110JB-G	TVS	Vrw=11.0V, Vbr=12.20..13.50V, Ipp=277.47A, 5000W(1ms), Bidirectional	DO-214AB	1ba	1j	Cmc
5BDY	5.0SMDJ12C	TVS	Vbr=13.3..16.3V, Vrw=12V, 229.5A, 5000W(1ms), Bidirectional	DO-214AB	1ba	1j	Ksm
5BDY	TV50C120KB-G	TVS	Vrw=12.0V, Vbr=13.30..16.30V, Ipp=229.55A, 5000W(1ms), Bidirectional	DO-214AB	1ba	1j	Cmc
5BDZ	5.0SMDJ12CA	TVS	Vbr=13.3..14.7V, Vrw=12V, 253.8A, 5000W(1ms), Bidirectional	DO-214AB	1ba	1j	Ksm
5BDZ	TV50C120JB-G	TVS	Vrw=12.0V, Vbr=13.30..14.70V, Ipp=253.77A, 5000W(1ms), Bidirectional	DO-214AB	1ba	1j	Cmc
5BE	SMA5J12A	TVS	Vbr=13.3..14.7V, Vrw=12V, 25.1A, 500W(1ms)	DO-214AC	1d	1k	Vs
5BE	SMA5J12CA	TVS	Vbr=13.3..14.7V, Vrw=12V, 25.1A, 500W(1ms), Bidirectional	DO-214AC	1ba	1l	Vs
5BED	5.0SMDJ13C	TVS	Vbr=14.4..17.6V, Vrw=13V, 212.2A, 5000W(1ms), Bidirectional	DO-214AB	1ba	1j	Ksm
5BED	TV50C130KB-G	TVS	Vrw=13.0V, Vbr=14.40..17.60V, Ipp=212.18A, 5000W(1ms), Bidirectional	DO-214AB	1ba	1j	Cmc
5BEE	5.0SMDJ13CA	TVS	Vbr=14.4..15.9V, Vrw=13V, 234.9A, 5000W(1ms), Bidirectional	DO-214AB	1ba	1j	Ksm
5BEE	TV50C130JB-G	TVS	Vrw=13.0V, Vbr=14.40..15.90V, Ipp=234.88A, 5000W(1ms), Bidirectional	DO-214AB	1ba	1j	Cmc
5BEF	5.0SMDJ14C	TVS	Vbr=15.6..19.1V, Vrw=14V, 195.7A, 5000W(1ms), Bidirectional	DO-214AB	1ba	1j	Ksm
5BEF	TV50C140KB-G	TVS	Vrw=14.0V, Vbr=15.60..19.10V, Ipp=195.74A, 5000W(1ms), Bidirectional	DO-214AB	1ba	1j	Cmc
5BEG	5.0SMDJ14CA	TVS	Vbr=15.6..17.2V, Vrw=14V, 217.7A, 5000W(1ms), Bidirectional	DO-214AB	1ba	1j	Ksm
5BEG	TV50C140JB-G	TVS	Vrw=14.0V, Vbr=15.60..17.20V, Ipp=217.67A, 5000W(1ms), Bidirectional	DO-214AB	1ba	1j	Cmc
5BEH	5.0SMDJ15C	TVS	Vbr=16.7..20.4V, Vrw=15V, 187.7A, 5000W(1ms), Bidirectional	DO-214AB	1ba	1j	Ksm
5BEH	TV50C150KB-G	TVS	Vrw=15.0V, Vbr=16.70..20.40V, Ipp=187.73A, 5000W(1ms), Bidirectional	DO-214AB	1ba	1j	Cmc
5BEK	5.0SMDJ15CA	TVS	Vbr=16.7..18.5V, Vrw=15V, 207.0A, 5000W(1ms), Bidirectional	DO-214AB	1ba	1j	Ksm
5BEK	TV50C150JB-G	TVS	Vrw=15.0V, Vbr=16.70..18.50V, Ipp=206.97A, 5000W(1ms), Bidirectional	DO-214AB	1ba	1j	Cmc
5BEL	5.0SMDJ16C	TVS	Vbr=17.8..21.8V, Vrw=16V, 175.3A, 5000W(1ms), Bidirectional	DO-214AB	1ba	1j	Ksm
5BEL	TV50C160KB-G	TVS	Vrw=16.0V, Vbr=17.80..21.80V, Ipp=175.35A, 5000W(1ms), Bidirectional	DO-214AB	1ba	1j	Cmc
5BEM	5.0SMDJ16CA	TVS	Vbr=17.8..19.7V, Vrw=16V, 194.2A, 5000W(1ms), Bidirectional	DO-214AB	1ba	1j	Ksm
5BEM	TV50C160JB-G	TVS	Vrw=16.0V, Vbr=17.80..19.70V, Ipp=194.23A, 5000W(1ms), Bidirectional	DO-214AB	1ba	1j	Cmc
5BEN	5.0SMCJ11CA	TVS	Vrw=11.0V, Vbr=12.2..13.5V, 275.0A, 5000W(1ms), Bidirectional	DO-214AB	1ba	1j	Ext
5BEN	5.0SMCJ11CA	TVS	Vrw=11.0V, Vbr=12.2..13.5V, 275.0A, 5000W(1ms), Bidirectional	DO-215AB	5ba	1a	Lge
5BEN	5.0SMDJ11CA	TVS	Vrw=11V, Vbr=12.2..13.5V, 275A, 5000W(1ms), Bidirectional	DO-214AB	1ba	1j	Cnc
5BEN	5.0SMDJ17C	TVS	Vrw=18.9..23.1V, Vrw=17V, 165.6A, 5000W(1ms), Bidirectional	DO-214AB	1ba	1j	Ksm
5BEN	5.0SMLJ11CA	TVS	Vrw=11V, Vbr=12.2..13.5V, 275A, 5000W(1ms), Bidirectional	DO-214AB	1ba	1j	Mde
5BEN	TV50C170KB-G	TVS	Vrw=17.0V, Vbr=18.90..23.10V, Ipp=165.57A, 5000W(1ms), Bidirectional	DO-214AB	1ba	1j	Cmc
5BEP	5.0SMCJ12CA	TVS	Vrw=12.0V, Vbr=13.3..14.7V, 252.0A, 5000W(1ms), Bidirectional	DO-214AB	1ba	1j	Ext
5BEP	5.0SMCJ12CA	TVS	Vrw=12.0V, Vbr=13.3..14.7V, 252.0A, 5000W(1ms), Bidirectional	DO-215AB	5ba	1a	Lge
5BEP	5.0SMDJ12CA	TVS	Vrw=12V, Vbr=13.3..14.7V, 252A, 5000W(1ms), Bidirectional	DO-214AB	1ba	1j	Cnc
5BEP	5.0SMDJ17CA	TVS	Vbr=18.9..20.9V, Vrw=17V, 183.0A, 5000W(1ms), Bidirectional	DO-214AB	1ba	1j	Ksm
5BEP	5.0SMLJ12CA	TVS	Vrw=12V, Vbr=13.3..14.7V, 252A, 5000W(1ms), Bidirectional	DO-214AB	1ba	1j	Mde
5BEP	TV50C170JB-G	TVS	Vrw=17.0V, Vbr=18.90..20.90V, Ipp=182.97A, 5000W(1ms), Bidirectional	DO-214AB	1ba	1j	Cmc
5BEQ	5.0SMCJ13CA	TVS	Vrw=13.0V, Vbr=14.4..15.9V, 233.0A, 5000W(1ms), Bidirectional	DO-214AB	1ba	1j	Ext
5BEQ	5.0SMCJ13CA	TVS	Vrw=13.0V, Vbr=14.4..15.9V, 233.0A, 5000W(1ms), Bidirectional	DO-215AB	5ba	1a	Lge
5BEQ	5.0SMDJ13CA	TVS	Vrw=13V, Vbr=14.4..15.9V, 233A, 5000W(1ms), Bidirectional	DO-214AB	1ba	1j	Cnc
5BEQ	5.0SMDJ18C	TVS	Vbr=20.0..24.4V, Vrw=18V, 156.8A, 5000W(1ms), Bidirectional	DO-214AB	1ba	1j	Ksm
5BEQ	5.0SMLJ13CA	TVS	Vrw=13V, Vbr=14.4..15.9V, 233A, 5000W(1ms), Bidirectional	DO-214AB	1ba	1j	Mde
5BEQ	TV50C180KB-G	TVS	Vrw=18.0V, Vbr=20.0..24.40V, Ipp=156.83A, 5000W(1ms), Bidirectional	DO-214AB	1ba	1j	Cmc
5BER	5.0SMCJ14CA	TVS	Vrw=14.0V, Vbr=15.6..17.2V, 216.0A, 5000W(1ms), Bidirectional	DO-214AB	1ba	1j	Ext
5BER	5.0SMCJ14CA	TVS	Vrw=14.0V, Vbr=15.6..17.2V, 216.0A, 5000W(1ms), Bidirectional	DO-215AB	5ba	1a	Lge
5BER	5.0SMDJ14CA	TVS	Vrw=14V, Vbr=15.6..17.2V, 216A, 5000W(1ms), Bidirectional	DO-214AB	1ba	1j	Cnc
5BER	5.0SMDJ18CA	TVS	Vbr=20.0..22.1V, Vrw=18V, 172.9A, 5000W(1ms), Bidirectional	DO-214AB	1ba	1j	Ksm
5BER	5.0SMLJ14CA	TVS	Vrw=14V, Vbr=15.6..17.2V, 216A, 5000W(1ms), Bidirectional	DO-214AB	1ba	1j	Mde
5BER	TV50C180JB-G	TVS	Vrw=18.0V, Vbr=20.0..22.10V, Ipp=172.95A, 5000W(1ms), Bidirectional	DO-214AB	1ba	1j	Cmc
5BES	5.0SMCJ15CA	TVS	Vrw=15.0V, Vbr=16.7..18.5V, 205.0A, 5000W(1ms), Bidirectional	DO-214AB	1ba	1j	Ext
5BES	5.0SMCJ15CA	TVS	Vrw=15.0V, Vbr=16.7..18.5V, 205.0A, 5000W(1ms), Bidirectional	DO-215AB	5ba	1a	Lge
5BES	5.0SMDJ15CA	TVS	Vrw=15V, Vbr=16.7..18.5V, 205A, 5000W(1ms), Bidirectional	DO-214AB	1ba	1j	Cnc
5BES	5.0SMDJ19C	TVS	Vbr=21.1..25.8V, Vrw=19V, 148.5A, 5000W(1ms), Bidirectional	DO-214AB	1ba	1j	Ksm
5BES	5.0SMLJ15CA	TVS	Vrw=15V, Vbr=16.7..18.5V, 205A, 5000W(1ms), Bidirectional	DO-214AB	1ba	1j	Mco
5BES	5.0SMLJ20CA	TVS	Vrw=15V, Vbr=16.7..18.5V, 205A, 5000W(1ms), Bidirectional	DO-214AB	1ba	1j	Mde
5BES	TV50C190KB-G	TVS	Vrw=19.0V, Vbr=21.13..25.76V, Ipp=148.49A, 5000W(1ms), Bidirectional	DO-214AB	1ba	1j	Cmc
5BET	5.0SMCJ16CA	TVS	Vrw=16.0V, Vbr=17.8..19.7V, 193.0A, 5000W(1ms), Bidirectional	DO-214AB	1ba	1j	Ext
5BET	5.0SMCJ16CA	TVS	Vrw=16.0V, Vbr=17.8..19.7V, 193.0A, 5000W(1ms), Bidirectional	DO-215AB	5ba	1a	Lge
5BET	5.0SMDJ16CA	TVS	Vrw=16V, Vbr=17.8..19.7V, 193A, 5000W(1ms), Bidirectional	DO-214AB	1ba	1j	Cnc
5BET	5.0SMDJ19CA	TVS	Vbr=21.1..23.3V, Vrw=19V, 164.1A, 5000W(1ms), Bidirectional	DO-214AB	1ba	1j	Ksm
5BET	5.0SMLJ16CA	TVS	Vrw=16V, Vbr=17.8..19.7V, 193A, 5000W(1ms), Bidirectional	DO-214AB	1ba	1j	Mco



SMD code	Type	Function	Short description	Case	Pinout	St.	Mnf.
5BET	5.0SMLJ20CA	TVS	Vrwm=16V, Vbr=17.8..19.7V, 193A, 5000W(1ms), Bidirectional	DO-214AB	1ba	1j	Mde
5BET	TV50C190JB-G	TVS	Vrwm=19.0V, Vbr=21.10..23.30V, Ipp=164.07A, 5000W(1ms), Bidirectional	DO-214AB	1ba	1j	Comc
5BEU	5.0SMCJ17CA	TVS	Vrwm=17.0V, Vbr=18.9..20.9V, 181.0A, 5000W(1ms), Bidirectional	DO-214AB	1ba	1j	Ext
5BEU	5.0SMDG20CA	TVS	Vrwm=17.0V, Vbr=18.9..20.9V, 181.0A, 5000W(1ms), Bidirectional	DO-215AB	5ba	1a	Lge
5BEU	5.0SMDJ17CA	TVS	Vrwm=17V, Vbr=18.9..20.9V, 181A, 5000W(1ms), Bidirectional	DO-214AB	1ba	1j	Cnc
5BEU	5.0SMDJ20C	TVS	Vbr=22.2..27.1V, Vrwm=20V, 141.1A, 5000W(1ms), Bidirectional	DO-214AB	1ba	1j	Ksm
5BEU	5.0SMLJ17CA	TVS	Vrwm=17V, Vbr=18.9..20.9V, 181A, 5000W(1ms), Bidirectional	DO-214AB	1ba	1j	Mco
5BEU	5.0SMLJ20CA	TVS	Vrwm=17V, Vbr=18.9..20.9V, 181A, 5000W(1ms), Bidirectional	DO-214AB	1ba	1j	Mde
5BEU	TV50C200KB-G	TVS	Vrwm=20.0V, Vbr=22.20..27.10V, Ipp=141.06A, 5000W(1ms), Bidirectional	DO-214AB	1ba	1j	Cmc
5BEV	5.0SMCJ18CA	TVS	Vrwm=18.0V, Vbr=20.0..22.1V, 172.0A, 5000W(1ms), Bidirectional	DO-214AB	1ba	1j	Ext
5BEV	5.0SMDG20CA	TVS	Vrwm=18.0V, Vbr=20.0..22.1V, 172.0A, 5000W(1ms), Bidirectional	DO-215AB	5ba	1a	Lge
5BEV	5.0SMDJ18CA	TVS	Vrwm=18V, Vbr=20.0..22.1V, 172A, 5000W(1ms), Bidirectional	DO-214AB	1ba	1j	Cnc
5BEV	5.0SMDJ20CA	TVS	Vbr=22.2..24.5V, Vrwm=20V, 155.9A, 5000W(1ms), Bidirectional	DO-214AB	1ba	1j	Ksm
5BEV	5.0SMLJ18CA	TVS	Vrwm=18V, Vbr=20.0..22.1V, 172A, 5000W(1ms), Bidirectional	DO-214AB	1ba	1j	Mco
5BEV	5.0SMLJ20CA	TVS	Vrwm=18V, Vbr=20.0..22.1V, 172A, 5000W(1ms), Bidirectional	DO-214AB	1ba	1j	Mde
5BEV	TV50C200JB-G	TVS	Vrwm=20.0V, Vbr=22.20..24.50V, Ipp=155.86A, 5000W(1ms), Bidirectional	DO-214AB	1ba	1j	Cmc
5BEW	5.0SMCJ20CA	TVS	Vrwm=20.0V, Vbr=22.2..24.5V, 155.0A, 5000W(1ms), Bidirectional	DO-214AB	1ba	1j	Ext
5BEW	5.0SMDG20CA	TVS	Vrwm=20.0V, Vbr=22.2..24.5V, 155.0A, 5000W(1ms), Bidirectional	DO-215AB	5ba	1a	Lge
5BEW	5.0SMDJ20CA	TVS	Vrwm=20V, Vbr=22.2..24.5V, 155A, 5000W(1ms), Bidirectional	DO-214AB	1ba	1j	Cnc
5BEW	5.0SMDJ22C	TVS	Vbr=24.4..29.8V, Vrwm=22V, 128.2A, 5000W(1ms), Bidirectional	DO-214AB	1ba	1j	Ksm
5BEW	5.0SMLJ20CA	TVS	Vrwm=20V, Vbr=22.2..24.5V, 155A, 5000W(1ms), Bidirectional	DO-214AB	1ba	1j	Mde
5BEW	TV50C220KB-G	TVS	Vrwm=22.0V, Vbr=24.40..29.80V, Ipp=128.17A, 5000W(1ms), Bidirectional	DO-214AB	1ba	1j	Cmc
5BEX	5.0SMCJ22CA	TVS	Vrwm=22.0V, Vbr=24.4..26.9V, 141.0A, 5000W(1ms), Bidirectional	DO-214AB	1ba	1j	Ext
5BEX	5.0SMDG22CA	TVS	Vrwm=22.0V, Vbr=24.4..26.9V, 141.0A, 5000W(1ms), Bidirectional	DO-215AB	5ba	1a	Lge
5BEX	5.0SMDJ22CA	TVS	Vrwm=22V, Vbr=24.4..26.9V, 141A, 5000W(1ms), Bidirectional	DO-214AB	1ba	1j	Cnc
5BEX	5.0SMLJ22CA	TVS	Vrwm=22V, Vbr=24.4..26.9V, 141A, 5000W(1ms), Bidirectional	DO-214AB	1ba	1j	Mde
5BEX	TV50C220JB-G	TVS	Vrwm=22.0V, Vbr=24.40..26.90V, Ipp=142.25A, 5000W(1ms), Bidirectional	DO-214AB	1ba	1j	Cmc
5BEY	5.0SMDJ24C	TVS	Vbr=26.7..32.6V, Vrwm=24V, 117.4A, 5000W(1ms), Bidirectional	DO-214AB	1ba	1j	Ksm
5BEY	TV50C240KB-G	TVS	Vrwm=24.0V, Vbr=26.70..32.60V, Ipp=117.44A, 5000W(1ms), Bidirectional	DO-214AB	1ba	1j	Cmc
5BEZ	5.0SMCJ24CA	TVS	Vrwm=24.0V, Vbr=26.7..29.5V, 129.0A, 5000W(1ms), Bidirectional	DO-214AB	1ba	1j	Ext
5BEZ	5.0SMDG24CA	TVS	Vrwm=24.0V, Vbr=26.7..29.5V, 129.0A, 5000W(1ms), Bidirectional	DO-215AB	5ba	1a	Lge
5BEZ	5.0SMDJ24CA	TVS	Vrwm=24V, Vbr=26.7..29.5V, 129A, 5000W(1ms), Bidirectional	DO-214AB	1ba	1j	Cnc
5BEZ	TV50C240JB-G	TVS	Vrwm=24.0V, Vbr=26.70..29.50V, Ipp=129.82A, 5000W(1ms), Bidirectional	DO-214AB	1ba	1j	Cmc
5BF	SMA5J13	TVS	Vbr=14.4..17.6V, Vrwm=13V, 21.0A, 500W(1ms)	DO-214AC	1d	1k	Vs
5BF	SMA5J13C	TVS	Vbr=14.4..17.6V, Vrwm=13V, 21.0A, 500W(1ms), Bidirectional	DO-214AC	1ba	1l	Vs
5BFD	5.0SMDJ26C	TVS	Vbr=28.9..35.3V, Vrwm=26V, 108.4A, 5000W(1ms), Bidirectional	DO-214AB	1ba	1j	Ksm
5BFD	TV50C260KB-G	TVS	Vrwm=26.0V, Vbr=28.90..35.30V, Ipp=108.37A, 5000W(1ms), Bidirectional	DO-214AB	1ba	1j	Cmc
5BFE	5.0SMCJ26CA	TVS	Vrwm=26.0V, Vbr=28.9..31.9V, 119.0A, 5000W(1ms), Bidirectional	DO-214AB	1ba	1j	Ext
5BFE	5.0SMDG26CA	TVS	Vrwm=26.0V, Vbr=28.9..31.9V, 119.0A, 5000W(1ms), Bidirectional	DO-215AB	5ba	1a	Lge
5BFE	5.0SMDJ26CA	TVS	Vrwm=26V, Vbr=28.9..31.9V, 119A, 5000W(1ms), Bidirectional	DO-214AB	1ba	1j	Cnc
5BFE	5.0SMLJ26CA	TVS	Vrwm=26V, Vbr=28.9..31.9V, 119A, 5000W(1ms), Bidirectional	DO-214AB	1ba	1j	Mde
5BFE	TV50C260JB-G	TVS	Vrwm=26.0V, Vbr=28.90..31.90V, Ipp=119.95A, 5000W(1ms), Bidirectional	DO-214AB	1ba	1j	Cmc
5BFF	5.0SMDJ28C	TVS	Vbr=31.1..38.0V, Vrwm=28V, 101.0A, 5000W(1ms), Bidirectional	DO-214AB	1ba	1j	Ksm
5BFF	TV50C280KB-G	TVS	Vrwm=28.0V, Vbr=31.10..38.0V, Ipp=101.0A, 5000W(1ms), Bidirectional	DO-214AB	1ba	1j	Cmc
5BFG	5.0SMCJ28CA	TVS	Vrwm=28.0V, Vbr=31.1..34.4V, 110.0A, 5000W(1ms), Bidirectional	DO-214AB	1ba	1j	Ext
5BFG	5.0SMDG28CA	TVS	Vrwm=28.0V, Vbr=31.1..34.4V, 110.0A, 5000W(1ms), Bidirectional	DO-215AB	5ba	1a	Lge
5BFG	5.0SMDJ28CA	TVS	Vrwm=28V, Vbr=31.1..34.4V, 110A, 5000W(1ms), Bidirectional	DO-214AB	1ba	1j	Cnc
5BFG	5.0SMLJ28CA	TVS	Vrwm=28V, Vbr=31.1..34.4V, 110A, 5000W(1ms), Bidirectional	DO-214AB	1ba	1j	Mde
5BFG	TV50C280JB-G	TVS	Vrwm=28.0V, Vbr=31.10..34.40V, Ipp=111.23A, 5000W(1ms), Bidirectional	DO-214AB	1ba	1j	Cmc
5BFH	5.0SMDJ30C	TVS	Vbr=33.3..40.7V, Vrwm=30V, 94.4A, 5000W(1ms), Bidirectional	DO-214AB	1ba	1j	Ksm
5BFH	TV50C300KB-G	TVS	Vrwm=30.0V, Vbr=33.30..40.70V, Ipp=94.39A, 5000W(1ms), Bidirectional	DO-214AB	1ba	1j	Cmc
5BFK	5.0SMCJ30CA	TVS	Vrwm=30.0V, Vbr=33.3..36.8V, 103.0A, 5000W(1ms), Bidirectional	DO-214AB	1ba	1j	Ext
5BFK	5.0SMDG30CA	TVS	Vrwm=30.0V, Vbr=33.3..36.8V, 103.0A, 5000W(1ms), Bidirectional	DO-215AB	5ba	1a	Lge
5BFK	5.0SMDJ30CA	TVS	Vrwm=30V, Vbr=33.3..36.8V, 103A, 5000W(1ms), Bidirectional	DO-214AB	1ba	1j	Cnc
5BFK	5.0SMLJ30CA	TVS	Vrwm=30V, Vbr=33.3..36.8V, 103A, 5000W(1ms), Bidirectional	DO-214AB	1ba	1j	Mde
5BFK	TV50C300JB-G	TVS	Vrwm=30.0V, Vbr=33.30..36.80V, Ipp=104.34A, 5000W(1ms), Bidirectional	DO-214AB	1ba	1j	Cmc
5BFL	5.0SMDJ33C	TVS	Vbr=33.0V, Vbr=36.7..44.9V, Vrwm=33V, 85.6A, 5000W(1ms), Bidirectional	DO-214AB	1ba	1j	Ksm
5BFL	TV50C330KB-G	TVS	Vrwm=33.0V, Vbr=36.70..44.90V, Ipp=85.59A, 5000W(1ms), Bidirectional	DO-214AB	1ba	1j	Cmc
5BFM	5.0SMCJ33CA	TVS	Vrwm=33.0V, Vbr=36.7..40.6V, 93.9A, 5000W(1ms), Bidirectional	DO-214AB	1ba	1j	Ext
5BFM	5.0SMDG33CA	TVS	Vrwm=33.0V, Vbr=36.7..40.6V, 93.9A, 5000W(1ms), Bidirectional	DO-215AB	5ba	1a	Lge
5BFM	5.0SMDJ33CA	TVS	Vrwm=33V, Vbr=36.7..40.6V, 93.9A, 5000W(1ms), Bidirectional	DO-214AB	1ba	1j	Cnc
5BFM	5.0SMLJ33CA	TVS	Vrwm=33V, Vbr=36.7..40.6V, 93.9A, 5000W(1ms), Bidirectional	DO-214AB	1ba	1j	Mde
5BFM	TV50C330JB-G	TVS	Vrwm=33.0V, Vbr=36.70..40.60V, Ipp=94.75A, 5000W(1ms), Bidirectional	DO-214AB	1ba	1j	Cmc
5BFN	5.0SMDJ36C	TVS	Vbr=40.0..48.9V, Vrwm=36V, 78.5A, 5000W(1ms), Bidirectional	DO-214AB	1ba	1j	Ksm
5BFN	TV50C360KB-G	TVS	Vrwm=36.0V, Vbr=40.0..48.90V, Ipp=78.54A, 5000W(1ms), Bidirectional	DO-214AB	1ba	1j	Cmc
5BFP	5.0SMCJ36CA	TVS	Vrwm=36.0V, Vbr=40.0..44.2V, 86.1A, 5000W(1ms), Bidirectional	DO-215AB	1ba	1j	Ext
5BFP	5.0SMDG36CA	TVS	Vrwm=36.0V, Vbr=40.0..44.2V, 86.1A, 5000W(1ms), Bidirectional	DO-215AB	5ba	1a	Lge
5BFP	5.0SMDJ36CA	TVS	Vrwm=36V, Vbr=40.0..44.2V, 86.1A, 5000W(1ms), Bidirectional	DO-214AB	1ba	1j	Cnc
5BFP	5.0SMLJ36CA	TVS	Vrwm=36V, Vbr=40.0..44.2V, 86.1A, 5000W(1ms), Bidirectional	DO-214AB	1ba	1j	Mde



SMD code	Type	Function	Short description	Case	Pinout	St.	Mnf.
5BFPP	TV50C360JB-G	TVS	Vrwm=36.0V, Vbr=40.0..44.20V, Ipp=86.92A, 5000W(1ms), Bidirectional	DO-214AB	1ba	1j	Cmc
5BFQ	5.0SMDJ40C	TVS	Vbr=44.4..54.3V, Vrwm=40V, 70.7A, 5000W(1ms), Bidirectional	DO-214AB	1ba	1j	Ksm
5BFQ	TV50C400KB-G	TVS	Vrwm=40.0V, Vbr=44.0..54.30V, Ipp=70.73A, 5000W(1ms), Bidirectional	DO-214AB	1ba	1j	Cmc
5BFR	5.0SMCJ40CA	TVS	Vrwm=40.0V, Vbr=44.4..49.1V, 77.6A, 5000W(1ms), Bidirectional	DO-214AB	1ba	1j	Ext
5BFR	5.0SMDG40CA	TVS	Vrwm=40.0V, Vbr=44.4..49.1V, 77.6A, 5000W(1ms), Bidirectional	DO-215AB	5ba	1a	Lge
5BFR	5.0SMDJ40CA	TVS	Vrwm=40.0V, Vbr=44.4..49.1V, 77.6A, 5000W(1ms), Bidirectional	DO-214AB	1ba	1j	Cnc
5BFR	5.0SMLJ40CA	TVS	Vrwm=40V, Vbr=44.4..49.1V, 77.6A, 5000W(1ms), Bidirectional	DO-214AB	1ba	1j	Mde
5BFR	TV50C400JB-G	TVS	Vrwm=40.0V, Vbr=44.0..49.10V, Ipp=78.29A, 5000W(1ms), Bidirectional	DO-214AB	1ba	1j	Cmc
5BFS	5.0SMDJ43C	TVS	Vbr=47.8..58.4V, Vrwm=43V, 65.8A, 5000W(1ms), Bidirectional	DO-214AB	1ba	1j	Ksm
5BFS	TV50C430KB-G	TVS	Vrwm=43.0V, Vbr=47.80..58.40V, Ipp=65.84A, 5000W(1ms), Bidirectional	DO-214AB	1ba	1j	Cmc
5BFT	5.0SMCJ43CA	TVS	Vrwm=43.0V, Vbr=47.8..52.8V, 72.1A, 5000W(1ms), Bidirectional	DO-214AB	1ba	1j	Ext
5BFT	5.0SMDG43CA	TVS	Vrwm=43.0V, Vbr=47.8..52.8V, 72.1A, 5000W(1ms), Bidirectional	DO-215AB	5ba	1a	Lge
5BFT	5.0SMDJ43CA	TVS	Vrwm=43V, Vbr=47.8..52.8V, 72.1A, 5000W(1ms), Bidirectional	DO-214AB	1ba	1j	Cnc
5BFT	5.0SMLJ43CA	TVS	Vrwm=43V, Vbr=47.8..52.8V, 72.1A, 5000W(1ms), Bidirectional	DO-214AB	1ba	1j	Mde
5BFT	TV50C430JB-G	TVS	Vrwm=43.0V, Vbr=47.80..52.80V, Ipp=72.77A, 5000W(1ms), Bidirectional	DO-214AB	1ba	1j	Cmc
5BFU	5.0SMDJ45C	TVS	Vbr=50.0..61.1V, Vrwm=45V, 62.9A, 5000W(1ms), Bidirectional	DO-214AB	1ba	1j	Ksm
5BFU	TV50C450KB-G	TVS	Vrwm=45.0V, Vbr=50.0..61.10V, Ipp=62.89A, 5000W(1ms), Bidirectional	DO-214AB	1ba	1j	Cmc
5BFV	5.0SMCJ45CA	TVS	Vrwm=45.0V, Vbr=50.0..55.3V, 68.8A, 5000W(1ms), Bidirectional	DO-214AB	1ba	1j	Ext
5BFV	5.0SMDG45CA	TVS	Vrwm=45.0V, Vbr=50.0..55.3V, 68.8A, 5000W(1ms), Bidirectional	DO-215AB	5ba	1a	Lge
5BFV	5.0SMDJ45CA	TVS	Vrwm=45V, Vbr=50.0..55.3V, 68.8A, 5000W(1ms), Bidirectional	DO-214AB	1ba	1j	Cnc
5BFV	5.0SMLJ45CA	TVS	Vrwm=45V, Vbr=50.0..55.3V, 68.8A, 5000W(1ms), Bidirectional	DO-214AB	1ba	1j	Mde
5BFV	TV50C450JB-G	TVS	Vrwm=45.0V, Vbr=50.0..55.30V, Ipp=69.46A, 5000W(1ms), Bidirectional	DO-214AB	1ba	1j	Cmc
5BFW	5.0SMDJ48C	TVS	Vbr=53.3..65.1V, Vrwm=48V, 59.1A, 5000W(1ms), Bidirectional	DO-214AB	1ba	1j	Ksm
5BFW	TV50C480KB-G	TVS	Vrwm=48.0V, Vbr=53.30..65.10V, Ipp=59.06A, 5000W(1ms), Bidirectional	DO-214AB	1ba	1j	Cmc
5BFX	5.0SMCJ48CA	TVS	Vrwm=48.0V, Vbr=53.3..58.9V, 64.7A, 5000W(1ms), Bidirectional	DO-214AB	1ba	1j	Ext
5BFX	5.0SMDJ48CA	TVS	Vbr=53.3..58.9V, Vrwm=48V, 65.2A, 5000W(1ms), Bidirectional	DO-214AB	1ba	1j	Ksm
5BFX	TV50C480JB-G	TVS	Vrwm=48.0V, Vbr=53.30..58.90V, Ipp=65.25A, 5000W(1ms), Bidirectional	DO-214AB	1ba	1j	Cmc
5BFY	5.0SMDJ51C	TVS	Vbr=56.7..69.3V, Vrwm=51V, 55.4A, 5000W(1ms), Bidirectional	DO-214AB	1ba	1j	Ksm
5BFY	TV50C510KB-G	TVS	Vrwm=51.0V, Vbr=56.70..69.30V, Ipp=55.43A, 5000W(1ms), Bidirectional	DO-214AB	1ba	1j	Cmc
5BFZ	5.0SMCJ51CA	TVS	Vrwm=51.0V, Vbr=56.7..62.7V, 60.7A, 5000W(1ms), Bidirectional	DO-214AB	1ba	1j	Ext
5BFZ	5.0SMDJ51CA	TVS	Vbr=56.7..62.7V, Vrwm=51V, 61.3A, 5000W(1ms), Bidirectional	DO-214AB	1ba	1j	Ksm
5BFZ	TV50C510JB-G	TVS	Vrwm=51.0V, Vbr=56.70..62.70V, Ipp=61.29A, 5000W(1ms), Bidirectional	DO-214AB	1ba	1j	Cmc
5BG	SMA5J13A	TVS	Vbr=14.4..15.9V, Vrwm=13V, 23.3A, 500W(1ms)	DO-214AC	1d	1k	Vs
5BG	SMA5J13CA	TVS	Vbr=14.4..15.9V, Vrwm=13V, 23.3A, 500W(1ms), Bidirectional	DO-214AC	1ba	1l	Vs
5BGA	5.0SMDJ80C	TVS	Vbr=89.0..109V, Vrwm=80V, 35.3A, 5000W(1ms), Bidirectional	DO-214AB	1ba	1j	Ksm
5BGA	TV50C800KB-G	TVS	Vrwm=80.0V, Vbr=88.96..108.80V, Ipp=35.27A, 5000W(1ms), Bidirectional	DO-214AB	1ba	1j	Cmc
5BGB	5.0SMDJ80CA	TVS	Vbr=88.8..97.6V, Vrwm=80V, 39.0A, 5000W(1ms), Bidirectional	DO-214AB	1ba	1j	Ksm
5BGB	TV50C800JB-G	TVS	Vrwm=80.0V, Vbr=88.80..97.60V, Ipp=38.97A, 5000W(1ms), Bidirectional	DO-214AB	1ba	1j	Cmc
5BGD	5.0SMDJ54C	TVS	Vbr=60.0..73.3V, Vrwm=54V, 52.4A, 5000W(1ms), Bidirectional	DO-214AB	1ba	1j	Ksm
5BGD	TV50C540KB-G	TVS	Vrwm=54.0V, Vbr=60.0..73.30V, Ipp=52.44A, 5000W(1ms), Bidirectional	DO-214AB	1ba	1j	Cmc
5BGE	5.0SMCJ54CA	TVS	Vrwm=54.0V, Vbr=60.0..66.3V, 57.5A, 5000W(1ms), Bidirectional	DO-214AB	1ba	1j	Ext
5BGE	TV50C540JB-G	TVS	Vrwm=54.0V, Vbr=60.0..66.30V, Ipp=57.98A, 5000W(1ms), Bidirectional	DO-214AB	1ba	1j	Cmc
5BGF	5.0SMDJ58C	TVS	Vbr=64.4..78.7V, Vrwm=58V, 49.0A, 5000W(1ms), Bidirectional	DO-214AB	1ba	1j	Ksm
5BGF	TV50C580KB-G	TVS	Vrwm=58.0V, Vbr=64.40..78.70V, Ipp=49.03A, 5000W(1ms), Bidirectional	DO-214AB	1ba	1j	Cmc
5BGG	5.0SMCJ58CA	TVS	Vrwm=58.0V, Vbr=64.4..71.2V, 53.5A, 5000W(1ms), Bidirectional	DO-214AB	1ba	1j	Ext
5BGG	5.0SMDJ58CA	TVS	Vbr=64.4..71.2V, Vrwm=58V, 54.0A, 5000W(1ms), Bidirectional	DO-214AB	1ba	1j	Ksm
5BGG	TV50C580JB-G	TVS	Vrwm=58.0V, Vbr=64.40..71.20V, Ipp=53.95A, 5000W(1ms), Bidirectional	DO-214AB	1ba	1j	Cmc
5BGH	5.0SMDJ60C	TVS	Vbr=66.7..81.5V, Vrwm=60V, 47.2A, 5000W(1ms), Bidirectional	DO-214AB	1ba	1j	Ksm
5BGH	TV50C600KB-G	TVS	Vrwm=60.0V, Vbr=66.70..81.50V, Ipp=47.20A, 5000W(1ms), Bidirectional	DO-214AB	1ba	1j	Cmc
5BGI	5.0SMCJ60CA	TVS	Vrwm=60.0V, Vbr=66.7..73.7V, 51.7A, 5000W(1ms), Bidirectional	DO-214AB	1ba	1j	Ext
5BGI	5.0SMDJ60CA	TVS	Vbr=66.7..73.7V, Vrwm=60V, 52.2A, 5000W(1ms), Bidirectional	DO-214AB	1ba	1j	Ksm
5BGK	TV50C600JB-G	TVS	Vrwm=60.0V, Vbr=66.70..73.70V, Ipp=52.17A, 5000W(1ms), Bidirectional	DO-214AB	1ba	1j	Cmc
5BGL	5.0SMDJ64C	TVS	Vbr=71.1..86.9V, Vrwm=64V, 44.3A, 5000W(1ms), Bidirectional	DO-214AB	1ba	1j	Ksm
5BGL	TV50C640KB-G	TVS	Vrwm=64.0V, Vbr=71.10..86.90V, Ipp=44.30A, 5000W(1ms), Bidirectional	DO-214AB	1ba	1j	Cmc
5BGM	5.0SMCJ64CA	TVS	Vrwm=64.0V, Vbr=71.1..78.6V, 48.6A, 5000W(1ms), Bidirectional	DO-214AB	1ba	1j	Ext
5BGM	5.0SMDJ64CA	TVS	Vbr=71.1..78.6V, Vrwm=64V, 49.0A, 5000W(1ms), Bidirectional	DO-214AB	1ba	1j	Ksm
5BGM	TV50C640JB-G	TVS	Vrwm=64.0V, Vbr=71.10..78.60V, Ipp=49.03A, 5000W(1ms), Bidirectional	DO-214AB	1ba	1j	Cmc
5BGN	5.0SMDJ70C	TVS	Vbr=77.8..95.1V, Vrwm=70V, 40.4A, 5000W(1ms), Bidirectional	DO-214AB	1ba	1j	Ksm
5BGN	TV50C700KB-G	TVS	Vrwm=70.0V, Vbr=77.80..95.10V, Ipp=40.40A, 5000W(1ms), Bidirectional	DO-214AB	1ba	1j	Cmc
5BGP	5.0SMCJ70CA	TVS	Vrwm=70.0V, Vbr=77.8..86.0V, 44.3A, 5000W(1ms), Bidirectional	DO-214AB	1ba	1j	Ext
5BGP	5.0SMDJ70CA	TVS	Vbr=77.8..86.0V, Vrwm=70V, 44.7A, 5000W(1ms), Bidirectional	DO-214AB	1ba	1j	Ksm
5BGP	TV50C700JB-G	TVS	Vrwm=70.0V, Vbr=77.80..86.0V, Ipp=44.69A, 5000W(1ms), Bidirectional	DO-214AB	1ba	1j	Cmc
5BGG	5.0SMDJ75C	TVS	Vbr=83.3..102V, Vrwm=75V, 37.7A, 5000W(1ms), Bidirectional	DO-214AB	1ba	1j	Ksm
5BGG	TV50C750KB-G	TVS	Vrwm=75.0V, Vbr=83.30..102.0V, Ipp=37.69A, 5000W(1ms), Bidirectional	DO-214AB	1ba	1j	Cmc
5BGR	5.0SMCJ75CA	TVS	Vrwm=75.0V, Vbr=83.3..92.1V, 41.4A, 5000W(1ms), Bidirectional	DO-214AB	1ba	1j	Ext
5BGR	5.0SMDJ75CA	TVS	Vbr=83.3..92.1V, Vrwm=75V, 41.7A, 5000W(1ms), Bidirectional	DO-214AB	1ba	1j	Ksm
5BGR	TV50C750JB-G	TVS	Vrwm=75.0V, Vbr=83.30..92.10V, Ipp=41.74A, 5000W(1ms), Bidirectional	DO-214AB	1ba	1j	Cmc
5BGS	5.0SMDJ78C	TVS	Vbr=86.7..106V, Vrwm=78V, 36.3A, 5000W(1ms), Bidirectional	DO-214AB	1ba	1j	Ksm
5BGS	TV50C780KB-G	TVS	Vrwm=78.0V, Vbr=86.70..106.0V, Ipp=36.33A, 5000W(1ms), Bidirectional	DO-214AB	1ba	1j	Cmc
5BGT	5.0SMCJ78CA	TVS	Vrwm=78.0V, Vbr=86.7..95.8V, 39.7A, 5000W(1ms), Bidirectional	DO-214AB	1ba	1j	Ext



SMD code	Type	Function	Short description	Case	Pinout	St.	Mnf.
5BGT	5.0SMDJ78CA	TVS	Vbr=86.7..95.8V, Vrwm=78V, 40.1A, 5000W(1ms), Bidirectional	DO-214AB	1ba	1j	Ksm
5BGT	TV50C780JB-G	TVS	Vrwm=78.0V, Vbr=86.70..95.80V, Ipp=40.08A, 5000W(1ms), Bidirectional	DO-214AB	1ba	1j	Cmc
5BGU	5.0SMDJ85C	TVS	Vbr=94.4..115V, Vrwm=85V, 33.4A, 5000W(1ms), Bidirectional	DO-214AB	1ba	1j	Ksm
5BGU	TV50C850KB-G	TVS	Vrwm=85.0V, Vbr=94.40..115.0V, Ipp=33.44A, 5000W(1ms), Bidirectional	DO-214AB	1ba	1j	Cmc
5BGV	5.0SMCJ85CA	TVS	Vrwm=85.0V, Vbr=94.4..104V, 36.5A, 5000W(1ms), Bidirectional	DO-214AB	1ba	1j	Ext
5BGV	5.0SMDJ85CA	TVS	Vbr=94.4..104V, Vrwm=85V, 36.9A, 5000W(1ms), Bidirectional	DO-214AB	1ba	1j	Ksm
5BGV	TV50C850JB-G	TVS	Vrwm=85.0V, Vbr=94.40..104.0V, Ipp=36.86A, 5000W(1ms), Bidirectional	DO-214AB	1ba	1j	Cmc
5BGW	5.0SMDJ90C	TVS	Vbr=100..122V, Vrwm=90V, 31.6A, 5000W(1ms), Bidirectional	DO-214AB	1ba	1j	Ksm
5BGW	TV50C900KB-G	TVS	Vrwm=90.0V, Vbr=100.0..122.0V, Ipp=31.56A, 5000W(1ms), Bidirectional	DO-214AB	1ba	1j	Cmc
5BGX	5.0SMCJ90CA	TVS	Vrwm=90.0V, Vrwm=100..111V, 34.3A, 5000W(1ms), Bidirectional	DO-214AB	1ba	1j	Ext
5BGX	5.0SMDJ90CA	TVS	Vbr=100..111V, Vrwm=90V, 34.6A, 5000W(1ms), Bidirectional	DO-214AB	1ba	1j	Ksm
5BGX	TV50C900JB-G	TVS	Vrwm=90.0V, Vbr=100.0..111.0V, Ipp=34.59A, 5000W(1ms), Bidirectional	DO-214AB	1ba	1j	Cmc
5BGY	5.0SMDJ100C	TVS	Vbr=111..136V, Vrwm=100V, 28.2A, 5000W(1ms), Bidirectional	DO-214AB	1ba	1j	Ksm
5BGY	TV50C101KB-G	TVS	Vrwm=100.0V, Vbr=111.0..136.0V, Ipp=28.21A, 5000W(1ms), Bidirectional	DO-214AB	1ba	1j	Cmc
5BGZ	5.0SMCJ100CA	TVS	Vrwm=100.0V, Vbr=111..123V, 30.9A, 5000W(1ms), Bidirectional	DO-214AB	1ba	1j	Ext
5BGZ	5.0SMDJ100CA	TVS	Vbr=111..123V, Vrwm=100V, 31.2A, 5000W(1ms), Bidirectional	DO-214AB	1ba	1j	Ksm
5BGZ	TV50C101JB-G	TVS	Vrwm=100.0V, Vbr=111.0..123.0V, Ipp=31.17A, 5000W(1ms), Bidirectional	DO-214AB	1ba	1j	Cmc
5BH	SMA5J14	TVS	Vbr=15.6..19.1V, Vrwm=14V, 19.4A, 500W(1ms)	DO-214AC	1d	1k	Vs
5BH	SMA5J14C	TVS	Vbr=15.6..19.1V, Vrwm=14V, 19.4A, 500W(1ms), Bidirectional	DO-214AC	1ba	1l	Vs
5BHA	5.0SMDJ140C	TVS	Vbr=156..190V, Vrwm=140V, 20.2A, 5000W(1ms), Bidirectional	DO-214AB	1ba	1j	Ksm
5BHA	TV50C141KB-G	TVS	Vrwm=140.0V, Vbr=155.68..190.40V, Ipp=20.15A, 5000W(1ms), Bidirectional	DO-214AB	1ba	1j	Cmc
5BHB	5.0SMDJ140CA	TVS	Vbr=155..171V, Vrwm=140V, 22.3A, 5000W(1ms), Bidirectional	DO-214AB	1ba	1j	Ksm
5BHB	TV50C141JB-G	TVS	Vrwm=140.0V, Vbr=155.0..171.0V, Ipp=22.27A, 5000W(1ms), Bidirectional	DO-214AB	1ba	1j	Cmc
5BHD	5.0SMDJ110C	TVS	Vbr=122..149V, Vrwm=110V, 25.8A, 5000W(1ms), Bidirectional	DO-214AB	1ba	1j	Ksm
5BHE	5.0SMCJ110CA	TVS	Vrwm=110.0V, Vbr=122..135V, 28.3A, 5000W(1ms), Bidirectional	DO-214AB	1ba	1j	Ext
5BHE	5.0SMDJ110CA	TVS	Vbr=122..135V, Vrwm=110V, 28.5A, 5000W(1ms), Bidirectional	DO-214AB	1ba	1j	Ksm
5BHF	5.0SMDJ120C	TVS	Vbr=133..163V, Vrwm=120V, 23.6A, 5000W(1ms), Bidirectional	DO-214AB	1ba	1j	Ksm
5BHF	TV50C111KB-G	TVS	Vrwm=110.0V, Vbr=122.0..149.0V, Ipp=25.77A, 5000W(1ms), Bidirectional	DO-214AB	1ba	1j	Cmc
5BHF	TV50C121KB-G	TVS	Vrwm=120.0V, Vbr=133.0..163.0V, Ipp=23.60A, 5000W(1ms), Bidirectional	DO-214AB	1ba	1j	Cmc
5BHG	5.0SMCJ120CA	TVS	Vrwm=120.0V, Vbr=133..147V, 26.0A, 5000W(1ms), Bidirectional	DO-214AB	1ba	1j	Ext
5BHG	5.0SMDJ120CA	TVS	Vbr=133..147V, Vrwm=120V, 26.2A, 5000W(1ms), Bidirectional	DO-214AB	1ba	1j	Ksm
5BHG	TV50C121JB-G	TVS	Vrwm=120.0V, Vbr=133.0..147.0V, Ipp=26.17A, 5000W(1ms), Bidirectional	DO-214AB	1ba	1j	Cmc
5BHH	5.0SMDJ130C	TVS	Vbr=144..176V, Vrwm=130V, 21.9A, 5000W(1ms), Bidirectional	DO-214AB	1ba	1j	Ksm
5BHH	TV50C131KB-G	TVS	Vrwm=130.0V, Vbr=144.0..176.0V, Ipp=21.86A, 5000W(1ms), Bidirectional	DO-214AB	1ba	1j	Cmc
5BHK	5.0SMCJ130CA	TVS	Vrwm=130.0V, Vbr=144..159V, 24.0A, 5000W(1ms), Bidirectional	DO-214AB	1ba	1j	Ext
5BHK	5.0SMDJ130CA	TVS	Vbr=144..159V, Vrwm=130V, 24.2A, 5000W(1ms), Bidirectional	DO-214AB	1ba	1j	Ksm
5BHK	TV50C131JB-G	TVS	Vrwm=130.0V, Vbr=144.0..159.0V, Ipp=24.16A, 5000W(1ms), Bidirectional	DO-214AB	1ba	1j	Cmc
5BHL	5.0SMDJ150C	TVS	Vbr=167..204V, Vrwm=150V, 18.8A, 5000W(1ms), Bidirectional	DO-214AB	1ba	1j	Ksm
5BHL	TV50C151KB-G	TVS	Vrwm=150.0V, Vbr=167.0..204.0V, Ipp=18.84A, 5000W(1ms), Bidirectional	DO-214AB	1ba	1j	Cmc
5BHM	5.0SMCJ150CA	TVS	Vrwm=150.0V, Vbr=167..185V, 20.6A, 5000W(1ms), Bidirectional	DO-214AB	1ba	1j	Ext
5BHM	5.0SMDJ150CA	TVS	Vbr=167..185V, Vrwm=150V, 20.8A, 5000W(1ms), Bidirectional	DO-214AB	1ba	1j	Ksm
5BHM	TV50C151JB-G	TVS	Vrwm=150.0V, Vbr=167.0..185.0V, Ipp=20.78A, 5000W(1ms), Bidirectional	DO-214AB	1ba	1j	Cmc
5BHN	5.0SMDJ160C	TVS	Vbr=178..218V, Vrwm=160V, 17.6A, 5000W(1ms), Bidirectional	DO-214AB	1ba	1j	Ksm
5BHN	TV50C161KB-G	TVS	Vrwm=160.0V, Vbr=178.0..218.0V, Ipp=17.60A, 5000W(1ms), Bidirectional	DO-214AB	1ba	1j	Cmc
5BHP	5.0SMCJ160CA	TVS	Vrwm=160.0V, Vbr=178..197V, 19.3A, 5000W(1ms), Bidirectional	DO-214AB	1ba	1j	Ext
5BHP	5.0SMDJ160CA	TVS	Vbr=178..197V, Vrwm=160V, 19.5A, 5000W(1ms), Bidirectional	DO-214AB	1ba	1j	Ksm
5BHP	TV50C161JB-G	TVS	Vrwm=160.0V, Vbr=178.0..197.0V, Ipp=19.50A, 5000W(1ms), Bidirectional	DO-214AB	1ba	1j	Cmc
5BHQ	5.0SMDJ170C	TVS	Vbr=189..231V, Vrwm=170V, 16.6A, 5000W(1ms), Bidirectional	DO-214AB	1ba	1j	Ksm
5BHQ	TV50C171KB-G	TVS	Vrwm=170.0V, Vbr=189.0..231.0V, Ipp=16.61A, 5000W(1ms), Bidirectional	DO-214AB	1ba	1j	Cmc
5BHR	5.0SMCJ170CA	TVS	Vrwm=170.0V, Vbr=189..209V, 18.2A, 5000W(1ms), Bidirectional	DO-214AB	1ba	1j	Ext
5BHR	5.0SMDJ170CA	TVS	Vbr=189..209V, Vrwm=170V, 18.4A, 5000W(1ms), Bidirectional	DO-214AB	1ba	1j	Ksm
5BHR	TV50C111JB-G	TVS	Vrwm=110.0V, Vbr=122.0..135.0V, Ipp=28.53A, 5000W(1ms), Bidirectional	DO-214AB	1ba	1j	Cmc
5BHR	TV50C171JB-G	TVS	Vrwm=170.0V, Vbr=189.0..209.0V, Ipp=18.36A, 5000W(1ms), Bidirectional	DO-214AB	1ba	1j	Cmc
5BHS	5.0SMDJ180C	TVS	Vbr=200..245V, Vrwm=180V, 15.7A, 5000W(1ms), Bidirectional	DO-214AB	1ba	1j	Ksm
5BHS	TV50C181KB-G	TVS	Vrwm=180.0V, Vbr=200.16..244.80V, Ipp=15.67A, 5000W(1ms), Bidirectional	DO-214AB	1ba	1j	Cmc
5BHT	5.0SMDJ180CA	TVS	Vbr=200..220V, Vrwm=180V, 17.3A, 5000W(1ms), Bidirectional	DO-214AB	1ba	1j	Ksm
5BHT	TV50C181JB-G	TVS	Vrwm=180.0V, Vbr=200.0..220.0V, Ipp=17.32A, 5000W(1ms), Bidirectional	DO-214AB	1ba	1j	Cmc
5BHU	5.0SMDJ190C	TVS	Vbr=211..258V, Vrwm=190V, 14.8A, 5000W(1ms), Bidirectional	DO-214AB	1ba	1j	Ksm
5BHU	TV50C191KB-G	TVS	Vrwm=190.0V, Vbr=211.28..258.40V, Ipp=14.85A, 5000W(1ms), Bidirectional	DO-214AB	1ba	1j	Cmc
5BHV	5.0SMDJ190CA	TVS	Vbr=211..232V, Vrwm=190V, 16.4A, 5000W(1ms), Bidirectional	DO-214AB	1ba	1j	Ksm
5BHV	TV50C191JB-G	TVS	Vrwm=190.0V, Vbr=211.0..232.0V, Ipp=16.41A, 5000W(1ms), Bidirectional	DO-214AB	1ba	1j	Cmc
5BHW	TV50C201JB-G	TVS	Vrwm=200.0V, Vbr=224.0..247.0V, Ipp=9.26A, 5000W(1ms), Bidirectional	DO-214AB	1ba	1j	Cmc
5BHX	TV50C221JB-G	TVS	Vrwm=220.0V, Vbr=246.0..272.0V, Ipp=8.43A, 5000W(1ms), Bidirectional	DO-214AB	1ba	1j	Cmc
5BHZ	TV50C251JB-G	TVS	Vrwm=250.0V, Vbr=279.0..309.0V, Ipp=7.41A, 5000W(1ms), Bidirectional	DO-214AB	1ba	1j	Cmc
5BJE	TV50C301JB-G	TVS	Vrwm=300.0V, Vbr=335.0..371.0V, Ipp=6.17A, 5000W(1ms), Bidirectional	DO-214AB	1ba	1j	Cmc
5BJG	TV50C351JB-G	TVS	Vrwm=350.0V, Vbr=391.0..432.0V, Ipp=5.29A, 5000W(1ms), Bidirectional	DO-214AB	1ba	1j	Cmc
5BJK	TV50C401JB-G	TVS	Vrwm=400.0V, Vbr=447.0..494.0V, Ipp=4.63A, 5000W(1ms), Bidirectional	DO-214AB	1ba	1j	Cmc
5BJM	TV50C441JB-G	TVS	Vrwm=440.0V, Vbr=492.0..543.0V, Ipp=4.21A, 5000W(1ms), Bidirectional	DO-214AB	1ba	1j	Cmc
5BK	SMA5J14A	TVS	Vbr=15.6..17.2V, Vrwm=14V, 21.6A, 500W(1ms)	DO-214AC	1d	1k	Vs
5BK	SMA5J14CA	TVS	Vbr=15.6..17.2V, Vrwm=14V, 21.6A, 500W(1ms), Bidirectional	DO-214AC	1ba	1l	Vs



SMD code	Type	Function	Short description	Case	Pinout	St.	Mnf.
5BL	SMA5J15	TVS	Vbr=16.7..20.4V, Vrw=15V, 18.6A, 500W(1ms)	DO-214AC	1d	1k	Vs
5BL	SMA5J15C	TVS	Vbr=16.7..20.4V, Vrw=15V, 18.6A, 500W(1ms), Bidirectional	DO-214AC	1ba	1l	Vs
5BM	SMA5J15A	TVS	Vbr=16.7..18.5V, Vrw=15V, 20.5A, 500W(1ms)	DO-214AC	1d	1k	Vs
5BM	SMA5J15CA	TVS	Vbr=16.7..18.5V, Vrw=15V, 20.5A, 500W(1ms), Bidirectional	DO-214AC	1ba	1l	Vs
5BN	SMA5J16C	TVS	Vbr=17.8..21.8V, Vrw=16V, 17.4A, 500W(1ms), Bidirectional	DO-214AC	1ba	1l	Vs
5BP	SMA5J16A	TVS	Vbr=17.8..19.7V, Vrw=16V, 19.2A, 500W(1ms)	DO-214AC	1d	1k	Vs
5BP	SMA5J16CA	TVS	Vbr=17.8..19.7V, Vrw=16V, 19.2A, 500W(1ms), Bidirectional	DO-214AC	1ba	1l	Vs
5BQ	SMA5J17	TVS	Vbr=18.9..23.1V, Vrw=17V, 16.4A, 500W(1ms)	DO-214AC	1d	1k	Vs
5BQ	SMA5J17C	TVS	Vbr=18.9..23.1V, Vrw=17V, 16.4A, 500W(1ms), Bidirectional	DO-214AC	1ba	1l	Vs
5BR	SMA5J17A	TVS	Vbr=18.9..20.9V, Vrw=17V, 18.1A, 500W(1ms)	DO-214AC	1d	1k	Vs
5BR	SMA5J17CA	TVS	Vbr=18.9..20.9V, Vrw=17V, 18.1A, 500W(1ms), Bidirectional	DO-214AC	1ba	1l	Vs
5BS	SMA5J18	TVS	Vbr=20.0..24.4V, Vrw=18V, 15.5A, 500W(1ms)	DO-214AC	1d	1k	Vs
5BS	SMA5J18C	TVS	Vbr=20.0..24.4V, Vrw=18V, 15.5A, 500W(1ms), Bidirectional	DO-214AC	1ba	1l	Vs
5BT	SMA5J18A	TVS	Vbr=20.0..22.1V, Vrw=18V, 17.1A, 500W(1ms)	DO-214AC	1d	1k	Vs
5BT	SMA5J18CA	TVS	Vbr=20.0..22.1V, Vrw=18V, 17.1A, 500W(1ms), Bidirectional	DO-214AC	1ba	1l	Vs
5BU	SMA5J20	TVS	Vbr=22.2..27.1V, Vrw=20V, 14.0A, 500W(1ms)	DO-214AC	1d	1k	Vs
5BU	SMA5J20C	TVS	Vbr=22.2..27.1V, Vrw=20V, 14.0A, 500W(1ms), Bidirectional	DO-214AC	1ba	1l	Vs
5BV	SMA5J20A	TVS	Vbr=22.2..24.5V, Vrw=20V, 15.4A, 500W(1ms)	DO-214AC	1d	1k	Vs
5BV	SMA5J20CA	TVS	Vbr=22.2..24.5V, Vrw=20V, 15.4A, 500W(1ms), Bidirectional	DO-214AC	1ba	1l	Vs
5BW	SMA5J22	TVS	Vbr=24.4..29.8V, Vrw=22V, 12.7A, 500W(1ms)	DO-214AC	1d	1k	Vs
5BW	SMA5J22C	TVS	Vbr=24.4..29.8V, Vrw=22V, 12.7A, 500W(1ms), Bidirectional	DO-214AC	1ba	1l	Vs
5BX	SMA5J22A	TVS	Vbr=24.4..26.9V, Vrw=22V, 14.1A, 500W(1ms)	DO-214AC	1d	1k	Vs
5BX	SMA5J22CA	TVS	Vbr=24.4..26.9V, Vrw=22V, 14.1A, 500W(1ms), Bidirectional	DO-214AC	1ba	1l	Vs
5BY	SMA5J24	TVS	Vbr=26.7..32.6V, Vrw=24V, 11.6A, 500W(1ms)	DO-214AC	1d	1k	Vs
5BY	SMA5J24C	TVS	Vbr=26.7..32.6V, Vrw=24V, 11.6A, 500W(1ms), Bidirectional	DO-214AC	1ba	1l	Vs
5BZ	SMA5J24A	TVS	Vbr=26.7..29.5V, Vrw=24V, 12.9A, 500W(1ms)	DO-214AC	1d	1k	Vs
5BZ	SMA5J24CA	TVS	Vbr=26.7..29.5V, Vrw=24V, 12.9A, 500W(1ms), Bidirectional	DO-214AC	1ba	1l	Vs
5C	BZT52C-28WU	Z-diode	26.60..29.40V, Izt=5mA, Zzt=80Ω, 200mW	SOD-723	7d	1a	Ttr
5C	BZX784C28	Z-diode	26.60..29.40V, Zzt=80Ω, Izt=5mA, 200mW	SOD-723	7d	1a	Pjt
5C	GBLC05C	TVS	Vbr=5V, 17A, 350W(1ms), 3pF, Bidirectional	SOD-323	5ba	1e	Prt
5C	HZU5CLL	Z-diode	4.9..5.3V, Izt=0.5mA, Zzt=380Ω, 150mW	URP	5d	1a	Ren
5C	MM1Z11	Z-diode	11V±5%, Izt=5mA, Zzt=30Ω, 500mW	SOD-123FL	7d	1a	Eic
5C	MM5Z7V5	Z-diode	7.0..7.9V, Zzt=15Ω, Izt=5mA, 200mW	SOD-523FL	7d	1a	F
5C	MMSZ11	Z-diode	11V±5%, Izt=5mA, Zzt=20Ω, 500mW	SOD-123	5d	1a	Eic
5C	TCBZ584C7V5	Z-diode	7.0..7.9V, Izt=5mA, Zzt=15Ω, 200mW	SOD-523FL	7d	1a	Tac
5C	TCMM5Z7V5	Z-diode	7.0..7.9V, Izt=5mA, Zzt=15Ω, 200mW	SOD-523FL	7d	1a	Tac
5C	TVS100W3V3D	TVS	Vrw=3.3V, Vbr=5.0V, 9.8A, 100W(1ms)	SOD-923	7d	1d	Did
5C	TVS225W24V0	TVS	Vrw=24V, Vbr=26.7..29.5V, 50A, 225W(1ms)	DS-123	7d	1d	Did
5C1	RKZ5.1CKU	Z-diode	5.09..5.37V, Izt=20mA, Zzt=130Ω, 500mW	TURP-FM	7d	1a	Ren
5C6	RKZ5.6CKU	Z-diode	5.61..5.91V, Izt=20mA, Zzt=80Ω, 500mW	TURP-FM	7d	1a	Ren
5CD	SMA5J26	TVS	Vbr=28.9..35.3V, Vrw=26V, 10.7A, 500W(1ms)	DO-214AC	1d	1k	Vs
5CD	SMA5J26C	TVS	Vbr=28.9..35.3V, Vrw=26V, 10.7A, 500W(1ms), Bidirectional	DO-214AC	1ba	1l	Vs
5CE	SMA5J26A	TVS	Vbr=28.9..31.9V, Vrw=26V, 11.9A, 500W(1ms)	DO-214AC	1d	1k	Vs
5CE	SMA5J26CA	TVS	Vbr=28.9..31.9V, Vrw=26V, 11.9A, 500W(1ms), Bidirectional	DO-214AC	1ba	1l	Vs
5CF	SMA5J28	TVS	Vbr=31.1..38.0V, Vrw=28V, 10.0A, 500W(1ms)	DO-214AC	1d	1k	Vs
5CF	SMA5J28C	TVS	Vbr=31.1..38.0V, Vrw=28V, 10.0A, 500W(1ms), Bidirectional	DO-214AC	1ba	1l	Vs
5CG	SMA5J28A	TVS	Vbr=31.1..34.4V, Vrw=28V, 11.0A, 500W(1ms)	DO-214AC	1d	1k	Vs
5CG	SMA5J28CA	TVS	Vbr=31.1..34.4V, Vrw=28V, 11.0A, 500W(1ms), Bidirectional	DO-214AC	1ba	1l	Vs
5CH	SMA5J30	TVS	Vbr=33.3..40.7V, Vrw=30V, 9.3A, 500W(1ms)	DO-214AC	1d	1k	Vs
5CH	SMA5J30C	TVS	Vbr=33.3..40.7V, Vrw=30V, 9.3A, 500W(1ms), Bidirectional	DO-214AC	1ba	1l	Vs
5CK	SMA5J30A	TVS	Vbr=33.3..36.8V, Vrw=30V, 10.3A, 500W(1ms)	DO-214AC	1d	1k	Vs
5CK	SMA5J30CA	TVS	Vbr=33.3..36.8V, Vrw=30V, 10.3A, 500W(1ms), Bidirectional	DO-214AC	1ba	1l	Vs
5CL	SMA5J33	TVS	Vbr=36.7..44.9V, Vrw=33V, 8.5A, 500W(1ms)	DO-214AC	1d	1k	Vs
5CL	SMA5J33C	TVS	Vbr=36.7..44.9V, Vrw=33V, 8.5A, 500W(1ms), Bidirectional	DO-214AC	1ba	1l	Vs
5CM	SMA5J33A	TVS	Vbr=36.7..40.6V, Vrw=33V, 9.4A, 500W(1ms)	DO-214AC	1d	1k	Vs
5CM	SMA5J33CA	TVS	Vbr=36.7..40.6V, Vrw=33V, 9.4A, 500W(1ms), Bidirectional	DO-214AC	1ba	1l	Vs
5CN	SMA5J36	TVS	Vbr=40.0..48.9V, Vrw=36V, 7.8A, 500W(1ms)	DO-214AC	1d	1k	Vs
5CN	SMA5J36C	TVS	Vbr=40.0..48.9V, Vrw=36V, 7.8A, 500W(1ms), Bidirectional	DO-214AC	1ba	1l	Vs
5CP	SMA5J36A	TVS	Vbr=40.0..44.2V, Vrw=36V, 8.6A, 500W(1ms)	DO-214AC	1d	1k	Vs
5CP	SMA5J36CA	TVS	Vbr=40.0..44.2V, Vrw=36V, 8.6A, 500W(1ms), Bidirectional	DO-214AC	1ba	1l	Vs
5CQ	SMA5J40	TVS	Vbr=44.4..54.3V, Vrw=40V, 7.0A, 500W(1ms)	DO-214AC	1d	1k	Vs
5CQ	SMA5J40C	TVS	Vbr=44.4..54.3V, Vrw=40V, 7.0A, 500W(1ms), Bidirectional	DO-214AC	1ba	1l	Vs
5CR	SMA5J40A	TVS	Vbr=44.4..49.1V, Vrw=40V, 7.8A, 500W(1ms)	DO-214AC	1d	1k	Vs
5CR	SMA5J40CA	TVS	Vbr=44.4..49.1V, Vrw=40V, 7.8A, 500W(1ms), Bidirectional	DO-214AC	1ba	1l	Vs
5D	1SS35PPT	Si-diode	Sw, 90V, 100mA, Vf<1.2V(100mA), 4ns	SOD-323	5d	1a	Chm
5D	MM1Z12	Z-diode	12V±5%, Izt=5mA, Zzt=35Ω, 500mW	SOD-123FL	7d	1a	Eic
5D	MM5Z8V2	Z-diode	7.7..8.7V, Zzt=15Ω, Izt=5mA, 200mW	SOD-523FL	7d	1a	F
5D	MMDL914	Si-diode	Sw, 100V, 200mA, 200mW, Vf<1V(10mA), <4ns	SOD-323	5d	1a	Ons
5D	MMSD914	Si-diode	Sw, 100V, 200mA, 225mW, Vf<1V(10mA), <4ns	SOD-123	5d	1a	Ons
5D	MMSZ12	Z-diode	12V±5%, Izt=5mA, Zzt=25Ω, 500mW	SOD-123	5d	1a	Eic



SMD code	Type	Function	Short description	Case	Pinout	St.	Mnf.
5D	S5D	Si-diode	Rectifier, 200V, 5A, Vf<1.15V(5A)	DO-214AB	1d	1k	Vs
5D	TCBZX584C8V2	Z-diode	7.7..8.7V, Izt=5mA, Zzt=15Ω, 200mW	SOD-523FL	7d	1a	Tac
5D	TCMMSZ8V2	Z-diode	7.7..8.7V, Izt=5mA, Zzt=15Ω, 200mW	SOD-523FL	7d	1a	Tac
5D	WOSD05	TVS	Vbr=6V, Vcl=9.8..14.5V, Ipp=24A, 300W(1ms)	SOD-323	5d	1e	Wtr
5E	MM1Z13	Z-diode	13V±5%, Izt=5mA, Zzt=35Ω, 500mW	SOD-123FL	7d	1a	Eic
5E	MMSZ9V1	Z-diode	8.5..9.6V, Izt=5mA, Zzt=15Ω, 200mW	SOD-523FL	7d	1a	F
5E	MMSZ13	Z-diode	13V±5%, Izt=5mA, Zzt=30Ω, 500mW	SOD-123	5d	1a	Eic
5E	RB751V40	Si-diode	Schottky, Hi-Speed, 40V, 20mA, 200mW, Vf<0.26V(1mA)	SOD-323	5d	1a	Ons
5E	TCBZX584C9V1	Z-diode	8.5..9.6V, Izt=5mA, Zzt=15Ω, 200mW	SOD-523FL	7d	1a	Tac
5E	TCMMSZ9V1	Z-diode	8.5..9.6V, Izt=5mA, Zzt=15Ω, 200mW	SOD-523FL	7d	1a	Tac
5F	CDZ55C5V6T	Z-diode	5.32..5.88V, Zzt=30Ω, Izt=5mA, 200mW	0603	70d	2d	Crp
5F	KDZ4.7FV	Z-diode	4.40..4.90V, Izt=5mA, Zzt=120Ω, 100mW	TFSC	7d	1a	Kec
5F	MAZD036	Z-diode	3.4..3.8V, Zzt=130Ω(5mA), 120mW	SSSMini2	7d	1a	Pan
5F	MM1Z15	Z-diode	15V±5%, Izt=5mA, Zzt=40Ω, 500mW	SOD-123FL	7d	1a	Eic
5F	MMSZ10V	Z-diode	9.4..10.6V, Zzt=20Ω, Izt=5mA, 200mW	SOD-523FL	7d	1a	F
5F	MMSZ15	Z-diode	15V±5%, Izt=5mA, Zzt=30Ω, 500mW	SOD-123	5d	1a	Eic
5F	TCBZX584C10V	Z-diode	9.4..10.6V, Izt=5mA, Zzt=20Ω, 200mW	SOD-523FL	7d	1a	Tac
5F	TCMMSZ10V	Z-diode	9.4..10.6V, Izt=5mA, Zzt=20Ω, 200mW	SOD-523FL	7d	1a	Tac
5G	MMSZ11V	Z-diode	10.4..11.6V, Zzt=20Ω, Izt=5mA, 200mW	SOD-523FL	7d	1a	F
5G	S5G	Si-diode	Rectifier, 400V, 5A, Vf<1.15V(5A)	DO-214AB	1d	1k	Vs
5G	TCBZX584C11V	Z-diode	10.4..11.6V, Izt=5mA, Zzt=20Ω, 200mW	SOD-523FL	7d	1a	Tac
5G	TCMMSZ11V	Z-diode	10.4..11.6V, Izt=5mA, Zzt=20Ω, 200mW	SOD-523FL	7d	1a	Tac
5H	MM1Z16	Z-diode	16V±5%, Izt=5mA, Zzt=40Ω, 500mW	SOD-123FL	7d	1a	Eic
5H	MMSZ12V	Z-diode	11.4..12.7V, Izt=5mA, Zzt=25Ω, 200mW	SOD-523FL	7d	1a	F
5H	MMDL770	Si-diode	UHF/VHF Det, Schottky Barrier, 70V, 200mW, <1pF	SOD-323	5d	1a	Ons
5H	MMSZ16	Z-diode	16V±5%, Izt=5mA, Zzt=40Ω, 500mW	SOD-123	5d	1a	Eic
5H	TCBZX584C12V	Z-diode	11.4..12.7V, Izt=5mA, Zzt=25Ω, 200mW	SOD-523FL	7d	1a	Tac
5H	TCMMSZ12V	Z-diode	11.4..12.7V, Izt=5mA, Zzt=25Ω, 200mW	SOD-523FL	7d	1a	Tac
5I	MMSD4148	Si-diode	Sw, 200V, 200mA, 225mW, Vf<1V(10mA), <4ns	SOD-123	5d	1a	Ons
5J	MM1Z18	Z-diode	18V±5%, Izt=5mA, Zzt=45Ω, 500mW	SOD-123FL	7d	1a	Eic
5J	MMSZ13V	Z-diode	12.4..14.1V, Zzt=30Ω, Izt=5mA, 200mW	SOD-523FL	7d	1a	F
5J	MMSZ18	Z-diode	18V±5%, Izt=5mA, Zzt=45Ω, 500mW	SOD-123	5d	1a	Eic
5J	S5J	Si-diode	Rectifier, 600V, 5A, Vf<1.15V(5A)	DO-214AB	1d	1k	Vs
5J	TCBZX584C13V	Z-diode	12.4..14.1V, Izt=5mA, Zzt=30Ω, 200mW	SOD-523FL	7d	1a	Tac
5J	TCMMSZ13V	Z-diode	12.4..14.1V, Izt=5mA, Zzt=30Ω, 200mW	SOD-523FL	7d	1a	Tac
5K	MM1Z20	Z-diode	20V±5%, Izt=5mA, Zzt=50Ω, 500mW	SOD-123FL	7d	1a	Eic
5K	MMSZ15V	Z-diode	14.3..15.8V, Zzt=30Ω, Izt=5mA, 200mW	SOD-523FL	7d	1a	F
5K	MMSZ20	Z-diode	20V±5%, Izt=5mA, Zzt=55Ω, 500mW	SOD-123	5d	1a	Eic
5K	MMVL809	C-diode	VHF-Tuning, 20V, 20mA, 200mW, 4.5fF(2V, 1MHz)	SOD-323	5d	1a	Ons
5K	S5K	Si-diode	Rectifier, 800V, 5A, Vf<1.15V(5A)	DO-214AB	1d	1k	Vs
5K	TCBZX584C15V	Z-diode	14.3..15.8V, Izt=5mA, Zzt=30Ω, 200mW	SOD-523FL	7d	1a	Tac
5K	TCMMSZ15V	Z-diode	14.3..15.8V, Izt=5mA, Zzt=30Ω, 200mW	SOD-523FL	7d	1a	Tac
5L	MMSZ16V	Z-diode	15.3..17.1V, Zzt=40Ω, Izt=5mA, 200mW	SOD-523FL	7d	1a	F
5L	TCBZX584C16V	Z-diode	15.3..17.1V, Izt=5mA, Zzt=40Ω, 200mW	SOD-523FL	7d	1a	Tac
5L	TCMMSZ16V	Z-diode	15.3..17.1V, Izt=5mA, Zzt=40Ω, 200mW	SOD-523FL	7d	1a	Tac
5M	MM1Z22	Z-diode	22V±5%, Izt=5mA, Zzt=55Ω, 500mW	SOD-123FL	7d	1a	Eic
5M	MMSZ18V	Z-diode	16.8..19.1V, Zzt=45Ω, Izt=5mA, 200mW	SOD-523FL	7d	1a	F
5M	MMSZ22	Z-diode	22V±5%, Izt=5mA, Zzt=55Ω, 500mW	SOD-123	5d	1a	Eic
5M	S5M	Si-diode	Rectifier, 1000V, 5A, Vf<1.15V(5A)	DO-214AB	1d	1k	Vs
5M	TCBZX584C18V	Z-diode	16.8..19.1V, Izt=5mA, Zzt=45Ω, 200mW	SOD-523FL	7d	1a	Tac
5M	TCMMSZ18V	Z-diode	16.8..19.1V, Izt=5mA, Zzt=45Ω, 200mW	SOD-523FL	7d	1a	Tac
5MS	S5MS	Si-diode	Rectifier, 1000V, 5A, Vf<1/15V(5A)	DO-214AB	1d	1k	Vs
5N	MM1Z24	Z-diode	24V±5%, Izt=5mA, Zzt=60Ω, 500mW	SOD-123FL	7d	1a	Eic
5N	MMSZ20V	Z-diode	18.8..21.2V, Zzt=55Ω, Izt=5mA, 200mW	SOD-523FL	7d	1a	F
5N	MMSZ24	Z-diode	24V±5%, Izt=5mA, Zzt=70Ω, 500mW	SOD-123	5d	1a	Eic
5N	TCBZX584C20V	Z-diode	18.8..21.2V, Izt=5mA, Zzt=55Ω, 200mW	SOD-523FL	7d	1a	Tac
5N	TCMMSZ20V	Z-diode	18.8..21.2V, Izt=5mA, Zzt=55Ω, 200mW	SOD-523FL	7d	1a	Tac
5P	CMDZ27L	Z-diode	25.10..28.90V, Izt=0.5mA, Zzt=150Ω, 250mW	SOD-323	5d	1a	Cen
5P	KDZ4.7FVY	Z-diode	4.55..4.75V, Izt=5mA, Zzt=120Ω, 100mW	TFSC	7d	1a	Kec
5P	MM1Z27	Z-diode	27V±5%, Izt=5mA, Zzt=70Ω, 500mW	SOD-123FL	7d	1a	Eic
5P	MMSZ22V	Z-diode	20.8..23.3V, Zzt=55Ω, Izt=5mA, 200mW	SOD-523FL	7d	1a	F
5P	TCBZX584C22V	Z-diode	20.8..23.3V, Izt=5mA, Zzt=55Ω, 200mW	SOD-523FL	7d	1a	Tac
5P	TCMMSZ22V	Z-diode	20.8..23.3V, Izt=5mA, Zzt=55Ω, 200mW	SOD-523FL	7d	1a	Tac
5P1	SML4733	Z-diode	5.1V±5%, Izt=49mA, Zzt=7Ω, 1W	DO-214AC	1d	1k	Vs
5P6	SML4734	Z-diode	5.6V±5%, Izt=45mA, Zzt=5Ω, 1W	DO-214AC	1d	1k	Vs
5PDW	5.0SMDJ11	TVS	Vbr=12.2..14.9V, Vrrwm=11V, 251.2A, 5000W(1ms)	DO-214AB	1d	1a	Ksm
5PDX	TV50C110K-G	TVS	Vrrwm=11.0V, Vbr=12.20..14.90V, Ipp=251.24A, 5000W(1ms)	DO-214AB	1d	1a	Cmc
5PDX	5.0SMDJ11A	TVS	Vbr=12.2..13.5V, Vrrwm=11V, 277.5A, 5000W(1ms)	DO-214AB	1d	1a	Ksm
5PDX	TV50C110J-G	TVS	Vrrwm=11.0V, Vbr=12.20..13.50V, Ipp=277.47A, 5000W(1ms)	DO-214AB	1d	1a	Cmc
5PDY	5.0SMDJ12	TVS	Vbr=13.3..16.3V, Vrrwm=12V, 229.5A, 5000W(1ms)	DO-214AB	1d	1a	Ksm



SMD code	Type	Function	Short description	Case	Pinout	St.	Mnf.
5PDY	TV50C120K-G	TVS	Vrwm=12.0V, Vbr=13.30..16.30V, Ipp=229.55A, 5000W(1ms)	DO-214AB	1d	1a	Cmc
5PDZ	5.0SMDJ12A	TVS	Vbr=13.3..14.7V, Vrwm=12V, 253.8A, 5000W(1ms)	DO-214AB	1d	1a	Ksm
5PDZ	TV50C120J-G	TVS	Vrwm=12.0V, Vbr=13.30..14.70V, Ipp=253.77A, 5000W(1ms)	DO-214AB	1d	1a	Cmc
5PED	5.0SMDJ13	TVS	Vbr=14.4..17.6V, Vrwm=13V, 212.2A, 5000W(1ms)	DO-214AB	1d	1a	Ksm
5PED	TV50C130K-G	TVS	Vrwm=13.0V, Vbr=14.40..17.60V, Ipp=212.18A, 5000W(1ms)	DO-214AB	1d	1a	Cmc
5PEE	5.0SMDJ13A	TVS	Vbr=14.4..15.9V, Vrwm=13V, 234.9A, 5000W(1ms)	DO-214AB	1d	1a	Ksm
5PEE	TV50C130J-G	TVS	Vrwm=13.0V, Vbr=14.40..15.90V, Ipp=234.88A, 5000W(1ms)	DO-214AB	1d	1a	Cmc
5PEF	5.0SMDJ14	TVS	Vbr=15.6..19.1V, Vrwm=14V, 195.7A, 5000W(1ms)	DO-214AB	1d	1a	Ksm
5PEF	TV50C140K-G	TVS	Vrwm=14.0V, Vbr=15.60..19.10V, Ipp=195.74A, 5000W(1ms)	DO-214AB	1d	1a	Cmc
5PEG	5.0SMDJ14A	TVS	Vbr=15.6..17.2V, Vrwm=14V, 217.7A, 5000W(1ms)	DO-214AB	1d	1a	Ksm
5PEG	TV50C140J-G	TVS	Vrwm=14.0V, Vbr=15.60..17.20V, Ipp=217.67A, 5000W(1ms)	DO-214AB	1d	1a	Cmc
5PEH	5.0SMDJ15	TVS	Vbr=16.7..20.4V, Vrwm=15V, 187.7A, 5000W(1ms)	DO-214AB	1d	1a	Ksm
5PEH	TV50C150K-G	TVS	Vrwm=15.0V, Vbr=16.70..20.40V, Ipp=187.73A, 5000W(1ms)	DO-214AB	1d	1a	Cmc
5PEK	5.0SMDJ15A	TVS	Vbr=16.7..18.5V, Vrwm=15V, 207.0A, 5000W(1ms)	DO-214AB	1d	1a	Ksm
5PEK	TV50C150J-G	TVS	Vrwm=15.0V, Vbr=16.70..18.50V, Ipp=206.97A, 5000W(1ms)	DO-214AB	1d	1a	Cmc
5PEL	5.0SMDJ16	TVS	Vbr=17.8..21.8V, Vrwm=16V, 175.3A, 5000W(1ms)	DO-214AB	1d	1a	Ksm
5PEL	TV50C160K-G	TVS	Vrwm=16.0V, Vbr=17.80..21.80V, Ipp=175.35A, 5000W(1ms)	DO-214AB	1d	1a	Cmc
5PEM	5.0SMDJ16A	TVS	Vbr=17.8..19.7V, Vrwm=16V, 194.2A, 5000W(1ms)	DO-214AB	1d	1a	Ksm
5PEM	TV50C160J-G	TVS	Vrwm=16.0V, Vbr=17.80..19.70V, Ipp=194.23A, 5000W(1ms)	DO-214AB	1d	1a	Cmc
5PEN	5.0SMCJ11A	TVS	Vrwm=11.0V, Vbr=12.2..13.5V, 275.0A, 5000W(1ms)	DO-214AB	1d	1a	Ext
5PEN	5.0SMGDJ11A	TVS	Vrwm=11.0V, Vbr=12.2..13.5V, 275.0A, 5000W(1ms)	DO-215AB	5d	1a	Lge
5PEN	5.0SMDJ11A	TVS	Vrwm=11V, Vbr=12.2..13.5V, 275A, 5000W(1ms)	DO-214AB	1d	1a	Cnc
5PEN	5.0SMDJ17	TVS	Vbr=18.9..23.1V, Vrwm=17V, 165.6A, 5000W(1ms)	DO-214AB	1d	1a	Ksm
5PEN	5.0SMLJ11A	TVS	Vrwm=11V, Vbr=12.2..13.5V, 275A, 5000W(1ms)	DO-214AB	1d	1a	Mde
5PEN	TV50C170K-G	TVS	Vrwm=17.0V, Vbr=18.90..23.10V, Ipp=165.57A, 5000W(1ms)	DO-214AB	1d	1a	Cmc
5PEP	5.0SMCJ12A	TVS	Vrwm=12.0V, Vbr=13.3..14.7V, 252.0A, 5000W(1ms)	DO-214AB	1d	1a	Ext
5PEP	5.0SMGDJ12A	TVS	Vrwm=12.0V, Vbr=13.3..14.7V, 252.0A, 5000W(1ms)	DO-215AB	5d	1a	Lge
5PEP	5.0SMDJ12A	TVS	Vrwm=12V, Vbr=13.3..14.7V, 252A, 5000W(1ms)	DO-214AB	1d	1a	Cnc
5PEP	5.0SMDJ17A	TVS	Vbr=18.9..20.9V, Vrwm=17V, 183.0A, 5000W(1ms)	DO-214AB	1d	1a	Ksm
5PEP	5.0SMLJ12A	TVS	Vrwm=12V, Vbr=13.3..14.7V, 252A, 5000W(1ms)	DO-214AB	1d	1a	Mde
5PEP	TV50C170J-G	TVS	Vrwm=17.0V, Vbr=18.90..20.90V, Ipp=182.97A, 5000W(1ms)	DO-214AB	1d	1a	Cmc
5PEQ	5.0SMCJ13A	TVS	Vrwm=13.0V, Vbr=14.4..15.9V, 233.0A, 5000W(1ms)	DO-214AB	1d	1a	Ext
5PEQ	5.0SMGDJ13A	TVS	Vrwm=13.0V, Vbr=14.4..15.9V, 233.0A, 5000W(1ms)	DO-215AB	5d	1a	Lge
5PEQ	5.0SMDJ13A	TVS	Vrwm=13V, Vbr=14.4..15.9V, 233A, 5000W(1ms)	DO-214AB	1d	1a	Cnc
5PEQ	5.0SMDJ18	TVS	Vbr=20.0..24.4V, Vrwm=18V, 156.8A, 5000W(1ms)	DO-214AB	1d	1a	Ksm
5PEQ	5.0SMLJ13A	TVS	Vrwm=13V, Vbr=14.4..15.9V, 233A, 5000W(1ms)	DO-214AB	1d	1a	Mde
5PEQ	TV50C180K-G	TVS	Vrwm=18.0V, Vbr=20.0..24.40V, Ipp=156.83A, 5000W(1ms)	DO-214AB	1d	1a	Cmc
5PER	5.0SMCJ14A	TVS	Vrwm=14.0V, Vbr=15.6..17.2V, 216.0A, 5000W(1ms)	DO-214AB	1d	1a	Ext
5PER	5.0SMGDJ14A	TVS	Vrwm=14.0V, Vbr=15.6..17.2V, 216.0A, 5000W(1ms)	DO-215AB	5d	1a	Lge
5PER	5.0SMDJ14A	TVS	Vrwm=14V, Vbr=15.6..17.2V, 216A, 5000W(1ms)	DO-214AB	1d	1a	Cnc
5PER	5.0SMDJ18A	TVS	Vbr=20.0..22.1V, Vrwm=18V, 172.9A, 5000W(1ms)	DO-214AB	1d	1a	Ksm
5PER	5.0SMLJ14A	TVS	Vrwm=14V, Vbr=15.6..17.2V, 216A, 5000W(1ms)	DO-214AB	1d	1a	Mde
5PER	TV50C180J-G	TVS	Vrwm=18.0V, Vbr=20.0..22.10V, Ipp=172.95A, 5000W(1ms)	DO-214AB	1d	1a	Cmc
5PES	5.0SMCJ15A	TVS	Vrwm=15.0V, Vbr=16.7..18.5V, 205.0A, 5000W(1ms)	DO-214AB	1d	1a	Ext
5PES	5.0SMGDJ15A	TVS	Vrwm=15.0V, Vbr=16.7..18.5V, 205.0A, 5000W(1ms)	DO-215AB	5d	1a	Lge
5PES	5.0SMDJ15A	TVS	Vrwm=15V, Vbr=16.7..18.5V, 205A, 5000W(1ms)	DO-214AB	1d	1a	Cnc
5PES	5.0SMDJ19	TVS	Vbr=21.1..25.8V, Vrwm=19V, 148.5A, 5000W(1ms)	DO-214AB	1d	1a	Ksm
5PES	5.0SMLJ15A	TVS	Vrwm=15V, Vbr=16.7..18.5V, 205A, 5000W(1ms)	DO-214AB	1d	1a	Mde
5PES	TV50C190K-G	TVS	Vrwm=19.0V, Vbr=21.13..25.76V, Ipp=148.49A, 5000W(1ms)	DO-214AB	1d	1a	Cmc
5PET	5.0SMCJ16A	TVS	Vrwm=16.0V, Vbr=17.8..19.7V, 193.0A, 5000W(1ms)	DO-214AB	1d	1a	Ext
5PET	5.0SMGDJ16A	TVS	Vrwm=16.0V, Vbr=17.8..19.7V, 193.0A, 5000W(1ms)	DO-215AB	5d	1a	Lge
5PET	5.0SMDJ16A	TVS	Vrwm=16V, Vbr=17.8..19.7V, 193A, 5000W(1ms)	DO-214AB	1d	1a	Cnc
5PET	5.0SMDJ19A	TVS	Vbr=21.1..23.3V, Vrwm=19V, 164.1A, 5000W(1ms)	DO-214AB	1d	1a	Ksm
5PET	5.0SMLJ16A	TVS	Vrwm=16V, Vbr=17.8..19.7V, 193A, 5000W(1ms)	DO-214AB	1d	1a	Mde
5PET	TV50C190J-G	TVS	Vrwm=19.0V, Vbr=21.10..23.30V, Ipp=164.07A, 5000W(1ms)	DO-214AB	1d	1a	Cmc
5PEU	5.0SMCJ17A	TVS	Vrwm=17.0V, Vbr=18.9..20.9V, 181.0A, 5000W(1ms)	DO-214AB	1d	1a	Ext
5PEU	5.0SMGDJ17A	TVS	Vrwm=17.0V, Vbr=18.9..20.9V, 181.0A, 5000W(1ms)	DO-215AB	5d	1a	Lge
5PEU	5.0SMDJ17A	TVS	Vrwm=17V, Vbr=18.9..20.9V, 181A, 5000W(1ms)	DO-214AB	1d	1a	Cnc
5PEU	5.0SMDJ20	TVS	Vbr=22.2..27.1V, Vrwm=20V, 141.1A, 5000W(1ms)	DO-214AB	1d	1a	Ksm
5PEU	5.0SMLJ17A	TVS	Vrwm=17V, Vbr=18.9..20.9V, 181A, 5000W(1ms)	DO-214AB	1d	1a	Mde
5PEU	TV50C200K-G	TVS	Vrwm=20.0V, Vbr=22.20..27.10V, Ipp=141.06A, 5000W(1ms)	DO-214AB	1d	1a	Cmc
5PEV	5.0SMCJ18A	TVS	Vrwm=18.0V, Vbr=20.0..22.1V, 172.0A, 5000W(1ms)	DO-214AB	1d	1a	Ext
5PEV	5.0SMGDJ18A	TVS	Vrwm=18.0V, Vbr=20.0..22.1V, 172.0A, 5000W(1ms)	DO-215AB	5d	1a	Lge
5PEV	5.0SMDJ18A	TVS	Vrwm=18V, Vbr=20.0..22.1V, 172A, 5000W(1ms)	DO-214AB	1d	1a	Cnc
5PEV	5.0SMDJ20A	TVS	Vbr=22.2..24.5V, Vrwm=20V, 155.9A, 5000W(1ms)	DO-214AB	1d	1a	Ksm
5PEV	5.0SMLJ18A	TVS	Vrwm=18V, Vbr=20.0..22.1V, 172A, 5000W(1ms)	DO-214AB	1d	1a	Mde
5PEV	TV50C200J-G	TVS	Vrwm=20.0V, Vbr=22.20..24.50V, Ipp=155.86A, 5000W(1ms)	DO-214AB	1d	1a	Cmc
5PEW	5.0SMCJ20A	TVS	Vrwm=20.0V, Vbr=22.2..24.5V, 155.0A, 5000W(1ms)	DO-214AB	1d	1a	Ext
5PEW	5.0SMGDJ20A	TVS	Vrwm=20.0V, Vbr=22.2..24.5V, 155.0A, 5000W(1ms)	DO-215AB	5d	1a	Lge
5PEW	5.0SMDJ20A	TVS	Vrwm=20V, Vbr=22.2..24.5V, 155A, 5000W(1ms)	DO-214AB	1d	1a	Cnc



SMD code	Type	Function	Short description	Case	Pinout	St.	Mnf.
5PEW	5.0SMDJ22	TVS	Vbr=24.4..29.8V, Vrwm=22V, 128.2A, 5000W(1ms)	DO-214AB	1d	1a	Ksm
5PEW	5.0SMLJ20A	TVS	Vrwm=20V, Vbr=22.2..24.5V, 155A, 5000W(1ms)	DO-214AB	1d	1a	Mde
5PEW	TV50C220K-G	TVS	Vrwm=22.0V, Vbr=24.40..29.80V, Ipp=128.17A, 5000W(1ms)	DO-214AB	1d	1a	Cmc
5PEX	5.0SMCJ22A	TVS	Vrwm=22.0V, Vbr=24.4..26.9V, 141.0A, 5000W(1ms)	DO-214AB	1d	1a	Ext
5PEX	5.0SMGD22A	TVS	Vrwm=22.0V, Vbr=24.4..26.9V, 141.0A, 5000W(1ms)	DO-215AB	5d	1a	Lge
5PEX	5.0SMDJ22A	TVS	Vrwm=22V, Vbr=24.4..26.9V, 141A, 5000W(1ms)	DO-214AB	1d	1a	Cnc
5PEX	5.0SMLJ22A	TVS	Vrwm=22V, Vbr=24.4..26.9V, 141A, 5000W(1ms)	DO-214AB	1d	1a	Mde
5PEX	TV50C220J-G	TVS	Vrwm=22.0V, Vbr=24.40..26.90V, Ipp=142.25A, 5000W(1ms)	DO-214AB	1d	1a	Cmc
5PEY	5.0SMDJ24	TVS	Vbr=26.7..32.6V, Vrwm=24V, 117.4A, 5000W(1ms)	DO-214AB	1d	1a	Ksm
5PEY	TV50C240K-G	TVS	Vrwm=24.0V, Vbr=26.70..32.60V, Ipp=117.44A, 5000W(1ms)	DO-214AB	1d	1a	Cmc
5PEZ	5.0SMCJ24A	TVS	Vrwm=24.0V, Vbr=26.7..29.5V, 129.0A, 5000W(1ms)	DO-214AB	1d	1a	Ext
5PEZ	5.0SMGD24A	TVS	Vrwm=24.0V, Vbr=26.7..29.5V, 129.0A, 5000W(1ms)	DO-215AB	5d	1a	Lge
5PEZ	5.0SMDJ24A	TVS	Vrwm=24V, Vbr=26.7..29.5V, 129A, 5000W(1ms)	DO-214AB	1d	1a	Cnc
5PEZ	5.0SMLJ24A	TVS	Vrwm=24V, Vbr=26.7..29.5V, 129A, 5000W(1ms)	DO-214AB	1d	1a	Mde
5PEZ	TV50C240J-G	TVS	Vrwm=24.0V, Vbr=26.70..29.50V, Ipp=129.82A, 5000W(1ms)	DO-214AB	1d	1a	Cmc
5PFD	5.0SMDJ26	TVS	Vbr=28.9..35.3V, Vrwm=26V, 108.4A, 5000W(1ms)	DO-214AB	1d	1a	Ksm
5PFD	TV50C260K-G	TVS	Vrwm=26.0V, Vbr=28.90..35.30V, Ipp=108.37A, 5000W(1ms)	DO-214AB	1d	1a	Cmc
5PFE	5.0SMCJ26A	TVS	Vrwm=26.0V, Vbr=28.9..31.9V, 119.0A, 5000W(1ms)	DO-214AB	1d	1a	Ext
5PFE	5.0SMGD26A	TVS	Vrwm=26.0V, Vbr=28.9..31.9V, 119.0A, 5000W(1ms)	DO-215AB	5d	1a	Lge
5PFE	5.0SMDJ26A	TVS	Vrwm=26V, Vbr=28.9..31.9V, 119A, 5000W(1ms)	DO-214AB	1d	1a	Cnc
5PFE	5.0SMLJ26A	TVS	Vrwm=26V, Vbr=28.9..31.9V, 119A, 5000W(1ms)	DO-214AB	1d	1a	Mde
5PFE	TV50C260J-G	TVS	Vrwm=26.0V, Vbr=28.90..31.90V, Ipp=119.95A, 5000W(1ms)	DO-214AB	1d	1a	Cmc
5PFF	5.0SMDJ28	TVS	Vbr=31.1..38.0V, Vrwm=28V, 101.0A, 5000W(1ms)	DO-214AB	1d	1a	Ksm
5PFF	TV50C280K-G	TVS	Vrwm=28.0V, Vbr=31.10..38.0V, Ipp=101.0A, 5000W(1ms)	DO-214AB	1d	1a	Cmc
5PFG	5.0SMCJ28A	TVS	Vrwm=28.0V, Vbr=31.1..34.4V, 110.0A, 5000W(1ms)	DO-214AB	1d	1a	Ext
5PFG	5.0SMGD28A	TVS	Vrwm=28.0V, Vbr=31.1..34.4V, 110.0A, 5000W(1ms)	DO-215AB	5d	1a	Lge
5PFG	5.0SMDJ28A	TVS	Vrwm=28V, Vbr=31.1..34.4V, 110A, 5000W(1ms)	DO-214AB	1d	1a	Cnc
5PFG	5.0SMLJ28A	TVS	Vrwm=28V, Vbr=31.1..34.4V, 110A, 5000W(1ms)	DO-214AB	1d	1a	Mde
5PFG	TV50C280J-G	TVS	Vrwm=28.0V, Vbr=31.10..34.40V, Ipp=111.23A, 5000W(1ms)	DO-214AB	1d	1a	Cmc
5PFH	5.0SMDJ30	TVS	Vbr=33.3..40.7V, Vrwm=30V, 94.4A, 5000W(1ms)	DO-214AB	1d	1a	Ksm
5PFH	TV50C300K-G	TVS	Vrwm=30.0V, Vbr=33.30..40.70V, Ipp=94.39A, 5000W(1ms)	DO-214AB	1d	1a	Cmc
5PFK	5.0SMCJ30A	TVS	Vrwm=30.0V, Vbr=33.3..36.8V, 103.0A, 5000W(1ms)	DO-214AB	1d	1a	Ext
5PFK	5.0SMGD30A	TVS	Vrwm=30.0V, Vbr=33.3..36.8V, 103.0A, 5000W(1ms)	DO-215AB	5d	1a	Lge
5PFK	5.0SMDJ30A	TVS	Vrwm=30V, Vbr=33.3..36.8V, 103A, 5000W(1ms)	DO-214AB	1d	1a	Cnc
5PFK	5.0SMLJ30A	TVS	Vrwm=30V, Vbr=33.3..36.8V, 103A, 5000W(1ms)	DO-214AB	1d	1a	Mde
5PFK	TV50C300J-G	TVS	Vrwm=30.0V, Vbr=33.30..36.80V, Ipp=104.34A, 5000W(1ms)	DO-214AB	1d	1a	Cmc
5PFL	5.0SMDJ33	TVS	Vbr=36.7..44.9V, Vrwm=33V, 85.6A, 5000W(1ms)	DO-214AB	1d	1a	Ksm
5PFL	TV50C330K-G	TVS	Vrwm=33.0V, Vbr=36.70..44.90V, Ipp=85.59A, 5000W(1ms)	DO-214AB	1d	1a	Cmc
5PFM	5.0SMCJ33A	TVS	Vrwm=33.0V, Vbr=36.7..40.6V, 93.9A, 5000W(1ms)	DO-214AB	1d	1a	Ext
5PFM	5.0SMGD33A	TVS	Vrwm=33.0V, Vbr=36.7..40.6V, 93.9A, 5000W(1ms)	DO-215AB	5d	1a	Lge
5PFM	5.0SMDJ33A	TVS	Vrwm=33V, Vbr=36.7..40.6V, 93.9A, 5000W(1ms)	DO-214AB	1d	1a	Cnc
5PFM	5.0SMLJ33A	TVS	Vrwm=33V, Vbr=36.7..40.6V, 93.9A, 5000W(1ms)	DO-214AB	1d	1a	Mde
5PFM	TV50C330J-G	TVS	Vrwm=33.0V, Vbr=36.70..40.60V, Ipp=94.75A, 5000W(1ms)	DO-214AB	1d	1a	Cmc
5PFN	5.0SMDJ36	TVS	Vbr=40.0..48.9V, Vrwm=36V, 78.5A, 5000W(1ms)	DO-214AB	1d	1a	Ksm
5PFN	TV50C360K-G	TVS	Vrwm=36.0V, Vbr=40.0..48.90V, Ipp=78.54A, 5000W(1ms)	DO-214AB	1d	1a	Cmc
5PFP	5.0SMCJ36A	TVS	Vrwm=36.0V, Vbr=40.0..44.2V, 86.1A, 5000W(1ms)	DO-214AB	1d	1a	Ext
5PFP	5.0SMGD36A	TVS	Vrwm=36.0V, Vbr=40.0..44.2V, 86.1A, 5000W(1ms)	DO-215AB	5d	1a	Lge
5PFP	5.0SMDJ36A	TVS	Vrwm=36V, Vbr=40.0..44.2V, 86.1A, 5000W(1ms)	DO-214AB	1d	1a	Cnc
5PFP	5.0SMLJ36A	TVS	Vrwm=36 V, Vbr=40.0..44.2V, 86.1A, 5000W(1ms)	DO-214AB	1d	1a	Mde
5PFP	TV50C360J-G	TVS	Vrwm=36.0V, Vbr=40.0..44.20V, Ipp=86.92A, 5000W(1ms)	DO-214AB	1d	1a	Cmc
5PFQ	5.0SMDJ40	TVS	Vbr=44.4..54.3V, Vrwm=40V, 70.7A, 5000W(1ms)	DO-214AB	1d	1a	Ksm
5PFQ	TV50C400K-G	TVS	Vrwm=40.0V, Vbr=44.40..54.30V, Ipp=70.73A, 5000W(1ms)	DO-214AB	1d	1a	Cmc
5PFR	5.0SMCJ40A	TVS	Vrwm=40.0V, Vbr=44.4..49.1V, 77.6A, 5000W(1ms)	DO-214AB	1d	1a	Ext
5PFR	5.0SMGD40A	TVS	Vrwm=40.0V, Vbr=44.4..49.1V, 77.6A, 5000W(1ms)	DO-215AB	5d	1a	Lge
5PFR	5.0SMDJ40A	TVS	Vrwm=40V, Vbr=44.4..49.1V, 77.6A, 5000W(1ms)	DO-214AB	1d	1a	Cnc
5PFR	5.0SMLJ40A	TVS	Vrwm=40V, Vbr=44.4..49.1V, 77.6A, 5000W(1ms)	DO-214AB	1d	1a	Mde
5PFR	TV50C400J-G	TVS	Vrwm=40.0V, Vbr=44.40..49.10V, Ipp=78.29A, 5000W(1ms)	DO-214AB	1d	1a	Cmc
5PFS	5.0SMDJ43	TVS	Vbr=47.8..58.4V, Vrwm=43V, 65.8A, 5000W(1ms)	DO-214AB	1d	1a	Ksm
5PFS	TV50C430K-G	TVS	Vrwm=43.0V, Vbr=47.80..58.40V, Ipp=65.84A, 5000W(1ms)	DO-214AB	1d	1a	Cmc
5PFT	5.0SMCJ43A	TVS	Vrwm=43.0V, Vbr=47.8..52.8V, 72.1A, 5000W(1ms)	DO-214AB	1d	1a	Ext
5PFT	5.0SMGD43A	TVS	Vrwm=43.0V, Vbr=47.8..52.8V, 72.1A, 5000W(1ms)	DO-215AB	5d	1a	Lge
5PFT	5.0SMDJ43A	TVS	Vrwm=43V, Vbr=47.8..52.8V, 72.1A, 5000W(1ms)	DO-214AB	1d	1a	Cnc
5PFT	5.0SMLJ43A	TVS	Vrwm=43V, Vbr=47.8..52.8V, 72.1A, 5000W(1ms)	DO-214AB	1d	1a	Mde
5PFT	TV50C430J-G	TVS	Vrwm=43.0V, Vbr=47.80..52.80V, Ipp=72.77A, 5000W(1ms)	DO-214AB	1d	1a	Cmc
5PFU	5.0SMDJ45	TVS	Vbr=50.0..61.1V, Vrwm=45V, 62.9A, 5000W(1ms)	DO-214AB	1d	1a	Ksm
5PFU	TV50C450K-G	TVS	Vrwm=45.0V, Vbr=50.0..61.10V, Ipp=62.89A, 5000W(1ms)	DO-214AB	1d	1a	Cmc
5PFV	5.0SMCJ45A	TVS	Vrwm=45.0V, Vbr=50.0..55.3V, 68.8A, 5000W(1ms)	DO-214AB	1d	1a	Ext
5PFV	5.0SMGD45A	TVS	Vrwm=45.0V, Vbr=50.0..55.3V, 68.8A, 5000W(1ms)	DO-215AB	5d	1a	Lge
5PFV	5.0SMDJ45A	TVS	Vrwm=45V, Vbr=50.0..55.3V, 68.8A, 5000W(1ms)	DO-214AB	1d	1a	Cnc
5PFV	5.0SMLJ45A	TVS	Vrwm=45V, Vbr=50.0..55.3V, 68.8A, 5000W(1ms)	DO-214AB	1d	1a	Mde



SMD code	Type	Function	Short description	Case	Pinout	St.	Mnf.
5PFV	TV50C450J-G	TVS	Vrwm=45.0V, Vbr=50.0..55.30V, Ipp=69.46A, 5000W(1ms)	DO-214AB	1d	1a	Cmc
5PFW	5.0SMDJ48	TVS	Vbr=53.3..65.1V, Vrwm=48V, 59.1A, 5000W(1ms)	DO-214AB	1d	1a	Ksm
5PFW	TV50C480K-G	TVS	Vrwm=48.0V, Vbr=53.30..65.10V, Ipp=59.06A, 5000W(1ms)	DO-214AB	1d	1a	Cmc
5PFX	5.0SMCJ48A	TVS	Vrwm=48.0V, Vbr=53.3..58.9V, 64.7A, 5000W(1ms)	DO-214AB	1d	1a	Ext
5PFX	5.0SMDG48A	TVS	Vrwm=48.0V, Vbr=53.3..58.9V, 64.7A, 5000W(1ms)	DO-215AB	5d	1a	Lge
5PFX	5.0SMDJ48A	TVS	Vrwm=48V, Vbr=53.3..58.9V, 64.7A, 5000W(1ms)	DO-214AB	1d	1a	Cnc
5PFX	5.0SMLJ48A	TVS	Vrwm=48V, Vbr=53.3..58.9V, 64.7A, 5000W(1ms)	DO-214AB	1d	1a	Mde
5PFX	TV50C480J-G	TVS	Vrwm=48.0V, Vbr=53.30..58.90V, Ipp=65.25A, 5000W(1ms)	DO-214AB	1d	1a	Cmc
5PFY	5.0SMDJ51	TVS	Vbr=56.7..69.3V, Vrwm=51V, 55.4A, 5000W(1ms)	DO-214AB	1d	1a	Ksm
5PFY	TV50C510K-G	TVS	Vrwm=51.0V, Vbr=56.70..69.30V, Ipp=55.43A, 5000W(1ms)	DO-214AB	1d	1a	Cmc
5PFZ	5.0SMCJ51A	TVS	Vrwm=51.0V, Vbr=56.7..62.7V, 60.7A, 5000W(1ms)	DO-214AB	1d	1a	Ext
5PFZ	5.0SMDG51A	TVS	Vrwm=51.0V, Vbr=56.7..62.7V, 60.7A, 5000W(1ms)	DO-215AB	5d	1a	Lge
5PFZ	5.0SMDJ51A	TVS	Vrwm=51V, Vbr=56.7..62.7V, 60.7A, 5000W(1ms)	DO-214AB	1d	1a	Cnc
5PFZ	5.0SMLJ51A	TVS	Vrwm=51V, Vbr=56.7..62.7V, 60.7A, 5000W(1ms)	DO-214AB	1d	1a	Mde
5PFZ	TV50C510J-G	TVS	Vrwm=51.0V, Vbr=56.70..62.70V, Ipp=61.29A, 5000W(1ms)	DO-214AB	1d	1a	Cmc
5PGA	5.0SMDJ80	TVS	Vbr=89.0..109V, Vrwm=80V, 35.3A, 5000W(1ms)	DO-214AB	1d	1a	Ksm
5PGA	TV50C800K-G	TVS	Vrwm=80.0V, Vbr=88.96..108.80V, Ipp=35.27A, 5000W(1ms)	DO-214AB	1d	1a	Cmc
5PGB	5.0SMDJ80A	TVS	Vbr=88.8..97.6V, Vrwm=80V, 39.0A, 5000W(1ms)	DO-214AB	1d	1a	Ksm
5PGB	TV50C800J-G	TVS	Vrwm=80.0V, Vbr=88.80..97.60V, Ipp=38.97A, 5000W(1ms)	DO-214AB	1d	1a	Cmc
5PGD	5.0SMDJ54	TVS	Vbr=60.0..73.3V, Vrwm=54V, 52.4A, 5000W(1ms)	DO-214AB	1d	1a	Ksm
5PGD	TV50C540K-G	TVS	Vrwm=54.0V, Vbr=60.0..73.30V, Ipp=52.44A, 5000W(1ms)	DO-214AB	1d	1a	Cmc
5PGE	5.0SMCJ54A	TVS	Vrwm=54.0V, Vbr=60.0..66.3V, 57.5A, 5000W(1ms)	DO-214AB	1d	1a	Ext
5PGE	5.0SMDG54A	TVS	Vrwm=54.0V, Vbr=60.0..66.3V, 57.5A, 5000W(1ms)	DO-215AB	5d	1a	Lge
5PGE	5.0SMLJ54A	TVS	Vrwm=54V, Vbr=60.0..66.3V, 57.5A, 5000W(1ms)	DO-214AB	1d	1a	Mde
5PGE	TV50C540J-G	TVS	Vrwm=54.0V, Vbr=60.0..66.30V, Ipp=57.98A, 5000W(1ms)	DO-214AB	1d	1a	Cmc
5PGF	5.0SMDJ58	TVS	Vbr=64.4..78.7V, Vrwm=58V, 49.0A, 5000W(1ms)	DO-214AB	1d	1a	Ksm
5PGF	TV50C580K-G	TVS	Vrwm=58.0V, Vbr=64.40..78.70V, Ipp=49.03A, 5000W(1ms)	DO-214AB	1d	1a	Cmc
5PGG	5.0SMCJ58A	TVS	Vrwm=58.0V, Vbr=64.4..71.2V, 53.5A, 5000W(1ms)	DO-214AB	1d	1a	Ext
5PGG	5.0SMDG58A	TVS	Vrwm=58.0V, Vbr=64.4..71.2V, 53.5A, 5000W(1ms)	DO-215AB	5d	1a	Lge
5PGG	5.0SMDJ58A	TVS	Vrwm=58V, Vbr=64.4..71.2V, 53.5A, 5000W(1ms)	DO-214AB	1d	1a	Cnc
5PGG	5.0SMLJ58A	TVS	Vrwm=58V, Vbr=64.4..71.2V, 53.5A, 5000W(1ms)	DO-214AB	1d	1a	Mde
5PGG	TV50C580J-G	TVS	Vrwm=58.0V, Vbr=64.40..71.20V, Ipp=53.95A, 5000W(1ms)	DO-214AB	1d	1a	Cmc
5PGH	5.0SMDJ60	TVS	Vbr=66.7..81.5V, Vrwm=60V, 47.2A, 5000W(1ms)	DO-214AB	1d	1a	Ksm
5PGH	TV50C600K-G	TVS	Vrwm=60.0V, Vbr=66.70..81.50V, Ipp=47.20A, 5000W(1ms)	DO-214AB	1d	1a	Cmc
5PGK	5.0SMCJ60A	TVS	Vrwm=60.0V, Vbr=66.7..73.7V, 51.7A, 5000W(1ms)	DO-214AB	1d	1a	Ext
5PGK	5.0SMDG60A	TVS	Vrwm=60.0V, Vbr=66.7..73.7V, 51.7A, 5000W(1ms)	DO-215AB	5d	1a	Lge
5PGK	5.0SMDJ60A	TVS	Vrwm=60V, Vbr=66.7..73.7V, 51.7A, 5000W(1ms)	DO-214AB	1d	1a	Cnc
5PGK	5.0SMLJ60A	TVS	Vrwm=60V, Vbr=66.7..73.7V, 51.7A, 5000W(1ms)	DO-214AB	1d	1a	Mde
5PGK	TV50C600J-G	TVS	Vrwm=60.0V, Vbr=66.70..73.70V, Ipp=52.17A, 5000W(1ms)	DO-214AB	1d	1a	Cmc
5PGL	5.0SMDJ64	TVS	Vbr=71.1..86.9V, Vrwm=64V, 44.3A, 5000W(1ms)	DO-214AB	1d	1a	Ksm
5PGL	TV50C640K-G	TVS	Vrwm=64.0V, Vbr=71.10..86.90V, Ipp=44.30A, 5000W(1ms)	DO-214AB	1d	1a	Cmc
5PGM	5.0SMCJ64A	TVS	Vrwm=64.0V, Vbr=71.1..78.6V, 48.6A, 5000W(1ms)	DO-214AB	1d	1a	Ext
5PGM	5.0SMDG64A	TVS	Vrwm=64.0V, Vbr=71.1..78.6V, 48.6A, 5000W(1ms)	DO-215AB	5d	1a	Lge
5PGM	5.0SMDJ64A	TVS	Vrwm=64V, Vbr=71.1..78.6V, 48.6A, 5000W(1ms)	DO-214AB	1d	1a	Cnc
5PGM	5.0SMLJ64A	TVS	Vrwm=64V, Vbr=71.1..78.6V, 48.6A, 5000W(1ms)	DO-214AB	1d	1a	Mde
5PGM	TV50C640J-G	TVS	Vrwm=64.0V, Vbr=71.10..78.60V, Ipp=49.03A, 5000W(1ms)	DO-214AB	1d	1a	Cmc
5PGN	5.0SMDJ70	TVS	Vbr=77.8..95.1V, Vrwm=70V, 40.4A, 5000W(1ms)	DO-214AB	1d	1a	Ksm
5PGN	TV50C700K-G	TVS	Vrwm=70.0V, Vbr=77.80..95.10V, Ipp=40.40A, 5000W(1ms)	DO-214AB	1d	1a	Cmc
5PGP	5.0SMCJ70A	TVS	Vrwm=70.0V, Vbr=77.8..86.0V, 44.3A, 5000W(1ms)	DO-214AB	1d	1a	Ext
5PGP	5.0SMDG70A	TVS	Vrwm=70.0V, Vbr=77.8..86.0V, 44.3A, 5000W(1ms)	DO-215AB	5d	1a	Lge
5PGP	5.0SMDJ70A	TVS	Vrwm=70V, Vbr=77.8..86V, 44.3A, 5000W(1ms)	DO-214AB	1d	1a	Cnc
5PGP	5.0SMLJ70A	TVS	Vrwm=70V, Vbr=77.8..86.0V, 44.3A, 5000W(1ms)	DO-214AB	1d	1a	Mde
5PQP	TV50C700J-G	TVS	Vrwm=70.0V, Vbr=77.80..86.0V, Ipp=44.69A, 5000W(1ms)	DO-214AB	1d	1a	Cmc
5PGQ	5.0SMDJ75	TVS	Vbr=83.3..102V, Vrwm=75V, 37.7A, 5000W(1ms)	DO-214AB	1d	1a	Ksm
5PGQ	TV50C750K-G	TVS	Vrwm=75.0V, Vbr=83.30..102.0V, Ipp=37.69A, 5000W(1ms)	DO-214AB	1d	1a	Cmc
5PGR	5.0SMCJ75A	TVS	Vrwm=75.0V, Vbr=83.3..92.1V, 41.4A, 5000W(1ms)	DO-214AB	1d	1a	Ext
5PGR	5.0SMDG75A	TVS	Vrwm=75.0V, Vbr=83.3..92.1V, 41.4A, 5000W(1ms)	DO-215AB	5d	1a	Lge
5PGR	5.0SMDJ75A	TVS	Vrwm=75V, Vbr=83.3..92.1V, 41.4A, 5000W(1ms)	DO-214AB	1d	1a	Cnc
5PGR	5.0SMLJ75A	TVS	Vrwm=75V, Vbr=83.3..92.1V, 41.4A, 5000W(1ms)	DO-214AB	1d	1a	Mde
5PGR	TV50C750J-G	TVS	Vrwm=75.0V, Vbr=83.30..92.10V, Ipp=41.74A, 5000W(1ms)	DO-214AB	1d	1a	Cmc
5PGS	5.0SMDJ78	TVS	Vbr=86.7..106V, Vrwm=78V, 36.3A, 5000W(1ms)	DO-214AB	1d	1a	Ksm
5PGS	TV50C780K-G	TVS	Vrwm=78.0V, Vbr=86.70..106.0V, Ipp=36.33A, 5000W(1ms)	DO-214AB	1d	1a	Cmc
5PGT	5.0SMCJ78A	TVS	Vrwm=78.0V, Vbr=86.7..95.8V, 39.7A, 5000W(1ms)	DO-214AB	1d	1a	Ext
5PGT	5.0SMDG78A	TVS	Vrwm=78.0V, Vbr=86.7..95.8V, 39.7A, 5000W(1ms)	DO-215AB	5d	1a	Lge
5PGT	5.0SMDJ78A	TVS	Vrwm=78V, Vbr=86.7..95.8V, 39.7A, 5000W(1ms)	DO-214AB	1d	1a	Cnc
5PGT	5.0SMLJ78A	TVS	Vrwm=78V, Vbr=86.7..95.8V, 39.7A, 5000W(1ms)	DO-214AB	1d	1a	Mde
5PGT	TV50C780J-G	TVS	Vrwm=78.0V, Vbr=86.70..95.80V, Ipp=40.08A, 5000W(1ms)	DO-214AB	1d	1a	Cmc
5PGU	5.0SMDJ85	TVS	Vbr=94.4..115V, Vrwm=85V, 33.4A, 5000W(1ms)	DO-214AB	1d	1a	Ksm
5PGU	TV50C850K-G	TVS	Vrwm=85.0V, Vbr=94.40..115.0V, Ipp=33.44A, 5000W(1ms)	DO-214AB	1d	1a	Cmc
5PGV	5.0SMCJ85A	TVS	Vrwm=85.0V, Vbr=94.4..104V, 36.5A, 5000W(1ms)	DO-214AB	1d	1a	Ext



SMD code	Type	Function	Short description	Case	Pinout	St.	Mnf.
5PGV	5.0SMDG85A	TVS	Vrwm=85.0V, Vbr=94.4..104.0V, 36.5A, 5000W(1ms)	DO-215AB	5d	1a	Lge
5PGV	5.0SMDJ85A	TVS	Vrwm=85V, Vbr=94.4..104V, 36.5A, 5000W(1ms)	DO-214AB	1d	1a	Cnc
5PGV	5.0SMLJ85A	TVS	Vrwm=85V, Vbr=94.4..104V, 36.5A, 5000W(1ms)	DO-214AB	1d	1a	Mde
5PGV	TV50C850J-G	TVS	Vrwm=85.0V, Vbr=94.40..104.0V, lpp=36.86A, 5000W(1ms)	DO-214AB	1d	1a	Cmc
5PGW	5.0SMDJ90	TVS	Vbr=100..122V, Vrwm=90V, 31.6A, 5000W(1ms)	DO-214AB	1d	1a	Ksm
5PGW	TV50C900K-G	TVS	Vrwm=90.0V, Vbr=100.0..122.0V, lpp=31.56A, 5000W(1ms)	DO-214AB	1d	1a	Cmc
5PGX	5.0SMCJ90A	TVS	Vrwm=90.0V, Vbr=100..111V, 34.3A, 5000W(1ms)	DO-214AB	1d	1a	Ext
5PGX	5.0SMDG90A	TVS	Vrwm=90.0V, Vbr=100.0..111.0V, 34.3A, 5000W(1ms)	DO-215AB	5d	1a	Lge
5PGX	5.0SMDJ90A	TVS	Vrwm=90.0V, Vbr=100..111V, 34.3A, 5000W(1ms)	DO-214AB	1d	1a	Cnc
5PGX	5.0SMLJ90A	TVS	Vrwm=90V, Vbr=100..111V, 34.3A, 5000W(1ms)	DO-214AB	1d	1a	Mde
5PGY	TV50C900J-G	TVS	Vrwm=90.0V, Vbr=100.0..111.0V, lpp=34.59A, 5000W(1ms)	DO-214AB	1d	1a	Cmc
5PGY	5.0SMDJ100	TVS	Vbr=111..136V, Vrwm=100V, 28.2A, 5000W(1ms)	DO-214AB	1d	1a	Ksm
5PGY	TV50C101K-G	TVS	Vrwm=100.0V, Vbr=111.0..136.0V, lpp=28.21A, 5000W(1ms)	DO-214AB	1d	1a	Cmc
5PGZ	5.0SMCJ100A	TVS	Vrwm=100.0V, Vbr=111..123V, 30.9A, 5000W(1ms)	DO-214AB	1d	1a	Ext
5PGZ	5.0SMDG100A	TVS	Vrwm=100.0V, Vbr=111.0..123.0V, 30.9A, 5000W(1ms)	DO-215AB	5d	1a	Lge
5PGZ	5.0SMDJ100A	TVS	Vrwm=100V, Vbr=111..123V, 30.9A, 5000W(1ms)	DO-214AB	1d	1a	Cnc
5PGZ	5.0SMLJ100A	TVS	Vrwm=100V, Vbr=111..123V, 30.9A, 5000W(1ms)	DO-214AB	1d	1a	Mde
5PGZ	TV50C101J-G	TVS	Vrwm=100.0V, Vbr=111.0..123.0V, lpp=31.17A, 5000W(1ms)	DO-214AB	1d	1a	Cmc
5PHA	5.0SMDJ140	TVS	Vbr=156..190V, Vrwm=140V, 20.2A, 5000W(1ms)	DO-214AB	1d	1a	Ksm
5PHA	TV50C141K-G	TVS	Vrwm=140.0V, Vbr=155.68..190.4V, lpp=20.15A, 5000W(1ms)	DO-214AB	1d	1a	Cmc
5PHB	5.0SMDJ140A	TVS	Vbr=155..171V, Vrwm=140V, 22.3A, 5000W(1ms)	DO-214AB	1d	1a	Ksm
5PHB	TV50C141J-G	TVS	Vrwm=140.0V, Vbr=155.0..171.0V, lpp=22.27A, 5000W(1ms)	DO-214AB	1d	1a	Cmc
5PHD	5.0SMDJ110	TVS	Vbr=122..149V, Vrwm=110V, 25.8A, 5000W(1ms)	DO-214AB	1d	1a	Ksm
5PHD	TV50C111K-G	TVS	Vrwm=110.0V, Vbr=122.0..149.0V, lpp=25.77A, 5000W(1ms)	DO-214AB	1d	1a	Cmc
5PHE	5.0SMCJ110A	TVS	Vrwm=110.0V, Vbr=122..135V, 28.3A, 5000W(1ms)	DO-214AB	1d	1a	Ext
5PHE	5.0SMDG110A	TVS	Vrwm=110.0V, Vbr=122.0..135.0V, 28.3A, 5000W(1ms)	DO-215AB	5d	1a	Lge
5PHE	5.0SMDJ110A	TVS	Vrwm=110V, Vbr=122..135V, 28.3A, 5000W(1ms)	DO-214AB	1d	1a	Cnc
5PHE	5.0SMLJ110A	TVS	Vrwm=110V, Vbr=122..135V, 28.3A, 5000W(1ms)	DO-214AB	1d	1a	Mde
5PHE	TV50C111J-G	TVS	Vrwm=110.0V, Vbr=122.0..135.0V, lpp=28.53A, 5000W(1ms)	DO-214AB	1d	1a	Cmc
5PHF	5.0SMDJ120	TVS	Vbr=133..163V, Vrwm=120V, 23.6A, 5000W(1ms)	DO-214AB	1d	1a	Ksm
5PHF	TV50C121K-G	TVS	Vrwm=120.0V, Vbr=133.0..163.0V, lpp=23.60A, 5000W(1ms)	DO-214AB	1d	1a	Cmc
5PHG	5.0SMCJ120A	TVS	Vrwm=120.0V, Vbr=133..147V, 26.0A, 5000W(1ms)	DO-214AB	1d	1a	Ext
5PHG	5.0SMDG120A	TVS	Vrwm=120.0V, Vbr=133.0..147.0V, 26.0A, 5000W(1ms)	DO-215AB	5d	1a	Lge
5PHG	5.0SMDJ120A	TVS	Vrwm=120V, Vbr=133..147V, 26.0A, 5000W(1ms)	DO-214AB	1d	1a	Cnc
5PHG	5.0SMLJ120A	TVS	Vrwm=120V, Vbr=133..147V, 26.0A, 5000W(1ms)	DO-214AB	1d	1a	Mde
5PHG	TV50C121J-G	TVS	Vrwm=120.0V, Vbr=133.0..147.0V, lpp=26.17A, 5000W(1ms)	DO-214AB	1d	1a	Cmc
5PHH	5.0SMDJ130	TVS	Vbr=144..176V, Vrwm=130V, 21.9A, 5000W(1ms)	DO-214AB	1d	1a	Ksm
5PHH	TV50C131K-G	TVS	Vrwm=130.0V, Vbr=144.0..176.0V, lpp=21.86A, 5000W(1ms)	DO-214AB	1d	1a	Cmc
5PHK	5.0SMCJ130A	TVS	Vrwm=130.0V, Vbr=144..159V, 24.0A, 5000W(1ms)	DO-214AB	1d	1a	Ext
5PHK	5.0SMDG130A	TVS	Vrwm=130.0V, Vbr=144.0..159.0V, 24.0A, 5000W(1ms)	DO-215AB	5d	1a	Lge
5PHK	5.0SMDJ130A	TVS	Vrwm=130V, Vbr=144..159V, 24.0A, 5000W(1ms)	DO-214AB	1d	1a	Cnc
5PHK	5.0SMLJ130A	TVS	Vrwm=130V, Vbr=144..159V, 24A, 5000W(1ms)	DO-214AB	1d	1a	Mde
5PHK	TV50C131J-G	TVS	Vrwm=130.0V, Vbr=144.0..159.0V, lpp=24.16A, 5000W(1ms)	DO-214AB	1d	1a	Cmc
5PHL	5.0SMDJ150	TVS	Vbr=167..204V, Vrwm=150V, 18.8A, 5000W(1ms)	DO-214AB	1d	1a	Ksm
5PHL	TV50C151K-G	TVS	Vrwm=150.0V, Vbr=167.0..204.0V, lpp=18.84A, 5000W(1ms)	DO-214AB	1d	1a	Cmc
5PHM	5.0SMCJ150A	TVS	Vrwm=150.0V, Vbr=167..185V, 20.6A, 5000W(1ms)	DO-214AB	1d	1a	Ext
5PHM	5.0SMDG150A	TVS	Vrwm=150.0V, Vbr=167.0..185.0V, 20.6A, 5000W(1ms)	DO-215AB	5d	1a	Lge
5PHM	5.0SMDJ150A	TVS	Vrwm=150V, Vbr=167..185V, 20.6A, 5000W(1ms)	DO-214AB	1d	1a	Cnc
5PHM	5.0SMLJ150A	TVS	Vrwm=150V, Vbr=167..185V, 20.6A, 5000W(1ms)	DO-214AB	1d	1a	Mde
5PHM	TV50C151J-G	TVS	Vrwm=150.0V, Vbr=167.0..185.0V, lpp=20.78A, 5000W(1ms)	DO-214AB	1d	1a	Cmc
5PHN	5.0SMDJ160	TVS	Vbr=178..218V, Vrwm=160V, 17.6A, 5000W(1ms)	DO-214AB	1d	1a	Ksm
5PHN	TV50C161K-G	TVS	Vrwm=160.0V, Vbr=178.0..218.0V, lpp=17.60A, 5000W(1ms)	DO-214AB	1d	1a	Cmc
5PHP	5.0SMCJ160A	TVS	Vrwm=160.0V, Vbr=178..197V, 19.3A, 5000W(1ms)	DO-214AB	1d	1a	Ext
5PHP	5.0SMDG160A	TVS	Vrwm=160.0V, Vbr=178.0..197.0V, 19.3A, 5000W(1ms)	DO-215AB	5d	1a	Lge
5PHP	5.0SMDJ160A	TVS	Vrwm=160V, Vbr=178..197V, 19.3A, 5000W(1ms)	DO-214AB	1d	1a	Cnc
5PHP	5.0SMLJ160A	TVS	Vrwm=160V, Vbr=178..197V, 19.3A, 5000W(1ms)	DO-214AB	1d	1a	Mde
5PHP	TV50C161J-G	TVS	Vrwm=160.0V, Vbr=178.0..197.0V, lpp=19.50A, 5000W(1ms)	DO-214AB	1d	1a	Cmc
5PHQ	5.0SMDJ170	TVS	Vbr=189..231V, Vrwm=170V, 16.6A, 5000W(1ms)	DO-214AB	1d	1a	Ksm
5PHQ	TV50C171K-G	TVS	Vrwm=170.0V, Vbr=189.0..231.0V, lpp=16.61A, 5000W(1ms)	DO-214AB	1d	1a	Cmc
5PHR	5.0SMCJ170A	TVS	Vrwm=170.0V, Vbr=189..209V, 18.2A, 5000W(1ms)	DO-214AB	1d	1a	Ext
5PHR	5.0SMDG170A	TVS	Vrwm=170.0V, Vbr=189.0..209.0V, 18.2A, 5000W(1ms)	DO-215AB	5d	1a	Lge
5PHR	5.0SMDJ170A	TVS	Vrwm=170V, Vbr=189..209V, 18.2A, 5000W(1ms)	DO-214AB	1d	1a	Cnc
5PHR	5.0SMLJ170A	TVS	Vrwm=170V, Vbr=189..209V, 18.2A, 5000W(1ms)	DO-214AB	1d	1a	Mde
5PHR	TV50C171J-G	TVS	Vrwm=170.0V, Vbr=189.0..209.0V, lpp=18.36A, 5000W(1ms)	DO-214AB	1d	1a	Cmc
5PHS	5.0SMDJ180	TVS	Vbr=200..245V, Vrwm=180V, 15.7A, 5000W(1ms)	DO-214AB	1d	1a	Ksm
5PHS	TV50C181K-G	TVS	Vrwm=180.0V, Vbr=200.16..244.80V, lpp=15.67A, 5000W(1ms)	DO-214AB	1d	1a	Cmc
5PHT	5.0SMDJ180A	TVS	Vrwm=180.0V, Vbr=200..220V, Vrwm=180V, 17.3A, 5000W(1ms)	DO-214AB	1d	1a	Ksm
5PHT	TV50C181J-G	TVS	Vrwm=180.0V, Vbr=200.0..220.0V, lpp=17.32A, 5000W(1ms)	DO-214AB	1d	1a	Cmc
5PHU	5.0SMDJ190	TVS	Vbr=211..258V, Vrwm=190V, 14.8A, 5000W(1ms)	DO-214AB	1d	1a	Ksm
5PHU	TV50C191K-G	TVS	Vrwm=190.0V, Vbr=211.28..258.40V, lpp=14.85A, 5000W(1ms)	DO-214AB	1d	1a	Cmc



SMD code	Type	Function	Short description	Case	Pinout	St.	Mnf.
5PHV	5.0SMDJ190A	TVS	Vbr=211.232V, Vrwm=190V, 16.4A, 5000W(1ms)	DO-214AB	1d	1a	Ksm
5PHV	TV50C191J-G	TVS	Vrwm=190.0V, Vbr=211.0.232.0V, Ipp=16.41A, 5000W(1ms)	DO-214AB	1d	1a	Cmc
5PHW	TV50C201J-G	TVS	Vrwm=200.0V, Vbr=224.0.247.0V, Ipp=9.26A, 5000W(1ms)	DO-214AB	1d	1a	Cmc
5PHX	TV50C221J-G	TVS	Vrwm=220.0V, Vbr=246.0.272.0V, Ipp=8.43A, 5000W(1ms)	DO-214AB	1d	1a	Cmc
5PHZ	TV50C251J-G	TVS	Vrwm=250.0V, Vbr=279.0.309.0V, Ipp=7.41A, 5000W(1ms)	DO-214AB	1d	1a	Cmc
5PJE	TV50C301J-G	TVS	Vrwm=300.0V, Vbr=335.0.371.0V, Ipp=6.17A, 5000W(1ms)	DO-214AB	1d	1a	Cmc
5PJG	TV50C351J-G	TVS	Vrwm=350.0V, Vbr=391.0.432.0V, Ipp=5.29A, 5000W(1ms)	DO-214AB	1d	1a	Cmc
5PJK	TV50C401J-G	TVS	Vrwm=400.0V, Vbr=447.0.494.0V, Ipp=4.63A, 5000W(1ms)	DO-214AB	1d	1a	Cmc
5PJM	TV50C441J-G	TVS	Vrwm=440.0V, Vbr=492.0.543.0V, Ipp=4.21A, 5000W(1ms)	DO-214AB	1d	1a	Cmc
5Q	DDZ39F	Z-diode	39V±10%, Izt=5mA, 200mW	SOD-523	5d	1d	Di
5Q	DDZ39FS	Z-diode	39V±10%, Izt=5mA, 200mW	SOD-323	5d	1d	Di
5R	MM1Z30	Z-diode	30V±5%, Izt=5mA, Zzt=80Ω, 500mW	SOD-123FL	7d	1a	Eic
5R	MMSZ24V	Z-diode	22.8..25.6V, Zzt=70Ω, Izt=5mA, 200mW	SOD-523FL	7d	1a	F
5R	TCBZX584C24V	Z-diode	22.8..25.6V, Izt=5mA, Zzt=70Ω, 200mW	SOD-523FL	7d	1a	Tac
5R	TCMMSZ24V	Z-diode	22.8..25.6V, Izt=5mA, Zzt=70Ω, 200mW	SOD-523FL	7d	1a	Tac
5RGE	5.0SMDJ54A	TVS	Vrwm=54V, Vbr=60.0..66.3V, 57.5A, 5000W(1ms)	DO-214AB	1d	1a	Cnc
5RGE	5.0SMDJ54CA	TVS	Vbr=60.0.66.3V, Vrwm=54V, 58.0A, 5000W(1ms), Bidirectional	DO-214AB	1ba	1j	Ksm
5S	MMSZ27V	Z-diode	25.1..28.9V, Zzt=80Ω, Izt=2mA, 200mW	SOD-523FL	7d	1a	F
5S	TCBZX584C27V	Z-diode	25.1..28.9V, Izt=2mA, Zzt=80Ω, 200mW	SOD-523FL	7d	1a	Tac
5S	TCMMSZ27V	Z-diode	25.1..28.9V, Izt=2mA, Zzt=80Ω, 200mW	SOD-523FL	7d	1a	Tac
5T	MMSZ30V	Z-diode	28..32V, Zzt=80Ω, Izt=2mA, 200mW	SOD-523FL	7d	1a	F
5T	TCBZX584C30V	Z-diode	28..32V, Izt=2mA, Zzt=80Ω, 200mW	SOD-523FL	7d	1a	Tac
5T	TCMMSZ30V	Z-diode	28..32V, Izt=2mA, Zzt=80Ω, 200mW	SOD-523FL	7d	1a	Tac
5U	MMSZ33V	Z-diode	31..35V, Zzt=80Ω, Izt=2mA, 200mW	SOD-523FL	7d	1a	F
5U	SD05	TVS	Vbr=5V, 24A, 350W(1ms)	SOD-323	5d	1a	Smt
5U	TCBZX584C33V	Z-diode	31..35V, Izt=2mA, Zzt=80Ω, 200mW	SOD-523FL	7d	1a	Tac
5U	TCMMSZ33V	Z-diode	31..35V, Izt=2mA, Zzt=80Ω, 200mW	SOD-523FL	7d	1a	Tac
5V	MMSZ36V	Z-diode	34..38V, Zzt=90Ω, Izt=2mA, 200mW	SOD-523FL	7d	1a	F
5V	TCBZX584C36V	Z-diode	34..38V, Izt=2mA, Zzt=90Ω, 200mW	SOD-523FL	7d	1a	Tac
5V	TCMMSZ36V	Z-diode	34..38V, Izt=2mA, Zzt=90Ω, 200mW	SOD-523FL	7d	1a	Tac
5V0	SMA5.0	TVS	Vbr=6.4.7.81V, Vrwm=5.0V, 31.3A, 300W(1ms)	DO-214AC	1d	1a	Mic
5V0	SMB5.0	TVS	Vbr=6.4.7.82V, Vrwm=5V, 62.5A, 600W(1ms)	DO-214AA	1d	1a	Mic
5V0	SMC5.0	TVS	Vbr=6.4.7.82V, Vrwm=5V, 156.3A, 1500W(1ms),	DO-214AB	1d	1a	Mic
5V0A	SMA5.0A	TVS	Vbr=6.4.7.08V, Vrwm=5.0V, 32.6A, 300W(1ms)	DO-214AC	1d	1a	Mic
5V0A	SMB5.0A	TVS	Vbr=6.4.7.07V, Vrwm=5V, 65.2A, 600W(1ms)	DO-214AA	1d	1a	Mic
5V0A	SMC5.0A	TVS	Vbr=6.4.7.07V, Vrwm=5V, 163A, 1500W(1ms),	DO-214AB	1d	1a	Mic
5V0C	SMA5.0C	TVS	Vbr=6.4.7.81V, Vrwm=5.0V, 31.3A, 300W(1ms), Bidirectional	DO-214AC	1ba	1j	Mic
5V0C	SMB5.0C	TVS	Vbr=6.4.7.82V, Vrwm=5V, 62.5A, 600W(1ms), Bidirectional	DO-214AA	1ba	1j	Mic
5V0C	SMC5.0C	TVS	Vbr=6.4.7.82V, Vrwm=5V, 156.3A, 1500W(1ms), Bidirectional	DO-214AB	1ba	1j	Mic
5V0CA	SMA5.0CA	TVS	Vbr=6.4.7.08V, Vrwm=5.0V, 32.6A, 300W(1ms), Bidirectional	DO-214AC	1ba	1j	Mic
5V0CA	SMB5.0CA	TVS	Vbr=6.4.7.07V, Vrwm=5V, 65.2A, 600W(1ms), Bidirectional	DO-214AA	1ba	1j	Mic
5V0CA	SMC5.0CA	TVS	Vbr=6.4.7.07V, Vrwm=5V, 163A, 1500W(1ms), Bidirectional	DO-214AB	1ba	1j	Mic
5V1	BZD27C5V1P	Z-diode	4.85..5.36V, Zzt=6Ω, Izt=100mA, 800mW	SOD-123FL	7d	1a	Pjt
5V1	BZY55-C5V1	Z-diode	4.85..5.36V, Izt=5mA, Zzt=50Ω, 500mW	0805	70d	2d	Tsc
5V1	CDZ55C5V1	Z-diode	4.85..5.36V, Zzt=50Ω, Izt=5mA, 500mW	1206	70d	2d	Crp
5V1	CDZ55C5V1S	Z-diode	4.85..5.36V, Zzt=50Ω, Izt=5mA, 500mW	0805	70d	2d	Crp
5V1	CTZ55C5V1	Z-diode	4.85..5.36V, Izt=5mA, Zzt=50Ω, 500mW	1206	70d	2d	Ctc
5V1	MFPZ5V1	Z-diode	4.85..5.36V, Izt=100mA, Zzt=6Ω, 800mW	SOD-123FL	7d	1a	Thr
5V1B	BZT52-B5V1	Z-diode	5.0..5.20V, Izt=5mA, Zzt=60Ω, 500mW	SOD-123FL	7d	1a	Tsc
5V1B	MMSZ5V1BW	Z-diode	5.0..5.20V, Izt=5mA, Zzt=60Ω, 500mW	SOD-123FL	7d	1a	Tac
5V1Z	BZT52-C5V1	Z-diode	4.85..5.36V, Izt=5mA, Zzt=60Ω, 500mW	SOD-123FL	7d	1a	Tsc
5V1Z	MMSZ5V1CW	Z-diode	4.85..5.36V, Izt=5mA, Zzt=60Ω, 500mW	SOD-123FL	7d	1a	Tac
5V1Z	TCMMSZ5V1	Z-diode	5.1V±5%, Izt=5mA, Zzt=56Ω, 500mW	SOD-123FL	7d	1a	Tac
5V1Z	ZGFM055V1C-MH	Z-diode	4.85..5.36V, Izt=5mA, Zzt=56Ω, 500mW	SOD-123	5d	1a	Pic
5V6	BZD27C5V6P	Z-diode	5.32..5.88V, Zzt=4Ω, Izt=100mA, 800mW	SOD-123FL	7d	1a	Pjt
5V6	BZY55-C5V6	Z-diode	5.32..5.88V, Izt=5mA, Zzt=30Ω, 500mW	0805	70d	2d	Tsc
5V6	CDZ55C5V6	Z-diode	5.32..5.88V, Zzt=30Ω, Izt=5mA, 500mW	1206	70d	2d	Crp
5V6	CDZ55C5V6S	Z-diode	5.32..5.88V, Zzt=30Ω, Izt=5mA, 500mW	0805	70d	2d	Crp
5V6	CTZ55C5V6	Z-diode	5.32..5.88V, Izt=5mA, Zzt=30Ω, 500mW	1206	70d	2d	Ctc
5V6	MFPZ5V6	Z-diode	5.32..5.88V, Izt=100mA, Zzt=4Ω, 800mW	SOD-123FL	7d	1a	Thr
5V6B	BZT52-B5V6	Z-diode	5.49..5.71V, Izt=5mA, Zzt=40Ω, 500mW	SOD-123FL	7d	1a	Tsc
5V6B	MMSZ5V6BW	Z-diode	5.49..5.71V, Izt=5mA, Zzt=40Ω, 500mW	SOD-123FL	7d	1a	Tac
5V6Z	BZT52-C5V6	Z-diode	5.32..5.88V, Izt=5mA, Zzt=40Ω, 500mW	SOD-123FL	7d	1a	Tsc
5V6Z	MMSZ5V6CW	Z-diode	5.32..5.88V, Izt=5mA, Zzt=40Ω, 500mW	SOD-123FL	7d	1a	Tac
5V6Z	TCMMSZ5V6	Z-diode	5.6V±5%, Izt=5mA, Zzt=37Ω, 500mW	SOD-123FL	7d	1a	Tac
5V6Z	ZGFM055V6C-MH	Z-diode	5.32..5.88V, Izt=5mA, Zzt=37Ω, 500mW	SOD-123	5d	1a	Pic
5X	MM1Z33	Z-diode	33V±5%, Izt=5mA, Zzt=80Ω, 500mW	SOD-123FL	7d	1a	Eic
5X	MMSZ39V	Z-diode	37..41V, Zzt=130Ω, Izt=2mA, 200mW	SOD-523FL	7d	1a	F
5X	TCBZX584C39V	Z-diode	37..41V, Izt=2mA, Zzt=130Ω, 200mW	SOD-523FL	7d	1a	Tac
5X	TCMMSZ39V	Z-diode	37..41V, Izt=2mA, Zzt=130Ω, 200mW	SOD-523FL	7d	1a	Tac



SMD code	Type	Function	Short description	Case	Pinout	St.	Mnf.
5Y	KDZ15VVY	Z-diode	14.34..14.98V, Izt=5mA, Zzt=15Ω, 100mW	VSC	7d	1a	Kec
5Y	MM1Z36	Z-diode	36V±5%, Izt=5mA, Zzt=90Ω, 500mW	SOD-123FL	7d	1a	Eic
5Y	MM5Z43V	Z-diode	40..46V, Zzt=150Ω, Izt=2mA, 200mW	SOD-523FL	7d	1a	F
5Y	TCBZX584C43V	Z-diode	40..46V, Izt=2mA, Zzt=150Ω, 200mW	SOD-523FL	7d	1a	Tac
5Y	TCMM5Z43V	Z-diode	40..46V, Izt=2mA, Zzt=150Ω, 200mW	SOD-523FL	7d	1a	Tac
5Y1	MM1Z2B4H	Z-diode	2.352..2.448V, Izt=5mA, Zzt=100Ω, 500mW	SOD-123	5d	1a	Zow
5Z	BZT52-B3V9S	Z-diode	3.82..3.98V, Izt=5mA, Zzt=90Ω, 200mW	SOD-323FL	7d	1a	Tsc
5Z	MM1Z39	Z-diode	39V±5%, Izt=2.5mA, Zzt=100Ω, 500mW	SOD-123FL	7d	1a	Eic
5Z	MM3Z3V9B	Z-diode	3.82..3.98V, Zzt=84Ω, Izt=5mA, 200mW	SOD-323FL	7d	1a	F
5Z	MM3Z3V9BW	Z-diode	3.82..3.98V, Izt=5mA, Zzt=90Ω, 200mW	SOD-323FL	7d	1a	Tac
5Z	MM5Z47V	Z-diode	44..50V, Zzt=170Ω, Izt=2mA, 200mW	SOD-523FL	7d	1a	F
5Z	TCBZX584C47V	Z-diode	44..50V, Izt=2mA, Zzt=170Ω, 200mW	SOD-523FL	7d	1a	Tac
5Z	TCMM3Z3V9B	Z-diode	3.9V±2%, Izt=5mA, Zzt=84Ω, 200mW	SOD-323FL	7d	1a	Tac
5Z	TCMM5Z47V	Z-diode	44..50V, Izt=2mA, Zzt=170Ω, 200mW	SOD-523FL	7d	1a	Tac
5Z1	MM1Z2B7H	Z-diode	2.646..2.754V, Izt=5mA, Zzt=110Ω, 500mW	SOD-123	5d	1a	Zow
5C	TCMM5Z51V	Z-diode	48..54V, Izt=2mA, Zzt=180Ω, 200mW	SOD-523	6d	1a	Tac
6	1SS400PT	Si-diode	Sw, 90V, 100mA, Vt<1.2V(100mA), 4ns	SOD-523	6d	1a	Chm
6	BAS16-02V	Si-diode	Sw, Fast, 80V, 200mA, 250mW, <6ns	SC-79	6d	1u	Inf
6	BAS516	Si-diode	Sw, 85V, 250mA, 500mW, Vt<1.25V(150mA), <4ns	SOD-523	6d	1a	Phi
6	BD4148FPT	Si-diode	Sw, 75V, 150mA, Vt<1V(10mA), 4ns	SOD-523	6d	1a	Chm
6	GBLC15	TVS	Vbr=15V, 10A, 350W(1ms), 3pF	SOD-323	5d	1a	Prt
6	HVU351	C-diode	VCO, 10V, 14..16pF(2V)	SOD-323	5d	1a	Ren
6	MAZS062	Z-diode	5.8..6.6V, 200mW	SOD-523	6d	1a	Pan
6	MM9D6V2	Z-diode	5.89..6.51V, Izt=5mA, Zzt=60Ω, 200mW	SOD-923	7d	1a	Wtr
6	MMBD4448FPT	Si-diode	Sw, 80V, 250mA, Vt<1V(100mA), 4ns	SOD-523	6d	1a	Chm
6	MMPZ5227SPT	Z-diode	3.528..3.762V, Izt=5mA, Zzt=90Ω, 225mW	SOD-323	5d	1a	Chm
6	NZ9F3V6ST	Z-diode	3.6..3.85V, Izt=5mA, Zzt=100Ω, 200mW	SOD-923	7d	1n	Ons
6	NZ9F6V2T	Z-diode	5.89..6.51V, Izt=5mA, Zzt=60Ω, 200mW	SOD-923	7d	1a	Ons
6-	MAZS0620M	Z-diode	6.05..6.36V, 200mW	SOD-523	6d	1a	Pan
6 (red)	BBY56-03W	C-diode	VCO-Tuning, 10V, 20mA, 59..67pF(3..1V)	SOD-323	5d	2	Inf
6 2	GDZ3V6B-V	Z-diode	3.6..3.845V, Izt=5mA, Zzt=100Ω, 200mW	SOD-323	5d	1k	Vs
6.0A	1SMC6.0A	TVS	Vbr=6.67..7.37V, Vrrwm=6.0V, 145.6A, 1500W(1ms)	DO-214AB	1d	1a	Eic
6.0A	SMAJ6.0A	TVS	Vrrwm=6.0V, Vbr=6.67..7.37V, 38.8A, 400W(1ms)	DO-214AC	1d	1a	Sus
6.0A	SMBJ6.0A	TVS	Vbr=6.67..7.37V, Vrrwm=6.0V, 58.3A, 600W(1ms)	DO-214AA	1d	1a	Sus
6.0A	SMCJ6.0A	TVS	Vrrwm=6V, Vbr=6.67..7.67V, 131.6A, 1500W(1ms)	DO-214AB	1d	1k	Sus
6.0CA	1SMC6.0CA	TVS	Vbr=6.67..7.37V, Vrrwm=6.0V, 145.6A, 1500W(1ms), Bidirectional	DO-214AB	1ba	1j	Eic
6.0CA	SMAJ6.0CA	TVS	Vrrwm=6.0V, Vbr=6.67..7.37V, 38.8A, 400W(1ms), Bidirectional	DO-214AC	1ba	1j	Sus
6.0CA	SMBJ6.0CA	TVS	Vbr=6.67..7.37V, Vrrwm=6.0V, 58.3A, 600W(1ms), Bidirectional	DO-214AA	1ba	1j	Sus
6.0CA	SMCJ6.0CA	TVS	Vrrwm=6V, Vbr=6.67..7.67V, 131.6A, 1500W(1ms), Bidirectional	DO-214AB	1ba	1l	Sus
6.2	MAZ5062	Z-diode	5.8..6.6V, Zzt=60Ω(5mA), 500mW	MP2	11d	1a	Pan
6.2	MAZ80620H	Z-diode	6.24..6.56V, Zzt=30Ω(5mA), 150mW	SC-76	6d	1a	Pan
6.2	MAZY062	Z-diode	5.8..6.8V, Zzt=40Ω(20mA), 1W	NMiniP2	1d	1a	Pan
6.2B	HZF6.2BP	Z-diode	6.2V±5%, 900mW	LRP	1d	2f	Ren
6.2B	PTZ6.2B	Z-diode	6.2V±10%, 40mA, 1W	DO-214AC	1d	1a	Rhm
6.2C	HZF6.2CP	Z-diode	6.2V±10%, 900mW	LRP	1d	2f	Ren
6.5A	1SMC6.5A	TVS	Vbr=7.22..7.98V, Vrrwm=6.5V, 133.9A, 1500W(1ms)	DO-214AB	1d	1a	Eic
6.5A	SMAJ6.5A	TVS	Vrrwm=6.5V, Vbr=7.22..7.98V, 35.7A, 400W(1ms)	DO-214AC	1d	1a	Sus
6.5A	SMBJ6.5A	TVS	Vbr=7.22..7.98V, Vrrwm=6.5V, 53.6A, 600W(1ms)	DO-214AA	1d	1a	Sus
6.5A	SMCJ6.5A	TVS	Vrrwm=6.5V, Vbr=7.22..8.3V, 122A, 1500W(1ms)	DO-214AB	1d	1k	Sus
6.5CA	1SMC6.5CA	TVS	Vbr=7.22..7.98V, Vrrwm=6.5V, 133.9A, 1500W(1ms), Bidirectional	DO-214AB	1ba	1j	Eic
6.5CA	SMAJ6.5CA	TVS	Vrrwm=6.5V, Vbr=7.22..7.98V, 35.7A, 400W(1ms), Bidirectional	DO-214AC	1ba	1j	Sus
6.5CA	SMBJ6.5CA	TVS	Vbr=7.22..7.98V, Vrrwm=6.5V, 53.6A, 600W(1ms), Bidirectional	DO-214AA	1ba	1j	Sus
6.5CA	SMCJ6.5CA	TVS	Vrrwm=6.5V, Vbr=7.22..8.3V, 122A, 1500W(1ms), Bidirectional	DO-214AB	1ba	1l	Sus
6.8	MAZ5068	Z-diode	6.4..7.2V, Zzt=60Ω(5mA), 500mW	MP2	11d	1a	Pan
6.8	MAZ80680H	Z-diode	6.85..7.2V, Zzt=20Ω(5mA), 150mW	SC-76	6d	1a	Pan
6.8	MAZY068	Z-diode	6.2..7.4V, Zzt=30Ω(10mA), 1W	NMiniP2	1d	1a	Pan
6.8	P4SMA6.8	TVS	Vbr=6.12..7.48V, Vrrwm=5.50V, 38.0A, 400W(1ms)	DO-214AC	1d	1a	Eic
6.8	U1Z6.8	Z-diode	6.2..7.4V, 1W	SOD-6	1d	1a	Tos
6.8	U1ZB6.8	Z-diode	6.2..7.4V, 1W	I-FLAT	1d	1a	Tos
6.8A	P4SMA6.8A	TVS	Vbr=6.45..7.14V, Vrrwm=5.80V, 40.0A, 400W(1ms)	DO-214AC	1d	1a	Eic
6.8A	P6SMB6.8A	TVS	Vbr=6.45..7.14V, Vrrwm=5.80V, 57.0A, 600W(1ms)	DO-214AA	1d	1a	Eic
6.8B	HZF6.8BP	Z-diode	6.8V±5%, 900mW	LRP	1d	2f	Ren
6.8B	PTZ6.8B	Z-diode	6.8V±10%, 40mA, 1W	DO-214AC	1d	1a	Rhm
6.8C	HZF6.8CP	Z-diode	6.8V±10%, 900mW	LRP	1d	2f	Ren
6.8C	P4SMA6.8C	TVS	Vbr=6.12..7.48V, Vrrwm=5.50V, 38.0A, 400W(1ms), Bidirectional	DO-214AC	1ba	1j	Eic
6.8CA	P4SMA6.8CA	TVS	Vbr=6.45..7.14V, Vrrwm=5.80V, 40.0A, 400W(1ms), Bidirectional	DO-214AC	1ba	1j	Eic
6.8CA	P6SMB6.8CA	TVS	Vbr=6.45..7.14V, Vrrwm=5.80V, 57.0A, 600W(1ms), Bidirectional	DO-214AA	1ba	1j	Eic
6*	MAZS0620H	Z-diode	6.24..6.56V, 200mW	SOD-523	6d	1a	Pan
6*2	MAZ80620H	Z-diode	6.24..6.56V, Zzt=30Ω(5mA), 150mW	SC-76	6d	1a	Pan
6*2	MAZ8062GHL	Z-diode	6.24..6.56V, Zzt=30Ω(5mA), 150mW	SMini2-F3	6d	1a	Pan



SMD
code

Type

Function

Short description

Case

Pinout

St.

Mnf.

6*8	MAZ80680H	Z-diode	6.85..7.2V, Zzt=20Q(5mA), 150mW	SC-76	6d	1a	Pan
6*8	MAZ8068GHL	Z-diode	6.85..7.2V, Zzt=20Q(5mA), 150mW	SMini2-F3	6d	1a	Pan
6_	MAZS0620L	Z-diode	5.85..6.15V, 200mW	SOD-523	6d	1a	Pan
6.2	MAZ80620L	Z-diode	5.85..6.15V, Zzt=30Q(5mA), 150mW	SC-76	6d	1a	Pan
6.2	MAZ8062GLL	Z-diode	5.85..6.15V, Zzt=30Q(5mA), 150mW	SMini2-F3	6d	1a	Pan
6.8	MAZ80680L	Z-diode	6.44..6.77V, Zzt=20Q(5mA), 150mW	SC-76	6d	1a	Pan
6.8	MAZ8068GLL	Z-diode	6.44..6.77V, Zzt=20Q(5mA), 150mW	SMini2-F3	6d	1a	Pan
6*2	HZU6.2B1	Z-diode	5.86..6.12V, lzt=5mA, Zzt=50Q, 200mW	URP	5d	1a	Ren
6*2	HZU6.2B2	Z-diode	6.06..6.33V, lzt=5mA, Zzt=50Q, 200mW	URP	5d	1a	Ren
6,2	HZU6.2B3	Z-diode	6.26..6.53V, lzt=5mA, Zzt=50Q, 200mW	URP	5d	1a	Ren
6*2	RKZ6.2B2KG	Z-diode	6.06..6.33V, lzt=5mA, Zzt=50Q, 200mW	URP	5d	2e	Ren
6*2	RKZ6.2B2KJ	Z-diode	6.06..6.33V, lzt=5mA, Zzt=50Q, 150mW	UPF	7d	2e	Ren
6*8	HZU6.8B1	Z-diode	6.47..6.73V, lzt=5mA, Zzt=30Q, 200mW	URP	5d	1a	Ren
6,8	HZU6.8B2	Z-diode	6.65..6.93V, lzt=5mA, Zzt=30Q, 200mW	URP	5d	1a	Ren
6,8	HZU6.8B3	Z-diode	6.86..7.14V, lzt=5mA, Zzt=30Q, 200mW	URP	5d	1a	Ren
6*8	RKZ6.8B2KG	Z-diode	6.65..6.93V, lzt=5mA, Zzt=30Q, 200mW	URP	5d	2e	Ren
6*8	RKZ6.8B2KJ	Z-diode	6.65..6.93V, lzt=5mA, Zzt=30Q, 150mW	UPF	7d	2e	Ren
60	BAT60J	Si-diode	SBD, Fast-Sw, 10V, 3A, Vf<0.3V(1A), 20pF	SOD-323	5d	1a	Ste
60	HMSZ5260B	Z-diode	43V±5%, lzt=3mA, Zzt=93Q, 225mW	SOD-323	5d	1d	Hsn
60	MMPZ5264SPT	Z-diode	58.80..61.20V, lzt=2.1mA, Zzt=170Q, 225mW	SOD-323	5d	1a	Chm
600A	P6SMA600A	TVS	Vbr=570..630V, Vrrwm=510V, 0.76A, 600W(1ms)	DO-214AC	1d	1a	Eic
600CA	P6SMA600CA	TVS	Vbr=570..630V, Vrrwm=510V, 0.76A, 600W(1ms), Bidirectional	DO-214AC	1ba	1j	Eic
6010	SMBJ8.5	TVS	Vbr=9.44..11.92V, 37.7A, 600W(1ms)	DO-214AA	1d	1a	Eic
6010	SMBJ8.5C	TVS	Vbr=9.44..11.5V, 37.7A, 600W(1ms), Bidirectional	DO-214AA	1ba	1j	Eic
6010	STB6010	TVS	Vbr=9.00..11.0V, Vrrwm=8.10V, 40.0A, 600W(1ms), Bidirectional	DO-214AA	1ba	1j	Eic
6010	STU6010	TVS	Vbr=9.00..11.0V, Vrrwm=8.10V, 40.0A, 600W(1ms)	DO-214AA	1d	1a	Eic
6010	SZ6010	Z-diode	10V±10%, lzt=125mA, Zzt=2Q, 5W	DO-214AA	1d	1a	Eic
6011	SMBJ9.0	TVS	Vbr=10.0..12.6V, 35.5A, 600W(1ms)	DO-214AA	1d	1a	Eic
6011	SMBJ9.0C	TVS	Vbr=10.0..12.2V, 35.5A, 600W(1ms), Bidirectional	DO-214AA	1ba	1j	Eic
6011	STB6011	TVS	Vbr=9.90..12.1V, Vrrwm=8.92V, 37.0A, 600W(1ms), Bidirectional	DO-214AA	1ba	1j	Eic
6011	STU6011	TVS	Vbr=9.90..12.1V, Vrrwm=8.92V, 37.0A, 600W(1ms)	DO-214AA	1d	1a	Eic
6011	SZ6011	Z-diode	11V±10%, lzt=125mA, Zzt=2.5Q, 5W	DO-214AA	1d	1a	Eic
6012	SMBJ10	TVS	Vbr=11.1..14.1V, 31.9A, 600W(1ms)	DO-214AA	1d	1a	Eic
6012	SMBJ10C	TVS	Vbr=11.1..13.6V, 31.9A, 600W(1ms), Bidirectional	DO-214AA	1ba	1j	Eic
6012	STB6012	TVS	Vbr=10.8..13.2V, Vrrwm=9.72V, 35.0A, 600W(1ms), Bidirectional	DO-214AA	1ba	1j	Eic
6012	STU6012	TVS	Vbr=10.8..13.2V, Vrrwm=9.72V, 35.0A, 600W(1ms)	DO-214AA	1d	1a	Eic
6012	SZ6012	Z-diode	12V±10%, lzt=100mA, Zzt=2.5Q, 5W	DO-214AA	1d	1a	Eic
6013	SMBJ11	TVS	Vbr=12.2..15.4V, 29.9A, 600W(1ms)	DO-214AA	1d	1a	Eic
6013	SMBJ11C	TVS	Vbr=12.2..14.9V, 29.9A, 600W(1ms), Bidirectional	DO-214AA	1ba	1j	Eic
6013	STB6013	TVS	Vbr=11.7..14.3V, Vrrwm=10.5V, 32.0A, 600W(1ms), Bidirectional	DO-214AA	1ba	1j	Eic
6013	STU6013	TVS	Vbr=11.7..14.3V, Vrrwm=10.5V, 32.0A, 600W(1ms)	DO-214AA	1d	1a	Eic
6013	SZ6013	Z-diode	13V±10%, lzt=100mA, Zzt=2.5Q, 5W	DO-214AA	1d	1a	Eic
6014	SMBJ12	TVS	Vbr=13.3..16.9V, 27.3A, 600W(1ms)	DO-214AA	1d	1a	Eic
6014	SMBJ12C	TVS	Vbr=13.3..16.3V, 27.3A, 600W(1ms), Bidirectional	DO-214AA	1ba	1j	Eic
6014	SZ6014	Z-diode	14V±10%, lzt=100mA, Zzt=2.5Q, 5W	DO-214AA	1d	1a	Eic
6015	SMBJ13	TVS	Vbr=14.4..18.2V, 25.2A, 600W(1ms)	DO-214AA	1d	1a	Eic
6015	SMBJ13C	TVS	Vbr=14.4..17.6V, 25.2A, 600W(1ms), Bidirectional	DO-214AA	1ba	1j	Eic
6015	STB6015	TVS	Vbr=13.5..16.5V, Vrrwm=12.1V, 27.0A, 600W(1ms), Bidirectional	DO-214AA	1ba	1j	Eic
6015	STU6015	TVS	Vbr=13.5..16.5V, Vrrwm=12.1V, 27.0A, 600W(1ms)	DO-214AA	1d	1a	Eic
6015	SZ6015	Z-diode	15V±10%, lzt=75mA, Zzt=2.5Q, 5W	DO-214AA	1d	1a	Eic
6016	STB6016	TVS	Vbr=14.4..17.6V, Vrrwm=12.9V, 26.0A, 600W(1ms), Bidirectional	DO-214AA	1ba	1j	Eic
6016	STU6016	TVS	Vbr=14.4..17.6V, Vrrwm=12.9V, 26.0A, 600W(1ms)	DO-214AA	1d	1a	Eic
6016	SZ6016	Z-diode	16V±10%, lzt=75mA, Zzt=2.5Q, 5W	DO-214AA	1d	1a	Eic
6017	SMBJ14	TVS	Vbr=15.6..19.8V, 23.3A, 600W(1ms)	DO-214AA	1d	1a	Eic
6017	SMBJ14C	TVS	Vbr=15.6..19.1V, 23.3A, 600W(1ms), Bidirectional	DO-214AA	1ba	1j	Eic
6017	SZ6017	Z-diode	17V±10%, lzt=70mA, Zzt=2.5Q, 5W	DO-214AA	1d	1a	Eic
6018	SMBJ15	TVS	Vbr=16.7..21.1V, 22.3A, 600W(1ms)	DO-214AA	1d	1a	Eic
6018	SMBJ15C	TVS	Vbr=16.7..20.4V, 22.3A, 600W(1ms), Bidirectional	DO-214AA	1ba	1j	Eic
6018	STB6018	TVS	Vbr=16.2..19.8V, Vrrwm=14.5V, 23.0A, 600W(1ms), Bidirectional	DO-214AA	1ba	1j	Eic
6018	STU6018	TVS	Vbr=16.2..19.8V, Vrrwm=14.5V, 23.0A, 600W(1ms)	DO-214AA	1d	1a	Eic
6018	SZ6018	Z-diode	18V±10%, lzt=65mA, Zzt=2.5Q, 5W	DO-214AA	1d	1a	Eic
6019	SMBJ16	TVS	Vbr=17.8..22.6V, 20.8A, 600W(1ms)	DO-214AA	1d	1a	Eic
6019	SMBJ16C	TVS	Vbr=17.8..21.8V, 20.8A, 600W(1ms), Bidirectional	DO-214AA	1ba	1j	Eic
6019	SZ6019	Z-diode	19V±10%, lzt=65mA, Zzt=3Q, 5W	DO-214AA	1d	1a	Eic
6020	SMBJ17	TVS	Vbr=18.9..23.9V, 19.7A, 600W(1ms)	DO-214AA	1d	1a	Eic
6020	SMBJ17C	TVS	Vbr=18.9..23.1V, 19.7A, 600W(1ms), Bidirectional	DO-214AA	1ba	1j	Eic
6020	STB6020	TVS	Vbr=18.0..22.0V, Vrrwm=16.2V, 21.0A, 600W(1ms), Bidirectional	DO-214AA	1ba	1j	Eic
6020	STU6020	TVS	Vbr=18.0..22.0V, Vrrwm=16.2V, 21.0A, 600W(1ms)	DO-214AA	1d	1a	Eic
6020	SZ6020	Z-diode	20V±10%, lzt=65mA, Zzt=3Q, 5W	DO-214AA	1d	1a	Eic
6022	SMBJ18	TVS	Vbr=20.0..25.3V, 18.6A, 600W(1ms)	DO-214AA	1d	1a	Eic



SMD
code

Type

Function

Short description

Case

Pinout

St.

Mnf.

SMD code	Type	Function	Short description	Case	Pinout	St.	Mnf.
6022	SMBJ18C	TVS	Vbr=20.0..24.4V, 18.6A, 600W(1ms), Bidirectional	DO-214AA	1ba	1j	Eic
6022	STB6022	TVS	Vbr=19.8..24.2V, Vvwm=17.8V, 19.0A, 600W(1ms), Bidirectional	DO-214AA	1ba	1j	Eic
6022	STU6022	TVS	Vbr=19.8..24.2V, Vvwm=17.8V, 19.0A, 600W(1ms)	DO-214AA	1d	1a	Eic
6022	SZ6022	Z-diode	22V±10%, Izt=50mA, Zzt=3.5Ω, 5W	DO-214AA	1d	1a	Eic
6024	SMBJ20	TVS	Vbr=22.2..28.1V, 16.7A, 600W(1ms)	DO-214AA	1d	1a	Eic
6024	SMBJ20C	TVS	Vbr=22.2..27.1V, 16.7A, 600W(1ms), Bidirectional	DO-214AA	1ba	1j	Eic
6024	STB6024	TVS	Vbr=21.6..26.4V, Vvwm=19.4V, 17.0A, 600W(1ms), Bidirectional	DO-214AA	1ba	1j	Eic
6024	STU6024	TVS	Vbr=21.6..26.4V, Vvwm=19.4V, 17.0A, 600W(1ms)	DO-214AA	1d	1a	Eic
6024	SZ6024	Z-diode	24V±10%, Izt=50mA, Zzt=3.5Ω, 5W	DO-214AA	1d	1a	Eic
6025	SZ6025	Z-diode	25V±10%, Izt=50mA, Zzt=4Ω, 5W	DO-214AA	1d	1a	Eic
6026	SMBJ22	TVS	Vbr=24.4..30.9V, 15.2A, 600W(1ms)	DO-214AA	1d	1a	Eic
6026	SMBJ22C	TVS	Vbr=24.4..29.8V, 15.2A, 600W(1ms), Bidirectional	DO-214AA	1ba	1j	Eic
6027	STB6027	TVS	Vbr=24.3..29.7V, Vvwm=21.8V, 15.0A, 600W(1ms), Bidirectional	DO-214AA	1ba	1j	Eic
6027	STU6027	TVS	Vbr=24.3..29.7V, Vvwm=21.8V, 15.0A, 600W(1ms)	DO-214AA	1d	1a	Eic
6027	SZ6027	Z-diode	27V±10%, Izt=50mA, Zzt=5Ω, 5W	DO-214AA	1d	1a	Eic
6028	SZ6028	Z-diode	28V±10%, Izt=50mA, Zzt=6Ω, 5W	DO-214AA	1d	1a	Eic
6029	SMBJ24	TVS	Vbr=26.7..33.8V, 14.0A, 600W(1ms)	DO-214AA	1d	1a	Eic
6029	SMBJ24C	TVS	Vbr=26.7..32.6V, 14.0A, 600W(1ms), Bidirectional	DO-214AA	1ba	1j	Eic
6030	STB6030	TVS	Vbr=27.0..33.0V, Vvwm=24.3V, 14.0A, 600W(1ms), Bidirectional	DO-214AA	1ba	1j	Eic
6030	STU6030	TVS	Vbr=27.0..33.0V, Vvwm=24.3V, 14.0A, 600W(1ms)	DO-214AA	1d	1a	Eic
6030	SZ6030	Z-diode	30V±10%, Izt=40mA, Zzt=8Ω, 5W	DO-214AA	1d	1a	Eic
6031	SMBJ26	TVS	Vbr=28.9..36.6V, 12.4A, 600W(1ms)	DO-214AA	1d	1a	Eic
6031	SMBJ26C	TVS	Vbr=28.9..35.3V, 12.4A, 600W(1ms), Bidirectional	DO-214AA	1ba	1j	Eic
6033	SMBJ28	TVS	Vbr=31.1..39.4V, 12.0A, 600W(1ms)	DO-214AA	1d	1a	Eic
6033	SMBJ28C	TVS	Vbr=31.1..38.1V, 12.0A, 600W(1ms), Bidirectional	DO-214AA	1ba	1j	Eic
6033	STB6033	TVS	Vbr=29.7..36.3V, Vvwm=26.8V, 12.6A, 600W(1ms), Bidirectional	DO-214AA	1ba	1j	Eic
6033	STU6033	TVS	Vbr=29.7..36.3V, Vvwm=26.8V, 12.6A, 600W(1ms)	DO-214AA	1d	1a	Eic
6033	SZ6033	Z-diode	33V±10%, Izt=40mA, Zzt=10Ω, 5W	DO-214AA	1d	1a	Eic
6036	SMBJ30	TVS	Vbr=33.3..42.2V, 11.2A, 600W(1ms)	DO-214AA	1d	1a	Eic
6036	SMBJ30C	TVS	Vbr=33.3..40.7V, 11.2A, 600W(1ms), Bidirectional	DO-214AA	1ba	1j	Eic
6036	STB6036	TVS	Vbr=32.4..39.6V, Vvwm=29.1V, 11.6A, 600W(1ms), Bidirectional	DO-214AA	1ba	1j	Eic
6036	STU6036	TVS	Vbr=32.4..39.6V, Vvwm=29.1V, 11.6A, 600W(1ms)	DO-214AA	1d	1a	Eic
6036	SZ6036	Z-diode	36V±10%, Izt=30mA, Zzt=11Ω, 5W	DO-214AA	1d	1a	Eic
6039	STB6039	TVS	Vbr=35.1..42.9V, Vvwm=31.6V, 10.6A, 600W(1ms), Bidirectional	DO-214AA	1ba	1j	Eic
6039	STU6039	TVS	Vbr=35.1..42.9V, Vvwm=31.6V, 10.6A, 600W(1ms)	DO-214AA	1d	1a	Eic
6039	SZ6039	Z-diode	39V±10%, Izt=30mA, Zzt=14Ω, 5W	DO-214AA	1d	1a	Eic
603D	SZ603D	Z-diode	3.3V±10%, Izt=380mA, Zzt=3Ω, 5W	DO-214AA	1d	1a	Eic
603G	SZ603G	Z-diode	3.6V±10%, Izt=350mA, Zzt=2.5Ω, 5W	DO-214AA	1d	1a	Eic
603J	SZ603J	Z-diode	3.9V±10%, Izt=320mA, Zzt=2Ω, 5W	DO-214AA	1d	1a	Eic
6040	SMBJ33	TVS	Vbr=36.7..46.5V, 10.2A, 600W(1ms)	DO-214AA	1d	1a	Eic
6040	SMBJ33C	TVS	Vbr=36.7..44.9V, 10.2A, 600W(1ms), Bidirectional	DO-214AA	1ba	1j	Eic
6043	SMBJ36	TVS	Vbr=40.0..50.7V, 9.3A, 600W(1ms)	DO-214AA	1d	1a	Eic
6043	SMBJ36C	TVS	Vbr=40.0..48.9V, 9.3A, 600W(1ms), Bidirectional	DO-214AA	1ba	1j	Eic
6043	STB6043	TVS	Vbr=38.7..47.3V, Vvwm=34.8V, 9.6A, 600W(1ms), Bidirectional	DO-214AA	1ba	1j	Eic
6043	STU6043	TVS	Vbr=38.7..47.3V, Vvwm=34.8V, 9.6A, 600W(1ms)	DO-214AA	1d	1a	Eic
6043	SZ6043	Z-diode	43V±10%, Izt=30mA, Zzt=20Ω, 5W	DO-214AA	1d	1a	Eic
6047	STB6047	TVS	Vbr=42.3..51.7V, Vvwm=38.1V, 8.9A, 600W(1ms), Bidirectional	DO-214AA	1ba	1j	Eic
6047	STU6047	TVS	Vbr=42.3..51.7V, Vvwm=38.1V, 8.9A, 600W(1ms)	DO-214AA	1d	1a	Eic
6047	SZ6047	Z-diode	47V±10%, Izt=25mA, Zzt=25Ω, 5W	DO-214AA	1d	1a	Eic
6048	SMBJ40	TVS	Vbr=44.4..56.3V, 8.4A, 600W(1ms)	DO-214AA	1d	1a	Eic
6048	SMBJ40C	TVS	Vbr=44.4..54.3V, 8.4A, 600W(1ms), Bidirectional	DO-214AA	1ba	1j	Eic
604D	SZ604D	Z-diode	4.3V±10%, Izt=290mA, Zzt=2Ω, 5W	DO-214AA	1d	1a	Eic
604H	SZ604H	Z-diode	4.7V±10%, Izt=260mA, Zzt=2Ω, 5W	DO-214AA	1d	1a	Eic
6051	SMBJ43	TVS	Vbr=47.8..60.5V, 7.8A, 600W(1ms)	DO-214AA	1d	1a	Eic
6051	SMBJ43C	TVS	Vbr=47.8..58.4V, 7.8A, 600W(1ms), Bidirectional	DO-214AA	1ba	1j	Eic
6051	STB6051	TVS	Vbr=45.9..56.1V, Vvwm=41.3V, 8.2A, 600W(1ms), Bidirectional	DO-214AA	1ba	1j	Eic
6051	STU6051	TVS	Vbr=45.9..56.1V, Vvwm=41.3V, 8.2A, 600W(1ms)	DO-214AA	1d	1a	Eic
6051	SZ6051	Z-diode	51V±10%, Izt=25mA, Zzt=27Ω, 5W	DO-214AA	1d	1a	Eic
6054	SMBJ45	TVS	Vbr=50.0..63.3V, 7.5A, 600W(1ms)	DO-214AA	1d	1a	Eic
6054	SMBJ45C	TVS	Vbr=50.0..61.1V, 7.5A, 600W(1ms), Bidirectional	DO-214AA	1ba	1j	Eic
6056	STB6056	TVS	Vbr=50.4..61.6V, Vvwm=45.4V, 7.4A, 600W(1ms), Bidirectional	DO-214AA	1ba	1j	Eic
6056	STU6056	TVS	Vbr=50.4..61.6V, Vvwm=45.4V, 7.4A, 600W(1ms)	DO-214AA	1d	1a	Eic
6056	SZ6056	Z-diode	56V±10%, Izt=20mA, Zzt=35Ω, 5W	DO-214AA	1d	1a	Eic
6057	SMBJ48	TVS	Vbr=53.3..67.5V, 7.0A, 600W(1ms)	DO-214AA	1d	1a	Eic
6057	SMBJ48C	TVS	Vbr=53.3..65.1V, 7.0A, 600W(1ms), Bidirectional	DO-214AA	1ba	1j	Eic
605B	SZ605B	Z-diode	5.1V±10%, Izt=240mA, Zzt=1.5Ω, 5W	DO-214AA	1d	1a	Eic
605G	SZ605G	Z-diode	5.6V±10%, Izt=220mA, Zzt=1Ω, 5W	DO-214AA	1d	1a	Eic
6060	SZ6060	Z-diode	60V±10%, Izt=20mA, Zzt=40Ω, 5W	DO-214AA	1d	1a	Eic
6061	SMBJ51	TVS	Vbr=56.7..71.8V, 6.6A, 600W(1ms)	DO-214AA	1d	1a	Eic
6061	SMBJ51C	TVS	Vbr=56.7..69.3V, 6.6A, 600W(1ms), Bidirectional	DO-214AA	1ba	1j	Eic



SMD code	Type	Function	Short description	Case	Pinout	St.	Mnf.
6062	STB6062	TVS	Vbr=55.8..68.2V, Vrwm=50.2V, 6.8A, 600W(1ms), Bidirectional	DO-214AA	1ba	1j	Eic
6062	STU6062	TVS	Vbr=55.8..68.2V, Vrwm=50.2V, 6.8A, 600W(1ms)	DO-214AA	1d	1a	Eic
6062	SZ6062	Z-diode	62V±10%, lzt=20mA, Zzt=42Ω, 5W	DO-214AA	1d	1a	Eic
6065	SMBJ54	TVS	Vbr=60.0..76.0V, 6.2A, 600W(1ms)	DO-214AA	1d	1a	Eic
6065	SMBJ54C	TVS	Vbr=60.0..73.3V, 6.2A, 600W(1ms), Bidirectional	DO-214AA	1ba	1j	Eic
6068	STB6068	TVS	Vbr=61.2..74.8V, Vrwm=55.1V, 6.1A, 600W(1ms), Bidirectional	DO-214AA	1ba	1j	Eic
6068	STU6068	TVS	Vbr=61.2..74.8V, Vrwm=55.1V, 6.1A, 600W(1ms)	DO-214AA	1d	1a	Eic
6068	SZ6068	Z-diode	68V±10%, lzt=20mA, Zzt=44Ω, 5W	DO-214AA	1d	1a	Eic
606A	SZ606A	Z-diode	6.0V±10%, lzt=200mA, Zzt=1Ω, 5W	DO-214AA	1d	1a	Eic
606C	SZ606C	Z-diode	6.2V±10%, lzt=200mA, Zzt=1Ω, 5W	DO-214AA	1d	1a	Eic
606I	SMBJ5.0	TVS	Vbr=6.40..7.55V, 62.5A, 600W(1ms)	DO-214AA	1d	1a	Eic
606I	SMBJ5.0C	TVS	Vbr=6.40..7.82V, 62.5A, 600W(1ms), Bidirectional	DO-214AA	1ba	1j	Eic
606I	STB606I	TVS	Vbr=6.12..7.48V, Vrwm=5.50V, 55.5A, 600W(1ms), Bidirectional	DO-214AA	1ba	1j	Eic
606I	STU606I	TVS	Vbr=6.12..7.48V, Vrwm=5.50V, 55.5A, 600W(1ms)	DO-214AA	1d	1a	Eic
606I	SZ606I	Z-diode	6.8V±10%, lzt=175mA, Zzt=1Ω, 5W	DO-214AA	1d	1a	Eic
6070	SMBJ58	TVS	Vbr=64.4..81.6V, 5.8A, 600W(1ms)	DO-214AA	1d	1a	Eic
6070	SMBJ58C	TVS	Vbr=64.4..78.7V, 5.8A, 600W(1ms), Bidirectional	DO-214AA	1ba	1j	Eic
6072	SMBJ60	TVS	Vbr=66.7..84.5V, 5.6A, 600W(1ms)	DO-214AA	1d	1a	Eic
6072	SMBJ60C	TVS	Vbr=66.7..81.5V, 5.6A, 600W(1ms), Bidirectional	DO-214AA	1ba	1j	Eic
6075	STB6075	TVS	Vbr=67.5..82.5V, Vrwm=60.7V, 5.5A, 600W(1ms), Bidirectional	DO-214AA	1ba	1j	Eic
6075	STU6075	TVS	Vbr=67.5..82.5V, Vrwm=60.7V, 5.5A, 600W(1ms)	DO-214AA	1d	1a	Eic
6075	SZ6075	Z-diode	75V±10%, lzt=20mA, Zzt=45Ω, 5W	DO-214AA	1d	1a	Eic
6076	SMBJ64	TVS	Vbr=71.1..90.1V, 5.3A, 600W(1ms)	DO-214AA	1d	1a	Eic
6076	SMBJ64C	TVS	Vbr=71.1..86.9V, 5.3A, 600W(1ms), Bidirectional	DO-214AA	1ba	1j	Eic
607C	SMBJ6.0	TVS	Vbr=6.67..8.45V, 52.6A, 600W(1ms)	DO-214AA	1d	1a	Eic
607C	SMBJ6.0C	TVS	Vbr=6.67..8.15V, 52.6A, 600W(1ms), Bidirectional	DO-214AA	1ba	1j	Eic
607F	STB607F	TVS	Vbr=6.75..8.25V, Vrwm=6.05V, 51.0A, 600W(1ms), Bidirectional	DO-214AA	1ba	1j	Eic
607F	STU607F	TVS	Vbr=6.75..8.25V, Vrwm=6.05V, 51.0A, 600W(1ms)	DO-214AA	1d	1a	Eic
607F	SZ607F	Z-diode	7.5V±10%, lzt=175mA, Zzt=1.5Ω, 5W	DO-214AA	1d	1a	Eic
607I	SMBJ6.5	TVS	Vbr=7.22..9.14V, 48.7A, 600W(1ms)	DO-214AA	1d	1a	Eic
607I	SMBJ6.5C	TVS	Vbr=7.22..8.82V, 48.7A, 600W(1ms), Bidirectional	DO-214AA	1ba	1j	Eic
6082	STB6082	TVS	Vbr=73.8..90.2V, Vrwm=66.4V, 5.1A, 600W(1ms), Bidirectional	DO-214AA	1ba	1j	Eic
6082	STU6082	TVS	Vbr=73.8..90.2V, Vrwm=66.4V, 5.1A, 600W(1ms)	DO-214AA	1d	1a	Eic
6082	SZ6082	Z-diode	82V±10%, lzt=15mA, Zzt=65Ω, 5W	DO-214AA	1d	1a	Eic
6084	SMBJ70	TVS	Vbr=77.8..98.6V, 4.8A, 600W(1ms)	DO-214AA	1d	1a	Eic
6084	SMBJ70C	TVS	Vbr=77.8..95.1V, 4.8A, 600W(1ms), Bidirectional	DO-214AA	1ba	1j	Eic
6087	SZ6087	Z-diode	87V±10%, lzt=15mA, Zzt=75Ω, 5W	DO-214AA	1d	1a	Eic
608C	STB608C	TVS	Vbr=7.38..9.02V, Vrwm=6.63V, 48.0A, 600W(1ms), Bidirectional	DO-214AA	1ba	1j	Eic
608C	STU608C	TVS	Vbr=7.38..9.02V, Vrwm=6.63V, 48.0A, 600W(1ms)	DO-214AA	1d	1a	Eic
608C	SZ608C	Z-diode	8.2V±10%, lzt=150mA, Zzt=1.5Ω, 5W	DO-214AA	1d	1a	Eic
608E	SMBJ7.0	TVS	Vbr=7.78..9.86V, 45.1A, 600W(1ms)	DO-214AA	1d	1a	Eic
608E	SMBJ7.0C	TVS	Vbr=7.78..9.51V, 45.1A, 600W(1ms), Bidirectional	DO-214AA	1ba	1j	Eic
608H	SZ608H	Z-diode	8.7V±10%, lzt=150mA, Zzt=2Ω, 5W	DO-214AA	1d	1a	Eic
6090	SMBJ75	TVS	Vbr=83.3..105.7V, 4.5A, 600W(1ms)	DO-214AA	1d	1a	Eic
6090	SMBJ75C	TVS	Vbr=83.3..102V, 4.5A, 600W(1ms), Bidirectional	DO-214AA	1ba	1j	Eic
6091	STB6091	TVS	Vbr=81.9..100V, Vrwm=73.7V, 4.5A, 600W(1ms), Bidirectional	DO-214AA	1ba	1j	Eic
6091	STU6091	TVS	Vbr=81.9..100V, Vrwm=73.7V, 4.5A, 600W(1ms)	DO-214AA	1d	1a	Eic
6091	SZ6091	Z-diode	91V±10%, lzt=15mA, Zzt=75Ω, 5W	DO-214AA	1d	1a	Eic
6093	SMBJ78	TVS	Vbr=86.7..109.8V, 4.3A, 600W(1ms)	DO-214AA	1d	1a	Eic
6093	SMBJ78C	TVS	Vbr=86.7..106V, 4.3A, 600W(1ms), Bidirectional	DO-214AA	1ba	1j	Eic
609A	SMBJ7.5	TVS	Vbr=8.33..10.67V, 42.0A, 600W(1ms)	DO-214AA	1d	1a	Eic
609A	SMBJ7.5C	TVS	Vbr=8.33..10.2V, 42.0A, 600W(1ms), Bidirectional	DO-214AA	1ba	1j	Eic
609B	STB609B	TVS	Vbr=8.19..10.0V, Vrwm=7.37V, 44.0A, 600W(1ms), Bidirectional	DO-214AA	1ba	1j	Eic
609B	STU609B	TVS	Vbr=8.19..10.0V, Vrwm=7.37V, 44.0A, 600W(1ms)	DO-214AA	1d	1a	Eic
609B	SZ609B	Z-diode	9.1V±10%, lzt=150mA, Zzt=2Ω, 5W	DO-214AA	1d	1a	Eic
609G	SMBJ8.0	TVS	Vbr=8.89..11.3V, 40.0A, 600W(1ms)	DO-214AA	1d	1a	Eic
609G	SMBJ8.0C	TVS	Vbr=8.89..10.9V, 40.0A, 600W(1ms), Bidirectional	DO-214AA	1ba	1j	Eic
60A	1SMC60A	TVS	Vbr=66.7..73.7V, Vrwm=60V, 15.5A, 1500W(1ms)	DO-214AB	1d	1a	Eic
60A	SMAJ60A	TVS	Vrwm=60V, Vbr=66.7..73.7V, 4.1A, 400W(1ms)	DO-214AC	1d	1a	Sus
60A	SMBJ60A	TVS	Vbr=66.7..73.7V, Vrwm=60V, 6.2A, 600W(1ms)	DO-214AA	1d	1a	Sus
60A	SMCJ60A	TVS	Vrwm=60V, Vbr=66.7..76.7V, 14A, 1500W(1ms)	DO-214AB	1d	1k	Sus
60A	UMA60A	TVS	Vrwm=60V, Vbr=66.7..96.8V, 5.2A, 500W(1ms)	UltraMite	14d	1v	Msc
60B	MMHZ5260BPT	Z-diode	40.85..45.15V, lzt=3.0mA, Zzt=93Ω, 225mW	SOD-123	5d	1a	Chm
60B	SMC5360B	Z-diode	25.0V±5%, Zzt=4.0(50.0mA), lzm=190.0mA, 5W	DO-214AB	1d	1a	Ers
60B0	SMBJ85	TVS	Vbr=94.4..119.2V, 3.9A, 600W(1ms)	DO-214AA	1d	1a	Eic
60B0	SMBJ85C	TVS	Vbr=94.4..115V, 3.9A, 600W(1ms), Bidirectional	DO-214AA	1ba	1j	Eic
60B0	STB60B0	TVS	Vbr=90.0..110V, Vrwm=81.0V, 4.2A, 600W(1ms), Bidirectional	DO-214AA	1ba	1j	Eic
60B0	STU60B0	TVS	Vbr=90.0..110V, Vrwm=81.0V, 4.2A, 600W(1ms)	DO-214AA	1d	1a	Eic
60B0	SZ60B0	Z-diode	100V±10%, lzt=12mA, Zzt=90Ω, 5W	DO-214AA	1d	1a	Eic
60B1	SMBJ90	TVS	Vbr=100..126.5V, 3.8A, 600W(1ms)	DO-214AA	1d	1a	Eic



SMD code	Type	Function	Short description	Case	Pinout	St.	Mnf.
60B1	SMBJ90C	TVS	Vbr=100..122V, 3.8A, 600W(1ms), Bidirectional	DO-214AA	1ba	1j	Eic
60B1	STB60B1	TVS	Vbr=99.0..121V, Vrw=89.2V, 3.8A, 600W(1ms), Bidirectional	DO-214AA	1ba	1j	Eic
60B1	STU60B1	TVS	Vbr=99.0..121V, Vrw=89.2V, 3.8A, 600W(1ms)	DO-214AA	1d	1a	Eic
60B1	SZ60B1	Z-diode	110V±10%, Izt=12mA, Zzt=125Ω, 5W	DO-214AA	1d	1a	Eic
60B2	SMBJ100	TVS	Vbr=111..141.0V, 3.4A, 600W(1ms)	DO-214AA	1d	1a	Eic
60B2	SMBJ100C	TVS	Vrw=100V, Vbr=111..128V, 3.4A, 600W(1ms), Bidirectional	DO-214AA	1ba	1j	Eic
60B2	STB60B2	TVS	Vbr=108..132V, Vrw=97.2V, 3.5A, 600W(1ms), Bidirectional	DO-214AA	1ba	1j	Eic
60B2	STU60B2	TVS	Vbr=108..132V, Vrw=97.2V, 3.5A, 600W(1ms)	DO-214AA	1d	1a	Eic
60B2	SZ60B2	Z-diode	120V±10%, Izt=10mA, Zzt=170Ω, 5W	DO-214AA	1d	1a	Eic
60B3	SMBJ110	TVS	Vbr=122..154.5V, 3.0A, 600W(1ms)	DO-214AA	1d	1a	Eic
60B3	SMBJ110C	TVS	Vbr=122..149V, 3.0A, 600W(1ms), Bidirectional	DO-214AA	1ba	1j	Eic
60B3	STB60B3	TVS	Vbr=117..143V, Vrw=106V, 3.2A, 600W(1ms), Bidirectional	DO-214AA	1ba	1j	Eic
60B3	STU60B3	TVS	Vbr=117..143V, Vrw=106V, 3.2A, 600W(1ms)	DO-214AA	1d	1a	Eic
60B3	SZ60B3	Z-diode	130V±10%, Izt=10mA, Zzt=190Ω, 5W	DO-214AA	1d	1a	Eic
60B4	SMBJ120	TVS	Vbr=133..169.0V, 2.8A, 600W(1ms)	DO-214AA	1d	1a	Eic
60B4	SMBJ120C	TVS	Vbr=133..163V, 2.8A, 600W(1ms), Bidirectional	DO-214AA	1ba	1j	Eic
60B4	SZ60B4	Z-diode	140V±10%, Izt=8mA, Zzt=230Ω, 5W	DO-214AA	1d	1a	Eic
60B5	SMBJ130	TVS	Vbr=144..182.5V, 2.6A, 600W(1ms)	DO-214AA	1d	1a	Eic
60B5	SMBJ130C	TVS	Vbr=144..176V, 2.6A, 600W(1ms), Bidirectional	DO-214AA	1ba	1j	Eic
60B5	STB60B5	TVS	Vbr=135..165V, Vrw=121V, 2.8A, 600W(1ms), Bidirectional	DO-214AA	1ba	1j	Eic
60B5	STU60B5	TVS	Vbr=135..165V, Vrw=121V, 2.8A, 600W(1ms)	DO-214AA	1d	1a	Eic
60B5	SZ60B5	Z-diode	150V±10%, Izt=8mA, Zzt=330Ω, 5W	DO-214AA	1d	1a	Eic
60B6	STB60B6	TVS	Vbr=144..176V, Vrw=130V, 2.6A, 600W(1ms), Bidirectional	DO-214AA	1ba	1j	Eic
60B6	STU60B6	TVS	Vbr=144..176V, Vrw=130V, 2.6A, 600W(1ms)	DO-214AA	1d	1a	Eic
60B6	SZ60B6	Z-diode	160V±10%, Izt=8mA, Zzt=350Ω, 5W	DO-214AA	1d	1a	Eic
60B7	STB60B7	TVS	Vbr=153..187V, Vrw=138V, 2.5A, 600W(1ms), Bidirectional	DO-214AA	1ba	1j	Eic
60B7	STU60B7	TVS	Vbr=153..187V, Vrw=138V, 2.5A, 600W(1ms)	DO-214AA	1d	1a	Eic
60B7	SZ60B7	Z-diode	170V±10%, Izt=8mA, Zzt=380Ω, 5W	DO-214AA	1d	1a	Eic
60B8	SMBJ150	TVS	Vbr=167..211.5V, 2.2A, 600W(1ms)	DO-214AA	1d	1a	Eic
60B8	SMBJ150C	TVS	Vbr=167..204V, 2.2A, 600W(1ms), Bidirectional	DO-214AA	1ba	1j	Eic
60B8	STB60B8	TVS	Vbr=162..198V, Vrw=146V, 2.3A, 600W(1ms), Bidirectional	DO-214AA	1ba	1j	Eic
60B8	STU60B8	TVS	Vbr=162..198V, Vrw=146V, 2.3A, 600W(1ms)	DO-214AA	1d	1a	Eic
60B8	SZ60B8	Z-diode	180V±10%, Izt=5mA, Zzt=430Ω, 5W	DO-214AA	1d	1a	Eic
60B9	SMBJ160	TVS	Vbr=178..226.0V, 2.1A, 600W(1ms)	DO-214AA	1d	1a	Eic
60B9	SMBJ160C	TVS	Vbr=178..218V, 2.1A, 600W(1ms), Bidirectional	DO-214AA	1ba	1j	Eic
60B9	SZ60B9	Z-diode	190V±10%, Izt=5mA, Zzt=450Ω, 5W	DO-214AA	1d	1a	Eic
60CA	1SMC60CA	TVS	Vbr=66.7..73.7V, Vrw=60V, 15.5A, 1500W(1ms), Bidirectional	DO-214AB	1ba	1j	Eic
60CA	SMAJ60CA	TVS	Vrw=60V, Vbr=66.7..73.7V, 4.1A, 400W(1ms), Bidirectional	DO-214AC	1ba	1j	Sus
60CA	SMBJ60CA	TVS	Vbr=66.7..73.7V, Vrw=60V, 6.2A, 600W(1ms), Bidirectional	DO-214AA	1ba	1j	Sus
60CA	SMCJ60CA	TVS	Vrw=60V, Vbr=66.7..76.7V, 14A, 1500W(1ms), Bidirectional	DO-214AB	1ba	1l	Sus
60CA	UMA60CA	TVS	Vrw=60V, Vbr=66.7..96.8V, 5.2A, 500W(1ms), Bidirectional	UltraMite	14ba	1v	Msc
60D0	SMBJ170	TVS	Vbr=189..239.5V, 2.0A, 600W(1ms)	DO-214AA	1d	1a	Eic
60D0	SMBJ170C	TVS	Vbr=189..231V, 2.0A, 600W(1ms), Bidirectional	DO-214AA	1ba	1j	Eic
60D0	STB60D0	TVS	Vbr=180..220V, Vrw=162V, 2.1A, 600W(1ms), Bidirectional	DO-214AA	1ba	1j	Eic
60D0	STU60D0	TVS	Vbr=180..220V, Vrw=162V, 2.1A, 600W(1ms)	DO-214AA	1d	1a	Eic
60D0	SZ60D0	Z-diode	200V±10%, Izt=5mA, Zzt=480Ω, 5W	DO-214AA	1d	1a	Eic
60D1	SMBJ188C	TVS	Vbr=189..255V, 1.7A, 600W(1ms), Bidirectional	DO-214AA	1ba	1j	Eic
60D2	STB60D2	TVS	Vbr=198..242V, Vrw=175V, 1.75A, 600W(1ms), Bidirectional	DO-214AA	1ba	1j	Eic
60D2	STU60D2	TVS	Vbr=198..242V, Vrw=175V, 1.75A, 600W(1ms)	DO-214AA	1d	1a	Eic
60D5	STB60D5	TVS	Vbr=225..275V, Vrw=202V, 1.67A, 600W(1ms), Bidirectional	DO-214AA	1ba	1j	Eic
60D5	STU60D5	TVS	Vbr=225..275V, Vrw=202V, 1.67A, 600W(1ms)	DO-214AA	1d	1a	Eic
60DPH	BYG60D	Si-diode	Fast, Soft-Recovery, 200V, 1A, Vf<0.98V(1A), 250ns	DO-214AC	1d	1a	Phi
60E0	STB60E0	TVS	Vbr=270..330V, Vrw=243V, 1.40A, 600W(1ms), Bidirectional	DO-214AA	1ba	1j	Eic
60E0	STU60E0	TVS	Vbr=270..330V, Vrw=243V, 1.40A, 600W(1ms)	DO-214AA	1d	1a	Eic
60E5	STB60E5	TVS	Vbr=315..385V, Vrw=284V, 1.20A, 600W(1ms), Bidirectional	DO-214AA	1ba	1j	Eic
60E5	STU60E5	TVS	Vbr=315..385V, Vrw=284V, 1.20A, 600W(1ms)	DO-214AA	1d	1a	Eic
60G0	STB60G0	TVS	Vbr=360..440V, Vrw=324V, 1.05A, 600W(1ms), Bidirectional	DO-214AA	1ba	1j	Eic
60G0	STU60G0	TVS	Vbr=360..440V, Vrw=324V, 1.05A, 600W(1ms)	DO-214AA	1d	1a	Eic
60G4	STB60G4	TVS	Vbr=396..484V, Vrw=356V, 0.95A, 600W(1ms), Bidirectional	DO-214AA	1ba	1j	Eic
60G4	STU60G4	TVS	Vbr=396..484V, Vrw=356V, 0.95A, 600W(1ms)	DO-214AA	1d	1a	Eic
60GPH	BYG60G	Si-diode	Fast, Soft-Recovery, 400V, 1A, Vf<0.98V(1A), 250ns	DO-214AC	1d	1a	Phi
60JPH	BYG60J	Si-diode	Fast, Soft-Recovery, 600V, 1A, Vf<0.98V(1A), 250ns	DO-214AC	1d	1a	Phi
60KPH	BYG60K	Si-diode	Fast, Soft-Recovery, 800V, 1A, Vf<0.98V(1A), 350ns	DO-214AC	1d	1a	Phi
60MPH	BYG60M	Si-diode	Fast, Soft-Recovery, 1000V, 1A, Vf<0.98V(1A), 350ns	DO-214AC	1d	1a	Phi
60S	MMHZ5260SPT	Z-diode	42.14..43.86V, Izt=3.0mA, Zzt=93Ω, 225mW	SOD-123	5d	1a	Chm
60V	SMA60	TVS	Vbr=66.7..81.5V, Vrw=60.0V, 2.8A, 300W(1ms)	DO-214AC	1d	1a	Mic
60V	SMB60	TVS	Vbr=66.7..81.5V, Vrw=60V, 5.6A, 600W(1ms)	DO-214AA	1d	1a	Mic
60V	SMC60	TVS	Vbr=66.7..81.5V, Vrw=60V, 14A, 1500W(1ms)	DO-214AB	1d	1a	Mic
60VA	SMA60A	TVS	Vbr=66.7..73.7V, Vrw=60.0V, 3.1A, 300W(1ms)	DO-214AC	1d	1a	Mic
60VA	SMB60A	TVS	Vbr=66.7..73.7V, Vrw=60V, 6.2A, 600W(1ms)	DO-214AA	1d	1a	Mic



SMD code	Type	Function	Short description	Case	Pinout	St.	Mnf.
60VA	SMC60A	TVS	Vbr=66.7..73.7V, Vrwmm=60V, 15.5A, 1500W(1ms),	DO-214AB	1d	1a	Mic
60VC	SMA60C	TVS	Vbr=66.7..81.5V, Vrwmm=60.0V, 2.8A, 300W(1ms), Bidirectional	DO-214AC	1ba	1j	Mic
60VC	SMB60C	TVS	Vbr=66.7..81.5V, Vrwmm=60V, 5.6A, 600W(1ms), Bidirectional	DO-214AA	1ba	1j	Mic
60VC	SMC60C	TVS	Vbr=66.7..81.5V, Vrwmm=60V, 14A, 1500W(1ms), Bidirectional	DO-214AB	1ba	1j	Mic
60VCA	SMA60CA	TVS	Vbr=66.7..73.7V, Vrwmm=60.0V, 3.1A, 300W(1ms), Bidirectional	DO-214AC	1ba	1j	Mic
60VCA	SMB60CA	TVS	Vbr=66.7..73.7V, Vrwmm=60V, 6.2A, 600W(1ms), Bidirectional	DO-214AA	1ba	1j	Mic
60VCA	SMC60CA	TVS	Vbr=66.7..73.7V, Vrwmm=60V, 15.5A, 1500W(1ms), Bidirectional	DO-214AB	1ba	1j	Mic
61	HMSZ5261B	Z-diode	47V±5%, lzt=2.7mA, Zzt=105Ω, 225mW	SOD-323	5d	1d	Hsn
61B	MMHZ5261BPT	Z-diode	44.65..49.35V, lzt=2.7mA, Zzt=105Ω, 225mW	SOD-123	5d	1a	Chm
61B	SMC5361B	Z-diode	27.0V±5%, Zzt=5.0(50.0mA), lzm=176.0mA, 5W	DO-214AB	1d	1a	Ers
61S	MMHZ5261SPT	Z-diode	46.06..47.94V, lzt=2.7mA, Zzt=105Ω, 225mW	SOD-123	5d	1a	Chm
62	BAT62-02W	Si-diode	Schottky, 40V, 20mA; Vf<1.0V, Cd<0.6pF	SCD-80	6d	1u	Inf
62	CDZ55C62	Z-diode	58.90..65.10V, Zzt=150Ω, lzt=2.25mA, 500mW	1206	70d	2d	Crp
62	CDZ55C62S	Z-diode	58.90..65.10V, Zzt=150Ω, lzt=2.25mA, 500mW	0805	70d	2d	Crp
62	CDZ55C62T	Z-diode	58.90..65.10V, Zzt=150Ω, lzt=2.25mA, 200mW	0603	70d	2d	Crp
62	EDZ3.6B	Z-diode	3.60..3.845V, lzt=5mA, Zzt=100Ω, 150mW	SOD-523	6d	1a	Rhm
62	FDZ3.6EV	Z-diode	3.600..3.845V, lzt=5mA, Zzt=100Ω, 150mW	SOD-523	7d	1a	Fis
62	FDZ3.6VT	Z-diode	3.600..3.845V, lzt=5mA, Zzt=100Ω, 200mW	SOD-323	5d	1a	Fis
62	HZC6.2	Z-diode	6.2V±10%, 150mW	SOD-523	6d	1a	Ren
62	HZU6.2G	Z-diode	5.86..6.53V, 200mW	SOD-323	5d	1a	Ren
62	KDZ6.2EV	Z-diode	5.8..6.6V, 150mW	SOD-523	6d	1a	Kec
62	KDZ6.2V	Z-diode	5.8..6.6V, 150mW	SOD-323	5d	1a	Kec
62	MMPZ5265SPT	Z-diode	60.76..63.24V, lzt=2mA, Zzt=185Ω, 225mW	SOD-323	5d	1a	Chm
62	P4SMA62	TVS	Vbr=55.8..68.2V, Vrwmm=50.2V, 4.7A, 400W(1ms)	DO-214AC	1d	1a	Eic
62	P6SMBJ62	TVS	Vbr=55.8..68.2V, 6.8A, 600W(1ms)	DO-214AA	1d	1n	Lif
62	SML4759	Z-diode	62V±5%, lzt=4mA, Zzt=125Ω, 1W	DO-214AC	1d	1k	Vs
62	TDZ3.6B	Z-diode	3.6V±2.5%, 10mA, 500mW	TUMJD2	7d	1s	Rhm
62	TZD6.2WS	Z-diode	5.80..6.60V, lzt=5mA, Zzt=30Ω, 200mW	SOD-323	5d	1a	Ttr
62	TZD6.2WT	Z-diode	5.80..6.60V, lzt=5mA, Zzt=30Ω, 150mW	SOD-523	6d	1a	Ttr
62	UDZS3.6B	Z-diode	3.60..3.84V, lzt=5mA, Zzt=100Ω, 200mW	SOD-323	5d	1a	Wtr
62	UDZS3.6B	Z-diode	3.6V±2.5%, lzt=5mA, 200mW	SOD-323FL	7d	1s	Rhm
62	VDZS3.6B	Z-diode	3.6V±5%, 5mA, 100mW	VMD2	50d	1z	Rhm
6-2	MAZ80620M	Z-diode	6.05..6.36V, Zzt=30Ω(5mA), 150mW	SC-76	6d	1a	Pan
6-2	MAZ8062GML	Z-diode	6.05..6.36V, Zzt=30Ω(5mA), 150mW	SMini2-F3	6d	1a	Pan
62*	TZD6.2YWS	Z-diode	6.06..6.33V, lzt=5mA, Zzt=30Ω, 200mW	SOD-323	5d	1a	Ttr
62*	TZD6.2YWT	Z-diode	6.06..6.33V, lzt=5mA, Zzt=30Ω, 150mW	SOD-523	6d	1a	Ttr
62A	1.5SMC62A	TVS	Vbr=58.9..65.1V, Vrwmm=53.0V, 17.6A, 1500W(1ms)	DO-214AB	1d,3d	1a,1k	Vs,Ons
62A	P4SMA62A	TVS	Vbr=58.9..65.1V, Vrwmm=53.0V, 5.0A, 400W(1ms)	DO-214AC	1d	1k	Vs
62A	P6SMB62A	TVS	Vrwmm=62V, Vbr=58.9..65.1V, 7.1A, 600W(1ms)	DO-214AA	1d,3d	1k,1a	Vs,Ons
62A	P6SMBJ62A	TVS	Vbr=58.9..65.1V, 7.1A, 600W(1ms)	DO-214AA	1d	1n	Lif
62B	1SMB3EZ62	Z-diode	62V±5%, Zzt=60Ω, lzt=12.0mA, 3W	DO-214AA	1d	1a	Pjt
62B	MMHZ5262BPT	Z-diode	48.45..53.35V, lzt=2.5mA, Zzt=125Ω, 225mW	SOD-123	5d	1a	Chm
62B	SMC5362B	Z-diode	28.0V±5%, Zzt=6.0(50.0mA), lzm=170.0mA, 5W	DO-214AB	1d	1a	Ers
62C	1.5SMC62CA	TVS	Vbr=58.9..65.1V, Vrwmm=53.0V, 17.6A, 1500W(1ms), Bidirectional	DO-214AB	1ba	1j	Vs
62C	P4SMA62C	TVS	Vbr=55.8..68.2V, Vrwmm=50.2V, 4.7A, 400W(1ms), Bidirectional	DO-214AC	1ba	1j	Eic
62C	P4SMA62CA	TVS	Vbr=58.9..65.1V, 4.7A, 400W(1ms), Bidirectional	DO-214AC	1ba	1l	Vs
62C	P6SMB62CA	TVS	Vrwmm=62V, Vbr=58.9..65.1V, 7.1A, 600W(1ms), Bidirectional	DO-214AA	1ba,3ba	1l,1e	Vs,Ons
62C	P6SMBJ62C	TVS	Vbr=55.8..68.2V, 6.8A, 600W(1ms), Bidirectional	DO-214AA	1ba	1p	Lif
62CA	P4SMA62CA	TVS	Vbr=58.9..65.1V, Vrwmm=53.0V, 5.0A, 400W(1ms), Bidirectional	DO-214AC	1ba	1j	Eic
62CA	P6SMB62CA	TVS	Vbr=58.9..65.1V, Vrwmm=53.0V, 7.1A, 600W(1ms), Bidirectional	DO-214AA	1ba	1j	Eic
62CA	P6SMBJ62CA	TVS	Vbr=58.9..65.1V, 7.1A, 600W(1ms), Bidirectional	DO-214AA	1ba	1p	Lif
62P	BZD27C62P	Z-diode	58.9..65.1V, Zzt=80Ω, lzt=10mA, 800mW	SOD-123FL	7d	1a	Pjt
62P	MFPZ62	Z-diode	58.90..65.10V, lzt=10mA, Zzt=80Ω, 800mW	SOD-123FL	7d	1a	Ttr
62S	MMHZ5262SPT	Z-diode	49.98..52.02V, lzt=2.5mA, Zzt=125Ω, 225mW	SOD-123	5d	1a	Chm
62VB	BZT52-B62	Z-diode	60.76..63.24V, lzt=2mA, Zzt=215Ω, 500mW	SOD-123FL	7d	1a	Tsc
62VB	MMSZ62VBW	Z-diode	60.76..63.24V, lzt=2mA, Zzt=215Ω, 500mW	SOD-123FL	7d	1a	Tac
62VZ	BZT52-C62	Z-diode	58.90..65.10V, lzt=2mA, Zzt=215Ω, 500mW	SOD-123FL	7d	1a	Tsc
62VZ	MMSZ62VCW	Z-diode	58.90..65.10V, lzt=2mA, Zzt=215Ω, 500mW	SOD-123FL	7d	1a	Tac
62VZ	TCMMSZ62V	Z-diode	62V±5%, lzt=5mA, Zzt=202Ω, 500mW	SOD-123FL	7d	1a	Tac
62VZ	ZGFM0562C-MH	Z-diode	58.90..65.1V, lzt=5mA, Zzt=202Ω, 500mW	SOD-123	5d	1a	Pic
62Z	HZU6.2Z	Z-diode	5.9..6.5V, 200mW	SOD-323	5d	1a	Ren
63	1SR159-200	Si-diode	Rectifier, 200V, 1A, Vf<0.98V(1A)	DO-214AC	1d	1k	Rhm
63B	MMHZ5263BPT	Z-diode	53.20..58.80V, lzt=2.2mA, Zzt=150Ω, 225mW	SOD-123	5d	1a	Chm
63B	SMC5363B	Z-diode	30.0V±5%, Zzt=8.0(40.0mA), lzm=158.0mA, 5W	DO-214AB	1d	1a	Ers
63S	MMHZ5263SPT	Z-diode	54.88..57.12V, lzt=2.2mA, Zzt=150Ω, 225mW	SOD-123	5d	1a	Chm
64	BAT64-02W	Si-diode	SBD, Fast-Sw, 30V, 250mA, Vf<0.75V, Cd<6pF	SCD-80	6d	1u	Inf
64A	1SMC64A	TVS	Vbr=71.1..78.6V, Vrwmm=64V, 14.6A, 1500W(1ms)	DO-214AB	1d	1a	Eic
64A	SMAJ64A	TVS	Vrwmm=64V, Vbr=71.1..78.6V, 3.9A, 400W(1ms)	DO-214AC	1d	1a	Sus
64A	SMBJ64A	TVS	Vbr=71.1..78.6V, Vrwmm=64V, 5.8A, 600W(1ms)	DO-214AA	1d	1a	Sus
64A	SMCJ64A	TVS	Vrwmm=64V, Vbr=71.1..81.8V, 13.2A, 1500W(1ms)	DO-214AB	1d	1k	Sus



SMD code	Type	Function	Short description	Case	Pinout	St.	Mnf.
64A	UMA64A	TVS	Vrwm=64V, Vbr=71.1..103.0V, 4.9A, 500W(1ms)	UltraMite	14d	1v	Msc
64B	MMHZ5264BPT	Z-diode	57.0..63.0V, Izt=2.1mA, Zzt=170Ω, 225mW	SOD-123	5d	1a	Chm
64B	SMC5364B	Z-diode	33.0V±5%, Zzt=10.0(40.0mA), Izm=144.0mA, 5W	DO-214AB	1d	1a	Ers
64CA	1SMC64CA	TVS	Vbr=71.1..78.6V, Vrwm=64V, 14.6A, 1500W(1ms), Bidirectional	DO-214AB	1ba	1j	Eic
64CA	SMAJ64CA	TVS	Vrwm=64V, Vbr=71.1..78.6V, 3.9A, 400W(1ms), Bidirectional	DO-214AC	1ba	1j	Sus
64CA	SMBJ64CA	TVS	Vbr=71.1..78.6V, Vrwm=64V, 5.8A, 600W(1ms), Bidirectional	DO-214AA	1ba	1j	Sus
64CA	SMCJ64CA	TVS	Vrwm=64V, Vbr=71.1..81.8V, 13.2A, 1500W(1ms), Bidirectional	DO-214AB	1ba	1l	Sus
64CA	UMA64CA	TVS	Vrwm=64V, Vbr=71.1..103.0V, 4.9A, 500W(1ms), Bidirectional	UltraMite	14ba	1v	Msc
64S	MMHZ5264SPT	Z-diode	58.80..61.20V, Izt=2.1mA, Zzt=170Ω, 225mW	SOD-123	5d	1a	Chm
64V	SMA64	TVS	Vbr=71.1..86.4V, Vrwm=64.0V, 2.6A, 300W(1ms)	DO-214AC	1d	1a	Mic
64V	SMB64	TVS	Vbr=71.1..86.9V, Vrwm=64V, 5.3A, 600W(1ms)	DO-214AA	1d	1a	Mic
64V	SMC64	TVS	Vbr=71.1..86.9V, Vrwm=64V, 13.2A, 1500W(1ms),	DO-214AB	1d	1a	Mic
64VA	SMA64A	TVS	Vbr=71.1..78.6V, Vrwm=64.0V, 2.9A, 300W(1ms)	DO-214AC	1d	1a	Mic
64VA	SMB64A	TVS	Vbr=71.1..78.6V, Vrwm=64V, 5.8A, 600W(1ms)	DO-214AA	1d	1a	Mic
64VA	SMC64A	TVS	Vbr=71.1..78.6V, Vrwm=64V, 14.6A, 1500W(1ms),	DO-214AB	1d	1a	Mic
64VC	SMA64C	TVS	Vbr=71.1..86.4V, Vrwm=64.0V, 2.6A, 300W(1ms), Bidirectional	DO-214AC	1ba	1j	Mic
64VC	SMB64C	TVS	Vbr=71.1..86.9V, Vrwm=64V, 5.3A, 600W(1ms), Bidirectional	DO-214AA	1ba	1j	Mic
64VC	SMC64C	TVS	Vbr=71.1..86.9V, Vrwm=64V, 13.2A, 1500W(1ms), Bidirectional	DO-214AB	1ba	1j	Mic
64VCA	SMA64CA	TVS	Vbr=71.1..78.6V, Vrwm=64.0V, 2.9A, 300W(1ms), Bidirectional	DO-214AC	1ba	1j	Mic
64VCA	SMB64CA	TVS	Vbr=71.1..78.6V, Vrwm=64V, 5.8A, 600W(1ms), Bidirectional	DO-214AA	1ba	1j	Mic
64VCA	SMC64CA	TVS	Vbr=71.1..78.6V, Vrwm=64V, 14.6A, 1500W(1ms), Bidirectional	DO-214AB	1ba	1j	Mic
65	BZX584B4V3	Z-diode	4.21..4.39V, Izt=5mA, Zzt=90Ω, 200mW	SOD-523FL	7d	1a	Tac
65	EDZ18B	Z-diode	17.56..18.35V, Izt=5mA, Zzt=65Ω, 150mW	SOD-523	6d	1a	Rhm
65	FDZ18EV	Z-diode	17.560..18.350V, Izt=5mA, Zzt=65Ω, 150mW	SOD-523	7d	1a	Fis
65	FDZ18VT	Z-diode	17.560..18.350V, Izt=5mA, Zzt=65Ω, 200mW	SOD-323	5d	1a	Fis
65	MMSZ4V3B	Z-diode	4.21..4.39V, Izt=5mA, Zzt=90Ω, 200mW	SOD-523FL	7d	1a	Tac
65	TDZ18B	Z-diode	18V±2.5%, 10mA, 500mW	TUMD2	7d	1s	Rhm
65	UDZS18B	Z-diode	18V±2.5%, Izt=5mA, 200mW	SOD-323FL	7d	1s	Rhm
65	UDZS18B	Z-diode	17.56..18.35V, Izt=5mA, Zzt=65Ω, 200mW	SOD-323	5d	1a	Wtr
65	VDZS18B	Z-diode	18V±5%, 5mA, 100mW	VMD2	5d	1z	Rhm
6510	SMBJ8.5A	TVS	Vbr=9.44..10.82V, 41.7A, 600W(1ms)	DO-214AA	1d	1a	Eic
6510	SMBJ8.5CA	TVS	Vbr=9.44..10.4V, 41.7A, 600W(1ms), Bidirectional	DO-214AA	1ba	1j	Eic
6510	STB6510	TVS	Vbr=9.50..10.5V, Vrwm=8.55V, 41.0A, 600W(1ms), Bidirectional	DO-214AA	1ba	1j	Eic
6510	STU6510	TVS	Vbr=9.50..10.5V, Vrwm=8.55V, 41.0A, 600W(1ms)	DO-214AA	1d	1a	Eic
6510	SZ6510	Z-diode	10V±5%, Izt=125mA, Zzt=2.0Ω, 5W	DO-214AA	1d	1a	Eic
6511	SMBJ9.0A	TVS	Vbr=10.0..11.5V, 39.0A, 600W(1ms)	DO-214AA	1d	1a	Eic
6511	SMBJ9.0CA	TVS	Vbr=10.0..11.1V, 39.0A, 600W(1ms), Bidirectional	DO-214AA	1ba	1j	Eic
6511	STB6511	TVS	Vbr=10.5..11.6V, Vrwm=9.40V, 38.0A, 600W(1ms), Bidirectional	DO-214AA	1ba	1j	Eic
6511	STU6511	TVS	Vbr=10.5..11.6V, Vrwm=9.40V, 38.0A, 600W(1ms)	DO-214AA	1d	1a	Eic
6511	SZ6511	Z-diode	11V±5%, Izt=125mA, Zzt=2.5Ω, 5W	DO-214AA	1d	1a	Eic
6512	SMBJ10A	TVS	Vrwm=10V, Vbr=11.1..12.8V, 35.3A, 600W(1ms)	DO-214AA	1d	1a	Eic
6512	SMBJ10CA	TVS	Vbr=11.1..12.3V, 35.3A, 600W(1ms), Bidirectional	DO-214AA	1ba	1j	Eic
6512	STB6512	TVS	Vbr=11.4..12.6V, Vrwm=10.2V, 36.0A, 600W(1ms), Bidirectional	DO-214AA	1ba	1j	Eic
6512	STU6512	TVS	Vbr=11.4..12.6V, Vrwm=10.2V, 36.0A, 600W(1ms)	DO-214AA	1d	1a	Eic
6512	SZ6512	Z-diode	12V±5%, Izt=100mA, Zzt=2.5Ω, 5W	DO-214AA	1d	1a	Eic
6513	SMBJ11A	TVS	Vbr=12.2..14.0V, 33.0A, 600W(1ms)	DO-214AA	1d	1a	Eic
6513	SMBJ11CA	TVS	Vbr=12.2..13.5V, 33.0A, 600W(1ms), Bidirectional	DO-214AA	1ba	1j	Eic
6513	STB6513	TVS	Vbr=12.4..13.7V, Vrwm=11.1V, 33.0A, 600W(1ms), Bidirectional	DO-214AA	1ba	1j	Eic
6513	STU6513	TVS	Vbr=12.4..13.7V, Vrwm=11.1V, 33.0A, 600W(1ms)	DO-214AA	1d	1a	Eic
6513	SZ6513	Z-diode	13V±5%, Izt=100mA, Zzt=2.5Ω, 5W	DO-214AA	1d	1a	Eic
6514	SMBJ12A	TVS	Vbr=13.3..15.3V, 30.2A, 600W(1ms)	DO-214AA	1d	1a	Eic
6514	SMBJ12CA	TVS	Vbr=13.3..14.7V, 30.2A, 600W(1ms), Bidirectional	DO-214AA	1ba	1j	Eic
6514	SZ6514	Z-diode	14V±5%, Izt=100mA, Zzt=2.5Ω, 5W	DO-214AA	1d	1a	Eic
6515	SMBJ13A	TVS	Vbr=14.4..16.5V, 27.9A, 600W(1ms)	DO-214AA	1d	1a	Eic
6515	SMBJ13CA	TVS	Vbr=14.4..15.9V, 27.9A, 600W(1ms), Bidirectional	DO-214AA	1ba	1j	Eic
6515	STB6515	TVS	Vbr=14.3..15.8V, Vrwm=12.8V, 28.0A, 600W(1ms), Bidirectional	DO-214AA	1ba	1j	Eic
6515	STU6515	TVS	Vbr=14.3..15.8V, Vrwm=12.8V, 28.0A, 600W(1ms)	DO-214AA	1d	1a	Eic
6515	SZ6515	Z-diode	15V±5%, Izt=75mA, Zzt=2.5Ω, 5W	DO-214AA	1d	1a	Eic
6516	STB6516	TVS	Vbr=15.2..16.8V, Vrwm=13.6V, 27.0A, 600W(1ms), Bidirectional	DO-214AA	1ba	1j	Eic
6516	STU6516	TVS	Vbr=15.2..16.8V, Vrwm=13.6V, 27.0A, 600W(1ms)	DO-214AA	1d	1a	Eic
6516	SZ6516	Z-diode	16V±5%, Izt=75mA, Zzt=2.5Ω, 5W	DO-214AA	1d	1a	Eic
6517	SMBJ14A	TVS	Vbr=15.6..17.9V, 25.8A, 600W(1ms)	DO-214AA	1d	1a	Eic
6517	SMBJ14CA	TVS	Vbr=15.6..17.2V, 25.8A, 600W(1ms), Bidirectional	DO-214AA	1ba	1j	Eic
6517	SZ6517	Z-diode	17V±5%, Izt=70mA, Zzt=2.5Ω, 5W	DO-214AA	1d	1a	Eic
6518	SMBJ15A	TVS	Vbr=16.7..19.2V, 24.0A, 600W(1ms)	DO-214AA	1d	1a	Eic
6518	SMBJ15CA	TVS	Vbr=16.7..18.5V, 24.0A, 600W(1ms), Bidirectional	DO-214AA	1ba	1j	Eic
6518	STB6518	TVS	Vbr=17.1..18.9V, Vrwm=15.3V, 24.0A, 600W(1ms), Bidirectional	DO-214AA	1ba	1j	Eic
6518	STU6518	TVS	Vbr=17.1..18.9V, Vrwm=15.3V, 24.0A, 600W(1ms)	DO-214AA	1d	1a	Eic
6518	SZ6518	Z-diode	18V±5%, Izt=65mA, Zzt=2.5Ω, 5W	DO-214AA	1d	1a	Eic
6519	SMBJ16A	TVS	Vbr=17.8..20.5V, 23.1A, 600W(1ms)	DO-214AA	1d	1a	Eic



SMD code	Type	Function	Short description	Case	Pinout	St.	Mnf.
6519	SMBJ16CA	TVS	Vbr=17.8..19.7V, 23.1A, 600W(1ms), Bidirectional	DO-214AA	1ba	1j	Eic
6519	SZ6519	Z-diode	19V±5%, Izt=65mA, Zzt=3.0Ω, 5W	DO-214AA	1d	1a	Eic
6520	SMBJ17A	TVS	Vbr=18.9..21.7V, 21.7A, 600W(1ms)	DO-214AA	1d	1a	Eic
6520	SMBJ17CA	TVS	Vbr=18.9..20.9V, 21.7A, 600W(1ms), Bidirectional	DO-214AA	1ba	1j	Eic
6520	STB6520	TVS	Vbr=19.0..21.0V, Vrrwm=17.1V, 22.0A, 600W(1ms), Bidirectional	DO-214AA	1ba	1j	Eic
6520	STU6520	TVS	Vbr=19.0..21.0V, Vrrwm=17.1V, 22.0A, 600W(1ms)	DO-214AA	1d	1a	Eic
6520	SZ6520	Z-diode	20V±5%, Izt=65mA, Zzt=3.0Ω, 5W	DO-214AA	1d	1a	Eic
6522	SMBJ18A	TVS	Vbr=20.0..23.3V, 20.5A, 600W(1ms)	DO-214AA	1d	1a	Eic
6522	SMBJ18CA	TVS	Vbr=20.0..22.1V, 20.5A, 600W(1ms), Bidirectional	DO-214AA	1ba	1j	Eic
6522	STB6522	TVS	Vbr=20.9..23.1V, Vrrwm=18.8V, 20.0A, 600W(1ms), Bidirectional	DO-214AA	1ba	1j	Eic
6522	STU6522	TVS	Vbr=20.9..23.1V, Vrrwm=18.8V, 20.0A, 600W(1ms)	DO-214AA	1d	1a	Eic
6522	SZ6522	Z-diode	22V±5%, Izt=50mA, Zzt=3.5Ω, 5W	DO-214AA	1d	1a	Eic
6524	SMBJ20A	TVS	Vbr=22.2..25.5V, 18.5A, 600W(1ms)	DO-214AA	1d	1a	Eic
6524	SMBJ20CA	TVS	Vbr=22.2..24.5V, 18.5A, 600W(1ms), Bidirectional	DO-214AA	1ba	1j	Eic
6524	STB6524	TVS	Vbr=22.8..25.2V, Vrrwm=20.5V, 18.0A, 600W(1ms), Bidirectional	DO-214AA	1ba	1j	Eic
6524	STU6524	TVS	Vbr=22.8..25.2V, Vrrwm=20.5V, 18.0A, 600W(1ms)	DO-214AA	1d	1a	Eic
6524	SZ6524	Z-diode	24V±5%, Izt=50mA, Zzt=3.5Ω, 5W	DO-214AA	1d	1a	Eic
6525	SZ6525	Z-diode	25V±5%, Izt=50mA, Zzt=4.0Ω, 5W	DO-214AA	1d	1a	Eic
6526	SMBJ22A	TVS	Vbr=24.4..28.0V, 16.9A, 600W(1ms)	DO-214AA	1d	1a	Eic
6526	SMBJ22CA	TVS	Vbr=24.4..26.9V, 16.9A, 600W(1ms), Bidirectional	DO-214AA	1ba	1j	Eic
6527	STB6527	TVS	Vbr=25.7..28.4V, Vrrwm=23.1V, 16.0A, 600W(1ms), Bidirectional	DO-214AA	1ba	1j	Eic
6527	STU6527	TVS	Vbr=25.7..28.4V, Vrrwm=23.1V, 16.0A, 600W(1ms)	DO-214AA	1d	1a	Eic
6527	SZ6527	Z-diode	27V±5%, Izt=50mA, Zzt=5.0Ω, 5W	DO-214AA	1d	1a	Eic
6528	SZ6528	Z-diode	28V±5%, Izt=50mA, Zzt=6.0Ω, 5W	DO-214AA	1d	1a	Eic
6529	SMBJ24A	TVS	Vbr=26.7..30.7V, 15.4A, 600W(1ms)	DO-214AA	1d	1a	Eic
6529	SMBJ24CA	TVS	Vbr=26.7..29.5V, 15.4A, 600W(1ms), Bidirectional	DO-214AA	1ba	1j	Eic
6530	STB6530	TVS	Vbr=28.5..31.5V, Vrrwm=25.6V, 14.4A, 600W(1ms), Bidirectional	DO-214AA	1ba	1j	Eic
6530	STU6530	TVS	Vbr=28.5..31.5V, Vrrwm=25.6V, 14.4A, 600W(1ms)	DO-214AA	1d	1a	Eic
6530	SZ6530	Z-diode	30V±5%, Izt=40mA, Zzt=8.0Ω, 5W	DO-214AA	1d	1a	Eic
6531	SMBJ26A	TVS	Vbr=28.9..33.2V, 14.2A, 600W(1ms)	DO-214AA	1d	1a	Eic
6531	SMBJ26CA	TVS	Vbr=28.9..31.9V, 14.2A, 600W(1ms), Bidirectional	DO-214AA	1ba	1j	Eic
6533	SMBJ28A	TVS	Vbr=31.1..35.8V, 13.2A, 600W(1ms)	DO-214AA	1d	1a	Eic
6533	SMBJ28CA	TVS	Vbr=31.1..34.4V, 13.2A, 600W(1ms), Bidirectional	DO-214AA	1ba	1j	Eic
6533	STB6533	TVS	Vbr=31.4..34.7V, Vrrwm=28.2V, 13.2A, 600W(1ms), Bidirectional	DO-214AA	1ba	1j	Eic
6533	STU6533	TVS	Vbr=31.4..34.7V, Vrrwm=28.2V, 13.2A, 600W(1ms)	DO-214AA	1d	1a	Eic
6533	SZ6533	Z-diode	33V±5%, Izt=40mA, Zzt=10Ω, 5W	DO-214AA	1d	1a	Eic
6536	SMBJ30A	TVS	Vbr=33.1..38.3V, 12.4A, 600W(1ms)	DO-214AA	1d	1a	Eic
6536	SMBJ30CA	TVS	Vbr=33.1..36.8V, 12.4A, 600W(1ms), Bidirectional	DO-214AA	1ba	1j	Eic
6536	STB6536	TVS	Vbr=34.2..37.8V, Vrrwm=30.8V, 12.0A, 600W(1ms), Bidirectional	DO-214AA	1ba	1j	Eic
6536	STU6536	TVS	Vbr=34.2..37.8V, Vrrwm=30.8V, 12.0A, 600W(1ms)	DO-214AA	1d	1a	Eic
6536	SZ6536	Z-diode	36V±5%, Izt=30mA, Zzt=11Ω, 5W	DO-214AA	1d	1a	Eic
6539	STB6539	TVS	Vbr=37.1..41.0V, Vrrwm=33.3V, 11.2A, 600W(1ms), Bidirectional	DO-214AA	1ba	1j	Eic
6539	STU6539	TVS	Vbr=37.1..41.0V, Vrrwm=33.3V, 11.2A, 600W(1ms)	DO-214AA	1d	1a	Eic
6539	SZ6539	Z-diode	39V±5%, Izt=30mA, Zzt=14Ω, 5W	DO-214AA	1d	1a	Eic
6540	SMBJ33A	TVS	Vbr=36.7..42.2V, 11.3A, 600W(1ms)	DO-214AA	1d	1a	Eic
6540	SMBJ33CA	TVS	Vbr=36.7..40.6V, 11.3A, 600W(1ms), Bidirectional	DO-214AA	1ba	1j	Eic
6543	SMBJ36A	TVS	Vbr=40.0..46.0V, 10.3A, 600W(1ms)	DO-214AA	1d	1a	Eic
6543	SMBJ36CA	TVS	Vbr=40.0..44.2V, 10.3A, 600W(1ms), Bidirectional	DO-214AA	1ba	1j	Eic
6543	STB6543	TVS	Vbr=40.9..45.2V, Vrrwm=36.8V, 10.1A, 600W(1ms), Bidirectional	DO-214AA	1ba	1j	Eic
6543	STU6543	TVS	Vbr=40.9..45.2V, Vrrwm=36.8V, 10.1A, 600W(1ms)	DO-214AA	1d	1a	Eic
6543	SZ6543	Z-diode	43V±5%, Izt=30mA, Zzt=20Ω, 5W	DO-214AA	1d	1a	Eic
6547	STB6547	TVS	Vbr=44.7..49.4V, Vrrwm=40.2V, 9.3A, 600W(1ms), Bidirectional	DO-214AA	1ba	1j	Eic
6547	STU6547	TVS	Vbr=44.7..49.4V, Vrrwm=40.2V, 9.3A, 600W(1ms)	DO-214AA	1d	1a	Eic
6547	SZ6547	Z-diode	47V±5%, Izt=25mA, Zzt=25Ω, 5W	DO-214AA	1d	1a	Eic
6548	SMBJ40A	TVS	Vbr=44.4..51.1V, 9.3A, 600W(1ms)	DO-214AA	1d	1a	Eic
6548	SMBJ40CA	TVS	Vbr=44.4..49.1V, 9.3A, 600W(1ms), Bidirectional	DO-214AA	1ba	1j	Eic
6551	SMBJ43A	TVS	Vbr=47.8..54.9V, 8.6A, 600W(1ms)	DO-214AA	1d	1a	Eic
6551	SMBJ43CA	TVS	Vbr=47.8..52.8V, 8.6A, 600W(1ms), Bidirectional	DO-214AA	1ba	1j	Eic
6551	STB6551	TVS	Vbr=48.5..53.6V, Vrrwm=43.6V, 8.6A, 600W(1ms), Bidirectional	DO-214AA	1ba	1j	Eic
6551	STU6551	TVS	Vbr=48.5..53.6V, Vrrwm=43.6V, 8.6A, 600W(1ms)	DO-214AA	1d	1a	Eic
6551	SZ6551	Z-diode	51V±5%, Izt=25mA, Zzt=27Ω, 5W	DO-214AA	1d	1a	Eic
6554	SMBJ45A	TVS	Vbr=50.0..57.5V, 8.3A, 600W(1ms)	DO-214AA	1d	1a	Eic
6554	SMBJ45CA	TVS	Vbr=50.0..55.3V, 8.3A, 600W(1ms), Bidirectional	DO-214AA	1ba	1j	Eic
6556	STB6556	TVS	Vbr=53.2..58.8V, Vrrwm=47.8V, 7.8A, 600W(1ms), Bidirectional	DO-214AA	1ba	1j	Eic
6556	STU6556	TVS	Vbr=53.2..58.8V, Vrrwm=47.8V, 7.8A, 600W(1ms)	DO-214AA	1d	1a	Eic
6556	SZ6556	Z-diode	56V±5%, Izt=20mA, Zzt=35Ω, 5W	DO-214AA	1d	1a	Eic
6557	SMBJ48A	TVS	Vbr=53.3..61.3V, 7.7A, 600W(1ms)	DO-214AA	1d	1a	Eic
6557	SMBJ48CA	TVS	Vbr=53.3..58.9V, 7.7A, 600W(1ms), Bidirectional	DO-214AA	1ba	1j	Eic
6558	SZ6558	Z-diode	5.1V±5%, Izt=240mA, Zzt=1.5Ω, 5W	DO-214AA	1d	1a	Eic
655G	SZ655G	Z-diode	5.6V±5%, Izt=220mA, Zzt=1.0Ω, 5W	DO-214AA	1d	1a	Eic



SMD code	Type	Function	Short description	Case	Pinout	St.	Mnf.
6560	SZ6560	Z-diode	60V±5%, I _z =20mA, Z _z =40Ω, 5W	DO-214AA	1d	1a	Eic
6561	SMBJ51A	TVS	V _{br} =56.7..65.2V, 7.3A, 600W(1ms)	DO-214AA	1d	1a	Eic
6561	SMBJ51CA	TVS	V _{br} =56.7..62.7V, 7.3A, 600W(1ms), Bidirectional	DO-214AA	1ba	1j	Eic
6562	STB6562	TVS	V _{br} =58.9..65.1V, V _{rw} =53.0V, 7.1A, 600W(1ms), Bidirectional	DO-214AA	1ba	1j	Eic
6562	STU6562	TVS	V _{br} =58.9..65.1V, V _{rw} =53.0V, 7.1A, 600W(1ms)	DO-214AA	1d	1a	Eic
6562	SZ6562	Z-diode	62V±5%, I _z =20mA, Z _z =42Ω, 5W	DO-214AA	1d	1a	Eic
6565	SMBJ54A	TVS	V _{br} =60.0..69.0V, 6.9A, 600W(1ms)	DO-214AA	1d	1a	Eic
6565	SMBJ54CA	TVS	V _{br} =60.0..66.3V, 6.9A, 600W(1ms), Bidirectional	DO-214AA	1ba	1j	Eic
6568	STB6568	TVS	V _{br} =64.6..71.4V, V _{rw} =58.1V, 6.5A, 600W(1ms), Bidirectional	DO-214AA	1ba	1j	Eic
6568	STU6568	TVS	V _{br} =64.6..71.4V, V _{rw} =58.1V, 6.5A, 600W(1ms)	DO-214AA	1d	1a	Eic
6568	SZ6568	Z-diode	68V±5%, I _z =20mA, Z _z =44Ω, 5W	DO-214AA	1d	1a	Eic
656A	SZ656A	Z-diode	6.0V±5%, I _z =200mA, Z _z =1.0Ω, 5W	DO-214AA	1d	1a	Eic
656C	SZ656C	Z-diode	6.2V±5%, I _z =200mA, Z _z =1.0Ω, 5W	DO-214AA	1d	1a	Eic
656I	SMBJ5.0A	TVS	V _{br} =6.40..7.25V, 65.2A, 600W(1ms)	DO-214AA	1d	1a	Eic
656I	SMBJ5.0CA	TVS	V _{br} =6.40..7.25V, 65.2A, 600W(1ms), Bidirectional	DO-214AA	1ba	1j	Eic
656I	STB656I	TVS	V _{br} =6.45..7.14V, V _{rw} =5.80V, 57.0A, 600W(1ms), Bidirectional	DO-214AA	1ba	1j	Eic
656I	STU656I	TVS	V _{br} =6.45..7.14V, V _{rw} =5.80V, 57.0A, 600W(1ms)	DO-214AA	1d	1a	Eic
656I	SZ656I	Z-diode	6.8V±5%, I _z =175mA, Z _z =1.0Ω, 5W	DO-214AA	1d	1a	Eic
6570	SMBJ58A	TVS	V _{br} =64.4..74.1V, 6.4A, 600W(1ms)	DO-214AA	1d	1a	Eic
6570	SMBJ58CA	TVS	V _{br} =64.4..71.2V, 6.4A, 600W(1ms), Bidirectional	DO-214AA	1ba	1j	Eic
6572	SMBJ60A	TVS	V _{br} =66.7..76.7V, 6.2A, 600W(1ms)	DO-214AA	1d	1a	Eic
6572	SMBJ60CA	TVS	V _{br} =66.7..73.7V, 6.2A, 600W(1ms), Bidirectional	DO-214AA	1ba	1j	Eic
6575	STB6575	TVS	V _{br} =71.3..78.8V, V _{rw} =64.1V, 5.8A, 600W(1ms), Bidirectional	DO-214AA	1ba	1j	Eic
6575	STU6575	TVS	V _{br} =71.3..78.8V, V _{rw} =64.1V, 5.8A, 600W(1ms)	DO-214AA	1d	1a	Eic
6575	SZ6575	Z-diode	75V±5%, I _z =20mA, Z _z =45Ω, 5W	DO-214AA	1d	1a	Eic
6576	SMBJ64A	TVS	V _{br} =71.1..81.8V, 5.8A, 600W(1ms)	DO-214AA	1d	1a	Eic
6576	SMBJ64CA	TVS	V _{br} =71.1..78.6V, 5.8A, 600W(1ms), Bidirectional	DO-214AA	1ba	1j	Eic
657C	SMBJ6.0CA	TVS	V _{br} =6.67..7.67V, 58.3A, 600W(1ms)	DO-214AA	1d	1a	Eic
657C	SMBJ6.0CA	TVS	V _{br} =6.67..7.37V, 58.3A, 600W(1ms), Bidirectional	DO-214AA	1ba	1j	Eic
657F	STB657F	TVS	V _{br} =7.13..7.88V, V _{rw} =6.40V, 53.0A, 600W(1ms), Bidirectional	DO-214AA	1ba	1j	Eic
657F	STU657F	TVS	V _{br} =7.13..7.88V, V _{rw} =6.40V, 53.0A, 600W(1ms)	DO-214AA	1d	1a	Eic
657F	SZ657F	Z-diode	7.5V±5%, I _z =175mA, Z _z =1.5Ω, 5W	DO-214AA	1d	1a	Eic
657I	SMBJ6.5A	TVS	V _{br} =7.22..8.30V, 53.6A, 600W(1ms)	DO-214AA	1d	1a	Eic
657I	SMBJ6.5CA	TVS	V _{br} =7.22..7.98V, 53.6A, 600W(1ms), Bidirectional	DO-214AA	1ba	1j	Eic
6582	STB6582	TVS	V _{br} =77.9..86.1V, V _{rw} =70.1V, 5.3A, 600W(1ms), Bidirectional	DO-214AA	1ba	1j	Eic
6582	STU6582	TVS	V _{br} =77.9..86.1V, V _{rw} =70.1V, 5.3A, 600W(1ms)	DO-214AA	1d	1a	Eic
6582	SZ6582	Z-diode	82V±5%, I _z =15mA, Z _z =65Ω, 5W	DO-214AA	1d	1a	Eic
6584	SMBJ70A	TVS	V _{br} =77.8..89.5V, 5.3A, 600W(1ms)	DO-214AA	1d	1a	Eic
6584	SMBJ70CA	TVS	V _{br} =77.8..86.1V, 5.3A, 600W(1ms), Bidirectional	DO-214AA	1ba	1j	Eic
6587	SZ6587	Z-diode	87V±5%, I _z =15mA, Z _z =75Ω, 5W	DO-214AA	1d	1a	Eic
658C	STB658C	TVS	V _{br} =7.79..8.61V, V _{rw} =7.02V, 50.0A, 600W(1ms), Bidirectional	DO-214AA	1ba	1j	Eic
658C	STU658C	TVS	V _{br} =7.79..8.61V, V _{rw} =7.02V, 50.0A, 600W(1ms)	DO-214AA	1d	1a	Eic
658C	SZ658C	Z-diode	8.2V±5%, I _z =150mA, Z _z =1.5Ω, 5W	DO-214AA	1d	1a	Eic
658E	SMBJ7.0A	TVS	V _{br} =7.78..8.95V, 50.0A, 600W(1ms)	DO-214AA	1d	1a	Eic
658E	SMBJ7.0CA	TVS	V _{br} =7.78..8.6V, 50.0A, 600W(1ms), Bidirectional	DO-214AA	1ba	1j	Eic
658H	SZ658H	Z-diode	8.7V±5%, I _z =150mA, Z _z =2.0Ω, 5W	DO-214AA	1d	1a	Eic
6590	SMBJ75A	TVS	V _{br} =83.3..95.8V, 4.9A, 600W(1ms)	DO-214AA	1d	1a	Eic
6590	SMBJ75CA	TVS	V _{br} =83.3..92.1V, 4.9A, 600W(1ms), Bidirectional	DO-214AA	1ba	1j	Eic
6591	STB6591	TVS	V _{br} =86.5..95.5V, V _{rw} =77.8V, 4.8A, 600W(1ms), Bidirectional	DO-214AA	1ba	1j	Eic
6591	STU6591	TVS	V _{br} =86.5..95.5V, V _{rw} =77.8V, 4.8A, 600W(1ms)	DO-214AA	1d	1a	Eic
6591	SZ6591	Z-diode	91V±5%, I _z =15mA, Z _z =75Ω, 5W	DO-214AA	1d	1a	Eic
6593	SMBJ78A	TVS	V _{br} =86.7..99.7V, 4.7A, 600W(1ms)	DO-214AA	1d	1a	Eic
6593	SMBJ78CA	TVS	V _{br} =86.7..95.8V, 4.7A, 600W(1ms), Bidirectional	DO-214AA	1ba	1j	Eic
659A	SMBJ7.5A	TVS	V _{br} =8.33..9.58V, 46.5A, 600W(1ms)	DO-214AA	1d	1a	Eic
659A	SMBJ7.5CA	TVS	V _{br} =8.33..9.21V, 46.5A, 600W(1ms), Bidirectional	DO-214AA	1ba	1j	Eic
659B	STB659B	TVS	V _{br} =8.65..9.55V, V _{rw} =7.78V, 45.0A, 600W(1ms), Bidirectional	DO-214AA	1ba	1j	Eic
659B	STU659B	TVS	V _{br} =8.65..9.55V, V _{rw} =7.78V, 45.0A, 600W(1ms)	DO-214AA	1d	1a	Eic
659B	SZ659B	Z-diode	9.1V±5%, I _z =150mA, Z _z =2.0Ω, 5W	DO-214AA	1d	1a	Eic
659G	SMBJ8.0A	TVS	V _{br} =8.89..10.23V, 44.1A, 600W(1ms)	DO-214AA	1d	1a	Eic
659G	SMBJ8.0CA	TVS	V _{br} =8.89..9.83V, 44.1A, 600W(1ms), Bidirectional	DO-214AA	1ba	1j	Eic
65B	MMHZS265BPT	Z-diode	58.90..65.10V, I _z =2mA, Z _z =185Ω, 225mW	SOD-123	2d	1a	Chm
65B	SMC5365B	Z-diode	36.0V±5%, Z _z =11.0(30.0mA), I _{zm} =132.0mA, 5W	DO-214AB	1d	1a	Ers
65B0	SMBJ85A	TVS	V _{br} =94.4..108.2V, 4.4A, 600W(1ms)	DO-214AA	1d	1a	Eic
65B0	SMBJ85CA	TVS	V _{br} =94.4..104V, 4.4A, 600W(1ms), Bidirectional	DO-214AA	1ba	1j	Eic
65B0	STB65B0	TVS	V _{br} =95.0..105V, V _{rw} =85.5V, 4.4A, 600W(1ms), Bidirectional	DO-214AA	1ba	1j	Eic
65B0	STU65B0	TVS	V _{br} =95.0..105V, V _{rw} =85.5V, 4.4A, 600W(1ms)	DO-214AA	1d	1a	Eic
65B0	SZ65B0	Z-diode	100V±5%, I _z =12mA, Z _z =90Ω, 5W	DO-214AA	1d	1a	Eic
65B1	SMBJ90A	TVS	V _{br} =100..115.5V, 4.1A, 600W(1ms)	DO-214AA	1d	1a	Eic
65B1	SMBJ90CA	TVS	V _{br} =100..111V, 4.1A, 600W(1ms), Bidirectional	DO-214AA	1ba	1j	Eic
65B1	STB65B1	TVS	V _{br} =105..116V, V _{rw} =94.0V, 4.0A, 600W(1ms), Bidirectional	DO-214AA	1ba	1j	Eic



SMD
code

Type

Function

Short description

Case

Pinout

St.

Mnf.

65B1	STU65B1	TVS	Vbr=105.116V, Vrwm=94.0V, 4.0A, 600W(1ms)
65B1	SZ65B1	Z-diode	110V±5%, Izt=12mA, Zzt=125Ω, 5W
65B2	SMBJ100A	TVS	Vbr=111.128.0V, 3.7A, 600W(1ms)
65B2	SMBJ100CA	TVS	Vrwm=100V, Vbr=111.128V, 3.7A, 600W(1ms), Bidirectional
65B2	STB65B2	TVS	Vbr=114.126V, Vrwm=102V, 3.6A, 600W(1ms), Bidirectional
65B2	STU65B2	TVS	Vbr=114.126V, Vrwm=102V, 3.6A, 600W(1ms)
65B2	SZ65B2	Z-diode	120V±5%, Izt=10mA, Zzt=170Ω, 5W
65B3	SMBJ110A	TVS	Vbr=122.140.5V, 3.4A, 600W(1ms)
65B3	SMBJ110CA	TVS	Vbr=122.135V, 3.4A, 600W(1ms), Bidirectional
65B3	STB65B3	TVS	Vbr=124.137V, Vrwm=111V, 3.3A, 600W(1ms), Bidirectional
65B3	STU65B3	TVS	Vbr=124.137V, Vrwm=111V, 3.3A, 600W(1ms)
65B3	SZ65B3	Z-diode	130V±5%, Izt=10mA, Zzt=190Ω, 5W
65B4	SMBJ120A	TVS	Vbr=133.153.0V, 3.1A, 600W(1ms)
65B4	SMBJ120CA	TVS	Vbr=133.147V, 3.1A, 600W(1ms), Bidirectional
65B4	SZ65B4	Z-diode	140V±5%, Izt=8.0mA, Zzt=230Ω, 5W
65B5	SMBJ130A	TVS	Vbr=144.165.5V, 2.9A, 600W(1ms)
65B5	SMBJ130CA	TVS	Vbr=144.159V, 2.9A, 600W(1ms), Bidirectional
65B5	STB65B5	TVS	Vbr=143.158V, Vrwm=128V, 2.9A, 600W(1ms), Bidirectional
65B5	STU65B5	TVS	Vbr=143.158V, Vrwm=128V, 2.9A, 600W(1ms)
65B5	SZ65B5	Z-diode	150V±5%, Izt=8.0mA, Zzt=330Ω, 5W
65B6	STB65B6	TVS	Vbr=152.168V, Vrwm=136V, 2.7A, 600W(1ms), Bidirectional
65B6	STU65B6	TVS	Vbr=152.168V, Vrwm=136V, 2.7A, 600W(1ms)
65B6	SZ65B6	Z-diode	160V±5%, Izt=8.0mA, Zzt=350Ω, 5W
65B7	STB65B7	TVS	Vbr=162.179V, Vrwm=145V, 2.6A, 600W(1ms), Bidirectional
65B7	STU65B7	TVS	Vbr=162.179V, Vrwm=145V, 2.6A, 600W(1ms)
65B7	SZ65B7	Z-diode	170V±5%, Izt=8.0mA, Zzt=380Ω, 5W
65B8	SMBJ150A	TVS	Vbr=167.192.5V, 2.5A, 600W(1ms)
65B8	SMBJ150CA	TVS	Vbr=167.185V, 2.5A, 600W(1ms), Bidirectional
65B8	STB65B8	TVS	Vbr=171.189V, Vrwm=154V, 2.4A, 600W(1ms), Bidirectional
65B8	STU65B8	TVS	Vbr=171.189V, Vrwm=154V, 2.4A, 600W(1ms)
65B8	SZ65B8	Z-diode	180V±5%, Izt=5.0mA, Zzt=430Ω, 5W
65B9	SMBJ160A	TVS	Vbr=178.205.0V, 2.3A, 600W(1ms)
65B9	SMBJ160CA	TVS	Vbr=178.197V, 2.3A, 600W(1ms), Bidirectional
65B9	SZ65B9	Z-diode	190V±5%, Izt=5.0mA, Zzt=450Ω, 5W
65D0	SMBJ170A	TVS	Vbr=189.217.5V, 2.2A, 600W(1ms)
65D0	SMBJ170CA	TVS	Vbr=189.209V, 2.2A, 600W(1ms), Bidirectional
65D0	STB65D0	TVS	Vbr=190.210V, Vrwm=171V, 2.2A, 600W(1ms), Bidirectional
65D0	STU65D0	TVS	Vbr=190.210V, Vrwm=171V, 2.2A, 600W(1ms)
65D0	SZ65D0	Z-diode	200V±5%, Izt=5.0mA, Zzt=480Ω, 5W
65D1	SMBJ188CA	TVS	Vbr=189.231V, 2.0A, 600W(1ms), Bidirectional
65D2	STB65D2	TVS	Vbr=209.231V, Vrwm=185V, 1.83A, 600W(1ms), Bidirectional
65D2	STU65D2	TVS	Vbr=209.231V, Vrwm=185V, 1.83A, 600W(1ms)
65D5	STB65D5	TVS	Vbr=237.263V, Vrwm=214V, 1.75A, 600W(1ms), Bidirectional
65D5	STU65D5	TVS	Vbr=237.263V, Vrwm=214V, 1.75A, 600W(1ms)
65E0	STB65E0	TVS	Vbr=285.315V, Vrwm=256V, 1.45A, 600W(1ms), Bidirectional
65E0	STU65E0	TVS	Vbr=285.315V, Vrwm=256V, 1.45A, 600W(1ms)
65E5	STB65E5	TVS	Vbr=332.368V, Vrwm=300V, 1.25A, 600W(1ms), Bidirectional
65E5	STU65E5	TVS	Vbr=332.368V, Vrwm=300V, 1.25A, 600W(1ms)
65G0	STB65G0	TVS	Vbr=380.420V, Vrwm=342V, 1.10A, 600W(1ms), Bidirectional
65G0	STU65G0	TVS	Vbr=380.420V, Vrwm=342V, 1.10A, 600W(1ms)
65G4	STB65G4	TVS	Vbr=418.462V, Vrwm=376V, 1.0A, 600W(1ms), Bidirectional
65G4	STU65G4	TVS	Vbr=418.462V, Vrwm=376V, 1.0A, 600W(1ms)
65S	MMHZ5265SPT	Z-diode	60.76.63.24V, Izt=2mA, Zzt=185Ω, 225mW
66	BBY56-02W	C-diode	VCO-Tuning, 10V, 20mA, 59.67pF(±.1V)
66B	MMHZ5266BPT	Z-diode	64.60.71.40V, Izt=1.8mA, Zzt=230Ω, 225mW
66B	SMC5366B	Z-diode	39.0V±5%, Zzt=14.0(30.0mA), Izm=122.0mA, 5W
66S	MMHZ5266SPT	Z-diode	66.64.69.36V, Izt=1.8mA, Zzt=230Ω, 225mW
67B	MMHZ5267BPT	Z-diode	71.25.78.75V, Izt=1.7mA, Zzt=270Ω, 225mW
67B	SMC5367B	Z-diode	43.0V±5%, Zzt=20.0(30.0mA), Izm=110.0mA, 5W
67S	MMHZ5267SPT	Z-diode	73.50.76.50V, Izt=1.7mA, Zzt=270Ω, 225mW
68	CDZ55C68	Z-diode	64.60.71.40V, Zzt=200Ω, Izt=2.25mA, 500mW
68	CDZ55C68S	Z-diode	64.60.71.40V, Zzt=200Ω, Izt=2.25mA, 500mW
68	CDZ55C68T	Z-diode	64.60.71.40V, Zzt=200Ω, Izt=2.25mA, 200mW
68	HZC6.8	Z-diode	6.8V±10%, 150mW
68	HZU6.8G	Z-diode	6.4.7.14V, 200mW
68	KDZ6.8EV	Z-diode	6.4.7.2V, 150mW
68	KDZ6.8V	Z-diode	6.4.7.2V, 150mW
68	MMPZ5266SPT	Z-diode	66.64.69.36V, Izt=1.8mA, Zzt=230Ω, 225mW
68	P4SMA68	TVS	Vbr=61.2.74.8V, Vrwm=55.1V, 4.3A, 400W(1ms)
68	P6SMBJ68	TVS	Vbr=61.2.74.8V, 6.1A, 600W(1ms)



SMD
code

Type

Function

Short description

Case

Pinout

St.

Mnf.

68	SML4760	Z-diode	68V±5%, Izt=3.7mA, Zzt=150Ω, 1W	DO-214AC	1d	1k	Vs
68	TZD6.8WS	Z-diode	6.40..7.20V, Izt=5mA, Zzt=25Ω, 200mW	SOD-323	5d	1a	Ttr
68	TZD6.8WT	Z-diode	6.40..7.20V, Izt=5mA, Zzt=25Ω, 150mW	SOD-523	6d	1a	Ttr
68	U1Z68	Z-diode	61.2..74.8V, 1W	SOD-6	1d	1a	Tos
68	U1ZB68	Z-diode	61.2..74.8V, 1W	I-FLAT	1d	1a	Tos
6-8	MAZ80680M	Z-diode	6.64..6.98V, Zzt=20Ω(5mA), 150mW	SC-76	6d	1a	Pan
6-8	MAZ8068GML	Z-diode	6.64..6.98V, Zzt=20Ω(5mA), 150mW	SMIn2-F3	6d	1a	Pan
68*	TZD6.8YVVS	Z-diode	6.65..6.93V, Izt=5mA, Zzt=25Ω, 200mW	SOD-323	5d	1a	Ttr
68*	TZD6.8YVWT	Z-diode	6.65..6.93V, Izt=5mA, Zzt=25Ω, 150mW	SOD-523	6d	1a	Ttr
68A	1.5SMC100A	TVS	Vrwm=85.50V, Vbr=95.0..105.0V, 11.1A, 1500W(1ms)	DO-214AB	1d	1a	Fee
68A	1.5SMC68A	TVS	Vbr=64.6..71.4V, Vrwm=58.1V, 16.3A, 1500W(1ms)	DO-214AB	1d,3d	1a,1k	Vs,Ons
68A	P4SMA68A	TVS	Vbr=64.6..71.4V, Vrwm=58.1V, 4.6A, 400W(1ms)	DO-214AC	1d	1k	Vs
68A	P6SMB68A	TVS	Vrwm=68V, Vbr=64.6..71.4V, 6.5A, 600W(1ms)	DO-214AA	1d,3d	1k,1a	Vs,Ons
68A	P6SMBJ68A	TVS	Vbr=64.6..71.4V, 6.5A, 600W(1ms)	DO-214AA	1d	1n	Lif
68B	1SMB3EZ68	Z-diode	68V±5%, Zzt=75Ω, Izt=11.0mA, 3W	DO-214AA	1d	1a	Pjt
68B	MMHZ5268BPT	Z-diode	77.90..86.10V, Izt=1.5mA, Zzt=330Ω, 225mW	SOD-123	5d	1a	Chm
68B	SMC5368B	Z-diode	47.0V±5%, Zzt=25(0.25mA), Izm=100.0mA, 5W	DO-214AB	1d	1a	Ers
68C	1.5SMC68CA	TVS	Vbr=64.6..71.4V, Vrwm=58.1V, 16.3A, 1500W(1ms), Bidirectional	DO-214AB	1ba	1l	Vs
68C	P4SMA68C	TVS	Vbr=61.2..74.8V, Vrwm=55.1V, 4.3A, 400W(1ms), Bidirectional	DO-214AC	1ba	1j	Eic
68C	P4SMA68CA	TVS	Vbr=64.6..71.4V, 4.3A, 400W(1ms), Bidirectional	DO-214AC	1ba	1l	Vs
68C	P6SMB68CA	TVS	Vrwm=68V, Vbr=64.6..71.4V, 6.5A, 600W(1ms), Bidirectional	DO-214AA	1ba,3ba	1l,1e	Vs,Ons
68C	P6SMBJ68C	TVS	Vbr=61.2..74.8V, 6.1A, 600W(1ms), Bidirectional	DO-214AA	1ba	1p	Lif
68CA	P4SMA68CA	TVS	Vbr=64.6..71.4V, Vrwm=58.1V, 4.6A, 400W(1ms), Bidirectional	DO-214AC	1ba	1j	Eic
68CA	P6SMB68CA	TVS	Vbr=64.6..71.4V, Vrwm=58.1V, 6.5A, 600W(1ms), Bidirectional	DO-214AA	1ba	1j	Eic
68CA	P6SMBJ68CA	TVS	Vbr=64.6..71.4V, 6.5A, 600W(1ms), Bidirectional	DO-214AA	1ba	1p	Lif
68P	BZD27C68P	Z-diode	64.6..71.4V, Zzt=80Ω, Izt=10mA, 800mW	SOD-123FL	7d	1a	Pjt
68P	MFPZ68	Z-diode	64.60..71.40V, Izt=10mA, Zzt=80Ω, 800mW	SOD-123FL	7d	1a	Ttr
68S	MMHZ5268SPT	Z-diode	80.36..83.64V, Izt=1.5mA, Zzt=330Ω, 225mW	SOD-123	5d	1a	Chm
68VB	BZT52-B68	Z-diode	66.64..69.36V, Izt=2mA, Zzt=240Ω, 500mW	SOD-123FL	7d	1a	Tsc
68VB	MMSZ68VBW	Z-diode	66.64..69.36V, Izt=2mA, Zzt=240Ω, 500mW	SOD-123FL	7d	1a	Tac
68VZ	BZT52-C68	Z-diode	64.60..71.40V, Izt=2mA, Zzt=240Ω, 500mW	SOD-123FL	7d	1a	Tsc
68VZ	MMSZ68VCW	Z-diode	64.60..71.40V, Izt=2mA, Zzt=240Ω, 500mW	SOD-123FL	7d	1a	Tac
68VZ	TCMMSZ68V	Z-diode	68V±5%, Izt=5mA, Zzt=226Ω, 500mW	SOD-123FL	7d	1a	Tac
68VZ	ZGFM0568C-MH	Z-diode	64.60..71.4V, Izt=5mA, Zzt=226Ω, 500mW	SOD-123	5d	1a	Pic
68Z	HZU6.8Z	Z-diode	6.47..7V, 200mW	SOD-323	5d	1a	Ren
69B	MMHZ5269BPT	Z-diode	82.65..91.35V, Izt=1.4mA, Zzt=370Ω, 225mW	SOD-123	5d	1a	Chm
69B	SMC5369B	Z-diode	51.0V±5%, Zzt=27(0.25mA), Izm=93.0mA, 5W	DO-214AB	1d	1a	Ers
69S	MMHZ5269SPT	Z-diode	85.26..88.74V, Izt=1.4mA, Zzt=370Ω, 225mW	SOD-123	5d	1a	Chm
6A	MAZ2360	C-diode	VHF/UHF-tuning, 30V, 20mA, 14.3/2pF(2/25V), 0.6Ω(470MHz)	SOD-123	5d	1a	Pan
6A	MAZ2360J	C-diode	VHF/UHF-tuning, 30V, 20mA, 14.3/2pF(2/25V), 0.6Ω(470MHz)	SOD-523	6d	1a	Pan
6A	MA321	C-diode	UHF-tuning, 30V, 15/2.25pF(2/25V)	SOD-123	5d	1a	Pan
6A	MA360	C-diode	VHF/UHF-tuning, 30V, 20mA, 14.3/2pF(2/25V), 0.6Ω(470MHz)	SOD-123	5d	1a	Pan
6A	MA360J	C-diode	VHF/UHF-tuning, 30V, 20mA, 14.3/2pF(2/25V), 0.6Ω(470MHz)	SOD-523	6d	1a	Pan
6A	MM1Z43	Z-diode	43V±5%, Izt=2.5mA, Zzt=130Ω, 500mW	SOD-123FL	7d	1a	Eic
6A1	MM1Z3B0H	Z-diode	2.94..3.06V, Izt=5mA, Zzt=120Ω, 500mW	SOD-123	5d	1a	Zow
6A2	RKZ6.2AKU	Z-diode	5.78..6.09V, Izt=20mA, Zzt=50Ω, 500mW	TURP-FM	7d	1a	Ren
6A2	RKZ6.8AKU	Z-diode	6.29..6.63V, Izt=20mA, Zzt=30Ω, 500mW	TURP-FM	7d	1a	Ren
6B	CDZ55C6V2T	Z-diode	5.89..6.51V, Zzt=10Ω, Izt=5mA, 200mW	0603	70d	2d	Crp
6B	MA2X329	C-diode	VHF-tuning, 32V, 20mA, 42/3pF(1/25V), 1.6Ω(470MHz)	SOD-123	5d	1a	Pan
6B	MA329	C-diode	VHF-tuning, 32V, 20mA, 42/3pF(1/25V), 1.6Ω(470MHz)	SOD-123	5d	1a	Pan
6B	MM1Z47	Z-diode	47V±5%, Izt=2.5mA, Zzt=150Ω, 500mW	SOD-123FL	7d	1a	Eic
6B1	MM1Z3B3H	Z-diode	3.234..3.366V, Izt=5mA, Zzt=130Ω, 500mW	SOD-123	5d	1a	Zow
6B2	RKZ6.2BKU	Z-diode	5.96..6.27V, Izt=20mA, Zzt=50Ω, 500mW	TURP-FM	7d	1a	Ren
6B2	RKZ6.8BKU	Z-diode	6.49..6.83V, Izt=20mA, Zzt=30Ω, 500mW	TURP-FM	7d	1a	Ren
6BN	SMA5J16	TVS	Vbr=17.8..21.8V, Vrwm=16V, 17.4A, 500W(1ms)	DO-214AC	1d	1k	Vs
6C	GBLC15C	TVS	Vbr=15V, 10A, 350W(1ms), 3pF, Bidirectional	SOD-323	5ba	1e	Prt
6C	MA2X333	C-diode	GaAs, UHF/VHF-TV-tun, VCO, 9V, 100mA, 15.5/4pF(2/6V)	SOD-123	5d	1a	Pan
6C	MA2362	C-diode	VHF/UHF-VCO, 9V, 20mA, 13.5/4pF(2/4V), 0.35Ω(470MHz)	SOD-123	5d	1a	Pan
6C	MA333	C-diode	GaAs, UHF/VHF-TV-tun, VCO, 9V, 100mA, 15.5/4pF(2/6V)	SOD-123	5d	1a	Pan
6C	MA362	C-diode	VHF/UHF-VCO, 9V, 20mA, 13.5/4pF(2/4V), 0.35Ω(470MHz)	SOD-123	5d	1a	Pan
6C	MM1Z51	Z-diode	51V±5%, Izt=2.5mA, Zzt=180Ω, 500mW	SOD-123FL	7d	1a	Eic
6C1	MM1Z3B6H	Z-diode	3.528..3.672V, Izt=5mA, Zzt=130Ω, 500mW	SOD-123	5d	1a	Zow
6C2	RKZ6.2CKU	Z-diode	6.12..6.44V, Izt=20mA, Zzt=50Ω, 500mW	TURP-FM	7d	1a	Ren
6C7	CMDD7006	Si-diode	HV, Sw, 600V, 100mA, 250mW, Vf<1V(10mA), <5pF	SOD-323	5d	1a	Cen
6C8	RKZ6.8CKU	Z-diode	6.66..7.01V, Izt=20mA, Zzt=30Ω, 500mW	TURP-FM	7d	1a	Ren
6D	1S380PT	Si-diode	Sw, 40V, 100mA, Vf<1.2V(100mA), 4ns	SOD-323	5d	1a	Chm
6D	MA2X334	C-diode	VHF/UHF-tuning, 30V, 20mA, 12/3.2pF(3/25V), 0.5Ω(470MHz)	SOD-123	5d	1a	Pan
6D	MA334	C-diode	VHF/UHF-tuning, 30V, 20mA, 12/3.2pF(3/25V), 0.5Ω(470MHz)	SOD-123	5d	1a	Pan
6D	MM1Z56	Z-diode	56V±5%, Izt=2.5mA, Zzt=180Ω, 500mW	SOD-123FL	7d	1a	Eic
6D1	MM1Z3B9H	Z-diode	3.822..3.978V, Izt=5mA, Zzt=130Ω, 500mW	SOD-123	5d	1a	Zow



SMD code	Type	Function	Short description	Case	Pinout	St.	Mnf.
6E	MA2X335	C-diode	CATV, VHF-tun, 30V, 20mA, 29.4/2.58pF(2/25V), 0.72Q(470MHz)	SOD-123	5d	1a	Pan
6E	MA335	C-diode	CATV, VHF-tun, 30V, 20mA, 29.4/2.58pF(2/25V), 0.72Q(470MHz)	SOD-123	5d	1a	Pan
6E	MM1Z62	Z-diode	62V±5%, Izt=2.5mA, Zzt=200Q, 500mW	SOD-123FL	7d	1a	Eic
6E1	MM1Z4B3H	Z-diode	4.214..4.386V, Izt=5mA, Zzt=130Q, 500mW	SOD-123	5d	1a	Zow
6F	KDZ5.1FV	Z-diode	4.80..5.40V, Izt=5mA, Zzt=70Q, 100mW	TFSC	7d	1a	Kec
6F	MA2Z365	C-diode	CATV-tuning, 32V, 20mA, 36/2.54pF(2/25V), 0.85Q(470MHz)	SOD-123	5d	1a	Pan
6F	MA337	C-diode	CATV-tuning, 32V, 2.6/3.1pF(25V)	SOD-123	5d	1a	Pan
6F	MA365	C-diode	CATV-tuning, 32V, 20mA, 36/2.54pF(2/25V), 0.85Q(470MHz)	SOD-123	5d	1a	Pan
6F	MAZD039	Z-diode	3.7..4.1V, Zzt=130Q(5mA), 120mW	SSSMini2	7d	1a	Pan
6F	MM1Z68	Z-diode	68V±5%, Izt=2.5mA, Zzt=250Q, 500mW	SOD-123FL	7d	1a	Eic
6F1	MM1Z4B7H	Z-diode	4.606..4.794V, Izt=5mA, Zzt=130Q, 500mW	SOD-123	5d	1a	Zow
6G1	MM1Z5B1H	Z-diode	4.998..5.202V, Izt=5mA, Zzt=130Q, 500mW	SOD-123	5d	1a	Zow
6H	CDZ55C6V8T	Z-diode	6.46..7.14V, Zzt=8Q, Izt=5mA, 200mW	0603	70d	2d	Crp
6H	MA2X338	C-diode	CATV-tuning, 34V, 20mA, 27.1/2.6pF(2/25V), 0.63Q(470MHz)	SOD-123	5d	1a	Pan
6H	MA2Z366	C-diode	CATV-tuning, 34V, 20mA, 37.1/2.6pF(2/25V), 0.63Q(470MHz)	SOD-123	5d	1a	Pan
6H	MA338	C-diode	CATV-tuning, 34V, 20mA, 27.1/2.6pF(2/25V), 0.63Q(470MHz)	SOD-123	5d	1a	Pan
6H	MA366	C-diode	CATV-tuning, 34V, 20mA, 37.1/2.6pF(2/25V), 0.63Q(470MHz)	SOD-123	5d	1a	Pan
6H	MM1Z75	Z-diode	75V±5%, Izt=2.5mA, Zzt=300Q, 500mW	SOD-123FL	7d	1a	Eic
6H1	MM1Z5B6H	Z-diode	5.488..5.712V, Izt=5mA, Zzt=80Q, 500mW	SOD-123	5d	1a	Zow
6J	MM1Z82	Z-diode	82V±5%, Izt=2.5mA, Zzt=300Q, 500mW	SOD-123	5d	1a	Bts
6J1	MM1Z6B2H	Z-diode	6.076..6.324V, Izt=5mA, Zzt=50Q, 500mW	SOD-123	5d	1a	Zow
6K	MA2X341	C-diode	VHF/UHF-AFC, 30V, 10/3.3pF(2/10V), 1.6Q(470MHz)	SOD-123	5d	1a	Pan
6K	MA2Z367	C-diode	VHF/UHF-AFC, 34V, 10.5/3.3pF(2/10V), 1.6Q(470MHz)	SOD-123	5d	1a	Pan
6K	MA341	C-diode	VHF/UHF-AFC, 30V, 10/3.3pF(2/10V), 1.6Q(470MHz)	SOD-123	5d	1a	Pan
6K	MA367	C-diode	VHF/UHF-AFC, 34V, 10.5/3.3pF(2/10V), 1.6Q(470MHz)	SOD-123	5d	1a	Pan
6K	MM1Z91	Z-diode	91V±5%, Izt=1mA, Zzt=700Q, 500mW	SOD-123	5d	1a	Bts
6K1	MM1Z6B8H	Z-diode	6.664..6.936V, Izt=5mA, Zzt=30Q, 500mW	SOD-123	5d	1a	Zow
6L	MA2Z368	C-diode	UHF/SHF-tuning, 30V, 20mA, 4.6/0.65pF(1/30V), 2Q(470MHz)	SOD-123	5d	1a	Pan
6L	MA368	C-diode	UHF/SHF-tuning, 30V, 20mA, 4.6/0.65pF(1/30V), 2Q(470MHz)	SOD-123	5d	1a	Pan
6L1	MM1Z7B5H	Z-diode	7.35..7.65V, Izt=5mA, Zzt=30Q, 500mW	SOD-123	5d	1a	Zow
6M	MM1Z100	Z-diode	100V±5%, Izt=1mA, Zzt=700Q, 500mW	SOD-123	5d	1a	Bts
6M1	MM1Z8B2H	Z-diode	8.036..8.364V, Izt=5mA, Zzt=30Q, 500mW	SOD-123	5d	1a	Zow
6N	MA2J372	C-diode	VCO, 32V, 20mA, 15/9pF(2/17V), 0.45Q(470MHz)	SOD-523	6d	1a	Pan
6N	MA2XA339	C-diode	VHF/UHF-tuning, 32V, 20mA, 14.2/2.1pF(2/25V), 0.45Q(470MHz)	SOD-123	5d	1a	Pan
6N	MA2Z372	C-diode	UHF/VHF-tuning, 32V, 20mA, 15/9pF(2/17V), 0.45Q(470MHz)	SOD-123	5d	1a	Pan
6N	MA339	C-diode	VHF/UHF-tuning, 32V, 20mA, 14.2/2.1pF(2/25V), 0.45Q(470MHz)	SOD-123	5d	1a	Pan
6N	MA372	C-diode	UHF/VHF-tuning, 32V, 20mA, 15/9pF(2/17V), 0.45Q(470MHz)	SOD-123	5d	1a	Pan
6N	MA372J	C-diode	UHF/VHF-tuning, 32V, 20mA, 15/9pF(2/17V), 0.45Q(470MHz)	SOD-523	6d	1a	Pan
6N	MM1Z110	Z-diode	110V±5%, Izt=1mA, Zzt=800Q, 500mW	SOD-123	5d	1a	Bts
6N1	MM1Z9B1H	Z-diode	8.918..9.282V, Izt=5mA, Zzt=30Q, 500mW	SOD-123	5d	1a	Zow
6P	CMDZ30L	Z-diode	28.50..31.50V, Izt=0.5mA, Zzt=200Q, 250mW	SOD-323	5d	1a	Cen
6P	KDZ5.1FVY	Z-diode	4.98..5.20V, Izt=5mA, Zzt=70Q, 100mW	TFSC	7d	1a	Kec
6P	MM1Z120	Z-diode	120V±5%, Izt=1mA, Zzt=900Q, 500mW	SOD-123	5d	1a	Bts
6P1	MM1ZB10H	Z-diode	9.8..10.2V, Izt=5mA, Zzt=30Q, 500mW	SOD-123	5d	1a	Zow
6P2	SML4735	Z-diode	6.2V±5%, Izt=41mA, Zzt=2Q, 1W	DO-214AC	1d	1k	Vs
6P8	SML4736	Z-diode	6.8V±5%, Izt=37mA, Zzt=3.5Q, 1W	DO-214AC	1d	1k	Vs
6Q1	MM1ZB11H	Z-diode	10.78..11.22V, Izt=5mA, Zzt=30Q, 500mW	SOD-123	5d	1a	Zow
6R1	MM1ZB12H	Z-diode	11.76..12.24V, Izt=5mA, Zzt=35Q, 500mW	SOD-123	5d	1a	Zow
6S	MA2Z371	C-diode	CATV-tuning, 32V, 20mA, 34/2.6pF(2/25V), 0.75Q(470MHz)	SOD-123	5d	1a	Pan
6S	MA353	C-diode	CATV-tuning, 32V, 2.6/3.2pF(25V)	SOD-123	5d	1a	Pan
6S	MA371	C-diode	CATV-tuning, 32V, 20mA, 34/2.6pF(2/25V), 0.75Q(470MHz)	SOD-123	5d	1a	Pan
6S	MMSD71RK	Si-diode	Sw, 80V, 200mA, 225mW, Vf<1.2V(100mA), <4ns	SOD-123	5d	1a	Ons
6S1	MM1ZB13H	Z-diode	12.74..13.26V, Izt=5mA, Zzt=35Q, 500mW	SOD-123	5d	1a	Zow
6T	MA2Z331	C-diode	UHF-AFC, 12V, 20mA, 17/5.5pF(1/10V), 0.18Q(470MHz)	SOD-123	5d	1a	Pan
6T	MA331	C-diode	UHF-AFC, 12V, 20mA, 17/5.5pF(1/10V), 0.18Q(470MHz)	SOD-123	5d	1a	Pan
6T1	MM1ZB15H	Z-diode	14.7..15.3V, Izt=5mA, Zzt=40Q, 500mW	SOD-123	5d	1a	Zow
6U	MA332	C-diode	UHF-AFC, 6V, 10.5..12.5pF(4V)	SOD-123	5d	1a	Pan
6U	SD12	TVS	Vbr=12V, 15A, 350W(1ms)	SOD-323	5d	1a	Smt
6U	WOSD12	TVS	Vbr=13.3V, Vcl=19..25V, Ipp=15A, 300W(1ms)	SOD-323	5d	1e	Wtr
6U1	MM1ZB16H	Z-diode	15.68..16.32V, Izt=5mA, Zzt=40Q, 500mW	SOD-123	5d	1a	Zow
6V0	SMA6.0	TVS	Vbr=6.67..8.15V, Vrvwm=6.0V, 26.3A, 300W(1ms)	DO-214AC	1d	1a	Mic
6V0	SMB6.0	TVS	Vbr=6.67..8.15V, Vrvwm=6V, 52.3A, 600W(1ms)	DO-214AA	1d	1a	Mic
6V0	SMC6.0	TVS	Vbr=6.67..8.15V, Vrvwm=6V, 131.6A, 1500W(1ms),	DO-214AB	1d	1a	Mic
6V0A	SMA6.0A	TVS	Vbr=6.67..7.37V, Vrvwm=6.0V, 29.1A, 300W(1ms)	DO-214AC	1d	1a	Mic
6V0A	SMB6.0A	TVS	Vbr=6.67..7.37V, Vrvwm=6V, 58.3A, 600W(1ms)	DO-214AA	1d	1a	Mic
6V0A	SMC6.0A	TVS	Vbr=6.67..7.37V, Vrvwm=6V, 145.6A, 1500W(1ms),	DO-214AB	1d	1a	Mic
6V0C	SMA6.0C	TVS	Vbr=6.67..8.15V, Vrvwm=6.0V, 26.3A, 300W(1ms), Bidirectional	DO-214AC	1ba	1j	Mic
6V0C	SMA6.5C	TVS	Vbr=7.22..8.82V, Vrvwm=6.5V, 24.4A, 300W(1ms), Bidirectional	DO-214AC	1ba	1j	Mic
6V0C	SMB6.0C	TVS	Vbr=6.67..8.15V, Vrvwm=6V, 52.3A, 600W(1ms), Bidirectional	DO-214AA	1ba	1j	Mic
6V0C	SMC6.0C	TVS	Vbr=6.67..8.15V, Vrvwm=6V, 131.6A, 1500W(1ms), Bidirectional	DO-214AB	1ba	1j	Mic



SMD code	Type	Function	Short description	Case	Pinout	St.	Mnf.
6V0CA	SMA6.0CA	TVS	Vbr=6.67..7.37V, Vrvwm=6.0V, 29.1A, 300W(1ms), Bidirectional	DO-214AC	1ba	1j	Mic
6V0CA	SMA6.5CA	TVS	Vbr=7.22..7.98V, Vrvwm=6.5V, 26.8A, 300W(1ms), Bidirectional	DO-214AC	1ba	1j	Mic
6V0CA	SMB6.0CA	TVS	Vbr=6.67..7.37V, Vrvwm=6V, 58.3A, 600W(1ms), Bidirectional	DO-214AA	1ba	1j	Mic
6V0CA	SMC6.0CA	TVS	Vbr=6.67..7.37V, Vrvwm=6V, 145.6A, 1500W(1ms), Bidirectional	DO-214AB	1ba	1j	Mic
6V1	BZD27C6V0P	Z-diode	5.70..6.30V, Zzt=3Ω, Izt=100mA, 800mW	SOD-123FL	7d	1a	Pjt
6V1	MFPZ6V0	Z-diode	5.70..6.30V, Izt=100mA, Zzt=3Ω, 800mW	SOD-123FL	7d	1a	Ttr
6V2	BZD27C6V2P	Z-diode	5.89..6.51V, Zzt=3Ω, Izt=100mA, 800mW	SOD-123FL	7d	1a	Pjt
6V2	BZY55-C6V2	Z-diode	5.89..6.51V, Izt=5mA, Zzt=10Ω, 500mW	0805	70d	2d	Tsc
6V2	CDZ55C6V2	Z-diode	5.89..6.51V, Zzt=10Ω, Izt=5mA, 500mW	1206	70d	2d	Crp
6V2	CDZ55C6V2S	Z-diode	5.89..6.51V, Zzt=10Ω, Izt=5mA, 500mW	0805	70d	2d	Crp
6V2	CTZ55C6V2	Z-diode	5.89..6.51V, Izt=5mA, Zzt=10Ω, 500mW	1206	70d	2d	Ctc
6V2	MFPZ6V2	Z-diode	5.89..6.51V, Izt=100mA, Zzt=3Ω, 800mW	SOD-123FL	7d	1a	Ttr
6V2B	BZT52-B6V2	Z-diode	6.08..6.32V, Izt=5mA, Zzt=10Ω, 500mW	SOD-123FL	7d	1a	Tsc
6V2B	MMSZ6V2BW	Z-diode	6.08..6.32V, Izt=5mA, Zzt=10Ω, 500mW	SOD-123FL	7d	1a	Tac
6V2Z	BZT52-C6V2	Z-diode	5.89..6.51V, Izt=5mA, Zzt=10Ω, 500mW	SOD-123FL	7d	1a	Tsc
6V2Z	MMSZ6V2CW	Z-diode	5.89..6.51V, Izt=5mA, Zzt=10Ω, 500mW	SOD-123FL	7d	1a	Tac
6V2Z	TCMMSZ6V2	Z-diode	6.2V±5%, Izt=5mA, Zzt=9Ω, 500mW	SOD-123FL	7d	1a	Tac
6V2Z	ZGFM056V2C-MH	Z-diode	5.89..6.51V, Izt=5mA, Zzt=9Ω, 500mW	SOD-123	5d	1a	Pic
6V5	SMA6.5	TVS	Vbr=7.22..8.82V, Vrvwm=6.5V, 24.4A, 300W(1ms)	DO-214AC	1d	1a	Mic
6V5	SMB6.5	TVS	Vbr=7.22..8.82V, Vrvwm=6.5V, 48.8A, 600W(1ms)	DO-214AA	1d	1a	Mic
6V5	SMC6.5	TVS	Vbr=7.22..8.82V, Vrvwm=6.5V, 122A, 1500W(1ms)	DO-214AB	1d	1a	Mic
6V5A	SMA6.5A	TVS	Vbr=7.22..7.98V, Vrvwm=6.5V, 26.8A, 300W(1ms)	DO-214AC	1d	1a	Mic
6V5A	SMC6.5A	TVS	Vbr=7.22..7.98V, Vrvwm=6.5V, 133.9A, 1500W(1ms)	DO-214AB	1d	1a	Mic
6V5C	SMB6.5C	TVS	Vbr=7.22..8.82V, Vrvwm=6.5V, 48.8A, 600W(1ms), Bidirectional	DO-214AA	1ba	1j	Mic
6V5C	SMC6.5C	TVS	Vbr=7.22..8.82V, Vrvwm=6.5V, 122A, 1500W(1ms), Bidirectional	DO-214AB	1ba	1j	Mic
6V5CA	SMC6.5CA	TVS	Vbr=7.22..7.98V, Vrvwm=6.5V, 133.9A, 1500W(1ms), Bidirectional	DO-214AB	1ba	1j	Mic
6V6A	SMB6.5A	TVS	Vbr=7.22..7.98V, Vrvwm=6.5V, 53.6A, 600W(1ms)	DO-214AA	1d	1a	Mic
6V6CA	SMB6.5CA	TVS	Vbr=7.22..7.98V, Vrvwm=6.5V, 53.6A, 600W(1ms), Bidirectional	DO-214AA	1ba	1j	Mic
6V8	BZD27C6V8P	Z-diode	6.46..7.14V, Zzt=3Ω, Izt=100mA, 800mW	SOD-123FL	7d	1a	Pjt
6V8	BZY55-C6V8	Z-diode	6.46..7.14V, Izt=5mA, Zzt=8Ω, 500mW	0805	70d	2d	Tsc
6V8	CDZ55C6V8	Z-diode	6.46..7.14V, Zzt=8Ω, Izt=5mA, 500mW	1206	70d	2d	Crp
6V8	CDZ55C6V8S	Z-diode	6.46..7.14V, Zzt=8Ω, Izt=5mA, 500mW	0805	70d	2d	Crp
6V8	CTZ55C6V8	Z-diode	6.46..7.14V, Izt=5mA, Zzt=8Ω, 500mW	1206	70d	2d	Ctc
6V8	MFPZ6V8	Z-diode	6.46..7.14V, Izt=100mA, Zzt=3Ω, 800mW	SOD-123FL	7d	1a	Ttr
6V8	P6SMBJ6V8	TVS	Vbr=6.12..7.48V, 56A, 600W(1ms)	DO-214AA	1d	1n	Lif
6V8A	1.5SMC6.8A	TVS	Vbr=6.45..7.14V, Vrvwm=5.80V, 143A, 1500W(1ms)	DO-214AB	1d,3d	1a,1k	Vs,Ons
6V8A	P4SMA6.8A	TVS	Vbr=6.45..7.14V, 38.1A, 400W(1ms)	DO-214AC	1d	1k	Vs
6V8A	P6SMB6.8A	TVS	Vbr=6.45..7.14V, 57.1A, 600W(1ms)	DO-214AA	1d	1k	Vs
6V8A	P6SMB-6.8A	TVS	Vbr=6.8V, 57A, 600W(1ms)	403A	3d	1s	Ons
6V8A	P6SMBJ6V8A	TVS	Vbr=6.45..7.14V, 57A, 600W(1ms)	DO-214AA	1d	1n	Lif
6V8B	BZT52-B6V8	Z-diode	6.66..6.94V, Izt=5mA, Zzt=15Ω, 500mW	SOD-123FL	7d	1a	Tsc
6V8B	MMSZ6V8BW	Z-diode	6.66..6.94V, Izt=5mA, Zzt=15Ω, 500mW	SOD-123FL	7d	1a	Tac
6V8B	Z3SMB6.8B	Z-diode	6.46..7.14V, Izt=110mA, Zzt=2Ω, 3W	DO-214AA	1d	1a	Ttr
6V8C	1.5SMC6.8CA	TVS	Vbr=6.45..7.14V, Vrvwm=5.80V, 143A, 1500W(1ms), Bidirectional	DO-214AB	1ba	1l	Vs
6V8C	P4SMA6.8CA	TVS	Vbr=6.45..7.14V, 38.1A, 400W(1ms), Bidirectional	DO-214AC	1ba	1l	Vs
6V8C	P6SMB6.8CA	TVS	Vbr=6.45..7.14V, 57.1A, 600W(1ms), Bidirectional	DO-214AA	1ba	1l	Vs
6V8C	P6SMBJ6V8C	TVS	Vbr=6.12..7.48V, 56A, 600W(1ms), Bidirectional	DO-214AA	1ba	1p	Lif
6V8CA	P6SMBJ6V8CA	TVS	Vbr=6.45..7.14V, 57A, 600W(1ms), Bidirectional	DO-214AA	1ba	1p	Lif
6V8Z	BZT52-C6V8	Z-diode	6.46..7.14V, Izt=5mA, Zzt=15Ω, 500mW	SOD-123FL	7d	1a	Tsc
6V8Z	MMSZ6V8CW	Z-diode	6.46..7.14V, Izt=5mA, Zzt=15Ω, 500mW	SOD-123FL	7d	1a	Tac
6V8Z	TCMMSZ6V8	Z-diode	6.8V±5%, Izt=5mA, Zzt=14Ω, 500mW	SOD-123FL	7d	1a	Tac
6V8Z	ZGFM056V8C-MH	Z-diode	6.46..7.14V, Izt=5mA, Zzt=14Ω, 500mW	SOD-123	5d	1a	Pic
6V1	MM1ZB18H	Z-diode	17.64..18.36V, Izt=5mA, Zzt=45Ω, 500mW	SOD-123	5d	1a	Zow
6X1	MM1ZB20H	Z-diode	19.6..20.4V, Izt=5mA, Zzt=50Ω, 500mW	SOD-123	5d	1a	Zow
6Y	KDZ16V VY	Z-diode	15.85..16.51V, Izt=5mA, Zzt=18Ω, 100mW	VSC	7d	1a	Kec
6Y	MA355	C-diode	CATV-tuning, 32V, 2.5/2.9pF(25V)	SOD-123	5d	1a	Pan
6Y1	MM1ZB22H	Z-diode	21.56..22.44V, Izt=5mA, Zzt=55Ω, 500mW	SOD-123	5d	1a	Zow
6Y8	CRY68	Z-diode	6.2..7.4V, 700mW	S-FLAT	6d	1a	Tos
6Z	BZT52-B4V3S	Z-diode	4.21..4.39V, Izt=5mA, Zzt=90Ω, 200mW	SOD-323FL	7d	1a	Tsc
6Z	MA373	C-diode	UHF-tuning, 32V, 0.84pF(25V)	SOD-123	5d	1a	Pan
6Z	MM3Z4V3B	Z-diode	4.21..4.39V, Zzt=84Ω, Izt=5mA, 200mW	SOD-323FL	7d	1a	F
6Z	MM3Z4V3BW	Z-diode	4.21..4.39V, Izt=5mA, Zzt=90Ω, 200mW	SOD-323FL	7d	1a	Tac
6Z	TCM3Z4V3B	Z-diode	4.3V±2%, Izt=5mA, Zzt=84Ω, 200mW	SOD-323FL	7d	1a	Tac
6Z1	MM1ZB24H	Z-diode	23.52..24.48V, Izt=5mA, Zzt=60Ω, 500mW	SOD-123	5d	1a	Zow
6Z2	CRY62	Z-diode	5.6..6.8V, 700mW	S-FLAT	6d	1a	Tos
7	1S5400GPT	Si-diode	Sw, 90V, 100mA, Vf<1.2V(100mA), 4ns	SOD-723	6d	1a	Chm
7	BA891	PN-diode	VHF, TV-Band-Sw, 35V, 100mA, 715mW, 0.8pF	SOD-523	6d	1a	Phi
7	BBY55-02V	C-diode	VCO-Tuning, 16V, 20mA, 14..16pF(10..2V)	SC-79	6d	1u	Inf
7	CDZ3.6B	Z-diode	3.6V±2.5%, Izt=40mA, 1W	VMN	7d	1s	Rhm
Z	CDZ5.6B	Z-diode	5.6V±2.5%, Izt=40mA, 1W	VMN	7d	1s	Rhm



SMD code	Type	Function	Short description	Case	Pinout	St.	Mnf.
7	HVU307	C-diode	VHF-Tuning, 32.2/37.5pF(2V)	SOD-123	5d	1a	Ren
7	MA2S377	C-diode	VXO, VCXO, TCXO, 12V, 20mA, 2.8/1.1pF(2/10V), 0.4Q(470MHz)	SOD-523	6d	1a	Pan
7	MAZS075	Z-diode	7..7.9V, 200mW	SOD-523	6d	1a	Pan
7	MMPZ5228SPT	Z-diode	3.822..3.987V, Izt=5mA, Zzt=90Ω, 225mW	SOD-323	5d	1a	Chm
7	MMSZ5248BPT	Z-diode	17.10..18.90V, Izt=5mA, Zzt=42Ω, 225mW	SOD-523	7d	1a	Chm
7	SPE0517D2RG	ESDP-diode	Vrwm=5V, Vbr=6..8.5V, 7A, 250W(1ms)	SOD-723	7d	1a	Syn
7-	MAZS0750M	Z-diode	7.29..7.67V, 200mW	SOD-523	6d	1a	Pan
7 (white)	BAS170W	Si-diode	Schottky, GP, Hi-sp, 70V, 70mA, Vf<1V(15mA), <100ps	SOD-323	5d	2	Inf
7 (white)	BBY55-03W	C-diode	VCO-Tuning, 16V, 20mA, 14..16pF(10..2V)	SOD-323	5d	2	Inf
7 2	GDZ3V9B-V	Z-diode	3.89..4.16V, Izt=5mA, Zzt=100Ω, 200mW	SOD-323	5d	1k	Vs
7.	MMSZ5248SPT	Z-diode	17.64..18.36V, Izt=5mA, Zzt=42Ω, 225mW	SOD-523	7d	1a	Chm
7.0A	1SMC7.0A	TVS	Vbr=7.78..8.6V, Vrwm=7.0V, 125.0A, 1500W(1ms)	DO-214AB	1d	1a	Eic
7.0A	SMAJ7.0A	TVS	Vrwm=7.0V, Vbr=7.78..8.60V, 33.3A, 400W(1ms)	DO-214AC	1d	1a	Sus
7.0A	SMBJ7.0A	TVS	Vbr=7.78..8.6V, Vrwm=7.0V, 50.0A, 600W(1ms)	DO-214AA	1d	1a	Sus
7.0A	SMCJ7.0A	TVS	Vrwm=7V, Vbr=7.78..8.95V, 112.8A, 1500W(1ms)	DO-214AB	1d	1k	Sus
7.0CA	1SMC7.0CA	TVS	Vbr=7.78..8.6V, Vrwm=7.0V, 125.0A, 1500W(1ms), Bidirectional	DO-214AB	1ba	1j	Eic
7.0CA	SMAJ7.0CA	TVS	Vrwm=7.0V, Vbr=7.78..8.60V, 33.3A, 400W(1ms), Bidirectional	DO-214AC	1ba	1j	Sus
7.0CA	SMBJ7.0CA	TVS	Vbr=7.78..8.6V, Vrwm=7.0V, 50.0A, 600W(1ms), Bidirectional	DO-214AA	1ba	1j	Sus
7.0CA	SMCJ7.0CA	TVS	Vrwm=7V, Vbr=7.78..8.95V, 112.8A, 1500W(1ms), Bidirectional	DO-214AB	1ba	1l	Sus
7.5	MAZ5075	Z-diode	7..7.9V, Zzt=6Ω(5mA), 500mW	MP2	11d	1a	Pan
7.5	MAZ80750H	Z-diode	7.51..7.89V, Zzt=20Ω(5mA), 150mW	SC-76	6d	1a	Pan
7.5	MAZY075	Z-diode	6.8..8.3V, Zzt=30Ω(10mA), 1W	NMiniP2	1d	1a	Pan
7.5	P4SMA7.5	TVS	Vbr=6.75..8.25V, Vrwm=6.05V, 36.0A, 400W(1ms)	DO-214AC	1d	1a	Eic
7.5	U1Z7.5	Z-diode	6.8..8.3V, 1W	SOD-6	1d	1a	Tos
7.5	U1ZB7.5	Z-diode	6.8..8.3V, 1W	I-FLAT	1d	1a	Tos
7.5A	1SMC7.5A	TVS	Vbr=8.33..9.21V, Vrwm=7.5V, 116.3A, 1500W(1ms)	DO-214AB	1d	1a	Eic
7.5A	P4SMA7.5A	TVS	Vbr=7.13..7.88V, Vrwm=6.40V, 37.0A, 400W(1ms)	DO-214AC	1d	1a	Eic
7.5A	P6SMB7.5A	TVS	Vbr=7.13..7.88V, Vrwm=6.40V, 53.0A, 600W(1ms)	DO-214AA	1d	1a	Eic
7.5A	SMAJ7.5A	TVS	Vrwm=7.5V, Vbr=8.33..9.21V, 31.0A, 400W(1ms)	DO-214AC	1d	1a	Sus
7.5A	SMBJ7.5A	TVS	Vbr=8.33..9.21V, Vrwm=7.5V, 46.5A, 600W(1ms)	DO-214AA	1d	1a	Sus
7.5A	SMCJ7.5A	TVS	Vrwm=7.5V, Vbr=8.33..9.58V, 104.9A, 1500W(1ms)	DO-214AB	1d	1k	Sus
7.5B	HZF7.5BP	Z-diode	7.5V±5%, 900mW	LRP	1d	2f	Ren
7.5B	PTZ7.5B	Z-diode	7.5V±10%, 40mA, 1W	DO-214AC	1d	1a	Rhm
7.5C	HZF7.5CP	Z-diode	7.5V±10%, 900mW	LRP	1d	2f	Ren
7.5C	P4SMA7.5C	TVS	Vbr=6.75..8.25V, Vrwm=6.05V, 36.0A, 400W(1ms), Bidirectional	DO-214AC	1ba	1j	Eic
7.5CA	1SMC7.5CA	TVS	Vbr=8.33..9.21V, Vrwm=7.5V, 116.3A, 1500W(1ms), Bidirectional	DO-214AB	1ba	1j	Eic
7.5CA	P4SMA7.5CA	TVS	Vbr=7.13..7.88V, Vrwm=6.40V, 37.0A, 400W(1ms), Bidirectional	DO-214AC	1ba	1j	Eic
7.5CA	P6SMB7.5CA	TVS	Vbr=7.13..7.88V, Vrwm=6.40V, 53.0A, 600W(1ms), Bidirectional	DO-214AA	1ba	1j	Eic
7.5CA	SMAJ7.5CA	TVS	Vrwm=7.5V, Vbr=8.33..9.21V, 31.0A, 400W(1ms), Bidirectional	DO-214AC	1ba	1j	Sus
7.5CA	SMBJ7.5CA	TVS	Vbr=8.33..9.21V, Vrwm=7.5V, 46.5A, 600W(1ms), Bidirectional	DO-214AA	1ba	1j	Sus
7.5CA	SMCJ7.5CA	TVS	Vrwm=7.5V, Vbr=8.33..9.58V, 104.9A, 1500W(1ms), Bidirectional	DO-214AB	1ba	1l	Sus
7A	MAZS0750H	Z-diode	7.51..7.89V, 200mW	SOD-523	6d	1a	Pan
7A5	MAZ80750H	Z-diode	7.51..7.89V, Zzt=20Ω(5mA), 150mW	SC-76	6d	1a	Pan
7A5	MAZ8075GHL	Z-diode	7.51..7.89V, Zzt=20Ω(5mA), 150mW	SMini2-F3	6d	1a	Pan
7_	MAZS0750L	Z-diode	7.07..7.43V, 200mW	SOD-523	6d	1a	Pan
7_5	MAZ80750L	Z-diode	7.07..7.43V, Zzt=20Ω(5mA), 150mW	SC-76	6d	1a	Pan
7_5	MAZ8075GLL	Z-diode	7.07..7.43V, Zzt=20Ω(5mA), 150mW	SMini2-F3	6d	1a	Pan
75	HZU7.5B1	Z-diode	7.06..7.36V, Izt=5mA, Zzt=30Ω, 200mW	URP	5d	1a	Ren
75	HZU7.5B2	Z-diode	7.28..7.60V, Izt=5mA, Zzt=30Ω, 200mW	URP	5d	1a	Ren
75	HZU7.5B3	Z-diode	7.52..7.84V, Izt=5mA, Zzt=30Ω, 200mW	URP	5d	1a	Ren
75	RKZ7.5B2KG	Z-diode	7.28..7.60V, Izt=5mA, Zzt=30Ω, 200mW	URP	5d	2e	Ren
75	RKZ7.5B2KJ	Z-diode	7.28..7.60V, Izt=5mA, Zzt=30Ω, 150mW	UFP	7d	2e	Ren
701	MA2P701	Si-diode	HFR, 20V, 1A, Vf<0.55V(1A), 210pF, 14ns	Mini Power	11d	1a	Pan
701A	MA2P701A	Si-diode	HFR, 40V, 1A, Vf<0.55V(1A), 210pF, 14ns	Mini Power	11d	1a	Pan
70A	1SMC70A	TVS	Vbr=77.8..86V, Vrwm=70V, 13.3A, 1500W(1ms)	DO-214AB	1d	1a	Eic
70A	SMAJ70A	TVS	Vrwm=70V, Vbr=77.8..86.0V, 3.5A, 400W(1ms)	DO-214AC	1d	1a	Sus
70A	SMBJ70A	TVS	Vbr=77.8..86V, Vrwm=70V, 5.3A, 600W(1ms)	DO-214AA	1d	1a	Sus
70A	SMCJ70A	TVS	Vrwm=70V, Vbr=77.8..89.5V, 12A, 1500W(1ms)	DO-214AB	1d	1k	Sus
70A	UMA70A	TVS	Vrwm=70V, Vbr=77.8..113V, 4.4A, 500W(1ms)	UltraMite	14d	1v	Msc
70B	MMHZ5270BPT	Z-diode	86.45..95.55V, Izt=1.4mA, Zzt=400Ω, 225mW	SOD-123	5d	1a	Chm
70B	SMC5370B	Z-diode	56.0V±5%, Zzt=35(20.0mA), Izm=86.0mA, 5W	DO-214AB	1d	1a	Ers
70CA	1SMC70CA	TVS	Vbr=77.8..86V, Vrwm=70V, 13.3A, 1500W(1ms), Bidirectional	DO-214AB	1ba	1j	Eic
70CA	SMAJ70CA	TVS	Vrwm=70V, Vbr=77.8..86V, 3.5A, 400W(1ms), Bidirectional	DO-214AC	1ba	1j	Sus
70CA	SMBJ70CA	TVS	Vbr=77.8..86V, Vrwm=70V, 5.3A, 600W(1ms), Bidirectional	DO-214AA	1ba	1j	Sus
70CA	SMCJ70CA	TVS	Vrwm=70V, Vbr=77.8..89.5V, 12A, 1500W(1ms), Bidirectional	DO-214AB	1ba	1l	Sus
70CA	UMA70CA	TVS	Vrwm=70V, Vbr=77.8..113V, 4.4A, 500W(1ms), Bidirectional	UltraMite	14ba	1v	Msc
70DHP	BYG70D	Si-diode	Fast, Soft-Recovery, 200V, 1A, Vf<2.1V(1A), 30ns	DO-214AC	1d	1a	Phi
70GPH	BYG70G	Si-diode	Fast, Soft-Recovery, 400V, 1A, Vf<2.1V(1A), 30ns	DO-214AC	1d	1a	Phi
70JPH	BYG70J	Si-diode	Fast, Soft-Recovery, 600V, 1A, Vf<2.1V(1A), 30ns	DO-214AC	1d	1a	Phi
70S	MMHZ5270SPT	Z-diode	89.18..92.82V, Izt=1.4mA, Zzt=400Ω, 225mW	SOD-123	5d	1a	Chm



SMD code	Type	Function	Short description	Case	Pinout	St.	Mnf.
70V	SMA70	TVS	Vbr=77.8..95.1V, Vrw=70.0V, 2.4A, 300W(1ms)	DO-214AC	1d	1a	Mic
70V	SMB70	TVS	Vbr=77.8..95.1V, Vrw=70V, 4.8A, 600W(1ms)	DO-214AA	1d	1a	Mic
70V	SMC70	TVS	Vbr=77.8..95.1V, Vrw=70V, 12A, 1500W(1ms),	DO-214AB	1d	1a	Mic
70VA	SMA70A	TVS	Vbr=77.8..86V, Vrw=70.0V, 2.7A, 300W(1ms)	DO-214AC	1d	1a	Mic
70VA	SMB70A	TVS	Vbr=77.8..86V, Vrw=70V, 5.3A, 600W(1ms)	DO-214AA	1d	1a	Mic
70VA	SMC70A	TVS	Vbr=77.8..86V, Vrw=70V, 13.3A, 1500W(1ms),	DO-214AB	1d	1a	Mic
70VC	SMA70C	TVS	Vbr=77.8..95.1V, Vrw=70.0V, 2.4A, 300W(1ms), Bidirectional	DO-214AC	1ba	1j	Mic
70VC	SMB70C	TVS	Vbr=77.8..95.1V, Vrw=70V, 4.8A, 600W(1ms), Bidirectional	DO-214AA	1ba	1j	Mic
70VC	SMC70C	TVS	Vbr=77.8..95.1V, Vrw=70V, 12A, 1500W(1ms), Bidirectional	DO-214AB	1ba	1j	Mic
70VCA	SMA70CA	TVS	Vbr=77.8..86V, Vrw=70.0V, 2.7A, 300W(1ms), Bidirectional	DO-214AC	1ba	1j	Mic
70VCA	SMB70CA	TVS	Vbr=77.8..86V, Vrw=70V, 5.3A, 600W(1ms), Bidirectional	DO-214AA	1ba	1j	Mic
70VCA	SMC70CA	TVS	Vbr=77.8..86V, Vrw=70V, 13.3A, 1500W(1ms), Bidirectional	DO-214AB	1ba	1j	Mic
71B	SMC5371B	Z-diode	60.0V±5%, Zzt=40.0(20.0mA), Izm=79.0mA, 5W	DO-214AB	1d	1a	Ers
72	EDZ3.9B	Z-diode	3.89..4.16V, Izt=5mA, Zzt=100Ω, 150mW	SOD-523	6d	1a	Rhm
72	FDZ3.9EV	Z-diode	3.890..4.160V, Izt=5mA, Zzt=100Ω, 150mW	SOD-523	7d	1a	Fis
72	FDZ3.9VT	Z-diode	3.890..4.160V, Izt=5mA, Zzt=100Ω, 200mW	SOD-323	5d	1a	Fis
72	TDZ3.9B	Z-diode	3.9V±2.5%, 10mA, 500mW	TUMD2	7d	1s	Rhm
72	UDZS3.9B	Z-diode	3.89..4.16V, Izt=5mA, Zzt=100Ω, 200mW	SOD-323	5d	1a	Wtr
72	UDZS3.9B	Z-diode	3.9V±2.5%, Izt=5mA, 200mW	SOD-323FL	7d	1s	Rhm
72	VDZS3.9B	Z-diode	3.9V±5%, 5mA, 100mW	VMD2	5d	1z	Rhm
728A	1SMA4728A	Z-diode	3.3V±10%, Izt=76.0mA, Zzt=10Ω, 1W	DO-214AC	1d	1a	Eic
729A	1SMA4729A	Z-diode	3.6V±10%, Izt=69.0mA, Zzt=10Ω, 1W	DO-214AC	1d	1a	Eic
72B	SMC5372B	Z-diode	62.0V±5%, Zzt=42.0(20.0mA), Izm=76.0mA, 5W	DO-214AB	1d	1a	Ers
73	BAS70-02W	Si-diode	Schottky, 70V, 70mA, Vf<1V(15mA), <2pF, 5ns	SCD-80	6d	1u	Inf
730A	1SMA4730A	Z-diode	3.9V±10%, Izt=64.0mA, Zzt=9Ω, 1W	DO-214AC	1d	1a	Eic
731A	1SMA4731A	Z-diode	4.3V±10%, Izt=58.0mA, Zzt=9Ω, 1W	DO-214AC	1d	1a	Eic
732A	1SMA4732A	Z-diode	4.7V±10%, Izt=53.0mA, Zzt=8Ω, 1W	DO-214AC	1d	1a	Eic
733A	1SMA4733A	Z-diode	5.1V±10%, Izt=49.0mA, Zzt=7Ω, 1W	DO-214AC	1d	1a	Eic
734A	1SMA4734A	Z-diode	5.6V±10%, Izt=45.0mA, Zzt=5Ω, 1W	DO-214AC	1d	1a	Eic
735A	1SMA4735A	Z-diode	6.2V±10%, Izt=41.0mA, Zzt=2Ω, 1W	DO-214AC	1d	1a	Eic
736A	1SMA4736A	Z-diode	6.8V±10%, Izt=37.0mA, Zzt=3.5Ω, 1W	DO-214AC	1d	1a	Eic
736B	Z1SMA4736A	Z-diode	6.46..7.14V, Izt=37mA, Zzt=3.5Ω, 1W	DO-214AC	1d	1a	Ttr
737A	1SMA4737A	Z-diode	7.5V±10%, Izt=34.0mA, Zzt=4Ω, 1W	DO-214AC	1d	1a	Eic
737B	Z1SMA4737A	Z-diode	7.13..7.88V, Izt=34mA, Zzt=4Ω, 1W	DO-214AC	1d	1a	Ttr
738A	1SMA4738A	Z-diode	8.2V±10%, Izt=31.0mA, Zzt=4.5Ω, 1W	DO-214AC	1d	1a	Eic
738B	Z1SMA4738A	Z-diode	7.79..8.61V, Izt=31mA, Zzt=4.5Ω, 1W	DO-214AC	1d	1a	Ttr
739A	1SMA4739A	Z-diode	9.1V±10%, Izt=28.0mA, Zzt=5Ω, 1W	DO-214AC	1d	1a	Eic
739B	Z1SMA4739A	Z-diode	8.65..9.56V, Izt=28mA, Zzt=5Ω, 1W	DO-214AC	1d	1a	Ttr
73B	SMC5373B	Z-diode	68.0V±5%, Zzt=44.0(20.0mA), Izm=70.0mA, 5W	DO-214AB	1d	1a	Ers
740A	1SMA4740A	Z-diode	10V±10%, Izt=25.0mA, Zzt=7Ω, 1W	DO-214AC	1d	1a	Eic
740B	Z1SMA4740A	Z-diode	9.50..10.50V, Izt=25mA, Zzt=7Ω, 1W	DO-214AC	1d	1a	Ttr
741A	1SMA4741A	Z-diode	11V±10%, Izt=23.0mA, Zzt=8Ω, 1W	DO-214AC	1d	1a	Eic
741B	1SMA4741	Z-diode	11V±5%, Izt=23.0mA, Zzt=8Ω, 1W	DO-214AC	1d	1a	Pjt
741B	Z1SMA4741A	Z-diode	10.45..11.55V, Izt=23mA, Zzt=8Ω, 1W	DO-214AC	1d	1a	Ttr
742A	1SMA4742A	Z-diode	12V±10%, Izt=21.0mA, Zzt=9Ω, 1W	DO-214AC	1d	1a	Eic
742B	1SMA4742	Z-diode	12V±5%, Izt=21.0mA, Zzt=9Ω, 1W	DO-214AC	1d	1a	Pjt
742B	Z1SMA4742A	Z-diode	11.40..12.60V, Izt=21mA, Zzt=9Ω, 1W	DO-214AC	1d	1a	Ttr
743A	1SMA4743A	Z-diode	13V±10%, Izt=19.0mA, Zzt=10Ω, 1W	DO-214AC	1d	1a	Eic
743B	1SMA4743	Z-diode	13V±5%, Izt=19.0mA, Zzt=10Ω, 1W	DO-214AC	1d	1a	Pjt
743B	Z1SMA4743A	Z-diode	12.35..13.65V, Izt=19mA, Zzt=10Ω, 1W	DO-214AC	1d	1a	Ttr
744A	1SMA4744A	Z-diode	15V±10%, Izt=17.0mA, Zzt=14Ω, 1W	DO-214AC	1d	1a	Eic
744B	1SMA4744	Z-diode	15V±5%, Izt=17.0mA, Zzt=14Ω, 1W	DO-214AC	1d	1a	Pjt
744B	Z1SMA4744A	Z-diode	14.25..15.75V, Izt=17mA, Zzt=14Ω, 1W	DO-214AC	1d	1a	Ttr
745A	1SMA4745A	Z-diode	16V±10%, Izt=15.5mA, Zzt=16Ω, 1W	DO-214AC	1d	1a	Eic
745B	1SMA4745	Z-diode	16V±5%, Izt=15.5mA, Zzt=16Ω, 1W	DO-214AC	1d	1a	Pjt
745B	Z1SMA4745A	Z-diode	15.20..16.80V, Izt=15mA, Zzt=16Ω, 1W	DO-214AC	1d	1a	Ttr
746A	1SMA4746A	Z-diode	18V±10%, Izt=14.0mA, Zzt=20Ω, 1W	DO-214AC	1d	1a	Eic
746B	1SMA4746	Z-diode	18V±5%, Izt=14.0mA, Zzt=20Ω, 1W	DO-214AC	1d	1a	Pjt
746B	Z1SMA4746A	Z-diode	17.10..18.90V, Izt=14mA, Zzt=20Ω, 1W	DO-214AC	1d	1a	Ttr
747A	1SMA4747A	Z-diode	20V±10%, Izt=12.5mA, Zzt=22Ω, 1W	DO-214AC	1d	1a	Eic
747B	1SMA4747	Z-diode	20V±5%, Izt=12.5mA, Zzt=22Ω, 1W	DO-214AC	1d	1a	Pjt
747B	Z1SMA4747A	Z-diode	19.0..21.0V, Izt=12.5mA, Zzt=22Ω, 1W	DO-214AC	1d	1a	Ttr
748A	1SMA4748A	Z-diode	22V±10%, Izt=11.5mA, Zzt=23Ω, 1W	DO-214AC	1d	1a	Eic
748B	1SMA4748	Z-diode	22V±5%, Izt=11.5mA, Zzt=23Ω, 1W	DO-214AC	1d	1a	Pjt
748B	Z1SMA4748A	Z-diode	20.90..23.10V, Izt=11.5mA, Zzt=23Ω, 1W	DO-214AC	1d	1a	Ttr
749A	1SMA4749A	Z-diode	24V±10%, Izt=10.5mA, Zzt=25Ω, 1W	DO-214AC	1d	1a	Eic
749B	1SMA4749	Z-diode	24V±5%, Izt=10.5mA, Zzt=25Ω, 1W	DO-214AC	1d	1a	Pjt
749B	Z1SMA4749A	Z-diode	22.80..25.20V, Izt=10.5mA, Zzt=25Ω, 1W	DO-214AC	1d	1a	Ttr
74B	SMC5374B	Z-diode	75.0V±5%, Zzt=45.0(20.0mA), Izm=63.0mA, 5W	DO-214AB	1d	1a	Ers
75	BZX584B4V7	Z-diode	4.61..4.79V, Izt=5mA, Zzt=80Ω, 200mW	SOD-523FL	7d	1a	Tac



SMD
code

Type

Function

Short description

Case

Pinout

St.

Mnf.

SMD code	Type	Function	Short description	Case	Pinout	St.	Mnf.
75	CDZ55C75	Z-diode	71.25..78.75V, Zzt=250Ω, Izt=2.25mA, 500mW	1206	70d	2d	Crp
75	CDZ55C75S	Z-diode	71.25..78.75V, Zzt=250Ω, Izt=2.25mA, 500mW	0805	70d	2d	Crp
75	CDZ55C75T	Z-diode	71.25..78.75V, Zzt=250Ω, Izt=2.25mA, 200mW	0603	70d	2d	Crp
75	EDZ20B	Z-diode	19.52..20.39V, Izt=5mA, Zzt=85Ω, 150mW	SOD-523	6d	1a	Rhm
75	FDZ20EV	Z-diode	19.520..20.390V, Izt=5mA, Zzt=85Ω, 150mW	SOD-523	7d	1a	Fis
75	FDZ20VT	Z-diode	19.520..20.390V, Izt=5mA, Zzt=85Ω, 200mW	SOD-323	5d	1a	Fis
75	HZC7.5	Z-diode	7.5V±10%, 150mW	SOD-523	6d	1a	Ren
75	HZU7.5G	Z-diode	7.06..7.84V, 200mW	SOD-323	5d	1a	Ren
75	KDZ7.5EV	Z-diode	7..7.9 5V, 150mW	SOD-523	6d	1a	Kec
75	KDZ7.5V	Z-diode	7..7.9V, 150mW	SOD-323	5d	1a	Kec
75	MMSZ4V7B	Z-diode	4.61..4.79V, Izt=5mA, Zzt=80Ω, 200mW	SOD-523FL	7d	1a	Tac
75	MMPZ52675PT	Z-diode	73.50..76.50V, Izt=1.7mA, Zzt=270Ω, 225mW	SOD-323	5d	1a	Chm
75	P4SMA75	TVS	Vbr=67.5..82.5V, Vrrwm=60.7V, 3.9A, 400W(1ms)	DO-214AC	1d	1a	Eic
75	P6SMBJ75	TVS	Vbr=67.5..82.5V, 5.5A, 600W(1ms)	DO-214AA	1d	1n	Lif
75	SML4761	Z-diode	75V±5%, Izt=3.3mA, Zzt=175Ω, 1W	DO-214AC	1d	1k	Vs
75	TDZ20B	Z-diode	20V±2.5%, 10mA, 500mW	TUMD2	7d	1s	Rhm
75	TZD7.5WS	Z-diode	7.0..7.90V, Izt=5mA, Zzt=23Ω, 200mW	SOD-323	5d	1a	Ttr
75	TZD7.5WT	Z-diode	7.0..7.90V, Izt=5mA, Zzt=23Ω, 150mW	SOD-523	6d	1a	Ttr
75	U1Z75	Z-diode	67.5..82.5V, 1W	SOD-6	1d	1a	Tos
75	U1ZB75	Z-diode	67.5..82.5V, 1W	I-FLAT	1d	1a	Tos
75	UDZS20B	Z-diode	19.52..20.39V, Izt=5mA, Zzt=85Ω, 200mW	SOD-323	5d	1a	Wtr
75	UDZS20B	Z-diode	20V±2.5%, Izt=5mA, 200mW	SOD-323FL	7d	1s	Rhm
75	VDZS20B	Z-diode	20V±5%, 5mA, 100mW	VMD2	5d	1z	Rhm
7-5	MAZ80750M	Z-diode	7.29..7.67V, Zzt=20Ω(5mA), 150mW	SC-76	6d	1a	Pan
7-5	MAZ8075GML	Z-diode	7.29..7.67V, Zzt=20Ω(5mA), 150mW	SMini2-F3	6d	1a	Pan
75+	TZD7.5YWS	Z-diode	7.28..7.60V, Izt=5mA, Zzt=23Ω, 200mW	SOD-323	5d	1a	Ttr
75+	TZD7.5YWT	Z-diode	7.28..7.60V, Izt=5mA, Zzt=23Ω, 150mW	SOD-523	6d	1a	Ttr
750A	1SMA4750A	Z-diode	27V±10%, Izt=9.5mA, Zzt=35Ω, 1W	DO-214AC	1d	1a	Eic
750B	1SMA4750	Z-diode	27V±5%, Izt=9.5mA, Zzt=35Ω, 1W	DO-214AC	1d	1a	Pjt
750B	Z1SMA4750A	Z-diode	25.65..28.35V, Izt=9.5mA, Zzt=35Ω, 1W	DO-214AC	1d	1a	Ttr
751A	1SMA4751A	Z-diode	30V±10%, Izt=8.5mA, Zzt=40Ω, 1W	DO-214AC	1d	1a	Eic
751B	1SMA4751	Z-diode	30V±5%, Izt=8.5mA, Zzt=40Ω, 1W	DO-214AC	1d	1a	Pjt
751B	Z1SMA4751A	Z-diode	28.50..31.50V, Izt=8.5mA, Zzt=40Ω, 1W	DO-214AC	1d	1a	Ttr
752A	1SMA4752A	Z-diode	33V±10%, Izt=7.5mA, Zzt=45Ω, 1W	DO-214AC	1d	1a	Eic
752B	1SMA4752	Z-diode	33V±5%, Izt=7.5mA, Zzt=45Ω, 1W	DO-214AC	1d	1a	Pjt
752B	Z1SMA4752A	Z-diode	31.35..34.65V, Izt=7.5mA, Zzt=45Ω, 1W	DO-214AC	1d	1a	Ttr
753A	1SMA4753A	Z-diode	36V±10%, Izt=7.0mA, Zzt=50Ω, 1W	DO-214AC	1d	1a	Eic
753B	1SMA4753	Z-diode	36V±5%, Izt=7.0mA, Zzt=50Ω, 1W	DO-214AC	1d	1a	Pjt
753B	Z1SMA4753A	Z-diode	34.20..37.80V, Izt=7.0mA, Zzt=50Ω, 1W	DO-214AC	1d	1a	Ttr
754A	1SMA4754A	Z-diode	39V±10%, Izt=6.5mA, Zzt=60Ω, 1W	DO-214AC	1d	1a	Eic
754B	1SMA4754	Z-diode	39V±5%, Izt=6.5mA, Zzt=60Ω, 1W	DO-214AC	1d	1a	Pjt
754B	Z1SMA4754A	Z-diode	37.05..40.95V, Izt=6.5mA, Zzt=60Ω, 1W	DO-214AC	1d	1a	Ttr
755A	1SMA4755A	Z-diode	43V±10%, Izt=6.0mA, Zzt=70Ω, 1W	DO-214AC	1d	1a	Eic
755B	1SMA4755	Z-diode	43V±5%, Izt=6.0mA, Zzt=70Ω, 1W	DO-214AC	1d	1a	Pjt
755B	Z1SMA4755A	Z-diode	40.85..45.15V, Izt=6.0mA, Zzt=70Ω, 1W	DO-214AC	1d	1a	Ttr
756A	1SMA4756A	Z-diode	47V±10%, Izt=5.5mA, Zzt=80Ω, 1W	DO-214AC	1d	1a	Eic
756B	1SMA4756	Z-diode	47V±5%, Izt=5.5mA, Zzt=80Ω, 1W	DO-214AC	1d	1a	Pjt
756B	Z1SMA4756A	Z-diode	44.65..49.35V, Izt=5.5mA, Zzt=80Ω, 1W	DO-214AC	1d	1a	Ttr
757A	1SMA4757A	Z-diode	51V±10%, Izt=5mA, Zzt=95Ω, 1W	DO-214AC	1d	1a	Eic
757B	1SMA4757	Z-diode	51V±5%, Izt=5mA, Zzt=95Ω, 1W	DO-214AC	1d	1a	Pjt
757B	Z1SMA4757A	Z-diode	48.45..53.55V, Izt=5.0mA, Zzt=95Ω, 1W	DO-214AC	1d	1a	Ttr
758A	1SMA4758A	Z-diode	56V±10%, Izt=4.5mA, Zzt=110Ω, 1W	DO-214AC	1d	1a	Eic
758B	1SMA4758	Z-diode	56V±5%, Izt=4.5mA, Zzt=110Ω, 1W	DO-214AC	1d	1a	Pjt
759A	1SMA4759A	Z-diode	62V±10%, Izt=4.0mA, Zzt=125Ω, 1W	DO-214AC	1d	1a	Eic
759B	1SMA4759	Z-diode	62V±5%, Izt=4.0mA, Zzt=125Ω, 1W	DO-214AC	1d	1a	Pjt
75A	1.5SMC110A	TVS	Vrrwm=94.0V, Vbr=105.0..116.0V, 10.0A, 1500W(1ms)	DO-214AB	1d	1a	Fee
75A	1.5SMC75A	TVS	Vbr=71.3..78.8V, Vrrwm=64.1V, 14.6A, 1500W(1ms)	DO-214AB	1d,3d	1a,1k	Vs,Ons
75A	1SMC75A	TVS	Vbr=83.3..92.1V, Vrrwm=75V, 12.4A, 1500W(1ms)	DO-214AB	1d	1a	Eic
75A	P4SMA75A	TVS	Vbr=71.3..78.8V, Vrrwm=64.1V, 4.1A, 400W(1ms)	DO-214AC	1d	1k	Vs
75A	P6SMB75A	TVS	Vrrwm=75V, Vbr=71.3..78.8V, 5.8A, 600W(1ms)	DO-214AA	1d,3d	1k,1a	Vs,Ons
75A	P6SMBJ75A	TVS	Vbr=71.3..78.8V, 5.8A, 600W(1ms)	DO-214AA	1d	1n	Lif
75A	SMAJ75A	TVS	Vrrwm=75V, Vbr=83.3..92.1V, 3.3A, 400W(1ms)	DO-214AC	1d	1a	Sus
75A	SMBJ75A	TVS	Vbr=83.3..92.1V, Vrrwm=75V, 4.9A, 600W(1ms)	DO-214AA	1d	1a	Sus
75A	SMCJ75A	TVS	Vrrwm=75V, Vbr=83.3..95.8V, 12.4A, 1500W(1mS)	DO-214AB	1d	1k	Sus
75A	UMA75A	TVS	Vrrwm=75V, Vbr=83.3..121V, 4.1A, 500W(1ms)	UltraMite	14d	1v	Msc
75B	1SMB3EZ75	Z-diode	75V±5%, Zzt=90Ω, Izt=10.0mA, 3W	DO-214AA	1d	1a	Pjt
75B	SMC5375B	Z-diode	82.0V±5%, Zzt=65.0(15.0mA), Izm=58.0mA, 5W	DO-214AB	1d	1a	Ers
75C	1.5SMC75CA	TVS	Vbr=71.3..78.8V, Vrrwm=64.1V, 14.6A, 1500W(1ms), Bidirectional	DO-214AB	1ba	1l	Vs
75C	P4SMA75C	TVS	Vbr=67.5..82.5V, Vrrwm=60.7V, 3.9A, 400W(1ms), Bidirectional	DO-214AC	1ba	1j	Eic
75C	P4SMA75CA	TVS	Vbr=71.3..78.8V, 3.9A, 400W(1ms), Bidirectional	DO-214AC	1ba	1l	Vs



SMD code	Type	Function	Short description	Case	Pinout	St.	Mnf.
75C	P6SMB75CA	TVS	Vrwm=75V, Vbr=71.3..78.8V, 5.8A, 600W(1ms), Bidirectional	DO-214AA	1ba,3ba	11,e	Vs,Ons
75C	P6SMBJ75C	TVS	Vbr=67.5..82.5V, 5.5A, 600W(1ms), Bidirectional	DO-214AA	1ba	1p	Lif
75CA	1SMC75CA	TVS	Vbr=83.3..92.1V, Vrwm=75V, 12.4A, 1500W(1ms), Bidirectional	DO-214AB	1ba	1j	Eic
75CA	P4SMA75CA	TVS	Vbr=71.3..78.8V, Vrwm=64.1V, 4.1A, 400W(1ms), Bidirectional	DO-214AC	1ba	1j	Eic
75CA	P6SMB75CA	TVS	Vbr=71.3..78.8V, Vrwm=64.1V, 5.8A, 600W(1ms), Bidirectional	DO-214AA	1ba	1j	Eic
75CA	P6SMBJ75CA	TVS	Vbr=71.3..78.8V, 5.8A, 600W(1ms), Bidirectional	DO-214AA	1ba	1p	Lif
75CA	SMAJ75CA	TVS	Vrwm=75V, Vbr=83.3..92.1V, 3.3A, 400W(1ms), Bidirectional	DO-214AC	1ba	1j	Sus
75CA	SMBJ75CA	TVS	Vbr=83.3..92.1V, Vrwm=75V, 4.9A, 600W(1ms), Bidirectional	DO-214AA	1ba	1j	Sus
75CA	SMCJ75CA	TVS	Vrwm=75V, Vbr=83.3..95.8V, 11.2A, 1500W(1ms), Bidirectional	DO-214AB	1ba	1l	Sus
75CA	UMA75CA	TVS	Vrwm=75V, Vbr=83.3..121V, 4.1A, 500W(1ms), Bidirectional	UltraMite	14ba	1v	Msc
75P	BZD27C75P	Z-diode	71.25..78.75V, Zt=100Ω, Izt=10mA, 800mW	SOD-123FL	7d	1a	Pjt
75P	MFPZ75	Z-diode	71.25..78.75V, Izt=10mA, Zt=100Ω, 800mW	SOD-123FL	7d	1a	Tr
75V	SMA75	TVS	Vbr=83.3..102V, Vrwm=75.0V, 2.2A, 300W(1ms)	DO-214AC	1d	1a	Mic
75V	SMB75	TVS	Vbr=83.3..102V, Vrwm=75V, 4.5A, 600W(1ms)	DO-214AA	1d	1a	Mic
75V	SMC75	TVS	Vbr=83.3..102V, Vrwm=75V, 11.2A, 1500W(1ms)	DO-214AB	1d	1a	Mic
75VA	SMA75A	TVS	Vbr=83.3..92.1V, Vrwm=75.0V, 2.5A, 300W(1ms)	DO-214AC	1d	1a	Mic
75VA	SMB75A	TVS	Vbr=83.3..92.1V, Vrwm=75V, 5A, 600W(1ms)	DO-214AA	1d	1a	Mic
75VA	SMC75A	TVS	Vbr=83.3..92.1V, Vrwm=75V, 12.4A, 1500W(1ms)	DO-214AB	1d	1a	Mic
75VB	BZT52-B75	Z-diode	73.50..76.50V, Izt=2mA, Zt=255Ω, 500mW	SOD-123FL	7d	1a	Tsc
75VB	MMSZ75VBW	Z-diode	73.50..76.50V, Izt=2mA, Zt=255Ω, 500mW	SOD-123FL	7d	1a	Tac
75VC	SMA75C	TVS	Vbr=83.3..102V, Vrwm=75.0V, 2.2A, 300W(1ms), Bidirectional	DO-214AC	1ba	1j	Mic
75VC	SMB75C	TVS	Vbr=83.3..102V, Vrwm=75V, 4.5A, 600W(1ms), Bidirectional	DO-214AA	1ba	1j	Mic
75VC	SMC75C	TVS	Vbr=83.3..102V, Vrwm=75V, 11.2A, 1500W(1ms), Bidirectional	DO-214AB	1ba	1j	Mic
75VCA	SMA75CA	TVS	Vbr=83.3..92.1V, Vrwm=75.0V, 2.5A, 300W(1ms), Bidirectional	DO-214AC	1ba	1j	Mic
75VCA	SMB75CA	TVS	Vbr=83.3..92.1V, Vrwm=75V, 5A, 600W(1ms), Bidirectional	DO-214AA	1ba	1j	Mic
75VCA	SMC75CA	TVS	Vbr=83.3..92.1V, Vrwm=75V, 12.4A, 1500W(1ms), Bidirectional	DO-214AB	1ba	1j	Mic
75VZ	BZT52-C75	Z-diode	71.25..78.75V, Izt=2mA, Zt=255Ω, 500mW	SOD-123FL	7d	1a	Tsc
75VZ	MMSZ75VCW	Z-diode	71.25..78.75V, Izt=2mA, Zt=255Ω, 500mW	SOD-123FL	7d	1a	Tac
75VZ	TCMMSZ75V	Z-diode	75V±5%, Izt=5mA, Zt=240Ω, 500mW	SOD-123FL	7d	1a	Tac
75VZ	ZGFM0575C-MH	Z-diode	71.25..78.75V, Izt=5mA, Zt=240Ω, 500mW	SOD-123	5d	1a	Pic
760A	1SMA4760A	Z-diode	68V±10%, Izt=3.7mA, Zt=150Ω, 1W	DO-214AC	1d	1a	Eic
760B	1SMA4760	Z-diode	68V±5%, Izt=3.7mA, Zt=150Ω, 1W	DO-214AC	1d	1a	Pjt
761A	1SMA4761A	Z-diode	75V±10%, Izt=3.3mA, Zt=175Ω, 1W	DO-214AC	1d	1a	Eic
761B	1SMA4761	Z-diode	75V±5%, Izt=3.3mA, Zt=175Ω, 1W	DO-214AC	1d	1a	Pjt
762A	1SMA4762A	Z-diode	82V±10%, Izt=3.0mA, Zt=200Ω, 1W	DO-214AC	1d	1a	Eic
762B	1SMA4762	Z-diode	82V±5%, Izt=3.0mA, Zt=200Ω, 1W	DO-214AC	1d	1a	Pjt
763A	1SMA4763A	Z-diode	91V±10%, Izt=2.8mA, Zt=250Ω, 1W	DO-214AC	1d	1a	Eic
763B	1SMA4763	Z-diode	91V±5%, Izt=2.8mA, Zt=250Ω, 1W	DO-214AC	1d	1a	Pjt
764A	1SMA4764A	Z-diode	100V±10%, Izt=2.5mA, Zt=350Ω, 1W	DO-214AC	1d	1a	Eic
764B	1SMA4764	Z-diode	100V±5%, Izt=2.5mA, Zt=350Ω, 1W	DO-214AC	1d	1a	Pjt
76B	SMC5376B	Z-diode	87.0V±5%, Zt=75.0(15.0mA), Izm=54.5mA, 5W	DO-214AB	1d	1a	Ers
77	BBY55-02W	C-diode	VCO-Tuning, 16V, 20mA, 14..16pF(10..2V)	SCD-80	6d	1u	Inf
77B	SMC5377B	Z-diode	91.0V±5%, Zt=75.0(15.0mA), Izm=52.5mA, 5W	DO-214AB	1d	1a	Ers
77ZA	BYD77A	Si-diode	U-Fast, Controlled avalanche, 50V, 1A, Vf<0.95V(1A), 30ns	1206	14d	1v	Zow
77ZB	BYD77B	Si-diode	U-Fast, Controlled avalanche, 100V, 1A, Vf<0.95V(1A), 30ns	1206	14d	1v	Zow
77ZD	BYD77D	Si-diode	U-Fast, Controlled avalanche, 200V, 1A, Vf<1V(1A), 25ns	1206	14d	1v	Zow
77ZG	BYD77G	Si-diode	U-Fast, Controlled avalanche, 400V, 1A, Vf<1V(1A), 50ns	1206	14d	1v	Zow
78A	1SMC78A	TVS	Vbr=86.7..95.8V, Vrwm=78V, 11.9A, 1500W(1ms)	DO-214AB	1d	1a	Eic
78A	SMAJ78A	TVS	Vrwm=78V, Vbr=86.7..95.8V, 3.2A, 400W(1ms)	DO-214AC	1d	1a	Sus
78A	SMBJ78A	TVS	Vbr=86.7..95.8V, Vrwm=78V, 4.7A, 600W(1ms)	DO-214AA	1d	1a	Sus
78A	SMCJ78A	TVS	Vrwm=78V, Vbr=86.7..99.7V, 10.8A, 1500W(1ms)	DO-214AB	1d	1k	Sus
78A	UMA78A	TVS	Vrwm=78V, Vbr=86.7..126V, 4.0A, 500W(1ms)	UltraMite	14d	1v	Msc
78B	SMC5378B	Z-diode	100.0V±5%, Zt=90.0(12.0mA), Izm=47.5mA, 5W	DO-214AB	1d	1a	Ers
78CA	1SMC78CA	TVS	Vbr=86.7..95.8V, Vrwm=78V, 11.9A, 1500W(1ms), Bidirectional	DO-214AB	1ba	1j	Eic
78CA	SMAJ78CA	TVS	Vrwm=78V, Vbr=86.7..95.8V, 3.2A, 400W(1ms), Bidirectional	DO-214AC	1ba	1j	Sus
78CA	SMBJ78CA	TVS	Vbr=86.7..95.8V, Vrwm=78V, 4.7A, 600W(1ms), Bidirectional	DO-214AA	1ba	1j	Sus
78CA	SMCJ78CA	TVS	Vrwm=78V, Vbr=86.7..99.7V, 10.8A, 1500W(1ms), Bidirectional	DO-214AB	1ba	1l	Sus
78CA	UMA78CA	TVS	Vrwm=78V, Vbr=86.7..126V, 4.0A, 500W(1ms), Bidirectional	UltraMite	14ba	1v	Msc
78V	SMA78	TVS	Vbr=86.7..106V, Vrwm=78.0V, 2.2A, 300W(1ms)	DO-214AC	1d	1a	Mic
78V	SMB78	TVS	Vbr=86.7..106V, Vrwm=78V, 4.3A, 600W(1ms)	DO-214AA	1d	1a	Mic
78V	SMC78	TVS	Vbr=86.7..106V, Vrwm=78V, 10.8A, 1500W(1ms)	DO-214AB	1d	1a	Mic
78VA	SMA78A	TVS	Vbr=86.7..95.8V, Vrwm=78.0V, 2.4A, 300W(1ms)	DO-214AC	1d	1a	Mic
78VA	SMB78A	TVS	Vbr=86.7..95.8V, Vrwm=78V, 4.8A, 600W(1ms)	DO-214AA	1d	1a	Mic
78VA	SMC78A	TVS	Vbr=86.7..95.8V, Vrwm=78V, 11.9A, 1500W(1ms)	DO-214AB	1d	1a	Mic
78VC	SMA78C	TVS	Vbr=86.7..106V, Vrwm=78.0V, 2.2A, 300W(1ms), Bidirectional	DO-214AC	1ba	1j	Mic
78VC	SMB78C	TVS	Vbr=86.7..106V, Vrwm=78V, 4.3A, 600W(1ms), Bidirectional	DO-214AA	1ba	1j	Mic
78VC	SMC78C	TVS	Vbr=86.7..106V, Vrwm=78V, 10.8A, 1500W(1ms), Bidirectional	DO-214AB	1ba	1j	Mic
78VCA	SMA78CA	TVS	Vbr=86.7..95.8V, Vrwm=78.0V, 2.4A, 300W(1ms), Bidirectional	DO-214AC	1ba	1j	Mic
78VCA	SMB78CA	TVS	Vbr=86.7..95.8V, Vrwm=78V, 4.8A, 600W(1ms), Bidirectional	DO-214AA	1ba	1j	Mic
78VCA	SMC78CA	TVS	Vbr=86.7..95.8V, Vrwm=78V, 11.9A, 1500W(1ms), Bidirectional	DO-214AB	1ba	1j	Mic



SMD code	Type	Function	Short description	Case	Pinout	St.	Mnf.
7A	MA2Z374	C-diode	CATV-tuning, 32V, 87/2pF(0/25V), 0.9C(470MHz)	SOD-123	5d	1a	Pan
7A	MA374	C-diode	CATV-tuning, 32V, 87/2pF(0/25V), 0.9C(470MHz)	SOD-123	5d	1a	Pan
7A1	MM1ZB27H	Z-diode	26.46..27.54V, Izt=5mA, Zzt=70Ω, 500mW	SOD-123	5d	1a	Zow
7A5	RKZ7.5AKU	Z-diode	6.85..7.22V, Izt=20mA, Zzt=30Ω, 500mW	TURP-FM	7d	1a	Ren
7B1	MM1ZB30H	Z-diode	29.4..30.6V, Izt=5mA, Zzt=80Ω, 500mW	SOD-123	5d	1a	Zow
7B5	RKZ7.5BKU	Z-diode	7.07..7.45V, Izt=20mA, Zzt=30Ω, 500mW	TURP-FM	7d	1a	Ren
7C	MA2Z376	C-diode	UHF-band VCO, 6V, 14/6.8pF(1/3V), 0.3C(470MHz)	SOD-123	5d	1a	Pan
7C	MA376	C-diode	UHF-band VCO, 6V, 14/6.8pF(1/3V), 0.3C(470MHz)	SOD-123	5d	1a	Pan
7C	MM3Z2V4B	Z-diode	2.30..2.65V, Izt=5mA, Zzt=100Ω, 300mW	SOD-323FL	7d	1a	Lge
7C1	MM1ZB33H	Z-diode	32.34..33.66V, Izt=5mA, Zzt=80Ω, 500mW	SOD-123	5d	1a	Zow
7C5	RKZ7.5CKU	Z-diode	7.29..7.67V, Izt=20mA, Zzt=30Ω, 500mW	TURP-FM	7d	1a	Ren
7D	MA2Z377	C-diode	UHF-band VCO, 12V, 20mA, 2.8/1.1pF(2/10V), 0.6C(470MHz)	SOD-123	5d	1a	Pan
7D	MA377	C-diode	UHF-band VCO, 12V, 20mA, 2.8/1.1pF(2/10V), 0.6C(470MHz)	SOD-123	5d	1a	Pan
7D	MM3Z2V7B	Z-diode	2.65..2.95V, Izt=5mA, Zzt=110Ω, 300mW	SOD-323FL	7d	1a	Lge
7D1	MM1ZB36H	Z-diode	35.28..36.72V, Izt=5mA, Zzt=90Ω, 500mW	SOD-123	5d	1a	Zow
7E	CDZ55C7V5T	Z-diode	7.13..7.88V, Zzt=7Ω, Izt=5mA, 200mW	0805	70d	2d	Crp
7E	MM3Z3V0B	Z-diode	2.95..3.25V, Izt=5mA, Zzt=120Ω, 300mW	SOD-323FL	7d	1a	Lge
7E1	MM1ZB39H	Z-diode	38.22..39.78V, Izt=2.5mA, Zzt=100Ω, 500mW	SOD-123	5d	1a	Zow
7F	MAZD390	Z-diode	37..41V, Zzt=300Ω(5mA), 120mW	SSSMini2	7d	1a	Pan
7F	MM3Z3V3B	Z-diode	3.25..3.55V, Izt=5mA, Zzt=120Ω, 300mW	SOD-323FL	7d	1a	Lge
7F1	MM1ZB43H	Z-diode	42.14..43.86V, Izt=2.5mA, Zzt=130Ω, 500mW	SOD-123	5d	1a	Zow
7G1	MM1ZB47H	Z-diode	46.06..47.94V, Izt=2.5mA, Zzt=150Ω, 500mW	SOD-123	5d	1a	Zow
7H	MM3Z3V6B	Z-diode	3.60..3.84V, Izt=5mA, Zzt=100Ω, 300mW	SOD-323FL	7d	1a	Lge
7H1	MM1ZB51H	Z-diode	49.98..52.02V, Izt=2.5mA, Zzt=180Ω, 500mW	SOD-123	5d	1a	Zow
7J	MM3Z3V9B	Z-diode	3.89..4.16V, Izt=5mA, Zzt=100Ω, 300mW	SOD-323FL	7d	1a	Lge
7J1	MM1ZB56H	Z-diode	54.88..57.12V, Izt=2.5mA, Zzt=180Ω, 500mW	SOD-123	5d	1a	Zow
7K	MA2Z357	C-diode	CATV-tuning, 34V, 58/2.53pF(0/25V), 0.54C(470MHz)	SOD-123	5d	1a	Pan
7K	MA2Z357J	C-diode	CATV-tuning, 34V, 58/2.53pF(0/25V), 0.54C(470MHz)	SOD-523	6d	1a	Pan
7K	MA357	C-diode	CATV-tuning, 34V, 58/2.53pF(0/25V), 0.54C(470MHz)	SOD-123	5d	1a	Pan
7K	MA357J	C-diode	CATV-tuning, 34V, 58/2.53pF(0/25V), 0.54C(470MHz)	SOD-523	6d	1a	Pan
7K	MM3Z4V3B	Z-diode	4.17..4.43V, Izt=5mA, Zzt=100Ω, 300mW	SOD-323FL	7d	1a	Lge
7K1	MM1ZB62H	Z-diode	60.76..63.24V, Izt=2.5mA, Zzt=200Ω, 500mW	SOD-123	5d	1a	Zow
7L	MA379	C-diode	UHF-tuner, 32V, 6.3/0.95pF(2/25V)	SOD-323	5d	1a	Pan
7L1	MM1ZB66H	Z-diode	66.64..69.36V, Izt=2.5mA, Zzt=250Ω, 500mW	SOD-123	5d	1a	Zow
7M	MM3Z4V7B	Z-diode	4.55..4.75V, Izt=5mA, Zzt=100Ω, 300mW	SOD-323FL	7d	1a	Lge
7M1	MM1ZB75H	Z-diode	73.5..76.5V, Izt=2.5mA, Zzt=300Ω, 500mW	SOD-123	5d	1a	Zow
7N	CMDZ1L8	Z-diode	1.71..1.89V, Izt=0.5mA, Zzt=1200Ω, 250mW	SOD-323	5d	1a	Cen
7N	MA2Z392	C-diode	GaAs, VCO, 10V, 40mA, 5/1.8pF(1/4V), 0.3C(470MHz)	SOD-123	5d	1a	Pan
7N	MA392	C-diode	GaAs, VCO, 10V, 40mA, 5/1.8pF(1/4V), 0.3C(470MHz)	SOD-123	5d	1a	Pan
7N	MM3Z5V1B	Z-diode	4.98..5.20V, Izt=5mA, Zzt=80Ω, 300mW	SOD-323FL	7d	1a	Lge
7P	CMDZ33L	Z-diode	31.35..34.65V, Izt=0.5mA, Zzt=250Ω, 250mW	SOD-323	5d	1a	Cen
7P	MA2Z393	C-diode	GaAs, VCO, 10V, 50mA, 10.5/3.6pF(1/4V), 0.3C(470MHz)	SOD-123	5d	1a	Pan
7P	MA393	C-diode	GaAs, VCO, 10V, 50mA, 10.5/3.6pF(1/4V), 0.3C(470MHz)	SOD-123	5d	1a	Pan
7P	MM3Z5B6H	Z-diode	5.488..5.712V, Izt=5mA, Zzt=80Ω, 300mW	SOD-323	5d	1a	Zow
7P	MM3Z5V6B	Z-diode	5.49..5.73V, Izt=5mA, Zzt=60Ω, 300mW	SOD-323FL	7d	1a	Lge
7P5	SML4737	Z-diode	7.5V±5%, Izt=34mA, Zzt=4Ω, 1W	DO-214AC	1d	1k	Vs
7R	MM3Z6V2B	Z-diode	6.06..6.33V, Izt=5mA, Zzt=60Ω, 300mW	SOD-323FL	7d	1a	Lge
7S	MA2Z391	C-diode	Ga-As VCO, 10V, 30mA, 3.7/1.4pF(1/4V), 0.3C(470MHz)	SOD-123	5d	1a	Pan
7S	MA391	C-diode	Ga-As VCO, 10V, 30mA, 3.7/1.4pF(1/4V), 0.3C(470MHz)	SOD-123	5d	1a	Pan
7U	MA10301	C-diode	VCO, 15V, 21.5/15.9pF(1/2V), 0.35C(100MHz)	SOD-123	5d	1b	Pan
7V0	SMA7.0	TVS	Vbr=7.78..9.51V, Vrw=7.0V, 22.6A, 300W(1ms)	DO-214AC	1d	1a	Mic
7V0	SMB7.0	TVS	Vbr=7.78..9.51V, Vrw=7V, 45.1A, 600W(1ms)	DO-214AA	1d	1a	Mic
7V0	SMC7.0	TVS	Vbr=7.78..9.51V, Vrw=7V, 112.8A, 1500W(1ms), Bidirectional	DO-214AB	1d	1a	Mic
7V0A	SMA7.0A	TVS	Vbr=7.78..8.6V, Vrw=7.0V, 25A, 300W(1ms)	DO-214AC	1d	1a	Mic
7V0A	SMB7.0A	TVS	Vbr=7.78..8.6V, Vrw=7V, 50A, 600W(1ms)	DO-214AA	1d	1a	Mic
7V0A	SMC7.0A	TVS	Vbr=7.78..8.6V, Vrw=7V, 125A, 1500W(1ms), Bidirectional	DO-214AB	1d	1a	Mic
7V0C	SMA7.0C	TVS	Vbr=7.78..9.51V, Vrw=7.0V, 22.6A, 300W(1ms), Bidirectional	DO-214AC	1ba	1j	Mic
7V0C	SMA7.5C	TVS	Vbr=8.33..10.3V, Vrw=7.5V, 21A, 300W(1ms), Bidirectional	DO-214AC	1ba	1j	Mic
7V0C	SMB7.0C	TVS	Vbr=7.78..9.51V, Vrw=7V, 45.1A, 600W(1ms), Bidirectional	DO-214AA	1ba	1j	Mic
7V0C	SMC7.0C	TVS	Vbr=7.78..9.51V, Vrw=7V, 112.8A, 1500W(1ms), Bidirectional	DO-214AB	1ba	1j	Mic
7V0CA	SMA7.0CA	TVS	Vbr=7.78..8.6V, Vrw=7.0V, 25A, 300W(1ms), Bidirectional	DO-214AC	1ba	1j	Mic
7V0CA	SMA7.5CA	TVS	Vbr=8.33..9.21V, Vrw=7.5V, 23.3A, 300W(1ms), Bidirectional	DO-214AC	1ba	1j	Mic
7V0CA	SMB7.0CA	TVS	Vbr=7.78..8.6V, Vrw=7V, 50A, 600W(1ms), Bidirectional	DO-214AA	1ba	1j	Mic
7V0CA	SMC7.0CA	TVS	Vbr=7.78..8.6V, Vrw=7V, 125A, 1500W(1ms), Bidirectional	DO-214AB	1ba	1j	Mic
7V5	BZD27C7V5P	Z-diode	7.13..7.88V, Zzt=2Ω, Izt=100mA, 800mW	SOD-123FL	7d	1a	Pjt
7V5	BZY55-C7V5	Z-diode	7.13..7.88V, Izt=5mA, Zzt=7Ω, 500mW	0805	70d	2d	Tsc
7V5	CDZ55C7V5	Z-diode	7.13..7.88V, Zzt=7Ω, Izt=5mA, 500mW	1206	70d	2d	Crp
7V5	CDZ55C7V5S	Z-diode	7.13..7.88V, Zzt=7Ω, Izt=5mA, 500mW	0805	70d	2d	Crp
7V5	CTZ55C7V5	Z-diode	7.13..7.88V, Izt=5mA, Zzt=7Ω, 500mW	1206	70d	2d	Ctc
7V5	MFPZ7V5	Z-diode	7.13..7.88V, Izt=100mA, Zzt=2Ω, 800mW	SOD-123FL	7d	1a	Tr



SMD code	Type	Function	Short description	Case	Pinout	St.	Mnf.
7V5	P6SMBJ7V5	TVS	Vbr=6.75..8.25V, 51A, 600W(1ms)	DO-214AA	1d	1n	Lif
7V5	SMA7.5	TVS	Vbr=8.33..10.3V, Vvwm=7.5V, 21A, 300W(1ms)	DO-214AC	1d	1a	Mic
7V5	SMB7.5	TVS	Vbr=8.33..10.2V, Vvwm=7.5V, 42A, 600W(1ms)	DO-214AA	1d	1a	Mic
7V5	SMC7.5	TVS	Vbr=8.33..10.2V, Vvwm=7.5V, 104.9A, 1500W(1ms),	DO-214AB	1d	1a	Mic
7V5A	1.5SMC7.5A	TVS	Vbr=7.13..7.88V, Vvwm=6.40V, 133A, 1500W(1ms)	DO-214AB	1d,3d	1a,1k	Vs,Ons
7V5A	P4SMA7.5A	TVS	Vbr=7.13..7.88V, 35.4A, 400W(1ms)	DO-214AC	1d	1k	Vs
7V5A	P6SMB7.5A	TVS	Vvwm=7.5V, Vbr=7.13..7.88V, 53.1A, 600W(1ms)	DO-214AA	1d,3d	1k,1a	Vs,Ons
7V5A	P6SMBJ7V5A	TVS	Vbr=7.13..7.88V, 53A, 600W(1ms)	DO-214AA	1d	1n	Lif
7V5A	SMA7.5A	TVS	Vbr=8.33..9.21V, Vvwm=7.5V, 23.3A, 300W(1ms)	DO-214AC	1d	1a	Mic
7V5A	SMB7.5A	TVS	Vbr=8.33..9.21V, Vvwm=7.5V, 46.5A, 600W(1ms)	DO-214AA	1d	1a	Mic
7V5A	SMC7.5A	TVS	Vbr=8.33..9.21V, Vvwm=7.5V, 116.3A, 1500W(1ms),	DO-214AB	1d	1a	Mic
7V5B	BZT52-B7V5	Z-diode	7.35..7.65V, Izt=5mA, Zzt=15Ω, 500mW	SOD-123FL	7d	1a	Tsc
7V5B	MMSZ7V5BW	Z-diode	7.35..7.65V, Izt=5mA, Zzt=15Ω, 500mW	SOD-123FL	7d	1a	Tac
7V5B	Z3SMB7.5B	Z-diode	7.13..7.88V, Izt=100mA, Zzt=2Ω, 3W	DO-214AA	1d	1a	Ttr
7V5C	1.5SMC7.5CA	TVS	Vbr=7.13..7.88V, Vvwm=6.40V, 133A, 1500W(1ms), Bidirectional	DO-214AB	1ba	1l	Vs
7V5C	P4SMA7.5CA	TVS	Vbr=7.13..7.88V, 35.4A, 400W(1ms), Bidirectional	DO-214AC	1ba	1l	Vs
7V5C	P6SMB7.5CA	TVS	Vbr=7.13..7.88V, 53.1A, 600W(1ms), Bidirectional	DO-214AA	1ba	1l	Vs
7V5C	P6SMBJ7V5C	TVS	Vbr=6.75..8.25V, 51A, 600W(1ms), Bidirectional	DO-214AA	1ba	1p	Lif
7V5C	SMB7.5C	TVS	Vbr=8.33..10.2V, Vvwm=7.5V, 42A, 600W(1ms), Bidirectional	DO-214AA	1ba	1j	Mic
7V5C	SMC7.5C	TVS	Vbr=8.33..10.2V, Vvwm=7.5V, 104.9A, 1500W(1ms), Bidirectional	DO-214AB	1ba	1j	Mic
7V5CA	P6SMBJ7V5CA	TVS	Vbr=7.13..7.88V, 53A, 600W(1ms), Bidirectional	DO-214AA	1ba	1p	Lif
7V5CA	SMB7.5CA	TVS	Vbr=8.33..9.21V, Vvwm=7.5V, 46.5A, 600W(1ms), Bidirectional	DO-214AA	1ba	1j	Mic
7V5CA	SMC7.5CA	TVS	Vbr=8.33..9.21V, Vvwm=7.5V, 116.3A, 1500W(1ms), Bidirectional	DO-214AB	1ba	1j	Mic
7V5Z	BZT52-C7V5	Z-diode	7.11..7.86V, Izt=5mA, Zzt=15Ω, 500mW	SOD-123FL	7d	1a	Tsc
7V5Z	MMSZ7V5CW	Z-diode	7.11..7.86V, Izt=5mA, Zzt=15Ω, 500mW	SOD-123FL	7d	1a	Tac
7V5Z	TCMMSZ7V5	Z-diode	7.5V±5%, Izt=5mA, Zzt=14Ω, 500mW	SOD-123FL	7d	1a	Tac
7V5Z	ZGFM057V5C-MH	Z-diode	7.11..7.86V, Izt=5mA, Zzt=14Ω, 500mW	SOD-123	5d	1a	Pic
7X	MA2ZV01	C-diode	VCO, 6V, 16/GpF(13V), 1Ω(470MHz)	SOD-123	5d	1a	Pan
7X	MM3Z6V8B	Z-diode	6.65..6.93V, Izt=5mA, Zzt=40Ω, 300mW	SOD-323FL	7d	1a	Lge
7Y	KDZ22VYV	Z-diode	21.54..22.47V, Izt=5mA, Zzt=30Ω, 100mW	VSC	7d	1a	Kec
7Y	MA2ZV02	C-diode	VCO, 6V, 19/8.1pF(14V), 0.3Ω(470MHz)	SOD-123	5d	1a	Pan
7Y	MM3Z7V5B	Z-diode	7.28..7.60V, Izt=5mA, Zzt=30Ω, 300mW	SOD-323FL	7d	1a	Lge
7Y5	CRY75	Z-diode	6.8..8.3V, 700mW	S-FLAT	6d	1a	Tos
7Z	BZT52-B4V7S	Z-diode	4.61..4.79V, Izt=5mA, Zzt=80Ω, 200mW	SOD-323FL	7d	1a	Tsc
7Z	MA2ZV03	C-diode	VCO, 6V, 5/52.35pF(14V), 0.3Ω(470MHz)	SOD-123	5d	1a	Pan
7Z	MM3Z4V7B	Z-diode	4.61..4.79V, Zzt=75Ω, Izt=5mA, 200mW	SOD-323FL	7d	1a	F
7Z	MM3Z4V7BW	Z-diode	4.61..4.79V, Izt=5mA, Zzt=80Ω, 200mW	SOD-323FL	7d	1a	Tac
7Z	MM3Z8V2B	Z-diode	8.02..8.36V, Izt=5mA, Zzt=30Ω, 300mW	SOD-323FL	7d	1a	Lge
7Z	TCMM3Z4V7B	Z-diode	4.7V±2%, Izt=5mA, Zzt=75Ω, 200mW	SOD-323FL	7d	1a	Tac
8	1S5420PT	Si-diode	Sw, 85V, 150mA, Vt<1.2V(150mA), 4ns	SOD-523	6d	1a	Chm
8	BB178	C-diode	TV-VHF-Tuning, 32V, 20mA, 62..2.9pF(1.28V), 160MHz	SOD-523	6d	1a	Phi
8	BBY58-02V	C-diode	VCO-Tuning, 10V, 20mA, 17.5..19.3pF(4..1V)	SC-79	6d	1u	Inf
8	GBLC08	TVS	Vbr=8V, 17A, 350W(1ms), 3pF	SOD-323	5d	1a	Prt
8	HVU308	C-diode	UHF-Tuning, 30V, 13.9..16.1pF(2V)	SOD-323	5d	1a	Ren
8	KDZ5.6FV	Z-diode	5.30..6.0V, Izt=5mA, Zzt=40Ω, 100mW	TFSC	7d	1a	Kec
8	MAZS082	Z-diode	7.7..8.7V, 200mW	SOD-523	6d	1a	Pan
8	MMPZ5229SPT	Z-diode	4.214..4.386V, Izt=5mA, Zzt=88Ω, 225mW	SOD-323	5d	1a	Chm
8	MMSZ5257BPT	Z-diode	31.35..34.65V, Izt=5mA, Zzt=88Ω, 225mW	SOD-523	7d	1a	Chm
8-	MAZS0820M	Z-diode	8.03..8.43V, 200mW	SOD-523	6d	1a	Pan
8 (yellow)	BBY58-03W	C-diode	VCO-Tuning, 10V, 20mA, 17.5..19.3pF(4..1V)	SOD-323	5d	2	Inf
8.2	GDZ4V3B-V	Z-diode	4.17..4.43V, Izt=5mA, Zzt=100Ω, 200mW	SOD-323	5d	1k	Vs
8.	MMSZ5257SPT	Z-diode	32.34..33.66V, Izt=5mA, Zzt=88Ω, 225mW	SOD-523	7d	1a	Chm
8.0A	1SMC8.0A	TVS	Vbr=8.89..9.83V, Vvwm=8.0V, 110.3A, 1500W(1ms)	DO-214AB	1d	1a	Eic
8.0A	SMAJ8.0A	TVS	Vvwm=8.0V, Vbr=8.89..9.83V, 29.4A, 400W(1ms)	DO-214AC	1d	1j	Sus
8.0A	SMBJ8.0A	TVS	Vbr=8.89..9.83V, Vvwm=8.0V, 44.1A, 600W(1ms)	DO-214AA	1d	1a	Sus
8.0A	SMCJ8.0A	TVS	Vvwm=8V, Vbr=8.89..9.83V, 100A, 1500W(1ms)	DO-214AB	1d	1k	Sus
8.0CA	1SMC8.0CA	TVS	Vbr=8.89..9.83V, Vvwm=8.0V, 110.3A, 1500W(1ms), Bidirectional	DO-214AB	1ba	1j	Eic
8.0CA	SMAJ8.0CA	TVS	Vvwm=8.0V, Vbr=8.89..9.83V, 29.4A, 400W(1ms), Bidirectional	DO-214AC	1ba	1j	Sus
8.0CA	SMBJ8.0CA	TVS	Vbr=8.89..9.83V, Vvwm=8.0V, 44.1A, 600W(1ms), Bidirectional	DO-214AA	1ba	1j	Sus
8.0CA	SMCJ8.0CA	TVS	Vvwm=8V, Vbr=8.89..9.83V, 100A, 1500W(1ms), Bidirectional	DO-214AB	1ba	1l	Sus
8.2	MAZ5082	Z-diode	7.7..8.7V, Zzt=6Ω(5mA), 500mW	MP2	11d	1a	Pan
8.2	MAZ80820H	Z-diode	8.29..8.7V, Zzt=20Ω(5mA), 150mW	SC-76	6d	1a	Pan
8.2	MAZY082	Z-diode	7.4..9.1V, Zzt=30Ω(10mA), 1W	NMiniP2	1d	1a	Pan
8.2	P4SMA8.2	TVS	Vbr=7.38..9.02V, Vvwm=6.63V, 33.0A, 400W(1ms)	DO-214AC	1d	1a	Eic
8.2	U1Z8.2	Z-diode	7.4..9.1V, 1W	SOD-6	1d	1a	Tos
8.2	U1ZB8.2	Z-diode	7.4..9.1V, 1W	I-FLAT	1d	1a	Tos
8.2A	P4SMA8.2A	TVS	Vbr=7.79..8.61V, Vvwm=7.02V, 35.0A, 400W(1ms)	DO-214AC	1d	1a	Eic
8.2A	P6SMB8.2A	TVS	Vbr=7.79..8.61V, Vvwm=7.02V, 50.0A, 600W(1ms)	DO-214AA	1d	1a	Eic
8.2B	HZF8.2BP	Z-diode	8.2V±5%, 900mW	LRP	1d	2f	Ren
8.2B	PTZ8.2B	Z-diode	8.2V±10%, 40mA, 1W	DO-214AC	1d	1a	Rhm



SMD code	Type	Function	Short description	Case	Pinout	St.	Mnf.
8.2C	HZF8.2CP	Z-diode	8.2V±10%, 900mW	LRP	1d	2f	Ren
8.2C	P4SMA8.2C	TVS	Vbr=7.38..9.02V, Vrvwm=6.63V, 33.0A, 400W(1ms), Bidirectional	DO-214AC	1ba	1j	Eic
8.2CA	P4SMA8.2CA	TVS	Vbr=7.79..8.61V, Vrvwm=7.02V, 35.0A, 400W(1ms), Bidirectional	DO-214AC	1ba	1j	Eic
8.2CA	P6SMB8.2CA	TVS	Vbr=7.79..8.61V, Vrvwm=7.02V, 50.0A, 600W(1ms), Bidirectional	DO-214AA	1ba	1j	Eic
8.5A	1SMC8.5A	TVS	Vbr=9.44..10.4V, Vrvwm=8.5V, 104.2A, 1500W(1ms)	DO-214AB	1d	1a	Eic
8.5A	SMAJ8.5A	TVS	Vrvwm=8.5V, Vbr=9.44..10.4V, 27.7A, 400W(1ms)	DO-214AC	1d	1j	Sus
8.5A	SMBJ8.5A	TVS	Vbr=9.44..10.4V, Vrvwm=8.5V, 41.7A, 600W(1ms)	DO-214AA	1d	1a	Sus
8.5A	SMCJ8.5A	TVS	Vrvwm=8.5V, Vbr=9.44..10.82V, 94.3A, 1500W(1ms)	DO-214AB	1d	1k	Sus
8.5CA	1SMC8.5CA	TVS	Vbr=9.44..10.4V, Vrvwm=8.5V, 104.2A, 1500W(1ms), Bidirectional	DO-214AB	1ba	1j	Eic
8.5CA	SMAJ8.5CA	TVS	Vrvwm=8.5V, Vbr=9.44..10.4V, 27.7A, 400W(1ms), Bidirectional	DO-214AC	1ba	1j	Sus
8.5CA	SMBJ8.5CA	TVS	Vbr=9.44..10.4V, Vrvwm=8.5V, 41.7A, 600W(1ms), Bidirectional	DO-214AA	1ba	1j	Sus
8.5CA	SMCJ8.5CA	TVS	Vrvwm=8.5V, Vbr=9.44..10.82V, 94.3A, 1500W(1ms), Bidirectional	DO-214AB	1ba	1l	Sus
8*	MAZS0820H	Z-diode	8.29..8.7V, 200mW	SOD-523	6d	1a	Pan
8*2	MAZ80820H	Z-diode	8.29..8.7V, Zzt=20Q(5mA), 150mW	SC-76	6d	1a	Pan
8*2	MAZ8082GHL	Z-diode	8.29..8.7V, Zzt=20Q(5mA), 150mW	SMIn2-F3	6d	1a	Pan
8_	MAZS0820L	Z-diode	7.77..8.17V, 200mW	SOD-523	6d	1a	Pan
8.2	MAZ80820L	Z-diode	8.03..8.43V, Zzt=20Q(5mA), 150mW	SC-76	6d	1a	Pan
8.2	MAZ8082GLL	Z-diode	8.03..8.43V, Zzt=20Q(5mA), 150mW	SMIn2-F3	6d	1a	Pan
8*2	HZU8.2B1	Z-diode	7.76..8.10V, lzt=5mA, Zzt=30Q, 200mW	URP	5d	1a	Ren
8*2	HZU8.2B2	Z-diode	8.02..8.36V, lzt=5mA, Zzt=30Q, 200mW	URP	5d	1a	Ren
8*2	HZU8.2B3	Z-diode	8.28..8.64V, lzt=5mA, Zzt=30Q, 200mW	URP	5d	1a	Ren
8*2	RKZ8.2B2KG	Z-diode	8.02..8.36V, lzt=5mA, Zzt=30Q, 200mW	URP	5d	2e	Ren
8*2	RKZ8.2B2KJ	Z-diode	8.02..8.36V, lzt=5mA, Zzt=30Q, 150mW	UPF	7d	2e	Ren
80APH	BYG80A	Si-diode	U-Fast, Controlled avalanche, 50V, 1.25A, Vf<0.67V(1.25A), 25ns	DO-214AC	1d	1a	Phi
80BPH	BYG80B	Si-diode	U-Fast, Controlled avalanche, 100V, 1.25A, Vf<0.67V(1.25A), 25ns	DO-214AC	1d	1a	Phi
80CPH	BYG80C	Si-diode	U-Fast, Controlled avalanche, 150V, 1.25A, Vf<0.67V(1.25A), 25ns	DO-214AC	1d	1a	Phi
80DPH	BYG80D	Si-diode	U-Fast, Controlled avalanche, 200V, 1.25A, Vf<0.67V(1.25A), 25ns	DO-214AC	1d	1a	Phi
80FPH	BYG80F	Si-diode	U-Fast, Controlled avalanche, 300V, 1.15A, Vf<0.73V(1.15A), 50ns	DO-214AC	1d	1a	Phi
80GPH	BYG80G	Si-diode	U-Fast, Controlled avalanche, 400V, 1.15A, Vf<0.73V(1.15A), 50ns	DO-214AC	1d	1a	Phi
80JPH	BYG80J	Si-diode	U-Fast, Controlled avalanche, 500V, 1.15A, Vf<0.96V(1.15A), 50ns	DO-214AC	1d	1a	Phi
81	ZV831BV2TA	C-diode	VHF/UHF-Tuning, 25V, 330mW, 15pF(2V), ΔC ±5%	SOD-523	6d	1a	Zx
813B	1SMA5913B	Z-diode	3.3V±5%, Zzt=10Q, lzm<455mA, 1.5W	403B-01	3d	1f	Mot
814B	1SMA5914B	Z-diode	3.6V±5%, Zzt=9Q, lzm<417mA, 1.5W	403B-01	3d	1f	Mot
815B	1SMA5915B	Z-diode	3.9V±5%, Zzt=7.5Q, lzm<385mA, 1.5W	403B-01	3d	1f	Mot
816B	1SMA5916B	Z-diode	4.3V±5%, Zzt=6Q, lzm<349mA, 1.5W	403B-01	3d	1f	Mot
817B	1SMA5917B	Z-diode	4.7V±5%, Zzt=5Q, lzm<319mA, 1.5W	403B-01	3d	1f	Mot
818B	1SMA5918B	Z-diode	5.1V±5%, Zzt=4Q, lzm<294mA, 1.5W	403B-01	3d	1f	Mot
819B	1SMA5919B	Z-diode	5.6V±5%, Zzt=2Q, lzm<268mA, 1.5W	403B-01	3d	1f	Mot
82	EDZ4.3B	Z-diode	4.17..4.43V, lzt=5mA, Zzt=100Q, 150mW	SOD-523	6d	1a	Rhm
82	FDZ4.3EV	Z-diode	4.170..4.430V, lzt=5mA, Zzt=100Q, 150mW	SOD-523	7d	1a	Fis
82	FDZ4.3VT	Z-diode	4.170..4.430V, lzt=5mA, Zzt=100Q, 200mW	SOD-323	5d	1a	Fis
82	HZC8.2	Z-diode	8.2V±10%, 150mW	SOD-523	6d	1a	Ren
82	HZU8.2G	Z-diode	7.76..8.64V, 200mW	SOD-323	5d	1a	Ren
82	KDZ8.2EV	Z-diode	7.7..8.7V, 150mW	SOD-523	6d	1a	Kec
82	KDZ8.2V	Z-diode	7.7..8.7V, 150mW	SOD-323	5d	1a	Kec
82	MMPZ25688SPT	Z-diode	80.36..83.64V, lzt=1.5mA, Zzt=330Q, 225mW	SOD-323	5d	1a	Chm
82	P4SMA82	TVS	Vbr=73.8..90.2V, Vrvwm=66.4V, 3.6A, 400W(1ms)	DO-214AC	1d	1a	Eic
82	P6SMBJ82	TVS	Vbr=73.8..90.2V, 5.1A, 600W(1ms)	DO-214AA	1d	1n	Lif
82	SML4762	Z-diode	82V±5%, lzt=3mA, Zzt=200Q, 1W	DO-214AC	1d	1k	Vs
82	TZD8.2WS	Z-diode	7.70..8.70V, lzt=5mA, Zzt=20Q, 200mW	SOD-323	5d	1a	Ttr
82	TZD8.2WT	Z-diode	7.70..8.70V, lzt=5mA, Zzt=20Q, 150mW	SOD-523	6d	1a	Ttr
82	U1Z82	Z-diode	73.8..90.2V, 1W	SOD-6	1d	1a	Tos
82	U1ZB82	Z-diode	73.8..90.2V, 1W	I-FLAT	1d	1a	Tos
82	UDZS4.3B	Z-diode	4.17..4.43V, lzt=5mA, Zzt=100Q, 200mW	SOD-323	5d	1a	Wtr
82	UDZS4.3B	Z-diode	4.3V±2.5%, lzt=5mA, 200mW	SOD-323FL	7d	1s	Rhm
82	VDZS4.3B	Z-diode	4.3V±5%, 5mA, 100mW	VMD2	5d	1z	Rhm
82	ZV832BV2TA	C-diode	VHF/UHF-Tuning, 25V, 330mW, 22pF(2V), ΔC ±5%	SOD-523	6d	1a	Zx
8-2	MAZ80820M	Z-diode	7.7..8.7V, Zzt=20Q(5mA), 150mW	SC-76	6d	1a	Pan
8-2	MAZ8082GML	Z-diode	7.7..8.7V, Zzt=20Q(5mA), 150mW	SMIn2-F3	6d	1a	Pan
82*	TZD8.2YWS	Z-diode	8.02..8.36V, lzt=5mA, Zzt=20Q, 200mW	SOD-323	5d	1a	Ttr
82*	TZD8.2YWT	Z-diode	8.02..8.36V, lzt=5mA, Zzt=20Q, 150mW	SOD-523	6d	1a	Ttr
820B	1SMA5920B	Z-diode	6.2V±5%, Zzt=2Q, lzm<242mA, 1.5W	403B-01	3d	1f	Mot
821B	1SMA5921B	Z-diode	6.8V±5%, Zzt=2.5Q, lzm<221mA, 1.5W	403B-01	3d	1f	Mot
822B	1SMA5922B	Z-diode	7.5V±5%, Zzt=3Q, lzm<200mA, 1.5W	403B-01	3d	1f	Mot
823B	1SMA5923B	Z-diode	8.2V±5%, Zzt=3.5Q, lzm<183mA, 1.5W	403B-01	3d	1f	Mot
824B	1SMA5924B	Z-diode	9.1V±5%, Zzt=4Q, lzm<165mA, 1.5W	403B-01	3d	1f	Mot
825B	1SMA5925B	Z-diode	10V±5%, Zzt=4.5Q, lzm<150mA, 1.5W	403B-01	3d	1f	Mot
826B	1SMA5926B	Z-diode	11V±5%, Zzt=5.5Q, lzm<136mA, 1.5W	403B-01	3d	1f	Mot
827B	1SMA5927B	Z-diode	12V±5%, Zzt=6.5Q, lzm<125mA, 1.5W	403B-01	3d	1f	Mot
828B	1SMA5928B	Z-diode	13V±5%, Zzt=7Q, lzm<115mA, 1.5W	403B-01	3d	1f	Mot



SMD
code

Type

Function

Short description

Case

Pinout

St.

Mnf.

SMD code	Type	Function	Short description	Case	Pinout	St.	Mnf.
829B	1SMA5929B	Z-diode	15V±5%, Zzt=9Ω, Izm<100mA, 1.5W	403B-01	3d	1f	Mot
82A	1.5SMC82A	TVS	Vbr=77.9..86.1V, Vnwm=70.1V, 13.3A, 1500W(1ms)	DO-214AB	1d,3d	1a,1k	Vs,Ons
82A	P4SMA82A	TVS	Vbr=77.9..86.1V, Vnwm=70.1V, 3.7A, 400W(1ms)	DO-214AC	1d	1k	Vs
82A	P6SMB82A	TVS	Vnwm=82V, Vbr=77.9..86.1V, 5.3A, 600W(1ms)	DO-214AA	1d,3d	1k,1a	Vs,Ons
82A	P6SMBJ82A	TVS	Vbr=77.9..86.1V, 5.3A, 600W(1ms)	DO-214AA	1d	1n	Lif
82B	1SM3E282	Z-diode	82V±5%, Zzt=100Ω, Izt=9.1mA, 3W	DO-214AA	1d	1a	Pjt
82C	1.5SMC82CA	TVS	Vbr=77.9..86.1V, Vnwm=70.1V, 13.3A, 1500W(1ms), Bidirectional	DO-214AB	1ba	1l	Vs
82C	P4SMA82C	TVS	Vbr=73.8..90.2V, Vnwm=66.4V, 3.6A, 400W(1ms), Bidirectional	DO-214AC	1ba	1j	Vic
82C	P4SMA82CA	TVS	Vbr=77.9..86.1V, 3.5A, 400W(1ms), Bidirectional	DO-214AC	1ba	1l	Vs
82C	P6SMB82CA	TVS	Vnwm=82V, Vbr=77.9..86.1V, 5.3A, 600W(1ms), Bidirectional	DO-214AA	1ba,3ba	11,e	Vs,Ons
82C	P6SMBJ82C	TVS	Vbr=73.8..90.2V, 5.1A, 600W(1ms), Bidirectional	DO-214AA	1ba	1p	Lif
82CA	P4SMA82CA	TVS	Vbr=77.9..86.1V, Vnwm=70.1V, 3.7A, 400W(1ms), Bidirectional	DO-214AC	1ba	1j	Eic
82CA	P6SMB82CA	TVS	Vbr=77.9..86.1V, Vnwm=70.1V, 5.3A, 600W(1ms), Bidirectional	DO-214AA	1ba	1j	Eic
82CA	P6SMBJ82CA	TVS	Vbr=77.9..86.1V, 5.3A, 600W(1ms), Bidirectional	DO-214AA	1ba	1p	Lif
830B	1SMA5930B	Z-diode	16V±5%, Zzt=10Ω, Izm<94mA, 1.5W	403B-01	3d	1f	Mot
831B	1SMA5931B	Z-diode	18V±5%, Zzt=12Ω, Izm<83mA, 1.5W	403B-01	3d	1f	Mot
832B	1SMA5932B	Z-diode	20V±5%, Zzt=14Ω, Izm<75mA, 1.5W	403B-01	3d	1f	Mot
833B	1SMA5933B	Z-diode	22V±5%, Zzt=17.5Ω, Izm<68mA, 1.5W	403B-01	3d	1f	Mot
834B	1SMA5934B	Z-diode	24V±5%, Zzt=19Ω, Izm<63mA, 1.5W	403B-01	3d	1f	Mot
835B	1SMA5935B	Z-diode	27V±5%, Zzt=23Ω, Izm<56mA, 1.5W	403B-01	3d	1f	Mot
836B	1SMA5936B	Z-diode	30V±5%, Zzt=26Ω, Izm<50mA, 1.5W	403B-01	3d	1f	Mot
837B	1SMA5937B	Z-diode	33V±5%, Zzt=33Ω, Izm<45mA, 1.5W	403B-01	3d	1f	Mot
838B	1SMA5938B	Z-diode	36V±5%, Zzt=38Ω, Izm<42mA, 1.5W	403B-01	3d	1f	Mot
839B	1SMA5939B	Z-diode	39V±5%, Zzt=45Ω, Izm<38mA, 1.5W	403B-01	3d	1f	Mot
840B	1SMA5940B	Z-diode	43V±5%, Zzt=53Ω, Izm<35mA, 1.5W	403B-01	3d	1f	Mot
841B	1SMA5941B	Z-diode	47V±5%, Zzt=67Ω, Izm<32mA, 1.5W	403B-01	3d	1f	Mot
842B	1SMA5942B	Z-diode	51V±5%, Zzt=70Ω, Izm<29mA, 1.5W	403B-01	3d	1f	Mot
843B	1SMA5943B	Z-diode	56V±5%, Zzt=86Ω, Izm<27mA, 1.5W	403B-01	3d	1f	Mot
844B	1SMA5944B	Z-diode	62V±5%, Zzt=100Ω, Izm<24mA, 1.5W	403B-01	3d	1f	Mot
845B	1SMA5945B	Z-diode	68V±5%, Zzt=120Ω, Izm<22mA, 1.5W	403B-01	3d	1f	Mot
85	BZX584B5V1	Z-diode	5.0..5.20V, Izt=5mA, Zzt=60Ω, 200mW	SOD-523FL	7d	1a	Tac
85	EDZ22B	Z-diode	21.54..22.47V, Izt=5mA, Zzt=100Ω, 150mW	SOD-523	6d	1a	Rhm
85	FDZ22EV	Z-diode	21.540..22.470V, Izt=5mA, Zzt=100Ω, 150mW	SOD-523	7d	1a	Fis
85	FDZ22VT	Z-diode	21.540..22.470V, Izt=5mA, Zzt=100Ω, 200mW	SOD-323	5d	1a	Fis
85	MM5Z5V1B	Z-diode	5.0..5.20V, Izt=5mA, Zzt=60Ω, 200mW	SOD-523FL	7d	1a	Tac
85	TDZ22B	Z-diode	22V±2.5%, 10mA, 500mW	TUMD2	7d	1s	Rhm
85	UDZS22B	Z-diode	21.54..22.47V, Izt=5mA, Zzt=100Ω, 200mW	SOD-323	5d	1a	Wtr
85	UDZS22B	Z-diode	22V±2.5%, Izt=5mA, 200mW	SOD-323FL	7d	1s	Rhm
85	VDZS22B	Z-diode	22V±5%, 5mA, 100mW	VMD2	5d	1z	Rhm
85A	1SMC85A	TVS	Vbr=94.4..104V, Vnwm=85V, 10.9A, 1500W(1ms)	DO-214AB	1d	1a	Eic
85A	SMAJ85A	TVS	Vnwm=85V, Vbr=94.4..104V, 2.9A, 400W(1ms)	DO-214AC	1d	1a	Sus
85A	SMBJ85A	TVS	Vbr=94.4..104V, Vnwm=85V, 4.4A, 600W(1ms)	DO-214AA	1d	1a	Sus
85A	SMCJ85A	TVS	Vnwm=85V, Vbr=94.4..108.2V, 9.9A, 1500W(1ms)	DO-214AB	1d	1k	Sus
85A	UMA85A	TVS	Vnwm=85V, Vbr=94.4..137V, 3.6A, 500W(1ms)	UltraMite	14d	1v	Msc
85CA	1SMC85CA	TVS	Vbr=94.4..104V, Vnwm=85V, 10.9A, 1500W(1ms), Bidirectional	DO-214AB	1ba	1j	Eic
85CA	SMAJ85CA	TVS	Vnwm=85V, Vbr=94.4..104V, 2.9A, 400W(1ms), Bidirectional	DO-214AC	1ba	1j	Sus
85CA	SMBJ85CA	TVS	Vbr=94.4..104V, Vnwm=85V, 4.4A, 600W(1ms), Bidirectional	DO-214AA	1ba	1j	Sus
85CA	SMCJ85CA	TVS	Vnwm=85V, Vbr=94.4..115V, 9.9A, 1500W(1ms), Bidirectional	DO-214AB	1ba	1l	Sus
85CA	UMA85CA	TVS	Vnwm=85V, Vbr=94.4..137V, 3.6A, 500W(1ms), Bidirectional	UltraMite	14ba	1v	Msc
85V	SMA85	TVS	Vbr=94.4..115V, Vnwm=85.0V, 2A, 300W(1ms)	DO-214AC	1d	1a	Mic
85V	SMB85	TVS	Vbr=94.4..115V, Vnwm=85V, 4A, 600W(1ms)	DO-214AA	1d	1a	Mic
85V	SMC85	TVS	Vbr=94.4..115V, Vnwm=85V, 9.9A, 1500W(1ms)	DO-214AB	1d	1a	Mic
85VA	SMA85A	TVS	Vbr=94.4..104V, Vnwm=85.0V, 2.2A, 300W(1ms)	DO-214AC	1d	1a	Mic
85VA	SMB85A	TVS	Vbr=94.4..104V, Vnwm=85V, 4.4A, 600W(1ms)	DO-214AA	1d	1a	Mic
85VA	SMC85A	TVS	Vbr=94.4..104V, Vnwm=85V, 10.9A, 1500W(1ms)	DO-214AB	1d	1a	Mic
85VC	SMA85C	TVS	Vbr=94.4..115V, Vnwm=85.0V, 2A, 300W(1ms), Bidirectional	DO-214AC	1ba	1j	Mic
85VC	SMB85C	TVS	Vbr=94.4..115V, Vnwm=85V, 4A, 600W(1ms), Bidirectional	DO-214AA	1ba	1j	Mic
85VC	SMC85C	TVS	Vbr=94.4..115V, Vnwm=85V, 9.9A, 1500W(1ms), Bidirectional	DO-214AB	1ba	1j	Mic
85VCA	SMA85CA	TVS	Vbr=94.4..104V, Vnwm=85.0V, 2.2A, 300W(1ms), Bidirectional	DO-214AC	1ba	1j	Mic
85VCA	SMB85CA	TVS	Vbr=94.4..104V, Vnwm=85V, 4.4A, 600W(1ms), Bidirectional	DO-214AA	1ba	1j	Mic
85VCA	SMC85CA	TVS	Vbr=94.4..104V, Vnwm=85V, 10.9A, 1500W(1ms), Bidirectional	DO-214AB	1ba	1j	Mic
87	MMPZ5269SPT	Z-diode	85.26..88.74V, Izt=1.4mA, Zzt=370Ω, 225mW	SOD-323	5d	1a	Chm
87C	BZT52C-8V7WT	Z-diode	8.27..9.14V, Izt=5mA, Zzt=15Ω, 200mW	SOD-523	6d	1a	Tfr
88	BBY58-02L	C-diode	VCO-Tuning, 10V, 20mA, 17.5..19.3pF(4..1V)	TSLP-2-1	13d	2b	Inf
88	BBY58-02W	C-diode	VCO-Tuning, 10V, 20mA, 17.5..19.3pF(4..1V)	SCD-80	6d	1a	Inf
8A	MM3Z9V1B	Z-diode	8.85..9.23V, Izt=5mA, Zzt=30Ω, 300mW	SOD-323FL	7d	1a	Lge
8A2	RKZ8.2AKU	Z-diode	7.53..7.92V, Izt=20mA, Zzt=30Ω, 500mW	TURP-FM	7d	1a	Ren
8B	CDZ58C8V2T	Z-diode	7.79..8.61V, Zzt=7Ω, Izt=5mA, 200mW	0603	70d	2d	Crp
8B	MAZ2V05	C-diode	VCO, 6V, 18.5/3.6pF(1/4V), 0.65ΩQ(470MHz)	SOD-123	5d	1a	Pan
8B	MM3Z10B	Z-diode	9.7..10.21V, Izt=5mA, Zzt=30Ω, 300mW	SOD-323FL	7d	1a	Lge



SMD code	Type	Function	Short description	Case	Pinout	St.	Mnf.
8B2	RKZ8.2BKU	Z-diode	7.78..8.19V, Izt=20mA, Zzt=30Ω, 500mW	TURP-FM	7d	1a	Ren
8C	GBL C08C	TVS	Vbr=8V, 17A, 350W(1ms), 3pF, Bidirectional	SOD-323	5ba	1e	Prt
8C	MA2ZV06	C-diode	VCO, 6V, 37/14pF(1/4V), 0.3Q(470MHz)	SOD-123	5d	1a	Pan
8C	MM3Z11B	Z-diode	10.76..11.22V, Izt=5mA, Zzt=30Ω, 300mW	SOD-323FL	7d	1a	Lge
8C2	RKZ8.2CKU	Z-diode	8.03..8.45V, Izt=20mA, Zzt=30Ω, 500mW	TURP-FM	7d	1a	Ren
8D	MM3Z12B	Z-diode	11.74..12.24V, Izt=5mA, Zzt=30Ω, 300mW	SOD-323FL	7d	1a	Lge
8E	MM3Z13B	Z-diode	12.91..13.49V, Izt=5mA, Zzt=37Ω, 300mW	SOD-323FL	7d	1a	Lge
8F	MM3Z15B	Z-diode	14.34..14.98V, Izt=5mA, Zzt=42Ω, 300mW	SOD-323FL	7d	1a	Lge
8H	MM3Z16B	Z-diode	15.85..16.51V, Izt=5mA, Zzt=50Ω, 300mW	SOD-323FL	7d	1a	Lge
8J	MM3Z18B	Z-diode	17.56..18.35V, Izt=5mA, Zzt=65V, 300mW	SOD-323FL	7d	1a	Lge
8K	MM3Z20B	Z-diode	19.52..20.39V, Izt=5mA, Zzt=85Ω, 300mW	SOD-323FL	7d	1a	Lge
8LU07	KP8L U07	Thy-SPD	V Of-St=65V, Ifsm=80A(1ms), Ith=100mA, Bidirectional	2F	1ba	1l	Shi
8M	MM3Z22B	Z-diode	21.54..22.47V, Izt=5mA, Zzt=100Ω, 300mW	SOD-323FL	7d	1a	Lge
8N	CMDZ2L0	Z-diode	1.900..2.100V, Izt=0.5mA, Zzt=1100Ω, 250mW	SOD-323	5d	1a	Cen
8N	MM3Z24B	Z-diode	23.72..24.78V, Izt=5mA, Zzt=120Ω, 300mW	SOD-323FL	7d	1a	Lge
8P	CMDZ36L	Z-diode	34.20..37.80V, Izt=0.5mA, Zzt=300Ω, 250mW	SOD-323	5d	1a	Cen
8P	KDZ5.6FVY	Z-diode	5.49..5.73V, Izt=5mA, Zzt=40Ω, 100mW	TFSC	7d	1a	Kec
8P	MM3Z27B	Z-diode	26.19..27.53V, Izt=5mA, Zzt=150Ω, 300mW	SOD-323FL	7d	1a	Lge
8P2	SML4738	Z-diode	8.2V±5%, Izt=31mA, Zzt=4.5Ω, 1W	DO-214AC	1d	1k	Vs
8R	1N5819WB	Si-diode	SBR, 40V, 1A, Vt<0.6V(1A), 120pF	SOD-123FL	7d	1a	Sme
8R	MA2Z304	C-diode	VCO, 30V, 24/6pF(1/4V), 1Q(100MHz)	SOD-123	5d	1a	Pan
8R	MA304	C-diode	VCO, 30V, 24/6pF(1/4V), 1Q(100MHz)	SOD-123	5d	1a	Pan
8R	MM3Z30B	Z-diode	29.19..30.69V, Izt=5mA, Zzt=200Ω, 300mW	SOD-323FL	7d	1a	Lge
8V0	SMA8.0	TVS	Vbr=8.89..10.9V, Vrw=8.0V, 20A, 300W(1ms)	DO-214AC	1d	1a	Mic
8V0	SMB8.0	TVS	Vbr=8.89..10.9V, Vrw=8V, 40A, 600W(1ms)	DO-214AA	1d	1a	Mic
8V0	SMC8.0	TVS	Vbr=8.89..10.9V, Vrw=8V, 100A, 1500W(1ms)	DO-214AB	1d	1a	Mic
8V0A	SMA8.0A	TVS	Vbr=8.89..9.83V, Vrw=8.0V, 22.1A, 300W(1ms)	DO-214AC	1d	1a	Mic
8V0A	SMB8.0A	TVS	Vbr=8.89..9.83V, Vrw=8V, 44.1A, 600W(1ms)	DO-214AA	1d	1a	Mic
8V0A	SMC8.0A	TVS	Vbr=8.89..9.83V, Vrw=8V, 110.3A, 1500W(1ms)	DO-214AB	1d	1a	Mic
8V0C	SMA8.0C	TVS	Vbr=8.89..10.9V, Vrw=8.0V, 20A, 300W(1ms), Bidirectional	DO-214AC	1ba	1j	Mic
8V0C	SMA8.5C	TVS	Vbr=9.44..11.5V, Vrw=8.5V, 18.9A, 300W(1ms), Bidirectional	DO-214AC	1ba	1j	Mic
8V0C	SMB8.0C	TVS	Vbr=8.89..10.9V, Vrw=8V, 40A, 600W(1ms), Bidirectional	DO-214AA	1ba	1j	Mic
8V0C	SMC8.0C	TVS	Vbr=8.89..10.9V, Vrw=8V, 100A, 1500W(1ms), Bidirectional	DO-214AB	1ba	1j	Mic
8V0CA	SMA8.0CA	TVS	Vbr=8.89..9.83V, Vrw=8.0V, 22.1A, 300W(1ms), Bidirectional	DO-214AC	1ba	1j	Mic
8V0CA	SMA8.5CA	TVS	Vbr=9.44..10.4V, Vrw=8.5V, 20.8A, 300W(1ms), Bidirectional	DO-214AC	1ba	1j	Mic
8V0CA	SMB8.0CA	TVS	Vbr=8.89..9.83V, Vrw=8V, 44.1A, 600W(1ms), Bidirectional	DO-214AA	1ba	1j	Mic
8V0CA	SMC8.0CA	TVS	Vbr=8.89..9.83V, Vrw=8V, 110.3A, 1500W(1ms), Bidirectional	DO-214AB	1ba	1j	Mic
8V2	BZD27C8V2P	Z-diode	7.79..8.61V, Zzt=2Q, Izt=100mA, 800mW	SOD-123FL	7d	1a	Pjt
8V2	BZY55-C8V2	Z-diode	7.79..8.61V, Izt=5mA, Zzt=7Ω, 500mW	0805	70d	2d	Tsc
8V2	CDZ55C8V2	Z-diode	7.79..8.61V, Zzt=7Q, Izt=5mA, 500mW	1206	70d	2d	Crp
8V2	CDZ55C8V2S	Z-diode	7.79..8.61V, Zzt=7Q, Izt=5mA, 500mW	0805	70d	2d	Crp
8V2	CTZ55C8V2	Z-diode	7.79..8.61V, Izt=5mA, Zzt=7Ω, 500mW	1206	70d	2d	Ctc
8V2	MFF28V2	Z-diode	7.79..8.61V, Izt=100mA, Zzt=2Q, 800mW	SOD-123FL	7d	1a	Tfr
8V2	P6SMBJ8V2	TVS	Vbr=7.38..9.02V, 48A, 600W(1ms)	DO-214AA	1d	1n	Lif
8V2A	1.5SMC8.2A	TVS	Vbr=7.79..8.61V, Vrw=7.02V, 124A, 1500W(1ms)	DO-214AB	1d,3d	1a,1k	Vs,Ons
8V2A	P4SMA8.2A	TVS	Vbr=7.79..8.61V, 33.1A, 400W(1ms)	DO-214AC	1d	1k	Vs
8V2A	P6SMB8.2A	TVS	Vrw=8.2V, Vbr=7.79..8.61V, 49.6A, 600W(1ms)	DO-214AA	1d,3d	1k,1a	Vs,Ons
8V2A	P6SMBJ8V2A	TVS	Vbr=7.79..8.61V, 50A, 600W(1ms)	DO-214AA	1d	1n	Lif
8V2B	BZT52-B8V2	Z-diode	8.04..8.36V, Izt=5mA, Zzt=15Ω, 500mW	SOD-123FL	7d	1a	Tsc
8V2B	MMSZ8V2BW	Z-diode	8.04..8.36V, Izt=5mA, Zzt=15Ω, 500mW	SOD-123FL	7d	1a	Tac
8V2B	Z3SMB8.2B	Z-diode	7.79..8.61V, Izt=91mA, Zzt=2Q, 3W	DO-214AA	1d	1a	Ttr
8V2C	1.5SMC8.2CA	TVS	Vbr=7.79..8.61V, Vrw=7.02V, 124A, 1500W(1ms), Bidirectional	DO-214AB	1ba	1l	Vs
8V2C	P4SMA8.2CA	TVS	Vbr=7.79..8.61V, 33.1A, 400W(1ms), Bidirectional	DO-214AC	1ba	1l	Vs
8V2C	P6SMB8.2CA	TVS	Vbr=7.79..8.61V, 49.6A, 600W(1ms), Bidirectional	DO-214AA	1ba	1l	Vs
8V2C	P6SMBJ8V2C	TVS	Vbr=7.38..9.02V, 48A, 600W(1ms), Bidirectional	DO-214AA	1ba	1p	Lif
8V2CA	P6SMBJ8V2CA	TVS	Vbr=7.79..8.61V, 50A, 600W(1ms), Bidirectional	DO-214AA	1ba	1p	Lif
8V2Z	BZT52-C8V2	Z-diode	7.79..8.61V, Izt=5mA, Zzt=15Ω, 500mW	SOD-123FL	7d	1a	Tsc
8V2Z	MMSZ8V2CW	Z-diode	7.79..8.61V, Izt=5mA, Zzt=15Ω, 500mW	SOD-123FL	7d	1a	Tac
8V2Z	TCMMSZ8V2	Z-diode	8.2V±5%, Izt=5mA, Zzt=14Q, 500mW	SOD-123FL	7d	1a	Tac
8V2Z	ZGFM058V2C-MH	Z-diode	7.79..8.61V, Izt=5mA, Zzt=14Ω, 500mW	SOD-123	5d	1a	Pic
8V5	SMA8.5	TVS	Vbr=9.44..11.5V, Vrw=8.5V, 18.9A, 300W(1ms)	DO-214AC	1d	1a	Mic
8V5	SMB8.5	TVS	Vbr=9.44..11.5V, Vrw=8.5V, 37.7A, 600W(1ms)	DO-214AA	1d	1a	Mic
8V5	SMC8.5	TVS	Vbr=9.44..11.5V, Vrw=8.5V, 94.3A, 1500W(1ms)	DO-214AB	1d	1a	Mic
8V5A	SMA8.5A	TVS	Vbr=9.44..10.4V, Vrw=8.5V, 20.8A, 300W(1ms)	DO-214AC	1d	1a	Mic
8V5A	SMB8.5A	TVS	Vbr=9.44..10.4V, Vrw=8.5V, 41.7A, 600W(1ms)	DO-214AA	1d	1a	Mic
8V5A	SMC8.5A	TVS	Vbr=9.44..10.4V, Vrw=8.5V, 104.2A, 1500W(1ms)	DO-214AB	1d	1a	Mic
8V5C	SMB8.5C	TVS	Vbr=9.44..11.5V, Vrw=8.5V, 37.7A, 600W(1ms), Bidirectional	DO-214AA	1ba	1j	Mic
8V5C	SMC8.5C	TVS	Vbr=9.44..11.5V, Vrw=8.5V, 94.3A, 1500W(1ms), Bidirectional	DO-214AB	1ba	1j	Mic
8V5CA	SMB8.5CA	TVS	Vbr=9.44..10.4V, Vrw=8.5V, 41.7A, 600W(1ms), Bidirectional	DO-214AA	1ba	1j	Mic
8V5CA	SMC8.5CA	TVS	Vbr=9.44..10.4V, Vrw=8.5V, 104.2A, 1500W(1ms), Bidirectional	DO-214AB	1ba	1j	Mic



SMD
code

Type

Function

Short description

Case

Pinout

St.

Mnf.

SMD code	Type	Function	Short description	Case	Pinout	St.	Mnf.
8V7	BZD27C8V7P	Z-diode	8.27..9.14V, Zzt=30Q, Izt=50mA, 800mW	SOD-123FL	7d	1a	Pjt
8V7	MFPZ8V7	Z-diode	8.27..9.14V, Izt=50mA, Zzt=30Q, 800mW	SOD-123FL	7d	1a	Ttr
8V7B	Z3SMB8.7B	Z-diode	8.27..9.14V, Izt=85mA, Zzt=20Q, 3W	DO-214AA	1d	1a	Ttr
8X	MM3Z33B	Z-diode	32.15..33.79V, Izt=5mA, Zzt=250Q, 300mW	SOD-323FL	7d	1a	Lge
8Y	KDZ18VVY	Z-diode	17.56..18.35V, Izt=5mA, Zzt=20Q, 100mW	VSC	7d	1a	Kec
8Y	MM3Z36B	Z-diode	35.07..36.87V, Izt=5mA, Zzt=300Q, 300mW	SOD-323FL	7d	1a	Lge
8Y2	CRY82	Z-diode	7.4..9V, 700mW	S-FLAT	6d	1a	Tos
8Y9	CRY91	Z-diode	8.2..10V, 700mW	S-FLAT	6d	1a	Tos
8Z	BZT52-B5V1S	Z-diode	5.0..5.20V, Izt=5mA, Zzt=60Q, 200mW	SOD-323FL	7d	1a	Tsc
8Z	MM3Z39B	Z-diode	37.0..41.0V, Izt=5mA, Zzt=100Q, 300mW	SOD-323FL	7d	1a	Lge
8Z	MM3Z5V1B	Z-diode	5.0..5.20V, Zzt=56Q, Izt=5mA, 200mW	SOD-323FL	7d	1a	F
8Z	MM3Z5V1BW	Z-diode	5.0..5.20V, Izt=5mA, Zzt=60Q, 200mW	SOD-323FL	7d	1a	Tac
8Z	TCMM3Z5V1B	Z-diode	5.1V±2%, Izt=5mA, Zzt=56Q, 200mW	SOD-323FL	7d	1a	Tac
9	BB179	C-diode	TV-VHF-Tuning, 32V, 20mA, 34.5..2.3pF(1..28V), 460MHz	SOD-523	6d	1a	Phi
9	KDZ16FV	Z-diode	15.30..17.10V, Izt=5mA, Zzt=18Q, 100mW	TFSC	7d	1a	Kec
9	MAZS091	Z-diode	8.5..9.6V, 200mW	SOD-523	6d	1a	Pan
9	MMPZ5230SPT	Z-diode	4.606..4.794V, Izt=5mA, Zzt=70Q, 225mW	SOD-323	5d	1a	Chm
9	MMSZ5250BPT	Z-diode	19.0..21.0V, Izt=5mA, Zzt=48Q, 225mW	SOD-523	7d	1a	Chm
9-	MAZS0910M	Z-diode	8.87..9.33V, 200mW	SOD-523	6d	1a	Pan
9 2	GDZ4V7B-V	Z-diode	4.55..4.75V, Izt=5mA, Zzt=100Q, 200mW	SOD-323	5d	1k	Vs
9.	MMSZ5250SPT	Z-diode	19.60..20.40V, Izt=5mA, Zzt=48Q, 225mW	SOD-523	7d	1a	Chm
9.0A	1SMC9.0A	TVS	Vbr=10.0..11.1V, Vrw=9.0V, 97.4A, 1500W(1ms)	DO-214AB	1d	1a	Eic
9.0A	SMAJ9.0A	TVS	Vrw=9.0V, Vbr=10.0..11.1V, 26.0A, 400W(1ms)	DO-214AC	1d	1j	Sus
9.0A	SMBJ9.0A	TVS	Vbr=10.0..11.1V, Vrw=9.0V, 39.0A, 600W(1ms)	DO-214AA	1d	1a	Sus
9.0A	SMCJ9.0A	TVS	Vrw=9V, Vbr=10.0..12.2V, 88.8A, 1500W(1ms)	DO-214AB	1d	1k	Sus
9.0CA	1SMC9.0CA	TVS	Vbr=10.0..11.1V, Vrw=9.0V, 97.4A, 1500W(1ms), Bidirectional	DO-214AB	1ba	1j	Eic
9.0CA	SMAJ9.0CA	TVS	Vrw=9.0V, Vbr=10.0..11.1V, 26.0A, 400W(1ms), Bidirectional	DO-214AC	1ba	1j	Sus
9.0CA	SMBJ9.0CA	TVS	Vbr=10.0..11.1V, Vrw=9.0V, 39.0A, 600W(1ms), Bidirectional	DO-214AA	1ba	1j	Sus
9.0CA	SMCJ9.0CA	TVS	Vrw=9V, Vbr=10.0..12.2V, 88.8A, 1500W(1ms), Bidirectional	DO-214AB	1ba	1l	Sus
9.1	MAZ5091	Z-diode	8.5..9.6V, Zzt=6Q(5mA), 500mW	MP2	11d	1a	Pan
9.1	MAZ80910H	Z-diode	9.14..9.6V, Zzt=20Q(5mA), 150mW	SC-76	6d	1a	Pan
9.1	MAZY091	Z-diode	8.2..10.1V, Zzt=30Q(10mA), 1W	NMiniP2	1d	1a	Pan
9.1	P4SMA9.1	TVS	Vbr=8.19..10.0V, Vrw=7.37V, 30.0A, 400W(1ms)	DO-214AC	1d	1a	Eic
9.1	U1Z9.1	Z-diode	8.2..10.1V, 1W	SOD-6	1d	1a	Tos
9.1	U1ZB9.1	Z-diode	8.2..10.1V, 1W	I-FLAT	1d	1a	Tos
9.1A	P4SMA9.1A	TVS	Vbr=8.65..9.55V, Vrw=7.78V, 31.0A, 400W(1ms)	DO-214AC	1d	1a	Eic
9.1A	P6SMB9.1A	TVS	Vbr=8.65..9.55V, Vrw=7.78V, 45.0A, 600W(1ms)	DO-214AA	1d	1a	Eic
9.1B	HZF9.1BP	Z-diode	9.1V±5%, 900mW	LRP	1d	2f	Ren
9.1B	PTZ9.1B	Z-diode	9.1V±10%, 40mA, 1W	DO-214AC	1d	1a	Rhm
9.1C	HZF9.1CP	Z-diode	9.1V±10%, 900mW	LRP	1d	2f	Ren
9.1C	P4SMA9.1C	TVS	Vbr=8.19..10.0V, Vrw=7.37V, 30.0A, 400W(1ms), Bidirectional	DO-214AC	1ba	1j	Eic
9.1CA	P4SMA9.1CA	TVS	Vbr=8.65..9.55V, Vrw=7.78V, 31.0A, 400W(1ms), Bidirectional	DO-214AC	1ba	1j	Eic
9.1CA	P6SMB9.1CA	TVS	Vbr=8.65..9.55V, Vrw=7.78V, 45.0A, 600W(1ms), Bidirectional	DO-214AA	1ba	1j	Eic
9A	MAZS0910H	Z-diode	9.14..9.6V, 200mW	SOD-523	6d	1a	Pan
9A1	MAZ80910H	Z-diode	9.14..9.6V, Zzt=20Q(5mA), 150mW	SC-76	6d	1a	Pan
9A1	MAZ8091GHL	Z-diode	9.14..9.6V, Zzt=20Q(5mA), 150mW	SMini2-F3	6d	1a	Pan
9	MAZS0910L	Z-diode	8.58..9.02V, 200mW	SOD-523	6d	1a	Pan
9_1	MAZ80910L	Z-diode	8.58..9.52V, Zzt=20Q(5mA), 150mW	SC-76	6d	1a	Pan
9.1	MAZ8091GLL	Z-diode	8.58..9.52V, Zzt=20Q(5mA), 150mW	SMini2-F3	6d	1a	Pan
9*1	HZU9.1B1	Z-diode	8.56..8.93V, Izt=5mA, Zzt=30Q, 200mW	URP	5d	1a	Ren
9*1	HZU9.1B2	Z-diode	8.85..9.23V, Izt=5mA, Zzt=30Q, 200mW	URP	5d	1a	Ren
9*1	HZU9.1B3	Z-diode	9.15..9.55V, Izt=5mA, Zzt=30Q, 200mW	URP	5d	1a	Ren
9*1	RKZ9.1B2KG	Z-diode	8.85..9.23V, Izt=5mA, Zzt=30Q, 200mW	URP	5d	2e	Ren
9*1	RKZ9.1B2KJ	Z-diode	8.85..9.23V, Izt=5mA, Zzt=30Q, 150mW	UFP	7d	2e	Ren
90A	1SMC90A	TVS	Vbr=100..111V, Vrw=90V, 10.3A, 1500W(1ms)	DO-214AB	1d	1a	Eic
90A	SMAJ90A	TVS	Vrw=90V, Vbr=100..111V, 2.7A, 400W(1ms),	DO-214AC	1d	1a	Sus
90A	SMBJ90A	TVS	Vbr=100..111V, Vrw=90V, 4.1A, 600W(1ms)	DO-214AA	1d	1a	Sus
90A	SMCJ90A	TVS	Vrw=90V, Vbr=100..122V, 9.4A, 1500W(1ms)	DO-214AB	1d	1k	Sus
90A	UMA90A	TVS	Vrw=90V, Vbr=100..146V, 3.4A, 500W(1ms)	UltraMite	14d	1v	Msc
90CA	1SMC90CA	TVS	Vbr=100..111V, Vrw=90V, 10.3A, 1500W(1ms), Bidirectional	DO-214AB	1ba	1j	Eic
90CA	SMAJ90CA	TVS	Vrw=90V, Vbr=100..111V, 2.7A, 400W(1ms), Bidirectional	DO-214AC	1ba	1j	Sus
90CA	SMBJ90CA	TVS	Vbr=100..111V, Vrw=90V, 4.1A, 600W(1ms), Bidirectional	DO-214AA	1ba	1j	Sus
90CA	SMCJ90CA	TVS	Vrw=90V, Vbr=100..122V, 9.4A, 1500W(1ms), Bidirectional	DO-214AB	1ba	1l	Sus
90CA	UMA90CA	TVS	Vrw=90V, Vbr=100..146V, 3.4A, 500W(1ms), Bidirectional	UltraMite	14ba	1v	Msc
90V	SMA90	TVS	Vbr=100..122V, Vrw=90.0V, 1.9A, 300W(1ms)	DO-214AC	1d	1a	Mic
90V	SMB90	TVS	Vbr=100..122V, Vrw=90V, 3.8A, 600W(1ms)	DO-214AA	1d	1a	Mic
90V	SMC90	TVS	Vbr=100..122V, Vrw=90V, 9.4A, 1500W(1ms)	DO-214AB	1d	1a	Mic
90VA	SMA90A	TVS	Vbr=100..111V, Vrw=90.0V, 2.1A, 300W(1ms)	DO-214AC	1d	1a	Mic
90VA	SMB90A	TVS	Vbr=100..111V, Vrw=90V, 4.1A, 600W(1ms)	DO-214AA	1d	1a	Mic
90VA	SMC90A	TVS	Vbr=100..111V, Vrw=90V, 10.3A, 1500W(1ms)	DO-214AB	1d	1a	Mic



SMD
code

Type

Function

Short description

Case

Pinout

St.

Mnf.

SMD code	Type	Function	Short description	Case	Pinout	St.	Mnf.
90VC	SMA90C	TVS	Vbr=100..122V, Vrwm=90.0V, 1.9A, 300W(1ms), Bidirectional	DO-214AC	1ba	1j	Mic
90VC	SMB90C	TVS	Vbr=100..122V, Vrwm=90V, 3.8A, 600W(1ms), Bidirectional	DO-214AA	1ba	1j	Mic
90VC	SMC90C	TVS	Vbr=100..122V, Vrwm=90V, 9.4A, 1500W(1ms), Bidirectional	DO-214AB	1ba	1j	Mic
90VCA	SMA90CA	TVS	Vbr=100..111V, Vrwm=90.0V, 2.1A, 300W(1ms), Bidirectional	DO-214AC	1ba	1j	Mic
90VCA	SMB90CA	TVS	Vbr=100..111V, Vrwm=90V, 4.1A, 600W(1ms), Bidirectional	DO-214AA	1ba	1j	Mic
90VCA	SMC90CA	TVS	Vbr=100..111V, Vrwm=90V, 10.3A, 1500W(1ms), Bidirectional	DO-214AB	1ba	1j	Mic
91	HZC9.1	Z-diode	9.1V±10%, 150mW	SOD-523	6d	1a	Ren
91	HZU9.1G	Z-diode	8.56..9.55V, 200mW	SOD-323	5d	1a	Ren
91	KDZ16FVY	Z-diode	15.85..16.51V, Izt=5mA, Zzt=18Ω, 100mW	TFSC	7d	1a	Kec
91	KDZ9.1EV	Z-diode	8.5..9.6V, 150mW	SOD-523	6d	1a	Kec
91	KDZ9.1V	Z-diode	8.5..9.6V, 150mW	SOD-323	5d	1a	Kec
91	MMPZ5270SPST	Z-diode	89.18..92.82V, Izt=1.4mA, Zzt=400Ω, 225mW	SOD-323	5d	1a	Chm
91	P4SMA91	TVS	Vbr=81.9..100V, Vrwm=73.7V, 3.2A, 400W(1ms)	DO-214AC	1d	1a	Eic
91	P6SMBJ91	TVS	Vbr=81.9..100V, 4.5A, 600W(1ms)	DO-214AA	1d	1n	Lif
91	SML4763	Z-diode	91V±5%, Izt=2.8mA, Zzt=250Ω, 1W	DO-214AC	1d	1k	Vs
91	TZD9.1WS	Z-diode	8.50..9.60V, Izt=5mA, Zzt=18Ω, 200mW	SOD-323	5d	1a	Ttr
91	TZD9.1WT	Z-diode	8.50..9.60V, Izt=5mA, Zzt=18Ω, 150mW	SOD-523	6d	1a	Ttr
91	ZV931V2TA	C-diode	VHF-Tuning, 12V, 6.5/7.8pF(2.5V)	SOD-523	6d	1a	Zx
9-1	MAZ80910M	Z-diode	8.87..9.33V, Zzt=20Ω(5mA), 150mW	SC-76	6d	1a	Pan
9-1	MAZ8091GML	Z-diode	8.87..9.33V, Zzt=20Ω(5mA), 150mW	SMIn2-F3	6d	1a	Pan
91*	TZD9.1YWS	Z-diode	8.85..9.23V, Izt=5mA, Zzt=18Ω, 200mW	SOD-323	5d	1a	Ttr
91*	TZD9.1YWT	Z-diode	8.85..9.23V, Izt=5mA, Zzt=18Ω, 150mW	SOD-523	6d	1a	Ttr
913A	1SMB5913A	Z-diode	3.3V±10%, Izt=113.6mA, Zzt=10Ω, 3W	DO-214AA	1d	1a	Eic
913B	1PMT5913B	Z-diode	3.3V±5%, 454mA, 2.5W	DO-216AA	4d	1s	Mot
913B	1SMB5913B	Z-diode	3.3V±5%, Izt=113.6mA, Zzt=10Ω, 3W	403A-03	3d	1s	Ons
914A	1SMB5914A	Z-diode	3.6V±10%, Izt=104.2mA, Zzt=9Ω, 3W	DO-214AA	1d	1a	Eic
914B	1PMT5914B	Z-diode	3.6V±5%, 416mA, 2.5W	DO-216AA	4d	1s	Mot
914B	1SMB5914B	Z-diode	3.6V±5%, Izt=104.2mA, Zzt=9Ω, 3W	403A-03	3d	1s	Ons
915A	1SMB5915A	Z-diode	3.9V±10%, Izt=96.1mA, Zzt=7.5Ω, 3W	DO-214AA	1d	1a	Eic
915B	1PMT5915B	Z-diode	3.9V±5%, 384mA, 2.5W	DO-216AA	4d	1s	Mot
915B	1SMB5915B	Z-diode	3.9V±5%, Izt=96.1mA, Zzt=7.5Ω, 3W	403A-03	3d	1s	Ons
916A	1SMB5916A	Z-diode	4.3V±10%, Izt=87.2mA, Zzt=6Ω, 3W	DO-214AA	1d	1a	Eic
916B	1PMT5916B	Z-diode	4.3V±5%, 348mA, 2.5W	DO-216AA	4d	1s	Mot
916B	1SMB5916B	Z-diode	4.3V±5%, Izt=87.2mA, Zzt=6Ω, 3W	403A-03	3d	1s	Ons
917A	1SMB5917A	Z-diode	4.7V±10%, Izt=79.8mA, Zzt=5Ω, 3W	DO-214AA	1d	1a	Eic
917B	1PMT5917B	Z-diode	4.7V±5%, 319mA, 2.5W	DO-216AA	4d	1s	Mot
917B	1SMB5917B	Z-diode	4.7V±5%, Izt=79.8mA, Zzt=5Ω, 3W	403A-03	3d	1s	Ons
918A	1SMB5918A	Z-diode	5.1V±10%, Izt=73.5mA, Zzt=4Ω, 3W	DO-214AA	1d	1a	Eic
918B	1PMT5918B	Z-diode	5.1V±5%, 294mA, 2.5W	DO-216AA	4d	1s	Mot
918B	1SMB5918B	Z-diode	5.1V±5%, Izt=73.5mA, Zzt=4Ω, 3W	403A-03	3d	1s	Ons
919A	1SMB5919A	Z-diode	5.6V±10%, Izt=66.9mA, Zzt=2Ω, 3W	DO-214AA	1d	1a	Eic
919B	1PMT5919B	Z-diode	5.6V±5%, 267mA, 2.5W	DO-216AA	4d	1s	Mot
919B	1SMB5919B	Z-diode	5.6V±5%, Izt=66.9mA, Zzt=2Ω, 3W	403A-03	3d	1s	Ons
91A	1.5SMC91A	TVS	Vbr=86.5..95.5V, Vrwm=77.8V, 12A, 1500W(1ms)	DO-214AB	1d,3d	1a,1k	Vs,Ons
91A	P4SMA91A	TVS	Vbr=86.5..95.5V, Vrwm=77.8V, 3.4A, 400W(1ms)	DO-214AC	1d	1k	Vs
91A	P6SMB91A	TVS	Vrwm=91V, Vbr=86.5..95.5V, 4.8A, 600W(1ms)	DO-214AA	1d,3d	1k,1a	Vs,Ons
91A	P6SMBJ91A	TVS	Vbr=86.5..95.5V, 4.8A, 600W(1ms)	DO-214AA	1d	1n	Lif
91B	1SMB3EZ91	Z-diode	91V±5%, Zzt=125Ω, Izt=8.2mA, 3W	DO-214AA	1d	1a	Pjt
91C	1.5SMC91CA	TVS	Vbr=86.5..95.5V, Vrwm=77.8V, 12A, 1500W(1ms), Bidirectional	DO-214AB	1ba	1l	Vs
91C	P4SMA91C	TVS	Vbr=81.9..100V, Vrwm=73.7V, 3.2A, 400W(1ms), Bidirectional	DO-214AC	1ba	1j	Eic
91C	P4SMA91CA	TVS	Vbr=86.5..95.5V, 3.2A, 400W(1ms), Bidirectional	DO-214AC	1ba	1l	Vs
91C	P6SMB91CA	TVS	Vrwm=91V, Vbr=86.5..95.5V, 4.8A, 600W(1ms), Bidirectional	DO-214AA	1ba,3ba	1l,1e	Vs,Ons
91C	P6SMBJ91C	TVS	Vbr=81.9..100V, 4.5A, 600W(1ms), Bidirectional	DO-214AA	1ba	1p	Lif
91CA	P4SMA91CA	TVS	Vbr=86.5..95.5V, Vrwm=77.8V, 3.4A, 400W(1ms), Bidirectional	DO-214AC	1ba	1j	Eic
91CA	P6SMB91CA	TVS	Vbr=86.5..95.5V, Vrwm=77.8V, 4.8A, 600W(1ms), Bidirectional	DO-214AA	1ba	1j	Eic
91CA	P6SMBJ91CA	TVS	Vbr=86.5..95.5V, 4.8A, 600W(1ms), Bidirectional	DO-214AA	1ba	1p	Lif
92	EDZ4.7B	Z-diode	4.55..4.75V, Izt=5mA, Zzt=100Ω, 150mW	SOD-523	6d	1a	Rhm
92	EDZS4.7B	Z-diode	4.7V±10%, 5mA, 100mW	SOD-523	6d	1a	Rhm
92	FDZ4.7EV	Z-diode	4.550..4.750V, Izt=5mA, Zzt=100Ω, 150mW	SOD-523	7d	1a	Fis
92	FDZ4.7VT	Z-diode	4.550..4.750V, Izt=5mA, Zzt=100Ω, 200mW	SOD-323	5d	1a	Fis
92	UDZS4.7B	Z-diode	4.55..4.75V, Izt=5mA, Zzt=100Ω, 200mW	SOD-323	5d	1a	Wtr
92	UDZS4.7B	Z-diode	4.7V±2.5%, Izt=5mA, 200mW	SOD-323FL	7d	1s	Rhm
92	VDSZ4.7B	Z-diode	4.7V±5%, 5mA, 100mW	VMD2	5d	1z	Rhm
92	ZV932V2TA	C-diode	VHF-Tuning, 12V, 8.5/10.5pF(2.5V)	SOD-523	6d	1a	Zx
920A	1SMB5920A	Z-diode	6.2V±10%, Izt=60.5mA, Zzt=2Ω, 3W	DO-214AA	1d	1a	Eic
920B	1PMT5920B	Z-diode	6.2V±5%, 241mA, 2.5W	DO-216AA	4d	1s	Mot
920B	1SMB5920B	Z-diode	6.2V±5%, Izt=60.5mA, Zzt=2Ω, 3W	403A-03	3d	1s	Ons
920B	CZRA5920B-G	Z-diode	6.2V±5%, Izt=60.5mA, Zzt=2.0Ω, 1.5W	DO-214AC	1d	1a	Cmc
921A	1SMB5921A	Z-diode	6.8V±10%, Izt=55.1mA, Zzt=2.5Ω, 3W	DO-214AA	1d	1a	Eic
921B	1PMT5921B	Z-diode	6.8V±5%, 220mA, 2.5W	DO-216AA	4d	1s	Mot



SMD code	Type	Function	Short description	Case	Pinout	St.	Mnf.
921B	1SMB5921B	Z-diode	6.8V±5%, Izt=55.1mA, Zzt=2.5Ω, 3W	403A-03	3d	1s	Ons
921B	CZRA5921B-G	Z-diode	6.8V±5%, Izt=55.1mA, Zzt=2.5Ω, 1.5W	DO-214AC	1d	1a	Cmc
921B	Z1.5SMB5921	Z-diode	6.46..7.14V, Izt=55.1mA, Zzt=3Ω, 1.5W	DO-214AA	1d	1a	Ttr
922A	1SMB5922A	Z-diode	7.5V±10%, Izt=50mA, Zzt=3Ω, 3W	DO-214AA	1d	1a	Eic
922B	1PMT5922B	Z-diode	7.5V±5%, 200mA, 2.5W	DO-216AA	4d	1s	Mot
922B	1SMB5922B	Z-diode	7.5V±5%, Izt=50mA, Zzt=3Ω, 3W	403A-03	3d	1s	Ons
922B	CZRA5922B-G	Z-diode	7.5V±5%, Izt=50.1mA, Zzt=3.0Ω, 1.5W	DO-214AC	1d	1a	Cmc
922B	Z1.5SMB5922	Z-diode	7.13..7.88V, Izt=50mA, Zzt=3Ω, 1.5W	DO-214AA	1d	1a	Ttr
923A	1SMB5923A	Z-diode	8.2V±10%, Izt=45.7mA, Zzt=3.5Ω, 3W	DO-214AA	1d	1a	Eic
923B	1PMT5923B	Z-diode	8.2V±5%, 182mA, 2.5W	DO-216AA	4d	1s	Mot
923B	1SMB5923B	Z-diode	8.2V±5%, Izt=45.7mA, Zzt=3.5Ω, 3W	403A-03	3d	1s	Ons
923B	CZRA5923B-G	Z-diode	8.2V±5%, Izt=45.7mA, Zzt=3.5Ω, 1.5W	DO-214AC	1d	1a	Cmc
923B	Z1.5SMB5923	Z-diode	7.79..8.61V, Izt=45.7mA, Zzt=4Ω, 1.5W	DO-214AA	1d	1a	Ttr
924A	1SMB5924A	Z-diode	9.1V±10%, Izt=41.2mA, Zzt=4Ω, 3W	DO-214AA	1d	1a	Eic
924B	1PMT5924B	Z-diode	9.1V±5%, 164mA, 2.5W	DO-216AA	4d	1s	Mot
924B	1SMB5924B	Z-diode	9.1V±5%, Izt=41.2mA, Zzt=4Ω, 3W	403A-03	3d	1s	Ons
924B	CZRA5924B-G	Z-diode	9.1V±5%, Izt=41.2mA, Zzt=4.0Ω, 1.5W	DO-214AC	1d	1a	Cmc
924B	Z1.5SMB5924	Z-diode	8.65..9.56V, Izt=41.2mA, Zzt=4Ω, 1.5W	DO-214AA	1d	1a	Ttr
925A	1SMB5925A	Z-diode	10V±10%, Izt=37.5mA, Zzt=4.5Ω, 3W	DO-214AA	1d	1a	Eic
925B	1PMT5925B	Z-diode	10V±5%, 150mA, 2.5W	DO-216AA	4d	1s	Mot
925B	1SMB5925B	Z-diode	10V±5%, Izt=37.5mA, Zzt=4.5Ω, 3W	403A-03	3d	1s	Ons
925B	CZRA5925B-G	Z-diode	10V±5%, Izt=37.5mA, Zzt=4.5Ω, 1.5W	DO-214AC	1d	1a	Cmc
925B	Z1.5SMB5925	Z-diode	9.50..10.50V, Izt=37.5mA, Zzt=4Ω, 1.5W	DO-214AA	1d	1a	Ttr
926A	1SMB5926A	Z-diode	11V±10%, Izt=34.1mA, Zzt=5.5Ω, 3W	DO-214AA	1d	1a	Eic
926B	1PMT5926B	Z-diode	11V±5%, 136mA, 2.5W	DO-216AA	4d	1s	Mot
926B	1SMB5926	Z-diode	11V±5%, Izt=34.1mA, Zzt=5.5Ω, 1.5W	DO-214AA	1d	1a	Pjt
926B	1SMB5926B	Z-diode	11V±5%, Izt=34.1mA, Zzt=5.5Ω, 3W	403A-03	3d	1s	Ons
926B	CZRA5926B-G	Z-diode	11V±5%, Izt=34.1mA, Zzt=5.5Ω, 1.5W	DO-214AC	1d	1a	Cmc
926B	Z1.5SMB5926	Z-diode	10.45..11.55V, Izt=34.1mA, Zzt=6Ω, 1.5W	DO-214AA	1d	1a	Ttr
927A	1SMB5927A	Z-diode	12V±10%, Izt=31.2mA, Zzt=6.5Ω, 3W	DO-214AA	1d	1a	Eic
927B	1PMT5927B	Z-diode	12V±5%, 125mA, 2.5W	DO-216AA	4d	1s	Mot
927B	1SMB5927	Z-diode	12V±5%, Izt=31.2mA, Zzt=6.5Ω, 1.5W	DO-214AA	1d	1a	Pjt
927B	1SMB5927B	Z-diode	12V±5%, Izt=31.2mA, Zzt=6.5Ω, 3W	403A-03	3d	1s	Ons
927B	CZRA5927B-G	Z-diode	12V±5%, Izt=31.2mA, Zzt=6.5Ω, 1.5W	DO-214AC	1d	1a	Cmc
927B	Z1.5SMB5927	Z-diode	11.40..12.60V, Izt=31.2mA, Zzt=7Ω, 1.5W	DO-214AA	1d	1a	Ttr
928A	1SMB5928A	Z-diode	13V±10%, Izt=28.8mA, Zzt=7Ω, 3W	DO-214AA	1d	1a	Eic
928B	1PMT5928B	Z-diode	13V±5%, 115mA, 2.5W	DO-216AA	4d	1s	Mot
928B	1SMB5928	Z-diode	13V±5%, Izt=28.8mA, Zzt=7Ω, 1.5W	DO-214AA	1d	1a	Pjt
928B	1SMB5928B	Z-diode	13V±5%, Izt=28.8mA, Zzt=7Ω, 3W	403A-03	3d	1s	Ons
928B	CZRA5928B-G	Z-diode	13V±5%, Izt=28.8mA, Zzt=7.0Ω, 1.5W	DO-214AC	1d	1a	Cmc
928B	Z1.5SMB5928	Z-diode	12.35..13.65V, Izt=28.8mA, Zzt=7Ω, 1.5W	DO-214AA	1d	1a	Ttr
929A	1SMB5929A	Z-diode	15V±10%, Izt=25mA, Zzt=9Ω, 3W	DO-214AA	1d	1a	Eic
929B	1PMT5929B	Z-diode	15V±5%, 100mA, 2.5W	DO-216AA	4d	1s	Mot
929B	1SMB5929	Z-diode	15V±5%, Izt=25mA, Zzt=9Ω, 31.5W	DO-214AA	1d	1a	Pjt
929B	1SMB5929B	Z-diode	15V±5%, Izt=25mA, Zzt=9Ω, 3W	403A-03	3d	1s	Ons
929B	CZRA5929B-G	Z-diode	15V±5%, Izt=25.0mA, Zzt=9.0Ω, 1.5W	DO-214AC	1d	1a	Cmc
929B	Z1.5SMB5929	Z-diode	14.25..15.75V, Izt=25mA, Zzt=9Ω, 1.5W	DO-214AA	1d	1a	Ttr
93	ZV933V2TA	C-diode	VHF-Tuning, 12V, 18/27pF(2.5V)	SOD-523	6d	1a	Zx
930A	1SMB5930A	Z-diode	16V±10%, Izt=23.4mA, Zzt=10Ω, 3W	DO-214AA	1d	1a	Eic
930B	1PMT5930B	Z-diode	16V±5%, 93mA, 2.5W	DO-216AA	4d	1s	Mot
930B	1SMB5930	Z-diode	16V±5%, Izt=23.4mA, Zzt=10Ω, 1.5W	DO-214AA	1d	1a	Pjt
930B	1SMB5930B	Z-diode	16V±5%, Izt=23.4mA, Zzt=10Ω, 3W	403A-03	3d	1s	Ons
930B	CZRA5930B-G	Z-diode	16V±5%, Izt=23.4mA, Zzt=10Ω, 1.5W	DO-214AC	1d	1a	Cmc
930B	Z1.5SMB5930	Z-diode	15.20..16.80V, Izt=23.4mA, Zzt=10Ω, 1.5W	DO-214AA	1d	1a	Ttr
931A	1SMB5931A	Z-diode	18V±10%, Izt=20.8mA, Zzt=12Ω, 3W	DO-214AA	1d	1a	Eic
931B	1PMT5931B	Z-diode	18V±5%, 83mA, 2.5W	DO-216AA	4d	1s	Mot
931B	1SMB5931	Z-diode	18V±5%, Izt=20.8mA, Zzt=12Ω, 1.5W	DO-214AA	1d	1a	Pjt
931B	1SMB5931B	Z-diode	18V±5%, Izt=20.8mA, Zzt=12Ω, 3W	403A-03	3d	1s	Ons
931B	CZRA5931B-G	Z-diode	18V±5%, Izt=20.8mA, Zzt=12Ω, 1.5W	DO-214AC	1d	1a	Cmc
931B	Z1.5SMB5931	Z-diode	17.10..18.90V, Izt=20.8mA, Zzt=12Ω, 1.5W	DO-214AA	1d	1a	Ttr
932A	1SMB5932A	Z-diode	20V±10%, Izt=18.7mA, Zzt=14Ω, 3W	DO-214AA	1d	1a	Eic
932B	1PMT5932B	Z-diode	20V±5%, 75mA, 2.5W	DO-216AA	4d	1s	Mot
932B	1SMB5932	Z-diode	20V±5%, Izt=18.7mA, Zzt=14Ω, 1.5W	DO-214AA	1d	1a	Pjt
932B	1SMB5932B	Z-diode	20V±5%, Izt=18.7mA, Zzt=14Ω, 3W	403A-03	3d	1s	Ons
932B	CZRA5932B-G	Z-diode	20V±5%, Izt=18.7mA, Zzt=14Ω, 1.5W	DO-214AC	1d	1a	Cmc
932B	Z1.5SMB5932	Z-diode	19.0..21.0V, Izt=18.7mA, Zzt=14Ω, 1.5W	DO-214AA	1d	1a	Ttr
933A	1SMB5933A	Z-diode	22V±10%, Izt=17mA, Zzt=17.5Ω, 3W	DO-214AA	1d	1a	Eic
933B	1PMT5933B	Z-diode	22V±5%, 68mA, 2.5W	DO-216AA	4d	1s	Mot
933B	1SMB5933	Z-diode	22V±5%, Izt=17mA, Zzt=17.5Ω, 1.5W	DO-214AA	1d	1a	Pjt
933B	1SMB5933B	Z-diode	22V±5%, Izt=17mA, Zzt=17.5Ω, 3W	403A-03	3d	1s	Ons



SMD
code

Type

Function

Short description

Case

Pinout

St.

Mnf.

SMD code	Type	Function	Short description	Case	Pinout	St.	Mnf.
933B	CZRA5933B-G	Z-diode	22V±5%, Izt=17.0mA, Zzt=18Ω, 1.5W	DO-214AC	1d	1a	Cmc
933B	Z1.5SMB5933	Z-diode	20.90...23.10V, Izt=17mA, Zzt=18Ω, 1.5W	DO-214AA	1d	1a	Ttr
934A	1SMB5934A	Z-diode	24V±10%, Izt=15.6mA, Zzt=19Ω, 3W	DO-214AA	1d	1a	Eic
934B	1PMT5934B	Z-diode	24V±5%, 62mA, 2.5W	DO-216AA	4d	1s	Mot
934B	1SMB5934	Z-diode	24V±5%, Izt=15.6mA, Zzt=19Ω, 1.5W	DO-214AA	1d	1a	Pjt
934B	1SMB5934B	Z-diode	24V±5%, Izt=15.6mA, Zzt=19Ω, 3W	403A-03	3d	1s	Ons
934B	CZRA5934B-G	Z-diode	24V±5%, Izt=15.6mA, Zzt=19Ω, 1.5W	DO-214AC	1d	1a	Cmc
934B	Z1.5SMB5934	Z-diode	22.80...25.20V, Izt=15.6mA, Zzt=19Ω, 1.5W	DO-214AA	1d	1a	Ttr
935A	1SMB5935A	Z-diode	27V±10%, Izt=13.9mA, Zzt=23Ω, 3W	DO-214AA	1d	1a	Eic
935B	1PMT5935B	Z-diode	27V±5%, 55mA, 2.5W	DO-216AA	4d	1s	Mot
935B	1SMB5935	Z-diode	27V±5%, Izt=13.9mA, Zzt=23Ω, 1.5W	DO-214AA	1d	1a	Pjt
935B	1SMB5935B	Z-diode	27V±5%, Izt=13.9mA, Zzt=23Ω, 3W	403A-03	3d	1s	Ons
935B	CZRA5935B-G	Z-diode	27V±5%, Izt=13.9mA, Zzt=23Ω, 1.5W	DO-214AC	1d	1a	Cmc
935B	Z1.5SMB5935	Z-diode	25.65...28.35V, Izt=13.9mA, Zzt=23Ω, 1.5W	DO-214AA	1d	1a	Ttr
936A	1SMB5936A	Z-diode	30V±10%, Izt=12.5mA, Zzt=26Ω, 3W	DO-214AA	1d	1a	Eic
936B	1PMT5936B	Z-diode	30V±5%, 50mA, 2.5W	DO-216AA	4d	1s	Mot
936B	1SMB5936	Z-diode	30V±5%, Izt=12.5mA, Zzt=26Ω, 1.5W	DO-214AA	1d	1a	Pjt
936B	1SMB5936B	Z-diode	30V±5%, Izt=12.5mA, Zzt=26Ω, 3W	403A-03	3d	1s	Ons
936B	CZRA5936B-G	Z-diode	30V±5%, Izt=12.5mA, Zzt=26Ω, 1.5W	DO-214AC	1d	1a	Cmc
936B	Z1.5SMB5936	Z-diode	28.50...31.50V, Izt=12.5mA, Zzt=26Ω, 1.5W	DO-214AA	1d	1a	Ttr
937A	1SMB5937A	Z-diode	33V±10%, Izt=11.4mA, Zzt=33Ω, 3W	DO-214AA	1d	1a	Eic
937B	1PMT5937B	Z-diode	33V±5%, 45mA, 2.5W	DO-216AA	4d	1s	Mot
937B	1SMB5937	Z-diode	33V±5%, Izt=11.4mA, Zzt=33Ω, 1.5W	DO-214AA	1d	1a	Pjt
937B	1SMB5937B	Z-diode	33V±5%, Izt=11.4mA, Zzt=33Ω, 3W	403A-03	3d	1s	Ons
937B	CZRA5937B-G	Z-diode	33V±5%, Izt=11.4mA, Zzt=33Ω, 1.5W	DO-214AC	1d	1a	Cmc
937B	Z1.5SMB5937	Z-diode	31.35...34.65V, Izt=11.4mA, Zzt=33Ω, 1.5W	DO-214AA	1d	1a	Ttr
938A	1SMB5938A	Z-diode	36V±10%, Izt=10.4mA, Zzt=38Ω, 3W	DO-214AA	1d	1a	Eic
938B	1PMT5938B	Z-diode	36V±5%, 41mA, 2.5W	DO-216AA	4d	1s	Mot
938B	1SMB5938	Z-diode	36V±5%, Izt=10.4mA, Zzt=38Ω, 1.5W	DO-214AA	1d	1a	Pjt
938B	1SMB5938B	Z-diode	36V±5%, Izt=10.4mA, Zzt=38Ω, 3W	403A-03	3d	1s	Ons
938B	CZRA5938B-G	Z-diode	36V±5%, Izt=10.4mA, Zzt=38Ω, 1.5W	DO-214AC	1d	1a	Cmc
938B	Z1.5SMB5938	Z-diode	34.20...37.80V, Izt=10.4mA, Zzt=38Ω, 1.5W	DO-214AA	1d	1a	Ttr
939A	1SMB5939A	Z-diode	39V±10%, Izt=9.6mA, Zzt=45Ω, 3W	DO-214AA	1d	1a	Eic
939B	1PMT5939B	Z-diode	39V±5%, 38mA, 2.5W	DO-216AA	4d	1s	Mot
939B	1SMB5939	Z-diode	39V±5%, Izt=9.6mA, Zzt=45Ω, 1.5W	DO-214AA	1d	1a	Pjt
939B	1SMB5939B	Z-diode	39V±5%, Izt=9.6mA, Zzt=45Ω, 3W	403A-03	3d	1s	Ons
939B	CZRA5939B-G	Z-diode	39V±5%, Izt=9.6mA, Zzt=45Ω, 1.5W	DO-214AC	1d	1a	Cmc
939B	Z1.5SMB5939	Z-diode	37.05...40.95V, Izt=9.6mA, Zzt=45Ω, 1.5W	DO-214AA	1d	1a	Ttr
940A	1SMB5940A	Z-diode	43V±10%, Izt=8.7mA, Zzt=53Ω, 3W	DO-214AA	1d	1a	Eic
940B	1PMT5940B	Z-diode	43V±5%, 34mA, 2.5W	DO-216AA	4d	1s	Mot
940B	1SMB5940	Z-diode	43V±5%, Izt=8.7mA, Zzt=53Ω, 1.5W	DO-214AA	1d	1a	Pjt
940B	1SMB5940B	Z-diode	43V±5%, Izt=8.7mA, Zzt=53Ω, 3W	403A-03	3d	1s	Ons
940B	CZRA5940B-G	Z-diode	43V±5%, Izt=8.7mA, Zzt=53Ω, 1.5W	DO-214AC	1d	1a	Cmc
940B	Z1.5SMB5940	Z-diode	40.85...45.15V, Izt=8.7mA, Zzt=53Ω, 1.5W	DO-214AA	1d	1a	Ttr
941A	1SMB5941A	Z-diode	47V±10%, Izt=8mA, Zzt=67Ω, 3W	DO-214AA	1d	1a	Eic
941B	1PMT5941B	Z-diode	47V±5%, 31mA, 2.5W	DO-216AA	4d	1s	Mot
941B	1SMB5941	Z-diode	47V±5%, Izt=8mA, Zzt=67Ω, 1.5W	DO-214AA	1d	1a	Pjt
941B	1SMB5941B	Z-diode	47V±5%, Izt=8mA, Zzt=67Ω, 3W	403A-03	3d	1s	Ons
941B	CZRA5941B-G	Z-diode	47V±5%, Izt=8.0mA, Zzt=67Ω, 1.5W	DO-214AC	1d	1a	Cmc
941B	Z1.5SMB5941	Z-diode	44.65...49.35V, Izt=8mA, Zzt=67Ω, 1.5W	DO-214AA	1d	1a	Ttr
942A	1SMB5942A	Z-diode	51V±10%, Izt=7.3mA, Zzt=70Ω, 3W	DO-214AA	1d	1a	Eic
942B	1PMT5942B	Z-diode	51V±5%, 29mA, 2.5W	DO-216AA	4d	1s	Mot
942B	1SMB5942	Z-diode	51V±5%, Izt=7.3mA, Zzt=70Ω, 1.5W	DO-214AA	1d	1a	Pjt
942B	1SMB5942B	Z-diode	51V±5%, Izt=7.3mA, Zzt=70Ω, 3W	403A-03	3d	1s	Ons
942B	CZRA5942B-G	Z-diode	51V±5%, Izt=7.3mA, Zzt=70Ω, 1.5W	DO-214AC	1d	1a	Cmc
942B	Z1.5SMB5942	Z-diode	48.45...53.55V, Izt=7.3mA, Zzt=70Ω, 1.5W	DO-214AA	1d	1a	Ttr
943A	1SMB5943A	Z-diode	56V±10%, Izt=6.7mA, Zzt=86Ω, 3W	DO-214AA	1d	1a	Eic
943B	1PMT5943B	Z-diode	56V±5%, 26mA, 2.5W	DO-216AA	4d	1s	Mot
943B	1SMB5943	Z-diode	56V±5%, Izt=6.7mA, Zzt=86Ω, 1.5W	DO-214AA	1d	1a	Pjt
943B	1SMB5943B	Z-diode	56V±5%, Izt=6.7mA, Zzt=86Ω, 3W	403A-03	3d	1s	Ons
943B	CZRA5943B-G	Z-diode	56V±5%, Izt=6.7mA, Zzt=86Ω, 1.5W	DO-214AC	1d	1a	Cmc
944A	1SMB5944A	Z-diode	62V±10%, Izt=6mA, Zzt=100Ω, 3W	DO-214AA	1d	1a	Eic
944B	1PMT5944B	Z-diode	62V±5%, 24mA, 2.5W	DO-216AA	4d	1s	Mot
944B	1SMB5944	Z-diode	62V±5%, Izt=6mA, Zzt=100Ω, 1.5W	DO-214AA	1d	1a	Pjt
944B	1SMB5944B	Z-diode	62V±5%, Izt=6mA, Zzt=100Ω, 3W	403A-03	3d	1s	Ons
944B	CZRA5944B-G	Z-diode	62V±5%, Izt=6.0mA, Zzt=100Ω, 1.5W	DO-214AC	1d	1a	Cmc
945A	1SMB5945A	Z-diode	68V±10%, Izt=5.5mA, Zzt=120Ω, 3W	DO-214AA	1d	1a	Eic
945B	1PMT5945B	Z-diode	68V±5%, 22mA, 2.5W	DO-216AA	4d	1s	Mot
945B	1SMB5945	Z-diode	68V±5%, Izt=5.5mA, Zzt=120Ω, 1.5W	DO-214AA	1d	1a	Pjt
945B	1SMB5945B	Z-diode	68V±5%, Izt=5.5mA, Zzt=120Ω, 3W	403A-03	3d	1s	Ons



SMD
code

Type

Function

Short description

Case

Pinout

St.

Mnf.

SMD code	Type	Function	Short description	Case	Pinout	St.	Mnf.
945B	CZRA5945B-G	Z-diode	68V±5%, Izt=5.5mA, Zzt=120Ω, 1.5W	DO-214AC	1d	1a	Cmc
946A	1SMB5946A	Z-diode	75V±10%, Izt=5mA, Zzt=140Ω, 3W	DO-214AA	1d	1a	Eic
946B	1PMT5946B	Z-diode	75V±5%, 20mA, 2.5W	DO-216AA	4d	1s	Mot
946B	1SMB5946	Z-diode	75V±5%, Izt=5mA, Zzt=140Ω, 1.5W	DO-214AA	1d	1a	Pjt
946B	1SMB5946B	Z-diode	75V±5%, Izt=5mA, Zzt=140Ω, 3W	403A-03	3d	1s	Ons
946B	CZRA5946B-G	Z-diode	75V±5%, Izt=5mA, Zzt=140Ω, 1.5W	DO-214AC	1d	1a	Cmc
947A	1SMB5947A	Z-diode	82V±10%, Izt=4.6mA, Zzt=160Ω, 3W	DO-214AA	1d	1a	Eic
947B	1PMT5947B	Z-diode	82V±5%, 18mA, 2.5W	DO-216AA	4d	1s	Mot
947B	1SMB5947	Z-diode	82V±5%, Izt=4.6mA, Zzt=160Ω, 1.5W	DO-214AA	1d	1a	Pjt
947B	1SMB5947B	Z-diode	82V±5%, Izt=4.6mA, Zzt=160Ω, 3W	403A-03	3d	1s	Ons
947B	CZRA5947B-G	Z-diode	82V±5%, Izt=4.6mA, Zzt=160Ω, 1.5W	DO-214AC	1d	1a	Cmc
948A	1SMB5948A	Z-diode	91V±10%, Izt=4.1mA, Zzt=200Ω, 3W	DO-214AA	1d	1a	Eic
948B	1PMT5948B	Z-diode	91V±5%, 16mA, 2.5W	DO-216AA	4d	1s	Mot
948B	1SMB5948	Z-diode	91V±5%, Izt=4.1mA, Zzt=200Ω, 1.5W	DO-214AA	1d	1a	Pjt
948B	1SMB5948B	Z-diode	91V±5%, Izt=4.1mA, Zzt=200Ω, 3W	403A-03	3d	1s	Ons
948B	CZRA5948B-G	Z-diode	91V±5%, Izt=4.1mA, Zzt=200Ω, 1.5W	DO-214AC	1d	1a	Cmc
949A	1SMB5949A	Z-diode	100V±10%, Izt=3.7mA, Zzt=250Ω, 3W	DO-214AA	1d	1a	Eic
949B	1SMB5949	Z-diode	100V±5%, Izt=3.7mA, Zzt=250Ω, 1.5W	DO-214AA	1d	1a	Pjt
949B	1SMB5949B	Z-diode	100V±5%, Izt=3.7mA, Zzt=250Ω, 3W	403A-03	3d	1s	Ons
949B	CZRA5949B-G	Z-diode	100V±5%, Izt=3.7mA, Zzt=250Ω, 1.5W	DO-214AC	1d	1a	Cmc
95	BZX584B5V6	Z-diode	5.49..5.71V, Izt=5mA, Zzt=40Ω, 200mW	SOD-523FL	7d	1a	Tac
95	EDZ24B	Z-diode	23.72..24.78V, Izt=5mA, Zzt=120Ω, 150mW	SOD-523	6d	1a	Rhm
95	FDZ24EV	Z-diode	23.720..24.780V, Izt=5mA, Zzt=120Ω, 150mW	SOD-523	7d	1a	Fis
95	FDZ24VT	Z-diode	23.720..24.780V, Izt=5mA, Zzt=120Ω, 200mW	SOD-323	5d	1a	Fis
95	MM5Z5V6B	Z-diode	5.49..5.71V, Izt=5mA, Zzt=40Ω, 200mW	SOD-523FL	7d	1a	Tac
95	TDZ24B	Z-diode	24V±2.5%, 10mA, 500mW	TUMD2	7d	1s	Rhm
95	UDZS24B	Z-diode	23.72..24.78V, Izt=5mA, Zzt=120Ω, 200mW	SOD-323	5d	1a	Wtr
95	UDZS24B	Z-diode	24V±2.5%, Izt=5mA, 200mW	SOD-323FL	7d	1s	Rhm
95	VDZS24B	Z-diode	24V±5%, 5mA, 100mW	VMD2	5d	1z	Rhm
950A	1SMB5950A	Z-diode	110V±10%, Izt=3.4mA, Zzt=300Ω, 3W	DO-214AA	1d	1a	Eic
950B	1SMB5950	Z-diode	110V±5%, Izt=3.4mA, Zzt=300Ω, 1.5W	DO-214AA	1d	1a	Pjt
950B	1SMB5950B	Z-diode	110V±5%, Izt=3.4mA, Zzt=300Ω, 3W	403A-03	3d	1s	Ons
950B	CZRA5950B-G	Z-diode	110V±5%, Izt=3.4mA, Zzt=300Ω, 1.5W	DO-214AC	1d	1a	Cmc
951A	1SMB5951A	Z-diode	120V±10%, Izt=3.1mA, Zzt=380Ω, 3W	DO-214AA	1d	1a	Eic
951B	1SMB5951	Z-diode	120V±5%, Izt=3.1mA, Zzt=380Ω, 1.5W	DO-214AA	1d	1a	Pjt
951B	1SMB5951B	Z-diode	120V±5%, Izt=3.1mA, Zzt=380Ω, 3W	403A-03	3d	1s	Ons
951B	CZRA5951B-G	Z-diode	120V±5%, Izt=3.1mA, Zzt=380Ω, 1.5W	DO-214AC	1d	1a	Cmc
952A	1SMB5952A	Z-diode	130V±10%, Izt=2.9mA, Zzt=450Ω, 3W	DO-214AA	1d	1a	Eic
952B	1SMB5952	Z-diode	130V±5%, Izt=2.9mA, Zzt=450Ω, 1.5W	DO-214AA	1d	1a	Pjt
952B	1SMB5952B	Z-diode	130V±5%, Izt=2.9mA, Zzt=450Ω, 3W	403A-03	3d	1s	Ons
952B	CZRA5952B-G	Z-diode	130V±5%, Izt=2.9mA, Zzt=450Ω, 1.5W	DO-214AC	1d	1a	Cmc
953A	1SMB5953A	Z-diode	150V±10%, Izt=2.5mA, Zzt=600Ω, 3W	DO-214AA	1d	1a	Eic
953B	1SMB5953	Z-diode	150V±5%, Izt=2.5mA, Zzt=600Ω, 1.5W	DO-214AA	1d	1a	Pjt
953B	1SMB5953B	Z-diode	150V±5%, Izt=2.5mA, Zzt=600Ω, 3W	403A-03	3d	1s	Ons
953B	CZRA5953B-G	Z-diode	150V±5%, Izt=2.5mA, Zzt=600Ω, 1.5W	DO-214AC	1d	1a	Cmc
954A	1SMB5954A	Z-diode	160V±10%, Izt=2.3mA, Zzt=700Ω, 3W	DO-214AA	1d	1a	Eic
954B	1SMB5954	Z-diode	160V±5%, Izt=2.3mA, Zzt=700Ω, 1.5W	DO-214AA	1d	1a	Pjt
954B	1SMB5954B	Z-diode	160V±5%, Izt=2.3mA, Zzt=700Ω, 3W	403A-03	3d	1s	Ons
954B	CZRA5954B-G	Z-diode	160V±5%, Izt=2.3mA, Zzt=700Ω, 1.5W	DO-214AC	1d	1a	Cmc
955A	1SMB5955A	Z-diode	180V±10%, Izt=2.1mA, Zzt=900Ω, 3W	DO-214AA	1d	1a	Eic
955B	1SMB5955	Z-diode	180V±5%, Izt=2.1mA, Zzt=900Ω, 1.5W	DO-214AA	1d	1a	Pjt
955B	1SMB5955B	Z-diode	180V±5%, Izt=2.1mA, Zzt=900Ω, 3W	403A-03	3d	1s	Ons
955B	CZRA5955B-G	Z-diode	180V±5%, Izt=2.1mA, Zzt=900Ω, 1.5W	DO-214AC	1d	1a	Cmc
956A	1SMB5956A	Z-diode	200V±10%, Izt=1.9mA, Zzt=1200Ω, 3W	DO-214AA	1d	1a	Eic
956B	1SMB5956	Z-diode	200V±5%, Izt=1.9mA, Zzt=1200Ω, 1.5W	DO-214AA	1d	1a	Pjt
956B	1SMB5956B	Z-diode	200V±5%, Izt=1.9mA, Zzt=1200Ω, 3W	403A-03	3d	1s	Ons
956B	CZRA5956B-G	Z-diode	200V±5%, Izt=1.9mA, Zzt=1200Ω, 1.5W	DO-214AC	1d	1a	Cmc
9A	BZT52-C5V6LP	Z-diode	5.6V±5%, Izt=5mA, Zzt=40Ω, 250mW	DFN1006-2	13d	2a	Di
9A	CDZ55C9V1T	Z-diode	8.65..9.56V, Zzt=10Ω, Izt=5mA, 200mW	0603	70d	2d	Crp
9A	MM1Z2V0B	Z-diode	2V±2%, Izt=5mA, Zzt=90Ω, 500mW	SOD-123FL	7d	1a	Sme
9A1	RKZ9.1AKU	Z-diode	8.29..8.73V, Izt=20mA, Zzt=30Ω, 500mW	TURP-FM	7d	1a	Ren
9B	BZT52-C6V2LP	Z-diode	6.2V±5%, Izt=5mA, Zzt=10Ω, 250mW	DFN1006-2	13d	2a	Di
9B	MM1Z2V2B	Z-diode	2.2V±2%, Izt=5mA, Zzt=90Ω, 500mW	SOD-123FL	7d	1a	Sme
9B1	RKZ9.1BKU	Z-diode	8.57..9.01V, Izt=20mA, Zzt=30Ω, 500mW	TURP-FM	7d	1a	Ren
9C	BZT52-C6V8LP	Z-diode	6.8V±5%, Izt=5mA, Zzt=15Ω, 250mW	DFN1006-2	13d	2a	Di
9C	MM1Z2V4B	Z-diode	2.4V±2%, Izt=5mA, Zzt=100Ω, 500mW	SOD-123FL	7d	1a	Sme
9C	WSB6.8D	TVS	Vbr=5.78..7.82V, Vvwm=6.8V, 1A, 10W(1ms)	SOD-923	7d	1a	Wtr
9C1	RKZ9.1CKU	Z-diode	8.83..9.30V, Izt=20mA, Zzt=30Ω, 500mW	TURP-FM	7d	1a	Ren
9D	BZT52-C7V5LP	Z-diode	7.5V±5%, Izt=5mA, Zzt=15Ω, 250mW	DFN1006-2	13d	2a	Di
9D	MM1Z2V7B	Z-diode	2.7V±2%, Izt=5mA, Zzt=110Ω, 500mW	SOD-123FL	7d	1a	Sme



SMD
code

Type

Function

Short description

Case

Pinout

St.

Mnf.

SMD code	Type	Function	Short description	Case	Pinout	St.	Mnf.
9E	BZT52-C8V2LP	Z-diode	8.2V±5%, Izt=5mA, Zzt=15Ω, 250mW	DFN1006-2	13d	2a	Di
9E	MM1Z3V0B	Z-diode	3V±2%, Izt=5mA, Zzt=120Ω, 500mW	SOD-123FL	7d	1a	Sme
9F	BZT52-C9V1LP	Z-diode	9.1V±5%, Izt=5mA, Zzt=15Ω, 250mW	DFN1006-2	13d	2a	Di
9F	KDZ6.2FV	Z-diode	5.80..6.60V, Izt=5mA, Zzt=30Ω, 100mW	TFSC	7d	1a	Kec
9F	KDZ6.2FVY	Z-diode	6.06..6.33V, Izt=5mA, Zzt=30Ω, 100mW	TFSC	7d	1a	Kec
9F	MM1Z3V3B	Z-diode	3.3V±2%, Izt=5mA, Zzt=130Ω, 500mW	SOD-123FL	7d	1a	Sme
9G	BZT52-C10LP	Z-diode	10V±5%, Izt=5mA, Zzt=20Ω, 250mW	DFN1006-2	13d	2a	Di
9H	BZT52-C11LP	Z-diode	11V±5%, Izt=5mA, Zzt=20Ω, 250mW	DFN1006-2	13d	2a	Di
9H	MM1Z3V6B	Z-diode	3.6V±2%, Izt=5mA, Zzt=130Ω, 500mW	SOD-123FL	7d	1a	Sme
9J	BZT52-C12LP	Z-diode	12V±5%, Izt=5mA, Zzt=25Ω, 250mW	DFN1006-2	13d	2a	Di
9J	MM1Z3V9B	Z-diode	3.9V±2%, Izt=5mA, Zzt=130Ω, 500mW	SOD-123FL	7d	1a	Sme
9K	BZT52-C13LP	Z-diode	13V±5%, Izt=5mA, Zzt=30Ω, 250mW	DFN1006-2	13d	2a	Di
9K	MM1Z4V3B	Z-diode	4.3V±2%, Izt=5mA, Zzt=130Ω, 500mW	SOD-123FL	7d	1a	Sme
9L	BZT52-C15LP	Z-diode	15V±5%, Izt=5mA, Zzt=30Ω, 250mW	DFN1006-2	13d	2a	Di
9M	BZT52-C16LP	Z-diode	16V±5%, Izt=5mA, Zzt=40Ω, 250mW	DFN1006-2	13d	2a	Di
9M	MM1Z4V7B	Z-diode	4.7V±2%, Izt=5mA, Zzt=130Ω, 500mW	SOD-123FL	7d	1a	Sme
9N	BZT52-C18LP	Z-diode	18V±5%, Izt=5mA, Zzt=45Ω, 250mW	DFN1006-2	13d	2a	Di
9N	CMDZ2L2	Z-diode	2.090..2.310V, Izt=0.5mA, Zzt=1000Ω, 250mW	SOD-323	5d	1a	Cen
9N	MM1Z5V1B	Z-diode	5.1V±2%, Izt=5mA, Zzt=130Ω, 500mW	SOD-123FL	7d	1a	Sme
9P	BZT52-C20LP	Z-diode	20V±5%, Izt=5mA, Zzt=55Ω, 250mW	DFN1006-2	13d	2a	Di
9P	CMDZ39L	Z-diode	37.05..40.95V, Izt=0.5mA, Zzt=350Ω, 250mW	SOD-323	5d	1a	Cen
9P	MM1Z5V6B	Z-diode	5.6V±2%, Izt=5mA, Zzt=80Ω, 500mW	SOD-123FL	7d	1a	Sme
9P1	SML4739	Z-diode	9.1V±5%, Izt=28mA, Zzt=5Ω, 1W	DO-214AC	1d	1k	Vs
9R	BZT52-C22LP	Z-diode	22V±5%, Izt=5mA, Zzt=55Ω, 250mW	DFN1006-2	13d	2a	Di
9R	MM1Z6V2B	Z-diode	6.2V±2%, Izt=5mA, Zzt=50Ω, 500mW	SOD-123FL	7d	1a	Sme
9S	BZT52-C24LP	Z-diode	24V±5%, Izt=5mA, Zzt=70Ω, 250mW	DFN1006-2	13d	2a	Di
9V0	SMA9.0	TVS	Vbr=10..12.2V, Vrw=9.0V, 17.8A, 300W(1ms)	DO-214AC	1d	1a	Mic
9V0	SMB9.0	TVS	Vbr=10..12.2V, Vrw=9V, 35.5A, 600W(1ms)	DO-214AA	1d	1a	Mic
9V0	SMC9.0	TVS	Vbr=10..12.2V, Vrw=9V, 88.8A, 1500W(1ms)	DO-214AB	1d	1a	Mic
9V0A	SMA9.0A	TVS	Vbr=10..11.1V, Vrw=9.0V, 19.5A, 300W(1ms)	DO-214AC	1d	1a	Mic
9V0A	SMB9.0A	TVS	Vbr=10..11.1V, Vrw=9V, 39A, 600W(1ms)	DO-214AA	1d	1a	Mic
9V0A	SMC9.0A	TVS	Vbr=10..11.1V, Vrw=9V, 97.4A, 1500W(1ms)	DO-214AB	1d	1a	Mic
9V0C	SMA9.0C	TVS	Vbr=10..12.2V, Vrw=9.0V, 17.8A, 300W(1ms), Bidirectional	DO-214AC	1ba	1j	Mic
9V0C	SMB9.0C	TVS	Vbr=10..12.2V, Vrw=9V, 35.5A, 600W(1ms), Bidirectional	DO-214AA	1ba	1j	Mic
9V0C	SMC9.0C	TVS	Vbr=10..12.2V, Vrw=9V, 88.8A, 1500W(1ms), Bidirectional	DO-214AB	1ba	1j	Mic
9V0CA	SMA9.0CA	TVS	Vbr=10..11.1V, Vrw=9.0V, 19.5A, 300W(1ms), Bidirectional	DO-214AC	1ba	1j	Mic
9V0CA	SMB9.0CA	TVS	Vbr=10..11.1V, Vrw=9V, 39A, 600W(1ms), Bidirectional	DO-214AA	1ba	1j	Mic
9V0CA	SMC9.0CA	TVS	Vbr=10..11.1V, Vrw=9V, 97.4A, 1500W(1ms), Bidirectional	DO-214AB	1ba	1j	Mic
9V1	BZD27C9V1P	Z-diode	8.65..9.56V, Zzt=4Ω, Izt=50mA, 800mW	SOD-123FL	7d	1a	Pjt
9V1	BZY55-C9V1	Z-diode	8.65..9.56V, Izt=5mA, Zzt=10Ω, 500mW	0805	70d	2d	Tsc
9V1	CDZ55C9V1	Z-diode	8.65..9.56V, Zzt=10Ω, Izt=5mA, 500mW	1206	70d	2d	Crp
9V1	CDZ55C9V1S	Z-diode	8.65..9.56V, Zzt=10Ω, Izt=5mA, 500mW	0805	70d	2d	Crp
9V1	CTZ55C9V1	Z-diode	8.65..9.56V, Izt=5mA, Zzt=10Ω, 500mW	1206	70d	2d	Ctc
9V1	MFPZ9V9	Z-diode	8.65..9.56V, Izt=50mA, Zzt=4Ω, 800mW	SOD-123FL	7d	1a	Tr
9V1	P6SMBJ9V1	TVS	Vbr=8.19..10V, 44A, 600W(1ms)	DO-214AA	1d	1n	Lif
9V1A	1.5SMC9.1A	TVS	Vbr=8.65..9.55V, Vrw=7.78V, 112A, 1500W(1ms)	DO-214AB	1d,3d	1a,1k	Vs,Ons
9V1A	P4SMA9.1A	TVS	Vbr=8.65..9.55V, 29.9A, 400W(1ms)	DO-214AC	1d	1k	Vs
9V1A	P6SMB9.1A	TVS	Vrw=9.1V, Vbr=8.65..9.55V, 44.8A, 600W(1ms)	DO-214AA	1d,3d	1k,1a	Vs,Ons
9V1A	P6SMBJ9V1A	TVS	Vbr=8.65..9.55V, 45A, 600W(1ms)	DO-214AA	1d	1n	Lif
9V1B	BZT52-B9V1	Z-diode	8.92..9.28V, Izt=5mA, Zzt=15Ω, 500mW	SOD-123FL	7d	1a	Tsc
9V1B	MMSZ9V1BW	Z-diode	8.92..9.28V, Izt=5mA, Zzt=15Ω, 500mW	SOD-123FL	7d	1a	Tac
9V1B	Z3SMB9.1B	Z-diode	8.65..9.56V, Izt=82mA, Zzt=3Ω, 3W	DO-214AA	1d	1a	Tr
9V1C	1.5SMC9.1CA	TVS	Vbr=8.65..9.55V, Vrw=7.78V, 112A, 1500W(1ms), Bidirectional	DO-214AB	1ba	1l	Vs
9V1C	P4SMA9.1CA	TVS	Vbr=8.65..9.55V, 29.9A, 400W(1ms), Bidirectional	DO-214AC	1ba	1l	Vs
9V1C	P6SMB9.1CA	TVS	Vbr=8.65..9.55V, 44.8A, 600W(1ms), Bidirectional	DO-214AA	1ba	1l	Vs
9V1C	P6SMBJ9V1C	TVS	Vbr=8.19..10V, 44A, 600W(1ms), Bidirectional	DO-214AA	1ba	1p	Lif
9V1CA	P6SMBJ9V1CA	TVS	Vbr=8.65..9.55V, 45A, 600W(1ms), Bidirectional	DO-214AA	1ba	1p	Lif
9V1Z	BZT52-C9V1	Z-diode	8.65..9.56V, Izt=5mA, Zzt=15Ω, 500mW	SOD-123FL	7d	1a	Tsc
9V1Z	MMSZ9V1CW	Z-diode	8.65..9.56V, Izt=5mA, Zzt=15Ω, 500mW	SOD-123FL	7d	1a	Tac
9V1Z	TCMMSZ9V1	Z-diode	9.1V±5%, Izt=5mA, Zzt=14Ω, 500mW	SOD-123FL	7d	1a	Tac
9V1Z	ZGFMO59V1C-MH	Z-diode	8.65..9.56V, Izt=5mA, Zzt=14Ω, 500mW	SOD-123	5d	1a	Pic
9X	MM1Z6V8B	Z-diode	6.8V±2%, Izt=5mA, Zzt=30Ω, 500mW	SOD-123FL	7d	1a	Sme
9Y	BZT52-C5V1LP	Z-diode	5.1V±5%, Izt=5mA, Zzt=60Ω, 250mW	DFN1006-2	13d	2a	Di
9Y	KDZ24VVY	Z-diode	23.72..24.78V, Izt=5mA, Zzt=40Ω, 100mW	VSC	7d	1a	Kec
9Y	MM1Z7V5B	Z-diode	7.5V±2%, Izt=5mA, Zzt=30Ω, 500mW	SOD-123FL	7d	1a	Sme
9Z	BZT52-B5V6S	Z-diode	5.49..5.71V, Izt=5mA, Zzt=40Ω, 200mW	SOD-323FL	7d	1a	Tsc
9Z	MM1Z8V2B	Z-diode	8.2V±2%, Izt=5mA, Zzt=30Ω, 500mW	SOD-123FL	7d	1a	Sme
9Z	MM3Z5V6B	Z-diode	5.49..5.71V, Zzt=37Ω, Izt=5mA, 200mW	SOD-323FL	7d	1a	F
9Z	MM3Z5V6BW	Z-diode	5.49..5.71V, Izt=5mA, Zzt=40Ω, 200mW	SOD-323FL	7d	1a	Tac
9Z	TCMM3Z5V6B	Z-diode	5.6V±2%, Izt=5mA, Zzt=37Ω, 200mW	SOD-323FL	7d	1a	Tac



SMD
code

Type

Function

Short description

Case

Pinout

St.

Mnf.

A	1SS355	Si-diode	Sw-Fast, 40V, 100mA, <3pF, <4ns	SOD-323	5d	1a	Rhm
A	1SS400	Si-diode	Sw, 80V, 100mA, Vf<1.2V(100mA), <4ns	SOD-523	6d	1a	Lrc
A	BA892-02V	PIN-diode	VHF, TV-Band-Sw, 35V, 0.1A, Vf<1V(100mA), 1.4pF, <120ns	SOD-523	6d	1a	Inf
a	BAR50-02V	PIN-diode	RF-Att, 50V, 100mA, 250mW, Vf<1.1V(50mA), <0.5pF	SOD-523	6d	1a	Inf
A	CH501S-40PT	Si-diode	SBD, 45V, 100mA, Vf<0.55V(100mA)	SOD-523	8d	1a	Chm
A	EP05Q04	Si-diode	SBR, 40V, 500mA, Vf<0.51V(500mA)	SOD-123	5d	1a	Nih
A	GBL C051	TVS	Vbr=5V, 5A, 350W(1ms), 0.6pF	SOD-323	5d	1a	Prt
A	MA2H735	Si-diode	SBR, HF, 30V, 1A, Vf<0.5V(1A), 50pF, 30ns	SOD-106	1d	1a	Pan
A	MM9D6V8	Z-diode	6.46..7.14V, Izt=5mA, Zzt=40Ω, 200mW	SOD-923	7d	1n	Wtr
a	MMSZ5228BPT	Z-diode	3.705..4.095V, Izt=5mA, Zzt=90Ω, 225mW	SOD-523	7d	1a	Chm
A	MMSZ5249BPT	Z-diode	18.05..19.95V, Izt=5mA, Zzt=42Ω, 225mW	SOD-523	7d	1a	Chm
A	NZ9F3V9ST	Z-diode	3.89..4.16V, Izt=5mA, Zzt=100Ω, 200mW	SOD-923	7d	2m	Ons
A	NZ9F6V8T	Z-diode	6.46..7.14V, Izt=5mA, Zzt=40Ω, 200mW	SOD-923	7d	1n	Ons
A (blue)	BAR50-03W	PIN-diode	RF-Att, 50V, 100mA, 250mW, Vf<1.1V(50mA), <0.5pF	SOD-323	5d	2	Inf
A (white)	BAT14-098	Si-diode	Schottky, UHF-mix, 4V, 90mA, Vf<0.66V(10mA), <0.35pF	SOD-123	5d	2	Siem
a	MMSZ5228SPT	Z-diode	3.822..3.987V, Izt=5mA, Zzt=90Ω, 225mW	SOD-523	7d	1a	Chm
A	MMSZ5249SPT	Z-diode	18.62..19.38V, Izt=5mA, Zzt=42Ω, 225mW	SOD-523	7d	1a	Chm
A0	1N5817WB	Si-diode	SBR, 20V, 1A, Vf<0.45V(1A), 120pF	SOD-123FL	7d	1a	Sme
A0	HVC202B	C-diode	UHF/VHF-Tuning, 32V, 2.06..14.15pF(25V..2V/1MHz)	UPF	6d	1b	Ren
A0	MMPZ5222BPT	Z-diode	2.375..2.625V, Izt=5mA, Zzt=100Ω, 225mW	SOD-323	5d	1a	Chm
A0	MMPZ5231SPT	Z-diode	4.998..5.202V, Izt=5mA, Zzt=50Ω, 225mW	SOD-323	5d	1a	Chm
A05	SMBYW02-50	Si-diode	Rectifier, Fast-Recovery, 50V, 2A, Vf<0.65V(1A), <35ns	DO-214AA	1d	1q	Ste
A1	BA591	PIN-diode	VHF, TV-Band-Sw, 35V, 100mA, 500mW, 0.8pF	SOD-323	5d	1a	Phi
A1	BAS240	Si-diode	SBD, 40V, 120mA, Vf<1V(40mA), <5pF	SOD-110	12d	1a	Phi
A1	BB208-02	C-diode	VCO/TCXO, 10V, 20mA, 21.5..4.9pF(1..7.5V)	SOD-523	7d	1a	Phi
A1	BZX884-B2V4	Z-diode	2.4V±2%, 250mW	SOD-882	13d	2b	Phi
A1	FSS12	Si-diode	SBR, 20V, 1A, Vf<0.75V(1A)	DO-214AC	1d	2j	Fag
A1	HVC300B	C-diode	VHF-Tuning, 34V, 2.65/47pF(25V..2V/1MHz)	UPF	6d	1b	Ren
A1	MM3Z5221B	Z-diode	2.4V±5%, Izt=20mA, Zzt=30Ω, 200mW	SOD-323FL	7d	1a	Bts
A1	MM3Z5221BH	Z-diode	2.28..2.52V, Izt=20mA, Zzt=30Ω, 300mW	SOD-323	5d	1a	Zow
A1	MMSZ10	Z-diode	10V±5%, Zzt=20Ω, 500mW	SOD-123	5d	1a	Mot
A1	PTV33V3S1UR	TVS	Vrwm=3.5V, Vbr=5.20..6.0V, 43.8A, 350W(1ms)	SOD-123W	7d	1a	Nxp
A1	SM4001SPT	Si-diode	Rectifier, 50V, 1A	SOD-123S	7d	1a	Chm
A10	SMBYW02-100	Si-diode	Rectifier, Fast-Recovery, 100V, 2A, Vf<0.71(1A), <35ns	DO-214AA	1d	1q	Ste
A10	SSCD110	Si-diode	SBR, 100V, 1A, Vf<0.85V(1A)	1206	14d	1v	Zow
A100A	SMA100A	TVS	Vrwm=100.0V, Vbr=111.0..123.0V, Ipp=2.47A, 400W(1ms)	DO-214AC	1d	1a	Ctc
A100CA	SMA100CA	TVS	Vrwm=100.0V, Vbr=111.0..123.0V, Ipp=2.47A, 400W(1ms), Bidirectional	DO-214AC	1ba	1j	Ctc
A10A	P4SSMJ16A	TVS	Vbr=15.2..16.8V, Vrwm=13.6V, 19A, 400W(1ms)	DO-214AC	1d	1a	Chm
A10A	SMA10A	TVS	Vrwm=10.0V, Vbr=11.10..12.30V, Ipp=23.50A, 400W(1ms)	DO-214AC	1d	1a	Ctc
A10C	P4SSMJ16CA	TVS	Vbr=15.2..16.8V, Vrwm=13.6V, 19A, 400W(1ms), Bidirectional	DO-214AC	1ba	1j	Chm
A10CA	SMA10CA	TVS	Vrwm=10.0V, Vbr=11.10..12.30V, Ipp=23.50A, 400W(1ms), Bidirectional	DO-214AC	1ba	1j	Ctc
A110A	SMA110A	TVS	Vrwm=110.0V, Vbr=122.0..135.0V, Ipp=2.26A, 400W(1ms)	DO-214AC	1d	1a	Ctc
A110CA	SMA110CA	TVS	Vrwm=110.0V, Vbr=122.0..135.0V, Ipp=2.26A, 400W(1ms), Bidirectional	DO-214AC	1ba	1j	Ctc
A11A	P4SSMJ18A	TVS	Vbr=17.1..18.9V, Vrwm=15.3V, 17A, 400W(1ms)	DO-214AC	1d	1a	Chm
A11A	SMA11A	TVS	Vrwm=11.0V, Vbr=12.20..13.50V, Ipp=22.0A, 400W(1ms)	DO-214AC	1d	1a	Ctc
A11C	P4SSMJ18CA	TVS	Vbr=17.1..18.9V, Vrwm=15.3V, 17A, 400W(1ms), Bidirectional	DO-214AC	1ba	1j	Chm
A11CA	SMA11CA	TVS	Vrwm=11.0V, Vbr=12.20..13.50V, Ipp=22.0A, 400W(1ms), Bidirectional	DO-214AC	1ba	1j	Ctc
A120A	SMA120A	TVS	Vrwm=120.0V, Vbr=133.0..147.0V, Ipp=2.07A, 400W(1ms)	DO-214AC	1d	1a	Ctc
A120CA	SMA120CA	TVS	Vrwm=120.0V, Vbr=133.0..147.0V, Ipp=2.07A, 400W(1ms), Bidirectional	DO-214AC	1ba	1j	Ctc
A12A	P4SSMJ20A	TVS	Vbr=19.0..21.0V, Vrwm=17.1V, 15A, 400W(1ms)	DO-214AC	1d	1a	Chm
A12A	SMA12A	TVS	Vrwm=12.0V, Vbr=13.30..14.70V, Ipp=20.10A, 400W(1ms)	DO-214AC	1d	1a	Ctc
A12C	P4SSMJ20CA	TVS	Vbr=19.0..21.0V, Vrwm=17.1V, 15A, 400W(1ms), Bidirectional	DO-214AC	1ba	1j	Chm
A12CA	SMA12CA	TVS	Vrwm=12.0V, Vbr=13.30..14.70V, Ipp=20.10A, 400W(1ms), Bidirectional	DO-214AC	1ba	1j	Ctc
A130A	SMA130A	TVS	Vrwm=130.0V, Vbr=144.0..159.0V, Ipp=1.91A, 400W(1ms)	DO-214AC	1d	1a	Ctc
A130CA	SMA130CA	TVS	Vrwm=130.0V, Vbr=144.0..159.0V, Ipp=1.91A, 400W(1ms), Bidirectional	DO-214AC	1ba	1j	Ctc
A13A	P4SSMJ22A	TVS	Vbr=20.9..23.1V, Vrwm=18.8V, 14A, 400W(1ms)	DO-214AC	1d	1a	Chm
A13A	SMA13A	TVS	Vrwm=13.0V, Vbr=14.40..15.90V, Ipp=18.60A, 400W(1ms)	DO-214AC	1d	1a	Ctc
A13C	P4SSMJ22CA	TVS	Vbr=20.9..23.1V, Vrwm=18.8V, 14A, 400W(1ms), Bidirectional	DO-214AC	1ba	1j	Chm
A13CA	SMA13CA	TVS	Vrwm=13.0V, Vbr=14.40..15.90V, Ipp=18.60A, 400W(1ms), Bidirectional	DO-214AC	1ba	1j	Ctc
A140A	SMA140A	TVS	Vrwm=140.0V, Vbr=155.0..171.0V, Ipp=1.76A, 400W(1ms)	DO-214AC	1d	1a	Ctc
A140CA	SMA140CA	TVS	Vrwm=140.0V, Vbr=155.0..171.0V, Ipp=1.76A, 400W(1ms), Bidirectional	DO-214AC	1ba	1j	Ctc
A14A	P4SSMJ24A	TVS	Vbr=22.8..25.2V, Vrwm=20.5V, 13A, 400W(1ms)	DO-214AC	1d	1a	Chm
A14A	SMA14A	TVS	Vrwm=14.0V, Vbr=15.60..17.20V, Ipp=17.20A, 400W(1ms)	DO-214AC	1d	1a	Ctc
A14C	P4SSMJ24CA	TVS	Vbr=22.8..25.2V, Vrwm=20.5V, 13A, 400W(1ms), Bidirectional	DO-214AC	1ba	1j	Chm
A14CA	SMA14CA	TVS	Vrwm=14.0V, Vbr=15.60..17.20V, Ipp=17.20A, 400W(1ms), Bidirectional	DO-214AC	1ba	1j	Ctc
A15	SMBYW02-150	Si-diode	Rectifier, Fast-Recovery, 150V, 2A, Vf<0.85V(1A), <35ns	DO-214AA	1d	1q	Ste
A150A	SMA150A	TVS	Vrwm=150.0V, Vbr=167.0..185.0V, Ipp=1.65A, 400W(1ms)	DO-214AC	1d	1a	Ctc
A150CA	SMA150CA	TVS	Vrwm=150.0V, Vbr=167.0..185.0V, Ipp=1.65A, 400W(1ms), Bidirectional	DO-214AC	1ba	1j	Ctc
A15A	P4SSMJ27A	TVS	Vbr=25.7..28.4V, Vrwm=23.1V, 11.2A, 400W(1ms)	DO-214AC	1d	1a	Chm
A15A	SMA15A	TVS	Vrwm=15.0V, Vbr=16.70..18.50V, Ipp=16.40A, 400W(1ms)	DO-214AC	1d	1a	Ctc



SMD code	Type	Function	Short description	Case	Pinout	St.	Mnf.
A15C	P4SSMJ27CA	TVS	Vbr=25.7..28.4V, Vrvwm=23.1V, 11.2A, 400W(1ms), Bidirectional	DO-214AC	1ba	1j	Chm
A15CA	SMA15CA	TVS	Vrvwm=15.0V, Vbr=16.70..18.50V, Ipp=16.40A, 400W(1ms), Bidirectional	DO-214AC	1ba	1j	Ctc
A160A	SMA160A	TVS	Vrvwm=160.0V, Vbr=178.0..197.0V, Ipp=1.54A, 400W(1ms)	DO-214AC	1d	1a	Ctc
A160CA	SMA160CA	TVS	Vrvwm=160.0V, Vbr=178.0..197.0V, Ipp=1.54A, 400W(1ms), Bidirectional	DO-214AC	1ba	1j	Ctc
A16A	P4SSMJ30A	TVS	Vbr=28.5..31.5V, Vrvwm=25.6V, 10A, 400W(1ms)	DO-214AC	1d	1a	Chm
A16A	SMA16A	TVS	Vrvwm=16.0V, Vbr=17.80..19.70V, Ipp=15.40A, 400W(1ms)	DO-214AC	1d	1a	Ctc
A16C	P4SSMJ30CA	TVS	Vbr=28.5..31.5V, Vrvwm=25.6V, 10A, 400W(1ms), Bidirectional	DO-214AC	1ba	1j	Chm
A16CA	SMA16CA	TVS	Vrvwm=16.0V, Vbr=17.80..19.70V, Ipp=15.40A, 400W(1ms), Bidirectional	DO-214AC	1ba	1j	Ctc
A170A	SMA170A	TVS	Vrvwm=170.0V, Vbr=189.0..209.0V, Ipp=1.45A, 400W(1ms)	DO-214AC	1d	1a	Ctc
A170CA	SMA170CA	TVS	Vrvwm=170.0V, Vbr=189.0..209.0V, Ipp=1.45A, 400W(1ms), Bidirectional	DO-214AC	1ba	1j	Ctc
A17A	P4SSMJ33A	TVS	Vbr=31.4..34.7V, Vrvwm=28.2V, 9A, 400W(1ms)	DO-214AC	1d	1a	Chm
A17A	SMA17A	TVS	Vrvwm=17.0V, Vbr=18.90..20.90V, Ipp=14.50A, 400W(1ms)	DO-214AC	1d	1a	Ctc
A17C	P4SSMJ33CA	TVS	Vbr=31.4..34.7V, Vrvwm=28.2V, 9A, 400W(1ms), Bidirectional	DO-214AC	1ba	1j	Chm
A17CA	SMA17CA	TVS	Vrvwm=17.0V, Vbr=18.90..20.90V, Ipp=14.50A, 400W(1ms), Bidirectional	DO-214AC	1ba	1j	Ctc
A180A	SMA180A	TVS	Vrvwm=180.0V, Vbr=200.0..220.0V, Ipp=1.37A, 400W(1ms)	DO-214AC	1d	1a	Ctc
A180CA	SMA180CA	TVS	Vrvwm=180.0V, Vbr=200.0..220.0V, Ipp=1.37A, 400W(1ms), Bidirectional	DO-214AC	1ba	1j	Ctc
A18A	P4SSMJ36A	TVS	Vbr=34.2..37.8V, Vrvwm=30.8V, 8.4A, 400W(1ms)	DO-214AC	1d	1a	Chm
A18A	SMA18A	TVS	Vrvwm=18.0V, Vbr=20.0..22.10V, Ipp=13.70A, 400W(1ms)	DO-214AC	1d	1a	Ctc
A18C	P4SSMJ36CA	TVS	Vbr=34.2..37.8V, Vrvwm=30.8V, 8.4A, 400W(1ms), Bidirectional	DO-214AC	1ba	1j	Chm
A18CA	SMA18CA	TVS	Vrvwm=18.0V, Vbr=20.0..22.10V, Ipp=13.70A, 400W(1ms), Bidirectional	DO-214AC	1ba	1j	Ctc
A190A	SMA190A	TVS	Vrvwm=190.0V, Vbr=211.0..232.0V, Ipp=1.30A, 400W(1ms)	DO-214AC	1d	1a	Ctc
A190CA	SMA190CA	TVS	Vrvwm=190.0V, Vbr=211.0..232.0V, Ipp=1.30A, 400W(1ms), Bidirectional	DO-214AC	1ba	1j	Ctc
A19A	P4SSMJ39A	TVS	Vbr=37.1..41.0V, Vrvwm=33.3V, 7.8A, 400W(1ms)	DO-214AC	1d	1a	Chm
A19A	SMA19A	TVS	Vrvwm=19.0V, Vbr=21.0..23.30V, Ipp=13.0A, 400W(1ms)	DO-214AC	1d	1a	Ctc
A19C	P4SSMJ39CA	TVS	Vbr=37.1..41.0V, Vrvwm=33.3V, 7.8A, 400W(1ms), Bidirectional	DO-214AC	1ba	1j	Chm
A19CA	SMA19CA	TVS	Vrvwm=19.0V, Vbr=21.0..23.30V, Ipp=13.0A, 400W(1ms), Bidirectional	DO-214AC	1ba	1j	Ctc
A1A	P4SSMJ6.8A	TVS	Vbr=6.45..7.14V, Vrvwm=5.80V, 40A, 400W(1ms)	DO-214AC	1d	1a	Chm
A1C	P4SSMJ6.8CA	TVS	Vbr=6.45..7.14V, Vrvwm=5.80V, 40A, 400W(1ms), Bidirectional	DO-214AC	1ba	1j	Chm
A2	1N4148W	Si-diode	Sw, Fast, 75V, 150mA, <2pF, <2ns	SOD-123	5d	1a	Cen
A2	1N4148WS	Si-diode	Sw, Fast, 75V, 150mA, <2pF, <2ns	SOD-323	5d	1a	Gse
A2	BA592	PIN-diode	VHF, TV-Band-Sw, 35V, 100mA, Vf<1V(100mA), 1.4pF, <120ns	SOD-323	5d	1a	Phi
A2	BB184	C-diode	VCO-TV tuning, 13V, 10mA, 2..14pF(10..1V)	SOD-523	6d	1a	Phi
A2	BB208-03	C-diode	VXCO/TCXO, 10V, 20mA, 21.5..4.9pF(1..7.5V)	SOD-323	5d	1a	Phi
A2	BZX884-B2V7	Z-diode	2.7V±2%, 250mW	SOD-882	13d	2b	Phi
A2	EDZ5.1B	Z-diode	4.98..5.20V, Izt=5mA, Zzt=80Ω, 150mW	SOD-523	6d	1a	Rhm
A2	EDZS5.1B	Z-diode	5.1V±10%, 5mA, 100mW	SOD-523	6d	1a	Rhm
A2	FDZ5.1EV	Z-diode	4.980..5.20V, Izt=5mA, Zzt=80Ω, 150mW	SOD-523	7d	1a	Fis
A2	FDZ5.1VT	Z-diode	4.980..5.200V, Izt=5mA, Zzt=80Ω, 200mW	SOD-323	5d	1a	Fis
A2	FSS13	Si-diode	SBR, 30V, 1A, Vf<0.75V(1A)	DO-214AC	1d	2j	Fag
A2	MM3Z5241B	Z-diode	11V±5%, Izt=20mA, Zzt=22Ω, 200mW	SOD-323FL	7d	1a	Bts
A2	MM3Z5241BH	Z-diode	10.45..11.55V, Izt=20mA, Zzt=22Ω, 300mW	SOD-323	5d	1a	Zow
A2	MMSZ11	Z-diode	11V±5%, Zzt=20Ω, 500mW	SOD-123	5d	1a	Mot
A2	MSCD102	Si-diode	SBR, 20V, 1A, Vf<0.45V(1A)	0805	14d	1v	Zow
A2	PTV5SV0S1UR	TVS	Vrvwm=5.0V, Vbr=6.40..7.0V, 43.5A, 400W(1ms)	SOD-123W	7d	1a	Nxp
A2	SM4002SPT	Si-diode	Rectifier, 100V, 1A	SOD-123S	7d	1a	Chm
A2	SSCD102	Si-diode	SBR, 20V, 1A, Vf<0.5V(1A)	1206	14d	1v	Zow
A2	TDZ5.1B	Z-diode	5.1V±2.5%, 10mA, 500mW	TUMD2	7d	1s	Rhm
A2	UDZS5.1B	Z-diode	4.98..5.20V, Izt=5mA, Zzt=80Ω, 200mW	SOD-323	5d	1a	Wtr
A2	UDZS5.1B	Z-diode	5.1V±2.5%, Izt=5mA, 200mW	SOD-323FL	7d	1s	Rhm
A2	VDZS5.1B	Z-diode	5.1V±5%, 5mA, 100mW	VMD2	5d	1z	Rhm
A20	SMBYW02-200	Si-diode	Rectifier, Fast-Recovery, 200V, 2A, Vf<0.91V(1A), <35ns	DO-214AA	1d	1q	Ste
A20A	P4SSMJ43A	TVS	Vbr=40.9..45.2V, Vrvwm=36.8V, 7.1A, 400W(1ms)	DO-214AC	1d	1a	Chm
A20A	SMA20A	TVS	Vrvwm=20.0V, Vbr=22.20..24.50V, Ipp=12.30A, 400W(1ms)	DO-214AC	1d	1a	Ctc
A20C	P4SSMJ43CA	TVS	Vbr=40.9..45.2V, Vrvwm=36.8V, 7.1A, 400W(1ms), Bidirectional	DO-214AC	1ba	1j	Chm
A20CA	SMA20CA	TVS	Vrvwm=20.0V, Vbr=22.20..24.50V, Ipp=12.30A, 400W(1ms), Bidirectional	DO-214AC	1ba	1j	Ctc
A21A	P4SSMJ47A	TVS	Vbr=44.7..49.4V, Vrvwm=40.2V, 5.0A, 400W(1ms)	DO-214AC	1d	1a	Chm
A21C	P4SSMJ47CA	TVS	Vbr=44.7..49.4V, Vrvwm=40.2V, 5.0A, 400W(1ms), Bidirectional	DO-214AC	1ba	1j	Chm
A22A	P4SSMJ51A	TVS	Vbr=48.5..53.6V, Vrvwm=43.6V, 6.0A, 400W(1ms)	DO-214AC	1d	1a	Chm
A22A	SMA22A	TVS	Vrvwm=22.0V, Vbr=24.40..26.90V, Ipp=11.30A, 400W(1ms)	DO-214AC	1d	1a	Ctc
A22C	P4SSMJ51CA	TVS	Vbr=48.5..53.6V, Vrvwm=43.6V, 6.0A, 400W(1ms), Bidirectional	DO-214AC	1ba	1j	Chm
A22CA	SMA22CA	TVS	Vrvwm=22.0V, Vbr=24.40..26.90V, Ipp=11.30A, 400W(1ms), Bidirectional	DO-214AC	1ba	1j	Ctc
A23A	P4SSMJ56A	TVS	Vbr=53.2..58.8V, Vrvwm=47.8V, 5.5A, 400W(1ms)	DO-214AC	1d	1a	Chm
A23C	P4SSMJ56CA	TVS	Vbr=53.2..58.8V, Vrvwm=47.8V, 5.5A, 400W(1ms), Bidirectional	DO-214AC	1ba	1j	Chm
A24A	P4SSMJ62A	TVS	Vbr=58.9..65.1V, Vrvwm=53.0V, 5.0A, 400W(1ms)	DO-214AC	1d	1a	Chm
A24A	SMA24A	TVS	Vrvwm=24.0V, Vbr=26.70..29.50V, Ipp=10.30A, 400W(1ms)	DO-214AC	1d	1a	Ctc
A24C	P4SSMJ62CA	TVS	Vbr=58.9..65.1V, Vrvwm=53.0V, 5.0A, 400W(1ms), Bidirectional	DO-214AC	1ba	1j	Chm
A24CA	SMA24CA	TVS	Vrvwm=24.0V, Vbr=26.70..29.50V, Ipp=10.30A, 400W(1ms), Bidirectional	DO-214AC	1ba	1j	Ctc
A25A	P4SSMJ68A	TVS	Vbr=64.6..71.4V, Vrvwm=58.0V, 4.6A, 400W(1ms)	DO-214AC	1d	1a	Chm
A25C	P4SSMJ68CA	TVS	Vbr=64.6..71.4V, Vrvwm=58.0V, 4.6A, 400W(1ms), Bidirectional	DO-214AC	1ba	1j	Chm
A26A	P4SSMJ75A	TVS	Vbr=71.3..78.8V, Vrvwm=64.1V, 4.1A, 400W(1ms)	DO-214AC	1d	1a	Chm



SMD
code

Type

Function

Short description

Case

Pinout

St.

Mnf.

SMD code	Type	Function	Short description	Case	Pinout	St.	Mnf.
A26A	SMA26A	TVS	Vrwm=26.0V, Vbr=28.90..31.90V, Ipp=9.50A, 400W(1ms)	DO-214AC	1d	1a	Ctc
A26C	P4SSMJ75CA	TVS	Vbr=71.3..78.8V, Vrwm=64.1V, 4.1A, 400W(1ms), Bidirectional	DO-214AC	1ba	1j	Chm
A26CA	SMA26CA	TVS	Vrwm=26.0V, Vbr=28.90..31.90V, Ipp=9.50A, 400W(1ms), Bidirectional	DO-214AC	1ba	1j	Ctc
A27A	P4SSMJ82A	TVS	Vbr=77.9..86.1V, Vrwm=70.1V, 3.7A, 400W(1ms)	DO-214AC	1d	1a	Chm
A27C	P4SSMJ82CA	TVS	Vbr=77.9..86.1V, Vrwm=70.1V, 3.7A, 400W(1ms), Bidirectional	DO-214AC	1ba	1j	Chm
A28A	P4SSMJ91A	TVS	Vbr=86.5..95.5V, Vrwm=77.8V, 3.4A, 400W(1ms)	DO-214AC	1d	1a	Chm
A28A	SMA28A	TVS	Vrwm=28.0V, Vbr=31.10..34.40V, Ipp=8.81A, 400W(1ms)	DO-214AC	1d	1a	Ctc
A28C	P4SSMJ91CA	TVS	Vbr=86.5..95.5V, Vrwm=77.8V, 3.4A, 400W(1ms), Bidirectional	DO-214AC	1ba	1j	Chm
A28CA	SMA28CA	TVS	Vrwm=28.0V, Vbr=31.10..34.40V, Ipp=8.81A, 400W(1ms), Bidirectional	DO-214AC	1ba	1j	Ctc
A29A	P4SSMJ100A	TVS	Vbr=95..105V, Vrwm=85.5V, 3.1A, 400W(1ms)	DO-214AC	1d	1a	Chm
A29C	P4SSMJ100CA	TVS	Vbr=95..105V, Vrwm=85.5V, 3.1A, 400W(1ms), Bidirectional	DO-214AC	1ba	1j	Chm
A2A	P4SSMJ7.5A	TVS	Vbr=7.13..7.88V, Vrwm=6.40V, 37A, 400W(1ms)	DO-214AC	1d	1a	Chm
A2C	P4SSMJ7.5CA	TVS	Vbr=7.13..7.88V, Vrwm=6.40V, 37A, 400W(1ms), Bidirectional	DO-214AC	1ba	1j	Chm
A3	1N4448W	Si-diode	Sw, Fast, 100V, 500mA, <2pF, <4ns	SOD-123	5d	1a	Cen
A3	1N4448WS	Si-diode	Sw, Fast, 100V, 500mA, <2pF, <4ns	SOD-323	5d	1a	Gse
A3	BAP64-03	PIN-diode	RF, 175V, 100mA, 500mW, 0.35pF, 2Ω(10mA/100MHz)	SOD-323	5d	1a	Phi
A3	BB198	C-diode	VCO, 20V, 100mA, 300mW, 6.8..28.5pF(4..1V)	SOD-523	6d	1a	Phi
A3	BZX884-B3V0	Z-diode	3V±2%, 250mW	SOD-882	13d	2b	Phi
A3	FSS14	Si-diode	SBR, 40V, 1A, Vf<0.75V(1A)	DO-214AC	1d	2j	Fag
A3	MM3Z5262B	Z-diode	51V±5%, Izt=2.5mA, Zzt=125Ω, 200mW	SOD-323FL	7d	1a	Bts
A3	MM3Z5262BH	Z-diode	48.45..53.55V, Izt=2.5mA, Zzt=125Ω, 300mW	SOD-323	5d	1a	Zow
A3	MMSZ12	Z-diode	12V±5%, Zzt=25Ω, 500mW	SOD-123	5d	1a	Mot
A3	PTVS6V0S1UR	TVS	Vrwm=6.0V, Vbr=6.67..7.37V, 38.8A, 400W(1ms)	SOD-123W	7d	1a	Nxp
A3	SM4003SPT	Si-diode	Rectifier, 200V, 1A	SOD-123S	7d	1a	Chm
A30A	P4SSMJ110A	TVS	Vbr=105..116V, Vrwm=94V, 2.8A, 400W(1ms)	DO-214AC	1d	1a	Chm
A30A	SMA30A	TVS	Vrwm=30.0V, Vbr=33.30..36.80V, Ipp=8.26A, 400W(1ms)	DO-214AC	1d	1a	Ctc
A30C	P4SSMJ110CA	TVS	Vbr=105..116V, Vrwm=94V, 2.8A, 400W(1ms), Bidirectional	DO-214AC	1ba	1j	Chm
A30CA	SMA30CA	TVS	Vrwm=30.0V, Vbr=33.30..36.80V, Ipp=8.26A, 400W(1ms), Bidirectional	DO-214AC	1ba	1j	Ctc
A31A	P4SSMJ120A	TVS	Vbr=114..126V, Vrwm=102V, 2.5A, 400W(1ms)	DO-214AC	1d	1a	Chm
A31C	P4SSMJ120CA	TVS	Vbr=114..126V, Vrwm=102V, 2.5A, 400W(1ms), Bidirectional	DO-214AC	1ba	1j	Chm
A32A	P4SSMJ130A	TVS	Vbr=124..137V, Vrwm=111V, 2.3A, 400W(1ms)	DO-214AC	1d	1a	Chm
A32C	P4SSMJ130CA	TVS	Vbr=124..137V, Vrwm=111V, 2.3A, 400W(1ms), Bidirectional	DO-214AC	1ba	1j	Chm
A33A	P4SSMJ150A	TVS	Vbr=143..158V, Vrwm=128V, 2.0A, 400W(1ms)	DO-214AC	1d	1a	Chm
A33A	SMA33A	TVS	Vrwm=33.0V, Vbr=36.70..40.60V, Ipp=7.50A, 400W(1ms)	DO-214AC	1d	1a	Ctc
A33C	P4SSMJ150CA	TVS	Vbr=143..158V, Vrwm=128V, 2.0A, 400W(1ms), Bidirectional	DO-214AC	1ba	1j	Chm
A33CA	SMA33CA	TVS	Vrwm=33.0V, Vbr=36.70..40.60V, Ipp=7.50A, 400W(1ms), Bidirectional	DO-214AC	1ba	1j	Ctc
A34	MBRA340	Si-diode	SBR, 40V, 3A, Vf<0.45V(3A)	DO-214AC	1d	1f	Ons
A34A	P4SSMJ160A	TVS	Vbr=152..168V, Vrwm=136V, 1.9A, 400W(1ms)	DO-214AC	1d	1a	Chm
A34C	P4SSMJ160CA	TVS	Vbr=152..168V, Vrwm=136V, 1.9A, 400W(1ms), Bidirectional	DO-214AC	1ba	1j	Chm
A35A	P4SSMJ170A	TVS	Vbr=162..179V, Vrwm=145V, 1.8A, 400W(1ms)	DO-214AC	1d	1a	Chm
A35C	P4SSMJ170CA	TVS	Vbr=162..179V, Vrwm=145V, 1.8A, 400W(1ms), Bidirectional	DO-214AC	1ba	1j	Chm
A36A	P4SSMJ180A	TVS	Vbr=171..189V, Vrwm=154V, 1.7A, 400W(1ms)	DO-214AC	1d	1a	Chm
A36A	SMA36A	TVS	Vrwm=36.0V, Vbr=40.0..44.20V, Ipp=6.88A, 400W(1ms)	DO-214AC	1d	1a	Ctc
A36C	P4SSMJ180CA	TVS	Vbr=171..189V, Vrwm=154V, 1.7A, 400W(1ms), Bidirectional	DO-214AC	1ba	1j	Chm
A36CA	SMA36CA	TVS	Vrwm=36.0V, Vbr=40.0..44.20V, Ipp=6.88A, 400W(1ms), Bidirectional	DO-214AC	1ba	1j	Ctc
A37A	P4SSMJ200A	TVS	Vbr=190..210V, Vrwm=171V, 1.53A, 400W(1ms)	DO-214AC	1d	1a	Chm
A37C	P4SSMJ200CA	TVS	Vbr=190..210V, Vrwm=171V, 1.53A, 400W(1ms), Bidirectional	DO-214AC	1ba	1j	Chm
A3A	P4SSMJ8.2A	TVS	Vbr=7.79..8.61V, Vrwm=7.02V, 35A, 400W(1ms)	DO-214AC	1d	1a	Chm
A3C	P4SSMJ8.2CA	TVS	Vbr=7.79..8.61V, Vrwm=7.02V, 35A, 400W(1ms), Bidirectional	DO-214AC	1ba	1j	Chm
A4	1N4150W	Si-diode	Sw, Fast, 50V, 200mA, <2.5pF(0V), <4ns	SOD-323	5d	1a	Cen
A4	BAT760	Si-diode	Schottky, Sw, U-Fast, 20V, 1A, Vf<0.55V(1A), <0.3ns	SOD-323	5d	1a	Phi
A4	BZX884-B3V3	Z-diode	3.3V±2%, 250mW	SOD-882	13d	2b	Phi
A4	FSS15	Si-diode	SBR, 50V, 1A, Vf<0.75V(1A)	DO-214AC	1d	2j	Fag
A4	MM1Z5221B	Z-diode	2.28..2.52V, Izt=20mA, Zzt=30Ω, 500mW	SOD-323FL	5d	1a	Eic
A4	MM1Z5221BH	Z-diode	2.28..2.52V, Izt=20mA, Zzt=30Ω, 500mW	SOD-123	5d	1a	Zow
A4	MMSZ13	Z-diode	13V±5%, Zzt=30Ω, 500mW	SOD-123	5d	1a	Mot
A4	MMSZ5221B	Z-diode	2.4V±5%, Izt=20mA, Zzt=30Ω, 500mW	SOD-123	5d	1a	Eic
A4	MSCD104	Si-diode	SBR, 40V, 1A, Vf<0.5V(1A)	0805	14d	1v	Zow
A4	PTVS6V5S1UR	TVS	Vrwm=6.5V, Vbr=7.22..7.98V, 35.7A, 400W(1ms)	SOD-123W	7d	1a	Nxp
A4	SM4004SPT	Si-diode	Rectifier, 400V, 1A	SOD-123S	7d	1a	Chm
A4	SSCD104	Si-diode	SBR, 40V, 1A, Vf<0.5V(1A)	1206	14d	1v	Zow
A40A	SMA40A	TVS	Vrwm=40.0V, Vbr=44.40..49.10V, Ipp=6.20A, 400W(1ms)	DO-214AC	1d	1a	Ctc
A40CA	SMA40CA	TVS	Vrwm=40.0V, Vbr=44.40..49.10V, Ipp=6.20A, 400W(1ms), Bidirectional	DO-214AC	1ba	1j	Ctc
A43A	SMA43A	TVS	Vrwm=43.0V, Vbr=47.80..52.80V, Ipp=5.76A, 400W(1ms)	DO-214AC	1d	1a	Ctc
A43CA	SMA43CA	TVS	Vrwm=43.0V, Vbr=47.80..52.80V, Ipp=5.76A, 400W(1ms), Bidirectional	DO-214AC	1ba	1j	Ctc
A45A	SMA45A	TVS	Vrwm=45.0V, Vbr=50.0..55.30V, Ipp=5.50A, 400W(1ms)	DO-214AC	1d	1a	Ctc
A45CA	SMA45CA	TVS	Vrwm=45.0V, Vbr=50.0..55.30V, Ipp=5.50A, 400W(1ms), Bidirectional	DO-214AC	1ba	1j	Ctc
A4741	SMA4741	Z-diode	11V±5%, Izt=23mA, Zzt=8Ω, 1W	DO-214AC	1d	1t	Dac
A4741A	SMA4741A	Z-diode	11V±10%, Izt=23mA, Zzt<8Ω, 1W	DO-214AC	1d	1t	Dac
A4742	SMA4742	Z-diode	12V±5%, Izt=21mA, Zzt<9Ω, 1W	DO-214AC	1d	1t	Dac



SMD code	Type	Function	Short description	Case	Pinout	St.	Mnf.
A4742A	SMA4742A	Z-diode	12V±10%, Izt=21mA, Zzt<9Ω, 1W	DO-214AC	1d	1t	Dac
A4743	SMA4743	Z-diode	13V±5%, Izt=19mA, Zzt<10Ω, 1W	DO-214AC	1d	1t	Dac
A4743A	SMA4743A	Z-diode	13V±10%, Izt=19mA, Zzt<10Ω, 1W	DO-214AC	1d	1t	Dac
A4744	SMA4744	Z-diode	15V±5%, Izt=17mA, Zzt<14Ω, 1W	DO-214AC	1d	1t	Dac
A4744A	SMA4744A	Z-diode	15V±10%, Izt=17mA, Zzt<14Ω, 1W	DO-214AC	1d	1t	Dac
A4745	SMA4745	Z-diode	16V±5%, Izt=15.5mA, Zzt<16Ω, 1W	DO-214AC	1d	1t	Dac
A4745A	SMA4745A	Z-diode	16V±10%, Izt=15.5mA, Zzt<16Ω, 1W	DO-214AC	1d	1t	Dac
A4746	SMA4746	Z-diode	18V±5%, Izt=14mA, Zzt<20Ω, 1W	DO-214AC	1d	1t	Dac
A4746A	SMA4746A	Z-diode	18V±10%, Izt=14mA, Zzt<20Ω, 1W	DO-214AC	1d	1t	Dac
A4747	SMA4747	Z-diode	20V±5%, Izt=12.5mA, Zzt<22Ω, 1W	DO-214AC	1d	1t	Dac
A4747A	SMA4747A	Z-diode	20V±10%, Izt=12.5mA, Zzt<22Ω, 1W	DO-214AC	1d	1t	Dac
A4748	SMA4748	Z-diode	22V±5%, Izt=11.5mA, Zzt<23Ω, 1W	DO-214AC	1d	1t	Dac
A4748A	SMA4748A	Z-diode	22V±10%, Izt=11.5mA, Zzt<23Ω, 1W	DO-214AC	1d	1t	Dac
A4749	SMA4749	Z-diode	24V±5%, Izt=10.5mA, Zzt<25Ω, 1W	DO-214AC	1d	1t	Dac
A4749A	SMA4749A	Z-diode	24V±10%, Izt=10.5mA, Zzt<25Ω, 1W	DO-214AC	1d	1t	Dac
A4750	SMA4750	Z-diode	27V±5%, Izt=9.5mA, Zzt<35Ω, 1W	DO-214AC	1d	1t	Dac
A4750A	SMA4750A	Z-diode	27V±10%, Izt=9.5mA, Zzt<35Ω, 1W	DO-214AC	1d	1t	Dac
A4751	SMA4751	Z-diode	30V±5%, Izt=8.5mA, Zzt<40Ω, 1W	DO-214AC	1d	1t	Dac
A4751A	SMA4751A	Z-diode	30V±10%, Izt=8.5mA, Zzt<40Ω, 1W	DO-214AC	1d	1t	Dac
A4752	SMA4752	Z-diode	33V±5%, Izt=7.5mA, Zzt<45Ω, 1W	DO-214AC	1d	1t	Dac
A4752A	SMA4752A	Z-diode	33V±10%, Izt=7.5mA, Zzt<45Ω, 1W	DO-214AC	1d	1t	Dac
A4753	SMA4753	Z-diode	36V±5%, Izt=7.0mA, Zzt<50Ω, 1W	DO-214AC	1d	1t	Dac
A4753A	SMA4753A	Z-diode	36V±10%, Izt=7.0mA, Zzt<50Ω, 1W	DO-214AC	1d	1t	Dac
A4754	SMA4754	Z-diode	39V±5%, Izt=6.5mA, Zzt<60Ω, 1W	DO-214AC	1d	1t	Dac
A4754A	SMA4754A	Z-diode	39V±10%, Izt=6.5mA, Zzt<60Ω, 1W	DO-214AC	1d	1t	Dac
A4755	SMA4755	Z-diode	43V±5%, Izt=6.0mA, Zzt<70Ω, 1W	DO-214AC	1d	1t	Dac
A4755A	SMA4755A	Z-diode	43V±10%, Izt=6.0mA, Zzt<70Ω, 1W	DO-214AC	1d	1t	Dac
A4756	SMA4756	Z-diode	47V±5%, Izt=5.5mA, Zzt<80Ω, 1W	DO-214AC	1d	1t	Dac
A4756A	SMA4756A	Z-diode	47V±10%, Izt=5.5mA, Zzt<80Ω, 1W	DO-214AC	1d	1t	Dac
A4757	SMA4757	Z-diode	51V±5%, Izt=5mA, Zzt<95Ω, 1W	DO-214AC	1d	1t	Dac
A4757A	SMA4757A	Z-diode	51V±10%, Izt=5mA, Zzt<95Ω, 1W	DO-214AC	1d	1t	Dac
A4758	SMA4758	Z-diode	56V±5%, Izt=4.5mA, Zzt<110Ω, 1W	DO-214AC	1d	1t	Dac
A4758A	SMA4758A	Z-diode	56V±10%, Izt=4.5mA, Zzt<110Ω, 1W	DO-214AC	1d	1t	Dac
A4759	SMA4759	Z-diode	62V±5%, Izt=4.0mA, Zzt<125Ω, 1W	DO-214AC	1d	1t	Dac
A4759A	SMA4759A	Z-diode	62V±10%, Izt=4.0mA, Zzt<125Ω, 1W	DO-214AC	1d	1t	Dac
A4760	SMA4760	Z-diode	68V±5%, Izt=3.7mA, Zzt<150Ω, 1W	DO-214AC	1d	1t	Dac
A4760A	SMA4760A	Z-diode	68V±10%, Izt=3.7mA, Zzt<150Ω, 1W	DO-214AC	1d	1t	Dac
A4761	SMA4761	Z-diode	75V±5%, Izt=3.3mA, Zzt<175Ω, 1W	DO-214AC	1d	1t	Dac
A4761A	SMA4761A	Z-diode	75V±10%, Izt=3.3mA, Zzt<175Ω, 1W	DO-214AC	1d	1t	Dac
A4762	SMA4762	Z-diode	82V±5%, Izt=3.0mA, Zzt<200Ω, 1W	DO-214AC	1d	1t	Dac
A4762A	SMA4762A	Z-diode	82V±10%, Izt=3.0mA, Zzt<200Ω, 1W	DO-214AC	1d	1t	Dac
A4763	SMA4763	Z-diode	91V±5%, Izt=2.8mA, Zzt<250Ω, 1W	DO-214AC	1d	1t	Dac
A4763A	SMA4763A	Z-diode	91V±10%, Izt=2.8mA, Zzt<250Ω, 1W	DO-214AC	1d	1t	Dac
A4764	SMA4764	Z-diode	100V±5%, Izt=2.5mA, Zzt<350Ω, 1W	DO-214AC	1d	1t	Dac
A4764A	SMA4764A	Z-diode	100V±10%, Izt=2.5mA, Zzt<350Ω, 1W	DO-214AC	1d	1t	Dac
A48A	SMA48A	TVS	Vrwm=48.0V, Vbr=53.30..58.90V, Ipp=5.17A, 400W(1ms)	DO-214AC	1d	1a	Ctc
A48CA	SMA48CA	TVS	Vrwm=48.0V, Vbr=53.30..58.90V, Ipp=5.17A, 400W(1ms), Bidirectional	DO-214AC	1ba	1j	Ctc
A4A	P4SSMJ9.1A	TVS	Vbr=8.65..9.55V, Vrwm=7.78V, 31A, 400W(1ms)	DO-214AC	1d	1a	Chm
A4C	P4SSMJ9.1CA	TVS	Vbr=8.65..9.55V, Vrwm=7.78V, 31A, 400W(1ms), Bidirectional	DO-214AC	1ba	1j	Chm
A5	1N4151W	Si-diode	Sw, Fast, 75V, 200mA, <2.5pF(0V), <4ns	SOD-323	5d	1a	Cen
A5	BAP51-03	PIN-diode	RF, 50V, 50mA, 500mW, 0.35pF, 5.5Ω(10mA/100MHz)	SOD-323	5d	1a	Phi
A5	BZX584B6V2	Z-diode	6.08..6.32V, Izt=5mA, Zzt=10Ω, 200mW	SOD-523FL	7d	1a	Tac
A5	BZX884-B3V6	Z-diode	3.6V±2%, 250mW	SOD-882	13d	2b	Phi
A5	EDZ27B	Z-diode	26.19..27.53V, Izt=2mA, Zzt=150Ω, 150mW	SOD-523	6d	1a	Rhm
A5	FDZ27EV	Z-diode	26.190..27.530V, Izt=2mA, Zzt=150Ω, 150mW	SOD-523	7d	1a	Fis
A5	FDZ27VT	Z-diode	26.190..27.530V, Izt=5mA, Zzt=150Ω, 200mW	SOD-323	5d	1a	Fis
A5	FSS16	Si-diode	SBR, 60V, 1A, Vf<0.75V(1A)	DO-214AC	1d	2j	Fag
A5	HVC317B	C-diode	UHF-Tuning, 30V, 0.6/9pF(25..1V/1MHz)	UPF	6d	1a	Ren
A5	MM1Z5241B	Z-diode	10.45..11.50V, Izt=20mA, Zzt=22Ω, 500mW	SOD-323FL	5d	1a	Eic
A5	MM1Z5241BH	Z-diode	10.45..11.55V, Izt=20mA, Zzt=22Ω, 500mW	SOD-123	5d	1a	Zow
A5	MMSZ62VB	Z-diode	6.08..6.32V, Izt=5mA, Zzt=10Ω, 200mW	SOD-523FL	7d	1a	Tac
A5	MMSZ15	Z-diode	15V±5%, Zzt=30Ω, 500mW	SOD-123	5d	1a	Mot
A5	MMSZ5241B	Z-diode	11V±5%, Izt=20mA, Zzt=22Ω, 500mW	SOD-123	5d	1a	Eic
A5	PTV57V0S1UR	TVS	Vrwm=7.0V, Vbr=7.78..8.60V, 33.3A, 400W(1ms)	SOD-123W	7d	1a	Nxp
A5	SM4005SPT	Si-diode	Rectifier, 600V, 1A	SOD-123S	7d	1a	Chm
A5	TDZ27B	Z-diode	27V±2.5%, 10mA, 500mW	TUMD2	7d	1s	Rhm
A5	UDZS27B	Z-diode	26.19..27.53V, Izt=5mA, Zzt=150Ω, 200mW	SOD-323	5d	1a	Wlr
A5	UDZS27B	Z-diode	27V±2.5%, Izt=5mA, 200mW	SOD-323FL	7d	1s	Rhm
A5	VDZS27B	Z-diode	27V±5%, 5mA, 100mW	VMD2	5d	1z	Rhm
A5.0A	SMA5.0A	TVS	Vrwm=5.0V, Vbr=6.40..7.0V, Ipp=43.50A, 400W(1ms)	DO-214AC	1d	1a	Ctc



SMD code	Type	Function	Short description	Case	Pinout	St.	Mnf.
A5_0CA	SMA50CA	TVS	Vrwm=5.0V, Vbr=6.40..7.0V, Ipp=43.50A, 400W(1ms), Bidirectional	DO-214AC	1ba	1j	Ctc
A51A	SMA51A	TVS	Vrwm=51.0V, Vbr=56.70..62.70V, Ipp=4.85A, 400W(1ms)	DO-214AC	1d	1a	Ctc
A51CA	SMA51CA	TVS	Vrwm=51.0V, Vbr=56.70..62.70V, Ipp=4.85A, 400W(1ms), Bidirectional	DO-214AC	1ba	1j	Ctc
A54A	SMA54A	TVS	Vrwm=54.0V, Vbr=60.0..66.30V, Ipp=4.59A, 400W(1ms)	DO-214AC	1d	1a	Ctc
A54CA	SMA54CA	TVS	Vrwm=54.0V, Vbr=60.0..66.30V, Ipp=4.59A, 400W(1ms), Bidirectional	DO-214AC	1ba	1j	Ctc
A58A	SMA58A	TVS	Vrwm=58.0V, Vbr=64.40..71.20V, Ipp=4.27A, 400W(1ms)	DO-214AC	1d	1a	Ctc
A58CA	SMA58CA	TVS	Vrwm=58.0V, Vbr=64.40..71.20V, Ipp=4.27A, 400W(1ms), Bidirectional	DO-214AC	1ba	1j	Ctc
A5913A	SMA5913A	Z-diode	3.3V±3%, Izt=113.6mA, Zzt<10Ω, 1.5W	DO-214AC	1d	1a	Dbp
A5913B	SMA5913B	Z-diode	3.3V±5%, Izt=113.6mA, Zzt<10Ω, 1.5W	DO-214AC	1d	1a	Dbp
A5914A	SMA5914A	Z-diode	3.6V±3%, Izt=104.2mA, Zzt<9Ω, 1.5W	DO-214AC	1d	1a	Dbp
A5914B	SMA5914B	Z-diode	3.6V±5%, Izt=104.2mA, Zzt<9Ω, 1.5W	DO-214AC	1d	1a	Dbp
A5915A	SMA5915A	Z-diode	3.9V±3%, Izt=96.1mA, Zzt<7.5Ω, 1.5W	DO-214AC	1d	1a	Dbp
A5915B	SMA5915B	Z-diode	3.9V±5%, Izt=96.1mA, Zzt<7.5Ω, 1.5W	DO-214AC	1d	1a	Dbp
A5916A	SMA5916A	Z-diode	4.3V±3%, Izt=87.2mA, Zzt<6Ω, 1.5W	DO-214AC	1d	1a	Dbp
A5916B	SMA5916B	Z-diode	4.3V±5%, Izt=87.2mA, Zzt<6Ω, 1.5W	DO-214AC	1d	1a	Dbp
A5917A	SMA5917A	Z-diode	4.7V±3%, Izt=79.8mA, Zzt<5Ω, 1.5W	DO-214AC	1d	1a	Dbp
A5917B	SMA5917B	Z-diode	4.7V±5%, Izt=79.8mA, Zzt<5Ω, 1.5W	DO-214AC	1d	1a	Dbp
A5918A	SMA5918A	Z-diode	5.1V±3%, Izt=73.5mA, Zzt<4Ω, 1.5W	DO-214AC	1d	1a	Dbp
A5918B	SMA5918B	Z-diode	5.1V±5%, Izt=73.5mA, Zzt<4Ω, 1.5W	DO-214AC	1d	1a	Dbp
A5919A	SMA5919A	Z-diode	5.6V±3%, Izt=66.9mA, Zzt<2Ω, 1.5W	DO-214AC	1d	1a	Dbp
A5919B	SMA5919B	Z-diode	5.6V±5%, Izt=66.9mA, Zzt<2Ω, 1.5W	DO-214AC	1d	1a	Dbp
A5920A	SMA5920A	Z-diode	6.2V±3%, Izt=60.5mA, Zzt<2Ω, 1.5W	DO-214AC	1d	1a	Dbp
A5920B	SMA5920B	Z-diode	6.2V±5%, Izt=60.5mA, Zzt<2Ω, 1.5W	DO-214AC	1d	1a	Dbp
A5921A	SMA5921A	Z-diode	6.8V±3%, Izt=55.1mA, Zzt<2.5Ω, 1.5W	DO-214AC	1d	1a	Dbp
A5921B	SMA5921B	Z-diode	6.8V±5%, Izt=55.1mA, Zzt<2.5Ω, 1.5W	DO-214AC	1d	1a	Dbp
A5922A	SMA5922A	Z-diode	7.5V±3%, Izt=50mA, Zzt<3Ω, 1.5W	DO-214AC	1d	1a	Dbp
A5922B	SMA5922B	Z-diode	7.5V±5%, Izt=50mA, Zzt<3Ω, 1.5W	DO-214AC	1d	1a	Dbp
A5923A	SMA5923A	Z-diode	8.2V±3%, Izt=45.7mA, Zzt<3.5Ω, 1.5W	DO-214AC	1d	1a	Dbp
A5923B	SMA5923B	Z-diode	8.2V±5%, Izt=45.7mA, Zzt<3.5Ω, 1.5W	DO-214AC	1d	1a	Dbp
A5924A	SMA5924A	Z-diode	9.1V±3%, Izt=41.2mA, Zzt<4Ω, 1.5W	DO-214AC	1d	1a	Dbp
A5924B	SMA5924B	Z-diode	9.1V±5%, Izt=41.2mA, Zzt<4Ω, 1.5W	DO-214AC	1d	1a	Dbp
A5925A	SMA5925A	Z-diode	10V±3%, Izt=37.5mA, Zzt<4.5Ω, 1.5W	DO-214AC	1d	1a	Dbp
A5925B	SMA5925B	Z-diode	10V±5%, Izt=37.5mA, Zzt<4.5Ω, 1.5W	DO-214AC	1d	1a	Dbp
A5926A	SMA5926A	Z-diode	11V±3%, Izt=34.1mA, Zzt<5.5Ω, 1.5W	DO-214AC	1d	1a	Dbp
A5926B	SMA5926B	Z-diode	11V±5%, Izt=34.1mA, Zzt<5.5Ω, 1.5W	DO-214AC	1d	1a	Dbp
A5927A	SMA5927A	Z-diode	12V±3%, Izt=31.2mA, Zzt<6.5Ω, 1.5W	DO-214AC	1d	1a	Dbp
A5927B	SMA5927B	Z-diode	12V±5%, Izt=31.2mA, Zzt<6.5Ω, 1.5W	DO-214AC	1d	1a	Dbp
A5928A	SMA5928A	Z-diode	13V±3%, Izt=28.8mA, Zzt<7Ω, 1.5W	DO-214AC	1d	1a	Dbp
A5928B	SMA5928B	Z-diode	13V±5%, Izt=28.8mA, Zzt<7Ω, 1.5W	DO-214AC	1d	1a	Dbp
A5929A	SMA5929A	Z-diode	15V±3%, Izt=25mA, Zzt<9Ω, 1.5W	DO-214AC	1d	1a	Dbp
A5929B	SMA5929B	Z-diode	15V±5%, Izt=25mA, Zzt<9Ω, 1.5W	DO-214AC	1d	1a	Dbp
A5930A	SMA5930A	Z-diode	16V±3%, Izt=23.4mA, Zzt<10Ω, 1.5W	DO-214AC	1d	1a	Dbp
A5930B	SMA5930B	Z-diode	16V±5%, Izt=23.4mA, Zzt<10Ω, 1.5W	DO-214AC	1d	1a	Dbp
A5931A	SMA5931A	Z-diode	18V±3%, Izt=20.8mA, Zzt<12Ω, 1.5W	DO-214AC	1d	1a	Dbp
A5931B	SMA5931B	Z-diode	18V±5%, Izt=20.8mA, Zzt<12Ω, 1.5W	DO-214AC	1d	1a	Dbp
A5932A	SMA5932A	Z-diode	20V±3%, Izt=18.7mA, Zzt<14Ω, 1.5W	DO-214AC	1d	1a	Dbp
A5932B	SMA5932B	Z-diode	20V±5%, Izt=18.7mA, Zzt<14Ω, 1.5W	DO-214AC	1d	1a	Dbp
A5933A	SMA5933A	Z-diode	22V±3%, Izt=17mA, Zzt<17.5Ω, 1.5W	DO-214AC	1d	1a	Dbp
A5933B	SMA5933B	Z-diode	22V±5%, Izt=17mA, Zzt<17.5Ω, 1.5W	DO-214AC	1d	1a	Dbp
A5934A	SMA5934A	Z-diode	24V±3%, Izt=15.6mA, Zzt<19Ω, 1.5W	DO-214AC	1d	1a	Dbp
A5934B	SMA5934B	Z-diode	24V±5%, Izt=15.6mA, Zzt<19Ω, 1.5W	DO-214AC	1d	1a	Dbp
A5935A	SMA5935A	Z-diode	27V±3%, Izt=13.9mA, Zzt<23Ω, 1.5W	DO-214AC	1d	1a	Dbp
A5935B	SMA5935B	Z-diode	27V±5%, Izt=13.9mA, Zzt<23Ω, 1.5W	DO-214AC	1d	1a	Dbp
A5936A	SMA5936A	Z-diode	30V±3%, Izt=12.5mA, Zzt<26Ω, 1.5W	DO-214AC	1d	1a	Dbp
A5936B	SMA5936B	Z-diode	30V±5%, Izt=12.5mA, Zzt<26Ω, 1.5W	DO-214AC	1d	1a	Dbp
A5937A	SMA5937A	Z-diode	33V±3%, Izt=11.4mA, Zzt<33Ω, 1.5W	DO-214AC	1d	1a	Dbp
A5937B	SMA5937B	Z-diode	33V±5%, Izt=11.4mA, Zzt<33Ω, 1.5W	DO-214AC	1d	1a	Dbp
A5938A	SMA5938A	Z-diode	36V±3%, Izt=10.4mA, Zzt<38Ω, 1.5W	DO-214AC	1d	1a	Dbp
A5938B	SMA5938B	Z-diode	36V±5%, Izt=10.4mA, Zzt<38Ω, 1.5W	DO-214AC	1d	1a	Dbp
A5939A	SMA5939A	Z-diode	39V±3%, Izt=9.6mA, Zzt<45Ω, 1.5W	DO-214AC	1d	1a	Dbp
A5939B	SMA5939B	Z-diode	39V±5%, Izt=9.6mA, Zzt<45Ω, 1.5W	DO-214AC	1d	1a	Dbp
A5940A	SMA5940A	Z-diode	43V±3%, Izt=8.7mA, Zzt<53Ω, 1.5W	DO-214AC	1d	1a	Dbp
A5940B	SMA5940B	Z-diode	43V±5%, Izt=8.7mA, Zzt<53Ω, 1.5W	DO-214AC	1d	1a	Dbp
A5A	P4SSMJ10A	TVS	Vbr=9.5..10.5V, Vrwm=8.55V, 29A, 400W(1ms)	DO-214AC	1d	1a	Chm
A5C	P4SSMJ10CA	TVS	Vbr=9.5..10V, Vrwm=8.55V, 29A, 400W(1ms), Bidirectional	DO-214AC	1ba	1j	Chm
A6	BAS16-02L	Si-diode	Sw, Fast, 80V, 200mA, 250mW, <6ns	TSLP-P-2.1	13d	2b	Inf
A6	BAS16-02W	Si-diode	Sw, Fast, 80V, 200mA, 250mW, <6ns	SCD-80	6d	1b	Inf
A6	BAS16D	Si-diode	Sw, Fast, 75V, 200mA, 200mW, <6ns	SOD-123	5d	1a	Cen
A6	BAS16H	Si-diode	Sw, Fast, 75V, 200mA, 200mW, <6ns	SOD-323	5d	1a	Ons
A6	BAS216	Si-diode	Sw, Fast, 75V, 250mA, 400mW, <4ns	SOD-110	12d	1a	Phi



SMD code	Type	Function	Short description	Case	Pinout	St.	Mnf.
A6	BAS316	Si-diode	Sw, Hi-Speed, 85V, 250mA, 400mW, 1.5pF, <4ns	SOD-323	5d	1a	Phi
A6	BAV16W	Si-diode	Sw, Fast, 100V, 300mA, <2pF, <2ns	SOD-123	5d	1a	Gse
A6	BAV16WS	Si-diode	Sw, Fast, 100V, 300mA, <2pF, <2ns	SOD-323	5d	1a	Gse
A6	BZX884-B3V9	Z-diode	3.9V±2%, 250mW	SOD-882	13d	2b	Phi
A6	MM1Z5262B	Z-diode	48.45..53.55V, Izt=2.5mA, Zzt=125Ω, 500mW	SOD-323FL	5d	1a	Eic
A6	MM1Z5262BH	Z-diode	48.45..53.55V, Izt=2.5mA, Zzt=125Ω, 500mW	SOD-123	5d	1a	Zow
A6	MMSZ5262B	Z-diode	51V±5%, Izt=2.5mA, Zzt=125Ω, 500mW	SOD-123	5d	1a	Eic
A6	MSCD106	Si-diode	SBR, 60V, 1A, Vf<0.65V(1A)	0805	14d	1v	Zow
A6	PTV57V51UR	TVS	Vrwm=7.5V, Vbr=8.33..9.21V, 31.0A, 400W(1ms)	SOD-123W	7d	1a	Nxp
A6	SM4006SPT	Si-diode	Rectifier, 800V, 1A	SOD-123S	7d	1a	Chm
A6	SSCD106	Si-diode	SBR, 60V, 1A, Vf<0.7V(1A)	1206	14d	1v	Zow
A6.0A	SMA6.0A	TVS	Vrwm=6.0V, Vbr=6.67..7.37V, Ipp=38.80A, 400W(1ms)	DO-214AC	1d	1a	Ctc
A6.0CA	SMA6.0CA	TVS	Vrwm=6.0V, Vbr=6.67..7.37V, Ipp=38.80A, 400W(1ms), Bidirectional	DO-214AC	1ba	1j	Ctc
A6.5A	SMA6.5A	TVS	Vrwm=6.5V, Vbr=7.22..7.98V, Ipp=35.70A, 400W(1ms)	DO-214AC	1d	1a	Ctc
A6.5CA	SMA6.5CA	TVS	Vrwm=6.5V, Vbr=7.22..7.98V, Ipp=35.70A, 400W(1ms), Bidirectional	DO-214AC	1ba	1j	Ctc
A60A	SMA60A	TVS	Vrwm=60.0V, Vbr=66.70..73.70V, Ipp=4.13A, 400W(1ms)	DO-214AC	1d	1a	Ctc
A60CA	SMA60CA	TVS	Vrwm=60.0V, Vbr=66.70..73.70V, Ipp=4.13A, 400W(1ms), Bidirectional	DO-214AC	1ba	1j	Ctc
A64A	SMA64A	TVS	Vrwm=64.0V, Vbr=71.10..78.60V, Ipp=3.88A, 400W(1ms)	DO-214AC	1d	1a	Ctc
A64CA	SMA64CA	TVS	Vrwm=64.0V, Vbr=71.10..78.60V, Ipp=3.88A, 400W(1ms), Bidirectional	DO-214AC	1ba	1j	Ctc
A6A	P4SSMJ11A	TVS	Vbr=10.5..11.6V, Vrwm=9.40V, 27A, 400W(1ms)	DO-214AC	1d	1a	Chm
A6C	P4SSMJ11CA	TVS	Vbr=10.5..11.6V, Vrwm=9.40V, 27A, 400W(1ms), Bidirectional	DO-214AC	1ba	1j	Chm
A7	BAS321	Si-diode	GP, 250V, 250mA, 300mW, Vf<1.2V(200mA), 2pF, <50ns	SOD-323	5d	1a	Phi
A7	BZX884-B4V3	Z-diode	4.3V±2%, 250mW	SOD-882	13d	2b	Phi
A7	PTV58V051UR	TVS	Vrwm=8.0V, Vbr=8.89..9.83V, 29.4A, 400W(1ms)	SOD-123W	7d	1a	Nxp
A7	RKV5000DKK	C-diode	TV-VCR-Tuners, 34V, C2=14.15..15.75pF, n>6.3, Rs<0.57Ω	SFP	6d	1a	Ren
A7	SM4007SPT	Si-diode	Rectifier, 1000V, 1A	SOD-123S	7d	1a	Chm
A7.0A	SMA7.0A	TVS	Vrwm=7.0V, Vbr=7.78..8.60V, Ipp=33.30A, 400W(1ms)	DO-214AC	1d	1a	Ctc
A7.0CA	SMA7.0CA	TVS	Vrwm=7.0V, Vbr=7.78..8.60V, Ipp=33.30A, 400W(1ms), Bidirectional	DO-214AC	1ba	1j	Ctc
A7.5A	SMA7.5A	TVS	Vrwm=7.5V, Vbr=8.33..9.21V, Ipp=31.0A, 400W(1ms)	DO-214AC	1d	1a	Ctc
A7.5CA	SMA7.5CA	TVS	Vrwm=7.5V, Vbr=8.33..9.21V, Ipp=31.0A, 400W(1ms), Bidirectional	DO-214AC	1ba	1j	Ctc
A70A	SMA70A	TVS	Vrwm=70.0V, Vbr=77.80..86.0V, Ipp=3.54A, 400W(1ms)	DO-214AC	1d	1a	Ctc
A70CA	SMA70CA	TVS	Vrwm=70.0V, Vbr=77.80..86.0V, Ipp=3.54A, 400W(1ms), Bidirectional	DO-214AC	1ba	1j	Ctc
A75A	SMA75A	TVS	Vrwm=75.0V, Vbr=83.30..92.10V, Ipp=3.31A, 400W(1ms)	DO-214AC	1d	1a	Ctc
A75CA	SMA75CA	TVS	Vrwm=75.0V, Vbr=83.30..92.10V, Ipp=3.31A, 400W(1ms), Bidirectional	DO-214AC	1ba	1j	Ctc
A78A	SMA78A	TVS	Vrwm=78.0V, Vbr=86.70..95.80V, Ipp=3.17A, 400W(1ms)	DO-214AC	1d	1a	Ctc
A78CA	SMA78CA	TVS	Vrwm=78.0V, Vbr=86.70..95.80V, Ipp=3.17A, 400W(1ms), Bidirectional	DO-214AC	1ba	1j	Ctc
A7A	P4SSMJ12A	TVS	Vbr=11.4..12.6V, Vrwm=10.2V, 25A, 400W(1ms)	DO-214AC	1d	1a	Chm
A7C	P4SSMJ12CA	TVS	Vbr=11.4..12.6V, Vrwm=10.2V, 25A, 400W(1ms), Bidirectional	DO-214AC	1ba	1j	Chm
A8	BAP50-03	PIN-diode	RF, 50V, 50mA, 500mW, 0.3pF, 3C(10mA/100MHz)	SOD-323	5d	1a	Phi
A8	BAV19W	Si-diode	Sw, 100V, 200mA, Vf<1.25V(200mA), <50ns	SOD-123	5d	1d	Gen,Di
A8	BAV19WS	Si-diode	Sw, 100V, 200mA, Vf<1.25V(200mA), <50ns	SOD-323	5d	1a	Di
A8	BZX884-B4V7	Z-diode	4.7V±2%, 250mW	SOD-882	13d	2b	Phi
A8	MMSZ2V7	Z-diode	2.7V±5%, Izt=5mA, Zzt=100Ω, 200mW	SOD-523	6d	1a	Eic
A8	MMSZ2V7H	Z-diode	2.5..2.9V, Izt=5mA, Zzt=100Ω, 200mW	SOD-523	7d	1a	Zow
A8	PTV58V51UR	TVS	Vrwm=8.5V, Vbr=9.44..10.40V, 27.8A, 400W(1ms)	SOD-123W	7d	1a	Nxp
A8	RKV5010DKK	C-diode	TV-VCR-Tuners, 34V, C2=14.15..15.75pF, n>6.3, Rs<0.57Ω	SFP	6d	1a	Ren
A8.0A	SMA8.0A	TVS	Vrwm=8.0V, Vbr=8.89..9.83V, Ipp=29.40A, 400W(1ms)	DO-214AC	1d	1a	Ctc
A8.0CA	SMA8.0CA	TVS	Vrwm=8.0V, Vbr=8.89..9.83V, Ipp=29.40A, 400W(1ms), Bidirectional	DO-214AC	1ba	1j	Ctc
A8.5A	SMA8.5A	TVS	Vrwm=8.5V, Vbr=9.44..10.40V, Ipp=27.80A, 400W(1ms)	DO-214AC	1d	1a	Ctc
A8.5CA	SMA8.5CA	TVS	Vrwm=8.5V, Vbr=9.44..10.40V, Ipp=27.80A, 400W(1ms), Bidirectional	DO-214AC	1ba	1j	Ctc
A80A	SMA80A	TVS	Vrwm=80.0V, Vbr=88.80..97.60V, Ipp=3.09A, 400W(1ms)	DO-214AC	1d	1a	Ctc
A80CA	SMA80CA	TVS	Vrwm=80.0V, Vbr=88.80..97.60V, Ipp=3.09A, 400W(1ms), Bidirectional	DO-214AC	1ba	1j	Ctc
A85A	SMA85A	TVS	Vrwm=85.0V, Vbr=94.40..104.0V, Ipp=2.92A, 400W(1ms)	DO-214AC	1d	1a	Ctc
A85CA	SMA85CA	TVS	Vrwm=85.0V, Vbr=94.40..104.0V, Ipp=2.92A, 400W(1ms), Bidirectional	DO-214AC	1ba	1j	Ctc
A8A	P4SSMJ13A	TVS	Vbr=12.4..13.7V, Vrwm=11.1V, 23A, 400W(1ms)	DO-214AC	1d	1a	Chm
A8C	P4SSMJ13CA	TVS	Vbr=12.4..13.7V, Vrwm=11.1V, 23A, 400W(1ms), Bidirectional	DO-214AC	1ba	1j	Chm
A9	BAP70-03	PIN-diode	RF, 50V, 100mA, 500mW, 0.57pF, 1.9C(100mA/100MHz)	SOD-323	5d	1a	Nxp
A9	BAV20W	Si-diode	Sw, 150V, 200mA, Vf<1.25V(200mA), <50ns	SOD-123	5d	1a	Gen
A9	BZX884-B5V1	Z-diode	5.1V±2%, 250mW	SOD-882	13d	2b	Phi
A9	MMSZ33H	Z-diode	31..35V, Izt=2mA, Zzt=80Ω, 200mW	SOD-523	7d	1a	Zow
A9	MMSZ33V	Z-diode	33V±5%, Izt=2mA, Zzt=80Ω, 200mW	SOD-523	6d	1a	Eic
A9	PTV59V051UR	TVS	Vrwm=9.0V, Vbr=10.0..11.10V, 26.0A, 400W(1ms)	SOD-123W	7d	1a	Nxp
A9	RKV5020DKK	Si-diode	HF, Sw, 35V, Vf<1V(10mA), <1.2pF, Rf<0.7Ω	SFP	6d	1a	Ren
A9.0A	SMA9.0A	TVS	Vrwm=9.0V, Vbr=10.0..11.10V, Ipp=26.0A, 400W(1ms)	DO-214AC	1d	1a	Ctc
A9.0CA	SMA9.0CA	TVS	Vrwm=9.0V, Vbr=10.0..11.10V, Ipp=26.0A, 400W(1ms), Bidirectional	DO-214AC	1ba	1j	Ctc
A90A	SMA90A	TVS	Vrwm=90.0V, Vbr=100.0..111.0V, Ipp=2.74A, 400W(1ms)	DO-214AC	1d	1a	Ctc
A90CA	SMA90CA	TVS	Vrwm=90.0V, Vbr=100.0..111.0V, Ipp=2.74A, 400W(1ms), Bidirectional	DO-214AC	1ba	1j	Ctc
A9A	P4SSMJ15A	TVS	Vbr=14.3..15.8V, Vrwm=12.8V, 20A, 400W(1ms)	DO-214AC	1d	1a	Chm
A9C	P4SSMJ15CA	TVS	Vbr=14.3..15.8V, Vrwm=12.8V, 20A, 400W(1ms), Bidirectional	DO-214AC	1ba	1j	Chm
AA	BA892	PIN-diode	VHF, TV-Band-Sw, 35V, 0.1A, Vf<1V(100mA), 1.4pF, <120ns	SCD-80	6d	1u	Inf



SMD
code

Type

Function

Short description

Case

Pinout

St.

Mnf.

AA	BA892-02L	PIN-diode	VHF, TV-B-Sw, 35V, 0.1A, Vf<1V(100mA), 1.4pF, <120ns	TSLP-2-1	13d	2b	Inf
AA	BAV21W	Si-diode	Sw, 200V, 200mA, Vf<1.25V(200mA), <50ns	SOD-123	5d	1a	Cen
AA	BZX884-B5V6	Z-diode	5.6V±2%, 250mW	SOD-882	13d	2b	Phi
AA	MA5Z200-L	Z-diode	200V, Iz=0.1mA, 150mW	S-Mini	8d	1a	Pan
AA	MAZU200-L	Z-diode	190..210V, 200mA, 150mW	S-Mini2	8d	1a	Pan
AA	PTVS110VS1UR	TVS	Vrwm=10V, Vbr=11.0..12.30V, 23.5A, 400W(1ms)	SOD-123W	7d	1a	Nxp
AA	SMAJ5.0CA	TVS	Vrwm=5.0V, Vbr=6.40..7.0V, 43.5A, 400W(1ms), Bidirectional	DO-214AC	1ba	1r	Ste
AA	ZMV829A	C-diode	VHF/UHF-Tuning, 25V, 330mW, 8.2pF(2V), ΔC ±10%	SOD-323	5d	1a	Zx
AAD	SMAJ5.0	TVS	Vbr=6.40..7.81V, Vrwm=5.0V, 41.7A, 400W(1ms)	DO-214AC	1d	1a	Gal
AAE	SMAJ5.0A	TVS	Vbr=6.40..7.08V, Vrwm=5.0V, 43.5A, 400W(1ms)	DO-214AC	1d	1a	Gal
AAF	SMAJ6.0	TVS	Vbr=6.67..8.15V, Vrwm=6.0V, 35.1A, 400W(1ms)	DO-214AC	1d	1a	Gal
AAG	SMAJ6.0A	TVS	Vbr=6.67..7.37V, Vrwm=6.0V, 38.8A, 400W(1ms)	DO-214AC	1d	1a	Gal
AAH	SMAJ6.5	TVS	Vbr=7.22..8.82V, Vrwm=6.5V, 32.5A, 400W(1ms)	DO-214AC	1d	1a	Gal
AAK	SMAJ6.5A	TVS	Vbr=7.22..7.98V, Vrwm=6.5V, 35.7A, 400W(1ms)	DO-214AC	1d	1a	Gal
AAL	SMAJ7.0	TVS	Vbr=7.78..9.51V, Vrwm=7.0V, 30.1A, 400W(1ms)	DO-214AC	1d	1a	Gal
AAM	SMAJ7.0A	TVS	Vbr=7.78..8.60V, Vrwm=7.0V, 33.3A, 400W(1ms)	DO-214AC	1d	1a	Gal
AAN	SMAJ7.5	TVS	Vbr=8.33..10.3V, Vrwm=7.5V, 28.0A, 400W(1ms)	DO-214AC	1d	1a	Gal
AAP	SMAJ7.5A	TVS	Vbr=8.33..9.21V, Vrwm=7.5V, 31.0A, 400W(1ms)	DO-214AC	1d	1a	Gal
AAQ	SMAJ8.0	TVS	Vbr=8.89..10.9V, Vrwm=8.0V, 26.7A, 400W(1ms)	DO-214AC	1d	1a	Gal
AAR	SMAJ8.0A	TVS	Vbr=8.89..9.83V, Vrwm=8.0V, 29.4A, 400W(1ms)	DO-214AC	1d	1a	Gal
AAS	SMAJ8.5	TVS	Vbr=9.44..11.5V, Vrwm=8.5V, 25.2A, 400W(1ms)	DO-214AC	1d	1a	Gal
AAT	SMAJ8.5A	TVS	Vbr=9.44..10.4V, Vrwm=8.5V, 27.8A, 400W(1ms)	DO-214AC	1d	1a	Gal
AAU	SMAJ9.0	TVS	Vbr=10.0..12.2V, Vrwm=9.0V, 23.7A, 400W(1ms)	DO-214AC	1d	1a	Gal
AAV	SMAJ9.0A	TVS	Vbr=10.0..11.1V, Vrwm=9.0V, 26.0A, 400W(1ms)	DO-214AC	1d	1a	Gal
AAW	SMAJ10	TVS	Vbr=11.1..13.6V, Vrwm=10V, 21.3A, 400W(1ms)	DO-214AC	1d	1a	Gal
AAX	SMAJ10A	TVS	Vbr=11.1..12.3V, Vrwm=10V, 23.5A, 400W(1ms)	DO-214AC	1d	1a	Gal
AAZ	SMAJ11	TVS	Vbr=12.2..14.9V, Vrwm=11V, 19.9A, 400W(1ms)	DO-214AC	1d	1a	Gal
AAZ	SMAJ11A	TVS	Vbr=12.2..13.5V, Vrwm=11V, 22.0A, 400W(1ms)	DO-214AC	1d	1a	Gal
AB	BAR50-02L	PIN-diode	RF-Att, 50V, 100mA, 250mW, Vf<1.1V(50mA), <0.5pF	TSLP-2-1	13d	2b	Inf
AB	BZX884-B6V2	Z-diode	6.2V±2%, 250mW	SOD-882	13d	2b	Phi
AB	MA5Z200-H	Z-diode	200V, Iz=0.1mA, 150mW	S-Mini	8d	1a	Pan
AB	MAZU200-H	Z-diode	190..210V, 200mA, 150mW	S-Mini2	8d	1a	Pan
AB	MM1Z5222B	Z-diode	2.5V±5%, Izt=20mA, Zzt=30Ω, 500mW	SOD-123FL	7d	1a	Bts
AB	MMSZ5222B	Z-diode	2.5V±5%, Izt=20mA, Zzt=30Ω, 500mW	SOD-123	5d	1a	Eic
AB	PTVS111VS1UR	TVS	Vrwm=11V, Vbr=12.20..13.50V, 22.0A, 400W(1ms)	SOD-123W	7d	1a	Nxp
AB	ZMV830A	C-diode	VHF/UHF-Tuning, 25V, 330mW, 10pF(2V), ΔC ±10%	SOD-323	5d	1a	Zx
ABD	SMAJ12	TVS	Vbr=13.3..16.3V, Vrwm=12V, 18.2A, 400W(1ms)	DO-214AC	1d	1a	Gal
ABE	SMAJ12A	TVS	Vbr=13.3..14.7V, Vrwm=12V, 20.1A, 400W(1ms)	DO-214AC	1d	1a	Gal
ABF	SMAJ13	TVS	Vbr=14.4..17.6V, Vrwm=13V, 16.8A, 400W(1ms)	DO-214AC	1d	1a	Gal
ABG	SMAJ13A	TVS	Vbr=14.4..15.9V, Vrwm=13V, 18.6A, 400W(1ms)	DO-214AC	1d	1a	Gal
ABH	SMAJ14	TVS	Vbr=15.6..19.1V, Vrwm=14V, 15.5A, 400W(1ms)	DO-214AC	1d	1a	Gal
ABK	SMAJ14A	TVS	Vbr=15.6..17.2V, Vrwm=14V, 17.2A, 400W(1ms)	DO-214AC	1d	1a	Gal
ABL	SMAJ15	TVS	Vbr=16.7..20.4V, Vrwm=15V, 14.9A, 400W(1ms)	DO-214AC	1d	1a	Gal
ABM	SMAJ15A	TVS	Vbr=16.7..18.5V, Vrwm=15V, 16.4A, 400W(1ms)	DO-214AC	1d	1a	Gal
ABN	SMAJ16	TVS	Vbr=17.8..21.8V, Vrwm=16V, 13.9A, 400W(1ms)	DO-214AC	1d	1a	Gal
ABP	SMAJ16A	TVS	Vbr=17.8..19.7V, Vrwm=16V, 15.4A, 400W(1ms)	DO-214AC	1d	1a	Gal
ABQ	SMAJ17	TVS	Vbr=18.9..23.1V, Vrwm=17V, 13.1A, 400W(1ms)	DO-214AC	1d	1a	Gal
ABR	SMAJ17A	TVS	Vbr=18.9..20.9V, Vrwm=17V, 14.5A, 400W(1ms)	DO-214AC	1d	1a	Gal
ABS	SMAJ18	TVS	Vbr=20.0..24.4V, Vrwm=18V, 12.4A, 400W(1ms)	DO-214AC	1d	1a	Gal
ABT	SMAJ18A	TVS	Vbr=20.0..22.1V, Vrwm=18V, 13.7A, 400W(1ms)	DO-214AC	1d	1a	Gal
ABU	SMAJ20	TVS	Vbr=22.2..27.1V, Vrwm=20V, 11.2A, 400W(1ms)	DO-214AC	1d	1a	Gal
ABV	SMAJ20A	TVS	Vbr=22.2..24.5V, Vrwm=20V, 12.3A, 400W(1ms)	DO-214AC	1d	1a	Gal
ABW	SMAJ22	TVS	Vbr=24.4..29.8V, Vrwm=22V, 10.2A, 400W(1ms)	DO-214AC	1d	1a	Gal
ABX	SMAJ22A	TVS	Vbr=24.4..26.9V, Vrwm=22V, 11.3A, 400W(1ms)	DO-214AC	1d	1a	Gal
ABY	SMAJ24	TVS	Vbr=26.7..32.6V, Vrwm=24V, 9.3A, 400W(1ms)	DO-214AC	1d	1a	Gal
ABZ	SMAJ24A	TVS	Vbr=26.7..29.5V, Vrwm=24V, 10.3A, 400W(1ms)	DO-214AC	1d	1a	Gal
AC	BZX884-B6V8	Z-diode	6.8V±2%, 250mW	SOD-882	13d	2b	Phi
AC	GBL C05C1	TVS	Vbr=5V, 5A, 350W(1ms), 0.6pF, Bidirectional	SOD-323	5ba	1e	Prt
AC	MA5Z220-L	Z-diode	220V, Iz=0.1mA, 150mW	S-Mini	8d	1a	Pan
AC	MAZU220-L	Z-diode	210..230V, 200mA, 150mW	S-Mini2	8d	1a	Pan
AC	MM1Z5224B	Z-diode	2.8V±5%, Izt=20mA, Zzt=30Ω, 500mW	SOD-123FL	7d	1a	Bts
AC	MMSZ5224B	Z-diode	2.8V±5%, Izt=20mA, Zzt=30Ω, 500mW	SOD-123	5d	1a	Eic
AC	PTVS12VS1UR	TVS	Vrwm=12V, Vbr=13.30..14.70V, 20.1A, 400W(1ms)	SOD-123W	7d	1a	Nxp
AC	SMAJ10CA	TVS	Vrwm=10V, Vbr=11.1..12.3V, 21.7A, 400W(1ms), Bidirectional	DO-214AC	1ba	1r	Ste
AC	SMAJ26	TVS	Vbr=28.9..35.3V, Vrwm=26V, 8.6A, 400W(1ms)	DO-214AC	1d	1a	Gal
AC	SMP3V3	TVS	Vbr=4.10..5.10V, Vrwm=3.3V, Ipp=54.8A, 400W(1ms)	DO-220AA	8d	1a	Zx
AC	ZMV831A	C-diode	VHF/UHF-Tuning, 25V, 330mW, 15pF(2V), ΔC ±10%	SOD-323	5d	1a	Vs
ACE	SMAJ26A	TVS	Vbr=28.9..31.9V, Vrwm=26V, 9.5A, 400W(1ms)	DO-214AC	1d	1a	Gal
ACF	SMAJ28	TVS	Vbr=31.1..38.0V, Vrwm=28V, 8.0A, 400W(1ms)	DO-214AC	1d	1a	Gal
ACG	SMAJ28A	TVS	Vbr=31.1..34.4V, Vrwm=28V, 8.8A, 400W(1ms)	DO-214AC	1d	1a	Gal



SMD code	Type	Function	Short description	Case	Pinout	St.	Mnf.
ACH	SMAJ30	TVS	Vbr=33.3..40.7V, Vrvwm=30V, 7.5A, 400W(1ms)	DO-214AC	1d	1a	Gal
ACK	SMAJ30A	TVS	Vbr=33.3..36.8V, Vrvwm=30V, 8.3A, 400W(1ms)	DO-214AC	1d	1a	Gal
ACL	SMAJ33	TVS	Vbr=36.7..44.9V, Vrvwm=33V, 5.1A, 400W(1ms)	DO-214AC	1d	1a	Gal
ACM	SMAJ33A	TVS	Vbr=36.7..40.6V, Vrvwm=33V, 5.6A, 400W(1ms)	DO-214AC	1d	1a	Gal
ACN	SMAJ36	TVS	Vbr=40.0..48.9V, Vrvwm=36V, 4.7A, 400W(1ms)	DO-214AC	1d	1a	Gal
ACP	SMAJ36A	TVS	Vbr=40.0..44.2V, Vrvwm=36V, 5.2A, 400W(1ms)	DO-214AC	1d	1a	Gal
ACQ	SMAJ40	TVS	Vbr=44.4..54.3V, Vrvwm=40V, 4.2A, 400W(1ms)	DO-214AC	1d	1a	Gal
ACR	SMAJ40A	TVS	Vbr=44.4..49.1V, Vrvwm=40V, 4.7A, 400W(1ms)	DO-214AC	1d	1a	Gal
ACS	SMAJ43	TVS	Vbr=47.8..58.4V, Vrvwm=43V, 3.9A, 400W(1ms)	DO-214AC	1d	1a	Gal
ACT	SMAJ43A	TVS	Vbr=47.8..52.8V, Vrvwm=43V, 4.3A, 400W(1ms)	DO-214AC	1d	1a	Gal
ACU	SMAJ45	TVS	Vbr=50.0..61.1V, Vrvwm=45V, 3.7A, 400W(1ms)	DO-214AC	1d	1a	Gal
ACV	SMAJ45A	TVS	Vbr=50.0..55.3V, Vrvwm=45V, 4.1A, 400W(1ms)	DO-214AC	1d	1a	Gal
ACW	SMAJ48	TVS	Vbr=53.3..65.1V, Vrvwm=48V, 3.5A, 400W(1ms)	DO-214AC	1d	1a	Gal
ACX	SMAJ48A	TVS	Vbr=53.3..58.9V, Vrvwm=48V, 3.9A, 400W(1ms)	DO-214AC	1d	1a	Gal
ACY	SMAJ51	TVS	Vbr=56.7..69.3V, Vrvwm=51V, 3.3A, 400W(1ms)	DO-214AC	1d	1a	Gal
ACZ	SMAJ51A	TVS	Vbr=56.7..62.7V, Vrvwm=51V, 3.6A, 400W(1ms)	DO-214AC	1d	1a	Gal
AD	BZX884-B7V5	Z-diode	7.5V±2%, 250mW	SOD-882	13d	2b	Phi
AD	KDZ20B	Z-diode	20V±2.5%, 20mA, 1W	PMDU	7d	1s	Rhm
AD	MA5Z220-H	Z-diode	220V, Iz=0.1mA, 150mW	S-Mini	8d	1a	Pan
AD	MAZU220-H	Z-diode	220..240V, 200mA, 150mW	S-Mini2	8d	1a	Pan
AD	MM1Z5233B	Z-diode	6.0V±5%, Izt=20mA, Zzt=7Ω, 500mW	SOD-123FL	7d	1a	Bts
AD	MMSZ5233B	Z-diode	6.0V±5%, Izt=20mA, Zzt=7Ω, 500mW	SOD-123	5d	1a	Eic
AD	P4SMA6.8	TVS	Vrvwm=6.8V, 38A, 400W (1ms),	DO-214AC	1d	2j	Fag
AD	P6SMBJ5.0C	TVS	Vbr=5V, 62.5A, 600W(1ms), Bidirectional	DO-214AA	1ba	1x,1y	Pjt,Srj
AD	PTV131V31UR	TVS	Vrvwm=13V, Vbr=14.40..15.90V, 18.6A, 400W (1ms)	SOD-123W	7d	1a	Nxp
AD	SMAJ5.0	TVS	Vrvwm=5.0V, Vbr=6.40..7.82V, 41.7A, 400W(1ms)	DO-214AC	1d	1k	Vs
AD	SMBG5.0C	TVS	Vbr=5V, 62.5A, 600W(1ms), Bidirectional	DO-215AA	5ba	1l	Vs
AD	SMBJ5.0C	TVS	Vbr=5V, 62.5A, 600W(1ms), Bidirectional	DO-214AA	1ba	1l	Vs
AD	TV04A5V0K-G	TVS	Vrvwm=5.0V, Vbr=6.40..7.30V, Ipp=41.67A, 400W(1ms)	DO-214AC	1d	1a	Cmc
AD	TV06B5V0KB-G	TVS	Vrvwm=5.0V, Vbr=6.40..7.30V, Ipp=62.50A, 600W(1ms), Bidirectional	DO-214AA	1ba	1j	Cmc
AD	ZMV832A	C-diode	VHF/UHF-Tuning, 25V, 330mW, 22pF(2V), ΔC ±10%	SOD-323	5d	1a	Zx
ADK	SMA6.8	TVS	Vbr=6.12..7.48V, Vrvwm=5.50V, 37.0A, 400W(1ms)	DO-214AC	1d	1a	Lge
ADM	SMA6.8C	TVS	Vbr=6.12..7.48V, Vrvwm=5.50V, 37.0A, 400W(1ms), Bidirectional	DO-214AC	1ba	1j	Lge
ADP	TPSMA6.8	TVS	Vbr=6.8V, 37A, 400W (1ms)	DO-214AC	1d	1k	Vs
ADP	TPSMP6.8	TVS	Vbr=6.12..7.48V, Vrvwm=5.50V, Ipp=23.2A, 250W(1ms)	DO-220AA	8d	1a	Vs
AE	BZX884-B8V2	Z-diode	8.2V±2%, 250mW	SOD-882	13d	2b	Phi
AE	CD214B-T5.0CA	TVS	Vbr=5.0V, Irsrm=65.2A, 600W(1ms), Bidirectional	DO-214AA	1ba	1j	Bm
AE	MA5Z240-L	Z-diode	240V, Iz=0.1mA, 150mW	S-Mini	8d	1a	Pan
AE	MAZU240-L	Z-diode	230..250V, 200mA, 150mW	S-Mini2	8d	1a	Pan
AE	MM1Z5238B	Z-diode	8.7V±5%, Izt=20mA, Zzt=8Ω, 500mW	SOD-123FL	7d	1a	Bts
AE	MMSZ5238B	Z-diode	8.7V±5%, Izt=20mA, Zzt=8Ω, 500mW	SOD-123	5d	1a	Eic
AE	P4SMA6.8A	TVS	Vrvwm=6.8V, 40A, 400W (1ms),	DO-214AC	1d	2j	Fag
AE	P4SMAJ5.0A	TVS	Vbr=5.0V, 43.5A, 400W(1ms)	DO-214AC	1d	1a	Mco
AE	P6SMBJ5.0AC	TVS	Vbr=5V, 65.2A, 600W(1ms), Bidirectional	DO-214AA	1ba	1x,1y	Pjt,Srj
AE	PTV141V31UR	TVS	Vrvwm=14V, Vbr=15.60..17.20V, 17.2A, 400W (1ms)	SOD-123W	7d	1a	Nxp
AE	SMAJ5.0A	TVS	Vrvwm=5.0V, Vbr=6.40..7.0V, 43.5A, 400W(1ms)	DO-214AC	1d	1k,1q	Ste
AE	SMBG5.0CA	TVS	Vbr=5V, 65.2A, 600W(1ms), Bidirectional	DO-215AA	5ba	1l	Vs
AE	SMBJ5.0CA	TVS	Vbr=5V, 65.2A, 600W(1ms), Bidirectional	DO-214AA	1ba	1l,1x	Di,Vs
AE	SMF5V0A	ESDP-diode	Vbr=6.4V, Vrvwm=5V, Ipp=21.7A, 200W(1ms)	DO-219AB	7d	1i	Vs
AE	SMP5.0A	TVS	Vbr=6.40..7.07V, Vrvwm=5.0V, Ipp=43.5A, 400W(1ms)	DO-220AA	8d	1a	Vs
AE	TV04A5V0J-G	TVS	Vrvwm=5.0V, Vbr=6.46..7.0V, Ipp=43.48A, 400W(1ms)	DO-214AC	1d	1a	Cmc
AE	TV06B5V0JB-G	TVS	Vrvwm=5.0V, Vbr=6.40..7.0V, Ipp=65.22A, 600W(1ms), Bidirectional	DO-214AA	1ba	1j	Cmc
AE	ZMV833A	C-diode	VHF/UHF-Tuning, 25V, 330mW, 33pF(2V), ΔC ±10%	SOD-323	5d	1a	Zx
AEK	SMA6.8A	TVS	Vbr=6.45..7.13V, Vrvwm=5.80V, 38.1A, 400W(1ms)	DO-214AC	1d	1a	Lge
AEM	SMA6.8CA	TVS	Vbr=6.45..7.13V, Vrvwm=5.80V, 38.1A, 400W(1ms), Bidirectional	DO-214AC	1ba	1j	Lge
AEP	TPSMA6.8A	TVS	Vbr=6.8V, 38.1A, 400W (1ms)	DO-214AC	1d	1k	Vs
AEP	TPSMP6.8A	TVS	Vbr=6.45..7.14V, Vrvwm=5.80V, Ipp=23.8A, 250W(1ms)	DO-220AA	8d	1a	Vs
AF	BZX884-B9V1	Z-diode	9.1V±2%, 250mW	SOD-882	13d	2b	Phi
AF	KDZ33FV	Z-diode	31.0..35.0V, Izt=2mA, Zzt=250Ω, 100mW	TFSC	7d	1a	Kec
AF	MA5Z240-M	Z-diode	240V, Iz=0.1mA, 150mW	S-Mini	8d	1a	Pan
AF	MAZD043	Z-diode	4..4.6V, Zzt=130Ω(5mA), 120mW	SSSMini2	7d	1a	Pan
AF	MAZU240-M	Z-diode	240..260V, 200mA, 150mW	S-Mini2	8d	1a	Pan
AF	MM1Z5244B	Z-diode	14V±5%, Izt=9.0mA, Zzt=15Ω, 500mW	SOD-123FL	7d	1a	Bts
AF	MMSZ5244B	Z-diode	14V±5%, Izt=9mA, Zzt=15Ω, 500mW	SOD-123	5d	1a	Eic
AF	P4SMA7.5	TVS	Vrvwm=7.5V, 36A, 400W (1ms),	DO-214AC	1d	2j	Fag
AF	P6SMBJ6.0C	TVS	Vbr=6V, 52.6A, 600W(1ms), Bidirectional	DO-214AA	1ba	1x,1y	Pjt,Srj
AF	PTV151V31UR	TVS	Vrvwm=15V, Vbr=16.70..18.50V, 16.4A, 400W (1ms)	SOD-123W	7d	1a	Nxp
AF	SMAJ6.0	TVS	Vrvwm=6.0V, Vbr=6.7..8.15V, 35.1A, 400W(1ms)	DO-214AC	1d	1k	Vs
AF	SMBG6.0C	TVS	Vbr=6V, 52.6A, 600W(1ms), Bidirectional	DO-215AA	5ba	1l	Vs
AF	SMBJ6.0C	TVS	Vbr=6V, 52.6A, 600W(1ms), Bidirectional	DO-214AA	1ba	1l	Vs



SMD
code

Type

Function

Short description

Case

Pinout

St.

Mnf.

AF	TV04A6V0K-G	TVS	Vrwm=6.0V, Vbr=6.67..8.15V, Ipp=35.09A, 400W(1ms)	DO-214AC	1d	1a	Cmc
AF	TV06B6V0KB-G	TVS	Vrwm=6.0V, Vbr=6.67..8.15V, Ipp=52.63A, 600W(1ms), Bidirectional	DO-214AA	1ba	1j	Cmc
AF	ZMV834A	C-diode	VHF/UHF-Tuning, 25V, 330mW, 47pF(2V), ΔC ±10%	SOD-323	5d	1a	Zx
AFK	SMA7.5	TVS	Vbr=6.75..8.25V, Vrwm=6.05V, 34.2A, 400W(1ms)	DO-214AC	1d	1a	Lge
AFM	SMA7.5C	TVS	Vbr=6.75..8.25V, Vrwm=6.05V, 34.2A, 400W(1ms), Bidirectional	DO-214AC	1ba	1j	Lge
AFP	TPSMA7.5	TVS	Vbr=7.5V, 34.2A, 400W(1ms)	DO-214AC	1d	1k	Vs
AFP	TPSMP7.5	TVS	Vbr=6.75..8.25V, Vrwm=6.05V, Ipp=25.6A, 300W(1ms)	DO-220AA	8d	1a	Vs
AG	BZX884-B10	Z-diode	10V±2%, 250mW	SOD-882	13d	2b	Phi
AG	CD214B-T6.0CA	TVS	Vbr=6.0V, Irm=58.3A, 600W(1ms), Bidirectional	DO-214AA	1ba	1j	Bm
AG	P4SMA7.5A	TVS	Vrwm=7.5V, 37A, 400W(1ms)	DO-214AC	1d	2j	Fag
AG	P4SMAJ6.0A	TVS	Vbr=6.0V, 38.8A, 400W(1ms)	DO-214AC	1d	1a	Mco
AG	P6SMBJ6.0AC	TVS	Vbr=6V, 58.3A, 600W(1ms), Bidirectional	DO-214AA	1ba	1x,1y	Pjt,Sj
AG	PTVS16VS1UR	TVS	Vrwm=16V, Vbr=17.80..19.70V, 15.4A, 400W(1ms)	SOD-123W	7d	1a	Nxp
AG	SMAJ6.0A	TVS	Vrwm=6.0V, Vbr=6.67..7.37V, 38.8A, 400W(1ms)	DO-214AC	1d	1k	Vs
AG	SMBG6.0CA	TVS	Vbr=6V, 58.3A, 600W(1ms), Bidirectional	DO-215AA	5ba	1l	Vs
AG	SMBJ6.0CA	TVS	Vbr=6V, 58.3A, 600W(1ms), Bidirectional	DO-214AA	1ba	1l,1x	Di,Vs
AG	SMF6V0A	ESDP-diode	Vbr=6.67V, Vrwm=6V, Ipp=19.4A, 200W(1ms)	DO-219AB	7d	1i	Vs
AG	SMF6.0A	TVS	Vbr=6.67..7.37V, Vrwm=6.0V, Ipp=38.8A, 400W(1ms)	DO-220AA	8d	1a	Vs
AG	TV04A6V0J-G	TVS	Vrwm=6.0V, Vbr=6.67..7.37V, Ipp=38.83A, 400W(1ms)	DO-214AC	1d	1a	Cmc
AG	TV06B6V0JB-G	TVS	Vrwm=6.0V, Vbr=6.67..7.37V, Ipp=58.25A, 600W(1ms), Bidirectional	DO-214AA	1ba	1j	Cmc
AG	ZMV835A	C-diode	VHF/UHF-Tuning, 25V, 330mW, 68pF(2V), ΔC ±10%	SOD-323	5d	1a	Zx
AGK	SMA7.5A	TVS	Vbr=7.13..7.88V, Vrwm=6.40V, 35.4A, 400W(1ms)	DO-214AC	1d	1a	Lge
AGM	SMA7.5CA	TVS	Vbr=7.13..7.88V, Vrwm=6.40V, 35.4A, 400W(1ms), Bidirectional	DO-214AC	1ba	1j	Lge
AGP	TPSMA7.5A	TVS	Vbr=7.5V, 35.4A, 400W(1ms)	DO-214AC	1d	1k	Vs
AGP	TPSMP7.5A	TVS	Vbr=7.13..7.88V, Vrwm=6.40V, Ipp=26.5A, 300W(1ms)	DO-220AA	8d	1a	Vs
AH	BZX884-B11	Z-diode	11V±2%, 250mW	SOD-882	13d	2b	Phi
AH	MA5Z240-H	Z-diode	240V, IZ=0.1mA, 150mW	S-Mini	8d	1a	Pan
AH	MAZU240-H	Z-diode	250..270V, 200mA, 150mW	S-Mini2	8d	1a	Pan
AH	MM1Z5247B	Z-diode	17V±5%, IZ=7.4mA, Zzt=19Ω, 500mW	SOD-123FL	7d	1a	Bts
AH	MMSZ5247B	Z-diode	17V±5%, IZ=7.4mA, Zzt=19Ω, 500mW	SOD-123	5d	1a	Eic
AH	P4SMA8.2	TVS	Vrwm=8.2V, 33A, 400W(1ms)	DO-214AC	1d	2j	Fag
AH	P6SMBJ6.5C	TVS	Vbr=6.5V, 48.7A, 600W(1ms), Bidirectional	DO-214AA	1ba	1x,1y	Pjt,Sj
AH	PTVS17VS1UR	TVS	Vrwm=17V, Vbr=18.90..20.90V, 14.5A, 400W(1ms)	SOD-123W	7d	1a	Nxp
AH	SMAJ6.5	TVS	Vrwm=6.5V, Vbr=7.22..8.82V, 32.5A, 400W(1ms)	DO-214AC	1d	1k	Vs
AH	SMBG6.5C	TVS	Vbr=6.5V, 48.8A, 600W(1ms), Bidirectional	DO-215AA	5ba	1l	Vs
AH	SMBJ6.5C	TVS	Vbr=6.5V, 48.8A, 600W(1ms), Bidirectional	DO-214AA	1ba	1l	Vs
AH	TV04A6V5K-G	TVS	Vrwm=6.50V, Vbr=7.22..8.82V, Ipp=32.52A, 400W(1ms)	DO-214AC	1d	1a	Cmc
AH	TV06B6V5KB-G	TVS	Vrwm=6.50V, Vbr=7.22..8.82V, Ipp=48.78A, 600W(1ms), Bidirectional	DO-214AA	1ba	1j	Cmc
AH	ZMV930TA	C-diode	VHF-Tuning, 12V, 4.3/5.5pF(2.5V)	SOD-323	5d	1a	Zx
AHK	SMA8.2	TVS	Vbr=7.38..9.0V, Vrwm=6.63V, 32.0A, 400W(1ms)	DO-214AC	1d	1a	Lge
AHM	SMA8.2C	TVS	Vbr=7.38..9.0V, Vrwm=6.63V, 32.0A, 400W(1ms), Bidirectional	DO-214AC	1ba	1j	Lge
AHP	TPSMA8.2	TVS	Vbr=8.2V, 32A, 400W(1ms)	DO-214AC	1d	1k	Vs
AHP	TPSMP8.2	TVS	Vbr=7.38..9.02V, Vrwm=6.63V, Ipp=24.0A, 300W(1ms)	DO-220AA	8d	1a	Vs
AI	MA5Z270-L	Z-diode	270V, IZ=0.1mA, 150mW	S-Mini	8d	1a	Pan
AI	MAZU270-L	Z-diode	270..280V, 200mA, 150mW	S-Mini2	8d	1a	Pan
AJ	BZX884-B12	Z-diode	12V±2%, 250mW	SOD-882	13d	2b	Phi
AJ	MM1Z5255B	Z-diode	28V±5%, IZ=4.5mA, Zzt=44Ω, 500mW	SOD-123FL	7d	1a	Bts
AJ	MMSZ5255B	Z-diode	29V±5%, IZ=4.5mA, Zzt=44Ω, 500mW	SOD-123	5d	1a	Eic
AJ	SMAJ15CA	TVS	Vrwm=15V, Vbr=16.7..18.5V, 16.4A, 400W(1ms), Bidirectional	DO-214AC	1ba	1r	Ste
AJ	ZMV931TA	C-diode	VHF-Tuning, 12V, 6.5/7.8pF(2.5V)	SOD-323	5d	1a	Zx
AJ05A	SMAJ5.0A	TVS	Vrwm=5.0V, Vbr=6.40..7.0V, 43.5A, 400W(1ms)	DO-214AC	1d	1a	Sec
AJ05A	SMAJ5.0CA	TVS	Vrwm=5.0V, Vbr=6.40..7.0V, 43.5A, 400W(1ms), Bidirectional	DO-214AC	1ba	1j	Sec
AJ06A	SMAJ6.0A	TVS	Vrwm=6.0V, Vbr=6.67..7.37V, 38.8A, 400W(1ms)	DO-214AC	1d	1a	Sec
AJ06A	SMAJ6.0CA	TVS	Vrwm=6.0V, Vbr=6.67..7.37V, 38.8A, 400W(1ms), Bidirectional	DO-214AC	1ba	1j	Sec
AJ07A	SMAJ7.0A	TVS	Vrwm=7.0V, Vbr=7.78..8.60V, 33.3A, 400W(1ms)	DO-214AC	1d	1a	Sec
AJ07A	SMAJ7.0CA	TVS	Vrwm=7.0V, Vbr=7.78..8.60V, 33.3A, 400W(1ms), Bidirectional	DO-214AC	1ba	1j	Sec
AJ08A	SMAJ8.0A	TVS	Vrwm=8.0V, Vbr=8.89..9.83V, 29.4A, 400W(1ms)	DO-214AC	1d	1j	Sec
AJ08A	SMAJ8.0CA	TVS	Vrwm=8.0V, Vbr=8.89..9.83V, 29.4A, 400W(1ms), Bidirectional	DO-214AC	1ba	1j	Sec
AJ09A	SMAJ9.0A	TVS	Vrwm=9.0V, Vbr=10.0..11.1V, 26.0A, 400W(1ms)	DO-214AC	1d	1j	Sec
AJ09A	SMAJ9.0CA	TVS	Vrwm=9.0V, Vbr=10.0..11.1V, 26.0A, 400W(1ms), Bidirectional	DO-214AC	1ba	1j	Sec
AJ100A	SMAJ100A	TVS	Vrwm=100V, Vbr=111.123V, 2.5A, 400W(1ms)	DO-214AC	1d	1a	Sec
AJ100A	SMAJ100CA	TVS	Vrwm=100V, Vbr=111.123V, 2.5A, 400W(1ms), Bidirectional	DO-214AC	1ba	1j	Sec
AJ10A	SMAJ10A	TVS	Vrwm=10V, Vbr=11.1..12.3V, 23.5A, 400W(1ms)	DO-214AC	1d	1j	Sec
AJ10A	SMAJ10CA	TVS	Vrwm=10V, Vbr=11.1..12.3V, 23.5A, 400W(1ms), Bidirectional	DO-214AC	1ba	1j	Sec
AJ110A	SMAJ110A	TVS	Vrwm=110V, Vbr=122.135V, 2.3A, 400W(1ms)	DO-214AC	1d	1a	Sec
AJ110A	SMAJ110CA	TVS	Vrwm=110V, Vbr=122.135V, 2.3A, 400W(1ms), Bidirectional	DO-214AC	1ba	1j	Sec
AJ11A	SMAJ11A	TVS	Vrwm=11V, Vbr=12.2..13.5V, 22A, 400W(1ms)	DO-214AC	1d	1j	Sec
AJ11A	SMAJ11CA	TVS	Vrwm=11V, Vbr=12.2..13.5V, 22A, 400W(1ms), Bidirectional	DO-214AC	1ba	1j	Sec
AJ120A	SMAJ120A	TVS	Vrwm=120V, Vbr=133.147V, 2.0A, 400W(1ms)	DO-214AC	1d	1a	Sec
AJ120A	SMAJ120CA	TVS	Vrwm=120V, Vbr=133.147V, 2.0A, 400W(1ms), Bidirectional	DO-214AC	1ba	1j	Sec



SMD code	Type	Function	Short description	Case	Pinout	St.	Mnf.
AJ12A	SMAJ12A	TVS	Vrwm=12V, Vbr=13.3..14.7V, 20.1A, 400W(1ms)	DO-214AC	1d	1a	Sec
AJ12A	SMAJ12CA	TVS	Vrwm=12V, Vbr=13.3..14.7V, 20.1A, 400W(1ms), Bidirectional	DO-214AC	1ba	1j	Sec
AJ130A	SMAJ130A	TVS	Vrwm=130V, Vbr=144..159V, 1.9A, 400W(1ms)	DO-214AC	1d	1a	Sec
AJ130A	SMAJ130CA	TVS	Vrwm=130V, Vbr=144..159V, 1.9A, 400W(1ms), Bidirectional	DO-214AC	1ba	1j	Sec
AJ13A	SMAJ13A	TVS	Vrwm=13V, Vbr=14.4..15.9V, 18.6A, 400W(1ms)	DO-214AC	1d	1a	Sec
AJ13A	SMAJ13CA	TVS	Vrwm=13V, Vbr=14.4..15.9V, 18.6A, 400W(1ms), Bidirectional	DO-214AC	1ba	1j	Sec
AJ14A	SMAJ14A	TVS	Vrwm=14V, Vbr=15.6..17.2V, 17.2A, 400W(1ms)	DO-214AC	1d	1a	Sec
AJ14A	SMAJ14CA	TVS	Vrwm=14V, Vbr=15.6..17.2V, 17.2A, 400W(1ms), Bidirectional	DO-214AC	1ba	1j	Sec
AJ150A	SMAJ150A	TVS	Vrwm=150V, Vbr=167..185V, 1.6A, 400W(1ms)	DO-214AC	1d	1a	Sec
AJ150A	SMAJ150CA	TVS	Vrwm=150V, Vbr=167..185V, 1.6A, 400W(1ms), Bidirectional	DO-214AC	1ba	1j	Sec
AJ15A	SMAJ15A	TVS	Vrwm=15V, Vbr=16.7..18.5V, 16.4A, 400W(1ms)	DO-214AC	1d	1a	Sec
AJ15A	SMAJ15CA	TVS	Vrwm=15V, Vbr=16.7..18.5V, 16.4A, 400W(1ms), Bidirectional	DO-214AC	1ba	1j	Sec
AJ160A	SMAJ160A	TVS	Vrwm=160V, Vbr=178..197V, 1.5A, 400W(1ms)	DO-214AC	1d	1a	Sec
AJ160A	SMAJ160CA	TVS	Vrwm=160V, Vbr=178..197V, 1.5A, 400W(1ms), Bidirectional	DO-214AC	1ba	1j	Sec
AJ16A	SMAJ16A	TVS	Vrwm=16V, Vbr=17.8..19.7V, 15.3A, 400W(1ms)	DO-214AC	1d	1a	Sec
AJ16A	SMAJ16CA	TVS	Vrwm=16V, Vbr=17.8..19.7V, 15.3A, 400W(1ms), Bidirectional	DO-214AC	1ba	1j	Sec
AJ170A	SMAJ170A	TVS	Vrwm=170V, Vbr=189..209V, 1.5A, 400W(1ms)	DO-214AC	1d	1a	Sec
AJ170A	SMAJ170CA	TVS	Vrwm=170V, Vbr=189..209V, 1.5A, 400W(1ms), Bidirectional	DO-214AC	1ba	1j	Sec
AJ17A	SMAJ17A	TVS	Vrwm=17V, Vbr=18.9..20.9V, 14.5A, 400W(1ms)	DO-214AC	1d	1a	Sec
AJ17A	SMAJ17CA	TVS	Vrwm=17V, Vbr=18.9..20.9V, 14.5A, 400W(1ms), Bidirectional	DO-214AC	1ba	1j	Sec
AJ180A	SMAJ180A	TVS	Vrwm=180V, Vbr=200..220V, 1.4A, 400W(1ms)	DO-214AC	1d	1a	Sec
AJ180A	SMAJ180CA	TVS	Vrwm=180V, Vbr=200..220V, 1.4A, 400W(1ms), Bidirectional	DO-214AC	1ba	1j	Sec
AJ18A	SMAJ18A	TVS	Vrwm=18V, Vbr=20.0..22.1V, 13.7A, 400W(1ms)	DO-214AC	1d	1a	Sec
AJ18A	SMAJ18CA	TVS	Vrwm=18V, Vbr=20.0..22.1V, 13.7A, 400W(1ms), Bidirectional	DO-214AC	1ba	1j	Sec
AJ190A	SMAJ190A	TVS	Vrwm=190V, Vbr=211..232V, 1.3A, 400W(1ms)	DO-214AC	1d	1a	Sec
AJ190A	SMAJ190CA	TVS	Vrwm=190V, Vbr=211..232V, 1.3A, 400W(1ms), Bidirectional	DO-214AC	1ba	1j	Sec
AJ200A	SMAJ200A	TVS	Vrwm=200V, Vbr=224..247V, 1.2A, 400W(1ms)	DO-214AC	1d	1a	Sec
AJ200A	SMAJ200CA	TVS	Vrwm=200V, Vbr=224..247V, 1.2A, 400W(1ms), Bidirectional	DO-214AC	1ba	1j	Sec
AJ20A	SMAJ20A	TVS	Vrwm=20V, Vbr=22.2..24.5V, 12.3A, 400W(1ms)	DO-214AC	1d	1a	Sec
AJ20A	SMAJ20CA	TVS	Vrwm=20V, Vbr=22.2..24.5V, 12.3A, 400W(1ms), Bidirectional	DO-214AC	1ba	1j	Sec
AJ220A	SMAJ220A	TVS	Vrwm=220V, Vbr=246..272V, 1.1A, 400W(1ms)	DO-214AC	1d	1a	Sec
AJ220A	SMAJ220CA	TVS	Vrwm=220V, Vbr=246..272V, 1.1A, 400W(1ms), Bidirectional	DO-214AC	1ba	1j	Sec
AJ22A	SMAJ22A	TVS	Vrwm=22V, Vbr=24.4..26.9V, 11.2A, 400W(1ms)	DO-214AC	1d	1a	Sec
AJ22A	SMAJ22CA	TVS	Vrwm=22V, Vbr=24.4..26.9V, 11.2A, 400W(1ms), Bidirectional	DO-214AC	1ba	1j	Sec
AJ24A	SMAJ24A	TVS	Vrwm=24V, Vbr=26.7..29.5V, 10.3A, 400W(1ms)	DO-214AC	1d	1a	Sec
AJ24A	SMAJ24CA	TVS	Vrwm=24V, Vbr=26.7..29.5V, 10.3A, 400W(1ms), Bidirectional	DO-214AC	1ba	1j	Sec
AJ250A	SMAJ250A	TVS	Vrwm=250V, Vbr=279..309V, 1.0A, 400W(1ms)	DO-214AC	1d	1a	Sec
AJ250A	SMAJ250CA	TVS	Vrwm=250V, Vbr=279..309V, 1.0A, 400W(1ms), Bidirectional	DO-214AC	1ba	1j	Sec
AJ26A	SMAJ26A	TVS	Vrwm=26V, Vbr=28.9..31.9V, 9.5A, 400W(1ms)	DO-214AC	1d	1a	Sec
AJ26A	SMAJ26CA	TVS	Vrwm=26V, Vbr=28.9..31.9V, 9.5A, 400W(1ms), Bidirectional	DO-214AC	1ba	1j	Sec
AJ28A	SMAJ28A	TVS	Vrwm=28V, Vbr=31.1..34.4V, 8.8A, 400W(1ms)	DO-214AC	1d	1a	Sec
AJ28A	SMAJ28CA	TVS	Vrwm=28V, Vbr=31.1..34.4V, 8.8A, 400W(1ms), Bidirectional	DO-214AC	1ba	1j	Sec
AJ300A	SMAJ300A	TVS	Vrwm=300V, Vbr=335..371V, 0.8A, 400W(1ms)	DO-214AC	1d	1a	Sec
AJ300A	SMAJ300CA	TVS	Vrwm=300V, Vbr=335..371V, 0.8A, 400W(1ms), Bidirectional	DO-214AC	1ba	1j	Sec
AJ30A	SMAJ30A	TVS	Vrwm=30V, Vbr=33.3..36.8V, 8.3A, 400W(1ms)	DO-214AC	1d	1a	Sec
AJ30A	SMAJ30CA	TVS	Vrwm=30V, Vbr=33.3..36.8V, 8.3A, 400W(1ms), Bidirectional	DO-214AC	1ba	1j	Sec
AJ33A	SMAJ33A	TVS	Vrwm=33V, Vbr=36.7..40.6V, 7.5A, 400W(1ms)	DO-214AC	1d	1a	Sec
AJ33A	SMAJ33CA	TVS	Vrwm=33V, Vbr=36.7..40.6V, 7.5A, 400W(1ms), Bidirectional	DO-214AC	1ba	1j	Sec
AJ350A	SMAJ350A	TVS	Vrwm=350V, Vbr=391..432V, 0.7A, 400W(1ms)	DO-214AC	1d	1a	Sec
AJ350A	SMAJ350CA	TVS	Vrwm=350V, Vbr=391..432V, 0.7A, 400W(1ms), Bidirectional	DO-214AC	1ba	1j	Sec
AJ36A	SMAJ36A	TVS	Vrwm=36V, Vbr=40.0..44.2V, 6.9A, 400W(1ms)	DO-214AC	1d	1a	Sec
AJ36A	SMAJ36CA	TVS	Vrwm=36V, Vbr=40.0..44.2V, 6.9A, 400W(1ms), Bidirectional	DO-214AC	1ba	1j	Sec
AJ400A	SMAJ400A	TVS	Vrwm=400V, Vbr=447..494V, 0.6A, 400W(1ms)	DO-214AC	1d	1a	Sec
AJ400A	SMAJ400CA	TVS	Vrwm=400V, Vbr=447..494V, 0.6A, 400W(1ms), Bidirectional	DO-214AC	1ba	1j	Sec
AJ40A	SMAJ40A	TVS	Vrwm=40V, Vbr=44.4..49.1V, 6.2A, 400W(1ms)	DO-214AC	1d	1a	Sec
AJ40A	SMAJ40CA	TVS	Vrwm=40V, Vbr=44.4..49.1V, 6.2A, 400W(1ms), Bidirectional	DO-214AC	1ba	1j	Sec
AJ43A	SMAJ43A	TVS	Vrwm=43V, Vbr=47.8..52.8V, 5.7A, 400W(1ms)	DO-214AC	1d	1a	Sec
AJ43A	SMAJ43CA	TVS	Vrwm=43V, Vbr=47.8..52.8V, 5.7A, 400W(1ms), Bidirectional	DO-214AC	1ba	1j	Sec
AJ440A	SMAJ440A	TVS	Vrwm=440V, Vbr=492..543V, 0.6A, 400W(1ms)	DO-214AC	1d	1a	Sec
AJ440A	SMAJ440CA	TVS	Vrwm=440V, Vbr=492..543V, 0.6A, 400W(1ms), Bidirectional	DO-214AC	1ba	1j	Sec
AJ45A	SMAJ45A	TVS	Vrwm=45V, Vbr=50.0..55.3V, 5.5A, 400W(1ms)	DO-214AC	1d	1a	Sec
AJ45A	SMAJ45CA	TVS	Vrwm=45V, Vbr=50.0..55.3V, 5.5A, 400W(1ms), Bidirectional	DO-214AC	1ba	1j	Sec
AJ48A	SMAJ48A	TVS	Vrwm=48V, Vbr=53.3..58.9V, 5.2A, 400W(1ms)	DO-214AC	1d	1a	Sec
AJ48A	SMAJ48CA	TVS	Vrwm=48V, Vbr=53.3..58.9V, 5.2A, 400W(1ms), Bidirectional	DO-214AC	1ba	1j	Sec
AJ51A	SMAJ51A	TVS	Vrwm=51V, Vbr=56.7..62.7V, 4.9A, 400W(1ms)	DO-214AC	1d	1a	Sec
AJ51A	SMAJ51CA	TVS	Vrwm=51V, Vbr=56.7..62.7V, 4.9A, 400W(1ms), Bidirectional	DO-214AC	1ba	1j	Sec
AJ54A	SMAJ54A	TVS	Vrwm=54V, Vbr=60.0..66.3V, 4.6A, 400W(1ms)	DO-214AC	1d	1a	Sec
AJ54A	SMAJ54CA	TVS	Vrwm=54V, Vbr=60.0..66.3V, 4.6A, 400W(1ms), Bidirectional	DO-214AC	1ba	1j	Sec
AJ58A	SMAJ58A	TVS	Vrwm=58V, Vbr=64.4..71.2V, 4.3A, 400W(1ms)	DO-214AC	1d	1a	Sec
AJ58A	SMAJ58CA	TVS	Vrwm=58V, Vbr=64.4..71.2V, 4.3A, 400W(1ms), Bidirectional	DO-214AC	1ba	1j	Sec



SMD code	Type	Function	Short description	Case	Pinout	St.	Mnf.
AJ6.5A	SMAJ6.5A	TVS	Vrwm=6.5V, Vbr=7.22..7.98V, 35.7A, 400W(1ms)	DO-214AC	1d	1a	Sec
AJ6.5A	SMAJ6.5CA	TVS	Vrwm=6.5V, Vbr=7.22..7.98V, 35.7A, 400W(1ms), Bidirectional	DO-214AC	1ba	1j	Sec
AJ60A	SMAJ60A	TVS	Vrwm=60V, Vbr=66.7..73.7V, 4.1A, 400W(1ms)	DO-214AC	1d	1a	Sec
AJ60A	SMAJ60CA	TVS	Vrwm=60V, Vbr=66.7..73.7V, 4.1A, 400W(1ms), Bidirectional	DO-214AC	1ba	1j	Sec
AJ64A	SMAJ64A	TVS	Vrwm=64V, Vbr=71.1..78.6V, 3.9A, 400W(1ms)	DO-214AC	1d	1a	Sec
AJ64A	SMAJ64CA	TVS	Vrwm=64V, Vbr=71.1..78.6V, 3.9A, 400W(1ms), Bidirectional	DO-214AC	1ba	1j	Sec
AJ7.5A	SMAJ7.5A	TVS	Vrwm=7.5V, Vbr=8.33..9.21V, 31.0A, 400W(1ms)	DO-214AC	1d	1a	Sec
AJ7.5A	SMAJ7.5CA	TVS	Vrwm=7.5V, Vbr=8.33..9.21V, 31.0A, 400W(1ms), Bidirectional	DO-214AC	1ba	1j	Sec
AJ70A	SMAJ70A	TVS	Vrwm=70V, Vbr=77.8..86.0V, 3.5A, 400W(1ms)	DO-214AC	1d	1a	Sec
AJ70A	SMAJ70CA	TVS	Vrwm=70V, Vbr=77.8..86V, 3.5A, 400W(1ms), Bidirectional	DO-214AC	1ba	1j	Sec
AJ75A	SMAJ75A	TVS	Vrwm=75V, Vbr=83.3..92.1V, 3.3A, 400W(1ms)	DO-214AC	1d	1a	Sec
AJ75A	SMAJ75CA	TVS	Vrwm=75V, Vbr=83.3..92.1V, 3.3A, 400W(1ms), Bidirectional	DO-214AC	1ba	1j	Sec
AJ78A	SMAJ78A	TVS	Vrwm=78V, Vbr=86.7..95.8V, 3.2A, 400W(1ms)	DO-214AC	1d	1a	Sec
AJ78A	SMAJ78CA	TVS	Vrwm=78V, Vbr=86.7..95.8V, 3.2A, 400W(1ms), Bidirectional	DO-214AC	1ba	1j	Sec
AJ8.5A	SMAJ8.5A	TVS	Vrwm=8.5V, Vbr=9.44..10.4V, 27.7A, 400W(1ms)	DO-214AC	1d	1j	Sec
AJ8.5A	SMAJ8.5CA	TVS	Vrwm=8.5V, Vbr=9.44..10.4V, 27.7A, 400W(1ms), Bidirectional	DO-214AC	1ba	1j	Sec
AJ85A	SMAJ85A	TVS	Vrwm=85V, Vbr=94.4..104V, 2.9A, 400W(1ms)	DO-214AC	1d	1a	Sec
AJ85A	SMAJ85CA	TVS	Vrwm=85V, Vbr=94.4..104V, 2.9A, 400W(1ms), Bidirectional	DO-214AC	1ba	1j	Sec
AJ90A	SMAJ90A	TVS	Vrwm=90V, Vbr=100..111V, 2.7A, 400W(1ms)	DO-214AC	1d	1a	Sec
AJ90A	SMAJ90CA	TVS	Vrwm=90V, Vbr=100..111V, 2.7A, 400W(1ms), Bidirectional	DO-214AC	1ba	1j	Sec
AK	BZX884-B13	Z-diode	13V±2%, 250mW	SOD-882	13d	2b	Phi
AK	CD214B-T6.5CA	TVS	Vbr=6.5V, Irm=53.6A, 600W(1ms), Bidirectional	DO-214AA	1ba	1j	Bm
AK	MA5Z270-M	Z-diode	270V, Iz=0.1mA, 150mW	S-Mini	8d	1a	Pan
AK	MAZU270-M	Z-diode	270..290V, 200mA, 150mW	S-Mini2	8d	1a	Pan
AK	MM1Z5264B	Z-diode	60V±5%, Izt=2.1mA, Zzt=170Ω, 500mW	SOD-123FL	7d	1a	Bts
AK	MMSZ5264B	Z-diode	60V±5%, Izt=2.1mA, Zzt=170Ω, 500mW	SOD-123	5d	1a	Eic
AK	P4SMA8.2A	TVS	Vrwm=8.2V, 35A, 400W(1ms)	DO-214AC	1d	2j	Fag
AK	P4SMAJ6.5A	TVS	Vbr=6.5V, 35.7A, 400W(1ms)	DO-214AC	1d	1a	Mco
AK	P6SMBJ6.5AC	TVS	Vbr=6.5V, 53.6A, 600W(1ms), Bidirectional	DO-214AA	1ba	1x,1y	Pjt,Sj
AK	PTVS18VS1UR	TVS	Vrwm=18V, Vbr=20.0..22.10V, 13.7A, 400W(1ms)	SOD-123W	7d	1a	Nxp
AK	SMAJ6.5A	TVS	Vrwm=6.5V, Vbr=7.22..7.98V, 35.7A, 400W(1ms)	DO-214AC	1d	1k	Vs
AK	SMBG6.5CA	TVS	Vbr=6.5V, 53.6A, 600W(1ms), Bidirectional	DO-215AA	5ba	1l	Vs
AK	SMBJ6.5CA	TVS	Vbr=6.5V, 53.6A, 600W(1ms), Bidirectional	DO-214AA	1ba	1l,1x	Di,Vs
AK	SMBF6V5A	ESDP-diode	Vbr=7.22V, Vrwm=6.5V, Ipp=17.9A, 200W(1ms)	DO-219AB	7d	1i	Vs
AK	SMP6.5A	TVS	Vbr=7.22..7.98V, Vrwm=6.5V, Ipp=35.7A, 400W(1ms)	DO-220AA	8d	1a	Vs
AK	TV04A6V5J-G	TVS	Vrwm=6.50V, Vbr=7.22..7.98V, Ipp=35.71A, 400W(1ms)	DO-214AC	1d	1a	Cmc
AK	TV06B6V5JB-G	TVS	Vrwm=6.50V, Vbr=7.22..7.98V, Ipp=53.57A, 600W(1ms), Bidirectional	DO-214AA	1ba	1j	Cmc
AK	ZMV932TA	C-diode	VHF-Tuning, 12V, 8.5/10.5pF(2.5V)	SOD-323	5d	1a	Zx
AK7	SM6T7V5CA	TVS	Vrwm=6.4V, Vbr=7.13..7.88V, 53A, 600W(1ms)	DO-214AA	1ba	1l	Vs
AKK	SMA8.2A	TVS	Vbr=7.9..8.61V, Vrwm=7.02V, 33.1A, 400W(1ms)	DO-214AC	1d	1a	Lge
AKM	SMA8.2CA	TVS	Vbr=7.9..8.61V, Vrwm=7.02V, 33.1A, 400W(1ms), Bidirectional	DO-214AC	1ba	1j	Lge
AKP	TPSMA8.2A	TVS	Vbr=8.2V, 33.1A, 400W(1ms)	DO-214AC	1d	1k	Vs
AKP	TPSPM8.2A	TVS	Vbr=7.9..8.61V, Vrwm=7.02V, Ipp=24.8A, 300W(1ms)	DO-220AA	8d	1a	Vs
AL	BZX884-B15	Z-diode	15V±2%, 250mW	SOD-882	13d	2b	Phi
AL	MA5Z270-H	Z-diode	270V, Iz=0.1mA, 150mW	S-Mini	8d	1a	Pan
AL	MAZU270-H	Z-diode	270..300V, 200mA, 150mW	S-Mini2	8d	1a	Pan
AL	P4SMA9.1	TVS	Vrwm=8.1V, 30A, 400W(1ms)	DO-214AC	1d	2j	Fag
AL	P6SMBJ7.0C	TVS	Vbr=7V, 45.1A, 600W(1ms), Bidirectional	DO-214AA	1ba	1x,1y	Pjt,Sj
AL	PTVS20VS1UR	TVS	Vrwm=20V, Vbr=22.20..24.50V, 12.3A, 400W(1ms)	SOD-123W	7d	1a	Nxp
AL	SMAJ7.0	TVS	Vrwm=7.0V, Vbr=7.78..9.51V, 30.1A, 400W(1ms)	DO-214AC	1d	1k	Vs
AL	SMBG7.0C	TVS	Vbr=7V, 45.1A, 600W(1ms), Bidirectional	DO-215AA	5ba	1l	Vs
AL	SMBJ7.0C	TVS	Vbr=7V, 45.1A, 600W(1ms), Bidirectional	DO-214AA	1ba	1l	Vs
AL	TV04A7V0K-G	TVS	Vrwm=7.0V, Vbr=7.78..9.51V, Ipp=30.08A, 400W(1ms)	DO-214AC	1d	1a	Cmc
AL	TV06B7V0KB-G	TVS	Vrwm=7.0V, Vbr=7.78..9.51V, Ipp=45.1A, 600W(1ms), Bidirectional	DO-214AA	1ba	1j	Cmc
AL	ZMV933TA	C-diode	VHF-Tuning, 12V, 18/27pF(2.5V)	SOD-323	5d	1a	Zx
ALK	SMA9.1	TVS	Vbr=8.19..10.0V, Vrwm=7.37V, 29.0A, 400W(1ms)	DO-214AC	1d	1a	Lge
ALM	SMA9.1C	TVS	Vbr=8.19..10.0V, Vrwm=7.37V, 29.0A, 400W(1ms), Bidirectional	DO-214AC	1ba	1j	Lge
ALP	TPSMA9.1	TVS	Vbr=9.1V, 29A, 400W(1ms)	DO-214AC	1d	1k	Vs
ALP	TPSPM9.1	TVS	Vbr=8.19..10.0V, Vrwm=7.37V, Ipp=21.7A, 300W(1ms)	DO-220AA	8d	1a	Vs
AM	CD214B-T7.0CA	TVS	Vbr=7.0V, Irm=50.0A, 600W(1ms), Bidirectional	DO-214AA	1ba	1j	Bm
AM	MA5Z300-L	Z-diode	300V, Iz=0.1mA, 150mW	S-Mini	8d	1a	Pan
AM	MAZU300-L	Z-diode	290..310V, 200mA, 150mW	S-Mini2	8d	1a	Pan
AM	MM3Z5222B	Z-diode	2.5V±5%, Izt=20mA, Zzt=30Ω, 200mW	SOD-323FL	7d	1a	Bts
AM	P4SMA9.1A	TVS	Vrwm=8.1V, 31A, 400W(1ms)	DO-214AC	1d	2j	Fag
AM	P4SMAJ7.0A	TVS	Vbr=7.0V, 33.3A, 400W(1ms)	DO-214AC	1d	1a	Mco
AM	P6SMBJ7.0AC	TVS	Vbr=7V, 50A, 600W(1ms), Bidirectional	DO-214AA	1ba	1x,1y	Pjt,Sj
AM	PTVS22VS1UR	TVS	Vrwm=22V, Vbr=24.40..26.90V, 11.3A, 400W(1ms)	SOD-123W	7d	1a	Nxp
AM	SMAJ7.0A	TVS	Vrwm=7.0V, Vbr=7.78..8.6V, 33.3A, 400W(1ms)	DO-214AC	1d	1k	Vs
AM	SMBG7.0CA	TVS	Vbr=7V, 50A, 600W(1ms), Bidirectional	DO-215AA	5ba	1l	Vs
AM	SMBJ7.0CA	TVS	Vbr=7V, 50A, 600W(1ms), Bidirectional	DO-214AA	1ba	1l,1x	Di,Vs



SMD code	Type	Function	Short description	Case	Pinout	St.	Mnf.
AM	SMF7V0A	ESDP-diode	Vbr=7.78V, Vrvwm=7V, Ipp=16.7A, 200W(1ms)	DO-219AB	7d	1i	Vs
AM	SMF7.0A	TVS	Vbr=7.78..8.60V, Vrvwm=7.0V, Ipp=33.3A, 400W(1ms)	DO-220AA	8d	1a	Vs
AM	TV04A7V0J-G	TVS	Vrvwm=7.0V, Vbr=7.78..8.60V, Ipp=33.33A, 400W(1ms)	DO-214AC	1d	1a	Cmc
AM	TV06B7V0JB-G	TVS	Vrvwm=7.0V, Vbr=7.78..8.60V, Ipp=50.0A, 600W(1ms), Bidirectional	DO-214AA	1ba	1j	Cmc
AM	ZMV933ATA	C-diode	VHF-Tuning, 12V, 20/24.7pF(2.5V)	SOD-323	5d	1a	Zx
AMK	SMA9.1A	TVS	Vbr=8.65..9.55V, Vrvwm=7.78V, 29.8A, 400W(1ms)	DO-214AC	1d	1a	Lge
AMM	SMA9.1CA	TVS	Vbr=8.65..9.55V, Vrvwm=7.78V, 29.8A, 400W(1ms), Bidirectional	DO-214AC	1ba	1j	Lge
AMP	TPSMA9.1A	TVS	Vbr=9.1V, 29.9A, 400W(1ms)	DO-214AC	1d	1k	Vs
AMP	TPSMP9.1A	TVS	Vbr=8.65..9.55V, Vrvwm=7.78V, Ipp=22.4A, 300W(1ms)	DO-220AA	8d	1a	Vs
AN	MA5Z300-M	Z-diode	300V, I _z =0.1mA, 150mW	S-Mini	8d	1a	Pan
AN	MAZU300-M	Z-diode	300..320V, 200mA, 150mW	S-Mini2	8d	1a	Pan
AN	MM3Z5224B	Z-diode	2.8V±5%, I _{zt} =20mA, Z _t =30Ω, 200mW	SOD-323FL	7d	1a	Bts
AN	P4SMA10	TVS	Vrvwm=10V, 28A, 400W(1ms),	DO-214AC	1d	2j	Fag
AN	P6SMBJ7.5C	TVS	Vbr=7.5V, 42A, 600W(1ms), Bidirectional	DO-214AA	1ba	1x,1y	Pjt,Sj
AN	PTVS24VS1UR	TVS	Vrvwm=24V, Vbr=26.70..29.50V, 10.3A, 400W(1ms)	SOD-123W	7d	1a	Nxp
AN	SMAJ7.5	TVS	Vrvwm=7.5V, Vbr=8.33..10.2V, 28A, 400W(1ms)	DO-214AC	1d	1k	Vs
AN	SMBG7.5C	TVS	Vbr=7.5V, 42A, 600W(1ms), Bidirectional	DO-215AA	5ba	1l	Vs
AN	SMBJ7.5C	TVS	Vbr=7.5V, 42A, 600W(1ms), Bidirectional	DO-214AA	1ba	1l	Vs
AN	SMF7.5A	TVS	Vbr=8.33..9.21V, Vrvwm=7.5V, Ipp=31.0A, 400W(1ms)	DO-220AA	8d	1a	Vs
AN	TV04A7V5K-G	TVS	Vrvwm=7.50V, Vbr=8.33..10.20V, Ipp=27.97A, 400W(1ms)	DO-214AC	1d	1a	Cmc
AN	TV06B7V5KB-G	TVS	Vrvwm=7.50V, Vbr=8.33..10.20V, Ipp=41.96A, 600W(1ms), Bidirectional	DO-214AA	1ba	1j	Cmc
AN	ZMV934TA	C-diode	VHF-Tuning, 12V, 40/65pF(2.5V)	SOD-323	5d	1a	Zx
ANK	SMA10	TVS	Vbr=9.0..11.0V, Vrvwm=8.10V, 26.7A, 400W(1ms)	DO-214AC	1d	1a	Lge
ANM	SMA10C	TVS	Vbr=9.0..11.0V, Vrvwm=8.10V, 26.7A, 400W(1ms), Bidirectional	DO-214AC	1ba	1j	Lge
ANP	TPSMA10	TVS	Vbr=10V, 26.7A, 400W(1ms)	DO-214AC	1d	1k	Vs
ANP	TPSMP10	TVS	Vbr=9.0..11.0V, Vrvwm=8.10V, Ipp=20.0A, 300W(1ms)	DO-220AA	8d	1a	Vs
AO	MA5Z300-H	Z-diode	300V, I _z =0.1mA, 150mW	S-Mini	8d	1a	Pan
AO	MAZU300-H	Z-diode	310..330V, 200mA, 150mW	S-Mini2	8d	1a	Pan
AO	ZMV934ATA	C-diode	VHF-Tuning, 12V, 47/57.7pF(2.5V)	SOD-323	5d	1a	Zx
AP	CD214B-T7.5CA	TVS	Vbr=7.5V, I _{rsm} =46.5A, 600W(1ms), Bidirectional	DO-214AA	1ba	1j	Bm
AP	CMDZ2L4	Z-diode	2.280..2.520V, I _{zt} =0.5mA, Z _t =900Ω, 250mW	SOD-323	5d	1a	Cen
AP	KDZ33FVY	Z-diode	32.15..33.79V, I _{zt} =2mA, Z _t =250Ω, 100mW	TFSC	7d	1a	Kec
AP	MA5Z330-L	Z-diode	330V, I _z =0.1mA, 150mW	S-Mini	8d	1a	Pan
AP	MAZU330-L	Z-diode	320..340V, 200mA, 150mW	S-Mini2	8d	1a	Pan
AP	MM3Z5233B	Z-diode	6.0V±5%, I _{zt} =20mA, Z _t =7Ω, 200mW	SOD-323FL	7d	1a	Bts
AP	P4SMA10A	TVS	Vrvwm=10V, 29A, 400W(1ms),	DO-214AC	1d	2j	Fag
AP	P4SMAJ7.5A	TVS	Vbr=7.5V, 31.0A, 400W(1ms)	DO-214AC	1d	1a	Mco
AP	P6SMBJ7.5AC	TVS	Vbr=7.5V, 46.5A, 600W(1ms), Bidirectional	DO-214AA	1ba	1x,1y	Pjt,Sj
AP	PTVS26VS1UR	TVS	Vrvwm=26V, Vbr=28.90..31.90V, 9.5A, 400W(1ms)	SOD-123W	7d	1a	Nxp
AP	SMAJ7.5A	TVS	Vrvwm=7.5V, Vbr=8.33..9.21V, 31A, 400W(1ms)	DO-214AC	1d	1k	Vs
AP	SMBG7.5CA	TVS	Vbr=7V, 46.5A, 600W(1ms), Bidirectional	DO-215AA	5ba	1l	Vs
AP	SMBJ7.5CA	TVS	Vbr=7V, 46.5A, 600W(1ms), Bidirectional	DO-214AA	1ba	1l,1x	Di,Vs
AP	SMF7V5A	ESDP-diode	Vbr=8.33V, Vrvwm=7.5V, Ipp=15.5A, 200W(1ms)	DO-219AB	7d	1i	Vs
AP	TV04A7V5J-G	TVS	Vrvwm=7.50V, Vbr=8.33..9.21V, Ipp=31.01A, 400W(1ms)	DO-214AC	1d	1a	Cmc
AP	TV06B7V5JB-G	TVS	Vrvwm=7.50V, Vbr=8.33..9.21V, Ipp=46.51A, 600W(1ms), Bidirectional	DO-214AA	1ba	1j	Cmc
APK	SMA10A	TVS	Vbr=9.50..10.5V, Vrvwm=8.55V, 27.6A, 400W(1ms)	DO-214AC	1d	1a	Lge
APM	SMA10CA	TVS	Vbr=9.50..10.5V, Vrvwm=8.55V, 27.6A, 400W(1ms), Bidirectional	DO-214AC	1ba	1j	Lge
APP	TPSMA10A	TVS	Vbr=10V, 27.6A, 400W(1ms)	DO-214AC	1d	1k	Vs
APP	TPSMP10A	TVS	Vbr=9.50..10.5V, Vrvwm=8.55V, Ipp=20.7A, 300W(1ms)	DO-220AA	8d	1a	Vs
AQ	P4SMA11	TVS	Vbr=9.90..12.1V, Vrvwm=8.92V, 26.0A, 400W(1ms)	DO-214AC	1d	2j	Fag
AQ	P6SMBJ8.0C	TVS	Vbr=8V, 40A, 600W(1ms), Bidirectional	DO-214AA	1ba	1x,1y	Pjt,Sj
AQ	SMAJ8.0	TVS	Vrvwm=8.0V, Vbr=8.89..10.9V, 26.7A, 400W(1ms)	DO-214AC	1d	1k	Vs
AQ	SMBG8.0C	TVS	Vbr=8V, 40A, 600W(1ms), Bidirectional	DO-215AA	5ba	1l	Vs
AQ	SMBJ8.0C	TVS	Vbr=8V, 40A, 600W(1ms), Bidirectional	DO-214AA	1ba	1l	Vs
AQ	TV04A8V0K-G	TVS	Vrvwm=8.0V, Vbr=8.89..10.90V, Ipp=26.67A, 400W(1ms)	DO-214AC	1d	1a	Cmc
AQ	TV06B8V0KB-G	TVS	Vrvwm=8.0V, Vbr=8.89..10.90V, Ipp=40.0A, 600W(1ms), Bidirectional	DO-214AA	1ba	1j	Cmc
AQK	SMA11	TVS	Vbr=9.90..12.1V, Vrvwm=8.92V, 24.7A, 400W(1ms)	DO-214AC	1d	1a	Lge
AQM	SMA11C	TVS	Vbr=9.90..12.1V, Vrvwm=8.92V, 24.7A, 400W(1ms), Bidirectional	DO-214AC	1ba	1j	Lge
AQP	TPSMA11	TVS	Vbr=11V, 24.7A, 400W(1ms)	DO-214AC	1d	1k	Vs
AQP	TPSMP11	TVS	Vbr=9.90..12.1V, Vrvwm=8.92V, Ipp=18.5A, 300W(1ms)	DO-220AA	8d	1a	Vs
AR	CD214B-T8.0CA	TVS	Vbr=8.0V, I _{rsm} =44.1A, 600W(1ms), Bidirectional	DO-214AA	1ba	1j	Bm
AR	CMDZ43L	Z-diode	40.85..45.15V, I _{zt} =0.5mA, Z _t =400Ω, 250mW	SOD-323	5d	1a	Cen
AR	MA5Z330-M	Z-diode	330V, I _z =0.1mA, 150mW	S-Mini	8d	1a	Pan
AR	MAZU330-M	Z-diode	330..350V, 200mA, 150mW	S-Mini2	8d	1a	Pan
AR	MM3Z5238B	Z-diode	8.7V±5%, I _{zt} =20mA, Z _t =8Ω, 200mW	SOD-323FL	7d	1a	Bts
AR	P4SMA11A	TVS	Vbr=10.5..11.6V, Vrvwm=9.40V, 27.0A, 400W(1ms)	DO-214AC	1d	2j	Fag
AR	P4SMAJ8.0A	TVS	Vbr=8.0V, 29.4A, 400W(1ms)	DO-214AC	1d	1a	Mco
AR	P6SMBJ8.0AC	TVS	Vbr=8V, 44.1A, 600W(1ms), Bidirectional	DO-214AA	1ba	1x,1y	Pjt,Sj
AR	PTVS28VS1UR	TVS	Vrvwm=28V, Vbr=31.10..34.40V, 8.8A, 400W(1ms)	SOD-123W	7d	1a	Nxp
AR	SMAJ8.0A	TVS	Vrvwm=8.0V, Vbr=8.89..9.83V, 29.4A, 400W(1ms)	DO-214AC	1d	1k	Vs



SMD
code

Type

Function

Short description

Case

Pinout

St.

Mnf.

SMD code	Type	Function	Short description	Case	Pinout	St.	Mnf.
AR	SMBG8.0CA	TVS	Vbr=8V, 44.1A, 600W(1ms), Bidirectional	DO-215AA	5ba	1l	Vs
AR	SMBJ8.0CA	TVS	Vbr=8V, 44.1A, 600W(1ms), Bidirectional	DO-214AA	1ba	1l,1x	Dj,Vs
AR	SMF8V0A	ESDP-diode	Vbr=8.89V, Vrwm=8V, Ipp=14.7A, 200W(1ms)	DO-219AB	7d	1i	Vs
AR	SMF8.0A	TVS	Vbr=8.89..9.83V, Vrwm=8.0V, Ipp=29.4A, 400W(1ms)	DO-220AA	8d	1a	Vs
AR	TV04A8V0J-G	TVS	Vrwm=8.0V, Vbr=8.89..9.83V, Ipp=29.41A, 400W(1ms)	DO-214AC	1d	1a	Cmc
AR	TV06B8V0JB-G	TVS	Vrwm=8.0V, Vbr=8.89..9.83V, Ipp=44.12A, 600W(1ms), Bidirectional	DO-214AA	1ba	1j	Cmc
ARD	SMAJ54	TVS	Vbr=60.0..73.3V, Vrwm=54V, 3.1A, 400W(1ms)	DO-214AC	1d	1a	Gal
ARE	SMAJ54A	TVS	Vbr=60.0..66.3V, Vrwm=54V, 3.4A, 400W(1ms)	DO-214AC	1d	1a	Gal
ARF	SMAJ58	TVS	Vbr=64.4..78.7V, Vrwm=58V, 2.9A, 400W(1ms)	DO-214AC	1d	1a	Gal
ARG	SMAJ58A	TVS	Vbr=64.4..71.2V, Vrwm=58V, 3.2A, 400W(1ms)	DO-214AC	1d	1a	Gal
ARH	SMAJ60	TVS	Vbr=66.7..81.5V, Vrwm=60V, 2.8A, 400W(1ms)	DO-214AC	1d	1a	Gal
ARK	SMA11A	TVS	Vbr=10.5..11.6V, Vrwm=9.40V, 25.6A, 400W(1ms)	DO-214AC	1d	1a	Lge
ARK	SMAJ60A	TVS	Vbr=66.7..73.7V, Vrwm=60V, 3.1A, 400W(1ms)	DO-214AC	1d	1a	Gal
ARL	SMAJ64	TVS	Vbr=71.1..86.9V, Vrwm=64V, 2.6A, 400W(1ms)	DO-214AC	1d	1a	Gal
ARM	SMA11CA	TVS	Vbr=10.5..11.6V, Vrwm=9.40V, 25.6A, 400W(1ms), Bidirectional	DO-214AC	1ba	1j	Lge
ARM	SMAJ64A	TVS	Vbr=71.1..78.6V, Vrwm=64V, 2.9A, 400W(1ms)	DO-214AC	1d	1a	Gal
ARN	SMAJ70	TVS	Vbr=77.8..95.1V, Vrwm=70V, 2.4A, 400W(1ms)	DO-214AC	1d	1a	Gal
ARP	SMAJ70A	TVS	Vbr=77.8..86.0V, Vrwm=70V, 2.7A, 400W(1ms)	DO-214AC	1d	1a	Gal
ARP	TPSMA11A	TVS	Vbr=11V, 5.6A, 400W(1ms)	DO-214AC	1d	1k	Vs
ARP	TPSMP11A	TVS	Vbr=10.5..11.6V, Vrwm=9.40V, Ipp=19.2A, 300W(1ms)	DO-220AA	8d	1a	Vs
ARQ	SMAJ75	TVS	Vbr=83.3..102V, Vrwm=75V, 2.2A, 400W(1ms)	DO-214AC	1d	1a	Gal
ARR	SMAJ75A	TVS	Vbr=83.3..92.1V, Vrwm=75V, 2.5A, 400W(1ms)	DO-214AC	1d	1a	Gal
ARS	SMAJ78	TVS	Vbr=86.7..106V, Vrwm=78V, 2.2A, 400W(1ms)	DO-214AC	1d	1a	Gal
ART	SMAJ78A	TVS	Vbr=86.7..95.8V, Vrwm=78V, 2.4A, 400W(1ms)	DO-214AC	1d	1a	Gal
ARU	SMAJ85	TVS	Vbr=94.4..115V, Vrwm=85V, 2.0A, 400W(1ms)	DO-214AC	1d	1a	Gal
ARV	SMAJ85A	TVS	Vbr=94.4..104V, Vrwm=85V, 2.2A, 400W(1ms)	DO-214AC	1d	1a	Gal
ARW	SMAJ90	TVS	Vbr=100..122V, Vrwm=90V, 1.9A, 400W(1ms)	DO-214AC	1d	1a	Gal
ARX	SMAJ90A	TVS	Vbr=100..111V, Vrwm=90V, 2.1A, 400W(1ms)	DO-214AC	1d	1a	Gal
ARY	SMAJ100	TVS	Vbr=111..136V, Vrwm=100V, 1.7A, 400W(1ms)	DO-214AC	1d	1a	Gal
ARZ	SMAJ100A	TVS	Vbr=111..123V, Vrwm=100V, 1.9A, 400W(1ms)	DO-214AC	1d	1a	Gal
AS	MA5Z330-H	Z-diode	330V, Iz=0.1mA, 150mW	S-Mini	8d	1a	Pan
AS	MAZU330-H	Z-diode	340..360V, 200mA, 150mW	S-Mini2	8d	1a	Pan
AS	P4SMA12	TVS	Vrwm=12V, 24A, 400W(1ms),	DO-214AC	1d	2j	Fag
AS	P6SMBJ8.5C	TVS	Vbr=8.5V, 37.7A, 600W(1ms), Bidirectional	DO-214AA	1ba	1x,1y	Pjt,Srj
AS	PTVS30VS1UR	TVS	Vrwm=30V, Vbr=33.30..36.80V, 8.3A, 400W(1ms)	SOD-123W	7d	1a	Nxp
AS	SMAJ8.5	TVS	Vrwm=8.5V, Vbr=9.44..11.5V, 25.2A, 400W(1ms)	DO-214AC	1d	1k	Vs
AS	SMBG8.5C	TVS	Vbr=8.5V, 37.7A, 600W(1ms), Bidirectional	DO-215AA	5ba	1l	Vs
AS	SMBJ8.5C	TVS	Vbr=8.5V, 37.7A, 600W(1ms), Bidirectional	DO-214AA	1ba	1l	Vs
AS	TV04A8V5K-G	TVS	Vrwm=8.55V, Vbr=9.44..11.50V, Ipp=25.16A, 400W(1ms)	DO-214AC	1d	1a	Cmc
AS	TV06B8V5KB-G	TVS	Vrwm=8.55V, Vbr=9.44..11.50V, Ipp=37.74A, 600W(1ms), Bidirectional	DO-214AA	1ba	1j	Cmc
ASD	AS1PD	Si-diode	Rectifier, 200V, 1.5A, Vf<1.15V(1.5A)	DO-220AA	8d	1k	Vs
ASD	SMAJ110	TVS	Vbr=122..149V, Vrwm=110V, 1.5A, 400W(1ms)	DO-214AC	1d	1a	Gal
ASE	SMAJ110A	TVS	Vbr=122..135V, Vrwm=110V, 1.7A, 400W(1ms)	DO-214AC	1d	1a	Gal
ASF	SMAJ120	TVS	Vbr=133..163V, Vrwm=120V, 1.4A, 400W(1ms)	DO-214AC	1d	1a	Gal
ASG	AS1PG	Si-diode	Rectifier, 400V, 1.5A, Vf<1.15V(1.5A)	DO-220AA	8d	1k	Vs
ASG	SMAJ120A	TVS	Vbr=133..147V, Vrwm=120V, 1.6A, 400W(1ms)	DO-214AC	1d	1a	Gal
ASH	SMAJ130	TVS	Vbr=144..176V, Vrwm=130V, 1.3A, 400W(1ms)	DO-214AC	1d	1a	Gal
ASJ	AS1PJ	Si-diode	Rectifier, 600V, 1.5A, Vf<1.15V(1.5A)	DO-220AA	8d	1k	Vs
ASK	AS1PK	Si-diode	Rectifier, 800V, 1.5A, Vf<1.15V(1.5A)	DO-220AA	8d	1k	Vs
ASK	SMA12	TVS	Vbr=10.8..13.2V, Vrwm=9.72V, 23.1A, 400W(1ms)	DO-214AC	1d	1a	Lge
ASK	SMAJ130A	TVS	Vbr=144..159V, Vrwm=130V, 1.4A, 400W(1ms)	DO-214AC	1d	1a	Gal
ASL	SMAJ150	TVS	Vbr=167..204V, Vrwm=150V, 1.1A, 400W(1ms)	DO-214AC	1d	1a	Gal
ASM	AS1PM	Si-diode	Rectifier, 1000V, 1.5A, Vf<1.15V(1.5A)	DO-220AA	8d	1k	Vs
ASM	SMA12C	TVS	Vbr=10.8..13.2V, Vrwm=9.72V, 23.1A, 400W(1ms), Bidirectional	DO-214AC	1ba	1j	Lge
ASM	SMAJ150A	TVS	Vbr=167..185V, Vrwm=150V, 1.2A, 400W(1ms)	DO-214AC	1d	1a	Gal
ASN	SMAJ160	TVS	Vbr=178..218V, Vrwm=160V, 1.0A, 400W(1ms)	DO-214AC	1d	1a	Gal
ASP	SMAJ160A	TVS	Vbr=178..197V, Vrwm=160V, 1.2A, 400W(1ms)	DO-214AC	1d	1a	Gal
ASP	TPSMA12	TVS	Vbr=12V, 23.1A, 400W(1ms)	DO-214AC	1d	1k	Vs
ASP	TPSMP12	TVS	Vbr=10.8..13.2V, Vrwm=9.72V, Ipp=17.3A, 300W(1ms)	DO-220AA	8d	1a	Vs
ASQ	SMAJ170	TVS	Vbr=189..231V, Vrwm=170V, 1.0A, 400W(1ms)	DO-214AC	1d	1a	Gal
ASR	SMAJ170A	TVS	Vbr=189..209V, Vrwm=170V, 1.1A, 400W(1ms)	DO-214AC	1d	1a	Gal
ASS	SMAJ188A	TVS	Vbr=209..231V, Vrwm=188V, 0.9A, 400W(1ms)	DO-214AC	1d	1a	Gal
AST	SMAJ188	TVS	Vbr=209..255V, Vrwm=188V, 0.9A, 400W(1ms)	DO-214AC	1d	1a	Gal
AT	CD214B-T8.5CA	TVS	Vbr=8.5V, Irs=41.7A, 600W(1ms), Bidirectional	DO-214AA	1ba	1j	Bm
AT	P4SMA12A	TVS	Vrwm=12V, 25A, 400W(1ms),	DO-214AC	1d	2j	Fag
AT	P4SMAJ8.5A	TVS	Vbr=8.5V, 27.7A, 400W(1ms)	DO-214AC	1d	1a	Mco
AT	P6SMBJ8.5AC	TVS	Vbr=8.5V, 41.7A, 600W(1ms), Bidirectional	DO-214AA	1ba	1x,1y	Pjt,Srj
AT	PTVS33VS1UR	TVS	Vrwm=33V, Vbr=36.70..40.60V, 7.5A, 400W(1ms)	SOD-123W	7d	1a	Nxp
AT	SMAJ8.5A	TVS	Vrwm=8.5V, Vbr=9.44..10.4V, 27.8A, 400W(1ms)	DO-214AC	1d	1k	Vs
AT	SMBG8.5CA	TVS	Vbr=8.5V, 41.7A, 600W(1ms), Bidirectional	DO-215AA	5ba	1l	Vs



SMD
code

Type

Function

Short description

Case

Pinout

St.

Mnf.

SMD code	Type	Function	Short description	Case	Pinout	St.	Mnf.
AT	SMBJ8.5CA	TVS	Vbr=8.5V, 41.7A, 600W(1ms), Bidirectional	DO-214AA	1ba	1i,1x	Di,Vs
AT	SMF8V5A	ESDP-diode	Vbr=9.44V, Vvwm=8.5V, Ipp=13.9A, 200W(1ms)	DO-219AB	7d	1i	Vs
AT	TV04A8V5J-G	TVS	Vvwm=8.55V, Vbr=9.44..10.40V, Ipp=27.78A, 400W(1ms)	DO-214AC	1d	1a	Cmc
AT	TV06B8V5JB-G	TVS	Vvwm=8.55V, Vbr=9.44..10.40V, Ipp=41.67A, 600W(1ms), Bidirectional	DO-214AA	1ba	1j	Cmc
AT7	SM6T10CA	TVS	Vbr=9.5..10.5V, 41A, 600W(1ms), Bidirectional	DO-214AA	1ba	1l	Vs
ATK	SMA12A	TVS	Vbr=11.4..12.6V, Vvwm=10.2V, 23.9A, 400W(1ms)	DO-214AC	1d	1a	Lge
ATM	SMA12CA	TVS	Vbr=11.4..12.6V, Vvwm=10.2V, 23.9A, 400W(1ms), Bidirectional	DO-214AC	1ba	1j	Lge
ATP	TPSMA12A	TVS	Vbr=12V, 24.0A, 400W (1ms)	DO-214AC	1d	1k	Vs
ATP	TPSMP12A	TVS	Vbr=11.4..12.6V, Vvwm=10.2V, Ipp=18.0A, 300W(1ms)	DO-220AA	8d	1a	Vs
AU	P4SMA13	TVS	Vvwm=13V, 22A, 400W (1ms),	DO-214AC	1d	2j	Fag
AU	P6SMBJ9.0C	TVS	Vbr=9V, 35.5A, 600W(1ms), Bidirectional	DO-214AA	1ba	1x,1y	Pjt,Srj
AU	PTVS36VS1UR	TVS	Vvwm=36V, Vbr=40.0..44.20V, 6.9A, 400W (1ms)	SOD-123W	7d	1a	Nxp
AU	SMAJ9.0	TVS	Vvwm=9.0V, Vbr=10.0..12.2V, 23.7A, 400W(1ms)	DO-214AC	1d	1k	Vs
AU	SMBG9.0C	TVS	Vbr=9V, 35.5A, 600W(1ms), Bidirectional	DO-215AA	5ba	1l	Vs
AU	SMBJ9.0C	TVS	Vbr=9V, 35.5A, 600W(1ms), Bidirectional	DO-214AA	1ba	1l	Vs
AU	TV04A9V0K-G	TVS	Vvwm=9.0V, Vbr=10.0..12.20V, Ipp=23.67A, 400W(1ms)	DO-214AC	1d	1a	Cmc
AU	TV06B9V0KB-G	TVS	Vvwm=9.0V, Vbr=10.0..12.20V, Ipp=35.50A, 600W(1ms), Bidirectional	DO-214AA	1ba	1j	Cmc
AUD	AU1PD	Si-diode	Rectifier, 200V, 1A, Vf<1.4V(1A)	DO-220AA	8d	1k	Vs
AUG	AU1PG	Si-diode	Rectifier, 400V, 1A, Vf<1.4V(1A)	DO-220AA	8d	1k	Vs
AUJ	AU1PJ	Si-diode	Rectifier, 600V, 1A, Vf<1.4V(1A)	DO-220AA	8d	1k	Vs
AUK	AU1PK	Si-diode	Rectifier, 800V, 1A, Vf<1.6V(1A)	DO-220AA	8d	1k	Vs
AUK	SMA13	TVS	Vbr=11.7..14.3V, Vvwm=10.5V, 21.0A, 400W(1ms)	DO-214AC	1d	1a	Lge
AUM	AU1PM	Si-diode	Rectifier, 1000V, 1A, Vf<1.6V(1A)	DO-220AA	8d	1k	Vs
AUM	SMA13C	TVS	Vbr=11.7..14.3V, Vvwm=10.5V, 21.0A, 400W(1ms), Bidirectional	DO-214AC	1ba	1j	Lge
AUP	TPSMA13	TVS	Vbr=13V, 21.1A, 400W (1ms)	DO-214AC	1d	1k	Vs
AUP	TPSMP13	TVS	Vbr=11.7..14.3V, Vvwm=10.5V, Ipp=21.1A, 400W(1ms)	DO-220AA	8d	1a	Vs
AV	CD214B-T9.0CA	TVS	Vbr=9.0V, Irsrm=39.0A, 600W(1ms), Bidirectional	DO-214AA	1ba	1j	Bm
AV	P4SMA13A	TVS	Vvwm=13V, 23A, 400W (1ms),	DO-214AC	1d	2j	Fag
AV	P4SMAJ9.0A	TVS	Vbr=9.0V, 26.0A, 400W(1ms)	DO-214AC	1d	1a	Mco
AV	P6SMB36A	TVS	Vvwm=36V, 12A, 600W(1ms)	DO-214AA	1d	2j	Fag
AV	P6SMBJ20A	TVS	Vbr=20V, 18.5A, 600W(1ms)	DO-214AA	1d	1m,1w	Pjt,Srj
AV	P6SMBJ9.0AC	TVS	Vbr=9V, 39A, 600W(1ms), Bidirectional	DO-214AA	1ba	1x,1y	Pjt,Srj
AV	PTVS40VS1UR	TVS	Vvwm=40V, Vbr=44.0..49.10V, 6.2A, 400W (1ms)	SOD-123W	7d	1a	Nxp
AV	SMAJ9.0A	TVS	Vvwm=9.0V, Vbr=10.0..11.1V, 26A, 400W(1ms)	DO-214AC	1d	1k	Vs
AV	SMBG9.0CA	TVS	Vbr=9V, 39A, 600W(1ms), Bidirectional	DO-215AA	5ba	1l	Vs
AV	SMBJ9.0CA	TVS	Vbr=9V, 39A, 600W(1ms), Bidirectional	DO-214AA	1ba	1i,1x	Di,Vs
AV	SMF9V0A	ESDP-diode	Vbr=10.0V, Vvwm=9V, Ipp=13.5A, 200W(1ms)	DO-219AB	7d	1i	Vs
AV	TV04A9V0J-G	TVS	Vvwm=9.0V, Vbr=10.0..11.10V, Ipp=25.97A, 400W(1ms)	DO-214AC	1d	1a	Cmc
AV	TV06B9V0JB-G	TVS	Vvwm=9.0V, Vbr=10.0..11.10V, Ipp=38.96A, 600W(1ms), Bidirectional	DO-214AA	1ba	1j	Cmc
AV7	SM6T24A	TVS	Vbr=22.8..25.2V, 18A, 600W(1ms)	DO-214AA	1d	1k	Vs
AV7	SM6T24CA	TVS	Vbr=22.8..25.2V, 18A, 600W(1ms), Bidirectional	DO-214AA	1ba	1l	Vs
AVD	SMAJ110C	TVS	Vbr=122..149V, Vvwm=110V, 1.5A, 400W(1ms), Bidirectional	DO-214AC	1ba	1j	Gal
AVE	SMAJ110CA	TVS	Vbr=122..135V, Vvwm=110V, 1.7A, 400W(1ms), Bidirectional	DO-214AC	1ba	1j	Gal
AVF	SMAJ120C	TVS	Vbr=133..163V, Vvwm=120V, 1.4A, 400W(1ms), Bidirectional	DO-214AC	1ba	1j	Gal
AVG	SMAJ120CA	TVS	Vbr=133..147V, Vvwm=120V, 1.6A, 400W(1ms), Bidirectional	DO-214AC	1ba	1j	Gal
AVH	SMAJ130C	TVS	Vbr=144..176V, Vvwm=130V, 1.3A, 400W(1ms), Bidirectional	DO-214AC	1ba	1j	Gal
AVK	SMA13A	TVS	Vbr=12.4..13.7V, Vvwm=11.1V, 22.0A, 400W(1ms)	DO-214AC	1d	1a	Lge
AVK	SMAJ130CA	TVS	Vbr=144..159V, Vvwm=130V, 1.4A, 400W(1ms), Bidirectional	DO-214AC	1ba	1j	Gal
AVL	SMAJ150C	TVS	Vbr=167..204V, Vvwm=150V, 1.1A, 400W(1ms), Bidirectional	DO-214AC	1ba	1j	Gal
AVM	SMA13CA	TVS	Vbr=12.4..13.7V, Vvwm=11.1V, 22.0A, 400W(1ms), Bidirectional	DO-214AC	1ba	1j	Lge
AVM	SMAJ150CA	TVS	Vbr=167..185V, Vvwm=150V, 1.2A, 400W(1ms), Bidirectional	DO-214AC	1ba	1j	Gal
AVN	SMAJ160C	TVS	Vbr=178..218V, Vvwm=160V, 1.0A, 400W(1ms), Bidirectional	DO-214AC	1ba	1j	Gal
AVP	SMAJ160CA	TVS	Vbr=178..197V, Vvwm=160V, 1.2A, 400W(1ms), Bidirectional	DO-214AC	1ba	1j	Gal
AVP	TPSMA13A	TVS	Vbr=13V, 22A, 400W (1ms)	DO-214AC	1d	1k	Vs
AVP	TPSMB36A	TVS	Vbr=36V, 12.0A, 600W(1ms)	DO-214AA	1d	1k	Vs
AVP	TPSMP13A	TVS	Vbr=12.4..13.7V, Vvwm=11.1V, Ipp=22.0A, 400W(1ms)	DO-220AA	8d	1a	Vs
AVQ	SMAJ170C	TVS	Vbr=189..231V, Vvwm=170V, 1.0A, 400W(1ms), Bidirectional	DO-214AC	1ba	1j	Gal
AVR	SMAJ170CA	TVS	Vbr=189..209V, Vvwm=170V, 1.1A, 400W(1ms), Bidirectional	DO-214AC	1ba	1j	Gal
AVS	SMAJ188CA	TVS	Vbr=209..231V, Vvwm=188V, 0.9A, 400W(1ms), Bidirectional	DO-214AC	1ba	1j	Gal
AVT	SMAJ188C	TVS	Vbr=209..255V, Vvwm=188V, 0.9A, 400W(1ms), Bidirectional	DO-214AC	1ba	1j	Gal
AW	P4SMA15	TVS	Vvwm=15V, 19A, 400W (1ms),	DO-214AC	1d	2j	Fag
AW	P6SMBJ10C	TVS	Vbr=10V, 31.9A, 600W(1ms), Bidirectional	DO-214AA	1ba	1x,1y	Pjt,Srj
AW	PTVS43VS1UR	TVS	Vvwm=43V, Vbr=47.80..52.80V, 5.8A, 400W (1ms)	SOD-123W	7d	1a	Nxp
AW	SMAJ10	TVS	Vvwm=10V, Vbr=11.1..13.6V, 21.3A, 400W(1ms)	DO-214AC	1d	1k	Vs
AW	SMBG10C	TVS	Vbr=10V, 31.9A, 600W(1ms), Bidirectional	DO-215AA	5ba	1l	Vs
AW	SMBJ10C	TVS	Vbr=10V, 31.9A, 600W(1ms), Bidirectional	DO-214AA	1ba	1l	Vs
AW	TV04A100K-G	TVS	Vvwm=10.0V, Vbr=11.0..13.60V, Ipp=21.28A, 400W(1ms)	DO-214AC	1d	1a	Cmc
AW	TV06B100KB-G	TVS	Vvwm=10.0V, Vbr=11.0..13.60V, Ipp=31.90A, 600W(1ms), Bidirectional	DO-214AA	1ba	1j	Cmc
AWD	SMAJ5.0C	TVS	Vbr=6.40..7.81V, Vvwm=5.0V, 41.7A, 400W(1ms), Bidirectional	DO-214AC	1ba	1j	Gal
AWE	SMAJ5.0CA	TVS	Vbr=6.40..7.08V, Vvwm=5.0V, 43.5A, 400W(1ms), Bidirectional	DO-214AC	1ba	1j	Gal



SMD
code

Type

Function

Short description

Case

Pinout

St.

Mnf.

SMD code	Type	Function	Short description	Case	Pinout	St.	Mnf.
AWF	SMAJ6.0C	TVS	Vbr=6.67..8.15V, Vrwm=6.0V, 35.1A, 400W(1ms), Bidirectional	DO-214AC	1ba	1j	Gal
AWG	SMAJ6.0CA	TVS	Vbr=6.67..7.37V, Vrwm=6.0V, 38.8A, 400W(1ms), Bidirectional	DO-214AC	1ba	1j	Gal
AWH	SMAJ6.5C	TVS	Vbr=7.22..8.82V, Vrwm=6.5V, 32.5A, 400W(1ms), Bidirectional	DO-214AC	1ba	1j	Gal
AWK	SMA15	TVS	Vbr=13.5..16.3V, Vrwm=12.1V, 18.2A, 400W(1ms)	DO-214AC	1d	1a	Lge
AWK	SMAJ6.5CA	TVS	Vbr=7.22..7.98V, Vrwm=6.5V, 35.7A, 400W(1ms), Bidirectional	DO-214AC	1ba	1j	Gal
AWL	SMAJ7.0C	TVS	Vbr=7.78..9.51V, Vrwm=7.0V, 30.1A, 400W(1ms), Bidirectional	DO-214AC	1ba	1j	Gal
AWM	SMA15C	TVS	Vbr=13.5..16.3V, Vrwm=12.1V, 18.2A, 400W(1ms), Bidirectional	DO-214AC	1ba	1j	Lge
AWM	SMAJ7.0CA	TVS	Vbr=7.78..8.60V, Vrwm=7.0V, 33.3A, 400W(1ms), Bidirectional	DO-214AC	1ba	1j	Gal
AWN	SMAJ7.5C	TVS	Vbr=8.33..10.3V, Vrwm=7.5V, 28.0A, 400W(1ms), Bidirectional	DO-214AC	1ba	1j	Gal
AWP	SMAJ7.5CA	TVS	Vbr=8.33..9.21V, Vrwm=7.5V, 31.0A, 400W(1ms), Bidirectional	DO-214AC	1ba	1j	Gal
AWP	TPSMA15	TVS	Vbr=15V, 18A, 400W(1ms)	DO-214AC	1d	1k	Vs
AWP	TPSMP15	TVS	Vbr=13.5..16.3V, Vrwm=12.1V, Ipp=18.2A, 400W(1ms)	DO-220AA	8d	1a	Vs
AWQ	SMAJ8.0C	TVS	Vbr=8.89..10.9V, Vrwm=8.0V, 26.7A, 400W(1ms), Bidirectional	DO-214AC	1ba	1j	Gal
AWR	SMAJ8.0CA	TVS	Vbr=8.89..9.83V, Vrwm=8.0V, 29.4A, 400W(1ms), Bidirectional	DO-214AC	1ba	1j	Gal
AWS	SMAJ8.5C	TVS	Vbr=9.44..11.5V, Vrwm=8.5V, 25.2A, 400W(1ms), Bidirectional	DO-214AC	1ba	1j	Gal
AWT	SMAJ8.5CA	TVS	Vbr=9.44..10.4V, Vrwm=8.5V, 27.8A, 400W(1ms), Bidirectional	DO-214AC	1ba	1j	Gal
AWU	SMAJ9.0C	TVS	Vbr=10.0..12.2V, Vrwm=9.0V, 23.7A, 400W(1ms), Bidirectional	DO-214AC	1ba	1j	Gal
AWV	SMAJ9.0CA	TVS	Vbr=10.0..11.1V, Vrwm=9.0V, 26.0A, 400W(1ms), Bidirectional	DO-214AC	1ba	1j	Gal
AWW	SMAJ10C	TVS	Vbr=11.1..13.6V, Vrwm=10V, 21.3A, 400W(1ms), Bidirectional	DO-214AC	1ba	1j	Gal
AWX	SMAJ10CA	TVS	Vbr=11.1..12.3V, Vrwm=10V, 23.5A, 400W(1ms), Bidirectional	DO-214AC	1ba	1j	Gal
AWY	SMAJ11C	TVS	Vbr=12.2..14.9V, Vrwm=11V, 19.9A, 400W(1ms), Bidirectional	DO-214AC	1ba	1j	Gal
AWZ	SMAJ11CA	TVS	Vbr=12.2..13.5V, Vrwm=11V, 22.0A, 400W(1ms), Bidirectional	DO-214AC	1ba	1j	Gal
AX	AOZ8831D1-05	TVS	Vrwm=5V, Vbr<6V, 2A, 40W(<20µs), Bidirectional	SOD-882	13ba	2a	Aom
AX	CD214B-T10CA	TVS	Vbr=10V, Irlsm=35.3A, 600W(1ms), Bidirectional	DO-214AA	1ba	1j	Bm
AX	MM3Z5244B	Z-diode	14V±5%, Izt=9.0mA, Zzt=15Ω, 200mW	SOD-323FL	7d	1a	Bts
AX	P4SMA15A	TVS	Vrwm=15V, 20A, 400W(1ms)	DO-214AC	1d	2j	Fag
AX	P4SMAJ10A	TVS	Vbr=10V, 23.5A, 400W(1ms)	DO-214AC	1d	1a	Mco
AX	P6SMBJ10AC	TVS	Vbr=10V, 35.3A, 600W(1ms), Bidirectional	DO-214AA	1ba	1x,1y	Pjt,Srj
AX	PTVS45VS1UR	TVS	Vrwm=45V, Vbr=50.0..55.30V, 5.5A, 400W(1ms)	SOD-123W	7d	1a	Nxp
AX	SMAJ10A	TVS	Vrwm=10V, Vbr=11.1..12.3V, 21.7A, 400W(1ms)	DO-214AC	1d	1q	Ste
AX	SMBG10CA	TVS	Vbr=10V, 35.3A, 600W(1ms), Bidirectional	DO-215AA	5ba	1l	Vs
AX	SMBJ10CA	TVS	Vbr=10V, 35.3A, 600W(1ms), Bidirectional	DO-214AA	1ba	1l,1x	Di,Vs
AX	SMF10A	ESDP-diode	Vbr=11.1V, Vrwm=10V, Ipp=11.8A, 200W(1ms)	DO-219AB	7d	1i	Vs
AX	TV04A100J-G	TVS	Vrwm=10.0V, Vbr=11.0..12.30V, Ipp=23.53A, 400W(1ms)	DO-214AC	1d	1a	Cmc
AX	TV06B100JB-G	TVS	Vrwm=10.0V, Vbr=11.0..12.30V, Ipp=35.29A, 600W(1ms), Bidirectional	DO-214AA	1ba	1j	Cmc
AX7	SM6T12CA	TVS	Vbr=11.4..12.6V, 36A, 600W(1ms), Bidirectional	DO-214AA	1ba	1l	Vs
AXD	SMAJ12C	TVS	Vbr=13.3..16.3V, Vrwm=12V, 18.2A, 400W(1ms), Bidirectional	DO-214AC	1ba	1j	Gal
AXE	SMAJ12CA	TVS	Vbr=13.3..14.7V, Vrwm=12V, 20.1A, 400W(1ms), Bidirectional	DO-214AC	1ba	1j	Gal
AXF	SMAJ13C	TVS	Vbr=14.4..17.6V, Vrwm=13V, 16.8A, 400W(1ms), Bidirectional	DO-214AC	1ba	1j	Gal
AXG	SMAJ13CA	TVS	Vbr=14.4..15.9V, Vrwm=13V, 18.6A, 400W(1ms), Bidirectional	DO-214AC	1ba	1j	Gal
AXH	SMAJ14C	TVS	Vbr=15.6..19.1V, Vrwm=14V, 15.5A, 400W(1ms), Bidirectional	DO-214AC	1ba	1j	Gal
AXK	SMA15A	TVS	Vbr=14.3..15.8V, Vrwm=12.8V, 18.7A, 400W(1ms)	DO-214AC	1d	1a	Lge
AXK	SMAJ14CA	TVS	Vbr=15.6..17.2V, Vrwm=14V, 17.2A, 400W(1ms), Bidirectional	DO-214AC	1ba	1j	Gal
AXL	SMAJ15C	TVS	Vbr=16.7..20.4V, Vrwm=15V, 14.9A, 400W(1ms), Bidirectional	DO-214AC	1ba	1j	Gal
AXM	SMA15CA	TVS	Vbr=14.3..15.8V, Vrwm=12.8V, 18.7A, 400W(1ms), Bidirectional	DO-214AC	1ba	1j	Lge
AXM	SMAJ15CA	TVS	Vbr=16.7..18.5V, Vrwm=15V, 16.4A, 400W(1ms), Bidirectional	DO-214AC	1ba	1j	Gal
AXN	SMAJ16C	TVS	Vbr=17.8..21.8V, Vrwm=16V, 13.9A, 400W(1ms), Bidirectional	DO-214AC	1ba	1j	Gal
AXP	SMAJ16CA	TVS	Vbr=17.8..19.7V, Vrwm=16V, 15.4A, 400W(1ms), Bidirectional	DO-214AC	1ba	1j	Gal
AXP	TPSMA15A	TVS	Vbr=15V, 18.9A, 400W(1ms)	DO-214AC	1d	1k	Vs
AXP	TPSMP15A	TVS	Vbr=14.3..15.8V, Vrwm=12.8V, Ipp=18.9A, 400W(1ms)	DO-220AA	8d	1a	Vs
AXQ	SMAJ17C	TVS	Vbr=18.9..23.1V, Vrwm=17V, 13.1A, 400W(1ms), Bidirectional	DO-214AC	1ba	1j	Gal
AXR	SMAJ17CA	TVS	Vbr=18.9..20.9V, Vrwm=17V, 14.5A, 400W(1ms), Bidirectional	DO-214AC	1ba	1j	Gal
AXS	SMAJ18C	TVS	Vbr=20.0..24.4V, Vrwm=18V, 12.4A, 400W(1ms), Bidirectional	DO-214AC	1ba	1j	Gal
AXT	SMAJ18CA	TVS	Vbr=20.0..22.1V, Vrwm=18V, 13.7A, 400W(1ms), Bidirectional	DO-214AC	1ba	1j	Gal
AXU	SMAJ20C	TVS	Vbr=22.2..27.1V, Vrwm=20V, 11.2A, 400W(1ms), Bidirectional	DO-214AC	1ba	1j	Gal
AXV	SMAJ20CA	TVS	Vbr=22.2..24.5V, Vrwm=20V, 12.3A, 400W(1ms), Bidirectional	DO-214AC	1ba	1j	Gal
AXW	SMAJ22C	TVS	Vbr=24.4..29.8V, Vrwm=22V, 10.2A, 400W(1ms), Bidirectional	DO-214AC	1ba	1j	Gal
AXX	SMAJ22CA	TVS	Vbr=24.4..26.9V, Vrwm=22V, 11.3A, 400W(1ms), Bidirectional	DO-214AC	1ba	1j	Gal
AXY	SMAJ24C	TVS	Vbr=26.7..32.6V, Vrwm=24V, 9.3A, 400W(1ms), Bidirectional	DO-214AC	1ba	1j	Gal
AXZ	SMAJ24CA	TVS	Vbr=26.7..29.5V, Vrwm=24V, 10.3A, 400W(1ms), Bidirectional	DO-214AC	1ba	1j	Gal
AY	KDZ2.0VYY	Z-diode	1.95..2.15V, Izt=5mA, Zzt=100Ω, 100mW	VSC	7d	1a	Kec
AY	MM3Z5247B	Z-diode	17V±5%, Izt=7.4mA, Zzt=19Ω, 200mW	SOD-323FL	7d	1a	Bts
AY	P4SMA16	TVS	Vrwm=16V, 18A, 400W(1ms)	DO-214AC	1d	2j	Fag
AY	P6SMBJ11C	TVS	Vbr=11V, 29.9A, 600W(1ms), Bidirectional	DO-214AA	1ba	1x,1y	Pjt,Srj
AY	PTVS48VS1UR	TVS	Vrwm=48V, Vbr=53.30..58.90V, 5.2A, 400W(1ms)	SOD-123W	7d	1a	Nxp
AY	SMAJ11	TVS	Vrwm=11V, Vbr=12.2..13.5V, 19.9A, 400W(1ms)	DO-214AC	1d	1k	Vs
AY	SMP11	TVS	Vbr=12.2..14.9V, Vrwm=11V, Ipp=19.9A, 400W(1ms)	DO-220AA	8d	1a	Vs
AY	TV04A110K-G	TVS	Vrwm=11.0V, Vbr=12.20..14.90V, Ipp=19.90A, 400W(1ms)	DO-214AC	1d	1a	Cmc
AY	TV06B110KB-G	TVS	Vrwm=11.0V, Vbr=12.20..14.90V, Ipp=29.85A, 600W(1ms), Bidirectional	DO-214AA	1ba	1j	Cmc
AYD	SMAJ26C	TVS	Vbr=28.9..35.3V, Vrwm=26V, 8.6A, 400W(1ms), Bidirectional	DO-214AC	1ba	1j	Gal



SMD code	Type	Function	Short description	Case	Pinout	St.	Mnf.
AYE	SMAJ26CA	TVS	Vbr=28.9..31.9V, Vrwm=26V, 9.5A, 400W(1ms), Bidirectional	DO-214AC	1ba	1j	Gal
AYF	SMAJ28C	TVS	Vbr=31.1..38.0V, Vrwm=28V, 8.0A, 400W(1ms), Bidirectional	DO-214AC	1ba	1j	Gal
AYG	SMAJ28CA	TVS	Vbr=31.1..34.4V, Vrwm=28V, 8.8A, 400W(1ms), Bidirectional	DO-214AC	1ba	1j	Gal
AYH	SMAJ30C	TVS	Vbr=33.3..40.7V, Vrwm=30V, 7.5A, 400W(1ms), Bidirectional	DO-214AC	1ba	1j	Gal
AYK	SMA16	TVS	Vbr=14.4..17.6V, Vrwm=12.9V, 17.0A, 400W(1ms)	DO-214AC	1d	1a	Lge
AYK	SMAJ30CA	TVS	Vbr=33.3..36.8V, Vrwm=30V, 8.3A, 400W(1ms), Bidirectional	DO-214AC	1ba	1j	Gal
AYL	SMAJ33C	TVS	Vbr=36.7..44.9V, Vrwm=33V, 5.1A, 400W(1ms), Bidirectional	DO-214AC	1ba	1j	Gal
AYM	SMA16C	TVS	Vbr=14.4..17.6V, Vrwm=12.9V, 17.0A, 400W(1ms), Bidirectional	DO-214AC	1ba	1j	Lge
AYM	SMAJ33CA	TVS	Vbr=36.7..40.6V, Vrwm=33V, 5.6A, 400W(1ms), Bidirectional	DO-214AC	1ba	1j	Gal
AYN	SMAJ36C	TVS	Vbr=40.0..48.9V, Vrwm=36V, 4.7A, 400W(1ms), Bidirectional	DO-214AC	1ba	1j	Gal
AYP	SMAJ36CA	TVS	Vbr=40.0..44.2V, Vrwm=36V, 5.2A, 400W(1ms), Bidirectional	DO-214AC	1ba	1j	Gal
AYP	TPSMA16	TVS	Vbr=16V, 17A, 400W(1ms)	DO-214AC	1d	1k	Vs
AYP	TPSMP16	TVS	Vbr=14.4..17.6V, Vrwm=12.9V, lpp=17.0A, 400W(1ms)	DO-220AA	8d	1a	Vs
AYQ	SMAJ40C	TVS	Vbr=44.4..54.3V, Vrwm=40V, 4.2A, 400W(1ms), Bidirectional	DO-214AC	1ba	1j	Gal
AYR	SMAJ40CA	TVS	Vbr=44.4..49.1V, Vrwm=40V, 4.7A, 400W(1ms), Bidirectional	DO-214AC	1ba	1j	Gal
AYS	SMAJ43C	TVS	Vbr=47.8..58.4V, Vrwm=43V, 3.9A, 400W(1ms), Bidirectional	DO-214AC	1ba	1j	Gal
AYT	SMAJ43CA	TVS	Vbr=47.8..52.8V, Vrwm=43V, 4.3A, 400W(1ms), Bidirectional	DO-214AC	1ba	1j	Gal
AYU	SMAJ45C	TVS	Vbr=50.0..61.1V, Vrwm=45V, 3.7A, 400W(1ms), Bidirectional	DO-214AC	1ba	1j	Gal
AYV	SMAJ45CA	TVS	Vbr=50.0..55.3V, Vrwm=45V, 4.1A, 400W(1ms), Bidirectional	DO-214AC	1ba	1j	Gal
AYW	SMAJ48C	TVS	Vbr=53.3..65.1V, Vrwm=48V, 3.5A, 400W(1ms), Bidirectional	DO-214AC	1ba	1j	Gal
AYX	SMAJ48CA	TVS	Vbr=53.3..58.9V, Vrwm=48V, 3.9A, 400W(1ms), Bidirectional	DO-214AC	1ba	1j	Gal
AYY	SMAJ51C	TVS	Vbr=56.7..69.3V, Vrwm=51V, 3.3A, 400W(1ms), Bidirectional	DO-214AC	1ba	1j	Gal
AYZ	SMAJ51CA	TVS	Vbr=56.7..62.7V, Vrwm=51V, 3.6A, 400W(1ms), Bidirectional	DO-214AC	1ba	1j	Gal
AZ	BZT52-B6V2S	Z-diode	6.08..6.32V, lzt=5mA, Zzt=10Ω, 200mW	SOD-323FL	7d	1a	Tsc
AZ	CD214B-T11CA	TVS	Vbr=11V, lrms=33.0A, 600W(1ms), Bidirectional	DO-214AA	1ba	1j	Bm
AZ	MA5Z190	Z-diode	190V, lz=0.1mA, 150mW	S-Mini	8d	1a	Pan
AZ	MAZU190	Z-diode	180..200V, 200mA, 150mW	S-Mini2	8d	1a	Pan
AZ	MM3Z5255B	Z-diode	28V±5%, lzt=4.5mA, Zzt=44Ω, 200mW	SOD-323FL	7d	1a	Bts
AZ	MM3Z6V2B	Z-diode	6.08..6.32V, Zzt=9Ω, lzt=5mA, 200mW	SOD-323FL	7d	1a	F
AZ	MM3Z6V2BW	Z-diode	6.08..6.32V, lzt=5mA, Zzt=10Ω, 200mW	SOD-323FL	7d	1a	Tac
AZ	P4SMA16A	TVS	Vrwm=16V, 19A, 400W(1ms),	DO-214AC	1d	2j	Fag
AZ	P4SMAJ11A	TVS	Vbr=11V, 22.0A, 400W(1ms)	DO-214AC	1d	1a	Mco
AZ	P6SMBJ11AC	TVS	Vbr=11V, 33A, 600W(1ms), Bidirectional	DO-214AA	1ba	1x,1y	Pjt,Srj
AZ	PTVS51V1UR	TVS	Vrwm=51V, Vbr=56.70..62.70V, 4.9A, 400W(1ms)	SOD-123W	7d	1a	Nxp
AZ	SMAJ11A	TVS	Vrwm=11V, Vbr=12.2..13.5V, 22A, 400W(1ms)	DO-214AC	1d	1k	Vs
AZ	SMBJ11CA	TVS	Vbr=11V, 33A, 600W(1ms), Bidirectional	DO-214AA	1ba	1x	Di
AZ	SMF11A	ESDP-diode	Vbr=12.2V, Vrwm=11V, lpp=11A, 200W(1ms)	DO-219AB	7d	1i	Vs
AZ	SMP11A	TVS	Vbr=12.2..13.5V, Vrwm=11V, lpp=22.0A, 400W(1ms)	DO-220AA	8d	1a	Vs
AZ	TCMM3Z6V2B	Z-diode	6.2V±2%, lzt=5mA, Zzt=9Ω, 200mW	SOD-323FL	7d	1a	Tac
AZ	TV04A110J-G	TVS	Vrwm=11.0V, Vbr=12.20..13.50V, lpp=21.98A, 400W(1ms)	DO-214AC	1d	1a	Cmc
AZ	TV06B110J-B-G	TVS	Vrwm=11.0V, Vbr=12.20..13.50V, lpp=32.97A, 600W(1ms), Bidirectional	DO-214AA	1ba	1j	Cmc
AZD	SMAJ54C	TVS	Vbr=60.0..73.3V, Vrwm=54V, 3.1A, 400W(1ms), Bidirectional	DO-214AC	1ba	1j	Gal
AZE	SMAJ54CA	TVS	Vbr=60.0..66.3V, Vrwm=54V, 3.4A, 400W(1ms), Bidirectional	DO-214AC	1ba	1j	Gal
AZF	SMAJ58C	TVS	Vbr=64.4..78.7V, Vrwm=58V, 2.9A, 400W(1ms), Bidirectional	DO-214AC	1ba	1j	Gal
AZG	SMAJ58CA	TVS	Vbr=64.4..71.2V, Vrwm=58V, 3.2A, 400W(1ms), Bidirectional	DO-214AC	1ba	1j	Gal
AZH	SMAJ60C	TVS	Vbr=66.7..81.5V, Vrwm=60V, 2.8A, 400W(1ms), Bidirectional	DO-214AC	1ba	1j	Gal
AZK	SMA16A	TVS	Vbr=15.2..16.8V, Vrwm=13.6V, 17.8A, 400W(1ms)	DO-214AC	1d	1a	Lge
AZK	SMAJ60CA	TVS	Vbr=66.7..73.7V, Vrwm=60V, 3.1A, 400W(1ms), Bidirectional	DO-214AC	1ba	1j	Gal
AZL	SMAJ64C	TVS	Vbr=71.1..86.9V, Vrwm=64V, 2.6A, 400W(1ms), Bidirectional	DO-214AC	1ba	1j	Gal
AZM	SMA16CA	TVS	Vbr=15.2..16.8V, Vrwm=13.6V, 17.8A, 400W(1ms), Bidirectional	DO-214AC	1ba	1j	Lge
AZM	SMAJ64CA	TVS	Vbr=71.1..78.6V, Vrwm=64V, 2.9A, 400W(1ms), Bidirectional	DO-214AC	1ba	1j	Gal
AZN	SMAJ70C	TVS	Vbr=77.8..95.1V, Vrwm=70V, 2.4A, 400W(1ms), Bidirectional	DO-214AC	1ba	1j	Gal
AZP	SMAJ70CA	TVS	Vbr=77.8..86.0V, Vrwm=70V, 2.7A, 400W(1ms), Bidirectional	DO-214AC	1ba	1j	Gal
AZP	TPSMA16A	TVS	Vbr=16V, 17.8A, 400W(1ms)	DO-214AC	1d	1k	Vs
AZP	TPSMP16A	TVS	Vbr=15.2..16.8V, Vrwm=13.6V, lpp=17.8A, 400W(1ms)	DO-220AA	8d	1a	Vs
AZQ	SMAJ75C	TVS	Vbr=83.3..102V, Vrwm=75V, 2.2A, 400W(1ms), Bidirectional	DO-214AC	1ba	1j	Gal
AZR	SMAJ75CA	TVS	Vbr=83.3..92.1V, Vrwm=75V, 2.5A, 400W(1ms), Bidirectional	DO-214AC	1ba	1j	Gal
AZS	SMAJ78C	TVS	Vbr=86.7..106V, Vrwm=78V, 2.2A, 400W(1ms), Bidirectional	DO-214AC	1ba	1j	Gal
AZT	SMAJ78CA	TVS	Vbr=86.7..95.8V, Vrwm=78V, 2.4A, 400W(1ms), Bidirectional	DO-214AC	1ba	1j	Gal
AZU	SMAJ85C	TVS	Vbr=94.4..115V, Vrwm=85V, 2.0A, 400W(1ms), Bidirectional	DO-214AC	1ba	1j	Gal
AZV	SMAJ85CA	TVS	Vbr=94.4..104V, Vrwm=85V, 2.2A, 400W(1ms), Bidirectional	DO-214AC	1ba	1j	Gal
AZW	SMAJ90C	TVS	Vbr=100..122V, Vrwm=90V, 1.9A, 400W(1ms), Bidirectional	DO-214AC	1ba	1j	Gal
AZX	SMAJ90CA	TVS	Vbr=100..111V, Vrwm=90V, 2.1A, 400W(1ms), Bidirectional	DO-214AC	1ba	1j	Gal
AZY	SMAJ100C	TVS	Vbr=111..136V, Vrwm=100V, 1.7A, 400W(1ms), Bidirectional	DO-214AC	1ba	1j	Gal
AZZ	SMAJ100CA	TVS	Vbr=111..123V, Vrwm=100V, 1.9A, 400W(1ms), Bidirectional	DO-214AC	1ba	1j	Gal
B	1S5388PT	Si-diode	SBD, 40V, 100mA, Vf<0.6V(50mA)	SOD-523	8d	1a	Chm
B	BB555-02V	C-diode	UHF TV-tuning, 30V, 20mA, 2.1..18.7pF(28..1V)	SC-79	6d	1u	Inf
B	CH520S-30PT	Si-diode	SBD, 30V, 200mA, Vf<0.6V(200mA)	SOD-523	8d	1a	Chm
B	EP05Q06	Si-diode	SBR, 60V, 500mA, Vf<0.62V(500mA)	SOD-123	5d	1a	Nih
B	GBLCO8I	TVS	Vbr=8V, 2A, 350W(1ms), 0.6pF	SOD-323	5d	1a	Prt



SMD code	Type	Function	Short description	Case	Pinout	St.	Mnf.
B	MA2H736	Si-diode	SBR, HF, 40V, 1A, Vf<0.55V(1A), 50pF, 30ns	SOD-106	1d	1a	Pan
b	MMSZ5229BPT	Z-diode	4.085, 4.515V, Izt=5mA, Zzt=88Ω, 225mW	SOD-523	7d	1a	Chm
B	MMSZ5251BPT	Z-diode	20.90..23.10V, Izt=5mA, Zzt=55Ω, 225mW	SOD-523	7d	1a	Chm
B	RB520S-30	Si-diode	SBR, 30V, 200mA, Vf<0.6V(200mA)	SOD-523	6d	1a	Rhm
B	TVS100W5V0D	TVS	Vrwm=5.0V, Vbr=6.2V, 8.7A, 100W(1ms)	SOD-923	7d	1d	Did
B (white)	BAS16-03W	Si-diode	Sw, Fast, 80V, 200mA, 200mW, <6ns	SOD-323	5d	2	Inf
B (white)	BAT15-098	Si-diode	Schottky, 4V, 110mA, Vf<0.32V, <0.35pF	SOD-123	5d	2	Sie
b.	MMSZ5229SPT	Z-diode	4.214, 4.386V, Izt=5mA, Zzt=88Ω, 225mW	SOD-523	7d	1a	Chm
B	MMSZ5251SPT	Z-diode	21.56..22.44V, Izt=5mA, Zzt=55Ω, 225mW	SOD-523	7d	1a	Chm
B0	BZX399-C4V3	Z-diode	4.3V±5%, 300mW	SOD-323	5d	1a	Phi
B0	HVC350B	C-diode	VCO, 15V, 5/15.5pF(4..1V/1MHz), <0.5Ω	UFFP	6d	1b	Ren
B0	MM3Z2V0	Z-diode	1.80..2.15V, Izt=5mA, Zzt=100Ω, 300mW	SOD-323FL	7d	1a	Lge
B0	MM3Z2V0B	Z-diode	1.80..2.15V, Izt=5mA, Zzt=100Ω, 300mW	SOD-323FL	7d	1a	Lge
B0	MMPZ5224BPT	Z-diode	2.660..2.940V, Izt=5mA, Zzt=100Ω, 225mW	SOD-323	5d	1a	Chm
B0	MMPZ5232SPT	Z-diode	5.488..5.712V, Izt=5mA, Zzt=25Ω, 225mW	SOD-323	5d	1a	Chm
B010	STBB010	TVS	Vbr=9.5..11V, 27.6A, 400W(1ms), Bidirectional	DO-214AC	1ba	1j	Eic
B010	STUB010	TVS	Vbr=9.5..11V, 27.6A, 400W(1ms)	DO-214AC	1d	1a	Eic
B011	STBB011	TVS	Vbr=10.5..12.1V, 25.7A, 400W(1ms), Bidirectional	DO-214AC	1ba	1j	Eic
B011	STUB011	TVS	Vbr=10.5..12.1V, 25.7A, 400W(1ms)	DO-214AC	1d	1a	Eic
B012	STBB012	TVS	Vbr=11.4..13.2V, 24A, 400W(1ms), Bidirectional	DO-214AC	1ba	1j	Eic
B012	STUB012	TVS	Vbr=11.4..13.2V, 24A, 400W(1ms)	DO-214AC	1d	1a	Eic
B013	STBB013	TVS	Vbr=12.4..14.3V, 22A, 400W(1ms), Bidirectional	DO-214AC	1ba	1j	Eic
B013	STUB013	TVS	Vbr=12.4..14.3V, 22A, 400W(1ms)	DO-214AC	1d	1a	Eic
B015	STBB015	TVS	Vbr=14.3..16.5V, 19A, 400W(1ms), Bidirectional	DO-214AC	1ba	1j	Eic
B015	STUB015	TVS	Vbr=14.3..16.5V, 19A, 400W(1ms)	DO-214AC	1d	1a	Eic
B016	STBB016	TVS	Vbr=15.2..17.6V, 17.8A, 400W(1ms), Bidirectional	DO-214AC	1ba	1j	Eic
B016	STUB016	TVS	Vbr=15.2..17.6V, 17.8A, 400W(1ms)	DO-214AC	1d	1a	Eic
B018	STBB018	TVS	Vbr=17.1..19.8V, 16A, 400W(1ms), Bidirectional	DO-214AC	1ba	1j	Eic
B018	STUB018	TVS	Vbr=17.1..19.8V, 16A, 400W(1ms)	DO-214AC	1d	1a	Eic
B020	STBB020	TVS	Vbr=19..22V, 14.5A, 400W(1ms), Bidirectional	DO-214AC	1ba	1j	Eic
B020	STUB020	TVS	Vbr=19..22V, 14.5A, 400W(1ms)	DO-214AC	1d	1a	Eic
B022	STBB022	TVS	Vbr=20.9..24.2V, 13A, 400W(1ms), Bidirectional	DO-214AC	1ba	1j	Eic
B022	STUB022	TVS	Vbr=20.9..24.2V, 13A, 400W(1ms)	DO-214AC	1d	1a	Eic
B024	STBB024	TVS	Vbr=22.8..26.4V, 12A, 400W(1ms), Bidirectional	DO-214AC	1ba	1j	Eic
B024	STUB024	TVS	Vbr=22.8..26.4V, 12A, 400W(1ms)	DO-214AC	1d	1a	Eic
B027	STBB027	TVS	Vbr=25.7..29.7V, 10.7A, 400W(1ms), Bidirectional	DO-214AC	1ba	1j	Eic
B027	STUB027	TVS	Vbr=25.7..29.7V, 10.7A, 400W(1ms)	DO-214AC	1d	1a	Eic
B030	STBB030	TVS	Vbr=28.5..33V, 9.6A, 400W(1ms), Bidirectional	DO-214AC	1ba	1j	Eic
B030	STUB030	TVS	Vbr=28.5..33V, 9.6A, 400W(1ms)	DO-214AC	1d	1a	Eic
B033	STBB033	TVS	Vbr=31.4..36.3V, 8.8A, 400W(1ms), Bidirectional	DO-214AC	1ba	1j	Eic
B033	STUB033	TVS	Vbr=31.4..36.3V, 8.8A, 400W(1ms)	DO-214AC	1d	1a	Eic
B036	STBB036	TVS	Vbr=34.2..39.6V, 8A, 400W(1ms), Bidirectional	DO-214AC	1ba	1j	Eic
B036	STUB036	TVS	Vbr=34.2..39.6V, 8A, 400W(1ms)	DO-214AC	1d	1a	Eic
B039	STBB039	TVS	Vbr=37.1..42.9V, 7.4A, 400W(1ms), Bidirectional	DO-214AC	1ba	1j	Eic
B039	STUB039	TVS	Vbr=37.1..42.9V, 7.4A, 400W(1ms)	DO-214AC	1d	1a	Eic
B043	STBB043	TVS	Vbr=40.9..47.3V, 6.7A, 400W(1ms), Bidirectional	DO-214AC	1ba	1j	Eic
B043	STUB043	TVS	Vbr=40.9..47.3V, 6.7A, 400W(1ms)	DO-214AC	1d	1a	Eic
B047	STBB047	TVS	Vbr=44.7..51.7V, 6.2A, 400W(1ms), Bidirectional	DO-214AC	1ba	1j	Eic
B047	STUB047	TVS	Vbr=44.7..51.7V, 6.2A, 400W(1ms)	DO-214AC	1d	1a	Eic
B051	STBB051	TVS	Vbr=48.5..56.1V 5.7A, 400W(1ms), Bidirectional	DO-214AC	1ba	1j	Eic
B051	STUB051	TVS	Vbr=48.5..56.1V 5.7A, 400W(1ms)	DO-214AC	1d	1a	Eic
B056	STBB056	TVS	Vbr=53.2..61.6V 5.2A, 400W(1ms), Bidirectional	DO-214AC	1ba	1j	Eic
B056	STUB056	TVS	Vbr=53.2..61.6V 5.2A, 400W(1ms)	DO-214AC	1d	1a	Eic
B062	STBB062	TVS	Vbr=58.9..68.2V 4.7A, 400W(1ms), Bidirectional	DO-214AC	1ba	1j	Eic
B062	STUB062	TVS	Vbr=58.9..68.2V 4.7A, 400W(1ms)	DO-214AC	1d	1a	Eic
B068	STBB068	TVS	Vbr=64.6..74.8V 4.3A, 400W(1ms), Bidirectional	DO-214AC	1ba	1j	Eic
B068	STUB068	TVS	Vbr=64.6..74.8V 4.3A, 400W(1ms)	DO-214AC	1d	1a	Eic
B061	STBB061	TVS	Vbr=64.5..74.8V, 3.8A, 400W(1ms), Bidirectional	DO-214AC	1ba	1j	Eic
B061	STUB061	TVS	Vbr=64.5..74.8V, 3.8A, 400W(1ms)	DO-214AC	1d	1a	Eic
B075	STBB075	TVS	Vbr=71.3..82.5V 3.9A, 400W(1ms), Bidirectional	DO-214AC	1ba	1j	Eic
B075	STUB075	TVS	Vbr=71.3..82.5V 3.9A, 400W(1ms)	DO-214AC	1d	1a	Eic
B07F	STBB07F	TVS	Vbr=7.13..8.25V, 35.4A, 400W(1ms), Bidirectional	DO-214AC	1ba	1j	Eic
B07F	STUB07F	TVS	Vbr=7.13..8.25V, 35.4A, 400W(1ms)	DO-214AC	1d	1a	Eic
B082	STBB082	TVS	Vbr=77.9..90.2V 3.5A, 400W(1ms), Bidirectional	DO-214AC	1ba	1j	Eic
B082	STUB082	TVS	Vbr=77.9..90.2V 3.5A, 400W(1ms)	DO-214AC	1d	1a	Eic
B08C	STBB08C	TVS	Vbr=7.79..9.02V, 33A, 400W(1ms), Bidirectional	DO-214AC	1ba	1j	Eic
B08C	STUB08C	TVS	Vbr=7.79..9.02V, 33A, 400W(1ms)	DO-214AC	1d	1a	Eic
B091	STBB091	TVS	Vbr=86.5..100V 3.2A, 400W(1ms), Bidirectional	DO-214AC	1ba	1j	Eic
B091	STUB091	TVS	Vbr=86.5..100V 3.2A, 400W(1ms)	DO-214AC	1d	1a	Eic
B09B	STBB09B	TVS	Vbr=8.65..10V, 30A, 400W(1ms), Bidirectional	DO-214AC	1ba	1j	Eic



SMD
code

Type

Function

Short description

Case

Pinout

St.

Mnf.

SMD code	Type	Function	Short description	Case	Pinout	St.	Mnf.
B09B	STUB09B	TVS	Vbr=8.65..10V, 30A, 400W(1ms)	DO-214AC	1d	1a	Eic
B09B	STBB09B	TVS	Vbr=95..110V 2.9A, 400W(1ms), Bidirectional	DO-214AC	1ba	1j	Eic
B0B0	STUB0B0	TVS	Vbr=95..110V 2.9A, 400W(1ms)	DO-214AC	1d	1a	Eic
B0B1	STBB0B1	TVS	Vbr=105..121V, 2.6A, 400W(1ms), Bidirectional	DO-214AC	1ba	1j	Eic
B0B1	STUB0B1	TVS	Vbr=105..121V, 2.6A, 400W(1ms)	DO-214AC	1d	1a	Eic
B0B2	STBB0B2	TVS	Vbr=114..132V, 2.4A, 400W(1ms), Bidirectional	DO-214AC	1ba	1j	Eic
B0B2	STUB0B2	TVS	Vbr=114..132V, 2.4A, 400W(1ms)	DO-214AC	1d	1a	Eic
B0B3	STBB0B3	TVS	Vbr=124..143V, 2.2A, 400W(1ms), Bidirectional	DO-214AC	1ba	1j	Eic
B0B3	STUB0B3	TVS	Vbr=124..143V, 2.2A, 400W(1ms)	DO-214AC	1d	1a	Eic
B0B5	STBB0B5	TVS	Vbr=143..165V, 2A, 400W(1ms), Bidirectional	DO-214AC	1ba	1j	Eic
B0B5	STUB0B5	TVS	Vbr=143..165V, 2A, 400W(1ms)	DO-214AC	1d	1a	Eic
B0B6	STBB0B6	TVS	Vbr=152..176V, 1.8A, 400W(1ms), Bidirectional	DO-214AC	1ba	1j	Eic
B0B6	STUB0B6	TVS	Vbr=152..176V, 1.8A, 400W(1ms)	DO-214AC	1d	1a	Eic
B0B7	STBB0B7	TVS	Vbr=161..187V, 1.7A, 400W(1ms), Bidirectional	DO-214AC	1ba	1j	Eic
B0B7	STUB0B7	TVS	Vbr=161..187V, 1.7A, 400W(1ms)	DO-214AC	1d	1a	Eic
B0B8	STBB0B8	TVS	Vbr=171..198V, 1.6A, 400W(1ms), Bidirectional	DO-214AC	1ba	1j	Eic
B0B8	STUB0B8	TVS	Vbr=171..198V, 1.6A, 400W(1ms)	DO-214AC	1d	1a	Eic
B0D0	STBB0D0	TVS	Vbr=190..220V 1.5A, 400W(1ms), Bidirectional	DO-214AC	1ba	1j	Eic
B0D0	STUB0D0	TVS	Vbr=190..220V 1.5A, 400W(1ms)	DO-214AC	1d	1a	Eic
B0D2	STBB0D2	TVS	Vbr=209..242V 1.4A, 400W(1ms), Bidirectional	DO-214AC	1ba	1j	Eic
B0D2	STUB0D2	TVS	Vbr=209..242V 1.4A, 400W(1ms)	DO-214AC	1d	1a	Eic
B0D5	STBB0D5	TVS	Vbr=237..275V 1.3A, 400W(1ms), Bidirectional	DO-214AC	1ba	1j	Eic
B0D5	STUB0D5	TVS	Vbr=237..275V 1.3A, 400W(1ms)	DO-214AC	1d	1a	Eic
B0D8	STBB0D8	TVS	Vbr=266..308V 1.3A, 400W(1ms), Bidirectional	DO-214AC	1ba	1j	Eic
B0D8	STUB0D8	TVS	Vbr=266..308V 1.3A, 400W(1ms)	DO-214AC	1d	1a	Eic
B0E0	STBB0E0	TVS	Vbr=285..330V 1.2A, 400W(1ms), Bidirectional	DO-214AC	1ba	1j	Eic
B0E0	STUB0E0	TVS	Vbr=285..330V 1.2A, 400W(1ms)	DO-214AC	1d	1a	Eic
B0E2	STBB0E2	TVS	Vbr=304..352V 1.2A, 400W(1ms), Bidirectional	DO-214AC	1ba	1j	Eic
B0E2	STUB0E2	TVS	Vbr=304..352V 1.2A, 400W(1ms)	DO-214AC	1d	1a	Eic
B0E5	STBB0E5	TVS	Vbr=332..385V 0.9A, 400W(1ms), Bidirectional	DO-214AC	1ba	1j	Eic
B0E5	STUB0E5	TVS	Vbr=332..385V 0.9A, 400W(1ms)	DO-214AC	1d	1a	Eic
B0G0	STBB0G0	TVS	Vbr=380..440V 0.9A, 400W(1ms), Bidirectional	DO-214AC	1ba	1j	Eic
B0G0	STUB0G0	TVS	Vbr=380..440V 0.9A, 400W(1ms)	DO-214AC	1d	1a	Eic
B0G4	STBB0G4	TVS	Vbr=418..484V 0.8A, 400W(1ms), Bidirectional	DO-214AC	1ba	1j	Eic
B0G4	STUB0G4	TVS	Vbr=418..484V 0.8A, 400W(1ms)	DO-214AC	1d	1a	Eic
B1	BZX399-C1V8	Z-diode	1.8V±5%, 300mW	SOD-323	5d	1a	Phi
B1	BZX884-C2V4	Z-diode	2.4V±5%, 250mW	SOD-882	13d	2b	Phi
B1	FSS22	Si-diode	SBR, 20V, 2A, Vf<0.7V(2A)	DO-214AA	1d	2j	Fag
B1	HVC355B	C-diode	VCO, 15V, 2.556.4pF(4..1V/1MHz), <0.6Ω	UFP	6d	1b	Ren
B1	MAZF033	Z-diode	3.1..3.5V, Zt=130Ω(5mA), 120mW	S-Mini	7d	1a	Pan
B1	MAZN033	Z-diode	3.1..3.5V, Zt=130Ω(5mA), 120mW	SSMini2	7d	1a	Pan
B1	MM3Z5223B	Z-diode	2.7V±5%, lzt=20mA, Zzt=30Ω, 200mW	SOD-323FL	7d	1a	Bts
B1	MM3Z5223BH	Z-diode	2.57..2.84V, lzt=20mA, Zzt=30Ω, 300mW	SOD-323	5d	1a	Zow
B1	PTVS54VS1UR	TVS	Vrwm=54V, Vbr=60.0..66.30V, 4.6A, 400W(1ms)	SOD-123W	7d	1a	Nxp
B1	SDB310D	Si-diode	SBR, 30V, 200mA, 150mW, <10pF, <5ns	SOD-323	5d	1a	Auk
B1	UDZ2V0B	Z-diode	2V±2.5%, lzt=5mA, 200mW	SOD-323	5d	1d	Di
B10A	P6SBMJ16A	TVS	Vbr=15.2..16.8V, Vrwm=13.6V, 19A, 600W(1ms)	DO-214AA	1d	1a	Chm
B10C	P6SBMJ16CA	TVS	Vbr=15.2..16.8V, Vrwm=13.6V, 19A, 600W(1ms), Bidirectional	DO-214AA	1ba	1j	Chm
B110	MBRS1100	Si-diode	SBR, 100V, 1A, Vf<0.75V(1A)	DO-214AA	1d	1a	Mot
B110	SBM110PT	Si-diode	Rectifier, Schottky, 100V, 1A, Vf<0.8V(1A)	DO-214AA	1d	1a	Chm
B110	SMAB110	Si-diode	SBR, 100V, 1A, Vf<0.8V(1A)	DO-214AC	1d	1a	Kec
B11A	P6SBMJ18A	TVS	Vbr=17.1..18.9V, Vrwm=15.3V, 17A, 600W(1ms)	DO-214AA	1d	1a	Chm
B11C	P6SBMJ18CA	TVS	Vbr=17.1..18.9V, Vrwm=15.3V, 17A, 600W(1ms), Bidirectional	DO-214AA	1ba	1j	Chm
B12	B120	Si-diode	SBR, 20V, 1A, Vf<0.52V(1A)	DO-214AC	1d	1k	Vs
B12	MBRS120	Si-diode	SBR, 20V, 1A, Vf=0.52V(1A)	403A	3d	1s	Ons
B12A	P6SBMJ20A	TVS	Vbr=19.0..21.0V, Vrwm=17.1V, 15A, 600W(1ms)	DO-214AA	1d	1a	Chm
B12C	P6SBMJ20CA	TVS	Vbr=19.0..21.0V, Vrwm=17.1V, 15A, 600W(1ms), Bidirectional	DO-214AA	1ba	1j	Chm
B12L	SBM12LPT	Si-diode	Rectifier, Schottky, 20V, 1A, Vf<0.38V(1A)	DO-214AA	1d	1a	Chm
B13	B130	Si-diode	SBR, 30V, 1A, Vf<0.52V(1A)	DO-214AC	1d	1k	Vs
B13	MBRS130	Si-diode	SBR, 30V, 1A, Vf=0.55V(1A)	403A-03	3d	1s	Ons
B13	SMAB13	Si-diode	SBR, 30V, 1A, Vf<0.42V(1A)	DO-214AC	1d	1a	Kec
B130	MBRS130	Si-diode	SBR, 30V, 1A, Vf=0.55V(1A)	403A	3d	1s	Mot
B13A	P6SBMJ22A	TVS	Vbr=20.9..23.1V, Vrwm=18.8V, 14A, 600W(1ms)	DO-214AA	1d	1a	Chm
B13C	P6SBMJ22CA	TVS	Vbr=20.9..23.1V, Vrwm=18.8V, 14A, 600W(1ms), Bidirectional	DO-214AA	1ba	1j	Chm
B13L	SBM13LPT	Si-diode	Rectifier, Schottky, 30V, 1A, Vf<0.38V(1A)	DO-214AA	1d	1a	Chm
B14	B140	Si-diode	SBR, 40V, 1A, Vf<0.52V(1A)	DO-214AC	1d	1k	Vs
B14	MBRA140	Si-diode	SBR, 40V, 1A, Vf<0.55V(1A)	DO-214AC	1d	1f	Ons
B14	MBRS140	Si-diode	SBR, 40V, 1A, Vf=0.55V(1A)	403A-03	3d	1s	Ons
B14	SMAB14	Si-diode	SBR, 40V, 1A, Vf<0.5V(1A)	DO-214AC	1d	1a	Kec
B140	MBRS140	Si-diode	SBR, 40V, 1A, Vf=0.55V(1A)	403A-03	3d	1s	Mot



SMD
code

Type

Function

Short description

Case

Pinout

St.

Mnf.

B14A	P6SBMJ24A	TVS	Vbr=22.8..25.2V, Vrw=20.5V, 13A, 600W(1ms)	DO-214AA	1d	1a	Chm
B14C	P6SBMJ24CA	TVS	Vbr=22.8..25.2V, Vrw=20.5V, 13A, 600W(1ms), Bidirectional	DO-214AA	1ba	1j	Chm
B14L	MBRS140L	Si-diode	SBR, 40V, 1A, Vf=0.55V(1A)	403A-03	3d	1s	Ons
B14L	SBM14LPT	Si-diode	Rectifier, Schottky, 40V, 1A, Vf<0.38V(1A)	DO-214AA	1d	1a	Chm
B15	B150	Si-diode	SBR, 50V, 1A, Vf<0.75V(1A)	DO-214AC	1d	1k	Vs
B15A	P6SBMJ27A	TVS	Vbr=25.7..28.4V, Vrw=23.1V, 11.2A, 600W(1ms)	DO-214AA	1d	1a	Chm
B15C	P6SBMJ27CA	TVS	Vbr=25.7..28.4V, Vrw=23.1V, 11.2A, 600W(1ms), Bidirectional	DO-214AA	1ba	1j	Chm
B16	B160	Si-diode	SBR, 60V, 1A, Vf<0.75V(1A)	DO-214AC	1d	1k	Vs
B16	MBRA160	Si-diode	SBR, 60V, 1A, Vf<0.47V(1A)	DO-214AC	1d	1f	Ons
B16	SMAB16	Si-diode	SBR, 60V, 1A, Vf<0.58V(1A)	DO-214AC	1d	1a	Kec
B16A	P6SBMJ30A	TVS	Vbr=28.5..31.5V, Vrw=25.6V, 10A, 600W(1ms)	DO-214AA	1d	1a	Chm
B16C	P6SBMJ30CA	TVS	Vbr=28.5..31.5V, Vrw=25.6V, 10A, 600W(1ms), Bidirectional	DO-214AA	1ba	1j	Chm
B17A	P6SBMJ33A	TVS	Vbr=31.4..34.7V, Vrw=28.2V, 9A, 600W(1ms)	DO-214AA	1d	1a	Chm
B17C	P6SBMJ33CA	TVS	Vbr=31.4..34.7V, Vrw=28.2V, 9A, 600W(1ms), Bidirectional	DO-214AA	1ba	1j	Chm
B18A	P6SBMJ36A	TVS	Vbr=34.2..37.8V, Vrw=30.8V, 8.4A, 600W(1ms)	DO-214AA	1d	1a	Chm
B18C	P6SBMJ36CA	TVS	Vbr=34.2..37.8V, Vrw=30.8V, 8.4A, 600W(1ms), Bidirectional	DO-214AA	1ba	1j	Chm
B19	MBRS190	Si-diode	SBR, 90V, 1A, Vf=0.75V(1A)	403A-03	3d	1s	Ons
B19A	P6SBMJ39A	TVS	Vbr=37.1..41.0V, Vrw=33.3V, 7.8A, 600W(1ms)	DO-214AA	1d	1a	Chm
B19C	P6SBMJ39CA	TVS	Vbr=37.1..41.0V, Vrw=33.3V, 7.8A, 600W(1ms), Bidirectional	DO-214AA	1ba	1j	Chm
B1A	P6SBMJ6.8A	TVS	Vbr=6.45..7.14V, Vrw=5.80V, 40A, 600W(1ms)	DO-214AA	1d	1a	Chm
B1C	MBRS1100	Si-diode	SBR, 100V, 1A, Vf=0.75V(1A)	403A	3d	1s	Ons
B1C	P6SBMJ6.8CA	TVS	Vbr=6.45..7.14V, Vrw=5.80V, 40A, 600W(1ms), Bidirectional	DO-214AA	1ba	1j	Chm
B1E2	MBRA120E	Si-diode	SBR, 20V, 1A, Vf<0.45V(1A)	DO-214AC	1d	1f	Ons
B1FD	CD1408-F1200	Si-diode	Rectifier, 200V, 1A, Vf=1.3V(1A), 300ns, 15pF	1408	14d	1v	Bm
B1FG	CD1408-F1400	Si-diode	Rectifier, 400V, 1A, Vf=1.3V(1A), 300ns, 15pF	1408	14d	1v	Bm
B1FJ	CD1408-F1600	Si-diode	Rectifier, 600V, 1A, Vf=1.3V(1A), 300ns, 15pF	1408	14d	1v	Bm
B1FK	CD1408-F1800	Si-diode	Rectifier, 800V, 1A, Vf=1.3V(1A), 300ns, 15pF	1408	14d	1v	Bm
B1FM	CD1408-F11000	Si-diode	Rectifier, 1000V, 1A, Vf=1.3V(1A), 300ns, 15pF	1408	14d	1v	Bm
B1L2	MBRA120	Si-diode	SBR, 20V, 1A, Vf<0.3V(1A)	DO-214AC	1d	1f	Ons
B1L3	MBRA130	Si-diode	SBR, 30V, 1A, Vf<0.41V(1A)	DO-214AC	1d	1f	Ons
B2	BZX399-C2V0	Z-diode	2.0V±5%, 300mW	SOD-323	5d	1a	Phi
B2	BZX884-C2V7	Z-diode	2.7V±5%, 250mW	SOD-882	13d	2b	Phi
B2	FSS23	Si-diode	SBR, 30V, 2A, Vf<0.7V(2A)	DO-214AA	1d	2j	Fag
B2	MAZF036	Z-diode	3.4..3.8V, Zzt=130Q(5mA), 120mW	S-Mini	7d	1a	Pan
B2	MAZN036	Z-diode	3.4..3.8V, Zzt=130Q(5mA), 120mW	SSMini2	7d	1a	Pan
B2	MBR0520	Si-diode	SBR, 20V, 500mA, Vf=0.33V(500mA)	SOD-123	5d	1a	Ons
B2	MM3Z5242B	Z-diode	12V±5%, Izt=20mA, Zzt=30Q, 200mW	SOD-323FL	7d	1a	Bts
B2	MM3Z5242BH	Z-diode	11.4..12.6V, Izt=20mA, Zzt=30Q, 300mW	SOD-323	5d	1a	Zow
B2	MSCD052	Si-diode	SBR, 20V, 0.5A, Vf<0.44V(0.5A)	0805	14d	1v	Zow
B2	PTV558V1UR	TVS	Vrw=58V, Vbr=64.0..71.20V, 4.3A, 400W(1ms)	SOD-123W	7d	1a	Nxp
B2	SMBY01-200	Si-diode	Rectifier, Fast-Recovery, 200V, 1A, Vf<0.71V(1A), <25ns	DO-214AA	1d	1q	Ste
B2	SSCD052	Si-diode	SBR, 20V, 500mA, Vf<0.42V(500mA)	1206	14d	1v	Zow
B2	UDZ2V2B	Z-diode	2.2V±2.5%, Izt=5mA, 200mW	SOD-323	5d	1d	Di
B20	SMBYW01-200	Si-diode	Rectifier, Fast-Recovery, 200V, 1A, Vf<0.71V(1A), <25ns	DO-214AA	1d	1q	Ste
B20A	P6SBMJ43A	TVS	Vbr=40.9..45.2V, Vrw=36.8V, 7.1A, 600W(1ms)	DO-214AA	1d	1a	Chm
B20C	P6SBMJ43CA	TVS	Vbr=40.9..45.2V, Vrw=36.8V, 7.1A, 600W(1ms), Bidirectional	DO-214AA	1ba	1j	Chm
B210	SBM210PT	Si-diode	Rectifier, Schottky, 100V, 2A, Vf<0.8V(2A)	DO-214AA	1d	1a	Chm
B210	SMAB210	Si-diode	SBR, 100V, 2A, Vf<0.8V(2A)	DO-214AC	1d	1a	Kec
B2100	CD1206-B2100	Si-diode	SBR, 100V, 2A, Vf=0.85V(2A)	1206	2d	1v	Bm
B21A	P6SBMJ47A	TVS	Vbr=44.7..49.4V, Vrw=40.2V, 5.0A, 600W(1ms)	DO-214AA	1d	1a	Chm
B21C	P6SBMJ47CA	TVS	Vbr=44.7..49.4V, Vrw=40.2V, 5.0A, 600W(1ms), Bidirectional	DO-214AA	1ba	1j	Chm
B220	CD1206-B220	Si-diode	SBR, 20V, 2A, Vf=0.5V(2A)	1206	2d	1v	Bm
B22A	P6SBMJ51A	TVS	Vbr=48.5..53.6V, Vrw=43.6V, 6.0A, 600W(1ms)	DO-214AA	1d	1a	Chm
B22C	P6SBMJ51CA	TVS	Vbr=48.5..53.6V, Vrw=43.6V, 6.0A, 600W(1ms), Bidirectional	DO-214AA	1ba	1j	Chm
B23	B230LA	Si-diode	SBR, 30V, 2A, Vf<0.55V(2A)	DO-214AC	1d	1k	Vs
B23A	P6SBMJ56A	TVS	Vbr=53.2..58.8V, Vrw=47.8V, 5.5A, 600W(1ms)	DO-214AA	1d	1a	Chm
B23C	P6SBMJ56CA	TVS	Vbr=53.2..58.8V, Vrw=47.8V, 5.5A, 600W(1ms), Bidirectional	DO-214AA	1ba	1j	Chm
B24	B240A	Si-diode	SBR, 40V, 2A, Vf<0.55V(2A)	DO-214AC	1d	1k	Vs
B240	CD1206-B240	Si-diode	SBR, 40V, 2A, Vf=0.5V(2A)	1206	2d	1v	Bm
B24A	P6SBMJ62A	TVS	Vbr=58.9..65.1V, Vrw=53.0V, 5.0A, 600W(1ms)	DO-214AA	1d	1a	Chm
B24C	P6SBMJ62CA	TVS	Vbr=58.9..65.1V, Vrw=53.0V, 5.0A, 600W(1ms), Bidirectional	DO-214AA	1ba	1j	Chm
B25A	P6SBMJ68A	TVS	Vbr=64.6..71.4V, Vrw=58.0V, 4.6A, 600W(1ms)	DO-214AA	1d	1a	Chm
B25C	P6SBMJ68CA	TVS	Vbr=64.6..71.4V, Vrw=58.0V, 4.6A, 600W(1ms), Bidirectional	DO-214AA	1ba	1j	Chm
B26	MBRS260	Si-diode	SBR, 60V, 2A, Vf=0.51V(2A)	403A-03	3d	1s	Ons
B260	CD1206-B260	Si-diode	SBR, 60V, 2A, Vf=0.7V(2A)	1206	2d	1v	Bm
B26A	P6SBMJ75A	TVS	Vbr=71.3..78.8V, Vrw=64.1V, 4.1A, 600W(1ms)	DO-214AA	1d	1a	Chm
B26C	P6SBMJ75CA	TVS	Vbr=71.3..78.8V, Vrw=64.1V, 4.1A, 600W(1ms), Bidirectional	DO-214AA	1ba	1j	Chm
B27A	P6SBMJ82A	TVS	Vbr=77.9..86.1V, Vrw=70.1V, 3.7A, 600W(1ms)	DO-214AA	1d	1a	Chm
B27C	P6SBMJ82CA	TVS	Vbr=77.9..86.1V, Vrw=70.1V, 3.7A, 600W(1ms), Bidirectional	DO-214AA	1ba	1j	Chm
B28A	P6SBMJ91A	TVS	Vbr=86.5..95.5V, Vrw=77.8V, 3.4A, 600W(1ms)	DO-214AA	1d	1a	Chm



SMD
code

Type

Function

Short description

Case

Pinout

St.

Mnf.

B28C	P6SBMJ91CA	TVS	Vbr=86.5..95.5V, Vrw=77.8V, 3.4A, 600W(1ms), Bidirectional	DO-214AA	1ba	1j	Chm
B29A	P6SBMJ100A	TVS	Vbr=95..105V, Vrw=85.5V, 3.1A, 600W(1ms)	DO-214AA	1d	1a	Chm
B29C	P6SBMJ100CA	TVS	Vbr=95..105V, Vrw=85.5V, 3.1A, 600W(1ms), Bidirectional	DO-214AA	1ba	1j	Chm
B2A	P6SBMJ7.5A	TVS	Vbr=7.13..7.88V, Vrw=6.40V, 37A, 600W(1ms)	DO-214AA	1d	1a	Chm
B2C	P6SBMJ7.5CA	TVS	Vbr=7.13..7.88V, Vrw=6.40V, 37A, 600W(1ms), Bidirectional	DO-214AA	1ba	1j	Chm
B2E1	MBRA210E	Si-diode	SBR, 10V, 2A, Vf<0.38V(1A)	DO-214AA	1d	1f	Ons
B2L1	MBRA210	Si-diode	SBR, 10V, 2A, Vf<0.23V(1A)	DO-214AA	1d	1f	Ons
B3	BZT52H-C2V4	Z-diode	2.2..2.6V, Izt=5mA, Zzt=85Ω, 375mW	SOD-123FL	7d	1a	Phi
B3	BZX399-C2V2	Z-diode	2.2V±5%, 300mW	SOD-323	5d	1a	Phi
B3	BZX884-C3V0	Z-diode	3V±5%, 250mW	SOD-882	13d	2b	Phi
B3	FSS24	Si-diode	SBR, 40V, 2A, Vf<0.7V(2A)	DO-214AA	1d	2j	Fag
B3	HVC369B	C-diode	VCO, 15V, 1.85/4.65pF(4..1V/1MHz), <0.5Ω	UPF	6d	1a	Ren
B3	MAZF039	Z-diode	3.7..4.1V, Zzt=130Q(5mA), 120mW	S-Mini	7d	1a	Pan
B3	MAZN039	Z-diode	3.7..4.1V, Zzt=130Q(5mA), 120mW	SSMini2	7d	1a	Pan
B3	MBR0530	Si-diode	SBR, 30V, 500mA, Vf=0.43V(500mA)	SOD-123	5d	1a	Ons
B3	MBRA130	Si-diode	SBR, 30V, 1A, Vf<0.41V(1A)	403B-01	3d	1s	Mot
B3	MM3Z5263B	Z-diode	56V±5%, Izt=2.2mA, Zzt=150Ω, 200mW	SOD-323FL	7d	1a	Bts
B3	MM3Z5263BH	Z-diode	53.2..58.8V, Izt=2.2mA, Zzt=150Ω, 300mW	SOD-323	5d	1a	Zow
B3	MSCD053	Si-diode	SBR, 30V, 0.5A, Vf<0.46V(0.5A)	0805	14d	1v	Zow
B3	PTV560VS1UR	TVS	Vrw=60V, Vbr=66.70..73.70V, 4.1A, 400W (1ms)	SOD-123W	7d	1a	Nxp
B3	SMBYT01-300	Si-diode	Rectifier, Fast-Recovery, 300V, 1A, Vf<0.85V(1A), <25ns	DO-214AA	1d	1q	Ste
B3	UDZ2V4B	Z-diode	2.4V±2.5%, Izt=5mA, 200mW	SOD-323	5d	1d	Di
B30A	P6SBMJ110A	TVS	Vbr=105..116V, Vrw=94V, 2.8A, 600W(1ms)	DO-214AA	1d	1a	Chm
B30C	P6SBMJ110CA	TVS	Vbr=105..116V, Vrw=94V, 2.8A, 600W(1ms), Bidirectional	DO-214AA	1ba	1j	Chm
B310	MBR3100	Si-diode	SBR, 100V, 3A, Vf=0.79V(2A)	403A-03	3d	1s	Ons
B310	SBM310PT	Si-diode	Rectifier, Schottky, 100V, 3A, Vf<0.8V(3A)	DO-214AA	1d	1a	Chm
B31A	P6SBMJ120A	TVS	Vbr=114..126V, Vrw=102V, 2.5A, 600W(1ms)	DO-214AA	1d	1a	Chm
B31C	P6SBMJ120CA	TVS	Vbr=114..126V, Vrw=102V, 2.5A, 600W(1ms), Bidirectional	DO-214AA	1ba	1j	Chm
B32	MBR320	Si-diode	SBR, 20V, 3A, Vf=0.5V(2A)	403A-03	3d	1s	Ons
B320	CD214C-B320	Si-diode	Rectifier, 20V, 3A, Vf<0.5V(3A), <250pF	DO-214AB	1d	1a	Bm
B320B	CD214B-B320	Si-diode	Rectifier, 20V, 3A, Vf<0.5V(3A), <250pF	DO-214AA	1d	1a	Bm
B32A	P6SBMJ130A	TVS	Vbr=124..137V, Vrw=111V, 2.3A, 600W(1ms)	DO-214AA	1d	1a	Chm
B32C	P6SBMJ130CA	TVS	Vbr=124..137V, Vrw=111V, 2.3A, 600W(1ms), Bidirectional	DO-214AA	1ba	1j	Chm
B33	B330LA	Si-diode	SBR, 30V, 3A, Vf<0.55V(3A)	DO-214AC	1d	1k	Vs
B33	MBR3110	Si-diode	SBR, 100V, 1A, Vf=0.75V(1A)	403A-03	3d	1s	Mot
B33	MBR330	Si-diode	SBR, 30V, 3A, Vf=0.5V(2A)	403A-03	3d	1s	Ons
B33	SMAB33	Si-diode	SBR, 30V, 3A, Vf<0.45V(3A)	DO-214AC	1d	1a	Kec
B330	CD214C-B330	Si-diode	Rectifier, 30V, 3A, Vf<0.5V(3A), <250pF	DO-214AB	1d	1a	Bm
B330B	CD214B-B330	Si-diode	Rectifier, 30V, 3A, Vf<0.5V(3A), <250pF	DO-214AA	1d	1a	Bm
B33A	P6SBMJ150A	TVS	Vbr=143..158V, Vrw=128V, 2.0A, 600W(1ms)	DO-214AA	1d	1a	Chm
B33C	P6SBMJ150CA	TVS	Vbr=143..158V, Vrw=128V, 2.0A, 600W(1ms), Bidirectional	DO-214AA	1ba	1j	Chm
B34	B340A	Si-diode	SBR, 40V, 3A, Vf<0.55V(3A)	DO-214AC	1d	1k	Vs
B34	B340LB	Si-diode	SBR, 40V, 3A, Vf<0.45V(3A)	DO-214AA	1d	1k	Vs
B34	MBR3340	Si-diode	SBR, 40V, 3A, Vf=0.52V(3A)	403A-03	3d	1s	Mot
B34	SMAB34	Si-diode	SBR, 40V, 3A, Vf<0.52V(3A)	DO-214AC	1d	1a	Kec
B340	CD214C-B340	Si-diode	Rectifier, 40V, 3A, Vf<0.5V(3A), <250pF	DO-214AB	1d	1a	Bm
B340B	CD214B-B340	Si-diode	Rectifier, 40V, 3A, Vf<0.5V(3A), <250pF	DO-214AA	1d	1a	Bm
B34A	P6SBMJ160A	TVS	Vbr=152..168V, Vrw=136V, 1.9A, 600W(1ms)	DO-214AA	1d	1a	Chm
B34C	P6SBMJ160CA	TVS	Vbr=152..168V, Vrw=136V, 1.9A, 600W(1ms), Bidirectional	DO-214AA	1ba	1j	Chm
B34L	SBM34LPT	Si-diode	Rectifier, Schottky, 40V, 3A, Vf<0.4V(3A)	DO-214AA	1d	1a	Chm
B35	B350A	Si-diode	SBR, 50V, 3A, Vf<0.72V(3A)	DO-214AC	1d	1k	Vs
B35	B350B	Si-diode	SBR, 50V, 3A, Vf<0.66V(3A)	DO-214AA	1d	1k	Vs
B35	B360A	Si-diode	SBR, 60V, 3A, Vf<0.72V(3A)	DO-214AC	1d	1k	Vs
B35	B360B	Si-diode	SBR, 60V, 3A, Vf<0.66V(3A)	DO-214AA	1d	1k	Vs
B350	CD214C-B350	Si-diode	Rectifier, 50V, 3A, Vf<0.7V(3A), <250pF	DO-214AB	1d	1a	Bm
B350B	CD214B-B350	Si-diode	Rectifier, 50V, 3A, Vf<0.7V(3A), <250pF	DO-214AA	1d	1a	Bm
B35A	P6SBMJ170A	TVS	Vbr=162..179V, Vrw=145V, 1.8A, 600W(1ms)	DO-214AA	1d	1a	Chm
B35C	P6SBMJ170CA	TVS	Vbr=162..179V, Vrw=145V, 1.8A, 600W(1ms), Bidirectional	DO-214AA	1ba	1j	Chm
B36	MBR360	Si-diode	SBR, 60V, 3A, Vf=0.74V(3A)	403A-03	3d	1s	Mot
B36	SMAB36	Si-diode	SBR, 60V, 3A, Vf<0.6V(3A)	DO-214AC	1d	1a	Kec
B360	CD214C-B360	Si-diode	Rectifier, 60V, 3A, Vf<0.7V(3A), <250pF	DO-214AB	1d	1a	Bm
B360B	CD214B-B360	Si-diode	Rectifier, 60V, 3A, Vf<0.7V(3A), <250pF	DO-214AA	1d	1a	Bm
B36A	P6SBMJ180A	TVS	Vbr=171..189V, Vrw=154V, 1.7A, 600W(1ms)	DO-214AA	1d	1a	Chm
B36C	P6SBMJ180CA	TVS	Vbr=171..189V, Vrw=154V, 1.7A, 600W(1ms), Bidirectional	DO-214AA	1ba	1j	Chm
B37A	P6SBMJ200A	TVS	Vbr=190..210V, Vrw=171V, 1.53A, 600W(1ms)	DO-214AA	1d	1a	Chm
B37C	P6SBMJ200CA	TVS	Vbr=190..210V, Vrw=171V, 1.53A, 600W(1ms), Bidirectional	DO-214AA	1ba	1j	Chm
B3A	P6SBMJ8.2A	TVS	Vbr=7.79..8.61V, Vrw=7.02V, 35A, 600W(1ms)	DO-214AA	1d	1a	Chm
B3C	P6SBMJ8.2CA	TVS	Vbr=7.79..8.61V, Vrw=7.02V, 35A, 600W(1ms), Bidirectional	DO-214AA	1ba	1j	Chm
B4	BZT52H-C2V7	Z-diode	2.5..2.9V, Izt=5mA, Zzt=83Ω, 375mW	SOD-123FL	7d	1a	Phi
B4	BZX399-C2V4	Z-diode	2.4V±5%, 300mW	SOD-323	5d	1a	Phi



SMD
code

Type

Function

Short description

Case

Pinout

St.

Mnf.

SMD code	Type	Function	Short description	Case	Pinout	St.	Mnf.
B4	BZX884-C3V3	Z-diode	3.3V±5%, 250mW	SOD-882	13d	2b	Phi
B4	FSS25	Si-diode	SBR, 50V, 2A, Vf<0.7V(2A)	DO-214AA	1d	2j	Fag
B4	MBR0540	Si-diode	SBR, 40V, 500mA, Vf=0.43V(500mA)	SOD-123	5d	1a	Ons
B4	MBRA140	Si-diode	SBR, 40V, 1A, Vf<0.55V(1A)	DO-214AC	3d	1a	Mot
B4	MM1Z5223B	Z-diode	2.57..2.84V, Izt=20mA, Zzt=30Ω, 500mW	SOD-323FL	5d	1a	Eic
B4	MM1Z5223BH	Z-diode	2.57..2.84V, Izt=20mA, Zzt=30Ω, 500mW	SOD-123	5d	1a	Zow
B4	MMSZ5223B	Z-diode	2.7V±5%, Izt=20mA, Zzt=30Ω, 500mW	SOD-123	5d	1a	Eic
B4	MSCD054	Si-diode	SBR, 40V, 0.5A, Vf<0.48V(0.5A)	0805	14d	1v	Zow
B4	PTV564VS1UR	TVS	Vrwm=64V, Vbr=71.10..78.60V, 3.9A, 400W(1ms)	SOD-123W	7d	1a	Nxp
B4	SMBYT01-400	Si-diode	Rectifier, Fast-Recovery, 400V, 1A, Vf<1.05V(1A), <25ns	DO-214AA	1d	1q	Ste
B4	SSCD054	Si-diode	SBR, 40V, 500mA, Vf<0.48V(500mA)	1206	14d	1v	Zow
B4	UDZ2V7B	Z-diode	2.7V±2.5%, Izt=5mA, 200mW	SOD-323	5d	1d	Di
B4A	P6SBMJ9.1A	TVS	Vbr=8.65..9.55V, Vrwm=7.78V, 31A, 600W(1ms)	DO-214AA	1d	1a	Chm
B4C	P6SBMJ9.1CA	TVS	Vbr=8.65..9.55V, Vrwm=7.78V, 31A, 600W(1ms), Bidirectional	DO-214AA	1ba	1j	Chm
B4E1	MBR5410E	Si-diode	SBR, 10V, 4A, Vf=0.5V(3A)	403A-03	3d	1s	Ons
B4L1	MBR5410	Si-diode	SBR, 10V, 4A, Vf=0.33V(3A)	403A-03	3d	1s	Ons
B5	BZT52H-C3V0	Z-diode	2.8..3.2V, Izt=5mA, Zzt=95Ω, 375mW	SOD-123FL	7d	1a	Phi
B5	BZX399-C2V7	Z-diode	2.7V±5%, 300mW	SOD-323	5d	1a	Phi
B5	BZX584B6V8	Z-diode	6.66..6.94V, Izt=5mA, Zzt=15Ω, 200mW	SOD-523FL	7d	1a	Tac
B5	BZX884-C3V6	Z-diode	3.6V±5%, 250mW	SOD-882	13d	2b	Phi
B5	FSS26	Si-diode	SBR, 60V, 2A, Vf<0.7V(2A)	DO-214AA	1d	2j	Fag
B5	HVC372B	C-diode	VCO, 15V, 7/15pF(4..1V/1MHz), <0.4Ω	UFP	6d	1a	Ren
B5	MM1Z5242B	Z-diode	11.40..12.60V, Izt=20mA, Zzt=30Ω, 500mW	SOD-323FL	5d	1a	Eic
B5	MM1Z5242BH	Z-diode	11.4..12.6V, Izt=20mA, Zzt=30Ω, 500mW	SOD-123	5d	1a	Zow
B5	MMSZ6V8B	Z-diode	6.66..6.94V, Izt=5mA, Zzt=15Ω, 200mW	SOD-523FL	7d	1a	Tac
B5	MMSZ5242B	Z-diode	12V±5%, Izt=20mA, Zzt=30Ω, 500mW	SOD-123	5d	1a	Eic
B5	UDZ3V0B	Z-diode	3V±2.5%, Izt=5mA, 200mW	SOD-323	5d	1d	Di
B510	SBM510PT	Si-diode	Rectifier, Schottky, 100V, 5A, Vf<0.8V(5A)	DO-214AA	1d	1a	Chm
B510	STBB510	TVS	Vbr=9.5..10.5V, 27.6A, 400W(1ms), Bidirectional	DO-214AC	1ba	1j	Eic
B510	STUB510	TVS	Vbr=9.5..10.5V, 27.6A, 400W(1ms)	DO-214AC	1d	1a	Eic
B511	STBB511	TVS	Vbr=10.5..11.6V, 25.7A, 400W(1ms), Bidirectional	DO-214AC	1ba	1j	Eic
B511	STUB511	TVS	Vbr=10.5..11.6V, 25.7A, 400W(1ms)	DO-214AC	1d	1a	Eic
B512	STBB512	TVS	Vbr=11.4..12.6V, 24A, 400W(1ms), Bidirectional	DO-214AC	1ba	1j	Eic
B512	STUB512	TVS	Vbr=11.4..12.6V, 24A, 400W(1ms)	DO-214AC	1d	1a	Eic
B513	STBB513	TVS	Vbr=12.4..13.7V, 22A, 400W(1ms), Bidirectional	DO-214AC	1ba	1j	Eic
B513	STUB513	TVS	Vbr=12.4..13.7V, 22A, 400W(1ms)	DO-214AC	1d	1a	Eic
B515	STBB515	TVS	Vbr=14.3..15.8V, 19A, 400W(1ms), Bidirectional	DO-214AC	1ba	1j	Eic
B515	STUB515	TVS	Vbr=14.3..15.8V, 19A, 400W(1ms)	DO-214AC	1d	1a	Eic
B516	STBB516	TVS	Vbr=15.2..16.8V, 17.8A, 400W(1ms), Bidirectional	DO-214AC	1ba	1j	Eic
B516	STUB516	TVS	Vbr=15.2..16.8V, 17.8A, 400W(1ms)	DO-214AC	1d	1a	Eic
B518	STBB518	TVS	Vbr=17.1..18.9V, 16A, 400W(1ms), Bidirectional	DO-214AC	1ba	1j	Eic
B518	STUB518	TVS	Vbr=17.1..18.9V, 16A, 400W(1ms)	DO-214AC	1d	1a	Eic
B520	STBB520	TVS	Vbr=19.21V, 14.5A, 400W(1ms), Bidirectional	DO-214AC	1ba	1j	Eic
B520	STUB520	TVS	Vbr=19.21V, 14.5A, 400W(1ms)	DO-214AC	1d	1a	Eic
B522	STBB522	TVS	Vbr=20.9..23.1V, 13A, 400W(1ms), Bidirectional	DO-214AC	1ba	1j	Eic
B522	STUB522	TVS	Vbr=20.9..23.1V, 13A, 400W(1ms)	DO-214AC	1d	1a	Eic
B524	STBB524	TVS	Vbr=22.8..25.2V, 12A, 400W(1ms), Bidirectional	DO-214AC	1ba	1j	Eic
B524	STUB524	TVS	Vbr=22.8..25.2V, 12A, 400W(1ms)	DO-214AC	1d	1a	Eic
B527	STBB527	TVS	Vbr=25.7..28.4V, 10.7A, 400W(1ms), Bidirectional	DO-214AC	1ba	1j	Eic
B527	STUB527	TVS	Vbr=25.7..28.4V, 10.7A, 400W(1ms)	DO-214AC	1d	1a	Eic
B530	STBB530	TVS	Vbr=28.5..31.5V, 9.6A, 400W(1ms), Bidirectional	DO-214AC	1ba	1j	Eic
B530	STUB530	TVS	Vbr=28.5..31.5V, 9.6A, 400W(1ms)	DO-214AC	1d	1a	Eic
B533	STBB533	TVS	Vbr=31.4..34.7V, 8.8A, 400W(1ms), Bidirectional	DO-214AC	1ba	1j	Eic
B533	STUB533	TVS	Vbr=31.4..34.7V, 8.8A, 400W(1ms)	DO-214AC	1d	1a	Eic
B536	STBB536	TVS	Vbr=34.2..37.8V, 8A, 400W(1ms), Bidirectional	DO-214AC	1ba	1j	Eic
B536	STUB536	TVS	Vbr=34.2..37.8V, 8A, 400W(1ms)	DO-214AC	1d	1a	Eic
B539	STBB539	TVS	Vbr=37.1..41V, 7.4A, 400W(1ms), Bidirectional	DO-214AC	1ba	1j	Eic
B539	STUB539	TVS	Vbr=37.1..41V, 7.4A, 400W(1ms)	DO-214AC	1d	1a	Eic
B543	STBB543	TVS	Vbr=40.9..45.2V 6.7A, 400W(1ms), Bidirectional	DO-214AC	1ba	1j	Eic
B543	STUB543	TVS	Vbr=40.9..45.2V 6.7A, 400W(1ms)	DO-214AC	1d	1a	Eic
B547	STBB547	TVS	Vbr=44.7..49.4V 6.2A, 400W(1ms), Bidirectional	DO-214AC	1ba	1j	Eic
B547	STUB547	TVS	Vbr=44.7..49.4V 6.2A, 400W(1ms)	DO-214AC	1d	1a	Eic
B551	STBB551	TVS	Vbr=48.5..53.6V 5.7A, 400W(1ms), Bidirectional	DO-214AC	1ba	1j	Eic
B551	STUB551	TVS	Vbr=48.5..53.6V 5.7A, 400W(1ms)	DO-214AC	1d	1a	Eic
B556	STBB556	TVS	Vbr=53.2..58.8V 5.2A, 400W(1ms), Bidirectional	DO-214AC	1ba	1j	Eic
B556	STUB556	TVS	Vbr=53.2..58.8V 5.2A, 400W(1ms)	DO-214AC	1d	1a	Eic
B562	STBB562	TVS	Vbr=58.9..65.1V 4.7A, 400W(1ms), Bidirectional	DO-214AC	1ba	1j	Eic
B562	STUB562	TVS	Vbr=58.9..65.1V 4.7A, 400W(1ms)	DO-214AC	1d	1a	Eic
B568	STBB568	TVS	Vbr=64.6..71.4V 4.3A, 400W(1ms), Bidirectional	DO-214AC	1ba	1j	Eic
B568	STUB568	TVS	Vbr=64.6..71.4V 4.3A, 400W(1ms)	DO-214AC	1d	1a	Eic



SMD
code

Type

Function

Short description

Case

Pinout

St.

Mnf.

SMD code	Type	Function	Short description	Case	Pinout	St.	Mnf.
B56I	STBB56I	TVS	Vbr=6.45..7.14V, 38A, 400W(1ms), Bidirectional	DO-214AC	1ba	1j	Eic
B56I	STUB56I	TVS	Vbr=6.45..7.14V, 38A, 400W(1ms)	DO-214AC	1d	1a	Eic
B575	STBB575	TVS	Vbr=71.3..78.8V 3.9A, 400W(1ms), Bidirectional	DO-214AC	1ba	1j	Eic
B575	STUB575	TVS	Vbr=71.3..78.8V 3.9A, 400W(1ms)	DO-214AC	1d	1a	Eic
B57F	STBB57F	TVS	Vbr=7.13..7.88V, 35.4A, 400W(1ms), Bidirectional	DO-214AC	1ba	1j	Eic
B57F	STUB57F	TVS	Vbr=7.13..7.88V, 35.4A, 400W(1ms)	DO-214AC	1d	1a	Eic
B582	STBB582	TVS	Vbr=77.9..86.1V 3.5A, 400W(1ms), Bidirectional	DO-214AC	1ba	1j	Eic
B582	STUB582	TVS	Vbr=77.9..86.1V 3.5A, 400W(1ms)	DO-214AC	1d	1a	Eic
B58C	STBB58C	TVS	Vbr=7.79..8.61V, 33A, 400W(1ms), Bidirectional	DO-214AC	1ba	1j	Eic
B58C	STUB58C	TVS	Vbr=7.79..8.61V, 33A, 400W(1ms)	DO-214AC	1d	1a	Eic
B591	STBB591	TVS	Vbr=86.5..95.5V 3.2A, 400W(1ms), Bidirectional	DO-214AC	1ba	1j	Eic
B591	STUB591	TVS	Vbr=86.5..95.5V 3.2A, 400W(1ms)	DO-214AC	1d	1a	Eic
B59B	STBB59B	TVS	Vbr=8.65..9.55V, 30A, 400W(1ms), Bidirectional	DO-214AC	1ba	1j	Eic
B59B	STUB59B	TVS	Vbr=8.65..9.55V, 30A, 400W(1ms)	DO-214AC	1d	1a	Eic
B5A	P6SBMJ10A	TVS	Vbr=9.5..10.5V, Vrw=8.55V, 29A, 600W(1ms)	DO-214AA	1d	1a	Chm
B5B0	STBB5B0	TVS	Vbr=95..105V 2.9A, 400W(1ms), Bidirectional	DO-214AC	1ba	1j	Eic
B5B0	STUB5B0	TVS	Vbr=95..105V 2.9A, 400W(1ms)	DO-214AC	1d	1a	Eic
B5B1	STBB5B1	TVS	Vbr=105..116V 2.6A, 400W(1ms), Bidirectional	DO-214AC	1ba	1j	Eic
B5B1	STUB5B1	TVS	Vbr=105..116V 2.6A, 400W(1ms)	DO-214AC	1d	1a	Eic
B5B2	STBB5B2	TVS	Vbr=114..126V 2.4A, 400W(1ms), Bidirectional	DO-214AC	1ba	1j	Eic
B5B2	STUB5B2	TVS	Vbr=114..126V 2.4A, 400W(1ms)	DO-214AC	1d	1a	Eic
B5B3	STBB5B3	TVS	Vbr=124..137V 2.2A, 400W(1ms), Bidirectional	DO-214AC	1ba	1j	Eic
B5B3	STUB5B3	TVS	Vbr=124..137V 2.2A, 400W(1ms)	DO-214AC	1d	1a	Eic
B5B5	STBB5B5	TVS	Vbr=143..158V 2A, 400W(1ms), Bidirectional	DO-214AC	1ba	1j	Eic
B5B5	STUB5B5	TVS	Vbr=143..158V 2A, 400W(1ms)	DO-214AC	1d	1a	Eic
B5B6	STBB5B6	TVS	Vbr=152..168V 1.8A, 400W(1ms), Bidirectional	DO-214AC	1ba	1j	Eic
B5B6	STUB5B6	TVS	Vbr=152..168V 1.8A, 400W(1ms)	DO-214AC	1d	1a	Eic
B5B7	STBB5B7	TVS	Vbr=161..179V 1.7A, 400W(1ms), Bidirectional	DO-214AC	1ba	1j	Eic
B5B7	STUB5B7	TVS	Vbr=161..179V 1.7A, 400W(1ms)	DO-214AC	1d	1a	Eic
B5B8	STBB5B8	TVS	Vbr=171..189V 1.6A, 400W(1ms), Bidirectional	DO-214AC	1ba	1j	Eic
B5B8	STUB5B8	TVS	Vbr=171..189V 1.6A, 400W(1ms)	DO-214AC	1d	1a	Eic
B5C	P6SBMJ10CA	TVS	Vbr=9.5..10.5V, Vrw=8.55V, 29A, 600W(1ms), Bidirectional	DO-214AA	1ba	1j	Chm
B5D0	STBB5D0	TVS	Vbr=190..210V 1.5A, 400W(1ms), Bidirectional	DO-214AC	1ba	1j	Eic
B5D0	STUB5D0	TVS	Vbr=190..210V 1.5A, 400W(1ms)	DO-214AC	1d	1a	Eic
B5D2	STBB5D2	TVS	Vbr=209..231V 1.4A, 400W(1ms), Bidirectional	DO-214AC	1ba	1j	Eic
B5D2	STUB5D2	TVS	Vbr=209..231V 1.4A, 400W(1ms)	DO-214AC	1d	1a	Eic
B5D5	STBB5D5	TVS	Vbr=237..263V 1.3A, 400W(1ms), Bidirectional	DO-214AC	1ba	1j	Eic
B5D5	STUB5D5	TVS	Vbr=237..263V 1.3A, 400W(1ms)	DO-214AC	1d	1a	Eic
B5D8	STBB5D8	TVS	Vbr=266..294V 1.3A, 400W(1ms), Bidirectional	DO-214AC	1ba	1j	Eic
B5D8	STUB5D8	TVS	Vbr=266..294V 1.3A, 400W(1ms)	DO-214AC	1d	1a	Eic
B5E0	STBB5E0	TVS	Vbr=285..315V 1.2A, 400W(1ms), Bidirectional	DO-214AC	1ba	1j	Eic
B5E0	STUB5E0	TVS	Vbr=285..315V 1.2A, 400W(1ms)	DO-214AC	1d	1a	Eic
B5E2	STBB5E2	TVS	Vbr=304..336V 1.2A, 400W(1ms), Bidirectional	DO-214AC	1ba	1j	Eic
B5E2	STUB5E2	TVS	Vbr=304..336V 1.2A, 400W(1ms)	DO-214AC	1d	1a	Eic
B5E5	STBB5E5	TVS	Vbr=332..368V 0.9A, 400W(1ms), Bidirectional	DO-214AC	1ba	1j	Eic
B5E5	STUB5E5	TVS	Vbr=332..368V 0.9A, 400W(1ms)	DO-214AC	1d	1a	Eic
B5G0	STBB5G0	TVS	Vbr=380..420V 0.9A, 400W(1ms), Bidirectional	DO-214AC	1ba	1j	Eic
B5G0	STUB5G0	TVS	Vbr=380..420V 0.9A, 400W(1ms)	DO-214AC	1d	1a	Eic
B5G4	STBB5G4	TVS	Vbr=418..462V 0.8A, 400W(1ms), Bidirectional	DO-214AC	1ba	1j	Eic
B5G4	STUB5G4	TVS	Vbr=418..462V 0.8A, 400W(1ms)	DO-214AC	1d	1a	Eic
B6	BZT52H-C3V3	Z-diode	3.1..3.5V, Izt=5mA, Zzt=95Ω, 375mW	SOD-123FL	7d	1a	Phi
B6	BZX399-C3V0	Z-diode	3.0V±5%, 300mW	SOD-323	5d	1a	Phi
B6	BZX884-C3V9	Z-diode	3.9V±5%, 250mW	SOD-882	13d	2b	Phi
B6	MM1Z5263B	Z-diode	53.20..58.80V, Izt=2.2mA, Zzt=150Ω, 500mW	SOD-323FL	5d	1a	Eic
B6	MM1Z5263BH	Z-diode	53.2..58.8V, Izt=2.2mA, Zzt=150Ω, 500mW	SOD-123	5d	1a	Zow
B6	MM5Z5263B	Z-diode	56V±5%, Izt=2.2mA, Zzt=150Ω, 500mW	SOD-123	5d	1a	Eic
B6	UDZ3V3B	Z-diode	3.3V±2.5%, Izt=5mA, 200mW	SOD-323	5d	1d	Di
B6A	P6SBMJ11A	TVS	Vbr=10.5..11.6V, Vrw=9.40V, 27A, 600W(1ms)	DO-214AA	1d	1a	Chm
B6C	P6SBMJ11CA	TVS	Vbr=10.5..11.6V, Vrw=9.40V, 27A, 600W(1ms), Bidirectional	DO-214AA	1ba	1j	Chm
B7	ASB0240BD	Si-diode	SBR, 40V, 200mA, Vf<0.45V(200mA)	0603	13d	2b	Ana
B7	ASB0240BF	Si-diode	SBR, 40V, 200mA, Vf<0.45V(200mA)	1005	13d	2b	Ana
B7	BZT52H-C3V6	Z-diode	3.4..3.8V, Izt=5mA, Zzt=95Ω, 375mW	SOD-123FL	7d	1a	Phi
B7	BZX399-C3V3	Z-diode	3.3V±5%, 300mW	SOD-323	5d	1a	Phi
B7	BZX884-C4V3	Z-diode	4.3V±5%, 250mW	SOD-882	13d	2b	Phi
B7	UDZ3V6B	Z-diode	3.6V±2.5%, Izt=5mA, 200mW	SOD-323	5d	1d	Di
B7A	P6SBMJ12A	TVS	Vbr=11.4..12.6V, Vrw=10.2V, 25A, 600W(1ms)	DO-214AA	1d	1a	Chm
B7C	P6SBMJ12CA	TVS	Vbr=11.4..12.6V, Vrw=10.2V, 25A, 600W(1ms), Bidirectional	DO-214AA	1ba	1j	Chm
B8	BZT52H-C3V9	Z-diode	3.7..4.1V, Izt=5mA, Zzt=95Ω, 375mW	SOD-123FL	7d	1a	Phi
B8	BZX399-C3V6	Z-diode	3.6V±5%, 300mW	SOD-323	5d	1a	Phi
B8	BZX884-C4V7	Z-diode	4.7V±5%, 250mW	SOD-882	13d	2b	Phi



SMD code	Type	Function	Short description	Case	Pinout	St.	Mnf.
B8	MM5Z3V0	Z-diode	3.0V±5%, Izt=5mA, Zzt=100Ω, 200mW	SOD-523	6d	1a	Eic
B8	MM5Z3V0H	Z-diode	2.8..3.2V, Izt=5mA, Zzt=100Ω, 200mW	SOD-523	7d	1a	Zow
B8	UDZ3V9B	Z-diode	3.9V±2.5%, Izt=5mA, 200mW	SOD-323	5d	1d	Di
B8A	P6SBMJ13A	TVS	Vbr=12.4..13.7V, Vrrwm=11.1V, 23A, 600W(1ms)	DO-214AA	1d	1a	Chm
B8C	P6SBMJ13CA	TVS	Vbr=12.4..13.7V, Vrrwm=11.1V, 23A, 600W(1ms), Bidirectional	DO-214AA	1ba	1j	Chm
B9	BZT52H-C4V3	Z-diode	4.0..4.6V, Izt=5mA, Zzt=95Ω, 375mW	SOD-123FL	7d	1a	Phi
B9	BZX399-C3V9	Z-diode	3.9V±5%, 300mW	SOD-323	5d	1a	Phi
B9	BZX884-C5V1	Z-diode	5.1V±5%, 250mW	SOD-882	13d	2b	Phi
B9	MM5Z36H	Z-diode	34..38V, Izt=2mA, Zzt=90Ω, 200mW	SOD-523	7d	1a	Zow
B9	MM5Z36V	Z-diode	36V±5%, Izt=2mA, Zzt=90Ω, 200mW	SOD-523	6d	1a	Eic
B9	UDZ4V3B	Z-diode	4.3V±2.5%, Izt=5mA, 200mW	SOD-323	5d	1d	Di
B920	1SMB5920B	Z-diode	6.2V±5%, Izt=60.5mA, Zzt=2Ω, 3W	DO-214AA	1d	1x	Di
B921	1SMB5921B	Z-diode	6.8V±5%, Izt=55.1mA, Zzt=2.5Ω, 3W	DO-214AA	1d	1x	Di
B922	1SMB5922B	Z-diode	7.5V±5%, Izt=50mA, Zzt=3Ω, 3W	DO-214AA	1d	1x	Di
B923	1SMB5923B	Z-diode	8.2V±5%, Izt=45.7mA, Zzt=3.5Ω, 3W	DO-214AA	1d	1x	Di
B924	1SMB5924B	Z-diode	9.1V±5%, Izt=41.2mA, Zzt=4Ω, 3W	DO-214AA	1d	1x	Di
B925	1SMB5925B	Z-diode	10V±5%, Izt=37.5mA, Zzt=4.5Ω, 3W	DO-214AA	1d	1x	Di
B926	1SMB5926B	Z-diode	11V±5%, Izt=34.1mA, Zzt=5.5Ω, 3W	DO-214AA	1d	1x	Di
B927	1SMB5927B	Z-diode	12V±5%, Izt=31.2mA, Zzt=6.5Ω, 3W	DO-214AA	1d	1x	Di
B928	1SMB5928B	Z-diode	13V±5%, Izt=28.8mA, Zzt=7Ω, 3W	DO-214AA	1d	1x	Di
B929	1SMB5929B	Z-diode	15V±5%, Izt=25mA, Zzt=9Ω, 3W	DO-214AA	1d	1x	Di
B930	1SMB5930B	Z-diode	16V±5%, Izt=23.4mA, Zzt=10Ω, 3W	DO-214AA	1d	1x	Di
B931	1SMB5931B	Z-diode	18V±5%, Izt=20.8mA, Zzt=12Ω, 3W	DO-214AA	1d	1x	Di
B932	1SMB5932B	Z-diode	20V±5%, Izt=18.7mA, Zzt=14Ω, 3W	DO-214AA	1d	1x	Di
B933	1SMB5933B	Z-diode	22V±5%, Izt=17mA, Zzt=17.5Ω, 3W	DO-214AA	1d	1x	Di
B934	1SMB5934B	Z-diode	24V±5%, Izt=15.6mA, Zzt=19Ω, 3W	DO-214AA	1d	1x	Di
B935	1SMB5935B	Z-diode	27V±5%, Izt=13.9mA, Zzt=23Ω, 3W	DO-214AA	1d	1x	Di
B936	1SMB5936B	Z-diode	30V±5%, Izt=12.5mA, Zzt=26Ω, 3W	DO-214AA	1d	1x	Di
B937	1SMB5937B	Z-diode	33V±5%, Izt=11.4mA, Zzt=33Ω, 3W	DO-214AA	1d	1x	Di
B938	1SMB5938B	Z-diode	36V±5%, Izt=10.4mA, Zzt=38Ω, 3W	DO-214AA	1d	1x	Di
B939	1SMB5939B	Z-diode	39V±5%, Izt=9.6mA, Zzt=45Ω, 3W	DO-214AA	1d	1x	Di
B9A	P6SBMJ15A	TVS	Vbr=14.3..15.8V, Vrrwm=12.8V, 20A, 600W(1ms)	DO-214AA	1d	1a	Chm
B9C	P6SBMJ15CA	TVS	Vbr=14.3..15.8V, Vrrwm=12.8V, 20A, 600W(1ms), Bidirectional	DO-214AA	1ba	1j	Chm
BA	BZT52H-C4V7	Z-diode	4.4..5.0V, Izt=5mA, Zzt=78Ω, 375mW	SOD-123FL	7d	1a	Phi
BA	BZX399-C4V7	Z-diode	4.7V±5%, 300mW	SOD-323	5d	1a	Phi
BA	BZX884-C5V6	Z-diode	5.6V±5%, 250mW	SOD-882	13d	2b	Phi
BA	MM3Z5264B	Z-diode	60V±5%, Izt=2.1mA, Zzt=170Ω, 200mW	SOD-323FL	7d	1a	Bts
BA	S1BA	Si-diode	Rectifier, 100V, 1A, Vf<1.1V(1A)	DO-214AC	1d	1k	Vs
BA	SD833-03	Si-diode	SBR, 30V, 3A, Vf<0.46V(2.5A)	PowD123	7d	1a	Fji
BA	TV04A190K-G	TVS	Vrrwm=19.0V, Vbr=21.13..25.76V, Ipp=11.76A, 400W(1ms)	DO-214AC	1d	1a	Cmc
BA	UDZ4V7B	Z-diode	4.7V±2.5%, Izt=5mA, 200mW	SOD-323	5d	1d	Di
BA	ZMS2800	Si-diode	SBR, 70V, 1A, 250mW, Vf<410mV(1mA)	SOD-323	5d	1a	Zx
BA1	CH157BPT	Si-diode	SBD, 70V, 15mA, Vf<1V(15mA), 1ns	SOD-123	5d	1a	Chm
BA2	CH156BPT	Si-diode	SBD, 60V, 15mA, Vf<1V(15mA), 1ns	SOD-123	5d	1a	Chm
BA3	CH140BPT	Si-diode	SBD, 40V, 15mA, Vf<0.9V(15mA), 1ns	SOD-123	5d	1a	Chm
BA4	CH150BPT	Si-diode	SBD, 50V, 15mA, Vf<0.95V(15mA), 1ns	SOD-123	5d	1a	Chm
BA5	CH160BPT	Si-diode	SBD, 60V, 15mA, Vf<1V(15mA), 1ns	SOD-123	5d	1a	Chm
BA6	CH320BPT	Si-diode	SBD, 20V, 350mA, Vf<0.6V(200mA), 1ns	SOD-123	5d	1a	Chm
BA7	CH330BPT	Si-diode	SBD, 30V, 350mA, Vf<0.6V(200mA), 1ns	SOD-123	5d	1a	Chm
BA8	CH340BPT	Si-diode	SBD, 40V, 350mA, Vf<0.6V(200mA), 1ns	SOD-123	5d	1a	Chm
BB	BB555	C-diode	UHF TV-tuning, 30V, 20mA, 2.1..18.7pF(28..1V)	SCD-80	6d	1u	Inf
BB	BZT52H-C5V1	Z-diode	4.8..5.4V, Izt=5mA, Zzt=60Ω, 375mW	SOD-123FL	7d	1a	Phi
BB	BZX399-C5V1	Z-diode	5.1V±5%, 300mW	SOD-323	5d	1a	Phi
BB	BZX884-C6V2	Z-diode	6.2V±5%, 250mW	SOD-882	13d	2b	Phi
BB	SC016-2	Si-diode	GP, Rectifier, 200V, 1A, Vf<1.1V(2A)	SOD-106	1d	1b	Fji
BB	SD833-04	Si-diode	SBR, 60V, 3A, Vf<0.58V(2.5A)	PowD123	7d	1a	Fji
BB	TV04A190J-G	TVS	Vrrwm=19.0V, Vbr=20.10..23.30V, Ipp=13.0A, 400W(1ms)	DO-214AC	1d	1a	Cmc
BB	UDZ5V1B	Z-diode	5.1V±2.5%, Izt=5mA, 200mW	SOD-323	5d	1d	Di
BB	ZMS5800	Si-diode	SBR, 50V, 1A, 250mW, Vf<410mV(1mA)	SOD-323	5d	1a	Zx
BBA	SMBJ6.0CA	TVS	Vbr=6V, 61A, 600W(1ms), Bidirectional	DO-214AA	1ba	1r	Ste
BBB	SMBJ6.5CA	TVS	Vbr=6.5V, 56A, 600W(1ms), Bidirectional	DO-214AA	1ba	1r	Ste
BBC	SMBJ8.5CA	TVS	Vbr=8.5V, 41.7A, 600W(1ms), Bidirectional	DO-214AA	1ba	1r	Ste
BBD	SMBJ10CA	TVS	Vbr=10V, 37A, 600W(1ms), Bidirectional	DO-214AA	1ba	1r	Ste
BBE	SMBJ12CA	TVS	Vbr=12V, 31A, 600W(1ms), Bidirectional	DO-214AA	1ba	1r	Ste
BBF	SMBJ13AC	TVS	Vbr=13V, 29A, 600W(1ms), Bidirectional	DO-214AA	1ba	1r	Ste
BBG	SMBJ15CA	TVS	Vbr=15V, 25.1A, 600W(1ms), Bidirectional	DO-214AA	1ba	1r	Ste
BBH	SMBJ18CA	TVS	Vbr=18V, 21.5A, 600W(1ms), Bidirectional	DO-214AA	1ba	1r	Ste
BBI	SMBJ20CA	TVS	Vbr=20V, 19.4A, 600W(1ms), Bidirectional	DO-214AA	1ba	1r	Ste
BBJ	SMBJ24CA	TVS	Vbr=24V, 16A, 600W(1ms), Bidirectional	DO-214AA	1ba	1r	Ste
BBK	SMBJ26CA	TVS	Vbr=26V, 14.9A, 600W(1ms), Bidirectional	DO-214AA	1ba	1r	Ste



SMD
code

Type

Function

Short description

Case

Pinout

St.

Mnf.

SMD code	Type	Function	Short description	Case	Pinout	St.	Mnf.
BBL	SMBJ28CA	TVS	Vbr=28V, 13.8A, 600W(1ms), Bidirectional	DO-214AA	1ba	1r	Ste
BBM	SMBJ30CA	TVS	Vbr=30V, 13A, 600W(1ms), Bidirectional	DO-214AA	1ba	1r	Ste
BBN	SMBJ33CA	TVS	Vbr=33V, 11.8A, 600W(1ms), Bidirectional	DO-214AA	1ba	1r	Ste
BBO	SMBJ58CA	TVS	Vbr=58V, 6.7A, 600W(1ms), Bidirectional	DO-214AA	1ba	1r	Ste
BBQ	SMBJ85CA	TVS	Vbr=85V, 4.6A, 600W(1ms), Bidirectional	DO-214AA	1ba	1r	Ste
BBS	SMBJ130CA	TVS	Vbr=130V, 3A, 600W(1ms), Bidirectional	DO-214AA	1ba	1r	Ste
BBT	SMBJ154CA	TVS	Vbr=154V, 2.4A, 600W(1ms), Bidirectional	DO-214AA	1ba	1r	Ste
BBU	SMBJ170CA	TVS	Vbr=170V, 2.2A, 600W(1ms), Bidirectional	DO-214AA	1ba	1r	Ste
BBV	SMBJ18CA	TVS	Vbr=110V, 3.4A, 600W(1ms), Bidirectional	DO-214AA	1ba	1r	Ste
BBW	SMBJ188CA	TVS	Vbr=188V, 2A, 600W(1ms), Bidirectional	DO-214AA	1ba	1r	Ste
BBX	SMBJ48CA	TVS	Vbr=48V, 8.1A, 600W(1ms), Bidirectional	DO-214AA	1ba	1r	Ste
BBZ	SMBJ5.0CA	TVS	Vbr=5V, 68A, 600W(1ms), Bidirectional	DO-214AA	1ba	1r	Ste
BC	BZT52H-C5V6	Z-diode	5.2..6.0V, Izt=5mA, Zzt=40Ω, 375mW	SOD-123FL	7d	1a	Phi
BC	BZX399-C5V6	Z-diode	5.6V±5%, 300mW	SOD-323	5d	1a	Phi
BC	BZX884-C6V8	Z-diode	6.8V±5%, 250mW	SOD-882	13d	2b	Phi
BC	GBLC08CI	TVS	Vbr=8V, 2A, 350W(1ms), 0.6pF, Bidirectional	SOD-323	5ba	1e	Prt
BC	MM1Z4678	Z-diode	1.71..1.89V, Izt=10mA, 500mW	SOD-123FL	7d	1a	Sme
BC	MMSZ4678	Z-diode	1.8V±5%, Izt=50μA, 500mW	SOD-123	5d	1a	Eic
BC	SC016-4	Si-diode	GP, Rectifier, 400V, 1A, Vf<1.1V(2A)	SOD-106	1d	1b	Fji
BC	SD833-06	Si-diode	SBR, 60V, 3A, Vf<0.58V(2.5A)	PowD123	7d	1a	Fji
BC	UDZ5V6B	Z-diode	5.6V±2.5%, Izt=5mA, 200mW	SOD-323	5d	1d	Di
BC	ZMS2811	Si-diode	SBR, 15V, 1A, 250mW, Vf<410mV(1mA)	SOD-323	5d	1a	Zx
BCF	MBRM120	Si-diode	SBR, 20V, 1A, Vf=0.41V(1A)	DO-216AA	4d	1h	Ons
BCG	MBRM130	Si-diode	SBR, 30V, 1A, Vf=0.33V(1A)	DO-216AA	4d	1h	Ons
BCJ	MBRM140	Si-diode	SBR, 40V, 1A, Vf=0.51V(1A)	DO-216AA	4d	1h	Ons
BCV	MBRM120E	Si-diode	SBR, 20V, 1A, Vf=0.45V(1A)	DO-216AA	4d	1h	Ons
BD	BZT52H-C6V2	Z-diode	5.8..6.6V, Izt=5mA, Zzt=10Ω, 375mW	SOD-123FL	7d	1a	Phi
BD	BZX399-C6V2	Z-diode	6.2V±5%, 300mW	SOD-323	5d	1a	Phi
BD	BZX884-C7V5	Z-diode	7.5V±5%, 250mW	SOD-882	13d	2b	Phi
BD	KDZ22B	Z-diode	22V±2.5%, 10mA, 1W	PHIDU	7d	1s	Rhm
BD	MM1Z4679	Z-diode	1.90..2.10V, Izt=10mA, 500mW	SOD-123FL	7d	1a	Sme
BD	MMSZ4679	Z-diode	2.0V±5%, Izt=50μA, 500mW	SOD-123	5d	1a	Eic
BD	P4SMA18	TVS	Vrnm=18V, 16A, 400W(1ms),	DO-214AC	1d	2j	Fag
BD	P6SMBJ12C	TVS	Vbr=12V, 27.3A, 600W(1ms), Bidirectional	DO-214AA	1ba	1x,1y	Pjt,Srj
BD	SC016-6	Si-diode	GP, Rectifier, 600V, 1A, Vf<1.1V(2A)	SOD-106	1d	1b	Fji
BD	SD833-09	Si-diode	SBR, 90V, 3A, Vf<0.85V(2.5A)	PowD123	7d	1a	Fji
BD	SMAJ12	TVS	Vrnm=12V, Vbr=13.3..16.3V, 18.2A, 400W(1ms)	DO-214AC	1d	1k	Vs
BD	SMBG12C	TVS	Vbr=12V, 27.3A, 600W(1ms), Bidirectional	DO-215AA	5ba	1l	Vs
BD	SMBJ12C	TVS	Vbr=12V, 27.3A, 600W(1ms), Bidirectional	DO-214AA	1ba	1l	Vs
BD	SMF12	TVS	Vbr=13.3..16.3V, Vrnm=12V, Ipp=18.2A, 400W(1ms)	DO-220AA	8d	1a	Vs
BD	TV04A120K-G	TVS	Vrnm=12.0V, Vbr=13.30..16.30V, Ipp=18.18A, 400W(1ms)	DO-214AC	1d	1a	Cmc
BD	TV06B120KB-G	TVS	Vrnm=12.0V, Vbr=13.30..16.30V, Ipp=27.27A, 600W(1ms), Bidirectional	DO-214AA	1ba	1j	Cmc
BD	UDZ6V2B	Z-diode	6.2V±2.5%, Izt=5mA, 200mW	SOD-323	5d	1d	Di
BD	ZHCS400	Si-diode	Schottky, Sw, 40V, 400mA, 10ns	SOD-323	5d	1a	Zx
BDD	1.5SMCJ5.0C	TVS	Vrnm=5V, 156.2A, 1500W(1ms), Bidirectional	DO-214AB	1ba	1x,1y	Pjt,Srj
BDD	SM15T6V8C	TVS	Vbr=6.45..7.14V, 143A, 1500W(1ms), Bidirectional	DO-214AB	1ba	1r	Ste
BDD	SMCG5.0C	TVS	Vbr=5V, 156.3A, 1500W(1ms), Bidirectional	DO-215AB	5ba	1l	Vs
BDD	SMCJ5.0C	TVS	Vrnm=5V, Vbr=6.4..7.25V, 156.3A, 1500W(1ms), Bidirectional	DO-214AB	1ba	1l	Vs
BDD	TFMCJ5.0C	TVS	Vbr=5V, 156.3A, 1500W(1ms), Bidirectional	DO-214AB	1ba	1j	Rec
BDD	TV15CV0KB-G	TVS	Vrnm=5.0V, Vbr=6.40..7.82V, Ipp=156.25A, 1500W(1ms), Bidirectional	DO-214AB	1ba	1j	Cmc
BDE	1.5SMCJ5.0CA	TVS	Vrnm=5V, 163A, 1500W(1ms), Bidirectional	DO-214AB	1ba	1x,1y	Pjt,Srj
BDE	CD214C-T5.0CA	TVS	Vbr=5V, Irm=163A, 1500W(1ms), Bidirectional	DO-214AB	1ba	1j	Bm
BDE	SM15T6V8CA	TVS	Vrnm=5.8V, Vbr=6.45..7.14V, 143A, 1500W(1ms), Bidirectional	DO-214AB	1ba	1j	Ste
BDE	SMCG5.0CA	TVS	Vbr=5V, 163A, 1500W(1ms), Bidirectional	DO-215AB	5ba	1l	Vs
BDE	SMCJ5.0CA	TVS	Vrnm=5V, Vbr=6.4..7.25V, 163A, 1500W(1ms), Bidirectional	DO-214AB	1ba	1l,1x	Di,Vs
BDE	TFMCJ5.0CA	TVS	Vbr=5V, 163A, 1500W(1ms), Bidirectional	DO-214AB	1ba	1j	Rec
BDE	TV15CV0JB-G	TVS	Vrnm=5.0V, Vbr=6.40..7.07V, Ipp=163.04A, 1500W(1ms), Bidirectional	DO-214AB	1ba	1j	Cmc
BDE7	SM15T6V8CA	TVS	Vrnm=5.80V, Vbr=6.45..7.14V, 143A, 1500W(1ms), Bidirectional	DO-214AB	1ba	1l	Vs
BDF	1.5SMCJ6.0C	TVS	Vrnm=6V, 131.6A, 1500W(1ms), Bidirectional	DO-214AB	1ba	1x,1y	Pjt,Srj
BDF	SM15T7V5C	TVS	Vbr=7.13..7.88V, 132A, 1500W(1ms), Bidirectional	DO-214AB	1ba	1r	Ste
BDF	SMCG6.0C	TVS	Vbr=6V, 131.6A, 1500W(1ms), Bidirectional	DO-215AB	5ba	1l	Vs
BDF	SMCJ6.0C	TVS	Vrnm=6V, Vbr=6.67..7.67V, 131.6A, 1500W(1ms), Bidirectional	DO-214AB	1ba	1l	Vs
BDF	TFMCJ6.0C	TVS	Vbr=6V, 131.6A, 1500W(1ms), Bidirectional	DO-214AB	1ba	1j	Rec
BDF	TV15CV0KB-G	TVS	Vrnm=6.0V, Vbr=6.67..8.15V, Ipp=131.58A, 1500W(1ms), Bidirectional	DO-214AB	1ba	1j	Cmc
BDG	1.5SMCJ6.0CA	TVS	Vrnm=6V, 145.6A, 1500W(1ms), Bidirectional	DO-214AB	1ba	1x,1y	Pjt,Srj
BDG	CD214C-T6.0CA	TVS	Vbr=6V, Irm=145.6A, 1500W(1ms), Bidirectional	DO-214AB	1ba	1j	Bm
BDG	SM15T7V5CA	TVS	Vrnm=6.4V, Vbr=7.13..7.88V, 133A, 1500W(1ms), Bidirectional	DO-214AB	1ba	1j	Ste
BDG	SMCG6.0CA	TVS	Vbr=6V, 145.6A, 1500W(1ms), Bidirectional	DO-215AB	5ba	1l	Vs
BDG	SMCG8.0C	TVS	Vbr=8V, 100A, 1500W(1ms), Bidirectional	DO-215AB	5ba	1l	Vs
BDG	SMCJ8.0C	TVS	Vrnm=8V, Vbr=8.89..9.83V, 100A, 1500W(1ms), Bidirectional	DO-214AB	1ba	1l	Vs



SMD
code

Type

Function

Short description

Case

Pinout

St.

Mnf.

SMD code	Type	Function	Short description	Case	Pinout	St.	Mnf.
BDG	TFMCJ6.0CA	TVS	Vbr=6V, 145.6A, 1500W(1ms), Bidirectional	DO-214AB	1ba	1j	Rec
BDG	TFMCJ8.0C	TVS	Vbr=8V, 100A, 1500W(1ms), Bidirectional	DO-214AB	1ba	1j	Rec
BDG	TV15C8V0JB-G	TVS	Vrwm=6.0V, Vbr=6.67..7.37V, Ipp=145.63A, 1500W(1ms), Bidirectional	DO-214AB	1ba	1j	Cmc
BDH	1.5SMCJ6.5C	TVS	Vrwm=6.5V, 122A, 1500W(1ms), Bidirectional	DO-214AB	1ba	1x,1y	Pjt,Srj
BDH	SMCG6.5C	TVS	Vbr=6.5V, 122A, 1500W(1ms), Bidirectional	DO-215AB	5ba	1l	Vs
BDH	SMCJ6.5C	TVS	Vrwm=6.5V, Vbr=7.22..8.3V, 122A, 1500W(1ms), Bidirectional	DO-214AB	1ba	1l	Vs
BDH	TFMCJ6.5C	TVS	Vbr=6.5V, 122A, 1500W(1ms), Bidirectional	DO-214AB	1ba	1j	Rec
BDH	TV15C8V5KB-G	TVS	Vrwm=6.50V, Vbr=7.22..8.82V, Ipp=121.95A, 1500W(1ms), Bidirectional	DO-214AB	1ba	1j	Cmc
BDK	1.5SMCJ6.5CA	TVS	Vrwm=6.5V, 133.9A, 1500W(1ms), Bidirectional	DO-214AB	1ba	1x,1y	Pjt,Srj
BDK	CD214C-T6.5CA	TVS	Vbr=6.5V, Irm=133.9A, 1500W(1ms), Bidirectional	DO-214AB	1ba	1j	Bm
BDK	SMA18	TVS	Vbr=16.2..19.8V, Vrwm=14.5V, 15.1A, 400W(1ms)	DO-214AC	1d	1a	Lge
BDK	SMCG6.5CA	TVS	Vbr=6.5V, 133.9A, 1500W(1ms), Bidirectional	DO-215AB	5ba	1l	Vs
BDK	SMCJ6.5CA	TVS	Vrwm=6.5V, Vbr=7.22..8.3V, 133.9A, 1500W(1ms), Bidirectional	DO-214AB	1ba	1l,1x	Di,Vs
BDK	TFMCJ6.5CA	TVS	Vbr=6.5V, 133.9A, 1500W(1ms), Bidirectional	DO-214AB	1ba	1j	Rec
BDK	TV15C8V5JB-G	TVS	Vrwm=6.50V, Vbr=7.22..7.98V, Ipp=133.93A, 1500W(1ms), Bidirectional	DO-214AB	1ba	1j	Cmc
BDK7	SM15T7V5CA	TVS	Vrwm=6.40V, Vbr=7.13..7.88V, 132A, 1500W(1ms), Bidirectional	DO-214AB	1ba	1l	Vs
BDL	1.5SMCJ7.0C	TVS	Vrwm=7V, 112.8A, 1500W(1ms), Bidirectional	DO-214AB	1ba	1x,1y	Pjt,Srj
BDL	SMCG7.0C	TVS	Vbr=7V, 112.8A, 1500W(1ms), Bidirectional	DO-215AB	5ba	1l	Vs
BDL	SMCJ7.0C	TVS	Vrwm=7V, Vbr=7.78..8.95V, 112.8A, 1500W(1ms), Bidirectional	DO-214AB	1ba	1l	Vs
BDL	TFMCJ7.0C	TVS	Vbr=7V, 112.8A, 1500W(1ms), Bidirectional	DO-214AB	1ba	1j	Rec
BDL	TV15C7V0KB-G	TVS	Vrwm=7.0V, Vbr=7.78..9.51V, Ipp=112.78A, 1500W(1ms), Bidirectional	DO-214AB	1ba	1j	Cmc
BDM	1.5SMCJ7.0CA	TVS	Vrwm=7V, 125A, 1500W(1ms), Bidirectional	DO-214AB	1ba	1x,1y	Pjt,Srj
BDM	CD214C-T7.0CA	TVS	Vbr=7V, Irm=125A, 1500W(1ms), Bidirectional	DO-214AB	1ba	1j	Bm
BDM	SMA18C	TVS	Vbr=16.2..19.8V, Vrwm=14.5V, 15.1A, 400W(1ms), Bidirectional	DO-214AC	1ba	1j	Lge
BDM	SMCG7.0CA	TVS	Vrwm=7V, 125A, 1500W(1ms), Bidirectional	DO-215AB	5ba	1l	Vs
BDM	SMCJ7.0CA	TVS	Vrwm=7V, Vbr=7.78..8.95V, 125A, 1500W(1ms), Bidirectional	DO-214AB	1ba	1l,1x	Di,Vs
BDM	TFMCJ7.0CA	TVS	Vbr=7V, 125A, 1500W(1ms), Bidirectional	DO-214AB	1ba	1j	Rec
BDM	TV15C7V0JB-G	TVS	Vrwm=7.0V, Vbr=7.78..8.60V, Ipp=125.0A, 1500W(1ms), Bidirectional	DO-214AB	1ba	1j	Cmc
BDN	1.5SMCJ7.5C	TVS	Vrwm=7.5V, 104.9A, 1500W(1ms), Bidirectional	DO-214AB	1ba	1x,1y	Pjt,Srj
BDN	SM15T10C	TVS	Vbr=9.5..10.5V, 103A, 1500W(1ms), Bidirectional	DO-214AB	1ba	1r	Ste
BDN	SMCG7.5C	TVS	Vbr=7.5V, 104.9A, 1500W(1ms), Bidirectional	DO-215AB	5ba	1l	Vs
BDN	SMCJ7.5C	TVS	Vrwm=7.5V, Vbr=8.33..9.58V, 104.9A, 1500W(1ms), Bidirectional	DO-214AB	1ba	1l	Vs
BDN	TFMCJ7.5C	TVS	Vbr=7.5V, 104.9A, 1500W(1ms), Bidirectional	DO-214AB	1ba	1j	Rec
BDN	TV15C7V5KB-G	TVS	Vrwm=7.50V, Vbr=8.33..10.20V, Ipp=104.90A, 1500W(1ms), Bidirectional	DO-214AB	1ba	1j	Cmc
BDP	1.5SMCJ7.5CA	TVS	Vrwm=7.5V, 116.3A, 1500W(1ms), Bidirectional	DO-214AB	1ba	1x,1y	Pjt,Srj
BDP	CD214C-T7.5CA	TVS	Vbr=7.5V, Irm=116.3A, 1500W(1ms), Bidirectional	DO-214AB	1ba	1j	Bm
BDP	SM15T10CA	TVS	Vrwm=8.55V, Vbr=9.5..10.5V, 103A, 1500W(1ms), Bidirectional	DO-214AB	1ba	1j	Mde
BDP	SMCG7.5CA	TVS	Vbr=7.5V, 116.3A, 1500W(1ms), Bidirectional	DO-215AB	5ba	1l	Vs
BDP	SMCJ7.5CA	TVS	Vrwm=7.5V, Vbr=8.33..9.58V, 116.3A, 1500W(1ms), Bidirectional	DO-214AB	1ba	1l,1x	Di,Vs
BDP	TFMCJ7.5CA	TVS	Vbr=7.5V, 116.3A, 1500W(1ms), Bidirectional	DO-214AB	1ba	1j	Rec
BDP	TPSMA18	TVS	Vbr=18V, 15.1A, 400W(1ms)	DO-214AC	1d	1k	Vs
BDP	TPSMP18	TVS	Vbr=16.2..19.8V, Vrwm=14.5V, Ipp=15.1A, 400W(1ms)	DO-220AA	8d	1a	Vs
BDP	TV15C7V5JB-G	TVS	Vrwm=7.50V, Vbr=8.33..9.21V, Ipp=116.28A, 1500W(1ms), Bidirectional	DO-214AB	1ba	1j	Cmc
BDQ	1.5SMCJ8.0C	TVS	Vrwm=8V, 100A, 1500W(1ms), Bidirectional	DO-214AB	1ba	1x,1y	Pjt,Srj
BDQ	SMCJ6.0CA	TVS	Vrwm=6V, Vbr=6.67..7.67V, 145.6A, 1500W(1ms), Bidirectional	DO-214AB	1ba	1l,1x	Di,Vs
BDQ	TV15C8V0KB-G	TVS	Vrwm=8.0V, Vbr=8.89..10.90V, Ipp=100.0A, 1500W(1ms), Bidirectional	DO-214AB	1ba	1j	Cmc
BDR	1.5SMCJ8.0CA	TVS	Vrwm=8V, 110.3A, 1500W(1ms), Bidirectional	DO-214AB	1ba	1x,1y	Pjt,Srj
BDR	CD214C-T8.0CA	TVS	Vbr=8V, Irm=110.3A, 1500W(1ms), Bidirectional	DO-214AB	1ba	1j	Bm
BDR	SMCG8.0CA	TVS	Vbr=8V, 110.3A, 1500W(1ms), Bidirectional	DO-215AB	5ba	1l	Vs
BDR	SMCJ8.0CA	TVS	Vrwm=8V, Vbr=8.89..10.23V, 110.3A, 1500W(1mS), Bidirectional	DO-214AB	1ba	1l,1x	Di,Vs
BDR	TFMCJ8.0CA	TVS	Vbr=8V, 110.3A, 1500W(1ms), Bidirectional	DO-214AB	1ba	1j	Rec
BDR	TV15C8V0JB-G	TVS	Vrwm=8.0V, Vbr=8.89..9.83V, Ipp=110.29A, 1500W(1ms), Bidirectional	DO-214AB	1ba	1j	Cmc
BDS	1.5SMCJ8.5C	TVS	Vrwm=8.5V, 94.3A, 1500W(1ms), Bidirectional	DO-214AB	1ba	1x,1y	Pjt,Srj
BDS	SM15T12C	TVS	Vbr=11.4..12.6V, 90A, 1500W(1ms), Bidirectional	DO-214AB	1ba	1r	Ste
BDS	SMCG8.5C	TVS	Vbr=8.5V, 94.3A, 1500W(1ms), Bidirectional	DO-215AB	5ba	1l	Vs
BDS	SMCJ8.5C	TVS	Vrwm=8.5V, Vbr=9.44..10.82V, 94.3A, 1500W(1ms), Bidirectional	DO-214AB	1ba	1l	Vs
BDS	TFMCJ8.5C	TVS	Vbr=8.5V, 94.3A, 1500W(1ms), Bidirectional	DO-214AB	1ba	1j	Rec
BDS	TV15C8V5KB-G	TVS	Vrwm=8.55V, Vbr=9.44..11.50V, Ipp=94.34A, 1500W(1ms), Bidirectional	DO-214AB	1ba	1j	Cmc
BDT	1.5SMCJ8.5CA	TVS	Vrwm=8.5V, 104.2A, 1500W(1ms), Bidirectional	DO-214AB	1ba	1x,1y	Pjt,Srj
BDT	CD214C-T8.5CA	TVS	Vbr=8.5V, Irm=104.2A, 1500W(1ms), Bidirectional	DO-214AB	1ba	1j	Bm
BDT	SM15T12CA	TVS	Vrwm=10.2V, Vbr=11.4..12.6V, 89.8A, 1500W(1ms), Bidirectional	DO-214AB	1ba	1r,1j	Ste
BDT	SMCG8.5CA	TVS	Vbr=8.5V, 104.2A, 1500W(1ms), Bidirectional	DO-215AB	5ba	1l	Vs
BDT	SMCJ8.5CA	TVS	Vrwm=8.5V, Vbr=9.44..10.82V, 104.2A, 1500W(1ms), Bidirectional	DO-214AB	1ba	1l,1x	Di,Vs
BDT	TFMCJ8.5CA	TVS	Vbr=8.5V, 104.2A, 1500W(1ms), Bidirectional	DO-214AB	1ba	1j	Rec
BDT	TV15C8V5JB-G	TVS	Vrwm=8.55V, Vbr=9.44..10.40V, Ipp=104.17A, 1500W(1ms), Bidirectional	DO-214AB	1ba	1j	Cmc
BDT7	SM15T10CA	TVS	Vrwm=8.55V, Vbr=9.5..10.5V, 103A, 1500W(1ms), Bidirectional	DO-214AB	1ba	1l	Vs
BDU	1.5SMCJ9.0C	TVS	Vrwm=9V, 88.7A, 1500W(1ms), Bidirectional	DO-214AB	1ba	1x,1y	Pjt,Srj
BDU	SMCG9.0C	TVS	Vbr=9V, 88.8A, 1500W(1ms), Bidirectional	DO-215AB	5ba	1l	Vs
BDU	SMCJ9.0C	TVS	Vrwm=9V, Vbr=10.0..12.2V, 88.8A, 1500W(1ms), Bidirectional	DO-214AB	1ba	1l	Vs
BDU	TFMCJ9.0C	TVS	Vbr=9V, 88.8A, 1500W(1ms), Bidirectional	DO-214AB	1ba	1j	Rec



SMD code	Type	Function	Short description	Case	Pinout	St.	Mnf.
BDU	TV15C9V0KB-G	TVS	Vrwm=9.0V, Vbr=10.0..12.20V, Ipp=88.76A, 1500W(1ms), Bidirectional	DO-214AB	1ba	1j	Cmc
BDV	1.5SMCJ9.0CA	TVS	Vrwm=9V, 97.4A, 1500W(1ms), Bidirectional	DO-214AB	1ba	1x,1y	Pjt,Srj
BDV	CD214C-T9.0CA	TVS	Vbr=9V, Irsm=97.4A, 1500W(1ms), Bidirectional	DO-214AB	1ba	1j	Bm
BDV	SMCG9.0CA	TVS	Vbr=9V, 97.4A, 1500W(1ms), Bidirectional	DO-215AB	5ba	1l	Vs
BDV	SMCJ9.0CA	TVS	Vrwm=9V, Vbr=10..11.5V, 97.4A, 1500W(1mS), Bidirectional	DO-214AB	1ba	1l,1x	Di,Vs
BDV	TFMCJ9.0CA	TVS	Vbr=9V, 97.4A, 1500W(1ms), Bidirectional	DO-214AB	1ba	1j	Rec
BDV	TV15C9V0JB-G	TVS	Vrwm=9.0V, Vbr=10.0..11.10V, Ipp=97.40A, 1500W(1ms), Bidirectional	DO-214AB	1ba	1j	Cmc
BDW	1.5SMCJ10C	TVS	Vrwm=10V, 79.8A, 1500W(1ms), Bidirectional	DO-214AB	1ba	1x,1y	Pjt,Srj
BDW	SM15T15C	TVS	Vbr=14.3..15.8V, 71A, 1500W(1ms), Bidirectional	DO-214AB	1ba	1r	Ste
BDW	SMCG10C	TVS	Vbr=10V, 79.8A, 1500W(1ms), Bidirectional	DO-215AB	5ba	1l	Vs
BDW	SMCJ10C	TVS	Vrwm=10V, Vbr=11.1..13.6V, 79.8A, 1500W(1ms), Bidirectional	DO-214AB	1ba	1l	Vs
BDW	TFMCJ10C	TVS	Vbr=10V, 79.8A, 1500W(1ms), Bidirectional	DO-214AB	1ba	1j	Rec
BDW	TV15C100KB-G	TVS	Vrwm=10.0V, Vbr=11.0..13.60 V, Ipp=79.79A, 1500W(1ms), Bidirectional	DO-214AB	1ba	1j	Cmc
BDX	1.5SMCJ10CA	TVS	Vrwm=10V, 88.2A, 1500W(1ms), Bidirectional	DO-214AB	1ba	1x,1y	Pjt,Srj
BDX	CD214C-T10CA	TVS	Vbr=10V, Irsm=88.2A, 1500W(1ms), Bidirectional	DO-214AB	1ba	1j	Bm
BDX	SM15T15CA	TVS	Vrwm=12.8V, Vbr=14.3..15.8V, 70.8A, 1500W(1ms), Bidirectional	DO-214AB	1ba	1r,1j	Ste
BDX	SMCG10CA	TVS	Vbr=10V, 88.2A, 1500W(1ms), Bidirectional	DO-215AB	5ba	1l	Vs
BDX	SMCJ10CA	TVS	Vrwm=10V, Vbr=11.1..12.8V, 88.2A, 1500W(1mS), Bidirectional	DO-214AB	1ba	1l,1x	Di,Vs
BDX	TFMCJ10CA	TVS	Vbr=10V, 88.2A, 1500W(1ms), Bidirectional	DO-214AB	1ba	1j	Rec
BDX	TV15C100JB-G	TVS	Vrwm=10.0V, Vbr=11.0..12.30V, Ipp=88.24A, 1500W(1ms), Bidirectional	DO-214AB	1ba	1j	Cmc
BDX7	SM15T12CA	TVS	Vrwm=10.2V, Vbr=11.4..12.6V, 90A, 1500W(1ms), Bidirectional	DO-214AB	1ba	1l	Vs
BDY	1.5SMCJ11C	TVS	Vrwm=11V, 74.6A, 1500W(1ms), Bidirectional	DO-214AB	1ba	1x,1y	Pjt,Srj
BDY	SMCG11C	TVS	Vbr=11V, 74.6A, 1500W(1ms), Bidirectional	DO-215AB	5ba	1l	Vs
BDY	SMCJ11C	TVS	Vrwm=11V, Vbr=12.2..14.9V, 74.6A, 1500W(1ms), Bidirectional	DO-214AB	1ba	1l	Vs
BDY	TFMCJ11C	TVS	Vbr=11V, 74.6A, 1500W(1ms), Bidirectional	DO-214AB	1ba	1j	Rec
BDY	TV15C110KB-G	TVS	Vrwm=11.0V, Vbr=12.20..14.90V, Ipp=74.63A, 1500W(1ms), Bidirectional	DO-214AB	1ba	1j	Cmc
BDZ	1.5SMCJ11CA	TVS	Vrwm=11V, 82.4A, 1500W(1ms), Bidirectional	DO-214AB	1ba	1x,1y	Pjt,Srj
BDZ	CD214C-T11CA	TVS	Vbr=11V, Irsm=82.4A, 1500W(1ms), Bidirectional	DO-214AB	1ba	1j	Bm
BDZ	SMCG11CA	TVS	Vbr=11V, 82.4A, 1500W(1ms), Bidirectional	DO-215AB	5ba	1l	Vs
BDZ	SMCJ11CA	TVS	Vrwm=11V, Vbr=12.2..14V, 82.4A, 1500W(1mS), Bidirectional	DO-214AB	1ba	1l,1x	Di,Vs
BDZ	TFMCJ11CA	TVS	Vbr=11V, 82.4A, 1500W(1ms), Bidirectional	DO-214AB	1ba	1j	Rec
BDZ	TV15C110JB-G	TVS	Vrwm=11.0V, Vbr=12.20..13.50V, Ipp=82.42A, 1500W(1ms), Bidirectional	DO-214AB	1ba	1j	Cmc
BE	BZT52H-C6V8	Z-diode	6.4..7.2V, Izt=5mA, Zzt=8Ω, 375mW	SOD-123FL	7d	1a	Phi
BE	BZX399-C6V8	Z-diode	6.8V±5%, 300mW	SOD-323	5d	1a	Phi
BE	BZX884-C8V2	Z-diode	8.2V±5%, 250mW	SOD-882	13d	2b	Phi
BE	CD214B-T12CA	TVS	Vbr=12V, Irsm=30.2A, 600W(1ms), Bidirectional	DO-214AA	1ba	1j	Bm
BE	MM1Z4680	Z-diode	2.09..2.31V, Izt=10mA, 500mW	SOD-123FL	7d	1a	Sme
BE	MMSZ4680	Z-diode	2.2V±5%, Izt=50μA, 500mW	SOD-123	5d	1a	Eic
BE	P4SMA18A	TVS	Vrwm=18V, 17A, 400W(1ms),	DO-214AC	1d	2j	Fag
BE	P4SMAJ12A	TVS	Vbr=12V, 20.1A, 400W(1ms)	DO-214AC	1d	1a	Mco
BE	P6SMBJ12AC	TVS	Vbr=12V, 30.2A, 600W(1ms), Bidirectional	DO-214AA	1ba	1x,1y	Pjt,Srj
BE	SC016-8	Si-diode	GP, Rectifier, 800V, 1A, Vf<1.1V(2A)	SOD-106	1d	1b	Fji
BE	SMAJ12A	TVS	Vrwm=12V, Vbr=13.3..14.7V, 20.1A, 400W(1ms)	DO-214AC	1d	1k	Vs
BE	SMBG12CA	TVS	Vbr=12V, 30.2A, 600W(1ms), Bidirectional	DO-215AA	5ba	1l	Vs
BE	SMBJ12CA	TVS	Vbr=12V, 30.2A, 600W(1ms), Bidirectional	DO-214AA	1ba	1l,1x	Di,Vs
BE	SMF12A	ESDP-diode	Vbr=13.3V, Vrwm=12V, Ipp=10..1A, 200W(1ms)	DO-219AB	7d	1i	Vs
BE	SMP12A	TVS	Vbr=13.3..14.7V, Vrwm=12V, Ipp=20..1A, 400W(1ms)	DO-220AA	8d	1a	Vs
BE	TV04A120J-G	TVS	Vrwm=12.0V, Vbr=13.30..14.70V, Ipp=20.10A, 400W(1ms)	DO-214AC	1d	1a	Cmc
BE	TV06B120JB-G	TVS	Vrwm=12.0V, Vbr=13.30..14.70V, Ipp=30.15A, 600W(1ms), Bidirectional	DO-214AA	1ba	1j	Cmc
BE	UDZ6V8B	Z-diode	6.8V±2.5%, Izt=5mA, 200mW	SOD-323	5d	1d	Di
BEA	TV15C190KB-G	TVS	Vrwm=19.0V, Vbr=21.13..25.76V, Ipp=44.10A, 1500W(1ms), Bidirectional	DO-214AB	1ba	1j	Cmc
BEB	TV15C190JB-G	TVS	Vrwm=19.0V, Vbr=21.10..23.30V, Ipp=48.73A, 1500W(1ms), Bidirectional	DO-214AB	1ba	1j	Cmc
BED	1.5SMCJ12C	TVS	Vrwm=12V, 68.2A, 1500W(1ms), Bidirectional	DO-214AB	1ba	1x,1y	Pjt,Srj
BED	SM15T18C	TVS	Vbr=17.1..18.9V, 59.5A, 1500W(1ms), Bidirectional	DO-214AB	1ba	1r	Ste
BED	SMCG12C	TVS	Vbr=12V, 68.2A, 1500W(1ms), Bidirectional	DO-215AB	5ba	1l	Vs
BED	SMCJ12C	TVS	Vrwm=12V, Vbr=13.3..15.3V, 68.2A, 1500W(1ms), Bidirectional	DO-214AB	1ba	1l	Vs
BED	TFMCJ12C	TVS	Vbr=12V, 68.2A, 1500W(1ms), Bidirectional	DO-214AB	1ba	1j	Rec
BED	TV15C120KB-G	TVS	Vrwm=12.0V, Vbr=13.30..16.30V, Ipp=68.18A, 1500W(1ms), Bidirectional	DO-214AB	1ba	1j	Cmc
BEE	1.5SMCJ12CA	TVS	Vrwm=12V, 75.3A, 1500W(1ms), Bidirectional	DO-214AB	1ba	1x,1y	Pjt,Srj
BEE	CD214C-T12CA	TVS	Vbr=12V, Irsm=75.3A, 1500W(1ms), Bidirectional	DO-214AB	1ba	1j	Bm
BEE	SM15T18CA	TVS	Vrwm=15.3V, Vbr=17.1..18.9V, 59.5A, 1500W(1ms), Bidirectional	DO-214AB	1ba	1r,1j	Ste
BEE	SMCG12CA	TVS	Vbr=12V, 75.4A, 1500W(1ms), Bidirectional	DO-215AB	5ba	1l	Vs
BEE	SMCJ12CA	TVS	Vrwm=12V, Vbr=13.3..15.3V, 75.3A, 1500W(1mS), Bidirectional	DO-214AB	1ba	1l,1x	Di,Vs
BEE	TFMCJ12CA	TVS	Vbr=12V, 75.4A, 1500W(1ms), Bidirectional	DO-214AB	1ba	1j	Rec
BEE	TV15C120JB-G	TVS	Vrwm=12.0V, Vbr=13.30..14.70V, Ipp=75.38A, 1500W(1ms), Bidirectional	DO-214AB	1ba	1j	Cmc
BEF	1.5SMCJ13C	TVS	Vrwm=13V, 63A, 1500W(1ms), Bidirectional	DO-214AB	1ba	1x,1y	Pjt,Srj
BEF	SMCG13C	TVS	Vbr=13V, 63A, 1500W(1ms), Bidirectional	DO-215AB	5ba	1l	Vs
BEF	SMCJ13C	TVS	Vrwm=13V, Vbr=14.4..16.5V, 63A, 1500W(1ms), Bidirectional	DO-214AB	1ba	1l	Vs
BEF	TFMCJ13C	TVS	Vbr=13V, 63A, 1500W(1ms), Bidirectional	DO-214AB	1ba	1j	Rec
BEF	TV15C130KB-G	TVS	Vrwm=13.0V, Vbr=14.40..17.60V, Ipp=63.03A, 1500W(1ms), Bidirectional	DO-214AB	1ba	1j	Cmc



SMD
code

Type

Function

Short description

Case

Pinout

St.

Mnf.

SMD code	Type	Function	Short description	Case	Pinout	St.	Mnf.
BEG	1.5SMCJ13CA	TVS	Vrwm=13V, 69.7A, 1500W(1ms), Bidirectional	DO-214AB	1ba	1x,1y	Pjt,Srj
BEG	CD214C-T13CA	TVS	Vbr=13V, Iism=69.7A, 1500W(1ms), Bidirectional	DO-214AB	1ba	1j	Bm
BEG	SMCG13CA	TVS	Vbr=13V, 69.8A, 1500W(1ms), Bidirectional	DO-215AB	5ba	1l	Vs
BEG	SMCJ13CA	TVS	Vrwm=13V, Vbr=14.4..16.5V, 69.8A, 1500W(1ms), Bidirectional	DO-214AB	1ba	1l,1x	Di,Vs
BEG	TFMCJ13CA	TVS	Vbr=13V, 69.8A, 1500W(1ms), Bidirectional	DO-214AB	1ba	1j	Rec
BEG	TV15C130JB-G	TVS	Vrwm=13.0V, Vbr=14.40..15.90V, Ipp=69.77A, 1500W(1ms), Bidirectional	DO-214AB	1ba	1j	Cmc
BEG7	SM15T15CA	TVS	Vrwm=12.8V, Vbr=14.3..15.8V, 71A, 1500W(1ms), Bidirectional	DO-214AB	1ba	1l	Vs
BEH	1.5SMCJ14C	TVS	Vrwm=14V, 58.1A, 1500W(1ms), Bidirectional	DO-214AB	1ba	1x,1y	Pjt,Srj
BEH	SM15T22C	TVS	Vbr=20.9..23.1V, 49A, 1500W(1ms), Bidirectional	DO-214AB	1ba	1r	Ste
BEH	SMCG14C	TVS	Vbr=14V, 58.1A, 1500W(1ms), Bidirectional	DO-215AB	5ba	1l	Vs
BEH	SMCJ14C	TVS	Vrwm=14V, Vbr=15.6..19.1V, 58.1A, 1500W(1ms), Bidirectional	DO-214AB	1ba	1l	Vs
BEH	TFMCJ14C	TVS	Vbr=14V, 58.1A, 1500W(1ms), Bidirectional	DO-214AB	1ba	1j	Rec
BEH	TV15C140KB-G	TVS	Vrwm=14.0V, Vbr=15.60..19.10V, Ipp=58.14A, 1500W(1ms), Bidirectional	DO-214AB	1ba	1j	Cmc
BEK	1.5SMCJ14CA	TVS	Vrwm=14V, 64.7A, 1500W(1ms), Bidirectional	DO-214AB	1ba	1x,1y	Pjt,Srj
BEK	CD214C-T14CA	TVS	Vbr=14V, Iism=64.7A, 1500W(1ms), Bidirectional	DO-214AB	1ba	1j	Bm
BEK	SM15T22CA	TVS	Vrwm=18.8V, Vbr=20.9..23.1V, 49A, 1500W(1ms), Bidirectional	DO-214AB	1ba	1r,1j	Ste
BEK	SMA18A	TVS	Vbr=17.1..18.9V, Vrwm=15.3V, 15.7A, 400W(1ms)	DO-214AC	1d	1a	Lge
BEK	SMCG14CA	TVS	Vbr=14V, 64.7A, 1500W(1ms), Bidirectional	DO-215AB	5ba	1l	Vs
BEK	SMCJ14CA	TVS	Vrwm=14V, Vbr=15.6..17.9V, 64.7A, 1500W(1ms), Bidirectional	DO-214AB	1ba	1l,1x	Di,Vs
BEK	TFMCJ14CA	TVS	Vbr=14V, 64.7A, 1500W(1ms), Bidirectional	DO-214AB	1ba	1j	Rec
BEK	TV15C140JB-G	TVS	Vrwm=14.0V, Vbr=15.60..17.20V, Ipp=64.66A, 1500W(1ms), Bidirectional	DO-214AB	1ba	1j	Cmc
BEL	1.5SMCJ15C	TVS	Vrwm=15V, 55.8A, 1500W(1ms), Bidirectional	DO-214AB	1ba	1x,1y	Pjt,Srj
BEL	SM15T24C	TVS	Vbr=22.8..25.2V, 45A, 1500W(1ms), Bidirectional	DO-214AB	1ba	1r	Ste
BEL	SMCG15C	TVS	Vbr=15V, 55.8A, 1500W(1ms), Bidirectional	DO-215AB	5ba	1l	Vs
BEL	SMCJ15C	TVS	Vrwm=15V, Vbr=16.7..19.2V, 55.8A, 1500W(1ms), Bidirectional	DO-214AB	1ba	1l	Vs
BEL	TFMCJ15C	TVS	Vbr=15V, 55.8A, 1500W(1ms), Bidirectional	DO-214AB	1ba	1j	Rec
BEL	TV15C150KB-G	TVS	Vrwm=15.0V, Vbr=16.70..20.40V, Ipp=55.76A, 1500W(1ms), Bidirectional	DO-214AB	1ba	1j	Cmc
BEM	1.5SMCJ15CA	TVS	Vrwm=15V, 61.5A, 1500W(1ms), Bidirectional	DO-214AB	1ba	1x,1y	Pjt,Srj
BEM	CD214C-T15CA	TVS	Vbr=15V, Iism=61.5A, 1500W(1ms), Bidirectional	DO-214AB	1ba	1j	Bm
BEM	SM15T24CA	TVS	Vrwm=20.5V, Vbr=22.8..25.2V, 45.2A, 1500W(1ms), Bidirectional	DO-214AB	1ba	1j	Ste
BEM	SMA18CA	TVS	Vbr=17.1..18.9V, Vrwm=15.3V, 15.7A, 400W(1ms), Bidirectional	DO-214AC	1ba	1j	Lge
BEM	SMCG15CA	TVS	Vbr=15V, 61.5A, 1500W(1ms), Bidirectional	DO-215AB	5ba	1l	Vs
BEM	SMCJ15CA	TVS	Vrwm=15V, Vbr=16.7..19.2V, 61.5A, 1500W(1ms), Bidirectional	DO-214AB	1ba	1l,1x	Di,Vs
BEM	TFMCJ15CA	TVS	Vbr=15V, 61.5A, 1500W(1ms), Bidirectional	DO-214AB	1ba	1j	Rec
BEM	TV15C150JB-G	TVS	Vrwm=15.0V, Vbr=16.70..18.50V, Ipp=61.48A, 1500W(1ms), Bidirectional	DO-214AB	1ba	1j	Cmc
BEM7	SM15T18CA	TVS	Vrwm=15.3V, Vbr=17.1..18.9V, 59.5A, 1500W(1ms), Bidirectional	DO-214AB	1ba	1k	Vs
BEN	1.5SMCJ16C	TVS	Vrwm=16V, 52.1A, 1500W(1ms), Bidirectional	DO-214AB	1ba	1x,1y	Pjt,Srj
BEN	SM15T27C	TVS	Vbr=25.7..28.4V, 40A, 1500W(1ms), Bidirectional	DO-214AB	1ba	1r	Ste
BEN	SMCG16C	TVS	Vbr=16V, 52.1A, 1500W(1ms), Bidirectional	DO-215AB	5ba	1l	Vs
BEN	SMCJ16C	TVS	Vrwm=16V, Vbr=17.8..19.7V, 52.1A, 1500W(1ms), Bidirectional	DO-214AB	1ba	1l	Vs
BEN	TFMCJ16C	TVS	Vbr=16V, 52.1A, 1500W(1ms), Bidirectional	DO-214AB	1ba	1j	Rec
BEN	TV15C160KB-G	TVS	Vrwm=16.0V, Vbr=17.80..21.80V, Ipp=52.08A, 1500W(1ms), Bidirectional	DO-214AB	1ba	1j	Cmc
BEP	1.5SMCJ16CA	TVS	Vrwm=16V, 57.7A, 1500W(1ms), Bidirectional	DO-214AB	1ba	1x,1y	Pjt,Srj
BEP	CD214C-T16CA	TVS	Vbr=16V, Iism=57.7A, 1500W(1ms), Bidirectional	DO-214AB	1ba	1j	Bm
BEP	SM15T27CA	TVS	Vrwm=23.1V, Vbr=25.7..28.4V, 40A, 1500W(1ms), Bidirectional	DO-214AB	1ba	1j	Ste
BEP	SMCG16CA	TVS	Vbr=16V, 57.7A, 1500W(1ms), Bidirectional	DO-215AB	5ba	1l	Vs
BEP	SMCJ16CA	TVS	Vrwm=16V, Vbr=17.8..19.7V, 57.7A, 1500W(1ms), Bidirectional	DO-214AB	1ba	1l,1x	Di,Vs
BEP	TFMCJ16CA	TVS	Vbr=16V, 57.7A, 1500W(1ms), Bidirectional	DO-214AB	1ba	1j	Rec
BEP	TPSMA18A	TVS	Vbr=18V, 15.9A, 400W(1ms)	DO-214AC	1d	1k	Vs
BEP	TPSP18A	TVS	Vbr=17.1..18.9V, Vrwm=15.3V, Ipp=15.9A, 400W(1ms)	DO-220AA	8d	1a	Vs
BEP	TV15C160JB-G	TVS	Vrwm=16.0V, Vbr=17.80..19.70V, Ipp=57.69A, 1500W(1ms), Bidirectional	DO-214AB	1ba	1j	Cmc
BEQ	1.5SMCJ17C	TVS	Vrwm=17V, 49.2A, 1500W(1ms), Bidirectional	DO-214AB	1ba	1x,1y	Pjt,Srj
BEQ	SM15T30C	TVS	Vrwm=25.6V, Vbr=28.5..31.5V, 36A, 1500W(1ms), Bidirectional	DO-214AB	1ba	1r	Ste
BEQ	SMCG17C	TVS	Vbr=17V, 49.2A, 1500W(1ms), Bidirectional	DO-215AB	5ba	1l	Vs
BEQ	SMCJ17C	TVS	Vrwm=17V, Vbr=18.9..21.7V, 49.2A, 1500W(1ms), Bidirectional	DO-214AB	1ba	1l	Vs
BEQ	TFMCJ17C	TVS	Vbr=17V, 49.2A, 1500W(1ms), Bidirectional	DO-214AB	1ba	1j	Rec
BEQ	TV15C170KB-G	TVS	Vrwm=17.0V, Vbr=18.90..23.10V, Ipp=49.18A, 1500W(1ms), Bidirectional	DO-214AB	1ba	1j	Cmc
BER	1.5SMCJ17CA	TVS	Vrwm=17V, 53.3A, 1500W(1ms), Bidirectional	DO-214AB	1ba	1x,1y	Pjt,Srj
BER	CD214C-T17CA	TVS	Vbr=17V, Iism=53.3A, 1500W(1ms), Bidirectional	DO-214AB	1ba	1j	Bm
BER	SM15T30CA	TVS	Vrwm=25.6V, Vbr=28.5..31.5V, 36.2A, 1500W(1ms), Bidirectional	DO-214AB	1ba	1j	Ste
BER	SMCG17CA	TVS	Vbr=17V, 54.3A, 1500W(1ms), Bidirectional	DO-215AB	5ba	1l	Vs
BER	SMCJ17CA	TVS	Vrwm=17V, Vbr=18.9..21.7V, 54.3A, 1500W(1ms), Bidirectional	DO-214AB	1ba	1l,1x	Di,Vs
BER	TFMCJ17CA	TVS	Vbr=17V, 54.3A, 1500W(1ms), Bidirectional	DO-214AB	1ba	1j	Rec
BER	TV15C170JB-G	TVS	Vrwm=17.0V, Vbr=18.90..20.90V, Ipp=54.35A, 1500W(1ms), Bidirectional	DO-214AB	1ba	1j	Cmc
BES	1.5SMCJ18C	TVS	Vrwm=18V, 46.6A, 1500W(1ms), Bidirectional	DO-214AB	1ba	1x,1y	Pjt,Srj
BES	SM15T33C	TVS	Vrwm=28.2V, Vbr=31.4..34.7V, 33A, 1500W(1ms), Bidirectional	DO-214AB	1ba	1r	Ste
BES	SMCG18C	TVS	Vbr=18V, 46.6A, 1500W(1ms), Bidirectional	DO-215AB	5ba	1l	Vs
BES	SMCJ18C	TVS	Vrwm=18V, Vbr=20..23.3V, 46.6A, 1500W(1ms), Bidirectional	DO-214AB	1ba	1l	Vs
BES	TFMCJ18C	TVS	Vbr=18V, 46.6A, 1500W(1ms), Bidirectional	DO-214AB	1ba	1j	Rec
BES	TV15C180KB-G	TVS	Vrwm=18.0V, Vbr=20.0..24.40V, Ipp=46.58A, 1500W(1ms), Bidirectional	DO-214AB	1ba	1j	Cmc



SMD code	Type	Function	Short description	Case	Pinout	St.	Mnf.
BET	1.5SMCJ18CA	TVS	Vrwm=18V, 51.4A, 1500W(1ms), Bidirectional	DO-214AB	1ba	1x,1y	Pjt,Srj
BET	CD214C-T18CA	TVS	Vbr=18V, Irlsm=51.4A, 1500W(1ms), Bidirectional	DO-214AB	1ba	1j	Bm
BET	SM15T33CA	TVS	Vrwm=28.2V, Vbr=31.4..34.7V, 32.8A, 1500W(1ms), Bidirectional	DO-214AB	1ba	1j	Ste
BET	SMCG18CA	TVS	Vbr=18V, 51.4A, 1500W(1ms), Bidirectional	DO-215AB	5ba	1l	Vs
BET	SMCJ18CA	TVS	Vrwm=18V, Vbr=20..23.3V, 51.4A, 1500W(1ms), Bidirectional	DO-214AB	1ba	1l,1x	Di,Vs
BET	TFMCJ18CA	TVS	Vbr=18V, 51.4A, 1500W(1ms), Bidirectional	DO-214AB	1ba	1j	Rec
BET	TV15C180JB-G	TVS	Vrwm=18.0V, Vbr=20.0..22.10V, Ipp=51.37A, 1500W(1ms), Bidirectional	DO-214AB	1ba	1j	Cmc
BET7	SM15T22CA	TVS	Vrwm=18.8V, Vbr=20.9..23.1V, 49A, 1500W(1ms), Bidirectional	DO-214AB	1ba	1l	Vs
BEU	1.5SMCJ20C	TVS	Vrwm=20V, 41.9A, 1500W(1ms), Bidirectional	DO-214AB	1ba	1x,1y	Pjt,Srj
BEU	SM15T36C	TVS	Vbr=34.2..37.8V, 30A, 1500W(1ms), Bidirectional	DO-214AB	1ba	1r	Ste
BEU	SMCG20C	TVS	Vbr=20V, 41.9A, 1500W(1ms), Bidirectional	DO-215AB	5ba	1l	Vs
BEU	SMCJ20C	TVS	Vrwm=20V, Vbr=22.2..25.5V, 41.9A, 1500W(1ms), Bidirectional	DO-214AB	1ba	1l	Vs
BEU	TFMCJ20C	TVS	Vbr=20V, 41.9A, 1500W(1ms), Bidirectional	DO-214AB	1ba	1j	Rec
BEU	TV15C200KB-G	TVS	Vrwm=20.0V, Vbr=22.20..27.10V, Ipp=41.90A, 1500W(1ms), Bidirectional	DO-214AB	1ba	1j	Cmc
BEV	1.5SMCJ20CA	TVS	Vrwm=20V, 46.3A, 1500W(1ms), Bidirectional	DO-214AB	1ba	1x,1y	Pjt,Srj
BEV	CD214C-T20CA	TVS	Vbr=20V, Irlsm=46.3A, 1500W(1ms), Bidirectional	DO-214AB	1ba	1j	Bm
BEV	SM15T36CA	TVS	Vrwm=30.8V, Vbr=34.2..37.8V, 30.1A, 1500W(1ms), Bidirectional	DO-214AB	1ba	1j	Ste
BEV	SMCG20CA	TVS	Vbr=20V, 46.3A, 1500W(1ms), Bidirectional	DO-215AB	5ba	1l	Vs
BEV	SMCJ20CA	TVS	Vrwm=20V, Vbr=22.2..25.5V, 46.3A, 1500W(1ms), Bidirectional	DO-214AB	1ba	1l,1x	Di,Vs
BEV	TFMCJ20CA	TVS	Vbr=20V, 46.3A, 1500W(1ms), Bidirectional	DO-214AB	1ba	1j	Rec
BEV	TV15C200JB-G	TVS	Vrwm=20.0V, Vbr=22.20..24.50V, Ipp=46.30A, 1500W(1ms), Bidirectional	DO-214AB	1ba	1j	Cmc
BEV7	SM15T24CA	TVS	Vrwm=20.5V, Vbr=22.8..25.2V, 45A, 1500W(1ms), Bidirectional	DO-214AB	1ba	1l	Vs
BEW	1.5SMCJ22C	TVS	Vrwm=22V, 38.1A, 1500W(1ms), Bidirectional	DO-214AB	1ba	1x,1y	Pjt,Srj
BEW	SM15T39C	TVS	Vbr=37.1..41V, 28A, 1500W(1ms), Bidirectional	DO-214AB	1ba	1r	Ste
BEW	SMCG22C	TVS	Vbr=22V, 38.1A, 1500W(1ms), Bidirectional	DO-215AB	5ba	1l	Vs
BEW	SMCJ22C	TVS	Vrwm=22V, Vbr=24.4..28V, 38.1A, 1500W(1ms), Bidirectional	DO-214AB	1ba	1l	Vs
BEW	TFMCJ22C	TVS	Vbr=22V, 38.1A, 1500W(1ms), Bidirectional	DO-214AB	1ba	1j	Rec
BEW	TV15C220KB-G	TVS	Vrwm=22.0V, Vbr=24.40..29.80V, Ipp=38.07A, 1500W(1ms), Bidirectional	DO-214AB	1ba	1j	Cmc
BEX	1.5SMCJ22CA	TVS	Vrwm=22V, 42.2A, 1500W(1ms), Bidirectional	DO-214AB	1ba	1x,1y	Pjt,Srj
BEX	CD214C-T22CA	TVS	Vbr=22V, Irlsm=42.2A, 1500W(1ms), Bidirectional	DO-214AB	1ba	1j	Bm
BEX	SM15T39CA	TVS	Vrwm=33.3V, Vbr=37.1..41V, 27.8A, 1500W(1ms), Bidirectional	DO-214AB	1ba	1j	Ste
BEX	SMCG22CA	TVS	Vbr=22V, 42.3A, 1500W(1ms), Bidirectional	DO-215AB	5ba	1l	Vs
BEX	SMCJ22CA	TVS	Vrwm=22V, Vbr=24.4..28V, 42.3A, 1500W(1ms), Bidirectional	DO-214AB	1ba	1l,1x	Di,Vs
BEX	TFMCJ22CA	TVS	Vbr=22V, 42.3A, 1500W(1ms), Bidirectional	DO-214AB	1ba	1j	Rec
BEX	TV15C220JB-G	TVS	Vrwm=22.0V, Vbr=24.40..26.90V, Ipp=42.25A, 1500W(1ms), Bidirectional	DO-214AB	1ba	1j	Cmc
BEX7	SM15T27CA	TVS	Vrwm=23.1V, Vbr=25.7..28.4V, 40A, 1500W(1ms), Bidirectional	DO-214AB	1ba	1l	Vs
BEY	1.5SMCJ24C	TVS	Vrwm=24V, 34.9A, 1500W(1ms), Bidirectional	DO-214AB	1ba	1x,1y	Pjt,Srj
BEY	SMCG24C	TVS	Vbr=24V, 34.9A, 1500W(1ms), Bidirectional	DO-215AB	5ba	1l	Vs
BEY	SMCJ24C	TVS	Vrwm=24V, Vbr=26.7..30.7V, 34.9A, 1500W(1ms), Bidirectional	DO-214AB	1ba	1l	Vs
BEY	TFMCJ24C	TVS	Vbr=24V, 34.9A, 1500W(1ms), Bidirectional	DO-214AB	1ba	1j	Rec
BEY	TV15C240KB-G	TVS	Vrwm=24.0V, Vbr=26.70..32.60V, Ipp=34.88A, 1500W(1ms), Bidirectional	DO-214AB	1ba	1j	Cmc
BEZ	1.5SMCJ24CA	TVS	Vrwm=24V, 38.6A, 1500W(1ms), Bidirectional	DO-214AB	1ba	1x,1y	Pjt,Srj
BEZ	CD214C-T24CA	TVS	Vbr=24V, Irlsm=38.6A, 1500W(1ms), Bidirectional	DO-214AB	1ba	1j	Bm
BEZ	SMCG24CA	TVS	Vbr=24V, 38.6A, 1500W(1ms), Bidirectional	DO-215AB	5ba	1l	Vs
BEZ	SMCJ24CA	TVS	Vrwm=24V, Vbr=26.7..30.7V, 38.6A, 1500W(1ms), Bidirectional	DO-214AB	1ba	1l,1x	Di,Vs
BEZ	TFMCJ24CA	TVS	Vbr=24V, 38.6A, 1500W(1ms), Bidirectional	DO-214AB	1ba	1j	Rec
BEZ	TV15C240JB-G	TVS	Vrwm=24.0V, Vbr=26.70..29.50V, Ipp=38.56A, 1500W(1ms), Bidirectional	DO-214AB	1ba	1j	Cmc
BF	BZT52-C7V5S	Z-diode	7.5V±5%, Izt=5mA, Zzt=15Ω, 200mW	SOD-323	5d	1d	Di
BF	BZT52H-C7V5	Z-diode	7.0..7.9V, Izt=5mA, Zzt=10Ω, 375mW	SOD-123FL	7d	1a	Phi
BF	BZX399-C7V5	Z-diode	7.5V±5%, 300mW	SOD-323	5d	1a	Phi
BF	BZX884-C9V1	Z-diode	9.1V±5%, 250mW	SOD-882	13d	2b	Phi
BF	KDZ6.8FV	Z-diode	6.40..7.20V, Izt=5mA, Zzt=25Ω, 100mW	TFSC	7d	1a	Kec
BF	MAZD051	Z-diode	4.8..5.4V, Zzt=60Ω(5mA), 120mW	SSSMini2	7d	1a	Pan
BF	MM1Z4681	Z-diode	2.28..2.52V, Izt=10mA, 500mW	SOD-123FL	7d	1a	Sme
BF	MMSZ4681	Z-diode	2.4V±5%, Izt=50μA, 500mW	SOD-123	5d	1a	Eic
BF	P4SMA20	TVS	Vrwm=20V, 14A, 400W(1ms)	DO-214AC	1d	2j	Fag
BF	P6SMBJ13C	TVS	Vbr=13V, 25.2A, 600W(1ms), Bidirectional	DO-214AA	1ba	1x,1y	Pjt,Srj
BF	SMAJ13	TVS	Vrwm=13V, Vbr=14.4..17.6V, 16.8A, 400W(1ms)	DO-214AC	1d	1k	Vs
BF	SMBG13C	TVS	Vbr=13V, 25.2A, 600W(1ms), Bidirectional	DO-215AA	5ba	1l	Vs
BF	SMBJ13C	TVS	Vbr=13V, 25.2A, 600W(1ms), Bidirectional	DO-214AA	1ba	1l	Vs
BF	SMP13	TVS	Vbr=14.4..17.6V, Vrwm=13V, Ipp=16.8A, 400W(1ms)	DO-220AA	8d	1a	Vs
BF	TV04A130K-G	TVS	Vrwm=13.0V, Vbr=14.40..17.60V, Ipp=16.81A, 400W(1ms)	DO-214AC	1d	1a	Cmc
BF	TV06B130KB-G	TVS	Vrwm=13.0V, Vbr=14.40..17.60V, Ipp=25.21A, 600W(1ms), Bidirectional	DO-214AA	1ba	1j	Cmc
BF	UDZ7V5B	Z-diode	7.5V±2.5%, Izt=5mA, 200mW	SOD-323	5d	1d	Di
BFD	1.5SMCJ26C	TVS	Vrwm=26V, 32.2A, 1500W(1ms), Bidirectional	DO-214AB	1ba	1x,1y	Pjt,Srj
BFD	SMCG26C	TVS	Vbr=26V, 32.2A, 1500W(1ms), Bidirectional	DO-215AB	5ba	1l	Vs
BFD	SMCJ26C	TVS	Vrwm=26V, Vbr=28.9..33.2V, 32.2A, 1500W(1ms), Bidirectional	DO-214AB	1ba	1l	Vs
BFD	TFMCJ26C	TVS	Vbr=26V, 32.2A, 1500W(1ms), Bidirectional	DO-214AB	1ba	1j	Rec
BFD	TV15C260KB-G	TVS	Vrwm=26.0V, Vbr=28.90..35.30V, Ipp=32.19A, 1500W(1ms), Bidirectional	DO-214AB	1ba	1j	Cmc
BFE	1.5SMCJ26CA	TVS	Vrwm=26V, 35.6A, 1500W(1ms), Bidirectional	DO-214AB	1ba	1x,1y	Pjt,Srj



SMD
code

Type

Function

Short description

Case

Pinout

St.

Mnf.

SMD code	Type	Function	Short description	Case	Pinout	St.	Mnf.
BFE	CD214C-T26CA	TVS	Vbr=26V, I _{rsm} =35.6A, 1500W(1ms), Bidirectional	DO-214AB	1ba	1j	Bm
BFE	SMCG26CA	TVS	Vbr=26V, 35.6A, 1500W(1ms), Bidirectional	DO-215AB	5ba	1l	Vs
BFE	SMCJ26CA	TVS	V _{rwm} =26V, Vbr=28.9..33.2V, 35.6A, 1500W(1ms), Bidirectional	DO-214AB	1ba	1l,1x	Di,Vs
BFE	TFMCJ26CA	TVS	Vbr=26V, 35.6A, 1500W(1ms), Bidirectional	DO-214AB	1ba	1j	Rec
BFE	TV15C260JB-G	TVS	V _{rwm} =26.0V, Vbr=28.90..31.90V, I _{pp} =35.63A, 1500W(1ms), Bidirectional	DO-214AB	1ba	1j	Cmc
BFE7	SM15T30CA	TVS	V _{rwm} =25.6V, Vbr=28.5..31.5V, 36A, 1500W(1ms), Bidirectional	DO-214AB	1ba	1l	Vs
BFF	1.5SMCJ28C	TVS	V _{rwm} =28V, 30A, 1500W(1ms), Bidirectional	DO-214AB	1ba	1x,1y	Pjt,Srj
BFF	SMCG28C	TVS	Vbr=28V, 30A, 1500W(1ms), Bidirectional	DO-215AB	5ba	1l	Vs
BFF	SMCJ28C	TVS	V _{rwm} =28V, Vbr=31.1..35.8V, 30A, 1500W(1ms), Bidirectional	DO-214AB	1ba	1l	Vs
BFF	TFMCJ28C	TVS	Vbr=28V, 30A, 1500W(1ms), Bidirectional	DO-214AB	1ba	1j	Rec
BFF	TV15C280KB-G	TVS	V _{rwm} =28.0V, Vbr=31.0..38.0V, I _{pp} =30.0A, 1500W(1ms), Bidirectional	DO-214AB	1ba	1j	Cmc
BFG	1.5SMCJ28CA	TVS	V _{rwm} =28V, 33A, 1500W(1ms), Bidirectional	DO-214AB	1ba	1x,1y	Pjt,Srj
BFG	CD214C-T28CA	TVS	Vbr=28V, I _{rsm} =33A, 1500W(1ms), Bidirectional	DO-214AB	1ba	1j	Bm
BFG	SMCG28CA	TVS	Vbr=28V, 33A, 1500W(1ms), Bidirectional	DO-215AB	5ba	1l	Vs
BFG	SMCJ28CA	TVS	V _{rwm} =28V, Vbr=31.1..35.8V, 33A, 1500W(1ms), Bidirectional	DO-214AB	1ba	1l,1x	Di,Vs
BFG	TFMCJ28CA	TVS	Vbr=28V, 33A, 1500W(1ms), Bidirectional	DO-214AB	1ba	1j	Rec
BFG	TV15C280JB-G	TVS	V _{rwm} =28.0V, Vbr=31.0..34.0V, I _{pp} =33.04A, 1500W(1ms), Bidirectional	DO-214AB	1ba	1j	Cmc
BFG7	SM15T33CA	TVS	V _{rwm} =28.2V, Vbr=31.4..34.7V, 33A, 1500W(1ms), Bidirectional	DO-214AB	1ba	1l	Vs
BFH	1.5SMCJ30C	TVS	V _{rwm} =30V, 28A, 1500W(1ms), Bidirectional	DO-214AB	1ba	1x,1y	Pjt,Srj
BFH	SMCG30C	TVS	Vbr=30V, 28A, 1500W(1ms), Bidirectional	DO-215AB	5ba	1l	Vs
BFH	SMCJ30C	TVS	V _{rwm} =30V, Vbr=33.3..38.3V, 28A, 1500W(1ms), Bidirectional	DO-214AB	1ba	1l	Vs
BFH	TFMCJ30C	TVS	Vbr=30V, 28A, 1500W(1ms), Bidirectional	DO-214AB	1ba	1j	Rec
BFH	TV15C300KB-G	TVS	V _{rwm} =30.0V, Vbr=33.30..40.70V, I _{pp} =28.04A, 1500W(1ms), Bidirectional	DO-214AB	1ba	1j	Cmc
BFK	1.5SMCJ30CA	TVS	V _{rwm} =30V, 31A, 1500W(1ms), Bidirectional	DO-214AB	1ba	1x,1y	Pjt,Srj
BFK	CD214C-T30CA	TVS	Vbr=30V, I _{rsm} =31A, 1500W(1ms), Bidirectional	DO-214AB	1ba	1j	Bm
BFK	SMA20	TVS	Vbr=18.0..22.0V, V _{rwm} =16.2V, 13.7A, 400W(1ms)	DO-214AC	1d	1a	Lge
BFK	SMCG30CA	TVS	Vbr=30V, 31A, 1500W(1ms), Bidirectional	DO-215AB	5ba	1l	Vs
BFK	SMCJ30CA	TVS	V _{rwm} =30V, Vbr=33.3..38.3V, 31A, 1500W(1ms), Bidirectional	DO-214AB	1ba	1l,1x	Di,Vs
BFK	TFMCJ30CA	TVS	Vbr=30V, 31A, 1500W(1ms), Bidirectional	DO-214AB	1ba	1j	Rec
BFK	TV15C300JB-G	TVS	V _{rwm} =30.0V, Vbr=33.30..36.80V, I _{pp} =30.99A, 1500W(1ms), Bidirectional	DO-214AB	1ba	1j	Cmc
BFK7	SM15T36CA	TVS	V _{rwm} =30.8V, Vbr=34.2..37.8V, 30A, 1500W(1ms)	DO-214AB	1d	1k	Vs
BFL	1.5SMCJ33C	TVS	V _{rwm} =33V, 25.2A, 1500W(1ms), Bidirectional	DO-214AB	1ba	1x,1y	Pjt,Srj
BFL	SMCG33C	TVS	Vbr=33V, 25.4A, 1500W(1ms), Bidirectional	DO-215AB	5ba	1l	Vs
BFL	SMCJ33C	TVS	V _{rwm} =33V, Vbr=36.7..44.9V, 25.4A, 1500W(1ms), Bidirectional	DO-214AB	1ba	1l	Vs
BFL	TFMCJ33C	TVS	Vbr=33V, 25.4A, 1500W(1ms), Bidirectional	DO-214AB	1ba	1j	Rec
BFL	TV15C330KB-G	TVS	V _{rwm} =33.0V, Vbr=36.7..44.9V, I _{pp} =25.2A, 1500W(1ms), Bidirectional	DO-214AB	1ba	1j	Cmc
BFM	1.5SMCJ33CA	TVS	V _{rwm} =33V, 28.1A, 1500W(1ms), Bidirectional	DO-214AB	1ba	1x,1y	Pjt,Srj
BFM	CD214C-T33CA	TVS	Vbr=33V, I _{rsm} =28.1A, 1500W(1ms), Bidirectional	DO-214AB	1ba	1j	Bm
BFM	SMA20C	TVS	Vbr=18.0..22.0V, V _{rwm} =16.2V, 13.7A, 400W(1ms), Bidirectional	DO-214AC	1ba	1j	Lge
BFM	SMCG33CA	TVS	Vbr=33V, 28.1A, 1500W(1ms), Bidirectional	DO-215AB	5ba	1l	Vs
BFM	SMCJ33CA	TVS	V _{rwm} =33V, Vbr=36.7..44.9V, 28.1A, 1500W(1ms), Bidirectional	DO-214AB	1ba	1l,1x	Di,Vs
BFM	TFMCJ33CA	TVS	Vbr=33V, 28.1A, 1500W(1ms), Bidirectional	DO-214AB	1ba	1j	Rec
BFM	TV15C330JB-G	TVS	V _{rwm} =33.0V, Vbr=36.7..40.6V, I _{pp} =28.1A, 1500W(1ms), Bidirectional	DO-214AB	1ba	1j	Cmc
BFM7	SM15T39CA	TVS	V _{rwm} =33.3V, Vbr=37.1..41V, 28A, 1500W(1ms), Bidirectional	DO-214AB	1ba	1l	Vs
BFN	1.5SMCJ36C	TVS	V _{rwm} =36V, 23.3A, 1500W(1ms), Bidirectional	DO-214AB	1ba	1x,1y	Pjt,Srj
BFN	SM15T68C	TVS	Vbr=64.6..71.4V, 16.3A, 1500W(1ms), Bidirectional	DO-214AB	1ba	1r	Ste
BFN	SMCG36C	TVS	Vbr=36V, 23.3A, 1500W(1ms), Bidirectional	DO-215AB	5ba	1l	Vs
BFN	SMCJ36C	TVS	V _{rwm} =36V, Vbr=40..46V, 23.3A, 1500W(1ms), Bidirectional	DO-214AB	1ba	1l	Vs
BFN	TFMCJ36C	TVS	Vbr=36V, 23.3A, 1500W(1ms), Bidirectional	DO-214AB	1ba	1j	Rec
BFN	TV15C360KB-G	TVS	V _{rwm} =36.0V, Vbr=40.0..48.90V, I _{pp} =23.33A, 1500W(1ms), Bidirectional	DO-214AB	1ba	1j	Cmc
BFP	1.5SMCJ36CA	TVS	V _{rwm} =36V, 25.8A, 1500W(1ms), Bidirectional	DO-214AB	1ba	1x,1y	Pjt,Srj
BFP	CD214C-T36CA	TVS	Vbr=36V, I _{rsm} =25.8A, 1500W(1ms), Bidirectional	DO-214AB	1ba	1j	Bm
BFP	SM15T68CA	TVS	V _{rwm} =58.1V, Vbr=64.6..71.4V, 16.3A, 1500W(1ms), Bidirectional	DO-214AB	1ba	1j	Ste
BFP	SMCG36CA	TVS	Vbr=36V, 25.8A, 1500W(1ms), Bidirectional	DO-215AB	5ba	1l	Vs
BFP	SMCJ36CA	TVS	V _{rwm} =36V, Vbr=40..46V, 25.8A, 1500W(1ms), Bidirectional	DO-214AB	1ba	1l,1x	Di,Vs
BFP	TFMCJ36CA	TVS	Vbr=36V, 25.8A, 1500W(1ms), Bidirectional	DO-214AB	1ba	1j	Rec
BFP	TPSMA20	TVS	Vbr=20V, 13.7A, 400W(1ms)	DO-214AC	1d	1k	Vs
BFP	TPSMP20	TVS	Vbr=18.0..22.0V, V _{rwm} =16.2V, I _{pp} =13.7A, 400W(1ms)	DO-220AA	8d	1a	Vs
BFP	TV15C360JB-G	TVS	V _{rwm} =36.0V, Vbr=40.0..44.20V, I _{pp} =25.82A, 1500W(1ms), Bidirectional	DO-214AB	1ba	1j	Cmc
BFQ	1.5SMCJ40C	TVS	V _{rwm} =40V, 21A, 1500W(1ms), Bidirectional	DO-214AB	1ba	1x,1y	Pjt,Srj
BFQ	SMCG40C	TVS	Vbr=40V, 21A, 1500W(1ms), Bidirectional	DO-215AB	5ba	1l	Vs
BFQ	SMCJ40C	TVS	V _{rwm} =40V, Vbr=44.4..51.1V, 21A, 1500W(1ms), Bidirectional	DO-214AB	1ba	1l	Vs
BFQ	TFMCJ40C	TVS	Vbr=40V, 21A, 1500W(1ms), Bidirectional	DO-214AB	1ba	1j	Rec
BFQ	TV15C400KB-G	TVS	V _{rwm} =40.0V, Vbr=44.40..54.30V, I _{pp} =21.01A, 1500W(1ms), Bidirectional	DO-214AB	1ba	1j	Cmc
BFR	1.5SMCJ40CA	TVS	V _{rwm} =40V, 23.2A, 1500W(1ms), Bidirectional	DO-214AB	1ba	1x,1y	Pjt,Srj
BFR	CD214C-T40CA	TVS	Vbr=40V, I _{rsm} =23.3A, 1500W(1ms), Bidirectional	DO-214AB	1ba	1j	Bm
BFR	SMCG40CA	TVS	Vbr=40V, 23.3A, 1500W(1ms), Bidirectional	DO-215AB	5ba	1l	Vs
BFR	SMCJ40CA	TVS	V _{rwm} =40V, Vbr=44.4..51.1V, 23.3A, 1500W(1ms), Bidirectional	DO-214AB	1ba	1l,1x	Di,Vs
BFR	TFMCJ40CA	TVS	Vbr=40V, 23.3A, 1500W(1ms), Bidirectional	DO-214AB	1ba	1j	Rec
BFR	TV15C400JB-G	TVS	V _{rwm} =40.0V, Vbr=44.40..49.10V, I _{pp} =23.26A, 1500W(1ms), Bidirectional	DO-214AB	1ba	1j	Cmc



SMD
code

Type

Function

Short description

Case

Pinout

St.

Mnf.

BFS	1.5SMCJ43C	TVS	Vrwm=43V, 19.6A, 1500W(1ms), Bidirectional	DO-214AB	1ba	1x,1y	Pjt,Srj
BFS	SMCG43C	TVS	Vbr=43V, 19.6A, 1500W(1ms), Bidirectional	DO-215AB	5ba	1l	Vs
BFS	SMCJ43C	TVS	Vrwm=43V, Vbr=47.8..54.9V, 19.6A, 1500W(1ms), Bidirectional	DO-214AB	1ba	1l	Vs
BFS	TFMCJ43C	TVS	Vbr=43V, 19.6A, 1500W(1ms), Bidirectional	DO-214AB	1ba	1j	Rec
BFS	TV15C430KB-G	TVS	Vrwm=43.0V, Vbr=47.80..58.40V, Ipp=19.56A, 1500W(1ms), Bidirectional	DO-214AB	1ba	1j	Cmc
BFT	1.5SMCJ43CA	TVS	Vrwm=43V, 21.6A, 1500W(1ms), Bidirectional	DO-214AB	1ba	1x,1y	Pjt,Srj
BFT	CD214C-T43CA	TVS	Vbr=43V, Irlsm=21.6A, 1500W(1ms), Bidirectional	DO-214AB	1ba	1j	Bm
BFT	SMCG43CA	TVS	Vbr=43V, 21.6A, 1500W(1ms), Bidirectional	DO-215AB	5ba	1l	Vs
BFT	SMCJ43CA	TVS	Vrwm=43V, Vbr=47.8..54.9V, 21.6A, 1500W(1ms), Bidirectional	DO-214AB	1ba	1l,1x	Di,Vs
BFT	TFMCJ43CA	TVS	Vbr=43V, 21.6A, 1500W(1ms), Bidirectional	DO-214AB	1ba	1j	Rec
BFT	TV15C430JB-G	TVS	Vrwm=43.0V, Vbr=47.80..52.80V, Ipp=21.61A, 1500W(1ms), Bidirectional	DO-214AB	1ba	1j	Cmc
BFU	1.5SMCJ45C	TVS	Vrwm=45V, 18.7A, 1500W(1ms), Bidirectional	DO-214AB	1ba	1x,1y	Pjt,Srj
BFU	SMCG45C	TVS	Vbr=45V, 18.7A, 1500W(1ms), Bidirectional	DO-215AB	5ba	1l	Vs
BFU	SMCJ45C	TVS	Vrwm=45V, Vbr=50.57..5V, 18.7A, 1500W(1ms), Bidirectional	DO-214AB	1ba	1l	Vs
BFU	TFMCJ45C	TVS	Vbr=45V, 18.7A, 1500W(1ms), Bidirectional	DO-214AB	1ba	1j	Rec
BFU	TV15C450KB-G	TVS	Vrwm=45.0V, Vbr=50.0..61..10V, Ipp=18.68A, 1500W(1ms), Bidirectional	DO-214AB	1ba	1j	Cmc
BFV	1.5SMCJ45CA	TVS	Vrwm=45V, 20.6A, 1500W(1ms), Bidirectional	DO-214AB	1ba	1x,1y	Pjt,Srj
BFV	CD214C-T45CA	TVS	Vbr=45V, Irlsm=20.6A, 1500W(1ms), Bidirectional	DO-214AB	1ba	1j	Bm
BFV	SMCG45CA	TVS	Vbr=45V, 20.6A, 1500W(1ms), Bidirectional	DO-215AB	5ba	1l	Vs
BFV	SMCJ45CA	TVS	Vrwm=45V, Vbr=50.57..5V, 20.6A, 1500W(1ms), Bidirectional	DO-214AB	1ba	1l,1x	Di,Vs
BFV	TFMCJ45CA	TVS	Vbr=45V, 20.6A, 1500W(1ms), Bidirectional	DO-214AB	1ba	1j	Rec
BFV	TV15C450JB-G	TVS	Vrwm=45.0V, Vbr=50.0..55.30V, Ipp=20.63A, 1500W(1ms), Bidirectional	DO-214AB	1ba	1j	Cmc
BFW	1.5SMCJ48C	TVS	Vrwm=48V, 17.5A, 1500W(1ms), Bidirectional	DO-214AB	1ba	1x,1y	Pjt,Srj
BFW	SM15T100C	TVS	Vrwm=85.5V, Vbr=95..105V, 11A, 1500W(1ms), Bidirectional	DO-214AB	1ba	1r	Ste
BFW	SMCG48C	TVS	Vbr=48V, 17.5A, 1500W(1ms), Bidirectional	DO-215AB	5ba	1l	Vs
BFW	SMCJ48C	TVS	Vrwm=48V, Vbr=53.3..61.3V, 17.5A, 1500W(1ms), Bidirectional	DO-214AB	1ba	1l	Vs
BFW	TFMCJ48C	TVS	Vbr=48V, 17.5A, 1500W(1ms), Bidirectional	DO-214AB	1ba	1j	Rec
BFW	TV15C480KB-G	TVS	Vrwm=48.0V, Vbr=53.30..65.10V, Ipp=17.54A, 1500W(1ms), Bidirectional	DO-214AB	1ba	1j	Cmc
BFX	1.5SMCJ48CA	TVS	Vrwm=48V, 19.4A, 1500W(1ms), Bidirectional	DO-214AB	1ba	1x,1y	Pjt,Srj
BFX	CD214C-T48CA	TVS	Vbr=48V, Irlsm=19.4A, 1500W(1ms), Bidirectional	DO-214AB	1ba	1j	Bm
BFX	SM15T100CA	TVS	Vrwm=85.5V, Vbr=95..105V, 11A, 1500W(1ms), Bidirectional	DO-214AB	1ba	1r,1j	Ste
BFX	SMCG48CA	TVS	Vbr=48V, 19.4A, 1500W(1ms), Bidirectional	DO-215AB	5ba	1l	Vs
BFX	SMCJ48CA	TVS	Vrwm=48V, Vbr=53.3..61.3V, 19.4A, 1500W(1ms), Bidirectional	DO-214AB	1ba	1l,1x	Di,Vs
BFX	TFMCJ48CA	TVS	Vbr=48V, 19.4A, 1500W(1ms), Bidirectional	DO-214AB	1ba	1j	Rec
BFX	TV15C480JB-G	TVS	Vrwm=48.0V, Vbr=53.30..58.90V, Ipp=19.38A, 1500W(1ms), Bidirectional	DO-214AB	1ba	1j	Cmc
BFY	1.5SMCJ51C	TVS	Vrwm=51V, 18.5A, 1500W(1ms), Bidirectional	DO-214AB	1ba	1x,1y	Pjt,Srj
BFY	TV15C510KB-G	TVS	Vrwm=51.0V, Vbr=56.70..69.30V, Ipp=16.47A, 1500W(1ms), Bidirectional	DO-214AB	1ba	1j	Cmc
BFZ	1.5SMCJ51CA	TVS	Vrwm=51V, 18.2A, 1500W(1ms), Bidirectional	DO-214AB	1ba	1x,1y	Pjt,Srj
BFZ	CD214C-T51CA	TVS	Vbr=51V, Irlsm=18.2A, 1500W(1ms), Bidirectional	DO-214AB	1ba	1j	Bm
BFZ	SMCJ51CA	TVS	Vrwm=51V, Vbr=56.7..65.2V, 18.2A, 1500W(1ms), Bidirectional	DO-214AB	1ba	1x	Di
BFZ	TV15C510JB-G	TVS	Vrwm=51.0V, Vbr=56.70..62.70V, Ipp=18.20A, 1500W(1ms), Bidirectional	DO-214AB	1ba	1j	Cmc
BG	BZT52H-C8V2	Z-diode	7.7..8.7V, Izt=5mA, Zzt=10Q, 375mW	SOD-123FL	7d	1a	Phi
BG	BZX399-C8V2	Z-diode	8.2V±5%, 300mW	SOD-323	5d	1a	Phi
BG	BZX884-C10	Z-diode	10V±5%, 250mW	SOD-882	13d	2b	Phi
BG	CD214B-T133CA	TVS	Vbr=13V, Irlsm=27.9A, 600W(1ms), Bidirectional	DO-214AA	1ba	1j	Bm
BG	P4SMA20A	TVS	Vrwm=20V, 15A, 400W(1ms),	DO-214AC	1d	2j	Fag
BG	P4SMAJ13A	TVS	Vbr=13V, 18.6A, 400W(1ms)	DO-214AC	1d	1a	Mco
BG	P6SMBJ13AC	TVS	Vbr=13V, 27.9A, 600W(1ms), Bidirectional	DO-214AA	1ba	1x,1y	Pjt,Srj
BG	SMAJ13A	TVS	Vrwm=13V, Vbr=14.4..15.9V, 18.6A, 400W(1ms)	DO-214AC	1d	1k,1q	Ste
BG	SMBG13CA	TVS	Vbr=13V, 27.9A, 600W(1ms), Bidirectional	DO-215AA	5ba	1l	Vs
BG	SMBJ13CA	TVS	Vbr=13V, 27.9A, 600W(1ms), Bidirectional	DO-214AA	1ba	1l,1x	Di,Vs
BG	SMF13A	ESDP-diode	Vbr=14.4V, Vrwm=13V, Ipp=9.3A, 200W(1ms)	DO-219AB	7d	1i	Vs
BG	SMF13A	TVS	Vbr=14.4..15.9V, Vrwm=13V, Ipp=18.6A, 400W(1ms)	DO-220AA	8d	1a	Vs
BG	TV04A130J-G	TVS	Vrwm=13.0V, Vbr=14.40..15.90V, Ipp=18.60A, 400W(1ms)	DO-214AC	1d	1a	Cmc
BG	TV06B130JB-G	TVS	Vrwm=13.0V, Vbr=14.40..15.90V, Ipp=27.91A, 600W(1ms), Bidirectional	DO-214AA	1ba	1j	Cmc
BG	UDZ8V2B	Z-diode	8.2V±2.5%, Izt=5mA, 200mW	SOD-323	5d	1d	Di
BGA	TV15C800KB-G	TVS	Vrwm=80.0V, Vbr=88.96..108.80V, Ipp=10.47A, 1500W(1ms), Bidirectional	DO-214AB	1ba	1j	Cmc
BGB	TV15C800JB-G	TVS	Vrwm=80.0V, Vbr=88.80..97.60V, Ipp=11.57A, 1500W(1ms), Bidirectional	DO-214AB	1ba	1j	Cmc
BGD	1.5SMCJ54C	TVS	Vrwm=54V, 15.6A, 1500W(1ms), Bidirectional	DO-214AB	1ba	1x,1y	Pjt,Srj
BGD	SMCG54C	TVS	Vbr=54V, 15.6A, 1500W(1ms), Bidirectional	DO-215AB	5ba	1l	Vs
BGD	SMCJ54C	TVS	Vrwm=54V, Vbr=60..69V, 15.6A, 1500W(1ms), Bidirectional	DO-214AB	1ba	1l	Vs
BGD	TFMCJ54C	TVS	Vbr=54V, 15.6A, 1500W(1ms), Bidirectional	DO-214AB	1ba	1j	Rec
BGD	TV15C540KB-G	TVS	Vrwm=54.0V, Vbr=60.0..73.30V, Ipp=15.58A, 1500W(1ms), Bidirectional	DO-214AB	1ba	1j	Cmc
BGE	1.5SMCJ54CA	TVS	Vrwm=54V, 17.2A, 1500W(1ms), Bidirectional	DO-214AB	1ba	1x,1y	Pjt,Srj
BGE	CD214C-T54CA	TVS	Vbr=54V, Irlsm=17.2A, 1500W(1ms), Bidirectional	DO-214AB	1ba	1j	Bm
BGE	SMCG54CA	TVS	Vbr=54V, 17.2A, 1500W(1ms), Bidirectional	DO-215AB	5ba	1l	Vs
BGE	SMCJ54CA	TVS	Vrwm=54V, Vbr=60..69V, 17.2A, 1500W(1ms), Bidirectional	DO-214AB	1ba	1l,1x	Di,Vs
BGE	TFMCJ54CA	TVS	Vbr=54V, 17.2A, 1500W(1ms), Bidirectional	DO-214AB	1ba	1j	Rec
BGE	TV15C540JB-G	TVS	Vrwm=54.0V, Vbr=60.0..66.30V, Ipp=17.22A, 1500W(1ms), Bidirectional	DO-214AB	1ba	1j	Cmc
BGF	1.5SMCJ58C	TVS	Vrwm=58V, 14.6A, 1500W(1ms), Bidirectional	DO-214AB	1ba	1x,1y	Pjt,Srj



SMD
code

Type

Function

Short description

Case

Pinout

St.

Mnf.

SMD code	Type	Function	Short description	Case	Pinout	St.	Mnf.
BGF	SMCG58C	TVS	Vbr=58V, 14.6A, 1500W(1ms), Bidirectional	DO-215AB	5ba	1l	Vs
BGF	SMCJ58C	TVS	Vrwm=58V, Vbr=64.4.74.1V, 14.6A, 1500W(1ms), Bidirectional	DO-214AB	1ba	1l	Vs
BGF	TFMCJ58C	TVS	Vbr=58V, 14.6A, 1500W(1ms), Bidirectional	DO-214AB	1ba	1j	Rec
BGF	TV15C580KB-G	TVS	Vrwm=58.0V, Vbr=64.40.78.70V, Ipp=14.56A, 1500W(1ms), Bidirectional	DO-214AB	1ba	1j	Cmc
BGG	1.5SMCJ58CA	TVS	Vrwm=58V, 16A, 1500W(1ms), Bidirectional	DO-214AB	1ba	1x,1y	Pjt,Srj
BGG	CD214C-T58CA	TVS	Vbr=58V, Irlsm=16A, 1500W(1ms), Bidirectional	DO-214AB	1ba	1j	Bm
BGG	SMCG58CA	TVS	Vbr=58V, 16A, 1500W(1ms), Bidirectional	DO-215AB	5ba	1l	Vs
BGG	SMCJ58CA	TVS	Vrwm=58V, Vbr=64.4.74.1V, 16A, 1500W(1ms), Bidirectional	DO-214AB	1ba	1l,1x	Di,Vs
BGG	TFMCJ58CA	TVS	Vbr=58V, 16A, 1500W(1ms), Bidirectional	DO-214AB	1ba	1j	Rec
BGG	TV15C580JB-G	TVS	Vrwm=58.0V, Vbr=64.40.71.20V, Ipp=16.03A, 1500W(1ms), Bidirectional	DO-214AB	1ba	1j	Cmc
BGG7	SM15T68CA	TVS	Vrwm=58.1V, Vbr=64.6.71.4V, 16.3A, 1500W(1ms), Bidirectional	DO-214AB	1ba	1l	Vs
BGH	1.5SMCJ60C	TVS	Vrwm=60V, 14A, 1500W(1ms), Bidirectional	DO-214AB	1ba	1x,1y	Pjt,Srj
BGH	SM15T150C	TVS	Vbr=143.158V, 7.2A, 1500W(1ms), Bidirectional	DO-214AB	1ba	1r	Ste
BGH	SMCG60C	TVS	Vbr=60V, 14A, 1500W(1ms), Bidirectional	DO-215AB	5ba	1l	Vs
BGH	SMCJ60C	TVS	Vrwm=60V, Vbr=66.7.76.7V, 14A, 1500W(1ms), Bidirectional	DO-214AB	1ba	1l	Vs
BGH	TFMCJ60C	TVS	Vbr=60V, 14A, 1500W(1ms), Bidirectional	DO-214AB	1ba	1j	Rec
BGH	TV15C600KB-G	TVS	Vrwm=60.0V, Vbr=66.70.81.50V, Ipp=14.02A, 1500W(1ms), Bidirectional	DO-214AB	1ba	1j	Cmc
BGJ	MBRS1540	Si-diode	SBR, 40V, 1.5A, V _K 0.46V(1.5A)	DO-214AA	1d	1a	Mot
BGK	1.5SMCJ60CA	TVS	Vrwm=60V, 15.5A, 1500W(1ms), Bidirectional	DO-214AB	1ba	1x,1y	Pjt,Srj
BGK	CD214C-T60CA	TVS	Vbr=60V, Irlsm=15.5A, 1500W(1ms), Bidirectional	DO-214AB	1ba	1j	Bm
BGK	SM15T150CA	TVS	Vrwm=128V, Vbr=143.158V, 7.2A, 1500W(1ms), Bidirectional	DO-214AB	1ba	1r,1j	Ste
BGK	SMA20A	TVS	Vbr=19.0.21.0V, Vrwm=17.1V, 14.4A, 400W(1ms)	DO-214AC	1d	1a	Lge
BGK	SMCG60CA	TVS	Vbr=60V, 15.5A, 1500W(1ms), Bidirectional	DO-215AB	5ba	1l	Vs
BGK	SMCJ60CA	TVS	Vrwm=60V, Vbr=66.7.76.7V, 15.5A, 1500W(1ms), Bidirectional	DO-214AB	1ba	1l,1x	Di,Vs
BGK	TFMCJ60CA	TVS	Vbr=60V, 15.5A, 1500W(1ms), Bidirectional	DO-214AB	1ba	1j	Rec
BGK	TV15C600JB-G	TVS	Vrwm=60.0V, Vbr=66.70.73.70V, Ipp=15.50A, 1500W(1ms), Bidirectional	DO-214AB	1ba	1j	Cmc
BGL	1.5SMCJ64C	TVS	Vrwm=64V, 13.2A, 1500W(1ms), Bidirectional	DO-214AB	1ba	1x,1y	Pjt,Srj
BGL	SMCG64C	TVS	Vbr=64V, 13.2A, 1500W(1ms), Bidirectional	DO-215AB	5ba	1l	Vs
BGL	SMCJ64C	TVS	Vrwm=64V, Vbr=71.1.81.8V, 13.2A, 1500W(1ms), Bidirectional	DO-214AB	1ba	1l	Vs
BGL	TFMCJ64C	TVS	Vbr=64V, 13.2A, 1500W(1ms), Bidirectional	DO-214AB	1ba	1j	Rec
BGL	TV15C640KB-G	TVS	Vrwm=64.0V, Vbr=71.10.86.90V, Ipp=13.16A, 1500W(1ms), Bidirectional	DO-214AB	1ba	1j	Cmc
BGM	1.5SMCJ64CA	TVS	Vrwm=64V, 14.6A, 1500W(1ms), Bidirectional	DO-214AB	1ba	1x,1y	Pjt,Srj
BGM	CD214C-T64CA	TVS	Vbr=64V, Irlsm=14.6A, 1500W(1ms), Bidirectional	DO-214AB	1ba	1j	Bm
BGM	SMA20CA	TVS	Vbr=19.0.21.0V, Vrwm=17.1V, 14.4A, 400W(1ms), Bidirectional	DO-214AC	1ba	1j	Lge
BGM	SMCG64CA	TVS	Vbr=64V, 14.6A, 1500W(1ms), Bidirectional	DO-215AB	5ba	1l	Vs
BGM	SMCJ64CA	TVS	Vrwm=64V, Vbr=71.1.81.8V, 14.6A, 1500W(1ms), Bidirectional	DO-214AB	1ba	1l,1x	Di,Vs
BGM	TFMCJ64CA	TVS	Vbr=64V, 14.6A, 1500W(1ms), Bidirectional	DO-214AB	1ba	1j	Rec
BGM	TV15C640JB-G	TVS	Vrwm=64.0V, Vbr=71.10.78.60V, Ipp=14.56A, 1500W(1ms), Bidirectional	DO-214AB	1ba	1j	Cmc
BGN	1.5SMCJ70C	TVS	Vrwm=70V, 12A, 1500W(1ms), Bidirectional	DO-214AB	1ba	1x,1y	Pjt,Srj
BGN	SMCG70C	TVS	Vbr=70V, 12A, 1500W(1ms), Bidirectional	DO-215AB	5ba	1l	Vs
BGN	SMCJ70C	TVS	Vrwm=70V, Vbr=77.8.89.5V, 12A, 1500W(1ms), Bidirectional	DO-214AB	1ba	1l	Vs
BGN	TFMCJ70C	TVS	Vbr=70V, 12A, 1500W(1ms), Bidirectional	DO-214AB	1ba	1j	Rec
BGN	TV15C700KB-G	TVS	Vrwm=70.0V, Vbr=77.80.95.10V, Ipp=12.0A, 1500W(1ms), Bidirectional	DO-214AB	1ba	1j	Cmc
BGP	1.5SMCJ70CA	TVS	Vrwm=70V, 13.3A, 1500W(1ms), Bidirectional	DO-214AB	1ba	1x,1y	Pjt,Srj
BGP	CD214C-T70CA	TVS	Vbr=70V, Irlsm=13.3A, 1500W(1ms), Bidirectional	DO-214AB	1ba	1j	Bm
BGP	SMCG70CA	TVS	Vbr=70V, 13.3A, 1500W(1ms), Bidirectional	DO-215AB	5ba	1l	Vs
BGP	SMCJ70CA	TVS	Vrwm=70V, Vbr=77.8.89.5V, 13.3A, 1500W(1ms), Bidirectional	DO-214AB	1ba	1l,1x	Di,Vs
BGP	TFMCJ70CA	TVS	Vbr=70V, 13.3A, 1500W(1ms), Bidirectional	DO-214AB	1ba	1j	Rec
BGP	TPSMA20A	TVS	Vbr=20V, 14.4A, 400W(1ms)	DO-214AC	1d	1k	Vs
BGP	TPSMP20A	TVS	Vbr=19.0.21.0V, Vrwm=17.1V, Ipp=14.4A, 400W(1ms)	DO-220AA	8d	1a	Vs
BGP	TV15C700JB-G	TVS	Vrwm=70.0V, Vbr=77.80.86.0V, Ipp=13.27A, 1500W(1ms), Bidirectional	DO-214AB	1ba	1j	Cmc
BGQ	1.5SMCJ75C	TVS	Vrwm=75V, 11.2A, 1500W(1ms), Bidirectional	DO-214AB	1ba	1x,1y	Pjt,Srj
BGQ	SMCG75C	TVS	Vbr=75V, 11.2A, 1500W(1ms), Bidirectional	DO-215AB	5ba	1l	Vs
BGQ	SMCJ75C	TVS	Vrwm=75V, Vbr=83.3.95.8V, 11.2A, 1500W(1ms), Bidirectional	DO-214AB	1ba	1l	Vs
BGQ	TFMCJ75C	TVS	Vbr=75V, 11.2A, 1500W(1ms), Bidirectional	DO-214AB	1ba	1j	Rec
BGQ	TV15C750KB-G	TVS	Vrwm=75.0V, Vbr=83.30.102.0V, Ipp=11.19A, 1500W(1ms), Bidirectional	DO-214AB	1ba	1j	Cmc
BGR	1.5SMCJ75CA	TVS	Vrwm=75V, 12.4A, 1500W(1ms), Bidirectional	DO-214AB	1ba	1x,1y	Pjt,Srj
BGR	CD214C-T75CA	TVS	Vbr=75V, Irlsm=12.4A, 1500W(1ms), Bidirectional	DO-214AB	1ba	1j	Bm
BGR	SMCG75CA	TVS	Vbr=75V, 12.4A, 1500W(1ms), Bidirectional	DO-215AB	5ba	1l	Vs
BGR	SMCJ75CA	TVS	Vrwm=75V, Vbr=83.3.95.8V, 12.4A, 1500W(1ms), Bidirectional	DO-214AB	1ba	1l,1x	Di,Vs
BGR	TFMCJ75CA	TVS	Vbr=75V, 12.4A, 1500W(1ms), Bidirectional	DO-214AB	1ba	1j	Rec
BGR	TV15C750JB-G	TVS	Vrwm=75.0V, Vbr=83.30.92.10V, Ipp=12.40A, 1500W(1ms), Bidirectional	DO-214AB	1ba	1j	Cmc
BGS	1.5SMCJ78C	TVS	Vrwm=78V, 10.8A, 1500W(1ms), Bidirectional	DO-214AB	1ba	1x,1y	Pjt,Srj
BGS	SMCG78C	TVS	Vbr=78V, 10.8A, 1500W(1ms), Bidirectional	DO-215AB	5ba	1l	Vs
BGS	SMCJ78C	TVS	Vrwm=78V, Vbr=86.7.99.7V, 10.8A, 1500W(1ms), Bidirectional	DO-214AB	1ba	1l	Vs
BGS	TFMCJ78C	TVS	Vbr=78V, 10.8A, 1500W(1ms), Bidirectional	DO-214AB	1ba	1j	Rec
BGS	TV15C780KB-G	TVS	Vrwm=78.0V, Vbr=86.70.106.0V, Ipp=10.79A, 1500W(1ms), Bidirectional	DO-214AB	1ba	1j	Cmc
BGT	1.5SMCJ78CA	TVS	Vrwm=78V, 11.4A, 1500W(1ms), Bidirectional	DO-214AB	1ba	1x,1y	Pjt,Srj
BGT	CD214C-T78CA	TVS	Vbr=78V, Irlsm=11.4A, 1500W(1ms), Bidirectional	DO-214AB	1ba	1j	Bm
BGT	SMCG78CA	TVS	Vbr=78V, 11.9A, 1500W(1ms), Bidirectional	DO-215AB	5ba	1l	Vs



SMD
code

Type

Function

Short description

Case

Pinout

St.

Mnf.

SMD code	Type	Function	Short description	Case	Pinout	St.	Mnf.
BGT	SMCJ78CA	TVS	Vrwm=78V, Vbr=86.7..99.7V, 11.9A, 1500W(1ms), Bidirectional	DO-214AB	1ba	1,1x	Di,Vs
BGT	TFMCJ78CA	TVS	Vbr=78V, 11.9A, 1500W(1ms), Bidirectional	DO-214AB	1ba	1j	Rec
BGT	TV15C780JB-G	TVS	Vrwm=78.0V, Vbr=86.70..95.80V, Ipp=11.90A, 1500W(1ms), Bidirectional	DO-214AB	1ba	1j	Cmc
BGU	1.5SMCJ85C	TVS	Vrwm=85V, 9.9A, 1500W(1ms), Bidirectional	DO-214AB	1ba	1x,1y	Pjt,Srj
BGU	SM15T200C	TVS	Vbr=190..210V, 5.5A, 1500W(1ms), Bidirectional	DO-214AB	1ba	1r	Ste
BGU	SMCG85C	TVS	Vbr=85V, 9.9A, 1500W(1ms), Bidirectional	DO-215AB	5ba	1l	Vs
BGU	SMCJ85C	TVS	Vrwm=85V, Vbr=94.4..115V, 9.9A, 1500W(1ms), Bidirectional	DO-214AB	1ba	1l	Vs
BGU	TFMCJ85C	TVS	Vbr=85V, 9.9A, 1500W(1ms), Bidirectional	DO-214AB	1ba	1j	Rec
BGU	TV15C850KB-G	TVS	Vrwm=85.0V, Vbr=94.40..115.0V, Ipp=9.93A, 1500W(1ms), Bidirectional	DO-214AB	1ba	1j	Cmc
BGV	1.5SMCJ85CA	TVS	Vrwm=85V, 10.4A, 1500W(1ms), Bidirectional	DO-214AB	1ba	1x,1y	Pjt,Srj
BGV	CD214C-T85CA	TVS	Vbr=85V, Irs=10.4A, 1500W(1ms), Bidirectional	DO-214AB	1ba	1j	Bm
BGV	SM15T200CA	TVS	Vrwm=171V, Vbr=190..210V, 5.5A, 1500W(1ms), Bidirectional	DO-214AB	1ba	1r,1j	Ste
BGV	SMCG85CA	TVS	Vbr=85V, 10.9A, 1500W(1ms), Bidirectional	DO-215AB	5ba	1l	Vs
BGV	SMCJ85CA	TVS	Vrwm=85V, Vbr=94.4..108.2V, 10.9A, 1500W(1ms), Bidirectional	DO-214AB	1ba	1,1x	Di,Vs
BGV	TFMCJ85CA	TVS	Vbr=85V, 10.9A, 1500W(1ms), Bidirectional	DO-214AB	1ba	1j	Rec
BGV	TV15C850JB-G	TVS	Vrwm=85.0V, Vbr=94.40..104.0V, Ipp=10.95A, 1500W(1ms), Bidirectional	DO-214AB	1ba	1j	Cmc
BGV7	SM15T100CA	TVS	Vrwm=85.5V, Vbr=95..105V, 11A, 1500W(1ms), Bidirectional	DO-214AB	1ba	1l	Vs
BGW	1.5SMCJ90C	TVS	Vrwm=90V, 9.4A, 1500W(1ms), Bidirectional	DO-214AB	1ba	1x,1y	Pjt,Srj
BGW	SMCG90C	TVS	Vbr=90V, 9.4A, 1500W(1ms), Bidirectional	DO-215AB	5ba	1l	Vs
BGW	SMCJ90C	TVS	Vrwm=90V, Vbr=100..122V, 9.4A, 1500W(1ms), Bidirectional	DO-214AB	1ba	1l	Vs
BGW	TFMCJ90C	TVS	Vbr=90V, 9.4A, 1500W(1ms), Bidirectional	DO-214AB	1ba	1j	Rec
BGW	TV15C900KB-G	TVS	Vrwm=90.0V, Vbr=100.0..122.0V, Ipp=9.38A, 1500W(1ms), Bidirectional	DO-214AB	1ba	1j	Cmc
BGX	1.5SMCJ90CA	TVS	Vrwm=90V, 10.3A, 1500W(1ms), Bidirectional	DO-214AB	1ba	1x,1y	Pjt,Srj
BGX	CD214C-T90CA	TVS	Vbr=90V, Irs=10.3A, 1500W(1ms), Bidirectional	DO-214AB	1ba	1j	Bm
BGX	SM15T220CA	TVS	Vrwm=188V, Vbr=208..231V, 4.6A, 1500W(1ms), Bidirectional	DO-214AB	1ba	1r,1j	Ste
BGX	SMCG90CA	TVS	Vbr=90V, 10.3A, 1500W(1ms), Bidirectional	DO-215AB	5ba	1l	Vs
BGX	SMCJ90A	TVS	Vrwm=90V, Vbr=100..122V, 10.7A, 1500W(1ms)	DO-214AB	1d	1c	Rfe
BGX	SMCJ90CA	TVS	Vrwm=90V, Vbr=100..115.5V, 10.3A, 1500W(1ms), Bidirectional	DO-214AB	1ba	1,1x	Di,Vs
BGX	TFMCJ90CA	TVS	Vbr=90V, 10.3A, 1500W(1ms), Bidirectional	DO-214AB	1ba	1j	Rec
BGX	TV15C900JB-G	TVS	Vrwm=90.0V, Vbr=100.0..111.0V, Ipp=10.27A, 1500W(1ms), Bidirectional	DO-214AB	1ba	1j	Cmc
BGY	1.5SMCJ100C	TVS	Vrwm=100V, 8.4A, 1500W(1ms), Bidirectional	DO-214AB	1ba	1x,1y	Pjt,Srj
BGY	SMCG100C	TVS	Vbr=100V, 8.4A, 1500W(1ms), Bidirectional	DO-215AB	5ba	1l	Vs
BGY	SMCJ100C	TVS	Vrwm=100V, Vbr=111..136V, 8.4A, 1500W(1ms), Bidirectional	DO-214AB	1ba	1l	Vs
BGY	TFMCJ100C	TVS	Vbr=100V, 8.4A, 1500W(1ms), Bidirectional	DO-214AB	1ba	1j	Rec
BGY	TV15C101KB-G	TVS	Vrwm=100.0V, Vbr=111.0..136.0V, Ipp=8.38A, 1500W(1ms), Bidirectional	DO-214AB	1ba	1j	Cmc
BGZ	1.5SMCJ100CA	TVS	Vrwm=100V, 9.3A, 1500W(1ms), Bidirectional	DO-214AB	1ba	1x,1y	Pjt,Srj
BGZ	CD214C-T100CA	TVS	Vbr=100V, Irs=9.3A, 1500W(1ms), Bidirectional	DO-214AB	1ba	1j	Bm
BGZ	SMCG100CA	TVS	Vbr=100V, 9.3A, 1500W(1ms), Bidirectional	DO-215AB	5ba	1l	Vs
BGZ	SMCJ100CA	TVS	Vrwm=100V, Vbr=111..123V, 9.3A, 1500W(1ms), Bidirectional	DO-214AB	1ba	1,1x	Di,Vs
BGZ	TFMCJ100CA	TVS	Vbr=100V, 9.3A, 1500W(1ms), Bidirectional	DO-214AB	1ba	1j	Rec
BGZ	TV15C101JB-G	TVS	Vrwm=100.0V, Vbr=111.0..123.0V, Ipp=9.26A, 1500W(1ms), Bidirectional	DO-214AB	1ba	1j	Cmc
BH	BZT52H-C9V1	Z-diode	8.5..9.6V, Izt=5mA, Zzt=10Q, 375mW	SOD-123FL	7d	1a	Phi
BH	BZX399-C9V1	Z-diode	9.1V±5%, 300mW	SOD-323	5d	1a	Phi
BH	BZX884-C11	Z-diode	11V±5%, 250mW	SOD-882	13d	2b	Phi
BH	MM1Z4682	Z-diode	2.565..2.835V, Izt=10mA, 500mW	SOD-123FL	7d	1a	Sme
BH	MMSZ4682	Z-diode	2.7V±5%, Izt=50µA, 500mW	SOD-123	5d	1a	Eic
BH	P4SMA22	TVS	Vrwm=22V, 13A, 400W(1ms)	DO-214AC	1d	2j	Fag
BH	P6SMBJ14C	TVS	Vbr=14V, 23.3A, 600W(1ms), Bidirectional	DO-214AA	1ba	1x,1y	Pjt,Srj
BH	SC017-2	Si-diode	GP, Rectifier, 200V, 1A, Vf<1.1V(2A)	SOD-106	1d	1b	Fjj
BH	SMAJ13CA	TVS	Vrwm=13V, Vbr=14.4..15.9V, 18.6A, 400W(1ms), Bidirectional	DO-214AC	1ba	1r	Ste
BH	SMAJ14	TVS	Vrwm=14V, Vbr=15.6..19.1V, 15.5A, 400W(1ms)	DO-214AC	1d	1k	Vs
BH	SMBG14C	TVS	Vbr=14V, 23.3A, 600W(1ms), Bidirectional	DO-215AA	5ba	1l	Vs
BH	SMBJ14C	TVS	Vbr=14V, 23.3A, 600W(1ms), Bidirectional	DO-214AA	1ba	1l	Vs
BH	SMP14	TVS	Vbr=15.6..19.1V, Vrwm=14V, Ipp=15.5A, 400W(1ms)	DO-220AA	8d	1a	Vs
BH	TV04A140K-G	TVS	Vrwm=14.0V, Vbr=15.60..19.10V, Ipp=15.50A, 400W(1ms)	DO-214AC	1d	1a	Cmc
BH	TV06B140KB-G	TVS	Vrwm=14.0V, Vbr=15.60..19.10V, Ipp=23.26A, 600W(1ms), Bidirectional	DO-214AA	1ba	1j	Cmc
BH	UDZ9V1B	Z-diode	9.1V±2.5%, Izt=5mA, 200mW	SOD-323	5d	1d	Di
BHA	TV15C114JB-G	TVS	Vrwm=140.0V, Vbr=155.68..190.40V, Ipp=5.99A, 1500W(1ms), Bidirectional	DO-214AB	1ba	1j	Cmc
BHB	TV15C114KB-G	TVS	Vrwm=140.0V, Vbr=155.0..171.40V, Ipp=6.61A, 1500W(1ms), Bidirectional	DO-214AB	1ba	1j	Cmc
BHD	1.5SMCJ110C	TVS	Vrwm=110V, 7.7A, 1500W(1ms), Bidirectional	DO-214AB	1ba	1x,1y	Pjt,Srj
BHD	SMCG110C	TVS	Vbr=110V, 7.7A, 1500W(1ms), Bidirectional	DO-215AB	5ba	1l	Vs
BHD	SMCJ110C	TVS	Vrwm=110V, Vbr=122..149V, 7.7A, 1500W(1ms), Bidirectional	DO-214AB	1ba	1l	Vs
BHD	TFMCJ110C	TVS	Vbr=110V, 7.7A, 1500W(1ms), Bidirectional	DO-214AB	1ba	1j	Rec
BHD	TV15C111KB-G	TVS	Vrwm=110.0V, Vbr=122.0..149.0V, Ipp=7.65A, 1500W(1ms), Bidirectional	DO-214AB	1ba	1j	Cmc
BHE	1.5SMCJ110CA	TVS	Vrwm=110V, 8.4A, 1500W(1ms), Bidirectional	DO-214AB	1ba	1x,1y	Pjt,Srj
BHE	CD214C-T110CA	TVS	Vbr=110V, Irs=8.4A, 1500W(1ms), Bidirectional	DO-214AB	1ba	1j	Bm
BHE	SMCG110CA	TVS	Vbr=110V, 8.5A, 1500W(1ms), Bidirectional	DO-215AB	5ba	1l	Vs
BHE	SMCJ110CA	TVS	Vrwm=110V, Vbr=122..140.5V, 8.4A, 1500W(1ms), Bidirectional	DO-214AB	1ba	1,1x	Di,Vs
BHE	TFMCJ110CA	TVS	Vbr=110V, 8.5A, 1500W(1ms), Bidirectional	DO-214AB	1ba	1j	Rec
BHE	TV15C111JB-G	TVS	Vrwm=110.0V, Vbr=122.0..135.0V, Ipp=8.47A, 1500W(1ms), Bidirectional	DO-214AB	1ba	1j	Cmc



SMD
code

Type

Function

Short description

Case

Pinout

St.

Mnf.

SMD code	Type	Function	Short description	Case	Pinout	St.	Mnf.
BHF	1.5SMCJ120C	TVS	Vrwm=120V, 7A, 1500W(1ms), Bidirectional	DO-214AB	1ba	1x,1y	Pjt,Sj
BHF	SMCG120C	TVS	Vbr=120V, 7A, 1500W(1ms), Bidirectional	DO-215AB	5ba	1l	Vs
BHF	SMCJ120C	TVS	Vrwm=120V, Vbr=133.163V, 7.0A, 1500W(1ms), Bidirectional	DO-214AB	1ba	1l	Vs
BHF	TFMCJ120C	TVS	Vbr=120V, 7A, 1500W(1ms), Bidirectional	DO-214AB	1ba	1j	Rec
BHF	TV15C121KB-G	TVS	Vrwm=120.0V, Vbr=133.0..163.0V, Ipp=7.01A, 1500W(1ms), Bidirectional	DO-214AB	1ba	1j	Cmc
BHG	1.5SMCJ120CA	TVS	Vrwm=120V, 7.9A, 1500W(1ms), Bidirectional	DO-214AB	1ba	1x,1y	Pjt,Sj
BHG	CD214C-T120CA	TVS	Vbr=120V, Irlsm=7.9A, 1500W(1ms), Bidirectional	DO-214AB	1ba	1j	Bm
BHG	SMCG120CA	TVS	Vbr=120V, 7.8A, 1500W(1ms), Bidirectional	DO-215AB	5ba	1l	Vs
BHG	SMCJ120CA	TVS	Vrwm=120V, Vbr=133.153V, 7.9A, 1500W(1mS), Bidirectional	DO-214AB	1ba	1l,1x	Di,Vs
BHG	TFMCJ120CA	TVS	Vbr=120V, 7.8A, 1500W(1ms), Bidirectional	DO-214AB	1ba	1j	Rec
BHG	TV15C121JB-G	TVS	Vrwm=120.0V, Vbr=133.0..147.0V, Ipp=7.77A, 1500W(1ms), Bidirectional	DO-214AB	1ba	1j	Cmc
BHH	1.5SMCJ130C	TVS	Vrwm=130V, 6.5A, 1500W(1ms), Bidirectional	DO-214AB	1ba	1x,1y	Pjt,Sj
BHH	SMCG130C	TVS	Vbr=130V, 6.5A, 1500W(1ms), Bidirectional	DO-215AB	5ba	1l	Vs
BHH	SMCJ130C	TVS	Vrwm=130V, Vbr=144.176V, 6.5A, 1500W(1ms), Bidirectional	DO-214AB	1ba	1l	Vs
BHH	TFMCJ130C	TVS	Vbr=130V, 6.5A, 1500W(1ms), Bidirectional	DO-214AB	1ba	1j	Rec
BHH	TV15C131KB-G	TVS	Vrwm=130.0V, Vbr=144.0..176.0V, Ipp=6.49A, 1500W(1ms), Bidirectional	DO-214AB	1ba	1j	Cmc
BHK	1.5SMCJ130CA	TVS	Vrwm=130V, 7.2A, 1500W(1ms), Bidirectional	DO-214AB	1ba	1x,1y	Pjt,Sj
BHK	CD214C-T130CA	TVS	Vbr=130V, Irlsm=7.2A, 1500W(1ms), Bidirectional	DO-214AB	1ba	1j	Bm
BHK	SMA22	TVS	Vbr=19.8..24.2V, Vrwm=17.8V, 12.5A, 400W(1ms)	DO-214AC	1d	1a	Lge
BHK	SMCG130CA	TVS	Vbr=130V, 7.2A, 1500W(1ms), Bidirectional	DO-215AB	5ba	1l	Vs
BHK	SMCJ130CA	TVS	Vrwm=130V, Vbr=144.165.5V, 7.2A, 1500W(1ms), Bidirectional	DO-214AB	1ba	1l,1x	Di,Vs
BHK	TFMCJ130CA	TVS	Vbr=130V, 7.2A, 1500W(1ms), Bidirectional	DO-214AB	1ba	1j	Rec
BHK	TV15C131JB-G	TVS	Vrwm=130.0V, Vbr=144.0..159.0V, Ipp=7.18A, 1500W(1ms), Bidirectional	DO-214AB	1ba	1j	Cmc
BHK7	SM15T150CA	TVS	Vrwm=128V, Vbr=143.158V, 7.2A, 1500W(1ms), Bidirectional	DO-214AB	1ba	1l	Vs
BHL	1.5SMCJ150C	TVS	Vrwm=150V, 5.6A, 1500W(1ms), Bidirectional	DO-214AB	1ba	1x,1y	Pjt,Sj
BHL	SMCG150C	TVS	Vbr=150V, 5.6A, 1500W(1ms), Bidirectional	DO-215AB	5ba	1l	Vs
BHL	SMCJ150C	TVS	Vrwm=150V, Vbr=167.192.5V, 5.6A, 1500W(1ms), Bidirectional	DO-214AB	1ba	1l	Vs
BHL	TFMCJ150C	TVS	Vbr=150V, 5.6A, 1500W(1ms), Bidirectional	DO-214AB	1ba	1j	Rec
BHL	TV15C151JB-G	TVS	Vrwm=150.0V, Vbr=167.0..204.0V, Ipp=5.60A, 1500W(1ms), Bidirectional	DO-214AB	1ba	1j	Cmc
BHM	1.5SMCJ150CA	TVS	Vrwm=150V, 6.2A, 1500W(1ms), Bidirectional	DO-214AB	1ba	1x,1y	Pjt,Sj
BHM	CD214C-T150CA	TVS	Vbr=150V, Irlsm=6.2A, 1500W(1ms), Bidirectional	DO-214AB	1ba	1j	Bm
BHM	SMA22C	TVS	Vbr=19.8..24.2V, Vrwm=17.8V, 12.5A, 400W(1ms), Bidirectional	DO-214AC	1ba	1j	Lge
BHM	SMCJ150CA	TVS	Vrwm=150V, Vbr=167.192.5V, 6.2A, 1500W(1ms), Bidirectional	DO-214AB	1ba	1x	Di
BHM	TV15C151KB-G	TVS	Vrwm=150.0V, Vbr=167.0..185.0V, Ipp=6.17A, 1500W(1ms), Bidirectional	DO-214AB	1ba	1j	Cmc
BHN	1.5SMCJ160C	TVS	Vrwm=160V, 5.2A, 1500W(1ms), Bidirectional	DO-214AB	1ba	1x,1y	Pjt,Sj
BHN	SMCG160C	TVS	Vbr=160V, 5.2A, 1500W(1ms), Bidirectional	DO-215AB	5ba	1l	Vs
BHN	SMCJ160C	TVS	Vrwm=160V, Vbr=178.205V, 5.2A, 1500W(1ms), Bidirectional	DO-214AB	1ba	1l	Vs
BHN	TFMCJ160C	TVS	Vbr=160V, 5.2A, 1500W(1ms), Bidirectional	DO-214AB	1ba	1j	Rec
BHN	TV15C161KB-G	TVS	Vrwm=160.0V, Vbr=178.0..218.0V, Ipp=5.23A, 1500W(1ms), Bidirectional	DO-214AB	1ba	1j	Cmc
BHP	1.5SMCJ160CA	TVS	Vrwm=160V, 5.8A, 1500W(1ms), Bidirectional	DO-214AB	1ba	1x,1y	Pjt,Sj
BHP	CD214C-T160CA	TVS	Vbr=160V, Irlsm=5.8A, 1500W(1ms), Bidirectional	DO-214AB	1ba	1j	Bm
BHP	SMCG160CA	TVS	Vbr=160V, 5.8A, 1500W(1ms), Bidirectional	DO-215AB	5ba	1l	Vs
BHP	SMCJ160CA	TVS	Vrwm=160V, Vbr=178.205V, 5.8A, 1500W(1ms), Bidirectional	DO-214AB	1ba	1l,1x	Di,Vs
BHP	TFMCJ160CA	TVS	Vbr=160V, 5.8A, 1500W(1ms), Bidirectional	DO-214AB	1ba	1j	Rec
BHP	TPSMA22	TVS	Vbr=22V, 12.5A, 400W(1ms)	DO-214AC	1d	1k	Vs
BHP	TPSP22	TVS	Vbr=19.8..24.2V, Vrwm=17.8V, Ipp=12.5A, 400W(1ms)	DO-220AA	8d	1a	Vs
BHP	TV15C161JB-G	TVS	Vrwm=160.0V, Vbr=178.0..197.0V, Ipp=5.79A, 1500W(1ms), Bidirectional	DO-214AB	1ba	1j	Cmc
BHQ	1.5SMCJ170C	TVS	Vrwm=170V, 4.9A, 1500W(1ms), Bidirectional	DO-214AB	1ba	1x,1y	Pjt,Sj
BHQ	SMCG170C	TVS	Vbr=170V, 4.9A, 1500W(1ms), Bidirectional	DO-215AB	5ba	1l	Vs
BHQ	SMCJ170C	TVS	Vrwm=170V, Vbr=189.217V, 4.9A, 1500W(1ms), Bidirectional	DO-214AB	1ba	1l	Vs
BHQ	TFMCJ170C	TVS	Vbr=170V, 4.9A, 1500W(1ms), Bidirectional	DO-214AB	1ba	1j	Rec
BHQ	TV15C171KB-G	TVS	Vrwm=170.0V, Vbr=189.0..231.0V, Ipp=4.93A, 1500W(1ms), Bidirectional	DO-214AB	1ba	1j	Cmc
BHR	1.5SMCJ170CA	TVS	Vrwm=170V, 5.5A, 1500W(1ms), Bidirectional	DO-214AB	1ba	1x,1y	Pjt,Sj
BHR	CD214C-T170CA	TVS	Vbr=170V, Irlsm=5.5A, 1500W(1ms), Bidirectional	DO-214AB	1ba	1j	Bm
BHR	SMCG170CA	TVS	Vbr=170V, 5.5A, 1500W(1ms), Bidirectional	DO-215AB	5ba	1l	Vs
BHR	SMCJ170CA	TVS	Vrwm=170V, Vbr=189.217V, 5.5A, 1500W(1ms), Bidirectional	DO-214AB	1ba	1l,1x	Di,Vs
BHR	TFMCJ170CA	TVS	Vbr=170V, 5.5A, 1500W(1ms), Bidirectional	DO-214AB	1ba	1j	Rec
BHR	TV15C171JB-G	TVS	Vrwm=170.0V, Vbr=189.0..209.0V, Ipp=5.45A, 1500W(1ms), Bidirectional	DO-214AB	1ba	1j	Cmc
BHR7	SM15T200CA	TVS	Vrwm=171V, Vbr=190.210V, 5.5A, 1500W(1ms), Bidirectional	DO-214AB	1ba	1l	Vs
BHR8	SM15T220CA	TVS	Vrwm=188V, Vbr=209.231V, 4.6A, 1500W(1ms), Bidirectional	DO-214AB	1ba	1l	Vs
BHS	1.5SMCJ180C	TVS	Vrwm=180V, 4.7A, 1500W(1ms), Bidirectional	DO-214AB	1ba	1x,1y	Pjt,Sj
BHS	SMCG188CA	TVS	Vbr=188V, 4.6A, 1500W(1ms), Bidirectional	DO-215AB	5ba	1l	Vs
BHS	SMCJ188CA	TVS	Vrwm=188V, Vbr=209.255V, 4.6A, 1500W(1ms), Bidirectional	DO-214AB	1ba	1l	Vs
BHS	TV15C181KB-G	TVS	Vrwm=180.0V, Vbr=200.16..244.8V, Ipp=4.66A, 1500W(1ms), Bidirectional	DO-214AB	1ba	1j	Cmc
BHT	1.5SMCJ180CA	TVS	Vrwm=180V, 5.1A, 1500W(1ms), Bidirectional	DO-214AB	1ba	1x,1y	Pjt,Sj
BHT	SMCG188C	TVS	Vbr=188V, 4.4A, 1500W(1ms), Bidirectional	DO-215AB	5ba	1l	Vs
BHT	SMCJ188C	TVS	Vrwm=188V, Vbr=209.255V, 4.4A, 1500W(1ms), Bidirectional	DO-214AB	1ba	1l	Vs
BHT	TV15C181JB-G	TVS	Vrwm=180.0V, Vbr=200.0..220.0V, Ipp=5.14A, 1500W(1ms), Bidirectional	DO-214AB	1ba	1j	Cmc
BHU	1.5SMCJ190C	TVS	Vrwm=170V, 4.4A, 1500W(1ms), Bidirectional	DO-214AB	1ba	1x,1y	Pjt,Sj
BHU	TV15C191KB-G	TVS	Vrwm=190.0V, Vbr=211.28..258.40V, Ipp=4.41A, 1500W(1ms), Bidirectional	DO-214AB	1ba	1j	Cmc



SMD code	Type	Function	Short description	Case	Pinout	St.	Mnf.
BHV	1.5SMCJ190CA	TVS	Vrwm=170V, 4.8A, 1500W(1ms), Bidirectional	DO-214AB	1ba	1x,1y	Pjt,Srj
BHV	TV15C191JB-G	TVS	Vrwm=190.0V, Vbr=211.0. 232.0V, lpp=4.87A, 1500W(1ms), Bidirectional	DO-214AB	1ba	1j	Cmc
BHW	1.5SMCJ200C	TVS	Vrwm=200V, 4.1A, 1500W(1ms), Bidirectional	DO-214AB	1ba	1x,1y	Pjt,Srj
BHW	TV15C201JB-G	TVS	Vrwm=200.0V, Vbr=224.0. 247.0V, lpp=4.60A, 1500W(1ms), Bidirectional	DO-214AB	1ba	1j	Cmc
BHX	1.5SMCJ200CA	TVS	Vrwm=200V, 4.6A, 1500W(1ms), Bidirectional	DO-214AB	1ba	1x,1y	Pjt,Srj
BHX	TV15C221JB-G	TVS	Vrwm=220.0V, Vbr=246.0. 272.0V, lpp=4.20A, 1500W(1ms), Bidirectional	DO-214AB	1ba	1j	Cmc
BHY	1.5SMCJ210C	TVS	Vrwm=210V, 4A, 1500W(1ms), Bidirectional	DO-214AB	1ba	1x,1y	Pjt,Srj
BHZ	1.5SMCJ210CA	TVS	Vrwm=210V, 4.4A, 1500W(1ms), Bidirectional	DO-214AB	1ba	1x,1y	Pjt,Srj
BHZ	TV15C251JB-G	TVS	Vrwm=250.0V, Vbr=279.0. 309.0V, lpp=3.70A, 1500W(1ms), Bidirectional	DO-214AB	1ba	1j	Cmc
BI	SC017-4	Si-diode	GP, Rectifier, 400V, 1A, Vf<1.1V(2A)	SOD-106	1d	1b	Fji
BI	UDZ10B	Z-diode	10V±2.5%, lzt=5mA, 200mW	SOD-323	5d	1d	Di
BID	1.5SMCJ220C	TVS	Vrwm=220V, 3.8A, 1500W(1ms), Bidirectional	DO-214AB	1ba	1x,1y	Pjt,Srj
BIE	1.5SMCJ220CA	TVS	Vrwm=220V, 4.2A, 1500W(1ms), Bidirectional	DO-214AB	1ba	1x,1y	Pjt,Srj
BJ	BZT52H-C10	Z-diode	9.4. 10.6V, lzt=5mA, Zzt=10Q, 375mW	SOD-123FL	7d	1a	Phi
BJ	BZX399-C10	Z-diode	10V±5%, 300mW	SOD-323	5d	1a	Phi
BJ	BZX884-C12	Z-diode	12V±5%, 250mW	SOD-882	13d	2b	Phi
BJ	MM1Z4683	Z-diode	2.85..3.15V, lzt=10mA, 500mW	SOD-123FL	7d	1a	Sme
BJ	MMSZ4683	Z-diode	3.0V±5%, lzt=50µA, 500mW	SOD-123	5d	1a	Eic
BJ	UDZ11B	Z-diode	11V±2.5%, lzt=5mA, 200mW	SOD-323	5d	1d	Di
BJ05A	SMBJ5.0A	TVS	Vrwm=5V, Vbr=6.4. 7.25V, 65.2A, 600W(1ms)	DO-214AA	1d	1a	Sec
BJ05A	SMBJ5.0CA	TVS	Vrwm=5V, Vbr=6.4. 7.25V, 65.2A, 600W(1ms), Bidirectional	DO-214AA	1ba	1j	Sec
BJ06A	SMBJ6.0A	TVS	Vrwm=6V, Vbr=6.67..7.67V, 58.3A, 600W(1ms)	DO-214AA	1d	1a	Sec
BJ06A	SMBJ6.0CA	TVS	Vrwm=6V, Vbr=6.67..7.67V, 58.3A, 600W(1ms), Bidirectional	DO-214AA	1ba	1j	Sec
BJ07A	SMBJ7.0A	TVS	Vrwm=7V, Vbr=7.78..8.95V, 50A, 600W(1ms)	DO-214AA	1d	1a	Sec
BJ07A	SMBJ7.0CA	TVS	Vrwm=7V, Vbr=7.78..8.95V, 50A, 600W(1ms), Bidirectional	DO-214AA	1ba	1j	Sec
BJ08A	SMBJ8.0A	TVS	Vrwm=8V, Vbr=8.89..10.23V, 44.1A, 600W(1ms)	DO-214AA	1d	1a	Sec
BJ08A	SMBJ8.0CA	TVS	Vrwm=8V, Vbr=8.89..10.23V, 44.1A, 600W(1ms), Bidirectional	DO-214AA	1ba	1j	Sec
BJ09A	SMBJ9.0A	TVS	Vrwm=9V, Vbr=10.11.5V, 39A, 600W(1ms)	DO-214AA	1d	1a	Sec
BJ09A	SMBJ9.0CA	TVS	Vrwm=9V, Vbr=10.11.5V, 39A, 600W(1ms), Bidirectional	DO-214AA	1ba	1j	Sec
BJ100A	SMBJ100A	TVS	Vrwm=100V, Vbr=111.128V, 3.7A, 600W(1ms)	DO-214AA	1d	1a	Sec
BJ100A	SMBJ100CA	TVS	Vrwm=100V, Vbr=111.128V, 3.7A, 600W(1ms), Bidirectional	DO-214AA	1ba	1j	Sec
BJ100A	SMBJ10A	TVS	Vrwm=10V, Vbr=11.1.12.8V, 35.3A, 600W(1ms)	DO-214AA	1d	1a	Sec
BJ100A	SMBJ10CA	TVS	Vrwm=10V, Vbr=11.1.12.8V, 35.3A, 600W(1ms), Bidirectional	DO-214AA	1ba	1j	Sec
BJ110A	SMBJ110A	TVS	Vrwm=110V, Vbr=122.140.5V, 3.4A, 600W(1ms)	DO-214AA	1d	1a	Sec
BJ110A	SMBJ110CA	TVS	Vrwm=110V, Vbr=122.140.5V, 3.4A, 600W(1ms), Bidirectional	DO-214AA	1ba	1j	Sec
BJ11A	SMBJ11A	TVS	Vrwm=11V, Vbr=12.2.14V, 33A, 600W(1ms)	DO-214AA	1d	1a	Sec
BJ11A	SMBJ11CA	TVS	Vrwm=11V, Vbr=12.2.14V, 33A, 600W(1ms), Bidirectional	DO-214AA	1ba	1j	Sec
BJ120A	SMBJ120A	TVS	Vrwm=120V, Vbr=133.153V, 3.1A, 600W(1ms)	DO-214AA	1d	1a	Sec
BJ120A	SMBJ120CA	TVS	Vrwm=120V, Vbr=133.153V, 3.1A, 600W(1ms), Bidirectional	DO-214AA	1ba	1j	Sec
BJ12A	SMBJ12A	TVS	Vrwm=12V, Vbr=13.3.15.3V, 30.2A, 600W(1ms)	DO-214AA	1d	1a	Sec
BJ12A	SMBJ12CA	TVS	Vrwm=12V, Vbr=13.3.15.3V, 30.2A, 600W(1ms), Bidirectional	DO-214AA	1ba	1j	Sec
BJ130A	SMBJ130A	TVS	Vrwm=130V, Vbr=144.165.5V, 2.9A, 600W(1ms)	DO-214AA	1d	1a	Sec
BJ130A	SMBJ130CA	TVS	Vrwm=130V, Vbr=144.165.5V, 2.9A, 600W(1ms), Bidirectional	DO-214AA	1ba	1j	Sec
BJ13A	SMBJ13A	TVS	Vrwm=13V, Vbr=14.4.16.5V, 27.9A, 600W(1ms)	DO-214AA	1d	1a	Sec
BJ13A	SMBJ13CA	TVS	Vrwm=13V, Vbr=14.4.16.5V, 27.9A, 600W(1ms), Bidirectional	DO-214AA	1ba	1j	Sec
BJ14A	SMBJ14A	TVS	Vrwm=14V, Vbr=15.6.17.9V, 25.8A, 600W(1ms)	DO-214AA	1d	1a	Sec
BJ14A	SMBJ14CA	TVS	Vrwm=14V, Vbr=15.6.17.9V, 25.8A, 600W(1ms), Bidirectional	DO-214AA	1ba	1j	Sec
BJ150A	SMBJ150A	TVS	Vrwm=150V, Vbr=167.192.5V, 2.5A, 600W(1ms)	DO-214AA	1d	1a	Sec
BJ150A	SMBJ150CA	TVS	Vrwm=150V, Vbr=167.192.5V, 2.5A, 600W(1ms), Bidirectional	DO-214AA	1ba	1j	Sec
BJ15A	SMBJ15A	TVS	Vrwm=15V, Vbr=16.7.19.2V, 24A, 600W(1ms)	DO-214AA	1d	1a	Sec
BJ15A	SMBJ15CA	TVS	Vrwm=15V, Vbr=16.7.19.2V, 24A, 600W(1ms), Bidirectional	DO-214AA	1ba	1j	Sec
BJ160A	SMBJ160A	TVS	Vrwm=160V, Vbr=178.205.1V, 2.3A, 600W(1ms)	DO-214AA	1d	1a	Sec
BJ160A	SMBJ160CA	TVS	Vrwm=160V, Vbr=178.205.1V, 2.3A, 600W(1ms), Bidirectional	DO-214AA	1ba	1j	Sec
BJ16A	SMBJ16A	TVS	Vrwm=16V, Vbr=17.8.20.5V, 23.1A, 600W(1ms)	DO-214AA	1d	1a	Sec
BJ16A	SMBJ16CA	TVS	Vrwm=16V, Vbr=17.8.20.5V, 23.1A, 600W(1ms), Bidirectional	DO-214AA	1ba	1j	Sec
BJ170A	SMBJ170A	TVS	Vrwm=170V, Vbr=189.217.5V, 2.2A, 600W(1ms)	DO-214AA	1d	1a	Sec
BJ170A	SMBJ170CA	TVS	Vrwm=170V, Vbr=189.217.5V, 2.2A, 600W(1ms), Bidirectional	DO-214AA	1ba	1j	Sec
BJ17A	SMBJ17A	TVS	Vrwm=17V, Vbr=18.9.21.7V, 21.7A, 600W(1ms)	DO-214AA	1d	1a	Sec
BJ17A	SMBJ17CA	TVS	Vrwm=17V, Vbr=18.9.21.7V, 21.7A, 600W(1ms), Bidirectional	DO-214AA	1ba	1j	Sec
BJ180A	SMBJ180A	TVS	Vrwm=180V, Vbr=200.220V, 2.06A, 600W(1ms)	DO-214AA	1d	1a	Sec
BJ180A	SMBJ180CA	TVS	Vrwm=180V, Vbr=200.220V, 2.06A, 600W(1ms), Bidirectional	DO-214AA	1ba	1j	Sec
BJ18A	SMBJ18A	TVS	Vrwm=18V, Vbr=20.23.3V, 20.5A, 600W(1ms)	DO-214AA	1d	1a	Sec
BJ18A	SMBJ18CA	TVS	Vrwm=18V, Vbr=20.23.3V, 20.5A, 600W(1ms), Bidirectional	DO-214AA	1ba	1j	Sec
BJ190A	SMBJ190A	TVS	Vrwm=190V, Vbr=211.232V, 1.95A, 600W(1ms)	DO-214AA	1d	1a	Sec
BJ190A	SMBJ190CA	TVS	Vrwm=190V, Vbr=211.232V, 1.95A, 600W(1ms), Bidirectional	DO-214AA	1ba	1j	Sec
BJ200A	SMBJ200A	TVS	Vrwm=200V, Vbr=224.247V, 1.9A, 600W(1ms)	DO-214AA	1d	1a	Sec
BJ200A	SMBJ200CA	TVS	Vrwm=200V, Vbr=224.247V, 1.9A, 600W(1ms), Bidirectional	DO-214AA	1ba	1j	Sec
BJ20A	SMBJ20A	TVS	Vrwm=20V, Vbr=22.2.25.5V, 18.5A, 600W(1ms)	DO-214AA	1d	1a	Sec
BJ20A	SMBJ20CA	TVS	Vrwm=20V, Vbr=22.2.25.5V, 18.5A, 600W(1ms), Bidirectional	DO-214AA	1ba	1j	Sec
BJ220A	SMBJ220A	TVS	Vrwm=220V, Vbr=246.272V, 1.7A, 600W(1ms)	DO-214AA	1d	1a	Sec



SMD code	Type	Function	Short description	Case	Pinout	St.	Mnf.
BJ220A	SMBJ220CA	TVS	Vrwm=220V, Vbr=246.272V, 1.7A, 600W(1ms), Bidirectional	DO-214AA	1ba	1j	Sec
BJ22A	SMBJ22A	TVS	Vrwm=22V, Vbr=24.4.28V, 16.9A, 600W(1ms)	DO-214AA	1d	1a	Sec
BJ22A	SMBJ22CA	TVS	Vrwm=22V, Vbr=24.4.28V, 16.9A, 600W(1ms), Bidirectional	DO-214AA	1ba	1j	Sec
BJ24A	SMBJ24A	TVS	Vrwm=24V, Vbr=26.7.30.7V, 15.4A, 600W(1ms)	DO-214AA	1d	1a	Sec
BJ24A	SMBJ24CA	TVS	Vrwm=24V, Vbr=26.7.30.7V, 15.4A, 600W(1ms), Bidirectional	DO-214AA	1ba	1j	Sec
BJ250A	SMBJ250A	TVS	Vrwm=250V, Vbr=279.309V, 1.5A, 600W(1ms)	DO-214AA	1d	1a	Sec
BJ250A	SMBJ250CA	TVS	Vrwm=250V, Vbr=279.309V, 1.5A, 600W(1ms), Bidirectional	DO-214AA	1ba	1j	Sec
BJ26A	SMBJ26A	TVS	Vrwm=26V, Vbr=28.9.33.2V, 14.2A, 600W(1ms)	DO-214AA	1d	1a	Sec
BJ26A	SMBJ26CA	TVS	Vrwm=26V, Vbr=28.9.33.2V, 14.2A, 600W(1ms), Bidirectional	DO-214AA	1ba	1j	Sec
BJ28A	SMBJ28A	TVS	Vrwm=28V, Vbr=31.1.35.8V, 13.2A, 600W(1ms)	DO-214AA	1d	1a	Sec
BJ28A	SMBJ28CA	TVS	Vrwm=28V, Vbr=31.1.35.8V, 13.2A, 600W(1ms), Bidirectional	DO-214AA	1ba	1j	Sec
BJ300A	SMBJ300A	TVS	Vrwm=300V, Vbr=335.371V, 1.3A, 600W(1ms)	DO-214AA	1d	1a	Sec
BJ300A	SMBJ300CA	TVS	Vrwm=300V, Vbr=335.371V, 1.3A, 600W(1ms), Bidirectional	DO-214AA	1ba	1j	Sec
BJ30A	SMBJ30A	TVS	Vrwm=30V, Vbr=33.3.38.3V, 12.4A, 600W(1ms)	DO-214AA	1d	1a	Sec
BJ30A	SMBJ30CA	TVS	Vrwm=30V, Vbr=33.3.38.3V, 12.4A, 600W(1ms), Bidirectional	DO-214AA	1ba	1j	Sec
BJ33A	SMBJ33A	TVS	Vrwm=33V, Vbr=36.7.42.2V, 11.3A, 600W(1ms)	DO-214AA	1d	1a	Sec
BJ33A	SMBJ33CA	TVS	Vrwm=33V, Vbr=36.7.42.2V, 11.3A, 600W(1ms), Bidirectional	DO-214AA	1ba	1j	Sec
BJ350A	SMBJ350A	TVS	Vrwm=350V, Vbr=391.432V, 1.1A, 600W(1ms)	DO-214AA	1d	1a	Sec
BJ350A	SMBJ350CA	TVS	Vrwm=350V, Vbr=391.432V, 1.1A, 600W(1ms), Bidirectional	DO-214AA	1ba	1j	Sec
BJ36A	SMBJ36A	TVS	Vrwm=36V, Vbr=40.46V, 10.3A, 600W(1ms)	DO-214AA	1d	1a	Sec
BJ36A	SMBJ36CA	TVS	Vrwm=36V, Vbr=40.46V, 10.3A, 600W(1ms), Bidirectional	DO-214AA	1ba	1j	Sec
BJ400A	SMBJ400A	TVS	Vrwm=400V, Vbr=447.494V, 0.9A, 600W(1ms)	DO-214AA	1d	1a	Sec
BJ400A	SMBJ400CA	TVS	Vrwm=400V, Vbr=447.494V, 0.9A, 600W(1ms), Bidirectional	DO-214AA	1ba	1j	Sec
BJ40A	SMBJ40A	TVS	Vrwm=40V, Vbr=44.4.51.1V, 9.3A, 600W(1ms)	DO-214AA	1d	1a	Sec
BJ40A	SMBJ40CA	TVS	Vrwm=40V, Vbr=44.4.51.1V, 9.3A, 600W(1ms), Bidirectional	DO-214AA	1ba	1j	Sec
BJ43A	SMBJ43A	TVS	Vrwm=43V, Vbr=47.8.54.9V, 8.6A, 600W(1ms)	DO-214AA	1d	1a	Sec
BJ43A	SMBJ43CA	TVS	Vrwm=43V, Vbr=47.8.54.9V, 8.6A, 600W(1ms), Bidirectional	DO-214AA	1ba	1j	Sec
BJ440A	SMBJ440A	TVS	Vrwm=440V, Vbr=492.543V, 0.9A, 600W(1ms)	DO-214AA	1d	1a	Sec
BJ440A	SMBJ440CA	TVS	Vrwm=440V, Vbr=492.543V, 0.9A, 600W(1ms), Bidirectional	DO-214AA	1ba	1j	Sec
BJ45A	SMBJ45A	TVS	Vrwm=45V, Vbr=50.57.5V, 8.3A, 600W(1ms)	DO-214AA	1d	1a	Sec
BJ45A	SMBJ45CA	TVS	Vrwm=45V, Vbr=50.57.5V, 8.3A, 600W(1ms), Bidirectional	DO-214AA	1ba	1j	Sec
BJ48A	SMBJ48A	TVS	Vrwm=48V, Vbr=53.3.61.3V, 7.7A, 600W(1ms)	DO-214AA	1d	1a	Sec
BJ48A	SMBJ48CA	TVS	Vrwm=48V, Vbr=53.3.61.3V, 7.7A, 600W(1ms), Bidirectional	DO-214AA	1ba	1j	Sec
BJ51A	SMBJ51A	TVS	Vrwm=51V, Vbr=56.7.65.2V, 7.3A, 600W(1ms)	DO-214AA	1d	1a	Sec
BJ51A	SMBJ51CA	TVS	Vrwm=51V, Vbr=56.7.65.2V, 7.3A, 600W(1ms), Bidirectional	DO-214AA	1ba	1j	Sec
BJ54A	SMBJ54A	TVS	Vrwm=54V, Vbr=60.69V, 6.9A, 600W(1ms)	DO-214AA	1d	1a	Sec
BJ54A	SMBJ54CA	TVS	Vrwm=54V, Vbr=60.69V, 6.9A, 600W(1ms), Bidirectional	DO-214AA	1ba	1j	Sec
BJ56A	SMBJ56A	TVS	Vrwm=58V, Vbr=64.4.74.1V, 6.4A, 600W(1ms)	DO-214AA	1d	1a	Sec
BJ56A	SMBJ56CA	TVS	Vrwm=58V, Vbr=64.4.74.1V, 6.4A, 600W(1ms), Bidirectional	DO-214AA	1ba	1j	Sec
BJ6.5A	SMBJ6.5CA	TVS	Vrwm=6.5V, Vbr=7.22.8.3V, 53.6A, 600W(1ms)	DO-214AA	1d	1a	Sec
BJ6.5A	SMBJ6.5A	TVS	Vrwm=6.5V, Vbr=7.22.8.3V, 53.6A, 600W(1ms), Bidirectional	DO-214AA	1ba	1j	Sec
BJ60A	SMBJ60A	TVS	Vrwm=60V, Vbr=66.7.76.7V, 6.2A, 600W(1ms)	DO-214AA	1d	1a	Sec
BJ60A	SMBJ60CA	TVS	Vrwm=60V, Vbr=66.7.76.7V, 6.2A, 600W(1ms), Bidirectional	DO-214AA	1ba	1j	Sec
BJ64A	SMBJ64A	TVS	Vrwm=64V, Vbr=71.1.81.8V, 5.8A, 600W(1ms)	DO-214AA	1d	1a	Sec
BJ64A	SMBJ64CA	TVS	Vrwm=64V, Vbr=71.1.81.8V, 5.8A, 600W(1ms), Bidirectional	DO-214AA	1ba	1j	Sec
BJ7.5A	SMBJ7.5A	TVS	Vrwm=7.5V, Vbr=8.33.9.58V, 46.5A, 600W(1ms)	DO-214AA	1d	1a	Sec
BJ7.5A	SMBJ7.5CA	TVS	Vrwm=7.5V, Vbr=8.33.9.58V, 46.5A, 600W(1ms), Bidirectional	DO-214AA	1ba	1j	Sec
BJ70A	SMBJ70A	TVS	Vrwm=70V, Vbr=77.8.89.5V, 5.3A, 600W(1ms)	DO-214AA	1d	1a	Sec
BJ70A	SMBJ70CA	TVS	Vrwm=70V, Vbr=77.8.89.5V, 5.3A, 600W(1ms), Bidirectional	DO-214AA	1ba	1j	Sec
BJ75A	SMBJ75A	TVS	Vrwm=75V, Vbr=83.3.95.8V, 4.9A, 600W(1ms)	DO-214AA	1d	1a	Sec
BJ75A	SMBJ75CA	TVS	Vrwm=75V, Vbr=83.3.95.8V, 4.9A, 600W(1ms), Bidirectional	DO-214AA	1ba	1j	Sec
BJ78A	SMBJ78A	TVS	Vrwm=78V, Vbr=86.7.99.7V, 4.7A, 600W(1ms)	DO-214AA	1d	1a	Sec
BJ78A	SMBJ78CA	TVS	Vrwm=78V, Vbr=86.7.99.7V, 4.7A, 600W(1ms), Bidirectional	DO-214AA	1ba	1j	Sec
BJ8.5A	SMBJ8.5A	TVS	Vrwm=8.5V, Vbr=9.44.10.82V, 41.7A, 600W(1ms)	DO-214AA	1d	1a	Sec
BJ8.5A	SMBJ8.5CA	TVS	Vrwm=8.5V, Vbr=9.44.10.82V, 41.7A, 600W(1ms), Bidirectional	DO-214AA	1ba	1j	Sec
BJ85A	SMBJ85A	TVS	Vrwm=85V, Vbr=94.4.108.2V, 4.4A, 600W(1ms)	DO-214AA	1d	1a	Sec
BJ85A	SMBJ85CA	TVS	Vrwm=85V, Vbr=94.4.108.2V, 4.4A, 600W(1ms), Bidirectional	DO-214AA	1ba	1j	Sec
BJ90A	SMBJ90A	TVS	Vrwm=90V, Vbr=100.115.5V, 4.1A, 600W(1ms)	DO-214AA	1d	1a	Sec
BJ90A	SMBJ90CA	TVS	Vrwm=90V, Vbr=100.115.5V, 4.1A, 600W(1ms), Bidirectional	DO-214AA	1ba	1j	Sec
BJE	TV15C301JB-G	TVS	Vrwm=300.0V, Vbr=335.0.371.0V, Ipp=3.10A, 1500W(1ms), Bidirectional	DO-214AB	1ba	1j	Cmc
BJG	TV15C351JB-G	TVS	Vrwm=350.0V, Vbr=391.0.432.0V, Ipp=2.60A, 1500W(1ms), Bidirectional	DO-214AB	1ba	1j	Cmc
BJK	TV15C401JB-G	TVS	Vrwm=400.0V, Vbr=447.0.494.0V, Ipp=2.30A, 1500W(1ms), Bidirectional	DO-214AB	1ba	1j	Cmc
BJM	TV15C441JB-G	TVS	Vrwm=440.0V, Vbr=492.0.543.0V, Ipp=2.10A, 1500W(1ms), Bidirectional	DO-214AB	1ba	1j	Cmc
BK	BZT52H-C11	Z-diode	10.4.11.6V, Izt=5mA, Zzt=10Ω, 375mW	SOD-123FL	7d	1a	Phi
BK	BZX399-C11	Z-diode	11V±5%, 300mW	SOD-323	5d	1a	Phi
BK	BZX884-C13	Z-diode	13V±5%, 250mW	SOD-882	13d	2b	Phi
BK	CD214B-T14CA	TVS	Vbr=14V, IrsM=25.8A, 600W(1ms), Bidirectional	DO-214AA	1ba	1j	Bm
BK	MM1Z4684	Z-diode	3.13.3.47V, Izt=10mA, 500mW	SOD-123FL	7d	1a	Sme
BK	MMSZ4684	Z-diode	3.3V±5%, Izt=50μA, 500mW	SOD-123	5d	1a	Eic
BK	P4SM2A22A	TVS	Vrwm=22V, 14A, 400W(1ms),	DO-214AC	1d	2j	Fag



SMD
code

Type

Function

Short description

Case

Pinout

St.

Mnf.

SMD code	Type	Function	Short description	Case	Pinout	St.	Mnf.
BK	P4SMAJ14A	TVS	Vbr=14V, 17.2A, 400W(1ms)	DO-214AC	1d	1a	Mco
BK	P6SMBJ14AC	TVS	Vbr=14V, 25.8A, 600W(1ms), Bidirectional	DO-214AA	1ba	1x,1y	Pjt,Srj
BK	SMAJ14A	TVS	Vrwm=14V, Vbr=15.6..17.2V, 17.2A, 400W(1ms)	DO-214AC	1d	1k	Vs
BK	SMBG14CA	TVS	Vbr=14V, 25.9A, 600W(1ms), Bidirectional	DO-215AA	5ba	1l	Vs
BK	SMBJ14CA	TVS	Vbr=14V, 25.9A, 600W(1ms), Bidirectional	DO-214AA	1ba	1l,1x	Di,Vs
BK	SMF14A	ESDP-diode	Vbr=15.6V, Vrwm=14V, lpp=8.6A, 200W(1ms)	DO-219AB	7d	1i	Vs
BK	SMP14A	TVS	Vbr=15.6..17.2V, Vrwm=14V, lpp=17.2A, 400W(1ms)	DO-220AA	8d	1a	Vs
BK	TV04A140J-G	TVS	Vrwm=14.0V, Vbr=15.60..17.20V, lpp=17.24A, 400W(1ms)	DO-214AC	1d	1a	Cmc
BK	TV06B140JB-G	TVS	Vrwm=14.0V, Vbr=15.60..17.20V, lpp=25.86A, 600W(1ms), Bidirectional	DO-214AA	1ba	1j	Cmc
BK	UDZ12B	Z-diode	12V±2.5%, Izt=5mA, 200mW	SOD-323	5d	1d	Di
BKJL	MBRS2040	Si-diode	SBR, 40V, 2A, Vf<0.43V(2A)	DO-214AA	1d	1a	Mot
BKK	SMA22A	TVS	Vbr=20.9..23.1V, Vrwm=18.8V, 13.1A, 400W(1ms)	DO-214AC	1d	1a	Lge
BKM	SMA22CA	TVS	Vbr=20.9..23.1V, Vrwm=18.8V, 13.1A, 400W(1ms), Bidirectional	DO-214AC	1ba	1j	Lge
BKP	TPSMA22A	TVS	Vbr=22V, 13.1A, 400W(1ms)	DO-214AC	1d	1k	Vs
BKP	TPSMP22A	TVS	Vbr=20.9..23.1V, Vrwm=18.8V, lpp=13.1A, 400W(1ms)	DO-220AA	8d	1a	Vs
BL	BZT52H-C12	Z-diode	11.4..12.7V, Izt=5mA, Zzt=10Ω, 375mW	SOD-123FL	7d	1a	Phi
BL	BZX399-C12	Z-diode	12V±5%, 300mW	SOD-323	5d	1a	Phi
BL	BZX884-C15	Z-diode	15V±5%, 250mW	SOD-882	13d	2b	Phi
BL	P4SMA24	TVS	Vrwm=24V, 12A, 400W(1ms),	DO-214AC	1d	2j	Fag
BL	P6SMBJ15C	TVS	Vbr=15V, 22.3A, 600W(1ms), Bidirectional	DO-214AA	1ba	1x,1y	Pjt,Srj
BL	SMAJ15	TVS	Vrwm=15V, Vbr=16.7..20.4V, 14.9A, 400W(1ms)	DO-214AC	1d	1k	Vs
BL	SMBG15C	TVS	Vbr=15V, 22.3A, 600W(1ms), Bidirectional	DO-215AA	5ba	1l	Vs
BL	SMBJ15C	TVS	Vbr=15V, 22.3A, 600W(1ms), Bidirectional	DO-214AA	1ba	1l	Vs
BL	SMP15	TVS	Vbr=16.7..20.4V, Vrwm=15V, lpp=14.9A, 400W(1ms)	DO-220AA	8d	1a	Vs
BL	TV04A150K-G	TVS	Vrwm=15.0V, Vbr=16.70..20.40V, lpp=14.87A, 400W(1ms)	DO-214AC	1d	1a	Cmc
BL	TV06B150KB-G	TVS	Vrwm=15.0V, Vbr=16.70..20.40V, lpp=22.30A, 600W(1ms), Bidirectional	DO-214AA	1ba	1j	Cmc
BL	UDZ13B	Z-diode	13V±2.5%, Izt=5mA, 200mW	SOD-323	5d	1d	Di
BLK	SMA24	TVS	Vbr=21.6..26.4V, Vrwm=19.4V, 11.5A, 400W(1ms)	DO-214AC	1d	1a	Lge
BLM	SMA24C	TVS	Vbr=21.6..26.4V, Vrwm=19.4V, 11.5A, 400W(1ms), Bidirectional	DO-214AC	1ba	1j	Lge
BLP	TPSMA24	TVS	Vbr=24V, 11.5A, 400W(1ms)	DO-214AC	1d	1k	Vs
BLP	TPSMP24	TVS	Vbr=21.6..26.4V, Vrwm=19.4V, lpp=11.5A, 400W(1ms)	DO-220AA	8d	1a	Vs
BM	BZT52H-C13	Z-diode	12.4..14.1V, Izt=5mA, Zzt=10Ω, 375mW	SOD-123FL	7d	1a	Phi
BM	BZX399-C13	Z-diode	13V±5%, 300mW	SOD-323	5d	1a	Phi
BM	CD214B-T15CA	TVS	Vbr=15V, Itrsm=24.0A, 600W(1ms), Bidirectional	DO-214AA	1ba	1j	Brn
BM	MM1Z4685	Z-diode	3.42..3.78V, Izt=10mA, 500mW	SOD-123FL	7d	1a	Sme
BM	MMSZ4685	Z-diode	3.6V±5%, Izt=50μA, 500mW	SOD-123	5d	1a	Eic
BM	P4SMA24A	TVS	Vrwm=24V, 13A, 400W(1ms),	DO-214AC	1d	2j	Fag
BM	P4SMAJ15A	TVS	Vbr=15V, 16.4A, 400W(1ms)	DO-214AC	1d	1a	Mco
BM	P6SMBJ15AC	TVS	Vbr=15V, 24A, 600W(1ms), Bidirectional	DO-214AA	1ba	1x,1y	Pjt,Srj
BM	SMAJ15A	TVS	Vrwm=15V, Vbr=16.7..18.5V, 16.4A, 400W(1ms)	DO-214AC	1d	1k,1q	Ste
BM	SMBG15CA	TVS	Vbr=15V, 24.6A, 600W(1ms), Bidirectional	DO-215AA	5ba	1l	Vs
BM	SMBJ15CA	TVS	Vbr=15V, 24.6A, 600W(1ms), Bidirectional	DO-214AA	1ba	1l,1x	Di,Vs
BM	SMF15A	ESDP-diode	Vbr=16.7V, Vrwm=15V, lpp=8.2A, 200W(1ms)	DO-219AB	7d	1i	Vs
BM	SMP15A	TVS	Vbr=16.7..18.5V, Vrwm=15V, lpp=16.4A, 400W(1ms)	DO-220AA	8d	1a	Vs
BM	TV04A150J-G	TVS	Vrwm=15.0V, Vbr=16.70..18.50V, lpp=16.39A, 400W(1ms)	DO-214AC	1d	1a	Cmc
BM	TV06B150JB-G	TVS	Vrwm=15.0V, Vbr=16.70..18.50V, lpp=24.59A, 600W(1ms), Bidirectional	DO-214AA	1ba	1j	Cmc
BM	UDZ15B	Z-diode	15V±2.5%, Izt=5mA, 200mW	SOD-323	5d	1d	Di
BM7	SM6T18CA	TVS	Vbr=17.1..18.9V, 24A, 600W(1ms), Bidirectional	DO-214AA	1ba	1l	Vs
BMK	SMA24A	TVS	Vbr=22.8..25.2V, Vrwm=20.5V, 12.0A, 400W(1ms)	DO-214AC	1d	1a	Lge
BMM	SMA24CA	TVS	Vbr=22.8..25.2V, Vrwm=20.5V, 12.0A, 400W(1ms), Bidirectional	DO-214AC	1ba	1j	Lge
BMP	TPSMA24A	TVS	Vbr=24V, 12A, 400W(1ms)	DO-214AC	1d	1k	Vs
BMP	TPSMP24A	TVS	Vbr=22.8..25.2V, Vrwm=20.5V, lpp=12.0A, 400W(1ms)	DO-220AA	8d	1a	Vs
BN	BZT52H-C15	Z-diode	13.8..15.6V, Izt=5mA, Zzt=15Ω, 375mW	SOD-123FL	7d	1a	Phi
BN	BZX399-C15	Z-diode	15V±5%, 300mW	SOD-323	5d	1a	Phi
BN	MM1Z4686	Z-diode	3.70..4.10V, Izt=10mA, 500mW	SOD-123FL	7d	1a	Sme
BN	MMSZ4686	Z-diode	3.9V±5%, Izt=50μA, 500mW	SOD-123	5d	1a	Eic
BN	P4SMA27	TVS	Vrwm=27V, 11A, 400W(1ms),	DO-214AC	1d	2j	Fag
BN	P6SMBJ16C	TVS	Vbr=16V, 20.8A, 600W(1ms), Bidirectional	DO-214AA	1ba	1x,1y	Pjt,Srj
BN	SMAJ16	TVS	Vrwm=16V, Vbr=17.8..21.8V, 13.9A, 400W(1ms)	DO-214AC	1d	1k	Vs
BN	SMBG16C	TVS	Vbr=16V, 20.8A, 600W(1ms), Bidirectional	DO-215AA	5ba	1l	Vs
BN	SMBJ16C	TVS	Vbr=16V, 20.8A, 600W(1ms), Bidirectional	DO-214AA	1ba	1l	Vs
BN	SMP16	TVS	Vbr=17.8..21.8V, Vrwm=16V, lpp=13.9A, 400W(1ms)	DO-220AA	8d	1a	Vs
BN	TV04A160K-G	TVS	Vrwm=16.0V, Vbr=17.80..21.80V, lpp=13.89A, 400W(1ms)	DO-214AC	1d	1a	Cmc
BN	TV06B160KB-G	TVS	Vrwm=16.0V, Vbr=17.80..21.80V, lpp=20.83A, 600W(1ms), Bidirectional	DO-214AA	1ba	1j	Cmc
BN	UDZ16B	Z-diode	16V±2.5%, Izt=5mA, 200mW	SOD-323	5d	1d	Di
BNK	SMA27	TVS	Vbr=24.3..29.7V, Vrwm=21.8V, 10.2A, 400W(1ms)	DO-214AC	1d	1a	Lge
BNM	SMA27C	TVS	Vbr=24.3..29.7V, Vrwm=21.8V, 10.2A, 400W(1ms), Bidirectional	DO-214AC	1ba	1j	Lge
BNP	TPSMA27	TVS	Vbr=27V, 10.2A, 400W(1ms)	DO-214AC	1d	1k	Vs
BNP	TPSMP27	TVS	Vbr=24.3..29.7V, Vrwm=21.8V, lpp=10.2A, 400W(1ms)	DO-220AA	8d	1a	Vs
BO	UDZ18B	Z-diode	18V±2.5%, Izt=5mA, 200mW	SOD-323	5d	1d	Di



SMD
code

Type

Function

Short description

Case

Pinout

St.

Mnf.

SMD code	Type	Function	Short description	Case	Pinout	St.	Mnf.
BP	TPSMA30	TVS	Vbr=30V, 9.2A, 400W (1ms)	DO-214AC	1d	1k	Vs
BP	BZT52H-C16	Z-diode	15.3..17.1V, Izt=5mA, Zzt=20Ω, 375mW	SOD-123FL	7d	1a	Phi
BP	BZX399-C16	Z-diode	16V±5%, 300mW	SOD-323	5d	1a	Phi
BP	CD214B-T16CA	TVS	Vbr=16V, I _{rsm} =23.1A, 600W(1ms), Bidirectional	DO-214AA	1ba	1j	Bm
BP	CMDZ2L5	Z-diode	2.375..2.625V, Izt=0.5mA, Zzt=900Ω, 250mW	SOD-323	5d	1a	Cen
BP	KDZ6.8FVY	Z-diode	6.65..6.93V, Izt=5mA, Zzt=25Ω, 100mW	TFSC	7d	1a	Kec
BP	MM1Z4687	Z-diode	4.09..4.52V, Izt=10mA, 500mW	SOD-123FL	7d	1a	Sme
BP	MMSZ4687	Z-diode	4.3V±5%, Izt=50μA, 500mW	SOD-123	5d	1a	Eic
BP	P4SMA27A	TVS	V _{rwm} =27V, 11.2A, 400W (1ms),	DO-214AC	1d	2j	Fag
BP	P4SMAJ16A	TVS	Vbr=16V, 15.3A, 400W(1ms)	DO-214AC	1d	1a	Mco
BP	P6SMBJ16AC	TVS	Vbr=16V, 23.1A, 600W(1ms), Bidirectional	DO-214AA	1ba	1x,1y	Pjt,Sjt
BP	SMAJ16A	TVS	V _{rwm} =16V, Vbr=17.8..21.8V, 15.4A, 400W(1ms)	DO-214AC	1d	1k	Vs
BP	SMBG16CA	TVS	Vbr=16V, 23.1A, 600W(1ms), Bidirectional	DO-215AA	5ba	1l	Vs
BP	SMBJ16CA	TVS	Vbr=16V, 23.1A, 600W(1ms), Bidirectional	DO-214AA	1ba	1l,1x	Di,Vs
BP	SMF16A	ESDP-diode	Vbr=17.8V, V _{rwm} =16V, I _{pp} =7.7A, 200W(1ms)	DO-219AB	7d	1i	Vs
BP	SMP16A	TVS	Vbr=17.8..19.7V, V _{rwm} =16V, I _{pp} =15.4A, 400W(1ms)	DO-220AA	8d	1a	Vs
BP	TV04A160J-G	TVS	V _{rwm} =16.0V, Vbr=17.80..19.70V, I _{pp} =15.38A, 400W(1ms)	DO-214AC	1d	1a	Cmc
BP	TV06B160JB-G	TVS	V _{rwm} =16.0V, Vbr=17.80..19.70V, I _{pp} =19.67A, 600W(1ms), Bidirectional	DO-214AA	1ba	1j	Cmc
BP	UDZ20B	Z-diode	20V±2.5%, Izt=5mA, 200mW	SOD-323	5d	1d	Di
BPK	SMA27A	TVS	Vbr=25.7..28.4V, V _{rwm} =23.1V, 10.7A, 400W(1ms)	DO-214AC	1d	1a	Lge
BPM	SMA27CA	TVS	Vbr=25.7..28.4V, V _{rwm} =23.1V, 10.7A, 400W(1ms), Bidirectional	DO-214AC	1ba	1j	Lge
BPP	TPSMA27A	TVS	Vbr=27V, 10.7A, 400W (1ms)	DO-214AC	1d	1k	Vs
BPP	TPSMP27A	TVS	Vbr=25.7..28.4V, V _{rwm} =23.1V, I _{pp} =10.7A, 400W(1ms)	DO-220AA	8d	1a	Vs
BQ	BZT52H-C18	Z-diode	16.8..19.1V, Izt=5mA, Zzt=20Ω, 375mW	SOD-123FL	7d	1a	Phi
BQ	BZX399-C18	Z-diode	18V±5%, 300mW	SOD-323	5d	1a	Phi
BQ	P4SMA30	TVS	V _{rwm} =30V, 10A, 400W (1ms),	DO-214AC	1d	2j	Fag
BQ	P6SMBJ17C	TVS	Vbr=17V, 19.7A, 600W(1ms), Bidirectional	DO-214AA	1ba	1x,1y	Pjt,Sjt
BQ	SMAJ17	TVS	V _{rwm} =17V, Vbr=18.9..23.1V, 13.1A, 400W(1ms)	DO-214AC	1d	1k	Vs
BQ	SMBG17C	TVS	Vbr=17V, 19.7A, 600W(1ms), Bidirectional	DO-215AA	5ba	1l	Vs
BQ	SMBJ17C	TVS	Vbr=17V, 19.7A, 600W(1ms), Bidirectional	DO-214AA	1ba	1l	Vs
BQ	SMP17	TVS	Vbr=18.9..23.1V, V _{rwm} =17V, I _{pp} =13.1A, 400W(1ms)	DO-220AA	8d	1a	Vs
BQ	TV04A170K-G	TVS	V _{rwm} =17.0V, Vbr=18.90..23.10V, I _{pp} =13.11A, 400W(1ms)	DO-214AC	1d	1a	Cmc
BQ	TV06B170KB-G	TVS	V _{rwm} =17.0V, Vbr=18.90..23.10V, I _{pp} =21.74A, 600W(1ms), Bidirectional	DO-214AA	1ba	1j	Cmc
BQ	UDZ22B	Z-diode	22V±2.5%, Izt=5mA, 200mW	SOD-323	5d	1d	Di
BQK	SMA30	TVS	Vbr=27.0..33.0V, V _{rwm} =24.3V, 9.2A, 400W(1ms)	DO-214AC	1d	1a	Lge
BQM	SMA30C	TVS	Vbr=27.0..33.0V, V _{rwm} =24.3V, 9.2A, 400W(1ms), Bidirectional	DO-214AC	1ba	1j	Lge
BQP	TPSMP30	TVS	Vbr=27.0..33.0V, V _{rwm} =24.3V, I _{pp} =9.2A, 400W(1ms)	DO-220AA	8d	1a	Vs
BR	BZT52H-C20	Z-diode	18.8..21.2V, Izt=5mA, Zzt=20Ω, 375mW	SOD-123FL	7d	1a	Phi
BR	BZX399-C20	Z-diode	20V±5%, 300mW	SOD-323	5d	1a	Phi
BR	CD214B-T17CA	TVS	Vbr=17V, I _{rsm} =21.7A, 600W(1ms), Bidirectional	DO-214AA	1ba	1j	Bm
BR	CMDZ47L	Z-diode	44.65..49.35V, Izt=0.5mA, Zzt=450Ω, 250mW	SOD-323	5d	1a	Cen
BR	MM1Z4688	Z-diode	4.47..4.94V, Izt=10mA, 500mW	SOD-123FL	7d	1a	Sme
BR	MMSZ4688	Z-diode	4.7V±5%, Izt=50μA, 500mW	SOD-123	5d	1a	Eic
BR	P4SMA30A	TVS	V _{rwm} =30V, 10A, 400W (1ms),	DO-214AC	1d	2j	Fag
BR	P4SMAJ17A	TVS	Vbr=17V, 14.5A, 400W(1ms)	DO-214AC	1d	1a	Mco
BR	P6SMBJ17AC	TVS	Vbr=17V, 21.7A, 600W(1ms), Bidirectional	DO-214AA	1ba	1x,1y	Pjt,Sjt
BR	SMAJ17A	TVS	V _{rwm} =17V, Vbr=18.9..20.9V, 14.5A, 400W(1ms)	DO-214AC	1d	1k	Vs
BR	SMBG17CA	TVS	Vbr=17V, 21.7A, 600W(1ms), Bidirectional	DO-215AA	5ba	1l	Vs
BR	SMBJ17CA	TVS	Vbr=17V, 21.7A, 600W(1ms), Bidirectional	DO-214AA	1ba	1l,1x	Di,Vs
BR	SMF17A	ESDP-diode	Vbr=18.9V, V _{rwm} =17V, I _{pp} =7.2A, 200W(1ms)	DO-219AB	7d	1i	Vs
BR	SMP17A	TVS	Vbr=18.9..20.9V, V _{rwm} =17V, I _{pp} =14.5A, 400W(1ms)	DO-220AA	8d	1a	Vs
BR	TV04A170J-G	TVS	V _{rwm} =17.0V, Vbr=18.90..20.90V, I _{pp} =14.49A, 400W(1ms)	DO-214AC	1d	1a	Cmc
BR	TV06B170JB-G	TVS	V _{rwm} =17.0V, Vbr=18.90..20.90V, I _{pp} =18.63A, 600W(1ms), Bidirectional	DO-214AA	1ba	1j	Cmc
BR	UDZ24B	Z-diode	24V±2.5%, Izt=5mA, 200mW	SOD-323	5d	1d	Di
BR1A	CD214A-R150	Si-diode	Rectifier, 50V, 1A, Vf<1V(1A), <12pF	DO-214AC	1d	1a	Bm
BR1B	CD214A-R1100	Si-diode	Rectifier, 100V, 1A, Vf<1V(1A), <12pF	DO-214AC	1d	1a	Bm
BR1D	CD214A-R1200	Si-diode	Rectifier, 200V, 1A, Vf<1V(1A), <12pF	DO-214AC	1d	1a	Bm
BR1G	CD214A-R1400	Si-diode	Rectifier, 400V, 1A, Vf<1V(1A), <12pF	DO-214AC	1d	1a	Bm
BR1J	CD214A-R1600	Si-diode	Rectifier, 600V, 1A, Vf<1V(1A), <12pF	DO-214AC	1d	1a	Bm
BR1K	CD214A-R1800	Si-diode	Rectifier, 800V, 1A, Vf<1.25V(1A), <12pF	DO-214AC	1d	1a	Bm
BR1M	CD214A-R11000	Si-diode	Rectifier, 1000V, 1A, Vf<1.25V(1A), <12pF	DO-214AC	1d	1a	Bm
BR1N	CD214A-R11100	Si-diode	Rectifier, 1100V, 1A, Vf<1.25V(1A), <12pF	DO-214AC	1d	1a	Bm
BR1Q	CD214A-R11200	Si-diode	Rectifier, 1200V, 1A, Vf<1.25V(1A), <12pF	DO-214AC	1d	1a	Bm
BR1Y	CD214A-R11600	Si-diode	Rectifier, 1600V, 1A, Vf<1.25V(1A), <12pF	DO-214AC	1d	1a	Bm
BRK	SMA30A	TVS	Vbr=28.5..31.5V, V _{rwm} =25.6V, 9.7A, 400W(1ms)	DO-214AC	1d	1a	Lge
BRM	SMA30CA	TVS	Vbr=28.5..31.5V, V _{rwm} =25.6V, 9.7A, 400W(1ms), Bidirectional	DO-214AC	1ba	1j	Lge
BRP	TPSMA30A	TVS	Vbr=30V, 9.7A, 400W (1ms)	DO-214AC	1d	1k	Vs
BRP	TPSMP30A	TVS	Vbr=28.5..31.5V, V _{rwm} =25.6V, I _{pp} =9.7A, 400W(1ms)	DO-220AA	8d	1a	Vs
BS	BZT52H-C22	Z-diode	20.8..23.3V, Izt=5mA, Zzt=25Ω, 375mW	SOD-123FL	7d	1a	Phi
BS	BZX399-C22	Z-diode	22V±5%, 300mW	SOD-323	5d	1a	Phi



SMD
code

Type

Function

Short description

Case

Pinout

St.

Mnf.

BS	P4SMA33	TVS	Vrwm=33V, 9A, 400W (1ms).	DO-214AC	1d	2j	Fag
BS	P6SMBJ18C	TVS	Vbr=18V, 18.6A, 600W(1ms), Bidirectional	DO-214AA	1ba	1x,1y	Pjt,Srj
BS	SMAJ18	TVS	Vrwm=18V, Vbr=20.0..24.4V, 12.4A, 400W(1ms)	DO-214AC	1d	1k	Vs
BS	SMBG18C	TVS	Vbr=18V, 18.6A, 600W(1ms), Bidirectional	DO-215AA	5ba	1l	Vs
BS	SMBJ18C	TVS	Vbr=18V, 18.6A, 600W(1ms), Bidirectional	DO-214AA	1ba	1l	Vs
BS	SMP18	TVS	Vbr=20.0..24.4V, Vrwm=18V, lpp=12.4A, 400W(1ms)	DO-220AA	8d	1a	Vs
BS	TV04A180K-G	TVS	Vrwm=18.0V, Vbr=20.0..24.40V, lpp=12.42A, 400W(1ms)	DO-214AC	1d	1a	Cmc
BS	TV06B180KB-G	TVS	Vrwm=18.0V, Vbr=20.0..24.40V, lpp=20.55A, 600W(1ms), Bidirectional	DO-214AA	1ba	1j	Cmc
BS	UDZ27B	Z-diode	27V±2.5%, lzt=5mA, 200mW	SOD-323	5d	1d	Di
BSK	SMA33	TVS	Vbr=29.7..36.3V, Vrwm=26.8V, 8.4A, 400W(1ms)	DO-214AC	1d	1a	Lge
BSP	SMA33C	TVS	Vbr=29.7..36.3V, Vrwm=26.8V, 8.4A, 400W(1ms), Bidirectional	DO-214AC	1ba	1j	Lge
BSP	TPSMA33	TVS	Vbr=33V, 8.4A, 400W (1ms)	DO-214AC	1d	1k	Vs
BSP	TPSMP33	TVS	Vbr=29.7..36.3V, Vrwm=26.8V, lpp=8.4A, 400W(1ms)	DO-220AA	8d	1a	Vs
BT	BZT52H-C24	Z-diode	22.8..25.6V, lzt=5mA, Zzt=30Ω, 375mW	SOD-123FL	7d	1a	Phi
BT	BZX399-C24	Z-diode	24V±5%, 300mW	SOD-323	5d	1a	Phi
BT	CD214B-T18CA	TVS	Vbr=18V, Irsm=20.5A, 600W(1ms), Bidirectional	DO-214AA	1ba	1j	Bm
BT	P4SMA33A	TVS	Vrwm=33V, 9A, 400W (1ms).	DO-214AC	1d	2j	Fag
BT	P4SMAJ18A	TVS	Vbr=18V, 13.7A, 400W(1ms)	DO-214AC	1d	1a	Mco
BT	P6SMBJ18AC	TVS	Vbr=18V, 20.5A, 600W(1ms), Bidirectional	DO-214AA	1ba	1x,1y	Pjt,Srj
BT	SMAJ18A	TVS	Vrwm=18V, Vbr=20.0..22.1V, 13.7A, 400W(1ms)	DO-214AC	1d	1k	Vs
BT	SMBG18CA	TVS	Vbr=18V, 20.5A, 600W(1ms), Bidirectional	DO-215AA	5ba	1l	Vs
BT	SMBJ18CA	TVS	Vbr=18V, 20.5A, 600W(1ms), Bidirectional	DO-214AA	1ba	1l,1x	Di,Vs
BT	SMF18A	ESDP-diode	Vbr=20.0V, Vrwm=18V, lpp=5.8A, 200W(1ms)	DO-219AB	7d	1i	Vs
BT	SMP18A	TVS	Vbr=20.0..22.1V, Vrwm=18V, lpp=13.7A, 400W(1ms)	DO-220AA	8d	1a	Vs
BT	TV04A180J-G	TVS	Vrwm=18.0V, Vbr=20.0..22.10V, lpp=13.70A, 400W(1ms)	DO-214AC	1d	1a	Cmc
BT	TV06B180JB-G	TVS	Vrwm=18.0V, Vbr=20.0..22.10V, lpp=17.64A, 600W(1ms), Bidirectional	DO-214AA	1ba	1j	Cmc
BT	UDZ30B	Z-diode	30V±2.5%, lzt=5mA, 200mW	SOD-323	5d	1d	Di
BT2	BAT43BPT	Si-diode	SBD, 30V, 200mA, Vf<1V(200mA), 5ns	SOD-123	5d	1a	Chm
BT3	BAT46BPT	Si-diode	SBD, 100V, 75mA, Vf<1V(200mA), 5ns	SOD-123	5d	1a	Chm
BT7	SM6T22CA	TVS	Vbr=20.9..23.1V, 20A, 600W(1ms), Bidirectional	DO-214AA	1ba	1l	Vs
BTk	SMA33A	TVS	Vbr=31.4..34.7V, Vrwm=28.2V, 8.8A, 400W(1ms)	DO-214AC	1d	1a	Lge
BTM	SMA33CA	TVS	Vbr=31.4..34.7V, Vrwm=28.2V, 8.8A, 400W(1ms), Bidirectional	DO-214AC	1ba	1j	Lge
BTP	TPSMA33A	TVS	Vbr=3V, 8.8A, 400W (1ms)	DO-214AC	1d	1k	Vs
BTP	TPSMP33A	TVS	Vbr=31.4..34.7V, Vrwm=28.2V, lpp=8.8A, 400W(1ms)	DO-220AA	8d	1a	Vs
BU	BAT54	Si-diode	SBR, 30V, 200mA, Vf<0.52V(100mA), <5ns	SOD-123	5d	1a	Ons
BU	BZT52H-C27	Z-diode	25.1..28.9V, lzt=5mA, Zzt=40Ω, 375mW	SOD-123FL	7d	1a	Phi
BU	BZX399-C27	Z-diode	27V±5%, 300mW	SOD-323	5d	1a	Phi
BU	P4SMA36	TVS	Vrwm=36V, 8A, 400W (1ms).	DO-214AC	1d	2j	Fag
BU	P6SMBJ20C	TVS	Vbr=20V, 16.7A, 600W(1ms), Bidirectional	DO-214AA	1ba	1x,1y	Pjt,Srj
BU	SMAJ20	TVS	Vrwm=20V, Vbr=22.2..27.1V, 11.2A, 400W(1ms)	DO-214AC	1d	1k	Vs
BU	SMBG20C	TVS	Vbr=202V, 16.8A, 600W(1ms), Bidirectional	DO-215AA	5ba	1l	Vs
BU	SMBJ20C	TVS	Vbr=202V, 16.8A, 600W(1ms), Bidirectional	DO-214AA	1ba	1l	Vs
BU	SMP20	TVS	Vbr=22.2..27.1V, Vrwm=20V, lpp=11.2A, 400W(1ms)	DO-220AA	8d	1a	Vs
BU	TV04A200K-G	TVS	Vrwm=20.0V, Vbr=22.20..27.10V, lpp=11.17A, 400W(1ms)	DO-214AC	1d	1a	Cmc
BU	TV06B200KB-G	TVS	Vrwm=20.0V, Vbr=22.20..27.10V, lpp=19.76A, 600W(1ms), Bidirectional	DO-214AA	1ba	1j	Cmc
BU	UDZ33B	Z-diode	33V±2.5%, lzt=5mA, 200mW	SOD-323	5d	1d	Di
BUA	SMBJ6.0A	TVS	Vbr=6V, 61A, 600W(1ms)	DO-214AA	1d	1q	Ste
BUB	SMBJ6.5A	TVS	Vbr=6.5V, 56A, 600W(1ms)	DO-214AA	1d	1q	Ste
BUC	SMBJ8.5A	TVS	Vbr=8.5V, 41.7A, 600W(1ms)	DO-214AA	1d	1q	Ste
BUD	SMBJ10A	TVS	Vbr=10V, 37A, 600W(1ms)	DO-214AA	1d	1q	Ste
BUE	SMBJ12A	TVS	Vbr=12V, 31A, 600W(1ms)	DO-214AA	1d	1q	Ste
BUF	SMBJ13A	TVS	Vbr=13V, 29A, 600W(1ms)	DO-214AA	1d	1q	Ste
BUG	SMBJ15A	TVS	Vbr=15V, 25.1A, 600W(1ms)	DO-214AA	1d	1q	Ste
BUH	SMBJ18A	TVS	Vbr=18V, 21.5A, 600W(1ms)	DO-214AA	1d	1q	Ste
BUI	SMBJ20A	TVS	Vbr=20V, 19.4A, 600W(1ms)	DO-214AA	1d	1q	Ste
BUJ	SMBJ24A	TVS	Vbr=24V, 16A, 600W(1ms)	DO-214AA	1d	1q	Ste
BUK	SMA36	TVS	Vbr=32.4..39.6V, Vrwm=29.1V, 7.7A, 400W(1ms)	DO-214AC	1d	1a	Lge
BUK	SMBJ26A	TVS	Vbr=26V, 14.9A, 600W(1ms)	DO-214AA	1d	1q	Ste
BUL	SMBJ28A	TVS	Vbr=28V, 13.8A, 600W(1ms)	DO-214AA	1d	1q	Ste
BUM	SMA36C	TVS	Vbr=32.4..39.6V, Vrwm=29.1V, 7.7A, 400W(1ms), Bidirectional	DO-214AC	1ba	1j	Lge
BUM	SMBJ30A	TVS	Vbr=30V, 13A, 600W(1ms)	DO-214AA	1d	1q	Ste
BUN	SMBJ33A	TVS	Vbr=33V, 11.8A, 600W(1ms)	DO-214AA	1d	1q	Ste
BUO	SMBJ58A	TVS	Vbr=58V, 6.7A, 600W(1ms)	DO-214AA	1d	1q	Ste
BUP	TPSMA36	TVS	Vbr=36V, 7.7A, 400W (1ms)	DO-214AC	1d	1k	Vs
BUP	TPSMP36	TVS	Vbr=32.4..39.6V, Vrwm=29.1V, lpp=7.7A, 400W(1ms)	DO-220AA	8d	1a	Vs
BUQ	SMBJ85A	TVS	Vbr=85V, 4.6A, 600W(1ms)	DO-214AA	1d	1q	Ste
BUS	SMBJ130A	TVS	Vbr=130V, 3A, 600W(1ms)	DO-214AA	1d	1q	Ste
BUT	SMBJ154A	TVS	Vbr=154V, 2.4A, 600W(1ms)	DO-214AA	1d	1q	Ste
BUU	SMBJ170A	TVS	Vbr=170V, 2.2A, 600W(1ms)	DO-214AA	1d	1q	Ste
BUV	SMBJ188A	TVS	Vbr=188V, 2A, 600W(1ms)	DO-214AA	1d	1q	Ste



SMD
code

Type

Function

Short description

Case

Pinout

St.

Mnf.

SMD code	Type	Function	Short description	Case	Pinout	St.	Mnf.
BUW	SMBJ48A	TVS	Vbr=48V, 8.1A, 600W(1ms)	DO-214AA	1d	1q	Ste
BUZ	SMBJ5.0A	TVS	Vbr=5V, 68A, 600W(1ms)	DO-214AA	1d	1q	Ste
BV	BZT52H-C30	Z-diode	28.0..32.0V, Izt=5mA, Zzt=40Ω, 375mW	SOD-123FL	7d	1a	Phi
BV	BZX399-C30	Z-diode	30V±5%, 300mW	SOD-323	5d	1a	Phi
BV	CD214B-T20CA	TVS	Vbr=20V, Irlsm=18.5A, 600W(1ms), Bidirectional	DO-214AA	1ba	1j	Bm
BV	P4SMA36A	TVS	Vrwm=36V, 8.4A, 400W(1ms),	DO-214AC	1d	2j	Fag
BV	P4SMAJ20A	TVS	Vbr=20V, 12.3A, 400W(1ms)	DO-214AC	1d	1a	Mco
BV	P6SMBJ20AC	TVS	Vbr=20V, 18.5A, 600W(1ms), Bidirectional	DO-214AA	1ba	1x,1y	Pjt,Srj
BV	SMAJ20A	TVS	Vrwm=20V, Vbr=22.2..24.5V, 12.3A, 400W(1ms)	DO-214AC	1d	1k	Vs
BV	SMBG20CA	TVS	Vbr=20V, 18.5A, 600W(1ms), Bidirectional	DO-215AA	5ba	1l	Vs
BV	SMBJ20CA	TVS	Vbr=20V, 18.5A, 600W(1ms), Bidirectional	DO-214AA	1ba	1l,1x	Di,Vs
BV	SMP20A	ESDP-diode	Vbr=22.2V, Vrwm=20V, Ipp=6.2A, 200W(1ms)	DO-219AB	7d	1i	Vs
BV	SMP20A	TVS	Vbr=22.2..24.5V, Vrwm=20V, Ipp=12.3A, 400W(1ms)	DO-220AA	8d	1a	Vs
BV	TV04A200J-G	TVS	Vrwm=20.0V, Vbr=22.20..24.50V, Ipp=12.35A, 400W(1ms)	DO-214AC	1d	1a	Cmc
BV	TV06B200JB-G	TVS	Vrwm=20.0V, Vbr=22.20..24.50V, Ipp=18.52A, 600W(1ms), Bidirectional	DO-214AA	1ba	1j	Cmc
BV	UDZ36B	Z-diode	36V±2.5%, Izt=5mA, 200mW	SOD-323	5d	1d	Di
BVA	SMBJ22A	TVS	Vbr=22V, 17.7A, 600W(1ms)	DO-214AA	1d	1q	Ste
BVK	SMA36A	TVS	Vbr=34.2..37.8V, Vrwm=30.8V, 8.0A, 400W(1ms)	DO-214AC	1d	1a	Lge
BVM	SMA36CA	TVS	Vbr=34.2..37.8V, Vrwm=30.8V, 8.0A, 400W(1ms), Bidirectional	DO-214AC	1ba	1j	Lge
BVP	TPSMA36A	TVS	Vbr=36V, 8.0A, 400W(1ms)	DO-214AC	1d	1k	Vs
BVP	TPSMP36A	TVS	Vbr=34.2..37.8V, Vrwm=30.8V, Ipp=8.0A, 400W(1ms)	DO-220AA	8d	1a	Vs
BW	BZT52H-C33	Z-diode	31.0..35.0V, Izt=5mA, Zzt=40Ω, 375mW	SOD-123FL	7d	1a	Phi
BW	BZX399-C33	Z-diode	33V±5%, 300mW	SOD-323	5d	1a	Phi
BW	P4SMA39	TVS	Vrwm=39V, 7.4A, 400W(1ms),	DO-214AC	1d	2j	Fag
BW	P6SMBJ22C	TVS	Vbr=22V, 15.2A, 600W(1ms), Bidirectional	DO-214AA	1ba	1x,1y	Pjt,Srj
BW	SMAJ22	TVS	Vrwm=22V, Vbr=24.4..29.8V, 10.2A, 400W(1ms)	DO-214AC	1d	1k	Vs
BW	SMBG22C	TVS	Vbr=22V, 15.2A, 600W(1ms), Bidirectional	DO-215AA	5ba	1l	Vs
BW	SMBJ22C	TVS	Vbr=22V, 15.2A, 600W(1ms), Bidirectional	DO-214AA	1ba	1l	Vs
BW	SMP22	TVS	Vbr=24.4..29.8V, Vrwm=22V, Ipp=10.2A, 400W(1ms)	DO-220AA	8d	1a	Vs
BW	TV04A220K-G	TVS	Vrwm=22.0V, Vbr=24.40..29.80V, Ipp=10.15A, 400W(1ms)	DO-214AC	1d	1a	Cmc
BW	TV06B220KB-G	TVS	Vrwm=22.0V, Vbr=24.40..29.80V, Ipp=15.23A, 600W(1ms), Bidirectional	DO-214AA	1ba	1j	Cmc
BW	UDZ39B	Z-diode	39V±2.5%, Izt=5mA, 200mW	SOD-323	5d	1d	Di
BWK	SMA39	TVS	Vbr=35.1..42.9V, Vrwm=31.6V, 7.1A, 400W(1ms)	DO-214AC	1d	1a	Lge
BWM	SMA39C	TVS	Vbr=35.1..42.9V, Vrwm=31.6V, 7.1A, 400W(1ms), Bidirectional	DO-214AC	1ba	1j	Lge
BWP	TPSMA39	TVS	Vbr=39V, 7.1A, 400W(1ms)	DO-214AC	1d	1k	Vs
BWP	TPSMP39	TVS	Vbr=35.1..42.9V, Vrwm=31.6V, Ipp=7.1A, 400W(1ms)	DO-220AA	8d	1a	Vs
BX	BZT52H-C36	Z-diode	34.0..38.0V, Izt=5mA, Zzt=60Ω, 375mW	SOD-123FL	7d	1a	Phi
BX	BZX399-C36	Z-diode	36V±5%, 300mW	SOD-323	5d	1a	Phi
BX	CD214B-T22CA	TVS	Vbr=22V, Irlsm=16.9A, 600W(1ms), Bidirectional	DO-214AA	1ba	1j	Bm
BX	MM1Z4689	Z-diode	4.85..5.36V, Izt=10mA, 500mW	SOD-323FL	5d	1a	Eic
BX	MMSZ4689	Z-diode	5.1V±5%, Izt=50μA, 500mW	SOD-123	5d	1a	Eic
BX	P4SMA39A	TVS	Vrwm=39V, 7.8A, 400W(1ms),	DO-214AC	1d	2j	Fag
BX	P4SMAJ22A	TVS	Vbr=22V, 11.2A, 400W(1ms)	DO-214AC	1d	1a	Mco
BX	P6SMBJ22AC	TVS	Vbr=22V, 16.9A, 600W(1ms), Bidirectional	DO-214AA	1ba	1x,1y	Pjt,Srj
BX	SMAJ22A	TVS	Vrwm=22V, Vbr=24.4..26.9V, 11.3A, 400W(1ms)	DO-214AC	1d	1k	Vs
BX	SMBG22CA	TVS	Vbr=22V, 16.9A, 600W(1ms), Bidirectional	DO-215AA	5ba	1l	Vs
BX	SMBJ22CA	TVS	Vbr=22V, 16.9A, 600W(1ms), Bidirectional	DO-214AA	1ba	1l,1x	Di,Vs
BX	SMP22A	ESDP-diode	Vbr=24.4V, Vrwm=22V, Ipp=5.6A, 200W(1ms)	DO-219AB	7d	1i	Vs
BX	SMP22A	TVS	Vbr=24.4..26.9V, Vrwm=22V, Ipp=11.3A, 400W(1ms)	DO-220AA	8d	1a	Vs
BX	TV04A220J-G	TVS	Vrwm=22.0V, Vbr=24.40..26.90V, Ipp=11.27A, 400W(1ms)	DO-214AC	1d	1a	Cmc
BX	TV06B220JB-G	TVS	Vrwm=22.0V, Vbr=24.40..26.90V, Ipp=16.90A, 600W(1ms), Bidirectional	DO-214AA	1ba	1j	Cmc
BX	UDZ43B	Z-diode	43V±2.5%, Izt=2mA, 200mW	SOD-323	5d	1d	Di
BX7	SM6T27CA	TVS	Vbr=25.7..28.4V, 16A, 600W(1ms), Bidirectional	DO-214AA	1ba	1l	Vs
BXK	SMA39A	TVS	Vbr=37.1..41.0V, Vrwm=33.3V, 7.4A, 400W(1ms)	DO-214AC	1d	1a	Lge
BXM	SMA39CA	TVS	Vbr=37.1..41.0V, Vrwm=33.3V, 7.4A, 400W(1ms), Bidirectional	DO-214AC	1ba	1j	Lge
BXP	TPSMA39A	TVS	Vbr=39V, 7.4A, 400W(1ms)	DO-214AC	1d	1k	Vs
BXP	TPSMP39A	TVS	Vbr=37.1..41.0V, Vrwm=33.3V, Ipp=7.4A, 400W(1ms)	DO-220AA	8d	1a	Vs
BY	BZT52H-C39	Z-diode	37.0..41.0V, Izt=5mA, Zzt=75Ω, 375mW	SOD-123FL	7d	1a	Phi
BY	BZX399-C39	Z-diode	39V±5%, 300mW	SOD-323	5d	1a	Phi
BY	KDZ2.2VYY	Z-diode	2.16..2.38V, Izt=5mA, Zzt=100Ω, 100mW	VSC	7d	1a	Kec
BY	MM1Z4690	Z-diode	5.32..5.88V, Izt=10mA, 500mW	SOD-323FL	5d	1a	Eic
BY	MMSZ4690	Z-diode	5.6V±5%, Izt=50μA, 500mW	SOD-123	5d	1a	Eic
BY	P4SMA43	TVS	Vrwm=43V, 6.8A, 400W(1ms),	DO-214AC	1d	2j	Fag
BY	P6SMBJ24C	TVS	Vbr=24V, 14A, 600W(1ms), Bidirectional	DO-214AA	1ba	1x,1y	Pjt,Srj
BY	SMAJ24	TVS	Vrwm=24V, Vbr=26.7..32.6V, 9.3A, 400W(1ms)	DO-214AC	1d	1k	Vs
BY	SMBG11C	TVS	Vbr=11V, 29.9A, 600W(1ms), Bidirectional	DO-215AA	5ba	1l	Vs
BY	SMBG24C	TVS	Vbr=24V, 14A, 600W(1ms), Bidirectional	DO-215AA	5ba	1l	Vs
BY	SMBJ11C	TVS	Vbr=11V, 29.9A, 600W(1ms), Bidirectional	DO-214AA	1ba	1l	Vs
BY	SMBJ24C	TVS	Vbr=24V, 14A, 600W(1ms), Bidirectional	DO-214AA	1ba	1l	Vs
BY	SMP24	TVS	Vbr=26.7..32.6V, Vrwm=24V, Ipp=9.3A, 400W(1ms)	DO-220AA	8d	1a	Vs



SMD code	Type	Function	Short description	Case	Pinout	St.	Mnf.
BY	TV04A240K-G	TVS	Vrwm=24.0V, Vbr=26.70..32.60V, Ipp=9.30A, 400W(1ms)	DO-214AC	1d	1a	Cmc
BY	TV06B240KB-G	TVS	Vrwm=24.0V, Vbr=26.70..32.60V, Ipp=13.95A, 600W(1ms), Bidirectional	DO-214AA	1ba	1j	Cmc
BY	UDZ47B	Z-diode	47V±2.5%, Izt=2mA, 200mW	SOD-323	5d	1d	Di
BYK	SMA43	TVS	Vbr=38.7..47.3V, Vrwm=34.8V, 6.5A, 400W(1ms)	DO-214AC	1d	1a	Lge
BYM	SMA43C	TVS	Vbr=38.7..47.3V, Vrwm=34.8V, 6.5A, 400W(1ms), Bidirectional	DO-214AC	1ba	1j	Lge
BYP	TPSMA43	TVS	Vbr=43V, 6.5A, 400W(1ms)	DO-214AC	1d	1k	Vs
BYP	TPSMP43	TVS	Vbr=38.7..47.3V, Vrwm=34.8V, Ipp=6.5A, 400W(1ms)	DO-220AA	8d	1a	Vs
BZ	BZT52-B6V8S	Z-diode	6.66..6.94V, Izt=5mA, Zzt=15Ω, 200mW	SOD-323FL	7d	1a	Tsc
BZ	BZT52H-C43	Z-diode	40.0..46.0V, Izt=5mA, Zzt=80Ω, 375mW	SOD-123FL	7d	1a	Phi
BZ	BZX399-C43	Z-diode	43V±5%, 300mW	SOD-323	5d	1a	Phi
BZ	CD214B-T24CA	TVS	Vbr=24V, Irlsm=15.4A, 600W(1ms), Bidirectional	DO-214AA	1ba	1j	Bm
BZ	MM1Z4691	Z-diode	5.89..6.51V, Izt=10mA, 500mW	SOD-323FL	5d	1a	Eic
BZ	MM3Z6V8B	Z-diode	6.66..6.94V, Zzt=14Ω, Izt=5mA, 200mW	SOD-323FL	7d	1a	F
BZ	MM3Z6V8BW	Z-diode	6.66..6.94V, Izt=5mA, Zzt=15Ω, 200mW	SOD-323FL	7d	1a	Tac
BZ	MMSZ4691	Z-diode	6.2V±5%, Izt=50μA, 500mW	SOD-123	5d	1a	Eic
BZ	P4SMA43A	TVS	Vrwm=43V, 7.1A, 400W(1ms)	DO-214AC	1d	2j	Fag
BZ	P4SMAJ24A	TVS	Vbr=24V, 10.3A, 400W(1ms)	DO-214AC	1d	1a	Mco
BZ	P6SMBJ24AC	TVS	Vbr=24V, 15.4A, 600W(1ms), Bidirectional	DO-214AA	1ba	1x,1y	Pjt,Srj
BZ	SMAJ24A	TVS	Vrwm=24V, Vbr=26.7..29.5V, 10.3A, 400W(1ms)	DO-214AC	1d	1k	Vs
BZ	SMBG11CA	TVS	Vbr=11V, 33A, 600W(1ms), Bidirectional	DO-215AA	5ba	1l	Vs
BZ	SMBG24CA	TVS	Vbr=24V, 15.4A, 600W(1ms), Bidirectional	DO-215AA	5ba	1l	Vs
BZ	SMBJ11CA	TVS	Vbr=11V, 33A, 600W(1ms), Bidirectional	DO-214AA	1ba	1l	Vs
BZ	SMBJ24CA	TVS	Vbr=24V, 15.4A, 600W(1ms), Bidirectional	DO-214AA	1ba	1l,1x	Di,Vs
BZ	SMP24A	ESDP-diode	Vbr=26.7V, Vrwm=24V, Ipp=5.1A, 200W(1ms)	DO-219AB	7d	1i	Vs
BZ	SMP24A	TVS	Vbr=26.7..29.5V, Vrwm=24V, Ipp=10.3A, 400W(1ms)	DO-220AA	8d	1a	Vs
BZ	TCMM3Z6V8B	Z-diode	6.8V±2%, Izt=5mA, Zzt=14Ω, 200mW	SOD-323FL	7d	1a	Tac
BZ	TV04A240J-G	TVS	Vrwm=24.0V, Vbr=26.70..29.50V, Ipp=10.28A, 400W(1ms)	DO-214AC	1d	1a	Cmc
BZ	TV06B240JB-G	TVS	Vrwm=24.0V, Vbr=26.70..29.50V, Ipp=15.42A, 600W(1ms), Bidirectional	DO-214AA	1ba	1j	Cmc
BZ	UDZ51B	Z-diode	51V±2.5%, Izt=2mA, 200mW	SOD-323	5d	1d	Di
BZK	SMA43A	TVS	Vbr=40.9..45.2V, Vrwm=36.8V, 6.7A, 400W(1ms)	DO-214AC	1d	1a	Lge
BZM	SMA43CA	TVS	Vbr=40.9..45.2V, Vrwm=36.8V, 6.7A, 400W(1ms), Bidirectional	DO-214AC	1ba	1j	Lge
BZP	TPSMA43A	TVS	Vbr=43V, 6.7A, 400W(1ms)	DO-214AC	1d	1k	Vs
BZP	TPSMP43A	TVS	Vbr=40.9..45.2V, Vrwm=36.8V, Ipp=6.7A, 400W(1ms)	DO-220AA	8d	1a	Vs
C	BB179B	C-diode	TV-VHF-Tuning, VCO, 30V, 20mA, 18.22..1.9pF(1..28V)	SOD-523	6d	1a	Phi
C	BB565-02V	C-diode	UHF TV-tuning, 30V, 20mA, 2.2..21.5pF(28..1V)	SC-79	6d	1u	Inf
C	CDZ15B	Z-diode	15V±2.5%, Izt=20mA, 1W	VMN	7d	1s	Rhm
C	CDZ6.2B	Z-diode	6.2V±2.5%, 40mA, 1W	VMN	7d	1s	Rhm
C	CH521S-30PT	Si-diode	SBD, 30V, 200mA, Vf<0.5V(200mA)	SOD-523	8d	1a	Chm
C	DSE010	Si-diode	Sw, Hi-sp, 90V, 150mA, Vf<1.2V(100mA), 3pF, 4ns	SOD-523	6d	1a	San
C	GBLCO3I	TVS	Vbr=3V, 5A, 350W(1ms), 0.6pF	SOD-323	5d	1a	Prt
C	HVR17	C-diode	FM-Tuning, 15V, 50..8.84pF(1..4.5V)	SOD-123	5d	1a	Ren
C	MMSZ5252BPT	Z-diode	22.80..25.20V, Izt=5mA, Zzt=62Ω, 225mW	SOD-523	7d	1a	Chm
C	RB521S-30	Si-diode	SBR, 30V, 200mA, Vf<0.5V(200mA)	SOD-523	6d	1a	Rhm
C (white)	BAT65	Si-diode	Schottky, 30V, 500mA, Vf<0.7V(500mA), Cd<12pF	SOD-123	5d	2	Inf
C	MMSZ5252SPT	Z-diode	23.52..24.48V, Izt=5mA, Zzt=62Ω, 225mW	SOD-523	7d	1a	Chm
C0	BZX585-B5V6	Z-diode	5.6V±2%, 300mW	SOD-523	6d	1a	Phi
C0	MM3Z2V2	Z-diode	2.08..2.33V, Izt=5mA, Zzt=100Ω, 300mW	SOD-323FL	7d	1a	Lge
C0	MMPZ5233BPT	Z-diode	5.700..6.300V, Izt=5mA, Zzt=25Ω, 225mW	SOD-323	5d	1a	Chm
C0	MMPZ5233SPT	Z-diode	5.880..6.120V, Izt=5mA, Zzt=25Ω, 225mW	SOD-323	5d	1a	Chm
C02	CMR1-02	Si-diode	GP, Rectifier, 100V, 1A, Vf<1.1V(1A)	DO-214AA	1d	1a	Cen
C02M	CMR1-02M	Si-diode	GP, Rectifier, 100V, 1A, Vf<1.1V(1A)	DO-214AC	1d	1a	Cen
C03	CMHD2003	Si-diode	HV, Sw, 250V, 250mA, 400mW, Vf<1V(100mA), 1.5pF	SOD-123	5d	1a	Cen
C04	CMR1-04	Si-diode	GP, Rectifier, 400V, 1A, Vf<1.1V(1A)	DO-214AA	1d	1a	Cen
C04M	CMR1-04M	Si-diode	GP, Rectifier, 400V, 1A, Vf<1.1V(1A)	DO-214AC	1d	1a	Cen
C06	CMR1-06	Si-diode	GP, Rectifier, 600V, 1A, Vf<1.1V(1A)	DO-214AA	1d	1a	Cen
C06M	CMR1-06M	Si-diode	GP, Rectifier, 600V, 1A, Vf<1.1V(1A)	DO-214AC	1d	1a	Cen
C1	1SS352	Si-diode	Sw, U-Fast, 80V, 100mA, 200mW, 0.5pF, 1.6ns	SOD-323	5d	1a	Tos
C1	1SS368	Si-diode	Sw, U-Fast, 80V, 100mA, 200mW, 0.5pF, 1.6ns	SOD-323	5d	1a	Tos
C1	1SS387	Si-diode	Sw, Fast, 85V, 100mA, <4ns	SOD-323	5d	1a	Tos
C1	BZT52H-C47	Z-diode	44.0..50.0V, Izt=5mA, Zzt=90Ω, 375mW	SOD-123FL	7d	1a	Phi
C1	BZX585-B2V4	Z-diode	2.4V±2%, 300mW	SOD-523	6d	1a	Phi
C1	BZX884-B16	Z-diode	16V±2%, 250mW	SOD-882	13d	2b	Phi
C1	CZRH5221B-G	Z-diode	2.28..2.52V, Zzt=30Ω, Izt=20mA, 150mW	SOD-523	5d	1a	Cmc
C1	CZRV5221B-G	Z-diode	2.28..2.52V, Zzt=30Ω, Izt=20mA, 200mW	SOD-323	5d	1a	Cmc
C1	CZRW5221B-G	Z-diode	2.28..2.52V, Zzt=30Ω, Izt=20mA, 500mW	SOD-123	5d	1a	Cmc
C1	FSS32	Si-diode	SBR, 20V, 3A, Vf<0.75V(3A)	DO-214AB	1d	2j	Fag
C1	MAZF043	Z-diode	4..4.6V, Zzt=130Ω(5mA), 120mW	S-Mini	7d	1a	Pan
C1	MAZN043	Z-diode	4..4.6V, Zzt=130Ω(5mA), 120mW	SSMini2	7d	1a	Pan
C1	MM3Z5221B	Z-diode	2.28..2.52V, Izt=20mA, Zzt=30Ω, 200mW	SOD-323	5d	1a	Ext
C1	MM3Z5225B	Z-diode	3.0V±5%, Izt=20mA, Zzt=29Ω, 200mW	SOD-323FL	7d	1a	Bts



SMD
code

Type

Function

Short description

Case

Pinout

St.

Mnf.

SMD code	Type	Function	Short description	Case	Pinout	St.	Mnf.
C1	MM3Z5225BH	Z-diode	2.85..3.15V, Izt=20mA, Zzt=29Ω, 300mW	SOD-323	5d	1a	Zow
C1	MMSZ5221B	Z-diode	2.4V±5%, Izt=20mA, Zzt=30Ω, 500mW	SOD-123	5d	1a,1d	Di,Mot
C1	MMSZ5221B	Z-diode	2.4V±5%, Izt=20mA, Zzt=30Ω, 500mW	SOD-123	5d	1d	Di
C1	MMSZ5221BS	Z-diode	2.4V±5%, Izt=20mA, Zzt=30Ω, 500mW	SOD-323	5d	1d	Di
C1	RKZ2.0BK	Z-diode	1.90..2.20V, Izt=5mA, Zzt=100Ω, 150mW	SFP	7d	1a	Ren
C1	RKZ2.0BKL	Z-diode	1.90..2.20V, Izt=5mA, Zzt=100Ω, 100mW	EPF	7d	1a	Ren
C10	BZG03-C10	Z-diode	10V±5%, Izt=50mA, Zzt=2Ω, 1.25W	DO-214AC	1d	1a	Eic
C10	CMR1-10	Si-diode	GP, Rectifier, 1000V, 1A, Vf<1.1V(1A)	DO-214AA	1d	1a	Cen
C10	SMBJ-LC10	TVS	Vbr=11.9..14.4V, Vrw=10V, 31.9A, 600W(1ms)	DO-214AA	1d	1a	Eic
C100	BZG03-C100	Z-diode	100V±5%, Izt=5mA, Zzt=60Ω, 1.25W	DO-214AC	1d	1a	Eic
C100	SMBJ-LC100	TVS	Vbr=111.8..136.8V, Vrw=100V, 3.4A, 600W(1ms)	DO-214AA	1d	1a	Eic
C100A	1.5SMC100A	TVS	Vbr=95.0..105V, Vrw=85.5V, 10.9A, 1500W(1ms)	DO-214AB	1d	1a	Cen
C100A	P6SMB100A	TVS	Vbr=95.0..105V, 4.4A, 600W(1ms)	DO-214AA	1d	1a	Cen
C100A	SMBJ-LC100A	TVS	Vbr=111.8..123.8V, Vrw=100V, 3.7A, 600W(1ms)	DO-214AA	1d	1a	Eic
C100C	1.5SCM100CA	TVS	Vbr=95.0..105V, Vrw=85.5V, 10.9A, 1500W(1ms), Bidirectional	DO-214AB	1ba	1j	Cen
C100C	P6SMB100CA	TVS	Vbr=95.0..105V, 4.4A, 600W(1ms), Bidirectional	DO-214AA	1ba	1j	Cen
C10A	1.5SCMJ16A	TVS	Vbr=15.2..16.8V, Vrw=13.6V, 19A, 1500W(1ms)	DO-214AB	1d	1a	Chm
C10A	1.5SMC10A	TVS	Vbr=9.50..10.5V, Vrw=8.55V, 103A, 1500W(1ms)	DO-214AB	1d	1a	Cen
C10A	P6SMB10A	TVS	Vbr=9.5..10.5V, 41A, 600W(1ms)	DO-214AA	1d	1a	Cen
C10A	SMBJ-LC10A	TVS	Vbr=11.9..13.1V, Vrw=10V, 35.3A, 600W(1ms)	DO-214AA	1d	1a	Eic
C10C	1.5SCMJ16CA	TVS	Vbr=15.2..16.8V, Vrw=13.6V, 19A, 1500W(1ms), Bidirectional	DO-214AB	1ba	1j	Chm
C10C	1.5SMC10CA	TVS	Vbr=9.50..10.5V, Vrw=8.55V, 103A, 1500W(1ms), Bidirectional	DO-214AB	1ba	1j	Cen
C10C	P6SMB10CA	TVS	Vbr=9.5..10.5V, 41A, 600W(1ms), Bidirectional	DO-214AA	1ba	1j	Cen
C10M	CMR1-10M	Si-diode	GP, Rectifier, 1000V, 1A, Vf<1.1V(1A)	DO-214AC	1d	1a	Cen
C11	BZG03-C11	Z-diode	11V±5%, Izt=50mA, Zzt=4Ω, 1.25W	DO-214AC	1d	1a	Eic
C11	SMBJ-LC11	TVS	Vbr=13.0..15.7V, Vrw=11V, 29.9A, 600W(1ms)	DO-214AA	1d	1a	Eic
C110	BZG03-C110	Z-diode	110V±5%, Izt=5mA, Zzt=80Ω, 1.25W	DO-214AC	1d	1a	Eic
C110	SMBJ-LC110	TVS	Vbr=122.8..149.8V, Vrw=110V, 3.0A, 600W(1ms)	DO-214AA	1d	1a	Eic
C110A	1.5SMC110A	TVS	Vbr=105..116V, Vrw=94.0V, 9.9A, 1500W(1ms)	DO-214AB	1d	1a	Cen
C110A	P6SMB110A	TVS	Vbr=104.5..115.5V, 4.0A, 600W(1ms)	DO-214AA	1d	1a	Cen
C110A	SMBJ-LC110A	TVS	Vbr=122.8..135.8V, Vrw=110V, 3.4A, 600W(1ms)	DO-214AA	1d	1a	Eic
C110C	1.5SCM110CA	TVS	Vbr=105..116V, Vrw=94.0V, 9.9A, 1500W(1ms), Bidirectional	DO-214AB	1ba	1j	Cen
C110C	P6SMB110CA	TVS	Vbr=104.5..115.5V, 4.0A, 600W(1ms), Bidirectional	DO-214AA	1ba	1j	Cen
C11A	1.5SCMJ18A	TVS	Vbr=17.1..18.9V, Vrw=15.3V, 17A, 1500W(1ms)	DO-214AB	1d	1a	Chm
C11A	1.5SMC11A	TVS	Vbr=105..116V, Vrw=9.40V, 96.2A, 1500W(1ms)	DO-214AB	1d	1a	Cen
C11A	P6SMB11A	TVS	Vbr=105..116V, 38A, 600W(1ms)	DO-214AA	1d	1a	Cen
C11A	SMBJ-LC11A	TVS	Vbr=13.0..14.3V, Vrw=11V, 33.0A, 600W(1ms)	DO-214AA	1d	1a	Eic
C11C	1.5SCMJ18CA	TVS	Vbr=17.1..18.9V, Vrw=15.3V, 17A, 1500W(1ms), Bidirectional	DO-214AB	1ba	1j	Chm
C11C	1.5SMC11CA	TVS	Vbr=105..116V, Vrw=9.40V, 96.2A, 1500W(1ms), Bidirectional	DO-214AB	1ba	1j	Cen
C11C	P6SMB11CA	TVS	Vbr=10.5..11.6V, 38A, 600W(1ms), Bidirectional	DO-214AA	1ba	1j	Cen
C12	BZG03-C12	Z-diode	12V±5%, Izt=50mA, Zzt=4Ω, 1.25W	DO-214AC	1d	1a	Eic
C12	SMBJ-LC12	TVS	Vbr=14.1..17.1V, Vrw=12V, 27.3A, 600W(1ms)	DO-214AA	1d	1a	Eic
C120	BZG03-C120	Z-diode	120V±5%, Izt=5mA, Zzt=80Ω, 1.25W	DO-214AC	1d	1a	Eic
C120	SMBJ-LC120	TVS	Vbr=133.8..163.8V, Vrw=120V, 2.8A, 600W(1ms)	DO-214AA	1d	1a	Eic
C120A	1.5SMC120A	TVS	Vbr=114..126V, Vrw=102V, 9.1A, 1500W(1ms)	DO-214AB	1d	1a	Cen
C120A	P6SMB120A	TVS	Vbr=114..126V, 3.6A, 600W(1ms)	DO-214AA	1d	1a	Cen
C120A	SMBJ-LC120A	TVS	Vbr=133.8..147.8V, Vrw=120V, 3.1A, 600W(1ms)	DO-214AA	1d	1a	Eic
C120C	1.5SCM120CA	TVS	Vbr=114..126V, Vrw=102V, 9.1A, 1500W(1ms), Bidirectional	DO-214AB	1ba	1j	Cen
C120C	P6SMB120CA	TVS	Vbr=114..126V, 3.6A, 600W(1ms), Bidirectional	DO-214AA	1ba	1j	Cen
C12A	1.5SCMJ20A	TVS	Vbr=19.0..21.0V, Vrw=17.1V, 15A, 1500W(1ms)	DO-214AB	1d	1a	Chm
C12A	1.5SMC12A	TVS	Vbr=11.4..12.6V, Vrw=10.2V, 89.8A, 1500W(1ms)	DO-214AB	1d	1a	Cen
C12A	P6SMB12A	TVS	Vbr=11.4..12.6V, 36A, 600W(1ms)	DO-214AA	1d	1a	Cen
C12A	SMBJ-LC12A	TVS	Vbr=14.1..15.5V, Vrw=12V, 30.2A, 600W(1ms)	DO-214AA	1d	1a	Eic
C12C	1.5SCMJ20CA	TVS	Vbr=19.0..21.0V, Vrw=17.1V, 15A, 1500W(1ms), Bidirectional	DO-214AB	1ba	1j	Chm
C12C	1.5SMC12CA	TVS	Vbr=11.4..12.6V, Vrw=10.2V, 89.8A, 1500W(1ms), Bidirectional	DO-214AB	1ba	1j	Cen
C12C	P6SMB12CA	TVS	Vbr=11.4..12.6V, 36A, 600W(1ms), Bidirectional	DO-214AA	1ba	1j	Cen
C13	BZG03-C13	Z-diode	13V±5%, Izt=50mA, Zzt=5Ω, 1.25W	DO-214AC	1d	1a	Eic
C13	SMBJ-LC13	TVS	Vbr=15.2..18.4V, Vrw=13V, 25.2A, 600W(1ms)	DO-214AA	1d	1a	Eic
C130	BZG03-C130	Z-diode	130V±5%, Izt=5mA, Zzt=110Ω, 1.25W	DO-214AC	1d	1a	Eic
C130	SMBJ-LC130	TVS	Vbr=144.8..176.8V, Vrw=130V, 2.6A, 600W(1ms)	DO-214AA	1d	1a	Eic
C130A	1.5SMC130A	TVS	Vbr=124..137V, Vrw=111V, 8.4A, 1500W(1ms)	DO-214AB	1d	1a	Cen
C130A	P6SMB130A	TVS	Vbr=123.5..136.5V, 3.3A, 600W(1ms)	DO-214AA	1d	1a	Cen
C130A	SMBJ-LC130A	TVS	Vbr=144.8..159.8V, Vrw=130V, 2.9A, 600W(1ms)	DO-214AA	1d	1a	Eic
C130C	1.5SCM130CA	TVS	Vbr=124..137V, Vrw=111V, 8.4A, 1500W(1ms), Bidirectional	DO-214AB	1ba	1j	Cen
C130C	P6SMB130CA	TVS	Vbr=123.5..136.5V, 3.3A, 600W(1ms), Bidirectional	DO-214AA	1ba	1j	Cen
C13A	1.5SCMJ22A	TVS	Vbr=20.9..23.1V, Vrw=18.8V, 14A, 1500W(1ms)	DO-214AB	1d	1a	Chm
C13A	1.5SMC13A	TVS	Vbr=12.4..13.7V, Vrw=11.1V, 82.4A, 1500W(1ms)	DO-214AB	1d	1a	Cen
C13A	P6SMB13A	TVS	Vbr=12.4..13.7V, 33A, 600W(1ms)	DO-214AA	1d	1a	Cen
C13A	SMBJ-LC13A	TVS	Vbr=15.2..16.7V, Vrw=13V, 27.9A, 600W(1ms)	DO-214AA	1d	1a	Eic
C13C	1.5SCMJ22CA	TVS	Vbr=20.9..23.1V, Vrw=18.8V, 14A, 1500W(1ms), Bidirectional	DO-214AB	1ba	1j	Chm



SMD
code

Type

Function

Short description

Case

Pinout

St.

Mnf.

C13C	1.5SMC13CA	TVS	Vbr=12.4..13.7V, Vrvwm=11.1V, 82.4A, 1500W(1ms), Bidirectional	DO-214AB	1ba	1j	Cen
C13C	P6SMB13CA	TVS	Vbr=12.4..13.7V, 33A, 600W(1ms), Bidirectional	DO-214AA	1ba	1j	Cen
C14	SMBJ-LC14	TVS	Vbr=16.4..19.9V, Vrvwm=14V, 23.3A, 600W(1ms)	DO-214AA	1d	1a	Eic
C14A	1.5SCMJ24A	TVS	Vbr=22.8..25.2V, Vrvwm=20.5V, 13A, 1500W(1ms)	DO-214AB	1d	1a	Chm
C14A	SMBJ-LC14A	TVS	Vbr=16.4..18.0V, Vrvwm=14V, 25.8A, 600W(1ms)	DO-214AA	1d	1a	Eic
C14C	1.5SCMJ24CA	TVS	Vbr=22.8..25.2V, Vrvwm=20.5V, 13A, 1500W(1ms), Bidirectional	DO-214AB	1ba	1j	Chm
C15	BZG03-C15	Z-diode	15V±5%, Izt=50mA, Zzt=5Ω, 1.25W	DO-214AC	1d	1a	Eic
C15	SMBJ-LC15	TVS	Vbr=17.5..21.2V, Vrvwm=15V, 22.3A, 600W(1ms)	DO-214AA	1d	1a	Eic
C150	BZG03-C150	Z-diode	150V±5%, Izt=5mA, Zzt=130Ω, 1.25W	DO-214AC	1d	1a	Eic
C150	SMBJ-LC150	TVS	Vbr=167.8..204.8V, Vrvwm=150V, 2.2A, 600W(1ms)	DO-214AA	1d	1a	Eic
C150A	1.5SMC150A	TVS	Vbr=143..158V, Vrvwm=128V, 7.2A, 1500W(1ms)	DO-214AB	1d	1a	Cen
C150A	P6SMB150A	TVS	Vbr=142.5..157.5V, 2.9A, 600W(1ms)	DO-214AA	1d	1a	Cen
C150A	SMBJ-LC150A	TVS	Vbr=167.8..185.8V, Vrvwm=150V, 2.5A, 600W(1ms)	DO-214AA	1d	1a	Eic
C150C	1.5SMC150CA	TVS	Vbr=143..158V, Vrvwm=128V, 7.2A, 1500W(1ms), Bidirectional	DO-214AB	1ba	1j	Cen
C150C	P6SMB150CA	TVS	Vbr=142.5..157.5V, 2.9A, 600W(1ms), Bidirectional	DO-214AA	1ba	1j	Cen
C15A	1.5SCMJ27A	TVS	Vbr=25.7..28.4V, Vrvwm=23.1V, 11.2A, 1500W(1ms)	DO-214AB	1d	1a	Chm
C15A	1.5SMC15A	TVS	Vbr=14.3..15.8V, Vrvwm=12.8V, 70.8A, 1500W(1ms)	DO-214AB	1d	1a	Cen
C15A	P6SMB15A	TVS	Vbr=14.3..15.8V, 28A, 600W(1ms)	DO-214AA	1d	1a	Cen
C15A	SMBJ-LC15A	TVS	Vbr=17.5..19.3V, Vrvwm=15V, 24.0A, 600W(1ms)	DO-214AA	1d	1a	Eic
C15C	1.5SCMJ27CA	TVS	Vbr=25.7..28.4V, Vrvwm=23.1V, 11.2A, 1500W(1ms), Bidirectional	DO-214AB	1ba	1j	Chm
C15C	1.5SMC15CA	TVS	Vbr=14.3..15.8V, Vrvwm=12.8V, 70.8A, 1500W(1ms), Bidirectional	DO-214AB	1ba	1j	Cen
C15C	P6SMB15CA	TVS	Vbr=14.3..15.8V, 28A, 600W(1ms), Bidirectional	DO-214AA	1ba	1j	Cen
C16	BZG03-C16	Z-diode	16V±5%, Izt=25mA, Zzt=6Ω, 1.25W	DO-214AC	1d	1a	Eic
C16	SMBJ-LC16	TVS	Vbr=18.6..22.6V, Vrvwm=16V, 20.8A, 600W(1ms)	DO-214AA	1d	1a	Eic
C160	BZG03-C160	Z-diode	160V±5%, Izt=5mA, Zzt=150Ω, 1.25W	DO-214AC	1d	1a	Eic
C160	SMBJ-LC160	TVS	Vbr=178.8..218.8V, Vrvwm=160V, 2.1A, 600W(1ms)	DO-214AA	1d	1a	Eic
C160A	1.5SMC160A	TVS	Vbr=152..168V, Vrvwm=136V, 6.8A, 1500W(1ms)	DO-214AB	1d	1a	Cen
C160A	P6SMB160A	TVS	Vbr=152..168V, 2.7A, 600W(1ms)	DO-214AA	1d	1a	Cen
C160A	SMBJ-LC160A	TVS	Vbr=178.8..197.8V, Vrvwm=160V, 2.3A, 600W(1ms)	DO-214AA	1d	1a	Eic
C160C	1.5SMC160CA	TVS	Vbr=152..168V, Vrvwm=136V, 6.8A, 1500W(1ms), Bidirectional	DO-214AB	1ba	1j	Cen
C160C	P6SMB160CA	TVS	Vbr=152..168V, 2.7A, 600W(1ms), Bidirectional	DO-214AA	1ba	1j	Cen
C16A	1.5SCMJ30A	TVS	Vbr=28.5..31.5V, Vrvwm=25.6V, 10A, 1500W(1ms)	DO-214AB	1d	1a	Chm
C16A	1.5SMC16A	TVS	Vbr=15.2..16.8V, Vrvwm=13.6V, 66.7A, 1500W(1ms)	DO-214AB	1d	1a	Cen
C16A	P6SMB16A	TVS	Vbr=15.2..16.8V, 27A, 600W(1ms)	DO-214AA	1d	1a	Cen
C16A	SMBJ-LC16A	TVS	Vbr=18.6..20.5V, Vrvwm=16V, 23.1A, 600W(1ms)	DO-214AA	1d	1a	Eic
C16C	1.5SCMJ30CA	TVS	Vbr=28.5..31.5V, Vrvwm=25.6V, 10A, 1500W(1ms), Bidirectional	DO-214AB	1ba	1j	Chm
C16C	1.5SMC16CA	TVS	Vbr=15.2..16.8V, Vrvwm=13.6V, 66.7A, 1500W(1ms), Bidirectional	DO-214AB	1ba	1j	Cen
C16C	P6SMB16CA	TVS	Vbr=15.2..16.8V, 27A, 600W(1ms), Bidirectional	DO-214AA	1ba	1j	Cen
C17	SMBJ-LC17	TVS	Vbr=19.7..23.9V, Vrvwm=17V, 19.7A, 600W(1ms)	DO-214AA	1d	1a	Eic
C170	SMBJ-LC170	TVS	Vbr=189.8..231.8V, Vrvwm=170V, 2.0A, 600W(1ms)	DO-214AA	1d	1a	Eic
C170A	1.5SMC170A	TVS	Vbr=162..179V, Vrvwm=145V, 6.4A, 1500W(1ms)	DO-214AB	1d	1a	Cen
C170A	P6SMB170A	TVS	Vbr=161.5..178.5V, 2.6A, 600W(1ms)	DO-214AA	1d	1a	Cen
C170A	SMBJ-LC170A	TVS	Vbr=189.8..209.8V, Vrvwm=170V, 2.2A, 600W(1ms)	DO-214AA	1d	1a	Eic
C170C	1.5SMC170CA	TVS	Vbr=162..179V, Vrvwm=145V, 6.4A, 1500W(1ms), Bidirectional	DO-214AB	1ba	1j	Cen
C170C	P6SMB170CA	TVS	Vbr=161.5..178.5V, 2.6A, 600W(1ms), Bidirectional	DO-214AA	1ba	1j	Cen
C17A	1.5SCMJ33A	TVS	Vbr=31.4..34.7V, Vrvwm=28.2V, 9A, 1500W(1ms)	DO-214AB	1d	1a	Chm
C17A	SMBJ-LC17A	TVS	Vbr=19.7..21.7V, Vrvwm=17V, 21.7A, 600W(1ms)	DO-214AA	1d	1a	Eic
C17C	1.5SCMJ33CA	TVS	Vbr=31.4..34.7V, Vrvwm=28.2V, 9A, 1500W(1ms), Bidirectional	DO-214AB	1ba	1j	Chm
C18	BZG03-C18	Z-diode	18V±5%, Izt=25mA, Zzt=6Ω, 1.25W	DO-214AC	1d	1a	Eic
C18	SMBJ-LC18	TVS	Vbr=20.8..25.2V, Vrvwm=18V, 18.6A, 600W(1ms)	DO-214AA	1d	1a	Eic
C180	BZG03-C180	Z-diode	180V±5%, Izt=5mA, Zzt=180Ω, 1.25W	DO-214AC	1d	1a	Eic
C180A	1.5SMC180A	TVS	Vbr=171..189V, Vrvwm=154V, 6.1A, 1500W(1ms)	DO-214AB	1d	1a	Cen
C180A	P6SMB180A	TVS	Vbr=171..189V, 2.4A, 600W(1ms)	DO-214AA	1d	1a	Cen
C180C	1.5SMC180CA	TVS	Vbr=171..189V, Vrvwm=154V, 6.1A, 1500W(1ms), Bidirectional	DO-214AB	1ba	1j	Cen
C180C	P6SMB180CA	TVS	Vbr=171..189V, 2.4A, 600W(1ms), Bidirectional	DO-214AA	1ba	1j	Cen
C188	SMBJ-LC188	TVS	Vbr=209.8..255.8V, Vrvwm=188V, 1.7A, 600W(1ms)	DO-214AA	1d	1a	Eic
C188A	SMBJ-LC188A	TVS	Vbr=209.8..231.8V, Vrvwm=188V, 2.0A, 600W(1ms)	DO-214AA	1d	1a	Eic
C18A	1.5SCMJ36A	TVS	Vbr=34.2..37.8V, Vrvwm=30.8V, 8.4A, 1500W(1ms)	DO-214AB	1d	1a	Chm
C18A	1.5SMC18A	TVS	Vbr=17.1..18.9V, Vrvwm=15.3V, 59.5A, 1500W(1ms)	DO-214AB	1d	1a	Cen
C18A	P6SMB18A	TVS	Vbr=17.1..18.9V, 24A, 600W(1ms)	DO-214AA	1d	1a	Cen
C18A	SMBJ-LC18A	TVS	Vbr=20.8..22.9V, Vrvwm=18V, 20.5A, 600W(1ms)	DO-214AA	1d	1a	Eic
C18C	1.5SCMJ36CA	TVS	Vbr=34.2..37.8V, Vrvwm=30.8V, 8.4A, 1500W(1ms), Bidirectional	DO-214AB	1ba	1j	Chm
C18C	1.5SMC18CA	TVS	Vbr=17.1..18.9V, Vrvwm=15.3V, 59.5A, 1500W(1ms), Bidirectional	DO-214AB	1ba	1j	Cen
C18C	P6SMB18CA	TVS	Vbr=17.1..18.9V, 24A, 600W(1ms), Bidirectional	DO-214AA	1ba	1j	Cen
C19A	1.5SCMJ39A	TVS	Vbr=37.1..41.0V, Vrvwm=33.3V, 7.8A, 1500W(1ms)	DO-214AB	1d	1a	Chm
C19C	1.5SCMJ39CA	TVS	Vbr=37.1..41.0V, Vrvwm=33.3V, 7.8A, 1500W(1ms), Bidirectional	DO-214AB	1ba	1j	Chm
C1A	1.5SCMJ6.8A	TVS	Vbr=6.45..7.14V, Vrvwm=5.80V, 40A, 1500W(1ms)	DO-214AB	1d	1a	Chm
C1C	1.5SCMJ6.8CA	TVS	Vbr=6.45..7.14V, Vrvwm=5.80V, 40A, 1500W(1ms), Bidirectional	DO-214AB	1ba	1j	Chm
C2	BZT52H-C51	Z-diode	48.0..54.0V, Izt=5mA, Zzt=100Ω, 375mW	SOD-123FL	7d	1a	Phi
C2	BZX585-B2V9	Z-diode	2.9V±2%, 300mW	SOD-523	6d	1a	Phi



SMD
code

Type

Function

Short description

Case

Pinout

St.

Mnf.

SMD code	Type	Function	Short description	Case	Pinout	St.	Mnf.
C2	BZX884-B18	Z-diode	18V±2%, 250mW	SOD-882	13d	2b	Phi
C2	CZRH5222B-G	Z-diode	2.38..2.63V, Zzt=30Ω, Izt=20mA, 150mW	SOD-523	5d	1a	Cmc
C2	CZRV5222B-G	Z-diode	2.38..2.63V, Zzt=30Ω, Izt=20mA, 200mW	SOD-323	5d	1a	Cmc
C2	EDZ5.6B	Z-diode	5.49..5.73V, Izt=5mA, Zzt=60Ω, 150mW	SOD-523	6d	1a	Rhm
C2	EDZ55.6B	Z-diode	5.6V±10%, 5mA, 100mW	SOD-523	6d	1a	Rhm
C2	FDZ5.6EV	Z-diode	5.490..5.730V, Izt=5mA, Zzt=60Ω, 150mW	SOD-523	7d	1a	Fis
C2	FDZ5.6VT	Z-diode	5.490..5.730V, Izt=5mA, Zzt=60Ω, 200mW	SOD-323	5d	1a	Fis
C2	FSS33	Si-diode	SBR, 30V, 3A, Vf<0.75V(3A)	DO-214AB	1d	2j	Fag
C2	MAZF047	Z-diode	4.4..5V, Zzt=80Ω(5mA), 120mW	S-Mini	7d	1a	Pan
C2	MAZN047	Z-diode	4.4..5V, Zzt=80Ω(5mA), 120mW	SSMini2	7d	1a	Pan
C2	MM3Z5222B	Z-diode	2.38..2.63V, Izt=20mA, Zzt=30Ω, 200mW	SOD-323	5d	1a	Ext
C2	MM3Z5243B	Z-diode	13V±5%, Izt=9.5mA, Zzt=13Ω, 200mW	SOD-323FL	7d	1a	Bts
C2	MM3Z5243BH	Z-diode	12.35..13.65V, Izt=9.5mA, Zzt=13Ω, 300mW	SOD-323	5d	1a	Zow
C2	MM3Z5222B	Z-diode	2.5V±5%, Izt=20mA, Zzt=30Ω, 500mW	SOD-123	5d	1a,1d	Di,Mot
C2	MSCD032	Si-diode	SBR, 20V, 0.3A, Vf<0.5V(0.3A)	8005	14d	1v	Zow
C2	RKZ2.2BKK	Z-diode	2.10..2.40V, Izt=5mA, Zzt=100Ω, 150mW	SFP	7d	1a	Ren
C2	RKZ2.2BKL	Z-diode	2.10..2.40V, Izt=5mA, Zzt=100Ω, 100mW	EPF	7d	1a	Ren
C2	SMBYT03-200	Si-diode	Rectifier, Fast-Recovery, 200V, 3A, Vf<0.71V(3A), <25ns	DO-214AC	1d	1q	Ste
C2	TDZ5.6B	Z-diode	5.6V±2.5%, 10mA, 500mW	TUMD2	7d	1s	Rhm
C2	UDZ55.6B	Z-diode	5.49..5.73V, Izt=5mA, Zzt=60Ω, 200mW	SOD-323	5d	1a	Wtr
C2	UDZ55.6B	Z-diode	5.6V±2.5%, Izt=5mA, 200mW	SOD-323FL	7d	1s	Rhm
C2	VDZ55.6B	Z-diode	5.6V±5%, 5mA, 100mW	VMD2	5d	1z	Rhm
C20	BZG03-C20	Z-diode	20V±5%, Izt=25mA, Zzt=6Ω, 1.25W	DO-214AC	1d	1a	Eic
C20	SMBJ-LC20	TVS	Vbr=23.0..27.9V, Vrrwm=20V, 16.7A, 600W(1ms)	DO-214AA	1d	1a	Eic
C200	BZG03-C200	Z-diode	200V±5%, Izt=5mA, Zzt=200Ω, 1.25W	DO-214AC	1d	1a	Eic
C200A	1.5SMC200A	TVS	Vbr=190..210V, Vrrwm=171V, 5.5A, 1500W(1ms)	DO-214AB	1d	1a	Cen
C200A	P6SMB200A	TVS	Vbr=190..210V, 2.2A, 600W(1ms)	DO-214AA	1d	1a	Cen
C200C	1.5SMC200CA	TVS	Vbr=190..210V, Vrrwm=171V, 5.5A, 1500W(1ms), Bidirectional	DO-214AB	1ba	1j	Cen
C200C	P6SMB200CA	TVS	Vbr=190..210V, 2.2A, 600W(1ms), Bidirectional	DO-214AA	1ba	1j	Cen
C202	CMR2-02	Si-diode	GP, Rectifier, 200V, 2A, Vf<1.1V(2A)	DO-214AA	1d	1a	Cen
C204	CMR2-04	Si-diode	GP, Rectifier, 400V, 2A, Vf<1.1V(2A)	DO-214AA	1d	1a	Cen
C206	CMR2-06	Si-diode	GP, Rectifier, 600V, 2A, Vf<1.1V(2A)	DO-214AA	1d	1a	Cen
C20A	1.5SCMJ43A	TVS	Vbr=40.9..45.2V, Vrrwm=36.8V, 7.1A, 1500W(1ms)	DO-214AB	1d	1a	Chm
C20A	1.5SMC20A	TVS	Vbr=19.0..21.0V, Vrrwm=17.1V, 54.2A, 1500W(1ms)	DO-214AB	1d	1a	Cen
C20A	P6SMB20A	TVS	Vbr=19.0..21.0V, 22A, 600W(1ms)	DO-214AA	1d	1a	Cen
C20A	SMBJ-LC20A	TVS	Vbr=23.0..25.3V, Vrrwm=20V, 18.5A, 600W(1ms)	DO-214AA	1d	1a	Eic
C20C	1.5SCMJ43CA	TVS	Vbr=40.9..45.2V, Vrrwm=36.8V, 7.1A, 1500W(1ms), Bidirectional	DO-214AB	1ba	1j	Chm
C20C	1.5SMC20CA	TVS	Vbr=19.0..21.0V, Vrrwm=17.1V, 54.2A, 1500W(1ms), Bidirectional	DO-214AB	1ba	1j	Cen
C20C	P6SMB20CA	TVS	Vbr=19.0..21.0V, 22A, 600W(1ms), Bidirectional	DO-214AA	1ba	1j	Cen
C210	CMR2-10	Si-diode	GP, Rectifier, 1000V, 2A, Vf<1.1V(2A)	DO-214AA	1d	1a	Cen
C21A	1.5SCMJ47A	TVS	Vbr=44.7..49.4V, Vrrwm=40.2V, 5.0A, 1500W(1ms)	DO-214AB	1d	1a	Chm
C21C	1.5SCMJ47CA	TVS	Vbr=44.7..49.4V, Vrrwm=40.2V, 5.0A, 1500W(1ms), Bidirectional	DO-214AB	1ba	1j	Chm
C22	BZG03-C22	Z-diode	22V±5%, Izt=25mA, Zzt=6Ω, 1.25W	DO-214AC	1d	1a	Eic
C22	SMBJ-LC22	TVS	Vbr=25.2..30.6V, Vrrwm=22V, 15.2A, 600W(1ms)	DO-214AA	1d	1a	Eic
C220	BZG03-C220	Z-diode	220V±5%, Izt=2mA, Zzt=350Ω, 1.25W	DO-214AC	1d	1a	Eic
C220A	1.5SMC220A	TVS	Vbr=209..231V, Vrrwm=185V, 4.6A, 1500W(1ms)	DO-214AB	1d	1a	Cen
C220A	P6SMB220A	TVS	Vbr=209..231V, 1.8A, 600W(1ms)	DO-214AA	1d	1a	Cen
C220C	1.5SMC220CA	TVS	Vbr=209..231V, Vrrwm=185V, 4.6A, 1500W(1ms), Bidirectional	DO-214AB	1ba	1j	Cen
C220C	P6SMB220CA	TVS	Vbr=209..231V, 1.8A, 600W(1ms), Bidirectional	DO-214AA	1ba	1j	Cen
C22A	1.5SCMJ51A	TVS	Vbr=48.5..53.6V, Vrrwm=43.6V, 6.0A, 1500W(1ms)	DO-214AB	1d	1a	Chm
C22A	1.5SMC22A	TVS	Vbr=20.9..23.1V, Vrrwm=18.8V, 49.0A, 1500W(1ms)	DO-214AB	1d	1a	Cen
C22A	P6SMB22A	TVS	Vbr=20.9..23.1V, 20A, 600W(1ms)	DO-214AA	1d	1a	Cen
C22A	SMBJ-LC22A	TVS	Vbr=25.2..27.7V, Vrrwm=22V, 16.9A, 600W(1ms)	DO-214AA	1d	1a	Eic
C22C	1.5SCMJ51CA	TVS	Vbr=48.5..53.6V, Vrrwm=43.6V, 6.0A, 1500W(1ms), Bidirectional	DO-214AB	1ba	1j	Chm
C22C	1.5SMC22CA	TVS	Vbr=20.9..23.1V, Vrrwm=18.8V, 49.0A, 1500W(1ms), Bidirectional	DO-214AB	1ba	1j	Cen
C22C	P6SMB22CA	TVS	Vbr=20.9..23.1V, 20A, 600W(1ms), Bidirectional	DO-214AA	1ba	1j	Cen
C23A	1.5SCMJ56A	TVS	Vbr=53.2..58.8V, Vrrwm=47.8V, 5.5A, 1500W(1ms)	DO-214AB	1d	1a	Chm
C23C	1.5SCMJ56CA	TVS	Vbr=53.2..58.8V, Vrrwm=47.8V, 5.5A, 1500W(1ms), Bidirectional	DO-214AB	1ba	1j	Chm
C24	BZG03-C24	Z-diode	24V±5%, Izt=25mA, Zzt=7Ω, 1.25W	DO-214AC	1d	1a	Eic
C24	CMDD2004	Si-diode	Sw, 240V, 200mA, 250mW, Vf<1V(100mA), <5pF	SOD-323	5d	1a	Cen
C24	SMBJ-LC24	TVS	Vbr=27.5..33.4V, Vrrwm=24V, 14.0A, 600W(1ms)	DO-214AA	1d	1a	Eic
C240	BZG03-C240	Z-diode	270V±5%, Izt=2mA, Zzt=400Ω, 1.25W	DO-214AC	1d	1a	Eic
C24A	1.5SCMJ62A	TVS	Vbr=58.9..65.1V, Vrrwm=53.0V, 5.0A, 1500W(1ms)	DO-214AB	1d	1a	Chm
C24A	1.5SMC24A	TVS	Vbr=22.8..25.2V, Vrrwm=20.5V, 45.2A, 1500W(1ms)	DO-214AB	1d	1a	Cen
C24A	P6SMB24A	TVS	Vbr=22.8..25.2V, 18A, 600W(1ms)	DO-214AA	1d	1a	Cen
C24A	SMBJ-LC24A	TVS	Vbr=27.5..30.3V, Vrrwm=24V, 15.4A, 600W(1ms)	DO-214AA	1d	1a	Eic
C24C	1.5SCMJ62CA	TVS	Vbr=58.9..65.1V, Vrrwm=53.0V, 5.0A, 1500W(1ms), Bidirectional	DO-214AB	1ba	1j	Chm
C24C	1.5SMC24CA	TVS	Vbr=22.8..25.2V, Vrrwm=20.5V, 45.2A, 1500W(1ms), Bidirectional	DO-214AB	1ba	1j	Cen
C24C	P6SMB24CA	TVS	Vbr=22.8..25.2V, 18A, 600W(1ms), Bidirectional	DO-214AA	1ba	1j	Cen
C250A	P6SMB250A	TVS	Vbr=237.5..262.5V, 1.7A, 600W(1ms)	DO-214AA	1d	1a	Cen



SMD
code

Type

Function

Short description

Case

Pinout

St.

Mnf.

SMD code	Type	Function	Short description	Case	Pinout	St.	Mnf.
C250C	P6SMB250CA	TVS	Vbr=237.5..262.5V, 1.7A, 600W(1ms), Bidirectional	DO-214AA	1ba	1j	Chm
C25A	1.5SCMJ68A	TVS	Vbr=64.6..71.4V, Vrw=58.0V, 4.6A, 1500W(1ms)	DO-214AB	1d	1a	Chm
C25C	1.5SCMJ68CA	TVS	Vbr=64.6..71.4V, Vrw=58.0V, 4.6A, 1500W(1ms), Bidirectional	DO-214AB	1ba	1j	Chm
C26	SMBJ-LC26	TVS	Vbr=29.7..36.1V, Vrw=26V, 12.4A, 600W(1ms)	DO-214AA	1d	1a	Eic
C26A	1.5SCMJ75A	TVS	Vbr=71.3..78.8V, Vrw=64.1V, 4.1A, 1500W(1ms)	DO-214AB	1d	1a	Chm
C26A	SMBJ-LC26A	TVS	Vbr=29.7..32.7V, Vrw=26V, 14.2A, 600W(1ms)	DO-214AA	1d	1a	Eic
C26C	1.5SCMJ75CA	TVS	Vbr=71.3..78.8V, Vrw=64.1V, 4.1A, 1500W(1ms), Bidirectional	DO-214AB	1ba	1j	Chm
C27	BZG03-C27	Z-diode	27V±5%, Izt=25mA, Zzt=7Ω, 1.25W	DO-214AC	1d	1a	Eic
C270	BZG03-C270	Z-diode	270V±5%, Izt=2mA, Zzt=450Ω, 1.25W	DO-214AC	1d	1a	Eic
C27A	1.5SCMJ82A	TVS	Vbr=77.9..86.1V, Vrw=70.1V, 3.7A, 1500W(1ms)	DO-214AB	1d	1a	Chm
C27A	1.5SMC27A	TVS	Vbr=25.7..28.4V, Vrw=23.1V, 40.0A, 1500W(1ms)	DO-214AB	1d	1a	Chm
C27A	P6SMB27A	TVS	Vbr=25.7..28.4V, 16A, 600W(1ms)	DO-214AA	1d	1a	Chm
C27C	1.5SCMJ82CA	TVS	Vbr=77.9..86.1V, Vrw=70.1V, 3.7A, 1500W(1ms), Bidirectional	DO-214AB	1ba	1j	Chm
C27C	1.5SMC27CA	TVS	Vbr=25.7..28.4V, Vrw=23.1V, 40.0A, 1500W(1ms), Bidirectional	DO-214AB	1ba	1j	Chm
C27C	P6SMB27CA	TVS	Vbr=25.7..28.4V, 16A, 600W(1ms), Bidirectional	DO-214AA	1ba	1j	Chm
C28	SMBJ-LC28	TVS	Vbr=31.9..38.8V, Vrw=28V, 12.0A, 600W(1ms)	DO-214AA	1d	1a	Eic
C28A	1.5SCMJ91A	TVS	Vbr=86.5..95.5V, Vrw=77.8V, 3.4A, 1500W(1ms)	DO-214AB	1d	1a	Chm
C28A	SMBJ-LC28A	TVS	Vbr=31.9..35.2V, Vrw=28V, 13.2A, 600W(1ms)	DO-214AA	1d	1a	Eic
C28C	1.5SCMJ91CA	TVS	Vbr=86.5..95.5V, Vrw=77.8V, 3.4A, 1500W(1ms), Bidirectional	DO-214AB	1ba	1j	Chm
C29A	1.5SCMJ100A	TVS	Vbr=95..105V, Vrw=85.5V, 3.1A, 1500W(1ms)	DO-214AB	1d	1a	Chm
C29C	1.5SCMJ100CA	TVS	Vbr=95..105V, Vrw=85.5V, 3.1A, 1500W(1ms), Bidirectional	DO-214AB	1ba	1j	Chm
C2A	1.5SCMJ7.5A	TVS	Vbr=7.13..7.88V, Vrw=6.40V, 37A, 1500W(1ms)	DO-214AB	1d	1a	Chm
C2C	1.5SCMJ7.5CA	TVS	Vbr=7.13..7.88V, Vrw=6.40V, 37A, 1500W(1ms), Bidirectional	DO-214AB	1ba	1j	Chm
C2L	CMHSH5-2L	Si-diode	HS, Sw, 20V, 500mA, Vf<0.38V(500mA), 60pF	SOD-123	5d	1a	Chm
C3	BZT52H-C56	Z-diode	52.0..60.0V, Izt=2mA, Zzt=120Ω, 375mW	SOD-123FL	7d	1a	Phi
C3	BZX585-B3V0	Z-diode	3V±2%, 300mW	SOD-523	6d	1a	Phi
C3	BZX884-B20	Z-diode	20V±2%, 250mW	SOD-882	13d	2b	Phi
C3	CZRH5223B-G	Z-diode	2.57..2.84V, Zzt=30Ω, Izt=20mA, 150mW	SOD-523	5d	1a	Cmc
C3	CZRV5223B-G	Z-diode	2.57..2.84V, Zzt=30Ω, Izt=20mA, 200mW	SOD-323	5d	1a	Cmc
C3	CZRW5223B-G	Z-diode	2.57..2.84V, Zzt=30Ω, Izt=20mA, 500mW	SOD-123	5d	1a	Cmc
C3	FSS34	Si-diode	SBR, 40V, 3A, Vf<0.75V(3A)	DO-214AB	1d	2j	Fag
C3	MM3Z5223B	Z-diode	2.57..2.84V, Izt=20mA, Zzt=30Ω, 200mW	SOD-323	5d	1a	Ext
C3	MM3Z5265B	Z-diode	62V±5%, Izt=2.0mA, Zzt=185Ω, 200mW	SOD-323FL	7d	1a	Bis
C3	MM3Z5265BH	Z-diode	58.9..65.1V, Izt=2mA, Zzt=185Ω, 300mW	SOD-323	5d	1a	Zow
C3	MMSZ5223B	Z-diode	2.7V±5%, Zzt=30Ω, 500mW	SOD-123	5d	1a,1d	Di,Mot
C3	MMSZ5223B	Z-diode	2.7V±5%, Zzt=30Ω, 500mW	SOD-123	5d	1d	Di
C3	MMSZ5223BS	Z-diode	2.7V±5%, Zzt=30Ω, 200mW	SOD-323	5d	1d	Di
C3	RKZ2.4BKX	Z-diode	2.30..2.60V, Izt=5mA, Zzt=100Ω, 150mW	SFP	7d	1a	Ren
C3	RKZ2.4BKL	Z-diode	2.30..2.60V, Izt=5mA, Zzt=100Ω, 100mW	EFP	7d	1a	Ren
C3	SMBY03-300	Si-diode	Rectifier, Fast-Recovery, 300V, 3A, Vf<0.85V(3A), <25ns	DO-214AC	1d	1q	Ste
C30	BZG03-C30	Z-diode	30V±5%, Izt=25mA, Zzt=8Ω, 1.25W	DO-214AC	1d	1a	Eic
C30	SMBJ-LC30	TVS	Vbr=34.1..41.5V, Vrw=30V, 11.2A, 600W(1ms)	DO-214AA	1d	1a	Eic
C302	CMR3-02	Si-diode	GP, Rectifier, 200V, 3A, Vf<1.2V(3A)	DO-214AB	1d	1a	Chm
C304	CMR3-04	Si-diode	GP, Rectifier, 400V, 3A, Vf<1.2V(3A)	DO-214AB	1d	1a	Chm
C306	CMR3-06	Si-diode	GP, Rectifier, 600V, 3A, Vf<1.2V(3A)	DO-214AB	1d	1a	Chm
C30A	1.5SCMJ110A	TVS	Vbr=105..116V, Vrw=94V, 2.8A, 1500W(1ms)	DO-214AB	1d	1a	Chm
C30A	1.5SMC30A	TVS	Vbr=28.5..31.5V, Vrw=25.6V, 36.2A, 1500W(1ms)	DO-214AB	1d	1a	Chm
C30A	P6SMB30A	TVS	Vbr=28.5..31.5V, 14.4A, 600W(1ms)	DO-214AA	1d	1a	Chm
C30A	SMBJ-LC30A	TVS	Vbr=34.1..37.6V, Vrw=30V, 12.4A, 600W(1ms)	DO-214AA	1d	1a	Eic
C30C	1.5SCMJ110CA	TVS	Vbr=105..116V, Vrw=94V, 2.8A, 1500W(1ms), Bidirectional	DO-214AB	1ba	1j	Chm
C30C	1.5SMC30CA	TVS	Vbr=28.5..31.5V, Vrw=25.6V, 36.2A, 1500W(1ms), Bidirectional	DO-214AB	1ba	1j	Chm
C30C	P6SMB30CA	TVS	Vbr=28.5..31.5V, 14.4A, 600W(1ms), Bidirectional	DO-214AA	1ba	1j	Chm
C310	CMR3-10	Si-diode	GP, Rectifier, 1000V, 3A, Vf<1.2V(3A)	DO-214AB	1d	1a	Chm
C310	SCM310PT	Si-diode	Rectifier, Schottky, 100V, 3A, Vf<0.8V(3A)	DO-214AB	1d	1a	Chm
C31A	1.5SCMJ120A	TVS	Vbr=114..126V, Vrw=102V, 2.5A, 1500W(1ms)	DO-214AB	1d	1a	Chm
C31C	1.5SCMJ120CA	TVS	Vbr=114..126V, Vrw=102V, 2.5A, 1500W(1ms), Bidirectional	DO-214AB	1ba	1j	Chm
C32A	1.5SCMJ130A	TVS	Vbr=124..137V, Vrw=111V, 2.3A, 1500W(1ms)	DO-214AB	1d	1a	Chm
C32C	1.5SCMJ130CA	TVS	Vbr=124..137V, Vrw=111V, 2.3A, 1500W(1ms), Bidirectional	DO-214AB	1ba	1j	Chm
C33	BZG03-C33	Z-diode	33V±5%, Izt=25mA, Zzt=8Ω, 1.25W	DO-214AC	1d	1a	Eic
C33	SMBJ-LC33	TVS	Vbr=37.5..45.7V, Vrw=33V, 10.2A, 600W(1ms)	DO-214AA	1d	1a	Eic
C33A	1.5SCMJ150A	TVS	Vbr=143..158V, Vrw=128V, 2.0A, 1500W(1ms)	DO-214AB	1d	1a	Chm
C33A	1.5SMC33A	TVS	Vbr=31.4..34.7V, Vrw=28.2V, 32.8A, 1500W(1ms)	DO-214AB	1d	1a	Chm
C33A	P6SMB33A	TVS	Vbr=31.4..34.7V, 13.2A, 600W(1ms)	DO-214AA	1d	1a	Chm
C33A	SMBJ-LC33A	TVS	Vbr=37.5..41.4V, Vrw=33V, 11.3A, 600W(1ms)	DO-214AA	1d	1a	Eic
C33C	1.5SCMJ150CA	TVS	Vbr=143..158V, Vrw=128V, 2.0A, 1500W(1ms), Bidirectional	DO-214AB	1ba	1j	Chm
C33C	1.5SMC33CA	TVS	Vbr=31.4..34.7V, Vrw=28.2V, 32.8A, 1500W(1ms), Bidirectional	DO-214AB	1ba	1j	Chm
C33C	P6SMB33CA	TVS	Vbr=31.4..34.7V, 13.2A, 600W(1ms), Bidirectional	DO-214AA	1ba	1j	Chm
C34A	1.5SCMJ160A	TVS	Vbr=152..168V, Vrw=136V, 1.9A, 1500W(1ms)	DO-214AB	1d	1a	Chm
C34C	1.5SCMJ160CA	TVS	Vbr=152..168V, Vrw=136V, 1.9A, 1500W(1ms), Bidirectional	DO-214AB	1ba	1j	Chm
C34H	SCM34LHPT	Si-diode	Rectifier, Schottky, 40V, 3A, Vf<0.48V(3A)	DO-214AB	1d	1a	Chm



SMD
code

Type

Function

Short description

Case

Pinout

St.

Mnf.

SMD code	Type	Function	Short description	Case	Pinout	St.	Mnf.
C34L	SCM34LPT	Si-diode	Rectifier, Schottky, 40V, 3A, Vf<0.42V(3A)	DO-214AB	1d	1a	Chm
C35A	1.5SCMJ170A	TVS	Vbr=162..179V, Vrvwm=145V, 1.8A, 1500W(1ms)	DO-214AB	1d	1a	Chm
C35C	1.5SCMJ170CA	TVS	Vbr=162..179V, Vrvwm=145V, 1.8A, 1500W(1ms), Bidirectional	DO-214AB	1ba	1j	Chm
C36	BZG03-C36	Z-diode	36V±5%, Izt=10mA, Zzt=21Ω, 1.25W	DO-214AC	1d	1a	Eic
C36	SMBJ-LC36	TVS	Vbr=40.8..49.7V, Vrvwm=36V, 9.3A, 600W(1ms)	DO-214AA	1d	1a	Eic
C36A	1.5SCMJ180A	TVS	Vbr=171..189V, Vrvwm=154V, 1.7A, 1500W(1ms)	DO-214AB	1d	1a	Chm
C36A	1.5SMC36A	TVS	Vbr=34.2..37.8V, Vrvwm=30.8V, 30.1A, 1500W(1ms)	DO-214AB	1d	1a	Cen
C36A	P6SMB36A	TVS	Vbr=34.2..37.8V, 12.0A, 600W(1ms)	DO-214AA	1d	1a	Cen
C36A	SMBJ-LC36A	TVS	Vbr=40.8..45.0V, Vrvwm=36V, 10.3A, 600W(1ms)	DO-214AA	1d	1a	Eic
C36C	1.5SCMJ180CA	TVS	Vbr=171..189V, Vrvwm=154V, 1.7A, 1500W(1ms), Bidirectional	DO-214AB	1ba	1j	Chm
C36C	1.5SMC36CA	TVS	Vbr=34.2..37.8V, Vrvwm=30.8V, 30.1A, 1500W(1ms), Bidirectional	DO-214AB	1ba	1j	Cen
C36C	P6SMB36CA	TVS	Vbr=34.2..37.8V, 12.0A, 600W(1ms), Bidirectional	DO-214AA	1ba	1j	Cen
C37A	1.5SCMJ200A	TVS	Vbr=190..210V, Vrvwm=171V, 1.53A, 1500W(1ms)	DO-214AB	1d	1a	Chm
C37C	1.5SCMJ200CA	TVS	Vbr=190..210V, Vrvwm=171V, 1.53A, 1500W(1ms), Bidirectional	DO-214AB	1ba	1j	Chm
C39	BZG03-C39	Z-diode	39V±5%, Izt=10mA, Zzt=21Ω, 1.25W	DO-214AC	1d	1a	Eic
C39A	1.5SMC39A	TVS	Vbr=37.1..41.0V, Vrvwm=33.3V, 27.8A, 1500W(1ms)	DO-214AB	1d	1a	Cen
C39A	P6SMB39A	TVS	Vbr=37.1..41.0V, 11.2A, 600W(1ms)	DO-214AA	1d	1a	Cen
C39C	1.5SMC39CA	TVS	Vbr=37.1..41.0V, Vrvwm=33.3V, 27.8A, 1500W(1ms), Bidirectional	DO-214AB	1ba	1j	Cen
C39C	P6SMB39CA	TVS	Vbr=37.1..41.0V, 11.2A, 600W(1ms), Bidirectional	DO-214AA	1ba	1j	Cen
C3A	1.5SCMJ8.2A	TVS	Vbr=7.79..8.61V, Vrvwm=7.02V, 35A, 1500W(1ms)	DO-214AB	1d	1a	Chm
C3C	1.5SCMJ8.2CA	TVS	Vbr=7.79..8.61V, Vrvwm=7.02V, 35A, 1500W(1ms), Bidirectional	DO-214AB	1ba	1j	Chm
C4	BZT52H-C62	Z-diode	58.0..66.0V, Izt=2mA, Zzt=140Ω, 375mW	SOD-123FL	7d	1a	Phi
C4	BZX585-B3V3	Z-diode	3.3V±2%, 300mW	SOD-523	6d	1a	Phi
C4	BZX884-B22	Z-diode	22V±2%, 250mW	SOD-882	13d	2b	Phi
C4	FSS35	Si-diode	SBR, 50V, 3A, Vf<0.75V(3A)	DO-214AB	1d	2j	Fag
C4	MM1Z5225B	Z-diode	2.85..3.15V, Izt=20mA, Zzt=29Ω, 500mW	SOD-323FL	5d	1a	Eic
C4	MM1Z5225BH	Z-diode	2.85..3.15V, Izt=20mA, Zzt=29Ω, 500mW	SOD-123	5d	1a	Zow
C4	MMSZ5224B	Z-diode	2.8V±5%, Zzt=30Ω, 500mW	SOD-123	5d	1a	Mot
C4	MMSZ5225B	Z-diode	3.0V±5%, Izt=20mA, Zzt=29Ω, 500mW	SOD-123	5d	1a	Eic
C4	MSCD034	Si-diode	SBR, 40V, 0.3A, Vf<0.5V(0.3A)	0805	14d	1v	Zow
C4	SMBYT03-400	Si-diode	Rectifier, Fast-Recovery, 200V, 3A, Vf<0.71V(3A), <25ns	DO-214AC	1d	1q	Ste
C40	SMBJ-LC40	TVS	Vbr=45.2..55.1V, Vrvwm=40V, 8.4A, 600W(1ms)	DO-214AA	1d	1a	Eic
C40A	SMBJ-LC40A	TVS	Vbr=45.2..49.9V, Vrvwm=40V, 9.3A, 600W(1ms)	DO-214AA	1d	1a	Eic
C43	BZG03-C43	Z-diode	43V±5%, Izt=10mA, Zzt=24Ω, 1.25W	DO-214AC	1d	1a	Eic
C43	SMBJ-LC43	TVS	Vbr=48.6..59.2V, Vrvwm=43V, 7.8A, 600W(1ms)	DO-214AA	1d	1a	Eic
C43A	1.5SMC43A	TVS	Vbr=40.9..45.2V, Vrvwm=36.8V, 25.3A, 1500W(1ms)	DO-214AB	1d	1a	Cen
C43A	P6SMB43A	TVS	Vbr=40.9..45.2V, 10.1A, 600W(1ms)	DO-214AA	1d	1a	Cen
C43A	SMBJ-LC43A	TVS	Vbr=48.6..53.6V, Vrvwm=43V, 8.6A, 600W(1ms)	DO-214AA	1d	1a	Eic
C43C	1.5SMC43CA	TVS	Vbr=40.9..45.2V, Vrvwm=36.8V, 25.3A, 1500W(1ms), Bidirectional	DO-214AB	1ba	1j	Cen
C43C	P6SMB43CA	TVS	Vbr=40.9..45.2V, 10.1A, 600W(1ms), Bidirectional	DO-214AA	1ba	1j	Cen
C45	SMBJ-LC45	TVS	Vbr=50.8..61.9V, Vrvwm=45V, 7.5A, 600W(1ms)	DO-214AA	1d	1a	Eic
C45A	SMBJ-LC45A	TVS	Vbr=50.8..56.1V, Vrvwm=45V, 8.3A, 600W(1ms)	DO-214AA	1d	1a	Eic
C47	BZG03-C47	Z-diode	47V±5%, Izt=10mA, Zzt=24Ω, 1.25W	DO-214AC	1d	1a	Eic
C47A	1.5SMC47A	TVS	Vbr=44.7..49.4V, Vrvwm=40.2V, 23.1A, 1500W(1ms)	DO-214AB	1d	1a	Cen
C47A	P6SMB47A	TVS	Vbr=44.7..49.4V, 9.3A, 600W(1ms)	DO-214AA	1d	1a	Cen
C47C	1.5SMC47CA	TVS	Vbr=44.7..49.4V, Vrvwm=40.2V, 23.1A, 1500W(1ms), Bidirectional	DO-214AB	1ba	1j	Cen
C47C	P6SMB47CA	TVS	Vrvwm=47V, Vbr=44.7..49.4V, 9.3A, 600W(1ms), Bidirectional	DO-214AA	1ba	1j	Cen
C48	CMHD448	Si-diode	HS, Sw, 75V, 250mA, 400mW, Vf<1V(100mA), <4pF	SOD-123	5d	1a	Cen
C48	SMBJ-LC48	TVS	Vbr=54.1..65.9V, Vrvwm=48V, 7.0A, 600W(1ms)	DO-214AA	1d	1a	Eic
C48A	SMBJ-LC48A	TVS	Vbr=54.1..59.7V, Vrvwm=48V, 7.7A, 600W(1ms)	DO-214AA	1d	1a	Eic
C4A	1.5SCMJ9.1A	TVS	Vbr=8.65..9.55V, Vrvwm=7.78V, 31A, 1500W(1ms)	DO-214AB	1d	1a	Chm
C4C	1.5SCMJ9.1CA	TVS	Vbr=8.65..9.55V, Vrvwm=7.78V, 31A, 1500W(1ms), Bidirectional	DO-214AB	1ba	1j	Chm
C5	BZT52H-C68	Z-diode	64.0..72.0V, Izt=2mA, Zzt=160Ω, 375mW	SOD-123FL	7d	1a	Phi
C5	BZX584B7V5	Z-diode	7.35..7.65V, Izt=5mA, Zzt=15Ω, 200mW	SOD-523FL	7d	1a	Tac
C5	BZX585-B3V6	Z-diode	3.6V±2%, 300mW	SOD-523	6d	1a	Phi
C5	BZX884-B24	Z-diode	24V±2%, 250mW	SOD-882	13d	2b	Phi
C5	CZRH5225B-G	Z-diode	2.85..3.15V, Zzt=30Ω, Izt=20mA, 150mW	SOD-523	5d	1a	Cmc
C5	CZR5225B-G	Z-diode	2.85..3.15V, Zzt=30Ω, Izt=20mA, 200mW	SOD-323	5d	1a	Cmc
C5	CZRW5225B-G	Z-diode	2.85..3.15V, Zzt=30Ω, Izt=20mA, 500mW	SOD-123	5d	1a	Cmc
C5	EDZ30B	Z-diode	29.19..30.69V, Izt=2mA, Zzt=200Ω, 150mW	SOD-523	6d	1a	Rhm
C5	FDZ30EV	Z-diode	29.190..30.690V, Izt=2mA, Zzt=200Ω, 150mW	SOD-523	7d	1a	Fis
C5	FDZ30VT	Z-diode	29.190..30.690V, Izt=5mA, Zzt=200Ω, 200mW	SOD-323	5d	1a	Fis
C5	FSS36	Si-diode	SBR, 60V, 3A, Vf<0.75V(3A)	DO-214AB	1d	2j	Fag
C5	MM1Z5243B	Z-diode	12.35..13.65V, Izt=9.5mA, Zzt=13Ω, 500mW	SOD-323FL	5d	1a	Eic
C5	MM1Z5243BH	Z-diode	12.35..13.65V, Izt=9.5mA, Zzt=13Ω, 500mW	SOD-123	5d	1a	Zow
C5	MM3Z5225B	Z-diode	2.85..3.15V, Izt=20mA, Zzt=30Ω, 200mW	SOD-323	5d	1a	Ext
C5	MMSZ7V5B	Z-diode	7.35..7.65V, Izt=5mA, Zzt=15Ω, 200mW	SOD-523FL	7d	1a	Tac
C5	MMSZ5225	Z-diode	3V±10%, Zzt=30Ω, 500mW	SOD-123	5d	1k	Vs
C5	MMSZ5225B	Z-diode	3V±5%, Zzt=30Ω, 500mW	SOD-123	5d	1a,1d	Di,Mot
C5	MMSZ5225B	Z-diode	3V±5%, Zzt=30Ω, 500mW	SOD-123	5d	1d	Di



SMD
code

Type

Function

Short description

Case

Pinout

St.

Mnf.

C5	MMSZ5225BS	Z-diode	3V±5%, Zzt=30Ω, 200mW	SOD-323	5d	1d	Di
C5	MMSZ5243B	Z-diode	1V±5%, Izt=9.5mA, Zzt=13Ω, 500mW	SOD-123	5d	1a	Eic
C5	RKZ2.7B2KK	Z-diode	2.65..2.90V, Izt=5mA, Zzt=110Ω, 150mW	SFP	7d	1a	Ren
C5	RKZ2.7B2KL	Z-diode	2.65..2.90V, Izt=5mA, Zzt=110Ω, 100mW	EPF	7d	1a	Ren
C5	TDZ30B	Z-diode	30V±2.5%, 10mA, 500mW	TUMD2	7d	1s	Rhm
C5	UDZ530B	Z-diode	30V±2.5%, Izt=5mA, 200mW	SOD-323FLF	7d	1s	Rhm
C5	VDZ530B	Z-diode	30V±5%, 5mA, 100mW	VMD2	5d	1z	Rhm
C5.0	SMBJ-LC5.0	TVS	Vbr=7.20..8.62V, Vrw=5.0V, 62.5A, 600W(1ms)	DO-214AA	1d	1a	Eic
C5.0A	SMBJ-LC5.0A	TVS	Vbr=7.20..7.87V, Vrw=5.0V, 65.2A, 600W(1ms)	DO-214AA	1d	1a	Eic
C50	CMHD4150	Si-diode	HS, Sw, 50V, 250mA, 400mW, Vf<1V(200mA), <4pF	SOD-123	5d	1a	Cen
C51	BZG03-C51	Z-diode	51V±5%, Izt=10mA, Zzt=25Ω, 1.25W	DO-214AC	1d	1a	Eic
C51	SMBJ-LC51	TVS	Vbr=57.5..70.1V, Vrw=51V, 6.6A, 600W(1ms)	DO-214AA	1d	1a	Eic
C51A	1.5SMC51A	TVS	Vbr=48.5..53.6V, Vrw=43.6V, 21.4A, 1500W(1ms)	DO-214AB	1d	1a	Cen
C51A	P6SMB51A	TVS	Vrw=51V, Vbr=48.5..53.6V, 8.6A, 600W(1ms)	DO-214AA	1d	1a	Cen
C51A	SMBJ-LC51A	TVS	Vbr=57.5..63.5V, Vrw=51V, 7.3A, 600W(1ms)	DO-214AA	1d	1a	Eic
C51C	1.5SMC51CA	TVS	Vbr=48.5..53.6V, Vrw=43.6V, 21.4A, 1500W(1ms), Bidirectional	DO-214AB	1ba	1j	Cen
C51C	P6SMB51CA	TVS	Vrw=51V, Vbr=48.5..53.6V, 8.6A, 600W(1ms), Bidirectional	DO-214AA	1ba	1j	Cen
C52L	SCM52LPT	Si-diode	Rectifier, Schottky, 20V, 5A, Vf<0.4V(5A)	DO-214AB	1d	1a	Chm
C5342B	CMZ5342B	Z-diode	6.8V±5%, Zzt=1.0Ω, 700mA, 5W	DO-214AB	1d	1a	Cen
C5343B	CMZ5343B	Z-diode	7.5V±5%, Zzt=1.5Ω, 630mA, 5W	DO-214AB	1d	1a	Cen
C5344B	CMZ5344B	Z-diode	8.2V±5%, Zzt=1.5Ω, 580mA, 5W	DO-214AB	1d	1a	Cen
C5345B	CMZ5345B	Z-diode	8.7V±5%, Zzt=2.0Ω, 545mA, 5W	DO-214AB	1d	1a	Cen
C5346B	CMZ5346B	Z-diode	9.1V±5%, Zzt=2.0Ω, 520mA, 5W	DO-214AB	1d	1a	Cen
C5347B	CMZ5347B	Z-diode	10V±5%, Zzt=2.0Ω, 475mA, 5W	DO-214AB	1d	1a	Cen
C5348B	CMZ5348B	Z-diode	11V±5%, Zzt=2.5Ω, 430mA, 5W	DO-214AB	1d	1a	Cen
C5349B	CMZ5349B	Z-diode	12V±5%, Zzt=2.5Ω, 395mA, 5W	DO-214AB	1d	1a	Cen
C5350B	CMZ5350B	Z-diode	13V±5%, Zzt=2.5Ω, 365mA, 5W	DO-214AB	1d	1a	Cen
C5351B	CMZ5351B	Z-diode	14V±5%, Zzt=2.5Ω, 340mA, 5W	DO-214AB	1d	1a	Cen
C5352B	CMZ5352B	Z-diode	15V±5%, Zzt=2.5Ω, 315mA, 5W	DO-214AB	1d	1a	Cen
C5353B	CMZ5353B	Z-diode	16V±5%, Zzt=2.5Ω, 295mA, 5W	DO-214AB	1d	1a	Cen
C5354B	CMZ5354B	Z-diode	17V±5%, Zzt=2.5Ω, 280mA, 5W	DO-214AB	1d	1a	Cen
C5355B	CMZ5355B	Z-diode	18V±5%, Zzt=2.5Ω, 264mA, 5W	DO-214AB	1d	1a	Cen
C5356B	CMZ5356B	Z-diode	19V±5%, Zzt=3.0Ω, 250mA, 5W	DO-214AB	1d	1a	Cen
C5357B	CMZ5357B	Z-diode	20V±5%, Zzt=3.0Ω, 237mA, 5W	DO-214AB	1d	1a	Cen
C5358B	CMZ5358B	Z-diode	22V±5%, Zzt=3.5Ω, 216mA, 5W	DO-214AB	1d	1a	Cen
C5359B	CMZ5359B	Z-diode	24V±5%, Zzt=3.5Ω, 198mA, 5W	DO-214AB	1d	1a	Cen
C5360B	CMZ5360B	Z-diode	25V±5%, Zzt=4.0Ω, 190mA, 5W	DO-214AB	1d	1a	Cen
C5361B	CMZ5361B	Z-diode	27V±5%, Zzt=5.0Ω, 176mA, 5W	DO-214AB	1d	1a	Cen
C5362B	CMZ5362B	Z-diode	28V±5%, Zzt=6.0Ω, 170mA, 5W	DO-214AB	1d	1a	Cen
C5363B	CMZ5363B	Z-diode	30V±5%, Zzt=8.0Ω, 158mA, 5W	DO-214AB	1d	1a	Cen
C5364B	CMZ5364B	Z-diode	33V±5%, Zzt=10Ω, 144mA, 5W	DO-214AB	1d	1a	Cen
C5365B	CMZ5365B	Z-diode	36V±5%, Zzt=11Ω, 132mA, 5W	DO-214AB	1d	1a	Cen
C5366B	CMZ5366B	Z-diode	39V±5%, Zzt=14Ω, 122mA, 5W	DO-214AB	1d	1a	Cen
C5367B	CMZ5367B	Z-diode	43V±5%, Zzt=20Ω, 110mA, 5W	DO-214AB	1d	1a	Cen
C5368B	CMZ5368B	Z-diode	47V±5%, Zzt=25Ω, 100mA, 5W	DO-214AB	1d	1a	Cen
C5369B	CMZ5369B	Z-diode	51V±5%, Zzt=27Ω, 93.0mA, 5W	DO-214AB	1d	1a	Cen
C5370B	CMZ5370B	Z-diode	56V±5%, Zzt=35Ω, 86.0mA, 5W	DO-214AB	1d	1a	Cen
C5371B	CMZ5371B	Z-diode	60V±5%, Zzt=40Ω, 79.0mA, 5W	DO-214AB	1d	1a	Cen
C5372B	CMZ5372B	Z-diode	62V±5%, Zzt=42Ω, 76.0mA, 5W	DO-214AB	1d	1a	Cen
C5373B	CMZ5373B	Z-diode	68V±5%, Zzt=44Ω, 70.0mA, 5W	DO-214AB	1d	1a	Cen
C5374B	CMZ5374B	Z-diode	75V±5%, Zzt=45Ω, 63.0mA, 5W	DO-214AB	1d	1a	Cen
C5375B	CMZ5375B	Z-diode	82V±5%, Zzt=65Ω, 58.0mA, 5W	DO-214AB	1d	1a	Cen
C5376B	CMZ5376B	Z-diode	87V±5%, Zzt=75Ω, 54.5mA, 5W	DO-214AB	1d	1a	Cen
C5377B	CMZ5377B	Z-diode	91V±5%, Zzt=75Ω, 52.5mA, 5W	DO-214AB	1d	1a	Cen
C5378B	CMZ5378B	Z-diode	100V±5%, Zzt=90Ω, 47.5mA, 5W	DO-214AB	1d	1a	Cen
C5379B	CMZ5379B	Z-diode	110V±5%, Zzt=125Ω, 43.0mA, 5W	DO-214AB	1d	1a	Cen
C5380B	CMZ5380B	Z-diode	120V±5%, Zzt=170Ω, 39.5mA, 5W	DO-214AB	1d	1a	Cen
C5381B	CMZ5381B	Z-diode	130V±5%, Zzt=190Ω, 36.6mA, 5W	DO-214AB	1d	1a	Cen
C5382B	CMZ5382B	Z-diode	140V±5%, Zzt=230Ω, 34.0mA, 5W	DO-214AB	1d	1a	Cen
C5383B	CMZ5383B	Z-diode	150V±5%, Zzt=330Ω, 31.6mA, 5W	DO-214AB	1d	1a	Cen
C5384B	CMZ5384B	Z-diode	160V±5%, Zzt=350Ω, 29.4mA, 5W	DO-214AB	1d	1a	Cen
C5385B	CMZ5385B	Z-diode	170V±5%, Zzt=380Ω, 28.0mA, 5W	DO-214AB	1d	1a	Cen
C5386B	CMZ5386B	Z-diode	180V±5%, Zzt=430Ω, 26.4mA, 5W	DO-214AB	1d	1a	Cen
C5387B	CMZ5387B	Z-diode	190V±5%, Zzt=450Ω, 25.0mA, 5W	DO-214AB	1d	1a	Cen
C5388B	CMZ5388B	Z-diode	200V±5%, Zzt=480Ω, 23.6mA, 5W	DO-214AB	1d	1a	Cen
C53L	SCM53LPT	Si-diode	Rectifier, Schottky, 30V, 5A, Vf<0.4V(5A)	DO-214AB	1d	1a	Chm
C54	CMHSH5-L	Si-diode	HS, Sw, 40V, 500mA, Vf<0.51V(500mA), 50pF	SOD-123	5d	1a	Cen
C54	SMBJ-LC54	TVS	Vbr=60.8..74.1V, Vrw=54V, 6.2A, 600W(1ms)	DO-214AA	1d	1a	Eic
C54A	SMBJ-LC54A	TVS	Vbr=60.8..67.1V, Vrw=54V, 6.9A, 600W(1ms)	DO-214AA	1d	1a	Eic
C54H	SCM54LHPT	Si-diode	Rectifier, Schottky, 40V, 5A, Vf<0.45V(5A)	DO-214AB	1d	1a	Chm



SMD code	Type	Function	Short description	Case	Pinout	St.	Mnf.
C54L	SCM54LPT	Si-diode	Rectifier, Schottky, 40V, 5A, Vf<0.4V(5A)	DO-214AB	1d	1a	Chm
C56	BZG03-C56	Z-diode	56V±5%, Izt=10mA, Zzt=25Ω, 1.25W	DO-214AC	1d	1a	Eic
C56A	1.5SMC56A	TVS	Vbr=53.2.58.8V, Vrw=47.8V, 19.5A, 1500W(1ms)	DO-214AB	1d	1a	Cen
C56A	P6SMB56A	TVS	Vrw=56V, Vbr=53.2.58.8V, 7.8A, 600W(1ms)	DO-214AA	1d	1a	Cen
C56C	1.5SMC56CA	TVS	Vbr=53.2.58.8V, Vrw=47.8V, 19.5A, 1500W(1ms), Bidirectional	DO-214AB	1ba	1j	Cen
C56C	P6SMB56CA	TVS	Vrw=56V, Vbr=53.2.58.8V, 7.8A, 600W(1ms), Bidirectional	DO-214AA	1ba	1j	Cen
C58	SMBJ-LC58	TVS	Vbr=65.2.79.5V, Vrw=58V, 5.8A, 600W(1ms)	DO-214AA	1d	1a	Eic
C58A	SMBJ-LC58A	TVS	Vbr=65.2.72.0V, Vrw=58V, 6.4A, 600W(1ms)	DO-214AA	1d	1a	Eic
C5913B	CMZ5913B	Z-diode	3.3V±5%, 113.6mA, Zzt=10Ω, 1.5W	DO-214AC	1d	1a	Cen
C5914B	CMZ5914B	Z-diode	3.6V±5%, 104.2mA, Zzt=9.0Ω, 1.5W	DO-214AC	1d	1a	Cen
C5915B	CMZ5915B	Z-diode	3.9V±5%, 96.1mA, Zzt=7.5Ω, 1.5W	DO-214AC	1d	1a	Cen
C5916B	CMZ5916B	Z-diode	4.3V±5%, 87.2mA, Zzt=6.0Ω, 1.5W	DO-214AC	1d	1a	Cen
C5917B	CMZ5917B	Z-diode	4.7V±5%, 79.8mA, Zzt=5.0Ω, 1.5W	DO-214AC	1d	1a	Cen
C5918B	CMZ5918B	Z-diode	5.1V±5%, 73.5mA, Zzt=4.0Ω, 1.5W	DO-214AC	1d	1a	Cen
C5919B	CMZ5919B	Z-diode	5.6V±5%, 66.9mA, Zzt=2.0Ω, 1.5W	DO-214AC	1d	1a	Cen
C5920B	CMZ5920B	Z-diode	6.2V±5%, 60.5mA, Zzt=2.0Ω, 1.5W	DO-214AC	1d	1a	Cen
C5921B	CMZ5921B	Z-diode	6.8V±5%, 55.1mA, Zzt=2.5Ω, 1.5W	DO-214AC	1d	1a	Cen
C5922B	CMZ5922B	Z-diode	7.5V±5%, 50.0mA, Zzt=3.0Ω, 1.5W	DO-214AC	1d	1a	Cen
C5923B	CMZ5923B	Z-diode	8.2V±5%, 45.7mA, Zzt=3.5Ω, 1.5W	DO-214AC	1d	1a	Cen
C5924B	CMZ5924B	Z-diode	9.1V±5%, 41.2mA, Zzt=4.0Ω, 1.5W	DO-214AC	1d	1a	Cen
C5925B	CMZ5925B	Z-diode	10V±5%, 37.5mA, Zzt=4.5Ω, 1.5W	DO-214AC	1d	1a	Cen
C5926B	CMZ5926B	Z-diode	11V±5%, 34.1mA, Zzt=5.5Ω, 1.5W	DO-214AC	1d	1a	Cen
C5927B	CMZ5927B	Z-diode	12V±5%, 31.2mA, Zzt=6.5Ω, 1.5W	DO-214AC	1d	1a	Cen
C5928B	CMZ5928B	Z-diode	13V±5%, 28.8mA, Zzt=7.0Ω, 1.5W	DO-214AC	1d	1a	Cen
C5929B	CMZ5929B	Z-diode	15V±5%, 25.0mA, Zzt=9.0Ω, 1.5W	DO-214AC	1d	1a	Cen
C5930B	CMZ5930B	Z-diode	16V±5%, 23.4mA, Zzt=10Ω, 1.5W	DO-214AC	1d	1a	Cen
C5931B	CMZ5931B	Z-diode	18V±5%, 20.8mA, Zzt=12Ω, 1.5W	DO-214AC	1d	1a	Cen
C5932B	CMZ5932B	Z-diode	20V±5%, 18.7mA, Zzt=14Ω, 1.5W	DO-214AC	1d	1a	Cen
C5933B	CMZ5933B	Z-diode	22V±5%, 17.0mA, Zzt=17.5Ω, 1.5W	DO-214AC	1d	1a	Cen
C5934B	CMZ5934B	Z-diode	24V±5%, 15.6mA, Zzt=19Ω, 1.5W	DO-214AC	1d	1a	Cen
C5935B	CMZ5935B	Z-diode	27V±5%, 13.9mA, Zzt=23Ω, 1.5W	DO-214AC	1d	1a	Cen
C5936B	CMZ5936B	Z-diode	30V±5%, 12.5mA, Zzt=26Ω, 1.5W	DO-214AC	1d	1a	Cen
C5937B	CMZ5937B	Z-diode	33V±5%, 11.4mA, Zzt=33Ω, 1.5W	DO-214AC	1d	1a	Cen
C5938B	CMZ5938B	Z-diode	36V±5%, 10.4mA, Zzt=38Ω, 1.5W	DO-214AC	1d	1a	Cen
C5939B	CMZ5939B	Z-diode	39V±5%, 9.6mA, Zzt=45Ω, 1.5W	DO-214AC	1d	1a	Cen
C5940B	CMZ5940B	Z-diode	43V±5%, 8.7mA, Zzt=53Ω, 1.5W	DO-214AC	1d	1a	Cen
C5941B	CMZ5941B	Z-diode	47V±5%, 8.0mA, Zzt=67Ω, 1.5W	DO-214AC	1d	1a	Cen
C5942B	CMZ5942B	Z-diode	51V±5%, 7.3mA, Zzt=70Ω, 1.5W	DO-214AC	1d	1a	Cen
C5943B	CMZ5943B	Z-diode	56V±5%, 6.7mA, Zzt=86Ω, 1.5W	DO-214AC	1d	1a	Cen
C5944B	CMZ5944B	Z-diode	62V±5%, 6.0mA, Zzt=100Ω, 1.5W	DO-214AC	1d	1a	Cen
C5945B	CMZ5945B	Z-diode	68V±5%, 5.5mA, Zzt=120Ω, 1.5W	DO-214AC	1d	1a	Cen
C5946B	CMZ5946B	Z-diode	75V±5%, 5.0mA, Zzt=140Ω, 1.5W	DO-214AC	1d	1a	Cen
C5947B	CMZ5947B	Z-diode	82V±5%, 4.6mA, Zzt=160Ω, 1.5W	DO-214AC	1d	1a	Cen
C5948B	CMZ5948B	Z-diode	91V±5%, 4.1mA, Zzt=200Ω, 1.5W	DO-214AC	1d	1a	Cen
C5949B	CMZ5949B	Z-diode	100V±5%, 3.7mA, Zzt=250Ω, 1.5W	DO-214AC	1d	1a	Cen
C5950B	CMZ5950B	Z-diode	110V±5%, 3.4mA, Zzt=300Ω, 1.5W	DO-214AC	1d	1a	Cen
C5951B	CMZ5951B	Z-diode	120V±5%, 3.1mA, Zzt=360Ω, 1.5W	DO-214AC	1d	1a	Cen
C5952B	CMZ5952B	Z-diode	130V±5%, 2.9mA, Zzt=450Ω, 1.5W	DO-214AC	1d	1a	Cen
C5953B	CMZ5953B	Z-diode	150V±5%, 2.5mA, Zzt=600Ω, 1.5W	DO-214AC	1d	1a	Cen
C5954B	CMZ5954B	Z-diode	160V±5%, 2.3mA, Zzt=700Ω, 1.5W	DO-214AC	1d	1a	Cen
C5955B	CMZ5955B	Z-diode	180V±5%, 2.1mA, Zzt=900Ω, 1.5W	DO-214AC	1d	1a	Cen
C5956B	CMZ5956B	Z-diode	200V±5%, 1.9mA, Zzt=1200Ω, 1.5W	DO-214AC	1d	1a	Cen
C5A	1.5SCMJ10A	TVS	Vbr=9.5.10.5V, Vrw=8.55V, 29A, 1500W(1ms)	DO-214AB	1d	1a	Chm
C5C	1.5SCMJ10CA	TVS	Vbr=9.5.10.5V, Vrw=8.55V, 29A, 1500W(1ms), Bidirectional	DO-214AB	1ba	1j	Chm
C6	BZT52H-C75	Z-diode	70.0.79.0V, Izt=2mA, Zzt=175Ω, 375mW	SOD-123FL	7d	1a	Phi
C6	BZX585-B3V9	Z-diode	3.9V±2%, 300mW	SOD-523	6d	1a	Phi
C6	BZX884-B27	Z-diode	27V±2%, 250mW	SOD-882	13d	2b	Phi
C6	MM1Z5265B	Z-diode	58.9.65.10V, Izt=2.0mA, Zzt=185Ω, 500mW	SOD-323FL	5d	1a	Eic
C6	MM1Z5265BH	Z-diode	58.9.65.1V, Izt=2mA, Zzt=185Ω, 500mW	SOD-123	5d	1a	Zow
C6	MM5Z5265B	Z-diode	62V±5%, Izt=2mA, Zzt=185Ω, 500mW	SOD-123	5d	1a	Eic
C6.0	SMBJ-LC6.0	TVS	Vbr=7.47.7.8.95V, Vrw=6.0V, 52.6A, 600W(1ms)	DO-214AA	1d	1a	Eic
C6.0A	SMBJ-LC6.0A	TVS	Vbr=7.47.8.17V, Vrw=6.0V, 58.3A, 600W(1ms)	DO-214AA	1d	1a	Eic
C6.5	SMBJ-LC6.5	TVS	Vbr=8.02.9.62V, Vrw=6.5V, 48.7A, 600W(1ms)	DO-214AA	1d	1a	Eic
C6.5A	SMBJ-LC6.5A	TVS	Vbr=8.02.8.78V, Vrw=6.5V, 53.6A, 600W(1ms)	DO-214AA	1d	1a	Eic
C60	SMBJ-LC60	TVS	Vbr=67.5.82.3V, Vrw=60V, 5.6A, 600W(1ms)	DO-214AA	1d	1a	Eic
C60A	SMBJ-LC60A	TVS	Vbr=67.5.74.5V, Vrw=60V, 6.2A, 600W(1ms)	DO-214AA	1d	1a	Eic
C61	CMDD601	Si-diode	Sw, 75V, 250mA, 250mW, Vf<1.1V(100mA), <2pF	SOD-323	5d	1a	Cen
C62	BZG03-C62	Z-diode	62V±5%, Izt=10mA, Zzt=25Ω, 1.25W	DO-214AC	1d	1a	Eic
C62A	1.5SMC62A	TVS	Vbr=58.9.65.1V, Vrw=53.0V, 17.6A, 1500W(1ms)	DO-214AB	1d	1a	Cen
C62A	P6SMB62A	TVS	Vbr=58.9.65.1V, 7.1A, 600W(1ms)	DO-214AA	1d	1a	Cen



SMD
code

Type

Function

Short description

Case

Pinout

St.

Mnf.

C62C	1.5SMC62CA	TVS	Vbr=58.9..65.1V, Vrwm=53.0V, 17.6A, 1500W(1ms), Bidirectional
C62C	P6SMB62CA	TVS	Vrwm=62V, Vbr=58.9..65.1V, 7.1A, 600W(1ms), Bidirectional
C64	SMBJ-LC64	TVS	Vbr=71.9..87.7V, Vrwm=64V, 5.3A, 600W(1ms)
C64A	SMBJ-LC64A	TVS	Vbr=71.9..79.4V, Vrwm=64V, 5.8A, 600W(1ms)
C68	BZG03-C68	Z-diode	68V±5%, Izt=10mA, Zzt=25Ω, 1.25W
C68A	1.5SMC68A	TVS	Vbr=64.6..71.4V, Vrwm=58.1V, 16.3A, 1500W(1ms)
C68A	P6SMB68A	TVS	Vrwm=68V, Vbr=64.6..71.4V, 6.5A, 600W(1ms)
C68C	1.5SMC68CA	TVS	Vbr=64.6..71.4V, Vrwm=58.1V, 16.3A, 1500W(1ms), Bidirectional
C68C	P6SMB68CA	TVS	Vrwm=68V, Vbr=64.6..71.4V, 6.5A, 600W(1ms), Bidirectional
C6A	1.5SCMJ11A	TVS	Vbr=10.5..11.6V, Vrwm=9.40V, 27A, 1500W(1ms)
C6C	1.5SCMJ11CA	TVS	Vbr=10.5..11.6V, Vrwm=9.40V, 27A, 1500W(1ms), Bidirectional
C6V8A	1.5SMC6.8A	TVS	Vbr=6.45..7.14V, Vrwm=5.80V, 143A, 1500W(1ms)
C6V8A	P6SMB6.8A	TVS	Vbr=6.45..7.14V, 57A, 600W(1ms)
C6V8C	1.5SMC6.8CA	TVS	Vbr=6.45..7.14V, Vrwm=5.80V, 143A, 1500W(1ms), Bidirectional
C6V8C	P6SMB6.8CA	TVS	Vbr=6.45..7.14V, 57A, 600W(1ms), Bidirectional
C7	BZX585-B4V3	Z-diode	4.3V±2%, 300mW
C7	BZX884-B30	Z-diode	30V±2%, 250mW
C7	RKZ3.0B2KK	Z-diode	2.95..3.20V, Izt=5mA, Zzt=120Ω, 150mW
C7	RKZ3.0B2KL	Z-diode	2.95..3.20V, Izt=5mA, Zzt=120Ω, 100mW
C7.0	SMBJ-LC7.0	TVS	Vbr=8.58..10.31V, Vrwm=7.0V, 45.1A, 600W(1ms)
C7.0A	SMBJ-LC7.0A	TVS	Vbr=8.58..9.40V, Vrwm=7.0V, 50.0A, 600W(1ms)
C7.5	SMBJ-LC7.5	TVS	Vbr=9.13..11.0V, Vrwm=7.5V, 42.0A, 600W(1ms)
C7.5A	SMBJ-LC7.5A	TVS	Vbr=9.13..10.01V, Vrwm=7.5V, 46.5A, 600W(1ms)
C70	SMBJ-LC70	TVS	Vbr=78.6..95.9V, Vrwm=70V, 4.8A, 600W(1ms)
C70A	SMBJ-LC70A	TVS	Vbr=78.6..86.8V, Vrwm=70V, 5.3A, 600W(1ms)
C75	BZG03-C75	Z-diode	75V±5%, Izt=10mA, Zzt=30Ω, 1.25W
C75	SMBJ-LC75	TVS	Vbr=84.1..102.8V, Vrwm=75V, 4.5A, 600W(1ms)
C75A	1.5SMC75A	TVS	Vbr=71.3..78.8V, Vrwm=64.1V, 14.6A, 1500W(1ms)
C75A	P6SMB75A	TVS	Vbr=71.3..78.8V, 5.8A, 600W(1ms)
C75A	SMBJ-LC75A	TVS	Vbr=84.1..92.9V, Vrwm=75V, 4.9A, 600W(1ms)
C75C	1.5SMC75CA	TVS	Vbr=71.3..78.8V, Vrwm=64.1V, 14.6A, 1500W(1ms), Bidirectional
C75C	P6SMB75CA	TVS	Vbr=71.3..78.8V, 5.8A, 600W(1ms), Bidirectional
C76	CMHD7006	Si-diode	HV, Sw, 600V, 100mA, 400mW, Vf<1.4V(100mA), <5pF
C78	SMBJ-LC78	TVS	Vbr=87.5..106.8V, Vrwm=78V, 4.3A, 600W(1ms)
C78A	SMBJ-LC78A	TVS	Vbr=87.5..96.6V, Vrwm=78V, 4.7A, 600W(1ms)
C7A	1.5SCMJ12A	TVS	Vbr=11.4..12.6V, Vrwm=10.2V, 25A, 1500W(1ms)
C7C	1.5SCMJ12CA	TVS	Vbr=11.4..12.6V, Vrwm=10.2V, 25A, 1500W(1ms), Bidirectional
C7V5A	1.5SMC7.5A	TVS	Vbr=7.13..7.88V, Vrwm=6.40V, 133A, 1500W(1ms)
C7V5A	P6SMB7.5A	TVS	Vrwm=7.5V, Vbr=7.13..7.88V, 53.1A, 600W(1ms)
C7V5C	1.5SMC7.5CA	TVS	Vbr=7.13..7.88V, Vrwm=6.40V, 133A, 1500W(1ms), Bidirectional
C7V5C	P6SMB7.5CA	TVS	Vbr=7.13..7.88V, 53A, 600W(1ms), Bidirectional
C8	BZX585-B4V7	Z-diode	4.7V±2%, 300mW
C8	BZX884-B33	Z-diode	33V±2%, 250mW
C8	MM5Z3V3	Z-diode	3.3V±5%, Izt=5mA, Zzt=95Ω, 200mW
C8	MM5Z3V3H	Z-diode	3.1..3.5V, Izt=5mA, Zzt=95Ω, 200mW
C8.0	SMBJ-LC8.0	TVS	Vbr=9.69..11.70V, Vrwm=8.0V, 40.0A, 600W(1ms)
C8.0A	SMBJ-LC8.0A	TVS	Vbr=9.69..10.63V, Vrwm=8.0V, 44.1A, 600W(1ms)
C8.5	SMBJ-LC8.5	TVS	Vbr=10.24..12.3V, Vrwm=8.5V, 37.7A, 600W(1ms)
C8.5A	SMBJ-LC8.5A	TVS	Vbr=10.24..11.2V, Vrwm=8.5V, 41.7A, 600W(1ms)
C82	BZG03-C82	Z-diode	82V±5%, Izt=10mA, Zzt=30Ω, 1.25W
C82A	1.5SMC82A	TVS	Vbr=77.9..86.1V, Vrwm=70.1V, 13.3A, 1500W(1ms)
C82A	P6SMB82A	TVS	Vbr=77.9..86.1V, 5.3A, 600W(1ms)
C82C	1.5SMC82CA	TVS	Vbr=77.9..86.1V, Vrwm=70.1V, 13.3A, 1500W(1ms), Bidirectional
C82C	P6SMB82CA	TVS	Vbr=77.9..86.1V, 5.3A, 600W(1ms), Bidirectional
C85	SMBJ-LC85	TVS	Vbr=95.2..115.8V, Vrwm=85V, 3.9A, 600W(1ms)
C85A	SMBJ-LC85A	TVS	Vbr=95.2..104.8V, Vrwm=85V, 4.4A, 600W(1ms)
C8A	1.5SCMJ13A	TVS	Vbr=12.4..13.7V, Vrwm=11.1V, 23A, 1500W(1ms)
C8C	1.5SCMJ13CA	TVS	Vbr=12.4..13.7V, Vrwm=11.1V, 23A, 1500W(1ms), Bidirectional
C8V2A	1.5SMC8.2A	TVS	Vbr=7.79..8.61V, Vrwm=7.02V, 124A, 1500W(1ms)
C8V2A	P6SMB8.2A	TVS	Vbr=7.79..8.61V, 50A, 600W(1ms)
C8V2C	1.5SMC8.2CA	TVS	Vbr=7.79..8.61V, Vrwm=7.02V, 124A, 1500W(1ms), Bidirectional
C8V2C	P6SMB8.2CA	TVS	Vbr=7.79..8.61V, 50A, 600W(1ms), Bidirectional
C9	BZX585-B5V1	Z-diode	5.1V±2%, 300mW
C9	BZX884-B36	Z-diode	36V±2%, 250mW
C9	MM5Z39H	Z-diode	37..41V, Izt=2mA, Zzt=130Ω, 200mW
C9	MM5Z39V	Z-diode	39V±5%, Izt=2mA, Zzt=130Ω, 200mW
C9	RKZ3.3B2KK	Z-diode	3.25..3.50V, Izt=5mA, Zzt=130Ω, 150mW
C9	RKZ3.3B2KL	Z-diode	3.25..3.50V, Izt=5mA, Zzt=130Ω, 100mW
C9.0	SMBJ-LC9.0	TVS	Vbr=10.8..13.0V, Vrwm=9.0V, 35.5A, 600W(1ms)
C9.0A	SMBJ-LC9.0A	TVS	Vbr=10.8..11.9V, Vrwm=9.0V, 39.0A, 600W(1ms)



SMD code	Type	Function	Short description	Case	Pinout	St.	Mnf.
C90	SMBJ-LC90	TVS	Vbr=100.8..122.8V, Vrwm=90V, 3.8A, 600W(1ms)	DO-214AA	1d	1a	Eic
C90A	SMBJ-LC90A	TVS	Vbr=100.8..111.8V, Vrwm=90V, 4.1A, 600W(1ms)	DO-214AA	1d	1a	Eic
C91	BZG03-C91	Z-diode	91V±5%, Izt=5mA, Zzt=60Ω, 1.25W	DO-214AC	1d	1a	Eic
C91A	1.5SMC91A	TVS	Vbr=86.5..95.5V, Vrwm=77.8V, 12A, 1500W(1ms)	DO-214AB	1d	1a	Cen
C91A	P6SMB91A	TVS	Vbr=86.5..95.5V, 4.8A, 600W(1ms)	DO-214AA	1d	1a	Cen
C91C	1.5SMC91CA	TVS	Vbr=86.5..95.5V, Vrwm=77.8V, 12A, 1500W(1ms), Bidirectional	DO-214AB	1ba	1j	Cen
C91C	P6SMB91CA	TVS	Vbr=86.5..95.5V, 4.8A, 600W(1ms), Bidirectional	DO-214AA	1ba	1j	Cen
C95	CMHD3595	Si-diode	Sw, 150V, 150mA, 400mW, Vf<1V(200mA), <8pF	SOD-123	5d	1a	Cen
C9A	1.5SCMJ15A	TVS	Vbr=14.3..15.8V, Vrwm=12.8V, 20A, 1500W(1ms)	DO-214AB	1d	1a	Chm
C9C	1.5SCMJ15CA	TVS	Vbr=14.3..15.8V, Vrwm=12.8V, 20A, 1500W(1ms), Bidirectional	DO-214AB	1ba	1j	Chm
C9V1A	1.5SMC9.1A	TVS	Vbr=8.65..9.55V, Vrwm=7.78V, 112A, 1500W(1ms)	DO-214AB	1d	1a	Cen
C9V1A	P6SMB9.1A	TVS	Vbr=8.65..9.55V, 45A, 600W(1ms)	DO-214AA	1d	1a	Cen
C9V1C	1.5SMC9.1CA	TVS	Vbr=8.65..9.55V, Vrwm=7.78V, 112A, 1500W(1ms), Bidirectional	DO-214AB	1ba	1j	Cen
C9V1C	P6SMB9.1CA	TVS	Vbr=8.65..9.55V, 45A, 600W(1ms), Bidirectional	DO-214AA	1ba	1j	Cen
CA	BZX884-B39	Z-diode	39V±2%, 250mW	SOD-882	13d	2b	Phi
CA	MM1Z4692	Z-diode	6.46..7.14V, Izt=10mA, 500mW	SOD-323FL	5d	1a	Eic
CA	MMSZ4691	Z-diode	6.2V±5%, 350mW	SOD-123	5d	1a,1k	Mot,Vs
CA	MMSZ4692	Z-diode	6.8V±5%, Izt=50μA, 500mW	SOD-123	5d	1a	Eic
CA	SD883-02	Si-diode	SBR, 20V, 3A, Vf<0.39V(2.5A)	PowDI123	7d	1a	Fji
CA	ZMV829B	C-diode	VHF/UHF-Tuning, 25V, 330mW, 8.2pF(2V), ΔC ±5%	SOD-323	5d	1a	Zx
CAD	SMCJ5.0	TVS	Vbr=6.40..7.82V, Vrwm=5.0V, 156.3A, 1500W(1ms)	DO-214AB	1d	1a	Gal
CAE	SMCJ5.0A	TVS	Vbr=6.40..7.07V, Vrwm=5.0V, 163.0A, 1500W(1ms)	DO-214AB	1d	1a	Gal
CAF	SMCJ6.0	TVS	Vbr=6.67..8.15V, Vrwm=5.0V, 131.6A, 1500W(1ms)	DO-214AB	1d	1a	Gal
CAG	SMCJ6.0A	TVS	Vbr=6.67..7.37V, Vrwm=6.0V, 145.6A, 1500W(1ms)	DO-214AB	1d	1a	Gal
CAH	SMCJ6.5	TVS	Vbr=7.22..8.82V, Vrwm=6.5V, 122.0A, 1500W(1ms)	DO-214AB	1d	1a	Gal
CAK	SMCJ6.5A	TVS	Vbr=7.22..7.98V, Vrwm=6.5V, 133.9A, 1500W(1ms)	DO-214AB	1d	1a	Gal
CAL	SMCJ7.0	TVS	Vbr=7.78..9.51V, Vrwm=7.0V, 112.8A, 1500W(1ms)	DO-214AB	1d	1a	Gal
CAM	SMCJ7.0A	TVS	Vbr=7.78..8.60V, Vrwm=7.0V, 125.0A, 1500W(1ms)	DO-214AB	1d	1a	Gal
CAN	SMCJ7.5	TVS	Vbr=8.33..10.2V, Vrwm=7.5V, 104.9A, 1500W(1ms)	DO-214AB	1d	1a	Gal
CAP	SMCJ7.5A	TVS	Vbr=8.33..9.21V, Vrwm=7.5V, 116.3A, 1500W(1ms)	DO-214AB	1d	1a	Gal
CAQ	SMCJ8.0	TVS	Vbr=8.89..10.9V, Vrwm=8.0V, 100.0A, 1500W(1ms)	DO-214AB	1d	1a	Gal
CAR	SMCJ8.0A	TVS	Vbr=8.89..9.83V, Vrwm=8.0V, 110.3A, 1500W(1ms)	DO-214AB	1d	1a	Gal
CAS	SMCJ8.5	TVS	Vbr=9.44..11.5V, Vrwm=8.5V, 94.3A, 1500W(1ms)	DO-214AB	1d	1a	Gal
CAT	SMCJ8.5A	TVS	Vbr=9.44..10.4V, Vrwm=8.5V, 104.2A, 1500W(1ms)	DO-214AB	1d	1a	Gal
CAU	SMCJ9.0	TVS	Vbr=10.0..12.2V, Vrwm=9.0V, 88.8A, 1500W(1ms)	DO-214AB	1d	1a	Gal
CAV	SMCJ9.0A	TVS	Vbr=10.0..11.1V, Vrwm=9.0V, 97.4A, 1500W(1ms)	DO-214AB	1d	1a	Gal
CAW	SMCJ10	TVS	Vbr=11.1..13.6V, Vrwm=10V, 79.8A, 1500W(1ms)	DO-214AB	1d	1a	Gal
CAX	SMCJ10A	TVS	Vbr=11.1..12.3V, Vrwm=10V, 88.2A, 1500W(1ms)	DO-214AB	1d	1a	Gal
CAY	SMCJ11	TVS	Vbr=12.2..14.9V, Vrwm=11V, 74.6A, 1500W(1ms)	DO-214AB	1d	1a	Gal
CAZ	SMCJ11A	TVS	Vbr=12.2..13.5V, Vrwm=11V, 82.4A, 1500W(1ms)	DO-214AB	1d	1a	Gal
CB	BZX884-B43	Z-diode	43V±2%, 250mW	SOD-882	13d	2b	Phi
CB	MM1Z4693	Z-diode	7.13..7.88V, Izt=10mA, 500mW	SOD-323FL	5d	1a	Eic
CB	MMSZ4693	Z-diode	7.5V±5%, Izt=50μA, 500mW	SOD-123	5d	1a	Eic
CB	SD883-04	Si-diode	SBR, 40V, 3A, Vf<0.45V(2.5A)	PowDI123	7d	1a	Fji
CB	ZMV830B	C-diode	VHF/UHF-Tuning, 25V, 330mW, 10pF(2V), ΔC ±5%	SOD-323	5d	1a	Zx
CBD	SMCJ12	TVS	Vbr=13.3..16.3V, Vrwm=12V, 68.2A, 1500W(1ms)	DO-214AB	1d	1a	Gal
CBDE	1SMC5.0CA	TVS	Vbr=6.40..7.07V, Vrwm=5.0V, 163.0A, 1500W(1ms), Bidirectional	DO-214AB	1ba	1j	Cen
CBDG	1SMC6.0CA	TVS	Vbr=6.67..7.37V, Vrwm=6.0V, 145.6A, 1500W(1ms), Bidirectional	DO-214AB	1ba	1j	Cen
CBDK	1SMC6.5CA	TVS	Vbr=7.22..7.98V, Vrwm=6.5V, 133.9A, 1500W(1ms), Bidirectional	DO-214AB	1ba	1j	Cen
CBDM	1SMC7.0CA	TVS	Vbr=7.78..8.6V, Vrwm=7.0V, 125.0A, 1500W(1ms), Bidirectional	DO-214AB	1ba	1j	Cen
CBDP	1SMC7.5CA	TVS	Vbr=8.33..9.21V, Vrwm=7.5V, 116.3A, 1500W(1ms), Bidirectional	DO-214AB	1ba	1j	Cen
CBDR	1SMC8.0CA	TVS	Vbr=8.89..9.83V, Vrwm=8.0V, 110.3A, 1500W(1ms), Bidirectional	DO-214AB	1ba	1j	Cen
CBDT	1SMC8.5CA	TVS	Vbr=9.44..10.4V, Vrwm=8.5V, 104.2A, 1500W(1ms), Bidirectional	DO-214AB	1ba	1j	Cen
CBDV	1SMC9.0CA	TVS	Vbr=10.0..11.1V, Vrwm=9.0V, 97.4A, 1500W(1ms), Bidirectional	DO-214AB	1ba	1j	Cen
CBDX	1SMC10CA	TVS	Vbr=11.1..12.3V, Vrwm=10V, 88.2A, 1500W(1ms), Bidirectional	DO-214AB	1ba	1j	Cen
CBDZ	1SMC11CA	TVS	Vbr=12.2..13.5V, Vrwm=11V, 82.4A, 1500W(1ms), Bidirectional	DO-214AB	1ba	1j	Cen
CBE	SMCJ12A	TVS	Vbr=13.3..14.7V, Vrwm=12V, 75.4A, 1500W(1ms)	DO-214AB	1d	1a	Gal
CBE	1SMC12CA	TVS	Vbr=13.3..14.7V, Vrwm=12V, 75.4A, 1500W(1ms), Bidirectional	DO-214AB	1ba	1j	Cen
CBEG	1SMC13CA	TVS	Vbr=14.4..15.9V, Vrwm=13V, 69.8A, 1500W(1ms), Bidirectional	DO-214AB	1ba	1j	Cen
CBEK	1SMC14CA	TVS	Vbr=15.6..17.2V, Vrwm=14V, 64.7A, 1500W(1ms), Bidirectional	DO-214AB	1ba	1j	Cen
CBE	1SMC15CA	TVS	Vbr=16.7..18.5V, Vrwm=15V, 61.5A, 1500W(1ms), Bidirectional	DO-214AB	1ba	1j	Cen
CBEP	1SMC16CA	TVS	Vbr=17.8..19.7V, Vrwm=16V, 57.7A, 1500W(1ms), Bidirectional	DO-214AB	1ba	1j	Cen
CBEP	1SMC17CA	TVS	Vbr=18.9..20.9V, Vrwm=17V, 54.3A, 1500W(1ms), Bidirectional	DO-214AB	1ba	1j	Cen
CBET	1SMC18CA	TVS	Vbr=20.0..22.1V, Vrwm=18V, 51.4A, 1500W(1ms), Bidirectional	DO-214AB	1ba	1j	Cen
CBEV	1SMC20CA	TVS	Vbr=22.2..24.5V, Vrwm=20V, 46.3A, 1500W(1ms), Bidirectional	DO-214AB	1ba	1j	Cen
CBEX	1SMC22CA	TVS	Vbr=24.4..26.9V, Vrwm=22V, 42.3A, 1500W(1ms), Bidirectional	DO-214AB	1ba	1j	Cen
CBEX	1SMC24CA	TVS	Vbr=26.7..29.5V, Vrwm=24V, 38.6A, 1500W(1ms), Bidirectional	DO-214AB	1ba	1j	Cen
CBF	SMCJ13	TVS	Vbr=14.4..17.6V, Vrwm=13V, 63.0A, 1500W(1ms)	DO-214AB	1d	1a	Gal
CBFE	1SMC26CA	TVS	Vbr=28.9..31.9V, Vrwm=26V, 35.6A, 1500W(1ms), Bidirectional	DO-214AB	1ba	1j	Cen
CBFG	1SMC28CA	TVS	Vbr=31.1..34.4V, Vrwm=28V, 33.0A, 1500W(1ms), Bidirectional	DO-214AB	1ba	1j	Cen



SMD code	Type	Function	Short description	Case	Pinout	St.	Mnf.
CBFK	1SMC30CA	TVS	Vbr=33.3..36.8V, Vrwm=30V, 31.0A, 1500W(1ms), Bidirectional	DO-214AB	1ba	1j	Cen
CBFM	1SMC33CA	TVS	Vbr=36.7..40.6V, Vrwm=33V, 28.1A, 1500W(1ms), Bidirectional	DO-214AB	1ba	1j	Cen
CBFP	1SMC36CA	TVS	Vbr=40.0..44.2V, Vrwm=36V, 25.8A, 1500W(1ms), Bidirectional	DO-214AB	1ba	1j	Cen
CBFR	1SMC40CA	TVS	Vbr=44.4..49.1V, Vrwm=40V, 23.3A, 1500W(1ms), Bidirectional	DO-214AB	1ba	1j	Cen
CBFT	1SMC43CA	TVS	Vbr=47.8..52.8V, Vrwm=43V, 21.6A, 1500W(1ms), Bidirectional	DO-214AB	1ba	1j	Cen
CBFV	1SMC45CA	TVS	Vbr=50.0..55.3V, Vrwm=45V, 20.6A, 1500W(1ms), Bidirectional	DO-214AB	1ba	1j	Cen
CBFX	1SMC48CA	TVS	Vbr=53.3..58.9V, Vrwm=48V, 19.4A, 1500W(1ms), Bidirectional	DO-214AB	1ba	1j	Cen
CBFY	1SMC51CA	TVS	Vbr=56.7..62.7V, Vrwm=51V, 18.2A, 1500W(1ms), Bidirectional	DO-214AB	1ba	1j	Cen
CBG	SMCJ13A	TVS	Vbr=14.4..15.9V, Vrwm=13V, 69.8A, 1500W(1ms)	DO-214AB	1d	1a	Gal
CBGE	1SMC54CA	TVS	Vbr=60.0..66.3V, Vrwm=54V, 17.2A, 1500W(1ms), Bidirectional	DO-214AB	1ba	1j	Cen
CBGG	1SMC58CA	TVS	Vbr=64.4..71.2V, Vrwm=58V, 16.0A, 1500W(1ms), Bidirectional	DO-214AB	1ba	1j	Cen
CBGK	1SMC60CA	TVS	Vbr=66.7..73.7V, Vrwm=60V, 15.5A, 1500W(1ms), Bidirectional	DO-214AB	1ba	1j	Cen
CBGM	1SMC64CA	TVS	Vbr=71.1..78.6V, Vrwm=64V, 14.6A, 1500W(1ms), Bidirectional	DO-214AB	1ba	1j	Cen
CBGP	1SMC70CA	TVS	Vbr=77.8..86V, Vrwm=70V, 13.3A, 1500W(1ms), Bidirectional	DO-214AB	1ba	1j	Cen
CBGR	1SMC75CA	TVS	Vbr=83.3..92.1V, Vrwm=75V, 12.4A, 1500W(1ms), Bidirectional	DO-214AB	1ba	1j	Cen
CBGT	1SMC78CA	TVS	Vbr=86.7..95.8V, Vrwm=78V, 11.9A, 1500W(1ms), Bidirectional	DO-214AB	1ba	1j	Cen
CBGV	1SMC85CA	TVS	Vbr=94.4..104V, Vrwm=85V, 10.9A, 1500W(1ms), Bidirectional	DO-214AB	1ba	1j	Cen
CBGX	1SMC90CA	TVS	Vbr=100..111V, Vrwm=90V, 10.3A, 1500W(1ms), Bidirectional	DO-214AB	1ba	1j	Cen
CBGZ	1SMC100CA	TVS	Vbr=111..123V, Vrwm=100V, 9.3A, 1500W(1ms), Bidirectional	DO-214AB	1ba	1j	Cen
CBH	SMBJ22CA	TVS	Vbr=22V, 17.7A, 600W(1ms), Bidirectional	DO-214AA	1ba	1r	Ste
CBH	SMCJ14	TVS	Vbr=15.6..19.1V, Vrwm=14V, 58.1A, 1500W(1ms)	DO-214AB	1d	1a	Gal
CBHE	1SMC110CA	TVS	Vbr=122..135V, Vrwm=110V, 8.5A, 1500W(1ms), Bidirectional	DO-214AB	1ba	1j	Cen
CBHG	1SMC120CA	TVS	Vbr=133..147V, Vrwm=120V, 7.8A, 1500W(1ms), Bidirectional	DO-214AB	1ba	1j	Cen
CBHK	1SMC130CA	TVS	Vbr=144..159V, Vrwm=130V, 7.2A, 1500W(1ms), Bidirectional	DO-214AB	1ba	1j	Cen
CBHM	1SMC150CA	TVS	Vbr=167..185V, Vrwm=150V, 6.2A, 1500W(1ms), Bidirectional	DO-214AB	1ba	1j	Cen
CBHP	1SMC160CA	TVS	Vbr=178..197V, Vrwm=160V, 5.8A, 1500W(1ms), Bidirectional	DO-214AB	1ba	1j	Cen
CBHR	1SMC170CA	TVS	Vbr=189..209V, Vrwm=170V, 5.5A, 1500W(1ms), Bidirectional	DO-214AB	1ba	1j	Cen
CBJ	SMBJ40CA	TVS	Vbr=40V, 9.7A, 600W(1ms), Bidirectional	DO-214AA	1ba	1r	Ste
CBK	SMCJ14A	TVS	Vbr=15.6..17.2V, Vrwm=14V, 64.7A, 1500W(1ms)	DO-214AB	1d	1a	Gal
CBL	SMCJ15	TVS	Vbr=16.7..20.4V, Vrwm=15V, 55.8A, 1500W(1ms)	DO-214AB	1d	1a	Gal
CBM	SMBJ70CA	TVS	Vbr=70V, 5.5A, 600W(1ms), Bidirectional	DO-214AA	1ba	1r	Ste
CBM	SMCJ15A	TVS	Vbr=16.7..18.5V, Vrwm=15V, 61.5A, 1500W(1ms)	DO-214AB	1d	1a	Gal
CBN	SMCJ16	TVS	Vbr=17.8..21.8V, Vrwm=16V, 52.1A, 1500W(1ms)	DO-214AB	1d	1a	Gal
CBP	SMCJ16A	TVS	Vbr=17.8..19.7V, Vrwm=16V, 57.7A, 1500W(1ms)	DO-214AB	1d	1a	Gal
CBQ	SMBJ100CA	TVS	Vrwm=100V, Vbr=111..128V, 3.7A, 600W(1ms), Bidirectional	DO-214AA	1ba	1r	Ste
CBR	SMCJ17A	TVS	Vbr=18.9..20.9V, Vrwm=17V, 54.3A, 1500W(1ms)	DO-214AB	1d	1a	Gal
CBT	SMCJ18	TVS	Vbr=20.0..24.4V, Vrwm=18V, 46.6A, 1500W(1ms)	DO-214AB	1d	1a	Gal
CBTS	SMCJ18A	TVS	Vbr=20.0..22.1V, Vrwm=18V, 51.4A, 1500W(1ms)	DO-214AB	1d	1a	Gal
CBU	SMCJ20	TVS	Vbr=22.2..27.1V, Vrwm=20V, 41.9A, 1500W(1ms)	DO-214AB	1d	1a	Gal
CBV	SMCJ20A	TVS	Vbr=22.2..24.5V, Vrwm=20V, 46.3A, 1500W(1ms)	DO-214AB	1d	1a	Gal
CBW	SMCJ17	TVS	Vbr=18.9..23.1V, Vrwm=17V, 49.2A, 1500W(1ms)	DO-214AB	1d	1a	Gal
CBW	SMCJ22	TVS	Vbr=24.4..29.8V, Vrwm=22V, 38.1A, 1500W(1ms)	DO-214AB	1d	1a	Gal
CBX	SMCJ22A	TVS	Vbr=24.4..26.9V, Vrwm=22V, 42.3A, 1500W(1ms)	DO-214AB	1d	1a	Gal
CBY	SMCJ24	TVS	Vbr=26.7..32.6V, Vrwm=24V, 34.9A, 1500W(1ms)	DO-214AB	1d	1a	Gal
CBZ	SMCJ24A	TVS	Vbr=26.7..29.5V, Vrwm=24V, 38.6A, 1500W(1ms)	DO-214AB	1d	1a	Gal
CC	BB565	C-diode	UHF TV-tuning, 30V, 20mA, 2.2..21.5pF(28..1V)	SCD-80	6d	1u	Inf
CC	BZX884-B47	Z-diode	47V±2%, 250mW	SOD-882	13d	2b	Phi
CC	GBLC03CI	TVS	Vbr=3V, 5A, 350W(1ms), 0.6pF, Bidirectional	SOD-323	5ba	1e	Prt
CC	MM1Z4694	Z-diode	7.79..8.61V, Izt=10mA, 500mW	SOD-323FL	5d	1a	Eic
CC	MMSZ4678	Z-diode	1.8V±5%, Izt=50µA, 500mW	SOD-123	5d	1a	Mot
CC	MMSZ4694	Z-diode	8.2V±5%, Izt=50µA, 500mW	SOD-123	5d	1a	Eic
CC	ZMV831B	C-diode	VHF/UHF-Tuning, 25V, 330mW, 15pF(2V), ΔC ±5%	SOD-323	5d	1a	Zx
CC1	CMHZ5221B	Z-diode	2.4V±5%, 500mW	SOD-123	5d	1a	Cen
CC2	CMHZ5222B	Z-diode	2.5V±5%, 500mW	SOD-123	5d	1a	Cen
CC3	CMHZ5223B	Z-diode	2.7V±5%, 500mW	SOD-123	5d	1a	Cen
CC4	CMHZ5224B	Z-diode	2.8V±5%, 500mW	SOD-123	5d	1a	Cen
CC5	CMHZ5225B	Z-diode	3.0V±5%, 500mW	SOD-123	5d	1a	Cen
CCA	CMHZ4691	Z-diode	LL, 6.2V±5%, 45.0mA, 400mW	SOD-123	5d	1a	Cen
CCC	CMHZ4678	Z-diode	LL, 1.8V±5%, 120.0mA, 400mW	SOD-123	5d	1a	Cen
CCD	CMHZ4679	Z-diode	LL, 2.0V±5%, 110.0mA, 400mW	SOD-123	5d	1a	Cen
CCD	SMCJ26	TVS	Vbr=28.9..35.3V, Vrwm=26V, 32.2A, 1500W(1ms)	DO-214AB	1d	1a	Gal
CCE	CMHZ4680	Z-diode	LL, 2.2V±5%, 100.0mA, 400mW	SOD-123	5d	1a	Cen
CCE	SMCJ26A	TVS	Vbr=28.9..31.9V, Vrwm=26V, 35.6A, 1500W(1ms)	DO-214AB	1d	1a	Gal
CCF	CMHZ4681	Z-diode	LL, 2.4V±5%, 95.0mA, 400mW	SOD-123	5d	1a	Cen
CCF	SMCJ28	TVS	Vbr=31.1..38.0V, Vrwm=28V, 30.0A, 1500W(1ms)	DO-214AB	1d	1a	Gal
CCG	SMCJ28A	TVS	Vbr=31.1..34.4V, Vrwm=28V, 33.0A, 1500W(1ms)	DO-214AB	1d	1a	Gal
CCH	CMHZ4682	Z-diode	LL, 2.7V±5%, 90.0mA, 400mW	SOD-123	5d	1a	Cen
CCH	SMCJ30	TVS	Vbr=33.3..40.7V, Vrwm=30V, 28.0A, 1500W(1ms)	DO-214AB	1d	1a	Gal
CCJ	CMHZ4683	Z-diode	LL, 3.0V±5%, 85.0mA, 400mW	SOD-123	5d	1a	Cen
CCK	CMHZ4684	Z-diode	LL, 3.3V±5%, 80.0mA, 400mW	SOD-123	5d	1a	Cen



SMD code	Type	Function	Short description	Case	Pinout	St.	Mnf.
CKK	SMCJ30A	TVS	Vbr=33.3..36.8V, Vrw=30V, 31.0A, 1500W(1ms)	DO-214AB	1d	1a	Gal
COL	SMCJ33	TVS	Vbr=36.7..44.9V, Vrw=33V, 25.4A, 1500W(1ms)	DO-214AB	1d	1a	Gal
CCM	CMHZ4685	Z-diode	LL, 3.6V±5%, 75.0mA, 400mW	SOD-123	5d	1a	Cen
CCM	SMCJ33A	TVS	Vbr=36.7..40.6V, Vrw=33V, 28.1A, 1500W(1ms)	DO-214AB	1d	1a	Gal
CCM	SMCJ36	TVS	Vbr=40.0..48.9V, Vrw=36V, 23.3A, 1500W(1ms)	DO-214AB	1d	1a	Gal
CCN	CMHZ4686	Z-diode	LL, 3.9V±5%, 70.0mA, 400mW	SOD-123	5d	1a	Cen
CCP	CMHZ4687	Z-diode	LL, 4.3V±5%, 65.0mA, 400mW	SOD-123	5d	1a	Cen
CCP	SMCJ36A	TVS	Vbr=40.0..44.2V, Vrw=36V, 25.8A, 1500W(1ms)	DO-214AB	1d	1a	Gal
CCQ	SMCJ40	TVS	Vbr=44.4..54.3V, Vrw=40V, 21.0A, 1500W(1ms)	DO-214AB	1d	1a	Gal
CCR	SMCJ40A	TVS	Vbr=44.4..49.1V, Vrw=40V, 23.3A, 1500W(1ms)	DO-214AB	1d	1a	Gal
CCS	SMCJ43	TVS	Vbr=47.8..58.4V, Vrw=43V, 19.6A, 1500W(1ms)	DO-214AB	1d	1a	Gal
CCT	CMHZ4688	Z-diode	LL, 4.7V±5%, 60.0mA, 400mW	SOD-123	5d	1a	Cen
CCT	SMCJ43A	TVS	Vbr=47.8..52.8V, Vrw=43V, 21.6A, 1500W(1ms)	DO-214AB	1d	1a	Gal
CCU	CMHZ4689	Z-diode	LL, 5.1V±5%, 55.0mA, 400mW	SOD-123	5d	1a	Cen
CCU	SMCJ45	TVS	Vbr=50.0..61.1V, Vrw=45V, 18.7A, 1500W(1ms)	DO-214AB	1d	1a	Gal
CCV	CMHZ4690	Z-diode	LL, 5.6V±5%, 50.0mA, 400mW	SOD-123	5d	1a	Cen
CCV	SMCJ45A	TVS	Vbr=50.0..55.3V, Vrw=45V, 20.6A, 1500W(1ms)	DO-214AB	1d	1a	Gal
CCW	SMCJ48	TVS	Vbr=53.3..65.1V, Vrw=48V, 17.5A, 1500W(1ms)	DO-214AB	1d	1a	Gal
CCX	CMHZ4692	Z-diode	LL, 6.8V±5%, 35.0mA, 400mW	SOD-123	5d	1a	Cen
CCX	SMCJ48A	TVS	Vbr=53.3..58.9V, Vrw=48V, 19.4A, 1500W(1ms)	DO-214AB	1d	1a	Gal
CCY	CMHZ4693	Z-diode	LL, 7.5V±5%, 31.8mA, 400mW	SOD-123	5d	1a	Cen
CCY	SMCJ51	TVS	Vbr=56.7..69.3V, Vrw=51V, 16.5A, 1500W(1ms)	DO-214AB	1d	1a	Gal
CCZ	CMHZ4694	Z-diode	LL, 8.2V±5%, 29.0mA, 400mW	SOD-123	5d	1a	Cen
CCZ	SMCJ51A	TVS	Vbr=56.7..62.7V, Vrw=51V, 18.2A, 1500W(1ms)	DO-214AB	1d	1a	Gal
CD	BZX884-B51	Z-diode	51V±2%, 250mW	SOD-882	13d	2b	Phi
CD	KDZ24B	Z-diode	24V±2.5%, 10mA, 1W	PMDU	7d	1s	Rhm
CD	MM1Z4695	Z-diode	8.27..9.14V, Izt=10mA, 500mW	SOD-123FL	7d	1a	Sme
CD	MMSZ4679	Z-diode	2.0V±5%, Izt=50µA, 500mW	SOD-123	5d	1a	Mot
CD	MMSZ4695	Z-diode	8.7V±5%, Izt=50µA, 500mW	SOD-123	5d	1a	Eic
CD	P4SMA47	TVS	Vrw=47V, 6.2A, 400W (1ms),	DO-214AC	1d	2j	Fag
CD	P6SMBJ26C	TVS	Vbr=26V, 12.4A, 600W(1ms), Bidirectional	DO-214AA	1ba	1x,1y	Pjt,Srj
CD	SMAJ26	TVS	Vrw=26V, Vbr=28.9..35.3V, 8.6A, 400W(1ms)	DO-214AC	1d	1k	Vs
CD	SMBG26C	TVS	Vbr=26V, 12.9A, 600W(1ms), Bidirectional	DO-215AA	5ba	1l	Vs
CD	SMBJ26C	TVS	Vbr=26V, 12.9A, 600W(1ms), Bidirectional	DO-214AA	1ba	1l	Vs
CD	SMP26	TVS	Vbr=28.9..35.3V, Vrw=26V, Ipp=8.6A, 400W(1ms)	DO-220AA	8d	1a	Vs
CD	TV04A260K-G	TVS	Vrw=26.0V, Vbr=28.90..35.30V, Ipp=8.58A, 400W(1ms)	DO-214AC	1d	1a	Cmc
CD	TV06B260KB-G	TVS	Vrw=26.0V, Vbr=28.90..35.30V, Ipp=12.88A, 600W(1ms), Bidirectional	DO-214AA	1ba	1j	Cmc
CD	ZMV832B	C-diode	VHF/UHF-Tuning, 25V, 330mW, 22pF(2V), ΔC ±5%	SOD-323	5d	1a	Zx
CD1	CMHZ5226B	Z-diode	3.3V±5%, 500mW	SOD-123	5d	1a	Cen
CD2	CMHZ5227B	Z-diode	3.6V±5%, 500mW	SOD-123	5d	1a	Cen
CD3	CMHZ5228B	Z-diode	3.9V±5%, 500mW	SOD-123	5d	1a	Cen
CD4	CMHZ5229B	Z-diode	4.3V±5%, 500mW	SOD-123	5d	1a	Cen
CD5	CMHZ5230B	Z-diode	4.7V±5%, 500mW	SOD-123	5d	1a	Cen
CDA	CMHZ4708	Z-diode	LL, 22V±5%, 10.8mA, 400mW	SOD-123	5d	1a	Cen
CDC	CMHZ4695	Z-diode	LL, 8.7V±5%, 27.4mA, 400mW	SOD-123	5d	1a	Cen
CDD	CMHZ4696	Z-diode	LL, 9.1V±5%, 26.2mA, 400mW	SOD-123	5d	1a	Cen
CDE	CMHZ4697	Z-diode	LL, 10V±5%, 24.8mA, 400mW	SOD-123	5d	1a	Cen
CDF	CMHZ4698	Z-diode	LL, 11V±5%, 21.6mA, 400mW	SOD-123	5d	1a	Cen
CDH	CMHZ4699	Z-diode	LL, 12V±5%, 20.4mA, 400mW	SOD-123	5d	1a	Cen
CDJ	CMHZ4700	Z-diode	LL, 13V±5%, 19.0mA, 400mW	SOD-123	5d	1a	Cen
CDK	CMHZ4701	Z-diode	LL, 14V±5%, 17.5mA, 400mW	SOD-123	5d	1a	Cen
CDK	SMA47	TVS	Vbr=42.3..51.7V, Vrw=38.1V, 5.90A, 400W(1ms)	DO-214AC	1d	1a	Lge
CDM	CMHZ4702	Z-diode	LL, 15V±5%, 16.3mA, 400mW	SOD-123	5d	1a	Cen
CDM	SMA47C	TVS	Vbr=42.3..51.7V, Vrw=38.1V, 5.90A, 400W(1ms), Bidirectional	DO-214AC	1ba	1j	Lge
CDN	CMHZ4703	Z-diode	LL, 16V±5%, 15.4mA, 400mW	SOD-123	5d	1a	Cen
CDP	CMHZ4704	Z-diode	LL, 17V±5%, 14.5mA, 400mW	SOD-123	5d	1a	Cen
CDT	CMHZ4705	Z-diode	LL, 18V±5%, 13.2mA, 400mW	SOD-123	5d	1a	Cen
CDU	CMHZ4706	Z-diode	LL, 19V±5%, 12.5mA, 400mW	SOD-123	5d	1a	Cen
CDV	CMHZ4707	Z-diode	LL, 20V±5%, 11.9mA, 400mW	SOD-123	5d	1a	Cen
CDY	CMHZ4710	Z-diode	LL, 25V±5%, 9.5mA, 400mW	SOD-123	5d	1a	Cen
CDZ	CMHZ4709	Z-diode	LL, 24V±5%, 9.9mA, 400mW	SOD-123	5d	1a	Cen
CE	BZX884-B56	Z-diode	56V±2%, 250mW	SOD-882	13d	2b	Phi
CE	CD214B-T26CA	TVS	Vbr=26V, Irs=14.2A, 600W(1ms), Bidirectional	DO-214AA	1ba	1j	Bm
CE	MM1Z4696	Z-diode	8.65..9.56V, Izt=10mA, 500mW	SOD-323FL	5d	1a	Eic
CE	MMSZ4680	Z-diode	2.2V±5%, Izt=50µA, 500mW	SOD-123	5d	1a	Mot
CE	MMSZ4696	Z-diode	9.1V±5%, Izt=50µA, 500mW	SOD-123	5d	1a	Eic
CE	P4SMA47A	TVS	Vrw=47V, 7A, 400W (1ms),	DO-214AC	1d	2j	Fag
CE	P4SMAJ26A	TVS	Vbr=26V, 9.5A, 400W(1ms)	DO-214AC	1d	1a	Mco
CE	P6SMBJ26AC	TVS	Vbr=26V, 14.2A, 600W(1ms), Bidirectional	DO-214AA	1ba	1x,1y	Pjt,Srj
CE	SMAJ26A	TVS	Vrw=26V, Vbr=28.9..31.9V, 9.5A, 400W(1ms)	DO-214AC	1d	1k	Vs



SMD code	Type	Function	Short description	Case	Pinout	St.	Mnf.
CE	SMBG26CA	TVS	Vbr=26V, 14.3A, 600W(1ms), Bidirectional	DO-215AA	5ba	1l	Vs
CE	SMBJ26CA	TVS	Vbr=26V, 14.3A, 600W(1ms), Bidirectional	DO-214AA	1ba	1l,1x	Di,Vs
CE	SMF26A	ESDP-diode	Vbr=28.9V, Vrwm=26V, lpp=4.8A, 200W(1ms)	DO-219AB	7d	1i	Vs
CE	SMF26A	TVS	Vbr=28.9.31.9V, Vrwm=26V, lpp=9.5A, 400W(1ms)	DO-220AA	8d	1a	Vs
CE	TV04A260J-G	TVS	Vrwm=26.0V, Vbr=28.90.31.90V, lpp=9.50A, 400W(1ms)	DO-214AC	1d	1a	Cmc
CE	TV06B260JB-G	TVS	Vrwm=26.0V, Vbr=28.90.31.90V, lpp=14.25A, 600W(1ms), Bidirectional	DO-214AA	1ba	1j	Cmc
CE	ZMV833B	C-diode	VHF/UHF-Tuning, 25V, 330mW, 33pF(2V), ΔC ±5%	SOD-323	5d	1a	Zx
CE1	CMHZ5231B	Z-diode	5.1V±5%, 500mW	SOD-123	5d	1a	Cen
CE2	CMHZ5232B	Z-diode	5.6V±5%, 500mW	SOD-123	5d	1a	Cen
CE3	CMHZ5233B	Z-diode	6.0V±5%, 500mW	SOD-123	5d	1a	Cen
CE4	CMHZ5234B	Z-diode	6.2V±5%, 500mW	SOD-123	5d	1a	Cen
CE5	CMHZ5235B	Z-diode	6.8V±5%, 500mW	SOD-123	5d	1a	Cen
CE7	SM6T30CA	TVS	Vbr=28.5.31.5V, 14.5A, 600W(1ms), Bidirectiona	DO-214AA	1ba	1l	Vs
CEA	CMHZ4711	Z-diode	LL, 27V±5%, 8.8mA, 400mW	SOD-123	5d	1a	Cen
CEC	CMHZ4712	Z-diode	LL, 28V±5%, 8.5mA, 400mW	SOD-123	5d	1a	Cen
CED	CMHZ4713	Z-diode	LL, 30V±5%, 7.9mA, 400mW	SOD-123	5d	1a	Cen
CEE	CMHZ4714	Z-diode	LL, 33V±5%, 7.2mA, 400mW	SOD-123	5d	1a	Cen
CEF	CMHZ4715	Z-diode	LL, 36V±5%, 6.6mA, 400mW	SOD-123	5d	1a	Cen
CEH	CMHZ4716	Z-diode	LL, 39V±5%, 6.1mA, 400mW	SOD-123	5d	1a	Cen
CEJ	CMHZ4717	Z-diode	LL, 43V±5%, 5.5mA, 400mW	SOD-123	5d	1a	Cen
CEK	SMA47A	TVS	Vbr=44.7.49.4V, Vrwm=40.2V, 6.17A, 400W(1ms)	DO-214AC	1d	1a	Lge
CEM	SMA47CA	TVS	Vbr=44.7.49.4V, Vrwm=40.2V, 6.17A, 400W(1ms), Bidirectional	DO-214AC	1ba	1j	Lge
CF	BZX884-B62	Z-diode	62V±2%, 250mW	SOD-882	13d	2b	Phi
CF	MAZD056	Z-diode	5.3.6V, Zzt=40C(5mA), 120mW	SSSMini2	7d	1a	Pan
CF	MM1Z4697	Z-diode	9.50.10.50V, lzt=10mA, 500mW	SOD-323FL	5d	1a	Eic
CF	MMSZ4681	Z-diode	2.4V±5%, lzt=50μA, 500mW	SOD-123	5d	1a,1k	Mot,Vs
CF	MMSZ4697	Z-diode	10V±5%, lzt=50μA, 500mW	SOD-123	5d	1a	Eic
CF	P4SMA51	TVS	Vrwm=51V, 5.7A, 400W(1ms)	DO-214AC	1d	2j	Fag
CF	P6SMBJ28C	TVS	Vbr=28V, 12A, 600W(1ms), Bidirectional	DO-214AA	1ba	1x,1y	Pjt,Srj
CF	SMAJ28	TVS	Vrwm=28V, Vbr=31.1.38.0V, 8A, 400W(1ms)	DO-214AC	1d	1k	Vs
CF	SMBG28C	TVS	Vbr=28V, 12A, 600W(1ms), Bidirectional	DO-215AA	5ba	1l	Vs
CF	SMBJ28C	TVS	Vbr=28V, 12A, 600W(1ms), Bidirectional	DO-214AA	1ba	1l	Vs
CF	SMF28	TVS	Vbr=31.1.38.0V, Vrwm=28V, lpp=8.0A, 400W(1ms)	DO-220AA	8d	1a	Vs
CF	TV04A280K-G	TVS	Vrwm=28.0V, Vbr=31.10.38.0V, lpp=8.0A, 400W(1ms)	DO-214AC	1d	1a	Cmc
CF	TV06B280KB-G	TVS	Vrwm=28.0V, Vbr=31.10.38.0V, lpp=12.0A, 600W(1ms), Bidirectional	DO-214AA	1ba	1j	Cmc
CF	ZMV834B	C-diode	VHF/UHF-Tuning, 25V, 330mW, 47pF(2V), ΔC ±5%	SOD-323	5d	1a	Zx
CF02M	CMR1F-02M	Si-diode	Rectifier, Fast-Recovery, 00V, 1A, Vf<1.3V(1A), <150ns	DO-214AC	1d	1a	Cen
CF04M	CMR1F-04M	Si-diode	Rectifier, Fast-Recovery, 400V, 1A, Vf<1.3V(1A), <150ns	DO-214AC	1d	1a	Cen
CF06M	CMR1F-06M	Si-diode	Rectifier, Fast-Recovery, 600V, 1A, Vf<1.3V(1A), <150ns	DO-214AC	1d	1a	Cen
CF1	CMHZ5236B	Z-diode	7.5V±5%, 500mW	SOD-123	5d	1a	Cen
CF10M	CMR1F-10M	Si-diode	Rectifier, Fast-Recovery, 1000V, 1A, Vf<1.3V(1A), <150ns	DO-214AC	1d	1a	Cen
CF2	CMHZ5237B	Z-diode	8.2V±5%, 500mW	SOD-123	5d	1a	Cen
CF3	CMHZ5238B	Z-diode	8.7V±5%, 500mW	SOD-123	5d	1a	Cen
CF4	CMHZ5239B	Z-diode	9.1V±5%, 500mW	SOD-123	5d	1a	Cen
CF5	CMHZ5240B	Z-diode	10V±5%, 500mW	SOD-123	5d	1a	Cen
CFK	SMA51	TVS	Vbr=45.9.56.1V, Vrwm=41.3V, 5.44A, 400W(1ms)	DO-214AC	1d	1a	Lge
CFM	SMA45C	TVS	Vbr=45.9.56.1V, Vrwm=41.3V, 5.44A, 400W(1ms), Bidirectional	DO-214AC	1ba	1j	Lge
CG	BZX884-B68	Z-diode	68V±2%, 250mW	SOD-882	13d	2b	Phi
CG	CD214B-T28CA	TVS	Vbr=28V, lsm=13.2A, 600W(1ms), Bidirectional	DO-214AA	1ba	1j	Bm
CG	P4SMA51A	TVS	Vrwm=51V, 6A, 400W(1ms)	DO-214AC	1d	2j	Fag
CG	P4SMAJ28A	TVS	Vbr=28V, 8.8A, 400W(1ms)	DO-214AC	1d	1a	Mco
CG	P6SMBJ28AC	TVS	Vbr=28V, 13.2A, 600W(1ms), Bidirectional	DO-214AA	1ba	1x,1y	Pjt,Srj
CG	SMAJ28A	TVS	Vrwm=28V, Vbr=31.1.34.4V, 400W(1ms)	DO-214AC	1d	1k,1q	Ste
CG	SMBG28CA	TVS	Vbr=28V, 13.2A, 600W(1ms), Bidirectional	DO-215AA	5ba	1l	Vs
CG	SMBJ28CA	TVS	Vbr=28V, 13.2A, 600W(1ms), Bidirectional	DO-214AA	1ba	1l,1x	Di,Vs
CG	SMF28A	ESDP-diode	Vbr=31.1V, Vrwm=28V, lpp=4.4A, 200W(1ms)	DO-219AB	7d	1i	Vs
CG	SMF28A	TVS	Vbr=31.1.34.4V, Vrwm=28V, lpp=8.8A, 400W(1ms)	DO-220AA	8d	1a	Vs
CG	TV04A280J-G	TVS	Vrwm=28.0V, Vbr=31.10.34.40V, lpp=8.81A, 400W(1ms)	DO-214AC	1d	1a	Cmc
CG	TV06B280JB-G	TVS	Vrwm=28.0V, Vbr=31.10.34.40V, lpp=13.22A, 600W(1ms), Bidirectional	DO-214AA	1ba	1j	Cmc
CG	ZMV835B	C-diode	VHF/UHF-Tuning, 25V, 330mW, 68pF(2V), ΔC ±5%	SOD-323	5d	1a	Zx
CGDE	1SMC5.0A	TVS	Vbr=6.40.7.07V, Vrwm=5.0V, 163.0A, 1500W(1ms)	DO-214AB	1d	1a	Cen
CGDG	1SMC6.0A	TVS	Vbr=6.67.7.37V, Vrwm=6.0V, 145.6A, 1500W(1ms)	DO-214AB	1d	1a	Cen
CGDK	1SMC6.5A	TVS	Vbr=7.22.7.98V, Vrwm=6.5V, 133.9A, 1500W(1ms)	DO-214AB	1d	1a	Cen
CGDM	1SMC7.0A	TVS	Vbr=7.78.8.6V, Vrwm=7.0V, 125.0A, 1500W(1ms)	DO-214AB	1d	1a	Cen
CGDP	1SMC7.5A	TVS	Vbr=8.33.9.21V, Vrwm=7.5V, 116.3A, 1500W(1ms)	DO-214AB	1d	1a	Cen
CGDR	1SMC8.0A	TVS	Vbr=8.89.9.83V, Vrwm=8.0V, 110.3A, 1500W(1ms)	DO-214AB	1d	1a	Cen
CGDT	1SMC8.5A	TVS	Vbr=9.44.10.4V, Vrwm=8.5V, 104.2A, 1500W(1ms)	DO-214AB	1d	1a	Cen
CGDV	1SMC9.0A	TVS	Vbr=10.0.11.1V, Vrwm=9.0V, 97.4A, 1500W(1ms)	DO-214AB	1d	1a	Cen
CGDX	1SMC10A	TVS	Vbr=11.1.12.3V, Vrwm=10V, 88.2A, 1500W(1ms)	DO-214AB	1d	1a	Cen
CGDZ	1SMC11A	TVS	Vbr=12.2.13.5V, Vrwm=11V, 82.4A, 1500W(1ms)	DO-214AB	1d	1a	Cen



SMD code	Type	Function	Short description	Case	Pinout	St.	Mnf.
CGEE	1SMC12A	TVS	Vbr=13.3..14.7V, Vrwm=12V, 75.4A, 1500W(1ms)	DO-214AB	1d	1a	Cen
CGEG	1SMC13A	TVS	Vbr=14.4..15.9V, Vrwm=13V, 69.8A, 1500W(1ms)	DO-214AB	1d	1a	Cen
CGEK	1SMC14A	TVS	Vbr=15.6..17.2V, Vrwm=14V, 64.7A, 1500W(1ms)	DO-214AB	1d	1a	Cen
CGEM	1SMC15A	TVS	Vbr=16.7..18.5V, Vrwm=15V, 61.5A, 1500W(1ms)	DO-214AB	1d	1a	Cen
CGEP	1SMC16A	TVS	Vbr=17.8..19.7V, Vrwm=16V, 57.7A, 1500W(1ms)	DO-214AB	1d	1a	Cen
CGER	1SMC17A	TVS	Vbr=18.9..20.9V, Vrwm=17V, 54.3A, 1500W(1ms)	DO-214AB	1d	1a	Cen
CGET	1SMC18A	TVS	Vbr=20.0..22.1V, Vrwm=18V, 51.4A, 1500W(1ms)	DO-214AB	1d	1a	Cen
CGEV	1SMC20A	TVS	Vbr=22.2..24.5V, Vrwm=20V, 46.3A, 1500W(1ms)	DO-214AB	1d	1a	Cen
CGEX	1SMC22A	TVS	Vbr=24.4..26.9V, Vrwm=22V, 42.3A, 1500W(1ms)	DO-214AB	1d	1a	Cen
CGEZ	1SMC24A	TVS	Vbr=26.7..29.5V, Vrwm=24V, 38.6A, 1500W(1ms)	DO-214AB	1d	1a	Cen
CGFE	1SMC26A	TVS	Vbr=28.9..31.9V, Vrwm=26V, 35.6A, 1500W(1ms)	DO-214AB	1d	1a	Cen
CGFG	1SMC28A	TVS	Vbr=31.1..34.4V, Vrwm=28V, 33.0A, 1500W(1ms)	DO-214AB	1d	1a	Cen
CGFK	1SMC30A	TVS	Vbr=33.3..36.8V, Vrwm=30V, 31.0A, 1500W(1ms)	DO-214AB	1d	1a	Cen
CGFM	1SMC33A	TVS	Vbr=36.7..40.6V, Vrwm=33V, 28.1A, 1500W(1ms)	DO-214AB	1d	1a	Cen
CGFP	1SMC36A	TVS	Vbr=40.0..44.2V, Vrwm=36V, 25.8A, 1500W(1ms)	DO-214AB	1d	1a	Cen
CGFR	1SMC40A	TVS	Vbr=44.4..49.1V, Vrwm=40V, 23.3A, 1500W(1ms)	DO-214AB	1d	1a	Cen
CGFT	1SMC43A	TVS	Vbr=47.8..52.8V, Vrwm=43V, 21.6A, 1500W(1ms)	DO-214AB	1d	1a	Cen
CGFV	1SMC45A	TVS	Vbr=50.0..55.3V, Vrwm=45V, 20.6A, 1500W(1ms)	DO-214AB	1d	1a	Cen
CGFX	1SMC48A	TVS	Vbr=53.3..58.9V, Vrwm=48V, 19.4A, 1500W(1ms)	DO-214AB	1d	1a	Cen
CGFX	1SMC51A	TVS	Vbr=56.7..62.7V, Vrwm=51V, 18.2A, 1500W(1ms)	DO-214AB	1d	1a	Cen
CGGE	1SMC54A	TVS	Vbr=60.0..66.3V, Vrwm=54V, 17.2A, 1500W(1ms)	DO-214AB	1d	1a	Cen
CGGG	1SMC58A	TVS	Vbr=64.4..71.2V, Vrwm=58V, 16.0A, 1500W(1ms)	DO-214AB	1d	1a	Cen
CGGK	1SMC60A	TVS	Vbr=66.7..73.7V, Vrwm=60V, 15.5A, 1500W(1ms)	DO-214AB	1d	1a	Cen
CGGM	1SMC64A	TVS	Vbr=71.1..78.6V, Vrwm=64V, 14.6A, 1500W(1ms)	DO-214AB	1d	1a	Cen
CGGP	1SMC70A	TVS	Vbr=77.8..86V, Vrwm=70V, 13.3A, 1500W(1ms)	DO-214AB	1d	1a	Cen
CGGR	1SMC75A	TVS	Vbr=83.3..92.1V, Vrwm=75V, 12.4A, 1500W(1ms)	DO-214AB	1d	1a	Cen
CGGT	1SMC78A	TVS	Vbr=86.7..95.8V, Vrwm=78V, 11.9A, 1500W(1ms)	DO-214AB	1d	1a	Cen
CGGV	1SMC85A	TVS	Vbr=94.4..104V, Vrwm=85V, 10.9A, 1500W(1ms)	DO-214AB	1d	1a	Cen
CGGX	1SMC90A	TVS	Vbr=100..111V, Vrwm=90V, 10.3A, 1500W(1ms)	DO-214AB	1d	1a	Cen
CGGZ	1SMC100A	TVS	Vbr=111..123V, Vrwm=100V, 9.3A, 1500W(1ms)	DO-214AB	1d	1a	Cen
CGHE	1SMC110A	TVS	Vbr=122..135V, Vrwm=110V, 8.5A, 1500W(1ms)	DO-214AB	1d	1a	Cen
CGHG	1SMC120A	TVS	Vbr=133..147V, Vrwm=120V, 7.8A, 1500W(1ms)	DO-214AB	1d	1a	Cen
CGHK	1SMC130A	TVS	Vbr=144..159V, Vrwm=130V, 7.2A, 1500W(1ms)	DO-214AB	1d	1a	Cen
CGHM	1SMC150A	TVS	Vbr=167..185V, Vrwm=150V, 6.2A, 1500W(1ms)	DO-214AB	1d	1a	Cen
CGHP	1SMC160A	TVS	Vbr=178..197V, Vrwm=160V, 5.8A, 1500W(1ms)	DO-214AB	1d	1a	Cen
CGHR	1SMC170A	TVS	Vbr=189..209V, Vrwm=170V, 5.50A, 1500W(1ms)	DO-214AB	1d	1a	Cen
CGK	SMA51A	TVS	Vbr=48.5..53.6V, Vrwm=43.6V, 5.71A, 400W(1ms)	DO-214AC	1d	1a	Lge
CGM	SMA45CA	TVS	Vbr=48.5..53.6V, Vrwm=43.6V, 5.71A, 400W(1ms), Bidirectional	DO-214AC	1ba	1j	Lge
CH	BZX884-B75	Z-diode	75V±2%, 250mW	SOD-882	13d	2b	Phi
CH	MM1Z4698	Z-diode	10.45..11.50V, Izt=10mA, 500mW	SOD-323FL	5d	1a	Eic
CH	MMSZ4682	Z-diode	2.7V±5%, Izt=50µA, 500mW	SOD-123	5d	1a,1k	Mot,Vs
CH	MMSZ4698	Z-diode	11V±5%, Izt=50µA, 500mW	SOD-123	5d	1a	Eic
CH	NZH3V0B	Z-diode	3.0V±5%, If=250mA, 500mW	SOD-123FL	7d	1a	Phi
CH	P4SMA56	TVS	Vrwm=56V, 5.2A, 400W (1ms)	DO-214AC	1d	2j	Fag
CH	P6SMBJ30C	TVS	Vbr=30V, 11.2A, 600W(1ms), Bidirectional	DO-214AA	1ba	1x,1y	Pjt,Srj
CH	SMAJ28CA	TVS	Vrwm=28V, Vbr=31.1..34.4V, 8.8A, 400W(1ms), Bidirectional	DO-214AC	1ba	1r	Ste
CH	SMAJ30	TVS	Vrwm=30V, Vbr=33.3..40.7V, 7.5A, 400W(1ms)	DO-214AC	1d	1k	Vs
CH	SMBG30C	TVS	Vbr=30V, 11.2A, 600W(1ms), Bidirectional	DO-215AA	5ba	1l	Vs
CH	SMBJ30C	TVS	Vbr=30V, 11.2A, 600W(1ms), Bidirectional	DO-214AA	1ba	1l	Vs
CH	SMP30	TVS	Vbr=33.3..40.7V, Vrwm=30V, Ipp=7.5A, 400W(1ms)	DO-220AA	8d	1a	Vs
CH	TV04A300K-G	TVS	Vrwm=30.0V, Vbr=33.30..40.70V, Ipp=7.48A, 400W(1ms)	DO-214AC	1d	1a	Cmc
CH	TV06B300K-B-G	TVS	Vrwm=30.0V, Vbr=33.30..40.70V, Ipp=11.21A, 600W(1ms), Bidirectional	DO-214AA	1ba	1j	Cmc
CH1	CMHZ5241B	Z-diode	11V±5%, 500mW	SOD-123	5d	1a	Cen
CH2	CMHZ5242B	Z-diode	12V±5%, 500mW	SOD-123	5d	1a	Cen
CH3	CMHSH-3	Si-diode	HS, Sw, 30V, 200mA, 150mW, Vf<0.5V(100mA), 10pF	SOD-123	5d	1a	Cen
CH3	CMHZ5243B	Z-diode	13V±5%, 500mW	SOD-123	5d	1a	Cen
CH4	CMHZ5244B	Z-diode	14V±5%, 500mW	SOD-123	5d	1a	Cen
CH5	CMHZ5245B	Z-diode	15V±5%, 500mW	SOD-123	5d	1a	Cen
CHA	CMHZ4627	Z-diode	LN, 6.2V±5%, 45mA, 500mW	SOD-123	5d	1a	Cen
CHC	CMHZ4614	Z-diode	LN, 1.8V±5%, 120mA, 500mW	SOD-123	5d	1a	Cen
CHD	CMHZ4615	Z-diode	LN, 2.0V±5%, 110mA, 500mW	SOD-123	5d	1a	Cen
CHDE	3SMC5.0A	TVS	Vrwm=5.0V, 326.0A, 3000W(1ms)	DO-214AB	1d	1a	Cen
CHDG	3SMC6.0A	TVS	Vrwm=6.0V, 291.3A, 3000W(1ms)	DO-214AB	1d	1a	Cen
CHDK	3SMC6.5A	TVS	Vrwm=6.5V, 267.9A, 3000W(1ms)	DO-214AB	1d	1a	Cen
CHDM	3SMC7.0A	TVS	Vrwm=7.0V, 250.0A, 3000W(1ms)	DO-214AB	1d	1a	Cen
CHDP	3SMC7.5A	TVS	Vrwm=7.5V, 232.6A, 3000W(1ms)	DO-214AB	1d	1a	Cen
CHDR	3SMC8.0A	TVS	Vrwm=8.0V, 220.6A, 3000W(1ms)	DO-214AB	1d	1a	Cen
CHDT	3SMC8.5A	TVS	Vrwm=8.5V, 208.4A, 3000W(1ms)	DO-214AB	1d	1a	Cen
CHDV	3SMC9.0A	TVS	Vrwm=9.0V, 194.8A, 3000W(1ms)	DO-214AB	1d	1a	Cen
CHDX	3SMC10A	TVS	Vrwm=10V, 176.4A, 3000W(1ms)	DO-214AB	1d	1a	Cen



SMD code	Type	Function	Short description	Case	Pinout	St.	Mnf.
CHDZ	3SMC11A	TVS	Vrwm=11V, 184.8A, 3000W(1ms)	DO-214AB	1d	1a	Cen
CHE	CMHZ4616	Z-diode	LN, 2.2V±5%, 100mA, 500mW	SOD-123	5d	1a	Cen
CHEE	3SMC12A	TVS	Vrwm=12V, 150.6A, 3000W(1ms)	DO-214AB	1d	1a	Cen
CHEG	3SMC13A	TVS	Vrwm=13V, 139.4A, 3000W(1ms)	DO-214AB	1d	1a	Cen
CHEK	3SMC14A	TVS	Vrwm=14V, 129.4A, 3000W(1ms)	DO-214AB	1d	1a	Cen
CHEM	3SMC15A	TVS	Vrwm=15V, 123.0A, 3000W(1ms)	DO-214AB	1d	1a	Cen
CHEP	3SMC16A	TVS	Vrwm=16V, 115.4A, 3000W(1ms)	DO-214AB	1d	1a	Cen
CHER	3SMC17A	TVS	Vrwm=17V, 106.6A, 3000W(1ms)	DO-214AB	1d	1a	Cen
CHET	3SMC18A	TVS	Vrwm=18V, 102.8A, 3000W(1ms)	DO-214AB	1d	1a	Cen
CHEV	3SMC20A	TVS	Vrwm=20V, 92.6A, 3000W(1ms)	DO-214AB	1d	1a	Cen
CHEX	3SMC22A	TVS	Vrwm=22V, 84.4A, 3000W(1ms)	DO-214AB	1d	1a	Cen
CHEZ	3SMC24A	TVS	Vrwm=24V, 77.2A, 3000W(1ms)	DO-214AB	1d	1a	Cen
CHF	CMHZ4617	Z-diode	LN, 2.4V±5%, 95mA, 500mW	SOD-123	5d	1a	Cen
CHFE	3SMC26A	TVS	Vrwm=26V, 71.2A, 3000W(1ms)	DO-214AB	1d	1a	Cen
CHFG	3SMC28A	TVS	Vrwm=28V, 66.0A, 3000W(1ms)	DO-214AB	1d	1a	Cen
CHFK	3SMC30A	TVS	Vrwm=30V, 62.0A, 3000W(1ms)	DO-214AB	1d	1a	Cen
CHFM	3SMC33A	TVS	Vrwm=33V, 56.2A, 3000W(1ms)	DO-214AB	1d	1a	Cen
CHFP	3SMC36A	TVS	Vrwm=36V, 51.6A, 3000W(1ms)	DO-214AB	1d	1a	Cen
CHFR	3SMC40A	TVS	Vrwm=40V, 46.4A, 3000W(1ms)	DO-214AB	1d	1a	Cen
CHFT	3SMC43A	TVS	Vrwm=43V, 43.2A, 3000W(1ms)	DO-214AB	1d	1a	Cen
CHFV	3SMC45A	TVS	Vrwm=45V, 41.2A, 3000W(1ms)	DO-214AB	1d	1a	Cen
CHFX	3SMC48A	TVS	Vrwm=48V, 38.8A, 3000W(1ms)	DO-214AB	1d	1a	Cen
CHFZ	3SMC51A	TVS	Vrwm=51V, 36.4A, 3000W(1ms)	DO-214AB	1d	1a	Cen
CHGE	3SMC54A	TVS	Vrwm=54V, 34.4A, 3000W(1ms)	DO-214AB	1d	1a	Cen
CHGG	3SMC58A	TVS	Vrwm=58V, 32.0A, 3000W(1ms)	DO-214AB	1d	1a	Cen
CHGK	3SMC60A	TVS	Vrwm=60V, 31.0A, 3000W(1ms)	DO-214AB	1d	1a	Cen
CHGM	3SMC64A	TVS	Vrwm=64V, 29.2A, 3000W(1ms)	DO-214AB	1d	1a	Cen
CHGP	3SMC70A	TVS	Vrwm=70V, 26.6A, 3000W(1ms)	DO-214AB	1d	1a	Cen
CHGR	3SMC75A	TVS	Vrwm=75V, 24.8A, 3000W(1ms)	DO-214AB	1d	1a	Cen
CHGT	3SMC78A	TVS	Vrwm=78V, 22.8A, 3000W(1ms)	DO-214AB	1d	1a	Cen
CHGV	3SMC85A	TVS	Vrwm=85V, 20.8A, 3000W(1ms)	DO-214AB	1d	1a	Cen
CHGX	3SMC90A	TVS	Vrwm=90V, 20.6A, 3000W(1ms)	DO-214AB	1d	1a	Cen
CHGZ	3SMC100A	TVS	Vrwm=100V, 18.6A, 3000W(1ms)	DO-214AB	1d	1a	Cen
CHH	CMHZ4618	Z-diode	LN, 2.7V±5%, 90mA, 500mW	SOD-123	5d	1a	Cen
CHHE	3SMC110A	TVS	Vrwm=110V, 16.8A, 3000W(1ms)	DO-214AB	1d	1a	Cen
CHHG	3SMC120A	TVS	Vrwm=120V, 15.6A, 3000W(1ms)	DO-214AB	1d	1a	Cen
CHHK	3SMC130A	TVS	Vrwm=130V, 14.4A, 3000W(1ms)	DO-214AB	1d	1a	Cen
CHHM	3SMC150A	TVS	Vrwm=150V, 12.4A, 3000W(1ms)	DO-214AB	1d	1a	Cen
CHHP	3SMC160A	TVS	Vrwm=160V, 11.6A, 3000W(1ms)	DO-214AB	1d	1a	Cen
CHHR	3SMC170A	TVS	Vrwm=170V, 11.0A, 3000W(1ms)	DO-214AB	1d	1a	Cen
CHJ	CMHZ4619	Z-diode	LN, 3.0V±5%, 85mA, 500mW	SOD-123	5d	1a	Cen
CHK	CMHZ4620	Z-diode	LN, 3.3V±5%, 80mA, 500mW	SOD-123	5d	1a	Cen
CHK	SMA56	TVS	Vbr=50.4, 61.6V, Vrwm=45.4V, 4.97A, 400W(1ms)	DO-214AC	1d	1a	Lge
CHM	CMHZ4621	Z-diode	LN, 3.6V±5%, 75mA, 500mW	SOD-123	5d	1a	Cen
CHM	SMA56C	TVS	Vbr=50.4, 61.6V, Vrwm=45.4V, 4.97A, 400W(1ms), Bidirectional	DO-214AC	1ba	1j	Lge
CHN	CMHZ4622	Z-diode	LN, 3.9V±5%, 70mA, 500mW	SOD-123	5d	1a	Cen
CHP	CMHZ4623	Z-diode	LN, 4.3V±5%, 65mA, 500mW	SOD-123	5d	1a	Cen
CHT	CMHZ4624	Z-diode	LN, 4.7V±5%, 60mA, 500mW	SOD-123	5d	1a	Cen
CHU	CMHZ4625	Z-diode	LN, 5.1V±5%, 55mA, 500mW	SOD-123	5d	1a	Cen
CHV	CMHZ4626	Z-diode	LN, 5.6V±5%, 50mA, 500mW	SOD-123	5d	1a	Cen
CHX	CMHZ4099	Z-diode	LN, 6.8V±5%, 35.0mA, 500mW	SOD-123	5d	1a	Cen
CHY	CMHZ4100	Z-diode	LN, 7.5V±5%, 31.8mA, 500mW	SOD-123	5d	1a	Cen
CHZ	CMHZ4101	Z-diode	LN, 8.2V±5%, 29.0mA, 500mW	SOD-123	5d	1a	Cen
CIDE	3SMC5.0CA	TVS	Vrwm=5.0V, 326.0A, 3000W(1ms), Bidirectional	DO-214AB	1ba	1j	Cen
QIDG	3SMC6.0CA	TVS	Vrwm=6.0V, 291.3A, 3000W(1ms), Bidirectional	DO-214AB	1ba	1j	Cen
QIDK	3SMC6.5CA	TVS	Vrwm=6.5V, 267.9A, 3000W(1ms), Bidirectional	DO-214AB	1ba	1j	Cen
QIDM	3SMC7.0CA	TVS	Vrwm=7.0V, 250.0A, 3000W(1ms), Bidirectional	DO-214AB	1ba	1j	Cen
QIDP	3SMC7.5CA	TVS	Vrwm=7.5V, 232.6A, 3000W(1ms), Bidirectional	DO-214AB	1ba	1j	Cen
QIDR	3SMC8.0CA	TVS	Vrwm=8.0V, 220.6A, 3000W(1ms), Bidirectional	DO-214AB	1ba	1j	Cen
QIDT	3SMC8.5CA	TVS	Vrwm=8.5V, 208.4A, 3000W(1ms), Bidirectional	DO-214AB	1ba	1j	Cen
QIDV	3SMC9.0CA	TVS	Vrwm=9.0V, 194.8A, 3000W(1ms), Bidirectional	DO-214AB	1ba	1j	Cen
QIDX	3SMC10CA	TVS	Vrwm=10V, 176.4A, 3000W(1ms), Bidirectional	DO-214AB	1ba	1j	Cen
QIDZ	3SMC11CA	TVS	Vrwm=11V, 184.8A, 3000W(1ms), Bidirectional	DO-214AB	1ba	1j	Cen
QIEE	3SMC12CA	TVS	Vrwm=12V, 150.6A, 3000W(1ms), Bidirectional	DO-214AB	1ba	1j	Cen
QIEG	3SMC13CA	TVS	Vrwm=13V, 139.4A, 3000W(1ms), Bidirectional	DO-214AB	1ba	1j	Cen
QIEK	3SMC14CA	TVS	Vrwm=14V, 129.4A, 3000W(1ms), Bidirectional	DO-214AB	1ba	1j	Cen
QIEM	3SMC15CA	TVS	Vrwm=15V, 123.0A, 3000W(1ms), Bidirectional	DO-214AB	1ba	1j	Cen
QIEP	3SMC16CA	TVS	Vrwm=16V, 115.4A, 3000W(1ms), Bidirectional	DO-214AB	1ba	1j	Cen
QIER	3SMC17CA	TVS	Vrwm=17V, 106.6A, 3000W(1ms), Bidirectional	DO-214AB	1ba	1j	Cen
QIET	3SMC18CA	TVS	Vrwm=18V, 102.8A, 3000W(1ms), Bidirectional	DO-214AB	1ba	1j	Cen



SMD code	Type	Function	Short description	Case	Pinout	St.	Mnf.
CIEV	3SMC20CA	TVS	Vrwm=20V, 92.6A, 3000W(1ms), Bidirectional	DO-214AB	1ba	1j	Cen
CIEY	3SMC22CA	TVS	Vrwm=22V, 84.4A, 3000W(1ms), Bidirectional	DO-214AB	1ba	1j	Cen
CIEZ	3SMC24CA	TVS	Vrwm=24V, 77.2A, 3000W(1ms), Bidirectional	DO-214AB	1ba	1j	Cen
CIFE	3SMC26CA	TVS	Vrwm=26V, 71.2A, 3000W(1ms), Bidirectional	DO-214AB	1ba	1j	Cen
CIFG	3SMC28CA	TVS	Vrwm=28V, 66.0A, 3000W(1ms), Bidirectional	DO-214AB	1ba	1j	Cen
CIFK	3SMC30CA	TVS	Vrwm=30V, 62.0A, 3000W(1ms), Bidirectional	DO-214AB	1ba	1j	Cen
CIFM	3SMC33CA	TVS	Vrwm=33V, 56.2A, 3000W(1ms), Bidirectional	DO-214AB	1ba	1j	Cen
CIFP	3SMC36CA	TVS	Vrwm=36V, 51.6A, 3000W(1ms), Bidirectional	DO-214AB	1ba	1j	Cen
CIFR	3SMC40CA	TVS	Vrwm=40V, 46.4A, 3000W(1ms), Bidirectional	DO-214AB	1ba	1j	Cen
CIFT	3SMC43CA	TVS	Vrwm=43V, 43.2A, 3000W(1ms), Bidirectional	DO-214AB	1ba	1j	Cen
CIFV	3SMC45CA	TVS	Vrwm=45V, 41.2A, 3000W(1ms), Bidirectional	DO-214AB	1ba	1j	Cen
CIFX	3SMC48CA	TVS	Vrwm=48V, 38.8A, 3000W(1ms), Bidirectional	DO-214AB	1ba	1j	Cen
CIFZ	3SMC51CA	TVS	Vrwm=51V, 36.4A, 3000W(1ms), Bidirectional	DO-214AB	1ba	1j	Cen
CIQE	3SMC54CA	TVS	Vrwm=54V, 34.4A, 3000W(1ms), Bidirectional	DO-214AB	1ba	1j	Cen
CIQG	3SMC58CA	TVS	Vrwm=58V, 32.0A, 3000W(1ms), Bidirectional	DO-214AB	1ba	1j	Cen
CIQK	3SMC60CA	TVS	Vrwm=60V, 31.0A, 3000W(1ms), Bidirectional	DO-214AB	1ba	1j	Cen
CIQM	3SMC64CA	TVS	Vrwm=64V, 29.2A, 3000W(1ms), Bidirectional	DO-214AB	1ba	1j	Cen
CIQP	3SMC70CA	TVS	Vrwm=70V, 26.6A, 3000W(1ms), Bidirectional	DO-214AB	1ba	1j	Cen
CIQR	3SMC75CA	TVS	Vrwm=75V, 24.8A, 3000W(1ms), Bidirectional	DO-214AB	1ba	1j	Cen
CIQT	3SMC78CA	TVS	Vrwm=78V, 22.8A, 3000W(1ms), Bidirectional	DO-214AB	1ba	1j	Cen
CIQV	3SMC85CA	TVS	Vrwm=85V, 20.8A, 3000W(1ms), Bidirectional	DO-214AB	1ba	1j	Cen
CIQX	3SMC90CA	TVS	Vrwm=90V, 20.6A, 3000W(1ms), Bidirectional	DO-214AB	1ba	1j	Cen
CIQZ	3SMC100CA	TVS	Vrwm=100V, 18.6A, 3000W(1ms), Bidirectional	DO-214AB	1ba	1j	Cen
CIHE	3SMC110CA	TVS	Vrwm=110V, 16.8A, 3000W(1ms), Bidirectional	DO-214AB	1ba	1j	Cen
CIHG	3SMC120CA	TVS	Vrwm=120V, 15.6A, 3000W(1ms), Bidirectional	DO-214AB	1ba	1j	Cen
CIHK	3SMC130CA	TVS	Vrwm=130V, 14.4A, 3000W(1ms), Bidirectional	DO-214AB	1ba	1j	Cen
CIHM	3SMC150CA	TVS	Vrwm=150V, 12.4A, 3000W(1ms), Bidirectional	DO-214AB	1ba	1j	Cen
CIHP	3SMC160CA	TVS	Vrwm=160V, 11.6A, 3000W(1ms), Bidirectional	DO-214AB	1ba	1j	Cen
CIHR	3SMC170CA	TVS	Vrwm=170V, 11.0A, 3000W(1ms), Bidirectional	DO-214AB	1ba	1j	Cen
CJ	MM1Z4699	Z-diode	11.40..12.60V, Izt=10mA, 500mW	SOD-323FL	5d	1a	Eic
CJ	MMSZ4683	Z-diode	3.0V±5%, Izt=50µA, 500mW	SOD-123	5d	1a,1k	Mot,Vs
CJ	MMSZ4699	Z-diode	12V±5%, Izt=50µA, 500mW	SOD-123	5d	1a	Eic
CJ	NZH3V3A	Z-diode	3.3V±5%, If=250mA, 500mW	SOD-123FL	7d	1a	Phi
CJ05A	SMCJ5.0A	TVS	Vrwm=5V, Vbr=6.4..7.25V, 163A, 1500W(1mS)	DO-214AB	1d	1a	Sec
CJ05A	SMCJ5.0CA	TVS	Vrwm=5V, Vbr=6.4..7.25V, 163A, 1500W(1mS), Bidirectional	DO-214AB	1ba	1j	Sec
CJ06A	SMCJ6.0A	TVS	Vrwm=6V, Vbr=6.67..7.67V, 145.6A, 1500W(1mS)	DO-214AB	1d	1a	Sec
CJ06A	SMCJ6.0CA	TVS	Vrwm=6V, Vbr=6.67..7.67V, 145.6A, 1500W(1mS), Bidirectional	DO-214AB	1ba	1j	Sec
CJ07A	SMCJ7.0A	TVS	Vrwm=7V, Vbr=7.78..8.95V, 125A, 1500W(1mS)	DO-214AB	1d	1a	Sec
CJ07A	SMCJ7.0CA	TVS	Vrwm=7V, Vbr=7.78..8.95V, 125A, 1500W(1mS), Bidirectional	DO-214AB	1ba	1j	Sec
CJ08A	SMCJ8.0A	TVS	Vrwm=8V, Vbr=8.89..10.23V, 110.3A, 1500W(1mS)	DO-214AB	1d	1a	Sec
CJ08A	SMCJ8.0CA	TVS	Vrwm=8V, Vbr=8.89..10.23V, 110.3A, 1500W(1mS), Bidirectional	DO-214AB	1ba	1j	Sec
CJ09A	SMCJ9.0A	TVS	Vrwm=9V, Vbr=10..11.5V, 97.4A, 1500W(1mS)	DO-214AB	1d	1a	Sec
CJ09A	SMCJ9.0CA	TVS	Vrwm=9V, Vbr=10..11.5V, 97.4A, 1500W(1mS), Bidirectional	DO-214AB	1ba	1j	Sec
CJ1	CMHZ5246B	Z-diode	16V±5%, 500mW	SOD-123	5d	1a	Cen
CJ10A	SMCJ10A	TVS	Vrwm=10V, Vbr=11.1..12.8V, 88.2A, 1500W(1mS)	DO-214AB	1d	1a	Sec
CJ10A	SMCJ10CA	TVS	Vrwm=10V, Vbr=11.1..12.8V, 88.2A, 1500W(1mS), Bidirectional	DO-214AB	1ba	1j	Sec
CJ110A	SMCJ110A	TVS	Vrwm=110V, Vbr=122..140.5V, 8.4A, 1500W(1mS)	DO-214AB	1d	1a	Sec
CJ110A	SMCJ110CA	TVS	Vrwm=110V, Vbr=122..140.5V, 8.4A, 1500W(1mS), Bidirectional	DO-214AB	1ba	1j	Sec
CJ11A	SMCJ11A	TVS	Vrwm=11V, Vbr=12.2..14V, 82.4A, 1500W(1mS)	DO-214AB	1d	1a	Sec
CJ11A	SMCJ11CA	TVS	Vrwm=11V, Vbr=12.2..14V, 82.4A, 1500W(1mS), Bidirectional	DO-214AB	1ba	1j	Sec
CJ120A	SMCJ120A	TVS	Vrwm=120V, Vbr=133..153V, 7.9A, 1500W(1mS)	DO-214AB	1d	1a	Sec
CJ120A	SMCJ120CA	TVS	Vrwm=120V, Vbr=133..153V, 7.9A, 1500W(1mS), Bidirectional	DO-214AB	1ba	1j	Sec
CJ12A	SMCJ12A	TVS	Vrwm=12V, Vbr=13.3..15.3V, 75.3A, 1500W(1mS)	DO-214AB	1d	1a	Sec
CJ12A	SMCJ12CA	TVS	Vrwm=12V, Vbr=13.3..15.3V, 75.3A, 1500W(1mS), Bidirectional	DO-214AB	1ba	1j	Sec
CJ130A	SMCJ130A	TVS	Vrwm=130V, Vbr=144..165.5V, Vcl=209V, 7.A, 1500W(1mS)	DO-214AB	1d	1a	Sec
CJ130A	SMCJ130CA	TVS	Vrwm=130V, Vbr=144..165.5V, 7.A, 1500W(1mS), Bidirectional	DO-214AB	1ba	1j	Sec
CJ13A	SMCJ13A	TVS	Vrwm=13V, Vbr=14.4..16.5V, 69.7A, 1500W(1mS)	DO-214AB	1d	1a	Sec
CJ13A	SMCJ13CA	TVS	Vrwm=13V, Vbr=14.4..16.5V, 69.7A, 1500W(1mS), Bidirectional	DO-214AB	1ba	1j	Sec
CJ14A	SMCJ14A	TVS	Vrwm=14V, Vbr=15.6..17.9V, 64.7A, 1500W(1mS)	DO-214AB	1d	1a	Sec
CJ14A	SMCJ14CA	TVS	Vrwm=14V, Vbr=15.6..17.9V, 64.7A, 1500W(1mS), Bidirectional	DO-214AB	1ba	1j	Sec
CJ150A	SMCJ150A	TVS	Vrwm=150V, Vbr=167..192.5V, 6.2A, 1500W(1mS)	DO-214AB	1d	1a	Sec
CJ150A	SMCJ150CA	TVS	Vrwm=150V, Vbr=167..192.5V, 6.2A, 1500W(1mS), Bidirectional	DO-214AB	1ba	1j	Sec
CJ15A	SMCJ15A	TVS	Vrwm=15V, Vbr=16.7..19.2V, 61.5A, 1500W(1mS)	DO-214AB	1d	1a	Sec
CJ15A	SMCJ15CA	TVS	Vrwm=15V, Vbr=16.7..19.2V, 61.5A, 1500W(1mS), Bidirectional	DO-214AB	1ba	1j	Sec
CJ160A	SMCJ160A	TVS	Vrwm=160V, Vbr=178..205V, 5.8A, 1500W(1mS)	DO-214AB	1d	1a	Sec
CJ160A	SMCJ160CA	TVS	Vrwm=160V, Vbr=178..205V, 5.8A, 1500W(1mS), Bidirectional	DO-214AB	1ba	1j	Sec
CJ16A	SMCJ16A	TVS	Vrwm=16V, Vbr=17.8..20.5V, 57.7A, 1500W(1mS)	DO-214AB	1d	1a	Sec
CJ16A	SMCJ16CA	TVS	Vrwm=16V, Vbr=17.8..20.5V, 57.7A, 1500W(1mS), Bidirectional	DO-214AB	1ba	1j	Sec
CJ170A	SMCJ170A	TVS	Vrwm=170V, Vbr=189..217V, 5.5A, 1500W(1mS)	DO-214AB	1d	1a	Sec
CJ170A	SMCJ170CA	TVS	Vrwm=170V, Vbr=189..217V, 5.5A, 1500W(1mS), Bidirectional	DO-214AB	1ba	1j	Sec



SMD code	Type	Function	Short description	Case	Pinout	St.	Mnf.
CJ17A	SMCJ17A	TVS	Vrwm=17V, Vbr=18.9..21.7V, 53.3A, 1500W(1mS)	DO-214AB	1d	1a	Sec
CJ17A	SMCJ17CA	TVS	Vrwm=17V, Vbr=18.9..21.7V, 53.3A, 1500W(1mS), Bidirectional	DO-214AB	1ba	1j	Sec
CJ180A	SMCJ180A	TVS	Vrwm=180V, Vbr=200..220V, 5.14A, 1500W(1mS)	DO-214AB	1d	1a	Sec
CJ180A	SMCJ180CA	TVS	Vrwm=180V, Vbr=200..220V, 5.14A, 1500W(1mS), Bidirectional	DO-214AB	1ba	1j	Sec
CJ18A	SMCJ18A	TVS	Vrwm=18V, Vbr=20..23.3V, 51.4A, 1500W(1mS)	DO-214AB	1d	1a	Sec
CJ18A	SMCJ18CA	TVS	Vrwm=18V, Vbr=20..23.3V, 51.4A, 1500W(1mS), Bidirectional	DO-214AB	1ba	1j	Sec
CJ190A	SMCJ190A	TVS	Vrwm=190V, Vbr=211..232V, 4.87A, 1500W(1mS)	DO-214AB	1d	1a	Sec
CJ190A	SMCJ190CA	TVS	Vrwm=190V, Vbr=211..232V, 4.87A, 1500W(1mS), Bidirectional	DO-214AB	1ba	1j	Sec
CJ2	CMHZ5247B	Z-diode	17V±5%, 500mW	SOD-123	5d	1a	Cen
CJ200A	SMCJ200A	TVS	Vrwm=200V, Vbr=224..247V, 4.6A, 1500W(1mS)	DO-214AB	1d	1a	Sec
CJ200A	SMCJ200CA	TVS	Vrwm=200V, Vbr=224..247V, 4.6A, 1500W(1mS), Bidirectional	DO-214AB	1ba	1j	Sec
CJ20A	SMCJ20A	TVS	Vrwm=20V, Vbr=22.2..25.5V, 46.3A, 1500W(1mS)	DO-214AB	1d	1a	Sec
CJ20A	SMCJ20CA	TVS	Vrwm=20V, Vbr=22.2..25.5V, 46.3A, 1500W(1mS), Bidirectional	DO-214AB	1ba	1j	Sec
CJ220A	SMCJ220A	TVS	Vrwm=220V, Vbr=246..272V, 4.2A, 1500W(1mS)	DO-214AB	1d	1a	Sec
CJ220A	SMCJ220CA	TVS	Vrwm=220V, Vbr=246..272V, 4.2A, 1500W(1mS), Bidirectional	DO-214AB	1ba	1j	Sec
CJ22A	SMCJ22A	TVS	Vrwm=22V, Vbr=24.4..28V, 42.2A, 1500W(1mS)	DO-214AB	1d	1a	Sec
CJ22A	SMCJ22CA	TVS	Vrwm=22V, Vbr=24.4..28V, 42.2A, 1500W(1mS), Bidirectional	DO-214AB	1ba	1j	Sec
CJ24A	SMCJ24A	TVS	Vrwm=24V, Vbr=26.7..30.7V, 38.6A, 1500W(1mS)	DO-214AB	1d	1a	Sec
CJ24A	SMCJ24CA	TVS	Vrwm=24V, Vbr=26.7..30.7V, 38.6A, 1500W(1mS), Bidirectional	DO-214AB	1ba	1j	Sec
CJ250A	SMCJ250A	TVS	Vrwm=250V, Vbr=279..309V, 3.7A, 1500W(1mS)	DO-214AB	1d	1a	Sec
CJ250A	SMCJ250CA	TVS	Vrwm=250V, Vbr=279..309V, 3.7A, 1500W(1mS), Bidirectional	DO-214AB	1ba	1j	Sec
CJ26A	SMCJ26A	TVS	Vrwm=26V, Vbr=28.9..33.2V, 35.6A, 1500W(1mS)	DO-214AB	1d	1a	Sec
CJ26A	SMCJ26CA	TVS	Vrwm=26V, Vbr=28.9..33.2V, 35.6A, 1500W(1mS), Bidirectional	DO-214AB	1ba	1j	Sec
CJ28A	SMCJ28A	TVS	Vrwm=28V, Vbr=31.1..35.8V, 33A, 1500W(1mS)	DO-214AB	1d	1a	Sec
CJ28A	SMCJ28CA	TVS	Vrwm=28V, Vbr=31.1..35.8V, 33A, 1500W(1mS), Bidirectional	DO-214AB	1ba	1j	Sec
CJ3	CMHZ5248B	Z-diode	18V±5%, 500mW	SOD-123	5d	1a	Cen
CJ300A	SMCJ300A	TVS	Vrwm=300V, Vbr=335..371V, 3.1A, 1500W(1mS)	DO-214AB	1d	1a	Sec
CJ300A	SMCJ300CA	TVS	Vrwm=300V, Vbr=335..371V, 3.1A, 1500W(1mS), Bidirectional	DO-214AB	1ba	1j	Sec
CJ30A	SMCJ30A	TVS	Vrwm=30V, Vbr=33.3..38.3V, Vcl=48.4V, 31A, 1500W(1mS)	DO-214AB	1d	1a	Sec
CJ30A	SMCJ30CA	TVS	Vrwm=30V, Vbr=33.3..38.3V, 31A, 1500W(1mS), Bidirectional	DO-214AB	1ba	1j	Sec
CJ350A	SMCJ350A	TVS	Vrwm=350V, Vbr=391..432V, 2.6A, 1500W(1mS)	DO-214AB	1d	1a	Sec
CJ350A	SMCJ350CA	TVS	Vrwm=350V, Vbr=391..432V, 2.6A, 1500W(1mS), Bidirectional	DO-214AB	1ba	1j	Sec
CJ36A	SMCJ36A	TVS	Vrwm=36V, Vbr= 40..46V, 25.8A, 1500W(1mS)	DO-214AB	1d	1a	Sec
CJ36A	SMCJ36CA	TVS	Vrwm=36V, Vbr= 40..46V, 25.8A, 1500W(1mS), Bidirectional	DO-214AB	1ba	1j	Sec
CJ4	CMHZ5249B	Z-diode	19V±5%, 500mW	SOD-123	5d	1a	Cen
CJ400A	SMCJ400A	TVS	Vrwm=400V, Vbr=447..494V, 2.3A, 1500W(1mS)	DO-214AB	1d	1a	Sec
CJ400A	SMCJ400CA	TVS	Vrwm=400V, Vbr=447..494V, 2.3A, 1500W(1mS), Bidirectional	DO-214AB	1ba	1j	Sec
CJ40A	SMCJ40A	TVS	Vrwm=40V, Vbr=44.4..51.1V, 23.2A, 1500W(1mS)	DO-214AB	1d	1a	Sec
CJ40A	SMCJ40CA	TVS	Vrwm=40V, Vbr=44.4..51.1V, 23.2A, 1500W(1mS), Bidirectional	DO-214AB	1ba	1j	Sec
CJ43A	SMCJ43A	TVS	Vrwm=43V, Vbr=47.8..54.9V, 21.6A, 1500W(1mS)	DO-214AB	1d	1a	Sec
CJ43A	SMCJ43CA	TVS	Vrwm=43V, Vbr=47.8..54.9V, 21.6A, 1500W(1mS), Bidirectional	DO-214AB	1ba	1j	Sec
CJ440A	SMCJ440A	TVS	Vrwm=440V, Vbr=492..543V, 2.1A, 1500W(1mS)	DO-214AB	1d	1a	Sec
CJ440A	SMCJ440CA	TVS	Vrwm=440V, Vbr=492..543V, 2.1A, 1500W(1mS), Bidirectional	DO-214AB	1ba	1j	Sec
CJ45A	SMCJ45A	TVS	Vrwm=45V, Vbr=50..57.5V, 20.6A, 1500W(1mS)	DO-214AB	1d	1a	Sec
CJ45A	SMCJ45CA	TVS	Vrwm=45V, Vbr=50..57.5V, 20.6A, 1500W(1mS), Bidirectional	DO-214AB	1ba	1j	Sec
CJ48A	SMCJ48A	TVS	Vrwm=48V, Vbr=53.3..61.3V, 19.4A, 1500W(1mS)	DO-214AB	1d	1a	Sec
CJ48A	SMCJ48CA	TVS	Vrwm=48V, Vbr=53.3..61.3V, 19.4A, 1500W(1mS), Bidirectional	DO-214AB	1ba	1j	Sec
CJ5	CMHZ5250B	Z-diode	20V±5%, 500mW	SOD-123	5d	1a	Cen
CJ51A	SMCJ51A	TVS	Vrwm=51V, Vbr=56.7..65.2V, 18.2A, 1500W(1mS)	DO-214AB	1d	1a	Sec
CJ51A	SMCJ51CA	TVS	Vrwm=51V, Vbr=56.7..65.2V, 18.2A, 1500W(1mS), Bidirectional	DO-214AB	1ba	1j	Sec
CJ54A	SMCJ54A	TVS	Vrwm=54V, Vbr=60..69V, 17.2A, 1500W(1mS)	DO-214AB	1d	1a	Sec
CJ54A	SMCJ54CA	TVS	Vrwm=54V, Vbr=60..69V, 17.2A, 1500W(1mS), Bidirectional	DO-214AB	1ba	1j	Sec
CJ58A	SMCJ58A	TVS	Vrwm=58V, Vbr=64.4..74.1V, 16A, 1500W(1mS)	DO-214AB	1d	1a	Sec
CJ58A	SMCJ58CA	TVS	Vrwm=58V, Vbr=64.4..74.1V, 16A, 1500W(1mS), Bidirectional	DO-214AB	1ba	1j	Sec
CJ6.5A	SMCJ6.5A	TVS	Vrwm=6.5V, Vbr=7.22..8.3V, 133.9A, 1500W(1mS)	DO-214AB	1d	1a	Sec
CJ6.5A	SMCJ6.5CA	TVS	Vrwm=6.5V, Vbr=7.22..8.3V, 133.9A, 1500W(1mS), Bidirectional	DO-214AB	1ba	1j	Sec
CJ60A	SMCJ60A	TVS	Vrwm=60V, Vbr=66.7..76.7V, 15.5A, 1500W(1mS)	DO-214AB	1d	1a	Sec
CJ60A	SMCJ60CA	TVS	Vrwm=60V, Vbr=66.7..76.7V, 15.5A, 1500W(1mS), Bidirectional	DO-214AB	1ba	1j	Sec
CJ64A	SMCJ64A	TVS	Vrwm=64V, Vbr=71.1..81.8V, 14.6A, 1500W(1mS)	DO-214AB	1d	1a	Sec
CJ64A	SMCJ64CA	TVS	Vrwm=64V, Vbr=71.1..81.8V, 14.6A, 1500W(1mS), Bidirectional	DO-214AB	1ba	1j	Sec
CJ7.5A	SMCJ7.5A	TVS	Vrwm=7.5V, Vbr=8.33..9.58V, 116.3A, 1500W(1mS)	DO-214AB	1d	1a	Sec
CJ7.5A	SMCJ7.5CA	TVS	Vrwm=7.5V, Vbr=8.33..9.58V, 116.3A, 1500W(1mS), Bidirectional	DO-214AB	1ba	1j	Sec
CJ70A	SMCJ70A	TVS	Vrwm=70V, Vbr=77.8..89.5V, 13.3A, 1500W(1mS)	DO-214AB	1d	1a	Sec
CJ70A	SMCJ70CA	TVS	Vrwm=70V, Vbr=77.8..89.5V, 13.3A, 1500W(1mS), Bidirectional	DO-214AB	1ba	1j	Sec
CJ75A	SMCJ75A	TVS	Vrwm=75V, Vbr=83.3..95.8V, 12.4A, 1500W(1mS)	DO-214AB	1d	1a	Sec
CJ75A	SMCJ75CA	TVS	Vrwm=75V, Vbr=83.3..95.8V, 12.4A, 1500W(1mS), Bidirectional	DO-214AB	1ba	1j	Sec
CJ78A	SMCJ78A	TVS	Vrwm=78V, Vbr=86.7..99.7V, 11.4A, 1500W(1mS)	DO-214AB	1d	1a	Sec
CJ78A	SMCJ78CA	TVS	Vrwm=78V, Vbr=86.7..99.7V, 11.4A, 1500W(1mS), Bidirectional	DO-214AB	1ba	1j	Sec
CJ8.5A	SMCJ8.5A	TVS	Vrwm=8.5V, Vbr=9.44..10.82V, 104.2A, 1500W(1mS)	DO-214AB	1d	1a	Sec
CJ8.5A	SMCJ8.5CA	TVS	Vrwm=8.5V, Vbr=9.44..10.82V, 104.2A, 1500W(1mS), Bidirectional	DO-214AB	1ba	1j	Sec



SMD
code

Type

Function

Short description

Case

Pinout

St.

Mnf.

SMD code	Type	Function	Short description	Case	Pinout	St.	Mnf.
CJ85A	SMCJ85A	TVS	Vrwm=85V, Vbr=94.4, 108.2V, 10.4A, 1500W(1mS)	DO-214AB	1d	1a	Sec
CJ85A	SMCJ85CA	TVS	Vrwm=85V, Vbr=94.4, 108.2V, 10.4A, 1500W(1mS), Bidirectional	DO-214AB	1ba	1j	Sec
CJ90A	SMCJ90A	TVS	Vrwm=90V, Vbr=100, 115.5V, 10.3A, 1500W(1mS)	DO-214AB	1d	1a	Sec
CJ90A	SMCJ90CA	TVS	Vrwm=90V, Vbr=100, 115.5V, 10.3A, 1500W(1mS), Bidirectional	DO-214AB	1ba	1j	Sec
CJA	CMHZ4115	Z-diode	LN, 22V±5%, 10.8mA, 500mW	SOD-123	5d	1a	Cen
CJC	CMHZ4102	Z-diode	LN, 8.7V±5%, 27.4mA, 500mW	SOD-123	5d	1a	Cen
CJD	CMHZ4103	Z-diode	LN, 9.1V±5%, 26.2mA, 500mW	SOD-123	5d	1a	Cen
CJE	CMHZ4104	Z-diode	LN, 10V±5%, 24.8mA, 500mW	SOD-123	5d	1a	Cen
CJF	CMHZ4105	Z-diode	LN, 11V±5%, 21.6mA, 500mW	SOD-123	5d	1a	Cen
CJH	CMHZ4106	Z-diode	LN, 12V±5%, 20.4mA, 500mW	SOD-123	5d	1a	Cen
CJJ	CMHZ4107	Z-diode	LN, 13V±5%, 19.0mA, 500mW	SOD-123	5d	1a	Cen
CJK	CMHZ4108	Z-diode	LN, 14V±5%, 17.5mA, 500mW	SOD-123	5d	1a	Cen
CJM	CMHZ4109	Z-diode	LN, 15V±5%, 16.3mA, 500mW	SOD-123	5d	1a	Cen
CJN	CMHZ4110	Z-diode	LN, 16V±5%, 15.4mA, 500mW	SOD-123	5d	1a	Cen
CJP	CMHZ4111	Z-diode	LN, 17V±5%, 14.5mA, 500mW	SOD-123	5d	1a	Cen
CJT	CMHZ4112	Z-diode	LN, 18V±5%, 13.2mA, 500mW	SOD-123	5d	1a	Cen
CJU	CMHZ4113	Z-diode	LN, 19V±5%, 12.5mA, 500mW	SOD-123	5d	1a	Cen
CJV	CMHZ4114	Z-diode	LN, 20V±5%, 11.9mA, 500mW	SOD-123	5d	1a	Cen
CJY	CMHZ4117	Z-diode	LN, 25V±5%, 9.5mA, 500mW	SOD-123	5d	1a	Cen
CJZ	CMHZ4116	Z-diode	LN, 24V±5%, 9.9mA, 500mW	SOD-123	5d	1a	Cen
CK	CD214B-T30CA	TVS	Vbr=30V, Irsrm=12.4A, 600W(1ms), Bidirectional	DO-214AA	1ba	1j	Bm
CK	MM1Z4700	Z-diode	12.35, 13.65V, Izt=10mA, 500mW	SOD-323FL	5d	1a	Eic
CK	MMSZ4684	Z-diode	3.3V±5%, Izt=50µA, 500mW	SOD-123	5d	1a,1k	Mot,Vs
CK	MMSZ4700	Z-diode	13V±5%, Izt=50µA, 500mW	SOD-123	5d	1a	Eic
CK	NZH3V6B	Z-diode	3.6V±5%, If=250mA, 500mW	SOD-123FL	7d	1a	Phi
CK	P4SMA56A	TVS	Vrwm=56V, 5.5A, 400W(1ms),	DO-214AC	1d	2j	Fag
CK	P4SMAJ30A	TVS	Vbr=30V, 8.3A, 400W(1ms)	DO-214AC	1d	1a	Mco
CK	P6SMBJ30AC	TVS	Vbr=30V, 12.4A, 600W(1ms), Bidirectional	DO-214AA	1ba	1x,1y	Pjt,Srj
CK	SMAJ30A	TVS	Vrwm=30V, Vbr=33.3, 36.8V, 8.3A, 400W(1ms)	DO-214AC	1d	1k,1q	Ste
CK	SMBG30CA	TVS	Vbr=30V, 12.4A, 600W(1ms), Bidirectional	DO-215AA	5ba	1l	Vs
CK	SMBJ30CA	TVS	Vbr=30V, 12.4A, 600W(1ms), Bidirectional	DO-214AA	1ba	11,1x	Di,Vs
CK	SMPF30A	ESDP-diode	Vbr=33.3V, Vrwm=30V, Ipp=4.1A, 200W(1ms)	DO-219AB	7d	1l	Vs
CK	SMP30A	TVS	Vbr=33.3, 36.8V, Vrwm=30V, Ipp=8.3A, 400W(1ms)	DO-220AA	8d	1a	Vs
CK	TV04A300J-G	TVS	Vrwm=30.0V, Vbr=33.30, 36.80V, Ipp=8.26A, 400W(1ms)	DO-214AC	1d	1a	Cmc
CK	TV06B300JB-G	TVS	Vrwm=30.0V, Vbr=33.30, 36.80V, Ipp=12.40A, 600W(1ms), Bidirectional	DO-214AA	1ba	1j	Cmc
CK1	CMHZ5251B	Z-diode	22V±5%, 500mW	SOD-123	5d	1a	Cen
CK2	CMHZ5252B	Z-diode	24V±5%, 500mW	SOD-123	5d	1a	Cen
CK3	CMHZ5253B	Z-diode	25V±5%, 500mW	SOD-123	5d	1a	Cen
CK4	CMHZ5254B	Z-diode	27V±5%, 500mW	SOD-123	5d	1a	Cen
CK5	CMHZ5255B	Z-diode	28V±5%, 500mW	SOD-123	5d	1a	Cen
CK7	SM6T36CA	TVS	Vbr=34.2, 37.8V, 12A, 600W(1ms), Bidirectional	DO-214AA	1ba	1l	Vs
CKA	CMHZ4118	Z-diode	LN, 27V±5%, 8.8mA, 500mW	SOD-123	5d	1a	Cen
CKC	CMHZ4119	Z-diode	LN, 28V±5%, 8.5mA, 500mW	SOD-123	5d	1a	Cen
CKD	CMHZ4120	Z-diode	LN, 30V±5%, 7.9mA, 500mW	SOD-123	5d	1a	Cen
CKE	1SMB5.0A	TVS	Vrwm=5V, 65.2A, 500W(1ms)	DO-214AA	1d	1a	Cen
CKE	CMHZ4121	Z-diode	LN, 33V±5%, 7.2mA, 500mW	SOD-123	5d	1a	Cen
CKEC	1SMB5.0CA	TVS	Vrwm=5.0V, 65.2A, 500W(1ms), Bidirectional	DO-214AA	1ba	1j	Cen
CKF	CMHZ4122	Z-diode	LN, 36V±5%, 6.6mA, 500mW	SOD-123	5d	1a	Cen
CKG	1SMB6.0A	TVS	Vrwm=6V, 58.3A, 500W(1ms)	DO-214AA	1d	1a	Cen
CKGC	1SMB6.0CA	TVS	Vrwm=6V, 58.3A, 500W(1ms), Bidirectional	DO-214AA	1ba	1j	Cen
CKH	CMHZ4123	Z-diode	LN, 39V±5%, 6.1mA, 500mW	SOD-123	5d	1a	Cen
CKJ	CMHZ4124	Z-diode	LN, 43V±5%, 5.5mA, 500mW	SOD-123	5d	1a	Cen
CKK	1SMB6.5A	TVS	Vrwm=6.5V, 53.6A, 500W(1ms)	DO-214AA	1d	1a	Cen
CKK	SMA56A	TVS	Vbr=53.2, 58.8V, Vrwm=47.8V, 5.19A, 400W(1ms)	DO-214AC	1d	1a	Lge
CKKC	1SMB6.5CA	TVS	Vrwm=6.5V, 53.6A, 500W(1ms), Bidirectional	DO-214AA	1ba	1j	Cen
CKL	CMHZ4125	Z-diode	LN, 47V±5%, 5.1mA, 500mW	SOD-123	5d	1a	Cen
CKM	1SMB7.0A	TVS	Vrwm=7V, 50A, 500W(1ms)	DO-214AA	1d	1a	Cen
CKM	SMA56CA	TVS	Vbr=53.2, 58.8V, Vrwm=47.8V, 5.19A, 400W(1ms), Bidirectional	DO-214AC	1ba	1j	Lge
CKMC	1SMB7.0CA	TVS	Vrwm=7V, 50A, 500W(1ms), Bidirectional	DO-214AA	1ba	1j	Cen
CKP	1SMB7.5A	TVS	Vrwm=7.5V, 46.5A, 500W(1ms)	DO-214AA	1d	1a	Cen
CKPC	1SMB7.5CA	TVS	Vrwm=7.5V, 46.5A, 500W(1ms), Bidirectional	DO-214AA	1ba	1j	Cen
CKR	1SMB8.0A	TVS	Vrwm=8V, 44.1A, 500W(1ms)	DO-214AA	1d	1a	Cen
CKRC	1SMB8.0CA	TVS	Vrwm=8V, 44.1A, 500W(1ms), Bidirectional	DO-214AA	1ba	1j	Cen
CKT	1SMB8.5A	TVS	Vrwm=8.5V, 41.7A, 500W(1ms)	DO-214AA	1d	1a	Cen
CKTC	1SMB8.5CA	TVS	Vrwm=8.5V, 41.7A, 500W(1ms), Bidirectional	DO-214AA	1ba	1j	Cen
CKV	1SMB9.0A	TVS	Vrwm=9V, 39A, 500W(1ms)	DO-214AA	1d	1a	Cen
CKVC	1SMB9.0CA	TVS	Vrwm=9V, 39A, 500W(1ms), Bidirectional	DO-214AA	1ba	1j	Cen
CKX	1SMB10A	TVS	Vrwm=10V, 35.3A, 500W(1ms)	DO-214AA	1d	1a	Cen
CKXC	1SMB10CA	TVS	Vrwm=10V, 35.3A, 500W(1ms), Bidirectional	DO-214AA	1ba	1j	Cen
CKZ	1SMB11A	TVS	Vrwm=11V, 33A, 500W(1ms)	DO-214AA	1d	1a	Cen



SMD
code

Type

Function

Short description

Case

Pinout

St.

Mnf.

CKZC	1SMB11CA	TVS	Vrwm=11V, 33.0A, 500W(1ms), Bidirectional	DO-214AA	1ba	1j	Cen
CL	NZH3V9B	Z-diode	3.9V±5%, If=250mA, 500mW	SOD-123FL	7d	1a	Phi
CL	P4SMA62	TVS	Vrwm=6.2V, 4.7A, 400W(1ms),	DO-214AC	1d	2j	Fag
CL	P6SMBJ33C	TVS	Vbr=33V, 10.2A, 600W(1ms), Bidirectional	DO-214AA	1ba	1x,1y	Pjt,Srj
CL	SMAJ30CA	TVS	Vrwm=30V, Vbr=33.3..36.8V, 8.3A, 400W(1ms), Bidirectional	DO-214AC	1ba	1r	Ste
CL	SMAJ33	TVS	Vrwm=33V, Vbr=36.7..44.9V, 6.8A, 400W(1ms)	DO-214AC	1d	1k	Vs
CL	SMBG33C	TVS	Vbr=33V, 10.2A, 600W(1ms), Bidirectional	DO-215AA	5ba	1l	Vs
CL	SMBJ33C	TVS	Vbr=33V, 10.2A, 600W(1ms), Bidirectional	DO-214AA	1ba	1l	Vs
CL	SMP33	TVS	Vbr=36.7..44.9V, Vrwm=33V, lpp=6.8A, 400W(1ms)	DO-220AA	8d	1a	Vs
CL	TV04A330K-G	TVS	Vrwm=33.0V, Vbr=36.70..44.90V, lpp=6.78A, 400W(1ms)	DO-214AC	1d	1a	Cmc
CL	TV06B330KB-G	TVS	Vrwm=33.0V, Vbr=36.70..44.90V, lpp=10.17A, 600W(1ms), Bidirectional	DO-214AA	1ba	1j	Cmc
CLE	1SMB12A	TVS	Vrwm=12V, 30.2A, 500W(1ms)	DO-214AA	1d	1a	Cen
CLEC	1SMB12CA	TVS	Vrwm=12V, 30.2A, 500W(1ms), Bidirectional	DO-214AA	1ba	1j	Cen
CLG	1SMB13A	TVS	Vrwm=13V, 27.9A, 500W(1ms)	DO-214AA	1d	1a	Cen
CLGC	1SMB13CA	TVS	Vrwm=13V, 27.9A, 500W(1ms), Bidirectional	DO-214AA	1ba	1j	Cen
CLK	1SMB14A	TVS	Vrwm=14V, 25.8A, 500W(1ms)	DO-214AA	1d	1a	Cen
CLK	SMA62	TVS	Vbr=55.8..68.2V, Vrwm=50.2V, 4.49A, 400W(1ms)	DO-214AC	1d	1a	Lge
CLKC	1SMB14CA	TVS	Vrwm=14V, 25.8A, 500W(1ms), Bidirectional	DO-214AA	1ba	1j	Cen
CLM	1SMB15A	TVS	Vrwm=15V, 24A, 500W(1ms)	DO-214AA	1d	1a	Cen
CLM	SMA62C	TVS	Vbr=55.8..68.2V, Vrwm=50.2V, 4.49A, 400W(1ms), Bidirectional	DO-214AC	1ba	1j	Lge
CLMC	1SMB15CA	TVS	Vrwm=15V, 24.0A, 500W(1ms), Bidirectional	DO-214AA	1ba	1j	Cen
CLP	1SMB16A	TVS	Vrwm=16V, 23.1A, 500W(1ms)	DO-214AA	1d	1a	Cen
CLPC	1SMB16CA	TVS	Vrwm=16V, 23.1A, 500W(1ms), Bidirectional	DO-214AA	1ba	1j	Cen
CLR	1SMB17A	TVS	Vrwm=17V, 21.7A, 500W(1ms)	DO-214AA	1d	1a	Cen
CLRC	1SMB17CA	TVS	Vrwm=17V, 21.7A, 500W(1ms), Bidirectional	DO-214AA	1ba	1j	Cen
CLT	1SMB18A	TVS	Vrwm=18V, 20.5A, 500W(1ms)	DO-214AA	1d	1a	Cen
CLTC	1SMB18CA	TVS	Vrwm=18V, 20.5A, 500W(1ms), Bidirectional	DO-214AA	1ba	1j	Cen
CLV	1SMB20A	TVS	Vrwm=20V, 18.5A, 500W(1ms)	DO-214AA	1d	1a	Cen
CLVC	1SMB20CA	TVS	Vrwm=20V, 18.5A, 500W(1ms), Bidirectional	DO-214AA	1ba	1j	Cen
CLX	1SMB22A	TVS	Vrwm=22V, 16.9A, 500W(1ms)	DO-214AA	1d	1a	Cen
CLXC	1SMB22CA	TVS	Vrwm=22V, 16.9A, 500W(1ms), Bidirectional	DO-214AA	1ba	1j	Cen
CLZ	1SMB24A	TVS	Vrwm=24V, 15.4A, 500W(1ms)	DO-214AA	1d	1a	Cen
CLZC	1SMB24CA	TVS	Vrwm=24V, 15.4A, 500W(1ms), Bidirectional	DO-214AA	1ba	1j	Cen
CM	CD214B-T33CA	TVS	Vbr=33V, lsrms=11.3A, 600W(1ms), Bidirectional	DO-214AA	1ba	1j	Brn
CM	MM1Z4701	Z-diode	13.30..14.70V, lzt=10mA, 500mW	SOD-123FL	7d	1a	Sme
CM	MMSZ4685	Z-diode	3.6V±5%, lzt=50µA, 500mW	SOD-123	5d	1a,1k	Mot,Vs
CM	MMSZ4701	Z-diode	14V±5%, lzt=50µA, 500mW	SOD-123	5d	1a	Eic
CM	NZH4V3B	Z-diode	4.3V±5%, If=250mA, 500mW	SOD-123FL	7d	1a	Phi
CM	P4SMA62A	TVS	Vrwm=6.2V, 5A, 400W(1ms),	DO-214AC	1d	2j	Fag
CM	P4SMAJ33A	TVS	Vbr=33V, 7.5A, 400W(1ms)	DO-214AC	1d	1a	Mco
CM	P6SMBJ33AC	TVS	Vbr=33V, 11.3A, 600W(1ms), Bidirectional	DO-214AA	1ba	1x,1y	Pjt,Srj
CM	SMAJ33A	TVS	Vrwm=33V, Vbr=36.7..40.6V, 7.5A, 400W(1ms)	DO-214AC	1d	1k,1q	Ste
CM	SMBG33CA	TVS	Vbr=33V, 11.3A, 600W(1ms), Bidirectional	DO-215AA	5ba	1l	Vs
CM	SMBJ33CA	TVS	Vbr=33V, 11.3A, 600W(1ms), Bidirectional	DO-214AA	1ba	1l,1x	Di,Vs
CM	SMP33A	ESDP-diode	Vbr=36.7V, Vrwm=33V, lpp=3.8A, 200W(1ms)	DO-219AB	7d	1l	Vs
CM	SMP33A	TVS	Vbr=36.7..40.6V, Vrwm=33V, lpp=7.5A, 400W(1ms)	DO-220AA	8d	1a	Vs
CM	TV04A330J-G	TVS	Vrwm=33.0V, Vbr=36.70..40.60V, lpp=7.50A, 400W(1ms)	DO-214AC	1d	1a	Cmc
CM	TV06B330JB-G	TVS	Vrwm=33.0V, Vbr=36.70..40.60V, lpp=11.26A, 600W(1ms), Bidirectional	DO-214AA	1ba	1j	Cmc
CM05A	CMF5.0A	TVS	Vrwm=5.0V, Vbr=6.4..7.0V, lpp=21.7A, 200W(1ms)	SOD-123F	6d	1a	Cen
CM065	CMF6.5A	TVS	Vrwm=6.5V, Vbr=7.22..7.98V, lpp=17.9A, 200W(1ms)	SOD-123F	6d	1a	Cen
CM06A	CMF6.0A	TVS	Vrwm=6.0V, Vbr=6.67..7.37V, lpp=19.4A, 200W(1ms)	SOD-123F	6d	1a	Cen
CM075	CMF7.5A	TVS	Vrwm=7.5V, Vbr=8.33..9.21V, lpp=15.5A, 200W(1ms)	SOD-123F	6d	1a	Cen
CM07A	CMF7.0A	TVS	Vrwm=7.0V, Vbr=7.78..8.6V, lpp=16.7A, 200W(1ms)	SOD-123F	6d	1a	Cen
CM085	CMF8.5A	TVS	Vrwm=8.5V, Vbr=9.44..10.4V, lpp=13.9A, 200W(1ms)	SOD-123F	6d	1a	Cen
CM08A	CMF8.0A	TVS	Vrwm=8.0V, Vbr=8.89..9.83V, lpp=14.7A, 200W(1ms)	SOD-123F	6d	1a	Cen
CM09A	CMF9.0A	TVS	Vrwm=9.0V, Vbr=10..11.1V, lpp=13A, 200W(1ms)	SOD-123F	6d	1a	Cen
CM1	CMHZ5256B	Z-diode	30V±5%, 500mW	SOD-123	5d	1a	Cen
CM100	CMF100A	TVS	Vrwm=100V, Vbr=111..123V, lpp=1.1A, 200W(1ms)	SOD-123F	6d	1a	Cen
CM10A	CMF10A	TVS	Vrwm=10V, Vbr=11.1..12.3V, lpp=11.8A, 200W(1ms)	SOD-123F	6d	1a	Cen
CM110	CMF110A	TVS	Vrwm=110V, Vbr=122..135V, lpp=1.0A, 200W(1ms)	SOD-123F	6d	1a	Cen
CM11A	CMF11A	TVS	Vrwm=11V, Vbr=12.2..13.5V, lpp=11A, 200W(1ms)	SOD-123F	6d	1a	Cen
CM120	CMF120A	TVS	Vrwm=120V, Vbr=133..147V, lpp=0.9A, 200W(1ms)	SOD-123F	6d	1a	Cen
CM12A	CMF12A	TVS	Vrwm=12V, Vbr=13.3..14.7V, lpp=10.1A, 200W(1ms)	SOD-123F	6d	1a	Cen
CM130	CMF130A	TVS	Vrwm=130V, Vbr=144..159V, lpp=0.8A, 200W(1ms)	SOD-123F	6d	1a	Cen
CM13A	CMF13A	TVS	Vrwm=13V, Vbr=14.4..15.9V, lpp=9.3A, 200W(1ms)	SOD-123F	6d	1a	Cen
CM14A	CMF14A	TVS	Vrwm=14V, Vbr=15.6..17.2V, lpp=8.6A, 200W(1ms)	SOD-123F	6d	1a	Cen
CM150	CMF150A	TVS	Vrwm=150V, Vbr=167..185V, lpp=0.7A, 200W(1ms)	SOD-123F	6d	1a	Cen
CM15A	CMF15A	TVS	Vrwm=15V, Vbr=16.7..18.5V, lpp=8.2A, 200W(1ms)	SOD-123F	6d	1a	Cen
CM160	CMF160A	TVS	Vrwm=160V, Vbr=178..197V, lpp=0.7A, 200W(1ms)	SOD-123F	6d	1a	Cen
CM16A	CMF16A	TVS	Vrwm=16V, Vbr=17.8..19.7V, lpp=7.7A, 200W(1ms)	SOD-123F	6d	1a	Cen



SMD code	Type	Function	Short description	Case	Pinout	St.	Mnf.
CM170	CMF170A	TVS	Vrwm=170V, Vbr=189.209V, lpp=0.6A, 200W(1ms)	SOD-123F	6d	1a	Cen
CM17A	CMF17A	TVS	Vrwm=17V, Vbr=18.9.20.9V, lpp=7.2A, 200W(1ms)	SOD-123F	6d	1a	Cen
CM18A	CMF18A	TVS	Vrwm=18V, Vbr=20..22.1V, lpp=6.8A, 200W(1ms)	SOD-123F	6d	1a	Cen
CM2	CMHZ5257B	Z-diode	33V±5%, 500mW	SOD-123	5d	1a	Cen
CM20A	CMF20A	TVS	Vrwm=20V, Vbr=22.2.24.5V, lpp=6.2A, 200W(1ms)	SOD-123F	6d	1a	Cen
CM22A	CMF22A	TVS	Vrwm=22V, Vbr=24.4.26.9V, lpp=5.6A, 200W(1ms)	SOD-123F	6d	1a	Cen
CM24A	CMF24A	TVS	Vrwm=24V, Vbr=26.7.29.5V, lpp=5.1A, 200W(1ms)	SOD-123F	6d	1a	Cen
CM26A	CMF26A	TVS	Vrwm=26V, Vbr=28.9.31.9V, lpp=4.8A, 200W(1ms)	SOD-123F	6d	1a	Cen
CM28A	CMF28A	TVS	Vrwm=28V, Vbr=31.1..34.4V, lpp=4.4A, 200W(1ms)	SOD-123F	6d	1a	Cen
CM3	CMHZ5258B	Z-diode	36V±5%, 500mW	SOD-123	5d	1a	Cen
CM30A	CMF30A	TVS	Vrwm=30V, Vbr=33.3.36.8V, lpp=4.1A, 200W(1ms)	SOD-123F	6d	1a	Cen
CM33A	CMF33A	TVS	Vrwm=33V, Vbr=36.7.40.6V, lpp=3.8A, 200W(1ms)	SOD-123F	6d	1a	Cen
CM36A	CMF36A	TVS	Vrwm=36V, Vbr=40..44.2V, lpp=3.4A, 200W(1ms)	SOD-123F	6d	1a	Cen
CM4	CMHZ5259B	Z-diode	39V±5%, 500mW	SOD-123	5d	1a	Cen
CM40A	CMF40A	TVS	Vrwm=40V, Vbr=44.4.49.1V, lpp=3.1A, 200W(1ms)	SOD-123F	6d	1a	Cen
CM43A	CMF43A	TVS	Vrwm=43V, Vbr=47.8.52.8V, lpp=2.9A, 200W(1ms)	SOD-123F	6d	1a	Cen
CM45A	CMF45A	TVS	Vrwm=45V, Vbr=50.55.3V, lpp=2.8A, 200W(1ms)	SOD-123F	6d	1a	Cen
CM48A	CMF48A	TVS	Vrwm=48V, Vbr=53.3.58.9V, lpp=2.6A, 200W(1ms)	SOD-123F	6d	1a	Cen
CM5	CMHZ5260B	Z-diode	43V±5%, 500mW	SOD-123	5d	1a	Cen
CM51A	CMF51A	TVS	Vrwm=51V, Vbr=56.7.62.7V, lpp=2.4A, 200W(1ms)	SOD-123F	6d	1a	Cen
CM54A	CMF54A	TVS	Vrwm=54V, Vbr=60.66.3V, lpp=2.3A, 200W(1ms)	SOD-123F	6d	1a	Cen
CM58A	CMF58A	TVS	Vrwm=58V, Vbr=64.4.71.2V, lpp=2.1A, 200W(1ms)	SOD-123F	6d	1a	Cen
CM60A	CMF60A	TVS	Vrwm=60V, Vbr=66.7.73.7V, lpp=1.8A, 200W(1ms)	SOD-123F	6d	1a	Cen
CM64A	CMF64A	TVS	Vrwm=64V, Vbr=71.1.78.6V, lpp=1.7A, 200W(1ms)	SOD-123F	6d	1a	Cen
CM7	SMGT39CA	TVS	Vrwm=33.3V, Vbr=37.1.41V, 11.1A, 600W(1ms), Bidirectional	DO-214AA	1ba	1l	Vs
CM70A	CMF70A	TVS	Vrwm=70V, Vbr=77.8.86V, lpp=1.5A, 200W(1ms)	SOD-123F	6d	1a	Cen
CM75A	CMF75A	TVS	Vrwm=75V, Vbr=83.3.92.1V, lpp=1.4A, 200W(1ms)	SOD-123F	6d	1a	Cen
CM78A	CMF78A	TVS	Vrwm=78V, Vbr=86.7.95.8V, lpp=1.4A, 200W(1ms)	SOD-123F	6d	1a	Cen
CM85A	CMF85A	TVS	Vrwm=85V, Vbr=94.4.104V, lpp=1.3A, 200W(1ms)	SOD-123F	6d	1a	Cen
CM90A	CMF90A	TVS	Vrwm=90V, Vbr=100..111V, lpp=1.2A, 200W(1ms)	SOD-123F	6d	1a	Cen
CME	1SMB26A	TVS	Vrwm=26V, 14.2A, 500W(1ms)	DO-214AA	1d	1a	Cen
CMEC	1SMB26CA	TVS	Vrwm=26V, 14.2A, 500W(1ms), Bidirectional	DO-214AA	1ba	1j	Cen
CMG	1SMB28A	TVS	Vrwm=28V, 13.2A, 500W(1ms)	DO-214AA	1d	1a	Cen
CMGC	1SMB28CA	TVS	Vrwm=28V, 13.2A, 500W(1ms), Bidirectional	DO-214AA	1ba	1j	Cen
CMK	1SMB30A	TVS	Vrwm=30V, 12.4A, 500W(1ms)	DO-214AA	1d	1a	Cen
CMK	SMA62A	TVS	Vbr=58.9.65.1V, Vrwm=53.0V, 4.71A, 400W(1ms)	DO-214AC	1d	1a	Lge
CMKC	1SMB30CA	TVS	Vrwm=30V, 12.4A, 500W(1ms), Bidirectional	DO-214AA	1ba	1j	Cen
CMM	1SMB33A	TVS	Vrwm=33V, 11.3A, 500W(1ms)	DO-214AA	1d	1a	Cen
CMIM	SMA62CA	TVS	Vbr=58.9.65.1V, Vrwm=53.0V, 4.71A, 400W(1ms), Bidirectional	DO-214AC	1ba	1j	Lge
CMIMC	1SMB33CA	TVS	Vrwm=33V, 11.3A, 500W(1ms), Bidirectional	DO-214AA	1ba	1j	Cen
CMP	1SMB36A	TVS	Vrwm=36V, 10.3A, 500W(1ms)	DO-214AA	1d	1a	Cen
CMPC	1SMB36CA	TVS	Vrwm=36V, 10.3A, 500W(1ms), Bidirectional	DO-214AA	1ba	1j	Cen
CMR	1SMB40A	TVS	Vrwm=40V, 9.3A, 500W(1ms)	DO-214AA	1d	1a	Cen
CMRC	1SMB40CA	TVS	Vrwm=40V, 9.3A, 500W(1ms), Bidirectional	DO-214AA	1ba	1j	Cen
CMT	1SMB43A	TVS	Vrwm=43V, 8.6A, 500W(1ms)	DO-214AA	1d	1a	Cen
CMTC	1SMB43CA	TVS	Vrwm=43V, 8.6A, 500W(1ms), Bidirectional	DO-214AA	1ba	1j	Cen
CMV	1SMB45A	TVS	Vrwm=45V, 8.3A, 500W(1ms)	DO-214AA	1d	1a	Cen
CMVC	1SMB45CA	TVS	Vrwm=45V, 8.3A, 500W(1ms), Bidirectional	DO-214AA	1ba	1j	Cen
CMX	1SMB48A	TVS	Vrwm=48V, 7.7A, 500W(1ms)	DO-214AA	1d	1a	Cen
CMXC	1SMB48CA	TVS	Vrwm=48V, 7.7A, 500W(1ms), Bidirectional	DO-214AA	1ba	1j	Cen
CMZ	1SMB51A	TVS	Vrwm=51V, 7.3A, 500W(1ms)	DO-214AA	1d	1a	Cen
CMZC	1SMB51CA	TVS	Vrwm=51V, 7.3A, 500W(1ms), Bidirectional	DO-214AA	1ba	1j	Cen
CN	MM1Z4702	Z-diode	14.25..15.75V, Izt=10mA, 500mW	SOD-323FL	5d	1a	Eic
CN	MMSZ4686	Z-diode	3.9V±5%, Izt=50µA, 500mW	SOD-123	5d	1a,1k	Mot,Vs
CN	MMSZ4702	Z-diode	15V±5%, Izt=50µA, 500mW	SOD-123	5d	1a	Eic
CN	NZH4V7B	Z-diode	4.7V±5%, If=250mA, 500mW	SOD-123FL	7d	1a	Phi
CN	P4SMA68	TVS	Vrwm=68V, 4.3A, 400W(1ms),	DO-214AC	1d	2j	Fag
CN	P6SMBJ36C	TVS	Vbr=36V, 9.3A, 600W(1ms), Bidirectional	DO-214AA	1ba	1x,1y	Pjt,Srj
CN	SMAJ33CA	TVS	Vrwm=33V, Vbr=36.7.40.6V, 7.5A, 400W(1ms), Bidirectional	DO-214AC	1ba	1r	Ste
CN	SMAJ36	TVS	Vrwm=36V, Vbr=40.0.48.9V, 6.2A, 400W(1ms)	DO-214AC	1d	1k	Vs
CN	SMBG36C	TVS	Vbr=36V, 9.3A, 600W(1ms), Bidirectional	DO-215AA	5ba	1l	Vs
CN	SMBJ36C	TVS	Vbr=36V, 9.3A, 600W(1ms), Bidirectional	DO-214AA	1ba	1l	Vs
CN	SMP36	TVS	Vbr=40.0.48.9V, Vrwm=36V, lpp=6.2A, 400W(1ms)	DO-220AA	8d	1a	Vs
CN	TV04A360K-G	TVS	Vrwm=36.0V, Vbr=40.0.48.90V, lpp=6.22A, 400W(1ms)	DO-214AC	1d	1a	Cmc
CN	TV06B360K-B-G	TVS	Vrwm=36.0V, Vbr=40.0.48.90V, lpp=9.33A, 600W(1ms), Bidirectional	DO-214AA	1ba	1j	Cmc
CN1	CMHZ5261B	Z-diode	47V±5%, 500mW	SOD-123	5d	1a	Cen
CN2	CMHZ5262B	Z-diode	51V±5%, 500mW	SOD-123	5d	1a	Cen
CN3	CMHZ5263B	Z-diode	56V±5%, 500mW	SOD-123	5d	1a	Cen
CN4	CMHZ5264B	Z-diode	60V±5%, 500mW	SOD-123	5d	1a	Cen
CN5	CMHZ5265B	Z-diode	62V±5%, 500mW	SOD-123	5d	1a	Cen



SMD code	Type	Function	Short description	Case	Pinout	St.	Mnf.
CNE	1SMB54A	TVS	Vrwm=54V, 6.9A, 500W(1ms)	DO-214AA	1d	1a	Cen
CNEC	1SMB54CA	TVS	Vrwm=54V, 6.9A, 500W(1ms), Bidirectional	DO-214AA	1ba	1j	Cen
CNG	1SMB58A	TVS	Vrwm=58V, 6.4A, 500W(1ms)	DO-214AA	1d	1a	Cen
CNGC	1SMB58CA	TVS	Vrwm=58V, 6.4A, 500W(1ms), Bidirectional	DO-214AA	1ba	1j	Cen
CNK	1SMB60A	TVS	Vrwm=60V, 6.2A, 500W(1ms)	DO-214AA	1d	1a	Cen
CNK	SMA68	TVS	Vbr=61.2..74.8V, Vrwm=55..1V, 4.08A, 400W(1ms)	DO-214AC	1d	1a	Lge
CNKC	1SMB60CA	TVS	Vrwm=60V, 6.2A, 500W(1ms), Bidirectional	DO-214AA	1ba	1j	Cen
CNM	1SMB64A	TVS	Vrwm=64V, 5.8A, 500W(1ms)	DO-214AA	1d	1a	Cen
CNM	SMA68C	TVS	Vbr=61.2..74.8V, Vrwm=55..1V, 4.08A, 400W(1ms), Bidirectional	DO-214AC	1ba	1j	Lge
CNMC	1SMB64CA	TVS	Vrwm=64V, 5.8A, 500W(1ms), Bidirectional	DO-214AA	1ba	1j	Cen
CNP	1SMB70A	TVS	Vrwm=70V, 5.3A, 500W(1ms)	DO-214AA	1d	1a	Cen
CNPC	1SMB70CA	TVS	Vrwm=70V, 5.3A, 500W(1ms), Bidirectional	DO-214AA	1ba	1j	Cen
CNR	1SMB75A	TVS	Vrwm=75V, 4.9A, 500W(1ms)	DO-214AA	1d	1a	Cen
CNRC	1SMB75CA	TVS	Vrwm=75V, 4.9A, 500W(1ms), Bidirectional	DO-214AA	1ba	1j	Cen
CNT	1SMB78A	TVS	Vrwm=78V, 4.7A, 500W(1ms)	DO-214AA	1d	1a	Cen
CNTC	1SMB78CA	TVS	Vrwm=78V, 4.7A, 500W(1ms), Bidirectional	DO-214AA	1ba	1j	Cen
CNV	1SMB85A	TVS	Vrwm=85V, 4.4A, 500W(1ms)	DO-214AA	1d	1a	Cen
CNVC	1SMB85CA	TVS	Vrwm=85V, 4.4A, 500W(1ms), Bidirectional	DO-214AA	1ba	1j	Cen
CNX	1SMB90A	TVS	Vrwm=90V, 4.1A, 500W(1ms)	DO-214AA	1d	1a	Cen
CNXC	1SMB90CA	TVS	Vrwm=90V, 4.1A, 500W(1ms), Bidirectional	DO-214AA	1ba	1j	Cen
CNZ	1SMB100A	TVS	Vrwm=100V, 3.7A, 500W(1ms)	DO-214AA	1d	1a	Cen
CNZC	1SMB100CA	TVS	Vrwm=100V, 3.7A, 500W(1ms), Bidirectional	DO-214AA	1ba	1j	Cen
CP	CD214B-T36CA	TVS	Vbr=36V, Irsrm=10.3A, 600W(1ms), Bidirectional	DO-214AA	1ba	1j	Bm
CP	CMDZ2L7	Z-diode	2.565..2.835V, Izt=0.5mA, Zzt=900Ω, 250mW	SOD-323	5d	1a	Cen
CP	MM1Z4703	Z-diode	15..20..16.80V, Izt=10mA, 500mW	SOD-323FL	5d	1a	Eic
CP	MMSZ4687	Z-diode	4.3V±5%, Izt=50μA, 500mW	SOD-123	5d	1a,1k	Mot,Vs
CP	MMSZ4703	Z-diode	16V±5%, Izt=50μA, 500mW	SOD-123	5d	1a	Eic
CP	NZH5V1B	Z-diode	5.1V±5%, If=250mA, 500mW	SOD-123FL	7d	1a	Phi
CP	P4SMA68A	TVS	Vrwm=68V, 4.6A, 400W(1ms)	DO-214AC	1d	2j	Fag
CP	P4SMAJ36A	TVS	Vbr=36V, 6.9A, 400W(1ms)	DO-214AC	1d	1a	Mco
CP	P6SMBJ36AC	TVS	Vbr=36V, 10.3A, 600W(1ms), Bidirectional	DO-214AA	1ba	1x,1y	Pjt,Srj
CP	SMAJ36A	TVS	Vrwm=36V, Vbr=40..0.44.2V, 6.9A, 400W(1ms)	DO-214AC	1d	1k	Vs
CP	SMBG36CA	TVS	Vbr=36V, 10.3A, 600W(1ms), Bidirectional	DO-215AA	5ba	1l	Vs
CP	SMBJ36CA	TVS	Vbr=36V, 10.3A, 600W(1ms), Bidirectional	DO-214AA	1ba	1l,1x	Di,Vs
CP	SMF36A	ESDP-diode	Vbr=40.0V, Vrwm=36V, Ipp=3.4A, 200W(1ms)	DO-219AB	7d	1l	Vs
CP	SMP36A	TVS	Vbr=40.0..44.2V, Vrwm=36V, Ipp=6.9A, 400W(1ms)	DO-220AA	8d	1a	Vs
CP	TV04A360J-G	TVS	Vrwm=36.0V, Vbr=40.0..44.20V, Ipp=6.88A, 400W(1ms)	DO-214AC	1d	1a	Cmc
CP	TV06B360JB-G	TVS	Vrwm=36.0V, Vbr=40.0..44.20V, Ipp=10.33A, 600W(1ms), Bidirectional	DO-214AA	1ba	1j	Cmc
CP1	CMHZ5266B	Z-diode	68V±5%, 500mW	SOD-123	5d	1a	Cen
CP2	CMHZ5267B	Z-diode	75V±5%, 500mW	SOD-123	5d	1a	Cen
CP3	CMHZ5268B	Z-diode	82V±5%, 500mW	SOD-123	5d	1a	Cen
CP4	CMHZ5269B	Z-diode	87V±5%, 500mW	SOD-123	5d	1a	Cen
CP5	CMHZ5270B	Z-diode	91V±5%, 500mW	SOD-123	5d	1a	Cen
CPE	1SMB110A	TVS	Vrwm=110V, 3.4A, 500W(1ms)	DO-214AA	1d	1a	Cen
CPEC	1SMB110CA	TVS	Vrwm=110V, 3.4A, 500W(1ms), Bidirectional	DO-214AA	1ba	1j	Cen
CPG	1SMB120A	TVS	Vrwm=120V, 3.1A, 500W(1ms)	DO-214AA	1d	1a	Cen
CPGC	1SMB120CA	TVS	Vrwm=120V, 3.1A, 500W(1ms), Bidirectional	DO-214AA	1ba	1j	Cen
CPK	1SMB130A	TVS	Vrwm=130V, 2.9A, 500W(1ms)	DO-214AA	1d	1a	Cen
CPK	SMA68A	TVS	Vbr=64.6..71.4V, Vrwm=58..1V, 4.35A, 400W(1ms)	DO-214AC	1d	1a	Lge
CPKC	1SMB130CA	TVS	Vrwm=130V, 2.9A, 500W(1ms), Bidirectional	DO-214AA	1ba	1j	Cen
CPM	1SMB150A	TVS	Vrwm=150V, 2.5A, 500W(1ms)	DO-214AA	1d	1a	Cen
CPM	SMA68CA	TVS	Vbr=64.6..71.4V, Vrwm=58..1V, 4.35A, 400W(1ms), Bidirectional	DO-214AC	1ba	1j	Lge
CPMC	1SMB150CA	TVS	Vrwm=150V, 2.5A, 500W(1ms), Bidirectional	DO-214AA	1ba	1j	Cen
CPP	1SMB160A	TVS	Vrwm=160V, 2.3A, 500W(1ms)	DO-214AA	1d	1a	Cen
CPPC	1SMB160CA	TVS	Vrwm=160V, 2.3A, 500W(1ms), Bidirectional	DO-214AA	1ba	1j	Cen
CPR	1SMB170A	TVS	Vrwm=170V, 2.2A, 500W(1ms)	DO-214AA	1d	1a	Cen
CPRC	1SMB170CA	TVS	Vrwm=170V, 2.2A, 500W(1ms), Bidirectional	DO-214AA	1ba	1j	Cen
CQ	NZH5V6B	Z-diode	5.6V±5%, If=250mA, 500mW	SOD-123FL	7d	1a	Phi
CQ	P4SMA75	TVS	Vrwm=75V, 3.9A, 400W(1ms)	DO-214AC	1d	2j	Fag
CQ	P6SMBJ40C	TVS	Vbr=40V, 8.4A, 600W(1ms), Bidirectional	DO-214AA	1ba	1x,1y	Pjt,Srj
CQ	SMAJ40	TVS	Vrwm=40V, Vbr=44.4..54.3V, 5.6A, 400W(1ms)	DO-214AC	1d	1k	Vs
CQ	SMBG40C	TVS	Vbr=40V, 8.4A, 600W(1ms), Bidirectional	DO-215AA	5ba	1l	Vs
CQ	SMBJ40C	TVS	Vbr=40V, 8.4A, 600W(1ms), Bidirectional	DO-214AA	1ba	1l	Vs
CQ	TV04A400K-G	TVS	Vrwm=40.0V, Vbr=44.40..54.30V, Ipp=5.60A, 400W(1ms)	DO-214AC	1d	1a	Cmc
CQ	TV06B400KB-G	TVS	Vrwm=40.0V, Vbr=44.40..54.30V, Ipp=8.40A, 600W(1ms), Bidirectional	DO-214AA	1ba	1j	Cmc
CQK	SMA75	TVS	Vbr=67.5..82.5V, Vrwm=60.7V, 3.70A, 400W(1ms)	DO-214AC	1d	1a	Lge
CQM	SMA75C	TVS	Vbr=67.5..82.5V, Vrwm=60.7V, 3.70A, 400W(1ms), Bidirectional	DO-214AC	1ba	1j	Lge
CR	CD214B-T40CA	TVS	Vbr=40V, Irsrm=9.3A, 600W(1ms), Bidirectional	DO-214AA	1ba	1j	Bm
CR	MM1Z4704	Z-diode	16..15..17.85V, Izt=10mA, 500mW	SOD-123FL	7d	1a	Sme
CR	MMSZ4704	Z-diode	17V±5%, Izt=50μA, 500mW	SOD-123	5d	1a	Eic



SMD code	Type	Function	Short description	Case	Pinout	St.	Mnf.
CR	NZH6V2B	Z-diode	6.2V±5%, If=250mA, 500mW	SOD-123FL	7d	1a	Phi
CR	P4SMA75A	TVS	Vrwm=75V, 4.1A, 400W(1ms)	DO-214AC	1d	2j	Fag
CR	P4SMAJ40A	TVS	Vbr=40V, 6.2A, 400W(1ms)	DO-214AC	1d	1a	Mco
CR	P6SMBJ40AC	TVS	Vbr=40V, 9.3A, 600W(1ms), Bidirectional	DO-214AA	1ba	1x,1y	Pjt,Srj
CR	PZU8.2B1A	Z-diode	8.2V±2%, If=200mA, 320mW	SOD-323	5d	1a	Phi
CR	SMAJ40A	TVS	Vrwm=40V, Vbr=44.4. 49.1V, 6.2A, 400W(1ms)	DO-214AC	1d	1k	Vs
CR	SMBG40CA	TVS	Vbr=40V, 9.3A, 600W(1ms), Bidirectional	DO-215AA	5ba	1l	Vs
CR	SMBJ40CA	TVS	Vbr=40V, 9.3A, 600W(1ms), Bidirectional	DO-214AA	1ba	1l,1x	Di,Vs
CR	SMF40A	ESDP-diode	Vbr=44.4V, Vrwm=40V, lpp=3.1A, 200W(1ms)	DO-219AB	7d	1i	Vs
CR	TV04A400J-G	TVS	Vrwm=40.0V, Vbr=44.40. 49.10V, lpp=6.20A, 400W(1ms)	DO-214AC	1d	1a	Cmc
CR	TV06B400JB-G	TVS	Vrwm=40.0V, Vbr=44.40. 49.10V, lpp=9.30A, 600W(1ms), Bidirectional	DO-214AA	1ba	1j	Cmc
CR1	CMHZ5271B	Z-diode	100V±5%, 500mW	SOD-123	5d	1a	Cen
CR2	CMHZ5272B	Z-diode	110V±5%, 500mW	SOD-123	5d	1a	Cen
CR3	CMHZ5273B	Z-diode	120V±5%, 500mW	SOD-123	5d	1a	Cen
CR4	CMHZ5274B	Z-diode	130V±5%, 500mW	SOD-123	5d	1a	Cen
CR5	CMHZ5275B	Z-diode	140V±5%, 500mW	SOD-123	5d	1a	Cen
CRD	SMCJ54	TVS	Vbr=60.0. 73.3V, Vrwm=54V, 15.6A, 1500W(1ms)	DO-214AB	1d	1a	Gal
CRE	SMCJ54A	TVS	Vbr=60.0. 66.3V, Vrwm=54V, 17.2A, 1500W(1ms)	DO-214AB	1d	1a	Gal
CRF	SMCJ58	TVS	Vbr=64.4. 78.7V, Vrwm=58V, 14.6A, 1500W(1ms)	DO-214AB	1d	1a	Gal
CRG	SMCJ58A	TVS	Vbr=64.4. 71.2V, Vrwm=58V, 16.0A, 1500W(1ms)	DO-214AB	1d	1a	Gal
CRH	SMCJ60	TVS	Vbr=66.7. 81.5V, Vrwm=60V, 14.0A, 1500W(1ms)	DO-214AB	1d	1a	Gal
CRK	SMA75A	TVS	Vbr=71.3. 78.8V, Vrwm=64.1V, 3.88A, 400W(1ms)	DO-214AC	1d	1a	Lge
CRK	SMCJ60A	TVS	Vbr=66.7. 73.7V, Vrwm=60V, 15.5A, 1500W(1ms)	DO-214AB	1d	1a	Gal
CRL	SMCJ64	TVS	Vbr=71.1. 86.9V, Vrwm=64V, 13.2A, 1500W(1ms)	DO-214AB	1d	1a	Gal
CRM	SMA75CA	TVS	Vbr=71.3. 78.8V, Vrwm=64.1V, 3.88A, 400W(1ms), Bidirectional	DO-214AC	1ba	1j	Lge
CRM	SMCJ64A	TVS	Vbr=71.1. 78.6V, Vrwm=64V, 14.6A, 1500W(1ms)	DO-214AB	1d	1a	Gal
CRN	SMCJ70	TVS	Vbr=77.8. 95.1V, Vrwm=70V, 12.0A, 1500W(1ms)	DO-214AB	1d	1a	Gal
CRP	SMCJ70A	TVS	Vbr=77.8. 86.0V, Vrwm=70V, 13.3A, 1500W(1ms)	DO-214AB	1d	1a	Gal
CRQ	SMCJ75	TVS	Vbr=83.3. 102V, Vrwm=75V, 11.2A, 1500W(1ms)	DO-214AB	1d	1a	Gal
CRR	SMCJ75A	TVS	Vbr=83.3. 92.1V, Vrwm=75V, 12.4A, 1500W(1ms)	DO-214AB	1d	1a	Gal
CRS	SMCJ78	TVS	Vbr=86.7. 106V, Vrwm=78V, 10.8A, 1500W(1ms)	DO-214AB	1d	1a	Gal
CRT	SMCJ78A	TVS	Vbr=86.7. 95.8V, Vrwm=78V, 11.9A, 1500W(1ms)	DO-214AB	1d	1a	Gal
CRU	SMCJ85	TVS	Vbr=94.4. 115V, Vrwm=85V, 9.9A, 1500W(1ms)	DO-214AB	1d	1a	Gal
CRV	SMCJ85A	TVS	Vbr=94.4. 104V, Vrwm=85V, 10.9A, 1500W(1ms)	DO-214AB	1d	1a	Gal
CRW	SMCJ90	TVS	Vbr=100. 122V, Vrwm=90V, 9.4A, 1500W(1ms)	DO-214AB	1d	1a	Gal
CRX	SMCJ90A	TVS	Vbr=100. 111V, Vrwm=90V, 10.3A, 1500W(1ms)	DO-214AB	1d	1a	Gal
CRY	SMCJ100	TVS	Vbr=111. 136V, Vrwm=100V, 8.4A, 1500W(1ms)	DO-214AB	1d	1a	Gal
CRZ	SMCJ100A	TVS	Vbr=111. 123V, Vrwm=100V, 9.3A, 1500W(1ms)	DO-214AB	1d	1a	Gal
CS	NZH6V8B	Z-diode	6.8V±5%, If=250mA, 500mW	SOD-123FL	7d	1a	Phi
CS	P4SMA82	TVS	Vrwm=82V, 3.6A, 400W(1ms)	DO-214AC	1d	2j	Fag
CS	P6SMBJ43C	TVS	Vbr=43V, 7.8A, 600W(1ms), Bidirectional	DO-214AA	1ba	1x,1y	Pjt,Srj
CS	PZU8.2B2A	Z-diode	8.2V±2%, If=200mA, 320mW	SOD-323	5d	1a	Phi
CS	SMAJ43	TVS	Vrwm=43V, Vbr=47.8. 58.4V, 5.2A, 400W(1ms)	DO-214AC	1d	1k	Vs
CS	SMBG43C	TVS	Vbr=43V, 7.8A, 600W(1ms), Bidirectional	DO-215AA	5ba	1l	Vs
CS	SMBJ43C	TVS	Vbr=43V, 7.8A, 600W(1ms), Bidirectional	DO-214AA	1ba	1l	Vs
CS	TV04A430K-G	TVS	Vrwm=43.0V, Vbr=47.80. 58.40V, lpp=5.22A, 400W(1ms)	DO-214AC	1d	1a	Cmc
CS	TV06B430KB-G	TVS	Vrwm=43.0V, Vbr=47.80. 58.40V, lpp=7.82A, 600W(1ms), Bidirectional	DO-214AA	1ba	1j	Cmc
CS1	CMHZ5276B	Z-diode	150V±5%, 500mW	SOD-123	5d	1a	Cen
CS100	CMSH1-100	Si-diode	SBR, 100V, 1A, Vf<0.85V(1A)	DO-214AA	1d	1a	Cen
CS100M	CMSH1-100M	Si-diode	SBR, 100V, 1A, Vf<0.85V(1A)	DO-214AC	1d	1a	Cen
CS2	CMHZ5277B	Z-diode	160V±5%, 500mW	SOD-123	5d	1a	Cen
CS20	CMSH1-20	Si-diode	SBR, 20V, 1A, Vf<0.55V(1A)	DO-214AA	1d	1a	Cen
CS20M	CMSH1-20M	Si-diode	SBR, 20V, 1A, Vf<0.55V(1A)	DO-214AC	1d	1a	Cen
CS20ML	CMSH1-20ML	Si-diode	SBR, 20V, 1A, Vf<0.38V(1A)	DO-214AC	1d	1a	Cen
CS2100	CMSH2-100	Si-diode	SBR, 100V, 2A, Vf<0.85V(2A)	DO-214AA	1d	1a	Cen
CS2100M	CMSH2-100M	Si-diode	SBR, 100V, 3A, Vf<0.85V(2A)	DO-214AC	1d	1a	Cen
CS220	CMSH2-20	Si-diode	SBR, 20V, 2A, Vf<0.55V(2A)	DO-214AA	1d	1a	Cen
CS220L	CMSH2-20L	Si-diode	SBR, 20V, 2A, Vf<0.38V(2A)	DO-214AA	1d	1a	Cen
CS220M	CMSH2-20M	Si-diode	SBR, 20V, 2A, Vf<0.55V(2A)	DO-214AC	1d	1a	Cen
CS240	CMSH2-40	Si-diode	SBR, 40V, 2A, Vf<0.55V(2A)	DO-214AA	1d	1a	Cen
CS240L	CMSH2-40L	Si-diode	SBR, 40V, 2A, Vf<0.4V(2A)	DO-214AA	1d	1a	Cen
CS240M	CMSH2-40M	Si-diode	SBR, 40V, 2A, Vf<0.55V(2A)	DO-214AC	1d	1a	Cen
CS260	CMSH2-60	Si-diode	SBR, 60V, 2A, Vf<0.7V(2A)	DO-214AA	1d	1a	Cen
CS260M	CMSH2-60M	Si-diode	SBR, 60V, 2A, Vf<0.7V(2A)	DO-214AC	1d	1a	Cen
CS3	CMHZ5278B	Z-diode	170V±5%, 500mW	SOD-123	5d	1a	Cen
CS3100	CMSH3-100	Si-diode	SBR, 100V, 3A, Vf<0.8V(3A)	DO-214AB	1d	1a	Cen
CS3100M	CMSH3-100M	Si-diode	SBR, 100V, 3A, Vf<0.85V(3A)	DO-214AA	1d	1a	Cen
CS3100MA	CMSH3-100MA	Si-diode	SBR, 100V, 3A, Vf<0.85V(3A)	DO-214AC	1d	1a	Cen
CS320	CMSH3-20	Si-diode	SBR, 20V, 3A, Vf<0.5V(3A)	DO-214AB	1d	1a	Cen
CS320L	CMSH3-20L	Si-diode	SBR, 20V, 4A, Vf<0.42V(4A)	DO-214AB	1d	1a	Cen



SMD code	Type	Function	Short description	Case	Pinout	St.	Mnf.
CS320M	CMSH3-20M	Si-diode	SBR, 20V, 3A, Vf<0.55V(3A)	DO-214AA	1d	1a	Cen
CS320MA	CMSH3-20MA	Si-diode	SBR, 20V, 3A, Vf<0.5V(3A)	DO-214AC	1d	1a	Cen
CS340	CMSH3-40	Si-diode	SBR, 40V, 3A, Vf<0.5V(3A)	DO-214AB	1d	1a	Cen
CS340L	CMSH3-40L	Si-diode	SBR, 40V, 4A, Vf<0.44V(4A)	DO-214AB	1d	1a	Cen
CS340M	CMSH3-40M	Si-diode	SBR, 40V, 3A, Vf<0.55V(3A)	DO-214AA	1d	1a	Cen
CS340MA	CMSH3-40MA	Si-diode	SBR, 40V, 3A, Vf<0.5V(3A)	DO-214AC	1d	1a	Cen
CS360	CMSH3-60	Si-diode	SBR, 60V, 3A, Vf<0.7V(3A)	DO-214AB	1d	1a	Cen
CS360M	CMSH3-60M	Si-diode	SBR, 60V, 3A, Vf<0.75V(3A)	DO-214AA	1d	1a	Cen
CS360MA	CMSH3-60MA	Si-diode	SBR, 60V, 3A, Vf<0.7V(3A)	DO-214AC	1d	1a	Cen
CS4	CMHZ5279B	Z-diode	180V±5%, 500mW	SOD-123	5d	1a	Cen
CS40	CMSH1-40	Si-diode	SBR, 40V, 1A, Vf<0.55V(1A)	DO-214AA	1d	1a	Cen
CS40M	CMSH1-40M	Si-diode	SBR, 40V, 1A, Vf<0.55V(1A)	DO-214AC	1d	1a	Cen
CS40ML	CMSH1-40ML	Si-diode	SBR, 40V, 1A, Vf<0.4V(1A)	DO-214AC	1d	1a	Cen
CS5	CMHZ5280B	Z-diode	190V±5%, 500mW	SOD-123	5d	1a	Cen
CS5100	CMSH5-100	Si-diode	SBR, 100V, 5A, Vf<0.85V(5A)	DO-214AB	1d	1a	Cen
CS520	CMSH5-20	Si-diode	SBR, 20V, 5A, Vf<0.55V(5A)	DO-214AB	1d	1a	Cen
CS540	CMSH5-40	Si-diode	SBR, 40V, 5A, Vf<0.55V(5A)	DO-214AB	1d	1a	Cen
CS560	CMSH5-60	Si-diode	SBR, 60V, 5A, Vf<0.75V(5A)	DO-214AB	1d	1a	Cen
CS60	CMSH1-60	Si-diode	SBR, 60V, 1A, Vf<0.7V(1A)	DO-214AA	1d	1a	Cen
CS60M	CMSH1-60M	Si-diode	SBR, 60V, 1A, Vf<0.7V(1A)	DO-214AC	1d	1a	Cen
CSd	SMCJ110	TVS	Vbr=122.149V, Vrwm=110V, 7.7A, 1500W(1ms)	DO-214AB	1d	1a	Gal
CSE	SMCJ110A	TVS	Vbr=122.135V, Vrwm=110V, 8.5A, 1500W(1ms)	DO-214AB	1d	1a	Gal
CSF	SMCJ120	TVS	Vbr=133.163V, Vrwm=120V, 7.0A, 1500W(1ms)	DO-214AB	1d	1a	Gal
CSF01	CMR1S-01	Si-diode	Rectifier, S-Fast-Recovery, 100V, 1A, Vf<0.95V(1A), <35ns	DO-214AA	1d	1a	Cen
CSF02	CMR1S-02	Si-diode	Rectifier, S-Fast-Recovery, 200V, 1A, Vf<0.95V(1A), <35ns	DO-214AA	1d	1a	Cen
CSG	SMCJ120A	TVS	Vbr=133.147V, Vrwm=120V, 7.8A, 1500W(1ms)	DO-214AB	1d	1a	Gal
CSH	SMCJ130	TVS	Vbr=144.176V, Vrwm=130V, 6.5A, 1500W(1ms)	DO-214AB	1d	1a	Gal
CSK	SMA82	TVS	Vbr=73.8.90.2V, Vrwm=66.4V, 3.39A, 400W(1ms)	DO-214AC	1d	1a	Lge
CSK	SMCJ130A	TVS	Vbr=144.159V, Vrwm=130V, 7.2A, 1500W(1ms)	DO-214AB	1d	1a	Gal
CSL	SMCJ150	TVS	Vbr=167.204V, Vrwm=150V, 5.6A, 1500W(1ms)	DO-214AB	1d	1a	Gal
CSM	SMA82C	TVS	Vbr=73.8.90.2V, Vrwm=66.4V, 3.39A, 400W(1ms), Bidirectional	DO-214AC	1ba	1j	Lge
CSM	SMCJ150A	TVS	Vbr=167.185V, Vrwm=150V, 6.2A, 1500W(1ms)	DO-214AB	1d	1a	Gal
CSN	SMCJ160	TVS	Vbr=178.218V, Vrwm=160V, 5.2A, 1500W(1ms)	DO-214AB	1d	1a	Gal
CSP	SMCJ160A	TVS	Vbr=178.197V, Vrwm=160V, 5.8A, 1500W(1ms)	DO-214AB	1d	1a	Gal
CSQ	SMCJ170	TVS	Vbr=189.231V, Vrwm=170V, 4.9A, 1500W(1ms)	DO-214AB	1d	1a	Gal
CSR	SMCJ170A	TVS	Vbr=189.209V, Vrwm=170V, 5.5A, 1500W(1ms)	DO-214AB	1d	1a	Gal
CSS	SMCJ188A	TVS	Vbr=209.231V, Vrwm=188V, 4.6A, 1500W(1ms)	DO-214AB	1d	1a	Gal
CST	SMCJ188	TVS	Vbr=209.255V, Vrwm=188V, 4.4A, 1500W(1ms)	DO-214AB	1d	1a	Gal
CT	CD214B-T43CA	TVS	Vbr=43V, Irsm=8.6A, 600W(1ms), Bidirectional	DO-214AA	1ba	1j	Bm
CT	MMSZ4688	Z-diode	4.7V±5%, 350mW	SOD-123	5d	1a,1k	Mot,Vs
CT	NZH7V5C	Z-diode	7.5V±5%, If=250mA, 500mW	SOD-123FL	7d	1a	Phi
CT	P4SMA82A	TVS	Vrwm=82V, 3.7A, 400W (1ms),	DO-214AC	1d	2j	Fag
CT	P4SMAJ43A	TVS	Vbr=43V, 5.7A, 400W(1ms)	DO-214AC	1d	1a	Mco
CT	P6SMBJ43AC	TVS	Vbr=43V, 8.6A, 600W(1ms), Bidirectional	DO-214AA	1ba	1x,1y	Pjt,Srj
CT	PZU8.2B3A	Z-diode	8.2V±2%, If=200mA, 320mW	SOD-323	5d	1a	Phi
CT	SMAJ43A	TVS	Vrwm=43V, Vbr=47.8.52.8V, 5.8A, 400W(1ms)	DO-214AC	1d	1k	Vs
CT	SMBG43CA	TVS	Vbr=43V, 8.6A, 600W(1ms), Bidirectional	DO-215AA	5ba	1l	Vs
CT	SMBJ43CA	TVS	Vbr=43V, 8.6A, 600W(1ms), Bidirectional	DO-214AA	1ba	1l,1x	Di,Vs
CT	SMF43A	ESDP-diode	Vbr=47.8V, Vrwm=43V, lpp=2.9A, 200W(1ms)	DO-219AB	7d	1i	Vs
CT	TV04A430J-G	TVS	Vrwm=43.0V, Vbr=47.80.52.80V, lpp=5.76A, 400W(1ms)	DO-214AC	1d	1a	Cmc
CT	TV06B430JB-G	TVS	Vrwm=43.0V, Vbr=47.80.52.80V, lpp=8.65A, 600W(1ms), Bidirectional	DO-214AA	1ba	1j	Cmc
CT1	CMHZ5281B	Z-diode	200V±5%, 500mW	SOD-123	5d	1a	Cen
CTK	SMA82A	TVS	Vbr=77.8.86.0V, Vrwm=70.1V, 3.54A, 400W(1ms)	DO-214AC	1d	1a	Lge
CTM	SMA82CA	TVS	Vbr=77.8.86.0V, Vrwm=70.1V, 3.54A, 400W(1ms), Bidirectional	DO-214AC	1ba	1j	Lge
CU	MMSZ4689	Z-diode	5.1V±5%, 350mW	SOD-123	5d	1a,1k	Mot,Vs
CU	NZH8V2B	Z-diode	8.2V±5%, If=250mA, 500mW	SOD-123FL	7d	1a	Phi
CU	P4SMA91	TVS	Vrwm=91V, 3.2A, 400W (1ms),	DO-214AC	1d	2j	Fag
CU	P6SMBJ45C	TVS	Vbr=45V, 7.5A, 600W(1ms), Bidirectional	DO-214AA	1ba	1x,1y	Pjt,Srj
CU	PZU9.1BA	Z-diode	9.1V±5%, If=200mA, 320mW	SOD-323	5d	1a	Phi
CU	SMAJ45	TVS	Vrwm=45V, Vbr=50.0.61.1V, 5A, 400W(1ms)	DO-214AC	1d	1k	Vs
CU	SMBG45C	TVS	Vbr=45V, 7.5A, 600W(1ms), Bidirectional	DO-215AA	5ba	1l	Vs
CU	SMBJ45C	TVS	Vbr=45V, 7.5A, 600W(1ms), Bidirectional	DO-214AA	1ba	1l	Vs
CU	TV04A450K-G	TVS	Vrwm=45.0V, Vbr=50.0.61.10V, lpp=4.98A, 400W(1ms)	DO-214AC	1d	1a	Cmc
CU	TV06B450KB-G	TVS	Vrwm=45.0V, Vbr=50.0.61.10V, lpp=7.47A, 600W(1ms), Bidirectional	DO-214AA	1ba	1j	Cmc
CU01	CMR1U-01	Si-diode	Rectifier, U-Fast-Rec, 100V, 1A, Vf<1V(1A), <50ns	DO-214AA	1d	1a	Cen
CU01M	CMR1U-01M	Si-diode	Rectifier, U-Fast-Rec, 100V, 1A, Vf<1V(1A), <35ns	DO-214AC	1d	1a	Cen
CU02	CMR1U-02	Si-diode	Rectifier, U-Fast-Rec, 200V, 1A, Vf<1V(1A), <50ns	DO-214AA	1d	1a	Cen
CU02M	CMR1U-02M	Si-diode	Rectifier, U-Fast-Rec, 200V, 1A, Vf<1V(1A), <35ns	DO-214AC	1d	1a	Cen
CU04	CMR1U-04	Si-diode	Rectifier, U-Fast-Rec, 400V, 1A, Vf<1V(1A), <50ns	DO-214AA	1d	1a	Cen
CU04M	CMR1U-04M	Si-diode	Rectifier, U-Fast-Rec, 400V, 1A, Vf<1V(1A), <50ns	DO-214AC	1d	1a	Cen



SMD
code

Type

Function

Short description

Case

Pinout

St.

Mnf.

SMD code	Type	Function	Short description	Case	Pinout	St.	Mnf.
CU06	CMR1U-06	Si-diode	Rectifier, U-Fast-Rec, 600V, 1A, Vf<1V(1A), <100ns	DO-214AA	1d	1a	Cen
CU06M	CMR1U-06M	Si-diode	Rectifier, U-Fast-Rec, 600V, 1A, Vf<1V(1A), <75ns	DO-214AC	1d	1a	Cen
CU10	CMR1U-10	Si-diode	Rectifier, U-Fast-Rec, 1000V, 1A, Vf<1V(1A), <100ns	DO-214AA	1d	1a	Cen
CU10M	CMR1U-10M	Si-diode	Rectifier, U-Fast-Rec, 1000V, 1A, Vf<1V(1A), <100ns	DO-214AC	1d	1a	Cen
CU201	CMR2U-01	Si-diode	Rectifier, U-Fast-Rec, 100V, 2A, Vf<1V(2A), <50ns	DO-214AA	1d	1a	Cen
CU202	CMR2U-02	Si-diode	Rectifier, U-Fast-Rec, 200V, 2A, Vf<1V(3A), <50ns	DO-214AA	1d	1a	Cen
CU204	CMR2U-04	Si-diode	Rectifier, U-Fast-Rec, 400V, 2A, Vf<1V(2A), <50ns	DO-214AA	1d	1a	Cen
CU206	CMR2U-06	Si-diode	Rectifier, U-Fast-Rec, 600V, 2A, Vf<1V(2A), <50ns	DO-214AA	1d	1a	Cen
CU301	CMR3U-01	Si-diode	Rectifier, U-Fast-Rec, 100V, 3A, Vf<1V(3A), <50ns	DO-214AB	1d	1a	Cen
CU301M	CMR3U-01M	Si-diode	Rectifier, U-Fast-Rec, 100V, 3A, Vf<1V(3A), <50ns	DO-214AA	1d	1a	Cen
CU302	CMR3U-02	Si-diode	Rectifier, U-Fast-Rec, 200V, 3A, Vf<1V(3A), <50ns	DO-214AB	1d	1a	Cen
CU302M	CMR3U-02M	Si-diode	Rectifier, U-Fast-Rec, 200V, 3A, Vf<1V(3A), <50ns	DO-214AA	1d	1a	Cen
CU304	CMR3U-04	Si-diode	Rectifier, U-Fast-Rec, 400V, 3A, Vf<1.25V(3A), <50ns	DO-214AB	1d	1a	Cen
CU304M	CMR3U-04M	Si-diode	Rectifier, U-Fast-Rec, 400V, 3A, Vf<1.25V(3A), <50ns	DO-214AA	1d	1a	Cen
CU306	CMR3U-06	Si-diode	Rectifier, U-Fast-Rec, 600V, 3A, Vf<1.4V(3A), <100ns	DO-214AB	1d	1a	Cen
CU306M	CMR3U-06M	Si-diode	Rectifier, U-Fast-Rec, 600V, 3A, Vf<1.4V(3A), <100ns	DO-214AA	1d	1a	Cen
CU310	CMR3U-10	Si-diode	Rectifier, U-Fast-Rec, 1000V, 3A, Vf<1.7V(3A), <100ns	DO-214AB	1d	1a	Cen
CU310M	CMR3U-10M	Si-diode	Rectifier, U-Fast-Rec, 1000V, 3A, Vf<1.7V(3A), <100ns	DO-214AA	1d	1a	Cen
CU502	CMR5U-02	Si-diode	Rectifier, U-Fast-Rec, 200V, 5A, Vf<1V(5A), <50ns	DO-214AB	1d	1a	Cen
CU504	CMR5U-04	Si-diode	Rectifier, U-Fast-Rec, 400V, 5A, Vf<1.3V(5A), <50ns	DO-214AB	1d	1a	Cen
CU506	CMR5U-06	Si-diode	Rectifier, U-Fast-Rec, 600V, 5A, Vf<1.7V(5A), <100ns	DO-214AB	1d	1a	Cen
CU508	CMR5U-08	Si-diode	Rectifier, U-Fast-Rec, 800V, 5A, Vf<1.7V(5A), <100ns	DO-214AB	1d	1a	Cen
CUJ	SMBJ40A	TVS	Vbr=40V, 9.7A, 600W(1ms)	DO-214AA	1d	1q	Ste
CUK	SMA91	TVS	Vbr=81.9..100V, Vrw=73.7V, 3.05A, 400W(1ms)	DO-214AC	1d	1a	Lge
CUM	SMA91C	TVS	Vbr=81.9..100V, Vrw=73.7V, 3.05A, 400W(1ms), Bidirectional	DO-214AC	1ba	1j	Lge
CUM	SMBJ70A	TVS	Vbr=70V, 5.5A, 600W(1ms)	DO-214AA	1d	1q	Ste
CUQ	SMBJ100A	TVS	Vbr=100V, 3.8A, 600W(1ms)	DO-214AA	1d	1q	Ste
CV	CD214B-T45CA	TVS	Vbr=45V, Irm=8.3A, 600W(1ms), Bidirectional	DO-214AA	1ba	1j	Bm
CV	MMSZ4690	Z-diode	5.6V±5%, 350mW	SOD-123	5d	1a,1k	Mot,Vs
CV	NZH9V1B	Z-diode	9.1V±5%, If=250mA, 500mW	SOD-123FL	7d	1a	Phi
CV	P4SMA91A	TVS	Vrw=91V, 3.4A, 400W(1ms),	DO-214AC	1d	2j	Fag
CV	P4SMAJ45A	TVS	Vbr=45V, 5.5A, 400W(1ms)	DO-214AC	1d	1a	Mco
CV	P6SMBJ45AC	TVS	Vbr=45V, 8.3A, 600W(1ms), Bidirectional	DO-214AA	1ba	1x,1y	Pjt,Srj
CV	PZU9.1B1A	Z-diode	9.1V±2%, If=200mA, 320mW	SOD-323	5d	1a	Phi
CV	SMAJ45A	TVS	Vrw=45V, Vbr=50.0..55.3V, 5.5A, 400W(1ms)	DO-214AC	1d	1k	Vs
CV	SMBG45CA	TVS	Vbr=45V, 8.3A, 600W(1ms), Bidirectional	DO-215AA	5ba	1l	Vs
CV	SMBJ45CA	TVS	Vbr=45V, 8.3A, 600W(1ms), Bidirectional	DO-214AA	1ba	1l,1x	Di,Vs
CV	SMF45A	ESDP-diode	Vbr=50.0V, Vrw=45V, Ipp=2.8A, 200W(1ms)	DO-219AB	7d	1i	Vs
CV	TV04A450-JG	TVS	Vrw=45.0V, Vbr=50.0..55.30V, Ipp=5.50A, 400W(1ms)	DO-214AC	1d	1a	Cmc
CV	TV06B450JB-G	TVS	Vrw=45.0V, Vbr=50.0..55.30V, Ipp=8.25A, 600W(1ms), Bidirectional	DO-214AA	1ba	1j	Cmc
CVD	SMCJ110C	TVS	Vbr=122..149V, Vrw=110V, 7.7A, 1500W(1ms), Bidirectional	DO-214AB	1ba	1j	Gal
CVE	SMCJ110CA	TVS	Vbr=122..135V, Vrw=110V, 8.5A, 1500W(1ms), Bidirectional	DO-214AB	1ba	1j	Gal
CVF	SMCJ120C	TVS	Vbr=133..163V, Vrw=120V, 7.0A, 1500W(1ms), Bidirectional	DO-214AB	1ba	1j	Gal
CVG	SMCJ120CA	TVS	Vbr=133..147V, Vrw=120V, 7.8A, 1500W(1ms), Bidirectional	DO-214AB	1ba	1j	Gal
CVH	SMCJ130C	TVS	Vbr=144..176V, Vrw=130V, 6.5A, 1500W(1ms), Bidirectional	DO-214AB	1ba	1j	Gal
CVK	SMA91A	TVS	Vbr=86.5..95.5V, Vrw=77.8V, 3.20A, 400W(1ms)	DO-214AC	1d	1a	Lge
CVK	SMCJ130CA	TVS	Vbr=144..159V, Vrw=130V, 7.2A, 1500W(1ms), Bidirectional	DO-214AB	1ba	1j	Gal
CVL	SMCJ150C	TVS	Vbr=167..204V, Vrw=150V, 5.6A, 1500W(1ms), Bidirectional	DO-214AB	1ba	1j	Gal
CVM	SMA91CA	TVS	Vbr=86.5..95.5V, Vrw=77.8V, 3.20A, 400W(1ms), Bidirectional	DO-214AC	1ba	1j	Lge
CVM	SMCJ150CA	TVS	Vbr=167..185V, Vrw=150V, 6.2A, 1500W(1ms), Bidirectional	DO-214AB	1ba	1j	Gal
CVN	SMCJ160C	TVS	Vbr=178..218V, Vrw=160V, 5.2A, 1500W(1ms), Bidirectional	DO-214AB	1ba	1j	Gal
CVP	SMCJ160CA	TVS	Vbr=178..197V, Vrw=160V, 5.8A, 1500W(1ms), Bidirectional	DO-214AB	1ba	1j	Gal
CVQ	SMCJ170C	TVS	Vbr=189..231V, Vrw=170V, 4.9A, 1500W(1ms), Bidirectional	DO-214AB	1ba	1j	Gal
CVR	SMCJ170CA	TVS	Vbr=189..209V, Vrw=170V, 5.5A, 1500W(1ms), Bidirectional	DO-214AB	1ba	1j	Gal
CVS	SMCJ188CA	TVS	Vbr=209..231V, Vrw=188V, 4.6A, 1500W(1ms), Bidirectional	DO-214AB	1ba	1j	Gal
CVT	SMCJ188C	TVS	Vbr=209..255V, Vrw=188V, 4.4A, 1500W(1ms), Bidirectional	DO-214AB	1ba	1j	Gal
CW	NZH10C	Z-diode	10V±5%, If=250mA, 500mW	SOD-123FL	7d	1a	Phi
CW	P4SMA100	TVS	Vrw=100V, 2.9A, 400W(1ms),	DO-214AC	1d	2j	Fag
CW	P6SMBJ48C	TVS	Vbr=48V, 7A, 600W(1ms), Bidirectional	DO-214AA	1ba	1x,1y	Pjt,Srj
CW	PZU9.1B2A	Z-diode	9.1V±2%, If=200mA, 320mW	SOD-323	5d	1a	Phi
CW	SMAJ48	TVS	Vrw=48V, Vbr=53.30..65.10V, 4.7A, 400W(1ms)	DO-214AC	1d	1k	Vs
CW	SMBG48C	TVS	Vbr=48V, 7A, 600W(1ms), Bidirectional	DO-215AA	5ba	1l	Vs
CW	SMBJ48C	TVS	Vbr=48V, 7A, 600W(1ms), Bidirectional	DO-214AA	1ba	1l	Vs
CW	TV04A480K-G	TVS	Vrw=48.0V, Vbr=53.30..65.10V, Ipp=4.68A, 400W(1ms)	DO-214AC	1d	1a	Cmc
CW	TV06B480KB-G	TVS	Vrw=48.0V, Vbr=53.30..65.10V, Ipp=7.02A, 600W(1ms), Bidirectional	DO-214AA	1ba	1j	Cmc
CWD	SMCJ5.0C	TVS	Vbr=6.40..7.82V, Vrw=5.0V, 156.3A, 1500W(1ms), Bidirectional	DO-214AB	1ba	1j	Gal
CWE	SMCJ5.0CA	TVS	Vbr=6.40..7.07V, Vrw=5.0V, 163.0A, 1500W(1ms), Bidirectional T	DO-214AB	1ba	1j	Gal
CWF	SMCJ6.0C	TVS	Vbr=6.67..8.15V, Vrw=5.0V, 131.6A, 1500W(1ms), Bidirectional	DO-214AB	1ba	1j	Gal
CWG	SMCJ6.0CA	TVS	Vbr=6.67..7.37V, Vrw=6.0V, 145.6A, 1500W(1ms), Bidirectional	DO-214AB	1ba	1j	Gal
CWH	SMCJ6.5C	TVS	Vbr=7.22..8.82V, Vrw=6.5V, 122.0A, 1500W(1ms), Bidirectional	DO-214AB	1ba	1j	Gal



SMD code	Type	Function	Short description	Case	Pinout	St.	Mnf.
CWK	SMA100	TVS	Vbr=90.0..110V, Vrwm=81.0V, 2.78A, 400W(1ms)	DO-214AC	1d	1a	Lge
CWK	SMCJ6.5CA	TVS	Vbr=7.22..7.98V, Vrwm=6.5V, 133.9A, 1500W(1ms), Bidirectional	DO-214AB	1ba	1j	Gal
CWL	SMCJ7.0C	TVS	Vbr=7.78..9.51V, Vrwm=7.0V, 112.8A, 1500W(1ms), Bidirectional	DO-214AB	1ba	1j	Gal
CWM	SMA100C	TVS	Vbr=90.0..110V, Vrwm=81.0V, 2.78A, 400W(1ms), Bidirectional	DO-214AC	1ba	1j	Lge
CWM	SMCJ7.0CA	TVS	Vbr=7.78..8.60V, Vrwm=7.0V, 125.0A, 1500W(1ms), Bidirectional	DO-214AB	1ba	1j	Gal
CWN	SMCJ7.5C	TVS	Vbr=8.33..10.2V, Vrwm=7.5V, 104.9A, 1500W(1ms), Bidirectional	DO-214AB	1ba	1j	Gal
CWP	SMCJ7.5CA	TVS	Vbr=8.33..9.21V, Vrwm=7.5V, 116.3A, 1500W(1ms), Bidirectional	DO-214AB	1ba	1j	Gal
CWQ	SMCJ8.0C	TVS	Vbr=8.89..10.9V, Vrwm=8.0V, 100.0A, 1500W(1ms), Bidirectional	DO-214AB	1ba	1j	Gal
CWR	SMCJ8.0CA	TVS	Vbr=8.89..9.83V, Vrwm=8.0V, 110.3A, 1500W(1ms), Bidirectional	DO-214AB	1ba	1j	Gal
CWS	SMCJ8.5C	TVS	Vbr=9.44..11.5V, Vrwm=8.5V, 94.3A, 1500W(1ms), Bidirectional	DO-214AB	1ba	1j	Gal
CWT	SMCJ8.5CA	TVS	Vbr=9.44..10.4V, Vrwm=8.5V, 104.2A, 1500W(1ms), Bidirectional	DO-214AB	1ba	1j	Gal
CWU	SMCJ9.0C	TVS	Vbr=10.0..12.2V, Vrwm=9.0V, 88.8A, 1500W(1ms), Bidirectional	DO-214AB	1ba	1j	Gal
CWV	SMCJ9.0CA	TVS	Vbr=10.0..11.1V, Vrwm=9.0V, 97.4A, 1500W(1ms), Bidirectional	DO-214AB	1ba	1j	Gal
CWW	SMCJ10C	TVS	Vbr=11.1..13.6V, Vrwm=10V, 79.8A, 1500W(1ms), Bidirectional	DO-214AB	1ba	1j	Gal
CWX	SMCJ10CA	TVS	Vbr=11.1..12.3V, Vrwm=10V, 88.2A, 1500W(1ms), Bidirectional	DO-214AB	1ba	1j	Gal
CWY	SMCJ11C	TVS	Vbr=12.2..14.9V, Vrwm=11V, 74.6A, 1500W(1ms), Bidirectional	DO-214AB	1ba	1j	Gal
CWZ	SMCJ11CA	TVS	Vbr=12.2..13.5V, Vrwm=11V, 82.4A, 1500W(1ms), Bidirectional	DO-214AB	1ba	1j	Gal
CX	CD214B-T48CA	TVS	Vbr=48V, Iism=7.7A, 600W(1ms), Bidirectional	DO-214AA	1ba	1j	Brn
CX	MM1Z4705	Z-diode	17.10..18.90V, Izt=10mA, 500mW	SOD-323FL	5d	1a	Eic
CX	MMSZ4692	Z-diode	6.8V±5%, 350mW	SOD-123	5d	1a,1k	Mot,Vs
CX	MMSZ4705	Z-diode	18V±5%, Izt=50µA, 500mW	SOD-123	5d	1a	Eic
CX	NZH11C	Z-diode	11V±5%, If=250mA, 500mW	SOD-123FL	7d	1a	Phi
CX	P4SMA100A	TVS	Vrwm=100V, 3.1A, 400W(1ms),	DO-214AC	1d	2j	Fag
CX	P4SMAJ48A	TVS	Vrwm=48V, Vbr=53.3..58.9V, 5.2A, 400W(1ms)	DO-214AC	1d	1a	Mco
CX	P6SMBJ48AC	TVS	Vbr=48V, 7.7A, 600W(1ms), Bidirectional	DO-214AA	1ba	1x,1y	Pjt,Srj
CX	PZU9.1B3A	Z-diode	9.1V±2%, If=200mA, 320mW	SOD-323	5d	1a	Phi
CX	SMAJ48A	TVS	Vrwm=48V, Vbr=53.3..58.9V, 5.2A, 400W(1ms)	DO-214AC	1d	1k,1q	Ste
CX	SMBG48CA	TVS	Vbr=48V, 7.8A, 600W(1ms), Bidirectional	DO-215AA	5ba	1l	Vs
CX	SMBJ48CA	TVS	Vbr=48V, 7.8A, 600W(1ms), Bidirectional	DO-214AA	1ba	1l,1x	Di,Vs
CX	SMF48A	ESDP-diode	Vbr=53.3V, Vrwm=48V, Ipp=2.6A, 200W(1ms)	DO-219AB	7d	1i	Vs
CX	TV04A480J-G	TVS	Vrwm=48.0V, Vbr=53.30..58.90V, Ipp=5.17A, 400W(1ms)	DO-214AC	1d	1a	Cmc
CX	TV06B480JB-G	TVS	Vrwm=48.0V, Vbr=53.30..58.90V, Ipp=7.75A, 600W(1ms), Bidirectional	DO-214AA	1ba	1j	Cmc
CXD	SMCJ12C	TVS	Vbr=13.3..16.3V, Vrwm=12V, 68.2A, 1500W(1ms), Bidirectional	DO-214AB	1ba	1j	Gal
CXE	SMCJ12CA	TVS	Vbr=13.3..14.7V, Vrwm=12V, 75.4A, 1500W(1ms), Bidirectional	DO-214AB	1ba	1j	Gal
CXF	SMCJ13C	TVS	Vbr=14.4..17.6V, Vrwm=13V, 63.0A, 1500W(1ms), Bidirectional	DO-214AB	1ba	1j	Gal
CXG	SMCJ13CA	TVS	Vbr=14.4..15.9V, Vrwm=13V, 69.8A, 1500W(1ms), Bidirectional	DO-214AB	1ba	1j	Gal
CXH	SMCJ14C	TVS	Vbr=15.6..19.1V, Vrwm=14V, 58.1A, 1500W(1ms), Bidirectional	DO-214AB	1ba	1j	Gal
CXK	SMA100A	TVS	Vbr=95.0..105V, Vrwm=85.5V, 2.92A, 400W(1ms)	DO-214AC	1d	1a	Lge
CXK	SMCJ14CA	TVS	Vbr=15.6..17.2V, Vrwm=14V, 64.7A, 1500W(1ms), Bidirectional	DO-214AB	1ba	1j	Gal
CXL	SMCJ15C	TVS	Vbr=16.7..20.4V, Vrwm=15V, 55.8A, 1500W(1ms), Bidirectional	DO-214AB	1ba	1j	Gal
CXM	SMA100CA	TVS	Vbr=95.0..105V, Vrwm=85.5V, 2.92A, 400W(1ms), Bidirectional	DO-214AC	1ba	1j	Lge
CXM	SMCJ15CA	TVS	Vbr=16.7..18.5V, Vrwm=15V, 61.5A, 1500W(1ms), Bidirectional	DO-214AB	1ba	1j	Gal
CXN	SMCJ16C	TVS	Vbr=17.8..21.8V, Vrwm=16V, 52.1A, 1500W(1ms), Bidirectional	DO-214AB	1ba	1j	Gal
CXP	SMCJ16CA	TVS	Vbr=17.8..19.7V, Vrwm=16V, 57.7A, 1500W(1ms), Bidirectional	DO-214AB	1ba	1j	Gal
CXQ	SMCJ17C	TVS	Vbr=18.9..23.1V, Vrwm=17V, 49.2A, 1500W(1ms), Bidirectional	DO-214AB	1ba	1j	Gal
CXR	SMCJ17CA	TVS	Vbr=18.9..20.9V, Vrwm=17V, 54.3A, 1500W(1ms), Bidirectional	DO-214AB	1ba	1j	Gal
CXS	SMCJ18C	TVS	Vbr=20.0..24.4V, Vrwm=18V, 46.6A, 1500W(1ms), Bidirectional	DO-214AB	1ba	1j	Gal
CXT	SMCJ18CA	TVS	Vbr=20.0..22.1V, Vrwm=18V, 51.4A, 1500W(1ms), Bidirectional	DO-214AB	1ba	1j	Gal
CXU	SMCJ20C	TVS	Vbr=22.2..27.1V, Vrwm=20V, 41.9A, 1500W(1ms), Bidirectional	DO-214AB	1ba	1j	Gal
CXV	SMCJ20CA	TVS	Vbr=22.2..24.5V, Vrwm=20V, 46.3A, 1500W(1ms), Bidirectional	DO-214AB	1ba	1j	Gal
CXW	SMCJ22C	TVS	Vbr=24.4..29.8V, Vrwm=22V, 38.1A, 1500W(1ms), Bidirectional	DO-214AB	1ba	1j	Gal
CXX	SMCJ22CA	TVS	Vbr=24.4..26.9V, Vrwm=22V, 42.3A, 1500W(1ms), Bidirectional	DO-214AB	1ba	1j	Gal
CXY	SMCJ24C	TVS	Vbr=26.7..32.6V, Vrwm=24V, 34.9A, 1500W(1ms), Bidirectional	DO-214AB	1ba	1j	Gal
CXZ	SMCJ24CA	TVS	Vbr=26.7..29.5V, Vrwm=24V, 38.6A, 1500W(1ms), Bidirectional	DO-214AB	1ba	1j	Gal
CY	KDZ2.4VVY	Z-diode	2.40..2.60V, Izt=5mA, Zzt=100Ω, 100mW	VSC	7d	1a	Kec
CY	MM1Z4706	Z-diode	18.05..19.95V, Izt=10mA, 500mW	SOD-123FL	7d	1a	Sme
CY	MMSZ4693	Z-diode	7.5V±5%, 350mW	SOD-123	5d	1a,1k	Mot,Vs
CY	MMSZ4706	Z-diode	19V±5%, Izt=50µA, 500mW	SOD-123	5d	1a	Eic
CY	NZH12B	Z-diode	12V±5%, If=250mA, 500mW	SOD-123FL	7d	1a	Phi
CY	P4SMA110	TVS	Vbr=99.0..121V, Vrwm=89.2V, 2.7A, 400W(1ms)	DO-214AC	1d	2j	Fag
CY	P6SMBJ51C	TVS	Vbr=51V, 6.6A, 600W(1ms), Bidirectional	DO-214AA	1ba	1x,1y	Pjt,Srj
CY	SMAJ48CA	TVS	Vrwm=48V, Vbr=53.3..58.9V, 5.2A, 400W(1ms), Bidirectional	DO-214AC	1ba	1r	Ste
CY	SMAJ51	TVS	Vrwm=51V, Vbr=56.7..69.3V, 4.4A, 400W(1ms)	DO-214AC	1d	1k	Vs
CY	SMBG51C	TVS	Vbr=51V, 6.6A, 600W(1ms), Bidirectional	DO-215AA	5ba	1l	Vs
CY	SMBJ51C	TVS	Vbr=51V, 6.6A, 600W(1ms), Bidirectional	DO-214AA	1ba	1l	Vs
CY	TV04A510K-G	TVS	Vrwm=51.0V, Vbr=56.70..69.30V, Ipp=4.39A, 400W(1ms)	DO-214AC	1d	1a	Cmc
CY	TV06B510KB-G	TVS	Vrwm=51.0V, Vbr=56.70..69.30V, Ipp=6.59A, 600W(1ms), Bidirectional	DO-214AA	1ba	1j	Cmc
CYD	SMCJ26C	TVS	Vbr=28.9..35.3V, Vrwm=26V, 32.2A, 1500W(1ms), Bidirectional	DO-214AB	1ba	1j	Gal
CYE	SMCJ26CA	TVS	Vbr=28.9..31.9V, Vrwm=26V, 35.6A, 1500W(1ms), Bidirectional	DO-214AB	1ba	1j	Gal
CYF	SMCJ28C	TVS	Vbr=31.1..38.0V, Vrwm=28V, 30.0A, 1500W(1ms), Bidirectional	DO-214AB	1ba	1j	Gal



SMD code	Type	Function	Short description	Case	Pinout	St.	Mnf.
CYG	SMCJ28CA	TVS	Vbr=31.1..34.4V, Vrw=28V, 33.0A, 1500W(1ms), Bidirectional	DO-214AB	1ba	1j	Gal
CYH	SMCJ30C	TVS	Vbr=33.3..40.7V, Vrw=30V, 28.0A, 1500W(1ms), Bidirectional	DO-214AB	1ba	1j	Gal
CYK	SMA110	TVS	Vbr=99.0..121V, Vrw=89.2V, 2.53A, 400W(1ms)	DO-214AC	1d	1a	Lge
CYK	SMCJ30CA	TVS	Vbr=33.3..36.8V, Vrw=30V, 31.0A, 1500W(1ms), Bidirectional	DO-214AB	1ba	1j	Gal
CYL	SMCJ33C	TVS	Vbr=36.7..44.9V, Vrw=33V, 25.4A, 1500W(1ms), Bidirectional	DO-214AB	1ba	1j	Gal
CYM	SMA110C	TVS	Vbr=99.0..121V, Vrw=89.2V, 2.53A, 400W(1ms), Bidirectional	DO-214AC	1ba	1j	Lge
CYM	SMCJ33CA	TVS	Vbr=36.7..40.6V, Vrw=33V, 28.1A, 1500W(1ms), Bidirectional	DO-214AB	1ba	1j	Gal
CYN	SMCJ36C	TVS	Vbr=40.0..48.9V, Vrw=36V, 23.3A, 1500W(1ms), Bidirectional	DO-214AB	1ba	1j	Gal
CYP	SMCJ36CA	TVS	Vbr=40.0..44.2V, Vrw=36V, 25.8A, 1500W(1ms), Bidirectional	DO-214AB	1ba	1j	Gal
CYQ	SMCJ40C	TVS	Vbr=44.4..54.3V, Vrw=40V, 21.0A, 1500W(1ms), Bidirectional	DO-214AB	1ba	1j	Gal
CYR	SMCJ40CA	TVS	Vbr=44.4..49.1V, Vrw=40V, 23.3A, 1500W(1ms), Bidirectional	DO-214AB	1ba	1j	Gal
CYS	SMCJ43C	TVS	Vbr=47.8..58.4V, Vrw=43V, 19.6A, 1500W(1ms), Bidirectional	DO-214AB	1ba	1j	Gal
CYT	SMCJ43CA	TVS	Vbr=47.8..52.8V, Vrw=43V, 21.6A, 1500W(1ms), Bidirectional	DO-214AB	1ba	1j	Gal
CYU	SMCJ45C	TVS	Vbr=50.0..61.1V, Vrw=45V, 18.7A, 1500W(1ms), Bidirectional	DO-214AB	1ba	1j	Gal
CYV	SMCJ45CA	TVS	Vbr=50.0..55.3V, Vrw=45V, 20.6A, 1500W(1ms), Bidirectional	DO-214AB	1ba	1j	Gal
CYW	SMCJ48C	TVS	Vbr=53.3..65.1V, Vrw=48V, 17.5A, 1500W(1ms), Bidirectional	DO-214AB	1ba	1j	Gal
CYX	SMCJ48CA	TVS	Vbr=53.3..58.9V, Vrw=48V, 19.4A, 1500W(1ms), Bidirectional	DO-214AB	1ba	1j	Gal
CYY	SMCJ51C	TVS	Vbr=56.7..69.3V, Vrw=51V, 16.5A, 1500W(1ms), Bidirectional	DO-214AB	1ba	1j	Gal
CYZ	SMCJ51CA	TVS	Vbr=56.7..62.7V, Vrw=51V, 18.2A, 1500W(1ms), Bidirectional	DO-214AB	1ba	1j	Gal
CZ	BZT52-B7V5S	Z-diode	7.35..7.65V, Izt=5mA, Zzt=15Ω, 200mW	SOD-323FL	7d	1a	Tsc
CZ	CD214B-T51CA	TVS	Vbr=51V, Itrsm=7.3A, 600W(1ms), Bidirectional	DO-214AA	1ba	1j	Bm
CZ	MM1Z4707	Z-diode	19.0..21.0V, Izt=10mA, 500mW	SOD-323FL	5d	1a	Eic
CZ	MM3Z7V5B	Z-diode	7.35..7.65V, Zzt=14Ω, Izt=5mA, 200mW	SOD-323FL	7d	1a	F
CZ	MM3Z7V5BW	Z-diode	7.35..7.65V, Izt=5mA, Zzt=15Ω, 200mW	SOD-323FL	7d	1a	Tac
CZ	MMSZ4694	Z-diode	8.2V±5%, 350mW	SOD-123	5d	1a,1k	Mot,Vs
CZ	MMSZ4707	Z-diode	20V±5%, Izt=50μA, 500mW	SOD-123	5d	1a	Eic
CZ	P4SMA110A	TVS	Vbr=105..116V, Vrw=94.0V, 2.8A, 400W(1ms)	DO-214AC	1d	2j	Fag
CZ	P4SMAJ51A	TVS	Vbr=51V, 4.9A, 400W(1ms)	DO-214AC	1d	1a	Mco
CZ	P6SMBJ51AC	TVS	Vbr=51V, 7.3A, 600W(1ms), Bidirectional	DO-214AA	1ba	1x,1y	Pjt,Srj
CZ	SMAJ51A	TVS	Vrw=51V, Vbr=56.7..62.7V, 4.9A, 400W(1ms)	DO-214AC	1d	1k	Vs
CZ	SMBG51CA	TVS	Vbr=51V, 7.3A, 600W(1ms), Bidirectional	DO-215AA	5ba	1l	Vs
CZ	SMBJ51CA	TVS	Vbr=51V, 7.3A, 600W(1ms), Bidirectional	DO-214AA	1ba	1l,1x	Di,Vs
CZ	SMF51A	ESDP-diode	Vbr=56.7V, Vrw=51V, Ipp=2.4A, 200W(1ms)	DO-219AB	7d	1i	Vs
CZ	TCCM3Z7V5B	Z-diode	7.5V±2%, Izt=5mA, Zzt=14Ω, 200mW	SOD-323FL	7d	1a	Tac
CZ	TV04A510J-G	TVS	Vrw=51.0V, Vbr=56.70..62.70V, Ipp=4.85A, 400W(1ms)	DO-214AC	1d	1a	Cmc
CZ	TV06B510J-B-G	TVS	Vrw=51.0V, Vbr=56.70..62.70V, Ipp=7.28A, 600W(1ms), Bidirectional	DO-214AA	1ba	1j	Cmc
CZD	SMCJ54C	TVS	Vbr=60.0..73.3V, Vrw=54V, 15.6A, 1500W(1ms), Bidirectional	DO-214AB	1ba	1j	Gal
CZE	SMCJ54CA	TVS	Vbr=60.0..66.3V, Vrw=54V, 17.2A, 1500W(1ms), Bidirectional	DO-214AB	1ba	1j	Gal
CZF	SMCJ58C	TVS	Vbr=64.4..78.7V, Vrw=58V, 14.6A, 1500W(1ms), Bidirectional	DO-214AB	1ba	1j	Gal
CZG	SMCJ58CA	TVS	Vbr=64.4..71.2V, Vrw=58V, 16.0A, 1500W(1ms), Bidirectional	DO-214AB	1ba	1j	Gal
CZH	SMCJ60C	TVS	Vbr=66.7..81.5V, Vrw=60V, 14.0A, 1500W(1ms), Bidirectional	DO-214AB	1ba	1j	Gal
CZK	SMA110A	TVS	Vbr=105..116V, Vrw=94.0V, 2.63A, 400W(1ms)	DO-214AC	1d	1a	Lge
CZK	SMCJ60CA	TVS	Vbr=66.7..73.7V, Vrw=60V, 15.5A, 1500W(1ms), Bidirectional	DO-214AB	1ba	1j	Gal
CZL	SMCJ64C	TVS	Vbr=71.1..86.9V, Vrw=64V, 13.2A, 1500W(1ms), Bidirectional	DO-214AB	1ba	1j	Gal
CZM	SMA110CA	TVS	Vbr=105..116V, Vrw=94.0V, 2.63A, 400W(1ms), Bidirectional	DO-214AC	1ba	1j	Lge
CZM	SMCJ64CA	TVS	Vbr=71.1..78.6V, Vrw=64V, 14.6A, 1500W(1ms), Bidirectional	DO-214AB	1ba	1j	Gal
CZN	SMCJ70C	TVS	Vbr=77.8..95.1V, Vrw=70V, 12A, 1500W(1ms), Bidirectional	DO-214AB	1ba	1j	Gal
CZP	SMCJ70CA	TVS	Vbr=77.8..86.0V, Vrw=70V, 13.3A, 1500W(1ms), Bidirectional	DO-214AB	1ba	1j	Gal
CZQ	SMCJ75C	TVS	Vbr=83.3..102V, Vrw=75V, 11.2A, 1500W(1ms), Bidirectional	DO-214AB	1ba	1j	Gal
CZR	SMCJ75CA	TVS	Vbr=83.3..92.1V, Vrw=75V, 12.4A, 1500W(1ms), Bidirectional	DO-214AB	1ba	1j	Gal
CZS	SMCJ78C	TVS	Vbr=86.7..106V, Vrw=78V, 10.8A, 1500W(1ms), Bidirectional	DO-214AB	1ba	1j	Gal
CZT	SMCJ78CA	TVS	Vbr=86.7..95.8V, Vrw=78V, 11.9A, 1500W(1ms), Bidirectional	DO-214AB	1ba	1j	Gal
CZU	SMCJ85C	TVS	Vbr=94.4..115V, Vrw=85V, 9.9A, 1500W(1ms), Bidirectional	DO-214AB	1ba	1j	Gal
CZV	SMCJ85CA	TVS	Vbr=94.4..104V, Vrw=85V, 10.9A, 1500W(1ms), Bidirectional	DO-214AB	1ba	1j	Gal
CZW	SMCJ90C	TVS	Vbr=100..122V, Vrw=90V, 9.4A, 1500W(1ms), Bidirectional	DO-214AB	1ba	1j	Gal
CZX	SMCJ90CA	TVS	Vbr=100..111V, Vrw=90V, 10.3A, 1500W(1ms), Bidirectional	DO-214AB	1ba	1j	Gal
CZY	SMCJ100C	TVS	Vbr=111..136V, Vrw=100V, 8.4A, 1500W(1ms), Bidirectional	DO-214AB	1ba	1j	Gal
CZZ	SMCJ100CA	TVS	Vbr=111..123V, Vrw=100V, 9.3A, 1500W(1ms), Bidirectional	DO-214AB	1ba	1j	Gal
D	1S5376	Si-diode	Sw, 300V, 100mA, Vf<1.2V(100mA), 30ns	SOT-323	5d	1a	Rhm
D	BAS21-03W	Si-diode	Sw, Fast, 200V, 250mA, Vf=1V(0.1A), 250mW, <50ns	SOD-323	5d	1a	Inf
D	GBLC12I	TVS	Vbr=12V, 1A, 350W(1ms), 0.6pF	SOD-323	5d	1a	Prt
D	MM9D7V5	Z-diode	7.13..7.88V, Izt=5mA, Zzt=30Ω, 200mW	SOD-923	7d	1n	Wtr
d	MMSZ5230BPT	Z-diode	4.465..4.935V, Izt=5mA, Zzt=70Ω, 225mW	SOD-523	7d	1a	Chm
D	MMSZ5253BPT	Z-diode	23.75..26.25V, Izt=5mA, Zzt=62Ω, 225mW	SOD-523	7d	1a	Chm
D	NZ9F4V3ST	Z-diode	4.17..4.43V, Izt=5mA, Zzt=100Ω, 200mW	SOD-923	7d	2m	Ons
D	NZ9F7V5T	Z-diode	7.13..7.88V, Izt=5mA, Zzt=30Ω, 200mW	SOD-923	7d	1n	Ons
D	RB551V-30	Si-diode	SEB, 30V, 500mA, Vf<0.47V(500mA)	SOD-323	5d	1a	Rhm
d.	MMSZ5230SPT	Z-diode	4.606..4.794V, Izt=5mA, Zzt=70Ω, 225mW	SOD-523	7d	1a	Chm
D.	MMSZ5253SPT	Z-diode	24.50..25.50V, Izt=5mA, Zzt=62Ω, 225mW	SOD-523	7d	1a	Chm
D<	UDZS3V3BW	Z-diode	3.32..3.53V, Izt=5mA, Zzt=120Ω, 200mW	SOD-123FL	7d	1a	Tac



SMD
code

Type

Function

Short description

Case

Pinout

St.

Mnf.

SMD code	Type	Function	Short description	Case	Pinout	St.	Mnf.
D=	UDZS2V4BW	Z-diode	2.43..2.63V, Izt=5mA, Zzt=100Ω, 200mW	SOD-123FL	7d	1a	Tac
D>	UDZS3V0BW	Z-diode	3.01..3.22V, Izt=5mA, Zzt=120Ω, 200mW	SOD-123FL	7d	1a	Tac
D≡	UDZS2V7BW	Z-diode	2.69..2.91V, Izt=5mA, Zzt=110Ω, 200mW	SOD-123FL	7d	1a	Tac
D0	BZD27C3V6P	Z-diode	3.4..3.8V, Zzt=4Ω, Izt=100mA, 800mW	SOD-123FL	7d	1a	Vs
D0	BZX384-C9V1	Z-diode	9.1V±5%, Izt=5mA, Zzt=6Ω, 200mW	SOD-323	5d	1k	Phi
D0	MMPZ52345PT	Z-diode	6.070..6.324V, Izt=5mA, Zzt=10Ω, 225mW	SOD-323	5d	1a	Chm
D0	MMPZ52388BPT	Z-diode	8.265..9.135V, Izt=5mA, Zzt=7Ω, 225mW	SOD-323	5d	1a	Chm
D0	TCUDZS3V6B	Z-diode	3.60..3.85V, Izt=5mA, Zzt=90Ω, 200mW	SOD-323FL	7d	1a	Tac
D0	UDZS3V6B	Z-diode	3.60..3.85V, Izt=5mA, Zzt=90Ω, 200mW	SOD-323FL	7d	1a	Tsc
D0	UDZS3V6BW	Z-diode	3.60..3.85V, Izt=5mA, Zzt=90Ω, 200mW	SOD-123FL	7d	1a	Tac
D1	1N4148W	Si-diode	Sw, Fast, 75V, 300mA, Vf<1V(10mA)	SOD-123FL	7d	1a	Tac
D1	3T064AB	Thy-SPD	Vdm=58V, Vs=77V, Ipp=35A, 80pF	DO-214AA	1d	1a	Mde
D1	BZD27C3V9P	Z-diode	3.7..4.1V, Zzt=4Ω, Izt=100mA, 800mW	SOD-123FL	7d	1a	Vs
D1	BZX884-C16	Z-diode	16V±5%, 250mW	SOD-882	13d	2b	Phi
D1	CZRH5226B-G	Z-diode	3.14..3.47V, Zzt=28Ω, Izt=20mA, 150mW	SOD-523	5d	1a	Cmc
D1	MAZF051	Z-diode	4.8..5.4V, Zzt=60Ω(5mA), 120mW	S-Mini	7d	1a	Pan
D1	MAZN051	Z-diode	4.8..5.4V, Zzt=60Ω(5mA), 120mW	SSMini2	7d	1a	Pan
D1	MM3Z5226B	Z-diode	3.14..3.47V, Izt=20mA, Zzt=28Ω, 200mW	SOD-323FL	7d	1a	Ext
D1	MM3Z5226BH	Z-diode	3.14..3.47V, Izt=20mA, Zzt=28Ω, 300mW	SOD-323	5d	1a	Zow
D1	MMSZ5226	Z-diode	3.3V±10%, Zzt=28Ω, 500mW	SOD-123	5d	1k	Vs
D1	MMSZ5226B	Z-diode	3.3V±5%, Zzt=28Ω, 500mW	SOD-123	5d	1a,1d	Di,Mot
D1	MMSZ5230	Z-diode	4.7V±10%, Zzt=19Ω, 500mW	SOD-123	5d	1k	Vs
D1	NZH15B	Z-diode	15V±5%, If=250mA, 500mW	SOD-123FL	7d	1a	Phi
D1	TCUDZS3V9B	Z-diode	3.89..4.16V, Izt=5mA, Zzt=90Ω, 200mW	SOD-323FL	7d	1a	Tac
D1	UDZS3V9B	Z-diode	3.89..4.16V, Izt=5mA, Zzt=90Ω, 200mW	SOD-323FL	7d	1a	Tsc
D1	UDZS3V9BW	Z-diode	3.89..4.16V, Izt=5mA, Zzt=90Ω, 200mW	SOD-123FL	7d	1a	Tac
D10	SMBYU04-100	Si-diode	Rectifier, Fast-Recovery, 100V, 4A, Vf<0.71(1A), <35ns	DO-214AB	1d	1q	Ste
D15	SMBYU04-150	Si-diode	Rectifier, Fast-Recovery, 150V, 4A, Vf<0.85V(1A), <35ns	DO-214AB	1d	1q	Ste
D2	1N4448W	Si-diode	Sw, Fast, 75V, 300mA, Vf<1V(100mA)	SOD-123FL	7d	1a	Tac
D2	3T072AB	Thy-SPD	Vdm=65V, Vs=88V, Ipp=35A, 80pF	DO-214AA	1d	1a	Mde
D2	BAP63-03	PIN-diode	RF, 50V, 100mA, 500mW, 0.35pF, 1.17Ω(10mA/100MHz)	SOD-323	5d	1a	Phi
D2	BZD27C4V3P	Z-diode	4.4..4.6V, Zzt=4Ω, Izt=100mA, 800mW	SOD-123FL	7d	1a	Vs
D2	BZX884-C18	Z-diode	18V±5%, 250mW	SOD-882	13d	2b	Phi
D2	CZRH5227B-G	Z-diode	3.42..3.78V, Zzt=24Ω, Izt=20mA, 150mW	SOD-523	5d	1a	Cmc
D2	MAZF056	Z-diode	5.3..6V, Zzt=40Ω(5mA), 120mW	S-Mini	7d	1a	Pan
D2	MAZN056	Z-diode	5.3..6V, Zzt=40Ω(5mA), 120mW	SSMini2	7d	1a	Pan
D2	MM3Z5227B	Z-diode	3.42..3.78V, Izt=20mA, Zzt=24Ω, 200mW	SOD-323	5d	1a	Ext
D2	MM3Z5245B	Z-diode	15V±5%, Izt=8.5mA, Zzt=16Ω, 200mW	SOD-323FL	7d	1a	Bts
D2	MM3Z5245BH	Z-diode	14.25..15.75V, Izt=8.5mA, Zzt=16Ω, 300mW	SOD-323	5d	1a	Zow
D2	MMSZ5227	Z-diode	3.6V±10%, Zzt=24Ω, 500mW	SOD-123	5d	1k	Vs
D2	MMSZ5227B	Z-diode	3.6V±5%, Zzt=24Ω, 500mW	SOD-123	5d	1a,1d	Di,Mot
D2	MSCD022	Si-diode	SBR, 20V, 0.2A, Vf<0.45V(0.2A)	0805	14d	1v	Zow
D2	NZH16C	Z-diode	16V±5%, If=250mA, 500mW	SOD-123FL	7d	1a	Phi
D2	RKZ3.6B2KK	Z-diode	3.55..3.80V, Izt=5mA, Zzt=130Ω, 150mW	SFP	7d	1a	Ren
D2	RKZ3.6B2KL	Z-diode	3.55..3.80V, Izt=5mA, Zzt=130Ω, 100mW	EPF	7d	1a	Ren
D2	TCUDZS4V3B	Z-diode	4.17..4.43V, Izt=5mA, Zzt=90Ω, 200mW	SOD-323FL	7d	1a	Tac
D2	UDZS4V3B	Z-diode	4.17..4.43V, Izt=5mA, Zzt=90Ω, 200mW	SOD-323FL	7d	1a	Tsc
D2	UDZS4V3BW	Z-diode	4.17..4.43V, Izt=5mA, Zzt=90Ω, 200mW	SOD-123FL	7d	1a	Tac
D20	SMBYU04-200	Si-diode	Rectifier, Fast-Recovery, 200V, 4A, Vf<0.91V(1A), <35ns	DO-214AB	1d	1q	Ste
D3	1N914BW	Si-diode	Sw, Fast, 75V, 300mA, Vf<1V(100mA)	SOD-123FL	7d	1a	Tac
D3	3T080AB	Thy-SPD	Vdm=75V, Vs=98V, Ipp=35A, 60pF	DO-214AA	1d	1a	Mde
D3	BAP65-03	PIN-diode	RF, 30V, 100mA, 500mW, 0.61pF, 0.3Ω(100mA/100MHz)	SOD-323	5d	1a	Phi
D3	BZD27C4V7P	Z-diode	4.4..4.5V, Zzt=3Ω, Izt=100mA, 800mW	SOD-123FL	7d	1a	Vs
D3	BZX884-C20	Z-diode	20V±5%, 250mW	SOD-882	13d	2b	Phi
D3	CZRH5228B-G	Z-diode	3.71..4.1V, Zzt=23Ω, Izt=20mA, 150mW	SOD-523	5d	1a	Cmc
D3	MM3Z5228B	Z-diode	3.71..4.10V, Izt=20mA, Zzt=23Ω, 200mW	SOD-323	5d	1a	Ext
D3	MM3Z5266B	Z-diode	68V±5%, Izt=1.8mA, Zzt=230Ω, 200mW	SOD-323FL	7d	1a	Bts
D3	MM3Z5266BH	Z-diode	64.6..71.4V, Izt=1.8mA, Zzt=230Ω, 300mW	SOD-323	5d	1a	Zow
D3	MMSZ5228	Z-diode	3.9V±10%, Zzt=23Ω, 500mW	SOD-123	5d	1k	Vs
D3	MMSZ5228B	Z-diode	3.9V±5%, Zzt=23Ω, 500mW	SOD-123	5d	1a,1d	Di,Mot
D3	NZH18C	Z-diode	18V±5%, If=250mA, 500mW	SOD-123FL	7d	1a	Phi
D3	TCUDZS4V7B	Z-diode	4.55..4.75V, Izt=5mA, Zzt=80Ω, 200mW	SOD-323FL	7d	1a	Tac
D3	UDZS4V7B	Z-diode	4.55..4.75V, Izt=5mA, Zzt=80Ω, 200mW	SOD-323FL	7d	1a	Tsc
D3	UDZS4V7BW	Z-diode	4.55..4.75V, Izt=5mA, Zzt=80Ω, 200mW	SOD-123FL	7d	1a	Tac
D4	3T110AB	Thy-SPD	Vdm=90V, Vs=130V, Ipp=35A, 60pF	DO-214AA	1d	1a	Mde
D4	BZD27C5V1P	Z-diode	4.8..5.4V, Zzt=3Ω, Izt=100mA, 800mW	SOD-123FL	7d	1a	Vs
D4	BZX884-C22	Z-diode	22V±5%, 250mW	SOD-882	13d	2b	Phi
D4	CZRH5229B-G	Z-diode	4.09..4.52V, Zzt=22Ω, Izt=20mA, 150mW	SOD-523	5d	1a	Cmc
D4	MM1Z5226B	Z-diode	3.14..3.47V, Izt=20mA, Zzt=28Ω, 500mW	SOD-323FL	5d	1a	Eic
D4	MM1Z5226BH	Z-diode	3.14..3.47V, Izt=20mA, Zzt=28Ω, 500mW	SOD-123	5d	1a	Zow



SMD
code

Type

Function

Short description

Case

Pinout

St.

Mnf.

SMD code	Type	Function	Short description	Case	Pinout	St.	Mnf.
D4	MM3Z5229B	Z-diode	4.09..4.52V, Izt=20mA, Zzt=22Ω, 200mW	SOD-323	5d	1a	Ext
D4	MMSZ5226B	Z-diode	3.3V±5%, Izt=20mA, Zzt=28Ω, 500mW	SOD-123	5d	1a	Eic
D4	MMSZ5229	Z-diode	4.3V±10%, Izt=20mA, Zzt=22Ω, 500mW	SOD-123	5d	1k	Vs
D4	MMSZ5229B	Z-diode	4.3V±5%, Izt=20mA, Zzt=22Ω, 500mW	SOD-123	5d	1a,1d	Di,Mot
D4	MSCD024	Si-diode	SBR, 40V, 0.2A, Vf<0.5V(0.2A)	0805	14d	1v	Zow
D4	NZH20C	Z-diode	20V±5%, If=250mA, 500mW	SOD-123FL	7d	1a	Phi
D4	RKZ3.9B2KK	Z-diode	3.87..4.10V, Izt=5mA, Zzt=130Ω, 150mW	SFP	7d	1a	Ren
D4	RKZ3.9B2KL	Z-diode	3.87..4.10V, Izt=5mA, Zzt=130Ω, 100mW	EPF	7d	1a	Ren
D4	TCUDZS5V1B	Z-diode	4.98..5.20V, Izt=5mA, Zzt=60Ω, 200mW	SOD-323FL	7d	1a	Tac
D4	UDZS5V1B	Z-diode	4.98..5.20V, Izt=5mA, Zzt=60Ω, 200mW	SOD-323FL	7d	1a	Tsc
D4	UDZS5V1BW	Z-diode	4.98..5.20V, Izt=5mA, Zzt=60Ω, 200mW	SOD-123FL	7d	1a	Tac
D5	3T130AB	Thy-SPD	Vdm=120V, Vs=160V, Ipp=35A, 40pF	DO-214AA	1d	1a	Mde
D5	BZD27C5V6P	Z-diode	5.2..6V, Zzt=2Ω, Izt=100mA, 800mW	SOD-123FL	7d	1a	Vs
D5	BZX384-C5V1	Z-diode	5.1V±5%, Izt=5mA, Zzt=40Ω, 200mW	SOD-323	5d	1k	Phi
D5	BZX584B8V2	Z-diode	8.04..8.36V, Izt=5mA, Zzt=15Ω, 200mW	SOD-523FL	7d	1a	Tac
D5	BZX884-C24	Z-diode	24V±5%, 250mW	SOD-882	13d	2b	Phi
D5	CZRH5230B-G	Z-diode	4.47..4.94V, Zzt=19Ω, Izt=20mA, 150mW	SOD-523	5d	1a	Cmc
D5	MM1Z5245B	Z-diode	14.25..15.75V, Izt=8.5mA, Zzt=16Ω, 500mW	SOD-323FL	5d	1a	Eic
D5	MM1Z5245BH	Z-diode	14.25..15.75V, Izt=8.5mA, Zzt=16Ω, 500mW	SOD-123	5d	1a	Zow
D5	MM3Z5230B	Z-diode	4.47..4.94V, Izt=20mA, Zzt=19Ω, 200mW	SOD-323	5d	1a	Ext
D5	MMSZ8V2B	Z-diode	8.04..8.36V, Izt=5mA, Zzt=15Ω, 200mW	SOD-523FL	7d	1a	Tac
D5	MMSZ5230B	Z-diode	4.7V±5%, Zzt=19Ω, 500mW	SOD-123	5d	1a,1d	Di,Mot
D5	MMSZ5245B	Z-diode	15V±5%, Izt=8.5mA, Zzt=16Ω, 500mW	SOD-123	5d	1a	Eic
D5	NZH22C	Z-diode	22V±5%, If=250mA, 500mW	SOD-123FL	7d	1a	Phi
D5	SMBY004-50	Si-diode	Rectifier, Fast-Recovery, 50V, 4A, Vf<0.65V(1A), <35ns	DO-214AB	1d	1q	Ste
D5	TCUDZS5V6B	Z-diode	5.49..5.73V, Izt=5mA, Zzt=40Ω, 200mW	SOD-323FL	7d	1a	Tac
D5	UDZS5V6B	Z-diode	5.49..5.73V, Izt=5mA, Zzt=40Ω, 200mW	SOD-323FL	7d	1a	Tsc
D5	UDZS5V6BW	Z-diode	5.49..5.73V, Izt=5mA, Zzt=40Ω, 200mW	SOD-123FL	7d	1a	Tac
D6	3T150AB	Thy-SPD	Vdm=140V, Vs=180V, Ipp=35A, 40pF	DO-214AA	1d	1a	Mde
D6	BZD27C6V2P	Z-diode	5.8..6.6V, Zzt=2Ω, Izt=100mA, 800mW	SOD-123FL	7d	1a	Vs
D6	BZX384-C5V6	Z-diode	5.6V±5%, Izt=5mA, Zzt=15Ω, 200mW	SOD-323	5d	1k	Phi
D6	BZX884-C27	Z-diode	27V±5%, 250mW	SOD-882	13d	2b	Phi
D6	MM1Z5266B	Z-diode	64.60..71.40V, Izt=1.8mA, Zzt=230Ω, 500mW	SOD-323FL	5d	1a	Eic
D6	MM1Z5266BH	Z-diode	64.6..71.4V, Izt=1.8mA, Zzt=230Ω, 500mW	SOD-123	5d	1a	Zow
D6	MMSZ5266B	Z-diode	64.60..71.40V, Izt=1.8mA, Zzt=230Ω, 500mW	SOD-123	5d	1a	Eic
D6	NZH24C	Z-diode	24V±5%, If=250mA, 500mW	SOD-123FL	7d	1a	Phi
D6	RKZ4.3B2KK	Z-diode	4.15..4.34V, Izt=5mA, Zzt=130Ω, 150mW	SFP	7d	1a	Ren
D6	RKZ4.3B2KL	Z-diode	4.15..4.34V, Izt=5mA, Zzt=130Ω, 100mW	EPF	7d	1a	Ren
D6	TCUDZS6V2B	Z-diode	6.06..6.33V, Izt=5mA, Zzt=40Ω, 200mW	SOD-323FL	7d	1a	Tac
D6	UDZS6V2B	Z-diode	6.06..6.33V, Izt=5mA, Zzt=40Ω, 200mW	SOD-323FL	7d	1a	Tsc
D6	UDZS6V2BW	Z-diode	6.06..6.33V, Izt=5mA, Zzt=40Ω, 200mW	SOD-123FL	7d	1a	Tac
D63	CMDD6263	Si-diode	Sw, 70V, 15mA, 250mW, Vf<0.41V(1mA), <2pF	SOD-323	5d	1a	Cen
D7	3T180AB	Thy-SPD	Vdm=160V, Vs=220V, Ipp=35A, 40pF	DO-214AA	1d	1a	Mde
D7	BZD27C6V8P	Z-diode	6.4..7.2V, Zzt=1Ω, Izt=100mA, 800mW	SOD-123FL	7d	1a	Vs
D7	BZX384-C6V8	Z-diode	6.8V±5%, Izt=5mA, Zzt=6Ω, 200mW	SOD-323	5d	1k	Phi
D7	BZX884-C30	Z-diode	30V±5%, 250mW	SOD-882	13d	2b	Phi
D7	NZH27C	Z-diode	27V±5%, If=250mA, 500mW	SOD-123FL	7d	1a	Phi
D7	TCUDZS6V8B	Z-diode	6.65..6.93V, Izt=5mA, Zzt=30Ω, 200mW	SOD-323FL	7d	1a	Tac
D7	UDZS6V8B	Z-diode	6.65..6.93V, Izt=5mA, Zzt=30Ω, 200mW	SOD-323FL	7d	1a	Tsc
D7	UDZS6V8BW	Z-diode	6.65..6.93V, Izt=5mA, Zzt=30Ω, 200mW	SOD-123FL	7d	1a	Tac
D76	BAR18J	Si-diode	Schottky, 70V, 50mA, 250mW, <2pF	SOD-323	5d	1a	Ste
D8	3T230AB	Thy-SPD	Vdm=190V, Vs=260V, Ipp=35A, 30pF	DO-214AA	1d	1a	Mde
D8	BZD27C7V5P	Z-diode	7..7.9 1V, Zzt=2Ω, Izt=100mA, 800mW	SOD-123FL	7d	1a	Vs
D8	BZX384-C7V5	Z-diode	7.5V±5%, Izt=5mA, Zzt=6Ω, 200mW	SOD-323	5d	1k	Phi
D8	BZX884-C33	Z-diode	33V±5%, 250mW	SOD-882	13d	2b	Phi
D8	MMSZ3V6	Z-diode	3.6V±5%, Izt=5mA, Zzt=90Ω, 200mW	SOD-523	6d	1a	Eic
D8	MMSZ3V6H	Z-diode	3.4..3.8V, Izt=5mA, Zzt=90Ω, 200mW	SOD-523	7d	1a	Zow
D8	TCUDZS7V5B	Z-diode	7.28..7.60V, Izt=5mA, Zzt=30Ω, 200mW	SOD-323FL	7d	1a	Tac
D8	UDZS7V5B	Z-diode	7.28..7.60V, Izt=5mA, Zzt=30Ω, 200mW	SOD-323FL	7d	1a	Tsc
D8	UDZS7V5BW	Z-diode	7.28..7.60V, Izt=5mA, Zzt=30Ω, 200mW	SOD-123FL	7d	1a	Tac
D86	BAT54J	Si-diode	SBR, 30V, 200mA, Vf<1V(100mA), 10pF, 5ns	SOD-323	5d	1a	Ste
D9	3T260AB	Thy-SPD	Vdm=220V, Vs=300V, Ipp=35A, 30pF	DO-214AA	1d	1a	Mde
D9	BZD27C8V2P	Z-diode	7.7..8.7V, Zzt=1Ω, Izt=100mA, 800mW	SOD-123FL	7d	1a	Vs
D9	BZX384-C8V2	Z-diode	8.2V±5%, Izt=5mA, Zzt=6Ω, 200mW	SOD-323	5d	1k	Phi
D9	BZX884-C36	Z-diode	36V±5%, 250mW	SOD-882	13d	2b	Phi
D9	MMSZ43H	Z-diode	40..46V, Izt=1mA, Zzt=150Ω, 200mW	SOD-523	7d	1a	Zow
D9	MMSZ43V	Z-diode	43V±5%, Izt=2mA, Zzt=150Ω, 200mW	SOD-523	6d	1a	Eic
D9	NZH13B	Z-diode	13V±5%, If=250mA, 500mW	SOD-123FL	7d	1a	Phi
D9	RKZ4.7B2KK	Z-diode	4.55..4.75V, Izt=5mA, Zzt=130Ω, 150mW	SFP	7d	1a	Ren
D9	RKZ4.7B2KL	Z-diode	4.55..4.75V, Izt=5mA, Zzt=130Ω, 100mW	EPF	7d	1a	Ren



SMD
code

Type

Function

Short description

Case

Pinout

St.

Mnf.

D9	TCUDZS8V2B	Z-diode	8.02..8.36V, Izt=5mA, Zzt=30Ω, 200mW	SOD-323FL	7d	1a	Tac
D9	UDZS8V2B	Z-diode	8.02..8.36V, Izt=5mA, Zzt=30Ω, 200mW	SOD-323FL	7d	1a	Tsc
D9	UDZS8V2BW	Z-diode	8.02..8.36V, Izt=5mA, Zzt=30Ω, 200mW	SOD-123FL	7d	1a	Tac
DA	3T310AB	Thy-SPD	Vdm=275V, Vs=350V, Ipp=35A, 30pF	DO-214AA	1d	1a	Mde
DA	BZX384-C11	Z-diode	11V±5%, Izt=5mA, Zzt=10Ω, 200mW	SOD-323	5d	1k	Phi
DA	BZX884-C39	Z-diode	39V±5%, 250mW	SOD-882	13d	2b	Phi
DA	EC2D01B	Si-diode	Rectifier, 30V, 70mA, Vf<0.65V(70mA), 3pF	ECSF1006-2T	13d	2b	San
DA	MM1Z4708	Z-diode	20.90..23.10V, Izt=10mA, 500mW	SOD-323FL	5d	1a	Eic
DA	MMSZ4708	Z-diode	22V±5%, Izt=50μA, 500mW	SOD-123	5d	1a	Eic
DA	NZH30C	Z-diode	30V±5%, If=250mA, 500mW	SOD-123FL	7d	1a	Phi
DA	S1DA	Si-diode	Rectifier, 200V, 1A, Vf<1.1V(1A)	DO-214AC	1d	1k	Vs
DA	TCUDZS9V1B	Z-diode	8.85..9.23V, Izt=5mA, Zzt=30Ω, 200mW	SOD-323FL	7d	1a	Tac
DA	TV06B800KB-G	TVS	Vrwm=80.0V, Vbr=88.96..108.80V, Ipp=4.19A, 600W(1ms), Bidirectional	DO-214AA	1ba	1j	Cmc
DA	UDZS9V1B	Z-diode	8.85..9.23V, Izt=5mA, Zzt=30Ω, 200mW	SOD-323FL	7d	1a	Tsc
DA	UDZS9V1BW	Z-diode	8.85..9.23V, Izt=5mA, Zzt=30Ω, 200mW	SOD-123FL	7d	1a	Tac
DA	ZMV829	C-diode	VHF/UHF-Tuning, 25V, 330mW, 8.2pF(2V), ΔC ±20%	SOD-323	5d	1a	Zx
DB	3T350AB	Thy-SPD	Vdm=300V, Vs=400V, Ipp=35A, 30pF	DO-214AA	1d	1a	Mde
DB	BZX384-C12	Z-diode	12V±5%, Izt=5mA, Zzt=10Ω, 200mW	SOD-323	5d	1k	Phi
DB	BZX884-C43	Z-diode	43V±5%, 250mW	SOD-882	13d	2b	Phi
DB	MM1Z4709	Z-diode	22.80..25.20V, Izt=10mA, 500mW	SOD-323FL	5d	1a	Eic
DB	MMSZ4709	Z-diode	24V±5%, Izt=50μA, 500mW	SOD-123	5d	1a	Eic
DB	TCUDZS10VB	Z-diode	9.77..10.21V, Izt=5mA, Zzt=20Ω, 200mW	SOD-323FL	7d	1a	Tac
DB	TV06B800JB-G	TVS	Vrwm=80.0V, Vbr=98.80..97.60V, Ipp=4.63A, 600W(1ms), Bidirectional	DO-214AA	1ba	1j	Cmc
DB	UDZS10B	Z-diode	9.77..10.21V, Izt=5mA, Zzt=20Ω, 200mW	SOD-323FL	7d	1a	Tsc
DB	UDZS10VBW	Z-diode	9.77..10.21V, Izt=5mA, Zzt=20Ω, 200mW	SOD-123FL	7d	1a	Tac
DB	ZMV830	C-diode	VHF/UHF-Tuning, 25V, 330mW, 10pF(2V), ΔC ±20%	SOD-323	5d	1a	Zx
DBB	SMAJ6.0CA	TVS	Vrwm=6.0V, Vbr=6.67..7.37V, 38.8A, 400W(1ms), Bidirectional	DO-214AC	1ba	1r	Ste
DBC	SMAJ6.5CA	TVS	Vrwm=6.5V, Vbr=7.22..7.98V, 35.7A, 400W(1ms), Bidirectional	DO-214AC	1ba	1r	Ste
DBH	SMAJ8.5CA	TVS	Vrwm=8.5V, Vbr=9.44..10.4V, 27.7A, 400W(1ms), Bidirectional	DO-214AC	1ba	1r	Ste
DBK	SMAJ12CA	TVS	Vrwm=12V, Vbr=13.3..14.7V, 20.1A, 400W(1ms), Bidirectional	DO-214AC	1ba	1r	Ste
DBQ	SMAJ18CA	TVS	Vrwm=18V, Vbr=20.0..22.1V, 13.7A, 400W(1ms), Bidirectional	DO-214AC	1ba	1r	Ste
DBR	SMAJ20CA	TVS	Vrwm=20V, Vbr=22.2..24.5V, 12.3A, 400W(1ms), Bidirectional	DO-214AC	1ba	1r	Ste
DBS	SMAJ22CA	TVS	Vrwm=22V, Vbr=24.4..26.9V, 11.2A, 400W(1ms), Bidirectional	DO-214AC	1ba	1r	Ste
DBT	SMAJ24CA	TVS	Vrwm=24V, Vbr=26.7..29.5V, 10.3A, 400W(1ms), Bidirectional	DO-214AC	1ba	1r	Ste
DBU	SMAJ26CA	TVS	Vrwm=26V, Vbr=28.9..31.9V, 9.5A, 400W(1ms), Bidirectional	DO-214AC	1ba	1r	Ste
DBZ	SMAJ40CA	TVS	Vrwm=40V, Vbr=44.4..49.1V, 6.2A, 400W(1ms), Bidirectional	DO-214AC	1ba	1r	Ste
DC	3T400AB	Thy-SPD	Vdm=360V, Vs=450V, Ipp=35A, 30pF	DO-214AA	1d	1a	Mde
DC	BZX384-C13	Z-diode	13V±5%, Izt=5mA, Zzt=10Ω, 200mW	SOD-323	5d	1k	Phi
DC	BZX884-C47	Z-diode	47V±5%, 250mW	SOD-882	13d	2b	Phi
DC	GBLC12CI	TVS	Vbr=12V, 1A, 350W(1ms), 0.6pF, Bidirectional	SOD-323	5ba	1e	Prt
DC	MM1Z4710	Z-diode	23.75..26.25V, Izt=10mA, 500mW	SOD-123FL	7d	1a	Sme
DC	MMSZ4695	Z-diode	8.7V±5%, 350mW	SOD-123	5d	1a,1k	Mot,Vs
DC	MMSZ4710	Z-diode	25V±5%, Izt=50μA, 500mW	SOD-123	5d	1a	Eic
DC	TCUDZS11VB	Z-diode	10.76..11.22V, Izt=5mA, Zzt=20Ω, 200mW	SOD-323FL	7d	1a	Tac
DC	UDZS11B	Z-diode	10.76..11.22V, Izt=5mA, Zzt=20Ω, 200mW	SOD-323FL	7d	1a	Tsc
DC	UDZS11VBW	Z-diode	10.76..11.22V, Izt=5mA, Zzt=20Ω, 200mW	SOD-123FL	7d	1a	Tac
DC	ZMV831	C-diode	VHF/UHF-Tuning, 25V, 330mW, 15pF(2V), ΔC ±20%	SOD-323	5d	1a	Zx
DD	BZX384-C15	Z-diode	15V±5%, Izt=5mA, Zzt=10Ω, 200mW	SOD-323	5d	1k	Phi
DD	BZX884-C51	Z-diode	51V±5%, 250mW	SOD-882	13d	2b	Phi
DD	KDZ27B	Z-diode	27V±2.5%, 10mA, 1W	PMDU	7d	1s	Rhm
DD	MM1Z4711	Z-diode	25.65..28.35V, Izt=10mA, 500mW	SOD-323FL	5d	1a	Eic
DD	MMSZ4696	Z-diode	9.1V±5%, 350mW	SOD-123	5d	1a,1k	Mot,Vs
DD	MMSZ4711	Z-diode	27V±5%, Izt=50μA, 500mW	SOD-123	5d	1a	Eic
DD	P4SMA120	TVS	Vrwm=120V, 2.4A, 400W(1ms)	DO-214AC	1d	2j	Fag
DD	P6SMBJ54C	TVS	Vbr=54V, 6.2A, 600W(1ms), Bidirectional	DO-214AA	1ba	1x,1y	Pjt,Srj
DD	SM6T6V8	TVS	Vbr=6.8V, 55A, 600W(1ms)	DO-214AA	1d	1q	Ste
DD	SMBG54C	TVS	Vbr=60V, 6.2A, 600W(1ms), Bidirectional	DO-215AA	5ba	1l	Vs
DD	SMBJ54C	TVS	Vbr=60V, 6.2A, 600W(1ms), Bidirectional	DO-214AA	1ba	1l	Vs
DD	TV06B540KB-G	TVS	Vrwm=54.0V, Vbr=60.0..73.30V, Ipp=6.23A, 600W(1ms), Bidirectional	DO-214AA	1ba	1j	Cmc
DD	ZMV832	C-diode	VHF/UHF-Tuning, 25V, 330mW, 22pF(2V), ΔC ±20%	SOD-323	5d	1a	Zx
DDD	SMLJ5.0C	TVS	Vrwm=5.0V, Vbr=6.40..7.30V, Ipp=312.5A, 3000W(1ms), Bidirectional	DO-214AB	1a	1j	Mco
DDE	SMDJ5.0C	TVS	Vrwm=5.0V, Vbr=6.7V±10%, 326.1A, 3000W(1ms), Bidirectional	DO-214AB	1ba	1j	Mde
DDE	SMDJ5.0CA	TVS	Vrwm=5.0V, Vbr=6.7V±5%, 326.1A, 3000W(1ms), Bidirectional	DO-214AB	1ba	1j	Mde
DDE	SMLJ5.0CA	TVS	Vrwm=5.0V, Vbr=6.40..7.0V, Ipp=326.0A, 3000W(1ms), Bidirectional	DO-214AB	1a	1j	Mco
DDF	SMLJ6.0C	TVS	Vrwm=6.0V, Vbr=6.67..8.15V, Ipp=263.2A, 3000W(1ms), Bidirectional	DO-214AB	1a	1j	Mco
DDG	SMDJ6.0C	TVS	Vrwm=6.0V, Vbr=6.78V±10%, 291.3A, 3000W(1ms), Bidirectional	DO-214AB	1ba	1j	Mde
DDG	SMDJ6.0CA	TVS	Vrwm=6.0V, Vbr=6.78V±5%, 291.3A, 3000W(1ms), Bidirectional	DO-214AB	1ba	1j	Mde
DDG	SMLJ6.0CA	TVS	Vrwm=6.0V, Vbr=6.67..7.37V, Ipp=291.3A, 3000W(1ms), Bidirectional	DO-214AB	1a	1j	Mco
DDH	SMLJ6.5C	TVS	Vrwm=6.5V, Vbr=7.22..8.82V, Ipp=243.9A, 3000W(1ms), Bidirectional	DO-214AB	1a	1j	Mco
DDK	SMDJ6.5C	TVS	Vrwm=6.5V, Vbr=7.02V±10%, 267.9A, 3000W(1ms), Bidirectional	DO-214AB	1ba	1j	Mde



SMD code

Type

Function

Short description

Case

Pinout

St.

Mnf.

SMD code	Type	Function	Short description	Case	Pinout	St.	Mnf.
DDK	SMDJ6.5CA	TVS	Vrwm=6.5V, Vbr=7.02V±5%, 267.9A, 3000W(1ms), Bidirectional	DO-214AB	1ba	1j	Mde
DDK	SMLJ6.5CA	TVS	Vrwm=6.5V, Vbr=7.22..7.98V, lpp=267.9A, 3000W(1ms), Bidirectional	DO-214AB	1a	1j	Mco
DDL	SMLJ7.0C	TVS	Vrwm=7.0V, Vbr=7.78..9.51V, lpp=225.6A, 3000W(1ms), Bidirectional	DO-214AB	1a	1j	Mco
DDM	SMDJ7.0C	TVS	Vrwm=7.0V, Vbr=8.19V±10%, 250.0A, 3000W(1ms), Bidirectional	DO-214AB	1ba	1j	Mde
DDM	SMDJ7.0CA	TVS	Vrwm=7.0V, Vbr=8.19V±5%, 250.0A, 3000W(1ms), Bidirectional	DO-214AB	1ba	1j	Mde
DDM	SMLJ7.0CA	TVS	Vrwm=7.0V, Vbr=7.78..8.60V, lpp=250.0A, 3000W(1ms), Bidirectional	DO-214AB	1a	1j	Mco
DDN	SMLJ7.5C	TVS	Vrwm=7.5V, Vbr=8.33..10.2V, lpp=209.8A, 3000W(1ms), Bidirectional	DO-214AB	1a	1j	Mco
DDP	SMDJ7.5C	TVS	Vrwm=7.5V, Vbr=8.77V±10%, 232.6A, 3000W(1ms), Bidirectional	DO-214AB	1ba	1j	Mde
DDP	SMDJ7.5CA	TVS	Vrwm=7.5V, Vbr=8.77V±5%, 232.6A, 3000W(1ms), Bidirectional	DO-214AB	1ba	1j	Mde
DDP	SMLJ7.5CA	TVS	Vrwm=7.5V, Vbr=8.33..9.21V, lpp=232.6A, 3000W(1ms), Bidirectional	DO-214AB	1a	1j	Mco
DDP	TPSMC6.8	TVS	Vbr=6.8V, 139A, 1500W(1ms)	DO-214AB	1d	1k	Vs
DDQ	SMLJ8.0C	TVS	Vrwm=8.0V, Vbr=8.89..10.9V, lpp=200.0A, 3000W(1ms), Bidirectional	DO-214AB	1a	1j	Mco
DDR	SMDJ8.0C	TVS	Vrwm=8.0V, Vbr=9.36V±10%, 220.6A, 3000W(1ms), Bidirectional	DO-214AB	1ba	1j	Mde
DDR	SMDJ8.0CA	TVS	Vrwm=8.0V, Vbr=9.36V±5%, 220.6A, 3000W(1ms), Bidirectional	DO-214AB	1ba	1j	Mde
DDR	SMLJ8.0CA	TVS	Vrwm=8.0V, Vbr=8.89..9.83V, lpp=220.6A, 3000W(1ms), Bidirectional	DO-214AB	1a	1j	Mco
DDS	SMLJ8.5C	TVS	Vrwm=8.5V, Vbr=9.44..11.5V, lpp=188.6A, 3000W(1ms), Bidirectional	DO-214AB	1a	1j	Mco
DDT	SMDJ8.5C	TVS	Vrwm=8.5V, Vbr=9.92V±10%, 208.3A, 3000W(1ms), Bidirectional	DO-214AB	1ba	1j	Mde
DDT	SMDJ8.5CA	TVS	Vrwm=8.5V, Vbr=9.92V±5%, 208.3A, 3000W(1ms), Bidirectional	DO-214AB	1ba	1j	Mde
DDT	SMLJ8.5CA	TVS	Vrwm=8.5V, Vbr=9.44..10.4V, lpp=208.4A, 3000W(1ms), Bidirectional	DO-214AB	1a	1j	Mco
DDU	SMLJ9.0C	TVS	Vrwm=9.0V, Vbr=10.0..12.2V, lpp=177.4A, 3000W(1ms), Bidirectional	DO-214AB	1a	1j	Mco
DDV	SMDJ9.0C	TVS	Vrwm=9.0V, Vbr=10.55V±10%, 194.8A, 3000W(1ms), Bidirectional	DO-214AB	1ba	1j	Mde
DDV	SMDJ9.0CA	TVS	Vrwm=9.0V, Vbr=10.55V±5%, 194.8A, 3000W(1ms), Bidirectional	DO-214AB	1ba	1j	Mde
DDV	SMLJ9.0CA	TVS	Vrwm=9.0V, Vbr=10.0..11.1V, lpp=194.8A, 3000W(1ms), Bidirectional	DO-214AB	1a	1j	Mco
DDW	SMLJ10C	TVS	Vrwm=10V, Vbr=11.1..13.6V, lpp=159.6A, 3000W(1ms), Bidirectional	DO-214AB	1a	1j	Mco
DDX	SMDJ10C	TVS	Vrwm=10V, Vbr=11.7V±10%, 176.5A, 3000W(1ms), Bidirectional	DO-214AB	1ba	1j	Mde
DDX	SMDJ10CA	TVS	Vrwm=10V, Vbr=11.7V±5%, 176.5A, 3000W(1ms), Bidirectional	DO-214AB	1ba	1j	Mde
DDX	SMLJ10CA	TVS	Vrwm=10V, Vbr=11.1..12.3V, lpp=176.4A, 3000W(1ms), Bidirectional	DO-214AB	1a	1j	Mco
DDY	SMLJ11C	TVS	Vrwm=11V, Vbr=12.2..14.9V, lpp=149.2A, 3000W(1ms), Bidirectional	DO-214AB	1a	1j	Mco
DDZ	SMDJ11C	TVS	Vrwm=11V, Vbr=12.85V±10%, 164.8A, 3000W(1ms), Bidirectional	DO-214AB	1ba	1j	Mde
DDZ	SMDJ11CA	TVS	Vrwm=11V, Vbr=12.85V±5%, 164.8A, 3000W(1ms), Bidirectional	DO-214AB	1ba	1j	Mde
DDZ	SMLJ11CA	TVS	Vrwm=11V, Vbr=12.2..13.5V, lpp=164.8A, 3000W(1ms), Bidirectional	DO-214AB	1a	1j	Mco
DE	BZX384-C16	Z-diode	16V±5%, Izt=5mA, Zzt=10Ω, 200mW	SOD-323	5d	1k	Phi
DE	BZX884-C56	Z-diode	56V±5%, 250mW	SOD-882	13d	2b	Phi
DE	CD214B-T54CA	TVS	Vbr=54V, Itrsm=6.9A, 600W(1ms), Bidirectional	DO-214AA	1ba	1j	Bm
DE	MM1Z4712	Z-diode	26.60..29.40V, Izt=10mA, 500mW	SOD-123FL	7d	1a	Sme
DE	MMSZ4697	Z-diode	10V±5%, 350mW	SOD-123	5d	1a,1k	Mot,Vs
DE	MMSZ4712	Z-diode	28V±5%, Izt=50µA, 500mW	SOD-123	5d	1a	Eic
DE	P4SMA120A	TVS	Vrwm=120V, 2.5A, 400W(1ms)	DO-214AC	1d	2j	Fag
DE	P6SMBJ54AC	TVS	Vbr=54V, 6.9A, 600W(1ms), Bidirectional	DO-214AA	1ba	1x,1y	Pjt,Srj
DE	SMT6T6V8A	TVS	Vrwm=5.8V, Vbr=6.45..7.14V, 57A, 600W(1ms)	DO-214AA	1d	1q,1a	Ste
DE	SMBG54CA	TVS	Vbr=60V, 6.9A, 600W(1ms), Bidirectional	DO-215AA	5ba	1l	Vs
DE	SMBJ54CA	TVS	Vbr=60V, 6.9A, 600W(1ms), Bidirectional	DO-214AA	1ba	1l,1x	Di,Vs
DE	TCUDZS12VB	Z-diode	11.74..12.24V, Izt=5mA, Zzt=20Ω, 200mW	SOD-323FL	7d	1a	Tac
DE	TV04A301J-G	TVS	Vrwm=300.0V, Vbr=335.0..371.0V, lpp=0.82A, 400W(1ms)	DO-214AC	1d	1a	Cmc
DE	TV06B540JB-G	TVS	Vrwm=54.0V, Vbr=60.0..66.30V, lpp=6.89A, 600W(1ms), Bidirectional	DO-214AA	1ba	1j	Cmc
DE	UDZS12B	Z-diode	11.74..12.24V, Izt=5mA, Zzt=20Ω, 200mW	SOD-323FL	7d	1a	Tsc
DE	UDZS12VBW	Z-diode	11.74..12.24V, Izt=5mA, Zzt=20Ω, 200mW	SOD-123FL	7d	1a	Tac
DE	ZMV833	C-diode	VHF/UHF-Tuning, 25V, 330mW, 33pF(2V), ΔC ±20%	SOD-323	5d	1a	Zx
DED	SMLJ12C	TVS	Vrwm=12V, Vbr=13.3..16.3V, lpp=136.4A, 3000W(1ms), Bidirectional	DO-214AB	1a	1j	Mco
DEE	SMDJ12C	TVS	Vrwm=12V, Vbr=14V±10%, 150.8A, 3000W(1ms), Bidirectional	DO-214AB	1ba	1j	Mde
DEE	SMDJ12CA	TVS	Vrwm=12V, Vbr=14V±5%, 150.8A, 3000W(1ms), Bidirectional	DO-214AB	1ba	1j	Mde
DEE	SMLJ12CA	TVS	Vrwm=12V, Vbr=13.3..14.7V, lpp=150.6A, 3000W(1ms), Bidirectional	DO-214AB	1a	1j	Mco
DEF	SMLJ13C	TVS	Vrwm=13V, Vbr=14.4..17.6V, lpp=126.0A, 3000W(1ms), Bidirectional	DO-214AB	1a	1j	Mco
DEG	SMDJ13C	TVS	Vrwm=13V, Vbr=15.15V±10%, 139.5A, 3000W(1ms), Bidirectional	DO-214AB	1ba	1j	Mde
DEG	SMDJ13CA	TVS	Vrwm=13V, Vbr=15.15V±5%, 139.5A, 3000W(1ms), Bidirectional	DO-214AB	1ba	1j	Mde
DEG	SMLJ13CA	TVS	Vrwm=13V, Vbr=14.4..15.9V, lpp=139.4A, 3000W(1ms), Bidirectional	DO-214AB	1a	1j	Mco
DEH	SMLJ14C	TVS	Vrwm=14V, Vbr=15.6..19.1V, lpp=116.2A, 3000W(1ms), Bidirectional	DO-214AB	1a	1j	Mco
DEK	SMDJ14C	TVS	Vrwm=14V, Vbr=16.4V±10%, 129.3A, 3000W(1ms), Bidirectional	DO-214AB	1ba	1j	Mde
DEK	SMDJ14CA	TVS	Vrwm=14V, Vbr=16.4V±5%, 129.3A, 3000W(1ms), Bidirectional	DO-214AB	1ba	1j	Mde
DEK	SMLJ14CA	TVS	Vrwm=14V, Vbr=15.6..17.2V, lpp=129.4A, 3000W(1ms), Bidirectional	DO-214AB	1a	1j	Mco
DEL	SMLJ15C	TVS	Vrwm=15V, Vbr=16.7..20.4V, lpp=111.6A, 3000W(1ms), Bidirectional	DO-214AB	1a	1j	Mco
DEM	SMDJ15C	TVS	Vrwm=15V, Vbr=17.6V±10%, 123.0A, 3000W(1ms), Bidirectional	DO-214AB	1ba	1j	Mde
DEM	SMDJ15CA	TVS	Vrwm=15V, Vbr=17.6V±5%, 123.0A, 3000W(1ms), Bidirectional	DO-214AB	1ba	1j	Mde
DEM	SMLJ15CA	TVS	Vrwm=15V, Vbr=16.7..18.5V, lpp=123.0A, 3000W(1ms), Bidirectional	DO-214AB	1a	1j	Mco
DEN	SMLJ16C	TVS	Vrwm=16V, Vbr=17.8..21.8V, lpp=104.2A, 3000W(1ms), Bidirectional	DO-214AB	1a	1j	Mco
DEP	SMDJ16C	TVS	Vrwm=16V, Vbr=18.7V±10%, 115.4A, 3000W(1ms), Bidirectional	DO-214AB	1ba	1j	Mde
DEP	SMDJ16CA	TVS	Vrwm=16V, Vbr=18.7V±5%, 115.4A, 3000W(1ms), Bidirectional	DO-214AB	1ba	1j	Mde
DEP	SMLJ16CA	TVS	Vrwm=16V, Vbr=17.8..19.7V, lpp=115.4A, 3000W(1ms), Bidirectional	DO-214AB	1a	1j	Mco
DEP	TPSMC6.8A	TVS	Vbr=6.8V, 143A, 1500W(1ms)	DO-214AB	1d	1k	Vs
DEQ	SMLJ17C	TVS	Vrwm=17V, Vbr=18.9..23.1V, lpp=98.4A, 3000W(1ms), Bidirectional	DO-214AB	1a	1j	Mco



SMD
code

Type

Function

Short description

Case

Pinout

St.

Mnf.

SMD code	Type	Function	Short description	Case	Pinout	St.	Mnf.
DER	SMDJ17C	TVS	Vrwm=17V, Vbr=19.9V±10%, 108.7A, 3000W(1ms), Bidirectional	DO-214AB	1ba	1j	Mde
DER	SMDJ17CA	TVS	Vrwm=17V, Vbr=19.9V±5%, 108.7A, 3000W(1ms), Bidirectional	DO-214AB	1ba	1j	Mde
DER	SMLJ17CA	TVS	Vrwm=17V, Vbr=18.9..20.9V, Ipp=106.6A, 3000W(1ms), Bidirectional	DO-214AB	1a	1j	Mco
DES	SMLJ18C	TVS	Vrwm=18V, Vbr=20.0..24.4V, Ipp=93.2A, 3000W(1ms), Bidirectional	DO-214AB	1a	1j	Mco
DET	SMDJ18C	TVS	Vrwm=18V, Vbr=21V±10%, 102.7A, 3000W(1ms), Bidirectional	DO-214AB	1ba	1j	Mde
DET	SMDJ18CA	TVS	Vrwm=18V, Vbr=21V±5%, 102.7A, 3000W(1ms), Bidirectional	DO-214AB	1ba	1j	Mde
DET	SMLJ18CA	TVS	Vrwm=18V, Vbr=20.0..22.1V, Ipp=102.8A, 3000W(1ms), Bidirectional	DO-214AB	1a	1j	Mco
DEU	SMLJ20C	TVS	Vrwm=20V, Vbr=22.2..27.1V, Ipp=83.8A, 3000W(1ms), Bidirectional	DO-214AB	1a	1j	Mco
DEV	SMDJ20C	TVS	Vrwm=20V, Vbr=23.3V±10%, 92.6A, 3000W(1ms), Bidirectional	DO-214AB	1ba	1j	Mde
DEV	SMDJ20CA	TVS	Vrwm=20V, Vbr=23.3V±5%, 92.6A, 3000W(1ms), Bidirectional	DO-214AB	1ba	1j	Mde
DEV	SMLJ20CA	TVS	Vrwm=20V, Vbr=22.2..24.5V, Ipp=92.6A, 3000W(1ms), Bidirectional	DO-214AB	1a	1j	Mco
DEW	SMLJ22C	TVS	Vrwm=22V, Vbr=24.4..29.8V, Ipp=76.2A, 3000W(1ms), Bidirectional	DO-214AB	1a	1j	Mco
DEX	SMDJ22C	TVS	Vrwm=22V, Vbr=25.6V±10%, 84.5A, 3000W(1ms), Bidirectional	DO-214AB	1ba	1j	Mde
DEX	SMDJ22CA	TVS	Vrwm=22V, Vbr=25.6V±5%, 84.5A, 3000W(1ms), Bidirectional	DO-214AB	1ba	1j	Mde
DEX	SMLJ22CA	TVS	Vrwm=22V, Vbr=24.4..26.9V, Ipp=84.4A, 3000W(1ms), Bidirectional	DO-214AB	1a	1j	Mco
DEY	SMLJ24C	TVS	Vrwm=24V, Vbr=26.7..32.6V, Ipp=69.8A, 3000W(1ms), Bidirectional	DO-214AB	1a	1j	Mco
DEZ	SMDJ24C	TVS	Vrwm=24V, Vbr=28.1V±10%, 77.1A, 3000W(1ms), Bidirectional	DO-214AB	1ba	1j	Mde
DEZ	SMDJ24CA	TVS	Vrwm=24V, Vbr=28.1V±5%, 77.1A, 3000W(1ms), Bidirectional	DO-214AB	1ba	1j	Mde
DEZ	SMLJ24CA	TVS	Vrwm=24V, Vbr=26.7..29.5V, Ipp=77.2A, 3000W(1ms), Bidirectional	DO-214AB	1a	1j	Mco
DF	BZX384-C18	Z-diode	18V±5%, Izt=5mA, Zzt=10Ω, 200mW	SOD-323	5d	1k	Phi
DF	BZX884-C62	Z-diode	62V±5%, 250mW	SOD-882	13d	2b	Phi
DF	KDZ8.2FV	Z-diode	7.70..8.70V, Izt=5mA, Zzt=20Ω, 100mW	TFSC	7d	1a	Kec
DF	MAZD062	Z-diode	5.8..6.6V, Zzt=30Ω(5mA), 120mW	SSSMini2	7d	1a	Pan
DF	MM1Z4713	Z-diode	28.50..31.50V, Izt=10mA, 500mW	SOD-323FL	5d	1a	Eic
DF	MMSZ4698	Z-diode	11V±5%, 350mW	SOD-123	5d	1a,1k	Mot,Vs
DF	MMSZ4713	Z-diode	30V±5%, Izt=50μA, 500mW	SOD-123	5d	1a	Eic
DF	P4SMA130	TVS	Vrwm=130V 2.2A, 400W(1ms),	DO-214AC	1d	2j	Fag
DF	P6SMBJ58C	TVS	Vbr=58V, 5.8A, 600W(1ms), Bidirectional	DO-214AA	1ba	1x,1y	Pjt,Srj
DF	SMT6T7V5	TVS	Vbr=7.5V, 51A, 600W(1ms)	DO-214AA	1d	1q	Ste
DF	SMBG58C	TVS	Vbr=58V, 5.8A, 600W(1ms), Bidirectional	DO-215AA	5ba	1l	Vs
DF	SMBJ58C	TVS	Vbr=58V, 5.8A, 600W(1ms), Bidirectional	DO-214AA	1ba	1l	Vs
DF	TCUDZS13VB	Z-diode	12.91..13.49V, Izt=5mA, Zzt=40Ω, 200mW	SOD-323FL	7d	1a	Tac
DF	TV06B580K-B	TVS	Vrwm=58.0V, Vbr=64.40..78.70V, Ipp=5.83A, 600W(1ms), Bidirectional	DO-214AA	1ba	1j	Cmc
DF	UDZS13B	Z-diode	12.91..13.49V, Izt=5mA, Zzt=40Ω, 200mW	SOD-323FL	7d	1a	Tsc
DF	UDZS13VBW	Z-diode	12.91..13.49V, Izt=5mA, Zzt=40Ω, 200mW	SOD-123FL	7d	1a	Tac
DF	ZMV834	C-diode	VHF/UHF-Tuning, 25V, 330mW, 47pF(2V), ΔC ±20%	SOD-323	5d	1a	Zx
DFD	SMLJ26C	TVS	Vrwm=26V, Vbr=28.9..35.3V, Ipp=64.4A, 3000W(1ms), Bidirectional	DO-214AB	1a	1j	Mco
DFF	SMDJ26C	TVS	Vrwm=26V, Vbr=30.4V±10%, 71.3A, 3000W(1ms), Bidirectional	DO-214AB	1ba	1j	Mde
DFF	SMDJ26CA	TVS	Vrwm=26V, Vbr=30.4V±5%, 71.3A, 3000W(1ms), Bidirectional	DO-214AB	1ba	1j	Mde
DFF	SMLJ26CA	TVS	Vrwm=26V, Vbr=28.9..31.9V, Ipp=71.2A, 3000W(1ms), Bidirectional	DO-214AB	1a	1j	Mco
DFF	SMLJ28C	TVS	Vrwm=28V, Vbr=31.1..38.0V, Ipp=60.0A, 3000W(1ms), Bidirectional	DO-214AB	1a	1j	Mco
DFG	SMDJ28C	TVS	Vrwm=28V, Vbr=32.7V±10%, 66.1A, 3000W(1ms), Bidirectional	DO-214AB	1ba	1j	Mde
DFG	SMDJ28CA	TVS	Vrwm=28V, Vbr=32.7V±5%, 66.1A, 3000W(1ms), Bidirectional	DO-214AB	1ba	1j	Mde
DFG	SMLJ28CA	TVS	Vrwm=28V, Vbr=31.1..34.4V, Ipp=66.0A, 3000W(1ms), Bidirectional	DO-214AB	1a	1j	Mco
DFH	SMLJ30C	TVS	Vrwm=30V, Vbr=33.3..40.7V, Ipp=56.0A, 3000W(1ms), Bidirectional	DO-214AB	1a	1j	Mco
DFK	SMDJ30C	TVS	Vrwm=30V, Vbr=35V±10%, 62.0A, 3000W(1ms), Bidirectional	DO-214AB	1ba	1j	Mde
DFK	SMDJ30CA	TVS	Vrwm=30V, Vbr=35V±5%, 62.0A, 3000W(1ms), Bidirectional	DO-214AB	1ba	1j	Mde
DFK	SMLJ30CA	TVS	Vrwm=30V, Vbr=33.3..36.8V, Ipp=62.0A, 3000W(1ms), Bidirectional	DO-214AB	1a	1j	Mco
DFL	SMLJ33C	TVS	Vrwm=33V, Vbr=36.7..44.9V, Ipp=50.4A, 3000W(1ms), Bidirectional	DO-214AB	1a	1j	Mco
DFM	SMDJ33C	TVS	Vrwm=33V, Vbr=38.6V±10%, 56.3A, 3000W(1ms), Bidirectional	DO-214AB	1ba	1j	Mde
DFM	SMDJ33CA	TVS	Vrwm=33V, Vbr=38.6V±5%, 56.3A, 3000W(1ms), Bidirectional	DO-214AB	1ba	1j	Mde
DFM	SMLJ33CA	TVS	Vrwm=33V, Vbr=36.7..40.6V, Ipp=56.2A, 3000W(1ms), Bidirectional	DO-214AB	1a	1j	Mco
DFN	SMLJ36C	TVS	Vrwm=36V, Vbr=40.0..48.9V, Ipp=46.6A, 3000W(1ms), Bidirectional	DO-214AB	1a	1j	Mco
DFF	SMDJ36C	TVS	Vrwm=36V, Vbr=42.1V±10%, 51.6A, 3000W(1ms), Bidirectional	DO-214AB	1ba	1j	Mde
DFF	SMDJ36CA	TVS	Vrwm=36V, Vbr=42.1V±5%, 51.6A, 3000W(1ms), Bidirectional	DO-214AB	1ba	1j	Mde
DFF	SMLJ36CA	TVS	Vrwm=36V, Vbr=40.0..44.2V, Ipp=51.6A, 3000W(1ms), Bidirectional	DO-214AB	1a	1j	Mco
DFF	TPSMC7.5	TVS	Vbr=7.5V, 128A, 1500W(1ms)	DO-214AB	1d	1k	Vs
DFQ	SMLJ40C	TVS	Vrwm=40V, Vbr=44.4..54.3V, Ipp=42.0A, 3000W(1ms), Bidirectional	DO-214AB	1a	1j	Mco
DFR	SMDJ40C	TVS	Vrwm=40V, Vbr=46.7V±10%, 46.5A, 3000W(1ms), Bidirectional	DO-214AB	1ba	1j	Mde
DFR	SMDJ40CA	TVS	Vrwm=40V, Vbr=46.7V±5%, 46.5A, 3000W(1ms), Bidirectional	DO-214AB	1ba	1j	Mde
DFR	SMLJ40CA	TVS	Vrwm=40V, Vbr=44.4..49.1V, Ipp=46.4A, 3000W(1ms), Bidirectional	DO-214AB	1a	1j	Mco
DFS	SMLJ43C	TVS	Vrwm=43V, Vbr=47.8..58.4V, Ipp=39.2A, 3000W(1ms), Bidirectional	DO-214AB	1a	1j	Mco
DFT	SMDJ43C	TVS	Vrwm=43V, Vbr=50.3V±10%, 43.2A, 3000W(1ms), Bidirectional	DO-214AB	1ba	1j	Mde
DFT	SMDJ43CA	TVS	Vrwm=43V, Vbr=50.3V±5%, 43.2A, 3000W(1ms), Bidirectional	DO-214AB	1ba	1j	Mde
DFT	SMLJ43CA	TVS	Vrwm=43V, Vbr=47.8..52.8V, Ipp=43.2A, 3000W(1ms), Bidirectional	DO-214AB	1a	1j	Mco
DFU	SMLJ45C	TVS	Vrwm=45V, Vbr=50.0..61.1V, Ipp=37.4A, 3000W(1ms), Bidirectional	DO-214AB	1a	1j	Mco
DFV	SMDJ45C	TVS	Vrwm=45V, Vbr=52.6V±10%, 41.3A, 3000W(1ms), Bidirectional	DO-214AB	1ba	1j	Mde
DFV	SMDJ45CA	TVS	Vrwm=45V, Vbr=52.6V±5%, 41.3A, 3000W(1ms), Bidirectional	DO-214AB	1ba	1j	Mde
DFV	SMLJ45CA	TVS	Vrwm=45V, Vbr=50.0..55.3V, Ipp=41.2A, 3000W(1ms), Bidirectional	DO-214AB	1a	1j	Mco
DFW	SMLJ48C	TVS	Vrwm=48V, Vbr=53.3..65.1V, Ipp=35.0A, 3000W(1ms), Bidirectional	DO-214AB	1a	1j	Mco



SMD code	Type	Function	Short description	Case	Pinout	St.	Mnf.
DFX	SMDJ48C	TVS	Vrwm=48V, Vbr=56.1V±10%, 38.8A, 3000W(1ms), Bidirectional	DO-214AB	1ba	1j	Mde
DFX	SMDJ48CA	TVS	Vrwm=48V, Vbr=56.1V±5%, 38.8A, 3000W(1ms), Bidirectional	DO-214AB	1ba	1j	Mde
DFX	SMLJ48CA	TVS	Vrwm=48V, Vbr=53.3.58.9V, lpp=38.4A, 3000W(1ms), Bidirectional	DO-214AB	1a	1j	Mco
DFY	SMLJ51C	TVS	Vrwm=51V, Vbr=56.7.69.3V, lpp=37.0A, 3000W(1ms), Bidirectional	DO-214AB	1a	1j	Mco
DFZ	SMDJ51C	TVS	Vrwm=51V, Vbr=59.7V±10%, 36.4A, 3000W(1ms), Bidirectional	DO-214AB	1ba	1j	Mde
DFZ	SMDJ51CA	TVS	Vrwm=51V, Vbr=59.7V±5%, 36.4A, 3000W(1ms), Bidirectional	DO-214AB	1ba	1j	Mde
DFZ	SMLJ51CA	TVS	Vrwm=51V, Vbr=56.7.62.7V, lpp=36.4A, 3000W(1ms), Bidirectional	DO-214AB	1a	1j	Mco
DG	BZX384-C20	Z-diode	20V±5%, lzt=5mA, Zzt=15Ω, 200mW	SOD-323	5d	1k	Phi
DG	BZX884-C68	Z-diode	68V±5%, 250mW	SOD-882	13d	2b	Phi
DG	CD214B-T58CA	TVS	Vbr=58V, Iism=6.4A, 600W(1ms), Bidirectional	DO-214AA	1ba	1j	Bm
DG	P4SMA130A	TVS	Vrwm=130V, 2.3A, 400W(1ms),	DO-214AC	1d	2j	Fag
DG	P6SMBJ58AC	TVS	Vbr=58V, 6.4A, 600W(1ms), Bidirectional	DO-214AA	1ba	1x,1y	Pjt,Srj
DG	SM6T7V5A	TVS	Vrwm=6.4V, Vbr=7.13.7.88V, 53A, 600W(1ms)	DO-214AA	1d	1q,1a	Ste
DG	SMBG58CA	TVS	Vbr=58V, 6.4A, 600W(1ms), Bidirectional	DO-215AA	5ba	1l	Vs
DG	SMBJ58CA	TVS	Vbr=58V, 6.4A, 600W(1ms), Bidirectional	DO-214AA	1ba	1l,1x	Di,Vs
DG	TCUDZS15VB	Z-diode	14.34.14.98V, lzt=5mA, Zzt=40Ω, 200mW	SOD-323FL	7d	1a	Tac
DG	TV04A351J-G	TVS	Vrwm=350.0V, Vbr=391.0.432.0V, lpp=0.71A, 400W(1ms)	DO-214AC	1d	1a	Cmc
DG	TV06B580JB-G	TVS	Vrwm=58.0V, Vbr=64.40.71.20V, lpp=6.41A, 600W(1ms), Bidirectional	DO-214AA	1ba	1j	Cmc
DG	UDZS15B	Z-diode	14.34.14.98V, lzt=5mA, Zzt=40Ω, 200mW	SOD-323FL	7d	1a	Tsc
DG	UDZS15VBW	Z-diode	14.34.14.98V, lzt=5mA, Zzt=40Ω, 200mW	SOD-123FL	7d	1a	Tac
DG	ZMV835	C-diode	VHF/UHF-Tuning, 25V, 330mW, 68pF(2V), ΔC ±20%	SOD-323	5d	1a	Zc
DGD	SMLJ54C	TVS	Vrwm=54V, Vbr=60.0.73.3V, lpp=31.2A, 3000W(1ms), Bidirectional	DO-214AB	1a	1j	Mco
DGE	SMDJ54C	TVS	Vrwm=54V, Vbr=63.1V±10%, 34.4A, 3000W(1ms), Bidirectional	DO-214AB	1ba	1j	Mde
DGE	SMDJ54CA	TVS	Vrwm=54V, Vbr=63.1V±5%, 34.4A, 3000W(1ms), Bidirectional	DO-214AB	1ba	1j	Mde
DGE	SMLJ54CA	TVS	Vrwm=54V, Vbr=60.0.66.3V, lpp=34.4A, 3000W(1ms), Bidirectional	DO-214AB	1a	1j	Mco
DGF	SMLJ58C	TVS	Vrwm=58V, Vbr=64.4.78.7V, lpp=39.2A, 3000W(1ms), Bidirectional	DO-214AB	1a	1j	Mco
DGG	SMDJ58C	TVS	Vrwm=58V, Vbr=67.8V±10%, 32.1A, 3000W(1ms), Bidirectional	DO-214AB	1ba	1j	Mde
DGG	SMDJ58CA	TVS	Vrwm=58V, Vbr=67.8V±5%, 32.1A, 3000W(1ms), Bidirectional	DO-214AB	1ba	1j	Mde
DGG	SMLJ58CA	TVS	Vrwm=58V, Vbr=64.4.71.2V, lpp=32.0A, 3000W(1ms), Bidirectional	DO-214AB	1a	1j	Mco
DGH	SMLJ60C	TVS	Vrwm=60V, Vbr=66.7.81.5V, lpp=28.0A, 3000W(1ms), Bidirectional	DO-214AB	1a	1j	Mco
DGK	SMDJ60C	TVS	Vrwm=60V, Vbr=73.3V±10%, 31A, 3000W(1ms), Bidirectional	DO-214AB	1ba	1j	Mde
DGK	SMDJ60CA	TVS	Vrwm=60V, Vbr=73.3V±5%, 31A, 3000W(1ms), Bidirectional	DO-214AB	1ba	1j	Mde
DGK	SMLJ60CA	TVS	Vrwm=60V, Vbr=66.7.73.7V, lpp=31.0A, 3000W(1ms), Bidirectional	DO-214AB	1a	1j	Mco
DGL	SMLJ64C	TVS	Vrwm=64V, Vbr=71.1.86.9V, lpp=26.4A, 3000W(1ms), Bidirectional	DO-214AB	1a	1j	Mco
DGM	SMDJ64C	TVS	Vrwm=64V, Vbr=74.8V±10%, 29.1A, 3000W(1ms), Bidirectional	DO-214AB	1ba	1j	Mde
DGM	SMDJ64CA	TVS	Vrwm=64V, Vbr=74.8V±5%, 29.1A, 3000W(1ms), Bidirectional	DO-214AB	1ba	1j	Mde
DGM	SMLJ64CA	TVS	Vrwm=64V, Vbr=71.1.78.6V, lpp=29.2A, 3000W(1ms), Bidirectional	DO-214AB	1a	1j	Mco
DGN	SMLJ70C	TVS	Vrwm=70V, Vbr=77.8.95.1V, lpp=24.0A, 3000W(1ms), Bidirectional	DO-214AB	1a	1j	Mco
DGP	SMDJ70C	TVS	Vrwm=70V, Vbr=71.9V±10%, 26.5A, 3000W(1ms), Bidirectional	DO-214AB	1ba	1j	Mde
DGP	SMDJ70CA	TVS	Vrwm=70V, Vbr=71.9V±5%, 26.5A, 3000W(1ms), Bidirectional	DO-214AB	1ba	1j	Mde
DGP	SMLJ70CA	TVS	Vrwm=70V, Vbr=77.8.86.0V, lpp=6.6A, 3000W(1ms), Bidirectional	DO-214AB	1a	1j	Mco
DGP	TPSMC7.5A	TVS	Vbr=7.5V, 133A, 1500W(1ms)	DO-214AB	1d	1k	Vs
DGQ	SMLJ75C	TVS	Vrwm=75V, Vbr=83.3.102V, lpp=22.4A, 3000W(1ms), Bidirectional	DO-214AB	1a	1j	Mco
DGR	SMDJ75C	TVS	Vrwm=75V, Vbr=87.7V±10%, 24.8A, 3000W(1ms), Bidirectional	DO-214AB	1ba	1j	Mde
DGR	SMDJ75CA	TVS	Vrwm=75V, Vbr=87.7V±5%, 24.8A, 3000W(1ms), Bidirectional	DO-214AB	1ba	1j	Mde
DGR	SMLJ75CA	TVS	Vrwm=75V, Vbr=83.3.92.1V, lpp=24.8A, 3000W(1ms), Bidirectional	DO-214AB	1a	1j	Mco
DGS	SMLJ78C	TVS	Vrwm=78V, Vbr=86.7.106V, lpp=21.6A, 3000W(1ms), Bidirectional	DO-214AB	1a	1j	Mco
DGT	SMDJ78C	TVS	Vrwm=78V, Vbr=91.2V±10%, 23.8A, 3000W(1ms), Bidirectional	DO-214AB	1ba	1j	Mde
DGT	SMDJ78CA	TVS	Vrwm=78V, Vbr=91.2V±5%, 23.8A, 3000W(1ms), Bidirectional	DO-214AB	1ba	1j	Mde
DGT	SMLJ78CA	TVS	Vrwm=78V, Vbr=86.7.95.8V, lpp=22.8A, 3000W(1ms), Bidirectional	DO-214AB	1a	1j	Mco
DGU	SMLJ85C	TVS	Vrwm=85V, Vbr=94.4.115V, lpp=19.8A, 3000W(1ms), Bidirectional	DO-214AB	1a	1j	Mco
DGV	SMDJ85C	TVS	Vrwm=85V, Vbr=99.2V±10%, 21.9A, 3000W(1ms), Bidirectional	DO-214AB	1ba	1j	Mde
DGV	SMDJ85CA	TVS	Vrwm=85V, Vbr=99.2V±5%, 21.9A, 3000W(1ms), Bidirectional	DO-214AB	1ba	1j	Mde
DGV	SMLJ85CA	TVS	Vrwm=85V, Vbr=94.4.104V, lpp=20.8A, 3000W(1ms), Bidirectional	DO-214AB	1a	1j	Mco
DGW	SMLJ90C	TVS	Vrwm=90V, Vbr=100.122V, lpp=18.8A, 3000W(1ms), Bidirectional	DO-214AB	1a	1j	Mco
DGX	SMDJ90C	TVS	Vrwm=90V, Vbr=105.5V±10%, 20.5A, 3000W(1ms), Bidirectional	DO-214AB	1ba	1j	Mde
DGX	SMLJ90CA	TVS	Vrwm=90V, Vbr=105.5V±5%, 20.5A, 3000W(1ms), Bidirectional	DO-214AB	1ba	1j	Mde
DGX	SMDJ90CA	TVS	Vrwm=90V, Vbr=100.111V, lpp=20.6A, 3000W(1ms), Bidirectional	DO-214AB	1a	1j	Mco
DGY	SMLJ100C	TVS	Vrwm=100V, Vbr=111.136V, lpp=16.8A, 3000W(1ms), Bidirectional	DO-214AB	1a	1j	Mco
DGZ	SMDJ100C	TVS	Vrwm=100V, Vbr=117V±10%, 18.5A, 3000W(1ms), Bidirectional	DO-214AB	1ba	1j	Mde
DGZ	SMDJ100CA	TVS	Vrwm=100V, Vbr=117V±5%, 18.5A, 3000W(1ms), Bidirectional	DO-214AB	1ba	1j	Mde
DGZ	SMLJ100CA	TVS	Vrwm=100V, Vbr=111.123V, lpp=18.6A, 3000W(1ms), Bidirectional	DO-214AB	1a	1j	Mco
DH	BZX384-C22	Z-diode	22V±5%, lzt=5mA, Zzt=20Ω, 200mW	SOD-323	5d	1k	Phi
DH	BZX884-C75	Z-diode	75V±5%, 250mW	SOD-882	13d	2b	Phi
DH	MM1Z4714	Z-diode	31.35.34.65V, lzt=10mA, 500mW	SOD-323FL	5d	1a	Eic
DH	MMSZ4699	Z-diode	12V±5%, 350mW	SOD-123	5d	1a,1k	Mot,Vs
DH	MMSZ4714	Z-diode	33V±5%, lzt=50μA, 500mW	SOD-123	5d	1a	Eic
DH	P4SMA150	TVS	Vrwm=150V, 2A, 400W(1ms),	DO-214AC	1d	2j	Fag
DH	P6SMBJ60C	TVS	Vbr=60V, 5.6A, 600W(1ms), Bidirectional	DO-214AA	1ba	1x,1y	Pjt,Srj
DH	SMBG60C	TVS	Vbr=60V, 5.6A, 600W(1ms), Bidirectional	DO-215AA	5ba	1l	Vs



SMD code	Type	Function	Short description	Case	Pinout	St.	Mnf.
DH	SMBJ60C	TVS	Vbr=60V, 5.6A, 600W(1ms), Bidirectional	DO-214AA	1ba	1l	Vs
DH	TCUDZS16VB	Z-diode	15.85..16.51V, Izt=5mA, Zzt=40Ω, 200mW	SOD-323FL	7d	1a	Tac
DH	TV06B600KB-G	TVS	Vrwm=60.0V, Vbr=66.70..81.50V, Ipp=5.61A, 600W(1ms), Bidirectional	DO-214AA	1ba	1j	Cmc
DH	UDZS16B	Z-diode	15.85..16.51V, Izt=5mA, Zzt=40Ω, 200mW	SOD-323FL	7d	1a	Tsc
DH	UDZS16VBW	Z-diode	15.85..16.51V, Izt=5mA, Zzt=40Ω, 200mW	SOD-123FL	7d	1a	Tac
DHD	SMLJ110C	TVS	Vrwm=110V, Vbr=122.149V, Ipp=15.4A, 3000W(1ms), Bidirectional	DO-214AB	1a	1j	Mco
DHE	SMDJ110C	TVS	Vrwm=110V, Vbr=128.5V±5%, 16.9A, 3000W(1ms), Bidirectional	DO-214AB	1ba	1j	Mde
DHE	SMDJ110CA	TVS	Vrwm=110V, Vbr=128.5V±5%, 16.9A, 3000W(1ms), Bidirectional	DO-214AB	1ba	1j	Mde
DHE	SMLJ110CA	TVS	Vrwm=110V, Vbr=122.135V, Ipp=16.8A, 3000W(1ms), Bidirectional	DO-214AB	1a	1j	Mco
DHF	SMLJ120C	TVS	Vrwm=120V, Vbr=133.163V, Ipp=14.0A, 3000W(1ms), Bidirectional	DO-214AB	1a	1j	Mco
DHG	SMDJ120C	TVS	Vrwm=120V, Vbr=140V±10%, 15.5A, 3000W(1ms), Bidirectional	DO-214AB	1ba	1j	Mde
DHG	SMDJ120CA	TVS	Vrwm=120V, Vbr=140V±5%, 15.5A, 3000W(1ms), Bidirectional	DO-214AB	1ba	1j	Mde
DHG	SMLJ120CA	TVS	Vrwm=120V, Vbr=133.147V, Ipp=15.6A, 3000W(1ms), Bidirectional	DO-214AB	1a	1j	Mco
DHH	SMLJ130C	TVS	Vrwm=130V, Vbr=144.176V, Ipp=13.0A, 3000W(1ms), Bidirectional	DO-214AB	1a	1j	Mco
DHK	SMDJ130C	TVS	Vrwm=130V, Vbr=151.5V±10%, 14.4A, 3000W(1ms), Bidirectional	DO-214AB	1ba	1j	Mde
DHK	SMDJ130CA	TVS	Vrwm=130V, Vbr=151.5V±5%, 14.4A, 3000W(1ms), Bidirectional	DO-214AB	1ba	1j	Mde
DHK	SMLJ130CA	TVS	Vrwm=130V, Vbr=144.159V, Ipp=14.4A, 3000W(1ms), Bidirectional	DO-214AB	1a	1j	Mco
DHL	SMLJ150C	TVS	Vrwm=150V, Vbr=167.204V, Ipp=11.2A, 3000W(1ms), Bidirectional	DO-214AB	1a	1j	Mco
DHM	SMDJ150C	TVS	Vrwm=150V, Vbr=176V±10%, 12.3A, 3000W(1ms), Bidirectional	DO-214AB	1ba	1j	Mde
DHM	SMDJ150CA	TVS	Vrwm=150V, Vbr=176V±5%, 12.3A, 3000W(1ms), Bidirectional	DO-214AB	1ba	1j	Mde
DHM	SMLJ150CA	TVS	Vrwm=150V, Vbr=167.185V, Ipp=12.4A, 3000W(1ms), Bidirectional	DO-214AB	1a	1j	Mco
DHN	SMLJ160C	TVS	Vrwm=160V, Vbr=178.218V, Ipp=10.4A, 3000W(1ms), Bidirectional	DO-214AB	1a	1j	Mco
DHP	SMDJ160C	TVS	Vrwm=160V, Vbr=187.5V±10%, 11.6A, 3000W(1ms), Bidirectional	DO-214AB	1ba	1j	Mde
DHP	SMDJ160CA	TVS	Vrwm=160V, Vbr=187.5V±5%, 11.6A, 3000W(1ms), Bidirectional	DO-214AB	1ba	1j	Mde
DHP	SMLJ160CA	TVS	Vrwm=160V, Vbr=178.197V, Ipp=11.6A, 3000W(1ms), Bidirectional	DO-214AB	1a	1j	Mco
DHP	TPSMC8.2	TVS	Vbr=8.2V, 120A, 1500W(1ms)	DO-214AB	1d	1k	Vs
DHQ	SMLJ170C	TVS	Vrwm=170V, Vbr=189.231V, Ipp=9.8A, 3000W(1ms), Bidirectional	DO-214AB	1a	1j	Mco
DHR	SMDJ170C	TVS	Vrwm=170V, Vbr=199V±10%, 10.9A, 3000W(1ms), Bidirectional	DO-214AB	1ba	1j	Mde
DHR	SMDJ170CA	TVS	Vrwm=170V, Vbr=199V±5%, 10.9A, 3000W(1ms), Bidirectional	DO-214AB	1ba	1j	Mde
DHR	SMLJ170CA	TVS	Vrwm=170V, Vbr=189.209V, Ipp=11.0A, 3000W(1ms), Bidirectional	DO-214AB	1a	1j	Mco
DJ	BZX384-C24	Z-diode	24V±5%, Izt=2mA, Zzt=25Ω, 200mW	SOD-323	5d	1k	Phi
DJ	MM1Z4715	Z-diode	34.20..37.80V, Izt=10mA, 500mW	SOD-323FL	5d	1a	Eic
DJ	MMSZ4700	Z-diode	13V±5%, 350mW	SOD-123	5d	1a,1k	Mot,Vs
DJ	MMSZ4715	Z-diode	36V±5%, Izt=50μA, 500mW	SOD-123	5d	1a	Eic
DJ	TCUDZS18VB	Z-diode	17.56..18.35V, Izt=5mA, Zzt=50Ω, 200mW	SOD-323FL	7d	1a	Tac
DJ	UDZS18B	Z-diode	17.56..18.35V, Izt=5mA, Zzt=50Ω, 200mW	SOD-323FL	7d	1a	Tsc
DJ	UDZS18VBW	Z-diode	17.56..18.35V, Izt=5mA, Zzt=50Ω, 200mW	SOD-123FL	7d	1a	Tac
DK	BZX384-C27	Z-diode	27V±5%, Izt=2mA, Zzt=25Ω, 200mW	SOD-323	5d	1k	Phi
DK	CD214B-T60CA	TVS	Vbr=60V, Ibrsm=6.2A, 600W(1ms), Bidirectional	DO-214AA	1ba	1j	Bm
DK	MM1Z4716	Z-diode	37.05..40.95V, Izt=10mA, 500mW	SOD-323FL	5d	1a	Eic
DK	MMSZ4701	Z-diode	14V±5%, 350mW	SOD-123	5d	1a,1k	Mot,Vs
DK	MMSZ4716	Z-diode	39V±5%, Izt=50μA, 500mW	SOD-123	5d	1a	Eic
DK	P6SMBJ60AC	TVS	Vbr=60V, 6.2A, 600W(1ms), Bidirectional	DO-214AA	1ba	1x,1y	Pjt,Srj
DK	SMBG60CA	TVS	Vbr=60V, 6.2A, 600W(1ms), Bidirectional	DO-215AA	5ba	1l	Vs
DK	SMBJ60CA	TVS	Vbr=60V, 6.2A, 600W(1ms), Bidirectional	DO-214AA	1ba	1l,1x	Di,Vs
DK	TCUDZS20VB	Z-diode	19.52..20.39V, Izt=5mA, Zzt=60Ω, 200mW	SOD-323FL	7d	1a	Tac
DK	TV04A401J-G	TVS	Vrwm=400.0V, Vbr=447.0..494.0V, Ipp=0.62A, 400W(1ms)	DO-214AC	1d	1a	Cmc
DK	TV06B600JB-G	TVS	Vrwm=60.0V, Vbr=66.70..73.70V, Ipp=6.20A, 600W(1ms), Bidirectional	DO-214AA	1ba	1j	Cmc
DK	UDZS20B	Z-diode	19.52..20.39V, Izt=5mA, Zzt=60Ω, 200mW	SOD-323FL	7d	1a	Tsc
DK	UDZS20VBW	Z-diode	19.52..20.39V, Izt=5mA, Zzt=60Ω, 200mW	SOD-123FL	7d	1a	Tac
DKP	TPSMC8.2A	TVS	Vbr=8.2V, 124A, 1500W(1ms)	DO-214AB	1d	1k	Vs
DL	BZX384-C30	Z-diode	30V±5%, Izt=2mA, Zzt=30Ω, 200mW	SOD-323	5d	1k	Phi
DL	P4SMA150A	TVS	Vrwm=150V, 2A, 400W(1ms),	DO-214AC	1d	2j	Fag
DL	P6SMBJ64C	TVS	Vbr=64V, 5.3A, 600W(1ms), Bidirectional	DO-214AA	1ba	1x,1y	Pjt,Srj
DL	SMBG64C	TVS	Vbr=64V, 5.3A, 600W(1ms), Bidirectional	DO-215AA	5ba	1l	Vs
DL	SMBJ64C	TVS	Vbr=64V, 5.3A, 600W(1ms), Bidirectional	DO-214AA	1ba	1l	Vs
DL	TCUDZS22VB	Z-diode	21.54..22.47V, Izt=5mA, Zzt=80Ω, 200mW	SOD-323FL	7d	1a	Tac
DL	TV06B640KB-G	TVS	Vrwm=64.0V, Vbr=71.10..86.90V, Ipp=5.26A, 600W(1ms), Bidirectional	DO-214AA	1ba	1j	Cmc
DL	UDZS22B	Z-diode	21.54..22.47V, Izt=5mA, Zzt=80Ω, 200mW	SOD-323FL	7d	1a	Tsc
DL	UDZS22VBW	Z-diode	21.54..22.47V, Izt=5mA, Zzt=80Ω, 200mW	SOD-123FL	7d	1a	Tac
DLP	TPSMC9.1	TVS	Vbr=9.1V, 109A, 1500W(1ms)	DO-214AB	1d	1k	Vs
DM	BZX384-C33	Z-diode	33V±5%, Izt=2mA, Zzt=35Ω, 200mW	SOD-323	5d	1k	Phi
DM	CD214B-T64CA	TVS	Vbr=64V, Ibrsm=5.8A, 600W(1ms), Bidirectional	DO-214AA	1ba	1j	Bm
DM	MM1Z4717	Z-diode	40.85..45.15V, Izt=10mA, 500mW	SOD-323FL	5d	1a	Eic
DM	MMSZ4702	Z-diode	15V±5%, 350mW	SOD-123	5d	1a,1k	Mot,Vs
DM	MMSZ4717	Z-diode	43V±5%, Izt=50μA, 500mW	SOD-123	5d	1a	Eic
DM	P4SMA160	TVS	Vrwm=160V, 1.8A, 400W(1ms),	DO-214AC	1d	2j	Fag
DM	P6SMBJ64AC	TVS	Vbr=64V, 5.8A, 600W(1ms), Bidirectional	DO-214AA	1ba	1x,1y	Pjt,Srj
DM	SMBG64CA	TVS	Vbr=64V, 5.8A, 600W(1ms), Bidirectional	DO-215AA	5ba	1l	Vs
DM	SMBJ64CA	TVS	Vbr=64V, 5.8A, 600W(1ms), Bidirectional	DO-214AA	1ba	1l,1x	Di,Vs



SMD
code

Type

Function

Short description

Case

Pinout

St.

Mnf.

SMD code	Type	Function	Short description	Case	Pinout	St.	Mnf.
DM	TCUDZS24VB	Z-diode	23.72..24.78V, Izt=5mA, Zzt=80Ω, 200mW	SOD-323FL	7d	1a	Tac
DM	TV04A441J-G	TVS	Vrwm=440.0V, Vbr=492.0..543.0V, Ipp=0.56A, 400W(1ms)	DO-214AC	1d	1a	Cmc
DM	TV06B640JB-G	TVS	Vrwm=64.0V, Vbr=71.10..78.60V, Ipp=5.83A, 600W(1ms), Bidirectional	DO-214AA	1ba	1j	Cmc
DM	UDZS24B	Z-diode	23.72..24.78V, Izt=5mA, Zzt=80Ω, 200mW	SOD-323FL	7d	1a	Tsc
DM	UDZS24VBW	Z-diode	23.72..24.78V, Izt=5mA, Zzt=80Ω, 200mW	SOD-123FL	7d	1a	Tac
DMP	TPSMC9.1A	TVS	Vbr=9.1V, 112A, 1500W(1ms)	DO-214AB	1d	1k	Vs
DN	BZX384-C36	Z-diode	36V±5%, Izt=2mA, Zzt=35Ω, 200mW	SOD-323	5d	1k	Phi
DN	MM3Z2B4H	Z-diode	2.352..2.448V, Izt=5mA, Zzt=100Ω, 300mW	SOD-323	5d	1a	Zow
DN	MMSZ4703	Z-diode	16V±5%, 350mW	SOD-123	5d	1a,1k	Mot,Vs
DN	P4SMA160A	TVS	Vrwm=160V, 1.9A, 400W (1ms),	DO-214AC	1d	2j	Fag
DN	P6SMBJ70C	TVS	Vbr=70V, 4.8A, 600W(1ms), Bidirectional	DO-214AA	1ba	1x,1y	Pjt,Srj
DN	SM6T10	TVS	Vbr=10V, 40A, 600W(1ms)	DO-214AA	1d	1q	Ste
DN	SMBG70C	TVS	Vbr=70V, 4.8A, 600W(1ms), Bidirectional	DO-215AA	5ba	1l	Vs
DN	SMBJ70C	TVS	Vbr=70V, 4.8A, 600W(1ms), Bidirectional	DO-214AA	1ba	1l	Vs
DN	TCUDZS27VB	Z-diode	26.19..27.53V, Izt=5mA, Zzt=100Ω, 200mW	SOD-323FL	7d	1a	Tac
DN	TV06B700KB-G	TVS	Vrwm=70.0V, Vbr=77.80..95.10V, Ipp=4.80A, 600W(1ms), Bidirectional	DO-214AA	1ba	1j	Cmc
DN	UDZS27B	Z-diode	26.19..27.53V, Izt=5mA, Zzt=100Ω, 200mW	SOD-323FL	7d	1a	Tsc
DN	UDZS27VBW	Z-diode	26.19..27.53V, Izt=5mA, Zzt=100Ω, 200mW	SOD-123FL	7d	1a	Tac
DNP	TPSMC10	TVS	Vbr=10V, 100A, 1500W(1ms)	DO-214AB	1d	1k	Vs
DP	BZX384-C39	Z-diode	39V±5%, Izt=2mA, Zzt=40Ω, 200mW	SOD-323	5d	1k	Phi
DP	CD214B-T70CA	TVS	Vbr=70V, Irsm=5.3A, 600W(1ms), Bidirectional	DO-214AA	1ba	1j	Bm
DP	CMDZ2L8	Z-diode	2.660..2.940V, Izt=0.5mA, Zzt=900Ω, 250mW	SOD-323	5d	1a	Cen
DP	KDZ8.2FVY	Z-diode	8.02..8.36V, Izt=5mA, Zzt=20Ω, 100mW	TFSC	7d	1a	Kec
DP	MM3Z2B7H	Z-diode	2.646..2.754V, Izt=5mA, Zzt=110Ω, 300mW	SOD-323	5d	1a	Zow
DP	MMSZ4704	Z-diode	17V±5%, 350mW	SOD-123	5d	1a,1k	Mot,Vs
DP	P4SMA170	TVS	Vrwm=170V, 1.7A, 400W (1ms),	DO-214AC	1d	2j	Fag
DP	P6SMBJ70AC	TVS	Vbr=70V, 5.3A, 600W(1ms), Bidirectional	DO-214AA	1ba	1x,1y	Pjt,Srj
DP	SM6T10A	TVS	Vrwm=8.55V, Vbr=9.5..10.5V, 41A, 600W(1ms)	DO-214AA	1d	1a	Ste
DP	SMBG70CA	TVS	Vbr=70V, 5.3A, 600W(1ms), Bidirectional	DO-215AA	5ba	1l	Vs
DP	SMBJ70CA	TVS	Vbr=70V, 5.3A, 600W(1ms), Bidirectional	DO-214AA	1ba	1l,1x	Di,Vs
DP	TCUDZS30VB	Z-diode	29.19..30.69V, Izt=5mA, Zzt=100Ω, 200mW	SOD-323FL	7d	1a	Tac
DP	TV06B700JB-G	TVS	Vrwm=70.0V, Vbr=77.80..86.0V, Ipp=5.31A, 600W(1ms), Bidirectional	DO-214AA	1ba	1j	Cmc
DP	UDZS30B	Z-diode	29.19..30.69V, Izt=5mA, Zzt=100Ω, 200mW	SOD-323FL	7d	1a	Tsc
DP	UDZS30VBW	Z-diode	29.19..30.69V, Izt=5mA, Zzt=100Ω, 200mW	SOD-123FL	7d	1a	Tac
DPP	TPSMC10A	TVS	Vbr=10V, 103A, 1500W(1ms)	DO-214AB	1d	1k	Vs
DQ	P4SMA170A	TVS	Vrwm=170V, 1.8A, 400W (1ms),	DO-214AC	1d	2j	Fag
DQ	P6SMBJ75C	TVS	Vbr=75V, 4.5A, 600W(1ms), Bidirectional	DO-214AA	1ba	1x,1y	Pjt,Srj
DQ	SMBG75C	TVS	Vbr=75V, 4.5A, 600W(1ms), Bidirectional	DO-215AA	5ba	1l	Vs
DQ	SMBJ75C	TVS	Vbr=75V, 4.5A, 600W(1ms), Bidirectional	DO-214AA	1ba	1l	Vs
DQ	TV06B750KB-G	TVS	Vrwm=75.0V, Vbr=83.30..102.0V, Ipp=4.48A, 600W(1ms), Bidirectional	DO-214AA	1ba	1j	Cmc
DQP	TPSMC11	TVS	Vbr=11V, 92.6A, 1500W(1ms)	DO-214AB	1d	1k	Vs
DR	BZX384-C43	Z-diode	43V±5%, Izt=2mA, Zzt=45Ω, 200mW	SOD-323	5d	1k	Phi
DR	CD214B-T75CA	TVS	Vbr=75V, Irsm=4.9A, 600W(1ms), Bidirectional	DO-214AA	1ba	1j	Bm
DR	MM3Z3B0H	Z-diode	2.94..3.06V, Izt=5mA, Zzt=120Ω, 300mW	SOD-323	5d	1a	Zow
DR	P4SMA180	TVS	Vrwm=180V, 1.6A, 400W (1ms),	DO-214AC	1d	2j	Fag
DR	P6SMBJ75AC	TVS	Vbr=75V, 4.9A, 600W(1ms), Bidirectional	DO-214AA	1ba	1x,1y	Pjt,Srj
DR	SMBG75CA	TVS	Vbr=75V, 5A, 600W(1ms), Bidirectional	DO-215AA	5ba	1l	Vs
DR	SMBJ75CA	TVS	Vbr=75V, 5A, 600W(1ms), Bidirectional	DO-214AA	1ba	1l,1x	Di,Vs
DR	TCUDZS33VB	Z-diode	32.15..33.79V, Izt=5mA, Zzt=100Ω, 200mW	SOD-323FL	7d	1a	Tac
DR	TV06B750JB-G	TVS	Vrwm=75.0V, Vbr=83.30..92.10V, Ipp=4.96A, 600W(1ms), Bidirectional	DO-214AA	1ba	1j	Cmc
DR	UDZS33B	Z-diode	32.15..33.79V, Izt=5mA, Zzt=100Ω, 200mW	SOD-323FL	7d	1a	Tsc
DR	UDZS33VBW	Z-diode	32.15..33.79V, Izt=5mA, Zzt=100Ω, 200mW	SOD-123FL	7d	1a	Tac
DRP	TPSMC11A	TVS	Vbr=11V, 96.2A, 1500W(1ms)	DO-214AB	1d	1k	Vs
DS	BZX384-C47	Z-diode	47V±5%, Izt=2mA, Zzt=50Ω, 200mW	SOD-323	5d	1k	Phi
DS	P4SMA180A	TVS	Vrwm=180V, 1.7A, 400W (1ms),	DO-214AC	1d	2j	Fag
DS	P6SMBJ78C	TVS	Vbr=78V, 4.3A, 600W(1ms), Bidirectional	DO-214AA	1ba	1x,1y	Pjt,Srj
DS	SMBG78C	TVS	Vbr=78V, 4.3A, 600W(1ms), Bidirectional	DO-215AA	5ba	1l	Vs
DS	SMBJ78C	TVS	Vbr=78V, 4.3A, 600W(1ms), Bidirectional	DO-214AA	1ba	1l	Vs
DS	TCUDZS36VB	Z-diode	35.07..36.87V, Izt=5mA, Zzt=100Ω, 200mW	SOD-323FL	7d	1a	Tac
DS	TV06B780KB-G	TVS	Vrwm=78.0V, Vbr=86.70..106.0V, Ipp=4.32A, 600W(1ms), Bidirectional	DO-214AA	1ba	1j	Cmc
DS	UDZS36B	Z-diode	35.07..36.87V, Izt=5mA, Zzt=100Ω, 200mW	SOD-323FL	7d	1a	Tsc
DS	UDZS36VBW	Z-diode	35.07..36.87V, Izt=5mA, Zzt=100Ω, 200mW	SOD-123FL	7d	1a	Tac
DSP	TPSMC12	TVS	Vbr=12V, 86.7A, 1500W(1ms)	DO-214AB	1d	1k	Vs
DT	BZX384-C51	Z-diode	51V±5%, Izt=2mA, Zzt=60Ω, 200mW	SOD-323	5d	1k	Phi
DT	CD214B-T78CA	TVS	Vbr=78V, Irsm=4.7A, 600W(1ms), Bidirectional	DO-214AA	1ba	1j	Bm
DT	MMSZ4705	Z-diode	18V±5%, 350mW	SOD-123	5d	1a,1k	Mot,Vs
DT	P4SMA200	TVS	Vrwm=200V, 1.5A, 400W (1ms),	DO-214AC	1d	2j	Fag
DT	P6SMBJ78AC	TVS	Vbr=78V, 4.7A, 600W(1ms), Bidirectional	DO-214AA	1ba	1x,1y	Pjt,Srj
DT	SM6T12A	TVS	Vrwm=10.2V, Vbr=11.4..12.6V, 36A, 600W(1ms)	DO-214AA	1d	1a	Ste
DT	SMBG78CA	TVS	Vbr=78V, 4.8A, 600W(1ms), Bidirectional	DO-215AA	5ba	1l	Vs



SMD
code

Type

Function

Short description

Case

Pinout

St.

Mnf.

SMD code	Type	Function	Short description	Case	Pinout	St.	Mnf.
DT	SMBJ78CA	TVS	Vbr=78V, 4.8A, 600W(1ms), Bidirectional	DO-214AA	1ba	1,1x	Di,Vs
DT	TV06B780JB-G	TVS	Vrwm=78.0V, Vbr=86.70..95.80V, Ipp=4.76A, 600W(1ms), Bidirectional	DO-214AA	1ba	1j	Cmc
DTP	TPSMC12A	TVS	Vbr=12V, 89.8A, 1500W(1ms)	DO-214AB	1d	1k	Vs
DU	BZX384-C56	Z-diode	56V±5%, Izt=2mA, Zzt=70Ω, 200mW	SOD-323	5d	1k	Phi
DU	MMSZ4706	Z-diode	19V±5%, 350mW	SOD-123	5d	1a,1k	Mot,Vs
DU	P4SMA200A	TVS	Vrwm=200V, 1.53A, 400W(1ms),	DO-214AC	1d	2j	Fag
DU	P6SMBJ85C	TVS	Vbr=85V, 3.9A, 600W(1ms), Bidirectional	DO-214AA	1ba	1x,1y	Pjt,Srj
DU	SMBG85C	TVS	Vbr=85V, 4A, 600W(1ms), Bidirectional	DO-215AA	5ba	1l	Vs
DU	SMBJ85C	TVS	Vbr=85V, 4A, 600W(1ms), Bidirectional	DO-214AA	1ba	1l	Vs
DU	TV06B850KB-G	TVS	Vrwm=85.0V, Vbr=94.40..115.0V, Ipp=3.97A, 600W(1ms), Bidirectional	DO-214AA	1ba	1j	Cmc
DUB	SMAJ6.0A	TVS	Vrwm=6.0V, Vbr=6.67..7.37V, 38.8A, 400W(1ms)	DO-214AC	1d	1q	Ste
DUC	SMAJ6.5A	TVS	Vrwm=6.5V, Vbr=7.22..7.98V, 35.7A, 400W(1ms)	DO-214AC	1d	1q	Ste
DUH	SMAJ8.5A	TVS	Vrwm=8.5V, Vbr=9.44..10.4V, 27.7A, 400W(1ms)	DO-214AC	1d	1q	Ste
DUK	SMAJ12A	TVS	Vrwm=12V, Vbr=13.3..14.7V, 20.1A, 400W(1ms)	DO-214AC	1d	1q	Ste
DUP	TPSMC13	TVS	Vbr=13V, 78.9A, 1500W(1ms)	DO-214AB	1d	1k	Vs
DUQ	SMAJ18A	TVS	Vrwm=18V, Vbr=20.0..22.1V, 13.7A, 400W(1ms)	DO-214AC	1d	1q	Ste
DUR	SMAJ20A	TVS	Vrwm=20V, Vbr=22.2..24.5V, 12.3A, 400W(1ms)	DO-214AC	1d	1q	Ste
DUS	SMAJ22A	TVS	Vrwm=22V, Vbr=24.4..26.9V, 11.2A, 400W(1ms)	DO-214AC	1d	1q	Ste
DUT	SMAJ24A	TVS	Vrwm=24V, Vbr=26.7..29.5V, 10.3A, 400W(1ms)	DO-214AC	1d	1q	Ste
DUU	SMAJ26A	TVS	Vrwm=26V, Vbr=28.9..31.9V, 9.5A, 400W(1ms)	DO-214AC	1d	1q	Ste
DUZ	SMAJ40A	TVS	Vrwm=40V, Vbr=44.4..49.1V, 6.2A, 400W(1ms)	DO-214AC	1d	1q	Ste
DV	BZX384-C62	Z-diode	62V±5%, Izt=2mA, Zzt=80Ω, 200mW	SOD-323	5d	1k	Phi
DV	CD214B-T85CA	TVS	Vbr=85V, Irsrm=4.4A, 600W(1ms), Bidirectional	DO-214AA	1ba	1j	Bm
DV	MMSZ4707	Z-diode	20V±5%, 350mW	SOD-123	5d	1a,1k	Mot,Vs
DV	P4SMA220	TVS	Vrwm=220V, 1.16A, 400W(1ms),	DO-214AC	1d	2j	Fag
DV	P6SMBJ85AC	TVS	Vbr=85V, 4.4A, 600W(1ms), Bidirectional	DO-214AA	1ba	1x,1y	Pjt,Srj
DV	SMBG85CA	TVS	Vbr=85V, 4.4A, 600W(1ms), Bidirectional	DO-215AA	5ba	1l	Vs
DV	SMBJ85CA	TVS	Vbr=85V, 4.4A, 600W(1ms), Bidirectional	DO-214AA	1ba	1,1,1x	Di,Vs
DV	TV06B850JB-G	TVS	Vrwm=85.0V, Vbr=94.40..104.0V, Ipp=4.38A, 600W(1ms), Bidirectional	DO-214AA	1ba	1j	Cmc
DVP	TPSMC13A	TVS	Vbr=13V, 82.4A, 1500W(1ms)	DO-214AB	1d	1k	Vs
DW	BZX384-C68	Z-diode	68V±5%, Izt=2mA, Zzt=90Ω, 200mW	SOD-323	5d	1k	Phi
DW	P6SMBJ90C	TVS	Vbr=90V, 3.8A, 600W(1ms), Bidirectional	DO-214AA	1ba	1x,1y	Pjt,Srj
DW	SM6T15	TVS	Vbr=15V, 27A, 600W(1ms)	DO-214AA	1d	1q	Ste
DW	SMBG90CC	TVS	Vbr=90V, 3.8A, 600W(1ms), Bidirectional	DO-215AA	5ba	1l	Vs
DW	SMBJ90CC	TVS	Vbr=90V, 3.8A, 600W(1ms), Bidirectional	DO-214AA	1ba	1l	Vs
DW	TV06B900KB-G	TVS	Vrwm=90.0V, Vbr=100.0..122.0V, Ipp=3.75A, 600W(1ms), Bidirectional	DO-214AA	1ba	1j	Cmc
DWP	TPSMC15	TVS	Vbr=15V, 68.2A, 1500W(1ms)	DO-214AB	1d	1k	Vs
DX	BZX384-C75	Z-diode	75V±5%, Izt=2mA, Zzt=95Ω, 200mW	SOD-323	5d	1k	Phi
DX	CD214B-T90CA	TVS	Vbr=90V, Irsrm=4.1A, 600W(1ms), Bidirectional	DO-214AA	1ba	1j	Bm
DX	MM3Z3B3H	Z-diode	3.234..3.366V, Izt=5mA, Zzt=130Ω, 300mW	SOD-323	5d	1a	Zow
DX	P4SMA220A	TVS	Vrwm=220V, 1.22A, 400W(1ms),	DO-214AC	1d	2j	Fag
DX	P6SMBJ90AC	TVS	Vbr=90V, 4.1A, 600W(1ms), Bidirectional	DO-214AA	1ba	1x,1y	Pjt,Srj
DX	SM6T15A	TVS	Vrwm=12.8V, Vbr=14.3..15.8V, 28A, 600W(1ms)	DO-214AA	1d	1a	Ste
DX	SMBG90CA	TVS	Vbr=90V, 4.1A, 600W(1ms), Bidirectional	DO-215AA	5ba	1l	Vs
DX	SMBJ90CA	TVS	Vbr=90V, 4.1A, 600W(1ms), Bidirectional	DO-214AA	1ba	1,1,1x	Di,Vs
DX	TV06B900JB-G	TVS	Vrwm=90.0V, Vbr=100.0..111.0V, Ipp=4.11A, 600W(1ms), Bidirectional	DO-214AA	1ba	1j	Cmc
DXP	TPSMC15A	TVS	Vbr=15V, 70.8A, 1500W(1ms)	DO-214AB	1d	1k	Vs
DY	KDZ2.7V7VY	Z-diode	2.65..2.90V, Izt=5mA, Zzt=110.Ω, 100mW	VSC	7d	1a	Kec
DY	MM3Z3B6H	Z-diode	3.528..3.672V, Izt=5mA, Zzt=130Ω, 300mW	SOD-323	5d	1a	Zow
DY	MMSZ4710	Z-diode	25V±5%, 350mW	SOD-123	5d	1a,1k	Mot,Vs
DY	P6SMBJ100C	TVS	Vbr=100V, 3.4A, 600W(1ms), Bidirectional	DO-214AA	1ba	1x,1y	Pjt,Srj
DY	SMBG100C	TVS	Vbr=100V, 3.4A, 600W(1ms), Bidirectional	DO-215AA	5ba	1l	Vs
DY	SMBJ100C	TVS	Vrwm=100V, Vbr=111..128V, 3.4A, 600W(1ms), Bidirectional	DO-214AA	1ba	1l	Vs
DY	TV06B101KB-G	TVS	Vrwm=100.0V, Vbr=111.0..136.0V, Ipp=3.35A, 600W(1ms), Bidirectional	DO-214AA	1ba	1j	Cmc
DYP	TPSMC16	TVS	Vbr=16V, 63.8A, 1500W(1ms)	DO-214AB	1d	1k	Vs
DZ	BZT52-B8V2S	Z-diode	8.04..8.36V, Izt=5mA, Zzt=15Ω, 200mW	SOD-323FL	7d	1a	Tsc
DZ	CD214B-T100CA	TVS	Vbr=100V, Irsrm=3.7A, 600W(1ms), Bidirectional	DO-214AA	1ba	1j	Bm
DZ	MM3Z3B9H	Z-diode	3.822..3.978V, Izt=5mA, Zzt=130Ω, 300mW	SOD-323	5d	1a	Zow
DZ	MM3Z8V2B	Z-diode	8.04..8.36V, Zzt=14Ω, Izt=5mA, 200mW	SOD-323FL	7d	1a	F
DZ	MM3Z8V2BW	Z-diode	8.04..8.36V, Izt=5mA, Zzt=15Ω, 200mW	SOD-323FL	7d	1a	Tac
DZ	MMSZ4709	Z-diode	24V±5%, 350mW	SOD-123	5d	1a,1k	Mot,Vs
DZ	P6SMBJ100AC	TVS	Vbr=100V, 3.7A, 600W(1ms), Bidirectional	DO-214AA	1ba	1x,1y	Pjt,Srj
DZ	SMBG100CA	TVS	Vbr=100V, 3.7A, 600W(1ms), Bidirectional	DO-215AA	5ba	1l	Vs
DZ	SMBJ100CA	TVS	Vrwm=100V, Vbr=111..128V, 3.7A, 600W(1ms), Bidirectional	DO-214AA	1ba	1,1,1x	Di,Vs
DZ	TCMM3Z8V2B	Z-diode	8.2V±2%, Izt=5mA, Zzt=14Ω, 200mW	SOD-323FL	7d	1a	Tac
DZ	TV06B101JB-G	TVS	Vrwm=100.0V, Vbr=111.0..123.0V, Ipp=3.70A, 600W(1ms), Bidirectional	DO-214AA	1ba	1j	Cmc
DZP	TPSMC16A	TVS	Vbr=16V, 66.7A, 1500W(1ms)	DO-214AB	1d	1k	Vs
E	1SS380	Si-diode	Sw, 40V, 100mA, Vf<1.2V(100mA), 4ns	SOD-123	5d	1a	Rhm
E	CDZ16B	Z-diode	16V±2.5%, Izt=20mA, 1W	VMN	7d	1s	Rhm
E	CDZ6.8B	Z-diode	6.8V±2.5%, 40mA, 1W	VMN	7d	1s	Rhm



SMD
code

Type

Function

Short description

Case

Pinout

St.

Mnf.

E	CH621S-40PT	Si-diode	SBD, 40V, 100mA, Vf<0.6V(50mA)	SOD-523	8d	1a	Chm
E	EP05H10	Si-diode	SBR, 100V, 500mA, Vf<0.8V(500mA)	SOD-123	5d	1a	Nih
E	ESD9Z3.3	TVS	Vrwm=3.3V, Vbr=5.0V, 10.4A, 102W(20ms)	SOD-923FL	7d	1a	Frm
E	GBLC151	TVS	Vbr=15V, 1A, 350W(1ms), 0.6pF	SOD-323	5d	1a	Prt
E	MM9D2V7	Z-diode	2.57..2.84V, Izt=5mA, Zzt=100Q, 200mW	SOD-923	7d	1b	Wtr
E	MM9D8V2	Z-diode	7.79..8.61V, Izt=5mA, Zzt=30Q, 200mW	SOD-923	7d	1n	Wtr
e	MMSZ5231BPT	Z-diode	4.845..5.355V, Izt=5mA, Zzt=50Q, 225mW	SOD-523	7d	1a	Chm
E	MMSZ5254BPT	Z-diode	25.65..28.35V, Izt=5mA, Zzt=70Q, 225mW	SOD-523	7d	1a	Chm
E	NZ9F2V7T	Z-diode	2.57..2.84V, Izt=5mA, Zzt=100Q, 200mW	SOD-923	7d	1b	Ons
E	NZ9F4V7ST	Z-diode	4.55..4.75V, Izt=5mA, Zzt=100Q, 200mW	SOD-923	7d	2m	Ons
E	NZ9F8V2T	Z-diode	7.79..8.61V, Izt=5mA, Zzt=30Q, 200mW	SOD-923	7d	1n	Ons
E	RB520G-30GH	Si-diode	SBD, 30V, 100mA, Vf<0.45V(10mA)	SOD-723	7d	1a	Zow
e.	MMSZ5231SPT	Z-diode	4.998..5.202V, Izt=5mA, Zzt=50Q, 225mW	SOD-523	7d	1a	Chm
E.	MMSZ5254SPT	Z-diode	26.46..27.54V, Izt=5mA, Zzt=70Q, 225mW	SOD-523	7d	1a	Chm
E0	BZD27C9V1P	Z-diode	8.5..9.6V, Zzt=2Q, Izt=50mA, 800mW	SOD-123FL	7d	1a	Vs
E0	BZX585-B15	Z-diode	15V±2%, 300mW	SOD-523	6d	1a	Phi
E0	ESD7Z3.3	TVS	Vrwm=3.3V, Vbr=5.0V, 11.9A, 113W(20ms)	SOD-723FL	7d	1a	Frm
E0	MMPZ5235SPT	Z-diode	6.664..6.936V, Izt=5mA, Zzt=8Q, 225mW	SOD-323	5d	1a	Chm
E0	MMPZ5244BPT	Z-diode	13.30..14.70V, Izt=5mA, Zzt=25Q, 225mW	SOD-323	5d	1a	Chm
E1	BZD27C10P	Z-diode	9.4..10.6V, Zzt=2Q, Izt=50mA, 800mW	SOD-123FL	7d	1a	Vs
E1	BZX585-B6V2	Z-diode	6.2V±2%, 300mW	SOD-523	6d	1a	Phi
E1	CZRH5231B-G	Z-diode	4.85..5.36V, Zzt=17Q, Izt=20mA, 150mW	SOD-523	5d	1a	Cmc
E1	CZRV5231B-G	Z-diode	4.85..5.36V, Zzt=17Q, Izt=20mA, 200mW	SOD-323	5d	1a	Cmc
E1	CZRW5231B-G	Z-diode	4.85..5.36V, Zzt=17Q, Izt=20mA, 500mW	SOD-123	5d	1a	Cmc
E1	MAZF062	Z-diode	5.8..6.6V, Zzt=30Q(5mA), 120mW	S-Mini	7d	1a	Pan
E1	MAZN062	Z-diode	5.8..6.6V, Zzt=30Q(5mA), 120mW	SSMini2	7d	1a	Pan
E1	MM3Z5227B	Z-diode	3.6V±5%, Izt=20mA, Zzt=24Q, 200mW	SOD-323FL	7d	1a	Bts
E1	MM3Z5227BH	Z-diode	3.42..3.78V, Izt=20mA, Zzt=24Q, 300mW	SOD-323	5d	1a	Zow
E1	MM3Z5231B	Z-diode	4.85..5.36V, Izt=20mA, Zzt=17Q, 200mW	SOD-323	5d	1a	Ext
E1	MMSZ5231B	Z-diode	5.1V±5%, Zzt=17Q, 500mW	SOD-123	5d	1a,1d	Di,Mot
E1	MMSZ5231B	Z-diode	5.1V±5%, Zzt=17Q, 500mW	SOD-123	5d	1d	Di
E1	MMSZ5231BS	Z-diode	5.1V±5%, Zzt=17Q, 200mW	SOD-323	5d	1d	Di
E10A	EGF10A	Si-diode	U-Fast Recovery Rectifier, 50V, 1A, Vf<1V(1A), 50ns	DO-214AC	1d	1b	Zow
E10B	EGF10B	Si-diode	U-Fast Recovery Rectifier, 100V, 1A, Vf<1V(1A), 50ns	DO-214AC	1d	1b	Zow
E10D	EGF10D	Si-diode	U-Fast Recovery Rectifier, 200V, 1A, Vf<1V(1A), 50ns	DO-214AC	1d	1b	Zow
E10G	EGF10G	Si-diode	U-Fast Recovery Rectifier, 400V, 1A, Vf<1.25V(1A), 50ns	DO-214AC	1d	1b	Zow
E10J	EGF10J	Si-diode	U-Fast Recovery Rectifier, 600V, 1A, Vf<1.7V(1A), 75ns	DO-214AC	1d	1b	Zow
E10K	EGF10K	Si-diode	U-Fast Recovery Rectifier, 800V, 1A, Vf<1.7V(1A), 75ns	DO-214AC	1d	1b	Zow
E10M	EGF10M	Si-diode	U-Fast Recovery Rectifier, 1000V, 1A, Vf<1.7V(1A), 75ns	DO-214AC	1d	1b	Zow
E16	STPS160U	Si-diode	SBR, 60V, 1A, Vf<0.55V(1A)	DO-214AA	1d	1a	Ste
E2	BZD27C11P	Z-diode	10.4..11.6V, Zzt=4Q, Izt=50mA, 800mW	SOD-123FL	7d	1a	Vs
E2	BZX585-B6V8	Z-diode	6.8V±2%, 300mW	SOD-523	6d	1a	Phi
E2	CZRH5232B-G	Z-diode	5.32..5.88V, Zzt=11Q, Izt=20mA, 150mW	SOD-523	5d	1a	Cmc
E2	CZRV5232B-G	Z-diode	5.32..5.88V, Zzt=11Q, Izt=20mA, 200mW	SOD-323	5d	1a	Cmc
E2	CZRW5232B-G	Z-diode	5.32..5.88V, Zzt=11Q, Izt=20mA, 500mW	SOD-123	5d	1a	Cmc
E2	EDZ6.2B	Z-diode	6.06..6.33V, Izt=5mA, Zzt=60Q, 150mW	SOD-523	6d	1a	Rhm
E2	EDZS6.2B	Z-diode	6.2V±10%, 5mA, 100mW	SOD-523	6d	1a	Rhm
E2	ESD7Z5.0	TVS	Vrwm=5.0V, Vbr=6.2V, 13.3A, 117W(20ms)	SOD-723FL	7d	1a	Frm
E2	FDZ6.2EV	Z-diode	6.060..6.330V, Izt=5mA, Zzt=60Q, 150mW	SOD-523	7d	1a	Fis
E2	FDZ6.2VT	Z-diode	6.060..6.330V, Izt=5mA, Zzt=60Q, 200mW	SOD-323	5d	1a	Fis
E2	MAZF068	Z-diode	6.4..7.2V, Zzt=20Q(5mA), 120mW	S-Mini	7d	1a	Pan
E2	MAZN068	Z-diode	6.4..7.2V, Zzt=20Q(5mA), 120mW	SSMini2	7d	1a	Pan
E2	MM3Z5232B	Z-diode	5.32..5.88V, Izt=20mA, Zzt=11Q, 200mW	SOD-323	5d	1a	Ext
E2	MM3Z5246B	Z-diode	16V±5%, Izt=7.8mA, Zzt=17Q, 200mW	SOD-323FL	7d	1a	Bts
E2	MM3Z5246BH	Z-diode	15.2..16.8V, Izt=7.8mA, Zzt=17Q, 300mW	SOD-323	5d	1a	Zow
E2	MMSZ5232B	Z-diode	5.6V±5%, Zzt=11Q, 500mW	SOD-123	5d	1a,1d	Di,Mot
E2	MMSZ5232B	Z-diode	5.6V±5%, Zzt=11Q, 500mW	SOD-123	5d	1d	Di
E2	MMSZ5232BS	Z-diode	5.6V±5%, Zzt=11Q, 200mW	SOD-323	5d	1d	Di
E2	TDZ6.2B	Z-diode	6.2V±2.5%, 10mA, 500mW	TUMD2	7d	1s	Rhm
E2	UDZS6.2B	Z-diode	6.06..6.33V, Izt=5mA, Zzt=60Q, 200mW	SOD-323	5d	1a	Wtr
E2	UDZS6.2B	Z-diode	6.2V±2.5%, Izt=5mA, 200mW	SOD-323FL	7d	1s	Rhm
E2	VDZS6.2B	Z-diode	6.2V±5%, 5mA, 100mW	VMD2	5d	1z	Rhm
E20A	EGF20A	Si-diode	U-Fast Recovery Rectifier, 50V, 2A, Vf<1V(2A), 50ns	DO-214AA	1d	1b	Zow
E20B	EGF20B	Si-diode	U-Fast Recovery Rectifier, 100V, 2A, Vf<1V(2A), 50ns	DO-214AA	1d	1b	Zow
E20D	EGF20D	Si-diode	U-Fast Recovery Rectifier, 200V, 2A, Vf<1V(2A), 50ns	DO-214AA	1d	1b	Zow
E20G	EGF20G	Si-diode	U-Fast Recovery Rectifier, 400V, 2A, Vf<1.25V(2A), 50ns	DO-214AA	1d	1b	Zow
E20J	EGF20J	Si-diode	U-Fast Recovery Rectifier, 600V, 2A, Vf<1.7V(2A), 75ns	DO-214AA	1d	1b	Zow
E20K	EGF20K	Si-diode	U-Fast Recovery Rectifier, 800V, 2A, Vf<1.7V(2A), 75ns	DO-214AA	1d	1b	Zow
E20M	EGF20M	Si-diode	U-Fast Recovery Rectifier, 1000V, 2A, Vf<1.7V(2A), 75ns	DO-214AA	1d	1b	Zow
E3	BZD27C12P	Z-diode	11.4..12.7V, Zzt=4Q, Izt=50mA, 800mW	SOD-123FL	7d	1a	Vs



SMD
code

Type

Function

Short description

Case

Pinout

St.

Mnf.

SMD code	Type	Function	Short description	Case	Pinout	St.	Mnf.
E3	BZX585-B7V5	Z-diode	7.5V±2%, 300mW	SOD-523	6d	1a	Phi
E3	CZRW5233B-G	Z-diode	5.70..6.30V, Zzt=7Ω, Izt=20mA, 500mW	SOD-123	5d	1a	Cmc
E3	ESD7Z23	TVS	Vnm=12.0V, Vbr=13.5V, 13.3A, 128W(20ms)	SOD-723FL	7d	1a	Fmm
E3	MM3Z5267B	Z-diode	75V±5%, Izt=1.7mA, Zzt=270Ω, 200mW	SOD-323FL	7d	1a	Bts
E3	MM3Z5267BH	Z-diode	71.25..78.75V, Izt=1.7mA, Zzt=270Ω, 300mW	SOD-323	5d	1a	Zow
E3	MMSZ5233B	Z-diode	6V±5%, Zzt=7Ω, 500mW	SOD-123	5d	1a,1d	Di,Mot
E3	MMSZ5233B	Z-diode	6V±5%, Zzt=7Ω, 500mW	SOD-123	5d	1d	Di
E3	MMSZ5233BS	Z-diode	6V±5%, Zzt=7Ω, 200mW	SOD-323	5d	1d	Di
E3	RKZ5.1B2KK	Z-diode	4.98..5.20V, Izt=5mA, Zzt=130Ω, 150mW	SFP	7d	1a	Ren
E3	RKZ5.1B2KL	Z-diode	4.98..5.20V, Izt=5mA, Zzt=130Ω, 100mW	EPF	7d	1a	Ren
E30A	EGF30A	Si-diode	U-Fast Recovery Rectifier, 50V, 3A, Vf<1V(3A), 50ns	DO-214AA	1d	1b	Zow
E30B	EGF30B	Si-diode	U-Fast Recovery Rectifier, 100V, 3A, Vf<1V(3A), 50ns	DO-214AA	1d	1b	Zow
E30D	EGF30D	Si-diode	U-Fast Recovery Rectifier, 200V, 3A, Vf<1V(3A), 50ns	DO-214AA	1d	1b	Zow
E30G	EGF30G	Si-diode	U-Fast Recovery Rectifier, 400V, 3A, Vf<1.25V(3A), 50ns	DO-214AA	1d	1b	Zow
E30J	EGF30J	Si-diode	U-Fast Recovery Rectifier, 600V, 3A, Vf<1.7V(3A), 75ns	DO-214AA	1d	1b	Zow
E30K	EGF30K	Si-diode	U-Fast Recovery Rectifier, 800V, 3A, Vf<1.7V(3A), 75ns	DO-214AA	1d	1b	Zow
E30M	EGF30M	Si-diode	U-Fast Recovery Rectifier, 1000V, 3A, Vf<1.7V(3A), 75ns	DO-214AA	1d	1b	Zow
E4	BZD27C13P	Z-diode	12.4..14.1V, Zzt=5Ω, Izt=50mA, 800mW	SOD-123FL	7d	1a	Vs
E4	BZX585-B8V2	Z-diode	8.2V±2%, 300mW	SOD-523	6d	1a	Phi
E4	CZRH5234B-G	Z-diode	5.89..6.51V, Zzt=7Ω, Izt=20mA, 150mW	SOD-523	5d	1a	Cmc
E4	CZRV5234B-G	Z-diode	5.89..6.51V, Zzt=7Ω, Izt=20mA, 200mW	SOD-323	5d	1a	Cmc
E4	CZRW5234B-G	Z-diode	5.89..6.51V, Zzt=7Ω, Izt=20mA, 500mW	SOD-123	5d	1a	Cmc
E4	MM1Z5227B	Z-diode	3.42..3.78V, Izt=20mA, Zzt=24Ω, 500mW	SOD-323FL	5d	1a	Eic
E4	MM1Z5227BH	Z-diode	3.42..3.78V, Izt=20mA, Zzt=24Ω, 500mW	SOD-123	5d	1a	Zow
E4	MM3Z5234B	Z-diode	5.89..6.51V, Izt=20mA, Zzt=7Ω, 200mW	SOD-323	5d	1a	Ext
E4	MMSZ5227B	Z-diode	3.6V±5%, Izt=20mA, Zzt=24Ω, 500mW	SOD-123	5d	1a	Eic
E4	MMSZ5234B	Z-diode	6.2V±5%, Zzt=7Ω, 500mW	SOD-123	5d	1a,1d	Di,Mot
E4	MMSZ5234B	Z-diode	6.2V±5%, Zzt=7Ω, 500mW	SOD-123	5d	1d	Di
E4	MMSZ5234BS	Z-diode	6.2V±5%, Zzt=7Ω, 200mW	SOD-323	5d	1d	Di
E5	BZD27C15P	Z-diode	13.8..15.6V, Zzt=5Ω, Izt=50mA, 800mW	SOD-123FL	7d	1a	Vs
E5	BZX584B9V1	Z-diode	8.92..9.28V, Izt=5mA, Zzt=15Ω, 200mW	SOD-523FL	7d	1a	Tac
E5	BZX585-B9V1	Z-diode	9.1V±2%, 300mW	SOD-523	6d	1a	Phi
E5	CZRH5235B-G	Z-diode	6.46..7.14V, Zzt=5Ω, Izt=20mA, 150mW	SOD-523	5d	1a	Cmc
E5	CZRV5235B-G	Z-diode	6.46..7.14V, Zzt=5Ω, Izt=20mA, 200mW	SOD-323	5d	1a	Cmc
E5	CZRW5235B-G	Z-diode	6.46..7.14V, Zzt=5Ω, Izt=20mA, 500mW	SOD-123	5d	1a	Cmc
E5	EDZ33B	Z-diode	32.15..33.79V, Izt=2mA, Zzt=250Ω, 150mW	SOD-523	6d	1a	Rhm
E5	FDZ33EV	Z-diode	32.150..33.790V, Izt=2mA, Zzt=250Ω, 150mW	SOD-523	7d	1a	Fis
E5	FDZ33VT	Z-diode	32.150..33.790V, Izt=5mA, Zzt=250Ω, 200mW	SOD-323	5d	1a	Fis
E5	MM1Z5246B	Z-diode	15.20..16.80V, Izt=7.8mA, Zzt=17Ω, 500mW	SOD-323FL	5d	1a	Eic
E5	MM1Z5246BH	Z-diode	15.2..16.8V, Izt=7.8mA, Zzt=17Ω, 500mW	SOD-123	5d	1a	Zow
E5	MM3Z5235B	Z-diode	6.46..7.14V, Izt=20mA, Zzt=5Ω, 200mW	SOD-323	5d	1a	Ext
E5	MMSZ9V1B	Z-diode	8.92..9.28V, Izt=5mA, Zzt=15Ω, 200mW	SOD-523FL	7d	1a	Tac
E5	MMSZ5235B	Z-diode	6.8V±5%, Zzt=5Ω, 500mW	SOD-123	5d	1a,1d	Di,Mot
E5	MMSZ5235B	Z-diode	6.8V±5%, Zzt=5Ω, 500mW	SOD-123	5d	1d	Di
E5	MMSZ5235BS	Z-diode	6.8V±5%, Zzt=5Ω, 200mW	SOD-323	5d	1d	Di
E5	MMSZ5246B	Z-diode	16V±5%, Izt=7.8mA, Zzt=17Ω, 500mW	SOD-123	5d	1a	Eic
E5	UDZS33B	Z-diode	32.15..33.79V, Izt=5mA, Zzt=250Ω, 200mW	SOD-323	5d	1a	Wtr
E5	UDZS33B	Z-diode	33V±2.5%, Izt=5mA, 200mW	SOD-323FL	7d	1s	Rhm
E5	VDZS33B	Z-diode	33V±5%, 5mA, 100mW	VMD2	5d	1z	Rhm
E6	BZD27C16P	Z-diode	15.3..17.1V, Zzt=6Ω, Izt=25mA, 800mW	SOD-123FL	7d	1a	Vs
E6	BZX585-B10	Z-diode	10V±2%, 300mW	SOD-523	6d	1a	Phi
E6	MM1Z5267B	Z-diode	71.25..78.75V, Izt=1.7mA, Zzt=270Ω, 500mW	SOD-323FL	5d	1a	Eic
E6	MM1Z5267BH	Z-diode	71.25..78.75V, Izt=1.7mA, Zzt=270Ω, 500mW	SOD-123	5d	1a	Zow
E6	MMSZ5267B	Z-diode	71.25..78.75V, Izt=1.7mA, Zzt=270Ω, 500mW	SOD-123	5d	1a	Eic
E6	RKZ5.6B2KK	Z-diode	5.49..5.73V, Izt=5mA, Zzt=80Ω, 150mW	SFP	7d	1a	Ren
E6	RKZ5.6B2KL	Z-diode	5.49..5.73V, Izt=5mA, Zzt=80Ω, 100mW	EPF	7d	1a	Ren
E7	BZD27C18P	Z-diode	16.8..19.1V, Zzt=6Ω, Izt=25mA, 800mW	SOD-123FL	7d	1a	Vs
E7	BZX585-B11	Z-diode	11V±2%, 300mW	SOD-523	6d	1a	Phi
E8	BZD27C20P	Z-diode	18.8..21.2V, Zzt=6Ω, Izt=25mA, 800mW	SOD-123FL	7d	1a	Vs
E8	BZX585-B12	Z-diode	12V±2%, 300mW	SOD-523	6d	1a	Phi
E8	MMSZ3V9	Z-diode	3.9V±5%, Izt=5mA, Zzt=90Ω, 200mW	SOD-523	6d	1a	Eic
E8	MMSZ3V9H	Z-diode	3.7..4.1V, Izt=5mA, Zzt=90Ω, 200mW	SOD-523	7d	1a	Zow
E9	BZD27C22P	Z-diode	20.8..23.3V, Zzt=6Ω, Izt=25mA, 800mW	SOD-123FL	7d	1a	Vs
E9	BZX585-B13	Z-diode	13V±2%, 300mW	SOD-523	6d	1a	Phi
E9	MMSZ47H	Z-diode	44..50V, Izt=1mA, Zzt=170Ω, 200mW	SOD-523	7d	1a	Zow
E9	MMSZ47V	Z-diode	47V±5%, Izt=2mA, Zzt=170Ω, 200mW	SOD-523	6d	1a	Eic
E9	RKZ6.2B2KK	Z-diode	6.06..6.33V, Izt=5mA, Zzt=50Ω, 150mW	SFP	7d	1a	Ren
E9	RKZ6.2B2KL	Z-diode	6.06..6.33V, Izt=5mA, Zzt=50Ω, 100mW	EPF	7d	1a	Ren
EA	EGF1A	Si-diode	Rectifier, 50V, 1A, Vf<0.10V(1A)	DO-214BA	1d	1k	Vs
EA	ES1A	Si-diode	Rectifier, 50V, 1A, Vf<0.92V(1A), Cd=7pF	DO-214AC	1d	1k	Vs



SMD
code

Type

Function

Short description

Case

Pinout

St.

Mnf.

SMD code	Type	Function	Short description	Case	Pinout	St.	Mnf.
EA	ES2A	Si-diode	Rectifier, 50V, 2A, Vf<0.9V(2A), Cd=18pF	DO-214AA	1d	1k	Vs
EA	ES3A	Si-diode	Rectifier, 50V, 3A, Vf<0.9V(3A), Cd=45pF	DO-214AB	1d	1k	Vs
EA	MMSZ4711	Z-diode	27V±5%, 500mW	SOD-123	5d	1a	Mot
EA	TV06B141KB-G	TVS	Vrwm=140.0V, Vbr=155.68..190.40V, Ipp=2.6A, 600W(1ms), Bidirectional	DO-214AA	1ba	1j	Cmc
EA	Z1SMA5V1	Z-diode	4.8..5.4V, Izt=100mA, Zzt=4Ω, 1W	DO-214AC	1d	1a	Ttr
EB	EGF1B	Si-diode	Rectifier, 100V, 1A, Vf<1.0V(1A)	DO-214BA	1d	1k	Vs
EB	ES1B	Si-diode	Rectifier, 100V, 1A, Vf<0.92V(1A), Cd=7pF	DO-214AC	1d	1k	Vs
EB	ES1PB	Si-diode	Rectifier, 100V, 1A, Vf<0.92V(1A)	DO-220AA	8d	1k	Vs
EB	ES2B	Si-diode	Rectifier, 100V, 2A, Vf<0.9V(2A), Cd=18pF	DO-214AA	1d	1k	Vs
EB	ES3B	Si-diode	Rectifier, 100V, 3A, Vf<0.9V(3A), Cd=45pF	DO-214AB	1d	1k	Vs
EB	MM3Z4B7H	Z-diode	4.606..4.794V, Izt=5mA, Zzt=130Ω, 300mW	SOD-323	5d	1a	Zow
EB	TV06B141JB-G	TVS	Vrwm=140.0V, Vbr=155.0..171.0V, Ipp=2.9A, 600W(1ms), Bidirectional	DO-214AA	1ba	1j	Cmc
EB	Z1SMA5V6	Z-diode	5.2..6.0V, Izt=100mA, Zzt=2Ω, 1W	DO-214AC	1d	1a	Ttr
EBA	SMAJ43CA	TVS	Vrwm=43V, Vbr=47.8..52.8V, 5.7A, 400W(1ms), Bidirectional	DO-214AC	1ba	1r	Ste
EBF	SMAJ58CA	TVS	Vrwm=58V, Vbr=64.4..71.2V, 4.3A, 400W(1ms), Bidirectional	DO-214AC	1ba	1r	Ste
EBI	SMAJ70CA	TVS	Vrwm=70V, Vbr=77.8..86V, 3.5A, 400W(1ms), Bidirectional	DO-214AC	1ba	1r	Ste
EBL	SMAJ85CA	TVS	Vrwm=85V, Vbr=94.4..104V, 2.9A, 400W(1ms), Bidirectional	DO-214AC	1ba	1r	Ste
EBN	SMAJ100CA	TVS	Vrwm=100V, Vbr=111..136V, 2.5A, 400W(1ms), Bidirectional	DO-214AC	1ba	1r	Ste
EBQ	SMAJ130CA	TVS	Vrwm=130V, Vbr=144..159V, 1.9A, 400W(1ms), Bidirectional	DO-214AC	1ba	1r	Ste
EBT	SMAJ154CA	TVS	Vrwm=154V, Vbr=167..185V, 1.6A, 400W(1ms), Bidirectional	DO-214AC	1ba	1r	Ste
EBV	SMAJ188CA	TVS	Vrwm=188V, Vbr=209..231V, 1.4A, 400W(1ms), Bidirectional	DO-214AC	1ba	1r	Ste
EC	EGF1C	Si-diode	Rectifier, 150V, 1A, Vf<1.0V(1A)	DO-214BA	1d	1k	Vs
EC	ES1C	Si-diode	Rectifier, 150V, 1A, Vf<0.92V(1A), Cd=7pF	DO-214AC	1d	1k	Vs
EC	ES1PC	Si-diode	Rectifier, 150V, 1A, Vf<1.0V(1A)	DO-220AA	8d	1k	Vs
EC	ES2C	Si-diode	Rectifier, 150V, 2A, Vf<0.9V(2A), Cd=18pF	DO-214AA	1d	1k	Vs
EC	ES3C	Si-diode	Rectifier, 150V, 3A, Vf<0.9V(3A), Cd=45pF	DO-214AB	1d	1k	Vs
EC	GBLC15C1	TVS	Vbr=15V, 1A, 350W(1ms), 0.6pF, Bidirectional	SOD-323	5ba	1e	Prt
EC	MM3Z5B1H	Z-diode	4.998..5.202V, Izt=5mA, Zzt=130Ω, 300mW	SOD-323	5d	1a	Zow
EC	MMSZ4712	Z-diode	28V±5%, 500mW	SOD-123	5d	1a	Mot
EC	Z1SMA6V2	Z-diode	5.8..6.6V, Izt=100mA, Zzt=2Ω, 1W	DO-214AC	1d	1a	Ttr
EC	Z1SMA-6V2	Z-diode	6.2V±5%, 1.3W	DO-214AC	1d	2j	Fag
ED	EGF1D	Si-diode	Rectifier, 200V, 1A, Vf<1.0V(1A)	DO-214BA	1d	1k	Vs
ED	ES1D	Si-diode	Rectifier, 200V, 1A, Vf<0.92V(1A), Cd=7pF	DO-214AC	1d	1k	Vs
ED	ES1PD	Si-diode	Rectifier, 200V, 1A, Vf<1.0V(1A)	DO-220AA	8d	1k	Vs
ED	ES2D	Si-diode	Rectifier, 200V, 2A, Vf<0.9V(2A), Cd=18pF	DO-214AA	1d	1k	Vs
ED	ES3D	Si-diode	Rectifier, 200V, 3A, Vf<0.9V(3A), Cd=45pF	DO-214AB	1d	1k	Vs
ED	KDZ30B	Z-diode	30V±2.5%, 10mA, 1W	PMDU	7d	1s	Rhm
ED	MMSZ4713	Z-diode	30V±5%, 500mW	SOD-123	5d	1a	Mot
ED	P6SMBJ110C	TVS	Vbr=110V, 3A, 600W(1ms), Bidirectional	DO-214AA	1ba	1x,1y	Pjt,Srj
ED	SM6T18	TVS	Vbr=18V, 23A, 600W(1ms)	DO-214AA	1d	1q	Ste
ED	SMBG110C	TVS	Vbr=110V, 3.1A, 600W(1ms), Bidirectional	DO-215AA	5ba	1l	Vs
ED	SMBJ110C	TVS	Vbr=110V, 3.1A, 600W(1ms), Bidirectional	DO-214AA	1ba	1l	Vs
ED	TV06B111KB-G	TVS	Vrwm=110.0V, Vbr=122.0..149.0V, Ipp=3.06A, 600W(1ms), Bidirectional	DO-214AA	1ba	1j	Cmc
ED	Z1SMA7V5	Z-diode	7.0..7.9V, Izt=100mA, Zzt=3Ω, 1W	DO-214AC	1d	1a	Ttr
ED	Z1SMA-7V5	Z-diode	7.5V±5%, 1.3W	DO-214AC	1d	2j	Fag
EDP	TPSMC18	TVS	Vbr=18V, 56.6A, 1500W(1ms)	DO-214AB	1d	1k	Vs
EE	CD214B-T110CA	TVS	Vbr=110V, Irsrm=3.4A, 600W(1ms), Bidirectional	DO-214AA	1ba	1j	Brm
EE	MM3Z6B2H	Z-diode	6.076..6.324V, Izt=5mA, Zzt=50Ω, 300mW	SOD-323	5d	1a	Zow
EE	MMSZ4714	Z-diode	33V±5%, 500mW	SOD-123	5d	1a	Mot
EE	P6SMBJ110AC	TVS	Vbr=110V, 3.4A, 600W(1ms), Bidirectional	DO-214AA	1ba	1x,1y	Pjt,Srj
EE	SM6T18A	TVS	Vrwm=15.3V, Vbr=17.1..18.9V, 24A, 600W(1ms)	DO-214AA	1d	1a	Ste
EE	SMBG110CA	TVS	Vbr=110V, 3.4A, 600W(1ms), Bidirectional	DO-215AA	5ba	1l	Vs
EE	SMBJ110CA	TVS	Vbr=110V, 3.4A, 600W(1ms), Bidirectional	DO-214AA	1ba	1l,1x	Di,Vs
EE	TV06B111JB-G	TVS	Vrwm=110.0V, Vbr=122.0..135.0V, Ipp=3.39A, 600W(1ms), Bidirectional	DO-214AA	1ba	1j	Cmc
EE	Z1SMA6V8	Z-diode	6.4..7.2V, Izt=100mA, Zzt=2.5Ω, 1W	DO-214AC	1d	1a	Ttr
EE	Z1SMA-6V8	Z-diode	6.8V±5%, 1.3W	DO-214AC	1d	2j	Fag
EEP	TPSMC18A	TVS	Vbr=18V, 59.5A, 1500W(1ms)	DO-214AB	1d	1k	Vs
EF	ES2F	Si-diode	Rectifier, 300V, 2A, Vf<1.1V(2A)	DO-214AA	1d	1k	Vs
EF	ES3F	Si-diode	Rectifier, 300V, 3A, Vf<1.1V(2A)	DO-214AB	1d	1k	Vs
EF	KDZ9.1FV	Z-diode	8.50..9.60V, Izt=5mA, Zzt=18Ω, 100mW	TFSC	7d	1a	Kec
EF	MAZD082	Z-diode	7.7..8.7V, Zzt=20Ω(5mA), 120mW	SSSMini2	7d	1a	Pan
EF	MM3Z6B8H	Z-diode	6.664..6.936V, Izt=5mA, Zzt=30Ω, 300mW	SOD-323	5d	1a	Zow
EF	MMSZ4715	Z-diode	36V±5%, 500mW	SOD-123	5d	1a	Mot
EF	P6SMBJ120C	TVS	Vbr=120V, 2.8A, 600W(1ms), Bidirectional	DO-214AA	1ba	1x,1y	Pjt,Srj
EF	SMBG120C	TVS	Vbr=120V, 2.8A, 600W(1ms), Bidirectional	DO-215AA	5ba	1l	Vs
EF	SMBJ120C	TVS	Vbr=120V, 2.8A, 600W(1ms), Bidirectional	DO-214AA	1ba	1l	Vs
EF	TV06B121KB-G	TVS	Vrwm=120.0V, Vbr=133.0..163.0V, Ipp=2.8A, 600W(1ms), Bidirectional	DO-214AA	1ba	1j	Cmc
EF	Z1SMA8V2	Z-diode	7.7..8.7V, Izt=100mA, Zzt=3.5Ω, 1W	DO-214AC	1d	1a	Ttr
EF	Z1SMA-8V2	Z-diode	8.2V±5%, 1.3W	DO-214AC	1d	2j	Fag
EFP	TPSMC20	TVS	Vbr=20V, 51.5A, 1500W(1ms)	DO-214AB	1d	1k	Vs



SMD
code

Type

Function

Short description

Case

Pinout

St.

Mnf.

SMD code	Type	Function	Short description	Case	Pinout	St.	Mnf.
EG	CD214B-T120CA	TVS	Vbr=120V, I _{rsm} =3.1A, 600W(1ms), Bidirectional	DO-214AA	1ba	1j	Bm
EG	ES2G	Si-diode	Rectifier, 400V, 2A, Vf<1.1V(2A)	DO-214AA	1d	1k	Vs
EG	ES3G	Si-diode	Rectifier, 400V, 3A, Vf<1.1V(2A)	DO-214AB	1d	1k	Vs
EG	P6SMBJ120AC	TVS	Vbr=120V, 3.1A, 600W(1ms), Bidirectional	DO-214AA	1ba	1x,1y	Pjt,Srj
EG	SMBG120CA	TVS	Vbr=120V, 3.1A, 600W(1ms), Bidirectional	DO-215AA	5ba	1l	Vs
EG	SMBJ120CA	TVS	Vbr=120V, 3.1A, 600W(1ms), Bidirectional	DO-214AA	1ba	1l,1x	Di,Vs
EG	TV06B121JB-G	TVS	V _{nm} =120.0V, V _{br} =133.0..147.0V, I _{pp} =3.1A, 600W(1ms), Bidirectional	DO-214AA	1ba	1j	Cmc
EG	Z1SMA9V1	Z-diode	8.5..9.6V, I _{zt} =50mA, Z _{zt} =4Ω, 1W	DO-214AC	1d	1a	Ttr
EG	Z1SMA-9V1	Z-diode	9.1V±5%, 1.3W	DO-214AC	1d	2j	Fag
EGP	TPSMC20A	TVS	Vbr=20V, 54.2A, 1500W(1ms)	DO-214AB	1d	1k	Vs
EH	MM3Z7B5H	Z-diode	7.35..7.65V, I _{zt} =5mA, Z _{zt} =30Ω, 300mW	SOD-323	5d	1a	Zow
EH	MMSZ4716	Z-diode	39V±5%, 500mW	SOD-123	5d	1a	Mot
EH	P6SMBJ130C	TVS	Vbr=130V, 2.6A, 600W(1ms), Bidirectional	DO-214AA	1ba	1x,1y	Pjt,Srj
EH	SM6T22	TVS	Vbr=22V, 18A, 600W(1ms), Bidirectional	DO-214AA	1ba	1r	Ste
EH	SMBG130C	TVS	Vbr=130V, 2.6A, 600W(1ms), Bidirectional	DO-215AA	5ba	1l	Vs
EH	SMBJ130C	TVS	Vbr=130V, 2.6A, 600W(1ms), Bidirectional	DO-214AA	1ba	1l	Vs
EH	TV06B131KB-G	TVS	V _{nm} =130.0V, V _{br} =144.0..176.0V, I _{pp} =2.6A, 600W(1ms), Bidirectional	DO-214AA	1ba	1j	Cmc
EH	Z1SMA10	Z-diode	9.4..10.6V, I _{zt} =50mA, Z _{zt} =4Ω, 1W	DO-214AC	1d	1a	Ttr
EH	Z1SMA-10	Z-diode	10V±5%, 1.3W	DO-214AC	1d	2j	Fag
EHB	ES1HB	Si-diode	Rectifier, 100V, 1A, Vf<0.92V(1A)	DO-214AC	1d	1k	Vs
EHB	ESH1B	Si-diode	Rectifier, 100V, 1A, Vf<0.9V(1A)	DO-214AC	1d	1k	Vs
EHB	ESH2B	Si-diode	Rectifier, 100V, 2A, Vf<0.93V(2A)	DO-214AA	1d	1k	Vs
EHB	ESH3B	Si-diode	Rectifier, 100V, 3A, Vf<0.9V(1A)	DO-214AB	1d	1k	Vs
EHC	ESH1C	Si-diode	Rectifier, 150V, 1A, Vf<0.9V(1A)	DO-214AC	1d	1k	Vs
EHC	ESH2C	Si-diode	Rectifier, 150V, 2A, Vf<0.93V(2A)	DO-214AA	1d	1k	Vs
EHC	ESH3C	Si-diode	Rectifier, 150V, 3A, Vf<0.9V(1A)	DO-214AB	1d	1k	Vs
EHD	ESH1D	Si-diode	Rectifier, 200V, 1A, Vf<0.9V(1A)	DO-214AC	1d	1k	Vs
EHD	ESH2D	Si-diode	Rectifier, 200V, 2A, Vf<0.93V(2A)	DO-214AA	1d	1k	Vs
EHD	ESH3D	Si-diode	Rectifier, 100V, 3A, Vf<0.9V(1A)	DO-214AB	1d	1k	Vs
EHP	TPSMC22	TVS	Vbr=22V, 47A, 1500W(1ms)	DO-214AB	1d	1k	Vs
EJ	MM3Z8B2H	Z-diode	8.036..8.364V, I _{zt} =5mA, Z _{zt} =30Ω, 300mW	SOD-323	5d	1a	Zow
EJ	MMSZ4717	Z-diode	43V±5%, 500mW	SOD-123	5d	1a	Mot
EK	CD214B-T130CA	TVS	Vbr=130V, I _{rsm} =2.9A, 600W(1ms), Bidirectional	DO-214AA	1ba	1j	Bm
EK	MM3Z9B1H	Z-diode	8.918..9.282V, I _{zt} =5mA, Z _{zt} =30Ω, 300mW	SOD-323	5d	1a	Zow
EK	P6SMBJ130AC	TVS	Vbr=130V, 2.9A, 600W(1ms), Bidirectional	DO-214AA	1ba	1x,1y	Pjt,Srj
EK	PMEG3015EJ	Si-diode	SBR, 30V, 1.5A, Vf<0.55V(1.5A), <72pF	SOD-323F	6d	1a	Phi
EK	SM6T22A	TVS	V _{nm} =18.5V, V _{br} =20.9..23.1V, 20A, 600W(1ms)	DO-214AA	1d	1a	Ste
EK	SMBG130CA	TVS	Vbr=130V, 2.9A, 600W(1ms), Bidirectional	DO-215AA	5ba	1l	Vs
EK	SMBJ130CA	TVS	Vbr=130V, 2.9A, 600W(1ms), Bidirectional	DO-214AA	1ba	1l,1x	Di,Vs
EK	TV06B131JB-G	TVS	V _{nm} =130.0V, V _{br} =144.0..159.0V, I _{pp} =2.9A, 600W(1ms), Bidirectional	DO-214AA	1ba	1j	Cmc
EK	Z1SMA11	Z-diode	10.4..11.6V, I _{zt} =50mA, Z _{zt} =7Ω, 1W	DO-214AC	1d	1a	Ttr
EK	Z1SMA-11	Z-diode	11V±5%, 1.3W	DO-214AC	1d	2j	Fag
EKP	TPSMC22A	TVS	Vbr=22V, 49A, 1500W(1ms)	DO-214AB	1d	1k	Vs
EL	P6SMBJ150C	TVS	Vbr=150V, 2.2A, 600W(1ms), Bidirectional	DO-214AA	1ba	1x,1y	Pjt,Srj
EL	SM6T24	TVS	Vbr=24V, 17A, 600W(1ms)	DO-214AA	1d	1q	Ste
EL	SMBG150C	TVS	Vbr=150V, 2.2A, 600W(1ms), Bidirectional	DO-215AA	5ba	1l	Vs
EL	SMBJ150C	TVS	Vbr=150V, 2.2A, 600W(1ms), Bidirectional	DO-214AA	1ba	1l	Vs
EL	TV06B151KB-G	TVS	V _{nm} =150.0V, V _{br} =167.0..204.0V, I _{pp} =2.2A, 600W(1ms), Bidirectional	DO-214AA	1ba	1j	Cmc
EL	Z1SMA12	Z-diode	11.4..12.7V, I _{zt} =50mA, Z _{zt} =7Ω, 1W	DO-214AC	1d	1a	Ttr
EL	Z1SMA-12	Z-diode	120V±5%, 1.3W	DO-214AC	1d	2j	Fag
ELP	TPSMC24	TVS	Vbr=24V, 43.2A, 1500W(1ms)	DO-214AB	1d	1k	Vs
EM	CD214B-T150CA	TVS	Vbr=150V, I _{rsm} =2.5A, 600W(1ms), Bidirectional	DO-214AA	1ba	1j	Bm
EM	MM3ZB10H	Z-diode	9.8..10.2V, I _{zt} =5mA, Z _{zt} =30Ω, 300mW	SOD-323	5d	1a	Zow
EM	P6SMBJ150AC	TVS	Vbr=150V, 2.5A, 600W(1ms), Bidirectional	DO-214AA	1ba	1x,1y	Pjt,Srj
EM	SM6T24A	TVS	V _{nm} =20.5V, V _{br} =22.8..25.2V, 18A, 600W(1ms)	DO-214AA	1d	1a	Ste
EM	SMBG150CA	TVS	Vbr=150V, 2.5A, 600W(1ms), Bidirectional	DO-215AA	5ba	1l	Vs
EM	SMBJ150CA	TVS	Vbr=150V, 2.5A, 600W(1ms), Bidirectional	DO-214AA	1ba	1l,1x	Di,Vs
EM	TV06B151JB-G	TVS	V _{nm} =150.0V, V _{br} =167.0..185.0V, I _{pp} =2.5A, 600W(1ms), Bidirectional	DO-214AA	1ba	1j	Cmc
EM	Z1SMA13	Z-diode	12.4..14.1V, I _{zt} =50mA, Z _{zt} =10Ω, 1W	DO-214AC	1d	1a	Ttr
EM	Z1SMA-13	Z-diode	130V±5%, 1.3W	DO-214AC	1d	2j	Fag
EMP	TPSMC24A	TVS	Vbr=24V, 45.2A, 1500W(1ms)	DO-214AB	1d	1k	Vs
EN	MM3ZB11H	Z-diode	10.78..11.22V, I _{zt} =5mA, Z _{zt} =30Ω, 300mW	SOD-323	5d	1a	Zow
EN	P6SMBJ160C	TVS	Vbr=160V, 2.1A, 600W(1ms), Bidirectional	DO-214AA	1ba	1x,1y	Pjt,Srj
EN	SM6T27	TVS	Vbr=27V, 15A, 600W(1ms)	DO-214AA	1d	1q	Ste
EN	SMBG160C	TVS	Vbr=160V, 2.1A, 600W(1ms), Bidirectional	DO-215AA	5ba	1l	Vs
EN	SMBJ160C	TVS	Vbr=160V, 2.1A, 600W(1ms), Bidirectional	DO-214AA	1ba	1l	Vs
EN	TV06B161KB-G	TVS	V _{nm} =160.0V, V _{br} =178.0..218.0V, I _{pp} =2.09A, 600W(1ms), Bidirectional	DO-214AA	1ba	1j	Cmc
EN	Z1SMA15	Z-diode	13.8..15.6V, I _{zt} =50mA, Z _{zt} =10Ω, 1W	DO-214AC	1d	1a	Ttr
EN	Z1SMA-15	Z-diode	15V±5%, 1.3W	DO-214AC	1d	2j	Fag
ENP	TPSMC27	TVS	Vbr=27V, 38.4A, 1500W(1ms)	DO-214AB	1d	1k	Vs



SMD
code

Type

Function

Short description

Case

Pinout

St.

Mnf.

SMD code	Type	Function	Short description	Case	Pinout	St.	Mnf.
EP	CD214B-T160CA	TVS	Vbr=160V, I _{rsm} =2.3A, 600W(1ms), Bidirectional	DO-214AA	1ba	1j	Bm
EP	CMDZ3L0	Z-diode	2.850..3.150V, I _z =0.5mA, Z _t =900Ω, 250mW	SOD-323	5d	1a	Cen
EP	KDZ9.1VY	Z-diode	8.85..9.23V, I _z =5mA, Z _t =18Ω, 100mW	TFSC	7d	1a	Kec
EP	MM3ZB12H	Z-diode	11.76..12.24V, I _z =5mA, Z _t =35Ω, 300mW	SOD-323	5d	1a	Zow
EP	P6SMBJ160AC	TVS	Vbr=160V, 2.3A, 600W(1ms), Bidirectional	DO-214AA	1ba	1x,1y	Pjt,Srj
EP	SM6T27A	TVS	V _{rwm} =23.1V, V _{br} =25.7..28.4V, 16A, 600W(1ms)	DO-214AA	1d	1a	Ste
EP	SMBG160CA	TVS	Vbr=160V, 2.3A, 600W(1ms), Bidirectional	DO-215AA	5ba	1l	Vs
EP	SMBJ160CA	TVS	Vbr=160V, 2.3A, 600W(1ms), Bidirectional	DO-214AA	1ba	1l	Vs
EP	TV06B161JB-G	TVS	V _{rwm} =160.0V, V _{br} =178.0..197.0V, I _{pp} =2.32A, 600W(1ms), Bidirectional	DO-214AA	1ba	1j	Cmc
EP	Z1SMA16	Z-diode	15.3..17.1V, I _z =25mA, Z _t =15Ω, 1W	DO-214AC	1d	1a	Trt
EP	Z1SMA-16	Z-diode	16V±5%, 1.3W	DO-214AC	1d	2j	Fag
EPP	TPSMC27A	TVS	Vbr=27V, 40A, 1500W(1ms)	DO-214AB	1d	1k	Vs
EQ	P6SMBJ170C	TVS	Vbr=170V, 2A, 600W(1ms), Bidirectional	DO-214AA	1ba	1x,1y	Pjt,Srj
EQ	SM6T30	TVS	Vbr=30V, 14.2A, 600W(1ms)	DO-214AA	1d	1q	Ste
EQ	SMBG170C	TVS	Vbr=170V, 2A, 600W(1ms), Bidirectional	DO-215AA	5ba	1l	Vs
EQ	SMBJ170C	TVS	Vbr=170V, 2A, 600W(1ms), Bidirectional	DO-214AA	1ba	1l	Vs
EQ	TV06B171KB-G	TVS	V _{rwm} =170.0V, V _{br} =189.0..231.0V, I _{pp} =1.97A, 600W(1ms), Bidirectional	DO-214AA	1ba	1j	Cmc
EQ	Z1SMA18	Z-diode	16.8..19.1V, I _z =25mA, Z _t =15Ω, 1W	DO-214AC	1d	1a	Trt
EQ	Z1SMA-18	Z-diode	18V±5%, 1.3W	DO-214AC	1d	2j	Fag
EQP	TPSMC30	TVS	Vbr=30V, 34.5A, 1500W(1ms)	DO-214AB	1d	1k	Vs
ER	CD214B-T170CA	TVS	Vbr=170V, I _{rsm} =2.2A, 600W(1ms), Bidirectional	DO-214AA	1ba	1j	Bm
ER	MM3ZB13H	Z-diode	12.74..13.26V, I _z =5mA, Z _t =35Ω, 300mW	SOD-323	5d	1a	Zow
ER	P6SMBJ170AC	TVS	Vbr=170V, 2.2A, 600W(1ms), Bidirectional	DO-214AA	1ba	1x,1y	Pjt,Srj
ER	PZU8.2B1A/DG	Z-diode	8.2V±2%, I _f =200mA, 320mW, halogen-free	SOD-323	5d	1a	Phi
ER	SM6T30A	TVS	V _{rwm} =25.6V, V _{br} =28.5..31.5V, 14.5A, 600W(1ms)	DO-214AA	1d	1a	Ste
ER	SMBG170CA	TVS	Vbr=170V, 2.2A, 600W(1ms), Bidirectional	DO-215AA	5ba	1l	Vs
ER	SMBJ170CA	TVS	Vbr=170V, 2.2A, 600W(1ms), Bidirectional	DO-214AA	1ba	1l,1x	Di,Vs
ER	TV06B171JB-G	TVS	V _{rwm} =170.0V, V _{br} =189.0..209.0V, I _{pp} =2.18A, 600W(1ms), Bidirectional	DO-214AA	1ba	1j	Cmc
ER	Z1SMA20	Z-diode	18.8..21.2V, I _z =25mA, Z _t =15Ω, 1W	DO-214AC	1d	1a	Trt
ER	Z1SMA-20	Z-diode	20V±5%, 1.3W	DO-214AC	1d	2j	Fag
ERP	TPSMC30A	TVS	Vbr=30V, 36.2A, 1500W(1ms)	DO-214AB	1d	1k	Vs
ES	P6SMBJ180C	TVS	Vbr=170V, 1.9A, 600W(1ms), Bidirectional	DO-214AA	1ba	1x,1y	Pjt,Srj
ES	PZU8.2B2A/DG	Z-diode	8.2V±2%, I _f =200mA, 320mW, halogen-free	SOD-323	5d	1a	Phi
ES	SM6T33	TVS	Vbr=33V, 13A, 600W(1ms)	DO-214AA	1d	1q	Ste
ES	SMBG188CA	TVS	Vbr=188V, 2A, 600W(1ms), Bidirectional	DO-215AA	5ba	1l	Vs
ES	SMBJ188CA	TVS	Vbr=188V, 2A, 600W(1ms), Bidirectional	DO-214AA	1ba	1l	Vs
ES	TV06B181KB-G	TVS	V _{rwm} =180.0V, V _{br} =200.16..244.80V, I _{pp} =1.86A, 600W(1ms), Bidirectional	DO-214AA	1ba	1j	Cmc
ES	Z1SMA22	Z-diode	20.8..23.3V, I _z =25mA, Z _t =15Ω, 1W	DO-214AC	1d	1a	Trt
ES	Z1SMA-22	Z-diode	22V±5%, 1.3W	DO-214AC	1d	2j	Fag
ESP	TPSMC33	TVS	Vbr=33V, 31.4A, 1500W(1ms)	DO-214AB	1d	1k	Vs
ET	EGF1T	Si-diode	Rectifier, 1300V, 1A, Vf<3.0V(1A)	DO-214BA	1d	1k	Vs
ET	P6SMBJ180AC	TVS	Vbr=170V, 2.1A, 600W(1ms), Bidirectional	DO-214AA	1ba	1x,1y	Pjt,Srj
ET	PZU8.2B3A/DG	Z-diode	8.2V±2%, I _f =200mA, 320mW, halogen-free	SOD-323	5d	1a	Phi
ET	SM6T33A	TVS	V _{rwm} =28.2V, V _{br} =31.4..34.7V, 13.1A, 600W(1ms)	DO-214AA	1d	1a	Ste
ET	SMBG188C	TVS	Vbr=188V, 1.7A, 600W(1ms), Bidirectional	DO-215AA	5ba	1l	Vs
ET	SMBJ188C	TVS	Vbr=188V, 1.7A, 600W(1ms), Bidirectional	DO-214AA	1ba	1l	Vs
ET	TV06B181JB-G	TVS	V _{rwm} =180.0V, V _{br} =200.0..220.0V, I _{pp} =2.06A, 600W(1ms), Bidirectional	DO-214AA	1ba	1j	Cmc
ET	Z1SMA24	Z-diode	22.8..25.6V, I _z =25mA, Z _t =15Ω, 1W	DO-214AC	1d	1a	Trt
ET	Z1SMA-24	Z-diode	24V±5%, 1.3W	DO-214AC	1d	2j	Fag
ETP	TPSMC33A	TVS	Vbr=33V, 32.8A, 1500W(1ms)	DO-214AB	1d	1k	Vs
EU	P6SMBJ190C	TVS	Vbr=170V, 1.8A, 600W(1ms), Bidirectional	DO-214AA	1ba	1x,1y	Pjt,Srj
EU	PZU9.1BA/DG	Z-diode	9.1V±5%, I _f =200mA, 320mW, halogen-free	SOD-323	5d	1a	Phi
EU	SM6T36	TVS	Vbr=36V, 11.8A, 600W(1ms)	DO-214AA	1d	1q	Ste
EU	TV06B191KB-G	TVS	V _{rwm} =190.0V, V _{br} =211.28..258.0V, I _{pp} =1.76A, 600W(1ms), Bidirectional	DO-214AA	1ba	1j	Cmc
EU	Z1SMA27	Z-diode	25.1..28.9V, I _z =25mA, Z _t =15Ω, 1W	DO-214AC	1d	1a	Trt
EU	Z1SMA-27	Z-diode	27V±5%, 1.3W	DO-214AC	1d	2j	Fag
EUA	SMAJ43A	TVS	V _{rwm} =43V, V _{br} =47.8..52.8V, 5.7A, 400W(1ms)	DO-214AC	1d	1q	Ste
EUF	SMAJ58A	TVS	V _{rwm} =58V, V _{br} =64.4..71.2V, 4.3A, 400W(1ms)	DO-214AC	1d	1q	Ste
EUI	SMAJ70A	TVS	V _{rwm} =70V, V _{br} =77.8..86V, 3.5A, 400W(1ms)	DO-214AC	1d	1q	Ste
EUL	SMAJ85A	TVS	V _{rwm} =85V, V _{br} =94.4..104V, 2.9A, 400W(1ms)	DO-214AC	1d	1q	Ste
EUN	SMAJ100A	TVS	V _{rwm} =100V, V _{br} =111..136V, 2.5A, 400W(1ms)	DO-214AC	1d	1q	Ste
EUP	TPSMC36	TVS	Vbr=36V, 28.8A, 1500W(1ms)	DO-214AB	1d	1k	Vs
EUQ	SMAJ130A	TVS	V _{rwm} =130V, V _{br} =144..159V, 1.9A, 400W(1ms)	DO-214AC	1d	1q	Ste
EUT	SMAJ154A	TVS	V _{rwm} =154V, V _{br} =167..185V, 1.6A, 400W(1ms)	DO-214AC	1d	1q	Ste
EUV	SMAJ188A	TVS	V _{rwm} =188V, V _{br} =209..231V, 1.4A, 400W(1ms)	DO-214AC	1d	1q	Ste
EV	P6SMBJ190AC	TVS	Vbr=170V, 2A, 600W(1ms), Bidirectional	DO-214AA	1ba	1x,1y	Pjt,Srj
EV	PZU9.1B1A/DG	Z-diode	9.1V±2%, I _f =200mA, 320mW, halogen-free	SOD-323	5d	1a	Phi
EV	SM6T36A	TVS	V _{rwm} =30.8V, V _{br} =34.2..37.8V, 12A, 600W(1ms)	DO-214AA	1d	1a	Ste
EV	TV06B191JB-G	TVS	V _{rwm} =190.0V, V _{br} =211.0..232.0V, I _{pp} =1.95A, 600W(1ms), Bidirectional	DO-214AA	1ba	1j	Cmc
EV	Z1SMA30	Z-diode	28..32V, I _z =25mA, Z _t =15Ω, 1W	DO-214AC	1d	1a	Trt



SMD code	Type	Function	Short description	Case	Pinout	St.	Mnf.
EV	Z1SMA-30	Z-diode	30V±5%, 1.3W	DO-214AC	1d	2j	Fag
EVP	TPSMC36A	TVS	Vbr=36V, 30.1A, 1500W(1ms)	DO-214AB	1d	1k	Vs
EW	P6SMBJ200C	TVS	Vbr=170V, 1.7A, 600W(1ms), Bidirectional	DO-214AA	1ba	1x,1y	Pjt,Srij
EW	PZU9.1B2A/DG	Z-diode	9.1V±2%, If=200mA, 320mW, halogen-free	SOD-323	5d	1a	Phi
EW	SM6T39	TVS	Vbr=39V, 11A, 600W(1ms)	DO-214AA	1d	1q	Ste
EW	TV06B201JB-G	TVS	Vrwm=200.0V, Vbr=224.0.247.0V, Ipp=1.85A, 600W(1ms), Bidirectional	DO-214AA	1ba	1j	Cmc
EW	Z1SMA33	Z-diode	31.35V, Izt=25mA, Zzt=15Ω, 1W	DO-214AC	1d	1a	Ttr
EW	Z1SMA-33	Z-diode	33V±5%, 1.3W	DO-214AC	1d	2j	Fag
EWP	TPSMC39	TVS	Vbr=39V, 26.6A, 1500W(1ms)	DO-214AB	1d	1k	Vs
EX	MM3ZB15H	Z-diode	14.7..15.3V, Izt=5mA, Zzt=40Ω, 300mW	SOD-323	5d	1a	Zow
EX	PZU9.1B3A/DG	Z-diode	9.1V±2%, If=200mA, 320mW, halogen-free	SOD-323	5d	1a	Phi
EX	SM6T39A	TVS	Vrwm=33.3V, Vbr=37.1.41V, 11.1A, 600W(1ms)	DO-214AA	1d	1q,1a	Ste
EX	TV06B221JB-G	TVS	Vrwm=220.0V, Vbr=246.0.272.0V, Ipp=1.69A, 600W(1ms), Bidirectional	DO-214AA	1ba	1j	Cmc
EX	Z1SMA36	Z-diode	34.38V, Izt=10mA, Zzt=40Ω, 1W	DO-214AC	1d	1a	Ttr
EX	Z1SMA-36	Z-diode	36V±5%, 1.3W	DO-214AC	1d	2j	Fag
EXP	TPSMC39A	TVS	Vbr=39V, 27.8A, 1500W(1ms)	DO-214AB	1d	1k	Vs
EY	KDZ3.0VVY	Z-diode	2.95..3.20V, Izt=5mA, Zzt=120Ω, 100mW	VSC	7d	1a	Kec
EY	MM3ZB16H	Z-diode	15.68..16.32V, Izt=5mA, Zzt=40Ω, 300mW	SOD-323	5d	1a	Zow
EY	P6SMBJ210C	TVS	Vbr=170V, 1.6A, 600W(1ms), Bidirectional	DO-214AA	1ba	1x,1y	Pjt,Srij
EY	Z1SMA39	Z-diode	37.41V, Izt=10mA, Zzt=40Ω, 1W	DO-214AC	1d	1a	Ttr
EY	Z1SMA-39	Z-diode	39V±5%, 1.3W	DO-214AC	1d	2j	Fag
EYP	TPSMC43	TVS	Vbr=43V, 24.2A, 1500W(1ms)	DO-214AB	1d	1k	Vs
EZ	BZT52-B9V1S	Z-diode	8.92..9.28V, Izt=5mA, Zzt=15Ω, 200mW	SOD-323FL	7d	1a	Tsc
EZ	MM3Z9V1B	Z-diode	8.92..9.28V, Zzt=14Ω, Izt=5mA, 200mW	SOD-323FL	7d	1a	F
EZ	MM3Z9V1BW	Z-diode	8.92..9.28V, Izt=5mA, Zzt=15Ω, 200mW	SOD-323FL	7d	1a	Tac
EZ	MM3ZB18H	Z-diode	17.64..18.36V, Izt=5mA, Zzt=45Ω, 300mW	SOD-323	5d	1a	Zow
EZ	P6SMBJ200AC	TVS	Vbr=170V, 1.9A, 600W(1ms), Bidirectional	DO-214AA	1ba	1x,1y	Pjt,Srij
EZ	P6SMBJ210AC	TVS	Vbr=170V, 1.8A, 600W(1ms), Bidirectional	DO-214AA	1ba	1x,1y	Pjt,Srij
EZ	TCMM3Z9V1B	Z-diode	9.1V±2%, Izt=5mA, Zzt=14Ω, 200mW	SOD-323FL	7d	1a	Tac
EZ	TV06B251JB-G	TVS	Vrwm=250.0V, Vbr=279.0.309.0V, Ipp=1.48A, 600W(1ms), Bidirectional	DO-214AA	1ba	1j	Cmc
EZ	Z1SMA43	Z-diode	40.46V, Izt=10mA, Zzt=45Ω, 1W	DO-214AC	1d	1a	Ttr
EZ	Z1SMA-43	Z-diode	43V±5%, 1.3W	DO-214AC	1d	2j	Fag
EZP	TPSMC43A	TVS	Vbr=43V, 25.3A, 1500W(1ms)	DO-214AB	1d	1k	Vs
F	1PS79SB10	Si-diode	SBD, U-Speed, 30V, 200mA, Vf<0.8V(100mA), <10pF	SOD-523	6d	1a	Phi
F	BAS70-02L	Si-diode	Schottky, 70V, 70mA, Vf<1V(15mA), <2pF, 5ns	TSLP-2-1	13d	2b	Inf
F	CDZ7.5B	Z-diode	7.5V±2.5%, 40mA, 1W	VMN	7d	1s	Rhm
F	CH740S-40PT	Si-diode	SBD, 40V, 40mA, Vf<1V(2mA)	SOD-523	8d	1a	Chm
F	GBLC18I	TVS	Vbr=18V, 1A, 350W(1ms), 0.6pF	SOD-323	5d	1a	Prt
F	HVU352	C-diode	VCO 15V, ..1GHz, 6/8pF(1V)	SOD-323	5d	1a	Ren
F	MAZF075	Z-diode	7..7.9V, Zzt=20Ω(5mA), 120mW	S-Mini	7d	1a	Pan
F	MAZNO75	Z-diode	7..7.9V, Zzt=20Ω(5mA), 120mW	SSMini2	7d	1a	Pan
F	MAZS033	Z-diode	3.1..3.5V, 200mW	SOD-523	6d	1a	Pan
F	MM9D24V	Z-diode	22.80..25.20V, Izt=5mA, Zzt=70Ω, 200mW	SOD-923	7d	1a	Wtr
F	MM9D9V1	Z-diode	8.65..9.56V, Izt=5mA, Zzt=30Ω, 200mW	SOD-923	7d	1n	Wtr
f	MMSZ5232BPT	Z-diode	5.320..5.880V, Izt=5mA, Zzt=25Ω, 225mW	SOD-523	7d	1a	Chm
E	MMSZ5255BPT	Z-diode	26.60..29.40V, Izt=5mA, Zzt=44Ω, 225mW	SOD-523	7d	1a	Chm
F	NZ9F24VT	Z-diode	22.80..25.20V, Izt=5mA, Zzt=70Ω, 200mW	SOD-923	7d	1a	Ons
F	NZ9F5V1ST	Z-diode	4.989..5.2V, Izt=5mA, Zzt=80Ω, 200mW	SOD-923	7d	2m	Ons
F	NZ9F9V1T	Z-diode	8.65..9.56V, Izt=5mA, Zzt=30Ω, 200mW	SOD-923	7d	1n	Ons
f	MMSZ5232SPT	Z-diode	5.488..5.712V, Izt=5mA, Zzt=25Ω, 225mW	SOD-523	7d	1a	Chm
E	MMSZ5255SPT	Z-diode	27.44..28.56V, Izt=5mA, Zzt=44Ω, 225mW	SOD-523	7d	1a	Chm
F^	MAZS0330H	Z-diode	3.25..3.5V, 200mW	SOD-523	6d	1a	Pan
F_	MAZS0330L	Z-diode	3.1..3.35V, 200mW	SOD-523	6d	1a	Pan
F0	BZD27C24P	Z-diode	22.8..25.6V, Zzt=7Ω, Izt=25mA, 800mW	SOD-123FL	7d	1a	Vs
F0	BZX585-C5V6	Z-diode	5.6V±5%, 300mW	SOD-523	6d	1a	Phi
F0	CMOZ5V6	Z-diode	5.32..5.88V, Izt=5mA, Zzt=40Ω, 250mW	SOD-523	6d	1a	Cen
F0	MMPZ5236SPT	Z-diode	7.350..7.650V, Izt=5mA, Zzt=7Ω, 225mW	SOD-323	5d	1a	Chm
F0	MMPZ5247BPT	Z-diode	16.15..17.85V, Izt=5mA, Zzt=36Ω, 225mW	SOD-323	5d	1a	Chm
F01	DFLS130-7	Si-diode	SBR, 30V, 1.1A, Vf=0.36V(1A), 1.67W	PowDI123	7d	1a	Di
F02	DFLS120L-7	Si-diode	SBR, 20V, 1A, Vf=0.32V(1A), 1.67W	PowDI123	7d	1a	Di
F04	DFLS140-7	Si-diode	SBR, 40V, 1.1A, Vf=0.45V(0.5A), 1.67W	PowDI123	7d	1a	Di
F05A	UMAF5.0A	TVS	Vrwm=5.0V, Vbr=6.40..9.2V, 54.3A, 500W(1ms)	UltraMite	14d	1v	Msc
F05CA	UMAF5.0CA	TVS	Vrwm=5.0V, Vbr=6.40..9.2V, 54.3A, 500W(1ms), Bidirectional	UltraMite	14ba	1v	Msc
F065A	UMAF6.5A	TVS	Vrwm=6.5V, Vbr=7.22..11.2V, 44.7A, 500W(1ms)	UltraMite	14d	1v	Msc
F065CA	UMAF6.5CA	TVS	Vrwm=6.5V, Vbr=7.22..11.2V, 44.7A, 500W(1ms), Bidirectional	UltraMite	14ba	1v	Msc
F06A	UMAF6.0A	TVS	Vrwm=6.0V, Vbr=6.67..10.3V, 48.5A, 500W(1ms)	UltraMite	14d	1v	Msc
F06CA	UMAF6.0CA	TVS	Vrwm=6.0V, Vbr=6.67..10.3V, 48.5A, 500W(1ms), Bidirectional	UltraMite	14ba	1v	Msc
F075A	UMAF7.5A	TVS	Vrwm=7.5V, Vbr=8.33..12.9V, 38.8A, 500W(1ms)	UltraMite	14d	1v	Msc
F075CA	UMAF7.5CA	TVS	Vrwm=7.5V, Vbr=8.33..12.9V, 38.8A, 500W(1ms), Bidirectional	UltraMite	14ba	1v	Msc
F07A	UMAF7.0A	TVS	Vrwm=7.0V, Vbr=7.78..12.0V, 41.7A, 500W(1ms)	UltraMite	14d	1v	Msc



SMD code	Type	Function	Short description	Case	Pinout	St.	Mnf.
F07CA	UMAF7.0CA	TVS	Vrwm=7.0V, Vbr=7.78..12.0V, 41.7A, 500W(1ms), Bidirectional	UltraMite	14ba	1v	Msc
F085A	UMAF8.5A	TVS	Vrwm=8.5V, Vbr=9.44..14.4V, 34.7A, 500W(1ms)	UltraMite	14d	1v	Msc
F085CA	UMAF8.5CA	TVS	Vrwm=8.5V, Vbr=9.44..14.4V, 34.7A, 500W(1ms), Bidirectional	UltraMite	14ba	1v	Msc
F08A	UMAF8.0A	TVS	Vrwm=8.0V, Vbr=8.89..13.6V, 36.7A, 500W(1ms)	UltraMite	14d	1v	Msc
F08CA	UMAF8.0CA	TVS	Vrwm=8.0V, Vbr=8.89..13.6V, 36.7A, 500W(1ms), Bidirectional	UltraMite	14ba	1v	Msc
F09A	UMAF9.0A	TVS	Vrwm=9.0V, Vbr=10.0..15.4V, 32.6A, 500W(1ms)	UltraMite	14d	1v	Msc
F09CA	UMAF9.0CA	TVS	Vrwm=9.0V, Vbr=10.0..15.4V, 32.6A, 500W(1ms), Bidirectional	UltraMite	14ba	1v	Msc
F1	BZD27C27P	Z-diode	25.1..28.9V, Zzt=7Ω, Izt=25mA, 800mW	SOD-123FL	7d	1a	Vs
F1	BZX585-C2V4	Z-diode	2.4V±5%, 300mW	SOD-523	6d	1a	Phi
F1	CMOZ2V4	Z-diode	2.28..2.52V, Izt=5mA, Zzt=100Ω, 250mW	SOD-523	6d	1a	Cen
F1	CZRH5236B-G	Z-diode	7.13..7.88V, Zzt=6Ω, Izt=20mA, 150mW	SOD-523	5d	1a	Cmc
F1	CZRV5236B-G	Z-diode	7.13..7.88V, Zzt=6Ω, Izt=20mA, 200mW	SOD-323	5d	1a	Cmc
F1	CZRW5236B-G	Z-diode	7.13..7.88V, Zzt=6Ω, Izt=20mA, 500mW	SOD-123	5d	1a	Cmc
F1	FFM101-MH	Si-diode	Rectifier, Fast-Recovery, 50V, 1A, Vf<1.3V(1A), <150ns	SOD-123H	10d	1a	Ffm
F1	FM101SPT	Si-diode	Rectifier, Fast, 50V, 1A	SOD-123S	7d	1a	Chm
F1	FRS1A	Si-diode	Rectifier, Fast-Recovery 50V, 1A, <250ns	DO-214AC	1d	2j	Fag
F1	MM3Z5228B	Z-diode	3.9V±5%, Izt=20mA, Zzt=23Ω, 200mW	SOD-323FL	7d	1a	Bts
F1	MM3Z5228BH	Z-diode	3.71..4.1V, Izt=20mA, Zzt=23Ω, 300mW	SOD-323	5d	1a	Zow
F1	MM3Z5236B	Z-diode	7.13..7.88V, Izt=20mA, Zzt=6Ω, 200mW	SOD-323	5d	1a	Ext
F1	MMSZ52336	Z-diode	7.5V±5%, 300mW	SOD-123	5d	1k	Vs
F1	MMSZ5236B	Z-diode	7.5V±5%, Zzt=6Ω, 500mW	SOD-123	5d	1a,1d	Di,Mot
F1	MMSZ5236B	Z-diode	7.5V±5%, Zzt=6Ω, 500mW	SOD-123	5d	1d	Di
F1	MMSZ5236BS	Z-diode	7.5V±5%, Zzt=6Ω, 200mW	SOD-323	5d	1d	Di
F100A	UMAF100A	TVS	Vrwm=100V, Vbr=111..162V, 3.1A, 500W(1ms)	UltraMite	14d	1v	Msc
F100CA	UMAF100CA	TVS	Vrwm=100V, Vbr=111..162V, 3.1A, 500W(1ms), Bidirectional	UltraMite	14ba	1v	Msc
F10A	UMAF10A	TVS	Vrwm=10V, Vbr=11.1..17.0V, 29.4A, 500W(1ms)	UltraMite	14d	1v	Msc
F10CA	UMAF10CA	TVS	Vrwm=10V, Vbr=11.1..17.0V, 29.4A, 500W(1ms), Bidirectional	UltraMite	14ba	1v	Msc
F110A	UMAF110A	TVS	Vrwm=110V, Vbr=122..177V, 2.8A, 500W(1ms)	UltraMite	14d	1v	Msc
F110CA	UMAF110CA	TVS	Vrwm=110V, Vbr=122..177V, 2.8A, 500W(1ms), Bidirectional	UltraMite	14ba	1v	Msc
F11A	UMAF11A	TVS	Vrwm=11V, Vbr=12.2..18.2V, 27.4A, 500W(1ms)	UltraMite	14d	1v	Msc
F11CA	UMAF11CA	TVS	Vrwm=11V, Vbr=12.2..18.2V, 27.4A, 500W(1ms), Bidirectional	UltraMite	14ba	1v	Msc
F12	STPS120MF	Si-diode	SBR, 20V, 1A, Vf<0.55V(1A)	DO-222-AA	8d	1a	Ste
F120A	UMAF120A	TVS	Vrwm=120V, Vbr=133..193V, 2.6A, 500W(1ms)	UltraMite	14d	1v	Msc
F120CA	UMAF120CA	TVS	Vrwm=120V, Vbr=133..193V, 2.6A, 500W(1ms), Bidirectional	UltraMite	14ba	1v	Msc
F12A	UMAF12A	TVS	Vrwm=12V, Vbr=13.3..19.9V, 25.1A, 500W(1ms)	UltraMite	14d	1v	Msc
F12CA	UMAF12CA	TVS	Vrwm=12V, Vbr=13.3..19.9V, 25.1A, 500W(1ms), Bidirectional	UltraMite	14ba	1v	Msc
F130A	UMAF130A	TVS	Vrwm=130V, Vbr=144..209V, 2.4A, 500W(1ms)	UltraMite	14d	1v	Msc
F130CA	UMAF130CA	TVS	Vrwm=130V, Vbr=144..209V, 2.4A, 500W(1ms), Bidirectional	UltraMite	14ba	1v	Msc
F13A	UMAF13A	TVS	Vrwm=13V, Vbr=14.4..21.5V, 23.2A, 500W(1ms)	UltraMite	14d	1v	Msc
F13CA	UMAF13CA	TVS	Vrwm=13V, Vbr=14.4..21.5V, 23.2A, 500W(1ms), Bidirectional	UltraMite	14ba	1v	Msc
F14A	UMAF14A	TVS	Vrwm=14V, Vbr=15.6..23.2V, 21.5A, 500W(1ms)	UltraMite	14d	1v	Msc
F14CA	UMAF14CA	TVS	Vrwm=14V, Vbr=15.6..23.2V, 21.5A, 500W(1ms), Bidirectional	UltraMite	14ba	1v	Msc
F150A	UMAF150A	TVS	Vrwm=150V, Vbr=167..243V, 2.1A, 500W(1ms)	UltraMite	14d	1v	Msc
F150CA	UMAF150CA	TVS	Vrwm=150V, Vbr=167..243V, 2.1A, 500W(1ms), Bidirectional	UltraMite	14ba	1v	Msc
F157	FSM157PT	Si-diode	Rectifier, Fast, 400V, 1A	DO-214AC	1d	1a	Chm
F158	FSM158PT	Si-diode	Rectifier, Fast, 600V, 1A	DO-214AC	1d	1a	Chm
F159	FSM159PT	Si-diode	Rectifier, Fast, 1000V, 1A	DO-214AC	1d	1a	Chm
F15A	UMAF15A	TVS	Vrwm=15V, Vbr=16.7..24.4V, 20.6A, 500W(1ms)	UltraMite	14d	1v	Msc
F15CA	UMAF15CA	TVS	Vrwm=15V, Vbr=16.7..24.4V, 20.6A, 500W(1ms), Bidirectional	UltraMite	14ba	1v	Msc
F160A	UMAF160A	TVS	Vrwm=160V, Vbr=178..259V, 1.9A, 500W(1ms)	UltraMite	14d	1v	Msc
F160CA	UMAF160CA	TVS	Vrwm=160V, Vbr=178..259V, 1.9A, 500W(1ms), Bidirectional	UltraMite	14ba	1v	Msc
F16A	UMAF16A	TVS	Vrwm=16V, Vbr=17.8..26.0V, 19.2A, 500W(1ms)	UltraMite	14d	1v	Msc
F16CA	UMAF16CA	TVS	Vrwm=16V, Vbr=17.8..26.0V, 19.2A, 500W(1ms), Bidirectional	UltraMite	14ba	1v	Msc
F170A	UMAF170A	TVS	Vrwm=170V, Vbr=189..275V, 1.8A, 500W(1ms)	UltraMite	14d	1v	Msc
F170CA	UMAF170CA	TVS	Vrwm=170V, Vbr=189..275V, 1.8A, 500W(1ms), Bidirectional	UltraMite	14ba	1v	Msc
F17A	UMAF17A	TVS	Vrwm=17V, Vbr=18.9..27.6V, 18.1A, 500W(1ms)	UltraMite	14d	1v	Msc
F17CA	UMAF17CA	TVS	Vrwm=17V, Vbr=18.9..27.6V, 18.1A, 500W(1ms), Bidirectional	UltraMite	14ba	1v	Msc
F18A	UMAF18A	TVS	Vrwm=18V, Vbr=20.0..29.2V, 17.2A, 500W(1ms)	UltraMite	14d	1v	Msc
F18CA	UMAF18CA	TVS	Vrwm=18V, Vbr=20.0..29.2V, 17.2A, 500W(1ms), Bidirectional	UltraMite	14ba	1v	Msc
F1A	CD214A-F150	Si-diode	Rect, Fast, 50V, 1A, Vf<0.95V(1A)	DO-214AC	1d	1a	Bm
F1A	CMOZ2V6	Z-diode	2.47..2.73V, Izt=5mA, Zzt=100Ω, 250mW	SOD-523	6d	1a	Cen
F1B	CD214A-F1100	Si-diode	Rect, Fast, 100V, 1A, Vf<0.95V(1A)	DO-214AC	1d	1a	Bm
F1C	CD214A-F1150	Si-diode	Rect, Fast, 150V, 1A, Vf<0.95V(1A)	DO-214AC	1d	1a	Bm
F1D	CD214A-F1200	Si-diode	Rect, Fast, 200V, 1A, Vf<0.95V(1A)	DO-214AC	1d	1a	Bm
F1G	CD214A-F1400	Si-diode	Rect, Fast, 400V, 1A, Vf<1.25V(1A)	DO-214AC	1d	1a	Bm
F1J	CD214A-F1600	Si-diode	Rect, Fast, 600V, 1A, Vf<1.7V(1A)	DO-214AC	1d	1a	Bm
F1L2	STPS1L20MF	Si-diode	SBR, 20V, 1A, Vf<0.37V(1A)	DO-222-AA	8d	1a	Ste
F1L4	STPS1L140MF	Si-diode	SBR, 40V, 1A, Vf<0.42V(1A)	DO-222-AA	8d	1a	Ste
F1L6	STPS1L60MF	Si-diode	SBR, 60V, 1A, Vf<0.56V(1A)	DO-222-AA	8d	1a	Ste
F2	BZD27C30P	Z-diode	28..32V, Zzt=8 15Ω, Izt=25mA, 800mW	SOD-123FL	7d	1a	Vs



SMD code	Type	Function	Short description	Case	Pinout	St.	Mnf.
F2	BZX585-C2V9	Z-diode	2.9V±5%, 300mW	SOD-523	6d	1a	Phi
F2	CMOZ2V7	Z-diode	2.57..2.84V, Izt=5mA, Zzt=100Ω, 250mW	SOD-523	6d	1a	Cen
F2	CZRH5237B-G	Z-diode	7.79..8.61V, Zzt=8Ω, Izt=20mA, 150mW	SOD-523	5d	1a	Cmc
F2	CZRW5237B-G	Z-diode	7.79..8.61V, Zzt=8Ω, Izt=20mA, 200mW	SOD-323	5d	1a	Cmc
F2	CZRW5237B-G	Z-diode	7.79..8.61V, Zzt=8Ω, Izt=20mA, 500mW	SOD-123	5d	1a	Cmc
F2	EDZ6.8B	Z-diode	6.65..6.93V, Izt=5mA, Zzt=40Ω, 150mW	SOD-523	6d	1a	Rhm
F2	EDZS6.8B	Z-diode	6.8V±10%, 5mA, 100mW	SOD-523	6d	1a	Rhm
F2	FDZ6.8EV	Z-diode	6.650..6.930V, Izt=5mA, Zzt=40Ω, 150mW	SOD-523	7d	1a	Fis
F2	FDZ6.8VT	Z-diode	6.650..6.930V, Izt=5mA, Zzt=40Ω, 200mW	SOD-323	5d	1a	Fis
F2	FFM102-MH	Si-diode	Rectifier, Fast-Recovery, 100V, 1A, Vf<1.3V(1A), <150ns	SOD-123H	10d	1a	Frm
F2	FM102SPT	Si-diode	Rectifier, Fast, 100V, 1A	SOD-123S	7d	1a	Chm
F2	FRS1B	Si-diode	Rectifier, Fast-Recovery 100V, 1A, <250ns	DO-214AC	1d	2j	Fag
F2	MM3Z5237B	Z-diode	7.79..8.61V, Izt=20mA, Zzt=8Ω, 200mW	SOD-323	5d	1a	Ext
F2	MM3Z5248B	Z-diode	18.1±5%, Izt=7.0mA, Zzt=21Ω, 200mW	SOD-323FL	7d	1a	Bts
F2	MM3Z5248BH	Z-diode	17.1..18.9V, Izt=7mA, Zzt=21Ω, 300mW	SOD-323	5d	1a	Zow
F2	MMSZ52337	Z-diode	8.2V±5%, 300mW	SOD-123	5d	1k	Vs
F2	MMSZ5237B	Z-diode	8.2V±5%, Zzt=8Ω, 500mW	SOD-123	5d	1a,1d	Di,Mot
F2	MMSZ5237B	Z-diode	8.2V±5%, Zzt=8Ω, 500mW	SOD-123	5d	1d	Di
F2	MMSZ5237BS	Z-diode	8.2V±5%, Zzt=8Ω, 200mW	SOD-323	5d	1d	Di
F2	MSCD012	Si-diode	SBR, 20V, 0.1A, Vf<0.45V(0.1A)	0805	14d	1v	Zow
F2	TDZ6.8B	Z-diode	6.8V±2.5%, 10mA, 500mW	TUMD2	7d	1s	Rhm
F2	UDZS6.8B	Z-diode	6.65..6.93V, Izt=5mA, Zzt=40Ω, 200mW	SOD-323	5d	1a	Wtr
F2	UDZS6.8B	Z-diode	6.8V±2.5%, Izt=5mA, 200mW	SOD-323FL	7d	1s	Rhm
F2	VDZS6.8B	Z-diode	6.8V±5%, 5mA, 100mW	VMD2	5d	1z	Rhm
F20A	UMAF20A	TVS	Vrwm=20V, Vbr=22.2..32.4V, 15.4A, 500W(1ms)	UltraMite	14d	1v	Msc
F20CA	UMAF20CA	TVS	Vrwm=20V, Vbr=22.2..32.4V, 15.4A, 500W(1ms), Bidirectional	UltraMite	14ba	1v	Msc
F22A	UMAF22A	TVS	Vrwm=22V, Vbr=24.4..35.5V, 14.1A, 500W(1ms)	UltraMite	14d	1v	Msc
F22CA	UMAF22CA	TVS	Vrwm=22V, Vbr=24.4..35.5V, 14.1A, 500W(1ms), Bidirectional	UltraMite	14ba	1v	Msc
F24A	UMAF24A	TVS	Vrwm=24V, Vbr=26.7..38.9V, 12.8A, 500W(1ms)	UltraMite	14d	1v	Msc
F24CA	UMAF24CA	TVS	Vrwm=24V, Vbr=26.7..38.9V, 12.8A, 500W(1ms), Bidirectional	UltraMite	14ba	1v	Msc
F26A	UMAF26A	TVS	Vrwm=26V, Vbr=28.9..42.1V, 11.9A, 500W(1ms)	UltraMite	14d	1v	Msc
F26CA	UMAF26CA	TVS	Vrwm=26V, Vbr=28.9..42.1V, 11.9A, 500W(1ms), Bidirectional	UltraMite	14ba	1v	Msc
F28A	UMAF28A	TVS	Vrwm=28V, Vbr=31.1..45.4V, 11.0A, 500W(1ms)	UltraMite	14d	1v	Msc
F28CA	UMAF28CA	TVS	Vrwm=28V, Vbr=31.1..45.4V, 11.0A, 500W(1ms), Bidirectional	UltraMite	14ba	1v	Msc
F3	BZD27C33P	Z-diode	31..35V, Zzt=8 15Ω, Izt=25mA, 800mW	SOD-123FL	7d	1a	Vs
F3	BZX585-C3V0	Z-diode	3V±5%, 300mW	SOD-523	6d	1a	Phi
F3	CMOZ3V0	Z-diode	2.85..3.15V, Izt=5mA, Zzt=95Ω, 250mW	SOD-523	6d	1a	Cen
F3	CZRW5238B-G	Z-diode	8.27..9.14V, Zzt=8Ω, Izt=20mA, 500mW	SOD-123	5d	1a	Cmc
F3	FFM103-MH	Si-diode	Rectifier, Fast-Recovery, 200V, 1A, Vf<1.3V(1A), <150ns	SOD-123H	10d	1a	Frm
F3	FM103SPT	Si-diode	Rectifier, Fast, 200V, 1A	SOD-123S	7d	1a	Chm
F3	FRS1D	Si-diode	Rectifier, Fast-Recovery 200V, 1A, <250ns	DO-214AC	1d	2j	Fag
F3	MM3Z5268B	Z-diode	82V±5%, Izt=1.5mA, Zzt=330Ω, 200mW	SOD-323FL	7d	1a	Bts
F3	MMSZ52338	Z-diode	8.7V±5%, 300mW	SOD-123	5d	1k	Vs
F3	MMSZ5238B	Z-diode	8.7V±5%, Zzt=8Ω, 500mW	SOD-123	5d	1a,1d	Di,Mot
F3	MMSZ5238B	Z-diode	8.7V±5%, Zzt=8Ω, 500mW	SOD-123	5d	1d	Di
F3	MMSZ5238BS	Z-diode	8.7V±5%, Zzt=8Ω, 200mW	SOD-323	5d	1d	Di
F3	PZU2.7B1	Z-diode	2.5..2.75V, Zzt=100Ω(Izt=5mA), 310mW	SOD-323FL	7d	1a	Phi
F3	RKZ6.8B2KK	Z-diode	6.65..6.93V, Izt=5mA, Zzt=30Ω, 150mW	SFP	7d	1a	Ren
F3	RKZ6.8B2KL	Z-diode	6.65..6.93V, Izt=5mA, Zzt=30Ω, 100mW	EPF	7d	1a	Ren
F30A	UMAF30A	TVS	Vrwm=30V, Vbr=33.3..48.4V, 10.3A, 500W(1ms)	UltraMite	14d	1v	Msc
F30CA	UMAF30CA	TVS	Vrwm=30V, Vbr=33.3..48.4V, 10.3A, 500W(1ms), Bidirectional	UltraMite	14ba	1v	Msc
F33A	UMAF33A	TVS	Vrwm=33V, Vbr=36.7..53.3V, 9.4A, 500W(1ms)	UltraMite	14d	1v	Msc
F33CA	UMAF33CA	TVS	Vrwm=33V, Vbr=36.7..53.3V, 9.4A, 500W(1ms), Bidirectional	UltraMite	14ba	1v	Msc
F36A	UMAF36A	TVS	Vrwm=36V, Vbr=40.0..58.1V, 8.6A, 500W(1ms)	UltraMite	14d	1v	Msc
F36CA	UMAF36CA	TVS	Vrwm=36V, Vbr=40.0..58.1V, 8.6A, 500W(1ms), Bidirectional	UltraMite	14ba	1v	Msc
F3A	CD214B-F350	Si-diode	Rect, Fast, 50V, 3A, Vf<0.95V(1A)	DO-214AA	1d	1a	Bm
F3A	CD214C-F350	Si-diode	Rect, Fast, 50V, 3A, Vf<0.92V(1A)	DO-214AB	1d	1a	Bm
F3B	CD214B-F3100	Si-diode	Rect, Fast, 100V, 3A, Vf<0.95V(1A)	DO-214AA	1d	1a	Bm
F3B	CD214C-F3100	Si-diode	Rect, Fast, 100V, 3A, Vf<0.92V(1A)	DO-214AB	1d	1a	Bm
F3C	CD214B-F3150	Si-diode	Rect, Fast, 150V, 3A, Vf<0.95V(1A)	DO-214AA	1d	1a	Bm
F3D	CD214B-F3200	Si-diode	Rect, Fast, 200V, 3A, Vf<0.95V(1A)	DO-214AA	1d	1a	Bm
F3D	CD214C-F3200	Si-diode	Rect, Fast, 200V, 3A, Vf<0.92V(1A)	DO-214AB	1d	1a	Bm
F3G	CD214B-F3400	Si-diode	Rect, Fast, 400V, 3A, Vf<1.25V(1A)	DO-214AA	1d	1a	Bm
F3G	CD214C-F3400	Si-diode	Rect, Fast, 400V, 3A, Vf<1.25V(1A)	DO-214AB	1d	1a	Bm
F3J	CD214B-F3600	Si-diode	Rect, Fast, 600V, 3A, Vf<1.7V(1A)	DO-214AA	1d	1a	Bm
F3J	CD214C-F3600	Si-diode	Rect, Fast, 600V, 3A, Vf<1.3V(1A)	DO-214AB	1d	1a	Bm
F4	BZD27C36P	Z-diode	34..38V, Zzt=21Ω, Izt=10mA, 800mW	SOD-123FL	7d	1a	Vs
F4	BZX585-C3V3	Z-diode	3.3V±5%, 300mW	SOD-523	6d	1a	Phi
F4	CMOZ3V3	Z-diode	3.14..3.47V, Izt=5.0V, Zzt=95Ω, 250mW	SOD-523	6d	1a	Cen
F4	CZRH5239B-G	Z-diode	8.65..9.56V, Zzt=10Ω, Izt=20mA, 150mW	SOD-523	5d	1a	Cmc



SMD
code

Type

Function

Short description

Case

Pinout

St.

Mnf.

SMD code	Type	Function	Short description	Case	Pinout	St.	Mnf.
F4	CZRV5239B-G	Z-diode	8.65..9.56V, Zzt=10Q, Izt=20mA, 200mW	SOD-323	5d	1a	Cmc
F4	CZRW5239B-G	Z-diode	8.65..9.56V, Zzt=10Q, Izt=20mA, 500mW	SOD-123	5d	1a	Cmc
F4	FFM104-MH	Si-diode	Rectifier, Fast-Recovery, 400V, 1A, Vf<1.3V(1A), <150ns	SOD-123H	10d	1a	Frm
F4	FM104SPT	Si-diode	Rectifier, Fast, 400V, 1A	SOD-123S	7d	1a	Chm
F4	FRS1G	Si-diode	Rectifier, Fast-Recovery 400V, 1A, <250ns	DO-214AC	1d	2j	Fag
F4	MM1Z5228B	Z-diode	3.71..10V, Izt=20mA, Zzt=23Q, 500mW	SOD-323FL	5d	1a	Eic
F4	MM1Z5228BH	Z-diode	3.71..4.1V, Izt=20mA, Zzt=23Q, 500mW	SOD-123	5d	1a	Zow
F4	MM3Z6239B	Z-diode	8.65..9.56V, Izt=20mA, Zzt=10Q, 200mW	SOD-323	5d	1a	Ext
F4	MMSZ5228B	Z-diode	3.9V±5%, Izt=20mA, Zzt=23Q, 500mW	SOD-123	5d	1a	Eic
F4	MMSZ52339	Z-diode	9.1V±5%, 300mW	SOD-123	5d	1k	Vs
F4	MMSZ5239B	Z-diode	9.1V±5%, Zzt=10Q, 500mW	SOD-123	5d	1a,1d	Di,Mot
F4	MMSZ5239B	Z-diode	9.1V±5%, Zzt=10Q, 500mW	SOD-123	5d	1d	Di
F4	MMSZ5239BS	Z-diode	9.1V±5%, Zzt=10Q, 200mW	SOD-323	5d	1d	Di
F4	MSCD014	Si-diode	SBR, 40V, 0.1A, Vf<0.5V(0.1A)	0805	14d	1v	Zow
F4	PZU3_0B1	Z-diode	2.8..3.05V, Zzt=95Q(Izt=5mA), 310mW	SOD-323FL	7d	1a	Phi
F40A	UMAF40A	TVS	Vrwm=40V, Vbr=44.4..64.5V, 7.8A, 500W(1ms)	UltraMite	14d	1v	Msc
F40CA	UMAF40CA	TVS	Vrwm=40V, Vbr=44.4..64.5V, 7.8A, 500W(1ms), Bidirectional	UltraMite	14ba	1v	Msc
F43A	UMAF43A	TVS	Vrwm=43V, Vbr=47.8..69.4V, 7.2A, 500W(1ms)	UltraMite	14d	1v	Msc
F43CA	UMAF43CA	TVS	Vrwm=43V, Vbr=47.8..69.4V, 7.2A, 500W(1ms), Bidirectional	UltraMite	14ba	1v	Msc
F45A	UMAF45A	TVS	Vrwm=45V, Vbr=50.0..72.7V, 6.9A, 500W(1ms)	UltraMite	14d	1v	Msc
F45CA	UMAF45CA	TVS	Vrwm=45V, Vbr=50.0..72.7V, 6.9A, 500W(1ms), Bidirectional	UltraMite	14ba	1v	Msc
F48A	UMAF48A	TVS	Vrwm=48V, Vbr=53.3..77.4V, 6.5A, 500W(1ms)	UltraMite	14d	1v	Msc
F48CA	UMAF48CA	TVS	Vrwm=48V, Vbr=53.3..77.4V, 6.5A, 500W(1ms), Bidirectional	UltraMite	14ba	1v	Msc
F5	BZD27C39P	Z-diode	37..41V, Zzt=21Q, Izt=10mA, 800mW	SOD-123FL	7d	1a	Vs
F5	BZX584B10V	Z-diode	9.80..10.20V, Izt=5mA, Zzt=20Q, 200mW	SOD-523FL	7d	1a	Tac
F5	BZX585-C3V6	Z-diode	3.6V±5%, 300mW	SOD-523	6d	1a	Phi
F5	CMOZ3V6	Z-diode	3.42..3.78V, Izt=5.0mA, Zzt=90Q, 250mW	SOD-523	6d	1a	Cen
F5	CZRH5240B-G	Z-diode	9.5..10.5V, Zzt=17Q, Izt=20mA, 150mW	SOD-523	5d	1a	Cmc
F5	CZRV5240B-G	Z-diode	9.5..10.5V, Zzt=17Q, Izt=20mA, 200mW	SOD-323	5d	1a	Cmc
F5	CZRW5240B-G	Z-diode	9.50..10.50V, Zzt=17Q, Izt=20mA, 500mW	SOD-123	5d	1a	Cmc
F5	EDZ36B	Z-diode	35.07..36.87V, Izt=2mA, Zzt=300Q, 150mW	SOD-523	6d	1a	Rhm
F5	FDZ36EV	Z-diode	35.070..36.870V, Izt=2mA, Zzt=300Q, 150mW	SOD-523	7d	1a	Fis
F5	FDZ36VT	Z-diode	35.070..36.870V, Izt=5mA, Zzt=300Q, 200mW	SOD-323	5d	1a	Fis
F5	FFM105-MH	Si-diode	Rectifier, Fast-Recovery, 600V, 1A, Vf<1.3V(1A), <250ns	SOD-123H	10d	1a	Frm
F5	FM105SPT	Si-diode	Rectifier, Fast, 600V, 1A	SOD-123S	7d	1a	Chm
F5	FRS1J	Si-diode	Rectifier, Fast-Recovery 600V, 1A, <250ns	DO-214AC	1d	2j	Fag
F5	MM1Z5248B	Z-diode	17.10..18.90V, Izt=7.0mA, Zzt=21Q, 500mW	SOD-323FL	5d	1a	Eic
F5	MM1Z5248BH	Z-diode	17.1..18.9V, Izt=7mA, Zzt=21Q, 500mW	SOD-123	5d	1a	Zow
F5	MM3Z5240B	Z-diode	9.50..10.50V, Izt=20mA, Zzt=17Q, 200mW	SOD-323	5d	1a	Ext
F5	MMSZ10VB	Z-diode	9.80..10.20V, Izt=5mA, Zzt=20Q, 200mW	SOD-523FL	7d	1a	Tac
F5	MMSZ52340	Z-diode	10V, 10%, 300mW	SOD-123	5d	1k	Vs
F5	MMSZ5240B	Z-diode	10V±5%, Zzt=17Q, 500mW	SOD-123	5d	1a,1d	Di,Mot
F5	MMSZ5240B	Z-diode	10V±5%, Zzt=17Q, 500mW	SOD-123	5d	1d	Di
F5	MMSZ5240BS	Z-diode	10V±5%, Zzt=17Q, 200mW	SOD-323	5d	1d	Di
F5	MMSZ5248B	Z-diode	18V±5%, Izt=7mA, Zzt=21Q, 500mW	SOD-123	5d	1a	Eic
F5	PZU3_3B1	Z-diode	3.1..3.35V, Zzt=95Q(Izt=5mA), 310mW	SOD-323FL	7d	1a	Phi
F5	UDZS36B	Z-diode	35.07..36.87V, Izt=5mA, Zzt=300Q, 200mW	SOD-323	5d	1a	Wtr
F5	UDZS36B	Z-diode	36V±2.5%, Izt=5mA, 200mW	SOD-323FL	7d	1s	Rhm
F5	VDZS36B	Z-diode	36V±5%, 5mA, 100mW	VMD2	5d	1z	Rhm
F51A	UMAF51A	TVS	Vrwm=51V, Vbr=56.7..82.4V, 6.1A, 500W(1ms)	UltraMite	14d	1v	Msc
F51CA	UMAF51CA	TVS	Vrwm=51V, Vbr=56.7..82.4V, 6.1A, 500W(1ms), Bidirectional	UltraMite	14ba	1v	Msc
F54A	UMAF54A	TVS	Vrwm=54V, Vbr=60.0..87.1V, 5.7A, 500W(1ms)	UltraMite	14d	1v	Msc
F54CA	UMAF54CA	TVS	Vrwm=54V, Vbr=60.0..87.1V, 5.7A, 500W(1ms), Bidirectional	UltraMite	14ba	1v	Msc
F58A	UMAF58A	TVS	Vrwm=58V, Vbr=64.4..93.6V, 5.3A, 500W(1ms)	UltraMite	14d	1v	Msc
F58CA	UMAF58CA	TVS	Vrwm=58V, Vbr=64.4..93.6V, 5.3A, 500W(1ms), Bidirectional	UltraMite	14ba	1v	Msc
F6	BZD27C43P	Z-diode	40..46V, Zzt=24Q, Izt=10mA, 800mW	SOD-123FL	7d	1a	Vs
F6	BZX585-C3V9	Z-diode	3.9V±5%, 300mW	SOD-523	6d	1a	Phi
F6	CMOZ3V9	Z-diode	3.71..4.10V, Izt=5mA, Zzt=90Q, 250mW	SOD-523	6d	1a	Cen
F6	FFM106-MH	Si-diode	Rectifier, Fast-Recovery, 800V, 1A, Vf<1.3V(1A), <500ns	SOD-123H	10d	1a	Frm
F6	FM106SPT	Si-diode	Rectifier, Fast, 800V, 1A	SOD-123S	7d	1a	Chm
F6	FRS1K	Si-diode	Rectifier, Fast-Recovery 800V, 1A, <250ns	DO-214AC	1d	2j	Fag
F6	MM1Z5268B	Z-diode	82V±5%, Izt=1.5mA, Zzt=330Q, 500mW	SOD-123FL	7d	1a	Bts
F6	MMSZ5268B	Z-diode	82V±5%, Izt=1.5mA, Zzt=330Q, 500mW	SOD-123	5d	1a	Eic
F6	PZU3_6B1	Z-diode	3.4..3.65V, Zzt=90Q(Izt=5mA), 310mW	SOD-323FL	7d	1a	Phi
F6	RKZ7_5B2KK	Z-diode	7.28..7.60V, Izt=5mA, Zzt=30Q, 150mW	SFP	7d	1a	Ren
F6	RKZ7_5B2KL	Z-diode	7.28..7.60V, Izt=5mA, Zzt=30Q, 100mW	EPF	7d	1a	Ren
F60A	UMAF60A	TVS	Vrwm=60V, Vbr=66.7..96.8V, 5.2A, 500W(1ms)	UltraMite	14d	1v	Msc
F60CA	UMAF60CA	TVS	Vrwm=60V, Vbr=66.7..96.8V, 5.2A, 500W(1ms), Bidirectional	UltraMite	14ba	1v	Msc
F64A	UMAF64A	TVS	Vrwm=64V, Vbr=71.1..103.0V, 4.9A, 500W(1ms)	UltraMite	14d	1v	Msc
F64CA	UMAF64CA	TVS	Vrwm=64V, Vbr=71.1..103.0V, 4.9A, 500W(1ms), Bidirectional	UltraMite	14ba	1v	Msc



SMD
code

Type

Function

Short description

Case

Pinout

St.

Mnf.

F7	BZD27C47P	Z-diode	44. 50V, Zzt=24Ω, Izt=10mA, 800mW	SOD-123FL	7d	1a	Vs
F7	BZX585-C4V3	Z-diode	4.3V±5%, 300mW	SOD-523	6d	1a	Phi
F7	CMOZ4V3	Z-diode	4.09..4.52V, Izt=5mA, Zzt=90Ω, 250mW	SOD-523	6d	1a	Cen
F7	FFM107-MH	Si-diode	Rectifier, Fast-Recovery, 1000V, 1A, Vf<1.3V(1A), <500ns	SOD-123H	10d	1a	Frm
F7	FM107SPT	Si-diode	Rectifier, Fast, 1000V, 1A	SOD-123S	7d	1a	Chm
F7	FRS1M	Si-diode	Rectifier, Fast-Recovery 1000V, 1A, <250ns	DO-214AC	1d	2j	Fag
F7	PZU3.9B1	Z-diode	3.7..3.97V, Zzt=90Ω(Izt=5mA), 310mW	SOD-323FL	7d	1a	Phi
F70A	UMAF70A	TVS	Vrwm=70V, Vbr=77.8..113V, 4.4A, 500W(1ms)	UltraMite	14d	1v	Msc
F70CA	UMAF70CA	TVS	Vrwm=70V, Vbr=77.8..113V, 4.4A, 500W(1ms), Bidirectional	UltraMite	14ba	1v	Msc
F75A	UMAF75A	TVS	Vrwm=75V, Vbr=83.3..121V, 4.1A, 500W(1ms)	UltraMite	14d	1v	Msc
F75CA	UMAF75CA	TVS	Vrwm=75V, Vbr=83.3..121V, 4.1A, 500W(1ms), Bidirectional	UltraMite	14ba	1v	Msc
F78A	UMAF78A	TVS	Vrwm=78V, Vbr=86.7..126V, 4.0A, 500W(1ms)	UltraMite	14d	1v	Msc
F78CA	UMAF78CA	TVS	Vrwm=78V, Vbr=86.7..126V, 4.0A, 500W(1ms), Bidirectional	UltraMite	14ba	1v	Msc
F8	BZD27C51P	Z-diode	48. 54V, Zzt=25Ω, Izt=10mA, 800mW	SOD-123FL	7d	1a	Vs
F8	BZX585-C4V7	Z-diode	4.7V±5%, 300mW	SOD-523	6d	1a	Phi
F8	CMOZ4V7	Z-diode	4.47..4.94V, Izt=5mA, Zzt=80Ω, 250mW	SOD-523	6d	1a	Cen
F8	MM5Z4V3	Z-diode	4.3V±5%, Izt=5mA, Zzt=90Ω, 200mW	SOD-523	6d	1a	Eic
F8	MM5Z4V3H	Z-diode	4..4.6V, Izt=5mA, Zzt=90Ω, 200mW	SOD-523	7d	1a	Zow
F8	PZU4.3B1	Z-diode	4.01..4.21V, Zzt=90Ω(Izt=5mA), 310mW	SOD-323FL	7d	1a	Phi
F85A	UMAF85A	TVS	Vrwm=85V, Vbr=94.4..137V, 3.6A, 500W(1ms)	UltraMite	14d	1v	Msc
F85CA	UMAF85CA	TVS	Vrwm=85V, Vbr=94.4..137V, 3.6A, 500W(1ms), Bidirectional	UltraMite	14ba	1v	Msc
F9	BZD27C56P	Z-diode	52. 60V, Zzt=25Ω, Izt=10mA, 800mW	SOD-123FL	7d	1a	Vs
F9	BZX585-C5V1	Z-diode	5.1V±5%, 300mW	SOD-523	6d	1a	Phi
F9	CMOZ5V1	Z-diode	4.85..5.36V, Izt=5mA, Zzt=60Ω, 250mW	SOD-523	6d	1a	Cen
F9	MM5Z51H	Z-diode	48. 54V, Izt=1mA, Zzt=180Ω, 200mW	SOD-523	7d	1a	Zow
F9	MM5Z51V	Z-diode	51V±5%, Izt=2mA, Zzt=180Ω, 200mW	SOD-523	6d	1a	Eic
F9	PZU4.7B1	Z-diode	4.42..4.61V, Zzt=80Ω(Izt=5mA), 310mW	SOD-323FL	7d	1a	Phi
F9	RKZ8.2B2KK	Z-diode	8.02..8.36V, Izt=5mA, Zzt=30Ω, 150mW	SFP	7d	1a	Ren
F9	RKZ8.2B2KL	Z-diode	8.02..8.36V, Izt=5mA, Zzt=30Ω, 100mW	EFP	7d	1a	Ren
F90A	UMAF90A	TVS	Vrwm=90V, Vbr=100..146V, 3.4A, 500W(1ms)	UltraMite	14d	1v	Msc
F90CA	UMAF90CA	TVS	Vrwm=90V, Vbr=100..146V, 3.4A, 500W(1ms), Bidirectional	UltraMite	14ba	1v	Msc
FA	MM3ZB20H	Z-diode	19.6..20.4V, Izt=5mA, Zzt=50Ω, 300mW	SOD-323	5d	1a	Zow
FA	PZU5.1B1	Z-diode	4.84..5.04V, Zzt=60Ω(Izt=5mA), 310mW	SOD-323FL	7d	1a	Phi
FA	Z1SMA3V3	Z-diode	3.1..3.5V, Izt=100mA, Zzt=10Ω, 1W	DO-214AC	1d	1a	Tr
FAE	DFLT5V0A	TVS	Vrwm=5.0V, Vbr=6.40..7.0V, 24.5A, 225W(1ms)	PowD1123	7d	1d	Di
FAG	DFLT6V0A	TVS	Vrwm=6.0V, Vbr=6.67..7.37V, 21.8A, 225W(1ms)	PowD1123	7d	1d	Di
FAK	DFLT6V5A	TVS	Vrwm=6.5V, Vbr=7.22..7.98V, 20.1A, 225W(1ms)	PowD1123	7d	1d	Di
FAM	DFLT7V0A	TVS	Vrwm=7.0V, Vbr=7.78..8.60V, 18.8A, 225W(1ms)	PowD1123	7d	1d	Di
FAP	DFLT7V5A	TVS	Vrwm=7.5V, Vbr=8.33..9.21V, 17.4A, 225W(1ms)	PowD1123	7d	1d	Di
FAR	DFLT8V0A	TVS	Vrwm=8.0V, Vbr=8.89..9.83V, 16.5A, 225W(1ms)	PowD1123	7d	1d	Di
FAT	DFLT8V5A	TVS	Vrwm=8.5V, Vbr=9.44..10.4V, 15.6A, 225W(1ms)	PowD1123	7d	1d	Di
FAV	DFLT9V0A	TVS	Vrwm=9.0V, Vbr=10.0..11.1V, 14.6A, 225W(1ms)	PowD1123	7d	1d	Di
FAX	DFLT10A	TVS	Vrwm=10V, Vbr=11.1..12.3V, 13.2A, 225W(1ms)	PowD1123	7d	1d	Di
FAZ	DFLT11A	TVS	Vrwm=11V, Vbr=12.2..13.5V, 12.4A, 225W(1ms)	PowD1123	7d	1d	Di
FB	MM3ZB22H	Z-diode	21.56..22.44V, Izt=5mA, Zzt=55Ω, 300mW	SOD-323	5d	1a	Zow
FB	PZU5.6B1	Z-diode	5.31..5.55V, Zzt=40Ω(Izt=5mA), 310mW	SOD-323FL	7d	1a	Phi
FB	Z1SMA3V6	Z-diode	3.4..3.8V, Izt=100mA, Zzt=9Ω, 1W	DO-214AC	1d	1a	Tr
FB11	FBM11PT	Si-diode	Rectifier, Fast, 50V, 1A	DO-214AA	1d	1a	Chm
FB12	FBM12PT	Si-diode	Rectifier, Fast, 100V, 1A	DO-214AA	1d	1a	Chm
FB13	FBM13PT	Si-diode	Rectifier, Fast, 200V, 1A	DO-214AA	1d	1a	Chm
FB14	FBM14PT	Si-diode	Rectifier, Fast, 400V, 1A	DO-214AA	1d	1a	Chm
FB15	FBM15PT	Si-diode	Rectifier, Fast, 600V, 1A	DO-214AA	1d	1a	Chm
FB16	FBM16PT	Si-diode	Rectifier, Fast, 800V, 1A	DO-214AA	1d	1a	Chm
FB17	FBM17PT	Si-diode	Rectifier, Fast, 1000V, 1A	DO-214AA	1d	1a	Chm
FB21	FBM21PT	Si-diode	Rectifier, Fast, 50V, 2A	DO-214AA	1d	1a	Chm
FB22	FBM22PT	Si-diode	Rectifier, Fast, 100V, 2A	DO-214AA	1d	1a	Chm
FB23	FBM23PT	Si-diode	Rectifier, Fast, 200V, 2A	DO-214AA	1d	1a	Chm
FB24	FBM24PT	Si-diode	Rectifier, Fast, 400V, 2A	DO-214AA	1d	1a	Chm
FB25	FBM25PT	Si-diode	Rectifier, Fast, 600V, 2A	DO-214AA	1d	1a	Chm
FB26	FBM26PT	Si-diode	Rectifier, Fast, 800V, 2A	DO-214AA	1d	1a	Chm
FB27	FBM27PT	Si-diode	Rectifier, Fast, 1000V, 2A	DO-214AA	1d	1a	Chm
FB31	FBM31PT	Si-diode	Rectifier, Fast, 50V, 3A	DO-214AA	1d	1a	Chm
FB32	FBM32PT	Si-diode	Rectifier, Fast, 100V, 3A	DO-214AA	1d	1a	Chm
FB33	FBM33PT	Si-diode	Rectifier, Fast, 200V, 3A	DO-214AA	1d	1a	Chm
FB34	FBM34PT	Si-diode	Rectifier, Fast, 400V, 3A	DO-214AA	1d	1a	Chm
FB35	FBM35PT	Si-diode	Rectifier, Fast, 600V, 3A	DO-214AA	1d	1a	Chm
FB36	FBM36PT	Si-diode	Rectifier, Fast, 800V, 3A	DO-214AA	1d	1a	Chm
FB37	FBM37PT	Si-diode	Rectifier, Fast, 1000V, 3A	DO-214AA	1d	1a	Chm
FBA	SMCJ5.0CA	TVS	Vrwm=5V, Vbr=6.4..7.25V, 171A, 1500W(1ms), Bidirectional	DO-214AB	1ba	1r	Ste
FBB	SMCJ6.0CA	TVS	Vrwm=6V, Vbr=6.67..7.67V, 52A, 1500W(1ms), Bidirectional	DO-214AB	1ba	1r	Ste



SMD code	Type	Function	Short description	Case	Pinout	St.	Mnf.
FBC	SMCJ6.5CA	TVS	Vrwm=6.5V, Vbr=7.22..8.3V, 140A, 1500W(1ms), Bidirectional	DO-214AB	1ba	1r	Ste
FBD	SMCJ8.5CA	TVS	Vrwm=8.5V, Vbr=9.44..10.82V, 105A, 1500W(1ms), Bidirectional	DO-214AB	1ba	1r	Ste
FBE	DFLT12A	TVS	Vrwm=12V, Vbr=13.3..14.7V, 11.3A, 225W(1ms)	PowD1123	7d	1d	Di
FBF	SMCJ10CA	TVS	Vrwm=10V, Vbr=11.1..12.8V, 88.2A, 1500W(1ms), Bidirectional	DO-214AB	1ba	1r	Ste
FBG	DFLT13A	TVS	Vrwm=13V, Vbr=14.4..15.9V, 10.5A, 225W(1ms)	PowD1123	7d	1d	Di
FBG	DFLT14A	TVS	Vrwm=14V, 9.7A, 225W(10/1000µs)	PowD1123	7d	1d	Di
FBH	SMCJ12CA	TVS	Vrwm=12V, Vbr=13.3..15.3V, 75.3A, 1500W(1ms), Bidirectional	DO-214AB	1ba	1r	Ste
FBI	SMCJ13CA	TVS	Vrwm=13V, Vbr=14.4..16.5V, 73A, 1500W(1ms), Bidirectional	DO-214AB	1ba	1r	Ste
FBJ	SMCJ15CA	TVS	Vrwm=15V, Vbr=16.7..19.2V, 61.5A, 1500W(1ms), Bidirectional	DO-214AB	1ba	1r	Ste
FBK	DFLT13A	TVS	Vrwm=13V, 10.5A, 225W(10/1000µs)	PowD1123	7d	1d	Di
FBK	DFLT14A	TVS	Vrwm=14V, Vbr=15.6..17.2V, 9.7A, 225W(1ms)	PowD1123	7d	1d	Di
FBL	SMCJ18CA	TVS	Vrwm=18V, Vbr=20..23.3V, 53A, 1500W(1ms), Bidirectional	DO-214AB	1ba	1r	Ste
FBM	DFLT15A	TVS	Vrwm=15V, Vbr=16.7..18.5V, 9.22A, 225W(1ms)	PowD1123	7d	1d	Di
FBM	SMCJ20CA	TVS	Vrwm=20V, Vbr=22.2..25.5V, 48A, 1500W(1ms), Bidirectional	DO-214AB	1ba	1r	Ste
FBN	SMCJ22CA	TVS	Vrwm=22V, Vbr=24.4..28V, 44A, 1500W(1ms), Bidirectional	DO-214AB	1ba	1r	Ste
FBO	SMCJ24CA	TVS	Vrwm=24V, Vbr=26.7..30.7V, 40A, 1500W(1ms), Bidirectional	DO-214AB	1ba	1r	Ste
FBP	DFLT16A	TVS	Vrwm=16V, Vbr=17.8..19.7V, 8.65A, 225W(1ms)	PowD1123	7d	1d	Di
FBP	SMCJ26CA	TVS	Vrwm=26V, Vbr=28.9..33.2V, 37A, 1500W(1ms), Bidirectional	DO-214AB	1ba	1r	Ste
FBQ	SMCJ28CA	TVS	Vrwm=28V, Vbr=31.1..35.8V, 34A, 1500W(1ms), Bidirectional	DO-214AB	1ba	1r	Ste
FBR	DFLT17A	TVS	Vrwm=17V, Vbr=18.9..20.9V, 8.15A, 225W(1ms)	PowD1123	7d	1d	Di
FBR	SMCJ30CA	TVS	Vrwm=30V, Vbr=33.3..38.3V, 32A, 1500W(1ms), Bidirectional	DO-214AB	1ba	1r	Ste
FBS	SMCJ33CA	TVS	Vrwm=33V, Vbr=36.7..44.9V, 29A, 1500W(1ms), Bidirectional	DO-214AB	1ba	1r	Ste
FBT	DFLT18A	TVS	Vrwm=18V, Vbr=20.0..22.1V, 7.71A, 225W(1ms)	PowD1123	7d	1d	Di
FBU	SMCJ40CA	TVS	Vrwm=40V, Vbr=44.4..51.1V, 24A, 1500W(1ms), Bidirectional	DO-214AB	1ba	1r	Ste
FBV	DFLT20A	TVS	Vrwm=20V, Vbr=22.2..24.5V, 6.94A, 225W(1ms)	PowD1123	7d	1d	Di
FBW	SMCJ48CA	TVS	Vrwm=48V, Vbr=53.3..61.3V, 20A, 1500W(1ms), Bidirectional	DO-214AB	1ba	1r	Ste
FBX	DFLT22A	TVS	Vrwm=22V, Vbr=24.4..26.9V, 6.34A, 225W(1ms)	PowD1123	7d	1d	Di
FBZ	DFLT24A	TVS	Vrwm=24V, Vbr=26.7..29.5V, 5.78A, 225W(1ms)	PowD1123	7d	1d	Di
FBZ	SMCJ58CA	TVS	Vrwm=58V, Vbr=64.4..74.1V, 16A, 1500W(1ms), Bidirectional	DO-214AB	1ba	1r	Ste
FC	GBLCL18CI	TVS	Vbr=18V, 1A, 350W(1ms), 0.6pF, Bidirectional	SOD-323	5ba	1e	Prt
FC	MM3ZB24H	Z-diode	23.52..24.48V, Izt=5mA, Zzt=60Ω, 300mW	SOD-323	5d	1a	Zow
FC	PZU6.2B1	Z-diode	5.86..6.12V, Zzt=30Ω(Izt=5mA), 310mW	SOD-323FL	7d	1a	Phi
FC	Z1SMA3V9	Z-diode	3.7..4.1V, Izt=100mA, Zzt=7.5Ω, 1W	DO-214AC	1d	1a	Ttr
FC31	FCM31PT	Si-diode	Rectifier, Fast, 50V, 3A	DO-214AB	1d	1a	Chm
FC32	FCM32PT	Si-diode	Rectifier, Fast, 100V, 3A	DO-214AB	1d	1a	Chm
FC33	FCM33PT	Si-diode	Rectifier, Fast, 200V, 3A	DO-214AB	1d	1a	Chm
FC34	FCM34PT	Si-diode	Rectifier, Fast, 400V, 3A	DO-214AB	1d	1a	Chm
FC35	FCM35PT	Si-diode	Rectifier, Fast, 600V, 3A	DO-214AB	1d	1a	Chm
FC36	FCM36PT	Si-diode	Rectifier, Fast, 800V, 3A	DO-214AB	1d	1a	Chm
FC37	FCM37PT	Si-diode	Rectifier, Fast, 1000V, 3A	DO-214AB	1d	1a	Chm
FCE	DFLT26A	TVS	Vrwm=26V, Vbr=28.9..31.9V, 5.35A, 225W(1ms)	PowD1123	7d	1d	Di
FCF	DFLT27A	TVS	Vrwm=27V, Vbr=30..33.15V, 5.15A, 225W(1ms)	PowD1123	7d	1d	Di
FCG	DFLT28A	TVS	Vrwm=28V, Vbr=31.1..34.4V, 4.96A, 225W(1ms)	PowD1123	7d	1d	Di
FCK	DFLT30A	TVS	Vrwm=30V, Vbr=33.3..36.8V, 4.65A, 225W(1ms)	PowD1123	7d	1d	Di
FCM	DFLT33A	TVS	Vrwm=33V, Vbr=36.7..40.6V, 4.22A, 225W(1ms)	PowD1123	7d	1d	Di
FCP	DFLT36A	TVS	Vrwm=36V, Vbr=40.0..44.2V, 3.87A, 225W(1ms)	PowD1123	7d	1d	Di
FCR	DFLT40A	TVS	Vrwm=40V, Vbr=44.4..49.1V, 3.49A, 225W(1ms)	PowD1123	7d	1d	Di
FCT	DFLT43A	TVS	Vrwm=43V, Vbr=47.8..52.8V, 3.24A, 225W(1ms)	PowD1123	7d	1d	Di
FCV	DFLT45A	TVS	Vrwm=45V, Vbr=50.0..55.3V, 3.10A, 225W(1ms)	PowD1123	7d	1d	Di
FCX	DFLT48A	TVS	Vrwm=48V, Vbr=53.3..58.9V, 2.91A, 225W(1ms)	PowD1123	7d	1d	Di
FCZ	DFLT51A	TVS	Vrwm=51V, Vbr=56.7..62.7V, 2.73A, 225W(1ms)	PowD1123	7d	1d	Di
FD	KDZ33B	Z-diode	33V±2.5%, 10mA, 1W	PMDU	7d	1s	Rhm
FD	MM3ZB27H	Z-diode	26.46..27.54V, Izt=5mA, Zzt=70Ω, 300mW	SOD-323	5d	1a	Zow
FD	P6SMBJ220C	TVS	Vbr=170V, 1.5A, 600W(1ms), Bidirectional	DO-214AA	1ba	1x,1y	Pjt,Srj
FD	PZU6.8B1	Z-diode	6.47..6.73V, Zzt=20Ω(Izt=5mA), 310mW	SOD-323FL	7d	1a	Phi
FD	Z1SMA47	Z-diode	44..50V, Izt=10mA, Zzt=45Ω, 1W	DO-214AC	1d	1a	Ttr
FD	Z1SMA-47	Z-diode	47V±5%, 1.3W	DO-214AC	1d	2j	Fag
FE	MM3ZB30H	Z-diode	29.4..30.6V, Izt=5mA, Zzt=80Ω, 300mW	SOD-323	5d	1a	Zow
FE	P6SMBJ220AC	TVS	Vbr=170V, 1.7A, 600W(1ms), Bidirectional	DO-214AA	1ba	1x,1y	Pjt,Srj
FE	PZU7.5B1	Z-diode	7.06..7.36V, Zzt=10Ω(Izt=5mA), 310mW	SOD-323FL	7d	1a	Phi
FE	SMF5.0A	TVS	Vrwm=5.0V, Vbr=6.4..7.0V, 21.7A, 200W(10/1000µs)	SOD-123FL	7d	1a	Ers
FE	TV02W120-G	TVS	Vrwm=12V, Vbr=13.3..14.7V, Ipp=10.1A, 200W(1ms)	SOD-123	5d	1a	Cmc
FE	TV02W5V0-G	TVS	Vrwm=5.0V, Vbr=6.40..7.0V, Ipp=21.7A, 200W(1ms)	SOD-123	5d	1a	Cmc
FE	TV06B301JB-G	TVS	Vrwm=300.0V, Vbr=335.0..371.0V, Ipp=1.23A, 600W(1ms), Bidirectional	DO-214AA	1ba	1j	Cmc
FF	MAZD091	Z-diode	8.5..9.6V, Zzt=20Ω(5mA), 120mW	SSSMini2	7d	1a	Pan
FF	MM3ZB33H	Z-diode	32.34..33.66V, Izt=5mA, Zzt=80Ω, 300mW	SOD-323	5d	1a	Zow
FF	PZU8.2B1	Z-diode	7.76..8.1V, Zzt=10Ω(Izt=5mA), 310mW	SOD-323FL	7d	1a	Phi
FF	Z1SMA51	Z-diode	48..54V, Izt=10mA, Zzt=60Ω, 1W	DO-214AC	1d	1a	Ttr
FF	Z1SMA-51	Z-diode	51V±5%, 1.3W	DO-214AC	1d	2j	Fag
FG	PZU9.1B1	Z-diode	8.56..8.93V, Zzt=10Ω(Izt=5mA), 310mW	SOD-323FL	7d	1a	Phi



SMD code	Type	Function	Short description	Case	Pinout	St.	Mnf.
FG	SMF6.0A	TVS	V _{nm} =6.0V, V _{br} =6.67..7.37V, 19.4A, 200W(10/1000µs)	SOD-123FL	7d	1a	Ers
FG	TV02W6V0-G	TVS	V _{nm} =6.0V, V _{br} =6.67..7.37V, I _{pp} =19.4A, 200W(1ms)	SOD-123	5d	1a	Cmc
FG	TV06B35.1JB-G	TVS	V _{nm} =350.0V, V _{br} =391.0..432.0V, I _{pp} =1.06A, 600W(1ms), Bidirectional	DO-214AA	1ba	1j	Cmc
FG	Z1SMA56	Z-diode	52..60V, I _{zt} =10mA, Z _{zt} =60Ω, 1W	DO-214AC	1d	1a	Ttr
FG	Z1SMA-56	Z-diode	56V±5%, 1.3W	DO-214AC	1d	2j	Fag
FG36	STPS3L60UF	Si-diode	SBR, 60V, 3A, V _f <0.59V(3A)	SMB-F	7d	1a	Ste
FH	MM3ZB36H	Z-diode	35.28..36.72V, I _{zt} =5mA, Z _{zt} =90Ω, 300mW	SOD-323	5d	1a	Zow
FH	PZU10B1	Z-diode	9.45..9.87V, Z _{zt} =10Ω(I _{zt} =5mA), 310mW	SOD-323FL	7d	1a	Phi
FH	Z1SMA62	Z-diode	58..66V, I _{zt} =10mA, Z _{zt} =80Ω, 1W	DO-214AC	1d	1a	Ttr
FH	Z1SMA-62	Z-diode	62V±5%, 1.3W	DO-214AC	1d	2j	Fag
FHK	DFLZ5V1	Z-diode	5.1V±5%, I _{zt} =100mA, Z _{zt} <6Ω, 1W	PowD1123	7d	1d	Di
FHL	DFLZ5V6	Z-diode	5.6V±5%, I _{zt} =100mA, Z _{zt} <4Ω, 1W	PowD1123	7d	1d	Di
FHN	DFLZ6V2	Z-diode	6.2V±5%, I _{zt} =100mA, Z _{zt} <3Ω, 1W	PowD1123	7d	1d	Di
FHO	DFLZ6V8	Z-diode	6.8V±5%, I _{zt} =100mA, Z _{zt} <3Ω, 1W	PowD1123	7d	1d	Di
FHQ	DFLZ7V5	Z-diode	7.5V±5%, I _{zt} =100mA, Z _{zt} <2Ω, 1W	PowD1123	7d	1d	Di
FHR	DFLZ8V2	Z-diode	8.2V±5%, I _{zt} =100mA, Z _{zt} <2Ω, 1W	PowD1123	7d	1d	Di
FHT	DFLZ9V1	Z-diode	9.1V±5%, I _{zt} =50mA, Z _{zt} <4Ω, 1W	PowD1123	7d	1d	Di
FHU	DFLZ10	Z-diode	10V±5%, I _{zt} =50mA, Z _{zt} <4Ω, 1W	PowD1123	7d	1d	Di
FHV	DFLZ11	Z-diode	11V±5%, I _{zt} =50mA, Z _{zt} <7Ω, 1W	PowD1123	7d	1d	Di
FHW	DFLZ12	Z-diode	12V±5%, I _{zt} =50mA, Z _{zt} <7Ω, 1W	PowD1123	7d	1d	Di
FHX	DFLZ13	Z-diode	13V±5%, I _{zt} =50mA, Z _{zt} <10Ω, 1W	PowD1123	7d	1d	Di
FHZ	DFLZ15	Z-diode	15V±5%, I _{zt} =50mA, Z _{zt} <10Ω, 1W	PowD1123	7d	1d	Di
FJ	MM3ZB39H	Z-diode	38.22..39.78V, I _{zt} =2.5mA, Z _{zt} =100Ω, 300mW	SOD-323	5d	1a	Zow
FJ	PZU11B1	Z-diode	10.44..10.88V, Z _{zt} =10Ω(I _{zt} =5mA), 310mW	SOD-323FL	7d	1a	Phi
FJA	DFLZ16	Z-diode	16V±5%, 25mA, Z _{zt} <15Ω, 1W	PowD1123	7d	1d	Di
FJF	DFLZ18	Z-diode	18V±5%, I _{zt} =25mA, Z _{zt} <15Ω, 1W	PowD1123	7d	1d	Di
FJG	DFLZ20	Z-diode	20V±5%, I _{zt} =25mA, Z _{zt} <15Ω, 1W	PowD1123	7d	1d	Di
FJK	DFLZ22	Z-diode	22V±5%, I _{zt} =25mA, Z _{zt} <15Ω, 1W	PowD1123	7d	1d	Di
FJL	DFLZ24	Z-diode	24V±5%, I _{zt} =25mA, Z _{zt} <15Ω, 1W	PowD1123	7d	1d	Di
FJN	DFLZ27	Z-diode	27V±5%, I _{zt} =25mA, Z _{zt} <15Ω, 1W	PowD1123	7d	1d	Di
FJQ	DFLZ30	Z-diode	30V±5%, I _{zt} =15mA, Z _{zt} <22Ω, 1W	PowD1123	7d	1d	Di
FJR	DFLZ33	Z-diode	33V±5%, I _{zt} =15mA, Z _{zt} <24Ω, 1W	PowD1123	7d	1d	Di
FJS	DFLZ36	Z-diode	36V±5%, I _{zt} =10mA, Z _{zt} <40Ω, 1W	PowD1123	7d	1d	Di
FJT	DFLZ39	Z-diode	39V±5%, I _{zt} =10mA, Z _{zt} <40Ω, 1W	PowD1123	7d	1d	Di
FK	PZU12B1	Z-diode	11.42..11.9V, Z _{zt} =10Ω(I _{zt} =5mA), 310mW	SOD-323FL	7d	1a	Phi
FK	SMF6.5A	TVS	V _{nm} =6.5V, V _{br} =7.22..7.98V, 17.9A, 200W(10/1000µs)	SOD-123FL	7d	1a	Ers
FK	TV02W6V5-G	TVS	V _{nm} =6.5V, V _{br} =7.22..7.98V, I _{pp} =17.9A, 200W(1ms)	SOD-123	5d	1a	Cmc
FK	TV06B401JB-G	TVS	V _{nm} =400.0V, V _{br} =447.0..494.0V, I _{pp} =0.93A, 600W(1ms), Bidirectional	DO-214AA	1ba	1j	Cmc
FK	Z1SMA68	Z-diode	64..72V, I _{zt} =10mA, Z _{zt} =80Ω, 1W	DO-214AC	1d	1a	Ttr
FK	Z1SMA-68	Z-diode	68V±5%, 1.3W	DO-214AC	1d	2j	Fag
FL	PZU13B1	Z-diode	12.47..13.03V, Z _{zt} =10Ω(I _{zt} =5mA), 310mW	SOD-323FL	7d	1a	Phi
FL	Z1SMA75	Z-diode	70..80V, I _{zt} =10mA, Z _{zt} =100Ω, 1W	DO-214AC	1d	1a	Ttr
FL	Z1SMA-75	Z-diode	75V±5%, 1.3W	DO-214AC	1d	2j	Fag
FM	1N60PW	Si-diode	SBD, Sw, 45V, 50mA, V _f <0.45V(50mA), 1pF	SOD-123FL	7d	1a	Sme
FM	PZU15B1	Z-diode	13.84..14.46V, Z _{zt} =15Ω(I _{zt} =5mA), 310mW	SOD-323FL	7d	1a	Phi
FM	SMF7.0A	TVS	V _{nm} =7.0V, V _{br} =7.78..8.60V, 16.7A, 200W(10/1000µs)	SOD-123FL	7d	1a	Ers
FM	TV02W7V0-G	TVS	V _{nm} =7.0V, V _{br} =7.78..8.60V, I _{pp} =16.7A, 200W(1ms)	SOD-123	5d	1a	Cmc
FM	TV06B44.1JB-G	TVS	V _{nm} =440.0V, V _{br} =492.0..543.0V, I _{pp} =0.84A, 600W(1ms), Bidirectional	DO-214AA	1ba	1j	Cmc
FM	Z1SMA82	Z-diode	77..87V, I _{zt} =10mA, Z _{zt} =100Ω, 1W	DO-214AC	1d	1a	Ttr
FM	Z1SMA-82	Z-diode	82V±5%, 1.3W	DO-214AC	1d	2j	Fag
FN	1N60SW	Si-diode	SBD, Sw, 45V, 50mA, V _f <0.45V(50mA), 1pF	SOD-123FL	7d	1a	Sme
FN	PZU16B1	Z-diode	15.37..16.01V, Z _{zt} =20Ω(I _{zt} =5mA), 310mW	SOD-323FL	7d	1a	Phi
FN	Z1SMA91	Z-diode	85..96V, I _{zt} =5mA, Z _{zt} =200Ω, 1W	DO-214AC	1d	1a	Ttr
FN	Z1SMA-91	Z-diode	91V±5%, 1.3W	DO-214AC	1d	2j	Fag
FP	CMDZ3L3	Z-diode	3.135..3.465V, I _{zt} =0.5mA, Z _{zt} =900Ω, 250mW	SOD-323	5d	1a	Cen
FP	PZU18B1	Z-diode	16.94..17.70V, Z _{zt} =20Ω(I _{zt} =5mA), 310mW	SOD-323FL	7d	1a	Phi
FP	SM6T68	TVS	V _{br} =68V, 6.3A, 600W(1ms)	DO-214AA	1d	1q	Ste
FP	SMBJ160CA	TVS	V _{br} =160V, 2.3A, 600W(1ms), Bidirectional	DO-214AA	1ba	1x	Di
FP	SMF7.5A	TVS	V _{nm} =7.5V, V _{br} =8.33..9.21V, 15.5A, 200W(10/1000µs)	SOD-123FL	7d	1a	Ers
FP	TV02W7V5-G	TVS	V _{nm} =7.5V, V _{br} =8.33..9.21V, I _{pp} =15.5A, 200W(1ms)	SOD-123	5d	1a	Cmc
FP	Z1SMA100	Z-diode	94..106V, I _{zt} =5mA, Z _{zt} =200Ω, 1W	DO-214AC	1d	1a	Ttr
FP	Z1SMA-100	Z-diode	100V±5%, 1.3W	DO-214AC	1d	2j	Fag
FQ	PZU20B1	Z-diode	18.86..19.7V, Z _{zt} =20Ω(I _{zt} =5mA), 310mW	SOD-323FL	7d	1a	Phi
FQ	SM6T68A	TVS	V _{br} =68V, 6.3A, 600W(1ms)	DO-214AA	1d	1q,1a	Ste
FQ	Z1SMA110	Z-diode	104..116V, I _{zt} =5mA, Z _{zt} =250Ω, 1W	DO-214AC	1d	1a	Ttr
FQ	Z1SMA-110	Z-diode	12V±5%, 1.3W	DO-214AC	1d	2j	Fag
FR	MM5Z3B0H	Z-diode	2.94..3.06V, Z _{zt} =120Ω, I _{zt} =5mA, 200mW	SOD-523	7d	1a	Zow
FR	PZU22B1	Z-diode	20.88..21.77V, Z _{zt} =25Ω(I _{zt} =5mA), 310mW	SOD-323FL	7d	1a	Phi
FR	SMF8.0A	TVS	V _{nm} =8.0V, V _{br} =8.89..9.83V, 14.7A, 200W(10/1000µs)	SOD-123FL	7d	1a	Ers
FR	TV02W8V0-G	TVS	V _{nm} =8.0V, V _{br} =8.89..9.83V, I _{pp} =14.7A, 200W(1ms)	SOD-123	5d	1a	Cmc



SMD
code

Type

Function

Short description

Case

Pinout

St.

Mnf.

FR	Z1SMA120	Z-diode	114..127V, Izt=5mA, Zzt=250Ω, 1W
FR	Z1SMA-120	Z-diode	13V±5%, 1.3W
FS	PZU24B1	Z-diode	22.93..23.96V, Zzt=30Ω(Izt=5mA), 310mW
FS	Z1SMA130	Z-diode	124..141V, Izt=5mA, Zzt=300Ω, 1W
FS	Z1SMA-130	Z-diode	15V±5%, 1.3W
FS11	FSM11PT	Si-diode	Rectifier, Fast, 50V, 1A
FS12	FSM12PT	Si-diode	Rectifier, Fast, 100V, 1A
FS13	FSM13PT	Si-diode	Rectifier, Fast, 200V, 1A
FS14	FSM14PT	Si-diode	Rectifier, Fast, 400V, 1A
FS15	FSM15PT	Si-diode	Rectifier, Fast, 600V, 1A
FS16	FSM16PT	Si-diode	Rectifier, Fast, 800V, 1A
FS17	FSM17PT	Si-diode	Rectifier, Fast, 1000V, 1A
FS21	FSM21PT	Si-diode	Rectifier, Fast, 50V, 2A
FS22	FSM22PT	Si-diode	Rectifier, Fast, 100V, 2A
FS23	FSM23PT	Si-diode	Rectifier, Fast, 200V, 2A
FS24	FSM24PT	Si-diode	Rectifier, Fast, 400V, 2A
FS25	FSM25PT	Si-diode	Rectifier, Fast, 600V, 2A
FS26	FSM26PT	Si-diode	Rectifier, Fast, 800V, 2A
FS27	FSM27PT	Si-diode	Rectifier, Fast, 1000V, 2A
FT	SMF8.5A	TVS	Vrwm=8.5V, Vbr=9.44..10.40V, 13.9A, 200W(10/1000μs)
FT	TV02W8V5-G	TVS	Vrwm=8.5V, Vbr=9.44..10.4V, Ipp=13.9A, 200W(1ms)
FT	Z1SMA150	Z-diode	138..156V, Izt=5mA, Zzt=300Ω, 1W
FT	Z1SMA-150	Z-diode	150V±5%, 1.3W
FU	Z1SMA160	Z-diode	153..171V, Izt=5mA, Zzt=350Ω, 1W
FU	Z1SMA-160	Z-diode	160V±5%, 1.3W
FUA	SMCJ5.0A	TVS	Vrwm=5V, Vbr=6.4.7.25V, 171A, 1500W(1ms)
FUB	SMCJ6.0A	TVS	Vrwm=6V, Vbr=6.67..7.67V, 152A, 1500W(1ms)
FUC	SMCJ6.5A	TVS	Vrwm=6.5V, Vbr=7.22..8.3V, 140A, 1500W(1ms)
FUD	SMCJ8.5A	TVS	Vrwm=8.5V, Vbr=9.44..10.82V, 105A, 1500W(1ms)
FUF	SMCJ10A	TVS	Vrwm=10V, Vbr=11.1..13.6V, 92A, 1500W(1ms)
FUH	SMCJ12A	TVS	Vrwm=12V, Vbr=13.3..15.3V, 79A, 1500W(1ms)
FUI	SMCJ13A	TVS	Vrwm=13V, Vbr=14.4..16.5V, 73A, 1500W(1ms)
FUJ	SMCJ15A	TVS	Vrwm=15V, Vbr=16.7..19.2V, 64A, 1500W(1ms)
FUL	SMCJ18A	TVS	Vrwm=18V, Vbr=20..23.3V, 53A, 1500W(1ms)
FUM	SMCJ20A	TVS	Vrwm=20V, Vbr=22.2..25.5V, 48A, 1500W(1ms)
FUN	SMCJ22A	TVS	Vrwm=22V, Vbr=24.4..28V, 44A, 1500W(1ms)
FUO	SMCJ24A	TVS	Vrwm=24V, Vbr=26.7..30.7V, 40A, 1500W(1ms)
FUP	SMCJ26A	TVS	Vrwm=26V, Vbr=28.9..33.2V, 37A, 1500W(1ms)
FUQ	SMCJ28A	TVS	Vrwm=28V, Vbr=31.1..38.0V, 34A, 1500W(1ms)
FUR	SMCJ30A	TVS	Vrwm=30V, Vbr=33.3..38.3V, 32A, 1500W(1ms)
FUS	SMCJ33A	TVS	Vrwm=33V, Vbr=36.7..44.9V, 29A, 1500W(1ms)
FUU	SMCJ40A	TVS	Vrwm=40V, Vbr=44.4..51.1V, 24A, 1500W(1ms)
FUW	SMCJ48A	TVS	Vrwm=48V, Vbr=53.3..61.3V, 20A, 1500W(1ms)
FUZ	SMCJ58A	TVS	Vrwm=58V, Vbr=64.4..74.1V, 16A, 1500W(1ms)
FV	SMF9.0A	TVS	Vrwm=9.0V, Vbr=10.0..11.10V, 13.0A, 200W(10/1000μs)
FV	TV02W9V0-G	TVS	Vrwm=9.0V, Vbr=10.0..11.1V, Ipp=13.0A, 200W(1ms)
FV	Z1SMA180	Z-diode	168..191V, Izt=5mA, Zzt=400Ω, 1W
FV	Z1SMA-180	Z-diode	180V±5%, 1.3W
FW	Z1SMA200	Z-diode	188..212V, Izt=5mA, Zzt=400Ω, 1W
FW	Z1SMA-200	Z-diode	200V±5%, 1.3W
FX	MM5Z3B3H	Z-diode	3.234..3.366V, Zzt=130Ω, Izt=5mA, 200mW
FX	SM6T100	TVS	Vbr=100V, 4.2A, 600W(1ms)
FX	SMF10A	TVS	Vrwm=10.0V, Vbr=11.0..12.30V, 11.8A, 200W(10/1000μs)
FX	TV02W100-G	TVS	Vrwm=10V, Vbr=11.1..12.3V, Ipp=11.8A, 200W(1ms)
FX	Z1SMA4V3	Z-diode	4.0..4.6V, Izt=100mA, Zzt=6Ω, 1W
FY	KDZ3.3VVY	Z-diode	3.25..3.50V, Izt=5mA, Zzt=130Ω, 100mW
FY	MM5Z3B6H	Z-diode	3.528..3.672V, Zzt=130Ω, Izt=5mA, 200mW
FY	SM6T100A	TVS	Vrwm=85.5V, Vbr=95..105V, 4.4A, 600W(1ms)
FY	Z1SMA4V7	Z-diode	4.4..5.0V, Izt=100mA, Zzt=5Ω, 1W
FZ	3T400AA	Thy-SPD	Vdr=360V, Vs=450V, Ipp=35A, 30pF
FZ	BZT52-B10S	Z-diode	9.80..10.20V, Izt=5mA, Zzt=20Ω, 200mW
FZ	MM3Z10VB	Z-diode	9.80..10.20V, Zzt=18Ω, Izt=5mA, 200mW
FZ	MM3Z10VBW	Z-diode	9.80..10.20V, Izt=5mA, Zzt=20Ω, 200mW
FZ	MM5Z3B9H	Z-diode	3.822..3.978V, Zzt=130Ω, Izt=5mA, 200mW
FZ	P4000SAA	Thy-SPD	Vdr=360V, Vs=450V, Ipp=35A(1ms), Bidirectional
FZ	SMF11A	TVS	Vrwm=11.0V, Vbr=12.20..13.50V, 11.0A, 200W(10/1000μs)
FZ	TCMM3Z10VB	Z-diode	10V±2%, Izt=5mA, Zzt=18Ω, 200mW
FZ	TV02W110-G	TVS	Vrwm=11V, Vbr=12.2..13.5V, Ipp=11.0A, 200W(1ms)
G	1PS79SB70	Si-diode	SBD, Hi-Speed, 70V, 70mA, <2pF
G	1SS387PT	Si-diode	Sw, 85V, 100mA, Vfk=1.2V(100mA), 4ns



SMD
code

Type

Function

Short description

Case

Pinout

St.

Mnf.

SMD code	Type	Function	Short description	Case	Pinout	St.	Mnf.
G	BAR63-02L	PIN-diode	Sw, RF, 100V, 100mA, Vf<1.1V(50mA), < 0.3pF	TSLP-2-1	13d	2b	Inf
G	BAR63-02V	PIN-diode	Sw, RF, 100V, 100mA, Vf<1.1V(50mA), < 0.3pF	SOD-523	6d	1a	Inf
G	BAR63-03W	PIN-diode	Sw, RF, 100V, 100mA, Vf<1.1V(50mA), < 0.3pF	SOD-323	5d	1a	Inf
G	ESD9Z5.0	TVS	Vrwm=5.0V, Vbr=6.2V, 12.3A, 107W(20ms)	SOD-723FL	7d	1a	Frm
G	MAZF082	Z-diode	7.7..8.7V, Zzt=20Ω(5mA), 120mW	Si-Mini	7d	1a	Pan
G	MAZN082	Z-diode	7.7..8.7V, Zzt=20Ω(5mA), 120mW	SSMini2	7d	1a	Pan
g	MMSZ5233BPT	Z-diode	5.700..6.300V, lzt=5mA, Zzt=25Ω, 225mW	SOD-523	7d	1a	Chm
g	MMSZ5239BPT	Z-diode	8.645..9.555V, lzt=5mA, Zzt=10Ω, 225mW	SOD-523	7d	1a	Chm
G	MMSZ5256BPT	Z-diode	28.50..31.50V, lzt=5mA, Zzt=78Ω, 225mW	SOD-523	7d	1a	Chm
G	TVS100W5V0D	TVS	Vrwm=5.0V, Vbr=6.2V, 8.7A, 100W(1ms)	SOD-923	7d	1d	Did
g.	MMSZ52335SPT	Z-diode	5.880..6.120V, lzt=5mA, Zzt=25Ω, 225mW	SOD-523	7d	1a	Chm
g.	MMSZ52395SPT	Z-diode	8.918..9.282V, lzt=5mA, Zzt=10Ω, 225mW	SOD-523	7d	1a	Chm
G.	MMSZ52565SPT	Z-diode	29.40..30.60V, lzt=5mA, Zzt=78Ω, 225mW	SOD-523	7d	1a	Chm
G0	BZD27C62P	Z-diode	58..66V, Zzt=25Ω, lzt=10mA, 800mW	SOD-123FL	7d	1a	Vs
G0	MMPZ52375SPT	Z-diode	8.036..8.364V, lzt=5mA, Zzt=7Ω, 225mW	SOD-323	5d	1a	Chm
G0	MMPZ5249BPT	Z-diode	18.05..19.95V, lzt=5mA, Zzt=42Ω, 225mW	SOD-323	5d	1a	Chm
G1	1PS79SB30	Si-diode	SBD, U-Speed, 40V, 200mA, <20pF	SOD-523	6d	1a	Phi
G1	3T064AA	Thy-SPD	Vdm=58V, Vs=77V, lpp=35A, 60pF	DO-214AA	1d	1a	Mde
G1	BZD27C68P	Z-diode	64..72V, Zzt=25Ω, lzt=10mA, 800mW	SOD-123FL	7d	1a	Vs
G1	CZRV5226B-G	Z-diode	3.14..3.47V, Zzt=28Ω, lzt=20mA, 200mW	SOD-323	5d	1a	Cmc
G1	CZRW5226B-G	Z-diode	3.14..3.47V, Zzt=28Ω, lzt=20mA, 500mW	SOD-123	5d	1a	Cmc
G1	FRS2A	Si-diode	Rectifier, Fast-Recovery 50V, 1.5A, <250ns	DO-214AA	1d	2j	Fag
G1	MMSZ5226B	Z-diode	3.3V±5%, Zzt=28Ω, 500mW	SOD-123	5d	1d	Di
G1	MMSZ5226B	Z-diode	3.3V±5%, Zzt=28Ω, 500mW	SOD-123	5d	1d	Di
G1	MMSZ5226BS	Z-diode	3.3V±5%, Zzt=28Ω, 200mW	SOD-323	5d	1d	Di
G1	P0640SAA	Thy-SPD	Vdm=58V, Vs=77V, lpp=35A(1ms), Bidirectional	DO-214AC	1ba	1j	Mde
G11	STPS1H100U	Si-diode	SBR, 100V, 1A, Vf<0.62V(1A)	DO-214AA	1d	1a	Ste
G12	STPS130U	Si-diode	SBR, 30V, 1A, Vf<0.55V(1A)	DO-214AA	1d	1a	Ste
G130	STPS130A	Si-diode	SBR, 30V, 1A, Vf<0.55V(1A)	DO-214AC	1d	1a	Ste
G2	3T072AA	Thy-SPD	Vdm=65V, Vs=88V, lpp=35A, 60pF	DO-214AA	1d	1a	Mde
G2	BA278	PIN-diode	VHF-band-Sw, 35V, 100mA, 715mW, 1.2pF, 0.7Ω(2mA/100MHz)	SOD-523	6d	1a	Phi
G2	BZD27C75P	Z-diode	70..79V, Zzt=30Ω, lzt=10mA, 800mW	SOD-123FL	7d	1a	Vs
G2	CZRV5227B-G	Z-diode	3.42..3.78V, Zzt=24Ω, lzt=20mA, 200mW	SOD-323	5d	1a	Cmc
G2	CZRW5227B-G	Z-diode	3.42..3.78V, Zzt=24Ω, lzt=20mA, 500mW	SOD-123	5d	1a	Cmc
G2	FRS2B	Si-diode	Rectifier, Fast-Recovery 100V, 1.5A, <250ns	DO-214AA	1d	2j	Fag
G2	MMSZ5227B	Z-diode	3.6V±5%, Zzt=24Ω, 500mW	SOD-123	5d	1d	Di
G2	MMSZ5227B	Z-diode	3.6V±5%, Zzt=24Ω, 500mW	SOD-123	5d	1d	Di
G2	MMSZ5227BS	Z-diode	3.6V±5%, Zzt=24Ω, 200mW	SOD-323	5d	1d	Di
G2	P0720SAA	Thy-SPD	Vdm=65V, Vs=88V, lpp=35A(1ms), Bidirectional	DO-214AC	1ba	1j	Mde
G3	1PS79SB31	Si-diode	SBD, U-Speed, 30V, 200mA, <25pF	SOD-523	6d	1a	Phi
G3	3T080AA	Thy-SPD	Vdm=75V, Vs=98V, lpp=35A, 60pF	DO-214AA	1d	1a	Mde
G3	BZD27C82P	Z-diode	77..87V, Zzt=30Ω, lzt=10mA, 800mW	SOD-123FL	7d	1a	Vs
G3	CZRV5228B-G	Z-diode	3.71..4.1V, Zzt=23Ω, lzt=20mA, 200mW	SOD-323	5d	1a	Cmc
G3	CZRW5228B-G	Z-diode	3.71..4.1V, Zzt=23Ω, lzt=20mA, 500mW	SOD-123	5d	1a	Cmc
G3	FRS2D	Si-diode	Rectifier, Fast-Recovery 200V, 1.5A, <250ns	DO-214AA	1d	2j	Fag
G3	MMSZ5228B	Z-diode	3.9V±5%, Zzt=23Ω, 500mW	SOD-123	5d	1d	Di,Mot
G3	MMSZ5228B	Z-diode	3.9V±5%, Zzt=23Ω, 500mW	SOD-123	5d	1d	Di
G3	MMSZ5228BS	Z-diode	3.9V±5%, Zzt=23Ω, 500mW	SOD-323	5d	1d	Di
G3	P0800SAA	Thy-SPD	Vdm=75V, Vs=98V, lpp=35A(1ms), Bidirectional	DO-214AC	1ba	1j	Mde
G3	PZU2.4B	Z-diode	2.3..2.6V, Zzt=100Ω(lzt=5mA), 310mW	SOD-323FL	7d	1a	Phi
G3	RKZ9.1B2KK	Z-diode	8.85..9.2V, lzt=5mA, Zzt=30Ω, 150mW	SFP	7d	1a	Ren
G3	RKZ9.1B2KL	Z-diode	8.85..9.23V, lzt=5mA, Zzt=30Ω, 100mW	EFP	7d	1a	Ren
G36	STPS3L60U	Si-diode	SBR, 60V, 3A, Vf<0.59V(3A)	DO-214AA	5d	1a	Ste
G4	3T110AA	Thy-SPD	Vdm=90V, Vs=130V, lpp=35A, 60pF	DO-214AA	1d	1a	Mde
G4	BZD27C91P	Z-diode	85..96V, Zzt=60Ω, lzt=5mA, 800mW	SOD-123FL	7d	1a	Vs
G4	CZRV5229B-G	Z-diode	4.09..4.52V, Zzt=22Ω, lzt=20mA, 200mW	SOD-323	5d	1a	Cmc
G4	CZRW5229B-G	Z-diode	4.09..4.52V, Zzt=22Ω, lzt=20mA, 500mW	SOD-123	5d	1a	Cmc
G4	FRS2G	Si-diode	Rectifier, Fast-Recovery 400V, 1.5A, <250ns	DO-214AA	1d	2j	Fag
G4	MMSZ5229B	Z-diode	4.3V±5%, lzt=20mA, Zzt=22Ω, 500mW	SOD-123	5d	1d	Di
G4	MMSZ5229B	Z-diode	4.3V±5%, lzt=20mA, Zzt=22Ω, 500mW	SOD-123	5d	1d	Di
G4	MMSZ5229BS	Z-diode	4.3V±5%, lzt=20mA, Zzt=22Ω, 200mW	SOD-323	5d	1d	Di
G4	P1100SAA	Thy-SPD	Vdm=90V, Vs=130V, lpp=35A(1ms), Bidirectional	DO-214AC	1ba	1j	Mde
G4	PZU2.7B	Z-diode	2.5..2.9V, Zzt=100Ω(lzt=5mA), 310mW	SOD-323FL	7d	1a	Phi
G4	3T130AA	Thy-SPD	Vdm=120V, Vs=160V, lpp=35A, 40pF	DO-214AA	1d	1a	Mde
G5	BZD27C100P	Z-diode	94..106V, Zzt=60Ω, lzt=5mA, 800mW	SOD-123FL	7d	1a	Vs
G5	BZX584B11V	Z-diode	10.78..11.22V, lzt=5mA, Zzt=20Ω, 200mW	SOD-523FL	7d	1a	Tac
G5	CZRV5230B-G	Z-diode	4.47..4.94V, Zzt=19Ω, lzt=20mA, 200mW	SOD-323	5d	1a	Cmc
G5	CZRW5230B-G	Z-diode	4.47..4.94V, Zzt=19Ω, lzt=20mA, 500mW	SOD-123	5d	1a	Cmc
G5	FRS2J	Si-diode	Rectifier, Fast-Recovery 600V, 1.5A, <250ns	DO-214AA	1d	2j	Fag
G5	MMSZ11VB	Z-diode	10.78..11.22V, lzt=5mA, Zzt=20Ω, 200mW	SOD-523FL	7d	1a	Tac



SMD
code

Type

Function

Short description

Case

Pinout

St.

Mnf.

SMD code	Type	Function	Short description	Case	Pinout	St.	Mnf.
G5	MMSZ5230B	Z-diode	4.7V±5%, Zzt=19Ω, 500mW	SOD-123	5d	1d	Di
G5	MMSZ5230B	Z-diode	4.7V±5%, Zzt=19Ω, 500mW	SOD-123	5d	1d	Di
G5	MMSZ5230BS	Z-diode	4.7V±5%, Zzt=19Ω, 200mW	SOD-323	5d	1d	Di
G5	P1300SAA	Thy-SPD	Vdm=120V, Vs=160V, lpp=35A(1ms), Bidirectional	DO-214AC	1ba	1j	Mde
G5	PZU3.0B	Z-diode	2.8..3.2V, Zzt=95Ω(lzt=5mA), 310mW	SOD-323FL	7d	1a	Phi
G6	3T150AA	Thy-SPD	Vdm=140V, Vs=180V, lpp=35A, 40pF	DO-214AA	1d	1a	Mde
G6	BZD27C110P	Z-diode	104..116V, Zzt=80Ω, lzt=5mA, 800mW	SOD-123FL	7d	1a	Vs
G6	FRS2K	Si-diode	Rectifier, Fast-Recovery 800V, 1.5A, <250ns	DO-214AA	1d	2j	Fag
G6	P1500SAA	Thy-SPD	Vdm=140V, Vs=180V, lpp=35A(1ms), Bidirectional	DO-214AC	1ba	1j	Mde
G6	PZU3.3B	Z-diode	3.1..3.5V, Zzt=95Ω(lzt=5mA), 310mW	SOD-323FL	7d	1a	Phi
G6	RKZ10B2KK	Z-diode	9.77..10.21V, lzt=5mA, Zzt=30Ω, 150mW	SFP	7d	1a	Ren
G6	RKZ10B2KL	Z-diode	9.77..10.21V, lzt=5mA, Zzt=30Ω, 100mW	EPF	7d	1a	Ren
G7	3T180AA	Thy-SPD	Vdm=160V, Vs=220V, lpp=35A, 40pF	DO-214AA	1d	1a	Mde
G7	BZD27C120P	Z-diode	114..127V, Zzt=80Ω, lzt=5mA, 800mW	SOD-123FL	7d	1a	Vs
G7	FRS2M	Si-diode	Rectifier, Fast-Recovery 1000V, 1.5A, <250ns	DO-214AC	1d	2j	Fag
G7	P1800SAA	Thy-SPD	Vdm=160V, Vs=220V, lpp=35A(1ms), Bidirectional	DO-214AC	1ba	1j	Mde
G7	PZU3.6B	Z-diode	3.4..3.8V, Zzt=90Ω(lzt=5mA), 310mW	SOD-323FL	7d	1a	Phi
G8	3T230AA	Thy-SPD	Vdm=190V, Vs=260V, lpp=35A, 30pF	DO-214AA	1d	1a	Mde
G8	BZD27C130P	Z-diode	124..141V, Zzt=110Ω, lzt=5mA, 800mW	SOD-123FL	7d	1a	Vs
G8	MMSZ4V7	Z-diode	4.7V±5%, lzt=5mA, Zzt=80Ω, 200mW	SOD-523	6d	1a	Eic
G8	MMSZ4V7H	Z-diode	4.4..5V, lzt=5mA, Zzt=80Ω, 200mW	SOD-523	7d	1a	Zow
G8	P2300SAA	Thy-SPD	Vdm=190V, Vs=260V, lpp=35A(1ms), Bidirectional	DO-214AC	1ba	1j	Mde
G8	PZU3.9B	Z-diode	3.7..4.1V, Zzt=90Ω(lzt=5mA), 310mW	SOD-323FL	7d	1a	Phi
G9	3T260AA	Thy-SPD	Vdm=220V, Vs=300V, lpp=35A, 30pF	DO-214AA	1d	1a	Mde
G9	BZD27C150P	Z-diode	138..156V, Zzt=130Ω, lzt=5mA, 800mW	SOD-123FL	7d	1a	Vs
G9	MMSZ56H	Z-diode	52..60V, lzt=1mA, Zzt=200Ω, 200mW	SOD-523	7d	1a	Zow
G9	MMSZ56V	Z-diode	56V±5%, lzt=2mA, Zzt=200Ω, 200mW	SOD-523	6d	1a	Eic
G9	P2600SAA	Thy-SPD	Vdm=220V, Vs=300V, lpp=35A(1ms), Bidirectional	DO-214AC	1ba	1j	Mde
G9	PZU4.3B	Z-diode	4.01..4.48V, Zzt=90Ω(lzt=5mA), 310mW	SOD-323FL	7d	1a	Phi
G9	RKZ11B2KK	Z-diode	10.76..11.22V, lzt=5mA, Zzt=30Ω, 150mW	SFP	7d	1a	Ren
G9	RKZ11B2KL	Z-diode	10.76..11.22V, lzt=5mA, Zzt=30Ω, 100mW	EPF	7d	1a	Ren
GA	3T310AA	Thy-SPD	Vdm=275V, Vs=350V, lpp=35A, 30pF	DO-214AA	1d	1a	Mde
GA	GF1A	Si-diode	Rectifier, 50V, 1A, Vf<1.1V(1A), 2μs	DO-214BA	1d	1k	Vs
GA	P3100SAA	Thy-SPD	Vdm=275V, Vs=350V, lpp=35A(1ms), Bidirectional	DO-214AC	1ba	1j	Mde
GA	PZU4.7B	Z-diode	4.42..4.9V, Zzt=80Ω(lzt=5mA), 310mW	SOD-323FL	7d	1a	Phi
GA	S1GA	Si-diode	Rectifier, 400V, 1A, Vf<1.1V(1A)	DO-214AC	1d	1k	Vs
GA6	STPS160A	Si-diode	SBR, 60V, 1A, Vf<0.55V(1A)	DO-214AC	1d	1a	Ste
GB	3T350AA	Thy-SPD	Vdm=300V, Vs=400V, lpp=35A, 30pF	DO-214AA	1d	1a	Mde
GB	GF1B	Si-diode	Rectifier, 100V, 1A, Vf<1.1V(1A), 2μs	DO-214BA	1d	1k	Vs
GB	KDZ3.6B	Z-diode	3.6V±2.5%, 40mA, 1W	PMDU	7d	1s	Rhm
GB	P3500SAA	Thy-SPD	Vdm=300V, Vs=400V, lpp=35A(1ms), Bidirectional	DO-214AC	1ba	1j	Mde
GB	PZU5.1B	Z-diode	4.84..5.37V, Zzt=60Ω(lzt=5mA), 310mW	SOD-323FL	7d	1a	Phi
GB4	STPS1L140A	Si-diode	SBR, 40V, 1A, Vf<0.42V(1A)	DO-214AC	1d	1a	Ste
GB6	STPS1L60A	Si-diode	SBR, 60V, 1A, Vf<0.56V(1A)	DO-214AC	1d	1a	Ste
GBA	SMCJ60CA	TVS	Vrwm=60V, Vbr=66.7..76.7V, 15.7A, 1500W(1ms), Bidirectional	DO-214AB	1ba	1r	Ste
GBB	SMCJ70CA	TVS	Vrwm=70V, Vbr=77.8..89.5V, 13.9A, 1500W(1ms), Bidirectional	DO-214AB	1ba	1r	Ste
GBE	SMCJ85CA	TVS	Vrwm=85V, Vbr=94.4..108.2V, 11.5A, 1500W(1ms), Bidirectional	DO-214AB	1ba	1r	Ste
GBG	SMCJ100CA	TVS	Vrwm=100V, Vbr=111..123V, 9.3A, 1500W(1ms), Bidirectional	DO-214AB	1ba	1r	Ste
GBI	SMCJ130CA	TVS	Vrwm=130V, Vbr=144..165.5V, 7.5A, 1500W(1ms), Bidirectional	DO-214AB	1ba	1r	Ste
GBL	SMCJ154CA	TVS	Vrwm=154V, Vbr=168..193.5V, 6.1A, 1500W(1ms), Bidirectional	DO-214AB	1ba	1r	Ste
GBM	SMCJ170CA	TVS	Vrwm=170V, Vbr=189..217V, 5.7A, 1500W(1ms), Bidirectional	DO-214AB	1ba	1r	Ste
GBN	SMCJ188CA	TVS	Vrwm=188V, Vbr=209..255V, 4.6A, 1500W(1ms), Bidirectional	DO-214AB	1ba	1r	Ste
GC	3T064A	Thy-SPD	Vdm=58V, Vs=77V, lpp=50A, 60pF	DO-214AA	1d	1a	Mde
GC	P0640SA	Thy-SPD	Vdm=58V, Vs=77V, lpp=50A(1ms), Bidirectional	DO-214AA	1ba	1j	Mde
GC	PZU5.6B	Z-diode	5.31..5.92V, Zzt=40Ω(lzt=5mA), 310mW	SOD-323FL	7d	1a	Phi
GC4	STPS1L140U	Si-diode	SBR, 40V, 1A, Vf<0.42V(1A)	DO-214AA	1d	1a	Ste
GCL	3T064ALC	Thy-SPD	Vdm=58V, Vs=77V, lpp=2.2A(1ms), 60pF	DO-214AA	1d	1a	Lfr
GD	3T072A	Thy-SPD	Vdm=65V, Vs=88V, lpp=50A, 60pF	DO-214AA	1d	1a	Mde
GD	GF1D	Si-diode	Rectifier, 200V, 1A, Vf<1.1V(1A), 2μs	DO-214BA	1d	1k	Vs
GD	KDZ36B	Z-diode	36V±2.5%, 10mA, 1W	PMDU	7d	1s	Rhm
GD	P0720SA	Thy-SPD	Vdm=65V, Vs=88V, lpp=50A(1ms), Bidirectional	DO-214AA	1ba	1j	Mde
GD	P4SMAJ220	TVS	Vbr=170V, 1A, 400W(1ms)	DO-214AC	1d	1m,1w	Pjt,Srj
GD	PZU6.2B	Z-diode	5.86..6.53V, Zzt=30Ω(lzt=5mA), 310mW	SOD-323FL	7d	1a	Phi
GD	Z2SMB-7V5	Z-diode	7.5V±5%, 2W	DO-214AA	1d	2j	Fag
GDD	1.5SMCJ5.0	TVS	Vrwm=5V, 156.2A, 1500W(1ms)	DO-214AB	1d	1m,1w	Pjt,Srj
GDD	SMCG5.0	TVS	Vbr=5V, 156.3A, 1500W(1ms)	DO-215AB	5d	1k	Vs
GDD	SMCJ5.0	TVS	Vrwm=5V, Vbr=6.4..7.25V, 156.3A, 1500W(1ms)	DO-214AB	1d	1k	Vs
GDD	SMCJ5.0C	TVS	Vrwm=5V, Vbr=6.40..7.82V, 156.3A, 1500W(1ms), Bidirectional	DO-214AB	1ba	1j	Eic
GDD	TFMCJ5.0	TVS	Vbr=5V, 156.3A, 1500W(1ms)	DO-214AB	1d	1b	Rec
GDD	TV15CV50K-G	TVS	Vrwm=5.0V, Vbr=6.40..7.82V, lpp=156.25A, 1500W(1ms)	DO-214AB	1d	1a	Cmc



SMD
code

Type

Function

Short description

Case

Pinout St.

Mnf.

SMD code	Type	Function	Short description	Case	Pinout	St.	Mnf.
GDE	1.5SMCJ5.0A	TVS	Vrwm=5V, 163A, 1500W(1ms)	DO-214AB	1d	1m,1w	Pjt,Srj
GDE	15MC5.0A	TVS	Vbr=6.40..7.07V, Vrwm=5.0V, 163.0A, 1500W(1ms)	403	3d	1s	Ons
GDE	CD214C-T5.0A	TVS	Vbr=5V, Irsm=163A, 1500W(1ms)	DO-214AB	1d	1a	Bm
GDE	SMCG5.0A	TVS	Vbr=5V, 163A, 1500W(1ms)	DO-215AB	5d	1k	Vs
GDE	SMCJ5.0A	TVS	Vrwm=5V, Vbr=6.4..7.25V, 163A, 1500W(1ms)	DO-214AB	1d	1k,1m	Di,Vs
GDE	SMCJ5.0CA	TVS	Vrwm=5V, Vbr=6.40..7.25V, 163.0A, 1500W(1ms), Bidirectional	DO-214AB	1ba	1j	Eic
GDE	TFMCJ5.0A	TVS	Vbr=5V, 163A, 1500W(1ms)	DO-214AB	1d	1b	Rec
GDE	TV15CV0J-G	TVS	Vrwm=5.0V, Vbr=6.40..7.07V, lpp=163.04A, 1500W(1ms)	DO-214AB	1d	1a	Cmc
GDE7	SM15T6V8A	TVS	Vrwm=5.80V, Vbr=6.45..7.14V, 143A, 1500W(1ms)	DO-214AB	1d	1k	Vs
GDF	1.5SMCJ6.0	TVS	Vrwm=6V, 131.6A, 1500W(1ms)	DO-214AB	1d	1m,1w	Pjt,Srj
GDF	SMCG6.0	TVS	Vbr=6V, 131.6A, 1500W(1ms)	DO-215AB	5d	1k	Vs
GDF	SMCJ6.0	TVS	Vrwm=6V, Vbr=6.67..7.67V, 131.6A, 1500W(1ms)	DO-214AB	1d	1k	Vs
GDF	SMCJ6.0C	TVS	Vrwm=6V, Vbr=6.67..8.15V, 131.6A, 1500W(1ms), Bidirectional	DO-214AB	1ba	1j	Eic
GDF	TFMCJ6.0	TVS	Vbr=6V, 131.6A, 1500W(1ms)	DO-214AB	1d	1b	Rec
GDF	TV15CV0K-G	TVS	Vrwm=6.0V, Vbr=6.67..8.15V, lpp=131.58A, 1500W(1ms)	DO-214AB	1d	1a	Cmc
GDG	1.5SMCJ6.0A	TVS	Vrwm=6V, 145.6A, 1500W(1ms)	DO-214AB	1d	1m,1w	Pjt,Srj
GDG	15MC6.0A	TVS	Vbr=6.67..7.37V, Vrwm=6.0V, 145.6A, 1500W(1ms)	403	3d	1s	Ons
GDG	CD214C-T6.0A	TVS	Vbr=6V, Irsm=145.6A, 1500W(1ms)	DO-214AB	1d	1a	Bm
GDG	SMCG6.0A	TVS	Vbr=6V, 145.6A, 1500W(1ms)	DO-215AB	5d	1k	Vs
GDG	SMCJ6.0A	TVS	Vrwm=6V, Vbr=6.67..7.67V, 145.6A, 1500W(1ms)	DO-214AB	1d	1k,1m	Di,Vs
GDG	SMCJ6.0CA	TVS	Vrwm=6V, Vbr=6.67..7.37V, 145.6A, 1500W(1ms), Bidirectional	DO-214AB	1ba	1j	Eic
GDG	TFMCJ6.0A	TVS	Vbr=6V, 145.6A, 1500W(1ms)	DO-214AB	1d	1b	Rec
GDG	TV15C130J-G	TVS	Vrwm=13.0V, Vbr=14.40..15.90V, lpp=69.77A, 1500W(1ms)	DO-214AB	1d	1a	Cmc
GDG	TV15C6V0J-G	TVS	Vrwm=6.0V, Vbr=6.67..7.37V, lpp=145.63A, 1500W(1ms)	DO-214AB	1d	1a	Cmc
GDH	1.5SMCJ6.5	TVS	Vrwm=6.5V, 122A, 1500W(1ms)	DO-214AB	1d	1m,1w	Pjt,Srj
GDH	SMCG6.5	TVS	Vbr=6.5V, 122A, 1500W(1ms)	DO-215AB	5d	1k	Vs
GDH	SMCJ6.5	TVS	Vrwm=6.5V, Vbr=7.22..8.3V, 122A, 1500W(1ms)	DO-214AB	1d	1k	Vs
GDH	SMCJ6.5C	TVS	Vrwm=6.5V, Vbr=7.22..8.82V, 122.0A, 1500W(1ms), Bidirectional	DO-214AB	1ba	1j	Eic
GDH	TFMCJ6.5	TVS	Vbr=6.5V, 122A, 1500W(1ms)	DO-214AB	1d	1b	Rec
GDH	TV15C6V5K-G	TVS	Vrwm=6.50V, Vbr=7.22..8.82V, lpp=121.95A, 1500W(1ms)	DO-214AB	1d	1a	Cmc
GDI	15MC8.5A	TVS	Vbr=9.44..10.4V, Vrwm=8.5V, 104.2A, 1500W(1ms)	403	3d	1s	Ons
GDK	1.5SMCJ6.5A	TVS	Vrwm=6.5V, 133.9A, 1500W(1ms)	DO-214AB	1d	1m,1w	Pjt,Srj
GDK	15MC6.5A	TVS	Vbr=7.22..7.98V, Vrwm=6.5V, 133.9A, 1500W(1ms)	403	3d	1s	Ons
GDK	CD214C-T6.5A	TVS	Vbr=6.5V, Irsm=133.9A, 1500W(1ms)	DO-214AB	1d	1a	Bm
GDK	SMCG6.5A	TVS	Vbr=6.5V, 133.9A, 1500W(1ms)	DO-215AB	5d	1k	Vs
GDK	SMCJ6.5A	TVS	Vrwm=6.5V, Vbr=7.22..8.3V, 133.9A, 1500W(1ms)	DO-214AB	1d	1k,1m	Di,Vs
GDK	SMCJ6.5CA	TVS	Vrwm=6.5V, Vbr=7.22..7.98V, 133.9A, 1500W(1ms), Bidirectional	DO-214AB	1ba	1j	Eic
GDK	TFMCJ6.5A	TVS	Vbr=6.5V, 133.9A, 1500W(1ms)	DO-214AB	1d	1b	Rec
GDK	TV15C6V5J-G	TVS	Vrwm=6.50V, Vbr=7.22..7.98V, lpp=133.93A, 1500W(1ms)	DO-214AB	1d	1a	Cmc
GDK7	SM15T7V5A	TVS	Vrwm=6.40V, Vbr=7.13..7.88V, 132A, 1500W(1ms)	DO-214AB	1d	1k	Vs
GDL	1.5SMCJ7.0	TVS	Vrwm=7V, 112.8A, 1500W(1ms)	DO-214AB	1d	1m,1w	Pjt,Srj
GDL	3T072ALC	Thy-SPD	Vdvm=65V, Vs=88V, lpp=2.2A(1ms), 60pF	DO-214AA	1d	1a	Lfr
GDL	SMCG7.0	TVS	Vbr=7V, 112.8A, 1500W(1ms)	DO-215AB	5d	1k	Vs
GDL	SMCJ7.0	TVS	Vrwm=7V, Vbr=7.78..8.95V, 112.8A, 1500W(1ms)	DO-214AB	1d	1k	Vs
GDL	SMCJ7.0C	TVS	Vrwm=7V, Vbr=7.78..9.51V, 112.8A, 1500W(1ms), Bidirectional	DO-214AB	1ba	1j	Eic
GDL	TFMCJ7.0	TVS	Vbr=7V, 112.8A, 1500W(1ms)	DO-214AB	1d	1b	Rec
GDL	TV15C7V0K-G	TVS	Vrwm=7.0V, Vbr=7.78..9.51V, lpp=112.78A, 1500W(1ms)	DO-214AB	1d	1a	Cmc
GDM	1.5SMCJ7.0A	TVS	Vrwm=7V, 125A, 1500W(1ms)	DO-214AB	1d	1m,1w	Pjt,Srj
GDM	15MC7.0A	TVS	Vbr=7.78..8.6V, Vrwm=7.0V, 125.0A, 1500W(1ms)	403	3d	1s	Ons
GDM	CD214C-T7.0A	TVS	Vbr=7V, Irsm=125A, 1500W(1ms)	DO-214AB	1d	1a	Bm
GDM	SMCG7.0A	TVS	Vbr=7V, 125A, 1500W(1ms)	DO-215AB	5d	1k	Vs
GDM	SMCJ7.0A	TVS	Vrwm=7V, Vbr=7.78..8.95V, 125A, 1500W(1ms)	DO-214AB	1d	1k,1m	Di,Vs
GDM	SMCJ7.0CA	TVS	Vrwm=7V, Vbr=7.78..8.6V, 125.0A, 1500W(1ms), Bidirectional	DO-214AB	1ba	1j	Eic
GDM	TFMCJ7.0A	TVS	Vbr=7V, 125A, 1500W(1ms)	DO-214AB	1d	1b	Rec
GDM	TV15C7V0J-G	TVS	Vrwm=7.0V, Vbr=7.78..8.60V, lpp=125.0A, 1500W(1ms)	DO-214AB	1d	1a	Cmc
GDN	1.5SMCJ7.5	TVS	Vrwm=7.5V, 104.9A, 1500W(1ms)	DO-214AB	1d	1m,1w	Pjt,Srj
GDN	SMCG7.5	TVS	Vbr=7.5V, 104.9A, 1500W(1ms)	DO-215AB	5d	1k	Vs
GDN	SMCJ7.5	TVS	Vrwm=7.5V, Vbr=8.33..9.58V, 104.9A, 1500W(1ms)	DO-214AB	1d	1k	Vs
GDN	SMCJ7.5C	TVS	Vrwm=7.5V, Vbr=8.33..10.2V, 104.9A, 1500W(1ms), Bidirectional	DO-214AB	1ba	1j	Eic
GDN	TFMCJ7.5	TVS	Vbr=7.5V, 104.9A, 1500W(1ms)	DO-214AB	1d	1b	Rec
GDN	TV15C7V5K-G	TVS	Vrwm=7.50V, Vbr=8.33..10.20V, lpp=104.90A, 1500W(1ms)	DO-214AB	1d	1a	Cmc
GDP	1.5SMCJ7.5A	TVS	Vrwm=7.5V, 116.3A, 1500W(1ms)	DO-214AB	1d	1m,1w	Pjt,Srj
GDP	15MC7.5A	TVS	Vbr=8.33..9.21V, Vrwm=7.5V, 116.3A, 1500W(1ms)	403	3d	1s	Ons
GDP	CD214C-T7.5A	TVS	Vbr=7.5V, Irsm=116.3A, 1500W(1ms)	DO-214AB	1d	1a	Bm
GDP	SMCG7.5A	TVS	Vbr=7.5V, 116.3A, 1500W(1ms)	DO-215AB	5d	1k	Vs
GDP	SMCJ7.5A	TVS	Vrwm=7.5V, Vbr=8.33..9.58V, 116.3A, 1500W(1ms)	DO-214AB	1d	1k,1m	Di,Vs
GDP	SMCJ7.5CA	TVS	Vrwm=7.5V, Vbr=8.33..9.21V, 116.3A, 1500W(1ms), Bidirectional	DO-214AB	1ba	1j	Eic
GDP	TFMCJ7.5A	TVS	Vbr=7.5V, 116.3A, 1500W(1ms)	DO-214AB	1d	1b	Rec
GDP	TV15C7V5J-G	TVS	Vrwm=7.50V, Vbr=8.33..9.21V, lpp=116.28A, 1500W(1ms)	DO-214AB	1d	1a	Cmc
GDQ	1.5SMCJ8.0	TVS	Vrwm=8V, 100A, 1500W(1ms)	DO-214AB	1d	1m,1w	Pjt,Srj



SMD
code

Type

Function

Short description

Case

Pinout

St.

Mnf.

SMD code	Type	Function	Short description	Case	Pinout	St.	Mnf.
GDQ	SMCG8.0	TVS	Vbr=8V, 100A, 1500W(1ms)	DO-215AB	5d	1k	Vs
GDQ	SMCJ8.0	TVS	Vrwm=8V, Vbr=8.89..9.83V, 100A, 1500W(1ms)	DO-214AB	1d	1k	Vs
GDQ	SMCJ8.0C	TVS	Vrwm=8V, Vbr=8.89..9.83V, 100.0A, 1500W(1ms), Bidirectional	DO-214AB	1ba	1j	Eic
GDQ	TFMCJ8.0	TVS	Vbr=8V, 100A, 1500W(1ms)	DO-214AB	1d	1b	Rec
GDQ	TV15C8V0K-G	TVS	Vrwm=8.0V, Vbr=8.89..10.90V, lpp=100.0A, 1500W(1ms)	DO-214AB	1d	1a	Cmc
GDR	1.5SMCJ8.0A	TVS	Vrwm=8V, 110.3A, 1500W(1ms)	DO-214AB	1d	1m,1w	Pjt,Srj
GDR	15MC8.0A	TVS	Vbr=8.89..9.83V, Vrwm=8.0V, 110.3A, 1500W(1ms)	403	3d	1s	Ons
GDR	CD214C-T8.0A	TVS	Vbr=8V, Irsrm=110.3A, 1500W(1ms)	DO-214AB	1d	1a	Bm
GDR	SMCG8.0A	TVS	Vbr=8V, 110.3A, 1500W(1ms)	DO-215AB	5d	1k	Vs
GDR	SMCJ8.0A	TVS	Vrwm=8V, Vbr=8.89..9.83V, 110.3A, 1500W(1ms)	DO-214AB	1d	1k,1m	Di,Vs
GDR	SMCJ8.0CA	TVS	Vrwm=8V, Vbr=8.89..9.83V, 110.3A, 1500W(1ms), Bidirectional	DO-214AB	1ba	1j	Eic
GDR	TFMCJ8.0A	TVS	Vbr=8V, 110.3A, 1500W(1ms)	DO-214AB	1d	1b	Rec
GDR	TV15C8V0J-G	TVS	Vrwm=8.0V, Vbr=8.89..9.83V, lpp=110.29A, 1500W(1ms)	DO-214AB	1d	1a	Cmc
GDS	1.5SMCJ8.5	TVS	Vrwm=8.5V, 94.3A, 1500W(1ms)	DO-214AB	1d	1m,1w	Pjt,Srj
GDS	SMCG8.5	TVS	Vbr=8.5V, 94.3A, 1500W(1ms)	DO-215AB	5d	1k	Vs
GDS	SMCJ8.5	TVS	Vrwm=8.5V, Vbr=9.44..10.82V, 94.3A, 1500W(1ms)	DO-214AB	1d	1k	Vs
GDS	SMCJ8.5C	TVS	Vrwm=8.5V, Vbr=9.44..11.5V, 94.3A, 1500W(1ms), Bidirectional	DO-214AB	1ba	1j	Eic
GDS	TFMCJ8.5	TVS	Vbr=8.5V, 94.3A, 1500W(1ms)	DO-214AB	1d	1b	Rec
GDS	TV15C8V5K-G	TVS	Vrwm=8.55V, Vbr=9.44..11.50V, lpp=94.34A, 1500W(1ms)	DO-214AB	1d	1a	Cmc
GDT	1.5SMCJ8.5A	TVS	Vrwm=8.5V, 104.2A, 1500W(1ms)	DO-214AB	1d	1m,1w	Pjt,Srj
GDT	CD214C-T8.5A	TVS	Vbr=8.5V, Irsrm=104.2A, 1500W(1ms)	DO-214AB	1d	1a	Bm
GDT	SMCG8.5A	TVS	Vbr=8.5V, 104.2A, 1500W(1ms)	DO-215AB	5d	1k	Vs
GDT	SMCJ8.5A	TVS	Vrwm=8.5V, Vbr=9.44..10.82V, 104.2A, 1500W(1ms)	DO-214AB	1d	1k,1m	Di,Vs
GDT	SMCJ8.5CA	TVS	Vrwm=8.5V, Vbr=9.44..10.82V, 104.2A, 1500W(1ms), Bidirectional	DO-214AB	1ba	1j	Eic
GDT	TFMCJ8.5A	TVS	Vbr=8.5V, 104.2A, 1500W(1ms)	DO-214AB	1d	1b	Rec
GDT	TV15C8V5J-G	TVS	Vrwm=8.55V, Vbr=9.44..10.40V, lpp=104.17A, 1500W(1ms)	DO-214AB	1d	1a	Cmc
GDT7	SM15T10A	TVS	Vrwm=8.55V, Vbr=9.5..10.5V, 103A, 1500W(1ms)	DO-214AB	1d	1k	Vs
GDU	1.5SMCJ9.0	TVS	Vrwm=9V, 88.7A, 1500W(1ms)	DO-214AB	1d	1m,1w	Pjt,Srj
GDU	SMCG9.0	TVS	Vbr=9V, 88.8A, 1500W(1ms)	DO-215AB	5d	1k	Vs
GDU	SMCJ9.0	TVS	Vrwm=9V, Vbr=10.0..12.2V, 88.8A, 1500W(1ms)	DO-214AB	1d	1k	Vs
GDU	SMCJ9.0C	TVS	Vrwm=9V, Vbr=10.0..12.2V, 88.8A, 1500W(1ms), Bidirectional	DO-214AB	1ba	1j	Eic
GDU	TFMCJ9.0	TVS	Vbr=9V, 88.8A, 1500W(1ms)	DO-214AB	1d	1b	Rec
GDU	TV15C9V0K-G	TVS	Vrwm=9.0V, Vbr=10.0..12.20V, lpp=88.76A, 1500W(1ms)	DO-214AB	1d	1a	Cmc
GDV	1.5SMCJ9.0A	TVS	Vrwm=9V, 97.4A, 1500W(1ms)	DO-214AB	1d	1m,1w	Pjt,Srj
GDV	15MC9.0A	TVS	Vbr=10.0..11.1V, Vrwm=9.0V, 97.4A, 1500W(1ms)	403	3d	1s	Ons
GDV	CD214C-T9.0A	TVS	Vbr=9V, Irsrm=97.4A, 1500W(1ms)	DO-214AB	1d	1a	Bm
GDV	SMCG9.0A	TVS	Vbr=9V, 97.4A, 1500W(1ms)	DO-215AB	5d	1k	Vs
GDV	SMCJ9.0A	TVS	Vrwm=9V, Vbr=10..11.5V, 97.4A, 1500W(1mS)	DO-214AB	1d	1k,1m	Di,Vs
GDV	SMCJ9.0CA	TVS	Vrwm=9V, Vbr=10..11.5V, 97.4A, 1500W(1mS), Bidirectional	DO-214AB	1ba	1j	Eic
GDV	TFMCJ9.0A	TVS	Vbr=9V, 97.4A, 1500W(1ms)	DO-214AB	1d	1b	Rec
GDV	TV15C9V0J-G	TVS	Vrwm=9.0V, Vbr=10.0..11.10V, lpp=97.40A, 1500W(1ms)	DO-214AB	1d	1a	Cmc
GDW	1.5SMCJ10	TVS	Vrwm=10V, 79.8A, 1500W(1ms)	DO-214AB	1d	1m,1w	Pjt,Srj
GDW	SMCG10	TVS	Vbr=10V, 79.8A, 1500W(1ms)	DO-215AB	5d	1k	Vs
GDW	SMCJ10	TVS	Vrwm=10V, Vbr=11.1..13.6V, 79.8A, 1500W(1ms)	DO-214AB	1d	1k	Vs
GDW	SMCJ10C	TVS	Vrwm=10V, Vbr=11.1..13.6V, 98A, 1500W(1ms), Bidirectional	DO-214AB	1ba	1j	Eic
GDW	TFMCJ10	TVS	Vbr=10V, 79.8A, 1500W(1ms)	DO-214AB	1d	1b	Rec
GDW	TV15C100K-G	TVS	Vrwm=10.0V, Vbr=11.10..13.60 V, lpp=79.79A, 1500W(1ms)	DO-214AB	1d	1a	Cmc
GDX	1.5SMCJ10A	TVS	Vrwm=10V, 88.2A, 1500W(1ms)	DO-214AB	1d	1m,1w	Pjt,Srj
GDX	15MC10A	TVS	Vbr=11.1..12.3V, Vrwm=10V, 88.2A, 1500W(1ms)	403	3d	1s	Ons
GDX	CD214C-T10A	TVS	Vbr=10V, Irsrm=88.2A, 1500W(1ms)	DO-214AB	1d	1a	Bm
GDX	SMCG10A	TVS	Vbr=10V, 88.2A, 1500W(1ms)	DO-215AB	5d	1k	Vs
GDX	SMCJ10A	TVS	Vrwm=10V, Vbr=11.1..13.6V, 88.2A, 1500W(1ms)	DO-214AB	1d	1k,1m	Di,Vs
GDX	SMCJ10CA	TVS	Vrwm=10V, Vbr=11.1..12.8V, 88.2A, 1500W(1mS), Bidirectional	DO-214AB	1ba	1j	Eic
GDX	TFMCJ10A	TVS	Vbr=10V, 88.2A, 1500W(1ms)	DO-214AB	1d	1b	Rec
GDX	TV15C100J-G	TVS	Vrwm=10.0V, Vbr=11.10..12.30V, lpp=88.24A, 1500W(1ms)	DO-214AB	1d	1a	Cmc
GDX7	SM15T12A	TVS	Vrwm=10.2V, Vbr=11.4..12.6V, 90A, 1500W(1ms)	DO-214AB	1d	1k	Vs
GDY	1.5SMCJ11	TVS	Vrwm=11V, 74.6A, 1500W(1ms)	DO-214AB	1d	1m,1w	Pjt,Srj
GDY	SMCG11	TVS	Vbr=11V, 74.6A, 1500W(1ms)	DO-215AB	5d	1k	Vs
GDY	SMCJ11	TVS	Vrwm=11V, Vbr=12.2..14V, 74.6A, 1500W(1ms)	DO-214AB	1d	1k	Vs
GDY	SMCJ11C	TVS	Vrwm=11V, Vbr=12.2..14.9V, 74.6A, 1500W(1ms), Bidirectional	DO-214AB	1ba	1j	Eic
GDY	TFMCJ11	TVS	Vbr=11V, 74.6A, 1500W(1ms)	DO-214AB	1d	1b	Rec
GDY	TV15C110K-G	TVS	Vrwm=11.0V, Vbr=12.20..14.90V, lpp=74.63A, 1500W(1ms)	DO-214AB	1d	1a	Cmc
GDZ	1.5SMCJ11A	TVS	Vrwm=11V, 82.4A, 1500W(1ms)	DO-214AB	1d	1m,1w	Pjt,Srj
GDZ	15MC11A	TVS	Vbr=12.2..13.5V, Vrwm=11V, 82.4A, 1500W(1ms)	403	3d	1s	Ons
GDZ	CD214C-T11A	TVS	Vbr=11V, Irsrm=82.4A, 1500W(1ms)	DO-214AB	1d	1a	Bm
GDZ	SMCG11A	TVS	Vbr=11V, 82.4A, 1500W(1ms)	DO-215AB	5d	1k	Vs
GDZ	SMCJ11A	TVS	Vrwm=11V, Vbr=12.2..14.9V, 82.4A, 1500W(1ms)	DO-214AB	1d	1k,1m	Di,Vs
GDZ	SMCJ11CA	TVS	Vrwm=11V, Vbr=12.2..14V, 82.4A, 1500W(1mS), Bidirectional	DO-214AB	1ba	1j	Eic
GDZ	TFMCJ11A	TVS	Vbr=11V, 82.4A, 1500W(1ms)	DO-214AB	1d	1b	Rec
GDZ	TV15C110J-G	TVS	Vrwm=11.0V, Vbr=12.20..13.50V, lpp=82.42A, 1500W(1ms)	DO-214AB	1d	1a	Cmc



SMD
code

Type

Function

Short description

Case

Pinout

St.

Mnf.

SMD code	Type	Function	Short description	Case	Pinout	St.	Mnf.
GE	3T080A	Thy-SPD	Vdm=75V, Vs=98V, Ipp=50A, 60pF	DO-214AA	1d	1a	Mde
GE	P0800SA	Thy-SPD	Vdm=75V, Vs=98V, Ipp=50A(1ms), Bidirectional	DO-214AA	1ba	1j	Mde
GE	P4SMAJ220A	TVS	Vbr=170V, 1.1A, 400W (1ms)	DO-214AC	1d	1m,1w	Pjt,Srj
GE	PZU6.8B	Z-diode	6.47..7.14V, Zzt=20Q(Izt=5mA), 310mW	SOD-323FL	7d	1a	Phi
GE	Z2SMB-6V8	Z-diode	6.8V±5%, 2W	DO-214AA	1d	2j	Fag
GEA	TV15C190K-G	TVS	Vrwm=19.0V, Vbr=21.13..25.76V, Ipp=44.10A, 1500W(1ms)	DO-214AB	1d	1a	Cmc
GEB	TV15C190J-G	TVS	Vrwm=19.0V, Vbr=21.10..23.30V, Ipp=48.73A, 1500W(1ms)	DO-214AB	1d	1a	Cmc
GED	1.5SMCJ12	TVS	Vrwm=12V, 68.2A, 1500W(1ms)	DO-214AB	1d	1m,1w	Pjt,Srj
GED	SMCG12	TVS	Vbr=12V, 68.2A, 1500W(1ms)	DO-215AB	5d	1k	Vs
GED	SMCJ12	TVS	Vrwm=12V, Vbr=13.3..15.3V, 68.2A, 1500W(1ms)	DO-214AB	1d	1k	Vs
GED	SMCJ12C	TVS	Vrwm=12V, Vbr=13.3..16.3V, 68.2A, 1500W(1ms), Bidirectional	DO-214AB	1ba	1j	Eic
GED	TFMCJ12	TVS	Vbr=12V, 68.2A, 1500W(1ms)	DO-214AB	1d	1b	Rec
GED	TV15C120K-G	TVS	Vrwm=12.0V, Vbr=13.30..16.30V, Ipp=68.18A, 1500W(1ms)	DO-214AB	1d	1a	Cmc
GEE	1.5SMCJ12A	TVS	Vrwm=12V, 75.3A, 1500W(1ms)	DO-214AB	1d	1m,1w	Pjt,Srj
GEE	1SMC12A	TVS	Vbr=13.3..14.7V, Vrwm=12V, 75.4A, 1500W(1ms)	403	3d	1s	Ons
GEE	CD214C-T12A	TVS	Vbr=12V, Irlsm=75.3A, 1500W(1ms)	DO-214AB	1d	1a	Bm
GEE	SMCG12A	TVS	Vbr=12V, 75.4A, 1500W(1ms)	DO-215AB	5d	1k	Vs
GEE	SMCJ12A	TVS	Vrwm=12V, Vbr=13.3..15.3V, 75.4A, 1500W(1ms)	DO-214AB	1d	1k,1m	Di,Vs
GEE	SMCJ12CA	TVS	Vrwm=12V, Vbr=13.3..15.3V, 75.3A, 1500W(1ms), Bidirectional	DO-214AB	1ba	1j	Eic
GEE	TFMCJ12A	TVS	Vbr=12V, 75.4A, 1500W(1ms)	DO-214AB	1d	1b	Rec
GEE	TV15C120J-G	TVS	Vrwm=12.0V, Vbr=13.30..14.70V, Ipp=75.38A, 1500W(1ms)	DO-214AB	1d	1a	Cmc
GEF	1.5SMCJ13	TVS	Vrwm=13V, 63A, 1500W(1ms)	DO-214AB	1d	1m,1w	Pjt,Srj
GEF	SMCG13	TVS	Vbr=13V, 63A, 1500W(1ms)	DO-215AB	5d	1k	Vs
GEF	SMCJ13	TVS	Vrwm=13V, Vbr=14.4..16.5V, 63A, 1500W(1ms)	DO-214AB	1d	1k	Vs
GEF	SMCJ13C	TVS	Vrwm=13V, Vbr=14.4..16.5V, 63.0A, 1500W(1ms), Bidirectional	DO-214AB	1ba	1j	Eic
GEF	TFMCJ13	TVS	Vbr=13V, 63A, 1500W(1ms)	DO-214AB	1d	1b	Rec
GEF	TV15C130K-G	TVS	Vrwm=13.0V, Vbr=14.40..17.60V, Ipp=63.03A, 1500W(1ms)	DO-214AB	1d	1a	Cmc
GEG	1.5SMCJ13A	TVS	Vrwm=13V, 69.7A, 1500W(1ms)	DO-214AB	1d	1m,1w	Pjt,Srj
GEG	1SMC13A	TVS	Vbr=14.4..15.9V, Vrwm=13V, 69.8A, 1500W(1ms)	403	3d	1s	Ons
GEG	CD214C-T13A	TVS	Vbr=13V, Irlsm=69.7A, 1500W(1ms)	DO-214AB	1d	1a	Bm
GEG	SMCG13A	TVS	Vbr=13V, 69.8A, 1500W(1ms)	DO-215AB	5d	1k	Vs
GEG	SMCJ13A	TVS	Vrwm=13V, Vbr=14.4..16.5V, 69.8A, 1500W(1ms)	DO-214AB	1d	1k,1m	Di,Vs
GEG	SMCJ13CA	TVS	Vrwm=13V, Vbr=14.4..16.5V, 69.8A, 1500W(1ms), Bidirectional	DO-214AB	1ba	1j	Eic
GEG	TFMCJ13A	TVS	Vbr=13V, 69.8A, 1500W(1ms)	DO-214AB	1d	1b	Rec
GEG7	SM15T15A	TVS	Vrwm=12.8V, Vbr=14.3..15.8V, 71A, 1500W(1ms)	DO-214AB	1d	1k	Vs
GEH	1.5SMCJ14	TVS	Vrwm=14V, 58.1A, 1500W(1ms)	DO-214AB	1d	1m,1w	Pjt,Srj
GEH	SMCG14	TVS	Vbr=14V, 58.1A, 1500W(1ms)	DO-215AB	5d	1k	Vs
GEH	SMCJ14	TVS	Vrwm=14V, Vbr=15.6..19.1V, 58.1A, 1500W(1ms)	DO-214AB	1d	1k	Vs
GEH	SMCJ14C	TVS	Vrwm=14V, Vbr=15.6..19.1V, 58.1A, 1500W(1ms), Bidirectional	DO-214AB	1ba	1j	Eic
GEH	TFMCJ14	TVS	Vbr=14V, 58.1A, 1500W(1ms)	DO-214AB	1d	1b	Rec
GEH	TV15C140K-G	TVS	Vrwm=14.0V, Vbr=15.60..19.10V, Ipp=58.14A, 1500W(1ms)	DO-214AB	1d	1a	Cmc
GEK	1.5SMCJ14A	TVS	Vrwm=14V, 64.7A, 1500W(1ms)	DO-214AB	1d	1m,1w	Pjt,Srj
GEK	1SMC14A	TVS	Vbr=15.6..17.2V, Vrwm=14V, 64.7A, 1500W(1ms)	403	3d	1s	Ons
GEK	CD214C-T14A	TVS	Vbr=14V, Irlsm=64.7A, 1500W(1ms)	DO-214AB	1d	1a	Bm
GEK	SMCG14A	TVS	Vbr=14V, 64.7A, 1500W(1ms)	DO-215AB	5d	1k	Vs
GEK	SMCJ14A	TVS	Vrwm=14V, Vbr=15.6..19.1V, 64.7A, 1500W(1ms)	DO-214AB	1d	1k,1m	Di,Vs
GEK	SMCJ14CA	TVS	Vrwm=14V, Vbr=15.6..17.9V, 64.7A, 1500W(1ms), Bidirectional	DO-214AB	1ba	1j	Eic
GEK	TFMCJ14A	TVS	Vbr=14V, 64.7A, 1500W(1ms)	DO-214AB	1d	1b	Rec
GEK	TV15C140J-G	TVS	Vrwm=14.0V, Vbr=15.60..17.20V, Ipp=64.66A, 1500W(1ms)	DO-214AB	1d	1a	Cmc
GEL	1.5SMCJ15	TVS	Vrwm=15V, 55.8A, 1500W(1ms)	DO-214AB	1d	1m,1w	Pjt,Srj
GEL	3T080ALC	Thy-SPD	Vdm=75V, Vs=98V, Ipp=2.2A(1ms), 60pF	DO-214AA	1d	1a	Lfr
GEL	SMCG15	TVS	Vbr=15V, 55.8A, 1500W(1ms)	DO-215AB	5d	1k	Vs
GEL	SMCJ15	TVS	Vrwm=15V, Vbr=16.7..19.2V, 55.8A, 1500W(1ms)	DO-214AB	1d	1k	Vs
GEL	SMCJ15C	TVS	Vrwm=15V, Vbr=16.7..20.4V, 55.8A, 1500W(1ms), Bidirectional	DO-214AB	1ba	1j	Eic
GEL	TFMCJ15	TVS	Vbr=15V, 55.8A, 1500W(1ms)	DO-214AB	1d	1b	Rec
GEL	TV15C150K-G	TVS	Vrwm=15.0V, Vbr=16.70..20.40V, Ipp=55.76A, 1500W(1ms)	DO-214AB	1d	1a	Cmc
GEM	1.5SMCJ15A	TVS	Vrwm=15V, 61.5A, 1500W(1ms)	DO-214AB	1d	1m,1w	Pjt,Srj
GEM	1SMC15A	TVS	Vbr=16.7..18.5V, Vrwm=15V, 61.5A, 1500W(1ms)	403	3d	1s	Ons
GEM	CD214C-T15A	TVS	Vbr=15V, Irlsm=61.5A, 1500W(1ms)	DO-214AB	1d	1a	Bm
GEM	SMCG15A	TVS	Vbr=15V, 61.5A, 1500W(1ms)	DO-215AB	5d	1k	Vs
GEM	SMCJ15A	TVS	Vrwm=15V, Vbr=16.7..19.2V, 61.5A, 1500W(1ms)	DO-214AB	1d	1k,1m	Di,Vs
GEM	SMCJ15CA	TVS	Vrwm=15V, Vbr=16.7..19.2V, 61.5A, 1500W(1ms), Bidirectional	DO-214AB	1ba	1j	Eic
GEM	TFMCJ15A	TVS	Vbr=15V, 61.5A, 1500W(1ms)	DO-214AB	1d	1b	Rec
GEM	TV15C150J-G	TVS	Vrwm=15.0V, Vbr=16.70..18.50V, Ipp=61.48A, 1500W(1ms)	DO-214AB	1d	1a	Cmc
GEM7	SM15T18A	TVS	Vrwm=15.3V, Vbr=17.1..18.9V, 59.5A, 1500W(1ms)	DO-214AB	1d	1k	Vs
GEN	1.5SMCJ16	TVS	Vrwm=16V, 52.1A, 1500W(1ms)	DO-214AB	1d	1m,1w	Pjt,Srj
GEN	SMCG16	TVS	Vbr=16V, 52.1A, 1500W(1ms)	DO-215AB	5d	1k	Vs
GEN	SMCJ16	TVS	Vrwm=16V, Vbr=17.8..20.5V, 52.1A, 1500W(1ms)	DO-214AB	1d	1k	Vs
GEN	SMCJ16C	TVS	Vrwm=16V, Vbr=17.8..21.8V, 52.1A, 1500W(1ms), Bidirectional	DO-214AB	1ba	1j	Eic
GEN	TFMCJ16	TVS	Vbr=16V, 52.1A, 1500W(1ms)	DO-214AB	1d	1b	Rec



SMD
code

Type

Function

Short description

Case

Pinout

St.

Mnf.

GEN	TV15C160K-G	TVS	Vrwm=16.0V, Vbr=17.80..21.80V, Ipp=52.08A, 1500W(1ms)	DO-214AB	1d	1a	Cmc
GEP	1.5SMCJ16A	TVS	Vrwm=16V, 57.7A, 1500W(1ms)	DO-214AB	1d	1m,1w	Pjt,Srj
GEP	1SMC16A	TVS	Vbr=17.8..19.7V, Vrwm=16V, 57.7A, 1500W(1ms)	403	3d	1s	Ons
GEP	CD214C-T16A	TVS	Vbr=16V, Irlsm=57.7A, 1500W(1ms)	DO-214AB	1d	1a	Bm
GEP	SMCG16A	TVS	Vbr=16V, 57.7A, 1500W(1ms)	DO-215AB	5d	1k	Vs
GEP	SMCJ16A	TVS	Vrwm=16V, Vbr=17.8..21.8V, 57.7A, 1500W(1ms)	DO-214AB	1d	1k,1m	Di,Vs
GEP	SMCJ16CA	TVS	Vrwm=16V, Vbr=17.8..19.7V, 57.7A, 1500W(1ms), Bidirectional	DO-214AB	1ba	1j	Eic
GEP	TFMCJ16A	TVS	Vbr=16V, 57.7A, 1500W(1ms)	DO-214AB	1d	1b	Rec
GEP	TV15C160J-G	TVS	Vrwm=16.0V, Vbr=17.80..19.70V, Ipp=57.69A, 1500W(1ms)	DO-214AB	1d	1a	Cmc
GEQ	1.5SMCJ17	TVS	Vrwm=17V, 49.2A, 1500W(1ms)	DO-214AB	1d	1m,1w	Pjt,Srj
GEQ	SMCG17	TVS	Vbr=17V, 49.2A, 1500W(1ms)	DO-215AB	5d	1k	Vs
GEQ	SMCJ17	TVS	Vrwm=17V, Vbr=18.9..21.7V, 49.2A, 1500W(1ms)	DO-214AB	1d	1k	Vs
GEQ	SMCJ17C	TVS	Vrwm=17V, Vbr=18.9..23.1V, 49.2A, 1500W(1ms), Bidirectional	DO-214AB	1ba	1j	Eic
GEQ	TFMCJ17	TVS	Vbr=17V, 49.2A, 1500W(1ms)	DO-214AB	1d	1b	Rec
GEQ	TV15C170K-G	TVS	Vrwm=17.0V, Vbr=18.90..23.10V, Ipp=49.18A, 1500W(1ms)	DO-214AB	1d	1a	Cmc
GER	1.5SMCJ17A	TVS	Vrwm=17V, 53.3A, 1500W(1ms)	DO-214AB	1d	1m,1w	Pjt,Srj
GER	1SMC17A	TVS	Vbr=18.9..20.9V, Vrwm=17V, 54.3A, 1500W(1ms)	403	3d	1s	Ons
GER	CD214C-T17A	TVS	Vbr=17V, Irlsm=53.3A, 1500W(1ms)	DO-214AB	1d	1a	Bm
GER	SMCG17A	TVS	Vbr=17V, 54.3A, 1500W(1ms)	DO-215AB	5d	1k	Vs
GER	SMCJ17A	TVS	Vrwm=17V, Vbr=18.9..21.7V, 54.3A, 1500W(1ms)	DO-214AB	1d	1k,1m	Di,Vs
GER	SMCJ17CA	TVS	Vrwm=17V, Vbr=18.9..21.7V, 54.3A, 1500W(1ms), Bidirectional	DO-214AB	1ba	1j	Eic
GER	TFMCJ17A	TVS	Vbr=17V, 54.3A, 1500W(1ms)	DO-214AB	1d	1b	Rec
GER	TV15C170J-G	TVS	Vrwm=17.0V, Vbr=18.90..20.90V, Ipp=54.35A, 1500W(1ms)	DO-214AB	1d	1a	Cmc
GES	1.5SMCJ18	TVS	Vrwm=18V, 46.6A, 1500W(1ms)	DO-214AB	1d	1m,1w	Pjt,Srj
GES	SMCG18	TVS	Vbr=18V, 46.6A, 1500W(1ms)	DO-215AB	5d	1k	Vs
GES	SMCJ18	TVS	Vrwm=18V, Vbr=20..23.3V, 46.6A, 1500W(1ms)	DO-214AB	1d	1k	Vs
GES	SMCJ18C	TVS	Vrwm=18V, Vbr=20.0..24.4V, 46.6A, 1500W(1ms), Bidirectional	DO-214AB	1ba	1j	Eic
GES	TFMCJ18	TVS	Vbr=18V, 46.6A, 1500W(1ms)	DO-214AB	1d	1b	Rec
GES	TV15C180K-G	TVS	Vrwm=18.0V, Vbr=20.0..24.40V, Ipp=46.58A, 1500W(1ms)	DO-214AB	1d	1a	Cmc
GET	1.5SMCJ18A	TVS	Vrwm=18V, 51.4A, 1500W(1ms)	DO-214AB	1d	1m,1w	Pjt,Srj
GET	1SMC18A	TVS	Vbr=20.0..22.1V, Vrwm=18V, 51.4A, 1500W(1ms)	403	3d	1s	Ons
GET	CD214C-T18A	TVS	Vbr=18V, Irlsm=51.4A, 1500W(1ms)	DO-214AB	1d	1a	Bm
GET	SMCG18A	TVS	Vbr=18V, 51.4A, 1500W(1ms)	DO-215AB	5d	1k	Vs
GET	SMCJ18A	TVS	Vrwm=18V, Vbr=20..23.3V, 51.4A, 1500W(1ms)	DO-214AB	1d	1k,1m	Di,Vs
GET	SMCJ18CA	TVS	Vrwm=18V, Vbr=20.0..22.1V, 51.4A, 1500W(1ms), Bidirectional	DO-214AB	1ba	1j	Eic
GET	TFMCJ18A	TVS	Vbr=18V, 51.4A, 1500W(1ms)	DO-214AB	1d	1b	Rec
GET	TV15C180J-G	TVS	Vrwm=18.0V, Vbr=20.0..22.10V, Ipp=51.37A, 1500W(1ms)	DO-214AB	1d	1a	Cmc
GET7	SM15T22A	TVS	Vrwm=18.8V, Vbr=20.9..23.1V, 49A, 1500W(1ms)	DO-214AB	1d	1k	Vs
GEU	1.5SMCJ20	TVS	Vrwm=20V, 41.9A, 1500W(1ms)	DO-214AB	1d	1m,1w	Pjt,Srj
GEU	SMCG20	TVS	Vbr=20V, 41.9A, 1500W(1ms)	DO-215AB	5d	1k	Vs
GEU	SMCJ20	TVS	Vrwm=20V, Vbr=22.2..25.5V, 41.9A, 1500W(1ms)	DO-214AB	1d	1k	Vs
GEU	SMCJ20C	TVS	Vrwm=20V, Vbr=22.2..27.1V, 41.9A, 1500W(1ms), Bidirectional	DO-214AB	1ba	1j	Eic
GEU	TFMCJ20	TVS	Vbr=20V, 41.9A, 1500W(1ms)	DO-214AB	1d	1b	Rec
GEU	TV15C200K-G	TVS	Vrwm=20.0V, Vbr=22.20..27.10V, Ipp=41.90A, 1500W(1ms)	DO-214AB	1d	1a	Cmc
GEV	1.5SMCJ20A	TVS	Vrwm=20.0V, 46.3A, 1500W(1ms)	DO-214AB	1d	1m,1w	Pjt,Srj
GEV	1SMC20A	TVS	Vbr=22.2..24.5V, Vrwm=20V, 46.3A, 1500W(1ms)	403	3d	1s	Ons
GEV	CD214C-T20A	TVS	Vbr=20V, Irlsm=46.3A, 1500W(1ms)	DO-214AB	1d	1a	Bm
GEV	SMCG20A	TVS	Vbr=20V, 46.3A, 1500W(1ms)	DO-215AB	5d	1k	Vs
GEV	SMCJ20A	TVS	Vrwm=20V, Vbr=22.2..25.5V, 46.3A, 1500W(1ms)	DO-214AB	1d	1k,1m	Di,Vs
GEV	SMCJ20CA	TVS	Vrwm=20V, Vbr=22.2..24.5V, 46.3A, 1500W(1ms), Bidirectional	DO-214AB	1ba	1j	Eic
GEV	TFMCJ20A	TVS	Vbr=20V, 46.3A, 1500W(1ms)	DO-214AB	1d	1b	Rec
GEV	TV15C200J-G	TVS	Vrwm=20.0V, Vbr=22.20..24.50V, Ipp=46.30A, 1500W(1ms)	DO-214AB	1d	1a	Cmc
GEV7	SM15T24A	TVS	Vrwm=20.5V, Vbr=22.8..25.2V, 45A, 1500W(1ms)	DO-214AB	1d	1k	Vs
GEW	1.5SMCJ22	TVS	Vrwm=22V, 38.1A, 1500W(1ms)	DO-214AB	1d	1m,1w	Pjt,Srj
GEW	SMCG22	TVS	Vbr=22V, 38.1A, 1500W(1ms)	DO-215AB	5d	1k	Vs
GEW	SMCJ22	TVS	Vrwm=22V, Vbr=24.4..28V, 38.1A, 1500W(1ms)	DO-214AB	1d	1k	Vs
GEW	SMCJ22C	TVS	Vrwm=22V, 24.4..29.8V, 38.1A, 1500W(1ms), Bidirectional	DO-214AB	1ba	1j	Eic
GEW	TFMCJ22	TVS	Vbr=22V, 38.1A, 1500W(1ms)	DO-214AB	1d	1b	Rec
GEW	TV15C220K-G	TVS	Vrwm=22.0V, Vbr=24.40..29.80V, Ipp=38.07A, 1500W(1ms)	DO-214AB	1d	1a	Cmc
GEX	1.5SMCJ22A	TVS	Vrwm=22V, 42.2A, 1500W(1ms)	DO-214AB	1d	1m,1w	Pjt,Srj
GEX	1SMC22A	TVS	Vbr=24.4..26.9V, Vrwm=22V, 42.3A, 1500W(1ms)	403	3d	1s	Ons
GEX	CD214C-T22A	TVS	Vbr=22V, Irlsm=42.2A, 1500W(1ms)	DO-214AB	1d	1a	Bm
GEX	SMCG22A	TVS	Vbr=22V, 42.3A, 1500W(1ms)	DO-215AB	5d	1k	Vs
GEX	SMCJ22A	TVS	Vrwm=22V, Vbr=24.4..28V, 42.3A, 1500W(1ms)	DO-214AB	1d	1k,1m	Di,Vs
GEX	SMCJ22CA	TVS	Vrwm=22V, 24.4..26.9V, 42.3A, 1500W(1ms), Bidirectional	DO-214AB	1ba	1j	Eic
GEX	TFMCJ22A	TVS	Vbr=22V, 42.3A, 1500W(1ms)	DO-214AB	1d	1b	Rec
GEX	TV15C220J-G	TVS	Vrwm=22.0V, Vbr=24.40..26.90V, Ipp=42.25A, 1500W(1ms)	DO-214AB	1d	1a	Cmc
GEX7	SM15T27A	TVS	Vrwm=23.1V, Vbr=25.7..28.4V, 40A, 1500W(1ms)	DO-214AB	1d	1k	Vs
GEY	1.5SMCJ24	TVS	Vrwm=24V, 34.9A, 1500W(1ms)	DO-214AB	1d	1m,1w	Pjt,Srj
GEY	SMCG24	TVS	Vbr=24V, 34.9A, 1500W(1ms)	DO-215AB	5d	1k	Vs



SMD
code

Type

Function

Short description

Case

Pinout

St.

Mnf.

SMD code	Type	Function	Short description	Case	Pinout	St.	Mnf.
GEY	SMCJ24	TVS	Vrwm=24V, Vbr=26.7..30.7V, 34.9A, 1500W(1ms)	DO-214AB	1d	1k	Vs
GEY	SMCJ24C	TVS	Vrwm=24V, Vbr=26.7..32.6V, 34.9A, 1500W(1ms), Bidirectional	DO-214AB	1ba	1j	Eic
GEY	TFMCJ24	TVS	Vbr=24V, 34.9A, 1500W(1ms)	DO-214AB	1d	1b	Rec
GEY	TV15C240K-G	TVS	Vrwm=24.0V, Vbr=26.70..32.60V, Ipp=34.88A, 1500W(1ms)	DO-214AB	1d	1a	Cmc
GEZ	1.5SMCJ24A	TVS	Vrwm=24V, 38.6A, 1500W(1ms)	DO-214AB	1d	1m,1w	Pjt,Srj
GEZ	1SMC24A	TVS	Vbr=26.7..29.5V, Vrwm=24V, 38.6A, 1500W(1ms)	403	3d	1s	Ons
GEZ	CD214C-T24A	TVS	Vbr=24V, Irlsm=38.6A, 1500W(1ms)	DO-214AB	1d	1a	Bm
GEZ	SMCG24A	TVS	Vbr=24V, 38.6A, 1500W(1ms)	DO-215AB	5d	1k	Vs
GEZ	SMCJ24A	TVS	Vrwm=24V, Vbr=26.7..30.7V, 38.6A, 1500W(1ms)	DO-214AB	1d	1k,1m	Di,Vs
GEZ	SMCJ24CA	TVS	Vrwm=24V, Vbr=26.7..29.5V, 38.6A, 1500W(1ms), Bidirectional	DO-214AB	1ba	1j	Eic
GEZ	TFMCJ24A	TVS	Vbr=24V, 38.6A, 1500W(1ms)	DO-214AB	1d	1b	Rec
GEZ	TV15C240J-G	TVS	Vrwm=24.0V, Vbr=26.70..29.50V, Ipp=38.56A, 1500W(1ms)	DO-214AB	1d	1a	Cmc
GF	3T110A	Thy-SPD	Vdr=90V, Vs=130V, Ipp=50A, 60pF	DO-214AA	1d	1a	Mde
GF	KDZ11FV	Z-diode	10.40..11.60V, Izt=5mA, Zzt=15Ω, 100mW	TFSC	7d	1a	Kec
GF	MAZD100	Z-diode	9.4..10.60V, Zzt=30Q(5mA), 120mW	SSSMini2	7d	1a	Pan
GF	P1100SA	Thy-SPD	Vdr=90V, Vs=130V, Ipp=50A(1ms), Bidirectional	DO-214AA	1ba	1j	Mde
GF	PZU7.5B	Z-diode	7.06..7.84V, Zzt=10Q(zt=5mA), 310mW	SOD-323FL	7d	1a	Phi
GF	T110AB-LC	Thy-SPD	V Of-St=90V, Vs=130V, Ipp=50A(1ms), Bidirectional	DO-214AA	1ba	1j	Wtr
GF	Z2SMB-8V2	Z-diode	8.2V±5%, 2W	DO-214AA	1d	2j	Fag
GFD	1.5SMCJ26	TVS	Vrwm=26V, 32.2A, 1500W(1ms)	DO-214AB	1d	1m,1w	Pjt,Srj
GFD	SMCG26	TVS	Vbr=26V, 32.2A, 1500W(1ms)	DO-215AB	5d	1k	Vs
GFD	SMCJ26	TVS	Vrwm=26V, Vbr=28.9..33.2V, 32.2A, 1500W(1ms)	DO-214AB	1d	1k	Vs
GFD	SMCJ26C	TVS	Vrwm=26V, Vbr=28.9..35.3V, 32.2A, 1500W(1ms), Bidirectional	DO-214AB	1ba	1j	Eic
GFD	TFMCJ26	TVS	Vbr=26V, 32.2A, 1500W(1ms)	DO-214AB	1d	1b	Rec
GFD	TV15C260K-G	TVS	Vrwm=26.0V, Vbr=28.90..35.30V, Ipp=32.19A, 1500W(1ms)	DO-214AB	1d	1a	Cmc
GFE	1.5SMCJ26A	TVS	Vrwm=26V, 35.6A, 1500W(1ms)	DO-214AB	1d	1m,1w	Pjt,Srj
GFE	1SMC26A	TVS	Vbr=28.9..31.9V, Vrwm=26V, 35.6A, 1500W(1ms)	403	3d	1s	Ons
GFE	CD214C-T26A	TVS	Vbr=26V, Irlsm=35.6A, 1500W(1ms)	DO-214AB	1d	1a	Bm
GFE	SMCG26A	TVS	Vbr=26V, 35.6A, 1500W(1ms)	DO-215AB	5d	1k	Vs
GFE	SMCJ26A	TVS	Vrwm=26V, Vbr=28.9..33.2V, 35.6A, 1500W(1ms)	DO-214AB	1d	1k,1m	Di,Vs
GFE	SMCJ26CA	TVS	Vrwm=26V, Vbr=28.9..31.9V, 35.6A, 1500W(1ms), Bidirectional	DO-214AB	1ba	1j	Eic
GFE	TFMCJ26A	TVS	Vbr=26V, 35.6A, 1500W(1ms)	DO-214AB	1d	1b	Rec
GFE	TV15C260J-G	TVS	Vrwm=26.0V, Vbr=28.90..31.90V, Ipp=35.63A, 1500W(1ms)	DO-214AB	1d	1a	Cmc
GFE7	SM15T30A	TVS	Vrwm=25.6V, Vbr=28.5..31.5V, 36A, 1500W(1ms)	DO-214AB	1d	1k	Vs
GFF	1.5SMCJ28	TVS	Vrwm=28V, 30A, 1500W(1ms)	DO-214AB	1d	1m,1w	Pjt,Srj
GFF	SMCG28	TVS	Vbr=28V, 30A, 1500W(1ms)	DO-215AB	5d	1k	Vs
GFF	SMCJ28	TVS	Vrwm=28V, Vbr=31.1..35.8V, 30A, 1500W(1ms)	DO-214AB	1d	1k	Vs
GFF	SMCJ28C	TVS	Vrwm=28V, Vbr=31.1..38.0V, 30.0A, 1500W(1ms), Bidirectional	DO-214AB	1ba	1j	Eic
GFF	TFMCJ28	TVS	Vbr=28V, 30A, 1500W(1ms)	DO-214AB	1d	1b	Rec
GFF	TV15C280K-G	TVS	Vrwm=28.0V, Vbr=31.10..38.0V, Ipp=30.0A, 1500W(1ms)	DO-214AB	1d	1a	Cmc
GFG	1.5SMCJ28A	TVS	Vrwm=28V, 33A, 1500W(1ms)	DO-214AB	1d	1m,1w	Pjt,Srj
GFG	1SMC28A	TVS	Vbr=31.1..34.4V, Vrwm=28V, 33.0A, 1500W(1ms)	403	3d	1s	Ons
GFG	CD214C-T28A	TVS	Vbr=28V, Irlsm=33A, 1500W(1ms)	DO-214AB	1d	1a	Bm
GFG	SMCG28A	TVS	Vbr=28V, 33A, 1500W(1ms)	DO-215AB	5d	1k	Vs
GFG	SMCJ28A	TVS	Vrwm=28V, Vbr=31.1..35.8V, 33A, 1500W(1ms)	DO-214AB	1d	1k,1m	Di,Vs
GFG	SMCJ28CA	TVS	Vrwm=28V, Vbr=31.1..34.4V, 33.0A, 1500W(1ms), Bidirectional	DO-214AB	1ba	1j	Eic
GFG	TFMCJ28A	TVS	Vbr=28V, 33A, 1500W(1ms)	DO-214AB	1d	1b	Rec
GFG	TV15C280J-G	TVS	Vrwm=28.0V, Vbr=31.10..34.40V, Ipp=33.04A, 1500W(1ms)	DO-214AB	1d	1a	Cmc
GFG7	SM15T33A	TVS	Vrwm=28.2V, Vbr=31.4..34.7V, 33A, 1500W(1ms)	DO-214AB	1d	1k	Vs
GFH	1.5SMCJ30	TVS	Vrwm=30V, 28A, 1500W(1ms)	DO-214AB	1d	1m,1w	Pjt,Srj
GFH	SMCG30	TVS	Vbr=30V, 28A, 1500W(1ms)	DO-215AB	5d	1k	Vs
GFH	SMCJ30	TVS	Vrwm=30V, Vbr=33.3..38.3V, 28A, 1500W(1ms)	DO-214AB	1d	1k	Vs
GFH	SMCJ30C	TVS	Vrwm=30V, Vbr=33.3..40.7V, 28.0A, 1500W(1ms), Bidirectional	DO-214AB	1ba	1j	Eic
GFH	TFMCJ30	TVS	Vbr=30V, 28A, 1500W(1ms)	DO-214AB	1d	1b	Rec
GFH	TV15C300K-G	TVS	Vrwm=30.0V, Vbr=33.30..40.70V, Ipp=28.04A, 1500W(1ms)	DO-214AB	1d	1a	Cmc
GFK	1.5SMCJ30A	TVS	Vrwm=30V, 31A, 1500W(1ms)	DO-214AB	1d	1m,1w	Pjt,Srj
GFK	1SMC30A	TVS	Vbr=33.3..36.8V, Vrwm=30V, 31.0A, 1500W(1ms)	403	3d	1s	Ons
GFK	CD214C-T30A	TVS	Vbr=30V, Irlsm=31A, 1500W(1ms)	DO-214AB	1d	1a	Bm
GFK	SMCG30A	TVS	Vbr=30V, 31A, 1500W(1ms)	DO-215AB	5d	1k	Vs
GFK	SMCJ30A	TVS	Vrwm=30V, Vbr=33.3..38.3V, 31A, 1500W(1ms)	DO-214AB	1d	1k,1m	Di,Vs
GFK	SMCJ30CA	TVS	Vrwm=30V, Vbr=33.3..36.8V, 31.0A, 1500W(1ms), Bidirectional	DO-214AB	1ba	1j	Eic
GFK	TFMCJ30A	TVS	Vbr=30V, 31A, 1500W(1ms)	DO-214AB	1d	1b	Rec
GFK	TV15C300J-G	TVS	Vrwm=30.0V, Vbr=33.30..36.80V, Ipp=30.99A, 1500W(1ms)	DO-214AB	1d	1a	Cmc
GFK7	SM15T36A	TVS	Vrwm=30.8V, Vbr=34.2..37.8V, 30A, 1500W(1ms)	DO-214AB	1d	1k	Vs
GFL	1.5SMCJ33	TVS	Vrwm=33V, 25.2A, 1500W(1ms)	DO-214AB	1d	1m,1w	Pjt,Srj
GFL	3T110ALC	Thy-SPD	Vdr=90V, Vs=130V, Ipp=2.2A(1ms), 60pF	DO-214AA	1d	1a	Lfr
GFL	SMCG33	TVS	Vbr=33V, 25.4A, 1500W(1ms)	DO-215AB	5d	1k	Vs
GFL	SMCJ33	TVS	Vrwm=33V, Vbr=36.7..44.9V, 25.4A, 1500W(1ms)	DO-214AB	1d	1k	Vs
GFL	SMCJ33C	TVS	Vrwm=33V, Vbr=36.7..44.9V, 25.4A, 1500W(1ms), Bidirectional	DO-214AB	1ba	1j	Eic
GFL	TFMCJ33	TVS	Vbr=33V, 25.4A, 1500W(1ms)	DO-214AB	1d	1b	Rec



SMD
code

Type

Function

Short description

Case

Pinout

St.

Mnf.

SMD code	Type	Function	Short description	Case	Pinout	St.	Mnf.
GFL	TV15C330K-G	TVS	Vrwm=33.0V, Vbr=36.7..44.9V, lpp=25.2A, 1500W(1ms)	DO-214AB	1d	1a	Cmc
GFM	1.5SMCJ33A	TVS	Vrwm=33V, 28.1A, 1500W(1ms)	DO-214AB	1d	1m,1w	Pjt,Srj
GFM	1SMC33A	TVS	Vbr=36.7..40.6V, Vrwm=33V, 28.1A, 1500W(1ms)	403	3d	1s	Ons
GFM	CD214C-T33A	TVS	Vbr=33V, Irsm=28.1A, 1500W(1ms)	DO-214AB	1d	1a	Bm
GFM	SMCG33A	TVS	Vbr=33V, 28.1A, 1500W(1ms)	DO-215AB	5d	1k	Vs
GFM	SMCJ33A	TVS	Vrwm=33.0V, Vbr=36.7..44.9V, 28.1A, 1500W(1ms)	DO-214AB	1d	1k,1m	Di,Vs
GFM	SMCJ33CA	TVS	Vrwm=33V, Vbr=36.7..40.6V, 28.1A, 1500W(1ms), Bidirectional	DO-214AB	1ba	1j	Eic
GFM	TFMCJ33A	TVS	Vbr=33V, 28.1A, 1500W(1ms)	DO-214AB	1d	1b	Rec
GFM	TV15C330J-G	TVS	Vrwm=33.0V, Vbr=36.7..40.6V, lpp=28.1A, 1500W(1ms)	DO-214AB	1d	1a	Cmc
GFM7	SM15T39A	TVS	Vrwm=33.3V, Vbr=37.1..41V, 28.0A, 1500W(1ms)	DO-214AB	1d	1k	Vs
GFN	1.5SMCJ36	TVS	Vrwm=36V, 23.3A, 1500W(1ms)	DO-214AB	1d	1m,1w	Pjt,Srj
GFN	SMCG36	TVS	Vbr=36V, 23.3A, 1500W(1ms)	DO-215AB	5d	1k	Vs
GFN	SMCJ36	TVS	Vrwm=36V, Vbr= 40..46V, 23.3A, 1500W(1ms)	DO-214AB	1d	1k	Vs
GFN	SMCJ36C	TVS	Vrwm=36V, Vbr= 40.0..48.9V, 23.3A, 1500W(1ms), Bidirectional	DO-214AB	1ba	1j	Eic
GFN	TFMCJ36	TVS	Vbr=36V, 23.3A, 1500W(1ms)	DO-214AB	1d	1b	Rec
GFN	TV15C360K-G	TVS	Vrwm=36.0V, Vbr=40.0..48.90V, lpp=23.33A, 1500W(1ms)	DO-214AB	1d	1a	Cmc
GFP	1.5SMCJ36A	TVS	Vrwm=36V, 25.8A, 1500W(1ms)	DO-214AB	1d	1m,1w	Pjt,Srj
GFP	1SMC36A	TVS	Vbr=40.0..44.2V, Vrwm=36V, 25.8A, 1500W(1ms)	403	3d	1s	Ons
GFP	CD214C-T36A	TVS	Vbr=36V, Irsm=25.8A, 1500W(1ms)	DO-214AB	1d	1a	Bm
GFP	SMCG36A	TVS	Vbr=36V, 25.8A, 1500W(1ms)	DO-215AB	5d	1k	Vs
GFP	SMCJ36A	TVS	Vrwm=36V, Vbr= 40..46V, 25.8A, 1500W(1ms)	DO-214AB	1d	1k,1m	Di,Vs
GFP	SMCJ36CA	TVS	Vrwm=36V, Vbr= 40.0..44.2V, 25.8A, 1500W(1ms), Bidirectional	DO-214AB	1ba	1j	Eic
GFP	TFMCJ36A	TVS	Vbr=36V, 25.8A, 1500W(1ms)	DO-214AB	1d	1b	Rec
GFP	TV15C360J-G	TVS	Vrwm=36.0V, Vbr=40.0..44.20V, lpp=25.82A, 1500W(1ms)	DO-214AB	1d	1a	Cmc
GFQ	1.5SMCJ40	TVS	Vrwm=40V, 21A, 1500W(1ms)	DO-214AB	1d	1m,1w	Pjt,Srj
GFQ	SMCG40	TVS	Vbr=40V, 21A, 1500W(1ms)	DO-215AB	5d	1k	Vs
GFQ	SMCJ40	TVS	Vrwm=40V, Vbr=44.4..51.1V, 21A, 1500W(1ms)	DO-214AB	1d	1k	Vs
GFQ	SMCJ40C	TVS	Vrwm=40V, Vbr=44.4..54.3V, 21.0A, 1500W(1ms), Bidirectional	DO-214AB	1ba	1j	Eic
GFQ	TFMCJ40	TVS	Vbr=40V, 21A, 1500W(1ms)	DO-214AB	1d	1b	Rec
GFQ	TV15C400K-G	TVS	Vrwm=40.0V, Vbr=44.40..54.30V, lpp=21.01A, 1500W(1ms)	DO-214AB	1d	1a	Cmc
GFR	1.5SMCJ40A	TVS	Vrwm=40V, 23.2A, 1500W(1ms)	DO-214AB	1d	1m,1w	Pjt,Srj
GFR	1SMC40A	TVS	Vbr=44.4..49.1V, Vrwm=40V, 23.3A, 1500W(1ms)	403	3d	1s	Ons
GFR	CD214C-T40A	TVS	Vbr=40V, Irsm=23.3A, 1500W(1ms)	DO-214AB	1d	1a	Bm
GFR	SMCG40A	TVS	Vbr=40V, 23.3A, 1500W(1ms)	DO-215AB	5d	1k	Vs
GFR	SMCJ40A	TVS	Vrwm=40V, Vbr=44.4..51.1V, 23.3A, 1500W(1ms)	DO-214AB	1d	1k,1m	Di,Vs
GFR	SMCJ40CA	TVS	Vrwm=40V, Vbr=44.4..49.1V, 23.3A, 1500W(1ms), Bidirectional	DO-214AB	1ba	1j	Eic
GFR	TFMCJ40A	TVS	Vbr=40V, 23.3A, 1500W(1ms)	DO-214AB	1d	1b	Rec
GFR	TV15C400J-G	TVS	Vrwm=40.0V, Vbr=44.40..49.10V, lpp=23.26A, 1500W(1ms)	DO-214AB	1d	1a	Cmc
GFS	1.5SMCJ43	TVS	Vrwm=43V, 19.6A, 1500W(1ms)	DO-214AB	1d	1m,1w	Pjt,Srj
GFS	SMCG43	TVS	Vbr=43V, 19.6A, 1500W(1ms)	DO-215AB	5d	1k	Vs
GFS	SMCJ43	TVS	Vrwm=43V, Vbr=47.8..54.9V, 19.6A, 1500W(1ms)	DO-214AB	1d	1k	Vs
GFS	SMCJ43C	TVS	Vrwm=43V, Vbr=47.8..58.4V, 19.6A, 1500W(1ms), Bidirectional	DO-214AB	1ba	1j	Eic
GFS	TFMCJ43	TVS	Vbr=43V, 19.6A, 1500W(1ms)	DO-214AB	1d	1b	Rec
GFS	TV15C430K-G	TVS	Vrwm=43.0V, Vbr=47.80..58.40V, lpp=19.56A, 1500W(1ms)	DO-214AB	1d	1a	Cmc
GFT	1.5SMCJ43A	TVS	Vrwm=43V, 21.6A, 1500W(1ms)	DO-214AB	1d	1m,1w	Pjt,Srj
GFT	1SMC43A	TVS	Vbr=47.8..52.8V, Vrwm=43V, 21.6A, 1500W(1ms)	403	3d	1s	Ons
GFT	CD214C-T43A	TVS	Vbr=43V, Irsm=21.6A, 1500W(1ms)	DO-214AB	1d	1a	Bm
GFT	SMCG43A	TVS	Vbr=43V, 21.6A, 1500W(1ms)	DO-215AB	5d	1k	Vs
GFT	SMCJ43A	TVS	Vrwm=43V, Vbr=47.8..54.9V, 21.6A, 1500W(1ms)	DO-214AB	1d	1k,1m	Di,Vs
GFT	SMCJ43CA	TVS	Vrwm=43V, Vbr=47.8..52.8V, 21.6A, 1500W(1ms), Bidirectional	DO-214AB	1ba	1j	Eic
GFT	TFMCJ43A	TVS	Vbr=43V, 21.6A, 1500W(1ms)	DO-214AB	1d	1b	Rec
GFT	TV15C430J-G	TVS	Vrwm=43.0V, Vbr=47.80..52.80V, lpp=21.61A, 1500W(1ms)	DO-214AB	1d	1a	Cmc
GFU	1.5SMCJ45	TVS	Vrwm=45V, 18.7A, 1500W(1ms)	DO-214AB	1d	1m,1w	Pjt,Srj
GFU	SMCG45	TVS	Vbr=45V, 18.7A, 1500W(1ms)	DO-215AB	5d	1k	Vs
GFU	SMCJ45	TVS	Vrwm=45V, Vbr=50..57.5V, 18.7A, 1500W(1ms)	DO-214AB	1d	1k	Vs
GFU	SMCJ45C	TVS	Vrwm=45V, Vbr=50.0..61.1V, 18.7A, 1500W(1ms), Bidirectional	DO-214AB	1ba	1j	Eic
GFU	TFMCJ45	TVS	Vbr=45V, 18.7A, 1500W(1ms)	DO-214AB	1d	1b	Rec
GFU	TV15C450K-G	TVS	Vrwm=45.0V, Vbr=50.0..61.10V, lpp=18.68A, 1500W(1ms)	DO-214AB	1d	1a	Cmc
GFV	1.5SMCJ45A	TVS	Vrwm=45V, 20.6A, 1500W(1ms)	DO-214AB	1d	1m,1w	Pjt,Srj
GFV	1SMC45A	TVS	Vbr=50.0..55.3V, Vrwm=45V, 20.6A, 1500W(1ms)	403	3d	1s	Ons
GFV	CD214C-T45A	TVS	Vbr=45V, Irsm=20.6A, 1500W(1ms)	DO-214AB	1d	1a	Bm
GFV	SMCG45A	TVS	Vbr=45V, 20.6A, 1500W(1ms)	DO-215AB	5d	1k	Vs
GFV	SMCJ45A	TVS	Vrwm=45V, Vbr=50..57.5V, 20.6A, 1500W(1ms)	DO-214AB	1d	1k,1m	Di,Vs
GFV	SMCJ45CA	TVS	Vrwm=45V, Vbr=50.0..55.3V, 20.6A, 1500W(1ms), Bidirectional	DO-214AB	1ba	1j	Eic
GFV	TFMCJ45A	TVS	Vbr=45V, 20.6A, 1500W(1ms)	DO-214AB	1d	1b	Rec
GFV	TV15C450J-G	TVS	Vrwm=45.0V, Vbr=50.0..55.30V, lpp=20.63A, 1500W(1ms)	DO-214AB	1d	1a	Cmc
GFW	1.5SMCJ48	TVS	Vrwm=48V, 17.5A, 1500W(1ms)	DO-214AB	1d	1m,1w	Pjt,Srj
GFW	SMCG48	TVS	Vbr=48V, 17.5A, 1500W(1ms)	DO-215AB	5d	1k	Vs
GFW	SMCJ48	TVS	Vrwm=48V, Vbr=53.3..61.3V, 17.5A, 1500W(1ms)	DO-214AB	1d	1k	Vs
GFW	SMCJ48C	TVS	Vrwm=48V, Vbr=53.3..65.1V, 17.5A, 1500W(1ms), Bidirectional	DO-214AB	1ba	1j	Eic



SMD code	Type	Function	Short description	Case	Pinout	St.	Mnf.
GFW	TFMCJ48	TVS	Vbr=48V, 17.5A, 1500W(1ms)	DO-214AB	1d	1b	Rec
GFW	TV15C480K-G	TVS	Vrwm=48.0V, Vbr=53.30..65.10V, Ipp=17.54A, 1500W(1ms)	DO-214AB	1d	1a	Cmc
GFX	1.5SMCJ48A	TVS	Vrwm=48V, 19.4A, 1500W(1ms)	DO-214AB	1d	1m,1w	Pjt,Srj
GFX	1SMC48A	TVS	Vbr=53.3..58.9V, Vrwm=48V, 19.4A, 1500W(1ms)	403	3d	1s	Ons
GFX	CD214C-T48A	TVS	Vbr=48V, Irlsm=19.4A, 1500W(1ms)	DO-214AB	1d	1a	Bm
GFX	SMCG48A	TVS	Vbr=48V, 19.4A, 1500W(1ms)	DO-215AB	5d	1k	Vs
GFX	SMCJ48A	TVS	Vrwm=48V, Vbr=53.3..61.3V, 19.4A, 1500W(1ms)	DO-214AB	1d	1k,1m	Di,Vs
GFX	SMCJ48CA	TVS	Vrwm=48V, Vbr=53.3..58.9V, 19.4A, 1500W(1ms), Bidirectional	DO-214AB	1ba	1j	Eic
GFX	TFMCJ48A	TVS	Vbr=48V, 19.4A, 1500W(1ms)	DO-214AB	1d	1b	Rec
GFX	TV15C480J-G	TVS	Vrwm=48.0V, Vbr=53.30..58.90V, Ipp=19.38A, 1500W(1ms)	DO-214AB	1d	1a	Cmc
GFY	1.5SMCJ51	TVS	Vrwm=51V, 18.5A, 1500W(1ms)	DO-214AB	1d	1m,1w	Pjt,Srj
GFY	SMCG51	TVS	Vbr=51V, 16.5A, 1500W(1ms)	DO-215AB	5d	1k	Vs
GFY	SMCG51C	TVS	Vbr=51V, 16.5A, 1500W(1ms), Bidirectional	DO-215AB	5ba	1l	Vs
GFY	SMCJ51	TVS	Vrwm=51V, Vbr=56.7..65.2V, 16.5A, 1500W(1ms)	DO-214AB	1d	1k	Vs
GFY	SMCJ51C	TVS	Vrwm=51V, Vbr=56.7..69.3V, 16.5A, 1500W(1ms), Bidirectional	DO-214AB	1ba	1a,1l	Eic,Vs
GFY	TFMCJ51	TVS	Vbr=51V, 16.5A, 1500W(1ms)	DO-214AB	1d	1b	Rec
GFY	TFMCJ51C	TVS	Vbr=51V, 16.5A, 1500W(1ms), Bidirectional	DO-214AB	1ba	1j	Rec
GFY	TV15C510K-G	TVS	Vrwm=51.0V, Vbr=56.70..69.30V, Ipp=16.47A, 1500W(1ms)	DO-214AB	1d	1a	Cmc
GFZ	1.5SMCJ51A	TVS	Vrwm=51V, 18.2A, 1500W(1ms)	DO-214AB	1d	1m,1w	Pjt,Srj
GFZ	1SMC51A	TVS	Vbr=56.7..62.7V, Vrwm=51V, 18.2A, 1500W(1ms)	403	3d	1s	Ons
GFZ	CD214C-T51A	TVS	Vbr=51V, Irlsm=18.2A, 1500W(1ms)	DO-214AB	1d	1a	Bm
GFZ	SMCG51A	TVS	Vbr=51V, 18.2A, 1500W(1ms)	DO-215AB	5d	1k	Vs
GFZ	SMCG51CA	TVS	Vbr=51V, 18.2A, 1500W(1ms), Bidirectional	DO-215AB	5ba	1l	Vs
GFZ	SMCJ51A	TVS	Vrwm=51V, Vbr=56.7..65.2V, 18.2A, 1500W(1ms)	DO-214AB	1d	1k,1m	Di,Vs
GFZ	SMCJ51CA	TVS	Vrwm=51V, Vbr=56.7..62.7V, 18.2A, 1500W(1ms), Bidirectional	DO-214AB	1ba	1a,1l	Eic,Vs
GFZ	TFMCJ51A	TVS	Vbr=51V, 18.2A, 1500W(1ms)	DO-214AB	1d	1b	Rec
GFZ	TFMCJ51CA	TVS	Vbr=51V, 18.2A, 1500W(1ms), Bidirectional	DO-214AB	1ba	1j	Rec
GFZ	TV15C510J-G	TVS	Vrwm=51.0V, Vbr=56.70..62.70V, Ipp=18.20A, 1500W(1ms)	DO-214AB	1d	1a	Cmc
GG	3T130A	Thy-SPD	Vdrm=120V, Vs=160V, Ipp=50A, 40pF	DO-214AA	1d	1a	Mde
GG	BAR63-02W	PIN-diode	Sw, RF, 100V, 100mA, Vf<1.1V(50mA), < 0.3pF	SCD-80	6d	1u	Inf
GG	DDZ3V3A	Z-diode	3.3V±10%, Izt=20mA, 500mW	SOD-123	5d	1d	Di
GG	GF1G	Si-diode	Rectifier, 400V, 1A, Vf<1.1V(1A), 2μs	DO-214BA	1d	1k	Vs
GG	P1300SA	Thy-SPD	Vdrm=120V, Vs=160V, Ipp=50A(1ms), Bidirectional	DO-214AA	1ba	1j	Mde
GG	PZU8.2B	Z-diode	7.76..8.64V, Zzt=10Q(Izt=5mA), 310mW	SOD-323FL	7d	1a	Phi
GG	T130AB-LC	Thy-SPD	V Of-St=120V, Vs=160V, Ipp=50A(1ms), Bidirectional	DO-214AA	1ba	1j	Wtr
GG	Z2SMB-9V1	Z-diode	9.1V±5%, 2W	DO-214AA	1d	2j	Fag
GGA	TV15C800K-G	TVS	Vrwm=80.0V, Vbr=88.96..108.80V, Ipp=10.47A, 1500W(1ms)	DO-214AB	1d	1a	Cmc
GGB	TV15C800J-G	TVS	Vrwm=80.0V, Vbr=88.80..97.60V, Ipp=11.57A, 1500W(1ms)	DO-214AB	1d	1a	Cmc
GGD	1.5SMCJ54	TVS	Vrwm=54V, 15.6A, 1500W(1ms)	DO-214AB	1d	1m,1w	Pjt,Srj
GGD	SMCG54	TVS	Vbr=54V, 15.6A, 1500W(1ms)	DO-215AB	5d	1k	Vs
GGD	SMCJ26	TVS	Vrwm=26V, Vbr=28.9..33.2V, 32.2A, 1500W(1ms)	DO-214AB	1d	1c	Rfe
GGD	SMCJ54	TVS	Vrwm=54V, Vbr=60..69V, 15.6A, 1500W(1ms)	DO-214AB	1d	1k	Vs
GGD	SMCJ54C	TVS	Vrwm=54V, Vbr=60.0..73.3V, 15.6A, 1500W(1ms), Bidirectional	DO-214AB	1ba	1j	Eic
GGD	TFMCJ54	TVS	Vbr=54V, 15.6A, 1500W(1ms)	DO-214AB	1d	1b	Rec
GGD	TV15C540K-G	TVS	Vrwm=54.0V, Vbr=60.0..73.30V, Ipp=15.58A, 1500W(1ms)	DO-214AB	1d	1a	Cmc
GGE	1.5SMCJ54A	TVS	Vrwm=54V, 17.2A, 1500W(1ms)	DO-214AB	1d	1m,1w	Pjt,Srj
GGE	1SMC54A	TVS	Vbr=60.0..66.3V, Vrwm=54V, 17.2A, 1500W(1ms)	403	3d	1s	Ons
GGE	CD214C-T54A	TVS	Vbr=54V, Irlsm=17.2A, 1500W(1ms)	DO-214AB	1d	1a	Bm
GGE	SMCG54A	TVS	Vbr=54V, 17.2A, 1500W(1ms)	DO-215AB	5d	1k	Vs
GGE	SMCJ26A	TVS	Vrwm=26V, Vbr=28.9..33.2V, 35.6A, 1500W(1ms)	DO-214AB	1d	1c	Rfe
GGE	SMCJ54A	TVS	Vrwm=54V, Vbr=60..69V, 17.2A, 1500W(1ms)	DO-214AB	1d	1k,1m	Di,Vs
GGE	SMCJ54CA	TVS	Vrwm=54V, Vbr=60.0..66.3V, 17.2A, 1500W(1ms), Bidirectional	DO-214AB	1ba	1j	Eic
GGE	TFMCJ54A	TVS	Vbr=54V, 17.2A, 1500W(1ms)	DO-214AB	1d	1b	Rec
GGE	TV15C540J-G	TVS	Vrwm=54.0V, Vbr=60.0..66.30V, Ipp=17.22A, 1500W(1ms)	DO-214AB	1d	1a	Cmc
GGF	1.5SMCJ58	TVS	Vrwm=58V, 14.6A, 1500W(1ms)	DO-214AB	1d	1m,1w	Pjt,Srj
GGF	SMCG58	TVS	Vbr=58V, 14.6A, 1500W(1ms)	DO-215AB	5d	1k	Vs
GGF	SMCJ28	TVS	Vrwm=28V, Vbr=31.1..35.8V, 30A, 1500W(1ms)	DO-214AB	1d	1c	Rfe
GGF	SMCJ58	TVS	Vrwm=58V, Vbr=64.4..74.1V, 14.6A, 1500W(1ms)	DO-214AB	1d	1k	Vs
GGF	SMCJ58C	TVS	Vrwm=58V, Vbr=64.4..78.7V, 14.6A, 1500W(1ms), Bidirectional	DO-214AB	1ba	1j	Eic
GGF	TFMCJ58	TVS	Vbr=58V, 14.6A, 1500W(1ms)	DO-214AB	1d	1b	Rec
GGF	TV15C580K-G	TVS	Vrwm=58.0V, Vbr=64.40..78.70V, Ipp=14.56A, 1500W(1ms)	DO-214AB	1d	1a	Cmc
GGG	1.5SMCJ58A	TVS	Vrwm=58V, 16A, 1500W(1ms)	DO-214AB	1d	1m,1w	Pjt,Srj
GGG	1SMC58A	TVS	Vbr=64.4..71.2V, Vrwm=58V, 16.0A, 1500W(1ms)	403	3d	1s	Ons
GGG	CD214C-T58A	TVS	Vbr=58V, Irlsm=16A, 1500W(1ms)	DO-214AB	1d	1a	Bm
GGG	SMCG58A	TVS	Vbr=58V, 16A, 1500W(1ms)	DO-215AB	5d	1k	Vs
GGG	SMCJ28A	TVS	Vrwm=28V, Vbr=31.1..35.8V, 33A, 1500W(1ms)	DO-214AB	1d	1c	Rfe
GGG	SMCJ58A	TVS	Vrwm=58V, Vbr=64.4..74.1V, 16A, 1500W(1ms)	DO-214AB	1d	1k,1m	Di,Vs
GGG	SMCJ58CA	TVS	Vrwm=58V, Vbr=64.4..71.2V, 16.0A, 1500W(1ms), Bidirectional	DO-214AB	1ba	1j	Eic
GGG	TFMCJ58A	TVS	Vbr=58V, 16A, 1500W(1ms)	DO-214AB	1d	1b	Rec
GGG	TV15C580J-G	TVS	Vrwm=58.0V, Vbr=64.40..71.20V, Ipp=16.03A, 1500W(1ms)	DO-214AB	1d	1a	Cmc



SMD
code

Type

Function

Short description

Case

Pinout

St.

Mnf.

GGG7	SM15T68A	TVS	Vrwm=58.1V, Vbr=64.6..71.4V, 16.3A, 1500W(1ms)	DO-214AB	1d	1k	Vs
GGH	1.5SMCJ60	TVS	Vrwm=60V, 14A, 1500W(1ms)	DO-214AB	1d	1m,1w	Pjt,Srj
GGH	SMCG60	TVS	Vbr=60V, 14A, 1500W(1ms)	DO-215AB	5d	1k	Vs
GGH	SMCJ30	TVS	Vrwm=30V, Vbr=33.3..38.3V, 28A, 1500W(1ms)	DO-214AB	1d	1c	Rfe
GGH	SMCJ60	TVS	Vrwm=60V, Vbr=66.7..76.7V, 14A, 1500W(1ms)	DO-214AB	1d	1k	Vs
GGH	SMCJ60C	TVS	Vrwm=60V, Vbr=66.7..81.5V, 14.0A, 1500W(1ms), Bidirectional	DO-214AB	1ba	1j	Eic
GGH	TFMCJ60	TVS	Vbr=60V, 14A, 1500W(1ms)	DO-214AB	1d	1b	Rec
GGH	TV15C600K-G	TVS	Vrwm=60.0V, Vbr=66.70..81.50V, Ipp=14.02A, 1500W(1ms)	DO-214AB	1d	1a	Cmc
GGK	1.5SMCJ60A	TVS	Vrwm=60V, 15.5A, 1500W(1ms)	DO-214AB	1d	1m,1w	Pjt,Srj
GGK	1SMC60A	TVS	Vbr=66.7..73.7V, Vrwm=60V, 15.5A, 1500W(1ms)	403	3d	1s	Ons
GGK	CD214C-T60A	TVS	Vbr=60V, Irlsm=15.5A, 1500W(1ms)	DO-214AB	1d	1a	Bm
GGK	SMCG60A	TVS	Vbr=60V, 15.5A, 1500W(1ms)	DO-215AB	5d	1k	Vs
GGK	SMCJ30A	TVS	Vrwm=30V, Vbr=33.3..38.3V, 31A, 1500W(1ms)	DO-214AB	1d	1c	Rfe
GGK	SMCJ60A	TVS	Vrwm=60V, Vbr=66.7..76.7V, 15.5A, 1500W(1ms)	DO-214AB	1d	1k,1m	Di,Vs
GGK	SMCJ60CA	TVS	Vrwm=60V, Vbr=66.7..73.7V, 15.5A, 1500W(1ms), Bidirectional	DO-214AB	1ba	1j	Eic
GGK	TFMCJ60A	TVS	Vbr=60V, 15.5A, 1500W(1ms)	DO-214AB	1d	1b	Rec
GGK	TV15C600J-G	TVS	Vrwm=60.0V, Vbr=66.70..73.70V, Ipp=15.50A, 1500W(1ms)	DO-214AB	1d	1a	Cmc
GGL	1.5SMCJ64	TVS	Vrwm=64V, 13.2A, 1500W(1ms)	DO-214AB	1d	1m,1w	Pjt,Srj
GGL	3T130ALC	Thy-SPD	Vdvm=120V, Vs=160V, Ipp=2.2A(1ms), 40pF	DO-214AA	1d	1a	Lfr
GGL	SMCG64	TVS	Vbr=64V, 13.2A, 1500W(1ms)	DO-215AB	5d	1k	Vs
GGL	SMCJ33	TVS	Vrwm=33V, Vbr=36.7..44.9V, 25.4A, 1500W(1ms)	DO-214AB	1d	1c	Rfe
GGL	SMCJ64	TVS	Vrwm=64V, Vbr=71.1..81.8V, 13.2A, 1500W(1ms)	DO-214AB	1d	1k	Vs
GGL	SMCJ64C	TVS	Vrwm=64V, Vbr=71.1..86.4V, 13.2A, 1500W(1ms), Bidirectional	DO-214AB	1ba	1j	Eic
GGL	TFMCJ64	TVS	Vbr=64V, 13.2A, 1500W(1ms)	DO-214AB	1d	1b	Rec
GGL	TV15C640K-G	TVS	Vrwm=64.0V, Vbr=71.10..86.90V, Ipp=13.16A, 1500W(1ms)	DO-214AB	1d	1a	Cmc
GGM	1.5SMCJ64A	TVS	Vrwm=64V, 14.6A, 1500W(1ms)	DO-214AB	1d	1m,1w	Pjt,Srj
GGM	1SMC64A	TVS	Vbr=71.1..78.6V, Vrwm=64V, 14.6A, 1500W(1ms)	403	3d	1s	Ons
GGM	CD214C-T64A	TVS	Vbr=64V, Irlsm=14.6A, 1500W(1ms)	DO-214AB	1d	1a	Bm
GGM	SMCG64A	TVS	Vbr=64V, 14.6A, 1500W(1ms)	DO-215AB	5d	1k	Vs
GGM	SMCJ33A	TVS	Vrwm=33V, Vbr=36.7..44.9V, 28.1A, 1500W(1ms)	DO-214AB	1d	1c	Rfe
GGM	SMCJ64A	TVS	Vrwm=64V, Vbr=71.1..81.8V, 14.6A, 1500W(1ms)	DO-214AB	1d	1k,1m	Di,Vs
GGM	SMCJ64CA	TVS	Vrwm=64V, Vbr=71.1..78.6V, 14.6A, 1500W(1ms), Bidirectional	DO-214AB	1ba	1j	Eic
GGM	TFMCJ64A	TVS	Vbr=64V, 14.6A, 1500W(1ms)	DO-214AB	1d	1b	Rec
GGM	TV15C640J-G	TVS	Vrwm=64.0V, Vbr=71.10..78.60V, Ipp=14.56A, 1500W(1ms)	DO-214AB	1d	1a	Cmc
GGN	1.5SMCJ70	TVS	Vrwm=70V, 12A, 1500W(1ms)	DO-214AB	1d	1m,1w	Pjt,Srj
GGN	SMCG70	TVS	Vbr=70V, 12A, 1500W(1ms)	DO-215AB	5d	1k	Vs
GGN	SMCJ36	TVS	Vrwm=36V, Vbr=40..46V, 23.3A, 1500W(1ms)	DO-214AB	1d	1c	Rfe
GGN	SMCJ70	TVS	Vrwm=70V, Vbr=77.8..89.5V, 12A, 1500W(1ms)	DO-214AB	1d	1k	Vs
GGN	SMCJ70C	TVS	Vrwm=70V, Vbr=77.8..95.1V, 12A, 1500W(1ms), Bidirectional	DO-214AB	1ba	1j	Eic
GGN	TFMCJ70	TVS	Vbr=70V, 12A, 1500W(1ms)	DO-214AB	1d	1b	Rec
GGN	TV15C700K-G	TVS	Vrwm=70.0V, Vbr=77.80..95.10V, Ipp=12.0A, 1500W(1ms)	DO-214AB	1d	1a	Cmc
GGP	1.5SMCJ70A	TVS	Vrwm=70V, 13.3A, 1500W(1ms)	DO-214AB	1d	1m,1w	Pjt,Srj
GGP	1SMC70A	TVS	Vbr=77.8..86V, Vrwm=70V, 13.3A, 1500W(1ms)	403	3d	1s	Ons
GGP	CD214C-T70A	TVS	Vbr=70V, Irlsm=13.3A, 1500W(1ms)	DO-214AB	1d	1a	Bm
GGP	SMCG70A	TVS	Vbr=70V, 13.3A, 1500W(1ms)	DO-215AB	5d	1k	Vs
GGP	SMCJ36A	TVS	Vrwm=36V, Vbr=40..46V, 25.8A, 1500W(1ms)	DO-214AB	1d	1c	Rfe
GGP	SMCJ70A	TVS	Vrwm=70V, Vbr=77.8..89.5V, 13.3A, 1500W(1ms)	DO-214AB	1d	1k,1m	Di,Vs
GGP	SMCJ70CA	TVS	Vrwm=70V, Vbr=77.8..86.1V, 13.3A, 1500W(1ms), Bidirectional	DO-214AB	1ba	1j	Eic
GGP	TFMCJ70A	TVS	Vbr=70V, 13.3A, 1500W(1ms)	DO-214AB	1d	1b	Rec
GGP	TV15C700J-G	TVS	Vrwm=70.0V, Vbr=77.80..86.0V, Ipp=13.27A, 1500W(1ms)	DO-214AB	1d	1a	Cmc
GGQ	1.5SMCJ75	TVS	Vrwm=75V, 11.2A, 1500W(1ms)	DO-214AB	1d	1m,1w	Pjt,Srj
GGQ	SMCG75	TVS	Vbr=75V, 11.2A, 1500W(1ms)	DO-215AB	5d	1k	Vs
GGQ	SMCJ40	TVS	Vrwm=40V, Vbr=44.4..51.1V, 21A, 1500W(1ms)	DO-214AB	1d	1c	Rfe
GGQ	SMCJ75	TVS	Vrwm=75V, Vbr=83.3..95.8V, 12.4A, 1500W(1ms)	DO-214AB	1d	1k	Vs
GGQ	SMCJ75C	TVS	Vrwm=75V, Vbr=83.3..102V, 11.2A, 1500W(1ms), Bidirectional	DO-214AB	1ba	1j	Eic
GGQ	TFMCJ75	TVS	Vbr=75V, 11.2A, 1500W(1ms)	DO-214AB	1d	1b	Rec
GGQ	TV15C750K-G	TVS	Vrwm=75.0V, Vbr=83.30..102.0V, Ipp=11.19A, 1500W(1ms)	DO-214AB	1d	1a	Cmc
GGR	1.5SMCJ75A	TVS	Vrwm=75V, 12.4A, 1500W(1ms)	DO-214AB	1d	1m,1w	Pjt,Srj
GGR	1SMC75A	TVS	Vbr=83.3..92.1V, Vrwm=75V, 12.4A, 1500W(1ms)	403	3d	1s	Ons
GGR	CD214C-T75A	TVS	Vbr=75V, Irlsm=12.4A, 1500W(1ms)	DO-214AB	1d	1a	Bm
GGR	SMCG75A	TVS	Vbr=75V, 12.4A, 1500W(1ms)	DO-215AB	5d	1k	Vs
GGR	SMCJ40A	TVS	Vrwm=40V, Vbr=44.4..51.1V, 23.3A, 1500W(1ms)	DO-214AB	1d	1c	Rfe
GGR	SMCJ75A	TVS	Vrwm=75V, Vbr=83.3..102V, 12.4A, 1500W(1ms)	DO-214AB	1d	1k,1m	Di,Vs
GGR	SMCJ75CA	TVS	Vrwm=75V, Vbr=83.3..92.1V, 12.4A, 1500W(1ms), Bidirectional	DO-214AB	1ba	1j	Eic
GGR	TFMCJ75A	TVS	Vbr=75V, 12.4A, 1500W(1ms)	DO-214AB	1d	1b	Rec
GGR	TV15C750J-G	TVS	Vrwm=75.0V, Vbr=83.30..92.10V, Ipp=12.40A, 1500W(1ms)	DO-214AB	1d	1a	Cmc
GGS	1.5SMCJ78	TVS	Vrwm=78V, 10.8A, 1500W(1ms)	DO-214AB	1d	1m,1w	Pjt,Srj
GGS	SMCG78	TVS	Vbr=78V, 10.8A, 1500W(1ms)	DO-215AB	5d	1k	Vs
GGS	SMCJ43	TVS	Vrwm=43V, Vbr=47.8..54.9V, 19.6A, 1500W(1ms)	DO-214AB	1d	1c	Rfe
GGS	SMCJ78	TVS	Vrwm=78V, Vbr=86.7..99.7V, 10.8A, 1500W(1ms)	DO-214AB	1d	1k	Vs



SMD
code

Type

Function

Short description

Case

Pinout

St.

Mnf.

SMD code	Type	Function	Short description	Case	Pinout	St.	Mnf.
GGG	SMCJ78C	TVS	Vrwm=78V, Vbr=86.7..106V, 10.8A, 1500W(1ms), Bidirectional	DO-214AB	1ba	1j	Eic
GGG	TFMCJ78	TVS	Vbr=78V, 10.8A, 1500W(1ms)	DO-214AB	1d	1b	Rec
GGG	TV15C780K-G	TVS	Vrwm=78.0V, Vbr=86.70..106.0V, Ipp=10.79A, 1500W(1ms)	DO-214AB	1d	1a	Cmc
GGT	1.5SMCJ78A	TVS	Vrwm=78V, 11.4A, 1500W(1ms)	DO-214AB	1d	1m,1w	Pjt,Srj
GGT	1SMC78A	TVS	Vbr=86.7..95.8V, Vrwm=78V, 11.9A, 1500W(1ms)	403	3d	1s	Ons
GGT	CD214C-T78A	TVS	Vbr=78V, Irsrm=11.4A, 1500W(1ms)	DO-214AB	1d	1a	Bm
GGT	SMCG78A	TVS	Vbr=78V, 11.9A, 1500W(1ms)	DO-215AB	5d	1k	Vs
GGT	SMCJ43A	TVS	Vrwm=43V, Vbr=47.8..54.9V, 21.6A, 1500W(1ms)	DO-214AB	1d	1c	Rfe
GGT	SMCJ78A	TVS	Vrwm=78V, Vbr=86.7..99.7V, 11.9A, 1500W(1ms)	DO-214AB	1d	1k,1m	Di,Vs
GGT	SMCJ78CA	TVS	Vrwm=78V, Vbr=86.7..95.8V, 11.9A, 1500W(1ms), Bidirectional	DO-214AB	1ba	1j	Eic
GGT	TFMCJ78A	TVS	Vbr=78V, 11.9A, 1500W(1ms)	DO-214AB	1d	1b	Rec
GGT	TV15C780J-G	TVS	Vrwm=78.0V, Vbr=86.70..95.80V, Ipp=11.90A, 1500W(1ms)	DO-214AB	1d	1a	Cmc
GGU	1.5SMCJ85	TVS	Vrwm=85V, 9.9A, 1500W(1ms)	DO-214AB	1d	1m,1w	Pjt,Srj
GGU	SMCG85	TVS	Vbr=85V, 9.9A, 1500W(1ms)	DO-215AB	5d	1k	Vs
GGU	SMCJ45	TVS	Vrwm=45V, Vbr=50..57.5V, 18.7A, 1500W(1ms)	DO-214AB	1d	1c	Rfe
GGU	SMCJ85	TVS	Vrwm=85V, Vbr=94.4..108.2V, 9.9A, 1500W(1ms)	DO-214AB	1d	1k	Vs
GGU	SMCJ85C	TVS	Vrwm=85V, Vbr=94.4..115V, 9.9A, 1500W(1ms), Bidirectional	DO-214AB	1ba	1j	Eic
GGU	TFMCJ85	TVS	Vbr=85V, 9.9A, 1500W(1ms)	DO-214AB	1d	1b	Rec
GGU	TV15C850K-G	TVS	Vrwm=85.0V, Vbr=94.40..115.0V, Ipp=9.93A, 1500W(1ms)	DO-214AB	1d	1a	Cmc
GGV	1.5SMCJ85A	TVS	Vrwm=85V, 10.4A, 1500W(1ms)	DO-214AB	1d	1m,1w	Pjt,Srj
GGV	CD214C-T85A	TVS	Vbr=85V, Irsrm=10.4A, 1500W(1ms)	DO-214AB	1d	1a	Bm
GGV	SMCG85A	TVS	Vbr=85V, 10.9A, 1500W(1ms)	DO-215AB	5d	1k	Vs
GGV	SMCJ45A	TVS	Vrwm=45V, Vbr=50..57.5V, 21A, 1500W(1ms)	DO-214AB	1d	1c	Rfe
GGV	SMCJ85A	TVS	Vrwm=85V, Vbr=94.4..115V, 10.9A, 1500W(1ms)	DO-214AB	1d	1k,1m	Di,Vs
GGV	SMCJ85CA	TVS	Vrwm=85V, Vbr=94.4..108.2V, 10.9A, 1500W(1ms), Bidirectional	DO-214AB	1ba	1j	Eic
GGV	TFMCJ85A	TVS	Vbr=85V, 10.9A, 1500W(1ms)	DO-214AB	1d	1b	Rec
GGV	TV15C850J-G	TVS	Vrwm=85.0V, Vbr=94.40..104.0V, Ipp=10.95A, 1500W(1ms)	DO-214AB	1d	1a	Cmc
GGV7	SM15T100A	TVS	Vrwm=85.5V, Vbr=95..105V, 11A, 1500W(1ms)	DO-214AB	1d	1k	Vs
GGW	1.5SMCJ90	TVS	Vrwm=90V, 9.4A, 1500W(1ms)	DO-214AB	1d	1m,1w	Pjt,Srj
GGW	SMCG90	TVS	Vbr=90V, 9.4A, 1500W(1ms)	DO-215AB	5d	1k	Vs
GGW	SMCJ48	TVS	Vrwm=48V, Vbr=53.3..61.3V, 18A, 1500W(1ms)	DO-214AB	1d	1c	Rfe
GGW	SMCJ90	TVS	Vrwm=90V, Vbr=100..122V, 9.4A, 1500W(1ms)	DO-214AB	1d	1k	Vs
GGW	SMCJ90C	TVS	Vrwm=90V, Vbr=100..122V, 9.4A, 1500W(1ms), Bidirectional	DO-214AB	1ba	1j	Eic
GGW	TFMCJ90	TVS	Vbr=90V, 9.4A, 1500W(1ms)	DO-214AB	1d	1b	Rec
GGW	TV15C900K-G	TVS	Vrwm=90.0V, Vbr=100.0..122.0V, Ipp=9.38A, 1500W(1ms)	DO-214AB	1d	1a	Cmc
GGX	1.5SMCJ90A	TVS	Vrwm=90V, 10.3A, 1500W(1ms)	DO-214AB	1d	1m,1w	Pjt,Srj
GGX	CD214C-T90A	TVS	Vbr=90V, Irsrm=10.3A, 1500W(1ms)	DO-214AB	1d	1a	Bm
GGX	SMCG90A	TVS	Vbr=90V, 10.3A, 1500W(1ms)	DO-215AB	5d	1k	Vs
GGX	SMCJ48A	TVS	Vrwm=48V, Vbr=53.3..61.3V, 19.4A, 1500W(1ms)	DO-214AB	1d	1c	Rfe
GGX	SMCJ90A	TVS	Vrwm=90V, Vbr=100..115.5V, 10.3A, 1500W(1mS)	DO-214AB	1d	1k,1m	Di,Vs
GGX	SMCJ90CA	TVS	Vrwm=90V, Vbr=100..115.5V, 10.3A, 1500W(1mS), Bidirectional	DO-214AB	1ba	1j	Eic
GGX	TFMCJ90A	TVS	Vbr=90V, 10.3A, 1500W(1ms)	DO-214AB	1d	1b	Rec
GGX	TV15C900J-G	TVS	Vrwm=90.0V, Vbr=100.0..111.0V, Ipp=10.27A, 1500W(1ms)	DO-214AB	1d	1a	Cmc
GGY	1.5SMCJ100	TVS	Vrwm=100V, 8.4A, 1500W(1ms)	DO-214AB	1d	1m,1w	Pjt,Srj
GGY	SMCG100	TVS	Vbr=100V, 8.4A, 1500W(1ms)	DO-215AB	5d	1k	Vs
GGY	SMCJ100	TVS	Vrwm=100V, Vbr=111..136V, 8.4A, 1500W(1ms)	DO-214AB	1d	1k	Vs
GGY	SMCJ100C	TVS	Vrwm=100V, Vbr=111..136V, 8.4A, 1500W(1ms), Bidirectional	DO-214AB	1ba	1j	Eic
GGY	SMCJ51	TVS	Vrwm=51V, Vbr=56.7..65.2V, 16.5A, 1500W(1ms)	DO-214AB	1d	1c	Rfe
GGY	TFMCJ100	TVS	Vbr=100V, 8.4A, 1500W(1ms)	DO-214AB	1d	1b	Rec
GGY	TV15C101K-G	TVS	Vrwm=100.0V, Vbr=111.0..136.0V, Ipp=8.38A, 1500W(1ms)	DO-214AB	1d	1a	Cmc
GGZ	1.5SMCJ100A	TVS	Vrwm=100V, 9.3A, 1500W(1ms)	DO-214AB	1d	1m,1w	Pjt,Srj
GGZ	CD214C-T100A	TVS	Vbr=100V, Irsrm=9.3A, 1500W(1ms)	DO-214AB	1d	1a	Bm
GGZ	SMCG100A	TVS	Vbr=100V, 9.3A, 1500W(1ms)	DO-215AB	5d	1k	Vs
GGZ	SMCJ100A	TVS	Vrwm=100V, Vbr=111..136V, 9.3A, 1500W(1ms)	DO-214AB	1d	1k,1m	Di,Vs
GGZ	SMCJ100CA	TVS	Vrwm=100V, Vbr=111..123V, 9.3A, 1500W(1ms), Bidirectional	DO-214AB	1ba	1j	Eic
GGZ	SMCJ51A	TVS	Vrwm=51V, Vbr=56.7..65.2V, 18.2A, 1500W(1ms)	DO-214AB	1d	1c	Rfe
GGZ	TFMCJ100A	TVS	Vbr=100V, 9.3A, 1500W(1ms)	DO-214AB	1d	1b	Rec
GGZ	TV15C101J-G	TVS	Vrwm=100.0V, Vbr=111.0..123.0V, Ipp=9.26A, 1500W(1ms)	DO-214AB	1d	1a	Cmc
GH	3T150A	Thy-SPD	Vdm=140V, Vs=180V, Ipp=50A, 40pF	DO-214AA	1d	1a	Mde
GH	P1500SA	Thy-SPD	Vdm=140V, Vs=180V, Ipp=50A(1ms), Bidirectional	DO-214AA	1ba	1j	Mde
GH	PZU9.1B	Z-diode	8.56..9.55V, Zzt=100Q(zt=5mA), 310mW	SOD-323FL	7d	1a	Phi
GH	T150AB-LC	Thy-SPD	V Of-St=140V, Vs=180V, Ipp=50A(1ms), Bidirectional	DO-214AA	1ba	1j	Wtr
GH	Z2SMB-10	Z-diode	10V±5%, 2W	DO-214AA	1d	2j	Fag
GHA	TV15C141J-G	TVS	Vrwm=140.0V, Vbr=155.68..190.40V, Ipp=5.99A, 1500W(1ms)	DO-214AB	1d	1a	Cmc
GHB	TV15C141K-G	TVS	Vrwm=140.0V, Vbr=155.0..171.40V, Ipp=6.61A, 1500W(1ms)	DO-214AB	1d	1a	Cmc
GHD	1.5SMCJ110	TVS	Vrwm=110V, 7.7A, 1500W(1ms)	DO-214AB	1d	1m,1w	Pjt,Srj
GHD	SMCG110	TVS	Vbr=110V, 7.7A, 1500W(1ms)	DO-215AB	5d	1k	Vs
GHD	SMCJ110	TVS	Vrwm=110V, Vbr=122..140.5V, 7.7A, 1500W(1ms)	DO-214AB	1d	1k	Vs
GHD	SMCJ110C	TVS	Vrwm=110V, Vbr=122..149V, 7.7A, 1500W(1ms), Bidirectional	DO-214AB	1ba	1j	Eic
GHD	SMCJ54	TVS	Vrwm=54V, Vbr=60..69V, 15.6A, 1500W(1ms)	DO-214AB	1d	1c	Rfe



SMD
code

Type

Function

Short description

Case

Pinout

St.

Mnf.

GHD	TFMCJ110	TVS	Vbr=110V, 7.7A, 1500W(1ms)	DO-214AB	1d	1b	Rec
GHD	TV15C111K-G	TVS	Vrwm=110.0V, Vbr=122.0..149.0V, Ipp=7.65A, 1500W(1ms)	DO-214AB	1d	1a	Cmc
GHE	1.5SMCJ110A	TVS	Vrwm=110V, 8.4A, 1500W(1ms)	DO-214AB	1d	1m,1w	Pjt,Srj
GHE	CD214C-T110A	TVS	Vbr=110V, Irlsm=8.4A, 1500W(1ms)	DO-214AB	1d	1a	Bm
GHE	SMCG110A	TVS	Vbr=110V, 8.5A, 1500W(1ms)	DO-215AB	5d	1k	Vs
GHE	SMCJ110A	TVS	Vrwm=110V, Vbr=122..140.5V, 8.5A, 1500W(1ms)	DO-214AB	1d	1k,1m	Di,Vs
GHE	SMCJ110CA	TVS	Vrwm=110V, Vbr=122..140.5V, 8.4A, 1500W(1mS), Bidirectional	DO-214AB	1ba	1j	Eic
GHE	SMCJ54A	TVS	Vrwm=54V, Vbr=60..69V, 17.2A, 1500W(1ms)	DO-214AB	1d	1c	Rfe
GHE	TFMCJ110A	TVS	Vbr=110V, 8.5A, 1500W(1ms)	DO-214AB	1d	1b	Rec
GHE	TV15C111J-G	TVS	Vrwm=110.0V, Vbr=122.0..135.0V, Ipp=8.47A, 1500W(1ms)	DO-214AB	1d	1a	Cmc
GHF	1.5SMCJ120	TVS	Vrwm=120V, 7A, 1500W(1ms)	DO-214AB	1d	1m,1w	Pjt,Srj
GHF	SMCG120	TVS	Vbr=120V, 7A, 1500W(1ms)	DO-215AB	5d	1k	Vs
GHF	SMCJ120	TVS	Vrwm=120V, Vbr=133..153V, 7A, 1500W(1ms)	DO-214AB	1d	1k	Vs
GHF	SMCJ120C	TVS	Vrwm=120V, Vbr=133..163V, 7.0A, 1500W(1ms), Bidirectional	DO-214AB	1ba	1j	Eic
GHF	SMCJ58	TVS	Vrwm=58V, Vbr=64.4..74.1V, 14.6A, 1500W(1ms)	DO-214AB	1d	1c	Rfe
GHF	TFMCJ120	TVS	Vbr=120V, 7A, 1500W(1ms)	DO-214AB	1d	1b	Rec
GHF	TV15C121K-G	TVS	Vrwm=120.0V, Vbr=133.0..163.0V, Ipp=7.01A, 1500W(1ms)	DO-214AB	1d	1a	Cmc
GHG	1.5SMCJ120A	TVS	Vrwm=120V, 7.9A, 1500W(1ms)	DO-214AB	1d	1m,1w	Pjt,Srj
GHG	CD214C-T120A	TVS	Vbr=120V, Irlsm=7.9A, 1500W(1ms)	DO-214AB	1d	1a	Bm
GHG	SMCG120A	TVS	Vbr=120V, 7.8A, 1500W(1ms)	DO-215AB	5d	1k	Vs
GHG	SMCJ120	TVS	Vrwm=120V, Vbr=133..153V, 7.3A, 1500W(1ms)	DO-214AB	1d	1c	Rfe
GHG	SMCJ120A	TVS	Vrwm=120V, Vbr=133..153V, Vcl=193V, 7.8A, 1500W(1ms)	DO-214AB	1d	1k,1m	Di,Vs
GHG	SMCJ120CA	TVS	Vrwm=120V, Vbr=133..153V, 7.9A, 1500W(1mS), Bidirectional	DO-214AB	1ba	1j	Eic
GHG	SMCJ58A	TVS	Vrwm=58V, Vbr=64.4..74.1V, 16A, 1500W(1ms)	DO-214AB	1d	1c	Rfe
GHG	TFMCJ120A	TVS	Vbr=120V, 7.8A, 1500W(1ms)	DO-214AB	1d	1b	Rec
GHG	TV15C121J-G	TVS	Vrwm=120.0V, Vbr=133.0..147.0V, Ipp=7.77A, 1500W(1ms)	DO-214AB	1d	1a	Cmc
GHH	1.5SMCJ130	TVS	Vrwm=130V, 6.5A, 1500W(1ms)	DO-214AB	1d	1m,1w	Pjt,Srj
GHH	SMCG130	TVS	Vbr=130V, 6.5A, 1500W(1ms)	DO-215AB	5d	1k	Vs
GHH	SMCJ130	TVS	Vrwm=130V, Vbr=144..165.5V, 6.5A, 1500W(1ms)	DO-214AB	1d	1k	Vs
GHH	SMCJ130C	TVS	Vrwm=130V, Vbr=144..176V, 6.5A, 1500W(1ms), Bidirectional	DO-214AB	1ba	1j	Eic
GHH	TFMCJ130	TVS	Vbr=130V, 6.5A, 1500W(1ms)	DO-214AB	1d	1b	Rec
GHH	TV15C131K-G	TVS	Vrwm=130.0V, Vbr=144.0..176.0V, Ipp=6.49A, 1500W(1ms)	DO-214AB	1d	1a	Cmc
GHK	1.5SMCJ130A	TVS	Vrwm=130V, 7.2A, 1500W(1ms)	DO-214AB	1d	1m,1w	Pjt,Srj
GHK	CD214C-T130A	TVS	Vbr=130V, Irlsm=7.2A, 1500W(1ms)	DO-214AB	1d	1a	Bm
GHK	SMCG130A	TVS	Vbr=130V, 7.2A, 1500W(1ms)	DO-215AB	5d	1k	Vs
GHK	SMCJ130A	TVS	Vrwm=130V, Vbr=144..176V, 7.2A, 1500W(1ms)	DO-214AB	1d	1k,1m	Di,Vs
GHK	SMCJ130CA	TVS	Vrwm=130V, Vbr=144..159V, 7.2A, 1500W(1ms), Bidirectional	DO-214AB	1ba	1j	Eic
GHK	TFMCJ130A	TVS	Vbr=130V, 7.2A, 1500W(1ms)	DO-214AB	1d	1b	Rec
GHK	TV15C131J-G	TVS	Vrwm=130.0V, Vbr=144.0..159.0V, Ipp=7.18A, 1500W(1ms)	DO-214AB	1d	1a	Cmc
GHK7	SM15T150A	TVS	Vrwm=128V, Vbr=143..158V, 7.2A, 1500W(1ms)	DO-214AB	1d	1k	Vs
GHL	1.5SMCJ150	TVS	Vrwm=150V, 5.6A, 1500W(1ms)	DO-214AB	1d	1m,1w	Pjt,Srj
GHL	3T150ALC	Thy-SPD	Vdr=140V, Vs=180V, Ipp=2.2A(1ms), 40pF	DO-214AA	1d	1a	Lfr
GHL	SMCG150	TVS	Vbr=150V, 5.6A, 1500W(1ms)	DO-215AB	5d	1k	Vs
GHL	SMCJ150	TVS	Vrwm=150V, Vbr=167..192.5V, 5.6A, 1500W(1ms)	DO-214AB	1d	1k	Vs
GHL	SMCJ150C	TVS	Vrwm=150V, Vbr=167..204V, 5.6A, 1500W(1ms), Bidirectional	DO-214AB	1ba	1j	Eic
GHL	TFMCJ150	TVS	Vbr=150V, 5.6A, 1500W(1ms)	DO-214AB	1d	1b	Rec
GHL	TV15C151J-G	TVS	Vrwm=150.0V, Vbr=167.0..204.0V, Ipp=5.60A, 1500W(1ms)	DO-214AB	1d	1a	Cmc
GHM	1.5SMCJ150A	TVS	Vrwm=150V, 6.2A, 1500W(1ms)	DO-214AB	1d	1m,1w	Pjt,Srj
GHM	CD214C-T150A	TVS	Vbr=150V, Irlsm=6.2A, 1500W(1ms)	DO-214AB	1d	1a	Bm
GHM	SMCG150A	TVS	Vbr=150V, 6.2A, 1500W(1ms)	DO-215AB	5d	1k	Vs
GHM	SMCG150CA	TVS	Vbr=150V, 6.2A, 1500W(1ms), Bidirectional	DO-215AB	5ba	1l	Vs
GHM	SMCJ150A	TVS	Vrwm=150V, Vbr=167..192.5V, 6.2A, 1500W(1ms)	DO-214AB	1d	1k,1m	Di,Vs
GHM	SMCJ150CA	TVS	Vrwm=150V, Vbr=167..185V, 6.2A, 1500W(1ms), Bidirectional	DO-214AB	1ba	1x,1y	Di,Eic
GHM	TFMCJ150A	TVS	Vbr=150V, 6.2A, 1500W(1ms)	DO-214AB	1d	1b	Rec
GHM	TFMCJ150CA	TVS	Vbr=150V, 6.2A, 1500W(1ms), Bidirectional	DO-214AB	1ba	1j	Rec
GHM	TV15C151K-G	TVS	Vrwm=150.0V, Vbr=167.0..185.0V, Ipp=6.17A, 1500W(1ms)	DO-214AB	1d	1a	Cmc
GHN	1.5SMCJ160	TVS	Vrwm=160V, 5.2A, 1500W(1ms)	DO-214AB	1d	1m,1w	Pjt,Srj
GHN	SMCG160	TVS	Vbr=160V, 5.2A, 1500W(1ms)	DO-215AB	5d	1k	Vs
GHN	SMCJ160	TVS	Vrwm=160V, Vbr=178..218V, 5.2A, 1500W(1ms)	DO-214AB	1d	1k	Vs
GHN	SMCJ160C	TVS	Vrwm=160V, Vbr=178..218V, 5.2A, 1500W(1ms), Bidirectional	DO-214AB	1ba	1j	Eic
GHN	TFMCJ160	TVS	Vbr=160V, 5.2A, 1500W(1ms)	DO-214AB	1d	1b	Rec
GHN	TV15C161K-G	TVS	Vrwm=160.0V, Vbr=178.0..218.0V, Ipp=5.23A, 1500W(1ms)	DO-214AB	1d	1a	Cmc
GHP	1.5SMCJ160A	TVS	Vrwm=160V, 5.8A, 1500W(1ms)	DO-214AB	1d	1m,1w	Pjt,Srj
GHP	CD214C-T160A	TVS	Vbr=160V, Irlsm=5.8A, 1500W(1ms)	DO-214AB	1d	1a	Bm
GHP	SMCG160A	TVS	Vbr=160V, 5.8A, 1500W(1ms)	DO-215AB	5d	1k	Vs
GHP	SMCJ160A	TVS	Vrwm=160V, Vbr=178..205V, 5.8A, 1500W(1ms)	DO-214AB	1d	1k,1m	Di,Vs
GHP	SMCJ160CA	TVS	Vrwm=160V, Vbr=178..197V, 5.8A, 1500W(1ms), Bidirectional	DO-214AB	1ba	1j	Eic
GHP	TFMCJ160A	TVS	Vbr=160V, 5.8A, 1500W(1ms)	DO-214AB	1d	1b	Rec
GHP	TV15C161J-G	TVS	Vrwm=160.0V, Vbr=178.0..197.0V, Ipp=5.79A, 1500W(1ms)	DO-214AB	1d	1a	Cmc
GHQ	1.5SMCJ170	TVS	Vrwm=170V, 4.9A, 1500W(1ms)	DO-214AB	1d	1m,1w	Pjt,Srj



SMD
code

Type

Function

Short description

Case

Pinout

St.

Mnf.

SMD code	Type	Function	Short description	Case	Pinout	St.	Mnf.
GHQ	SMCG170	TVS	Vbr=170V, 4.9A, 1500W(1ms)	DO-215AB	5d	1k	Vs
GHQ	SMCJ170	TVS	Vrwm=170V, Vbr=189.217V, 4.9A, 1500W(1ms)	DO-214AB	1d	1k	Vs
GHQ	SMCJ170C	TVS	Vrwm=170V, Vbr=189.231V, 4.90A, 1500W(1ms), Bidirectional	DO-214AB	1ba	1j	Eic
GHQ	TFMCJ170	TVS	Vbr=170V, 4.9A, 1500W(1ms)	DO-214AB	1d	1b	Rec
GHQ	TV15C171K-G	TVS	Vrwm=170.0V, Vbr=189.0..231.0V, lpp=4.93A, 1500W(1ms)	DO-214AB	1d	1a	Cmc
GHR	1.5SMCJ170A	TVS	Vrwm=170V, 5.5A, 1500W(1ms)	DO-214AB	1d	1m,1w	Pjt,Sj
GHR	CD214C-T170A	TVS	Vbr=170V, lrrsm=5.5A, 1500W(1ms)	DO-214AB	1d	1a	Bm
GHR	SMCG170A	TVS	Vbr=170V, 5.5A, 1500W(1ms)	DO-215AB	5d	1k	Vs
GHR	SMCJ170A	TVS	Vrwm=170V, Vbr=189.217V, 5.5A, 1500W(1ms)	DO-214AB	1d	1k,1m	Di,Vs
GHR	TFMCJ170A	TVS	Vbr=170V, 5.5A, 1500W(1ms)	DO-214AB	1d	1b	Rec
GHR	TV15C171J-G	TVS	Vrwm=170.0V, Vbr=189.0..209.0V, lpp=5.45A, 1500W(1ms)	DO-214AB	1d	1a	Cmc
GHR7	SM15T200A	TVS	Vrwm=171V, Vbr=190.210V, 5.5A, 1500W(1ms)	DO-214AB	1d	1k	Vs
GHR8	SM15T220A	TVS	Vrwm=188V, Vbr=209.231V, 4.60A, 1500W(1ms)	DO-214AB	1d	1k	Vs
GHS	1.5SMCJ180	TVS	Vrwm=180V, 4.7A, 1500W(1ms)	DO-214AB	1d	1m,1w	Pjt,Sj
GHS	SMCG188A	TVS	Vbr=188V, 4.6A, 1500W(1ms)	DO-215AB	5d	1k	Vs
GHS	SMCJ188A	TVS	Vrwm=188V, Vbr=209.255V, 4.6A, 1500W(1ms)	DO-214AB	1d	1k	Vs
GHS	TV15C181K-G	TVS	Vrwm=180.0V, Vbr=200.16..244.8V, lpp=4.66A, 1500W(1ms)	DO-214AB	1d	1a	Cmc
GHT	1.5SMCJ180A	TVS	Vrwm=180V, 5.1A, 1500W(1ms)	DO-214AB	1d	1m,1w	Pjt,Sj
GHT	SMCG188	TVS	Vbr=188V, 4.4A, 1500W(1ms)	DO-215AB	5d	1k	Vs
GHT	SMCJ188	TVS	Vrwm=188V, Vbr=209.255V, 4.4A, 1500W(1ms)	DO-214AB	1d	1k	Vs
GHT	TV15C181J-G	TVS	Vrwm=180.0V, Vbr=200.0..220.0V, lpp=5.14A, 1500W(1ms)	DO-214AB	1d	1a	Cmc
GHU	1.5SMCJ190	TVS	Vrwm=170V, 4.4A, 1500W(1ms)	DO-214AB	1d	1m,1w	Pjt,Sj
GHU	TV15C191K-G	TVS	Vrwm=190.0V, Vbr=211.28..258.40V, lpp=4.41A, 1500W(1ms)	DO-214AB	1d	1a	Cmc
GHV	1.5SMCJ190A	TVS	Vrwm=170V, 4.8A, 1500W(1ms)	DO-214AB	1d	1m,1w	Pjt,Sj
GHV	TV15C191J-G	TVS	Vrwm=190.0V, Vbr=211.0..232.0V, lpp=4.87A, 1500W(1ms)	DO-214AB	1d	1a	Cmc
GHW	1.5SMCJ200	TVS	Vrwm=200V, 4.1A, 1500W(1ms)	DO-214AB	1d	1m,1w	Pjt,Sj
GHW	TV15C201J-G	TVS	Vrwm=200.0V, Vbr=224.0..247.0V, lpp=4.60A, 1500W(1ms)	DO-214AB	1d	1a	Cmc
GHX	1.5SMCJ200A	TVS	Vrwm=200V, 4.6A, 1500W(1ms)	DO-214AB	1d	1m,1w	Pjt,Sj
GHX	TV15C221J-G	TVS	Vrwm=220.0V, Vbr=246.0..272.0V, lpp=4.20A, 1500W(1ms)	DO-214AB	1d	1a	Cmc
GHY	1.5SMCJ210	TVS	Vrwm=210V, 4A, 1500W(1ms)	DO-214AB	1d	1m,1w	Pjt,Sj
GHZ	1.5SMCJ210A	TVS	Vrwm=210V, 4.4A, 1500W(1ms)	DO-214AB	1d	1m,1w	Pjt,Sj
GHZ	TV15C251J-G	TVS	Vrwm=250.0V, Vbr=279.0..309.0V, lpp=3.70A, 1500W(1ms)	DO-214AB	1d	1a	Cmc
GI	3T180A	Thy-SPD	Vdm=160V, Vs=220V, lpp=50A, 40pF	DO-214AA	1d	1a	Mde
GI	P1800SA	Thy-SPD	Vdm=160V, Vs=220V, lpp=50A(1ms), Bidirectional	DO-214AA	1ba	1j	Mde
GI	T180AB-LC	Thy-SPD	V Of-St=160V, Vs=220V, lpp=50A(1ms), Bidirectional	DO-214AA	1ba	1j	Wtr
GID	1.5SMCJ220	TVS	Vrwm=220V, 3.8A, 1500W(1ms)	DO-214AB	1d	1m,1w	Pjt,Sj
GIE	1.5SMCJ220A	TVS	Vrwm=220V, 4.2A, 1500W(1ms)	DO-214AB	1d	1m,1w	Pjt,Sj
GIL	3T180ALC	Thy-SPD	Vdm=160V, Vs=220V, lpp=2.2A(1ms), 40pF	DO-214AA	1d	1a	Lfr
GJ	3T230A	Thy-SPD	Vdm=190V, Vs=260V, lpp=50A, 30pF	DO-214AA	1d	1a	Mde
GJ	GF1J	Si-diode	Rectifier, 600V, 1A, Vf<1.1V(1A), 2μs	DO-214BA	1d	1k	Vs
GJ	P2300SA	Thy-SPD	Vdm=190V, Vs=260V, lpp=50A(1ms), Bidirectional	DO-214AA	1ba	1j	Mde
GJ	PZU10B	Z-diode	9.45..10.55, Zzt=10Ω(zt=5mA), 310mW	SOD-323FL	7d	1a	Phi
GJ	T230AB-LC	Thy-SPD	V Of-St=190V, Vs=260V, lpp=50A(1ms), Bidirectional	DO-214AA	1ba	1j	Wtr
GJE	TV15C301J-G	TVS	Vrwm=300.0V, Vbr=335.0..371.0V, lpp=3.10A, 1500W(1ms)	DO-214AB	1d	1a	Cmc
GJG	TV15C351J-G	TVS	Vrwm=350.0V, Vbr=391.0..432.0V, lpp=2.60A, 1500W(1ms)	DO-214AB	1d	1a	Cmc
GJK	TV15C401J-G	TVS	Vrwm=400.0V, Vbr=447.0..494.0V, lpp=2.30A, 1500W(1ms)	DO-214AB	1d	1a	Cmc
GJL	3T230ALC	Thy-SPD	Vdm=190V, Vs=260V, lpp=2.2A(1ms), 30pF	DO-214AA	1d	1a	Lfr
GJM	TV15C441J-G	TVS	Vrwm=440.0V, Vbr=492.0..543.0V, lpp=2.10A, 1500W(1ms)	DO-214AB	1d	1a	Cmc
GK	3T260A	Thy-SPD	Vdm=220V, Vs=300V, lpp=50A, 30pF	DO-214AA	1d	1a	Mde
GK	GF1K	Si-diode	Rectifier, 800V, 1A, Vf<1.2V(1A), 2μs	DO-214BA	1d	1k	Vs
GK	P2600SA	Thy-SPD	Vdm=220V, Vs=300V, lpp=50A(1ms), Bidirectional	DO-214AA	1ba	1j	Mde
GK	PZU11B	Z-diode	10.44..11.56V, Zzt=10Ω(zt=5mA), 310mW	SOD-323FL	7d	1a	Phi
GK	SM6T150	TVS	Vbr=150V, 2.7A, 600W(1ms)	DO-214AA	1d	1q	Ste
GK	T260AB-LC	Thy-SPD	V Of-St=220V, Vs=300V, lpp=50A(1ms), Bidirectional	DO-214AA	1ba	1j	Wtr
GK	Z2SMB-11	Z-diode	11V±5%, 2W	DO-214AA	1d	2j	Fag
GKL	3T260ALC	Thy-SPD	Vdm=220V, Vs=300V, lpp=2.2A(1ms), 30pF	DO-214AA	1d	1a	Lfr
GL	3T310A	Thy-SPD	Vdm=275V, Vs=350V, lpp=50A, 30pF	DO-214AA	1d	1a	Mde
GL	P3100SA	Thy-SPD	Vdm=275V, Vs=350V, lpp=50A(1ms), Bidirectional	DO-214AA	1ba	1j	Mde
GL	PZU12B	Z-diode	11.42..12.6V, Zzt=10Ω(zt=5mA), 310mW	SOD-323FL	7d	1a	Phi
GL	SM6T150A	TVS	Vrwm=128V, Vbr=143..158V, 2.9A, 600W(1ms)	DO-214AA	1d	1a	Ste
GL	T310AB-LC	Thy-SPD	V Of-St=275V, Vs=350V, lpp=50A(1ms), Bidirectional	DO-214AA	1ba	1j	Wtr
GL	Z2SMB-12	Z-diode	12V±5%, 2W	DO-214AA	1d	2j	Fag
GLL	3T310ALC	Thy-SPD	Vdm=275V, Vs=350V, lpp=2.2A(1ms), 30pF	DO-214AA	1d	1a	Lfr
GM	3T350A	Thy-SPD	Vdm=300V, Vs=400V, lpp=50A, 30pF	DO-214AA	1d	1a	Mde
GM	GF1M	Si-diode	Rectifier, 1000V, 1A, Vf<1.2V(1A), 2μs	DO-214BA	1d	1k	Vs
GM	P3500SA	Thy-SPD	Vdm=300V, Vs=400V, lpp=50A(1ms), Bidirectional	DO-214AA	1ba	1j	Mde
GM	PZU13B	Z-diode	12.47..13.96V, Zzt=10Ω(zt=5mA), 310mW	SOD-323FL	7d	1a	Phi
GM	T350AB-LC	Thy-SPD	V Of-St=300V, Vs=400V, lpp=50A(1ms), Bidirectional	DO-214AA	1ba	1j	Wtr
GM	Z2SMB-13	Z-diode	13V±5%, 2W	DO-214AA	1d	2j	Fag
GML	3T350ALC	Thy-SPD	Vdm=300V, Vs=400V, lpp=2.2A(1ms), 30pF	DO-214AA	1d	1a	Lfr



SMD code	Type	Function	Short description	Case	Pinout	St.	Mnf.
GN	3T400B	Thy-SPD	Vdm=360V, Vs=400V, Ipp=75A, 40pF	DO-214AA	1d	1a	Mde
GN	P4000SB	Thy-SPD	Vdm=360V, Vs=450V, Ipp=80A(1ms), Bidirectional	DO-214AA	1ba	1j	Mde
GN	PZU15B	Z-diode	13.84..15.52V, Zzt=10Ω(Izt=5mA), 310mW	SOD-323FL	7d	1a	Phi
GN	T400BB-LC	Thy-SPD	V Of-St=360V, Vs=400V, Ipp=75A(1ms), Bidirectional	DO-214AA	1ba	1j	Wtr
GN	Z2SMB-15	Z-diode	15V±5%, 2W	DO-214AA	1d	2j	Fag
GO	3T400A	Thy-SPD	Vdm=360V, Vs=450V, Ipp=50A, 30pF	DO-214AA	1d	1a	Mde
GO	P4000SA	Thy-SPD	Vdm=360V, Vs=450V, Ipp=35A(1ms), Bidirectional	DO-214AA	1ba	1j	Mde
GO	T400AB-LC	Thy-SPD	V Of-St=360V, Vs=450V, Ipp=50A(1ms), Bidirectional	DO-214AA	1ba	1j	Wtr
GP	3T064B	Thy-SPD	Vdm=58V, Vs=77V, Ipp=100A, 60pF	DO-214AA	1d	1a	Mde
GP	CMDZ3L6	Z-diode	3.420..3.780V, Izt=0.5mA, Zzt=900Ω, 250mW	SOD-323	5d	1a	Cen
GP	KDZ11FVY	Z-diode	10.76..11.22V, Izt=5mA, Zzt=15Ω, 100mW	TFSC	7d	1a	Kec
GP	P0640SB	Thy-SPD	Vdm=58V, Vs=77V, Ipp=80A(1ms), Bidirectional	DO-214AA	1ba	1j	Mde
GP	PZU16B	Z-diode	15.37..17.09V, Zzt=20Ω(Izt=5mA), 310mW	SOD-323FL	7d	1a	Phi
GP	Z2SMB-16	Z-diode	16V±5%, 2W	DO-214AA	1d	2j	Fag
GPL	3T064BLC	Thy-SPD	Vdm=58V, Vs=77V, Ipp=2.2A(1ms), 60pF	DO-214AA	1d	1a	Lfr
GQ	3T072B	Thy-SPD	Vdm=65V, Vs=88V, Ipp=100A, 60pF	DO-214AA	1d	1a	Mde
GQ	P0720SB	Thy-SPD	Vdm=65V, Vs=88V, Ipp=80A(1ms), Bidirectional	DO-214AA	1ba	1j	Mde
GQ	PZU18B	Z-diode	16.94..19.03V, Zzt=20Ω(Izt=5mA), 310mW	SOD-323FL	7d	1a	Phi
GQ	Z2SMB-18	Z-diode	18V±5%, 2W	DO-214AA	1d	2j	Fag
GQL	3T072BLC	Thy-SPD	Vdm=65V, Vs=88V, Ipp=2.2A(1ms), 60pF	DO-214AA	1d	1a	Lfr
GR	3T080B	Thy-SPD	Vdm=75V, Vs=98V, Ipp=100A, 60pF	DO-214AA	1d	1a	Mde
GR	P0800SB	Thy-SPD	Vdm=75V, Vs=98V, Ipp=80A(1ms), Bidirectional	DO-214AA	1ba	1j	Mde
GR	PZU20B	Z-diode	18.86..21.08V, Zzt=20Ω(Izt=5mA), 310mW	SOD-323FL	7d	1a	Phi
GR	Z2SMB-20	Z-diode	20V±5%, 2W	DO-214AA	1d	2j	Fag
GRL	3T080BLC	Thy-SPD	Vdm=75V, Vs=98V, Ipp=2.2A(1ms), 60pF	DO-214AA	1d	1a	Lfr
GS	3T110B	Thy-SPD	Vdm=90V, Vs=130V, Ipp=100A, 60pF	DO-214AA	1d	1a	Mde
GS	P1100SB	Thy-SPD	Vdm=90V, Vs=130V, Ipp=80A(1ms), Bidirectional	DO-214AA	1ba	1j	Mde
GS	PZU22B	Z-diode	20.88..23.17V, Zzt=25Ω(Izt=5mA), 310mW	SOD-323FL	7d	1a	Phi
GS	T110BB-LC	Thy-SPD	V Of-St=90V, Vs=130V, Ipp=75A(1ms), Bidirectional	DO-214AA	1ba	1j	Wtr
GS	Z2SMB-22	Z-diode	22V±5%, 2W	DO-214AA	1d	2j	Fag
GSL	3T110BLC	Thy-SPD	Vdm=90V, Vs=130V, Ipp=2.2A(1ms), 60pF	DO-214AA	1d	1a	Lfr
GT	3T130B	Thy-SPD	Vdm=120V, Vs=160V, Ipp=100A, 40pF	DO-214AA	1d	1a	Mde
GT	P1300SB	Thy-SPD	Vdm=120V, Vs=160V, Ipp=80A(1ms), Bidirectional	DO-214AA	1ba	1j	Mde
GT	PZU24B3	Z-diode	24.54..25.57V, Zzt=30Ω(Izt=5mA), 310mW	SOD-323FL	7d	1a	Phi
GT	SM6T200	TVS	Vbr=200V, 2A, 600W(1ms)	DO-214AA	1d	1q	Ste
GT	T130BB-LC	Thy-SPD	V Of-St=120V, Vs=160V, Ipp=75A(1ms), Bidirectional	DO-214AA	1ba	1j	Wtr
GT	Z2SMB-24	Z-diode	24V±5%, 2W	DO-214AA	1d	2j	Fag
GTL	3T130BLC	Thy-SPD	Vdm=120V, Vs=160V, Ipp=2.2A(1ms), 60pF	DO-214AA	1d	1a	Lfr
GU	3T150B	Thy-SPD	Vdm=140V, Vs=180V, Ipp=100A, 40pF	DO-214AA	1d	1a	Mde
GU	P1500SB	Thy-SPD	Vdm=140V, Vs=180V, Ipp=80A(1ms), Bidirectional	DO-214AA	1ba	1j	Mde
GU	PZU27B	Z-diode	25.1..28.9V, Zzt=40Ω(Izt=5mA), 310mW	SOD-323FL	7d	1a	Phi
GU	SM6T200A	TVS	Vrwm=171V, Vbr=190..210V, 2.2A, 600W(1ms)	DO-214AA	1d	1a	Ste
GU	T150BB-LC	Thy-SPD	V Of-St=140V, Vs=180V, Ipp=75A(1ms), Bidirectional	DO-214AA	1ba	1j	Wtr
GU	Z2SMB-27	Z-diode	27V±5%, 2W	DO-214AA	1d	2j	Fag
GUA	SMCJ60A	TVS	Vrwm=60V, Vbr=66.7..76.7V, 15.7A, 1500W(1ms)	DO-214AB	1d	1q	Ste
GUB	SMCJ70A	TVS	Vrwm=70V, Vbr=77.8..89.5V, 13.9A, 1500W(1ms)	DO-214AB	1d	1q	Ste
GUE	SMCJ85A	TVS	Vrwm=85V, Vbr=94.4..115V, 11.5A, 1500W(1ms)	DO-214AB	1d	1q	Ste
GUG	SMCJ100A	TVS	Vrwm=100V, Vbr=111..136V, 9.7A, 1500W(1ms)	DO-214AB	1d	1q	Ste
GUI	SMCJ130A	TVS	Vrwm=130V, Vbr=144..176V, 7.5A, 1500W(1ms)	DO-214AB	1d	1q	Ste
GUL	3T150BLC	Thy-SPD	Vdm=140V, Vs=180V, Ipp=2.2A(1ms), 40pF	DO-214AA	1d	1a	Lfr
GUL	SMCJ154A	TVS	Vrwm=154V, Vbr=168..193.5V, 6.1A, 1500W(1ms)	DO-214AB	1d	1q	Ste
GUM	SMCJ170A	TVS	Vrwm=170V, Vbr=189..217V, 5.7A, 1500W(1ms)	DO-214AB	1d	1q	Ste
GUN	SMCJ188A	TVS	Vrwm=188V, Vbr=209..255V, 4.6A, 1500W(1ms)	DO-214AB	1d	1q	Ste
GV	3T180B	Thy-SPD	Vdm=160V, Vs=220V, Ipp=100A, 40pF	DO-214AA	1d	1a	Mde
GV	P1800SB	Thy-SPD	Vdm=160V, Vs=220V, Ipp=80A(1ms), Bidirectional	DO-214AA	1ba	1j	Mde
GV	PZU30B	Z-diode	28..32V, Zzt=40Ω(Izt=5mA), 310mW	SOD-323FL	7d	1a	Phi
GV	SM6T220	TVS	Vbr=220V, 1.8A, 600W(1ms)	DO-214AA	1d	1q	Ste
GV	T180BB-LC	Thy-SPD	V Of-St=160V, Vs=220V, Ipp=75A(1ms), Bidirectional	DO-214AA	1ba	1j	Wtr
GV	Z2SMB-30	Z-diode	30V±5%, 2W	DO-214AA	1d	2j	Fag
GVL	3T180BLC	Thy-SPD	Vdm=160V, Vs=220V, Ipp=2.2A(1ms), 40pF	DO-214AA	1d	1a	Lfr
GW	3T230B	Thy-SPD	Vdm=190V, Vs=260V, Ipp=100A, 30pF	DO-214AA	1d	1a	Mde
GW	P2300SB	Thy-SPD	Vdm=190V, Vs=260V, Ipp=80A(1ms), Bidirectional	DO-214AA	1ba	1j	Mde
GW	PZU33B	Z-diode	31..35V, Zzt=40Ω(Izt=5mA), 310mW	SOD-323FL	7d	1a	Phi
GW	SM6T220A	TVS	Vrwm=188V, Vbr=209..231V, 2.0A, 600W(1ms)	DO-214AA	1d	1a	Ste
GW	T230BB-LC	Thy-SPD	V Of-St=190V, Vs=260V, Ipp=75A(1ms), Bidirectional	DO-214AA	1ba	1j	Wtr
GW	Z2SMB-33	Z-diode	33V±5%, 2W	DO-214AA	1d	2j	Fag
GWL	3T230BLC	Thy-SPD	Vdm=190V, Vs=260V, Ipp=2.2A(1ms), 30pF	DO-214AA	1d	1a	Lfr
GX	3T260B	Thy-SPD	Vdm=220V, Vs=300V, Ipp=100A, 30pF	DO-214AA	1d	1a	Mde
GX	DDZ14	Z-diode	14V±10%, Izt=10mA, 500mW	SOD-123	5d	1d	Di
GX	DDZ14S	Z-diode	14V±10%, Izt=10mA, 200mW	SOD-323	5d	1d	Di



SMD code	Type	Function	Short description	Case	Pinout	St.	Mnf.
GX	P2600SB	Thy-SPD	Vdm=220V, Vs=300V, Ipp=80A(1ms), Bidirectional	DO-214AA	1ba	1j	Mde
GX	PZU36B	Z-diode	34.38V, Zzt=60Ω(Izt=5mA), 310mW	SOD-323FL	7d	1a	Phi
GX	T260BB-LC	Thy-SPD	V Of-St=220V, Vs=300V, Ipp=75A(1ms), Bidirectional	DO-214AA	1ba	1j	Wtr
GX	Z2SMB-36	Z-diode	36V±5%, 2W	DO-214AA	1d	2j	Fag
GXL	3T260BLC	Thy-SPD	Vdm=220V, Vs=300V, Ipp=2.2A(1ms), 30pF	DO-214AA	1d	1a	Lfr
GY	3T310B	Thy-SPD	Vdm=275V, Vs=350V, Ipp=100A, 30pF	DO-214AA	1d	1a	Mde
GY	DDZ15	Z-diode	15V±10%, Izt=10mA, 500mW	SOD-123	5d	1d	Di
GY	DDZ15S	Z-diode	15V±10%, Izt=10mA, 200mW	SOD-323	5d	1d	Di
GY	KDZ3.6VVY	Z-diode	3.60..3.84 5V, Izt=5mA, Zzt=130Ω, 100mW	VSC	7d	1a	Kec
GY	P3100SB	Thy-SPD	Vdm=275V, Vs=350V, Ipp=80A(1ms), Bidirectional	DO-214AA	1ba	1j	Mde
GY	T310BB-LC	Thy-SPD	V Of-St=275V, Vs=350V, Ipp=75A(1ms), Bidirectional	DO-214AA	1ba	1j	Wtr
GY	Z2SMB-39	Z-diode	39V±5%, 2W	DO-214AA	1d	2j	Fag
GYL	3T310BLC	Thy-SPD	Vdm=275V, Vs=350V, Ipp=2.2A(1ms), 30pF	DO-214AA	1d	1a	Lfr
GZ	3T350B	Thy-SPD	Vdm=300V, Vs=400V, Ipp=100A, 30pF	DO-214AA	1d	1a	Mde
GZ	BZT52-B11S	Z-diode	10.78..11.22V, Izt=5mA, Zzt=20Ω, 200mW	SOD-323FL	7d	1a	Tsc
GZ	MM3Z11VB	Z-diode	10.78..11.22V, Izt=18Ω, Izt=5mA, 200mW	SOD-323FL	7d	1a	F
GZ	MM3Z11VBW	Z-diode	10.78..11.22V, Izt=5mA, Zzt=20Ω, 200mW	SOD-323FL	7d	1a	Tac
GZ	P3500SB	Thy-SPD	Vdm=300V, Vs=400V, Ipp=80A(1ms), Bidirectional	DO-214AA	1ba	1j	Mde
GZ	T350BB-LC	Thy-SPD	V Of-St=300V, Vs=400V, Ipp=75A(1ms), Bidirectional	DO-214AA	1ba	1j	Wtr
GZ	TCMM3Z11VB	Z-diode	11V±2%, Izt=5mA, Zzt=18Ω, 200mW	SOD-323FL	7d	1a	Tac
GZ	Z2SMB-43	Z-diode	43V±5%, 2W	DO-214AA	1d	2j	Fag
GZL	3T350BLC	Thy-SPD	Vdm=300V, Vs=400V, Ipp=2.2A(1ms), 30pF	DO-214AA	1d	1a	Lfr
H	BB141	C-diode	VCO, 6V, 20mA, 2.38/4.2pF(4V/1V, 1MHz), <0.4Ω	SOD-523	6d	1a	Phi
h	BBY66-02V	C-diode	VCO-Tuning, 12V, 50mA, 12.7..68.7pF(4.5..1V)	SC-79	6d	1u	Inf
H	CDZ8.2B	Z-diode	8.2V±2.5%, 40mA, 1W	VMN	4d	1s	Rhm
H	CH025S-40PT	Si-diode	SBD, 40V, 250mA, Vf<0.6V(200mA), 10ns	SOD-523	7d	1a	Chm
H	EP05Q03L	Si-diode	SBR, 30V, 500mA, Vf<0.45V(500mA)	SOD-123	5d	1a	Nih
H	GBL C24I	TVS	Vbr=24V, 1A, 350W(1ms)	SOD-323	5d	1a	Prt
H	HVU354	C-diode	VCO, 10V, 16/18.5pF(1V)	SOD-323	5d	1a	Ren
H	MAZD047	Z-diode	4.4..5V, Zzt=80Ω(5mA), 120mW	SSSMini2	7d	1a	Pan
H	MAZF091	Z-diode	8.5..9.6V, Zzt=20Ω(5mA), 120mW	S-Mini	7d	1a	Pan
H	MAZN091	Z-diode	8.5..9.6V, Zzt=20Ω(5mA), 120mW	SSMini2	7d	1a	Pan
H	MAZS036	Z-diode	3.4..3.8V, 200mW	SOD-523	6d	1a	Pan
h	MMSZ5238BPT	Z-diode	8.265..9.135V, Izt=5mA, Zzt=7Ω, 225mW	SOD-523	7d	1a	Chm
H	MMSZ5258BPT	Z-diode	34.20..37.80V, Izt=5mA, Zzt=95Ω, 225mW	SOD-523	7d	1a	Chm
h.	MMSZ5238SPT	Z-diode	8.526..8.874V, Izt=5mA, Zzt=7Ω, 225mW	SOD-523	7d	1a	Chm
H.	MMSZ5258SPT	Z-diode	35.28..36.72V, Izt=5mA, Zzt=95Ω, 225mW	SOD-523	7d	1a	Chm
H^	MAZS0360H	Z-diode	3.55..3.8V, 200mW	SOD-523	6d	1a	Pan
H_	MAZS0360L	Z-diode	3.4..3.65V, 200mW	SOD-523	6d	1a	Pan
H0	BZD27C160P	Z-diode	153..171V, Zzt=150Ω, Izt=5mA, 800mW	SOD-123FL	7d	1a	Vs
H0	BZX585-C15	Z-diode	15V±5%, 300mW	SOD-523	6d	1a	Phi
H0	CMOZ15V	Z-diode	14.25..15.75V, Izt=5mA, Zzt=30Ω, 250mW	SOD-523	6d	1a	Cen
H0	MMPZ5238SPT	Z-diode	8.526..8.874V, Izt=5mA, Zzt=7Ω, 225mW	SOD-323	5d	1a	Chm
H0	MMPZ5253BPT	Z-diode	23.75..26.25V, Izt=5mA, Zzt=62Ω, 225mW	SOD-323	5d	1a	Chm
H1	BZD27C180P	Z-diode	168..191V, Zzt=180Ω, Izt=5mA, 800mW	SOD-123FL	7d	1a	Vs
H1	BZX585-C6V2	Z-diode	6.2V±5%, 300mW	SOD-523	6d	1a	Phi
H1	CMOZ6V2	Z-diode	5.89..6.51V, Izt=5mA, Zzt=10Ω, 250mW	SOD-523	6d	1a	Cen
H1	CZRH5241B-G	Z-diode	10.45..11.55V, Zzt=22Ω, Izt=20mA, 150mW	SOD-523	5d	1a	Cmc
H1	CZRV5241B-G	Z-diode	10.45..11.55V, Zzt=22Ω, Izt=20mA, 200mW	SOD-323	5d	1a	Cmc
H1	CZRW5241B-G	Z-diode	10.45..11.55V, Zzt=22Ω, Izt=20mA, 500mW	SOD-123	5d	1a	Cmc
H1	MM3Z5229B	Z-diode	4.3V±5%, Izt=20mA, Zzt=22Ω, 200mW	SOD-323FL	7d	1a	Bts
H1	MM3Z5229BH	Z-diode	4.09..4.52V, Izt=20mA, Zzt=22Ω, 300mW	SOD-323	5d	1a	Zow
H1	MM3Z5241B	Z-diode	10.45..11.55V, Izt=20mA, Zzt=22Ω, 200mW	SOD-323	5d	1a	Ext
H1	MMSZ52341	Z-diode	11V, 10%, 300mW	SOD-123	5d	1k	Vs
H1	MMSZ5241B	Z-diode	11V±5%, Zzt=22Ω, 500mW	SOD-123	5d	1a,1d	Di,Mot
H1	MMSZ5241B	Z-diode	11V±5%, Zzt=22Ω, 500mW	SOD-123	5d	1d	Di
H1	MMSZ5241BS	Z-diode	11V±5%, Zzt=22Ω, 200mW	SOD-323	5d	1d	Di
H1	PZU2.7B2	Z-diode	2.65..2.9V, Zzt=100Ω(Izt=5mA), 310mW	SOD-323FL	7d	1a	Phi
H1	PZU6.2B2L	Z-diode	6.2V±2%, If=200mA, 250mW	SOT-882	13d	2b	Phi
H11	HSM11SPT	Si-diode	Rectifier, U-fast, 50V, 1A	SOD-123S	7d	1a	Chm
H12	HSM12SPT	Si-diode	Rectifier, U-fast, 100V, 1A	SOD-123S	7d	1a	Chm
H13	HSM13SPT	Si-diode	Rectifier, U-fast, 200V, 1A	SOD-123S	7d	1a	Chm
H14	HSM14SPT	Si-diode	Rectifier, U-fast, 300V, 1A	SOD-123S	7d	1a	Chm
H15	HSM15SPT	Si-diode	Rectifier, U-fast, 400V, 1A	SOD-123S	7d	1a	Chm
H16	HSM16SPT	Si-diode	Rectifier, U-fast, 600V, 1A	SOD-123S	7d	1a	Chm
H17	HSM17SPT	Si-diode	Rectifier, U-fast, 800V, 1A	SOD-123S	7d	1a	Chm
H18	HSM18SPT	Si-diode	Rectifier, U-fast, 1000V, 1A	SOD-123S	7d	1a	Chm
H2	BZD27C200P	Z-diode	188..212V, Zzt=200Ω, Izt=5mA, 800mW	SOD-123FL	7d	1a	Vs
H2	BZX585-C6V8	Z-diode	6.8V±5%, 300mW	SOD-523	6d	1a	Phi
H2	CMOZ6V8	Z-diode	6.46..7.14V, Izt=5mA, Zzt=15Ω, 250mW	SOD-523	6d	1a	Cen



SMD
code

Type

Function

Short description

Case

Pinout

St.

Mnf.

SMD code	Type	Function	Short description	Case	Pinout	St.	Mnf.
H2	CZRH5242B-G	Z-diode	11.4..12.6V, Zzt=30Ω, Izt=20mA, 150mW	SOD-523	5d	1a	Cmc
H2	CZRV5242B-G	Z-diode	11.4..12.6V, Zzt=30Ω, Izt=20mA, 200mW	SOD-323	5d	1a	Cmc
H2	CZRW5242B-G	Z-diode	11.40..12.60V, Zzt=30Ω, Izt=20mA, 500mW	SOD-123	5d	1a	Cmc
H2	EDZ7.5B	Z-diode	7.28..7.60V, Izt=5mA, Zzt=30Ω, 150mW	SOD-523	6d	1a	Rhm
H2	FDZ7.5EV	Z-diode	7.280..7.600V, Izt=5mA, Zzt=30Ω, 150mW	SOD-523	7d	1a	Fis
H2	FDZ7.5VT	Z-diode	7.280..7.600V, Izt=5mA, Zzt=30Ω, 200mW	SOD-323	5d	1a	Fis
H2	MM3Z5242B	Z-diode	11.40..12.60V, Izt=20mA, Zzt=30Ω, 200mW	SOD-323	5d	1a	Ext
H2	MM3Z5250B	Z-diode	20V±5%, Izt=6.2mA, Zzt=25Ω, 200mW	SOD-323FL	7d	1a	Bts
H2	MM3Z5250BH	Z-diode	19..21V, Izt=6.2mA, Zzt=25Ω, 300mW	SOD-323	5d	1a	Zow
H2	MMSZ52342	Z-diode	12V, 10%, 300mW	SOD-123	5d	1k	Vs
H2	MMSZ5242B	Z-diode	12V±5%, Zzt=30Ω, 500mW	SOD-123	5d	1a,1d	Di,Mot
H2	MMSZ5242B	Z-diode	12V±5%, Zzt=30Ω, 500mW	SOD-123	5d	1d	Di
H2	MMSZ5242BS	Z-diode	12V±5%, Zzt=30Ω, 200mW	SOD-323	5d	1d	Di
H2	PZU2.4BL	Z-diode	2.4V±2%, If=200mA, 250mW	SOT-882	13d	2b	Phi
H2	PZU3.0B2	Z-diode	2.95..3.2V, Zzt=95Ω(Izt=5mA), 310mW	SOD-323FL	7d	1a	Phi
H2	TDZ7.5B	Z-diode	7.5V±2.5%, 10mA, 500mW	TUMD2	7d	1s	Rhm
H2	UDZS7.5B	Z-diode	7.28..7.60V, Izt=5mA, Zzt=30Ω, 200mW	SOD-323	5d	1a	Wtr
H2	UDZS7.5B	Z-diode	7.5V±2.5%, Izt=5mA, 200mW	SOD-323FL	7d	1s	Rhm
H2	VDZS7.5B	Z-diode	7.5V±5%, 5mA, 100mW	VMD2	5d	1z	Rhm
H3	BZD27C220P	Z-diode	208..233V, Zzt=350Ω, Izt=2mA, 800mW	SOD-123FL	7d	1a	Tsc
H3	BZX585-C7V5	Z-diode	7.5V±5%, 300mW	SOD-523	6d	1a	Phi
H3	CMOZ7V5	Z-diode	7.12..7.88V, Izt=5mA, Zzt=15Ω, 250mW	SOD-523	6d	1a	Cen
H3	CZRH5243B-G	Z-diode	12.35..13.65V, Zzt=13Ω, Izt=9.5mA, 150mW	SOD-523	5d	1a	Cmc
H3	CZRV5243B-G	Z-diode	12.35..13.65V, Zzt=13Ω, Izt=9.5mA, 200mW	SOD-323	5d	1a	Cmc
H3	CZRW5243B-G	Z-diode	12.35..13.65V, Zzt=13Ω, Izt=9.5mA, 500mW	SOD-123	5d	1a	Cmc
H3	MM3Z5243B	Z-diode	12.35..13.65V, Izt=9.5mA, Zzt=13Ω, 200mW	SOD-323	5d	1a	Ext
H3	MMSZ52343	Z-diode	13V, 10%, 300mW	SOD-123	5d	1k	Vs
H3	MMSZ5243B	Z-diode	13V±5%, Zzt=13Ω, 500mW	SOD-123	5d	1a,1d	Di,Mot
H3	MMSZ5243B	Z-diode	13V±5%, Zzt=13Ω, 500mW	SOD-123	5d	1d	Di
H3	MMSZ5243BS	Z-diode	13V±5%, Zzt=13Ω, 200mW	SOD-323	5d	1d	Di
H3	PZU2.7BL	Z-diode	2.7V±5%, If=200mA, 250mW	SOT-882	13d	2b	Phi
H3	PZU3.3B2	Z-diode	3.25..3.5V, Zzt=95Ω(Izt=5mA), 310mW	SOD-323FL	7d	1a	Phi
H4	BZD27C240P	Z-diode	228..256V, Zzt=400Ω, Izt=2mA, 800mW	SOD-123FL	7d	1a	Tsc
H4	BZX585-C8V2	Z-diode	8.2V±5%, 300mW	SOD-523	6d	1a	Phi
H4	CMOZ8V2	Z-diode	7.79..8.61V, Izt=5mA, Zzt=15Ω, 250mW	SOD-523	6d	1a	Cen
H4	CZRH5244B-G	Z-diode	13.3..14.7V, Zzt=15Ω, Izt=9.0mA, 150mW	SOD-523	5d	1a	Cmc
H4	CZRV5244B-G	Z-diode	13.3..14.7V, Zzt=15Ω, Izt=9.0mA, 200mW	SOD-323	5d	1a	Cmc
H4	CZRW5244B-G	Z-diode	13.30..14.70V, Zzt=15Ω, Izt=9.0mA, 500mW	SOD-123	5d	1a	Cmc
H4	MM1Z5229B	Z-diode	4.09..4.52V, Izt=20mA, Zzt=22Ω, 500mW	SOD-323FL	5d	1a	Eic
H4	MM1Z5229BH	Z-diode	4.09..4.52V, Izt=20mA, Zzt=22Ω, 500mW	SOD-123	5d	1a	Zow
H4	MM3Z5244B	Z-diode	13.30..14.70V, Izt=9.0mA, Zzt=15Ω, 200mW	SOD-323	5d	1a	Ext
H4	MMSZ5229B	Z-diode	4.3V±5%, Izt=20mA, Zzt=22Ω, 500mW	SOD-123	5d	1a	Eic
H4	MMSZ52344	Z-diode	14V, 10%, 300mW	SOD-123	5d	1k	Vs
H4	MMSZ5244B	Z-diode	14V±5%, Zzt=15Ω, 500mW	SOD-123	5d	1a	Mot
H4	PZU3.0BL	Z-diode	3.0V±5%, If=200mA, 250mW	SOT-882	13d	2b	Phi
H4	PZU3.6B2	Z-diode	3.55..3.8V, Zzt=90Ω(Izt=5mA), 310mW	SOD-323FL	7d	1a	Phi
H5	BZD27C270P	Z-diode	251..289V, Zzt=450Ω, Izt=2mA, 800mW	SOD-123FL	7d	1a	Tsc
H5	BZX584B12V	Z-diode	11.76..12.24V, Izt=5mA, Zzt=25Ω, 200mW	SOD-523FL	7d	1a	Tac
H5	BZX585-C9V1	Z-diode	9.1V±5%, 300mW	SOD-523	6d	1a	Phi
H5	CMOZ9V1	Z-diode	8.65..9.56V, Izt=5mA, Zzt=15Ω, 250mW	SOD-523	6d	1a	Cen
H5	CZRH5245B-G	Z-diode	14.25..15.75V, Zzt=16Ω, Izt=8.5mA, 150mW	SOD-523	5d	1a	Cmc
H5	CZRV5245B-G	Z-diode	14.25..15.75V, Zzt=16Ω, Izt=8.5mA, 200mW	SOD-323	5d	1a	Cmc
H5	CZRW5245B-G	Z-diode	14.25..15.75V, Zzt=16Ω, Izt=8.5mA, 500mW	SOD-123	5d	1a	Cmc
H5	MM1Z5250B	Z-diode	19.0..21.0V, Izt=6.2mA, Zzt=25Ω, 500mW	SOD-323FL	5d	1a	Eic
H5	MM1Z5250BH	Z-diode	19..21V, Izt=6.2mA, Zzt=25Ω, 500mW	SOD-123	5d	1a	Zow
H5	MM3Z5245B	Z-diode	14.25..15.75V, Izt=8.5mA, Zzt=16Ω, 200mW	SOD-323	5d	1a	Ext
H5	MMSZ12VB	Z-diode	11.76..12.24V, Izt=5mA, Zzt=25Ω, 200mW	SOD-523FL	7d	1a	Tac
H5	MMSZ52345	Z-diode	15V, 10%, 300mW	SOD-123	5d	1k	Vs
H5	MMSZ5245B	Z-diode	15V±5%, Zzt=16Ω, 500mW	SOD-123	5d	1a,1d	Di,Mot
H5	MMSZ5245B	Z-diode	15V±5%, Zzt=16Ω, 500mW	SOD-123	5d	1d	Di
H5	MMSZ5245BS	Z-diode	15V±5%, Zzt=16Ω, 500mW	SOD-323	5d	1d	Di
H5	MMSZ5250B	Z-diode	20V±5%, Izt=6.2mA, Zzt=25Ω, 500mW	SOD-123	5d	1a	Eic
H5	PZU3.3BL	Z-diode	3.3V±5%, If=200mA, 250mW	SOT-882	13d	2b	Phi
H5	PZU3.9B2	Z-diode	3.87..4.1V, Zzt=90Ω(Izt=5mA), 310mW	SOD-323FL	7d	1a	Phi
H5	TVSSVESPT	TVS	Vbr=6.2V, Vrrwm=5V, 9.4A, 240W(1ms)	SC-79	7d	1a	Chm
H6	BZX585-C10	Z-diode	10V±5%, 300mW	SOD-523	6d	1a	Phi
H6	CMOZ10V	Z-diode	9.50..10.50V, Izt=5mA, Zzt=20Ω, 250mW	SOD-523	6d	1a	Cen
H6	PZU3.6BL	Z-diode	3.6V±5%, If=200mA, 250mW	SOT-882	13d	2b	Phi
H6	PZU4.3B2	Z-diode	4.15..4.34V, Zzt=90Ω(Izt=5mA), 310mW	SOD-323FL	7d	1a	Phi
H7	BZX585-C11	Z-diode	11V±5%, 300mW	SOD-523	6d	1a	Phi



SMD
code

Type

Function

Short description

Case

Pinout

St.

Mnf.

H7	CMOZ11V	Z-diode	10.45..11.55V, Izt=5mA, Zzt=20Ω, 250mW	SOD-523	6d	1a	Cen
H7	PZU3.9BL	Z-diode	3.9V±5%, If=200mA, 250mW	SOT-882	13d	2b	Phi
H7	PZU4.7B2	Z-diode	4.55..4.75V, Zzt=80Ω(Izt=5mA), 310mW	SOD-323FL	7d	1a	Phi
H8	BZX585-C12	Z-diode	12V±5%, 300mW	SOD-523	6d	1a	Phi
H8	CMOZ12V	Z-diode	11.40..12.60V, Izt=5mA, Zzt=25Ω, 250mW	SOD-523	6d	1a	Cen
H8	MM5Z5V1	Z-diode	5.1V±5%, Izt=5mA, Zzt=60Ω, 200mW	SOD-523	6d	1a	Eic
H8	MM5Z5V1H	Z-diode	4.8..5.4V, Izt=5mA, Zzt=60Ω, 200mW	SOD-523	7d	1a	Zow
H8	PZU4.3BL	Z-diode	4.3V±5%, If=200mA, 250mW	SOT-882	13d	2b	Phi
H8	PZU5.1B2	Z-diode	4.98..5.2V, Zzt=60Ω(Izt=5mA), 310mW	SOD-323FL	7d	1a	Phi
H9	BZX585-C13	Z-diode	13V±5%, 300mW	SOD-523	6d	1a	Phi
H9	CMOZ13V	Z-diode	12.35..13.65V, Izt=5mA, Zzt=30Ω, 250mW	SOD-523	6d	1a	Cen
H9	DDZ9681	Z-diode	2.4V±5%, 500mW	SOD-123	5d	1d	Di
H9	MM5Z62H	Z-diode	58..66V, Izt=1mA, Zzt=215Ω, 200mW	SOD-523	7d	1a	Zow
H9	MM5Z62V	Z-diode	62V±5%, Izt=2mA, Zzt=215Ω, 200mW	SOD-523	6d	1a	Eic
H9	PZU4.7BL	Z-diode	4.7V±5%, If=200mA, 250mW	SOT-882	13d	2b	Phi
H9	PZU5.6B2	Z-diode	5.49..5.73V, Zzt=40Ω(Izt=5mA), 310mW	SOD-323FL	7d	1a	Phi
HA	DDZ9682	Z-diode	2.7V±5%, 500mW	SOD-123	5d	1d	Di
HA	DDZ9682S	Z-diode	2.7V±5%, 200mW	SOD-323	5d	1d	Di
HA	MM5Z4B3H	Z-diode	4.214..4.386V, Zzt=130Ω, Izt=5mA, 200mW	SOD-523	7d	1a	Zow
HA	PZU5.1BL	Z-diode	5.1V±5%, If=200mA, 250mW	SOT-882	13d	2b	Phi
HA	PZU6.2B2	Z-diode	6.06..6.33V, Zzt=30Ω(Izt=5mA), 310mW	SOD-323FL	7d	1a	Phi
HB	DDZ9683	Z-diode	3V±5%, 500mW	SOD-123	5d	1d	Di
HB	DDZ9683S	Z-diode	3V±5%, 200mW	SOD-323	5d	1d	Di
HB	KDZ3.9B	Z-diode	3.9V±2.5%, 40mA, 1W	PMDU	7d	1s	Rhm
HB	MM5Z4B7H	Z-diode	4.606..4.794V, Zzt=130Ω, Izt=5mA, 200mW	SOD-523	7d	1a	Zow
HB	MUH1PB	Si-diode	Rectifier, 100V, 1A, Vf<0.9V(1A)	MicroSMP	8d	1k	Vs
HB	PZU5.6BL	Z-diode	5.6V±5%, If=200mA, 250mW	SOT-882	13d	2b	Phi
HB	PZU6.8B2	Z-diode	6.65..6.93V, Zzt=20Ω(Izt=5mA), 310mW	SOD-323FL	7d	1a	Phi
HB	SMF19A	TVS	Vrwm=19.0V, Vbr=21.10..23.30V, 6.54A, 200W(10/1000μs)	SOD-123FL	7d	1a	Ers
HB	TV02W190-G	TVS	Vrwm=19V, Vbr=21.1..23.3V, Ipp=6.54A, 200W(1ms)	SOD-123	5d	1a	Cmc
HB	UH1B	Si-diode	Rectifier, 100V, 1A, Vf<0.96V(1A)	DO-214AC	1d	1k	Vs
HB	UH1PB	Si-diode	Rectifier, 100V, 1A, Vf<0.95V(1A)	DO-220AA	8d	1k	Vs
HB	UH2B	Si-diode	Rectifier, 100V, 2A, Vf<0.9V(2A)	DO-214AA	1d	1k	Vs
HB	UH3B	Si-diode	Rectifier, 100V, 3A, Vf<0.9V(2A)	DO-214AB	1d	1k	Vs
HB11	HBM11PT	Si-diode	Rectifier, U-fast, 50V, 1A	DO-214AA	1d	1a	Chm
HB12	HBM12PT	Si-diode	Rectifier, U-fast, 100V, 1A	DO-214AA	1d	1a	Chm
HB13	HBM13PT	Si-diode	Rectifier, U-fast, 200V, 1A	DO-214AA	1d	1a	Chm
HB14	HBM14PT	Si-diode	Rectifier, U-fast, 300V, 1A	DO-214AA	1d	1a	Chm
HB15	HBM15PT	Si-diode	Rectifier, U-fast, 400V, 1A	DO-214AA	1d	1a	Chm
HB16	HBM16PT	Si-diode	Rectifier, U-fast, 600V, 1A	DO-214AA	1d	1a	Chm
HB17	HBM17PT	Si-diode	Rectifier, U-fast, 800V, 1A	DO-214AA	1d	1a	Chm
HB18	HBM18PT	Si-diode	Rectifier, U-fast, 1000V, 1A	DO-214AA	1d	1a	Chm
HB21	HBM21PT	Si-diode	Rectifier, U-fast, 50V, 2A	DO-214AA	1d	1a	Chm
HB22	HBM22PT	Si-diode	Rectifier, U-fast, 100V, 2A	DO-214AA	1d	1a	Chm
HB23	HBM23PT	Si-diode	Rectifier, U-fast, 200V, 2A	DO-214AA	1d	1a	Chm
HB24	HBM24PT	Si-diode	Rectifier, U-fast, 300V, 2A	DO-214AA	1d	1a	Chm
HB25	HBM25PT	Si-diode	Rectifier, U-fast, 400V, 2A	DO-214AA	1d	1a	Chm
HB26	HBM26PT	Si-diode	Rectifier, U-fast, 600V, 2A	DO-214AA	1d	1a	Chm
HB27	HBM27PT	Si-diode	Rectifier, U-fast, 800V, 2A	DO-214AA	1d	1a	Chm
HB28	HBM28PT	Si-diode	Rectifier, U-fast, 1000V, 2A	DO-214AA	1d	1a	Chm
HB31	HBM31PT	Si-diode	Rectifier, U-fast, 50V, 3A	DO-214AA	1d	1a	Chm
HB32	HBM32PT	Si-diode	Rectifier, U-fast, 100V, 3A	DO-214AA	1d	1a	Chm
HB33	HBM33PT	Si-diode	Rectifier, U-fast, 200V, 3A	DO-214AA	1d	1a	Chm
HB34	HBM34PT	Si-diode	Rectifier, U-fast, 300V, 3A	DO-214AA	1d	1a	Chm
HB35	HBM35PT	Si-diode	Rectifier, U-fast, 400V, 3A	DO-214AA	1d	1a	Chm
HB36	HBM36PT	Si-diode	Rectifier, U-fast, 600V, 3A	DO-214AA	1d	1a	Chm
HB37	HBM37PT	Si-diode	Rectifier, U-fast, 800V, 3A	DO-214AA	1d	1a	Chm
HB38	HBM38PT	Si-diode	Rectifier, U-fast, 1000V, 3A	DO-214AA	1d	1a	Chm
HC	3T064C	Thy-SPD	Vdm=58V, Vs=77V, Ipp=100A, 120pF	DO-214AA	1d	1a	Mde
HC	DDZ9684	Z-diode	3.3V±5%, 500mW	SOD-123	5d	1d	Di
HC	DDZ9684S	Z-diode	3.3V±5%, 200mW	SOD-323	5d	1d	Di
HC	GBL C24CI	TVS	Vbr=24V, 1A, 350W(1ms), Bidirectional	SOD-323	5ba	1e	Prt
HC	MM5Z5B1H	Z-diode	4.998..5.202V, Zzt=130Ω, Izt=5mA, 200mW	SOD-523	7d	1a	Zow
HC	MUH1PC	Si-diode	Rectifier, 150V, 1A, Vf<0.9V(1A)	MicroSMP	8d	1k	Vs
HC	P0640SC	Thy-SPD	Vdm=58V, Vs=77V, Ipp=100A(1ms), Bidirectional	DO-214AA	1ba	1j	Mde
HC	PZU6.2BL	Z-diode	6.2V±5%, If=200mA, 250mW	SOT-882	13d	2b	Phi
HC	PZU7.5B2	Z-diode	7.28..7.6V, Zzt=10Ω(Izt=5mA), 310mW	SOD-323FL	7d	1a	Phi
HC	UH1C	Si-diode	Rectifier, 150V, 1A, Vf<0.96V(1A)	DO-214AC	1d	1k	Vs
HC	UH1PC	Si-diode	Rectifier, 150V, 1A, Vf<0.95V(1A)	DO-220AA	8d	1k	Vs
HC	UH3C	Si-diode	Rectifier, 150V, 2A, Vf<0.9V(2A)	DO-214AA	1d	1k	Vs



SMD
code

Type

Function

Short description

Case

Pinout

St.

Mnf.

SMD code	Type	Function	Short description	Case	Pinout	St.	Mnf.
HC31	HCM31PT	Si-diode	Rectifier, U-fast, 50V, 3A	DO-214AB	1d	1a	Chm
HC32	HCM32PT	Si-diode	Rectifier, U-fast, 100V, 3A	DO-214AB	1d	1a	Chm
HC33	HCM33PT	Si-diode	Rectifier, U-fast, 200V, 3A	DO-214AB	1d	1a	Chm
HC34	HCM34PT	Si-diode	Rectifier, U-fast, 300V, 3A	DO-214AB	1d	1a	Chm
HC35	HCM35PT	Si-diode	Rectifier, U-fast, 400V, 3A	DO-214AB	1d	1a	Chm
HC36	HCM36PT	Si-diode	Rectifier, U-fast, 600V, 3A	DO-214AB	1d	1a	Chm
HC37	HCM37PT	Si-diode	Rectifier, U-fast, 800V, 3A	DO-214AB	1d	1a	Chm
HC38	HCM38PT	Si-diode	Rectifier, U-fast, 1000V, 3A	DO-214AB	1d	1a	Chm
HCL	3T064CLC	Thy-SPD	Vdm=58V, Vs=77V, Ipp=2.2A(1ms), 90pF	DO-214AA	1d	1a	Lfr
HD	3T072C	Thy-SPD	Vdm=65V, Vs=88V, Ipp=100A, 120pF	DO-214AA	1d	1a	Mde
HD	DDZ9685	Z-diode	3.6V±5%, 500mW	SOD-123	5d	1d	Di
HD	DDZ9685S	Z-diode	3.6V±5%, 200mW	SOD-323	5d	1d	Di
HD	MM5Z5B6H	Z-diode	5.488..5.712V, Zzt=80Ω, Izt=5mA, 200mW	SOD-523	7d	1a	Zow
HD	MUH1PD	Si-diode	Rectifier, 200V, 1A, Vf<0.9V(1A)	MicroSMP	8d	1k	Vs
HD	P0720SC	Thy-SPD	Vdm=65V, Vs=88V, Ipp=100A(1ms), Bidirectional	DO-214AA	1ba	1j	Mde
HD	P4SMAJ5.0	TVS	Vbr=5V, 41.6A, 400W(1ms)	DO-214AC	1d	1m,1w	Pjt,Srj
HD	PZU6.8BL	Z-diode	6.8V±5%, If=200mA, 250mW	SOT-882	13d	2b	Phi
HD	PZU8.2B2	Z-diode	8.02..8.36V, Zzt=10Ω(Izt=5mA), 310mW	SOD-323FL	7d	1a	Phi
HD	SMAJ530	TVS	Vrwm=530V, Vbr=513..567V, 1A, 400W(1ms)	DO-214AC	1d	1k	Vs
HD	UH1D	Si-diode	Rectifier, 200V, 1A, Vf<0.96V(1A)	DO-214AC	1d	1k	Vs
HD	UH1PD	Si-diode	Rectifier, 200V, 1A, Vf<0.95V(1A)	DO-220AA	8d	1k	Vs
HD	UH3D	Si-diode	Rectifier, 200V, 2A, Vf<0.9V(2A)	DO-214AA	1d	1k	Vs
HD	Z2SMB-47	Z-diode	47V±5%, 2W	DO-214AA	1d	2j	Fag
HDD	3.0SMCJ5.0	TVS	Vbr=6.4..7.55V, Vrwm=5.0V, 312.5A, 3000W(1ms)	DO-214AB	1d	1m,1w	Pjt,Srj
HDD	TV30CV50K-G	TVS	Vrwm=5.0V, Vbr=6.40..7.30V, Ipp=312.50A, 3000W(1ms)	DO-214AB	1d	1a	Cmc
HDE	3.0SMCJ5.0A	TVS	Vbr=6.4..7.25V, Vrwm=5.0V, 9.2 326A, 3000W(1ms)	DO-214AB	1d	1m,1w	Pjt,Srj
HDE	TV30CV50J-G	TVS	Vrwm=5.0V, Vbr=6.40..7.0V, Ipp=326.09A, 3000W(1ms)	DO-214AB	1d	1a	Cmc
HDF	3.0SMCJ6.0	TVS	Vbr=6.67..7.845V, Vrwm=6.0V, 263.2A, 3000W(1ms)	DO-214AB	1d	1m,1w	Pjt,Srj
HDF	TV30CV60K-G	TVS	Vrwm=6.0V, Vbr=6.67..8.15V, Ipp=263.16A, 3000W(1ms)	DO-214AB	1d	1a	Cmc
HDG	3.0SMCJ6.0A	TVS	Vbr=6.67..7.67V, Vrwm=6.0V, 291.3A, 3000W(1ms)	DO-214AB	1d	1m,1w	Pjt,Srj
HDG	TV30CV60J-G	TVS	Vrwm=6.0V, Vbr=6.67..7.37V, Ipp=291.26A, 3000W(1ms)	DO-214AB	1d	1a	Cmc
HDH	3.0SMCJ6.5	TVS	Vbr=7.22..9.14V, Vrwm=6.5V, 243.9A, 3000W(1ms)	DO-214AB	1d	1m,1w	Pjt,Srj
HDH	TV30CV65K-G	TVS	Vrwm=6.5V, Vbr=7.22..8.82V, Ipp=243.90A, 3000W(1ms)	DO-214AB	1d	1a	Cmc
HDK	3.0SMCJ6.5A	TVS	Vbr=7.22..8.30V, Vrwm=6.5V, 267.9A, 3000W(1ms)	DO-214AB	1d	1m,1w	Pjt,Srj
HDK	TV30CV65J-G	TVS	Vrwm=6.5V, Vbr=7.22..7.98V, Ipp=267.86A, 3000W(1ms)	DO-214AB	1d	1a	Cmc
HDL	3.0SMCJ7.0	TVS	Vbr=7.78..9.86V, Vrwm=7.0V, 225.6A, 3000W(1ms)	DO-214AB	1d	1m,1w	Pjt,Srj
HDL	3T072CLC	Thy-SPD	Vdm=65V, Vs=88V, Ipp=2.2A(1ms), 90pF	DO-214AA	1d	1a	Lfr
HDL	SMLJ7.0	TVS	Vrwm=7.0V, Vbr=7.78..9.51V, Ipp=225.6A, 3000W(1ms)	DO-214AB	1a	1a	Mco
HDL	TV30CV70K-G	TVS	Vrwm=7.0V, Vbr=7.78..9.51V, Ipp=225.56A, 3000W(1ms)	DO-214AB	1d	1a	Cmc
HDM	3.0SMCJ7.0A	TVS	Vbr=7.78..8.95V, Vrwm=7.0V, 250A, 3000W(1ms)	DO-214AB	1d	1m,1w	Pjt,Srj
HDM	SMLJ7.0A	TVS	Vrwm=7.0V, Vbr=7.78..8.60V, Ipp=250.0A, 3000W(1ms)	DO-214AB	1a	1a	Mco
HDM	TV30CV70J-G	TVS	Vrwm=7.0V, Vbr=7.78..8.60V, Ipp=250.0A, 3000W(1ms)	DO-214AB	1d	1a	Cmc
HDN	3.0SMCJ7.5	TVS	Vbr=8.33..10.67V, Vrwm=7.5V, 209.8A, 3000W(1ms)	DO-214AB	1d	1m,1w	Pjt,Srj
HDN	SMLJ7.5	TVS	Vrwm=7.5V, Vbr=8.33..10.2V, Ipp=209.8A, 3000W(1ms)	DO-214AB	1a	1a	Mco
HDN	TV30CV75K-G	TVS	Vrwm=7.5V, Vbr=8.33..10.20V, Ipp=209.79A, 3000W(1ms)	DO-214AB	1d	1a	Cmc
HDP	3.0SMCJ7.5A	TVS	Vbr=8.33..9.58V, Vrwm=7.5V, 232.6A, 3000W(1ms)	DO-214AB	1d	1m,1w	Pjt,Srj
HDP	CD214L-77.5ALF	TVS	Vbr=8.33..9.21V, Vrwm=7.5V, Irs=232.6A, 3000W(1ms)	DO-214AB	1d	1a	Bm
HDP	SMLJ7.5A	TVS	Vbr=8.33..9.21V, Vrwm=7.5V, Irs=232.6A, 3000W(1ms)	DO-214AB	1d	1a	Bm
HDP	TV30CV75J-G	TVS	Vrwm=7.5V, Vbr=8.33..9.21V, Ipp=232.56A, 3000W(1ms)	DO-214AB	1d	1a	Cmc
HDQ	3.0SMCJ8.0	TVS	Vbr=8.89..11.30V, Vrwm=8.0V, 200A, 3000W(1ms)	DO-214AB	1d	1m,1w	Pjt,Srj
HDQ	SMLJ8.0	TVS	Vrwm=8.0V, Vbr=8.89..10.9V, Ipp=200.0A, 3000W(1ms)	DO-214AB	1a	1a	Mco
HDQ	TV30CV80K-G	TVS	Vrwm=8.0V, Vbr=8.89..10.90V, Ipp=200.0A, 3000W(1ms)	DO-214AB	1d	1a	Cmc
HDR	3.0SMCJ8.0A	TVS	Vbr=8.89..10.23V, Vrwm=8.0V, 220.6A, 3000W(1ms)	DO-214AB	1d	1m,1w	Pjt,Srj
HDR	CD214L-78.0ALF	TVS	Vbr=8.89..9.83V, Vrwm=8V, Irs=220.6A, 3000W(1ms)	DO-214AB	1d	1a	Bm
HDR	SMLJ8.0A	TVS	Vbr=8.89..9.83V, Vrwm=8V, Irs=220.6A, 3000W(1ms)	DO-214AB	1d	1a	Bm
HDR	TV30CV80J-G	TVS	Vrwm=8.0V, Vbr=8.89..9.83V, Ipp=220.59A, 3000W(1ms)	DO-214AB	1d	1a	Cmc
HDS	3.0SMCJ8.5	TVS	Vbr=9.44..11.92V, Vrwm=8.5V, 188.8A, 3000W(1ms)	DO-214AB	1d	1m,1w	Pjt,Srj
HDS	SMLJ8.5	TVS	Vrwm=8.5V, Vbr=9.44..11.5V, Ipp=188.6A, 3000W(1ms)	DO-214AB	1a	1a	Mco
HDS	TV30CV85K-G	TVS	Vrwm=8.5V, Vbr=9.44..11.50V, Ipp=188.68A, 3000W(1ms)	DO-214AB	1d	1a	Cmc
HDT	3.0SMCJ8.5A	TVS	Vbr=9.44..10.82V, Vrwm=8.5V, 208.4A, 3000W(1ms)	DO-214AB	1d	1m,1w	Pjt,Srj
HDT	CD214L-78.5ALF	TVS	Vbr=9.44..10.43V, Vrwm=8.5V, Irs=208.4A, 3000W(1ms)	DO-214AB	1d	1a	Bm
HDT	SMLJ8.5A	TVS	Vbr=9.44..10.43V, Vrwm=8.5V, Irs=208.4A, 3000W(1ms)	DO-214AB	1d	1a	Bm
HDT	TV30CV85J-G	TVS	Vrwm=8.5V, Vbr=9.44..10.40V, Ipp=208.33A, 3000W(1ms)	DO-214AB	1d	1a	Cmc
HDU	3.0SMCJ9.0	TVS	Vbr=10.0..12.6V, Vrwm=9.0V, 177.4A, 3000W(1ms)	DO-214AB	1d	1m,1w	Pjt,Srj
HDU	SMLJ9.0	TVS	Vrwm=9.0V, Vbr=10.0..12.2V, Ipp=177.4A, 3000W(1ms)	DO-214AB	1a	1a	Mco
HDU	TV30CV90K-G	TVS	Vrwm=9.0V, Vbr=10.0..12.20V, Ipp=177.51A, 3000W(1ms)	DO-214AB	1d	1a	Cmc
HDV	3.0SMCJ9.0A	TVS	Vbr=10.0..11.5V, Vrwm=9.0V, 194.8A, 3000W(1ms)	DO-214AB	1d	1m,1w	Pjt,Srj
HDV	CD214L-79.0ALF	TVS	Vbr=10.0..11.05V, Vrwm=9V, Irs=194.8A, 3000W(1ms)	DO-214AB	1d	1a	Bm
HDV	SMLJ9.0A	TVS	Vbr=10.0..11.05V, Vrwm=9V, Irs=194.8A, 3000W(1ms)	DO-214AB	1d	1a	Bm
HDV	TV30CV90J-G	TVS	Vrwm=9.0V, Vbr=10.0..11.10V, Ipp=194.81A, 3000W(1ms)	DO-214AB	1d	1a	Cmc



SMD code	Type	Function	Short description	Case	Pinout	St.	Mnf.
HDW	3.0SMCJ10	TVS	Vbr=11.1..14.1V, Vrwm=10V, 159.6A, 3000W(1ms)	DO-214AB	1d	1m,1w	Pjt,Srj
HDW	SMLJ10	TVS	Vrwm=10V, Vbr=11.1..13.6V, Ipp=159.6A, 3000W(1ms)	DO-214AB	1a	1a	Mco
HDW	TV30C100K-G	TVS	Vrwm=10.0V, Vbr=11.10..13.60V, Ipp=159.57A, 3000W(1ms)	DO-214AB	1d	1a	Cmc
HDX	3.0SMCJ10A	TVS	Vbr=11.1..12.8V, Vrwm=10V, 176.4A, 3000W(1ms)	DO-214AB	1d	1m,1w	Pjt,Srj
HDX	CD214L-T10ALF	TVS	Vbr=11.10..12.27V, Vrwm=10V, Irs=176.4A, 3000W(1ms)	DO-214AB	1d	1a	Bm
HDX	SMLJ10A	TVS	Vbr=11.10..12.27V, Vrwm=10V, Irs=176.4A, 3000W(1ms)	DO-214AB	1d	1a	Bm
HDX	TV30C100J-G	TVS	Vrwm=10.0V, Vbr=11.10..12.30V, Ipp=176.47A, 3000W(1ms)	DO-214AB	1d	1a	Cmc
HDY	3.0SMCJ11	TVS	Vbr=12.2..15.4V, Vrwm=11V, 149.2A, 3000W(1ms)	DO-214AB	1d	1m,1w	Pjt,Srj
HDY	SMLJ11	TVS	Vrwm=11V, Vbr=12.2..14.9V, Ipp=149.2A, 3000W(1ms)	DO-214AB	1a	1a	Mco
HDY	TV30C110K-G	TVS	Vrwm=11.0V, Vbr=12.20..14.90V, Ipp=149.25A, 3000W(1ms)	DO-214AB	1d	1a	Cmc
HDZ	3.0SMCJ11A	TVS	Vbr=12.2..14.0V, Vrwm=11V, 184.8A, 3000W(1ms)	DO-214AB	1d	1m,1w	Pjt,Srj
HDZ	CD214L-T11ALF	TVS	Vbr=12.20..13.50V, Vrwm=11V, Irs=164.8A, 3000W(1ms)	DO-214AB	1d	1a	Bm
HDZ	SMLJ11A	TVS	Vbr=12.20..13.50V, Vrwm=11V, Irs=164.8A, 3000W(1ms)	DO-214AB	1d	1a	Bm
HDZ	TV30C110J-G	TVS	Vrwm=11.0V, Vbr=12.20..13.50V, Ipp=164.84A, 3000W(1ms)	DO-214AB	1d	1a	Cmc
HE	3T080C	Thy-SPD	Vdm=75V, Vs=98V, Ipp=100A, 100pF	DO-214AA	1d	1a	Mde
HE	CD214A-T5.0A	TVS	Vbr=5.0V, Irs=43.5A, 400W(1ms)	DO-214AC	1d	1a	Bm
HE	DDZ9686	Z-diode	3.9V±5%, 500mW	SOD-123	5d	1d	Di
HE	DDZ9686S	Z-diode	3.9V±5%, 200mW	SOD-323	5d	1d	Di
HE	MM5Z6B2H	Z-diode	6.076..6.324V, Zzt=50Ω, Izt=5mA, 200mW	SOD-523	7d	1a	Zow
HE	P0800SC	Thy-SPD	Vdm=75V, Vs=98V, Ipp=100A(1ms), Bidirectional	DO-214AA	1ba	1j	Mde
HE	P4SMAJ5.0A	TVS	Vbr=5V, 43.5A, 400W (1ms)	DO-214AC	1d	1m,1w	Pjt,Srj
HE	PZU7.5BL	Z-diode	7.5V±5%, If=200mA, 250mW	SOT-882	13d	2b	Phi
HE	PZU9.1B2	Z-diode	8.85..9.23V, Zzt=10Ω(Izt=5mA), 310mW	SOD-323FL	7d	1a	Phi
HE	SMAJ5.0A	TVS	Vrwm=5.0V, Vbr=6.40..7.0V, 43.5A, 400W(1ms)	DO-214AC	1d	1m	Di
HE	SMF12A	TVS	Vrwm=12.0V, Vbr=13.30..14.70V, 10.1A, 200W(10/1000μs)	SOD-123FL	7d	1a	Ers
HE	TV04A301JB-G	TVS	Vrwm=300.0V, Vbr=335.0..371.0V, Ipp=0.82A, 400W(1ms), Bidirectional	DO-214AC	1ba	1j	Cmc
HEA	TV30C190K-G	TVS	Vrwm=19.0V, Vbr=21.13..25.76V, Ipp=88.21A, 3000W(1ms)	DO-214AB	1d	1a	Cmc
HEB	TV30C190J-G	TVS	Vrwm=19.0V, Vbr=21.10..23.30V, Ipp=97.47A, 3000W(1ms)	DO-214AB	1d	1a	Cmc
HED	3.0SMCJ12	TVS	Vbr=13.3..16.9V, Vrwm=12V, 136.4A, 3000W(1ms)	DO-214AB	1d	1m,1w	Pjt,Srj
HED	SMLJ12	TVS	Vrwm=12V, Vbr=13.3..16.3V, Ipp=136.4A, 3000W(1ms)	DO-214AB	1a	1a	Mco
HED	TV30C120K-G	TVS	Vrwm=12.0V, Vbr=13.30..16.30V, Ipp=136.36A, 3000W(1ms)	DO-214AB	1d	1a	Cmc
HEE	3.0SMCJ12A	TVS	Vbr=13.3..15.3V, Vrwm=12V, 150.6A, 3000W(1ms)	DO-214AB	1d	1m,1w	Pjt,Srj
HEE	CD214L-T12ALF	TVS	Vbr=13.30..14.70V, Vrwm=12V, Irs=150.6A, 3000W(1ms)	DO-214AB	1d	1a	Bm
HEE	SMLJ12A	TVS	Vbr=13.30..14.70V, Vrwm=12V, Irs=150.6A, 3000W(1ms)	DO-214AB	1d	1a	Bm
HEE	TV30C120J-G	TVS	Vrwm=12.0V, Vbr=13.30..14.70V, Ipp=150.75A, 3000W(1ms)	DO-214AB	1d	1a	Cmc
HEF	3.0SMCJ13	TVS	Vbr=14.4..18.2V, Vrwm=13V, 126.0A, 3000W(1ms)	DO-214AB	1d	1m,1w	Pjt,Srj
HEF	SMLJ13	TVS	Vrwm=13V, Vbr=14.4..17.6V, Ipp=126.0A, 3000W(1ms)	DO-214AB	1a	1a	Mco
HEF	TV30C130K-G	TVS	Vrwm=13.0V, Vbr=14.40..17.60V, Ipp=126.05A, 3000W(1ms)	DO-214AB	1d	1a	Cmc
HEG	3.0SMCJ13A	TVS	Vbr=14.4..16.5V, Vrwm=13V, 139.4A, 3000W(1ms)	DO-214AB	1d	1m,1w	Pjt,Srj
HEG	CD214L-T13ALF	TVS	Vbr=14.40..15.90V, Vrwm=13V, Irs=139.4A, 3000W(1ms)	DO-214AB	1d	1a	Bm
HEG	SMLJ13A	TVS	Vbr=14.40..15.90V, Vrwm=13V, Irs=139.4A, 3000W(1ms)	DO-214AB	1d	1a	Bm
HEG	TV30C130J-G	TVS	Vrwm=13.0V, Vbr=14.40..15.90V, Ipp=139.53A, 3000W(1ms)	DO-214AB	1d	1a	Cmc
HEH	3.0SMCJ14	TVS	Vbr=15.6..19.8V, Vrwm=14V, 116.2A, 3000W(1ms)	DO-214AB	1d	1m,1w	Pjt,Srj
HEH	SMLJ14	TVS	Vrwm=14V, Vbr=15.6..19.1V, Ipp=116.2A, 3000W(1ms)	DO-214AB	1a	1a	Mco
HEH	TV30C140K-G	TVS	Vrwm=14.0V, Vbr=15.60..19.10V, Ipp=116.28A, 3000W(1ms)	DO-214AB	1d	1a	Cmc
HEK	3.0SMCJ14A	TVS	Vbr=15.6..17.9V, Vrwm=14V, 129.4A, 3000W(1ms)	DO-214AB	1d	1m,1w	Pjt,Srj
HEK	CD214L-T14ALF	TVS	Vbr=15.60..17.20V, Vrwm=14V, Irs=129.4A, 3000W(1ms)	DO-214AB	1d	1a	Bm
HEK	SMLJ14A	TVS	Vbr=15.60..17.20V, Vrwm=14V, Irs=129.4A, 3000W(1ms)	DO-214AB	1d	1a	Bm
HEK	TV30C140J-G	TVS	Vrwm=14.0V, Vbr=15.60..17.20V, Ipp=129.31A, 3000W(1ms)	DO-214AB	1d	1a	Cmc
HEL	3.0SMCJ15	TVS	Vbr=16.7..21.1V, Vrwm=15V, 111.6A, 3000W(1ms)	DO-214AB	1d	1m,1w	Pjt,Srj
HEL	3T080CLC	Thy-SPD	Vdm=75V, Vs=98V, Ipp=2.2A(1ms), 90pF	DO-214AA	1d	1a	Lfr
HEL	SMLJ15	TVS	Vrwm=15V, Vbr=16.7..20.4V, Ipp=111.6A, 3000W(1ms)	DO-214AB	1a	1a	Mco
HEL	TV30C150K-G	TVS	Vrwm=15.0V, Vbr=16.70..20.40V, Ipp=111.52A, 3000W(1ms)	DO-214AB	1d	1a	Cmc
HEM	3.0SMCJ15A	TVS	Vbr=16.7..19.2V, Vrwm=15V, 123.0A, 3000W(1ms)	DO-214AB	1d	1m,1w	Pjt,Srj
HEM	CD214L-T15ALF	TVS	Vbr=16.70..18.50V, Vrwm=15V, Irs=123.0A, 3000W(1ms)	DO-214AB	1d	1a	Bm
HEM	SMLJ15A	TVS	Vbr=16.70..18.50V, Vrwm=15V, Irs=123.0A, 3000W(1ms)	DO-214AB	1d	1a	Bm
HEM	TV30C150J-G	TVS	Vrwm=15.0V, Vbr=16.70..18.50V, Ipp=122.95A, 3000W(1ms)	DO-214AB	1d	1a	Cmc
HEN	3.0SMCJ16	TVS	Vbr=17.8..22.6V, Vrwm=16V, 104.2A, 3000W(1ms)	DO-214AB	1d	1m,1w	Pjt,Srj
HEN	SMLJ16	TVS	Vrwm=16V, Vbr=17.8..21.8V, Ipp=104.2A, 3000W(1ms)	DO-214AB	1a	1a	Mco
HEN	TV30C160K-G	TVS	Vrwm=16.0V, Vbr=17.80..21.80V, Ipp=104.17A, 3000W(1ms)	DO-214AB	1d	1a	Cmc
HEP	3.0SMCJ16A	TVS	Vbr=17.8..20.5V, Vrwm=16V, 115.4A, 3000W(1ms)	DO-214AB	1d	1m,1w	Pjt,Srj
HEP	CD214L-T16ALF	TVS	Vbr=17.80..19.70V, Vrwm=16V, Irs=115.4A, 3000W(1ms)	DO-214AB	1d	1a	Bm
HEP	SMLJ16A	TVS	Vbr=17.80..19.70V, Vrwm=16V, Irs=115.4A, 3000W(1ms)	DO-214AB	1d	1a	Bm
HEP	TV30C160J-G	TVS	Vrwm=16.0V, Vbr=17.80..19.70V, Ipp=115.38A, 3000W(1ms)	DO-214AB	1d	1a	Cmc
HEQ	3.0SMCJ17	TVS	Vbr=18.9..23.9V, Vrwm=17V, 98.4A, 3000W(1ms)	DO-214AB	1d	1m,1w	Pjt,Srj
HEQ	SMLJ17	TVS	Vrwm=17V, Vbr=18.9..23.1V, Ipp=98.4A, 3000W(1ms)	DO-214AB	1a	1a	Mco
HEQ	TV30C170K-G	TVS	Vrwm=17.0V, Vbr=18.90..23.10V, Ipp=98.36A, 3000W(1ms)	DO-214AB	1d	1a	Cmc
HER	3.0SMCJ17A	TVS	Vbr=18.9..21.7V, Vrwm=17V, 106.6A, 3000W(1ms)	DO-214AB	1d	1m,1w	Pjt,Srj
HER	CD214L-T17ALF	TVS	Vbr=18.90..20.90V, Vrwm=17V, Irs=106.6A, 3000W(1ms)	DO-214AB	1d	1a	Bm
HER	SMLJ17A	TVS	Vbr=18.90..20.90V, Vrwm=17V, Irs=106.6A, 3000W(1ms)	DO-214AB	1d	1a	Bm



SMD code	Type	Function	Short description	Case	Pinout	St.	Mnf.
HER	TV30C170J-G	TVS	Vrwm=17.0V, Vbr=18.90..20.90V, Ipp=108.70A, 3000W(1ms)	DO-214AB	1d	1a	Cmc
HES	3.0SMCJ18	TVS	Vbr=20.0..25.3V, Vrwm=18V, 93.2A, 3000W(1ms)	DO-214AB	1d	1m,1w	Pjt,Srj
HES	SMLJ18	TVS	Vrwm=18V, Vbr=20.0..24.4V, Ipp=93.2A, 3000W(1ms)	DO-214AB	1a	1a	Mco
HES	TV30C180K-G	TVS	Vrwm=18.0V, Vbr=20.0..24.40V, Ipp=93.17A, 3000W(1ms)	DO-214AB	1d	1a	Cmc
HET	3.0SMCJ18A	TVS	Vbr=20.0..23.3V, Vrwm=18V, 102.8A, 3000W(1ms)	DO-214AB	1d	1m,1w	Pjt,Srj
HET	CD214L-T18ALF	TVS	Vbr=20.0..22.10V, Vrwm=18V, Irs=102.8A, 3000W(1ms)	DO-214AB	1d	1a	Bm
HET	SMLJ18A	TVS	Vbr=20.0..22.10V, Vrwm=18V, Irs=102.8A, 3000W(1ms)	DO-214AB	1d	1a	Bm
HET	TV30C180J-G	TVS	Vrwm=18.0V, Vbr=20.0..22.10V, Ipp=102.74A, 3000W(1ms)	DO-214AB	1d	1a	Cmc
HEU	3.0SMCJ20	TVS	Vbr=22.2..28.1V, Vrwm=20V, 83.8A, 3000W(1ms)	DO-214AB	1d	1m,1w	Pjt,Srj
HEU	SMLJ20	TVS	Vrwm=20V, Vbr=22.2..27.1V, Ipp=83.8A, 3000W(1ms)	DO-214AB	1a	1a	Mco
HEU	TV30C200K-G	TVS	Vrwm=20.0V, Vbr=21.13..27.10V, Ipp=83.80A, 3000W(1ms)	DO-214AB	1d	1a	Cmc
HEV	3.0SMCJ20A	TVS	Vbr=22.2..25.5V, Vrwm=20V, 92.6A, 3000W(1ms)	DO-214AB	1d	1m,1w	Pjt,Srj
HEV	CD214L-T20ALF	TVS	Vbr=22.20..24.50V, Vrwm=20V, Irs=92.6A, 3000W(1ms)	DO-214AB	1d	1a	Bm
HEV	SMLJ20A	TVS	Vbr=22.20..24.50V, Vrwm=20V, Irs=92.6A, 3000W(1ms)	DO-214AB	1d	1a	Bm
HEV	TV30C200J-G	TVS	Vrwm=20.0V, Vbr=21.10..24.50V, Ipp=92.59A, 3000W(1ms)	DO-214AB	1d	1a	Cmc
HEW	3.0SMCJ22	TVS	Vbr=24.4..30.9V, Vrwm=22V, 76.2A, 3000W(1ms)	DO-214AB	1d	1m,1w	Pjt,Srj
HEW	SMLJ22	TVS	Vrwm=22V, Vbr=24.4..29.8V, Ipp=76.2A, 3000W(1ms)	DO-214AB	1a	1a	Mco
HEW	TV30C220K-G	TVS	Vrwm=22.0V, Vbr=24.40..29.80V, Ipp=76.14A, 3000W(1ms)	DO-214AB	1d	1a	Cmc
HEX	3.0SMCJ22A	TVS	Vbr=24.4..28.0V, Vrwm=22V, 84.4A, 3000W(1ms)	DO-214AB	1d	1m,1w	Pjt,Srj
HEX	CD214L-T22ALF	TVS	Vbr=24.40..27.0V, Vrwm=22V, Irs=84.4A, 3000W(1ms)	DO-214AB	1d	1a	Bm
HEX	SMLJ22A	TVS	Vbr=24.40..27.0V, Vrwm=22V, Irs=84.4A, 3000W(1ms)	DO-214AB	1d	1a	Bm
HEX	TV30C220J-G	TVS	Vrwm=22.0V, Vbr=24.40..26.90V, Ipp=84.51A, 3000W(1ms)	DO-214AB	1d	1a	Cmc
HEY	3.0SMCJ24	TVS	Vbr=26.7..33.8V, Vrwm=24V, 69.8A, 3000W(1ms)	DO-214AB	1d	1m,1w	Pjt,Srj
HEY	SMLJ24	TVS	Vrwm=24V, Vbr=26.7..32.6V, Ipp=69.8A, 3000W(1ms)	DO-214AB	1a	1a	Mco
HEY	TV30C240K-G	TVS	Vrwm=24.0V, Vbr=26.70..32.60V, Ipp=69.77A, 3000W(1ms)	DO-214AB	1d	1a	Cmc
HEZ	3.0SMCJ24A	TVS	Vbr=26.7..30.7V, Vrwm=24V, 77.2A, 3000W(1ms)	DO-214AB	1d	1m,1w	Pjt,Srj
HEZ	CD214L-T24ALF	TVS	Vbr=26.70..29.50V, Vrwm=24V, Irs=77.2A, 3000W(1ms)	DO-214AB	1d	1a	Bm
HEZ	SMLJ24A	TVS	Vbr=26.70..29.50V, Vrwm=24V, Irs=77.2A, 3000W(1ms)	DO-214AB	1d	1a	Bm
HEZ	TV30C240J-G	TVS	Vrwm=24.0V, Vbr=26.70..29.50V, Ipp=77.12A, 3000W(1ms)	DO-214AB	1d	1a	Cmc
HF	3T110C	Thy-SPD	Vdm=90V, Vs=130V, Ipp=100A, 100pF	DO-214AA	1d	1a	Mde
HF	DDZ9687	Z-diode	4.3V±5%, 500mW	SOD-123	5d	1d	Di
HF	DDZ9687S	Z-diode	4.3V±5%, 200mW	SOD-323	5d	1d	Di
HF	KDZ12FV	Z-diode	11.40..12.60V, Izt=5mA, Zzt=15Ω, 100mW	TFSC	7d	1a	Kec
HF	MM5Z68BH	Z-diode	6.664..6.936V, Zzt=30Ω, Izt=5mA, 200mW	SOD-523	7d	1a	Zow
HF	P1100SC	Thy-SPD	Vdm=90V, Vs=130V, Ipp=100A(1ms), Bidirectional	DO-214AA	1ba	1j	Mde
HF	P4SMAJ6.0	TVS	Vbr=6V, 35.1A, 400W(1ms)	DO-214AC	1d	1m,1w	Pjt,Srj
HF	PZU10B2	Z-diode	9.77..10.21V, Zzt=10Ω(Izt=5mA), 310mW	SOD-323FL	7d	1a	Phi
HF	PZU8.2BL	Z-diode	8.2V±5%, If=200mA, 250mW	SO-T-882	13d	2b	Phi
HF	T110CB-LC	Thy-SPD	V Of-St=90V, Vs=130V, Ipp=100A(1ms), Bidirectional	DO-214AA	1ba	1j	Wtr
HF	Z2SMB-51	Z-diode	51V±5%, 2W	DO-214AA	1d	2j	Fag
HFD	3.0SMCJ26	TVS	Vbr=28.9..36.6V, Vrwm=26V, 64.4A, 3000W(1ms)	DO-214AB	1d	1m,1w	Pjt,Srj
HFD	SMLJ26	TVS	Vrwm=26V, Vbr=28.9..35.3V, Ipp=64.4A, 3000W(1ms)	DO-214AB	1a	1a	Mco
HFD	TV30C260K-G	TVS	Vrwm=26.0V, Vbr=28.90..35.30V, Ipp=64.38A, 3000W(1ms)	DO-214AB	1d	1a	Cmc
HFE	3.0SMCJ26A	TVS	Vbr=28.9..33.2V, Vrwm=26V, 71.2A, 3000W(1ms)	DO-214AB	1d	1m,1w	Pjt,Srj
HFE	CD214L-T26ALF	TVS	Vbr=28.90..31.90V, Vrwm=26V, Irs=71.2A, 3000W(1ms)	DO-214AB	1d	1a	Bm
HFE	SMLJ26A	TVS	Vbr=28.90..31.90V, Vrwm=26V, Irs=71.2A, 3000W(1ms)	DO-214AB	1d	1a	Bm
HFE	TV30C260J-G	TVS	Vrwm=26.0V, Vbr=28.90..31.90V, Ipp=71.26A, 3000W(1ms)	DO-214AB	1d	1a	Cmc
HFF	3.0SMCJ28	TVS	Vbr=31.1..39.4V, Vrwm=28V, 60.0A, 3000W(1ms)	DO-214AB	1d	1m,1w	Pjt,Srj
HFF	SMLJ28	TVS	Vrwm=28V, Vbr=31.1..38.0V, Ipp=60.0A, 3000W(1ms)	DO-214AB	1a	1a	Mco
HFF	TV30C280K-G	TVS	Vrwm=28.0V, Vbr=31.10..38.0V, Ipp=60.0A, 3000W(1ms)	DO-214AB	1d	1a	Cmc
HFG	3.0SMCJ28A	TVS	Vbr=31.1..35.8V, Vrwm=28V, 66.0A, 3000W(1ms)	DO-214AB	1d	1m,1w	Pjt,Srj
HFG	CD214L-T28ALF	TVS	Vbr=31.10..34.40V, Vrwm=28V, Irs=66.0A, 3000W(1ms)	DO-214AB	1d	1a	Bm
HFG	SMLJ28A	TVS	Vbr=31.10..34.40V, Vrwm=28V, Irs=66.0A, 3000W(1ms)	DO-214AB	1d	1a	Bm
HFG	TV30C280J-G	TVS	Vrwm=28.0V, Vbr=31.10..34.40V, Ipp=66.08A, 3000W(1ms)	DO-214AB	1d	1a	Cmc
HFH	3.0SMCJ30	TVS	Vbr=33.3..42.2V, Vrwm=30V, 56.0A, 3000W(1ms)	DO-214AB	1d	1m,1w	Pjt,Srj
HFH	SMLJ30	TVS	Vrwm=30V, Vbr=33.3..40.7V, Ipp=56.0A, 3000W(1ms)	DO-214AB	1a	1a	Mco
HFH	TV30C300K-G	TVS	Vrwm=30.0V, Vbr=33.30..40.70V, Ipp=56.07A, 3000W(1ms)	DO-214AB	1d	1a	Cmc
HFH	3.0SMCJ30A	TVS	Vbr=33.3..38.3V, Vrwm=30V, 62.0A, 3000W(1ms)	DO-214AB	1d	1m,1w	Pjt,Srj
HFH	CD214L-T30ALF	TVS	Vbr=33.30..36.80V, Vrwm=30V, Irs=62.0A, 3000W(1ms)	DO-214AB	1d	1a	Bm
HFH	SMLJ30A	TVS	Vbr=33.30..36.80V, Vrwm=30V, Irs=62.0A, 3000W(1ms)	DO-214AB	1d	1a	Bm
HFH	TV30C300J-G	TVS	Vrwm=30.0V, Vbr=33.30..36.80V, Ipp=61.98A, 3000W(1ms)	DO-214AB	1d	1a	Cmc
HFL	3.0SMCJ33	TVS	Vbr=36.7..46.5V, Vrwm=33V, 50.4A, 3000W(1ms)	DO-214AB	1d	1m,1w	Pjt,Srj
HFL	3T110CLC	Thy-SPD	Vdm=90V, Vs=130V, Ipp=2.2A(1ms), 90pF	DO-214AA	1d	1a	Lfr
HFL	SMLJ33	TVS	Vrwm=33V, Vbr=36.7..44.9V, Ipp=50.4A, 3000W(1ms)	DO-214AB	1a	1a	Mco
HFL	TV30C330K-G	TVS	Vrwm=33.0V, Vbr=36.70..44.90V, Ipp=50.85A, 3000W(1ms)	DO-214AB	1d	1a	Cmc
HFM	3.0SMCJ33A	TVS	Vbr=36.7..42.2V, Vrwm=33V, 56.2A, 3000W(1ms)	DO-214AB	1d	1m,1w	Pjt,Srj
HFM	CD214L-T33ALF	TVS	Vbr=36.70..40.60V, Vrwm=33V, Irs=56.2A, 3000W(1ms)	DO-214AB	1d	1a	Bm
HFM	SMLJ33A	TVS	Vbr=36.70..40.60V, Vrwm=33V, Irs=56.2A, 3000W(1ms)	DO-214AB	1d	1a	Bm
HFM	TV30C330J-G	TVS	Vrwm=33.0V, Vbr=36.70..40.60V, Ipp=56.29A, 3000W(1ms)	DO-214AB	1d	1a	Cmc
HFN	3.0SMCJ36	TVS	Vbr=40.0..50.7V, Vrwm=36V, 46.6A, 3000W(1ms)	DO-214AB	1d	1m,1w	Pjt,Srj



SMD code	Type	Function	Short description	Case	Pinout	St.	Mnf.
HFN	SMLJ36	TVS	Vrwm=36V, Vbr=40.0..48.9V, Ipp=46.6A, 3000W(1ms)	DO-214AB	1a	1a	Mco
HFN	TV30C360K-G	TVS	Vrwm=36.0V, Vbr=40.0..48.90V, Ipp=46.66A, 3000W(1ms)	DO-214AB	1d	1a	Cmc
HFP	3.0SMCJ36A	TVS	Vbr=40.0..46.0V, Vrwm=36V, Irs=51.6A, 3000W(1ms)	DO-214AB	1d	1m,1w	Pjt,Srj
HFP	CD214L-T36ALF	TVS	Vbr=40.0..44.20V, Vrwm=36V, Irs=51.6A, 3000W(1ms)	DO-214AB	1d	1a	Bm
HFP	SMLJ36A	TVS	Vbr=40.0..44.20V, Vrwm=36V, Irs=51.6A, 3000W(1ms)	DO-214AB	1d	1a	Bm
HFP	TV30C360J-G	TVS	Vrwm=36.0V, Vbr=40.0..44.20V, Ipp=51.64A, 3000W(1ms)	DO-214AB	1d	1a	Cmc
HFQ	3.0SMCJ40	TVS	Vbr=44.4..56.3V, Vrwm=40V, Irs=42.0A, 3000W(1ms)	DO-214AB	1d	1m,1w	Pjt,Srj
HFQ	SMLJ40	TVS	Vrwm=40V, Vbr=44.4..54.3V, Ipp=42.0A, 3000W(1ms)	DO-214AB	1a	1a	Mco
HFQ	TV30C400K-G	TVS	Vrwm=40.0V, Vbr=44.40..54.30V, Ipp=42.02A, 3000W(1ms)	DO-214AB	1d	1a	Cmc
HFR	3.0SMCJ40A	TVS	Vbr=44.4..51.1V, Vrwm=40V, Irs=46.4A, 3000W(1ms)	DO-214AB	1d	1m,1w	Pjt,Srj
HFR	CD214L-T40ALF	TVS	Vbr=44.40..49.10V, Vrwm=40V, Irs=46.4A, 3000W(1ms)	DO-214AB	1d	1a	Bm
HFR	SMLJ40A	TVS	Vbr=44.40..49.10V, Vrwm=40V, Irs=46.4A, 3000W(1ms)	DO-214AB	1d	1a	Bm
HFR	TV30C400J-G	TVS	Vrwm=40.0V, Vbr=44.40..49.10V, Ipp=46.51A, 3000W(1ms)	DO-214AB	1d	1a	Cmc
HFS	3.0SMCJ43	TVS	Vbr=47.8..60.5V, Vrwm=43V, Irs=39.2A, 3000W(1ms)	DO-214AB	1d	1m,1w	Pjt,Srj
HFS	SMLJ43	TVS	Vrwm=43V, Vbr=47.8..58.4V, Ipp=39.2A, 3000W(1ms)	DO-214AB	1a	1a	Mco
HFS	TV30C430K-G	TVS	Vrwm=43.0V, Vbr=47.80..58.40V, Ipp=39.11A, 3000W(1ms)	DO-214AB	1d	1a	Cmc
HFT	3.0SMCJ43A	TVS	Vbr=47.8..54.9V, Vrwm=43V, Irs=43.2A, 3000W(1ms)	DO-214AB	1d	1m,1w	Pjt,Srj
HFT	CD214L-T43ALF	TVS	Vbr=47.80..52.80V, Vrwm=43V, Irs=43.2A, 3000W(1ms)	DO-214AB	1d	1a	Bm
HFT	SMLJ43A	TVS	Vbr=47.80..52.80V, Vrwm=43V, Irs=43.2A, 3000W(1ms)	DO-214AB	1d	1a	Bm
HFT	TV30C430J-G	TVS	Vrwm=43.0V, Vbr=47.80..52.80V, Ipp=43.23A, 3000W(1ms)	DO-214AB	1d	1a	Cmc
HFU	3.0SMCJ45	TVS	Vbr=50.0..63.3V, Vrwm=45V, Irs=37.4A, 3000W(1ms)	DO-214AB	1d	1m,1w	Pjt,Srj
HFU	SMLJ45	TVS	Vrwm=45V, Vbr=50.0..61.1V, Ipp=37.4A, 3000W(1ms)	DO-214AB	1a	1a	Mco
HFU	TV30C450K-G	TVS	Vrwm=45.0V, Vbr=50.0..61.10V, Ipp=37.36A, 3000W(1ms)	DO-214AB	1d	1a	Cmc
HFV	3.0SMCJ45A	TVS	Vbr=50.0..57.5V, Vrwm=45V, Irs=41.2A, 3000W(1ms)	DO-214AB	1d	1m,1w	Pjt,Srj
HFV	CD214L-T45ALF	TVS	Vbr=50.0..55.30V, Vrwm=45V, Irs=41.2A, 3000W(1ms)	DO-214AB	1d	1a	Bm
HFV	SMLJ45A	TVS	Vbr=50.0..55.30V, Vrwm=45V, Irs=41.2A, 3000W(1ms)	DO-214AB	1d	1a	Bm
HFV	TV30C450J-G	TVS	Vrwm=45.0V, Vbr=50.0..55.30V, Ipp=41.27A, 3000W(1ms)	DO-214AB	1d	1a	Cmc
HFW	3.0SMCJ48	TVS	Vbr=53.3..67.5V, Vrwm=48V, Irs=35.0A, 3000W(1ms)	DO-214AB	1d	1m,1w	Pjt,Srj
HFW	SMLJ48	TVS	Vrwm=48V, Vbr=53.3..65.1V, Ipp=35.0A, 3000W(1ms)	DO-214AB	1a	1a	Mco
HFW	TV30C480K-G	TVS	Vrwm=48.0V, Vbr=53.30..65.10V, Ipp=35.09A, 3000W(1ms)	DO-214AB	1d	1a	Cmc
HFX	3.0SMCJ48A	TVS	Vbr=53.3..61.3V, Vrwm=48V, Irs=38.8A, 3000W(1ms)	DO-214AB	1d	1m,1w	Pjt,Srj
HFX	CD214L-T48ALF	TVS	Vbr=53.30..58.90V, Vrwm=48V, Irs=38.8A, 3000W(1ms)	DO-214AB	1d	1a	Bm
HFX	SMLJ48A	TVS	Vbr=53.30..58.90V, Vrwm=48V, Irs=38.8A, 3000W(1ms)	DO-214AB	1d	1a	Bm
HFX	TV30C480J-G	TVS	Vrwm=48.0V, Vbr=53.30..58.90V, Ipp=38.76A, 3000W(1ms)	DO-214AB	1d	1a	Cmc
HFY	3.0SMCJ51	TVS	Vbr=56.7..71.8V, Vrwm=51V, Irs=37.0A, 3000W(1ms)	DO-214AB	1d	1m,1w	Pjt,Srj
HFY	SMLJ51	TVS	Vrwm=51V, Vbr=56.7..69.3V, Ipp=37.0A, 3000W(1ms)	DO-214AB	1a	1a	Mco
HFY	TV30C510K-G	TVS	Vrwm=51.0V, Vbr=56.70..69.30V, Ipp=32.93A, 3000W(1ms)	DO-214AB	1d	1a	Cmc
HFZ	3.0SMCJ51A	TVS	Vbr=56.7..65.2V, Vrwm=51V, Irs=36.4A, 3000W(1ms)	DO-214AB	1d	1m,1w	Pjt,Srj
HFZ	CD214L-T51ALF	TVS	Vbr=56.70..62.70V, Vrwm=51V, Irs=36.4A, 3000W(1ms)	DO-214AB	1d	1a	Bm
HFZ	SMLJ51A	TVS	Vbr=56.70..62.70V, Vrwm=51V, Irs=36.4A, 3000W(1ms)	DO-214AB	1d	1a	Bm
HFZ	TV30C510J-G	TVS	Vrwm=51.0V, Vbr=56.70..62.70V, Ipp=36.41A, 3000W(1ms)	DO-214AB	1d	1a	Cmc
HG	3T130C	Thy-SPD	Vd=120V, Vs=160V, Ipp=100A, 70pF	DO-214AA	1d	1a	Mde
HG	CD214A-T6.0A	TVS	Vbr=6.0V, Irs=38.8A, 400W(1ms)	DO-214AC	1d	1a	Bm
HG	DDZ9688	Z-diode	4.7V±5%, 500mW	SOD-123	5d	1d	Di
HG	DDZ9688S	Z-diode	4.7V±5%, 200mW	SOD-323	5d	1d	Di
HG	P1300C	Thy-SPD	Vd=120V, Vs=160V, Ipp=100A(1ms), Bidirectional	DO-214AA	1ba	1j	Mde
HG	P4SMAJ6.0A	TVS	Vbr=6V, Irs=38.8A, 400W(1ms)	DO-214AC	1d	1m,1w	Pjt,Srj
HG	PZU11B2	Z-diode	10.76..11.22V, Zzt=10Ω(zt=5mA), 310mW	SOD-323FL	7d	1a	Phi
HG	PZU9.1BL	Z-diode	9.1V±5%, If=200mA, 250mW	SOT-882	13d	2b	Phi
HG	SMAJ6.0A	TVS	Vrwm=6.0V, Vbr=6.7..7.37V, Irs=38.8A, 400W(1ms)	DO-214AC	1d	1m	Di
HG	SMF13A	TVS	Vrwm=13.0V, Vbr=14.40..15.90V, Irs=9.3A, 200W(10/1000μs)	SOD-123FL	7d	1a	Ers
HG	T130CB-LC	Thy-SPD	V Of-St=120V, Vs=160V, Ipp=100A(1ms), Bidirectional	DO-214AA	1ba	1j	Wtr
HG	TV02W130-G	TVS	Vrwm=13V, Vbr=14.4..15.9V, Ipp=9.30A, 200W(1ms)	SOD-123	5d	1a	Cmc
HG	TV04A35.1JB-G	TVS	Vrwm=350.0V, Vbr=391.0..432.0V, Ipp=0.71A, 400W(1ms), Bidirectional	DO-214AC	1ba	1j	Cmc
HG	Z2SMB-56	Z-diode	56V±5%, 2W	DO-214AA	1d	2j	Fag
HGA	TV30C800K-G	TVS	Vrwm=80.0V, Vbr=88.96..108.80V, Ipp=20.95A, 3000W(1ms)	DO-214AB	1d	1a	Cmc
HGB	TV30C800J-G	TVS	Vrwm=80.0V, Vbr=88.80..97.60V, Ipp=23.15A, 3000W(1ms)	DO-214AB	1d	1a	Cmc
HGD	3.0SMCJ54	TVS	Vbr=60.0..76.0V, Vrwm=54V, Irs=31.2A, 3000W(1ms)	DO-214AB	1d	1m,1w	Pjt,Srj
HGD	SMLJ54	TVS	Vrwm=54V, Vbr=60.0..73.3V, Ipp=31.2A, 3000W(1ms)	DO-214AB	1a	1a	Mco
HGD	TV30C540K-G	TVS	Vrwm=54.0V, Vbr=60.0..73.30V, Ipp=31.15A, 3000W(1ms)	DO-214AB	1d	1a	Cmc
HGE	3.0SMCJ54A	TVS	Vbr=60.0..69.0V, Vrwm=54V, Irs=34.4A, 3000W(1ms)	DO-214AB	1d	1m,1w	Pjt,Srj
HGE	CD214L-T54ALF	TVS	Vbr=60.0..66.30V, Vrwm=54V, Irs=34.4A, 3000W(1ms)	DO-214AB	1d	1a	Bm
HGE	SMLJ54A	TVS	Vbr=60.0..66.30V, Vrwm=54V, Irs=34.4A, 3000W(1ms)	DO-214AB	1d	1a	Bm
HGE	TV30C540J-G	TVS	Vrwm=54.0V, Vbr=60.0..66.30V, Ipp=34.44A, 3000W(1ms)	DO-214AB	1d	1a	Cmc
HGF	3.0SMCJ58	TVS	Vbr=64.4..81.6V, Vrwm=58V, Irs=29.2A, 3000W(1ms)	DO-214AB	1d	1m,1w	Pjt,Srj
HGF	SMLJ58	TVS	Vrwm=58V, Vbr=64.4..78.7V, Ipp=29.2A, 3000W(1ms)	DO-214AB	1a	1a	Mco
HGF	TV30C580K-G	TVS	Vrwm=58.0V, Vbr=64.40..78.70V, Ipp=29.13A, 3000W(1ms)	DO-214AB	1d	1a	Cmc
HGG	3.0SMCJ58A	TVS	Vbr=64.4..74.1V, Vrwm=58V, Irs=32.0A, 3000W(1ms)	DO-214AB	1d	1m,1w	Pjt,Srj
HGG	CD214L-T58ALF	TVS	Vbr=64.40..71.20V, Vrwm=58V, Irs=32.0A, 3000W(1ms)	DO-214AB	1d	1a	Bm
HGG	SMLJ58A	TVS	Vbr=64.40..71.20V, Vrwm=58V, Irs=32.0A, 3000W(1ms)	DO-214AB	1d	1a	Bm



SMD
code

Type

Function

Short description

Case

Pinout

St.

Mnf.

HGG	TV30C580J-G	TVS	Vrwm=58.0V, Vbr=64.40..71.20V, Ipp=32.05A, 3000W(1ms)	DO-214AB	1d	1a	Cmc
HGH	3.0SMCJ60	TVS	Vbr=66.7..84.5V, Vrwm=60V, 28.0A, 3000W(1ms)	DO-214AB	1d	1m,1w	Pjt,Srj
HGH	SMLJ60	TVS	Vrwm=60V, Vbr=66.7..81.5V, Ipp=28.0A, 3000W(1ms)	DO-214AB	1a	1a	Mco
HGH	TV30C600K-G	TVS	Vrwm=60.0V, Vbr=66.70..81.50V, Ipp=28.04A, 3000W(1ms)	DO-214AB	1d	1a	Cmc
HGK	3.0SMCJ60A	TVS	Vbr=66.7..76.7V, Vrwm=60V, 31.0A, 3000W(1ms)	DO-214AB	1d	1m,1w	Pjt,Srj
HGK	CD214L-T60ALF	TVS	Vbr=66.70..73.70V, Vrwm=60V, Irsrm=31.0A, 3000W(1ms)	DO-214AB	1d	1a	Bm
HGK	SMLJ60A	TVS	Vbr=66.70..73.70V, Vrwm=60V, Irsrm=31.0A, 3000W(1ms)	DO-214AB	1d	1a	Bm
HGK	TV30C600J-G	TVS	Vrwm=60.0V, Vbr=66.70..73.70V, Ipp=30.99A, 3000W(1ms)	DO-214AB	1d	1a	Cmc
HGL	3.0SMCJ64	TVS	Vbr=71.1..90.1V, Vrwm=64V, 26.4A, 3000W(1ms)	DO-214AB	1d	1m,1w	Pjt,Srj
HGL	3T130CLC	Thy-SPD	Vdcm=120V, Vs=160V, Ipp=2.2A(1ms), 70pF	DO-214AA	1d	1a	Lfr
HGL	SMLJ64	TVS	Vrwm=64V, Vbr=71.1..86.9V, Ipp=26.4A, 3000W(1ms)	DO-214AB	1a	1a	Mco
HGL	TV30C640K-G	TVS	Vrwm=64.0V, Vbr=71.10..86.90V, Ipp=26.32A, 3000W(1ms)	DO-214AB	1d	1a	Cmc
HGM	3.0SMCJ64A	TVS	Vbr=71.1..81.8V, Vrwm=64V, 29.2A, 3000W(1ms)	DO-214AB	1d	1m,1w	Pjt,Srj
HGM	CD214L-T64ALF	TVS	Vbr=71.10..78.60V, Vrwm=64V, Irsrm=29.2A, 3000W(1ms)	DO-214AB	1d	1a	Bm
HGM	SMLJ64A	TVS	Vbr=71.10..78.60V, Vrwm=64V, Irsrm=29.2A, 3000W(1ms)	DO-214AB	1d	1a	Bm
HGM	TV30C640J-G	TVS	Vrwm=64.0V, Vbr=71.10..78.60V, Ipp=29.13A, 3000W(1ms)	DO-214AB	1d	1a	Cmc
HGN	3.0SMCJ70	TVS	Vbr=77.8..98.6V, Vrwm=70V, 24.0A, 3000W(1ms)	DO-214AB	1d	1m,1w	Pjt,Srj
HGN	SMLJ70	TVS	Vrwm=70V, Vbr=77.8..95.1V, Ipp=24.0A, 3000W(1ms)	DO-214AB	1a	1a	Mco
HGN	TV30C700K-G	TVS	Vrwm=70.0V, Vbr=77.80..95.10V, Ipp=24.0A, 3000W(1ms)	DO-214AB	1d	1a	Cmc
HGP	3.0SMCJ70A	TVS	Vbr=77.8..89.5V, Vrwm=70V, 26.6A, 3000W(1ms)	DO-214AB	1d	1m,1w	Pjt,Srj
HGP	CD214L-T70ALF	TVS	Vbr=77.80..86.0V, Vrwm=70V, Irsrm=26.6A, 3000W(1ms)	DO-214AB	1d	1a	Bm
HGP	SMLJ70A	TVS	Vbr=77.80..86.0V, Vrwm=70V, Irsrm=26.6A, 3000W(1ms)	DO-214AB	1d	1a	Bm
HGP	TV30C700J-G	TVS	Vrwm=70.0V, Vbr=77.80..86.0V, Ipp=26.55A, 3000W(1ms)	DO-214AB	1d	1a	Cmc
HGQ	3.0SMCJ75	TVS	Vbr=83.3..105.7V, Vrwm=75V, 22.4A, 3000W(1ms)	DO-214AB	1d	1m,1w	Pjt,Srj
HGQ	SMLJ75	TVS	Vrwm=75V, Vbr=83.3..102V, Ipp=22.4A, 3000W(1ms)	DO-214AB	1a	1a	Mco
HGQ	TV30C750K-G	TVS	Vrwm=75.0V, Vbr=83.30..102.0V, Ipp=22.39A, 3000W(1ms)	DO-214AB	1d	1a	Cmc
HGR	3.0SMCJ75A	TVS	Vbr=83.3..95.8V, Vrwm=75V, 24.8A, 3000W(1ms)	DO-214AB	1d	1m,1w	Pjt,Srj
HGR	CD214L-T75ALF	TVS	Vbr=83.30..92.10V, Vrwm=75V, Irsrm=24.8A, 3000W(1ms)	DO-214AB	1d	1a	Bm
HGR	SMLJ75A	TVS	Vbr=83.30..92.10V, Vrwm=75V, Irsrm=24.8A, 3000W(1ms)	DO-214AB	1d	1a	Bm
HGR	TV30C750J-G	TVS	Vrwm=75.0V, Vbr=83.30..92.10V, Ipp=24.79A, 3000W(1ms)	DO-214AB	1d	1a	Cmc
HGS	3.0SMCJ78	TVS	Vbr=86.7..109.8V, Vrwm=78V, 21.6A, 3000W(1ms)	DO-214AB	1d	1m,1w	Pjt,Srj
HGS	SMLJ78	TVS	Vrwm=78V, Vbr=86.7..106V, Ipp=21.6A, 3000W(1ms)	DO-214AB	1a	1a	Mco
HGS	TV30C780K-G	TVS	Vrwm=78.0V, Vbr=86.70..106.0V, Ipp=21.58A, 3000W(1ms)	DO-214AB	1d	1a	Cmc
HGT	3.0SMCJ78A	TVS	Vbr=86.7..99.7V, Vrwm=78V, 22.8A, 3000W(1ms)	DO-214AB	1d	1m,1w	Pjt,Srj
HGT	CD214L-T78ALF	TVS	Vbr=86.70..95.80V, Vrwm=78V, Irsrm=22.8A, 3000W(1ms)	DO-214AB	1d	1a	Bm
HGT	SMLJ78A	TVS	Vbr=86.70..95.80V, Vrwm=78V, Irsrm=22.8A, 3000W(1ms)	DO-214AB	1d	1a	Bm
HGT	TV30C780J-G	TVS	Vrwm=78.0V, Vbr=86.70..95.80V, Ipp=23.81A, 3000W(1ms)	DO-214AB	1d	1a	Cmc
HGU	3.0SMCJ85	TVS	Vbr=94.4..119.2V, Vrwm=85V, 19.8A, 3000W(1ms)	DO-214AB	1d	1m,1w	Pjt,Srj
HGU	SMLJ85	TVS	Vrwm=85V, Vbr=94.4..115V, Ipp=19.8A, 3000W(1ms)	DO-214AB	1a	1a	Mco
HGU	TV30C850K-G	TVS	Vrwm=85.0V, Vbr=94.40..115.0V, Ipp=19.87A, 3000W(1ms)	DO-214AB	1d	1a	Cmc
HGV	3.0SMCJ85A	TVS	Vbr=94.4..108.2V, Vrwm=85V, 20.8A, 3000W(1ms)	DO-214AB	1d	1m,1w	Pjt,Srj
HGV	CD214L-T85ALF	TVS	Vbr=94.40..104.30V, Vrwm=85V, Irsrm=20.8A, 3000W(1ms)	DO-214AB	1d	1a	Bm
HGV	SMLJ85A	TVS	Vbr=94.40..104.30V, Vrwm=85V, Irsrm=20.8A, 3000W(1ms)	DO-214AB	1d	1a	Bm
HGV	TV30C850J-G	TVS	Vrwm=85.0V, Vbr=94.40..104.0V, Ipp=21.90A, 3000W(1ms)	DO-214AB	1d	1a	Cmc
HGW	3.0SMCJ90	TVS	Vbr=100..126.5V, Vrwm=90V, 18.8A, 3000W(1ms)	DO-214AB	1d	1m,1w	Pjt,Srj
HGW	SMLJ90	TVS	Vrwm=90V, Vbr=100..122V, Ipp=18.8A, 3000W(1ms)	DO-214AB	1a	1a	Mco
HGW	TV30C900K-G	TVS	Vrwm=90.0V, Vbr=100.0..122.0V, Ipp=18.75A, 3000W(1ms)	DO-214AB	1d	1a	Cmc
HGX	3.0SMCJ90A	TVS	Vbr=100..115.5V, Vrwm=90V, 20.6A, 3000W(1ms)	DO-214AB	1d	1m,1w	Pjt,Srj
HGX	CD214L-T90ALF	TVS	Vbr=100.0..110.50V, Vrwm=90V, Irsrm=20.6A, 3000W(1ms)	DO-214AB	1d	1a	Bm
HGX	SMLJ90A	TVS	Vbr=100.0..110.50V, Vrwm=90V, Irsrm=20.6A, 3000W(1ms)	DO-214AB	1d	1a	Bm
HGX	TV30C900J-G	TVS	Vrwm=90.0V, Vbr=100.0..111.0V, Ipp=20.55A, 3000W(1ms)	DO-214AB	1d	1a	Cmc
HGY	3.0SMCJ100	TVS	Vbr=111..141.0V, Vrwm=100V, 16.6A, 3000W(1ms)	DO-214AB	1d	1m,1w	Pjt,Srj
HGY	SMLJ100	TVS	Vrwm=100V, Vbr=111..136V, Ipp=16.8A, 3000W(1ms)	DO-214AB	1a	1a	Mco
HGY	TV30C101K-G	TVS	Vrwm=100.0V, Vbr=111.0..136.0V, Ipp=16.76A, 3000W(1ms)	DO-214AB	1d	1a	Cmc
HGZ	3.0SMCJ100A	TVS	Vbr=111..128.0V, Vrwm=100V, 18.6A, 3000W(1ms)	DO-214AB	1d	1m,1w	Pjt,Srj
HGZ	CD214L-T100ALF	TVS	Vbr=111.0..122.70V, Vrwm=100V, Irsrm=18.6A, 3000W(1ms)	DO-214AB	1d	1a	Bm
HGZ	SMLJ100A	TVS	Vbr=111.0..122.70V, Vrwm=100V, Irsrm=18.6A, 3000W(1ms)	DO-214AB	1d	1a	Bm
HGZ	TV30C101J-G	TVS	Vrwm=100.0V, Vbr=111.0..123.0V, Ipp=18.52A, 3000W(1ms)	DO-214AB	1d	1a	Cmc
HH	3T150C	Thy-SPD	Vdcm=140V, Vs=180V, Ipp=100A, 70pF	DO-214AA	1d	1a	Mde
HH	DDZ9689	Z-diode	5.1V±5%, 500mW	SOD-123	5d	1d	Di
HH	DDZ9689S	Z-diode	2.4V±5%, 200mW	SOD-323	5d	1d	Di
HH	DDZ9689T	Z-diode	5.1V±1%, Izt=50µA, 150mW	SOD-523	8d	1a	Di
HH	MM5Z7B5H	Z-diode	7.35..7.65V, Zzt=30Q, Izt=5mA, 200mW	SOD-523	7d	1a	Zow
HH	P1500SC	Thy-SPD	Vdcm=140V, Vs=180V, Ipp=100A(1ms), Bidirectional	DO-214AA	1ba	1j	Mde
HH	P4SMAJ6.5	TVS	Vbr=6.5V, 32.5A, 400W (1ms)	DO-214AC	1d	1m,1w	Pjt,Srj
HH	PZU10BL	Z-diode	10V±5%, If=200mA, 250mW	SOT-882	13d	2b	Phi
HH	PZU12B2	Z-diode	11.74..12.24V, Zzt=10Q(Izt=5mA), 310mW	SOD-323FL	7d	1a	Phi
HH	T150CB-LC	Thy-SPD	V Of-St=140V, Vs=180V, Ipp=100A(1ms), Bidirectional	DO-214AA	1ba	1j	Wtr
HH	Z2SMB-62	Z-diode	62V±5%, 2W	DO-214AA	1d	2j	Fag
HHA	TV30C141K-G	TVS	Vrwm=140.0V, Vbr=155.68..190.4V, Ipp=11.97A, 3000W(1ms)	DO-214AB	1d	1a	Cmc



SMD
code

Type

Function

Short description

Case

Pinout

St.

Mnf.

SMD code	Type	Function	Short description	Case	Pinout	St.	Mnf.
HBB	TV30C141J-G	TVS	Vrwm=140.0V, Vbr=155.0..171.0V, lpp=13.23A, 3000W(1ms)	DO-214AB	1d	1a	Cmc
HBD	3.0SMCJ110	TVS	Vbr=122..154.5V, Vrwm=110V, 15.4A, 3000W(1ms)	DO-214AB	1d	1m,1w	Pjt,Srj
HBD	SMLJ110	TVS	Vrwm=110V, Vbr=122..149V, lpp=15.4A, 3000W(1ms)	DO-214AB	1a	1a	Mco
HBD	TV30C111K-G	TVS	Vrwm=110.0V, Vbr=122.0..149.0V, lpp=15.31A, 3000W(1ms)	DO-214AB	1d	1a	Cmc
HBE	3.0SMCJ110A	TVS	Vbr=122..140.5V, Vrwm=110V, 16.8A, 3000W(1ms)	DO-214AB	1d	1m,1w	Pjt,Srj
HBE	CD214L-T110ALF	TVS	Vbr=122.0..134.80V, Vrwm=110V, lrm=16.8A, 3000W(1ms)	DO-214AB	1d	1a	Bm
HBE	SMLJ110A	TVS	Vbr=122.0..134.80V, Vrwm=110V, lrm=16.8A, 3000W(1ms)	DO-214AB	1d	1a	Bm
HBE	TV30C111J-G	TVS	Vrwm=110.0V, Vbr=122.0..135.0V, lpp=16.9A, 3000W(1ms)	DO-214AB	1d	1a	Cmc
HBF	3.0SMCJ120	TVS	Vbr=133..169.0V, Vrwm=120V, 14.0A, 3000W(1ms)	DO-214AB	1d	1m,1w	Pjt,Srj
HBF	SMLJ120	TVS	Vrwm=120V, Vbr=133..163V, lpp=14.0A, 3000W(1ms)	DO-214AB	1a	1a	Mco
HBF	TV30C121K-G	TVS	Vrwm=120.0V, Vbr=133.0..163.0V, lpp=14.02A, 3000W(1ms)	DO-214AB	1d	1a	Cmc
HBG	3.0SMCJ120A	TVS	Vbr=133..153.0V, Vrwm=120V, 15.6A, 3000W(1ms)	DO-214AB	1d	1m,1w	Pjt,Srj
HBG	CD214L-T120ALF	TVS	Vbr=133.0..147.0V, Vrwm=120V, lrm=15.6A, 3000W(1ms)	DO-214AB	1d	1a	Bm
HBG	SMLJ120A	TVS	Vbr=133.0..147.0V, Vrwm=120V, lrm=15.6A, 3000W(1ms)	DO-214AB	1d	1a	Bm
HBG	TV30C121J-G	TVS	Vrwm=120.0V, Vbr=133.0..147.0V, lpp=15.54A, 3000W(1ms)	DO-214AB	1d	1a	Cmc
HHH	3.0SMCJ130	TVS	Vbr=144..182.5V, Vrwm=130V, 13.0A, 3000W(1ms)	DO-214AB	1d	1m,1w	Pjt,Srj
HHH	CD214L-T130ALF	TVS	Vbr=144.0..159.20V, Vrwm=130V, lrm=14.4A, 3000W(1ms)	DO-214AB	1d	1a	Bm
HHH	SMLJ130	TVS	Vrwm=130V, Vbr=144..176V, lpp=13.0A, 3000W(1ms)	DO-214AB	1a	1a	Mco
HHH	SMLJ130A	TVS	Vbr=144.0..159.20V, Vrwm=130V, lrm=14.4A, 3000W(1ms)	DO-214AB	1d	1a	Bm
HHH	TV30C131K-G	TVS	Vrwm=130.0V, Vbr=144.0..176.0V, lpp=12.99A, 3000W(1ms)	DO-214AB	1d	1a	Cmc
HHK	3.0SMCJ130A	TVS	Vbr=144..165.5V, Vrwm=130V, 14.4A, 3000W(1ms)	DO-214AB	1d	1m,1w	Pjt,Srj
HHK	SMLJ130A	TVS	Vrwm=130V, Vbr=144..159V, lpp=14.4A, 3000W(1ms)	DO-214AB	1a	1a	Mco
HHK	TV30C131J-G	TVS	Vrwm=130.0V, Vbr=144.0..159.0V, lpp=14.35A, 3000W(1ms)	DO-214AB	1d	1a	Cmc
HHL	3.0SMCJ150	TVS	Vbr=167..211.5V, Vrwm=150V, 11.2A, 3000W(1ms)	DO-214AB	1d	1m,1w	Pjt,Srj
HHL	3T150CLC	Thy-SPD	Vdm=140V, Vs=180V, lpp=2.2A(1ms), 70pF	DO-214AA	1d	1a	Lfr
HHL	SMLJ150	TVS	Vrwm=150V, Vbr=167..204V, lpp=11.2A, 3000W(1ms)	DO-214AB	1a	1a	Mco
HHL	TV30C151K-G	TVS	Vrwm=150.0V, Vbr=167.0..204.0V, lpp=11.19A, 3000W(1ms)	DO-214AB	1d	1a	Cmc
HHM	3.0SMCJ150A	TVS	Vbr=167..192.5V, Vrwm=150V, 12.4A, 3000W(1ms)	DO-214AB	1d	1m,1w	Pjt,Srj
HHM	CD214L-T150ALF	TVS	Vbr=167.0..184.60V, Vrwm=150V, lrm=12.4A, 3000W(1ms)	DO-214AB	1d	1a	Bm
HHM	SMLJ150A	TVS	Vbr=167.0..184.60V, Vrwm=150V, lrm=12.4A, 3000W(1ms)	DO-214AB	1d	1a	Bm
HHM	TV30C151J-G	TVS	Vrwm=150.0V, Vbr=167.0..185.0V, lpp=12.35A, 3000W(1ms)	DO-214AB	1d	1a	Cmc
HHN	3.0SMCJ160	TVS	Vbr=178..226.0V, Vrwm=160V, 10.4A, 3000W(1ms)	DO-214AB	1d	1m,1w	Pjt,Srj
HHN	SMLJ160	TVS	Vrwm=160V, Vbr=178..218V, lpp=10.4A, 3000W(1ms)	DO-214AB	1a	1a	Mco
HHN	TV30C161K-G	TVS	Vrwm=160.0V, Vbr=178.0..218.0V, lpp=10.45A, 3000W(1ms)	DO-214AB	1d	1a	Cmc
HHP	3.0SMCJ160A	TVS	Vbr=178..205.0V, Vrwm=160V, 11.6A, 3000W(1ms)	DO-214AB	1d	1m,1w	Pjt,Srj
HHP	CD214L-T160ALF	TVS	Vbr=178.0..196.70V, Vrwm=160V, lrm=11.6A, 3000W(1ms)	DO-214AB	1d	1a	Bm
HHP	SMLJ160A	TVS	Vbr=178.0..196.70V, Vrwm=160V, lrm=11.6A, 3000W(1ms)	DO-214AB	1d	1a	Bm
HHP	TV30C161J-G	TVS	Vrwm=160.0V, Vbr=178.0..197.0V, lpp=11.58A, 3000W(1ms)	DO-214AB	1d	1a	Cmc
HHQ	3.0SMCJ170	TVS	Vbr=189..239.5V, Vrwm=170V, 9.8A, 3000W(1ms)	DO-214AB	1d	1m,1w	Pjt,Srj
HHQ	SMLJ170	TVS	Vrwm=170V, Vbr=189..231V, lpp=9.8A, 3000W(1ms)	DO-214AB	1a	1a	Mco
HHQ	TV30C171K-G	TVS	Vrwm=170.0V, Vbr=189.0..231.0V, lpp=9.87A, 3000W(1ms)	DO-214AB	1d	1a	Cmc
HHR	3.0SMCJ170A	TVS	Vbr=189..217.5V, Vrwm=170V, 11.0A, 3000W(1ms)	DO-214AB	1d	1m,1w	Pjt,Srj
HHR	CD214L-T170ALF	TVS	Vbr=189.0..208.90V, Vrwm=170V, lrm=11.0A, 3000W(1ms)	DO-214AB	1d	1a	Bm
HHR	SMLJ170A	TVS	Vbr=189.0..208.90V, Vrwm=170V, lrm=11.0A, 3000W(1ms)	DO-214AB	1d	1a	Bm
HHR	TV30C171J-G	TVS	Vrwm=170.0V, Vbr=189.0..209.0V, lpp=10.91A, 3000W(1ms)	DO-214AB	1d	1a	Cmc
HHS	3.0SMCJ180	TVS	Vbr=198..253.8V, Vrwm=180V, 9.3A, 3000W(1ms)	DO-214AB	1d	1m,1w	Pjt,Srj
HHS	TV30C181K-G	TVS	Vrwm=180.0V, Vbr=200.16..244.80V, lpp=9.31A, 3000W(1ms)	DO-214AB	1d	1a	Cmc
HHT	3.0SMCJ180A	TVS	Vbr=198..230.4V, Vrwm=180V, 10.3A, 3000W(1ms)	DO-214AB	1d	1m,1w	Pjt,Srj
HHT	TV30C181J-G	TVS	Vrwm=180.0V, Vbr=200.0..220.0V, lpp=10.29A, 3000W(1ms)	DO-214AB	1d	1a	Cmc
HHU	3.0SMCJ190	TVS	Vbr=209..267.9V, Vrwm=190V, 8.8A, 3000W(1ms)	DO-214AB	1d	1m,1w	Pjt,Srj
HHU	TV30C191K-G	TVS	Vrwm=190.0V, Vbr=211.28..258.40V, lpp=8.82A, 3000W(1ms)	DO-214AB	1d	1a	Cmc
HHV	3.0SMCJ190A	TVS	Vbr=209..243.2V, Vrwm=190V, 9.7A, 3000W(1ms)	DO-214AB	1d	1m,1w	Pjt,Srj
HHV	TV30C191J-G	TVS	Vrwm=190.0V, Vbr=211.0..232.0V, lpp=9.75A, 3000W(1ms)	DO-214AB	1d	1a	Cmc
HHW	3.0SMCJ200	TVS	Vbr=220..282.0V, Vrwm=200V, 8.4A, 3000W(1ms)	DO-214AB	1d	1m,1w	Pjt,Srj
HHW	TV30C201J-G	TVS	Vrwm=200.0V, Vbr=224.0..247.0V, lpp=9.26A, 3000W(1ms)	DO-214AB	1d	1a	Cmc
HHX	3.0SMCJ200A	TVS	Vbr=220..256.0V, Vrwm=200V, 9.3A, 3000W(1ms)	DO-214AB	1d	1m,1w	Pjt,Srj
HHX	TV30C221J-G	TVS	Vrwm=220.0V, Vbr=246.0..272.0V, lpp=8.43A, 3000W(1ms)	DO-214AB	1d	1a	Cmc
HHY	3.0SMCJ210	TVS	Vbr=231..296.1V, Vrwm=210V, 7.8A, 3000W(1ms)	DO-214AB	1d	1m,1w	Pjt,Srj
HHZ	3.0SMCJ210A	TVS	Vbr=231..268.9V, Vrwm=210V, 8.8A, 3000W(1ms)	DO-214AB	1d	1m,1w	Pjt,Srj
HHZ	TV30C251J-G	TVS	Vrwm=250.0V, Vbr=279.0..309.0V, lpp=7.4A, 3000W(1ms)	DO-214AB	1d	1a	Cmc
HI	3T180C	Thy-SPD	Vdm=160V, Vs=220V, lpp=100A, 70pF	DO-214AA	1d	1a	Mde
HI	P1800SC	Thy-SPD	Vdm=160V, Vs=220V, lpp=100A(1ms), Bidirectional	DO-214AA	1ba	1j	Mde
HI	T180CB-LC	Thy-SPD	V Of-St=160V, Vs=220V, lpp=100A(1ms), Bidirectional	DO-214AA	1ba	1j	Wtr
HID	3.0SMCJ220	TVS	Vbr=242..310.2V, Vrwm=220V, 7.8A, 3000W(1ms)	DO-214AB	1d	1m,1w	Pjt,Srj
HIE	3.0SMCJ220A	TVS	Vbr=242..281.6V, Vrwm=220V, 8.4A, 3000W(1ms)	DO-214AB	1d	1m,1w	Pjt,Srj
HIL	3T180CLC	Thy-SPD	Vdm=160V, Vs=220V, lpp=2.2A(1ms), 70pF	DO-214AA	1d	1a	Lfr
HJ	3T230C	Thy-SPD	Vdm=190V, Vs=260V, lpp=100A, 50pF	DO-214AA	1d	1a	Mde
HJ	DDZ9690	Z-diode	5.6V±5%, 500mW	SOD-123	5d	1d	Di
HJ	DDZ9690S	Z-diode	5.6V±5%, 200mW	SOD-323	5d	1d	Di
HJ	DDZ9690T	Z-diode	5.6V±1%, lzt=50µA, 150mW	SOD-523	8d	1a	Di



SMD
code

Type

Function

Short description

Case

Pinout

St.

Mnf.

SMD code	Type	Function	Short description	Case	Pinout	St.	Mnf.
HJ	MM5Z8B2H	Z-diode	8.036..8.364V, Zzt=30Ω, Izt=5mA, 200mW	SOD-523	7d	1a	Zow
HJ	P2300SC	Thy-SPD	Vdm=190V, Vs=260V, Ipp=100A(1ms), Bidirectional	DO-214AA	1ba	1j	Mde
HJ	PZU13B2	Z-diode	12.91..13.49V, Zzt=10Ω(Izt=5mA), 310mW	SOD-323FL	7d	1a	Phi
HJ	T230CB-LC	Thy-SPD	V Of-St=190V, Vs=260V, Ipp=100A(1ms), Bidirectional	DO-214AA	1ba	1j	Wtr
HJE	TV30C301J-G	TVS	Vrwm=300.0V, Vbr=335.0..371.0V, Ipp=6.17A, 3000W(1ms)	DO-214AB	1d	1a	Cmc
HJG	TV30C351J-G	TVS	Vrwm=350.0V, Vbr=391.0..432.0V, Ipp=5.29A, 3000W(1ms)	DO-214AB	1d	1a	Cmc
HJK	TV30C401J-G	TVS	Vrwm=400.0V, Vbr=447.0..494.0V, Ipp=4.63A, 3000W(1ms)	DO-214AB	1d	1a	Cmc
HJL	3T230CLC	Thy-SPD	Vdm=190V, Vs=260V, Ipp=2.2A(1ms), 60pF	DO-214AA	1d	1a	Lfr
HJM	TV30C441J-G	TVS	Vrwm=440.0V, Vbr=492.0..543.0V, Ipp=4.21A, 3000W(1ms)	DO-214AB	1d	1a	Cmc
HK	3T260C	Thy-SPD	Vdm=220V, Vs=300V, Ipp=100A, 50pF	DO-214AA	1d	1a	Mde
HK	CD214A-T6.5A	TVS	Vbr=6.5V, Irlsm=35.7A, 400W(1ms)	DO-214AC	1d	1a	Bm
HK	DDZ9691	Z-diode	6.2V±5%, 500mW	SOD-123	5d	1d	Di
HK	DDZ9691S	Z-diode	6.2V±5%, 200mW	SOD-323	5d	1d	Di
HK	DDZ9691T	Z-diode	6.2V±1%, Izt=50μA, 150mW	SOD-523	8d	1a	Di
HK	MM5Z9B1H	Z-diode	8.918..9.282V, Zzt=30Ω, Izt=5mA, 200mW	SOD-523	7d	1a	Zow
HK	P2600SC	Thy-SPD	Vdm=220V, Vs=300V, Ipp=100A(1ms), Bidirectional	DO-214AA	1ba	1j	Mde
HK	P4SMAJ6.5A	TVS	Vbr=6.5V, 35.7A, 400W(1ms)	DO-214AC	1d	1m,1w	Pjt,Sj
HK	PZU11BL	Z-diode	11V±5%, If=200mA, 250mW	SOT-882	13d	2b	Phi
HK	PZU14B2	Z-diode	13.7..14.3V, Zzt=10Ω(Izt=5mA), 310mW	SOD-323FL	7d	1a	Phi
HK	SMAJ6.5A	TVS	Vrwm=6.5V, Vbr=7.22..7.98V, 35.7A, 400W(1ms)	DO-214AC	1d	1m	Di
HK	SMF14A	TVS	Vrwm=14.0V, Vbr=15.60..17.20V, 8.62A, 200W(10/1000μs)	SOD-123FL	7d	1a	Ers
HK	T260CB-LC	Thy-SPD	V Of-St=220V, Vs=300V, Ipp=100A(1ms), Bidirectional	SOD-323FL	1ba	1j	Wtr
HK	TV02W140-G	TVS	Vrwm=14V, Vbr=15.6..17.2V, Ipp=8.62A, 200W(1ms)	SOD-123	5d	1a	Cmc
HK	TV04A401JB-G	TVS	Vrwm=400.0V, Vbr=447.0..494.0V, Ipp=0.62A, 400W(1ms), Bidirectional	DO-214AC	1ba	1j	Cmc
HK	Z2SMB-68	Z-diode	68V±5%, 2W	DO-214AA	1d	2j	Fag
HKL	3T260CLC	Thy-SPD	Vdm=220V, Vs=300V, Ipp=2.2A(1ms), 60pF	DO-214AA	1d	1a	Lfr
HL	3T310C	Thy-SPD	Vdm=275V, Vs=350V, Ipp=100A, 40pF	DO-214AA	1d	1a	Mde
HL	DDZ9692	Z-diode	6.9V±5%, 500mW	SOD-123	5d	1d	Di
HL	DDZ9692S	Z-diode	6.9V±5%, 200mW	SOD-323	5d	1d	Di
HL	DDZ9692T	Z-diode	6.8V±1%, Izt=50μA, 150mW	SOD-523	8d	1a	Di
HL	P3100SC	Thy-SPD	Vdm=275V, Vs=350V, Ipp=100A(1ms), Bidirectional	DO-214AA	1ba	1j	Mde
HL	P4SMAJ7.0A	TVS	Vbr=7V, 30.1A, 400W(1ms)	DO-214AC	1d	1m,1w	Pjt,Sj
HL	PZU12BL	Z-diode	12V±5%, If=200mA, 250mW	SOT-882	13d	2b	Phi
HL	PZU15B2	Z-diode	14.34..14.98V, Zzt=15Ω(Izt=5mA), 310mW	SOD-323FL	7d	1a	Phi
HL	T310CB-LC	Thy-SPD	V Of-St=275V, Vs=350V, Ipp=100A(1ms), Bidirectional	DO-214AA	1ba	1j	Wtr
HL	Z2SMB-75	Z-diode	75V±5%, 2W	DO-214AA	1d	2j	Fag
HLL	3T310CLC	Thy-SPD	Vdm=275V, Vs=350V, Ipp=2.2A(1ms), 60pF	DO-214AA	1d	1a	Lfr
HM	3T350C	Thy-SPD	Vdm=300V, Vs=400V, Ipp=100A, 40pF	DO-214AA	1d	1a	Mde
HM	CD214A-T7.0A	TVS	Vbr=7.0V, Irlsm=33.3A, 400W(1ms)	DO-214AC	1d	1a	Bm
HM	DDZ9693	Z-diode	7.5V±5%, 500mW	SOD-123	5d	1d	Di
HM	DDZ9693S	Z-diode	7.5V±5%, 200mW	SOD-323	5d	1d	Di
HM	DDZ9693T	Z-diode	7.5V±1%, Izt=50μA, 150mW	SOD-523	8d	1a	Di
HM	MM5ZB10H	Z-diode	9.8..10.2V, Zzt=30Ω, Izt=5mA, 200mW	SOD-523	7d	1a	Zow
HM	P3500SC	Thy-SPD	Vdm=300V, Vs=400V, Ipp=100A(1ms), Bidirectional	DO-214AA	1ba	1j	Mde
HM	P4SMAJ7.0A	TVS	Vbr=7V, 33.3A, 400W(1ms)	DO-214AC	1d	1m,1w	Pjt,Sj
HM	PZU13BL	Z-diode	13V±5%, If=200mA, 250mW	SOT-882	13d	2b	Phi
HM	PZU16B2	Z-diode	15.85..16.51V, Zzt=20Ω(Izt=5mA), 310mW	SOD-323FL	7d	1a	Phi
HM	SMAJ7.0A	TVS	Vrwm=7.0V, Vbr=7.78..8.6V, 33.3A, 400W(1ms)	DO-214AC	1d	1m	Di
HM	SMF15A	TVS	Vrwm=15.0V, Vbr=16.70..18.50V, 8.20A, 200W(10/1000μs)	SOD-123FL	7d	1a	Ers
HM	T350CB-LC	Thy-SPD	V Of-St=300V, Vs=400V, Ipp=100A(1ms), Bidirectional	DO-214AA	1ba	1j	Wtr
HM	TV02W150-G	TVS	Vrwm=15V, Vbr=16.7..18.5V, Ipp=8.20A, 200W(1ms)	SOD-123	5d	1a	Cmc
HM	TV04A441JB-G	TVS	Vrwm=440.0V, Vbr=492.0..543.0V, Ipp=0.56A, 400W(1ms), Bidirectional	DO-214AC	1ba	1j	Cmc
HM	Z2SMB-82	Z-diode	82V±5%, 2W	DO-214AA	1d	2j	Fag
HML	3T350CLC	Thy-SPD	Vdm=300V, Vs=400V, Ipp=2.2A(1ms), 60pF	DO-214AA	1d	1a	Lfr
HN	DDZ9694	Z-diode	8.2V±5%, 500mW	SOD-123	5d	1d	Di
HN	DDZ9694S	Z-diode	8.2V±5%, 200mW	SOD-323	5d	1d	Di
HN	DDZ9694T	Z-diode	8.2V±1%, Izt=50μA, 150mW	SOD-523	8d	1a	Di
HN	MM5ZB11H	Z-diode	10.78..11.22V, Zzt=30Ω, Izt=5mA, 200mW	SOD-523	7d	1a	Zow
HN	P4SMAJ7.5	TVS	Vbr=7.5V, 28A, 400W(1ms)	DO-214AC	1d	1m,1w	Pjt,Sj
HN	PZU15BL	Z-diode	15V±5%, If=200mA, 250mW	SOT-882	13d	2b	Phi
HN	PZU18B2	Z-diode	17.56..18.35V, Zzt=20Ω(Izt=5mA), 310mW	SOD-323FL	7d	1a	Phi
HN	Z2SMB-91	Z-diode	91V±5%, 2W	DO-214AA	1d	2j	Fag
HP	CD214A-T7.5A	TVS	Vbr=7.5V, Irlsm=31.0A, 400W(1ms)	DO-214AC	1d	1a	Bm
HP	CMDZ3L9	Z-diode	3.705..4.095V, Izt=0.5mA, Zzt=900Ω, 250mW	SOD-323	5d	1a	Cen
HP	DDZ9696	Z-diode	9.1V±5%, 500mW	SOD-123	5d	1d	Di
HP	DDZ9696S	Z-diode	9.1V±5%, 200mW	SOD-323	5d	1d	Di
HP	DDZ9696T	Z-diode	9.1V±1%, Izt=50μA, 150mW	SOD-523	8d	1a	Di
HP	KDZ12FVY	Z-diode	11.74..12.24V, Izt=5mA, Zzt=15Ω, 100mW	TFSC	7d	1a	Kec
HP	MM5ZB12H	Z-diode	11.76..12.24V, Zzt=35Ω, Izt=5mA, 200mW	SOD-523	7d	1a	Zow
HP	P4SMAJ7.5A	TVS	Vbr=7.5V, 31A, 400W(1ms)	DO-214AC	1d	1m,1w	Pjt,Sj



SMD
code

Type

Function

Short description

Case

Pinout

St.

Mnf.

SMD code	Type	Function	Short description	Case	Pinout	St.	Mnf.
HP	PZU16BL	Z-diode	16V±5%, If=200mA, 250mW	SOT-882	13d	2b	Phi
HP	PZU20B2	Z-diode	19.52..20.39V, Zzt=20Ω(zt=5mA), 310mW	SOD-323FL	7d	1a	Phi
HP	SMAJ7.5A	TVS	Vrwm=7.5V, Vbr=8.33..9.21V, 31A, 400W(1ms)	DO-214AC	1d	1m	Di
HP	SMF16A	TVS	Vrwm=16.0V, Vbr=17.80..19.70V, 7.69A, 200W(10/1000μs)	SOD-123FL	7d	1a	Ers
HP	TV02W160-G	TVS	Vrwm=16V, Vbr=17.8..19.7V, Ipp=7.69A, 200W(1ms)	SOD-123	5d	1a	Cmc
HP	Z2SMB-100	Z-diode	100V±5%, 2W	DO-214AA	1d	2j	Fag
HQ	DDZ9697	Z-diode	10V±5%, 500mW	SOD-123	5d	1d	Di
HQ	DDZ9697S	Z-diode	10V±5%, 200mW	SOD-323	5d	1d	Di
HQ	DDZ9697T	Z-diode	10V±1%, Izt=50μA, 150mW	SOD-523	8d	1a	Di
HQ	P4SMAJ8.0	TVS	Vbr=8V, 26.5A, 400W(1ms)	DO-214AC	1d	1m,1w	Pjt,Srj
HQ	PZU22B2	Z-diode	21.54..22.47V, Zzt=25Ω(zt=5mA), 310mW	SOD-323FL	7d	1a	Phi
HQ	Z2SMB-110	Z-diode	110V±5%, 2W	DO-214AA	1d	2j	Fag
HR	CD214A-T8.0A	TVS	Vbr=8.0V, Irs=29.4A, 400W(1ms)	DO-214AC	1d	1a	Bm
HR	DDZ9698	Z-diode	11V±5%, 500mW	SOD-123	5d	1d	Di
HR	DDZ9698S	Z-diode	11V±5%, 200mW	SOD-323	5d	1d	Di
HR	DDZ9698T	Z-diode	11V±1%, Izt=50μA, 150mW	SOD-523	8d	1a	Di
HR	MM5ZB13H	Z-diode	12.74..13.26V, Zzt=35Ω, Izt=5mA, 200mW	SOD-523	7d	1a	Zow
HR	P4SMAJ8.0A	TVS	Vbr=8V, 29.4A, 400W(1ms)	DO-214AC	1d	1m,1w	Pjt,Srj
HR	PZU18BL	Z-diode	18V±5%, If=200mA, 250mW	SOT-882	13d	2b	Phi
HR	PZU24B2	Z-diode	23.72..24.78V, Zzt=30Ω(zt=5mA), 310mW	SOD-323FL	7d	1a	Phi
HR	SMAJ8.0A	TVS	Vrwm=8.0V, Vbr=8.89..9.83V, 29.4A, 400W(1ms)	DO-214AC	1d	1m	Di
HR	SMF17A	TVS	Vrwm=17.0V, Vbr=18.90..20.90V, 7.25A, 200W(10/1000μs)	SOD-123FL	7d	1a	Ers
HR	TV02W170-G	TVS	Vrwm=17V, Vbr=18.9..20.9V, Ipp=7.25A, 200W(1ms)	SOD-123	5d	1a	Cmc
HR	Z2SMB-120	Z-diode	120V±5%, 2W	DO-214AA	1d	2j	Fag
HS	3T400C	Thy-SPD	Vdm=360V, Vs=450V, Ipp=100A, 40pF	DO-214AA	1d	1a	Mde
HS	DDZ9699	Z-diode	12V±5%, 500mW	SOD-123	5d	1d	Di
HS	DDZ9699S	Z-diode	12V±5%, 200mW	SOD-323	5d	1d	Di
HS	DDZ9699T	Z-diode	12V±1%, Izt=50μA, 150mW	SOD-523	8d	1a	Di
HS	P4000SC	Thy-SPD	Vdm=360V, Vs=150V, Ipp=100A(1ms), Bidirectional	DO-214AA	1ba	1j	Mde
HS	P4SMAJ8.5	TVS	Vbr=8.5V, 25.1A, 400W(1ms)	DO-214AC	1d	1m,1w	Pjt,Srj
HS	PZU20BL	Z-diode	20V±5%, If=200mA, 250mW	SOT-882	13d	2b	Phi
HS	PZU4.3B3	Z-diode	4.28..4.48V, Zzt=90Ω(zt=5mA), 310mW	SOD-323FL	7d	1a	Phi
HS	T400CBL-C	Thy-SPD	V Of-St=360V, Vs=450V, Ipp=100A(1ms), Bidirectional	DO-214AA	1ba	1j	Wtr
HS	Z2SMB-130	Z-diode	130V±5%, 2W	DO-214AA	1d	2j	Fag
HS11	HSM11PT	Si-diode	Rectifier, U-fast, 50V, 1A	DO-214AC	1d	1a	Chm
HS12	HSM12PT	Si-diode	Rectifier, U-fast, 100V, 1A	DO-214AC	1d	1a	Chm
HS13	HSM13PT	Si-diode	Rectifier, U-fast, 200V, 1A	DO-214AC	1d	1a	Chm
HS14	HSM14PT	Si-diode	Rectifier, U-fast, 300V, 1A	DO-214AC	1d	1a	Chm
HS15	HSM15PT	Si-diode	Rectifier, U-fast, 400V, 1A	DO-214AC	1d	1a	Chm
HS16	HSM16PT	Si-diode	Rectifier, U-fast, 600V, 1A	DO-214AC	1d	1a	Chm
HS17	HSM17PT	Si-diode	Rectifier, U-fast, 800V, 1A	DO-214AC	1d	1a	Chm
HS18	HSM18PT	Si-diode	Rectifier, U-fast, 1000V, 1A	DO-214AC	1d	1a	Chm
HS21	HSM21PT	Si-diode	Rectifier, U-fast, 50V, 2A	DO-214AC	1d	1a	Chm
HS22	HSM22PT	Si-diode	Rectifier, U-fast, 100V, 2A	DO-214AC	1d	1a	Chm
HS23	HSM23PT	Si-diode	Rectifier, U-fast, 200V, 2A	DO-214AC	1d	1a	Chm
HS24	HSM24PT	Si-diode	Rectifier, U-fast, 300V, 2A	DO-214AC	1d	1a	Chm
HS25	HSM25PT	Si-diode	Rectifier, U-fast, 400V, 2A	DO-214AC	1d	1a	Chm
HS26	HSM26PT	Si-diode	Rectifier, U-fast, 600V, 2A	DO-214AC	1d	1a	Chm
HS27	HSM27PT	Si-diode	Rectifier, U-fast, 800V, 2A	DO-214AC	1d	1a	Chm
HS28	HSM28PT	Si-diode	Rectifier, U-fast, 1000V, 2A	DO-214AC	1d	1a	Chm
HT	CD214A-T8.5A	TVS	Vbr=8.5V, Irs=27.7A, 400W(1ms)	DO-214AC	1d	1a	Bm
HT	DDZ9700	Z-diode	13V±5%, 500mW	SOD-123	5d	1d	Di
HT	DDZ9700S	Z-diode	13V±5%, 200mW	SOD-323	5d	1d	Di
HT	DDZ9700T	Z-diode	13V±1%, Izt=50μA, 150mW	SOD-523	8d	1a	Di
HT	P4SMAJ8.5A	TVS	Vbr=8.5V, 27.7A, 400W(1ms)	DO-214AC	1d	1m,1w	Pjt,Srj
HT	PZU22BL	Z-diode	22V±5%, If=200mA, 250mW	SOT-882	13d	2b	Phi
HT	PZU4.7B3	Z-diode	4.69..4.9V, Zzt=80Ω(zt=5mA), 310mW	SOD-323FL	7d	1a	Phi
HT	SMAJ8.5A	TVS	Vrwm=8.5V, Vbr=9.44..10.4V, 27.8A, 400W(1ms)	DO-214AC	1d	1m	Di
HT	SMF18A	TVS	Vrwm=18.0V, Vbr=20.0..22.10V, 6.85A, 200W(10/1000μs)	SOD-123FL	7d	1a	Ers
HT	TV02W180-G	TVS	Vrwm=18V, Vbr=20.0..22.1V, Ipp=6.85A, 200W(1ms)	SOD-123	5d	1a	Cmc
HT	Z2SMB-150	Z-diode	150V±5%, 2W	DO-214AA	1d	2j	Fag
HU	DDZ9701	Z-diode	14V±5%, 500mW	SOD-123	5d	1d	Di
HU	DDZ9701S	Z-diode	14V±5%, 200mW	SOD-323	5d	1d	Di
HU	DDZ9701T	Z-diode	14V±1%, Izt=50μA, 150mW	SOD-523	8d	1a	Di
HU	P4SMAJ9.0	TVS	Vbr=9V, 23.6A, 400W(1ms)	DO-214AC	1d	1m,1w	Pjt,Srj
HU	PZU24BL	Z-diode	24V±5%, If=200mA, 250mW	SOT-882	13d	2b	Phi
HU	PZU5.1B3	Z-diode	5.14..5.37V, Zzt=60Ω(zt=5mA), 310mW	SOD-323FL	7d	1a	Phi
HU	Z2SMB-160	Z-diode	160V±5%, 2W	DO-214AA	1d	2j	Fag
HV	CD214A-T9.0A	TVS	Vbr=9.0V, Irs=26.0A, 400W(1ms)	DO-214AC	1d	1a	Bm
HV	DDZ9702	Z-diode	15V±5%, 500mW	SOD-123	5d	1d	Di



SMD
code

Type

Function

Short description

Case

Pinout

St.

Mnf.

SMD code	Type	Function	Short description	Case	Pinout	St.	Mnf.
HV	DDZ9702S	Z-diode	15V±5%, 200mW	SOD-323	5d	1d	Di
HV	DDZ9702T	Z-diode	15V±1%, Izt=50µA, 150mW	SOD-523	8d	1a	Di
HV	P4SMAJ9.0A	TVS	Vbr=9V, 26A, 400W(1ms)	DO-214AC	1d	1m,1w	Pjt,Srj
HV	PZU27BL	Z-diode	27V±5%, If=200mA, 250mW	SOT-882	13d	2b	Phi
HV	PZU5.6B3	Z-diode	5.67..5.92V, Zzt=40Ω(Izt=5mA), 310mW	SOD-323FL	7d	1a	Phi
HV	SMAJ9.0A	TVS	Vrwm=9.0V, Vbr=10.0..11.1V, 26A, 400W(1ms)	DO-214AC	1d	1m	Di
HV	SMF20A	TVS	Vrwm=20.0V, Vbr=22.20..24.50V, 6.17A, 200W(10/1000µs)	SOD-123FL	7d	1a	Ers
HV	TV02W200-G	TVS	Vrwm=20V, Vbr=22.2..24.5V, Ipp=6.17A, 200W(1ms)	SOD-123	5d	1a	Cmc
HV	Z2SMB-180	Z-diode	180V±5%, 2W	DO-214AA	1d	2j	Fag
HW	DDZ9703	Z-diode	16V±5%, 500mW	SOD-123	5d	1d	Di
HW	DDZ9703S	Z-diode	16V±5%, 200mW	SOD-323	5d	1d	Di
HW	DDZ9703T	Z-diode	16V±1%, Izt=50µA, 150mW	SOD-523	8d	1a	Di
HW	P4SMAJ10	TVS	Vbr=10V, 21.2A, 400W(1ms)	DO-214AC	1d	1m,1w	Pjt,Srj
HW	PZU30BL	Z-diode	30V±5%, If=200mA, 250mW	SOT-882	13d	2b	Phi
HW	PZU6.2B3	Z-diode	6.26..6.53V, Zzt=30Ω(Izt=5mA), 310mW	SOD-323FL	7d	1a	Phi
HW	Z2SMB-200	Z-diode	200V±5%, 2W	DO-214AA	1d	2j	Fag
HX	CD214A-T10A	TVS	Vbr=10V, Irsrm=23.5A, 400W(1ms)	DO-214AC	1d	1a	Bm
HX	MMSZB15H	Z-diode	14.7..15.3V, Zzt=40Ω, Izt=5mA, 200mW	SOD-523	7d	1a	Zow
HX	P4SMAJ10A	TVS	Vbr=10V, 23.5A, 400W(1ms)	DO-214AC	1d	1m,1w	Pjt,Srj
HX	PZU33BL	Z-diode	33V±5%, If=200mA, 250mW	SOT-882	13d	2b	Phi
HX	PZU6.8B3	Z-diode	6.86..7.14V, Zzt=20Ω(Izt=5mA), 310mW	SOD-323FL	7d	1a	Phi
HX	SMAJ10A	TVS	Vrwm=10V, Vbr=11.1..12.3V, 21.7A, 400W(1ms)	DO-214AC	1d	1m	Di
HX	SMF22A	TVS	Vrwm=22.0V, Vbr=24.40..26.90V, 5.63A, 200W(10/1000µs)	SOD-123FL	7d	1a	Ers
HX	TV02W220-G	TVS	Vrwm=22V, Vbr=24.4..26.9V, Ipp=5.63A, 200W(1ms)	SOD-123	5d	1a	Cmc
HY	DDZ9705	Z-diode	18V±5%, 500mW	SOD-123	5d	1d	Di
HY	DDZ9705S	Z-diode	18V±5%, 200mW	SOD-323	5d	1d	Di
HY	DDZ9705T	Z-diode	18V±1%, Izt=50µA, 150mW	SOD-523	8d	1a	Di
HY	KDZ3.9VYY	Z-diode	3.89..4.16V, Izt=5mA, Zzt=130Ω, 100mW	VSC	7d	1a	Kec
HY	MMSZB16H	Z-diode	15.68..16.32V, Zzt=40Ω, Izt=5mA, 200mW	SOD-523	7d	1a	Zow
HY	P4SMAJ11	TVS	Vbr=11V, 20A, 400W(1ms)	DO-214AC	1d	1m,1w	Pjt,Srj
HY	PZU36BL	Z-diode	36V±5%, If=200mA, 250mW	SOT-882	13d	2b	Phi
HY	PZU7.5B3	Z-diode	7.52..7.84V, Zzt=10Ω(Izt=5mA), 310mW	SOD-323FL	7d	1a	Phi
HZ	BZT52-B12S	Z-diode	11.76..12.24V, Izt=5mA, Zzt=25Ω, 200mW	SOD-323FL	7d	1a	Tsc
HZ	CD214A-T11A	TVS	Vbr=11V, Irsrm=22.0A, 400W(1ms)	DO-214AC	1d	1a	Bm
HZ	MM3Z12VB	Z-diode	11.76..12.24V, Zzt=23Ω, Izt=5mA, 200mW	SOD-323FL	7d	1a	F
HZ	MM3Z12VBW	Z-diode	11.76..12.24V, Izt=5mA, Zzt=25Ω, 200mW	SOD-323FL	7d	1a	Tac
HZ	MMSZB18H	Z-diode	17.64..18.36V, Zzt=45Ω, Izt=5mA, 200mW	SOD-523	7d	1a	Zow
HZ	P4SMAJ11A	TVS	Vbr=11V, 22A, 400W(1ms)	DO-214AC	1d	1m,1w	Pjt,Srj
HZ	PZU2.7B2L	Z-diode	2.7V±2%, If=200mA, 250mW	SOT-882	13d	2b	Phi
HZ	PZU8.2B3	Z-diode	8.28..8.64V, Zzt=10Ω(Izt=5mA), 310mW	SOD-323FL	7d	1a	Phi
HZ	SMAJ11A	TVS	Vrwm=11V, Vbr=12.2..13.5V, 22A, 400W(1ms)	DO-214AC	1d	1m	Di
HZ	SMF24A	TVS	Vrwm=24.0V, Vbr=26.70..29.50V, 5.14A, 200W(10/1000µs)	SOD-123FL	7d	1a	Ers
HZ	TCMM3Z12VB	Z-diode	12V±2%, Izt=5mA, Zzt=23Ω, 200mW	SOD-323FL	7d	1a	Tac
HZ	TV02W240-G	TVS	Vrwm=24V, Vbr=26.7..29.5V, Ipp=5.14A, 200W(1ms)	SOD-123	5d	1a	Cmc
I	1N6263WT	Si-diode	SBD, VHF/UHF-Def, 60V, 15mA, Vt<1V(15mA), 2pF	SOD-523FL	7d	1a	Sme
I	MMSZ5235BPT	Z-diode	6.460..7.140V, Izt=5mA, Zzt=8Ω, 225mW	SOD-523	7d	1a	Chm
I	MMSZ5259BPT	Z-diode	37.05..40.95V, Izt=5mA, Zzt=130Ω, 225mW	SOD-523	7d	1a	Chm
I	MMSZ5235SPT	Z-diode	6.664..6.936V, Izt=5mA, Zzt=8Ω, 225mW	SOD-523	7d	1a	Chm
I	MMSZ5259SPT	Z-diode	38.22..39.78V, Izt=5mA, Zzt=130Ω, 225mW	SOD-523	7d	1a	Chm
I0	MMPZ5239SPT	Z-diode	8.918..9.282V, Izt=5mA, Zzt=10Ω, 225mW	SOD-323	5d	1a	Chm
I8	MM5Z5V6	Z-diode	5.6V±5%, Izt=5mA, Zzt=40Ω, 200mW	SOD-523	6d	1a	Eic
I8	MM5Z5V6H	Z-diode	5.2..6V, Izt=5mA, Zzt=40Ω, 200mW	SOD-523	7d	1a	Zow
I9	MM5Z68H	Z-diode	64..72V, Izt=1mA, Zzt=240Ω, 200mW	SOD-523	7d	1a	Zow
I9	MM5Z68V	Z-diode	68V±5%, Izt=2mA, Zzt=240Ω, 200mW	SOD-523	6d	1a	Eic
ID	P4SMAJ12	TVS	Vbr=12V, 18.1A, 400W(1ms)	DO-214AC	1d	1m,1w	Pjt,Srj
IDD	3.0SMCJ5.0C	TVS	Vbr=6.4..7.55V, Vrwm=5.0V, 312.5A, 3000W(1ms), Bidirectional	DO-214AB	1ba	1x,1y	Pjt,Srj
IDD	SMLJ5.0C	TVS	Vrwm=5.0V, Vbr=6.40..7.30V, Ipp=312.5A, 3000W(1ms), Bidirectional	DO-214AB	1a	1j	Mco
IDD	TV30C5V0KB-G	TVS	Vrwm=5.0V, Vbr=6.40..7.30V, Ipp=312.50A, 3000W(1ms), Bidirectional	DO-214AB	1ba	1j	Cmc
IDE	3.0SMCJ5.0CA	TVS	Vbr=6.4..7.25V, Vrwm=5.0V, 326A, 3000W(1ms), Bidirectional	DO-214AB	1ba	1x,1y	Pjt,Srj
IDE	CD214L-T5.0ALF	TVS	Vbr=6.40..7.82V, Vrwm=5V, Irsrm=326.0A, 3000W(1ms)	DO-214AB	1d	1a	Bm
IDE	CD214L-T5.0CALF	TVS	Vbr=6.40..7.82V, Vrwm=5V, Irsrm=326.0A, 3000W(1ms), Bidirectional	DO-214AB	1d	1j	Bm
IDE	SMLJ5.0A	TVS	Vbr=6.40..7.82V, Vrwm=5V, Irsrm=326.0A, 3000W(1ms)	DO-214AB	1d	1a	Bm
IDE	SMLJ5.0CA	TVS	Vbr=6.40..7.82V, Vrwm=5V, Irsrm=326.0A, 3000W(1ms), Bidirectional	DO-214AB	1d	1j	Bm
IDE	TV30C5V0JB-G	TVS	Vrwm=5.0V, Vbr=6.40..7.0V, Ipp=326.09A, 3000W(1ms), Bidirectional	DO-214AB	1ba	1j	Cmc
IDF	3.0SMCJ6.0C	TVS	Vbr=6.67..8.45V, Vrwm=6.0V, 263.2A, 3000W(1ms), Bidirectional	DO-214AB	1ba	1x,1y	Pjt,Srj
IDF	SMLJ6.0C	TVS	Vrwm=6.0V, Vbr=6.67..8.15V, Ipp=263.2A, 3000W(1ms), Bidirectional	DO-214AB	1a	1j	Mco
IDF	TV30C6V0KB-G	TVS	Vrwm=6.0V, Vbr=6.67..8.15V, Ipp=263.16A, 3000W(1ms), Bidirectional	DO-214AB	1ba	1j	Cmc
IDG	3.0SMCJ6.0CA	TVS	Vbr=6.67..7.67V, Vrwm=6.0V, 291.3A, 3000W(1ms), Bidirectional	DO-214AB	1ba	1x,1y	Pjt,Srj
IDG	CD214L-T6.0ALF	TVS	Vbr=6.67..8.15V, Vrwm=6V, Irsrm=291.3A, 3000W(1ms)	DO-214AB	1d	1a	Bm
IDG	CD214L-T6.0CALF	TVS	Vbr=6.67..8.15V, Vrwm=6V, Irsrm=291.3A, 3000W(1ms), Bidirectional	DO-214AB	1d	1j	Bm



SMD
code

Type

Function

Short description

Case

Pinout

St.

Mnf.

IDG	SMLJ6.0A	TVS	Vbr=6.67..8.15V, Vrwm=6V, Irs=291.3A, 3000W(1ms)	DO-214AB	1d	1a	Bm
IDG	SMLJ6.0CA	TVS	Vbr=6.67..8.15V, Vrwm=6V, Irs=291.3A, 3000W(1ms), Bidirectional	DO-214AB	1d	1j	Bm
IDG	TV30C6V0JB-G	TVS	Vrwm=6.0V, Vbr=6.67..7.37V, Ipp=291.26A, 3000W(1ms), Bidirectional	DO-214AB	1ba	1j	Cmc
IDH	3.0SMCJ6.5C	TVS	Vbr=7.22..9.14V, Vrwm=6.5V, 243.9A, 3000W(1ms), Bidirectional	DO-214AB	1ba	1x,1y	Pjt,Srj
IDH	SMLJ6.5C	TVS	Vrwm=6.5V, Vbr=7.22..8.82V, Ipp=243.9A, 3000W(1ms), Bidirectional	DO-214AB	1a	1j	Mco
IDH	TV30C6V5KB-G	TVS	Vrwm=6.5V, Vbr=7.22..8.82V, Ipp=243.90A, 3000W(1ms), Bidirectional	DO-214AB	1ba	1j	Cmc
IDK	3.0SMCJ6.5CA	TVS	Vbr=7.22..8.30V, Vrwm=6.5V, 267.9A, 3000W(1ms), Bidirectional	DO-214AB	1ba	1x,1y	Pjt,Srj
IDK	CD214L-T6.5ALF	TVS	Vbr=7.22..7.98V, Vrwm=6.5V, Irs=267.9A, 3000W(1ms)	DO-214AB	1d	1a	Bm
IDK	CD214L-T6.5CALF	TVS	Vbr=7.22..7.98V, Vrwm=6.5V, Irs=267.9A, 3000W(1ms), Bidirectional	DO-214AB	1d	1j	Bm
IDK	SMLJ6.5A	TVS	Vbr=7.22..7.98V, Vrwm=6.5V, Irs=267.9A, 3000W(1ms)	DO-214AB	1d	1a	Bm
IDK	SMLJ6.5CA	TVS	Vbr=7.22..7.98V, Vrwm=6.5V, Irs=267.9A, 3000W(1ms), Bidirectional	DO-214AB	1d	1j	Bm
IDK	TV30C6V5JB-G	TVS	Vrwm=6.5V, Vbr=7.22..7.98V, Ipp=267.86A, 3000W(1ms), Bidirectional	DO-214AB	1ba	1j	Cmc
IDL	3.0SMCJ7.0C	TVS	Vbr=7.78..9.86V, Vrwm=7.0V, 225.6A, 3000W(1ms), Bidirectional	DO-214AB	1ba	1x,1y	Pjt,Srj
IDL	SMLJ7.0C	TVS	Vrwm=7.0V, Vbr=7.78..9.51V, Ipp=225.6A, 3000W(1ms), Bidirectional	DO-214AB	1a	1j	Mco
IDL	TV30C7V0KB-G	TVS	Vrwm=7.0V, Vbr=7.78..9.51V, Ipp=225.56A, 3000W(1ms), Bidirectional	DO-214AB	1ba	1j	Cmc
IDM	3.0SMCJ7.0CA	TVS	Vbr=7.78..8.95V, Vrwm=7.0V, 250A, 3000W(1ms), Bidirectional	DO-214AB	1ba	1x,1y	Pjt,Srj
IDM	CD214L-T7.0ALF	TVS	Vbr=7.78..8.60V, Vrwm=7V, Irs=250.0A, 3000W(1ms)	DO-214AB	1d	1a	Bm
IDM	CD214L-T7.0CALF	TVS	Vbr=7.78..8.60V, Vrwm=7V, Irs=250.0A, 3000W(1ms), Bidirectional	DO-214AB	1d	1j	Bm
IDM	SMLJ7.0A	TVS	Vbr=7.78..8.60V, Vrwm=7V, Irs=250.0A, 3000W(1ms)	DO-214AB	1d	1a	Bm
IDM	SMLJ7.0CA	TVS	Vbr=7.78..8.60V, Vrwm=7V, Irs=250.0A, 3000W(1ms), Bidirectional	DO-214AB	1d	1j	Bm
IDM	TV30C7V0JB-G	TVS	Vrwm=7.0V, Vbr=7.78..8.60V, Ipp=250.0A, 3000W(1ms), Bidirectional	DO-214AB	1ba	1j	Cmc
IDN	3.0SMCJ7.5C	TVS	Vbr=8.33..10.67V, Vrwm=7.5V, 209.8A, 3000W(1ms), Bidirectional	DO-214AB	1ba	1x,1y	Pjt,Srj
IDN	SMLJ7.5C	TVS	Vrwm=7.5V, Vbr=8.33..10.2V, Ipp=209.8A, 3000W(1ms), Bidirectional	DO-214AB	1a	1j	Mco
IDN	TV30C7V5KB-G	TVS	Vrwm=7.5V, Vbr=8.33..10.20V, Ipp=209.79A, 3000W(1ms), Bidirectional	DO-214AB	1ba	1j	Cmc
IDP	3.0SMCJ7.5CA	TVS	Vbr=8.33..9.58V, Vrwm=7.5V, 232.6A, 3000W(1ms), Bidirectional	DO-214AB	1ba	1x,1y	Pjt,Srj
IDP	CD214L-T7.5CALF	TVS	Vbr=8.33..9.21V, Vrwm=7.5V, Irs=232.6A, 3000W(1ms), Bidirectional	DO-214AB	1d	1j	Bm
IDP	SMLJ7.5CA	TVS	Vbr=8.33..9.21V, Vrwm=7.5V, Irs=232.6A, 3000W(1ms), Bidirectional	DO-214AB	1d	1j	Bm
IDP	TV30C7V5JB-G	TVS	Vrwm=7.5V, Vbr=8.33..9.21V, Ipp=232.56A, 3000W(1ms), Bidirectional	DO-214AB	1ba	1j	Cmc
IDQ	3.0SMCJ8.0C	TVS	Vbr=8.89..11.30V, Vrwm=8.0V, 200A, 3000W(1ms), Bidirectional	DO-214AB	1ba	1x,1y	Pjt,Srj
IDQ	SMLJ8.0C	TVS	Vrwm=8.0V, Vbr=8.89..10.9V, Ipp=200.0A, 3000W(1ms), Bidirectional	DO-214AB	1a	1j	Mco
IDQ	TV30C8V0KB-G	TVS	Vrwm=8.0V, Vbr=8.89..10.90V, Ipp=200.0A, 3000W(1ms), Bidirectional	DO-214AB	1ba	1j	Cmc
IDR	3.0SMCJ8.0CA	TVS	Vbr=8.89..10.23V, Vrwm=8.0V, 220.6A, 3000W(1ms), Bidirectional	DO-214AB	1ba	1x,1y	Pjt,Srj
IDR	CD214L-T8.0CALF	TVS	Vbr=8.89..9.83V, Vrwm=8V, Irs=220.6A, 3000W(1ms), Bidirectional	DO-214AB	1d	1j	Bm
IDR	SMLJ8.0CA	TVS	Vbr=8.89..9.83V, Vrwm=8V, Irs=220.6A, 3000W(1ms), Bidirectional	DO-214AB	1d	1j	Bm
IDR	TV30C8V0JB-G	TVS	Vrwm=8.0V, Vbr=8.89..9.83V, Ipp=220.59A, 3000W(1ms), Bidirectional	DO-214AB	1ba	1j	Cmc
IDS	3.0SMCJ8.5C	TVS	Vbr=9.44..11.92V, Vrwm=8.5V, 188.8A, 3000W(1ms), Bidirectional	DO-214AB	1ba	1x,1y	Pjt,Srj
IDS	SMLJ8.5C	TVS	Vrwm=8.5V, Vbr=9.44..11.5V, Ipp=188.6A, 3000W(1ms), Bidirectional	DO-214AB	1a	1j	Mco
IDS	TV30C8V5KB-G	TVS	Vrwm=8.5V, Vbr=9.44..11.50V, Ipp=188.68A, 3000W(1ms), Bidirectional	DO-214AB	1ba	1j	Cmc
IDT	3.0SMCJ8.5CA	TVS	Vbr=9.44..10.82V, Vrwm=8.5V, 208.4A, 3000W(1ms), Bidirectional	DO-214AB	1ba	1x,1y	Pjt,Srj
IDT	CD214L-T8.5CALF	TVS	Vbr=9.44..10.43V, Vrwm=8.5V, Irs=208.4A, 3000W(1ms), Bidirectional	DO-214AB	1d	1j	Bm
IDT	SMLJ8.5CA	TVS	Vbr=9.44..10.43V, Vrwm=8.5V, Irs=208.4A, 3000W(1ms), Bidirectional	DO-214AB	1d	1j	Bm
IDT	TV30C8V5JB-G	TVS	Vrwm=8.5V, Vbr=9.44..10.40V, Ipp=208.33A, 3000W(1ms), Bidirectional	DO-214AB	1ba	1j	Cmc
IDU	3.0SMCJ9.0C	TVS	Vbr=10.0..12.6V, Vrwm=9.0V, 177.4A, 3000W(1ms), Bidirectional	DO-214AB	1ba	1x,1y	Pjt,Srj
IDU	SMLJ9.0C	TVS	Vrwm=9.0V, Vbr=10.0..12.2V, Ipp=177.4A, 3000W(1ms), Bidirectional	DO-214AB	1a	1j	Mco
IDU	TV30C9V0KB-G	TVS	Vrwm=9.0V, Vbr=10.0..12.20V, Ipp=177.51A, 3000W(1ms), Bidirectional	DO-214AB	1ba	1j	Cmc
IDV	3.0SMCJ9.0CA	TVS	Vbr=10.0..11.5V, Vrwm=9.0V, 194.8A, 3000W(1ms), Bidirectional	DO-214AB	1ba	1x,1y	Pjt,Srj
IDV	CD214L-T9.0CALF	TVS	Vbr=10.0..11.05V, Vrwm=9V, Irs=194.8A, 3000W(1ms), Bidirectional	DO-214AB	1d	1j	Bm
IDV	SMLJ9.0CA	TVS	Vbr=10.0..11.05V, Vrwm=9V, Irs=194.8A, 3000W(1ms), Bidirectional	DO-214AB	1d	1j	Bm
IDV	TV30C9V0JB-G	TVS	Vrwm=9.0V, Vbr=10.0..11.10V, Ipp=194.81A, 3000W(1ms), Bidirectional	DO-214AB	1ba	1j	Cmc
IDW	3.0SMCJ10C	TVS	Vbr=11.1..14.1V, Vrwm=10V, 159.6A, 3000W(1ms), Bidirectional	DO-214AB	1ba	1x,1y	Pjt,Srj
IDW	SMLJ10C	TVS	Vrwm=10V, Vbr=11.1..13.6V, Ipp=159.6A, 3000W(1ms), Bidirectional	DO-214AB	1a	1j	Mco
IDW	TV30C100KB-G	TVS	Vrwm=10.0V, Vbr=11.10..13.60V, Ipp=159.57A, 3000W(1ms), Bidirectional	DO-214AB	1ba	1j	Cmc
IDX	3.0SMCJ10CA	TVS	Vbr=11.1..12.8V, Vrwm=10V, 176.4A, 3000W(1ms), Bidirectional	DO-214AB	1ba	1x,1y	Pjt,Srj
IDX	CD214L-T10CALF	TVS	Vbr=11.10..12.27V, Vrwm=10V, Irs=176.4A, 3000W(1ms), Bidirectional	DO-214AB	1d	1j	Bm
IDX	SMLJ10CA	TVS	Vbr=11.10..12.27V, Vrwm=10V, Irs=176.4A, 3000W(1ms), Bidirectional	DO-214AB	1d	1j	Bm
IDX	TV30C100JB-G	TVS	Vrwm=10.0V, Vbr=11.10..12.30V, Ipp=176.47A, 3000W(1ms), Bidirectional	DO-214AB	1ba	1j	Cmc
IDY	3.0SMCJ11C	TVS	Vbr=12.2..15.4V, Vrwm=11V, 149.2A, 3000W(1ms), Bidirectional	DO-214AB	1ba	1x,1y	Pjt,Srj
IDY	SMLJ11C	TVS	Vrwm=11V, Vbr=12.2..14.9V, Ipp=149.2A, 3000W(1ms), Bidirectional	DO-214AB	1a	1j	Mco
IDY	TV30C110KB-G	TVS	Vrwm=11.0V, Vbr=12.20..14.90V, Ipp=149.25A, 3000W(1ms), Bidirectional	DO-214AB	1ba	1j	Cmc
IDZ	3.0SMCJ11CA	TVS	Vbr=12.2..14.0V, Vrwm=11V, 184.8A, 3000W(1ms), Bidirectional	DO-214AB	1ba	1x,1y	Pjt,Srj
IDZ	CD214L-T11CALF	TVS	Vbr=12.20..13.50V, Vrwm=11V, Irs=164.8A, 3000W(1ms), Bidirectional	DO-214AB	1d	1j	Bm
IDZ	SMLJ11CA	TVS	Vbr=12.20..13.50V, Vrwm=11V, Irs=164.8A, 3000W(1ms), Bidirectional	DO-214AB	1d	1j	Bm
IDZ	TV30C110JB-G	TVS	Vrwm=11.0V, Vbr=12.20..13.50V, Ipp=164.84A, 3000W(1ms), Bidirectional	DO-214AB	1ba	1j	Cmc
IE	CD214A-T12A	TVS	Vbr=12V, Irs=20.1A, 400W(1ms)	DO-214AC	1d	1a	Bm
IE	P4SMAJ12A	TVS	Vbr=12V, 20.1A, 400W(1ms)	DO-214AC	1d	1m,1w	Pjt,Srj
IE	SMAJ12A	TVS	Vrwm=12V, Vbr=13.3..14.7V, 20.1A, 400W(1ms)	DO-214AC	1d	1m	Di
IEA	TV30C190KB-G	TVS	Vrwm=19.0V, Vbr=21.13..25.76V, Ipp=88.21A, 3000W(1ms), Bidirectional	DO-214AB	1ba	1j	Cmc
IEB	TV30C190JB-G	TVS	Vrwm=19.0V, Vbr=21.10..23.30V, Ipp=97.47A, 3000W(1ms), Bidirectional	DO-214AB	1ba	1j	Cmc
IED	3.0SMCJ12C	TVS	Vbr=13.3..16.9V, Vrwm=12V, 136.4A, 3000W(1ms), Bidirectional	DO-214AB	1ba	1x,1y	Pjt,Srj
IED	SMLJ12C	TVS	Vrwm=12V, Vbr=13.3..16.3V, Ipp=136.4A, 3000W(1ms), Bidirectional	DO-214AB	1a	1j	Mco



SMD
code

Type

Function

Short description

Case

Pinout

St.

Mnf.

SMD code	Type	Function	Short description	Case	Pinout	St.	Mnf.
IED	TV30C120KB-G	TVS	Vrwm=12.0V, Vbr=13.30..16.30V, Ipp=136.36A, 3000W(1ms), Bidirectional	DO-214AB	1ba	1j	Cmc
IEE	3.0SMCJ12CA	TVS	Vbr=13.3..15.3V, Vrwm=12V, 150.6A, 3000W(1ms), Bidirectional	DO-214AB	1ba	1x,1y	Pjt,Srj
IEE	CD214L-T12CALF	TVS	Vbr=13.30..14.70V, Vrwm=12V, Irs=150.6A, 3000W(1ms), Bidirectional	DO-214AB	1d	1j	Bm
IEE	SMLJ12CA	TVS	Vbr=13.30..14.70V, Vrwm=12V, Irs=150.6A, 3000W(1ms), Bidirectional	DO-214AB	1d	1j	Bm
IEE	TV30C120JB-G	TVS	Vrwm=12.0V, Vbr=13.30..14.70V, Ipp=150.75A, 3000W(1ms), Bidirectional	DO-214AB	1ba	1j	Cmc
IEF	3.0SMCJ13C	TVS	Vbr=14.4..18.2V, Vrwm=13V, 126.0A, 3000W(1ms), Bidirectional	DO-214AB	1ba	1x,1y	Pjt,Srj
IEF	SMLJ13C	TVS	Vrwm=13V, Vbr=14.4..17.6V, Ipp=126.0A, 3000W(1ms), Bidirectional	DO-214AB	1a	1j	Mco
IEF	TV30C130KB-G	TVS	Vrwm=13.0V, Vbr=14.40..17.60V, Ipp=126.05A, 3000W(1ms), Bidirectional	DO-214AB	1ba	1j	Cmc
IEG	3.0SMCJ13CA	TVS	Vbr=14.4..16.5V, Vrwm=13V, 139.4A, 3000W(1ms), Bidirectional	DO-214AB	1ba	1x,1y	Pjt,Srj
IEG	CD214L-T13CALF	TVS	Vbr=14.40..15.90V, Vrwm=13V, Irs=139.4A, 3000W(1ms), Bidirectional	DO-214AB	1d	1j	Bm
IEG	SMLJ13CA	TVS	Vbr=14.40..15.90V, Vrwm=13V, Irs=139.4A, 3000W(1ms), Bidirectional	DO-214AB	1d	1j	Bm
IEG	TV30C130JB-G	TVS	Vrwm=13.0V, Vbr=14.40..15.90V, Ipp=139.53A, 3000W(1ms), Bidirectional	DO-214AB	1ba	1j	Cmc
IEH	3.0SMCJ14C	TVS	Vbr=15.6..19.8V, Vrwm=14V, 116.2A, 3000W(1ms), Bidirectional	DO-214AB	1ba	1x,1y	Pjt,Srj
IEH	SMLJ14C	TVS	Vrwm=14V, Vbr=15.6..19.1V, Ipp=116.2A, 3000W(1ms), Bidirectional	DO-214AB	1a	1j	Mco
IEH	TV30C140KB-G	TVS	Vrwm=14.0V, Vbr=15.60..19.10V, Ipp=116.28A, 3000W(1ms), Bidirectional	DO-214AB	1ba	1j	Cmc
IEK	3.0SMCJ14CA	TVS	Vbr=15.6..17.9V, Vrwm=14V, 129.4A, 3000W(1ms), Bidirectional	DO-214AB	1ba	1x,1y	Pjt,Srj
IEK	CD214L-T14CALF	TVS	Vbr=15.60..17.20V, Vrwm=14V, Irs=129.4A, 3000W(1ms), Bidirectional	DO-214AB	1d	1j	Bm
IEK	SMLJ14CA	TVS	Vbr=15.60..17.20V, Vrwm=14V, Irs=129.4A, 3000W(1ms), Bidirectional	DO-214AB	1d	1j	Bm
IEK	TV30C140JB-G	TVS	Vrwm=14.0V, Vbr=15.60..17.20V, Ipp=129.31A, 3000W(1ms), Bidirectional	DO-214AB	1ba	1j	Cmc
IEL	3.0SMCJ15C	TVS	Vbr=16.7..21.1V, Vrwm=15V, 111.6A, 3000W(1ms), Bidirectional	DO-214AB	1ba	1x,1y	Pjt,Srj
IEL	SMLJ15C	TVS	Vrwm=15V, Vbr=16.7..20.4V, Ipp=111.6A, 3000W(1ms), Bidirectional	DO-214AB	1a	1j	Mco
IEL	TV30C150KB-G	TVS	Vrwm=15.0V, Vbr=16.70..20.40V, Ipp=111.52A, 3000W(1ms), Bidirectional	DO-214AB	1ba	1j	Cmc
IEM	3.0SMCJ15CA	TVS	Vbr=16.7..19.2V, Vrwm=15V, 123.0A, 3000W(1ms), Bidirectional	DO-214AB	1ba	1x,1y	Pjt,Srj
IEM	CD214L-T15CALF	TVS	Vbr=16.70..18.50V, Vrwm=15V, Irs=123.0A, 3000W(1ms), Bidirectional	DO-214AB	1d	1j	Bm
IEM	SMLJ15CA	TVS	Vbr=16.70..18.50V, Vrwm=15V, Irs=123.0A, 3000W(1ms), Bidirectional	DO-214AB	1d	1j	Bm
IEM	TV30C150JB-G	TVS	Vrwm=15.0V, Vbr=16.70..18.50V, Ipp=122.95A, 3000W(1ms), Bidirectional	DO-214AB	1ba	1j	Cmc
IEN	3.0SMCJ16C	TVS	Vbr=17.8..22.6V, Vrwm=16V, 104.2A, 3000W(1ms), Bidirectional	DO-214AB	1ba	1x,1y	Pjt,Srj
IEN	SMLJ16C	TVS	Vrwm=16V, Vbr=17.8..21.8V, Ipp=104.2A, 3000W(1ms), Bidirectional	DO-214AB	1a	1j	Mco
IEN	TV30C160KB-G	TVS	Vrwm=16.0V, Vbr=17.80..21.80V, Ipp=104.17A, 3000W(1ms), Bidirectional	DO-214AB	1ba	1j	Cmc
IEP	3.0SMCJ16CA	TVS	Vbr=17.8..20.5V, Vrwm=16V, 115.4A, 3000W(1ms), Bidirectional	DO-214AB	1ba	1x,1y	Pjt,Srj
IEP	CD214L-T16CALF	TVS	Vbr=17.80..19.70V, Vrwm=16V, Irs=115.4A, 3000W(1ms), Bidirectional	DO-214AB	1d	1j	Bm
IEP	SMLJ16CA	TVS	Vbr=17.80..19.70V, Vrwm=16V, Irs=115.4A, 3000W(1ms), Bidirectional	DO-214AB	1d	1j	Bm
IEP	TV30C160JB-G	TVS	Vrwm=16.0V, Vbr=17.80..19.70V, Ipp=115.38A, 3000W(1ms), Bidirectional	DO-214AB	1ba	1j	Cmc
IEQ	3.0SMCJ17C	TVS	Vbr=18.9..23.9V, Vrwm=17V, 98.4A, 3000W(1ms), Bidirectional	DO-214AB	1ba	1x,1y	Pjt,Srj
IEQ	SMLJ17C	TVS	Vrwm=17V, Vbr=18.9..23.1V, Ipp=98.4A, 3000W(1ms), Bidirectional	DO-214AB	1a	1j	Mco
IEQ	TV30C170KB-G	TVS	Vrwm=17.0V, Vbr=18.90..23.10V, Ipp=98.36A, 3000W(1ms), Bidirectional	DO-214AB	1ba	1j	Cmc
IER	3.0SMCJ17CA	TVS	Vbr=18.9..21.7V, Vrwm=17V, 106.6A, 3000W(1ms), Bidirectional	DO-214AB	1ba	1x,1y	Pjt,Srj
IER	CD214L-T17CALF	TVS	Vbr=18.90..20.90V, Vrwm=17V, Irs=106.6A, 3000W(1ms), Bidirectional	DO-214AB	1d	1j	Bm
IER	SMLJ17CA	TVS	Vbr=18.90..20.90V, Vrwm=17V, Irs=106.6A, 3000W(1ms), Bidirectional	DO-214AB	1d	1j	Bm
IER	TV30C170JB-G	TVS	Vrwm=17.0V, Vbr=18.90..20.90V, Ipp=108.70A, 3000W(1ms), Bidirectional	DO-214AB	1ba	1j	Cmc
IES	3.0SMCJ18C	TVS	Vbr=20.0..25.3V, Vrwm=18V, 93.2A, 3000W(1ms), Bidirectional	DO-214AB	1ba	1x,1y	Pjt,Srj
IES	SMLJ18C	TVS	Vrwm=18V, Vbr=20.0..24.4V, Ipp=93.2A, 3000W(1ms), Bidirectional	DO-214AB	1a	1j	Mco
IES	TV30C180KB-G	TVS	Vrwm=18.0V, Vbr=20.0..24.40V, Ipp=93.17A, 3000W(1ms), Bidirectional	DO-214AB	1ba	1j	Cmc
IET	3.0SMCJ18CA	TVS	Vbr=20.0..23.3V, Vrwm=18V, 102.8A, 3000W(1ms), Bidirectional	DO-214AB	1ba	1x,1y	Pjt,Srj
IET	CD214L-T18CALF	TVS	Vbr=20.0..22.10V, Vrwm=18V, Irs=102.8A, 3000W(1ms), Bidirectional	DO-214AB	1d	1j	Bm
IET	SMLJ18CA	TVS	Vbr=20.0..22.10V, Vrwm=18V, Irs=102.8A, 3000W(1ms), Bidirectional	DO-214AB	1d	1j	Bm
IET	TV30C180JB-G	TVS	Vrwm=18.0V, Vbr=20.0..22.10V, Ipp=102.74A, 3000W(1ms), Bidirectional	DO-214AB	1ba	1j	Cmc
IEU	3.0SMCJ20C	TVS	Vbr=22.2..28.1V, Vrwm=20V, 83.8A, 3000W(1ms), Bidirectional	DO-214AB	1ba	1x,1y	Pjt,Srj
IEU	SMLJ20C	TVS	Vrwm=20V, Vbr=22.2..27.1V, Ipp=83.8A, 3000W(1ms), Bidirectional	DO-214AB	1a	1j	Mco
IEU	TV30C200KB-G	TVS	Vrwm=20.0V, Vbr=21.13..27.10V, Ipp=83.80A, 3000W(1ms), Bidirectional	DO-214AB	1ba	1j	Cmc
IEV	3.0SMCJ20CA	TVS	Vbr=22.2..25.5V, Vrwm=20V, 92.6A, 3000W(1ms), Bidirectional	DO-214AB	1ba	1x,1y	Pjt,Srj
IEV	CD214L-T20CALF	TVS	Vbr=22.20..24.50V, Vrwm=20V, Irs=92.6A, 3000W(1ms), Bidirectional	DO-214AB	1d	1j	Bm
IEV	SMLJ20CA	TVS	Vbr=22.20..24.50V, Vrwm=20V, Irs=92.6A, 3000W(1ms), Bidirectional	DO-214AB	1d	1j	Bm
IEV	TV30C200JB-G	TVS	Vrwm=20.0V, Vbr=21.10..24.50V, Ipp=92.59A, 3000W(1ms), Bidirectional	DO-214AB	1ba	1j	Cmc
IEW	3.0SMCJ22C	TVS	Vbr=24.4..30.9V, Vrwm=22V, 76.2A, 3000W(1ms), Bidirectional	DO-214AB	1ba	1x,1y	Pjt,Srj
IEW	SMLJ22C	TVS	Vrwm=22V, Vbr=24.4..29.8V, Ipp=76.2A, 3000W(1ms), Bidirectional	DO-214AB	1a	1j	Mco
IEW	TV30C220KB-G	TVS	Vrwm=22.0V, Vbr=24.40..29.80V, Ipp=76.14A, 3000W(1ms), Bidirectional	DO-214AB	1ba	1j	Cmc
IEX	3.0SMCJ22CA	TVS	Vbr=24.4..28.0V, Vrwm=22V, 84.4A, 3000W(1ms), Bidirectional	DO-214AB	1ba	1x,1y	Pjt,Srj
IEX	CD214L-T22CALF	TVS	Vbr=24.40..27.0V, Vrwm=22V, Irs=84.4A, 3000W(1ms), Bidirectional	DO-214AB	1d	1j	Bm
IEX	SMLJ22CA	TVS	Vbr=24.40..27.0V, Vrwm=22V, Irs=84.4A, 3000W(1ms), Bidirectional	DO-214AB	1d	1j	Bm
IEX	TV30C220JB-G	TVS	Vrwm=22.0V, Vbr=24.40..26.90V, Ipp=84.51A, 3000W(1ms), Bidirectional	DO-214AB	1ba	1j	Cmc
IEY	3.0SMCJ24C	TVS	Vbr=26.7..33.8V, Vrwm=24V, 69.8A, 3000W(1ms), Bidirectional	DO-214AB	1ba	1x,1y	Pjt,Srj
IEY	SMLJ24C	TVS	Vrwm=24V, Vbr=26.7..32.6V, Ipp=69.8A, 3000W(1ms), Bidirectional	DO-214AB	1a	1j	Mco
IEY	TV30C240KB-G	TVS	Vrwm=24.0V, Vbr=26.70..32.60V, Ipp=69.77A, 3000W(1ms), Bidirectional	DO-214AB	1ba	1j	Cmc
IEZ	3.0SMCJ24CA	TVS	Vbr=26.7..30.7V, Vrwm=24V, 77.2A, 3000W(1ms), Bidirectional	DO-214AB	1ba	1x,1y	Pjt,Srj
IEZ	CD214L-T24CALF	TVS	Vbr=26.70..29.50V, Vrwm=24V, Irs=77.2A, 3000W(1ms), Bidirectional	DO-214AB	1d	1j	Bm
IEZ	SMLJ24CA	TVS	Vbr=26.70..29.50V, Vrwm=24V, Irs=77.2A, 3000W(1ms), Bidirectional	DO-214AB	1d	1j	Bm
IEZ	TV30C240JB-G	TVS	Vrwm=24.0V, Vbr=26.70..29.50V, Ipp=77.12A, 3000W(1ms), Bidirectional	DO-214AB	1ba	1j	Cmc
IF	P4SMAJ13	TVS	Vbr=13V, 16.8A, 400W(1ms)	DO-214AC	1d	1m,1w	Pjt,Srj
IFD	3.0SMCJ26C	TVS	Vbr=28.9..36.6V, Vrwm=26V, 64.4A, 3000W(1ms), Bidirectional	DO-214AB	1ba	1x,1y	Pjt,Srj



SMD
code

Type

Function

Short description

Case

Pinout

St.

Mnf.

SMD code	Type	Function	Short description	Case	Pinout	St.	Mnf.
IFD	SMLJ26C	TVS	Vrwm=26V, Vbr=28.9..35.3V, Ipp=64.4A, 3000W(1ms), Bidirectional	DO-214AB	1a	1j	Mco
IFD	TV30C260KB-G	TVS	Vrwm=26.0V, Vbr=28.90..35.30V, Ipp=64.38A, 3000W(1ms), Bidirectional	DO-214AB	1ba	1j	Cmc
IFE	3.0SMCJ26CA	TVS	Vbr=28.9..33.2V, Vrwm=26V, 71.2A, 3000W(1ms), Bidirectional	DO-214AB	1ba	1x,1y	Pjt,Srij
IFE	CD214L-T26CALF	TVS	Vbr=28.90..31.90V, Vrwm=26V, Irlsm=71.2A, 3000W(1ms), Bidirectional	DO-214AB	1d	1j	Bm
IFE	SMLJ26CA	TVS	Vbr=28.90..31.90V, Vrwm=26V, Irlsm=71.2A, 3000W(1ms), Bidirectional	DO-214AB	1d	1j	Bm
IFE	TV30C260JB-G	TVS	Vrwm=26.0V, Vbr=28.90..31.90V, Ipp=71.26A, 3000W(1ms), Bidirectional	DO-214AB	1ba	1j	Cmc
IFF	3.0SMCJ28C	TVS	Vbr=31.1..39.4V, Vrwm=28V, 60.0A, 3000W(1ms), Bidirectional	DO-214AB	1ba	1x,1y	Pjt,Srij
IFF	SMLJ28C	TVS	Vrwm=28V, Vbr=31.1..38.0V, Ipp=60.0A, 3000W(1ms), Bidirectional	DO-214AB	1a	1j	Mco
IFF	TV30C280KB-G	TVS	Vrwm=28.0V, Vbr=31.10..38.0V, Ipp=60.0A, 3000W(1ms), Bidirectional	DO-214AB	1ba	1j	Cmc
IFG	3.0SMCJ28CA	TVS	Vbr=31.1..35.8V, Vrwm=28V, 66.0A, 3000W(1ms), Bidirectional	DO-214AB	1ba	1x,1y	Pjt,Srij
IFG	CD214L-T28CALF	TVS	Vbr=31.10..34.40V, Vrwm=28V, Irlsm=66.0A, 3000W(1ms), Bidirectional	DO-214AB	1d	1j	Bm
IFG	SMLJ28CA	TVS	Vbr=31.10..34.40V, Vrwm=28V, Irlsm=66.0A, 3000W(1ms), Bidirectional	DO-214AB	1d	1j	Bm
IFG	TV30C280JB-G	TVS	Vrwm=28.0V, Vbr=31.10..34.40V, Ipp=66.08A, 3000W(1ms), Bidirectional	DO-214AB	1ba	1j	Cmc
IFH	3.0SMCJ30C	TVS	Vbr=33.3..42.2V, Vrwm=30V, 56.0A, 3000W(1ms), Bidirectional	DO-214AB	1ba	1x,1y	Pjt,Srij
IFH	SMLJ30C	TVS	Vrwm=30V, Vbr=33.3..40.7V, Ipp=56.0A, 3000W(1ms), Bidirectional	DO-214AB	1a	1j	Mco
IFH	TV30C300KB-G	TVS	Vrwm=30.0V, Vbr=33.30..40.70V, Ipp=56.07A, 3000W(1ms), Bidirectional	DO-214AB	1ba	1j	Cmc
IFK	3.0SMCJ30CA	TVS	Vbr=33.3..38.3V, Vrwm=30V, 62.0A, 3000W(1ms), Bidirectional	DO-214AB	1ba	1x,1y	Pjt,Srij
IFK	CD214L-T30CALF	TVS	Vbr=33.30..36.80V, Vrwm=30V, Irlsm=62.0A, 3000W(1ms), Bidirectional	DO-214AB	1d	1j	Bm
IFK	SMLJ30CA	TVS	Vbr=33.30..36.80V, Vrwm=30V, Irlsm=62.0A, 3000W(1ms), Bidirectional	DO-214AB	1d	1j	Bm
IFK	TV30C300JB-G	TVS	Vrwm=30.0V, Vbr=33.30..36.80V, Ipp=61.98A, 3000W(1ms), Bidirectional	DO-214AB	1ba	1j	Cmc
IFL	3.0SMCJ33C	TVS	Vbr=36.7..46.5V, Vrwm=33V, 50.4A, 3000W(1ms), Bidirectional	DO-214AB	1ba	1x,1y	Pjt,Srij
IFL	SMLJ33C	TVS	Vrwm=33V, Vbr=36.7..44.9V, Ipp=50.4A, 3000W(1ms), Bidirectional	DO-214AB	1a	1j	Mco
IFL	TV30C330KB-G	TVS	Vrwm=33.0V, Vbr=36.70..44.90V, Ipp=50.85A, 3000W(1ms), Bidirectional	DO-214AB	1ba	1j	Cmc
IFM	3.0SMCJ33CA	TVS	Vbr=36.7..42.2V, Vrwm=33V, 56.2A, 3000W(1ms), Bidirectional	DO-214AB	1ba	1x,1y	Pjt,Srij
IFM	CD214L-T33CALF	TVS	Vbr=36.70..40.60V, Vrwm=33V, Irlsm=56.2A, 3000W(1ms), Bidirectional	DO-214AB	1d	1j	Bm
IFM	SMLJ33CA	TVS	Vbr=36.70..40.60V, Vrwm=33V, Irlsm=56.2A, 3000W(1ms), Bidirectional	DO-214AB	1d	1j	Bm
IFM	TV30C330JB-G	TVS	Vrwm=33.0V, Vbr=36.70..40.60V, Ipp=56.29A, 3000W(1ms), Bidirectional	DO-214AB	1ba	1j	Cmc
IFN	3.0SMCJ36C	TVS	Vrwm=30V, Vbr=36.7..46.6A, 3000W(1ms), Bidirectional	DO-214AB	1ba	1x,1y	Pjt,Srij
IFN	SMLJ36C	TVS	Vrwm=36V, Vbr=40.0..48.9V, Ipp=46.6A, 3000W(1ms), Bidirectional	DO-214AB	1a	1j	Mco
IFN	TV30C360KB-G	TVS	Vrwm=36.0V, Vbr=40.0..48.90V, Ipp=46.66A, 3000W(1ms), Bidirectional	DO-214AB	1ba	1j	Cmc
IFP	3.0SMCJ36CA	TVS	Vbr=40.0..46.0V, Vrwm=36V, 51.6A, 3000W(1ms), Bidirectional	DO-214AB	1ba	1x,1y	Pjt,Srij
IFP	CD214L-T36CALF	TVS	Vbr=40.0..44.20V, Vrwm=36V, Irlsm=51.6A, 3000W(1ms), Bidirectional	DO-214AB	1d	1j	Bm
IFP	SMLJ36CA	TVS	Vbr=40.0..44.20V, Vrwm=36V, Irlsm=51.6A, 3000W(1ms), Bidirectional	DO-214AB	1d	1j	Bm
IFP	TV30C360JB-G	TVS	Vrwm=36.0V, Vbr=40.0..44.20V, Ipp=51.64A, 3000W(1ms), Bidirectional	DO-214AB	1ba	1j	Cmc
IFQ	3.0SMCJ40C	TVS	Vbr=44.4..56.3V, Vrwm=40V, 42.0A, 3000W(1ms), Bidirectional	DO-214AB	1ba	1x,1y	Pjt,Srij
IFQ	SMLJ40C	TVS	Vrwm=40V, Vbr=44.4..54.3V, Ipp=42.0A, 3000W(1ms), Bidirectional	DO-214AB	1a	1j	Mco
IFQ	TV30C400KB-G	TVS	Vrwm=40.0V, Vbr=44.40..54.30V, Ipp=42.02A, 3000W(1ms), Bidirectional	DO-214AB	1ba	1j	Cmc
IFQ	3.0SMCJ40CA	TVS	Vbr=44.4..51.1V, Vrwm=40V, 46.4A, 3000W(1ms), Bidirectional	DO-214AB	1ba	1x,1y	Pjt,Srij
IFR	CD214L-T40CALF	TVS	Vbr=44.40..49.10V, Vrwm=40V, Irlsm=46.4A, 3000W(1ms), Bidirectional	DO-214AB	1d	1j	Bm
IFR	SMLJ40CA	TVS	Vbr=44.40..49.10V, Vrwm=40V, Irlsm=46.4A, 3000W(1ms), Bidirectional	DO-214AB	1d	1j	Bm
IFR	TV30C400JB-G	TVS	Vrwm=40.0V, Vbr=44.40..49.10V, Ipp=46.51A, 3000W(1ms), Bidirectional	DO-214AB	1ba	1j	Cmc
IFS	3.0SMCJ43C	TVS	Vbr=47.8..60.5V, Vrwm=43V, 39.2A, 3000W(1ms), Bidirectional	DO-214AB	1ba	1x,1y	Pjt,Srij
IFS	SMLJ43C	TVS	Vrwm=43V, Vbr=47.8..58.4V, Ipp=39.2A, 3000W(1ms), Bidirectional	DO-214AB	1a	1j	Mco
IFS	TV30C430KB-G	TVS	Vrwm=43.0V, Vbr=47.80..58.40V, Ipp=39.11A, 3000W(1ms), Bidirectional	DO-214AB	1ba	1j	Cmc
IFT	3.0SMCJ43CA	TVS	Vbr=47.8..54.9V, Vrwm=43V, 43.2A, 3000W(1ms), Bidirectional	DO-214AB	1ba	1x,1y	Pjt,Srij
IFT	CD214L-T43CALF	TVS	Vbr=47.80..52.80V, Vrwm=43V, Irlsm=43.2A, 3000W(1ms), Bidirectional	DO-214AB	1d	1j	Bm
IFT	SMLJ43CA	TVS	Vbr=47.80..52.80V, Vrwm=43V, Irlsm=43.2A, 3000W(1ms), Bidirectional	DO-214AB	1d	1j	Bm
IFT	TV30C430JB-G	TVS	Vrwm=43.0V, Vbr=47.80..52.80V, Ipp=43.23A, 3000W(1ms), Bidirectional	DO-214AB	1ba	1j	Cmc
IFU	3.0SMCJ45C	TVS	Vbr=50.0..63.3V, Vrwm=45V, 37.4A, 3000W(1ms), Bidirectional	DO-214AB	1ba	1x,1y	Pjt,Srij
IFU	SMLJ45C	TVS	Vrwm=45V, Vbr=50.0..61.1V, Ipp=37.4A, 3000W(1ms), Bidirectional	DO-214AB	1a	1j	Mco
IFU	TV30C450KB-G	TVS	Vrwm=45.0V, Vbr=50.0..61.10V, Ipp=37.36A, 3000W(1ms), Bidirectional	DO-214AB	1ba	1j	Cmc
IFV	3.0SMCJ45CA	TVS	Vbr=50.0..57.5V, Vrwm=45V, 41.2A, 3000W(1ms), Bidirectional	DO-214AB	1ba	1x,1y	Pjt,Srij
IFV	CD214L-T45CALF	TVS	Vbr=50.0..55.30V, Vrwm=45V, Irlsm=41.2A, 3000W(1ms), Bidirectional	DO-214AB	1d	1j	Bm
IFV	SMLJ45CA	TVS	Vbr=50.0..55.30V, Vrwm=45V, Irlsm=41.2A, 3000W(1ms), Bidirectional	DO-214AB	1d	1j	Bm
IFV	TV30C450JB-G	TVS	Vrwm=45.0V, Vbr=50.0..55.30V, Ipp=41.27A, 3000W(1ms), Bidirectional	DO-214AB	1ba	1j	Cmc
IFW	3.0SMCJ48C	TVS	Vbr=53.3..67.5V, Vrwm=48V, 35.0A, 3000W(1ms), Bidirectional	DO-214AB	1ba	1x,1y	Pjt,Srij
IFW	SMLJ48C	TVS	Vrwm=48V, Vbr=53.3..65.1V, Ipp=35.0A, 3000W(1ms), Bidirectional	DO-214AB	1a	1j	Mco
IFW	TV30C480KB-G	TVS	Vrwm=48.0V, Vbr=53.30..65.10V, Ipp=35.09A, 3000W(1ms), Bidirectional	DO-214AB	1ba	1j	Cmc
IFX	3.0SMCJ48CA	TVS	Vbr=53.3..61.3V, Vrwm=48V, 38.8A, 3000W(1ms), Bidirectional	DO-214AB	1ba	1x,1y	Pjt,Srij
IFX	CD214L-T48CALF	TVS	Vbr=53.30..58.90V, Vrwm=48V, Irlsm=38.8A, 3000W(1ms), Bidirectional	DO-214AB	1d	1j	Bm
IFX	SMLJ48CA	TVS	Vbr=53.30..58.90V, Vrwm=48V, Irlsm=38.8A, 3000W(1ms), Bidirectional	DO-214AB	1d	1j	Bm
IFX	TV30C480JB-G	TVS	Vrwm=48.0V, Vbr=53.30..58.90V, Ipp=38.76A, 3000W(1ms), Bidirectional	DO-214AB	1ba	1j	Cmc
IFY	3.0SMCJ51C	TVS	Vbr=56.7..71.8V, Vrwm=51V, 37.0A, 3000W(1ms), Bidirectional	DO-214AB	1ba	1x,1y	Pjt,Srij
IFY	SMLJ51C	TVS	Vrwm=51V, Vbr=56.7..69.3V, Ipp=37.0A, 3000W(1ms), Bidirectional	DO-214AB	1a	1j	Mco
IFY	TV30C510KB-G	TVS	Vrwm=51.0V, Vbr=56.70..69.30V, Ipp=32.93A, 3000W(1ms), Bidirectional	DO-214AB	1ba	1j	Cmc
IFZ	3.0SMCJ51CA	TVS	Vbr=56.7..65.2V, Vrwm=51V, 36.4A, 3000W(1ms), Bidirectional	DO-214AB	1ba	1x,1y	Pjt,Srij
IFZ	CD214L-T51CALF	TVS	Vbr=56.70..62.70V, Vrwm=51V, Irlsm=36.4A, 3000W(1ms), Bidirectional	DO-214AB	1d	1j	Bm
IFZ	SMLJ51CA	TVS	Vbr=56.70..62.70V, Vrwm=51V, Irlsm=36.4A, 3000W(1ms), Bidirectional	DO-214AB	1d	1j	Bm
IFZ	TV30C510JB-G	TVS	Vrwm=51.0V, Vbr=56.70..62.70V, Ipp=36.41A, 3000W(1ms), Bidirectional	DO-214AB	1ba	1j	Cmc
IG	CD214A-T13A	TVS	Vbr=13V, Irlsm=18.6A, 400W(1ms)	DO-214AC	1d	1a	Bm



SMD
code

Type

Function

Short description

Case

Pinout

St.

Mnf.

IG	P4SMAJ13A	TVS	Vbr=13V, 18.6A, 400W (1ms)	DO-214AC	1d	1m,1w	Pjt,Srj
IG	SMAJ13A	TVS	Vrwm=13V, Vbr=14.4. 15.9V, 18.6A, 400W(1ms)	DO-214AC	1d	1m	Di
IGA	TV30C800KB-G	TVS	Vrwm=80.0V, Vbr=88.96..108.80V, Ipp=20.95A, 3000W(1ms), Bidirectional	DO-214AB	1ba	1j	Cmc
IGB	TV30C800JB-G	TVS	Vrwm=80.0V, Vbr=88.80..97.60V, Ipp=23.15A, 3000W(1ms), Bidirectional	DO-214AB	1ba	1j	Cmc
IGD	3.0SMCJ54C	TVS	Vbr=60.0..76.0V, Vrwm=54V, 31.2A, 3000W(1ms), Bidirectional	DO-214AB	1ba	1x,1y	Pjt,Srj
IGD	SMLJ54C	TVS	Vrwm=54V, Vbr=60.0. 73.3V, Ipp=31.2A, 3000W(1ms), Bidirectional	DO-214AB	1a	1j	Mco
IGD	TV30C540KB-G	TVS	Vrwm=54.0V, Vbr=60.0. 73.30V, Ipp=31.15A, 3000W(1ms), Bidirectional	DO-214AB	1ba	1j	Cmc
IGE	3.0SMCJ54CA	TVS	Vbr=60.0. 69.0V, Vrwm=54V, 34.4A, 3000W(1ms), Bidirectional	DO-214AB	1ba	1x,1y	Pjt,Srj
IGE	CD214L-T54CALF	TVS	Vbr=60.0. 66.30V, Vrwm=54V, Irs=34.4A, 3000W(1ms), Bidirectional	DO-214AB	1d	1j	Bm
IGE	SMLJ54CA	TVS	Vbr=60.0. 66.30V, Vrwm=54V, Irs=34.4A, 3000W(1ms), Bidirectional	DO-214AB	1d	1j	Bm
IGE	TV30C540JB-G	TVS	Vrwm=54.0V, Vbr=60.0. 66.30V, Ipp=34.44A, 3000W(1ms), Bidirectional	DO-214AB	1ba	1j	Cmc
IGF	3.0SMCJ58C	TVS	Vbr=64.4. 81.6V, Vrwm=58V, 39.2A, 3000W(1ms), Bidirectional	DO-214AB	1ba	1x,1y	Pjt,Srj
IGF	SMLJ58C	TVS	Vrwm=58V, Vbr=64.4. 78.7V, Ipp=39.2A, 3000W(1ms), Bidirectional	DO-214AB	1a	1j	Mco
IGF	TV30C580KB-G	TVS	Vrwm=58.0V, Vbr=64.40. 78.70V, Ipp=39.13A, 3000W(1ms), Bidirectional	DO-214AB	1ba	1j	Cmc
IGG	3.0SMCJ58CA	TVS	Vbr=64.4. 74.1V, Vrwm=58V, 32.0A, 3000W(1ms), Bidirectional	DO-214AB	1ba	1x,1y	Pjt,Srj
IGG	CD214L-T58CALF	TVS	Vbr=64.40. 71.20V, Vrwm=58V, Irs=32.0A, 3000W(1ms), Bidirectional	DO-214AB	1d	1j	Bm
IGG	SMLJ58CA	TVS	Vbr=64.40. 71.20V, Vrwm=58V, Irs=32.0A, 3000W(1ms), Bidirectional	DO-214AB	1d	1j	Bm
IGG	TV30C580JB-G	TVS	Vrwm=58.0V, Vbr=64.40. 71.20V, Ipp=32.05A, 3000W(1ms), Bidirectional	DO-214AB	1ba	1j	Cmc
IGH	3.0SMCJ60C	TVS	Vbr=66.7. 84.5V, Vrwm=60V, 28.0A, 3000W(1ms), Bidirectional	DO-214AB	1ba	1x,1y	Pjt,Srj
IGH	SMLJ60C	TVS	Vrwm=60V, Vbr=66.7. 81.5V, Ipp=28.0A, 3000W(1ms), Bidirectional	DO-214AB	1a	1j	Mco
IGH	TV30C600KB-G	TVS	Vrwm=60.0V, Vbr=66.70. 81.50V, Ipp=28.04A, 3000W(1ms), Bidirectional	DO-214AB	1ba	1j	Cmc
IGK	3.0SMCJ60CA	TVS	Vbr=66.7. 76.7V, Vrwm=60V, 31.0A, 3000W(1ms), Bidirectional	DO-214AB	1ba	1x,1y	Pjt,Srj
IGK	CD214L-T60CALF	TVS	Vbr=66.70. 73.70V, Vrwm=60V, Irs=31.0A, 3000W(1ms), Bidirectional	DO-214AB	1d	1j	Bm
IGK	SMLJ60CA	TVS	Vbr=66.70. 73.70V, Vrwm=60V, Irs=31.0A, 3000W(1ms), Bidirectional	DO-214AB	1d	1j	Bm
IGK	TV30C600JB-G	TVS	Vrwm=60.0V, Vbr=66.70. 73.70V, Ipp=30.99A, 3000W(1ms), Bidirectional	DO-214AB	1ba	1j	Cmc
IGL	3.0SMCJ64C	TVS	Vbr=71.1. 90.1V, Vrwm=64V, 26.4A, 3000W(1ms), Bidirectional	DO-214AB	1ba	1x,1y	Pjt,Srj
IGL	SMLJ64C	TVS	Vrwm=64V, Vbr=71.1. 86.9V, Ipp=26.4A, 3000W(1ms), Bidirectional	DO-214AB	1a	1j	Mco
IGL	TV30C640KB-G	TVS	Vrwm=64.0V, Vbr=71.10. 86.90V, Ipp=26.32A, 3000W(1ms), Bidirectional	DO-214AB	1ba	1j	Cmc
IGM	3.0SMCJ64CA	TVS	Vbr=71.1. 81.8V, Vrwm=64V, 29.2A, 3000W(1ms), Bidirectional	DO-214AB	1ba	1x,1y	Pjt,Srj
IGM	CD214L-T64CALF	TVS	Vbr=71.10. 78.60V, Vrwm=64V, Irs=29.2A, 3000W(1ms), Bidirectional	DO-214AB	1d	1j	Bm
IGM	SMLJ64CA	TVS	Vbr=71.10. 78.60V, Vrwm=64V, Irs=29.2A, 3000W(1ms), Bidirectional	DO-214AB	1d	1j	Bm
IGM	TV30C640JB-G	TVS	Vrwm=64.0V, Vbr=71.10. 78.60V, Ipp=29.13A, 3000W(1ms), Bidirectional	DO-214AB	1ba	1j	Cmc
IGN	3.0SMCJ70C	TVS	Vbr=77.8. 98.6V, Vrwm=70V, 24.0A, 3000W(1ms), Bidirectional	DO-214AB	1ba	1x,1y	Pjt,Srj
IGN	SMLJ70C	TVS	Vrwm=70V, Vbr=77.8. 95.1V, Ipp=24.0A, 3000W(1ms), Bidirectional	DO-214AB	1a	1j	Mco
IGN	TV30C700KB-G	TVS	Vrwm=70.0V, Vbr=77.80. 95.10V, Ipp=24.0A, 3000W(1ms), Bidirectional	DO-214AB	1ba	1j	Cmc
IGP	3.0SMCJ70CA	TVS	Vbr=77.8. 89.5V, Vrwm=70V, 26.6A, 3000W(1ms), Bidirectional	DO-214AB	1ba	1x,1y	Pjt,Srj
IGP	CD214L-T70CALF	TVS	Vbr=77.80. 86.0V, Vrwm=70V, Irs=26.6A, 3000W(1ms), Bidirectional	DO-214AB	1d	1j	Bm
IGP	SMLJ70CA	TVS	Vbr=77.80. 86.0V, Vrwm=70V, Irs=26.6A, 3000W(1ms), Bidirectional	DO-214AB	1d	1j	Bm
IGP	TV30C700JB-G	TVS	Vrwm=70.0V, Vbr=77.80. 86.0V, Ipp=26.55A, 3000W(1ms), Bidirectional	DO-214AB	1ba	1j	Cmc
IGQ	3.0SMCJ75C	TVS	Vbr=83.3. 105.7V, Vrwm=75V, 22.4A, 3000W(1ms), Bidirectional	DO-214AB	1ba	1x,1y	Pjt,Srj
IGQ	SMLJ75C	TVS	Vrwm=75V, Vbr=83.3. 102V, Ipp=22.4A, 3000W(1ms), Bidirectional	DO-214AB	1a	1j	Mco
IGQ	TV30C750KB-G	TVS	Vrwm=75.0V, Vbr=83.30..102.0V, Ipp=22.39A, 3000W(1ms), Bidirectional	DO-214AB	1ba	1j	Cmc
IGR	3.0SMCJ75CA	TVS	Vbr=83.3. 95.8V, Vrwm=75V, 24.8A, 3000W(1ms), Bidirectional	DO-214AB	1ba	1x,1y	Pjt,Srj
IGR	CD214L-T75CALF	TVS	Vbr=83.30. 92.10V, Vrwm=75V, Irs=24.8A, 3000W(1ms), Bidirectional	DO-214AB	1d	1j	Bm
IGR	SMLJ75CA	TVS	Vbr=83.30. 92.10V, Vrwm=75V, Irs=24.8A, 3000W(1ms), Bidirectional	DO-214AB	1d	1j	Bm
IGR	TV30C750JB-G	TVS	Vrwm=75.0V, Vbr=83.30. 92.10V, Ipp=24.79A, 3000W(1ms), Bidirectional	DO-214AB	1ba	1j	Cmc
IGS	3.0SMCJ78C	TVS	Vbr=86.7. 109.8V, Vrwm=78V, 21.6A, 3000W(1ms), Bidirectional	DO-214AB	1ba	1x,1y	Pjt,Srj
IGS	SMLJ78C	TVS	Vrwm=78V, Vbr=86.7. 106V, Ipp=21.6A, 3000W(1ms), Bidirectional	DO-214AB	1a	1j	Mco
IGS	TV30C780KB-G	TVS	Vrwm=78.0V, Vbr=86.70. 106.0V, Ipp=21.58A, 3000W(1ms), Bidirectional	DO-214AB	1ba	1j	Cmc
IGT	3.0SMCJ78CA	TVS	Vbr=86.7. 99.7V, Vrwm=78V, 22.8A, 3000W(1ms), Bidirectional	DO-214AB	1ba	1x,1y	Pjt,Srj
IGT	CD214L-T78CALF	TVS	Vbr=86.70. 95.80V, Vrwm=78V, Irs=22.8A, 3000W(1ms), Bidirectional	DO-214AB	1d	1j	Bm
IGT	SMLJ78CA	TVS	Vbr=86.70. 95.80V, Vrwm=78V, Irs=22.8A, 3000W(1ms), Bidirectional	DO-214AB	1d	1j	Bm
IGT	TV30C780JB-G	TVS	Vrwm=78.0V, Vbr=86.70. 95.80V, Ipp=23.81A, 3000W(1ms), Bidirectional	DO-214AB	1ba	1j	Cmc
IGU	3.0SMCJ85C	TVS	Vbr=94.4. 119.2V, Vrwm=85V, 19.8A, 3000W(1ms), Bidirectional	DO-214AB	1ba	1x,1y	Pjt,Srj
IGU	SMLJ85C	TVS	Vrwm=85V, Vbr=94.4. 115V, Ipp=19.8A, 3000W(1ms), Bidirectional	DO-214AB	1a	1j	Mco
IGU	TV30C850KB-G	TVS	Vrwm=85.0V, Vbr=94.40..115.0V, Ipp=19.87A, 3000W(1ms), Bidirectional	DO-214AB	1ba	1j	Cmc
IGV	3.0SMCJ85CA	TVS	Vbr=94.4. 108.2V, Vrwm=85V, 20.8A, 3000W(1ms), Bidirectional	DO-214AB	1ba	1x,1y	Pjt,Srj
IGV	CD214L-T85CALF	TVS	Vbr=94.40. 104.30V, Vrwm=85V, Irs=20.8A, 3000W(1ms), Bidirectional	DO-214AB	1d	1j	Bm
IGV	SMLJ85CA	TVS	Vbr=94.40. 104.30V, Vrwm=85V, Irs=20.8A, 3000W(1ms), Bidirectional	DO-214AB	1d	1j	Bm
IGV	TV30C850JB-G	TVS	Vrwm=85.0V, Vbr=94.40..104.0V, Ipp=21.90A, 3000W(1ms), Bidirectional	DO-214AB	1ba	1j	Cmc
IGW	3.0SMCJ90C	TVS	Vbr=100. 126.5V, Vrwm=90V, 18.8A, 3000W(1ms), Bidirectional	DO-214AB	1ba	1x,1y	Pjt,Srj
IGW	SMLJ90C	TVS	Vrwm=90V, Vbr=100. 122V, Ipp=18.8A, 3000W(1ms), Bidirectional	DO-214AB	1a	1j	Mco
IGW	TV30C900KB-G	TVS	Vrwm=90.0V, Vbr=100.0. 122.0V, Ipp=18.75A, 3000W(1ms), Bidirectional	DO-214AB	1ba	1j	Cmc
IGX	3.0SMCJ90CA	TVS	Vbr=100. 115.5V, Vrwm=90V, 20.6A, 3000W(1ms), Bidirectional	DO-214AB	1ba	1x,1y	Pjt,Srj
IGX	CD214L-T90CALF	TVS	Vbr=100.0. 110.50V, Vrwm=90V, Irs=20.6A, 3000W(1ms), Bidirectional	DO-214AB	1d	1j	Bm
IGX	SMLJ90CA	TVS	Vbr=100.0. 110.50V, Vrwm=90V, Irs=20.6A, 3000W(1ms), Bidirectional	DO-214AB	1d	1j	Bm
IGX	TV30C900JB-G	TVS	Vrwm=90.0V, Vbr=100.0. 111.0V, Ipp=20.55A, 3000W(1ms), Bidirectional	DO-214AB	1ba	1j	Cmc
IGY	3.0SMCJ100C	TVS	Vbr=111. 141.0V, Vrwm=100V, 16.6A, 3000W(1ms), Bidirectional	DO-214AB	1ba	1x,1y	Pjt,Srj
IGY	SMLJ100C	TVS	Vrwm=100V, Vbr=111. 136V, Ipp=16.8A, 3000W(1ms), Bidirectional	DO-214AB	1a	1j	Mco
IGY	TV30C101KB-G	TVS	Vrwm=100.0V, Vbr=111.0. 136.0V, Ipp=16.76A, 3000W(1ms), Bidirectional	DO-214AB	1ba	1j	Cmc



SMD
code

Type

Function

Short description

Case

Pinout

St.

Mnf.

SMD code	Type	Function	Short description	Case	Pinout	St.	Mnf.
IGZ	3.0SMCJ100CA	TVS	Vbr=111.128.0V, Vrwm=100V, 18.6A, 3000W(1ms), Bidirectional	DO-214AB	1ba	1x,1y	Pjt,Srj
IGZ	CD214L-T100CALF	TVS	Vbr=111.0.122.70V, Vrwm=100V, Irsm=18.6A, 3000W(1ms), Bidirectional	DO-214AB	1d	1j	Bm
IGZ	SMLJ100CA	TVS	Vbr=111.0.122.70V, Vrwm=100V, Irsm=18.6A, 3000W(1ms), Bidirectional	DO-214AB	1d	1j	Bm
IGZ	TV30C101JB-G	TVS	Vrwm=100.0V, Vbr=111.0.123.0V, lpp=18.52A, 3000W(1ms), Bidirectional	DO-214AB	1ba	1j	Cmc
IH	P4SMAJ14	TVS	Vbr=14V, 15.5A, 400W (1ms)	DO-214AC	1d	1m,1w	Pjt,Srj
IHA	TV30C141KB-G	TVS	Vrwm=140.0V, Vbr=155.68.190.4V, lpp=11.97A, 3000W(1ms), Bidirectional	DO-214AB	1ba	1j	Cmc
IHB	TV30C141JB-G	TVS	Vrwm=140.0V, Vbr=155.0.171.0V, lpp=13.23A, 3000W(1ms), Bidirectional	DO-214AB	1ba	1j	Cmc
IHD	3.0SMCJ110C	TVS	Vbr=122.154.5V, Vrwm=110V, 15.4A, 3000W(1ms), Bidirectional	DO-214AB	1ba	1x,1y	Pjt,Srj
IHD	SMLJ110C	TVS	Vrwm=110V, Vbr=122.149V, lpp=15.4A, 3000W(1ms), Bidirectional	DO-214AB	1a	1j	Mco
IHD	TV30C111KB-G	TVS	Vrwm=110.0V, Vbr=122.0.149.0V, lpp=15.31A, 3000W(1ms), Bidirectional	DO-214AB	1ba	1j	Cmc
IHE	3.0SMCJ110CA	TVS	Vbr=122.140.5V, Vrwm=110V, 16.8A, 3000W(1ms), Bidirectional	DO-214AB	1ba	1x,1y	Pjt,Srj
IHE	CD214L-T110CALF	TVS	Vbr=122.0.134.80V, Vrwm=110V, Irsm=16.8A, 3000W(1ms), Bidirectional	DO-214AB	1d	1j	Bm
IHE	SMLJ110CA	TVS	Vbr=122.0.134.80V, Vrwm=110V, Irsm=16.8A, 3000W(1ms), Bidirectional	DO-214AB	1d	1j	Bm
IHE	TV30C111JB-G	TVS	Vrwm=110.0V, Vbr=122.0.135.0V, lpp=16.9A, 3000W(1ms), Bidirectional	DO-214AB	1ba	1j	Cmc
IHF	3.0SMCJ120C	TVS	Vbr=133.169.0V, Vrwm=120V, 14.0A, 3000W(1ms), Bidirectional	DO-214AB	1ba	1x,1y	Pjt,Srj
IHF	SMLJ120C	TVS	Vrwm=120V, Vbr=133.163V, lpp=14.0A, 3000W(1ms), Bidirectional	DO-214AB	1a	1j	Mco
IHF	TV30C121KB-G	TVS	Vrwm=120.0V, Vbr=133.0.163.0V, lpp=14.02A, 3000W(1ms), Bidirectional	DO-214AB	1ba	1j	Cmc
IHG	3.0SMCJ120CA	TVS	Vbr=133.153.0V, Vrwm=120V, 15.6A, 3000W(1ms), Bidirectional	DO-214AB	1ba	1x,1y	Pjt,Srj
IHG	CD214L-T120CALF	TVS	Vbr=133.0.147.0V, Vrwm=120V, Irsm=15.6A, 3000W(1ms), Bidirectional	DO-214AB	1d	1j	Bm
IHG	SMLJ120CA	TVS	Vbr=133.0.147.0V, Vrwm=120V, Irsm=15.6A, 3000W(1ms), Bidirectional	DO-214AB	1d	1j	Bm
IHG	TV30C121JB-G	TVS	Vrwm=120.0V, Vbr=133.0.147.0V, lpp=15.54A, 3000W(1ms), Bidirectional	DO-214AB	1ba	1j	Cmc
IHH	3.0SMCJ130C	TVS	Vbr=144.182.5V, Vrwm=130V, 13.0A, 3000W(1ms), Bidirectional	DO-214AB	1ba	1x,1y	Pjt,Srj
IHH	CD214L-T130CALF	TVS	Vbr=144.0.159.20V, Vrwm=130V, Irsm=14.4A, 3000W(1ms), Bidirectional	DO-214AB	1d	1j	Bm
IHH	SMLJ130C	TVS	Vrwm=130V, Vbr=144.176V, lpp=13.0A, 3000W(1ms), Bidirectional	DO-214AB	1a	1j	Mco
IHH	SMLJ130CA	TVS	Vbr=144.0.159.20V, Vrwm=130V, Irsm=14.4A, 3000W(1ms), Bidirectional	DO-214AB	1d	1j	Bm
IHH	TV30C131KB-G	TVS	Vrwm=130.0V, Vbr=144.0.176.0V, lpp=12.99A, 3000W(1ms), Bidirectional	DO-214AB	1ba	1j	Cmc
IHK	3.0SMCJ130CA	TVS	Vbr=144.165.5V, Vrwm=130V, 14.4A, 3000W(1ms), Bidirectional	DO-214AB	1ba	1x,1y	Pjt,Srj
IHK	SMLJ130CA	TVS	Vrwm=130V, Vbr=144.159V, lpp=14.4A, 3000W(1ms), Bidirectional	DO-214AB	1a	1j	Mco
IHK	TV30C131JB-G	TVS	Vrwm=130.0V, Vbr=144.0.159.0V, lpp=14.35A, 3000W(1ms), Bidirectional	DO-214AB	1ba	1j	Cmc
IHL	3.0SMCJ150C	TVS	Vbr=167.211.5V, Vrwm=150V, 11.2A, 3000W(1ms), Bidirectional	DO-214AB	1ba	1x,1y	Pjt,Srj
IHL	SMLJ150C	TVS	Vrwm=150V, Vbr=167.204V, lpp=11.2A, 3000W(1ms), Bidirectional	DO-214AB	1a	1j	Mco
IHL	TV30C151KB-G	TVS	Vrwm=150.0V, Vbr=167.0.204.0V, lpp=11.19A, 3000W(1ms), Bidirectional	DO-214AB	1ba	1j	Cmc
IHM	3.0SMCJ150CA	TVS	Vbr=167.192.5V, Vrwm=150V, 12.4A, 3000W(1ms), Bidirectional	DO-214AB	1ba	1x,1y	Pjt,Srj
IHM	CD214L-T150CALF	TVS	Vbr=167.0.184.60V, Vrwm=150V, Irsm=12.4A, 3000W(1ms), Bidirectional	DO-214AB	1d	1j	Bm
IHM	SMLJ150CA	TVS	Vbr=167.0.184.60V, Vrwm=150V, Irsm=12.4A, 3000W(1ms), Bidirectional	DO-214AB	1d	1j	Bm
IHM	TV30C151JB-G	TVS	Vrwm=150.0V, Vbr=167.0.185.0V, lpp=12.35A, 3000W(1ms), Bidirectional	DO-214AB	1ba	1j	Cmc
IHN	3.0SMCJ160C	TVS	Vbr=178.226.0V, Vrwm=160V, 10.4A, 3000W(1ms), Bidirectional	DO-214AB	1ba	1x,1y	Pjt,Srj
IHN	SMLJ160C	TVS	Vrwm=160V, Vbr=178.218V, lpp=10.4A, 3000W(1ms), Bidirectional	DO-214AB	1a	1j	Mco
IHN	TV30C161KB-G	TVS	Vrwm=160.0V, Vbr=178.0.218.0V, lpp=10.45A, 3000W(1ms), Bidirectional	DO-214AB	1ba	1j	Cmc
IHP	3.0SMCJ160CA	TVS	Vbr=178.205.0V, Vrwm=160V, 11.6A, 3000W(1ms), Bidirectional	DO-214AB	1ba	1x,1y	Pjt,Srj
IHP	CD214L-T160CALF	TVS	Vbr=178.0.196.70V, Vrwm=160V, Irsm=11.6A, 3000W(1ms), Bidirectional	DO-214AB	1d	1j	Bm
IHP	SMLJ160CA	TVS	Vbr=178.0.196.70V, Vrwm=160V, Irsm=11.6A, 3000W(1ms), Bidirectional	DO-214AB	1d	1j	Bm
IHP	TV30C161JB-G	TVS	Vrwm=160.0V, Vbr=178.0.197.0V, lpp=11.58A, 3000W(1ms), Bidirectional	DO-214AB	1ba	1j	Cmc
IHQ	3.0SMCJ170C	TVS	Vbr=189.239.5V, Vrwm=170V, 9.8A, 3000W(1ms), Bidirectional	DO-214AB	1ba	1x,1y	Pjt,Srj
IHQ	SMLJ170C	TVS	Vrwm=170V, Vbr=189.231V, lpp=9.8A, 3000W(1ms), Bidirectional	DO-214AB	1a	1j	Mco
IHQ	TV30C171KB-G	TVS	Vrwm=170.0V, Vbr=189.0.231.0V, lpp=9.87A, 3000W(1ms), Bidirectional	DO-214AB	1ba	1j	Cmc
IHR	3.0SMCJ170CA	TVS	Vbr=189.217.5V, Vrwm=170V, 11.0A, 3000W(1ms), Bidirectional	DO-214AB	1ba	1x,1y	Pjt,Srj
IHR	CD214L-T170CALF	TVS	Vbr=189.0.208.90V, Vrwm=170V, Irsm=11.0A, 3000W(1ms), Bidirectional	DO-214AB	1d	1j	Bm
IHR	SMLJ170CA	TVS	Vbr=189.0.208.90V, Vrwm=170V, Irsm=11.0A, 3000W(1ms), Bidirectional	DO-214AB	1d	1j	Bm
IHR	TV30C171JB-G	TVS	Vrwm=170.0V, Vbr=189.0.209.0V, lpp=10.91A, 3000W(1ms), Bidirectional	DO-214AB	1ba	1j	Cmc
IHS	3.0SMCJ180C	TVS	Vbr=198.253.8V, Vrwm=180V, 9.3A, 3000W(1ms), Bidirectional	DO-214AB	1ba	1x,1y	Pjt,Srj
IHS	TV30C181KB-G	TVS	Vrwm=180.0V, Vbr=200.16.244.80V, lpp=9.31A, 3000W(1ms), Bidirectional	DO-214AB	1ba	1j	Cmc
IHT	3.0SMCJ180CA	TVS	Vbr=198.230.4V, Vrwm=180V, 10.3A, 3000W(1ms), Bidirectional	DO-214AB	1ba	1x,1y	Pjt,Srj
IHT	TV30C181JB-G	TVS	Vrwm=180.0V, Vbr=200.0.220.0V, lpp=10.29A, 3000W(1ms), Bidirectional	DO-214AB	1ba	1j	Cmc
IHU	3.0SMCJ190C	TVS	Vbr=209.267.9V, Vrwm=190V, 8.8A, 3000W(1ms), Bidirectional	DO-214AB	1ba	1x,1y	Pjt,Srj
IHU	TV30C191KB-G	TVS	Vrwm=190.0V, Vbr=211.28.258.40V, lpp=8.82A, 3000W(1ms), Bidirectional	DO-214AB	1ba	1j	Cmc
IHV	3.0SMCJ190CA	TVS	Vbr=209.243.2V, Vrwm=190V, 9.7A, 3000W(1ms), Bidirectional	DO-214AB	1ba	1x,1y	Pjt,Srj
IHV	TV30C191JB-G	TVS	Vrwm=190.0V, Vbr=211.0.232.0V, lpp=9.75A, 3000W(1ms), Bidirectional	DO-214AB	1ba	1j	Cmc
IHW	3.0SMCJ200C	TVS	Vbr=220.282.0V, Vrwm=200V, 8.4A, 3000W(1ms), Bidirectional	DO-214AB	1ba	1x,1y	Pjt,Srj
IHW	TV30C201JB-G	TVS	Vrwm=200.0V, Vbr=224.0.247.0V, lpp=9.26A, 3000W(1ms), Bidirectional	DO-214AB	1ba	1j	Cmc
IHX	3.0SMCJ200CA	TVS	Vbr=220.256.0V, Vrwm=200V, 9.3A, 3000W(1ms), Bidirectional	DO-214AB	1ba	1x,1y	Pjt,Srj
IHX	TV30C221JB-G	TVS	Vrwm=220.0V, Vbr=246.0.272.0V, lpp=8.43A, 3000W(1ms), Bidirectional	DO-214AB	1ba	1j	Cmc
IHY	3.0SMCJ210C	TVS	Vbr=231.296.1V, Vrwm=210V, 7.8A, 3000W(1ms), Bidirectional	DO-214AB	1ba	1x,1y	Pjt,Srj
IHY	3.0SMCJ210CA	TVS	Vbr=231.268.8V, Vrwm=210V, 8.8A, 3000W(1ms), Bidirectional	DO-214AB	1ba	1x,1y	Pjt,Srj
IHZ	TV30C251JB-G	TVS	Vrwm=250.0V, Vbr=279.0.309.0V, lpp=7.4A, 3000W(1ms), Bidirectional	DO-214AB	1ba	1j	Cmc
IIE	3.0SMCJ220C	TVS	Vbr=242.310.2V, Vrwm=220V, 7.6A, 3000W(1ms), Bidirectional	DO-214AB	1ba	1x,1y	Pjt,Srj
IIE	3.0SMCJ220CA	TVS	Vbr=242.281.6V, Vrwm=220V, 8.4A, 3000W(1ms), Bidirectional	DO-214AB	1ba	1x,1y	Pjt,Srj
IJE	TV30C301JB-G	TVS	Vrwm=300.0V, Vbr=335.0.371.0V, lpp=6.17A, 3000W(1ms), Bidirectional	DO-214AB	1ba	1j	Cmc
IJG	TV30C351JB-G	TVS	Vrwm=350.0V, Vbr=391.0.432.0V, lpp=5.29A, 3000W(1ms), Bidirectional	DO-214AB	1ba	1j	Cmc
IJK	TV30C401JB-G	TVS	Vrwm=400.0V, Vbr=447.0.494.0V, lpp=4.63A, 3000W(1ms), Bidirectional	DO-214AB	1ba	1j	Cmc



SMD
code

Type

Function

Short description

Case

Pinout

St.

Mnf.

SMD code	Type	Function	Short description	Case	Pinout	St.	Mnf.
IJM	TV30C441JB-G	TVS	Vrwm=440.0V, Vbr=492.0..543.0V, Ipp=4.21A, 3000W(1ms), Bidirectional	DO-214AB	1ba	1j	Cmc
IK	CD214A-T14A	TVS	Vbr=14V, Irlsm=17.2A, 400W(1ms)	DO-214AC	1d	1a	Bm
IK	P4SMAJ14A	TVS	Vbr=14V, 17.2A, 400W (1ms)	DO-214AC	1d	1m,1w	Pjt,Srij
IK	SMAJ14A	TVS	Vrwm=14V, Vbr=15.6..17.2V, 17.2A, 400W(1ms)	DO-214AC	1d	1m	Di
IL	P4SMAJ15	TVS	Vbr=15V, 14.8A, 400W (1ms)	DO-214AB	1d	1m,1w	Pjt,Srij
IM	CD214A-T15A	TVS	Vbr=15V, Irlsm=16.4A, 400W(1ms)	DO-214AC	1d	1a	Bm
IM	P4SMAJ15A	TVS	Vbr=15V, 16.4A, 400W (1ms)	DO-214AB	1d	1m,1w	Pjt,Srij
IM	SMAJ15A	TVS	Vrwm=15V, Vbr=16.7..18.5V, 16.4A, 400W(1ms)	DO-214AC	1d	1m	Di
IN	P4SMAJ16	TVS	Vbr=16V, 13.8A, 400W (1ms)	DO-214AB	1d	1m,1w	Pjt,Srij
IP	CD214A-T16A	TVS	Vbr=16V, Irlsm=15.3A, 400W(1ms)	DO-214AC	1d	1a	Bm
IP	P4SMAJ16A	TVS	Vbr=16V, 15.3A, 400W (1ms)	DO-214AB	1d	1m,1w	Pjt,Srij
IP	SMAJ16A	TVS	Vrwm=16V, Vbr=17.8..21.8V, 15.4A, 400W(1ms)	DO-214AC	1d	1m	Di
IQ	P4SMAJ17	TVS	Vbr=17V, 13.1A, 400W (1ms)	DO-214AB	1d	1m,1w	Pjt,Srij
IR	CD214A-T17A	TVS	Vbr=17V, Irlsm=14.5A, 400W(1ms)	DO-214AC	1d	1a	Bm
IR	P4SMAJ17A	TVS	Vbr=17V, 14.5A, 400W (1ms)	DO-214AB	1d	1m,1w	Pjt,Srij
IR	SMAJ17A	TVS	Vrwm=17V, Vbr=18.9..20.9V, 14.5A, 400W(1ms)	DO-214AC	1d	1m	Di
IR12	MBR5120	Si-diode	SBR, 20V, 1A, Vf<0.35V(1A)	DO-214AA	1d	1b	Inr
IR12A	MBRA120	Si-diode	SBR, 20V, 1A, Vf<0.34V(1A)	DO-214AC	1d	1b	Inr
IR14	MBRA140TR	Si-diode	SBR, 40V, 1A, Vf<0.49V(1A)	DO-214AC	1d	1b	Inr
IR1C	10BQ015	Si-diode	SBR, 15V, 1A, Vf<0.32V(1A)	DO-214AA	1d	1b	Inr
IR32	MBR5320TR	Si-diode	SBR, 20V, 3A, Vf<0.36V(3A)	DO-214AB	1d	1b	Inr
IR3C	30BQ015	Si-diode	SBR, 15V, 3A, Vf<0.3V(1A)	DO-214AB	1d	1b	Inr
IS	P4SMAJ18	TVS	Vbr=18V, 12.4A, 400W (1ms)	DO-214AB	1d	1m,1w	Pjt,Srij
IT	CD214A-T18A	TVS	Vbr=18V, Irlsm=13.7A, 400W(1ms)	DO-214AC	1d	1a	Bm
IT	P4SMAJ18A	TVS	Vbr=18V, 13.7A, 400W (1ms)	DO-214AB	1d	1m,1w	Pjt,Srij
IT	SMAJ18A	TVS	Vrwm=18V, Vbr=20.0..22.1V, 13.7A, 400W(1ms)	DO-214AC	1d	1m	Di
IU	P4SMAJ20	TVS	Vbr=20V, 11.1A, 400W (1ms)	DO-214AB	1d	1m,1w	Pjt,Srij
IV	CD214A-T20A	TVS	Vbr=20V, Irlsm=12.3A, 400W(1ms)	DO-214AC	1d	1a	Bm
IV	P4SMAJ20A	TVS	Vbr=20V, 12.3A, 400W (1ms)	DO-214AC	1d	1m,1w	Pjt,Srij
IV	SMAJ20A	TVS	Vrwm=20V, Vbr=22.2..24.5V, 12.3A, 400W(1ms)	DO-214AC	1d	1m	Di
IW	P4SMAJ22	TVS	Vbr=22V, 10.1A, 400W (1ms)	DO-214AC	1d	1m,1w	Pjt,Srij
IX	CD214A-T22A	TVS	Vbr=22V, Irlsm=11.2A, 400W(1ms)	DO-214AC	1d	1a	Bm
IX	P4SMAJ22A	TVS	Vbr=22V, 11.2A, 400W (1ms)	DO-214AC	1d	1m,1w	Pjt,Srij
IX	SMAJ22A	TVS	Vrwm=22V, Vbr=24.4..26.9V, 11.2A, 400W(1ms)	DO-214AC	1d	1m	Di
IY	P4SMAJ24	TVS	Vbr=24V, 9.3A, 400W (1ms)	DO-214AC	1d	1m,1w	Pjt,Srij
IZ	CD214A-T24A	TVS	Vbr=24V, Irlsm=10.3A, 400W(1ms)	DO-214AC	1d	1a	Bm
IZ	P4SMAJ24A	TVS	Vbr=24V, 10.3A, 400W (1ms)	DO-214AC	1d	1m,1w	Pjt,Srij
IZ	SMAJ24A	TVS	Vrwm=24V, Vbr=26.7..29.5V, 10.3A, 400W(1ms)	DO-214AC	1d	1m	Di
J	1SS06AWT	Si-diode	SBD, Sw, 40V, 200mA, Vf<0.6V(200mA)	SOD-523FL	7d	1a	Sme
J	CDZ9.1B	Z-diode	9.1V±2.5%, 40mA, 1W	VMN	7d	1s	Rhm
J	CH500H-40PT	Si-diode	SBD, 45V, 100mA, Vf<0.45V(10mA)	SOD-323	5d	1a	Chm
J	HVU357	C-diode	VCO, 10V, 19.5/23.5pF(1V)	SOD-323	5d	1a	Ren
J	MA27V15	C-diode	VCO, 6V, 2.98..7.30pF	SOD-523	6d	1a	Pan
J	MM9D10V	Z-diode	9.50..10.50V, Izt=5mA, Zzt=30Ω, 200mW	SOD-923	7d	1n	Wtr
J	MM9D2V4	Z-diode	2.28..2.52V, Izt=5mA, Zzt=100Ω, 200mW	SOD-923	7d	1a	Wtr
j	MMSZ5236BPT	Z-diode	7.125..7.875V, Izt=5mA, Zzt=7Ω, 225mW	SOD-523	7d	1a	Chm
j	MMSZ5260BPT	Z-diode	40.85..45.15V, Izt=3.0mA, Zzt=93Ω, 225mW	SOD-523	7d	1a	Chm
J	NZ9F10VT	Z-diode	9.50..10.50V, Izt=5mA, Zzt=30Ω, 200mW	SOD-923	7d	1n	Ons
J	NZ9F2V4T	Z-diode	2.28..2.52V, Izt=5mA, Zzt=100Ω, 200mW	SOD-923	7d	1a	Ons
J	NZ9F5V6ST	Z-diode	5.49..5.73V, Izt=5mA, Zzt=60Ω, 200mW	SOD-923	7d	2m	Ons
j	MMSZ5236SPT	Z-diode	7.350..7.650V, Izt=5mA, Zzt=7Ω, 225mW	SOD-523	7d	1a	Chm
j	MMSZ5260SPT	Z-diode	42.14..43.86V, Izt=3.0mA, Zzt=93Ω, 225mW	SOD-523	7d	1a	Chm
J0	CMOZ39V	Z-diode	37.05..40.95V, Izt=5mA, Zzt=130Ω, 250mW	SOD-523	6d	1a	Cen
J0	MMPZ5240SPT	Z-diode	9.800..10.20V, Izt=5mA, Zzt=15Ω, 225mW	SOD-323	5d	1a	Chm
J0	MMPZ5255BPT	Z-diode	26.60..29.40V, Izt=5mA, Zzt=44Ω, 225mW	SOD-323	5d	1a	Chm
J1	CMOZ16V	Z-diode	15.20..16.80V, Izt=5mA, Zzt=40Ω, 250mW	SOD-523	6d	1a	Cen
J1	CZRH5246B-G	Z-diode	15.2..16.8V, Zzt=17Ω, Izt=7.8mA, 150mW	SOD-523	5d	1a	Cmc
J1	CZRV5246B-G	Z-diode	15.2..16.8V, Zzt=17Ω, Izt=7.8mA, 200mW	SOD-323	5d	1a	Cmc
J1	CZRW5246B-G	Z-diode	15.20..16.80V, Zzt=17Ω, Izt=7.8mA, 500mW	SOD-123	5d	1a	Cmc
J1	FRS3A	Si-diode	Rectifier, Fast-Recovery 50V, 3A, <250ns	DO-214AB	1d	2j	Fag
J1	MM3Z5230B	Z-diode	4.7V±5%, Izt=20mA, Zzt=19Ω, 200mW	SOD-323FL	7d	1a	Bts
J1	MM3Z5230BH	Z-diode	4.47..4.94V, Izt=20mA, Zzt=19Ω, 300mW	SOD-323	5d	1a	Zow
J1	MM3Z5246B	Z-diode	15.20..16.80V, Izt=7.8mA, Zzt=17Ω, 200mW	SOD-323	5d	1a	Ext
J1	MMSZ5246	Z-diode	16V±5%, Zzt=17Ω, 500mW	SOD-123	5d	1k	Vs
J1	MMSZ5246B	Z-diode	16V±5%, Zzt=17Ω, 500mW	SOD-123	5d	1a,1d	Di,Mot
J1	MMSZ5246B	Z-diode	16V±5%, Zzt=17Ω, 500mW	SOD-123	5d	1d	Di
J1	MMSZ5246BS	Z-diode	16V±5%, Zzt=17Ω, 200mW	SOD-323	5d	1d	Di
J2	CMOZ18V	Z-diode	17.10..18.90V, Izt=5mA, Zzt=45Ω, 250mW	SOD-523	6d	1a	Cen
J2	CZRH5247B-G	Z-diode	16.15..17.85V, Zzt=19Ω, Izt=7.5mA, 500mW	SOD-523	5d	1a	Cmc
J2	CZRV5247B-G	Z-diode	16.15..17.85V, Zzt=19Ω, Izt=7.5mA, 200mW	SOD-323	5d	1a	Cmc



SMD
code

Type

Function

Short description

Case

Pinout

St.

Mnf.

J2	CZRW5247B-G	Z-diode	16.15..17.85V, Zzt=19Ω, Izt=7.4mA, 500mW	SOD-123	5d	1a	Cmc
J2	EDZ8.2B	Z-diode	8.02..8.36V, Izt=5mA, Zzt=30Ω, 150mW	SOD-523	6d	1a	Rhm
J2	FDZ8.2EV	Z-diode	8.020..8.360V, Izt=5mA, Zzt=30Ω, 150mW	SOD-523	7d	1a	Fis
J2	FDZ8.2VT	Z-diode	8.020..8.360V, Izt=5mA, Zzt=30Ω, 200mW	SOD-323	5d	1a	Fis
J2	FRS3B	Si-diode	Rectifier, Fast-Recovery 100V, 3A, <250ns	DO-214AB	1d	2j	Fag
J2	MM3Z5247B	Z-diode	16.15..17.85V, Izt=7.4mA, Zzt=19Ω, 200mW	SOD-323	5d	1a	Ext
J2	MM3Z5251B	Z-diode	22V±5%, Izt=5.6mA, Zzt=29Ω, 200mW	SOD-323FL	7d	1a	Bts
J2	MM3Z5251BH	Z-diode	20.9..23.1V, Izt=5.6mA, Zzt=29Ω, 300mW	SOD-323	5d	1a	Zow
J2	MMSZ5247	Z-diode	17V±5%, Zzt=19Ω, 500mW	SOD-123	5d	1k	Vs
J2	MMSZ5247B	Z-diode	17V±5%, Zzt=19Ω, 500mW	SOD-123	5d	1a	Mot
J2	TDZ8.2B	Z-diode	8.2V±2.5%, 10mA, 500mW	TUMD2	7d	1s	Rhm
J2	UDZS8.2B	Z-diode	8.02..8.36V, Izt=5mA, Zzt=30Ω, 200mW	SOD-323	5d	1a	Wtr
J2	UDZS8.2B	Z-diode	8.2V±2.5%, Izt=5mA, 200mW	SOD-323FL	7d	1s	Rhm
J2	VDZS8.2B	Z-diode	8.2V±5%, 5mA, 100mW	VMD2	5d	1z	Rhm
J3	CMOZ20V	Z-diode	19.0..21.0V, Izt=5mA, Zzt=55Ω, 250mW	SOD-523	6d	1a	Cen
J3	CZRH5248B-G	Z-diode	17.1..18.9V, Zzt=21Ω, Izt=7mA, 150mW	SOD-523	5d	1a	Cmc
J3	CZRW5248B-G	Z-diode	17.1..18.9V, Zzt=21Ω, Izt=7mA, 200mW	SOD-323	5d	1a	Cmc
J3	CZRW5248B-G	Z-diode	17.10..18.90V, Zzt=21Ω, Izt=7.0mA, 500mW	SOD-123	5d	1a	Cmc
J3	FRS3D	Si-diode	Rectifier, Fast-Recovery 200V, 3A, <250ns	DO-214AB	1d	2j	Fag
J3	MM3Z5248B	Z-diode	17.10..18.9V, Izt=7.0mA, Zzt=21Ω, 200mW	SOD-323	5d	1a	Ext
J3	MMSZ5248	Z-diode	18V±5%, Zzt=21Ω, 500mW	SOD-123	5d	1k	Vs
J3	MMSZ5248B	Z-diode	18V±5%, Zzt=21Ω, 500mW	SOD-123	5d	1a,1d	Di,Mot
J3	MMSZ5248B	Z-diode	18V±5%, Zzt=21Ω, 500mW	SOD-123	5d	1d	Di
J3	MMSZ5248BS	Z-diode	18V±5%, Zzt=21Ω, 200mW	SOD-323	5d	1d	Di
J3	RKZ12B2KK	Z-diode	11.74..12.24V, Izt=5mA, Zzt=35Ω, 150mW	SFP	7d	1a	Ren
J3	RKZ12B2KL	Z-diode	11.74..12.24V, Izt=5mA, Zzt=35Ω, 100mW	EFP	7d	1a	Ren
J4	CMOZ22V	Z-diode	20.90..23.10V, Izt=5mA, Zzt=55Ω, 250mW	SOD-523	6d	1a	Cen
J4	FRS3G	Si-diode	Rectifier, Fast-Recovery 400V, 3A, <250ns	DO-214AB	1d	2j	Fag
J4	MM1Z5230B	Z-diode	4.47..4.94V, Izt=20mA, Zzt=19Ω, 500mW	SOD-323FL	5d	1a	Eic
J4	MM1Z5230BH	Z-diode	4.47..4.94V, Izt=20mA, Zzt=19Ω, 500mW	SOD-123	5d	1a	Zow
J4	MMSZ5230B	Z-diode	4.7V±5%, Izt=20mA, Zzt=19Ω, 500mW	SOD-123	5d	1a	Eic
J4	MMSZ5249	Z-diode	19V±5%, Zzt=23Ω, 500mW	SOD-123	5d	1k	Vs
J4	MMSZ5249B	Z-diode	19V±5%, Zzt=23Ω, 500mW	SOD-123	5d	1a	Mot
J5	BZX584B13V	Z-diode	12.74..13.26V, Izt=5mA, Zzt=30Ω, 200mW	SOD-523FL	7d	1a	Tac
J5	CMOZ24V	Z-diode	22.80..25.20V, Izt=5mA, Zzt=70Ω, 250mW	SOD-523	6d	1a	Cen
J5	CZRH5250B-G	Z-diode	19..21V, Zzt=25Ω, Izt=6.2mA, 150mW	SOD-523	5d	1a	Cmc
J5	CZRW5250B-G	Z-diode	19..21V, Zzt=25Ω, Izt=6.2mA, 200mW	SOD-323	5d	1a	Cmc
J5	CZRW5250B-G	Z-diode	19.0..21.0V, Zzt=25Ω, Izt=6.2mA, 500mW	SOD-123	5d	1a	Cmc
J5	FRS3J	Si-diode	Rectifier, Fast-Recovery 600V, 3A, <250ns	DO-214AB	1d	2j	Fag
J5	MM1Z5251B	Z-diode	20.90..23.10V, Izt=5.6mA, Zzt=29Ω, 500mW	SOD-323FL	5d	1a	Eic
J5	MM1Z5251BH	Z-diode	20.9..23.1V, Izt=5.6mA, Zzt=29Ω, 500mW	SOD-123	5d	1a	Zow
J5	MM3Z5250B	Z-diode	19.0..21.0V, Izt=6.2mA, Zzt=25Ω, 200mW	SOD-323	5d	1a	Ext
J5	MMSZ13VB	Z-diode	12.74..13.26V, Izt=5mA, Zzt=30Ω, 200mW	SOD-523FL	7d	1a	Tac
J5	MMSZ5250	Z-diode	20V±5%, Zzt=25Ω, 300mW	SOD-123	5d	1k	Vs
J5	MMSZ5250B	Z-diode	20V±5%, Zzt=25Ω, 500mW	SOD-123	5d	1a,1d	Di,Mot
J5	MMSZ5250B	Z-diode	20V±5%, Zzt=25Ω, 500mW	SOD-123	5d	1d	Di
J5	MMSZ5250BS	Z-diode	20V±5%, Zzt=25Ω, 200mW	SOD-323	5d	1d	Di
J5	MMSZ5251B	Z-diode	22V±5%, Izt=5.6mA, Zzt=29Ω, 500mW	SOD-123	5d	1a	Eic
J6	CMOZ27V	Z-diode	25.65..28.35V, Izt=5mA, Zzt=80Ω, 250mW	SOD-523	6d	1a	Cen
J6	FRS3K	Si-diode	Rectifier, Fast-Recovery 800V, 3A, <250ns	DO-214AB	1d	2j	Fag
J6	RKZ13B2KK	Z-diode	12.91..13.49V, Izt=5mA, Zzt=35Ω, 150mW	SFP	7d	1a	Ren
J6	RKZ13B2KL	Z-diode	12.91..13.49V, Izt=5mA, Zzt=35Ω, 100mW	EFP	7d	1a	Ren
J7	CMOZ30V	Z-diode	28.50..31.50V, Izt=5mA, Zzt=80Ω, 250mW	SOD-523	6d	1a	Cen
J7	FRS3M	Si-diode	Rectifier, Fast-Recovery 1000V, 3A, <250ns	DO-214AB	1d	2j	Fag
J8	BZD27C7V5P	TVS	Vbr=7V, Vcl=11.3V, 13.3A, 150W(1ms)	SOD123FL	7d	1a	Lge
J8	CMOZ33V	Z-diode	31.35..34.65V, Izt=5mA, Zzt=80Ω, 250mW	SOD-523	6d	1a	Cen
J8	MMSZ6V2	Z-diode	6.2V±5%, Izt=5mA, Zzt=10Ω, 200mW	SOD-523	6d	1a	Eic
J8	MMSZ6V2H	Z-diode	5.8..6.6V, Izt=5mA, Zzt=10Ω, 200mW	SOD-523	7d	1a	Zow
J9	BZD27C8V2P	TVS	Vbr=7.7V, Vcl=12.3V, 12.2A, 150W(1ms)	SOD123FL	7d	1a	Lge
J9	CMOZ36V	Z-diode	34.20..37.80V, Izt=5mA, Zzt=90Ω, 250mW	SOD-523	6d	1a	Cen
J9	MMSZ75H	Z-diode	70..79V, Izt=1mA, Zzt=255Ω, 200mW	SOD-523	7d	1a	Zow
J9	MMSZ75V	Z-diode	75V±5%, Izt=2mA, Zzt=255Ω, 200mW	SOD-523	6d	1a	Eic
J9	RKZ15B2KK	Z-diode	14.34..14.98V, Izt=5mA, Zzt=40Ω, 150mW	SFP	7d	1a	Ren
J9	RKZ15B2KL	Z-diode	14.34..14.98V, Izt=5mA, Zzt=40Ω, 100mW	EFP	7d	1a	Ren
JA	KDS135	Si-diode	Sw, 250V, 100mA, Vf<1.2V(100mA), 100ns	USC	5d	1a	Kec
JA	MMSZB20H	Z-diode	19.6..20.4V, Zzt=50Ω, Izt=5mA, 200mW	SOD-523	7d	1a	Zow
JA	S1JA	Si-diode	Rectifier, 600V, 1A, Vf<1.1V(1A)	DO-214AC	1d	1k	Vs
JB	KDZ4.3B	Z-diode	4.3V±2.5%, 40mA, 1W	PMDU	7d	1s	Rhm
JB	MMSZB22H	Z-diode	21.56..22.44V, Zzt=55Ω, Izt=5mA, 200mW	SOD-523	7d	1a	Zow
JC	CH740H-40PT	Si-diode	SBD, 40V, 40mA, Vf<1V(2mA)	SOD-323	5d	1a	Chm



SMD
code

Type

Function

Short description

Case

Pinout

St.

Mnf.

JC	MM5ZB24H	Z-diode	23.52..24.48V, Zzt=60Ω, Izt=5mA, 200mW	SOD-523	7d	1a	Zow
JD	MM5ZB27H	Z-diode	26.46..27.54V, Zzt=70Ω, Izt=2mA, 200mW	SOD-523	7d	1a	Zow
JD	P4SMAJ26	TVS	Vbr=26V, 8.6A, 400W (1ms)	DO-214AC	1d	1m,1w	Pjt,Srj
JE	CD214A-T26A	TVS	Vbr=26V, Irlsm=9.5A, 400W(1ms)	DO-214AC	1d	1a	Bm
JE	MM5ZB30H	Z-diode	29.4..30.6V, Zzt=80Ω, Izt=2mA, 200mW	SOD-523	7d	1a	Zow
JE	P4SMAJ26A	TVS	Vbr=26V, 9.5A, 400W (1ms)	DO-214AC	1d	1m,1w	Pjt,Srj
JE	SMAJ26A	TVS	Vrwm=26V, Vbr=28.9..31.9V, 9.5A, 400W(1ms)	DO-214AC	1d	1m	Di
JE	SMF26A	TVS	Vrwm=26.0V, Vbr=28.90..31.90V, 4.75A, 200W(10/1000μs)	SOD-123FL	7d	1a	Ers
JE	TV02W260-G	TVS	Vrwm=26V, Vbr=28.9..31.9V, Ipp=4.75A, 200W(1ms)	SOD-123	5d	1a	Cmc
JE	Z2SMB-6V2	Z-diode	6.2V±5%, 2W	DO-214AA	1d	2j	Fag
JF	KDZ13FV	Z-diode	12.40..14.10V, Izt=5mA, Zzt=15Ω, 100mW	TFSC	7d	1a	Kec
JF	MAZD110	Z-diode	10.40..11.6V, Zzt=30Ω(5mA), 120mW	SSSMini2	7d	1a	Pan
JF	MM5ZB33H	Z-diode	32.34..33.66V, Zzt=80Ω, Izt=2mA, 200mW	SOD-523	7d	1a	Zow
JF	P4SMAJ28	TVS	Vbr=28V, 8A, 400W (1ms)	DO-214AC	1d	1m,1w	Pjt,Srj
JG	CD214A-T28A	TVS	Vbr=28V, Irlsm=8.8A, 400W(1ms)	DO-214AC	1d	1a	Bm
JG	P4SMAJ28A	TVS	Vbr=28V, 8.8A, 400W (1ms)	DO-214AC	1d	1m,1w	Pjt,Srj
JG	SMAJ28A	TVS	Vrwm=28V, Vbr=31.1..34.4V, 400W(1ms)	DO-214AC	1d	1m	Di
JG	SMF28A	TVS	Vrwm=28.0V, Vbr=31.10..34.40V, 4.41A, 200W(10/1000μs)	SOD-123FL	7d	1a	Ers
JG	TV02W130B-G	TVS	Vrwm=13V, Vbr=14.4..15.9V, Ipp=9.30A, 200W(1ms), Bidirectional	SOD-123	5ba	1j	Cmc
JG	TV02W280-G	TVS	Vrwm=28V, Vbr=31.1..34.4V, Ipp=4.41A, 200W(1ms)	SOD-123	5d	1a	Cmc
JH	MM5ZB36H	Z-diode	35.28..36.72V, Zzt=90Ω, Izt=2mA, 200mW	SOD-523	7d	1a	Zow
JH	P4SMAJ30	TVS	Vbr=30V, 7.5A, 400W (1ms)	DO-214AC	1d	1m,1w	Pjt,Srj
JI	CH321H-10PT	Si-diode	SBD, 10V, 2A, Vf<0.6V(1A)	SOD-323	5d	1a	Chm
JJ	MM5ZB39H	Z-diode	38.22..39.78V, Zzt=100Ω, Izt=2mA, 200mW	SOD-523	7d	1a	Zow
JK	CD214A-T30A	TVS	Vbr=30V, Irlsm=8.3A, 400W(1ms)	DO-214AC	1d	1a	Bm
JK	CH331H-10PT	Si-diode	SBD, 10V, 3A, Vf<0.6V(1A)	SOD-323	5d	1a	Chm
JK	MM5ZB43H	Z-diode	42.14..43.86V, Zzt=130Ω, Izt=2mA, 200mW	SOD-523	7d	1a	Zow
JK	P4SMAJ30A	TVS	Vbr=30V, 8.3A, 400W (1ms)	DO-214AC	1d	1m,1w	Pjt,Srj
JK	SMAJ30A	TVS	Vrwm=30V, Vbr=33.3..36.8V, 8.3A, 400W(1ms)	DO-214AC	1d	1m	Di
JK	SMF30A	TVS	Vrwm=30.0V, Vbr=33.30..36.80V, 4.13A, 200W(10/1000μs)	SOD-123FL	7d	1a	Ers
JK	TV02W300-G	TVS	Vrwm=30V, Vbr=33.3..36.8V, Ipp=4.13A, 200W(1ms)	SOD-123	5d	1a	Cmc
JL	CH301H-40PT	Si-diode	SBD, 40V, 100mA, Vf<0.55V(100mA)	SOD-323	5d	1a	Chm
JL	P4SMAJ33	TVS	Vbr=33V, 6.8A, 400W (1ms)	DO-214AC	1d	1m,1w	Pjt,Srj
JM	CD214A-T33A	TVS	Vbr=33V, Irlsm=7.5A, 400W(1ms)	DO-214AC	1d	1a	Bm
JM	MM5ZB47H	Z-diode	46.06..47.94V, Zzt=150Ω, Izt=2mA, 200mW	SOD-523	7d	1a	Zow
JM	P4SMAJ33A	TVS	Vbr=33V, 7.5A, 400W (1ms)	DO-214AC	1d	1m,1w	Pjt,Srj
JM	SMAJ33A	TVS	Vrwm=33V, Vbr=36.7..40.6V, 7.5A, 400W(1ms)	DO-214AC	1d	1m	Di
JM	SMF33A	TVS	Vrwm=33.0V, Vbr=36.70..40.60V, 3.75A, 200W(10/1000μs)	SOD-123FL	7d	1a	Ers
JM	TV02W330-G	TVS	Vrwm=33V, Vbr=36.7..40.6V, Ipp=3.75A, 200W(1ms)	SOD-123	5d	1a	Cmc
JN	P4SMAJ36	TVS	Vbr=36V, 6.2A, 400W (1ms)	DO-214AC	1d	1m,1w	Pjt,Srj
JP	CD214A-T36A	TVS	Vbr=36V, Irlsm=6.9A, 400W(1ms)	DO-214AC	1d	1a	Bm
JP	CMDZ4L3	Z-diode	4.085..4.515V, Izt=0.5mA, Zzt=900Ω, 250mW	SOD-323	5d	1a	Cen
JP	KDZ13FVY	Z-diode	12.91..13.49V, Izt=5mA, Zzt=15Ω, 100mW	TFSC	7d	1a	Kec
JP	P4SMAJ36A	TVS	Vbr=36V, 6.9A, 400W (1ms)	DO-214AC	1d	1m,1w	Pjt,Srj
JP	SMAJ36A	TVS	Vrwm=36V, Vbr=40.0..44.2V, 6.9A, 400W(1ms)	DO-214AC	1d	1m	Di
JP	SMF36A	TVS	Vrwm=36.0V, Vbr=40.0..44.20V, 3.44A, 200W(10/1000μs)	SOD-123FL	7d	1a	Ers
JP	TV02W360-G	TVS	Vrwm=36V, Vbr=40.0..44.2V, Ipp=3.44A, 200W(1ms)	SOD-123	5d	1a	Cmc
JQ	P4SMAJ40	TVS	Vbr=40V, 5.6A, 400W (1ms)	DO-214AC	1d	1m,1w	Pjt,Srj
JR	BAS20H	Si-diode	Sw, Fast, 150V, 250mA, 250mW, <50ns	SOD-323	5d	1u	Ons
JR	CD214A-T40A	TVS	Vbr=40V, Irlsm=6.2A, 400W(1ms)	DO-214AC	1d	1a	Bm
JR	P4SMAJ40A	TVS	Vbr=40V, 6.2A, 400W (1ms)	DO-214AC	1d	1m,1w	Pjt,Srj
JR	SMAJ40A	TVS	Vrwm=40V, Vbr=44.4..49.1V, 6.2A, 400W(1ms)	DO-214AC	1d	1m	Di
JR	SMF40A	TVS	Vrwm=40.0V, Vbr=44.40..49.10V, 3.10A, 200W(10/1000μs)	SOD-123FL	7d	1a	Ers
JR	TV02W400-G	TVS	Vrwm=40V, Vbr=44.4..49.1V, Ipp=3.10A, 200W(1ms)	SOD-123	5d	1a	Cmc
JS	BAS21H	Si-diode	Sw, Fast, 200V, 250mA, 250mW, <50ns	SOD-323	5d	1a	Ons
JS	BAS221	Si-diode	GP, 200V, 300mA, 400mW, Vf<1.4V(300mA), <50ns	SOD-110	12d	1a	Phi
JS	CH501H-40PT	Si-diode	SBD, 45V, 100mA, Vf<0.55V(100mA)	SOD-323	5d	1a	Chm
JS	CH801H-30PT	Si-diode	SBD, 30V, 100mA, Vf<0.45V(100mA)	SOD-323	5d	1a	Chm
JS	MMSD103	Si-diode	Sw, 250V, 200mA, 400mW, Vf<1.25V(200mA), <50ns	SOD-123	5d	1a	Ons
JS	P4SMAJ43	TVS	Vbr=43V, 5.2A, 400W (1ms)	DO-214AC	1d	1m,1w	Pjt,Srj
JT	CD214A-T43A	TVS	Vbr=43V, Irlsm=5.7A, 400W(1ms)	DO-214AC	1d	1a	Bm
JT	CH511H-40PT	Si-diode	SBD, 40V, 1A, Vf<0.6V(1A)	SOD-323	5d	1a	Chm
JT	CH651H-40PT	Si-diode	SBD, 40V, 750mA, Vf<0.7V(750mA)	SOD-323	5d	1a	Chm
JT	P4SMAJ43A	TVS	Vbr=43V, 5.7A, 400W (1ms)	DO-214AC	1d	1m,1w	Pjt,Srj
JT	SMAJ43A	TVS	Vrwm=43V, Vbr=47.8..52.8V, 5.7A, 400W(1ms)	DO-214AC	1d	1m	Di
JT	SMF43A	TVS	Vrwm=43.0V, Vbr=47.80..52.80V, 2.88A, 200W(10/1000μs)	SOD-123FL	7d	1a	Ers
JT	TV02W430-G	TVS	Vrwm=43V, Vbr=47.8..52.8V, Ipp=2.88A, 200W(1ms)	SOD-123	5d	1a	Cmc
JU	CH351H-30PT	Si-diode	SBD, 30V, 200mA, Vf<0.55V(100mA)	SOD-323	5d	1a	Chm
JU	P4SMAJ45	TVS	Vbr=45V, 5A, 400W (1ms)	DO-214AC	1d	1m,1w	Pjt,Srj
JV	BAT54H	Si-diode	SBR, 30V, 200mA, Vf<0.52V(100mA), <5ns	SOD-323	5d	1a	Ons



SMD
code

Type

Function

Short description

Case

Pinout

St.

Mnf.

SMD code	Type	Function	Short description	Case	Pinout	St.	Mnf.
JV	CD214A-T45A	TVS	Vbr=45V, I _{rsm} =5.5A, 400W(1ms)	DO-214AC	1d	1a	Bm
JV	CH751H-40PT	Si-diode	SBD, 40V, 30mA, Vf<0.37V(1mA)	SOD-323	5d	1a	Chm
JV	P4SMAJ45A	TVS	Vbr=45V, 5.5A, 400W(1ms)	DO-214AC	1d	1m,1w	Pjt,Srj
JV	SMAJ45A	TVS	V _{rwm} =45V, V _{br} =50.0..55.3V, 5.5A, 400W(1ms)	DO-214AC	1d	1m	Di
JV	SMF45A	TVS	V _{rwm} =45.0V, V _{br} =50.0..55.30V, 2.75A, 200W(10/1000µs)	SOD-123FL	7d	1a	Ers
JV	TV02W450-G	TVS	V _{rwm} =45V, V _{br} =50.0..55.3V, I _{pp} =2.75A, 200W(1ms)	SOD-123	5d	1a	Cmc
JW	CH651H-60PT	Si-diode	SBD, 60V, 1A, Vf<0.58V(700mA)	SOD-323	5d	1a	Chm
JW	P4SMAJ48	TVS	Vbr=48V, 4.7A, 400W(1ms)	DO-214AC	1d	1m,1w	Pjt,Srj
JX	CD214A-T48A	TVS	Vbr=48V, I _{rsm} =5.2A, 400W(1ms)	DO-214AC	1d	1a	Bm
JX	CH651L-40PT	Si-diode	SBD, 40V, 1A, Vf<0.52V(700mA)	SOD-323	5d	1a	Chm
JX	P4SMAJ48A	TVS	Vbr=48V, 5.2A, 400W(1ms)	DO-214AC	1d	1m,1w	Pjt,Srj
JX	SMAJ48A	TVS	V _{rwm} =48V, V _{br} =53.3..58.9V, 5.2A, 400W(1ms)	DO-214AC	1d	1m	Di
JX	SMF48A	TVS	V _{rwm} =48.0V, V _{br} =53.30..58.90V, 2.58A, 200W(10/1000µs)	SOD-123FL	7d	1a	Ers
JX	TV02W480-G	TVS	V _{rwm} =48V, V _{br} =53.3..58.9V, I _{pp} =2.58A, 200W(1ms)	SOD-123	5d	1a	Cmc
JY	KDZ4.3V3VY	Z-diode	4.17..4.43V, I _z =5mA, Z _z =130Ω, 100mW	VSC	7d	1a	Kec
JY	P4SMAJ51	TVS	Vbr=51V, 4.4A, 400W(1ms)	DO-214AC	1d	1m,1w	Pjt,Srj
JZ	BZT52-B13S	Z-diode	12.74..13.26V, I _z =5mA, Z _z =30Ω, 200mW	SOD-323FL	7d	1a	Tsc
JZ	CD214A-T51A	TVS	Vbr=51V, I _{rsm} =4.9A, 400W(1ms)	DO-214AC	1d	1a	Bm
JZ	MM3Z13VB	Z-diode	12.74..13.26V, Z _z =28Ω, I _z =5mA, 200mW	SOD-323FL	7d	1a	F
JZ	MM3Z13VBW	Z-diode	12.74..13.26V, I _z =5mA, Z _z =30Ω, 200mW	SOD-323FL	7d	1a	Tac
JZ	P4SMAJ51A	TVS	Vbr=51V, 4.9A, 400W(1ms)	DO-214AC	1d	1m,1w	Pjt,Srj
JZ	SMAJ51A	TVS	V _{rwm} =51V, V _{br} =56.7..62.7V, 4.9A, 400W(1ms)	DO-214AC	1d	1m	Di
JZ	SMF51A	TVS	V _{rwm} =51.0V, V _{br} =56.70..62.70V, 2.43A, 200W(10/1000µs)	SOD-123FL	7d	1a	Ers
JZ	TCCMM3Z13VB	Z-diode	13V±2%, I _z =5mA, Z _z =28Ω, 200mW	SOD-323FL	7d	1a	Tac
JZ	TV02W510-G	TVS	V _{rwm} =51V, V _{br} =56.7..62.7V, I _{pp} =2.43A, 200W(1ms)	SOD-123	5d	1a	Cmc
K	BB142	C-diode	VCO, 6V, 20mA, 2.05/4.6pF(4V/1V, 1MHz), <0.5Ω	SOD-523	6d	1a	Phi
K	BBY52-02L	C-diode	VCO-Tuning, 7V, 20mA, 1.4..2.2pF(4..1V)	TSLP-P-2.1	13d	2b	Inf
K	CDZ10B	Z-diode	10V±2.5%, I _z =40mA, 1W	VMN	7d	1s	Rhm
K	CH551H-30PT	Si-diode	SBD, 30V, 500mA, Vf<0.47V(500mA)	SOD-323	5d	1a	Chm
K	CH551S-30PT	Si-diode	SBD, 30V, 500mA, Vf<0.47V(500mA)	SOD-523	8d	1a	Chm
K	HVU315	C-diode	VHF-Tuning, 27.6/32.1pF(2V)	SOD-123	5d	1a	Ren
K	MAZS039	Z-diode	3.7..4.1V, 200mW	SOD-523	6d	1a	Pan
K	MM9D11V	Z-diode	10.45..11.55V, I _z =5mA, Z _z =30Ω, 200mW	SOD-923	7d	1n	Wtr
K	NZ9F11VT	Z-diode	10.45..11.55V, I _z =5mA, Z _z =30Ω, 200mW	SOD-923	7d	1n	Ons
K	NZ9F6V2ST	Z-diode	6.06..6.33V, I _z =5mA, Z _z =60Ω, 200mW	SOD-923	7d	2m	Ons
K ^A	MAZS0390H	Z-diode	3.87..4.1V, 200mW	SOD-523	6d	1a	Pan
K ₋	MAZS0390L	Z-diode	3.7..3.97V, 200mW	SOD-523	6d	1a	Pan
K0	BZD27C9V1P	TVS	Vbr=8.5V, V _{cl} =13.3V, 11.3A, 150W(1ms)	SOD123FL	7d	1a	Lege
K0	MMPZ5241SPT	Z-diode	10.78..11.22V, I _z =5mA, Z _z =18Ω, 225mW	SOD-323	5d	1a	Chm
K0	MMPZ5264BPT	Z-diode	57.0..63.0V, I _z =2.1mA, Z _z =170Ω, 225mW	SOD-323	5d	1a	Chm
K010	STBK010	TVS	Vbr=9.00..11.0V, V _{rwm} =8.10V, 100A, 1500W(1ms), Bidirectional	DO-214AB	1ba	1j	Eic
K010	STUK010	TVS	Vbr=9.00..11.0V, V _{rwm} =8.10V, 100A, 1500W(1ms)	DO-214AB	1d	1a	Eic
K011	STBK011	TVS	Vbr=9.90..12.1V, V _{rwm} =8.92V, 93.0A, 1500W(1ms), Bidirectional	DO-214AB	1ba	1j	Eic
K011	STUK011	TVS	Vbr=9.90..12.1V, V _{rwm} =8.92V, 93.0A, 1500W(1ms)	DO-214AB	1d	1a	Eic
K012	STBK012	TVS	Vbr=10.8..13.2V, V _{rwm} =9.72V, 87.0A, 1500W(1ms), Bidirectional	DO-214AB	1ba	1j	Eic
K012	STUK012	TVS	Vbr=10.8..13.2V, V _{rwm} =9.72V, 87.0A, 1500W(1ms)	DO-214AB	1d	1a	Eic
K013	STBK013	TVS	Vbr=11.7..14.3V, V _{rwm} =10.5V, 79.0A, 1500W(1ms), Bidirectional	DO-214AB	1ba	1j	Eic
K013	STUK013	TVS	Vbr=11.7..14.3V, V _{rwm} =10.5V, 79.0A, 1500W(1ms)	DO-214AB	1d	1a	Eic
K015	STBK015	TVS	Vbr=13.5..16.5V, V _{rwm} =12.1V, 68.0A, 1500W(1ms), Bidirectional	DO-214AB	1ba	1j	Eic
K015	STUK015	TVS	Vbr=13.5..16.5V, V _{rwm} =12.1V, 68.0A, 1500W(1ms)	DO-214AB	1d	1a	Eic
K016	STBK016	TVS	Vbr=14.4..17.6V, V _{rwm} =12.9V, 64.0A, 1500W(1ms), Bidirectional	DO-214AB	1ba	1j	Eic
K016	STUK016	TVS	Vbr=14.4..17.6V, V _{rwm} =12.9V, 64.0A, 1500W(1ms)	DO-214AB	1d	1a	Eic
K018	STBK018	TVS	Vbr=16.2..19.8V, V _{rwm} =14.5V, 56.5A, 1500W(1ms), Bidirectional	DO-214AB	1ba	1j	Eic
K018	STUK018	TVS	Vbr=16.2..19.8V, V _{rwm} =14.5V, 56.5A, 1500W(1ms)	DO-214AB	1d	1a	Eic
K020	STBK020	TVS	Vbr=18.0..22.0V, V _{rwm} =16.2V, 51.5A, 1500W(1ms), Bidirectional	DO-214AB	1ba	1j	Eic
K020	STUK020	TVS	Vbr=18.0..22.0V, V _{rwm} =16.2V, 51.5A, 1500W(1ms)	DO-214AB	1d	1a	Eic
K022	STBK022	TVS	Vbr=19.8..24.2V, V _{rwm} =17.8V, 47.0A, 1500W(1ms), Bidirectional	DO-214AB	1ba	1j	Eic
K022	STUK022	TVS	Vbr=19.8..24.2V, V _{rwm} =17.8V, 47.0A, 1500W(1ms)	DO-214AB	1d	1a	Eic
K024	STBK024	TVS	Vbr=21.6..26.4V, V _{rwm} =19.4V, 43.0A, 1500W(1ms), Bidirectional	DO-214AB	1ba	1j	Eic
K024	STUK024	TVS	Vbr=21.6..26.4V, V _{rwm} =19.4V, 43.0A, 1500W(1ms)	DO-214AB	1d	1a	Eic
K027	STBK027	TVS	Vbr=24.3..29.7V, V _{rwm} =21.8V, 38.5A, 1500W(1ms), Bidirectional	DO-214AB	1ba	1j	Eic
K027	STUK027	TVS	Vbr=24.3..29.7V, V _{rwm} =21.8V, 38.5A, 1500W(1ms)	DO-214AB	1d	1a	Eic
K030	STBK030	TVS	Vbr=27.0..33.0V, V _{rwm} =24.3V, 34.5A, 1500W(1ms), Bidirectional	DO-214AB	1ba	1j	Eic
K030	STUK030	TVS	Vbr=27.0..33.0V, V _{rwm} =24.3V, 34.5A, 1500W(1ms)	DO-214AB	1d	1a	Eic
K033	STBK033	TVS	Vbr=29.7..36.3V, V _{rwm} =26.8V, 31.5A, 1500W(1ms), Bidirectional	DO-214AB	1ba	1j	Eic
K033	STUK033	TVS	Vbr=29.7..36.3V, V _{rwm} =26.8V, 31.5A, 1500W(1ms)	DO-214AB	1d	1a	Eic
K036	STBK036	TVS	Vbr=32.4..39.6V, V _{rwm} =29.1V, 29.0A, 1500W(1ms), Bidirectional	DO-214AB	1ba	1j	Eic
K036	STUK036	TVS	Vbr=32.4..39.6V, V _{rwm} =29.1V, 29.0A, 1500W(1ms)	DO-214AB	1d	1a	Eic
K039	STBK039	TVS	Vbr=35.1..42.9V, V _{rwm} =31.6V, 26.5A, 1500W(1ms), Bidirectional	DO-214AB	1ba	1j	Eic
K039	STUK039	TVS	Vbr=35.1..42.9V, V _{rwm} =31.6V, 26.5A, 1500W(1ms)	DO-214AB	1d	1a	Eic



SMD
code

Type

Function

Short description

Case

Pinout

St.

Mnf.

SMD code	Type	Function	Short description	Case	Pinout	St.	Mnf.
K043	STBK043	TVS	Vbr=38.7..47.3V, Vrwm=34.8V, 24.0A, 1500W(1ms), Bidirectional	DO-214AB	1ba	1j	Eic
K043	STUK043	TVS	Vbr=38.7..47.3V, Vrwm=34.8V, 24.0A, 1500W(1ms)	DO-214AB	1d	1a	Eic
K047	STBK047	TVS	Vbr=42.3..51.7V, Vrwm=38.1V, 22.2A, 1500W(1ms), Bidirectional	DO-214AB	1ba	1j	Eic
K047	STUK047	TVS	Vbr=42.3..51.7V, Vrwm=38.1V, 22.2A, 1500W(1ms)	DO-214AB	1d	1a	Eic
K051	STBK051	TVS	Vbr=45.9..56.1V, Vrwm=41.3V, 20.4A, 1500W(1ms), Bidirectional	DO-214AB	1ba	1j	Eic
K051	STUK051	TVS	Vbr=45.9..56.1V, Vrwm=41.3V, 20.4A, 1500W(1ms)	DO-214AB	1d	1a	Eic
K056	STBK056	TVS	Vbr=50.4..61.6V, Vrwm=45.4V, 18.6A, 1500W(1ms), Bidirectional	DO-214AB	1ba	1j	Eic
K056	STUK056	TVS	Vbr=50.4..61.6V, Vrwm=45.4V, 18.6A, 1500W(1ms)	DO-214AB	1d	1a	Eic
K062	STBK062	TVS	Vbr=55.8..68.2V, Vrwm=50.2V, 16.9A, 1500W(1ms), Bidirectional	DO-214AB	1ba	1j	Eic
K062	STUK062	TVS	Vbr=55.8..68.2V, Vrwm=50.2V, 16.9A, 1500W(1ms)	DO-214AB	1d	1a	Eic
K068	STBK068	TVS	Vbr=61.2..74.8V, Vrwm=55.1V, 15.3A, 1500W(1ms), Bidirectional	DO-214AB	1ba	1j	Eic
K068	STUK068	TVS	Vbr=61.2..74.8V, Vrwm=55.1V, 15.3A, 1500W(1ms)	DO-214AB	1d	1a	Eic
K061	STBK061	TVS	Vbr=61.2..74.8V, Vrwm=55.1V, 15.3A, 1500W(1ms)	DO-214AB	1ba	1j	Eic
K061	STUK061	TVS	Vbr=61.2..74.8V, Vrwm=55.1V, 15.3A, 1500W(1ms)	DO-214AB	1d	1a	Eic
K075	STBK075	TVS	Vbr=67.5..82.5V, Vrwm=60.7V, 13.9A, 1500W(1ms), Bidirectional	DO-214AB	1ba	1j	Eic
K075	STUK075	TVS	Vbr=67.5..82.5V, Vrwm=60.7V, 13.9A, 1500W(1ms)	DO-214AB	1d	1a	Eic
K07F	STBK07F	TVS	Vbr=67.5..82.5V, Vrwm=60.7V, 13.9A, 1500W(1ms), Bidirectional	DO-214AB	1ba	1j	Eic
K07F	STUK07F	TVS	Vbr=67.5..82.5V, Vrwm=60.7V, 13.9A, 1500W(1ms)	DO-214AB	1d	1a	Eic
K082	STBK082	TVS	Vbr=73.8..90.2V, Vrwm=66.4V, 12.7A, 1500W(1ms), Bidirectional	DO-214AB	1ba	1j	Eic
K082	STUK082	TVS	Vbr=73.8..90.2V, Vrwm=66.4V, 12.7A, 1500W(1ms)	DO-214AB	1d	1a	Eic
K08C	STBK08C	TVS	Vbr=73.8..90.2V, Vrwm=66.4V, 12.7A, 1500W(1ms), Bidirectional	DO-214AB	1ba	1j	Eic
K08C	STUK08C	TVS	Vbr=73.8..90.2V, Vrwm=66.4V, 12.7A, 1500W(1ms)	DO-214AB	1d	1a	Eic
K091	STBK091	TVS	Vbr=81.9..100V, Vrwm=73.7V, 11.4A, 1500W(1ms), Bidirectional	DO-214AB	1ba	1j	Eic
K091	STUK091	TVS	Vbr=81.9..100V, Vrwm=73.7V, 11.4A, 1500W(1ms)	DO-214AB	1d	1a	Eic
K09B	STBK09B	TVS	Vbr=81.9..100V, Vrwm=73.7V, 11.4A, 1500W(1ms), Bidirectional	DO-214AB	1ba	1j	Eic
K09B	STUK09B	TVS	Vbr=81.9..100V, Vrwm=73.7V, 11.4A, 1500W(1ms)	DO-214AB	1d	1a	Eic
K0B0	STBK0B0	TVS	Vbr=90.0..110V, Vrwm=81.0V, 10.4A, 1500W(1ms), Bidirectional	DO-214AB	1ba	1j	Eic
K0B0	STUK0B0	TVS	Vbr=90.0..110V, Vrwm=81.0V, 10.4A, 1500W(1ms)	DO-214AB	1d	1a	Eic
K0B1	STBK0B1	TVS	Vbr=99.0..121V, Vrwm=89.2V, 9.5A, 1500W(1ms), Bidirectional	DO-214AB	1ba	1j	Eic
K0B1	STUK0B1	TVS	Vbr=99.0..121V, Vrwm=89.2V, 9.5A, 1500W(1ms)	DO-214AB	1d	1a	Eic
K0B2	STBK0B2	TVS	Vbr=108..132V, Vrwm=97.2V, 8.7A, 1500W(1ms), Bidirectional	DO-214AB	1ba	1j	Eic
K0B2	STUK0B2	TVS	Vbr=108..132V, Vrwm=97.2V, 8.7A, 1500W(1ms)	DO-214AB	1d	1a	Eic
K0B3	STBK0B3	TVS	Vbr=117..143V, Vrwm=105V, 8.0A, 1500W(1ms), Bidirectional	DO-214AB	1ba	1j	Eic
K0B3	STUK0B3	TVS	Vbr=117..143V, Vrwm=105V, 8.0A, 1500W(1ms)	DO-214AB	1d	1a	Eic
K0B5	STBK0B5	TVS	Vbr=135..165V, Vrwm=121V, 7.0A, 1500W(1ms), Bidirectional	DO-214AB	1ba	1j	Eic
K0B5	STUK0B5	TVS	Vbr=135..165V, Vrwm=121V, 7.0A, 1500W(1ms)	DO-214AB	1d	1a	Eic
K0B6	STBK0B6	TVS	Vbr=144..176V, Vrwm=130V, 6.5A, 1500W(1ms), Bidirectional	DO-214AB	1ba	1j	Eic
K0B6	STUK0B6	TVS	Vbr=144..176V, Vrwm=130V, 6.5A, 1500W(1ms)	DO-214AB	1d	1a	Eic
K0B7	STBK0B7	TVS	Vbr=153..187V, Vrwm=138V, 6.2A, 1500W(1ms), Bidirectional	DO-214AB	1ba	1j	Eic
K0B7	STUK0B7	TVS	Vbr=153..187V, Vrwm=138V, 6.2A, 1500W(1ms)	DO-214AB	1d	1a	Eic
K0B8	STBK0B8	TVS	Vbr=162..198V, Vrwm=146V, 5.8A, 1500W(1ms), Bidirectional	DO-214AB	1ba	1j	Eic
K0B8	STUK0B8	TVS	Vbr=162..198V, Vrwm=146V, 5.8A, 1500W(1ms)	DO-214AB	1d	1a	Eic
K0D0	STBK0D0	TVS	Vbr=180..220V, Vrwm=162V, 5.2A, 1500W(1ms), Bidirectional	DO-214AB	1ba	1j	Eic
K0D0	STUK0D0	TVS	Vbr=180..220V, Vrwm=162V, 5.2A, 1500W(1ms)	DO-214AB	1d	1a	Eic
K0D2	STBK0D2	TVS	Vbr=198..242V, Vrwm=175V, 4.3A, 1500W(1ms), Bidirectional	DO-214AB	1ba	1j	Eic
K0D2	STUK0D2	TVS	Vbr=198..242V, Vrwm=175V, 4.3A, 1500W(1ms)	DO-214AB	1d	1a	Eic
K0D5	STBK0D5	TVS	Vbr=225..275V, Vrwm=202V, 4.2A, 1500W(1ms), Bidirectional	DO-214AB	1ba	1j	Eic
K0D5	STUK0D5	TVS	Vbr=225..275V, Vrwm=202V, 4.2A, 1500W(1ms)	DO-214AB	1d	1a	Eic
K0E0	STBK0E0	TVS	Vbr=270..330V, Vrwm=243V, 3.5A, 1500W(1ms), Bidirectional	DO-214AB	1ba	1j	Eic
K0E0	STUK0E0	TVS	Vbr=270..330V, Vrwm=243V, 3.5A, 1500W(1ms)	DO-214AB	1d	1a	Eic
K0E5	STBK0E5	TVS	Vbr=315..385V, Vrwm=284V, 3.0A, 1500W(1ms), Bidirectional	DO-214AB	1ba	1j	Eic
K0E5	STUK0E5	TVS	Vbr=315..385V, Vrwm=284V, 3.0A, 1500W(1ms)	DO-214AB	1d	1a	Eic
K0G0	STBK0G0	TVS	Vbr=360..440V, Vrwm=324V, 2.6A, 1500W(1ms), Bidirectional	DO-214AB	1ba	1j	Eic
K0G0	STUK0G0	TVS	Vbr=360..440V, Vrwm=324V, 2.6A, 1500W(1ms)	DO-214AB	1d	1a	Eic
K0G4	STBK0G4	TVS	Vbr=396..484V, Vrwm=356V, 2.4A, 1500W(1ms), Bidirectional	DO-214AB	1ba	1j	Eic
K0G4	STUK0G4	TVS	Vbr=396..484V, Vrwm=356V, 2.4A, 1500W(1ms)	DO-214AB	1d	1a	Eic
K1	BAP51-02	Pin-diode	RF, 50V, 50mA, 715mW, 0.35pF, 5.5Ω(10mA/100MHz)	SOD-523	6d	1a	Phi
K1	BAS21BPT	Si-diode	Sw, 250V, 200mA, Vf<1.25V(200mA), 50ns	SOD-123	5d	1a	Chm
K1	BZD27C10P	TVS	Vbr=9.4V, Vcl=14.8V, 10..1A, 150W(1ms)	SOD123FL	7d	1a	Lge
K1	BZX384-B2V4	Z-diode	2.4V±5%, Izt=5mA, Zzt=70Ω, 200mW	SOD-323	5d	1k	Phi
K1	CMOZ43V	Z-diode	40.85..45.15V, Izt=5mA, Zzt=150Ω, 250mW	SOD-523	6d	1a	Cen
K1	CZRH5251B-G	Z-diode	20.9..23.1V, Zzt=29Ω, Izt=5.6mA, 150mW	SOD-523	5d	1a	Cmc
K1	CZR5251B-G	Z-diode	20.9..23.1V, Zzt=29Ω, Izt=5.6mA, 200mW	SOD-323	5d	1a	Cmc
K1	CZR5251B-G	Z-diode	20.90..23.10V, Zzt=29Ω, Izt=5.6mA, 500mW	SOD-123	5d	1a	Cmc
K1	MM3Z5231B	Z-diode	5.1V±5%, Izt=20mA, Zzt=17Ω, 200mW	SOD-323FL	7d	1a	Bts
K1	MM3Z5231BH	Z-diode	4.85..5.36V, Izt=20mA, Zzt=17Ω, 300mW	SOD-323	5d	1a	Zow
K1	MM3Z5251B	Z-diode	20.90..23.10V, Izt=5.6mA, Zzt=29Ω, 200mW	SOD-323	5d	1a	Ext
K1	MMSZ52351	Z-diode	22V, 10%, 300mW	SOD-123	5d	1k	Vs
K1	MMSZ5251B	Z-diode	22V±5%, Zzt=29Ω, 500mW	SOD-123	5d	1a,1d	Di,Mot
K1	MMSZ5251B	Z-diode	22V±5%, Zzt=29Ω, 500mW	SOD-123	5d	1d	Di



SMD
code

Type

Function

Short description

Case

Pinout

St.

Mnf.

SMD code	Type	Function	Short description	Case	Pinout	St.	Mnf.
K1	MMSZ5251BS	Z-diode	22V±5%, Zzt=29Ω, 200mW	SOD-323	5d	1d	Di
K1	PZU3 0B2L	Z-diode	3.0V±2%, If=200mA, 250mW	SOT-882	13d	2b	Phi
K13	SSM0160SPT	Si-diode	Rectifier, Schottky, 60V, 1A, Vf<0.55V(1A)	SOD-123	5d	1a	Chm
K14	SMD33PT	Si-diode	Rectifier, Schottky, 30V, 3A, Vf<0.9V(3A)	SOD-123	5d	1a	Chm
K15	SMD22LLPT	Si-diode	Rectifier, Schottky, 20V, 2A, Vf<0.27V(2A)	SOD-123	5d	1a	Chm
K16	SMD34PT	Si-diode	Rectifier, Schottky, 40V, 3A, Vf<1V(3A)	SOD-123	5d	1a	Chm
K17	SSM0140SPT	Si-diode	Rectifier, Schottky, 40V, 1A, Vf<0.46V(1A)	SOD-123	5d	1a	Chm
K18	SSM05150SPT	Si-diode	Rectifier, Schottky, 150V, 500mA, Vf<0.8V(500mA)	SOD-123	5d	1a	Chm
K19	SSM02150SPT	Si-diode	SBD, 150V, 200mA, Vf<0.6V(200mA)	SOD-123	5d	1a	Chm
K2	BZD27C11P	TVS	Vbr=10.4V, Vcl=15.7V, 9.6A, 150W(1ms)	SOD123FL	7d	1a	Lge
K2	BZX384-B2V7	Z-diode	2.7V±2.5%, Izt=5mA, Zzt=75Ω, 200mW	SOD-323	5d	1k	Phi
K2	CZRH5252B-G	Z-diode	22.8 .25.2V, Zzt=33Ω, Izt=5.2mA, 150mW	SOD-523	5d	1a	Cmc
K2	CZRV5252B-G	Z-diode	22.8 .25.2V, Zzt=33Ω, Izt=5.2mA, 200mW	SOD-323	5d	1a	Cmc
K2	CZRW5252B-G	Z-diode	22.80 .25.20V, Zzt=33Ω, Izt=5.2mA, 500mW	SOD-123	5d	1a	Cmc
K2	MM3Z5252B	Z-diode	22.80 .25.20V, Izt=5.2mA, Zzt=33Ω, 200mW	SOD-323FL	7d	1a	Ext
K2	MM3Z5252BH	Z-diode	22.8 .25.2V, Izt=5.2mA, Zzt=33Ω, 300mW	SOD-323	5d	1a	Zow
K2	MMSZ52352	Z-diode	24V, 10%, 300mW	SOD-123	5d	1k	Vs
K2	MMSZ5252B	Z-diode	24V±5%, Zzt=33Ω, 500mW	SOD-123	5d	1a,1d	Di,Mot
K2	MMSZ5252B	Z-diode	24V±5%, Zzt=33Ω, 500mW	SOD-123	5d	1d	Di
K2	MMSZ5252BS	Z-diode	24V±5%, Zzt=33Ω, 200mW	SOD-323	5d	1d	Di
K2	PZU3.3B2L	Z-diode	3.3V±2%, If=200mA, 250mW	SOT-882	13d	2b	Phi
K2	RKS1500DKK	C-diode	TV-VCR-Tuners, 34V, C2=14.15 .15.75pF, n>6.3, Rs<0.57Ω	SFP	6d	1a	ren
K2	SSM5817SAPT	Si-diode	Rectifier, Schottky, 20V, 1A, Vf<0.45V(1A)	SOD-123S	8d	1a	Chm
K2	SSM5817SPT	Si-diode	Rectifier, Schottky, 20V, 1A, Vf<0.45V(1A)	SOD-123	5d	1a	Chm
K20	SSM05200SPT	Si-diode	Rectifier, Schottky, 200V, 500mA, Vf<0.95V(500mA)	SOD-123	5d	1a	Chm
K21	SSM1200SPT	Si-diode	Rectifier, Schottky, 200V, 1A, Vf<0.9V(1A)	SOD-123	5d	1a	Chm
K22	SSM0240SPT	Si-diode	SBD, 40V, 200mA, Vf<0.6V(200mA)	SOD-123	5d	1a	Chm
K3	BB145C	C-diode	VCO, 10V, 20mA, 2.55/6.4pF(4V/1V, 1MHz), <0.6Ω	SOD-523	6d	1a	Phi
K3	BZD27C12P	TVS	Vbr=11.4V, Vcl=17V, 8.8A, 150W(1ms)	SOD123FL	7d	1a	Lge
K3	BZX384-B3V0	Z-diode	3.0V±2.5%, Izt=5mA, Zzt=80Ω, 200mW	SOD-323	5d	1k	Phi
K3	MMSZ52353	Z-diode	25V, 10%, 300mW	SOD-123	5d	1k	Vs
K3	MMSZ5253B	Z-diode	25V±5%, Zzt=35Ω, 500mW	SOD-123	5d	1a	Mot
K3	PZU3 6B2L	Z-diode	3.6V±2%, If=200mA, 250mW	SOT-882	13d	2b	Phi
K3	SSM5818SAPT	Si-diode	Rectifier, Schottky, 30V, 1A, Vf<0.55V(1A)	SOD-123S	8d	1a	Chm
K3	SSM5818SPT	Si-diode	Rectifier, Schottky, 30V, 1A, Vf<0.55V(1A)	SOD-123	5d	1a	Chm
K4	BAP50-02	PIN-diode	RF, 50V, 50mA, 500mW, 0.3pF, 3Ω(10mA/100MHz)	SOD-523	6d	1a	Phi
K4	BZD27C13P	TVS	Vbr=12.4V, Vcl=18.9V, 7.9A, 150W(1ms)	SOD123FL	7d	1a	Lge
K4	BZX384-B3V3	Z-diode	3.3V±2.5%, Izt=5mA, Zzt=85Ω, 200mW	SOD-323	5d	1k	Phi
K4	CZRH5254B-G	Z-diode	25.65 .28.35V, Zzt=41Ω, Izt=5mA, 150mW	SOD-523	5d	1a	Cmc
K4	CZRV5254B-G	Z-diode	25.65 .28.35V, Zzt=41Ω, Izt=5mA, 200mW	SOD-323	5d	1a	Cmc
K4	CZRW5254B-G	Z-diode	25.65 .28.35V, Zzt=41Ω, Izt=5mA, 500mW	SOD-123	5d	1a	Cmc
K4	MM1Z5231B	Z-diode	4.85 .5.36V, Izt=20mA, Zzt=17Ω, 500mW	SOD-323FL	5d	1a	Eic
K4	MM1Z5231BH	Z-diode	4.85 .5.36V, Izt=20mA, Zzt=17Ω, 500mW	SOD-123	5d	1a	Zow
K4	MM3Z5254B	Z-diode	25.65 .28.35V, Izt=4.6mA, Zzt=41Ω, 200mW	SOD-323	5d	1a	Ext
K4	MMSZ5231B	Z-diode	5.1V±5%, Izt=20mA, Zzt=17Ω, 500mW	SOD-123	5d	1a	Eic
K4	MMSZ52354	Z-diode	27V, 10%, 300mW	SOD-123	5d	1k	Vs
K4	MMSZ5254B	Z-diode	27V±5%, Zzt=41Ω, 500mW	SOD-123	5d	1a,1d	Di,Mot
K4	MMSZ5254B	Z-diode	27V±5%, Zzt=41Ω, 500mW	SOD-123	5d	1d	Di
K4	MMSZ5254BS	Z-diode	27V±5%, Zzt=41Ω, 200mW	SOD-323	5d	1d	Di
K4	PZU3.9B2L	Z-diode	3.9V±2%, If=200mA, 250mW	SOT-882	13d	2b	Phi
K4	SSM5819SAPT	Si-diode	Rectifier, Schottky, 40V, 1A, Vf<0.6V(1A)	SOD-123S	8d	1a	Chm
K4	SSM5819SPT	Si-diode	Rectifier, Schottky, 40V, 1A, Vf<0.6V(1A)	SOD-123	5d	1a	Chm
K5	BAP63-02	PIN-diode	RF, 50V, 100mA, 715mW, 0.36pF, 1.17Ω(10mA/100MHz)	SOD-523	6d	1a	Phi
K5	BZD27C15P	TVS	Vbr=13.8V, Vcl=20.9V, 7.2A, 150W(1ms)	SOD123FL	7d	1a	Lge
K5	BZX384-B3V6	Z-diode	3.6V±2.5%, Izt=5mA, Zzt=85Ω, 200mW	SOD-323	5d	1k	Phi
K5	BZX584B15V	Z-diode	14.70 .15.30V, Izt=5mA, Zzt=30Ω, 200mW	SOD-523FL	7d	1a	Tac
K5	CZRH5255B-G	Z-diode	26.6 .29.4V, Zzt=44Ω, Izt=4.5mA, 150mW	SOD-523	5d	1a	Cmc
K5	CZRV5255B-G	Z-diode	26.6 .29.4V, Zzt=44Ω, Izt=4.5mA, 200mW	SOD-323	5d	1a	Cmc
K5	CZRW5255B-G	Z-diode	26.60 .29.40V, Zzt=44Ω, Izt=4.5mA, 500mW	SOD-123	5d	1a	Cmc
K5	MM1Z5252B	Z-diode	22.80 .25.20V, Izt=5.2mA, Zzt=33Ω, 500mW	SOD-323FL	5d	1a	Eic
K5	MM1Z5252BH	Z-diode	22.8 .25.2V, Izt=5.2mA, Zzt=33Ω, 500mW	SOD-123	5d	1a	Zow
K5	MM3Z5255B	Z-diode	26.60 .29.40V, Izt=4.5mA, Zzt=44Ω, 200mW	SOD-323	5d	1a	Ext
K5	MMSZ15VB	Z-diode	14.70 .15.30V, Izt=5mA, Zzt=30Ω, 200mW	SOD-523FL	7d	1a	Tac
K5	MMSZ52355	Z-diode	28V, 10%, 300mW	SOD-123	5d	1k	Vs
K5	MMSZ5252B	Z-diode	24V±5%, Izt=5.2mA, Zzt=33Ω, 500mW	SOD-123	5d	1a	Eic
K5	MMSZ5255B	Z-diode	28V±5%, Zzt=44Ω, 500mW	SOD-123	5d	1a,1d	Di,Mot
K5	MMSZ5255B	Z-diode	28V±5%, Zzt=44Ω, 500mW	SOD-123	5d	1d	Di
K5	MMSZ5255BS	Z-diode	28V±5%, Zzt=44Ω, 200mW	SOD-323	5d	1d	Di
K5	PZU4.3B2L	Z-diode	4.3V±2%, If=200mA, 250mW	SOT-882	13d	2b	Phi
K5	SMD22PT	Si-diode	Rectifier, Schottky, 20V, 2A, Vf<0.65V(2A)	SOD-123	5d	1a	Chm



SMD
code

Type

Function

Short description

Case

Pinout

St.

Mnf.

SMD code	Type	Function	Short description	Case	Pinout	St.	Mnf.
K510	STBK510	TVS	Vbr=9.50..10.5V, Vrwm=8.55V, 103A, 1500W(1ms), Bidirectional	DO-214AB	1ba	1j	Eic
K510	STUK510	TVS	Vbr=9.50..10.5V, Vrwm=8.55V, 103A, 1500W(1ms)	DO-214AB	1d	1a	Eic
K511	STBK511	TVS	Vbr=10.5..11.6V, Vrwm=9.40V, 96.0A, 1500W(1ms), Bidirectional	DO-214AB	1ba	1j	Eic
K511	STUK511	TVS	Vbr=10.5..11.6V, Vrwm=9.40V, 96.0A, 1500W(1ms)	DO-214AB	1d	1a	Eic
K512	STBK512	TVS	Vbr=11.4..12.6V, Vrwm=10.2V, 90.0A, 1500W(1ms), Bidirectional	DO-214AB	1ba	1j	Eic
K512	STUK512	TVS	Vbr=11.4..12.6V, Vrwm=10.2V, 90.0A, 1500W(1ms)	DO-214AB	1d	1a	Eic
K513	STBK513	TVS	Vbr=12.4..13.7V, Vrwm=11.1V, 82.0A, 1500W(1ms), Bidirectional	DO-214AB	1ba	1j	Eic
K513	STUK513	TVS	Vbr=12.4..13.7V, Vrwm=11.1V, 82.0A, 1500W(1ms)	DO-214AB	1d	1a	Eic
K515	STBK515	TVS	Vbr=14.3..15.8V, Vrwm=12.8V, 71.0A, 1500W(1ms), Bidirectional	DO-214AB	1ba	1j	Eic
K515	STUK515	TVS	Vbr=14.3..15.8V, Vrwm=12.8V, 71.0A, 1500W(1ms)	DO-214AB	1d	1a	Eic
K516	STBK516	TVS	Vbr=15.2..16.8V, Vrwm=13.6V, 67.0A, 1500W(1ms), Bidirectional	DO-214AB	1ba	1j	Eic
K516	STUK516	TVS	Vbr=15.2..16.8V, Vrwm=13.6V, 67.0A, 1500W(1ms)	DO-214AB	1d	1a	Eic
K518	STBK518	TVS	Vbr=17.1..18.9V, Vrwm=15.3V, 59.5A, 1500W(1ms), Bidirectional	DO-214AB	1ba	1j	Eic
K518	STUK518	TVS	Vbr=17.1..18.9V, Vrwm=15.3V, 59.5A, 1500W(1ms)	DO-214AB	1d	1a	Eic
K520	STBK520	TVS	Vbr=19.0..21.0V, Vrwm=17.1V, 54.0A, 1500W(1ms), Bidirectional	DO-214AB	1ba	1j	Eic
K520	STUK520	TVS	Vbr=19.0..21.0V, Vrwm=17.1V, 54.0A, 1500W(1ms)	DO-214AB	1d	1a	Eic
K522	STBK522	TVS	Vbr=20.9..23.1V, Vrwm=18.8V, 49.0A, 1500W(1ms), Bidirectional	DO-214AB	1ba	1j	Eic
K522	STUK522	TVS	Vbr=20.9..23.1V, Vrwm=18.8V, 49.0A, 1500W(1ms)	DO-214AB	1d	1a	Eic
K524	STBK524	TVS	Vbr=22.8..25.2V, Vrwm=20.5V, 45.0A, 1500W(1ms), Bidirectional	DO-214AB	1ba	1j	Eic
K524	STUK524	TVS	Vbr=22.8..25.2V, Vrwm=20.5V, 45.0A, 1500W(1ms)	DO-214AB	1d	1a	Eic
K527	STBK527	TVS	Vbr=25.7..28.4V, Vrwm=23.1V, 40.0A, 1500W(1ms), Bidirectional	DO-214AB	1ba	1j	Eic
K527	STUK527	TVS	Vbr=25.7..28.4V, Vrwm=23.1V, 40.0A, 1500W(1ms)	DO-214AB	1d	1a	Eic
K530	STBK530	TVS	Vbr=28.5..31.5V, Vrwm=25.6V, 36.0A, 1500W(1ms), Bidirectional	DO-214AB	1ba	1j	Eic
K530	STUK530	TVS	Vbr=28.5..31.5V, Vrwm=25.6V, 36.0A, 1500W(1ms)	DO-214AB	1d	1a	Eic
K533	STBK533	TVS	Vbr=31.4..34.7V, Vrwm=28.2V, 33.0A, 1500W(1ms), Bidirectional	DO-214AB	1ba	1j	Eic
K533	STUK533	TVS	Vbr=31.4..34.7V, Vrwm=28.2V, 33.0A, 1500W(1ms)	DO-214AB	1d	1a	Eic
K536	STBK536	TVS	Vbr=34.2..37.8V, Vrwm=30.8V, 30.0A, 1500W(1ms), Bidirectional	DO-214AB	1ba	1j	Eic
K536	STUK536	TVS	Vbr=34.2..37.8V, Vrwm=30.8V, 30.0A, 1500W(1ms)	DO-214AB	1d	1a	Eic
K539	STBK539	TVS	Vbr=37.1..41.0V, Vrwm=33.3V, 28.0A, 1500W(1ms), Bidirectional	DO-214AB	1ba	1j	Eic
K539	STUK539	TVS	Vbr=37.1..41.0V, Vrwm=33.3V, 28.0A, 1500W(1ms)	DO-214AB	1d	1a	Eic
K543	STBK543	TVS	Vbr=40.9..45.2V, Vrwm=36.8V, 25.3A, 1500W(1ms), Bidirectional	DO-214AB	1ba	1j	Eic
K543	STUK543	TVS	Vbr=40.9..45.2V, Vrwm=36.8V, 25.3A, 1500W(1ms)	DO-214AB	1d	1a	Eic
K547	STBK547	TVS	Vbr=44.7..49.4V, Vrwm=40.2V, 23.2A, 1500W(1ms), Bidirectional	DO-214AB	1ba	1j	Eic
K547	STUK547	TVS	Vbr=44.7..49.4V, Vrwm=40.2V, 23.2A, 1500W(1ms)	DO-214AB	1d	1a	Eic
K551	STBK551	TVS	Vbr=48.5..53.6V, Vrwm=43.6V, 21.4A, 1500W(1ms), Bidirectional	DO-214AB	1ba	1j	Eic
K551	STUK551	TVS	Vbr=48.5..53.6V, Vrwm=43.6V, 21.4A, 1500W(1ms)	DO-214AB	1d	1a	Eic
K556	STBK556	TVS	Vbr=53.2..58.8V, Vrwm=47.8V, 19.5A, 1500W(1ms), Bidirectional	DO-214AB	1ba	1j	Eic
K556	STUK556	TVS	Vbr=53.2..58.8V, Vrwm=47.8V, 19.5A, 1500W(1ms)	DO-214AB	1d	1a	Eic
K562	STBK562	TVS	Vbr=58.9..65.1V, Vrwm=53.0V, 17.7A, 1500W(1ms), Bidirectional	DO-214AB	1ba	1j	Eic
K562	STUK562	TVS	Vbr=58.9..65.1V, Vrwm=53.0V, 17.7A, 1500W(1ms)	DO-214AB	1d	1a	Eic
K568	STBK568	TVS	Vbr=64.6..71.4V, Vrwm=58.1V, 16.3A, 1500W(1ms), Bidirectional	DO-214AB	1ba	1j	Eic
K568	STUK568	TVS	Vbr=64.6..71.4V, Vrwm=58.1V, 16.3A, 1500W(1ms)	DO-214AB	1d	1a	Eic
K561	STBK561	TVS	Vbr=6.45..7.14V, Vrwm=5.80V, 143A, 1500W(1ms), Bidirectional	DO-214AB	1ba	1j	Eic
K561	STUK561	TVS	Vbr=6.45..7.14V, Vrwm=5.80V, 143A, 1500W(1ms)	DO-214AB	1d	1a	Eic
K575	STBK575	TVS	Vbr=71.3..78.8V, Vrwm=64.1V, 14.6A, 1500W(1ms), Bidirectional	DO-214AB	1ba	1j	Eic
K575	STUK575	TVS	Vbr=71.3..78.8V, Vrwm=64.1V, 14.6A, 1500W(1ms)	DO-214AB	1d	1a	Eic
K57F	STBK57F	TVS	Vbr=7.13..7.88V, Vrwm=6.40V, 132A, 1500W(1ms), Bidirectional	DO-214AB	1ba	1j	Eic
K57F	STUK57F	TVS	Vbr=7.13..7.88V, Vrwm=6.40V, 132A, 1500W(1ms)	DO-214AB	1d	1a	Eic
K582	STBK582	TVS	Vbr=77.9..86.1V, Vrwm=70.1V, 13.3A, 1500W(1ms), Bidirectional	DO-214AB	1ba	1j	Eic
K582	STUK582	TVS	Vbr=77.9..86.1V, Vrwm=70.1V, 13.3A, 1500W(1ms)	DO-214AB	1d	1a	Eic
K58C	STBK58C	TVS	Vbr=7.79..8.61V, Vrwm=7.02V, 124A, 1500W(1ms), Bidirectional	DO-214AB	1ba	1j	Eic
K58C	STUK58C	TVS	Vbr=7.79..8.61V, Vrwm=7.02V, 124A, 1500W(1ms)	DO-214AB	1d	1a	Eic
K591	STBK591	TVS	Vbr=86.5..95.5V, Vrwm=77.8V, 12.0A, 1500W(1ms), Bidirectional	DO-214AB	1ba	1j	Eic
K591	STUK591	TVS	Vbr=86.5..95.5V, Vrwm=77.8V, 12.0A, 1500W(1ms)	DO-214AB	1d	1a	Eic
K59B	STBK59B	TVS	Vbr=8.65..9.6V, Vrwm=7.78V, 112A, 1500W(1ms), Bidirectional	DO-214AB	1ba	1j	Eic
K59B	STUK59B	TVS	Vbr=8.65..9.6V, Vrwm=7.78V, 112A, 1500W(1ms)	DO-214AB	1d	1a	Eic
K5B0	STBK5B0	TVS	Vbr=95.0..105V, Vrwm=85.5V, 11.0A, 1500W(1ms), Bidirectional	DO-214AB	1ba	1j	Eic
K5B0	STUK5B0	TVS	Vbr=95.0..105V, Vrwm=85.5V, 11.0A, 1500W(1ms)	DO-214AB	1d	1a	Eic
K5B1	STBK5B1	TVS	Vbr=105..116V, Vrwm=94.0V, 9.9A, 1500W(1ms), Bidirectional	DO-214AB	1ba	1j	Eic
K5B1	STUK5B1	TVS	Vbr=105..116V, Vrwm=94.0V, 9.9A, 1500W(1ms)	DO-214AB	1d	1a	Eic
K5B2	STBK5B2	TVS	Vbr=114..126V, Vrwm=102V, 9.1A, 1500W(1ms), Bidirectional	DO-214AB	1ba	1j	Eic
K5B2	STUK5B2	TVS	Vbr=114..126V, Vrwm=102V, 9.1A, 1500W(1ms)	DO-214AB	1d	1a	Eic
K5B3	STBK5B3	TVS	Vbr=124..137V, Vrwm=111V, 8.4A, 1500W(1ms), Bidirectional	DO-214AB	1ba	1j	Eic
K5B3	STUK5B3	TVS	Vbr=124..137V, Vrwm=111V, 8.4A, 1500W(1ms)	DO-214AB	1d	1a	Eic
K5B5	STBK5B5	TVS	Vbr=143..158V, Vrwm=128V, 7.2A, 1500W(1ms), Bidirectional	DO-214AB	1ba	1j	Eic
K5B5	STUK5B5	TVS	Vbr=143..158V, Vrwm=128V, 7.2A, 1500W(1ms)	DO-214AB	1d	1a	Eic
K5B6	STBK5B6	TVS	Vbr=152..168V, Vrwm=136V, 6.8A, 1500W(1ms), Bidirectional	DO-214AB	1ba	1j	Eic
K5B6	STUK5B6	TVS	Vbr=152..168V, Vrwm=136V, 6.8A, 1500W(1ms)	DO-214AB	1d	1a	Eic
K5B7	STBK5B7	TVS	Vbr=162..179V, Vrwm=145V, 6.4A, 1500W(1ms), Bidirectional	DO-214AB	1ba	1j	Eic
K5B7	STUK5B7	TVS	Vbr=162..179V, Vrwm=145V, 6.4A, 1500W(1ms)	DO-214AB	1d	1a	Eic



SMD
code

Type

Function

Short description

Case

Pinout

St.

Mnf.

SMD code	Type	Function	Short description	Case	Pinout	St.	Mnf.
K5B8	STBK5B8	TVS	Vbr=171.189V, Vrwm=154V, 6.1A, 1500W(1ms), Bidirectional	DO-214AB	1ba	1j	Eic
K5B8	STUK5B8	TVS	Vbr=171.189V, Vrwm=154V, 6.1A, 1500W(1ms)	DO-214AB	1d	1a	Eic
K5D0	STBK5D0	TVS	Vbr=190.210V, Vrwm=171V, 5.5A, 1500W(1ms), Bidirectional	DO-214AB	1ba	1j	Eic
K5D0	STUK5D0	TVS	Vbr=190.210V, Vrwm=171V, 5.5A, 1500W(1ms)	DO-214AB	1d	1a	Eic
K5D2	STBK5D2	TVS	Vbr=209.231V, Vrwm=185V, 4.6A, 1500W(1ms), Bidirectional	DO-214AB	1ba	1j	Eic
K5D2	STUK5D2	TVS	Vbr=209.231V, Vrwm=185V, 4.6A, 1500W(1ms)	DO-214AB	1d	1a	Eic
K5D5	STBK5D5	TVS	Vbr=237.263V, Vrwm=214V, 4.4A, 1500W(1ms), Bidirectional	DO-214AB	1ba	1j	Eic
K5D5	STUK5D5	TVS	Vbr=237.263V, Vrwm=214V, 4.4A, 1500W(1ms)	DO-214AB	1d	1a	Eic
K5E0	STBK5E0	TVS	Vbr=285.315V, Vrwm=256V, 3.6A, 1500W(1ms), Bidirectional	DO-214AB	1ba	1j	Eic
K5E0	STUK5E0	TVS	Vbr=285.315V, Vrwm=256V, 3.6A, 1500W(1ms)	DO-214AB	1d	1a	Eic
K5E5	STBK5E5	TVS	Vbr=332.368V, Vrwm=300V, 3.1A, 1500W(1ms), Bidirectional	DO-214AB	1ba	1j	Eic
K5E5	STUK5E5	TVS	Vbr=332.368V, Vrwm=300V, 3.1A, 1500W(1ms)	DO-214AB	1d	1a	Eic
K5G0	STBK5G0	TVS	Vbr=380.420V, Vrwm=342V, 2.7A, 1500W(1ms), Bidirectional	DO-214AB	1ba	1j	Eic
K5G0	STUK5G0	TVS	Vbr=380.420V, Vrwm=342V, 2.7A, 1500W(1ms)	DO-214AB	1d	1a	Eic
K5G4	STBK5G4	TVS	Vbr=418.462V, Vrwm=376V, 2.5A, 1500W(1ms), Bidirectional	DO-214AB	1ba	1j	Eic
K5G4	STUK5G4	TVS	Vbr=418.462V, Vrwm=376V, 2.5A, 1500W(1ms)	DO-214AB	1d	1a	Eic
K6	BAP65-01	PIN-diode	RF, 30V, 100mA, 315mW, 0.61pF, 0.3Q(100mA/100MHz)	SOD-723A	6d	1a	Phi
K6	BAP65-02	PIN-diode	RF, 30V, 100mA, 715mW, 0.61pF, 0.3Q(100mA/100MHz)	SOD-523	6d	1a	Phi
K6	BZD27C16P	TVS	Vbr=15.3V, Vcl=22.9V, 6.6A, 150W(1ms)	SOD123FL	7d	1a	Lge
K6	BZX384-B3V9	Z-diode	3.9V±2.5%, Izt=5mA, Zzt=85Ω, 200mW	SOD-323	5d	1k	Phi
K6	PZU4.7B2L	Z-diode	4.7V±2%, If=200mA, 250mW	SOT-882	13d	2b	Phi
K6	SMD23PT	Si-diode	Rectifier, Schottky, 30V, 2A, Vf<0.68V(2A)	SOD-123	5d	1a	Chm
K7	BAP1321-02	PIN-diode	RF, 60V, 100mA, 715mW, 0.45pF, 1.3Q(100mA/100MHz)	SOD-523	6d	1a	Phi
K7	BZD27C18P	TVS	Vbr=16.8V, Vcl=25.6V, 5.9A, 150W(1ms)	SOD123FL	7d	1a	Lge
K7	BZX384-B4V3	Z-diode	4.3V±2.5%, Izt=5mA, Zzt=80Ω, 200mW	SOD-323	5d	1k	Phi
K7	PZU5.1B2L	Z-diode	5.1V±2%, If=200mA, 250mW	SOT-882	13d	2b	Phi
K7	SMD24PT	Si-diode	Rectifier, Schottky, 40V, 2A, Vf<0.72V(2A)	SOD-123	5d	1a	Chm
K8	BAP70-02	PIN-diode	RF, 50V, 100mA, 415mW, 0.57pF, 1.9Q(100mA/100MHz)	SOD-523	7d	1a	Nxp
K8	BZD27C20P	TVS	Vbr=18.8V, Vcl=28.4V, 5.3A, 150W(1ms)	SOD123FL	7d	1a	Lge
K8	BZX384-B4V7	Z-diode	4.7V±2.5%, Izt=5mA, Zzt=50Ω, 200mW	SOD-323	5d	1k	Phi
K8	MM5Z6V8	Z-diode	6.8V±5%, Izt=5mA, Zzt=15Ω, 200mW	SOD-523	6d	1a	Eic
K8	MM5Z6V8H	Z-diode	6.4..7.2V, Izt=5mA, Zzt=15Ω, 200mW	SOD-523	7d	1a	Zow
K8	PZU5.6B2L	Z-diode	5.6V±2%, If=200mA, 250mW	SOT-882	13d	2b	Phi
K8	SSM515SLPT	Si-diode	Rectifier, Schottky, 30V, 500mA, Vf<0.47V(500mA)	SOD-123	5d	1a	Chm
K9	BB199	C-diode	VCO, 20V, 100mA, 300mW, 13.8..42.5pF(2..0.5V)	SOD-523	6d	1a	Phi
K9	BZD27C22P	TVS	Vbr=20.8V, Vcl=31V, 4.8A, 150W(1ms)	SOD123FL	7d	1a	Lge
K9	BZX384-B5V1	Z-diode	5.1V±2.5%, Izt=5mA, Zzt=40Ω, 200mW	SOD-323	5d	1k	Phi
K9	MM1Z5249B	Z-diode	18.05..19.95V, Izt=6.6mA, Zzt=23Ω, 500mW	SOD-323FL	5d	1a	Eic
K9	MM1Z5249BH	Z-diode	18.05..19.95V, Izt=6.6mA, Zzt=23Ω, 500mW	SOD-123	5d	1a	Zow
K9	MM5Z5249B	Z-diode	19V±5%, Izt=6.6mA, Zzt=23Ω, 500mW	SOD-123	5d	1a	Eic
K9	PZU6.8B2L	Z-diode	6.8V±2%, If=200mA, 250mW	SOT-882	13d	2b	Phi
K9	SSM05100SPT	Si-diode	Rectifier, Schottky, 100V, 500mA, Vf<0.57V(500mA)	SOD-123	5d	1a	Chm
KA	PZU7.5B2L	Z-diode	7.5V±2%, If=200mA, 250mW	SOT-882	13d	2b	Phi
KA	PZU9.1B3	Z-diode	9.15..9.55V, Zzt=10Ω(Izt=5mA), 310mW	SOD-323FL	7d	1a	Phi
KA	S1KA	Si-diode	Rectifier, 800V, 1A, Vf<1.1V(1A)	DO-214AC	1d	1k	Vs
KB	KDZ4.7B	Z-diode	4.7V±2.5%, 40mA, 1W	PMDU	7d	1s	Rhm
KB	PZU10B3	Z-diode	10.11..10.55V, Zzt=10Ω(Izt=5mA), 310mW	SOD-323FL	7d	1a	Phi
KB	PZU8.2B2L	Z-diode	8.2V±2%, If=200mA, 250mW	SOT-882	13d	2b	Phi
KC	PZU11B3	Z-diode	11.1..11.56V, Zzt=10Ω(Izt=5mA), 310mW	SOD-323FL	7d	1a	Phi
KC	PZU9.1B2L	Z-diode	9.1V±2%, If=200mA, 250mW	SOT-882	13d	2b	Phi
KD	P6SMB6V8	TVS	Vrwm=6.8V, 56A, 600W(1ms)	DO-214AA	1d	2j	Fag
KD	P6SMBJ5.0	TVS	Vbr=5V, 62.5A, 600W(1ms)	DO-214AA	1d	1m,1w	Pjt,Srj
KD	PZU10B2L	Z-diode	10V±2%, If=200mA, 250mW	SOT-882	13d	2b	Phi
KD	PZU12B3	Z-diode	12.08..12.6V, Zzt=10Ω(Izt=5mA), 310mW	SOD-323FL	7d	1a	Phi
KD	SMBG5.0	TVS	Vbr=5V, 62.5A, 600W(1ms)	DO-215AA	5d	1k	Vs
KD	SMBJ5.0	TVS	Vbr=5V, 62.5A, 600W(1ms)	DO-214AA	1d	1k	Vs
KD	TV06B5V0K-G	TVS	Vrwm=5.0V, Vbr=6.40..7.30V, Ipp=62.50A, 600W(1ms)	DO-214AA	1d	1a	Cmc
KDK	SMB6.8	TVS	Vbr=6.12..7.48V, Vrwm=5.50V, 55.6A, 600W(1ms)	DO-214AA	1d	1a	Lge
KDM	SMB6.8C	TVS	Vbr=6.12..7.48V, Vrwm=5.50V, 55.6A, 600W(1ms), Bidirectional	DO-214AA	1ba	1j	Lge
KDP	TPSMB6.8	TVS	Vbr=6.8V, 55.6A, 600W(1ms)	DO-214AA	1d	1k	Vs
KE	1SMB5.0A	TVS	Vrwm=5V, 62.5A, 600W(1ms)	403A	3d	1s	Ons
KE	CD214B-T5.0A	TVS	Vbr=5.0V, Irsrm=65.2A, 600W(1ms)	DO-214AA	1d	1a	Bm
KE	P6SMB6V8A	TVS	Vrwm=6.8V, 57A, 600W(1ms)	DO-214AA	1d	2j	Fag
KE	P6SMBJ5.0A	TVS	Vbr=5V, 65.2A, 600W(1ms)	DO-214AA	1d	1m,1w	Pjt,Srj
KE	PZU11B2L	Z-diode	11V±2%, If=200mA, 250mW	SOT-882	13d	2b	Phi
KE	PZU13B3	Z-diode	13.37..13.96V, Zzt=10Ω(Izt=5mA), 310mW	SOD-323FL	7d	1a	Phi
KE	SMBG5.0A	TVS	Vbr=5V, 65.2A, 600W(1ms)	DO-215AA	5d	1k	Vs
KE	SMBJ5.0A	TVS	Vbr=5V, 65.2A, 600W(1ms)	DO-214AA	1d	1k,1m	Di,Vs
KE	SMF5.0A	TVS	Vrwm=5.0V, Vbr=6.40..7.0V, 21.7A, 200W(1ms)	SOD-123FL	7d	1a	Eic
KE	SMF5.0CA	TVS	Vrwm=5.0V, Vbr=6.4..7.0V, 21.7A, 200W(10/100μs), Bidirectional	SOD-123FL	7ba	1j	Ers



SMD
code

Type

Function

Short description

Case

Pinout

St.

Mnf.

SMD code	Type	Function	Short description	Case	Pinout	St.	Mnf.
KE	TV02W5V0B-G	TVS	Vrwm=5.0V, Vbr=6.40..7.0V, Ipp=21.7A, 200W(1ms), Bidirectional	SOD-123	5ba	1j	Cmc
KE	TV06B5V0J-G	TVS	Vrwm=5.0V, Vbr=6.40..7.0V, Ipp=65.22A, 600W(1ms)	DO-214AA	1d	1a	Cmc
KE7	SM6T6V8A	TVS	Vrwm=5.8V, Vbr=6.45..7.14V, 57A, 600W(1ms)	DO-214AA	1d	1k	Vs
KE7	SM6T6V8CA	TVS	Vrwm=5.8V, Vbr=6.45..7.14V, 57A, 600W(1ms), Bidirectional	DO-214AA	1ba	1l	Vs
KEK	SMB6.8A	TVS	Vbr=6.45..7.14V, Vrwm=5.80V, 57.1A, 600W(1ms)	DO-214AA	1d	1a	Lge
KEM	SMB6.8CA	TVS	Vbr=6.45..7.14V, Vrwm=5.80V, 57.1A, 600W(1ms), Bidirectional	DO-214AA	1ba	1j	Lge
KEP	TPSMB6.8A	TVS	Vbr=8.2V, 57.1A, 600W(1ms)	DO-214AA	1d	1k	Vs
KEKX	SMAT70A	TVS	Vbr=70V, 40A, 400W(1ms)	DO-214AC	1d	1m	Di
KF	KDZ15FV	Z-diode	13.80..15.60V, Izt=5mA, Zzt=15Ω, 100mW	TFSC	7d	5A	Kec
KF	MAZD120	Z-diode	11.4..12.7V, Zzt=30Ω(5mA), 120mW	SSSMini2	7d	1a	Pan
KF	P6SMB7V5	TVS	Vrwm=7.5V, 51A, 600W(1ms)	DO-214AA	1d	2j	Fag
KF	P6SMBJ6.0	TVS	Vbr=6V, 52.6A, 600W(1ms)	DO-214AA	1d	1m,1w	Pjt,Srj
KF	PZU12B2L	Z-diode	12V±2%, If=200mA, 250mW	SOT-882	13d	2b	Phi
KF	PZU15B3	Z-diode	14.85..15.52V, Zzt=15Ω(Izt=5mA), 310mW	SOD-323FL	7d	1a	Phi
KF	SMBG6.0	TVS	Vbr=6V, 52.6A, 600W(1ms)	DO-215AA	5d	1k	Vs
KF	SMBJ6.0	TVS	Vbr=6V, 52.6A, 600W(1ms)	DO-214AA	1d	1k	Vs
KF	TV06B6V0K-G	TVS	Vrwm=6.0V, Vbr=6.67..8.15V, Ipp=52.63A, 600W(1ms)	DO-214AA	1d	1a	Cmc
KFK	SMB7.5	TVS	Vbr=6.75..8.25V, Vrwm=6.05V, 51.3A, 600W(1ms)	DO-214AA	1d	1a	Lge
KFM	SMB7.5C	TVS	Vbr=6.75..8.25V, Vrwm=6.05V, 51.3A, 600W(1ms), Bidirectional	DO-214AA	1ba	1j	Lge
KFP	TPSMB7.5	TVS	Vbr=7.5V, 51.3A, 600W(1ms)	DO-214AA	1d	1k	Vs
KG	1SMB6.0A	TVS	Vrwm=6V, 58.3A, 600W(1ms)	403A	3d	1s	Ons
KG	CD214B-T6.0A	TVS	Vbr=6.0V, Irlsm=58.3A, 600W(1ms)	DO-214AA	1d	1a	Bm
KG	P6SMB7V5A	TVS	Vrwm=7.5V, Vbr=7.13..7.88V, 53.1A, 600W(1ms)	DO-214AA	1d	2j	Fag
KG	P6SMBJ6.0A	TVS	Vbr=6V, 58.3A, 600W(1ms)	DO-214AA	1d	1m,1w	Pjt,Srj
KG	PZU13B2L	Z-diode	13V±2%, If=200mA, 250mW	SOT-882	13d	2b	Phi
KG	PZU16B3	Z-diode	16.35..17.09V, Zzt=20Ω(Izt=5mA), 310mW	SOD-323FL	7d	1a	Phi
KG	SMBG6.0A	TVS	Vbr=6V, 58.3A, 600W(1ms)	DO-215AA	5d	1k	Vs
KG	SMBJ6.0A	TVS	Vbr=6V, 58.3A, 600W(1ms)	DO-214AA	1d	1k,1m	Di,Vs
KG	SMF6.0A	TVS	Vrwm=6.0V, Vbr=6.67..7.37V, 19.4A, 200W(1ms)	SOD-123FL	7d	1a	Eic
KG	SMF6.0CA	TVS	Vrwm=6.0V, Vbr=6.67..7.37V, 19.4A, 200W(10/1000μs), Bidirectional	SOD-123FL	7ba	1j	Ers
KG	TV02W6V0B-G	TVS	Vrwm=6.0V, Vbr=6.67..7.37V, Ipp=19.4A, 200W(1ms), Bidirectional	SOD-123	5ba	1j	Cmc
KG	TV06B6V0J-G	TVS	Vrwm=6.0V, Vbr=6.67..7.37V, Ipp=58.25A, 600W(1ms)	DO-214AA	1d	1a	Cmc
KGK	SMB7.5A	TVS	Vbr=7.13..7.88V, Vrwm=6.40V, 53.1A, 600W(1ms)	DO-214AA	1d	1a	Lge
KGM	SMB7.5CA	TVS	Vbr=7.13..7.88V, Vrwm=6.40V, 53.1A, 600W(1ms), Bidirectional	DO-214AA	1ba	1j	Lge
KGP	TPSMB7.5A	TVS	Vbr=7.5V, 53.1A, 600W(1ms)	DO-214AA	1d	1k	Vs
KH	DDZ3V6B	Z-diode	3.6V±5%, Izt=20mA, 500mW	SOD-123	5d	1d	Di
KH	P6SMB8V2	TVS	Vrwm=8.2V, 48A, 600W(1ms)	DO-214AA	1d	2j	Fag
KH	P6SMBJ6.5	TVS	Vbr=6.5V, 48.7A, 600W(1ms)	DO-214AA	1d	1m,1w	Pjt,Srj
KH	PZU14B2L	Z-diode	14V±2%, If=200mA, 250mW	SOT-882	13d	2b	Phi
KH	PZU18B3	Z-diode	18.21..19.03V, Zzt=20Ω(Izt=5mA), 310mW	SOD-323FL	7d	1a	Phi
KH	SMBG6.5	TVS	Vbr=6.5V, 48.8A, 600W(1ms)	DO-215AA	5d	1k	Vs
KH	SMBJ6.5	TVS	Vbr=6.5V, 48.8A, 600W(1ms)	DO-214AA	1d	1k	Vs
KH	TV06B6V5K-G	TVS	Vrwm=6.50V, Vbr=7.22..8.82V, Ipp=48.78A, 600W(1ms)	DO-214AA	1d	1a	Cmc
KHK	SMB8.2	TVS	Vbr=7.38..9.02V, Vrwm=6.63V, 48.0A, 600W(1ms)	DO-214AA	1d	1a	Lge
KHM	SMB8.2C	TVS	Vbr=7.38..9.02V, Vrwm=6.63V, 48.0A, 600W(1ms), Bidirectional	DO-214AA	1ba	1j	Lge
KHP	TPSMB8.2	TVS	Vbr=8.2V, 48A, 600W(1ms)	DO-214AA	1d	1k	Vs
KJ	DDZ3V9B	Z-diode	3.9V±5%, Izt=20mA, 500mW	SOD-123	5d	1d	Di
KJ	PZU20B3	Z-diode	20.21..21.08V, Zzt=20Ω(Izt=5mA), 310mW	SOD-323FL	7d	1a	Phi
KK	1SMB6.5A	TVS	Vrwm=6.5V, 53.6A, 600W(1ms)	403A	3d	1s	Ons
KK	BBY52-02W	C-diode	VCO-Tuning, 7V, 20mA, 1.4..2.2pF(4..1V)	SCD-80	6d	1u	Inf
KK	CD214B-T6.5A	TVS	Vbr=6.5V, Irlsm=53.6A, 600W(1ms)	DO-214AA	1d	1a	Bm
KK	DDZ4V3B	Z-diode	4.3V±5%, Izt=20mA, 500mW	SOD-123	5d	1d	Di
KK	P6SMB8V2A	TVS	Vrwm=8.2V, 50A, 600W(1ms)	DO-214AA	1d	2j	Fag
KK	P6SMBJ6.5A	TVS	Vbr=6.5V, 53.6A, 600W(1ms)	DO-214AA	1d	1m,1w	Pjt,Srj
KK	PZU15B2L	Z-diode	15V±2%, If=200mA, 250mW	SOT-882	13d	2b	Phi
KK	PZU22B3	Z-diode	22.23..23.17V, Zzt=25Ω(Izt=5mA), 310mW	SOD-323FL	7d	1a	Phi
KK	SMBG6.5A	TVS	Vbr=6.5V, 53.6A, 600W(1ms)	DO-215AA	5d	1k	Vs
KK	SMBJ6.5A	TVS	Vbr=6.5V, 53.6A, 600W(1ms)	DO-214AA	1d	1k,1m	Di,Vs
KK	SMF6.5A	TVS	Vrwm=6.5V, Vbr=7.22..7.98V, 17.9A, 200W(1ms)	SOD-123FL	7d	1a	Eic
KK	SMF6.5CA	TVS	Vrwm=6.5V, Vbr=7.22..7.98V, 17.9A, 200W(10/1000μs), Bidirectional	SOD-123FL	7ba	1j	Ers
KK	TV02W6V5B-G	TVS	Vrwm=6.5V, Vbr=7.22..7.98V, Ipp=17.9A, 200W(1ms), Bidirectional	SOD-123	5ba	1j	Cmc
KK	TV06B6V5J-G	TVS	Vrwm=6.50V, Vbr=7.22..7.98V, Ipp=53.57A, 600W(1ms)	DO-214AA	1d	1a	Cmc
KK7	SM6T7V5A	TVS	Vrwm=6.4V, Vbr=7.13..7.88V, 53A, 600W(1ms)	DO-214AA	1d	1k	Vs
KKK	SMB8.2A	TVS	Vbr=7.79..8.61V, Vrwm=7.02V, 49.6A, 600W(1ms)	DO-214AA	1d	1a	Lge
KKM	SMB8.2CA	TVS	Vbr=7.79..8.61V, Vrwm=7.02V, 49.6A, 600W(1ms), Bidirectional	DO-214AA	1ba	1j	Lge
KKP	TPSMB8.2A	TVS	Vbr=8.2V, 49.6A, 600W(1ms)	DO-214AA	1d	1k	Vs
KL	DDZ4V7B	Z-diode	4.7V±5%, Izt=20mA, 500mW	SOD-123	5d	1d	Di
KL	P6SMB9V1	TVS	Vrwm=9.1V, 44A, 600W(1ms)	DO-214AA	1d	2j	Fag
KL	P6SMBJ7.0	TVS	Vbr=7V, 45.1A, 600W(1ms)	DO-214AA	1d	1m,1w	Pjt,Srj
KL	PZU16B2L	Z-diode	16V±2%, If=200mA, 250mW	SOT-882	13d	2b	Phi



SMD
code

Type

Function

Short description

Case

Pinout

St.

Mnf.

SMD code	Type	Function	Short description	Case	Pinout	St.	Mnf.
KL	PZU24B	Z-diode	22.93..25.57V, Zzt=30Ω(Izt=5mA), 310mW	SOD-323FL	7d	1a	Phi
KL	SMBG7.0	TVS	Vbr=7V, 45.1A, 600W(1ms)	DO-215AA	5d	1k	Vs
KL	SMBJ7.0	TVS	Vbr=7V, 45.1A, 600W(1ms)	DO-214AA	1d	1k	Vs
KL	TV06B7V0K-G	TVS	Vrwm=7.0V, Vbr=7.78..9.51V, Ipp=45.11A, 600W(1ms)	DO-214AA	1d	1a	Cmc
KLK	SMB9.1	TVS	Vbr=8.19..10.0V, Vrwm=7.37V, 44.0A, 600W(1ms)	DO-214AA	1d	1a	Lge
KLm	SMB9.1C	TVS	Vbr=8.19..10.0V, Vrwm=7.37V, 44.0A, 600W(1ms), Bidirectional	DO-214AA	1ba	1j	Lge
KLP	TPSMB9.1	TVS	Vbr=9.1V, 43.5A, 600W(1ms)	DO-214AA	1d	1k	Vs
KM	1SMB7.0A	TVS	Vrwm=7V, 50A, 600W(1ms)	403A	3d	1s	Ons
KM	CD214B-T7.0A	TVS	Vbr=7.0V, Irs=50.0A, 600W(1ms)	DO-214AA	1d	1a	Bm
KM	DDZ5V1B	Z-diode	5.1V±2.5%, Izt=20mA, 500mW	SOD-123	5d	1d	Di
KM	DDZ5V1BS	Z-diode	5.1V±2.5%, Izt=20mA, 200mW	SOD-323	5d	1d	Di
KM	P6SMB9V1A	TVS	Vrwm=9.1V, 45A, 600W(1ms)	DO-214AA	1d	2j	Fag
KM	P6SMBJ7.0A	TVS	Vbr=7V, 50A, 600W(1ms)	DO-214AA	1d	1m,1w	Pjt,Srj
KM	PZU18B2L	Z-diode	18V±2%, If=200mA, 250mW	SOT-882	13d	2b	Phi
KM	SMBG7.0A	TVS	Vbr=7V, 50A, 600W(1ms)	DO-215AA	5d	1k	Vs
KM	SMBJ7.0A	TVS	Vbr=7V, 50A, 600W(1ms)	DO-214AA	1d	1k,1m	Di,Vs
KM	SMF7.0A	TVS	Vrwm=7.0V, Vbr=7.78..8.60V, 16.7A, 200W(1ms)	SOD-123FL	7d	1a	Eic
KM	SMF7.0CA	TVS	Vrwm=7.0V, Vbr=7.78..8.60V, 16.7A, 200W(10/1000μs), Bidirectional	SOD-123FL	7ba	1j	Ers
KM	TV02W7V0B-G	TVS	Vbr=7.0V, Vbr=7.78..8.60V, Ipp=16.7A, 200W(1ms), Bidirectional	DO-214AA	5ba	1j	Cmc
KM	TV06B7V0J-G	TVS	Vrwm=7.0V, Vbr=7.78..8.60V, Ipp=50.0A, 600W(1ms)	DO-214AA	1d	1a	Cmc
KMK	SMB9.1A	TVS	Vbr=8.65..9.55V, Vrwm=7.78V, 44.8A, 600W(1ms)	DO-214AA	1d	1a	Lge
KMM	SMB9.1CA	TVS	Vbr=8.65..9.55V, Vrwm=7.78V, 44.8A, 600W(1ms), Bidirectional	DO-214AA	1ba	1j	Lge
KMP	TPSMB9.1A	TVS	Vbr=9.1V, 44.8A, 600W(1ms)	DO-214AA	1d	1k	Vs
KN	DDZ5V6B	Z-diode	5.6V±2.5%, Izt=20mA, 500mW	SOD-123	5d	1d	Di
KN	DDZ5V6BS	Z-diode	5.6V±2.5%, Izt=20mA, 200mW	SOD-323	5d	1d	Di
KN	P6SMB10	TVS	Vrwm=10V, 40A, 600W(1ms)	DO-214AA	1d	2j	Fag
KN	P6SMBJ7.5	TVS	Vbr=7.5V, 42A, 600W(1ms)	DO-214AA	1d	1m,1w	Pjt,Srj
KN	PZU20B2L	Z-diode	20V±2%, If=200mA, 250mW	SOT-882	13d	2b	Phi
KN	SMBG7.5	TVS	Vbr=7.5V, 42A, 600W(1ms)	DO-215AA	5d	1k	Vs
KN	SMBJ7.5	TVS	Vbr=7.5V, 42A, 600W(1ms)	DO-214AA	1d	1k	Vs
KN	TV06B7V5K-G	TVS	Vrwm=7.50V, Vbr=8.33..10.20V, Ipp=41.96A, 600W(1ms)	DO-214AA	1d	1a	Cmc
KNK	SMB10	TVS	Vbr=9.0..11.0V, Vrwm=8.10V, 40.0A, 600W(1ms)	DO-214AA	1d	1a	Lge
KNM	SMB10C	TVS	Vbr=9.0..11.0V, Vrwm=8.10V, 40.0A, 600W(1ms), Bidirectional	DO-214AA	1ba	1j	Lge
KNP	TPSMB10	TVS	Vbr=10V, 40A, 600W(1ms)	DO-214AA	1d	1k	Vs
KO	DDZ6V2B	Z-diode	6.2V±2.5%, Izt=20mA, 500mW	SOD-123	5d	1d	Di
KO	DDZ6V2BS	Z-diode	6.2V±2.5%, Izt=20mA, 200mW	SOD-323	5d	1d	Di
KP	1SMB7.5A	TVS	Vrwm=7.5V, 46.5A, 600W(1ms)	403A	3d	1s	Ons
KP	CD214B-T7.5A	TVS	Vbr=7.5V, Irs=46.5A, 600W(1ms)	DO-214AA	1d	1a	Bm
KP	CMDZ4L7	Z-diode	4.465..4.935V, Izt=0.5mA, Zzt=750Ω, 250mW	SOD-323	5d	1a	Cen
KP	DDZ6V8B	Z-diode	6.8V±2.5%, Izt=20mA, 500mW	SOD-123	5d	1d	Di
KP	KDZ15FVY	Z-diode	14.34..14.98V, Izt=5mA, Zzt=15Ω, 100mW	TFSC	7d	1a	Kec
KP	P6SMB10A	TVS	Vrwm=10V, 41A, 600W(1ms)	DO-214AA	1d	2j	Fag
KP	P6SMBJ7.5A	TVS	Vbr=7.5V, 46.5A, 600W(1ms)	DO-214AA	1d	1m,1w	Pjt,Srj
KP	PZU22B2L	Z-diode	22V±2%, If=200mA, 250mW	SOT-882	13d	2b	Phi
KP	SMBG7.5A	TVS	Vbr=7.5V, 46.5A, 600W(1ms)	DO-215AA	5d	1k	Vs
KP	SMBJ7.5A	TVS	Vbr=7.5V, 46.5A, 600W(1ms)	DO-214AA	1d	1k,1m	Di,Vs
KP	SMF7.5A	TVS	Vrwm=7.5V, Vbr=8.33..9.21V, 15.5A, 200W(1ms)	SOD-123FL	7d	1a	Eic
KP	SMF7.5CA	TVS	Vrwm=7.5V, Vbr=8.33..9.21V, 15.5A, 200W(10/1000μs), Bidirectional	SOD-123FL	7ba	1j	Ers
KP	TV02W7V5B-G	TVS	Vrwm=7.5V, Vbr=8.33..9.21V, Ipp=15.5A, 200W(1ms), Bidirectional	SOD-123	5ba	1j	Cmc
KP	TV06B7V5J-G	TVS	Vrwm=7.50V, Vbr=8.33..9.21V, Ipp=46.51A, 600W(1ms)	DO-214AA	1d	1a	Cmc
KPK	SMB10A	TVS	Vbr=9.50..10.5V, Vrwm=8.55V, 41.4A, 600W(1ms)	DO-214AA	1d	1a	Lge
KPM	SMB10CA	TVS	Vbr=9.50..10.5V, Vrwm=8.55V, 41.4A, 600W(1ms), Bidirectional	DO-214AA	1ba	1j	Lge
KPP	TPSMB10A	TVS	Vbr=10V, 41.4A, 600W(1ms)	DO-214AA	1d	1k	Vs
KQ	DDZ7V5B	Z-diode	7.5V±2.5%, Izt=20mA, 500mW	SOD-123	5d	1d	Di
KQ	P6SMB11	TVS	Vrwm=11V, 37A, 600W(1ms)	DO-214AA	1d	2j	Fag
KQ	P6SMBJ8.0	TVS	Vbr=8V, 40A, 600W(1ms)	DO-214AA	1d	1m,1w	Pjt,Srj
KQ	SMBG8.0	TVS	Vbr=8V, 40A, 600W(1ms)	DO-215AA	5d	1k	Vs
KQ	SMBJ8.0	TVS	Vbr=8V, 40A, 600W(1ms)	DO-214AA	1d	1k	Vs
KQ	TV06B8V0K-G	TVS	Vrwm=8.0V, Vbr=8.89..10.90V, Ipp=40.0A, 600W(1ms)	DO-214AA	1d	1a	Cmc
KQK	SMB11	TVS	Vbr=9.90..12.1V, Vrwm=8.92V, 37.0A, 600W(1ms)	DO-214AA	1d	1a	Lge
KQM	SMB11C	TVS	Vbr=9.90..12.1V, Vrwm=8.92V, 37.0A, 600W(1ms), Bidirectional	DO-214AA	1ba	1j	Lge
KQP	TPSMB11	TVS	Vbr=11V, 37A, 600W(1ms)	DO-214AA	1d	1k	Vs
KR	1SMB8.0A	TVS	Vrwm=8V, 44.1A, 600W(1ms)	403A	3d	1s	Ons
KR	CD214B-T8.0A	TVS	Vbr=8.0V, Irs=44.1A, 600W(1ms)	DO-214AA	1d	1a	Bm
KR	DDZ8V2B	Z-diode	8.2V±2.5%, Izt=20mA, 500mW	SOD-123	5d	1d	Di
KR	P6SMB11A	TVS	Vrwm=11V, 38A, 600W(1ms)	DO-214AA	1d	2j	Fag
KR	P6SMBJ8.0A	TVS	Vbr=8V, 44.1A, 600W(1ms)	DO-214AA	1d	1m,1w	Pjt,Srj
KR	PZU24B2L	Z-diode	24V±2%, If=200mA, 250mW	SOT-882	13d	2b	Phi
KR	SMBG8.0A	TVS	Vbr=8V, 44.1A, 600W(1ms)	DO-215AA	5d	1k	Vs
KR	SMBJ8.0A	TVS	Vbr=8V, 44.1A, 600W(1ms)	DO-214AA	1d	1k,1m	Di,Vs



SMD
code

Type

Function

Short description

Case

Pinout St.

Mnf.

SMD code	Type	Function	Short description	Case	Pinout	St.	Mnf.
KR	SMF8.0A	TVS	Vrwm=8.0V, Vbr=8.89..9.83V, 14.7A, 200W(1ms)	SOD-123FL	7d	1a	Eic
KR	SMF8.0CA	TVS	Vrwm=8.0V, Vbr=8.89..9.83V, 14.7A, 200W(10/1000µs), Bidirectional	SOD-123FL	7ba	1j	Ers
KR	TV02W8V0B-G	TVS	Vrwm=8.0V, Vbr=8.89..9.83V, Ipp=14.7A, 200W(1ms), Bidirectional	SOD-123	5ba	1j	Cmc
KR	TV06B8V0J-G	TVS	Vrwm=8.0V, Vbr=8.89..9.83V, Ipp=44.12A, 600W(1ms)	DO-214AA	1d	1a	Cmc
KRK	SMB11A	TVS	Vbr=10.5..11.6V, Vrwm=9.40V, 38.5A, 600W(1ms)	DO-214AA	1d	1a	Lge
KRM	SMB11CA	TVS	Vbr=10.5..11.6V, Vrwm=9.40V, 38.5A, 600W(1ms), Bidirectional	DO-214AA	1ba	1j	Lge
KRP	TPSMB11A	TVS	Vbr=11V, 38.5A, 600W(1ms)	DO-214AA	1d	1k	Vs
KS	DDZ9V1B	Z-diode	9.1V±2.5%, Izt=20mA, 500mW	SOD-123	5d	1d	Di
KS	P6SMB12	TVS	Vrwm=12V, 35A, 600W(1ms)	DO-214AA	1d	2j	Fag
KS	P6SMBJ8.5	TVS	Vbr=8.5V, 37.7A, 600W(1ms)	DO-214AA	1d	1m,1w	Pjt,Srj
KS	SMBG8.5	TVS	Vbr=8.5V, 37.7A, 600W(1ms)	DO-215AA	5d	1k	Vs
KS	SMBJ8.5	TVS	Vbr=8.5V, 37.7A, 600W(1ms)	DO-214AA	1d	1k	Vs
KS	TV06B8V5K-G	TVS	Vrwm=8.55V, Vbr=9.44..11.50V, Ipp=37.74A, 600W(1ms)	DO-214AA	1d	1a	Cmc
KSK	SMB12	TVS	Vbr=10.8..13.2V, Vrwm=9.72V, 34.7A, 600W(1ms)	DO-214AA	1d	1a	Lge
KSM	SMB12C	TVS	Vbr=10.8..13.2V, Vrwm=9.72V, 34.7A, 600W(1ms), Bidirectional	DO-214AA	1ba	1j	Lge
KSP	TPSMB12	TVS	Vbr=12V, 34.7A, 600W(1ms)	DO-214AA	1d	1k	Vs
KT	1SMB8.5A	TVS	Vrwm=8.5V, 41.7A, 600W(1ms)	403A	3d	1s	Ons
KT	CD214B-T8.5A	TVS	Vbr=8.5V, Irlsm=41.7A, 600W(1ms)	DO-214AA	1d	1a	Bm
KT	DDZ10B	Z-diode	10V±2.5%, Izt=20mA, 500mW	SOD-123	5d	1d	Di
KT	P6SMB12A	TVS	Vrwm=12V, 36A, 600W(1ms)	DO-214AA	1d	2j	Fag
KT	P6SMBJ8.5A	TVS	Vbr=8.5V, 41.7A, 600W(1ms)	DO-214AA	1d	1m,1w	Pjt,Srj
KT	SMBG8.5A	TVS	Vbr=8.5V, 41.7A, 600W(1ms)	DO-215AA	5d	1k	Vs
KT	SMBJ8.5A	TVS	Vbr=8.5V, 41.7A, 600W(1ms)	DO-214AA	1d	1k,1m	Di,Vs
KT	SMF8.5A	TVS	Vrwm=8.5V, Vbr=9.44..10.4V, 13.9A, 200W(1ms)	SOD-123FL	7d	1a	Eic
KT	SMF8.5CA	TVS	Vrwm=8.5V, Vbr=9.44..10.40V, 13.9A, 200W(10/1000µs), Bidirectional	SOD-123FL	7ba	1j	Ers
KT	TV02W8V5B-G	TVS	Vrwm=8.5V, Vbr=9.44..10.4V, Ipp=13.9A, 200W(1ms), Bidirectional	SOD-123	5ba	1j	Cmc
KT	TV06B8V5J-G	TVS	Vrwm=8.55V, Vbr=9.44..10.40V, Ipp=41.67A, 600W(1ms)	DO-214AA	1d	1a	Cmc
KT7	SM6T10A	TVS	Vbr=9.5..10.5V, 41A, 600W(1ms)	DO-214AA	1d	1k	Vs
KTK	SMB12A	TVS	Vbr=11.4..12.6V, Vrwm=10.2V, 35.9A, 600W(1ms)	DO-214AA	1d	1a	Lge
KTM	SMB12CA	TVS	Vbr=11.4..12.6V, Vrwm=10.2V, 35.9A, 600W(1ms), Bidirectional	DO-214AA	1ba	1j	Lge
KTP	TPSMB12A	TVS	Vbr=12V, 35.9A, 600W(1ms)	DO-214AA	1d	1k	Vs
KU	DDZ11B	Z-diode	11V±2.5%, Izt=10mA, 500mW	SOD-123	5d	1d	Di
KU	P6SMB13	TVS	Vrwm=13V, 32A, 600W(1ms)	DO-214AA	1d	2j	Fag
KU	P6SMBJ9.0	TVS	Vbr=9V, 35.5A, 600W(1ms)	DO-214AA	1d	1m,1w	Pjt,Srj
KU	SMBG9.0	TVS	Vbr=9V, 35.5A, 600W(1ms)	DO-215AA	5d	1k	Vs
KU	SMBJ9.0	TVS	Vbr=9V, 35.5A, 600W(1ms)	DO-214AA	1d	1k	Vs
KU	TV06B9V0K-G	TVS	Vrwm=9.0V, Vbr=10.0..12.20V, Ipp=35.50A, 600W(1ms)	DO-214AA	1d	1a	Cmc
KUK	SMB13	TVS	Vbr=11.7..14.3V, Vrwm=10.5V, 31.6A, 600W(1ms)	DO-214AA	1d	1a	Lge
KUM	SMB13C	TVS	Vbr=11.7..14.3V, Vrwm=10.5V, 31.6A, 600W(1ms), Bidirectional	DO-214AA	1ba	1j	Lge
KUP	TPSMB13	TVS	Vbr=13V, 31.6A, 600W(1ms)	DO-214AA	1d	1k	Vs
KV	1SMB9.0A	TVS	Vrwm=9V, 39A, 600W(1ms)	403A	3d	1s	Ons
KV	CD214B-T9.0A	TVS	Vbr=9.0V, Irlsm=39.0A, 600W(1ms)	DO-214AA	1d	1a	Bm
KV	DDZ12B	Z-diode	12V±2.5%, Izt=10mA, 500mW	SOD-123	5d	1d	Di
KV	P6SMB13A	TVS	Vrwm=13V, 33A, 600W(1ms)	DO-214AA	1d	2j	Fag
KV	P6SMBJ9.0A	TVS	Vbr=9V, 39A, 600W(1ms)	DO-214AA	1d	1m,1w	Pjt,Srj
KV	SMBG9.0A	TVS	Vbr=9V, 39A, 600W(1ms)	DO-215AA	5d	1k	Vs
KV	SMBJ9.0A	TVS	Vbr=9V, 39A, 600W(1ms)	DO-214AA	1d	1k,1m	Di,Vs
KV	SMF9.0A	TVS	Vrwm=9.0V, Vbr=10.0..11.1V, 13.0A, 200W(1ms)	SOD-123FL	7d	1a	Eic
KV	SMF9.0CA	TVS	Vrwm=9.0V, Vbr=10.0..11.10V, 13.0A, 200W(10/1000µs), Bidirectional	SOD-123FL	7ba	1j	Ers
KV	TV02W9V0B-G	TVS	Vrwm=9.0V, Vbr=10.0..11.1V, Ipp=13.0A, 200W(1ms), Bidirectional	SOD-123	5ba	1j	Cmc
KV	TV06B9V0J-G	TVS	Vrwm=9.0V, Vbr=10.0..11.10V, Ipp=38.96A, 600W(1ms)	DO-214AA	1d	1a	Cmc
KVK	SMB13A	TVS	Vbr=12.4..13.7V, Vrwm=11.1V, 33.0A, 600W(1ms)	DO-214AA	1d	1a	Lge
KVM	SMB13CA	TVS	Vbr=12.4..13.7V, Vrwm=11.1V, 33.0A, 600W(1ms), Bidirectional	DO-214AA	1ba	1j	Lge
KVP	TPSMB13A	TVS	Vbr=13V, 33.0A, 600W(1ms)	DO-214AA	1d	1k	Vs
KW	DDZ13B	Z-diode	13V±2.5%, 2Izt=10mA, 500mW	SOD-123	5d	1d	Di
KW	DDZ13BS	Z-diode	13V±2.5%, Izt=10mA, 200mW	SOD-323	5d	1d	Di
KW	P6SMB15	TVS	Vrwm=15V, 27A, 600W(1ms)	DO-214AA	1d	2j	Fag
KW	P6SMBJ10	TVS	Vbr=10V, 31.9A, 600W(1ms)	DO-214AA	1d	1m,1w	Pjt,Srj
KW	SMBG10	TVS	Vbr=10V, 31.9A, 600W(1ms)	DO-215AA	5d	1k	Vs
KW	SMBJ10	TVS	Vbr=10V, 31.9A, 600W(1ms)	DO-214AA	1d	1k	Vs
KW	TV06B100K-G	TVS	Vrwm=10.0V, Vbr=11.10..13.60V, Ipp=31.90A, 600W(1ms)	DO-214AA	1d	1a	Cmc
KWK	SMB15	TVS	Vbr=13.5..16.3V, Vrwm=12.1V, 27.3A, 600W(1ms)	DO-214AA	1d	1a	Lge
KWM	SMB15C	TVS	Vbr=13.5..16.3V, Vrwm=12.1V, 27.3A, 600W(1ms), Bidirectional	DO-214AA	1ba	1j	Lge
KWP	TPSMB15	TVS	Vbr=15V, 27.3A, 600W(1ms)	DO-214AA	1d	1k	Vs
KX	1SMB10A	TVS	Vrwm=10V, 35.3A, 600W(1ms)	403A	3d	1a	Ons
KX	CD214B-T10A	TVS	Vbr=10V, Irlsm=35.3A, 600W(1ms)	DO-214AA	1d	1a	Bm
KX	DDZ14B	Z-diode	14V±2.5%, Izt=10mA, 500mW	SOD-123	5d	1d	Di
KX	P6SMB15A	TVS	Vrwm=15V, 28A, 600W(1ms)	DO-214AA	1d	2j	Fag
KX	P6SMBJ10A	TVS	Vbr=10V, 35.3A, 600W(1ms)	DO-214AA	1d	1m,1w	Pjt,Srj
KX	SMBG10A	TVS	Vbr=10V, 35.3A, 600W(1ms)	DO-215AA	5d	1k	Vs



SMD
code

Type

Function

Short description

Case

Pinout

St.

Mnf.

KX	SMBJ10A	TVS	Vbr=10V, 35.3A, 600W(1ms)	DO-214AA	1d	1k,1m	Di,Vs
KX	SMF10A	TVS	Vrwm=10V, Vbr=11.1..12.3V, 11.8A, 200W(1ms)	SOD-123FL	7d	1a	Eic
KX	SMF10CA	TVS	Vrwm=10.0V, Vbr=11.10..12.30V, 11.8A, 200W(10/1000µs), Bidirectional	SOD-123FL	7ba	1j	Ers
KX	TV02W100B-G	TVS	Vrwm=10V, Vbr=11.1..12.3V, lpp=11.8A, 200W(1ms), Bidirectional	SOD-123	5ba	1j	Cmc
KX	TV06B100J-G	TVS	Vrwm=10.0V, Vbr=11.10..12.30V, lpp=35.29A, 600W(1ms)	DO-214AA	1d	1a	Cmc
KX7	SM6T12A	TVS	Vbr=11.4..12.6V, 36A, 600W(1ms)	DO-214AA	1d	1k	Vs
KXC	1SMB10CA	TVS	Vrwm=10V, 135.3A, 600W(1ms), Bidirectional	403A	3ba	1e	Ons
KXC	SMB15A	TVS	Vbr=14.3..15.8V, Vrwm=12.8V, 28.3A, 600W(1ms)	DO-214AA	1d	1a	Lge
KXM	SMB15CA	TVS	Vbr=14.3..15.8V, Vrwm=12.8V, 28.3A, 600W(1ms), Bidirectional	DO-214AA	1ba	1j	Lge
KXP	TPSMB15A	TVS	Vbr=15V, 28.3A, 600W(1ms)	DO-214AA	1d	1k	Vs
KY	DDZ16B	Z-diode	16V±2.5%, lzt=10mA, 500mW	SOD-123	5d	1d	Di
KY	KDZ4.7V7VY	Z-diode	4.55..4.75V, lzt=5mA, Zzt=120Q, 100mW	VSC	7d	1a	Kec
KY	P6SMB16	TVS	Vrwm=16V, 26A, 600W(1ms)	DO-214AA	1d	2j	Fag
KY	P6SMBJ11	TVS	Vbr=11V, 29.9A, 600W(1ms)	DO-214AA	1d	1m,1w	Pjt,Srj
KY	SMBG11	TVS	Vbr=11V, 29.9A, 600W(1ms)	DO-215AA	5d	1k	Vs
KY	SMBJ11	TVS	Vbr=11V, 29.9A, 600W(1ms)	DO-214AA	1d	1k	Vs
KY	TV06B110K-G	TVS	Vrwm=11.0V, Vbr=12.20..14.90V, lpp=29.85A, 600W(1ms)	DO-214AA	1d	1a	Cmc
KYK	SMB16	TVS	Vbr=14.4..17.6V, Vrwm=12.9V, 25.5A, 600W(1ms)	DO-214AA	1d	1a	Lge
KYM	SMB16C	TVS	Vbr=14.4..17.6V, Vrwm=12.9V, 25.5A, 600W(1ms), Bidirectional	DO-214AA	1ba	1j	Lge
KYP	TPSMB16	TVS	Vbr=16V, 25.5A, 600W(1ms)	DO-214AA	1d	1k	Vs
KZ	1SMB11A	TVS	Vrwm=11V, 33A, 600W(1ms)	403A	3d	1s	Ons
KZ	BZT52-B15S	Z-diode	14.70..15.30V, lzt=5mA, Zzt=30Q, 200mW	SOD-323FL	7d	1a	Tsc
KZ	CD214B-T11A	TVS	Vbr=11V, lrrm=33.0A, 600W(1ms)	DO-214AA	1d	1a	Bm
KZ	DDZ17	Z-diode	17V±10%, lzt=10mA, 500mW	SOD-123	5d	1d	Di
KZ	MM3Z15VB	Z-diode	14.70..15.30V, Zzt=28Q, lzt=5mA, 200mW	SOD-323FL	7d	1a	F
KZ	MM3Z15VBW	Z-diode	14.70..15.30V, lzt=5mA, Zzt=30Q, 200mW	SOD-323FL	7d	1a	Tac
KZ	P6SMB16A	TVS	Vrwm=16V, 27A, 600W(1ms)	DO-214AA	1d	2j	Fag
KZ	P6SMBJ11A	TVS	Vbr=11V, 33A, 600W(1ms)	DO-214AA	1d	1m,1w	Pjt,Srj
KZ	SMBG11A	TVS	Vbr=11V, 33A, 600W(1ms)	DO-215AA	5d	1k	Vs
KZ	SMBJ11A	TVS	Vbr=11V, 33A, 600W(1ms)	DO-214AA	1d	1k,1m	Di,Vs
KZ	SMF11A	TVS	Vrwm=11V, Vbr=12.2..13.5V, 11.0A, 200W(1ms)	SOD-123FL	7d	1a	Eic
KZ	SMF11CA	TVS	Vrwm=11.0V, Vbr=12.20..13.50V, 11.0A, 200W(10/1000µs), Bidirectional	SOD-123FL	7ba	1j	Ers
KZ	TCMM3Z15VB	Z-diode	15V±2%, lzt=5mA, Zzt=28Q, 200mW	SOD-323FL	7d	1a	Tac
KZ	TV02W110B-G	TVS	Vrwm=11V, Vbr=12.2..13.5V, lpp=11.0A, 200W(1ms), Bidirectional	SOD-123	5ba	1j	Cmc
KZ	TV06B110J-G	TVS	Vrwm=11.0V, Vbr=12.20..13.50V, lpp=32.97A, 600W(1ms)	DO-214AA	1d	1a	Cmc
KZC	1SMB11CA	TVS	Vrwm=11V, 33A, 600W(1ms), Bidirectional	403A	3ba	1e	Ons
KZK	SMB16A	TVS	Vbr=15.2..16.8V, Vrwm=13.6V, 26.7A, 600W(1ms)	DO-214AA	1d	1a	Lge
KZM	SMB16CA	TVS	Vbr=15.2..16.8V, Vrwm=13.6V, 26.7A, 600W(1ms), Bidirectional	DO-214AA	1ba	1j	Lge
KZP	TPSMB16A	TVS	Vbr=16V, 26.7A, 600W(1ms)	DO-214AA	1d	1k	Vs
L	BAT62-02L	Si-diode	Schottky, 40V, 20mA; Vf<1.0V, Cd<0.6pF	TSLP-P-2.1	13d	2b	Inf
L	BAT62-03W	Si-diode	Schottky, 40V, 20mA; Vf<1.0V, Cd<0.6pF	SOD-323	5d	1a	Inf
L	BB143	C-diode	VCO, 6V, 20mA, 2.25/5.3pF(4V/1V, 1MHz), <0.5Ω	SOD-523	6d	1a	Phi
L	BBY53-02V	C-diode	VCO-Tuning, 6V, 20mA, 3.1..5.8pF(3..1V)	SC-79	6d	1u	Sie
L	CDZ11B	Z-diode	11V±2.5%, lzt=20mA, 1W	VMN	7d	1s	Rhm
L	CH511H-30PT	Si-diode	SBD, 30V, 1A, Vf<0.47V(1A)	SOD-323	5d	1a	Chm
L	HVU356	C-diode	VCO, BS-Tuner, 15V, 27.7/31.8pF(2V)	SOD-323	5d	1a	Ren
L	MAZS372	C-diode	UHF/VHF-tun, 32V, 20mA, 14.2/2.9pF(2/17V), 0.45Ω(470MHz)	SOD-523	6d	1a	Pan
L	MAZS043	Z-diode	4..4.6V, 200mW	SOD-523	6d	1a	Pan
L	MM9D12V	Z-diode	11.40..12.60V, lzt=5mA, Zzt=30Q, 200mW	SOD-923	7d	1n	Wtr
L	MMSZ5261BPT	Z-diode	44.65..49.35V, lzt=2.7mA, Zzt=105Q, 225mW	SOD-523	7d	1a	Chm
L	NZ9F12VT	Z-diode	11.40..12.60V, lzt=5mA, Zzt=30Q, 200mW	SOD-923	7d	1n	Ons
L	NZ9F6V8ST	Z-diode	6.65..6.93V, lzt=5mA, Zzt=40Q, 200mW	SOD-923	7d	2m	Ons
L	MAZS0430M	Z-diode	4.17..4.4V, 200mW	SOD-523	6d	1a	Pan
L	MMSZ5261SPT	Z-diode	46.06..47.94V, lzt=2.7mA, Zzt=105Q, 225mW	SOD-523	7d	1a	Chm
L*	MAZS0430H	Z-diode	4.31..4.54V, 200mW	SOD-523	6d	1a	Pan
L	MAZS0430L	Z-diode	4.03..4.26V, 200mW	SOD-523	6d	1a	Pan
L0	BZD27C24P	TVS	Vbr=22.8V, Vcl=33.8V, 4.4A, 150W(1ms)	SOD123FL	7d	1a	Lge
L0	CMOZZL2	Z-diode	2.09..2.31V, lzt=0.25mA, Zzt=140Q, 250mW	SOD-523	6d	1a	Cen
L0	MMPZ5242SPT	Z-diode	11.76..12.24V, lzt=5mA, Zzt=22Q, 225mW	SOD-323	5d	1a	Chm
L0	MMPZ5268BPT	Z-diode	77.90..86.10V, lzt=1.5mA, Zzt=330Q, 225mW	SOD-323	5d	1a	Chm
L1	BZD27C27P	TVS	Vbr=25.1V, Vcl=38.1V, 3.9A, 150W(1ms)	SOD123FL	7d	1a	Lge
L1	BZX384-B5V6	Z-diode	5.6V±2.5%, lzt=5mA, Zzt=15Q, 200mW	SOD-323	5d	1k	Phi
L10	SMGJ10	TVS	Vrwm=10V, Vbr=11.1..13.6V, lpp=159.6A, 3000W(1ms)	DO-215AB	5d	1a	Msc
L10	SMLJ10	TVS	Vrwm=10V, Vbr=11.1..13.6V, lpp=159.6A, 3000W(1ms)	DO-214AB	1a	1a	Msc
L10	SSCD210	Si-diode	SBR, 100V, 2A, Vf<0.85V(2A)	1206	14d	1v	Zow
L100	SMGJ100	TVS	Vrwm=100V, Vbr=111..136V, lpp=16.8A, 3000W(1ms)	DO-215AB	5d	1a	Msc
L100	SMLJ100	TVS	Vrwm=100V, Vbr=111..136V, lpp=16.8A, 3000W(1ms)	DO-214AB	1a	1a	Msc
L100A	SMGJ100A	TVS	Vrwm=100V, Vbr=111..123V, lpp=18.6A, 3000W(1ms)	DO-215AB	5d	1a	Msc
L100A	SMLJ100A	TVS	Vrwm=100V, Vbr=111..123V, lpp=18.6A, 3000W(1ms)	DO-214AB	1a	1a	Msc
L100C	SMGJ100C	TVS	Vrwm=100V, Vbr=111..136V, lpp=16.8A, 3000W(1ms), Bidirectional	DO-215AB	5ba	1j	Msc



SMD code	Type	Function	Short description	Case	Pinout	St.	Mnf.
L100C	SMLJ100C	TVS	Vrwm=100V, Vbr=111..136V, lpp=16.8A, 3000W(1ms), Bidirectional	DO-214AB	1a	1j	Msc
L100CA	SMGJ100CA	TVS	Vrwm=100V, Vbr=111..123V, lpp=18.6A, 3000W(1ms), Bidirectional	DO-215AB	5ba	1j	Msc
L100CA	SMLJ100CA	TVS	Vrwm=100V, Vbr=111..123V, lpp=18.6A, 3000W(1ms), Bidirectional	DO-214AB	1a	1j	Msc
L10A	SMGJ10A	TVS	Vrwm=10V, Vbr=11.1..12.3V, lpp=176.4A, 3000W(1ms)	DO-215AB	5d	1a	Msc
L10A	SMLJ10A	TVS	Vrwm=10V, Vbr=11.1..12.3V, lpp=176.4A, 3000W(1ms)	DO-214AB	1a	1a	Msc
L10C	SMGJ10C	TVS	Vrwm=10V, Vbr=11.1..13.6V, lpp=159.6A, 3000W(1ms), Bidirectional	DO-215AB	5ba	1j	Msc
L10C	SMLJ10C	TVS	Vrwm=10V, Vbr=11.1..13.6V, lpp=159.6A, 3000W(1ms), Bidirectional	DO-214AB	1a	1j	Msc
L10CA	SMGJ10CA	TVS	Vrwm=10V, Vbr=11.1..12.3V, lpp=176.4A, 3000W(1ms), Bidirectional	DO-215AB	5d	1j	Msc
L10CA	SMLJ10CA	TVS	Vrwm=10V, Vbr=11.1..12.3V, lpp=176.4A, 3000W(1ms), Bidirectional	DO-214AB	1a	1j	Msc
L11	SMGJ11	TVS	Vrwm=11V, Vbr=12.2..14.9V, lpp=149.2A, 3000W(1ms)	DO-215AB	5d	1a	Msc
L11	SMLJ11	TVS	Vrwm=11V, Vbr=12.2..14.9V, lpp=149.2A, 3000W(1ms)	DO-214AB	1a	1a	Msc
L110	SMGJ110	TVS	Vrwm=110V, Vbr=122..149V, lpp=15.4A, 3000W(1ms)	DO-215AB	5d	1a	Msc
L110	SMLJ110	TVS	Vrwm=110V, Vbr=122..149V, lpp=15.4A, 3000W(1ms)	DO-214AB	1a	1a	Msc
L110A	SMGJ110A	TVS	Vrwm=110V, Vbr=122..135V, lpp=16.8A, 3000W(1ms)	DO-215AB	5d	1a	Msc
L110A	SMLJ110A	TVS	Vrwm=110V, Vbr=122..135V, lpp=16.8A, 3000W(1ms)	DO-214AB	1a	1a	Msc
L110C	SMGJ110C	TVS	Vrwm=110V, Vbr=122..149V, lpp=15.4A, 3000W(1ms), Bidirectional	DO-215AB	5ba	1j	Msc
L110C	SMLJ110C	TVS	Vrwm=110V, Vbr=122..149V, lpp=15.4A, 3000W(1ms), Bidirectional	DO-214AB	1a	1j	Msc
L110CA	SMGJ110CA	TVS	Vrwm=110V, Vbr=122..135V, lpp=16.8A, 3000W(1ms), Bidirectional	DO-215AB	5ba	1j	Msc
L110CA	SMLJ110CA	TVS	Vrwm=110V, Vbr=122..135V, lpp=16.8A, 3000W(1ms), Bidirectional	DO-214AB	1a	1j	Msc
L11A	SMGJ11A	TVS	Vrwm=11V, Vbr=12.2..13.5V, lpp=164.8A, 3000W(1ms)	DO-215AB	5d	1a	Msc
L11A	SMLJ11A	TVS	Vrwm=11V, Vbr=12.2..13.5V, lpp=164.8A, 3000W(1ms)	DO-214AB	1a	1a	Msc
L11C	SMGJ11C	TVS	Vrwm=11V, Vbr=12.2..14.9V, lpp=149.2A, 3000W(1ms), Bidirectional	DO-215AB	5ba	1j	Msc
L11C	SMLJ11C	TVS	Vrwm=11V, Vbr=12.2..14.9V, lpp=149.2A, 3000W(1ms), Bidirectional	DO-214AB	1a	1j	Msc
L11CA	SMGJ11CA	TVS	Vrwm=11V, Vbr=12.2..13.5V, lpp=164.8A, 3000W(1ms), Bidirectional	DO-215AB	5d	1j	Msc
L11CA	SMLJ11CA	TVS	Vrwm=11V, Vbr=12.2..13.5V, lpp=164.8A, 3000W(1ms), Bidirectional	DO-214AB	1a	1j	Msc
L12	SMGJ12	TVS	Vrwm=12V, Vbr=13.3..16.3V, lpp=136.4A, 3000W(1ms)	DO-215AB	5d	1a	Msc
L12	SMLJ12	TVS	Vrwm=12V, Vbr=13.3..16.3V, lpp=136.4A, 3000W(1ms)	DO-214AB	1a	1a	Msc
L120	SMGJ120	TVS	Vrwm=120V, Vbr=133..163V, lpp=14.0A, 3000W(1ms)	DO-215AB	5d	1a	Msc
L120	SMLJ120	TVS	Vrwm=120V, Vbr=133..163V, lpp=14.0A, 3000W(1ms)	DO-214AB	1a	1a	Msc
L120A	SMGJ120A	TVS	Vrwm=120V, Vbr=133..147V, lpp=15.6A, 3000W(1ms)	DO-215AB	5d	1a	Msc
L120A	SMLJ120A	TVS	Vrwm=120V, Vbr=133..147V, lpp=15.6A, 3000W(1ms)	DO-214AB	1a	1a	Msc
L120C	SMGJ120C	TVS	Vrwm=120V, Vbr=133..163V, lpp=14.0A, 3000W(1ms), Bidirectional	DO-215AB	5ba	1j	Msc
L120C	SMLJ120C	TVS	Vrwm=120V, Vbr=133..163V, lpp=14.0A, 3000W(1ms), Bidirectional	DO-214AB	1a	1j	Msc
L120CA	SMGJ120CA	TVS	Vrwm=120V, Vbr=133..147V, lpp=15.6A, 3000W(1ms), Bidirectional	DO-215AB	5ba	1j	Msc
L120CA	SMLJ120CA	TVS	Vrwm=120V, Vbr=133..147V, lpp=15.6A, 3000W(1ms), Bidirectional	DO-214AB	1a	1j	Msc
L12A	SMGJ12A	TVS	Vrwm=12V, Vbr=13.3..14.7V, lpp=150.6A, 3000W(1ms)	DO-215AB	5d	1a	Msc
L12A	SMLJ12A	TVS	Vrwm=12V, Vbr=13.3..14.7V, lpp=150.6A, 3000W(1ms)	DO-214AB	1a	1a	Msc
L12C	SMGJ12C	TVS	Vrwm=12V, Vbr=13.3..16.3V, lpp=136.4A, 3000W(1ms), Bidirectional	DO-215AB	5d	1j	Msc
L12C	SMLJ12C	TVS	Vrwm=12V, Vbr=13.3..16.3V, lpp=136.4A, 3000W(1ms), Bidirectional	DO-214AB	1a	1j	Msc
L12CAA	SMGJ12CA	TVS	Vrwm=12V, Vbr=13.3..14.7V, lpp=150.6A, 3000W(1ms), Bidirectional	DO-215AB	5d	1j	Msc
L12CAA	SMLJ12CA	TVS	Vrwm=12V, Vbr=13.3..14.7V, lpp=150.6A, 3000W(1ms), Bidirectional	DO-214AB	1a	1j	Msc
L13	SMGJ13	TVS	Vrwm=13V, Vbr=14.4..17.6V, lpp=126.0A, 3000W(1ms)	DO-215AB	5d	1a	Msc
L13	SMLJ13	TVS	Vrwm=13V, Vbr=14.4..17.6V, lpp=126.0A, 3000W(1ms)	DO-214AB	1a	1a	Msc
L130	SMGJ130	TVS	Vrwm=130V, Vbr=144..176V, lpp=13.0A, 3000W(1ms)	DO-215AB	5d	1a	Msc
L130	SMLJ130	TVS	Vrwm=130V, Vbr=144..176V, lpp=13.0A, 3000W(1ms)	DO-214AB	1a	1a	Msc
L130A	SMGJ130A	TVS	Vrwm=130V, Vbr=144..159V, lpp=14.4A, 3000W(1ms)	DO-215AB	5d	1a	Msc
L130A	SMLJ130A	TVS	Vrwm=130V, Vbr=144..159V, lpp=14.4A, 3000W(1ms)	DO-214AB	1a	1a	Msc
L130C	SMGJ130C	TVS	Vrwm=130V, Vbr=144..176V, lpp=13.0A, 3000W(1ms), Bidirectional	DO-215AB	5ba	1j	Msc
L130C	SMLJ130C	TVS	Vrwm=130V, Vbr=144..176V, lpp=13.0A, 3000W(1ms), Bidirectional	DO-214AB	1a	1j	Msc
L130CA	SMGJ130CA	TVS	Vrwm=130V, Vbr=144..159V, lpp=14.4A, 3000W(1ms), Bidirectional	DO-215AB	5ba	1j	Msc
L130CA	SMLJ130CA	TVS	Vrwm=130V, Vbr=144..159V, lpp=14.4A, 3000W(1ms), Bidirectional	DO-214AB	1a	1j	Msc
L13A	SMGJ13A	TVS	Vrwm=13V, Vbr=14.4..15.9V, lpp=139.4A, 3000W(1ms)	DO-215AB	5d	1a	Msc
L13A	SMLJ13A	TVS	Vrwm=13V, Vbr=14.4..15.9V, lpp=139.4A, 3000W(1ms)	DO-214AB	1a	1a	Msc
L13C	SMGJ13C	TVS	Vrwm=13V, Vbr=14.4..17.6V, lpp=126.0A, 3000W(1ms), Bidirectional	DO-215AB	5ba	1j	Msc
L13C	SMLJ13C	TVS	Vrwm=13V, Vbr=14.4..17.6V, lpp=126.0A, 3000W(1ms), Bidirectional	DO-214AB	1a	1j	Msc
L13CAA	SMGJ13CA	TVS	Vrwm=13V, Vbr=14.4..15.9V, lpp=139.4A, 3000W(1ms), Bidirectional	DO-215AB	5ba	1j	Msc
L13CAA	SMLJ13CA	TVS	Vrwm=13V, Vbr=14.4..15.9V, lpp=139.4A, 3000W(1ms), Bidirectional	DO-214AB	1a	1j	Msc
L14	SMGJ14	TVS	Vrwm=14V, Vbr=15.6..19.1V, lpp=116.2A, 3000W(1ms)	DO-215AB	5d	1a	Msc
L14	SMLJ14	TVS	Vrwm=14V, Vbr=15.6..19.1V, lpp=116.2A, 3000W(1ms)	DO-214AB	1a	1a	Msc
L14A	SMGJ14A	TVS	Vrwm=14V, Vbr=15.6..17.2V, lpp=129.4A, 3000W(1ms)	DO-215AB	5d	1a	Msc
L14A	SMLJ14A	TVS	Vrwm=14V, Vbr=15.6..17.2V, lpp=129.4A, 3000W(1ms)	DO-214AB	1a	1a	Msc
L14C	SMGJ14C	TVS	Vrwm=14V, Vbr=15.6..19.1V, lpp=116.2A, 3000W(1ms), Bidirectional	DO-215AB	5ba	1j	Msc
L14C	SMLJ14C	TVS	Vrwm=14V, Vbr=15.6..19.1V, lpp=116.2A, 3000W(1ms), Bidirectional	DO-214AB	1a	1j	Msc
L14CA	SMGJ14CA	TVS	Vrwm=14V, Vbr=15.6..17.2V, lpp=129.4A, 3000W(1ms), Bidirectional	DO-215AB	5ba	1j	Msc
L14CA	SMLJ14CA	TVS	Vrwm=14V, Vbr=15.6..17.2V, lpp=129.4A, 3000W(1ms), Bidirectional	DO-214AB	1a	1j	Msc
L15	SMGJ15	TVS	Vrwm=15V, Vbr=16.7..20.4V, lpp=111.6A, 3000W(1ms)	DO-215AB	5d	1a	Msc
L15	SMLJ15	TVS	Vrwm=15V, Vbr=16.7..20.4V, lpp=111.6A, 3000W(1ms)	DO-214AB	1a	1a	Msc
L150	SMGJ150	TVS	Vrwm=150V, Vbr=167..204V, lpp=11.2A, 3000W(1ms)	DO-215AB	5d	1a	Msc
L150	SMLJ150	TVS	Vrwm=150V, Vbr=167..204V, lpp=11.2A, 3000W(1ms)	DO-214AB	1a	1a	Msc
L150A	SMGJ150A	TVS	Vrwm=150V, Vbr=167..185V, lpp=12.4A, 3000W(1ms)	DO-215AB	5d	1a	Msc



SMD code	Type	Function	Short description	Case	Pinout	St.	Mnf.
L150A	SMLJ150A	TVS	Vrwm=150V, Vbr=167..185V, lpp=12.4A, 3000W(1ms)	DO-214AB	1a	1a	Msc
L150C	SMGJ150C	TVS	Vrwm=150V, Vbr=167..204V, lpp=11.2A, 3000W(1ms), Bidirectional	DO-215AB	5ba	1j	Msc
L150C	SMLJ150C	TVS	Vrwm=150V, Vbr=167..204V, lpp=11.2A, 3000W(1ms), Bidirectional	DO-214AB	1a	1j	Msc
L150CA	SMGJ150CA	TVS	Vrwm=150V, Vbr=167..185V, lpp=12.4A, 3000W(1ms), Bidirectional	DO-215AB	5ba	1j	Msc
L150CA	SMLJ150CA	TVS	Vrwm=150V, Vbr=167..185V, lpp=12.4A, 3000W(1ms), Bidirectional	DO-214AB	1a	1j	Msc
L15A	SMGJ15A	TVS	Vrwm=15V, Vbr=16.7..18.5V, lpp=123.0A, 3000W(1ms)	DO-215AB	5d	1a	Msc
L15A	SMLJ15A	TVS	Vrwm=15V, Vbr=16.7..18.5V, lpp=123.0A, 3000W(1ms)	DO-214AB	1a	1a	Msc
L15C	SMGJ15C	TVS	Vrwm=15V, Vbr=16.7..20.4V, lpp=111.6A, 3000W(1ms), Bidirectional	DO-215AB	5ba	1j	Msc
L15C	SMLJ15C	TVS	Vrwm=15V, Vbr=16.7..20.4V, lpp=111.6A, 3000W(1ms), Bidirectional	DO-214AB	1a	1j	Msc
L15CA	SMGJ15CA	TVS	Vrwm=15V, Vbr=16.7..18.5V, lpp=123.0A, 3000W(1ms), Bidirectional	DO-215AB	5ba	1j	Msc
L15CA	SMLJ15CA	TVS	Vrwm=15V, Vbr=16.7..18.5V, lpp=123.0A, 3000W(1ms), Bidirectional	DO-214AB	1a	1j	Msc
L16	SMGJ16	TVS	Vrwm=16V, Vbr=17.8..21.8V, lpp=104.2A, 3000W(1ms)	DO-215AB	5d	1a	Msc
L16	SMLJ16	TVS	Vrwm=16V, Vbr=17.8..21.8V, lpp=104.2A, 3000W(1ms)	DO-214AB	1a	1a	Msc
L160	SMGJ160	TVS	Vrwm=160V, Vbr=178..218V, lpp=10.4A, 3000W(1ms)	DO-215AB	5d	1a	Msc
L160	SMLJ160	TVS	Vrwm=160V, Vbr=178..218V, lpp=10.4A, 3000W(1ms)	DO-214AB	1a	1a	Msc
L160A	SMGJ160A	TVS	Vrwm=160V, Vbr=178..197V, lpp=11.6A, 3000W(1ms)	DO-215AB	5d	1a	Msc
L160A	SMLJ160A	TVS	Vrwm=160V, Vbr=178..197V, lpp=11.6A, 3000W(1ms)	DO-214AB	1a	1a	Msc
L160C	SMGJ160C	TVS	Vrwm=160V, Vbr=178..218V, lpp=10.4A, 3000W(1ms), Bidirectional	DO-215AB	5ba	1j	Msc
L160C	SMLJ160C	TVS	Vrwm=160V, Vbr=178..218V, lpp=10.4A, 3000W(1ms), Bidirectional	DO-214AB	1a	1j	Msc
L160CA	SMGJ160CA	TVS	Vrwm=160V, Vbr=178..197V, lpp=11.6A, 3000W(1ms), Bidirectional	DO-215AB	5ba	1j	Msc
L160CA	SMLJ160CA	TVS	Vrwm=160V, Vbr=178..197V, lpp=11.6A, 3000W(1ms), Bidirectional	DO-214AB	1a	1j	Msc
L16A	SMGJ16A	TVS	Vrwm=16V, Vbr=17.8..19.7V, lpp=115.4A, 3000W(1ms)	DO-215AB	5d	1a	Msc
L16A	SMLJ16A	TVS	Vrwm=16V, Vbr=17.8..19.7V, lpp=115.4A, 3000W(1ms)	DO-214AB	1a	1a	Msc
L16C	SMGJ16C	TVS	Vrwm=16V, Vbr=17.8..21.8V, lpp=104.2A, 3000W(1ms), Bidirectional	DO-215AB	5ba	1j	Msc
L16C	SMLJ16C	TVS	Vrwm=16V, Vbr=17.8..21.8V, lpp=104.2A, 3000W(1ms), Bidirectional	DO-214AB	1a	1j	Msc
L16CA	SMGJ16CA	TVS	Vrwm=16V, Vbr=17.8..19.7V, lpp=115.4A, 3000W(1ms), Bidirectional	DO-215AB	5ba	1j	Msc
L16CA	SMLJ16CA	TVS	Vrwm=16V, Vbr=17.8..19.7V, lpp=115.4A, 3000W(1ms), Bidirectional	DO-214AB	1a	1j	Msc
L17	SMGJ17	TVS	Vrwm=17V, Vbr=18.9..23.1V, lpp=98.4A, 3000W(1ms)	DO-215AB	5d	1a	Msc
L17	SMLJ17	TVS	Vrwm=17V, Vbr=18.9..23.1V, lpp=98.4A, 3000W(1ms)	DO-214AB	1a	1a	Msc
L170	SMGJ170	TVS	Vrwm=170V, Vbr=189..231V, lpp=9.8A, 3000W(1ms)	DO-215AB	5d	1a	Msc
L170	SMLJ170	TVS	Vrwm=170V, Vbr=189..231V, lpp=9.8A, 3000W(1ms)	DO-214AB	1a	1a	Msc
L170A	SMGJ170A	TVS	Vrwm=170V, Vbr=189..209V, lpp=11.0A, 3000W(1ms)	DO-215AB	5d	1a	Msc
L170A	SMLJ170A	TVS	Vrwm=170V, Vbr=189..209V, lpp=11.0A, 3000W(1ms)	DO-214AB	1a	1a	Msc
L170C	SMGJ170C	TVS	Vrwm=170V, Vbr=189..231V, lpp=9.8A, 3000W(1ms), Bidirectional	DO-215AB	5ba	1j	Msc
L170C	SMLJ170C	TVS	Vrwm=170V, Vbr=189..231V, lpp=9.8A, 3000W(1ms), Bidirectional	DO-214AB	1a	1j	Msc
L170CA	SMGJ170CA	TVS	Vrwm=170V, Vbr=189..209V, lpp=11.0A, 3000W(1ms), Bidirectional	DO-215AB	5ba	1j	Msc
L170CA	SMLJ170CA	TVS	Vrwm=170V, Vbr=189..209V, lpp=11.0A, 3000W(1ms), Bidirectional	DO-214AB	1a	1j	Msc
L17A	SMGJ17A	TVS	Vrwm=17V, Vbr=18.9..20.9V, lpp=106.6A, 3000W(1ms)	DO-215AB	5d	1a	Msc
L17A	SMLJ17A	TVS	Vrwm=17V, Vbr=18.9..20.9V, lpp=106.6A, 3000W(1ms)	DO-214AB	1a	1a	Msc
L17C	SMGJ17C	TVS	Vrwm=17V, Vbr=18.9..23.1V, lpp=98.4A, 3000W(1ms), Bidirectional	DO-215AB	5ba	1j	Msc
L17C	SMLJ17C	TVS	Vrwm=17V, Vbr=18.9..23.1V, lpp=98.4A, 3000W(1ms), Bidirectional	DO-214AB	1a	1j	Msc
L17CA	SMGJ17CA	TVS	Vrwm=17V, Vbr=18.9..20.9V, lpp=106.6A, 3000W(1ms), Bidirectional	DO-215AB	5ba	1j	Msc
L17CA	SMLJ17CA	TVS	Vrwm=17V, Vbr=18.9..20.9V, lpp=106.6A, 3000W(1ms), Bidirectional	DO-214AB	1a	1j	Msc
L18	SMGJ18	TVS	Vrwm=18V, Vbr=20.0..24.4V, lpp=93.2A, 3000W(1ms)	DO-215AB	5d	1a	Msc
L18	SMLJ18	TVS	Vrwm=18V, Vbr=20.0..24.4V, lpp=93.2A, 3000W(1ms)	DO-214AB	1a	1a	Msc
L18A	SMGJ18A	TVS	Vrwm=18V, Vbr=20.0..22.1V, lpp=102.8A, 3000W(1ms)	DO-215AB	5d	1a	Msc
L18A	SMLJ18A	TVS	Vrwm=18V, Vbr=20.0..22.1V, lpp=102.8A, 3000W(1ms)	DO-214AB	1a	1a	Msc
L18C	SMGJ18C	TVS	Vrwm=18V, Vbr=20.0..24.4V, lpp=93.2A, 3000W(1ms), Bidirectional	DO-215AB	5ba	1j	Msc
L18C	SMLJ18C	TVS	Vrwm=18V, Vbr=20.0..24.4V, lpp=93.2A, 3000W(1ms), Bidirectional	DO-214AB	1a	1j	Msc
L18CA	SMGJ18CA	TVS	Vrwm=18V, Vbr=20.0..22.1V, lpp=102.8A, 3000W(1ms), Bidirectional	DO-215AB	5ba	1j	Msc
L18CA	SMLJ18CA	TVS	Vrwm=18V, Vbr=20.0..22.1V, lpp=102.8A, 3000W(1ms), Bidirectional	DO-214AB	1a	1j	Msc
L2	BAP51LX	PIN-diode	RF, 60V, 100mA, 140mW, 0.3pF, 1.5Ω(100mA/100MHz), 13dB(2.45GHz)	SOD-882T	13d	2b	Phi
L2	BAT42W	Si-diode	SBR, 30V, 200mA, Vf<1V(200mA), 4pF, 5ns	SOD-123	5d	1a	Cen
L2	BB202	C-diode	VCO, FM-radio, 6V, 10mA, 11.2..33.5pF(2.3..0.2V)	SOD-523	6d	1a	Phi
L2	BZD27C30P	TVS	Vbr=28V, Vcl=42.2V, 3.6A, 150W(1ms)	SOD123FL	7d	1a	Lge
L2	BZX384-B6V2	Z-diode	6.2V±2.5%, Izt=5mA, Zzt=6Ω, 200mW	SOD-323	5d	1k	Phi
L2	CD1607-B120	Si-diode	SBR, 20V, 1A, Vf=0.5V(1A), 110pF	1607	10d	1a	Bm
L2	CD1607-B120L	Si-diode	SBR, 20V, 1A, Vf=0.38V(1A), 100pF	1607	10d	1a	Bm
L2	EDZ9.1B	Z-diode	8.85..9.23V, Izt=5mA, Zzt=30Ω, 150mW	SOD-523	6d	1a	Rhm
L2	FDZ9.1EV	Z-diode	8.850..9.230V, Izt=5mA, Zzt=30Ω, 150mW	SOD-523	7d	1a	Fis
L2	FDZ9.1VT	Z-diode	8.850..9.230V, Izt=5mA, Zzt=30Ω, 200mW	SOD-323	5d	1a	Fis
L2	SSCD202	Si-diode	SBR, 20V, 2A, Vf<0.5V(2A)	1206	14d	1v	Zow
L2	TDZ9.1B	Z-diode	9.1V±2.5%, 10mA, 500mW	TUMD2	7d	1s	Rhm
L2	UDZS9.1B	Z-diode	8.85..9.23V, Izt=5mA, Zzt=30Ω, 200mW	SOD-323	5d	1a	Wtr
L2	UDZS9.1B	Z-diode	9.1V±2.5%, Izt=5mA, 200mW	SOD-323FL	7d	1s	Rhm
L2	VDZS9.1B	Z-diode	9.1V±5%, 5mA, 100mW	VMD2	5d	1z	Rhm
L20	SMGJ20	TVS	Vrwm=20V, Vbr=22.2..27.1V, lpp=83.8A, 3000W(1ms)	DO-215AB	5d	1a	Msc
L20	SMLJ20	TVS	Vrwm=20V, Vbr=22.2..27.1V, lpp=83.8A, 3000W(1ms)	DO-214AB	1a	1a	Msc
L20A	SMGJ20A	TVS	Vrwm=20V, Vbr=22.2..24.5V, lpp=92.6A, 3000W(1ms)	DO-215AB	5d	1a	Msc
L20A	SMLJ20A	TVS	Vrwm=20V, Vbr=22.2..24.5V, lpp=92.6A, 3000W(1ms)	DO-214AB	1a	1a	Msc



SMD code	Type	Function	Short description	Case	Pinout	St.	Mnf.
L20C	SMGJ20C	TVS	Vrwm=20V, Vbr=22.2.27.1V, lpp=83.8A, 3000W(1ms), Bidirectional	DO-215AB	5ba	1j	Msc
L20C	SMLJ20C	TVS	Vrwm=20V, Vbr=22.2.27.1V, lpp=83.8A, 3000W(1ms), Bidirectional	DO-214AB	1a	1j	Msc
L20CA	SMGJ20CA	TVS	Vrwm=20V, Vbr=22.2.24.5V, lpp=92.6A, 3000W(1ms), Bidirectional	DO-215AB	5ba	1j	Msc
L20CA	SMLJ20CA	TVS	Vrwm=20V, Vbr=22.2.24.5V, lpp=92.6A, 3000W(1ms), Bidirectional	DO-214AB	1a	1j	Msc
L22	SMGJ22	TVS	Vrwm=22V, Vbr=24.4.29.8V, lpp=76.2A, 3000W(1ms)	DO-215AB	5d	1a	Msc
L22	SMLJ22	TVS	Vrwm=22V, Vbr=24.4.29.8V, lpp=76.2A, 3000W(1ms)	DO-214AB	1a	1a	Msc
L22A	SMGJ22A	TVS	Vrwm=22V, Vbr=24.4.26.9V, lpp=84.4A, 3000W(1ms)	DO-215AB	5d	1a	Msc
L22A	SMLJ22A	TVS	Vrwm=22V, Vbr=24.4.26.9V, lpp=84.4A, 3000W(1ms)	DO-214AB	1a	1a	Msc
L22C	SMGJ22C	TVS	Vrwm=22V, Vbr=24.4.29.8V, lpp=76.2A, 3000W(1ms), Bidirectional	DO-215AB	5ba	1j	Msc
L22C	SMLJ22C	TVS	Vrwm=22V, Vbr=24.4.29.8V, lpp=76.2A, 3000W(1ms), Bidirectional	DO-214AB	1a	1j	Msc
L22CA	SMGJ22CA	TVS	Vrwm=22V, Vbr=24.4.26.9V, lpp=84.4A, 3000W(1ms), Bidirectional	DO-215AB	5ba	1j	Msc
L22CA	SMLJ22CA	TVS	Vrwm=22V, Vbr=24.4.26.9V, lpp=84.4A, 3000W(1ms), Bidirectional	DO-214AB	1a	1j	Msc
L24	SMGJ24	TVS	Vrwm=24V, Vbr=26.7.32.6V, lpp=69.8A, 3000W(1ms)	DO-215AB	5d	1a	Msc
L24	SMLJ24	TVS	Vrwm=24V, Vbr=26.7.32.6V, lpp=69.8A, 3000W(1ms)	DO-214AB	1a	1a	Msc
L24A	SMGJ24A	TVS	Vrwm=24V, Vbr=26.7.29.5V, lpp=77.2A, 3000W(1ms)	DO-215AB	5d	1a	Msc
L24A	SMLJ24A	TVS	Vrwm=24V, Vbr=26.7.29.5V, lpp=77.2A, 3000W(1ms)	DO-214AB	1a	1a	Msc
L24C	SMGJ24C	TVS	Vrwm=24V, Vbr=26.7.32.6V, lpp=69.8A, 3000W(1ms), Bidirectional	DO-215AB	5ba	1j	Msc
L24C	SMLJ24C	TVS	Vrwm=24V, Vbr=26.7.32.6V, lpp=69.8A, 3000W(1ms), Bidirectional	DO-214AB	1a	1j	Msc
L24CA	SMGJ24CA	TVS	Vrwm=24V, Vbr=26.7.29.5V, lpp=77.2A, 3000W(1ms), Bidirectional	DO-215AB	5ba	1j	Msc
L24CA	SMLJ24CA	TVS	Vrwm=24V, Vbr=26.7.29.5V, lpp=77.2A, 3000W(1ms), Bidirectional	DO-214AB	1a	1j	Msc
L26	SMGJ26	TVS	Vrwm=26V, Vbr=28.9.35.3V, lpp=64.4A, 3000W(1ms)	DO-215AB	5d	1a	Msc
L26	SMLJ26	TVS	Vrwm=26V, Vbr=28.9.35.3V, lpp=64.4A, 3000W(1ms)	DO-214AB	1a	1a	Msc
L26A	SMGJ26A	TVS	Vrwm=26V, Vbr=28.9.31.9V, lpp=71.2A, 3000W(1ms)	DO-215AB	5d	1a	Msc
L26A	SMLJ26A	TVS	Vrwm=26V, Vbr=28.9.31.9V, lpp=71.2A, 3000W(1ms)	DO-214AB	1a	1a	Msc
L26C	SMGJ26C	TVS	Vrwm=26V, Vbr=28.9.35.3V, lpp=64.4A, 3000W(1ms), Bidirectional	DO-215AB	5ba	1j	Msc
L26C	SMLJ26C	TVS	Vrwm=26V, Vbr=28.9.35.3V, lpp=64.4A, 3000W(1ms), Bidirectional	DO-214AB	1a	1j	Msc
L26CA	SMGJ26CA	TVS	Vrwm=26V, Vbr=28.9.31.9V, lpp=71.2A, 3000W(1ms), Bidirectional	DO-215AB	5ba	1j	Msc
L26CA	SMLJ26CA	TVS	Vrwm=26V, Vbr=28.9.31.9V, lpp=71.2A, 3000W(1ms), Bidirectional	DO-214AB	1a	1j	Msc
L28	SMGJ28	TVS	Vrwm=28V, Vbr=31.1.38.0V, lpp=60.0A, 3000W(1ms)	DO-215AB	5d	1a	Msc
L28	SMLJ28	TVS	Vrwm=28V, Vbr=31.1.38.0V, lpp=60.0A, 3000W(1ms)	DO-214AB	1a	1a	Msc
L28A	SMGJ28A	TVS	Vrwm=28V, Vbr=31.1.34.4V, lpp=66.0A, 3000W(1ms)	DO-215AB	5d	1a	Msc
L28A	SMLJ28A	TVS	Vrwm=28V, Vbr=31.1.34.4V, lpp=66.0A, 3000W(1ms)	DO-214AB	1a	1a	Msc
L28C	SMGJ28C	TVS	Vrwm=28V, Vbr=31.1.38.0V, lpp=60.0A, 3000W(1ms), Bidirectional	DO-215AB	5ba	1j	Msc
L28C	SMLJ28C	TVS	Vrwm=28V, Vbr=31.1.38.0V, lpp=60.0A, 3000W(1ms), Bidirectional	DO-214AB	1a	1j	Msc
L28CA	SMGJ28CA	TVS	Vrwm=28V, Vbr=31.1.34.4V, lpp=66.0A, 3000W(1ms), Bidirectional	DO-215AB	5ba	1j	Msc
L28CA	SMLJ28CA	TVS	Vrwm=28V, Vbr=31.1.34.4V, lpp=66.0A, 3000W(1ms), Bidirectional	DO-214AB	1a	1j	Msc
L2E	MBR120ESF	Si-diode	SBR, 20V, 1A, Vf=0.45V(1A)	SOD-123FL	7d	1g	Ons
L2L	MBR120LSF	Si-diode	SBR, 20V, 1A, Vf=0.41V(1A)	SOD-123FL	7d	1g	Ons
L3	BAT43W	Si-diode	SBR, 30V, 200mA, Vf<1V(200mA), 4pF, 5ns	SOD-123	5d	1a	Vs
L3	BZD27C33P	TVS	Vbr=31V, Vcl=46.2V, 3.2A, 150W(1ms)	SOD123FL	7d	1a	Lge
L3	BZX384-B6V8	Z-diode	6.8V±2.5%, Izt=5mA, Zzt=6Ω, 200mW	SOD-323	5d	1k	Phi
L30	SMGJ30	TVS	Vrwm=30V, Vbr=33.3.40.7V, lpp=56.0A, 3000W(1ms)	DO-215AB	5d	1a	Msc
L30	SMLJ30	TVS	Vrwm=30V, Vbr=33.3.40.7V, lpp=56.0A, 3000W(1ms)	DO-214AB	1a	1a	Msc
L30A	SMGJ30A	TVS	Vrwm=30V, Vbr=33.3.36.8V, lpp=62.0A, 3000W(1ms)	DO-215AB	5d	1a	Msc
L30A	SMLJ30A	TVS	Vrwm=30V, Vbr=33.3.36.8V, lpp=62.0A, 3000W(1ms)	DO-214AB	1a	1a	Msc
L30C	SMGJ30C	TVS	Vrwm=30V, Vbr=33.3.40.7V, lpp=56.0A, 3000W(1ms), Bidirectional	DO-215AB	5ba	1j	Msc
L30C	SMLJ30C	TVS	Vrwm=30V, Vbr=33.3.40.7V, lpp=56.0A, 3000W(1ms), Bidirectional	DO-214AB	1a	1j	Msc
L30CA	SMGJ30CA	TVS	Vrwm=30V, Vbr=33.3.36.8V, lpp=62.0A, 3000W(1ms), Bidirectional	DO-215AB	5ba	1j	Msc
L30CA	SMLJ30CA	TVS	Vrwm=30V, Vbr=33.3.36.8V, lpp=62.0A, 3000W(1ms), Bidirectional	DO-214AB	1a	1j	Msc
L33	SMGJ33	TVS	Vrwm=33V, Vbr=36.7.44.9V, lpp=50.4A, 3000W(1ms)	DO-215AB	5d	1a	Msc
L33	SMLJ33	TVS	Vrwm=33V, Vbr=36.7.44.9V, lpp=50.4A, 3000W(1ms)	DO-214AB	1a	1a	Msc
L33A	SMGJ33A	TVS	Vrwm=33V, Vbr=36.7.40.6V, lpp=56.2A, 3000W(1ms)	DO-215AB	5d	1a	Msc
L33A	SMLJ33A	TVS	Vrwm=33V, Vbr=36.7.40.6V, lpp=56.2A, 3000W(1ms)	DO-214AB	1a	1a	Msc
L33C	SMGJ33C	TVS	Vrwm=33V, Vbr=36.7.44.9V, lpp=50.4A, 3000W(1ms), Bidirectional	DO-215AB	5ba	1j	Msc
L33C	SMLJ33C	TVS	Vrwm=33V, Vbr=36.7.44.9V, lpp=50.4A, 3000W(1ms), Bidirectional	DO-214AB	1a	1j	Msc
L33CA	SMGJ33CA	TVS	Vrwm=33V, Vbr=36.7.40.6V, lpp=56.2A, 3000W(1ms), Bidirectional	DO-215AB	5ba	1j	Msc
L33CA	SMLJ33CA	TVS	Vrwm=33V, Vbr=36.7.40.6V, lpp=56.2A, 3000W(1ms), Bidirectional	DO-214AB	1a	1j	Msc
L36	SMGJ36	TVS	Vrwm=36V, Vbr=40.0.48.9V, lpp=46.6A, 3000W(1ms)	DO-215AB	5d	1a	Msc
L36	SMLJ36	TVS	Vrwm=36V, Vbr=40.0.48.9V, lpp=46.6A, 3000W(1ms)	DO-214AB	1a	1a	Msc
L36A	SMGJ36A	TVS	Vrwm=36V, Vbr=40.0.44.2V, lpp=51.6A, 3000W(1ms)	DO-215AB	5d	1a	Msc
L36A	SMLJ36A	TVS	Vrwm=36V, Vbr=40.0.44.2V, lpp=51.6A, 3000W(1ms)	DO-214AB	1a	1a	Msc
L36C	SMGJ36C	TVS	Vrwm=36V, Vbr=40.0.48.9V, lpp=46.6A, 3000W(1ms), Bidirectional	DO-215AB	5ba	1j	Msc
L36C	SMLJ36C	TVS	Vrwm=36V, Vbr=40.0.48.9V, lpp=46.6A, 3000W(1ms), Bidirectional	DO-214AB	1a	1j	Msc
L36CA	SMGJ36CA	TVS	Vrwm=36V, Vbr=40.0.44.2V, lpp=51.6A, 3000W(1ms), Bidirectional	DO-215AB	5ba	1j	Msc
L36CA	SMLJ36CA	TVS	Vrwm=36V, Vbr=40.0.44.2V, lpp=51.6A, 3000W(1ms), Bidirectional	DO-214AB	1a	1j	Msc
L4	BAT254	Si-diode	SBR, U-Fast, 30V, 200mA, Vf<0.8V(100mA), <5ns	SOD-110	12d	1a	Phi
L4	BZD27C36P	TVS	Vbr=34V, Vcl=50.1V, 3A, 150W(1ms)	SOD123FL	7d	1a	Lge
L4	BZX384-B7V5	Z-diode	7.5V±2.5%, Izt=5mA, Zzt=6Ω, 200mW	SOD-323	5d	1k	Phi
I4	CD1607-B140	Si-diode	SBR, 40V, 1A, Vf=0.5V(1A), 110pF	1607	10d	1a	Bm
L4	CD1607-B140L	Si-diode	SBR, 40V, 1A, Vf=0.4V(1A), 110pF	1607	10d	1a	Bm



SMD code	Type	Function	Short description	Case	Pinout	St.	Mnf.
L4	SSCD204	Si-diode	SBR, 40V, 2A, Vf<0.5V(2A)	1206	14d	1v	Zow
L40	SMGJ40	TVS	Vrwm=40V, Vbr=44.4. 54.3V, lpp=42.0A, 3000W(1ms)	DO-215AB	5d	1a	Msc
L40	SMLJ40	TVS	Vrwm=40V, Vbr=44.4. 54.3V, lpp=42.0A, 3000W(1ms)	DO-214AB	1a	1a	Msc
L40A	SMGJ40A	TVS	Vrwm=40V, Vbr=44.4. 49.1V, lpp=46.4A, 3000W(1ms)	DO-215AB	5d	1a	Msc
L40A	SMLJ40A	TVS	Vrwm=40V, Vbr=44.4. 49.1V, lpp=46.4A, 3000W(1ms)	DO-214AB	1a	1a	Msc
L40C	SMGJ40C	TVS	Vrwm=40V, Vbr=44.4. 54.3V, lpp=42.0A, 3000W(1ms), Bidirectional	DO-215AB	5ba	1j	Msc
L40C	SMLJ40C	TVS	Vrwm=40V, Vbr=44.4. 54.3V, lpp=42.0A, 3000W(1ms), Bidirectional	DO-214AB	1a	1j	Msc
L40CA	SMGJ40CA	TVS	Vrwm=40V, Vbr=44.4. 49.1V, lpp=46.4A, 3000W(1ms), Bidirectional	DO-215AB	5ba	1j	Msc
L40CA	SMLJ40CA	TVS	Vrwm=40V, Vbr=44.4. 49.1V, lpp=46.4A, 3000W(1ms), Bidirectional	DO-214AB	1a	1j	Msc
L43	SMGJ43	TVS	Vrwm=43V, Vbr=47.8. 58.4V, lpp=39.2A, 3000W(1ms)	DO-215AB	5d	1a	Msc
L43	SMLJ43	TVS	Vrwm=43V, Vbr=47.8. 58.4V, lpp=39.2A, 3000W(1ms)	DO-214AB	1a	1a	Msc
L43A	SMGJ43A	TVS	Vrwm=43V, Vbr=47.8. 52.8V, lpp=43.2A, 3000W(1ms)	DO-215AB	5d	1a	Msc
L43A	SMLJ43A	TVS	Vrwm=43V, Vbr=47.8. 52.8V, lpp=43.2A, 3000W(1ms)	DO-214AB	1a	1a	Msc
L43C	SMGJ43C	TVS	Vrwm=43V, Vbr=47.8. 58.4V, lpp=39.2A, 3000W(1ms), Bidirectional	DO-215AB	5ba	1j	Msc
L43C	SMLJ43C	TVS	Vrwm=43V, Vbr=47.8. 58.4V, lpp=39.2A, 3000W(1ms), Bidirectional	DO-214AB	1a	1j	Msc
L43CA	SMGJ43CA	TVS	Vrwm=43V, Vbr=47.8. 52.8V, lpp=43.2A, 3000W(1ms), Bidirectional	DO-215AB	5d	1j	Msc
L43CA	SMLJ43CA	TVS	Vrwm=43V, Vbr=47.8. 52.8V, lpp=43.2A, 3000W(1ms), Bidirectional	DO-214AB	1a	1j	Msc
L45	SMGJ45	TVS	Vrwm=45V, Vbr=50.0. 61.1V, lpp=37.4A, 3000W(1ms)	DO-215AB	5d	1a	Msc
L45	SMLJ45	TVS	Vrwm=45V, Vbr=50.0. 61.1V, lpp=37.4A, 3000W(1ms)	DO-214AB	1a	1a	Msc
L45A	SMGJ45A	TVS	Vrwm=45V, Vbr=50.0. 55.3V, lpp=41.2A, 3000W(1ms)	DO-215AB	5d	1a	Msc
L45A	SMLJ45A	TVS	Vrwm=45V, Vbr=50.0. 55.3V, lpp=41.2A, 3000W(1ms)	DO-214AB	1a	1a	Msc
L45C	SMGJ45C	TVS	Vrwm=45V, Vbr=50.0. 61.1V, lpp=37.4A, 3000W(1ms), Bidirectional	DO-215AB	5ba	1j	Msc
L45C	SMLJ45C	TVS	Vrwm=45V, Vbr=50.0. 61.1V, lpp=37.4A, 3000W(1ms), Bidirectional	DO-214AB	1a	1j	Msc
L45CA	SMGJ45CA	TVS	Vrwm=45V, Vbr=50.0. 55.3V, lpp=41.2A, 3000W(1ms), Bidirectional	DO-215AB	5ba	1j	Msc
L45CA	SMLJ45CA	TVS	Vrwm=45V, Vbr=50.0. 55.3V, lpp=41.2A, 3000W(1ms), Bidirectional	DO-214AB	1a	1j	Msc
L48	SMGJ48	TVS	Vrwm=48V, Vbr=53.3. 65.1V, lpp=35.0A, 3000W(1ms)	DO-215AB	5d	1a	Msc
L48	SMLJ48	TVS	Vrwm=48V, Vbr=53.3. 65.1V, lpp=35.0A, 3000W(1ms)	DO-214AB	1a	1a	Msc
L48A	SMGJ48A	TVS	Vrwm=48V, Vbr=53.3. 58.9V, lpp=38.8A, 3000W(1ms)	DO-215AB	5d	1a	Msc
L48A	SMLJ48A	TVS	Vrwm=48V, Vbr=53.3. 58.9V, lpp=38.8A, 3000W(1ms)	DO-214AB	1a	1a	Msc
L48C	SMGJ48C	TVS	Vrwm=48V, Vbr=53.3. 65.1V, lpp=35.0A, 3000W(1ms), Bidirectional	DO-215AB	5ba	1j	Msc
L48C	SMLJ48C	TVS	Vrwm=48V, Vbr=53.3. 65.1V, lpp=35.0A, 3000W(1ms), Bidirectional	DO-214AB	1a	1j	Msc
L48CA	SMGJ48CA	TVS	Vrwm=48V, Vbr=53.3. 58.9V, lpp=38.8A, 3000W(1ms), Bidirectional	DO-215AB	5ba	1j	Msc
L48CA	SMLJ48CA	TVS	Vrwm=48V, Vbr=53.3. 58.9V, lpp=38.8A, 3000W(1ms), Bidirectional	DO-214AB	1a	1j	Msc
L4F	MBR140SF	Si-diode	SBR, 40V, 1A, Vf=0.51V(1A)	SOD-123FL	7d	1g	Ons
L5	BZD27C39P	TVS	Vbr=37V, Vcl=54.1V, 2.8A, 150W(1ms)	SOD113FL	7d	1a	Lge
L5	BZX384-B8V2	Z-diode	8.2V±2.5%, Izt=5mA, Zzt=6Ω, 200mW	SOD-323	5d	1k	Phi
L5	BZX584B16V	Z-diode	15.68...16.32V, Izt=5mA, Zzt=40Ω, 200mW	SOD-523FL	7d	1a	Tac
L5	MMSZ16V	Z-diode	15.68...16.32V, Izt=5mA, Zzt=40Ω, 200mW	SOD-523FL	7d	1a	Tac
L5.0	SMGJ5.0	TVS	Vrwm=5.0V, Vbr=6.40. 7.30V, lpp=312.5A, 3000W(1ms)	DO-215AB	5d	1a	Msc
L5.0	SMLJ5.0	TVS	Vrwm=5.0V, Vbr=6.40. 7.30V, lpp=312.5A, 3000W(1ms)	DO-214AB	1a	1a	Msc
L5.0A	SMGJ5.0A	TVS	Vrwm=5.0V, Vbr=6.40. 7.0V, lpp=326.0A, 3000W(1ms)	DO-215AB	5d	1a	Msc
L5.0A	SMLJ5.0A	TVS	Vrwm=5.0V, Vbr=6.40. 7.0V, lpp=326.0A, 3000W(1ms)	DO-214AB	1a	1a	Msc
L5.0C	SMGJ5.0C	TVS	Vrwm=5.0V, Vbr=6.40. 7.30V, lpp=312.5A, 3000W(1ms), Bidirectional	DO-215AB	5ba	1j	Msc
L5.0C	SMLJ5.0C	TVS	Vrwm=5.0V, Vbr=6.40. 7.30V, lpp=312.5A, 3000W(1ms), Bidirectional	DO-214AB	1a	1j	Msc
L5.0CA	SMGJ5.0CA	TVS	Vrwm=5.0V, Vbr=6.40. 7.0V, lpp=326.0A, 3000W(1ms), Bidirectional	DO-215AB	5ba	1j	Msc
L5.0CA	SMLJ5.0CA	TVS	Vrwm=5.0V, Vbr=6.40. 7.0V, lpp=326.0A, 3000W(1ms), Bidirectional	DO-214AB	1a	1j	Msc
L51	SMGJ51	TVS	Vrwm=51V, Vbr=56.7. 69.3V, lpp=37.0A, 3000W(1ms)	DO-215AB	5d	1a	Msc
L51	SMLJ51	TVS	Vrwm=51V, Vbr=56.7. 69.3V, lpp=37.0A, 3000W(1ms)	DO-214AB	1a	1a	Msc
L51A	SMGJ51A	TVS	Vrwm=51V, Vbr=56.7. 62.7V, lpp=36.4A, 3000W(1ms)	DO-215AB	5d	1a	Msc
L51A	SMLJ51A	TVS	Vrwm=51V, Vbr=56.7. 62.7V, lpp=36.4A, 3000W(1ms)	DO-214AB	1a	1a	Msc
L51C	SMGJ51C	TVS	Vrwm=51V, Vbr=56.7. 69.3V, lpp=37.0A, 3000W(1ms), Bidirectional	DO-215AB	5ba	1j	Msc
L51C	SMLJ51C	TVS	Vrwm=51V, Vbr=56.7. 69.3V, lpp=37.0A, 3000W(1ms), Bidirectional	DO-214AB	1a	1j	Msc
L51CA	SMGJ51CA	TVS	Vrwm=51V, Vbr=56.7. 62.7V, lpp=36.4A, 3000W(1ms), Bidirectional	DO-215AB	5ba	1j	Msc
L51CA	SMLJ51CA	TVS	Vrwm=51V, Vbr=56.7. 62.7V, lpp=36.4A, 3000W(1ms), Bidirectional	DO-214AB	1a	1j	Msc
L54	SMGJ54	TVS	Vrwm=54V, Vbr=60.0. 73.3V, lpp=31.2A, 3000W(1ms)	DO-215AB	5d	1a	Msc
L54	SMLJ54	TVS	Vrwm=54V, Vbr=60.0. 73.3V, lpp=31.2A, 3000W(1ms)	DO-214AB	1a	1a	Msc
L54A	SMGJ54A	TVS	Vrwm=54V, Vbr=60.0. 66.3V, lpp=34.4A, 3000W(1ms)	DO-215AB	5d	1a	Msc
L54A	SMLJ54A	TVS	Vrwm=54V, Vbr=60.0. 66.3V, lpp=34.4A, 3000W(1ms)	DO-214AB	1a	1a	Msc
L54C	SMGJ54C	TVS	Vrwm=54V, Vbr=60.0. 73.3V, lpp=31.2A, 3000W(1ms), Bidirectional	DO-215AB	5ba	1j	Msc
L54C	SMLJ54C	TVS	Vrwm=54V, Vbr=60.0. 73.3V, lpp=31.2A, 3000W(1ms), Bidirectional	DO-214AB	1a	1j	Msc
L54CA	SMGJ54CA	TVS	Vrwm=54V, Vbr=60.0. 66.3V, lpp=34.4A, 3000W(1ms), Bidirectional	DO-215AB	5ba	1j	Msc
L54CA	SMLJ54CA	TVS	Vrwm=54V, Vbr=60.0. 66.3V, lpp=34.4A, 3000W(1ms), Bidirectional	DO-214AB	1a	1j	Msc
L55	SMGJ58	TVS	Vrwm=58V, Vbr=64.4. 78.7V, lpp=39.2A, 3000W(1ms)	DO-215AB	5d	1a	Msc
L55	SMLJ58	TVS	Vrwm=58V, Vbr=64.4. 78.7V, lpp=39.2A, 3000W(1ms)	DO-214AB	1a	1a	Msc
L55A	SMGJ58A	TVS	Vrwm=58V, Vbr=64.4. 71.2V, lpp=32.0A, 3000W(1ms)	DO-215AB	5d	1a	Msc
L55A	SMLJ58A	TVS	Vrwm=58V, Vbr=64.4. 71.2V, lpp=32.0A, 3000W(1ms)	DO-214AB	1a	1a	Msc
L58C	SMGJ58C	TVS	Vrwm=58V, Vbr=64.4. 78.7V, lpp=39.2A, 3000W(1ms), Bidirectional	DO-215AB	5ba	1j	Msc
L58C	SMLJ58C	TVS	Vrwm=58V, Vbr=64.4. 78.7V, lpp=39.2A, 3000W(1ms), Bidirectional	DO-214AB	1a	1j	Msc
L58CA	SMGJ58CA	TVS	Vrwm=58V, Vbr=64.4. 71.2V, lpp=32.0A, 3000W(1ms), Bidirectional	DO-215AB	5ba	1j	Msc
L58CA	SMLJ58CA	TVS	Vrwm=58V, Vbr=64.4. 71.2V, lpp=32.0A, 3000W(1ms), Bidirectional	DO-214AB	1a	1j	Msc



SMD
code

Type

Function

Short description

Case

Pinout

St.

Mnf.

L6	BAT46W	Si-diode	SBD, 100V, 150mA, Vf<1V(250mA), 6pF	SOD-123	5d	1d	Tsc
L6	BZD27C43P	TVS	Vbr=40V, Vcl=60.7V, 2.5A, 150W(1ms)	SOD123FL	7d	1a	Lge
L6	BZX384-B9V1	Z-diode	9.1V±2.5%, Izt=5mA, Zzt=6Ω, 200mW	SOD-323	5d	1k	Phi
L6	SSCD206	Si-diode	SBR, 60V, 2A, Vf<0.7V(2A)	1206	14d	1v	Zow
L6.0	SMGJ6.0	TVS	Vrwm=6.0V, Vbr=6.67.8.15V, Ipp=263.2A, 3000W(1ms)	DO-215AB	5d	1a	Msc
L6.0	SMLJ6.0	TVS	Vrwm=6.0V, Vbr=6.67.8.15V, Ipp=263.2A, 3000W(1ms)	DO-214AB	1a	1a	Msc
L6.0A	SMGJ6.0A	TVS	Vrwm=6.0V, Vbr=6.67.7.37V, Ipp=291.3A, 3000W(1ms)	DO-215AB	5d	1a	Msc
L6.0A	SMLJ6.0A	TVS	Vrwm=6.0V, Vbr=6.67.7.37V, Ipp=291.3A, 3000W(1ms)	DO-214AB	1a	1a	Msc
L6.0C	SMGJ6.0C	TVS	Vrwm=6.0V, Vbr=6.67.8.15V, Ipp=263.2A, 3000W(1ms), Bidirectional	DO-215AB	5d	1j	Msc
L6.0C	SMLJ6.0C	TVS	Vrwm=6.0V, Vbr=6.67.8.15V, Ipp=263.2A, 3000W(1ms), Bidirectional	DO-214AB	1a	1j	Msc
L6.0CA	SMGJ6.0CA	TVS	Vrwm=6.0V, Vbr=6.67.7.37V, Ipp=291.3A, 3000W(1ms), Bidirectional	DO-215AB	5d	1j	Msc
L6.0CA	SMLJ6.0CA	TVS	Vrwm=6.0V, Vbr=6.67.7.37V, Ipp=291.3A, 3000W(1ms), Bidirectional	DO-214AB	1a	1j	Msc
L6.5	SMGJ6.5	TVS	Vrwm=6.5V, Vbr=7.22.8.82V, Ipp=243.9A, 3000W(1ms)	DO-215AB	5d	1a	Msc
L6.5	SMLJ6.5	TVS	Vrwm=6.5V, Vbr=7.22.8.82V, Ipp=243.9A, 3000W(1ms)	DO-214AB	1a	1a	Msc
L6.5A	SMGJ6.5A	TVS	Vrwm=6.5V, Vbr=7.22.7.98V, Ipp=267.9A, 3000W(1ms)	DO-215AB	5d	1a	Msc
L6.5A	SMLJ6.5A	TVS	Vrwm=6.5V, Vbr=7.22.7.98V, Ipp=267.9A, 3000W(1ms)	DO-214AB	1a	1a	Msc
L6.5C	SMGJ6.5C	TVS	Vrwm=6.5V, Vbr=7.22.8.82V, Ipp=243.9A, 3000W(1ms), Bidirectional	DO-215AB	5ba	1j	Msc
L6.5C	SMLJ6.5C	TVS	Vrwm=6.5V, Vbr=7.22.8.82V, Ipp=243.9A, 3000W(1ms), Bidirectional	DO-214AB	1a	1j	Msc
L6.5CA	SMGJ6.5CA	TVS	Vrwm=6.5V, Vbr=7.22.7.98V, Ipp=267.9A, 3000W(1ms), Bidirectional	DO-215AB	5ba	1j	Msc
L6.5CA	SMLJ6.5CA	TVS	Vrwm=6.5V, Vbr=7.22.7.98V, Ipp=267.9A, 3000W(1ms), Bidirectional	DO-214AB	1a	1j	Msc
L60	SMGJ60	TVS	Vrwm=60V, Vbr=66.7.81.5V, Ipp=28.0A, 3000W(1ms)	DO-215AB	5d	1a	Msc
L60	SMLJ60	TVS	Vrwm=60V, Vbr=66.7.81.5V, Ipp=28.0A, 3000W(1ms)	DO-214AB	1a	1a	Msc
L60A	SMGJ60A	TVS	Vrwm=60V, Vbr=66.7.73.7V, Ipp=31.0A, 3000W(1ms)	DO-215AB	5d	1a	Msc
L60A	SMLJ60A	TVS	Vrwm=60V, Vbr=66.7.73.7V, Ipp=31.0A, 3000W(1ms)	DO-214AB	1a	1a	Msc
L60C	SMGJ60C	TVS	Vrwm=60V, Vbr=66.7.81.5V, Ipp=28.0A, 3000W(1ms), Bidirectional	DO-215AB	5ba	1j	Msc
L60C	SMLJ60C	TVS	Vrwm=60V, Vbr=66.7.81.5V, Ipp=28.0A, 3000W(1ms), Bidirectional	DO-214AB	1a	1j	Msc
L60CA	SMGJ60CA	TVS	Vrwm=60V, Vbr=66.7.73.7V, Ipp=31.0A, 3000W(1ms), Bidirectional	DO-215AB	5ba	1j	Msc
L60CA	SMLJ60CA	TVS	Vrwm=60V, Vbr=66.7.73.7V, Ipp=31.0A, 3000W(1ms), Bidirectional	DO-214AB	1a	1j	Msc
L64	SMGJ64	TVS	Vrwm=64V, Vbr=71.1.86.9V, Ipp=26.4A, 3000W(1ms)	DO-215AB	5d	1a	Msc
L64	SMLJ64	TVS	Vrwm=64V, Vbr=71.1.86.9V, Ipp=26.4A, 3000W(1ms)	DO-214AB	1a	1a	Msc
L64A	SMGJ64A	TVS	Vrwm=64V, Vbr=71.1.78.6V, Ipp=29.2A, 3000W(1ms)	DO-215AB	5d	1a	Msc
L64A	SMLJ64A	TVS	Vrwm=64V, Vbr=71.1.78.6V, Ipp=29.2A, 3000W(1ms)	DO-214AB	1a	1a	Msc
L64C	SMGJ64C	TVS	Vrwm=64V, Vbr=71.1.86.9V, Ipp=26.4A, 3000W(1ms), Bidirectional	DO-215AB	5ba	1j	Msc
L64C	SMLJ64C	TVS	Vrwm=64V, Vbr=71.1.86.9V, Ipp=26.4A, 3000W(1ms), Bidirectional	DO-214AB	1a	1j	Msc
L64CA	SMGJ64CA	TVS	Vrwm=64V, Vbr=71.1.78.6V, Ipp=29.2A, 3000W(1ms), Bidirectional	DO-215AB	5ba	1j	Msc
L64CA	SMLJ64CA	TVS	Vrwm=64V, Vbr=71.1.78.6V, Ipp=29.2A, 3000W(1ms), Bidirectional	DO-214AB	1a	1j	Msc
L7	BAT17W	Si-diode	Schottky, UHF-Mix, 4V, 130mA, Vf<0.6V(10mA), C<0.75pF	SOD-123	5d	1a	Gen
L7	BZD27C47P	TVS	Vbr=44V, Vcl=65.5V, 2.3A, 150W(1ms)	SOD123FL	7d	1a	Lge
L7	BZX384-B10	Z-diode	10V±2.5%, Izt=5mA, Zzt=8Ω, 200mW	SOD-323	5d	1k	Phi
L7.0	SMGJ7.0	TVS	Vrwm=7.0V, Vbr=7.78.9.51V, Ipp=225.6A, 3000W(1ms)	DO-215AB	5d	1a	Msc
L7.0	SMLJ7.0	TVS	Vrwm=7.0V, Vbr=7.78.9.51V, Ipp=225.6A, 3000W(1ms)	DO-214AB	1a	1a	Msc
L7.0A	SMGJ7.0A	TVS	Vrwm=7.0V, Vbr=7.78.8.60V, Ipp=250.0A, 3000W(1ms)	DO-215AB	5d	1a	Msc
L7.0A	SMLJ7.0A	TVS	Vrwm=7.0V, Vbr=7.78.8.60V, Ipp=250.0A, 3000W(1ms)	DO-214AB	1a	1a	Msc
L7.0C	SMGJ7.0C	TVS	Vrwm=7.0V, Vbr=7.78.9.51V, Ipp=225.6A, 3000W(1ms), Bidirectional	DO-215AB	5ba	1j	Msc
L7.0C	SMLJ7.0C	TVS	Vrwm=7.0V, Vbr=7.78.9.51V, Ipp=225.6A, 3000W(1ms), Bidirectional	DO-214AB	1a	1j	Msc
L7.0CA	SMGJ7.0CA	TVS	Vrwm=7.0V, Vbr=7.78.8.60V, Ipp=250.0A, 3000W(1ms), Bidirectional	DO-215AB	5ba	1j	Msc
L7.0CA	SMLJ7.0CA	TVS	Vrwm=7.0V, Vbr=7.78.8.60V, Ipp=250.0A, 3000W(1ms), Bidirectional	DO-214AB	1a	1j	Msc
L7.5	SMGJ7.5	TVS	Vrwm=7.5V, Vbr=8.33.10.2V, Ipp=209.8A, 3000W(1ms)	DO-215AB	5d	1a	Msc
L7.5	SMLJ7.5	TVS	Vrwm=7.5V, Vbr=8.33.10.2V, Ipp=209.8A, 3000W(1ms)	DO-214AB	1a	1a	Msc
L7.5A	SMGJ7.5A	TVS	Vrwm=7.5V, Vbr=8.33.9.21V, Ipp=232.6A, 3000W(1ms)	DO-215AB	5d	1a	Msc
L7.5A	SMLJ7.5A	TVS	Vrwm=7.5V, Vbr=8.33.9.21V, Ipp=232.6A, 3000W(1ms)	DO-214AB	1a	1a	Msc
L7.5C	SMGJ7.5C	TVS	Vrwm=7.5V, Vbr=8.33.10.2V, Ipp=209.8A, 3000W(1ms), Bidirectional	DO-215AB	5ba	1j	Msc
L7.5C	SMLJ7.5C	TVS	Vrwm=7.5V, Vbr=8.33.10.2V, Ipp=209.8A, 3000W(1ms), Bidirectional	DO-214AB	1a	1j	Msc
L7.5CA	SMGJ7.5CA	TVS	Vrwm=7.5V, Vbr=8.33.9.21V, Ipp=232.6A, 3000W(1ms), Bidirectional	DO-215AB	5ba	1j	Msc
L7.5CA	SMLJ7.5CA	TVS	Vrwm=7.5V, Vbr=8.33.9.21V, Ipp=232.6A, 3000W(1ms), Bidirectional	DO-214AB	1a	1j	Msc
L70	SMGJ70	TVS	Vrwm=70V, Vbr=77.8.95.1V, Ipp=24.0A, 3000W(1ms)	DO-215AB	5d	1a	Msc
L70	SMLJ70	TVS	Vrwm=70V, Vbr=77.8.95.1V, Ipp=24.0A, 3000W(1ms)	DO-214AB	1a	1a	Msc
L70A	SMGJ70A	TVS	Vrwm=70V, Vbr=77.8.86.0V, Ipp=26.6A, 3000W(1ms)	DO-215AB	5d	1a	Msc
L70A	SMLJ70A	TVS	Vrwm=70V, Vbr=77.8.86.0V, Ipp=26.6A, 3000W(1ms)	DO-214AB	1a	1a	Msc
L70C	SMGJ70C	TVS	Vrwm=70V, Vbr=77.8.95.1V, Ipp=24.0A, 3000W(1ms), Bidirectional	DO-215AB	5ba	1j	Msc
L70C	SMLJ70C	TVS	Vrwm=70V, Vbr=77.8.95.1V, Ipp=24.0A, 3000W(1ms), Bidirectional	DO-214AB	1a	1j	Msc
L70CA	SMGJ70CA	TVS	Vrwm=70V, Vbr=77.8.86.0V, Ipp=26.6A, 3000W(1ms), Bidirectional	DO-215AB	5ba	1j	Msc
L70CA	SMLJ70CA	TVS	Vrwm=70V, Vbr=77.8.86.0V, Ipp=26.6A, 3000W(1ms), Bidirectional	DO-214AB	1a	1j	Msc
L75	SMGJ75	TVS	Vrwm=75V, Vbr=83.3.102V, Ipp=22.4A, 3000W(1ms)	DO-215AB	5d	1a	Msc
L75	SMLJ75	TVS	Vrwm=75V, Vbr=83.3.102V, Ipp=22.4A, 3000W(1ms)	DO-214AB	1a	1a	Msc
L75A	SMGJ75A	TVS	Vrwm=75V, Vbr=83.3.92.1V, Ipp=24.8A, 3000W(1ms)	DO-215AB	5d	1a	Msc
L75A	SMLJ75A	TVS	Vrwm=75V, Vbr=83.3.92.1V, Ipp=24.8A, 3000W(1ms)	DO-214AB	1a	1a	Msc
L75C	SMGJ75C	TVS	Vrwm=75V, Vbr=83.3.102V, Ipp=22.4A, 3000W(1ms), Bidirectional	DO-215AB	5ba	1j	Msc
L75C	SMLJ75C	TVS	Vrwm=75V, Vbr=83.3.102V, Ipp=22.4A, 3000W(1ms), Bidirectional	DO-214AB	1a	1j	Msc
L75CA	SMGJ75CA	TVS	Vrwm=75V, Vbr=83.3.92.1V, Ipp=24.8A, 3000W(1ms), Bidirectional	DO-215AB	5ba	1j	Msc



SMD code	Type	Function	Short description	Case	Pinout	St.	Mnf.
L75CA	SMLJ75CA	TVS	Vrwm=75V, Vbr=83.3..92.1V, lpp=24.8A, 3000W(1ms), Bidirectional	DO-214AB	1a	1j	Msc
L78	SMGJ78	TVS	Vrwm=78V, Vbr=86.7..106V, lpp=21.6A, 3000W(1ms)	DO-215AB	5d	1a	Msc
L78	SMLJ78	TVS	Vrwm=78V, Vbr=86.7..106V, lpp=21.6A, 3000W(1ms)	DO-214AB	1a	1a	Msc
L78A	SMGJ78A	TVS	Vrwm=78V, Vbr=86.7..95.8V, lpp=22.8A, 3000W(1ms)	DO-215AB	5d	1a	Msc
L78A	SMLJ78A	TVS	Vrwm=78V, Vbr=86.7..95.8V, lpp=22.8A, 3000W(1ms)	DO-214AB	1a	1a	Msc
L78C	SMGJ78C	TVS	Vrwm=78V, Vbr=86.7..106V, lpp=21.6A, 3000W(1ms), Bidirectional	DO-215AB	5ba	1j	Msc
L78C	SMLJ78C	TVS	Vrwm=78V, Vbr=86.7..106V, lpp=21.6A, 3000W(1ms), Bidirectional	DO-214AB	1a	1j	Msc
L78CA	SMGJ78CA	TVS	Vrwm=78V, Vbr=86.7..95.8V, lpp=22.8A, 3000W(1ms), Bidirectional	DO-215AB	5ba	1j	Msc
L78CA	SMLJ78CA	TVS	Vrwm=78V, Vbr=86.7..95.8V, lpp=22.8A, 3000W(1ms), Bidirectional	DO-214AB	1a	1j	Msc
L8	BA792	PIN-diode	VHF, TV-Band-Sw, 35V, 100mA, 1.1pF	SOD-110	12d	1a	Phi
L8	BZD27C51P	TVS	Vbr=48V, Vcl=70.8V, 2.1A, 150W(1ms)	SOD123FL	7d	1a	Lge
L8	BZX384-B11	Z-diode	11V±2.5%, lzt=5mA, Zzt=10Ω, 200mW	SOD-323	5d	1k	Phi
L8	CMOZ1L8	Z-diode	1.71..1.89V, lzt=0.25mA, Zzt=1400Ω, 250mW	SOD-523	6d	1a	Cen
L8	MM5Z7V5	Z-diode	7.5V±5%, lzt=5mA, Zzt=15Ω, 200mW	SOD-523	6d	1a	Eic
L8	MM5Z7V5H	Z-diode	7.7..9V, lzt=5mA, Zzt=15Ω, 200mW	SOD-523	7d	1a	Zow
L8.0	SMGJ8.0	TVS	Vrwm=8.0V, Vbr=8.89..10.9V, lpp=200.0A, 3000W(1ms)	DO-215AB	5d	1a	Msc
L8.0	SMLJ8.0	TVS	Vrwm=8.0V, Vbr=8.89..10.9V, lpp=200.0A, 3000W(1ms)	DO-214AB	1a	1a	Msc
L8.0A	SMGJ8.0A	TVS	Vrwm=8.0V, Vbr=8.89..9.83V, lpp=220.6A, 3000W(1ms)	DO-215AB	5d	1a	Msc
L8.0A	SMLJ8.0A	TVS	Vrwm=8.0V, Vbr=8.89..9.83V, lpp=220.6A, 3000W(1ms)	DO-214AB	1a	1a	Msc
L8.0C	SMGJ8.0C	TVS	Vrwm=8.0V, Vbr=8.89..10.9V, lpp=200.0A, 3000W(1ms), Bidirectional	DO-215AB	5ba	1j	Msc
L8.0C	SMLJ8.0C	TVS	Vrwm=8.0V, Vbr=8.89..10.9V, lpp=200.0A, 3000W(1ms), Bidirectional	DO-214AB	1a	1j	Msc
L8.0CA	SMGJ8.0CA	TVS	Vrwm=8.0V, Vbr=8.89..9.83V, lpp=220.6A, 3000W(1ms), Bidirectional	DO-215AB	5d	1j	Msc
L8.0CA	SMLJ8.0CA	TVS	Vrwm=8.0V, Vbr=8.89..9.83V, lpp=220.6A, 3000W(1ms), Bidirectional	DO-214AB	1a	1j	Msc
L8.5	SMGJ8.5	TVS	Vrwm=8.5V, Vbr=9.44..11.5V, lpp=188.6A, 3000W(1ms)	DO-215AB	5d	1a	Msc
L8.5	SMLJ8.5	TVS	Vrwm=8.5V, Vbr=9.44..11.5V, lpp=188.6A, 3000W(1ms)	DO-214AB	1a	1a	Msc
L8.5A	SMGJ8.5A	TVS	Vrwm=8.5V, Vbr=9.44..10.4V, lpp=208.4A, 3000W(1ms)	DO-215AB	5d	1a	Msc
L8.5A	SMLJ8.5A	TVS	Vrwm=8.5V, Vbr=9.44..10.4V, lpp=208.4A, 3000W(1ms)	DO-214AB	1a	1a	Msc
L8.5C	SMGJ8.5C	TVS	Vrwm=8.5V, Vbr=9.44..11.5V, lpp=188.6A, 3000W(1ms), Bidirectional	DO-215AB	5ba	1j	Msc
L8.5C	SMLJ8.5C	TVS	Vrwm=8.5V, Vbr=9.44..11.5V, lpp=188.6A, 3000W(1ms), Bidirectional	DO-214AB	1a	1j	Msc
L8.5CA	SMGJ8.5CA	TVS	Vrwm=8.5V, Vbr=9.44..10.4V, lpp=208.4A, 3000W(1ms), Bidirectional	DO-215AB	5ba	1j	Msc
L8.5CA	SMLJ8.5CA	TVS	Vrwm=8.5V, Vbr=9.44..10.4V, lpp=208.4A, 3000W(1ms), Bidirectional	DO-214AB	1a	1j	Msc
L85	SMGJ85	TVS	Vrwm=85V, Vbr=94.4..115V, lpp=19.8A, 3000W(1ms)	DO-215AB	5d	1a	Msc
L85	SMLJ85	TVS	Vrwm=85V, Vbr=94.4..115V, lpp=19.8A, 3000W(1ms)	DO-214AB	1a	1a	Msc
L85A	SMGJ85A	TVS	Vrwm=85V, Vbr=94.4..104V, lpp=20.8A, 3000W(1ms)	DO-215AB	5d	1a	Msc
L85A	SMLJ85A	TVS	Vrwm=85V, Vbr=94.4..104V, lpp=20.8A, 3000W(1ms)	DO-214AB	1a	1a	Msc
L85C	SMGJ85C	TVS	Vrwm=85V, Vbr=94.4..115V, lpp=19.8A, 3000W(1ms), Bidirectional	DO-215AB	5ba	1j	Msc
L85C	SMLJ85C	TVS	Vrwm=85V, Vbr=94.4..115V, lpp=19.8A, 3000W(1ms), Bidirectional	DO-214AB	1a	1j	Msc
L85CA	SMGJ85CA	TVS	Vrwm=85V, Vbr=94.4..104V, lpp=20.8A, 3000W(1ms), Bidirectional	DO-215AB	5ba	1j	Msc
L85CA	SMLJ85CA	TVS	Vrwm=85V, Vbr=94.4..104V, lpp=20.8A, 3000W(1ms), Bidirectional	DO-214AB	1a	1j	Msc
L9	BAT54WS	Si-diode	SBR, 30V, 200mA, Vf<0.52V(100mA), <5ns	SOD-323	1d	2a	Di
L9	BAT54WT	Si-diode	SBR, 30V, 200mA, Vf<0.52V(100mA), <5ns	SOD-523	8d	2a	Di
L9	BZD27C56P	TVS	Vbr=52V, Vcl=78.6V, 1.9A, 150W(1ms)	SOD123FL	7d	1a	Lge
L9	BZX384-B12	Z-diode	12V±2.5%, lzt=5mA, Zzt=10Ω, 200mW	SOD-323	5d	1k	Phi
L9	CMOZ2L0	Z-diode	1.90..2.10V, lzt=0.25mA, Zzt=1400Ω, 250mW	SOD-523	6d	1a	Cen
L9.0	SMGJ9.0	TVS	Vrwm=9.0V, Vbr=10.0..12.2V, lpp=177.4A, 3000W(1ms)	DO-215AB	5d	1a	Msc
L9.0	SMLJ9.0	TVS	Vrwm=9.0V, Vbr=10.0..12.2V, lpp=177.4A, 3000W(1ms)	DO-214AB	1a	1a	Msc
L9.0A	SMGJ9.0A	TVS	Vrwm=9.0V, Vbr=10.0..11.1V, lpp=194.8A, 3000W(1ms)	DO-215AB	5d	1a	Msc
L9.0A	SMLJ9.0A	TVS	Vrwm=9.0V, Vbr=10.0..11.1V, lpp=194.8A, 3000W(1ms)	DO-214AB	1a	1a	Msc
L9.0C	SMGJ9.0C	TVS	Vrwm=9.0V, Vbr=10.0..12.2V, lpp=177.4A, 3000W(1ms), Bidirectional	DO-215AB	5ba	1j	Msc
L9.0C	SMLJ9.0C	TVS	Vrwm=9.0V, Vbr=10.0..12.2V, lpp=177.4A, 3000W(1ms), Bidirectional	DO-214AB	1a	1j	Msc
L9.0CA	SMGJ9.0CA	TVS	Vrwm=9.0V, Vbr=10.0..11.1V, lpp=194.8A, 3000W(1ms), Bidirectional	DO-215AB	5ba	1j	Msc
L9.0CA	SMLJ9.0CA	TVS	Vrwm=9.0V, Vbr=10.0..11.1V, lpp=194.8A, 3000W(1ms), Bidirectional	DO-214AB	1a	1j	Msc
L90C	SMGJ90C	TVS	Vrwm=90V, Vbr=100..122V, lpp=18.8A, 3000W(1ms), Bidirectional	DO-215AB	5ba	1j	Msc
L90C	SMLJ90C	TVS	Vrwm=90V, Vbr=100..122V, lpp=18.8A, 3000W(1ms), Bidirectional	DO-214AB	1a	1j	Msc
L90CA	SMGJ90CA	TVS	Vrwm=90V, Vbr=100..111V, lpp=20.6A, 3000W(1ms), Bidirectional	DO-215AB	5ba	1j	Msc
L90CA	SMLJ90CA	TVS	Vrwm=90V, Vbr=100..111V, lpp=20.6A, 3000W(1ms), Bidirectional	DO-214AB	1a	1j	Msc
L92	SMGJ90	TVS	Vrwm=90V, Vbr=100..122V, lpp=18.8A, 3000W(1ms)	DO-215AB	5d	1a	Msc
L92	SMLJ90	TVS	Vrwm=90V, Vbr=100..122V, lpp=18.8A, 3000W(1ms)	DO-214AB	1a	1a	Msc
L92A	SMGJ90A	TVS	Vrwm=90V, Vbr=100..111V, lpp=20.6A, 3000W(1ms)	DO-215AB	5d	1a	Msc
L92A	SMLJ90A	TVS	Vrwm=90V, Vbr=100..111V, lpp=20.6A, 3000W(1ms)	DO-214AB	1a	1a	Msc
LB	KDZ5.1B	Z-diode	5.1V±2.5%, 40mA, 1W	PHD10	7d	1s	Rhm
LB	SMF19CA	TVS	Vrwm=19.0V, Vbr=21.10..23.30V, 6.54A, 200W(10/1000µs), Bidirectional	SOD-123FL	7ba	1j	Ers
LB	TV02W190B-G	TVS	Vrwm=19V, Vbr=21.1..23.3V, lpp=6.54A, 200W(1ms), Bidirectional	SOD-123	5ba	1j	Cmc
LC10	SMGJLCE10	TVS	Vrwm=10V, Vbr=11.1..13.6V, 80A, 1500W(1ms)	DO-214AB	1d	1a	Eic
LC100	SMGJLCE100	TVS	Vrwm=100V, Vbr=111..136V, 8.4A, 1500W(1ms)	DO-214AB	1d	1a	Eic
LC100A	SMGJLCE100A	TVS	Vrwm=100V, Vbr=111..123V, 9.3A, 1500W(1ms)	DO-214AB	1d	1a	Eic
LC100C	SMGJLCE100C	TVS	Vrwm=100V, Vbr=111..136V, 8.4A, 1500W(1ms), Bidirectional	DO-214AB	1ba	1j	Eic
LC100CA	SMGJLCE100CA	TVS	Vrwm=100V, Vbr=111..123V, 9.3A, 1500W(1ms), Bidirectional	DO-214AB	1ba	1j	Eic
LC10A	SMGJLCE10A	TVS	Vrwm=10V, Vbr=11.1..12.3V, 88A, 1500W(1ms)	DO-214AB	1d	1a	Eic
LC10C	SMGJLCE10C	TVS	Vrwm=10V, Vbr=11.1..13.6V, 80A, 1500W(1ms), Bidirectional	DO-214AB	1ba	1j	Eic



SMD code	Type	Function	Short description	Case	Pinout	St.	Mnf.
LC10CA	SMCJLCE10CA	TVS	Vrwm=10V, Vbr=11.1..12.3V, 88A, 1500W(1ms), Bidirectional	DO-214AB	1ba	1j	Eic
LC11	SMCJLCE11	TVS	Vrwm=11V, Vbr=12.2..14.9V, 74A, 1500W(1ms)	DO-214AB	1d	1a	Eic
LC110	SMCJLCE110	TVS	Vrwm=110V, Vbr=122..149V, 7.7A, 1500W(1ms)	DO-214AB	1d	1a	Eic
LC110A	SMCJLCE110A	TVS	Vrwm=110V, Vbr=122..135V, 8.4A, 1500W(1ms)	DO-214AB	1d	1a	Eic
LC110C	SMCJLCE110C	TVS	Vrwm=110V, Vbr=122..149V, 7.7A, 1500W(1ms), Bidirectional	DO-214AB	1ba	1j	Eic
LC110CA	SMCJLCE110CA	TVS	Vrwm=110V, Vbr=122..135V, 8.4A, 1500W(1ms), Bidirectional	DO-214AB	1ba	1j	Eic
LC11A	SMCJLCE11A	TVS	Vrwm=11V, Vbr=12.2..13.5V, 82A, 1500W(1ms)	DO-214AB	1d	1a	Eic
LC11C	SMCJLCE11C	TVS	Vrwm=11V, Vbr=12.2..14.9V, 74A, 1500W(1ms), Bidirectional	DO-214AB	1ba	1j	Eic
LC11CA	SMCJLCE11CA	TVS	Vrwm=11V, Vbr=12.2..13.5V, 82A, 1500W(1ms), Bidirectional	DO-214AB	1ba	1j	Eic
LC12	SMCJLCE12	TVS	Vrwm=12V, Vbr=13.3..16.3V, 68A, 1500W(1ms)	DO-214AB	1d	1a	Eic
LC120	SMCJLCE120	TVS	Vrwm=120V, Vbr=133..163V, 7.0A, 1500W(1ms)	DO-214AB	1d	1a	Eic
LC120A	SMCJLCE120A	TVS	Vrwm=120V, Vbr=133..147V, 7.8A, 1500W(1ms)	DO-214AB	1d	1a	Eic
LC120C	SMCJLCE120C	TVS	Vrwm=120V, Vbr=133..163V, 7.0A, 1500W(1ms), Bidirectional	DO-214AB	1ba	1j	Eic
LC120CA	SMCJLCE120CA	TVS	Vrwm=120V, Vbr=133..147V, 7.8A, 1500W(1ms), Bidirectional	DO-214AB	1ba	1j	Eic
LC12A	SMCJLCE12A	TVS	Vrwm=12V, Vbr=13.3..14.7V, 75A, 1500W(1ms)	DO-214AB	1d	1a	Eic
LC12C	SMCJLCE12C	TVS	Vrwm=12V, Vbr=13.3..16.3V, 68A, 1500W(1ms), Bidirectional	DO-214AB	1ba	1j	Eic
LC12CA	SMCJLCE12CA	TVS	Vrwm=12V, Vbr=13.3..14.7V, 75A, 1500W(1ms), Bidirectional	DO-214AB	1ba	1j	Eic
LC13	SMCJLCE13	TVS	Vrwm=13V, Vbr=14.4..17.6V, 63A, 1500W(1ms)	DO-214AB	1d	1a	Eic
LC130	SMCJLCE130	TVS	Vrwm=130V, Vbr=144..176V, 6.5A, 1500W(1ms)	DO-214AB	1d	1a	Eic
LC130A	SMCJLCE130A	TVS	Vrwm=130V, Vbr=144..159V, 7.2A, 1500W(1ms)	DO-214AB	1d	1a	Eic
LC130C	SMCJLCE130C	TVS	Vrwm=130V, Vbr=144..176V, 6.5A, 1500W(1ms), Bidirectional	DO-214AB	1ba	1j	Eic
LC130CA	SMCJLCE130CA	TVS	Vrwm=130V, Vbr=144..159V, 7.2A, 1500W(1ms), Bidirectional	DO-214AB	1ba	1j	Eic
LC13A	SMCJLCE13A	TVS	Vrwm=13V, Vbr=14.4..15.9V, 70A, 1500W(1ms)	DO-214AB	1d	1a	Eic
LC13C	SMCJLCE13C	TVS	Vrwm=13V, Vbr=14.4..17.6V, 63A, 1500W(1ms), Bidirectional	DO-214AB	1ba	1j	Eic
LC13CA	SMCJLCE13CA	TVS	Vrwm=13V, Vbr=14.4..15.9V, 70A, 1500W(1ms), Bidirectional	DO-214AB	1ba	1j	Eic
LC14	SMCJLCE14	TVS	Vrwm=14V, Vbr=15.6..19.1V, 58A, 1500W(1ms)	DO-214AB	1d	1a	Eic
LC14A	SMCJLCE14A	TVS	Vrwm=14V, Vbr=15.6..17.2V, 65A, 1500W(1ms)	DO-214AB	1d	1a	Eic
LC14C	SMCJLCE14C	TVS	Vrwm=14V, Vbr=15.6..19.1V, 58A, 1500W(1ms), Bidirectional	DO-214AB	1ba	1j	Eic
LC14CA	SMCJLCE14CA	TVS	Vrwm=14V, Vbr=15.6..17.2V, 65A, 1500W(1ms), Bidirectional	DO-214AB	1ba	1j	Eic
LC15	SMCJLCE15	TVS	Vrwm=15V, Vbr=16.7..20.4V, 56A, 1500W(1ms)	DO-214AB	1d	1a	Eic
LC150	SMCJLCE150	TVS	Vrwm=150V, Vbr=167..204V, 5.6A, 1500W(1ms)	DO-214AB	1d	1a	Eic
LC150A	SMCJLCE150A	TVS	Vrwm=150V, Vbr=167..185V, 6.2A, 1500W(1ms)	DO-214AB	1d	1a	Eic
LC150C	SMCJLCE150C	TVS	Vrwm=150V, Vbr=167..204V, 5.6A, 1500W(1ms), Bidirectional	DO-214AB	1ba	1j	Eic
LC150CA	SMCJLCE150CA	TVS	Vrwm=150V, Vbr=167..185V, 6.2A, 1500W(1ms), Bidirectional	DO-214AB	1ba	1j	Eic
LC15A	SMCJLCE15A	TVS	Vrwm=15V, Vbr=16.7..18.5V, 61A, 1500W(1ms)	DO-214AB	1d	1a	Eic
LC15C	SMCJLCE15C	TVS	Vrwm=15V, Vbr=16.7..20.4V, 56A, 1500W(1ms), Bidirectional	DO-214AB	1ba	1j	Eic
LC15CA	SMCJLCE15CA	TVS	Vrwm=15V, Vbr=16.7..18.5V, 61A, 1500W(1ms), Bidirectional	DO-214AB	1ba	1j	Eic
LC16	SMCJLCE16	TVS	Vrwm=16V, Vbr=17.8..21.8V, 52A, 1500W(1ms)	DO-214AB	1d	1a	Eic
LC160	SMCJLCE160	TVS	Vrwm=160V, Vbr=178..218V, 5.2A, 1500W(1ms)	DO-214AB	1d	1a	Eic
LC160A	SMCJLCE160A	TVS	Vrwm=160V, Vbr=178..197V, 5.8A, 1500W(1ms)	DO-214AB	1d	1a	Eic
LC160C	SMCJLCE160C	TVS	Vrwm=160V, Vbr=178..218V, 5.2A, 1500W(1ms), Bidirectional	DO-214AB	1ba	1j	Eic
LC160CA	SMCJLCE160CA	TVS	Vrwm=160V, Vbr=178..197V, 5.8A, 1500W(1ms), Bidirectional	DO-214AB	1ba	1j	Eic
LC16A	SMCJLCE16A	TVS	Vrwm=16V, Vbr=17.8..19.7V, 57A, 1500W(1ms)	DO-214AB	1d	1a	Eic
LC16C	SMCJLCE16C	TVS	Vrwm=16V, Vbr=17.8..21.8V, 52A, 1500W(1ms), Bidirectional	DO-214AB	1ba	1j	Eic
LC16CA	SMCJLCE16CA	TVS	Vrwm=16V, Vbr=17.8..19.7V, 57A, 1500W(1ms), Bidirectional	DO-214AB	1ba	1j	Eic
LC17	SMCJLCE17	TVS	Vrwm=17V, Vbr=18.9..23.1V, 49A, 1500W(1ms)	DO-214AB	1d	1a	Eic
LC170	SMCJLCE170	TVS	Vrwm=170V, Vbr=189..231V, 4.9A, 1500W(1ms)	DO-214AB	1d	1a	Eic
LC170A	SMCJLCE170A	TVS	Vrwm=170V, Vbr=189..209V, 5.4A, 1500W(1ms)	DO-214AB	1d	1a	Eic
LC170C	SMCJLCE170C	TVS	Vrwm=170V, Vbr=189..231V, 4.9A, 1500W(1ms), Bidirectional	DO-214AB	1ba	1j	Eic
LC170CA	SMCJLCE170CA	TVS	Vrwm=170V, Vbr=189..209V, 5.4A, 1500W(1ms), Bidirectional	DO-214AB	1ba	1j	Eic
LC17A	SMCJLCE17A	TVS	Vrwm=17V, Vbr=18.9..20.9V, 54A, 1500W(1ms)	DO-214AB	1d	1a	Eic
LC17C	SMCJLCE17C	TVS	Vrwm=17V, Vbr=18.9..23.1V, 49A, 1500W(1ms), Bidirectional	DO-214AB	1ba	1j	Eic
LC17CA	SMCJLCE17CA	TVS	Vrwm=17V, Vbr=18.9..20.9V, 54A, 1500W(1ms), Bidirectional	DO-214AB	1ba	1j	Eic
LC18	SMCJLCE18	TVS	Vrwm=18V, Vbr=20.0..24.4V, 46A, 1500W(1ms)	DO-214AB	1d	1a	Eic
LC18A	SMCJLCE18A	TVS	Vrwm=18V, Vbr=20.0..22.1V, 51A, 1500W(1ms)	DO-214AB	1d	1a	Eic
LC18C	SMCJLCE18C	TVS	Vrwm=18V, Vbr=20.0..24.4V, 46A, 1500W(1ms), Bidirectional	DO-214AB	1ba	1j	Eic
LC18CA	SMCJLCE18CA	TVS	Vrwm=18V, Vbr=20.0..22.1V, 51A, 1500W(1ms), Bidirectional	DO-214AB	1ba	1j	Eic
LC20	SMCJLCE20	TVS	Vrwm=20V, Vbr=22.2..27.1V, 42A, 1500W(1ms)	DO-214AB	1d	1a	Eic
LC20A	SMCJLCE20A	TVS	Vrwm=20V, Vbr=22.2..24.5V, 46A, 1500W(1ms)	DO-214AB	1d	1a	Eic
LC20C	SMCJLCE20C	TVS	Vrwm=20V, Vbr=22.2..27.1V, 42A, 1500W(1ms), Bidirectional	DO-214AB	1ba	1j	Eic
LC20CA	SMCJLCE20CA	TVS	Vrwm=20V, Vbr=22.2..24.5V, 46A, 1500W(1ms), Bidirectional	DO-214AB	1ba	1j	Eic
LC22	SMCJLCE22	TVS	Vrwm=22V, Vbr=24.4..29.8V, 38A, 1500W(1ms)	DO-214AB	1d	1a	Eic
LC22A	SMCJLCE22A	TVS	Vrwm=22V, Vbr=24.4..26.9V, 42A, 1500W(1ms)	DO-214AB	1d	1a	Eic
LC22C	SMCJLCE22C	TVS	Vrwm=22V, Vbr=24.4..29.8V, 38A, 1500W(1ms), Bidirectional	DO-214AB	1ba	1j	Eic
LC22CA	SMCJLCE22CA	TVS	Vrwm=22V, Vbr=24.4..26.9V, 42A, 1500W(1ms), Bidirectional	DO-214AB	1ba	1j	Eic
LC24	SMCJLCE24	TVS	Vrwm=24V, Vbr=26.7..32.6V, 35A, 1500W(1ms)	DO-214AB	1d	1a	Eic
LC24A	SMCJLCE24A	TVS	Vrwm=24V, Vbr=26.7..29.5V, 39A, 1500W(1ms)	DO-214AB	1d	1a	Eic
LC24C	SMCJLCE24C	TVS	Vrwm=24V, Vbr=26.7..32.6V, 35A, 1500W(1ms), Bidirectional	DO-214AB	1ba	1j	Eic
LC24CA	SMCJLCE24CA	TVS	Vrwm=24V, Vbr=26.7..29.5V, 39A, 1500W(1ms), Bidirectional	DO-214AB	1ba	1j	Eic
LC26	SMCJLCE26	TVS	Vrwm=26V, Vbr=28.9..35.3V, 32A, 1500W(1ms)	DO-214AB	1d	1a	Eic



SMD code	Type	Function	Short description	Case	Pinout	St.	Mnf.
LC26A	SMCJLCE26A	TVS	Vrwm=26V, Vbr=28.9..31.9V, 36A, 1500W(1ms)	DO-214AB	1d	1a	Eic
LC26C	SMCJLCE26C	TVS	Vrwm=26V, Vbr=28.9..35.3V, 32A, 1500W(1ms), Bidirectional	DO-214AB	1ba	1j	Eic
LC26CA	SMCJLCE26CA	TVS	Vrwm=26V, Vbr=28.9..31.9V, 36A, 1500W(1ms), Bidirectional	DO-214AB	1ba	1j	Eic
LC28	SMCJLCE28	TVS	Vrwm=28V, Vbr=31.1..38.0V, 30A, 1500W(1ms)	DO-214AB	1d	1a	Eic
LC28A	SMCJLCE28A	TVS	Vrwm=28V, Vbr=31.1..34.4V, 33A, 1500W(1ms)	DO-214AB	1d	1a	Eic
LC28C	SMCJLCE28C	TVS	Vrwm=28V, Vbr=31.1..38.0V, 30A, 1500W(1ms), Bidirectional	DO-214AB	1ba	1j	Eic
LC28CA	SMCJLCE28CA	TVS	Vrwm=28V, Vbr=31.1..34.4V, 33A, 1500W(1ms), Bidirectional	DO-214AB	1ba	1j	Eic
LC30	SMCJLCE30	TVS	Vrwm=30V, Vbr=33.3..40.7V, 28A, 1500W(1ms)	DO-214AB	1d	1a	Eic
LC30A	SMCJLCE30A	TVS	Vrwm=30V, Vbr=33.3..36.8V, 31A, 1500W(1ms)	DO-214AB	1d	1a	Eic
LC30C	SMCJLCE30C	TVS	Vrwm=30V, Vbr=33.3..40.7V, 28A, 1500W(1ms), Bidirectional	DO-214AB	1ba	1j	Eic
LC30CA	SMCJLCE30CA	TVS	Vrwm=30V, Vbr=33.3..36.8V, 31A, 1500W(1ms), Bidirectional	DO-214AB	1ba	1j	Eic
LC33	SMCJLCE33	TVS	Vrwm=33V, Vbr=36.7..44.9V, 25.4A, 1500W(1ms)	DO-214AB	1d	1a	Eic
LC33A	SMCJLCE33A	TVS	Vrwm=33V, Vbr=36.7..40.6V, 28.1A, 1500W(1ms)	DO-214AB	1d	1a	Eic
LC33C	SMCJLCE33C	TVS	Vrwm=33V, Vbr=36.7..44.9V, 25.4A, 1500W(1ms), Bidirectional	DO-214AB	1ba	1j	Eic
LC33CA	SMCJLCE33CA	TVS	Vrwm=33V, Vbr=36.7..40.6V, 28.1A, 1500W(1ms), Bidirectional	DO-214AB	1ba	1j	Eic
LC36	SMCJLCE36	TVS	Vrwm=36V, Vbr=40.0..48.9V, 23.3A, 1500W(1ms)	DO-214AB	1d	1a	Eic
LC36A	SMCJLCE36A	TVS	Vrwm=36V, Vbr=40.0..44.2V, 25.8A, 1500W(1ms)	DO-214AB	1d	1a	Eic
LC36C	SMCJLCE36C	TVS	Vrwm=36V, Vbr=40.0..48.9V, 23.3A, 1500W(1ms), Bidirectional	DO-214AB	1ba	1j	Eic
LC36CA	SMCJLCE36CA	TVS	Vrwm=36V, Vbr=40.0..44.2V, 25.8A, 1500W(1ms), Bidirectional	DO-214AB	1ba	1j	Eic
LC40	SMCJLCE40	TVS	Vrwm=40V, Vbr=44.4..54.3V, 21A, 1500W(1ms)	DO-214AB	1d	1a	Eic
LC40A	SMCJLCE40A	TVS	Vrwm=40V, Vbr=44.4..49.1V, 23.3A, 1500W(1ms)	DO-214AB	1d	1a	Eic
LC40C	SMCJLCE40C	TVS	Vrwm=40V, Vbr=44.4..54.3V, 21A, 1500W(1ms), Bidirectional	DO-214AB	1ba	1j	Eic
LC40CA	SMCJLCE40CA	TVS	Vrwm=40V, Vbr=44.4..49.1V, 23.3A, 1500W(1ms), Bidirectional	DO-214AB	1ba	1j	Eic
LC43	SMCJLCE43	TVS	Vrwm=43V, Vbr=47.8..58.4V, 19.5A, 1500W(1ms)	DO-214AB	1d	1a	Eic
LC43A	SMCJLCE43A	TVS	Vrwm=43V, Vbr=47.8..52.8V, 21.6A, 1500W(1ms)	DO-214AB	1d	1a	Eic
LC43C	SMCJLCE43C	TVS	Vrwm=43V, Vbr=47.8..58.4V, 19.5A, 1500W(1ms), Bidirectional	DO-214AB	1ba	1j	Eic
LC43CA	SMCJLCE43CA	TVS	Vrwm=43V, Vbr=47.8..52.8V, 21.6A, 1500W(1ms), Bidirectional	DO-214AB	1ba	1j	Eic
LC45	SMCJLCE45	TVS	Vrwm=45V, Vbr=50.0..61.1V, 18.7A, 1500W(1ms)	DO-214AB	1d	1a	Eic
LC45A	SMCJLCE45A	TVS	Vrwm=45V, Vbr=50.0..55.3V, 20.6A, 1500W(1ms)	DO-214AB	1d	1a	Eic
LC45C	SMCJLCE45C	TVS	Vrwm=45V, Vbr=50.0..61.1V, 18.7A, 1500W(1ms), Bidirectional	DO-214AB	1ba	1j	Eic
LC45CA	SMCJLCE45CA	TVS	Vrwm=45V, Vbr=50.0..55.3V, 20.6A, 1500W(1ms), Bidirectional	DO-214AB	1ba	1j	Eic
LC48	SMCJLCE48	TVS	Vrwm=48V, Vbr=53.3..65.1V, 17.5A, 1500W(1ms)	DO-214AB	1d	1a	Eic
LC48A	SMCJLCE48A	TVS	Vrwm=48V, Vbr=53.3..58.9V, 19.4A, 1500W(1ms)	DO-214AB	1d	1a	Eic
LC48C	SMCJLCE48C	TVS	Vrwm=48V, Vbr=53.3..65.1V, 17.5A, 1500W(1ms), Bidirectional	DO-214AB	1ba	1j	Eic
LC48CA	SMCJLCE48CA	TVS	Vrwm=48V, Vbr=53.3..58.9V, 19.4A, 1500W(1ms), Bidirectional	DO-214AB	1ba	1j	Eic
LC51	SMCJLCE51	TVS	Vrwm=51V, Vbr=56.7..69.3V, 16.5A, 1500W(1ms)	DO-214AB	1d	1a	Eic
LC51A	SMCJLCE51A	TVS	Vrwm=51V, Vbr=56.7..62.7V, 18.2A, 1500W(1ms)	DO-214AB	1d	1a	Eic
LC51C	SMCJLCE51C	TVS	Vrwm=51V, Vbr=56.7..69.3V, 16.5A, 1500W(1ms), Bidirectional	DO-214AB	1ba	1j	Eic
LC51CA	SMCJLCE51CA	TVS	Vrwm=51V, Vbr=56.7..62.7V, 18.2A, 1500W(1ms), Bidirectional	DO-214AB	1ba	1j	Eic
LC54	SMCJLCE54	TVS	Vrwm=54V, Vbr=60.0..73.3V, 15.6A, 1500W(1ms)	DO-214AB	1d	1a	Eic
LC54A	SMCJLCE54A	TVS	Vrwm=54V, Vbr=60.0..66.3V, 17.2A, 1500W(1ms)	DO-214AB	1d	1a	Eic
LC54C	SMCJLCE54C	TVS	Vrwm=54V, Vbr=60.0..73.3V, 15.6A, 1500W(1ms), Bidirectional	DO-214AB	1ba	1j	Eic
LC54CA	SMCJLCE54CA	TVS	Vrwm=54V, Vbr=60.0..66.3V, 17.2A, 1500W(1ms), Bidirectional	DO-214AB	1ba	1j	Eic
LC58	SMCJLCE58	TVS	Vrwm=58V, Vbr=64.4..78.7V, 14.6A, 1500W(1ms)	DO-214AB	1d	1a	Eic
LC58A	SMCJLCE58A	TVS	Vrwm=58V, Vbr=64.4..71.2V, 16A, 1500W(1ms)	DO-214AB	1d	1a	Eic
LC58C	SMCJLCE58C	TVS	Vrwm=58V, Vbr=64.4..78.7V, 14.6A, 1500W(1ms), Bidirectional	DO-214AB	1ba	1j	Eic
LC58CA	SMCJLCE58CA	TVS	Vrwm=58V, Vbr=64.4..71.2V, 16A, 1500W(1ms), Bidirectional	DO-214AB	1ba	1j	Eic
LC6.5	SMCJLCE6.5	TVS	Vrwm=6.5V, Vbr=7.22..8.82V, 100A, 1500W(1ms)	DO-214AB	1d	1a	Eic
LC6.5A	SMCJLCE6.5A	TVS	Vrwm=6.5V, Vbr=7.22..7.98V, 100A, 1500W(1ms)	DO-214AB	1d	1a	Eic
LC6.5C	SMCJLCE6.5C	TVS	Vrwm=6.5V, Vbr=7.22..8.82V, 100A, 1500W(1ms), Bidirectional	DO-214AB	1ba	1j	Eic
LC6.5CA	SMCJLCE6.5CA	TVS	Vrwm=6.5V, Vbr=7.22..7.98V, 100A, 1500W(1ms), Bidirectional	DO-214AB	1ba	1j	Eic
LC60	SMCJLCE60	TVS	Vrwm=60V, Vbr=66.7..81.5V, 14A, 1500W(1ms)	DO-214AB	1d	1a	Eic
LC60A	SMCJLCE60A	TVS	Vrwm=60V, Vbr=66.7..73.7V, 15.5A, 1500W(1ms)	DO-214AB	1d	1a	Eic
LC60C	SMCJLCE60C	TVS	Vrwm=60V, Vbr=66.7..81.5V, 14A, 1500W(1ms), Bidirectional	DO-214AB	1ba	1j	Eic
LC60CA	SMCJLCE60CA	TVS	Vrwm=60V, Vbr=66.7..73.7V, 15.5A, 1500W(1ms), Bidirectional	DO-214AB	1ba	1j	Eic
LC64	SMCJLCE64	TVS	Vrwm=64V, Vbr=71.1..86.9V, 13.2A, 1500W(1ms)	DO-214AB	1d	1a	Eic
LC64A	SMCJLCE64A	TVS	Vrwm=64V, Vbr=71.1..78.6V, 14.6A, 1500W(1ms)	DO-214AB	1d	1a	Eic
LC64C	SMCJLCE64C	TVS	Vrwm=64V, Vbr=71.1..86.9V, 13.2A, 1500W(1ms), Bidirectional	DO-214AB	1ba	1j	Eic
LC64CA	SMCJLCE64CA	TVS	Vrwm=64V, Vbr=71.1..78.6V, 14.6A, 1500W(1ms), Bidirectional	DO-214AB	1ba	1j	Eic
LC7.0	SMCJLCE7.0	TVS	Vrwm=7.0V, Vbr=7.78..9.51V, 100A, 1500W(1ms)	DO-214AB	1d	1a	Eic
LC7.0A	SMCJLCE7.0A	TVS	Vrwm=7.0V, Vbr=7.78..8.60V, 100A, 1500W(1ms)	DO-214AB	1d	1a	Eic
LC7.0C	SMCJLCE7.0C	TVS	Vrwm=7.0V, Vbr=7.78..9.51V, 100A, 1500W(1ms), Bidirectional	DO-214AB	1ba	1j	Eic
LC7.0CA	SMCJLCE7.0CA	TVS	Vrwm=7.0V, Vbr=7.78..8.60V, 100A, 1500W(1ms), Bidirectional	DO-214AB	1ba	1j	Eic
LC7.5	SMCJLCE7.5	TVS	Vrwm=7.5V, Vbr=8.33..10.2V, 100A, 1500W(1ms)	DO-214AB	1d	1a	Eic
LC7.5A	SMCJLCE7.5A	TVS	Vrwm=7.5V, Vbr=8.33..9.21V, 100A, 1500W(1ms)	DO-214AB	1d	1a	Eic
LC7.5C	SMCJLCE7.5C	TVS	Vrwm=7.5V, Vbr=8.33..10.2V, 100A, 1500W(1ms), Bidirectional	DO-214AB	1ba	1j	Eic
LC7.5CA	SMCJLCE7.5CA	TVS	Vrwm=7.5V, Vbr=8.33..9.21V, 100A, 1500W(1ms), Bidirectional	DO-214AB	1ba	1j	Eic
LC70	SMCJLCE70	TVS	Vrwm=70V, Vbr=77.8..95.1V, 12.0A, 1500W(1ms)	DO-214AB	1d	1a	Eic
LC70A	SMCJLCE70A	TVS	Vrwm=70V, Vbr=77.8..86.0V, 13.3A, 1500W(1ms)	DO-214AB	1d	1a	Eic
LC70C	SMCJLCE70C	TVS	Vrwm=70V, Vbr=77.8..95.1V, 12.0A, 1500W(1ms), Bidirectional	DO-214AB	1ba	1j	Eic



SMD code	Type	Function	Short description	Case	Pinout	St.	Mnf.
LC70CA	SMCJLCE70CA	TVS	Vrwm=70V, Vbr=77.8..86.0V, 13.3A, 1500W(1ms), Bidirectional	DO-214AB	1ba	1j	Eic
LC75	SMCJLCE75	TVS	Vrwm=75V, Vbr=83.3..102V, 11.2A, 1500W(1ms)	DO-214AB	1d	1a	Eic
LC75A	SMCJLCE75A	TVS	Vrwm=75V, Vbr=83.3..92.1V, 12.4A, 1500W(1ms)	DO-214AB	1d	1a	Eic
LC75C	SMCJLCE75C	TVS	Vrwm=75V, Vbr=83.3..102V, 11.2A, 1500W(1ms), Bidirectional	DO-214AB	1ba	1j	Eic
LC75CA	SMCJLCE75CA	TVS	Vrwm=75V, Vbr=83.3..92.1V, 12.4A, 1500W(1ms), Bidirectional	DO-214AB	1ba	1j	Eic
LC8.0	SMCJLCE8.0	TVS	Vrwm=8.0V, Vbr=8.89..10.9V, 100A, 1500W(1ms)	DO-214AB	1d	1a	Eic
LC8.0A	SMCJLCE8.0A	TVS	Vrwm=8.0V, Vbr=8.89..9.83V, 100A, 1500W(1ms)	DO-214AB	1d	1a	Eic
LC8.0C	SMCJLCE8.0C	TVS	Vrwm=8.0V, Vbr=8.89..10.9V, 100A, 1500W(1ms), Bidirectional	DO-214AB	1ba	1j	Eic
LC8.0CA	SMCJLCE8.0CA	TVS	Vrwm=8.0V, Vbr=8.89..9.83V, 100A, 1500W(1ms), Bidirectional	DO-214AB	1ba	1j	Eic
LC8.5	SMCJLCE8.5	TVS	Vrwm=8.5V, Vbr=9.44..11.5V, 94A, 1500W(1ms)	DO-214AB	1d	1a	Eic
LC8.5A	SMCJLCE8.5A	TVS	Vrwm=8.5V, Vbr=9.44..10.4V, 100A, 1500W(1ms)	DO-214AB	1d	1a	Eic
LC8.5C	SMCJLCE8.5C	TVS	Vrwm=8.5V, Vbr=9.44..11.5V, 94A, 1500W(1ms), Bidirectional	DO-214AB	1ba	1j	Eic
LC8.5CA	SMCJLCE8.5CA	TVS	Vrwm=8.5V, Vbr=9.44..10.4V, 100A, 1500W(1ms), Bidirectional	DO-214AB	1ba	1j	Eic
LC80	SMCJLCE80	TVS	Vrwm=80V, Vbr=88.7..108V, 10.6A, 1500W(1ms)	DO-214AB	1d	1a	Eic
LC80A	SMCJLCE80A	TVS	Vrwm=80V, Vbr=88.7..98.0V, 11.6A, 1500W(1ms)	DO-214AB	1d	1a	Eic
LC80C	SMCJLCE80C	TVS	Vrwm=80V, Vbr=88.7..108V, 10.6A, 1500W(1ms), Bidirectional	DO-214AB	1ba	1j	Eic
LC80CA	SMCJLCE80CA	TVS	Vrwm=80V, Vbr=88.7..98.0V, 11.6A, 1500W(1ms), Bidirectional	DO-214AB	1ba	1j	Eic
LC9.0	SMCJLCE9.0	TVS	Vrwm=9.0V, Vbr=10.0..12.2V, 89A, 1500W(1ms)	DO-214AB	1d	1a	Eic
LC9.0A	SMCJLCE9.0A	TVS	Vrwm=9.0V, Vbr=10.0..11.1V, 97A, 1500W(1ms)	DO-214AB	1d	1a	Eic
LC9.0C	SMCJLCE9.0C	TVS	Vrwm=9.0V, Vbr=10.0..12.2V, 89A, 1500W(1ms), Bidirectional	DO-214AB	1ba	1j	Eic
LC9.0CA	SMCJLCE9.0CA	TVS	Vrwm=9.0V, Vbr=10.0..11.1V, 97A, 1500W(1ms), Bidirectional	DO-214AB	1ba	1j	Eic
LC90	SMCJLCE90	TVS	Vrwm=90V, Vbr=100..122V, 9.4A, 1500W(1ms)	DO-214AB	1d	1a	Eic
LC90A	SMCJLCE90A	TVS	Vrwm=90V, Vbr=100..111V, 10.3A, 1500W(1ms)	DO-214AB	1d	1a	Eic
LC90C	SMCJLCE90C	TVS	Vrwm=90V, Vbr=100..122V, 9.4A, 1500W(1ms), Bidirectional	DO-214AB	1ba	1j	Eic
LC90CA	SMCJLCE90CA	TVS	Vrwm=90V, Vbr=100..111V, 10.3A, 1500W(1ms), Bidirectional	DO-214AB	1ba	1j	Eic
LD	P6SMB18	TVS	Vrwm=18V, 23A, 600W(1ms)	DO-214AA	1d	2j	Fag
LD	P6SMBJ12	TVS	Vbr=12V, 27.3A, 600W(1ms)	DO-214AA	1d	1m,1w	Pjt,Srj
LD	SM6T6V8C	TVS	Vbr=6.8V, 55A, 600W(1ms), Bidirectional	DO-214AA	1ba	1r	Ste
LD	SMBG12	TVS	Vbr=12V, 27.3A, 600W(1ms)	DO-215AA	5d	1k	Vs
LD	SMBJ12	TVS	Vbr=12V, 27.3A, 600W(1ms)	DO-214AA	1d	1k	Vs
LD	TV06B120K-G	TVS	Vrwm=12.0V, Vbr=13.30..16.30V, Ipp=27.27A, 600W(1ms)	DO-214AA	1d	1a	Cmc
LDK	SMB18	TVS	Vbr=16.2..19.8V, Vrwm=14.5V, 22.6A, 600W(1ms)	DO-214AA	1d	1a	Lge
LDM	SMB18C	TVS	Vbr=16.2..19.8V, Vrwm=14.5V, 22.6A, 600W(1ms), Bidirectional	DO-214AA	1ba	1j	Lge
LE	1SMB12A	TVS	Vrwm=12V, 30.2A, 600W(1ms)	403A	3d	1s	Ons
LE	CD214B-T12A	TVS	Vbr=12V, Irsrm=30.2A, 600W(1ms)	DO-214AA	1d	1a	Bm
LE	P6SMB18A	TVS	Vrwm=18V, 24A, 600W(1ms)	DO-214AA	1d	2j	Fag
LE	P6SMBJ12A	TVS	Vbr=12V, 30.2A, 600W(1ms)	DO-214AA	1d	1m,1w	Pjt,Srj
LE	SM6T6V8CA	TVS	Vrwm=5.8V, Vbr=6.45..7.14V, 57A, 600W(1ms), Bidirectional	DO-214AA	1ba	1j	Ste
LE	SMBG12A	TVS	Vbr=12V, 30.2A, 600W(1ms)	DO-215AA	5d	1k	Vs
LE	SMBJ12A	TVS	Vbr=12V, 30.2A, 600W(1ms)	DO-214AA	1d	1k,1m	Di,Vs
LE	SMF12A	TVS	Vrwm=12V, Vbr=13.3..14.7V, 10.1A, 200W(1ms)	SOD-123FL	7d	1a	Eic
LE	SMF12CA	TVS	Vrwm=12.0V, Vbr=13.30..14.70V, 10.1A, 200W(10/1000µs), Bidirectional	SOD-123FL	7ba	1j	Ers
LE	TV02W120B-G	TVS	Vrwm=12V, Vbr=13.3..14.7V, Ipp=10.1A, 200W(1ms), Bidirectional	SOD-123	5ba	1j	Cmc
LE	TV06B120J-G	TVS	Vrwm=12.0V, Vbr=13.30..14.70V, Ipp=30.15A, 600W(1ms)	DO-214AA	1d	1a	Cmc
LEG	1SMB12CA	TVS	Vrwm=12V, 30.2A, 600W(1ms), Bidirectional	403A	3ba	1e	Ons
LEK	SMB18A	TVS	Vbr=17.1..18.9V, Vrwm=15.3V, 23.5A, 600W(1ms)	DO-214AA	1d	1a	Lge
LEM	SMB18CA	TVS	Vbr=17.1..18.9V, Vrwm=15.3V, 23.5A, 600W(1ms), Bidirectional	DO-214AA	1ba	1j	Lge
LEP	TPSMB18A	TVS	Vbr=18V, 23.8A, 600W(1ms)	DO-214AA	1d	1k	Vs
LF	KDZ18FV	Z-diode	16.80..19.10V, Izt=5mA, Zzt=20Ω, 100mW	TFSC	7d	1a	Kec
LF	MAZD130	Z-diode	12.4..14.1V, Zzt=35Ω(5mA), 120mW	SSSMini2	7d	1a	Pan
LF	P6SMB20	TVS	Vrwm=20V, 21A, 600W(1ms)	DO-214AA	1d	2j	Fag
LF	P6SMBJ13	TVS	Vbr=13V, 25.2A, 600W(1ms)	DO-214AA	1d	1m,1w	Pjt,Srj
LF	PZU5.6BA	Z-diode	5.6V±5%, If=200mA, 320mW	SOD-323	5d	1a	Phi
LF	SM6T7V5C	TVS	Vbr=7.5V, 51A, 600W(1ms), Bidirectional	DO-214AA	1ba	1r	Ste
LF	SMBG13	TVS	Vbr=13V, 25.2A, 600W(1ms)	DO-215AA	5d	1k	Vs
LF	SMBJ13	TVS	Vbr=13V, 25.2A, 600W(1ms)	DO-214AA	1d	1k	Vs
LF	TV06B130K-G	TVS	Vrwm=13.0V, Vbr=14.40..17.60V, Ipp=25.21A, 600W(1ms)	DO-214AA	1d	1a	Cmc
LFK	SMB20	TVS	Vbr=18.0..22.0V, Vrwm=16.2V, 20.6A, 600W(1ms)	DO-214AA	1d	1a	Lge
LFM	SMB20C	TVS	Vbr=18.0..22.0V, Vrwm=16.2V, 20.6A, 600W(1ms), Bidirectional	DO-214AA	1ba	1j	Lge
LFP	TPSMB20	TVS	Vbr=20V, 20.6A, 600W(1ms)	DO-214AA	1d	1k	Vs
LG	1SMB13A	TVS	Vrwm=13V, 27.9A, 600W(1ms)	403A	3d	1s	Ons
LG	CD214B-T13A	TVS	Vbr=13V, Irsrm=27.9A, 600W(1ms)	DO-214AA	1d	1a	Bm
LG	P6SMB20A	TVS	Vrwm=20V, 20A, 600W(1ms)	DO-214AA	1d	2j	Fag
LG	P6SMBJ13A	TVS	Vbr=13V, 27.9A, 600W(1ms)	DO-214AA	1d	1m,1w	Pjt,Srj
LG	PZU5.6B1A	Z-diode	5.6V±2%, If=200mA, 320mW	SOD-323	5d	1a	Phi
LG	SM6T7V5CA	TVS	Vrwm=6.4V, Vbr=7.13..7.88V, 53A, 600W(1ms), Bidirectional	DO-214AA	1ba	1r,1j	Ste
LG	SMBG13A	TVS	Vbr=13V, 27.9A, 600W(1ms)	DO-215AA	5d	1k	Vs
LG	SMBJ13A	TVS	Vbr=13V, 27.9A, 600W(1ms)	DO-214AA	1d	1k,1m	Di,Vs
LG	SMF13A	TVS	Vrwm=13V, Vbr=14.4..15.9V, 9.3A, 200W(1ms)	SOD-123FL	7d	1a	Eic
LG	SMF13CA	TVS	Vrwm=13.0V, Vbr=14.40..15.90V, 9.3A, 200W(10/1000µs), Bidirectional	SOD-123FL	7ba	1j	Ers



SMD
code

Type

Function

Short description

Case

Pinout

St.

Mnf.

SMD code	Type	Function	Short description	Case	Pinout	St.	Mnf.
LG	TV06B130J-G	TVS	Vrwm=13.0V, Vbr=14.40..15.90V, Ipp=27.91A, 600W(1ms)	DO-214AA	1d	1a	Cmc
LG7	SM6T15A	TVS	Vbr=14.3..15.8V, 28A, 600W(1ms)	DO-214AA	1d	1k	Vs
LG7	SM6T15CA	TVS	Vbr=14.3..15.8V, 28A, 600W(1ms), Bidirectional	DO-214AA	1ba	1l	Vs
LGC	1SMB13CA	TVS	Vrwm=13V, 27.9A, 600W(1ms), Bidirectional	403A	3ba	1e	Ons
L GK	SMB20A	TVS	Vbr=19.0..21.0V, Vrwm=17.1V, 21.7A, 600W(1ms)	DO-214AA	1d	1a	Lge
LGM	SMB20CA	TVS	Vbr=19.0..21.0V, Vrwm=17.1V, 21.7A, 600W(1ms), Bidirectional	DO-214AA	1ba	1j	Lge
LGP	TPSMB20A	TVS	Vbr=20V, 21.7A, 600W(1ms)	DO-214AA	1d	1k	Vs
LH	P6SMB22	TVS	Vrwm=22V, 19A, 600W(1ms)	DO-214AA	1d	2j	Fag
LH	P6SMBJ14	TVS	Vbr=14V, 23.3A, 600W(1ms)	DO-214AA	1d	1m,1w	Pjt,Srj
LH	PZU5.6B2A	Z-diode	5.6V±2%, If=200mA, 320mW	SOD-323	5d	1a	Phi
LH	SMBG14	TVS	Vbr=14V, 23.3A, 600W(1ms)	DO-215AA	1d	1k	Vs
LH	SMBJ14	TVS	Vbr=14V, 23.3A, 600W(1ms)	DO-214AA	1d	1k	Vs
LH	TV06B140K-G	TVS	Vrwm=14.0V, Vbr=15.60..19.10V, Ipp=23.26A, 600W(1ms)	DO-214AA	1d	1a	Cmc
LHK	SMB22	TVS	Vbr=19.8..24.2V, Vrwm=17.8V, 18.8A, 600W(1ms)	DO-214AA	1d	1a	Lge
LHM	SMB22C	TVS	Vbr=19.8..24.2V, Vrwm=17.8V, 18.8A, 600W(1ms), Bidirectional	DO-214AA	1ba	1j	Lge
LHP	TPSMB22	TVS	Vbr=22V, 18.8A, 600W(1ms)	DO-214AA	1d	1k	Vs
LJ	SDM10U45LP	Si-diode	Schottky, 45V, 100mA, Vf<800mV(100mA)	DFN1006-2	13d	2a	Di
LK	1SMB14A	TVS	Vrwm=14V, 25.8A, 600W(1ms)	403A	3d	1s	Ons
LK	CD214B-T14A	TVS	Vbr=14V, Irs=25.8A, 600W(1ms)	DO-214AA	1d	1a	Bm
LK	P6SMB22A	TVS	Vrwm=22V, 20A, 600W(1ms)	DO-214AA	1d	2j	Fag
LK	P6SMBJ14A	TVS	Vbr=14V, 25.8A, 600W(1ms)	DO-214AA	1d	1m,1w	Pjt,Srj
LK	PZU5.6B3A	Z-diode	5.6V±2%, If=200mA, 320mW	SOD-323	5d	1a	Phi
LK	SMBG14A	TVS	Vbr=14V, 25.9A, 600W(1ms)	DO-215AA	5d	1k	Vs
LK	SMBJ14A	TVS	Vbr=14V, 25.9A, 600W(1ms)	DO-214AA	1d	1k,1m	Di,Vs
LK	SMF14A	TVS	Vrwm=14V, Vbr=15.6..17.2V, 8.6A, 200W(1ms)	SOD-123FL	7d	1a	Eic
LK	SMF14CA	TVS	Vrwm=14.0V, Vbr=15.60..17.20V, 8.62A, 200W(10/1000µs), Bidirectional	SOD-123FL	7ba	1j	Ers
LK	TV02W140B-G	TVS	Vrwm=14V, Vbr=15.6..17.2V, Ipp=8.62A, 200W(1ms), Bidirectional	SOD-123	5ba	1j	Cmc
LK	TV06B140J-G	TVS	Vrwm=14.0V, Vbr=15.60..17.20V, Ipp=25.86A, 600W(1ms)	DO-214AA	1d	1a	Cmc
LKC	1SMB14CA	TVS	Vrwm=14V, 25.8A, 600W(1ms), Bidirectional	403A	3ba	1e	Ons
LKK	SMB22A	TVS	Vbr=20.9..23.1V, Vrwm=18.8V, 19.6A, 600W(1ms)	DO-214AA	1d	1a	Lge
LKM	SMB22CA	TVS	Vbr=20.9..23.1V, Vrwm=18.8V, 19.6A, 600W(1ms), Bidirectional	DO-214AA	1ba	1j	Lge
LKP	TPSMB22A	TVS	Vbr=22V, 19.6A, 600W(1ms)	DO-214AA	1d	1k	Vs
LL	BBY53-02L	C-diode	VCO-Tuning, 6V, 20mA, 3.1..5.8pF(3..1V)	TSLP2-1	13d	2b	Sie
LL	BBY53-02W	C-diode	VCO-Tuning, 6V, 20mA, 3.1..5.8pF(3..1V)	SCD-80	6d	1u	Sie
LL	P6SMB24	TVS	Vrwm=24V, 17A, 600W(1ms)	DO-214AA	1d	2j	Fag
LL	P6SMBJ15	TVS	Vbr=15V, 22.3A, 600W(1ms)	DO-214AA	1d	1m,1w	Pjt,Srj
LL	PZU6.2BA	Z-diode	6.2V±5%, If=200mA, 320mW	SOD-323	5d	1a	Phi
LL	SMBG15	TVS	Vbr=15V, 22.3A, 600W(1ms)	DO-215AA	5d	1k	Vs
LL	SMBJ15	TVS	Vbr=15V, 22.3A, 600W(1ms)	DO-214AA	1d	1k	Vs
LL	TV06B150K-G	TVS	Vrwm=15.0V, Vbr=16.70..20.40V, Ipp=22.30A, 600W(1ms)	DO-214AA	1d	1a	Cmc
LLK	SMB24	TVS	Vbr=21.6..26.4V, Vrwm=19.4V, 17.3A, 600W(1ms)	DO-214AA	1d	1a	Lge
LLM	SMB24C	TVS	Vbr=21.6..26.4V, Vrwm=19.4V, 17.3A, 600W(1ms), Bidirectional	DO-214AA	1ba	1j	Lge
LLP	TPSMB24	TVS	Vbr=24V, 17.3A, 600W(1ms)	DO-214AA	1d	1k	Vs
LLM	1SMB15A	TVS	Vrwm=15V, 24.0A, 600W(1ms)	403A	3d	1s	Ons
LM	CD214B-T15A	TVS	Vbr=15V, Irs=24.0A, 600W(1ms)	DO-214AA	1d	1a	Bm
LM	P6SMB24A	TVS	Vrwm=24V, 18A, 600W(1ms)	DO-214AA	1d	2j	Fag
LM	P6SMBJ15A	TVS	Vbr=15V, 24A, 600W(1ms)	DO-214AA	1d	1m,1w	Pjt,Srj
LM	PZU6.2B1A	Z-diode	6.2V±2%, If=200mA, 320mW	SOD-323	5d	1a	Phi
LM	SDM20U30	Si-diode	Schottky, 30V, 200mA, Vf<500mV(200mA)	SOD-523	6d	1a	Di
LM	SDM20U30LP	Si-diode	Schottky, 30V, 200mA, Vf<575mV(200mA)	DFN1006-2	13d	2a	Di
LM	SMBG15A	TVS	Vbr=15V, 24.6A, 600W(1ms)	DO-215AA	5d	1k	Vs
LM	SMBJ15A	TVS	Vbr=15V, 24.6A, 600W(1ms)	DO-214AA	1d	1k,1m	Di,Vs
LM	SMF15A	TVS	Vrwm=15V, Vbr=16.7..18.5V, 8.2A, 200W(1ms)	SOD-123FL	7d	1a	Eic
LM	SMF15CA	TVS	Vrwm=15.0V, Vbr=16.70..18.50V, 8.20A, 200W(10/1000µs), Bidirectional	SOD-123FL	7ba	1j	Ers
LM	TV02W150B-G	TVS	Vrwm=15V, Vbr=16.7..18.5V, Ipp=8.20A, 200W(1ms), Bidirectional	SOD-123	5ba	1j	Cmc
LM	TV06B150J-G	TVS	Vrwm=15.0V, Vbr=16.70..18.50V, Ipp=24.59A, 600W(1ms)	DO-214AA	1d	1a	Cmc
LM7	SM6T18A	TVS	Vbr=17.1..18.9V, 24A, 600W(1ms)	DO-214AA	1d	1k	Vs
LMC	1SMB15CA	TVS	Vrwm=15V, 24.0A, 600W(1ms), Bidirectional	403A	3ba	1e	Ons
LMK	SMB24A	TVS	Vbr=22.8..25.2V, Vrwm=20.5V, 18.1A, 600W(1ms)	DO-214AA	1d	1a	Lge
LMM	SMB24CA	TVS	Vbr=22.8..25.2V, Vrwm=20.5V, 18.1A, 600W(1ms), Bidirectional	DO-214AA	1ba	1j	Lge
LMP	TPSMB24A	TVS	Vbr=14V, 18.1A, 600W(1ms)	DO-214AA	1d	1k	Vs
LN	P6SMB27	TVS	Vrwm=27V, 16A, 600W(1ms)	DO-214AA	1d	2j	Fag
LN	P6SMBJ16	TVS	Vbr=16V, 20.8A, 600W(1ms)	DO-214AA	1d	1m,1w	Pjt,Srj
LN	PZU6.2B2A	Z-diode	6.2V±2%, If=200mA, 320mW	SOD-323	5d	1a	Phi
LN	SM6T10C	TVS	Vbr=10V, 40A, 600W(1ms), Bidirectional	DO-214AA	1ba	1r	Ste
LN	SMBG16	TVS	Vbr=16V, 20.8A, 600W(1ms)	DO-215AA	5d	1k	Vs
LN	SMBJ16	TVS	Vbr=16V, 20.8A, 600W(1ms)	DO-214AA	1d	1k	Vs
LN	TV06B160K-G	TVS	Vrwm=16.0V, Vbr=17.80..21.80V, Ipp=20.83A, 600W(1ms)	DO-214AA	1d	1a	Cmc
LNK	SMB27	TVS	Vbr=24.3..29.7V, Vrwm=21.8V, 15.3A, 600W(1ms)	DO-214AA	1d	1a	Lge
LNM	SMB27C	TVS	Vbr=24.3..29.7V, Vrwm=21.8V, 15.3A, 600W(1ms), Bidirectional	DO-214AA	1ba	1j	Lge



SMD
code

Type

Function

Short description

Case

Pinout

St.

Mnf.

LNP	TPSMB27	TVS	Vbr=27V, 15.3A, 600W(1ms)	DO-214AA	1d	1k	Vs
LOP	TPSMB18	TVS	Vbr=18V, 22.6A, 600W(1ms)	DO-214AA	1d	1k	Vs
LP	1SMB16A	TVS	Vrwm=16V, 23.1A, 600W(1ms)	403A	3d	1s	Ons
LP	CD214B-T16A	TVS	Vbr=16V, Irsm=23.1A, 600W(1ms)	DO-214AA	1d	1a	Bm
LP	CMDZL1	Z-diode	4.845..5.355V, Izt=0.5mA, Zzt=400Ω, 250mW	SOD-323	5d	1a	Cen
LP	KDZ18FVY	Z-diode	17.56..18.35V, Izt=5mA, Zzt=20Ω, 100mW	TFSC	7d	1a	Kec
LP	P6SMB27A	TVS	Vrwm=27V, 17A, 600W(1ms)	DO-214AA	1d	2j	Fag
LP	P6SMBJ16A	TVS	Vbr=16V, 23.1A, 600W(1ms)	DO-214AA	1d	1m,1w	Pjt,Sj
LP	PZU6.2B3A	Z-diode	6.2V±2%, If=200mA, 320mW	SOD-323	5d	1a	Phi
LP	SM6T10CA	TVS	Vrwm=8.55V, Vbr=9.5..10.5V, 41A, 600W(1ms), Bidirectional	DO-214AA	1ba	1j	Ste
LP	SMBG16A	TVS	Vbr=16V, 23.1A, 600W(1ms)	DO-215AA	5d	1k	Vs
LP	SMBJ16A	TVS	Vbr=16V, 23.1A, 600W(1ms)	DO-214AA	1d	1k,1m	Di,Vs
LP	SMF16A	TVS	Vrwm=16V, Vbr=17.8..19.7V, 7.7A, 200W(1ms)	SOD-123FL	7d	1a	Eic
LP	SMF16CA	TVS	Vrwm=16.0V, Vbr=17.80..19.70V, 7.69A, 200W(10/1000μs), Bidirectional	SOD-123FL	7ba	1j	Ers
LP	TV02W160B-G	TVS	Vrwm=16V, Vbr=17.8..19.7V, Ipp=7.69A, 200W(1ms), Bidirectional	SOD-123	5ba	1j	Cmc
LP	TV06B160J-G	TVS	Vrwm=16.0V, Vbr=17.80..19.70V, Ipp=19.67A, 600W(1ms)	DO-214AA	1d	1a	Cmc
LPC	1SMB16CA	TVS	Vrwm=16V, 23.1A, 600W(1ms), Bidirectional	403A	3ba	1e	Ons
LPK	SMB27A	TVS	Vbr=25.7..28.4V, Vrwm=23.1V, 16.0A, 600W(1ms)	DO-214AA	1d	1a	Lge
LPM	SMB27CA	TVS	Vbr=25.7..28.4V, Vrwm=23.1V, 16.0A, 600W(1ms), Bidirectional	DO-214AA	1ba	1j	Lge
PPP	TPSMB27A	TVS	Vbr=27V, 16A, 600W(1ms)	DO-214AA	1d	1k	Vs
LQ	P6SMB30	TVS	Vrwm=30V, 14A, 600W(1ms)	DO-214AA	1d	2j	Fag
LQ	P6SMBJ17	TVS	Vbr=17V, 19.7A, 600W(1ms)	DO-214AA	1d	1m,1w	Pjt,Sj
LQ	SMBG17	TVS	Vbr=17V, 19.7A, 600W(1ms)	DO-215AA	5d	1k	Vs
LQ	SMBJ17	TVS	Vbr=17V, 19.7A, 600W(1ms)	DO-214AA	1d	1k	Vs
LQ	TV06B170K-G	TVS	Vrwm=17.0V, Vbr=18.90..23.10V, Ipp=21.74A, 600W(1ms)	DO-214AA	1d	1a	Cmc
LQK	SMB30	TVS	Vbr=27.0..33.0V, Vrwm=24.3V, 13.8A, 600W(1ms)	DO-214AA	1d	1a	Lge
LQM	SMB30C	TVS	Vbr=27.0..33.0V, Vrwm=24.3V, 13.8A, 600W(1ms), Bidirectional	DO-214AA	1ba	1j	Lge
LQP	TPSMB30	TVS	Vbr=30V, 13.8A, 600W(1ms)	DO-214AA	1d	1k	Vs
LR	1SMB17A	TVS	Vrwm=17V, 21.7A, 600W(1ms)	403A	3d	1s	Ons
LR	CD214B-T17A	TVS	Vbr=17V, Irsm=21.7A, 600W(1ms)	DO-214AA	1d	1a	Bm
LR	P6SMB30A	TVS	Vrwm=30V, 14.4A, 600W(1ms)	DO-214AA	1d	2j	Fag
LR	P6SMBJ17A	TVS	Vbr=17V, 21.7A, 600W(1ms)	DO-214AA	1d	1m,1w	Pjt,Sj
LR	PZU6.8BA	Z-diode	6.8V±5%, If=200mA, 320mW	SOD-323	5d	1a	Phi
LR	SMBG17A	TVS	Vbr=17V, 21.7A, 600W(1ms)	DO-215AA	5d	1k	Vs
LR	SMBJ17A	TVS	Vbr=17V, 21.7A, 600W(1ms)	DO-214AA	1d	1k,1m	Di,Vs
LR	SMF17A	TVS	Vrwm=17V, Vbr=18.9..20.9V, 7.2A, 200W(1ms)	SOD-123FL	7d	1a	Eic
LR	SMF17CA	TVS	Vrwm=17.0V, Vbr=18.90..20.90V, 7.25A, 200W(10/1000μs), Bidirectional	SOD-123FL	7ba	1j	Ers
LR	TV02W170B-G	TVS	Vrwm=17V, Vbr=18.9..20.9V, Ipp=7.25A, 200W(1ms), Bidirectional	SOD-123	5ba	1j	Cmc
LR	TV06B170J-G	TVS	Vrwm=17.0V, Vbr=18.90..20.90V, Ipp=18.63A, 600W(1ms)	DO-214AA	1d	1a	Cmc
LRC	1SMB17CA	TVS	Vrwm=17V, 21.7A, 600W(1ms), Bidirectional	403A	3ba	1e	Ons
LRK	SMB30A	TVS	Vbr=28.5..31.5V, Vrwm=25.6V, 14.4A, 600W(1ms)	DO-214AA	1d	1a	Lge
LRM	SMB30CA	TVS	Vbr=28.5..31.5V, Vrwm=25.6V, 14.4A, 600W(1ms), Bidirectional	DO-214AA	1ba	1j	Lge
LRP	TPSMB30A	TVS	Vbr=30V, 14.5A, 600W(1ms)	DO-214AA	1d	1k	Vs
LS	P6SMB33	TVS	Vrwm=33V, 12.6A, 600W(1ms)	DO-214AA	1d	2j	Fag
LS	P6SMBJ18	TVS	Vbr=18V, 18.6A, 600W(1ms)	DO-214AA	1d	1m,1w	Pjt,Sj
LS	PZU6.8B1A	Z-diode	6.8V±2%, If=200mA, 320mW	SOD-323	5d	1a	Phi
LS	SMBG18	TVS	Vbr=18V, 18.6A, 600W(1ms)	DO-215AA	5d	1k	Vs
LS	SMBJ18	TVS	Vbr=18V, 18.6A, 600W(1ms)	DO-214AA	1d	1k	Vs
LS	TV06B180K-G	TVS	Vrwm=18.0V, Vbr=20.0..24.40V, Ipp=20.55A, 600W(1ms)	DO-214AA	1d	1a	Cmc
LSK	SMB33	TVS	Vbr=29.7..36.3V, Vrwm=26.8V, 12.6A, 600W(1ms)	DO-214AA	1d	1a	Lge
LSM	SMB33C	TVS	Vbr=29.7..36.3V, Vrwm=26.8V, 12.6A, 600W(1ms), Bidirectional	DO-214AA	1ba	1j	Lge
LSP	TPSMB33	TVS	Vbr=33V, 12.6A, 600W(1ms)	DO-214AA	1d	1k	Vs
LT	1SMB18A	TVS	Vrwm=18V, 20.5A, 600W(1ms)	403A	3d	1s	Ons
LT	CD214B-T18A	TVS	Vbr=18V, Irsm=20.5A, 600W(1ms)	DO-214AA	1d	1a	Bm
LT	P6SMB33A	TVS	Vrwm=33V, 13.2A, 600W(1ms)	DO-214AA	1d	2j	Fag
LT	P6SMBJ18A	TVS	Vbr=18V, 20.5A, 600W(1ms)	DO-214AA	1d	1m,1w	Pjt,Sj
LT	PZU6.8B2A	Z-diode	6.8V±2%, If=200mA, 320mW	SOD-323	5d	1a	Phi
LT	SM6T12CA	TVS	Vrwm=10.2V, Vbr=11.4..12.6V, 36A, 600W(1ms), Bidirectional	DO-214AA	1ba	1j	Ste
LT	SMBG18A	TVS	Vbr=18V, 20.5A, 600W(1ms)	DO-215AA	5d	1k	Vs
LT	SMBJ18A	TVS	Vbr=18V, 20.5A, 600W(1ms)	DO-214AA	1d	1k,1m	Di,Vs
LT	SMF18A	TVS	Vrwm=18V, Vbr=20.0..22.1V, 6.8A, 200W(1ms)	SOD-123FL	7d	1a	Eic
LT	SMF18CA	TVS	Vrwm=18.0V, Vbr=20.0..22.10V, 6.85A, 200W(10/1000μs), Bidirectional	SOD-123FL	7ba	1j	Ers
LT	TV02W180B-G	TVS	Vrwm=18V, Vbr=20.0..22.1V, Ipp=6.85A, 200W(1ms), Bidirectional	SOD-123	5ba	1j	Cmc
LT	TV06B180J-G	TVS	Vrwm=18.0V, Vbr=20.0..22.10V, Ipp=17.64A, 600W(1ms)	DO-214AA	1d	1a	Cmc
LT7	SM6T22A	TVS	Vbr=20.9..23.1V, 20A, 600W(1ms)	DO-214AA	1d	1k	Vs
LTC	1SMB18CA	TVS	Vrwm=18V, 20.5A, 600W(1ms), Bidirectional	403A	3ba	1e	Ons
LTK	SMB33A	TVS	Vbr=31.4..34.7V, Vrwm=28.2V, 13.2A, 600W(1ms)	DO-214AA	1d	1a	Lge
LTM	SMB33CA	TVS	Vbr=31.4..34.7V, Vrwm=28.2V, 13.2A, 600W(1ms), Bidirectional	DO-214AA	1ba	1j	Lge
LTP	TPSMB33A	TVS	Vbr=33V, 13.1A, 600W(1ms)	DO-214AA	1d	1k	Vs
LU	P6SMB36	TVS	Vrwm=36V, 11.6A, 600W(1ms)	DO-214AA	1d	2j	Fag



SMD
code

Type

Function

Short description

Case

Pinout St.

Mnf.

SMD code	Type	Function	Short description	Case	Pinout	St.	Mnf.
LU	P6SMBJ20	TVS	Vbr=20V, 16.7A, 600W(1ms)	DO-214AA	1d	1m,1w	Pjt,Srj
LU	PZU6 8B3A	Z-diode	6.8V±2%, If=200mA, 320mW	SOD-323	5d	1a	Phi
LU	SMBG20	TVS	Vbr=20V, 16.8A, 600W(1ms)	DO-215AA	5d	1k	Vs
LU	SMBJ20	TVS	Vbr=20V, 16.8A, 600W(1ms)	DO-214AA	1d	1k	Vs
LU	TV06B200K-G	TVS	Vrwm=20.0V, Vbr=22.20..27.10V, Ipp=19.76A, 600W(1ms)	DO-214AA	1d	1a	Cmc
LUK	SMB36	TVS	Vbr=32.4..39.6V, Vrwm=29.1V, 11.6A, 600W(1ms)	DO-214AA	1d	1a	Lge
LUM	SMB36C	TVS	Vbr=32.4..39.6V, Vrwm=29.1V, 11.6A, 600W(1ms), Bidirectional	DO-214AA	1ba	1j	Lge
LUP	TPSMB36	TVS	Vbr=36V, 11.5A, 600W(1ms)	DO-214AA	1d	1k	Vs
LV	1SMB20A	TVS	Vrwm=20V, 18.5A, 600W(1ms)	403A	3d	1s	Ons
LV	CD214B-T20A	TVS	Vbr=20V, Irlsm=18.5A, 600W(1ms)	DO-214AA	1d	1a	Bm
LV	PZU7.5BA	Z-diode	7.5V±5%, If=200mA, 320mW	SOD-323	5d	1a	Phi
LV	SMBG20A	TVS	Vbr=20V, 18.5A, 600W(1ms)	DO-215AA	5d	1k	Vs
LV	SMBJ20A	TVS	Vbr=20V, 18.5A, 600W(1ms)	DO-214AA	1d	1k,1m	Di,Vs
LV	SMF20A	TVS	Vrwm=20V, Vbr=22.2..24.5V, 6.2A, 200W(1ms)	SOD-123FL	7d	1a	Eic
LV	SMF20CA	TVS	Vrwm=20.0V, Vbr=22.20..24.50V, 6.17A, 200W(10/100µs), Bidirectional	SOD-123FL	7ba	1j	Ers
LV	TV02W200B-G	TVS	Vrwm=20V, Vbr=22.2..24.5V, Ipp=6.17A, 200W(1ms), Bidirectional	SOD-123	5ba	1j	Cmc
LV	TV06B200J-G	TVS	Vrwm=20.0V, Vbr=22.20..24.50V, Ipp=18.52A, 600W(1ms)	DO-214AA	1d	1a	Cmc
LVC	1SMB20CA	TVS	Vrwm=20V, 18.5A, 600W(1ms), Bidirectional	403A	3ba	1e	Ons
LVK	SMB36A	TVS	Vbr=34.2..37.8V, Vrwm=30.8V, 12.0A, 600W(1ms)	DO-214AA	1d	1a	Lge
LVM	SMB36CA	TVS	Vbr=34.2..37.8V, Vrwm=30.8V, 12.0A, 600W(1ms), Bidirectional	DO-214AA	1ba	1j	Lge
LW	P6SMB39	TVS	Vrwm=39V, 10.6A, 600W(1ms)	DO-214AA	1d	2j	Fag
LW	P6SMBJ22	TVS	Vbr=22V, 15.2A, 600W(1ms)	DO-214AA	1d	1m,1w	Pjt,Srj
LW	PZU7.5B1A	Z-diode	7.5V±2%, If=200mA, 320mW	SOD-323	5d	1a	Phi
LW	SM6T15C	TVS	Vbr=15V, 27A, 600W(1ms), Bidirectional	DO-214AA	1ba	1r	Ste
LW	SMBG22	TVS	Vbr=22V, 15.2A, 600W(1ms)	DO-215AA	5d	1k	Vs
LW	SMBJ22	TVS	Vbr=22V, 15.2A, 600W(1ms)	DO-214AA	1d	1k	Vs
LW	TV06B220K-G	TVS	Vrwm=22.0V, Vbr=24.40..29.80V, Ipp=15.23A, 600W(1ms)	DO-214AA	1d	1a	Cmc
LWK	SMB39	TVS	Vbr=35.1..42.9V, Vrwm=31.6V, 10.6A, 600W(1ms)	DO-214AA	1d	1a	Lge
LWM	SMB39C	TVS	Vbr=35.1..42.9V, Vrwm=31.6V, 10.6A, 600W(1ms), Bidirectional	DO-214AA	1ba	1j	Lge
LWP	TPSMB39	TVS	Vbr=39V, 10.6A, 600W(1ms)	DO-214AA	1d	1k	Vs
LX	1SMB22A	TVS	Vrwm=22V, 16.9A, 600W(1ms)	403A	3d	1s	Ons
LX	CD214B-T22A	TVS	Vbr=22V, Irlsm=16.9A, 600W(1ms)	DO-214AA	1d	1a	Bm
LX	P6SMB39A	TVS	Vrwm=39V, 11.2A, 600W(1ms)	DO-214AA	1d	2j	Fag
LX	P6SMBJ22A	TVS	Vbr=22V, 16.9A, 600W(1ms)	DO-214AA	1d	1m,1w	Pjt,Srj
LX	PZU7.5B2A	Z-diode	7.5V±2%, If=200mA, 320mW	SOD-323	5d	1a	Phi
LX	SM6T15CA	TVS	Vrwm=12.8V, Vbr=14.3..15.8V, 28A, 600W(1ms), Bidirectional	DO-214AA	1ba	1j	Ste
LX	SMBG22A	TVS	Vbr=22V, 16.9A, 600W(1ms)	DO-215AA	5d	1k	Vs
LX	SMBJ22A	TVS	Vbr=22V, 16.9A, 600W(1ms)	DO-214AA	1d	1k,1m	Di,Vs
LX	SMF22A	TVS	Vrwm=22V, Vbr=24.4..26.9V, 5.6A, 200W(1ms)	SOD-123FL	7d	1a	Eic
LX	SMF22CA	TVS	Vrwm=22.0V, Vbr=24.40..26.90V, 5.63A, 200W(10/100µs), Bidirectional	SOD-123FL	7ba	1j	Ers
LX	TV02W220B-G	TVS	Vrwm=22.0V, Vbr=24.4..26.9V, Ipp=5.63A, 200W(1ms), Bidirectional	SOD-123	5ba	1j	Cmc
LX	TV06B220J-G	TVS	Vrwm=22.0V, Vbr=24.40..26.90V, Ipp=16.90A, 600W(1ms)	DO-214AA	1d	1a	Cmc
LX7	SM6T27A	TVS	Vbr=25.7..28.4V, 16A, 600W(1ms)	DO-214AA	1d	1k	Vs
LXC	1SMB22CA	TVS	Vrwm=22V, 16.9A, 600W(1ms), Bidirectional	403A	3ba	1e	Ons
LXK	SMB39A	TVS	Vbr=37.1..41.0V, Vrwm=33.3V, 11.2A, 600W(1ms)	DO-214AA	1d	1a	Lge
LXM	SMB39CA	TVS	Vbr=37.1..41.0V, Vrwm=33.3V, 11.2A, 600W(1ms), Bidirectional	DO-214AA	1ba	1j	Lge
LXP	TPSMB39A	TVS	Vbr=39V, 11.1A, 600W(1ms)	DO-214AA	1d	1k	Vs
LY	KDZ5.1VVY	Z-diode	4.98..5.20V, Izt=5mA, Zzt=70Ω, 100mW	VSC	7d	1a	Kec
LY	P6SMB43	TVS	Vrwm=43V, 9.6A, 600W(1ms)	DO-214AA	1d	2j	Fag
LY	P6SMBJ24	TVS	Vbr=24V, 14A, 600W(1ms)	DO-214AA	1d	1m,1w	Pjt,Srj
LY	PZU7.5B3A	Z-diode	7.5V±2%, If=200mA, 320mW	SOD-323	5d	1a	Phi
LY	SMBG24	TVS	Vbr=24V, 14A, 600W(1ms)	DO-215AA	5d	1k	Vs
LY	SMBJ24	TVS	Vbr=24V, 14A, 600W(1ms)	DO-214AA	1d	1k	Vs
LY	TV06B240K-G	TVS	Vrwm=24.0V, Vbr=26.70..32.60V, Ipp=13.95A, 600W(1ms)	DO-214AA	1d	1a	Cmc
LYK	SMB43	TVS	Vbr=38.7..47.3V, Vrwm=34.8V, 9.6A, 600W(1ms)	DO-214AA	1d	1a	Lge
LYM	SMB43C	TVS	Vbr=38.7..47.3V, Vrwm=34.8V, 9.6A, 600W(1ms), Bidirectional	DO-214AA	1ba	1j	Lge
LZP	TPSMB43	TVS	Vbr=43V, 9.7A, 600W(1ms)	DO-214AA	1d	1k	Vs
LZ	1SMB24A	TVS	Vrwm=24V, 15.4A, 600W(1ms)	403A	3d	1s	Ons
LZ	BZT52-B16S	Z-diode	15.68..16.32V, Izt=5mA, Zzt=40Ω, 200mW	SOD-323FL	7d	1a	Tsc
LZ	CD214B-T24A	TVS	Vbr=24V, Irlsm=15.4A, 600W(1ms)	DO-214AA	1d	1a	Bm
LZ	MM3Z16VB	Z-diode	15.68..16.32V, Zzt=37Ω, Izt=5mA, 200mW	SOD-323FL	7d	1a	F
LZ	MM3Z16VBW	Z-diode	15.68..16.32V, Izt=5mA, Zzt=40Ω, 200mW	SOD-323FL	7d	1a	Tac
LZ	P6SMB43A	TVS	Vrwm=43V, 10.1A, 600W(1ms)	DO-214AA	1d	2j	Fag
LZ	P6SMBJ24A	TVS	Vbr=24V, 15.4A, 600W(1ms)	DO-214AA	1d	1m,1w	Pjt,Srj
LZ	PZU8.2BA	Z-diode	8.2V±5%, If=200mA, 320mW	SOD-323	5d	1a	Phi
LZ	SMBG24A	TVS	Vbr=24V, 15.4A, 600W(1ms)	DO-215AA	5d	1k	Vs
LZ	SMBJ24A	TVS	Vbr=24V, 15.4A, 600W(1ms)	DO-214AA	1d	1k,1m	Di,Vs
LZ	SMF24A	TVS	Vrwm=24V, Vbr=26.7..29.5V, 5.1A, 200W(1ms)	SOD-123FL	7d	1a	Eic
LZ	SMF24CA	TVS	Vrwm=24.0V, Vbr=26.70..29.50V, 5.14A, 200W(10/100µs), Bidirectional	SOD-123FL	7ba	1j	Ers
LZ	TCMM3Z16VB	Z-diode	16V±2%, Izt=5mA, Zzt=37Ω, 200mW	SOD-323FL	7d	1a	Tac



SMD
code

Type

Function

Short description

Case

Pinout

St.

Mnf.

LZ	TV02W240B-G	TVS	Vrwm=24V, Vbr=26.7..29.5V, Ipp=5.14A, 200W(1ms), Bidirectional	SOD-123	5ba	1j	Cmc
LZ	TV06B240J-G	TVS	Vrwm=24.0V, Vbr=26.70..29.50V, Ipp=15.42A, 600W(1ms)	DO-214AA	1d	1a	Cmc
LZC	1SMB24CA	TVS	Vrwm=24V, 15.4A, 600W(1ms), Bidirectional	403A	3ba	1e	Ons
LZK	SMB43A	TVS	Vbr=40.9..45.2V, Vrwm=36.8V, 10.1A, 600W(1ms)	DO-214AA	1d	1a	Lge
LZM	SMB43CA	TVS	Vbr=40.9..45.2V, Vrwm=36.8V, 10.1A, 600W(1ms), Bidirectional	DO-214AA	1ba	1j	Lge
LZP	TPSMB43A	TVS	Vbr=43V, 10.1A, 600W(1ms)	DO-214AA	1d	1k	Vs
M	BB837	C-diode	SATV-Tuning, 35V, 6.0.65pF(1..28V)	SOD-323	5d	1a	Sie
m	MMSZ5237BPT	Z-diode	7.790..8.610V, Izt=5mA, Zzt=7Ω, 225mW	SOD-523	7d	1a	Chm
M	MMSZ5262BPT	Z-diode	48.45..53.35V, Izt=2.5mA, Zzt=125Ω, 225mW	SOD-523	7d	1a	Chm
M (blue)	BAR65-03W	PIN-diode	TV-Tuner, 30V, 100mA, Vf<1V(50mA), <0.9pF	SOD-323	5d	2	Inf
M (white)	BB512	C-diode	AM-Tuning, 12V, 50mA, Ir<0.02μA, Cv=440/520pF	SOD-123	5d	2	Sie
m.	MMSZ5237SPT	Z-diode	8.036..8.364V, Izt=5mA, Zzt=7Ω, 225mW	SOD-523	7d	1a	Chm
M.	MMSZ5262SPT	Z-diode	49.98..52.02V, Izt=2.5mA, Zzt=125Ω, 225mW	SOD-523	7d	1a	Chm
M0	BZD27C62P	TVS	Vbr=58V, Vcl=86.5V, 1.7A, 150W(1ms)	SOD123FL	7d	1a	Lge
M0	CMOZ5L6	Z-diode	5.32..5.88V, Izt=0.25mA, Zzt=140Ω, 250mW	SOD-523	6d	1a	Cen
M0	MMPZ5243SPT	Z-diode	12.74..13.26V, Izt=5mA, Zzt=25Ω, 225mW	SOD-323	5d	1a	Chm
M0	MMPZ5269BPT	Z-diode	82.65..91.35V, Izt=1.4mA, Zzt=370Ω, 225mW	SOD-323	5d	1a	Chm
M1	BAP27-01	PIN-diode	RF, 50V, 100mA, 315mW, 0.61pF, 0.95Ω(10mA/100MHz)	SOD-723A	6d	1a	Phi
M1	BZD27C68P	TVS	Vbr=64V, Vcl=94.4V, 1.6A, 150W(1ms)	SOD123FL	7d	1a	Lge
M1	BZX384-B13	Z-diode	13V±2.5%, Izt=5mA, Zzt=10Ω, 200mW	SOD-323	5d	1k	Phi
M1	CMOZ2L4	Z-diode	2.28..2.52V, Izt=0.25mA, Zzt=1400Ω, 250mW	SOD-523	6d	1a	Cen
M1	CZRH5256B-G	Z-diode	28.5..31.5V, Zzt=49Ω, Izt=4.2mA, 150mW	SOD-523	5d	1a	Cmc
M1	CZRV5256B-G	Z-diode	28.5..31.5V, Zzt=49Ω, Izt=4.2mA, 200mW	SOD-323	5d	1a	Cmc
M1	CZRW5256B-G	Z-diode	28.50..31.50V, Zzt=49Ω, Izt=4.2mA, 500mW	SOD-123	5d	1a	Cmc
M1	MM3Z5232B	Z-diode	5.6V±5%, Izt=20mA, Zzt=11Ω, 200mW	SOD-323FL	7d	1a	Bts
M1	MM3Z5232BH	Z-diode	5.32..5.88V, Izt=20mA, Zzt=11Ω, 300mW	SOD-323	5d	1a	Zow
M1	MM3Z5256B	Z-diode	28.50..31.50V, Izt=4.2mA, Zzt=49Ω, 200mW	SOD-323	5d	1a	Ext
M1	MMSZ5256	Z-diode	30V±5%, Zzt=49Ω, 300mW	SOD-123	5d	1k	Vs
M1	MMSZ5256B	Z-diode	30V±5%, Zzt=49Ω, 500mW	SOD-123	5d	1a,1d	Di,Mot
M1	MMSZ5256B	Z-diode	30V±5%, Zzt=49Ω, 500mW	SOD-123	5d	1d	Di
M1	MMSZ5256BS	Z-diode	30V±5%, Zzt=49Ω, 200mW	SOD-323	5d	1d	Di
M11	STPS1H100MF	Si-diode	SBR, 100V, 1A, Vf<0.62V(1A)	DO-222-AA	8d	1a	Ste
M12	1PMT12A	TVS	Vrwm=12V, Vbr=13.3..14.7V, Ipp=8.8A, 175W(1ms)	DO-216AA	4d	1g	Ons
M16	1PMT16A	TVS	Vrwm=16V, Vbr=17.8..19.7V, 7A, 175W(1ms)	DO-216AA	4d	1g	Ons
M18	1PMT18A	TVS	Vrwm=18V, Vbr=20.0..22.1V, 6A, 175W(1ms)	DO-216AA	4d	1g	Ons
M2	BA277-01	PIN-diode	VHF-band-Sw, 35V, 100mA, 715mW, 1.2pF, 0.7Ω(2mA/100MHz)	SOD-723	6d	1a	Phi
M2	BZD27C75P	TVS	Vbr=70V, Vcl=103.5V, 1.5A, 150W(1ms)	SOD123FL	7d	1a	Lge
M2	BZX384-B15	Z-diode	15V±2.5%, Izt=5mA, Zzt=10Ω, 200mW	SOD-323	5d	1k	Phi
M2	CMOZ2L5	Z-diode	2.37..2.63V, Izt=0.25mA, Zzt=1500Ω, 250mW	SOD-523	6d	1a	Cen
M2	CZRH5257B-G	Z-diode	31.35..34.65V, Zzt=58Ω, Izt=3.8mA, 150mW	SOD-523	5d	1a	Cmc
M2	CZRV5257B-G	Z-diode	31.35..34.65V, Zzt=58Ω, Izt=3.8mA, 200mW	SOD-323	5d	1a	Cmc
M2	CZRW5257B-G	Z-diode	31.35..34.65V, Zzt=58Ω, Izt=3.8mA, 500mW	SOD-123	5d	1a	Cmc
M2	MM3Z5254B	Z-diode	27V±5%, Izt=4.6mA, Zzt=41Ω, 200mW	SOD-323FL	7d	1a	Bts
M2	MM3Z5254BH	Z-diode	25.65..28.35V, Izt=4.6mA, Zzt=41Ω, 300mW	SOD-323	5d	1a	Zow
M2	MM3Z5257B	Z-diode	31.35..34.65V, Izt=3.8mA, Zzt=58Ω, 200mW	SOD-323	5d	1a	Ext
M2	MMSZ5257	Z-diode	33V±5%, Zzt=58Ω, 300mW	SOD-123	5d	1k	Vs
M2	MMSZ5257B	Z-diode	33V±5%, Zzt=58Ω, 500mW	SOD-123	5d	1a,1d	Di,Mot
M2	MMSZ5257B	Z-diode	33V±5%, Zzt=58Ω, 500mW	SOD-123	5d	1d	Di
M2	MMSZ5257BS	Z-diode	33V±5%, Zzt=58Ω, 200mW	SOD-323	5d	1d	Di
M22	1PMT22A	TVS	Vrwm=22V, Vbr=24.4..26.9V, 4.9A, 175W(1ms)	DO-216AA	4d	1g	Ons
M24	1PMT24A	TVS	Vrwm=24V, Vbr=26.7..29.5, 4.5A, 175W(1ms)	DO-216AA	4d	1g	Ons
M26	1PMT26A	TVS	Vrwm=26V, Vbr=28.9..31.9V, 4.2A, 175W(1ms)	DO-216AA	4d	1g	Ons
M28	1PMT28A	TVS	Vrwm=28V, Vbr=31.1..34.4V, 3.9A, 175W(1ms)	DO-216AA	4d	1g	Ons
M3	BZD27C82P	TVS	Vbr=77V, Vcl=114V, 1.3A, 150W(1ms)	SOD123FL	7d	1a	Lge
M3	BZX384-B16	Z-diode	16V±2.5%, Izt=5mA, Zzt=10Ω, 200mW	SOD-323	5d	1k	Phi
M3	CMOZ2L7	Z-diode	2.57..2.84V, Izt=0.25mA, Zzt=1500Ω, 250mW	SOD-523	6d	1a	Cen
M3	CZRH5258B-G	Z-diode	34.2..37.8V, Zzt=70Ω, Izt=3.4mA, 150mW	SOD-523	5d	1a	Cmc
M3	CZRV5258B-G	Z-diode	34.2..37.8V, Zzt=70Ω, Izt=3.4mA, 200mW	SOD-323	5d	1a	Cmc
M3	CZRW5258B-G	Z-diode	34.20..37.80V, Zzt=70Ω, Izt=3.4mA, 500mW	SOD-123	5d	1a	Cmc
M3	MM3Z5258B	Z-diode	34.20..37.80V, Izt=3.4mA, Zzt=70Ω, 200mW	SOD-323	5d	1a	Ext
M3	MMSZ5258	Z-diode	36V±5%, Zzt=70Ω, 500mW	SOD-123	5d	1k	Vs
M3	MMSZ5258B	Z-diode	36V±5%, Zzt=70Ω, 500mW	SOD-123	5d	1a,1d	Di,Mot
M3	MMSZ5258B	Z-diode	36V±5%, Zzt=70Ω, 500mW	SOD-123	5d	1d	Di
M3	MMSZ5258BS	Z-diode	36V±5%, Zzt=70Ω, 200mW	SOD-323	5d	1d	Di
M3	RKZ16B2KK	Z-diode	15.85..16.51V, Izt=5mA, Zzt=40Ω, 150mW	SFP	7d	1a	Ren
M3	RKZ16B2KL	Z-diode	15.85..16.51V, Izt=5mA, Zzt=40Ω, 100mW	EPF	7d	1a	Ren
M30	1PMT30A	TVS	Vrwm=30V, Vbr=33.3..36.8V, 3.6A, 175W(1ms)	DO-216AA	4d	1g	Ons
M30	CMOZ3L0	Z-diode	2.85..3.15V, Izt=0.25mA, Zzt=1600Ω, 250mW	SOD-523	6d	1a	Cen
M33	1PMT33A	TVS	Vrwm=33V, Vbr=36.7..40.6V, 3.3A, 175W(1ms)	DO-216AA	4d	1g	Ons
M36	1PMT36A	TVS	Vrwm=36V, Vbr=40.0..44.2V, 3A, 175W(1ms)	DO-216AA	4d	1g	Ons



SMD
code

Type

Function

Short description

Case

Pinout

St.

Mnf.

SMD code	Type	Function	Short description	Case	Pinout	St.	Mnf.
M4	BZD27C91P	TVS	Vbr=85V, Vcl=126V, 1.2A, 150W(1ms)	SOD123FL	7d	1a	Lge
M4	BZX384-B18	Z-diode	18V±2.5%, Izt=5mA, Zzt=10Ω, 200mW	SOD-323	5d	1k	Phi
M4	CMOZ3L3	Z-diode	3.14..3.47V, Izt=0.25mA, Zzt=1600Ω, 250mW	SOD-523	6d	1a	Cen
M4	CZRH5259B-G	Z-diode	37.05..40.95V, Zzt=80Ω, Izt=3.2mA, 150mW	SOD-523	5d	1a	Cmc
M4	CZRV5259B-G	Z-diode	37.05..40.95V, Zzt=80Ω, Izt=3.2mA, 200mW	SOD-323	5d	1a	Cmc
M4	CZRW5259B-G	Z-diode	37.05..40.95V, Zzt=80Ω, Izt=3.2mA, 500mW	SOD-123	5d	1a	Cmc
M4	MM1Z5232B	Z-diode	5.32..5.88V, Izt=20mA, Zzt=11Ω, 500mW	SOD-323FL	5d	1a	Eic
M4	MM1Z5232BH	Z-diode	5.32..5.88V, Izt=20mA, Zzt=11Ω, 500mW	SOD-123	5d	1a	Zow
M4	MM3Z5259B	Z-diode	37.05..40.95V, Izt=3.2mA, Zzt=80Ω, 200mW	SOD-323	5d	1a	Ext
M4	MMSZ5232B	Z-diode	5.6V±5%, Izt=20mA, Zzt=11Ω, 500mW	SOD-123	5d	1a	Eic
M4	MMSZ5259	Z-diode	39V±5%, 300mW	SOD-123	5d	1k	Vs
M4	MMSZ5259B	Z-diode	39V±5%, Zzt=80Ω, 500mW	SOD-123	5d	1a,1d	Di,Mot
M4	MMSZ5259B	Z-diode	39V±5%, Zzt=80Ω, 500mW	SOD-123	5d	1d	Di
M4	MMSZ5259BS	Z-diode	39V±5%, Zzt=80Ω, 200mW	SOD-323	5d	1d	Di
M40	1PMT40A	TVS	Vrwm=40V, Vbr=44.4..49.1V, 2.7A, 175W(1ms)	DO-216AA	4d	1g	Ons
M48	1PMT48A	TVS	Vrwm=48V, Vbr=53.3..58.9V, 2.3A, 175W(1ms)	DO-216AA	4d	1g	Ons
M5	1PMT5.0A	TVS	Vrwm=5V, Vbr=6.4..7.0V, 19A, 175W(1ms)	DO-216AA	4d	1g	Ons
M5	BZD27C100P	TVS	Vbr=94V, Vcl=139V, 1.1A, 150W(1ms)	SOD123FL	7d	1a	Lge
M5	BZX384-B20	Z-diode	20V±2.5%, Izt=5mA, Zzt=15Ω, 200mW	SOD-323	5d	1k	Phi
M5	BZX584B18V	Z-diode	17.64..18.36V, Izt=5mA, Zzt=45Ω, 200mW	SOD-523FL	7d	1a	Tac
M5	CMOZ3L6	Z-diode	3.42..3.78V, Izt=0.25mA, Zzt=1700Ω, 250mW	SOD-523	6d	1a	Cen
M5	CZRH5260B-G	Z-diode	40.85..45.15V, Zzt=93Ω, Izt=3mA, 150mW	SOD-523	5d	1a	Cmc
M5	CZRV5260B-G	Z-diode	40.85..45.15V, Zzt=93Ω, Izt=3mA, 200mW	SOD-323	5d	1a	Cmc
M5	MM1Z5254B	Z-diode	25.65..28.35V, Izt=4.6mA, Zzt=41Ω, 500mW	SOD-323FL	5d	1a	Eic
M5	MM1Z5254BH	Z-diode	25.65..28.35V, Izt=4.6mA, Zzt=41Ω, 500mW	SOD-123	5d	1a	Zow
M5	MM3Z5260B	Z-diode	40.85..45.15V, Izt=3.0mA, Zzt=93Ω, 200mW	SOD-323	5d	1a	Ext
M5	MMSZ18VB	Z-diode	17.64..18.36V, Izt=5mA, Zzt=45Ω, 200mW	SOD-523FL	7d	1a	Tac
M5	MMSZ5254B	Z-diode	27V±5%, Izt=4.6mA, Zzt=41Ω, 500mW	SOD-123	5d	1a	Eic
M5	MMSZ5260	Z-diode	43V±5%, 300mW	SOD-123	5d	1k	Vs
M5	MMSZ5260B	Z-diode	43V±5%, Zzt=93Ω, 500mW	SOD-123	5d	1a	Mot
M51	1PMT51A	TVS	Vrwm=51V, Vbr=56.7..62.7V, 2.1A, 175W(1ms)	DO-216AA	4d	1g	Ons
M58	1PMT58A	TVS	Vrwm=58V, Vbr=64.4..71.2V, 1.9A, 175W(1ms)	DO-216AA	4d	1g	Ons
M6	BZD27C110P	TVS	Vbr=104V, Vcl=139V, 0.72A, 150W(1ms)	SOD123FL	7d	1a	Lge
M6	BZX384-B22	Z-diode	22V±2.5%, Izt=5mA, Zzt=20Ω, 200mW	SOD-323	5d	1k	Phi
M6	CMOZ3L9	Z-diode	3.71..4.10V, Izt=0.25mA, Zzt=1600Ω, 250mW	SOD-523	6d	1a	Cen
M6	RKZ18B2KK	Z-diode	17.56..18.35V, Izt=5mA, Zzt=45Ω, 150mW	SFP	7d	1a	Ren
M6	RKZ18B2KL	Z-diode	17.56..18.35V, Izt=2mA, Zzt=45Ω, 100mW	EPF	7d	1a	Ren
M7	1PMT7.0A	TVS	Vrwm=7.0V, Vbr=7.78..8.6V, 14.6A, 175W(1ms)	DO-216AA	4d	1g	Ons
M7	BZD27C120P	TVS	Vbr=114V, Vcl=152V, 0.65A, 150W(1ms)	SOD123FL	7d	1a	Lge
M7	BZX384-B24	Z-diode	24V±2.5%, Izt=2mA, Zzt=25Ω, 200mW	SOD-323	5d	1k	Phi
M7	CMOZ4L3	Z-diode	4.09..4.52V, Izt=0.25mA, Zzt=1600Ω, 250mW	SOD-523	6d	1a	Cen
M8	BZD27C130P	TVS	Vbr=124V, Vcl=169V, 0.59A, 150W(1ms)	SOD123FL	7d	1a	Lge
M8	BZX384-B27	Z-diode	27V±2.5%, Izt=2mA, Zzt=25Ω, 200mW	SOD-323	5d	1k	Phi
M8	CMOZ4L7	Z-diode	4.47..4.94V, Izt=0.25mA, Zzt=1500Ω, 250mW	SOD-523	6d	1a	Cen
M8	MMSZ8V2	Z-diode	8.2V±5%, Izt=5mA, Zzt=15Ω, 200mW	SOD-523	6d	1a	Eic
M8	MMSZ8V2H	Z-diode	7.7..8.7V, Izt=5mA, Zzt=15Ω, 200mW	SOD-523	7d	1a	Zow
M9	BZD27C150P	TVS	Vbr=136V, Vcl=187V, 0.53A, 150W(1ms)	SOD123FL	7d	1a	Lge
M9	BZX384-B30	Z-diode	30V±2.5%, Izt=2mA, Zzt=30Ω, 200mW	SOD-323	5d	1k	Phi
M9	CMOZ5L1	Z-diode	4.85..5.36V, Izt=0.25mA, Zzt=1500Ω, 250mW	SOD-523	6d	1a	Cen
M9	MM1Z5253B	Z-diode	23.75..26.25V, Izt=5.0mA, Zzt=35Ω, 500mW	SOD-323FL	5d	1a	Eic
M9	MM1Z5253BH	Z-diode	23.75..26.25V, Izt=5.23mA, Zzt=35Ω, 500mW	SOD-123	5d	1a	Zow
M9	MMSZ5253B	Z-diode	25V±5%, Izt=5mA, Zzt=35Ω, 500mW	SOD-123	5d	1a	Eic
M9	RKZ20B2K	Z-diode	19.52..20.39V, Izt=5mA, Zzt=50Ω, 100mW	SFP	7d	1a	Ren
M9	RKZ20B2KL	Z-diode	19.52..20.39V, Izt=2mA, Zzt=50Ω, 150mW	EPF	7d	1a	Ren
MA	1N60PWS	Si-diode	SBD, Sw, 45V, 50mA, Vf<0.45V(50mA), 1pF	SOD-323FL	7d	1a	Sme
MA	S1MA	Si-diode	Rectifier, 1000V, 1A, Vf<1.1V(1A)	DO-214AC	1d	1k	Vs
MB	KDZ5.6B	Z-diode	5.6V±2.5%, 40mA, 1W	PMDU	7d	1s	Rhm
MC	PZU3.6B1A	Z-diode	3.6V±2%, If=200mA, 320mW	SOD-323	5d	1a	Phi
MD	DDZ9707	Z-diode	20V±5%, 500mW	SOD-123	5d	1d	Di
MD	DDZ9707S	Z-diode	20V±5%, 200mW	SOD-323	5d	1d	Di
MD	DDZ9707T	Z-diode	20V±1%, Izt=50μA, 150mW	SOD-523	8d	1a	Di
MD	MURS120	Si-diode	Rectifier, 200V, 1A, Vf<0.71V(1A)	DO-214AA	1d	1k	Vs
MD	MURS320	Si-diode	Rectifier, 200V, 3A, Vf<0.71V(3A)	DO-214AB	1d	1k	Vs
MD	P6SMB47	TVS	Vrwm=47V, 8.9A, 600W(1ms)	DO-214AA	1d	2j	Fag
MD	P6SMBJ26	TVS	Vbr=26V, 12.4A, 600W(1ms)	DO-214AA	1d	1m,1w	Pjt,Srj
MD	PZU3.6B2A	Z-diode	3.6V±2%, If=200mA, 320mW	SOD-323	5d	1a	Phi
MD	SM6T18C	TVS	Vbr=18V, 23A, 600W(1ms), Bidirectional	DO-214AA	1ba	1r	Ste
MD	SMBG26	TVS	Vbr=26V, 12.9A, 600W(1ms)	DO-215AA	5d	1k	Vs
MD	SMBJ26	TVS	Vbr=26V, 12.9A, 600W(1ms)	DO-214AA	1d	1k	Vs
MD	TV06B260K-G	TVS	Vrwm=26.0V, Vbr=28.90..35.30V, Ipp=12.88A, 600W(1ms)	DO-214AA	1d	1a	Cmc



SMD
code

Type

Function

Short description

Case

Pinout

St.

Mnf.

SMD code	Type	Function	Short description	Case	Pinout	St.	Mnf.
MDD	SM15T6V8	TVS	Vbr=6.45..7.14V, 143A, 1500W(1ms)	DO-214AB	1d	1q	Ste
MDE	SM15T6V8A	TVS	Vrwm=5.8V, Vbr=6.45..7.14V, 143A, 1500W(1ms)	DO-214AB	1d	1a	Ste
MDF	SM15T7V5	TVS	Vbr=7.13..7.88V, 132A, 1500W(1ms)	DO-214AB	1d	1q	Ste
MDG	SM15T7V5A	TVS	Vrwm=6.4V, Vbr=7.13..7.88V, 133A, 1500W(1ms)	DO-214AB	1d	1a	Ste
MDK	SMB47	TVS	Vbr=42.3..51.7V, Vrwm=38.1V, 8.85A, 600W(1ms)	DO-214AA	1d	1a	Lge
MDM	SMB47C	TVS	Vbr=42.3..51.7V, Vrwm=38.1V, 8.85A, 600W(1ms), Bidirectional	DO-214AA	1ba	1j	Lge
MDN	SM15T10	TVS	Vbr=9.5..10.5V, 103A, 1500W(1ms)	DO-214AB	1d	1q	Ste
MDS	SM15T10A	TVS	Vrwm=8.55V, Vbr=9.5..10.5V, 103A, 1500W(1ms)	DO-214AB	1d	1a	Ste
MDP	SM15T12	TVS	Vbr=11.4..12.6V, 90A, 1500W(1ms)	DO-214AB	1d	1q	Ste
MDT	SM15T12A	TVS	Vrwm=10.2V, Vbr=11.4..12.6V, 89.8A, 1500W(1ms)	DO-214AB	1d	1a	Ste
MDW	SM15T15	TVS	Vbr=14.3..15.8V, 71A, 1500W(1ms)	DO-214AB	1d	1q	Ste
MDX	SM15T15A	TVS	Vrwm=12.8V, Vbr=14.3..15.8V, 70.8A, 1500W(1ms)	DO-214AB	1d	1q,1a	Ste
ME	1N5818WB	Si-diode	SBR, 30V, 1A, Vf<0.55V(1A), 120pF	SOD-123FL	7d	1a	Sme
ME	1SMB26A	TVS	Vrwm=26V, 14.2A, 600W(1ms)	403A	3d	1s	Ons
ME	CD214B-T26A	TVS	Vbr=26V, Irms=14.2A, 600W(1ms)	DO-214AA	1d	1a	Bm
ME	DDZ9708	Z-diode	22V±5%, 500mW	SOD-123	5d	1d	Di
ME	DDZ9708S	Z-diode	22V±5%, 200mW	SOD-323	5d	1d	Di
ME	DDZ9708T	Z-diode	22V±1%, Izt=50µA, 150mW	SOD-523	8d	1a	Di
ME	P6SMB47A	TVS	Vrwm=47V, 9.3A, 600W(1ms)	DO-214AA	1d	2j	Fag
ME	P6SMBJ26A	TVS	Vbr=26V, 14.2A, 600W(1ms)	DO-214AA	1d	1m,1w	Pjt,Srj
ME	PZU3.9BA	Z-diode	3.9V±5%, If=200mA, 320mW	SOD-323	5d	1a	Phi
ME	SM6T18CA	TVS	Vrwm=15.3V, Vbr=17.1..18.9V, 24A, 600W(1ms), Bidirectional	DO-214AA	1ba	1j	Ste
ME	SMBG26A	TVS	Vbr=26V, 14.3A, 600W(1ms)	DO-215AA	5d	1k	Vs
ME	SMBJ26A	TVS	Vbr=26V, 14.3A, 600W(1ms)	DO-214AA	1d	1k,1m	Di,Vs
ME	SMF26A	TVS	Vrwm=26V, Vbr=28.9..31.9V, 4.8A, 200W(1ms)	SOD-123FL	7d	1a	Eic
ME	SMF26CA	TVS	Vrwm=26.0V, Vbr=28.90..31.90V, 4.75A, 200W(10/1000µs), Bidirectional	SOD-123FL	7ba	1j	Ers
ME	TV02W260B-G	TVS	Vbr=26V, Vbr=28.9..31.9V, Ipp=4.75A, 200W(1ms), Bidirectional	SOD-123	5ba	1j	Cmc
ME	TV06B260J-G	TVS	Vrwm=26.0V, Vbr=28.90..31.90V, Ipp=14.25A, 600W(1ms)	DO-214AA	1d	1a	Cmc
ME7	SM6T30A	TVS	Vbr=28.5..31.5V, 14.5A, 600W(1ms)	DO-214AA	1d	1k	Vs
MEC	1SMB26CA	TVS	Vrwm=26V, 14.2A, 600W(1ms), Bidirectional	403A	3ba	1e	Ons
MED	SM15T18	TVS	Vbr=17.1..18.9V, 59.5A, 1500W(1ms)	DO-214AB	1d	1q	Ste
MEE	SM15T18A	TVS	Vrwm=15.3V, Vbr=17.1..18.9V, 59.5A, 1500W(1ms)	DO-214AB	1d	1q,1a	Ste
MEH	SM15T22	TVS	Vbr=20.9..23.1V, 49A, 1500W(1ms)	DO-214AB	1d	1q	Ste
MEK	SM15T22A	TVS	Vrwm=18.8V, Vbr=20.9..23.1V, 49A, 1500W(1ms)	DO-214AB	1d	1q,1a	Ste
MEK	SMB47A	TVS	Vbr=44.7..49.4V, Vrwm=40.2V, 9.26A, 600W(1ms)	DO-214AA	1d	1a	Lge
MEL	SM15T24	TVS	Vbr=22.8..25.2V, 45A, 1500W(1ms)	DO-214AB	1d	1q	Ste
MEM	SM15T24A	TVS	Vrwm=20.5V, Vbr=22.8..25.2V, 45.2A, 1500W(1ms)	DO-214AB	1d	1q,1a	Ste
MEM	SMB47CA	TVS	Vbr=44.7..49.4V, Vrwm=40.2V, 9.26A, 600W(1ms), Bidirectional	DO-214AA	1ba	1j	Lge
MEN	SM15T27	TVS	Vbr=25.7..28.4V, 40A, 1500W(1ms)	DO-214AB	1d	1q	Ste
MEP	SM15T27A	TVS	Vrwm=23.1V, Vbr=25.7..28.4V, 40A, 1500W(1ms)	DO-214AB	1d	1q,1a	Ste
MEQ	SM15T30	TVS	Vrwm=25.6V, Vbr=28.5..31.5V, 36.2A, 1500W(1ms)	DO-214AB	1d	1q	Ste
MER	SM15T30A	TVS	Vrwm=25.6V, Vbr=28.5..31.5V, 36.2A, 1500W(1ms)	DO-214AB	1d	1a	Ste
MES	SM15T33	TVS	Vrwm=28.2V, Vbr=31.4..34.7V, 32.8A, 1500W(1ms)	DO-214AB	1d	1q	Ste
MET	SM15T33A	TVS	Vrwm=28.2V, Vbr=31.4..34.7V, 32.8A, 1500W(1ms)	DO-214AB	1d	1a	Ste
MEU	SM15T36	TVS	Vbr=34.2..37.8V, 30A, 1500W(1ms)	DO-214AB	1d	1q	Ste
MEV	SM15T36A	TVS	Vrwm=30.8V, Vbr=34.2..37.8V, 30.1A, 1500W(1ms)	DO-214AB	1d	1a	Ste
MEW	SM15T39	TVS	Vbr=37.1..41V, 28A, 1500W(1ms)	DO-214AB	1d	1q	Ste
MEX	SM15T39A	TVS	Vrwm=33.3V, Vbr=37.1..41V, 27.8A, 1500W(1ms)	DO-214AB	1d	1a	Ste
MF	DDZ9709	Z-diode	24V±5%, 500mW	SOD-123	5d	1d	Di
MF	DDZ9709S	Z-diode	24V±5%, 200mW	SOD-323	5d	1d	Di
MF	DDZ9709T	Z-diode	24V±1%, Izt=50µA, 150mW	SOD-523	8d	1a	Di
MF	KDZ20FV	Z-diode	18.80..21.20V, Izt=5mA, Zzt=25Ω, 100mW	TFSC	7d	1a	Kec
MF	MAZD150	Z-diode	13.9..15.6V, Zzt=40Ω(5mA), 120mW	SSSMini2	7d	1a	Pan
MF	MM3Z2V2B	Z-diode	2.08..2.33V, Izt=5mA, Zzt=100Ω, 300mW	SOD-323FL	7d	1a	Lge
MF	P6SMB51	TVS	Vrwm=51V, 8.2A, 600W(1ms)	DO-214AA	1d	2j	Fag
MF	P6SMBJ28	TVS	Vbr=28V, 12A, 600W(1ms)	DO-214AA	1d	1m,1w	Pjt,Srj
MF	PZU3.9B1A	Z-diode	3.9V±2%, If=200mA, 320mW	SOD-323	5d	1a	Phi
MF	SMBG28	TVS	Vbr=28V, 12A, 600W(1ms)	DO-215AA	5d	1k	Vs
MF	SMBJ28	TVS	Vbr=28V, 12A, 600W(1ms)	DO-214AA	1d	1k	Vs
MF	TV06B280K-G	TVS	Vrwm=28.0V, Vbr=31.10..38.0V, Ipp=12.0A, 600W(1ms)	DO-214AA	1d	1a	Cmc
MPK	SMB51	TVS	Vbr=45.9..56.1V, Vrwm=41.3V, 8.16A, 600W(1ms)	DO-214AA	1d	1a	Lge
MPM	SMB45C	TVS	Vbr=45.9..56.1V, Vrwm=41.3V, 8.16A, 600W(1ms), Bidirectional	DO-214AA	1ba	1j	Lge
MPN	SM15T68	TVS	Vbr=64.6..71.4V, 16.3A, 1500W(1ms)	DO-214AB	1d	1q	Ste
MPP	SM15T68A	TVS	Vrwm=58.1V, Vbr=64.6..71.4V, 16.3A, 1500W(1ms)	DO-214AB	1d	1a	Ste
MPW	SM15T100	TVS	Vbr=95..105V, 11A, 1500W(1ms)	DO-214AB	1d	1q	Ste
MPX	SM15T100A	TVS	Vrwm=85.5V, Vbr=95..105V, 11A, 1500W(1ms)	DO-214AB	1d	1q,1a	Ste
MG	1SMB28A	TVS	Vrwm=28V, 13.2A, 600W(1ms)	403A	3d	1s	Ons
MG	CD214B-T28A	TVS	Vbr=28V, Irms=13.2A, 600W(1ms)	DO-214AA	1d	1a	Bm
MG	MURS140	Si-diode	Rectifier, 400V, 1A, Vf<1.05V(1A)	DO-214AA	1d	1k	Vs
MG	MURS240	Si-diode	Rectifier, 400V, 2A, Vf<1.2V(2A)	DO-214AA	1d	1k	Vs



SMD
code

Type

Function

Short description

Case

Pinout

St.

Mnf.

MG	MURS340	Si-diode	Rectifier, 400V, 3A, Vf<1.25V(3A)	DO-214AB	1d	1k	Vs
MG	P6SMB51A	TVS	Vrwm=51V, Vbr=48.5..53.6V, 8.6A, 600W(1ms)	DO-214AA	1d	2j	Fag
MG	P6SMBJ28A	TVS	Vbr=28V, 13.2A, 600W(1ms)	DO-214AA	1d	1m,1w	Pjt,Srj
MG	PZU3.9B2A	Z-diode	3.9V±2%, If=200mA, 320mW	SOD-323	5d	1a	Phi
MG	SMBG28A	TVS	Vbr=28V, 13.2A, 600W(1ms)	DO-215AA	5d	1k	Vs
MG	SMBJ28A	TVS	Vbr=28V, 13.2A, 600W(1ms)	DO-214AA	1d	1k,1m	Di,Vs
MG	SMF28A	TVS	Vrwm=28V, Vbr=31.1..34.4V, 4.4A, 200W(1ms)	SOD-123FL	7d	1a	Eic
MG	SMF28CA	TVS	Vrwm=28.0V, Vbr=31.10..34.40V, 4.41A, 200W(10/1000µs), Bidirectional	SOD-123FL	7ba	1j	Ers
MG	TV02W280B-G	TVS	Vrwm=28V, Vbr=31.1..34.4V, Ipp=4.41A, 200W(1ms), Bidirectional	SOD-123	5ba	1j	Cmc
MG	TV06B280J-G	TVS	Vrwm=28.0V, Vbr=31.10..34.40V, Ipp=13.22A, 600W(1ms)	DO-214AA	1d	1a	Cmc
MG7	SM6T33A	TVS	Vbr=31.4..34.7V, 13.1A, 600W(1ms)	DO-214AA	1d	1k	Vs
MG7	SM6T33CA	TVS	Vbr=31.4..34.7V, 13.1A, 600W(1ms), Bidirectional	DO-214AA	1ba	1l	Vs
MGC	1SMB28CA	TVS	Vrwm=28V, 13.2A, 600W(1ms), Bidirectional	403A	3ba	1e	Ons
MGH	SM15T150	TVS	Vbr=143..158V, 7.2A, 1500W(1ms)	DO-214AB	1d	1q	Ste
MGK	SM15T150A	TVS	Vrwm=128V, Vbr=143..158V, 7.2A, 1500W(1ms)	DO-214AB	1d	1q,1a	Ste
MGK	SMB51A	TVS	Vbr=48.5..53.6V, Vrwm=43.6V, 8.56A, 600W(1ms)	DO-214AA	1d	1a	Lge
MGM	SMB45CA	TVS	Vbr=48.5..53.6V, Vrwm=43.6V, 8.56A, 600W(1ms), Bidirectional	DO-214AA	1ba	1j	Lge
MGU	SM15T200	TVS	Vbr=190..210V, 5.5A, 1500W(1ms)	DO-214AB	1d	1q	Ste
MGV	SM15T200A	TVS	Vrwm=171V, Vbr=190..210V, 5.5A, 1500W(1ms)	DO-214AB	1d	1q,1a	Ste
MGW	SM15T220	TVS	Vbr=209..231V, 4.6A, 1500W(1ms)	DO-214AB	1d	1q	Ste
MGX	SM15T220A	TVS	Vrwm=188V, Vbr=208..231V, 4.6A, 1500W(1ms)	DO-214AB	1d	1q,1a	Ste
MH	DDZ9711	Z-diode	27V±5%, 500mW	SOD-123	5d	1d	Di
MH	DDZ9711S	Z-diode	27V±5%, 200mW	SOD-323	5d	1d	Di
MH	DDZ9711T	Z-diode	27V±1%, Izt=50µA, 150mW	SOD-523	8d	1a	Di
MH	P6SMB56	TVS	Vrwm=56V, Vbr=53.2..58.8V, 7.4A, 600W(1ms)	DO-214AA	1d	2j	Fag
MH	P6SMBJ30	TVS	Vbr=30V, 11.2A, 600W(1ms)	DO-214AA	1d	1m,1w	Pjt,Srj
MH	PZU30BA	Z-diode	30V±5%, If=200mA, 320mW	SOD-323	5d	1a	Phi
MH	SM6T22C	TVS	Vbr=22V, 18A, 600W(1ms), Bidirectional	DO-214AA	1ba	1r	Ste
MH	SMBG30	TVS	Vbr=30V, 11.2A, 600W(1ms)	DO-215AA	5d	1k	Vs
MH	SMBJ30	TVS	Vbr=30V, 11.2A, 600W(1ms)	DO-214AA	1d	1k	Vs
MH	TV06B300K-G	TVS	Vrwm=30.0V, Vbr=33.30..40.70V, Ipp=11.21A, 600W(1ms)	DO-214AA	1d	1a	Cmc
MHK	SMB56	TVS	Vbr=50.4..61.6V, Vrwm=45.4V, 7.45A, 600W(1ms)	DO-214AA	1d	1a	Lge
MHM	SMB56C	TVS	Vbr=50.4..61.6V, Vrwm=45.4V, 7.45A, 600W(1ms), Bidirectional	DO-214AA	1ba	1j	Lge
MJ	DDZ9712	Z-diode	28V±5%, 500mW	SOD-123	5d	1d	Di
MJ	DDZ9712S	Z-diode	28V±5%, 200mW	SOD-323	5d	1d	Di
MJ	DDZ9712T	Z-diode	28V±1%, Izt=50µA, 150mW	SOD-523	8d	1a	Di
MJ	MURS160	Si-diode	Rectifier, 600V, 1A, Vf<1.05V(1A)	DO-214AA	1d	1k	Vs
MJ	MURS260	Si-diode	Rectifier, 600V, 2A, Vf<1.2V(2A)	DO-214AA	1d	1k	Vs
MJ	MURS360	Si-diode	Rectifier, 600V, 3A, Vf<1.25V(3A)	DO-214AB	1d	1k	Vs
MK	1SMB30A	TVS	Vrwm=30V, 12.4A, 600W(1ms)	403A	3d	1s	Ons
MK	CD214B-T30A	TVS	Vbr=30V, Irlsm=12.4A, 600W(1ms)	DO-214AA	1d	1a	Bm
MK	DDZ9713	Z-diode	30V±5%, 500mW	SOD-123	5d	1d	Di
MK	DDZ9713S	Z-diode	30V±5%, 200mW	SOD-323	5d	1d	Di
MK	DDZ9713T	Z-diode	30V±1%, Izt=50µA, 150mW	SOD-523	8d	1a	Di
MK	P6SMB56A	TVS	Vrwm=56V, Vbr=53.2..58.8V, 7.8A, 600W(1ms)	DO-214AA	1d	2j	Fag
MK	P6SMBJ30A	TVS	Vbr=30V, 12.4A, 600W(1ms)	DO-214AA	1d	1m,1w	Pjt,Srj
MK	PZU33BA	Z-diode	33V±5%, If=200mA, 320mW	SOD-323	5d	1a	Phi
MK	SM6T22CA	TVS	Vrwm=18.8V, Vbr=20.9..23.1V, 20A, 600W(1ms), Bidirectional	DO-214AA	1ba	1j	Ste
MK	SMBG30A	TVS	Vbr=30V, 12.4A, 600W(1ms)	DO-215AA	5d	1k	Vs
MK	SMBJ30A	TVS	Vbr=30V, 12.4A, 600W(1ms)	DO-214AA	1d	1k,1m	Di,Vs
MK	SMF30A	TVS	Vrwm=30V, Vbr=33.3..36.8V, 4.1A, 200W(1ms)	SOD-123FL	7d	1a	Eic
MK	SMF30CA	TVS	Vrwm=30.0V, Vbr=33.30..36.80V, 4.13A, 200W(10/1000µs), Bidirectional	SOD-123FL	7ba	1j	Ers
MK	TV02W300B-G	TVS	Vrwm=30V, Vbr=33.3..36.8V, Ipp=4.13A, 200W(1ms), Bidirectional	SOD-123	5ba	1j	Cmc
MK	TV06B300J-G	TVS	Vrwm=30.0V, Vbr=33.30..36.80V, Ipp=12.40A, 600W(1ms)	DO-214AA	1d	1a	Cmc
MK7	SM6T36A	TVS	Vbr=34.2..37.8V, 12A, 600W(1ms)	DO-214AA	1d	1k	Vs
MKC	1SMB30CA	TVS	Vrwm=30V, 12.4A, 600W(1ms), Bidirectional	403A	3ba	1e	Ons
MKE	1PMT5.0A	TVS	Vrwm=5V, Vbr=6.4..7.0V, 19A, 175W(1ms)	DO-216AA	4d	1g	Mot
MKK	SMB56A	TVS	Vbr=53.2..58.8V, Vrwm=47.8V, 7.79A, 600W(1ms)	DO-214AA	1d	1a	Lge
MKM	1PMT7.0A	TVS	Vrwm=7.0V, Vbr=7.78..8.6V, 14.6A, 175W(1ms)	DO-216AA	4d	1g	Mot
MKM	SMB56CA	TVS	Vbr=53.2..58.8V, Vrwm=47.8V, 7.79A, 600W(1ms), Bidirectional	DO-214AA	1ba	1j	Lge
ML	DDZ9714	Z-diode	33V±5%, 500mW	SOD-123	5d	1d	Di
ML	DDZ9714S	Z-diode	33V±5%, 200mW	SOD-323	5d	1d	Di
ML	DDZ9714T	Z-diode	33V±1%, Izt=50µA, 150mW	SOD-523	8d	1a	Di
ML	P6SMB62	TVS	Vrwm=62V, 6.8A, 600W(1ms)	DO-214AA	1d	2j	Fag
ML	P6SMBJ33	TVS	Vbr=33V, 10.2A, 600W(1ms)	DO-214AA	1d	1m,1w	Pjt,Srj
ML	PZU36BA	Z-diode	36V±5%, If=200mA, 320mW	SOD-323	5d	1a	Phi
ML	SM6T24C	TVS	Vbr=24V, 17A, 600W(1ms), Bidirectional	DO-214AA	1ba	1r	Ste
ML	SMBG33	TVS	Vbr=33V, 10.2A, 600W(1ms)	DO-215AA	5d	1k	Vs
ML	SMBJ33	TVS	Vbr=33V, 10.2A, 600W(1ms)	DO-214AA	1d	1k	Vs
ML	TV06B330K-G	TVS	Vrwm=33.0V, Vbr=36.70..44.90V, Ipp=10.17A, 600W(1ms)	DO-214AA	1d	1a	Cmc



SMD
code

Type

Function

Short description

Case

Pinout

St.

Mnf.

SMD code	Type	Function	Short description	Case	Pinout	St.	Mnf.
ML21	ML21PT	Si-diode	Rectifier, 50V, 2A	DO-214AC	1d	1a	Chm
ML22	ML22PT	Si-diode	Rectifier, 100V, 2A	DO-214AC	1d	1a	Chm
ML23	ML23PT	Si-diode	Rectifier, 200V, 2A	DO-214AC	1d	1a	Chm
ML24	ML24PT	Si-diode	Rectifier, 400V, 2A	DO-214AC	1d	1a	Chm
ML25	ML25PT	Si-diode	Rectifier, 600V, 2A	DO-214AC	1d	1a	Chm
ML26	ML26PT	Si-diode	Rectifier, 800V, 2A	DO-214AC	1d	1a	Chm
ML27	ML27PT	Si-diode	Rectifier, 1000V, 2A	DO-214AA	1d	1a	Chm
ML31	MCL31PT	Si-diode	Rectifier, 50V, 3A	DO-214AB	1d	1a	Chm
ML31	ML31PT	Si-diode	Rectifier, 50V, 3A	DO-214AA	1d	1a	Chm
ML32	MCL32PT	Si-diode	Rectifier, 100V, 3A	DO-214AB	1d	1a	Chm
ML32	ML32PT	Si-diode	Rectifier, 100V, 3A	DO-214AA	1d	1a	Chm
ML33	MCL33PT	Si-diode	Rectifier, 200V, 3A	DO-214AB	1d	1a	Chm
ML33	ML33PT	Si-diode	Rectifier, 200V, 3A	DO-214AA	1d	1a	Chm
ML34	MCL34PT	Si-diode	Rectifier, 400V, 3A	DO-214AB	1d	1a	Chm
ML34	ML34PT	Si-diode	Rectifier, 400V, 3A	DO-214AA	1d	1a	Chm
ML35	MCL35PT	Si-diode	Rectifier, 600V, 3A	DO-214AB	1d	1a	Chm
ML35	ML35PT	Si-diode	Rectifier, 600V, 3A	DO-214AA	1d	1a	Chm
ML36	MCL36PT	Si-diode	Rectifier, 800V, 3A	DO-214AB	1d	1a	Chm
ML36	ML36PT	Si-diode	Rectifier, 800V, 3A	DO-214AA	1d	1a	Chm
ML37	MCL37PT	Si-diode	Rectifier, 1000V, 3A	DO-214AB	1d	1a	Chm
ML37	ML37PT	Si-diode	Rectifier, 1000V, 3A	DO-214AA	1d	1a	Chm
ML51	MCL51PT	Si-diode	Rectifier, 50V, 5A	DO-214AB	1d	1a	Chm
ML52	MCL52PT	Si-diode	Rectifier, 100V, 5A	DO-214AB	1d	1a	Chm
ML53	MCL53PT	Si-diode	Rectifier, 200V, 5A	DO-214AB	1d	1a	Chm
ML54	MCL54PT	Si-diode	Rectifier, 400V, 5A	DO-214AB	1d	1a	Chm
ML55	MCL55PT	Si-diode	Rectifier, 600V, 5A	DO-214AB	1d	1a	Chm
ML56	MCL56PT	Si-diode	Rectifier, 800V, 5A	DO-214AB	1d	1a	Chm
ML57	MCL57PT	Si-diode	Rectifier, 1000V, 5A	DO-214AB	1d	1a	Chm
MLE	1PMT12A	TVS	Vrwm=12V, Vbr=13.3..14.7V, Ipp=8.8A, 175W(1ms)	DO-216AA	4d	1g	Mot
MLK	SMB62	TVS	Vbr=55.8..68.2V, Vrwm=50.2V, 6.74A, 600W(1ms)	DO-214AA	1d	1a	Lge
MLM	SMB62C	TVS	Vbr=55.8..68.2V, Vrwm=50.2V, 6.74A, 600W(1ms), Bidirectional	DO-214AA	1ba	1j	Lge
MLP	1PMT16A	TVS	Vrwm=16V, Vbr=17.8..19.7V, 7A, 175W(1ms)	DO-216AA	4d	1g	Mot
MLT	1PMT18A	TVS	Vrwm=18V, Vbr=20.0..22.1V, 6A, 175W(1ms)	DO-216AA	4d	1g	Mot
MLX	1PMT22A	TVS	Vrwm=22V, Vbr=24.4..26.9V, 4.9A, 175W(1ms)	DO-216AA	4d	1g	Mot
MLZ	1PMT24A	TVS	Vrwm=24V, Vbr=26.7..29.5, 4.5A, 175W(1ms)	DO-216AA	4d	1g	Mot
MM	1SMB33A	TVS	Vrwm=33V, 11.3A, 600W(1ms)	403A	3d	1s	Ons
MM	BAR64-02L	PIN-diode	Sw, RF-Att, 150V, 100mA, Vf<1.1V(50mA), < 0.35pF	TSLP-2-1	13d	2b	Inf
MM	CD214B-T33A	TVS	Vbr=33V, Irs=11.3A, 600W(1ms)	DO-214AA	1d	1a	Bm
MM	DDZ9715	Z-diode	36V±5%, 500mW	SOD-123	5d	1d	Di
MM	DDZ9715S	Z-diode	36V±5%, 200mW	SOD-323	5d	1d	Di
MM	DDZ9715T	Z-diode	36V±1%, Izt=50µA, 150mW	SOD-523	8d	1a	Di
MM	P6SMB62A	TVS	Vrwm=62V, 7.1A, 600W(1ms)	DO-214AA	1d	2j	Fag
MM	P6SMBJ33A	TVS	Vbr=33V, 11.3A, 600W(1ms)	DO-214AA	1d	1m,1w	Pjt,Sj
MM	PZU4.3BA	Z-diode	4.3V±5%, If=200mA, 320mW	SOD-323	5d	1a	Phi
MM	SM6T2ACA	TVS	Vrwm=20.5V, Vbr=22.8..25.2V, 18A, 600W(1ms), Bidirectional	DO-214AA	1ba	1j	Ste
MM	SMBG33A	TVS	Vbr=33V, 11.3A, 600W(1ms)	DO-215AA	5d	1k	Vs
MM	SMBJ33A	TVS	Vbr=33V, 11.3A, 600W(1ms)	DO-214AA	1d	1k,1m	Di,Vs
MM	SMBF33A	TVS	Vrwm=33V, Vbr=36.7..40.6V, 3.8A, 200W(1ms)	SOD-123FL	7d	1a	Eic
MM	SMBF33CA	TVS	Vrwm=33.0V, Vbr=36.70..40.60V, 3.75A, 200W(10/100µs), Bidirectional	SOD-123FL	7ba	1j	Ers
MM	TV02W330B-G	TVS	Vrwm=33V, Vbr=36.7..40.6V, Ipp=3.75A, 200W(1ms), Bidirectional	SOD-123	5ba	1j	Cmc
MM	TV06B330J-G	TVS	Vrwm=33.0V, Vbr=36.70..40.60V, Ipp=11.26A, 600W(1ms)	DO-214AA	1d	1a	Cmc
MM7	SM6T39A	TVS	Vrwm=33.3V, Vbr=37.1..41V, 11.1A, 600W(1ms)	DO-214AA	1d	1k	Vs
MMC	1SMB33CA	TVS	Vrwm=33V, 11.3A, 600W(1ms), Bidirectional	403A	3ba	1e	Ons
MME	1PMT26A	TVS	Vrwm=26V, Vbr=28.9..31.9V, 4.2A, 175W(1ms)	DO-216AA	4d	1g	Mot
MMG	1PMT28A	TVS	Vrwm=28V, Vbr=31.1..34.4V, 3.9A, 175W(1ms)	DO-216AA	4d	1g	Mot
MMK	1PMT30A	TVS	Vrwm=30V, Vbr=33.3..36.8V, 3.6A, 175W(1ms)	DO-216AA	4d	1g	Mot
MMK	SMB62A	TVS	Vbr=58.9..65.1V, Vrwm=53.0V, 7.06A, 600W(1ms)	DO-214AA	1d	1a	Lge
MMM	1PMT33A	TVS	Vrwm=33V, Vbr=36.7..40.6V, 3.3A, 175W(1ms)	DO-216AA	4d	1g	Mot
MMM	SMB62CA	TVS	Vbr=58.9..65.1V, Vrwm=53.0V, 7.06A, 600W(1ms), Bidirectional	DO-214AA	1ba	1j	Lge
MMP	1PMT36A	TVS	Vrwm=36V, Vbr=40.0..44.2V, 3A, 175W(1ms)	DO-216AA	4d	1g	Mot
MMR	1PMT40A	TVS	Vrwm=40V, Vbr=44.4..49.1V, 2.7A, 175W(1ms)	DO-216AA	4d	1g	Mot
MMX	1PMT48A	TVS	Vrwm=48V, Vbr=53.3..58.9V, 2.3A, 175W(1ms)	DO-216AA	4d	1g	Mot
MMZ	1PMT51A	TVS	Vrwm=51V, Vbr=56.7..62.7V, 2.1A, 175W(1ms)	DO-216AA	4d	1g	Mot
MN	DDZ9716	Z-diode	39V±5%, 500mW	SOD-123	5d	1d	Di
MN	DDZ9716S	Z-diode	39V±5%, 200mW	SOD-323	5d	1d	Di
MN	DDZ9716T	Z-diode	39V±1%, Izt=50µA, 150mW	SOD-523	8d	1a	Di
MN	P6SMB68	TVS	Vrwm=68V, 6.1A, 600W(1ms)	DO-214AA	1d	2j	Fag
MN	P6SMBJ36	TVS	Vbr=36V, 9.3A, 600W(1ms)	DO-214AA	1d	1m,1w	Pjt,Sj
MN	PZU4.3B1A	Z-diode	4.3V±2%, If=200mA, 320mW	SOD-323	5d	1a	Phi
MN	SM6T27C	TVS	Vbr=27V, 15A, 600W(1ms), Bidirectional	DO-214AA	1ba	1r	Ste



SMD code	Type	Function	Short description	Case	Pinout	St.	Mnf.
MN	SMBG36	TVS	Vbr=36V, 9.3A, 600W(1ms)	DO-215AA	5d	1k	Vs
MN	SMBJ36	TVS	Vbr=36V, 9.3A, 600W(1ms)	DO-214AA	1d	1k	Vs
MN	TV06B360K-G	TVS	Vrwm=36.0V, Vbr=40.0, 48.90V, Ipp=9.33A, 600W(1ms)	DO-214AA	1d	1a	Cmc
MNG	1PMT58A	TVS	Vrwm=58V, Vbr=64.4, 71.2V, 1.9A, 175W(1ms)	DO-216AA	4d	1g	Mot
MNK	SMB68	TVS	Vbr=61.2..74.8V, Vrwm=55.1V, 6.12A, 600W(1ms)	DO-214AA	1d	1a	Lge
MNM	SMB68C	TVS	Vbr=61.2..74.8V, Vrwm=55.1V, 6.12A, 600W(1ms), Bidirectional	DO-214AA	1ba	1j	Lge
MO	DDZ9717	Z-diode	43V±5%, 500mW	SOD-123	5d	1d	Di
MO	DDZ9717T	Z-diode	43V±1%, Izt=50µA, 150mW	SOD-523	8d	1a	Di
MO	DDZX9717	Z-diode	43V±5%, 500mW	SOD-123	5d	1d	Di
MP	1SMB36A	TVS	Vrwm=36V, 10.3A, 600W(1ms)	403A	3d	1s	Ons
MP	CD214B-T36A	TVS	Vbr=36V, Irlsm=10.3A, 600W(1ms)	DO-214AA	1d	1a	Bm
MP	KDZ20FVY	Z-diode	19.52, 20.39V, Izt=5mA, Zzt=25Ω, 100mW	TFSC	7d	1a	Kec
MP	P6SMB68A	TVS	Vrwm=68V, Vbr=64.6, 71.4V, 6.5A, 600W(1ms)	DO-214AA	1d	2j	Fag
MP	P6SMBJ36A	TVS	Vbr=36V, 10.3A, 600W(1ms)	DO-214AA	1d	1m,1w	Pjt,Sjt
MP	PZU4.3B2A	Z-diode	4.3V±2%, If=200mA, 320mW	SOD-323	5d	1a	Phi
MP	SM6T27CA	TVS	Vrwm=23.1V, Vbr=25.7..28.4V, 16A, 600W(1ms), Bidirectional	DO-214AA	1ba	1j	Ste
MP	SMBG36A	TVS	Vbr=36V, 10.3A, 600W(1ms)	DO-215AA	5d	1k	Vs
MP	SMBJ36A	TVS	Vbr=36V, 10.3A, 600W(1ms)	DO-214AA	1d	1k,1m	Di,Vs
MP	SMF36A	TVS	Vrwm=36V, Vbr=40.0, 44.2V, 3.4A, 200W(1ms)	SOD-123FL	7d	1a	Eic
MP	SMF36CA	TVS	Vrwm=36.0V, Vbr=40.0, 44.20V, 3.44A, 200W(10/1000µs), Bidirectional	SOD-123FL	7ba	1j	Ers
MP	TV02W360B-G	TVS	Vrwm=36V, Vbr=40.0, 44.2V, Ipp=3.44A, 200W(1ms), Bidirectional	SOD-123	5ba	1j	Cmc
MP	TV06B360J-G	TVS	Vrwm=36.0V, Vbr=40.0, 44.20V, Ipp=10.33A, 600W(1ms)	DO-214AA	1d	1a	Cmc
MPC	1SMB36CA	TVS	Vrwm=36V, 10.3A, 600W(1ms), Bidirectional	403A	3ba	1e	Ons
MPK	SMB68A	TVS	Vbr=64.6..71.4V, Vrwm=58.1V, 6.52A, 600W(1ms)	DO-214AA	1d	1a	Lge
MPM	SMB68CA	TVS	Vbr=64.6..71.4V, Vrwm=58.1V, 6.52A, 600W(1ms), Bidirectional	DO-214AA	1ba	1j	Lge
MQ	P6SMB75	TVS	Vrwm=75V, 5.5A, 600W(1ms)	DO-214AA	1d	2j	Fag
MQ	P6SMBJ40	TVS	Vbr=40V, 8.4A, 600W(1ms)	DO-214AA	1d	1m,1w	Pjt,Sjt
MQ	SM6T30C	TVS	Vbr=30V, 14.2A, 600W(1ms), Bidirectional	DO-214AA	1ba	1r	Ste
MQ	SMBG40	TVS	Vbr=40V, 8.4A, 600W(1ms)	DO-215AA	5d	1k	Vs
MQ	SMBJ40	TVS	Vbr=40V, 8.4A, 600W(1ms)	DO-214AA	1d	1k	Vs
MQ	TV06B400K-G	TVS	Vrwm=40.0V, Vbr=44.0, 54.30V, Ipp=8.40A, 600W(1ms)	DO-214AA	1d	1a	Cmc
MQK	SMB75	TVS	Vbr=67.5, 82.5V, Vrwm=60.7V, 5.56A, 600W(1ms)	DO-214AA	1d	1a	Lge
MQM	SMB75C	TVS	Vbr=67.5, 82.5V, Vrwm=60.7V, 5.56A, 600W(1ms), Bidirectional	DO-214AA	1ba	1j	Lge
MR	1SMB40A	TVS	Vrwm=40V, 9.3A, 600W(1ms)	403A	3d	1s	Ons
MR	CD214B-T40A	TVS	Vbr=40V, Irlsm=9.3A, 600W(1ms)	DO-214AA	1d	1a	Bm
MR	P6SMB75A	TVS	Vrwm=75V, 5.8A, 600W(1ms)	DO-214AA	1d	2j	Fag
MR	P6SMBJ40A	TVS	Vbr=40V, 9.3A, 600W(1ms)	DO-214AA	1d	1m,1w	Pjt,Sjt
MR	PZU4.3B3A	Z-diode	4.3V±2%, If=200mA, 320mW	SOD-323	5d	1a	Phi
MR	SM6T30CA	TVS	Vrwm=25.6V, Vbr=28.5..31.5V, 14.5A, 600W(1ms), Bidirectional	DO-214AA	1ba	1j	Ste
MR	SMBG40A	TVS	Vbr=40V, 9.3A, 600W(1ms)	DO-215AA	5d	1k	Vs
MR	SMBJ40A	TVS	Vbr=40V, 9.3A, 600W(1ms)	DO-214AA	1d	1k,1m	Di,Vs
MR	SMF40A	TVS	Vrwm=40V, Vbr=44.4, 49.1V, 3.1A, 200W(1ms)	SOD-123FL	7d	1a	Eic
MR	SMF40CA	TVS	Vrwm=40.0V, Vbr=44.0, 49.10V, 3.10A, 200W(10/1000µs), Bidirectional	SOD-123FL	7ba	1j	Ers
MR	TV02W400B-G	TVS	Vrwm=40V, Vbr=44.4, 49.1V, Ipp=3.10A, 200W(1ms), Bidirectional	SOD-123	5ba	1j	Cmc
MR	TV06B400J-G	TVS	Vrwm=40.0V, Vbr=44.0, 49.10V, Ipp=9.30A, 600W(1ms)	DO-214AA	1d	1a	Cmc
MRC	1SMB40CA	TVS	Vrwm=40V, 9.3A, 600W(1ms), Bidirectional	403A	3ba	1e	Ons
MRK	SMB75A	TVS	Vbr=71.3..78.8V, Vrwm=64.1V, 5.83A, 600W(1ms)	DO-214AA	1d	1a	Lge
MRM	SMB75CA	TVS	Vbr=71.3..78.8V, Vrwm=64.1V, 5.83A, 600W(1ms), Bidirectional	DO-214AA	1ba	1j	Lge
MS	P6SMB82	TVS	Vrwm=82V, 5.1A, 600W(1ms)	DO-214AA	1d	2j	Fag
MS	P6SMBJ43	TVS	Vbr=43V, 7.8A, 600W(1ms)	DO-214AA	1d	1m,1w	Pjt,Sjt
MS	PZU4.7BA	Z-diode	4.7V±5%, If=200mA, 320mW	SOD-323	5d	1a	Phi
MS	SM6T33C	TVS	Vbr=33V, 13A, 600W(1ms), Bidirectional	DO-214AA	1ba	1r	Ste
MS	SMBG43	TVS	Vbr=43V, 7.8A, 600W(1ms)	DO-215AA	5d	1k	Vs
MS	SMBJ43	TVS	Vbr=43V, 7.8A, 600W(1ms)	DO-214AA	1d	1k	Vs
MS	TV06B430K-G	TVS	Vrwm=43.0V, Vbr=47.80..58.40V, Ipp=7.82A, 600W(1ms)	DO-214AA	1d	1a	Cmc
MS10	SS2H10	Si-diode	SBR, 100V, 2A, Vf<0.79V(2A)	DO-214AA	1d	1k	Vs
MS10	SS3H10	Si-diode	SBR, 90V, 3A, Vf<0.8V(3A)	DO-214AB	1d	1k	Vs
MS9	SS2H9	Si-diode	SBR, 90V, 2A, Vf<0.79V(2A)	DO-214AA	1d	1k	Vs
MS9	SS3H9	Si-diode	SBR, 100V, 3A, Vf<0.8V(3A)	DO-214AB	1d	1k	Vs
MSK	SMB82	TVS	Vbr=73.8..90.2V, Vrwm=66.4V, 5.08A, 600W(1ms)	DO-214AA	1d	1a	Lge
MSM	SMB82C	TVS	Vbr=73.8..90.2V, Vrwm=66.4V, 5.08A, 600W(1ms), Bidirectional	DO-214AA	1ba	1j	Lge
MT	1SMB43A	TVS	Vrwm=43V, 8.6A, 600W(1ms)	403A	3d	1s	Ons
MT	CD214B-T43A	TVS	Vbr=43V, Irlsm=8.6A, 600W(1ms)	DO-214AA	1d	1a	Bm
MT	P6SMB82A	TVS	Vrwm=82V, 5.3A, 600W(1ms)	DO-214AA	1d	2j	Fag
MT	P6SMBJ43A	TVS	Vbr=43V, 8.6A, 600W(1ms)	DO-214AA	1d	1m,1w	Pjt,Sjt
MT	PZU4.7B1A	Z-diode	4.7V±2%, If=200mA, 320mW	SOD-323	5d	1a	Phi
MT	SM6T33CA	TVS	Vrwm=28.2V, Vbr=31.4..34.7V, 13.1A, 600W(1ms), Bidirectional	DO-214AA	1ba	1j	Ste
MT	SMBG43A	TVS	Vbr=43V, 8.6A, 600W(1ms)	DO-215AA	5d	1k	Vs
MT	SMBJ43A	TVS	Vbr=43V, 8.6A, 600W(1ms)	DO-214AA	1d	1k,1m	Di,Vs
MT	SMF43A	TVS	Vrwm=43V, Vbr=47.8, 52.8V, 2.9A, 200W(1ms)	SOD-123FL	7d	1a	Eic



SMD
code

Type

Function

Short description

Case

Pinout St.

Mnf.

SMD code	Type	Function	Short description	Case	Pinout	St.	Mnf.
MT	SMF43CA	TVS	Vrwm=43.0V, Vbr=47.80..52.80V, 2.88A, 200W(10/1000µs), Bidirectional	SOD-123FL	7ba	1j	Ers
MT	TV02W430B-G	TVS	Vrwm=43V, Vbr=47.8..52.8V, lpp=2.88A, 200W(1ms), Bidirectional	SOD-123	5ba	1j	Cmc
MT	TV06B430J-G	TVS	Vrwm=43.0V, Vbr=47.80..52.80V, lpp=8.65A, 600W(1ms)	DO-214AA	1d	1a	Cmc
MTC	1SMB43CA	TVS	Vrwm=43V, 8.6A, 600W(1ms), Bidirectional	403A	3ba	1e	Ons
MTK	SMB82A	TVS	Vbr=77.8..86.0V, Vrwm=70.1V, 5.31A, 600W(1ms)	DO-214AA	1d	1a	Lge
MTM	SMB82CA	TVS	Vbr=77.8..86.0V, Vrwm=70.1V, 5.31A, 600W(1ms), Bidirectional	DO-214AA	1ba	1j	Lge
MU	P6SMB91	TVS	Vrwm=91V, 4.5A, 600W(1ms)	DO-214AA	1d	2j	Fag
MU	P6SMBJ45	TVS	Vbr=45V, 7.5A, 600W(1ms)	DO-214AA	1d	1m,1w	Pjt,Srj
MU	PZU4.7B2A	Z-diode	4.7V±2%, If=200mA, 320mW	SOD-323	5d	1a	Phi
MU	SM6T36C	TVS	Vbr=36V, 11.8A, 600W(1ms), Bidirectional	DO-214AA	1ba	1r	Ste
MU	SMBG45	TVS	Vbr=45V, 7.5A, 600W(1ms)	DO-215AA	5d	1k	Vs
MU	SMBJ45	TVS	Vbr=45V, 7.5A, 600W(1ms)	DO-214AA	1d	1k	Vs
MU	TV06B450K-G	TVS	Vrwm=45.0V, Vbr=50.0..61.10V, lpp=7.47A, 600W(1ms)	DO-214AA	1d	1a	Cmc
MUA	SM2T6V8A	TVS	Vrwm=5V, 20A, 200W(1ms)	DO-216AA	4d	1q	Ste
MUG	SM2T18A	TVS	Vrwm=16V, 20A, 200W(1ms)	DO-216AA	4d	1q	Ste
MUJ	SM2T27A	TVS	Vrwm=24V, 20A, 200W(1ms)	DO-216AA	4d	1q	Ste
MUK	SMB91	TVS	Vbr=81.9..100V, Vrwm=73.7V, 4.58A, 600W(1ms)	DO-214AA	1d	1a	Lge
MUM	SMB91C	TVS	Vbr=81.9..100V, Vrwm=73.7V, 4.58A, 600W(1ms), Bidirectional	DO-214AA	1ba	1j	Lge
MV	1SMB45A	TVS	Vrwm=45V, 8.3A, 600W(1ms)	403A	3d	1s	Ons
MV	CD214B-T45A	TVS	Vbr=45V, lrrsm=8.3A, 600W(1ms)	DO-214AA	1d	1a	Bm
MV	P6SMB91A	TVS	Vrwm=91V, 4.8A, 600W(1ms)	DO-214AA	1d	2j	Fag
MV	P6SMBJ45A	TVS	Vbr=45V, 8.3A, 600W(1ms)	DO-214AA	1d	1m,1w	Pjt,Srj
MV	PZU4.7B3A	Z-diode	4.7V±2%, If=200mA, 320mW	SOD-323	5d	1a	Phi
MV	SM6T36CA	TVS	Vrwm=30.8V, Vbr=34.2..37.8V, 12A, 600W(1ms), Bidirectional	DO-214AA	1ba	1j	Ste
MV	SMBG45A	TVS	Vbr=45V, 8.3A, 600W(1ms)	DO-215AA	5d	1k	Vs
MV	SMBJ45A	TVS	Vbr=45V, 8.3A, 600W(1ms)	DO-214AA	1d	1k,1m	Di,Vs
MV	SMF45A	TVS	Vrwm=45V, Vbr=50.0..55.3V, 2.8A, 200W(1ms)	SOD-123FL	7d	1a	Eic
MV	SMF45CA	TVS	Vrwm=45.0V, Vbr=50.0..55.30V, 2.75A, 200W(10/1000µs), Bidirectional	SOD-123FL	7ba	1j	Ers
MV	TV02W450B-G	TVS	Vrwm=45V, Vbr=50.0..55.3V, lpp=2.75A, 200W(1ms), Bidirectional	SOD-123	5ba	1j	Cmc
MV	TV06B450J-G	TVS	Vrwm=45.0V, Vbr=50.0..55.30V, lpp=8.25A, 600W(1ms)	DO-214AA	1d	1a	Cmc
MVC	1SMB45CA	TVS	Vrwm=45V, 8.3A, 600W(1ms), Bidirectional	403A	3ba	1e	Ons
MVK	SMB91A	TVS	Vbr=86.5..95.5V, Vrwm=77.8V, 4.80A, 600W(1ms)	DO-214AA	1d	1a	Lge
MVM	SMB91CA	TVS	Vbr=86.5..95.5V, Vrwm=77.8V, 4.80A, 600W(1ms), Bidirectional	DO-214AA	1ba	1j	Lge
MW	P6SMB100	TVS	Vrwm=100V, 4.2A, 600W(1ms)	DO-214AA	1d	2j	Fag
MW	P6SMBJ48	TVS	Vbr=48V, 7A, 600W(1ms)	DO-214AA	1d	1m,1w	Pjt,Srj
MW	PZU5.1B1A	Z-diode	5.1V±5%, If=200mA, 320mW	SOD-323	5d	1a	Phi
MW	SM6T39C	TVS	Vbr=39V, 11A, 600W(1ms), Bidirectional	DO-214AA	1ba	1r	Ste
MW	SMBG48	TVS	Vbr=48V, 7A, 600W(1ms)	DO-215AA	5d	1k	Vs
MW	SMBJ48	TVS	Vbr=48V, 7A, 600W(1ms)	DO-214AA	1d	1k	Vs
MW	TV06B480K-G	TVS	Vrwm=48.0V, Vbr=53.30..65.10V, lpp=7.02A, 600W(1ms)	DO-214AA	1d	1a	Cmc
MWK	SMB100	TVS	Vbr=90.0..110V, Vrwm=81.0V, 4.17A, 600W(1ms)	DO-214AA	1d	1a	Lge
MWM	SMB100C	TVS	Vbr=90.0..110V, Vrwm=81.0V, 4.17A, 600W(1ms), Bidirectional	DO-214AA	1ba	1j	Lge
MX	1SMB48A	TVS	Vrwm=48V, 7.7A, 600W(1ms)	403A	3d	1s	Ons
MX	CD214B-T48A	TVS	Vbr=48V, lrrsm=7.7A, 600W(1ms)	DO-214AA	1d	1a	Bm
MX	P6SMB100A	TVS	Vrwm=100V, 4.4A, 600W(1ms)	DO-214AA	1d	2j	Fag
MX	P6SMBJ48A	TVS	Vbr=48V, 7.7A, 600W(1ms)	DO-214AA	1d	1m,1w	Pjt,Srj
MX	PZU5.1B1A	Z-diode	5.1V±2%, If=200mA, 320mW	SOD-323	5d	1a	Phi
MX	SM6T39CA	TVS	Vrwm=33.3V, Vbr=37.1..41V, 11.1A, 600W(1ms), Bidirectional	DO-214AA	1ba	1j	Ste
MX	SMBG48A	TVS	Vbr=48V, 7.8A, 600W(1ms)	DO-215AA	5d	1k	Vs
MX	SMBJ48A	TVS	Vbr=48V, 7.8A, 600W(1ms)	DO-214AA	1d	1k,1m	Di,Vs
MX	SMF48A	TVS	Vrwm=48V, Vbr=53.3..58.9V, 2.6A, 200W(1ms)	SOD-123FL	7d	1a	Eic
MX	SMF48CA	TVS	Vrwm=48.0V, Vbr=53.30..58.90V, 2.58A, 200W(10/1000µs), Bidirectional	SOD-123FL	7ba	1j	Ers
MX	TV02W480B-G	TVS	Vrwm=48V, Vbr=53.3..58.9V, lpp=2.58A, 200W(1ms), Bidirectional	SOD-123	5ba	1j	Cmc
MX	TV06B480J-G	TVS	Vrwm=48.0V, Vbr=53.30..58.90V, lpp=7.75A, 600W(1ms)	DO-214AA	1d	1a	Cmc
MXC	1SMB48CA	TVS	Vrwm=48V, 7.7A, 600W(1ms), Bidirectional	403A	3ba	1e	Ons
MXK	SMB100A	TVS	Vbr=95.0..105V, Vrwm=85.5V, 4.38A, 600W(1ms)	DO-214AA	1d	1a	Lge
MXM	SMB100CA	TVS	Vbr=95.0..105V, Vrwm=85.5V, 4.38A, 600W(1ms), Bidirectional	DO-214AA	1ba	1j	Lge
MY	KDZ5.6VVY	Z-diode	5.49..5.73V, lzt=5mA, Zzt=40Q, 100mW	V5C	7d	1a	Kec
MY	P6SMB110	TVS	Vrwm=110V, 3.8A, 600W(1ms)	DO-214AA	1d	2j	Fag
MY	P6SMBJ51	TVS	Vbr=51V, 6.6A, 600W(1ms)	DO-214AA	1d	1m,1w	Pjt,Srj
MY	PZU5.1B2A	Z-diode	5.1V±2%, If=200mA, 320mW	SOD-323	5d	1a	Phi
MY	SMBG51	TVS	Vbr=51V, 6.6A, 600W(1ms)	DO-215AA	5d	1k	Vs
MY	SMBJ51	TVS	Vbr=51V, 6.6A, 600W(1ms)	DO-214AA	1d	1k	Vs
MY	TV06B510K-G	TVS	Vrwm=51.0V, Vbr=56.70..69.30V, lpp=6.59A, 600W(1ms)	DO-214AA	1d	1a	Cmc
MYK	SMB110	TVS	Vbr=99.0..121V, Vrwm=89.2V, 3.80A, 600W(1ms)	DO-214AA	1d	1a	Lge
MYM	SMB110C	TVS	Vbr=99.0..121V, Vrwm=89.2V, 3.80A, 600W(1ms), Bidirectional	DO-214AA	1ba	1j	Lge
MZ	1SMB51A	TVS	Vrwm=51V, 7.3A, 600W(1ms)	403A	3d	1s	Ons
MZ	BZT52-B18S	Z-diode	17.64..18.36V, lzt=5mA, Zzt=45Q, 200mW	SOD-323FL	7d	1a	Tsc
MZ	CD214B-T51A	TVS	Vbr=51V, lrrsm=7.3A, 600W(1ms)	DO-214AA	1d	1a	Bm
MZ	MM3Z18VB	Z-diode	17.64..18.36V, Zzt=42Q, lzt=5mA, 200mW	SOD-323FL	7d	1a	F



SMD
code

Type

Function

Short description

Case

Pinout

St.

Mnf.

SMD code	Type	Function	Short description	Case	Pinout	St.	Mnf.
MZ	MM3Z18VBW	Z-diode	17.64..18.36V, Izt=5mA, Zzt=45Ω, 200mW	SOD-323FL	7d	1a	Tac
MZ	P6SMB110A	TVS	Vrwm=110V, 4A, 600W(1ms)	DO-214AA	1d	2j	Fag
MZ	P6SMBJ51A	TVS	Vbr=51V, 7.3A, 600W(1ms)	DO-214AA	1d	1m,1w	Pjt,Sj
MZ	PZU5.1B3A	Z-diode	5.1V±2%, If=200mA, 320mW	SOD-323	5d	1a	Phi
MZ	SMBG51A	TVS	Vbr=51V, 7.3A, 600W(1ms)	DO-215AA	5d	1k	Vs
MZ	SMBJ51A	TVS	Vbr=51V, 7.3A, 600W(1ms)	DO-214AA	1d	1k,1m	Di,Vs
MZ	SMF51A	TVS	Vrwm=51V, Vbr=56.7..62.7V, 2.4A, 200W(1ms)	SOD-123FL	7d	1a	Eic
MZ	SMF51CA	TVS	Vrwm=51.0V, Vbr=56.70..62.70V, 2.43A, 200W(10/1000μs), Bidirectional	SOD-123FL	7ba	1j	Ers
MZ	TCMM3Z18VB	Z-diode	18V±2%, Izt=5mA, Zzt=42Ω, 200mW	SOD-323FL	7d	1a	Tac
MZ	TV02W510B-G	TVS	Vrwm=51V, Vbr=56.7..62.7V, Ipp=2.43A, 200W(1ms), Bidirectional	SOD-123	5ba	1j	Cmc
MZ	TV06B510J-G	TVS	Vrwm=51.0V, Vbr=56.70..62.70V, Ipp=7.28A, 600W(1ms)	DO-214AA	1d	1a	Cmc
MZC	1SMB51CA	TVS	Vrwm=51V, 7.3A, 600W(1ms), Bidirectional	403A	3ba	1e	Ons
MZK	SMB110A	TVS	Vbr=105..116V, Vrwm=94.0V, 3.95A, 600W(1ms)	DO-214AA	1d	1a	Lge
MZM	SMB110CA	TVS	Vbr=105..116V, Vrwm=94.0V, 3.95A, 600W(1ms), Bidirectional	DO-214AA	1ba	1j	Lge
N	BAR65-02V	PIN-diode	TV-Tuner, 30V, 100mA, Vf<1V(50mA), <0.9pF	SOD-523	6d	1a	Inf
n	BAT15-02V	Si-diode	Schottky, DBS-mix, 4V, 100mA, <12GHz, <0.35pF	SOD-523	6d	1a	Inf
N	BB181	C-diode	TV-VHF-Tuning, VCO, 30V, 20mA, 0.7..8pF(1.28V)	SOD-523	6d	1a	Phi
N	CDZ12B	Z-diode	12V±2.5%, Izt=20mA, 1W	VMN	7d	1s	Rhm
N	CH651S-40PT	Si-diode	SBD, 40V, 750mA, Vf<0.7V(750mA)	SOD-523	8d	1a	Chm
N	HVU316	C-diode	BS/CS Tuning, 30V, 5.16..0.78pF(1.25V)	SOD-123	5d	1a	Ren
N	MA2S357	C-diode	CATV, 34V, 58/3.5pF(0/17V), 0.54Ω(470MHz)	SOD-523	6d	1a	Pan
N	MAZS047	Z-diode	4.4..5V, 200mW	SOD-523	6d	1a	Pan
n	MMSZ5234BPT	Z-diode	5.890..6.510V, Izt=5mA, Zzt=10Ω, 225mW	SOD-523	7d	1a	Chm
N	MMSZ5263BPT	Z-diode	53.20..58.80V, Izt=2.2mA, Zzt=150Ω, 225mW	SOD-523	7d	1a	Chm
N-	MAZS0470GM	Z-diode	4.45..4.83V, Zzt=80Ω(5mA), 150mW	SSMini2	7d	1a	Pan
N-	MAZS0470M	Z-diode	4.59..4.83V, 200mW	SOD-523	6d	1a	Pan
n.	MMSZ5234SPT	Z-diode	6.070..6.324V, Izt=5mA, Zzt=10Ω, 225mW	SOD-523	7d	1a	Chm
N.	MMSZ5263SPT	Z-diode	54.88..57.12V, Izt=2.2mA, Zzt=150Ω, 225mW	SOD-523	7d	1a	Chm
N*	MAZS0470H	Z-diode	4.74..4.99V, 200mW	SOD-523	6d	1a	Pan
N_	MAZS0470GL	Z-diode	4.45..4.83V, Zzt=80Ω(5mA), 150mW	SSMini2	7d	1a	Pan
N_	MAZS0470L	Z-diode	4.45..4.69V, 200mW	SOD-523	6d	1a	Pan
N0	BZX384-B33	Z-diode	33V±2.5%, Izt=2mA, Zzt=35Ω, 200mW	SOD-323	5d	1k	Phi
N0	CMOZ15L	Z-diode	14.25..15.75V, Izt=0.25mA, Zzt=100Ω, 250mW	SOD-523	6d	1a	Cen
N0	MMPZ5244SPT	Z-diode	13.72..14.28V, Izt=5mA, Zzt=25Ω, 225mW	SOD-323	5d	1a	Chm
N0	MMPZ5270BPT	Z-diode	86.45..95.55V, Izt=1.4mA, Zzt=400Ω, 225mW	SOD-323	5d	1a	Chm
N010	STBN10	TVS	Vbr=9.0..11.0V, Vrwm=8.10V, 100A, 1500W(1ms), Bidirectional	DO-214AB	1ba	1j	Eic
N010	STUN10	TVS	Vbr=9.0..11.0V, Vrwm=8.10V, 100A, 1500W(1ms)	DO-214AB	1d	1a	Eic
N011	STBN011	TVS	Vbr=9.90..12.1V, Vrwm=8.92V, 93.0A, 1500W(1ms), Bidirectional	DO-214AB	1ba	1j	Eic
N011	STUN011	TVS	Vbr=9.90..12.1V, Vrwm=8.92V, 93.0A, 1500W(1ms)	DO-214AB	1d	1a	Eic
N012	STBN012	TVS	Vbr=10.8..13.2V, Vrwm=9.72V, 87.0A, 1500W(1ms), Bidirectional	DO-214AB	1ba	1j	Eic
N012	STUN012	TVS	Vbr=10.8..13.2V, Vrwm=9.72V, 87.0A, 1500W(1ms)	DO-214AB	1d	1a	Eic
N013	STBN013	TVS	Vbr=11.7..14.3V, Vrwm=10.5V, 79.0A, 1500W(1ms), Bidirectional	DO-214AB	1ba	1j	Eic
N013	STUN013	TVS	Vbr=11.7..14.3V, Vrwm=10.5V, 79.0A, 1500W(1ms)	DO-214AB	1d	1a	Eic
N015	STBN015	TVS	Vbr=13.5..16.5V, Vrwm=12.1V, 68.0A, 1500W(1ms), Bidirectional	DO-214AB	1ba	1j	Eic
N015	STUN015	TVS	Vbr=13.5..16.5V, Vrwm=12.1V, 68.0A, 1500W(1ms)	DO-214AB	1d	1a	Eic
N016	STBN016	TVS	Vbr=14.4..17.6V, Vrwm=12.9V, 64.0A, 1500W(1ms), Bidirectional	DO-214AB	1ba	1j	Eic
N016	STUN016	TVS	Vbr=14.4..17.6V, Vrwm=12.9V, 64.0A, 1500W(1ms)	DO-214AB	1d	1a	Eic
N018	STBN018	TVS	Vbr=16.2..19.8V, Vrwm=14.5V, 56.5A, 1500W(1ms), Bidirectional	DO-214AB	1ba	1j	Eic
N018	STUN018	TVS	Vbr=16.2..19.8V, Vrwm=14.5V, 56.5A, 1500W(1ms)	DO-214AB	1d	1a	Eic
N020	STBN020	TVS	Vbr=18.0..22.0V, Vrwm=16.2V, 51.5A, 1500W(1ms), Bidirectional	DO-214AB	1ba	1j	Eic
N020	STUN020	TVS	Vbr=18.0..22.0V, Vrwm=16.2V, 51.5A, 1500W(1ms)	DO-214AB	1d	1a	Eic
N022	STBN022	TVS	Vbr=19.8..24.2V, Vrwm=17.8V, 47.0A, 1500W(1ms), Bidirectional	DO-214AB	1ba	1j	Eic
N022	STUN022	TVS	Vbr=19.8..24.2V, Vrwm=17.8V, 47.0A, 1500W(1ms)	DO-214AB	1d	1a	Eic
N024	STBN024	TVS	Vbr=21.6..26.4V, Vrwm=19.4V, 43.0A, 1500W(1ms), Bidirectional	DO-214AB	1ba	1j	Eic
N024	STUN024	TVS	Vbr=21.6..26.4V, Vrwm=19.4V, 43.0A, 1500W(1ms)	DO-214AB	1d	1a	Eic
N027	STBN027	TVS	Vbr=24.3..29.7V, Vrwm=21.8V, 38.5A, 1500W(1ms), Bidirectional	DO-214AB	1ba	1j	Eic
N027	STUN027	TVS	Vbr=24.3..29.7V, Vrwm=21.8V, 38.5A, 1500W(1ms)	DO-214AB	1d	1a	Eic
N030	STBN030	TVS	Vbr=27.0..33.0V, Vrwm=24.3V, 34.5A, 1500W(1ms), Bidirectional	DO-214AB	1ba	1j	Eic
N030	STUN030	TVS	Vbr=27.0..33.0V, Vrwm=24.3V, 34.5A, 1500W(1ms)	DO-214AB	1d	1a	Eic
N033	STBN033	TVS	Vbr=29.7..36.3V, Vrwm=26.8V, 31.5A, 1500W(1ms), Bidirectional	DO-214AB	1ba	1j	Eic
N033	STUN033	TVS	Vbr=29.7..36.3V, Vrwm=26.8V, 31.5A, 1500W(1ms)	DO-214AB	1d	1a	Eic
N036	STBN036	TVS	Vbr=32.4..39.6V, Vrwm=29.1V, 29.0A, 1500W(1ms), Bidirectional	DO-214AB	1ba	1j	Eic
N036	STUN036	TVS	Vbr=32.4..39.6V, Vrwm=29.1V, 29.0A, 1500W(1ms)	DO-214AB	1d	1a	Eic
N039	STBN039	TVS	Vbr=35.1..42.9V, Vrwm=31.6V, 26.5A, 1500W(1ms), Bidirectional	DO-214AB	1ba	1j	Eic
N039	STUN039	TVS	Vbr=35.1..42.9V, Vrwm=31.6V, 26.5A, 1500W(1ms)	DO-214AB	1d	1a	Eic
N043	STBN043	TVS	Vbr=38.7..47.3V, Vrwm=34.8V, 24.0A, 1500W(1ms), Bidirectional	DO-214AB	1ba	1j	Eic
N043	STUN043	TVS	Vbr=38.7..47.3V, Vrwm=34.8V, 24.0A, 1500W(1ms)	DO-214AB	1d	1a	Eic
N047	STBN047	TVS	Vbr=42.3..51.7V, Vrwm=36.1V, 22.2A, 1500W(1ms), Bidirectional	DO-214AB	1ba	1j	Eic
N047	STUN047	TVS	Vbr=42.3..51.7V, Vrwm=36.1V, 22.2A, 1500W(1ms)	DO-214AB	1d	1a	Eic
N051	STBN051	TVS	Vbr=45.9..56.1V, Vrwm=41.3V, 20.4A, 1500W(1ms), Bidirectional	DO-214AB	1ba	1j	Eic



SMD
code

Type

Function

Short description

Case

Pinout

St.

Mnf.

SMD code	Type	Function	Short description	Case	Pinout	St.	Mnf.
N051	STUN051	TVS	Vbr=45.9..56.1V, Vrwm=41.3V, 20.4A, 1500W(1ms)	DO-214AB	1d	1a	Eic
N056	STBN056	TVS	Vbr=50.4..61.6V, Vrwm=45.4V, 18.6A, 1500W(1ms), Bidirectional	DO-214AB	1ba	1j	Eic
N056	STUN056	TVS	Vbr=50.4..61.6V, Vrwm=45.4V, 18.6A, 1500W(1ms)	DO-214AB	1d	1a	Eic
N062	STBN062	TVS	Vbr=55.8..68.2V, Vrwm=50.2V, 1S.9A, 1500W(1ms), Bidirectional	DO-214AB	1ba	1j	Eic
N062	STUN062	TVS	Vbr=55.8..68.2V, Vrwm=50.2V, 1S.9A, 1500W(1ms)	DO-214AB	1d	1a	Eic
N068	STBN068	TVS	Vbr=61.2..74.8V, Vrwm=55.1V, 15.3A, 1500W(1ms), Bidirectional	DO-214AB	1ba	1j	Eic
N068	STUN068	TVS	Vbr=61.2..74.8V, Vrwm=55.1V, 15.3A, 1500W(1ms)	DO-214AB	1d	1a	Eic
N061	STBN061	TVS	Vbr=6.12..7.48V, Vrwm=5.50V, 139A, 1500W(1ms), Bidirectional	DO-214AB	1ba	1j	Eic
N061	STUN061	TVS	Vbr=6.12..7.48V, Vrwm=5.50V, 139A, 1500W(1ms)	DO-214AB	1d	1a	Eic
N075	STBN075	TVS	Vbr=67.5..82.5V, Vrwm=60.7V, 13.9A, 1500W(1ms), Bidirectional	DO-214AB	1ba	1j	Eic
N075	STUN075	TVS	Vbr=67.5..82.5V, Vrwm=60.7V, 13.9A, 1500W(1ms)	DO-214AB	1d	1a	Eic
N07F	STBN07F	TVS	Vbr=6.75..8.25V, Vrwm=6.05V, 128A, 1500W(1ms), Bidirectional	DO-214AB	1ba	1j	Eic
N07F	STUN07F	TVS	Vbr=6.75..8.25V, Vrwm=6.05V, 128A, 1500W(1ms)	DO-214AB	1d	1a	Eic
N082	STBN082	TVS	Vbr=73.8..90.2V, Vrwm=66.4V, 12.7A, 1500W(1ms), Bidirectional	DO-214AB	1ba	1j	Eic
N082	STUN082	TVS	Vbr=73.8..90.2V, Vrwm=66.4V, 12.7A, 1500W(1ms)	DO-214AB	1d	1a	Eic
N08C	STBN08C	TVS	Vbr=7.38..9.02V, Vrwm=6.63V, 120A, 1500W(1ms), Bidirectional	DO-214AB	1ba	1j	Eic
N08C	STUN08C	TVS	Vbr=7.38..9.02V, Vrwm=6.63V, 120A, 1500W(1ms)	DO-214AB	1d	1a	Eic
N091	STBN091	TVS	Vbr=81.9..100V, Vrwm=73.7V, 11.4A, 1500W(1ms), Bidirectional	DO-214AB	1ba	1j	Eic
N091	STUN091	TVS	Vbr=81.9..100V, Vrwm=73.7V, 11.4A, 1500W(1ms)	DO-214AB	1d	1a	Eic
N09B	STBN09B	TVS	Vbr=8.19..10.0V, Vrwm=7.37V, 109A, 1500W(1ms), Bidirectional	DO-214AB	1ba	1j	Eic
N09B	STUN09B	TVS	Vbr=8.19..10.0V, Vrwm=7.37V, 109A, 1500W(1ms)	DO-214AB	1d	1a	Eic
N0B0	STBN0B0	TVS	Vbr=90.0..110V, Vrwm=81.0V, 10.4A, 1500W(1ms), Bidirectional	DO-214AB	1ba	1j	Eic
N0B0	STUN0B0	TVS	Vbr=90.0..110V, Vrwm=81.0V, 10.4A, 1500W(1ms)	DO-214AB	1d	1a	Eic
N0B1	STBN0B1	TVS	Vbr=99.0..121V, Vrwm=8S.2V, 9.5A, 1500W(1ms), Bidirectional	DO-214AB	1ba	1j	Eic
N0B1	STUN0B1	TVS	Vbr=99.0..121V, Vrwm=8S.2V, 9.5A, 1500W(1ms)	DO-214AB	1d	1a	Eic
N0B2	STBN0B2	TVS	Vbr=108..132V, Vrwm=97.2V, 8.7A, 1500W(1ms), Bidirectional	DO-214AB	1ba	1j	Eic
N0B2	STUN0B2	TVS	Vbr=108..132V, Vrwm=97.2V, 8.7A, 1500W(1ms)	DO-214AB	1d	1a	Eic
N0B3	STBN0B3	TVS	Vbr=117..143V, Vrwm=105V, 8.0A, 1500W(1ms), Bidirectional	DO-214AB	1ba	1j	Eic
N0B3	STUN0B3	TVS	Vbr=117..143V, Vrwm=105V, 8.0A, 1500W(1ms)	DO-214AB	1d	1a	Eic
N0B5	STBN0B5	TVS	Vbr=135..165V, Vrwm=121V, 7.0A, 1500W(1ms), Bidirectional	DO-214AB	1ba	1j	Eic
N0B5	STUN0B5	TVS	Vbr=135..165V, Vrwm=121V, 7.0A, 1500W(1ms)	DO-214AB	1d	1a	Eic
N0B6	STBN0B6	TVS	Vbr=144..176V, Vrwm=130V, 6.5A, 1500W(1ms), Bidirectional	DO-214AB	1ba	1j	Eic
N0B6	STUN0B6	TVS	Vbr=144..176V, Vrwm=130V, 6.5A, 1500W(1ms)	DO-214AB	1d	1a	Eic
N0B7	STBN0B7	TVS	Vbr=153..187V, Vrwm=138V, 6.2A, 1500W(1ms), Bidirectional	DO-214AB	1ba	1j	Eic
N0B7	STUN0B7	TVS	Vbr=153..187V, Vrwm=138V, 6.2A, 1500W(1ms)	DO-214AB	1d	1a	Eic
N0B8	STBN0B8	TVS	Vbr=162..198V, Vrwm=146V, 5.8A, 1500W(1ms), Bidirectional	DO-214AB	1ba	1j	Eic
N0B8	STUN0B8	TVS	Vbr=162..198V, Vrwm=146V, 5.8A, 1500W(1ms)	DO-214AB	1d	1a	Eic
N0D0	STBN0D0	TVS	Vbr=180..220V, Vrwm=162V, 5.2A, 1500W(1ms), Bidirectional	DO-214AB	1ba	1j	Eic
N0D0	STUN0D0	TVS	Vbr=180..220V, Vrwm=162V, 5.2A, 1500W(1ms)	DO-214AB	1d	1a	Eic
N1	BZD27C160P	TVS	Vbr=153V, Vcl=205V, 0.48A, 150W(1ms)	SOD123FL	7d	1a	Lge
N1	BZX384-B36	Z-diode	36V±2.5%, Izt=2mA, Zzt=35Ω, 200mW	SOD-323	5d	1k	Phi
N1	CMOZ6L2	Z-diode	5.89..6.51V, Izt=0.25mA, Zzt=1200Ω, 250mW	SOD-523	6d	1a	Cen
N1	CZRHS261B-G	Z-diode	44.65..49.35V, Zzt=105Ω, Izt=2.7mA, 150mW	SOD-523	5d	1a	Cmc
N1	CZRV5261B-G	Z-diode	44.65..49.35V, Zzt=105Ω, Izt=2.7mA, 200mW	SOD-323	5d	1a	Cmc
N1	MM3Z5234B	Z-diode	6.2V±5%, Izt=20mA, Zzt=7Ω, 200mW	SOD-323FL	7d	1a	Bts
N1	MM3Z5234BH	Z-diode	5.89..6.51V, Izt=20mA, Zzt=7Ω, 300mW	SOD-323	5d	1a	Zow
N1	MM3Z5261B	Z-diode	44.65..49.35V, Izt=2.7mA, Zzt=105Ω, 200mW	SOD-323	5d	1a	Ext
N1	MMSZ5261	Z-diode	47V±5%, 300mW	SOD-123	5d	1k	Vs
N1	MMSZ5261B	Z-diode	47V±5%, Zzt=105Ω, 500mW	SOD-123	5d	1a	Mot
N1	PESD3V3S1UB	ESDP-diode	Vbr=3.3V, 18A, 330W(8/20 ms)	SOD-523	6d	1a	Phi
N10A	1KSMBJ6.8	TVS	Vbr=6.12..7.48V, 92.5A, 1000W(1ms)	DO-214AA	1d	1n	Lif
N10B	1KSMBJ6.8A	TVS	Vbr=6.45..7.14V, 95A, 1000W(1ms)	DO-214AA	1d	1n	Lif
N10C	1KSMBJ7.5	TVS	Vbr=6.75..8.25V, 85A, 1000W(1ms)	DO-214AA	1d	1n	Lif
N10D	1KSMBJ7.5A	TVS	Vbr=7.13..7.88V, 88.3A, 1000W(1ms)	DO-214AA	1d	1n	Lif
N10E	1KSMBJ8.2	TVS	Vbr=7.38..9.02V, 80A, 1000W(1ms)	DO-214AA	1d	1n	Lif
N10F	1KSMBJ8.2A	TVS	Vbr=7.79..8.61V, 83.3A, 1000W(1ms)	DO-214AA	1d	1n	Lif
N10G	1KSMBJ9.1	TVS	Vbr=8.19..10V, 73.3A, 1000W(1ms)	DO-214AA	1d	1n	Lif
N10H	1KSMBJ9.1A	TVS	Vbr=8.65..9.55V, 75A, 1000W(1ms)	DO-214AA	1d	1n	Lif
N10I	1KSMBJ10	TVS	Vbr=9..11V, 66.7A, 1000W(1ms)	DO-214AA	1d	1n	Lif
N10J	1KSMBJ10A	TVS	Vbr=9.5..10.5V, 68.3A, 1000W(1ms)	DO-214AA	1d	1n	Lif
N10K	1KSMBJ11	TVS	Vbr=9.9..12.1V, 61.7A, 1000W(1ms)	DO-214AA	1d	1n	Lif
N10L	1KSMBJ11A	TVS	Vbr=10.5..11.6V, 63.3A, 1000W(1ms)	DO-214AA	1d	1n	Lif
N10M	1KSMBJ12	TVS	Vbr=10.8..13.2V, 58.3A, 1000W(1ms)	DO-214AA	1d	1n	Lif
N10N	1KSMBJ12A	TVS	Vbr=11.4..12.6V, 60A, 1000W(1ms)	DO-214AA	1d	1n	Lif
N10O	1KSMBJ13	TVS	Vbr=11.7..14.3V, 53.3A, 1000W(1ms)	DO-214AA	1d	1n	Lif
N10P	1KSMBJ13A	TVS	Vbr=12.4..13.7V, 55A, 1000W(1ms)	DO-214AA	1d	1n	Lif
N10Q	1KSMBJ15	TVS	Vbr=13.5..16.5V, 45A, 1000W(1ms)	DO-214AA	1d	1n	Lif
N10R	1KSMBJ15A	TVS	Vbr=14.3..15.8V, 46.7A, 1000W(1ms)	DO-214AA	1d	1n	Lif
N10S	1KSMBJ16	TVS	Vbr=14.4..17.6V, 43.3A, 1000W(1ms)	DO-214AA	1d	1n	Lif
N10T	1KSMBJ16A	TVS	Vbr=15.2..16.8V, 45A, 1000W(1ms)	DO-214AA	1d	1n	Lif



SMD code	Type	Function	Short description	Case	Pinout	St.	Mnf.
N10U	1KSMBJ18	TVS	Vbr=16.2..19.8V, 38A, 1000W(1ms)	DO-214AA	1d	1n	Lif
N10V	1KSMBJ18A	TVS	Vbr=17.1..18.9V, 40A, 1000W(1ms)	DO-214AA	1d	1n	Lif
N10X	1KSMBJ20A	TVS	Vbr=19.21V, 36.7A, 1000W(1ms)	DO-214AA	1d	1n	Lif
N10Y	1KSMBJ22	TVS	Vbr=19.8..24.2V, 31.7A, 1000W(1ms)	DO-214AA	1d	1n	Lif
N10Y*	1KSMBJ20	TVS	Vbr=18..22V, 35A, 1000W(1ms)	DO-214AA	1d	1n	Lif
N10Z	1KSMBJ22A	TVS	Vbr=20.9..23.1V, 33.3A, 1000W(1ms)	DO-214AA	1d	1n	Lif
N2	BZD27C180P	TVS	Vbr=168V, Vcl=229V, 0.43A, 150W(1ms)	SOD123FL	7d	1a	Lge
N2	BZX384-B39	Z-diode	39V±2.5%, Izt=2mA, Zzt=40Ω, 200mW	SOD-323	5d	1k	Phi
N2	CMOZ6L8	Z-diode	6.46..7.14V, Izt=0.25mA, Zzt=200Ω, 250mW	SOD-523	6d	1a	Cen
N2	CZRH5262B-G	Z-diode	48.45..53.55V, Zzt=125Ω, Izt=2.5mA, 150mW	SOD-523	5d	1a	Cmc
N2	CZRV5262B-G	Z-diode	48.45..53.55V, Zzt=125Ω, Izt=2.5mA, 200mW	SOD-323	5d	1a	Cmc
N2	MM3Z5256B	Z-diode	30V±5%, Izt=4.2mA, Zzt=49Ω, 200mW	SOD-323FL	7d	1a	Bts
N2	MM3Z5256BH	Z-diode	28.5..31.5V, Izt=4.2mA, Zzt=49Ω, 300mW	SOD-323	5d	1a	Zow
N2	MM3Z5262B	Z-diode	48.45..53.55V, Izt=2.5mA, Zzt=125Ω, 200mW	SOD-323	5d	1a	Ext
N2	MMSZ5262	Z-diode	51V±5%, 300mW	SOD-123	5d	1k	Vs
N2	MMSZ5262B	Z-diode	51V±5%, Zzt=125Ω, 500mW	SOD-123	5d	1a	Mot
N2	PESD5V0S1UB	ESDP-diode	Vbr=5V, 15A, 260W(8/20 ms)	SOD-523	6d	1a	Phi
N3	BZD27C200P	TVS	Vbr=188V, Vcl=254V, 0.39A, 150W(1ms)	SOD123FL	7d	1a	Lge
N3	BZX384-B43	Z-diode	43V±2.5%, Izt=2mA, Zzt=45Ω, 200mW	SOD-323	5d	1k	Phi
N3	CMOZ7L5	Z-diode	7.12..7.88V, Izt=0.25mA, Zzt=200Ω, 250mW	SOD-523	6d	1a	Cen
N3	CZRH5263B-G	Z-diode	53.2..58.8V, Zzt=150Ω, Izt=2.2mA, 150mW	SOD-523	5d	1a	Cmc
N3	CZRV5263B-G	Z-diode	53.2..58.8V, Zzt=150Ω, Izt=2.2mA, 200mW	SOD-323	5d	1a	Cmc
N3	MM3Z5263B	Z-diode	53.20..58.80V, Izt=2.2mA, Zzt=150Ω, 200mW	SOD-323	5d	1a	Ext
N3	MMSZ5263	Z-diode	56V±5%, 300mW	SOD-123	5d	1k	Vs
N3	MMSZ5263B	Z-diode	56V±5%, Zzt=150Ω, 500mW	SOD-123	5d	1a	Mot
N3	PESD12VS1UB	ESDP-diode	Vbr=12V, 5A, 180W(8/20 ms)	SOD-523	6d	1a	Phi
N3	ZD5211BSG	Z-diode	2.4V±5%, 5mA, Zzt=100Ω, 500mW	SOD-323-S	7d	1a	Cys
N4	BZX384-B47	Z-diode	47V±2.5%, Izt=2mA, Zzt=50Ω, 200mW	SOD-323	5d	1k	Phi
N4	CMOZ8L2	Z-diode	7.79..8.61V, Izt=0.25mA, Zzt=200Ω, 250mW	SOD-523	6d	1a	Cen
N4	CZRH5264B-G	Z-diode	57..63V, Zzt=170Ω, Izt=2.1mA, 150mW	SOD-523	5d	1a	Cmc
N4	CZRV5264B-G	Z-diode	57..63V, Zzt=170Ω, Izt=2.1mA, 200mW	SOD-323	5d	1a	Cmc
N4	MM1Z5234B	Z-diode	5.89..6.51V, Izt=20mA, Zzt=7Ω, 500mW	SOD-323FL	5d	1a	Eic
N4	MM1Z5234BH	Z-diode	5.89..6.51V, Izt=20mA, Zzt=7Ω, 500mW	SOD-123	5d	1a	Zow
N4	MM3Z5264B	Z-diode	57.0..63.0V, Izt=2.1mA, Zzt=170Ω, 200mW	SOD-323	5d	1a	Ext
N4	MMSZ5234B	Z-diode	6.2V±5%, Izt=20mA, Zzt=7Ω, 500mW	SOD-123	5d	1a	Eic
N4	MMSZ5264	Z-diode	60V±5%, 300mW	SOD-123	5d	1k	Vs
N4	MMSZ5264B	Z-diode	60V±5%, Zzt=170Ω, 500mW	SOD-123	5d	1a	Mot
N4	PESD15VS1UB	ESDP-diode	Vbr=15V, 5A, 160W(8/20 ms)	SOD-523	6d	1a	Phi
N4	RKZ33BKK	Z-diode	31.0..35.0V, Izt=2mA, Zzt=80Ω, 150mW	SFP	7d	1a	Ren
N4	RKZ33BKL	Z-diode	31.0..35.0V, Izt=2mA, Zzt=80Ω, 100mW	EPF	7d	1a	Ren
N4	ZD5223BSG	Z-diode	2.7V±5%, 5mA, Zzt=100Ω, 500mW	SOD-323-S	7d	1a	Cys
N5	BZX384-B51	Z-diode	51V±2.5%, Izt=2mA, Zzt=60Ω, 200mW	SOD-323	5d	1k	Phi
N5	BZX584B20V	Z-diode	19.60..20.40V, Izt=5mA, Zzt=55Ω, 200mW	SOD-523FL	7d	1a	Tac
N5	CMOZ9L1	Z-diode	8.65..9.56V, Izt=0.25mA, Zzt=200Ω, 250mW	SOD-523	6d	1a	Cen
N5	CZRH5265B-G	Z-diode	58.9..65.1V, Zzt=185Ω, Izt=2mA, 150mW	SOD-523	5d	1a	Cmc
N5	CZRV5265B-G	Z-diode	58.9..65.1V, Zzt=185Ω, Izt=2mA, 200mW	SOD-323	5d	1a	Cmc
N5	MM1Z5256B	Z-diode	28.50..31.50V, Izt=4.2mA, Zzt=49Ω, 500mW	SOD-323FL	5d	1a	Eic
N5	MM1Z5256BH	Z-diode	28.5..31.5V, Izt=4.2mA, Zzt=49Ω, 500mW	SOD-123	5d	1a	Zow
N5	MM3Z5265B	Z-diode	58.90..65.10V, Izt=2.0mA, Zzt=185Ω, 200mW	SOD-323	5d	1a	Ext
N5	MMSZ20VB	Z-diode	19.60..20.40V, Izt=5mA, Zzt=55Ω, 200mW	SOD-523FL	7d	1a	Tac
N5	MMSZ5256B	Z-diode	30V±5%, Izt=4.2mA, Zzt=49Ω, 500mW	SOD-123	5d	1a	Eic
N5	MMSZ5265	Z-diode	62V±5%, 300mW	SOD-123	5d	1k	Vs
N5	MMSZ5265B	Z-diode	62V±5%, Zzt=185Ω, 500mW	SOD-123	5d	1a	Mot
N5	PESD24VS1UB	ESDP-diode	Vbr=24V, 3A, 160W(8/20 ms)	SOD-523	6d	1a	Phi
N5	RKZ36BKK	Z-diode	34.0..38.0V, Izt=2mA, Zzt=90Ω, 150mW	SFP	7d	1a	Ren
N5	RKZ36BKL	Z-diode	34.0..38.0V, Izt=2mA, Zzt=90Ω, 100mW	EPF	7d	1a	Ren
N510	STBN510	TVS	Vbr=9.50..10.5V, Vrw=8.55V, 103A, 1500W(1ms), Bidirectional	DO-214AB	1ba	1j	Eic
N510	STUN510	TVS	Vbr=9.50..10.5V, Vrw=8.55V, 103A, 1500W(1ms)	DO-214AB	1d	1a	Eic
N511	STBN511	TVS	Vbr=10.5..11.6V, Vrw=9.40V, 96.0A, 1500W(1ms), Bidirectional	DO-214AB	1ba	1j	Eic
N511	STUN511	TVS	Vbr=10.5..11.6V, Vrw=9.40V, 96.0A, 1500W(1ms)	DO-214AB	1d	1a	Eic
N512	STBN512	TVS	Vbr=11.4..12.6V, Vrw=10.2V, 90.0A, 1500W(1ms), Bidirectional	DO-214AB	1ba	1j	Eic
N512	STUN512	TVS	Vbr=11.4..12.6V, Vrw=10.2V, 90.0A, 1500W(1ms)	DO-214AB	1d	1a	Eic
N513	STBN513	TVS	Vbr=12.4..13.7V, Vrw=11.1V, 82.0A, 1500W(1ms), Bidirectional	DO-214AB	1ba	1j	Eic
N513	STUN513	TVS	Vbr=12.4..13.7V, Vrw=11.1V, 82.0A, 1500W(1ms)	DO-214AB	1d	1a	Eic
N515	STBN515	TVS	Vbr=14.3..15.8V, Vrw=12.8V, 71.0A, 1500W(1ms), Bidirectional	DO-214AB	1ba	1j	Eic
N515	STUN515	TVS	Vbr=14.3..15.8V, Vrw=12.8V, 71.0A, 1500W(1ms)	DO-214AB	1d	1a	Eic
N516	STBN516	TVS	Vbr=15.2..16.8V, Vrw=13.6V, 67.0A, 1500W(1ms), Bidirectional	DO-214AB	1ba	1j	Eic
N516	STUN516	TVS	Vbr=15.2..16.8V, Vrw=13.6V, 67.0A, 1500W(1ms)	DO-214AB	1d	1a	Eic
N518	STBN518	TVS	Vbr=17.1..18.9V, Vrw=15.3V, 59.5A, 1500W(1ms), Bidirectional	DO-214AB	1ba	1j	Eic
N518	STUN518	TVS	Vbr=17.1..18.9V, Vrw=15.3V, 59.5A, 1500W(1ms)	DO-214AB	1d	1a	Eic



SMD
code

Type

Function

Short description

Case

Pinout

St.

Mnf.

SMD code	Type	Function	Short description	Case	Pinout	St.	Mnf.
N520	STUN520	TVS	Vbr=19.0..21.0V, Vrwm=17.1V, 54.0A, 1500W(1ms)	DO-214AB	1d	1a	Eic
N522	STBN522	TVS	Vbr=20.9..23.1V, Vrwm=18.8V, 49.0A, 1500W(1ms), Bidirectional	DO-214AB	1ba	1j	Eic
N522	STUN522	TVS	Vbr=20.9..23.1V, Vrwm=18.8V, 49.0A, 1500W(1ms)	DO-214AB	1d	1a	Eic
N524	STBN524	TVS	Vbr=22.8..25.2V, Vrwm=20.5V, 45.0A, 1500W(1ms), Bidirectional	DO-214AB	1ba	1j	Eic
N524	STUN524	TVS	Vbr=22.8..25.2V, Vrwm=20.5V, 45.0A, 1500W(1ms)	DO-214AB	1d	1a	Eic
N527	STBN527	TVS	Vbr=25.7..28.4V, Vrwm=23.1V, 40.0A, 1500W(1ms), Bidirectional	DO-214AB	1ba	1j	Eic
N527	STUN527	TVS	Vbr=25.7..28.4V, Vrwm=23.1V, 40.0A, 1500W(1ms)	DO-214AB	1d	1a	Eic
N520	STBN520	TVS	Vbr=19.0..21.0V, Vrwm=17.1V, 54.0A, 1500W(1ms), Bidirectional	DO-214AB	1ba	1j	Eic
N530	STBN530	TVS	Vbr=28.5..31.5V, Vrwm=25.6V, 36.0A, 1500W(1ms), Bidirectional	DO-214AB	1ba	1j	Eic
N530	STUN530	TVS	Vbr=28.5..31.5V, Vrwm=25.6V, 36.0A, 1500W(1ms)	DO-214AB	1d	1a	Eic
N533	STBN533	TVS	Vbr=31.4..34.7V, Vrwm=28.2V, 33.0A, 1500W(1ms), Bidirectional	DO-214AB	1ba	1j	Eic
N533	STUN533	TVS	Vbr=31.4..34.7V, Vrwm=28.2V, 33.0A, 1500W(1ms)	DO-214AB	1d	1a	Eic
N536	STBN536	TVS	Vbr=34.2..37.8V, Vrwm=30.8V, 30.0A, 1500W(1ms), Bidirectional	DO-214AB	1ba	1j	Eic
N536	STUN536	TVS	Vbr=34.2..37.8V, Vrwm=30.8V, 30.0A, 1500W(1ms)	DO-214AB	1d	1a	Eic
N539	STBN539	TVS	Vbr=37.1..41.0V, Vrwm=33.3V, 28.0A, 1500W(1ms), Bidirectional	DO-214AB	1ba	1j	Eic
N539	STUN539	TVS	Vbr=37.1..41.0V, Vrwm=33.3V, 28.0A, 1500W(1ms)	DO-214AB	1d	1a	Eic
N543	STBN543	TVS	Vbr=40.9..45.2V, Vrwm=36.8V, 25.3A, 1500W(1ms), Bidirectional	DO-214AB	1ba	1j	Eic
N543	STUN543	TVS	Vbr=40.9..45.2V, Vrwm=36.8V, 25.3A, 1500W(1ms)	DO-214AB	1d	1a	Eic
N547	STBN547	TVS	Vbr=44.7..49.4V, Vrwm=40.2V, 23.2A, 1500W(1ms), Bidirectional	DO-214AB	1ba	1j	Eic
N547	STUN547	TVS	Vbr=44.7..49.4V, Vrwm=40.2V, 23.2A, 1500W(1ms)	DO-214AB	1d	1a	Eic
N551	STBN551	TVS	Vbr=48.5..53.6V, Vrwm=43.6V, 21.4A, 1500W(1ms), Bidirectional	DO-214AB	1ba	1j	Eic
N551	STUN551	TVS	Vbr=48.5..53.6V, Vrwm=43.6V, 21.4A, 1500W(1ms)	DO-214AB	1d	1a	Eic
N556	STBN556	TVS	Vbr=53.2..58.8V, Vrwm=47.8V, 19.5A, 1500W(1ms), Bidirectional	DO-214AB	1ba	1j	Eic
N556	STUN556	TVS	Vbr=53.2..58.8V, Vrwm=47.8V, 19.5A, 1500W(1ms)	DO-214AB	1d	1a	Eic
N562	STBN562	TVS	Vbr=58.9..65.1V, Vrwm=53.0V, 17.7A, 1500W(1ms), Bidirectional	DO-214AB	1ba	1j	Eic
N562	STUN562	TVS	Vbr=58.9..65.1V, Vrwm=53.0V, 17.7A, 1500W(1ms)	DO-214AB	1d	1a	Eic
N568	STBN568	TVS	Vbr=64.6..71.4V, Vrwm=58.1V, 16.3A, 1500W(1ms), Bidirectional	DO-214AB	1ba	1j	Eic
N568	STUN568	TVS	Vbr=64.6..71.4V, Vrwm=58.1V, 16.3A, 1500W(1ms)	DO-214AB	1d	1a	Eic
N561	STBN561	TVS	Vbr=5.45..7.14V, Vrwm=5.80V, 143A, 1500W(1ms), Bidirectional	DO-214AB	1ba	1j	Eic
N561	STUN561	TVS	Vbr=5.45..7.14V, Vrwm=5.80V, 143A, 1500W(1ms)	DO-214AB	1d	1a	Eic
N575	STBN575	TVS	Vbr=71.3..78.8V, Vrwm=64.1V, 14.6A, 1500W(1ms), Bidirectional	DO-214AB	1ba	1j	Eic
N575	STUN575	TVS	Vbr=71.3..78.8V, Vrwm=64.1V, 14.6A, 1500W(1ms)	DO-214AB	1d	1a	Eic
N57F	STBN57F	TVS	Vbr=7.13..7.88V, Vrwm=6.40V, 132A, 1500W(1ms), Bidirectional	DO-214AB	1ba	1j	Eic
N57F	STUN57F	TVS	Vbr=7.13..7.88V, Vrwm=6.40V, 132A, 1500W(1ms)	DO-214AB	1d	1a	Eic
N582	STBN582	TVS	Vbr=77.9..86.1V, Vrwm=70.1V, 13.3A, 1500W(1ms), Bidirectional	DO-214AB	1ba	1j	Eic
N582	STUN582	TVS	Vbr=77.9..86.1V, Vrwm=70.1V, 13.3A, 1500W(1ms)	DO-214AB	1d	1a	Eic
N58C	STBN58C	TVS	Vbr=7.79..8.61V, Vrwm=7.02V, 124A, 1500W(1ms), Bidirectional	DO-214AB	1ba	1j	Eic
N58C	STUN58C	TVS	Vbr=7.79..8.61V, Vrwm=7.02V, 124A, 1500W(1ms)	DO-214AB	1d	1a	Eic
N591	STBN591	TVS	Vbr=86.5..95.5V, Vrwm=77.8V, 12.0A, 1500W(1ms), Bidirectional	DO-214AB	1ba	1j	Eic
N591	STUN591	TVS	Vbr=86.5..95.5V, Vrwm=77.8V, 12.0A, 1500W(1ms)	DO-214AB	1d	1a	Eic
N59B	STBN59B	TVS	Vbr=8.65..9.55V, Vrwm=7.78V, 112A, 1500W(1ms), Bidirectional	DO-214AB	1ba	1j	Eic
N59B	STUN59B	TVS	Vbr=8.65..9.55V, Vrwm=7.78V, 112A, 1500W(1ms)	DO-214AB	1d	1a	Eic
N5B0	STBN5B0	TVS	Vbr=95.0..105V, Vrwm=85.5V, 11.0A, 1500W(1ms), Bidirectional	DO-214AB	1ba	1j	Eic
N5B0	STUN5B0	TVS	Vbr=95.0..105V, Vrwm=85.5V, 11.0A, 1500W(1ms)	DO-214AB	1d	1a	Eic
N5B1	STBN5B1	TVS	Vbr=105..116V, Vrwm=94.0V, 9.9A, 1500W(1ms), Bidirectional	DO-214AB	1ba	1j	Eic
N5B1	STUN5B1	TVS	Vbr=105..116V, Vrwm=94.0V, 9.9A, 1500W(1ms)	DO-214AB	1d	1a	Eic
N5B2	STBN5B2	TVS	Vbr=114..126V, Vrwm=102V, 9.1A, 1500W(1ms), Bidirectional	DO-214AB	1ba	1j	Eic
N5B2	STUN5B2	TVS	Vbr=114..126V, Vrwm=102V, 9.1A, 1500W(1ms)	DO-214AB	1d	1a	Eic
N5B3	STBN5B3	TVS	Vbr=124..137V, Vrwm=111V, 8.4A, 1500W(1ms), Bidirectional	DO-214AB	1ba	1j	Eic
N5B3	STUN5B3	TVS	Vbr=124..137V, Vrwm=111V, 8.4A, 1500W(1ms)	DO-214AB	1d	1a	Eic
N5B5	STBN5B5	TVS	Vbr=143..158V, Vrwm=128V, 7.2A, 1500W(1ms), Bidirectional	DO-214AB	1ba	1j	Eic
N5B5	STUN5B5	TVS	Vbr=143..158V, Vrwm=128V, 7.2A, 1500W(1ms)	DO-214AB	1d	1a	Eic
N5B6	STBN5B6	TVS	Vbr=152..168V, Vrwm=136V, 6.8A, 1500W(1ms), Bidirectional	DO-214AB	1ba	1j	Eic
N5B6	STUN5B6	TVS	Vbr=152..168V, Vrwm=136V, 6.8A, 1500W(1ms)	DO-214AB	1d	1a	Eic
N5B7	STBN5B7	TVS	Vbr=162..179V, Vrwm=145V, 6.4A, 1500W(1ms), Bidirectional	DO-214AB	1ba	1j	Eic
N5B7	STUN5B7	TVS	Vbr=162..179V, Vrwm=145V, 6.4A, 1500W(1ms)	DO-214AB	1d	1a	Eic
N5B8	STBN5B8	TVS	Vbr=171..189V, Vrwm=154V, 6.1A, 1500W(1ms), Bidirectional	DO-214AB	1ba	1j	Eic
N5B8	STUN5B8	TVS	Vbr=171..189V, Vrwm=154V, 6.1A, 1500W(1ms)	DO-214AB	1d	1a	Eic
N5D0	STBN5D0	TVS	Vbr=190..210V, Vrwm=171V, 5.5A, 1500W(1ms), Bidirectional	DO-214AB	1ba	1j	Eic
N5D0	STUN5D0	TVS	Vbr=190..210V, Vrwm=171V, 5.5A, 1500W(1ms)	DO-214AB	1d	1a	Eic
N6	BZX384-B56	Z-diode	56V±2.5%, Izt=2mA, Zzt=70Ω, 200mW	SOD-323	5d	1k	Phi
N6	CMOZ10L	Z-diode	9.50..10.50V, Izt=0.25mA, Zzt=200Ω, 250mW	SOD-523	6d	1a	Cen
N6	ZD5225BSG	Z-diode	3.0V±5%, 5mA, Zzt=95Ω, 500mW	SOD-323-S	7d	1a	Cys
N7	BZX384-B62	Z-diode	62V±2.5%, Izt=2mA, Zzt=80Ω, 200mW	SOD-323	5d	1k	Phi
N7	CMOZ11L	Z-diode	10.45..11.55V, Izt=0.25mA, Zzt=200Ω, 250mW	SOD-523	6d	1a	Cen
N8	BZX384-B68	Z-diode	68V±2.5%, Izt=2mA, Zzt=90Ω, 200mW	SOD-323	5d	1k	Phi
N8	CMOZ12L	Z-diode	11.40..12.60V, Izt=0.25mA, Zzt=200Ω, 250mW	SOD-523	6d	1a	Cen
N8	MM5Z9V1	Z-diode	9.1V±5%, Izt=5mA, Zzt=15Ω, 200mW	SOD-523	6d	1a	Eic
N8	MM5Z9V1H	Z-diode	8.5..9.6V, Izt=5mA, Zzt=15Ω, 200mW	SOD-523	7d	1a	Zow
N9	BZX384-B75	Z-diode	75V±2.5%, Izt=2mA, Zzt=95Ω, 200mW	SOD-323	5d	1k	Phi



SMD
code

Type

Function

Short description

Case

Pinout

St.

Mnf.

N9	CMOZ13L	Z-diode	12.35..13.65V, Izt=0.25mA, Zzt=200Ω, 250mW	SOD-523	6d	1a	Cen
N9	MM3Z5249B	Z-diode	19V±5%, Izt=6.6mA, Zzt=23Ω, 200mW	SOD-323FL	7d	1a	Bts
N9	MM3Z5249BH	Z-diode	18.05..19.95V, Izt=6.6mA, Zzt=23Ω, 300mW	SOD-323	5d	1a	Zow
NA	TV06B800K-G	TVS	Vrwm=80.0V, Vbr=88.96..108.80V, Ipp=4.19A, 600W(1ms)	DO-214AA	1d	1a	Cmc
NB	KDZ6.2B	Z-diode	6.2V±2.5%, 40mA, 1W	PMDU	7d	1s	Rhm
NB	SMF80CA	TVS	Vrwm=80.0V, Vbr=88.80..97.60V, 1.55A, 200W(10/1000μs), Bidirectional	SOD-123FL	7ba	1j	Ers
NB	TV02W800B-G	TVS	Vrwm=80V, Vbr=88.8..97.6V, Ipp=1.55A, 200W(1ms), Bidirectional	SOD-123	5ba	1j	Cmc
NB	TV06B800J-G	TVS	Vrwm=80.0V, Vbr=98.80..97.60V, Ipp=4.63A, 600W(1ms)	DO-214AA	1d	1a	Cmc
NC	PZU3.6B1A/DG	Z-diode	3.6V±2%, If=200mA, 320mW, halogen-free	SOD-323	5d	1a	Phi
ND	P6SMB120	TVS	Vrwm=120V, 3.5A, 600W(1ms)	DO-214AA	1d	2j	Fag
ND	P6SMBJ54	TVS	Vbr=54V, 6.2A, 600W(1ms)	DO-214AA	1d	1m,1w	Pjt,Srj
ND	PZU3.6B2A/DG	Z-diode	3.6V±2%, If=200mA, 320mW, halogen-free	SOD-323	5d	1a	Phi
ND	SMBG54	TVS	Vbr=60V, 6.2A, 600W(1ms)	DO-215AA	5d	1k	Vs
ND	SMBJ54	TVS	Vbr=60V, 6.2A, 600W(1ms)	DO-214AA	1d	1k	Vs
ND	TV06B540K-G	TVS	Vrwm=54.0V, Vbr=60.0..73.30V, Ipp=6.23A, 600W(1ms)	DO-214AA	1d	1a	Cmc
NDK	SMB120	TVS	Vbr=108..132V, Vrwm=97.2V, 3.47A, 600W(1ms)	DO-214AA	1d	1a	Lge
NDM	SMB120C	TVS	Vbr=108..132V, Vrwm=97.2V, 3.47A, 600W(1ms), Bidirectional	DO-214AA	1ba	1j	Lge
NDP	SM15T10CA	TVS	Vrwm=8.55V, Vbr=9.5..10.5V, 103A, 1500W(1ms), Bidirectional	DO-214AB	1ba	1r	Ste
NE	1SMB54A	TVS	Vrwm=54V, 6.9A, 600W(1ms)	403A	3d	1s	Ons
NE	CD214B-T54A	TVS	Vbr=54V, Irlsm=6.9A, 600W(1ms)	DO-214AA	1d	1a	Bm
NE	P6SMB120A	TVS	Vrwm=120V, 3.6A, 600W(1ms)	DO-214AA	1d	2j	Fag
NE	P6SMBJ54A	TVS	Vbr=54V, 6.9A, 600W(1ms)	DO-214AA	1d	1m,1w	Pjt,Srj
NE	PZU3.9BA/DG	Z-diode	3.9V±5%, If=200mA, 320mW, halogen-free	SOD-323	5d	1a	Phi
NE	SMBG54A	TVS	Vbr=60V, 6.9A, 600W(1ms)	DO-215AA	5d	1k	Vs
NE	SMBJ54A	TVS	Vbr=60V, 6.9A, 600W(1ms)	DO-214AA	1d	1k,1m	Di,Vs
NE	SMF54A	TVS	Vrwm=54V, Vbr=60.0..66.3V, 2.3A, 200W(1ms)	SOD-123FL	7d	1a	Eic
NE	SMF54CA	TVS	Vrwm=54.0V, Vbr=60.0..66.30V, 2.30A, 200W(10/1000μs), Bidirectional	SOD-123FL	7ba	1j	Ers
NE	TV02W540B-G	TVS	Vrwm=54V, Vbr=60.0..66.3V, Ipp=2.30A, 200W(1ms), Bidirectional	SOD-123	5ba	1j	Cmc
NE	TV06B540J-G	TVS	Vrwm=54.0V, Vbr=60.0..66.30V, Ipp=6.89A, 600W(1ms)	DO-214AA	1d	1a	Cmc
NEC	1SMB54CA	TVS	Vrwm=54V, 6.9A, 600W(1ms), Bidirectional	403A	3ba	1e	Ons
NEK	SMB120A	TVS	Vbr=114..126V, Vrwm=102V, 3.64A, 600W(1ms)	DO-214AA	1d	1a	Lge
NEM	SMB120CA	TVS	Vbr=114..126V, Vrwm=102V, 3.64A, 600W(1ms), Bidirectional	DO-214AA	1ba	1j	Lge
NF	KDZ22FV	Z-diode	20.80..23.30V, Izt=5mA, Zzt=30Ω, 100mW	TFSC	7d	1a	Kec
NF	MAZD160	Z-diode	15.3..17.1V, Zzt=50Ω(5mA), 120mW	SSSMini2	7d	1a	Pan
NF	P6SMB130	TVS	Vrwm=130V, 3.2A, 600W(1ms)	DO-214AA	1d	2j	Fag
NF	P6SMBJ58	TVS	Vbr=58V, 5.8A, 600W(1ms)	DO-214AA	1d	1m,1w	Pjt,Srj
NF	PZU3.9B1A/DG	Z-diode	3.9V±2%, If=200mA, 320mW, halogen-free	SOD-323	5d	1a	Phi
NF	SMBG58	TVS	Vbr=58V, 5.8A, 600W(1ms)	DO-215AA	5d	1k	Vs
NF	SMBJ58	TVS	Vbr=58V, 5.8A, 600W(1ms)	DO-214AA	1d	1k	Vs
NF	TV06B580K-G	TVS	Vrwm=58.0V, Vbr=64.40..78.70V, Ipp=5.83A, 600W(1ms)	DO-214AA	1d	1a	Cmc
NFK	SMB130	TVS	Vbr=117..143V, Vrwm=105V, 3.21A, 600W(1ms)	DO-214AA	1d	1a	Lge
NFM	SMB130C	TVS	Vbr=117..143V, Vrwm=105V, 3.21A, 600W(1ms), Bidirectional	DO-214AA	1ba	1j	Lge
NG	1SMB58A	TVS	Vrwm=58V, 6.4A, 600W(1ms)	403A	3d	1s	Ons
NG	CD214B-T58A	TVS	Vbr=58V, Irlsm=6.4A, 600W(1ms)	DO-214AA	1d	1a	Bm
NG	P6SMB130A	TVS	Vrwm=130V, 3.3A, 600W(1ms)	DO-214AA	1d	2j	Fag
NG	P6SMBJ58A	TVS	Vbr=58V, 6.4A, 600W(1ms)	DO-214AA	1d	1m,1w	Pjt,Srj
NG	PZU3.9B2A/DG	Z-diode	3.9V±2%, If=200mA, 320mW, halogen-free	SOD-323	5d	1a	Phi
NG	SMBG58A	TVS	Vbr=58V, 6.4A, 600W(1ms)	DO-215AA	5d	1k	Vs
NG	SMBJ58A	TVS	Vbr=58V, 6.4A, 600W(1ms)	DO-214AA	1d	1k,1m	Di,Vs
NG	SMF58A	TVS	Vrwm=58V, Vbr=64.4..71.2V, 2.1A, 200W(1ms)	SOD-123FL	7d	1a	Eic
NG	SMF58CA	TVS	Vrwm=58.0V, Vbr=64.40..71.20V, 2.1A, 200W(10/1000μs), Bidirectional	SOD-123FL	7ba	1j	Ers
NG	TV02W580B-G	TVS	Vrwm=58V, Vbr=64.4..71.2V, Ipp=2.1A, 200W(1ms), Bidirectional	SOD-123	5ba	1j	Cmc
NG	TV06B580J-G	TVS	Vrwm=58.0V, Vbr=64.40..71.20V, Ipp=6.41A, 600W(1ms)	DO-214AA	1d	1a	Cmc
NG7	SM6T68A	TVS	Vrwm=58.1V, Vbr=64.6..71.40V, 6.5A, 600W(1ms), Bidirectional	DO-214AA	1d	1k	Vs
NG7	SM6T68CA	TVS	Vrwm=58.1V, Vbr=64.6..71.40V, 6.5A, 600W(1ms), Bidirectional	DO-214AA	1ba	1l	Vs
NGC	1SMB58CA	TVS	Vrwm=58V, 6.4A, 600W(1ms), Bidirectional	403A	3ba	1e	Ons
NGK	SMB130A	TVS	Vbr=124..137V, Vrwm=111V, 3.35A, 600W(1ms)	DO-214AA	1d	1a	Lge
NGM	SMB130CA	TVS	Vbr=124..137V, Vrwm=111V, 3.35A, 600W(1ms), Bidirectional	DO-214AA	1ba	1j	Lge
NH	P6SMB150	TVS	Vrwm=150V, 2.8A, 600W(1ms)	DO-214AA	1d	2j	Fag
NH	P6SMBJ60	TVS	Vbr=60V, 5.6A, 600W(1ms)	DO-214AA	1d	1m,1w	Pjt,Srj
NH	PZU30BA/DG	Z-diode	30V±5%, If=200mA, 320mW, halogen-free	SOD-323	5d	1a	Phi
NH	SMBG60	TVS	Vbr=60V, 5.6A, 600W(1ms)	DO-215AA	5d	1k	Vs
NH	SMBJ60	TVS	Vbr=60V, 5.6A, 600W(1ms)	DO-214AA	1d	1k	Vs
NH	TV06B600K-G	TVS	Vrwm=60.0V, Vbr=66.70..81.50V, Ipp=5.61A, 600W(1ms)	DO-214AA	1d	1a	Cmc
NHK	SMB150	TVS	Vbr=135..165V, Vrwm=121V, 2.79A, 600W(1ms)	DO-214AA	1d	1a	Lge
NHM	SMB150C	TVS	Vbr=135..165V, Vrwm=121V, 2.79A, 600W(1ms), Bidirectional	DO-214AA	1ba	1j	Lge
NIC	1SMB78CA	TVS	Vrwm=78V, 4.7A, 600W(1ms), Bidirectional	403A	3ba	1e	Ons
NK	1SMB60A	TVS	Vrwm=60V, 6.2A, 600W(1ms)	403A	3d	1s	Ons
NK	CD214B-T60A	TVS	Vbr=60V, Irlsm=6.2A, 600W(1ms)	DO-214AA	1d	1a	Bm
NK	P6SMB150A	TVS	Vrwm=150V, 2.9A, 600W(1ms)	DO-214AA	1d	2j	Fag



SMD
code

Type

Function

Short description

Case

Pinout

St.

Mnf.

SMD code	Type	Function	Short description	Case	Pinout	St.	Mnf.
NK	P6SMBJ60A	TVS	Vbr=60V, 6.2A, 600W(1ms)	DO-214AA	1d	1m,1w	Pjt,Srij
NK	PZU33BA/DG	Z-diode	33V±5%, If=200mA, 320mW, halogen-free	SOD-323	5d	1a	Phi
NK	SMBG60A	TVS	Vbr=60V, 6.2A, 600W(1ms)	DO-215AA	5d	1k	Vs
NK	SMBJ60A	TVS	Vbr=60V, 6.2A, 600W(1ms)	DO-214AA	1d	1k,1m	Di,Vs
NK	SMF60A	TVS	Vrwm=60V, Vbr=66.7..73.7V, 1.8A, 200W(1ms)	SOD-123FL	7d	1a	Eic
NK	SMF60CA	TVS	Vrwm=60.0V, Vbr=66.70..73.70V, 2.07A, 200W(10/1000µs), Bidirectional	SOD-123FL	7ba	1j	Ers
NK	TV02W600B-G	TVS	Vrwm=60V, Vbr=66.7..73.7V, Ipp=2.07A, 200W(1ms), Bidirectional	SOD-123	5ba	1j	Cmc
NK	TV06B600J-G	TVS	Vrwm=60.0V, Vbr=66.70..73.70V, Ipp=6.20A, 600W(1ms)	DO-214AA	1d	1a	Cmc
NKC	1SMB60CA	TVS	Vrwm=60V, 6.2A, 600W(1ms), Bidirectional	403A	3ba	1e	Ons
NKK	SMB150A	TVS	Vbr=143..158V, Vrwm=128V, 2.90A, 600W(1ms)	DO-214AA	1d	1a	Lge
NKM	SMB150CA	TVS	Vbr=143..158V, Vrwm=128V, 2.90A, 600W(1ms), Bidirectional	DO-214AA	1ba	1j	Lge
NL	P6SMB160	TVS	Vrwm=160V, 2.6A, 600W(1ms)	DO-214AA	1d	2j	Fag
NL	P6SMBJ64	TVS	Vbr=64V, 5.3A, 600W(1ms)	DO-214AA	1d	1m,1w	Pjt,Srij
NL	SMBG64	TVS	Vbr=64V, 5.3A, 600W(1ms)	DO-215AA	5d	1k	Vs
NL	SMBJ64	TVS	Vbr=64V, 5.3A, 600W(1ms)	DO-214AA	1d	1k	Vs
NL	TV06B640K-G	TVS	Vrwm=64.0V, Vbr=71.10..86.90V, Ipp=5.26A, 600W(1ms)	DO-214AA	1d	1a	Cmc
NLK	SMB160	TVS	Vbr=144..176V, Vrwm=130V, 2.61A, 600W(1ms)	DO-214AA	1d	1a	Lge
NLM	SMB160C	TVS	Vbr=144..176V, Vrwm=130V, 2.61A, 600W(1ms), Bidirectional	DO-214AA	1ba	1j	Lge
NM	1SMB64A	TVS	Vrwm=64V, 5.8A, 600W(1ms)	403A	3d	1s	Ons
NM	CD214B-T64A	TVS	Vbr=64V, Iism=5.8A, 600W(1ms)	DO-214AA	1d	1a	Bm
NM	P6SMB160A	TVS	Vrwm=160V, 2.7A, 600W(1ms)	DO-214AA	1d	2j	Fag
NM	P6SMBJ64A	TVS	Vbr=64V, 5.8A, 600W(1ms)	DO-214AA	1d	1m,1w	Pjt,Srij
NM	PZU4.3BA/DG	Z-diode	4.3V±5%, If=200mA, 320mW, halogen-free	SOD-323	5d	1a	Phi
NM	SMBG64A	TVS	Vbr=64V, 5.8A, 600W(1ms)	DO-215AA	5d	1k	Vs
NM	SMBJ64A	TVS	Vbr=64V, 5.8A, 600W(1ms)	DO-214AA	1d	1k,1m	Di,Vs
NM	SMF64A	TVS	Vrwm=64V, Vbr=71.1..78.6V, 1.7A, 200W(1ms)	SOD-123FL	7d	1a	Eic
NM	SMF64CA	TVS	Vrwm=64.0V, Vbr=71.10..78.60V, 1.94A, 200W(10/1000µs), Bidirectional	SOD-123FL	7ba	1j	Ers
NM	TV02W640B-G	TVS	Vrwm=64V, Vbr=71.1..78.6V, Ipp=1.94A, 200W(1ms), Bidirectional	SOD-123	5ba	1j	Cmc
NM	TV06B640J-G	TVS	Vrwm=64.0V, Vbr=71.10..78.60V, Ipp=5.83A, 600W(1ms)	DO-214AA	1d	1a	Cmc
NMIC	1SMB64CA	TVS	Vrwm=64V, 5.8A, 600W(1ms), Bidirectional	403A	3ba	1e	Ons
NMIK	SMB160A	TVS	Vbr=152..168V, Vrwm=136V, 2.74A, 600W(1ms)	DO-214AA	1d	1a	Lge
NMIM	SMB160CA	TVS	Vbr=152..168V, Vrwm=136V, 2.74A, 600W(1ms), Bidirectional	DO-214AA	1ba	1j	Lge
NN	BAR65-02L	PIN-diode	TV-Tuner, 30V, 100mA, Vf<1V(50mA), <0.9pF	TSLP-2-1	13d	2b	Inf
NN	P6SMB170	TVS	Vrwm=170V, 2.5A, 600W(1ms)	DO-214AA	1d	2j	Fag
NN	P6SMBJ70	TVS	Vbr=70V, 4.8A, 600W(1ms)	DO-214AA	1d	1m,1w	Pjt,Srij
NN	PZU4.3B1A/DG	Z-diode	4.3V±2%, If=200mA, 320mW, halogen-free	SOD-323	5d	1a	Phi
NN	SMBG70	TVS	Vbr=70V, 4.8A, 600W(1ms)	DO-215AA	5d	1k	Vs
NN	SMBJ70	TVS	Vbr=70V, 4.8A, 600W(1ms)	DO-214AA	1d	1k	Vs
NN	TV06B700K-G	TVS	Vrwm=70.0V, Vbr=77.80..95.10V, Ipp=4.80A, 600W(1ms)	DO-214AA	1d	1a	Cmc
NNK	SMB170	TVS	Vbr=153..187V, Vrwm=138V, 2.46A, 600W(1ms)	DO-214AA	1d	1a	Lge
NMIM	SMB170C	TVS	Vbr=153..187V, Vrwm=138V, 2.46A, 600W(1ms), Bidirectional	DO-214AA	1ba	1j	Lge
NP	1SMB70A	TVS	Vrwm=70V, 5.3A, 600W(1ms)	403A	3d	1s	Ons
NP	BAT15-02L	Si-diode	Schottky, DBS-mix, 4V, 100mA, <12GHz, <0.35pF	TSLP-2-1	13d	2b	Inf
NP	CD214B-T70A	TVS	Vbr=70V, Iism=5.3A, 600W(1ms)	DO-214AA	1d	1a	Bm
NP	CMDZ5L6	Z-diode	5.320..5.880V, Izt=0.5mA, Zzt=325Ω, 250mW	SOD-323	5d	1a	Cen
NP	KDZ22FVY	Z-diode	21.54..22.47V, Izt=5mA, Zzt=30Ω, 100mW	TFSC	7d	1a	Kec
NP	P6SMB170A	TVS	Vrwm=170V, 2.6A, 600W(1ms)	DO-214AA	1d	2j	Fag
NP	P6SMBJ70A	TVS	Vbr=70V, 5.3A, 600W(1ms)	DO-214AA	1d	1m,1w	Pjt,Srij
NP	PZU4.3B2A/DG	Z-diode	4.3V±2%, If=200mA, 320mW, halogen-free	SOD-323	5d	1a	Phi
NP	SM6T68C	TVS	Vbr=68V, 6.3A, 600W(1ms), Bidirectional	DO-214AA	1ba	1r	Ste
NP	SMBG70A	TVS	Vbr=70V, 5.3A, 600W(1ms)	DO-215AA	5d	1k	Vs
NP	SMBJ70A	TVS	Vbr=70V, 5.3A, 600W(1ms)	DO-214AA	1d	1k,1m	Di,Vs
NP	SMF70A	TVS	Vrwm=70V, Vbr=77.8..86.0V, 1.5A, 200W(1ms)	SOD-123FL	7d	1a	Eic
NP	SMF70CA	TVS	Vrwm=70.0V, Vbr=77.80..86.0V, 1.77A, 200W(10/1000µs), Bidirectional	SOD-123FL	7ba	1j	Ers
NP	TV02W700B-G	TVS	Vrwm=70V, Vbr=77.8..86.0V, Ipp=1.77A, 200W(1ms), Bidirectional	SOD-123	5ba	1j	Cmc
NP	TV06B700J-G	TVS	Vrwm=70.0V, Vbr=77.80..86.0V, Ipp=5.31A, 600W(1ms)	DO-214AA	1d	1a	Cmc
NPC	1SMB70CA	TVS	Vrwm=70V, 5.3A, 600W(1ms), Bidirectional	403A	3ba	1e	Ons
NPK	SMB170A	TVS	Vbr=162..179V, Vrwm=145V, 2.56A, 600W(1ms)	DO-214AA	1d	1a	Lge
NPM	SMB170CA	TVS	Vbr=162..179V, Vrwm=145V, 2.56A, 600W(1ms), Bidirectional	DO-214AA	1ba	1j	Lge
NPX	SMBT70A	TVS	Vbr=70V, 100A, 600W(1ms)	DO-214AC	1d	1m	Di
NQ	P6SMB180	TVS	Vrwm=180V, 2.3A, 600W(1ms)	DO-214AA	1d	2j	Fag
NQ	P6SMBJ75	TVS	Vbr=75V, 4.5A, 600W(1ms)	DO-214AA	1d	1m,1w	Pjt,Srij
NQ	SM6T68CA	TVS	Vrwm=58.1V, Vbr=64.6..71.40V, 6.5A, 600W(1ms), Bidirectional	DO-214AA	1ba	1j	Ste
NQ	SMBG75	TVS	Vbr=75V, 4.5A, 600W(1ms)	DO-215AA	5d	1k	Vs
NQ	SMBJ75	TVS	Vbr=75V, 4.5A, 600W(1ms)	DO-214AA	1d	1k	Vs
NQ	TV06B750K-G	TVS	Vrwm=75.0V, Vbr=83.30..102.0V, Ipp=4.48A, 600W(1ms)	DO-214AA	1d	1a	Cmc
NQK	SMB180	TVS	Vbr=162..198V, Vrwm=146V, 2.33A, 600W(1ms)	DO-214AA	1d	1a	Lge
NQM	SMB180C	TVS	Vbr=162..198V, Vrwm=146V, 2.33A, 600W(1ms), Bidirectional	DO-214AA	1ba	1j	Lge
NR	1SMB75A	TVS	Vrwm=75V, 4.9A, 600W(1ms)	403A	3d	1s	Ons
NR	CD214B-T75A	TVS	Vbr=75V, Iism=4.9A, 600W(1ms)	DO-214AA	1d	1a	Bm



SMD
code

Type

Function

Short description

Case

Pinout

St.

Mnf.

NR	P6SMB180A	TVS	Vrwm=180V, 2.4A, 600W(1ms)	DO-214AA	1d	2j	Fag
NR	P6SMBJ75A	TVS	Vbr=75V, 4.9A, 600W(1ms)	DO-214AA	1d	1m,1w	Pjt,Srj
NR	PZU4.3B3A/DG	Z-diode	4.3V±2%, If=200mA, 320mW, halogen-free	SOD-323	5d	1a	Phi
NR	SMBG75A	TVS	Vbr=75V, 5A, 600W(1ms)	DO-215AA	5d	1k	Vs
NR	SMBJ75A	TVS	Vbr=75V, 5A, 600W(1ms)	DO-214AA	1d	1k,1m	Di,Vs
NR	SMF75A	TVS	Vrwm=75V, Vbr=83.3.92.1V, 1.4A, 200W(1ms)	SOD-123FL	7d	1a	Eic
NR	SMF75CA	TVS	Vrwm=75.0V, Vbr=83.30.92.10V, 1.65A, 200W(10/1000µs), Bidirectional	SOD-123FL	7ba	1j	Ers
NR	TV02W750B-G	TVS	Vrwm=75V, Vbr=83.3.92.1V, Ipp=1.65A, 200W(1ms), Bidirectional	SOD-123	5ba	1j	Cmc
NR	TV06B750J-G	TVS	Vrwm=75.0V, Vbr=83.30.92.10V, Ipp=4.96A, 600W(1ms)	DO-214AA	1d	1a	Cmc
NRC	1SMB75CA	TVS	Vrwm=75V, 4.9A, 600W(1ms), Bidirectional	403A	3ba	1e	Ons
NRK	SMB180A	TVS	Vbr=171.189V, Vrwm=154V, 2.44A, 600W(1ms)	DO-214AA	1d	1a	Lge
NRM	SMB180CA	TVS	Vbr=171.189V, Vrwm=154V, 2.44A, 600W(1ms), Bidirectional	DO-214AA	1ba	1j	Lge
NS	P6SMB200	TVS	Vrwm=200V, 2.1A, 600W(1ms)	DO-214AA	1d	2j	Fag
NS	P6SMBJ78	TVS	Vbr=78V, 4.3A, 600W(1ms)	DO-214AA	1d	1m,1w	Pjt,Srj
NS	PZU4.7BA/DG	Z-diode	4.7V±5%, If=200mA, 320mW, halogen-free	SOD-323	5d	1a	Phi
NS	SMBG78	TVS	Vbr=78V, 4.3A, 600W(1ms)	DO-215AA	5d	1k	Vs
NS	SMBJ78	TVS	Vbr=78V, 4.3A, 600W(1ms)	DO-214AA	1d	1k	Vs
NS	TV06B780K-G	TVS	Vrwm=78.0V, Vbr=86.70.106.0V, Ipp=4.32A, 600W(1ms)	DO-214AA	1d	1a	Cmc
NSK	SMB200	TVS	Vbr=180.220V, Vrwm=162V, 2.09A, 600W(1ms)	DO-214AA	1d	1a	Lge
NSM	SMB200C	TVS	Vbr=180.220V, Vrwm=162V, 2.09A, 600W(1ms), Bidirectional	DO-214AA	1ba	1j	Lge
NT	1SMB78A	TVS	Vrwm=78V, 4.7A, 600W(1ms)	403A	3d	1s	Ons
NT	CD214B-T78A	TVS	Vbr=78V, Irs=4.7A, 600W(1ms)	DO-214AA	1d	1a	Bm
NT	P6SMB200A	TVS	Vrwm=200V, 2.2A, 600W(1ms)	DO-214AA	1d	2j	Fag
NT	P6SMBJ78A	TVS	Vbr=78V, 4.7A, 600W(1ms)	DO-214AA	1d	1m,1w	Pjt,Srj
NT	PZU4.7B1A/DG	Z-diode	4.7V±2%, If=200mA, 320mW, halogen-free	SOD-323	5d	1a	Phi
NT	SMBG78A	TVS	Vbr=78V, 4.8A, 600W(1ms)	DO-215AA	5d	1k	Vs
NT	SMBJ78A	TVS	Vbr=78V, 4.8A, 600W(1ms)	DO-214AA	1d	1k,1m	Di,Vs
NT	SMF78A	TVS	Vrwm=78V, Vbr=86.7.95.8V, 1.4A, 200W(1ms)	SOD-123FL	7d	1a	Eic
NT	SMF78CA	TVS	Vrwm=78.0V, Vbr=86.70.95.80V, 1.59A, 200W(10/1000µs), Bidirectional	SOD-123FL	7ba	1j	Ers
NT	TV02W780B-G	TVS	Vrwm=78V, Vbr=86.7.95.8V, Ipp=1.59A, 200W(1ms), Bidirectional	SOD-123	5ba	1j	Cmc
NT	TV06B780J-G	TVS	Vrwm=78.0V, Vbr=86.70.95.80V, Ipp=4.76A, 600W(1ms)	DO-214AA	1d	1a	Cmc
NTK	SMB200A	TVS	Vbr=190.210V, Vrwm=171V, 2.19A, 600W(1ms)	DO-214AA	1d	1a	Lge
NTM	SMB200CA	TVS	Vbr=190.210V, Vrwm=171V, 2.19A, 600W(1ms), Bidirectional	DO-214AA	1ba	1j	Lge
NU	P6SMB220	TVS	Vrwm=220V, 1.75A, 600W(1ms)	DO-214AA	1d	2j	Fag
NU	P6SMBJ85	TVS	Vbr=85V, 3.9A, 600W(1ms)	DO-214AA	1d	1m,1w	Pjt,Srj
NU	PZU4.7B2A/DG	Z-diode	4.7V±2%, If=200mA, 320mW, halogen-free	SOD-323	5d	1a	Phi
NU	SMBG85	TVS	Vbr=85V, 4A, 600W(1ms)	DO-215AA	5d	1k	Vs
NU	SMBJ85	TVS	Vbr=85V, 4A, 600W(1ms)	DO-214AA	1d	1k	Vs
NU	TV06B850K-G	TVS	Vrwm=85.0V, Vbr=94.40.115.0V, Ipp=3.97A, 600W(1ms)	DO-214AA	1d	1a	Cmc
NUe	SM2T14A	TVS	Vrwm=12V, 20A, 200W(1ms)	DO-216AA	4d	1q	Ste
NV	1SMB85A	TVS	Vrwm=85V, 4.4A, 600W(1ms)	403A	3d	1s	Ons
NV	CD214B-T85A	TVS	Vbr=85V, Irs=4.4A, 600W(1ms)	DO-214AA	1d	1a	Bm
NV	P6SMB220A	TVS	Vrwm=220V, 1.83A, 600W(1ms)	DO-214AA	1d	2j	Fag
NV	P6SMBJ85A	TVS	Vbr=85V, 4.4A, 600W(1ms)	DO-214AA	1d	1m,1w	Pjt,Srj
NV	PZU4.7B3A/DG	Z-diode	4.7V±2%, If=200mA, 320mW, halogen-free	SOD-323	5d	1a	Phi
NV	SMBG85A	TVS	Vbr=85V, 4.4A, 600W(1ms)	DO-215AA	5d	1k	Vs
NV	SMBJ85A	TVS	Vbr=85V, 4.4A, 600W(1ms)	DO-214AA	1d	1k,1m	Di,Vs
NV	SMF85A	TVS	Vrwm=85V, Vbr=94.4.104V, 1.3A, 200W(1ms)	SOD-123FL	7d	1a	Eic
NV	SMF85CA	TVS	Vrwm=85.0V, Vbr=94.40.104.0V, 1.46A, 200W(10/1000µs), Bidirectional	SOD-123FL	7ba	1j	Ers
NV	TV02W850B-G	TVS	Vrwm=85V, Vbr=94.4.104V, Ipp=1.46A, 200W(1ms), Bidirectional	SOD-123	5ba	1j	Cmc
NV	TV06B850J-G	TVS	Vrwm=85.0V, Vbr=94.40.104.0V, Ipp=4.38A, 600W(1ms)	DO-214AA	1d	1a	Cmc
NV7	SM6T100A	TVS	Vbr=95.105V, 4.4A, 600W(1ms)	DO-214AA	1d	1k	Vs
NV7	SM6T100CA	TVS	Vbr=95.105V, 4.4A, 600W(1ms), Bidirectional	DO-214AA	1ba	1j	Vs
NW	P6SMB250	TVS	Vrwm=250V, 1.67A, 600W(1ms)	DO-214AA	1d	2j	Fag
NW	P6SMBJ90	TVS	Vbr=90V, 3.8A, 600W(1ms)	DO-214AA	1d	1m,1w	Pjt,Srj
NW	PZU5.1BA/DG	Z-diode	5.1V±5%, If=200mA, 320mW, halogen-free	SOD-323	5d	1a	Phi
NW	SMBG90	TVS	Vbr=90V, 3.8A, 600W(1ms)	DO-215AA	5d	1k	Vs
NW	SMBJ90	TVS	Vbr=90V, 3.8A, 600W(1ms)	DO-214AA	1d	1k	Vs
NW	TV06B900K-G	TVS	Vrwm=90.0V, Vbr=100.0.122.0V, Ipp=3.75A, 600W(1ms)	DO-214AA	1d	1a	Cmc
NX	1SMB90A	TVS	Vrwm=90V, 4.1A, 600W(1ms)	403A	3d	1s	Ons
NX	CD214B-T90A	TVS	Vbr=90V, Irs=4.1A, 600W(1ms)	DO-214AA	1d	1a	Bm
NX	P6SMB250A	TVS	Vrwm=250V, 1.65A, 600W(1ms)	DO-214AA	1d	2j	Fag
NX	P6SMBJ90A	TVS	Vbr=90V, 4.1A, 600W(1ms)	DO-214AA	1d	1m,1w	Pjt,Srj
NX	PZU5.1B1A/DG	Z-diode	5.1V±2%, If=200mA, 320mW, halogen-free	SOD-323	5d	1a	Phi
NX	SM6T100C	TVS	Vbr=100V, 4.2A, 600W(1ms), Bidirectional	DO-214AA	1ba	1r	Ste
NX	SMBG90A	TVS	Vbr=90V, 4.1A, 600W(1ms)	DO-215AA	5d	1k	Vs
NX	SMBJ90A	TVS	Vbr=90V, 4.1A, 600W(1ms)	DO-214AA	1d	1k,1m	Di,Vs
NX	SMF90A	TVS	Vrwm=90V, Vbr=100.111V, 1.2A, 200W(1ms)	SOD-123FL	7d	1a	Eic
NX	SMF90CA	TVS	Vrwm=90.0V, Vbr=100.0.111.0V, 1.37A, 200W(10/1000µs), Bidirectional	SOD-123FL	7ba	1j	Ers
NX	TV02W900B-G	TVS	Vrwm=90V, Vbr=100.111V, Ipp=1.3A, 200W(1ms), Bidirectional	SOD-123	5ba	1j	Cmc



SMD code	Type	Function	Short description	Case	Pinout	St.	Mnf.
NX	TV06B900J-G	TVS	Vrwm=90.0V, Vbr=100.0..111.0V, Ipp=4.11A, 600W(1ms)	DO-214AA	1d	1a	Cmc
NY	KDZ6.2VYV	Z-diode	6.06..6.33V, Izt=5mA, Zzt=30Ω, 100mW	VSC	7d	1a	Kec
NY	P6SMBJ100	TVS	Vbr=100V, 3.4A, 600W(1ms)	DO-214AA	1d	1m,1w	Pjt,Srj
NY	PZU5.1B2A/DG	Z-diode	5.1V±2%, If=200mA, 320mW, halogen-free	SOD-323	5d	1a	Phi
NY	SM6T100CA	TVS	Vrwm=85.5V, Vbr=95..105V, 4.4A, 600W(1ms), Bidirectional	DO-214AA	1ba	1j	Ste
NY	SMBG100	TVS	Vbr=100V, 3.4A, 600W(1ms)	DO-215AA	5d	1k	Vs
NY	SMBJ100	TVS	Vbr=100V, 3.4A, 600W(1ms)	DO-214AA	1d	1k	Vs
NY	TV06B101K-G	TVS	Vrwm=100.0V, Vbr=111.0..136.0V, Ipp=3.35A, 600W(1ms)	DO-214AA	1d	1a	Cmc
NZ	1SMB100A	TVS	Vrwm=100V, 3.7A, 600W(1ms)	403A	3d	1s	Ons
NZ	BZT52-B20S	Z-diode	19.60..20.40V, Izt=5mA, Zzt=55Ω, 200mW	SOD-323FL	7d	1a	Tsc
NZ	CD214B-T100A	TVS	Vbr=100V, Irs=3.7A, 600W(1ms)	DO-214AA	1d	1a	Bm
NZ	MM3Z20VB	Z-diode	19.60..20.40V, Zzt=51Ω, Izt=5mA, 200mW	SOD-323FL	7d	1a	F
NZ	MM3Z20VBW	Z-diode	19.60..20.40V, Izt=5mA, Zzt=55Ω, 200mW	SOD-323FL	7d	1a	Tac
NZ	P6SMBJ100A	TVS	Vbr=100V, 3.7A, 600W(1ms)	DO-214AA	1d	1m,1w	Pjt,Srj
NZ	PZU5.1B3A/DG	Z-diode	5.1V±2%, If=200mA, 320mW, halogen-free	SOD-323	5d	1a	Phi
NZ	SMBG100A	TVS	Vbr=100V, 3.7A, 600W(1ms)	DO-215AA	5d	1k	Vs
NZ	SMBJ100A	TVS	Vbr=100V, 3.7A, 600W(1ms)	DO-214AA	1d	1k,1m	Di,Vs
NZ	SMF100A	TVS	Vrwm=100V, Vbr=111..123V, 1.1A, 200W(1ms)	SOD-123FL	7d	1a	Eic
NZ	SMF100CA	TVS	Vrwm=100.0V, Vbr=111.0..123.0V, 1.23A, 200W(10/1000μs), Bidirectional	SOD-123FL	7ba	1j	Ers
NZ	TCMM3Z20VB	Z-diode	20V±2%, Izt=5mA, Zzt=51Ω, 200mW	SOD-323FL	7d	1a	Tac
NZ	TV02W101B-G	TVS	Vrwm=100V, Vbr=111..123V, Ipp=1.23A, 200W(1ms), Bidirectional	SOD-123	5ba	1j	Cmc
NZ	TV06B101J-G	TVS	Vrwm=100.0V, Vbr=111.0..123.0V, Ipp=3.70A, 600W(1ms)	DO-214AA	1d	1a	Cmc
O	BAR64-02V	PIN-diode	Sw, RF-Att, 150V, 100mA, Vf<1.1V(50mA), < 0.35pF	SOD-523	6d	1a	Inf
O	MMSZ5264BPT	Z-diode	57.0..63.0V, Izt=2.1mA, Zzt=170Ω, 225mW	SOD-523	7d	1a	Chm
O	SPE057D372RG	ESDP-diode	Vrwm=5V, Vbr=6..8.5V, 7A, 250W(1ms), Bidirectional	SOD-723	7d	1j	Syn
O (white)	BAT14-03W	Si-diode	Schottky, UHF-mix, 4V, 90mA, Vf<0.66V(10mA), <0.35pF	SOD-323	5d	2	Inf
O	MMSZ5264SPT	Z-diode	58.80..61.20V, Izt=2.1mA, Zzt=170Ω, 225mW	SOD-523	7d	1a	Chm
OO	MMPZ5245SPT	Z-diode	14.70..15.30V, Izt=5mA, Zzt=32Ω, 225mW	SOD-323	5d	1a	Chm
O10A	1KSMBJ24	TVS	Vbr=21.6..26.4V, 28.3A, 1000W(1ms)	DO-214AA	1d	1n	Lif
O10B	1KSMBJ24A	TVS	Vbr=22.8..25.2V, 30A, 1000W(1ms)	DO-214AA	1d	1n	Lif
O10C	1KSMBJ27	TVS	Vbr=24.3..29.7V, 25.5A, 1000W(1ms)	DO-214AA	1d	1n	Lif
O10D	1KSMBJ27A	TVS	Vbr=25.7..28.4V, 26.7A, 1000W(1ms)	DO-214AA	1d	1n	Lif
O10E	1KSMBJ30	TVS	Vbr=27..33V, 22.9A, 1000W(1ms)	DO-214AA	1d	1n	Lif
O10F	1KSMBJ30A	TVS	Vbr=28.5..31.5V, 24A, 1000W(1ms)	DO-214AA	1d	1n	Lif
O10G	1KSMBJ33	TVS	Vbr=29.7..36.3V, 21A, 1000W(1ms)	DO-214AA	1d	1n	Lif
O10H	1KSMBJ33A	TVS	Vbr=31.4..34.7V, 22A, 1000W(1ms)	DO-214AA	1d	1n	Lif
O10I	1KSMBJ36	TVS	Vbr=32.4..39.6V, 19.2A, 1000W(1ms)	DO-214AA	1d	1n	Lif
O10J	1KSMBJ36A	TVS	Vbr=34.2..37.8V, 20A, 1000W(1ms)	DO-214AA	1d	1n	Lif
O10K	1KSMBJ39	TVS	Vbr=35.1..42.9V, 17.5A, 1000W(1ms)	DO-214AA	1d	1n	Lif
O10L	1KSMBJ39A	TVS	Vbr=37.1..41V, 18.7A, 1000W(1ms)	DO-214AA	1d	1n	Lif
O10M	1KSMBJ43	TVS	Vbr=38.7..47.3V, 16A, 1000W(1ms)	DO-214AA	1d	1n	Lif
O10N	1KSMBJ43A	TVS	Vbr=40.9..45.2V, 16.8A, 1000W(1ms)	DO-214AA	1d	1n	Lif
O10O	1KSMBJ47	TVS	Vbr=42.3..51.7V, 14.8A, 1000W(1ms)	DO-214AA	1d	1n	Lif
O10P	1KSMBJ47A	TVS	Vbr=44.7..49.4V, 15.5A, 1000W(1ms)	DO-214AA	1d	1n	Lif
O10Q	1KSMBJ51	TVS	Vbr=45.9..56.1V, 13.7A, 1000W(1ms)	DO-214AA	1d	1n	Lif
O10R	1KSMBJ51A	TVS	Vbr=48.5..53.6V, 14.3A, 1000W(1ms)	DO-214AA	1d	1n	Lif
O10S	1KSMBJ56	TVS	Vbr=50.4..61.6V, 12.3A, 1000W(1ms)	DO-214AA	1d	1n	Lif
O10T	1KSMBJ56A	TVS	Vbr=53.2..58.8V, 13A, 1000W(1ms)	DO-214AA	1d	1n	Lif
O10U	1KSMBJ62	TVS	Vbr=55.8..68.2V, 11.3A, 1000W(1ms)	DO-214AA	1d	1n	Lif
O10V	1KSMBJ62A	TVS	Vbr=58.9..65.1V, 11.8A, 1000W(1ms)	DO-214AA	1d	1n	Lif
O10W	1KSMBJ68	TVS	Vbr=61.2..74.8V, 10.2A, 1000W(1ms)	DO-214AA	1d	1n	Lif
O10X	1KSMBJ68A	TVS	Vbr=64.6..71.4V, 10.8A, 1000W(1ms)	DO-214AA	1d	1n	Lif
O10Y	1KSMBJ75	TVS	Vbr=67.5..82.5V, 9.2A, 1000W(1ms)	DO-214AA	1d	1n	Lif
O10Z	1KSMBJ75A	TVS	Vbr=71.3..78.8V, 9.7A, 1000W(1ms)	DO-214AA	1d	1n	Lif
O8	MMSZ10H	Z-diode	9.4..10.6V, Izt=5mA, Zzt=20Ω, 200mW	SOD-523	7d	1a	Zow
O8	MMSZ10V	Z-diode	10V±5%, Izt=5mA, Zzt=20Ω, 200mW	SOD-523	6d	1a	Eic
OET	5.0SMCJ18A	TVS	Vrwm=18.0V, Vbr=20.0..22.1V, 172.0A, 5000W(1ms)	DO-214AB	1d	1a	Wpl
OEV	5.0SMCJ20A	TVS	Vrwm=20.0V, Vbr=22.2..24.5V, 155.0A, 5000W(1ms)	DO-214AB	1d	1a	Wpl
OEX	5.0SMCJ22A	TVS	Vrwm=22.0V, Vbr=24.4..26.9V, 141.0A, 5000W(1ms)	DO-214AB	1d	1a	Wpl
OEZ	5.0SMCJ24A	TVS	Vrwm=24.0V, Vbr=26.7..29.5V, 129.0A, 5000W(1ms)	DO-214AB	1d	1a	Wpl
OFFE	5.0SMCJ26A	TVS	Vrwm=26.0V, Vbr=28.9..31.9V, 119.0A, 5000W(1ms)	DO-214AB	1d	1a	Wpl
OFG	5.0SMCJ28A	TVS	Vrwm=28.0V, Vbr=31.1..34.4V, 110.0A, 5000W(1ms)	DO-214AB	1d	1a	Wpl
OFK	5.0SMCJ30A	TVS	Vrwm=30.0V, Vbr=33.3..36.8V, 103.0A, 5000W(1ms)	DO-214AB	1d	1a	Wpl
OFM	5.0SMCJ33A	TVS	Vrwm=33.0V, Vbr=36.7..40.6V, 93.9A, 5000W(1ms)	DO-214AB	1d	1a	Wpl
OFFP	5.0SMCJ36A	TVS	Vrwm=36.0V, Vbr=40.0..44.2V, 86.1A, 5000W(1ms)	DO-214AB	1d	1a	Wpl
OK	SM6T150C	TVS	Vbr=150V, 2.7A, 600W(1ms), Bidirectional	DO-214AA	1ba	1r	Ste
OL	SM6T150CA	TVS	Vrwm=128V, Vbr=143..158V, 2.9A, 600W(1ms), Bidirectional	DO-214AA	1ba	1j	Ste
OO	BB857	C-diode	SATV-Tuning, 35V, 6..0.65pF(1..28V)	SCD-80	6d	1u	Sie
OP	CMDZ6L2	Z-diode	5.890..6.510V, Izt=0.5mA, Zzt=90Ω, 250mW	SOD-323	5d	1a	Cen
OT	SM6T200C	TVS	Vbr=200V, 2A, 600W(1ms)	DO-214AA	1d	1q	Ste



SMD
code

Type

Function

Short description

Case

Pinout

St.

Mnf.

OU	SM6T20CA	TVS	Vrwm=171V, Vbr=190..210V, 2.2A, 600W(1ms), Bidirectional	DO-214AA	1ba	1j	Ste
OW	SM6T20CA	TVS	Vrwm=188V, Vbr=209..231V, 2.0A, 600W(1ms), Bidirectional	DO-214AA	1ba	1j	Ste
P	CH411S-40PT	Si-diode	SBD, 40V, 500mA, Vf<0.5V(500mA)	SOD-523	8d	1a	Chm
P	HVU314	C-diode	BS Tuning, 32V, 6.4, 0.47pF(1..25V)	SOD-123	5d	1a	Ren
P	MA2S367	C-diode	CATV, 34V, 10.5/3.3pF(2/10V), 1.6Ω(470MHz)	SOD-523	6d	1a	Pan
P	MAZS056	Z-diode	5.3..6V, 200mW	SOD-523	6d	1a	Pan
P	MM9D13V	Z-diode	12.35..13.65V, Izt=5mA, Zzt=37Ω, 200mW	SOD-923	7d	1n	Wtr
P	MMSZ5265BPT	Z-diode	58.90..65.10V, Izt=2mA, Zzt=185Ω, 225mW	SOD-523	7d	1a	Chm
P	NZ9F13VT	Z-diode	12.35..13.65V, Izt=5mA, Zzt=37Ω, 200mW	SOD-923	7d	1n	Ons
P	NZ9F7V5ST	Z-diode	7.28..7.6V, Izt=5mA, Zzt=30Ω, 200mW	SOD-923	7d	2m	Ons
P-	MAZS0560M	Z-diode	5.48..5.76V, 200mW	SOD-523	6d	1a	Pan
P (white)	BA586	PIN-diode	Attenuator, >1MHz, 50V, 50mA, Vf<1, 15V, Cd<0.2pF	SOD-123	5d	2	Sie
P (white)	BAT15-03W	Si-diode	Schottky, DBS-mix, 4V, 100mA, <12GHz, <0.35pF	SOD-323	5d	2	Inf
P	MMSZ5265SPT	Z-diode	60.76..63.24V, Izt=2mA, Zzt=185Ω, 225mW	SOD-523	7d	1a	Chm
PA	MAZS0560H	Z-diode	5.66..5.95V, 200mW	SOD-523	6d	1a	Pan
P	MAZS0560L	Z-diode	5.3..5.58V, 200mW	SOD-523	6d	1a	Pan
P0	BB150	C-diode	TV-VHF/CATV-Tuning, 30V, ..460MHz, 38..2.2pF(0.5..28V)	SOD-123	5d	1a	Phi
P0	MMPZ5246SPT	Z-diode	15.68..16.32V, Izt=5mA, Zzt=36Ω, 225mW	SOD-323	5d	1a	Chm
P010	STBP010	TVS	Vbr=9.00..11.0V, Vrwm=8.10V, 28.0A, 400W(1ms), Bidirectional	DO-214AC	1ba	1j	Eic
P010	STUP010	TVS	Vbr=9.00..11.0V, Vrwm=8.10V, 28.0A, 400W(1ms)	DO-214AC	1d	1a	Eic
P011	STBP011	TVS	Vbr=9.90..12.1V, Vrwm=8.92V, 26.0A, 400W(1ms), Bidirectional	DO-214AC	1ba	1j	Eic
P011	STUP011	TVS	Vbr=9.90..12.1V, Vrwm=8.92V, 26.0A, 400W(1ms)	DO-214AC	1d	1a	Eic
P012	STBP012	TVS	Vbr=10.8..13.2V, Vrwm=9.72V, 24.0A, 400W(1ms), Bidirectional	DO-214AC	1ba	1j	Eic
P012	STUP012	TVS	Vbr=10.8..13.2V, Vrwm=9.72V, 24.0A, 400W(1ms)	DO-214AC	1d	1a	Eic
P013	STBP013	TVS	Vbr=11.7..14.3V, Vrwm=10.5V, 22.0A, 400W(1ms), Bidirectional	DO-214AC	1ba	1j	Eic
P013	STUP013	TVS	Vbr=11.7..14.3V, Vrwm=10.5V, 22.0A, 400W(1ms)	DO-214AC	1d	1a	Eic
P015	STBP015	TVS	Vbr=13.5..16.5V, Vrwm=12.1V, 19.0A, 400W(1ms), Bidirectional	DO-214AC	1ba	1j	Eic
P015	STUP015	TVS	Vbr=13.5..16.5V, Vrwm=12.1V, 19.0A, 400W(1ms)	DO-214AC	1d	1a	Eic
P016	STBP016	TVS	Vbr=14.4..17.6V, Vrwm=12.9V, 18.0A, 400W(1ms), Bidirectional	DO-214AC	1ba	1j	Eic
P016	STUP016	TVS	Vbr=14.4..17.6V, Vrwm=12.9V, 18.0A, 400W(1ms)	DO-214AC	1d	1a	Eic
P018	STBP018	TVS	Vbr=16.2..19.8V, Vrwm=14.5V, 16.0A, 400W(1ms), Bidirectional	DO-214AC	1ba	1j	Eic
P018	STUP018	TVS	Vbr=16.2..19.8V, Vrwm=14.5V, 16.0A, 400W(1ms)	DO-214AC	1d	1a	Eic
P020	STBP020	TVS	Vbr=18.0..22.0V, Vrwm=16.2V, 14.0A, 400W(1ms), Bidirectional	DO-214AC	1ba	1j	Eic
P020	STUP020	TVS	Vbr=18.0..22.0V, Vrwm=16.2V, 14.0A, 400W(1ms)	DO-214AC	1d	1a	Eic
P022	STBP022	TVS	Vbr=19.8..24.2V, Vrwm=17.8V, 13.0A, 400W(1ms), Bidirectional	DO-214AC	1ba	1j	Eic
P022	STUP022	TVS	Vbr=19.8..24.2V, Vrwm=17.8V, 13.0A, 400W(1ms)	DO-214AC	1d	1a	Eic
P024	STBP024	TVS	Vbr=21.6..26.4V, Vrwm=19.4V, 12.0A, 400W(1ms), Bidirectional	DO-214AC	1ba	1j	Eic
P024	STUP024	TVS	Vbr=21.6..26.4V, Vrwm=19.4V, 12.0A, 400W(1ms)	DO-214AC	1d	1a	Eic
P027	STBP027	TVS	Vbr=24.3..29.7V, Vrwm=21.8V, 11.0A, 400W(1ms), Bidirectional	DO-214AC	1ba	1j	Eic
P027	STUP027	TVS	Vbr=24.3..29.7V, Vrwm=21.8V, 11.0A, 400W(1ms)	DO-214AC	1d	1a	Eic
P030	STBP030	TVS	Vbr=27.0..33.0V, Vrwm=24.3V, 10.0A, 400W(1ms), Bidirectional	DO-214AC	1ba	1j	Eic
P030	STUP030	TVS	Vbr=27.0..33.0V, Vrwm=24.3V, 10.0A, 400W(1ms)	DO-214AC	1d	1a	Eic
P033	STBP033	TVS	Vbr=29.7..36.3V, Vrwm=26.8V, 9.0A, 400W(1ms), Bidirectional	DO-214AC	1ba	1j	Eic
P033	STUP033	TVS	Vbr=29.7..36.3V, Vrwm=26.8V, 9.0A, 400W(1ms)	DO-214AC	1d	1a	Eic
P036	STBP036	TVS	Vbr=32.4..39.6V, Vrwm=29.1V, 8.0A, 400W(1ms), Bidirectional	DO-214AC	1ba	1j	Eic
P036	STUP036	TVS	Vbr=32.4..39.6V, Vrwm=29.1V, 8.0A, 400W(1ms)	DO-214AC	1d	1a	Eic
P039	STBP039	TVS	Vbr=35.1..42.9V, Vrwm=31.6V, 7.4A, 400W(1ms), Bidirectional	DO-214AC	1ba	1j	Eic
P039	STUP039	TVS	Vbr=35.1..42.9V, Vrwm=31.6V, 7.4A, 400W(1ms)	DO-214AC	1d	1a	Eic
P043	STBP043	TVS	Vbr=38.7..47.3V, Vrwm=34.8V, 6.8A, 400W(1ms), Bidirectional	DO-214AC	1ba	1j	Eic
P043	STUP043	TVS	Vbr=38.7..47.3V, Vrwm=34.8V, 6.8A, 400W(1ms)	DO-214AC	1d	1a	Eic
P047	STBP047	TVS	Vbr=42.3..51.7V, Vrwm=38.1V, 6.2A, 400W(1ms), Bidirectional	DO-214AC	1ba	1j	Eic
P047	STUP047	TVS	Vbr=42.3..51.7V, Vrwm=38.1V, 6.2A, 400W(1ms)	DO-214AC	1d	1a	Eic
P051	STBP051	TVS	Vbr=45.9..56.1V, Vrwm=41.3V, 5.7A, 400W(1ms), Bidirectional	DO-214AC	1ba	1j	Eic
P051	STUP051	TVS	Vbr=45.9..56.1V, Vrwm=41.3V, 5.7A, 400W(1ms)	DO-214AC	1d	1a	Eic
P056	STBP056	TVS	Vbr=50.4..61.6V, Vrwm=45.4V, 5.2A, 400W(1ms), Bidirectional	DO-214AC	1ba	1j	Eic
P056	STUP056	TVS	Vbr=50.4..61.6V, Vrwm=45.4V, 5.2A, 400W(1ms)	DO-214AC	1d	1a	Eic
P062	STBP062	TVS	Vbr=55.8..68.2V, Vrwm=50.2V, 4.7A, 400W(1ms), Bidirectional	DO-214AC	1ba	1j	Eic
P062	STUP062	TVS	Vbr=55.8..68.2V, Vrwm=50.2V, 4.7A, 400W(1ms)	DO-214AC	1d	1a	Eic
P068	STBP068	TVS	Vbr=61.2..74.8V, Vrwm=55.1V, 4.3A, 400W(1ms), Bidirectional	DO-214AC	1ba	1j	Eic
P068	STUP068	TVS	Vbr=61.2..74.8V, Vrwm=55.1V, 4.3A, 400W(1ms)	DO-214AC	1d	1a	Eic
P061	STBP061	TVS	Vbr=6.12..7.48V, Vrwm=5.50V, 38.0A, 400W(1ms), Bidirectional	DO-214AC	1ba	1j	Eic
P061	STUP061	TVS	Vbr=6.12..7.48V, Vrwm=5.50V, 38.0A, 400W(1ms)	DO-214AC	1d	1a	Eic
P075	STBP075	TVS	Vbr=67.5..82.5V, Vrwm=60.7V, 3.9A, 400W(1ms), Bidirectional	DO-214AC	1ba	1j	Eic
P075	STUP075	TVS	Vbr=67.5..82.5V, Vrwm=60.7V, 3.9A, 400W(1ms)	DO-214AC	1d	1a	Eic
P07F	STBP07F	TVS	Vbr=6.75..8.25V, Vrwm=6.05V, 36.0A, 400W(1ms), Bidirectional	DO-214AC	1ba	1j	Eic
P07F	STUP07F	TVS	Vbr=6.75..8.25V, Vrwm=6.05V, 36.0A, 400W(1ms)	DO-214AC	1d	1a	Eic
P082	STBP082	TVS	Vbr=73.8..90.2V, Vrwm=66.4V, 3.6A, 400W(1ms), Bidirectional	DO-214AC	1ba	1j	Eic
P082	STUP082	TVS	Vbr=73.8..90.2V, Vrwm=66.4V, 3.6A, 400W(1ms)	DO-214AC	1d	1a	Eic
P08C	STBP08C	TVS	Vbr=7.38..9.02V, Vrwm=6.63V, 33.0A, 400W(1ms), Bidirectional	DO-214AC	1ba	1j	Eic
P08C	STUP08C	TVS	Vbr=7.38..9.02V, Vrwm=6.63V, 33.0A, 400W(1ms)	DO-214AC	1d	1a	Eic



SMD
code

Type

Function

Short description

Case

Pinout

St.

Mnf.

SMD code	Type	Function	Short description	Case	Pinout	St.	Mnf.
P091	STBP091	TVS	Vbr=81.9..100V, Vrwm=73.7V, 3.2A, 400W(1ms), Bidirectional	DO-214AC	1ba	1j	Eic
P091	STUP091	TVS	Vbr=81.9..100V, Vrwm=73.7V, 3.2A, 400W(1ms)	DO-214AC	1d	1a	Eic
P09B	STBP09B	TVS	Vbr=8.19..10.0V, Vrwm=7.37V, 30.0A, 400W(1ms), Bidirectional	DO-214AC	1ba	1j	Eic
P09B	STUP09B	TVS	Vbr=8.19..10.0V, Vrwm=7.37V, 30.0A, 400W(1ms)	DO-214AC	1d	1a	Eic
P0B0	STBP0B0	TVS	Vbr=90.0..110V, Vrwm=81.0V, 2.9A, 400W(1ms), Bidirectional	DO-214AC	1ba	1j	Eic
P0B0	STUP0B0	TVS	Vbr=90.0..110V, Vrwm=81.0V, 2.9A, 400W(1ms)	DO-214AC	1d	1a	Eic
P0B1	STBP0B1	TVS	Vbr=99.0..121V, Vrwm=89.2V, 2.7A, 400W(1ms), Bidirectional	DO-214AC	1ba	1j	Eic
P0B1	STUP0B1	TVS	Vbr=99.0..121V, Vrwm=89.2V, 2.7A, 400W(1ms)	DO-214AC	1d	1a	Eic
P0B2	STBP0B2	TVS	Vbr=108..132V, Vrwm=97.2V, 2.4A, 400W(1ms), Bidirectional	DO-214AC	1ba	1j	Eic
P0B2	STUP0B2	TVS	Vbr=108..132V, Vrwm=97.2V, 2.4A, 400W(1ms)	DO-214AC	1d	1a	Eic
P0B3	STBP0B3	TVS	Vbr=117..143V, Vrwm=105V, 2.2A, 400W(1ms), Bidirectional	DO-214AC	1ba	1j	Eic
P0B3	STUP0B3	TVS	Vbr=117..143V, Vrwm=105V, 2.2A, 400W(1ms)	DO-214AC	1d	1a	Eic
P0B5	STBP0B5	TVS	Vbr=135..165V, Vrwm=121V, 2.0A, 400W(1ms), Bidirectional	DO-214AC	1ba	1j	Eic
P0B5	STUP0B5	TVS	Vbr=135..165V, Vrwm=121V, 2.0A, 400W(1ms)	DO-214AC	1d	1a	Eic
P0B6	STBP0B6	TVS	Vbr=144..176V, Vrwm=130V, 1.8A, 400W(1ms), Bidirectional	DO-214AC	1ba	1j	Eic
P0B6	STUP0B6	TVS	Vbr=144..176V, Vrwm=130V, 1.8A, 400W(1ms)	DO-214AC	1d	1a	Eic
P0B7	STBP0B7	TVS	Vbr=153..187V, Vrwm=138V, 1.7A, 400W(1ms), Bidirectional	DO-214AC	1ba	1j	Eic
P0B7	STUP0B7	TVS	Vbr=153..187V, Vrwm=138V, 1.7A, 400W(1ms)	DO-214AC	1d	1a	Eic
P0B8	STBP0B8	TVS	Vbr=162..198V, Vrwm=146V, 1.6A, 400W(1ms), Bidirectional	DO-214AC	1ba	1j	Eic
P0B8	STUP0B8	TVS	Vbr=162..198V, Vrwm=146V, 1.6A, 400W(1ms)	DO-214AC	1d	1a	Eic
P0D0	STBP0D0	TVS	Vbr=180..220V, Vrwm=162V, 1.5A, 400W(1ms), Bidirectional	DO-214AC	1ba	1j	Eic
P0D0	STUP0D0	TVS	Vbr=180..220V, Vrwm=162V, 1.5A, 400W(1ms)	DO-214AC	1d	1a	Eic
P0D2	STBP0D2	TVS	Vbr=198..242V, Vrwm=175V, 1.16A, 400W(1ms), Bidirectional	DO-214AC	1ba	1j	Eic
P0D2	STUP0D2	TVS	Vbr=198..242V, Vrwm=175V, 1.16A, 400W(1ms)	DO-214AC	1d	1a	Eic
P0D5	STBP0D5	TVS	Vbr=225..275V, Vrwm=202V, 1.11A, 400W(1ms), Bidirectional	DO-214AC	1ba	1j	Eic
P0D5	STUP0D5	TVS	Vbr=225..275V, Vrwm=202V, 1.11A, 400W(1ms)	DO-214AC	1d	1a	Eic
P0E0	STBP0E0	TVS	Vbr=270..330V, Vrwm=243V, 0.93A, 400W(1ms), Bidirectional	DO-214AC	1ba	1j	Eic
P0E0	STUP0E0	TVS	Vbr=270..330V, Vrwm=243V, 0.93A, 400W(1ms)	DO-214AC	1d	1a	Eic
P0E5	STBP0E5	TVS	Vbr=315..385V, Vrwm=284V, 0.79A, 400W(1ms), Bidirectional	DO-214AC	1ba	1j	Eic
P0E5	STUP0E5	TVS	Vbr=315..385V, Vrwm=284V, 0.79A, 400W(1ms)	DO-214AC	1d	1a	Eic
P0G0	STBP0G0	TVS	Vbr=360..440V, Vrwm=324V, 0.70A, 400W(1ms), Bidirectional	DO-214AC	1ba	1j	Eic
P0G0	STUP0G0	TVS	Vbr=360..440V, Vrwm=324V, 0.70A, 400W(1ms)	DO-214AC	1d	1a	Eic
P0G4	STBP0G4	TVS	Vbr=396..484V, Vrwm=356V, 0.95A, 400W(1ms), Bidirectional	DO-214AC	1ba	1j	Eic
P0G4	STUP0G4	TVS	Vbr=396..484V, Vrwm=356V, 0.95A, 400W(1ms)	DO-214AC	1d	1a	Eic
P1	CMOZ16L	Z-diode	15.20..16.80V, Izt=0.25mA, Zzt=100Ω, 250mW	SOD-523	6d	1a	Cen
P1	CZRH5266B-G	Z-diode	64.6..71.4V, Zzt=230Ω, Izt=1.8mA, 150mW	SOD-523	5d	1a	Cmc
P1	CZRV5266B-G	Z-diode	64.6..71.4V, Zzt=230Ω, Izt=1.8mA, 200mW	SOD-323	5d	1a	Cmc
P1	HVC131	PIN-diode	HF-Sw, 65V, 100mA, 150mW, 0.8pF, <2Q(10mA/100MHz)	UFP	6d	1b	Hit
P1	HVU131	PIN-diode	Antenna-Sw, 65V, 100mA, <1Q(10mA)	SOD-123	5d	1a	Ren
P1	MM3Z5235B	Z-diode	6.8V±5%, Izt=20mA, Zzt=5Ω, 200mW	SOD-323FL	7d	1a	Bts
P1	MM3Z5235BH	Z-diode	6.46..7.14V, Izt=20mA, Zzt=5Ω, 300mW	SOD-323	5d	1a	Zow
P1	MM3Z5266B	Z-diode	64.60..71.40V, Izt=1.8mA, Zzt=230Ω, 200mW	SOD-323	5d	1a	Ext
P1	MM3Z5266	Z-diode	64.60..71.40V, Izt=1.8mA, Zzt=230Ω, 300mW	SOD-123	5d	1k	Vs
P1	MM3Z5266B	Z-diode	64.60..71.40V, Izt=1.8mA, Zzt=230Ω, 500mW	SOD-123	5d	1a	Mot
P1	BB131	C-diode	TV-UHF-Tuning, 30V, 20mA, 21.45..62.02pF(4.5/15V)	SOD-323	5d	1a	Phi
P10A	1KSMBJ82	TVS	Vbr=73.8..90.2V, 8.5A, 1000W(1ms)	DO-214AA	1d	1n	Lif
P10B	1KSMBJ82A	TVS	Vbr=77.9..86.1V, 8.8A, 1000W(1ms)	DO-214AA	1d	1n	Lif
P10C	1KSMBJ91	TVS	Vbr=81.9..100V, 7.5A, 1000W(1ms)	DO-214AA	1d	1n	Lif
P10D	1KSMBJ91A	TVS	Vbr=86.5..95.5V, 8A, 1000W(1ms)	DO-214AA	1d	1n	Lif
P10E	1KSMBJ100	TVS	Vbr=90..110V, 7A, 1000W(1ms)	DO-214AA	1d	1n	Lif
P10F	1KSMBJ100A	TVS	Vbr=95..105V, 7.3A, 1000W(1ms)	DO-214AA	1d	1n	Lif
P10G	1KSMBJ110	TVS	Vbr=99..121V, 6.3A, 1000W(1ms)	DO-214AA	1d	1n	Lif
P10H	1KSMBJ110A	TVS	Vbr=105..116V, 6.6A, 1000W(1ms)	DO-214AA	1d	1n	Lif
P10I	1KSMBJ120	TVS	Vbr=108..132V, 5.8A, 1000W(1ms)	DO-214AA	1d	1n	Lif
P10J	1KSMBJ120A	TVS	Vbr=114..126V, 6.1A, 1000W(1ms)	DO-214AA	1d	1n	Lif
P10K	1KSMBJ130	TVS	Vbr=117..143V, 5.3A, 1000W(1ms)	DO-214AA	1d	1n	Lif
P10L	1KSMBJ130A	TVS	Vbr=124..137V, Vrwm=130V, 5.6A, 1000W(1ms)	DO-214AA	1d	1n	Lif
P10M	1KSMBJ150	TVS	Vbr=135..165V, 4.7A, 1000W(1ms)	DO-214AA	1d	1n	Lif
P10N	1KSMBJ150A	TVS	Vbr=143..158V, 4.8A, 1000W(1ms)	DO-214AA	1d	1n	Lif
P10O	1KSMBJ160	TVS	Vbr=144..176V, 4.3A, 1000W(1ms)	DO-214AA	1d	1n	Lif
P10P	1KSMBJ160A	TVS	Vbr=152..168V, 4.6A, 1000W(1ms)	DO-214AA	1d	1n	Lif
P2	BB132	C-diode	TV-UHF-Tuning, 30V, 20mA, 2.75..30pF(28/0.5V), <2Q,	SOD-323	5d	1a	Phi
P2	CMOZ18L	Z-diode	17.10..18.90V, Izt=0.25mA, Zzt=100Ω, 250mW	SOD-523	6d	1a	Cen
P2	CZRH5267B-G	Z-diode	71.25..78.75V, Zzt=270Ω, Izt=1.7mA, 150mW	SOD-523	5d	1a	Cmc
P2	CZRV5267B-G	Z-diode	71.25..78.75V, Zzt=270Ω, Izt=1.7mA, 200mW	SOD-323	5d	1a	Cmc
P2	HVC132	PIN-diode	HF-Sw, 65V, 100mA, 150mW, 0.5pF, <2Q(10mA/100MHz)	UFP	6d	1b	Hit
P2	HVU132	PIN-diode	Antenna-Sw, 65V, 100mA, <2Q(10mA)	SOD-123	5d	1a	Ren
P2	MM3Z5257B	Z-diode	33V±5%, Izt=3.8mA, Zzt=58Ω, 200mW	SOD-323FL	7d	1a	Bts
P2	MM3Z5257BH	Z-diode	31.35..34.65V, Izt=3.8mA, Zzt=58Ω, 300mW	SOD-323	5d	1a	Zow
P2	MM3Z5267B	Z-diode	71.25..78.75V, Izt=1.7mA, Zzt=270Ω, 200mW	SOD-323	5d	1a	Ext



SMD code	Type	Function	Short description	Case	Pinout	St.	Mnf.
P2	MMSZ5267	Z-diode	71.25..78.75V, Izt=1.7mA, Zzt=270Ω, 300mW	SOD-123	5d	1k	Vs
P2	MMSZ5267B	Z-diode	71.25..78.75V, Izt=1.7mA, Zzt=270Ω, 500mW	SOD-123	5d	1a	Mot
P2B	ESH2PB	Si-diode	Rectifier, 100V, 2A, Vf<0.92V(2A)	DO-220AA	8d	1k	Vs
P2C	ESH2PC	Si-diode	Rectifier, 150V, 2A, Vf<0.92V(1A)	DO-220AA	8d	1k	Vs
P2D	ESH2PD	Si-diode	Rectifier, 200V, 2A, Vf<0.92V(1A)	DO-220AA	8d	1k	Vs
P3	BB133	C-diode	TV-UHF-Tuning, 30V, 20mA, 2.6..46pF(28/0.5V), <0.9Ω	SOD-323	5d	1a	Phi
P3	CMOZ20L	Z-diode	19.0..21.0V, Izt=0.25mA, Zzt=150Ω, 250mW	SOD-523	6d	1a	Cen
P3	D3FP3	Si-diode	SBR, 30V, 2.6A, Vf<0.45V(2.6A)	SOD-15	1d	1a	Shi
P3	HVC133	PIN-diode	HF-Sw, 30V, 100mA, 150mW, 0.9pF, <0.7Ω(10mA/100MHz)	UFP	6d	1b	Hit
P3	HVU133	PIN-diode	Antenna-Sw, 15V, <0.7Ω(20mA)	SOD-123	5d	1a	Ren
P3	MMSZ5268B	Z-diode	82V±5%, Zzt=330Ω, 500mW	SOD-123	5d	1a	Mot
P3	RKZ22B2KK	Z-diode	21.54..22.47V, Izt=5mA, Zzt=150Ω, 150mW	SFP	7d	1a	Ren
P3	RKZ22B2KL	Z-diode	21.54..22.47V, Izt=2mA, Zzt=55Ω, 100mW	EFP	7d	1a	Ren
P4	BB134	C-diode	TV-UHF-Tuning, 30V, 20mA, 2.1..21pF(28/0.5V), <0.75Ω	SOD-323	5d	1a	Phi
P4	CMOZ22L	Z-diode	20.90..23.10V, Izt=0.25mA, Zzt=150Ω, 250mW	SOD-523	6d	1a	CenM
P4	HVC134	PIN-diode	HF-Sw, 65V, 100mA, 150mW, 0.4pF, <2Ω(10mA/100MHz)	UFP	6d	1b	Hit
P4	MM1Z5235B	Z-diode	6.46..7.14V, Izt=20mA, Zzt=5Ω, 500mW	SOD-323FL	5d	1a	Eic
P4	MM1Z5235BH	Z-diode	6.46..7.14V, Izt=20mA, Zzt=5Ω, 500mW	SOD-123	5d	1a	Zow
P4	MMSZ5235B	Z-diode	6.8V±5%, Izt=20mA, Zzt=5Ω, 500mW	SOD-123	5d	1a	Eic
P4	MMSZ5269B	Z-diode	87V±5%, Zzt=370Ω, 500mW	SOD-123	5d	1a	Mot
P5	BB135	C-diode	TV-UHF-Tuning, 30V, 20mA, 2.1..21pF(28/0.5V), <0.75Ω	SOD-323	5d	1a	Phi
P5	BZX584B22V	Z-diode	21.56..22.44V, Izt=5mA, Zzt=55Ω, 200mW	SOD-523FL	7d	1a	Tac
P5	CMOZ24L	Z-diode	22.80..25.20V, Izt=0.25mA, Zzt=150Ω, 250mW	SOD-523	6d	1a	Cen
P5	HVC135	PIN-diode	Ant-Sw, 65V, 100mA, 150mW, 0.6pF, <2Ω(2mA/100MHz)	UFP	6d	1b	Hit
P5	MM1Z5257B	Z-diode	31.35..34.65V, Izt=3.8mA, Zzt=58Ω, 500mW	SOD-323FL	5d	1a	Eic
P5	MM1Z5257BH	Z-diode	31.35..34.65V, Izt=3.8mA, Zzt=58Ω, 500mW	SOD-123	5d	1a	Zow
P5	MMSZ22Vb	Z-diode	21.56..22.44V, Izt=5mA, Zzt=55Ω, 200mW	SOD-523FL	7d	1a	Tac
P5	MMSZ5257B	Z-diode	33V±5%, Izt=3.8mA, Zzt=58Ω, 500mW	SOD-123	5d	1a	Eic
P5	MMSZ5270B	Z-diode	91V±5%, Zzt=400Ω, 500mW	SOD-123	5d	1a	Mot
P510	STBP510	TVS	Vbr=9.50..10.5V, Vrw=8.55V, 29.0A, 400W(1ms), Bidirectional	DO-214AC	1ba	1j	Eic
P510	STUP510	TVS	Vbr=9.50..10.5V, Vrw=8.55V, 29.0A, 400W(1ms)	DO-214AC	1d	1a	Eic
P511	STBP511	TVS	Vbr=10.5..11.6V, Vrw=9.40V, 27.0A, 400W(1ms), Bidirectional	DO-214AC	1ba	1j	Eic
P511	STUP511	TVS	Vbr=10.5..11.6V, Vrw=9.40V, 27.0A, 400W(1ms)	DO-214AC	1d	1a	Eic
P512	STBP512	TVS	Vbr=11.4..12.6V, Vrw=10.2V, 25.0A, 400W(1ms), Bidirectional	DO-214AC	1ba	1j	Eic
P512	STUP512	TVS	Vbr=11.4..12.6V, Vrw=10.2V, 25.0A, 400W(1ms)	DO-214AC	1d	1a	Eic
P513	STBP513	TVS	Vbr=12.4..13.7V, Vrw=11.1V, 23.0A, 400W(1ms), Bidirectional	DO-214AC	1ba	1j	Eic
P513	STUP513	TVS	Vbr=12.4..13.7V, Vrw=11.1V, 23.0A, 400W(1ms)	DO-214AC	1d	1a	Eic
P515	STBP515	TVS	Vbr=14.3..15.8V, Vrw=12.8V, 20.0A, 400W(1ms), Bidirectional	DO-214AC	1ba	1j	Eic
P515	STUP515	TVS	Vbr=14.3..15.8V, Vrw=12.8V, 20.0A, 400W(1ms)	DO-214AC	1d	1a	Eic
P516	STBP516	TVS	Vbr=15.2..16.8V, Vrw=13.6V, 19.0A, 400W(1ms), Bidirectional	DO-214AC	1ba	1j	Eic
P516	STUP516	TVS	Vbr=15.2..16.8V, Vrw=13.6V, 19.0A, 400W(1ms)	DO-214AC	1d	1a	Eic
P518	STBP518	TVS	Vbr=17.1..18.9V, Vrw=15.3V, 17.0A, 400W(1ms), Bidirectional	DO-214AC	1ba	1j	Eic
P518	STUP518	TVS	Vbr=17.1..18.9V, Vrw=15.3V, 17.0A, 400W(1ms)	DO-214AC	1d	1a	Eic
P520	STBP520	TVS	Vbr=19.0..21.0V, Vrw=17.1V, 15.0A, 400W(1ms), Bidirectional	DO-214AC	1ba	1j	Eic
P520	STUP520	TVS	Vbr=19.0..21.0V, Vrw=17.1V, 15.0A, 400W(1ms)	DO-214AC	1d	1a	Eic
P522	STBP522	TVS	Vbr=20.9..23.1V, Vrw=18.8V, 14.0A, 400W(1ms), Bidirectional	DO-214AC	1ba	1j	Eic
P522	STUP522	TVS	Vbr=20.9..23.1V, Vrw=18.8V, 14.0A, 400W(1ms)	DO-214AC	1d	1a	Eic
P524	STBP524	TVS	Vbr=22.8..25.2V, Vrw=20.5V, 13.0A, 400W(1ms), Bidirectional	DO-214AC	1ba	1j	Eic
P524	STUP524	TVS	Vbr=22.8..25.2V, Vrw=20.5V, 13.0A, 400W(1ms)	DO-214AC	1d	1a	Eic
P527	STBP527	TVS	Vbr=25.7..28.4V, Vrw=23.1V, 11.2A, 400W(1ms), Bidirectional	DO-214AC	1ba	1j	Eic
P527	STUP527	TVS	Vbr=25.7..28.4V, Vrw=23.1V, 11.2A, 400W(1ms)	DO-214AC	1d	1a	Eic
P530	STBP530	TVS	Vbr=28.5..31.5V, Vrw=25.6V, 10.0A, 400W(1ms), Bidirectional	DO-214AC	1ba	1j	Eic
P530	STUP530	TVS	Vbr=28.5..31.5V, Vrw=25.6V, 10.0A, 400W(1ms)	DO-214AC	1d	1a	Eic
P533	STBP533	TVS	Vbr=31.4..34.7V, Vrw=28.2V, 9.0A, 400W(1ms), Bidirectional	DO-214AC	1ba	1j	Eic
P533	STUP533	TVS	Vbr=31.4..34.7V, Vrw=28.2V, 9.0A, 400W(1ms)	DO-214AC	1d	1a	Eic
P536	STBP536	TVS	Vbr=34.2..37.8V, Vrw=30.8V, 8.4A, 400W(1ms), Bidirectional	DO-214AC	1ba	1j	Eic
P536	STUP536	TVS	Vbr=34.2..37.8V, Vrw=30.8V, 8.4A, 400W(1ms)	DO-214AC	1d	1a	Eic
P539	STBP539	TVS	Vbr=37.1..41.0V, Vrw=33.3V, 7.8A, 400W(1ms), Bidirectional	DO-214AC	1ba	1j	Eic
P539	STUP539	TVS	Vbr=37.1..41.0V, Vrw=33.3V, 7.8A, 400W(1ms)	DO-214AC	1d	1a	Eic
P543	STBP543	TVS	Vbr=40.9..45.2V, Vrw=36.8V, 7.1A, 400W(1ms), Bidirectional	DO-214AC	1ba	1j	Eic
P543	STUP543	TVS	Vbr=40.9..45.2V, Vrw=36.8V, 7.1A, 400W(1ms)	DO-214AC	1d	1a	Eic
P547	STBP547	TVS	Vbr=44.7..49.4V, Vrw=40.2V, 6.5A, 400W(1ms), Bidirectional	DO-214AC	1ba	1j	Eic
P547	STUP547	TVS	Vbr=44.7..49.4V, Vrw=40.2V, 6.5A, 400W(1ms)	DO-214AC	1d	1a	Eic
P551	STBP551	TVS	Vbr=48.5..53.6V, Vrw=43.6V, 6.0A, 400W(1ms), Bidirectional	DO-214AC	1ba	1j	Eic
P551	STUP551	TVS	Vbr=48.5..53.6V, Vrw=43.6V, 6.0A, 400W(1ms)	DO-214AC	1d	1a	Eic
P556	STBP556	TVS	Vbr=53.2..58.8V, Vrw=47.8V, 5.5A, 400W(1ms), Bidirectional	DO-214AC	1ba	1j	Eic
P556	STUP556	TVS	Vbr=53.2..58.8V, Vrw=47.8V, 5.5A, 400W(1ms)	DO-214AC	1d	1a	Eic
P562	STBP562	TVS	Vbr=58.9..65.1V, Vrw=53.0V, 5.0A, 400W(1ms), Bidirectional	DO-214AC	1ba	1j	Eic
P562	STUP562	TVS	Vbr=58.9..65.1V, Vrw=53.0V, 5.0A, 400W(1ms)	DO-214AC	1d	1a	Eic
P568	STBP568	TVS	Vbr=64.6..71.4V, Vrw=58.1V, 4.6A, 400W(1ms), Bidirectional	DO-214AC	1ba	1j	Eic



SMD
code

Type

Function

Short description

Case

Pinout

St.

Mnf.

P568	STUP568	TVS	Vbr=64.6..71.4V, Vrwm=58.1V, 4.6A, 400W(1ms)	DO-214AC	1d	1a	Eic
P56I	STBP56I	TVS	Vbr=6.45..7.14V, Vrwm=5.80V, 40.0A, 400W(1ms), Bidirectional	DO-214AC	1ba	1j	Eic
P56I	STUP56I	TVS	Vbr=6.45..7.14V, Vrwm=5.80V, 40.0A, 400W(1ms)	DO-214AC	1d	1a	Eic
P575	STBP575	TVS	Vbr=71.3..78.8V, Vrwm=64.1V, 4.1A, 400W(1ms), Bidirectional	DO-214AC	1ba	1j	Eic
P575	STUP575	TVS	Vbr=71.3..78.8V, Vrwm=64.1V, 4.1A, 400W(1ms)	DO-214AC	1d	1a	Eic
P57F	STBP57F	TVS	Vbr=77.9..86.1V, Vrwm=6.40V, 37.0A, 400W(1ms), Bidirectional	DO-214AC	1ba	1j	Eic
P57F	STUP57F	TVS	Vbr=77.9..86.1V, Vrwm=6.40V, 37.0A, 400W(1ms)	DO-214AC	1d	1a	Eic
P582	STBP582	TVS	Vbr=77.9..86.1V, Vrwm=70.1V, 3.7A, 400W(1ms), Bidirectional	DO-214AC	1ba	1j	Eic
P582	STUP582	TVS	Vbr=77.9..86.1V, Vrwm=70.1V, 3.7A, 400W(1ms)	DO-214AC	1d	1a	Eic
P58C	STBP58C	TVS	Vbr=7.79..8.61V, Vrwm=7.02V, 35.0A, 400W(1ms), Bidirectional	DO-214AC	1ba	1j	Eic
P58C	STUP58C	TVS	Vbr=7.79..8.61V, Vrwm=7.02V, 35.0A, 400W(1ms)	DO-214AC	1d	1a	Eic
P591	STBP591	TVS	Vbr=86.5..95.5V, Vrwm=77.8V, 3.4A, 400W(1ms), Bidirectional	DO-214AC	1ba	1j	Eic
P591	STUP591	TVS	Vbr=86.5..95.5V, Vrwm=77.8V, 3.4A, 400W(1ms)	DO-214AC	1d	1a	Eic
P59B	STBP59B	TVS	Vbr=8.65..9.55V, Vrwm=7.78V, 31.0A, 400W(1ms), Bidirectional	DO-214AC	1ba	1j	Eic
P59B	STUP59B	TVS	Vbr=8.65..9.55V, Vrwm=7.78V, 31.0A, 400W(1ms)	DO-214AC	1d	1a	Eic
P5B0	STBP5B0	TVS	Vbr=95.0..105V, Vrwm=85.5V, 3.1A, 400W(1ms), Bidirectional	DO-214AC	1ba	1j	Eic
P5B0	STUP5B0	TVS	Vbr=95.0..105V, Vrwm=85.5V, 3.1A, 400W(1ms)	DO-214AC	1d	1a	Eic
P5B1	STBP5B1	TVS	Vbr=105..116V, Vrwm=94.0V, 2.8A, 400W(1ms), Bidirectional	DO-214AC	1ba	1j	Eic
P5B1	STUP5B1	TVS	Vbr=105..116V, Vrwm=94.0V, 2.8A, 400W(1ms)	DO-214AC	1d	1a	Eic
P5B2	STBP5B2	TVS	Vbr=114..126V, Vrwm=102V, 2.5A, 400W(1ms), Bidirectional	DO-214AC	1ba	1j	Eic
P5B2	STUP5B2	TVS	Vbr=114..126V, Vrwm=102V, 2.5A, 400W(1ms)	DO-214AC	1d	1a	Eic
P5B3	STBP5B3	TVS	Vbr=124..137V, Vrwm=111V, 2.3A, 400W(1ms), Bidirectional	DO-214AC	1ba	1j	Eic
P5B3	STUP5B3	TVS	Vbr=124..137V, Vrwm=111V, 2.3A, 400W(1ms)	DO-214AC	1d	1a	Eic
P5B5	STBP5B5	TVS	Vbr=143..158V, Vrwm=128V, 2.0A, 400W(1ms), Bidirectional	DO-214AC	1ba	1j	Eic
P5B5	STUP5B5	TVS	Vbr=143..158V, Vrwm=128V, 2.0A, 400W(1ms)	DO-214AC	1d	1a	Eic
P5B6	STBP5B6	TVS	Vbr=152..168V, Vrwm=136V, 1.9A, 400W(1ms), Bidirectional	DO-214AC	1ba	1j	Eic
P5B6	STUP5B6	TVS	Vbr=152..168V, Vrwm=136V, 1.9A, 400W(1ms)	DO-214AC	1d	1a	Eic
P5B7	STBP5B7	TVS	Vbr=162..179V, Vrwm=145V, 1.8A, 400W(1ms), Bidirectional	DO-214AC	1ba	1j	Eic
P5B7	STUP5B7	TVS	Vbr=162..179V, Vrwm=145V, 1.8A, 400W(1ms)	DO-214AC	1d	1a	Eic
P5B8	STBP5B8	TVS	Vbr=171..189V, Vrwm=154V, 1.7A, 400W(1ms), Bidirectional	DO-214AC	1ba	1j	Eic
P5B8	STUP5B8	TVS	Vbr=171..189V, Vrwm=154V, 1.7A, 400W(1ms)	DO-214AC	1d	1a	Eic
P5D0	STBP5D0	TVS	Vbr=190..210V, Vrwm=171V, 1.53A, 400W(1ms), Bidirectional	DO-214AC	1ba	1j	Eic
P5D0	STUP5D0	TVS	Vbr=190..210V, Vrwm=171V, 1.53A, 400W(1ms)	DO-214AC	1d	1a	Eic
P5D2	STBP5D2	TVS	Vbr=209..231V, Vrwm=185V, 1.22A, 400W(1ms), Bidirectional	DO-214AC	1ba	1j	Eic
P5D2	STUP5D2	TVS	Vbr=209..231V, Vrwm=185V, 1.22A, 400W(1ms)	DO-214AC	1d	1a	Eic
P5D5	STBP5D5	TVS	Vbr=237..263V, Vrwm=214V, 1.16A, 400W(1ms), Bidirectional	DO-214AC	1ba	1j	Eic
P5D5	STUP5D5	TVS	Vbr=237..263V, Vrwm=214V, 1.16A, 400W(1ms)	DO-214AC	1d	1a	Eic
P5E0	STBP5E0	TVS	Vbr=285..315V, Vrwm=256V, 0.97A, 400W(1ms), Bidirectional	DO-214AC	1ba	1j	Eic
P5E0	STUP5E0	TVS	Vbr=285..315V, Vrwm=256V, 0.97A, 400W(1ms)	DO-214AC	1d	1a	Eic
P5E5	STBP5E5	TVS	Vbr=332..368V, Vrwm=300V, 0.83A, 400W(1ms), Bidirectional	DO-214AC	1ba	1j	Eic
P5E5	STUP5E5	TVS	Vbr=332..368V, Vrwm=300V, 0.83A, 400W(1ms)	DO-214AC	1d	1a	Eic
P5G0	STBP5G0	TVS	Vbr=380..420V, Vrwm=342V, 0.73A, 400W(1ms), Bidirectional	DO-214AC	1ba	1j	Eic
P5G0	STUP5G0	TVS	Vbr=380..420V, Vrwm=342V, 0.73A, 400W(1ms)	DO-214AC	1d	1a	Eic
P5G4	STBP5G4	TVS	Vbr=418..462V, Vrwm=376V, 1.0A, 400W(1ms), Bidirectional	DO-214AC	1ba	1j	Eic
P5G4	STUP5G4	TVS	Vbr=418..462V, Vrwm=376V, 1.0A, 400W(1ms)	DO-214AC	1d	1a	Eic
P6	BB146	C-diode	TV-VHF-Tuning, ext, Band, 30V, 20mA, 1.7..35pF(28..0.5V)	SOD-323	5d	1a	Phi
P6	CMOZ27L	Z-diode	25.65..28.35V, Izt=0.25mA, Zzt=150Ω, 250mW	SOD-523	6d	1a	Cen
P6	HVC136	Pin-diode	Ant-SW, 65V, 100mA, 150mW, 0.45pF, <2.5C(2mA/100MHz)	UFP	6d	1b	Hit
P6	RKZ24B2KK	Z-diode	23.72..24.78V, Izt=5mA, Zzt=60Ω, 150mW	SFP	7d	1a	Ren
P6	RKZ24B2KL	Z-diode	23.72..24.78V, Izt=2mA, Zzt=60Ω, 100mW	EFP	7d	1a	Ren
P7	BB147	C-diode	TV-VHF-Tuning, ext, Band, 30V, 20mA, 2.4..92pF(28..0.5V)	SOD-323	5d	1a	Phi
P7	CMOZ30L	Z-diode	28.50..31.50V, Izt=0.25mA, Zzt=200Ω, 250mW	SOD-523	6d	1a	Cen
P7	RKZ27BKL	Z-diode	25.10..28.9V, Izt=2mA, Zzt=70Ω, 100mW	EFP	7d	1a	Ren
P8	BB148	C-diode	TV-VHF/CATV-Tuning, 30V, 20mA, 2.4..36.8pF(28..1V)	SOD-323	5d	1a	Phi
P8	CMOZ33L	Z-diode	31.35..34.65V, Izt=0.25mA, Zzt=250Ω, 250mW	SOD-523	6d	1a	Cen
P8	MMSZ11H	Z-diode	10.4..11.6V, Izt=5mA, Zzt=20Ω, 200mW	SOD-523	7d	1a	Zow
P8	MMSZ11V	Z-diode	11V±5%, Izt=5mA, Zzt=20Ω, 200mW	SOD-523	6d	1a	Eic
P8	RKZ27BKK	Z-diode	25.10..28.9V, Izt=2mA, Zzt=70Ω, 150mW	SFP	7d	1a	Ren
P8	RKZ30BKL	Z-diode	28.0..32.0V, Izt=2mA, Zzt=80Ω, 100mW	EFP	7d	1a	Ren
P9	BB149	C-diode	TV-UHF-Tuning, 30V, 20mA, 1.9..18pF(28..1V)	SOD-323	5d	1a	Phi
P9	CMOZ36L	Z-diode	34.20..37.80V, Izt=0.25mA, Zzt=200Ω, 250mW	SOD-523	6d	1a	Cen
P9	MMSZ5253B	Z-diode	25V±5%, Izt=5mA, Zzt=35Ω, 200mW	SOD-323FL	7d	1a	Bts
P9	MMSZ5253BH	Z-diode	23.75..26.25V, Izt=5.23mA, Zzt=35Ω, 300mW	SOD-323	5d	1a	Zow
P9	RKZ30BKK	Z-diode	28.0..32.0V, Izt=2mA, Zzt=80Ω, 150mW	SFP	7d	1a	Ren
PA	BB151	C-diode	VCO, 10V, 20mA, 9..19pF(4..0.5V)	SOD-323	5d	1a	Phi
PA	KDV142UL	Pin-diode	Sw, RF-Att, 30V, 100mA, Vf<1V(10mA), 0.35pF	ULP-2	13d	2b	Kec
PA	MA2Q735	Si-diode	SBR, HF, 30V, 1A, Vf<0.5V(1A), 50pF, 30ns	SOD-106	1d	1a	Pan
PA	MA735	Si-diode	SBR, HF, 30V, 1A, Vf<0.5V(1A), 50pF, 30ns	SOD-106	1d	1a	Pan
PA	TV06B141K-G	TVS	Vrwm=140.0V, Vbr=155.68..190.4V, Ipp=2.6A, 600W(1ms)	DO-214AA	1d	1a	Cmc
PB	BB152	C-diode	TV-UHF-Tuning, 32V, 20mA, 2.48..52pF(28..1V)	SOD-323	5d	1a	Phi



SMD
code

Type

Function

Short description

Case

Pinout St.

Mnf.

SMD code	Type	Function	Short description	Case	Pinout	St.	Mnf.
PB	ESH1PB	Si-diode	Rectifier, 100V, 1A, Vf<0.92V(1A)	DO-220AA	8d	1k	Vs
PB	KDV143UL	PIN-diode	Sw, RF-Att, 30V, 100mA, Vf<0.9V(2mA), 0.43pF	ULP-2	13d	2b	Kec
PB	KDZ6.8B	Z-diode	6.8V±2.5%, 40mA, 1W	PMDU	7d	1s	Rhm
PB	MA2Q736	Si-diode	SBR, HF, 40V, 1A, Vf<0.55V(1A), 50pF, 30ns	SOD-106	1d	1a	Pan
PB	MA736	Si-diode	SBR, HF, 40V, 1A, Vf<0.55V(1A), 50pF, 30ns	SOD-106	1d	1a	Pan
PB	SMF140CA	TVS	Vrwm=140.0V, Vbr=155.0..171.0V, 0.89A, 200W(10/1000µs), Bidirectional	SOD-123FL	7ba	1j	Ers
PB	TV02W111B-G	TVS	Vrwm=140V, Vbr=155.171V, Ipp=0.89A, 200W(1ms), Bidirectional	SOD-123	5ba	1j	Cmc
PB	TV06B141J-G	TVS	Vrwm=140.0V, Vbr=155.0..171.0V, Ipp=2.9A, 600W(1ms)	DO-214AA	1d	1a	Cmc
PC	BB153	C-diode	TV-UHF-Tuning, 32V, 20mA, 2.36..34.6pF(28..1V)	SOD-323	5d	1a	Phi
PC	ESH1PC	Si-diode	Rectifier, 150V, 1A, Vf<0.92V(1A)	DO-220AA	8d	1k	Vs
PC	MA2Q737	Si-diode	SBR, HF, 30V, 1.5A, Vf<0.5V(1A), 70pF, 50ns	SOD-106	1d	1a	Pan
PC	MA737	Si-diode	SBR, HF, 30V, 1.5A, Vf<0.5V(1A), 70pF, 50ns	SOD-106	1d	1a	Pan
PD	ESH1PD	Si-diode	Rectifier, 200V, 1A, Vf<0.92V(1A)	DO-220AA	8d	1k	Vs
PD	MA2Q738	Si-diode	SBR, HF, 40V, 1.5A, Vf<0.55V(1A), 70pF, 50ns	SOD-106	1d	1a	Pan
PD	MA738	Si-diode	SBR, HF, 40V, 1.5A, Vf<0.55V(1A), 70pF, 50ns	SOD-106	1d	1a	Pan
PD	P6SMB6V8C	TVS	Vrwm=6.8V, 56A, 600W(1ms), Bidirectional	DO-214AA	1ba	2k	Fag
PD	P6SMBJ110	TVS	Vbr=110V, 3A, 600W(1ms)	DO-214AA	1d	1m,1w	Pjt,Sij
PD	SMBG110	TVS	Vbr=110V, 3.1A, 600W(1ms)	DO-215AA	5d	1k	Vs
PD	SMBJ110	TVS	Vbr=110V, 3.1A, 600W(1ms)	DO-214AA	1d	1k	Vs
PD	TV06B111K-G	TVS	Vrwm=110.0V, Vbr=122.0..149.0V, Ipp=3.06A, 600W(1ms)	DO-214AA	1d	1a	Cmc
PDL	SMLJ7.0	TVS	Vrwm=7.0V, Vbr=7.78..9.51V, Ipp=225.6A, 3000W(1ms)	DO-214AB	1a	1a	Mco
PDM	SMDJ7.0	TVS	Vrwm=7.0V, Vbr=8.19V±10%, 250.0A, 3000W(1ms)	DO-214AB	1d	1a	Mde
PDM	SMDJ7.0A	TVS	Vrwm=7.0V, Vbr=8.19V±5%, 250.0A, 3000W(1ms)	DO-214AB	1d	1a	Mde
PDM	SMLJ7.0A	TVS	Vrwm=7.0V, Vbr=7.78..8.60V, Ipp=250.0A, 3000W(1ms)	DO-214AB	1a	1a	Mco
PDN	SMLJ7.5	TVS	Vrwm=7.5V, Vbr=8.33..10.2V, Ipp=209.8A, 3000W(1ms)	DO-214AB	1a	1a	Mco
PDO	SMLJ7.5A	TVS	Vrwm=7.5V, Vbr=8.33..9.21V, Ipp=232.6A, 3000W(1ms)	DO-214AB	1a	1a	Mco
PDP	SMDJ7.5	TVS	Vrwm=7.5V, Vbr=8.77V±10%, 232.6A, 3000W(1ms)	DO-214AB	1d	1a	Mde
PDP	SMDJ7.5A	TVS	Vrwm=7.5V, Vbr=8.77V±5%, 232.6A, 3000W(1ms)	DO-214AB	1d	1a	Mde
PDP	SMLJ8.0	TVS	Vrwm=8.0V, Vbr=8.89..10.9V, Ipp=200.0A, 3000W(1ms)	DO-214AB	1a	1a	Mco
PDQ	SMLJ8.0A	TVS	Vrwm=8.0V, Vbr=8.89..9.83V, Ipp=220.6A, 3000W(1ms)	DO-214AB	1a	1a	Mco
PDR	SMDJ8.0	TVS	Vrwm=8.0V, Vbr=9.36V±10%, 220.6A, 3000W(1ms)	DO-214AB	1d	1a	Mde
PDR	SMDJ8.0A	TVS	Vrwm=8.0V, Vbr=9.36V±5%, 220.6A, 3000W(1ms)	DO-214AB	1d	1a	Mde
PDR	SMLJ8.5	TVS	Vrwm=8.5V, Vbr=9.44..11.5V, Ipp=188.6A, 3000W(1ms)	DO-214AB	1a	1a	Mco
PDS	SMLJ8.5A	TVS	Vrwm=8.5V, Vbr=9.44..10.4V, Ipp=208.4A, 3000W(1ms)	DO-214AB	1a	1a	Mco
PDT	SMDJ8.5	TVS	Vrwm=8.5V, Vbr=9.92V±10%, 208.3A, 3000W(1ms)	DO-214AB	1d	1a	Mde
PDT	SMDJ8.5A	TVS	Vrwm=8.5V, Vbr=9.92V±5%, 208.3A, 3000W(1ms)	DO-214AB	1d	1a	Mde
PDT	SMLJ9.0	TVS	Vrwm=9.0V, Vbr=10.0..12.2V, Ipp=177.4A, 3000W(1ms)	DO-214AB	1a	1a	Mco
PDU	SMLJ9.0A	TVS	Vrwm=9.0V, Vbr=10.0..11.1V, Ipp=194.8A, 3000W(1ms)	DO-214AB	1a	1a	Mco
PDV	SMDJ9.0	TVS	Vrwm=9.0V, Vbr=10.55V±10%, 194.8A, 3000W(1ms)	DO-214AB	1d	1a	Mde
PDV	SMDJ9.0A	TVS	Vrwm=9.0V, Vbr=10.55V±5%, 194.8A, 3000W(1ms)	DO-214AB	1d	1a	Mde
PDV	SMLJ10	TVS	Vrwm=10V, Vbr=11.1..13.6V, Ipp=159.6A, 3000W(1ms)	DO-214AB	1a	1a	Mco
PDW	SMLJ10A	TVS	Vrwm=10V, Vbr=11.1..12.3V, Ipp=176.4A, 3000W(1ms)	DO-214AB	1a	1a	Mco
PDX	SMDJ10	TVS	Vrwm=10V, Vbr=11.7V±10%, 176.5A, 3000W(1ms)	DO-214AB	1d	1a	Mde
PDX	SMDJ10A	TVS	Vrwm=10V, Vbr=11.7V±5%, 176.5A, 3000W(1ms)	DO-214AB	1d	1a	Mde
PDX	SMLJ11	TVS	Vrwm=11V, Vbr=12.2..14.9V, Ipp=149.2A, 3000W(1ms)	DO-214AB	1a	1a	Mco
PDY	SMLJ11A	TVS	Vrwm=11V, Vbr=12.2..13.5V, Ipp=164.8A, 3000W(1ms)	DO-214AB	1a	1a	Mco
PDZ	SMDJ11	TVS	Vrwm=11V, Vbr=12.85V±10%, 164.8A, 3000W(1ms)	DO-214AB	1d	1a	Mde
PDZ	SMDJ11A	TVS	Vrwm=11V, Vbr=12.85V±5%, 164.8A, 3000W(1ms)	DO-214AB	1d	1a	Mde
PDZ	SMLJ12	TVS	Vrwm=12V, Vbr=13.3..16.3V, Ipp=136.4A, 3000W(1ms)	DO-214AB	1a	1a	Mco
PE	1SMB110A	TVS	Vrwm=110V, 3.4A, 600W(1ms)	403A	3d	1s	Ons
PE	BB155	C-diode	Mobile Comm, VCO, 10V, 20mA, 24.5..45.2pF(2.82..0.34V)	SOD-323	5d	1a	Phi
PE	CD214B-T110A	TVS	Vbr=110V, Irlsm=3.4A, 600W(1ms)	DO-214AA	1d	1a	Bm
PE	MA2Q739	Si-diode	SBR, HF, 90V, 800mA, Vf<0.8V(700mA), 50pF, 100ns	SOD-106	1d	1a	Pan
PE	MA739	Si-diode	SBR, HF, 90V, 800mA, Vf<0.8V(700mA), 50pF, 100ns	SOD-106	1d	1a	Pan
PE	P6SMB6V8CA	TVS	Vrwm=6.8V, 57A, 600W(1ms), Bidirectional	DO-214AA	1ba	2k	Fag
PE	P6SMBJ110A	TVS	Vbr=110V, 3.4A, 600W(1ms)	DO-214AA	1d	1m,1w	Pjt,Sij
PE	SMBG110A	TVS	Vbr=110V, 3.4A, 600W(1ms)	DO-215AA	5d	1k	Vs
PE	SMBJ110A	TVS	Vbr=110V, 3.4A, 600W(1ms)	DO-214AA	1d	1k,1m	Di,Vs
PE	SMF110A	TVS	Vrwm=110V, Vbr=122..135V, 1.0A, 200W(1ms)	SOD-123FL	7d	1a	Eic
PE	SMF110CA	TVS	Vrwm=110.0V, Vbr=122.0..135.0V, 1.13A, 200W(10/1000µs), Bidirectional	SOD-123FL	7ba	1j	Ers
PE	TV02W111B-G	TVS	Vrwm=110V, Vbr=122..135V, Ipp=1.13A, 200W(1ms), Bidirectional	SOD-123	5ba	1j	Cmc
PE	TV06B111J-G	TVS	Vrwm=110.0V, Vbr=122.0..135.0V, Ipp=3.39A, 600W(1ms)	DO-214AA	1d	1a	Cmc
PED	SMLJ12A	TVS	Vrwm=12V, Vbr=13.3..14.7V, Ipp=150.6A, 3000W(1ms)	DO-214AB	1a	1a	Mco
PEE	SMDJ12	TVS	Vrwm=12V, Vbr=14V±10%, 150.8A, 3000W(1ms)	DO-214AB	1d	1a	Mde
PEE	SMDJ12A	TVS	Vrwm=12V, Vbr=14V±5%, 150.8A, 3000W(1ms)	DO-214AB	1d	1a	Mde
PEF	SMLJ13	TVS	Vrwm=13V, Vbr=14.4..17.6V, Ipp=126.0A, 3000W(1ms)	DO-214AB	1a	1a	Mco
PEG	SMDJ13	TVS	Vrwm=13V, Vbr=15.15V±10%, 139.5A, 3000W(1ms)	DO-214AB	1d	1a	Mde
PEG	SMDJ13A	TVS	Vrwm=13V, Vbr=15.15V±5%, 139.5A, 3000W(1ms)	DO-214AB	1d	1a	Mde
PEG	SMLJ13A	TVS	Vrwm=13V, Vbr=14.4..15.9V, Ipp=139.4A, 3000W(1ms)	DO-214AB	1a	1a	Mco
PEH	SMLJ14	TVS	Vrwm=14V, Vbr=15.6..19.1V, Ipp=116.2A, 3000W(1ms)	DO-214AB	1a	1a	Mco



SMD
code

Type

Function

Short description

Case

Pinout

St.

Mnf.

SMD code	Type	Function	Short description	Case	Pinout	St.	Mnf.
PEK	SMDJ14	TVS	Vrwm=14V, Vbr=16.4V±10%, 129.3A, 3000W(1ms)	DO-214AB	1d	1a	Mde
PEK	SMDJ14A	TVS	Vrwm=14V, Vbr=16.4V±5%, 129.3A, 3000W(1ms)	DO-214AB	1d	1a	Mde
PEK	SMLJ14A	TVS	Vrwm=14V, Vbr=15.6..17.2V, lpp=129.4A, 3000W(1ms)	DO-214AB	1a	1a	Mco
PEL	SMLJ15	TVS	Vrwm=15V, Vbr=16.7..20.4V, lpp=111.6A, 3000W(1ms)	DO-214AB	1a	1a	Mco
PEM	SMDJ15	TVS	Vrwm=15V, Vbr=17.6V±10%, 123.0A, 3000W(1ms)	DO-214AB	1d	1a	Mde
PEM	SMDJ15A	TVS	Vrwm=15V, Vbr=17.6V±5%, 123.0A, 3000W(1ms)	DO-214AB	1d	1a	Mde
PEM	SMLJ15A	TVS	Vrwm=15V, Vbr=16.7..18.5V, lpp=123.0A, 3000W(1ms)	DO-214AB	1a	1a	Mco
PEN	SMLJ16	TVS	Vrwm=16V, Vbr=17.8..21.8V, lpp=104.2A, 3000W(1ms)	DO-214AB	1a	1a	Mco
PEP	SMDJ16	TVS	Vrwm=16V, Vbr=18.7V±10%, 115.4A, 3000W(1ms)	DO-214AB	1d	1a	Mde
PEP	SMDJ16A	TVS	Vrwm=16V, Vbr=18.7V±5%, 115.4A, 3000W(1ms)	DO-214AB	1d	1a	Mde
PEP	SMLJ16A	TVS	Vrwm=16V, Vbr=17.8..19.7V, lpp=115.4A, 3000W(1ms)	DO-214AB	1a	1a	Mco
PEQ	SMLJ17	TVS	Vrwm=17V, Vbr=18.9..23.1V, lpp=98.4A, 3000W(1ms)	DO-214AB	1a	1a	Mco
PER	SMDJ17	TVS	Vrwm=17V, Vbr=19.9V±10%, 108.7A, 3000W(1ms)	DO-214AB	1d	1a	Mde
PER	SMDJ17A	TVS	Vrwm=17V, Vbr=19.9V±5%, 108.7A, 3000W(1ms)	DO-214AB	1d	1a	Mde
PER	SMLJ17A	TVS	Vrwm=17V, Vbr=18.9..20.9V, lpp=106.6A, 3000W(1ms)	DO-214AB	1a	1a	Mco
PES	SMLJ18	TVS	Vrwm=18V, Vbr=20.0..24.4V, lpp=93.2A, 3000W(1ms)	DO-214AB	1a	1a	Mco
PET	SMDJ18	TVS	Vrwm=18V, Vbr=21V±10%, 102.7A, 3000W(1ms)	DO-214AB	1d	1a	Mde
PET	SMDJ18A	TVS	Vrwm=18V, Vbr=21V±5%, 102.7A, 3000W(1ms)	DO-214AB	1d	1a	Mde
PET	SMLJ18A	TVS	Vrwm=18V, Vbr=20.0..22.1V, lpp=102.8A, 3000W(1ms)	DO-214AB	1a	1a	Mco
PEU	SMLJ20	TVS	Vrwm=20V, Vbr=22.2..27.1V, lpp=83.8A, 3000W(1ms)	DO-214AB	1a	1a	Mco
PEV	SMDJ20	TVS	Vrwm=20V, Vbr=23.3V±10%, 92.6A, 3000W(1ms)	DO-214AB	1d	1a	Mde
PEV	SMDJ20A	TVS	Vrwm=20V, Vbr=23.3V±5%, 92.6A, 3000W(1ms)	DO-214AB	1d	1a	Mde
PEV	SMLJ20A	TVS	Vrwm=20V, Vbr=22.2..24.5V, lpp=92.6A, 3000W(1ms)	DO-214AB	1a	1a	Mco
PEW	SMLJ22	TVS	Vrwm=22V, Vbr=24.4..29.8V, lpp=76.2A, 3000W(1ms)	DO-214AB	1a	1a	Mco
PEX	SMDJ22	TVS	Vrwm=22V, Vbr=25.6V±10%, 84.5A, 3000W(1ms)	DO-214AB	1d	1a	Mde
PEX	SMDJ22A	TVS	Vrwm=22V, Vbr=25.6V±5%, 84.5A, 3000W(1ms)	DO-214AB	1d	1a	Mde
PEX	SMLJ22A	TVS	Vrwm=22V, Vbr=24.4..26.9V, lpp=84.4A, 3000W(1ms)	DO-214AB	1a	1a	Mco
PEY	SMLJ24	TVS	Vrwm=24V, Vbr=26.7..32.6V, lpp=69.8A, 3000W(1ms)	DO-214AB	1a	1a	Mco
PEZ	SMDJ24	TVS	Vrwm=24V, Vbr=28.1V±10%, 77.1A, 3000W(1ms)	DO-214AB	1d	1a	Mde
PEZ	SMDJ24A	TVS	Vrwm=24V, Vbr=28.1V±5%, 77.1A, 3000W(1ms)	DO-214AB	1d	1a	Mde
PEZ	SMLJ24A	TVS	Vrwm=24V, Vbr=26.7..29.5V, lpp=77.2A, 3000W(1ms)	DO-214AB	1a	1a	Mco
PF	BB156	C-diode	VCO, 10V, 20mA, 4.2..14.4pF(7.5..1V), <0.4Ω	SOD-323	5d	1a	Phi
PF	KDZ7.5FV	Z-diode	7.0..7.90V, lzt=5mA, Zzt=23Ω, 100mW	TFSC	7d	1a	Kec
PF	MAZD180	Z-diode	16.9..19.1V, Zzt=60Ω(5mA), 120mW	SSSMini2	7d	1a	Pan
PF	P6SMB7V5C	TVS	Vrwm=7.5V, 51A, 600W(1ms), Bidirectional	DO-214AA	1ba	2k	Fag
PF	P6SMBJ120	TVS	Vbr=120V, 2.8A, 600W(1ms)	DO-214AA	1d	1m,1w	Pjt,Srj
PF	SMBG120	TVS	Vbr=120V, 2.8A, 600W(1ms)	DO-215AA	5d	1k	Vs
PF	SMBJ120	TVS	Vbr=120V, 2.8A, 600W(1ms)	DO-214AA	1d	1k	Vs
PF	TV06B121K-G	TVS	Vrwm=120.0V, Vbr=133.0..163.0V, lpp=2.8A, 600W(1ms)	DO-214AA	1d	1a	Cmc
PFD	SMLJ26	TVS	Vrwm=26V, Vbr=28.9..35.3V, lpp=64.4A, 3000W(1ms)	DO-214AB	1a	1a	Mco
PFE	SMDJ26	TVS	Vrwm=26V, Vbr=30.4V±10%, 71.3A, 3000W(1ms)	DO-214AB	1d	1a	Mde
PFE	SMDJ26A	TVS	Vrwm=26V, Vbr=30.4V±5%, 71.3A, 3000W(1ms)	DO-214AB	1d	1a	Mde
PFE	SMLJ26A	TVS	Vrwm=26V, Vbr=28.9..31.9V, lpp=71.2A, 3000W(1ms)	DO-214AB	1a	1a	Mco
PFF	SMLJ28	TVS	Vrwm=28V, Vbr=31.1..38.0V, lpp=60.0A, 3000W(1ms)	DO-214AB	1a	1a	Mco
PFG	SMDJ28	TVS	Vrwm=28V, Vbr=32.7V±10%, 66.1A, 3000W(1ms)	DO-214AB	1d	1a	Mde
PFG	SMDJ28A	TVS	Vrwm=28V, Vbr=32.7V±5%, 66.1A, 3000W(1ms)	DO-214AB	1d	1a	Mde
PFG	SMLJ28A	TVS	Vrwm=28V, Vbr=31.1..34.4V, lpp=66.0A, 3000W(1ms)	DO-214AB	1a	1a	Mco
PFH	SMLJ30	TVS	Vrwm=30V, Vbr=33.3..40.7V, lpp=56.0A, 3000W(1ms)	DO-214AB	1a	1a	Mco
PFK	SMDJ30	TVS	Vrwm=30V, Vbr=35V±10%, 62.0A, 3000W(1ms)	DO-214AB	1d	1a	Mde
PFK	SMDJ30A	TVS	Vrwm=30V, Vbr=35V±5%, 62.0A, 3000W(1ms)	DO-214AB	1d	1a	Mde
PFK	SMLJ30A	TVS	Vrwm=30V, Vbr=33.3..36.8V, lpp=62.0A, 3000W(1ms)	DO-214AB	1a	1a	Mco
PFL	SMLJ33	TVS	Vrwm=33V, Vbr=36.7..44.9V, lpp=50.4A, 3000W(1ms)	DO-214AB	1a	1a	Mco
PFM	SMDJ33	TVS	Vrwm=33V, Vbr=38.6V±10%, 56.3A, 3000W(1ms)	DO-214AB	1d	1a	Mde
PFM	SMDJ33A	TVS	Vrwm=33V, Vbr=38.6V±5%, 56.3A, 3000W(1ms)	DO-214AB	1d	1a	Mde
PFM	SMLJ33A	TVS	Vrwm=33V, Vbr=36.7..40.6V, lpp=56.2A, 3000W(1ms)	DO-214AB	1a	1a	Mco
PFN	SMLJ36	TVS	Vrwm=36V, Vbr=40.0..48.9V, lpp=46.6A, 3000W(1ms)	DO-214AB	1a	1a	Mco
PFP	SMDJ36	TVS	Vrwm=36V, Vbr=42.1V±10%, 51.6A, 3000W(1ms)	DO-214AB	1d	1a	Mde
PFP	SMDJ36A	TVS	Vrwm=36V, Vbr=42.1V±5%, 51.6A, 3000W(1ms)	DO-214AB	1d	1a	Mde
PFP	SMLJ36A	TVS	Vrwm=36V, Vbr=40.0..44.2V, lpp=51.6A, 3000W(1ms)	DO-214AB	1a	1a	Mco
PFQ	SMLJ40	TVS	Vrwm=40V, Vbr=44.4..54.3V, lpp=42.0A, 3000W(1ms)	DO-214AB	1a	1a	Mco
PFR	SMDJ40	TVS	Vrwm=40V, Vbr=46.7V±10%, 46.5A, 3000W(1ms)	DO-214AB	1d	1a	Mde
PFR	SMDJ40A	TVS	Vrwm=40V, Vbr=46.7V±5%, 46.5A, 3000W(1ms)	DO-214AB	1d	1a	Mde
PFR	SMLJ40A	TVS	Vrwm=40V, Vbr=44.4..49.1V, lpp=46.4A, 3000W(1ms)	DO-214AB	1a	1a	Mco
PFS	SMLJ43	TVS	Vrwm=43V, Vbr=47.8..58.4V, lpp=39.2A, 3000W(1ms)	DO-214AB	1a	1a	Mco
PFT	SMDJ43	TVS	Vrwm=43V, Vbr=50.3V±10%, 43.2A, 3000W(1ms)	DO-214AB	1d	1a	Mde
PFT	SMDJ43A	TVS	Vrwm=43V, Vbr=50.3V±5%, 43.2A, 3000W(1ms)	DO-214AB	1d	1a	Mde
PFT	SMLJ43A	TVS	Vrwm=43V, Vbr=47.8..52.8V, lpp=43.2A, 3000W(1ms)	DO-214AB	1a	1a	Mco
PFU	SMLJ45	TVS	Vrwm=45V, Vbr=50.0..61.1V, lpp=37.4A, 3000W(1ms)	DO-214AB	1a	1a	Mco
PVV	SMDJ45	TVS	Vrwm=45V, Vbr=52.6V±10%, 41.3A, 3000W(1ms)	DO-214AB	1d	1a	Mde
PVV	SMDJ45A	TVS	Vrwm=45V, Vbr=52.6V±5%, 41.3A, 3000W(1ms)	DO-214AB	1d	1a	Mde



SMD code	Type	Function	Short description	Case	Pinout	St.	Mnf.
PFV	SMLJ45A	TVS	Vrwm=45V, Vbr=50.0.55.3V, lpp=41.2A, 3000W(1ms)	DO-214AB	1a	1a	Mco
PFW	SMLJ48	TVS	Vrwm=48V, Vbr=53.3.65.1V, lpp=35.0A, 3000W(1ms)	DO-214AB	1a	1a	Mco
PFX	SMDJ48	TVS	Vrwm=48V, Vbr=56.1V±10%, 38.8A, 3000W(1ms)	DO-214AB	1d	1a	Mde
PFX	SMDJ48A	TVS	Vrwm=48V, Vbr=56.1V±5%, 38.8A, 3000W(1ms)	DO-214AB	1d	1a	Mde
PFX	SMLJ48A	TVS	Vrwm=48V, Vbr=53.3.58.9V, lpp=38.8A, 3000W(1ms)	DO-214AB	1a	1a	Mco
PFY	SMLJ51	TVS	Vrwm=51V, Vbr=56.7.69.3V, lpp=37.0A, 3000W(1ms)	DO-214AB	1a	1a	Mco
PFZ	SMDJ51	TVS	Vrwm=51V, Vbr=59.7V±10%, 36.4A, 3000W(1ms)	DO-214AB	1d	1a	Mde
PFZ	SMDJ51A	TVS	Vrwm=51V, Vbr=59.7V±5%, 36.4A, 3000W(1ms)	DO-214AB	1d	1a	Mde
PFZ	SMLJ51A	TVS	Vrwm=51V, Vbr=56.7.62.7V, lpp=36.4A, 3000W(1ms)	DO-214AB	1a	1a	Mco
PG	1SMB120A	TVS	Vrwm=120V, 3.1A, 600W(1ms)	403A	3d	1s	Ons
PG	BB157	C-diode	VCO, VHF-TV tuning, 30V, 20mA, 2.76..43.8pF(28..1V)	SOD-323	5d	1a	Phi
PG	CD214B-T120A	TVS	Vbr=120V, Irsm=3.1A, 600W(1ms)	DO-214AA	1d	1a	Bm
PG	P6SMB7V5CA	TVS	Vrwm=7.5V, 53A, 600W(1ms), Bidirectional	DO-214AA	1ba	2k	Fag
PG	P6SMBJ120A	TVS	Vbr=120V, 3.1A, 600W(1ms)	DO-214AA	1d	1m,1w	Pjt,Sj
PG	SMBG120A	TVS	Vbr=120V, 3.1A, 600W(1ms)	DO-215AA	5d	1k	Vs
PG	SMBJ120A	TVS	Vbr=120V, 3.1A, 600W(1ms)	DO-214AA	1d	1k,1m	Di,Vs
PG	SMF120A	TVS	Vrwm=120V, Vbr=133..147V, 0.9A, 200W(1ms)	SOD-123FL	7d	1a	Eic
PG	SMF120CA	TVS	Vrwm=120.0V, Vbr=133.0..147.0V, 1.04A, 200W(10/100µs), Bidirectional	SOD-123FL	7ba	1j	Ers
PG	TV02W121B-G	TVS	Vrwm=120V, Vbr=133..147V, lpp=1.04A, 200W(1ms), Bidirectional	SOD-123	5ba	1j	Cmc
PG	TV06B121J-G	TVS	Vrwm=120.0V, Vbr=133.0..147.0V, lpp=3.1A, 600W(1ms)	DO-214AA	1d	1a	Cmc
PGD	SMLJ54	TVS	Vrwm=54V, Vbr=60.0.73.3V, lpp=31.2A, 3000W(1ms)	DO-214AB	1a	1a	Mco
PGE	SMDJ54	TVS	Vrwm=54V, Vbr=63.1V±10%, 34.4A, 3000W(1ms)	DO-214AB	1d	1a	Mde
PGE	SMDJ54A	TVS	Vrwm=54V, Vbr=63.1V±5%, 34.4A, 3000W(1ms)	DO-214AB	1d	1a	Mde
PGE	SMLJ54A	TVS	Vrwm=54V, Vbr=60.0.66.3V, lpp=34.4A, 3000W(1ms)	DO-214AB	1a	1a	Mco
PGF	SMLJ58	TVS	Vrwm=58V, Vbr=64.4.78.7V, lpp=39.2A, 3000W(1ms)	DO-214AB	1a	1a	Mco
PGG	SMDJ58	TVS	Vrwm=58V, Vbr=67.8V±10%, 32.1A, 3000W(1ms)	DO-214AB	1d	1a	Mde
PGG	SMDJ58A	TVS	Vrwm=58V, Vbr=67.8V±5%, 32.1A, 3000W(1ms)	DO-214AB	1d	1a	Mde
PGG	SMLJ58A	TVS	Vrwm=58V, Vbr=64.4.71.2V, lpp=32.0A, 3000W(1ms)	DO-214AB	1a	1a	Mco
PGH	SMLJ60	TVS	Vrwm=60V, Vbr=66.7.81.5V, lpp=28.0A, 3000W(1ms)	DO-214AB	1a	1a	Mco
PGK	SMDJ60	TVS	Vrwm=60V, Vbr=73.3V±10%, 31A, 3000W(1ms)	DO-214AB	1d	1a	Mde
PGK	SMDJ60A	TVS	Vrwm=60V, Vbr=73.3V±5%, 31A, 3000W(1ms)	DO-214AB	1d	1a	Mde
PGK	SMLJ60A	TVS	Vrwm=60V, Vbr=66.7.73.7V, lpp=31.0A, 3000W(1ms)	DO-214AB	1a	1a	Mco
PGL	SMLJ64	TVS	Vrwm=64V, Vbr=71.1.86.9V, lpp=26.4A, 3000W(1ms)	DO-214AB	1a	1a	Mco
PGM	SMDJ64	TVS	Vrwm=64V, Vbr=74.8V±10%, 29.1A, 3000W(1ms)	DO-214AB	1d	1a	Mde
PGM	SMDJ64A	TVS	Vrwm=64V, Vbr=74.8V±5%, 29.1A, 3000W(1ms)	DO-214AB	1d	1a	Mde
PGM	SMLJ64A	TVS	Vrwm=64V, Vbr=71.1.78.6V, lpp=29.2A, 3000W(1ms)	DO-214AB	1a	1a	Mco
PGN	SMLJ70	TVS	Vrwm=70V, Vbr=77.8.95.1V, lpp=24.0A, 3000W(1ms)	DO-214AB	1a	1a	Mco
PGP	SMDJ70	TVS	Vrwm=70V, Vbr=81.9V±10%, 26.5A, 3000W(1ms)	DO-214AB	1d	1a	Mde
PGP	SMDJ70A	TVS	Vrwm=70V, Vbr=81.9V±5%, 26.5A, 3000W(1ms)	DO-214AB	1d	1a	Mde
PGP	SMLJ70A	TVS	Vrwm=70V, Vbr=77.8.86.0V, lpp=26.6A, 3000W(1ms)	DO-214AB	1a	1a	Mco
PGQ	SMLJ75	TVS	Vrwm=75V, Vbr=83.3.102V, lpp=22.4A, 3000W(1ms)	DO-214AB	1a	1a	Mco
PGR	SMDJ75	TVS	Vrwm=75V, Vbr=87.7V±10%, 24.8A, 3000W(1ms)	DO-214AB	1d	1a	Mde
PGR	SMDJ75A	TVS	Vrwm=75V, Vbr=87.7V±5%, 24.8A, 3000W(1ms)	DO-214AB	1d	1a	Mde
PGR	SMLJ75A	TVS	Vrwm=75V, Vbr=83.3.92.1V, lpp=24.8A, 3000W(1ms)	DO-214AB	1a	1a	Mco
PGS	SMLJ78	TVS	Vrwm=78V, Vbr=86.7.106V, lpp=21.6A, 3000W(1ms)	DO-214AB	1a	1a	Mco
PGT	SMDJ78	TVS	Vrwm=78V, Vbr=91.2V±10%, 23.8A, 3000W(1ms)	DO-214AB	1d	1a	Mde
PGT	SMDJ78A	TVS	Vrwm=78V, Vbr=91.2V±5%, 23.8A, 3000W(1ms)	DO-214AB	1d	1a	Mde
PGT	SMLJ78A	TVS	Vrwm=78V, Vbr=86.7.95.8V, lpp=22.8A, 3000W(1ms)	DO-214AB	1a	1a	Mco
PGU	SMLJ85	TVS	Vrwm=85V, Vbr=94.4.115V, lpp=19.8A, 3000W(1ms)	DO-214AB	1a	1a	Mco
PGV	SMDJ85	TVS	Vrwm=85V, Vbr=99.2V±10%, 21.9A, 3000W(1ms)	DO-214AB	1d	1a	Mde
PGV	SMDJ85A	TVS	Vrwm=85V, Vbr=99.2V±5%, 21.9A, 3000W(1ms)	DO-214AB	1d	1a	Mde
PGV	SMLJ85A	TVS	Vrwm=85V, Vbr=94.4.104V, lpp=20.8A, 3000W(1ms)	DO-214AB	1a	1a	Mco
PGW	SMLJ90	TVS	Vrwm=90V, Vbr=100..122V, lpp=18.8A, 3000W(1ms)	DO-214AB	1a	1a	Mco
PGX	SMDJ90	TVS	Vrwm=90V, Vbr=105.5V±10%, 20.5A, 3000W(1ms)	DO-214AB	1d	1a	Mde
PGX	SMDJ90A	TVS	Vrwm=90V, Vbr=105.5V±5%, 20.5A, 3000W(1ms)	DO-214AB	1d	1a	Mde
PGX	SMLJ90A	TVS	Vrwm=90V, Vbr=100..111V, lpp=20.6A, 3000W(1ms)	DO-214AB	1a	1a	Mco
PGY	SMLJ100	TVS	Vrwm=100V, Vbr=111.136V, lpp=16.8A, 3000W(1ms)	DO-214AB	1a	1a	Mco
PGZ	SMDJ100	TVS	Vrwm=100V, Vbr=117V±10%, 18.5A, 3000W(1ms)	DO-214AB	1d	1a	Mde
PGZ	SMDJ100A	TVS	Vrwm=100V, Vbr=117V±5%, 18.5A, 3000W(1ms)	DO-214AB	1d	1a	Mde
PGZ	SMLJ100A	TVS	Vrwm=100V, Vbr=111..123V, lpp=18.6A, 3000W(1ms)	DO-214AB	1a	1a	Mco
PH	BB158	C-diode	TV-UHF-Tuning, 19.5..2.25pF(1..28V)	SOD-323	5d	1a	Phi
PH	P6SMB8V2C	TVS	Vrwm=8.2V, 48A, 600W(1ms), Bidirectional	DO-214AA	1ba	2k	Fag
PH	P6SMBJ130	TVS	Vbr=130V, 2.6A, 600W(1ms)	DO-214AA	1d	1m,1w	Pjt,Sj
PH	SMBG130	TVS	Vbr=130V, 2.6A, 600W(1ms)	DO-215AA	5d	1k	Vs
PH	SMBJ130	TVS	Vbr=130V, 2.6A, 600W(1ms)	DO-214AA	1d	1k	Vs
PH	TV06B131K-K	TVS	Vrwm=130.0V, Vbr=144.0..176.0V, lpp=2.6A, 600W(1ms)	DO-214AA	1d	1a	Cmc
PHD	SMLJ110	TVS	Vrwm=110V, Vbr=122..149V, lpp=15.4A, 3000W(1ms)	DO-214AB	1a	1a	Mco
PHE	SMDJ110	TVS	Vrwm=110V, Vbr=128.5V±10%, 16.9A, 3000W(1ms)	DO-214AB	1d	1a	Mde
PHE	SMDJ110A	TVS	Vrwm=110V, Vbr=128.5V±5%, 16.9A, 3000W(1ms)	DO-214AB	1d	1a	Mde
PHE	SMLJ110A	TVS	Vrwm=110V, Vbr=122..135V, lpp=16.8A, 3000W(1ms)	DO-214AB	1a	1a	Mco



SMD
code

Type

Function

Short description

Case

Pinout

St.

Mnf.

PHF	SMLJ120	TVS	Vrwm=120V, Vbr=133..163V, lpp=14.0A, 3000W(1ms)	DO-214AB	1a	1a	Mco
PHG	SMDJ120	TVS	Vrwm=120V, Vbr=140V±10%, 15.5A, 3000W(1ms)	DO-214AB	1d	1a	Mde
PHG	SMDJ120A	TVS	Vrwm=120V, Vbr=140V±5%, 15.5A, 3000W(1ms)	DO-214AB	1d	1a	Mde
PHG	SMLJ120A	TVS	Vrwm=120V, Vbr=133..147V, lpp=15.6A, 3000W(1ms)	DO-214AB	1a	1a	Mco
PHH	SMLJ130	TVS	Vrwm=130V, Vbr=144..176V, lpp=13.0A, 3000W(1ms)	DO-214AB	1a	1a	Mco
PHK	SMDJ130	TVS	Vrwm=130V, Vbr=151.5V±10%, 14.4A, 3000W(1ms)	DO-214AB	1d	1a	Mde
PHK	SMDJ130A	TVS	Vrwm=130V, Vbr=151.5V±5%, 14.4A, 3000W(1ms)	DO-214AB	1d	1a	Mde
PHK	SMLJ130A	TVS	Vrwm=130V, Vbr=144..159V, lpp=14.4A, 3000W(1ms)	DO-214AB	1a	1a	Mco
PHL	SMLJ150	TVS	Vrwm=150V, Vbr=167..204V, lpp=11.2A, 3000W(1ms)	DO-214AB	1a	1a	Mco
PHM	SMDJ150	TVS	Vrwm=150V, Vbr=176V±10%, 12.3A, 3000W(1ms)	DO-214AB	1d	1a	Mde
PHM	SMDJ150A	TVS	Vrwm=150V, Vbr=176V±5%, 12.3A, 3000W(1ms)	DO-214AB	1d	1a	Mde
PHM	SMLJ150A	TVS	Vrwm=150V, Vbr=167..185V, lpp=12.4A, 3000W(1ms)	DO-214AB	1a	1a	Mco
PHN	SMLJ160	TVS	Vrwm=160V, Vbr=178..218V, lpp=10.4A, 3000W(1ms)	DO-214AB	1a	1a	Mco
PHP	SMDJ160	TVS	Vrwm=160V, Vbr=187.5V±10%, 11.6A, 3000W(1ms)	DO-214AB	1d	1a	Mde
PHP	SMDJ160A	TVS	Vrwm=160V, Vbr=187.5V±5%, 11.6A, 3000W(1ms)	DO-214AB	1d	1a	Mde
PHP	SMLJ160A	TVS	Vrwm=160V, Vbr=178..197V, lpp=11.6A, 3000W(1ms)	DO-214AB	1a	1a	Mco
PHQ	SMLJ170	TVS	Vrwm=170V, Vbr=189..231V, lpp=9.8A, 3000W(1ms)	DO-214AB	1a	1a	Mco
PHR	SMDJ170	TVS	Vrwm=170V, Vbr=199V±10%, 10.9A, 3000W(1ms)	DO-214AB	1d	1a	Mde
PHR	SMDJ170A	TVS	Vrwm=170V, Vbr=199V±5%, 10.9A, 3000W(1ms)	DO-214AB	1d	1a	Mde
PHR	SMLJ170A	TVS	Vrwm=170V, Vbr=189..209V, lpp=11.0A, 3000W(1ms)	DO-214AB	1a	1a	Mco
PJ	BB159	C-diode	TV-UHF-Tuning, 30V, 20mA, 19.5..2.25pF(1..28V)	SOD-323	5d	1a	Phi
PJ	DDZ20C	Z-diode	20V±5%, Izt=10mA, 500mW	SOD-123	5d	1d	Di
PJ	DDZ20CS	Z-diode	20V±5%, Izt=10mA, 200mW	SOD-323	5d	1d	Di
PK	1SMB130A	TVS	Vrwm=130V, 2.9A, 600W(1ms)	403A	3d	1s	Ons
PK	BB164	C-diode	TV-VHF-Tuning, 30V, 20mA, 62..2.9pF(1..28V), 160MHz	SOD-323	5d	1a	Phi
PK	CD214B-T130A	TVS	Vbr=130V, Irsrm=2.9A, 600W(1ms)	DO-214AA	1d	1a	Bm
PK	MA10705	Si-diode	SBR, HF, 30V, 1.5A, Vf<0.37V(1A), 90pF, 50ns	SOD-106	1d	1a	Pan
PK	MA2Q705	Si-diode	SBR, HF, 30V, 1.5A, Vf<0.37V(1A), 90pF, 50ns	SOD-106	1d	1A	Pan
PK	P6SMB8V2CA	TVS	Vrwm=8.2V, 50A, 600W(1ms), Bidirectional	DO-214AA	1ba	2k	Fag
PK	P6SMBJ130A	TVS	Vbr=130V, 2.9A, 600W(1ms)	DO-214AA	1d	1m,1w	Pjt,Srj
PK	SMBG130A	TVS	Vbr=130V, 2.9A, 600W(1ms)	DO-215AA	5d	1k	Vs
PK	SMBJ130A	TVS	Vbr=130V, 2.9A, 600W(1ms)	DO-214AA	1d	1k,1m	Di,Vs
PK	SMF130A	TVS	Vrwm=130V, Vbr=144..159V, 0.8A, 200W(1ms)	SOD-123FL	7d	1a	Eic
PK	SMF130CA	TVS	Vrwm=130.0V, Vbr=144.0..159.0V, 0.96A, 200W(10/1000µs), Bidirectional	SOD-123FL	7ba	1j	Ers
PK	TV02W131B-G	TVS	Vrwm=130V, Vbr=144..159V, lpp=0.96A, 200W(1ms), Bidirectional	SOD-123	5ba	1j	Cmc
PK	TV06B131J-G	TVS	Vrwm=130.0V, Vbr=144.0..159.0V, lpp=2.9A, 600W(1ms)	DO-214AA	1d	1a	Cmc
PK7	SM6T150A	TVS	Vbr=143..158V, 2.9A, 600W(1ms)	DO-214AA	1d	1k	Vs
PK7	SM6T150CA	TVS	Vbr=143..158V, 2.9A, 600W(1ms), Bidirectional	DO-214AA	1ba	1l	Vs
PL	BB149A	C-diode	TV-UHF-Tuning, 30V, 20mA, 1.8..18.22pF(28..1V)	SOD-323	5d	1a	Phi
PL	DDZ24C	Z-diode	24V±5%, Izt=5mA, 500mW	SOD-123	5d	1d	Di
PL	DDZ24CS	Z-diode	24V±5%, Izt=5mA, 200mW	SOD-323	5d	1d	Di
PL	MA2QD01	Si-diode	SBR, HF, 60V, 1.5A, Vf<0.55V(1.5A), 110pF, 100ns	SOD-106	1d	1b	Pan
PL	P6SMB9V1C	TVS	Vrwm=9.1V, 44A, 600W(1ms), Bidirectional	DO-214AA	1ba	2k	Fag
PL	P6SMBJ150	TVS	Vbr=150V, 2.2A, 600W(1ms)	DO-214AA	1d	1m,1w	Pjt,Srj
PL	SMBG150	TVS	Vbr=150V, 2.2A, 600W(1ms)	DO-215AA	5d	1k	Vs
PL	SMBJ150	TVS	Vbr=150V, 2.2A, 600W(1ms)	DO-214AA	1d	1k	Vs
PL	TV06B151K-G	TVS	Vrwm=150.0V, Vbr=167.0..204.0V, lpp=2.2A, 600W(1ms)	DO-214AA	1d	1a	Cmc
PL13	PLED13Q12	ESD-Prot	Vbr=13..26V, Vrwm=13V, 1A, 250V/µs	QFN	13d	2b	Lif
PL13	PLED13S	ESD-Prot	Vbr=13..26V, Vrwm=13V, 1A, 250V/µs	DO-214AA	1d	1a	Lif
PL6	PLED6Q12	ESD-Prot	Vbr=6..16V, Vrwm=6V, 1A, 250V/µs	QFN	13d	2b	Lif
PL6	PLED6S	ESD-Prot	Vbr=6..16V, Vrwm=6V, 1A, 250V/µs	DO-214AA	1d	1a	Lif
PL9	PLED9Q12	ESD-Prot	Vbr=9..18V, Vrwm=9V, 1A, 250V/µs	QFN	13d	2b	Lif
PL9	PLED9S	ESD-Prot	Vbr=9..18V, Vrwm=9V, 1A, 250V/µs	DO-214AA	1d	1a	Lif
PM	1SMB150A	TVS	Vrwm=150V, 2.5A, 600W(1ms)	403A	3d	1s	Ons
PM	CD214B-T150A	TVS	Vbr=150V, Irsrm=2.5A, 600W(1ms)	DO-214AA	1d	1a	Bm
PM	MA2QA01	Si-diode	SBR, 400V, 1A, Vf<1.1V(1A)	SOD-106	1d	1b	Pan
PM	P6SMB9V1CA	TVS	Vrwm=9.1V, 45A, 600W(1ms), Bidirectional	DO-214AA	1ba	2k	Fag
PM	P6SMBJ150A	TVS	Vbr=150V, 2.5A, 600W(1ms)	DO-214AA	1d	1m,1w	Pjt,Srj
PM	SMBG150A	TVS	Vbr=150V, 2.5A, 600W(1ms)	DO-215AA	5d	1k	Vs
PM	SMBJ150A	TVS	Vbr=150V, 2.5A, 600W(1ms)	DO-214AA	1d	1k,1m	Di,Vs
PM	SMF150A	TVS	Vrwm=150V, Vbr=167..185V, 0.7A, 200W(1ms)	SOD-123FL	7d	1a	Eic
PM	SMF150CA	TVS	Vrwm=150.0V, Vbr=167.0..185.0V, 0.82A, 200W(10/1000µs), Bidirectional	SOD-123FL	7ba	1j	Ers
PM	TV02W151B-G	TVS	Vrwm=150V, Vbr=167..185V, lpp=0.82A, 200W(1ms), Bidirectional	SOD-123	5ba	1j	Cmc
PM	TV06B151J-G	TVS	Vrwm=150.0V, Vbr=167.0..185.0V, lpp=2.5A, 600W(1ms)	DO-214AA	1d	1a	Cmc
PN	BB190	C-diode	Radio-UHF-Tun, 10V, 20mA, 15..6pF(2..10V), <0.4Ω (470MHz)	SOD-323	5d	1a	Phi
PN	MA2QA02	Si-diode	SBR, 600V, 1A, Vf<1.1V(1A)	SOD-106	1d	1b	Pan
PN	P6SMB10C	TVS	Vrwm=10V, 40A, 600W(1ms), Bidirectional	DO-214AA	1ba	2k	Fag
PN	P6SMBJ160	TVS	Vbr=160V, 2.1A, 600W(1ms)	DO-214AA	1d	1m,1w	Pjt,Srj
PN	SMBG160	TVS	Vbr=160V, 2.1A, 600W(1ms)	DO-215AA	5d	1k	Vs
PN	SMBJ160	TVS	Vbr=160V, 2.1A, 600W(1ms)	DO-214AA	1d	1k	Vs



SMD
code

Type

Function

Short description

Case

Pinout St.

Mnf.

SMD code	Type	Function	Short description	Case	Pinout	St.	Mnf.
PN	TV06B161K-G	TVS	Vrwm=160.0V, Vbr=178.0..218.0V, Ipp=2.09A, 600W(1ms)	DO-214AA	1d	1a	Cmc
PP	1N728VA	Si-diode	SBD, VHF/UHF-Dem, 30V, 30mA, Vf<1V(30mA), 1.5pF	SOD-323FL	7d	1a	Sme
PP	1SMB160A	TVS	Vrwm=160V, 2.3A, 600W(1ms)	403A	3d	1s	Ons
PP	CD214B-T160A	TVS	Vbr=160V, Irs=2.3A, 600W(1ms)	DO-214AA	1d	1a	Bm
PP	CMDZ6L8	Z-diode	6.460..7.140V, Izt=0.5mA, Zzt=60Ω, 250mW	SOD-323	5d	1a	Cen
PP	KDZ7.5FVY	Z-diode	7.28..7.60V, Izt=5mA, Zzt=23Ω, 100mW	TFSC	7d	1a	Kec
PP	MA2HD08	Si-diode	SBR, HF, 30V, 1A, Vf<0.3V(1A), 50pF, 15ns	SOD-106	1d	1a	Pan
PP	P6SMB10CA	TVS	Vrwm=10V, 41A, 600W(1ms), Bidirectional	DO-214AA	1ba	2k	Fag
PP	P6SMBJ160A	TVS	Vbr=160V, 2.3A, 600W(1ms)	DO-214AA	1d	1m,1w	Pjt,Srj
PP	SMBG160A	TVS	Vbr=160V, 2.3A, 600W(1ms)	DO-215AA	5d	1k	Vs
PP	SMBJ160A	TVS	Vbr=160V, 2.3A, 600W(1ms)	DO-214AA	1d	1k,1m	Di,Vs
PP	SMF160A	TVS	Vrwm=160V, Vbr=178..197V, 0.7A, 200W(1ms)	SOD-123FL	7d	1a	Eic
PP	SMF160CA	TVS	Vrwm=160.0V, Vbr=178.0..197.0V, 0.77A, 200W(10/1000μs), Bidirectional	SOD-123FL	7ba	1j	Ers
PP	TV02W161B-G	TVS	Vrwm=160V, Vbr=178..197V, Ipp=0.77A, 200W(1ms), Bidirectional	SOD-123	5ba	1j	Cmc
PP	TV06B161J-G	TVS	Vrwm=160.0V, Vbr=178.0..197.0V, Ipp=2.32A, 600W(1ms)	DO-214AA	1d	1a	Cmc
PQ	MA2HD07	Si-diode	SBR, HF, 30V, 1A, Vf<0.37V(1A), 50pF, 15ns	SOD-106	1d	1a	Pan
PQ	P6SMB11C	TVS	Vrwm=11V, 37A, 600W(1ms), Bidirectional	DO-214AA	1ba	2k	Fag
PQ	P6SMBJ170	TVS	Vbr=170V, 2A, 600W(1ms)	DO-214AA	1d	1m,1w	Pjt,Srj
PQ	SMBG170	TVS	Vbr=170V, 2A, 600W(1ms)	DO-215AA	5d	1k	Vs
PQ	SMBJ170	TVS	Vbr=170V, 2A, 600W(1ms)	DO-214AA	1d	1k	Vs
PQ	TV06B171K-G	TVS	Vrwm=170.0V, Vbr=189.0..231.0V, Ipp=1.97A, 600W(1ms)	DO-214AA	1d	1a	Cmc
PR	1SMB170A	TVS	Vrwm=170V, 2.2A, 600W(1ms)	403A	3d	1s	Ons
PR	CD214B-T170A	TVS	Vbr=170V, Irs=2.2A, 600W(1ms)	DO-214AA	1d	1a	Bm
PR	MA2HD09	Si-diode	SBR, HF, 30V, 1A, Vf<0.4V(1A), 50pF, 15ns	SOD-106	1d	1a	Pan
PR	P6SMB11CA	TVS	Vrwm=11V, 38A, 600W(1ms), Bidirectional	DO-214AA	1ba	2k	Fag
PR	P6SMBJ170A	TVS	Vbr=170V, 2.2A, 600W(1ms)	DO-214AA	1d	1m,1w	Pjt,Srj
PR	SMBG170A	TVS	Vbr=170V, 2.2A, 600W(1ms)	DO-215AA	5d	1k	Vs
PR	SMBJ170A	TVS	Vbr=170V, 2.2A, 600W(1ms)	DO-214AA	1d	1k,1m	Di,Vs
PR	SMF170A	TVS	Vrwm=170V, Vbr=189..209V, 0.6A, 200W(1ms)	SOD-123FL	7d	1a	Eic
PR	SMF170CA	TVS	Vrwm=170.0V, Vbr=189.0..209.0V, 0.73A, 200W(10/1000μs), Bidirectional	SOD-123FL	7ba	1j	Ers
PR	TV02W171B-G	TVS	Vrwm=170V, Vbr=189..209V, Ipp=0.73A, 200W(1ms), Bidirectional	SOD-123	5ba	1j	Cmc
PR	TV06B171J-G	TVS	Vrwm=170.0V, Vbr=189.0..209.0V, Ipp=2.18A, 600W(1ms)	DO-214AA	1d	1a	Cmc
PR7	SM6T200A	TVS	Vbr=190..210V, 2.2A, 600W(1ms)	DO-214AA	1d	1k	Vs
PR7	SM6T200CA	TVS	Vbr=190..210V, 2.2A, 600W(1ms), Bidirectional	DO-214AA	1ba	1l	Vs
PR8	SM6T220A	TVS	Vbr=209..231V, 2A, 600W(1ms)	DO-214AA	1d	1k	Vs
PR8	SM6T220CA	TVS	Vbr=209..231V, 2A, 600W(1ms), Bidirectional	DO-214AA	1ba	1l	Vs
PS	P6SMB12C	TVS	Vrwm=12V, 35A, 600W(1ms), Bidirectional	DO-214AA	1ba	2k	Fag
PS	P6SMBJ190	TVS	Vbr=170V, 1.9A, 600W(1ms)	DO-214AA	1d	1m,1w	Pjt,Srj
PS	SMBG188A	TVS	Vbr=188V, 2A, 600W(1ms)	DO-215AA	5d	1k	Vs
PS	SMBJ188A	TVS	Vbr=188V, 2A, 600W(1ms)	DO-214AA	1d	1k	Vs
PS	TV06B181K-G	TVS	Vrwm=180.0V, Vbr=200.16..244.80V, Ipp=1.86A, 600W(1ms)	DO-214AA	1d	1a	Cmc
PT	P6SMB12CA	TVS	Vrwm=12V, 36A, 600W(1ms), Bidirectional	DO-214AA	1ba	2k	Fag
PT	P6SMBJ180A	TVS	Vbr=170V, 2.1A, 600W(1ms)	DO-214AA	1d	1m,1w	Pjt,Srj
PT	SMBG188	TVS	Vbr=188V, 1.7A, 600W(1ms)	DO-215AA	5d	1k	Vs
PT	SMBJ12A822	TVS	Vbr=13.2..14.3V, 17.5A, 600W(1ms)	DO-214AA	1d	1a	F
PT	SMBJ188	TVS	Vbr=188V, 1.7A, 600W(1ms)	DO-214AA	1d	1k	Vs
PT	SMF180CA	TVS	Vrwm=180.0V, Vbr=200.0..220.0V, 0.69A, 200W(10/1000μs), Bidirectional	SOD-123FL	7ba	1j	Ers
PT	TV02W181B-G	TVS	Vrwm=180V, Vbr=200..220V, Ipp=0.69A, 200W(1ms), Bidirectional	SOD-123	5ba	1j	Cmc
PT	TV06B181J-G	TVS	Vrwm=180.0V, Vbr=200.0..220.0V, Ipp=2.06A, 600W(1ms)	DO-214AA	1d	1a	Cmc
PU	P6SMB13C	TVS	Vrwm=13V, 32A, 600W(1ms), Bidirectional	DO-214AA	1ba	2k	Fag
PU	P6SMBJ190	TVS	Vbr=170V, 1.8A, 600W(1ms)	DO-214AA	1d	1m,1w	Pjt,Srj
PU	TV06B191K-G	TVS	Vrwm=190.0V, Vbr=211.28..258.0V, Ipp=1.76A, 600W(1ms)	DO-214AA	1d	1a	Cmc
PV	P6SMB13CA	TVS	Vrwm=13V, 33A, 600W(1ms), Bidirectional	DO-214AA	1ba	2k	Fag
PV	P6SMBJ190A	TVS	Vbr=170V, 2A, 600W(1ms)	DO-214AA	1d	1m,1w	Pjt,Srj
PV	SMF190CA	TVS	Vrwm=190.0V, Vbr=211.0..232.0V, 0.69A, 200W(10/1000μs), Bidirectional	SOD-123FL	7ba	1j	Ers
PV	TV02W191B-G	TVS	Vrwm=190V, Vbr=211..232V, Ipp=0.69A, 200W(1ms), Bidirectional	SOD-123	5ba	1j	Cmc
PV	TV06B191J-G	TVS	Vrwm=190.0V, Vbr=211.0..232.0V, Ipp=1.95A, 600W(1ms)	DO-214AA	1d	1a	Cmc
PW	P6SMB15C	TVS	Vrwm=15V, 27A, 600W(1ms), Bidirectional	DO-214AA	1ba	2k	Fag
PW	P6SMBJ200	TVS	Vbr=170V, 1.7A, 600W(1ms)	DO-214AA	1d	1m,1w	Pjt,Srj
PW	TV06B201J-G	TVS	Vrwm=200.0V, Vbr=224.0..247.0V, Ipp=1.85A, 600W(1ms)	DO-214AA	1d	1a	Cmc
PX	P6SMB15CA	TVS	Vrwm=15V, 28A, 600W(1ms), Bidirectional	DO-214AA	1ba	2k	Fag
PX	TV06B221J-G	TVS	Vrwm=220.0V, Vbr=246.0..272.0V, Ipp=1.69A, 600W(1ms)	DO-214AA	1d	1a	Cmc
PY	KDZ6.8VYV	Z-diode	6.65..6.93V, Izt=5mA, Zzt=25Ω, 100mW	VSC	7d	1a	Kec
PY	P6SMB16C	TVS	Vrwm=16V, 26A, 600W(1ms), Bidirectional	DO-214AA	1ba	2k	Fag
PY	P6SMBJ210	TVS	Vbr=170V, 1.6A, 600W(1ms)	DO-214AA	1d	1m,1w	Pjt,Srj
PZ	BZT52-B22S	Z-diode	21.56..22.44V, Izt=5mA, Zzt=55Ω, 200mW	SOD-323FL	7d	1a	Tsc
PZ	MM3Z22VB	Z-diode	21.56..22.44V, Zzt=51Ω, Izt=5mA, 200mW	SOD-323FL	7d	1a	F
PZ	MM3Z22VBW	Z-diode	21.56..22.44V, Izt=5mA, Zzt=55Ω, 200mW	SOD-323FL	7d	1a	Tac
PZ	P6SMB16CA	TVS	Vrwm=16V, 27A, 600W(1ms), Bidirectional	DO-214AA	1ba	2k	Fag
PZ	P6SMBJ200A	TVS	Vbr=170V, 1.9A, 600W(1ms)	DO-214AA	1d	1m,1w	Pjt,Srj



SMD
code

Type

Function

Short description

Case

Pinout

St.

Mnf.

PZ	P6SMBJ210A	TVS	Vbr=170V, 1.8A, 600W(1ms)	DO-214AA	1d	1m,1w	Pjt,Srj
PZ	TCMM3Z22VB	Z-diode	22V±2%, lzt=5mA, Zzt=51Ω, 200mW	SOD-323FL	7d	1a	Tac
PZ	TV06B251J-G	TVS	Vrwm=250.0V, Vbr=279.0..309.0V, lpp=1.48A, 600W(1ms)	DO-214AA	1d	1a	Cmc
Q	HVC202A	C-diode	UHF/VHF-Tuning, 34V, 2.06..14.11pF(25V..2V/1MHz)	UFP	6d	1b	Ren
Q	MM9D15V	Z-diode	14.25..15.75V, lzt=5mA, Zzt=42Ω, 200mW	SOD-923	7d	1n	Wtr
Q	MM9D3V3	Z-diode	3.14..3.47V, lzt=5mA, Zzt=100Ω, 200mW	SOD-923	7d	1a	Wtr
Q	MMSZ5266BPT	Z-diode	64.60..71.40V, lzt=1.8mA, Zzt=230Ω, 225mW	SOD-523	7d	1a	Chm
Q	NZ9F15VT	Z-diode	14.25..15.75V, lzt=5mA, Zzt=42Ω, 200mW	SOD-923	7d	1n	Ons
Q	NZ9F3V3T	Z-diode	3.14..3.47V, lzt=5mA, Zzt=100Ω, 200mW	SOD-923	7d	1a	Ons
Q	NZ9F8V2ST	Z-diode	8.02..8.36V, lzt=5mA, Zzt=30Ω, 200mW	SOD-923	7d	2m	Ons
Q	MMSZ5266SPT	Z-diode	66.64..69.36V, lzt=1.8mA, Zzt=230Ω, 225mW	SOD-523	7d	1a	Chm
Q0	MMPZ5247SPT	Z-diode	16.66..17.34V, lzt=5mA, Zzt=36Ω, 225mW	SOD-323	5d	1a	Chm
Q8	MMSZ12H	Z-diode	11.4..12.7V, lzt=5mA, Zzt=25Ω, 200mW	SOD-523	7d	1a	Zow
Q8	MMSZ12V	Z-diode	12V±5%, lzt=5mA, Zzt=25Ω, 200mW	SOD-523	6d	1a	Eic
QAA	SMP30-62	TVS	Vbr=62V, 30A, 3W (1ms), Bidirectional	DO-214AC	1ba	1r	Ste
QAB	SMP30-68	TVS	Vbr=68V, 30A, 3W (1ms), Bidirectional	DO-214AC	1ba	1r	Ste
QAC	SMP30-100	TVS	Vbr=100V, 30A, 3W (1ms), Bidirectional	DO-214AC	1ba	1r	Ste
QAD	SMP30-120	TVS	Vbr=120V, 30A, 3W (1ms), Bidirectional	DO-214AC	1ba	1r	Ste
QAE	SMP30-130	TVS	Vbr=130V, 30A, 3W (1ms), Bidirectional	DO-214AC	1ba	1r	Ste
QAF	SMP30-180	TVS	Vbr=180V, 30A, 3W (1ms), Bidirectional	DO-214AC	1ba	1r	Ste
QAG	SMP30-200	TVS	Vbr=200V, 30A, 3W (1ms), Bidirectional	DO-214AC	1ba	1r	Ste
QAH	SMP30-220	TVS	Vbr=220V, 30A, 3W (1ms), Bidirectional	DO-214AC	1ba	1r	Ste
QAI	SMP30-240	TVS	Vbr=240V, 30A, 3W (1ms), Bidirectional	DO-214AC	1ba	1r	Ste
QAJ	SMP30-270	TVS	Vbr=270V, 30A, 3W (1ms), Bidirectional	DO-214AC	1ba	1r	Ste
QB	KDZ7.5B	Z-diode	7.5V±2.5%, 40mA, 1W	PMDU	7d	1s	Rhm
QD	P6SMB18C	TVS	Vrwm=18V, 23A, 600W(1ms), Bidirectional	DO-214AA	1ba	2k	Fag
QD	P6SMBJ220	TVS	Vbr=170V, 1.5A, 600W(1ms)	DO-214AA	1d	1m,1w	Pjt,Srj
QD	SM4T6V8	TVS	Vbr=6.8V, 38A, 400W(1ms)	SOD-6	1d	1q	Ste
QE	1SMA5.0A	TVS	Vrwm=5V±5%, 43.5A, 400W (1ms)	403B-01	3d	1f	Ons
QE	P6SMB18CA	TVS	Vrwm=18V, 24A, 600W(1ms), Bidirectional	DO-214AA	1ba	2k	Fag
QE	P6SMBJ220A	TVS	Vbr=170V, 1.7A, 600W(1ms)	DO-214AA	1d	1m,1w	Pjt,Srj
QE	SM4T6V8A	TVS	Vbr=6.8V, 38A, 400W(1ms)	SOD-6	1d	1q	Ste
QE	TV06B301J-G	TVS	Vrwm=300.0V, Vbr=335.0..371.0V, lpp=1.23A, 600W(1ms)	DO-214AA	1d	1a	Cmc
QF	KDZ24FV	Z-diode	22.80..25.60V, lzt=5mA, Zzt=40Ω, 100mW	TFSC	7d	1a	Kec
QF	P6SMB20C	TVS	Vrwm=20V, 21A, 600W(1ms), Bidirectional	DO-214AA	1ba	2k	Fag
QF	SM4T7V5	TVS	Vbr=7.5V, 35.4A, 400W(1ms)	SOD-6	1d	1q	Ste
QG	1SMA6.0A	TVS	Vrwm=6V±5%, 38.8A, 400W (1ms)	403B-01	3d	1s	Ons
QG	P6SMB20CA	TVS	Vrwm=20V, 20A, 600W(1ms), Bidirectional	DO-214AA	1ba	2k	Fag
QG	SM4T7V5A	TVS	Vbr=7.5V, 35.4A, 400W(1ms)	SOD-6	1d	1q	Ste
QG	TV06B351J-G	TVS	Vrwm=350.0V, Vbr=391.0..432.0V, lpp=1.06A, 600W(1ms)	DO-214AA	1d	1a	Cmc
QH	P6SMB22C	TVS	Vrwm=22V, 19A, 600W(1ms), Bidirectional	DO-214AA	1ba	2k	Fag
QK	1SMA6.5A	TVS	Vrwm=6.5V±5%, 35.7A, 400W (1ms)	403B-01	3d	1s	Ons
QK	P6SMB22CA	TVS	Vrwm=22V, 20A, 600W(1ms), Bidirectional	DO-214AA	1ba	2k	Fag
QK	TV06B401J-G	TVS	Vrwm=400.0V, Vbr=447.0..494.0V, lpp=0.93A, 600W(1ms)	DO-214AA	1d	1a	Cmc
QL	P6SMB24C	TVS	Vrwm=24V, 17A, 600W(1ms), Bidirectional	DO-214AA	1ba	2k	Fag
QM	1SMA7.0A	TVS	Vrwm=7V±5%, 33.3A, 400W (1ms)	403B-01	3d	1s	Ons
QM	P6SMB24CA	TVS	Vrwm=24V, 18A, 600W(1ms), Bidirectional	DO-214AA	1ba	2k	Fag
QM	TV06B441J-G	TVS	Vrwm=440.0V, Vbr=492.0..543.0V, lpp=0.84A, 600W(1ms)	DO-214AA	1d	1a	Cmc
QN	P6SMB27C	TVS	Vrwm=27V, 16A, 600W(1ms), Bidirectional	DO-214AA	1ba	2k	Fag
QN	SM4T10	TVS	Vbr=10V, 27.6A, 400W(1ms)	SOD-6	1d	1q	Ste
QP	1SMA7.5A	TVS	Vrwm=7.5V±5%, 31A, 400W (1ms)	403B-01	3d	1s	Ons
QP	CMDZ7L5	Z-diode	7.125..7.875V, lzt=0.5mA, Zzt=60Ω, 250mW	SOD-323	5d	1a	Cen
QP	KDZ24FVY	Z-diode	23.72..24.78V, lzt=5mA, Zzt=40Ω, 100mW	TFSC	7d	1a	Kec
QP	P6SMB27CA	TVS	Vrwm=27V, 17A, 600W(1ms), Bidirectional	DO-214AA	1ba	2k	Fag
QP	SM4T10A	TVS	Vbr=10V, 27.6A, 400W(1ms)	SOD-6	1d	1q	Ste
QQ	P6SMB30C	TVS	Vrwm=30V, 14A, 600W(1ms), Bidirectional	DO-214AA	1ba	2k	Fag
QR	1SMA8.0A	TVS	Vrwm=8.5V±5%, 27.8A, 400W (1ms)	403B-01	3d	1s	Ons
QR	P6SMB30CA	TVS	Vrwm=30V, 14.4A, 600W(1ms), Bidirectional	DO-214AA	1ba	2k	Fag
QS	P6SMB33C	TVS	Vrwm=33V, 12.6A, 600W(1ms), Bidirectional	DO-214AA	1ba	2k	Fag
QS	SM4T12	TVS	Vbr=12V, 24A, 400W(1ms)	SOD-6	1d	1q	Ste
QT	1SMA8.5A	TVS	Vrwm=8.5V±5%, 29.4A, 400W (1ms)	403B-01	3d	1s	Ons
QT	P6SMB33CA	TVS	Vrwm=33V, 13.2A, 600W(1ms), Bidirectional	DO-214AA	1ba	2k	Fag
QT	SM4T12A	TVS	Vbr=12V, 24A, 400W(1ms)	SOD-6	1d	1q	Ste
QU	P6SMB36C	TVS	Vrwm=36V, 11.6A, 600W(1ms), Bidirectional	DO-214AA	1ba	2k	Fag
QV	1SMA9.0A	TVS	Vrwm=9V±5%, 26A, 400W (1ms)	403B-01	3d	1s	Ons
QV	P6SMB36CA	TVS	Vrwm=36V, 12A, 600W(1ms), Bidirectional	DO-214AA	1ba	2k	Fag
QW	P6SMB39C	TVS	Vrwm=39V, 10.6A, 600W(1ms), Bidirectional	DO-214AA	1ba	2k	Fag
QW	SM4T15	TVS	Vbr=15V, 19A, 400W(1ms)	SOD-6	1d	1q	Ste
QX	1SMA10A	TVS	Vrwm=10V±5%, 23.5A, 400W(1ms)	403B-01	3d	1f	Ons
QX	P6SMB39CA	TVS	Vrwm=39V, 11.2A, 600W(1ms), Bidirectional	DO-214AA	1ba	2k	Fag



SMD
code

Type

Function

Short description

Case

Pinout

St.

Mnf.

QX	SM4T15A	TVS	Vbr=15V, 19A, 400W(1ms)	SOD-6	1d	1q	Ste
QXC	15MA10CA	TVS	Vrnm=10V±5%, 23.5A, 400W(1ms), Bidirectional	403B-01	3ba	1e	Ons
QY	KDZ7.5VVY	Z-diode	7.28..7.60V, Izt=5mA, Zzt=23Ω, 100mW	VSC	7d	1a	Kec
QY	P6SMB43C	TVS	Vrnm=43V, 9.6A, 600W(1ms), Bidirectional	DO-214AA	1ba	2k	Fag
QZ	15MA11A	TVS	Vrnm=11V±5%, 22A, 400W(1ms)	403B-01	3d	1f	Ons
QZ	P6SMB43CA	TVS	Vrnm=43V, 10.1A, 600W(1ms), Bidirectional	DO-214AA	1ba	2k	Fag
QZC	15MA11CA	TVS	Vrnm=11V±5%, 22.0A, 400W(1ms), Bidirectional	403B-01	3ba	1e	Ons
R	HVU358	C-diode	VCO, 15V, 19/21pF(1V)	SOD-323	5d	1a	Ren
R	MAZS068	Z-diode	6.4..7.2V, 200mW	SOD-523	6d	1a	Pan
R	MM9D16V	Z-diode	15.20..16.80V, Izt=5mA, Zzt=50Ω, 200mW	SOD-923	7d	1n	Wtr
r	MMSZ5240BPT	Z-diode	9.500..10.50V, Izt=5mA, Zzt=15Ω, 225mW	SOD-523	7d	1a	Chm
R	MMSZ5267BPT	Z-diode	71.25..78.75V, Izt=1.7mA, Zzt=270Ω, 225mW	SOD-523	7d	1a	Chm
R	NZ9F16VT	Z-diode	15.20..16.80V, Izt=5mA, Zzt=50Ω, 200mW	SOD-923	7d	1n	Ons
R	NZ9F9V1ST	Z-diode	8.85..9.23V, Izt=5mA, Zzt=30Ω, 200mW	SOD-923	7d	2m	Ons
R-	MAZS0680M	Z-diode	6.64..6.98V, 200mW	SOD-523	6d	1a	Pan
R (red)	BB620	C-diode	VHF-TV/VTR-Tuning, HBand, 30V, 20mA, 62/76pF	SOD-123	5d	2	Inf
R (red)	BB644	C-diode	VHF-Tuning, 35V, 2.6/42pF(28/1V)	SOD-123	5d	2	Sie
R (white)	BA585	PIN-diode	SATV Ant, Sw, Att., 2GHz, 50V, 50mA, Vf<1.1V(50mA), 0.4pF	SOD-123	5d	2	Sie
R (white)	BA595	PIN-diode	UHF TV-sat, 50V, 50mA, Vf<1.1V(50mA), 0.22pF, <2GHz	SOD-323	5d	2	Inf
R yellow	BA597	PIN-diode	Attenuator, 50V, 100mA, >10MHz	SOD-123	5d	2	Sie
r.	MMSZ5240SPT	Z-diode	9.800..10.20V, Izt=5mA, Zzt=15Ω, 225mW	SOD-523	7d	1a	Chm
R	MMSZ5267SPT	Z-diode	73.50..76.50V, Izt=1.7mA, Zzt=270Ω, 225mW	SOD-523	7d	1a	Chm
RA	MAZS0680H	Z-diode	6.85..7.2V, 200mW	SOD-523	6d	1a	Pan
R	MAZS0680L	Z-diode	6.44..6.77V, 200mW	SOD-523	6d	1a	Pan
RO	CMOZ39L	Z-diode	37.05..40.95V, Izt=0.25mA, Zzt=200Ω, 250mW	SOD-523	6d	1a	Ken
RO	MMPZ5248SPT	Z-diode	17.64..18.36V, Izt=5mA, Zzt=42Ω, 225mW	SOD-323	5d	1a	Chm
R1	CMOZ43L	Z-diode	40.85..45.15V, Izt=0.25mA, Zzt=250Ω, 250mW	SOD-523	6d	1a	Ken
R1	FS1A	Si-diode	Rectifier, 50V, 1A, Vf<1.1V(1A)	DO-214AC	1d	2j	Fag
R1	MM3Z5236B	Z-diode	7.5V±5%, Izt=20mA, Zzt=6Ω, 200mW	SOD-323FL	7d	1a	Bts
R1	MM3Z5236BH	Z-diode	7.13..7.88V, Izt=20mA, Zzt=6Ω, 300mW	SOD-323	5d	1a	Zow
R1	PDZ2.4B	Z-diode	2.4V±2.5%, 400mW	SOD-323	5d	1a	Pjt
R10A	RGF10A	Si-diode	Rectifier, Fast-Recovery 50V, 1A, Vf<1.3V(1A), 150ns	DO-214AC	1d	1b	Zow
R10B	RGF10B	Si-diode	Rectifier, Fast-Recovery 100V, 1A, Vf<1.3V(1A), 150ns	DO-214AC	1d	1b	Zow
R10D	RGF10D	Si-diode	Rectifier, Fast-Recovery 200V, 1A, Vf<1.3V(1A), 150ns	DO-214AC	1d	1b	Zow
R10G	RGF10G	Si-diode	Rectifier, Fast-Recovery 400V, 1A, Vf<1.3V(1A), 150ns	DO-214AC	1d	1b	Zow
R10J	RGF10J	Si-diode	Rectifier, Fast-Recovery 600V, 1A, Vf<1.3V(1A), 250ns	DO-214AC	1d	1b	Zow
R10J	RGF10K	Si-diode	Rectifier, Fast-Recovery 800V, 1A, Vf<1.3V(1A), 500ns	DO-214AC	1d	1b	Zow
R10J	RGF10M	Si-diode	Rectifier, Fast-Recovery 1000V, 1A, Vf<1.3V(1A), 500ns	DO-214AC	1d	1b	Zow
R10JA	RGF10JA	Si-diode	Rectifier, Fast-Recovery 600V, 1A, Vf<1.3V(1A), 150ns	DO-214AC	1d	1b	Zow
R10JA	RGF10KA	Si-diode	Rectifier, Fast-Recovery 800V, 1A, Vf<1.3V(1A), 300ns	DO-214AC	1d	1b	Zow
R10JA	RGF10MA	Si-diode	Rectifier, Fast-Recovery 1000V, 1A, Vf<1.3V(1A), 300ns	DO-214AC	1d	1b	Zow
R13	MRA4003	Si-diode	Rectifier, 300V, 1A, Vf<1.1V(1A)	DO-214AC	1d	1f	Ons
R14	MRA4004	Si-diode	Rectifier, 400V, 1A, Vf<1.1V(1A)	DO-214AC	1d	1f	Ons
R15	MRA4005	Si-diode	Rectifier, 600V, 1A, Vf<1.1V(1A)	DO-214AC	1d	1f	Ons
R16	MRA4006	Si-diode	Rectifier, 800V, 1A, Vf<1.1V(1A)	DO-214AC	1d	1f	Ons
R17	MRA4007	Si-diode	Rectifier, 1000V, 1A, Vf<1.1V(1A)	DO-214AC	1d	1f	Ons
R2	CMOZ47L	Z-diode	44.65..49.35V, Izt=0.25mA, Zzt=250Ω, 250mW	SOD-523	6d	1a	Ken
R2	FS1B	Si-diode	Rectifier, 100V, 1A, Vf<1.1V(1A)	DO-214AC	1d	2j	Fag
R2	MM3Z5258B	Z-diode	36V±5%, Izt=3.4mA, Zzt=70Ω, 200mW	SOD-323FL	7d	1a	Bts
R2	MM3Z5258BH	Z-diode	34.2..37.8V, Izt=3.4mA, Zzt=70Ω, 300mW	SOD-323	5d	1a	Zow
R2	PDZ2.7B	Z-diode	2.7V±2.5%, 400mW	SOD-323	5d	1a	Pjt
R20A	RGF20A	Si-diode	Rectifier, Fast-Recovery 50V, 2A, Vf<1.3V(2A), 150ns	DO-214AA	1d	1b	Zow
R20B	RGF20B	Si-diode	Rectifier, Fast-Recovery 100V, 2A, Vf<1.3V(2A), 150ns	DO-214AA	1d	1b	Zow
R20D	RGF20D	Si-diode	Rectifier, Fast-Recovery 200V, 2A, Vf<1.3V(2A), 150ns	DO-214AA	1d	1b	Zow
R20G	RGF20G	Si-diode	Rectifier, Fast-Recovery 400V, 2A, Vf<1.3V(2A), 150ns	DO-214AA	1d	1b	Zow
R20J	RGF20J	Si-diode	Rectifier, Fast-Recovery 600V, 2A, Vf<1.3V(2A), 250ns	DO-214AA	1d	1b	Zow
R20J	RGF20K	Si-diode	Rectifier, Fast-Recovery 800V, 2A, Vf<1.3V(2A), 500ns	DO-214AA	1d	1b	Zow
R20J	RGF20M	Si-diode	Rectifier, Fast-Recovery 1000V, 2A, Vf<1.3V(2A), 500ns	DO-214AA	1d	1b	Zow
R20JA	RGF20JA	Si-diode	Rectifier, Fast-Recovery 600V, 2A, Vf<1.3V(2A), 150ns	DO-214AA	1d	1b	Zow
R20JA	RGF20KA	Si-diode	Rectifier, Fast-Recovery 800V, 2A, Vf<1.3V(2A), 300ns	DO-214AA	1d	1b	Zow
R20JA	RGF20MA	Si-diode	Rectifier, Fast-Recovery 1000V, 2A, Vf<1.3V(2A), 300ns	DO-214AA	1d	1b	Zow
R3	FS1D	Si-diode	Rectifier, 200V, 1A, Vf<1.1V(1A)	DO-214AC	1d	2j	Fag
R3	PDZ3.0B	Z-diode	3.0V±2.5%, 400mW	SOD-323	5d	1a	Pjt
R30A	RGF30A	Si-diode	Rectifier, Fast-Recovery 50V, 3A, Vf<1.3V(3A), 150ns	DO-214AA	1d	1b	Zow
R30B	RGF30B	Si-diode	Rectifier, Fast-Recovery 100V, 3A, Vf<1.3V(3A), 150ns	DO-214AA	1d	1b	Zow
R30D	RGF30D	Si-diode	Rectifier, Fast-Recovery 200V, 3A, Vf<1.3V(3A), 150ns	DO-214AA	1d	1b	Zow
R30G	RGF30G	Si-diode	Rectifier, Fast-Recovery 400V, 3A, Vf<1.3V(3A), 150ns	DO-214AA	1d	1b	Zow
R30J	RGF30J	Si-diode	Rectifier, Fast-Recovery 600V, 3A, Vf<1.3V(3A), 250ns	DO-214AA	1d	1b	Zow
R30J	RGF30K	Si-diode	Rectifier, Fast-Recovery 800V, 3A, Vf<1.3V(3A), 500ns	DO-214AA	1d	1b	Zow
R30J	RGF30M	Si-diode	Rectifier, Fast-Recovery 1000V, 3A, Vf<1.3V(3A), 500ns	DO-214AA	1d	1b	Zow



SMD code	Type	Function	Short description	Case	Pinout	St.	Mnf.
R30JA	RGF30JA	Si-diode	Rectifier, Fast-Recovery 600V, 3A, Vf<1.3V(3A), 150ns	DO-214AA	1d	1b	Zow
R30JA	RGF30KA	Si-diode	Rectifier, Fast-Recovery 800V, 3A, Vf<1.3V(3A), 300ns	DO-214AA	1d	1b	Zow
R30JA	RGF30MA	Si-diode	Rectifier, Fast-Recovery 1000V, 3A, Vf<1.3V(3A), 300ns	DO-214AA	1d	1b	Zow
R4	FS1G	Si-diode	Rectifier, 400V, 1A, Vf<1.1V(1A), 4μs	DO-214AC	1d	2j	Fag
R4	MM1Z5236B	Z-diode	7.13..7.88V, Izt=20mA, Zzt=6Ω, 500mW	SOD-323FL	5d	1a	Eic
R4	MM1Z5236BH	Z-diode	7.13..7.88V, Izt=20mA, Zzt=6Ω, 500mW	SOD-123	5d	1a	Zow
R4	MMSZ5236B	Z-diode	7.5V±5%, Izt=20mA, Zzt=6Ω, 500mW	SOD-123	5d	1a	Eic
R4	PDZ3.3B	Z-diode	3.3V±2.5%, 400mW	SOD-323	5d	1a	Pjt
R5	BZX584B24V	Z-diode	23.52..24.48V, Izt=5mA, Zzt=70Ω, 200mW	SOD-523FL	7d	1a	Tac
R5	FS1J	Si-diode	Rectifier, 600V, 1A, Vf<1.1V(1A), 4μs	DO-214AC	1d	2j	Fag
R5	MM1Z5258B	Z-diode	34.20..37.80V, Izt=3.4mA, Zzt=70Ω, 500mW	SOD-323FL	5d	1a	Eic
R5	MM1Z5258BH	Z-diode	34.2..37.8V, Izt=3.4mA, Zzt=70Ω, 500mW	SOD-123	5d	1a	Zow
R5	MMSZ24VB	Z-diode	23.52..24.48V, Izt=5mA, Zzt=70Ω, 200mW	SOD-523FL	7d	1a	Tac
R5	MMSZ5258B	Z-diode	36V±5%, Izt=3.4mA, Zzt=70Ω, 500mW	SOD-123	5d	1a	Eic
R5	PDZ3.6B	Z-diode	3.6V±2.5%, 400mW	SOD-323	5d	1a	Pjt
R6	FS1K	Si-diode	Rectifier, 800V, 1A, Vf<1.1V(1A), 4μs	DO-214AC	1d	2j	Fag
R6	PDZ3.9B	Z-diode	3.9V±2.5%, 400mW	SOD-323	5d	1a	Pjt
R7	FS1M	Si-diode	Rectifier, 1000V, 1A, Vf<1.1V(1A), 4μs	DO-214AC	1d	2j	Fag
R7	PDZ4.3B	Z-diode	4.3V±2.5%, 400mW	SOD-323	5d	1a	Pjt
R8	MMSZ13H	Z-diode	12.4..14.1V, Izt=5mA, Zzt=30Ω, 200mW	SOD-523	7d	1a	Zow
R8	MMSZ13V	Z-diode	13V±5%, Izt=5mA, Zzt=30Ω, 200mW	SOD-523	6d	1a	Eic
R8	PDZ4.7B	Z-diode	4.7V±2.5%, 400mW	SOD-323	5d	1a	Pjt
R9	FS1Q	Si-diode	GP, Rectifier, 1200V, 1A, 4μs	DO-214AC	1d	2j	Fag
R9	PDZ5.1B	Z-diode	5.1V±2.5%, 400mW	SOD-323	5d	1a	Pjt
RA	BA895	PIN-Diode	UHF TV-sat, 50V, 50mA, Vf<1.1V(50mA), 0.22pF, <2GHz	SCD-80	6d	1u	Inf
RA	P4SMA6.8C	TVS	Vrwm=6.8V, 38A, 400W (1ms), Bidirectional	DO-214AC	1ba	2k	Fag
RA	PDZ5.6B	Z-diode	5.6V±2.5%, 400mW	SOD-323	5d	1a	Pjt
RA	RGF1A	Si-diode	Rectifier, 50V, 1A, Vf<1.3V(1A), 150..500ns	DO-214BA	1d	1k	Vs
RA	RS1A	Si-diode	Rectifier, 50V, 1A, Vf<1.3V(1A)	DO-214AC	1d	1k	Vs
RA	RS2A	Si-diode	Rectifier, 50V, 1.5A, Vf<1.3V(1.5A)	DO-214AA	1d	1k	Vs
RA	RS3A	Si-diode	Rectifier, 50V, 3A, Vf<1.3V(3A)	DO-214AB	1d	1k	Vs
RB	KDZ8.2B	Z-diode	8.2V±2.5%, 40mA, 1W	PMDU	7d	1s	Rhm
RB	PDZ6.2B	Z-diode	6.2V±2.5%, 400mW	SOD-323	5d	1a	Pjt
RB	RGF1B	Si-diode	Rectifier, 100V, 1A, Vf<1.3V(1A), 150..500ns	DO-214BA	1d	1k	Vs
RB	RS1B	Si-diode	Rectifier, 100V, 1A, Vf<1.3V(1A)	DO-214AC	1d	1k	Vs
RB	RS1PB	Si-diode	Rectifier, 100V, 1A, Vf<1.3V(1A)	DO-220AA	8d	1k	Vs
RB	RS2B	Si-diode	Rectifier, 100V, 1.5A, Vf<1.3V(1.5A)	DO-214AA	1d	1k	Vs
RB	RS3B	Si-diode	Rectifier, 100V, 3A, Vf<1.3V(3A)	DO-214AB	1d	1k	Vs
RC	P4SMA7.5C	TVS	Vrwm=7.5V, 36A, 400W (1ms), Bidirectional	DO-214AC	1ba	2k	Fag
RC	PDZ6.8B	Z-diode	6.8V±2.5%, 400mW	SOD-323	5d	1a	Pjt
RD	MMSZ2V0	Z-diode	2.0V±5%, Izt=5mA, Zzt=10Ω, 200mW	SOD-523	6d	1a	Rfe
RD	MMSZ2V0H	Z-diode	1.8..2.15V, Izt=5mA, Zzt=100Ω, 200mW	SOD-523	7d	1a	Zow
RD	P4SMAJ54	TVS	Vbr=54V, 4.2A, 400W (1ms)	DO-214AC	1d	1m,1w	Pjt,Sj
RD	PDZ7.5B	Z-diode	7.5V±2.5%, 400mW	SOD-323	5d	1a	Pjt
RD	RGF1D	Si-diode	Rectifier, 200V, 1A, Vf<1.3V(1A), 150..500ns	DO-214BA	1d	1k	Vs
RD	RS1D	Si-diode	Rectifier, 200V, 1A, Vf<1.3V(1A)	DO-214AC	1d	1k	Vs
RD	RS1PD	Si-diode	Rectifier, 200V, 1A, Vf<1.3V(1A)	DO-220AA	8d	1k	Vs
RD	RS2D	Si-diode	Rectifier, 200V, 1.5A, Vf<1.3V(1.5A)	DO-214AA	1d	1k	Vs
RD	RS3D	Si-diode	Rectifier, 200V, 3A, Vf<1.3V(3A)	DO-214AB	1d	1k	Vs
RD	SM4T18	TVS	Vbr=18V, 16A, 400W(1ms)	SOD-6	1d	1q	Ste
RD	SMAJ54	TVS	Vrwm=54V, Vbr=60.0..73.3V, 4.2A, 400W(1ms)	DO-214AC	1d	1k	Vs
RD	TV04A540K-G	TVS	Vrwm=54.0V, Vbr=60.0..73.30V, Ipp=4.15A, 400W(1ms)	DO-214AC	1d	1a	Cmc
RDD	SMLJ5.0	TVS	Vrwm=5.0V, Vbr=6.40..7.30V, Ipp=312.5A, 3000W(1ms)	DO-214AB	1a	1a	Mco
RDE	SMDJ5.0	TVS	Vrwm=5.0V, Vbr=6.7V±10%, 326.1A, 3000W(1ms)	DO-214AB	1d	1a	Mde
RDE	SMDJ5.0A	TVS	Vrwm=5.0V, Vbr=6.7V±5%, 326.1A, 3000W(1ms)	DO-214AB	1d	1a	Mde
RDE	SMLJ5.0A	TVS	Vrwm=5.0V, Vbr=6.40..7.0V, Ipp=326.0A, 3000W(1ms)	DO-214AB	1a	1a	Mco
RDF	SMLJ6.0	TVS	Vrwm=6.0V, Vbr=6.67..8.15V, Ipp=263.2A, 3000W(1ms)	DO-214AB	1a	1a	Mco
RDG	SMDJ6.0	TVS	Vrwm=6.0V, Vbr=6.78V±10%, 291.3A, 3000W(1ms)	DO-214AB	1d	1a	Mde
RDG	SMDJ6.0A	TVS	Vrwm=6.0V, Vbr=6.78V±5%, 291.3A, 3000W(1ms)	DO-214AB	1d	1a	Mde
RDG	SMLJ6.0A	TVS	Vrwm=6.0V, Vbr=6.67..7.37V, Ipp=291.3A, 3000W(1ms)	DO-214AB	1a	1a	Mco
RDH	SMLJ6.5	TVS	Vrwm=6.5V, Vbr=7.22..8.82V, Ipp=243.9A, 3000W(1ms)	DO-214AB	1a	1a	Mco
RDK	SMA120	TVS	Vbr=108..132V, Vrwm=97.2V, 2.31A, 400W(1ms)	DO-214AC	1d	1a	Lge
RDK	SMDJ6.5	TVS	Vrwm=6.5V, Vbr=7.02V±10%, 267.9A, 3000W(1ms)	DO-214AB	1d	1a	Mde
RDK	SMDJ6.5A	TVS	Vrwm=6.5V, Vbr=7.02V±5%, 267.9A, 3000W(1ms)	DO-214AB	1d	1a	Mde
RDK	SMLJ6.5A	TVS	Vrwm=6.5V, Vbr=7.22..7.98V, Ipp=267.9A, 3000W(1ms)	DO-214AB	1a	1a	Mco
RDm	SMA120C	TVS	Vbr=108..132V, Vrwm=97.2V, 2.31A, 400W(1ms), Bidirectional	DO-214AC	1ba	1j	Lge
RE	1SMA12A	TVS	Vrwm=12V±5%, 20.1A, 400W (1ms)	403B-01	3d	1f	Ons
RE	CD214A-T54A	TVS	Vbr=54V, Ibrsm=4.6A, 400W(1ms)	DO-214AC	1d	1a	Bm
RE	MMSZ2V2	Z-diode	2.2V±5%, Izt=5mA, Zzt=10Ω, 200mW	SOD-523	6d	1a	Rfe
RE	MMSZ2V2H	Z-diode	2.08..2.33V, Izt=5mA, Zzt=100Ω, 200mW	SOD-523	7d	1a	Zow



SMD
code

Type

Function

Short description

Case

Pinout

St.

Mnf.

SMD code	Type	Function	Short description	Case	Pinout	St.	Mnf.
RE	P4SMA8.2C	TVS	Vrwm=8.2V, 33A, 400W (1ms), Bidirectional	DO-214AC	1ba	2k	Fag
RE	P4SMAJ54A	TVS	Vbr=54V, 4.6A, 400W (1ms)	DO-214AC	1d	1m,1w	Pjt,Srj
RE	PDZ8.2B	Z-diode	8.2V±2.5%, 400mW	SOD-323	5d	1a	Pjt
RE	SM4T18A	TVS	Vbr=18V, 16A, 400W(1ms)	SOD-6	1d	1q	Ste
RE	SMAJ54A	TVS	Vrwm=54V, Vbr=60.0..73.3V, 4.6A, 400W(1ms)	DO-214AC	1d	1k,1m	Di,Vs
RE	TV04A540J-G	TVS	Vrwm=54.0V, Vbr=60.0..66.30V, Ipp=4.59A, 400W(1ms)	DO-214AC	1d	1a	Cmc
REC	1SMA12CA	TVS	Vrwm=12V±5%, 20.1A, 400W (1ms), Bidirectional	403B-01	3ba	1e	Ons
REK	SMA120A	TVS	Vbr=114..126V, Vrwm=102V, 2.42A, 400W(1ms)	DO-214AC	1d	1a	Lge
REM	SMA120CA	TVS	Vbr=114..126V, Vrwm=102V, 2.42A, 400W(1ms), Bidirectional	DO-214AC	1ba	1j	Lge
RF	KDZ27FV	Z-diode	25.10..28.90V, Izt=2mA, Zzt=150Ω, 100mW	TFSC	7d	1a	Kec
RF	MAZD200	Z-diode	18.8..21.2V, Zzt=80Ω(5mA), 120mW	SSSMini2	7d	1a	Pan
RF	P4SMAJ58	TVS	Vbr=58V, 3.9A, 400W (1ms)	DO-214AC	1d	1m,1w	Pjt,Srj
RF	PDZ9.1B	Z-diode	9.1V±2.5%, 400mW	SOD-323	5d	1a	Pjt
RF	PZU5.6BA/DG	Z-diode	5.6V±5%, If=200mA, 320mW, halogen-free	SOD-323	5d	1a	Phi
RF	SMAJ58	TVS	Vrwm=58V, Vbr=64.4..78.7V, 400W(1ms)	DO-214AC	1d	1k	Vs
RF	TV04A580K-G	TVS	Vrwm=58.0V, Vbr=64.40..78.70V, Ipp=3.88A, 400W(1ms)	DO-214AC	1d	1a	Cmc
RFK	SMA130	TVS	Vbr=117..143V, Vrwm=105V, 2.14A, 400W(1ms)	DO-214AC	1d	1a	Lge
RFM	SMA130C	TVS	Vbr=117..143V, Vrwm=105V, 2.14A, 400W(1ms), Bidirectional	DO-214AC	1ba	1j	Lge
RG	1SMA13A	TVS	Vrwm=13V±5%, 18.6A, 400W (1ms)	403B-01	3d	1f	Ons
RG	CD214A-T58A	TVS	Vbr=58V, Iism=4.3A, 400W(1ms)	DO-214AC	1d	1a	Bm
RG	P4SMA9.1C	TVS	Vrwm=8.1V, 30A, 400W (1ms), Bidirectional	DO-214AC	1ba	2k	Fag
RG	P4SMAJ58A	TVS	Vbr=58V, 4.3A, 400W (1ms)	DO-214AC	1d	1m,1w	Pjt,Srj
RG	PDZ10B	Z-diode	10V±2.5%, 400mW	SOD-323	5d	1a	Pjt
RG	PZU5.6B1A/DG	Z-diode	5.6V±2%, If=200mA, 320mW, halogen-free	SOD-323	5d	1a	Phi
RG	RGF1G	Si-diode	Rectifier, 400V, 1A, Vf<1.3V(1A), 150..500ns	DO-214BA	1d	1k	Vs
RG	RS1G	Si-diode	Rectifier, 400V, 1A, Vf<1.3V(1A)	DO-214AC	1d	1k	Vs
RG	RS1PG	Si-diode	Rectifier, 400V, 1A, Vf<1.3V(1A)	DO-220AA	8d	1k	Vs
RG	RS2G	Si-diode	Rectifier, 400V, 1.5A, Vf<1.3V(1.5A)	DO-214AA	1d	1k	Vs
RG	RS3G	Si-diode	Rectifier, 400V, 3A, Vf<1.3V(3A)	DO-214AB	1d	1k	Vs
RG	SMAJ58A	TVS	Vrwm=58V, Vbr=64.4..71.2V, 4.3A, 400W(1ms)	DO-214AC	1d	1k,1m	Di,Vs
RG	TV04A580J-G	TVS	Vrwm=58.0V, Vbr=64.40..71.20V, Ipp=4.27A, 400W(1ms)	DO-214AC	1d	1a	Cmc
RGC	1SMA13CA	TVS	Vrwm=13V±5%, 18.6A, 400W (1ms), Bidirectional	403B-01	3ba	1e	Ons
RGG	MRS1504T3	Si-diode	Power rectifier, 400V, 1.5A, Vf=1V(1.5A)	403A	3d	1f	Mot
RGG	MURS1504	Si-diode	Rectifier, 400V, 1.5A, Vf<1.04V(1.5A)	DO-214AA	1d	1a	Ons
RGK	SMA130A	TVS	Vbr=124..137V, Vrwm=111V, 2.23A, 400W(1ms)	DO-214AC	1d	1a	Lge
RGM	SMA130CA	TVS	Vbr=124..137V, Vrwm=111V, 2.23A, 400W(1ms), Bidirectional	DO-214AC	1ba	1j	Lge
RH	P4SMAJ60	TVS	Vbr=60V, 3.7A, 400W (1ms)	DO-214AC	1d	1m,1w	Pjt,Srj
RH	PDZ11B	Z-diode	11V±2.5%, 400mW	SOD-323	5d	1a	Pjt
RH	PZU5.6B2A/DG	Z-diode	5.6V±2%, If=200mA, 320mW, halogen-free	SOD-323	5d	1a	Phi
RH	SM4T22	TVS	Vbr=22V, 13A, 400W(1ms)	SOD-6	1d	1q	Ste
RH	SMAJ60	TVS	Vrwm=60V, Vbr=66.7..81.5V, 3.7A, 400W(1ms)	DO-214AC	1d	1k	Vs
RH	TV04A600K-G	TVS	Vrwm=60.0V, Vbr=66.70..81.50V, Ipp=3.74A, 400W(1ms)	DO-214AC	1d	1a	Cmc
RHK	SMA150	TVS	Vbr=135..165V, Vrwm=121V, 1.86A, 400W(1ms)	DO-214AC	1d	1a	Lge
RHM	SMA150C	TVS	Vbr=135..165V, Vrwm=121V, 1.86A, 400W(1ms), Bidirectional	DO-214AC	1ba	1j	Lge
RI	P4SMA10C	TVS	Vrwm=10V, 28A, 400W (1ms), Bidirectional	DO-214AC	1ba	2k	Fag
RI	PDZ12B	Z-diode	12V±2.5%, 400mW	SOD-323	5d	1a	Pjt
RJ	RGF1J	Si-diode	Rectifier, 600V, 1A, Vf<1.3V(1A), 150..500ns	DO-214BA	1d	1k	Vs
RJ	RS1J	Si-diode	Rectifier, 600V, 1A, Vf<1.3V(1A)	DO-214AC	1d	1k	Vs
RJ	RS1PJ	Si-diode	Rectifier, 600V, 1A, Vf<1.3V(1A)	DO-220AA	8d	1k	Vs
RJ	RS2J	Si-diode	Rectifier, 600V, 1.5A, Vf<1.3V(1.5A)	DO-214AA	1d	1k	Vs
RJ	RS3J	Si-diode	Rectifier, 600V, 3A, Vf<1.3V(3A)	DO-214AB	1d	1k	Vs
RK	1SMA14A	TVS	Vrwm=14V±5%, 17.2A, 400W (1ms),	403B-01	3d	1f	Ons
RK	CD214A-T60A	TVS	Vbr=60V, Iism=4.1A, 400W(1ms)	DO-214AC	1d	1a	Bm
RK	P4SMA11C	TVS	Vbr=9.90..12.1V, Vrwm=8.92V, 26.0A, 400W(1ms), Bidirectional	DO-214AC	1ba	2k	Fag
RK	P4SMAJ60A	TVS	Vbr=60V, 4.1A, 400W (1ms)	DO-214AC	1d	1m,1w	Pjt,Srj
RK	PDZ13B	Z-diode	13V±2.5%, 400mW	SOD-323	5d	1a	Pjt
RK	PZU5.6B3A/DG	Z-diode	5.6V±2%, If=200mA, 320mW, halogen-free	SOD-323	5d	1a	Phi
RK	RGF1K	Si-diode	Rectifier, 800V, 1A, Vf<1.3V(1A), 150..500ns	DO-214BA	1d	1k	Vs
RK	RS1K	Si-diode	Rectifier, 800V, 1A, Vf<1.3V(1A)	DO-214AC	1d	1k	Vs
RK	RS2K	Si-diode	Rectifier, 800V, 1.5A, Vf<1.3V(1.5A)	DO-214AA	1d	1k	Vs
RK	RS3K	Si-diode	Rectifier, 800V, 3A, Vf<1.3V(3A)	DO-214AB	1d	1k	Vs
RK	SM4T22A	TVS	Vbr=22V, 13A, 400W(1ms)	SOD-6	1d	1q	Ste
RK	SMAJ60A	TVS	Vrwm=60V, Vbr=66.7..73.7V, 4.1A, 400W(1ms)	DO-214AC	1d	1k,1m	Di,Vs
RK	TV04A600J-G	TVS	Vrwm=60.0V, Vbr=66.70..73.70V, Ipp=4.13A, 400W(1ms)	DO-214AC	1d	1a	Cmc
RKC	1SMA14CA	TVS	Vrwm=14V±5%, 17.2A, 400W (1ms), Bidirectional	403B-01	3ba	1e	Ons
RKM	SMA150A	TVS	Vbr=143..158V, Vrwm=128V, 1.93A, 400W(1ms)	DO-214AC	1d	1a	Lge
RKM	SMA150CA	TVS	Vbr=143..158V, Vrwm=128V, 1.93A, 400W(1ms), Bidirectional	DO-214AC	1ba	1j	Lge
RL	P4SMAJ64	TVS	Vbr=64V, 3.5A, 400W (1ms)	DO-214AC	1d	1m,1w	Pjt,Srj
RL	PDZ15B	Z-diode	15V±2.5%, 400mW	SOD-323	5d	1a	Pjt
RL	PZU6.2BA/DG	Z-diode	6.2V±5%, If=200mA, 320mW, halogen-free	SOD-323	5d	1a	Phi



SMD
code

Type

Function

Short description

Case

Pinout

St.

Mnf.

SMD code	Type	Function	Short description	Case	Pinout	St.	Mnf.
RL	SMA4T24	TVS	Vbr=24V, 12A, 400W(1ms)	SOD-6	1d	1q	Ste
RL	SMAJ64	TVS	Vrwm=64V, Vbr=71.1..86.4V, 3.5A, 400W(1ms)	DO-214AC	1d	1k	Vs
RL	TV04A640K-G	TVS	Vrwm=64.0V, Vbr=71.10..86.90V, Ipp=3.51A, 400W(1ms)	DO-214AC	1d	1a	Cmc
RLK	SMA160	TVS	Vbr=144..176V, Vrwm=130V, 1.74A, 400W(1ms)	DO-214AC	1d	1a	Lge
RLM	SMA160C	TVS	Vbr=144..176V, Vrwm=130V, 1.74A, 400W(1ms), Bidirectional	DO-214AC	1ba	1j	Lge
RM	1SMA15A	TVS	Vrwm=15V±5%, 16.4A, 400W(1ms)	403B-01	3d	1f	Ons
RM	CD214A-T64A	TVS	Vbr=64V, Irlsm=3.9A, 400W(1ms)	DO-214AC	1d	1a	Bm
RM	P4SMA12C	TVS	Vrwm=12V, 24A, 400W(1ms), Bidirectional	DO-214AC	1ba	2k	Fag
RM	P4SMAJ64A	TVS	Vbr=64V, 3.9A, 400W(1ms)	DO-214AC	1d	1m,1w	Pjt,Sj
RM	PDZ16B	Z-diode	16V±2.5%, 400mW	SOD-323	5d	1a	Pjt
RM	PZU6.2B1A/DG	Z-diode	6.2V±2%, If=200mA, 320mW, halogen-free	SOD-323	5d	1a	Phi
RM	RGF1M	Si-diode	Rectifier, 1000V, 1A, Vf<1.3V(1A), 150..500ns	DO-214BA	1d	1k	Vs
RM	SMA4T24A	TVS	Vbr=24V, 12A, 400W(1ms)	SOD-6	1d	1q	Ste
RM	SMAJ64A	TVS	Vrwm=64V, Vbr=71.1..78.6V, 3.9A, 400W(1ms)	DO-214AC	1d	1k,1m	Di,Vs
RM	TV04A640J-G	TVS	Vrwm=64.0V, Vbr=71.10..78.60V, Ipp=3.88A, 400W(1ms)	DO-214AC	1d	1a	Cmc
RMC	1SMA15CA	TVS	Vrwm=15V±5%, 16.4A, 400W(1ms), Bidirectional	403B-01	3ba	1e	Ons
RMK	SMA160A	TVS	Vbr=152..168V, Vrwm=136V, 1.83A, 400W(1ms)	DO-214AC	1d	1a	Lge
RMM	SMA160CA	TVS	Vbr=152..168V, Vrwm=136V, 1.83A, 400W(1ms), Bidirectional	DO-214AC	1ba	1j	Lge
RM	P4SMAJ70	TVS	Vbr=70V, 3.2A, 400W(1ms)	DO-214AC	1d	1m,1w	Pjt,Sj
RN	PDZ18B	Z-diode	18V±2.5%, 400mW	SOD-323	5d	1a	Pjt
RN	PZU6.2B2A/DG	Z-diode	6.2V±2%, If=200mA, 320mW, halogen-free	SOD-323	5d	1a	Phi
RN	SMA4T27	TVS	Vbr=27V, 10.7A, 400W(1ms)	SOD-6	1d	1q	Ste
RN	SMAJ70	TVS	Vrwm=70V, Vbr=77.8..95.1V, 3.2A, 400W(1ms)	DO-214AC	1d	1k	Vs
RN	TV04A700K-G	TVS	Vrwm=70.0V, Vbr=77.80..95.10V, Ipp=3.20A, 400W(1ms)	DO-214AC	1d	1a	Cmc
RNK	SMA170	TVS	Vbr=153..187V, Vrwm=138V, 1.64A, 400W(1ms)	DO-214AC	1d	1a	Lge
RNM	SMA170C	TVS	Vbr=153..187V, Vrwm=138V, 1.64A, 400W(1ms), Bidirectional	DO-214AC	1ba	1j	Lge
RO	P4SMA13C	TVS	Vrwm=13V, 22A, 400W(1ms), Bidirectional	DO-214AC	1ba	2k	Fag
RO	PDZ20B	Z-diode	20V±2.5%, 400mW	SOD-323	5d	1a	Pjt
RP	1SMA16A	TVS	Vrwm=16V±5%, 15.4A, 400W(1ms)	403B-01	3d	1f	Ons
RP	CD214A-T70A	TVS	Vbr=70V, Irlsm=3.5A, 400W(1ms)	DO-214AC	1d	1a	Bm
RP	CMDZ8L2	Z-diode	7.790..8.610V, Izt=0.5mA, Zzt=60Ω, 250mW	SOD-323	5d	1a	Cen
RP	DDZ33	Z-diode	33V±10%, Izt=10mA, 500mW	SOD-123	5d	1d	Di
RP	DDZ33S	Z-diode	33V±10%, Izt=5mA, 200mW	SOD-323	5d	1d	Di
RP	KDZ27FVY	Z-diode	26.19..27.53V, Izt=2mA, Zzt=150.Ω, 100mW	TFSC	7d	1a	Kec
RP	P4SMAJ70A	TVS	Vbr=70V, 3.5A, 400W(1ms)	DO-214AC	1d	1m,1w	Pjt,Sj
RP	PDZ22B	Z-diode	22V±2.5%, 400mW	SOD-323	5d	1a	Pjt
RP	PZU6.2B3A/DG	Z-diode	6.2V±2%, If=200mA, 320mW, halogen-free	SOD-323	5d	1a	Phi
RP	SMA4T27A	TVS	Vbr=27V, 10.7A, 400W(1ms)	SOD-6	1d	1q	Ste
RP	SMAJ70A	TVS	Vrwm=70V, Vbr=77.8..86V, 3.5A, 400W(1ms)	DO-214AC	1d	1k,1m	Di,Vs
RP	SMAJ70CA	TVS	Vrwm=70V, Vbr=77.8..86V, 3.5A, 400W(1ms), Bidirectional	DO-214AC	1ba	1x	Di
RP	TV04A700J-G	TVS	Vrwm=70.0V, Vbr=77.80..86.0V, Ipp=3.54A, 400W(1ms)	DO-214AC	1d	1a	Cmc
RPC	1SMA16CA	TVS	Vrwm=16V±5%, 15.4A, 400W(1ms), Bidirectional	403B-01	3ba	1e	Ons
RPK	SMA170A	TVS	Vbr=162..179V, Vrwm=145V, 1.71A, 400W(1ms)	DO-214AC	1d	1a	Lge
RPM	SMA170CA	TVS	Vbr=162..179V, Vrwm=145V, 1.71A, 400W(1ms), Bidirectional	DO-214AC	1ba	1j	Lge
RQ	P4SMAJ75	TVS	Vbr=75V, 3A, 400W(1ms)	DO-214AC	1d	1m,1w	Pjt,Sj
RQ	PDZ24B	Z-diode	24V±2.5%, 400mW	SOD-323	5d	1a	Pjt
RQ	SMA4T30	TVS	Vbr=30V, 9.6A, 400W(1ms)	SOD-6	1d	1q	Ste
RQ	SMAJ75	TVS	Vrwm=75V, Vbr=83.3..102V, 3A, 400W(1ms)	DO-214AC	1d	1k	Vs
RQ	TV04A750K-G	TVS	Vrwm=75.0V, Vbr=83.30..102.0V, Ipp=2.99A, 400W(1ms)	DO-214AC	1d	1a	Cmc
RQK	SMA180	TVS	Vbr=162..198V, Vrwm=146V, 1.55A, 400W(1ms)	DO-214AC	1d	1a	Lge
RQM	SMA180C	TVS	Vbr=162..198V, Vrwm=146V, 1.55A, 400W(1ms), Bidirectional	DO-214AC	1ba	1j	Lge
RR	1SMA17A	TVS	Vrwm=17V±5%, 14.5A, 400W(1ms)	403B-01	3d	1f	Ons
RR	CD214A-T75A	TVS	Vbr=75V, Irlsm=3.3A, 400W(1ms)	DO-214AC	1d	1a	Bm
RR	P4SMA15C	TVS	Vrwm=15V, 19A, 400W(1ms), Bidirectional	DO-214AC	1ba	2k	Fag
RR	P4SMAJ75A	TVS	Vbr=75V, 3.3A, 400W(1ms)	DO-214AC	1d	1m,1w	Pjt,Sj
RR	PZU6.8BA/DG	Z-diode	6.8V±5%, If=200mA, 320mW, halogen-free	SOD-323	5d	1a	Phi
RR	SMA4T30A	TVS	Vbr=30V, 9.6A, 400W(1ms)	SOD-6	1d	1q	Ste
RR	SMAJ75A	TVS	Vrwm=75V, Vbr=83.3..92.1V, 3.3A, 400W(1ms)	DO-214AC	1d	1k,1m	Di,Vs
RR	TV04A750J-G	TVS	Vrwm=75.0V, Vbr=83.30..92.10V, Ipp=3.31A, 400W(1ms)	DO-214AC	1d	1a	Cmc
RRC	1SMA17CA	TVS	Vrwm=17V±5%, 14.5A, 400W(1ms), Bidirectional	403B-01	3ba	1e	Ons
RRK	SMA180A	TVS	Vbr=171..189V, Vrwm=154V, 1.63A, 400W(1ms)	DO-214AC	1d	1a	Lge
RRM	SMA180CA	TVS	Vbr=171..189V, Vrwm=154V, 1.63A, 400W(1ms), Bidirectional	DO-214AC	1ba	1j	Lge
RS	BAR89-02L	Si-diode	Ant, Sw, 80V, 0.1A, 250mW, Vf<1.1V(0.1A), 0.19pF(1GHz)	TSLP-2-1	13d	2b	Inf
RS	P4SMAJ78	TVS	Vbr=78V, 2.9A, 400W(1ms)	DO-214AC	1d	1m,1w	Pjt,Sj
RS	PDZ27B	Z-diode	27V±2.5%, 400mW	SOD-323	5d	1a	Pjt
RS	PZU6.8B1A/DG	Z-diode	6.8V±2%, If=200mA, 320mW, halogen-free	SOD-323	5d	1a	Phi
RS	SMA4T33	TVS	Vbr=33V, 8.8A, 400W(1ms)	SOD-6	1d	1q	Ste
RS	SMAJ78	TVS	Vrwm=78V, Vbr=86.7..106V, 2.9A, 400W(1ms)	DO-214AC	1d	1k	Vs
RS	TV04A780K-G	TVS	Vrwm=78.0V, Vbr=86.70..106.0V, Ipp=2.88A, 400W(1ms)	DO-214AC	1d	1a	Cmc
RS	TV04A800K-G	TVS	Vrwm=80.0V, Vbr=88.96..108.80V, Ipp=2.79A, 400W(1ms)	DO-214AC	1d	1a	Cmc



SMD
code

Type

Function

Short description

Case

Pinout

St.

Mnf.

SMD code	Type	Function	Short description	Case	Pinout	St.	Mnf.
RSK	SMA200	TVS	Vbr=180.220V, Vrwm=162V, 1.39A, 400W(1ms)	DO-214AC	1d	1a	Lge
RSM	SMA200C	TVS	Vbr=180.220V, Vrwm=162V, 1.39A, 400W(1ms), Bidirectional	DO-214AC	1ba	1j	Lge
RT	1SMA18A	TVS	Vrwm=18V±5%, 13.7A, 400W(1ms)	403B-01	3d	1f	Ons
RT	CD214A-T78A	TVS	Vbr=78V, Irs=3.2A, 400W(1ms)	DO-214AC	1d	1a	Bm
RT	P4SMA16C	TVS	Vrwm=16V, 18A, 400W(1ms), Bidirectional	DO-214AC	1ba	2k	Fag
RT	P4SMAJ78A	TVS	Vbr=78V, 2.2A, 400W(1ms)	DO-214AC	1d	1m,1w	Pjt,Srj
RT	PDZ30B	Z-diode	30V±2.5%, 400mW	SOD-323	5d	1a	Pjt
RT	PZU6.8B2A/DG	Z-diode	6.8V±2%, If=200mA, 320mW, halogen-free	SOD-323	5d	1a	Phi
RT	SM4T33A	TVS	Vbr=33V, 8.8A, 400W(1ms)	SOD-6	1d	1q	Ste
RT	SMAJ78A	TVS	Vrwm=78V, Vbr=86.7.958V, 3.2A, 400W(1ms)	DO-214AC	1d	1k,1m	Di,Vs
RT	TV04A780J-G	TVS	Vrwm=78.0V, Vbr=86.70.9580V, Ipp=3.17A, 400W(1ms)	DO-214AC	1d	1a	Cmc
RT	TV04A800J-G	TVS	Vrwm=80.0V, Vbr=88.80.9760V, Ipp=3.09A, 400W(1ms)	DO-214AC	1d	1a	Cmc
RTC	1SMA18CA	TVS	Vrwm=18V±5%, 13.7A, 400W(1ms), Bidirectional	403B-01	3ba	1e	Ons
RTK	SMA200A	TVS	Vbr=190.210V, Vrwm=171V, 1.46A, 400W(1ms)	DO-214AC	1d	1a	Lge
RTM	SMA200CA	TVS	Vbr=190.210V, Vrwm=171V, 1.46A, 400W(1ms), Bidirectional	DO-214AC	1ba	1j	Lge
RU	P4SMAJ85	TVS	Vbr=85V, 2.6A, 400W(1ms)	DO-214AC	1d	1m,1w	Pjt,Srj
RU	PDZ33B	Z-diode	33V±2.5%, 400mW	SOD-323	5d	1a	Pjt
RU	PZU6.8B3A/DG	Z-diode	6.8V±2%, If=200mA, 320mW, halogen-free	SOD-323	5d	1a	Phi
RU	SM4T36	TVS	Vbr=36V, 8A, 400W(1ms)	SOD-6	1d	1q	Ste
RU	SMAJ85	TVS	Vrwm=85V, Vbr=94.4.115V, 2A, 400W(1ms)	DO-214AC	1d	1k	Vs
RU	TV04A850K-G	TVS	Vrwm=85.0V, Vbr=94.40.1150V, Ipp=2.65A, 400W(1ms)	DO-214AC	1d	1a	Cmc
RV	1SMA20A	TVS	Vrwm=20V±5%, 12.3A, 400W(1ms)	403B-01	3d	1f	Ons
RV	CD214A-T85A	TVS	Vbr=85V, Irs=2.9A, 400W(1ms)	DO-214AC	1d	1a	Bm
RV	P4SMA18C	TVS	Vrwm=18V, 16A, 400W(1ms), Bidirectional	DO-214AC	1ba	2k	Fag
RV	P4SMAJ85A	TVS	Vbr=85V, 2.9A, 400W(1ms)	DO-214AC	1d	1m,1w	Pjt,Srj
RV	PZU7.5BA/DG	Z-diode	7.5V±5%, If=200mA, 320mW, halogen-free	SOD-323	5d	1a	Phi
RV	SM4T36A	TVS	Vbr=36V, 8A, 400W(1ms)	SOD-6	1d	1q	Ste
RV	SMAJ85A	TVS	Vrwm=85V, Vbr=94.4.104V, 2.2A, 400W(1ms)	DO-214AC	1d	1k,1m	Di,Vs
RV	TV04A850J-G	TVS	Vrwm=85.0V, Vbr=94.40.1040V, Ipp=2.92A, 400W(1ms)	DO-214AC	1d	1a	Cmc
RVC	1SMA20CA	TVS	Vrwm=20V±5%, 12.3A, 400W(1ms), Bidirectional	403B-01	3ba	1e	Ons
RW	P4SMAJ90	TVS	Vbr=90V, 2.5A, 400W(1ms)	DO-214AC	1d	1m,1w	Pjt,Srj
RW	PDZ36B	Z-diode	36V±2.5%, 400mW	SOD-323	5d	1a	Pjt
RW	PZU7.5B1A/DG	Z-diode	7.5V±2%, If=200mA, 320mW, halogen-free	SOD-323	5d	1a	Phi
RW	SM4T39	TVS	Vbr=39V, 7.4A, 400W(1ms)	SOD-6	1d	1q	Ste
RW	SMAJ90	TVS	Vrwm=90V, Vbr=100.122V, 1.9A, 400W(1ms)	DO-214AC	1d	1k	Vs
RW	TV04A900K-G	TVS	Vrwm=90.0V, Vbr=100.0.1220V, Ipp=2.50A, 400W(1ms)	DO-214AC	1d	1a	Cmc
RX	1SMA22A	TVS	Vrwm=22V±5%, 11.3A, 400W(1ms)	403B-01	3d	1f	Ons
RX	CD214A-T90A	TVS	Vbr=90V, Irs=2.7A, 400W(1ms)	DO-214AC	1d	1a	Bm
RX	P4SMA20C	TVS	Vrwm=20V, 14A, 400W(1ms), Bidirectional	DO-214AC	1ba	2k	Fag
RX	P4SMAJ90A	TVS	Vbr=90V, 2.7A, 400W(1ms)	DO-214AC	1d	1m,1w	Pjt,Srj
RX	PZU7.5B2A/DG	Z-diode	7.5V±2%, If=200mA, 320mW, halogen-free	SOD-323	5d	1a	Phi
RX	SM4T39A	TVS	Vbr=39V, 7.4A, 400W(1ms)	SOD-6	1d	1q	Ste
RX	SMAJ90A	TVS	Vrwm=90V, Vbr=100.111V, 2.1A, 400W(1ms)	DO-214AC	1d	1k,1m	Di,Vs
RX	TV04A900J-G	TVS	Vrwm=90.0V, Vbr=100.0.1110V, Ipp=2.74A, 400W(1ms)	DO-214AC	1d	1a	Cmc
RXC	1SMA22CA	TVS	Vrwm=22V±5%, 11.3A, 400W(1ms), Bidirectional	403B-01	3ba	1e	Ons
RY	KDZ8.2VY	Z-diode	8.02.8.36V, Izt=5mA, Zzt=20Ω, 100mW	VSC	7d	1a	Kec
RY	P4SMAJ100	TVS	Vbr=100V, 2.2A, 400W(1ms)	DO-214AC	1d	1m,1w	Pjt,Srj
RY	PZU7.5B3A/DG	Z-diode	7.5V±2%, If=200mA, 320mW, halogen-free	SOD-323	5d	1a	Phi
RY	SMAJ100	TVS	Vrwm=100V, Vbr=111.136V, 1.7A, 400W(1ms)	DO-214AC	1d	1k	Vs
RY	TV04A101K-G	TVS	Vrwm=100.0V, Vbr=111.0.1360V, Ipp=2.23A, 400W(1ms)	DO-214AC	1d	1a	Cmc
RZ	1SMA24A	TVS	Vrwm=24V, 24V±5%, 10.3A, 400W(1ms)	403B-01	3d	1f	Ons
RZ	BZT52-B24S	Z-diode	23.52.24.48V, Izt=5mA, Zzt=70Ω, 200mW	SOD-323FL	7d	1a	Tsc
RZ	CD214A-T100A	TVS	Vbr=100V, Irs=2.5A, 400W(1ms)	DO-214AC	1d	1a	Bm
RZ	MM3Z24VB	Z-diode	23.52.24.48V, Zzt=65Ω, Izt=5mA, 200mW	SOD-323FL	7d	1a	F
RZ	MM3Z24VBW	Z-diode	23.52.24.48V, Izt=5mA, Zzt=70Ω, 200mW	SOD-323FL	7d	1a	Tac
RZ	P4SMA22C	TVS	Vrwm=22V, 13A, 400W(1ms), Bidirectional	DO-214AC	1ba	2k	Fag
RZ	P4SMAJ100A	TVS	Vbr=100V, 2.5A, 400W(1ms)	DO-214AC	1d	1m,1w	Pjt,Srj
RZ	PZU8.2BA/DG	Z-diode	8.2V±5%, If=200mA, 320mW, halogen-free	SOD-323	5d	1a	Phi
RZ	SMAJ100A	TVS	Vrwm=100V, Vbr=111.136V, 1.9A, 400W(1ms)	DO-214AC	1d	1k,1m	Di,Vs
RZ	TCCMM3Z24VB	Z-diode	24V±2%, Izt=5mA, Zzt=65Ω, 200mW	SOD-323FL	7d	1a	Tac
RZ	TV04A101J-G	TVS	Vrwm=100.0V, Vbr=111.0.1230V, Ipp=2.47A, 400W(1ms)	DO-214AC	1d	1a	Cmc
RZC	1SMA24CA	TVS	Vrwm=24V, 24V±5%, 10.3A, 400W(1ms), Bidirectional	403B-01	3ba	1e	Ons
S	CDZ13B	Z-diode	13V±2.5%, Izt=20mA, 1W	VMN	7d	1s	Rhm
S	CH751G1-40PT	Si-diode	SBD, 40V, 30mA, Vf<0.37V(1mA)	FBPD-723	13d	2b	Chm
S	CH751S-40PT	Si-diode	SBD, 40V, 30mA, Vf<0.37V(2mA)	SOD-523	8d	1a	Chm
S	MM3S268BPT	Z-diode	77.90.86.10V, Izt=1.5mA, Zzt=330Ω, 225mW	SOD-523	7d	1a	Chm
S (blue)	BA582	PIN-diode	TV, VTR, VHF-Band-Sw, 35V, 100mA, Vf<1.1pF	SOD-123	5d	2	Sie
S (blue)	BA592	PIN-diode	VHF, TV-Band-Sw, 35V, 100mA, Vf<1(100mA), 1.4pF, <120ns	SOD-323	5d	2	Inf
S (red)	BB640	C-diode	VHF-TV/VTR-Tuning, Hyperband, 30V, 20mA, 62/76pF	SOD-323	5d	2	Inf
S (white)	BB515	C-diode	AM-Tuning, 30V, 20mA, I<0.01μA, Cv=17.5/20pF	SOD-123	5d	2	Sie



SMD
code

Type

Function

Short description

Case

Pinout

St.

Mnf.

S (white)	BB535	C-diode	UHF TV-tuning, 30V, 20mA, 2.1..18.7pF(28..1V)	SOD-323	5d	2	Inf
S (yellow)	BB619	C-diode	VHF-TV-Tuning, 30V, 20mA, Ir<0.01μA, Cv=36/42pF	SOD-123	5d	2	Inf
S (yellow)	BB639	C-diode	VHF-TV-Tuning, 30V, 20mA, Ir<0.01μA, Cv=36/42pF	SOD-323	5d	2	Inf
§	MMSZ5268SPT	Z-diode	80.36..83.64V, Izt=1.5mA, Zzt=330Ω, 225mW	SOD-523	7d	1a	Chm
S0	1PS76SB10	Si-diode	SBD, U-Speed, 40V, 200mA, <10pF	SOD-323	5d	1a	Phi
S0	MMPZ5249SPT	Z-diode	18.62..19.38V, Izt=5mA, Zzt=42Ω, 225mW	SOD-323	5d	1a	Chm
S010	SMAJ8.5	TVS	Vrwm=8.5V, Vbr=9.44..11.5V, 25.2A, 400W(1ms)	DO-214AC	1d	1a	Eic
S010	SMAJ8.5C	TVS	Vrwm=8.5V, Vbr=9.44..11.5V, 25.2A, 400W(1ms), Bidirectional	DO-214AC	1ba	1j	Eic
S010	STBS010	TVS	Vbr=9.44..11.5V, 31.4A, 500W(1ms), Bidirectional	DO-214AC	1ba	1j	Eic
S010	STUS010	TVS	Vbr=9.44..11.5V, 31.4A, 500W(1ms)	DO-214AC	1d	1a	Eic
S011	SMAJ9.0	TVS	Vrwm=9.0V, Vbr=10.0..12.2V, 23.7A, 400W(1ms)	DO-214AC	1d	1a	Eic
S011	SMAJ9.0C	TVS	Vrwm=9.0V, Vbr=10.0..12.2V, 23.7A, 400W(1ms), Bidirectional	DO-214AC	1ba	1j	Eic
S011	STBS011	TVS	Vbr=10..12.2V, 29.5A, 500W(1ms), Bidirectional	DO-214AC	1ba	1j	Eic
S011	STUS011	TVS	Vbr=10..12.2V, 29.5A, 500W(1ms)	DO-214AC	1d	1a	Eic
S012	SMAJ10	TVS	Vrwm=10V, Vbr=11.1..13.6V, 21.2A, 400W(1ms)	DO-214AC	1d	1a	Eic
S012	SMAJ10C	TVS	Vrwm=10V, Vbr=11.1..13.6V, 21.2A, 400W(1ms), Bidirectional	DO-214AC	1ba	1j	Eic
S012	STBS012	TVS	Vbr=11.1..13.6V, 26.6A, 500W(1ms), Bidirectional	DO-214AC	1ba	1j	Eic
S012	STUS012	TVS	Vbr=11.1..13.6V, 26.6A, 500W(1ms)	DO-214AC	1d	1a	Eic
S013	SMAJ11	TVS	Vrwm=11V, Vbr=12.2..14.9V, 19.9A, 400W(1ms)	DO-214AC	1d	1a	Eic
S013	SMAJ11C	TVS	Vrwm=11V, Vbr=12.2..14.9V, 19.9A, 400W(1ms), Bidirectional	DO-214AC	1ba	1j	Eic
S013	STBS013	TVS	Vbr=12.2..14.9V, 24.9A, 500W(1ms), Bidirectional	DO-214AC	1ba	1j	Eic
S013	STUS013	TVS	Vbr=12.2..14.9V, 24.9A, 500W(1ms)	DO-214AC	1d	1a	Eic
S014	SMAJ12	TVS	Vrwm=12V, Vbr=13.3..16.3V, 18.2A, 400W(1ms)	DO-214AC	1d	1a	Eic
S014	SMAJ12C	TVS	Vrwm=12V, Vbr=13.3..16.3V, 18.2A, 400W(1ms), Bidirectional	DO-214AC	1ba	1j	Eic
S014	STBS014	TVS	Vbr=13.3..16.3V, 22.7A, 500W(1ms), Bidirectional	DO-214AC	1ba	1j	Eic
S014	STUS014	TVS	Vbr=13.3..16.3V, 22.7A, 500W(1ms)	DO-214AC	1d	1a	Eic
S015	SMAJ13	TVS	Vrwm=13V, Vbr=14.4..17.6V, 16.8A, 400W(1ms)	DO-214AC	1d	1a	Eic
S015	SMAJ13C	TVS	Vrwm=13V, Vbr=14.4..17.6V, 16.8A, 400W(1ms), Bidirectional	DO-214AC	1ba	1j	Eic
S015	STBS015	TVS	Vbr=14.4..17.6V, 21A, 500W(1ms), Bidirectional	DO-214AC	1ba	1j	Eic
S015	STUS015	TVS	Vbr=14.4..17.6V, 21A, 500W(1ms)	DO-214AC	1d	1a	Eic
S016	SMAJ14	TVS	Vrwm=14V, Vbr=15.6..19.1V, 15.5A, 400W(1ms)	DO-214AC	1d	1a	Eic
S016	SMAJ14C	TVS	Vrwm=14V, Vbr=15.6..19.1V, 15.5A, 400W(1ms), Bidirectional	DO-214AC	1ba	1j	Eic
S016	STBS016	TVS	Vbr=15.6..19.1V, 19.4A, 500W(1ms), Bidirectional	DO-214AC	1ba	1j	Eic
S016	STUS016	TVS	Vbr=15.6..19.1V, 19.4A, 500W(1ms)	DO-214AC	1d	1a	Eic
S018	SMAJ15	TVS	Vrwm=15V, Vbr=16.7..20.4V, 14.8A, 400W(1ms)	DO-214AC	1d	1a	Eic
S018	SMAJ15C	TVS	Vrwm=15V, Vbr=16.7..20.4V, 14.8A, 400W(1ms), Bidirectional	DO-214AC	1ba	1j	Eic
S018	STBS018	TVS	Vbr=16.7..20.4V, 18.8A, 500W(1ms), Bidirectional	DO-214AC	1ba	1j	Eic
S018	STUS018	TVS	Vbr=16.7..20.4V, 18.8A, 500W(1ms)	DO-214AC	1d	1a	Eic
S019	SMAJ16	TVS	Vrwm=16V, Vbr=17.8..21.8V, 13.9A, 400W(1ms)	DO-214AC	1d	1a	Eic
S019	SMAJ16C	TVS	Vrwm=16V, Vbr=17.8..21.8V, 13.9A, 400W(1ms), Bidirectional	DO-214AC	1ba	1j	Eic
S019	STBS019	TVS	Vbr=17.8..21.8V, 17.6A, 500W(1ms), Bidirectional	DO-214AC	1ba	1j	Eic
S019	STUS019	TVS	Vbr=17.8..21.8V, 17.6A, 500W(1ms)	DO-214AC	1d	1a	Eic
S020	SMAJ17	TVS	Vrwm=17V, Vbr=18.9..23.1V, 13.1A, 400W(1ms)	DO-214AC	1d	1a	Eic
S020	SMAJ17C	TVS	Vrwm=17V, Vbr=18.9..23.1V, 13.1A, 400W(1ms), Bidirectional	DO-214AC	1ba	1j	Eic
S020	STBS020	TVS	Vbr=18.9..23.1V, 16.4A, 500W(1ms), Bidirectional	DO-214AC	1ba	1j	Eic
S020	STUS020	TVS	Vbr=18.9..23.1V, 16.4A, 500W(1ms)	DO-214AC	1d	1a	Eic
S021	SMAJ18	TVS	Vrwm=18V, Vbr=20.0..24.4V, 12.4A, 400W(1ms)	DO-214AC	1d	1a	Eic
S021	SMAJ18C	TVS	Vrwm=18V, Vbr=20.0..24.4V, 12.4A, 400W(1ms), Bidirectional	DO-214AC	1ba	1j	Eic
S021	STBS021	TVS	Vbr=20..24.4V, 15.5A, 500W(1ms), Bidirectional	DO-214AC	1ba	1j	Eic
S021	STUS021	TVS	Vbr=20..24.4V, 15.5A, 500W(1ms)	DO-214AC	1d	1a	Eic
S023	SMAJ20	TVS	Vrwm=20V, Vbr=22.2..27.1V, 11.2A, 400W(1ms)	DO-214AC	1d	1a	Eic
S023	SMAJ20C	TVS	Vrwm=20V, Vbr=22.2..27.1V, 11.2A, 400W(1ms), Bidirectional	DO-214AC	1ba	1j	Eic
S023	STBS023	TVS	Vbr=22.2..27.1V, 13.9A, 500W(1ms), Bidirectional	DO-214AC	1ba	1j	Eic
S023	STUS023	TVS	Vbr=22.2..27.1V, 13.9A, 500W(1ms)	DO-214AC	1d	1a	Eic
S026	SMAJ22	TVS	Vrwm=22V, Vbr=24.4..29.8V, 10.2A, 400W(1ms)	DO-214AC	1d	1a	Eic
S026	SMAJ22C	TVS	Vrwm=22V, Vbr=24.4..29.8V, 10.2A, 400W(1ms), Bidirectional	DO-214AC	1ba	1j	Eic
S026	STBS026	TVS	Vbr=24.4..29.8V, 12.7A, 500W(1ms), Bidirectional	DO-214AC	1ba	1j	Eic
S026	STUS026	TVS	Vbr=24.4..29.8V, 12.7A, 500W(1ms)	DO-214AC	1d	1a	Eic
S028	SMAJ24	TVS	Vrwm=24V, Vbr=26.7..32.6V, 9.3A, 400W(1ms)	DO-214AC	1d	1a	Eic
S028	SMAJ24C	TVS	Vrwm=24V, Vbr=26.7..32.6V, 9.3A, 400W(1ms), Bidirectional	DO-214AC	1ba	1j	Eic
S028	STBS028	TVS	Vbr=26.7..32.6V, 11.6A, 500W(1ms), Bidirectional	DO-214AC	1ba	1j	Eic
S028	STUS028	TVS	Vbr=26.7..32.6V, 11.6A, 500W(1ms)	DO-214AC	1d	1a	Eic
S030	SMAJ26	TVS	Vrwm=26V, Vbr=28.9..35.3V, 8.6A, 400W(1ms)	DO-214AC	1d	1a	Eic
S030	SMAJ26C	TVS	Vrwm=26V, Vbr=28.9..35.3V, 8.6A, 400W(1ms), Bidirectional	DO-214AC	1ba	1j	Eic
S030	STBS030	TVS	Vbr=28.9..35.3V, 10.7A, 500W(1ms), Bidirectional	DO-214AC	1ba	1j	Eic
S030	STUS030	TVS	Vbr=28.9..35.3V, 10.7A, 500W(1ms)	DO-214AC	1d	1a	Eic
S033	SMAJ28	TVS	Vrwm=28V, Vbr=31.1..38.0V, 8.0A, 400W(1ms)	DO-214AC	1d	1a	Eic
S033	SMAJ28C	TVS	Vrwm=28V, Vbr=31.1..38.0V, 8.0A, 400W(1ms), Bidirectional	DO-214AC	1ba	1j	Eic
S033	STBS033	TVS	Vbr=31.1..38V, 9.9A, 500W(1ms), Bidirectional	DO-214AC	1ba	1j	Eic
S033	STUS033	TVS	Vbr=31.1..38V, 9.9A, 500W(1ms)	DO-214AC	1d	1a	Eic



SMD
code

Type

Function

Short description

Case

Pinout

St.

Mnf.

S035	SMAJ30	TVS	Vrwm=30V, Vbr=33.3..40.7V, 7.5A, 400W(1ms)	DO-214AC	1d	1a	Eic
S035	SMAJ30C	TVS	Vrwm=30V, Vbr=33.3..40.7V, 7.5A, 400W(1ms), Bidirectional	DO-214AC	1ba	1j	Eic
S035	STBS035	TVS	Vbr=33.3..40.7V, 9.3A, 500W(1ms), Bidirectional	DO-214AC	1ba	1j	Eic
S035	STUS035	TVS	Vbr=33.3..40.7V, 9.3A, 500W(1ms)	DO-214AC	1d	1a	Eic
S039	SMAJ33	TVS	Vrwm=33V, Vbr=36.7..44.9V, 6.8A, 400W(1ms)	DO-214AC	1d	1a	Eic
S039	SMAJ33C	TVS	Vrwm=33V, Vbr=36.7..44.9V, 6.8A, 400W(1ms), Bidirectional	DO-214AC	1ba	1j	Eic
S039	STBS039	TVS	Vbr=36.7..44.9V, 8.5A, 500W(1ms), Bidirectional	DO-214AC	1ba	1j	Eic
S039	STUS039	TVS	Vbr=36.7..44.9V, 8.5A, 500W(1ms)	DO-214AC	1d	1a	Eic
S042	SMAJ36	TVS	Vrwm=36V, Vbr=40.0..48.9V, 6.2A, 400W(1ms)	DO-214AC	1d	1a	Eic
S042	SMAJ36C	TVS	Vrwm=36V, Vbr=40.0..48.9V, 6.2A, 400W(1ms), Bidirectional	DO-214AC	1ba	1j	Eic
S042	STBS042	TVS	Vbr=40.0..48.9V, 7.8A, 500W(1ms), Bidirectional	DO-214AC	1ba	1j	Eic
S042	STUS042	TVS	Vbr=40.0..48.9V, 7.8A, 500W(1ms)	DO-214AC	1d	1a	Eic
S047	SMAJ40	TVS	Vrwm=40V, Vbr=44.4..54.3V, 5.6A, 400W(1ms)	DO-214AC	1d	1a	Eic
S047	SMAJ40C	TVS	Vrwm=40V, Vbr=44.4..54.3V, 5.6A, 400W(1ms), Bidirectional	DO-214AC	1ba	1j	Eic
S047	STBS047	TVS	Vbr=44.4..54.3V, 7A, 500W(1ms), Bidirectional	DO-214AC	1ba	1j	Eic
S047	STUS047	TVS	Vbr=44.4..54.3V, 7A, 500W(1ms)	DO-214AC	1d	1a	Eic
S050	SMAJ43	TVS	Vrwm=43V, Vbr=47.8..58.4V, 5.2A, 400W(1ms)	DO-214AC	1d	1a	Eic
S050	SMAJ43C	TVS	Vrwm=43V, Vbr=47.8..58.4V, 5.2A, 400W(1ms), Bidirectional	DO-214AC	1ba	1j	Eic
S050	STBS050	TVS	Vbr=47.8..58.4V, 6.5A, 500W(1ms), Bidirectional	DO-214AC	1ba	1j	Eic
S050	STUS050	TVS	Vbr=47.8..58.4V, 6.5A, 500W(1ms)	DO-214AC	1d	1a	Eic
S053	SMAJ45	TVS	Vrwm=45V, Vbr=50.0..61.1V, 5.0A, 400W(1ms)	DO-214AC	1d	1a	Eic
S053	SMAJ45C	TVS	Vrwm=45V, Vbr=50.0..61.1V, 5.0A, 400W(1ms), Bidirectional	DO-214AC	1ba	1j	Eic
S053	STBS053	TVS	Vbr=50.0..61.1V, 6.2A, 500W(1ms), Bidirectional	DO-214AC	1ba	1j	Eic
S053	STUS053	TVS	Vbr=50.0..61.1V, 6.2A, 500W(1ms)	DO-214AC	1d	1a	Eic
S056	SMAJ48	TVS	Vrwm=48V, Vbr=53.3..65.1V, 4.7A, 400W(1ms)	DO-214AC	1d	1a	Eic
S056	SMAJ48C	TVS	Vrwm=48V, Vbr=53.3..65.1V, 4.7A, 400W(1ms), Bidirectional	DO-214AC	1ba	1j	Eic
S056	STBS056	TVS	Vbr=53.3..65.1V, 5.8A, 500W(1ms), Bidirectional	DO-214AC	1ba	1j	Eic
S056	STUS056	TVS	Vbr=53.3..65.1V, 5.8A, 500W(1ms)	DO-214AC	1d	1a	Eic
S060	SMAJ51	TVS	Vrwm=51V, Vbr=56.7..69.3V, 4.4A, 400W(1ms)	DO-214AC	1d	1a	Eic
S060	SMAJ51C	TVS	Vrwm=51V, Vbr=56.7..69.3V, 4.4A, 400W(1ms), Bidirectional	DO-214AC	1ba	1j	Eic
S060	STBS060	TVS	Vbr=56.7..69.3V, 5.5A, 500W(1ms), Bidirectional	DO-214AC	1ba	1j	Eic
S060	STUS060	TVS	Vbr=56.7..69.3V, 5.5A, 500W(1ms)	DO-214AC	1d	1a	Eic
S063	SMAJ54	TVS	Vrwm=54V, Vbr=60.0..73.3V, 4.2A, 400W(1ms)	DO-214AC	1d	1a	Eic
S063	SMAJ54C	TVS	Vrwm=54V, Vbr=60.0..73.3V, 4.2A, 400W(1ms), Bidirectional	DO-214AC	1ba	1j	Eic
S063	STBS063	TVS	Vbr=60.0..73.3V, 5.2A, 500W(1ms), Bidirectional	DO-214AC	1ba	1j	Eic
S063	STUS063	TVS	Vbr=60.0..73.3V, 5.2A, 500W(1ms)	DO-214AC	1d	1a	Eic
S068	SMAJ58	TVS	Vrwm=58V, Vbr=64.4..78.7V, 3.9A, 400W(1ms)	DO-214AC	1d	1a	Eic
S068	SMAJ58C	TVS	Vrwm=58V, Vbr=64.4..78.7V, 3.9A, 400W(1ms), Bidirectional	DO-214AC	1ba	1j	Eic
S068	STBS068	TVS	Vbr=64.4..78.7V, 4.9A, 500W(1ms), Bidirectional	DO-214AC	1ba	1j	Eic
S068	STUS068	TVS	Vbr=64.4..78.7V, 4.9A, 500W(1ms)	DO-214AC	1d	1a	Eic
S06H	SMAJ5.0	TVS	Vrwm=5.0V, Vbr=6.40..7.82V, 41.7A, 400W(1ms)	DO-214AC	1d	1a	Eic
S06H	SMAJ5.0C	TVS	Vrwm=5.0V, Vbr=6.40..7.82V, 41.7A, 400W(1ms), Bidirectional	DO-214AC	1ba	1j	Eic
S06H	STBS06H	TVS	Vbr=6.4..7.3V, 52A, 500W(1ms), Bidirectional	DO-214AC	1ba	1j	Eic
S06H	STUS06H	TVS	Vbr=6.4..7.3V, 52A, 500W(1ms)	DO-214AC	1d	1a	Eic
S071	SMAJ60	TVS	Vrwm=60V, Vbr=66.7..81.5V, 3.7A, 400W(1ms)	DO-214AC	1d	1a	Eic
S071	SMAJ60C	TVS	Vrwm=60V, Vbr=66.7..81.5V, 3.7A, 400W(1ms), Bidirectional	DO-214AC	1ba	1j	Eic
S071	STBS071	TVS	Vbr=66.7..81.5V, 4.7A, 500W(1ms), Bidirectional	DO-214AC	1ba	1j	Eic
S071	STUS071	TVS	Vbr=66.7..81.5V, 4.7A, 500W(1ms)	DO-214AC	1d	1a	Eic
S075	SMAJ64	TVS	Vrwm=64V, Vbr=71.1..86.4V, 3.5A, 400W(1ms)	DO-214AC	1d	1a	Eic
S075	SMAJ64C	TVS	Vrwm=64V, Vbr=71.1..86.4V, 3.5A, 400W(1ms), Bidirectional	DO-214AC	1ba	1j	Eic
S075	STBS075	TVS	Vbr=71.1..86.9V, 4.4A, 500W(1ms), Bidirectional	DO-214AC	1ba	1j	Eic
S075	STUS075	TVS	Vbr=71.1..86.9V, 4.4A, 500W(1ms)	DO-214AC	1d	1a	Eic
S07A	SMAJ6.0	TVS	Vrwm=6.0V, Vbr=6.67..8.15V, 35.1A, 400W(1ms)	DO-214AC	1d	1a	Eic
S07A	SMAJ6.0C	TVS	Vrwm=6.0V, Vbr=6.67..8.15V, 35.1A, 400W(1ms), Bidirectional	DO-214AC	1ba	1j	Eic
S07A	STBS07A	TVS	Vbr=6.67..8.15V, 43.9A, 500W(1ms), Bidirectional	DO-214AC	1ba	1j	Eic
S07A	STUS07A	TVS	Vbr=6.67..8.15V, 43.9A, 500W(1ms)	DO-214AC	1d	1a	Eic
S07G	SMAJ6.5	TVS	Vrwm=6.5V, Vbr=7.22..8.82V, 32.5A, 400W(1ms)	DO-214AC	1d	1a	Eic
S07G	SMAJ6.5C	TVS	Vrwm=6.5V, Vbr=7.22..8.82V, 32.5A, 400W(1ms), Bidirectional	DO-214AC	1ba	1j	Eic
S07G	STBS07G	TVS	Vbr=7.22..8.82V, 40.7A, 500W(1ms), Bidirectional	DO-214AC	1ba	1j	Eic
S07G	STUS07G	TVS	Vbr=7.22..8.82V, 40.7A, 500W(1ms)	DO-214AC	1d	1a	Eic
S082	SMAJ70	TVS	Vrwm=70V, Vbr=77.8..95.1V, 3.2A, 400W(1ms)	DO-214AC	1d	1a	Eic
S082	SMAJ70C	TVS	Vrwm=70V, Vbr=77.8..95.1V, 3.2A, 400W(1ms), Bidirectional	DO-214AC	1ba	1j	Eic
S082	STBS082	TVS	Vbr=77.8..95.1V, 4A, 500W(1ms), Bidirectional	DO-214AC	1ba	1j	Eic
S082	STUS082	TVS	Vbr=77.8..95.1V, 4A, 500W(1ms)	DO-214AC	1d	1a	Eic
S088	SMAJ75	TVS	Vrwm=75V, Vbr=83.3..102V, 3A, 400W(1ms)	DO-214AC	1d	1a	Eic
S088	SMAJ75C	TVS	Vrwm=75V, Vbr=83.3..102V, 3A, 400W(1ms), Bidirectional	DO-214AC	1ba	1j	Eic
S088	STBS088	TVS	Vbr=83.3..102V, 3.7A, 500W(1ms), Bidirectional	DO-214AC	1ba	1j	Eic
S088	STUS088	TVS	Vbr=83.3..102V, 3.7A, 500W(1ms)	DO-214AC	1d	1a	Eic
S08C	SMAJ7.0	TVS	Vrwm=7.0V, Vbr=7.78..9.51V, 30.1A, 400W(1ms)	DO-214AC	1d	1a	Eic
S08C	SMAJ7.0C	TVS	Vrwm=7.0V, Vbr=7.78..9.51V, 30.1A, 400W(1ms), Bidirectional	DO-214AC	1ba	1j	Eic



SMD
code

Type

Function

Short description

Case

Pinout

St.

Mnf.

SMD code	Type	Function	Short description	Case	Pinout	St.	Mnf.
S08C	STBS08C	TVS	Vbr=7.78..9.51V, 37.8A, 500W(1ms), Bidirectional	DO-214AC	1ba	1j	Eic
S08C	STBS08C	TVS	Vbr=7.78..9.51V, 37.8A, 500W(1ms)	DO-214AC	1d	1a	Eic
S08I	SMAJ7.5	TVS	Vrwm=7.5V, Vbr=8.33..10.2V, 28.0A, 400W(1ms)	DO-214AC	1d	1a	Eic
S08I	SMAJ7.5C	TVS	Vrwm=7.5V, Vbr=8.33..10.2V, 28.0A, 400W(1ms), Bidirectional	DO-214AC	1ba	1j	Eic
S08I	STBS08I	TVS	Vbr=8.33..10.2V, 35A, 500W(1ms), Bidirectional	DO-214AC	1ba	1j	Eic
S08I	STUS08I	TVS	Vbr=8.33..10.2V, 35A, 500W(1ms)	DO-214AC	1d	1a	Eic
S091	SMAJ78	TVS	Vrwm=78V, Vbr=86.7..106V, 2.9A, 400W(1ms)	DO-214AC	1d	1a	Eic
S091	SMAJ78C	TVS	Vrwm=78V, Vbr=86.7..106V, 2.9A, 400W(1ms), Bidirectional	DO-214AC	1ba	1j	Eic
S091	STBS091	TVS	Vbr=86.7..106V, 3.6A, 500W(1ms), Bidirectional	DO-214AC	1ba	1j	Eic
S091	STUS091	TVS	Vbr=86.7..106V, 3.6A, 500W(1ms)	DO-214AC	1d	1a	Eic
S099	SMAJ85	TVS	Vrwm=85V, Vbr=94.4..115V, 2.0A, 400W(1ms)	DO-214AC	1d	1a	Eic
S099	SMAJ85C	TVS	Vrwm=85V, Vbr=94.4..115V, 2.0A, 400W(1ms), Bidirectional	DO-214AC	1ba	1j	Eic
S099	STBS099	TVS	Vbr=94.4..115V, 3.3A, 500W(1ms), Bidirectional	DO-214AC	1ba	1j	Eic
S099	STUS099	TVS	Vbr=94.4..115V, 3.3A, 500W(1ms)	DO-214AC	1d	1a	Eic
S09B	SMAJ8.0	TVS	Vrwm=8.0V, Vbr=8.89..10.9V, 26.7A, 400W(1ms)	DO-214AC	1d	1a	Eic
S09B	SMAJ8.0C	TVS	Vrwm=8.0V, Vbr=8.89..10.9V, 26.7A, 400W(1ms), Bidirectional	DO-214AC	1ba	1j	Eic
S09B	STBS09B	TVS	Vbr=8.89..10.9V, 33.3A, 500W(1ms), Bidirectional	DO-214AC	1ba	1j	Eic
S09B	STUS09B	TVS	Vbr=8.89..10.9V, 33.3A, 500W(1ms)	DO-214AC	1d	1a	Eic
S0B1	SMAJ90	TVS	Vrwm=90V, Vbr=100..122V, 1.9A, 400W(1ms)	DO-214AC	1d	1a	Eic
S0B1	SMAJ90C	TVS	Vrwm=90V, Vbr=100..122V, 1.9A, 400W(1ms), Bidirectional	DO-214AC	1ba	1j	Eic
S0B1	STBS0B1	TVS	Vbr=100..122V, 3.1A, 500W(1ms), Bidirectional	DO-214AC	1ba	1j	Eic
S0B1	STUS0B1	TVS	Vbr=100..122V, 3.1A, 500W(1ms)	DO-214AC	1d	1a	Eic
S0B2	SMAJ100	TVS	Vrwm=100V, Vbr=111..136V, 1.7A, 400W(1ms)	DO-214AC	1d	1a	Eic
S0B2	SMAJ100C	TVS	Vrwm=100V, Vbr=111..136V, 1.7A, 400W(1ms), Bidirectional	DO-214AC	1ba	1j	Eic
S0B2	STBS0B2	TVS	Vbr=111..136V, 2.8A, 500W(1ms), Bidirectional	DO-214AC	1ba	1j	Eic
S0B2	STUS0B2	TVS	Vbr=111..136V, 2.8A, 500W(1ms)	DO-214AC	1d	1a	Eic
S0B3	SMAJ110	TVS	Vrwm=110V, Vbr=122..149V, 1.5A, 400W(1ms)	DO-214AC	1d	1a	Eic
S0B3	SMAJ110C	TVS	Vrwm=110V, Vbr=122..149V, 1.5A, 400W(1ms), Bidirectional	DO-214AC	1ba	1j	Eic
S0B3	STBS0B3	TVS	Vbr=122..149V, 2.6A, 500W(1ms), Bidirectional	DO-214AC	1ba	1j	Eic
S0B3	STUS0B3	TVS	Vbr=122..149V, 2.6A, 500W(1ms)	DO-214AC	1d	1a	Eic
S0B4	SMAJ120	TVS	Vrwm=120V, Vbr=133..163V, 1.4A, 400W(1ms)	DO-214AC	1d	1a	Eic
S0B4	SMAJ120C	TVS	Vrwm=120V, Vbr=133..163V, 1.4A, 400W(1ms), Bidirectional	DO-214AC	1ba	1j	Eic
S0B4	STBS0B4	TVS	Vbr=133..163V, 2.3A, 500W(1ms), Bidirectional	DO-214AC	1ba	1j	Eic
S0B4	STUS0B4	TVS	Vbr=133..163V, 2.3A, 500W(1ms)	DO-214AC	1d	1a	Eic
S0B5	SMAJ130	TVS	Vrwm=130V, Vbr=144..176V, 1.3A, 400W(1ms)	DO-214AC	1d	1a	Eic
S0B5	SMAJ130C	TVS	Vrwm=130V, Vbr=144..176V, 1.3A, 400W(1ms), Bidirectional	DO-214AC	1ba	1j	Eic
S0B5	STBS0B5	TVS	Vbr=144..176V, 2.2A, 500W(1ms), Bidirectional	DO-214AC	1ba	1j	Eic
S0B5	STUS0B5	TVS	Vbr=144..176V, 2.2A, 500W(1ms)	DO-214AC	1d	1a	Eic
S0B8	SMAJ150	TVS	Vrwm=150V, Vbr=167..204V, 1.1A, 400W(1ms)	DO-214AC	1d	1a	Eic
S0B8	SMAJ150C	TVS	Vrwm=150V, Vbr=167..204V, 1.1A, 400W(1ms), Bidirectional	DO-214AC	1ba	1j	Eic
S0B8	STBS0B8	TVS	Vbr=167..204V, 1.9A, 500W(1ms), Bidirectional	DO-214AC	1ba	1j	Eic
S0B8	STUS0B8	TVS	Vbr=167..204V, 1.9A, 500W(1ms)	DO-214AC	1d	1a	Eic
S0B9	SMAJ160	TVS	Vrwm=160V, Vbr=178..218V, 1A, 400W(1ms)	DO-214AC	1d	1a	Eic
S0B9	SMAJ160C	TVS	Vrwm=160V, Vbr=178..218V, 1A, 400W(1ms), Bidirectional	DO-214AC	1ba	1j	Eic
S0B9	STBS0B9	TVS	Vbr=178..218V, 1.7A, 500W(1ms), Bidirectional	DO-214AC	1ba	1j	Eic
S0B9	STUS0B9	TVS	Vbr=178..218V, 1.7A, 500W(1ms)	DO-214AC	1d	1a	Eic
S0D0	SMAJ170	TVS	Vrwm=170V, Vbr=189..231V, 0.99A, 400W(1ms)	DO-214AC	1d	1a	Eic
S0D0	SMAJ170C	TVS	Vrwm=170V, Vbr=189..231V, 0.99A, 400W(1ms), Bidirectional	DO-214AC	1ba	1j	Eic
S0D0	STBS0D0	TVS	Vbr=189..231V, 1.6A, 500W(1ms), Bidirectional	DO-214AC	1ba	1j	Eic
S0D0	STUS0D0	TVS	Vbr=189..231V, 1.6A, 500W(1ms)	DO-214AC	1d	1a	Eic
S0D1	SMAJ188	TVS	Vrwm=188V, Vbr=209..231V, 0.9A, 400W(1ms)	DO-214AC	1d	1a	Eic
S0D1	SMAJ188C	TVS	Vrwm=188V, Vbr=209..255V, 0.90A, 400W(1ms), Bidirectional	DO-214AC	1ba	1j	Eic
S1	1PS10SB21	Si-diode	Schottky, Sw, Fast, 40V, 20mA, Vf<0.8V(1mA), <0.6pF	SOD-882	13d	2b	Phi
S1	1PS76SB21	Si-diode	SBR, U-Fast, Sw, 40V, 0.2A, Vf<0.55V(0.2A), <0.3ns	SOD-323	5d	1a	Phi
S1	1SS239	Si-diode	Schottky, VHF/UHF, 6V, 30mA	SOD-323	5d	1a	Tos
S1	BAV70BPT	Si-diode	Sw, 100V, 150mA, Vf<1.25V(150mA), 4ns	SOD-123	5d	1a	Chm
S1	CMDSH-3	Si-diode	Sw, 30V, 100mA, 250mW, Vf<0.8V(100mA), 7pF	SOD-323	5d	1a	Ken
S1	FS2A	Si-diode	Rectifier, 50V, 1.5A, Vf<1.1V(1.5A), 4µs	DO-214AA	1d	2j	Fag
S1	SD101AW	Si-diode	Schottky, Fast Sw, 60V, 15mA, 2pF, 1ns	SOD-123	5d	1d	Di
S1	SD101AWS	Si-diode	Schottky, Fast Sw, 60V, 15mA, 2pF, 1ns	SOD-323	5d	1d	Di
S10	SS1H10	Si-diode	SBR, 100V, 1A, Vf<0.7V(2A)	DO-214AC	1d	1k	Vs
S10A	GF10A	Si-diode	Rectifier, 50V 1A, Vf<0.94V(1A)	DO-214AC	1d	1o	Zow
S10A	GF10AH	Si-diode	Rectifier, 50V 1A, Vf<0.94V(1A), Halogen free	DO-214AC	1d	1o	Zow
S10B	GF10B	Si-diode	Rectifier, 100V 1A, Vf<0.94V(1A)	DO-214AC	1d	1o	Zow
S10B	GF10BH	Si-diode	Rectifier, 100V 1A, Vf<0.94V(1A), Halogen free	DO-214AC	1d	1o	Zow
S10D	GF10D	Si-diode	Rectifier, 200V 1A, Vf<0.94V(1A)	DO-214AC	1d	1o	Zow
S10D	GF10DH	Si-diode	Rectifier, 200V 1A, Vf<0.94V(1A), Halogen free	DO-214AC	1d	1o	Zow
S10DL	GF110DL	Si-diode	Rectifier, 200V 1A, Vf<0.91V(1A)	DO-214AC	1d	1o	Zow
S10DL	GF110DLH	Si-diode	Rectifier, 200V 1A, Vf<0.91V(1A), Halogen free	DO-214AC	1d	1o	Zow
S10G	GF10G	Si-diode	Rectifier, 400V 1A, Vf<0.94V(1A)	DO-214AC	1d	1o	Zow



SMD code	Type	Function	Short description	Case	Pinout	St.	Mnf.
S10G■	GF10GH	Si-diode	Rectifier, 400V 1A, Vf<0.94V(1A), Halogen free	DO-214AC	1d	1o	Zow
S10GL	GF110GL	Si-diode	Rectifier, 400V 1A, Vf<0.91V(1A)	DO-214AC	1d	1o	Zow
S10GL■	GF110GLH	Si-diode	Rectifier, 400V 1A, Vf<0.91V(1A), Halogen free	DO-214AC	1d	1o	Zow
S10J	GF10J	Si-diode	Rectifier, 600V 1A, Vf<0.94V(1A)	DO-214AC	1d	1o	Zow
S10J■	GF10JH	Si-diode	Rectifier, 600V 1A, Vf<0.94V(1A), Halogen free	DO-214AC	1d	1o	Zow
S10JL	GF110JL	Si-diode	Rectifier, 600V 1A, Vf<0.91V(1A)	DO-214AC	1d	1o	Zow
S10JL■	GF110JLH	Si-diode	Rectifier, 600V 1A, Vf<0.91V(1A), Halogen free	DO-214AC	1d	1o	Zow
S10K	GF10K	Si-diode	Rectifier, 800V 1A, Vf<0.94V(1A)	DO-214AC	1d	1o	Zow
S10K■	GF10KH	Si-diode	Rectifier, 800V 1A, Vf<0.94V(1A), Halogen free	DO-214AC	1d	1o	Zow
S10KL	GF110KL	Si-diode	Rectifier, 800V 1A, Vf<0.92V(1A)	DO-214AC	1d	1o	Zow
S10KL■	GF110KLH	Si-diode	Rectifier, 800V 1A, Vf<0.92V(1A), Halogen free	DO-214AC	1d	1o	Zow
S10M	GF10M	Si-diode	Rectifier, 1000V 1A, Vf<0.94V(1A)	DO-214AC	1d	1o	Zow
S10M■	GF10MH	Si-diode	Rectifier, 1000V 1A, Vf<0.94V(1A), Halogen free	DO-214AC	1d	1o	Zow
S10ML	GF110ML	Si-diode	Rectifier, 1000V 1A, Vf<0.92V(1A)	DO-214AC	1d	1o	Zow
S10ML■	GF110MLH	Si-diode	Rectifier, 1000V 1A, Vf<0.92V(1A), Halogen free	DO-214AC	1d	1o	Zow
S10Q	GF10Q	Si-diode	Rectifier, 1200V 1A, Vf<0.98V(1A)	DO-214AC	1d	1o	Zow
S10Q■	GF10QH	Si-diode	Rectifier, 1200V 1A, Vf<0.98V(1A), Halogen free	DO-214AC	1d	1o	Zow
S10Y	GF10Y	Si-diode	Rectifier, 1600V 1A, Vf<0.98V(1A), Halogen free	DO-214AC	1d	1o	Zow
S10Y■	GF10YH	Si-diode	Rectifier, 1600V 1A, Vf<0.98V(1A), Halogen free	DO-214AC	1d	1o	Zow
S11	STPS1H100A	Si-diode	SBR, 100V, 1A, Vf<0.62V(1A)	DO-214AC	1d	1a	Ste
S110	SSM110PT	Si-diode	Rectifier, Schottky, 100V, 1A, Vf<0.8V(1A)	DO-214AC	1d	1a	Chm
S12L	SSM12LPT	Si-diode	Rectifier, Schottky, 20V, 1A, Vf<0.38V(1A)	DO-214AC	1d	1a	Chm
S13L	SSM13LPT	Si-diode	Rectifier, Schottky, 30V, 1A, Vf<0.38V(1A)	DO-214AC	1d	1a	Chm
S14	STPS140Z	Si-diode	SBR, 40V, 1A, Vf<0.55V(1A), 5ms	SOD-123	5d	1a	Ste
S14H	SSM14LHPT	Si-diode	Rectifier, Schottky, 40V, 1A, Vf<0.35V(1A)	DO-214AC	1d	1a	Chm
S14L	SSM14LPT	Si-diode	Rectifier, Schottky, 40V, 1A, Vf<0.38V(1A)	DO-214AC	1d	1a	Chm
S2	1PS76SB70	Si-diode	SBD, U-Speed, 70V, 70mA, Vf<1V(15mA), <2pF	SOD-323	5d	1a	Phi
S2	1SS242	Si-diode	Schottky, VHF-Mix/Band-Sw, 5V, 30mA	SOD-123	5d	1a	Tos
S2	1SS315	C-diode	Schottky, UHF-Band Mix, 5V, 30mA, 0.6pF	SOD-323	5d	1a	Tos
S2	CMDSH2-3	Si-diode	Sw, 30V, 200mA, 250mW, Vf<0.55V(200mA), 15pF	SOD-323	5d	1a	Cen
S2	FS2B	Si-diode	Rectifier, 100V, 1.5A, Vf<1.1V(1.5A), 4μs	DO-214AA	1d	2j	Fag
S2	SD101BW	Si-diode	Schottky, Fast Sw, 50V, 15mA, 2.1pF, 1ns	SOD-123	5d	1d	Di
S2	SD101BWS	Si-diode	Schottky, Fast Sw, 50V, 15mA, 2.1pF, 1ns	SOD-323	5d	1d	Di
S2	SDB110Q	Si-diode	SBR, 30V, 30mA, 150mW, <10pF, <5ns	SOD-523	6d	1a	Auk
S2	SDB310Q	Si-diode	SBR, 30V, 200mA, 150mW, <10pF, <5ns	SOD-523	6d	1a	Auk
S2	SS12	Si-diode	SBR, 20V, 1A, Vf<0.5V(1A)	DO-214AC	1d	1k	Vs
S2	SS22	Si-diode	SBR, 20V, 2A, Vf<0.5V(2A)	DO-214AA	1d	1k	Vs
S2	SS32	Si-diode	SBR, 20V, 3A, Vf<0.5V(3A)	DO-214AB	1d	1k	Vs
S2	SSM5817SLPT	Si-diode	Rectifier, Schottky, 20V, 500mA, Vf<0.385V(500mA)	SOD-123	5d	1a	Chm
S210	SSM210PT	Si-diode	Rectifier, Schottky, 100V, 2A, Vf<0.8V(2A)	DO-214AC	1d	1a	Chm
S22L	SSM22LPT	Si-diode	Rectifier, Schottky, 20V, 2A, Vf<0.4V(2A)	DO-214AC	1d	1a	Chm
S23	STPS3L25S	Si-diode	SBR, 25V, 3A, Vf<0.44V(3A)	DO-214AB	5d	1a	Ste
S23L	SSM23LPT	Si-diode	Rectifier, Schottky, 30V, 2A, Vf<0.4V(2A)	DO-214AC	1d	1a	Chm
S24	SSA24	Si-diode	SBR, 40V, 2A, Vf<0.49V(2A)	DO-214AC	1d	1k	Vs
S24L	SSM24LPT	Si-diode	Rectifier, Schottky, 40V, 2A, Vf<0.4V(2A)	DO-214AC	1d	1a	Chm
S3	1SS357	Si-diode	Schottky, 40V, 100mA, Vf<0.6V(100mA), <25pF	SOD-323	5d	1a	Tos
S3	1SS369	Si-diode	Schottky, 40V, 100mA, Vf<0.6V(100mA), <25pF	SOD-323	5d	1a	Tos
S3	1SS388	Si-diode	Schottky, 45V, 100mA, Vf<0.6V(50mA)	SOD-523	6d	1a	Tos
S3	FS2D	Si-diode	Rectifier, 200V, 1.5A, Vf<1.1V(1.5A), 4μs	DO-214AA	1d	2j	Fag
S3	SD101CW	Si-diode	Schottky, Fast Sw, 40V, 15mA, 2.2pF, 1ns	SOD-123	5d	1d	Di
S3	SD101CWS	Si-diode	Schottky, Fast Sw, 40V, 15mA, 2.2pF, 1ns	SOD-323	5d	1d	Di
S3	SS13	Si-diode	SBR, 30V, 1A, Vf<0.5V(1A)	DO-214AC	1d	1k	Vs
S3	SS23	Si-diode	SBR, 30V, 2A, Vf<0.5V(2A)	DO-214AA	1d	1k	Vs
S3	SS33	Si-diode	SBR, 30V, 3A, Vf<0.5V(3A)	DO-214AB	1d	1k	Vs
S3	SSM5818SLPT	Si-diode	Rectifier, Schottky, 30V, 500mA, Vf<0.43V(500mA)	SOD-123	5d	1a	Chm
S310	1SS357	Si-diode	Schottky, 40V, 100mA, Vf<0.6V(100mA), <25pF	SOD-323	5d	1a	Trs
S310	SSM310PT	Si-diode	Rectifier, Schottky, 100V, 3A, Vf<0.85V(3A)	DO-214AC	1d	1a	Chm
S32L	SSM32LPT	Si-diode	Rectifier, Schottky, 20V, 3A, Vf<0.4V(3A)	DO-214AC	1d	1a	Chm
S33L	SSM33LPT	Si-diode	Rectifier, Schottky, 30V, 3A, Vf<0.4V(3A)	DO-214AC	1d	1a	Chm
S34	SSA34	Si-diode	SBR, 40V, 3A, Vf<0.49V(3A)	DO-214AC	1d	1k	Vs
S34H	SSM34LHPT	Si-diode	Rectifier, Schottky, 40V, 3A, Vf<0.45V(3A)	DO-214AC	1d	1a	Chm
S34L	SSM34LPT	Si-diode	Rectifier, Schottky, 40V, 3A, Vf<0.4V(3A)	DO-214AC	1d	1a	Chm
S4	1PS10SB63	Si-diode	Schottky, Sw, Fast, 5V, 20mA, Vf<0.3V(1mA), <0.5pF	SOD-882	13d	2b	Phi
S4	1PS76SB40	Si-diode	SBD, Hi-Speed, 40V, 120mA, <5pF	SOD-323	5d	1a	Phi
S4	1SS367	Si-diode	Schottky, Sw, 15V, 100mA	SOD-123	5d	1a	Tos
S4	1SS373	Si-diode	Schottky, Sw, 15V, 100mA	SOD-323	5d	1a	Tos
S4	1SS389	Si-diode	Schottky, 40V, 100mA	SOD-523	6d	1a	Tos
S4	FS2G	Si-diode	Rectifier, 400V, 1.5A, Vf<1.1V(1.5A), 4μs	DO-214AA	1d	2j	Fag
S4	SD103AW	Si-diode	Schottky, Sw, 40V, 350mA, 400mW, 10ns, 28pF	SOD-123	5d	1d	Di
S4	SD103AWS	Si-diode	Schottky, Sw, 40V, 350mA, 200mW, 10ns, 28pF	SOD-323	5d	1d	Di



SMD
code

Type

Function

Short description

Case

Pinout

St.

Mnf.

SMD code	Type	Function	Short description	Case	Pinout	St.	Mnf.
S4	SD103BW	Si-diode	Schottky, Sw, 30V, 350mA, 400mW, 10ns, 28pF	SOD-123	5d	1d	Di
S4	SD103BWS	Si-diode	Schottky, Sw, 30V, 350mA, 200mW, 10ns, 28pF	SOD-323	5d	1d	Di
S4	SD103CW	Si-diode	Schottky, Sw, 20V, 350mA, 400mW, 10ns, 28pF	SOD-123	5d	1d	Di
S4	SD103CWS	Si-diode	Schottky, Sw, 20V, 350mA, 200mW, 10ns, 28pF	SOD-323	5d	1d	Di
S4	SS14	Si-diode	SBR, 40V, 1A, Vf<0.5V(1A)	DO-214AC	1d	1k	Vs
S4	SS24	Si-diode	SBR, 40V, 2A, Vf<0.5V(2A)	DO-214AA	1d	1k	Vs
S4	SS34	Si-diode	SBR, 40V, 3A, Vf<0.5V(3A)	DO-214AB	1d	1k	Vs
S4	SSM5819SLPT	Si-diode	Rectifier, Schottky, 40V, 500mA, Vf<0.51V(500mA)	SOD-123	5d	1a	Chm
S44	SSB44	Si-diode	SBR, 40V, 4A, Vf<0.49V(4A)	DO-214AA	1d	1k	Vs
S5	1PS10SB82	Si-diode	Schottky, Sw, Fast, 15V, 30mA, Vf<0.7V(30mA), <1pF	SOD-882	13d	2b	Phi
S5	BZX584B27V	Z-diode	26.46..27.54V, Izt=2mA, Zzt=80Ω, 200mW	SOD-523FL	7d	1a	Tac
S5	FS2J	Si-diode	Rectifier, 600V, 1.5A, Vf<1.1V(1.5A), 4μs	DO-214AA	1d	2j	Fag
S5	MM5Z27VB	Z-diode	26.46..27.54V, Izt=2mA, Zzt=80Ω, 200mW	SOD-523FL	7d	1a	Tac
S5	PSM11PT	Si-diode	Rectifier, S-fast, 50V, 800mA	SOD-123S	7d	1a	Chm
S5	SD103BW	Si-diode	Schottky, Sw, 30V, 350mA, 400mW, 10ns, 28pF	SOD-123	5d	1d	Di
S5	SD103BWS	Si-diode	Schottky, Sw, 30V, 350mA, 200mW, 10ns, 28pF	SOD-323	5d	1d	Di
S5	SD103CW	Si-diode	Schottky, Sw, 20V, 350mA, 400mW, 10ns, 28pF	SOD-123	5d	1d	Di
S5	SD103CWS	Si-diode	Schottky, Sw, 20V, 350mA, 200mW, 10ns, 28pF	SOD-323	5d	1d	Di
S5	SS15	Si-diode	SBR, 50V, 1A, Vf<0.75V(1A)	DO-214AC	1d	1k	Vs
S5	SS25	Si-diode	SBR, 50V, 2A, Vf<0.7V(2A)	DO-214AA	1d	1k	Vs
S5	SS35	Si-diode	SBR, 50V, 3A, Vf<0.7V(3A)	DO-214AB	1d	1k	Vs
S510	SMAJ8.5A	TVS	Vrwm=8.5V, Vbr=9.44..10.4V, 27.8A, 400W(1ms)	DO-214AC	1d	1a	Eic
S510	SMAJ8.5CA	TVS	Vrwm=8.5V, Vbr=9.44..10.4V, 27.8A, 400W(1ms), Bidirectional	DO-214AC	1ba	1j	Eic
S510	STBS510	TVS	Vbr=9.44..10.4V, 34.7A, 500W(1ms), Bidirectional	DO-214AC	1ba	1j	Eic
S510	STUS510	TVS	Vbr=9.44..10.4V, 34.7A, 500W(1ms)	DO-214AC	1d	1a	Eic
S511	SMAJ9.0A	TVS	Vrwm=9.0V, Vbr=10.0..11.1V, 26.0A, 400W(1ms)	DO-214AC	1d	1a	Eic
S511	SMAJ9.0CA	TVS	Vrwm=9.0V, Vbr=10.0..11.1V, 26.0A, 400W(1ms), Bidirectional	DO-214AC	1ba	1j	Eic
S511	STBS511	TVS	Vbr=10..11.1V, 32.5A, 500W(1ms), Bidirectional	DO-214AC	1ba	1j	Eic
S511	STUS511	TVS	Vbr=10..11.1V, 32.5A, 500W(1ms)	DO-214AC	1d	1a	Eic
S512	SMAJ10A	TVS	Vrwm=10V, Vbr=11.1..12.3V, 23.5A, 400W(1ms)	DO-214AC	1d	1a	Eic
S512	SMAJ10CA	TVS	Vrwm=10V, Vbr=11.1..12.3V, 23.5A, 400W(1ms), Bidirectional	DO-214AC	1ba	1j	Eic
S512	STBS512	TVS	Vbr=11.1..12.3V, 29.4A, 500W(1ms), Bidirectional	DO-214AC	1ba	1j	Eic
S512	STUS512	TVS	Vbr=11.1..12.3V, 29.4A, 500W(1ms)	DO-214AC	1d	1a	Eic
S513	SMAJ11A	TVS	Vrwm=11V, Vbr=12.2..13.5V, 22A, 400W(1ms)	DO-214AC	1d	1a	Eic
S513	SMAJ11CA	TVS	Vrwm=11V, Vbr=12.2..13.5V, 22A, 400W(1ms), Bidirectional	DO-214AC	1ba	1j	Eic
S513	STBS513	TVS	Vbr=12.2..13.5V, 27.4A, 500W(1ms), Bidirectional	DO-214AC	1ba	1j	Eic
S513	STUS513	TVS	Vbr=12.2..13.5V, 27.4A, 500W(1ms)	DO-214AC	1d	1a	Eic
S514	SMAJ12A	TVS	Vrwm=12V, Vbr=13.3..14.7V, 20.1A, 400W(1ms)	DO-214AC	1d	20.1A	Eic
S514	SMAJ12CA	TVS	Vrwm=12V, Vbr=13.3..14.7V, 20.1A, 400W(1ms), Bidirectional	DO-214AC	1ba	1j	Eic
S514	STBS514	TVS	Vbr=13.3..14.7V, 25.1A, 500W(1ms), Bidirectional	DO-214AC	1ba	1j	Eic
S514	STUS514	TVS	Vbr=13.3..14.7V, 25.1A, 500W(1ms)	DO-214AC	1d	1a	Eic
S515	SMAJ13A	TVS	Vrwm=13V, Vbr=14.4..15.9V, 18.6A, 400W(1ms)	DO-214AC	1d	1a	Eic
S515	SMAJ13CA	TVS	Vrwm=13V, Vbr=14.4..15.9V, 18.6A, 400W(1ms), Bidirectional	DO-214AC	1ba	1j	Eic
S515	STBS515	TVS	Vbr=14.4..15.9V, 23.2A, 500W(1ms), Bidirectional	DO-214AC	1ba	1j	Eic
S515	STUS515	TVS	Vbr=14.4..15.9V, 23.2A, 500W(1ms)	DO-214AC	1d	1a	Eic
S516	SMAJ14A	TVS	Vrwm=14V, Vbr=15.6..17.2V, 17.2A, 400W(1ms)	DO-214AC	1d	1a	Eic
S516	SMAJ14CA	TVS	Vrwm=14V, Vbr=15.6..17.2V, 17.2A, 400W(1ms), Bidirectional	DO-214AC	1ba	1j	Eic
S516	STBS516	TVS	Vbr=15.6..17.2V, 21.5A, 500W(1ms), Bidirectional	DO-214AC	1ba	1j	Eic
S516	STUS516	TVS	Vbr=15.6..17.2V, 21.5A, 500W(1ms)	DO-214AC	1d	1a	Eic
S518	SMAJ15A	TVS	Vrwm=15V, Vbr=16.7..18.5V, 16.4A, 400W(1ms)	DO-214AC	1d	1a	Eic
S518	SMAJ15CA	TVS	Vrwm=15V, Vbr=16.7..18.5V, 16.4A, 400W(1ms), Bidirectional	DO-214AC	1ba	1j	Eic
S518	STBS518	TVS	Vbr=16.7..18.5V, 20.6A, 500W(1ms), Bidirectional	DO-214AC	1ba	1j	Eic
S518	STUS518	TVS	Vbr=16.7..18.5V, 20.6A, 500W(1ms)	DO-214AC	1d	1a	Eic
S519	SMAJ16A	TVS	Vrwm=16V, Vbr=17.8..19.7V, 15.4A, 400W(1ms)	DO-214AC	1d	1a	Eic
S519	SMAJ16CA	TVS	Vrwm=16V, Vbr=17.8..19.7V, 15.4A, 400W(1ms), Bidirectional	DO-214AC	1ba	1j	Eic
S519	STBS519	TVS	Vbr=17.8..19.7V, 19.2A, 500W(1ms), Bidirectional	DO-214AC	1ba	1j	Eic
S519	STUS519	TVS	Vbr=17.8..19.7V, 19.2A, 500W(1ms)	DO-214AC	1d	1a	Eic
S520	SMAJ17A	TVS	Vrwm=17V, Vbr=18.9..20.9V, 14.5A, 400W(1ms)	DO-214AC	1d	1a	Eic
S520	SMAJ17CA	TVS	Vrwm=17V, Vbr=18.9..20.9V, 14.5A, 400W(1ms), Bidirectional	DO-214AC	1ba	1j	Eic
S520	STBS520	TVS	Vbr=18.9..20.9V, 18.1A, 500W(1ms), Bidirectional	DO-214AC	1ba	1j	Eic
S520	STUS520	TVS	Vbr=18.9..20.9V, 18.1A, 500W(1ms)	DO-214AC	1d	1a	Eic
S521	SMAJ18A	TVS	Vrwm=18V, Vbr=20.0..22.1V, 13.7A, 400W(1ms)	DO-214AC	1d	1a	Eic
S521	SMAJ18CA	TVS	Vrwm=18V, Vbr=20.0..22.1V, 13.7A, 400W(1ms), Bidirectional	DO-214AC	1ba	1j	Eic
S521	STBS521	TVS	Vbr=20.0..22.1V, 17.2A, 500W(1ms), Bidirectional	DO-214AC	1ba	1j	Eic
S521	STUS521	TVS	Vbr=20.0..22.1V, 17.2A, 500W(1ms)	DO-214AC	1d	1a	Eic
S523	SMAJ20A	TVS	Vrwm=20V, Vbr=22.2..24.5V, 12.3A, 400W(1ms)	DO-214AC	1d	1a	Eic
S523	SMAJ20CA	TVS	Vrwm=20V, Vbr=22.2..24.5V, 12.3A, 400W(1ms), Bidirectional	DO-214AC	1ba	1j	Eic
S523	STBS523	TVS	Vbr=22.2..24.5V, 15.4A, 500W(1ms), Bidirectional	DO-214AC	1ba	1j	Eic
S523	STUS523	TVS	Vbr=22.2..24.5V, 15.4A, 500W(1ms)	DO-214AC	1d	1a	Eic
S526	SMAJ22A	TVS	Vrwm=22V, Vbr=24.4..26.9V, 11.3A, 400W(1ms)	DO-214AC	1d	1a	Eic



SMD
code

Type

Function

Short description

Case

Pinout

St.

Mnf.

SMD code	Type	Function	Short description	Case	Pinout	St.	Mnf.
S526	SMAJ22CA	TVS	Vrwm=22V, Vbr=24.4..26.9V, 11.3A, 400W(1ms), Bidirectional	DO-214AC	1ba	1j	Eic
S526	STBS526	TVS	Vbr=24.4..26.9V, 14.1A, 500W(1ms), Bidirectional	DO-214AC	1ba	1j	Eic
S526	STUS526	TVS	Vbr=24.4..26.9V, 14.1A, 500W(1ms)	DO-214AC	1d	1a	Eic
S528	SMAJ24A	TVS	Vrwm=24V, Vbr=26.7..29.5V, 10.3A, 400W(1ms)	DO-214AC	1d	1a	Eic
S528	SMAJ24CA	TVS	Vrwm=24V, Vbr=26.7..29.5V, 10.3A, 400W(1ms), Bidirectional	DO-214AC	1ba	1j	Eic
S528	STBS528	TVS	Vbr=26.7..29.5V, 12.8A, 500W(1ms), Bidirectional	DO-214AC	1ba	1j	Eic
S528	STUS528	TVS	Vbr=26.7..29.5V, 12.8A, 500W(1ms)	DO-214AC	1d	1a	Eic
S52H	SSM52LHPT	Si-diode	Rectifier, Schottky, 20V, 5A, Vf<0.45V(5A)	DO-214AC	1d	1a	Chm
S52L	SSM52LPT	Si-diode	Rectifier, Schottky, 20V, 5A, Vf<0.4V(5A)	DO-214AC	1d	1a	Chm
S530	SMAJ26A	TVS	Vrwm=26V, Vbr=28.9..31.9V, 9.5A, 400W(1ms)	DO-214AC	1d	1a	Eic
S530	SMAJ26CA	TVS	Vrwm=26V, Vbr=28.9..31.9V, 9.5A, 400W(1ms), Bidirectional	DO-214AC	1ba	1j	Eic
S530	STBS530	TVS	Vbr=28.9..31.9V, 11.9A, 500W(1ms), Bidirectional	DO-214AC	1ba	1j	Eic
S530	STUS530	TVS	Vbr=28.9..31.9V, 11.9A, 500W(1ms)	DO-214AC	1d	1a	Eic
S533	SMAJ28A	TVS	Vrwm=28V, Vbr=31.1..34.4V, 8.8A, 400W(1ms)	DO-214AC	1d	1a	Eic
S533	SMAJ28CA	TVS	Vrwm=28V, Vbr=31.1..34.4V, 8.8A, 400W(1ms), Bidirectional	DO-214AC	1ba	1j	Eic
S533	STBS533	TVS	Vbr=31.1..34.4V, 11A, 500W(1ms), Bidirectional	DO-214AC	1ba	1j	Eic
S533	STUS533	TVS	Vbr=31.1..34.4V, 11A, 500W(1ms)	DO-214AC	1d	1a	Eic
S535	SMAJ30A	TVS	Vrwm=30V, Vbr=33.3..36.8V, 8.3A, 400W(1ms)	DO-214AC	1d	1a	Eic
S535	SMAJ30CA	TVS	Vrwm=30V, Vbr=33.3..36.8V, 8.3A, 400W(1ms), Bidirectional	DO-214AC	1ba	1j	Eic
S535	STBS535	TVS	Vbr=33.3..36.8V, 10.3A, 500W(1ms), Bidirectional	DO-214AC	1ba	1j	Eic
S535	STUS535	TVS	Vbr=33.3..36.8V, 10.3A, 500W(1ms)	DO-214AC	1d	1a	Eic
S539	SMAJ33A	TVS	Vrwm=33V, Vbr=36.7..40.6V, 7.5A, 400W(1ms)	DO-214AC	1d	1a	Eic
S539	SMAJ33CA	TVS	Vrwm=33V, Vbr=36.7..40.6V, 7.5A, 400W(1ms), Bidirectional	DO-214AC	1ba	1j	Eic
S539	STBS539	TVS	Vbr=36.7..40.6V, 9.4A, 500W(1ms), Bidirectional	DO-214AC	1ba	1j	Eic
S539	STUS539	TVS	Vbr=36.7..40.6V, 9.4A, 500W(1ms)	DO-214AC	1d	1a	Eic
S54	SSC54	Si-diode	SBR, 40V, 5A, Vf<0.49V(5A)	DO-214AB	1d	1k	Vs
S542	SMAJ36A	TVS	Vrwm=36V, Vbr=40.0..44.2V, 6.9A, 400W(1ms)	DO-214AC	1d	1a	Eic
S542	SMAJ36CA	TVS	Vrwm=36V, Vbr=40.0..44.2V, 6.9A, 400W(1ms), Bidirectional	DO-214AC	1ba	1j	Eic
S542	STBS542	TVS	Vbr=40..44.2V, 8.6A, 500W(1ms), Bidirectional	DO-214AC	1ba	1j	Eic
S542	STUS542	TVS	Vbr=40..44.2V, 8.6A, 500W(1ms)	DO-214AC	1d	1a	Eic
S547	SMAJ40A	TVS	Vrwm=40V, Vbr=44.4..49.1V, 6.2A, 400W(1ms)	DO-214AC	1d	1a	Eic
S547	SMAJ40CA	TVS	Vrwm=40V, Vbr=44.4..49.1V, 6.2A, 400W(1ms), Bidirectional	DO-214AC	1ba	1j	Eic
S547	STBS547	TVS	Vbr=44.4..49.1V, 7.8A, 500W(1ms), Bidirectional	DO-214AC	1ba	1j	Eic
S547	STUS547	TVS	Vbr=44.4..49.1V, 7.8A, 500W(1ms)	DO-214AC	1d	1a	Eic
S54L	SSM54LPT	Si-diode	Rectifier, Schottky, 40V, 5A, Vf<0.4V(5A)	DO-214AC	1d	1a	Chm
S550	SMAJ43A	TVS	Vrwm=43V, Vbr=47.8..52.8V, 5.7A, 400W(1ms)	DO-214AC	1d	1a	Eic
S550	SMAJ43CA	TVS	Vrwm=43V, Vbr=47.8..52.8V, 5.7A, 400W(1ms), Bidirectional	DO-214AC	1ba	1j	Eic
S550	STBS550	TVS	Vbr=47.8..52.8V, 7.2A, 500W(1ms), Bidirectional	DO-214AC	1ba	1j	Eic
S550	STUS550	TVS	Vbr=47.8..52.8V, 7.2A, 500W(1ms)	DO-214AC	1d	1a	Eic
S553	SMAJ45A	TVS	Vrwm=45V, Vbr=50.0..55.3V, 5.5A, 400W(1ms)	DO-214AC	1d	1a	Eic
S553	SMAJ45CA	TVS	Vrwm=45V, Vbr=50.0..55.3V, 5.5A, 400W(1ms), Bidirectional	DO-214AC	1ba	1j	Eic
S553	STBS553	TVS	Vbr=50..55.3V, 6.9A, 500W(1ms), Bidirectional	DO-214AC	1ba	1j	Eic
S553	STUS553	TVS	Vbr=50..55.3V, 6.9A, 500W(1ms)	DO-214AC	1d	1a	Eic
S556	SMAJ48A	TVS	Vrwm=48V, Vbr=53.3..58.9V, 5.2A, 400W(1ms)	DO-214AC	1d	1a	Eic
S556	SMAJ48CA	TVS	Vrwm=48V, Vbr=53.3..58.9V, 5.2A, 400W(1ms), Bidirectional	DO-214AC	1ba	1j	Eic
S556	STBS556	TVS	Vbr=53.3..58.9V, 6.5A, 500W(1ms), Bidirectional	DO-214AC	1ba	1j	Eic
S556	STUS556	TVS	Vbr=53.3..58.9V, 6.5A, 500W(1ms)	DO-214AC	1d	1a	Eic
S560	SMAJ51A	TVS	Vrwm=51V, Vbr=56.7..62.7V, 4.9A, 400W(1ms)	DO-214AC	1d	1a	Eic
S560	SMAJ51CA	TVS	Vrwm=51V, Vbr=56.7..62.7V, 4.9A, 400W(1ms), Bidirectional	DO-214AC	1ba	1j	Eic
S560	STBS560	TVS	Vbr=56.7..62.7V, 6.1A, 500W(1ms), Bidirectional	DO-214AC	1ba	1j	Eic
S560	STUS560	TVS	Vbr=56.7..62.7V, 6.1A, 500W(1ms)	DO-214AC	1d	1a	Eic
S563	SMAJ54A	TVS	Vrwm=54V, Vbr=60.0..66.3V, 4.6A, 400W(1ms)	DO-214AC	1d	1a	Eic
S563	SMAJ54CA	TVS	Vrwm=54V, Vbr=60.0..66.3V, 4.6A, 400W(1ms), Bidirectional	DO-214AC	1ba	1j	Eic
S563	STBS563	TVS	Vbr=60..66.3V, 5.7A, 500W(1ms), Bidirectional	DO-214AC	1ba	1j	Eic
S563	STUS563	TVS	Vbr=60..66.3V, 5.7A, 500W(1ms)	DO-214AC	1d	1a	Eic
S568	SMAJ58A	TVS	Vrwm=58V, Vbr=64.4..71.2V, 4.3A, 400W(1ms)	DO-214AC	1d	1a	Eic
S568	SMAJ58CA	TVS	Vrwm=58V, Vbr=64.4..71.2V, 4.3A, 400W(1ms), Bidirectional	DO-214AC	1ba	1j	Eic
S568	STBS568	TVS	Vbr=64.4..71.2V, 5.3A, 500W(1ms), Bidirectional	DO-214AC	1ba	1j	Eic
S568	STUS568	TVS	Vbr=64.4..71.2V, 5.3A, 500W(1ms)	DO-214AC	1d	1a	Eic
S56H	SMAJ5.0A	TVS	Vrwm=5.0V, Vbr=6.40..7.25V, 43.5A, 400W(1ms)	DO-214AC	1d	1a	Eic
S56H	SMAJ5.0CA	TVS	Vrwm=5.0V, Vbr=6.40..7.25V, 43.5A, 400W(1ms), Bidirectional	DO-214AC	1ba	1j	Eic
S56H	STBS56H	TVS	Vbr=6.4..7V, 54.3A, 500W(1ms), Bidirectional	DO-214AC	1ba	1j	Eic
S56H	STUS56H	TVS	Vbr=6.4..7V, 54.3A, 500W(1ms)	DO-214AC	1d	1a	Eic
S571	SMAJ60A	TVS	Vrwm=60V, Vbr=66.7..73.7V, 4.1A, 400W(1ms)	DO-214AC	1d	1a	Eic
S571	SMAJ60CA	TVS	Vrwm=60V, Vbr=66.7..73.7V, 4.1A, 400W(1ms), Bidirectional	DO-214AC	1ba	1j	Eic
S571	STBS571	TVS	Vbr=66.7..73.7V, 5.2A, 500W(1ms), Bidirectional	DO-214AC	1ba	1j	Eic
S571	STUS571	TVS	Vbr=66.7..73.7V, 5.2A, 500W(1ms)	DO-214AC	1d	1a	Eic
S575	SMAJ64A	TVS	Vrwm=64V, Vbr=71.1..78.6V, 3.9A, 400W(1ms)	DO-214AC	1d	1a	Eic
S575	SMAJ64CA	TVS	Vrwm=64V, Vbr=71.1..78.6V, 3.9A, 400W(1ms), Bidirectional	DO-214AC	1ba	1j	Eic
S575	STBS575	TVS	Vbr=71.1..78.6V, 4.9A, 500W(1ms), Bidirectional	DO-214AC	1ba	1j	Eic



SMD
code

Type

Function

Short description

Case

Pinout

St.

Mnf.

SMD code	Type	Function	Short description	Case	Pinout	St.	Mnf.
S575	STUS575	TVS	Vbr=71.1..78.6V, 4.9A, 500W(1ms)	DO-214AC	1d	1a	Eic
S57A	SMAJ6.0A	TVS	Vrwm=6.0V, Vbr=6.67..7.37V, 38.8A, 400W(1ms)	DO-214AC	1d	1a	Eic
S57A	SMAJ6.0CA	TVS	Vrwm=6.0V, Vbr=6.67..7.37V, 38.8A, 400W(1ms), Bidirectional	DO-214AC	1ba	1j	Eic
S57A	STBS57A	TVS	Vbr=6.67..7.37V, 48.5A, 500W(1ms), Bidirectional	DO-214AC	1ba	1j	Eic
S57A	STUS57A	TVS	Vbr=6.67..7.37V, 48.5A, 500W(1ms)	DO-214AC	1d	1a	Eic
S57G	SMAJ6.5A	TVS	Vrwm=6.5V, Vbr=7.22..7.98V, 35.7A, 400W(1ms)	DO-214AC	1d	1a	Eic
S57G	SMAJ6.5CA	TVS	Vrwm=6.5V, Vbr=7.22..7.98V, 35.7A, 400W(1ms), Bidirectional	DO-214AC	1ba	1j	Eic
S57G	STBS57G	TVS	Vbr=7.22..7.98V, 44.7A, 500W(1ms), Bidirectional	DO-214AC	1ba	1j	Eic
S57G	STUS57G	TVS	Vbr=7.22..7.98V, 44.7A, 500W(1ms)	DO-214AC	1d	1a	Eic
S582	SMAJ70A	TVS	Vrwm=70V, Vbr=77.8..86V, 3.5A, 400W(1ms)	DO-214AC	1d	1a	Eic
S582	SMAJ70CA	TVS	Vrwm=70V, Vbr=77.8..86V, 3.5A, 400W(1ms), Bidirectional	DO-214AC	1ba	1j	Eic
S582	STBS582	TVS	Vbr=77.8..86V, 4.4A, 500W(1ms), Bidirectional	DO-214AC	1ba	1j	Eic
S582	STUS582	TVS	Vbr=77.8..86V, 4.4A, 500W(1ms)	DO-214AC	1d	1a	Eic
S588	SMAJ75A	TVS	Vrwm=75V, Vbr=83.3..92.1V, 3.3A, 400W(1ms)	DO-214AC	1d	1a	Eic
S588	SMAJ75CA	TVS	Vrwm=75V, Vbr=83.3..92.1V, 3.3A, 400W(1ms), Bidirectional	DO-214AC	1ba	1j	Eic
S588	STBS588	TVS	Vbr=83.3..92.1V, 4.1A, 500W(1ms), Bidirectional	DO-214AC	1ba	1j	Eic
S588	STUS588	TVS	Vbr=83.3..92.1V, 4.1A, 500W(1ms)	DO-214AC	1d	1a	Eic
S58C	SMAJ7.0A	TVS	Vrwm=7.0V, Vbr=7.78..8.6V, 33.3A, 400W(1ms)	DO-214AC	1d	1a	Eic
S58C	SMAJ7.0CA	TVS	Vrwm=7.0V, Vbr=7.78..8.6V, 33.3A, 400W(1ms), Bidirectional	DO-214AC	1ba	1j	Eic
S58C	STBS58C	TVS	Vbr=7.78..8.6V, 41.7A, 500W(1ms), Bidirectional	DO-214AC	1ba	1j	Eic
S58C	STUS58C	TVS	Vbr=7.78..8.6V, 41.7A, 500W(1ms)	DO-214AC	1d	1a	Eic
S58I	SMAJ7.5A	TVS	Vrwm=7.5V, Vbr=8.33..9.21V, 31.0A, 400W(1ms)	DO-214AC	1d	1a	Eic
S58I	SMAJ7.5CA	TVS	Vrwm=7.5V, Vbr=8.33..9.21V, 31.0A, 400W(1ms), Bidirectional	DO-214AC	1ba	1j	Eic
S58I	STBS58I	TVS	Vbr=8.33..9.21V, 38.8A, 500W(1ms), Bidirectional	DO-214AC	1ba	1j	Eic
S58I	STUS58I	TVS	Vbr=8.33..9.21V, 38.8A, 500W(1ms)	DO-214AC	1d	1a	Eic
S591	SMAJ78A	TVS	Vrwm=78V, Vbr=86.7..95.8V, 3.2A, 400W(1ms)	DO-214AC	1d	1a	Eic
S591	SMAJ78CA	TVS	Vrwm=78V, Vbr=86.7..95.8V, 3.2A, 400W(1ms), Bidirectional	DO-214AC	1ba	1j	Eic
S591	STBS591	TVS	Vbr=86.7..95.8V, 4A, 500W(1ms), Bidirectional	DO-214AC	1ba	1j	Eic
S591	STUS591	TVS	Vbr=86.7..95.8V, 4A, 500W(1ms)	DO-214AC	1d	1a	Eic
S599	SMAJ85A	TVS	Vrwm=85V, Vbr=94.4..104V, 2.2A, 400W(1ms)	DO-214AC	1d	1a	Eic
S599	SMAJ85CA	TVS	Vrwm=85V, Vbr=94.4..104V, 2.2A, 400W(1ms), Bidirectional	DO-214AC	1ba	1j	Eic
S599	STBS599	TVS	Vbr=94.4..104V, 3.6A, 500W(1ms), Bidirectional	DO-214AC	1ba	1j	Eic
S599	STUS599	TVS	Vbr=94.4..104V, 3.6A, 500W(1ms)	DO-214AC	1d	1a	Eic
S59B	SMAJ8.0A	TVS	Vrwm=8.0V, Vbr=8.89..9.83V, 29.4A, 400W(1ms)	DO-214AC	1d	1a	Eic
S59B	SMAJ8.0CA	TVS	Vrwm=8.0V, Vbr=8.89..9.83V, 29.4A, 400W(1ms), Bidirectional	DO-214AC	1ba	1j	Eic
S59B	STBS59B	TVS	Vbr=8.89..9.3V, 36.7A, 500W(1ms), Bidirectional	DO-214AC	1ba	1j	Eic
S59B	STUS59B	TVS	Vbr=8.89..9.3V, 36.7A, 500W(1ms)	DO-214AC	1d	1a	Eic
S5B1	SMAJ90A	TVS	Vrwm=90V, Vbr=100..111V, 2.1A, 400W(1ms)	DO-214AC	1d	1a	Eic
S5B1	SMAJ90CA	TVS	Vrwm=90V, Vbr=100..111V, 2.1A, 400W(1ms), Bidirectional	DO-214AC	1ba	1j	Eic
S5B1	STBS5B1	TVS	Vbr=100..111V, 3.4A, 500W(1ms), Bidirectional	DO-214AC	1ba	1j	Eic
S5B1	STUS5B1	TVS	Vbr=100..111V, 3.4A, 500W(1ms)	DO-214AC	1d	1a	Eic
S5B2	SMAJ100A	TVS	Vrwm=100V, Vbr=111..123V, 1.9A, 400W(1ms)	DO-214AC	1d	1a	Eic
S5B2	SMAJ100CA	TVS	Vrwm=100V, Vbr=111..123V, 1.9A, 400W(1ms), Bidirectional	DO-214AC	1ba	1j	Eic
S5B2	STBS5B2	TVS	Vbr=111..123V, 3.1A, 500W(1ms), Bidirectional	DO-214AC	1ba	1j	Eic
S5B2	STUS5B2	TVS	Vbr=111..123V, 3.1A, 500W(1ms)	DO-214AC	1d	1a	Eic
S5B3	SMAJ110A	TVS	Vrwm=110V, Vbr=122..135V, 1.7A, 400W(1ms)	DO-214AC	1d	1a	Eic
S5B3	SMAJ110CA	TVS	Vrwm=110V, 122..135V, 1.7A, 400W(1ms), Bidirectional	DO-214AC	1ba	1j	Eic
S5B3	STBS5B3	TVS	Vbr=122..135V, 2.8A, 500W(1ms), Bidirectional	DO-214AC	1ba	1j	Eic
S5B3	STUS5B3	TVS	Vbr=122..135V, 2.8A, 500W(1ms)	DO-214AC	1d	1a	Eic
S5B4	SMAJ120A	TVS	Vrwm=120V, Vbr=133..147V, 1.6A, 400W(1ms)	DO-214AC	1d	1a	Eic
S5B4	SMAJ120CA	TVS	Vrwm=120V, Vbr=133..147V, 1.6A, 400W(1ms), Bidirectional	DO-214AC	1ba	1j	Eic
S5B4	STBS5B4	TVS	Vbr=133..147V, 2A, 500W(1ms), Bidirectional	DO-214AC	1ba	1j	Eic
S5B4	STUS5B4	TVS	Vbr=133..147V, 2A, 500W(1ms)	DO-214AC	1d	1a	Eic
S5B5	SMAJ130A	TVS	Vrwm=130V, Vbr=144..159V, 1.4A, 400W(1ms)	DO-214AC	1d	1a	Eic
S5B5	SMAJ130CA	TVS	Vrwm=130V, Vbr=144..159V, 1.4A, 400W(1ms), Bidirectional	DO-214AC	1ba	1j	Eic
S5B5	STBS5B5	TVS	Vbr=144..159V, 2.4A, 500W(1ms), Bidirectional	DO-214AC	1ba	1j	Eic
S5B5	STUS5B5	TVS	Vbr=144..159V, 2.4A, 500W(1ms)	DO-214AC	1d	1a	Eic
S5B8	SMAJ150A	TVS	Vrwm=150V, Vbr=167..185V, 1.2A, 400W(1ms)	DO-214AC	1d	1a	Eic
S5B8	SMAJ150CA	TVS	Vrwm=150V, Vbr=167..185V, 1.2A, 400W(1ms), Bidirectional	DO-214AC	1ba	1j	Eic
S5B8	STBS5B8	TVS	Vbr=167..185V, 2.1A, 500W(1ms), Bidirectional	DO-214AC	1ba	1j	Eic
S5B8	STUS5B8	TVS	Vbr=167..185V, 2.1A, 500W(1ms)	DO-214AC	1d	1a	Eic
S5B9	SMAJ160A	TVS	Vrwm=160V, Vbr=178..197V, 1.2A, 400W(1ms)	DO-214AC	1d	1a	Eic
S5B9	SMAJ160CA	TVS	Vrwm=160V, Vbr=178..197V, 1.2A, 400W(1ms), Bidirectional	DO-214AC	1ba	1j	Eic
S5B9	STBS5B9	TVS	Vbr=178..197V, 1.9A, 500W(1ms), Bidirectional	DO-214AC	1ba	1j	Eic
S5B9	STUS5B9	TVS	Vbr=178..197V, 1.9A, 500W(1ms)	DO-214AC	1d	1a	Eic
S5D0	SMAJ170A	TVS	Vrwm=170V, Vbr=189..209V, 1.09A, 400W(1ms)	DO-214AC	1d	1a	Eic
S5D0	SMAJ170CA	TVS	Vrwm=170V, Vbr=189..209V, 1.09A, 400W(1ms), Bidirectional	DO-214AC	1ba	1j	Eic
S5D0	STBS5D0	TVS	Vbr=189..209V, 1.8A, 500W(1ms), Bidirectional	DO-214AC	1ba	1j	Eic
S5D0	STUS5D0	TVS	Vbr=189..209V, 1.8A, 500W(1ms)	DO-214AC	1d	1a	Eic
S5D1	SMAJ188A	TVS	Vrwm=188V, Vbr=209..231V, 0.91A, 400W(1ms)	DO-214AC	1d	1a	Eic



SMD
code

Type

Function

Short description

Case

Pinout

St.

Mnf.

SMD code	Type	Function	Short description	Case	Pinout	St.	Mnf.
S5D1	SMAJ188CA	TVS	Vrwm=188V, Vbr=209.231V, 0.91A, 400W(1ms), Bidirectional	DO-214AC	1ba	1j	Eic
S5s	BBY52-03W	C-diode	VCO-Tuning, 7V, 20mA, 1.4. 2.2pF(4..1V)	SOD-323	5d	1a	Inf
S6	1PS76SB62	Si-diode	Schottky, Sw, 40V, 20mA, Vf<0.8V(2mA), <0.6pF	SOD-323	5d	1a	Phi
S6	D3FS6	Si-diode	SBR, 60V, 3A, Vf<0.58V(3A)	SOD-15	1d	1a	Shi
S6	FS2K	Si-diode	Rectifier, 800V, 1.5A, Vf<1.1V(1.5A), 4µs	DO-214AA	1d	2j	Fag
S6	PSM12PT	Si-diode	Rectifier, S-fast, 100V, 800mA	SOD-123S	7d	1a	Chm
S6	SD103AW	Si-diode	Schottky, Sw, 40V, 350mA, 400mW, 10ns, 28pF	SOD-123	5d	1d	Vs
S6	SD103AWS	Si-diode	Schottky, Sw, 40V, 350mA, 200mW, 10ns, 28pF	SOD-323	5d	1a	Vs
S6	SD103CW	Si-diode	Schottky, Sw, 20V, 350mA, 400mW, 10ns, 28pF	SOD-123	5d	1d	Di
S6	SD103CWS	Si-diode	Schottky, Sw, 20V, 350mA, 200mW, 10ns, 28pF	SOD-323	5d	1d	Di
S6	SS16	Si-diode	SBR, 60V, 1A, Vf<0.75V(1A)	DO-214AC	1d	1k	Vs
S6	SS26	Si-diode	SBR, 60V, 2A, Vf<0.7V(2A)	DO-214AA	1d	1k	Vs
S6	SS36	Si-diode	SBR, 60V, 3A, Vf<0.7V(3A)	DO-214AB	1d	1k	Vs
S7	1PS76SB17	Si-diode	Schottky, Sw, 4V, 30mA, Vf<0.6V(10mA), <0.65pF	SOD-323	5d	1a	Phi
S7	BAT42W	Si-diode	SBR, 30V, 200mA, Vf<1V(200mA), 4pF, 5ns	SOD-123	5d	1d	Di
S7	BAT42WS	Si-diode	SBR, 30V, 200mA, Vf<1V(200mA), 4pF, 5ns	SOD-323	5d	1d	Di
S7	FS2M	Si-diode	Rectifier, 1000V, 1.5A, Vf<1.1V(1.5A), 4µs	DO-214AA	1d	2j	Fag
S7	PSM13PT	Si-diode	Rectifier, S-fast, 200V, 800mA	SOD-123S	7d	1a	Chm
S7	SD103BW	Si-diode	Schottky, Sw, 30V, 350mA, 400mW, 10ns, 28pF	SOD-123	5d	1d	Vs
S7	SD103BWS	Si-diode	Schottky, Sw, 30V, 350mA, 200mW, 10ns, 28pF	SOD-323	5d	1a	Vs
S8	BAT43W	Si-diode	SBR, 30V, 200mA, Vf<1V(200mA), 4pF, 5ns	SOD-123	5d	1d	Di
S8	BAT43WS	Si-diode	SBR, 30V, 200mA, Vf<1V(200mA), 4pF, 5ns	SOD-323	5d	1d	Di
S8	BZX84J-B10	Z-diode	10V±2%, If=250mA, 550mW	SOD-323FL	7d	1a	Phi
S8	MMSZ15H	Z-diode	14.3..15.8V, Izt=5mA, Zzt=30Ω, 200mW	SOD-523	7d	1a	Zow
S8	MMSZ15V	Z-diode	15V±5%, Izt=5mA, Zzt=30Ω, 200mW	SOD-523	6d	1a	Eic
S8	SD103CW	Si-diode	Schottky, Sw, 20V, 350mA, 400mW, 10ns, 28pF	SOD-123	5d	1d	Vs
S8	SD103CWS	Si-diode	Schottky, Sw, 20V, 350mA, 200mW, 10ns, 28pF	SOD-323	5d	1a	Vs
S8	SMD24SPT	Si-diode	Rectifier, Schottky, 40V, 1.5A, Vf<0.65V(1.1A)	SOD-123	5d	1a	Chm
S9	1PS79SB62	Si-diode	SBD, U-Speed, 40V, 20mA, <0.6pF	SOD-523	6d	1a	Phi
S9	BAT46W	Si-diode	SBD, 100V, 150mA, Vf<1V(250mA), 6pF	SOD-123	5d	1d	Di
S9	BZX84J-B11	Z-diode	11V±2%, If=250mA, 550mW	SOD-323FL	7d	1a	Phi
S9	SS1H9	Si-diode	SBR, 90V, 1A, Vf<0.7V(2A)	DO-214AC	1d	1k	Vs
S9	SS29	Si-diode	SBR, 90V, 2A, Vf<0.7V(2A)	DO-214AA	1d	1k	Vs
S9	SSM08150SPT	Si-diode	Rectifier, Schottky, 150V, 800mA, Vf<0.85V(800mA)	SOD-123	5d	1a	Chm
SA	1N5711W	Si-diode	Schottky, VHF/UHF-Dem, 70V, 15mA, <2pF	SOD-123	5d	1a	Di
SA	1N5711WS	Si-diode	Schottky, VHF/UHF-Dem, 70V, 15mA, <2pF	SOD-323	5d	1a	Di
SA	BZX84J-B12	Z-diode	12V±2%, If=250mA, 550mW	SOD-323FL	7d	1a	Phi
SA	CH157H-70PT	Si-diode	SBD, 70V, 15mA, Vf<1V(15mA), 1ns	SOD-323	5d	1a	Chm
SA	S1A	Si-diode	Rectifier, 50V, 1A, Vf<1.1V(1A)	DO-214AC	1d	1k	Vs
SA	S2A	Si-diode	Rectifier, 50V, 1.5A, Vf<1.15V(1.5A)	DO-214AA	1d	1k	Vs
SA	S3A	Si-diode	Rectifier, 50V, 3A, Vf<1.15V(2.5A)	DO-214AB	1d	1k	Vs
SA	SD101AW	Si-diode	Schottky, Fast Sw, 60V, 30mA, 2pF, 1ns	SOD-123	5d	1a	Vs
SA	SD101AWS	Si-diode	Schottky, Fast Sw, 60V, 30mA, 2pF, 1ns	SOD-323	5d	1a	Vs
SA	TV04A141K-G	TVS	Vrwm=140.0V, Vbr=155.68..190.40V, Ipp=1.60A, 400W(1ms)	DO-214AC	1d	1a	Cmc
SB	1N6263W	Si-diode	SBD, VHF/UHF-Dem, 60V, 15mA, Vf<1V(15mA), 2pF	SOD-123	5d	1d	Di
SB	BZX84J-B13	Z-diode	13V±2%, If=250mA, 550mW	SOD-323FL	7d	1a	Phi
SB	KDZ9.1B	Z-diode	9.1V±2.5%, 40mA, 1W	PMDU	7d	1s	Rhm
SB	MSE1PB	Si-diode	Rectifier, 100V, 1A, Vf<1.1V(3A)	MicroSMP	8d	1k	Vs
SB	P4SMA24C	TVS	Vrwm=24V, 12A, 400W (1ms), Bidirectional	DO-214AC	1ba	2k	Fag
SB	S1B	Si-diode	Rectifier, 100V, 1A, Vf<1.1V(1A)	DO-214AC	1d	1k	Vs
SB	S1PB	Si-diode	Rectifier, 100V, 1A, Vf<1.1V(1A)	DO-220AA	8d	1k	Vs
SB	S2B	Si-diode	Rectifier, 100V, 1.5A, Vf<1.15V(1.5A)	DO-214AA	1d	1k	Vs
SB	S3B	Si-diode	Rectifier, 100V, 3A, Vf<1.15V(2.5A)	DO-214AB	1d	1k	Vs
SB	SD101BW	Si-diode	Schottky, Fast Sw, 50V, 30mA, 2pF, 1ns	SOD-123	5d	1a	Vs
SB	SD101BWS	Si-diode	Schottky, Fast Sw, 50V, 30mA, 2pF, 1ns	SOD-323	5d	1a	Vs
SB	SMAJ550	TVS	Vrwm=550V, Vbr=513.577V, 1A, 400W(1ms)	DO-214AC	1d	1k	Vs
SB	TV04A141J-G	TVS	Vrwm=140.0V, Vbr=155.0..171.0V, Ipp=1.76A, 400W(1ms)	DO-214AC	1d	1a	Cmc
SB12	SBM12PT	Si-diode	Rectifier, Schottky, 20V, 1A, Vf<0.5V(1A)	DO-214AA	1d	1a	Chm
SB13	SBM13PT	Si-diode	Rectifier, Schottky, 30V, 1A, Vf<0.5V(1A)	DO-214AA	1d	1a	Chm
SB14	SBM14PT	Si-diode	Rectifier, Schottky, 40V, 1A, Vf<0.5V(1A)	DO-214AA	1d	1a	Chm
SB15	SBM15PT	Si-diode	Rectifier, Schottky, 50V, 1A, Vf<0.7V(1A)	DO-214AA	1d	1a	Chm
SB16	SBM16PT	Si-diode	Rectifier, Schottky, 60V, 1A, Vf<0.7V(1A)	DO-214AA	1d	1a	Chm
SB17	SBM17PT	Si-diode	Rectifier, Schottky, 70V, 1A, Vf<0.75V(1A)	DO-214AA	1d	1a	Chm
SB18	SBM18PT	Si-diode	Rectifier, Schottky, 80V, 1A, Vf<0.75V(1A)	DO-214AA	1d	1a	Chm
SB19	SBM19PT	Si-diode	Rectifier, Schottky, 90V, 1A, Vf<0.8V(1A)	DO-214AA	1d	1a	Chm
SB22	SBM22PT	Si-diode	Rectifier, Schottky, 20V, 2A, Vf<0.55V(2A)	DO-214AA	1d	1a	Chm
SB23	SBM23PT	Si-diode	Rectifier, Schottky, 30V, 2A, Vf<0.55V(2A)	DO-214AA	1d	1a	Chm
SB24	SBM24PT	Si-diode	Rectifier, Schottky, 40V, 2A, Vf<0.55V(2A)	DO-214AA	1d	1a	Chm
SB25	SBM25PT	Si-diode	Rectifier, Schottky, 50V, 2A, Vf<0.7V(2A)	DO-214AA	1d	1a	Chm
SB26	SBM26PT	Si-diode	Rectifier, Schottky, 60V, 2A, Vf<0.7V(2A)	DO-214AA	1d	1a	Chm



SMD code	Type	Function	Short description	Case	Pinout	St.	Mnf.
SB27	SBM27PT	Si-diode	Rectifier, Schottky, 70V, 2A, Vf<0.75V(2A)	DO-214AA	1d	1a	Chm
SB28	SBM28PT	Si-diode	Rectifier, Schottky, 80V, 2A, Vf<0.75V(2A)	DO-214AA	1d	1a	Chm
SB29	SBM29PT	Si-diode	Rectifier, Schottky, 90V, 2A, Vf<0.8V(2A)	DO-214AA	1d	1a	Chm
SB32	SBM32PT	Si-diode	Rectifier, Schottky, 20V, 3A, Vf<0.55V(3A)	DO-214AA	1d	1a	Chm
SB33	SBM33PT	Si-diode	Rectifier, Schottky, 30V, 3A, Vf<0.55V(3A)	DO-214AA	1d	1a	Chm
SB34	SBM34PT	Si-diode	Rectifier, Schottky, 40V, 3A, Vf<0.55V(3A)	DO-214AA	1d	1a	Chm
SB35	SBM35PT	Si-diode	Rectifier, Schottky, 50V, 3A, Vf<0.75V(3A)	DO-214AA	1d	1a	Chm
SB36	SBM36PT	Si-diode	Rectifier, Schottky, 60V, 3A, Vf<0.75V(3A)	DO-214AA	1d	1a	Chm
SB37	SBM37PT	Si-diode	Rectifier, Schottky, 70V, 3A, Vf<0.75V(3A)	DO-214AA	1d	1a	Chm
SB38	SBM38PT	Si-diode	Rectifier, Schottky, 80V, 3A, Vf<0.75V(3A)	DO-214AA	1d	1a	Chm
SB39	SBM39PT	Si-diode	Rectifier, Schottky, 90V, 3A, Vf<0.8V(3A)	DO-214AA	1d	1a	Chm
SB52	SBM52PT	Si-diode	Rectifier, Schottky, 20V, 5A, Vf<0.55V(5A)	DO-214AA	1d	1a	Chm
SB53	SBM53PT	Si-diode	Rectifier, Schottky, 30V, 5A, Vf<0.55V(5A)	DO-214AA	1d	1a	Chm
SB54	SBM54PT	Si-diode	Rectifier, Schottky, 40V, 5A, Vf<0.55V(5A)	DO-214AA	1d	1a	Chm
SB55	SBM55PT	Si-diode	Rectifier, Schottky, 50V, 5A, Vf<0.7V(5A)	DO-214AA	1d	1a	Chm
SB56	SBM56PT	Si-diode	Rectifier, Schottky, 60V, 5A, Vf<0.7V(5A)	DO-214AA	1d	1a	Chm
SB84	SBM84PT	Si-diode	Rectifier, Schottky, 40V, 8A, Vf<0.55V(8A)	DO-214AB	1d	1a	Chm
SB86	SBM86PT	Si-diode	Rectifier, Schottky, 60V, 8A, Vf<0.75V(8A)	DO-214AB	1d	1a	Chm
SC	BZX84J-B15	Z-diode	15V±2%, If=250mA, 550mW	SOD-323FL	7d	1a	Phi
SC	CH43H-30PT	Si-diode	SBD, 30V, 200mA, Vf<1V(200mA), 5ns	SOD-323	5d	1a	Chm
SC	SD101CW	Si-diode	Schottky, Fast Sw, 40V, 30mA, 2pF, 1ns	SOD-123	5d	1a	Vs
SC	SD101CWS	Si-diode	Schottky, Fast Sw, 40V, 15mA, 2.2pF, 1ns	SOD-323	5d	1a	Di,Vs
SC32	SCM32PT	Si-diode	Rectifier, Schottky, 20V, 3A, Vf<0.55V(3A)	DO-214AB	1d	1a	Chm
SC33	SCM33PT	Si-diode	Rectifier, Schottky, 30V, 3A, Vf<0.55V(3A)	DO-214AB	1d	1a	Chm
SC34	SCM34PT	Si-diode	Rectifier, Schottky, 40V, 3A, Vf<0.55V(3A)	DO-214AB	1d	1a	Chm
SC35	SCM35PT	Si-diode	Rectifier, Schottky, 50V, 3A, Vf<0.7V(3A)	DO-214AB	1d	1a	Chm
SC36	SCM36PT	Si-diode	Rectifier, Schottky, 60V, 3A, Vf<0.7V(3A)	DO-214AB	1d	1a	Chm
SC37	SCM37PT	Si-diode	Rectifier, Schottky, 70V, 3A, Vf<0.75V(3A)	DO-214AB	1d	1a	Chm
SC38	SCM38PT	Si-diode	Rectifier, Schottky, 80V, 3A, Vf<0.75V(3A)	DO-214AB	1d	1a	Chm
SC39	SCM39PT	Si-diode	Rectifier, Schottky, 90V, 3A, Vf<0.8V(3A)	DO-214AB	1d	1a	Chm
SC52	SCM52PT	Si-diode	Rectifier, Schottky, 20V, 5A, Vf<0.55V(5A)	DO-214AB	1d	1a	Chm
SC53	SCM53PT	Si-diode	Rectifier, Schottky, 30V, 5A, Vf<0.55V(5A)	DO-214AB	1d	1a	Chm
SC54	SCM54PT	Si-diode	Rectifier, Schottky, 40V, 5A, Vf<0.55V(5A)	DO-214AB	1d	1a	Chm
SC55	SCM55PT	Si-diode	Rectifier, Schottky, 50V, 5A, Vf<0.7V(5A)	DO-214AB	1d	1a	Chm
SC56	SCM56PT	Si-diode	Rectifier, Schottky, 60V, 5A, Vf<0.7V(5A)	DO-214AB	1d	1a	Chm
SD	B0520LW	Si-diode	SBR, 20V, 500mA, Vf<0.33V(500mA)	SOD-123	5d	1d	Di
SD	B0520WS	Si-diode	SBR, 20V, 500mA, Vf<0.33V(500mA)	SOD-323	5d	1a	Di
SD	BZX84J-B16	Z-diode	16V±2%, If=250mA, 550mW	SOD-323FL	7d	1a	Phi
SD	MSE1PD	Si-diode	Rectifier, 200V, 1A, Vf<1.1V(3A)	MicroSMP	8d	1k	Vs
SD	P4SMA27C	TVS	Vrwm=27V, 11A, 400W(1ms), Bidirectional	DO-214AC	1ba	2k	Fag
SD	P4SMAJ110	TVS	Vbr=110V, 2A, 400W(1ms)	DO-214AC	1d	1m,1w	Pjt,Srj
SD	S1D	Si-diode	Rectifier, 200V, 1A, Vf<1.1V(1A)	DO-214AC	1d	1k	Vs
SD	S1PD	Si-diode	Rectifier, 200V, 1A, Vf<1.1V(1A)	DO-220AA	8d	1k	Vs
SD	S2D	Si-diode	Rectifier, 200V, 1.5A, Vf<1.15V(1.5A)	DO-214AA	1d	1k	Vs
SD	S3D	Si-diode	Rectifier, 200V, 3A, Vf<1.15V(2.5A)	DO-214AB	1d	1k	Vs
SD	TV04A111K-G	TVS	Vrwm=110.0V, Vbr=122.0..149.0V, lpp=2.04A, 400W(1ms)	DO-214AC	1d	1a	Cmc
SE	1SMA26A	TVS	Vrwm=26V±5%, 9.5A, 400W(1ms)	403B-01	3d	1f	Ons
SE	B0530W	Si-diode	SBR, 30V, 500mA, Vf<0.45V(500mA)	SOD-123	5d	1d	Di
SE	B0530WS	Si-diode	SBR, 30V, 500mA, Vf<0.45V(500mA)	SOD-323	5d	1d	Di
SE	BZX84J-B18	Z-diode	18V±2%, If=250mA, 550mW	SOD-323FL	7d	1a	Phi
SE	CD214A-T110A	TVS	Vbr=110V, Irs=2.3A, 400W(1ms)	DO-214AC	1d	1a	Bm
SE	CH451H-30PT	Si-diode	SBD, 30V, 500mA, Vf<0.55V(500mA)	SOD-323	5d	1a	Chm
SE	P4SMAJ110A	TVS	Vbr=110V, 2.3A, 400W(1ms)	DO-214AC	1d	1m,1w	Pjt,Srj
SE	SMAJ110A	TVS	Vrwm=110V, Vbr=122..135V, 1.7A, 400W(1ms)	DO-214AC	1d	1k,1m	Di,Vs
SE	TV04A111J-G	TVS	Vrwm=110.0V, Vbr=122.0..135.0V, lpp=2.26A, 400W(1ms)	DO-214AC	1d	1a	Cmc
SEC	1SMA26CA	TVS	Vrwm=26V±5%, 9.5A, 400W(1ms), Bidirectional	403B-01	3ba	1e	Ons
SF	B0540W	Si-diode	SBR, 40V, 500mA, Vf<0.46V(500mA), 170pF	SOD-123	5d	1d	Di
SF	B0540WS	Si-diode	SBR, 40V, 500mA, Vf<0.48V(500mA), 120pF	SOD-323	5d	1d	Di
SF	BZX84J-B20	Z-diode	20V±2%, If=250mA, 550mW	SOD-323FL	7d	1a	Phi
SF	KDZ30FV	Z-diode	28.0..32.0V, Izt=2mA, Zzt=200Ω, 100mW	TFSC	7d	1a	Kec
SF	MAZD220	Z-diode	20.8..23.3V, Zzt=80Ω(5mA), 120mW	SSSMini2	7d	1a	Pan
SF	P4SMA30C	TVS	Vrwm=30V, 10A, 400W(1ms), Bidirectional	DO-214AC	1ba	2k	Fag
SF	P4SMAJ120	TVS	Vbr=120V, 1.9A, 400W(1ms)	DO-214AC	1d	1m,1w	Pjt,Srj
SF	SMAJ120	TVS	Vrwm=120V, Vbr=133..163V, 1.4A, 400W(1ms)	DO-214AC	1d	1k	Vs
SF	TV04A121K-G	TVS	Vrwm=120.0V, Vbr=133.0..163.0V, lpp=1.87A, 400W(1ms)	DO-214AC	1d	1a	Cmc
SG	1SMA28A	TVS	Vrwm=28V±5%, 8.8A, 400W(1ms)	403B-01	3d	1f	Ons
SG	BZX84J-B22	Z-diode	22V±2%, If=250mA, 550mW	SOD-323FL	7d	1a	Phi
SG	CD214A-T120A	TVS	Vbr=120V, Irs=2.0A, 400W(1ms)	DO-214AC	1d	1a	Bm
SG	MSE1PG	Si-diode	Rectifier, 400V, 1A, Vf<1.1V(3A)	MicroSMP	8d	1k	Vs
SG	P4SMAJ120A	TVS	Vbr=120V, 2A, 400W(1ms)	DO-214AC	1d	1m,1w	Pjt,Srj



SMD code	Type	Function	Short description	Case	Pinout	St.	Mnf.
SG	S1G	Si-diode	Rectifier, 400V, 1A, Vf<1.1V(1A)	DO-214AC	1d	1k	Vs
SG	S1PG	Si-diode	Rectifier, 400V, 1A, Vf<1.1V(1A)	DO-220AA	8d	1k	Vs
SG	S2G	Si-diode	Rectifier, 400V, 1.5A, Vf<1.15V(1.5A)	DO-214AA	1d	1k	Vs
SG	S3G	Si-diode	Rectifier, 400V, 3A, Vf<1.15V(2.5A)	DO-214AB	1d	1k	Vs
SG	SMAJ120A	TVS	Vrwm=120V, Vbr=133..147V, 1.6A, 400W(1ms)	DO-214AC	1d	1k,1m	Di,Vs
SG	TV04A121J-G	TVS	Vrwm=120.0V, Vbr=133.0..147.0V, lpp=2.07A, 400W(1ms)	DO-214AC	1d	1A	Cmc
SGC	1SMA28CA	TVS	Vrwm=28V±5%, If=8.8A, 400W(1ms), Bidirectional	403B-01	3ba	1e	Ons
SH	BZX84J-B24	Z-diode	24V±2%, If=250mA, 550mW	SOD-323FL	7d	1a	Phi
SH	P4SMA33C	TVS	Vrwm=33V, 9A, 400W(1ms), Bidirectional	DO-214AC	1ba	2k	Fag
SH	P4SMAJ130	TVS	Vbr=130V, 1.7A, 400W(1ms)	DO-214AC	1d	1m,1w	Pjt,Srj
SH	SMAJ130	TVS	Vrwm=130V, Vbr=144..176V, 1.3A, 400W(1ms)	DO-214AC	1d	1k	Vs
SH	TV04A131K-G	TVS	Vrwm=130.0V, Vbr=144.0..176.0V, lpp=1.73A, 400W(1ms)	DO-214AC	1d	1a	Cmc
SI	SDB310Q	Si-diode	SBR, 30V, 0.2A, 150mW, <5ns	SOD-523	6d	1a	Sme
SJ	1N6263W	Si-diode	SBD, VHF/UHF-Dem, 60V, 15mA, Vf<1.15V(15mA), 2pF	SOD-323FL	7d	1a	Sme
SJ	MSE1PJ	Si-diode	Rectifier, 600V, 1A, Vf<1.1V(3A)	MicroSMP	8d	1k	Vs
SJ	P4SMA36C	TVS	Vrwm=36V, 8A, 400W(1ms), Bidirectional	DO-214AC	1ba	2k	Fag
SJ	S1J	Si-diode	Rectifier, 600V, 1A, Vf<1.1V(1A)	DO-214AC	1d	1k	Vs
SJ	S1PJ	Si-diode	Rectifier, 600V, 1A, Vf<1.1V(1A)	DO-220AA	8d	1k	Vs
SJ	S2J	Si-diode	Rectifier, 600V, 1.5A, Vf<1.15V(1.5A)	DO-214AA	1d	1k	Vs
SJ	S3J	Si-diode	Rectifier, 600V, 3A, Vf<1.15V(2.5A)	DO-214AB	1d	1k	Vs
SK	1SMA30A	TVS	Vrwm=30V±5%, 8.3A, 400W(1ms)	403B-01	3d	1f	Ons
SK	BZX84J-B27	Z-diode	27V±2%, If=250mA, 550mW	SOD-323FL	7d	1a	Phi
SK	CD214A-T130A	TVS	Vbr=130V, Irlsm=1.9A, 400W(1ms)	DO-214AC	1d	1a	Bm
SK	P4SMAJ130A	TVS	Vbr=130V, 1.9A, 400W(1ms)	DO-214AC	1d	1m,1w	Pjt,Srj
SK	S1K	Si-diode	Rectifier, 800V, 1A, Vf<1.1V(1A)	DO-214AC	1d	1k	Vs
SK	S1PK	Si-diode	Rectifier, 800V, 1A, Vf<1.1V(1A)	DO-220AA	8d	1k	Vs
SK	S2K	Si-diode	Rectifier, 800V, 1.5A, Vf<1.15V(1.5A)	DO-214AA	1d	1k	Vs
SK	S3K	Si-diode	Rectifier, 800V, 3A, Vf<1.15V(2.5A)	DO-214AB	1d	1k	Vs
SK	SD101AW	Si-diode	Schottky, Fast Sw, 60V, 15mA, 2pF, 1ns	SOD-123	5d	1d	Di
SK	SD101AWS	Si-diode	Schottky, Fast Sw, 60V, 15mA, 2pF, 1ns	SOD-323	5d	1d	Di
SK	SD101BW	Si-diode	Schottky, Fast Sw, 50V, 15mA, 2.1pF, 1ns	SOD-123	5d	1d	Di
SK	SD101BWS	Si-diode	Schottky, Fast Sw, 50V, 15mA, 2.1pF, 1ns	SOD-323	5d	1d	Di
SK	SD101CW	Si-diode	Schottky, Fast Sw, 40V, 15mA, 2.2pF, 1ns	SOD-123	5d	1d	Di
SK	SD101CWS	Si-diode	Schottky, Fast Sw, 40V, 15mA, 2.2pF, 1ns	SOD-323	5d	1d	Di
SK	SMAJ130A	TVS	Vrwm=130V, Vbr=144..159V, 1.4A, 400W(1ms)	DO-214AC	1d	1k,1m	Di,Vs
SK	TV04A131J-G	TVS	Vrwm=130.0V, Vbr=144.0..159.0V, lpp=1.91A, 400W(1ms)	DO-214AC	1d	1a	Cmc
SK14	SSM14APT	Si-diode	Rectifier, Schottky, 40V, 1A, Vf<0.5V(1A)	SMA-S	8d	1a	Chm
SK210	SSM210APT	Si-diode	Rectifier, Schottky, 100V, 2A, Vf<0.8V(2A)	SMA-S	8d	1a	Chm
SK24	SSM24APT	Si-diode	Rectifier, Schottky, 40V, 2A, Vf<0.5V(2A)	SMA-S	8d	1a	Chm
SK27	SSM27APT	Si-diode	Rectifier, Schottky, 70V, 2A, Vf<0.75V(2A)	SMA-S	8d	1a	Chm
SK28	SSM28APT	Si-diode	Rectifier, Schottky, 80V, 2A, Vf<0.75V(2A)	SMA-S	8d	1a	Chm
SK29	SSM29APT	Si-diode	Rectifier, Schottky, 90V, 2A, Vf<0.8V(2A)	SMA-S	8d	1a	Chm
SK34	SSM34APT	Si-diode	Rectifier, Schottky, 40V, 3A, Vf<0.5V(3A)	SMA-S	8d	1a	Chm
SKC	1SMA30CA	TVS	Vrwm=30V±5%, 8.3A, 400W(1ms), Bidirectional	403B-01	3ba	1e	Ons
SKE	SACB5.0	TVS	Vrwm=5.0V, Vbr=7.6V, 44A, 500W(1ms)	DO-214AA	1d	1a	Pic
SKG	SACB6.0	TVS	Vrwm=6.0V, Vbr=7.9V, 41A, 500W(1ms)	DO-214AA	1d	1a	Pic
SKM	SACB7.0	TVS	Vrwm=7.0V, Vbr=8.3V, 38A, 500W(1ms)	DO-214AA	1d	1a	Pic
SKR	SACB8.0	TVS	Vrwm=8.0V, Vbr=8.9V, 36A, 500W(1ms)	DO-214AA	1d	1a	Pic
SKT	SACB8.5	TVS	Vrwm=8.5V, Vbr=9.44V, 34A, 500W(1ms)	DO-214AA	1d	1a	Pic
SKX	SACB10	TVS	Vrwm=10V, Vbr=11.1V, 29A, 500W(1ms)	DO-214AA	1d	1a	Pic
SL	1N5819HW	Si-diode	SBR, 40V, 1A, Vf<0.45V(1A), 50pF	SOD-123	5d	1d	Di
SL	BZX84J-B2V4	Z-diode	2.4V±2%, If=250mA, 550mW	SOD-323FL	7d	1a	Phi
SL	P4SMA39C	TVS	Vrwm=39V, 7.4A, 400W(1ms), Bidirectional	DO-214AC	1ba	2k	Fag
SL	P4SMAJ150	TVS	Vbr=150V, 1.5A, 400W(1ms)	DO-214AB	1d	1m,1w	Pjt,Srj
SL	SMAJ150	TVS	Vrwm=150V, Vbr=167..204V, 1.1A, 400W(1ms)	DO-214AC	1d	1k	Vs
SL	TV04A151K-G	TVS	Vrwm=150.0V, Vbr=167.0..204.0V, lpp=1.49A, 400W(1ms)	DO-214AC	1d	1a	Cmc
SL2	SL12	Si-diode	SBR, 20V, 1.5A, Vf<0.44V(1A)	DO-214AC	1d	1k	Vs
SL2	SL22	Si-diode	SBR, 20V, 2A, Vf<0.44V(2A)	DO-214AA	1d	1k	Vs
SL2	SL42	Si-diode	SBR, 20V, 4A, Vf<0.42V(4A)	DO-214AB	1d	1k	Vs
SL3	SL13	Si-diode	SBR, 30V, 1.5A, Vf<0.44V(1A)	DO-214AC	1d	1k	Vs
SL3	SL23	Si-diode	SBR, 30V, 2A, Vf<0.44V(2A)	DO-214AA	1d	1k	Vs
SL3	SL43	Si-diode	SBR, 30V, 4A, Vf<0.42V(4A)	DO-214AB	1d	1k	Vs
SL4	SL44	Si-diode	SBR, 40V, 4A, Vf<0.42V(4A)	DO-214AB	1d	1k	Vs
SLE	SACB12	TVS	Vrwm=12V, Vbr=13.3V, 25A, 500W(1ms)	DO-214AA	1d	1a	Pic
SLM	SACB15	TVS	Vrwm=15V, Vbr=16.7V, 20A, 500W(1ms)	DO-214AA	1d	1a	Pic
SLT	SACB18	TVS	Vrwm=18V, Vbr=20.0V, 15A, 500W(1ms)	DO-214AA	1d	1a	Pic
SLX	SACB22	TVS	Vrwm=22V, Vbr=24.4V, 14A, 500W(1ms)	DO-214AA	1d	1a	Pic
SM	1SMA33A	TVS	Vrwm=33V±5%, 7.5A, 400W(1ms)	403B-01	3d	1f	Ons
SM	BZX84J-B2V7	Z-diode	2.7V±2%, If=250mA, 550mW	SOD-323FL	7d	1a	Phi
SM	CD214A-T150A	TVS	Vbr=150V, Irlsm=1.6A, 400W(1ms)	DO-214AC	1d	1a	Bm



SMD code	Type	Function	Short description	Case	Pinout	St.	Mnf.
SM	P4SMAJ150A	TVS	Vbr=150V, 1.6A, 400W (1ms)	DO-214AB	1d	1m,1w	Pjt,Srj
SM	S1M	Si-diode	Rectifier, 1000V, 1A, Vf<1.1V(1A)	DO-214AC	1d	1k	Vs
SM	S1PM	Si-diode	Rectifier, 1000V, 1A, Vf<1.1V(1A)	DO-220AA	8d	1k	Vs
SM	S2M	Si-diode	Rectifier, 1000V, 1.5A, Vf<1.15V(1.5A)	DO-214AA	1d	1k	Vs
SM	S3M	Si-diode	Rectifier, 1000V, 3A, Vf<1.15V(2.5A)	DO-214AB	1d	1k	Vs
SM	SMAJ150A	TVS	Vrwm=150V, Vbr=167.185V, 1.2A, 400W(1ms)	DO-214AC	1d	1k,1m	Di,Vs
SM	TV04A151J-G	TVS	Vrwm=150.0V, Vbr=167.0.185.0V, Ipp=1.65A, 400W(1ms)	DO-214AC	1d	1a	Cmc
SM17	SSM5817PT	Si-diode	Rectifier, Schottky, 20V, 1A, Vf<0.45V(1A)	DO-214AC	1d	1a	Chm
SM18	SSM5818PT	Si-diode	Rectifier, Schottky, 30V, 1A, Vf<0.55V(1A)	DO-214AC	1d	1a	Chm
SM19	SSM5819PT	Si-diode	Rectifier, Schottky, 40V, 1A, Vf<0.6V(1A)	DO-214AC	1d	1a	Chm
SM84	SCM84PT	Si-diode	Rectifier, Schottky, 40V, 8A, Vf<0.55V(8A)	DO-214AB	1d	1a	Chm
SMA10A	PSMA10A	TVS	Vrwm=10V, 23.5A, 400W (1ms)	DO-214AC	1d	1a	Phi
SMA11A	PSMA11A	TVS	Vrwm=11V, 22A, 400W (1ms)	DO-214AC	1d	1a	Phi
SMA12A	PSMA12A	TVS	Vrwm=12V, 20.1A, 400W (1ms)	DO-214AC	1d	1a	Phi
SMA13A	PSMA13A	TVS	Vrwm=13V, 18.6A, 400W (1ms)	DO-214AC	1d	1a	Phi
SMA14A	PSMA14A	TVS	Vrwm=14V, 17.2A, 400W (1ms)	DO-214AC	1d	1a	Phi
SMA15A	PSMA15A	TVS	Vrwm=15V, 16.4A, 400W (1ms)	DO-214AC	1d	1a	Phi
SMA16A	PSMA16A	TVS	Vrwm=16V, 15.4A, 400W (1ms)	DO-214AC	1d	1a	Phi
SMA17A	PSMA17A	TVS	Vrwm=17V, 14.5A, 400W (1ms)	DO-214AC	1d	1a	Phi
SMA18A	PSMA18A	TVS	Vrwm=18V 13.7A, 400W (1ms)	DO-214AC	1d	1a	Phi
SMA20A	PSMA20A	TVS	Vrwm=20V, 12.3A, 400W (1ms)	DO-214AC	1d	1a	Phi
SMA22A	PSMA22A	TVS	Vrwm=22V, 11.3A, 400W (1ms)	DO-214AC	1d	1a	Phi
SMA24A	PSMA24A	TVS	Vrwm=24V, 10.3A, 400W (1ms)	DO-214AC	1d	1a	Phi
SMA25B	PSMA5925B	Z-diode	10V±2.5%, 1.5W	DO-214AC	1d	1a	Phi
SMA26A	PSMA26A	TVS	Vrwm=26V, 9.5A, 400W (1ms)	DO-214AC	1d	1a	Phi
SMA26B	PSMA5926B	Z-diode	11V±2.5%, 1.5W	DO-214AC	1d	1a	Phi
SMA27B	PSMA5927B	Z-diode	12V±2.5%, 1.5W	DO-214AC	1d	1a	Phi
SMA28A	PSMA28A	TVS	Vrwm=28V, 8.8A, 400W (1ms)	DO-214AC	1d	1a	Phi
SMA28B	PSMA5928B	Z-diode	13V±2.5%, 1.5W	DO-214AC	1d	1a	Phi
SMA29B	PSMA5929B	Z-diode	15V±2.5%, 1.5W	DO-214AC	1d	1a	Phi
SMA30A	PSMA30A	TVS	Vrwm=30V, 8.3A, 400W (1ms)	DO-214AC	1d	1a	Phi
SMA30B	PSMA5930B	Z-diode	16V±2.5%, 1.5W	DO-214AC	1d	1a	Phi
SMA31B	PSMA5931B	Z-diode	18V±2.5%, 1.5W	DO-214AC	1d	1a	Phi
SMA32B	PSMA5932B	Z-diode	20V±2.5%, 1.5W	DO-214AC	1d	1a	Phi
SMA33A	PSMA33A	TVS	Vrwm=33V, 6.9A, 400W (1ms)	DO-214AC	1d	1a	Phi
SMA33B	PSMA5933B	Z-diode	22V±2.5%, 1.5W	DO-214AC	1d	1a	Phi
SMA34B	PSMA5934B	Z-diode	24V±2.5%, 1.5W	DO-214AC	1d	1a	Phi
SMA35B	PSMA5935B	Z-diode	27V±2.5%, 1.5W	DO-214AC	1d	1a	Phi
SMA36A	PSMA36A	TVS	Vrwm=36V, 6.2A, 400W (1ms)	DO-214AC	1d	1a	Phi
SMA36B	PSMA5936B	Z-diode	30V±2.5%, 1.5W	DO-214AC	1d	1a	Phi
SMA37B	PSMA5937B	Z-diode	33V±2.5%, 1.5W	DO-214AC	1d	1a	Phi
SMA38B	PSMA5938B	Z-diode	36V±2.5%, 1.5W	DO-214AC	1d	1a	Phi
SMA39B	PSMA5939B	Z-diode	39V±2.5%, 1.5W	DO-214AC	1d	1a	Phi
SMA40A	PSMA40A	TVS	Vrwm=40V, 5.8A, 400W (1ms)	DO-214AC	1d	1a	Phi
SMA40B	PSMA5940B	Z-diode	43V±2.5%, 1.5W	DO-214AC	1d	1a	Phi
SMA41B	PSMA5941B	Z-diode	47V±2.5%, 1.5W	DO-214AC	1d	1a	Phi
SMA42B	PSMA5942B	Z-diode	51V±2.5%, 1.5W	DO-214AC	1d	1a	Phi
SMA43A	PSMA43A	TVS	Vrwm=43V, 5.5A, 400W (1ms)	DO-214AC	1d	1a	Phi
SMA43B	PSMA5943B	Z-diode	56V±2.5%, 1.5W	DO-214AC	1d	1a	Phi
SMA44B	PSMA5944B	Z-diode	62V±2.5%, 1.5W	DO-214AC	1d	1a	Phi
SMA45A	PSMA45A	TVS	Vrwm=45V, 5.2A, 400W (1ms)	DO-214AC	1d	1a	Phi
SMA45B	PSMA5945B	Z-diode	68V±2.5%, 1.5W	DO-214AC	1d	1a	Phi
SMA48A	PSMA48A	TVS	Vrwm=48V, 4.9A, 400W (1ms)	DO-214AC	1d	1a	Phi
SMA51A	PSMA51A	TVS	Vrwm=51V, 4.6A, 400W (1ms)	DO-214AC	1d	1a	Phi
SMA54A	PSMA54A	TVS	Vrwm=54V, 4.3A, 400W (1ms)	DO-214AC	1d	1a	Phi
SMA58A	PSMA58A	TVS	Vrwm=58V, 4.1A, 400W (1ms)	DO-214AC	1d	1a	Phi
SMA60A	PSMA60A	TVS	Vrwm=60V, 3.9A, 400W (1ms)	DO-214AC	1d	1a	Phi
SMA64A	PSMA64A	TVS	Vrwm=64V, 3.6A, 400W (1ms)	DO-214AC	1d	1a	Phi
SMA70A	PSMA70A	TVS	Vrwm=70V, 3.5A, 400W (1ms)	DO-214AC	1d	1a	Phi
SMA75A	PSMA75A	TVS	Vrwm=75V, 3.3A, 400W (1ms)	DO-214AC	1d	1a	Phi
SMA78A	PSMA78A	TVS	Vrwm=78V, 3.2A, 400W (1ms)	DO-214AC	1d	1a	Phi
SMA8.5	PSMA8.5A	TVS	Vrwm=8.5V, 27.8A, 400W (1ms)	DO-214AC	1d	1a	Phi
SMA9.0	PSMA9.0A	TVS	Vrwm=9V, 26A, 400W (1ms)	DO-214AC	1d	1a	Phi
SMC	1SMA33CA	TVS	Vrwm=33V±5%, 7.5A, 400W (1ms), Bidirectional	403B-01	3ba	1e	Ons
SME	SACB26	TVS	Vrwm=26V, Vbr=28.9V, 11.1A, 500W(1ms)	DO-214AA	1d	1a	Pic
SMK	SACB30	TVS	Vrwm=30V, Vbr=33.3V, 10A, 500W(1ms)	DO-214AA	1d	1a	Pic
SMP	SACB36	TVS	Vrwm=36V, Vbr=40V, 8.6A, 500W(1ms)	DO-214AA	1d	1a	Pic
SMV	SACB45	TVS	Vrwm=45V, Vbr=50V, 6.8A, 500W(1ms)	DO-214AA	1d	1a	Pic
SMZ	SACB50	TVS	Vrwm=50V, Vbr=55.5V, 5.8A, 500W(1ms)	DO-214AA	1d	1a	Pic
SN	BZX84J-B30	Z-diode	30V±2%, If=250mA, 550mW	SOD-323FL	7d	1a	Phi



SMD
code

Type

Function

Short description

Case

Pinout

St.

Mnf.

SMD code	Type	Function	Short description	Case	Pinout	St.	Mnf.
SN	P4SMA43C	TVS	Vrwm=43V, 6.8A, 400W (1ms), Bidirectional	DO-214AC	1ba	2k	Fag
SN	P4SMAJ160	TVS	Vbr=160V, 1.4A, 400W (1ms)	DO-214AB	1d	1m,1w	Pjt,Srj
SN	SM4T68	TVS	Vbr=68V, 4.3A, 400W(1ms)	SOD-6	1d	1q	Ste
SN	SMAJ160	TVS	Vrwm=160V, Vbr=178..218V, 1A, 400W(1ms)	DO-214AC	1d	1k	Vs
SN	TV04A161K-G	TVS	Vrwm=160.0V, Vbr=178.0..218.0V, Ipp=1.39A, 400W(1ms)	DO-214AC	1d	1a	Cmc
SP	1SMA36A	TVS	Vrwm=36V±5%, 6.9A, 400W (1ms)	403B-01	3d	1f	Ons
SP	BZX84J-B33	Z-diode	33V±2%, If=250mA, 550mW	SOD-323FL	7d	1a	Phi
SP	CD214A-T160A	TVS	Vbr=160V, Irsrm=1.5A, 400W(1ms)	DO-214AC	1d	1a	Bm
SP	CMDZ9L1	Z-diode	8.645..9.555V, Izt=0.5mA, Zzt=60Ω, 250mW	SOD-323	5d	1a	Cen
SP	KDZ30FVY	Z-diode	29.19..30.69V, Izt=2mA, Zzt=200Ω, 100mW	TFSC	7d	1a	Kec
SP	P4SMA47C	TVS	Vrwm=47V, 6.2A, 400W (1ms), Bidirectional	DO-214AC	1ba	2k	Fag
SP	P4SMAJ160A	TVS	Vbr=160V, 1.5A, 400W (1ms)	DO-214AB	1d	1m,1w	Pjt,Srj
SP	SM4T68A	TVS	Vbr=68V, 4.3A, 400W(1ms)	SOD-6	1d	1q	Ste
SP	SMAJ160A	TVS	Vrwm=160V, Vbr=178..197V, 1.2A, 400W(1ms)	DO-214AC	1d	1k,1m	Di,Vs
SP	TV04A161J-G	TVS	Vrwm=160.0V, Vbr=178.0..197.0V, Ipp=1.54A, 400W(1ms)	DO-214AC	1d	1a	Cmc
SPC	1SMA36CA	TVS	Vrwm=36V±5%, 6.9A, 400W (1ms), Bidirectional	403B-01	3ba	1e	Ons
SQ	P4SMAJ170	TVS	Vbr=170V, 1.3A, 400W (1ms)	DO-214AB	1d	1m,1w	Pjt,Srj
SQ	SMAJ170	TVS	Vrwm=170V, Vbr=189..231V, 0.99A, 400W(1ms)	DO-214AC	1d	1k	Vs
SQ	TV04A171K-G	TVS	Vrwm=170.0V, Vbr=189.0..231.0V, Ipp=1.32A, 400W(1ms)	DO-214AC	1d	1a	Cmc
SR	1SMA40A	TVS	Vrwm=40V±5%, 6.2A, 400W (1ms)	403B-01	3d	1f	Ons
SR	BZX84J-B36	Z-diode	36V±2%, If=250mA, 550mW	SOD-323FL	7d	1a	Phi
SR	CD214A-T170A	TVS	Vbr=170V, Irsrm=1.4A, 400W(1ms)	DO-214AC	1d	1a	Bm
SR	P4SMAJ170A	TVS	Vbr=170V, 1.4A, 400W (1ms)	DO-214AB	1d	1m,1w	Pjt,Srj
SR	SMAJ170A	TVS	Vrwm=170V, Vbr=189..209V, 1.4A, 400W(1ms)	DO-214AC	1d	1m,1q	Di,Ste
SR	TV04A171J-G	TVS	Vrwm=170.0V, Vbr=189.0..209.0V, Ipp=1.54A, 400W(1ms)	DO-214AC	1d	1a	Cmc
SRC	1SMA40CA	TVS	Vrwm=40V±5%, 6.2A, 400W (1ms), Bidirectional	403B-01	3ba	1e	Ons
SS	BZX84J-B39	Z-diode	39V±2%, If=250mA, 550mW	SOD-323FL	7d	1a	Phi
SS	P4SMA51C	TVS	Vrwm=51V, 5.7A, 400W (1ms), Bidirectional	DO-214AC	1ba	2k	Fag
SS	P4SMAJ180	TVS	Vbr=180V, 1.2A, 400W (1ms)	DO-214AB	1d	1m,1w	Pjt,Srj
SS	SMAJ170CA	TVS	Vrwm=170V, Vbr=189..209V, 1.4A, 400W(1ms), Bidirectional	DO-214AC	1ba	1r	Ste
SS	SMAJ188A	TVS	Vrwm=188V, Vbr=209..231V, 0.91A, 400W(1ms)	DO-214AC	1d	1k	Vs
SS	TV04A181K-G	TVS	Vrwm=180.0V, Vbr=200..244.80V, Ipp=1.24A, 400W(1ms)	DO-214AC	1d	1a	Cmc
SS12	SSM12PT	Si-diode	Rectifier, Schottky, 20V, 1A, Vf<0.5V(1A)	DO-214AC	1d	1a	Chm
SS13	SSM13PT	Si-diode	Rectifier, Schottky, 30V, 1A, Vf<0.5V(1A)	DO-214AC	1d	1a	Chm
SS14	SSM14PT	Si-diode	Rectifier, Schottky, 40V, 1A, Vf<0.5V(1A)	DO-214AC	1d	1a	Chm
SS15	SSM15PT	Si-diode	Rectifier, Schottky, 50V, 1A, Vf<0.7V(1A)	DO-214AC	1d	1a	Chm
SS16	SSM16PT	Si-diode	Rectifier, Schottky, 60V, 1A, Vf<0.7V(1A)	DO-214AC	1d	1a	Chm
SS17	SSM17PT	Si-diode	Rectifier, Schottky, 70V, 1A, Vf<0.75V(1A)	DO-214AC	1d	1a	Chm
SS18	SSM18PT	Si-diode	Rectifier, Schottky, 80V, 1A, Vf<0.75V(1A)	DO-214AC	1d	1a	Chm
SS19	SSM19PT	Si-diode	Rectifier, Schottky, 90V, 1A, Vf<0.8V(1A)	DO-214AC	1d	1a	Chm
SS22	SSM22PT	Si-diode	Rectifier, Schottky, 20V, 2A, Vf<0.55V(2A)	SOD-123S	8d	1a	Chm
SS23	SSM23PT	Si-diode	Rectifier, Schottky, 30V, 2A, Vf<0.55V(2A)	DO-214AC	1d	1a	Chm
SS24	SSM24PT	Si-diode	Rectifier, Schottky, 40V, 2A, Vf<0.55V(2A)	DO-214AC	1d	1a	Chm
SS25	SSM25PT	Si-diode	Rectifier, Schottky, 50V, 2A, Vf<0.7V(2A)	DO-214AC	1d	1a	Chm
SS26	SS26	Si-diode	SBR, 60V, 2A, Vf=0.51V(1A)	403A	3d	1a	Ons
SS26	SSM26PT	Si-diode	Rectifier, Schottky, 60V, 2A, Vf<0.7V(2A)	DO-214AC	1d	1a	Chm
SS27	SSM27PT	Si-diode	Rectifier, Schottky, 70V, 2A, Vf<0.75V(2A)	DO-214AC	1d	1a	Chm
SS28	SSM28PT	Si-diode	Rectifier, Schottky, 80V, 2A, Vf<0.75V(2A)	DO-214AC	1d	1a	Chm
SS29	SSM29PT	Si-diode	Rectifier, Schottky, 90V, 2A, Vf<0.8V(2A)	DO-214AC	1d	1a	Chm
SS32	SSM32PT	Si-diode	Rectifier, Schottky, 20V, 3A, Vf<0.55V(3A)	DO-214AC	1d	1a	Chm
SS33	SSM33PT	Si-diode	Rectifier, Schottky, 30V, 3A, Vf<0.55V(3A)	DO-214AC	1d	1a	Chm
SS34	SSM34PT	Si-diode	Rectifier, Schottky, 40V, 3A, Vf<0.55V(3A)	DO-214AC	1d	1a	Chm
SS35	SSM35PT	Si-diode	Rectifier, Schottky, 50V, 3A, Vf<0.7V(3A)	DO-214AC	1d	1a	Chm
SS36	SSM36PT	Si-diode	Rectifier, Schottky, 60V, 3A, Vf<0.7V(3A)	DO-214AC	1d	1a	Chm
SS52	SSM52PT	Si-diode	Rectifier, Schottky, 20V, 5A, Vf<0.55V(5A)	DO-214AC	1d	1a	Chm
SS53	SSM53PT	Si-diode	Rectifier, Schottky, 30V, 5A, Vf<0.55V(5A)	DO-214AC	1d	1a	Chm
SS54	SSM54PT	Si-diode	Rectifier, Schottky, 40V, 5A, Vf<0.55V(5A)	DO-214AC	1d	1a	Chm
SS55	SSM55PT	Si-diode	Rectifier, Schottky, 50V, 5A, Vf<0.7V(5A)	DO-214AC	1d	1a	Chm
SS56	SSM56PT	Si-diode	Rectifier, Schottky, 60V, 5A, Vf<0.7V(5A)	DO-214AC	1d	1a	Chm
ST	1SMA43A	TVS	Vrwm=43V±5%, 5.8A, 400W (1ms),	403B-01	3d	1f	Ons
ST	BZX84J-B3V0	Z-diode	3.0V±2%, If=250mA, 550mW	SOD-323FL	7d	1a	Phi
ST	P4SMA56C	TVS	Vrwm=56V, 5.2A, 400W (1ms), Bidirectional	DO-214AC	1ba	2k	Fag
ST	P4SMAJ180A	TVS	Vbr=180V, 1.3A, 400W (1ms)	DO-214AB	1d	1m,1w	Pjt,Srj
ST	SMAJ188	TVS	Vrwm=188V, Vbr=209..231V, 0.9A, 400W(1ms)	DO-214AC	1d	1k	Vs
ST	TV04A181J-G	TVS	Vrwm=180.0V, Vbr=200.0..220.0V, Ipp=1.37A, 400W(1ms)	DO-214AC	1d	1a	Cmc
STC	1SMA43CA	TVS	Vrwm=43V±5%, 5.8A, 400W (1ms), Bidirectional	403B-01	3ba	1e	Ons
SU	BZX84J-B3V3	Z-diode	3.3V±2%, If=250mA, 550mW	SOD-323FL	7d	1a	Phi
SU	CH035H-20PT	Si-diode	SBD, 20V, 350mA, Vf<0.6V(200mA), 10ns	SOD-323	5d	1a	Chm
SU	P4SMA62C	TVS	Vrwm=6.2V, 4.7A, 400W (1ms), Bidirectional	DO-214AC	1ba	2k	Fag
SU	P4SMAJ190	TVS	Vbr=190V, 1.2A, 400W (1ms)	DO-214AB	1d	1m,1w	Pjt,Srj



SMD code	Type	Function	Short description	Case	Pinout	St.	Mnf.
SU	TV04A191K-G	TVS	Vrwm=190.0V, Vbr=211.28...258.40V, Ipp=1.18A, 400W(1ms)	DO-214AC	1d	1a	Cmc
SV	1SMA45A	TVS	Vrwm=45V±5%, 5.5A, 400W (1ms)	403B-01	3d	1f	Ons
SV	BZX84J-B3V6	Z-diode	3.6V±2%, If=250mA, 550mW	SOD-323FL	7d	1a	Phi
SV	CH035H-30PT	Si-diode	SBD, 30V, 350mA, Vf<0.6V(200mA), 10ns	SOD-323	5d	1a	Chm
SV	P4SMAJ190A	TVS	Vbr=190V, 1.3A, 400W (1ms)	DO-214AB	1d	1m,1w	Pjt,Srj
SV	P4SMAJ200A	TVS	Vbr=200V, 1.2A, 400W(1ms)	DO-214AC	1d	1a	Mco
SV	TV04A191J-G	TVS	Vrwm=190.0V, Vbr=211.0...232.0V, Ipp=1.30A, 400W(1ms)	DO-214AC	1d	1a	Cmc
SVC	1SMA45CA	TVS	Vrwm=45V±5%, 5.5A, 400W (1ms), Bidirectional	403B-01	3ba	1e	Ons
SW	BZX84J-B3V9	Z-diode	3.9V±2%, If=250mA, 550mW	SOD-323FL	7d	1a	Phi
SW	CH035H-40PT	Si-diode	SBD, 40V, 350mA, Vf<0.6V(200mA), 10ns	SOD-323	5d	1a	Chm
SW	P4SMA68C	TVS	Vrwm=68V, 4.3A, 400W (1ms), Bidirectional	DO-214AC	1ba	2k	Fag
SW	P4SMAJ200	TVS	Vbr=170V, 1.1A, 400W (1ms)	DO-214AB	1d	1m,1w	Pjt,Srj
SW	SM4T100	TVS	Vbr=100V, 2.9A, 400W(1ms)	SOD-6	1d	1q	Ste
SW	TV04A201J-G	TVS	Vrwm=200.0V, Vbr=224.0...247.0V, Ipp=1.23A, 400W(1ms)	DO-214AC	1d	1a	Cmc
SX	1SMA48A	TVS	Vrwm=48V±5%, 5.2A, 400W (1ms)	403B-01	3d	1f	Ons
SX	B130LAW	Si-diode	SBR, 30V, 1A, Vf<0.42V(1A), 40pF	SOD-123	5d	1d	Di
SX	BZX84J-B43	Z-diode	43V±2%, If=250mA, 550mW	SOD-323FL	7d	1a	Phi
SX	CH015H-40PT	Si-diode	SBD, 40V, 15mA, Vf<0.9V(15mA), 1ns	SOD-323	5d	1a	Chm
SX	P4SMAJ200A	TVS	Vbr=170V, 1.2A, 400W (1ms)	DO-214AB	1d	1m,1w	Pjt,Srj
SX	P4SMAJ20A	TVS	Vbr=220V, 1.1A, 400W(1ms)	DO-214AC	1d	1a	Mco
SX	SM4T100A	TVS	Vbr=100V, 2.9A, 400W(1ms)	SOD-6	1d	1q	Ste
SX	TV04A221J-G	TVS	Vrwm=220.0V, Vbr=246.0...272.0V, Ipp=1.12A, 400W(1ms)	DO-214AC	1d	1a	Cmc
SXC	1SMA48CA	TVS	Vrwm=48V±5%, 5.2A, 400W (1ms), Bidirectional	403B-01	3ba	1e	Ons
SY	BZX84J-B47	Z-diode	47V±2%, If=250mA, 550mW	SOD-323FL	7d	1a	Phi
SY	CH015H-50PT	Si-diode	SBD, 50V, 15mA, Vf<0.95V(15mA), 1ns	SOD-323	5d	1a	Chm
SY	KDZ9.1VYY	Z-diode	8.85...9.23V, Izt=5mA, Zzt=18Ω, 100mW	VSC	7d	1a	Kec
SY	P4SMA75C	TVS	Vrwm=75V, 3.9A, 400W (1ms), Bidirectional	DO-214AC	1ba	2k	Fag
SY	P4SMAJ210	TVS	Vbr=170V, 1.1A, 400W (1ms)	DO-214AC	1d	1m,1w	Pjt,Srj
SZ	1SMA51A	TVS	Vrwm=51V±5%, 4.9A, 400W (1ms)	403B-01	3d	1f	Ons
SZ	BZT52-B27S	Z-diode	26.46...27.54V, Izt=2mA, Zzt=80Ω, 200mW	SOD-323FL	7d	1a	Tsc
SZ	BZX84J-B4V3	Z-diode	4.3V±2%, If=250mA, 550mW	SOD-323FL	7d	1a	Phi
SZ	CH015H-60PT	Si-diode	SBD, 60V, 15mA, Vf<1V(15mA), 1ns	SOD-323	5d	1a	Chm
SZ	MM3Z27VB	Z-diode	26.46...27.54V, Zzt=75Ω, Izt=2mA, 200mW	SOD-323FL	7d	1a	F
SZ	MM3Z27VBW	Z-diode	26.46...27.54V, Izt=2mA, Zzt=80Ω, 200mW	SOD-323FL	7d	1a	Tac
SZ	P4SMAJ210A	TVS	Vbr=170V, 1.2A, 400W (1ms)	DO-214AC	1d	1m,1w	Pjt,Srj
SZ	P4SMAJ250A	TVS	Vbr=250V, 1.0A, 400W(1ms)	DO-214AC	1d	1a	Mco
SZ	TCMM3Z27VB	Z-diode	27V±2%, Izt=5mA, Zzt=75Ω, 200mW	SOD-323FL	7d	1a	Tac
SZ	TV04A251J-G	TVS	Vrwm=250.0V, Vbr=279.0...309.0V, Ipp=0.99A, 400W(1ms)	DO-214AC	1d	1a	Cmc
SZC	1SMA51CA	TVS	Vrwm=51V±5%, 4.9A, 400W (1ms), Bidirectional	403B-01	3ba	1e	Ons
T	1P579SB40	Si-diode	SBD, U-Speed, 40V, 120mA, <5pF	SOD-523	6d	1a	Phi
T	BAR67-02V	PIN-diode	Sw, RF, 150V, 200mA, 150mW, Vf<1.2V(50mA), <0.9pF	SOD-523	6d	1a	Inf
T	BB515	C-diode	AM-Tuning, 30V, 20mA, Ir<0.01μA, Cv=17.5/20pF	SOD-323	5d	1a	Sie
T	MA2S374	C-diode	CATV, 34V, 87/3.7pF(0/17V), 0.9Q(470MHz)	SOD-523	6d	1a	Pan
T	MAZD075	Z-diode	7...7.9V, Zzt=20Ω(5mA), 120mW	SSSMini2	7d	1a	Pan
T	MAZS024	Z-diode	2.28...2.6V, 200mW	SOD-523	6d	1a	Pan
T	MM9D18V	Z-diode	17.10...18.90V, Izt=5mA, Zzt=50Ω, 200mW	SOD-923	7d	1n	Wtr
T	MM9D3V0	Z-diode	2.85...3.15V, Izt=5mA, Zzt=100Ω, 200mW	SOD-923	7d	1b	Wtr
T	MMSZ5221BPT	Z-diode	2.28...2.52V, Izt=5mA, Zzt=100Ω, 225mW	SOD-523	7d	1a	Chm
t	MMSZ5241BPT	Z-diode	10.45...11.55V, Izt=5mA, Zzt=18Ω, 225mW	SOD-523	7d	1a	Chm
I	MMSZ5269BPT	Z-diode	82.65...91.35V, Izt=1.4mA, Zzt=37Ω, 225mW	SOD-523	7d	1a	Chm
T	NZ9F10VST	Z-diode	9.77...10.21V, Izt=5mA, Zzt=30Ω, 200mW	SOD-923	7d	2m	Ons
T	NZ9F18VT	Z-diode	17.10...18.90V, Izt=5mA, Zzt=50Ω, 200mW	SOD-923	7d	1n	Ons
T	NZ9F3V0T	Z-diode	2.85...3.15V, Izt=5mA, Zzt=100Ω, 200mW	SOD-923	7d	1b	Ons
T (white)	BB811	C-diode	SATV-Tuning, 30V, 20mA, 1.02...8.8pF(28...1V), 2GHz	SOD-123	5d	2	Inf
T1	GDZ5V1B-V	Z-diode	4.98...5.20V, Izt=5mA, Zzt=80Ω, 200mW	SOD-323	5d	1k	Vs
T2	GDZ5V6B-V	Z-diode	5.49...5.73V, Izt=5mA, Zzt=60Ω, 200mW	SOD-323	5d	1k	Vs
T3	GDZ6V2B-V	Z-diode	6.06...6.33V, Izt=5mA, Zzt=60Ω, 200mW	SOD-323	5d	1k	Vs
T4	GDZ6V8B-V	Z-diode	6.65...6.93V, Izt=5mA, Zzt=40Ω, 200mW	SOD-323	5d	1k	Vs
T5	GDZ7V5B-V	Z-diode	7.28...7.6V, Izt=5mA, Zzt=30Ω, 200mW	SOD-323	5d	1k	Vs
T6	GDZ8V2B-V	Z-diode	8.02...8.36V, Izt=5mA, Zzt=30Ω, 200mW	SOD-323	5d	1k	Vs
T7	GDZ9V1B-V	Z-diode	8.85...9.23V, Izt=5mA, Zzt=30Ω, 200mW	SOD-323	5d	1k	Vs
T8	GDZ10B-V	Z-diode	9.77...10.21V, Izt=5mA, Zzt=30Ω, 200mW	SOD-323	5d	1k	Vs
T9	GDZ11B-V	Z-diode	10.76...11.22V, Izt=5mA, Zzt=30Ω, 200mW	SOD-323	5d	1k	Vs
TA	GDZ12B-V	Z-diode	11.74...12.24V, Izt=5mA, Zzt=30Ω, 200mW	SOD-323	5d	1k	Vs
TB	GDZ13B-V	Z-diode	12.91...13.49V, Izt=5mA, Zzt=37Ω, 200mW	SOD-323	5d	1k	Vs
TC	GDZ15B-V	Z-diode	14.34...14.98V, Izt=5mA, Zzt=42Ω, 200mW	SOD-323	5d	1k	Vs
TD	GDZ16B-V	Z-diode	15.85...16.51V, Izt=5mA, Zzt=50Ω, 200mW	SOD-323	5d	1k	Vs
TE	GDZ18B-V	Z-diode	17.56...18.35V, Izt=5mA, Zzt=65Ω, 200mW	SOD-323	5d	1k	Vs
TH	GDZ20B-V	Z-diode	19.52...20.39V, Izt=5mA, Zzt=85Ω, 200mW	SOD-323	5d	1k	Vs
TK	GDZ22B-V	Z-diode	21.54...22.47V, Izt=5mA, Zzt=100Ω, 200mW	SOD-323	5d	1k	Vs



SMD
code

Type

Function

Short description

Case

Pinout

St.

Mnf.

T L	GDZ24B-V	Z-diode	23.72..24.78V, Izt=5mA, Zzt=120Ω, 200mW	SOD-323	5d	1k	Vs
T M	GDZ27B-V	Z-diode	26.19..27.53V, Izt=5mA, Zzt=150Ω, 200mW	SOD-323	5d	1k	Vs
T N	GDZ30B-V	Z-diode	29.19..30.69V, Izt=5mA, Zzt=200Ω, 200mW	SOD-323	5d	1k	Vs
T P	GDZ33B-V	Z-diode	32.15..33.79V, Izt=5mA, Zzt=250Ω, 200mW	SOD-323	5d	1k	Vs
T T	GDZ36B-V	Z-diode	35.07..36.87V, Izt=5mA, Zzt=300Ω, 200mW	SOD-323	5d	1k	Vs
I.	MMSZ5221SPST	Z-diode	2.352..2.448V, Izt=5mA, Zzt=100Ω, 225mW	SOD-523	7d	1a	Chm
t.	MMSZ5241SPST	Z-diode	10.78..11.22V, Izt=5mA, Zzt=18Ω, 225mW	SOD-523	7d	1a	Chm
T.	MMSZ5269SPST	Z-diode	85.26..88.74V, Izt=1.4mA, Zzt=370Ω, 225mW	SOD-523	7d	1a	Chm
T0	BZX384-C4V7	Z-diode	4.7V±5%, Izt=5mA, Zzt=50Ω, 200mW	SOD-323	5d	1k	Phi
T0	MMPZ5250SPST	Z-diode	19.60..20.40V, Izt=5mA, Zzt=48Ω, 225mW	SOD-323	5d	1a	Chm
T064H	TB0640H	Thy-SPD	V Of-St=58V, 100A(1ms), Bidirectional	DO-214AA	1ba	1x	Di
T064L	TB0640L	Thy-SPD	V Of-St=58V, 30A(1ms), Bidirectional	DO-214AA	1ba	1x	Di
T064M	TB0640M	Thy-SPD	V Of-St=58V, 50A(1ms), Bidirectional	DO-214AA	1ba	1x	Di
T072H	TB0720H	Thy-SPD	V Of-St=65V, 100A(1ms), Bidirectional	DO-214AA	1ba	1x	Di
T072L	TB0720L	Thy-SPD	V Of-St=65V, 30A(1ms), Bidirectional	DO-214AA	1ba	1x	Di
T072M	TB0720M	Thy-SPD	V Of-St=65V, 50A(1ms), Bidirectional	DO-214AA	1ba	1x	Di
T090H	TB0900H	Thy-SPD	V Of-St=75V, 100A(1ms), Bidirectional	DO-214AA	1ba	1x	Di
T090L	TB0900L	Thy-SPD	V Of-St=75V, 30A(1ms), Bidirectional	DO-214AA	1ba	1x	Di
T090M	TB0900M	Thy-SPD	V Of-St=75V, 50A(1ms), Bidirectional	DO-214AA	1ba	1x	Di
T1	1PS79SB63	Si-diode	Schottky, Sw, 5V, 20mA, Vf<0.3V(1mA), <0.5pF	SOD-323	5d	1a	Phi
T1	BZX384-C6V2	Z-diode	6.2V±5%, Izt=5mA, Zzt=6Ω, 200mW	SOD-323	5d	1k	Phi
T1	FS2A	Si-diode	GP, Rectifier, 50V, 3A, 4μs	DO-214AB	1d	2j	Fag
T1	FS3A	Si-diode	Rectifier, 50V, 3A, Vf<1.15V(3A)	DO-214AB	1d	2j	Fag
T1	MMSZ2V4	Z-diode	2.4V±5%, Izt=5mA, Zzt=100Ω, 500mW	SOD-123	5d	1a	Mot
T10	TPSMC10	TVS	Vbr=9.00..11.0V, Vrwm=8.10V, 100A, 1500W(1ms)	DO-214AB	1d	1a	Eic
T10A	TPSMC10A	TVS	Vbr=9.50..10.5V, Vrwm=8.55V, 103A, 1500W(1ms)	DO-214AB	1d	1a	Eic
T10C	TPSMC10C	TVS	Vbr=9.00..11.0V, Vrwm=8.10V, 100A, 1500W(1ms), Bidirectional	DO-214AB	1ba	1j	Eic
T10CA	TPSMC10CA	TVS	Vbr=9.50..10.5V, Vrwm=8.55V, 103A, 1500W(1ms), Bidirectional	DO-214AB	1ba	1j	Eic
T11	TPSMC11	TVS	Vbr=9.90..12.1V, Vrwm=8.92V, 92.6A, 1500W(1ms)	DO-214AB	1d	1a	Eic
T110H	TB1100H	Thy-SPD	V Of-St=90V, 100A(1ms), Bidirectional	DO-214AA	1ba	1x	Di
T110L	TB1100L	Thy-SPD	V Of-St=90V, 30A(1ms), Bidirectional	DO-214AA	1ba	1x	Di
T110M	TB1100M	Thy-SPD	V Of-St=90V, 50A(1ms), Bidirectional	DO-214AA	1ba	1x	Di
T11A	TPSMC11A	TVS	Vbr=10.5..11.6V, Vrwm=9.40V, 96.2A, 1500W(1ms)	DO-214AB	1d	1a	Eic
T11C	TPSMC11C	TVS	Vbr=9.90..12.1V, Vrwm=8.92V, 92.6A, 1500W(1ms), Bidirectional	DO-214AB	1ba	1j	Eic
T11CA	TPSMC11CA	TVS	Vbr=10.5..11.6V, Vrwm=9.40V, 96.2A, 1500W(1ms), Bidirectional	DO-214AB	1ba	1j	Eic
T12	TPSMC12	TVS	Vbr=10.8..13.2V, Vrwm=9.72V, 86.7A, 1500W(1ms)	DO-214AB	1d	1a	Eic
T12A	TPSMC12A	TVS	Vbr=11.4..12.6V, Vrwm=10.2V, 89.8A, 1500W(1ms)	DO-214AB	1d	1a	Eic
T12C	TPSMC12C	TVS	Vbr=10.8..13.2V, Vrwm=9.72V, 86.7A, 1500W(1ms), Bidirectional	DO-214AB	1ba	1j	Eic
T12CA	TPSMC12CA	TVS	Vbr=11.4..12.6V, Vrwm=10.2V, 89.8A, 1500W(1ms), Bidirectional	DO-214AB	1ba	1j	Eic
T13	TPSMC13	TVS	Vbr=11.7..14.3V, Vrwm=10.5V, 78.9A, 1500W(1ms)	DO-214AB	1d	1a	Eic
T130H	TB1300H	Thy-SPD	V Of-St=120V, 100A(1ms), Bidirectional	DO-214AA	1ba	1x	Di
T130L	TB1300L	Thy-SPD	V Of-St=120V, 30A(1ms), Bidirectional	DO-214AA	1ba	1x	Di
T130M	TB1300M	Thy-SPD	V Of-St=120V, 50A(1ms), Bidirectional	DO-214AA	1ba	1x	Di
T13A	TPSMC13A	TVS	Vbr=12.4..13.7V, Vrwm=11.1V, 82.4A, 1500W(1ms)	DO-214AB	1d	1a	Eic
T13C	TPSMC13C	TVS	Vbr=11.7..14.3V, Vrwm=10.5V, 78.9A, 1500W(1ms), Bidirectional	DO-214AB	1ba	1j	Eic
T13CA	TPSMC13CA	TVS	Vbr=12.4..13.7V, Vrwm=11.1V, 82.4A, 1500W(1ms), Bidirectional	DO-214AB	1ba	1j	Eic
T15	TPSMC15	TVS	Vbr=13.5..16.5V, Vrwm=12.1V, 68.2A, 1500W(1ms)	DO-214AB	1d	1a	Eic
T150H	TB1500H	Thy-SPD	V Of-St=140V, 100A(1ms), Bidirectional	DO-214AA	1ba	1x	Di
T150L	TB1500L	Thy-SPD	V Of-St=140V, 30A(1ms), Bidirectional	DO-214AA	1ba	1x	Di
T150M	TB1500M	Thy-SPD	V Of-St=140V, 50A(1ms), Bidirectional	DO-214AA	1ba	1x	Di
T15A	TPSMC15A	TVS	Vbr=14.3..15.8V, Vrwm=12.8V, 70.8A, 1500W(1ms)	DO-214AB	1d	1a	Eic
T15C	TPSMC15C	TVS	Vbr=13.5..16.5V, Vrwm=12.1V, 68.2A, 1500W(1ms), Bidirectional	DO-214AB	1ba	1j	Eic
T15CA	TPSMC15CA	TVS	Vbr=14.3..15.8V, Vrwm=12.8V, 70.8A, 1500W(1ms), Bidirectional	DO-214AB	1ba	1j	Eic
T16	TPSMC16	TVS	Vbr=14.4..17.6V, Vrwm=12.9V, 63.8A, 1500W(1ms)	DO-214AB	1d	1a	Eic
T16A	TPSMC16A	TVS	Vbr=15.2..16.8V, Vrwm=13.6V, 66.7A, 1500W(1ms)	DO-214AB	1d	1a	Eic
T16C	TPSMC16C	TVS	Vbr=14.4..17.6V, Vrwm=12.9V, 63.8A, 1500W(1ms), Bidirectional	DO-214AB	1ba	1j	Eic
T16CA	TPSMC16CA	TVS	Vbr=15.2..16.8V, Vrwm=13.6V, 66.7A, 1500W(1ms), Bidirectional	DO-214AB	1ba	1j	Eic
T18	TPSMC18	TVS	Vbr=16.2..19.8V, Vrwm=14.5V, 56.6A, 1500W(1ms)	DO-214AB	1d	1a	Eic
T180H	TB1800H	Thy-SPD	V Of-St=160V, 100A(1ms), Bidirectional	DO-214AA	1ba	1x	Di
T180L	TB1800L	Thy-SPD	V Of-St=160V, 30A(1ms), Bidirectional	DO-214AA	1ba	1x	Di
T180M	TB1800M	Thy-SPD	V Of-St=160V, 50A(1ms), Bidirectional	DO-214AA	1ba	1x	Di
T18A	TPSMC18A	TVS	Vbr=17.1..18.9V, Vrwm=15.3V, 59.5A, 1500W(1ms)	DO-214AB	1d	1a	Eic
T18C	TPSMC18C	TVS	Vbr=16.2..19.8V, Vrwm=14.5V, 56.6A, 1500W(1ms), Bidirectional	DO-214AB	1ba	1j	Eic
T18CA	TPSMC18CA	TVS	Vbr=17.1..18.9V, Vrwm=15.3V, 59.5A, 1500W(1ms), Bidirectional	DO-214AB	1ba	1j	Eic
T2	1PS79SB17	Si-diode	Schottky, Sw, 4V, 30mA, Vf<0.6V(10mA), <0.65pF	SOD-523	6d	1a	Phi
T2	BAV19W	Si-diode	Sw, 100V, 200mA, Vf<1.25V(200mA), <50ns	SOD-123	5d	1a	Di
T2	BAV19WS	Si-diode	Sw, 100V, 200mA, Vf<1.25V(200mA), <50ns	SOD-323	5d	1a	Di
T2	BAV20W	Si-diode	Sw, 150V, 200mA, Vf<1.25V(200mA), <50ns	SOD-123	5d	1a	Di
T2	BAV20WS	Si-diode	Sw, 150V, 200mA, Vf<1.25V(200mA), <50ns	SOD-323	5d	1a	Di
T2	BZX384-C10	Z-diode	10V±5%, Izt=5mA, Zzt=8Ω, 200mW	SOD-323	5d	1k	Phi



SMD code	Type	Function	Short description	Case	Pinout	St.	Mnf.
T2	FS2B	Si-diode	GP, Rectifier, 100V, 3A, 4μs	DO-214AB	1d	2j	Fag
T2	FS3B	Si-diode	Rectifier, 100V, 3A, Vf<1.15V(3A)	DO-214AB	1d	2j	Fag
T2	MM3Z2V4S	Z-diode	2.43..2.63V, Izt=5mA, Zzt=100Ω, 200mW	SOD-323FL	7d	1u	Ons
T2	MMSZ2V7	Z-diode	2.7V±5%, Izt=5mA, Zzt=100Ω, 500mW	SOD-123	5d	1a	Mot
T20	TPSMC20	TVS	Vbr=18.0..22.0V, Vrvwm=16.2V, 51.5A, 1500W(1ms)	DO-214AB	1d	1a	Eic
T20A	TPSMC20A	TVS	Vbr=19.0..21.0V, Vrvwm=17.1V, 54.2A, 1500W(1ms)	DO-214AB	1d	1a	Eic
T20C	TPSMC20C	TVS	Vbr=18.0..22.0V, Vrvwm=16.2V, 51.5A, 1500W(1ms), Bidirectional	DO-214AB	1ba	1j	Eic
T20CA	TPSMC20CA	TVS	Vbr=19.0..21.0V, Vrvwm=17.1V, 54.2A, 1500W(1ms), Bidirectional	DO-214AB	1ba	1j	Eic
T22	TPSMC22	TVS	Vbr=19.8..24.2V, Vrvwm=17.8V, 47.0A, 1500W(1ms)	DO-214AB	1d	1a	Eic
T22A	TPSMC22A	TVS	Vbr=20.9..23.1V, Vrvwm=18.8V, 49.0A, 1500W(1ms)	DO-214AB	1d	1a	Eic
T22C	TPSMC22C	TVS	Vbr=19.8..24.2V, Vrvwm=17.8V, 47.0A, 1500W(1ms), Bidirectional	DO-214AB	1ba	1j	Eic
T22CA	TPSMC22CA	TVS	Vbr=20.9..23.1V, Vrvwm=18.8V, 49.0A, 1500W(1ms), Bidirectional	DO-214AB	1ba	1j	Eic
T230H	TB2300H	Thy-SPD	V Of-St=190V, 100A(1ms), Bidirectional	DO-214AA	1ba	1x	Di
T230L	TB2300L	Thy-SPD	V Of-St=190V, 30A(1ms), Bidirectional	DO-214AA	1ba	1x	Di
T230M	TB2300M	Thy-SPD	V Of-St=190V, 50A(1ms), Bidirectional	DO-214AA	1ba	1x	Di
T24	TPSMC24	TVS	Vbr=21.6..26.4V, Vrvwm=19.4V, 43.2A, 1500W(1ms)	DO-214AB	1d	1a	Eic
T24A	TPSMC24A	TVS	Vbr=22.8..25.2V, Vrvwm=20.5V, 45.2A, 1500W(1ms)	DO-214AB	1d	1a	Eic
T24C	TPSMC24C	TVS	Vbr=21.6..26.4V, Vrvwm=19.4V, 43.2A, 1500W(1ms), Bidirectional	DO-214AB	1ba	1j	Eic
T24CA	TPSMC24CA	TVS	Vbr=22.8..25.2V, Vrvwm=20.5V, 45.2A, 1500W(1ms), Bidirectional	DO-214AB	1ba	1j	Eic
T260H	TB2600H	Thy-SPD	V Of-St=220V, 100A(1ms), Bidirectional	DO-214AA	1ba	1x	Di
T260L	TB2600L	Thy-SPD	V Of-St=220V, 30A(1ms), Bidirectional	DO-214AA	1ba	1x	Di
T260M	TB2600M	Thy-SPD	V Of-St=220V, 50A(1ms), Bidirectional	DO-214AA	1ba	1x	Di
T27	TPSMC27	TVS	Vbr=24.3..29.7V, Vrvwm=21.8V, 38.4A, 1500W(1ms)	DO-214AB	1d	1a	Eic
T27A	TPSMC27A	TVS	Vbr=25.7..28.4V, Vrvwm=23.1V, 40.0A, 1500W(1ms)	DO-214AB	1d	1a	Eic
T27C	TPSMC27C	TVS	Vbr=24.3..29.7V, Vrvwm=21.8V, 38.4A, 1500W(1ms), Bidirectional	DO-214AB	1ba	1j	Eic
T27CA	TPSMC27CA	TVS	Vbr=25.7..28.4V, Vrvwm=23.1V, 40.0A, 1500W(1ms), Bidirectional	DO-214AB	1ba	1j	Eic
T3	1SV186	C-diode	UHF/SHF-Tuning, 30V, 0.82..4.55pF(25..2V)	SOD-123	5d	1a	Tos
T3	1SV245	C-diode	UHF/SHF-Tun, 35V, 0.61..0.77pF(25V), Rs<2Ω(470MHz)	SOD-123	5d	1a	Tos
T3	1SV261	C-diode	UHF/SHF-Tuning, 35V, 0.61..0.77pF(25V), Rs<2Ω(470MHz)	SOD-323	5d	1a	Tos
T3	BAV19W	Si-diode	Sw, 100V, 200mA, Vf<1.25V(200mA), <50ns	SOD-123	5d	1a	Di
T3	BAV19WS	Si-diode	Sw, 100V, 200mA, Vf<1.25V(200mA), <50ns	SOD-323	5d	1a	Di
T3	BAV20W	Si-diode	Sw, 150V, 200mA, Vf<1.25V(200mA), <50ns	SOD-123	5d	1a	Di
T3	BAV20WS	Si-diode	Sw, 150V, 200mA, Vf<1.25V(200mA), <50ns	SOD-323	5d	1a	Di
T3	BAV21W	Si-diode	Sw, 200V, 200mA, Vf<1.25V(200mA), <50ns	SOD-123	5d	1a	Di
T3	BAV21WS	Si-diode	Sw, 200V, 200mA, Vf<1.25V(200mA), <50ns	SOD-323	5d	1a	Di
T3	BZX384-C2V4	Z-diode	2.4V±5%, Izt=5mA, Zzt=70Ω, 200mW	SOD-323	5d	1k	Phi
T3	FS2D	Si-diode	GP, Rectifier, 200V, 3A, 4μs	DO-214AB	1d	2j	Fag
T3	FS3D	Si-diode	Rectifier, 200V, 3A, Vf<1.15V(3A)	DO-214AB	1d	2j	Fag
T3	MM3Z2V7S	Z-diode	2.67..2.91V, Izt=5mA, Zzt=100Ω, 200mW	SOD-323FL	7d	1u	Ons
T3	MMSZ3V0	Z-diode	3.0V±5%, Izt=5mA, Zzt=95Ω, 500mW	SOD-123	5d	1a	Mot
T30	TPSMC30	TVS	Vbr=27.0..33.0V, Vrvwm=24.3V, 34.5A, 1500W(1ms)	DO-214AB	1d	1a	Eic
T30A	TPSMC30A	TVS	Vbr=28.5..31.5V, Vrvwm=25.6V, 36.2A, 1500W(1ms)	DO-214AB	1d	1a	Eic
T30C	TPSMC30C	TVS	Vbr=27.0..33.0V, Vrvwm=24.3V, 34.5A, 1500W(1ms), Bidirectional	DO-214AB	1ba	1j	Eic
T30CA	TPSMC30CA	TVS	Vbr=28.5..31.5V, Vrvwm=25.6V, 36.2A, 1500W(1ms), Bidirectional	DO-214AB	1ba	1j	Eic
T310H	TB3100H	Thy-SPD	V Of-St=275V, 100A(1ms), Bidirectional	DO-214AA	1ba	1x	Di
T310L	TB3100L	Thy-SPD	V Of-St=275V, 30A(1ms), Bidirectional	DO-214AA	1ba	1x	Di
T310M	TB3100M	Thy-SPD	V Of-St=275V, 50A(1ms), Bidirectional	DO-214AA	1ba	1x	Di
T33	TPSMC33	TVS	Vbr=29.7..36.3V, Vrvwm=26.8V, 31.4A, 1500W(1ms)	DO-214AB	1d	1a	Eic
T33A	TPSMC33A	TVS	Vbr=31.4..34.7V, Vrvwm=28.2V, 32.8A, 1500W(1ms)	DO-214AB	1d	1a	Eic
T33C	TPSMC33C	TVS	Vbr=29.7..36.3V, Vrvwm=26.8V, 31.4A, 1500W(1ms), Bidirectional	DO-214AB	1ba	1j	Eic
T33CA	TPSMC33CA	TVS	Vbr=31.4..34.7V, Vrvwm=28.2V, 32.8A, 1500W(1ms), Bidirectional	DO-214AB	1ba	1j	Eic
T350H	TB3500H	Thy-SPD	V Of-St=320V, 100A(1ms), Bidirectional	DO-214AA	1ba	1x	Di
T350L	TB3500L	Thy-SPD	V Of-St=320V, 30A(1ms), Bidirectional	DO-214AA	1ba	1x	Di
T350M	TB3500M	Thy-SPD	V Of-St=320V, 50A(1ms), Bidirectional	DO-214AA	1ba	1x	Di
T36	TPSMC36	TVS	Vbr=32.4..39.6V, Vrvwm=29.1V, 28.8A, 1500W(1ms)	DO-214AB	1d	1a	Eic
T36A	TPSMC36A	TVS	Vbr=34.2..37.8V, Vrvwm=30.8V, 30.1A, 1500W(1ms)	DO-214AB	1d	1a	Eic
T36C	TPSMC36C	TVS	Vbr=32.4..39.6V, Vrvwm=29.1V, 28.8A, 1500W(1ms), Bidirectional	DO-214AB	1ba	1j	Eic
T36CA	TPSMC36CA	TVS	Vbr=34.2..37.8V, Vrvwm=30.8V, 30.1A, 1500W(1ms), Bidirectional	DO-214AB	1ba	1j	Eic
T39	TPSMC39	TVS	Vbr=35.1..42.9V, Vrvwm=31.6V, 26.6A, 1500W(1ms)	DO-214AB	1d	1a	Eic
T39A	TPSMC39A	TVS	Vbr=37.1..41.0V, Vrvwm=33.3V, 27.8A, 1500W(1ms)	DO-214AB	1d	1a	Eic
T39C	TPSMC39C	TVS	Vbr=35.1..42.9V, Vrvwm=31.6V, 26.6A, 1500W(1ms), Bidirectional	DO-214AB	1ba	1j	Eic
T39CA	TPSMC39CA	TVS	Vbr=37.1..41.0V, Vrvwm=33.3V, 27.8A, 1500W(1ms), Bidirectional	DO-214AB	1ba	1j	Eic
T4	1N4148W	Si-diode	Sw, Fast, 75V, 150mA, <2pF, <4ns	SOD-123	5d	1a	Di
T4	1N4148WS	Si-diode	Sw, Fast, 75V, 150mA, <2pF, <4ns	SOD-323	5d	1a	Di
T4	1N4148WT	Si-diode	Sw, Fast, 100V, 125mA, <2pF, <4ns	SOD-523	6d	1a	Di
T4	1SV204	C-diode	VHF/UHF-AFC, 35V, 3.3/5.7pF(10V)	SOD-123	5d	1a	Tos
T4	1SV216	C-diode	VHF/UHF-AFC, 35V, 3.3/5.7pF(10V)	SOD-123	5d	1a	Tos
T4	1SV256	C-diode	VHF/UHF-AFC, 35V, 3.3/5.7pF(10V)	SOD-323	5d	1a	Tos
T4	BZX384-C2V7	Z-diode	2.7V±5%, Izt=5mA, Zzt=75Ω, 200mW	SOD-323	5d	1k	Phi
T4	FS2G	Si-diode	GP, Rectifier, 400V, 3A, 4μs	DO-214AB	1d	2j	Fag



SMD
code

Type

Function

Short description

Case

Pinout

St.

Mnf.

SMD code	Type	Function	Short description	Case	Pinout	St.	Mnf.
T4	FS3G	Si-diode	Rectifier, 400V, 3A, Vf<1.15V(3A)	DO-214AB	1d	2j	Fag
T4	MM5Z3V3	Z-diode	3.3V±5%, Izt=5mA, Zzt=95Ω, 500mW	SOD-123	5d	1a	Mot
T43	TPSMC43	TVS	Vbr=38.7..47.3V, Vrw=34.8V, 24.2A, 1500W(1ms)	DO-214AB	1d	1a	Eic
T43A	TPSMC43A	TVS	Vbr=40.9..45.2V, Vrw=36.8V, 25.3A, 1500W(1ms)	DO-214AB	1d	1a	Eic
T43C	TPSMC43C	TVS	Vbr=38.7..47.3V, Vrw=34.8V, 24.2A, 1500W(1ms), Bidirectional	DO-214AB	1ba	1j	Eic
T43CA	TPSMC43CA	TVS	Vbr=40.9..45.2V, Vrw=36.8V, 25.3A, 1500W(1ms), Bidirectional	DO-214AB	1ba	1j	Eic
T5	1N4448HWS	Si-diode	Sw, Fast, 100V, 500mA, <2pF, <4ns	SOD-323	5d	1a	Di
T5	1N4448W	Si-diode	Sw, Fast, 100V, 500mA, <2pF, <4ns	SOD-123	5d	1a	Di
T5	1N4448WS	Si-diode	Sw, Fast, 100V, 500mA, <2pF, <4ns	SOD-323	5d	1a	Di
T5	BZX384-C3V0	Z-diode	3.0V±5%, Izt=5mA, Zzt=80Ω, 200mW	SOD-323	5d	1k	Phi
T5	BZX584B30V	Z-diode	29.40..30.60V, Izt=2mA, Zzt=80Ω, 200mW	SOD-523FL	7d	1a	Tac
T5	FS2J	Si-diode	GP, Rectifier, 500V, 3A, 4μs	DO-214AB	1d	2j	Fag
T5	FS3J	Si-diode	Rectifier, 600V, 3A, Vf<1.15V(3A)	DO-214AB	1d	2j	Fag
T5	MM3Z3V3S	Z-diode	3.32..3.53V, Izt=5mA, Zzt=95Ω, 200mW	SOD-323FL	7d	1u	Ons
T5	MM5Z30VB	Z-diode	29.40..30.60V, Izt=2mA, Zzt=80Ω, 200mW	SOD-523FL	7d	1a	Tac
T5	MM5Z3V6	Z-diode	3.6V±5%, Izt=5mA, Zzt=90Ω, 500mW	SOD-123	5d	1a	Mot
T6	1SV211	C-diode	UHF-CATV-Tuning, 30V, 33..39pF(2V)	SOD-123	5d	1a	Tos
T6	1SV217	C-diode	UHF-CATV-Tunung, 30V, 33..39pF(2V)	SOD-323	5d	1a	Tos
T6	BAV16W	Si-diode	Sw, Fast, 100V, 300mA, <2pF, <2ns	SOD-123	5d	1a	Di
T6	BAV16WS	Si-diode	Sw, Fast, 100V, 300mA, <2pF, <2ns	SOD-323	5d	1a	Di
T6	BZX384-C3V3	Z-diode	3.3V±5%, Izt=5mA, Zzt=85Ω, 200mW	SOD-323	5d	1k	Phi
T6	FS2K	Si-diode	GP, Rectifier, 800V, 3A, 4μs	DO-214AB	1d	2j	Fag
T6	FS3K	Si-diode	Rectifier, 800V, 3A, Vf<1.15V(3A)	DO-214AB	1d	2j	Fag
T6	MM3Z3V6S	Z-diode	3.60..3.85V, Izt=5mA, Zzt=90Ω, 200mW	SOD-323FL	7d	1u	Ons
T6.8	TPSMC6.8	TVS	Vbr=6.12..7.48V, Vrw=5.50V, 139A, 1500W(1ms)	DO-214AB	1d	1a	Eic
T6.8A	TPSMC6.8A	TVS	Vbr=6.45..7.14V, Vrw=5.80V, 143A, 1500W(1ms)	DO-214AB	1d	1a	Eic
T6.8C	TPSMC6.8C	TVS	Vbr=6.12..7.48V, Vrw=5.50V, 139A, 1500W(1ms), Bidirectional	DO-214AB	1ba	1j	Eic
T6.8CA	TPSMC6.8CA	TVS	Vbr=6.45..7.14V, Vrw=5.80V, 143A, 1500W(1ms), Bidirectional	DO-214AB	1ba	1j	Eic
T7	1SV224	C-diode	CATV, 35V, 1.7/2.1pF(20V)	SOD-123	5d	1a	Tos
T7	1SV230	C-diode	CATV, 35V, 1.7/2.1pF(20V)	SOD-123	5d	1a	Tos
T7	1SV258	C-diode	CATV, 35V, 1.7/2.1pF(20V)	SOD-323	5d	1a	Tos
T7	BZX384-C3V6	Z-diode	3.6V±5%, Izt=5mA, Zzt=85Ω, 200mW	SOD-323	5d	1k	Phi
T7	FS2M	Si-diode	GP, Rectifier, 1000V, 3A, 4μs	DO-214AB	1d	2j	Fag
T7	FS3M	Si-diode	Rectifier, 1000V, 3A, Vf<1.15V(3A)	DO-214AB	1d	2j	Fag
T7	MM3Z3V9S	Z-diode	3.89..4.16V, Izt=5mA, Zzt=90Ω, 200mW	SOD-323FL	7d	1u	Ons
T7.5	TPSMC7.5	TVS	Vbr=6.75..8.25V, Vrw=6.05V, 128A, 1500W(1ms)	DO-214AB	1d	1a	Eic
T7.5A	TPSMC7.5A	TVS	Vbr=7.13..7.88V, Vrw=6.40V, 132A, 1500W(1ms)	DO-214AB	1d	1a	Eic
T7.5C	TPSMC7.5C	TVS	Vbr=6.75..8.25V, Vrw=6.05V, 128A, 1500W(1ms), Bidirectional	DO-214AB	1ba	1j	Eic
T7.5CA	TPSMC7.5CA	TVS	Vbr=7.13..7.88V, Vrw=6.40V, 132A, 1500W(1ms), Bidirectional	DO-214AB	1ba	1j	Eic
T8	1N4148HWT	Si-diode	Sw, Fast, 100V, 125mA, <2pF, <4ns	SOD-523	6d	1a	Di
T8	1SV212	C-diode	UHF-VCO, 15V, 5.5/6.5pF(10V)	SOD-123	5d	1a	Tos
T8	1SV229	C-diode	UHF-VCO, 15V, 5.5/6.5pF(10V)	SOD-323	5d	1a	Tos
T8	1SV257	C-diode	UHF-VCO, 15V, 6..15pF(10..2V)	1F1A	5d	1a	Tos
T8	BZX384-C3V9	Z-diode	3.9V±5%, Izt=5mA, Zzt=85Ω, 200mW	SOD-323	5d	1k	Phi
T8	MM3Z4V3S	Z-diode	4.17..4.43V, Izt=5mA, Zzt=90Ω, 200mW	SOD-323FL	7d	1u	Ons
T8	MM5Z16H	Z-diode	15.3..17.1V, Izt=2mA, Zzt=40Ω, 200mW	SOD-523	7d	1a	Zow
T8	MM5Z16V	Z-diode	16V±5%, Izt=5mA, Zzt=40Ω, 200mW	SOD-523	6d	1a	Eic
T8.2	TPSMC8.2	TVS	Vbr=7.38..9.02V, Vrw=6.63V, 120A, 1500W(1ms)	DO-214AB	1d	1a	Eic
T8.2A	TPSMC8.2A	TVS	Vbr=7.79..8.61V, Vrw=7.02V, 124A, 1500W(1ms)	DO-214AB	1d	1a	Eic
T8.2C	TPSMC8.2C	TVS	Vbr=7.38..9.02V, Vrw=6.63V, 120A, 1500W(1ms), Bidirectional	DO-214AB	1ba	1j	Eic
T8.2CA	TPSMC8.2CA	TVS	Vbr=7.79..8.61V, Vrw=7.02V, 124A, 1500W(1ms), Bidirectional	DO-214AB	1ba	1j	Eic
T9	1SV227	C-diode	CATV-Tuning, 35V, 2.75/3.1pF(25V)	SOD-123	5d	1a	Tos
T9	1SV232	C-diode	CATV-Tuning, 35V, 2.75/3.1pF(25V)	SOD-123	5d	1a	Tos
T9	1SV259	C-diode	CATV-Tuning, 35V, 2.75/3.1pF(25V)	SOD-323	5d	1a	Tos
T9	BZX384-C4V3	Z-diode	4.3V±5%, Izt=5mA, Zzt=80Ω, 200mW	SOD-323	5d	1k	Phi
T9	MM3Z4V7S	Z-diode	4.55..4.75V, Izt=5mA, Zzt=80Ω, 200mW	SOD-323FL	7d	1u	Ons
T9.1	TPSMC9.1	TVS	Vbr=8.19..10.0V, Vrw=7.37V, 109A, 1500W(1ms)	DO-214AB	1d	1a	Eic
T9.1A	TPSMC9.1A	TVS	Vbr=8.65..9.55V, Vrw=7.78V, 112A, 1500W(1ms)	DO-214AB	1d	1a	Eic
T9.1C	TPSMC9.1C	TVS	Vbr=8.19..10.0V, Vrw=7.37V, 109A, 1500W(1ms), Bidirectional	DO-214AB	1ba	1j	Eic
T9.1CA	TPSMC9.1CA	TVS	Vbr=8.65..9.55V, Vrw=7.78V, 112A, 1500W(1ms), Bidirectional	DO-214AB	1ba	1j	Eic
TA	1SV226	C-diode	CATV-Tuning, 35V, 2.7/3.4pF(25V)	SOD-123	5d	1a	Tos
TA	1SV231	C-diode	CATV-Tuning, 35V, 2.7/3.4pF(25V)	SOD-123	5d	1a	Tos
TA	BZX84J-B4V7	Z-diode	4.7V±2%, If=250mA, 550mW	SOD-323FL	7d	1a	Phi
TA	MM3Z5V1S	Z-diode	4.98..5.2V, Izt=5mA, Zzt=60Ω, 200mW	SOD-323FL	7d	1u	Ons
TB	1SV238	C-diode	CATV-Tuning, 35V, 2.75/3.25pF(25V)	SOD-123	5d	1a	Tos
TB	BZX84J-B51	Z-diode	5.1V±2%, If=250mA, 550mW	SOD-323FL	7d	1a	Phi
TB	KDZ10B	Z-diode	10V±2.5%, 40mA, 1W	PMDO	7d	1s	Rhm
TB	SMF140A	TVS	Vrw=140.0V, Vbr=155.0..171.0V, 0.89A, 200W(10/1000μs)	SOD-123FL	7d	1a	Ers
TB	TV02W141-G	TVS	Vrw=140V, Vbr=155..171V, Ipp=0.89A, 200W(1ms)	SOD-123	5d	1a	Cmc
TC	1SV239	C-diode	UHF-VCO, 15V, 1.5/2pF(10V)	SOD-123	5d	1a	Tos



SMD
code

Type

Function

Short description

Case

Pinout

St.

Mnf.

SMD code	Type	Function	Short description	Case	Pinout	St.	Mnf.
TC	1SV260	C-diode	UHF-VCO, 15V, 1.5/2pF(10V)	SOD-323	5d	1a	Tos
TC	BZX84J-B56	Z-diode	5.6V±2%, If=250mA, 550mW	SOD-323FL	7d	1a	Phi
TC	MM3Z5V6S	Z-diode	5.49..5.73V, Izt=5mA, Zzt=40Ω, 200mW	SOD-323FL	7d	1u	Ons
TD	1SV262	C-diode	UHF-CATV-Tuning, 36V, 2.6..3pF(25V)	SOD-123	5d	1a	Tos
TD	BZX84J-B5V1	Z-diode	5.1V±2%, If=250mA, 550mW	SOD-323FL	7d	1a	Phi
TD	P4SMAJ5.0C	TVS	Vbr=5V, 41.6A, 400W (1ms), Bidirectional	DO-214AC	1ba	1x,1y	Pjt,Srj
TD	P6SMB47C	TVS	Vrnm=47V, 8.9A, 600W(1ms), Bidirectional	DO-214AA	1ba	2k	Fag
TE	1SMA54A	TVS	Vrnm=54V±5%, 4.6A, 400W (1ms)	403B-01	3d	1f	Ons
TE	1SV269	C-diode	CATV-Tuning, 36V, 2.5/2.9pF(25V)	SOD-123	5d	1a	Tos
TE	BZX84J-B5V6	Z-diode	5.6V±2%, If=250mA, 550mW	SOD-323FL	7d	1a	Phi
TE	CD214A-T5.0CA	TVS	Vbr=5.0V, Irs=43.5A, 400W(1ms), Bidirectional	DO-214AC	1ba	1j	Bm
TE	MM3Z6V2S	Z-diode	6.06..6.33V, Izt=5mA, Zzt=10Ω, 200mW	SOD-323FL	7d	1u	Ons
TE	P4SMAJ300A	TVS	Vbr=300V, 0.8A, 400W(1ms)	DO-214AC	1d	1a	Mco
TE	P4SMAJ5.0AC	TVS	Vbr=5V, 43.5A, 400W (1ms), Bidirectional	DO-214AC	1ba	1x,1y	Pjt,Srj
TE	P6SMB47CA	TVS	Vrnm=47V, Vbr=44.7..49.4V, 9.3A, 600W(1ms), Bidirectional	DO-214AA	1ba	2k	Fag
TE	SMAJ5.0CA	TVS	Vrnm=5.0V, Vbr=6.40..7.0V, 43.5A, 400W(1ms), Bidirectional	DO-214AC	1ba	1x	Di
TE	SMF110A	TVS	Vrnm=110.0V, Vbr=122.0..135.0V, 1.13A, 200W(10/1000μs)	SOD-123FL	7d	1a	Ers
TE	TV02W111-G	TVS	Vrnm=110V, Vbr=122..135V, Ipp=1.13A, 200W(1ms)	SOD-123	5d	1a	Cmc
TEC	1SMA54CA	TVS	Vrnm=54V±5%, 4.6A, 400W (1ms), Bidirectional	403B-01	3ba	1e	Ons
TF	1SV270	C-diode	UHF-VCO, 10V, 8..7.16pF(4..1V)	SOD-123	5d	1a	Tos
TF	BZX84J-B62	Z-diode	6.2V±2%, If=250mA, 550mW	SOD-323FL	7d	1a	Phi
TF	KDZ36FV	Z-diode	34.0..38.0V, Izt=2mA, Zzt=300Ω, 100mW	TFSC	7d	1a	Kec
TF	MM3Z6V8S	Z-diode	6.65..6.93V, Izt=5mA, Zzt=15Ω, 200mW	SOD-323FL	7d	1u	Ons
TF	P4SMAJ6.0C	TVS	Vbr=6V, 35.1A, 400W (1ms), Bidirectional	DO-214AC	1ba	1x,1y	Pjt,Srj
TF	P6SMB51C	TVS	Vrnm=51V, Vbr=48.5..53.6V, 8.2A, 600W(1ms), Bidirectional	DO-214AA	1ba	2k	Fag
TG	1SMA58A	TVS	Vrnm=58V±5%, 4.8A, 400W (1ms)	403B-01	3d	1f	Ons
TG	BZX84J-B68	Z-diode	6.8V±2%, If=250mA, 550mW	SOD-323FL	7d	1a	Phi
TG	CD214A-T6.0CA	TVS	Vbr=6.0V, Irs=38.8A, 400W(1ms), Bidirectional	DO-214AC	1ba	1j	Bm
TG	MM3Z7V5S	Z-diode	7.28..7.6V, Izt=5mA, Zzt=15Ω, 200mW	SOD-323FL	7d	1u	Ons
TG	P4SMAJ350A	TVS	Vbr=350V, 0.7A, 400W(1ms)	DO-214AC	1d	1a	Mco
TG	P4SMAJ6.0AC	TVS	Vbr=6V, 38.8A, 400W (1ms), Bidirectional	DO-214AC	1ba	1x,1y	Pjt,Srj
TG	P6SMB51CA	TVS	Vrnm=51V, Vbr=48.5..53.6V, 8.6A, 600W(1ms), Bidirectional	DO-214AA	1ba	2k	Fag
TG	SMAJ6.0CA	TVS	Vrnm=6.0V, Vbr=6.67..7.37V, 38.8A, 400W(1ms), Bidirectional	DO-214AC	1ba	1x	Di
TG	SMF120A	TVS	Vrnm=120.0V, Vbr=133.0..147.0V, 1.04A, 200W(10/1000μs)	SOD-123FL	7d	1a	Ers
TG	TV02W121-G	TVS	Vrnm=120V, Vbr=133..147V, Ipp=1.04A, 200W(1ms)	SOD-123	5d	1a	Cmc
TGC	1SMA58CA	TVS	Vrnm=58V±5%, 4.3A, 400W (1ms), Bidirectional	403B-01	3ba	1e	Ons
TH	1SV293	C-diode	VCO for UHF-Band, 10V, 20/11.6pF(1/4V), Rs<0.4Ω	SOD-123	5d	1a	Tos
TH	BZX84J-B6V2	Z-diode	6.2V±2%, If=250mA, 550mW	SOD-323FL	7d	1a	Phi
TH	MM3Z8V2S	Z-diode	8.02..8.36V, Izt=5mA, Zzt=15Ω, 200mW	SOD-323FL	7d	1u	Ons
TH	P4SMAJ6.5C	TVS	Vbr=6.5V, 32.5A, 400W (1ms), Bidirectional	DO-214AC	1ba	1x,1y	Pjt,Srj
TH	P6SMB56C	TVS	Vrnm=56V, Vbr=53.2..58.8V, 7.4A, 600W(1ms), Bidirectional	DO-214AA	1ba	2k	Fag
TH	SM4T150	TVS	Vbr=150V, 2A, 400W(1ms)	SOD-6	1d	1q	Ste
TJ	1SV288	C-diode	CATV-Tuning, 35V, 45/2.8pF(2/25V)	SOD-123	5d	1a	Tos
TJ	1SV290	C-diode	CATV-Tuning, 35V, 45/2.8pF(2/25V)	SOD-323	5d	1a	Tos
TK	1SMA60A	TVS	Vrnm=60V±5%, 4.1A, 400W (1ms)	403B-01	3d	1s	Ons
TK	1SV287	C-diode	UHF/SHF-Tuning, 35V, 0.53..0.68pF(25V), Rs<2.3Ω(470MHz)	SOD-123	5d	1a	Tos
TK	1SV291	C-diode	UHF/SHF-Tuning, 35V, 0.53..0.68pF(25V), Rs<2.3Ω(470MHz)	SOD-323	5d	1a	Tos
TK	BZX84J-B6V8	Z-diode	6.8V±2%, If=250mA, 550mW	SOD-323FL	7d	1a	Phi
TK	CD214A-T6.5CA	TVS	Vbr=6.5V, Irs=35.7A, 400W(1ms), Bidirectional	DO-214AC	1ba	1j	Bm
TK	MM3Z9V1S	Z-diode	8.85..9.23V, 5mA, Zzt=15Ω, 200mW	SOD-323FL	7d	1u	Ons
TK	P4SMAJ400A	TVS	Vbr=400V, 0.6A, 400W(1ms)	DO-214AC	1d	1a	Mco
TK	P4SMAJ6.5AC	TVS	Vbr=6.5V, 35.7A, 400W (1ms), Bidirectional	DO-214AC	1ba	1x,1y	Pjt,Srj
TK	P6SMB56CA	TVS	Vrnm=56V, Vbr=53.2..58.8V, 7.8A, 600W(1ms), Bidirectional	DO-214AA	1ba	2k	Fag
TK	SM4T150A	TVS	Vbr=150V, 2A, 400W(1ms)	SOD-6	1d	1q	Ste
TK	SMAJ6.5CA	TVS	Vrnm=6.5V, Vbr=7.22..7.98V, 35.7A, 400W(1ms), Bidirectional	DO-214AC	1ba	1x	Di
TK	SMF130A	TVS	Vrnm=130.0V, Vbr=144.0..159.0V, 0.96A, 200W(10/1000μs)	SOD-123FL	7d	1a	Ers
TK	TV02W131-G	TVS	Vrnm=130V, Vbr=144..159V, Ipp=0.96A, 200W(1ms)	SOD-123	5d	1a	Cmc
TKC	1SMA60CA	TVS	Vrnm=60V±5%, 4.1A, 400W (1ms), Bidirectional	403B-01	3ba	1e	Ons
TL	BZX84J-B75	Z-diode	7.5V±2%, If=250mA, 550mW	SOD-323FL	7d	1a	Phi
TL	P4SMAJ7.0C	TVS	Vbr=7V, 30.1A, 400W (1ms), Bidirectional	DO-214AC	1ba	1x,1y	Pjt,Srj
TL	P6SMB62C	TVS	Vrnm=62V, 6.8A, 600W(1ms), Bidirectional	DO-214AA	1ba	2k	Fag
TM	1SMA64A	TVS	Vrnm=64V±5%, 3.9A, 400W (1ms)	403B-01	3d	1s	Ons
TM	BZX84J-B7V5	Z-diode	7.5V±2%, If=250mA, 550mW	SOD-323FL	7d	1a	Phi
TM	CD214A-T7.0CA	TVS	Vbr=7.0V, Irs=33.3A, 400W(1ms), Bidirectional	DO-214AC	1ba	1j	Bm
TM	P4SMAJ440A	TVS	Vbr=440V, 0.6A, 400W(1ms)	DO-214AC	1d	1a	Mco
TM	P4SMAJ7.0AC	TVS	Vbr=7V, 33.3A, 400W (1ms), Bidirectional	DO-214AC	1ba	1x,1y	Pjt,Srj
TM	P6SMB62CA	TVS	Vrnm=62V, Vbr=58.9..65.1V, 7.1A, 600W(1ms), Bidirectional	DO-214AA	1ba	2k	Fag
TM	SMAJ7.0CA	TVS	Vrnm=7.0V, Vbr=7.78..8.6V, 33.3A, 400W(1ms), Bidirectional	DO-214AC	1ba	1x	Di
TM	SMF150A	TVS	Vrnm=150.0V, Vbr=167.0..185.0V, 0.82A, 200W(10/1000μs)	SOD-123FL	7d	1a	Ers
TM	TV02W151-G	TVS	Vrnm=150V, Vbr=167..185V, Ipp=0.82A, 200W(1ms)	SOD-123	5d	1a	Cmc



SMD
code

Type

Function

Short description

Case

Pinout

St.

Mnf.

SMD code	Type	Function	Short description	Case	Pinout	St.	Mnf.
TMC	1SMA64CA	TVS	V _{rw} m=64V±5%, 3.9A, 400W (1ms), Bidirectional	403B-01	3ba	1e	Ons
TN	BZX84J-B8V2	Z-diode	8.2V±2%, I _f =250mA, 550mW	SOD-323FL	7d	1a	Phi
TN	MM3Z12VS	Z-diode	11.74..12.24V, I _z t=5mA, Z _t =25Ω, 200mW	SOD-323FL	7d	1u	Ons
TN	P4SMAJ7.5C	TVS	V _{br} =7.5V, 28A, 400W (1ms), Bidirectional	DO-214AC	1ba	1x,1y	Pjt,Sj
TN	P6SMB68C	TVS	V _{rw} m=68V, 6.1A, 600W(1ms), Bidirectional	DO-214AA	1ba	2k	Fag
TP	1SMA70A	TVS	V _{rw} m=70V±5%, 3.5A, 400W (1ms)	403B-01	3d	1s	Ons
TP	BZX84J-B9V1	Z-diode	9.1V±2%, I _f =250mA, 550mW	SOD-323FL	7d	1a	Phi
TP	CD214A-T7.5CA	TVS	V _{br} =7.5V, I _{rsm} =31.0A, 400W(1ms), Bidirectional	DO-214AC	1ba	1j	Bm
TP	CMDZ10L	Z-diode	9.50..10.50V, I _z t=0.5mA, Z _t =80Ω, 250mW	SOD-323	5d	1a	Cen
TP	KDZ36FVY	Z-diode	35.07..36.87V, I _z t=2mA, Z _t =300Ω, 100mW	TFSC	7d	1a	Kec
TP	MM3Z15VS	Z-diode	14.34..14.98V, I _z t=5mA, Z _t =40Ω, 200mW	SOD-323FL	7d	1u	Ons
TP	P4SMAJ7.5AC	TVS	V _{br} =7.5V, 31A, 400W (1ms), Bidirectional	DO-214AC	1ba	1x,1y	Pjt,Sj
TP	P6SMB68CA	TVS	V _{rw} m=68V, V _{br} =64.6..71.4V, 6.5A, 600W(1ms), Bidirectional	DO-214AA	1ba	2k	Fag
TP	SMAJ7.5CA	TVS	V _{rw} m=7.5V, V _{br} =8.33..9.21V, 31A, 400W(1ms), Bidirectional	DO-214AC	1ba	1x	Di
TP	SMF160A	TVS	V _{rw} m=160.0V, V _{br} =178.0..197.0V, 0.77A, 200W(10/1000μs)	SOD-123FL	7d	1a	Ers
TP	TV02W161-G	TVS	V _{rw} m=160V, V _{br} =178..197V, I _{pp} =0.77A, 200W(1ms)	SOD-123	5d	1a	Cmc
TPC	1SMA70CA	TVS	V _{rw} m=70V±5%, 3.5A, 400W (1ms), Bidirectional	403B-01	3ba	1e	Ons
TQ	P4SMAJ8.0C	TVS	V _{br} =8V, 26.5A, 400W (1ms), Bidirectional	DO-214AC	1ba	1x,1y	Pjt,Sj
TQ	P6SMB75C	TVS	V _{rw} m=75V, 5.5A, 600W(1ms), Bidirectional	DO-214AA	1ba	2k	Fag
TR	1SMA75A	TVS	V _{rw} m=75V±5%, 3.3A, 400W (1ms)	403B-01	3d	1s	Ons
TR	BZX84J-C10	Z-diode	10V±5%, I _f =250mA, 550mW	SOD-323FL	7d	1a	Phi
TR	CD214A-T8.0CA	TVS	V _{br} =8.0V, I _{rsm} =29.4A, 400W(1ms), Bidirectional	DO-214AC	1ba	1j	Bm
TR	P4SMAJ8.0AC	TVS	V _{br} =8V, 29.4A, 400W (1ms), Bidirectional	DO-214AC	1ba	1x,1y	Pjt,Sj
TR	P6SMB75CA	TVS	V _{rw} m=75V, 5.8A, 600W(1ms), Bidirectional	DO-214AA	1ba	2k	Fag
TR	SMAJ8.0CA	TVS	V _{rw} m=8.0V, V _{br} =8.89..9.83V, 29.4A, 400W(1ms), Bidirectional	DO-214AC	1ba	1x	Di
TR	SMF170A	TVS	V _{rw} m=170.0V, V _{br} =189.0..209.0V, 0.73A, 200W(10/1000μs)	SOD-123FL	7d	1a	Ers
TR	TV02W171-G	TVS	V _{rw} m=170V, V _{br} =189..209V, I _{pp} =0.73A, 200W(1ms)	SOD-123	5d	1a	Cmc
TRC	1SMA75CA	TVS	V _{rw} m=75V±5%, 3.3A, 400W (1ms), Bidirectional	403B-01	3ba	1e	Ons
TS	1SMA78A	TVS	V _{rw} m=78V±5%, 3.2A, 400W (1ms)	403B-01	3d	1s	Ons
TS	BAT54M1PT	Si-diode	SBD, 30V, 200mA, V _f <1V(100mA), 5ns	FBPT-723	13d	2b	Chm
TS	BZX84J-C11	Z-diode	11V±5%, I _f =250mA, 550mW	SOD-323FL	7d	1a	Phi
TS	P4SMAJ8.5C	TVS	V _{br} =8.5V, 25.1A, 400W (1ms), Bidirectional	DO-214AC	1ba	1x,1y	Pjt,Sj
TS	P6SMB82C	TVS	V _{rw} m=82V, 5.1A, 600W(1ms), Bidirectional	DO-214AA	1ba	2k	Fag
TS	SM4T200	TVS	V _{br} =200V, 1.5A, 400W(1ms)	SOD-6	1d	1q	Ste
TSC	1SMA78CA	TVS	V _{rw} m=78V±5%, 3.2A, 400W (1ms), Bidirectional	403B-01	3ba	1e	Ons
TT	1SV302	C-diode	CATV-Tuning, 35V, 47/2.6pF(2..25V)	SOD-123	5d	1a	Tos
TT	1SV303	C-diode	CATV-tuning, 30V, 2.6/47pF(25V..2V), R _s <1.25Ω	SOD-523	6d	1a	Tos
TT	BZX84J-C12	Z-diode	12V±5%, I _f =250mA, 550mW	SOD-323FL	7d	1a	Phi
TT	CD214A-T8.5CA	TVS	V _{br} =8.5V, I _{rsm} =27.7A, 400W(1ms), Bidirectional	DO-214AC	1ba	1j	Bm
TT	P4SMAJ8.5AC	TVS	V _{br} =8.5V, 27.7A, 400W (1ms), Bidirectional	DO-214AC	1ba	1x,1y	Pjt,Sj
TT	P6SMB82CA	TVS	V _{rw} m=82V, 5.3A, 600W(1ms), Bidirectional	DO-214AA	1ba	2k	Fag
TT	SM4T200A	TVS	V _{br} =200V, 1.5A, 400W(1ms)	SOD-6	1d	1q	Ste
TT	SMAJ8.5CA	TVS	V _{rw} m=8.5V, V _{br} =9.44..10.4V, 27.7A, 400W(1ms), Bidirectional	DO-214AC	1ba	1x	Di
TT	SMF180A	TVS	V _{rw} m=180.0V, V _{br} =200.0..220.0V, 0.69A, 200W(10/1000μs)	SOD-123FL	7d	1a	Ers
TT	TV02W181-G	TVS	V _{rw} m=180V, V _{br} =200..220V, I _{pp} =0.69A, 200W(1ms)	SOD-123	5d	1a	Cmc
TU	BZX84J-C13	Z-diode	13V±5%, I _f =250mA, 550mW	SOD-323FL	7d	1a	Phi
TU	MM3Z16VS	Z-diode	15.85..16.51V, I _z t=5mA, Z _t =40Ω, 200mW	SOD-323FL	7d	1u	Ons
TU	P4SMAJ9.0C	TVS	V _{br} =9V, 23.6A, 400W (1ms), Bidirectional	DO-214AC	1ba	1x,1y	Pjt,Sj
TU	P6SMB91C	TVS	V _{rw} m=91V, 4.5A, 600W(1ms), Bidirectional	DO-214AA	1ba	2k	Fag
TU	SM4T220	TVS	V _{br} =220V, 1.4A, 400W(1ms)	SOD-6	1d	1q	Ste
TV	1SV304	C-diode	VCO-VHF-Band Radio, 10V, 19.3/6.6pF(1..4V), R _s <0.32Ω	SOD-123	5d	1a	Tos
TV	1SV305	C-diode	VHF-VCO, 10V, 6.1..18.3pF(4..1V), R _s <0.32Ω	SOD-523	6d	1a	Tos
TV	BZX84J-C15	Z-diode	15V±5%, I _f =250mA, 550mW	SOD-323FL	7d	1a	Phi
TV	CD214A-T9.0CA	TVS	V _{br} =9.0V, I _{rsm} =26.0A, 400W(1ms), Bidirectional	DO-214AC	1ba	1j	Bm
TV	P4SMAJ9.0AC	TVS	V _{br} =9V, 26A, 400W (1ms), Bidirectional	DO-214AC	1ba	1x,1y	Pjt,Sj
TV	P6SMB91CA	TVS	V _{rw} m=91V, 4.8A, 600W(1ms), Bidirectional	DO-214AA	1ba	2k	Fag
TV	SM4T220A	TVS	V _{br} =220V, 1.4A, 400W(1ms)	SOD-6	1d	1q	Ste
TV	SMAJ9.0CA	TVS	V _{rw} m=9.0V, V _{br} =10.0..11.1V, 26A, 400W(1ms), Bidirectional	DO-214AC	1ba	1x	Di
TV	SMF190A	TVS	V _{rw} m=190.0V, V _{br} =211.0..232.0V, 0.69A, 200W(10/1000μs)	SOD-123FL	7d	1a	Ers
TV	TV02W191-G	TVS	V _{rw} m=190V, V _{br} =211..232V, I _{pp} =0.69A, 200W(1ms)	SOD-123	5d	1a	Cmc
TW	BZX84J-C16	Z-diode	16V±5%, I _f =250mA, 550mW	SOD-323FL	7d	1a	Phi
TW	MM3Z18VS	Z-diode	17.56..18.35V, I _z t=5mA, Z _t =45Ω, 200mW	SOD-323FL	7d	1u	Ons
TW	P4SMAJ10C	TVS	V _{br} =10V, 21.2A, 400W (1ms), Bidirectional	DO-214AC	1ba	1x,1y	Pjt,Sj
TW	P6SMB100C	TVS	V _{rw} m=100V, 4.2A, 600W(1ms), Bidirectional	DO-214AA	1ba	1j	Fag
TX	BZX84J-C18	Z-diode	18V±5%, I _f =250mA, 550mW	SOD-323FL	7d	1a	Phi
TX	CD214A-T10CA	TVS	V _{br} =10V, I _{rsm} =23.5A, 400W(1ms), Bidirectional	DO-214AC	1ba	1j	Bm
TX	MM3Z33VT	Z-diode	3.19..3.41V, I _z t=5mA, Z _t =95Ω, 200mW	SOD-323FL	7d	1u	Ons
TX	P4SMAJ10AC	TVS	V _{br} =10V, 23.5A, 400W (1ms), Bidirectional	DO-214AC	1ba	1x,1y	Pjt,Sj
TX	P6SMB100CA	TVS	V _{rw} m=100V, 4.4A, 600W(1ms), Bidirectional	DO-214AA	1ba	2k	Fag
TX	SMAJ10CA	TVS	V _{rw} m=10V, V _{br} =11.1..12.3V, 21.7A, 400W(1ms), Bidirectional	DO-214AC	1ba	1x	Di



SMD
code

Type

Function

Short description

Case

Pinout

St.

Mnf.

SMD code	Type	Function	Short description	Case	Pinout	St.	Mnf.
TY	1SS241	C-diode	VHF-Band-Sw, 30V, <1.2pF(6V), <0.9Ω	SOD-123	5d	1a	Tos
TY	1SS314	C-diode	UHF-Band Switch, 30V, 100mA, 0.7pF(6V), <0.9Ω	SOD-323	5d	1a	Tos
TY	1SS371	C-diode	VHF-Band-Sw, 30V, <1.2pF(6V), <0.9Ω	SOD-323	5d	1a	Tos
TY	1SS381	Si-diode	VHF Tuner Band Switch, 30V, 100mA, 0.7pF, <0.6Ω(100MHz)	SOD-523	7d	1a	Tos
TY	BZX84J-C20	Z-diode	20V±5%, If=250mA, 550mW	SOD-323FL	7d	1a	Phi
TY	KDZ27VVY	Z-diode	26.19..27.53V, Izt=2mA, Zzt=150Ω, 100mW	VSC	7d	1a	Kec
TY	P4SMAJ11C	TVS	Vbr=11V, 20A, 400W(1ms), Bidirectional	DO-214AC	1ba	1x,1y	Pjt,Srj
TY	P6SMB110C	TVS	Vrwm=110V, 3.8A, 600W(1ms), Bidirectional	DO-214AA	1ba	2k	Fag
TZ	BZT52-B30S	Z-diode	29.40..30.60V, Izt=2mA, Zzt=80Ω, 200mW	SOD-323FL	7d	1a	Tsc
TZ	BZX84J-C22	Z-diode	22V±5%, If=250mA, 550mW	SOD-323FL	7d	1a	Phi
TZ	CD214A-T11CA	TVS	Vbr=11V, Irlsm=22.0A, 400W(1ms), Bidirectional	DO-214AC	1ba	1j	Bm
TZ	MM3Z30VB	Z-diode	29.40..30.60V, Zzt=75Ω, Izt=2mA, Zzt=80Ω, 200mW	SOD-323FL	7d	1a	F
TZ	MM3Z30VBW	Z-diode	29.40..30.60V, Izt=2mA, Zzt=80Ω, 200mW	SOD-323FL	7d	1a	Tac
TZ	P4SMAJ11AC	TVS	Vbr=11V, 22A, 400W(1ms), Bidirectional	DO-214AC	1ba	1x,1y	Pjt,Srj
TZ	P6SMB110CA	TVS	Vrwm=110V, 4A, 600W(1ms), Bidirectional	DO-214AA	1ba	2k	Fag
TZ	SMAJ11CA	TVS	Vrwm=11V, Vbr=12.2..13.5V, 22A, 400W(1ms), Bidirectional	DO-214AC	1ba	1x	Di
TZ	TCMM3Z30VB	Z-diode	30V±2%, Izt=5mA, Zzt=75Ω, 200mW	SOD-323FL	7d	1a	Tac
U	BAR88-02V	Si-diode	Ant, Sw, 80V, 0.1A, 250mW, Vf<1.2V(100mA), 0.28pF(1GHz)	SOD-523	5d	1a	Inf
U	BAT62-02LS	Si-diode	Schottky, 40V, 20mA; Vf<1.0V, Cd<0.6pF	TSSLP-2-1	13d	2i	Inf
U	BB145	C-diode	VCO, 6V, 20mA, 2.75/6.4pF(4V/1V, 1MHz), <0.6Ω	SOD-523	6d	1a	Phi
U	HVU355	C-diode	VCO, 15V, 6.4/7.4pF(1V)	SOD-323	5d	1a	Ren
U	MA2SV01	C-diode	VCO, 6V, 16..6pF(1..3V)	SOD-523	6d	1a	Pan
U	MMSZ5222BPT	Z-diode	2.375..2.625V, Izt=5mA, Zzt=100Ω, 225mW	SOD-523	7d	1a	Chm
U	MMSZ5270BPT	Z-diode	86.45..95.55V, Izt=1.4mA, Zzt=400Ω, 225mW	SOD-523	7d	1a	Chm
U (white)	BB545	C-diode	UHF TV-tuning, 30V, 20mA, 2.2..21.5pF(28..1V)	SOD-323	5d	2	Inf
U	MMSZ5222SPT	Z-diode	2.450..2.550V, Izt=5mA, Zzt=100Ω, 225mW	SOD-523	7d	1a	Chm
U	MMSZ5270SPT	Z-diode	89.18..92.82V, Izt=1.4mA, Zzt=400Ω, 225mW	SOD-523	7d	1a	Chm
U01	SMTPA62	TVS	Vbr=62V, 50A(1ms), 5W, Bidirectional	DO-214AA	1ba	1r	Ste
U05	SMTPA68	TVS	Vbr=68V, 50A(1ms), 5W, Bidirectional	DO-214AA	1ba	1r	Ste
U1	BZX84J-C24	Z-diode	24V±5%, If=250mA, 550mW	SOD-323FL	7d	1a	Phi
U1	FES1A	Si-diode	Ultrafast Recovery, 50V, 1A, <50ns	DO-214AC	1d	2j	Fag
U1	MMSZ3V9	Z-diode	3.9V±5%, Izt=5mA, Zzt=90Ω, 500mW	SOD-123	5d	1a	Mot
U1	UDZ56B	Z-diode	56V±2.5%, Izt=2mA, 200mW	SOD-323	5d	1d	Di
U10A	UGF10A	Si-diode	U-Fast Recovery Rectifier, 50V, 1A, Vf<0.95V(1A), 35ns	DO-214AC	1d	1b	Zow
U10B	UGF10B	Si-diode	U-Fast Recovery Rectifier, 100V, 1A, Vf<0.95V(1A), 35ns	DO-214AC	1d	1b	Zow
U10D	UGF10D	Si-diode	U-Fast Recovery Rectifier, 200V, 1A, Vf<0.95V(1A), 35ns	DO-214AC	1d	1b	Zow
U10G	UGF10G	Si-diode	U-Fast Recovery Rectifier, 400V, 1A, Vf<1.25V(1A), 35ns	DO-214AC	1d	1b	Zow
U10J	UGF10J	Si-diode	U-Fast Recovery Rectifier, 600V, 1A, Vf<1.7V(1A), 35ns	DO-214AC	1d	1b	Zow
U10K	UGF10K	Si-diode	U-Fast Recovery Rectifier, 800V, 1A, Vf<2.2V(1A), 35ns	DO-214AC	1d	1b	Zow
U11	USM11SPT	Si-diode	Rectifier, S-fast, 50V, 1A	SOD-123S	7d	1a	Chm
U12	USM12SPT	Si-diode	Rectifier, S-fast, 100V, 1A	SOD-123S	7d	1a	Chm
U13	SMTPA100	TVS	Vbr=100V, 50A(1ms), 5W, Bidirectional	DO-214AA	1ba	1r	Ste
U13	USM13SPT	Si-diode	Rectifier, S-fast, 200V, 1A	SOD-123S	7d	1a	Chm
U14	USM14SPT	Si-diode	Rectifier, S-fast, 300V, 1A	SOD-123S	7d	1a	Chm
U15	USM15SPT	Si-diode	Rectifier, S-fast, 400V, 1A	SOD-123S	7d	1a	Chm
U16	USM16SPT	Si-diode	Rectifier, S-fast, 600V, 1A	SOD-123S	7d	1a	Chm
U17	SMTPA120	TVS	Vbr=120V, 50A(1ms), 5W, Bidirectional	DO-214AA	1ba	1r	Ste
U17	USM17SPT	Si-diode	Rectifier, S-fast, 800V, 1A	SOD-123S	7d	1a	Chm
U18	USM18SPT	Si-diode	Rectifier, S-fast, 1000V, 1A	SOD-123S	7d	1a	Chm
U19	SMTPA130	TVS	Vbr=130V, 50A(1ms), 5W, Bidirectional	DO-214AA	1ba	1r	Ste
U1A	MURS105	Si-diode	U-Fast Rectifier, 50V, 1A, Vf<0.71V(1A), 25ns	DO-214AC	1d	1a	Ons
U1B	MURS110	Si-diode	U-Fast Rectifier, 100V, 1A, Vf<0.71V(1A), 25ns	DO-214AC	1d	1a	Ons
U1C	MURS115	Si-diode	U-Fast Rectifier, 150V, 1A, Vf<0.71V(1A), 25ns	DO-214AC	1d	1a	Ons
U1D	MURS120	Si-diode	U-Fast Rectifier, 200V, 1A, Vf<0.87V(1A), 25ns	DO-214AC	1d	1a	Mot
U1D	SMAU1D	Si-diode	U-Fast Recovery, 200V, 1A, Vf<0.98V(1A), <50ns	DO-214AC	1d	1a	Kec
U1G	MURS140	Si-diode	U-Fast Rectifier, 400V, 1A, Vf<1.25V(1A), 50ns	DO-214AC	1d	1a	Ons
U1G	SMAU1G	Si-diode	U-Fast Recovery, 400V, 1A, Vf<1.3V(1A), <50ns	DO-214AC	1d	1a	Kec
U1GB	MURS140	Si-diode	U-Fast Rectifier, 283V, 1A, Vf<1.25V(1A), 50ns	DO-214AA	1d	1a	Di
U1J	MURS160	Si-diode	U-Fast Rectifier, 600V, 1A, Vf<1.25V(1A), 50ns	DO-214AC	1d	1a	Mot
U1J	SMAU1J	Si-diode	U-Fast Recovery, 600V, 1A, Vf<1.7V(1A), <75ns	DO-214AC	1d	1a	Kec
U1JB	MURS160	Si-diode	U-Fast Rectifier, 424V, 1A, Vf<1.25V(1A), 50ns	DO-214AA	1d	1a	Di
U2	BZX84J-C27	Z-diode	27V±5%, If=250mA, 550mW	SOD-323FL	7d	1a	Phi
U2	CZR2F24B	Z-diode	2.34..2.46V, Izt=5mA, Zzt=100Ω, 200mW	1005	70d	2d	Cmc
U2	CZRQR2V4B	Z-diode	2.34..2.46V, Izt=5mA, Zzt=100Ω, 125mW	4002	13d	2b	Cmc
U2	CZRUR2V4B	Z-diode	2.34..2.46V, Izt=5mA, Zzt=100Ω, 150mW	0603	13d	2b	Cmc
U2	FES1B	Si-diode	Ultrafast Recovery, 100V, 1A, <50ns	DO-214AC	1d	2j	Fag
U2	MMSZ4V3	Z-diode	4.3V±5%, Zzt=90Ω, 500mW	SOD-123	5d	1a	Mot
U20A	UGF20A	Si-diode	U-Fast Recovery Rectifier, 50V, 2A, Vf<0.95V(2A), 35ns	DO-214AA	1d	1b	Zow
U20B	UGF20B	Si-diode	U-Fast Recovery Rectifier, 100V, 2A, Vf<0.95V(2A), 35ns	DO-214AA	1d	1b	Zow
U20D	UGF20D	Si-diode	U-Fast Recovery Rectifier, 200V, 2A, Vf<0.95V(2A), 35ns	DO-214AA	1d	1b	Zow



SMD
code

Type

Function

Short description

Case

Pinout

St.

Mnf.

U20G	UGF20G	Si-diode	U-Fast Recovery Rectifier, 400V, 2A, Vf<1.25V(2A), 35ns
U20J	UGF20J	Si-diode	U-Fast Recovery Rectifier, 600V, 2A, Vf<1.7V(2A), 35ns
U20K	UGF20K	Si-diode	U-Fast Recovery Rectifier, 800V, 2A, Vf<2.2V(2A), 35ns
U25	SMTPA180	TVS	Vbr=180V, 50A(1ms), 5W, Bidirectional
U27	SMTPA200	TVS	Vbr=200V, 50A(1ms), 5W, Bidirectional
U2D	MURS220	Si-diode	U-Fast Rectifier, 200V, 2A, Vf<0.95V(2A), 35ns
U2D	SMAU2D	Si-diode	U-Fast Recovery, 200V, 2A, Vf<0.98V(2A), <50ns
U2F	MURS230	Si-diode	U-Fast Rectifier, 300V, 2A, Vf<1.3V(2A), 65ns
U2G	MURS240	Si-diode	U-Fast Rectifier, 400V, 2A, Vf<1.3V(2A), 65ns
U2G	SMAU2G	Si-diode	U-Fast Recovery, 400V, 2A, Vf<1.3V(2A), <50ns
U2J	MURS260	Si-diode	U-Fast Rectifier, 600V, 2A, Vf<1.45V(2A), 75ns
U2J	SMAU2J	Si-diode	U-Fast Recovery, 600V, 2A, Vf<1.7V(2A), <75ns
U3	BZX84J-C2V4	Z-diode	2.4V±5%, If=250mA, 550mW
U3	CZRF2V7B	Z-diode	2.63..2.77V, Izt=5mA, Zzt=100Ω, 200mW
U3	CZRQR2V7B	Z-diode	2.63..2.77V, Izt=5mA, Zzt=100Ω, 125mW
U3	CZRZU2V7B	Z-diode	2.63..2.77V, Izt=5mA, Zzt=100Ω, 150mW
U3	FES1D	Si-diode	Ultrafast Recovery, 200V, 1A, <50ns
U3	MMSZ4V7	Z-diode	4.7V±5%, Zzt=80Ω, 500mW
U30A	UGF30A	Si-diode	U-Fast Recovery Rectifier, 50V, 3A, Vf<0.95V(3A), 35ns
U30B	UGF30B	Si-diode	U-Fast Recovery Rectifier, 100V, 3A, Vf<0.95V(3A), 35ns
U30D	UGF30D	Si-diode	U-Fast Recovery Rectifier, 200V, 3A, Vf<0.95V(3A), 35ns
U30G	UGF30G	Si-diode	U-Fast Recovery Rectifier, 400V, 3A, Vf<1.25V(3A), 35ns
U30J	UGF30J	Si-diode	U-Fast Recovery Rectifier, 600V, 3A, Vf<1.7V(3A), 35ns
U30K	UGF30K	Si-diode	U-Fast Recovery Rectifier, 800V, 3A, Vf<2.2V(3A), 35ns
U31	SMTPA220	TVS	Vbr=220V, 50A(1ms), 5W, Bidirectional
U35	SMTPA240	TVS	Vbr=240V, 50A(1ms), 5W, Bidirectional
U39	SMTPA270	TVS	Vbr=270V, 50A(1ms), 5W, Bidirectional
U3D	MURS320	Si-diode	U-Fast Rectifier, 200V, 3A, Vf<0.87V(3A), 25ns
U3G	MURS340	Si-diode	U-Fast Rectifier, 400V, 3A, Vf<1.25V(3A), 75ns
U3J	MURS360	Si-diode	U-Fast Rectifier, 600V, 3A, Vf<1.25V(3A), 75ns
U4	BZX84J-C2V7	Z-diode	2.7V±5%, If=250mA, 550mW
U4	CZRF3V0B	Z-diode	2.93..3.08V, Izt=5mA, Zzt=95Ω, 200mW
U4	CZRQR3V0B	Z-diode	2.93..3.08V, Izt=5mA, Zzt=95Ω, 125mW
U4	CZRZU3V0B	Z-diode	2.93..3.08V, Izt=5mA, Zzt=95Ω, 150mW
U4	FES1F	Si-diode	Ultrafast Recovery, 300V, 1A, <50ns
U4	MMSZ5V1	Z-diode	5.1V±5%, Zzt=60Ω, 500mW
U4A	MURA105	Si-diode	Schottky, U-Fast Rectifier, 50V, 1A, Vf<0.66V(1A), <30ns
U4B	MURA110	Si-diode	Schottky, U-Fast Rectifier, 100V, 1A, Vf<0.66V(1A), <30ns
U4C	MURA115	Si-diode	Schottky, U-Fast Rectifier, 150V, 1A, Vf<0.71V(1A), <35ns
U4D	MURA120	Si-diode	Schottky, U-Fast Rectifier, 200V, 1A, Vf<0.71V(1A), <35ns
U4F	MURA130	Si-diode	Schottky, U-Fast Rectifier, 300V, 1A, Vf<0.8V(1A), <65ns
U4G	MURA140	Si-diode	Schottky, U-Fast Rectifier, 400V, 1A, Vf<0.8V(1A), <65ns
U4J	MURA160	Si-diode	Schottky, U-Fast Rectifier, 600V, 1A, Vf<1.05V(1A), <75ns
U5	BZX584B33V	Z-diode	32.34..33.66V, Izt=2mA, Zzt=80Ω, 200mW
U5	BZX84J-C30	Z-diode	30V±5%, If=250mA, 550mW
U5	CZRF3V3B	Z-diode	3.22..3.38V, Izt=5mA, Zzt=95Ω, 200mW
U5	CZRQR3V3B	Z-diode	3.22..3.38V, Izt=5mA, Zzt=95Ω, 125mW
U5	CZRZU3V3B	Z-diode	3.22..3.38V, Izt=5mA, Zzt=95Ω, 150mW
U5	FES1G	Si-diode	Ultrafast Recovery, 400V, 1A, <50ns
U5	MMSZ33VB	Z-diode	32.34..33.66V, Izt=2mA, Zzt=80Ω, 200mW
U5	MMSZ5V6	Z-diode	5.6V±5%, Zzt=40Ω, 500mW
U5A	MURA205	Si-diode	Schottky, U-Fast Rectifier, 50V, 1A, Vf<0.94V(2A), <30ns
U5B	MURA210	Si-diode	Schottky, U-Fast Rectifier, 100V, 1A, Vf<0.94V(2A), <30ns
U5C	MURA215	Si-diode	Schottky, U-Fast Rectifier, 150V, 1A, Vf<0.95V(2A), <35ns
U5D	MURA220	Si-diode	Schottky, U-Fast Rectifier, 200V, 1A, Vf<0.95V(2A), <35ns
U5F	MURA230	Si-diode	Schottky, U-Fast Rectifier, 300V, 1A, Vf<1.3V(2A), <65ns
U5G	MURA240	Si-diode	Schottky, U-Fast Rectifier, 400V, 1A, Vf<1.3V(2A), <65ns
U5J	MURA260	Si-diode	Schottky, U-Fast Rectifier, 600V, 1A, Vf<1.45V(2A), <75ns
U6	BZX84J-C33	Z-diode	33V±5%, If=250mA, 550mW
U6	CZRF3V6B	Z-diode	3.51..3.69V, Izt=5mA, Zzt=90Ω, 200mW
U6	CZRQR3V6B	Z-diode	3.51..3.69V, Izt=5mA, Zzt=90Ω, 125mW
U6	CZRZU3V6B	Z-diode	3.51..3.69V, Izt=5mA, Zzt=90Ω, 150mW
U6	FES1J	Si-diode	Ultrafast Recovery, 600V, 1A, <50ns
U60	USB260	Si-diode	Rectifier, 600V, 2A, Vf<1.6V(2A)
U7	BZX84J-C36	Z-diode	36V±5%, If=250mA, 550mW
U7	CZRF3V9B	Z-diode	3.80..4.0V, Izt=5mA, Zzt=90Ω, 200mW
U7	CZRQR3V9B	Z-diode	3.80..4.0V, Izt=5mA, Zzt=90Ω, 125mW
U7	CZRZU3V9B	Z-diode	3.80..4.0V, Izt=5mA, Zzt=90Ω, 150mW
U8	BZX84J-C39	Z-diode	39V±5%, If=250mA, 550mW
U8	CZRF4V3B	Z-diode	4.19..4.41V, Izt=5mA, Zzt=88Ω, 200mW

DO-214AA	1d	1b	Zow
DO-214AA	1d	1b	Zow
DO-214AA	1d	1b	Zow
DO-214AA	1ba	1r	Ste
DO-214AA	1ba	1r	Ste
DO-214AA	1d	1a	Ons
DO-214AC	1d	1a	Kec
DO-214AA	1d	1a	Ons
DO-214AA	1d	1a	Ons
DO-214AC	1d	1a	Kec
DO-214AA	1d	1a	Ons
DO-214AC	1d	1a	Kec
SOD-323FL	7d	1a	Phi
1005	70d	2d	Cmc
0402	13d	2b	Cmc
0603	13d	2b	Cmc
DO-214AC	1d	2j	Fag
SOD-123	5d	1a	Mot
DO-214AA	1d	1b	Zow
DO-214AA	1d	1b	Zow
DO-214AA	1d	1b	Zow
DO-214AA	1d	1b	Zow
DO-214AA	1d	1b	Zow
DO-214AA	1ba	1r	Ste
DO-214AA	1ba	1r	Ste
DO-214AA	1ba	1r	Ste
DO-214AC	1d	1h	Ons
DO-214AC	1d	1h	Ons
DO-214AC	1d	1h	Ons
SOD-323FL	7d	1a	Phi
1005	70d	2d	Cmc
0402	13d	2b	Cmc
0603	13d	2b	Cmc
DO-214AC	1d	2j	Fag
SOD-123	5d	1a	Mot
DO-214AC	1d	1f	Ons
DO-214AC	1d	1f	Ons
DO-214AC	1d	1f	Ons
DO-214AC	1d	1f	Ons
DO-214AC	1d	1f	Ons
DO-214AC	1d	1f	Ons
DO-214AC	1d	1f	Ons
SOD-523FL	7d	1a	Tac
SOD-323FL	7d	1a	Phi
1005	70d	2d	Cmc
0402	13d	2b	Cmc
0603	13d	2b	Cmc
DO-214AC	1d	2j	Fag
SOD-523FL	7d	1a	Tac
SOD-123	5d	1a	Mot
DO-214AC	1d	1f	Ons
DO-214AC	1d	1f	Ons
DO-214AC	1d	1f	Ons
DO-214AC	1d	1f	Ons
DO-214AC	1d	1f	Ons
DO-214AC	1d	1f	Ons
DO-214AC	1d	1f	Ons
SOD-323FL	7d	1a	Phi
1005	70d	2d	Cmc
0402	13d	2b	Cmc
0603	13d	2b	Cmc
DO-214AC	1d	2j	Fag
DO-214AA	1d	1k	Vs
SOD-323FL	7d	1a	Phi
1005	70d	2d	Cmc
0402	13d	2b	Cmc
0603	13d	2b	Cmc
DO-214AC	1d	2j	Fag
DO-214AA	1d	1k	Vs
SOD-323FL	7d	1a	Phi
1005	70d	2d	Cmc



SMD
code

Type

Function

Short description

Case

Pinout

St.

Mnf.

U8	CZRQR4V3B	Z-diode	4.19..4.41V, Izt=5mA, Zzt=88Ω, 125mW	0402	13d	2b	Cmc
U8	CZRUR4V3B	Z-diode	4.19..4.41V, Izt=5mA, Zzt=88Ω, 150mW	0603	13d	2b	Cmc
U8	MMSZ18H	Z-diode	16.8..19.1V, Izt=2mA, Zzt=45Ω, 200mW	SOD-523	7d	1a	Zow
U8	MMSZ18V	Z-diode	18V±5%, Izt=5mA, Zzt=45Ω, 200mW	SOD-523	6d	1a	Eic
U9	BZX84J-C3V0	Z-diode	3.0V±5%, If=250mA, 550mW	SOD-323FL	7d	1a	Phi
U9	CZRF4V7B	Z-diode	4.58..4.82V, Izt=5mA, Zzt=70Ω, 200mW	1005	70d	2d	Cmc
U9	CZRQR4V7B	Z-diode	4.58..4.82V, Izt=5mA, Zzt=70Ω, 125mW	0402	13d	2b	Cmc
U9	CZRUR4V7B	Z-diode	4.58..4.82V, Izt=5mA, Zzt=70Ω, 150mW	0603	13d	2b	Cmc
UA	BZX84J-C3V3	Z-diode	3.3V±5%, If=250mA, 550mW	SOD-323FL	7d	1a	Phi
UA	CZRF5V1B	Z-diode	4.97..5.23V, Izt=5mA, Zzt=50Ω, 200mW	1005	70d	2d	Cmc
UA	CZRQR5V1B	Z-diode	4.97..5.23V, Izt=5mA, Zzt=50Ω, 125mW	0402	13d	2b	Cmc
UA	CZRUR5V1B	Z-diode	4.97..5.23V, Izt=5mA, Zzt=50Ω, 150mW	0603	13d	2b	Cmc
UA	FUES1A	Si-diode	Ultrafast Recovery Rectifier, 50V, 1A, <25ns	DO-214AC	1d	2j	Fag
UA	KDV154	C-diode	VCO for UHF-Band, 20V, 13.9..4.5pF(6..2V)	USC	5d	1a	Kec
UA	KDV154E	C-diode	VCO for UHF-Band, 20V, 13.9..4.5pF(6..2V)	ESC	6d	1a	Kec
UA	US1A	Si-diode	Rectifier, 500V, 1A, Vf<1.0V(1A), 75ns, 15pF	DO-214AC	1d	1k	Vs
UB	BZX84J-C3V6	Z-diode	3.6V±5%, If=250mA, 550mW	SOD-323FL	7d	1a	Phi
UB	CZRF5V6B	Z-diode	5.46..5.74V, Izt=5mA, Zzt=25Ω, 200mW	1005	70d	2d	Cmc
UB	CZRQR5V6B	Z-diode	5.46..5.74V, Izt=5mA, Zzt=25Ω, 125mW	0402	13d	2b	Cmc
UB	CZRUR5V6B	Z-diode	5.46..5.74V, Izt=5mA, Zzt=25Ω, 150mW	0603	13d	2b	Cmc
UB	FUES1B	Si-diode	Ultrafast Recovery Rectifier, 100V, 1A, <25ns	DO-214AC	1d	2j	Fag
UB	KDZ11B	Z-diode	11V±2.5%, 20mA, 1W	PMDU	7d	1s	Rhm
UB	US1B	Si-diode	Rectifier, 100V, 1A, Vf<1.0V(1A) 75ns, 15pF	DO-214AC	1d	1k	Vs
UB11	UBM11PT	Si-diode	Rectifier, S-fast, 50V, 1A	DO-214AC	1d	1a	Chm
UB12	UBM12PT	Si-diode	Rectifier, S-fast, 100V, 1A	DO-214AC	1d	1a	Chm
UB13	UBM13PT	Si-diode	Rectifier, S-fast, 200V, 1A	DO-214AC	1d	1a	Chm
UB14	UBM14PT	Si-diode	Rectifier, S-fast, 300V, 1A	DO-214AC	1d	1a	Chm
UB15	UBM15PT	Si-diode	Rectifier, S-fast, 400V, 1A	DO-214AC	1d	1a	Chm
UB16	UBM16PT	Si-diode	Rectifier, S-fast, 600V, 1A	DO-214AC	1d	1a	Chm
UB17	UBM17PT	Si-diode	Rectifier, S-fast, 800V, 1A	DO-214AC	1d	1a	Chm
UB18	UBM18PT	Si-diode	Rectifier, S-fast, 1000V, 1A	DO-214AC	1d	1a	Chm
UB21	UBM21PT	Si-diode	Rectifier, S-fast, 50V, 2A	DO-214AA	1d	1a	Chm
UB22	UBM22PT	Si-diode	Rectifier, S-fast, 100V, 2A	DO-214AA	1d	1a	Chm
UB23	UBM23PT	Si-diode	Rectifier, S-fast, 200V, 2A	DO-214AA	1d	1a	Chm
UB24	UBM24PT	Si-diode	Rectifier, S-fast, 300V, 2A	DO-214AA	1d	1a	Chm
UB25	UBM25PT	Si-diode	Rectifier, S-fast, 400V, 2A	DO-214AA	1d	1a	Chm
UB26	UBM26PT	Si-diode	Rectifier, S-fast, 600V, 2A	DO-214AA	1d	1a	Chm
UB27	UBM27PT	Si-diode	Rectifier, S-fast, 800V, 2A	DO-214AA	1d	1a	Chm
UB28	UBM28PT	Si-diode	Rectifier, S-fast, 1000V, 2A	DO-214AA	1d	1a	Chm
UB31	UBM31PT	Si-diode	Rectifier, S-fast, 50V, 3A	DO-214AA	1d	1a	Chm
UB32	UBM32PT	Si-diode	Rectifier, S-fast, 100V, 3A	DO-214AA	1d	1a	Chm
UB33	UBM33PT	Si-diode	Rectifier, S-fast, 200V, 3A	DO-214AA	1d	1a	Chm
UB34	UBM34PT	Si-diode	Rectifier, S-fast, 300V, 3A	DO-214AA	1d	1a	Chm
UB35	UBM35PT	Si-diode	Rectifier, S-fast, 400V, 3A	DO-214AA	1d	1a	Chm
UB36	UBM36PT	Si-diode	Rectifier, S-fast, 600V, 3A	DO-214AA	1d	1a	Chm
UB37	UBM37PT	Si-diode	Rectifier, S-fast, 800V, 3A	DO-214AA	1d	1a	Chm
UB38	UBM38PT	Si-diode	Rectifier, S-fast, 1000V, 3A	DO-214AA	1d	1a	Chm
UC	BZX84J-C3V9	Z-diode	3.9V±5%, If=250mA, 550mW	SOD-323FL	7d	1a	Phi
UC	CZRF6V2B	Z-diode	6.05..6.36V, Izt=5mA, Zzt=10Ω, 200mW	1005	70d	2d	Cmc
UC	CZRQR6V2B	Z-diode	6.05..6.36V, Izt=5mA, Zzt=10Ω, 125mW	0402	13d	2b	Cmc
UC	CZRUR6V2B	Z-diode	6.05..6.36V, Izt=5mA, Zzt=10Ω, 150mW	0603	13d	2b	Cmc
UC31	UCM31PT	Si-diode	Rectifier, S-fast, 50V, 3A	DO-214AB	1d	1a	Chm
UC32	UCM32PT	Si-diode	Rectifier, S-fast, 100V, 3A	DO-214AB	1d	1a	Chm
UC33	UCM33PT	Si-diode	Rectifier, S-fast, 200V, 3A	DO-214AB	1d	1a	Chm
UC34	UCM34PT	Si-diode	Rectifier, S-fast, 300V, 3A	DO-214AB	1d	1a	Chm
UC35	UCM35PT	Si-diode	Rectifier, S-fast, 400V, 3A	DO-214AB	1d	1a	Chm
UC36	UCM36PT	Si-diode	Rectifier, S-fast, 600V, 3A	DO-214AB	1d	1a	Chm
UC37	UCM37PT	Si-diode	Rectifier, S-fast, 800V, 3A	DO-214AB	1d	1a	Chm
UC38	UCM38PT	Si-diode	Rectifier, S-fast, 1000V, 3A	DO-214AB	1d	1a	Chm
UD	BZX84J-C43	Z-diode	43V±5%, If=250mA, 550mW	SOD-323FL	7d	1a	Phi
UD	FUES1D	Si-diode	Ultrafast Recovery Rectifier, 200V, 1A, <25ns	DO-214AC	1d	2j	Fag
UD	KDS114	Si-diode	Band-Switch, 30V, 100mA, Vf<0.85V(2mA), 100MHz	USC	5d	1a	Kec
UD	KDS114E	Si-diode	Band-Switch, 30V, 100mA, Vf<0.85V(2mA), 100MHz	ESC	6d	1a	Kec
UD	KDV175	Si-diode	VHF/UHF-Band Att, 50V, 50mA, Vf<0.95V(50mA), 100MHz	USC	5d	1a	Kec
UD	KDV175E	Si-diode	VHF/UHF-Band Att, 50V, 50mA, Vf<0.95V(50mA), 100MHz	ESC	6d	1a	Kec
UD	P4SMAJ12C	TVS	Vbr=12V, 18.1A, 400W(1ms), Bidirectional	DO-214AC	1ba	1x,1y	Pjt,Srj
UD	SM4T18C	TVS	Vbr=18V, 16A, 400W(1ms), Bidirectional	SOD-6	1ba	1r	Ste
UD	US1D	Si-diode	Rectifier, 200V, 1A, Vf<1.0V(1A) 75ns, 15pF	DO-214AC	1d	1k	Vs
UE	BZX84J-C47	Z-diode	47V±5%, If=250mA, 550mW	SOD-323FL	7d	1a	Phi
UE	CD214A-T12CA	TVS	Vbr=12V, Iism=20.1A, 400W(1ms), Bidirectional	DO-214AC	1ba	1j	Bm



SMD
code

Type

Function

Short description

Case

Pinout

St.

Mnf.

SMD code	Type	Function	Short description	Case	Pinout	St.	Mnf.
UE	CZRF6V8B	Z-diode	6.63..6.97V, Izt=5mA, Zzt=8Ω, 200mW	1005	70d	2d	Cmc
UE	CZRQR6V8B	Z-diode	6.63..6.97V, Izt=5mA, Zzt=8Ω, 125mW	0402	13d	2b	Cmc
UE	CZRU6V8B	Z-diode	6.63..6.97V, Izt=5mA, Zzt=8Ω, 150mW	0603	13d	2b	Cmc
UE	FUF1A	Si-diode	Ultrafast Recovery Rectifier, 50V, 1A, 50..75ns	DO-214AC	1d	2j	Fag
UE	P4SMAJ12AC	TVS	Vbr=12V, 20.1A, 400W (1ms), Bidirectional	DO-214AC	1ba	1x,1y	Pjt,Srj
UE	P4SMAJ300CA	TVS	Vbr=300V, 0.8A, 400W(1ms), Bidirectional	DO-214AC	1ba	1j	Mco
UE	SM4T18CA	TVS	Vbr=18V, 16A, 400W(1ms), Bidirectional	SOD-6	1ba	1r	Ste
UE	SMAJ12CA	TVS	Vrwm=12V, Vbr=13.3..14.7V, 20.1A, 400W(1ms), Bidirectional	DO-214AC	1ba	1x	Di
UF	BZX84J-C4V3	Z-diode	4.3V±5%, If=250mA, 550mW	SOD-323FL	7d	1a	Phi
UF	CZRF7V5B	Z-diode	7.31..7.69V, Izt=5mA, Zzt=7Ω, 200mW	1005	70d	2d	Cmc
UF	CZRQR7V5B	Z-diode	7.31..7.69V, Izt=5mA, Zzt=7Ω, 125mW	0402	13d	2b	Cmc
UF	CZRU7V5B	Z-diode	7.31..7.69V, Izt=5mA, Zzt=7Ω, 150mW	0603	13d	2b	Cmc
UF	FUF1B	Si-diode	Ultrafast Recovery Rectifier, 100V, 1A, 50..75ns	DO-214AC	1d	2j	Fag
UF	KDS160	Si-diode	Sw, 80V, 100mA, Vf<1.2V(100mA), 4ns	USC	5d	1a	Kec
UF	KDS160E	Si-diode	Sw, 80V, 100mA, Vf<1.2V(100mA), 4ns	ESC	6d	1a	Kec
UF	KDS160V	Si-diode	Sw, 80V, 100mA, Vf<1.2V(100mA), 4ns	VSC	6d	1a	Kec
UF	KDZ10FV	Z-diode	9.40..10.60V, Izt=5mA, Zzt=15Ω, 100mW	TFSC	7d	1a	Kec
UF	MAZD240	Z-diode	22.8..25.6V, Zzt=100Ω(5mA), 120mW	SSSMini2	7d	1a	Pan
UF	P4SMAJ13C	TVS	Vbr=13V, 16.8A, 400W (1ms), Bidirectional	DO-214AC	1ba	1x,1y	Pjt,Srj
UG	BZX84J-C4V7	Z-diode	4.7V±5%, If=250mA, 550mW	SOD-323FL	7d	1a	Phi
UG	CD214A-T13CA	TVS	Vbr=13V, Irsm=18.6A, 400W(1ms), Bidirectional	DO-214AC	1ba	1j	Bm
UG	CZRF8V2B	Z-diode	8.0..8.41V, Izt=5mA, Zzt=7Ω, 200mW	1005	70d	2d	Cmc
UG	CZRQR8V2B	Z-diode	8.0..8.41V, Izt=5mA, Zzt=7Ω, 125mW	0402	13d	2b	Cmc
UG	CZRU8V2B	Z-diode	8.0..8.41V, Izt=5mA, Zzt=7Ω, 150mW	0603	13d	2b	Cmc
UG	FUF1D	Si-diode	Ultrafast Recovery Rectifier, 200V, 1A, 50..75ns	DO-214AC	1d	2j	Fag
UG	P4SMAJ13AC	TVS	Vbr=13V, 18.6A, 400W (1ms), Bidirectional	DO-214AC	1ba	1x,1y	Pjt,Srj
UG	P4SMAJ350CA	TVS	Vbr=350V, 0.7A, 400W(1ms), Bidirectional	DO-214AC	1ba	1j	Mco
UG	SMAJ13CA	TVS	Vrwm=13V, Vbr=14.4..15.9V, 18.6A, 400W(1ms), Bidirectional	DO-214AC	1ba	1x	Di
UG	US1G	Si-diode	Rectifier, 400V, 1A, Vf<1.0V(1A) 75ns, 15pF	DO-214AC	1d	1k	Vs
UH	BZX84J-C51	Z-diode	51V±5%, If=250mA, 550mW	SOD-323FL	7d	1a	Phi
UH	CZRF9V1B	Z-diode	8.87..9.33V, Izt=5mA, Zzt=10Ω, 200mW	1005	70d	2d	Cmc
UH	CZRQR9V1B	Z-diode	8.87..9.33V, Izt=5mA, Zzt=10Ω, 125mW	0402	13d	2b	Cmc
UH	CZRU9V1B	Z-diode	8.87..9.33V, Izt=5mA, Zzt=10Ω, 150mW	0603	13d	2b	Cmc
UH	FUF1G	Si-diode	Ultrafast Recovery Rectifier, 400V, 1A, 50..75ns	DO-214AC	1d	2j	Fag
UH	KDS4148U	Si-diode	Sw, 75V, 150mA, Vf<1.2V(100mA), 4ns	USC	5d	1a	Kec
UH	P4SMAJ14C	TVS	Vbr=14V, 15.5A, 400W (1ms), Bidirectional	DO-214AB	1ba	1x,1y	Pjt,Srj
UH	SM4T22C	TVS	Vbr=22V, 13A, 400W(1ms), Bidirectional	SOD-6	1ba	1r	Ste
UI	FUF1J	Si-diode	Ultrafast Recovery Rectifier, 600V, 1A, 50..75ns	DO-214AC	1d	2j	Fag
UJ	CZRF10VB	Z-diode	9.75..10.25V, Izt=5mA, Zzt=15Ω, 200mW	1005	70d	2d	Cmc
UJ	CZRQR10VB	Z-diode	9.75..10.25V, Izt=5mA, Zzt=15Ω, 125mW	0402	13d	2b	Cmc
UJ	CZRU10VB	Z-diode	9.75..10.25V, Izt=5mA, Zzt=15Ω, 150mW	0603	13d	2b	Cmc
UJ	FUF1K	Si-diode	Ultrafast Recovery Rectifier, 800V, 1A, 50..75ns	DO-214AC	1d	2j	Fag
UJ	US1J	Si-diode	Rectifier, 600V, 1A, Vf<1.7V(1A) 75ns, 15pF	DO-214AC	1d	1k	Vs
UK	BZX84J-C56	Z-diode	56V±5%, If=250mA, 550mW	SOD-323FL	7d	1a	Phi
UK	CD214A-T14CA	TVS	Vbr=14V, Irsm=17.2A, 400W(1ms), Bidirectional	DO-214AC	1ba	1j	Bm
UK	CZRF11VB	Z-diode	10.73..11.27V, Izt=5mA, Zzt=18Ω, 200mW	1005	70d	2d	Cmc
UK	CZRQR11VB	Z-diode	10.73..11.27V, Izt=5mA, Zzt=18Ω, 125mW	0402	13d	2b	Cmc
UK	CZRU11VB	Z-diode	10.73..11.27V, Izt=5mA, Zzt=18Ω, 150mW	0603	13d	2b	Cmc
UK	FUF1M	Si-diode	Ultrafast Recovery Rectifier, 1000V, 1A, 50..75ns	DO-214AC	1d	2j	Fag
UK	KDV350	C-diode	VCO, 15V, 15/17.5pF(1V)	USC	5d	1a	Kec
UK	P4SMAJ14AC	TVS	Vbr=14V, 17.2A, 400W (1ms), Bidirectional	DO-214AB	1ba	1x,1y	Pjt,Srj
UK	P4SMAJ400CA	TVS	Vbr=400V, 0.6A, 400W(1ms), Bidirectional	DO-214AC	1ba	1j	Mco
UK	SM4T22CA	TVS	Vbr=22V, 13A, 400W(1ms), Bidirectional	SOD-6	1ba	1r	Ste
UK	SMAJ14CA	TVS	Vrwm=14V, Vbr=15.6..17.2V, 17.2A, 400W(1ms), Bidirectional	DO-214AC	1ba	1x	Di
UK	US1K	Si-diode	Rectifier, 800V, 1A, Vf<1.7V(1A) 75ns, 15pF	DO-214AC	1d	1k	Vs
UL	BZX84J-C5V1	Z-diode	5.1V±5%, If=250mA, 550mW	SOD-323FL	7d	1a	Phi
UL	P4SMAJ15C	TVS	Vbr=15V, 14.8A, 400W (1ms), Bidirectional	DO-214AB	1ba	1x,1y	Pjt,Srj
UL	SM4T24C	TVS	Vbr=24V, 12A, 400W(1ms), Bidirectional	SOD-6	1ba	1r	Ste
UM	BZX84J-C5V6	Z-diode	5.6V±5%, If=250mA, 550mW	SOD-323FL	7d	1a	Phi
UM	CD214A-T15CA	TVS	Vbr=15V, Irsm=16.4A, 400W(1ms), Bidirectional	DO-214AC	1ba	1j	Bm
UM	CZRF12VB	Z-diode	11.70..12.30V, Izt=5mA, Zzt=22Ω, 200mW	1005	70d	2d	Cmc
UM	CZRQR12VB	Z-diode	11.70..12.30V, Izt=5mA, Zzt=22Ω, 125mW	0402	13d	2b	Cmc
UM	CZRU12VB	Z-diode	11.70..12.30V, Izt=5mA, Zzt=22Ω, 150mW	0603	13d	2b	Cmc
UM	P4SMAJ15AC	TVS	Vbr=15V, 16.4A, 400W (1ms), Bidirectional	DO-214AB	1ba	1x,1y	Pjt,Srj
UM	P4SMAJ440CA	TVS	Vbr=440V, 0.6A, 400W(1ms), Bidirectional	DO-214AC	1ba	1j	Mco
UM	SM4T24CA	TVS	Vbr=24V, 12A, 400W(1ms), Bidirectional	SOD-6	1ba	1r	Ste
UM	SMAJ15CA	TVS	Vrwm=15V, Vbr=16.7..18.5V, 16.4A, 400W(1ms), Bidirectional	DO-214AC	1ba	1x	Di
UM	US1M	Si-diode	Rectifier, 1000V, 1A, Vf<1.7V(1A) 75ns, 15pF	DO-214AC	1d	1k	Vs
UN	BZX84J-C62	Z-diode	62V±5%, If=250mA, 550mW	SOD-323FL	7d	1a	Phi
UN	CZRF13VB	Z-diode	12.68..13.32V, Izt=5mA, Zzt=25Ω, 200mW	1005	70d	2d	Cmc



SMD
code

Type

Function

Short description

Case

Pinout

St.

Mnf.

UN	CZRQR13VB	Z-diode	12.68..13.32V, Izt=5mA, Zzt=25Ω, 125mW	0402	13d	2b	Cmc
UN	CZRUR13VB	Z-diode	12.68..13.32V, Izt=5mA, Zzt=25Ω, 150mW	0603	13d	2b	Cmc
UN	P4SMAJ16C	TVS	Vbr=16V, 13.8A, 400W (1ms), Bidirectional	DO-214AB	1ba	1x,1y	Pjt,Srj
UN	SM4T27C	TVS	Vbr=27V, 10.7A, 400W(1ms), Bidirectional	SOD-6	1ba	1r	Ste
UO	KDV214E	C-diode	TV-Tuning, 30V, 14.5..2.06pF(2..25V)	ESC	6d	1a	Kec
UP	BZX84J-C68	Z-diode	68V±5%, If=250mA, 550mW	SOD-323FL	7d	1a	Phi
UP	CD214A-T16CA	TVS	Vbr=16V, Iism=15.3A, 400W(1ms), Bidirectional	DO-214AC	1ba	1j	Bm
UP	CMDZ11L	Z-diode	10.45..11.55V, Izt=0.5mA, Zzt=80Ω, 250mW	SOD-323	5d	1a	Cen
UP	CZRF15VB	Z-diode	14.63..15.37V, Izt=5mA, Zzt=32Ω, 200mW	1005	70d	2d	Cmc
UP	CZRQR15VB	Z-diode	14.63..15.37V, Izt=5mA, Zzt=32Ω, 125mW	0402	13d	2b	Cmc
UP	CZRUR15VB	Z-diode	14.63..15.37V, Izt=5mA, Zzt=32Ω, 150mW	0603	13d	2b	Cmc
UP	KDZ10FVY	Z-diode	9.77..10.21V, Izt=5mA, Zzt=15Ω, 100mW	TFSC	7d	1a	Kec
UP	P4SMAJ16AC	TVS	Vbr=16V, 15.3A, 400W (1ms), Bidirectional	DO-214AB	1ba	1x,1y	Pjt,Srj
UP	SM4T27CA	TVS	Vbr=27V, 10.7A, 400W(1ms), Bidirectional	SOD-6	1ba	1r	Ste
UP	SMAJ16CA	TVS	Vnm=16V, Vbr=17.8..21.8V, 15.4A, 400W(1ms), Bidirectional	DO-214AC	1ba	1x	Di
UQ	CZRF16VB	Z-diode	15.6..16.4V, Izt=5mA, Zzt=36Ω, 200mW	1005	70d	2d	Cmc
UQ	CZRQR16VB	Z-diode	15.60..16.40V, Izt=5mA, Zzt=36Ω, 125mW	0402	13d	2b	Cmc
UQ	CZRUR16VB	Z-diode	15.60..16.40V, Izt=5mA, Zzt=36Ω, 150mW	0603	13d	2b	Cmc
UQ	P4SMAJ17C	TVS	Vbr=17V, 13.1A, 400W (1ms), Bidirectional	DO-214AB	1ba	1x,1y	Pjt,Srj
UQ	SM4T30C	TVS	Vbr=30V, 9.6A, 400W(1ms), Bidirectional	SOD-6	1ba	1r	Ste
UR	BZX84J-C6V2	Z-diode	6.2V±5%, If=250mA, 550mW	SOD-323FL	7d	1a	Phi
UR	CD214A-T17CA	TVS	Vbr=17V, Iism=14.5A, 400W(1ms), Bidirectional	DO-214AC	1ba	1j	Bm
UR	CZRF18VB	Z-diode	17.55..18.45V, Izt=5mA, Zzt=42Ω, 200mW	1005	70d	2d	Cmc
UR	CZRQR18VB	Z-diode	17.55..18.45V, Izt=5mA, Zzt=42Ω, 125mW	0402	13d	2b	Cmc
UR	CZRUR18VB	Z-diode	17.55..18.45V, Izt=5mA, Zzt=42Ω, 150mW	0603	13d	2b	Cmc
UR	P4SMAJ17AC	TVS	Vbr=17V, 14.5A, 400W (1ms), Bidirectional	DO-214AB	1ba	1x,1y	Pjt,Srj
UR	SM4T30CA	TVS	Vbr=30V, 9.6A, 400W(1ms), Bidirectional	SOD-6	1ba	1r	Ste
UR	SMAJ17CA	TVS	Vnm=17V, Vbr=18.9..20.9V, 14.5A, 400W(1ms), Bidirectional	DO-214AC	1ba	1x	Di
US	BZX84J-C6V8	Z-diode	6.8V±5%, If=250mA, 550mW	SOD-323FL	7d	1a	Phi
US	CZRF20VB	Z-diode	19.5..20.5V, Izt=5mA, Zzt=48Ω, 200mW	1005	70d	2d	Cmc
US	CZRQR20VB	Z-diode	19.50..20.50V, Izt=5mA, Zzt=48Ω, 125mW	0402	13d	2b	Cmc
US	CZRUR20VB	Z-diode	19.50..20.50V, Izt=5mA, Zzt=48Ω, 150mW	0603	13d	2b	Cmc
US	P4SMAJ18C	TVS	Vbr=18V, 12.4A, 400W (1ms), Bidirectional	DO-214AB	1ba	1x,1y	Pjt,Srj
US	SM4T33C	TVS	Vbr=33V, 8.8A, 400W(1ms), Bidirectional	SOD-6	1ba	1r	Ste
US11	USM11PT	Si-diode	Rectifier, S-fast, 50V, 1A	DO-214AC	1d	1a	Chm
US12	USM12PT	Si-diode	Rectifier, S-fast, 100V, 1A	DO-214AC	1d	1a	Chm
US13	USM13PT	Si-diode	Rectifier, S-fast, 200V, 1A	DO-214AC	1d	1a	Chm
US14	USM14PT	Si-diode	Rectifier, S-fast, 300V, 1A	DO-214AC	1d	1a	Chm
US15	USM15PT	Si-diode	Rectifier, S-fast, 400V, 1A	DO-214AC	1d	1a	Chm
US16	USM16PT	Si-diode	Rectifier, S-fast, 600V, 1A	DO-214AC	1d	1a	Chm
US17	USM17PT	Si-diode	Rectifier, S-fast, 800V, 1A	DO-214AC	1d	1a	Chm
US18	USM18PT	Si-diode	Rectifier, S-fast, 1000V, 1A	DO-214AC	1d	1a	Chm
US21	USM21PT	Si-diode	Rectifier, S-fast, 50V, 2A	DO-214AC	1d	1a	Chm
US22	USM22PT	Si-diode	Rectifier, S-fast, 100V, 2A	DO-214AC	1d	1a	Chm
US23	USM23PT	Si-diode	Rectifier, S-fast, 200V, 2A	DO-214AC	1d	1a	Chm
US24	USM24PT	Si-diode	Rectifier, S-fast, 300V, 2A	DO-214AC	1d	1a	Chm
US25	USM25PT	Si-diode	Rectifier, S-fast, 400V, 2A	DO-214AC	1d	1a	Chm
US26	USM26PT	Si-diode	Rectifier, S-fast, 600V, 2A	DO-214AC	1d	1a	Chm
US27	USM27PT	Si-diode	Rectifier, S-fast, 800V, 2A	DO-214AC	1d	1a	Chm
US28	USM28PT	Si-diode	Rectifier, S-fast, 1000V, 2A	DO-214AC	1d	1a	Chm
UT	BZX84J-C75	Z-diode	75V±5%, If=250mA, 550mW	SOD-323FL	7d	1a	Phi
UT	CD214A-T18CA	TVS	Vbr=18V, Iism=13.7A, 400W(1ms), Bidirectional	DO-214AC	1ba	1j	Bm
UT	CZRF22VB	Z-diode	21.45..22.55V, Izt=5mA, Zzt=55Ω, 200mW	1005	70d	2d	Cmc
UT	CZRQR22VB	Z-diode	21.45..22.55V, Izt=5mA, Zzt=55Ω, 125mW	0402	13d	2b	Cmc
UT	CZRUR22VB	Z-diode	21.45..22.55V, Izt=5mA, Zzt=55Ω, 150mW	0603	13d	2b	Cmc
UT	P4SMAJ18AC	TVS	Vbr=18V, 13.7A, 400W (1ms), Bidirectional	DO-214AB	1ba	1x,1y	Pjt,Srj
UT	SM4T33CA	TVS	Vbr=33V, 8.8A, 400W(1ms), Bidirectional	SOD-6	1ba	1r	Ste
UT	SMAJ18CA	TVS	Vnm=18V, Vbr=20.0..22.1V, 13.7A, 400W(1ms), Bidirectional	DO-214AC	1ba	1x	Di
UU	BAR88-02L	Si-diode	Ant, Sw, 80V, 0.1A, 250mW, Vf<1.2V(0.1A), 0.28pF(1GHz)	TSLP-2-1	13d	2b	Inf
UU	BZX84J-C7V5	Z-diode	7.5V±5%, If=250mA, 550mW	SOD-323FL	7d	1a	Phi
UU	CZRF24VB	Z-diode	23.4..24.6V, Izt=5mA, Zzt=62Ω, 200mW	1005	70d	2d	Cmc
UU	CZRQR24VB	Z-diode	23.40..24.60V, Izt=5mA, Zzt=62Ω, 125mW	0402	13d	2b	Cmc
UU	CZRUR24VB	Z-diode	23.40..24.60V, Izt=5mA, Zzt=62Ω, 150mW	0603	13d	2b	Cmc
UU	P4SMAJ20C	TVS	Vbr=20V, 11.1A, 400W (1ms), Bidirectional	DO-214AC	1ba	1x,1y	Pjt,Srj
UU	SM4T36C	TVS	Vbr=36V, 8A, 400W(1ms), Bidirectional	SOD-6	1ba	1r	Ste
UV	BZX84J-C8V2	Z-diode	8.2V±5%, If=250mA, 550mW	SOD-323FL	7d	1a	Phi
UV	CD214A-T20CA	TVS	Vbr=20V, Iism=12.3A, 400W(1ms), Bidirectional	DO-214AC	1ba	1j	Bm
UV	CZRF27VB	Z-diode	26.33..27.67V, Izt=5mA, Zzt=70Ω, 200mW	1005	70d	2d	Cmc
UV	CZRQR27VB	Z-diode	26.33..27.67V, Izt=5mA, Zzt=70Ω, 125mW	0402	13d	2b	Cmc
UV	CZRUR27VB	Z-diode	26.33..27.67V, Izt=5mA, Zzt=70Ω, 150mW	0603	13d	2b	Cmc



SMD
code

Type

Function

Short description

Case

Pinout St.

Mnf.

SMD code	Type	Function	Short description	Case	Pinout	St.	Mnf.
UV	P4SMAJ20AC	TVS	Vbr=20V, 12.3A, 400W (1ms), Bidirectional	DO-214AC	1ba	1x,1y	Pjt,Sj
UV	SM4T36CA	TVS	Vbr=36V, 8A, 400W(1ms), Bidirectional	SOD-6	1ba	1r	Ste
UV	SMAJ20CA	TVS	Vrwm=20V, Vbr=22.2..24.5V, 12.3A, 400W(1ms), Bidirectional	DO-214AC	1ba	1x	Di
UW	BZX84J-C9V1	Z-diode	9.1V±5%, If=250mA, 550mW	SOD-323FL	7d	1a	Phi
UW	CZRF30VB	Z-diode	29.25..30.75V, Izt=5mA, Zzt=78Ω, 200mW	1005	70d	2d	Cmc
UW	CZRQR30VB	Z-diode	29.25..30.75V, Izt=5mA, Zzt=78Ω, 125mW	0402	13d	2b	Cmc
UW	CZRU30VB	Z-diode	29.25..30.75V, Izt=5mA, Zzt=78Ω, 150mW	0603	13d	2b	Cmc
UW	P4SMAJ22C	TVS	Vbr=22V, 10.1A, 400W (1ms), Bidirectional	DO-214AC	1ba	1x,1y	Pjt,Sj
UW	SM4T39C	TVS	Vbr=39V, 7.4A, 400W(1ms), Bidirectional	SOD-6	1ba	1r	Ste
UX	CD214A-T22CA	TVS	Vbr=22V, Irlsm=11.2A, 400W(1ms), Bidirectional	DO-214AC	1ba	1j	Bm
UX	CZRF33VB	Z-diode	32.18..33.82V, Izt=5mA, Zzt=88Ω, 200mW	1005	70d	2d	Cmc
UX	CZRQR33VB	Z-diode	32.18..33.82V, Izt=5mA, Zzt=88Ω, 125mW	0402	13d	2b	Cmc
UX	CZRU33VB	Z-diode	32.18..33.82V, Izt=5mA, Zzt=88Ω, 150mW	0603	13d	2b	Cmc
UX	P4SMAJ22AC	TVS	Vbr=22V, 11.2A, 400W (1ms), Bidirectional	DO-214AC	1ba	1x,1y	Pjt,Sj
UX	SM4T39CA	TVS	Vbr=39V, 7.4A, 400W(1ms), Bidirectional	SOD-6	1ba	1r	Ste
UX	SMAJ22CA	TVS	Vrwm=22V, Vbr=24.4..26.9V, 11.2A, 400W(1ms), Bidirectional	DO-214AC	1ba	1x	Di
UY	CZRF36VB	Z-diode	35.1..36.9V, Izt=5mA, Zzt=95Ω, 200mW	1005	70d	2d	Cmc
UY	CZRQR36VB	Z-diode	35.10..36.90V, Izt=5mA, Zzt=95Ω, 125mW	0402	13d	2b	Cmc
UY	CZRU36VB	Z-diode	35.10..36.90V, Izt=5mA, Zzt=95Ω, 150mW	0603	13d	2b	Cmc
UY	KDZ30VVY	Z-diode	29.19..30.69V, Izt=2mA, Zzt=200Ω, 100mW	VSC	7d	1a	Kec
UY	P4SMAJ24C	TVS	Vbr=24V, 9.3A, 400W (1ms), Bidirectional	DO-214AC	1ba	1x,1y	Pjt,Sj
UZ	BZT52-B33S	Z-diode	32.34..33.66V, Izt=2mA, Zzt=80Ω, 200mW	SOD-323FL	7d	1a	Tsc
UZ	CD214A-T24CA	TVS	Vbr=24V, Irlsm=10.3A, 400W(1ms), Bidirectional	DO-214AC	1ba	1j	Bm
UZ	CZRF39VB	Z-diode	38.03..39.97V, Izt=5mA, Zzt=130Ω, 200mW	1005	70d	2d	Cmc
UZ	CZRQR39VB	Z-diode	38.03..39.97V, Izt=5mA, Zzt=130Ω, 125mW	0402	13d	2b	Cmc
UZ	CZRU39VB	Z-diode	38.03..39.97V, Izt=5mA, Zzt=130Ω, 150mW	0603	13d	2b	Cmc
UZ	MM3Z33VB	Z-diode	32.34..33.66V, Zzt=75Ω, Izt=2mA, 200mW	SOD-323FL	7d	1a	F
UZ	MM3Z33VBW	Z-diode	32.34..33.66V, Izt=2mA, Zzt=80Ω, 200mW	SOD-323FL	7d	1a	Tac
UZ	P4SMAJ24AC	TVS	Vbr=24V, 10.3A, 400W (1ms), Bidirectional	DO-214AC	1ba	1x,1y	Pjt,Sj
UZ	SMAJ24CA	TVS	Vrwm=24V, Vbr=26.7..29.5V, 10.3A, 400W(1ms), Bidirectional	DO-214AC	1ba	1x	Di
UZ	TCMM3Z33VB	Z-diode	33V±2%, Izt=5mA, Zzt=75Ω, 200mW	SOD-323FL	7d	1a	Tac
V	MM9D20V	Z-diode	19.0..21.0V, Izt=5mA, Zzt=55Ω, 200mW	SOD-923	7d	1n	Wtr
V	MM9D39V	Z-diode	3.71..4.10V, Izt=5mA, Zzt=100Ω, 200mW	SOD-923	7d	1b	Wtr
V	MMSZ5223BPT	Z-diode	2.565..2.835V, Izt=5mA, Zzt=100Ω, 225mW	SOD-523	7d	1a	Chm
V	NZ9F11VST	Z-diode	10.76..11.22V, Izt=5mA, Zzt=30Ω, 200mW	SOD-923	7d	2m	Ons
V	NZ9F20VT	Z-diode	19.0..21.0V, Izt=5mA, Zzt=55Ω, 200mW	SOD-923	7d	1n	Ons
V	NZ9F39VT	Z-diode	3.71..4.10V, Izt=5mA, Zzt=100Ω, 200mW	SOD-923	7d	1b	Ons
V.	MMSZ5223SPPT	Z-diode	2.646..2.754V, Izt=5mA, Zzt=100Ω, 225mW	SOD-523	7d	1a	Chm
V1	1SV310	C-diode	UHF, VCO, 10V, 4.45/5.45pF(4V), Rs<0.4Ω(470MHz)	SOD-123	5d	1a	Tos
V1	1SV311	C-diode	UHF, VCO, 10V, 4.45/5.45pF(4V), Rs<0.4Ω(470MHz)	SOD-323	5d	1a	Tos
V1	FES2A	Si-diode	Ultrafast Recovery, 50V, 2A, <50ns	DO-214AA	1d	2j	Fag
V1	MMSZ6V2	Z-diode	6.2V±5%, Zzt=10Ω, 500mW	SOD-123	5d	1a	Mot
V2	1SV329	C-diode	UHF-VCO, 10V, 1.85/2.45pF(4V), Rs<0.7Ω(470MHz)	SOD-123	5d	1a	Tos
V2	FES2B	Si-diode	Ultrafast Recovery, 100V, 2A, <50ns	DO-214AA	1d	2j	Fag
V2	HVU362	C-diode	VCO, 15V, 41.6/49.9pF(1V)	SOD-323	5d	1a	Ren
V2	MMSZ6V8	Z-diode	6.8V±5%, Zzt=15Ω, 500mW	SOD-123	5d	1a	Mot
V3	FES2D	Si-diode	Ultrafast Recovery, 200V, 2A, <50ns	DO-214AA	1d	2j	Fag
V3	HVU363A	C-diode	VHF-Tuning, 32V, 34.6/42.3pF(1V)	SOD-323	5d	1a	Ren
V3	MMSZ7V5	Z-diode	7.5V±5%, Zzt=15Ω, 500mW	SOD-123	5d	1a	Mot
V4	FES2F	Si-diode	Ultrafast Recovery, 300V, 2A, <50ns	DO-214AA	1d	2j	Fag
V4	MMSZ8V2	Z-diode	8.2V±5%, Zzt=15Ω, 500mW	SOD-123	5d	1a	Mot
V5	BZX584B36V	Z-diode	35.28..36.72V, Izt=2mA, Zzt=90Ω, 200mW	SOD-523FL	7d	1a	Tac
V5	FES2G	Si-diode	Ultrafast Recovery, 400V, 2A, <50ns	DO-214AA	1d	2j	Fag
V5	MMSZ36VB	Z-diode	35.28..36.72V, Izt=2mA, Zzt=90Ω, 200mW	SOD-523FL	7d	1a	Tac
V5	MMSZ9V1	Z-diode	9.1V±5%, Zzt=15Ω, 500mW	SOD-123	5d	1a	Mot
V5	UDZS30B	Z-diode	29.19..30.69V, Izt=5mA, Zzt=200Ω, 200mW	SOD-323	5d	1a	Wtr
V6	1SV313	C-diode	UHF, VCO, 10V, 2.75/3.4pF(2.5V), Rs<0.45Ω(470MHz)	SOD-123	5d	1a	Tos
V6	1SV314	C-diode	UHF, VCO, 10V, 2.75/3.4pF(2.5V), Rs<0.45Ω(470MHz)	SOD-323	5d	1a	Tos
V6	FES2J	Si-diode	Ultrafast Recovery, 600V, 2A, <50ns	DO-214AA	1d	2j	Fag
V6	HVU365	C-diode	VCO, 15V, 3..27pF(4..1V)	SOD-323	5d	1a	Ren
V61	F1V61B	Si-Varistor	VDR/Varistor, 150mA, 2.3V(10A)	SOD-123	5d	1a	Org
V62	F1V62B	Si-Varistor	VDR/Varistor, 150mA, 2.3V(10A)	SOD-123	5d	1a	Org
V7	1SV322	C-diode	TCXO/VCO, 10V, 6.7..1pF(4V), Rs<0.8Ω(100MHz)	SOD-123	5d	1a	Tos
V7	1SV323	C-diode	TCXO/VCO, 10V, 6.7..1pF(4V), Rs<0.8Ω(100MHz)	SOD-323	5d	1a	Tos
V8	1SV324	C-diode	TCXO/VCO, 10V, 9.2..12pF(4V), Rs<0.8Ω(100MHz)	SOD-123	5d	1a	Tos
V8	1SV325	C-diode	TCXO/VCO, 10V, 9.2..12pF(4V), Rs<0.8Ω(100MHz)	SOD-323	5d	1a	Tos
V8	BAP1321-03	PIN-diode	RF, 60V, 100mA, 500mW, 0.45pF, 1.3Ω(100mA/100MHz)	SOD-323	5d	1a	Phi
V8	MMSZ20H	Z-diode	18.8..21.2V, Izt=2mA, Zzt=55Ω, 200mW	SOD-523	7d	1a	Zow
V8	MMSZ20V	Z-diode	20V±5%, Izt=5mA, Zzt=55Ω, 200mW	SOD-523	6d	1a	Eic
VA	BAV16BPT	Si-diode	Sw, 75V, 150mA, Vf<<1.25V(150mA), 4ns	SOD-123	5d	1a	Chm



SMD
code

Type

Function

Short description

Case

Pinout

St.

Mnf.

SMD code	Type	Function	Short description	Case	Pinout	St.	Mnf.
VA	PZU10BA	Z-diode	10V±5%, If=200mA, 320mW	SOD-323	5d	1a	Phi
VA	TV04A141KB-G	TVS	Vrwm=140.0V, Vbr=155.68..190.40V, Ipp=1.60A, 400W(1ms), Bidirectional	DO-214AC	1ba	1j	Cmc
VB	KDZ12B	Z-diode	12V±2.5%, 20mA, 1W	PMDU	7d	1s	Rhm
VB	MMBD4448BPT	Si-diode	Sw, 80V, 250mA, Vf<1V(100mA), 4ns	SOD-123	5d	1a	Chm
VB	PZU10B1A	Z-diode	10V±2%, If=200mA, 320mW	SOD-323	5d	1a	Phi
VB	TV04A141JB-G	TVS	Vrwm=140.0V, Vbr=155.0..171.0V, Ipp=1.76A, 400W(1ms), Bidirectional	DO-214AC	1ba	1j	Cmc
VC	CHBD3004BPT	Si-diode	Sw, 350V, 225mA, Vf<1V(100mA), 50ns	SOD-123	5d	1a	Chm
VC	PZU10B2A	Z-diode	10V±2%, If=200mA, 320mW	SOD-323	5d	1a	Phi
VD	P4SMAJ26C	TVS	Vbr=26V, 8.6A, 400W(1ms), Bidirectional	DO-214AC	1ba	1x,1y	Pjt,Srj
VD	P6SMB120C	TVS	Vrwm=120V, 3.5A, 600W(1ms), Bidirectional	DO-214AA	1ba	2k	Fag
VD	P6SMB130C	TVS	Vrwm=130V, 3.2A, 600W(1ms), Bidirectional	DO-214AA	1ba	2k	Fag
VD	PZU10B3A	Z-diode	10V±2%, If=200mA, 320mW	SOD-323	5d	1a	Phi
VD	SM4T6V8C	TVS	Vbr=6.8V, 38A, 400W(1ms), Bidirectional	SOD-6	1ba	1r	Ste
VD	SMAJ110	TVS	Vrwm=110V, Vbr=122..149V, 1.5A, 400W(1ms)	DO-214AC	1d	1k	Vs
VD	SMAJ110C	TVS	Vrwm=110V, Vbr=122..135V, 1.5A, 400W(1ms), Bidirectional	DO-214AC	1ba	1l	Vs
VD	TV04A111KB-G	TVS	Vrwm=110.0V, Vbr=122.0..149.0V, Ipp=2.04A, 400W(1ms), Bidirectional	DO-214AC	1ba	1j	Cmc
VDD	TVS10W6V8T	TVS	Vrwm=6.8V, Vbr=5.78..7.82V, 10W(8..20µs), Bidirectional	SOD-523	7d	1d	Did
VE	CD214A-T26CA	TVS	Vbr=26V, Irs=9.5A, 400W(1ms), Bidirectional	DO-214AC	1ba	1j	Bm
VE	P4SMAJ10CA	TVS	Vbr=110V, 2.3A, 400W(1ms), Bidirectional	DO-214AC	1ba	1j	Mco
VE	P4SMAJ26AC	TVS	Vbr=26V, 9.5A, 400W(1ms), Bidirectional	DO-214AC	1ba	1x,1y	Pjt,Srj
VE	P6SMB120CA	TVS	Vrwm=120V, 3.6A, 600W(1ms), Bidirectional	DO-214AA	1ba	2k	Fag
VE	PZU11BA	Z-diode	11V±5%, If=200mA, 320mW	SOD-323	5d	1a	Phi
VE	SM4T6V8CA	TVS	Vbr=6.8V, 38A, 400W(1ms), Bidirectional	SOD-6	1ba	1r	Ste
VE	SMAJ110CA	TVS	Vrwm=110V, 122..135V, 1.7A, 400W(1ms), Bidirectional	DO-214AC	1ba	1l	Vs
VE	SMAJ26CA	TVS	Vrwm=26V, Vbr=28.9..35.3V, 8.6A, 400W(1ms), Bidirectional	DO-214AC	1ba	1x	Di
VE	TV04A111JB-G	TVS	Vrwm=110.0V, Vbr=122.0..135.0V, Ipp=2.26A, 400W(1ms), Bidirectional	DO-214AC	1ba	1j	Cmc
VF	MAZD270	Z-diode	25.1..28.9V, Zzt=120C(5mA), 120mW	SSSMini2	7d	1a	Pan
VF	P4SMAJ28C	TVS	Vbr=28V, 8A, 400W(1ms), Bidirectional	DO-214AC	1ba	1x,1y	Pjt,Srj
VF	PZU11B1A	Z-diode	11V±2%, If=200mA, 320mW	SOD-323	5d	1a	Phi
VF	SDM100K30L	Si-diode	Schottky, Sw, 30V, 1A, Vf<0.485V(1A), 22pF	SOD-323	5d	1d	Di
VF	SM4T7V5C	TVS	Vbr=7.5V, 35.4A, 400W(1ms), Bidirectional	SOD-6	1ba	1r	Ste
VF	SMAJ120C	TVS	Vrwm=120V, Vbr=133..163V, 1.4A, 400W(1ms), Bidirectional	DO-214AC	1ba	1l	Vs
VF	TV04A121KB-G	TVS	Vrwm=120.0V, Vbr=133.0..163.0V, Ipp=1.87A, 400W(1ms), Bidirectional	DO-214AC	1ba	1j	Cmc
VG	CD214A-T26CA	TVS	Vbr=28V, Irs=8.8A, 400W(1ms), Bidirectional	DO-214AC	1ba	1j	Bm
VG	P4SMAJ120CA	TVS	Vbr=120V, 2.1A, 400W(1ms), Bidirectional	DO-214AC	1ba	1j	Mco
VG	P4SMAJ28AC	TVS	Vbr=28V, 8.8A, 400W(1ms), Bidirectional	DO-214AC	1ba	1x,1y	Pjt,Srj
VG	P6SMB130CA	TVS	Vrwm=130V, 3.3A, 600W(1ms), Bidirectional	DO-214AA	1ba	2k	Fag
VG	PZU11B2A	Z-diode	11V±2%, If=200mA, 320mW	SOD-323	5d	1a	Phi
VG	SM4T7V5CA	TVS	Vbr=7.5V, 35.4A, 400W(1ms), Bidirectional	SOD-6	1ba	1r	Ste
VG	SMAJ120CA	TVS	Vrwm=120V, Vbr=133..147V, 1.6A, 400W(1ms), Bidirectional	DO-214AC	1ba	1l	Vs
VG	SMAJ28CA	TVS	Vrwm=28V, Vbr=31.1..34.4V, 8.8A, 400W(1ms), Bidirectional	DO-214AC	1ba	1x	Di
VG	TV04A121JB-G	TVS	Vrwm=120.0V, Vbr=133.0..147.0V, Ipp=2.07A, 400W(1ms), Bidirectional	DO-214AC	1ba	1j	Cmc
VH	P4SMAJ30C	TVS	Vbr=30V, 7.5A, 400W(1ms), Bidirectional	DO-214AC	1ba	1x,1y	Pjt,Srj
VH	P6SMB150C	TVS	Vrwm=150V, 2.8A, 600W(1ms), Bidirectional	DO-214AA	1ba	2k	Fag
VH	PZU11B3A	Z-diode	11V±2%, If=200mA, 320mW	SOD-323	5d	1a	Phi
VH	SMAJ130C	TVS	Vrwm=130V, Vbr=144..176V, 1.3A, 400W(1ms), Bidirectional	DO-214AC	1ba	1l	Vs
VH	TV04A131KB-G	TVS	Vrwm=130.0V, Vbr=144.0..176.0V, Ipp=1.73A, 400W(1ms), Bidirectional	DO-214AC	1ba	1j	Cmc
VK	CD214A-T30CA	TVS	Vbr=30V, Irs=8.3A, 400W(1ms), Bidirectional	DO-214AC	1ba	1j	Bm
VK	P4SMAJ130CA	TVS	Vbr=130V, 1.9A, 400W(1ms), Bidirectional	DO-214AC	1ba	1j	Mco
VK	P4SMAJ30AC	TVS	Vbr=30V, 8.3A, 400W(1ms), Bidirectional	DO-214AC	1ba	1x,1y	Pjt,Srj
VK	P6SMB150CA	TVS	Vrwm=150V, 2.9A, 600W(1ms), Bidirectional	DO-214AA	1ba	2k	Fag
VK	PZU12BA	Z-diode	12V±5%, If=200mA, 320mW	SOD-323	5d	1a	Phi
VK	SMAJ30CA	TVS	Vrwm=30V, Vbr=33.3..36.8V, 8.3A, 400W(1ms), Bidirectional	DO-214AC	1ba	1x	Di
VK	SMZG3788A	Z-diode	9.1V±5%, 140mA, Zzt=4Ω, 1.5W	DO-215AA	5d	1k	Vs
VK	SMZJ3788A	Z-diode	9.1V±5%, 140mA, Zzt=4Ω, 1.5W	DO-214AA	1d	1k	Vs
VK	TV04A131JB-G	TVS	Vrwm=130.0V, Vbr=144.0..159.0V, Ipp=1.91A, 400W(1ms), Bidirectional	DO-214AC	1ba	1j	Cmc
VL	P4SMAJ33C	TVS	Vbr=33V, 6.8A, 400W(1ms), Bidirectional	DO-214AC	1ba	1x,1y	Pjt,Srj
VL	P6SMB160C	TVS	Vrwm=160V, 2.7A, 600W(1ms), Bidirectional	DO-214AA	1ba	2k	Fag
VL	PZU12B1A	Z-diode	12V±2%, If=200mA, 320mW	SOD-323	5d	1a	Phi
VL	SMAJ150C	TVS	Vrwm=150V, Vbr=167..204V, 1.1A, 400W(1ms), Bidirectional	DO-214AC	1ba	1l	Vs
VL	SMZG3788B	Z-diode	9.1V±10%, 140mA, 1.5W, Zzt=4Ω, 1.5W	DO-215AA	5d	1k	Vs
VL	SMZJ3788B	Z-diode	9.1V±10%, 140mA, Zzt=4Ω, 1.5W	DO-214AA	1d	1k	Vs
VL	TV04A151KB-G	TVS	Vrwm=150.0V, Vbr=167.0..204.0V, Ipp=1.49A, 400W(1ms), Bidirectional	DO-214AC	1ba	1j	Cmc
VM	CD214A-T33CA	TVS	Vbr=33V, Irs=7.5A, 400W(1ms), Bidirectional	DO-214AC	1ba	1j	Bm
VM	P4SMAJ150CA	TVS	Vbr=150V, 1.6A, 400W(1ms), Bidirectional	DO-214AC	1ba	1j	Mco
VM	P4SMAJ33AC	TVS	Vbr=33V, 7.5A, 400W(1ms), Bidirectional	DO-214AC	1ba	1x,1y	Pjt,Srj
VM	P6SMB160CA	TVS	Vrwm=160V, 2.6A, 600W(1ms), Bidirectional	DO-214AA	1ba	2k	Fag
VM	PZU12B2A	Z-diode	12V±2%, If=200mA, 320mW	SOD-323	5d	1a	Phi
VM	SMAJ150CA	TVS	Vrwm=150V, Vbr=167..185V, 1.2A, 400W(1ms), Bidirectional	DO-214AC	1ba	1l	Vs
VM	SMAJ33CA	TVS	Vrwm=33V, Vbr=36.7..40.6V, 7.5A, 400W(1ms), Bidirectional	DO-214AC	1ba	1x	Di



SMD
code

Type

Function

Short description

Case

Pinout

St.

Mnf.

VM	TV04A151JB-G	TVS	Vrwm=150.0V, Vbr=167.0..185.0V, Ipp=1.65A, 400W(1ms), Bidirectional	DO-214AC	1ba	1j	Cmc
VN	P4SMAJ36C	TVS	Vbr=36V, 6.2A, 400W(1ms), Bidirectional	DO-214AC	1ba	1x,1y	Pjt,Srj
VN	P6SMB170C	TVS	Vrwm=170V, 2.5A, 600W(1ms), Bidirectional	DO-214AA	1ba	2k	Fag
VN	PZU12B3A	Z-diode	12V±2%, If=200mA, 320mW	SOD-323	5d	1a	Phi
VN	SM4T10C	TVS	Vbr=10V, 27.6A, 400W(1ms), Bidirectional	SOD-6	1ba	1r	Ste
VN	SMAJ160C	TVS	Vrwm=160V, Vbr=178.218V, 1A, 400W(1ms), Bidirectional	DO-214AC	1ba	1l	Vs
VN	TV04A161KB-G	TVS	Vrwm=160.0V, Vbr=178.0.218.0V, Ipp=1.39A, 400W(1ms), Bidirectional	DO-214AC	1ba	1j	Cmc
VP	CD214A-T36CA	TVS	Vbr=36V, Irlsm=6.9A, 400W(1ms), Bidirectional	DO-214AC	1ba	1j	Bm
VP	CMDZ12L	Z-diode	11.40..12.60V, Izt=0.5mA, Zzt=80Ω, 250mW	SOD-323	5d	1a	Cen
VP	P4SMAJ160CA	TVS	Vbr=160V, 1.5A, 400W(1ms), Bidirectional	DO-214AC	1ba	1j	Mco
VP	P4SMAJ36AC	TVS	Vbr=36V, 6.9A, 400W(1ms), Bidirectional	DO-214AC	1ba	1x,1y	Pjt,Srj
VP	P6SMB170CA	TVS	Vrwm=170V, 2.6A, 600W(1ms), Bidirectional	DO-214AA	1ba	2k	Fag
VP	PZU13BA	Z-diode	13V±5%, If=200mA, 320mW	SOD-323	5d	1a	Phi
VP	SM4T10CA	TVS	Vbr=10V, 27.6A, 400W(1ms), Bidirectional	SOD-6	1ba	1r	Ste
VP	SMAJ160CA	TVS	Vrwm=160V, Vbr=178.197V, 1.2A, 400W(1ms), Bidirectional	DO-214AC	1ba	1l	Vs
VP	SMAJ36CA	TVS	Vrwm=36V, Vbr=40.0..44.2V, 6.9A, 400W(1ms), Bidirectional	DO-214AC	1ba	1x	Di
VP	TV04A161JB-G	TVS	Vrwm=160.0V, Vbr=178.0..197.0V, Ipp=1.54A, 400W(1ms), Bidirectional	DO-214AC	1ba	1j	Cmc
VQ	P4SMAJ40C	TVS	Vbr=40V, 5.6A, 400W(1ms), Bidirectional	DO-214AC	1ba	1x,1y	Pjt,Srj
VQ	P6SMB180C	TVS	Vrwm=180V, 2.3A, 600W(1ms), Bidirectional	DO-214AA	1ba	2k	Fag
VQ	SMAJ170C	TVS	Vrwm=170V, Vbr=189.209V, 0.99A, 400W(1ms), Bidirectional	DO-214AC	1ba	1l	Vs
VQ	TV04A171KB-G	TVS	Vrwm=170.0V, Vbr=189.0..231.0V, Ipp=1.32A, 400W(1ms), Bidirectional	DO-214AC	1ba	1j	Cmc
VR	CD214A-T40CA	TVS	Vbr=40V, Irlsm=6.2A, 400W(1ms), Bidirectional	DO-214AC	1ba	1j	Bm
VR	P4SMAJ170CA	TVS	Vbr=170V, 1.5A, 400W(1ms), Bidirectional	DO-214AC	1ba	1j	Mco
VR	P4SMAJ40AC	TVS	Vbr=40V, 6.2A, 400W(1ms), Bidirectional	DO-214AC	1ba	1x,1y	Pjt,Srj
VR	P6SMB180CA	TVS	Vrwm=180V, 2.4A, 600W(1ms), Bidirectional	DO-214AA	1ba	2k	Fag
VR	PZU13B1A	Z-diode	13V±2%, If=200mA, 320mW	SOD-323	5d	1a	Phi
VR	SMAJ40CA	TVS	Vrwm=40V, Vbr=44.4.49.1V, 6.2A, 400W(1ms), Bidirectional	DO-214AC	1ba	1x	Di
VR	TV04A171JB-G	TVS	Vrwm=170.0V, Vbr=189.0.209.0V, Ipp=1.45A, 400W(1ms), Bidirectional	DO-214AC	1ba	1j	Cmc
VS	P4SMAJ43C	TVS	Vbr=43V, 5.2A, 400W(1ms), Bidirectional	DO-214AC	1ba	1x,1y	Pjt,Srj
VS	P6SMB200C	TVS	Vrwm=200V, 2.1A, 600W(1ms), Bidirectional	DO-214AA	1ba	2k	Fag
VS	PZU13B2A	Z-diode	13V±2%, If=200mA, 320mW	SOD-323	5d	1a	Phi
VS	SM4T12C	TVS	Vbr=12V, 24A, 400W(1ms), Bidirectional	SOD-6	1ba	1r	Ste
VS	TV04A181KB-G	TVS	Vrwm=180.0V, Vbr=200.16..244.80V, Ipp=1.24A, 400W(1ms), Bidirectional	DO-214AC	1ba	1j	Cmc
VT	CD214A-T43CA	TVS	Vbr=43V, Irlsm=5.7A, 400W(1ms), Bidirectional	DO-214AC	1ba	1j	Bm
VT	P4SMAJ180CA	TVS	Vbr=180V, 1.4A, 400W(1ms), Bidirectional	DO-214AC	1ba	1j	Mco
VT	P4SMAJ43AC	TVS	Vbr=43V, 5.7A, 400W(1ms), Bidirectional	DO-214AC	1ba	1x,1y	Pjt,Srj
VT	P6SMB200CA	TVS	Vrwm=200V, 2.2A, 600W(1ms), Bidirectional	DO-214AA	1ba	2k	Fag
VT	PZU13B3A	Z-diode	13V±2%, If=200mA, 320mW	SOD-323	5d	1a	Phi
VT	SM4T12CA	TVS	Vbr=12V, 24A, 400W(1ms), Bidirectional	SOD-6	1ba	1r	Ste
VT	SMAJ188C	TVS	Vrwm=188V, Vbr=209.255V, 0.9A, 400W(1ms), Bidirectional	DO-214AC	1ba	1l	Vs
VT	SMAJ43CA	TVS	Vrwm=43V, Vbr=47.8..52.8V, 5.7A, 400W(1ms), Bidirectional	DO-214AC	1ba	1x	Di
VT	TV04A181JB-G	TVS	Vrwm=180.0V, Vbr=200.0..220.0V, Ipp=1.37A, 400W(1ms), Bidirectional	DO-214AC	1ba	1j	Cmc
VU	P4SMAJ45C	TVS	Vbr=45V, 5A, 400W(1ms), Bidirectional	DO-214AC	1ba	1x,1y	Pjt,Srj
VU	P6SMB220C	TVS	Vrwm=220V, 1.75A, 600W(1ms), Bidirectional	DO-214AA	1ba	2k	Fag
VU	PZU14B2A	Z-diode	14V±2%, If=200mA, 320mW	SOD-323	5d	1a	Phi
VU	TV04A191KB-G	TVS	Vrwm=190.0V, Vbr=211.28..258.40V, Ipp=1.18A, 400W(1ms), Bidirectional	DO-214AC	1ba	1j	Cmc
VV	CD214A-T45CA	TVS	Vbr=45V, Irlsm=5.5A, 400W(1ms), Bidirectional	DO-214AC	1ba	1j	Bm
VV	P4SMAJ200CA	TVS	Vbr=200V, 1.2A, 400W(1ms), Bidirectional	DO-214AC	1ba	1j	Mco
VV	P4SMAJ45AC	TVS	Vbr=45V, 5.5A, 400W(1ms), Bidirectional	DO-214AC	1ba	1x,1y	Pjt,Srj
VV	P6SMB220CA	TVS	Vrwm=220V, 1.83A, 600W(1ms), Bidirectional	DO-214AA	1ba	2k	Fag
VV	PZU15BA	Z-diode	15V±5%, If=200mA, 320mW	SOD-323	5d	1a	Phi
VV	SMAJ45CA	TVS	Vrwm=45V, Vbr=50.0..55.3V, 5.5A, 400W(1ms), Bidirectional	DO-214AC	1ba	1x	Di
VV	TV04A191JB-G	TVS	Vrwm=190.0V, Vbr=211.0..232.0V, Ipp=1.30A, 400W(1ms), Bidirectional	DO-214AC	1ba	1j	Cmc
VW	P4SMAJ48C	TVS	Vbr=48V, 4.7A, 400W(1ms), Bidirectional	DO-214AC	1ba	1x,1y	Pjt,Srj
VW	P6SMB250C	TVS	Vrwm=250V, 1.67A, 600W(1ms), Bidirectional	DO-214AA	1ba	2k	Fag
VW	PZU15B1A	Z-diode	15V±2%, If=200mA, 320mW	SOD-323	5d	1a	Phi
VW	SM4T15C	TVS	Vbr=15V, 19A, 400W(1ms), Bidirectional	SOD-6	1ba	1r	Ste
VW	TV04A201JB-G	TVS	Vrwm=200.0V, Vbr=224.0..247.0V, Ipp=1.23A, 400W(1ms), Bidirectional	DO-214AC	1ba	1j	Cmc
VX	CD214A-T48CA	TVS	Vbr=48V, Irlsm=5.2A, 400W(1ms), Bidirectional	DO-214AC	1ba	1j	Bm
VX	P4SMAJ220CA	TVS	Vbr=220V, 1.1A, 400W(1ms), Bidirectional	DO-214AC	1ba	1j	Mco
VX	P4SMAJ48AC	TVS	Vbr=48V, 5.2A, 400W(1ms), Bidirectional	DO-214AC	1ba	1x,1y	Pjt,Srj
VX	P6SMB250CA	TVS	Vrwm=250V, 1.65A, 600W(1ms), Bidirectional	DO-214AA	1ba	2k	Fag
VX	PZU15B2A	Z-diode	15V±2%, If=200mA, 320mW	SOD-323	5d	1a	Phi
VX	SM4T15CA	TVS	Vbr=15V, 19A, 400W(1ms), Bidirectional	SOD-6	1ba	1r	Ste
VX	SMAJ48CA	TVS	Vrwm=48V, Vbr=53.3..58.9V, 5.2A, 400W(1ms), Bidirectional	DO-214AC	1ba	1x	Di
VX	TV04A221JB-G	TVS	Vrwm=220.0V, Vbr=246.0..272.0V, Ipp=1.12A, 400W(1ms), Bidirectional	DO-214AC	1ba	1j	Cmc
VY	KDZ33VYV	Z-diode	32.15..33.79V, Izt=2mA, Zzt=250Ω, 100mW	VSC	7d	1a	Kec
VY	P4SMAJ51C	TVS	Vbr=51V, 4.4A, 400W(1ms), Bidirectional	DO-214AC	1ba	1x,1y	Pjt,Srj
VY	PZU15B3A	Z-diode	15V±2%, If=200mA, 320mW	SOD-323	5d	1a	Phi
VZ	BZT52-B36S	Z-diode	35.28..36.72V, Izt=2mA, Zzt=90Ω, 200mW	SOD-323FL	7d	1a	Tsc



SMD
code

Type

Function

Short description

Case

Pinout

St.

Mnf.

SMD code	Type	Function	Short description	Case	Pinout	St.	Mnf.
VZ	CD214A-T51CA	TVS	Vbr=51V, I _{rsm} =4.9A, 400W(1ms), Bidirectional	DO-214AC	1ba	1j	Bm
VZ	MM3Z36VB	Z-diode	35.28..36.72V, Zzt=84Ω, Izt=2mA, 200mW	SOD-323FL	7d	1a	F
VZ	MM3Z36VBW	Z-diode	35.28..36.72V, Izt=2mA, Zzt=90Ω, 200mW	SOD-323FL	7d	1a	Tac
VZ	P4SMAJ250CA	TVS	Vbr=250V, 1.0A, 400W(1ms), Bidirectional	DO-214AC	1ba	1j	Mco
VZ	P4SMAJ51AC	TVS	Vbr=51V, 4.9A, 400W(1ms), Bidirectional	DO-214AC	1ba	1x,1y	Pjt,Srj
VZ	PZU16BA	Z-diode	16V±5%, If=200mA, 320mW	SOD-323	5d	1a	Phi
VZ	SMAJ51CA	TVS	V _{rnm} =51V, V _{br} =56.7..69.3V, 4.9A, 400W(1ms), Bidirectional	DO-214AC	1ba	1x	Di
VZ	TCCMM3Z36VB	Z-diode	36V±2%, Izt=5mA, Zzt=84Ω, 200mW	SOD-323FL	7d	1a	Tac
VZ	TV04A251JB-G	TVS	V _{rnm} =250.0V, V _{br} =279.0..309.0V, I _{pp} =0.99A, 400W(1ms), Bidirectional	DO-214AC	1ba	1j	Cmc
W	MAZD068	Z-diode	6.4..7.2V, Zzt=20Ω(5mA), 120mW	SSSMini2	7d	1a	Pan
W	MMSZ5224BPT	Z-diode	2.660..2.940V, Izt=5mA, Zzt=100Ω, 225mW	SOD-523	7d	1a	Chm
W	MMSZ5224SPT	Z-diode	2.774..2.856V, Izt=5mA, Zzt=100Ω, 225mW	SOD-523	7d	1a	Chm
W07	SMTPB62	TVS	Vbr=62V, 100A, 5W(1ms), Bidirectional	DO-214AB	1ba	1r	Ste
W1	BZT52-C2V4	Z-diode	2.4V±5%, Izt=5mA, Zzt=100Ω, 500mW	SOD-123	5d	1k	Vs
W1	BZT52-C2V4S	Z-diode	2.4V±5%, Izt=5mA, Zzt=100Ω, 200mW	SOD-323	5d	1a	Pjt
W1	BZT52C-2V4WT	Z-diode	2.28..2.52V, Izt=5mA, Zzt=100Ω, 200mW	SOD-523	6d	1a	Tr
W1	BZT52C-2V4WU	Z-diode	2.28..2.52V, Izt=5mA, Zzt=100Ω, 200mW	SOD-723	7d	1a	Tr
W1	BZT52-C2V7	Z-diode	2.7V±5%, Izt=5mA, Zzt=100Ω, 500mW	SOD-123	5d	1d	Di
W1	BZT52-C2V7	Z-diode	2.7V±5%, Izt=5mA, Zzt=100Ω, 500mW	SOD-123	5d	1d	Di
W1	BZT52-C2V7S	Z-diode	2.7V±5%, Izt=5mA, Zzt=100Ω, 200mW	SOD-323	5d	1d	Di
W1	BZT52-C2V7S	Z-diode	2.7V±5%, Izt=5mA, Zzt=100Ω, 200mW	SOD-323	5d	1d	Di
W1	BZT52-C2V7T	Z-diode	2.7V±5%, Izt=5mA, Zzt=100Ω, 150mW	SOD-523	5d	1d	Di
W1	BZX384-C2V4	Z-diode	2.4V±5%, Izt=5mA, Zzt=70Ω, 200mW	SOD-323	5d	1k	Vs
W1	BZX784C2V4	Z-diode	2.28..2.52V, Zzt=100Ω, Izt=5mA, 200mW	SOD-723	7d	1a	Pjt
W1	CZRW55C2V7-G	Z-diode	2.7..2.90V, Zzt=100Ω, Izt=5mA, 500mW	SOD-123	5d	1a	Cmc
W1	FES3A	Si-diode	Ultrafast Recovery, 50V, 3A, <50ns	DO-214AB	1d	2j	Fag
W1	MM3Z2V7	Z-diode	2.5..2.9V, Izt=5mA, Zzt=100Ω, 200mW	SOD-323	5d	1a	Sec
W11	SMTPB68	TVS	Vbr=68V, 100A, 5W(1ms), Bidirectional	DO-214AB	1ba	1r	Ste
W17	SMTPB100	TVS	Vbr=100V, 100A, 5W(1ms), Bidirectional	DO-214AB	1ba	1r	Ste
W2	BZT52-C2V7	Z-diode	2.7V±5%, Izt=5mA, Zzt=100Ω, 500mW	SOD-123	5d	1k	Vs
W2	BZT52-C2V7S	Z-diode	2.7V±5%, Izt=5mA, Zzt=100Ω, 200mW	SOD-323	5d	1a	Pjt
W2	BZT52C-2V7WT	Z-diode	2.57..2.84V, Izt=5mA, Zzt=100Ω, 200mW	SOD-523	6d	1a	Tr
W2	BZT52C-2V7WU	Z-diode	2.57..2.84V, Izt=5mA, Zzt=100Ω, 200mW	SOD-723	7d	1a	Tr
W2	BZT52-C3V0	Z-diode	3.0V±5%, Izt=5mA, Zzt=95Ω, 500mW	SOD-123	5d	1d	Di
W2	BZT52-C3V0	Z-diode	3.0V±5%, Izt=5mA, Zzt=95Ω, 500mW	SOD-123	5d	1d	Di
W2	BZT52-C3V0S	Z-diode	3.0V±5%, Izt=5mA, Zzt=95Ω, 200mW	SOD-323	5d	1d	Di
W2	BZT52-C3V0S	Z-diode	3.0V±5%, Izt=5mA, Zzt=95Ω, 200mW	SOD-323	5d	1d	Di
W2	BZT52-C3V0T	Z-diode	3.0V±5%, Izt=5mA, Zzt=95Ω, 150mW	SOD-523	5d	1d	Di
W2	BZX384-C2V7	Z-diode	2.7V±5%, Izt=5mA, Zzt=75Ω, 200mW	SOD-323	5d	1k	Vs
W2	BZX784C2V7	Z-diode	2.57..2.84V, Zzt=100Ω, Izt=5mA, 200mW	SOD-723	7d	1a	Pjt
W2	CZRW55C3V0-G	Z-diode	3.0..3.20V, Zzt=95Ω, Izt=5mA, 500mW	SOD-123	5d	1a	Cmc
W2	FES3B	Si-diode	Ultrafast Recovery, 100V, 3A, <50ns	DO-214AB	1d	2j	Fag
W2	MM3Z3V0	Z-diode	2.8..3.2V, Izt=5mA, Zzt=95Ω, 200mW	SOD-323	5d	1a	Sec
W21	SMTPB120	TVS	Vbr=120V, 100A, 5W(1ms), Bidirectional	DO-214AB	1ba	1r	Ste
W23	SMTPB130	TVS	Vbr=130V, 100A, 5W(1ms), Bidirectional	DO-214AB	1ba	1r	Ste
W29	SMTPB180	TVS	Vbr=180V, 100A, 5W(1ms), Bidirectional	DO-214AB	1ba	1r	Ste
W3	BZT52-C3V0	Z-diode	3.0V±5%, Izt=5mA, Zzt=95Ω, 500mW	SOD-123	5d	1k	Vs
W3	BZT52-C3V0S	Z-diode	3.0V±5%, Izt=5mA, Zzt=95Ω, 200mW	SOD-323	5d	1a	Pjt
W3	BZT52C-3V0WT	Z-diode	2.85..3.15V, Izt=5mA, Zzt=95Ω, 200mW	SOD-523	6d	1a	Tr
W3	BZT52C-3V0WU	Z-diode	2.85..3.15V, Izt=5mA, Zzt=95Ω, 200mW	SOD-723	7d	1a	Tr
W3	BZT52-C3V3	Z-diode	3.3V±5%, Izt=5mA, Zzt=95Ω, 500mW	SOD-123	5d	1d	Di
W3	BZT52-C3V3	Z-diode	3.3V±5%, Izt=5mA, Zzt=95Ω, 500mW	SOD-123	5d	1d	Di
W3	BZT52-C3V3S	Z-diode	3.3V±5%, Izt=5mA, Zzt=95Ω, 200mW	SOD-323	5d	1d	Di
W3	BZT52-C3V3S	Z-diode	3.3V±5%, Izt=5mA, Zzt=95Ω, 200mW	SOD-323	5d	1d	Di
W3	BZT52-C3V3T	Z-diode	3.3V±5%, Izt=5mA, Zzt=95Ω, 150mW	SOD-523	5d	1d	Di
W3	BZX384-C3V0	Z-diode	3.0V±5%, Izt=5mA, Zzt=80Ω, 200mW	SOD-323	5d	1k	Vs
W3	BZX784C3V0	Z-diode	2.85..3.15V, Zzt=95Ω, Izt=5mA, 200mW	SOD-723	7d	1a	Pjt
W3	CZRW55C3V3-G	Z-diode	3.3..3.50V, Zzt=95Ω, Izt=5mA, 500mW	SOD-123	5d	1a	Cmc
W3	FES3D	Si-diode	Ultrafast Recovery, 200V, 3A, <50ns	DO-214AB	1d	2j	Fag
W3	MM3Z3V3	Z-diode	3.1..3.5V, Izt=5mA, Zzt=95Ω, 200mW	SOD-323	5d	1a	Sec
W31	SMTPB200	TVS	Vbr=200V, 100A, 5W(1ms), Bidirectional	DO-214AB	1ba	1r	Ste
W35	SMTPB220	TVS	Vbr=220V, 100A, 5W(1ms), Bidirectional	DO-214AB	1ba	1r	Ste
W39	SMTPB240	TVS	Vbr=240V, 100A, 5W(1ms), Bidirectional	DO-214AB	1ba	1r	Ste
W4	BZT52-C3V3	Z-diode	3.3V±5%, Izt=5mA, Zzt=95Ω, 500mW	SOD-123	5d	1k	Vs
W4	BZT52-C3V3S	Z-diode	3.3V±5%, Izt=5mA, Zzt=95Ω, 200mW	SOD-323	5d	1a	Pjt
W4	BZT52C-3V3WT	Z-diode	3.14..3.47V, Izt=5mA, Zzt=95Ω, 200mW	SOD-523	6d	1a	Tr
W4	BZT52C-3V3WU	Z-diode	3.14..3.47V, Izt=5mA, Zzt=95Ω, 200mW	SOD-723	7d	1a	Tr
W4	BZT52-C3V6	Z-diode	3.6V±5%, Izt=5mA, Zzt=90Ω, 500mW	SOD-123	5d	1d	Di
W4	BZT52-C3V6	Z-diode	3.6V±5%, Izt=5mA, Zzt=90Ω, 500mW	SOD-123	5d	1d	Di
W4	BZT52-C3V6S	Z-diode	3.6V±5%, Izt=5mA, Zzt=90Ω, 200mW	SOD-323	5d	1d	Di



SMD
code

Type

Function

Short description

Case

Pinout

St.

Mnf.

SMD code	Type	Function	Short description	Case	Pinout	St.	Mnf.
W4	BZT52-C3V6S	Z-diode	3.6V±5%, Izt=5mA, Zzt=90Ω, 200mW	SOD-323	5d	1d	Di
W4	BZT52-C3V6T	Z-diode	3.6V±5%, Izt=5mA, Zzt=90Ω, 150mW	SOD-523	5d	1d	Di
W4	BZX384-C3V3	Z-diode	3.3V±5%, Izt=5mA, Zzt=85Ω, 200mW	SOD-323	5d	1k	Vs
W4	BZX784C3V3	Z-diode	3.14..3.47V, Zzt=95Ω, Izt=5mA, 200mW	SOD-723	7d	1a	Pjt
W4	CZRW55C3V6-G	Z-diode	3.6..3.80V, Zzt=90Ω, Izt=5mA, 500mW	SOD-123	5d	1a	Cmc
W4	FES3F	Si-diode	Ultrafast Recovery, 300V, 3A, <50ns	DO-214AB	1d	2j	Fag
W4	MM3Z3V6	Z-diode	3.4..3.8V, Izt=5mA, Zzt=90Ω, 200mW	SOD-323	5d	1a	Sec
W43	SMTPB270	TVS	Vbr=270V, 100A, 5W(1ms), Bidirectional	DO-214AB	1ba	1r	Ste
W5	BZT52-C3V6	Z-diode	3.6V±5%, Izt=5mA, Zzt=90Ω, 500mW	SOD-123	5d	1k	Vs
W5	BZT52-C3V6S	Z-diode	3.6V±5%, Izt=5mA, Zzt=90Ω, 200mW	SOD-323	5d	1a	Pjt
W5	BZT52C-3V6WT	Z-diode	3.42..3.78V, Izt=5mA, Zzt=90Ω, 200mW	SOD-523	6d	1a	Ttr
W5	BZT52C-3V6WU	Z-diode	3.42..3.78V, Izt=5mA, Zzt=90Ω, 200mW	SOD-723	7d	1a	Ttr
W5	BZT52-C3V9	Z-diode	3.9V±5%, Izt=5mA, Zzt=90Ω, 500mW	SOD-123	5d	1d	Di
W5	BZT52-C3V9S	Z-diode	3.9V±5%, Izt=5mA, Zzt=90Ω, 500mW	SOD-123	5d	1d	Di
W5	BZT52-C3V9S	Z-diode	3.9V±5%, Izt=5mA, Zzt=90Ω, 200mW	SOD-323	5d	1d	Di
W5	BZT52-C3V9S	Z-diode	3.9V±5%, Izt=5mA, Zzt=90Ω, 200mW	SOD-323	5d	1d	Di
W5	BZT52-C3V9T	Z-diode	3.9V±5%, Izt=5mA, Zzt=90Ω, 150mW	SOD-523	5d	1d	Di
W5	BZX384-C3V6	Z-diode	3.6V±5%, Izt=5mA, Zzt=85Ω, 200mW	SOD-323	5d	1k	Vs
W5	BZX784C3V6	Z-diode	3.42..3.78V, Zzt=90Ω, Izt=5mA, 200mW	SOD-723	7d	1a	Pjt
W5	CZRW55C3V9-G	Z-diode	3.9..4.10V, Zzt=90Ω, Izt=5mA, 500mW	SOD-123	5d	1a	Cmc
W5	FES3G	Si-diode	Ultrafast Recovery, 400V, 3A, <50ns	DO-214AB	1d	2j	Fag
W5	MM3Z3V9	Z-diode	3.7..4.1V, Izt=5mA, Zzt=90Ω, 200mW	SOD-323	5d	1a	Sec
W6	BZT52-C3V9	Z-diode	3.9V±5%, Izt=5mA, Zzt=90Ω, 500mW	SOD-123	5d	1k	Vs
W6	BZT52-C3V9S	Z-diode	3.9V±5%, Izt=5mA, Zzt=90Ω, 200mW	SOD-323	5d	1a	Pjt
W6	BZT52C-3V9WT	Z-diode	3.71..4.1V, Izt=5mA, Zzt=90Ω, 200mW	SOD-523	6d	1a	Ttr
W6	BZT52C-3V9WU	Z-diode	3.71..4.1V, Izt=5mA, Zzt=90Ω, 200mW	SOD-723	7d	1a	Ttr
W6	BZT52-C4V3	Z-diode	4.3V±5%, Izt=5mA, Zzt=90Ω, 500mW	SOD-123	5d	1d	Di
W6	BZT52-C4V3	Z-diode	4.3V±5%, Izt=5mA, Zzt=90Ω, 500mW	SOD-123	5d	1d	Di
W6	BZT52-C4V3S	Z-diode	4.3V±5%, Izt=5mA, Zzt=90Ω, 200mW	SOD-323	5d	1d	Di
W6	BZT52-C4V3S	Z-diode	4.3V±5%, Izt=5mA, Zzt=90Ω, 200mW	SOD-323	5d	1d	Di
W6	BZT52-C4V3T	Z-diode	4.3V±5%, Izt=5mA, Zzt=90Ω, 150mW	SOD-523	5d	1d	Di
W6	BZX384-C3V9	Z-diode	3.9V±5%, Izt=5mA, Zzt=85Ω, 200mW	SOD-323	5d	1k	Vs
W6	BZX784C3V9	Z-diode	3.71..4.10V, Zzt=90Ω, Izt=5mA, 200mW	SOD-723	7d	1a	Pjt
W6	CZRW55C4V3-G	Z-diode	4.3..4.60V, Zzt=90Ω, Izt=5mA, 500mW	SOD-123	5d	1a	Cmc
W6	FES3J	Si-diode	Ultrafast Recovery, 600V, 3A, <50ns	DO-214AB	1d	2j	Fag
W6	MM3Z4V3	Z-diode	4.0..4.6V, Izt=5mA, Zzt=90Ω, 200mW	SOD-323	5d	1a	Sec
W7	BZT52-C4V3	Z-diode	4.3V±5%, Izt=5mA, Zzt=90Ω, 500mW	SOD-123	5d	1k	Vs
W7	BZT52-C4V3S	Z-diode	4.3V±5%, Izt=5mA, Zzt=90Ω, 200mW	SOD-323	5d	1a	Pjt
W7	BZT52C-4V3WT	Z-diode	4.09..4.52V, Izt=5mA, Zzt=90Ω, 200mW	SOD-523	6d	1a	Ttr
W7	BZT52C-4V3WU	Z-diode	4.09..4.52V, Izt=5mA, Zzt=90Ω, 200mW	SOD-723	7d	1a	Ttr
W7	BZT52-C4V7	Z-diode	4.7V±5%, Izt=5mA, Zzt=80Ω, 500mW	SOD-123	5d	1d	Di
W7	BZT52-C4V7	Z-diode	4.7V±5%, Izt=5mA, Zzt=80Ω, 500mW	SOD-123	5d	1d	Di
W7	BZT52-C4V7S	Z-diode	4.7V±5%, Izt=5mA, Zzt=80Ω, 200mW	SOD-323	5d	1d	Di
W7	BZT52-C4V7S	Z-diode	4.7V±5%, Izt=5mA, Zzt=80Ω, 200mW	SOD-323	5d	1d	Di
W7	BZT52-C4V7T	Z-diode	4.7V±5%, Izt=5mA, Zzt=80Ω, 150mW	SOD-523	5d	1d	Di
W7	BZX384-C4V3	Z-diode	4.3V±5%, Izt=5mA, Zzt=80Ω, 200mW	SOD-323	5d	1k	Vs
W7	BZX784C4V3	Z-diode	4.09..4.52V, Zzt=90Ω, Izt=5mA, 200mW	SOD-723	7d	1a	Pjt
W7	CZRW55C4V7-G	Z-diode	4.7..5.0V, Zzt=80Ω, Izt=5mA, 500mW	SOD-123	5d	1a	Cmc
W7	MM3Z4V7	Z-diode	4.4..5.0V, Izt=5mA, Zzt=80Ω, 200mW	SOD-323	5d	1a	Sec
W8	BZT52-C4V7	Z-diode	4.7V±5%, Izt=5mA, Zzt=80Ω, 500mW	SOD-123	5d	1k	Vs
W8	BZT52-C4V7S	Z-diode	4.7V±5%, Izt=5mA, Zzt=80Ω, 200mW	SOD-323	5d	1a	Pjt
W8	BZT52C-4V7WT	Z-diode	4.47..4.94V, Izt=5mA, Zzt=80Ω, 200mW	SOD-523	6d	1a	Ttr
W8	BZT52C-4V7WU	Z-diode	4.47..4.94V, Izt=5mA, Zzt=80Ω, 200mW	SOD-723	7d	1a	Ttr
W8	BZT52-C5V1	Z-diode	5.1V±5%, Izt=5mA, Zzt=60Ω, 500mW	SOD-123	5d	1d	Di
W8	BZT52-C5V1	Z-diode	5.1V±5%, Izt=5mA, Zzt=60Ω, 500mW	SOD-123	5d	1d	Di
W8	BZT52-C5V1S	Z-diode	5.1V±5%, Izt=5mA, Zzt=60Ω, 200mW	SOD-323	5d	1d	Di
W8	BZT52-C5V1S	Z-diode	5.1V±5%, Izt=5mA, Zzt=60Ω, 200mW	SOD-323	5d	1d	Di
W8	BZT52-C5V1T	Z-diode	5.1V±5%, Izt=5mA, Zzt=60Ω, 150mW	SOD-523	5d	1d	Di
W8	BZX384-C4V7	Z-diode	4.7V±5%, Izt=5mA, Zzt=50Ω, 200mW	SOD-323	5d	1k	Vs
W8	BZX784C4V7	Z-diode	4.47..4.94V, Zzt=80Ω, Izt=5mA, 200mW	SOD-723	7d	1a	Pjt
W8	CZRW55C5V1-G	Z-diode	5.1..5.40V, Zzt=60Ω, Izt=5mA, 500mW	SOD-123	5d	1a	Cmc
W8	MM3Z5V1	Z-diode	4.8..5.4V, Izt=5mA, Zzt=60Ω, 200mW	SOD-323	5d	1a	Sec
W8	MM5Z22H	Z-diode	20.8..23.3V, Izt=2mA, Zzt=55Ω, 200mW	SOD-523	7d	1a	Zow
W8	MM5Z22V	Z-diode	22V±5%, Izt=5mA, Zzt=55Ω, 200mW	SOD-523	6d	1a	Eic
W9	BZT52-C5V1	Z-diode	5.1V±5%, Izt=5mA, Zzt=60Ω, 500mW	SOD-123	5d	1k	Vs
W9	BZT52-C5V1S	Z-diode	5.1V±5%, Izt=5mA, Zzt=60Ω, 200mW	SOD-323	5d	1a	Pjt
W9	BZT52C-5V1WT	Z-diode	4.85..5.36V, Izt=5mA, Zzt=60Ω, 200mW	SOD-523	6d	1a	Ttr
W9	BZT52C-5V1WU	Z-diode	4.85..5.36V, Izt=5mA, Zzt=60Ω, 200mW	SOD-723	7d	1a	Ttr
W9	BZT52-C5V6	Z-diode	5.6V±5%, Izt=5mA, Zzt=40Ω, 500mW	SOD-123	5d	1d	Di
W9	BZT52-C5V6	Z-diode	5.6V±5%, Izt=5mA, Zzt=40Ω, 500mW	SOD-123	5d	1d	Di



SMD
code

Type

Function

Short description

Case

Pinout

St.

Mnf.

SMD code	Type	Function	Short description	Case	Pinout	St.	Mnf.
W9	BZT52-C5V6S	Z-diode	5.6V±5%, Izt=5mA, Zzt=40Ω, 200mW	SOD-323	5d	1d	Di
W9	BZT52-C5V6S	Z-diode	5.6V±5%, Izt=5mA, Zzt=40Ω, 200mW	SOD-323	5d	1d	Di
W9	BZT52-C5V6T	Z-diode	5.6V±5%, Izt=5mA, Zzt=40Ω, 150mW	SOD-523	5d	1d	Di
W9	BZX384-C5V1	Z-diode	5.1V±5%, Izt=5mA, Zzt=40Ω, 200mW	SOD-323	5d	1k	Vs
W9	BZX784C5V1	Z-diode	4.85..5.36V, Zzt=60Ω, Izt=5mA, 200mW	SOD-723	7d	1a	Pjt
W9	CZRW55C5V6-G	Z-diode	5.6..6.0V, Zzt=40Ω, Izt=5mA, 500mW	SOD-123	5d	1a	Cmc
W9	MM3Z5V6	Z-diode	5.2..6.0V, Izt=5mA, Zzt=40Ω, 200mW	SOD-323	5d	1a	Sec
WA	BZT52-C5V6	Z-diode	5.6V±5%, Izt=5mA, Zzt=40Ω, 500mW	SOD-123	5d	1k	Vs
WA	BZT52-C5V6S	Z-diode	5.6V±5%, Izt=5mA, Zzt=40Ω, 200mW	SOD-323	5d	1a	Pjt
WA	BZT52C-5V6WT	Z-diode	5.32..5.88V, Izt=5mA, Zzt=40Ω, 200mW	SOD-523	6d	1a	Ttr
WA	BZT52C-5V6WU	Z-diode	5.32..5.88V, Izt=5mA, Zzt=40Ω, 200mW	SOD-723	7d	1a	Ttr
WA	BZT52-C6V2	Z-diode	6.2V±5%, Izt=5mA, Zzt=10Ω, 500mW	SOD-123	5d	1d	Di
WA	BZT52-C6V2	Z-diode	6.2V±5%, Izt=5mA, Zzt=10Ω, 500mW	SOD-123	5d	1d	Di
WA	BZT52-C6V2S	Z-diode	6.2V±5%, Izt=5mA, Zzt=10Ω, 200mW	SOD-323	5d	1d	Di
WA	BZT52-C6V2S	Z-diode	6.2V±5%, Izt=5mA, Zzt=10Ω, 200mW	SOD-323	5d	1d	Di
WA	BZT52-C6V2T	Z-diode	6.2V±5%, Izt=5mA, Zzt=10Ω, 150mW	SOD-523	5d	1d	Di
WA	BZX384-C5V6	Z-diode	5.6V±5%, Izt=5mA, Zzt=15Ω, 200mW	SOD-323	5d	1k	Vs
WA	BZX784C5V6	Z-diode	5.32..5.88V, Zzt=40Ω, Izt=5mA, 200mW	SOD-723	7d	1a	Pjt
WA	CZRW55C6V2-G	Z-diode	6.2..6.60V, Zzt=10Ω, Izt=5mA, 500mW	SOD-123	5d	1a	Cmc
WA	MM3Z6V2	Z-diode	5.8..6.6V, Izt=5mA, Zzt=10Ω, 200mW	SOD-323	5d	1a	Sec
WA	P4SMA82C	TVS	Vrwm=82V, 3.6A, 400W (1ms), Bidirectional	DO-214AC	1ba	2k	Fag
WA	PZU10BA/DG	Z-diode	10V±5%, If=200mA, 320mW, halogen-free	SOD-323	5d	1a	Phi
WA	SMZG3789A	Z-diode	10V±5%, 125mA, Zzt=5Ω, 1.5W	DO-215AA	5d	1k	Vs
WA	SMZJ3789A	Z-diode	10V±5%, 125mA, Zzt=5Ω, 1.5W	DO-214AA	1d	1k	Vs
WB	BZT52-C6V2	Z-diode	6.2V±5%, Izt=5mA, Zzt=10Ω, 500mW	SOD-123	5d	1k	Vs
WB	BZT52-C6V2S	Z-diode	6.2V±5%, Izt=5mA, Zzt=10Ω, 200mW	SOD-323	5d	1a	Pjt
WB	BZT52C-6V2WT	Z-diode	5.89..6.51V, Izt=5mA, Zzt=10Ω, 200mW	SOD-523	6d	1a	Ttr
WB	BZT52C-6V2WU	Z-diode	5.89..6.51V, Izt=5mA, Zzt=10Ω, 200mW	SOD-723	7d	1a	Ttr
WB	BZT52-C6V8	Z-diode	6.8V±5%, Izt=5mA, Zzt=15Ω, 500mW	SOD-123	5d	1d	Di
WB	BZT52-C6V8	Z-diode	6.8V±5%, Izt=5mA, Zzt=15Ω, 500mW	SOD-123	5d	1d	Di
WB	BZT52-C6V8S	Z-diode	6.8V±5%, Izt=5mA, Zzt=15Ω, 200mW	SOD-323	5d	1d	Di
WB	BZT52-C6V8S	Z-diode	6.8V±5%, Izt=5mA, Zzt=15Ω, 200mW	SOD-323	5d	1d	Di
WB	BZT52-C6V8T	Z-diode	6.8V±5%, Izt=5mA, Zzt=15Ω, 150mW	SOD-523	5d	1d	Di
WB	BZX384-C6V2	Z-diode	6.2V±5%, Izt=5mA, Zzt=6Ω, 200mW	SOD-323	5d	1k	Vs
WB	BZX784C6V2	Z-diode	5.89..6.51V, Zzt=10Ω, Izt=5mA, 200mW	SOD-723	7d	1a	Pjt
WB	CZRW55C6V8-G	Z-diode	6.8..7.20V, Zzt=15Ω, Izt=5mA, 500mW	SOD-123	5d	1a	Cmc
WB	KDZ13B	Z-diode	13V±2.5%, 20mA, 1W	PMDU	7d	1s	Rhm
WB	MM3Z10VS	Z-diode	9.80..10.20V, Izt=5mA, Zzt=15Ω, 200mW	SOD-323FL	7d	1u	Ons
WB	MM3Z6V8	Z-diode	6.4..7.2V, Izt=5mA, Zzt=15Ω, 200mW	SOD-323	5d	1a	Sec
WB	PZU10B1A/DG	Z-diode	10V±2%, If=200mA, 320mW, halogen-free	SOD-323	5d	1a	Phi
WB	SMZG3789B	Z-diode	10V±10%, 125mA, Zzt=5Ω, 1.5W	DO-215AA	5d	1k	Vs
WB	SMZJ3789B	Z-diode	10V±10%, 125mA, Zzt=5Ω, 1.5W	DO-214AA	1d	1k	Vs
WC	BZT52-C6V8	Z-diode	6.8V±5%, Izt=5mA, Zzt=15Ω, 500mW	SOD-123	5d	1k	Vs
WC	BZT52-C6V8S	Z-diode	6.8V±5%, Izt=5mA, Zzt=15Ω, 200mW	SOD-323	5d	1a	Pjt
WC	BZT52C-6V8WT	Z-diode	6.46..7.14V, Izt=5mA, Zzt=15Ω, 200mW	SOD-523	6d	1a	Ttr
WC	BZT52C-6V8WU	Z-diode	6.46..7.14V, Izt=5mA, Zzt=15Ω, 200mW	SOD-723	7d	1a	Ttr
WC	BZT52-C7V5	Z-diode	7.5V±5%, Izt=5mA, Zzt=15Ω, 500mW	SOD-123	5d	1d	Di
WC	BZT52-C7V5	Z-diode	7.5V±5%, Izt=5mA, Zzt=15Ω, 500mW	SOD-123	5d	1d	Di
WC	BZT52-C7V5S	Z-diode	7.5V±5%, Izt=5mA, Zzt=15Ω, 200mW	SOD-323	5d	1d	Di
WC	BZT52-C7V5S	Z-diode	7.5V±5%, Izt=5mA, Zzt=15Ω, 200mW	SOD-323	5d	1d	Di
WC	BZT52-C7V5T	Z-diode	7.5V±5%, Izt=5mA, Zzt=15Ω, 150mW	SOD-523	5d	1d	Di
WC	BZX384-C6V8	Z-diode	6.8V±5%, Izt=5mA, Zzt=6Ω, 200mW	SOD-323	5d	1k	Vs
WC	BZX784C6V8	Z-diode	6.46..7.14V, Zzt=15Ω, Izt=5mA, 200mW	SOD-723	7d	1a	Pjt
WC	CZRW55C7V5-G	Z-diode	7.5..7.90V, Zzt=15Ω, Izt=5mA, 500mW	SOD-123	5d	1a	Cmc
WC	MM3Z11VS	Z-diode	10.78..11.22V, Izt=5mA, Zzt=15Ω, 200mW	SOD-323FL	7d	1u	Ons
WC	MM3Z7V5	Z-diode	7.0..7.9V, Izt=5mA, Zzt=15Ω, 200mW	SOD-323	5d	1a	Sec
WC	P4SMA91C	TVS	Vrwm=91V, 3.2A, 400W (1ms), Bidirectional	DO-214AC	1ba	2k	Fag
WC	PZU10B2A/DG	Z-diode	10V±2%, If=200mA, 320mW, halogen-free	SOD-323	5d	1a	Phi
WC	SMZG3790A	Z-diode	11V±5%, 115mA, Zzt=6Ω, 1.5W	DO-215AA	5d	1k	Vs
WC	SMZJ3790A	Z-diode	11V±5%, 115mA, Zzt=6Ω, 1.5W	DO-214AA	1d	1k	Vs
WD	BZT52-C7V5	Z-diode	7.5V±5%, Izt=5mA, Zzt=15Ω, 500mW	SOD-123	5d	1k	Vs
WD	BZT52-C7V5S	Z-diode	7.5V±5%, Izt=5mA, Zzt=15Ω, 200mW	SOD-323	5d	1a	Pjt
WD	BZT52C-7V5WT	Z-diode	7.13..7.88V, Izt=5mA, Zzt=15Ω, 200mW	SOD-523	6d	1a	Ttr
WD	BZT52C-7V5WU	Z-diode	7.13..7.88V, Izt=5mA, Zzt=15Ω, 200mW	SOD-723	7d	1a	Ttr
WD	BZT52-C8V2	Z-diode	8.2V±5%, Izt=5mA, Zzt=15Ω, 500mW	SOD-123	5d	1d	Di
WD	BZT52-C8V2	Z-diode	8.2V±5%, Izt=5mA, Zzt=15Ω, 500mW	SOD-123	5d	1d	Di
WD	BZT52-C8V2S	Z-diode	8.2V±5%, Izt=5mA, Zzt=15Ω, 200mW	SOD-323	5d	1d	Di
WD	BZT52-C8V2S	Z-diode	8.2V±5%, Izt=5mA, Zzt=15Ω, 200mW	SOD-323	5d	1d	Di
WD	BZT52-C8V2T	Z-diode	8.2V±5%, Izt=5mA, Zzt=15Ω, 150mW	SOD-523	5d	1d	Di
WD	BZX384-C7V5	Z-diode	7.5V±5%, Izt=5mA, Zzt=6Ω, 200mW	SOD-323	5d	1k	Vs



SMD
code

Type

Function

Short description

Case

Pinout

St.

Mnf.

SMD code	Type	Function	Short description	Case	Pinout	St.	Mnf.
WD	BZX784C7V5	Z-diode	7.13..7.88V, Zzt=15Ω, Izt=5mA, 200mW	SOD-723	7d	1a	Pjt
WD	CZRW55C8V2-G	Z-diode	8.2..8.70V, Zzt=15Ω, Izt=5mA, 500mW	SOD-123	5d	1a	Cmc
WD	MM3Z8V2	Z-diode	7.7..8.7V, Izt=5mA, Zzt=15Ω, 200mW	SOD-323	5d	1a	Sec
WD	P4SMAJ54C	TVS	Vbr=54V, 4.2A, 400W (1ms), Bidirectional	DO-214AC	1ba	1x,1y	Pjt,Sj
WD	PZU10B3A/DG	Z-diode	10V±2%, If=200mA, 320mW, halogen-free	SOD-323	5d	1a	Phi
WD	SMAJ5.0C	TVS	Vrwm=5.0V, Vbr=6.40..7.0V, 41.7A, 400W(1ms), Bidirectional	DO-214AC	1ba	1l	Vs
WD	SMZG3790B	Z-diode	11V±10%, 115mA, Zzt=6Ω, 1.5W	DO-215AA	5d	1k	Vs
WD	SMZJ3790B	Z-diode	11V±10%, 115mA, Zzt=6Ω, 1.5W	DO-214AA	1d	1k	Vs
WD	TV04A5V0KB-G	TVS	Vrwm=5.0V, Vbr=6.40..7.30V, Ipp=41.67A, 400W(1ms), Bidirectional	DO-214AC	1ba	1j	Cmc
WE	BZT52-C8V2	Z-diode	8.2V±5%, Izt=5mA, Zzt=15Ω, 500mW	SOD-123	5d	1k	Vs
WE	BZT52-C8V2S	Z-diode	8.2V±5%, Izt=5mA, Zzt=15Ω, 200mW	SOD-323	5d	1a	Pjt
WE	BZT52C-8V2WT	Z-diode	7.79..8.61V, Izt=5mA, Zzt=15Ω, 200mW	SOD-523	6d	1a	Ttr
WE	BZT52C-8V2WU	Z-diode	7.79..8.61V, Izt=5mA, Zzt=15Ω, 200mW	SOD-723	7d	1a	Ttr
WE	BZT52-C9V1	Z-diode	9.1V±5%, Izt=5mA, Zzt=15Ω, 500mW	SOD-123	5d	1d	Di
WE	BZT52-C9V1	Z-diode	9.1V±5%, Izt=5mA, Zzt=15Ω, 500mW	SOD-123	5d	1d	Di
WE	BZT52-C9V1S	Z-diode	9.1V±5%, Izt=5mA, Zzt=15Ω, 200mW	SOD-323	5d	1d	Di
WE	BZT52-C9V1S	Z-diode	9.1V±5%, Izt=5mA, Zzt=15Ω, 200mW	SOD-323	5d	1d	Di
WE	BZT52-C9V1T	Z-diode	9.1V±5%, Izt=5mA, Zzt=15Ω, 150mW	SOD-523	5d	1d	Di
WE	BZX384-C8V2	Z-diode	8.2V±5%, Izt=5mA, Zzt=6Ω, 200mW	SOD-323	5d	1k	Vs
WE	BZX784C8V2	Z-diode	7.79..8.61V, Zzt=15Ω, Izt=5mA, 200mW	SOD-723	7d	1a	Pjt
WE	CD214A-T54CA	TVS	Vbr=54V, Iism=4.6A, 400W(1ms), Bidirectional	DO-214AC	1ba	1j	Bm
WE	CZRW55C9V1-G	Z-diode	9.1..9.60V, Zzt=15Ω, Izt=5mA, 500mW	SOD-123	5d	1a	Cmc
WE	MM3Z9V1	Z-diode	8.5..9.6V, Izt=5mA, Zzt=15Ω, 200mW	SOD-323	5d	1a	Sec
WE	P4SMA100C	TVS	Vrwm=100V, 2.9A, 400W (1ms), Bidirectional	DO-214AC	1ba	2k	Fag
WE	P4SMAJ5.0CA	TVS	Vbr=5.0V, 43.5A, 400W(1ms), Bidirectional	DO-214AC	1ba	1j	Mco
WE	P4SMAJ54AC	TVS	Vbr=54V, 4.6A, 400W (1ms), Bidirectional	DO-214AC	1ba	1x,1y	Pjt,Sj
WE	PZU11B1A/DG	Z-diode	11V±5%, If=200mA, 320mW, halogen-free	SOD-323	5d	1a	Phi
WE	SMAJ5.0CA	TVS	Vrwm=5.0V, Vbr=6.40..7.0V, 43.5A, 400W(1ms), Bidirectional	DO-214AC	1ba	1l	Vs
WE	SMAJ54CA	TVS	Vrwm=54V, Vbr=60.0..66.3V, 4.6A, 400W(1ms), Bidirectional	DO-214AC	1ba	1x	Di
WE	SMZG3791A	Z-diode	12V±5%, 105mA, Zzt=7Ω, 1.5W	DO-215AA	5d	1k	Vs
WE	SMZJ3791A	Z-diode	12V±5%, 105mA, Zzt=7Ω, 1.5W	DO-214AA	1d	1k	Vs
WE	TV04A5V0JB-G	TVS	Vrwm=5.0V, Vbr=6.46..7.0V, Ipp=43.48A, 400W(1ms), Bidirectional	DO-214AC	1ba	1j	Cmc
WF	BZT52-C10	Z-diode	10V±5%, Izt=5mA, Zzt=20Ω, 500mW	SOD-123	5d	1d	Di
WF	BZT52-C10	Z-diode	10V±5%, Izt=5mA, Zzt=20Ω, 500mW	SOD-123	5d	1d	Di
WF	BZT52-C10S	Z-diode	10V±5%, Izt=5mA, Zzt=20Ω, 200mW	SOD-323	5d	1d	Di
WF	BZT52-C10S	Z-diode	10V±5%, Izt=5mA, Zzt=20Ω, 200mW	SOD-323	5d	1d	Di
WF	BZT52-C10T	Z-diode	10V±5%, Izt=5mA, Zzt=20Ω, 150mW	SOD-523	5d	1d	Di
WF	BZT52-C9V1	Z-diode	9.1V±5%, Izt=5mA, Zzt=15Ω, 500mW	SOD-123	5d	1k	Vs
WF	BZT52-C9V1S	Z-diode	9.1V±5%, Izt=5mA, Zzt=15Ω, 200mW	SOD-323	5d	1a	Pjt
WF	BZT52C-9V1WT	Z-diode	8.65..9.56V, Izt=5mA, Zzt=15Ω, 200mW	SOD-523	6d	1a	Ttr
WF	BZT52C-9V1WU	Z-diode	8.65..9.56V, Izt=5mA, Zzt=15Ω, 200mW	SOD-723	7d	1a	Ttr
WF	BZX384-C9V1	Z-diode	9.1V±5%, Izt=5mA, Zzt=6Ω, 200mW	SOD-323	5d	1k	Vs
WF	BZX784C9V1	Z-diode	8.65..9.56V, Zzt=15Ω, Izt=5mA, 200mW	SOD-723	7d	1a	Pjt
WF	CZRW55C10-G	Z-diode	10.0..10.60V, Zzt=20Ω, Izt=5mA, 500mW	SOD-123	5d	1a	Cmc
WF	MM3Z10V	Z-diode	9.4..10.6V, Izt=5mA, Zzt=20Ω, 200mW	SOD-323	5d	1a	Sec
WF	P4SMAJ58C	TVS	Vbr=58V, 3.9A, 400W (1ms), Bidirectional	DO-214AC	1ba	1x,1y	Pjt,Sj
WF	PZU11B1A/DG	Z-diode	11V±2%, If=200mA, 320mW, halogen-free	SOD-323	5d	1a	Phi
WF	SMAJ6.0C	TVS	Vrwm=6.0V, Vbr=6.67..8.15V, 35.1A, 400W(1ms), Bidirectional	DO-214AC	1ba	1l	Vs
WF	SMZG3791B	Z-diode	12V±10%, 105mA, Zzt=7Ω, 1.5W	DO-215AA	5d	1k	Vs
WF	SMZJ3791B	Z-diode	12V±10%, 105mA, Zzt=7Ω, 1.5W	DO-214AA	1d	1k	Vs
WF	TV04A6V0KB-G	TVS	Vrwm=6.0V, Vbr=6.67..8.15V, Ipp=35.09A, 400W(1ms), Bidirectional	DO-214AC	1ba	1j	Cmc
WG	BZT52-C10	Z-diode	10V±5%, Izt=5mA, Zzt=20Ω, 500mW	SOD-123	5d	1k	Vs
WG	BZT52-C10S	Z-diode	10V±5%, Izt=5mA, Zzt=20Ω, 200mW	SOD-323	5d	1a	Pjt
WG	BZT52C-10WT	Z-diode	9.50..10.50V, Izt=5mA, Zzt=20Ω, 200mW	SOD-523	5d	1a	Ttr
WG	BZT52C-10WU	Z-diode	9.50..10.50V, Izt=5mA, Zzt=20Ω, 200mW	SOD-723	7d	1a	Ttr
WG	BZT52-C11	Z-diode	11V±5%, Izt=5mA, Zzt=20Ω, 500mW	SOD-123	5d	1d	Di
WG	BZT52-C11	Z-diode	11V±5%, Izt=5mA, Zzt=20Ω, 500mW	SOD-123	5d	1d	Di
WG	BZT52-C11S	Z-diode	11V±5%, Izt=5mA, Zzt=20Ω, 200mW	SOD-323	5d	1d	Di
WG	BZT52-C11S	Z-diode	11V±5%, Izt=5mA, Zzt=20Ω, 200mW	SOD-323	5d	1d	Di
WG	BZT52-C11T	Z-diode	11V±5%, Izt=5mA, Zzt=20Ω, 150mW	SOD-523	5d	1d	Di
WG	BZX384-C10	Z-diode	10V±5%, Izt=5mA, Zzt=8Ω, 200mW	SOD-323	5d	1k	Vs
WG	CD214A-T58CA	TVS	Vbr=58V, Iism=4.3A, 400W(1ms), Bidirectional	DO-214AC	1ba	1j	Bm
WG	CZRW55C11-G	Z-diode	11.0..11.60V, Zzt=20Ω, Izt=5mA, 500mW	SOD-123	5d	1a	Cmc
WG	MM3Z11V	Z-diode	10.4..11.6V, Izt=5mA, Zzt=20Ω, 200mW	SOD-323	5d	1a	Sec
WG	P4SMA110C	TVS	Vbr=99.0..121V, Vrwm=89.2V, 2.7A, 400W(1ms), Bidirectional	DO-214AC	1ba	2k	Fag
WG	P4SMAJ58AC	TVS	Vbr=58V, 4.3A, 400W (1ms), Bidirectional	DO-214AC	1ba	1x,1y	Pjt,Sj
WG	P4SMAJ6.0CA	TVS	Vbr=6.0V, 38.8A, 400W(1ms), Bidirectional	DO-214AC	1ba	1j	Mco
WG	PZU11B2A/DG	Z-diode	11V±2%, If=200mA, 320mW, halogen-free	SOD-323	5d	1a	Phi
WG	SMAJ58CA	TVS	Vrwm=58V, Vbr=64.4..71.2V, 4.3A, 400W(1ms), Bidirectional	DO-214AC	1ba	1x	Di
WG	SMAJ6.0CA	TVS	Vrwm=6.0V, Vbr=6.67..7.37V, 38.8A, 400W(1ms), Bidirectional	DO-214AC	1ba	1l	Vs



SMD
code

Type

Function

Short description

Case

Pinout

St.

Mnf.

SMD code	Type	Function	Short description	Case	Pinout	St.	Mnf.
WG	SMZG3792A	Z-diode	13V±5%, 98mA, Zzt=7.5Ω, 1.5W	DO-215AA	5d	1k	Vs
WG	SMZJ3792A	Z-diode	13V±5%, 98mA, Zzt=7.5Ω, 1.5W	DO-214AA	1d	1k	Vs
WG	TV04A6V0JB-G	TVS	Vrwm=6.0V, Vbr=6.67..7.37V, Ipp=38.83A, 400W(1ms), Bidirectional	DO-214AC	1ba	1j	Cmc
WH	BZT52-C11	Z-diode	11V±5%, Izt=5mA, Zzt=20Ω, 500mW	SOD-123	5d	1k	Vs
WH	BZT52-C11S	Z-diode	11V±5%, Izt=5mA, Zzt=20Ω, 200mW	SOD-323	5d	1a	Pjt
WH	BZT52C-11WT	Z-diode	10.45..11.55V, Izt=5mA, Zzt=20Ω, 200mW	SOD-523	6d	1a	Ttr
WH	BZT52C-11WU	Z-diode	10.45..11.55V, Izt=5mA, Zzt=20Ω, 200mW	SOD-723	7d	1a	Ttr
WH	BZT52-C12	Z-diode	12V±5%, Izt=5mA, Zzt=25Ω, 500mW	SOD-123	5d	1d	Di
WH	BZT52-C12	Z-diode	12V±5%, Izt=5mA, Zzt=25Ω, 500mW	SOD-123	5d	1d	Di
WH	BZT52-C12S	Z-diode	12V±5%, Izt=5mA, Zzt=25Ω, 200mW	SOD-323	5d	1d	Di
WH	BZT52-C12S	Z-diode	12V±5%, Izt=5mA, Zzt=25Ω, 200mW	SOD-323	5d	1d	Di
WH	BZT52-C12T	Z-diode	12V±5%, Izt=5mA, Zzt=25Ω, 150mW	SOD-523	5d	1d	Di
WH	BZX384-C11	Z-diode	11V±5%, Izt=5mA, Zzt=10Ω, 200mW	SOD-323	5d	1k	Vs
WH	BZX784C11	Z-diode	10.45..11.55V, Zzt=20Ω, Izt=5mA, 200mW	SOD-723	7d	1a	Pjt
WH	CZRW55C12-G	Z-diode	12.0..12.70V, Zzt=25Ω, Izt=5mA, 500mW	SOD-123	5d	1a	Cmc
WH	MM3Z12V	Z-diode	11.4..12.7V, Izt=5mA, Zzt=25Ω, 200mW	SOD-323	5d	1a	Sec
WH	P4SMAJ60C	TVS	Vbr=60V, 3.7A, 400W(1ms), Bidirectional	DO-214AC	1ba	1x,1y	Pjt,Sj
WH	PZU11B3A/DG	Z-diode	11V±2%, If=200mA, 320mW, halogen-free	SOD-323	5d	1a	Phi
WH	SMAJ6.5C	TVS	Vrwm=6.5V, Vbr=7.22..8.82V, 32.5A, 400W(1ms), Bidirectional	DO-214AC	1ba	1l	Vs
WH	SMZG3792B	Z-diode	13V±10%, 98mA, Zzt=7.5Ω, 1.5W	DO-215AA	5d	1k	Vs
WH	SMZJ3792B	Z-diode	13V±10%, 98mA, Zzt=7.5Ω, 1.5W	DO-214AA	1d	1k	Vs
WH	TV04A6V5KB-G	TVS	Vrwm=6.50V, Vbr=7.22..8.82V, Ipp=32.52A, 400W(1ms), Bidirectional	DO-214AC	1ba	1j	Cmc
WI	BZT52-C12	Z-diode	12V±5%, Izt=5mA, Zzt=25Ω, 500mW	SOD-123	5d	1k	Vs
WI	BZT52-C12S	Z-diode	12V±5%, Izt=5mA, Zzt=25Ω, 200mW	SOD-323	5d	1a	Pjt
WI	BZT52C-12WT	Z-diode	11.40..12.60V, Izt=5mA, Zzt=25Ω, 200mW	SOD-523	6d	1a	Ttr
WI	BZT52C-12WU	Z-diode	11.40..12.60V, Izt=5mA, Zzt=25Ω, 200mW	SOD-723	7d	1a	Ttr
WI	BZT52-C13	Z-diode	13V±5%, Izt=5mA, Zzt=30Ω, 500mW	SOD-123	5d	1d	Di
WI	BZT52-C13	Z-diode	13V±5%, Izt=5mA, Zzt=30Ω, 500mW	SOD-123	5d	1d	Di
WI	BZT52-C13S	Z-diode	13V±5%, Izt=5mA, Zzt=30Ω, 200mW	SOD-323	5d	1d	Di
WI	BZT52-C13S	Z-diode	13V±5%, Izt=5mA, Zzt=30Ω, 200mW	SOD-323	5d	1d	Di
WI	BZT52-C13T	Z-diode	13V±5%, Izt=5mA, Zzt=30Ω, 150mW	SOD-523	5d	1d	Di
WI	BZX384-C12	Z-diode	12V±5%, Izt=5mA, Zzt=10Ω, 200mW	SOD-323	5d	1k	Vs
WI	BZX784C12	Z-diode	11.40..12.60V, Zzt=25Ω, Izt=5mA, 200mW	SOD-723	7d	1a	Pjt
WI	MM3Z13V	Z-diode	12.4..14.1V, Izt=5mA, Zzt=30Ω, 200mW	SOD-323	5d	1a	Sec
WI	P4SMA120C	TVS	Vrwm=120V, 2.4A, 400W(1ms), Bidirectional	DO-214AC	1ba	2k	Fag
WI	SMZG3793A	Z-diode	15V±5%, 85mA, Zzt=9Ω, 1.5W	DO-215AA	5d	1k	Vs
WI	SMZJ3793A	Z-diode	15V±5%, 85mA, Zzt=9Ω, 1.5W	DO-214AA	1d	1k	Vs
WJ	BZT52C-14WT	Z-diode	13.30..14.70V, Izt=5mA, Zzt=30Ω, 200mW	SOD-523	6d	1a	Ttr
WJ	BZT52C-14WU	Z-diode	13.30..14.70V, Izt=5mA, Zzt=30Ω, 200mW	SOD-723	7d	1a	Ttr
WJ	BZT52-C15	Z-diode	15V±5%, Izt=5mA, Zzt=30Ω, 500mW	SOD-123	5d	1d	Di
WJ	BZT52-C15	Z-diode	15V±5%, Izt=5mA, Zzt=30Ω, 500mW	SOD-123	5d	1d	Di
WJ	BZT52-C15S	Z-diode	15V±5%, Izt=5mA, Zzt=30Ω, 200mW	SOD-323	5d	1d	Di
WJ	BZT52-C15S	Z-diode	15V±5%, Izt=5mA, Zzt=30Ω, 200mW	SOD-323	5d	1d	Di
WJ	BZT52-C15T	Z-diode	15V±5%, Izt=5mA, Zzt=30Ω, 150mW	SOD-523	5d	1d	Di
WJ	BZX784C14	Z-diode	13.30..14.70V, Zzt=30Ω, Izt=5mA, 200mW	SOD-723	7d	1a	Pjt
WJ	CZRW55C15-G	Z-diode	15.0..15.60V, Zzt=30Ω, Izt=5mA, 500mW	SOD-123	5d	1a	Cmc
WJ	MM3Z15V	Z-diode	14.3..15.8V, Izt=5mA, Zzt=30Ω, 200mW	SOD-323	5d	1a	Sec
WJ	SMZG3793B	Z-diode	15V±10%, 85mA, Zzt=9Ω, 1.5W	DO-215AA	5d	1k	Vs
WJ	SMZJ3793B	Z-diode	15V±10%, 85mA, Zzt=9Ω, 1.5W	DO-214AA	1d	1k	Vs
WK	BZT52-C13	Z-diode	13V±5%, Izt=5mA, Zzt=30Ω, 500mW	SOD-123	5d	1k	Vs
WK	BZT52-C13S	Z-diode	13V±5%, Izt=5mA, Zzt=30Ω, 200mW	SOD-323	5d	1a	Pjt
WK	BZT52C-13WT	Z-diode	12.35..13.65V, Izt=5mA, Zzt=30Ω, 200mW	SOD-523	6d	1a	Ttr
WK	BZT52C-13WU	Z-diode	12.35..13.65V, Izt=5mA, Zzt=30Ω, 200mW	SOD-723	7d	1a	Ttr
WK	BZT52-C16	Z-diode	16V±5%, Izt=5mA, Zzt=40Ω, 500mW	SOD-123	5d	1d	Di
WK	BZT52-C16	Z-diode	16V±5%, Izt=5mA, Zzt=40Ω, 500mW	SOD-123	5d	1d	Di
WK	BZT52-C16S	Z-diode	16V±5%, Izt=5mA, Zzt=40Ω, 200mW	SOD-323	5d	1d	Di
WK	BZT52-C16S	Z-diode	16V±5%, Izt=5mA, Zzt=40Ω, 200mW	SOD-323	5d	1d	Di
WK	BZT52-C16T	Z-diode	16V±5%, Izt=5mA, Zzt=40Ω, 150mW	SOD-523	5d	1d	Di
WK	BZX384-C13	Z-diode	13V±5%, Izt=5mA, Zzt=10Ω, 200mW	SOD-323	5d	1k	Vs
WK	BZX784C13	Z-diode	12.35..13.65V, Zzt=30Ω, Izt=5mA, 200mW	SOD-723	7d	1a	Pjt
WK	CD214A-T60CA	TVS	Vbr=60V, Irlsm=4.1A, 400W(1ms), Bidirectional	DO-214AC	1ba	1j	Bm
WK	CZRW55C16-G	Z-diode	16.0..17.10V, Zzt=40Ω, Izt=5mA, 500mW	SOD-123	5d	1a	Cmc
WK	MM3Z16V	Z-diode	15.3..17.1V, Izt=5mA, Zzt=40Ω, 200mW	SOD-323	5d	1a	Sec
WK	P4SMA130C	TVS	Vrwm=130V 2.2A, 400W(1ms), Bidirectional	DO-214AC	1ba	2k	Fag
WK	P4SMAJ6.5CA	TVS	Vbr=6.5V, 35.7A, 400W(1ms), Bidirectional	DO-214AC	1ba	1j	Mco
WK	P4SMAJ60AC	TVS	Vbr=60V, 4.1A, 400W(1ms), Bidirectional	DO-214AC	1ba	1x,1y	Pjt,Sj
WK	PZU12BA/DG	Z-diode	12V±5%, If=200mA, 320mW, halogen-free	SOD-323	5d	1a	Phi
WK	SMAJ6.5CA	TVS	Vrwm=6.5V, Vbr=7.22..7.98V, 35.7A, 400W(1ms), Bidirectional	DO-214AC	1ba	1l	Vs
WK	SMAJ60CA	TVS	Vrwm=60V, Vbr=66.7..73.7V, 4.1A, 400W(1ms), Bidirectional	DO-214AC	1ba	1x	Di
WK	SMZG3794A	Z-diode	16V±5%, 80mA, Zzt=10Ω, 1.5W	DO-215AA	5d	1k	Vs



SMD
code

Type

Function

Short description

Case

Pinout

St.

Mnf.

SMD code	Type	Function	Short description	Case	Pinout	St.	Mnf.
WK	SMZJ3794A	Z-diode	16V±5%, 80mA, Zzt=10Ω, 1.5W	DO-214AA	1d	1k	Vs
WK	TV04A6V5JB-G	TVS	Vrwm=6.50V, Vbr=7.22..7.98V, Ipp=35.71A, 400W(1ms), Bidirectional	DO-214AC	1ba	1j	Cmc
WL	BZT52-C15	Z-diode	15V±5%, Izt=5mA, Zzt=30Ω, 500mW	SOD-123	5d	1k	Vs
WL	BZT52-C15S	Z-diode	15V±5%, Izt=5mA, Zzt=30Ω, 200mW	SOD-323	5d	1a	Pjt
WL	BZT52C-15WT	Z-diode	14.25..15.75V, Izt=5mA, Zzt=30Ω, 200mW	SOD-523	6d	1a	Ttr
WL	BZT52C-15WU	Z-diode	14.25..15.75V, Izt=5mA, Zzt=30Ω, 200mW	SOD-723	7d	1a	Ttr
WL	BZT52-C18	Z-diode	18V±5%, Izt=5mA, Zzt=45Ω, 500mW	SOD-123	5d	1d	Di
WL	BZT52-C18	Z-diode	18V±5%, Izt=5mA, Zzt=45Ω, 500mW	SOD-123	5d	1d	Di
WL	BZT52-C18S	Z-diode	18V±5%, Izt=5mA, Zzt=45Ω, 200mW	SOD-323	5d	1d	Di
WL	BZT52-C18S	Z-diode	18V±5%, Izt=5mA, Zzt=45Ω, 200mW	SOD-323	5d	1d	Di
WL	BZT52-C18T	Z-diode	18V±5%, Izt=5mA, Zzt=45Ω, 150mW	SOD-523	5d	1d	Di
WL	BZX384-C15	Z-diode	15V±5%, Izt=5mA, Zzt=10Ω, 200mW	SOD-323	5d	1k	Vs
WL	BZX784C15	Z-diode	14.25..15.75V, Zzt=30Ω, Izt=5mA, 200mW	SOD-723	7d	1a	Pjt
WL	CZRW55C13-G	Z-diode	13.0..14.10V, Zzt=30Ω, Izt=5mA, 500mW	SOD-123	5d	1a	Cmc
WL	CZRW55C18-G	Z-diode	18.0..19.10V, Zzt=45Ω, Izt=5mA, 500mW	SOD-123	5d	1a	Cmc
WL	MM3Z18V	Z-diode	16.8..19.1V, Izt=5mA, Zzt=45Ω, 200mW	SOD-323	5d	1a	Sec
WL	P4SMAJ64C	TVS	Vbr=64V, 3.5A, 400W(1ms), Bidirectional	DO-214AC	1ba	1x,1y	Pjt,Sj
WL	PZU12B1A/DG	Z-diode	12V±2%, If=200mA, 320mW, halogen-free	SOD-323	5d	1a	Phi
WL	SMAJ7.0C	TVS	Vrwm=7.0V, Vbr=7.78..9.51V, 30.1A, 400W(1ms), Bidirectional	DO-214AC	1ba	1l	Vs
WL	SMZG3794B	Z-diode	16V±10%, 80mA, Zzt=10Ω, 1.5W	DO-215AA	5d	1k	Vs
WL	SMZJ3794B	Z-diode	16V±10%, 80mA, Zzt=10Ω, 1.5W	DO-214AA	1d	1k	Vs
WL	TV04A7V0KB-G	TVS	Vrwm=7.0V, Vbr=7.78..9.51V, Ipp=30.08A, 400W(1ms), Bidirectional	DO-214AC	1ba	1j	Cmc
WM	BZT52-C16	Z-diode	16V±5%, Izt=5mA, Zzt=40Ω, 500mW	SOD-123	5d	1k	Vs
WM	BZT52-C16S	Z-diode	16V±5%, Izt=5mA, Zzt=40Ω, 200mW	SOD-323	5d	1a	Pjt
WM	BZT52C-16WT	Z-diode	15.20..16.80V, Izt=5mA, Zzt=40Ω, 200mW	SOD-523	6d	1a	Ttr
WM	BZT52C-16WU	Z-diode	15.20..16.80V, Izt=5mA, Zzt=40Ω, 200mW	SOD-723	7d	1a	Ttr
WM	BZT52-C20	Z-diode	20V±5%, Izt=5mA, Zzt=55Ω, 500mW	SOD-123	5d	1d	Di
WM	BZT52-C20	Z-diode	20V±5%, Izt=5mA, Zzt=55Ω, 500mW	SOD-123	5d	1d	Di
WM	BZT52-C20S	Z-diode	20V±5%, Izt=5mA, Zzt=55Ω, 200mW	SOD-323	5d	1d	Di
WM	BZT52-C20S	Z-diode	20V±5%, Izt=5mA, Zzt=55Ω, 200mW	SOD-323	5d	1d	Di
WM	BZT52-C20T	Z-diode	20V±5%, Izt=5mA, Zzt=55Ω, 150mW	SOD-523	5d	1d	Di
WM	BZX384-C16	Z-diode	16V±5%, Izt=5mA, Zzt=10Ω, 200mW	SOD-323	5d	1k	Vs
WM	BZX784C16	Z-diode	15.20..16.80V, Zzt=40Ω, Izt=5mA, 200mW	SOD-723	7d	1a	Pjt
WM	CD214A-T64CA	TVS	Vbr=64V, Itrsm=3.9A, 400W(1ms), Bidirectional	DO-214AC	1ba	1j	Bm
WM	CZRW55C20-G	Z-diode	20.0..21.20V, Zzt=55Ω, Izt=5mA, 500mW	SOD-123	5d	1a	Cmc
WM	MM3Z20V	Z-diode	18.8..21.2V, Izt=5mA, Zzt=55Ω, 200mW	SOD-323	5d	1a	Sec
WM	P4SMA150C	TVS	Vrwm=150V, 2A, 400W(1ms), Bidirectional	DO-214AC	1ba	2k	Fag
WM	P4SMAJ64AC	TVS	Vbr=64V, 3.9A, 400W(1ms), Bidirectional	DO-214AC	1ba	1x,1y	Pjt,Sj
WM	P4SMAJ7.0CA	TVS	Vbr=7.0V, 33.3A, 400W(1ms), Bidirectional	DO-214AC	1ba	1j	Mco
WM	PZU12B2A/DG	Z-diode	12V±2%, If=200mA, 320mW, halogen-free	SOD-323	5d	1a	Phi
WM	SMAJ64CA	TVS	Vrwm=64V, Vbr=71.1..78.6V, 3.9A, 400W(1ms), Bidirectional	DO-214AC	1ba	1x	Di
WM	SMAJ7.0CA	TVS	Vrwm=7.0V, Vbr=7.78..8.6V, 33.3A, 400W(1ms), Bidirectional	DO-214AC	1ba	1l	Vs
WM	TV04A7V0JB-G	TVS	Vrwm=7.0V, Vbr=7.78..8.6V, Ipp=33.33A, 400W(1ms), Bidirectional	DO-214AC	1ba	1j	Cmc
WN	BZT52-C18	Z-diode	18V±5%, Izt=5mA, Zzt=45Ω, 500mW	SOD-123	5d	1k	Vs
WN	BZT52-C18S	Z-diode	18V±5%, Izt=5mA, Zzt=45Ω, 200mW	SOD-323	5d	1a	Pjt
WN	BZT52C-18WT	Z-diode	17.10..18.90V, Izt=5mA, Zzt=45Ω, 200mW	SOD-523	6d	1a	Ttr
WN	BZT52C-18WU	Z-diode	17.10..18.90V, Izt=5mA, Zzt=45Ω, 200mW	SOD-723	7d	1a	Ttr
WN	BZT52-C22	Z-diode	22V±5%, Izt=5mA, Zzt=55Ω, 500mW	SOD-123	5d	1d	Di
WN	BZT52-C22	Z-diode	22V±5%, Izt=5mA, Zzt=55Ω, 500mW	SOD-123	5d	1d	Di
WN	BZT52-C22S	Z-diode	22V±5%, Izt=5mA, Zzt=55Ω, 200mW	SOD-323	5d	1d	Di
WN	BZT52-C22S	Z-diode	22V±5%, Izt=5mA, Zzt=55Ω, 200mW	SOD-323	5d	1d	Di
WN	BZT52-C22T	Z-diode	22V±5%, Izt=5mA, Zzt=55Ω, 150mW	SOD-523	5d	1d	Di
WN	BZX384-C18	Z-diode	18V±5%, Izt=5mA, Zzt=10Ω, 200mW	SOD-323	5d	1k	Vs
WN	BZX784C18	Z-diode	17.10..18.90V, Zzt=45Ω, Izt=5mA, 200mW	SOD-723	7d	1a	Pjt
WN	CZRW55C22-G	Z-diode	22.0..23.30V, Zzt=55Ω, Izt=5mA, 500mW	SOD-123	5d	1a	Cmc
WN	MM3Z22V	Z-diode	20.8..23.3V, Izt=5mA, Zzt=55Ω, 200mW	SOD-323	5d	1a	Sec
WN	P4SMAJ70C	TVS	Vbr=70V, 3.2A, 400W(1ms), Bidirectional	DO-214AC	1ba	1x,1y	Pjt,Sj
WN	PZU12B3A/DG	Z-diode	12V±2%, If=200mA, 320mW, halogen-free	SOD-323	5d	1a	Phi
WN	SM4T68C	TVS	Vbr=68V, 4.3A, 400W(1ms), Bidirectional	SOD-6	1ba	1r	Ste
WN	SMAJ7.5C	TVS	Vrwm=7.5V, Vbr=8.33..10.2V, 28A, 400W(1ms), Bidirectional	DO-214AC	1ba	1l	Vs
WN	TV04A7V5KB-G	TVS	Vrwm=7.50V, Vbr=8.33..10.20V, Ipp=27.97A, 400W(1ms), Bidirectional	DO-214AC	1ba	1j	Cmc
WO	BZT52-C20	Z-diode	20V±5%, Izt=5mA, Zzt=55Ω, 500mW	SOD-123	5d	1k	Vs
WO	BZT52-C20S	Z-diode	20V±5%, Izt=5mA, Zzt=55Ω, 200mW	SOD-323	5d	1a	Pjt
WO	BZT52C-20WT	Z-diode	19.0..21.0V, Izt=5mA, Zzt=55Ω, 200mW	SOD-523	6d	1a	Ttr
WO	BZT52C-20WU	Z-diode	19.0..21.0V, Izt=5mA, Zzt=55Ω, 200mW	SOD-723	7d	1a	Ttr
WO	BZT52-C24	Z-diode	24V±5%, Izt=5mA, Zzt=70Ω, 500mW	SOD-123	5d	1d	Di
WO	BZT52-C24	Z-diode	24V±5%, Izt=5mA, Zzt=70Ω, 500mW	SOD-123	5d	1d	Di
WO	BZT52-C24S	Z-diode	24V±5%, Izt=5mA, Zzt=70Ω, 200mW	SOD-323	5d	1d	Di
WO	BZT52-C24S	Z-diode	24V±5%, Izt=5mA, Zzt=70Ω, 200mW	SOD-323	5d	1d	Di
WO	BZT52-C24T	Z-diode	24V±5%, Izt=5mA, Zzt=70Ω, 150mW	SOD-523	5d	1d	Di



SMD
code

Type

Function

Short description

Case

Pinout

St.

Mnf.

SMD code	Type	Function	Short description	Case	Pinout	St.	Mnf.
WO	BZX284-B2V4	Z-diode	2.4V±2%, 400mW	SOD-110	12d	1a	Phi
WO	BZX384-C20	Z-diode	20V±5%, Izt=5mA, Zzt=15Ω, 200mW	SOD-323	5d	1k	Vs
WO	BZX784C20	Z-diode	19.0..21.00V, Zzt=55Ω, Izt=5mA, 200mW	SOD-723	7d	1a	Pjt
WO	CZRW55C24-G	Z-diode	24.0..25.60V, Zzt=70Ω, Izt=5mA, 500mW	SOD-123	5d	1a	Cmc
WO	MM3Z24V	Z-diode	22.8..25.6V, Izt=5mA, Zzt=70Ω, 200mW	SOD-323	5d	1a	Sec
WO	P4SMA160C	TVS	Vrwm=160V, 1.8A, 400W(1ms), Bidirectional	DO-214AC	1ba	2k	Fag
WP	BZT52-C22	Z-diode	22V±5%, Izt=5mA, Zzt=55Ω, 500mW	SOD-123	5d	1k	Vs
WP	BZT52-C22S	Z-diode	22V±5%, Izt=5mA, Zzt=55Ω, 200mW	SOD-323	5d	1a	Pjt
WP	BZT52C-22WT	Z-diode	20.90..23.10V, Izt=5mA, Zzt=55Ω, 200mW	SOD-523	6d	1a	Ttr
WP	BZT52C-22WU	Z-diode	20.90..23.10V, Izt=5mA, Zzt=55Ω, 200mW	SOD-723	7d	1a	Ttr
WP	BZT52-C27	Z-diode	27V±5%, Izt=5mA, Zzt=80Ω, 500mW	SOD-123	5d	1d	Di
WP	BZT52-C27	Z-diode	27V±5%, Izt=5mA, Zzt=80Ω, 500mW	SOD-123	5d	1d	Di
WP	BZT52-C27S	Z-diode	27V±5%, Izt=2.5mA, Zzt=80Ω, 200mW	SOD-323	5d	1d	Di
WP	BZT52-C27S	Z-diode	27V±5%, Izt=2.5mA, Zzt=80Ω, 200mW	SOD-323	5d	1d	Di
WP	BZX284-B2V7	Z-diode	2.7V±2%, 400mW	SOD-110	12d	1a	Phi
WP	BZX784C22	Z-diode	20.90..23.10V, Zzt=55Ω, Izt=5mA, 200mW	SOD-723	7d	1a	Pjt
WP	CD214A-T70CA	TVS	Vbr=70V, Iism=3.5A, 400W(1ms), Bidirectional	DO-214AC	1ba	1j	Bm
WP	CZRW55C27-G	Z-diode	27.0..28.90V, Zzt=80Ω, Izt=2mA, 500mW	SOD-123	5d	1a	Cmc
WP	MM3Z27V	Z-diode	25.1..28.9V, Izt=2mA, Zzt=80Ω, 200mW	SOD-323	5d	1a	Sec
WP	P4SMAJ7.5CA	TVS	Vbr=7.5V, 31.0A, 400W(1ms), Bidirectional	DO-214AC	1ba	1j	Mco
WP	P4SMAJ70AC	TVS	Vbr=70V, 3.5A, 400W(1ms), Bidirectional	DO-214AC	1ba	1x,1y	Pjt,Srj
WP	PZU13BA/DG	Z-diode	13V±5%, If=200mA, 320mW, halogen-free	SOD-323	5d	1a	Phi
WP	SM4T68CA	TVS	Vbr=68V, 4.3A, 400W(1ms), Bidirectional	SOD-6	1ba	1r	Ste
WP	TV04A7V5JB-G	TVS	Vrwm=7.50V, Vbr=8.33..9.21V, Ipp=31.01A, 400W(1ms), Bidirectional	DO-214AC	1ba	1j	Cmc
WQ	BZT52-C30	Z-diode	30V±5%, Izt=5mA, Zzt=80Ω, 500mW	SOD-123	5d	1d	Di
WQ	BZT52-C30	Z-diode	30V±5%, Izt=5mA, Zzt=80Ω, 500mW	SOD-123	5d	1d	Di
WQ	BZT52-C30S	Z-diode	30V±5%, Izt=2.5mA, Zzt=80Ω, 200mW	SOD-323	5d	1d	Di
WQ	BZT52-C30S	Z-diode	30V±5%, Izt=2.5mA, Zzt=80Ω, 200mW	SOD-323	5d	1d	Di
WQ	BZX284-B3V0	Z-diode	3V±2%, 400mW	SOD-110	12d	1a	Phi
WQ	CZRW55C30-G	Z-diode	30.0..32.0V, Zzt=80Ω, Izt=2mA, 500mW	SOD-123	5d	1a	Cmc
WQ	MM3Z30V	Z-diode	28..32V, Izt=2mA, Zzt=80Ω, 200mW	SOD-323	5d	1a	Sec
WQ	P4SMAJ75C	TVS	Vbr=75V, 3A, 400W(1ms), Bidirectional	DO-214AC	1ba	1x,1y	Pjt,Srj
WQ	SMAJ8.0C	TVS	Vrwm=8.0V, Vbr=8.89..10.9V, 26.7A, 400W(1ms), Bidirectional	DO-214AC	1ba	1l	Vs
WQ	TV04A8V0KB-G	TVS	Vrwm=8.0V, Vbr=8.89..10.90V, Ipp=26.67A, 400W(1ms), Bidirectional	DO-214AC	1ba	1j	Cmc
WR	BZT52-C24	Z-diode	24V±5%, Izt=5mA, Zzt=70Ω, 500mW	SOD-123	5d	1k	Vs
WR	BZT52-C24S	Z-diode	24V±5%, Izt=5mA, Zzt=70Ω, 200mW	SOD-323	5d	1a	Pjt
WR	BZT52C-24WT	Z-diode	22.80..25.20V, Izt=5mA, Zzt=70Ω, 200mW	SOD-523	6d	1a	Ttr
WR	BZT52C-24WU	Z-diode	22.80..25.20V, Izt=5mA, Zzt=70Ω, 200mW	SOD-723	7d	1a	Ttr
WR	BZT52-C33	Z-diode	33V±5%, Izt=5mA, Zzt=80Ω, 500mW	SOD-123	5d	1d	Di
WR	BZT52-C33	Z-diode	33V±5%, Izt=5mA, Zzt=80Ω, 500mW	SOD-123	5d	1d	Di
WR	BZT52-C33S	Z-diode	33V±5%, Izt=2.5mA, Zzt=80Ω, 200mW	SOD-323	5d	1d	Di
WR	BZT52-C33S	Z-diode	33V±5%, Izt=2.5mA, Zzt=80Ω, 200mW	SOD-323	5d	1d	Di
WR	BZX284-B3V3	Z-diode	3.3V±2%, 400mW	SOD-110	12d	1a	Phi
WR	BZX384-C24	Z-diode	24V±5%, Izt=2mA, Zzt=25Ω, 200mW	SOD-323	5d	1k	Vs
WR	BZX784C24	Z-diode	22.80..25.20V, Zzt=70Ω, Izt=5mA, 200mW	SOD-723	7d	1a	Pjt
WR	CD214A-T75CA	TVS	Vbr=75V, Iism=3.3A, 400W(1ms), Bidirectional	DO-214AC	1ba	1j	Bm
WR	CZRW55C33-G	Z-diode	33.0..35.0V, Zzt=80Ω, Izt=2mA, 500mW	SOD-123	5d	1a	Cmc
WR	MM3Z33V	Z-diode	31..35V, Izt=2mA, Zzt=80Ω, 200mW	SOD-323	5d	1a	Sec
WR	P4SMA170C	TVS	Vrwm=170V, 1.7A, 400W(1ms), Bidirectional	DO-214AC	1ba	2k	Fag
WR	P4SMAJ75AC	TVS	Vbr=75V, 3.3A, 400W(1ms), Bidirectional	DO-214AC	1ba	1x,1y	Pjt,Srj
WR	P4SMAJ8.0CA	TVS	Vbr=8.0V, 29.4A, 400W(1ms), Bidirectional	DO-214AC	1ba	1j	Mco
WR	PZU13B1A/DG	Z-diode	13V±2%, If=200mA, 320mW, halogen-free	SOD-323	5d	1a	Phi
WR	SMAJ75CA	TVS	Vrwm=75V, Vbr=83.3..92.1V, 3.3A, 400W(1ms), Bidirectional	DO-214AC	1ba	1x	Di
WR	SMAJ8.0CA	TVS	Vrwm=8.0V, Vbr=8.89..9.83V, 29.4A, 400W(1ms), Bidirectional	DO-214AC	1ba	1l	Vs
WR	TV04A8V0JB-G	TVS	Vrwm=8.0V, Vbr=8.89..9.83V, Ipp=29.41A, 400W(1ms), Bidirectional	DO-214AC	1ba	1j	Cmc
WS	BZT52-C27	Z-diode	27V±5%, Izt=5mA, Zzt=80Ω, 500mW	SOD-123	5d	1k	Vs
WS	BZT52-C27S	Z-diode	27V±5%, Izt=2.5mA, Zzt=80Ω, 200mW	SOD-323	5d	1a	Pjt
WS	BZT52C-27WT	Z-diode	25.65..28.35V, Izt=5mA, Zzt=80Ω, 200mW	SOD-523	6d	1a	Ttr
WS	BZT52C-27WU	Z-diode	25.65..28.35V, Izt=5mA, Zzt=80Ω, 200mW	SOD-723	7d	1a	Ttr
WS	BZT52-C36	Z-diode	36V±5%, Izt=5mA, Zzt=90Ω, 500mW	SOD-123	5d	1d	Di
WS	BZT52-C36	Z-diode	36V±5%, Izt=5mA, Zzt=90Ω, 500mW	SOD-123	5d	1d	Di
WS	BZT52-C36S	Z-diode	36V±5%, Izt=2.5mA, Zzt=90Ω, 200mW	SOD-323	5d	1d	Di
WS	BZT52-C36S	Z-diode	36V±5%, Izt=2.5mA, Zzt=90Ω, 200mW	SOD-323	5d	1d	Di
WS	BZX284-B3V6	Z-diode	6V±2%, 400mW	SOD-110	12d	1a	Phi
WS	BZX384-C27	Z-diode	27V±5%, Izt=2mA, Zzt=25Ω, 200mW	SOD-323	5d	1k	Vs
WS	BZX784C27	Z-diode	25.65..28.35V, Zzt=80Ω, Izt=5mA, 200mW	SOD-723	7d	1a	Pjt
WS	CZRW55C36-G	Z-diode	36.0..38.0V, Zzt=90Ω, Izt=2mA, 500mW	SOD-123	5d	1a	Cmc
WS	MM3Z36V	Z-diode	34..38V, Izt=2mA, Zzt=90Ω, 200mW	SOD-323	5d	1a	Sec
WS	P4SMAJ78C	TVS	Vbr=78V, 2.9A, 400W(1ms), Bidirectional	DO-214AC	1ba	1x,1y	Pjt,Srj
WS	PZU13B2A/DG	Z-diode	13V±2%, If=200mA, 320mW, halogen-free	SOD-323	5d	1a	Phi



SMD
code

Type

Function

Short description

Case

Pinout

St.

Mnf.

WS	SMAJ8.5C	TVS	Vrwm=8.5V, Vbr=9.44..11.5V, 25.2A, 400W(1ms), Bidirectional	DO-214AC	1ba	1l	Vs
WS	TV04A8V5KB-G	TVS	Vrwm=8.55V, Vbr=9.44..11.50V, Ipp=25.16A, 400W(1ms), Bidirectional	DO-214AC	1ba	1j	Cmc
WT	BZT52-C30	Z-diode	30V±5%, Izt=5mA, Zzt=80Ω, 500mW	SOD-123	5d	1k	Vs
WT	BZT52-C30S	Z-diode	30V±5%, Izt=2.5mA, Zzt=80Ω, 200mW	SOD-323	5d	1a	Pjt
WT	BZT52C-30WT	Z-diode	28.50..31.50V, Izt=5mA, Zzt=80Ω, 200mW	SOD-523	6d	1a	Ttr
WT	BZT52C-30WU	Z-diode	28.50..31.50V, Izt=5mA, Zzt=80Ω, 200mW	SOD-723	7d	1a	Ttr
WT	BZT52-C39	Z-diode	39V±5%, Izt=5mA, Zzt=130Ω, 500mW	SOD-123	5d	1d	Di
WT	BZT52-C39	Z-diode	39V±5%, Izt=5mA, Zzt=130Ω, 500mW	SOD-123	5d	1d	Di
WT	BZT52-C39S	Z-diode	39V±5%, Izt=2.5mA, Zzt=130Ω, 200mW	SOD-323	5d	1d	Di
WT	BZT52-C39S	Z-diode	39V±5%, Izt=2.5mA, Zzt=130Ω, 200mW	SOD-323	5d	1d	Di
WT	BZX284-B3V9	Z-diode	3.9V±2%, 400mW	SOD-110	12d	1a	Phi
WT	BZX384-C30	Z-diode	30V±5%, Izt=2mA, Zzt=30Ω, 200mW	SOD-323	5d	1k	Vs
WT	BZX784C30	Z-diode	28.50..31.50V, Zzt=80Ω, Izt=5mA, 200mW	SOD-723	7d	1a	Pjt
WT	CD214A-T78CA	TVS	Vbr=78V, Irlsm=3.2A, 400W(1ms), Bidirectional	DO-214AC	1ba	1j	Bm
WT	CZRW55C39-G	Z-diode	39.0..41.0V, Zzt=130Ω, Izt=2mA, 500mW	SOD-123	5d	1a	Cmc
WT	MM3Z39V	Z-diode	37..41V, Izt=2mA, Zzt=130Ω, 200mW	SOD-323	5d	1a	Sec
WT	P4SMA180C	TVS	Vrwm=180V, 1.6A, 400W(1ms), Bidirectional	DO-214AC	1ba	2k	Fag
WT	P4SMAJ78AC	TVS	Vbr=78V, 2.2A, 400W(1ms), Bidirectional	DO-214AC	1ba	1x,1y	Pjt,Srj
WT	P4SMAJ8.5CA	TVS	Vbr=8.5V, 27.7A, 400W(1ms), Bidirectional	DO-214AC	1ba	1j	Mco
WT	PZU13B3A/DG	Z-diode	13V±2%, If=200mA, 320mW, halogen-free	SOD-323	5d	1a	Phi
WT	SMAJ78CA	TVS	Vrwm=78V, Vbr=86.7..95.8V, 3.2A, 400W(1ms), Bidirectional	DO-214AC	1ba	1x	Di
WT	SMAJ8.5CA	TVS	Vrwm=8.5V, Vbr=9.44..10.4V, 27.8A, 400W(1ms), Bidirectional	DO-214AC	1ba	1l	Vs
WT	TV04A8V5JB-G	TVS	Vrwm=8.55V, Vbr=9.44..10.40V, Ipp=27.78A, 400W(1ms), Bidirectional	DO-214AC	1ba	1j	Cmc
WU	BZT52-C33	Z-diode	33V±5%, Izt=5mA, Zzt=80Ω, 500mW	SOD-123	5d	1k	Vs
WU	BZT52-C33S	Z-diode	33V±5%, Izt=2.5mA, Zzt=80Ω, 200mW	SOD-323	5d	1a	Pjt
WU	BZT52C-33WT	Z-diode	31.35..34.65V, Izt=5mA, Zzt=80Ω, 200mW	SOD-523	6d	1a	Ttr
WU	BZT52C-33WU	Z-diode	31.35..34.65V, Izt=5mA, Zzt=80Ω, 200mW	SOD-723	7d	1a	Ttr
WU	BZX284-B4V3	Z-diode	4.3V±2%, 400mW	SOD-110	12d	1a	Phi
WU	BZX384-C33	Z-diode	33V±5%, Izt=2mA, Zzt=35Ω, 200mW	SOD-323	5d	1k	Vs
WU	BZX784C33	Z-diode	31.35..34.65V, Zzt=80Ω, Izt=5mA, 200mW	SOD-723	7d	1a	Pjt
WU	MM3Z43V	Z-diode	40..46V, Izt=2mA, Zzt=150Ω, 200mW	SOD-323	5d	1a	Sec
WU	P4SMAJ85C	TVS	Vbr=85V, 2.6A, 400W(1ms), Bidirectional	DO-214AC	1ba	1x,1y	Pjt,Srj
WU	PZU14B2A/DG	Z-diode	14V±2%, If=200mA, 320mW, halogen-free	SOD-323	5d	1a	Phi
WU	SMAJ9.0C	TVS	Vrwm=9.0V, Vbr=10.0..12.2V, 23.7A, 400W(1ms), Bidirectional	DO-214AC	1ba	1l	Vs
WU	TV04A9V0KB-G	TVS	Vrwm=9.0V, Vbr=10.0..12.20V, Ipp=23.67A, 400W(1ms), Bidirectional	DO-214AC	1ba	1j	Cmc
WV	BZX284-B4V7	Z-diode	4.7V±2%, 400mW	SOD-110	12d	1a	Phi
WV	CD214A-T85CA	TVS	Vbr=85V, Irlsm=2.9A, 400W(1ms), Bidirectional	DO-214AC	1ba	1j	Bm
WV	MM3Z47V	Z-diode	44..50V, Izt=2mA, Zzt=170Ω, 200mW	SOD-323	5d	1a	Sec
WV	P4SMA200C	TVS	Vrwm=200V, 1.5A, 400W(1ms), Bidirectional	DO-214AC	1ba	2k	Fag
WV	P4SMAJ85AC	TVS	Vbr=85V, 2.9A, 400W(1ms), Bidirectional	DO-214AC	1ba	1x,1y	Pjt,Srj
WV	P4SMAJ9.0CA	TVS	Vbr=9.0V, 26.0A, 400W(1ms), Bidirectional	DO-214AC	1ba	1j	Mco
WV	PZU15BA/DG	Z-diode	15V±5%, If=200mA, 320mW, halogen-free	SOD-323	5d	1a	Phi
WV	SMAJ85CA	TVS	Vrwm=85V, Vbr=94.4..104V, 2.9A, 400W(1ms), Bidirectional	DO-214AC	1ba	1x	Di
WV	SMAJ9.0CA	TVS	Vrwm=9.0V, Vbr=10.0..11.1V, 26A, 400W(1ms), Bidirectional	DO-214AC	1ba	1l	Vs
WV	TV04A9V0JB-G	TVS	Vrwm=9.0V, Vbr=10.0..11.10V, Ipp=25.97A, 400W(1ms), Bidirectional	DO-214AC	1ba	1j	Cmc
WV	BZT52-C36	Z-diode	36V±5%, Izt=5mA, Zzt=90Ω, 500mW	SOD-123	5d	1k	Vs
WV	BZT52-C36S	Z-diode	36V±5%, Izt=2.5mA, Zzt=90Ω, 200mW	SOD-323	5d	1a	Pjt
WV	BZT52C-36WT	Z-diode	34.20..37.80V, Izt=5mA, Zzt=90Ω, 200mW	SOD-523	6d	1a	Ttr
WV	BZT52C-36WU	Z-diode	34.20..37.80V, Izt=5mA, Zzt=90Ω, 200mW	SOD-723	7d	1a	Ttr
WV	BZX284-B5V1	Z-diode	5.1V±2%, 400mW	SOD-110	12d	1a	Phi
WV	BZX384-C36	Z-diode	36V±5%, Izt=2mA, Zzt=35Ω, 200mW	SOD-323	5d	1k	Vs
WV	BZX784C36	Z-diode	34.20..37.80V, Zzt=90Ω, Izt=5mA, 200mW	SOD-723	7d	1a	Pjt
WV	MM3Z51V	Z-diode	48..54V, Izt=2mA, Zzt=180Ω, 200mW	SOD-323	5d	1a	Sec
WV	P4SMAJ90C	TVS	Vbr=90V, 2.5A, 400W(1ms), Bidirectional	DO-214AC	1ba	1x,1y	Pjt,Srj
WV	PZU15B1A/DG	Z-diode	15V±2%, If=200mA, 320mW, halogen-free	SOD-323	5d	1a	Phi
WV	SM4T100C	TVS	Vbr=100V, 2.9A, 400W(1ms), Bidirectional	SOD-6	1ba	1r	Ste
WV	SMAJ10C	TVS	Vrwm=10V, Vbr=11.1..12.3V, 21.3A, 400W(1ms), Bidirectional	DO-214AC	1ba	1l	Vs
WV	TV04A100KB-G	TVS	Vrwm=10.0V, Vbr=11.10..13.60V, Ipp=21.28A, 400W(1ms), Bidirectional	DO-214AC	1ba	1j	Cmc
WX	BZT52-C2V4	Z-diode	2.4V±5%, Izt=5mA, Zzt=100Ω, 500mW	SOD-123	5d	1d	Di
WX	BZT52-C2V4	Z-diode	2.4V±5%, Izt=5mA, Zzt=100Ω, 500mW	SOD-123	5d	1d	Di
WX	BZT52-C2V4S	Z-diode	2.4V±5%, Izt=5mA, Zzt=100Ω, 200mW	SOD-323	5d	1d	Di
WX	BZT52-C2V4S	Z-diode	2.4V±5%, Izt=5mA, Zzt=100Ω, 200mW	SOD-323	5d	1d	Di
WX	BZT52-C2V4T	Z-diode	2.4V±5%, Izt=5mA, Zzt=100Ω, 150mW	SOD-523	5d	1d	Di
WX	BZT52-C39	Z-diode	39V±5%, Izt=5mA, Zzt=130Ω, 500mW	SOD-123	5d	1k	Vs
WX	BZT52-C39S	Z-diode	39V±5%, Izt=2.5mA, Zzt=90Ω, 200mW	SOD-323	5d	1a	Pjt
WX	BZT52C-39WT	Z-diode	37.05..40.95V, Izt=5mA, Zzt=130Ω, 200mW	SOD-523	6d	1a	Ttr
WX	BZT52C-39WU	Z-diode	37.05..40.95V, Izt=5mA, Zzt=130Ω, 200mW	SOD-723	7d	1a	Ttr
WX	BZX284-B5V6	Z-diode	5.6V±2%, 400mW	SOD-110	12d	1a	Phi
WX	BZX384-C39	Z-diode	39V±5%, Izt=2mA, Zzt=40Ω, 200mW	SOD-323	5d	1k	Vs
WX	BZX784C39	Z-diode	37.05..40.95V, Zzt=130Ω, Izt=5mA, 200mW	SOD-723	7d	1a	Pjt



SMD
code

Type

Function

Short description

Case

Pinout

St.

Mnf.

SMD code	Type	Function	Short description	Case	Pinout	St.	Mnf.
WX	CD214A-T90CA	TVS	Vbr=90V, I _{rsm} =2.7A, 400W(1ms), Bidirectional	DO-214AC	1ba	1j	Bm
WX	CZRW55C2V4-G	Z-diode	2.4..2.60V, Zzt=100Ω, Izt=5mA, 500mW	SOD-123	5d	1a	Cmc
WX	MM3Z2V4	Z-diode	2.2..2.6V, Izt=5mA, Zzt=100Ω, 200mW	SOD-323	5d	1a	Sec
WX	P4SMA220C	TVS	V _{rwm} =220V, 1.16A, 400W(1ms), Bidirectional	DO-214AC	1ba	2k	Fag
WX	P4SMAJ10CA	TVS	Vbr=10V, 23.5A, 400W(1ms), Bidirectional	DO-214AC	1ba	1j	Mco
WX	P4SMAJ90AC	TVS	Vbr=90V, 2.7A, 400W(1ms), Bidirectional	DO-214AC	1ba	1x,1y	Pjt,Sj
WX	PZU15B2A/DG	Z-diode	15V±2%, If=200mA, 320mW, halogen-free	SOD-323	5d	1a	Phi
WX	SM4T100CA	TVS	Vbr=100V, 2.9A, 400W(1ms), Bidirectional	SOD-6	1ba	1r	Sts
WX	SMAJ10CA	TVS	V _{rwm} =10V, Vbr=11.1..12.3V, 23.5A, 400W(1ms), Bidirectional	DO-214AC	1ba	1l	Ve
WX	SMAJ90CA	TVS	V _{rwm} =90V, Vbr=100..111V, 2.1A, 400W(1ms), Bidirectional	DO-214AC	1ba	1x	Di
WX	TV04A100JB-G	TVS	V _{rwm} =10.0V, Vbr=11.0..12.30V, I _{pp} =23.53A, 400W(1ms), Bidirectional	DO-214AC	1ba	1j	Cmc
WY	BZT52-C2V0	Z-diode	2V±5%, Izt=5mA, Zzt=100Ω, 500mW	SOD-123	5d	1d	Di
WY	BZT52-C2V0	Z-diode	2V±5%, Izt=5mA, Zzt=100Ω, 500mW	SOD-123	5d	1d	Di
WY	BZT52-C2V0S	Z-diode	2V±5%, Izt=5mA, Zzt=100Ω, 200mW	SOD-323	5d	1d	Di
WY	BZT52-C2V0S	Z-diode	2V±5%, Izt=5mA, Zzt=100Ω, 200mW	SOD-323	5d	1d	Di
WY	BZT52-C2V0T	Z-diode	2.0V±5%, Izt=5mA, Zzt=100Ω, 150mW	SOD-523	5d	1d	Di
WY	BZT52-C43	Z-diode	43V±5%, Izt=5mA, Zzt=60Ω, 500mW	SOD-123	5d	1k	Vs
WY	BZT52C-43WT	Z-diode	40.85..45.15V, Izt=5mA, Zzt=150Ω, 200mW	SOD-523	6d	1a	Ttr
WY	BZT52C-43WU	Z-diode	40.85..45.15V, Izt=5mA, Zzt=150Ω, 200mW	SOD-723	7d	1a	Ttr
WY	BZX284-B6V2	Z-diode	6.2V±2%, 400mW	SOD-110	12d	1a	Phi
WY	BZX384-C43	Z-diode	43V±5%, Izt=2mA, Zzt=45Ω, 200mW	SOD-323	5d	1k	Vs
WY	BZX784C43	Z-diode	40.85..45.15V, Zzt=150Ω, Izt=5mA, 200mW	SOD-723	7d	1a	Pjt
WY	KDZ36VYV	Z-diode	35.07..36.87V, Izt=2mA, Zzt=300Ω, 100mW	VSC	7d	1a	Kec
WY	MM3Z2V0	Z-diode	1.91..2.09V, Izt=5mA, Zzt=100Ω, 200mW	SOD-323	5d	1a	Sec
WY	P4SMAJ100C	TVS	Vbr=100V, 2.2A, 400W(1ms), Bidirectional	DO-214AC	1ba	1x,1y	Pjt,Sj
WY	PZU15B3A/DG	Z-diode	15V±2%, If=200mA, 320mW, halogen-free	SOD-323	5d	1a	Phi
WY	SMAJ11C	TVS	V _{rwm} =11V, Vbr=12.2..13.5V, 19.9A, 400W(1ms), Bidirectional	DO-214AC	1ba	1l	Vs
WY	TV04A110KB-G	TVS	V _{rwm} =11.0V, Vbr=12.20..14.90V, I _{pp} =19.90A, 400W(1ms), Bidirectional	DO-214AC	1ba	1j	Cmc
WZ	BZT52-B39S	Z-diode	38.22..39.78V, Izt=2mA, Zzt=130Ω, 200mW	SOD-323FL	7d	1a	Tsc
WZ	BZT52-C47	Z-diode	47V±5%, Izt=5mA, Zzt=70Ω, 500mW	SOD-123	5d	1k	Vs
WZ	BZT52C-47WT	Z-diode	44.65..49.35V, Izt=5mA, Zzt=170Ω, 200mW	SOD-523	6d	1a	Ttr
WZ	BZT52C-47WU	Z-diode	44.65..49.35V, Izt=5mA, Zzt=170Ω, 200mW	SOD-723	7d	1a	Ttr
WZ	BZX284-B6V8	Z-diode	6.3V±2%, 400mW	SOD-110	12d	1a	Phi
WZ	BZX384-C47	Z-diode	47V±5%, Izt=2mA, Zzt=50Ω, 200mW	SOD-323	5d	1k	Vs
WZ	BZX784C47	Z-diode	44.65..49.35V, Zzt=170Ω, Izt=5mA, 200mW	SOD-723	7d	1a	Pjt
WZ	CD214A-T100CA	TVS	Vbr=100V, I _{rsm} =2.5A, 400W(1ms), Bidirectional	DO-214AC	1ba	1j	Bm
WZ	MM3Z39VB	Z-diode	38.22..39.78V, Zzt=122Ω, Izt=2mA, 200mW	SOD-323FL	7d	1a	F
WZ	MM3Z39VBW	Z-diode	38.22..39.78V, Izt=2mA, Zzt=130Ω, 200mW	SOD-323FL	7d	1a	Tac
WZ	P4SMAJ100AC	TVS	Vbr=100V, 2.5A, 400W(1ms), Bidirectional	DO-214AC	1ba	1x,1y	Pjt,Sj
WZ	P4SMAJ11CA	TVS	Vbr=11V, 22.0A, 400W(1ms), Bidirectional	DO-214AC	1ba	1j	Mco
WZ	PZU16BA/DG	Z-diode	16V±5%, If=200mA, 320mW, halogen-free	SOD-323	5d	1a	Phi
WZ	SMAJ100CA	TVS	V _{rwm} =100V, Vbr=111..136V, 2.5A, 400W(1ms), Bidirectional	DO-214AC	1ba	1x	Di
WZ	SMAJ11CA	TVS	V _{rwm} =11V, Vbr=12.2..13.5V, 22A, 400W(1ms), Bidirectional	DO-214AC	1ba	1l	Vs
WZ	TCMM3Z39VB	Z-diode	39V±2%, Izt=5mA, Zzt=122Ω, 200mW	SOD-323FL	7d	1a	Tac
WZ	TV04A110JB-G	TVS	V _{rwm} =11.0V, Vbr=12.20..13.50V, I _{pp} =21.98A, 400W(1ms), Bidirectional	DO-214AC	1ba	1j	Cmc
X	BB187	C-diode	TV-VHF-Tuning, 32V, 20mA, 29.3..2.57pF(2..25V), ΔC=2%	SOD-523	6d	1a	Phi
X	MMSZ5225BPT	Z-diode	2.850..3.150V, Izt=5mA, Zzt=95Ω, 225mW	SOD-523	7d	1a	Chm
X (white)	BB813	C-diode	SAT-TV-Tuning, 30V, 20mA, 0.9..8.5pF(28..1V)	SOD-123	5d	2	Sie
X (white)	BB833	C-diode	SAT-TV-Tuning, 30V, 20mA, 0.75..9.3pF(28..1V)	SOD-323	5d	2	Inf
X (yellow)	BB835	C-diode	SATV-Tuning, 30V, 2.8GHz, 0.6pF..9.1pF	SOD-323	5d	2	Sie
X	MMSZ5225SPT	Z-diode	2.940..3.060V, Izt=5mA, Zzt=95Ω, 225mW	SOD-523	7d	1a	Chm
X1	BZF10C3V3	Z-diode	3.1..3.5V, Izt=76mA, Zzt=10Ω, 1W	SOD-123F	10d	1a	Did
X1	BZT52-C51	Z-diode	51V±5%, Izt=5mA, Zzt=707Ω, 500mW	SOD-123	5d	1k	Vs
X1	BZX384-C51	Z-diode	51V±5%, Izt=2mA, Zzt=60Ω, 200mW	SOD-323	5d	1k	Vs
X1	CMDZ5221B	Z-diode	2.4V±5%, 20mA, Zzt=30Ω, 250mW	SOD-323	5d	1a	Cen
X1	MM3Z5237B	Z-diode	8.2V±5%, Izt=20mA, Zzt=8Ω, 200mW	SOD-323FL	7d	1a	Bts
X1	MM3Z5237BH	Z-diode	7.79..8.61V, Izt=20mA, Zzt=8Ω, 300mW	SOD-323	5d	1a	Zow
X1	MMSZ16	Z-diode	16V±5%, Zzt=40Ω, 500mW	SOD-123	5d	1a	Mot
X1	PZU16B1A	Z-diode	16V±2%, If=200mA, 320mW	SOD-323	5d	1a	Phi
X1	ZD5226BSG	Z-diode	3.3V±5%, 5mA, Zzt=95Ω, 500mW	SOD-323-S	7d	1a	Cys
X1	ZGFM103V3-MH	Z-diode	3.3V±10%, Zzt=10Ω(Izt=76mA), 1W	SOD-123H	10d	1a	Frm
X1	ZGFM103V3-N	Z-diode	3.1..3.5V, Izt=76mA, Zzt=10Ω, 1W	SOD-123F	10d	1a	Frm
X2	BZF10C3V6	Z-diode	3.4..3.8V, Izt=69mA, Zzt=10Ω, 1W	SOD-123F	10d	1a	Did
X2	BZT52-C56	Z-diode	56V±5%, Izt=2.5mA, Zzt=135Ω, 500mW	SOD-123	5d	1k	Vs
X2	BZX384-C56	Z-diode	56V±5%, Izt=2mA, Zzt=70Ω, 200mW	SOD-323	5d	1k	Vs
X2	CMDZ5222B	Z-diode	2.5V±5%, 20mA, Zzt=30Ω, 250mW	SOD-323	5d	1a	Cen
X2	MM3Z5259B	Z-diode	39V±5%, Izt=3.2mA, Zzt=80Ω, 200mW	SOD-323FL	7d	1a	Bts
X2	MM3Z5259BH	Z-diode	37.05..40.95V, Izt=3.2mA, Zzt=80Ω, 300mW	SOD-323	5d	1a	Zow
X2	MMSZ18	Z-diode	18V±5%, Zzt=45Ω, 500mW	SOD-123	5d	1a	Mot
X2	PZU16B2A	Z-diode	16V±2%, If=200mA, 320mW	SOD-323	5d	1a	Phi



SMD code	Type	Function	Short description	Case	Pinout	St.	Mnf.
X2	ZD5227BSG	Z-diode	3.6V±5%, 5mA, Zzt=90Ω, 500mW	SOD-323-S	7d	1a	Cys
X2	ZGFM103V6-MH	Z-diode	3.6V±10%, Zzt=10Ω(zt=69mA), 1W	SOD-123H	10d	1a	Frm
X2	ZGFM103V6-N	Z-diode	3.4..3.8V, Izt=69mA, Zzt=10Ω, 1W	SOD-123F	10d	1a	Frm
X3	BZF10C3V9	Z-diode	3.7..4.1V, Izt=64mA, Zzt=9Ω, 1W	SOD-123F	10d	1a	Did
X3	BZT52-C62	Z-diode	62V±5%, Izt=2.5mA, Zzt=150Ω, 500mW	SOD-123	5d	1k	Vs
X3	BZX384-C62	Z-diode	62V±5%, Izt=2mA, Zzt=80Ω, 200mW	SOD-323	5d	1k	Vs
X3	CMDZ5223B	Z-diode	2.7V±5%, 20mA, Zzt=30Ω, 250mW	SOD-323	5d	1a	Cen
X3	MMSZ20	Z-diode	20V±5%, Zzt=55Ω, 500mW	SOD-123	5d	1a	Mot
X3	PZU16B3A	Z-diode	16V±2%, If=200mA, 320mW	SOD-323	5d	1a	Phi
X3	ZD5228BSG	Z-diode	3.9V±5%, 5mA, Zzt=90Ω, 500mW	SOD-323-S	7d	1a	Cys
X3	ZGFM103V9-MH	Z-diode	3.9V±10%, Zzt=9Ω(zt=64mA), 1W	SOD-123H	10d	1a	Frm
X3	ZGFM103V9-N	Z-diode	3.7..4.1V, Izt=64mA, Zzt=9Ω, 1W	SOD-123F	10d	1a	Frm
X4	BZF10C4V3	Z-diode	4.1..4.5V, Izt=58mA, Zzt=9Ω, 1W	SOD-123F	10d	1a	Did
X4	BZT52-C68	Z-diode	68V±5%, Izt=2.5mA, Zzt=200Ω, 500mW	SOD-123	5d	1k	Vs
X4	BZX384-C68	Z-diode	68V±5%, Izt=2mA, Zzt=90Ω, 200mW	SOD-323	5d	1k	Vs
X4	CMDZ5224B	Z-diode	2.8V±5%, 20mA, Zzt=30Ω, 250mW	SOD-323	5d	1a	Cen
X4	MM1Z5237B	Z-diode	7.79..8.61V, Izt=20mA, Zzt=8Ω, 500mW	SOD-323FL	5d	1a	Eic
X4	MM1Z5237BH	Z-diode	7.79..8.61V, Izt=20mA, Zzt=8Ω, 500mW	SOD-123	5d	1a	Zow
X4	MMSZ22	Z-diode	22V±5%, Zzt=55Ω, 500mW	SOD-123	5d	1a	Mot
X4	MMSZ5237B	Z-diode	8.2V±5%, Izt=20mA, Zzt=8Ω, 500mW	SOD-123	5d	1a	Eic
X4	PZU18BA	Z-diode	18V±5%, If=200mA, 320mW	SOD-323	5d	1a	Phi
X4	ZD5229BSG	Z-diode	4.3V±5%, 5mA, Zzt=88Ω, 500mW	SOD-323-S	7d	1a	Cys
X4	ZGFM104V3-MH	Z-diode	4.3V±10%, Zzt=9Ω(zt=58mA), 1W	SOD-123H	10d	1a	Frm
X4	ZGFM104V3-N	Z-diode	4.1..4.5V, Izt=58mA, Zzt=9Ω, 1W	SOD-123F	10d	1a	Frm
X5	BZF10C4V7	Z-diode	4.5..4.9V, Izt=53mA, Zzt=8Ω, 1W	SOD-123F	10d	1a	Did
X5	BZT52-C75	Z-diode	75V±5%, Izt=2.5mA, Zzt=250Ω, 500mW	SOD-123	5d	1k	Vs
X5	BZX384-C75	Z-diode	75V±5%, Izt=2mA, Zzt=95Ω, 200mW	SOD-323	5d	1k	Vs
X5	BZX584B39V	Z-diode	38.22..39.78V, Izt=2mA, Zzt=130Ω, 200mW	SOD-523FL	7d	1a	Tac
X5	CMDZ5225B	Z-diode	3.0V±5%, 20mA, Zzt=29Ω, 250mW	SOD-323	5d	1a	Cen
X5	MM1Z5259B	Z-diode	37.05..40.95V, Izt=3.2mA, Zzt=80Ω, 500mW	SOD-323FL	5d	1a	Eic
X5	MM1Z5259BH	Z-diode	37.05..40.95V, Izt=3.2mA, Zzt=80Ω, 500mW	SOD-123	5d	1a	Zow
X5	MMSZ39VB	Z-diode	38.22..39.78V, Izt=2mA, Zzt=130Ω, 200mW	SOD-523FL	7d	1a	Tac
X5	MMSZ24	Z-diode	24V±5%, Zzt=70Ω, 500mW	SOD-123	5d	1a	Mot
X5	MMSZ5259B	Z-diode	39V±5%, Izt=3.2mA, Zzt=80Ω, 500mW	SOD-123	5d	1a	Eic
X5	MMVL409	C-diode	VHF-Tuning, 20V, 200mA, 200mW, 26/32pF(3V, 1MHz)	SOD-323	5d	1a	Ons
X5	PZU18B1A	Z-diode	18V±2%, If=200mA, 320mW	SOD-323	5d	1a	Phi
X5	ZD5230BSG	Z-diode	4.7V±5%, 5mA, Zzt=70Ω, 500mW	SOD-323-S	7d	1a	Cys
X5	ZGFM104V7-MH	Z-diode	4.7V±10%, Zzt=8Ω(zt=53mA), 1W	SOD-123H	10d	1a	Frm
X5	ZGFM104V7-N	Z-diode	4.5..4.9V, Izt=53mA, Zzt=8Ω, 1W	SOD-123F	10d	1a	Frm
X6	BZF10C5V1	Z-diode	4.8..5.4V, Izt=49mA, Zzt=7Ω, 1W	SOD-123F	10d	1a	Did
X6	CMDZ5226B	Z-diode	3.3V±5%, 20mA, Zzt=28Ω, 250mW	SOD-323	5d	1a	Cen
X6	PZU18B2A	Z-diode	18V±2%, If=200mA, 320mW	SOD-323	5d	1a	Phi
X6	ZD5231BSG	Z-diode	5.1V±5%, 5mA, Zzt=50Ω, 500mW	SOD-323-S	7d	1a	Cys
X6	ZGFM105V1-MH	Z-diode	5.1V±10%, Zzt=7Ω(zt=49mA), 1W	SOD-123H	10d	1a	Frm
X6	ZGFM105V1-N	Z-diode	4.8..5.4V, Izt=49mA, Zzt=7Ω, 1W	SOD-123F	10d	1a	Frm
X7	BZF10C5V6	Z-diode	5.3..5.9V, Izt=45mA, Zzt=5Ω, 1W	SOD-123F	10d	1a	Did
X7	CMDZ5227B	Z-diode	3.6V±5%, 20mA, Zzt=24Ω, 250mW	SOD-323	5d	1a	Cen
X7	PZU18B3A	Z-diode	18V±2%, If=200mA, 320mW	SOD-323	5d	1a	Phi
X7	ZD5232BSG	Z-diode	5.6V±5%, 5mA, Zzt=25Ω, 500mW	SOD-323-S	7d	1a	Cys
X7	ZGFM105V6-MH	Z-diode	5.6V±10%, Zzt=5Ω(zt=45mA), 1W	SOD-123H	10d	1a	Frm
X7	ZGFM105V6-N	Z-diode	5.3..5.9V, Izt=45mA, Zzt=5Ω, 1W	SOD-123F	10d	1a	Frm
X8	BZF10C6V2	Z-diode	5.9..6.5V, Izt=41mA, Zzt=2Ω, 1W	SOD-123F	10d	1a	Did
X8	CMDZ5228B	Z-diode	3.9V±5%, 20mA, Zzt=23Ω, 250mW	SOD-323	5d	1a	Cen
X8	MMSZ24H	Z-diode	22.8..25.6V, Izt=2mA, Zzt=70Ω, 200mW	SOD-523	7d	1a	Zow
X8	MMSZ24V	Z-diode	24V±5%, Izt=5mA, Zzt=70Ω, 200mW	SOD-523	6d	1a	Eic
X8	PZU2.4BA	Z-diode	2.4V±5%, If=200mA, 320mW	SOD-323	5d	1a	Phi
X8	ZD5234BSG	Z-diode	6.2V±5%, 5mA, Zzt=10Ω, 500mW	SOD-323-S	7d	1a	Cys
X8	ZGFM106V2-MH	Z-diode	6.2V±10%, Zzt=2Ω(zt=41mA), 1W	SOD-123H	10d	1a	Frm
X8	ZGFM106V2-N	Z-diode	5.9..6.5V, Izt=41mA, Zzt=2Ω, 1W	SOD-123F	10d	1a	Frm
X9	BAS21HPT	Si-diode	Sw, 250V, 200mA, Vf<<1.25V(200mA), 50ns	SOD-323	5d	1a	Chm
X9	BZF10C6V8	Z-diode	6.5..7.1V, Izt=37mA, Zzt=3.5Ω, 1W	SOD-123F	10d	1a	Did
X9	CMDZ5229B	Z-diode	4.3V±5%, 20mA, Zzt=22Ω, 250mW	SOD-323	5d	1a	Cen
X9	PZU2.7BA	Z-diode	2.7V±5%, If=200mA, 320mW	SOD-323	5d	1a	Phi
X9	VGFM02-C6V8-M	TVS	Vrwm=5.8V, Vbr=6.45..7.14V, 19.0A, 200W(1ms)	SOD-123F	10d	1a	Frm
X9	ZD5235BSG	Z-diode	6.8V±5%, 5mA, Zzt=8Ω, 500mW	SOD-323-S	7d	1a	Cys
X9	ZGFM106V8-MH	Z-diode	6.8V±10%, Zzt=3.5Ω(zt=37mA), 1W	SOD-123H	10d	1a	Frm
X9	ZGFM106V8-N	Z-diode	6.5..7.1V, Izt=37mA, Zzt=3.5Ω, 1W	SOD-123F	10d	1a	Frm
XA	BZT52C-51WT	Z-diode	48.45..53.55V, Izt=5mA, Zzt=100Ω, 200mW	SOD-523	6d	1a	Ttr
XA	BZT52C-51WU	Z-diode	48.45..53.55V, Izt=5mA, Zzt=100Ω, 200mW	SOD-723	7d	1a	Ttr
XA	BZX284-B7V5	Z-diode	7.5V±2%, 400mW	SOD-110	12d	1a	Phi



SMD
code

Type

Function

Short description

Case

Pinout

St.

Mnf.

SMD code	Type	Function	Short description	Case	Pinout	St.	Mnf.
XA	BZX784C51	Z-diode	48.45..53.55V, Zzt=100Ω, Izt=5mA, 200mW	SOD-723	7d	1a	Pjt
XA	CMDZ5230B	Z-diode	4.7V±5%, 20mA, Zzt=19Ω, 250mW	SOD-323	5d	1a	Cen
XA	PZU2.7B1A	Z-diode	2.7V±2%, If=200mA, 320mW	SOD-323	5d	1a	Phi
XA	SMZG3795A	Z-diode	18V±5%, 70mA, Zzt=12Ω, 1.5W	DO-215AA	5d	1k	Vs
XA	SMZJ3795A	Z-diode	18V±5%, 70mA, Zzt=12Ω, 1.5W	DO-214AA	1d	1k	Vs
XA	TV04A190KB-G	TVS	Vrwm=19.0V, Vbr=21.13..25.76V, Ipp=11.76A, 400W(1ms), Bidirectional	DO-214AC	1ba	1j	Cmc
XB	BZX284-B8V2	Z-diode	8.2V±2%, 400mW	SOD-110	12d	1a	Phi
XB	BZX784C10	Z-diode	9.50..10.50V, Zzt=20Ω, Izt=5mA, 200mW	SOD-723	7d	1a	Pjt
XB	CMDZ5231B	Z-diode	5.1V±5%, 20mA, Zzt=17Ω, 250mW	SOD-323	5d	1a	Cen
XB	KDZ15B	Z-diode	15V±2.5%, 20mA, 1W	PMDU	7d	1s	Rhm
XB	PZU2.7B2A	Z-diode	2.7V±2%, If=200mA, 320mW	SOD-323	5d	1a	Phi
XB	SMF80A	TVS	Vrwm=80.0V, Vbr=88.8..97.60V, 1.55A, 200W(10/1000μs)	SOD-123FL	7d	1a	Ers
XB	SMZG3795B	Z-diode	18V±10%, 70mA, Zzt=12Ω, 1.5W	DO-215AA	5d	1k	Vs
XB	SMZJ3795B	Z-diode	18V±10%, 70mA, Zzt=12Ω, 1.5W	DO-214AA	1d	1k	Vs
XB	TV02W800-G	TVS	Vrwm=80V, Vbr=88.8..97.6V, Ipp=1.55A, 200W(1ms)	SOD-123	5d	1a	Cmc
XB	TV04A190JB-G	TVS	Vrwm=19.0V, Vbr=20.10..23.30V, Ipp=13.0A, 400W(1ms), Bidirectional	DO-214AC	1ba	1j	Cmc
XC	BZX284-B9V1	Z-diode	9.1V±2%, 400mW	SOD-110	12d	1a	Phi
XC	CMDZ5232B	Z-diode	5.6V±5%, 20mA, Zzt=11Ω, 250mW	SOD-323	5d	1a	Cen
XC	PZU20BA	Z-diode	20V±5%, If=200mA, 320mW	SOD-323	5d	1a	Phi
XC	SMZG3796A	Z-diode	20V±5%, 62mA, Zzt=14Ω, 1.5W	DO-215AA	5d	1k	Vs
XC	SMZJ3796A	Z-diode	20V±5%, 62mA, Zzt=14Ω, 1.5W	DO-214AA	1d	1k	Vs
XD	BZX284-B10	Z-diode	10V±2%, 400mW	SOD-110	12d	1a	Phi
XD	CMDZ5233B	Z-diode	6.0V±5%, 20mA, Zzt=7.0Ω, 250mW	SOD-323	5d	1a	Cen
XD	P4SMAJ110C	TVS	Vbr=110V, 2A, 400W(1ms), Bidirectional	DO-214AC	1ba	1x,1y	Pjt,Srj
XD	PZU20B1A	Z-diode	20V±2%, If=200mA, 320mW	SOD-323	5d	1a	Phi
XD	SMAJ12C	TVS	Vrwm=12V, Vbr=13.3..14.7V, 18.2A, 400W(1ms), Bidirectional	DO-214AC	1ba	1l	Vs
XD	SMZG3796B	Z-diode	20V±10%, 62mA, Zzt=14Ω, 1.5W	DO-215AA	5d	1k	Vs
XD	SMZJ3796B	Z-diode	20V±10%, 62mA, Zzt=14Ω, 1.5W	DO-214AA	1d	1k	Vs
XD	TV04A120KB-G	TVS	Vrwm=12.0V, Vbr=13.30..16.30V, Ipp=18.18A, 400W(1ms), Bidirectional	DO-214AC	1ba	1j	Cmc
XE	BZX284-B11	Z-diode	11V±2%, 400mW	SOD-110	12d	1a	Phi
XE	CD214A-T110CA	TVS	Vbr=110V, Irlsm=2.3A, 400W(1ms), Bidirectional	DO-214AC	1ba	1j	Bm
XE	CMDZ5234B	Z-diode	6.2V±5%, 20mA, Zzt=7.0Ω, 250mW	SOD-323	5d	1a	Cen
XE	P4SMAJ110AC	TVS	Vbr=110V, 2.3A, 400W(1ms), Bidirectional	DO-214AC	1ba	1x,1y	Pjt,Srj
XE	P4SMAJ12CA	TVS	Vbr=12V, 20.1A, 400W(1ms), Bidirectional	DO-214AC	1ba	1j	Mco
XE	PZU20B2A	Z-diode	20V±2%, If=200mA, 320mW	SOD-323	5d	1a	Phi
XE	SMAJ110CA	TVS	Vrwm=110V, 122..135V, 1.5A, 400W(1ms), Bidirectional	DO-214AC	1ba	1x	Di
XE	SMAJ12CA	TVS	Vrwm=12V, Vbr=13.3..14.7V, 20.1A, 400W(1ms), Bidirectional	DO-214AC	1ba	1l	Vs
XE	SMF54A	TVS	Vrwm=54.0V, Vbr=60.0..66.30V, 2.30A, 200W(10/1000μs)	SOD-123FL	7d	1a	Ers
XE	SMZG3797A	Z-diode	22V±5%, 56mA, Zzt=17.5Ω, 1.5W	DO-215AA	5d	1k	Vs
XE	SMZJ3797A	Z-diode	22V±5%, 56mA, Zzt=17.5Ω, 1.5W	DO-214AA	1d	1k	Vs
XE	TV02W540-G	TVS	Vrwm=54V, Vbr=60.0..66.3V, Ipp=2.30A, 200W(1ms)	SOD-123	5d	1a	Cmc
XE	TV04A120JB-G	TVS	Vrwm=12.0V, Vbr=13.30..14.70V, Ipp=20.10A, 400W(1ms), Bidirectional	DO-214AC	1ba	1j	Cmc
XF	BZX284-B12	Z-diode	12V±2%, 400mW	SOD-110	12d	1a	Phi
XF	CMDZ5235B	Z-diode	6.8V±5%, 20mA, Zzt=5.0Ω, 250mW	SOD-323	5d	1a	Cen
XF	MAZD300	Z-diode	28..32V, Zzt=160Ω(5mA), 120mW	SSSMini2	7d	1a	Pan
XF	P4SMAJ120C	TVS	Vbr=120V, 1.9A, 400W(1ms), Bidirectional	DO-214AC	1ba	1x,1y	Pjt,Srj
XF	PZU20B3A	Z-diode	20V±2%, If=200mA, 320mW	SOD-323	5d	1a	Phi
XF	SMAJ13C	TVS	Vrwm=13V, Vbr=14.4..17.6V, 16.8A, 400W(1ms), Bidirectional	DO-214AC	1ba	1l	Vs
XF	SMZG3797B	Z-diode	22V±10%, 56mA, Zzt=17.5Ω, 1.5W	DO-215AA	5d	1k	Vs
XF	SMZJ3797B	Z-diode	22V±10%, 56mA, Zzt=17.5Ω, 1.5W	DO-214AA	1d	1k	Vs
XF	TV04A130KB-G	TVS	Vrwm=13.0V, Vbr=14.40..17.60V, Ipp=16.81A, 400W(1ms), Bidirectional	DO-214AC	1ba	1j	Cmc
XG	BZX284-B13	Z-diode	13V±2%, 400mW	SOD-110	12d	1a	Phi
XG	CD214A-T120CA	TVS	Vbr=120V, Irlsm=2.0A, 400W(1ms), Bidirectional	DO-214AC	1ba	1j	Bm
XG	CMDZ5236B	Z-diode	7.5V±5%, 20mA, Zzt=6.0Ω, 250mW	SOD-323	5d	1a	Cen
XG	P4SMAJ120AC	TVS	Vbr=120V, 2A, 400W(1ms), Bidirectional	DO-214AC	1ba	1x,1y	Pjt,Srj
XG	P4SMAJ13CA	TVS	Vbr=13V, 18.6A, 400W(1ms), Bidirectional	DO-214AC	1ba	1j	Mco
XG	PZU22BA	Z-diode	22V±5%, If=200mA, 320mW	SOD-323	5d	1a	Phi
XG	SMAJ120CA	TVS	Vrwm=120V, Vbr=133..147V, 1.6A, 400W(1ms), Bidirectional	DO-214AC	1ba	1x	Di
XG	SMAJ13CA	TVS	Vrwm=13V, Vbr=14.4..15.9V, 18.6A, 400W(1ms), Bidirectional	DO-214AC	1ba	1l	Vs
XG	SMF58A	TVS	Vrwm=58.0V, Vbr=64.40..71.20V, 2.14A, 200W(10/1000μs)	SOD-123FL	7d	1a	Ers
XG	SMZG3798A	Z-diode	24V±5%, 51mA, Zzt=19Ω, 1.5W	DO-215AA	5d	1k	Vs
XG	SMZJ3798A	Z-diode	24V±5%, 51mA, Zzt=19Ω, 1.5W	DO-214AA	1d	1k	Vs
XG	TV02W580-G	TVS	Vrwm=58V, Vbr=64.4..71.2V, Ipp=2.14A, 200W(1ms)	SOD-123	5d	1a	Cmc
XG	TV04A130JB-G	TVS	Vrwm=13.0V, Vbr=14.40..15.90V, Ipp=18.60A, 400W(1ms), Bidirectional	DO-214AC	1ba	1j	Cmc
XH	BAT46W	Si-diode	SBD, 100V, 150mA, Vf<1V(250mA), 6pF	SOD-123	5d	1d	Sme
XH	BZX284-B15	Z-diode	15V±2%, 400mW	SOD-110	12d	1a	Phi
XH	CMDZ5237B	Z-diode	8.2V±5%, 20mA, Zzt=8.0Ω, 250mW	SOD-323	5d	1a	Cen
XH	MMSD701	Si-diode	UHf/VHf Det, Schottky Barrier, 70V, 225mW, <1pF	SOD-123	5d	1a	Ons
XH	P4SMAJ130C	TVS	Vbr=130V, 1.7A, 400W(1ms), Bidirectional	DO-214AC	1ba	1x,1y	Pjt,Srj
XH	PZU22B1A	Z-diode	22V±2%, If=200mA, 320mW	SOD-323	5d	1a	Phi



SMD
code

Type

Function

Short description

Case

Pinout

St.

Mnf.

SMD code	Type	Function	Short description	Case	Pinout	St.	Mnf.
XH	SM4T150C	TVS	Vbr=150V, 2A, 400W(1ms), Bidirectional	SOD-6	1ba	1r	Ste
XH	SMAJ14C	TVS	Vrwm=14V, Vbr=15.6..19.1V, 15.5A, 400W(1ms), Bidirectional	DO-214AC	1ba	1l	Vs
XH	SMZG3798B	Z-diode	24V±10%, 51mA, Zzt=19Ω, 1.5W	DO-215AA	5d	1k	Vs
XH	SMZJ3798B	Z-diode	24V±10%, 51mA, Zzt=19Ω, 1.5W	DO-214AA	1d	1k	Vs
XH	TV04A140KB-G	TVS	Vrwm=14.0V, Vbr=15.60..19.10V, Ipp=15.50A, 400W(1ms), Bidirectional	DO-214AC	1ba	1j	Cmc
XI	BZX284-B16	Z-diode	16V±2%, 400mW	SOD-110	12d	1a	Phi
XI	SMZG3799A	Z-diode	27V±5%, 46mA, Zzt=23Ω, 1.5W	DO-215AA	5d	1k	Vs
XI	SMZJ3799A	Z-diode	27V±5%, 46mA, Zzt=23Ω, 1.5W	DO-214AA	1d	1k	Vs
XJ	BZX284-B18	Z-diode	18V±2%, 400mW	SOD-110	12d	1a	Phi
XJ	CMDZ5238B	Z-diode	8.7V±5%, 20mA, Zzt=8.0Ω, 250mW	SOD-323	5d	1a	Cen
XJ	MM3ZB43H	Z-diode	42.14..43.86V, Izt=2.5mA, Zzt=130Ω, 300mW	SOD-323	5d	1a	Zow
XJ	SMZG3799B	Z-diode	27V±10%, 46mA, Zzt=23Ω, 1.5W	DO-215AA	5d	1k	Vs
XJ	SMZJ3799B	Z-diode	27V±10%, 46mA, Zzt=23Ω, 1.5W	DO-214AA	1d	1k	Vs
XK	BZX284-B20	Z-diode	20V±2%, 400mW	SOD-110	12d	1a	Phi
XK	CD214A-T130CA	TVS	Vbr=130V, Irs=1.9A, 400W(1ms), Bidirectional	DO-214AC	1ba	1j	Bm
XK	CMDZ5239B	Z-diode	9.1V±5%, 20mA, Zzt=10Ω, 250mW	SOD-323	5d	1a	Cen
XK	MM3ZB47H	Z-diode	46.06..47.94V, Izt=2.5mA, Zzt=150Ω, 300mW	SOD-323	5d	1a	Zow
XK	P4SMAJ130AC	TVS	Vbr=130V, 1.9A, 400W (1ms), Bidirectional	DO-214AC	1ba	1x,1y	Pjt,Srj
XK	P4SMAJ14CA	TVS	Vbr=14V, 17.2A, 400W(1ms), Bidirectional	DO-214AC	1ba	1j	Mco
XK	PZU22B2A	Z-diode	22V±2%, If=200mA, 320mW	SOD-323	5d	1a	Phi
XK	SM4T150CA	TVS	Vbr=150V, 2A, 400W(1ms), Bidirectional	SOD-6	1ba	1r	Ste
XK	SMAJ130CA	TVS	Vrwm=130V, Vbr=144..159V, 1.9A, 400W(1ms), Bidirectional	DO-214AC	1ba	1x	Di
XK	SMAJ14CA	TVS	Vrwm=14V, Vbr=15.6..17.2V, 17.2A, 400W(1ms), Bidirectional	DO-214AC	1ba	1l	Vs
XK	SMF60A	TVS	Vrwm=60.0V, Vbr=66.70..73.70V, 2.07A, 200W(10/1000µs)	SOD-123FL	7d	1a	Ers
XK	SMZG3800A	Z-diode	30V±5%, 41mA, Zzt=26Ω, 1.5W	DO-215AA	5d	1k	Vs
XK	SMZJ3800A	Z-diode	30V±5%, 41mA, Zzt=26Ω, 1.5W	DO-214AA	1d	1k	Vs
XK	TV02W600-G	TVS	Vrwm=60V, Vbr=66.7..73.7V, Ipp=2.07A, 200W(1ms)	SOD-123	5d	1a	Cmc
XK	TV04A140JB-G	TVS	Vrwm=14.0V, Vbr=15.60..17.20V, Ipp=17.24A, 400W(1ms), Bidirectional	DO-214AC	1ba	1j	Cmc
XL	BZX284-B22	Z-diode	22V±2%, 400mW	SOD-110	12d	1a	Phi
XL	CMDZ5240B	Z-diode	10V±5%, 20mA, Zzt=17Ω, 250mW	SOD-323	5d	1a	Cen
XL	P4SMAJ150C	TVS	Vbr=150V, 1.5A, 400W (1ms), Bidirectional	DO-214AB	1ba	1x,1y	Pjt,Srj
XL	PZU22B3A	Z-diode	22V±2%, If=200mA, 320mW	SOD-323	5d	1a	Phi
XL	SMAJ15C	TVS	Vrwm=15V, Vbr=16.7..18.5V, 14.9A, 400W(1ms), Bidirectional	DO-214AC	1ba	1l	Vs
XL	SMZG3800B	Z-diode	30V±10%, 41mA, Zzt=26Ω, 1.5W	DO-215AA	5d	1k	Vs
XL	SMZJ3800B	Z-diode	30V±10%, 41mA, Zzt=26Ω, 1.5W	DO-214AA	1d	1k	Vs
XL	TV04A150KB-G	TVS	Vrwm=15.0V, Vbr=16.70..20.40V, Ipp=14.87A, 400W(1ms), Bidirectional	DO-214AC	1ba	1j	Cmc
XM	BZX284-B24	Z-diode	24V±2%, 400mW	SOD-110	12d	1a	Phi
XM	CD214A-T150CA	TVS	Vbr=150V, Irs=1.6A, 400W(1ms), Bidirectional	DO-214AC	1ba	1j	Bm
XM	MM3ZB51H	Z-diode	49.98..52.02V, Izt=2.5mA, Zzt=180Ω, 300mW	SOD-323	5d	1a	Zow
XM	P4SMAJ150AC	TVS	Vbr=150V, 1.6A, 400W (1ms), Bidirectional	DO-214AB	1ba	1x,1y	Pjt,Srj
XM	P4SMAJ15CA	TVS	Vbr=15V, 16.4A, 400W(1ms), Bidirectional	DO-214AC	1ba	1j	Mco
XM	PZU24BA	Z-diode	24V±5%, If=200mA, 320mW	SOD-323	5d	1a	Phi
XM	SMAJ150CA	TVS	Vrwm=150V, Vbr=167..185V, 1.2A, 400W(1ms), Bidirectional	DO-214AC	1ba	1x	Di
XM	SMAJ15CA	TVS	Vrwm=15V, Vbr=16.7..18.5V, 16.4A, 400W(1ms), Bidirectional	DO-214AC	1ba	1l	Vs
XM	SMF64A	TVS	Vrwm=64.0V, Vbr=71.10..78.60V, 1.94A, 200W(10/1000µs)	SOD-123FL	7d	1a	Ers
XM	TV02W640-G	TVS	Vrwm=64V, Vbr=71.1..78.6V, Ipp=1.94A, 200W(1ms)	SOD-123	5d	1a	Cmc
XM	TV04A150JB-G	TVS	Vrwm=15.0V, Vbr=16.70..18.50V, Ipp=16.39A, 400W(1ms), Bidirectional	DO-214AC	1ba	1j	Cmc
XN	BZX284-B27	Z-diode	27V±2%, 400mW	SOD-110	12d	1a	Phi
XN	CMDZ5241B	Z-diode	11V±5%, 20mA, Zzt=22Ω, 250mW	SOD-323	5d	1a	Cen
XN	MM3ZB56H	Z-diode	54.88..57.12V, Izt=2.5mA, Zzt=180Ω, 300mW	SOD-323	5d	1a	Zow
XN	P4SMAJ160C	TVS	Vbr=160V, 1.4A, 400W (1ms), Bidirectional	DO-214AB	1ba	1x,1y	Pjt,Srj
XN	PZU24B1A	Z-diode	24V±2%, If=200mA, 320mW	SOD-323	5d	1a	Phi
XN	SMAJ16C	TVS	Vrwm=16V, Vbr=17.8..21.8V, 13.9A, 400W(1ms), Bidirectional	DO-214AC	1ba	1l	Vs
XN	TV04A160KB-G	TVS	Vrwm=16.0V, Vbr=17.80..21.80V, Ipp=13.89A, 400W(1ms), Bidirectional	DO-214AC	1ba	1j	Cmc
XO	BZX284-B30	Z-diode	30V±2%, 400mW	SOD-110	12d	1a	Phi
XO	CMDZ5242B	Z-diode	12V±5%, 20mA, Zzt=30Ω, 250mW	SOD-323	5d	1a	Cen
XP	BZX284-B33	Z-diode	33V±2%, 400mW	SOD-110	12d	1a	Phi
XP	CD214A-T160CA	TVS	Vbr=160V, Irs=1.5A, 400W(1ms), Bidirectional	DO-214AC	1ba	1j	Bm
XP	CMDZ13L	Z-diode	12.35..13.65V, Izt=0.5mA, Zzt=80Ω, 250mW	SOD-323	5d	1a	Cen
XP	CMDZ5243B	Z-diode	13V±5%, 9.5mA, Zzt=13Ω, 250mW	SOD-323	5d	1a	Cen
XP	MM3ZB62H	Z-diode	60.76..63.24V, Izt=2.5mA, Zzt=200Ω, 300mW	SOD-323	5d	1a	Zow
XP	P4SMAJ160AC	TVS	Vbr=160V, 1.5A, 400W (1ms), Bidirectional	DO-214AB	1ba	1x,1y	Pjt,Srj
XP	P4SMAJ16CA	TVS	Vbr=16V, 15.3A, 400W(1ms), Bidirectional	DO-214AC	1ba	1j	Mco
XP	PZU24B2A	Z-diode	24V±2%, If=200mA, 320mW	SOD-323	5d	1a	Phi
XP	SMAJ160CA	TVS	Vrwm=160V, Vbr=178..197V, 1.2A, 400W(1ms), Bidirectional	DO-214AC	1ba	1x	Di
XP	SMAJ16CA	TVS	Vrwm=16V, Vbr=17.8..21.8V, 15.4A, 400W(1ms), Bidirectional	DO-214AC	1ba	1l	Vs
XP	SMF70A	TVS	Vrwm=70.0V, Vbr=77.80..86.0V, 1.77A, 200W(10/1000µs)	SOD-123FL	7d	1a	Ers
XP	TV02W700-G	TVS	Vrwm=70V, Vbr=77.8..86.0V, Ipp=1.77A, 200W(1ms)	SOD-123	5d	1a	Cmc
XP	TV04A160JB-G	TVS	Vrwm=16.0V, Vbr=17.80..19.70V, Ipp=15.38A, 400W(1ms), Bidirectional	DO-214AC	1ba	1j	Cmc
XQ	BZX284-B36	Z-diode	36V±2%, 400mW	SOD-110	12d	1a	Phi



SMD
code

Type

Function

Short description

Case

Pinout

St.

Mnf.

XQ	CMDZ5244B	Z-diode	14V±5%, 9.0mA, Zzt=15Ω, 250mW	SOD-323	5d	1a	Cen
XQ	P4SMAJ170C	TVS	Vbr=170V, 1.3A, 400W(1ms), Bidirectional	DO-214AB	1ba	1x,1y	Pjt,Srj
XQ	SMAJ17C	TVS	Vrwm=17V, Vbr=18.9..23.1V, 13.1A, 400W(1ms), Bidirectional	DO-214AC	1ba	1l	Vs
XQ	TV04A170KB-G	TVS	Vrwm=17.0V, Vbr=18.90..23.10V, Ipp=13.11A, 400W(1ms), Bidirectional	DO-214AC	1ba	1j	Cmc
XR	BZX284-B39	Z-diode	39V±2%, 400mW	SOD-110	12d	1a	Phi
XR	CD214A-T170CA	TVS	Vbr=170V, Irs=1.4A, 400W(1ms), Bidirectional	DO-214AC	1ba	1j	Bm
XR	CMDZ5245B	Z-diode	15V±5%, 8.5mA, Zzt=16Ω, 250mW	SOD-323	5d	1a	Cen
XR	MM3ZB68H	Z-diode	66.64..69.36V, Izt=2.5mA, Zzt=250Ω, 300mW	SOD-323	5d	1a	Zow
XR	P4SMAJ170AC	TVS	Vbr=170V, 1.4A, 400W(1ms), Bidirectional	DO-214AB	1ba	1x,1y	Pjt,Srj
XR	P4SMAJ17CA	TVS	Vbr=17V, 14.5A, 400W(1ms), Bidirectional	DO-214AC	1ba	1j	Mco
XR	PZU24B3A	Z-diode	24V±2%, If=200mA, 320mW	SOD-323	5d	1a	Phi
XR	SMAJ170CA	TVS	Vrwm=170V, Vbr=189..209V, 1.4A, 400W(1ms), Bidirectional	DO-214AC	1ba	1x	Di
XR	SMAJ17CA	TVS	Vrwm=17V, Vbr=18.9..20.9V, 14.5A, 400W(1ms), Bidirectional	DO-214AC	1ba	1l	Vs
XR	SMF75A	TVS	Vrwm=75.0V, Vbr=83.30..92.10V, 1.65A, 200W(10/100μs)	SOD-123FL	7d	1a	Ers
XR	TV02W750-G	TVS	Vrwm=75V, Vbr=83.3..92.1V, Ipp=1.65A, 200W(1ms)	SOD-123	5d	1a	Cmc
XR	TV04A170JB-G	TVS	Vrwm=17.0V, Vbr=18.90..20.90V, Ipp=14.49A, 400W(1ms), Bidirectional	DO-214AC	1ba	1j	Cmc
XS	BZX284-B43	Z-diode	43V±2%, 400mW	SOD-110	12d	1a	Phi
XS	CMDZ5246B	Z-diode	16V±5%, 7.8mA, Zzt=17Ω, 250mW	SOD-323	5d	1a	Cen
XS	PZU27BA	Z-diode	27V±5%, If=200mA, 320mW	SOD-323	5d	1a	Phi
XS	SM4T200C	TVS	Vbr=200V, 1.5A, 400W(1ms), Bidirectional	SOD-6	1ba	1r	Ste
XS	SMAJ18C	TVS	Vrwm=18V, Vbr=20.0..24.4V, 12.4A, 400W(1ms), Bidirectional	DO-214AC	1ba	1l	Vs
XS	TV04A180KB-G	TVS	Vrwm=18.0V, Vbr=20.0..24.40V, Ipp=12.42A, 400W(1ms), Bidirectional	DO-214AC	1ba	1j	Cmc
XT	BZX284-B47	Z-diode	47V±2%, 400mW	SOD-110	12d	1a	Phi
XT	CMDZ5247B	Z-diode	17V±5%, 7.4mA, Zzt=19Ω, 250mW	SOD-323	5d	1a	Cen
XT	MMSD301	Si-diode	UHF/VHF Det, Schottky Barrier, 30V, 225mW, <1.5pF	SOD-123	5d	1a	Ons
XT	P4SMAJ18CA	TVS	Vbr=18V, 13.7A, 400W(1ms), Bidirectional	DO-214AC	1ba	1j	Mco
XT	PZU3.0BA	Z-diode	3.0V±5%, If=200mA, 320mW	SOD-323	5d	1a	Phi
XT	SM4T200CA	TVS	Vbr=200V, 1.5A, 400W(1ms), Bidirectional	SOD-6	1ba	1r	Ste
XT	SMAJ18CA	TVS	Vrwm=18V, Vbr=20.0..22.1V, 13.7A, 400W(1ms), Bidirectional	DO-214AC	1ba	1l	Vs
XT	SMF78A	TVS	Vrwm=78.0V, Vbr=86.70..95.80V, 1.59A, 200W(10/100μs)	SOD-123FL	7d	1a	Ers
XT	TV02W780-G	TVS	Vrwm=78V, Vbr=86.7..95.8V, Ipp=1.59A, 200W(1ms)	SOD-123	5d	1a	Cmc
XT	TV04A180JB-G	TVS	Vrwm=18.0V, Vbr=20.0..22.10V, Ipp=13.70A, 400W(1ms), Bidirectional	DO-214AC	1ba	1j	Cmc
XU	BZX284-B51	Z-diode	51V±2%, 400mW	SOD-110	12d	1a	Phi
XU	CMDZ5248B	Z-diode	18V±5%, 7.0mA, Zzt=21Ω, 250mW	SOD-323	5d	1a	Cen
XU	PZU3.0B1A	Z-diode	3.0V±2%, If=200mA, 320mW	SOD-323	5d	1a	Phi
XU	SMAJ20C	TVS	Vrwm=20V, Vbr=22.2..27.1V, 11.2A, 400W(1ms), Bidirectional	DO-214AC	1ba	1l	Vs
XU	TV04A200KB-G	TVS	Vrwm=20.0V, Vbr=22.20..27.10V, Ipp=11.17A, 400W(1ms), Bidirectional	DO-214AC	1ba	1j	Cmc
XV	BZX284-B56	Z-diode	56V±2%, 400mW	SOD-110	12d	1a	Phi
XV	CMDZ5249B	Z-diode	19V±5%, 6.6mA, Zzt=23Ω, 250mW	SOD-323	5d	1a	Cen
XV	P4SMAJ20CA	TVS	Vbr=20V, 12.3A, 400W(1ms), Bidirectional	DO-214AC	1ba	1j	Mco
XV	PZU3.0B2A	Z-diode	3.0V±2%, If=200mA, 320mW	SOD-323	5d	1a	Phi
XV	SMAJ20CA	TVS	Vrwm=20V, Vbr=22.2..24.5V, 12.3A, 400W(1ms), Bidirectional	DO-214AC	1ba	1l	Vs
XV	SMF85A	TVS	Vrwm=85.0V, Vbr=94.40..104.0V, 1.46A, 200W(10/100μs)	SOD-123FL	7d	1a	Ers
XV	TV02W850-G	TVS	Vrwm=85V, Vbr=94.4..104V, Ipp=1.46A, 200W(1ms)	SOD-123	5d	1a	Cmc
XV	TV04A200JB-G	TVS	Vrwm=20.0V, Vbr=22.20..24.50V, Ipp=12.35A, 400W(1ms), Bidirectional	DO-214AC	1ba	1j	Cmc
XW	BZX284-B62	Z-diode	62V±2%, 400mW	SOD-110	12d	1a	Phi
XW	PZU3.3BA	Z-diode	3.3V±5%, If=200mA, 320mW	SOD-323	5d	1a	Phi
XW	SMAJ22C	TVS	Vrwm=22V, Vbr=24.4..29.8V, 10.2A, 400W(1ms), Bidirectional	DO-214AC	1ba	1l	Vs
XW	TV04A220KB-G	TVS	Vrwm=22.0V, Vbr=24.40..29.80V, Ipp=10.15A, 400W(1ms), Bidirectional	DO-214AC	1ba	1j	Cmc
XX	BZX284-B68	Z-diode	68V±2%, 400mW	SOD-110	12d	1a	Phi
XX	CMDZ5250B	Z-diode	20V±5%, 6.2mA, Zzt=25Ω, 250mW	SOD-323	5d	1a	Cen
XX	MM3ZB75H	Z-diode	73.5..76.5V, Izt=2.5mA, Zzt=300Ω, 300mW	SOD-323	5d	1a	Zow
XX	P4SMAJ22CA	TVS	Vbr=22V, 11.2A, 400W(1ms), Bidirectional	DO-214AC	1ba	1j	Mco
XX	PZU3.3B1A	Z-diode	3.3V±2%, If=200mA, 320mW	SOD-323	5d	1a	Phi
XX	SMAJ22CA	TVS	Vrwm=22V, Vbr=24.4..26.9V, 11.3A, 400W(1ms), Bidirectional	DO-214AC	1ba	1l	Vs
XX	SMF90A	TVS	Vrwm=90.0V, Vbr=100.0..111.0V, 1.37A, 200W(10/100μs)	SOD-123FL	7d	1a	Ers
XX	TV02W900-G	TVS	Vrwm=90V, Vbr=100..111V, Ipp=1.3A, 200W(1ms)	SOD-123	5d	1a	Cmc
XX	TV04A220JB-G	TVS	Vrwm=22.0V, Vbr=24.40..26.90V, Ipp=11.27A, 400W(1ms), Bidirectional	DO-214AC	1ba	1j	Cmc
XY	BZX284-B75	Z-diode	75V±2%, 400mW	SOD-110	12d	1a	Phi
XY	CMDZ5251B	Z-diode	22V±5%, 5.6mA, Zzt=29Ω, 250mW	SOD-323	5d	1a	Cen
XY	MM5Z2B4H	Z-diode	2.352..2.448V, Zzt=100Ω, Izt=5mA, 200mW	SOD-523	7d	1a	Zow
XY	PZU3.3B2A	Z-diode	3.3V±2%, If=200mA, 320mW	SOD-323	5d	1a	Phi
XY	SMAJ24C	TVS	Vrwm=24V, Vbr=26.7..32.6V, 9.3A, 400W(1ms), Bidirectional	DO-214AC	1ba	1l	Vs
XY	TV04A240KB-G	TVS	Vrwm=24.0V, Vbr=26.70..32.60V, Ipp=9.30A, 400W(1ms), Bidirectional	DO-214AC	1ba	1j	Cmc
XZ	BZT52-B43S	Z-diode	42.14..43.86V, Izt=2mA, Zzt=150Ω, 200mW	SOD-323FL	7d	1a	Tsc
XZ	CMDZ5252B	Z-diode	24V±5%, 5.2mA, Zzt=33Ω, 250mW	SOD-323	5d	1a	Cen
XZ	MM3Z43VB	Z-diode	42.14..43.86V, Zzt=141Ω, Izt=2mA, 200mW	SOD-323FL	7d	1a	F
XZ	MM3Z43VBW	Z-diode	42.14..43.86V, Izt=2mA, Zzt=150Ω, 200mW	SOD-323FL	7d	1a	Tac
XZ	MM5Z2B7H	Z-diode	2.646..2.754V, Zzt=110Ω, Izt=5mA, 200mW	SOD-523	7d	1a	Zow
XZ	P4SMAJ24CA	TVS	Vbr=24V, 10.3A, 400W(1ms), Bidirectional	DO-214AC	1ba	1j	Mco



SMD
code

Type

Function

Short description

Case

Pinout

St.

Mnf.

XZ	PZU3.6BA	Z-diode	3.6V±5%, If=200mA, 320mW		SOD-323	5d	1a	Phi
XZ	SMAJ24CA	TVS	Vrwm=24V, Vbr=26.7.29.5V, 10.3A, 400W(1ms), Bidirectional		DO-214AC	1ba	1l	Vs
XZ	SMF100A	TVS	Vrwm=100.0V, Vbr=111.0..123.0V, 1.23A, 200W(10/1000µs)		SOD-123FL	7d	1a	Ers
XZ	TCMMSZ43VB	Z-diode	43V±2%, Izt=5mA, Zzt=141Ω, 200mW		SOD-323FL	7d	1a	Tac
XZ	TV02W101-G	TVS	Vrwm=100V, Vbr=111..123V, Ipp=1.23A, 200W(1ms)		SOD-123	5d	1a	Cmc
XZ	TV04A240JB-G	TVS	Vrwm=24.0V, Vbr=26.70..29.50V, Ipp=10.28A, 400W(1ms), Bidirectional		DO-214AC	1ba	1j	Cmc
Y	BB182B	C-diode	TV-VHF-Tuning, 34V, 20mA, 47..2.65pF(2..25V), 160MHz		SOD-523	6d	1a	Phi
Y	EP10QY03	Si-diode	SBR, 30V, 1A, Vf<0.47V(1A)		SOD-123	5d	1a	Nih
Y	MA2ST07	C-diode	SBD, UHF-mix, 5V, 100mA, Vf=0.25V(2mA), 0.85pF		SOD-523	6d	1a	Pan
Y	MM9D22V	Z-diode	20.90..23.10V, Izt=5mA, Zzt=55Ω, 200mW		SOD-923	7d	1n	Wtr
Y	MM9D4V3	Z-diode	4.09..4.52V, Izt=5mA, Zzt=100Ω, 200mW		SOD-923	7d	1b	Wtr
Y	MMSZ5226BPT	Z-diode	3.135..3.465V, Izt=5mA, Zzt=95Ω, 225mW		SOD-523	7d	1a	Chm
y	MMSZ5242BPT	Z-diode	11.40..12.60V, Izt=5mA, Zzt=22Ω, 225mW		SOD-523	7d	1a	Chm
Y	NZ9F12VST	Z-diode	11.74..12.24V, Izt=5mA, Zzt=30Ω, 200mW		SOD-923	7d	2m	Ons
Y	NZ9F22VT	Z-diode	20.90..23.10V, Izt=5mA, Zzt=55Ω, 200mW		SOD-923	7d	1n	Ons
Y	NZ9F4V3T	Z-diode	4.0..4.52V, Izt=5mA, Zzt=100Ω, 200mW		SOD-923	7d	1b	Ons
Y*P*	SMAJ7.5CA	TVS	Vrwm=7.5V, Vbr=8.33..9.21V, 31A, 400W(1ms), Bidirectional		DO-214AC	1ba	1l	Vs
Y.	MMSZ5226SPT	Z-diode	3.234..3.366V, Izt=5mA, Zzt=95Ω, 225mW		SOD-523	7d	1a	Chm
y.	MMSZ5242SPT	Z-diode	11.76..12.24V, Izt=5mA, Zzt=22Ω, 225mW		SOD-523	7d	1a	Chm
Y1	BZF10C7V5	Z-diode	7.1..7.9V, Izt=34mA, Zzt=4.0Ω, 1W		SOD-123F	10d	1a	Did
Y1	BZT52-C11T	Z-diode	11V±5%, Izt=5mA, Zzt=20Ω, 100mW		SOD-523	6d	1a	Mco
Y1	CMDZ5253B	Z-diode	25V±5%, 5.0mA, Zzt=35Ω, 250mW		SOD-323	5d	1a	Cen
Y1	MM3Z5239B	Z-diode	9.1V±5%, Izt=20mA, Zzt=10Ω, 200mW		SOD-323FL	7d	1a	Bts
Y1	MM3Z5239BH	Z-diode	8.65..9.56V, Izt=20mA, Zzt=10Ω, 300mW		SOD-323	5d	1a	Zow
Y1	MMSZ11V	Z-diode	11V±5%, Izt=5mA, Zzt=20Ω, 200mW		SOD-523	6d	1a	Sec
Y1	MMSZ27	Z-diode	27V±5%, Zzt=80Ω, 500mW		SOD-123	5d	1a	Mot
Y1	PZU16B1A/DG	Z-diode	16V±2%, If=200mA, 320mW, halogen-free		SOD-323	5d	1a	Phi
Y1	VGFM02-C7V5-M	TVS	Vrwm=6.4V, Vbr=7.13..7.88V, 17.7A, 200W(1ms)		SOD-123F	10d	1a	Fmm
Y1	ZD5236BSG	Z-diode	7.5V±5%, 5mA, Zzt=7Ω, 500mW		SOD-323-S	7d	1a	Cys
Y1	ZGFM107V5-MH	Z-diode	7.5V±10%, Zzt=40Ω(Izt=34mA), 1W		SOD-123H	10d	1a	Fmm
Y1	ZGFM107V5-N	Z-diode	7.1..7.9V, Izt=34mA, Zzt=4.0Ω, 1W		SOD-123F	10d	1a	Fmm
Y10	BZT52-C27T	Z-diode	27V±5%, Izt=5mA, Zzt=80Ω, 100mW		SOD-523	6d	1a	Mco
Y10	MMSZ27V	Z-diode	25.1..28.9V, 2mA, Zzt=80Ω, 100mW		SOD-523	6d	1a	Sec
Y11	BZT52-C30T	Z-diode	30V±5%, Izt=5mA, Zzt=80Ω, 100mW		SOD-523	6d	1a	Mco
Y11	MMSZ30V	Z-diode	30V±5%, Izt=2mA, Zzt=80Ω, 100mW		SOD-523	6d	1a	Sec
Y12	BZT52-C33T	Z-diode	33V±5%, Izt=5mA, Zzt=80Ω, 100mW		SOD-523	6d	1a	Mco
Y12	MMSZ33V	Z-diode	33V±5%, Izt=2mA, Zzt=80Ω, 200mW		SOD-523	6d	1a	Sec
Y13	BZT52-C36T	Z-diode	36V±5%, Izt=5mA, Zzt=90Ω, 100mW		SOD-523	6d	1a	Mco
Y13	MMSZ36V	Z-diode	36V±5%, Izt=2mA, Zzt=90Ω, 200mW		SOD-523	6d	1a	Sec
Y14	BZT52-C39T	Z-diode	39V±5%, Izt=5mA, Zzt=130Ω, 100mW		SOD-523	6d	1a	Mco
Y14	MMSZ39V	Z-diode	39V±5%, Izt=2mA, Zzt=130Ω, 200mW		SOD-523	6d	1a	Sec
Y15	MMSZ43V	Z-diode	43V±5%, Izt=2mA, Zzt=150Ω, 200mW		SOD-523	6d	1a	Sec
Y16	MMSZ47V	Z-diode	47V±5%, Izt=2mA, Zzt=170Ω, 200mW		SOD-523	6d	1a	Sec
Y17	MMSZ51V	Z-diode	51V±5%, Izt=2mA, Zzt=180Ω, 200mW		SOD-523	6d	1a	Sec
Y2	BZF10C8V2	Z-diode	7.8..8.6V, Izt=31mA, Zzt=4.5Ω, 1W		SOD-123F	10d	1a	Did
Y2	BZT52-C12T	Z-diode	12V±5%, Izt=5mA, Zzt=25Ω, 100mW		SOD-523	6d	1a	Mco
Y2	CMDZ5254B	Z-diode	27V±5%, 4.6mA, Zzt=41Ω, 250mW		SOD-323	5d	1a	Cen
Y2	MM3Z5260B	Z-diode	43V±5%, Izt=3.0mA, Zzt=93Ω, 200mW		SOD-323FL	7d	1a	Bts
Y2	MM3Z5260BH	Z-diode	40.85..45.15V, Izt=3mA, Zzt=93Ω, 300mW		SOD-323	5d	1a	Zow
Y2	MMSZ12V	Z-diode	12V±5%, Izt=5mA, Zzt=25Ω, 200mW		SOD-523	6d	1a	Sec
Y2	MMSZ30	Z-diode	30V±5%, Zzt=80Ω, 500mW		SOD-123	5d	1a	Mot
Y2	PZU16B2A/DG	Z-diode	16V±2%, If=200mA, 320mW, halogen-free		SOD-323	5d	1a	Phi
Y2	VGFM02-C8V2-M	TVS	Vrwm=7.02V, Vbr=7.79..8.61V, 16.6A, 200W(1ms)		SOD-123F	10d	1a	Fmm
Y2	ZD5237BSG	Z-diode	8.2V±5%, 5mA, Zzt=7Ω, 500mW		SOD-323-S	7d	1a	Cys
Y2	ZGFM108V2-MH	Z-diode	8.2V±10%, Zzt=4.5Ω(Izt=31mA), 1W		SOD-123H	10d	1a	Fmm
Y2	ZGFM108V2-N	Z-diode	7.8..8.6V, Izt=31mA, Zzt=4.5Ω, 1W		SOD-123F	10d	1a	Fmm
Y3	BZF10C9V1	Z-diode	8.6..9.6V, Izt=28mA, Zzt=5Ω, 1W		SOD-123F	10d	1a	Did
Y3	BZT52-C13T	Z-diode	13V±5%, Izt=5mA, Zzt=30Ω, 100mW		SOD-523	6d	1a	Mco
Y3	CMDZ5255B	Z-diode	28V±5%, 4.5mA, Zzt=44Ω, 250mW		SOD-323	5d	1a	Cen
Y3	MMSZ13V	Z-diode	13V±5%, Izt=5mA, Zzt=30Ω, 200mW		SOD-523	6d	1a	Sec
Y3	MMSZ33	Z-diode	33V±5%, Zzt=80Ω, 500mW		SOD-123	5d	1a	Mot
Y3	PZU16B3A/DG	Z-diode	16V±2%, If=200mA, 320mW, halogen-free		SOD-323	5d	1a	Phi
Y3	VGFM02-C9V1-M	TVS	Vrwm=7.78V, Vbr=8.65..9.55V, 15.0A, 200W(1ms)		SOD-123F	10d	1a	Fmm
Y3	ZD5239BSG	Z-diode	9.1V±5%, 5mA, Zzt=10Ω, 500mW		SOD-323-S	7d	1a	Cys
Y3	ZGFM109V1-MH	Z-diode	9.1V±10%, Zzt=5Ω(Izt=28mA), 1W		SOD-123H	10d	1a	Fmm
Y3	ZGFM109V1-N	Z-diode	8.6..9.6V, Izt=28mA, Zzt=5Ω, 1W		SOD-123F	10d	1a	Fmm
Y4	BZF10C10	Z-diode	9.5..10.5V, Izt=25mA, Zzt=7Ω, 1W		SOD-123F	10d	1a	Did
Y4	BZT52-C15T	Z-diode	15V±5%, Izt=5mA, Zzt=30Ω, 100mW		SOD-523	6d	1a	Mco
Y4	CMDZ5256B	Z-diode	30V±5%, 4.2mA, Zzt=49Ω, 250mW		SOD-323	5d	1a	Cen
Y4	MM1Z5239B	Z-diode	8.65..9.56V, Izt=20mA, Zzt=10Ω, 500mW		SOD-323FL	5d	1a	Eic



SMD
code

Type

Function

Short description

Case

Pinout

St.

Mnf.

Y4	MM1Z5239BH	Z-diode	8.65..9.56V, Izt=20mA, Zzt=10Ω, 500mW
Y4	MM5Z15V	Z-diode	15V±5%, Izt=5mA, Zzt=30Ω, 200mW
Y4	MMSZ36	Z-diode	36V±5%, Zzt=90Ω, 500mW
Y4	MMSZ5239B	Z-diode	9.1V±5%, Izt=20mA, Zzt=10Ω, 500mW
Y4	PZU18BA/DG	Z-diode	18V±5%, If=200mA, 320mW, halogen-free
Y4	VGFMO2-C10-M	TVS	Vrwm=8.55V, Vbr=9.50..10.5V, 13.8A, 200W(1ms)
Y4	ZD5240BSG	Z-diode	10V±5%, 5mA, Zzt=15Ω, 500mW
Y4	ZGFM1010-MH	Z-diode	10V±10%, Zzt=7Ω(Izt=25mA), 1W
Y4	ZGFM1010-N	Z-diode	9.5..10.5V, Izt=25mA, Zzt=7Ω, 1W
Y5	BZF10C11	Z-diode	10.5..11.6V, Izt=23mA, Zzt=8Ω, 1W
Y5	BZT52-C16T	Z-diode	16V±5%, Izt=5mA, Zzt=40Ω, 100mW
Y5	BZX584B43V	Z-diode	42.14.43.86V, Izt=2mA, Zzt=150Ω, 200mW
Y5	CMDZ5257B	Z-diode	33V±5%, 3.8mA, Zzt=58Ω, 250mW
Y5	MM1Z5260B	Z-diode	40.85..45.15V, Izt=3.0mA, Zzt=93Ω, 500mW
Y5	MM1Z5260BH	Z-diode	40.85..45.15V, Izt=3mA, Zzt=93Ω, 500mW
Y5	MMSZ16V	Z-diode	16V±5%, Izt=5mA, Zzt=40Ω, 200mW
Y5	MMSZ43VB	Z-diode	42.14.43.86V, Izt=2mA, Zzt=150Ω, 200mW
Y5	MMSZ39	Z-diode	39V±5%, Zzt=130Ω, 500mW
Y5	MMSZ5260B	Z-diode	43V±5%, Izt=3mA, Zzt=93Ω, 500mW
Y5	PZU18B1A/DG	Z-diode	18V±2%, If=200mA, 320mW, halogen-free
Y5	VGFMO2-C11-M	TVS	Vrwm=9.40V, Vbr=10.5..11.6V, 12.8A, 200W(1ms)
Y5	ZD5241BSG	Z-diode	11V±5%, 5mA, Zzt=18Ω, 500mW
Y5	ZGFM1011-MH	Z-diode	11V±10%, Zzt=8Ω(Izt=23mA), 1W
Y5	ZGFM1011-N	Z-diode	10.5..11.6V, Izt=23mA, Zzt=8Ω, 1W
Y6	BZF10C12	Z-diode	11.4..12.6V, Izt=21mA, Zzt=9Ω, 1W
Y6	BZT52-C18T	Z-diode	18V±5%, Izt=5mA, Zzt=45Ω, 100mW
Y6	CMDZ5258B	Z-diode	36V±5%, 3.4mA, Zzt=70Ω, 250mW
Y6	MM5Z18V	Z-diode	18V±5%, Izt=5mA, Zzt=45Ω, 200mW
Y6	PZU18B2A/DG	Z-diode	18V±2%, If=200mA, 320mW, halogen-free
Y6	VGFMO2-C12-M	TVS	Vrwm=10.2V, Vbr=11.4..12.6V, 12.0A, 200W(1ms)
Y6	ZD5242BSG	Z-diode	12V±5%, 5mA, Zzt=22Ω, 500mW
Y6	ZGFM1012-MH	Z-diode	12V±10%, Zzt=9Ω(Izt=21mA), 1W
Y6	ZGFM1012-N	Z-diode	11.4..12.6V, Izt=21mA, Zzt=9Ω, 1W
Y7	BZF10C13	Z-diode	12.4..13.7V, Izt=19mA, Zzt=10Ω, 1W
Y7	BZT52-C20T	Z-diode	20V±5%, Izt=5mA, Zzt=55Ω, 100mW
Y7	CMDZ5259B	Z-diode	39V±5%, 3.2mA, Zzt=80Ω, 250mW
Y7	MMSZ20V	Z-diode	20V±5%, Izt=5mA, Zzt=55Ω, 200mW
Y7	PZU18B3A/DG	Z-diode	18V±2%, If=200mA, 320mW, halogen-free
Y7	VGFMO2-C13-M	TVS	Vrwm=11.1V, Vbr=12.4..13.7V, 11.0A, 200W(1ms)
Y7	ZD5243BSG	Z-diode	13V±5%, 5mA, Zzt=25Ω, 500mW
Y7	ZGFM1013-MH	Z-diode	13V±10%, Zzt=10Ω(Izt=19mA), 1W
Y7	ZGFM1013-N	Z-diode	12.4..13.7V, Izt=19mA, Zzt=10Ω, 1W
Y8	BZF10C15	Z-diode	14.3..15.8V, Izt=17mA, Zzt=14Ω, 1W
Y8	BZT52-C22T	Z-diode	22V±5%, Izt=5mA, Zzt=55Ω, 100mW
Y8	CMDZ5260B	Z-diode	43V±5%, 3.0mA, Zzt=93Ω, 250mW
Y8	MMSZ22V	Z-diode	22V±5%, Izt=5mA, Zzt=55Ω, 200mW
Y8	MMSZ27H	Z-diode	25.1..28.9V, Izt=2mA, Zzt=80Ω, 200mW
Y8	MMSZ27V	Z-diode	27V±5%, Izt=2mA, Zzt=80Ω, 200mW
Y8	PZU2.4BA/DG	Z-diode	2.4V±5%, If=200mA, 320mW, halogen-free
Y8	VGFMO2-C15-M	TVS	Vrwm=12.8V, Vbr=14.3..15.8V, 9.45A, 200W(1ms)
Y8	ZD5245BSG	Z-diode	15V±5%, 5mA, Zzt=32Ω, 500mW
Y8	ZGFM1015-MH	Z-diode	15V±10%, Zzt=14Ω(Izt=17mA), 1W
Y8	ZGFM1015-N	Z-diode	14.3..15.8V, Izt=17mA, Zzt=14Ω, 1W
Y9	BZF10C16	Z-diode	15.2..16.8V, Izt=15.5mA, Zzt=16Ω, 1W
Y9	BZT52-C24T	Z-diode	24V±5%, Izt=5mA, Zzt=70Ω, 100mW
Y9	CMDZ5261B	Z-diode	47V±5%, 2.7mA, Zzt=105Ω, 250mW
Y9	MMSZ24V	Z-diode	24V±5%, Izt=5mA, Zzt=70Ω, 200mW
Y9	MMBD4448HPT	Si-diode	Sw, 80V, 250mA, Vt<1V(100mA), 4ns
Y9	PZU2.7BA/DG	Z-diode	2.7V±5%, If=200mA, 320mW, halogen-free
Y9	VGFMO2-C16-M	TVS	Vrwm=13.6V, Vbr=15.2..16.8V, 8.90A, 200W(1ms)
Y9	ZD5246BSG	Z-diode	16V±5%, 5mA, Zzt=36Ω, 500mW
Y9	ZGFM1016-MH	Z-diode	16V±10%, Zzt=16Ω(Izt=15.5mA), 1W
Y9	ZGFM1016-N	Z-diode	15.2..16.8V, Izt=15.5mA, Zzt=16Ω, 1W
Y9	MM5ZB51H	Z-diode	49.98..52.02V, Zzt=180Ω, Izt=2mA, 200mW
YA	PZU2.7B1A/DG	Z-diode	2.7V±2%, If=200mA, 320mW, halogen-free
YA	SMZG3801A	Z-diode	33V±5%, 38mA, Zzt=33Ω, 1.5W
YA	SMZJ3801A	Z-diode	33V±5%, 38mA, Zzt=33Ω, 1.5W
YB	KDZ16B	Z-diode	16V±2.5%, 20mA, 1W
YB	MMSZB56H	Z-diode	54.88..57.12V, Zzt=180Ω, Izt=2mA, 200mW
YB	PZU2.7B2A/DG	Z-diode	2.7V±2%, If=200mA, 320mW, halogen-free



SMD
code

Type

Function

Short description

Case

Pinout

St.

Mnf.

YB	SMZG3801B	Z-diode	33V±10%, 38mA, Zzt=33Ω, 1.5W	DO-215AA	5d	1k	Vs
YB	SMZJ3801B	Z-diode	33V±10%, 38mA, Zzt=33Ω, 1.5W	DO-214AA	1d	1k	Vs
YC	MMSZB62H	Z-diode	60.76..63.24V, Zzt=200Ω, Izt=2mA, 200mW	SOD-523	7d	1a	Zow
YC	PZU20BA/DG	Z-diode	20V±5%, If=200mA, 320mW, halogen-free	SOD-323	5d	1a	Phi
YC	SMZG3802A	Z-diode	36V±5%, 35mA, Zzt=38Ω, 1.5W	DO-215AA	5d	1k	Vs
YC	SMZJ3802A	Z-diode	36V±5%, 35mA, Zzt=38Ω, 1.5W	DO-214AA	1d	1k	Vs
YD	MMSZB66H	Z-diode	66.64..69.36V, Zzt=250Ω, Izt=2mA, 200mW	SOD-523	7d	1a	Zow
YD	PZU20B1A/DG	Z-diode	20V±2%, If=200mA, 320mW, halogen-free	SOD-323	5d	1a	Phi
YD	SMAJ26C	TVS	Vrwm=26V, Vbr=28.9..35.3V, 8.6A, 400W(1ms), Bidirectional	DO-214AC	1ba	1l	Vs
YD	SMZG3802B	Z-diode	36V±10%, 35mA, Zzt=38Ω, 1.5W	DO-215AA	5d	1k	Vs
YD	SMZJ3802B	Z-diode	36V±10%, 35mA, Zzt=38Ω, 1.5W	DO-214AA	1d	1k	Vs
YD	TV04A260KB-G	TVS	Vrwm=26.0V, Vbr=28.90..35.30V, Ipp=8.58A, 400W(1ms), Bidirectional	DO-214AC	1ba	1lj	Cmc
YE	MMSZB75H	Z-diode	73.5..76.5V, Zzt=300Ω, Izt=2mA, 200mW	SOD-523	7d	1a	Zow
YE	P4SMAJ26CA	TVS	Vbr=26V, 9.5A, 400W(1ms), Bidirectional	DO-214AC	1ba	1lj	Mco
YE	PZU20B2A/DG	Z-diode	20V±2%, If=200mA, 320mW, halogen-free	SOD-323	5d	1a	Phi
YE	SMAJ26CA	TVS	Vrwm=26V, Vbr=28.9..31.9V, 9.5A, 400W(1ms), Bidirectional	DO-214AC	1ba	1l	Vs
YE	SMZG3803A	Z-diode	39V±5%, 31mA, Zzt=45Ω, 1.5W	DO-215AA	5d	1k	Vs
YE	SMZJ3803A	Z-diode	39V±5%, 31mA, Zzt=45Ω, 1.5W	DO-214AA	1d	1k	Vs
YE	TV04A260JB-G	TVS	Vrwm=26.0V, Vbr=28.90..31.90V, Ipp=9.50A, 400W(1ms), Bidirectional	DO-214AC	1ba	1lj	Cmc
YF	MAZD330	Z-diode	31..35V, Zzt=200Ω(5mA), 120mW	SSSMini2	7d	1a	Pan
YF	PZU20B3A/DG	Z-diode	20V±2%, If=200mA, 320mW, halogen-free	SOD-323	5d	1a	Phi
YF	SMAJ28C	TVS	Vrwm=28V, Vbr=31.1..38.0V, 8A, 400W(1ms), Bidirectional	DO-214AC	1ba	1l	Vs
YF	SMZG3803B	Z-diode	39V±10%, 31mA, Zzt=45Ω, 1.5W	DO-215AA	5d	1k	Vs
YF	SMZJ3803B	Z-diode	39V±10%, 31mA, Zzt=45Ω, 1.5W	DO-214AA	1d	1k	Vs
YF	TV04A280KB-G	TVS	Vrwm=28.0V, Vbr=31.10..38.0V, Ipp=8.0A, 400W(1ms), Bidirectional	DO-214AC	1ba	1lj	Cmc
YG	P4SMAJ28CA	TVS	Vbr=28V, 8.8A, 400W(1ms), Bidirectional	DO-214AC	1ba	1lj	Mco
YG	PZU22BA/DG	Z-diode	22V±5%, If=200mA, 320mW, halogen-free	SOD-323	5d	1a	Phi
YG	SMAJ28CA	TVS	Vrwm=28V, Vbr=31.1..34.4V, 8.8A, 400W(1ms), Bidirectional	DO-214AC	1ba	1l	Vs
YG	SMZG3804A	Z-diode	43V±5%, 28mA, Zzt=53Ω, 1.5W	DO-215AA	5d	1k	Vs
YG	SMZJ3804A	Z-diode	43V±5%, 28mA, Zzt=53Ω, 1.5W	DO-214AA	1d	1k	Vs
YG	TV04A280JB-G	TVS	Vrwm=28.0V, Vbr=31.10..34.40V, Ipp=8.81A, 400W(1ms), Bidirectional	DO-214AC	1ba	1lj	Cmc
YH	PZU22B1A/DG	Z-diode	22V±2%, If=200mA, 320mW, halogen-free	SOD-323	5d	1a	Phi
YH	SMAJ30C	TVS	Vrwm=30V, Vbr=33.3..40.7V, 7.5A, 400W(1ms), Bidirectional	DO-214AC	1ba	1l	Vs
YH	SMZG3804B	Z-diode	43V±10%, 28mA, Zzt=53Ω, 1.5W	DO-215AA	5d	1k	Vs
YH	SMZJ3804B	Z-diode	43V±10%, 28mA, Zzt=53Ω, 1.5W	DO-214AA	1d	1k	Vs
YH	TV04A300KB-G	TVS	Vrwm=30.0V, Vbr=33.30..40.70V, Ipp=7.48A, 400W(1ms), Bidirectional	DO-214AC	1ba	1lj	Cmc
YI	SMZG3805A	Z-diode	47V±5%, 26mA, Zzt=67Ω, 1.5W	DO-215AA	5d	1k	Vs
YI	SMZJ3805A	Z-diode	47V±5%, 26mA, Zzt=67Ω, 1.5W	DO-214AA	1d	1k	Vs
YJ	SMZG3805B	Z-diode	47V±10%, 26mA, Zzt=67Ω, 1.5W	DO-215AA	5d	1k	Vs
YJ	SMZJ3805B	Z-diode	47V±10%, 26mA, Zzt=67Ω, 1.5W	DO-214AA	1d	1k	Vs
YK	P4SMAJ30CA	TVS	Vbr=30V, 8.3A, 400W(1ms), Bidirectional	DO-214AC	1ba	1lj	Mco
YK	PZU22B2A/DG	Z-diode	22V±2%, If=200mA, 320mW, halogen-free	SOD-323	5d	1a	Phi
YK	SMAJ30CA	TVS	Vrwm=30V, Vbr=33.3..36.8V, 8.3A, 400W(1ms), Bidirectional	DO-214AC	1ba	1l	Vs
YK	SMZG3806A	Z-diode	51V±5%, 24mA, Zzt=70Ω, 1.5W	DO-215AA	5d	1k	Vs
YK	SMZJ3806A	Z-diode	51V±5%, 24mA, Zzt=70Ω, 1.5W	DO-214AA	1d	1k	Vs
YK	TV04A300JB-G	TVS	Vrwm=30.0V, Vbr=33.30..36.80V, Ipp=8.26A, 400W(1ms), Bidirectional	DO-214AC	1ba	1lj	Cmc
YL	PZU22B3A/DG	Z-diode	22V±2%, If=200mA, 320mW, halogen-free	SOD-323	5d	1a	Phi
YL	SMAJ33C	TVS	Vrwm=33V, Vbr=36.7..44.9V, 6.8A, 400W(1ms), Bidirectional	DO-214AC	1ba	1l	Vs
YL	SMZG3806B	Z-diode	51V±10%, 24mA, Zzt=70Ω, 1.5W	DO-215AA	5d	1k	Vs
YL	SMZJ3806B	Z-diode	51V±10%, 24mA, Zzt=70Ω, 1.5W	DO-214AA	1d	1k	Vs
YL	TV04A330KB-G	TVS	Vrwm=33.0V, Vbr=36.70..44.90V, Ipp=6.78A, 400W(1ms), Bidirectional	DO-214AC	1ba	1lj	Cmc
YM	P4SMAJ33CA	TVS	Vbr=33V, 7.5A, 400W(1ms), Bidirectional	DO-214AC	1ba	1lj	Mco
YM	PZU24BA/DG	Z-diode	24V±5%, If=200mA, 320mW, halogen-free	SOD-323	5d	1a	Phi
YM	TV04A330JB-G	TVS	Vrwm=33.0V, Vbr=36.70..40.60V, Ipp=7.50A, 400W(1ms), Bidirectional	DO-214AC	1ba	1lj	Cmc
YN	PZU24B1A/DG	Z-diode	24V±2%, If=200mA, 320mW, halogen-free	SOD-323	5d	1a	Phi
YN	SMAJ36C	TVS	Vrwm=36V, Vbr=40.0..48.9V, 6.2A, 400W(1ms), Bidirectional	DO-214AC	1ba	1l	Vs
YN	TV04A360KB-G	TVS	Vrwm=36.0V, Vbr=40.0..48.90V, Ipp=6.22A, 400W(1ms), Bidirectional	DO-214AC	1ba	1lj	Cmc
YO	BZX284-C2V4	Z-diode	2.4V±5%, 400mW	SOD-110	12d	1a	Phi
YP	BZX284-C2V7	Z-diode	2.7V±5%, 400mW	SOD-110	12d	1a	Phi
YP	BZX384-C22	Z-diode	22V±5%, Izt=5mA, Zzt=20Ω, 200mW	SOD-323	5d	1k	Vs
YP	CMDZ15L	Z-diode	14.25..15.75V, Izt=0.5mA, Zzt=80Ω, 250mW	SOD-323	5d	1a	Cen
YP	DDZ6V8C	Z-diode	6.8V±5%, Izt=20mA, 500mW	SOD-123	5d	1d	Di
YP	DDZ6V8CS	Z-diode	6.8V±5%, Izt=20mA, 200mW	SOD-323	5d	1d	Di
YP	P4SMAJ36CA	TVS	Vbr=36V, 6.9A, 400W(1ms), Bidirectional	DO-214AC	1ba	1lj	Mco
YP	PZU24B2A/DG	Z-diode	24V±2%, If=200mA, 320mW, halogen-free	SOD-323	5d	1a	Phi
YP	SMAJ36CA	TVS	Vrwm=36V, Vbr=40.0..44.2V, 6.9A, 400W(1ms), Bidirectional	DO-214AC	1ba	1l	Vs
YP	TV04A360JB-G	TVS	Vrwm=36.0V, Vbr=40.0..44.20V, Ipp=6.88A, 400W(1ms), Bidirectional	DO-214AC	1ba	1lj	Cmc
YQ	BZX284-C3V0	Z-diode	3V±5%, 400mW	SOD-110	12d	1a	Phi
YQ	DDZ7V5C	Z-diode	7.5V±5%, Izt=20mA, 500mW	SOD-123	5d	1d	Di
YQ	DDZ7V5CS	Z-diode	7.5V±5%, Izt=20mA, 200mW	SOD-323	5d	1d	Di



SMD
code

Type

Function

Short description

Case

Pinout

St.

Mnf.

SMD code	Type	Function	Short description	Case	Pinout	St.	Mnf.
YQ	SMAJ40C	TVS	Vrwm=40V, Vbr=44.4..54.3V, 5.6A, 400W(1ms), Bidirectional	DO-214AC	1ba	1l	Vs
YQ	TV04A400KB-G	TVS	Vrwm=40.0V, Vbr=44.40..54.30V, Ipp=5.60A, 400W(1ms), Bidirectional	DO-214AC	1ba	1j	Cmc
YR	BZX284-C3V3	Z-diode	3.3V±5%, 400mW	SOD-110	12d	1a	Phi
YR	DDZ8V2C	Z-diode	8.2V±5%, Izt=20mA, 500mW	SOD-123	5d	1d	Di
YR	DDZ8V2CS	Z-diode	8.2V±5%, Izt=20mA, 200mW	SOD-323	5d	1d	Di
YR	P4SMAJ40CA	TVS	Vbr=40V, 6.2A, 400W(1ms), Bidirectional	DO-214AC	1ba	1j	Mco
YR	PZU24B3A/DG	Z-diode	24V±2%, If=200mA, 320mW, halogen-free	SOD-323	5d	1a	Phi
YR	SMAJ40CA	TVS	Vrwm=40V, Vbr=44.4..49.1V, 6.2A, 400W(1ms), Bidirectional	DO-214AC	1ba	1l	Vs
YR	TV04A400JB-G	TVS	Vrwm=40.0V, Vbr=44.40..49.10V, Ipp=6.20A, 400W(1ms), Bidirectional	DO-214AC	1ba	1j	Cmc
YS	BZX284-C3V6	Z-diode	3.6V±5%, 400mW	SOD-110	12d	1a	Phi
YS	DDZ9V1C	Z-diode	9.1V±5%, Izt=20mA, 500mW	SOD-123	5d	1d	Di
YS	DDZ9V1CS	Z-diode	9.1V±5%, Izt=20mA, 200mW	SOD-323	5d	1d	Di
YS	P4SMAJ180C	TVS	Vbr=180V, 1.2A, 400W (1ms), Bidirectional	DO-214AB	1ba	1x,1y	Pjt,Srj
YS	PZU27BA/DG	Z-diode	27V±5%, If=200mA, 320mW, halogen-free	SOD-323	5d	1a	Phi
YS	SMAJ43C	TVS	Vrwm=43V, Vbr=47.8..58.4V, 5.2A, 400W(1ms), Bidirectional	DO-214AC	1ba	1l	Vs
YS	TV04A430KB-G	TVS	Vrwm=43.0V, Vbr=47.80..58.40V, Ipp=5.22A, 400W(1ms), Bidirectional	DO-214AC	1ba	1j	Cmc
YT	BZX284-C3V9	Z-diode	3.9V±5%, 400mW	SOD-110	12d	1a	Phi
YT	DDZ10C	Z-diode	10V±5%, Izt=20mA, 500mW	SOD-123	5d	1d	Di
YT	DDZ10CS	Z-diode	10V±5%, Izt=20mA, 200mW	SOD-323	5d	1d	Di
YT	P4SMAJ180AC	TVS	Vbr=180V, 1.3A, 400W (1ms), Bidirectional	DO-214AB	1ba	1x,1y	Pjt,Srj
YT	P4SMAJ43CA	TVS	Vbr=43V, 5.7A, 400W(1ms), Bidirectional	DO-214AC	1ba	1j	Mco
YT	PZU3.0BA/DG	Z-diode	3.0V±5%, If=200mA, 320mW, halogen-free	SOD-323	5d	1a	Phi
YT	TV04A430JB-G	TVS	Vrwm=43.0V, Vbr=47.80..52.80V, Ipp=5.76A, 400W(1ms), Bidirectional	DO-214AC	1ba	1j	Cmc
YU	BZX284-C4V3	Z-diode	4.3V±5%, 400mW	SOD-110	12d	1a	Phi
YU	DDZ11C	Z-diode	11V±5%, Izt=10mA, 500mW	SOD-123	5d	1d	Di
YU	DDZ11CS	Z-diode	11V±5%, Izt=10mA, 200mW	SOD-323	5d	1d	Di
YU	P4SMAJ190C	TVS	Vbr=190V, 1.2A, 400W (1ms), Bidirectional	DO-214AB	1ba	1x,1y	Pjt,Srj
YU	PZU3.0B1A/DG	Z-diode	3.0V±2%, If=200mA, 320mW, halogen-free	SOD-323	5d	1a	Phi
YU	SMAJ45C	TVS	Vrwm=45V, Vbr=50.0..61.1V, 5A, 400W(1ms), Bidirectional	DO-214AC	1ba	1l	Vs
YU	TV04A450KB-G	TVS	Vrwm=45.0V, Vbr=50.0..61.10V, Ipp=4.98A, 400W(1ms), Bidirectional	DO-214AC	1ba	1j	Cmc
YV	BZX284-C4V7	Z-diode	4.7V±5%, 400mW	SOD-110	12d	1a	Phi
YV	DDZ12C	Z-diode	12V±5%, Izt=10mA, 500mW	SOD-123	5d	1d	Di
YV	DDZ12CS	Z-diode	12V±5%, Izt=10mA, 200mW	SOD-323	5d	1d	Di
YV	P4SMAJ190AC	TVS	Vbr=190V, 1.3A, 400W (1ms), Bidirectional	DO-214AB	1ba	1x,1y	Pjt,Srj
YV	P4SMAJ45CA	TVS	Vbr=45V, 5.5A, 400W(1ms), Bidirectional	DO-214AC	1ba	1j	Mco
YV	PZU3.0B2A/DG	Z-diode	3.0V±2%, If=200mA, 320mW, halogen-free	SOD-323	5d	1a	Phi
YV	SMAJ45CA	TVS	Vrwm=45V, Vbr=50.0..55.3V, 5.5A, 400W(1ms), Bidirectional	DO-214AC	1ba	1l	Vs
YV	TV04A450JB-G	TVS	Vrwm=45.0V, Vbr=50.0..55.30V, Ipp=5.50A, 400W(1ms), Bidirectional	DO-214AC	1ba	1j	Cmc
YW	BZX284-C5V1	Z-diode	5.1V±5%, 400mW	SOD-110	12d	1a	Phi
YW	DDZ13C	Z-diode	13V±5%, 2Izt=10mA, 500mW	SOD-123	5d	1d	Di
YW	P4SMAJ200C	TVS	Vbr=170V, 1.1A, 400W (1ms), Bidirectional	DO-214AC	1ba	1x,1y	Pjt,Srj
YW	PZU3.3BA/DG	Z-diode	3.3V±5%, If=200mA, 320mW, halogen-free	SOD-323	5d	1a	Phi
YW	SMAJ48C	TVS	Vrwm=48V, Vbr=53.3..65.1V, 4.7A, 400W(1ms), Bidirectional	DO-214AC	1ba	1l	Vs
YW	TV04A480KB-G	TVS	Vrwm=48.0V, Vbr=53.30..65.10V, Ipp=4.68A, 400W(1ms), Bidirectional	DO-214AC	1ba	1j	Cmc
YX	BZX284-C5V6	Z-diode	5.6V±5%, 400mW	SOD-110	12d	1a	Phi
YX	P4SMAJ200AC	TVS	Vbr=170V, 1.2A, 400W (1ms), Bidirectional	DO-214AC	1ba	1x,1y	Pjt,Srj
YX	P4SMAJ48CA	TVS	Vbr=48V, 5.2A, 400W(1ms), Bidirectional	DO-214AC	1ba	1j	Mco
YX	PZU3.3B1A/DG	Z-diode	3.3V±2%, If=200mA, 320mW, halogen-free	SOD-323	5d	1a	Phi
YX	TV04A480JB-G	TVS	Vrwm=48.0V, Vbr=53.30..58.90V, Ipp=5.17A, 400W(1ms), Bidirectional	DO-214AC	1ba	1j	Cmc
YY	BZX284-C6V2	Z-diode	6.2V±5%, 400mW	SOD-110	12d	1a	Phi
YY	DDZ16S	Z-diode	16V±10%, Izt=10mA, 200mW	SOD-323	5d	1d	Di
YY	P4SMAJ210C	TVS	Vbr=170V, 1.1A, 400W (1ms), Bidirectional	DO-214AC	1ba	1x,1y	Pjt,Srj
YY	PZU3.3B2A/DG	Z-diode	3.3V±2%, If=200mA, 320mW, halogen-free	SOD-323	5d	1a	Phi
YY	SMAJ51C	TVS	Vrwm=51V, Vbr=56.7..69.3V, 4.4A, 400W(1ms), Bidirectional	DO-214AC	1ba	1l	Vs
YY	TV04A510KB-G	TVS	Vrwm=51.0V, Vbr=56.70..69.30V, Ipp=4.39A, 400W(1ms), Bidirectional	DO-214AC	1ba	1j	Cmc
YZ	BZT52-B47S	Z-diode	46.06..47.94V, Izt=2mA, Zzt=170Ω, 200mW	SOD-323FL	7d	1a	Tsc
YZ	BZX284-C6V8	Z-diode	6.8V±5%, 400mW	SOD-110	12d	1a	Phi
YZ	DDZ18C	Z-diode	18V±5%, Izt=10mA, 500mW	SOD-123	5d	1d	Di
YZ	DDZ18CS	Z-diode	18V±5%, Izt=10mA, 200mW	SOD-323	5d	1d	Di
YZ	MM3Z47VB	Z-diode	46.06..47.94V, Zzt=160Ω, Izt=2mA, 200mW	SOD-323FL	7d	1a	F
YZ	MM3Z47VBW	Z-diode	46.06..47.94V, Izt=2mA, Zzt=170Ω, 200mW	SOD-323FL	7d	1a	Tac
YZ	P4SMAJ210AC	TVS	Vbr=170V, 1.2A, 400W (1ms), Bidirectional	DO-214AC	1ba	1x,1y	Pjt,Srj
YZ	P4SMAJ51CA	TVS	Vbr=51V, 4.9A, 400W(1ms), Bidirectional	DO-214AC	1ba	1j	Mco
YZ	PZU3.6BA/DG	Z-diode	3.6V±5%, If=200mA, 320mW, halogen-free	SOD-323	5d	1a	Phi
YZ	SMAJ51CA	TVS	Vrwm=51V, Vbr=56.7..69.3V, 4.9A, 400W(1ms), Bidirectional	DO-214AC	1ba	1l	Vs
YZ	TCM3Z47VB	Z-diode	47V±2%, Izt=5mA, Zzt=160Ω, 200mW	SOD-323FL	7d	1a	Tac
YZ	TV04A510JB-G	TVS	Vrwm=51.0V, Vbr=56.70..62.70V, Ipp=4.85A, 400W(1ms), Bidirectional	DO-214AC	1ba	1j	Cmc
Z	BB145B	C-diode	VCO, 8V, 20mA, 2.55/6.4pF(4V/1V, 1MHz), <0.6Ω	SOD-523	6d	1a	Phi
Z	EP10LA03	Si-diode	SBR, 30V, 1A, Vf<0.39V(1A)	SOD-123	5d	1a	Nih
Z	MMSZ5227BPT	Z-diode	3.420..3.780V, Izt=5mA, Zzt=90Ω, 225mW	SOD-523	7d	1a	Chm



SMD
code

Type

Function

Short description

Case

Pinout

St.

Mnf.

Z-	TCMM3Z51VC	Z-diode	51V±5%, Izt=5mA, Zzt=169Ω, 200mW
-Z	BZT52-B51S	Z-diode	49.98..52.02V, Izt=2mA, Zzt=180Ω, 200mW
-Z	MM3Z51VBW	Z-diode	49.98..52.02V, Izt=2mA, Zzt=180Ω, 200mW
-Z	TCMM3Z51VB	Z-diode	51V±2%, Izt=5mA, Zzt=169Ω, 200mW
Z	MMSZ52Z7SPT	Z-diode	3.528..3.762V, Izt=5mA, Zzt=90Ω, 225mW
Z	MM3Z51VC	Z-diode	48.45..53.55V, Zzt=188Ω, Izt=2mA, 200mW
Z<	MM3Z75VC	Z-diode	71.25..75.78.75.240Q, Izt=2mA, 200mW
Z<	TCMM3Z75VC	Z-diode	75V±5%, Izt=5mA, Zzt=240Ω, 200mW
Z=	MM3Z56VC	Z-diode	53.2..58.8V, Zzt=188Ω, Izt=2mA, 200mW
Z=	TCMM3Z56VC	Z-diode	56V±5%, Izt=5mA, Zzt=188Ω, 200mW
Z>	MM3Z68VC	Z-diode	64.6..71.4V, Zzt=226Ω, Izt=2mA, 200mW
Z>	TCMM3Z68VC	Z-diode	68V±5%, Izt=5mA, Zzt=226Ω, 200mW
Z≡	MM3Z62VC	Z-diode	58.9..65.1V, Zzt=202Ω, Izt=2mA, 200mW
Z-	TCMM3Z62VC	Z-diode	62V±5%, Izt=5mA, Zzt=202Ω, 200mW
Z0	CD0603-Z2	Z-diode	1.9..2.1V, 5mA, Zzt=100Q, 150mW
Z0	CD1005-Z2	Z-diode	1.9..2.1V, 5mA, Zzt=100Q, 200mW
Z0	CZRER52C2	Z-diode	1.90..2.10V, Izt=5mA, Zzt=100Q, 150mW
Z0	CZRERT52C2	Z-diode	1.90..2.10V, Izt=5mA, Zzt=100Q, 150mW
Z0	CZRF52C2	Z-diode	1.90..2.10V, Izt=5mA, Zzt=100Q, 200mW
Z0	CZRF52C2C2	Z-diode	1.90..2.10V, Izt=5mA, Zzt=100Q, 200mW
Z0	CZRQR52C2	Z-diode	1.90..2.10V, Izt=5mA, Zzt=100Q, 125mW
Z0	CZRUR52C2	Z-diode	1.90..2.10V, Izt=5mA, Zzt=100Q, 150mW
Z0	MM3Z2V4C	Z-diode	2.28..2.52V, Zzt=94Ω, Izt=5mA, 200mW
Z0	MM3Z4B3H	Z-diode	4.214..4.386V, Izt=5mA, Zzt=130Q, 300mW
Z0	PDZ2.4B	Z-diode	2.4V±2.5%, 400mW
Z0	TCMM3Z2V4C	Z-diode	2.4V±5%, Izt=5mA, Zzt=94Q, 200mW
Z0	TSZL52C2V0	Z-diode	1.90..2.10V, Izt=5mA, Zzt=100Q, 200mW
Z0	TSZU52C2V0	Z-diode	1.90..2.10V, Izt=5mA, Zzt=100Q, 150mW
Z0G	PD3Z284C5V1	Z-diode	5.1..5.4V, 5mA, Zzt=60, 500mW
Z0H	PD3Z284C5V6	Z-diode	5.6..6.0V, 5mA, Zzt=40, 500mW
Z0K	PD3Z284C6V2	Z-diode	6.2..6.6V, 5mA, Zzt=10, 500mW
Z0L	PD3Z284C6V8	Z-diode	6.8..7.2V, 5mA, Zzt=15, 500mW
Z0M	PD3Z284C7V5	Z-diode	7.5..7.9V, 5mA, Zzt=10, 500mW
Z0N	PD3Z284C8V2	Z-diode	8.2..8.7V, 5mA, Zzt=10, 500mW
Z0P	PD3Z284C9V1	Z-diode	9.1..9.6V, 5mA, Zzt=10, 500mW
Z0Q	PD3Z284C10	Z-diode	10..10.6V, 5mA, Zzt=10, 500mW
Z0R	PD3Z284C11	Z-diode	11..11.6V, 5mA, Zzt=10, 500mW
Z0S	PD3Z284C12	Z-diode	12..12.7V, 5mA, Zzt=10, 500mW
Z1	BZF10C18	Z-diode	17.1..18.9V, Izt=14mA, Zzt=20Q, 1W
Z1	BZT52-C4V7T	Z-diode	4.7V±5%, Izt=5mA, Zzt=80Q, 100mW
Z1	CD0603-Z2V2	Z-diode	2.09..2.31V, 5mA, Zzt=100Q, 150mW
Z1	CD1005-Z2V2	Z-diode	2.09..2.31V, 5mA, Zzt=100Q, 200mW
Z1	CZRER52C2V2	Z-diode	2.09..2.31V, Izt=5mA, Zzt=100Q, 150mW
Z1	CZRERT52C2V2	Z-diode	2.09..2.31V, Izt=5mA, Zzt=100Q, 150mW
Z1	CZRF52C2V2	Z-diode	2.09..2.31V, Izt=5mA, Zzt=100Q, 200mW
Z1	CZRF52C2V2C2	Z-diode	2.09..2.31V, Izt=5mA, Zzt=100Q, 200mW
Z1	CZRQR52C2V2	Z-diode	2.09..2.31V, Izt=5mA, Zzt=100Q, 125mW
Z1	CZRUR52C2V2	Z-diode	2.09..2.31V, Izt=5mA, Zzt=100Q, 150mW
Z1	KL3Z07	Thy-SPD	V Of-St=5.5V, Ifsm=30A(1ms), Ih=50mA, Bidirectional
Z1	KL3Z18	Thy-SPD	V Of-St=15.5V, Ifsm=30A(1ms), Ih=50mA, Bidirectional
Z1	MM3Z2V7C	Z-diode	2.57..2.84V, Zzt=94Q, Izt=5mA, 200mW
Z1	MM3Z5240B	Z-diode	10V±5%, Izt=20mA, Zzt=17Ω, 200mW
Z1	MM3Z5240BH	Z-diode	9.5..10.5V, Izt=20mA, Zzt=17Q, 300mW
Z1	MMSZ4V7	Z-diode	4.7V±5%, Izt=5mA, Zzt=80Q, 200mW
Z1	MMSZ43	Z-diode	43V±5%, Zzt=150Q, 500mW
Z1	PDZ2.7B	Z-diode	2.7V±2.5%, 400mW
Z1	TCMM3Z2V7C	Z-diode	2.7V±5%, Izt=5mA, Zzt=94Q, 200mW
Z1	TSZL52C2V2	Z-diode	2.09..2.31V, Izt=5mA, Zzt=100Q, 200mW
Z1	TSZU52C2V2	Z-diode	2.09..2.31V, Izt=5mA, Zzt=100Q, 150mW
Z1	VGFM02-C18-M	TVS	Vrwm=15.3V, Vbr=17.1..18.9V, 7.95A, 200W(1ms)
Z1	ZD5248BSG	Z-diode	18V±5%, 5mA, Zzt=42Q, 500mW
Z1	ZGFM1018-MH	Z-diode	18V±10%, Zzt=20Q(Izt=14mA), 1W
Z1	ZGFM1018-N	Z-diode	17.1..18.9V, Izt=14mA, Zzt=20Q, 1W
Z10	BZA10C10	Z-diode	9.5..10.5V, Izt=25mA, Zzt=7Q, 1W
Z10	CRZ10	Z-diode	9..11V, 700mW
Z10	CZRA4740-G	Z-diode	10V±5%, Izt=25mA, Zzt=7Q, 1W
Z10	SMAZ10	Z-diode	10V±5%, 50mA, Zzt<4Q, 1W
Z10	SMFZ10V	Z-diode	10.0..11.2V, Izt=40mA, 1W
Z10	ZS4740A	Z-diode	10V±5%, 25mA, Zzt=7Q, 1W
Z10V	MMSZ5240B	Z-diode	9.50..10.50V, Izt=20mA, Zzt=17Ω, 500mW



SMD code	Type	Function	Short description	Case	Pinout	St.	Mnf.
Z10V	MMSZ5240BSW	Z-diode	9.50..10.50V, Izt=20mA, Zzt=17Ω, 200mW	SOD-323FL	7d	1a	Tac
Z10V	MMSZ5240BW	Z-diode	9.50..10.50V, Izt=20mA, Zzt=17Ω, 500mW	SOD-123FL	7d	1a	Tac
Z10V	TCMMSZ5240B	Z-diode	10V±5%, Izt=20mA, Zzt=17Ω, 500mW	SOD-123FL	7d	1a	Tac
Z11	BZA10C11	Z-diode	10.45..11.55V, Izt=23mA, Zzt=8Ω, 1W	SOD-123F	10d	1a	Did
Z11	BZT52-C2V4T	Z-diode	2.4V±5%, Izt=5mA, Zzt=100Ω, 100mW	SOD-523	6d	1a	Mco
Z11	CRZ11	Z-diode	9.9..12.1V, 700mW	S-FLAT	6d	1a	Tos
Z11	CZRA4741-G	Z-diode	11V±5%, Izt=23mA, Zzt=8Ω, 1W	SMA	10d	1a	Cmc
Z11	MMSZ2V4	Z-diode	2.4V±5%, Izt=5mA, Zzt=100Ω, 100mW	SOD-523	6d	1a	Sec
Z11	SMFZ11V	Z-diode	11.0..12.3V, Izt=20mA, 1W	SMF	9d	1c	Kec
Z11	ZS4741A	Z-diode	11V±5%, 23mA, Zzt=8Ω, 1W	SMA-1	10d	1a	Fmm
Z11V	MMSZ5241B	Z-diode	10.45..11.55V, Izt=20mA, Zzt=22Ω, 500mW	SOD-123FL	7d	1a	Tsc
Z11V	MMSZ5241BSW	Z-diode	10.45..11.55V, Izt=20mA, Zzt=22Ω, 500mW	SOD-323FL	7d	1a	Tac
Z11V	MMSZ5241BW	Z-diode	10.45..11.55V, Izt=20mA, Zzt=22Ω, 500mW	SOD-123FL	7d	1a	Tac
Z11V	TCMMSZ5241B	Z-diode	11V±5%, Izt=20mA, Zzt=22Ω, 500mW	SOD-123FL	7d	1a	Tac
Z12	BZA10C12	Z-diode	11.4..12.6V, Izt=21mA, Zzt=9Ω, 1W	SOD-123F	10d	1a	Did
Z12	BZT52-C2V7T	Z-diode	2.7V±5%, Izt=5mA, Zzt=100Ω, 100mW	SOD-523	6d	1a	Mco
Z12	CRZ12	Z-diode	10.8..13.2V, 700mW	S-FLAT	6d	1a	Tos
Z12	CZRA4742-G	Z-diode	12V±5%, Izt=21mA, Zzt=9Ω, 1W	SMA	10d	1a	Cmc
Z12	MMSZ2V7	Z-diode	2.7V±5%, Izt=5mA, Zzt=100Ω, 100mW	SOD-523	6d	1a	Sec
Z12	SMAZ12	Z-diode	12V±5%, 50mA, Zzt<7Ω, 1W	DO-214AC	1d	1a	Exc
Z12	SMFZ12V	Z-diode	12.0..13.5V, Izt=20mA, 1W	SMF	9d	1c	Kec
Z12	ZS4742A	Z-diode	12V±5%, 21mA, Zzt=9Ω, 1W	SMA-1	10d	1a	Fmm
Z12V	MMSZ5242B	Z-diode	11.40..12.60V, Izt=20mA, Zzt=30Ω, 500mW	SOD-123FL	7d	1a	Tsc
Z12V	MMSZ5242BSW	Z-diode	11.40..12.60V, Izt=20mA, Zzt=30Ω, 200mW	SOD-323FL	7d	1a	Tac
Z12V	MMSZ5242BW	Z-diode	11.40..12.60V, Izt=20mA, Zzt=30Ω, 500mW	SOD-123FL	7d	1a	Tac
Z12V	TCMMSZ5242B	Z-diode	12V±5%, Izt=20mA, Zzt=30Ω, 500mW	SOD-123FL	7d	1a	Tac
Z13	BZA10C13	Z-diode	12.35..13.65V, Izt=19mA, Zzt=10Ω, 1W	SOD-123F	10d	1a	Did
Z13	BZT52-C3V0T	Z-diode	3.0V±5%, Izt=5mA, Zzt=95Ω, 100mW	SOD-523	6d	1a	Mco
Z13	CRZ13	Z-diode	11.7..14.3V, 700mW	S-FLAT	6d	1a	Tos
Z13	CZRA4743-G	Z-diode	13V±5%, Izt=19mA, Zzt=10Ω, 1W	SMA	10d	1a	Cmc
Z13	MMSZ3V0	Z-diode	3.0V±5%, Izt=5mA, Zzt=100Ω, 200mW	SOD-523	6d	1a	Sec
Z13	SMFZ13V	Z-diode	13.3..15.0V, Izt=20mA, 1W	SMF	9d	1c	Kec
Z13	ZS4743A	Z-diode	13V±5%, 19mA, Zzt=10Ω, 1W	SMA-1	10d	1a	Fmm
Z13V	MMSZ5243B	Z-diode	12.35..13.65V, Izt=9.5mA, Zzt=13Ω, 500mW	SOD-123FL	7d	1a	Tsc
Z13V	MMSZ5243BSW	Z-diode	12.35..13.65V, Izt=9.5mA, Zzt=13Ω, 200mW	SOD-323FL	7d	1a	Tac
Z13V	MMSZ5243BW	Z-diode	12.35..13.65V, Izt=9.5mA, Zzt=13Ω, 500mW	SOD-123FL	7d	1a	Tac
Z13V	TCMMSZ5243B	Z-diode	13V±5%, Izt=9.5mA, Zzt=13Ω, 500mW	SOD-123FL	7d	1a	Tac
Z14	BZT52-C3V3T	Z-diode	3.3V±5%, Izt=5mA, Zzt=95Ω, 100mW	SOD-523	6d	1a	Mco
Z14	MMSZ3V3	Z-diode	3.3V±5%, Izt=5mA, Zzt=95Ω, 200mW	SOD-523	6d	1a	Sec
Z14V	MMSZ5244B	Z-diode	13.30..14.70V, Izt=9.0mA, Zzt=15Ω, 500mW	SOD-123FL	7d	1a	Tsc
Z14V	MMSZ5244BSW	Z-diode	13.30..14.70V, Izt=9mA, Zzt=15Ω, 200mW	SOD-323FL	7d	1a	Tac
Z14V	MMSZ5244BW	Z-diode	13.30..14.70V, Izt=9mA, Zzt=15Ω, 500mW	SOD-123FL	7d	1a	Tac
Z14V	TCMMSZ5244B	Z-diode	14V±5%, Izt=9mA, Zzt=15Ω, 500mW	SOD-123FL	7d	1a	Tac
Z15	BZA10C15	Z-diode	14.25..15.75V, Izt=17mA, Zzt=14Ω, 1W	SOD-123F	10d	1a	Did
Z15	BZT52-C3V6T	Z-diode	3.6V±5%, Izt=5mA, Zzt=90Ω, 100mW	SOD-523	6d	1a	Mco
Z15	CRZ15	Z-diode	13.5..16.5V, 700mW	S-FLAT	6d	1a	Tos
Z15	CZRA4744-G	Z-diode	15V±5%, Izt=17mA, Zzt=14Ω, 1W	SMA	10d	1a	Cmc
Z15	MMSZ3V6	Z-diode	3.6V±5%, Izt=5mA, Zzt=90Ω, 200mW	SOD-523	6d	1a	Sec
Z15	SMAZ15	Z-diode	15V±5%, 50mA, Zzt<10Ω, 1W	DO-214AC	1d	1a	Exc
Z15	SMFZ15V	Z-diode	14.7..16.5V, Izt=20mA, 1W	SMF	9d	1c	Kec
Z15	ZS4744A	Z-diode	15V±5%, 17mA, Zzt=14Ω, 1W	SMA-1	10d	1a	Fmm
Z15V	MMSZ5245B	Z-diode	14.25..15.75V, Izt=8.5mA, Zzt=16Ω, 500mW	SOD-123FL	7d	1a	Tsc
Z15V	MMSZ5245BSW	Z-diode	14.25..15.75V, Izt=8.5mA, Zzt=16Ω, 200mW	SOD-323FL	7d	1a	Tac
Z15V	MMSZ5245BW	Z-diode	14.25..15.75V, Izt=8.5mA, Zzt=16Ω, 500mW	SOD-123FL	7d	1a	Tac
Z15V	TCMMSZ5245B	Z-diode	15V±5%, Izt=8.5mA, Zzt=16Ω, 500mW	SOD-123FL	7d	1a	Tac
Z16	BZA10C16	Z-diode	15.2..16.8V, Izt=15.5mA, Zzt=16Ω, 1W	SOD-123F	10d	1a	Did
Z16	BZT52-C3V9T	Z-diode	3.9V±5%, Izt=5mA, Zzt=90Ω, 100mW	SOD-523	6d	1a	Mco
Z16	CRZ16	Z-diode	14.4..17.6V, 700mW	S-FLAT	6d	1a	Tos
Z16	CZRA4745-G	Z-diode	16V±5%, Izt=15.5mA, Zzt=16Ω, 1W	SMA	10d	1a	Cmc
Z16	MMSZ3V9	Z-diode	3.9V±5%, Izt=5mA, Zzt=90Ω, 200mW	SOD-523	6d	1a	Sec
Z16	SMAZ16	Z-diode	16V±5%, 25mA, Zzt<15Ω, 1W	DO-214AC	1d	1a	Exc
Z16	SMFZ16V	Z-diode	16.2..18.3V, Izt=20mA, 1W	SMF	9d	1c	Kec
Z16	ZS4745A	Z-diode	16V±5%, 15.5mA, Zzt=16Ω, 1W	SMA-1	10d	1a	Fmm
Z16V	MMSZ5246B	Z-diode	15.20..16.80V, Izt=7.8mA, Zzt=17Ω, 500mW	SOD-123FL	7d	1a	Tsc
Z16V	MMSZ5246BSW	Z-diode	15.20..16.80V, Izt=7.8mA, Zzt=17Ω, 200mW	SOD-323FL	7d	1a	Tac
Z16V	MMSZ5246BW	Z-diode	15.20..16.80V, Izt=7.8mA, Zzt=17Ω, 500mW	SOD-123FL	7d	1a	Tac
Z16V	TCMMSZ5246B	Z-diode	16V±5%, Izt=7.8mA, Zzt=17Ω, 500mW	SOD-123FL	7d	1a	Tac
Z17	BZT52-C4V3T	Z-diode	4.3V±5%, Izt=5mA, Zzt=90Ω, 100mW	SOD-523	6d	1a	Mco
Z17	MMSZ4V3	Z-diode	4.3V±5%, Izt=5mA, Zzt=90Ω, 200mW	SOD-523	6d	1a	Sec
Z17V	MMSZ5247B	Z-diode	16.15..17.85V, Izt=7.4mA, Zzt=19Ω, 500mW	SOD-123FL	7d	1a	Tsc



SMD code	Type	Function	Short description	Case	Pinout	St.	Mnf.
Z17V	MMSZ5247BSW	Z-diode	16.15..17.85V, Izt=7.4mA, Zzt=19Ω, 200mW	SOD-323FL	7d	1a	Tac
Z17V	MMSZ5247BW	Z-diode	16.15..17.85V, Izt=7.4mA, Zzt=19Ω, 500mW	SOD-123FL	7d	1a	Tac
Z17V	TCMMSZ5247B	Z-diode	17V±5%, Izt=7.4mA, Zzt=19Ω, 500mW	SOD-123FL	7d	1a	Tac
Z18	BZA10C18	Z-diode	17.1..18.9V, Izt=14mA, Zzt=20Ω, 1W	SOD-123F	10d	1a	Did
Z18	CRZ18	Z-diode	16.2..19.83V, 700mW	S-FLAT	6d	1a	Tos
Z18	CZRA4746-G	Z-diode	18V±5%, Izt=14mA, Zzt=20Ω, 1W	SMA	10d	1a	Cmc
Z18	SMAZ18	Z-diode	18V±5%, 25mA, Zzt<15Ω, 1W	DO-214AC	1d	1a	Exc
Z18	SMFZ18V	Z-diode	18.0..20.3V, Izt=20mA, 1W	SMF	9d	1c	Kec
Z18	ZS4746A	Z-diode	18V±5%, 14mA, Zzt=20Ω, 1W	SMA-1	10d	1a	Frm
Z18V	MMSZ5248B	Z-diode	17.10..18.9V, Izt=7.0mA, Zzt=21Ω, 500mW	SOD-123FL	7d	1a	Tsc
Z18V	MMSZ5248BSW	Z-diode	17.10..18.90V, Izt=7mA, Zzt=21Ω, 200mW	SOD-323FL	7d	1a	Tac
Z18V	MMSZ5248BW	Z-diode	17.10..18.90V, Izt=7mA, Zzt=21Ω, 500mW	SOD-123FL	7d	1a	Tac
Z18V	TCMMSZ5248B	Z-diode	18V±5%, Izt=7mA, Zzt=21Ω, 500mW	SOD-123FL	7d	1a	Tac
Z19V	MMSZ5249B	Z-diode	18.05..19.95V, Izt=6.6mA, Zzt=23Ω, 500mW	SOD-123FL	7d	1a	Tsc
Z19V	MMSZ5249BSW	Z-diode	18.05..19.95V, Izt=6.6mA, Zzt=23Ω, 200mW	SOD-323FL	7d	1a	Tac
Z19V	MMSZ5249BW	Z-diode	18.05..19.95V, Izt=6.6mA, Zzt=23Ω, 500mW	SOD-123FL	7d	1a	Tac
Z19V	TCMMSZ5249B	Z-diode	19V±5%, Izt=6.6mA, Zzt=23Ω, 500mW	SOD-123FL	7d	1a	Tac
Z2	BZF10C20	Z-diode	19.0..21.0V, Izt=12.5mA, Zzt=22Ω, 1W	SOD-123F	10d	1a	Did
Z2	BZT52-C5V1T	Z-diode	5.1V±5%, Izt=5mA, Zzt=60Ω, 100mW	SOD-523	6d	1a	Mco
Z2	CD0603-Z2V4	Z-diode	2.28..2.52V, 5mA, Zzt=85Ω, 150mW	0603	13d	2b	Bm
Z2	CD1005-Z2V4	Z-diode	2.28..2.52V, 5mA, Zzt=85Ω, 200mW	1005	13d	2b	Bm
Z2	CZRER52C2V4	Z-diode	2.28..2.52V, Izt=5mA, Zzt=85Ω, 150mW	0503	13d	2b	Cmc
Z2	CZRERT52C2V4	Z-diode	2.28..2.52V, Izt=5mA, Zzt=85Ω, 150mW	0503	13d	2b	Cmc
Z2	CZRF52C2V4	Z-diode	2.28..2.52V, Izt=5mA, Zzt=85Ω, 200mW	1005	13d	2b	Cmc
Z2	CZRF52C2V4	Z-diode	2.28..2.52V, Izt=5mA, Zzt=85Ω, 200mW	1005	13d	2b	Cmc
Z2	CZRF52C2V4	Z-diode	2.28..2.52V, Izt=5mA, Zzt=85Ω, 200mW	1005	13d	2b	Cmc
Z2	CZRQR52C2V4	Z-diode	2.28..2.52V, Izt=5mA, Zzt=85Ω, 125mW	0402	13d	2b	Cmc
Z2	CZRUR52C2V4	Z-diode	2.28..2.52V, Izt=5mA, Zzt=85Ω, 150mW	0603	13d	2b	Cmc
Z2	MM3Z3V0C	Z-diode	2.85..3.15V, Zzt=89Ω, Izt=5mA, 200mW	SOD-323FL	7d	1a	F
Z2	MM3Z5261B	Z-diode	47V±5%, Izt=2.7mA, Zzt=105Ω, 200mW	SOD-323FL	7d	1a	Bts
Z2	MM3Z5261BH	Z-diode	44.65..49.35V, Izt=2.7mA, Zzt=105Ω, 300mW	SOD-323	5d	1a	Zow
Z2	MMSZ5V1	Z-diode	5.1V±5%, Izt=5mA, Zzt=60Ω, 200mW	SOD-523	6d	1a	Sec
Z2	MMSZ47	Z-diode	47V±5%, Zzt=170Ω, 500mW	SOD-123	5d	1a	Mot
Z2	PDZ3.0B	Z-diode	3.0V±2.5%, 400mW	SOD-323	5d	1a	Phi
Z2	TCMM3Z3V0C	Z-diode	3.0V±5%, Izt=5mA, Zzt=89Ω, 200mW	SOD-323FL	7d	1a	Tac
Z2	TSZL52C2V4	Z-diode	2.28..2.52V, Izt=5mA, Zzt=85Ω, 200mW	1005	70d	2d	Tsc
Z2	TSZU52C2V4	Z-diode	2.28..2.52V, Izt=5mA, Zzt=85Ω, 150mW	0603	70d	2d	Tsc
Z2	VGFM02-C20-M	TVS	Vrwm=17.1V, Vbr=19.0..21.0V, 7.20A, 200W(1ms)	SOD-123F	10d	1a	Frm
Z2	ZD5250BSG	Z-diode	20V±5%, 5mA, Zzt=48Ω, 500mW	SOD-323-S	7d	1a	Cys
Z2	ZGFM1020-MH	Z-diode	20V±10%, Zzt=22Ω(Izt=12mA), 1W	SOD-123H	10d	1a	Frm
Z2	ZGFM1020-N	Z-diode	19.0..21.0V, Izt=12.5mA, Zzt=22Ω, 1W	SOD-123F	10d	1a	Frm
Z20	BZA10C20	Z-diode	19..21V, Izt=12.5mA, Zzt=22Ω, 1W	SOD-123F	10d	1a	Did
Z20	CRZ20	Z-diode	18.0..22.04V, 700mW	S-FLAT	6d	1a	Tos
Z20	CZRA4747-G	Z-diode	20V±5%, Izt=12.5mA, Zzt=22Ω, 1W	SMA	10d	1a	Cmc
Z20	SMAZ20	Z-diode	20V±5%, 25mA, Zzt<15Ω, 1W	DO-214AC	1d	1a	Exc
Z20	SMFZ20V	Z-diode	20.0..22.4V, Izt=20mA, 1W	SMF	9d	1c	Kec
Z20	ZS4747A	Z-diode	20V±5%, 12.5mA, Zzt=22Ω, 1W	SMA-1	10d	1a	Frm
Z20V	MMSZ5250B	Z-diode	19.0..21.0V, Izt=6.2mA, Zzt=25Ω, 500mW	SOD-123FL	7d	1a	Tsc
Z20V	MMSZ5250BSW	Z-diode	19.0..21.0V, Izt=6.2mA, Zzt=25Ω, 200mW	SOD-323FL	7d	1a	Tac
Z20V	MMSZ5250BW	Z-diode	19.0..21.0V, Izt=6.2mA, Zzt=25Ω, 500mW	SOD-123FL	7d	1a	Tac
Z20V	TCMMSZ5250B	Z-diode	20V±5%, Izt=6.2mA, Zzt=25Ω, 500mW	SOD-123FL	7d	1a	Tac
Z22	BZA10C22	Z-diode	20.9..23.1V, Izt=11.5mA, Zzt=23Ω, 1W	SOD-123F	10d	1a	Did
Z22	CRZ22	Z-diode	19.8..24.26V, 700mW	S-FLAT	6d	1a	Tos
Z22	CZRA4748-G	Z-diode	22V±5%, Izt=11.5mA, Zzt=23Ω, 1W	SMA	10d	1a	Cmc
Z22	SMAZ22	Z-diode	22V±5%, 25mA, Zzt<15Ω, 1W	DO-214AC	1d	1a	Exc
Z22	SMFZ22V	Z-diode	22.0..24.5V, Izt=10mA, 1W	SMF	9d	1c	Kec
Z22	ZS4748A	Z-diode	22V±5%, 11.5mA, Zzt=23Ω, 1W	SMA-1	10d	1a	Frm
Z22V	MMSZ5251B	Z-diode	20.90..23.10V, Izt=5.6mA, Zzt=29Ω, 500mW	SOD-123FL	7d	1a	Tsc
Z22V	MMSZ5251BSW	Z-diode	20.90..23.10V, Izt=5.6mA, Zzt=29Ω, 200mW	SOD-323FL	7d	1a	Tac
Z22V	MMSZ5251BW	Z-diode	20.90..23.10V, Izt=5.6mA, Zzt=29Ω, 500mW	SOD-123FL	7d	1a	Tac
Z22V	TCMMSZ5251B	Z-diode	22V±5%, Izt=5.6mA, Zzt=29Ω, 500mW	SOD-123FL	7d	1a	Tac
Z24	BZA10C24	Z-diode	22.8..25.2V, Izt=10.5mA, Zzt=25Ω, 1W	SOD-123F	10d	1a	Did
Z24	CRZ24	Z-diode	21.6..26.47V, 700mW	S-FLAT	6d	1a	Tos
Z24	CZRA4749-G	Z-diode	24V±5%, Izt=10.5mA, Zzt=25Ω, 1W	SMA	10d	1a	Cmc
Z24	SMAZ24	Z-diode	24V±5%, 25mA, Zzt<15Ω, 1W	DO-214AC	1d	1a	Exc
Z24	SMFZ24V	Z-diode	24.0..27.6V, Izt=10mA, 1W	SMF	9d	1c	Kec
Z24	ZS4749A	Z-diode	24V±5%, 10.5mA, Zzt=25Ω, 1W	SMA-1	10d	1a	Frm
Z24V	MMSZ5252B	Z-diode	22.80..25.20V, Izt=5.2mA, Zzt=33Ω, 500mW	SOD-123FL	7d	1a	Tsc
Z24V	MMSZ5252BSW	Z-diode	22.80..25.20V, Izt=5.2mA, Zzt=33Ω, 200mW	SOD-323FL	7d	1a	Tac
Z24V	MMSZ5252BW	Z-diode	22.80..25.20V, Izt=5.2mA, Zzt=33Ω, 500mW	SOD-123FL	7d	1a	Tac
Z24V	TCMMSZ5252B	Z-diode	24V±5%, Izt=5.2mA, Zzt=33Ω, 500mW	SOD-123FL	7d	1a	Tac



SMD
code

Type

Function

Short description

Case

Pinout

St.

Mnf.

Z25V	MMSZ5253B	Z-diode	23.75..26.25V, Izt=5mA, Zzt=35Ω, 500mW	SOD-123FL	7d	1a	Tsc
Z25V	MMSZ5253BSW	Z-diode	23.75..26.25V, Izt=5mA, Zzt=35Ω, 200mW	SOD-323FL	7d	1a	Tac
Z25V	MMSZ5253BW	Z-diode	23.75..26.25V, Izt=5mA, Zzt=35Ω, 500mW	SOD-123FL	7d	1a	Tac
Z25V	TCMMSZ5253B	Z-diode	25V±5%, Izt=5mA, Zzt=35Ω, 500mW	SOD-123FL	7d	1a	Tac
Z27	BZA10C27	Z-diode	25.65..28.35V, Izt=9.5mA, Zzt=35Ω, 1W	SOD-123F	10d	1a	Did
Z27	CRZ27	Z-diode	24.3..29.7V, 700mW	S-FLAT	6d	1a	Tos
Z27	CZRA4750-G	Z-diode	27V±5%, Izt=9.5mA, Zzt=35Ω, 1W	SMA	10d	1a	Cmc
Z27	SMAZ27	Z-diode	27V±5%, 25mA, Zzt<15Ω, 1W	DO-214AC	1d	1a	Exc
Z27	SMFZ27V	Z-diode	27.0..30.8V, Izt=10mA, 1W	SMF	9d	1c	Kec
Z27	U5ZA27Z	Z-diode	24..30V, Zzt=30Ω, 5W	DO-218	8d	1a	Tos
Z27	ZS4750A	Z-diode	27V±5%, 9.5mA, Zzt=35Ω, 1W	SMA-1	10d	1a	Fmm
Z27V	MMSZ5254B	Z-diode	25.65..28.35V, Izt=4.6mA, Zzt=41Ω, 500mW	SOD-123FL	7d	1a	Tsc
Z27V	MMSZ5254BSW	Z-diode	25.65..28.35V, Izt=4.6mA, Zzt=41Ω, 200mW	SOD-323FL	7d	1a	Tac
Z27V	MMSZ5254BW	Z-diode	25.65..28.35V, Izt=4.6mA, Zzt=41Ω, 500mW	SOD-123FL	7d	1a	Tac
Z27V	TCMMSZ5254B	Z-diode	27V±5%, Izt=4.6mA, Zzt=41Ω, 500mW	SOD-123FL	7d	1a	Tac
Z28V	MMSZ5255B	Z-diode	26.60..29.40V, Izt=4.5mA, Zzt=44Ω, 500mW	SOD-123FL	7d	1a	Tsc
Z28V	MMSZ5255BSW	Z-diode	26.60..29.40V, Izt=4.5mA, Zzt=44Ω, 200mW	SOD-323FL	7d	1a	Tac
Z28V	MMSZ5255BW	Z-diode	26.60..29.40V, Izt=4.5mA, Zzt=44Ω, 500mW	SOD-123FL	7d	1a	Tac
Z28V	TCMMSZ5255B	Z-diode	28V±5%, Izt=4.5mA, Zzt=44Ω, 500mW	SOD-123FL	7d	1a	Tac
Z2V4	MMSZ5221B	Z-diode	2.28..2.52V, Izt=20mA, Zzt=30Ω, 500mW	SOD-123FL	7d	1a	Tsc
Z2V4	MMSZ5221BSW	Z-diode	2.28..2.52V, Izt=20mA, Zzt=30Ω, 200mW	SOD-323FL	7d	1a	Tac
Z2V4	MMSZ5221BW	Z-diode	2.28..2.52V, Izt=20mA, Zzt=30Ω, 500mW	SOD-123FL	7d	1a	Tac
Z2V4	TCMMSZ5221B	Z-diode	2.4V±5%, Izt=20mA, Zzt=30Ω, 500mW	SOD-123FL	7d	1a	Tac
Z2V5	MMSZ5222B	Z-diode	2.38..2.63V, Izt=20mA, Zzt=30Ω, 500mW	SOD-123FL	7d	1a	Tsc
Z2V5	MMSZ5222BSW	Z-diode	2.38..2.63V, Izt=20mA, Zzt=30Ω, 200mW	SOD-323FL	7d	1a	Tac
Z2V5	MMSZ5222BW	Z-diode	2.38..2.63V, Izt=20mA, Zzt=30Ω, 500mW	SOD-123FL	7d	1a	Tac
Z2V5	TCMMSZ5222B	Z-diode	2.5V±5%, Izt=20mA, Zzt=30Ω, 500mW	SOD-123FL	7d	1a	Tac
Z2V7	MMSZ5223B	Z-diode	2.57..2.84V, Izt=20mA, Zzt=30Ω, 500mW	SOD-123FL	7d	1a	Tsc
Z2V7	MMSZ5223BSW	Z-diode	2.57..2.84V, Izt=20mA, Zzt=30Ω, 200mW	SOD-323FL	7d	1a	Tac
Z2V7	MMSZ5223BW	Z-diode	2.57..2.84V, Izt=20mA, Zzt=30Ω, 500mW	SOD-123FL	7d	1a	Tac
Z2V7	TCMMSZ5223B	Z-diode	2.7V±5%, Izt=20mA, Zzt=30Ω, 500mW	SOD-123FL	7d	1a	Tac
Z2V8	MMSZ5224B	Z-diode	2.66..2.94V, Izt=20mA, Zzt=30Ω, 500mW	SOD-123FL	7d	1a	Tsc
Z2V8	MMSZ5224BSW	Z-diode	2.66..2.94V, Izt=20mA, Zzt=30Ω, 200mW	SOD-323FL	7d	1a	Tac
Z2V8	MMSZ5224BW	Z-diode	2.66..2.94V, Izt=20mA, Zzt=30Ω, 500mW	SOD-123FL	7d	1a	Tac
Z2V8	TCMMSZ5224B	Z-diode	2.8V±5%, Izt=20mA, Zzt=30Ω, 500mW	SOD-123FL	7d	1a	Tac
Z3	BZF10C22	Z-diode	20.9..23.1V, Izt=11.5mA, Zzt=23Ω, 1W	SOD-123F	10d	1a	Did
Z3	BZT52-C5V6T	Z-diode	5.6V±5%, Izt=5mA, Zzt=40Ω, 100mW	SOD-523	6d	1a	Mco
Z3	CD0603-Z2V7	Z-diode	2.57..2.84V, 5mA, Zzt=83Ω, 150mW	0603	13d	2b	Bm
Z3	CD1005-Z2V7	Z-diode	2.57..2.84V, 5mA, Zzt=83Ω, 200mW	1005	13d	2b	Bm
Z3	CZRR52C2V7	Z-diode	2.57..2.84V, Izt=5mA, Zzt=83Ω, 150mW	0503	13d	2b	Cmc
Z3	CZRR52C2V7	Z-diode	2.57..2.84V, Izt=5mA, Zzt=83Ω, 150mW	0503	13d	2b	Cmc
Z3	CZRF52C2V7	Z-diode	2.57..2.84V, Izt=5mA, Zzt=83Ω, 200mW	1005	13d	2b	Cmc
Z3	CZRF52C2V7	Z-diode	2.57..2.84V, Izt=5mA, Zzt=83Ω, 200mW	1005	13d	2b	Cmc
Z3	CZRR52C2V7	Z-diode	2.57..2.84V, Izt=5mA, Zzt=83Ω, 125mW	0402	13d	2b	Cmc
Z3	CZRUR52C2V7	Z-diode	2.57..2.84V, Izt=5mA, Zzt=83Ω, 150mW	0603	13d	2b	Cmc
Z3	MM3Z3V3C	Z-diode	3.14..3.47V, Zzt=89Ω, Izt=5mA, 200mW	SOD-323FL	7d	1a	F
Z3	MMSZ5V6	Z-diode	5.6V±5%, Izt=5mA, Zzt=40Ω, 200mW	SOD-523	6d	1a	Sec
Z3	MMSZ51	Z-diode	51V±5%, Zzt=180Ω, 500mW	SOD-123	5d	1a	Mot
Z3	PDZ3 3B	Z-diode	3.3V±2.5%, 400mW	SOD-323	5d	1a	Phi
Z3	TCMM3Z3V3C	Z-diode	3.3V±5%, Izt=5mA, Zzt=89Ω, 200mW	SOD-323FL	7d	1a	Tac
Z3	TSZL52C2V7	Z-diode	2.57..2.84V, Izt=5mA, Zzt=83Ω, 200mW	1005	70d	2d	Tsc
Z3	TSZU52C2V7	Z-diode	2.57..2.84V, Izt=5mA, Zzt=83Ω, 150mW	0603	70d	2d	Tsc
Z3	VGFM02-C22-M	TVS	Vrwm=18.8V, Vbr=20.9..23.1V, 6.55A, 200W(1ms)	SOD-123F	10d	1a	Fmm
Z3	ZD5251BSG	Z-diode	22V±5%, 5mA, Zzt=55Ω, 500mW	SOD-323-S	7d	1a	Cys
Z3	ZGFM1022-MH	Z-diode	22V±10%, Zzt=23Ω(Izt=11.5mA), 1W	SOD-123H	10d	1a	Fmm
Z3	ZGFM1022-N	Z-diode	20.9..23.1V, Izt=11.5mA, Zzt=23Ω, 1W	SOD-123F	10d	1a	Fmm
Z30	BZA10C30	Z-diode	28.5..31.5V, Izt=8.5mA, Zzt=40Ω, 1W	SOD-123F	10d	1a	Did
Z30	CRZ30	Z-diode	27..33V, 700mW	S-FLAT	6d	1a	Tos
Z30	CZRA4751-G	Z-diode	30V±5%, Izt=8.5mA, Zzt=40Ω, 1W	SMA	10d	1a	Cmc
Z30	SMAZ30	Z-diode	30V±5%, 25mA, Zzt<15Ω, 1W	DO-214AC	1d	1a	Exc
Z30	SMFZ30V	Z-diode	30.0..34.0V, Izt=10mA, 1W	SMF	9d	1c	Kec
Z30	ZS4751A	Z-diode	30V±5%, 8.5mA, Zzt=40Ω, 1W	SMA-1	10d	1a	Fmm
Z30V	MMSZ5256B	Z-diode	28.50..31.50V, Izt=4.2mA, Zzt=49Ω, 500mW	SOD-123FL	7d	1a	Tsc
Z30V	MMSZ5256BSW	Z-diode	28.50..31.50V, Izt=4.2mA, Zzt=49Ω, 200mW	SOD-323FL	7d	1a	Tac
Z30V	MMSZ5256BW	Z-diode	28.50..31.50V, Izt=4.2mA, Zzt=49Ω, 500mW	SOD-123FL	7d	1a	Tac
Z30V	TCMMSZ5256B	Z-diode	30V±5%, Izt=4.2mA, Zzt=49Ω, 500mW	SOD-123FL	7d	1a	Tac
Z33	BZA10C33	Z-diode	31.35..34.65V, Izt=7.5mA, Zzt=45Ω, 1W	SOD-123F	10d	1a	Did
Z33	CRZ33	Z-diode	29.7..36.3V, 700mW	S-FLAT	6d	1a	Tos
Z33	CZRA4752-G	Z-diode	33V±5%, Izt=7.5mA, Zzt=45Ω, 1W	SMA	10d	1a	Cmc
Z33	SMAZ33	Z-diode	33V±5%, 25mA, Zzt<15Ω, 1W	DO-214AC	1d	1a	Exc



SMD
code

Type

Function

Short description

Case

Pinout

St.

Mnf.

SMD code	Type	Function	Short description	Case	Pinout	St.	Mnf.
Z33	SMFZ33V	Z-diode	33.0.37.0V, Izt=10mA, 1W	SMF	9d	1c	Kec
Z33	ZS4752A	Z-diode	33V±5%, 7.5mA, Zzt=45Ω, 1W	SMA-1	10d	1a	Frm
Z33V	MMSZ5257B	Z-diode	31.35.34.65V, Izt=3.8mA, Zzt=58Ω, 500mW	SOD-123FL	7d	1a	Tsc
Z33V	MMSZ5257BSW	Z-diode	31.35.34.65V, Izt=3.8mA, Zzt=58Ω, 200mW	SOD-323FL	7d	1a	Tac
Z33V	MMSZ5257BW	Z-diode	31.35.34.65V, Izt=3.8mA, Zzt=58Ω, 500mW	SOD-123FL	7d	1a	Tac
Z33V	TCMMSZ5257B	Z-diode	33V±5%, Izt=3.8mA, Zzt=58Ω, 500mW	SOD-123FL	7d	1a	Tac
Z36	BZA10C36	Z-diode	34.2.37.8V, Izt=7mA, Zzt=50Ω, 1W	SOD-123F	10d	1a	Did
Z36	CRZ36	Z-diode	32.4.39.6V, 700mW	S-FLAT	6d	1a	Tos
Z36	CZRA4753-G	Z-diode	36V±5%, Izt=7mA, Zzt=50Ω, 1W	SMA	10d	1a	Cmc
Z36	SMAZ36	Z-diode	36V±5%, 10mA, Zzt<40Ω, 1W	DO-214AC	1d	1a	Exc
Z36	SMFZ36V	Z-diode	36.0.40.0V, Izt=10mA, 1W	SMF	9d	1c	Kec
Z36	ZS4753A	Z-diode	36V±5%, 7mA, Zzt=50Ω, 1W	SMA-1	10d	1a	Frm
Z36V	MMSZ5258B	Z-diode	34.20.37.80V, Izt=3.4mA, Zzt=70Ω, 500mW	SOD-123FL	7d	1a	Tsc
Z36V	MMSZ5258BSW	Z-diode	34.20.37.80V, Izt=3.4mA, Zzt=70Ω, 200mW	SOD-323FL	7d	1a	Tac
Z36V	MMSZ5258BW	Z-diode	34.20.37.80V, Izt=3.4mA, Zzt=70Ω, 500mW	SOD-123FL	7d	1a	Tac
Z36V	TCMMSZ5258B	Z-diode	36V±5%, Izt=3.4mA, Zzt=70Ω, 500mW	SOD-123FL	7d	1a	Tac
Z39	CRZ39	Z-diode	35.1.42.9V, 700mW	S-FLAT	6d	1a	Tos
Z39	SMAZ39	Z-diode	39V±5%, 10mA, Zzt<40Ω, 1W	DO-214AC	1d	1a	Exc
Z39V	MMSZ5259B	Z-diode	37.05.40.95V, Izt=3.2mA, Zzt=80Ω, 500mW	SOD-123FL	7d	1a	Tsc
Z39V	MMSZ5259BSW	Z-diode	37.05.40.95V, Izt=3.2mA, Zzt=80Ω, 200mW	SOD-323FL	7d	1a	Tac
Z39V	MMSZ5259BW	Z-diode	37.05.40.95V, Izt=3.2mA, Zzt=80Ω, 500mW	SOD-123FL	7d	1a	Tac
Z39V	TCMMSZ5259B	Z-diode	39V±5%, Izt=3.2mA, Zzt=80Ω, 500mW	SOD-123FL	7d	1a	Tac
Z3V0	MMSZ5225B	Z-diode	2.85.3.15V, Izt=20mA, Zzt=29Ω, 500mW	SOD-123FL	7d	1a	Tsc
Z3V0	MMSZ5225BSW	Z-diode	2.85.3.15V, Izt=20mA, Zzt=29Ω, 200mW	SOD-323FL	7d	1a	Tac
Z3V0	MMSZ5225BW	Z-diode	2.85.3.15V, Izt=20mA, Zzt=29Ω, 500mW	SOD-123FL	7d	1a	Tac
Z3V0	TCMMSZ5225B	Z-diode	3.0V±5%, Izt=20mA, Zzt=29Ω, 500mW	SOD-123FL	7d	1a	Tac
Z3V3	BZA10C39	Z-diode	37.05.40.95V, Izt=7mA, Zzt=10Ω, 1W	SOD-123F	10d	1a	Did
Z3V3	BZA10C3V3	Z-diode	3.135.3.465 V, Izt=7mA, Zzt=10Ω, 1W	SOD-123F	10d	1a	Did
Z3V3	CZRA4728-G	Z-diode	3.3V±5%, Izt=76mA, Zzt=10Ω, 1W	SMA	10d	1a	Cmc
Z3V3	MMSZ5226B	Z-diode	3.14.3.47V, Izt=20mA, Zzt=28Ω, 500mW	SOD-123FL	7d	1a	Tsc
Z3V3	MMSZ5226BSW	Z-diode	3.14.3.47V, Izt=20mA, Zzt=28Ω, 200mW	SOD-323FL	7d	1a	Tac
Z3V3	MMSZ5226BW	Z-diode	3.14.3.47V, Izt=20mA, Zzt=28Ω, 500mW	SOD-123FL	7d	1a	Tac
Z3V3	TCMMSZ5226B	Z-diode	3.3V±5%, Izt=20mA, Zzt=28Ω, 500mW	SOD-123FL	7d	1a	Tac
Z3V3	ZS4728A	Z-diode	3.3V±5%, 76mA, Zzt=10Ω, 1W	SMA-1	10d	1a	Frm
Z3V6	BZA10C3V6	Z-diode	3.42.3.78V, Izt=69mA, Zzt=10Ω, 1W	SOD-123F	10d	1a	Did
Z3V6	BZA10C43	Z-diode	40.85.45.15V, Izt=69mA, Zzt=10Ω, 1W	SOD-123F	10d	1a	Did
Z3V6	CZRA4729-G	Z-diode	3.6V±5%, Izt=69mA, Zzt=10Ω, 1W	SMA	10d	1a	Cmc
Z3V6	MMSZ5227B	Z-diode	3.42.3.78V, Izt=20mA, Zzt=24Ω, 500mW	SOD-123FL	7d	1a	Tsc
Z3V6	MMSZ5227BSW	Z-diode	3.42.3.78V, Izt=20mA, Zzt=24Ω, 200mW	SOD-323FL	7d	1a	Tac
Z3V6	MMSZ5227BW	Z-diode	3.42.3.78V, Izt=20mA, Zzt=24Ω, 500mW	SOD-123FL	7d	1a	Tac
Z3V6	TCMMSZ5227B	Z-diode	3.6V±5%, Izt=20mA, Zzt=24Ω, 500mW	SOD-123FL	7d	1a	Tac
Z3V6	ZS4729A	Z-diode	3.6V±5%, 69mA, Zzt=10Ω, 1W	SMA-1	10d	1a	Frm
Z3V9	BZA10C3V9	Z-diode	3.705.4.095V, Izt=64mA, Zzt=9Ω, 1W	SOD-123F	10d	1a	Did
Z3V9	CZRA4730-G	Z-diode	3.9V±5%, Izt=64mA, Zzt=9Ω, 1W	SMA	10d	1a	Cmc
Z3V9	MMSZ5228B	Z-diode	3.71.4.10V, Izt=20mA, Zzt=23Ω, 500mW	SOD-123FL	7d	1a	Tsc
Z3V9	MMSZ5228BSW	Z-diode	3.71.4.10V, Izt=20mA, Zzt=23Ω, 200mW	SOD-323FL	7d	1a	Tac
Z3V9	MMSZ5228BW	Z-diode	3.71.4.10V, Izt=20mA, Zzt=23Ω, 500mW	SOD-123FL	7d	1a	Tac
Z3V9	TCMMSZ5228B	Z-diode	3.9V±5%, Izt=20mA, Zzt=23Ω, 500mW	SOD-123FL	7d	1a	Tac
Z3V9	ZS4730A	Z-diode	3.9V±5%, 64mA, Zzt=9Ω, 1W	SMA-1	10d	1a	Frm
Z4	BZF10C24	Z-diode	22.8.25.2V, Izt=10.5mA, Zzt=25Ω, 1W	SOD-123F	10d	1a	Did
Z4	BZT52-C6VZT	Z-diode	6.2V±5%, Izt=5mA, Zzt=10Ω, 100mW	SOD-523	6d	1a	Mco
Z4	CD0603-Z3	Z-diode	2.85.3.15V, 5mA, Zzt=95Ω, 150mW	0603	13d	2b	Bm
Z4	CD1005-Z3	Z-diode	2.85.3.15V, 5mA, Zzt=95Ω, 200mW	1005	13d	2b	Bm
Z4	CZRER52C3	Z-diode	2.85.3.15V, Izt=5mA, Zzt=95Ω, 150mW	0503	13d	2b	Cmc
Z4	CZRERT52C3	Z-diode	2.85.3.15V, Izt=5mA, Zzt=95Ω, 150mW	0503	13d	2b	Cmc
Z4	CZRF52C3	Z-diode	2.85.3.15V, Izt=5mA, Zzt=95Ω, 200mW	1005	13d	2b	Cmc
Z4	CZRFR52C3	Z-diode	2.85.3.15V, Izt=5mA, Zzt=95Ω, 200mW	1005	13d	2b	Cmc
Z4	CZRQR52C3	Z-diode	2.85.3.15V, Izt=5mA, Zzt=95Ω, 125mW	0402	13d	2b	Cmc
Z4	CZRUR52C3	Z-diode	2.85.3.15V, Izt=5mA, Zzt=95Ω, 150mW	0603	13d	2b	Cmc
Z4	MM1Z5240B	Z-diode	9.50.10.50V, Izt=20mA, Zzt=17Ω, 500mW	SOD-323FL	5d	1a	Eic
Z4	MM1Z5240BH	Z-diode	9.5.10.5V, Izt=20mA, Zzt=17Ω, 500mW	SOD-123	5d	1a	Zow
Z4	MM3Z3V6C	Z-diode	3.42.3.78V, Zzt=84Ω, Izt=5mA, 200mW	SOD-323FL	7d	1a	F
Z4	MMSZ6V2	Z-diode	6.2V±5%, Izt=5mA, Zzt=10Ω, 200mW	SOD-523	6d	1a	Sec
Z4	MMSZ5240B	Z-diode	10V±5%, Izt=20mA, Zzt=17Ω, 500mW	SOD-123	5d	1a	Eic
Z4	MMSZ56	Z-diode	56V±5%, Zzt=200Ω, 500mW	SOD-123	5d	1a	Mot
Z4	PDZ3.6B	Z-diode	3.6V±2.5%, 400mW	SOD-323	5d	1a	Phi
Z4	TCMM3Z3V6C	Z-diode	3.6V±5%, Izt=5mA, Zzt=84Ω, 200mW	SOD-323FL	7d	1a	Tac
Z4	TSZL52C3V0	Z-diode	2.85.3.15V, Izt=5mA, Zzt=95Ω, 200mW	1005	70d	2d	Tsc
Z4	TSZU52C3V0	Z-diode	2.85.3.15V, Izt=5mA, Zzt=95Ω, 150mW	0603	70d	2d	Tsc
Z4	VGFM02-C24-M	TVS	Vrwm=20.5V, Vbr=22.8.25.2V, 6.0A, 200W(1ms)	SOD-123F	10d	1a	Frm



SMD
code

Type

Function

Short description

Case

Pinout

St.

Mnf.

SMD code	Type	Function	Short description	Case	Pinout	St.	Mnf.
Z4	ZD5252BSG	Z-diode	24V±5%, 5mA, Zzt=62Ω, 500mW	SOD-323-S	7d	1a	Cys
Z4	ZGFM1024-MH	Z-diode	24V±10%, Zzt=25Ω(lzt=10.5mA), 1W	SOD-123H	10d	1a	Fmm
Z4	ZGFM1024-N	Z-diode	22.8..25.2V, lzt=10.5mA, Zzt=25Ω, 1W	SOD-123F	10d	1a	Fmm
Z43	CRZ43	Z-diode	38.7..47.3V, 700mW	S-FLAT	6d	1a	Tos
Z43V	MMSZ5260B	Z-diode	40.85..45.15V, lzt=3.0mA, Zzt=93Ω, 500mW	SOD-123FL	7d	1a	Tsc
Z43V	MMSZ5260BSW	Z-diode	40.85..45.15V, lzt=3mA, Zzt=93Ω, 200mW	SOD-323FL	7d	1a	Tac
Z43V	MMSZ5260BW	Z-diode	40.85..45.15V, lzt=3mA, Zzt=93Ω, 500mW	SOD-123FL	7d	1a	Tac
Z43V	TCMMSZ5260B	Z-diode	43V±5%, lzt=3.93mA, Zzt=93Ω, 500mW	SOD-123FL	7d	1a	Tac
Z46	BAT46Z	Si-diode	SBD, 100V, 150mA, Vf<1V(250mA), 6pF	SOD-123	5d	1d	Ste
Z47	CRZ47	Z-diode	42.3..51.7V, 700mW	S-FLAT	6d	1a	Tos
Z47V	MMSZ5261B	Z-diode	44.65..49.35V, lzt=2.7mA, Zzt=105Ω, 500mW	SOD-123FL	7d	1a	Tsc
Z47V	MMSZ5261BSW	Z-diode	44.65..49.35V, lzt=2.7mA, Zzt=105Ω, 200mW	SOD-323FL	7d	1a	Tac
Z47V	MMSZ5261BW	Z-diode	44.65..49.35V, lzt=2.7mA, Zzt=105Ω, 500mW	SOD-123FL	7d	1a	Tac
Z47V	TCMMSZ5261B	Z-diode	47V±5%, lzt=2.7mA, Zzt=105Ω, 500mW	SOD-123FL	7d	1a	Tac
Z4V3	BZA10C4V3	Z-diode	4.085..4.515V, lzt=58mA, Zzt=9Ω, 1W	SOD-123F	10d	1a	Did
Z4V3	CZRA4731-G	Z-diode	4.3V±5%, lzt=58mA, Zzt=9Ω, 1W	SMA	10d	1a	Cmc
Z4V3	MMSZ5229B	Z-diode	4.09..4.52V, lzt=20mA, Zzt=22Ω, 500mW	SOD-123FL	7d	1a	Tsc
Z4V3	MMSZ5229BSW	Z-diode	4.09..4.52V, lzt=20mA, Zzt=22Ω, 200mW	SOD-323FL	7d	1a	Tac
Z4V3	MMSZ5229BW	Z-diode	4.09..4.52V, lzt=20mA, Zzt=22Ω, 500mW	SOD-123FL	7d	1a	Tac
Z4V3	TCMMSZ5229B	Z-diode	4.3V±5%, lzt=20mA, Zzt=22Ω, 500mW	SOD-123FL	7d	1a	Tac
Z4V3	ZS4731A	Z-diode	4.3V±5%, 58mA, Zzt=9Ω, 1W	SMA-1	10d	1a	Fmm
Z4V7	BZA10C4V7	Z-diode	4.465..4.935V, lzt=53mA, Zzt=8Ω, 1W	SOD-123F	10d	1a	Did
Z4V7	CZRA4732-G	Z-diode	4.7V±5%, lzt=53mA, Zzt=8Ω, 1W	SMA	10d	1a	Cmc
Z4V7	MMSZ5230B	Z-diode	4.47..4.94V, lzt=20mA, Zzt=19Ω, 500mW	SOD-123FL	7d	1a	Tsc
Z4V7	MMSZ5230BSW	Z-diode	4.47..4.94V, lzt=20mA, Zzt=19Ω, 200mW	SOD-323FL	7d	1a	Tac
Z4V7	MMSZ5230BW	Z-diode	4.47..4.94V, lzt=20mA, Zzt=19Ω, 500mW	SOD-123FL	7d	1a	Tac
Z4V7	TCMMSZ5230B	Z-diode	4.7V±5%, lzt=20mA, Zzt=19Ω, 500mW	SOD-123FL	7d	1a	Tac
Z4V7	ZS4732A	Z-diode	4.7V±5%, 53mA, Zzt=8Ω, 1W	SMA-1	10d	1a	Fmm
Z5	BZF10C27	Z-diode	25.7..28.4V, lzt=9.5mA, Zzt=35Ω, 1W	SOD-123F	10d	1a	Did
Z5	BZT52-C6V8T	Z-diode	6.8V±5%, lzt=5mA, Zzt=15Ω, 100mW	SOD-523	6d	1a	Mco
Z5	BZX584B47V	Z-diode	46.06..47.94V, lzt=2mA, Zzt=170Ω, 200mW	SOD-523FL	7d	1a	Tac
Z5	CD0603-Z3V3	Z-diode	3.14..3.47V 5mA, Zzt=95Ω, 150mW	0603	13d	2b	Bm
Z5	CD1005-Z3V3	Z-diode	3.14..3.47V 5mA, Zzt=95Ω, 200mW	1005	13d	2b	Bm
Z5	CZRRER52C3V3	Z-diode	3.14..3.47V, lzt=5mA, Zzt=95Ω, 150mW	0503	13d	2b	Cmc
Z5	CZRRER52C3V3	Z-diode	3.14..3.47V, lzt=5mA, Zzt=95Ω, 150mW	0503	13d	2b	Cmc
Z5	CZRF52C3V3	Z-diode	3.14..3.47V, lzt=5mA, Zzt=95Ω, 200mW	1005	13d	2b	Cmc
Z5	CZRRFR52C3V3	Z-diode	3.14..3.47V, lzt=5mA, Zzt=95Ω, 200mW	1005	13d	2b	Cmc
Z5	CZRRQR52C3V3	Z-diode	3.14..3.47V, lzt=5mA, Zzt=95Ω, 125mW	0402	13d	2b	Cmc
Z5	CZRUR52C3V3	Z-diode	3.14..3.47V, lzt=5mA, Zzt=95Ω, 150mW	0603	13d	2b	Cmc
Z5	MM1Z5261B	Z-diode	44.65..49.35V, lzt=2.7mA, Zzt=105Ω, 500mW	SOD-323FL	5d	1a	Eic
Z5	MM1Z5261BH	Z-diode	44.65..49.35V, lzt=2.7mA, Zzt=105Ω, 500mW	SOD-123	5d	1a	Zow
Z5	MM3Z3V9C	Z-diode	3.71..4.1V, Zzt=84Ω, lzt=5mA, 200mW	SOD-323FL	7d	1a	F
Z5	MMSZ47VB	Z-diode	46.06..47.94V, lzt=2mA, Zzt=170Ω, 200mW	SOD-523FL	7d	1a	Tac
Z5	MMSZ6V8	Z-diode	6.8V±5%, lzt=5mA, Zzt=15Ω, 200mW	SOD-523	6d	1a	Sec
Z5	MMSZ5261B	Z-diode	47V±5%, lzt=2.7mA, Zzt=105Ω, 500mW	SOD-123	5d	1a	Eic
Z5	MMSZ62	Z-diode	62V±5%, Zzt=215Ω, 500mW	SOD-123	5d	1a	Mot
Z5	PDZ3.9B	Z-diode	3.9V±2.5%, 400mW	SOD-323	5d	1a	Phi
Z5	TCMM3Z3V9C	Z-diode	3.9V±5%, lzt=5mA, Zzt=84Ω, 200mW	SOD-323FL	7d	1a	Tac
Z5	TSZL52C3V3	Z-diode	3.14..3.47V, lzt=5mA, Zzt=95Ω, 200mW	1005	70d	2d	Tsc
Z5	TSZU52C3V3	Z-diode	3.14..3.47V, lzt=5mA, Zzt=95Ω, 150mW	0603	70d	2d	Tsc
Z5	VGFMO2-C27-M	TVS	Vrwm=23.1V, Vbr=25.7..28.4V, 5.35A, 200W(1ms)	SOD-123F	10d	1a	Fmm
Z5	ZD5254BSG	Z-diode	27V±5%, 5mA, Zzt=70Ω, 500mW	SOD-323-S	7d	1a	Cys
Z5	ZGFM1027-MH	Z-diode	27V±10%, Zzt=35Ω(lzt=9.5mA), 1W	SOD-123H	10d	1a	Fmm
Z5	ZGFM1027-N	Z-diode	25.7..28.4V, lzt=9.5mA, Zzt=35Ω, 1W	SOD-123F	10d	1a	Fmm
Z51V	MMSZ5262B	Z-diode	48.45..53.55V, lzt=2.5mA, Zzt=125Ω, 500mW	SOD-123FL	7d	1a	Tsc
Z51V	MMSZ5262BSW	Z-diode	48.45..53.55V, lzt=2.5mA, Zzt=125Ω, 200mW	SOD-323FL	7d	1a	Tac
Z51V	MMSZ5262BW	Z-diode	48.45..53.55V, lzt=2.5mA, Zzt=125Ω, 500mW	SOD-123FL	7d	1a	Tac
Z51V	TCMMSZ5262B	Z-diode	51V±5%, lzt=2.5mA, Zzt=125Ω, 500mW	SOD-123FL	7d	1a	Tac
Z53	STPS0503Z	Si-diode	SBR, 30V, 500mA, Vf<0.33V(500mA)	SOD-123	5d	1a	Ste
Z54	STPS0540Z	Si-diode	SBR, 40V, 500mA, Vf<0.5V(500mA), 5ms	SOD-123	5d	1a	Ste
Z56	STPS0560Z	Si-diode	SBR, 60V, 500mA, Vf<0.53V(500mA), 5ms	SOD-123	5d	1a	Ste
Z56V	MMSZ5263B	Z-diode	53.20..58.80V, lzt=2.2mA, Zzt=150Ω, 500mW	SOD-123FL	7d	1a	Tsc
Z56V	MMSZ5263BSW	Z-diode	53.20..58.80V, lzt=2.2mA, Zzt=150Ω, 200mW	SOD-323FL	7d	1a	Tac
Z56V	MMSZ5263BW	Z-diode	53.2..58.80V, lzt=2.2mA, Zzt=150Ω, 500mW	SOD-123FL	7d	1a	Tac
Z56V	TCMMSZ5263B	Z-diode	56V±5%, lzt=2.2mA, Zzt=150Ω, 500mW	SOD-123FL	7d	1a	Tac
Z5V1	BZA10C5V1	Z-diode	4.845..5.355V, lzt=49mA, Zzt=7Ω, 1W	SOD-123F	10d	1a	Did
Z5V1	CZRA4733-G	Z-diode	5.1V±5%, lzt=49mA, Zzt=7Ω, 1W	SMA	10d	1a	Cmc
Z5V1	MMSZ5231B	Z-diode	4.85..5.36V, lzt=20mA, Zzt=17Ω, 500mW	SOD-123FL	7d	1a	Tsc
Z5V1	MMSZ5231BSW	Z-diode	4.85..5.36V, lzt=20mA, Zzt=17Ω, 200mW	SOD-323FL	7d	1a	Tac
Z5V1	MMSZ5231BW	Z-diode	4.85..5.36V, lzt=20mA, Zzt=17Ω, 500mW	SOD-123FL	7d	1a	Tac



SMD
code

Type

Function

Short description

Case

Pinout

St.

Mnf.

SMD code	Type	Function	Short description	Case	Pinout	St.	Mnf.
Z5V1	SMAZ5V1	Z-diode	5.1V±5%, 100mA, Zzt=5Ω, 1W	DO-214AC	1d	1a	Exc
Z5V1	TCMMSZ5231B	Z-diode	5.1V±5%, Izt=20mA, Zzt=17Ω, 500mW	SOD-123FL	7d	1a	Tac
Z5V1	ZS4733A	Z-diode	5.1V±5%, 49mA, Zzt=7Ω, 1W	SMA-1	10d	1a	Fmm
Z5V6	BZA10C5V6	Z-diode	5.32..5.88V, Izt=45mA, Zzt=5Ω, 1W	SOD-123F	10d	1a	Did
Z5V6	CZRA4734-G	Z-diode	5.6V±5%, Izt=45mA, Zzt=5Ω, 1W	SMA	10d	1a	Cmc
Z5V6	MMSZ5232B	Z-diode	5.32..5.88V, Izt=20mA, Zzt=11Ω, 500mW	SOD-123FL	7d	1a	Tsc
Z5V6	MMSZ5232BSW	Z-diode	5.32..5.88V, Izt=20mA, Zzt=11Ω, 200mW	SOD-323FL	7d	1a	Tac
Z5V6	MMSZ5232BW	Z-diode	5.32..5.88V, Izt=20mA, Zzt=11Ω, 500mW	SOD-123FL	7d	1a	Tac
Z5V6	SMAZ5V6	Z-diode	5.6V±5%, 100mA, Zzt<2Ω, 1W	DO-214AC	1d	1a	Exc
Z5V6	TCMMSZ5232B	Z-diode	5.6V±5%, Izt=20mA, Zzt=11Ω, 500mW	SOD-123FL	7d	1a	Tac
Z5V6	ZS4734A	Z-diode	5.6V±5%, 45mA, Zzt=5Ω, 1W	SMA-1	10d	1a	Fmm
Z6	BZF10C30	Z-diode	28.5..31.5V, Izt=8.5mA, Zzt=40Ω, 1W	SOD-123F	10d	1a	Did
Z6	BZT52-C7V5T	Z-diode	8.2V±5%, Izt=5mA, Zzt=15Ω, 100mW	SOD-523	6d	1a	Mco
Z6	CD0603-Z3V6	Z-diode	3.42..3.78V, 5mA, Zzt=95Ω, 150mW	0603	13d	2b	Bm
Z6	CD1005-Z3V6	Z-diode	3.42..3.78V, 5mA, Zzt=95Ω, 200mW	1005	13d	2b	Bm
Z6	CZRRER52C3V6	Z-diode	3.42..3.78V, Izt=5mA, Zzt=95Ω, 150mW	0503	13d	2b	Cmc
Z6	CZRRERT52C3V6	Z-diode	3.42..3.78V, Izt=5mA, Zzt=95Ω, 150mW	0503	13d	2b	Cmc
Z6	CZRF52C3V6	Z-diode	3.42..3.78V, Izt=5mA, Zzt=95Ω, 200mW	1005	13d	2b	Cmc
Z6	CZRF52C3V6	Z-diode	3.42..3.78V, Izt=5mA, Zzt=95Ω, 200mW	1005	13d	2b	Cmc
Z6	CZRRFR52C3V6	Z-diode	3.42..3.78V, Izt=5mA, Zzt=95Ω, 200mW	1005	13d	2b	Cmc
Z6	CZRRQR52C3V6	Z-diode	3.42..3.78V, Izt=5mA, Zzt=95Ω, 125mW	0402	13d	2b	Cmc
Z6	CZRRUR52C3V6	Z-diode	3.42..3.78V, Izt=5mA, Zzt=95Ω, 150mW	0603	13d	2b	Cmc
Z6	MM3Z4V3C	Z-diode	4.09..4.52V, Zzt=84Ω, Izt=5mA, 200mW	SOD-323FL	7d	1a	F
Z6	MMSZ7V5	Z-diode	7.5V±5%, Izt=5mA, Zzt=15Ω, 200mW	SOD-523	6d	1a	Sec
Z6	MMSZ68	Z-diode	68V±5%, Zzt=240Ω, 500mW	SOD-123	5d	1a	Mot
Z6	PDZ4.3B	Z-diode	4.3V±2.5%, 400mW	SOD-323	5d	1a	Phi
Z6	TCMM3Z4V3C	Z-diode	4.3V±5%, Izt=5mA, Zzt=84Ω, 200mW	SOD-323FL	7d	1a	Tac
Z6	TSZL52C3V6	Z-diode	3.42..3.78V, Izt=5mA, Zzt=95Ω, 200mW	1005	70d	2d	Tsc
Z6	TSZU52C3V6	Z-diode	3.42..3.78V, Izt=5mA, Zzt=95Ω, 150mW	0603	70d	2d	Tsc
Z6	VGFM02-C30-M	TVS	Vrwm=25.6V, Vbr=28.59..31.5V, 4.85A, 200W(1ms)	SOD-123F	10d	1a	Fmm
Z6	ZD5256BSG	Z-diode	30V±5%, 5mA, Zzt=78Ω, 500mW	SOD-323-S	7d	1a	Cys
Z6	ZGFM1030-MH	Z-diode	30V±10%, Zzt=40Ω(Izt=8.5mA), 1W	SOD-123H	10d	1a	Fmm
Z6	ZGFM1030-N	Z-diode	28.5..31.5V, Izt=8.5mA, Zzt=40Ω, 1W	SOD-123F	10d	1a	Fmm
Z60V	MMSZ5264BSW	Z-diode	57.0..63.0V, Izt=2.1mA, Zzt=170Ω, 200mW	SOD-323FL	7d	1a	Tac
Z60V	MMSZ5264BW	Z-diode	57.0..63.0V, Izt=2.1mA, Zzt=170Ω, 500mW	SOD-123FL	7d	1a	Tac
Z62V	MMSZ5266BSW	Z-diode	58.90..65.10V, Izt=2.0mA, Zzt=185Ω, 200mW	SOD-323FL	7d	1a	Tac
Z62V	MMSZ5266BW	Z-diode	58.90..65.10V, Izt=2.0mA, Zzt=185Ω, 500mW	SOD-123FL	7d	1a	Tac
Z68V	MMSZ5266BSW	Z-diode	64.60..71.40V, Izt=1.8mA, Zzt=230Ω, 200mW	SOD-323FL	7d	1a	Tac
Z68V	MMSZ5266BW	Z-diode	64.60..71.40V, Izt=1.8mA, Zzt=230Ω, 500mW	SOD-123FL	7d	1a	Tac
Z6V0	MMSZ5233B	Z-diode	5.70..6.30V, Izt=20mA, Zzt=7Ω, 500mW	SOD-123FL	7d	1a	Tsc
Z6V0	MMSZ5233BSW	Z-diode	5.70..6.30V, Izt=20mA, Zzt=7Ω, 200mW	SOD-323FL	7d	1a	Tac
Z6V0	MMSZ5233BW	Z-diode	5.70..6.30V, Izt=20mA, Zzt=7Ω, 500mW	SOD-123FL	7d	1a	Tac
Z6V0	TCMMSZ5233B	Z-diode	6.0V±5%, Izt=20mA, Zzt=7Ω, 500mW	SOD-123FL	7d	1a	Tac
Z6V2	BZA10C6V2	Z-diode	5.89..6.51V, Izt=41mA, Zzt=2Ω, 1W	SOD-123F	10d	1a	Did
Z6V2	CZRA4735-G	Z-diode	6.2V±5%, Izt=41mA, Zzt=2Ω, 1W	SMA	10d	1a	Cmc
Z6V2	MMSZ5234B	Z-diode	5.89..6.51V, Izt=20mA, Zzt=7Ω, 500mW	SOD-123FL	7d	1a	Tsc
Z6V2	MMSZ5234BSW	Z-diode	5.89..6.51V, Izt=20mA, Zzt=7Ω, 200mW	SOD-323FL	7d	1a	Tac
Z6V2	MMSZ5234BW	Z-diode	5.89..6.51V, Izt=20mA, Zzt=7Ω, 500mW	SOD-123FL	7d	1a	Tac
Z6V2	SMAZ6V2	Z-diode	6.2V±5%, 100mA, Zzt<2Ω, 1W	DO-214AC	1d	1a	Exc
Z6V2	TCMMSZ5234B	Z-diode	6.2V±5%, Izt=20mA, Zzt=7Ω, 500mW	SOD-123FL	7d	1a	Tac
Z6V2	ZS4735A	Z-diode	6.2V±5%, 41mA, Zzt=2Ω, 1W	SMA-1	10d	1a	Fmm
Z6V8	BZA10C6V8	Z-diode	6.46..7.14V, Izt=37mA, Zzt=3.5Ω, 1W	SOD-123F	10d	1a	Did
Z6V8	CZRA4736-G	Z-diode	6.8V±5%, Izt=37mA, Zzt=3.5Ω, 1W	SMA	10d	1a	Cmc
Z6V8	MMSZ5235B	Z-diode	6.46..7.14V, Izt=20mA, Zzt=5Ω, 500mW	SOD-123FL	7d	1a	Tsc
Z6V8	MMSZ5235BSW	Z-diode	6.46..7.14V, Izt=20mA, Zzt=5Ω, 200mW	SOD-323FL	7d	1a	Tac
Z6V8	MMSZ5235BW	Z-diode	6.46..7.14V, Izt=20mA, Zzt=5Ω, 500mW	SOD-123FL	7d	1a	Tac
Z6V8	SMAZ6V8	Z-diode	6.8V±5%, 100mA, Zzt<2Ω, 1W	DO-214AC	1d	1a	Exc
Z6V8	TCMMSZ5235B	Z-diode	6.8V±5%, Izt=20mA, Zzt=5Ω, 500mW	SOD-123FL	7d	1a	Tac
Z6V8	ZS4736A	Z-diode	6.8V±5%, 37mA, Zzt=3.5Ω, 1W	SMA-1	10d	1a	Fmm
Z7	BZF10C33	Z-diode	31.4..34.7V, Izt=7.5mA, Zzt=45Ω, 1W	SOD-123F	10d	1a	Did
Z7	BZT52-C8V2T	Z-diode	8.2V±5%, Izt=5mA, Zzt=15Ω, 100mW	SOD-523	6d	1a	Mco
Z7	CD0603-Z3V9	Z-diode	3.71..4.10V, 5mA, Zzt=95Ω, 150mW	0603	13d	2b	Bm
Z7	CD1005-Z3V9	Z-diode	3.71..4.10V, 5mA, Zzt=95Ω, 200mW	1005	13d	2b	Bm
Z7	CZRRER52C3V9	Z-diode	3.71..4.10V, Izt=5mA, Zzt=95Ω, 150mW	0503	13d	2b	Cmc
Z7	CZRRERT52C3V9	Z-diode	3.71..4.10V, Izt=5mA, Zzt=95Ω, 150mW	0503	13d	2b	Cmc
Z7	CZRF52C3V9	Z-diode	3.71..4.10V, Izt=5mA, Zzt=95Ω, 200mW	1005	13d	2b	Cmc
Z7	CZRF52C3V9	Z-diode	3.71..4.10V, Izt=5mA, Zzt=95Ω, 200mW	1005	13d	2b	Cmc
Z7	CZRRFR52C3V9	Z-diode	3.71..4.10V, Izt=5mA, Zzt=95Ω, 125mW	0402	13d	2b	Cmc
Z7	CZRRUR52C3V9	Z-diode	3.71..4.10V, Izt=5mA, Zzt=95Ω, 150mW	0603	13d	2b	Cmc
Z7	MM3Z4V7C	Z-diode	4.47..4.94V, Zzt=75Ω, Izt=5mA, 200mW	SOD-323FL	7d	1a	F
Z7	MMSZ2V4	Z-diode	2.4V±5%, Izt=5mA, Zzt=70Ω, 200mW	SOD-523	6d	1a	Eic



SMD
code

Type

Function

Short description

Case

Pinout

St.

Mnf.

SMD code	Type	Function	Short description	Case	Pinout	St.	Mnf.
Z7	MMSZ2V4H	Z-diode	2.2..2.6V, Izt=5mA, Zzt=100Ω, 200mW	SOD-523	7d	1a	Zow
Z7	MMSZ8V2	Z-diode	8.2V±5%, Izt=5mA, Zzt=15Ω, 200mW	SOD-523	6d	1a	Sec
Z7	MMSZ75	Z-diode	75V±5%, Zzt=255Ω, 500mW	SOD-123	5d	1a	Mot
Z7	PDZ4.7B	Z-diode	4.7V±2.5%, 400mW	SOD-323	5d	1a	Phi
Z7	PDZ4.7BF	Z-diode	4.55..4.75V, Zzt=90Ω, Izt=5mA, 400mW	SOD-323FL	7d	1a	Pjt
Z7	TCMMSZ4V7C	Z-diode	4.7V±5%, Izt=5mA, Zzt=75Ω, 200mW	SOD-323FL	7d	1a	Tac
Z7	TSZL52C3V9	Z-diode	3.71..4.10V, Izt=5mA, Zzt=95Ω, 200mW	1005	70d	2d	Tsc
Z7	TSZU52C3V9	Z-diode	3.71..4.10V, Izt=5mA, Zzt=95Ω, 150mW	0603	70d	2d	Tsc
Z7	VGFM02-C33-M	TVS	Vrwm=28.2V, Vbr=31.4..34.7V, 4.40A, 200W(1ms)	SOD-123F	10d	1a	Fmm
Z7	ZD5257BSG	Z-diode	33V±5%, 5mA, Zzt=88Ω, 500mW	SOD-323-S	7d	1a	Cys
Z7	ZGFM1033-MH	Z-diode	33V±10%, Zzt=45Ω(Izt=7.5mA), 1W	SOD-123H	10d	1a	Fmm
Z7	ZGFM1033-N	Z-diode	31.4..34.7V, Izt=7.5mA, Zzt=45Ω, 1W	SOD-123F	10d	1a	Fmm
Z75V	MMSZ5267BSW	Z-diode	71.25..78.75V, Izt=1.7mA, Zzt=270Ω, 200mW	SOD-323FL	7d	1a	Tac
Z75V	MMSZ5267BW	Z-diode	71.25..78.75V, Izt=1.7mA, Zzt=270Ω, 500mW	SOD-123FL	7d	1a	Tac
Z75V	BZA10C7V5	Z-diode	7.125..7.875V, Izt=34mA, Zzt=4Ω, 1W	SOD-123F	10d	1a	Did
Z75V	CZRA4737-G	Z-diode	7.5V±5%, Izt=34mA, Zzt=4Ω, 1W	SMA	10d	1a	Cmc
Z75V	MMSZ5236B	Z-diode	7.13..7.88V, Izt=20mA, Zzt=6Ω, 500mW	SOD-123FL	7d	1a	Tsc
Z75V	MMSZ5236BSW	Z-diode	7.13..7.88V, Izt=20mA, Zzt=6Ω, 200mW	SOD-323FL	7d	1a	Tac
Z75V	MMSZ5236BW	Z-diode	7.13..7.88V, Izt=20mA, Zzt=6Ω, 500mW	SOD-123FL	7d	1a	Tac
Z75V	SMAZ7V5	Z-diode	7.5V±5%, 100mA, Zzt<2Ω, 1W	DO-214AC	1d	1a	Exc
Z75V	TCMMSZ5236B	Z-diode	7.5V±5%, Izt=20mA, Zzt=6Ω, 500mW	SOD-123FL	7d	1a	Tac
Z75V	ZS4737A	Z-diode	7.5V±5%, 34mA, Zzt=4Ω, 1W	SMA-1	10d	1a	Fmm
Z8	BZF10C36	Z-diode	34.2..37.8V, Izt=7.0mA, Zzt=50Ω, 1W	SOD-123F	10d	1a	Did
Z8	BZT52-C9V1T	Z-diode	9.1V±5%, Izt=5mA, Zzt=15Ω, 100mW	SOD-523	6d	1a	Mco
Z8	CD0603-Z4V3	Z-diode	4.09..4.52V, 5mA, Zzt=95Ω, 150mW	0603	13d	2b	Bm
Z8	CD1005-Z4V3	Z-diode	4.09..4.52V, 5mA, Zzt=95Ω, 200mW	1005	13d	2b	Bm
Z8	CZRER52C4V3	Z-diode	4.09..4.52V, Izt=5mA, Zzt=95Ω, 150mW	0503	13d	2b	Cmc
Z8	CZRERT52C4V3	Z-diode	4.09..4.52V, Izt=5mA, Zzt=95Ω, 150mW	0503	13d	2b	Cmc
Z8	CZRF52C4V3	Z-diode	4.09..4.52V, Izt=5mA, Zzt=95Ω, 200mW	1005	13d	2b	Cmc
Z8	CZFR52C4V3	Z-diode	4.09..4.52V, Izt=5mA, Zzt=95Ω, 200mW	1005	13d	2b	Cmc
Z8	CZRQR52C4V3	Z-diode	4.09..4.52V, Izt=5mA, Zzt=95Ω, 125mW	0402	13d	2b	Cmc
Z8	CZRUR52C4V3	Z-diode	4.09..4.52V, Izt=5mA, Zzt=95Ω, 150mW	0603	13d	2b	Cmc
Z8	MM3Z5V1C	Z-diode	4.85..5.36V, Zzt=56Ω, Izt=5mA, 200mW	SOD-323FL	7d	1a	F
Z8	MM5Z30H	Z-diode	28..32V, Izt=2mA, Zzt=80Ω, 200mW	SOD-523	7d	1a	Zow
Z8	MM5Z30V	Z-diode	30V±5%, Izt=2mA, Zzt=80Ω, 200mW	SOD-523	6d	1a	Eic
Z8	MM5Z9V1	Z-diode	9.1V±5%, Izt=5mA, Zzt=15Ω, 200mW	SOD-523	6d	1a	Sec
Z8	PDZ5.1B	Z-diode	5.1V±2.5%, 400mW	SOD-323	5d	1a	Phi
Z8	TCMMSZ5V1C	Z-diode	5.1V±5%, Izt=5mA, Zzt=56Ω, 200mW	SOD-323FL	7d	1a	Tac
Z8	TSZL52C4V3	Z-diode	4.09..4.52V, Izt=5mA, Zzt=95Ω, 200mW	1005	70d	2d	Tsc
Z8	TSZU52C4V3	Z-diode	4.09..4.52V, Izt=5mA, Zzt=95Ω, 150mW	0603	70d	2d	Tsc
Z8	VGFM02-C36-M	TVS	Vrwm=30.8V, Vbr=34.2..37.8V, 4.0A, 200W(1ms)	SOD-123F	10d	1a	Fmm
Z8	ZD5258BSG	Z-diode	36V±5%, 5mA, Zzt=95Ω, 500mW	SOD-323-S	7d	1a	Cys
Z8	ZGFM1036-MH	Z-diode	36V±10%, Zzt=50Ω(Izt=7mA), 1W	SOD-123H	10d	1a	Fmm
Z8	ZGFM1036-N	Z-diode	34.2..37.8V, Izt=7.0mA, Zzt=50Ω, 1W	SOD-123F	10d	1a	Fmm
Z8V2	BZA10C8V2	Z-diode	7.79..8.61V, Izt=31mA, Zzt=4.5Ω, 1W	SOD-123F	10d	1a	Did
Z8V2	CZRA4738-G	Z-diode	8.2V±5%, Izt=31mA, Zzt=4.5Ω, 1W	SMA	10d	1a	Cmc
Z8V2	MMSZ5237B	Z-diode	7.79..8.61V, Izt=20mA, Zzt=8Ω, 500mW	SOD-123FL	7d	1a	Tsc
Z8V2	MMSZ5237BSW	Z-diode	7.79..8.61V, Izt=20mA, Zzt=8Ω, 200mW	SOD-323FL	7d	1a	Tac
Z8V2	MMSZ5237BW	Z-diode	7.79..8.61V, Izt=20mA, Zzt=8Ω, 500mW	SOD-123FL	7d	1a	Tac
Z8V2	SMAZ8V2	Z-diode	8.2V±5%, 100mA, Zzt<2Ω, 1W	DO-214AC	1d	1a	Exc
Z8V2	TCMMSZ5237B	Z-diode	8.2V±5%, Izt=20mA, Zzt=8Ω, 500mW	SOD-123FL	7d	1a	Tac
Z8V2	ZS4738A	Z-diode	8.2V±5%, 31mA, Zzt=4.5Ω, 1W	SMA-1	10d	1a	Fmm
Z8V7	MMSZ5238B	Z-diode	8.27..9.14V, Izt=20mA, Zzt=8Ω, 500mW	SOD-123FL	7d	1a	Tsc
Z8V7	MMSZ5238BSW	Z-diode	8.27..9.14V, Izt=20mA, Zzt=8Ω, 200mW	SOD-323FL	7d	1a	Tac
Z8V7	MMSZ5238BW	Z-diode	8.27..9.14V, Izt=20mA, Zzt=8Ω, 500mW	SOD-123FL	7d	1a	Tac
Z8V7	TCMMSZ5238B	Z-diode	8.7V±5%, Izt=20mA, Zzt=8Ω, 500mW	SOD-123FL	7d	1a	Tac
Z9	BAS316PT	Si-diode	Sw, 100V, 250mA, Vf<1.25V(150mA), 4ns	SOD-323	5d	1a	Chm
Z9	BZF10C39	Z-diode	37.1..41.0V, Izt=6.5mA, Zzt=60Ω, 1W	SOD-123F	10d	1a	Did
Z9	BZT52-C10T	Z-diode	10V±5%, Izt=5mA, Zzt=20Ω, 100mW	SOD-523	5d	1a	Mco
Z9	CD0603-Z4V7	Z-diode	4.47..4.94V, 5mA, Zzt=78Ω, 150mW	0603	13d	2b	Bm
Z9	CD1005-Z4V7	Z-diode	4.47..4.94V, 5mA, Zzt=78Ω, 200mW	1005	13d	2b	Bm
Z9	CZRER52C4V7	Z-diode	4.47..4.94V, Izt=5mA, Zzt=78Ω, 150mW	0503	13d	2b	Cmc
Z9	CZRERT52C4V7	Z-diode	4.47..4.94V, Izt=5mA, Zzt=78Ω, 150mW	0503	13d	2b	Cmc
Z9	CZRF52C4V7	Z-diode	4.47..4.94V, Izt=5mA, Zzt=78Ω, 200mW	1005	13d	2b	Cmc
Z9	CZFR52C4V7	Z-diode	4.47..4.94V, Izt=5mA, Zzt=78Ω, 200mW	1005	13d	2b	Cmc
Z9	CZRQR52C4V7	Z-diode	4.47..4.94V, Izt=5mA, Zzt=78Ω, 125mW	0402	13d	2b	Cmc
Z9	CZRUR52C4V7	Z-diode	4.47..4.94V, Izt=5mA, Zzt=78Ω, 150mW	0603	13d	2b	Cmc
Z9	MM3Z5V6C	Z-diode	5.32..5.88V, Zzt=37Ω, Izt=5mA, 200mW	SOD-323FL	7d	1a	F
Z9	MM5Z10V	Z-diode	10V±5%, Izt=5mA, Zzt=20Ω, 200mW	SOD-523	6d	1a	Sec
Z9	PDZ5.6B	Z-diode	5.6V±2.5%, 400mW	SOD-323	5d	1a	Phi



SMD
code

Type

Function

Short description

Case

Pinout

St.

Mnf.

Z9	PDZ5.6BF	Z-diode	5.50..5.71V, Zzt=50Q, Izt=5mA, 400mW
Z9	TCMM3Z5V6C	Z-diode	5.6V±5%, Izt=5mA, Zzt=37Q, 200mW
Z9	TSZL52C4V7	Z-diode	4.47..4.94V, Izt=5mA, Zzt=78Q, 200mW
Z9	TSZU52C4V7	Z-diode	4.47..4.94V, Izt=5mA, Zzt=78Q, 150mW
Z9	VGFM02-C39-M	TVS	Vrwm=33.3V, Vbr=37.1..41.1V, 3.70A, 200W(1ms)
Z9	ZD5259BSG	Z-diode	39V±5%, 5mA, Zzt=130Q, 500mW
Z9	ZGFM1039-MH	Z-diode	39V±10%, Zzt=60Q(Izt=6.5mA), 1W
Z9	ZGFM1039-N	Z-diode	37.1..41.0V, Izt=6.5mA, Zzt=60Q, 1W
Z9V1	BZA10C9V1	Z-diode	8.645..9.555V, Izt=28mA, Zzt=5Q, 1W
Z9V1	CZRA4739-G	Z-diode	9.1V±5%, Izt=28mA, Zzt=5Q, 1W
Z9V1	MMSZ5239B	Z-diode	8.65..9.56V, Izt=20mA, Zzt=10Q, 500mW
Z9V1	MMSZ5239BSW	Z-diode	8.65..9.56V, Izt=20mA, Zzt=10Q, 200mW
Z9V1	MMSZ5239BW	Z-diode	8.65..9.56V, Izt=20mA, Zzt=10Q, 500mW
Z9V1	SMAZ9V1	Z-diode	9.1V±5%, 50mA, Zzt=4Q, 1W
Z9V1	TCMMSZ5239B	Z-diode	9.1V±5%, Izt=20mA, Zzt=10Q, 500mW
Z9V1	ZS4739A	Z-diode	9.1V±5%, 28mA, Zzt=5Q, 1W
ZA	BZF10C43	Z-diode	40.9..45.2V, Izt=6.0mA, Zzt=70Q, 1W
ZA	BZX284-C7V5	Z-diode	7.5V±5%, 400mW
ZA	CD0603-Z5V1	Z-diode	4.85..5.36V, 5mA, Zzt=60Q, 150mW
ZA	CD1005-Z5V1	Z-diode	4.85..5.36V, 5mA, Zzt=60Q, 200mW
ZA	CZRE52C5V1	Z-diode	4.85..5.36V, Izt=5mA, Zzt=60Q, 150mW
ZA	CZRE52C5V1	Z-diode	4.85..5.36V, Izt=5mA, Zzt=60Q, 150mW
ZA	CZRF52C5V1	Z-diode	4.85..5.36V, Izt=5mA, Zzt=60Q, 200mW
ZA	CZRF52C5V1	Z-diode	4.85..5.36V, Izt=5mA, Zzt=60Q, 200mW
ZA	CZRF52C5V1	Z-diode	4.85..5.36V, Izt=5mA, Zzt=60Q, 200mW
ZA	CZQR52C5V1	Z-diode	4.85..5.36V, Izt=5mA, Zzt=60Q, 125mW
ZA	CZRUR52C5V1	Z-diode	4.85..5.36V, Izt=5mA, Zzt=60Q, 150mW
ZA	KDZ2.0V	Z-diode	1.85..2.15V, Izt=5mA, Zzt=100Q, 100mW
ZA	MM3Z6V2C	Z-diode	5.89..6.51V, Zzt=9Q, Izt=5mA, 200mW
ZA	PDZ6.2B	Z-diode	6.2V±2.5%, 400mW
ZA	PDZ6.2BF	Z-diode	6.06..6.33V, Zzt=50Q, Izt=5mA, 400mW
ZA	SMZG3807A	Z-diode	56V±5%, 22mA, Zzt=86Q, 1.5W
ZA	SMZJ3807A	Z-diode	56V±5%, 22mA, Zzt=86Q, 1.5W
ZA	TCMM3Z6V2C	Z-diode	6.2V±5%, Izt=5mA, Zzt=9Q, 200mW
ZA	TSZL52C5V1	Z-diode	4.85..5.36V, Izt=5mA, Zzt=60Q, 200mW
ZA	TSZU52C5V1	Z-diode	4.85..5.36V, Izt=5mA, Zzt=60Q, 150mW
ZA	ZGFM1043-MH	Z-diode	43V±10%, Zzt=70Q(Izt=6mA), 1W
ZA	ZGFM1043-N	Z-diode	40.9..45.2V, Izt=6.0mA, Zzt=70Q, 1W
ZB	BZF10C47	Z-diode	44.7..49.4V, Izt=5.5mA, Zzt=80Q, 1W
ZB	BZX284-C8V2	Z-diode	8.2V±5%, 400mW
ZB	CD0603-Z5V6	Z-diode	5.32..5.88V, 5mA, Zzt=40Q, 150mW
ZB	CD1005-Z5V6	Z-diode	5.32..5.88V, 5mA, Zzt=40Q, 200mW
ZB	CZRE52C5V6	Z-diode	5.32..5.88V, Izt=5mA, Zzt=40Q, 150mW
ZB	CZRE52C5V6	Z-diode	5.32..5.88V, Izt=5mA, Zzt=40Q, 150mW
ZB	CZRF52C5V6	Z-diode	5.32..5.88V, Izt=5mA, Zzt=40Q, 200mW
ZB	CZRF52C5V6	Z-diode	5.32..5.88V, Izt=5mA, Zzt=40Q, 200mW
ZB	CZRF52C5V6	Z-diode	5.32..5.88V, Izt=5mA, Zzt=40Q, 200mW
ZB	CZQR52C5V6	Z-diode	5.32..5.88V, Izt=5mA, Zzt=40Q, 125mW
ZB	CZRUR52C5V6	Z-diode	5.32..5.88V, Izt=5mA, Zzt=40Q, 150mW
ZB	KDZ18B	Z-diode	18V±2.5%, 20mA, 1W
ZB	KDZ2.2V	Z-diode	2.05..2.38V, Izt=5mA, Zzt=100Q, 100mW
ZB	MM3Z6V8C	Z-diode	6.46..7.14V, Zzt=14Q, Izt=5mA, 200mW
ZB	PDZ6.8B	Z-diode	6.8V±2.5%, 400mW
ZB	PDZ6.8BF	Z-diode	6.65..6.93V, Zzt=40Q, Izt=5mA, 400mW
ZB	SMZG3807B	Z-diode	56V±10%, 22mA, Zzt=86Q, 1.5W
ZB	SMZJ3807B	Z-diode	56V±10%, 22mA, Zzt=86Q, 1.5W
ZB	TCMM3Z6V8C	Z-diode	6.8V±5%, Izt=5mA, Zzt=14Q, 200mW
ZB	TSZL52C5V6	Z-diode	5.32..5.88V, Izt=5mA, Zzt=40Q, 200mW
ZB	TSZU52C5V6	Z-diode	5.32..5.88V, Izt=5mA, Zzt=40Q, 150mW
ZB	ZGFM1047-MH	Z-diode	47V±10%, Zzt=80Q(Izt=5.5mA), 1W
ZB	ZGFM1047-N	Z-diode	44.7..49.4V, Izt=5.5mA, Zzt=80Q, 1W
ZC	BZF10C51	Z-diode	48.5..53.6V, Izt=5.0mA, Zzt=95Q, 1W
ZC	BZX284-C9V1	Z-diode	9.1V±5%, 400mW
ZC	CD0603-Z6V2	Z-diode	5.89..6.51V, 5mA, Zzt=10Q, 150mW
ZC	CD1005-Z6V2	Z-diode	5.89..6.51V, 5mA, Zzt=10Q, 200mW
ZC	CZRE52C6V2	Z-diode	5.89..6.51V, Izt=5mA, Zzt=10Q, 150mW
ZC	CZRE52C6V2	Z-diode	5.89..6.51V, Izt=5mA, Zzt=10Q, 150mW
ZC	CZRF52C6V2	Z-diode	5.89..6.51V, Izt=5mA, Zzt=10Q, 200mW
ZC	CZRF52C6V2	Z-diode	5.89..6.51V, Izt=5mA, Zzt=10Q, 200mW
ZC	CZQR52C6V2	Z-diode	5.89..6.51V, Izt=5mA, Zzt=10Q, 125mW
ZC	CZRUR52C6V2	Z-diode	5.89..6.51V, Izt=5mA, Zzt=10Q, 150mW
ZC	KDZ2.4V	Z-diode	2.28..2.60V, Izt=5mA, Zzt=100Q, 100mW



SMD
code

Type

Function

Short description

Case

Pinout

St.

Mnf.

SMD code	Type	Function	Short description	Case	Pinout	St.	Mnf.
ZC	MM3Z7V5C	Z-diode	7.11..7.86V, Zzt=14Ω, Izt=5mA, 200mW	SOD-323FL	7d	1a	F
ZC	PDZ7.5B	Z-diode	7.5V±2.5%, 400mW	SOD-323	5d	1a	Phi
ZC	PDZ7.5BF	Z-diode	7.28..7.60V, Zzt=10Ω, Izt=5mA, 400mW	SOD-323FL	7d	1a	Pjt
ZC	SMZG3808A	Z-diode	62V±5%, 20mA, Zzt=100Ω, 1.5W	DO-215AA	5d	1k	Vs
ZC	SMZJ3808A	Z-diode	62V±5%, 20mA, Zzt=100Ω, 1.5W	DO-214AA	1d	1k	Vs
ZC	TCMM3Z7V5C	Z-diode	7.5V±5%, Izt=5mA, Zzt=14Ω, 200mW	SOD-323FL	7d	1a	Tac
ZC	TSZL52C6V2	Z-diode	5.89..6.51V, Izt=5mA, Zzt=10Ω, 200mW	1005	70d	2d	Tsc
ZC	TSZU52C6V2	Z-diode	5.89..6.51V, Izt=5mA, Zzt=10Ω, 150mW	0603	70d	2d	Tsc
ZC	ZGFM1051-MH	Z-diode	51V±10%, Zzt=95Ω(Izt=5mA), 1W	SOD-123H	10d	1a	Fmm
ZC	ZGFM1051-N	Z-diode	48.5..53.6V, Izt=5.0mA, Zzt=95Ω, 1W	SOD-123F	10d	1a	Fmm
ZD	BZF10C56	Z-diode	53.2..58.8V, Izt=4.5mA, Zzt=110Ω, 1W	SOD-123F	10d	1a	Did
ZD	BZX284-C10	Z-diode	10V±5%, 400mW	SOD-110	12d	1a	Phi
ZD	KDZ2.7V	Z-diode	2.50..2.90V, Izt=5mA, Zzt=110Ω, 100mW	VSC	7d	1a	Kec
ZD	MM3Z8V2C	Z-diode	7.79..8.61V, Zzt=14Ω, Izt=5mA, 200mW	SOD-323FL	7d	1a	F
ZD	P4SMAJ220C	TVS	Vbr=170V, 1A, 400W(1ms), Bidirectional	DO-214AC	1ba	1x,1y	Pjt,Srj
ZD	PDZ8.2B	Z-diode	8.2V±2.5%, 400mW	SOD-323	5d	1a	Phi
ZD	PDZ8.2BF	Z-diode	8.02..8.36V, Zzt=10Ω, Izt=5mA, 400mW	SOD-323FL	7d	1a	Pjt
ZD	SMAJ54C	TVS	Vrwm=54V, Vbr=60.0..73.3V, 4.2A, 400W(1ms), Bidirectional	DO-214AC	1ba	1l	Vs
ZD	SMZG3808B	Z-diode	62V±10%, 20mA, Zzt=100Ω, 1.5W	DO-215AA	5d	1k	Vs
ZD	SMZJ3808B	Z-diode	62V±10%, 20mA, Zzt=100Ω, 1.5W	DO-214AA	1d	1k	Vs
ZD	TCMM3Z8V2C	Z-diode	8.2V±5%, Izt=5mA, Zzt=14Ω, 200mW	SOD-323FL	7d	1a	Tac
ZD	TV04A540JB-G	TVS	Vrwm=54.0V, Vbr=60.0..73.30V, Ipp=4.15A, 400W(1ms), Bidirectional	DO-214AC	1ba	1j	Cmc
ZD	ZGFM1056-MH	Z-diode	56V±10%, Zzt=110Ω(Izt=4.5mA), 1W	SOD-123H	10d	1a	Fmm
ZD	ZGFM1056-N	Z-diode	53.2..58.8V, Izt=4.5mA, Zzt=110Ω, 1W	SOD-123F	10d	1a	Fmm
ZDD	SM5Z3V3A	TVS	Vbr=3.3V±2%, 5W	DO-214AA	1d	1q	Ste
ZDE	SM5Z3V6A	TVS	Vbr=3.6V±2%, 5W	DO-214AA	1d	1q	Ste
ZDF	SM5Z3V9A	TVS	Vbr=3.9V±2%, 5W	DO-214AA	1d	1q	Ste
ZDG	SM5Z4V3A	TVS	Vbr=4.3V±2%, 5W	DO-214AA	1d	1q	Ste
ZDH	SM5Z4V7A	TVS	Vbr=4.7V±2%, 5W	DO-214AA	1d	1q	Ste
ZDK	SM5Z5V1A	TVS	Vbr=5.1V±2%, 5W	DO-214AA	1d	1q	Ste
ZDL	SM5Z5V6A	TVS	Vbr=5.6V±2%, 5W	DO-214AA	1d	1q	Ste
ZDN	SM5Z6V2A	TVS	Vbr=6.2V±2%, 5W	DO-214AA	1d	1q	Ste
ZDP	SM5Z6V8A	TVS	Vbr=6.8V±2%, 5W	DO-214AA	1d	1q	Ste
ZDQ	SM5Z7V5A	TVS	Vbr=7.5V±2%, 5W	DO-214AA	1d	1q	Ste
ZDR	SM5Z8V2A	TVS	Vbr=8.2V±2%, 5W	DO-214AA	1d	1q	Ste
ZDT	SM5Z9V1A	TVS	Vbr=9.2V±2%, 5W	DO-214AA	1d	1q	Ste
ZDU	SM5Z10A	TVS	Vbr=10V±2%, 5W	DO-214AA	1d	1q	Ste
ZDW	SM5Z12A	TVS	Vbr=12V±2%, 5W	DO-214AA	1d	1q	Ste
ZDX	SM5Z13A	TVS	Vbr=13V±2%, 5W	DO-214AA	1d	1q	Ste
ZDY	SM5Z14A	TVS	Vbr=14V±2%, 5W	DO-214AA	1d	1q	Ste
ZDZ	SM5Z15A	TVS	Vbr=15V±2%, 5W	DO-214AA	1d	1q	Ste
ZE	BZF10C62	Z-diode	58.9..65.1V, Izt=4.0mA, Zzt=125Ω, 1W	SOD-123F	10d	1a	Did
ZE	BZX284-C11	Z-diode	11V±5%, 400mW	SOD-110	12d	1a	Phi
ZE	CD0603-Z6V8	Z-diode	6.46..7.14V, 5mA, Zzt=8Ω, 150mW	0603	13d	2b	Bm
ZE	CD1005-Z6V8	Z-diode	6.46..7.14V, 5mA, Zzt=8Ω, 200mW	1005	13d	2b	Bm
ZE	CZRER52C6V8	Z-diode	6.46..7.14V, Izt=5mA, Zzt=8Ω, 150mW	0503	13d	2b	Cmc
ZE	CZRERT52C6V8	Z-diode	6.46..7.14V, Izt=5mA, Zzt=8Ω, 150mW	0503	13d	2b	Cmc
ZE	CZRF52C6V8	Z-diode	6.46..7.14V, Izt=5mA, Zzt=8Ω, 200mW	1005	13d	2b	Cmc
ZE	CZRF52C6V8	Z-diode	6.46..7.14V, Izt=5mA, Zzt=8Ω, 200mW	1005	13d	2b	Cmc
ZE	CZRQR52C6V8	Z-diode	6.46..7.14V, Izt=5mA, Zzt=8Ω, 125mW	4002	13d	2b	Cmc
ZE	CZRUR52C6V8	Z-diode	6.46..7.14V, Izt=5mA, Zzt=8Ω, 150mW	0603	13d	2b	Cmc
ZE	KDZ3.0V	Z-diode	2.80..3.20V, Izt=5mA, Zzt=120Ω, 100mW	VSC	7d	1a	Kec
ZE	MM3Z9V1C	Z-diode	8.65..9.56V, Zzt=14Ω, Izt=5mA, 200mW	SOD-323FL	7d	1a	F
ZE	P4SMAJ220AC	TVS	Vbr=170V, 1.1A, 400W(1ms), Bidirectional	DO-214AC	1ba	1x,1y	Pjt,Srj
ZE	P4SMAJ54CA	TVS	Vbr=54V, 4.6A, 400W(1ms), Bidirectional	DO-214AC	1ba	1j	Mco
ZE	PDZ9.1B	Z-diode	9.1V±2.5%, 400mW	SOD-323	5d	1a	Phi
ZE	PDZ9.1BF	Z-diode	8.85..9.23V, Zzt=10Ω, Izt=5mA, 400mW	SOD-323FL	7d	1a	Pjt
ZE	SMAJ54CA	TVS	Vrwm=54V, Vbr=60.0..66.3V, 4.6A, 400W(1ms), Bidirectional	DO-214AC	1ba	1l	Vs
ZE	SMZG3809A	Z-diode	68V±5%, 18mA, Zzt=120Ω, 1.5W	DO-215AA	5d	1k	Vs
ZE	SMZJ3809A	Z-diode	68V±5%, 18mA, Zzt=120Ω, 1.5W	DO-214AA	1d	1k	Vs
ZE	TCMM3Z9V1C	Z-diode	9.1V±5%, Izt=5mA, Zzt=14Ω, 200mW	SOD-323FL	7d	1a	Tac
ZE	TSZL52C6V8	Z-diode	6.46..7.14V, Izt=5mA, Zzt=8Ω, 200mW	1005	70d	2d	Tsc
ZE	TSZU52C6V8	Z-diode	6.46..7.14V, Izt=5mA, Zzt=8Ω, 150mW	0603	70d	2d	Tsc
ZE	TV04A540JB-G	TVS	Vrwm=54.0V, Vbr=60.0..66.30V, Ipp=4.59A, 400W(1ms), Bidirectional	DO-214AC	1ba	1j	Cmc
ZE	TVSS3.3VESPT	TVS	Vbr=5V, Vrwm=3.3V, 11.2A, 150W(1ms)	SC-79	7d	1a	Chm
ZE	ZGFM1062-MH	Z-diode	62V±10%, Zzt=125Ω(Izt=4mA), 1W	SOD-123H	10d	1a	Fmm
ZE	ZGFM1062-N	Z-diode	58.9..65.1V, Izt=4.0mA, Zzt=125Ω, 1W	SOD-123F	10d	1a	Fmm
ZED	SM5Z16A	TVS	Vbr=16V±2%, 5W	DO-214AA	1d	1q	Ste
ZEF	SM5Z18A	TVS	Vbr=18V±2%, 5W	DO-214AA	1d	1q	Ste
ZEH	SM5Z20A	TVS	Vbr=20V±2%, 5W	DO-214AA	1d	1q	Ste



SMD code	Type	Function	Short description	Case	Pinout	St.	Mnf.
ZEK	SM5Z22A	TVS	Vbr=22V±2%, 5W	DO-214AA	1d	1q	Ste
ZEL	SM5Z24A	TVS	Vbr=24V, 24V±2%, 5W	DO-214AA	1d	1q	Ste
ZEN	SM5Z27A	TVS	Vbr=27V±2%, 5W	DO-214AA	1d	1q	Ste
ZEP	SM5Z28A	TVS	Vbr=28V±2%, 5W	DO-214AA	1d	1q	Ste
ZEQ	SM5Z30A	TVS	Vbr=30V±2%, 5W	DO-214AA	1d	1q	Ste
ZER	SM5Z33A	TVS	Vbr=33V±2%, 5W	DO-214AA	1d	1q	Ste
ZET	SM5Z39A	TVS	Vbr=39V±2%, 5W	DO-214AA	1d	1q	Ste
ZEV	SM5Z47A	TVS	Vbr=47V±2%, 5W	DO-214AA	1d	1q	Ste
ZF	BZF10C68	Z-diode	64.6..71.4V, Izt=3.7mA, Zzt=150Ω, 1W	SOD-123F	10d	1a	Did
ZF	BZX284-C12	Z-diode	12V±5%, 400mW	SOD-110	12d	1a	Phi
ZF	CD0603-Z7V5	Z-diode	7.13..7.88V, 5mA, Zzt=7Ω, 150mW	0603	13d	2b	Bm
ZF	CD1005-Z7V5	Z-diode	7.13..7.88V, 5mA, Zzt=7Ω, 200mW	1005	13d	2b	Bm
ZF	CZRRER52C7V5	Z-diode	7.13..7.88V, Izt=5mA, Zzt=7Ω, 150mW	0503	13d	2b	Cmc
ZF	CZRRERT52C7V5	Z-diode	7.13..7.88V, Izt=5mA, Zzt=7Ω, 150mW	0503	13d	2b	Cmc
ZF	CZRF52C7V5	Z-diode	7.13..7.88V, Izt=5mA, Zzt=7Ω, 200mW	1005	13d	2b	Cmc
ZF	CZRRFR52C7V5	Z-diode	7.13..7.88V, Izt=5mA, Zzt=7Ω, 200mW	1005	13d	2b	Cmc
ZF	CZRRQR52C7V5	Z-diode	7.13..7.88V, Izt=5mA, Zzt=7Ω, 125mW	0402	13d	2b	Cmc
ZF	CZRUR52C7V5	Z-diode	7.13..7.88V, Izt=5mA, Zzt=7Ω, 150mW	0603	13d	2b	Cmc
ZF	KDZ3.3V	Z-diode	3.10..3.50V, Izt=5mA, Zzt=130Ω, 100mW	VSC	7d	1a	Kec
ZF	MAZD360	Z-diode	34..38V, Zzt=250Ω(5mA), 120mW	SSSMini2	7d	1a	Pan
ZF	MM3Z10VC	Z-diode	9.5..10.5V, Zzt=18Ω, Izt=5mA, 200mW	SOD-323FL	7d	1a	F
ZF	PDZ10B	Z-diode	10V±2.5%, 400mW	SOD-323	5d	1a	Phi
ZF	PDZ10BF	Z-diode	9.77..10.21V, Zzt=10Ω, Izt=5mA, 400mW	SOD-323FL	7d	1a	Pjt
ZF	SMAJ58C	TVS	Vrwm=58V, Vbr=64.4..78.7V, 3.9A, 400W(1ms), Bidirectional	DO-214AC	1ba	1l	Vs
ZF	SMZG3809B	Z-diode	68V±10%, 18mA, Zzt=120Ω, 1.5W	DO-215AA	5d	1k	Vs
ZF	SMZJ3809B	Z-diode	68V±10%, 18mA, Zzt=120Ω, 1.5W	DO-214AA	1d	1k	Vs
ZF	TCMM3Z10VC	Z-diode	10V±5%, Izt=5mA, Zzt=18Ω, 200mW	SOD-323FL	7d	1a	Tac
ZF	TSZL52C7V5	Z-diode	7.13..7.88V, Izt=5mA, Zzt=7Ω, 200mW	1005	70d	2d	Tsc
ZF	TSZU52C7V5	Z-diode	7.13..7.88V, Izt=5mA, Zzt=7Ω, 150mW	0603	70d	2d	Tsc
ZF	TV04A580KB-G	TVS	Vrwm=58.0V, Vbr=64.40..78.70V, Ipp=3.88A, 400W(1ms), Bidirectional	DO-214AC	1ba	1j	Cmc
ZF	ZGFM1068-MH	Z-diode	68V±10%, Zzt=150Ω(Izt=3.7mA), 1W	SOD-123H	10d	1a	Fmm
ZF	ZGFM1068-N	Z-diode	64.6..71.4V, Izt=3.7mA, Zzt=150Ω, 1W	SOD-123F	10d	1a	Fmm
ZFD	SM5Z62A	TVS	Vbr=62V±2%, 5W	DO-214AA	1d	1q	Ste
ZFG	SM5Z82A	TVS	Vbr=82V±2%, 5W	DO-214AA	1d	1q	Ste
ZFK	SM5Z91A	TVS	Vbr=91V±2%, 5W	DO-214AA	1d	1q	Ste
ZFL	SM5Z100A	Z-diode	100V±2%, 5W	DO-214AA	1d	1q	Ste
ZFM	SM5Z110A	TVS	Vbr=110V±2%, 5W	DO-214AA	1d	1q	Ste
ZFR	SM5Z150A	TVS	Vbr=150V±2%, 5W	DO-214AA	1d	1q	Ste
ZFS	SM5Z160A	TVS	Vbr=160V±2%, 5W	DO-214AA	1d	1q	Ste
ZFU	SM5Z180A	TVS	Vbr=180V±2%, 5W	DO-214AA	1d	1q	Ste
ZFW	SM5Z200A	TVS	Vbr=200V±2%, 5W	DO-214AA	1d	1q	Ste
ZG	BZF10C75	Z-diode	71.3..78.8V, Izt=3.3mA, Zzt=175Ω, 1W	SOD-123F	10d	1a	Did
ZG	BZX284-C13	Z-diode	13V±5%, 400mW	SOD-110	12d	1a	Phi
ZG	CD0603-Z8V2	Z-diode	7.79..8.61V, 5mA, Zzt=7Ω, 150mW	0603	13d	2b	Bm
ZG	CD1005-Z8V2	Z-diode	7.79..8.61V, 5mA, Zzt=7Ω, 200mW	1005	13d	2b	Bm
ZG	CZRRER52C8V2	Z-diode	7.79..8.61V, Izt=5mA, Zzt=7Ω, 150mW	0503	13d	2b	Cmc
ZG	CZRRERT52C8V2	Z-diode	7.79..8.61V, Izt=5mA, Zzt=7Ω, 150mW	0503	13d	2b	Cmc
ZG	CZRF52C8V2	Z-diode	7.79..8.61V, Izt=5mA, Zzt=7Ω, 200mW	1005	13d	2b	Cmc
ZG	CZRRFR52C8V2	Z-diode	7.79..8.61V, Izt=5mA, Zzt=7Ω, 200mW	1005	13d	2b	Cmc
ZG	CZRRQR52C8V2	Z-diode	7.79..8.61V, Izt=5mA, Zzt=7Ω, 125mW	0402	13d	2b	Cmc
ZG	CZRUR52C8V2	Z-diode	7.79..8.61V, Izt=5mA, Zzt=7Ω, 150mW	0603	13d	2b	Cmc
ZG	KDZ3.6V	Z-diode	3.40..3.80V, Izt=5mA, Zzt=130Ω, 100mW	VSC	7d	1a	Kec
ZG	MM3Z11VC	Z-diode	10.45..11.55V, Zzt=18Ω, Izt=5mA, 200mW	SOD-323FL	7d	1a	F
ZG	P4SMAJ58CA	TVS	Vbr=58V, 4.3A, 400W(1ms), Bidirectional	DO-214AC	1ba	1j	Mco
ZG	PDZ11B	Z-diode	11V±2.5%, 400mW	SOD-323	5d	1a	Phi
ZG	PDZ11BF	Z-diode	10.78..11.22V, Zzt=10Ω, Izt=5mA, 400mW	SOD-323FL	7d	1a	Pjt
ZG	TCMM3Z11VC	Z-diode	11V±5%, Izt=5mA, Zzt=18Ω, 200mW	SOD-323FL	7d	1a	Tac
ZG	TSZL52C8V2	Z-diode	7.79..8.61V, Izt=5mA, Zzt=7Ω, 200mW	1005	70d	2d	Tsc
ZG	TSZU52C8V2	Z-diode	7.79..8.61V, Izt=5mA, Zzt=7Ω, 150mW	0603	70d	2d	Tsc
ZG	TV04A580JB-G	TVS	Vrwm=58.0V, Vbr=64.40..71.20V, Ipp=4.27A, 400W(1ms), Bidirectional	DO-214AC	1ba	1j	Cmc
ZG	TZD3.6W	Z-diode	3.60..3.845V, Izt=5mA, Zzt=100Ω, 100mW	SOD-723	7d	1a	Ttr
ZG	ZGFM1075-MH	Z-diode	75V±10%, Zzt=175Ω(Izt=3.3mA), 1W	SOD-123H	10d	1a	Fmm
ZG	ZGFM1075-N	Z-diode	71.3..78.8V, Izt=3.3mA, Zzt=175Ω, 1W	SOD-123F	10d	1a	Fmm
ZH	BZF10C82	Z-diode	77.9..86.1V, Izt=3.0mA, Zzt=200Ω, 1W	SOD-123F	10d	1a	Did
ZH	BZX284-C15	Z-diode	15V±5%, 400mW	SOD-110	12d	1a	Phi
ZH	CD0603-Z9V1	Z-diode	8.65..9.56V, 5mA, Zzt=10Ω, 150mW	0603	13d	2b	Bm
ZH	CD1005-Z9V1	Z-diode	8.65..9.56V, 5mA, Zzt=10Ω, 200mW	1005	13d	2b	Bm
ZH	CZRRER52C9V1	Z-diode	8.65..9.56V, Izt=5mA, Zzt=10Ω, 150mW	0503	13d	2b	Cmc
ZH	CZRRERT52C9V1	Z-diode	8.65..9.56V, Izt=5mA, Zzt=10Ω, 150mW	0503	13d	2b	Cmc
ZH	CZRF52C9V1	Z-diode	8.65..9.56V, Izt=5mA, Zzt=10Ω, 200mW	1005	13d	2b	Cmc



SMD
code

Type

Function

Short description

Case

Pinout

St.

Mnf.

SMD code	Type	Function	Short description	Case	Pinout	St.	Mnf.
ZK	CD1005-Z11	Z-diode	10.45..11.55V, 5mA, Zzt=20Ω, 200mW	1005	13d	2b	Bm
ZK	CZRER52C11	Z-diode	10.45..11.55V, lzt=5mA, Zzt=20Ω, 150mW	0503	13d	2b	Cmc
ZK	CZRERT52C11	Z-diode	10.45..11.55V, lzt=5mA, Zzt=20Ω, 150mW	0503	13d	2b	Cmc
ZK	CZRF52C11	Z-diode	10.45..11.55V, lzt=5mA, Zzt=20Ω, 200mW	1005	13d	2b	Cmc
ZK	CZRF52C11	Z-diode	10.45..11.55V, lzt=5mA, Zzt=20Ω, 200mW	1005	13d	2b	Cmc
ZK	CZRQR52C11	Z-diode	10.45..11.55V, lzt=5mA, Zzt=20Ω, 125mW	0402	13d	2b	Cmc
ZK	CZRUR52C11	Z-diode	10.45..11.55V, lzt=5mA, Zzt=20Ω, 150mW	0603	13d	2b	Cmc
ZK	DDZ21	Z-diode	21V±10%, lzt=10mA, 500mW	SOD-123	5d	1d	Di
ZK	KDZ4.7V	Z-diode	4.40..4.90V, lzt=5mA, Zzt=120Ω, 100mW	VSC	7d	1a	Kec
ZK	MM3Z15VC	Z-diode	14.25..15.75V, Zzt=28Ω, lzt=5mA, 200mW	SOD-323FL	7d	1a	F
ZK	P4SMAJ60CA	TVS	Vbr=60V, 4.1A, 400W(1ms), Bidirectional	DO-214AC	1ba	1j	Mco
ZK	PDZ15B	Z-diode	15V±2.5%, 400mW	SOD-323	5d	1a	Phi
ZK	PDZ15BF	Z-diode	14.34..14.98V, Zzt=15Ω, lzt=5mA, 400mW	SOD-323FL	7d	1a	Pjt
ZK	SMAJ60CA	TVS	Vrwm=60V, Vbr=66.7..73.7V, 4.1A, 400W(1ms), Bidirectional	DO-214AC	1ba	1l	Vs
ZK	TCMM3Z15VC	Z-diode	15V±5%, lzt=5mA, Zzt=28Ω, 200mW	SOD-323FL	7d	1a	Tac
ZK	TSZL52C11	Z-diode	10.45..11.55V, lzt=5mA, Zzt=20Ω, 200mW	1005	70d	2d	Tsc
ZK	TSZU52C11	Z-diode	10.45..11.55V, lzt=5mA, Zzt=20Ω, 150mW	0603	70d	2d	Tsc
ZK	TV04A600JB-G	TVS	Vrwm=60.0V, Vbr=66.70..73.70V, Ipp=4.13A, 400W(1ms), Bidirectional	DO-214AC	1ba	1j	Cmc
ZK	TZD4.7W	Z-diode	4.55..4.75V, lzt=5mA, Zzt=100Ω, 100mW	SOD-723	7d	1a	Ttr
ZK	ZGFM10100-MH	Z-diode	100V±10%, Zzt=350Ω(lzt=2.5mA), 1W	SOD-123H	10d	1a	Frm
ZK	ZGFM10100-N	Z-diode	95.0..105.0V, lzt=2.5mA, Zzt=35Ω, 1W	SOD-123F	10d	1a	Frm
ZKR	SMZ2150	Z-diode	150V±2%, 5mA, 2W	DO-214AB	1d	1q	Ste
ZKW	SMZ2200	Z-diode	200V±2%, 5mA, 2W	DO-214AB	1d	1q	Ste
ZL	BZX284-C22	Z-diode	22V±5%, 400mW	SOD-110	12d	1a	Phi
ZL	DDZ23	Z-diode	23V±10%, lzt=10mA, 500mW	SOD-123	5d	1d	Di
ZL	KDZ5.1V	Z-diode	4.80..5.40V, lzt=5mA, Zzt=70Ω, 100mW	VSC	7d	1a	Kec
ZL	MM3Z16VC	Z-diode	15.2..16.8V, Zzt=37Ω, lzt=5mA, 200mW	SOD-323FL	7d	1a	F
ZL	PDZ16B	Z-diode	16V±2.5%, 400mW	SOD-323	5d	1a	Phi
ZL	PDZ16BF	Z-diode	15.85..16.51V, Zzt=20Ω, lzt=5mA, 400mW	SOD-323FL	7d	1a	Pjt
ZL	SMAJ64C	TVS	Vrwm=64V, Vbr=71.1..86.4V, 3.5A, 400W(1ms), Bidirectional	DO-214AC	1ba	1l	Vs
ZL	TCMM3Z16VC	Z-diode	16V±5%, lzt=5mA, Zzt=37Ω, 200mW	SOD-323FL	7d	1a	Tac
ZL	TV04A640KB-G	TVS	Vrwm=64.0V, Vbr=71.10..86.90V, Ipp=3.51A, 400W(1ms), Bidirectional	DO-214AC	1ba	1j	Cmc
ZL	TZD5.1W	Z-diode	4.98..5.20V, lzt=5mA, Zzt=80Ω, 100mW	SOD-723	7d	1a	Ttr
ZM	BZX284-C24	Z-diode	24V±5%, 400mW	SOD-110	12d	1a	Phi
ZM	CD0603-Z12	Z-diode	11.4..12.6V, 5mA, Zzt=20Ω, 150mW	0603	13d	2b	Bm
ZM	CD1005-Z12	Z-diode	11.4..12.6V, 5mA, Zzt=20Ω, 200mW	1005	13d	2b	Bm
ZM	CZRER52C12	Z-diode	11.40..12.60V, lzt=5mA, Zzt=20Ω, 150mW	0503	13d	2b	Cmc
ZM	CZRERT52C12	Z-diode	11.40..12.60V, lzt=5mA, Zzt=20Ω, 150mW	0503	13d	2b	Cmc
ZM	CZRF52C12	Z-diode	11.40..12.60V, lzt=5mA, Zzt=20Ω, 200mW	1005	13d	2b	Cmc
ZM	CZRF52C12	Z-diode	11.40..12.60V, lzt=5mA, Zzt=20Ω, 200mW	1005	13d	2b	Cmc
ZM	CZRQR52C12	Z-diode	11.40..12.60V, lzt=5mA, Zzt=20Ω, 125mW	0402	13d	2b	Cmc
ZM	CZRUR52C12	Z-diode	11.40..12.60V, lzt=5mA, Zzt=20Ω, 150mW	0603	13d	2b	Cmc
ZM	DDZ26	Z-diode	26V±10%, lzt=10mA, 500mW	SOD-123	5d	1d	Di
ZM	KDZ5.6V	Z-diode	5.30..6.0V, lzt=5mA, Zzt=40Ω, 100mW	VSC	7d	1a	Kec
ZM	MM3Z18VC	Z-diode	17.1..18.9V, Zzt=42Ω, lzt=5mA, 200mW	SOD-323FL	7d	1a	F
ZM	P4SMAJ64CA	TVS	Vbr=64V, 3.9A, 400W(1ms), Bidirectional	DO-214AC	1ba	1j	Mco
ZM	PDZ18B	Z-diode	18V±2.5%, 400mW	SOD-323	5d	1a	Phi
ZM	PDZ18BF	Z-diode	17.56..18.35V, Zzt=20Ω, lzt=5mA, 400mW	SOD-323FL	7d	1a	Pjt
ZM	SMAJ64CA	TVS	Vrwm=64V, Vbr=71.1..78.6V, 3.9A, 400W(1ms), Bidirectional	DO-214AC	1ba	1l	Vs
ZM	TCMM3Z18VC	Z-diode	18V±5%, lzt=5mA, Zzt=42Ω, 200mW	SOD-323FL	7d	1a	Tac
ZM	TSZL52C12	Z-diode	11.40..12.60V, lzt=5mA, Zzt=20Ω, 200mW	1005	70d	2d	Tsc
ZM	TSZU52C12	Z-diode	11.40..12.60V, lzt=5mA, Zzt=20Ω, 150mW	0603	70d	2d	Tsc
ZM	TV04A640JB-G	TVS	Vrwm=64.0V, Vbr=71.10..78.60V, Ipp=3.88A, 400W(1ms), Bidirectional	DO-214AC	1ba	1j	Cmc
ZM	TZD5.6W	Z-diode	5.49..5.73V, lzt=5mA, Zzt=60Ω, 100mW	SOD-723	7d	1a	Ttr
ZN	BZX284-C27	Z-diode	27V±5%, 400mW	SOD-110	12d	1a	Phi
ZN	CD0603-Z13	Z-diode	12.35..13.65V, 5mA, Zzt=25Ω, 150mW	0603	13d	2b	Bm
ZN	CD1005-Z13	Z-diode	12.35..13.65V, 5mA, Zzt=25Ω, 200mW	1005	13d	2b	Bm
ZN	CZRER52C13	Z-diode	12.35..13.65V, lzt=5mA, Zzt=25Ω, 150mW	0503	13d	2b	Cmc
ZN	CZRERT52C13	Z-diode	12.35..13.65V, lzt=5mA, Zzt=25Ω, 150mW	0503	13d	2b	Cmc
ZN	CZRF52C13	Z-diode	12.35..13.65V, lzt=5mA, Zzt=25Ω, 200mW	1005	13d	2b	Cmc
ZN	CZRF52C13	Z-diode	12.35..13.65V, lzt=5mA, Zzt=25Ω, 200mW	1005	13d	2b	Cmc
ZN	CZRQR52C13	Z-diode	12.35..13.65V, lzt=5mA, Zzt=25Ω, 125mW	0402	13d	2b	Cmc
ZN	CZRUR52C13	Z-diode	12.35..13.65V, lzt=5mA, Zzt=25Ω, 150mW	0603	13d	2b	Cmc
ZN	DDZ28	Z-diode	28V±10%, lzt=10mA, 500mW	SOD-123	5d	1d	Di
ZN	KDZ6.2V	Z-diode	5.80..6.60V, lzt=5mA, Zzt=30Ω, 100mW	VSC	7d	1a	Kec
ZN	MM3Z20VC	Z-diode	19..21V, Zzt=51Ω, lzt=5mA, 200mW	SOD-323FL	7d	1a	F
ZN	PDZ20B	Z-diode	20V±2.5%, 400mW	SOD-323	5d	1a	Phi
ZN	PDZ20BF	Z-diode	19.52..20.39V, Zzt=20Ω, lzt=5mA, 400mW	SOD-323FL	7d	1a	Pjt
ZN	SMAJ70C	TVS	Vrwm=70V, Vbr=77.8..95.1V, 3.2A, 400W(1ms), Bidirectional	DO-214AC	1ba	1l	Vs
ZN	TCMM3Z20VC	Z-diode	20V±5%, lzt=5mA, Zzt=51Ω, 200mW	SOD-323FL	7d	1a	Tac



SMD
code

Type

Function

Short description

Case

Pinout

St.

Mnf.

ZN	TSZL52C13	Z-diode	12.35..13.65V, Izt=5mA, Zzt=25Ω, 200mW	1005	70d	2d	Tsc
ZN	TSZU52C13	Z-diode	12.35..13.65V, Izt=5mA, Zzt=25Ω, 150mW	0603	70d	2d	Tsc
ZN	TV04A700KB-G	TVS	Vrwm=70.0V, Vbr=77.80..95.10V, Ipp=3.20A, 400W(1ms), Bidirectional	DO-214AC	1ba	1j	Cmc
ZN	TZD6.2WU	Z-diode	6.06..6.33V, Izt=5mA, Zzt=60Ω, 100mW	SOD-723	7d	1a	Ttr
ZO	BZX284-C30	Z-diode	30V±5%, 400mW	SOD-110	12d	1a	Phi
ZO	DDZ31	Z-diode	31V±10%, Izt=10mA, 500mW	SOD-123	5d	1d	Di
ZP	BZX284-C33	Z-diode	33V±5%, 400mW	SOD-110	12d	1a	Phi
ZP	CD0603-Z15	Z-diode	14.25..15.75V, 5mA, Zzt=30Ω, 150mW	0603	13d	2b	Bm
ZP	CD1005-Z15	Z-diode	14.25..15.75V, 5mA, Zzt=30Ω, 200mW	1005	13d	2b	Bm
ZP	CMDZ16L	Z-diode	15.20..16.80V, Izt=0.5mA, Zzt=80Ω, 250mW	SOD-323	5d	1a	Cen
ZP	CZRER52C15	Z-diode	14.25..15.75V, Izt=5mA, Zzt=30Ω, 150mW	0503	13d	2b	Cmc
ZP	CZRERT52C15	Z-diode	14.25..15.75V, Izt=5mA, Zzt=30Ω, 150mW	0503	13d	2b	Cmc
ZP	CZRF52C15	Z-diode	14.25..15.75V, Izt=5mA, Zzt=30Ω, 200mW	1005	13d	2b	Cmc
ZP	CZRR52C15	Z-diode	14.25..15.75V, Izt=5mA, Zzt=30Ω, 200mW	1005	13d	2b	Cmc
ZP	CZRQR52C15	Z-diode	14.25..15.75V, Izt=5mA, Zzt=30Ω, 125mW	0402	13d	2b	Cmc
ZP	CZRUR52C15	Z-diode	14.25..15.75V, Izt=5mA, Zzt=30Ω, 150mW	0603	13d	2b	Cmc
ZP	DDZ34	Z-diode	34V±10%, Izt=10mA, 500mW	SOD-123	5d	1d	Di
ZP	KDZ6.8VU	Z-diode	6.40..7.20V, Izt=5mA, Zzt=25Ω, 100mW	VSC	7d	1a	Kec
ZP	MM3Z22VC	Z-diode	20.9..23.1V, Zzt=51Ω, Izt=5mA, 200mW	SOD-323FL	7d	1a	F
ZP	P4SMAJ70CA	TVS	Vbr=70V, 3.5A, 400W(1ms), Bidirectional	DO-214AC	1ba	1j	Mco
ZP	PDZ22B	Z-diode	22V±2.5%, 400mW	SOD-323	5d	1a	Phi
ZP	PDZ22BF	Z-diode	21.54..22.47V, Zzt=25Ω, Izt=5mA, 400mW	SOD-323FL	7d	1a	Pjt
ZP	TCMM3Z22VC	Z-diode	22V±5%, Izt=5mA, Zzt=51Ω, 200mW	SOD-323FL	7d	1a	Tac
ZP	TSZL52C15	Z-diode	14.25..15.75V, Izt=5mA, Zzt=30Ω, 200mW	1005	70d	2d	Tsc
ZP	TSZU52C15	Z-diode	14.25..15.75V, Izt=5mA, Zzt=30Ω, 150mW	0603	70d	2d	Tsc
ZP	TV04A700JB-G	TVS	Vrwm=70.0V, Vbr=77.80..86.0V, Ipp=3.54A, 400W(1ms), Bidirectional	DO-214AC	1ba	1j	Cmc
ZP	TZD6.8WU	Z-diode	6.65..6.93V, Izt=5mA, Zzt=40Ω, 100mW	SOD-723	7d	1a	Ttr
ZQ	BZX284-C36	Z-diode	36V±5%, 400mW	SOD-110	12d	1a	Phi
ZQ	CD0603-Z16	Z-diode	15.2..16.8V, 5mA, Zzt=40Ω, 150mW	0603	13d	2b	Bm
ZQ	CD1005-Z16	Z-diode	15.2..16.8V, 5mA, Zzt=40Ω, 200mW	1005	13d	2b	Bm
ZQ	CZRER52C16	Z-diode	15.20..16.80V, Izt=5mA, Zzt=40Ω, 150mW	0503	13d	2b	Cmc
ZQ	CZRERT52C16	Z-diode	15.20..16.80V, Izt=5mA, Zzt=40Ω, 150mW	0503	13d	2b	Cmc
ZQ	CZRF52C16	Z-diode	15.20..16.80V, Izt=5mA, Zzt=40Ω, 200mW	1005	13d	2b	Cmc
ZQ	CZRR52C16	Z-diode	15.20..16.80V, Izt=5mA, Zzt=40Ω, 200mW	1005	13d	2b	Cmc
ZQ	CZRQR52C16	Z-diode	15.20..16.80V, Izt=5mA, Zzt=40Ω, 125mW	0402	13d	2b	Cmc
ZQ	CZRUR52C16	Z-diode	15.20..16.80V, Izt=5mA, Zzt=40Ω, 150mW	0603	13d	2b	Cmc
ZQ	DDZ36	Z-diode	36V±10%, Izt=10mA, 500mW	SOD-123	5d	1d	Di
ZQ	DDZ36S	Z-diode	36V±10%, Izt=5mA, 200mW	SOD-323	5d	1d	Di
ZQ	KDZ7.5VU	Z-diode	7.0..7.90V, Izt=5mA, Zzt=23Ω, 100mW	VSC	7d	1a	Kec
ZQ	PDZ24B	Z-diode	24V±2.5%, 400mW	SOD-323	5d	1a	Phi
ZQ	PDZ24BF	Z-diode	23.72..24.78V, Zzt=30Ω, Izt=5mA, 400mW	SOD-323FL	7d	1a	Pjt
ZQ	SMAJ75C	TVS	Vrwm=75V, Vbr=83.3..102V, 3A, 400W(1ms), Bidirectional	DO-214AC	1ba	1l	Vs
ZQ	TSZL52C16	Z-diode	15.20..16.80V, Izt=5mA, Zzt=40Ω, 200mW	1005	70d	2d	Tsc
ZQ	TSZU52C16	Z-diode	15.20..16.80V, Izt=5mA, Zzt=40Ω, 150mW	0603	70d	2d	Tsc
ZQ	TV04A750KB-G	TVS	Vrwm=75.0V, Vbr=83.30..102.0V, Ipp=3.99A, 400W(1ms), Bidirectional	DO-214AC	1ba	1j	Cmc
ZQ	TZD7.5WU	Z-diode	7.28..7.60V, Izt=5mA, Zzt=30Ω, 100mW	SOD-723	7d	1a	Ttr
ZR	BZX284-C39	Z-diode	39V±5%, 400mW	SOD-110	12d	1a	Phi
ZR	CD0603-Z18	Z-diode	17.1..18.9V, 5mA, Zzt=50Ω, 150mW	0603	13d	2b	Bm
ZR	CD1005-Z18	Z-diode	17.1..18.9V, 5mA, Zzt=50Ω, 200mW	1005	13d	2b	Bm
ZR	CZRER52C18	Z-diode	17.10..18.90V, Izt=5mA, Zzt=50Ω, 150mW	0503	13d	2b	Cmc
ZR	CZRERT52C18	Z-diode	17.10..18.90V, Izt=5mA, Zzt=50Ω, 150mW	0503	13d	2b	Cmc
ZR	CZRF52C18	Z-diode	17.10..18.90V, Izt=5mA, Zzt=50Ω, 200mW	1005	13d	2b	Cmc
ZR	CZRR52C18	Z-diode	17.10..18.90V, Izt=5mA, Zzt=50Ω, 200mW	1005	13d	2b	Cmc
ZR	CZRQR52C18	Z-diode	17.10..18.90V, Izt=5mA, Zzt=50Ω, 125mW	0402	13d	2b	Cmc
ZR	CZRUR52C18	Z-diode	17.10..18.90V, Izt=5mA, Zzt=50Ω, 150mW	0603	13d	2b	Cmc
ZR	DDZ43	Z-diode	43V±10%, Izt=10mA, 500mW	SOD-123	5d	1d	Di
ZR	DDZ43S	Z-diode	43V±10%, Izt=5mA, 200mW	SOD-323	5d	1d	Di
ZR	KDZ8.2VU	Z-diode	7.70..8.70V, Izt=5mA, Zzt=20Ω, 100mW	VSC	7d	1a	Kec
ZR	MM3Z24VC	Z-diode	22.8..25.2V, Zzt=65Ω, Izt=5mA, 200mW	SOD-323FL	7d	1a	F
ZR	P4SMAJ75CA	TVS	Vbr=75V, 3.3A, 400W(1ms), Bidirectional	DO-214AC	1ba	1j	Mco
ZR	PDZ27B	Z-diode	27V±2.5%, 400mW	SOD-323	5d	1a	Phi
ZR	PDZ27BF	Z-diode	26.19..27.53V, Zzt=40Ω, Izt=5mA, 400mW	SOD-323FL	7d	1a	Pjt
ZR	SMAJ75CA	TVS	Vrwm=75V, Vbr=83.3..92.1V, 3.3A, 400W(1ms), Bidirectional	DO-214AC	1ba	1l	Vs
ZR	TCMM3Z24VC	Z-diode	24V±5%, Izt=5mA, Zzt=65Ω, 200mW	SOD-323FL	7d	1a	Tac
ZR	TSZL52C18	Z-diode	17.10..18.90V, Izt=5mA, Zzt=50Ω, 200mW	1005	70d	2d	Tsc
ZR	TSZU52C18	Z-diode	17.10..18.90V, Izt=5mA, Zzt=50Ω, 150mW	0603	70d	2d	Tsc
ZR	TV04A750JB-G	TVS	Vrwm=75.0V, Vbr=83.30..92.10V, Ipp=3.31A, 400W(1ms), Bidirectional	DO-214AC	1ba	1j	Cmc
ZR	TZD8.2WU	Z-diode	8.02..8.36V, Izt=5mA, Zzt=30Ω, 100mW	SOD-723	7d	1a	Ttr
ZS	BZX284-C43	Z-diode	43V±5%, 400mW	SOD-110	12d	1a	Phi
ZS	CD0603-Z20	Z-diode	19..21V, 5mA, Zzt=50Ω, 150mW	0603	13d	2b	Bm



SMD
code

Type

Function

Short description

Case

Pinout

St.

Mnf.

ZS	CD1005-Z20	Z-diode	19..21V, 5mA, Zzt=50Ω, 200mW	1005	13d	2b	Bm
ZS	CZRER52C20	Z-diode	19.0..21.0V, Izt=5mA, Zzt=50Ω, 150mW	0503	13d	2b	Cmc
ZS	CZRERT52C20	Z-diode	19.0..21.0V, Izt=5mA, Zzt=50Ω, 150mW	0503	13d	2b	Cmc
ZS	CZRF52C20	Z-diode	19.0..21.0V, Izt=5mA, Zzt=50Ω, 200mW	1005	13d	2b	Cmc
ZS	CZRF52C20	Z-diode	19.0..21.0V, Izt=5mA, Zzt=50Ω, 200mW	1005	13d	2b	Cmc
ZS	CZRQR52C20	Z-diode	19.0..21.0V, Izt=5mA, Zzt=50Ω, 125mW	0402	13d	2b	Cmc
ZS	CZRUR52C20	Z-diode	19.0..21.0V, Izt=5mA, Zzt=50Ω, 150mW	0603	13d	2b	Cmc
ZS	DDZ47S	Z-diode	47V±10%, Izt=5mA, 200mW	SOD-323	5d	1d	Di
ZS	KDZ9.1V	Z-diode	8.50..9.60V, Izt=5mA, Zzt=18Ω, 100mW	VSC	7d	1a	Kec
ZS	MM3Z27VC	Z-diode	25.65..28.35V, Zzt=75Ω, Izt=2mA, 200mW	SOD-323FL	7d	1a	F
ZS	PDZ30B	Z-diode	30V±2.5%, 400mW	SOD-323	5d	1a	Phi
ZS	PDZ30BF	Z-diode	29.19..30.69V, Zzt=40Ω, Izt=5mA, 400mW	SOD-323FL	7d	1a	Pjt
ZS	SMAJ78C	TVS	Vrwm=78V, Vbr=86.7..106V, 2.9A, 400W(1ms), Bidirectional	DO-214AC	1ba	1j	Vs
ZS	TCMM3Z27VC	Z-diode	27V±5%, Izt=5mA, Zzt=75Ω, 200mW	SOD-323FL	7d	1a	Tac
ZS	TSZL52C20	Z-diode	19.0..21.0V, Izt=5mA, Zzt=50Ω, 200mW	1005	70d	2d	Tsc
ZS	TSZU52C20	Z-diode	19.0..21.0V, Izt=5mA, Zzt=50Ω, 150mW	0603	70d	2d	Tsc
ZS	TV04A780KB-G	TVS	Vrwm=78.0V, Vbr=86.70..106.0V, Ipp=2.88A, 400W(1ms), Bidirectional	DO-214AC	1ba	1j	Cmc
ZS	TV04A800KB-G	TVS	Vrwm=80.0V, Vbr=88.96..108.80V, Ipp=2.79A, 400W(1ms), Bidirectional	DO-214AC	1ba	1j	Cmc
ZS	TZD9.1W	Z-diode	8.85..9.23V, Izt=5mA, Zzt=30Ω, 100mW	SOD-723	7d	1a	Ttr
ZT	BZX284-C47	Z-diode	47V±5%, 400mW	SOD-110	12d	1a	Phi
ZT	CD0603-Z22	Z-diode	20.9..23.1V, 5mA, Zzt=55Ω, 150mW	0603	13d	2b	Bm
ZT	CD1005-Z22	Z-diode	20.9..23.1V, 5mA, Zzt=55Ω, 200mW	1005	13d	2b	Bm
ZT	CZRER52C22	Z-diode	20.90..23.10V, Izt=5mA, Zzt=55Ω, 150mW	0503	13d	2b	Cmc
ZT	CZRERT52C22	Z-diode	20.90..23.10V, Izt=5mA, Zzt=55Ω, 150mW	0503	13d	2b	Cmc
ZT	CZRF52C22	Z-diode	20.90..23.10V, Izt=5mA, Zzt=55Ω, 200mW	1005	13d	2b	Cmc
ZT	CZRF52C22	Z-diode	20.90..23.10V, Izt=5mA, Zzt=55Ω, 200mW	1005	13d	2b	Cmc
ZT	CZRQR52C22	Z-diode	20.90..23.10V, Izt=5mA, Zzt=55Ω, 125mW	0402	13d	2b	Cmc
ZT	CZRUR52C22	Z-diode	20.90..23.10V, Izt=5mA, Zzt=55Ω, 150mW	0603	13d	2b	Cmc
ZT	MM3Z30VC	Z-diode	28.5..31.5V, Zzt=75Ω, Izt=2mA, 200mW	SOD-323FL	7d	1a	F
ZT	P4SMAJ78CA	TVS	Vbr=78V, 2.2A, 400W(1ms), Bidirectional	DO-214AC	1ba	1j	Mco
ZT	PDZ33B	Z-diode	33V±2.5%, 400mW	SOD-323	5d	1a	Phi
ZT	PDZ33BF	Z-diode	32.15..33.79V, Zzt=40Ω, Izt=5mA, 400mW	SOD-323FL	7d	1a	Pjt
ZT	SMAJ78CA	TVS	Vrwm=78V, Vbr=86.7..95.8V, 3.2A, 400W(1ms), Bidirectional	DO-214AC	1ba	1j	Vs
ZT	TCMM3Z30VC	Z-diode	30V±5%, Izt=5mA, Zzt=75Ω, 200mW	SOD-323FL	7d	1a	Tac
ZT	TSZL52C22	Z-diode	20.90..23.10V, Izt=5mA, Zzt=55Ω, 200mW	1005	70d	2d	Tsc
ZT	TSZU52C22	Z-diode	20.90..23.10V, Izt=5mA, Zzt=55Ω, 150mW	0603	70d	2d	Tsc
ZT	TV04A780JB-G	TVS	Vrwm=78.0V, Vbr=86.70..95.80V, Ipp=3.17A, 400W(1ms), Bidirectional	DO-214AC	1ba	1j	Cmc
ZT	TV04A800JB-G	TVS	Vrwm=80.0V, Vbr=88.80..97.60V, Ipp=3.09A, 400W(1ms), Bidirectional	DO-214AC	1ba	1j	Cmc
ZU	BZX284-C51	Z-diode	51V±5%, 400mW	SOD-110	12d	1a	Phi
ZU	CD0603-Z24	Z-diode	22.8..25.2V, 5mA, Zzt=80Ω, 150mW	0603	13d	2b	Bm
ZU	CD1005-Z24	Z-diode	22.8..25.2V, 5mA, Zzt=80Ω, 200mW	1005	13d	2b	Bm
ZU	CZRER52C24	Z-diode	22.80..25.20V, Izt=5mA, Zzt=80Ω, 150mW	0503	13d	2b	Cmc
ZU	CZRERT52C24	Z-diode	22.80..25.20V, Izt=5mA, Zzt=80Ω, 150mW	0503	13d	2b	Cmc
ZU	CZRF52C24	Z-diode	22.80..25.20V, Izt=5mA, Zzt=80Ω, 200mW	1005	13d	2b	Cmc
ZU	CZRF52C24	Z-diode	22.80..25.20V, Izt=5mA, Zzt=80Ω, 200mW	1005	13d	2b	Cmc
ZU	CZRQR52C24	Z-diode	22.80..25.20V, Izt=5mA, Zzt=80Ω, 125mW	0402	13d	2b	Cmc
ZU	CZRUR52C24	Z-diode	22.80..25.20V, Izt=5mA, Zzt=80Ω, 150mW	0603	13d	2b	Cmc
ZU	MM3Z33VC	Z-diode	31.35..34.65V, Zzt=75Ω, Izt=2mA, 200mW	SOD-323FL	7d	1a	F
ZU	PDZ36B	Z-diode	36V±2.5%, 400mW	SOD-323	5d	1a	Phi
ZU	PDZ36BF	Z-diode	35.07..36.87V, Zzt=60Ω, Izt=5mA, 400mW	SOD-323FL	7d	1a	Pjt
ZU	SMAJ85C	TVS	Vrwm=85V, Vbr=94.4..115V, 400W(1ms), Bidirectional	DO-214AC	1ba	1j	Vs
ZU	TCMM3Z33VC	Z-diode	33V±5%, Izt=5mA, Zzt=75Ω, 200mW	SOD-323FL	7d	1a	Tac
ZU	TSZL52C24	Z-diode	22.80..25.20V, Izt=5mA, Zzt=80Ω, 200mW	1005	70d	2d	Tsc
ZU	TSZU52C24	Z-diode	22.80..25.20V, Izt=5mA, Zzt=80Ω, 150mW	0603	70d	2d	Tsc
ZU	TV04A850KB-G	TVS	Vrwm=85.0V, Vbr=94.40..115.0V, Ipp=2.65A, 400W(1ms), Bidirectional	DO-214AC	1ba	1j	Cmc
ZV	BZX284-C56	Z-diode	56V±5%, 400mW	SOD-110	12d	1a	Phi
ZV	CD0603-Z27	Z-diode	25.65..28.35V, 5mA, Zzt=80Ω, 150mW	0603	13d	2b	Bm
ZV	CD1005-Z27	Z-diode	25.65..28.35V, 5mA, Zzt=80Ω, 200mW	1005	13d	2b	Bm
ZV	CZRER52C27	Z-diode	25.65..28.35V, Izt=5mA, Zzt=80Ω, 150mW	0503	13d	2b	Cmc
ZV	CZRERT52C27	Z-diode	25.65..28.35V, Izt=5mA, Zzt=80Ω, 150mW	0503	13d	2b	Cmc
ZV	CZRF52C27	Z-diode	25.65..28.35V, Izt=5mA, Zzt=80Ω, 200mW	1005	13d	2b	Cmc
ZV	CZRF52C27	Z-diode	25.65..28.35V, Izt=5mA, Zzt=80Ω, 200mW	1005	13d	2b	Cmc
ZV	CZRQR52C27	Z-diode	25.65..28.35V, Izt=5mA, Zzt=80Ω, 125mW	0402	13d	2b	Cmc
ZV	CZRUR52C27	Z-diode	25.65..28.35V, Izt=5mA, Zzt=80Ω, 150mW	0603	13d	2b	Cmc
ZV	MM3Z36VC	Z-diode	34.2..37.8V, Zzt=84Ω, Izt=2mA, 200mW	SOD-323FL	7d	1a	F
ZV	P4SMAJ85CA	TVS	Vbr=85V, 2.9A, 400W(1ms), Bidirectional	DO-214AC	1ba	1j	Mco
ZV	TCMM3Z36VC	Z-diode	36V±5%, Izt=5mA, Zzt=84Ω, 200mW	SOD-323FL	7d	1a	Tac
ZV	TSZL52C27	Z-diode	25.65..28.35V, Izt=5mA, Zzt=80Ω, 200mW	1005	70d	2d	Tsc
ZV	TSZU52C27	Z-diode	25.65..28.35V, Izt=5mA, Zzt=80Ω, 150mW	0603	70d	2d	Tsc
ZV	TV04A850JB-G	TVS	Vrwm=85.0V, Vbr=94.40..104.0V, Ipp=2.92A, 400W(1ms), Bidirectional	DO-214AC	1ba	1j	Cmc



SECTION 2
SOD-80 CASES SMD SEMICONDUCTOR COMPONENTS



SMD code	Type	Function	Short description	Case	Pinout	St.	Mnf.
10A	GLZ10A	Z-diode	9.12..9.59V, Zzt=8Ω, Izt=20mA, 500mW	SOD-80	15d	2c	Pjt
10A	TLZ10A	Z-diode	9.12..9.59V, Izt=20mA, Zzt=8Ω, 500mW	SOD-80	15d	2g	Ttr
10B	GLZ10B	Z-diode	9.41..9.90V, Zzt=8Ω, Izt=20mA, 500mW	SOD-80	15d	2c	Pjt
10B	TLZ10B	Z-diode	9.41..9.90V, Izt=20mA, Zzt=8Ω, 500mW	SOD-80	15d	2g	Ttr
10C	GLZ10C	Z-diode	9.70..10.20V, Zzt=8Ω, Izt=20mA, 500mW	SOD-80	15d	2c	Pjt
10C	TLZ10C	Z-diode	9.70..10.20V, Izt=20mA, Zzt=8Ω, 500mW	SOD-80	15d	2g	Ttr
10D	GLZ10D	Z-diode	9.94..10.44V, Zzt=8Ω, Izt=20mA, 500mW	SOD-80	15d	2c	Pjt
10D	TLZ10D	Z-diode	9.94..10.44V, Izt=20mA, Zzt=8Ω, 500mW	SOD-80	15d	2g	Ttr
11A	GLZ11A	Z-diode	10.18..10.71V, Zzt=10Ω, Izt=10mA, 500mW	SOD-80	15d	2c	Pjt
11A	TLZ11A	Z-diode	10.18..10.71V, Izt=10mA, Zzt=10Ω, 500mW	SOD-80	15d	2g	Ttr
11B	GLZ11B	Z-diode	10.50..11.05V, Zzt=10Ω, Izt=10mA, 500mW	SOD-80	15d	2c	Pjt
11B	TLZ11B	Z-diode	10.50..11.05V, Izt=10mA, Zzt=10Ω, 500mW	SOD-80	15d	2g	Ttr
11C	GLZ11C	Z-diode	10.82..11.38V, Zzt=10Ω, Izt=10mA, 500mW	SOD-80	15d	2c	Pjt
11C	TLZ11C	Z-diode	10.82..11.38V, Izt=10mA, Zzt=10Ω, 500mW	SOD-80	15d	2g	Ttr
11D	GLZ11D	Z-diode	9.94..10.44V, Izt=20mA, Zzt=8Ω, 500mW	LL-34	15d	2c	Kd
12A	GLZ12A	Z-diode	11.13..11.71V, Zzt=12Ω, Izt=10mA, 500mW	SOD-80	15d	2c	Pjt
12A	TLZ12A	Z-diode	11.13..11.71V, Izt=10mA, Zzt=12Ω, 500mW	SOD-80	15d	2g	Ttr
12B	GLZ12B	Z-diode	11.44..12.03V, Zzt=12Ω, Izt=10mA, 500mW	SOD-80	15d	2c	Pjt
12B	TLZ12B	Z-diode	11.44..12.03V, Izt=10mA, Zzt=12Ω, 500mW	SOD-80	15d	2g	Ttr
12C	GLZ12C	Z-diode	11.74..12.35V, Zzt=12Ω, Izt=10mA, 500mW	SOD-80	15d	2c	Pjt
12C	TLZ12C	Z-diode	11.74..12.35V, Izt=10mA, Zzt=12Ω, 500mW	SOD-80	15d	2g	Ttr
13A	GLZ13A	Z-diode	12.11..12.75V, Zzt=14Ω, Izt=10mA, 500mW	SOD-80	15d	2c	Pjt
13A	TLZ13A	Z-diode	12.11..12.75V, Izt=10mA, Zzt=14Ω, 500mW	SOD-80	15d	2g	Ttr
13B	GLZ13B	Z-diode	12.55..13.21V, Zzt=14Ω, Izt=10mA, 500mW	SOD-80	15d	2c	Pjt
13B	TLZ13B	Z-diode	12.55..13.21V, Izt=10mA, Zzt=14Ω, 500mW	SOD-80	15d	2g	Ttr
13C	GLZ13C	Z-diode	12.99..13.66V, Zzt=14Ω, Izt=10mA, 500mW	SOD-80	15d	2c	Pjt
13C	TLZ13C	Z-diode	12.99..13.66V, Izt=10mA, Zzt=14Ω, 500mW	SOD-80	15d	2g	Ttr
15 blue	RKZ15-2KD	Z-diode	14.5..15.1V, Izt=5mA, Zzt=40Ω, 500mW	LLD	15d	2g	Ren
15 pink	RKZ15-1KD	Z-diode	14.1..14.7V, Izt=5mA, Zzt=40Ω, 500mW	LLD	15d	2g	Ren
15 white	RKZ15-3KD	Z-diode	14.9..15.5V, Izt=5mA, Zzt=40Ω, 500mW	LLD	15d	2g	Ren
15A	GLZ15A	Z-diode	13.44..14.13V, Zzt=16Ω, Izt=10mA, 500mW	SOD-80	15d	2c	Pjt
15A	TLZ15A	Z-diode	13.44..14.13V, Izt=10mA, Zzt=16Ω, 500mW	SOD-80	15d	2g	Ttr
15B	GLZ15B	Z-diode	13.89..14.62V, Zzt=16Ω, Izt=10mA, 500mW	SOD-80	15d	2c	Pjt
15B	TLZ15B	Z-diode	13.89..14.62V, Izt=10mA, Zzt=16Ω, 500mW	SOD-80	15d	2g	Ttr
15C	GLZ15C	Z-diode	14.35..15.09V, Zzt=16Ω, Izt=10mA, 500mW	SOD-80	15d	2c	Pjt
15C	TLZ15C	Z-diode	14.35..15.09V, Izt=10mA, Zzt=16Ω, 500mW	SOD-80	15d	2g	Ttr
16 blue	RKZ16-2KD	Z-diode	15.7..16.5V, Izt=5mA, Zzt=45Ω, 500mW	LLD	15d	2g	Ren
16 pink	RKZ16-1KD	Z-diode	15.3..15.9V, Izt=5mA, Zzt=45Ω, 500mW	LLD	15d	2g	Ren
16 white	RKZ16-3KD	Z-diode	16.3..17.1V, Izt=5mA, Zzt=45Ω, 500mW	LLD	15d	2g	Ren
16A	GLZ16A	Z-diode	14.80..15.57V, Zzt=18Ω, Izt=10mA, 500mW	SOD-80	15d	2c	Pjt
16A	TLZ16A	Z-diode	14.80..15.57V, Izt=10mA, Zzt=18Ω, 500mW	SOD-80	15d	2g	Ttr
16B	GLZ16B	Z-diode	15.25..16.04V, Zzt=18Ω, Izt=10mA, 500mW	SOD-80	15d	2c	Pjt
16B	TLZ16B	Z-diode	15.25..16.04V, Izt=10mA, Zzt=18Ω, 500mW	SOD-80	15d	2g	Ttr
16C	GLZ16C	Z-diode	15.69..16.51V, Zzt=18Ω, Izt=10mA, 500mW	SOD-80	15d	2c	Pjt
16C	TLZ16C	Z-diode	15.69..16.51V, Izt=10mA, Zzt=18Ω, 500mW	SOD-80	15d	2g	Ttr
18 blue	RKZ18-2KD	Z-diode	17.5..18.3V, Izt=5mA, Zzt=55Ω, 500mW	LLD	15d	2g	Ren
18 pink	RKZ18-1KD	Z-diode	16.9..17.7V, Izt=5mA, Zzt=55Ω, 500mW	LLD	15d	2g	Ren
18 white	RKZ18-3KD	Z-diode	18.1..19.0V, Izt=5mA, Zzt=55Ω, 500mW	LLD	15d	2g	Ren
18A	GLZ18A	Z-diode	16.22..17.06V, Zzt=23Ω, Izt=10mA, 500mW	SOD-80	15d	2c	Pjt
18A	TLZ18A	Z-diode	16.22..17.06V, Izt=10mA, Zzt=23Ω, 500mW	SOD-80	15d	2g	Ttr
18B	GLZ18B	Z-diode	16.82..17.70V, Zzt=23Ω, Izt=10mA, 500mW	SOD-80	15d	2c	Pjt
18B	TLZ18B	Z-diode	16.82..17.70V, Izt=10mA, Zzt=23Ω, 500mW	SOD-80	15d	2g	Ttr
18C	GLZ18C	Z-diode	17.42..18.33V, Zzt=23Ω, Izt=10mA, 500mW	SOD-80	15d	2c	Pjt
18C	TLZ18C	Z-diode	16.22..18.33V, Izt=10mA, Zzt=23Ω, 500mW	SOD-80	15d	2g	Ttr
20 blue	RKZ20-2KD	Z-diode	19.5..20.4V, Izt=2mA, Zzt=60Ω, 500mW	LLD	15d	2g	Ren
20 pink	RKZ20-1KD	Z-diode	18.8..19.7V, Izt=2mA, Zzt=60Ω, 500mW	LLD	15d	2g	Ren
20 white	RKZ20-3KD	Z-diode	20.2..21.1V, Izt=2mA, Zzt=60Ω, 500mW	LLD	15d	2g	Ren
20A	GLZ20A	Z-diode	18.02..18.96V, Zzt=28Ω, Izt=10mA, 500mW	SOD-80	15d	2c	Pjt
20A	TLZ20A	Z-diode	18.02..18.96V, Izt=10mA, Zzt=28Ω, 500mW	SOD-80	15d	2g	Ttr
20B	GLZ20B	Z-diode	18.63..19.59V, Zzt=28Ω, Izt=10mA, 500mW	SOD-80	15d	2c	Pjt
20B	TLZ20B	Z-diode	18.63..19.59V, Izt=10mA, Zzt=28Ω, 500mW	SOD-80	15d	2g	Ttr
20C	GLZ20C	Z-diode	19.23..20.22V, Zzt=28Ω, Izt=10mA, 500mW	SOD-80	15d	2c	Pjt
20C	TLZ20C	Z-diode	19.23..20.22V, Izt=10mA, Zzt=28Ω, 500mW	SOD-80	15d	2g	Ttr
20D	GLZ20D	Z-diode	19.72..20.72V, Zzt=28Ω, Izt=10mA, 500mW	SOD-80	15d	2c	Pjt
20D	TLZ20D	Z-diode	19.72..20.72V, Izt=10mA, Zzt=28Ω, 500mW	SOD-80	15d	2g	Ttr
22 blue	RKZ22-2KD	Z-diode	21.6..22.6V, Izt=2mA, Zzt=65Ω, 500mW	LLD	15d	2g	Ren
22 pink	RKZ22-1KD	Z-diode	20.9..21.9V, Izt=2mA, Zzt=65Ω, 500mW	LLD	15d	2g	Ren
22 white	RKZ22-3KD	Z-diode	22.3..23.3V, Izt=2mA, Zzt=65Ω, 500mW	LLD	15d	2g	Ren
22A	GLZ22A	Z-diode	20.15..21.20V, Zzt=30Ω, Izt=5mA, 500mW	SOD-80	15d	2c	Pjt
22B	GLZ22B	Z-diode	20.64..21.71V, Zzt=30Ω, Izt=5mA, 500mW	SOD-80	15d	2c	Pjt



SMD code	Type	Function	Short description	Case	Pinout	St.	Mnf.
22C	GLZ22C	Z-diode	21.08..22.17V, Zzt=30Ω, lzt=5mA, 500mW	SOD-80	15d	2c	Pjt
22D	GLZ22D	Z-diode	21.52..22.63V, Zzt=30Ω, lzt=5mA, 500mW	SOD-80	15d	2c	Pjt
24 blue	RKZ24-2KD	Z-diode	23.6..24.7V, lzt=2mA, Zzt=70Ω, 500mW	LLD	15d	2g	Ren
24 pink	RKZ24-1KD	Z-diode	22.9..24.0V, lzt=2mA, Zzt=70Ω, 500mW	LLD	15d	2g	Ren
24 white	RKZ24-3KD	Z-diode	24.3..25.5V, lzt=2mA, Zzt=70Ω, 500mW	LLD	15d	2g	Ren
24A	GLZ24A	Z-diode	22.05..23.18V, Zzt=35Ω, lzt=5mA, 500mW	SOD-80	15d	2c	Pjt
24B	GLZ24B	Z-diode	22.61..23.77V, Zzt=35Ω, lzt=5mA, 500mW	SOD-80	15d	2c	Pjt
24C	GLZ24C	Z-diode	23.12..24.31V, Zzt=35Ω, lzt=5mA, 500mW	SOD-80	15d	2c	Pjt
24D	GLZ24D	Z-diode	23.63..24.85V, Zzt=35Ω, lzt=5mA, 500mW	SOD-80	15d	2c	Pjt
27 blue	RKZ27-2KD	Z-diode	26.2..27.6V, lzt=5mA, Zzt=100Ω, 500mW	LLD	15d	2g	Ren
27 pink	RKZ27-1KD	Z-diode	25.2..26.6V, lzt=2mA, Zzt=80Ω, 500mW	LLD	15d	2g	Ren
27 white	RKZ27-3KD	Z-diode	27.2..28.6V, lzt=5mA, Zzt=100Ω, 500mW	LLD	15d	2g	Ren
27A	GLZ27A	Z-diode	24.26..25.52V, Zzt=45Ω, lzt=5mA, 500mW	SOD-80	15d	2c	Pjt
27B	GLZ27B	Z-diode	24.97..26.26V, Zzt=45Ω, lzt=5mA, 500mW	SOD-80	15d	2c	Pjt
27C	GLZ27C	Z-diode	25.63..26.95V, Zzt=45Ω, lzt=5mA, 500mW	SOD-80	15d	2c	Pjt
27D	GLZ27D	Z-diode	26.29..27.64V, Zzt=45Ω, lzt=5mA, 500mW	SOD-80	15d	2c	Pjt
2A0	GLZ2.0A	Z-diode	1.88..2.10V, Zzt=140Ω, lzt=20mA, 500mW	SOD-80	15d	2c	Pjt
2A0	TLZ2.0A	Z-diode	1.88..2.10V, lzt=20mA, Zzt=140Ω, 500mW	SOD-80	15d	2g	Ttr
2A2	GLZ2.2A	Z-diode	2.12..2.30V, Zzt=120Ω, lzt=20mA, 500mW	SOD-80	15d	2c	Pjt
2A2	TLZ2.2A	Z-diode	2.12..2.30V, lzt=20mA, Zzt=120Ω, 500mW	SOD-80	15d	2g	Ttr
2A4	GLZ2.4A	Z-diode	2.33..2.52V, Zzt=100Ω, lzt=20mA, 500mW	SOD-80	15d	2c	Pjt
2A4	TLZ2.4A	Z-diode	2.33..2.52V, lzt=20mA, Zzt=100Ω, 500mW	SOD-80	15d	2g	Ttr
2A7	GLZ2.7A	Z-diode	2.54..2.75V, Zzt=100Ω, lzt=20mA, 500mW	SOD-80	15d	2c	Pjt
2A7	TLZ2.7A	Z-diode	2.54..2.75V, lzt=20mA, Zzt=100Ω, 500mW	SOD-80	15d	2g	Ttr
2B blue	RKZ2B2KD	Z-diode	2.0..2.2V, lzt=5mA, Zzt=100Ω, 500mW	LLD	15d	2g	Ren
2B pink	RKZ2B1KD	Z-diode	1.9..2.1V, lzt=5mA, Zzt=100Ω, 500mW	LLD	15d	2g	Ren
2B white	RKZ2B3KD	Z-diode	2.1..2.3V, lzt=5mA, Zzt=100Ω, 500mW	LLD	15d	2g	Ren
2B0	GLZ2.0B	Z-diode	2.02..2.20V, Zzt=140Ω, lzt=20mA, 500mW	SOD-80	15d	2c	Pjt
2B0	TLZ2.0B	Z-diode	2.02..2.20V, lzt=20mA, Zzt=140Ω, 500mW	SOD-80	15d	2g	Ttr
2B2	GLZ2.2B	Z-diode	2.22..2.41V, Zzt=120Ω, lzt=20mA, 500mW	SOD-80	15d	2c	Pjt
2B2	TLZ2.2B	Z-diode	2.22..2.41V, lzt=20mA, Zzt=120Ω, 500mW	SOD-80	15d	2g	Ttr
2B4	GLZ2.4B	Z-diode	2.43..2.63V, Zzt=100Ω, lzt=20mA, 500mW	SOD-80	15d	2c	Pjt
2B4	TLZ2.4B	Z-diode	2.43..2.63V, lzt=20mA, Zzt=100Ω, 500mW	SOD-80	15d	2g	Ttr
2B7	GLZ2.7B	Z-diode	2.69..2.91V, Zzt=100Ω, lzt=20mA, 500mW	SOD-80	15d	2c	Pjt
2B7	TLZ2.7B	Z-diode	2.69..2.91V, lzt=20mA, Zzt=100Ω, 500mW	SOD-80	15d	2g	Ttr
2C blue	RKZ2C2KD	Z-diode	2.3..2.5V, lzt=5mA, Zzt=100Ω, 500mW	LLD	15d	2g	Ren
2C pink	RKZ2C1KD	Z-diode	2.2..2.4V, lzt=5mA, Zzt=100Ω, 500mW	LLD	15d	2g	Ren
2C white	RKZ2C3KD	Z-diode	2.4..2.6V, lzt=5mA, Zzt=100Ω, 500mW	LLD	15d	2g	Ren
30 blue	RKZ30-2KD	Z-diode	29.2..30.6V, lzt=2mA, Zzt=100Ω, 500mW	LLD	15d	2g	Ren
30 pink	RKZ30-1KD	Z-diode	28.2..29.6V, lzt=2mA, Zzt=100Ω, 500mW	LLD	15d	2g	Ren
30 white	RKZ30-3KD	Z-diode	30.2..31.6V, lzt=2mA, Zzt=100Ω, 500mW	LLD	15d	2g	Ren
30A	GLZ30A	Z-diode	26.99..28.39V, Zzt=55Ω, lzt=5mA, 500mW	SOD-80	15d	2c	Pjt
30B	GLZ30B	Z-diode	27.70..29.13V, Zzt=55Ω, lzt=5mA, 500mW	SOD-80	15d	2c	Pjt
30C	GLZ30C	Z-diode	28.36..29.82V, Zzt=55Ω, lzt=5mA, 500mW	SOD-80	15d	2c	Pjt
30D	GLZ30D	Z-diode	29.02..30.51V, Zzt=55Ω, lzt=5mA, 500mW	SOD-80	15d	2c	Pjt
33 blue	RKZ33-2KD	Z-diode	32.2..33.6V, lzt=2mA, Zzt=120Ω, 500mW	LLD	15d	2g	Ren
33 pink	RKZ33-1KD	Z-diode	31.2..32.6V, lzt=2mA, Zzt=120Ω, 500mW	LLD	15d	2g	Ren
33 white	RKZ33-3KD	Z-diode	33.2..34.6V, lzt=2mA, Zzt=120Ω, 500mW	LLD	15d	2g	Ren
33A	GLZ33A	Z-diode	29.68..31.22V, Zzt=65Ω, lzt=5mA, 500mW	SOD-80	15d	2c	Pjt
33B	GLZ33B	Z-diode	30.32..31.88V, Zzt=65Ω, lzt=5mA, 500mW	SOD-80	15d	2c	Pjt
33C	GLZ33C	Z-diode	30.90..32.50V, Zzt=65Ω, lzt=5mA, 500mW	SOD-80	15d	2c	Pjt
33D	GLZ33D	Z-diode	31.49..33.11V, Zzt=65Ω, lzt=5mA, 500mW	SOD-80	15d	2c	Pjt
36 blue	RKZ36-2KD	Z-diode	35.3..36.8V, lzt=2mA, Zzt=140Ω, 500mW	LLD	15d	2g	Ren
36 pink	RKZ36-1KD	Z-diode	34.2..35.7V, lzt=2mA, Zzt=140Ω, 500mW	LLD	15d	2g	Ren
36 white	RKZ36-3KD	Z-diode	36.4..38.0V, lzt=2mA, Zzt=140Ω, 500mW	LLD	15d	2g	Ren
36A	GLZ36A	Z-diode	32.14..33.79V, Zzt=75Ω, lzt=5mA, 500mW	SOD-80	15d	2c	Pjt
36B	GLZ36B	Z-diode	32.79..34.49V, Zzt=75Ω, lzt=5mA, 500mW	SOD-80	15d	2c	Pjt
36C	GLZ36C	Z-diode	33.40..35.13V, Zzt=75Ω, lzt=5mA, 500mW	SOD-80	15d	2c	Pjt
36D	GLZ36D	Z-diode	34.01..35.77V, Zzt=75Ω, lzt=5mA, 500mW	SOD-80	15d	2c	Pjt
39A	GLZ39A	Z-diode	34.68..36.47V, Zzt=85Ω, lzt=5mA, 500mW	SOD-80	15d	2c	Pjt
39B	GLZ39B	Z-diode	35.36..37.19V, Zzt=85Ω, lzt=5mA, 500mW	SOD-80	15d	2c	Pjt
39C	GLZ39C	Z-diode	36.0..37.85V, Zzt=85Ω, lzt=5mA, 500mW	SOD-80	15d	2c	Pjt
39D	GLZ39D	Z-diode	36.63..38.52V, Zzt=85Ω, lzt=5mA, 500mW	SOD-80	15d	2c	Pjt
3A blue	RKZ3A2KD	Z-diode	2.6..2.8V, lzt=5mA, Zzt=100Ω, 500mW	LLD	15d	2g	Ren
3A pink	RKZ3A1KD	Z-diode	2.5..2.7V, lzt=5mA, Zzt=100Ω, 500mW	LLD	15d	2g	Ren
3A white	RKZ3A3KD	Z-diode	2.7..2.9V, lzt=5mA, Zzt=100Ω, 500mW	LLD	15d	2g	Ren
3A0	GLZ3.0A	Z-diode	2.85..3.07V, Zzt=80Ω, lzt=20mA, 500mW	SOD-80	15d	2c	Pjt
3A0	TLZ3.0A	Z-diode	2.85..3.07V, lzt=20mA, Zzt=80Ω, 500mW	SOD-80	15d	2g	Ttr
3A3	GLZ3.3A	Z-diode	3.16..3.38V, Zzt=70Ω, lzt=20mA, 500mW	SOD-80	15d	2c	Pjt
3A3	TLZ3.3A	Z-diode	3.16..3.38V, lzt=20mA, Zzt=70Ω, 500mW	SOD-80	15d	2g	Ttr



SMD code	Type	Function	Short description	Case	Pinout	St.	Mnf.
3A6	GLZ3.6A	Z-diode	3.46..3.70V, Zzt=60Ω, Izt=20mA, 500mW	SOD-80	15d	2c	Pjt
3A6	TLZ3.6A	Z-diode	3.46..3.70V, Izt=20mA, Zzt=60Ω, 500mW	SOD-80	15d	2g	Ttr
3A9	GLZ3.9A	Z-diode	3.74..4.01V, Zzt=50Ω, Izt=20mA, 500mW	SOD-80	15d	2c	Pjt
3A9	TLZ3.9A	Z-diode	3.74..4.01V, Izt=20mA, Zzt=50Ω, 500mW	SOD-80	15d	2g	Ttr
3B blue	RKZ3B2KD	Z-diode	2.9..3.1V, Izt=5mA, Zzt=100Ω, 500mW	LLD	15d	2g	Ren
3B pink	RKZ3B1KD	Z-diode	2.8..3.0V, Izt=5mA, Zzt=100Ω, 500mW	LLD	15d	2g	Ren
3B white	RKZ3B3KD	Z-diode	3.0..3.2V, Izt=5mA, Zzt=100Ω, 500mW	LLD	15d	2g	Ren
3B0	GLZ3.0B	Z-diode	3.01..3.22V, Zzt=80Ω, Izt=20mA, 500mW	SOD-80	15d	2c	Pjt
3B0	TLZ3.0B	Z-diode	3.01..3.22V, Izt=20mA, Zzt=80Ω, 500mW	SOD-80	15d	2g	Ttr
3B3	GLZ3.3B	Z-diode	3.32..3.53V, Zzt=70Ω, Izt=20mA, 500mW	SOD-80	15d	2c	Pjt
3B3	TLZ3.3B	Z-diode	3.32..3.53V, Izt=20mA, Zzt=70Ω, 500mW	SOD-80	15d	2g	Ttr
3B6	GLZ3.6B	Z-diode	3.60..3.85V, Zzt=60Ω, Izt=20mA, 500mW	SOD-80	15d	2c	Pjt
3B6	TLZ3.6B	Z-diode	3.60..3.85V, Izt=20mA, Zzt=60Ω, 500mW	SOD-80	15d	2g	Ttr
3B9	GLZ3.9B	Z-diode	3.89..4.16V, Zzt=50Ω, Izt=20mA, 500mW	SOD-80	15d	2c	Pjt
3B9	TLZ3.9B	Z-diode	3.89..4.16V, Izt=20mA, Zzt=50Ω, 500mW	SOD-80	15d	2g	Ttr
3C blue	RKZ3C2KD	Z-diode	3.2..3.4V, Izt=5mA, Zzt=100Ω, 500mW	LLD	15d	2g	Ren
3C pink	RKZ3C1KD	Z-diode	3.1..3.3V, Izt=5mA, Zzt=100Ω, 500mW	LLD	15d	2g	Ren
3C white	RKZ3C3KD	Z-diode	3.3..3.5V, Izt=5mA, Zzt=100Ω, 500mW	LLD	15d	2g	Ren
43	GLZ43	Z-diode	40.0..45.00V, Zzt=90Ω, Izt=5mA, 500mW	SOD-80	15d	2c	Pjt
45APH	BAS45AL	Si-diode	Sw, 125V, 250mA, 400mW, Vf<1V(100mA), 4pF	SOD-80C	15d	2c	Phi
47	GLZ47	Z-diode	44.0..49.00V, Zzt=90Ω, Izt=5mA, 500mW	SOD-80	15d	2c	Pjt
4A blue	RKZ4A2KD	Z-diode	3.5..3.7V, Izt=5mA, Zzt=100Ω, 500mW	LLD	15d	2g	Ren
4A pink	RKZ4A1KD	Z-diode	3.4..3.6V, Izt=5mA, Zzt=100Ω, 500mW	LLD	15d	2g	Ren
4A white	RKZ4A3KD	Z-diode	3.6..3.8V, Izt=5mA, Zzt=100Ω, 500mW	LLD	15d	2g	Ren
4A3	GLZ4.3A	Z-diode	4.04..4.29V, Zzt=40Ω, Izt=20mA, 500mW	SOD-80	15d	2c	Pjt
4A3	TLZ4.3A	Z-diode	4.04..4.29V, Izt=20mA, Zzt=40Ω, 500mW	SOD-80	15d	2g	Ttr
4A7	GLZ4.7A	Z-diode	4.44..4.68V, Zzt=25Ω, Izt=20mA, 500mW	SOD-80	15d	2c	Pjt
4A7	TLZ4.7A	Z-diode	4.44..4.68V, Izt=20mA, Zzt=25Ω, 500mW	SOD-80	15d	2g	Ttr
4B blue	RKZ4B2KD	Z-diode	3.8..4.0V, Izt=5mA, Zzt=100Ω, 500mW	LLD	15d	2g	Ren
4B pink	RKZ4B1KD	Z-diode	3.7..3.9V, Izt=5mA, Zzt=100Ω, 500mW	LLD	15d	2g	Ren
4B white	RKZ4B3KD	Z-diode	3.9..4.1V, Izt=5mA, Zzt=100Ω, 500mW	LLD	15d	2g	Ren
4B3	GLZ4.3B	Z-diode	4.17..4.43V, Zzt=40Ω, Izt=20mA, 500mW	SOD-80	15d	2c	Pjt
4B3	TLZ4.3B	Z-diode	4.17..4.43V, Izt=20mA, Zzt=40Ω, 500mW	SOD-80	15d	2g	Ttr
4B7	GLZ4.7B	Z-diode	4.55..4.80V, Zzt=25Ω, Izt=20mA, 500mW	SOD-80	15d	2c	Pjt
4B7	TLZ4.7B	Z-diode	4.55..4.80V, Izt=20mA, Zzt=25Ω, 500mW	SOD-80	15d	2g	Ttr
4C blue	RKZ4C2KD	Z-diode	4.1..4.3V, Izt=5mA, Zzt=100Ω, 500mW	LLD	15d	2g	Ren
4C pink	RKZ4C1KD	Z-diode	4.0..4.2V, Izt=5mA, Zzt=100Ω, 500mW	LLD	15d	2g	Ren
4C white	RKZ4C3KD	Z-diode	4.2..4.4V, Izt=5mA, Zzt=100Ω, 500mW	LLD	15d	2g	Ren
4C3	GLZ4.3C	Z-diode	4.30..4.57V, Zzt=40Ω, Izt=20mA, 500mW	SOD-80	15d	2c	Pjt
4C3	TLZ4.3C	Z-diode	4.30..4.57V, Izt=20mA, Zzt=40Ω, 500mW	SOD-80	15d	2g	Ttr
4C7	GLZ4.7C	Z-diode	4.68..4.93V, Zzt=25Ω, Izt=20mA, 500mW	SOD-80	15d	2c	Pjt
4C7	TLZ4.7C	Z-diode	4.68..4.93V, Izt=20mA, Zzt=25Ω, 500mW	SOD-80	15d	2g	Ttr
51	GLZ51	Z-diode	48.0..54.00V, Zzt=110Ω, Izt=5mA, 500mW	SOD-80	15d	2c	Pjt
5221	MMGZ5221BPT	Z-diode	2.280..2.520V, Izt=20mA, Zzt=30Ω, 500mW	SOD-80	15d	2c	Chm
5221	MMGZ5221SPT	Z-diode	2.352..2.448V, Izt=20mA, Zzt=30Ω, 500mW	SOD-80	15d	2c	Chm
5221	ZMM5221B	Z-diode	2.28..2.52V, Izt=20mA, Zzt=30Ω, 500mW	SOD-80	15d	2h	Ttr
5222	MMGZ5222BPT	Z-diode	2.375..2.625V, Izt=20mA, Zzt=30V, 500mW	SOD-80	15d	2c	Chm
5222	MMGZ5222SPT	Z-diode	2.450..2.550V, Izt=20mA, Zzt=30Ω, 500mW	SOD-80	15d	2c	Chm
5222	ZMM5222B	Z-diode	2.38..2.63V, Izt=20mA, Zzt=30Ω, 500mW	SOD-80	15d	2h	Ttr
5223	MMGZ5223BPT	Z-diode	2.565..2.835V, Izt=20mA, Zzt=30Ω, 500mW	SOD-80	15d	2c	Chm
5223	MMGZ5223SPT	Z-diode	2.646..2.754V, Izt=20mA, Zzt=30Ω, 500mW	SOD-80	15d	2c	Chm
5223	ZMM5223B	Z-diode	2.57..2.84V, Izt=20mA, Zzt=30Ω, 500mW	SOD-80	15d	2h	Ttr
5224	MMGZ5224BPT	Z-diode	2.660..2.940V, Izt=20mA, Zzt=30Ω, 500mW	SOD-80	15d	2c	Chm
5224	MMGZ5224SPT	Z-diode	2.774..2.856V, Izt=20mA, Zzt=30Ω, 500mW	SOD-80	15d	2c	Chm
5224	ZMM5224B	Z-diode	2.66..2.94V, Izt=20mA, Zzt=30Ω, 500mW	SOD-80	15d	2h	Ttr
5225	MMGZ5225BPT	Z-diode	2.850..3.150V, Izt=20mA, Zzt=29Ω, 500mW	SOD-80	15d	2c	Chm
5225	MMGZ5225SPT	Z-diode	2.940..3.060V, Izt=20mA, Zzt=29Ω, 500mW	SOD-80	15d	2c	Chm
5225	ZMM5225B	Z-diode	2.85..3.15V, Izt=20mA, Zzt=29Ω, 500mW	SOD-80	15d	2h	Ttr
5226	MMGZ5226BPT	Z-diode	3.135..3.465V, Izt=20mA, Zzt=28Ω, 500mW	SOD-80	15d	2c	Chm
5226	MMGZ5226SPT	Z-diode	3.234..3.366V, Izt=20mA, Zzt=28Ω, 500mW	SOD-80	15d	2c	Chm
5226	ZMM5226B	Z-diode	3.14..3.47V, Izt=20mA, Zzt=28Ω, 500mW	SOD-80	15d	2h	Ttr
5227	MMGZ5227BPT	Z-diode	3.420..3.780V, Izt=20mA, Zzt=24Ω, 500mW	SOD-80	15d	2c	Chm
5227	MMGZ5227SPT	Z-diode	3.528..3.762V, Izt=20mA, Zzt=24V, 500mW	SOD-80	15d	2c	Chm
5227	ZMM5227B	Z-diode	3.42..3.78V, Izt=20mA, Zzt=24Ω, 500mW	SOD-80	15d	2h	Ttr
5228	MMGZ5228BPT	Z-diode	3.705..4.095V, Izt=20mA, Zzt=23Ω, 500mW	SOD-80	15d	2c	Chm
5228	MMGZ5228SPT	Z-diode	3.822..3.987V, Izt=20mA, Zzt=23Ω, 500mW	SOD-80	15d	2c	Chm
5228	ZMM5228B	Z-diode	3.71..4.10V, Izt=20mA, Zzt=23Ω, 500mW	SOD-80	15d	2h	Ttr
5229	MMGZ5229BPT	Z-diode	4.085..4.515V, Izt=20mA, Zzt=22Ω, 500mW	SOD-80	15d	2c	Chm
5229	MMGZ5229SPT	Z-diode	4.214..4.386V, Izt=20mA, Zzt=22Ω, 500mW	SOD-80	15d	2c	Chm
5229	ZMM5229B	Z-diode	4.09..4.52V, Izt=20mA, Zzt=22Ω, 500mW	SOD-80	15d	2h	Ttr



SMD code	Type	Function	Short description	Case	Pinout	St.	Mnf.
5230	MMGZ5230BPT	Z-diode	4.465..4.935V, Izt=20mA, Zzt=19Ω, 500mW	SOD-80	15d	2c	Chm
5230	MMGZ5230SPT	Z-diode	4.606..4.794V, Izt=20mA, Zzt=19Ω, 500mW	SOD-80	15d	2c	Chm
5230	ZMM5230B	Z-diode	4.47..4.94V, Izt=20mA, Zzt=19Ω, 500mW	SOD-80	15d	2h	Ttr
5231	MMGZ5231BPT	Z-diode	4.845..5.355V, Izt=20mA, Zzt=17Ω, 500mW	SOD-80	15d	2c	Chm
5231	MMGZ5231SPT	Z-diode	4.998..5.202V, Izt=20mA, Zzt=17Ω, 500mW	SOD-80	15d	2c	Chm
5231	ZMM5231B	Z-diode	4.85..5.36V, Izt=20mA, Zzt=17Ω, 500mW	SOD-80	15d	2h	Ttr
5232	MMGZ5232BPT	Z-diode	5.320..5.880V, Izt=20mA, Zzt=11Ω, 500mW	SOD-80	15d	2c	Chm
5232	MMGZ5232SPT	Z-diode	5.488..5.712V, Izt=20mA, Zzt=11Ω, 500mW	SOD-80	15d	2c	Chm
5232	ZMM5232B	Z-diode	5.32..5.88V, Izt=20mA, Zzt=11Ω, 500mW	SOD-80	15d	2h	Ttr
5233	MMGZ5233BPT	Z-diode	5.700..6.300V, Izt=20mA, Zzt=7Ω, 500mW	SOD-80	15d	2c	Chm
5233	MMGZ5233SPT	Z-diode	5.880..6.120V, Izt=20mA, Zzt=7Ω, 500mW	SOD-80	15d	2c	Chm
5233	ZMM5233B	Z-diode	5.70..6.30V, Izt=20mA, Zzt=7Ω, 500mW	SOD-80	15d	2h	Ttr
5234	MMGZ5234BPT	Z-diode	5.890..6.510V, Izt=20mA, Zzt=7Ω, 500mW	SOD-80	15d	2c	Chm
5234	MMGZ5234SPT	Z-diode	6.070..6.324V, Izt=20mA, Zzt=7Ω, 500mW	SOD-80	15d	2c	Chm
5234	ZMM5234B	Z-diode	5.89..6.51V, Izt=20mA, Zzt=7Ω, 500mW	SOD-80	15d	2h	Ttr
5235	MMGZ5235BPT	Z-diode	6.460..7.140V, Izt=20mA, Zzt=5Ω, 500mW	SOD-80	15d	2c	Chm
5235	MMGZ5235SPT	Z-diode	6.664..6.936V, Izt=20mA, Zzt=5Ω, 500mW	SOD-80	15d	2c	Chm
5235	ZMM5235B	Z-diode	6.46..7.14V, Izt=20mA, Zzt=5Ω, 500mW	SOD-80	15d	2h	Ttr
5236	MMGZ5236BPT	Z-diode	7.125..7.875V, Izt=20mA, Zzt=6Ω, 500mW	SOD-80	15d	2c	Chm
5236	MMGZ5236SPT	Z-diode	7.350..7.650V, Izt=20mA, Zzt=6Ω, 500mW	SOD-80	15d	2c	Chm
5236	ZMM5236B	Z-diode	7.13..7.88V, Izt=20mA, Zzt=6Ω, 500mW	SOD-80	15d	2h	Ttr
5237	MMGZ5237BPT	Z-diode	7.790..8.610V, Izt=20mA, Zzt=8Ω, 500mW	SOD-80	15d	2c	Chm
5237	MMGZ5237SPT	Z-diode	8.036..8.364V, Izt=20mA, Zzt=8Ω, 500mW	SOD-80	15d	2c	Chm
5237	ZMM5237B	Z-diode	7.79..8.61V, Izt=20mA, Zzt=8Ω, 500mW	SOD-80	15d	2h	Ttr
5238	MMGZ5238BPT	Z-diode	8.265..9.135V, Izt=20mA, Zzt=8Ω, 500mW	SOD-80	15d	2c	Chm
5238	MMGZ5238SPT	Z-diode	8.526..8.874V, Izt=20mA, Zzt=8Ω, 500mW	SOD-80	15d	2c	Chm
5238	ZMM5238B	Z-diode	8.27..9.14V, Izt=20mA, Zzt=8Ω, 500mW	SOD-80	15d	2h	Ttr
5239	MMGZ5239BPT	Z-diode	8.645..9.555V, Izt=20mA, Zzt=10Ω, 500mW	SOD-80	15d	2c	Chm
5239	MMGZ5239SPT	Z-diode	8.918..9.282V, Izt=20mA, Zzt=10Ω, 500mW	SOD-80	15d	2c	Chm
5239	ZMM5239B	Z-diode	8.65..9.56V, Izt=20mA, Zzt=10Ω, 500mW	SOD-80	15d	2h	Ttr
5240	MMGZ5240BPT	Z-diode	9.500..10.50V, Izt=20mA, Zzt=17Ω, 500mW	SOD-80	15d	2c	Chm
5240	MMGZ5240SPT	Z-diode	9.800..10.20V, Izt=20mA, Zzt=17Ω, 500mW	SOD-80	15d	2c	Chm
5240	ZMM5240B	Z-diode	9.50..10.50V, Izt=20mA, Zzt=17Ω, 500mW	SOD-80	15d	2h	Ttr
5241	MMGZ5241BPT	Z-diode	10.45..11.55V, Izt=20mA, Zzt=22Ω, 500mW	SOD-80	15d	2c	Chm
5241	MMGZ5241SPT	Z-diode	10.78..11.22V, Izt=20mA, Zzt=22Ω, 500mW	SOD-80	15d	2c	Chm
5241	ZMM5241B	Z-diode	10.45..11.55V, Izt=20mA, Zzt=22Ω, 500mW	SOD-80	15d	2h	Ttr
5242	MMGZ5242BPT	Z-diode	11.40..12.60V, Izt=20mA, Zzt=30Ω, 500mW	SOD-80	15d	2c	Chm
5242	MMGZ5242SPT	Z-diode	11.76..12.24V, Izt=20mA, Zzt=30Ω, 500mW	SOD-80	15d	2c	Chm
5242	ZMM5242B	Z-diode	11.40..12.60V, Izt=20mA, Zzt=30Ω, 500mW	SOD-80	15d	2h	Ttr
5243	MMGZ5243BPT	Z-diode	12.35..13.65V, Izt=9.5mA, Zzt=13Ω, 500mW	SOD-80	15d	2c	Chm
5243	MMGZ5243SPT	Z-diode	12.74..13.26V, Izt=9.5mA, Zzt=13Ω, 500mW	SOD-80	15d	2c	Chm
5243	ZMM5243B	Z-diode	12.35..13.65V, Izt=9.5mA, Zzt=13Ω, 500mW	SOD-80	15d	2h	Ttr
5244	MMGZ5244BPT	Z-diode	13.30..14.70V, Izt=9.0mA, Zzt=15Ω, 500mW	SOD-80	15d	2c	Chm
5244	MMGZ5244SPT	Z-diode	13.72..14.28V, Izt=9.0mA, Zzt=15Ω, 500mW	SOD-80	15d	2c	Chm
5244	ZMM5244B	Z-diode	13.30..14.70V, Izt=9.0mA, Zzt=15Ω, 500mW	SOD-80	15d	2h	Ttr
5245	MMGZ5245BPT	Z-diode	14.25..15.75V, Izt=8.5mA, Zzt=16Ω, 500mW	SOD-80	15d	2c	Chm
5245	MMGZ5245SPT	Z-diode	14.70..15.30V, Izt=8.5mA, Zzt=16Ω, 500mW	SOD-80	15d	2c	Chm
5245	ZMM5245B	Z-diode	14.25..15.75V, Izt=8.5mA, Zzt=16Ω, 500mW	SOD-80	15d	2h	Ttr
5246	MMGZ5246BPT	Z-diode	15.20..16.80V, Izt=7.8mA, Zzt=17Ω, 500mW	SOD-80	15d	2c	Chm
5246	MMGZ5246SPT	Z-diode	15.68..16.32V, Izt=7.8mA, Zzt=17Ω, 500mW	SOD-80	15d	2c	Chm
5246	ZMM5246B	Z-diode	15.20..16.80V, Izt=7.8mA, Zzt=17Ω, 500mW	SOD-80	15d	2h	Ttr
5247	MMGZ5247BPT	Z-diode	16.15..17.85V, Izt=7.4mA, Zzt=19Ω, 500mW	SOD-80	15d	2c	Chm
5247	MMGZ5247SPT	Z-diode	16.66..17.34V, Izt=7.4mA, Zzt=19Ω, 500mW	SOD-80	15d	2c	Chm
5247	ZMM5247B	Z-diode	16.15..17.85V, Izt=7.4mA, Zzt=19Ω, 500mW	SOD-80	15d	2h	Ttr
5248	MMGZ5248BPT	Z-diode	17.10..18.90V, Izt=7.0mA, Zzt=21Ω, 500mW	SOD-80	15d	2c	Chm
5248	MMGZ5248SPT	Z-diode	17.64..18.36V, Izt=7.0mA, Zzt=21Ω, 500mW	SOD-80	15d	2c	Chm
5248	ZMM5248B	Z-diode	17.10..18.90V, Izt=7.0mA, Zzt=21Ω, 500mW	SOD-80	15d	2h	Ttr
5249	MMGZ5249BPT	Z-diode	18.05..19.95V, Izt=6.6mA, Zzt=23Ω, 500mW	SOD-80	15d	2c	Chm
5249	MMGZ5249SPT	Z-diode	18.62..19.38V, Izt=6.6mA, Zzt=23Ω, 500mW	SOD-80	15d	2c	Chm
5249	ZMM5249B	Z-diode	18.05..19.95V, Izt=6.6mA, Zzt=23Ω, 500mW	SOD-80	15d	2h	Ttr
5250	MMGZ5250BPT	Z-diode	19.0..21.0V, Izt=6.2mA, Zzt=25Ω, 500mW	SOD-80	15d	2c	Chm
5250	MMGZ5250SPT	Z-diode	19.60..20.40V, Izt=6.2mA, Zzt=25Ω, 500mW	SOD-80	15d	2c	Chm
5250	ZMM5250B	Z-diode	19.0..21.0V, Izt=6.2mA, Zzt=25Ω, 500mW	SOD-80	15d	2h	Ttr
5251	MMGZ5251BPT	Z-diode	20.90..23.10V, Izt=5.6mA, Zzt=29Ω, 500mW	SOD-80	15d	2c	Chm
5251	MMGZ5251SPT	Z-diode	21.56..22.44V, Izt=5.6mA, Zzt=29Ω, 500mW	SOD-80	15d	2c	Chm
5251	ZMM5251B	Z-diode	20.90..23.10V, Izt=5.6mA, Zzt=29Ω, 500mW	SOD-80	15d	2h	Ttr
5252	MMGZ5252BPT	Z-diode	22.80..25.20V, Izt=5.2mA, Zzt=33Ω, 500mW	SOD-80	15d	2c	Chm
5252	MMGZ5252SPT	Z-diode	23.52..24.48V, Izt=5.2mA, Zzt=33Ω, 500mW	SOD-80	15d	2c	Chm
5252	ZMM5252B	Z-diode	22.80..25.20V, Izt=5.2mA, Zzt=33Ω, 500mW	SOD-80	15d	2h	Ttr
5253	MMGZ5253BPT	Z-diode	23.75..26.25V, Izt=5mA, Zzt=35V, 500mW	SOD-80	15d	2c	Chm



SMD code	Type	Function	Short description	Case	Pinout	St.	Mnf.
5253	MMGZ5253SPT	Z-diode	24.50..25.50V, Izt=5mA, Zzt=35Ω, 500mW	SOD-80	15d	2c	Chm
5253	ZMM5253B	Z-diode	23.75..26.25V, Izt=5.0mA, Zzt=35Ω, 500mW	SOD-80	15d	2h	Ttr
5254	MMGZ5254BPT	Z-diode	25.65..28.35V, Izt=4.6mA, Zzt=41Ω, 500mW	SOD-80	15d	2c	Chm
5254	MMGZ5254SPT	Z-diode	26.46..27.54V, Izt=4.6mA, Zzt=41Ω, 500mW	SOD-80	15d	2c	Chm
5254	ZMM5254B	Z-diode	25.65..28.35V, Izt=4.6mA, Zzt=41Ω, 500mW	SOD-80	15d	2h	Ttr
5255	MMGZ5255BPT	Z-diode	26.60..29.40V, Izt=4.5mA, Zzt=44Ω, 500mW	SOD-80	15d	2c	Chm
5255	MMGZ5255SPT	Z-diode	27.44..28.56V, Izt=4.5mA, Zzt=44Ω, 500mW	SOD-80	15d	2c	Chm
5255	ZMM5255B	Z-diode	26.60..29.40V, Izt=4.5mA, Zzt=44Ω, 500mW	SOD-80	15d	2h	Ttr
5256	MMGZ5256BPT	Z-diode	28.50..31.50V, Izt=4.2mA, Zzt=49Ω, 500mW	SOD-80	15d	2c	Chm
5256	MMGZ5256SPT	Z-diode	29.40..30.60V, Izt=4.2mA, Zzt=49Ω, 500mW	SOD-80	15d	2c	Chm
5256	ZMM5256B	Z-diode	28.50..31.50V, Izt=4.2mA, Zzt=49Ω, 500mW	SOD-80	15d	2h	Ttr
5257	MMGZ5257BPT	Z-diode	31.35..34.65V, Izt=3.8mA, Zzt=58Ω, 500mW	SOD-80	15d	2c	Chm
5257	MMGZ5257SPT	Z-diode	32.34..33.66V, Izt=3.8mA, Zzt=58Ω, 500mW	SOD-80	15d	2c	Chm
5257	ZMM5257B	Z-diode	31.35..34.65V, Izt=3.8mA, Zzt=58Ω, 500mW	SOD-80	15d	2h	Ttr
5258	MMGZ5258BPT	Z-diode	34.20..37.80V, Izt=3.4mA, Zzt=70Ω, 500mW	SOD-80	15d	2c	Chm
5258	MMGZ5258SPT	Z-diode	35.28..36.72V, Izt=3.4mA, Zzt=70Ω, 500mW	SOD-80	15d	2c	Chm
5258	ZMM5258B	Z-diode	34.20..37.80V, Izt=3.4mA, Zzt=70Ω, 500mW	SOD-80	15d	2h	Ttr
5259	MMGZ5259BPT	Z-diode	37.05..40.95V, Izt=3.2mA, Zzt=80Ω, 500mW	SOD-80	15d	2c	Chm
5259	MMGZ5259SPT	Z-diode	38.22..39.78V, Izt=3.2mA, Zzt=80Ω, 500mW	SOD-80	15d	2c	Chm
5259	ZMM5259B	Z-diode	37.05..40.95V, Izt=3.2mA, Zzt=80Ω, 500mW	SOD-80	15d	2h	Ttr
5260	MMGZ5260BPT	Z-diode	40.85..45.15V, Izt=3.0mA, Zzt=93Ω, 500mW	SOD-80	15d	2c	Chm
5260	MMGZ5260SPT	Z-diode	42.14..43.86V, Izt=3.0mA, Zzt=93Ω, 500mW	SOD-80	15d	2c	Chm
5260	ZMM5260B	Z-diode	40.85..45.15V, Izt=3.0mA, Zzt=93Ω, 500mW	SOD-80	15d	2h	Ttr
5261	MMGZ5261BPT	Z-diode	44.65..49.35V, Izt=2.7mA, Zzt=105Ω, 500mW	SOD-80	15d	2c	Chm
5261	MMGZ5261SPT	Z-diode	46.06..47.94V, Izt=2.7mA, Zzt=105Ω, 500mW	SOD-80	15d	2c	Chm
5261	ZMM5261B	Z-diode	44.65..49.35V, Izt=2.7mA, Zzt=105Ω, 500mW	SOD-80	15d	2h	Ttr
5262	MMGZ5262BPT	Z-diode	48.45..53.35V, Izt=2.5mA, Zzt=125Ω, 500mW	SOD-80	15d	2c	Chm
5262	MMGZ5262SPT	Z-diode	49.98..52.02V, Izt=2.5mA, Zzt=125Ω, 500mW	SOD-80	15d	2c	Chm
5262	ZMM5262B	Z-diode	48.45..53.35V, Izt=2.5mA, Zzt=125Ω, 500mW	SOD-80	15d	2h	Ttr
5263	MMGZ5263BPT	Z-diode	53.20..58.80V, Izt=2.2mA, Zzt=150Ω, 500mW	SOD-80	15d	2c	Chm
5263	MMGZ5263SPT	Z-diode	54.88..57.12V, Izt=2.2mA, Zzt=150Ω, 500mW	SOD-80	15d	2c	Chm
5263	ZMM5263B	Z-diode	53.20..58.80V, Izt=2.2mA, Zzt=150Ω, 500mW	SOD-80	15d	2h	Ttr
5264	MMGZ5264BPT	Z-diode	57.0..63.0V, Izt=2.1mA, Zzt=170Ω, 500mW	SOD-80	15d	2c	Chm
5264	MMGZ5264SPT	Z-diode	58.80..61.20V, Izt=2.1mA, Zzt=170Ω, 500mW	SOD-80	15d	2c	Chm
5264	ZMM5264B	Z-diode	57.0..63.0V, Izt=2.1mA, Zzt=170Ω, 500mW	SOD-80	15d	2h	Ttr
5265	MMGZ5265BPT	Z-diode	58.90..65.10V, Izt=2mA, Zzt=185Ω, 500mW	SOD-80	15d	2c	Chm
5265	MMGZ5265SPT	Z-diode	60.76..63.24V, Izt=2mA, Zzt=185Ω, 500mW	SOD-80	15d	2c	Chm
5265	ZMM5265B	Z-diode	58.90..65.10V, Izt=2.0mA, Zzt=185Ω, 500mW	SOD-80	15d	2h	Ttr
5266	MMGZ5266BPT	Z-diode	64.60..71.40V, Izt=1.8mA, Zzt=230Ω, 500mW	SOD-80	15d	2c	Chm
5266	MMGZ5266SPT	Z-diode	66.64..69.36V, Izt=1.8mA, Zzt=230Ω, 500mW	SOD-80	15d	2c	Chm
5266	ZMM5266B	Z-diode	64.60..71.40V, Izt=1.8mA, Zzt=230Ω, 500mW	SOD-80	15d	2h	Ttr
5267	MMGZ5267BPT	Z-diode	71.25..78.75V, Izt=1.7mA, Zzt=270Ω, 500mW	SOD-80	15d	2c	Chm
5267	MMGZ5267SPT	Z-diode	73.50..76.50V, Izt=1.7mA, Zzt=270Ω, 500mW	SOD-80	15d	2c	Chm
5267	ZMM5267B	Z-diode	71.25..78.75V, Izt=1.7mA, Zzt=270Ω, 500mW	SOD-80	15d	2h	Ttr
5268	MMGZ5268BPT	Z-diode	77.90..86.10V, Izt=1.5mA, Zzt=330Ω, 500mW	SOD-80	15d	2c	Chm
5268	MMGZ5268SPT	Z-diode	80.36..83.64V, Izt=1.5mA, Zzt=330Ω, 500mW	SOD-80	15d	2c	Chm
5269	MMGZ5269BPT	Z-diode	82.65..91.35V, Izt=1.4mA, Zzt=370Ω, 500mW	SOD-80	15d	2c	Chm
5269	MMGZ5269SPT	Z-diode	85.26..88.74V, Izt=1.4mA, Zzt=370Ω, 500mW	SOD-80	15d	2c	Chm
5270	MMGZ5270SPT	Z-diode	89.18..92.82V, Izt=1.4mA, Zzt=400Ω, 500mW	SOD-80	15d	2c	Chm
56	GLZ56	Z-diode	53.0..60.00V, Zzt=110Ω, Izt=5mA, 500mW	SOD-80	15d	2c	Pjt
5A blue	RKZ5A2KD	Z-diode	4.4..4.6V, Izt=5mA, Zzt=100Ω, 500mW	LLD	15d	2g	Ren
5A pink	RKZ5A1KD	Z-diode	4.3..4.5V, Izt=5mA, Zzt=100Ω, 500mW	LLD	15d	2g	Ren
5A white	RKZ5A3KD	Z-diode	4.5..4.7V, Izt=5mA, Zzt=100Ω, 500mW	LLD	15d	2g	Ren
5A1	GLZ5.1A	Z-diode	4.81..5.07V, Zzt=20Ω, Izt=20mA, 500mW	SOD-80	15d	2c	Pjt
5A1	TLZ5.1A	Z-diode	4.81..5.07V, Izt=20mA, Zzt=20Ω, 500mW	SOD-80	15d	2g	Ttr
5A6	GLZ5.6A	Z-diode	5.28..5.55V, Zzt=13Ω, Izt=20mA, 500mW	SOD-80	15d	2c	Pjt
5A6	TLZ5.6A	Z-diode	5.28..5.55V, Izt=20mA, Zzt=13Ω, 500mW	SOD-80	15d	2g	Ttr
5B blue	RKZ5B2KD	Z-diode	4.7..4.9V, Izt=5mA, Zzt=100Ω, 500mW	LLD	15d	2g	Ren
5B pink	RKZ5B1KD	Z-diode	4.6..4.8V, Izt=5mA, Zzt=100Ω, 500mW	LLD	15d	2g	Ren
5B white	RKZ5B3KD	Z-diode	4.8..5.0V, Izt=5mA, Zzt=100Ω, 500mW	LLD	15d	2g	Ren
5B1	GLZ5.1B	Z-diode	4.94..5.20V, Zzt=20Ω, Izt=20mA, 500mW	SOD-80	15d	2c	Pjt
5B1	TLZ5.1B	Z-diode	4.94..5.20V, Izt=20mA, Zzt=20Ω, 500mW	SOD-80	15d	2g	Ttr
5B6	GLZ5.6B	Z-diode	5.45..5.73V, Zzt=13Ω, Izt=20mA, 500mW	SOD-80	15d	2c	Pjt
5B6	TLZ5.6B	Z-diode	5.45..5.73V, Izt=20mA, Zzt=13Ω, 500mW	SOD-80	15d	2g	Ttr
5C blue	RKZ5C2KD	Z-diode	5.0..5.2V, Izt=5mA, Zzt=100Ω, 500mW	LLD	15d	2g	Ren
5C pink	RKZ5C1KD	Z-diode	4.9..5.1V, Izt=5mA, Zzt=100Ω, 500mW	LLD	15d	2g	Ren
5C white	RKZ5C3KD	Z-diode	5.1..5.3V, Izt=5mA, Zzt=100Ω, 500mW	LLD	15d	2g	Ren
5C1	GLZ5.1C	Z-diode	5.09..5.37V, Zzt=20Ω, Izt=20mA, 500mW	SOD-80	15d	2c	Pjt
5C1	TLZ5.1C	Z-diode	5.09..5.37V, Izt=20mA, Zzt=20Ω, 500mW	SOD-80	15d	2g	Ttr
5C6	GLZ5.6C	Z-diode	5.61..5.91V, Zzt=13Ω, Izt=20mA, 500mW	SOD-80	15d	2c	Pjt



SMD code	Type	Function	Short description	Case	Pinout	St.	Mnf.
5C6	TLZ5.6C	Z-diode	5.61..5.91V, Izt=20mA, Zzt=13Ω, 500mW	SOD-80	15d	2g	Ttr
6A blue	RKZ6A2KD	Z-diode	5.3..5.6V, Izt=5mA, Zzt=40Ω, 500mW	LLD	15d	2g	Ren
6A pink	RKZ6A1KD	Z-diode	5.2..5.5V, Izt=5mA, Zzt=40Ω, 500mW	LLD	15d	2g	Ren
6A white	RKZ6A3KD	Z-diode	5.4..5.7V, Izt=5mA, Zzt=40Ω, 500mW	LLD	15d	2g	Ren
6A2	GLZ6.2A	Z-diode	5.78..6.09V, Zzt=10Ω, Izt=20mA, 500mW	SOD-80	15d	2c	Pjt
6A2	TLZ6.2A	Z-diode	5.78..6.09V, Izt=20mA, Zzt=10Ω, 500mW	SOD-80	15d	2g	Ttr
6A8	GLZ6.8A	Z-diode	6.29..6.63V, Zzt=8Ω, Izt=20mA, 500mW	SOD-80	15d	2c	Pjt
6A8	TLZ6.8A	Z-diode	6.29..6.63V, Izt=20mA, Zzt=8Ω, 500mW	SOD-80	15d	2g	Ttr
6B blue	RKZ6B2KD	Z-diode	5.6..5.9V, Izt=5mA, Zzt=40Ω, 500mW	LLD	15d	2g	Ren
6B pink	RKZ6B1KD	Z-diode	5.5..5.8V, Izt=5mA, Zzt=40Ω, 500mW	LLD	15d	2g	Ren
6B white	RKZ6B3KD	Z-diode	5.7..6.0V, Izt=5mA, Zzt=40Ω, 500mW	LLD	15d	2g	Ren
6B2	GLZ6.2B	Z-diode	5.96..6.27V, Zzt=10Ω, Izt=20mA, 500mW	SOD-80	15d	2c	Pjt
6B2	TLZ6.2B	Z-diode	5.96..6.27V, Izt=20mA, Zzt=10Ω, 500mW	SOD-80	15d	2g	Ttr
6B8	GLZ6.8B	Z-diode	6.49..6.83V, Zzt=8Ω, Izt=20mA, 500mW	SOD-80	15d	2c	Pjt
6B8	TLZ6.8B	Z-diode	6.49..6.83V, Izt=20mA, Zzt=8Ω, 500mW	SOD-80	15d	2g	Ttr
6C blue	RKZ6C2KD	Z-diode	6.0..6.3V, Izt=5mA, Zzt=40Ω, 500mW	LLD	15d	2g	Ren
6C pink	RKZ6C1KD	Z-diode	5.8..6.1V, Izt=5mA, Zzt=40Ω, 500mW	LLD	15d	2g	Ren
6C white	RKZ6C3KD	Z-diode	6.1..6.4V, Izt=5mA, Zzt=40Ω, 500mW	LLD	15d	2g	Ren
6C2	GLZ6.2C	Z-diode	6.12..6.44V, Zzt=10Ω, Izt=20mA, 500mW	SOD-80	15d	2c	Pjt
6C2	TLZ6.2C	Z-diode	6.12..6.44V, Izt=20mA, Zzt=10Ω, 500mW	SOD-80	15d	2g	Ttr
6C8	GLZ6.8C	Z-diode	6.66..7.01V, Zzt=8Ω, Izt=20mA, 500mW	SOD-80	15d	2c	Pjt
6C8	TLZ6.8C	Z-diode	6.66..7.01V, Izt=20mA, Zzt=8Ω, 500mW	SOD-80	15d	2g	Ttr
7A blue	RKZ7A2KD	Z-diode	6.4..6.7V, Izt=5mA, Zzt=15Ω, 500mW	LLD	15d	2g	Ren
7A pink	RKZ7A1KD	Z-diode	6.3..6.6V, Izt=5mA, Zzt=15Ω, 500mW	LLD	15d	2g	Ren
7A white	RKZ7A3KD	Z-diode	6.6..6.9V, Izt=5mA, Zzt=15Ω, 500mW	LLD	15d	2g	Ren
7A5	GLZ7.5A	Z-diode	6.85..7.22V, Zzt=8Ω, Izt=20mA, 500mW	SOD-80	15d	2c	Pjt
7A5	TLZ7.5A	Z-diode	6.85..7.22V, Izt=20mA, Zzt=8Ω, 500mW	SOD-80	15d	2g	Ttr
7B blue	RKZ7B2KD	Z-diode	6.9..7.2V, Izt=5mA, Zzt=15Ω, 500mW	LLD	15d	2g	Ren
7B pink	RKZ7B1KD	Z-diode	6.7..7.0V, Izt=5mA, Zzt=15Ω, 500mW	LLD	15d	2g	Ren
7B white	RKZ7B3KD	Z-diode	7.0..7.3V, Izt=5mA, Zzt=15Ω, 500mW	LLD	15d	2g	Ren
7B5	GLZ7.5B	Z-diode	7.07..7.45V, Zzt=8Ω, Izt=20mA, 500mW	SOD-80	15d	2c	Pjt
7B5	TLZ7.5B	Z-diode	7.07..7.45V, Izt=20mA, Zzt=8Ω, 500mW	SOD-80	15d	2g	Ttr
7C blue	RKZ7C2KD	Z-diode	7.3..7.7V, Izt=5mA, Zzt=15Ω, 500mW	LLD	15d	2g	Ren
7C pink	RKZ7C1KD	Z-diode	7.2..7.6V, Izt=5mA, Zzt=15Ω, 500mW	LLD	15d	2g	Ren
7C white	RKZ7C3KD	Z-diode	7.5..7.9V, Izt=5mA, Zzt=15Ω, 500mW	LLD	15d	2g	Ren
7C5	GLZ7.5C	Z-diode	7.29..7.67V, Zzt=8Ω, Izt=20mA, 500mW	SOD-80	15d	2c	Pjt
7C5	TLZ7.5C	Z-diode	7.29..7.67V, Izt=20mA, Zzt=8Ω, 500mW	SOD-80	15d	2g	Ttr
8A2	GLZ8.2A	Z-diode	7.53..7.92V, Zzt=8Ω, Izt=20mA, 500mW	SOD-80	15d	2c	Pjt
8A2	TLZ8.2A	Z-diode	7.53..7.92V, Izt=20mA, Zzt=8Ω, 500mW	SOD-80	15d	2g	Ttr
8B2	GLZ8.2B	Z-diode	7.78..8.19V, Zzt=8Ω, Izt=20mA, 500mW	SOD-80	15d	2c	Pjt
8B2	TLZ8.2B	Z-diode	7.78..8.19V, Izt=20mA, Zzt=8Ω, 500mW	SOD-80	15d	2g	Ttr
8C2	GLZ8.2C	Z-diode	8.03..8.45V, Zzt=8Ω, Izt=20mA, 500mW	SOD-80	15d	2c	Pjt
8C2	TLZ8.2C	Z-diode	8.03..8.45V, Izt=20mA, Zzt=8Ω, 500mW	SOD-80	15d	2g	Ttr
9A blue	RKZ9A2KD	Z-diode	7.9..8.3V, Izt=5mA, Zzt=20Ω, 500mW	LLD	15d	2g	Ren
9A pink	RKZ9A1KD	Z-diode	7.7..8.1V, Izt=5mA, Zzt=20Ω, 500mW	LLD	15d	2g	Ren
9A white	RKZ9A3KD	Z-diode	8.1..8.5V, Izt=5mA, Zzt=20Ω, 500mW	LLD	15d	2g	Ren
9A1	GLZ9.1A	Z-diode	8.29..8.73V, Zzt=8Ω, Izt=20mA, 500mW	SOD-80	15d	2c	Pjt
9A1	TLZ9.1A	Z-diode	8.29..8.73V, Izt=20mA, Zzt=8Ω, 500mW	SOD-80	15d	2g	Ttr
9B blue	RKZ9B2KD	Z-diode	8.5..8.9V, Izt=5mA, Zzt=20Ω, 500mW	LLD	15d	2g	Ren
9B pink	RKZ9B1KD	Z-diode	8.3..8.7V, Izt=5mA, Zzt=20Ω, 500mW	LLD	15d	2g	Ren
9B white	RKZ9B3KD	Z-diode	8.7..9.1V, Izt=5mA, Zzt=20Ω, 500mW	LLD	15d	2g	Ren
9B1	GLZ9.1B	Z-diode	8.57..9.01V, Zzt=8Ω, Izt=20mA, 500mW	SOD-80	15d	2c	Pjt
9B1	TLZ9.1B	Z-diode	8.57..9.01V, Izt=20mA, Zzt=8Ω, 500mW	SOD-80	15d	2g	Ttr
9C blue	RKZ9C2KD	Z-diode	9.1..9.5V, Izt=5mA, Zzt=20Ω, 500mW	LLD	15d	2g	Ren
9C pink	RKZ9C1KD	Z-diode	8.9..9.3V, Izt=5mA, Zzt=20Ω, 500mW	LLD	15d	2g	Ren
9C white	RKZ9C3KD	Z-diode	9.3..9.7V, Izt=5mA, Zzt=20Ω, 500mW	LLD	15d	2g	Ren
9C1	GLZ9.1C	Z-diode	8.83..9.30V, Zzt=8Ω, Izt=20mA, 500mW	SOD-80	15d	2c	Pjt
9C1	TLZ9.1C	Z-diode	8.83..9.30V, Izt=20mA, Zzt=8Ω, 500mW	SOD-80	15d	2g	Ttr
AA blue	RKZ11A2KD	Z-diode	9.7..10.1V, Izt=5mA, Zzt=25Ω, 500mW	LLD	15d	2g	Ren
AA pink	RKZ11A1KD	Z-diode	9.5..9.9V, Izt=5mA, Zzt=25Ω, 500mW	LLD	15d	2g	Ren
AA white	RKZ11A3KD	Z-diode	9.9..10.3V, Izt=5mA, Zzt=25Ω, 500mW	LLD	15d	2g	Ren
AB blue	RKZ11B2KD	Z-diode	10.4..10.8V, Izt=5mA, Zzt=25Ω, 500mW	LLD	15d	2g	Ren
AB pink	RKZ11B1KD	Z-diode	10.2..10.6V, Izt=5mA, Zzt=25Ω, 500mW	LLD	15d	2g	Ren
AB white	RKZ11B3KD	Z-diode	10.7..11.1V, Izt=5mA, Zzt=25Ω, 500mW	LLD	15d	2g	Ren
AC blue	RKZ11C2KD	Z-diode	11.1..11.6V, Izt=5mA, Zzt=25Ω, 500mW	LLD	15d	2g	Ren
AC pink	RKZ11C1KD	Z-diode	10.9..11.3V, Izt=5mA, Zzt=25Ω, 500mW	LLD	15d	2g	Ren
AC white	RKZ11C3KD	Z-diode	11.4..11.9V, Izt=5mA, Zzt=25Ω, 500mW	LLD	15d	2g	Ren
BA blue	RKZ12A2KD	Z-diode	11.9..12.4V, Izt=5mA, Zzt=35Ω, 500mW	LLD	15d	2g	Ren
BA pink	RKZ12A1KD	Z-diode	11.6..12.1V, Izt=5mA, Zzt=35Ω, 500mW	LLD	15d	2g	Ren
BA white	RKZ12A3KD	Z-diode	12.2..12.7V, Izt=5mA, Zzt=35Ω, 500mW	LLD	15d	2g	Ren



SMD code	Type	Function	Short description	Case	Pinout	St.	Mnf.
BB blue	RKZ12B2KD	Z-diode	12.6..13.1V, Izt=5mA, Zzt=35Ω, 500mW	LLD	15d	2g	Ren
BB pink	RKZ12B1KD	Z-diode	12.4..12.9V, Izt=5mA, Zzt=35Ω, 500mW	LLD	15d	2g	Ren
BB white	RKZ12B3KD	Z-diode	12.9..13.4V, Izt=5mA, Zzt=35Ω, 500mW	LLD	15d	2g	Ren
BC blue	RKZ12C2KD	Z-diode	13.5..14.0V, Izt=5mA, Zzt=35Ω, 500mW	LLD	15d	2g	Ren
BC pink	RKZ12C1KD	Z-diode	13.2..13.7V, Izt=5mA, Zzt=35Ω, 500mW	LLD	15d	2g	Ren
BC white	RKZ12C3KD	Z-diode	13.8..14.3V, Izt=5mA, Zzt=35Ω, 500mW	LLD	15d	2g	Ren
C100	ZMIMC100	Z-diode	94..106V, Izt=5mA, Zzt=450Ω, 500mW	SOD-80	15d	2h	Ttr
C10V	ZMM55-C10	Z-diode	9.40..10.60V, Zzt=15Ω, Izt=5mA, 500mW	SOD-80	15d	2c	Pjt
C10V	ZMIMC10	Z-diode	9.4..10.6V, Izt=5mA, Zzt=15Ω, 500mW	SOD-80	15d	2h	Ttr
C11V	ZMM55-C11	Z-diode	10.40..11.60V, Zzt=20Ω, Izt=5mA, 500mW	SOD-80	15d	2c	Pjt
C11V	ZMIMC11	Z-diode	10.4..11.6V, Izt=5mA, Zzt=20Ω, 500mW	SOD-80	15d	2h	Ttr
C12V	ZMM55-C12	Z-diode	11.40..12.70V, Zzt=20Ω, Izt=5mA, 500mW	SOD-80	15d	2c	Pjt
C12V	ZMIMC12	Z-diode	11.4..12.7V, Izt=5mA, Zzt=20Ω, 500mW	SOD-80	15d	2h	Ttr
C13V	ZMM55-C13	Z-diode	12.40..14.10V, Zzt=28Ω, Izt=5mA, 500mW	SOD-80	15d	2c	Pjt
C13V	ZMIMC13	Z-diode	12.4..14.1V, Izt=5mA, Zzt=28Ω, 500mW	SOD-80	15d	2h	Ttr
C15V	ZMM55-C15	Z-diode	13.80..15.60V, Zzt=30Ω, Izt=5mA, 500mW	SOD-80	15d	2c	Pjt
C15V	ZMIMC15	Z-diode	13.8..15.6V, Izt=5mA, Zzt=30Ω, 500mW	SOD-80	15d	2h	Ttr
C16V	ZMM55-C16	Z-diode	15.30..17.10V, Zzt=40Ω, Izt=5mA, 500mW	SOD-80	15d	2c	Pjt
C16V	ZMIMC16	Z-diode	15.3..17.1V, Izt=5mA, Zzt=40Ω, 500mW	SOD-80	15d	2h	Ttr
C18V	ZMM55-C18	Z-diode	16.80..19.10V, Zzt=50Ω, Izt=5mA, 500mW	SOD-80	15d	2c	Pjt
C18V	ZMIMC18	Z-diode	16.8..19.1V, Izt=5mA, Zzt=50Ω, 500mW	SOD-80	15d	2h	Ttr
C20V	ZMM55-C20	Z-diode	18.80..21.20V, Zzt=55Ω, Izt=5mA, 500mW	SOD-80	15d	2c	Pjt
C20V	ZMIMC20	Z-diode	18.8..21.2V, Izt=5mA, Zzt=55Ω, 500mW	SOD-80	15d	2h	Ttr
C22V	ZMM55-C22	Z-diode	20.80..23.30V, Zzt=55Ω, Izt=5mA, 500mW	SOD-80	15d	2c	Pjt
C22V	ZMIMC22	Z-diode	20.8..23.3V, Izt=5mA, Zzt=55Ω, 500mW	SOD-80	15d	2h	Ttr
C24V	ZMM55-C24	Z-diode	22.80..25.60V, Zzt=80Ω, Izt=5mA, 500mW	SOD-80	15d	2c	Pjt
C24V	ZMIMC24	Z-diode	22.8..25.6V, Izt=5mA, Zzt=80Ω, 500mW	SOD-80	15d	2h	Ttr
C27V	ZMM55-C27	Z-diode	25.10..28.90V, Zzt=80Ω, Izt=5mA, 500mW	SOD-80	15d	2c	Pjt
C27V	ZMIMC27	Z-diode	25.1..28.9V, Izt=5mA, Zzt=80Ω, 500mW	SOD-80	15d	2h	Ttr
C24V	ZMM55-C24V	Z-diode	2.28..2.56V, Zzt=85Ω, Izt=5mA, 500mW	SOD-80	15d	2c	Pjt
C24V	ZMIMC24V	Z-diode	2.28..2.56V, Izt=5mA, Zzt=85Ω, 500mW	SOD-80	15d	2h	Ttr
C27V	ZMM55-C27V	Z-diode	2.50..2.90V, Zzt=85Ω, Izt=5mA, 500mW	SOD-80	15d	2c	Pjt
C27V	ZMIMC27V	Z-diode	2.5..2.9V, Izt=5mA, Zzt=85Ω, 500mW	SOD-80	15d	2h	Ttr
C30V	ZMM55-C30	Z-diode	28.0..32.00V, Zzt=80Ω, Izt=5mA, 500mW	SOD-80	15d	2c	Pjt
C30V	ZMIMC30	Z-diode	28..32V, Izt=5mA, Zzt=80Ω, 500mW	SOD-80	15d	2h	Ttr
C33V	ZMM55-C33	Z-diode	31.0..35.00V, Zzt=80Ω, Izt=5mA, 500mW	SOD-80	15d	2c	Pjt
C33V	ZMIMC33	Z-diode	31..35V, Izt=5mA, Zzt=80Ω, 500mW	SOD-80	15d	2h	Ttr
C36V	ZMM55-C36	Z-diode	34.0..38.00V, Zzt=80Ω, Izt=5mA, 500mW	SOD-80	15d	2c	Pjt
C36V	ZMIMC36	Z-diode	34..38V, Izt=5mA, Zzt=80Ω, 500mW	SOD-80	15d	2h	Ttr
C39V	ZMM55-C39	Z-diode	37.0..41.00V, Zzt=90Ω, Izt=2.5mA, 500mW	SOD-80	15d	2c	Pjt
C39V	ZMIMC39	Z-diode	37..41V, Izt=5mA, Zzt=90Ω, 500mW	SOD-80	15d	2h	Ttr
C30V	ZMM55-C30V	Z-diode	2.80..3.20V, Zzt=85Ω, Izt=5mA, 500mW	SOD-80	15d	2c	Pjt
C30V	ZMIMC30V	Z-diode	2.8..3.2V, Izt=5mA, Zzt=85Ω, 500mW	SOD-80	15d	2h	Ttr
C33V	ZMM55-C33V	Z-diode	3.10..3.50V, Zzt=85Ω, Izt=5mA, 500mW	SOD-80	15d	2c	Pjt
C33V	ZMIMC33V	Z-diode	3.1..3.5V, Izt=5mA, Zzt=85Ω, 500mW	SOD-80	15d	2h	Ttr
C36V	ZMM55-C36V	Z-diode	3.40..3.80V, Zzt=85Ω, Izt=5mA, 500mW	SOD-80	15d	2c	Pjt
C36V	ZMIMC36V	Z-diode	3.4..3.8V, Izt=5mA, Zzt=85Ω, 500mW	SOD-80	15d	2h	Ttr
C39V	ZMM55-C39V	Z-diode	3.70..4.10V, Zzt=85Ω, Izt=5mA, 500mW	SOD-80	15d	2c	Pjt
C39V	ZMIMC39V	Z-diode	3.7..4.1V, Izt=5mA, Zzt=85Ω, 500mW	SOD-80	15d	2h	Ttr
C43V	ZMM55-C43	Z-diode	40.0..46.00V, Zzt=90Ω, Izt=2.5mA, 500mW	SOD-80	15d	2c	Pjt
C43V	ZMIMC43	Z-diode	40..46V, Izt=5mA, Zzt=90Ω, 500mW	SOD-80	15d	2h	Ttr
C47V	ZMM55-C47	Z-diode	44.0..50.00V, Zzt=110Ω, Izt=2.5mA, 500mW	SOD-80	15d	2c	Pjt
C47V	ZMIMC47	Z-diode	44..50V, Izt=5mA, Zzt=110Ω, 500mW	SOD-80	15d	2h	Ttr
C43V	ZMM55-C43V	Z-diode	4.0..4.60V, Zzt=75Ω, Izt=5mA, 500mW	SOD-80	15d	2c	Pjt
C43V	ZMIMC43V	Z-diode	4..4.6V, Izt=5mA, Zzt=75Ω, 500mW	SOD-80	15d	2h	Ttr
C47V	ZMM55-C47V	Z-diode	4.40..5.00V, Zzt=60Ω, Izt=5mA, 500mW	SOD-80	15d	2c	Pjt
C47V	ZMIMC47V	Z-diode	4.4..5V, Izt=5mA, Zzt=60Ω, 500mW	SOD-80	15d	2h	Ttr
C51V	ZMIMC51	Z-diode	48..54V, Izt=5mA, Zzt=125Ω, 500mW	SOD-80	15d	2h	Ttr
C56V	ZMIMC56	Z-diode	52..60V, Izt=5mA, Zzt=135Ω, 500mW	SOD-80	15d	2h	Ttr
C5V1	ZMM55-C5V1	Z-diode	4.80..5.40V, Zzt=35Ω, Izt=5mA, 500mW	SOD-80	15d	2c	Pjt
C5V1	ZMIMC5V1	Z-diode	4.8..5.4V, Izt=5mA, Zzt=35Ω, 500mW	SOD-80	15d	2h	Ttr
C5V6	ZMM55-C5V6	Z-diode	5.20..6.00V, Zzt=25Ω, Izt=5mA, 500mW	SOD-80	15d	2c	Pjt
C5V6	ZMIMC5V6	Z-diode	5.2..6V, Izt=5mA, Zzt=25Ω, 500mW	SOD-80	15d	2h	Ttr
C62V	ZMIMC62	Z-diode	58..66V, Izt=5mA, Zzt=150Ω, 500mW	SOD-80	15d	2h	Ttr
C68V	ZMIMC68	Z-diode	64..72V, Izt=5mA, Zzt=200Ω, 500mW	SOD-80	15d	2h	Ttr
C6V2	ZMM55-C6V2	Z-diode	5.80..6.60V, Zzt=10Ω, Izt=5mA, 500mW	SOD-80	15d	2c	Pjt
C6V2	ZMIMC6V2	Z-diode	5.8..6.6V, Izt=5mA, Zzt=10Ω, 500mW	SOD-80	15d	2h	Ttr
C6V8	ZMM55-C6V8	Z-diode	6.40..7.20V, Zzt=8Ω, Izt=5mA, 500mW	SOD-80	15d	2c	Pjt
C6V8	ZMIMC6V8	Z-diode	6.4..7.2V, Izt=5mA, Zzt=8Ω, 500mW	SOD-80	15d	2h	Ttr
C75V	ZMIMC75	Z-diode	70..79V, Izt=5mA, Zzt=250Ω, 500mW	SOD-80	15d	2h	Ttr



SMD code	Type	Function	Short description	Case	Pinout	St.	Mnf.
C7V5	ZMM55-C7V5	Z-diode	7.0..7.90V, Zzt=7Ω, Izt=5mA, 500mW	SOD-80	15d	2c	Pjt
C7V5	ZMMC7V5	Z-diode	7.7..9V, Izt=5mA, Zzt=7Ω, 500mW	SOD-80	15d	2h	Ttr
C82V	ZMMC82	Z-diode	77..87V, Izt=5mA, Zzt=300Ω, 500mW	SOD-80	15d	2h	Ttr
C8V2	ZMM55-C8V2	Z-diode	7.70..8.70V, Zzt=7Ω, Izt=5mA, 500mW	SOD-80	15d	2c	Pjt
C8V2	ZMMC8V2	Z-diode	7.7..8.7V, Izt=5mA, Zzt=7Ω, 500mW	SOD-80	15d	2h	Ttr
C91V	ZMMC91	Z-diode	85..96V, Izt=5mA, Zzt=450Ω, 500mW	SOD-80	15d	2h	Ttr
C9V1	ZMM55-C9V1	Z-diode	8.50..9.60V, Zzt=10Ω, Izt=5mA, 500mW	SOD-80	15d	2c	Pjt
C9V1	ZMMC9V1	Z-diode	8.5..9.6V, Izt=5mA, Zzt=10Ω, 500mW	SOD-80	15d	2h	Ttr
Z10A	GLZJ10A	Z-diode	9.12..9.59V, Zzt=30Ω, Izt=5mA, 500mW	SOD-80	15d	2c	Pjt
Z10A	TLZJ10A	Z-diode	9.12..9.59V, Izt=5mA, Zzt=30Ω, 500mW	SOD-80	15d	2g	Ttr
Z10B	GLZJ10B	Z-diode	9.41..9.90V, Zzt=30Ω, Izt=5mA, 500mW	SOD-80	15d	2c	Pjt
Z10B	TLZJ10B	Z-diode	9.41..9.90V, Izt=5mA, Zzt=30Ω, 500mW	SOD-80	15d	2g	Ttr
Z10C	GLZJ10C	Z-diode	9.70..10.20V, Zzt=30Ω, Izt=5mA, 500mW	SOD-80	15d	2c	Pjt
Z10C	TLZJ10C	Z-diode	9.70..10.20V, Izt=5mA, Zzt=30Ω, 500mW	SOD-80	15d	2g	Ttr
Z10D	GLZJ10D	Z-diode	9.94..10.44V, Zzt=30Ω, Izt=5mA, 500mW	SOD-80	15d	2c	Pjt
Z10D	TLZJ10D	Z-diode	9.94..10.44V, Izt=5mA, Zzt=30Ω, 500mW	SOD-80	15d	2g	Ttr
Z11A	GLZJ11A	Z-diode	10.18..10.71V, Zzt=30Ω, Izt=5mA, 500mW	SOD-80	15d	2c	Pjt
Z11A	TLZJ11A	Z-diode	10.18..10.71V, Izt=5mA, Zzt=30Ω, 500mW	SOD-80	15d	2g	Ttr
Z11B	GLZJ11B	Z-diode	10.50..11.05V, Zzt=30Ω, Izt=5mA, 500mW	SOD-80	15d	2c	Pjt
Z11B	TLZJ11B	Z-diode	10.50..11.05V, Izt=5mA, Zzt=30Ω, 500mW	SOD-80	15d	2g	Ttr
Z11C	GLZJ11C	Z-diode	10.82..11.38V, Zzt=30Ω, Izt=5mA, 500mW	SOD-80	15d	2c	Pjt
Z11C	TLZJ11C	Z-diode	10.82..11.38V, Izt=5mA, Zzt=30Ω, 500mW	SOD-80	15d	2g	Ttr
Z12A	GLZJ12A	Z-diode	11.13..11.71V, Zzt=30Ω, Izt=5mA, 500mW	SOD-80	15d	2c	Pjt
Z12A	TLZJ12A	Z-diode	11.13..11.71V, Izt=5mA, Zzt=30Ω, 500mW	SOD-80	15d	2g	Ttr
Z12B	GLZJ12B	Z-diode	11.44..12.03V, Zzt=30Ω, Izt=5mA, 500mW	SOD-80	15d	2c	Pjt
Z12B	TLZJ12B	Z-diode	11.44..12.03V, Izt=5mA, Zzt=30Ω, 500mW	SOD-80	15d	2g	Ttr
Z12C	GLZJ12C	Z-diode	11.74..12.35V, Zzt=30Ω, Izt=5mA, 500mW	SOD-80	15d	2c	Pjt
Z12C	TLZJ12C	Z-diode	11.74..12.35V, Izt=5mA, Zzt=30Ω, 500mW	SOD-80	15d	2g	Ttr
Z13A	GLZJ13A	Z-diode	12.11..12.75V, Zzt=35Ω, Izt=5mA, 500mW	SOD-80	15d	2c	Pjt
Z13A	TLZJ13A	Z-diode	12.11..12.75V, Izt=5mA, Zzt=35Ω, 500mW	SOD-80	15d	2g	Ttr
Z13B	GLZJ13B	Z-diode	12.55..13.21V, Zzt=35Ω, Izt=5mA, 500mW	SOD-80	15d	2c	Pjt
Z13B	TLZJ13B	Z-diode	12.55..13.21V, Izt=5mA, Zzt=35Ω, 500mW	SOD-80	15d	2g	Ttr
Z13C	GLZJ13C	Z-diode	12.99..13.66V, Zzt=35Ω, Izt=5mA, 500mW	SOD-80	15d	2c	Pjt
Z13C	TLZJ13C	Z-diode	12.99..13.66V, Izt=5mA, Zzt=35Ω, 500mW	SOD-80	15d	2g	Ttr
Z15A	GLZJ15A	Z-diode	13.44..14.13V, Zzt=40Ω, Izt=5mA, 500mW	SOD-80	15d	2c	Pjt
Z15A	TLZJ15A	Z-diode	13.44..14.13V, Izt=5mA, Zzt=40Ω, 500mW	SOD-80	15d	2g	Ttr
Z15B	GLZJ15B	Z-diode	13.89..14.62V, Zzt=40Ω, Izt=5mA, 500mW	SOD-80	15d	2c	Pjt
Z15B	TLZJ15B	Z-diode	13.89..14.62V, Izt=5mA, Zzt=40Ω, 500mW	SOD-80	15d	2g	Ttr
Z15C	GLZJ15C	Z-diode	14.35..15.09V, Zzt=40Ω, Izt=5mA, 500mW	SOD-80	15d	2c	Pjt
Z15C	TLZJ15C	Z-diode	14.35..15.09V, Izt=5mA, Zzt=40Ω, 500mW	SOD-80	15d	2g	Ttr
Z16A	GLZJ16A	Z-diode	14.80..15.57V, Zzt=40Ω, Izt=5mA, 500mW	SOD-80	15d	2c	Pjt
Z16A	TLZJ16A	Z-diode	14.80..15.57V, Izt=5mA, Zzt=40Ω, 500mW	SOD-80	15d	2g	Ttr
Z16B	GLZJ16B	Z-diode	15.25..16.04V, Zzt=40Ω, Izt=5mA, 500mW	SOD-80	15d	2c	Pjt
Z16B	TLZJ16B	Z-diode	15.25..16.04V, Izt=5mA, Zzt=40Ω, 500mW	SOD-80	15d	2g	Ttr
Z16C	GLZJ16C	Z-diode	15.69..16.51V, Zzt=40Ω, Izt=5mA, 500mW	SOD-80	15d	2c	Pjt
Z16C	TLZJ16C	Z-diode	15.69..16.51V, Izt=5mA, Zzt=40Ω, 500mW	SOD-80	15d	2g	Ttr
Z18A	GLZJ18A	Z-diode	16.22..17.06V, Zzt=45Ω, Izt=5mA, 500mW	SOD-80	15d	2c	Pjt
Z18A	TLZJ18A	Z-diode	16.22..17.06V, Izt=5mA, Zzt=45Ω, 500mW	SOD-80	15d	2g	Ttr
Z18B	GLZJ18B	Z-diode	16.82..17.70V, Zzt=45Ω, Izt=5mA, 500mW	SOD-80	15d	2c	Pjt
Z18B	TLZJ18B	Z-diode	16.82..17.70V, Izt=5mA, Zzt=45Ω, 500mW	SOD-80	15d	2g	Ttr
Z18C	GLZJ18C	Z-diode	17.42..18.33V, Zzt=45Ω, Izt=5mA, 500mW	SOD-80	15d	2c	Pjt
Z18C	TLZJ18C	Z-diode	17.42..18.33V, Izt=5mA, Zzt=45Ω, 500mW	SOD-80	15d	2g	Ttr
Z20A	GLZJ20A	Z-diode	18.02..18.96V, Zzt=55Ω, Izt=5mA, 500mW	SOD-80	15d	2c	Pjt
Z20A	TLZJ20A	Z-diode	18.02..18.96V, Izt=5mA, Zzt=55Ω, 500mW	SOD-80	15d	2g	Ttr
Z20B	GLZJ20B	Z-diode	18.63..19.59V, Zzt=55Ω, Izt=5mA, 500mW	SOD-80	15d	2c	Pjt
Z20B	TLZJ20B	Z-diode	18.63..19.59V, Izt=5mA, Zzt=55Ω, 500mW	SOD-80	15d	2g	Ttr
Z20C	GLZJ20C	Z-diode	19.23..20.22V, Zzt=55Ω, Izt=5mA, 500mW	SOD-80	15d	2c	Pjt
Z20C	TLZJ20C	Z-diode	19.23..20.22V, Izt=5mA, Zzt=55Ω, 500mW	SOD-80	15d	2g	Ttr
Z20D	GLZJ20D	Z-diode	19.72..20.72V, Zzt=55Ω, Izt=5mA, 500mW	SOD-80	15d	2c	Pjt
Z20D	TLZJ20D	Z-diode	19.72..20.72V, Izt=5mA, Zzt=55Ω, 500mW	SOD-80	15d	2g	Ttr
Z22A	GLZJ22A	Z-diode	20.15..21.20V, Zzt=30Ω, Izt=5mA, 500mW	SOD-80	15d	2c	Pjt
Z22A	TLZJ22A	Z-diode	20.15..21.20V, Izt=5mA, Zzt=30Ω, 500mW	SOD-80	15d	2g	Ttr
Z22B	GLZJ22B	Z-diode	20.64..21.71V, Zzt=30Ω, Izt=5mA, 500mW	SOD-80	15d	2c	Pjt
Z22B	TLZJ22B	Z-diode	20.64..21.71V, Izt=5mA, Zzt=30Ω, 500mW	SOD-80	15d	2g	Ttr
Z22C	GLZJ22C	Z-diode	21.08..22.17V, Zzt=30Ω, Izt=5mA, 500mW	SOD-80	15d	2c	Pjt
Z22C	TLZJ22C	Z-diode	21.08..22.17V, Izt=5mA, Zzt=30Ω, 500mW	SOD-80	15d	2g	Ttr
Z22D	GLZJ22D	Z-diode	21.52..22.63V, Zzt=30Ω, Izt=5mA, 500mW	SOD-80	15d	2c	Pjt
Z22D	TLZJ22D	Z-diode	21.52..22.63V, Izt=5mA, Zzt=30Ω, 500mW	SOD-80	15d	2g	Ttr
Z24A	GLZJ24A	Z-diode	22.05..23.18V, Zzt=35Ω, Izt=5mA, 500mW	SOD-80	15d	2c	Pjt
Z24A	TLZJ24A	Z-diode	22.05..23.18V, Izt=5mA, Zzt=35Ω, 500mW	SOD-80	15d	2g	Ttr



SMD code	Type	Function	Short description	Case	Pinout	St.	Mnf.
Z24B	GLZJ24B	Z-diode	22.61..23.77V, Zzt=35Ω, Izt=5mA, 500mW	SOD-80	15d	2c	Pjt
Z24B	TLZJ24B	Z-diode	22.61..23.77V, Izt=5mA, Zzt=35Ω, 500mW	SOD-80	15d	2g	Ttr
Z24C	GLZJ24C	Z-diode	23.12..24.31V, Zzt=35Ω, Izt=5mA, 500mW	SOD-80	15d	2c	Pjt
Z24C	TLZJ24C	Z-diode	23.12..24.31V, Izt=5mA, Zzt=35Ω, 500mW	SOD-80	15d	2g	Ttr
Z24D	GLZJ24D	Z-diode	23.63..24.85V, Zzt=35Ω, Izt=5mA, 500mW	SOD-80	15d	2c	Pjt
Z24D	TLZJ24D	Z-diode	23.63..24.85V, Izt=5mA, Zzt=35Ω, 500mW	SOD-80	15d	2g	Ttr
Z27A	GLZJ27A	Z-diode	24.26..25.52V, Zzt=45Ω, Izt=5mA, 500mW	SOD-80	15d	2c	Pjt
Z27A	TLZJ27A	Z-diode	24.26..25.52V, Izt=5mA, Zzt=45Ω, 500mW	SOD-80	15d	2g	Ttr
Z27B	GLZJ27B	Z-diode	24.97..26.26V, Zzt=45Ω, Izt=5mA, 500mW	SOD-80	15d	2c	Pjt
Z27B	TLZJ27B	Z-diode	24.97..26.26V, Izt=5mA, Zzt=45Ω, 500mW	SOD-80	15d	2g	Ttr
Z27C	GLZJ27C	Z-diode	25.63..26.95V, Zzt=45Ω, Izt=5mA, 500mW	SOD-80	15d	2c	Pjt
Z27C	TLZJ27C	Z-diode	25.63..26.95V, Izt=5mA, Zzt=45Ω, 500mW	SOD-80	15d	2g	Ttr
Z27D	GLZJ27D	Z-diode	26.29..27.64V, Zzt=45Ω, Izt=5mA, 500mW	SOD-80	15d	2c	Pjt
Z27D	TLZJ27D	Z-diode	26.29..27.64V, Izt=5mA, Zzt=45Ω, 500mW	SOD-80	15d	2g	Ttr
Z2A0	GLZJ2.0A	Z-diode	1.88..2.10V, Zzt=100Ω, Izt=5mA, 500mW	SOD-80	15d	2c	Pjt
Z2A0	TLZJ2.0A	Z-diode	1.88..2.10V, Izt=5mA, Zzt=100Ω, 500mW	SOD-80	15d	2g	Ttr
Z2A2	GLZJ2.2A	Z-diode	2.12..2.30V, Zzt=100Ω, Izt=5mA, 500mW	SOD-80	15d	2c	Pjt
Z2A2	TLZJ2.2A	Z-diode	2.12..2.30V, Izt=5mA, Zzt=100Ω, 500mW	SOD-80	15d	2g	Ttr
Z2A4	GLZJ2.4A	Z-diode	2.33..2.52V, Zzt=100Ω, Izt=5mA, 500mW	SOD-80	15d	2c	Pjt
Z2A4	TLZJ2.4A	Z-diode	2.33..2.52V, Izt=5mA, Zzt=100Ω, 500mW	SOD-80	15d	2g	Ttr
Z2A7	GLZJ2.7A	Z-diode	2.54..2.75V, Zzt=110Ω, Izt=5mA, 500mW	SOD-80	15d	2c	Pjt
Z2A7	TLZJ2.7A	Z-diode	2.54..2.75V, Izt=5mA, Zzt=110Ω, 500mW	SOD-80	15d	2g	Ttr
Z2B0	GLZJ2.0B	Z-diode	2.02..2.20V, Zzt=100Ω, Izt=5mA, 500mW	SOD-80	15d	2c	Pjt
Z2B0	TLZJ2.0B	Z-diode	2.02..2.20V, Izt=5mA, Zzt=100Ω, 500mW	SOD-80	15d	2g	Ttr
Z2B2	GLZJ2.2B	Z-diode	2.22..2.41V, Zzt=100Ω, Izt=5mA, 500mW	SOD-80	15d	2c	Pjt
Z2B2	TLZJ2.2B	Z-diode	2.22..2.41V, Izt=5mA, Zzt=100Ω, 500mW	SOD-80	15d	2g	Ttr
Z2B4	GLZJ2.4B	Z-diode	2.43..2.63V, Zzt=100Ω, Izt=5mA, 500mW	SOD-80	15d	2c	Pjt
Z2B4	TLZJ2.4B	Z-diode	2.43..2.63V, Izt=5mA, Zzt=100Ω, 500mW	SOD-80	15d	2g	Ttr
Z2B7	GLZJ2.7B	Z-diode	2.69..2.91V, Zzt=110Ω, Izt=5mA, 500mW	SOD-80	15d	2c	Pjt
Z2B7	TLZJ2.7B	Z-diode	2.69..2.91V, Izt=5mA, Zzt=110Ω, 500mW	SOD-80	15d	2g	Ttr
Z30A	GLZJ30A	Z-diode	26.99..28.39V, Zzt=55Ω, Izt=5mA, 500mW	SOD-80	15d	2c	Pjt
Z30A	TLZJ30A	Z-diode	26.99..28.39V, Izt=5mA, Zzt=55Ω, 500mW	SOD-80	15d	2g	Ttr
Z30B	GLZJ30B	Z-diode	27.70..29.13V, Zzt=55Ω, Izt=5mA, 500mW	SOD-80	15d	2c	Pjt
Z30B	TLZJ30B	Z-diode	27.70..29.13V, Izt=5mA, Zzt=55Ω, 500mW	SOD-80	15d	2g	Ttr
Z30C	GLZJ30C	Z-diode	28.36..29.82V, Zzt=55Ω, Izt=5mA, 500mW	SOD-80	15d	2c	Pjt
Z30C	TLZJ30C	Z-diode	28.36..29.82V, Izt=5mA, Zzt=55Ω, 500mW	SOD-80	15d	2g	Ttr
Z30D	GLZJ30D	Z-diode	29.02..30.51V, Zzt=55Ω, Izt=5mA, 500mW	SOD-80	15d	2c	Pjt
Z30D	TLZJ30D	Z-diode	29.02..30.51V, Izt=5mA, Zzt=55Ω, 500mW	SOD-80	15d	2g	Ttr
Z33A	GLZJ33A	Z-diode	29.68..31.22V, Zzt=65Ω, Izt=5mA, 500mW	SOD-80	15d	2c	Pjt
Z33A	TLZJ33A	Z-diode	29.68..31.22V, Izt=5mA, Zzt=65Ω, 500mW	SOD-80	15d	2g	Ttr
Z33B	GLZJ33B	Z-diode	30.32..31.88V, Zzt=65Ω, Izt=5mA, 500mW	SOD-80	15d	2c	Pjt
Z33B	TLZJ33B	Z-diode	30.32..31.88V, Izt=5mA, Zzt=65Ω, 500mW	SOD-80	15d	2g	Ttr
Z33C	GLZJ33C	Z-diode	30.90..32.50V, Zzt=65Ω, Izt=5mA, 500mW	SOD-80	15d	2c	Pjt
Z33C	TLZJ33C	Z-diode	30.90..32.50V, Izt=5mA, Zzt=65Ω, 500mW	SOD-80	15d	2g	Ttr
Z33D	GLZJ33D	Z-diode	31.49..33.11V, Zzt=65Ω, Izt=5mA, 500mW	SOD-80	15d	2c	Pjt
Z33D	TLZJ33D	Z-diode	31.49..33.11V, Izt=5mA, Zzt=65Ω, 500mW	SOD-80	15d	2g	Ttr
Z36A	GLZJ36A	Z-diode	32.14..33.79V, Zzt=75Ω, Izt=5mA, 500mW	SOD-80	15d	2c	Pjt
Z36A	TLZJ36A	Z-diode	32.14..33.79V, Izt=5mA, Zzt=75Ω, 500mW	SOD-80	15d	2g	Ttr
Z36B	GLZJ36B	Z-diode	32.79..34.49V, Zzt=75Ω, Izt=5mA, 500mW	SOD-80	15d	2c	Pjt
Z36B	TLZJ36B	Z-diode	32.79..34.49V, Izt=5mA, Zzt=75Ω, 500mW	SOD-80	15d	2g	Ttr
Z36C	GLZJ36C	Z-diode	33.4..35.13V, Zzt=75Ω, Izt=5mA, 500mW	SOD-80	15d	2c	Pjt
Z36C	TLZJ36C	Z-diode	33.40..35.13V, Izt=5mA, Zzt=75Ω, 500mW	SOD-80	15d	2g	Ttr
Z36D	GLZJ36D	Z-diode	34.01..35.77V, Zzt=75Ω, Izt=5mA, 500mW	SOD-80	15d	2c	Pjt
Z36D	TLZJ36D	Z-diode	34.01..35.77V, Izt=5mA, Zzt=75Ω, 500mW	SOD-80	15d	2g	Ttr
Z39A	GLZJ39A	Z-diode	34.68..36.47V, Zzt=85Ω, Izt=5mA, 500mW	SOD-80	15d	2c	Pjt
Z39A	TLZJ39A	Z-diode	34.68..36.47V, Izt=5mA, Zzt=85Ω, 500mW	SOD-80	15d	2g	Ttr
Z39B	GLZJ39B	Z-diode	35.36..37.19V, Zzt=85Ω, Izt=5mA, 500mW	SOD-80	15d	2c	Pjt
Z39B	TLZJ39B	Z-diode	35.36..37.19V, Izt=5mA, Zzt=85Ω, 500mW	SOD-80	15d	2g	Ttr
Z39C	GLZJ39C	Z-diode	36.00..37.85V, Zzt=85Ω, Izt=5mA, 500mW	SOD-80	15d	2c	Pjt
Z39C	TLZJ39C	Z-diode	36.0..37.85V, Izt=5mA, Zzt=85Ω, 500mW	SOD-80	15d	2g	Ttr
Z39D	GLZJ39D	Z-diode	36.63..38.52V, Zzt=85Ω, Izt=5mA, 500mW	SOD-80	15d	2c	Pjt
Z39D	TLZJ39D	Z-diode	36.63..38.52V, Izt=5mA, Zzt=85Ω, 500mW	SOD-80	15d	2g	Ttr
Z3A0	GLZJ3.0A	Z-diode	2.85..3.07V, Zzt=120Ω, Izt=5mA, 500mW	SOD-80	15d	2c	Pjt
Z3A0	TLZJ3.0A	Z-diode	2.85..3.07V, Izt=5mA, Zzt=120Ω, 500mW	SOD-80	15d	2g	Ttr
Z3A3	GLZJ3.3A	Z-diode	3.16..3.38V, Zzt=120Ω, Izt=5mA, 500mW	SOD-80	15d	2c	Pjt
Z3A3	TLZJ3.3A	Z-diode	3.16..3.38V, Izt=5mA, Zzt=120Ω, 500mW	SOD-80	15d	2g	Ttr
Z3A6	GLZJ3.6A	Z-diode	3.46..3.69V, Zzt=100Ω, Izt=5mA, 500mW	SOD-80	15d	2c	Pjt
Z3A6	TLZJ3.6A	Z-diode	3.46..3.70V, Izt=5mA, Zzt=100Ω, 500mW	SOD-80	15d	2g	Ttr
Z3A9	GLZJ3.9A	Z-diode	3.74..4.01V, Zzt=100Ω, Izt=5mA, 500mW	SOD-80	15d	2c	Pjt
Z3A9	TLZJ3.9A	Z-diode	3.74..4.01V, Izt=5mA, Zzt=100Ω, 500mW	SOD-80	15d	2g	Ttr



SMD code	Type	Function	Short description	Case	Pinout	St.	Mnf.
Z3B0	GLZJ3.0B	Z-diode	3.01..3.22V, Zzt=120Ω, lzt=5mA, 500mW	SOD-80	15d	2c	Pjt
Z3B0	TLZJ3.0B	Z-diode	3.01..3.22V, lzt=5mA, Zzt=120Ω, 500mW	SOD-80	15d	2g	Ttr
Z3B3	GLZJ3.3B	Z-diode	3.32..3.53V, Zzt=120Ω, lzt=5mA, 500mW	SOD-80	15d	2c	Pjt
Z3B3	TLZJ3.3B	Z-diode	3.32..3.53V, lzt=5mA, Zzt=120Ω, 500mW	SOD-80	15d	2g	Ttr
Z3B6	GLZJ3.6B	Z-diode	3.60..3.84V, Zzt=100Ω, lzt=5mA, 500mW	SOD-80	15d	2c	Pjt
Z3B6	TLZJ3.6B	Z-diode	3.60..3.85V, lzt=5mA, Zzt=100Ω, 500mW	SOD-80	15d	2g	Ttr
Z3B9	GLZJ3.9B	Z-diode	3.89..4.16V, Zzt=100Ω, lzt=5mA, 500mW	SOD-80	15d	2c	Pjt
Z3B9	TLZJ3.9B	Z-diode	3.89..4.16V, lzt=5mA, Zzt=100Ω, 500mW	SOD-80	15d	2g	Ttr
Z43	GLZJ4.3	Z-diode	40.0..45.0V, Zzt=90Ω, lzt=5mA, 500mW	SOD-80	15d	2c	Pjt
Z43	TLZJ4.3	Z-diode	40.0..45V, lzt=5mA, Zzt=90Ω, 500mW	SOD-80	15d	2g	Ttr
Z47	GLZJ4.7	Z-diode	44.0..49.0V, Zzt=90Ω, lzt=5mA, 500mW	SOD-80	15d	2c	Pjt
Z47	TLZJ4.7	Z-diode	44.49V, lzt=5mA, Zzt=90Ω, 500mW	SOD-80	15d	2g	Ttr
Z4A3	GLZJ4.3A	Z-diode	4.04..4.29V, Zzt=100Ω, lzt=5mA, 500mW	SOD-80	15d	2c	Pjt
Z4A3	TLZJ4.3A	Z-diode	4.04..4.29V, lzt=5mA, Zzt=100Ω, 500mW	SOD-80	15d	2g	Ttr
Z4A7	GLZJ4.7A	Z-diode	4.44..4.68V, Zzt=90Ω, lzt=5mA, 500mW	SOD-80	15d	2c	Pjt
Z4A7	TLZJ4.7A	Z-diode	4.44..4.68V, lzt=5mA, Zzt=90Ω, 500mW	SOD-80	15d	2g	Ttr
Z4B3	GLZJ4.3B	Z-diode	4.17..4.43V, Zzt=100Ω, lzt=5mA, 500mW	SOD-80	15d	2c	Pjt
Z4B3	TLZJ4.3B	Z-diode	4.17..4.43V, lzt=5mA, Zzt=100Ω, 500mW	SOD-80	15d	2g	Ttr
Z4B7	GLZJ4.7B	Z-diode	4.55..4.80V, Zzt=90Ω, lzt=5mA, 500mW	SOD-80	15d	2c	Pjt
Z4B7	TLZJ4.7B	Z-diode	4.55..4.80V, lzt=5mA, Zzt=90Ω, 500mW	SOD-80	15d	2g	Ttr
Z4C3	GLZJ4.3C	Z-diode	4.30..4.57V, Zzt=100Ω, lzt=5mA, 500mW	SOD-80	15d	2c	Pjt
Z4C3	TLZJ4.3C	Z-diode	4.30..4.57V, lzt=5mA, Zzt=100Ω, 500mW	SOD-80	15d	2g	Ttr
Z4C7	GLZJ4.7C	Z-diode	4.68..4.93V, Zzt=90Ω, lzt=5mA, 500mW	SOD-80	15d	2c	Pjt
Z4C7	TLZJ4.7C	Z-diode	4.68..4.93V, lzt=5mA, Zzt=90Ω, 500mW	SOD-80	15d	2g	Ttr
Z51	GLZJ5.1	Z-diode	48.0..54.0V, Zzt=110Ω, lzt=5mA, 500mW	SOD-80	15d	2c	Pjt
Z51	TLZJ5.1	Z-diode	48.0..54V, lzt=5mA, Zzt=110Ω, 500mW	SOD-80	15d	2g	Ttr
Z56	GLZJ5.6	Z-diode	53.0..60.0V, Zzt=110Ω, lzt=5mA, 500mW	SOD-80	15d	2c	Pjt
Z56	TLZJ5.6	Z-diode	53.60V, lzt=5mA, Zzt=110Ω, 500mW	SOD-80	15d	2g	Ttr
Z5A1	GLZJ5.1A	Z-diode	4.81..5.07V, Zzt=80Ω, lzt=5mA, 500mW	SOD-80	15d	2c	Pjt
Z5A1	TLZJ5.1A	Z-diode	4.81..5.07V, lzt=5mA, Zzt=80Ω, 500mW	SOD-80	15d	2g	Ttr
Z5A6	GLZJ5.6A	Z-diode	5.28..5.55V, Zzt=60Ω, lzt=5mA, 500mW	SOD-80	15d	2c	Pjt
Z5A6	TLZJ5.6A	Z-diode	5.28..5.55V, lzt=5mA, Zzt=60Ω, 500mW	SOD-80	15d	2g	Ttr
Z5B1	GLZJ5.1B	Z-diode	4.94..5.20V, Zzt=80Ω, lzt=5mA, 500mW	SOD-80	15d	2c	Pjt
Z5B1	TLZJ5.1B	Z-diode	4.94..5.20V, lzt=5mA, Zzt=80Ω, 500mW	SOD-80	15d	2g	Ttr
Z5B6	GLZJ5.6B	Z-diode	5.45..5.73V, Zzt=60Ω, lzt=5mA, 500mW	SOD-80	15d	2c	Pjt
Z5B6	TLZJ5.6B	Z-diode	5.451..5.73V, lzt=5mA, Zzt=60Ω, 500mW	SOD-80	15d	2g	Ttr
Z5C1	GLZJ5.1C	Z-diode	5.09..5.37V, Zzt=80Ω, lzt=5mA, 500mW	SOD-80	15d	2c	Pjt
Z5C1	TLZJ5.1C	Z-diode	5.09..5.37V, lzt=5mA, Zzt=80Ω, 500mW	SOD-80	15d	2g	Ttr
Z5C6	GLZJ5.6C	Z-diode	5.61..5.91V, Zzt=60Ω, lzt=5mA, 500mW	SOD-80	15d	2c	Pjt
Z5C6	TLZJ5.6C	Z-diode	5.61..5.91V, lzt=5mA, Zzt=60Ω, 500mW	SOD-80	15d	2g	Ttr
Z6A2	GLZJ6.2A	Z-diode	5.78..6.09V, Zzt=60Ω, lzt=5mA, 500mW	SOD-80	15d	2c	Pjt
Z6A2	TLZJ6.2A	Z-diode	5.78..6.09V, lzt=5mA, Zzt=60Ω, 500mW	SOD-80	15d	2g	Ttr
Z6A8	GLZJ6.8A	Z-diode	6.29..6.63V, Zzt=20Ω, lzt=5mA, 500mW	SOD-80	15d	2c	Pjt
Z6A8	TLZJ6.8A	Z-diode	6.29..6.63V, lzt=5mA, Zzt=20Ω, 500mW	SOD-80	15d	2g	Ttr
Z6B2	GLZJ6.2B	Z-diode	5.96..6.27V, Zzt=60Ω, lzt=5mA, 500mW	SOD-80	15d	2c	Pjt
Z6B2	TLZJ6.2B	Z-diode	5.96..6.27V, lzt=5mA, Zzt=60Ω, 500mW	SOD-80	15d	2g	Ttr
Z6B8	GLZJ6.8B	Z-diode	6.49..6.83V, Zzt=20Ω, lzt=5mA, 500mW	SOD-80	15d	2c	Pjt
Z6B8	TLZJ6.8B	Z-diode	6.49..6.83V, lzt=5mA, Zzt=20Ω, 500mW	SOD-80	15d	2g	Ttr
Z6C2	GLZJ6.2C	Z-diode	6.12..6.44V, Zzt=60Ω, lzt=5mA, 500mW	SOD-80	15d	2c	Pjt
Z6C2	TLZJ6.2C	Z-diode	6.12..6.44V, lzt=5mA, Zzt=60Ω, 500mW	SOD-80	15d	2g	Ttr
Z6C8	GLZJ6.8C	Z-diode	6.66..7.01V, Zzt=20Ω, lzt=5mA, 500mW	SOD-80	15d	2c	Pjt
Z6C8	TLZJ6.8C	Z-diode	6.66..7.01V, lzt=5mA, Zzt=20Ω, 500mW	SOD-80	15d	2g	Ttr
Z7A5	GLZJ7.5A	Z-diode	6.85..7.22V, Zzt=20Ω, lzt=5mA, 500mW	SOD-80	15d	2c	Pjt
Z7A5	TLZJ7.5A	Z-diode	6.85..7.22V, lzt=5mA, Zzt=20Ω, 500mW	SOD-80	15d	2g	Ttr
Z7B5	GLZJ7.5B	Z-diode	7.07..7.45V, Zzt=20Ω, lzt=5mA, 500mW	SOD-80	15d	2c	Pjt
Z7B5	TLZJ7.5B	Z-diode	7.07..7.45V, lzt=5mA, Zzt=20Ω, 500mW	SOD-80	15d	2g	Ttr
Z7C5	GLZJ7.5C	Z-diode	7.29..7.67V, Zzt=20Ω, lzt=5mA, 500mW	SOD-80	15d	2c	Pjt
Z7C5	TLZJ7.5C	Z-diode	7.29..7.67V, lzt=5mA, Zzt=20Ω, 500mW	SOD-80	15d	2g	Ttr
Z8A2	GLZJ8.2A	Z-diode	7.53..7.92V, Zzt=20Ω, lzt=5mA, 500mW	SOD-80	15d	2c	Pjt
Z8A2	TLZJ8.2A	Z-diode	7.53..7.92V, lzt=5mA, Zzt=20Ω, 500mW	SOD-80	15d	2g	Ttr
Z8B2	GLZJ8.2B	Z-diode	7.78..8.19V, Zzt=20Ω, lzt=5mA, 500mW	SOD-80	15d	2c	Pjt
Z8B2	TLZJ8.2B	Z-diode	7.78..8.19V, lzt=5mA, Zzt=20Ω, 500mW	SOD-80	15d	2g	Ttr
Z8C2	GLZJ8.2C	Z-diode	8.03..8.45V, Zzt=20Ω, lzt=5mA, 500mW	SOD-80	15d	2c	Pjt
Z8C2	TLZJ8.2C	Z-diode	8.03..8.45V, lzt=5mA, Zzt=20Ω, 500mW	SOD-80	15d	2g	Ttr
Z9A1	GLZJ9.1A	Z-diode	8.29..8.73V, Zzt=25Ω, lzt=5mA, 500mW	SOD-80	15d	2c	Pjt
Z9A1	TLZJ9.1A	Z-diode	8.29..8.73V, lzt=5mA, Zzt=25Ω, 500mW	SOD-80	15d	2g	Ttr
Z9B1	GLZJ9.1B	Z-diode	8.57..9.01V, Zzt=25Ω, lzt=5mA, 500mW	SOD-80	15d	2c	Pjt
Z9B1	TLZJ9.1B	Z-diode	8.57..9.01V, lzt=5mA, Zzt=25Ω, 500mW	SOD-80	15d	2g	Ttr
Z9C1	GLZJ9.1C	Z-diode	8.83..9.30V, Zzt=25Ω, lzt=5mA, 500mW	SOD-80	15d	2c	Pjt
Z9C1	TLZJ9.1C	Z-diode	8.83..9.30V, lzt=5mA, Zzt=25Ω, 500mW	SOD-80	15d	2g	Ttr



SECTION 3
3-pin CASES SMD SEMICONDUCTOR COMPONENTS

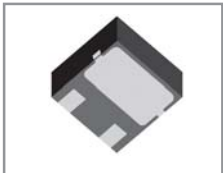
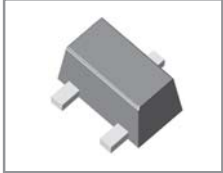

SMD code	Type	Function	Short description	Case	Pinout	Sch.	St.	Mnf.
#LN	ELM7541CEB	Vdet-IC	4.1V±2%, +Reset PPO	SC-70	16vdb	VD7	3d	Elm
#LN	ELM7541NEB	Vdet-IC	4.1V±2%, +Reset ODO	SC-70	16vdb	VD6	3d	Elm
*LN	ELM7546CEB	Vdet-IC	4.6V±2%, +Reset PPO	SC-70	16vdb	VD7	3d	Elm
*LN	ELM7546NEB	Vdet-IC	4.6V±2%, +Reset ODO	SC-70	16vdb	VD6	3d	Elm
/LN	ELM7554CEB	Vdet-IC	5.4V±2%, +Reset PPO	SC-70	16vdb	VD7	3d	Elm
/LN	ELM7554NEB	Vdet-IC	5.4V±2%, +Reset ODO	SC-70	16vdb	VD6	3d	Elm
+LN	ELM7547CEB	Vdet-IC	4.7V±2%, +Reset PPO	SC-70	16vdb	VD7	3d	Elm
+LN	ELM7547NEB	Vdet-IC	4.7V±2%, +Reset ODO	SC-70	16vdb	VD6	3d	Elm
+P2	BFR92A	Si-npn	UHF-A-Band, 20V, 25mA, 300mW, B>40, >5GHz	SOT-23	16ta	-	3a	Sil
+P5	BFR92AR	Si-npn	UHF-A-Band, 20V, 25mA, 300mW, B>40, >5GHz	SOT-23	16te	-	3a	Sil
+R2	BFR93A	Si-npn	UHF-A-Band, 15V, 30mA, 300mW, B>40, >5GHz	SOT-23	16ta	-	3a	Sil
+R5	BFR93AR	Si-npn	UHF-A-Band, 15V, 30mA, 300mW, B>40, >5GHz	SOT-23	16te	-	3a	Sil
<LN	ELM7553CEB	Vdet-IC	5.3V±2%, +Reset PPO	SC-70	16vdb	VD7	3d	Elm
<LN	ELM7553NEB	Vdet-IC	5.3V±2%, +Reset ODO	SC-70	16vdb	VD6	3d	Elm
=LN	ELM7544CEB	Vdet-IC	4.4V±2%, +Reset PPO	SC-70	16vdb	VD7	3d	Elm
=LN	ELM7544NEB	Vdet-IC	4.4V±2%, +Reset ODO	SC-70	16vdb	VD6	3d	Elm
>LN	ELM7549CEB	Vdet-IC	4.9V±2%, +Reset PPO	SC-70	16vdb	VD7	3d	Elm
>LN	ELM7549NEB	Vdet-IC	4.9V±2%, +Reset ODO	SC-70	16vdb	VD6	3d	Elm
005	SO2484R	Si-npn	AF, LN, 60V, 50mA, 360mW, 100MHz, B>100	SOT-23	16te	-	-	Ste
01	PDTA143EE	Si-pnp-Digi	Sw, 50V, 100mA, 150mW, R1/R2=4.7k/4.7k	SOT-416	16ta	-	3a	Phi
01	PDTA143EK	Si-pnp-Digi	Sw, 50V, 100mA, 250mW, R1/R2=4.7k/4.7k	SC-59	16ta	-	3a	Phi
011	SO2369R	Si-npn	Sw, 40V, 200mA, 330mW, B=40..120, 400MHz	SOT-23	16te	-	3a	Zx
012	SO2221R	Si-npn	GP, 60V, 800mA, 500mW, >250MHz, B>20	SOT-23	16te	-	-	Ste
013	SO2222R	Si-npn	GP, 60V, 800mA, 350mW, B=100..300, >300MHz	SOT-23	16te	-	3a	Ste
018	SO1711R	Si-npn	GP, 75V, 1A, 1W, >70MHz	SOT-23	16ta	-	-	Zx
01A	APR3001-15A	Vdet-IC	1.5V, -Reset PPO	SOT-23	16vdb	VD7	3b	Anp
01A	RA101C	Si-pnp-Digi	Sw, 50V, 100mA, 200mW, 250MHz, R1/R2=47k/47k	SOT-23	16ta	-	3a	San
01B	APR3001-17A	Vdet-IC	1.75V, -Reset PPO	SOT-23	16vdb	VD7	3b	Anp
01C	APR3001-23A	Vdet-IC	2.32V, -Reset PPO	SOT-23	16vdb	VD7	3b	Anp
01C	RC101C	Si-npn-Digi	Sw, 50V, 100mA, 200mW, 250MHz, R1/R2=47k/47k	SOT-23	16ta	-	3a	San
01D	APR3001-26A	Vdet-IC	2.63V, -Reset PPO	SOT-23	16vdb	VD7	3b	Anp
01E	APR3001-29A	Vdet-IC	2.93V, -Reset PPO	SOT-23	16vdb	VD7	3b	Anp
01F	APR3001-30A	Vdet-IC	3.08V, -Reset PPO	SOT-23	16vdb	VD7	3b	Anp
01G	APR3001-39A	Vdet-IC	3.9V, -Reset PPO	SOT-23	16vdb	VD7	3b	Anp
01H	APR3001-43A	Vdet-IC	4.38V, -Reset PPO	SOT-23	16vdb	VD7	3b	Anp
01J	APR3001-46A	Vdet-IC	4.63V, -Reset PPO	SOT-23	16vdb	VD7	3b	Anp
02	2N7002	n-MOSFET-e	TMOS, 60V, 115mA, 225mW, <7.5Ω(500mA), 20/40ns	SOT-23	16fh	-	3b	Sec
02	BSX39	Si-npn	Sw, Driver, 45V, 0.2A, <12/18ns	SOT-23	16te	-	3a	lMot
02	PDTC143EE	Si-npn-Digi	Sw, 50V, 100mA, 150mW, R1/R2=4.7k/4.7k	SOT-416	16ta	-	3a	Phi
02	PDTC143EK	Si-npn-Digi	Sw, 50V, 100mA, 150mW, R1/R2=4.7k/4.7k	SC-59	16ta	-	3a	Phi
02	2N7002	n-MOSFET-e	TMOS, 60V, 115mA, 225mW, <7.5Ω(500mA), 20/40ns	SOT-23	16fh	-	3b	Frm
020	SO1711AR	Si-npn	GP, 75V, 1A, 1W, >70MHz	SOT-23	16te	-	-	Zx
020	SO2222AR	Si-npn	GP, 75V, 600mA, 330mW, B=120..360, >300MHz	SOT-23	16te	-	3a	Ste
027	SO1893R	Si-npn	AF, Sw, 120V, 500mA, 800mW, 70MHz	SOT-23	16te	-	-	Ste
02A	APR3002-15A	Vdet-IC	1.5V, +Reset PPO	SOT-23	16vdb	VD7	3b	Anp
02C	APR3002-23A	Vdet-IC	2.32V, +Reset PPO	SOT-23	16vdb	VD7	3b	Anp
02D	APR3002-26A	Vdet-IC	2.63V, +Reset PPO	SOT-23	16vdb	VD7	3b	Anp
02E	APR3002-29A	Vdet-IC	2.93V, +Reset PPO	SOT-23	16vdb	VD7	3b	Anp
02F	APR3002-30A	Vdet-IC	3.08V, +Reset PPO	SOT-23	16vdb	VD7	3b	Anp
02F	CH493DPT	Si-diode	Dual, SBD, 40V, 400mA, Vf<0.5V(200mA)	SOT-23	16dg	-	3a	Chm
02G	APR3002-39A	Vdet-IC	3.9V, +Reset PPO	SOT-23	16vdb	VD7	3b	Anp
02H	APR3002-43A	Vdet-IC	4.38V, +Reset PPO	SOT-23	16vdb	VD7	3b	Anp
02J	APR3002-46A	Vdet-IC	4.63V, +Reset PPO	SOT-23	16vdb	VD7	3b	Anp
02K	2N7002	n-MOSFET-e*	TMOS, 60V, 115mA, 225mW, <7.5Ω(500mA), 20/40ns	SOT-23	16fh	-	3b	Frm
03	DTC143TE	Si-npn-Digi	Sw, 50V, 100mA, 150mW, 250MHz, R1=4k7	SOT-416	16ta	-	3a	Rhm
03	DTC143TKA	Si-npn-Digi	Sw, 50V, 100mA, 200mW, 250MHz, R1=4k7	SOT-346	16ta	-	3a	Rhm
03	DTC143TM	Si-npn-Digi	Sw, 50V, 100mA, 150mW, 250MHz, R1=4k7	VMT3	18ta	-	3a	Rhm
03	DTC143TUA	Si-npn-Digi	Sw, 50V, 100mA, 200mW, 250MHz, R1=4.7k	UMT3	16ta	-	3a	Rhm
03	MSCT03	TVS	3.3V, 300W (8/20μs)	SOT-23	16dh	-	3a	lMsp
03	PDTA114EE	Si-pnp-Digi	Sw, 50V, 100mA, 150mW, R1/R2=10k/10k	SOT-416	16ta	-	3a	Phi
03	PDTA114EEF	Si-pnp-Digi	Sw, 50V, 100mA, 250mW, R1/R2=10k/10k	SOT-490	18ta	-	3a	Phi
03	PDTA114EK	Si-pnp-Digi	Sw, 50V, 100mA, 250mW, R1/R2=10k/10k	SC-59	16ta	-	3a	Phi
-03	PDTA114EU	Si-pnp-Digi	Sw, 50V, 100mA, 200mW, R1/R2=10k/10k	SOT-323	16ta	-	3a	PhH
03A	APR3003-15A	Vdet-IC	1.5V, -Reset ODO	SOT-23	16vdb	VD6	3b	Anp
03B	APR3003-17A	Vdet-IC	1.75V, -Reset ODO	SOT-23	16vdb	VD6	3b	Anp
03C	APR3003-23A	Vdet-IC	2.32V, -Reset ODO	SOT-23	16vdb	VD6	3b	Anp
03C	MSCT03C	TVS	Dual, Vrrm=3.3V, 300W (8/20μs), Bidirectional	SOT-23	16dp	-	3a	lMsp
03D	APR3003-26A	Vdet-IC	2.63V, -Reset ODO	SOT-23	16vdb	VD6	3b	Anp
03E	APR3003-29A	Vdet-IC	2.93V, -Reset ODO	SOT-23	16vdb	VD6	3b	Anp
03F	APR3003-30A	Vdet-IC	3.08V, -Reset ODO	SOT-23	16vdb	VD6	3b	Anp



SMD code	Type	Function	Short description	Case	Pinout	Sch.	St.	Mnf.
03F	CH494DPT	Si-diode	Dual, SBD, 40V, 400mA, Vf<0.5V(200mA)	SOT-23	16dl	-	3a	Chm
03F	CH494WSPt	Si-diode	Dual, SBD, 40V, 400mA, Vf<0.5V(200mA)	SOT-323	16dl	-	3a	Chm
03G	APR3003-39A	Vdet-IC	3.9V, -Reset ODO	SOT-23	16vdb	VD6	3b	Anp
03H	APR3003-43A	Vdet-IC	4.38V, -Reset ODO	SOT-23	16vdb	VD6	3b	Anp
03J	APR3003-46A	Vdet-IC	4.63V, -Reset ODO	SOT-23	16vdb	VD6	3b	Anp
03J	FM803JS3X	Vdet-IC	4.0V±1.5%, -Reset ODO	SOT-23	16vdc	VD6	3a	F
03L	FM803LS3X	Vdet-IC	4.63V±1.5%, -Reset ODO	SOT-23	16vdc	VD6	3a	F
03M	FM803MS3X	Vdet-IC	4.38V±1.5%, -Reset ODO	SOT-23	16vdc	VD6	3a	F
03R	FM803RS3X	Vdet-IC	2.63V±1.5%, -Reset ODO	SOT-23	16vdc	VD6	3a	F
03S	FM803SS3X	Vdet-IC	2.93V±1.5%, -Reset ODO	SOT-23	16vdc	VD6	3a	F
03T	FM803TS3X	Vdet-IC	3.08V±1.5%, -Reset ODO	SOT-23	16vdc	VD6	3a	F
04	PDTc114EK	Si-npn-Digi	Sw, 50V, 100mA, 250mW, R1/R2=10k/10k	SC-59	16ta	-	3a	Phi
-04	PMSS3904	Si-npn	GP, 60V, 100mA, 200mW, B=100..300, >180MHz	SOT-323	16ta	-	3a	PhH
04A	RA104C	Si-pnp-Digi	SW, 50V, 100mA, 200mW, 250MHz, R1/R2=10k/47k	SOT-23	16ta	-	3a	San
04C	RC104C	Si-npn-Digi	SW, 50V, 100mA, 200mW, 250MHz, R1/R2=10k/47k	SOT-23	16ta	-	3a	San
04C	TVS2303PT	TVS	Dual, Vbr=4V, Vrwm=3.3V, 1A, 300W(1ms)	SOT-23	16df	-	3a	Chm
04F	CH495DPT	Si-diode	Dual, SBD, 40V, 400mA, Vf<0.5V(200mA)	SOT-23	16df	-	3a	Chm
04LN	ELM7514CBB	Vdet-IC	1.4V±2%, +Reset PPO	SOT-23	16vdb	VD7	3d	Elm
04LN	ELM7514NBB	Vdet-IC	1.4V±2%, +Reset ODO	SOT-23	16vdb	VD6	3d	Elm
05	DTC124TE	Si-npn-Digi	Sw, 50V, 100mA, 150mW, 250MHz, R1=22k	SOT-416	16ta	-	3a	Rhm
05	DTC124TKA	Si-npn-Digi	Sw, 50V, 100mA, 200mW, 250MHz, R1=22k	SOT-346	16ta	-	3a	Rhm
05	DTC124TM	Si-npn-Digi	Sw, 50V, 100mA, 150mW, 250MHz, R1=22k	VMT3	18ta	-	3a	Rhm
05	DTC124TUA	Si-npn-Digi	Sw, 50V, 100mA, 200mW, B=111..600, >200MHz, R1=22k	UMT3	16ta	-	3a	Rhm
05	MSCT05	TVS	Vrwm=5V, 300W (8/20µs)	SOT-23	16dh	-	3a	Msp
05	PDTA124EE	Si-pnp-Digi	Sw, 50V, 100mA, 150mW, R1/R2=22k/22k	SOT-416	16ta	-	3a	Phi
05	PDTA124EK	Si-pnp-Digi	Sw, 50V, 100mA, 250mW, R1/R2=22k/22k	SC-59	16ta	-	3a	Phi
054	SO2221AR	Si-npn	GP, 75V, 800mA, 500mW, >250MHz, B>20	SOT-23	16te	-	-	Ste
05C	MSCT05C	TVS	Dual, Vrwm=5V, 300W (8/20µs), Bidirectional	SOT-23	16dp	-	3a	Msp
05C	TVS2305PT	TVS	Dual, Vbr=6V, Vrwm=5V, 1A, 300W(1ms)	SOT-23	16df	-	3a	Chm
05F	CH400DPT	Si-diode	SBD, 40V, 500mA, Vf<0.55V(500mA)	SOT-23	16dc	-	3a	Chm
05H	CH401DPT	Si-diode	SBD, 30V, 200mA, Vf<0.5V(300mA)	SOT-23	16dc	-	3a	Chm
05K	CH402DPT	Si-diode	SBD, 30V, 300mA, Vf<0.5V(300mA)	SOT-23	16dc	-	3a	Chm
05LN	ELM7515CBB	Vdet-IC	1.5V±2%, +Reset PPO	SOT-23	16vdb	VD7	3d	Elm
05LN	ELM7515NBB	Vdet-IC	1.5V±2%, +Reset ODO	SOT-23	16vdb	VD6	3d	Elm
05T	CH411DPT	Si-diode	SBD, 40V, 500mA, Vf<0.5V(500mA)	SOT-23	16dc	-	3a	Chm
06	PDTc124EE	Si-npn-Digi	Sw, 50V, 100mA, 150mW, R1/R2=22k/22k	SOT-416	16ta	-	3a	Phi
06	PDTc124EK	Si-npn-Digi	Sw, 50V, 100mA, 250mW, R1/R2=22k/22k	SC-59	16ta	-	3a	Phi
-06	PMSS3906	Si-pnp	GP, 60V, 100mA, 200mW, B=100..300, >150MHz	SOT-323	16ta	-	3a	PhH
06LN	ELM7516CBB	Vdet-IC	1.6V±2%, +Reset PPO	SOT-23	16vdb	VD7	3d	Elm
06LN	ELM7516NBB	Vdet-IC	1.6V±2%, +Reset ODO	SOT-23	16vdb	VD6	3d	Elm
07	PDTA144EE	Si-pnp-Digi	Sw, 50V, 100mA, 150mW, R1/R2=47k/47k	SOT-416	16ta	-	3a	Phi
07	PDTA144EEF	Si-pnp-Digi	Sw, 50V, 100mA, 250mW, R1/R2=47k/47k	SOT-490	18ta	-	3a	Phi
07	PDTA144EK	Si-pnp-Digi	Sw, 50V, 100mA, 250mW, R1/R2=47k/47k	SC-59	16ta	-	3a	Phi
071	SO3904R	Si-npn	GP, 60V, 100mA, 200mW, B= 100..300, >300MHz	SOT-23	16te	-	-	Ste
079	SO5550R	Si-npn	HV, 140V, 600mA, 225mW, B=80..250, >300MHz	SOT-23	16te	-	-	Ste
07LN	ELM7517CBB	Vdet-IC	1.7V±2%, +Reset PPO	SOT-23	16vdb	VD7	3d	Elm
07LN	ELM7517NBB	Vdet-IC	1.7V±2%, +Reset ODO	SOT-23	16vdb	VD6	3d	Elm
08	MSCT08	TVS	Vrwm=8V, 300W (8/20µs)	SOT-23	16dh	-	3a	Msp
08	PDTc144EE	Si-npn-Digi	Sw, 50V, 100mA, 150mW, R1/R2=47k/47k	SOT-416	16ta	-	3a	Phi
08	PDTc144EEF	Si-npn-Digi	Sw, 50V, 100mA, 250mW, R1/R2=47k/47k	SOT-490	18ta	-	3a	Phi
08	PDTc144EK	Si-npn-Digi	Sw, 50V, 100mA, 250mW, R1/R2=47k/47k	SC-59	16ta	-	3a	Phi
081	SO2369AR	Si-npn	Sw, 40V, 200mA, 330mW, B=40..120, 500MHz	SOT-23	16te	-	3a	Zx
08C	MSCT08C	TVS	Dual, Vrwm=8V, 300W (8/20µs), Bidirectional	SOT-23	16dp	-	3a	Msp
08LN	ELM7518CBB	Vdet-IC	1.8V±2%, +Reset PPO	SOT-23	16vdb	VD7	3d	Elm
08LN	ELM7518NBB	Vdet-IC	1.8V±2%, +Reset ODO	SOT-23	16vdb	VD6	3d	Elm
09	DTC115TE	Si-npn-Digi	Sw, 50V, 100mA, 150mW, 250MHz, R1=100k	SOT-416	16ta	-	3a	Rhm
09	DTC115TKA	Si-npn-Digi	Sw, 50V, 100mA, 200mW, 250MHz, R1=100k	SOT-346	16ta	-	3a	Rhm
09	DTC115TM	Si-npn-Digi	Sw, 50V, 100mA, 150mW, 250MHz, R1=100k	VMT3	18ta	-	3a	Rhm
09	DTC115TUA	Si-npn-Digi	Sw, 50V, 100mA, 200mW, 250MHz, R1=100k	UMT3	16ta	-	3a	Rhm
09	PDTc114EE	Si-npn-Digi	Sw, 50V, 100mA, 150mW, R1/R2=10k/10k	SOT-416	16ta	-	3a	Phi
09	PDTc114EEF	Si-npn-Digi	Sw, 50V, 100mA, 250mW, R1/R2=10k/10k	SOT-490	18ta	-	3a	Phi
-09	PDTc114EU	Si-npn-Digi	Sw, 50V, 100mA, 200mW, R1/R2=10k/10k	SOT-323	16ta	-	3a	PhH
091	SO642R	Si-npn	HV, Vid, 300V, 100mA, 310mW, B>25, 50MHz	SOT-23	16te	-	3a	Zx
09J	FM809JS3X	Vdet-IC	4.0V±1.5%, -Reset PPO	SOT-23	16vdc	VD7	3a	F
09J	LSP2200CALJ	Vdet-IC	4.0V±5%, -Reset PPO	SOT-23	16vdc	VD7	3a	Jbs
09L	FM809LS3X	Vdet-IC	4.63V±1.5%, -Reset PPO	SOT-23	16vdc	VD7	3a	F
09L	LSP2200CALL	Vdet-IC	4.63V±5%, -Reset PPO	SOT-23	16vdc	VD7	3a	Jbs
09LN	ELM7519CBB	Vdet-IC	1.9V±2%, +Reset PPO	SOT-23	16vdb	VD7	3d	Elm
09LN	ELM7519NBB	Vdet-IC	1.9V±2%, +Reset ODO	SOT-23	16vdb	VD6	3d	Elm
09M	FM809MS3X	Vdet-IC	4.38V±1.5%, -Reset PPO	SOT-23	16vdc	VD7	3a	F



SMD code	Type	Function	Short description	Case	Pinout	Sch.	St.	Mnf.
09M	LSP2200CALM	Vdet-IC	4.38V±5%, -Reset PPO	SOT-23	16vdc	VD7	3a	Jbs
09R	FM809RS3X	Vdet-IC	2.63V±1.5%, -Reset PPO	SOT-23	16vdc	VD7	3a	F
09R	LSP2200CALR	Vdet-IC	2.63V±5%, -Reset PPO	SOT-23	16vdc	VD7	3a	Jbs
09S	FM809SS3X	Vdet-IC	2.93V±1.5%, -Reset PPO	SOT-23	16vdc	VD7	3a	F
09S	LSP2200CALS	Vdet-IC	2.93V±5%, -Reset PPO	SOT-23	16vdc	VD7	3a	Jbs
09T	FM809TS3X	Vdet-IC	3.08V±1.5%, -Reset PPO	SOT-23	16vdc	VD7	3a	F
09T	LSP2200CALT	Vdet-IC	3.08V±5%, -Reset PPO	SOT-23	16vdc	VD7	3a	Jbs
09Z	LSP2200CALZ	Vdet-IC	2.35V±5%, -Reset PPO	SOT-23	16vdc	VD7	3a	Jbs
0A	DTC125TKA	Si-npn-Digi	Sw, 50V, 100mA, 200mW, 250MHz, R2=100k	SOT-346	16ta	-	3a	Rhm
0A	DTC125TUA	Si-npn-Digi	Sw, 50V, 100mA, 200mW, 250MHz, R1=200k	UMT3	16ta	-	3a	Rhm
0A0	XC6120C10H	Vdet-IC	1V±2%, CMOS +Reset PPO	USP-3	17vdy	VD7	9a	Tor
0A1	XC6120C11H	Vdet-IC	1.1V±2%, CMOS +Reset PPO	USP-3	17vdy	VD7	9a	Tor
0A2	XC6120C12H	Vdet-IC	1.2V±2%, CMOS +Reset PPO	USP-3	17vdy	VD7	9a	Tor
0A3	XC6120C13H	Vdet-IC	1.3V±2%, CMOS +Reset PPO	USP-3	17vdy	VD7	9a	Tor
0A4	XC6120C14H	Vdet-IC	1.4V±2%, CMOS +Reset PPO	USP-3	17vdy	VD7	9a	Tor
0A5	XC6120C15H	Vdet-IC	1.5V±2%, CMOS +Reset PPO	USP-3	17vdy	VD7	9a	Tor
0A6	XC6120C16H	Vdet-IC	1.6V±2%, CMOS +Reset PPO	USP-3	17vdy	VD7	9a	Tor
0A7	XC6120C17H	Vdet-IC	1.7V±2%, CMOS +Reset PPO	USP-3	17vdy	VD7	9a	Tor
0A8	XC6120C18H	Vdet-IC	1.8V±2%, CMOS +Reset PPO	USP-3	17vdy	VD7	9a	Tor
0A9	XC6120C19H	Vdet-IC	1.9V±2%, CMOS +Reset PPO	USP-3	17vdy	VD7	9a	Tor
0B	R3131N20EC	Vdet-IC	2V, +Reset ODO, 240ms	SOT-23	16vdc	VD6	3b	Ric
0B0	XC6120C20H	Vdet-IC	2V±2%, CMOS +Reset PPO	USP-3	17vdy	VD7	9a	Tor
0B1	XC6120C21H	Vdet-IC	2.1V±2%, CMOS +Reset PPO	USP-3	17vdy	VD7	9a	Tor
0B2	XC6120C22H	Vdet-IC	2.2V±2%, CMOS +Reset PPO	USP-3	17vdy	VD7	9a	Tor
0B3	XC6120C23H	Vdet-IC	2.3V±2%, CMOS +Reset PPO	USP-3	17vdy	VD7	9a	Tor
0B4	XC6120C24H	Vdet-IC	2.4V±2%, CMOS +Reset PPO	USP-3	17vdy	VD7	9a	Tor
0B5	XC6120C25H	Vdet-IC	2.5V±2%, CMOS +Reset PPO	USP-3	17vdy	VD7	9a	Tor
0B6	XC6120C26H	Vdet-IC	2.6V±2%, CMOS +Reset PPO	USP-3	17vdy	VD7	9a	Tor
0B7	XC6120C27H	Vdet-IC	2.7V±2%, CMOS +Reset PPO	USP-3	17vdy	VD7	9a	Tor
0B8	XC6120C28H	Vdet-IC	2.8V±2%, CMOS +Reset PPO	USP-3	17vdy	VD7	9a	Tor
0B9	XC6120C29H	Vdet-IC	2.9V±2%, CMOS +Reset PPO	USP-3	17vdy	VD7	9a	Tor
0C	R3131N30EC	Vdet-IC	3V, +Reset ODO, 240ms	SOT-23	16vdc	VD6	3b	Ric
0C0	XC6120C30H	Vdet-IC	3V±2%, CMOS +Reset PPO	USP-3	17vdy	VD7	9a	Tor
0C1	XC6120C31H	Vdet-IC	3.1V±2%, CMOS +Reset PPO	USP-3	17vdy	VD7	9a	Tor
0C2	XC6120C32H	Vdet-IC	3.2V±2%, CMOS +Reset PPO	USP-3	17vdy	VD7	9a	Tor
0C3	XC6120C33H	Vdet-IC	3.3V±2%, CMOS +Reset PPO	USP-3	17vdy	VD7	9a	Tor
0C4	XC6120C34H	Vdet-IC	3.4V±2%, CMOS +Reset PPO	USP-3	17vdy	VD7	9a	Tor
0C5	XC6120C35H	Vdet-IC	3.5V±2%, CMOS +Reset PPO	USP-3	17vdy	VD7	9a	Tor
0C6	XC6120C36H	Vdet-IC	3.6V±2%, CMOS +Reset PPO	USP-3	17vdy	VD7	9a	Tor
0C7	XC6120C37H	Vdet-IC	3.7V±2%, CMOS +Reset PPO	USP-3	17vdy	VD7	9a	Tor
0C8	XC6120C38H	Vdet-IC	3.8V±2%, CMOS +Reset PPO	USP-3	17vdy	VD7	9a	Tor
0C9	XC6120C39H	Vdet-IC	3.9V±2%, CMOS +Reset PPO	USP-3	17vdy	VD7	9a	Tor
0D	R3131N40EC	Vdet-IC	4V, +Reset ODO, 240ms	SOT-23	16vdc	VD6	3b	Ric
0D0	XC6120C40H	Vdet-IC	4V±2%, CMOS +Reset PPO	USP-3	17vdy	VD7	9a	Tor
0D1	XC6120C41H	Vdet-IC	4.1V±2%, CMOS +Reset PPO	USP-3	17vdy	VD7	9a	Tor
0D2	XC6120C42H	Vdet-IC	4.2V±2%, CMOS +Reset PPO	USP-3	17vdy	VD7	9a	Tor
0D3	XC6120C43H	Vdet-IC	4.3V±2%, CMOS +Reset PPO	USP-3	17vdy	VD7	9a	Tor
0D4	XC6120C44H	Vdet-IC	4.4V±2%, CMOS +Reset PPO	USP-3	17vdy	VD7	9a	Tor
0D5	TC590302ECB	LVR-IC	LDO, -0.3V±2%, 200mA	SOT-23	16cj	VR2	3d	Mcc
0D5	XC6120C45H	Vdet-IC	4.5V±2%, CMOS +Reset PPO	USP-3	17vdy	VD7	9a	Tor
0D6	XC6120C46H	Vdet-IC	4.6V±2%, CMOS +Reset PPO	USP-3	17vdy	VD7	9a	Tor
0D7	XC6120C47H	Vdet-IC	4.7V±2%, CMOS +Reset PPO	USP-3	17vdy	VD7	9a	Tor
0D8	XC6120C48H	Vdet-IC	4.8V±2%, CMOS +Reset PPO	USP-3	17vdy	VD7	9a	Tor
0D9	XC6120C49H	Vdet-IC	4.9V±2%, CMOS +Reset PPO	USP-3	17vdy	VD7	9a	Tor
0E	R3131N26EC3	Vdet-IC	2.6V, +Reset ODO, 240ms	SOT-23	16vdc	VD6	3b	Ric
0E0	XC6120C50H	Vdet-IC	5V±2%, CMOS +Reset PPO	USP-3	17vdy	VD7	9a	Tor
0E5	TC590402ECB	LVR-IC	LDO, -0.4V±2%, 200mA	SOT-23	16cj	VR2	3d	Mcc
0F0	XC6120N10H	Vdet-IC	1V±2%, N-ch, +Reset ODO	USP-3	17vdy	VD6	9a	Tor
0F1	XC6120N11H	Vdet-IC	1.1V±2%, N-ch, +Reset ODO	USP-3	17vdy	VD6	9a	Tor
0F2	XC6120N12H	Vdet-IC	1.2V±2%, N-ch, +Reset ODO	USP-3	17vdy	VD6	9a	Tor
0F3	XC6120N13H	Vdet-IC	1.3V±2%, N-ch, +Reset ODO	USP-3	17vdy	VD6	9a	Tor
0F4	XC6120N14H	Vdet-IC	1.4V±2%, N-ch, +Reset ODO	USP-3	17vdy	VD6	9a	Tor
0F5	TC590502ECB	LVR-IC	LDO, -0.5V±2%, 200mA	SOT-23	16cj	VR2	3d	Mcc
0F5	XC6120N15H	Vdet-IC	1.5V±2%, N-ch, +Reset ODO	USP-3	17vdy	VD6	9a	Tor
0F6	XC6120N16H	Vdet-IC	1.6V±2%, N-ch, +Reset ODO	USP-3	17vdy	VD6	9a	Tor
0F7	XC6120N17H	Vdet-IC	1.7V±2%, N-ch, +Reset ODO	USP-3	17vdy	VD6	9a	Tor
0F8	XC6120N18H	Vdet-IC	1.8V±2%, N-ch, +Reset ODO	USP-3	17vdy	VD6	9a	Tor
0F9	XC6120N19H	Vdet-IC	1.9V±2%, N-ch, +Reset ODO	USP-3	17vdy	VD6	9a	Tor
0G	R3131N20EA	Vdet-IC	2V, +Reset PPO, 240ms	SOT-23	16vdc	VD7	3b	Ric
0H	R3131N30EA	Vdet-IC	3V, +Reset PPO, 240ms	SOT-23	16vdc	VD7	3b	Ric



SMD code	Type	Function	Short description	Case	Pinout	Sch.	St.	Mnf.
0H0	XC6120N20H	Vdet-IC	2V±2%, N-ch, +Reset ODO	USP-3	17vdy	VD6	9a	Tor
0H1	XC6120N21H	Vdet-IC	2.1V±2%, N-ch, +Reset ODO	USP-3	17vdy	VD6	9a	Tor
0H2	XC6120N22H	Vdet-IC	2.2V±2%, N-ch, +Reset ODO	USP-3	17vdy	VD6	9a	Tor
0H3	XC6120N23H	Vdet-IC	2.3V±2%, N-ch, +Reset ODO	USP-3	17vdy	VD6	9a	Tor
0H4	XC6120N24H	Vdet-IC	2.4V±2%, N-ch, +Reset ODO	USP-3	17vdy	VD6	9a	Tor
0H5	TC5906202ECB	LVR-IC	LDO, -0.6V±2%, 200mA	SOT-23	16cjd	VR2	3d	Mcc
0H5	XC6120N25H	Vdet-IC	2.5V±2%, N-ch, +Reset ODO	USP-3	17vdy	VD6	9a	Tor
0H6	XC6120N26H	Vdet-IC	2.6V±2%, N-ch, +Reset ODO	USP-3	17vdy	VD6	9a	Tor
0H7	XC6120N27H	Vdet-IC	2.7V±2%, N-ch, +Reset ODO	USP-3	17vdy	VD6	9a	Tor
0H8	XC6120N28H	Vdet-IC	2.8V±2%, N-ch, +Reset ODO	USP-3	17vdy	VD6	9a	Tor
0H9	XC6120N29H	Vdet-IC	2.9V±2%, N-ch, +Reset ODO	USP-3	17vdy	VD6	9a	Tor
0J	R3131N40EA	Vdet-IC	4V, +Reset PPO, 240ms	SOT-23	16vdc	VD7	3b	Ric
0K	R3131N26EA3	Vdet-IC	2.6V, +Reset PPO, 240ms	SOT-23	16vdc	VD7	3b	Ric
0K0	XC6120N30H	Vdet-IC	3V±2%, N-ch, +Reset ODO	USP-3	17vdy	VD6	9a	Tor
0K1	XC6120N31H	Vdet-IC	3.1V±2%, N-ch, +Reset ODO	USP-3	17vdy	VD6	9a	Tor
0K2	XC6120N32H	Vdet-IC	3.2V±2%, N-ch, +Reset ODO	USP-3	17vdy	VD6	9a	Tor
0K3	XC6120N33H	Vdet-IC	3.3V±2%, N-ch, +Reset ODO	USP-3	17vdy	VD6	9a	Tor
0K4	XC6120N34H	Vdet-IC	3.4V±2%, N-ch, +Reset ODO	USP-3	17vdy	VD6	9a	Tor
0K5	TC590702ECB	LVR-IC	LDO, -0.7V±2%, 200mA	SOT-23	16cjd	VR2	3d	Mcc
0K5	XC6120N35H	Vdet-IC	3.5V±2%, N-ch, +Reset ODO	USP-3	17vdy	VD6	9a	Tor
0K6	XC6120N36H	Vdet-IC	3.6V±2%, N-ch, +Reset ODO	USP-3	17vdy	VD6	9a	Tor
0K7	XC6120N37H	Vdet-IC	3.7V±2%, N-ch, +Reset ODO	USP-3	17vdy	VD6	9a	Tor
0K8	XC6120N38H	Vdet-IC	3.8V±2%, N-ch, +Reset ODO	USP-3	17vdy	VD6	9a	Tor
0K9	XC6120N39H	Vdet-IC	3.9V±2%, N-ch, +Reset ODO	USP-3	17vdy	VD6	9a	Tor
0L	R3131N40AC	Vdet-IC	4V, +Reset ODO, 50ms	SOT-23	16vdc	VD6	3b	Ric
0L0	XC6120N40H	Vdet-IC	4V±2%, N-ch, +Reset ODO	USP-3	17vdy	VD6	9a	Tor
0L1	XC6120N41H	Vdet-IC	4.1V±2%, N-ch, +Reset ODO	USP-3	17vdy	VD6	9a	Tor
0L2	XC6120N42H	Vdet-IC	4.2V±2%, N-ch, +Reset ODO	USP-3	17vdy	VD6	9a	Tor
0L3	XC6120N43H	Vdet-IC	4.3V±2%, N-ch, +Reset ODO	USP-3	17vdy	VD6	9a	Tor
0L4	XC6120N44H	Vdet-IC	4.4V±2%, N-ch, +Reset ODO	USP-3	17vdy	VD6	9a	Tor
0L5	TC590802ECB	LVR-IC	LDO, -0.8V±2%, 200mA	SOT-23	16cjd	VR2	3d	Mcc
0L5	XC6120N45H	Vdet-IC	4.5V±2%, N-ch, +Reset ODO	USP-3	17vdy	VD6	9a	Tor
0L6	XC6120N46H	Vdet-IC	4.6V±2%, N-ch, +Reset ODO	USP-3	17vdy	VD6	9a	Tor
0L7	XC6120N47H	Vdet-IC	4.7V±2%, N-ch, +Reset ODO	USP-3	17vdy	VD6	9a	Tor
0L8	XC6120N48H	Vdet-IC	4.8V±2%, N-ch, +Reset ODO	USP-3	17vdy	VD6	9a	Tor
0L9	XC6120N49H	Vdet-IC	4.9V±2%, N-ch, +Reset ODO	USP-3	17vdy	VD6	9a	Tor
0LN	ELM7552CEB	Vdet-IC	5.2V±2%, +Reset PPO	SC-70	16vdb	VD7	3d	Elm
0LN	ELM7552NEB	Vdet-IC	5.2V±2%, +Reset ODO	SC-70	16vdb	VD6	3d	Elm
0M	R3131N40BC	Vdet-IC	4V, +Reset ODO, 100ms	SOT-23	16vdc	VD6	3b	Ric
0M0	XC6120N50H	Vdet-IC	5V±2%, N-ch, +Reset ODO	USP-3	17vdy	VD6	9a	Tor
0M5	TC590902ECB	LVR-IC	LDO, -0.9V±2%, 200mA	SOT-23	16cjd	VR2	3d	Mcc
0N	R3131N40DC	Vdet-IC	4V, +Reset ODO, 200ms	SOT-23	16vdc	VD6	3b	Ric
0P	R3131N40HC	Vdet-IC	4V, +Reset ODO, 400ms	SOT-23	16vdc	VD6	3b	Ric
0Q	R3131N40AA	Vdet-IC	4V, +Reset PPO, 50ms	SOT-23	16vdc	VD7	3b	Ric
0R	R3131N40BA	Vdet-IC	4V, +Reset PPO, 100ms	SOT-23	16vdc	VD7	3b	Ric
0S	R3131N40DA	Vdet-IC	4V, +Reset PPO, 200ms	SOT-23	16vdc	VD7	3b	Ric
0T	R3131N40HA	Vdet-IC	4V, +Reset PPO, 400ms	SOT-23	16vdc	VD7	3b	Ric
1	AX6904FA	Vdet-IC	2.63V±1.5%, +Reset PPO	SC-70	16vda	VD7	3b	Axl
10	1PS59SB10	Si-diode	Schottky, Sw, Fast, 30V, 200mA, Vf<0.8V(100mA), <5ns	SC-59	16dc	-	3a	Phi
10	MAZW100H	SA-Z-diode	Dual, 10V, 5mA, 150mW	SSSMini3	18df	-	3a	Pan
10	MRF9411	Si-npn	VHF/UHF, 20V, 50mA, 250mW, B=50..200, 8GHz	SOT-323	16ta	-	3a	Mot
10	TZT10W	Z-diode	9.40..10.60V, Izt=5mA, Zzt=15Ω, 200mW	SOT-323	16dc	-	3a	Ttr
10	Z02W10V	Z-diode	9.40..10.60V, Izt=5mA, Zzt=15Ω, 200mW	SOT-23	16dc	-	3f	Kec
100	HZM10NB	Z-diode	9.45..10.55V, 200mW	SC-59A	16dc	-	3a	Ren
101	HZM10NB1	Z-diode	9.45..9.87V, 200mW	SC-59A	16dc	-	3a	Ren
101	PZM10NB1	Z-diode	10V±2.5%, 300mW	SOT-346	16dc	-	3a	Phi
102	HZM10NB2	Z-diode	9.77..10.21V, 200mW	SC-59A	16dc	-	3a	Ren
102	PZM10NB2	Z-diode	10V±2.5%, 300mW	SOT-346	16dc	-	3a	Phi
103	HZM10NB3	Z-diode	10.11..10.55V, 200mW	SC-59A	16dc	-	3a	Ren
103	PZM10NB3	Z-diode	10V±2.5%, 300mW	SOT-346	16dc	-	3a	Phi
10A	MA3100WA	Z-diode	Dual, 9.4..10.6V, If=100mA, Zzt=20Ω, 100mW	SC-59	16df	-	3a	Pan
10A	MAZ3100WA	Z-diode	Dual, 9.4..10.6V, If=100mA, Zzt=20Ω, 200mW	SC-59	16df	-	3a	Pan
10A	MMBZ10VA	TVS	Dual, Vbrwm=6.5V, Vbr=9.50..10.5V, 1.7A, 24W(1ms)	SOT-23	16gd	-	3a	Wtr
10A	PZM10NB2A	Z-diode	Dual, 10V±2.5%, 300mW	SOT-346	16df	-	3a	Phi
10A	ZXRE1004FF	Vref-IC	1.22V, 0.08..20mA, <0.6Ω, 3%	SOT-23	16dk	-	3a	Zx
10B	ZXRE1004EF	Vref-IC	1.22V, 0.08..20mA, <0.6Ω, 2%	SOT-23	16dk	-	3a	Zx
10C	ZXRE1004DF	Vref-IC	1.22V, 0.08..20mA, <0.6Ω, 1%	SOT-23	16dk	-	3a	Zx
10D	ZXRE1004CF	Vref-IC	1.22V, 0.08..20mA, <0.6Ω, 0.5%	SOT-23	16dk	-	3a	Zx
10F	CH490DPT	Si-diode	SBD, 40V, 1A, Vf<0.53V(1A)	SOT-23	16dc	-	3a	Chm
10F	ZXRE4041FF	Vref-IC	1.225V, 0.03..12mA, <0.6Ω, 3%	SOT-23	16dk	-	3a	Zx



Note: ELM75xxCBB series LN- lot number L=0...9 N=A to Z(I, O, X excepted); ELM75xxNBB series LN- lot number L=A to Z(I, O, X excepted) N=0...9

SMD code	Type	Function	Short description	Case	Pinout	Sch.	St.	Mnf.
10G	ZXRE4041EF	Vref-IC	1.225V, 0.03..12mA, <0.6Ω, 2%	SOT-23	16dk	-	3a	Zx
10H	BZX84-C10-V	Z-diode	9.73..10.26V, Izt=5mA, Zzt=15Ω, 300mW	SOT-23	16dc	-	3f	Kec
10H	MAZ3100-H	Z-diode	9.4..10.6V, If=100mA, Zzt=20Ω, 200mW	SC-59	16dc	-	3a	Pan
10H	ZXRE4041DF	Vref-IC	1.225V, 0.03..12mA, <0.6Ω, 1%	SOT-23	16dk	-	3a	Zx
10H10	SS10PH10	Si-diode	SBR, 100V, 10A, Vf<0.88V(10A)	TO-277A	76dh	-	3o	Vs
10H45	SS10PH45	Si-diode	SBR, 45V, 10A, Vf<0.72V(10A)	TO-277A	76dh	-	3o	Vs
10H9	SS10PH9	Si-diode	SBR, 90V, 10A, Vf<0.88V(10A)	TO-277A	76dh	-	3o	Vs
10J	FM810JS3X	Vdet-IC	4.0V±1.5%, +Reset PPO	SOT-23	16vdc	VD7	3a	F
10J	ZXRE4041CF	Vref-IC	1.225V, 0.03..12mA, <0.6Ω, 0.5%	SOT-23	16dk	-	3a	Zx
10K	MA3100WK	Z-diode	Dual, 9.4..10.6V, If=100mA, Zzt=20Ω, 100mW	SC-59	16dg	-	3a	Pan
10K	MAZ3100WK	Z-diode	Dual, 9.4..10.6V, If=100mA, Zzt=20Ω, 200mW	SC-59	16dg	-	3a	Pan
10L	FM810LS3X	Vdet-IC	4.63V±1.5%, +Reset PPO	SOT-23	16vdc	VD7	3a	F
10L	MAZ3100-L	Z-diode	9.4..10.6V, If=100mA, Zzt=20Ω, 200mW	SC-59	16dc	-	3a	Pan
10M	FM810MS3X	Vdet-IC	4.38V±1.5%, +Reset PPO	SOT-23	16vdc	VD7	3a	F
10M	MAZ3100-M	Z-diode	9.4..10.6V, If=100mA, Zzt=20Ω, 200mW	SC-59	16dc	-	3a	Pan
10R	FM810RS3X	Vdet-IC	2.63V±1.5%, +Reset PPO	SOT-23	16vdc	VD7	3a	F
10S	FM810SS3X	Vdet-IC	2.93V±1.5%, +Reset PPO	SOT-23	16vdc	VD7	3a	F
10T	CH491DPT	Si-diode	SBD, 25V, 1A, Vf<0.45V(1A)	SOT-23	16dc	-	3a	Chm
10T	FM810TS3X	Vdet-IC	3.08V±1.5%, +Reset PPO	SOT-23	16vdc	VD7	3a	F
10V	CHPZ10VPT	Z-diode	Dual, 9.4..10.6V, Izt=5mA, Zzt=20Ω, 350mW	SOT-23	16df	-	3a	Chm
10V	PZM10NB	Z-diode	10V±2.5%, 300mW	SOT-346	16dc	-	3a	Phi
10W	CMSZDA27V	Z-diode	Dual, 25.1..28.9V, Zzt=80Ω, 6.2mA, 275mW	SOT-323	16df	-	3a	Cen
10X	O2CZ10-X	Z-diode	9.40..9.93V, 200mW	SC-59	16dc	-	3a	Tos
10X	TZT10XW	Z-diode	9.40..9.93V, Izt=5mA, Zzt=15Ω, 200mW	SOT-323	16dc	-	3a	Ttr
10X	Z02W10VX	Z-diode	9.40..9.93V, Izt=5mA, Zzt=15Ω, 200mW	SOT-23	16dc	-	3f	Kec
10Y	O2CZ10-Y	Z-diode	9.73..10.26V, 200mW	SC-59	16dc	-	3a	Tos
10Y	TZT10YW	Z-diode	9.73..10.26V, Izt=5mA, Zzt=15Ω, 200mW	SOT-323	16dc	-	3a	Ttr
10Y	Z02W10VY	Z-diode	9.73..10.26V, Izt=5mA, Zzt=15Ω, 200mW	SOT-23	16dc	-	3f	Kec
10Z	O2CZ10-Z	Z-diode	10.06..10.6V, 200mW	SC-59	16dc	-	3a	Tos
10Z	CZ1W10	Z-diode	10V±5%, 600mW	SOT-23	16dc	-	3a	Cdi
10Z	MAZ9100H	SA-Z-diode	Dual, 10V, Zzt=30Ω(5mA), 200mW	SC-59	16df	-	3a	Pan
10Z	MAZT100H	SA-Z-diode	Dual, 10V, 5mA, 150mW	SC-81	18df	-	3a	Pan
10Z	TZT10ZV	Z-diode	10.06..10.60V, Izt=5mA, Zzt=15Ω, 200mW	SOT-323	16dc	-	3a	Ttr
10Z	Z02W10VZ	Z-diode	10.06..10.60V, Izt=5mA, Zzt=15Ω, 200mW	SOT-23	16dc	-	3f	Kec
11	CH715MCPT	Si-diode	Dual, SBD, 40V, 30mA, Vf<0.37V(1mA)	SOT-723	18df	-	3a	Chm
11	MMD1501	Si-diode	Sw 180V, 200mA, Vf<1.5V(300mA), <4pF	SOT-23	16dc	-	3a	Nsc
11	MMD1701	Si-diode	Fast, 30V, 150mA, 350mW, Vf<1.1V(50mA), 0.7ns	SOT-23	16dc	-	3a	Nsc
11	MMD4148	Si-diode	Sw, Fast, 75V, 200mA, 350mW, <4ns, 4pF	SOT-23	16dc	-	3a	Nsc
11	MRF9511	Si-npn	VHF/UHF, 20V, 100mA, 322mW, B=50..200, 8GHz	SOT-323	16ta	-	3a	Mot
11	PDTA114TE	Si-pnp-Digi	Sw, 50V, 100mA, 150mW, R1=10k	SOT-416	16ta	-	3a	Phi
11	TZT11W	Z-diode	10.40..11.60V, Izt=5mA, Zzt=15Ω, 200mW	SOT-323	16dc	-	3a	Ttr
11	Z02W11V	Z-diode	10.40..11.60V, Izt=5mA, Zzt=15Ω, 200mW	SOT-23	16dc	-	3f	Kec
110	HZM11NB	Z-diode	10.44..11.56V, 200mW	SC-59A	16dc	-	3a	Ren
110	KTY82/110	Tdet-IC	Sensor, Rs=990..1010Ω(25°C, 1mA)	SOT-23	16ag	-	3a	Nxp
111	DTA113ZUA	Si-pnp-Digi	Sw, 50V, 100mA, 200mW, 200MHz, R1/R2=1k/10k	UMT3	16ta	-	3a	Rhm
111	HZM11NB1	Z-diode	10.44..10.88V, 200mW	SC-59A	16dc	-	3a	Ren
111	PZM11NB1	Z-diode	11V±2.5%, 300mW	SOT-346	16dc	-	3a	Phi
111	SST111	n-FET	Sw, 35V, 350mW, Idss=20mA, Rds(on)=30Ω, 2/6ns	SOT-23	16fj	-	3a	Cal
112	HZM11NB2	Z-diode	10.76..11.22V, 200mW	SC-59A	16dc	-	3a	Ren
112	PZM11NB2	Z-diode	11V±2.5%, 300mW	SOT-346	16dc	-	3a	Phi
112	SST112	n-FET	Sw, 35V, 350mW, Idss=5mA, Rds(on)=50Ω, 2/6ns	SOT-23	16fj	-	3a	Cal
113	DTA143ZUA	Si-pnp-Digi	Sw, 50V, 100mA, 200mW, 250MHz, R1/R2=4k7/47k	UMT3	16ta	-	3a	Rhm
113	HZM11NB3	Z-diode	11.1..11.56V, 200mW	SC-59A	16dc	-	3a	Ren
113	PZM11NB3	Z-diode	11V±2.5%, 300mW	SOT-346	16dc	-	3a	Phi
113	SST113	n-FET	Sw, 35V, 350mW, Idss=2mA, Rds(on)=100Ω, 2/6ns	SOT-23	16fj	-	3a	Cal
115	2STR1215	Si-npn	Sw, 15V, 1.5A, 500mW, B=200..560, 60/310ns	SOT-23	16ta	-	3a	Ste
118A	AAT60118A-S14	Vdet-IC	1.8V±2%, +Reset ODO	TSOT-23	16vdc	VD7	3d	Aat
118A	AAT60118A-S2	Vdet-IC	1.8V±2%, +Reset ODO	SOT-23	16vdc	VD7	3d	Aat
118B	AAT60118B-S14	Vdet-IC	1.8V±2%, +Reset PPO	TSOT-23	16vdc	VD7	3d	Aat
118B	AAT60118B-S2	Vdet-IC	1.8V±2%, +Reset PPO	SOT-23	16vdc	VD7	3d	Aat
118C	AAT60118C-S14	Vdet-IC	1.8V±2%, -Reset ODO	TSOT-23	16vdc	VD7	3d	Aat
118C	AAT60118C-S2	Vdet-IC	1.8V±2%, -Reset ODO	SOT-23	16vdc	VD7	3d	Aat
118D	AAT60118D-S14	Vdet-IC	1.8V±2%, -Reset PPO	TSOT-23	16vdc	VD7	3d	Aat
118D	AAT60118D-S2	Vdet-IC	1.8V±2%, -Reset PPO	SOT-23	16vdc	VD7	3d	Aat
119A	AAT60119A-S14	Vdet-IC	1.9V±2%, +Reset ODO	TSOT-23	16vdc	VD7	3d	Aat
119A	AAT60119A-S2	Vdet-IC	1.9V±2%, +Reset ODO	SOT-23	16vdc	VD7	3d	Aat
119B	AAT60119B-S14	Vdet-IC	1.9V±2%, +Reset PPO	TSOT-23	16vdc	VD7	3d	Aat
119B	AAT60119B-S2	Vdet-IC	1.9V±2%, +Reset PPO	SOT-23	16vdc	VD7	3d	Aat
119C	AAT60119C-S14	Vdet-IC	1.9V±2%, -Reset ODO	TSOT-23	16vdc	VD7	3d	Aat
119C	AAT60119C-S2	Vdet-IC	1.9V±2%, -Reset ODO	SOT-23	16vdc	VD7	3d	Aat



SMD code	Type	Function	Short description	Case	Pinout	Sch.	St.	Mnf.
119D	AAT60119D-S14	Vdet-IC	1.9V±2%, -Reset PPO	TSOT-23	16vdc	VD7	3d	Aat
119D	AAT60119D-S2	Vdet-IC	1.9V±2%, -Reset PPO	SOT-23	16vdc	VD7	3d	Aat
11A	APR3011-15A	Vdet-IC	1.5V, -Reset PPO	SOT-23	16vdc	VD7	3b	Anp
11A	PZM11NB2A	Z-diode	Dual, 11V±2.5%, 300mW	SOT-346	16df	-	3a	Phi
11B	APR3011-17A	Vdet-IC	1.75V, -Reset PPO	SOT-23	16vdc	VD7	3b	Anp
11C	APR3011-23A	Vdet-IC	2.32V, -Reset PPO	SOT-23	16vdc	VD7	3b	Anp
11D	APR3011-26A	Vdet-IC	2.63V, -Reset PPO	SOT-23	16vdc	VD7	3b	Anp
11E	APR3011-29A	Vdet-IC	2.93V, -Reset PPO	SOT-23	16vdc	VD7	3b	Anp
11F	APR3011-30A	Vdet-IC	3.08V, -Reset PPO	SOT-23	16vdc	VD7	3b	Anp
11G	APR3011-39A	Vdet-IC	3.9V, -Reset PPO	SOT-23	16vdc	VD7	3b	Anp
11H	APR3011-43A	Vdet-IC	4.38V, -Reset PPO	SOT-23	16vdc	VD7	3b	Anp
11H	BZX84-C11-V	Z-diode	10.73..11.26V, Izt=5mA, Zzt=15Ω, 300mW	SOT-23	16dc	-	3f	Kec
11H	MAZ3110-H	Z-diode	10.4..11.6V, If=100mA, Zzt=20Ω, 200mW	SC-59	16dc	-	3a	Pan
11J	APR3011-46A	Vdet-IC	4.63V, -Reset PPO	SOT-23	16vdc	VD7	3b	Anp
11L	MAZ3110-L	Z-diode	10.4..11.6V, If=100mA, Zzt=20Ω, 200mW	SC-59	16dc	-	3a	Pan
11M	MAZ3110-M	Z-diode	10.4..11.6V, If=100mA, Zzt=20Ω, 200mW	SC-59	16dc	-	3a	Pan
11V	CHPZ11VPT	Z-diode	Dual, 10.4..11.6V, Izt=5mA, Zzt=20Ω, 350mW	SOT-23	16df	-	3a	Chm
11V	PZM11NB	Z-diode	11V±2.5%, 300mW	SOT-346	16dc	-	3a	Phi
11W	CMSZDA30V	Z-diode	Dual, 28.0..32.0V, Izt=80Q, 5.6mA, 275mW	SOT-323	16df	-	3a	Cen
11X	02CZ11-X	Z-diode	10.4..10.98V, 200mW	SC-59	16dc	-	3a	Tos
11X	TZT11XW	Z-diode	10.40..10.98V, Izt=5mA, Zzt=15Ω, 200mW	SOT-323	16dc	-	3a	Ttr
11X	Z02W11VX	Z-diode	10.40..0.98V, Izt=5mA, Zzt=15Ω, 200mW	SOT-23	16dc	-	3f	Kec
11Y	02CZ11-Y	Z-diode	10.73..11.26V, 200mW	SC-59	16dc	-	3a	Tos
11Y	TZT11YW	Z-diode	10.73..11.26V, Izt=5mA, Zzt=15Ω, 200mW	SOT-323	16dc	-	3a	Ttr
11Y	Z02W11VY	Z-diode	10.73..11.26V, Izt=5mA, Zzt=15Ω, 200mW	SOT-23	16dc	-	3f	Kec
11Z	02CZ11-Z	Z-diode	11.06..11.6V, 200mW	SC-59	16dc	-	3a	Tos
11Z	CZ1W11	Z-diode	11V±5%, 600mW	SOT-23	16dc	-	3a	Cdi
11Z	TZT11ZW	Z-diode	11.06..11.60V, Izt=5mA, Zzt=15Ω, 200mW	SOT-323	16dc	-	3a	Ttr
11Z	Z02W11VZ	Z-diode	11.06..11.60V, Izt=5mA, Zzt=15Ω, 200mW	SOT-23	16dc	-	3f	Kec
12	DTA123EE	Si-pnp-Digi	Sw, 50V, 100mA, 150mW, 250MHz, R1/R2=2k2/2k2	SOT-416	16ta	-	3a	Rhm
12	DTA123EKA	Si-pnp-Digi	Sw, 50V, 100mA, 200mW, 250MHz, R1/R2=2k2/2k2	SOT-346	16ta	-	3a	Rhm
12	DTA123EM	Si-pnp-Digi	Sw, 50V, 100mA, 150mW, 250MHz, R1/R2=2k2/2k2	VMT3	18ta	-	3a	Rhm
12	DTA123EUA	Si-pnp-Digi	Sw, 50V, 100mA, 200mW, 250MHz, R1/R2=2k2/2k2	UMT3	16ta	-	3a	Rhm
12	MAZW120H	SA-Z-diode	Dual, 12V, 5mA, 150mW	SSSMini3	18df	-	3a	Pan
12	MSCT12	TVS	Vrwm=12V, 300W (8/20μs)	SOT-23	16dh	-	3a	Msp
12	TZT12W	Z-diode	11.40..12.60V, Izt=5mA, Zzt=15Ω, 200mW	SOT-323	16dc	-	3a	Ttr
12	Z02W12V	Z-diode	11.40..12.60V, Izt=5mA, Zzt=15Ω, 200mW	SOT-23	16dc	-	3f	Kec
120	HZM12NB	Z-diode	11.42..12.6V, 200mW	SC-59A	16dc	-	3a	Ren
120	KTY82/120	Tdet-IC	Sensor, Rs=980..1020Ω(25°C, 1mA)	SOT-23	16ag	-	3a	Nxp
120A	AAT60120A-S14	Vdet-IC	2.0V±2%, +Reset ODO	TSOT-23	16vdc	VD7	3d	Aat
120A	AAT60120A-S2	Vdet-IC	2.0V±2%, +Reset ODO	SOT-23	16vdc	VD7	3d	Aat
120B	AAT60120B-S14	Vdet-IC	2.0V±2%, +Reset PPO	TSOT-23	16vdc	VD7	3d	Aat
120B	AAT60120B-S2	Vdet-IC	2.0V±2%, +Reset PPO	SOT-23	16vdc	VD7	3d	Aat
120C	AAT60120C-S14	Vdet-IC	2.0V±2%, -Reset S14	TSOT-23	16vdc	VD7	3d	Aat
120C	AAT60120C-S2	Vdet-IC	2.0V±2%, -Reset ODO	SOT-23	16vdc	VD7	3d	Aat
120D	AAT60120D-S14	Vdet-IC	2.0V±2%, -Reset PPO	TSOT-23	16vdc	VD7	3d	Aat
120D	AAT60120D-S2	Vdet-IC	2.0V±2%, -Reset PPO	SOT-23	16vdc	VD7	3d	Aat
121	DTC113ZUA	Si-npn-Digi	Sw, 50V, 100mA, 200mW, 250MHz, R1/R2=1k/10k	UMT3	16ta	-	3a	Rhm
121	HZM12NB1	Z-diode	11.42..11.9V, 200mW	SC-59A	16dc	-	3a	Ren
121	KTY82/121	Tdet-IC	Sensor, Rs=980..1000Ω(25°C, 1mA)	SOT-23	16ag	-	3a	Nxp
121	PZM12NB1	Z-diode	12V±2.5%, 300mW	SOT-346	16dc	-	3a	Phi
121A	AAT60121A-S14	Vdet-IC	2.1V±2%, +Reset ODO	TSOT-23	16vdc	VD7	3d	Aat
121A	AAT60121A-S2	Vdet-IC	2.1V±2%, +Reset ODO	SOT-23	16vdc	VD7	3d	Aat
121B	AAT60121B-S14	Vdet-IC	2.1V±2%, +Reset PPO	TSOT-23	16vdc	VD7	3d	Aat
121B	AAT60121B-S2	Vdet-IC	2.1V±2%, +Reset PPO	SOT-23	16vdc	VD7	3d	Aat
121C	AAT60121C-S14	Vdet-IC	2.1V±2%, -Reset ODO	TSOT-23	16vdc	VD7	3d	Aat
121C	AAT60121C-S2	Vdet-IC	2.1V±2%, -Reset ODO	SOT-23	16vdc	VD7	3d	Aat
121D	AAT60121D-S14	Vdet-IC	2.1V±2%, -Reset PPO	TSOT-23	16vdc	VD7	3d	Aat
121D	AAT60121D-S2	Vdet-IC	2.1V±2%, -Reset PPO	SOT-23	16vdc	VD7	3d	Aat
122	HZM12NB2	Z-diode	11.74..12.24V, 200mW	SC-59A	16dc	-	3a	Ren
122	KTY82/122	Tdet-IC	Sensor, Rs=1000..1020Ω(25°C, 1mA)	SOT-23	16ag	-	3a	Nxp
122	PZM12NB2	Z-diode	12V±2.5%, 300mW	SOT-346	16dc	-	3a	Phi
122A	AAT60122A-S14	Vdet-IC	2.2V±2%, +Reset ODO	TSOT-23	16vdc	VD7	3d	Aat
122A	AAT60122A-S2	Vdet-IC	2.2V±2%, +Reset ODO	SOT-23	16vdc	VD7	3d	Aat
122B	AAT60122B-S14	Vdet-IC	2.2V±2%, +Reset PPO	TSOT-23	16vdc	VD7	3d	Aat
122B	AAT60122B-S2	Vdet-IC	2.2V±2%, +Reset PPO	SOT-23	16vdc	VD7	3d	Aat
122C	AAT60122C-S14	Vdet-IC	2.2V±2%, -Reset ODO	TSOT-23	16vdc	VD7	3d	Aat
122C	AAT60122C-S2	Vdet-IC	2.2V±2%, -Reset ODO	SOT-23	16vdc	VD7	3d	Aat
122D	AAT60122D-S14	Vdet-IC	2.2V±2%, -Reset PPO	TSOT-23	16vdc	VD7	3d	Aat
122D	AAT60122D-S2	Vdet-IC	2.2V±2%, -Reset PPO	SOT-23	16vdc	VD7	3d	Aat



SMD code	Type	Function	Short description	Case	Pinout	Sch. St.	Mnf.
123	HZM12NB3	Z-diode	12.08..12.6V, 200mW	SC-59A	16dc	-	3a Ren
123	PZM12NB3	Z-diode	12V±2.5%, 300mW	SOT-346	16dc	-	3a Phi
123	STD123UF	Si-npn	Hi-beta, Lo-sat, 20V, 1A, 200mW, B>150, 260MHz	SOT-23F	18ta	-	3a Auk
123A	AAT60123A-S14	Vdet-IC	2.3V±2%, +Reset ODO	TSOT-23	16vdc	VD7	3d Aat
123A	AAT60123A-S2	Vdet-IC	2.3V±2%, +Reset ODO	SOT-23	16vdc	VD7	3d Aat
123B	AAT60123B-S14	Vdet-IC	2.3V±2%, +Reset PPO	TSOT-23	16vdc	VD7	3d Aat
123B	AAT60123B-S2	Vdet-IC	2.3V±2%, +Reset PPO	SOT-23	16vdc	VD7	3d Aat
123C	AAT60123C-S14	Vdet-IC	2.3V±2%, -Reset ODO	TSOT-23	16vdc	VD7	3d Aat
123C	AAT60123C-S2	Vdet-IC	2.3V±2%, -Reset ODO	SOT-23	16vdc	VD7	3d Aat
123D	AAT60123D-S14	Vdet-IC	2.3V±2%, -Reset PPO	TSOT-23	16vdc	VD7	3d Aat
123D	AAT60123D-S2	Vdet-IC	2.3V±2%, -Reset PPO	SOT-23	16vdc	VD7	3d Aat
124	STA124SF	Si-npn	Hi-beta, 15V, 1A, 350mW, B=200..450, 260MHz	SOT-23F	18ta	-	3a Auk
124A	AAT60124A-S14	Vdet-IC	2.4V±2%, +Reset ODO	TSOT-23	16vdc	VD7	3d Aat
124A	AAT60124A-S2	Vdet-IC	2.4V±2%, +Reset ODO	SOT-23	16vdc	VD7	3d Aat
124B	AAT60124B-S14	Vdet-IC	2.4V±2%, +Reset PPO	TSOT-23	16vdc	VD7	3d Aat
124B	AAT60124B-S2	Vdet-IC	2.4V±2%, +Reset PPO	SOT-23	16vdc	VD7	3d Aat
124C	AAT60124C-S14	Vdet-IC	2.4V±2%, -Reset ODO	TSOT-23	16vdc	VD7	3d Aat
124C	AAT60124C-S2	Vdet-IC	2.4V±2%, -Reset ODO	SOT-23	16vdc	VD7	3d Aat
124D	AAT60124D-S14	Vdet-IC	2.4V±2%, -Reset PPO	TSOT-23	16vdc	VD7	3d Aat
124D	AAT60124D-S2	Vdet-IC	2.4V±2%, -Reset PPO	SOT-23	16vdc	VD7	3d Aat
124S	SS12P4S	Si-diode	SBR, 40V, 12A, Vf<0.60V(10A)	TO-277A	76dg	-	3o Vs
125A	AAT60125A-S14	Vdet-IC	2.5V±2%, +Reset ODO	TSOT-23	16vdc	VD7	3d Aat
125A	AAT60125A-S2	Vdet-IC	2.5V±2%, +Reset ODO	SOT-23	16vdc	VD7	3d Aat
125B	AAT60125B-S14	Vdet-IC	2.5V±2%, +Reset PPO	TSOT-23	16vdc	VD7	3d Aat
125B	AAT60125B-S2	Vdet-IC	2.5V±2%, +Reset PPO	SOT-23	16vdc	VD7	3d Aat
125C	AAT60125C-S14	Vdet-IC	2.5V±2%, -Reset ODO	TSOT-23	16vdc	VD7	3d Aat
125C	AAT60125C-S2	Vdet-IC	2.5V±2%, -Reset ODO	SOT-23	16vdc	VD7	3d Aat
125D	AAT60125D-S14	Vdet-IC	2.5V±2%, -Reset PPO	TSOT-23	16vdc	VD7	3d Aat
125D	AAT60125D-S2	Vdet-IC	2.5V±2%, -Reset PPO	SOT-23	16vdc	VD7	3d Aat
126A	AAT60126A-S14	Vdet-IC	2.6V±2%, +Reset ODO	TSOT-23	16vdc	VD7	3d Aat
126A	AAT60126A-S2	Vdet-IC	2.6V±2%, +Reset ODO	SOT-23	16vdc	VD7	3d Aat
126B	AAT60126B-S14	Vdet-IC	2.6V±2%, +Reset PPO	TSOT-23	16vdc	VD7	3d Aat
126B	AAT60126B-S2	Vdet-IC	2.6V±2%, +Reset PPO	SOT-23	16vdc	VD7	3d Aat
126C	AAT60126C-S14	Vdet-IC	2.6V±2%, -Reset ODO	TSOT-23	16vdc	VD7	3d Aat
126C	AAT60126C-S2	Vdet-IC	2.6V±2%, -Reset ODO	SOT-23	16vdc	VD7	3d Aat
126D	AAT60126D-S14	Vdet-IC	2.6V±2%, -Reset PPO	TSOT-23	16vdc	VD7	3d Aat
126D	AAT60126D-S2	Vdet-IC	2.6V±2%, -Reset PPO	SOT-23	16vdc	VD7	3d Aat
127A	AAT60127A-S14	Vdet-IC	2.7V±2%, +Reset ODO	TSOT-23	16vdc	VD7	3d Aat
127A	AAT60127A-S2	Vdet-IC	2.7V±2%, +Reset ODO	SOT-23	16vdc	VD7	3d Aat
127B	AAT60127B-S14	Vdet-IC	2.7V±2%, +Reset PPO	TSOT-23	16vdc	VD7	3d Aat
127B	AAT60127B-S2	Vdet-IC	2.7V±2%, +Reset PPO	SOT-23	16vdc	VD7	3d Aat
127C	AAT60127C-S14	Vdet-IC	2.7V±2%, -Reset ODO	TSOT-23	16vdc	VD7	3d Aat
127C	AAT60127C-S2	Vdet-IC	2.7V±2%, -Reset ODO	SOT-23	16vdc	VD7	3d Aat
127D	AAT60127D-S14	Vdet-IC	2.7V±2%, -Reset PPO	TSOT-23	16vdc	VD7	3d Aat
127D	AAT60127D-S2	Vdet-IC	2.7V±2%, -Reset PPO	SOT-23	16vdc	VD7	3d Aat
128A	AAT60128A-S14	Vdet-IC	2.8V±2%, +Reset ODO	TSOT-23	16vdc	VD7	3d Aat
128A	AAT60128A-S2	Vdet-IC	2.8V±2%, +Reset ODO	SOT-23	16vdc	VD7	3d Aat
128B	AAT60128B-S14	Vdet-IC	2.8V±2%, +Reset PPO	TSOT-23	16vdc	VD7	3d Aat
128B	AAT60128B-S2	Vdet-IC	2.8V±2%, +Reset PPO	SOT-23	16vdc	VD7	3d Aat
128C	AAT60128C-S14	Vdet-IC	2.8V±2%, -Reset ODO	TSOT-23	16vdc	VD7	3d Aat
128C	AAT60128C-S2	Vdet-IC	2.8V±2%, -Reset ODO	SOT-23	16vdc	VD7	3d Aat
128D	AAT60128D-S14	Vdet-IC	2.8V±2%, -Reset PPO	TSOT-23	16vdc	VD7	3d Aat
128D	AAT60128D-S2	Vdet-IC	2.8V±2%, -Reset PPO	SOT-23	16vdc	VD7	3d Aat
129A	AAT60129A-S14	Vdet-IC	2.9V±2%, +Reset ODO	TSOT-23	16vdc	VD7	3d Aat
129A	AAT60129A-S2	Vdet-IC	2.9V±2%, +Reset ODO	SOT-23	16vdc	VD7	3d Aat
129B	AAT60129B-S14	Vdet-IC	2.9V±2%, +Reset PPO	TSOT-23	16vdc	VD7	3d Aat
129B	AAT60129B-S2	Vdet-IC	2.9V±2%, +Reset PPO	SOT-23	16vdc	VD7	3d Aat
129C	AAT60129C-S14	Vdet-IC	2.9V±2%, -Reset ODO	TSOT-23	16vdc	VD7	3d Aat
129C	AAT60129C-S2	Vdet-IC	2.9V±2%, -Reset ODO	SOT-23	16vdc	VD7	3d Aat
129D	AAT60129D-S14	Vdet-IC	2.9V±2%, -Reset PPO	TSOT-23	16vdc	VD7	3d Aat
129D	AAT60129D-S2	Vdet-IC	2.9V±2%, -Reset PPO	SOT-23	16vdc	VD7	3d Aat
12A	APR3012-15A	Vdet-IC	1.5V, +Reset PPO	SOT-23	16vdc	VD7	3b Anp
12A	MAZ3120WA	Z-diode	Dual, 11.4..12.7V, If=100mA, Zzt=25Ω, 200mW	SC-59	16df	-	3a Pan
12A	MMBZ12VA	TVS	Dual, V _{rwm} =8.5V, V _{br} =11.40..12.60V, 2.35A, 40W(1ms)	SOT-23	16dg	-	3a Wtr
12A	PZM12NB2A	Z-diode	Dual, 12V±2.5%, 300mW	SOT-346	16df	-	3a Phi
12A	STD123ASF	Si-npn	Hi-beta, Lo-sat, 10V, 1A, 350mW, B>400, 260MHz	SOT-23F	18ta	-	3a Auk
12B	APR3002-17A	Vdet-IC	1.75V, +Reset PPO	SOT-23	16vdc	VD7	3b Anp
12B	APR3012-17A	Vdet-IC	1.75V, +Reset PPO	SOT-23	16vdc	VD7	3b Anp
12C	APR3012-23A	Vdet-IC	2.32V, +Reset PPO	SOT-23	16vdc	VD7	3b Anp
12C	MSC12C	TVS	Dual, V _{rwm} =12V, 300W (8/20μs), Bidirectional	SOT-23	16dp	-	3a Msp



SMD code	Type	Function	Short description	Case	Pinout	Sch.	St.	Mnf.
12C	TVS2312PT	TVS	Dual, Vbr=13.3V, Vrw=12V, 1A, 300W(1ms)	SOT-23	16df	-	3a	Chm
12D	APR3012-26A	Vdet-IC	2.63V, +Reset PPO	SOT-23	16vdc	VD7	3b	Anp
12E	APR3012-29A	Vdet-IC	2.93V, +Reset PPO	SOT-23	16vdc	VD7	3b	Anp
12E	ZC2812E	Si-diode	Dual, Schottky, 15V, Vf<0.41V, Cd<1.2pF	SOT-23	16dg	-	3a	Zx
12F	APR3012-30A	Vdet-IC	3.08V, +Reset PPO	SOT-23	16vdc	VD7	3b	Anp
12F	ZXRE125FF	Vref-IC	1.22V, 0.03..5mA, <0.6Q, 3%	SOT-23	16dk	-	3a	Zx
12G	APR3012-39A	Vdet-IC	3.9V, +Reset PPO	SOT-23	16vdc	VD7	3b	Anp
12G	ZXRE125EF	Vref-IC	1.22V, 0.03..5mA, <0.6Q, 2%	SOT-23	16dk	-	3a	Zx
12H	APR3012-43A	Vdet-IC	4.38V, +Reset PPO	SOT-23	16vdc	VD7	3b	Anp
12H	BZX84-C12-V	Z-diode	11.73..12.26V, Izt=5mA, Zzt=15Q, 300mW	SOT-23	16dc	-	3f	Kec
12H	MAZ3120-H	Z-diode	11.4..12.7V, If=100mA, Zzt=25Q, 200mW	SC-59	16dc	-	3a	Pan
12H	ZXRE125DF	Vref-IC	1.22V, 0.03..5mA, <0.6Q, 1%	SOT-23	16dk	-	3a	Zx
12J	APR3012-46A	Vdet-IC	4.63V, +Reset PPO	SOT-23	16vdc	VD7	3b	Anp
12J	ZXRE125CF	Vref-IC	1.22V, 0.03..5mA, <0.6Q, 0.5%	SOT-23	16dk	-	3a	Zx
12L	CESD12VCP	ESDP-diode	Dual, Vbr=13.3..15.75V, Vrw=12V, Ipp=11.2A, 300W(1ms)	SOT-23	16dg	-	3a	Joe
12L	MAZ3120-L	Z-diode	11.4..12.7V, If=100mA, Zzt=25Q, 200mW	SC-59	16dc	-	3a	Pan
12M	MAZ3120-M	Z-diode	11.4..12.7V, If=100mA, Zzt=25Q, 200mW	SC-59	16dc	-	3a	Pan
12V	CHPZ12VPT	Z-diode	Dual, 11.4..12.7V, Izt=5mA, Zzt=25Q, 350mW	SOT-23	16df	-	3a	Chm
12V	PZM12NB	Z-diode	12V±2.5%, 300mW	SOT-346	16dc	-	3a	Phi
12W	CMSZDA33V	Z-diode	Dual, 31.0..35.0V, Zzt=80Q, 5.0mA, 275mW	SOT-323	16df	-	3a	Cen
12X	O2CZ12-X	Z-diode	11.4..11.93V, 200mW	SC-59	16dc	-	3a	Tos
12X	TZT12XW	Z-diode	11.40..11.93V, Izt=5mA, Zzt=15Q, 200mW	SOT-323	16dc	-	3a	TTr
12X	Z02W12VX	Z-diode	11.40..11.93V, Izt=5mA, Zzt=15Q, 200mW	SOT-23	16dc	-	3f	Kec
12Y	O2CZ12-Y	Z-diode	11.73..12.26V, 200mW	SC-59	16dc	-	3a	Tos
12Y	TZT12YW	Z-diode	11.73..12.26V, Izt=5mA, Zzt=15Q, 200mW	SOT-323	16dc	-	3a	TTr
12Y	Z02W12VY	Z-diode	11.73..12.26V, Izt=5mA, Zzt=15Q, 200mW	SOT-23	16dc	-	3f	Kec
12Z	O2CZ12-Z	Z-diode	12.06..12.6V, 200mW	SC-59	16dc	-	3a	Tos
12Z	CZ1W12	Z-diode	12V±5%, 600mW	SOT-23	16dc	-	3a	Cdi
12Z	MAZ9120H	SA-Z-diode	Dual, 12V, Zzt=30Q(5mA), 200mW	SC-59	16df	-	3a	Pan
12Z	MAZT120H	SA-Z-diode	Dual, 12V, 5mA, 150mW	SC-81	18df	-	3a	Pan
12Z	TZT12ZW	Z-diode	12.06..12.60V, Izt=5mA, Zzt=15Q, 200mW	SOT-323	16dc	-	3a	TTr
12Z	Z02W12VZ	Z-diode	12.06..12.60V, Izt=5mA, Zzt=15Q, 200mW	SOT-23	16dc	-	3f	Kec
13	DTA143EE	Si-pnp-Digi	Sw, 50V, 100mA, 150mW, 250MHz, R1/R2=4k7/4k7	SOT-416	16ta	-	3a	Rhm
13	DTA143EKA	Si-pnp-Digi	Sw, 50V, 100mA, 200mW, 250MHz, R1/R2=4k7/4k7	SOT-346	16ta	-	3a	Rhm
13	DTA143EM	Si-pnp-Digi	Sw, 50V, 100mA, 150mW, 250MHz, R1/R2=4k7/4k7	VMT3	18ta	-	3a	Rhm
13	DTA143EUA	Si-pnp-Digi	Sw, 50V, 100mA, 200mW, 250MHz, R1/R2=4k7/4k7	UMT3	16ta	-	3a	Rhm
13	MMBD1503	Si-diode	Dua 180V, 200mA, Vf<1.5V(300mA), <4pF	SOT-23	16dl	-	3a	Nsc
13	MMBD1703	Si-diode	Dual, Fast, 30V, 150mA, 350mW, Vf<1.1V(50mA), 0.7ns	SOT-23	16dl	-	3a	Nsc
13	MMBD4148CA	Si-diode	Dual, Sw, Fast, 75V, 200mA, 350mW, <4ns, 4pF	SOT-23	16df	-	3a	Nsc
13	TZT13W	Z-diode	12.40..14.10V, Izt=5mA, Zzt=15Q, 200mW	SOT-323	16dc	-	3a	TTr
13	Z02W13V	Z-diode	12.40..14.10V, Izt=5mA, Zzt=15Q, 200mW	SOT-23	16dc	-	3f	Kec
130	HZM13NB	Z-diode	12.47..13.96V, 200mW	SC-59A	16dc	-	3a	Ren
130A	AAT60130A-S14	Vdet-IC	3.0V±2%, +Reset ODO	TSOT-23	16vdc	VD7	3d	Aat
130A	AAT60130A-S2	Vdet-IC	3.0V±2%, +Reset ODO	SOT-23	16vdc	VD7	3d	Aat
130B	AAT60130B-S14	Vdet-IC	3.0V±2%, +Reset PPO	TSOT-23	16vdc	VD7	3d	Aat
130B	AAT60130B-S2	Vdet-IC	3.0V±2%, +Reset PPO	SOT-23	16vdc	VD7	3d	Aat
130C	AAT60130C-S14	Vdet-IC	3.0V±2%, -Reset ODO	TSOT-23	16vdc	VD7	3d	Aat
130C	AAT60130C-S2	Vdet-IC	3.0V±2%, -Reset ODO	SOT-23	16vdc	VD7	3d	Aat
130D	AAT60130D-S14	Vdet-IC	3.0V±2%, -Reset PPO	TSOT-23	16vdc	VD7	3d	Aat
130D	AAT60130D-S2	Vdet-IC	3.0V±2%, -Reset PPO	SOT-23	16vdc	VD7	3d	Aat
131	HZM13NB1	Z-diode	12.47..13.03V, 200mW	SC-59A	16dc	-	3a	Ren
131	PZM13NB1	Z-diode	13V±2.5%, 300mW	SOT-346	16dc	-	3a	Phi
131A	AAT60131A-S14	Vdet-IC	3.1V±2%, +Reset ODO	TSOT-23	16vdc	VD7	3d	Aat
131A	AAT60131A-S2	Vdet-IC	3.1V±2%, +Reset ODO	SOT-23	16vdc	VD7	3d	Aat
131B	AAT60131B-S14	Vdet-IC	3.1V±2%, +Reset PPO	TSOT-23	16vdc	VD7	3d	Aat
131B	AAT60131B-S2	Vdet-IC	3.1V±2%, +Reset PPO	SOT-23	16vdc	VD7	3d	Aat
131C	AAT60131C-S14	Vdet-IC	3.1V±2%, -Reset ODO	TSOT-23	16vdc	VD7	3d	Aat
131C	AAT60131C-S2	Vdet-IC	3.1V±2%, -Reset ODO	SOT-23	16vdc	VD7	3d	Aat
131D	AAT60131D-S14	Vdet-IC	3.1V±2%, -Reset PPO	TSOT-23	16vdc	VD7	3d	Aat
131D	AAT60131D-S2	Vdet-IC	3.1V±2%, -Reset PPO	SOT-23	16vdc	VD7	3d	Aat
132	DTA123JE	Si-pnp-Digi	Sw, 50V, 100mA, 150mW, 250MHz, R1/R2=2k2/47k	SOT-416	16ta	-	3a	Rhm
132	DTA123JM	Si-pnp-Digi	Sw, 50V, 100mA, 150mW, 250MHz, R1/R2=2k2/47k	VMT3	18ta	-	3a	Rhm
132	DTA123JUA	Si-pnp-Digi	Sw, 50V, 100mA, 200mW, 250MHz, R1/R2=2k2/47k	UMT3	16ta	-	3a	Rhm
132	HZM13NB2	Z-diode	12.91..13.49V, 200mW	SC-59A	16dc	-	3a	Ren
132	PZM13NB2	Z-diode	13V±2.5%, 300mW	SOT-346	16dc	-	3a	Phi
132A	AAT60132A-S14	Vdet-IC	3.2V±2%, +Reset ODO	TSOT-23	16vdc	VD7	3d	Aat
132A	AAT60132A-S2	Vdet-IC	3.2V±2%, +Reset ODO	SOT-23	16vdc	VD7	3d	Aat
132B	AAT60132B-S14	Vdet-IC	3.2V±2%, +Reset PPO	TSOT-23	16vdc	VD7	3d	Aat
132B	AAT60132B-S2	Vdet-IC	3.2V±2%, +Reset PPO	SOT-23	16vdc	VD7	3d	Aat
132C	AAT60132C-S14	Vdet-IC	3.2V±2%, -Reset ODO	TSOT-23	16vdc	VD7	3d	Aat



SMD code	Type	Function	Short description	Case	Pinout	Sch.	St.	Mnf.
132C	AAT60132C-S2	Vdet-IC	3.2V±2%, -Reset ODO	SOT-23	16vdc	VD7	3d	Aat
132D	AAT60132D-S14	Vdet-IC	3.2V±2%, -Reset PPO	TSOT-23	16vdc	VD7	3d	Aat
132D	AAT60132D-S2	Vdet-IC	3.2V±2%, -Reset PPO	SOT-23	16vdc	VD7	3d	Aat
133	HZM13NB3	Z-diode	13.37..13.96V, 200mW	SC-59A	16dc	-	3a	Ren
133	PZM13NB3	Z-diode	13V±2.5%, 300mW	SOT-346	16dc	-	3a	Phi
133A	AAT60133A-S14	Vdet-IC	3.3V±2%, +Reset ODO	TSOT-23	16vdc	VD7	3d	Aat
133A	AAT60133A-S2	Vdet-IC	3.3V±2%, +Reset ODO	SOT-23	16vdc	VD7	3d	Aat
133B	AAT60133B-S14	Vdet-IC	3.3V±2%, +Reset PPO	TSOT-23	16vdc	VD7	3d	Aat
133B	AAT60133B-S2	Vdet-IC	3.3V±2%, +Reset PPO	SOT-23	16vdc	VD7	3d	Aat
133C	AAT60133C-S14	Vdet-IC	3.3V±2%, -Reset ODO	TSOT-23	16vdc	VD7	3d	Aat
133C	AAT60133C-S2	Vdet-IC	3.3V±2%, -Reset ODO	SOT-23	16vdc	VD7	3d	Aat
133D	AAT60133D-S14	Vdet-IC	3.3V±2%, -Reset PPO	TSOT-23	16vdc	VD7	3d	Aat
133D	AAT60133D-S2	Vdet-IC	3.3V±2%, -Reset PPO	SOT-23	16vdc	VD7	3d	Aat
134A	AAT60134A-S14	Vdet-IC	3.4V±2%, +Reset ODO	TSOT-23	16vdc	VD7	3d	Aat
134A	AAT60134A-S2	Vdet-IC	3.4V±2%, +Reset ODO	SOT-23	16vdc	VD7	3d	Aat
134B	AAT60134B-S14	Vdet-IC	3.4V±2%, +Reset PPO	TSOT-23	16vdc	VD7	3d	Aat
134B	AAT60134B-S2	Vdet-IC	3.4V±2%, +Reset PPO	SOT-23	16vdc	VD7	3d	Aat
134C	AAT60134C-S14	Vdet-IC	3.4V±2%, -Reset ODO	TSOT-23	16vdc	VD7	3d	Aat
134C	AAT60134C-S2	Vdet-IC	3.4V±2%, -Reset ODO	SOT-23	16vdc	VD7	3d	Aat
134D	AAT60134D-S14	Vdet-IC	3.4V±2%, -Reset PPO	TSOT-23	16vdc	VD7	3d	Aat
134D	AAT60134D-S2	Vdet-IC	3.4V±2%, -Reset PPO	SOT-23	16vdc	VD7	3d	Aat
135A	AAT60135A-S14	Vdet-IC	3.5V±2%, +Reset ODO	TSOT-23	16vdc	VD7	3d	Aat
135A	AAT60135A-S2	Vdet-IC	3.5V±2%, +Reset ODO	SOT-23	16vdc	VD7	3d	Aat
135B	AAT60135B-S14	Vdet-IC	3.5V±2%, +Reset PPO	TSOT-23	16vdc	VD7	3d	Aat
135B	AAT60135B-S2	Vdet-IC	3.5V±2%, +Reset PPO	SOT-23	16vdc	VD7	3d	Aat
135C	AAT60135C-S14	Vdet-IC	3.5V±2%, -Reset ODO	TSOT-23	16vdc	VD7	3d	Aat
135C	AAT60135C-S2	Vdet-IC	3.5V±2%, -Reset ODO	SOT-23	16vdc	VD7	3d	Aat
135D	AAT60135D-S14	Vdet-IC	3.5V±2%, -Reset PPO	TSOT-23	16vdc	VD7	3d	Aat
135D	AAT60135D-S2	Vdet-IC	3.5V±2%, -Reset PPO	SOT-23	16vdc	VD7	3d	Aat
136A	AAT60136A-S14	Vdet-IC	3.6V±2%, +Reset ODO	TSOT-23	16vdc	VD7	3d	Aat
136A	AAT60136A-S2	Vdet-IC	3.6V±2%, +Reset ODO	SOT-23	16vdc	VD7	3d	Aat
136B	AAT60136B-S14	Vdet-IC	3.6V±2%, +Reset PPO	TSOT-23	16vdc	VD7	3d	Aat
136B	AAT60136B-S2	Vdet-IC	3.6V±2%, +Reset PPO	SOT-23	16vdc	VD7	3d	Aat
136C	AAT60136C-S14	Vdet-IC	3.6V±2%, -Reset ODO	TSOT-23	16vdc	VD7	3d	Aat
136C	AAT60136C-S2	Vdet-IC	3.6V±2%, -Reset ODO	SOT-23	16vdc	VD7	3d	Aat
136D	AAT60136D-S14	Vdet-IC	3.6V±2%, -Reset PPO	TSOT-23	16vdc	VD7	3d	Aat
136D	AAT60136D-S2	Vdet-IC	3.6V±2%, -Reset PPO	SOT-23	16vdc	VD7	3d	Aat
137A	AAT60137A-S14	Vdet-IC	3.7V±2%, +Reset ODO	TSOT-23	16vdc	VD7	3d	Aat
137A	AAT60137A-S2	Vdet-IC	3.7V±2%, +Reset ODO	SOT-23	16vdc	VD7	3d	Aat
137B	AAT60137B-S14	Vdet-IC	3.7V±2%, +Reset PPO	TSOT-23	16vdc	VD7	3d	Aat
137B	AAT60137B-S2	Vdet-IC	3.7V±2%, +Reset PPO	SOT-23	16vdc	VD7	3d	Aat
137C	AAT60137C-S14	Vdet-IC	3.7V±2%, -Reset ODO	TSOT-23	16vdc	VD7	3d	Aat
137C	AAT60137C-S2	Vdet-IC	3.7V±2%, -Reset ODO	SOT-23	16vdc	VD7	3d	Aat
137D	AAT60137D-S14	Vdet-IC	3.7V±2%, -Reset PPO	TSOT-23	16vdc	VD7	3d	Aat
137D	AAT60137D-S2	Vdet-IC	3.7V±2%, -Reset PPO	SOT-23	16vdc	VD7	3d	Aat
138A	AAT60138A-S14	Vdet-IC	3.8V±2%, +Reset ODO	TSOT-23	16vdc	VD7	3d	Aat
138A	AAT60138A-S2	Vdet-IC	3.8V±2%, +Reset ODO	SOT-23	16vdc	VD7	3d	Aat
138B	AAT60138B-S14	Vdet-IC	3.8V±2%, +Reset PPO	TSOT-23	16vdc	VD7	3d	Aat
138B	AAT60138B-S2	Vdet-IC	3.8V±2%, +Reset PPO	SOT-23	16vdc	VD7	3d	Aat
138C	AAT60138C-S14	Vdet-IC	3.8V±2%, -Reset ODO	TSOT-23	16vdc	VD7	3d	Aat
138C	AAT60138C-S2	Vdet-IC	3.8V±2%, -Reset ODO	SOT-23	16vdc	VD7	3d	Aat
138D	AAT60138D-S14	Vdet-IC	3.8V±2%, -Reset PPO	TSOT-23	16vdc	VD7	3d	Aat
138D	AAT60138D-S2	Vdet-IC	3.8V±2%, -Reset PPO	SOT-23	16vdc	VD7	3d	Aat
139A	AAT60139A-S14	Vdet-IC	3.9V±2%, +Reset ODO	TSOT-23	16vdc	VD7	3d	Aat
139A	AAT60139A-S2	Vdet-IC	3.9V±2%, +Reset ODO	SOT-23	16vdc	VD7	3d	Aat
139B	AAT60139B-S14	Vdet-IC	3.9V±2%, +Reset PPO	TSOT-23	16vdc	VD7	3d	Aat
139B	AAT60139B-S2	Vdet-IC	3.9V±2%, +Reset PPO	SOT-23	16vdc	VD7	3d	Aat
139C	AAT60139C-S14	Vdet-IC	3.9V±2%, -Reset ODO	TSOT-23	16vdc	VD7	3d	Aat
139C	AAT60139C-S2	Vdet-IC	3.9V±2%, -Reset ODO	SOT-23	16vdc	VD7	3d	Aat
139D	AAT60139D-S14	Vdet-IC	3.9V±2%, -Reset PPO	TSOT-23	16vdc	VD7	3d	Aat
139D	AAT60139D-S2	Vdet-IC	3.9V±2%, -Reset PPO	SOT-23	16vdc	VD7	3d	Aat
13A	APR3013-15A	Vdet-IC	1.5V, -Reset ODO	SOT-23	16vdc	VD6	3b	Anp
13A	MAZ3130WA	Z-diode	Dual, 12.4..14.1V, If=100mA, Zzt=30Ω, 200mW	SC-59	16df	-	3a	Pan
13A	PZM13NB2A	Z-diode	Dual, 13V±2.5%, 300mW	SOT-346	16df	-	3a	Phi
13B	APR3013-17A	Vdet-IC	1.75V, -Reset ODO	SOT-23	16vdc	VD6	3b	Anp
13C	APR3013-23A	Vdet-IC	2.32V, -Reset ODO	SOT-23	16vdc	VD6	3b	Anp
13D	APR3013-26A	Vdet-IC	2.63V, -Reset ODO	SOT-23	16vdc	VD6	3b	Anp
13E	APR3013-29A	Vdet-IC	2.93V, -Reset ODO	SOT-23	16vdc	VD6	3b	Anp
13E	ZC2813E	Si-diode	Dual RF, Schottky, 15V, Vf<0.41V, Cd<1.2pF	SOT-23	16df	-	3a	Zx
13F	APR3013-30A	Vdet-IC	3.08V, -Reset ODO	SOT-23	16vdc	VD6	3b	Anp



SMD code	Type	Function	Short description	Case	Pinout	Sch. St.	Mnf.
13G	APR3013-39A	Vdet-IC	3.9V, -Reset ODO	SOT-23	16vdc	VD6	3b Anp
13H	APR3013-43A	Vdet-IC	4.38V, -Reset ODO	SOT-23	16vdc	VD6	3b Anp
13H	BZX84-C13-V	Z-diode	12.88..13.57V, Izt=5mA, Zzt=15Ω, 300mW	SOT-23	16dc	-	3f Kec
13H	MAZ3130-H	Z-diode	12.4..14.1V, If=100mA, Zzt=30Ω, 200mW	SC-59	16dc	-	3a Pan
13J	APR3013-46A	Vdet-IC	4.63V, -Reset ODO	SOT-23	16vdc	VD6	3b Anp
13L	MAZ3130-L	Z-diode	12.4..14.1V, If=100mA, Zzt=30Ω, 200mW	SC-59	16dc	-	3a Pan
13M	MAZ3130-M	Z-diode	12.4..14.1V, If=100mA, Zzt=30Ω, 200mW	SC-59	16dc	-	3a Pan
13s	BAS125	Si-diode	Schottky, 25V, 100mA, Vf<0.9V(35mA), Cd<1.1pF	SOT-23	16dc	-	3c Inf
13s	BAS125W	Si-diode	Schottky, 25V, 100mA, Vf<0.9V(35mA), Cd<1.1pF	SOT-323	16dc	-	3c Inf
13V	CHPZ13VPT	Z-diode	Dual, 12.4..14.1V, Izt=5mA, Zzt=30Ω, 350mW	SOT-23	16df	-	3a Chm
13V	PZM13NB	Z-diode	13V±2.5%, 300mW	SOT-346	16dc	-	3a Phi
13W	CMSZDA36V	Z-diode	Dual, 34.0..38.0V, Izt=90Ω, 4.6mA, 275mW	SOT-323	16df	-	3a Cen
13X	02CZ13-X	Z-diode	12.4..13.08V, 200mW	SC-59	16dc	-	3a Tos
13X	TZT13XW	Z-diode	12.40..13.08V, Izt=5mA, Zzt=15Ω, 200mW	SOT-323	16dc	-	3a TTr
13X	Z02W13VX	Z-diode	12.40..13.08V, Izt=5mA, Zzt=15Ω, 200mW	SOT-23	16dc	-	3f Kec
13Y	02CZ13-Y	Z-diode	12.88..13.57V, 200mW	SC-59	16dc	-	3a Tos
13Y	TZT13YW	Z-diode	12.88..13.57V, Izt=5mA, Zzt=15Ω, 200mW	SOT-323	16dc	-	3a TTr
13Y	Z02W13VY	Z-diode	12.88..13.57V, Izt=5mA, Zzt=15Ω, 200mW	SOT-23	16dc	-	3f Kec
13Z	02CZ13-Z	Z-diode	13.37..14.1V, 200mW	SC-59	16dc	-	3a Tos
13Z	CZ1W13	Z-diode	13V±5%, 600mW	SOT-23	16dc	-	3a Cdi
13Z	TZT13ZW	Z-diode	13.37..14.10V, Izt=5mA, Zzt=15Ω, 200mW	SOT-323	16dc	-	3a TTr
13Z	Z02W13VZ	Z-diode	13.37..14.10V, Izt=5mA, Zzt=15Ω, 200mW	SOT-23	16dc	-	3f Kec
14	1PS59SB14	Si-diode	Dual, Schottky, Sw, Fast, 30V, 200mA, Vf<0.8V(100mA), <5ns	SC-59	16dl	-	3a Phi
14	CMBT9014	Si-npn	GP, 30V, 100mA, 250mW, B=150..1000, >125MHz	SOT-23	16ta	-	3a Cdi
14	DTA114ECA	Si-pnp-Digi	Sw, 50V, 100mA, 200mW, 200MHz, R1/R2=10k/10k	SST3	16ta	-	3a Rhm
14	DTA114EE	Si-pnp-Digi	Sw, 50V, 100mA, 200mW, 200MHz, R1/R2=10k/10k	SOT-416	16ta	-	3a Rhm
14	DTA114EKA	Si-pnp-Digi	Sw, 50V, 100mA, 200mW, 200MHz, R1/R2=10k/10k	SOT-346	16ta	-	3a Rhm
14	DTA114EM	Si-pnp-Digi	Sw, 50V, 100mA, 150mW, 200MHz, R1/R2=10k/10k	VMT3	16ta	-	3a Rhm
14	DTA114EUA	Si-pnp-Digi	Sw, 50V, 100mA, 200mW, 200MHz, R1/R2=10k/10k	UMT3	16ta	-	3a Rhm
14	MMBD1504	Si-diode	Dual, Sw, 180V, 200mA, Vf<1.5V(300mA), <4pF	SOT-23	16dg	-	3a Nsc
14	MMBD1704	Si-diode	Dual, Fast, 30V, 150mA, 350mW, Vf<1.1V(50mA), 0.7ns	SOT-23	16dg	-	3a Nsc
140A	AAT60140A-S14	Vdet-IC	4.0V±2%, +Reset ODO	TSOT-23	16vdc	VD7	3d Aat
140A	AAT60140A-S2	Vdet-IC	4.0V±2%, +Reset ODO	SOT-23	16vdc	VD7	3d Aat
140B	AAT60140B-S14	Vdet-IC	4.0V±2%, +Reset PPO	TSOT-23	16vdc	VD7	3d Aat
140B	AAT60140B-S2	Vdet-IC	4.0V±2%, +Reset PPO	SOT-23	16vdc	VD7	3d Aat
140C	AAT60140C-S14	Vdet-IC	4.0V±2%, -Reset ODO	TSOT-23	16vdc	VD7	3d Aat
140C	AAT60140C-S2	Vdet-IC	4.0V±2%, -Reset ODO	SOT-23	16vdc	VD7	3d Aat
140D	AAT60140D-S14	Vdet-IC	4.0V±2%, -Reset PPO	TSOT-23	16vdc	VD7	3d Aat
140D	AAT60140D-S2	Vdet-IC	4.0V±2%, -Reset PPO	SOT-23	16vdc	VD7	3d Aat
141A	AAT60141A-S14	Vdet-IC	4.1V±2%, +Reset ODO	TSOT-23	16vdc	VD7	3d Aat
141A	AAT60141A-S2	Vdet-IC	4.1V±2%, +Reset ODO	SOT-23	16vdc	VD7	3d Aat
141B	AAT60141B-S14	Vdet-IC	4.1V±2%, +Reset PPO	TSOT-23	16vdc	VD7	3d Aat
141B	AAT60141B-S2	Vdet-IC	4.1V±2%, +Reset PPO	SOT-23	16vdc	VD7	3d Aat
141C	AAT60141C-S14	Vdet-IC	4.1V±2%, -Reset ODO	TSOT-23	16vdc	VD7	3d Aat
141C	AAT60141C-S2	Vdet-IC	4.1V±2%, -Reset ODO	SOT-23	16vdc	VD7	3d Aat
141D	AAT60141D-S14	Vdet-IC	4.1V±2%, -Reset PPO	TSOT-23	16vdc	VD7	3d Aat
141D	AAT60141D-S2	Vdet-IC	4.1V±2%, -Reset PPO	SOT-23	16vdc	VD7	3d Aat
142A	AAT60142A-S14	Vdet-IC	4.2V±2%, +Reset ODO	TSOT-23	16vdc	VD7	3d Aat
142A	AAT60142A-S2	Vdet-IC	4.2V±2%, +Reset ODO	SOT-23	16vdc	VD7	3d Aat
142B	AAT60142B-S14	Vdet-IC	4.2V±2%, +Reset PPO	TSOT-23	16vdc	VD7	3d Aat
142B	AAT60142B-S2	Vdet-IC	4.2V±2%, +Reset PPO	SOT-23	16vdc	VD7	3d Aat
142C	AAT60142C-S14	Vdet-IC	4.2V±2%, -Reset ODO	TSOT-23	16vdc	VD7	3d Aat
142C	AAT60142C-S2	Vdet-IC	4.2V±2%, -Reset ODO	SOT-23	16vdc	VD7	3d Aat
142D	AAT60142D-S14	Vdet-IC	4.2V±2%, -Reset PPO	TSOT-23	16vdc	VD7	3d Aat
142D	AAT60142D-S2	Vdet-IC	4.2V±2%, -Reset PPO	SOT-23	16vdc	VD7	3d Aat
143A	AAT60143A-S14	Vdet-IC	4.3V±2%, +Reset ODO	TSOT-23	16vdc	VD7	3d Aat
143A	AAT60143A-S2	Vdet-IC	4.3V±2%, +Reset ODO	SOT-23	16vdc	VD7	3d Aat
143B	AAT60143B-S14	Vdet-IC	4.3V±2%, +Reset PPO	TSOT-23	16vdc	VD7	3d Aat
143B	AAT60143B-S2	Vdet-IC	4.3V±2%, +Reset PPO	SOT-23	16vdc	VD7	3d Aat
143C	AAT60143C-S14	Vdet-IC	4.3V±2%, -Reset ODO	TSOT-23	16vdc	VD7	3d Aat
143C	AAT60143C-S2	Vdet-IC	4.3V±2%, -Reset ODO	SOT-23	16vdc	VD7	3d Aat
143D	AAT60143D-S14	Vdet-IC	4.3V±2%, -Reset PPO	TSOT-23	16vdc	VD7	3d Aat
143D	AAT60143D-S2	Vdet-IC	4.3V±2%, -Reset PPO	SOT-23	16vdc	VD7	3d Aat
144A	AAT60144A-S14	Vdet-IC	4.4V±2%, +Reset ODO	TSOT-23	16vdc	VD7	3d Aat
144A	AAT60144A-S2	Vdet-IC	4.4V±2%, +Reset ODO	SOT-23	16vdc	VD7	3d Aat
144B	AAT60144B-S14	Vdet-IC	4.4V±2%, +Reset PPO	TSOT-23	16vdc	VD7	3d Aat
144B	AAT60144B-S2	Vdet-IC	4.4V±2%, +Reset PPO	SOT-23	16vdc	VD7	3d Aat
144C	AAT60144C-S14	Vdet-IC	4.4V±2%, -Reset ODO	TSOT-23	16vdc	VD7	3d Aat
144C	AAT60144C-S2	Vdet-IC	4.4V±2%, -Reset ODO	SOT-23	16vdc	VD7	3d Aat
144D	AAT60144D-S14	Vdet-IC	4.4V±2%, -Reset PPO	TSOT-23	16vdc	VD7	3d Aat



SMD code	Type	Function	Short description	Case	Pinout	Sch. St.	Mnf.
144D	AAT60144D-S2	Vdet-IC	4.4V±2%, -Reset PPO	SOT-23	16vdc	VD7	3d Aat
145A	AAT60145A-S14	Vdet-IC	4.5V±2%, +Reset ODO	TSOT-23	16vdc	VD7	3d Aat
145A	AAT60145A-S2	Vdet-IC	4.5V±2%, +Reset ODO	SOT-23	16vdc	VD7	3d Aat
145B	AAT60145B-S14	Vdet-IC	4.5V±2%, +Reset PPO	TSOT-23	16vdc	VD7	3d Aat
145B	AAT60145B-S2	Vdet-IC	4.5V±2%, +Reset PPO	SOT-23	16vdc	VD7	3d Aat
145C	AAT60145C-S14	Vdet-IC	4.5V±2%, -Reset ODO	TSOT-23	16vdc	VD7	3d Aat
145C	AAT60145C-S2	Vdet-IC	4.5V±2%, -Reset ODO	SOT-23	16vdc	VD7	3d Aat
145D	AAT60145D-S14	Vdet-IC	4.5V±2%, -Reset PPO	TSOT-23	16vdc	VD7	3d Aat
145D	AAT60145D-S2	Vdet-IC	4.5V±2%, -Reset PPO	SOT-23	16vdc	VD7	3d Aat
146A	AAT60146A-S14	Vdet-IC	4.6V±2%, +Reset ODO	TSOT-23	16vdc	VD7	3d Aat
146A	AAT60146A-S2	Vdet-IC	4.6V±2%, +Reset ODO	SOT-23	16vdc	VD7	3d Aat
146B	AAT60146B-S14	Vdet-IC	4.6V±2%, +Reset PPO	TSOT-23	16vdc	VD7	3d Aat
146B	AAT60146B-S2	Vdet-IC	4.6V±2%, +Reset PPO	SOT-23	16vdc	VD7	3d Aat
146C	AAT60146C-S14	Vdet-IC	4.6V±2%, -Reset ODO	TSOT-23	16vdc	VD7	3d Aat
146C	AAT60146C-S2	Vdet-IC	4.6V±2%, -Reset ODO	SOT-23	16vdc	VD7	3d Aat
146D	AAT60146D-S14	Vdet-IC	4.6V±2%, -Reset PPO	TSOT-23	16vdc	VD7	3d Aat
146D	AAT60146D-S2	Vdet-IC	4.6V±2%, -Reset PPO	SOT-23	16vdc	VD7	3d Aat
147A	AAT60147A-S14	Vdet-IC	4.7V±2%, +Reset ODO	TSOT-23	16vdc	VD7	3d Aat
147A	AAT60147A-S2	Vdet-IC	4.7V±2%, +Reset ODO	SOT-23	16vdc	VD7	3d Aat
147B	AAT60147B-S14	Vdet-IC	4.7V±2%, +Reset PPO	TSOT-23	16vdc	VD7	3d Aat
147B	AAT60147B-S2	Vdet-IC	4.7V±2%, +Reset PPO	SOT-23	16vdc	VD7	3d Aat
147C	AAT60147C-S14	Vdet-IC	4.7V±2%, -Reset ODO	TSOT-23	16vdc	VD7	3d Aat
147C	AAT60147C-S2	Vdet-IC	4.7V±2%, -Reset ODO	SOT-23	16vdc	VD7	3d Aat
147D	AAT60147D-S14	Vdet-IC	4.7V±2%, -Reset PPO	TSOT-23	16vdc	VD7	3d Aat
147D	AAT60147D-S2	Vdet-IC	4.7V±2%, -Reset PPO	SOT-23	16vdc	VD7	3d Aat
148A	AAT60148A-S14	Vdet-IC	4.8V±2%, +Reset ODO	TSOT-23	16vdc	VD7	3d Aat
148A	AAT60148A-S2	Vdet-IC	4.8V±2%, +Reset ODO	SOT-23	16vdc	VD7	3d Aat
148B	AAT60148B-S14	Vdet-IC	4.8V±2%, +Reset PPO	TSOT-23	16vdc	VD7	3d Aat
148B	AAT60148B-S2	Vdet-IC	4.8V±2%, +Reset PPO	SOT-23	16vdc	VD7	3d Aat
148C	AAT60148C-S14	Vdet-IC	4.8V±2%, -Reset ODO	TSOT-23	16vdc	VD7	3d Aat
148C	AAT60148C-S2	Vdet-IC	4.8V±2%, -Reset ODO	SOT-23	16vdc	VD7	3d Aat
148D	AAT60148D-S14	Vdet-IC	4.8V±2%, -Reset PPO	TSOT-23	16vdc	VD7	3d Aat
148D	AAT60148D-S2	Vdet-IC	4.8V±2%, -Reset PPO	SOT-23	16vdc	VD7	3d Aat
149A	AAT60149A-S14	Vdet-IC	4.9V±2%, +Reset ODO	TSOT-23	16vdc	VD7	3d Aat
149A	AAT60149A-S2	Vdet-IC	4.9V±2%, +Reset ODO	SOT-23	16vdc	VD7	3d Aat
149B	AAT60149B-S14	Vdet-IC	4.9V±2%, +Reset PPO	TSOT-23	16vdc	VD7	3d Aat
149B	AAT60149B-S2	Vdet-IC	4.9V±2%, +Reset PPO	SOT-23	16vdc	VD7	3d Aat
149C	AAT60149C-S14	Vdet-IC	4.9V±2%, -Reset ODO	TSOT-23	16vdc	VD7	3d Aat
149C	AAT60149C-S2	Vdet-IC	4.9V±2%, -Reset ODO	SOT-23	16vdc	VD7	3d Aat
149D	AAT60149D-S14	Vdet-IC	4.9V±2%, -Reset PPO	TSOT-23	16vdc	VD7	3d Aat
149D	AAT60149D-S2	Vdet-IC	4.9V±2%, -Reset PPO	SOT-23	16vdc	VD7	3d Aat
14B	CMBT9014	Si-npn	GP, 30V, 100mA, 250mW, B=100..300, >125MHz	SOT-23	16ta	-	3a Cdi
14C	CMBT9014	Si-npn	GP, 30V, 100mA, 250mW, B=200.600, >125MHz	SOT-23	16ta	-	3a Cdi
14D	CMBT9014	Si-npn	GP, 30V, 100mA, 250mW, B=400..1000, >125MHz	SOT-23	16ta	-	3a Cdi
14M	MAZ3140-M	Z-diode	13.65..14.35V, If=100mA, Zzt=30Ω, 200mW	SC-59	16dc	-	3a Pan
14s	BAS125-04	Si-diode	Dual, Schottky, 25V, 100mA, Vf<0.9V(35mA), Cd<1.1pF	SOT-23	16dl	-	3c Inf
14s	BAS125-04W	Si-diode	Dual, Schottky, 25V, 100mA, Vf<0.9V(35mA), Cd<1.1pF	SOT-323	16dl	-	3c Inf
14V	CHP214VPT	Z-diode	Dual, 13.3..14.7V, Izt=5mA, Zzt=30Ω, 350mW	SOT-23	16df	-	3a Chm
14W	CMSZDA39V	Z-diode	Dual, 37.0..41.0V, Zzt=130Ω, 4.3mA, 275mW	SOT-323	16df	-	3a Cen
15	1PS59SB15	Si-diode	Dual, Schottky, Sw, Fast, 30V, 200mA, Vf<0.8V(100mA), <5ns	SC-59	16dg	-	3a Phi
15	CMBT9015	Si-pnp	GP, 30V, 100mA, 250mW, B=150..1000, >125MHz	SOT-23	16ta	-	3a Cdi
15	DTA124ECA	Si-pnp-Digi	Sw, 50V, 100mA, 200mW, 250MHz, R1/R2=22k/22k	SOT-23	16ta	-	3a Rhm
15	DTA124EE	Si-pnp-Digi	Sw, 50V, 100mA, 1500mW, 250MHz, R1/R2=22k/22k	SOT-416	16ta	-	3a Rhm
15	DTA124EKA	Si-pnp-Digi	Sw, 50V, 100mA, 200mW, 250MHz, R1/R2=22k/22k	SOT-346	16ta	-	3a Rhm
15	DTA124EM	Si-pnp-Digi	Sw, 50V, 100mA, 1500mW, 250MHz, R1/R2=22k/22k	VMT3	18ta	-	3a Rhm
15	DTA124EUA	Si-pnp-Digi	Sw, 50V, 100mA, 200mW, 250MHz, R1/R2=22k/22k	UMT3	16ta	-	3a Rhm
15	MMBD1505	Si-diode	Dual, Sw, 180V, 200mA, Vf<1.5V(300mA), <4pF	SOT-23	16df	-	3a Nsc
15	MSCT15	TVS	Vrwm=15V, 300W(8/20µs)	SOT-23	16dh	-	3a Msp
15	TZT15W	Z-diode	13.80..15.60V, Izt=5mA, Zzt=15Ω, 200mW	SOT-323	16dc	-	3a Ttr
15	Z02W15V	Z-diode	13.80..15.60V, Izt=5mA, Zzt=15Ω, 200mW	SOT-23	16dc	-	3f Kec
150	HZM15NB	Z-diode	13.84..15.52V, 200mW	SC-59A	16dc	-	3a Ren
150	KTY82/150	Tdet-IC	Sensor, Rs=950..1050Ω(25°C, 1mA)	SOT-23	16ag	-	3a Nxp
150A	AAT60150A-S14	Vdet-IC	5.0V±2%, +Reset ODO	TSOT-23	16vdc	VD7	3d Aat
150A	AAT60150A-S2	Vdet-IC	5.0V±2%, +Reset ODO	SOT-23	16vdc	VD7	3d Aat
150B	AAT60150B-S14	Vdet-IC	5.0V±2%, +Reset PPO	TSOT-23	16vdc	VD7	3d Aat
150B	AAT60150B-S2	Vdet-IC	5.0V±2%, +Reset PPO	SOT-23	16vdc	VD7	3d Aat
150C	AAT60150C-S14	Vdet-IC	5.0V±2%, -Reset ODO	TSOT-23	16vdc	VD7	3d Aat
150C	AAT60150C-S2	Vdet-IC	5.0V±2%, -Reset ODO	SOT-23	16vdc	VD7	3d Aat
150D	AAT60150D-S14	Vdet-IC	5.0V±2%, -Reset PPO	TSOT-23	16vdc	VD7	3d Aat
150D	AAT60150D-S2	Vdet-IC	5.0V±2%, -Reset PPO	SOT-23	16vdc	VD7	3d Aat



SMD code	Type	Function	Short description	Case	Pinout	Sch. St.	Mnf.
151	HZM15NB1	Z-diode	13.84..14.46V, 200mW	SC-59A	16dc -	3a	Ren
151	KTY82/151	Tdet-IC	Sensor, Rs=950, 1000Ω(25°C, 1mA)	SOT-23	16ag -	3a	Nxp
151	PZM15NB1	Z-diode	15V±2.5%, 300mW	SOT-346	16dc -	3a	Phi
151A	AAT60151A-S14	Vdet-IC	5.1V±2%, +Reset ODO	TSOT-23	16vdc VD7	3d	Aat
151A	AAT60151A-S2	Vdet-IC	5.1V±2%, +Reset ODO	SOT-23	16vdc VD7	3d	Aat
151B	AAT60151B-S14	Vdet-IC	5.1V±2%, +Reset PPO	TSOT-23	16vdc VD7	3d	Aat
151B	AAT60151B-S2	Vdet-IC	5.1V±2%, +Reset PPO	SOT-23	16vdc VD7	3d	Aat
151C	AAT60151C-S14	Vdet-IC	5.1V±2%, -Reset ODO	TSOT-23	16vdc VD7	3d	Aat
151C	AAT60151C-S2	Vdet-IC	5.1V±2%, -Reset ODO	SOT-23	16vdc VD7	3d	Aat
151D	AAT60151D-S14	Vdet-IC	5.1V±2%, -Reset PPO	TSOT-23	16vdc VD7	3d	Aat
151D	AAT60151D-S2	Vdet-IC	5.1V±2%, -Reset PPO	SOT-23	16vdc VD7	3d	Aat
152	HZM15NB2	Z-diode	14.34..14.98V, 200mW	SC-59A	16dc -	3a	Ren
152	PZM15NB2	Z-diode	15V±2.5%, 300mW	SOT-346	16dc -	3a	Phi
152A	AAT60152A-S14	Vdet-IC	5.2V±2%, +Reset ODO	TSOT-23	16vdc VD7	3d	Aat
152A	AAT60152A-S2	Vdet-IC	5.2V±2%, +Reset ODO	SOT-23	16vdc VD7	3d	Aat
152B	AAT60152B-S14	Vdet-IC	5.2V±2%, +Reset PPO	TSOT-23	16vdc VD7	3d	Aat
152B	AAT60152B-S2	Vdet-IC	5.2V±2%, +Reset PPO	SOT-23	16vdc VD7	3d	Aat
152C	AAT60152C-S14	Vdet-IC	5.2V±2%, -Reset ODO	TSOT-23	16vdc VD7	3d	Aat
152C	AAT60152C-S2	Vdet-IC	5.2V±2%, -Reset ODO	SOT-23	16vdc VD7	3d	Aat
152D	AAT60152D-S14	Vdet-IC	5.2V±2%, -Reset PPO	TSOT-23	16vdc VD7	3d	Aat
152D	AAT60152D-S2	Vdet-IC	5.2V±2%, -Reset PPO	SOT-23	16vdc VD7	3d	Aat
153	HZM15NB3	Z-diode	14.85..15.52V, 200mW	SC-59A	16dc -	3a	Ren
153	PZM15NB3	Z-diode	15V±2.5%, 300mW	SOT-346	16dc -	3a	Phi
153A	AAT60153A-S14	Vdet-IC	5.3V±2%, +Reset ODO	TSOT-23	16vdc VD7	3d	Aat
153A	AAT60153A-S2	Vdet-IC	5.3V±2%, +Reset ODO	SOT-23	16vdc VD7	3d	Aat
153B	AAT60153B-S14	Vdet-IC	5.3V±2%, +Reset PPO	TSOT-23	16vdc VD7	3d	Aat
153B	AAT60153B-S2	Vdet-IC	5.3V±2%, +Reset PPO	SOT-23	16vdc VD7	3d	Aat
153C	AAT60153C-S14	Vdet-IC	5.3V±2%, -Reset ODO	TSOT-23	16vdc VD7	3d	Aat
153C	AAT60153C-S2	Vdet-IC	5.3V±2%, -Reset ODO	SOT-23	16vdc VD7	3d	Aat
153D	AAT60153D-S14	Vdet-IC	5.3V±2%, -Reset PPO	TSOT-23	16vdc VD7	3d	Aat
153D	AAT60153D-S2	Vdet-IC	5.3V±2%, -Reset PPO	SOT-23	16vdc VD7	3d	Aat
153S	SS15P3S	Si-diode	SBR, 30V, 15A, Vf<0.57V(10A)	TO-277A	76dg -	3o	Vs
154A	AAT60154A-S14	Vdet-IC	5.4V±2%, +Reset ODO	TSOT-23	16vdc VD7	3d	Aat
154A	AAT60154A-S2	Vdet-IC	5.4V±2%, +Reset ODO	SOT-23	16vdc VD7	3d	Aat
154B	AAT60154B-S14	Vdet-IC	5.4V±2%, +Reset PPO	TSOT-23	16vdc VD7	3d	Aat
154B	AAT60154B-S2	Vdet-IC	5.4V±2%, +Reset PPO	SOT-23	16vdc VD7	3d	Aat
154C	AAT60154C-S14	Vdet-IC	5.4V±2%, -Reset ODO	TSOT-23	16vdc VD7	3d	Aat
154C	AAT60154C-S2	Vdet-IC	5.4V±2%, -Reset ODO	SOT-23	16vdc VD7	3d	Aat
154D	AAT60154D-S14	Vdet-IC	5.4V±2%, -Reset PPO	TSOT-23	16vdc VD7	3d	Aat
154D	AAT60154D-S2	Vdet-IC	5.4V±2%, -Reset PPO	SOT-23	16vdc VD7	3d	Aat
155A	AAT60155A-S14	Vdet-IC	5.5V±2%, +Reset ODO	TSOT-23	16vdc VD7	3d	Aat
155A	AAT60155A-S2	Vdet-IC	5.5V±2%, +Reset ODO	SOT-23	16vdc VD7	3d	Aat
155B	AAT60155B-S14	Vdet-IC	5.5V±2%, +Reset PPO	TSOT-23	16vdc VD7	3d	Aat
155B	AAT60155B-S2	Vdet-IC	5.5V±2%, +Reset PPO	SOT-23	16vdc VD7	3d	Aat
155C	AAT60155C-S14	Vdet-IC	5.5V±2%, -Reset ODO	TSOT-23	16vdc VD7	3d	Aat
155C	AAT60155C-S2	Vdet-IC	5.5V±2%, -Reset ODO	SOT-23	16vdc VD7	3d	Aat
155D	AAT60155D-S14	Vdet-IC	5.5V±2%, -Reset PPO	TSOT-23	16vdc VD7	3d	Aat
155D	AAT60155D-S2	Vdet-IC	5.5V±2%, -Reset PPO	SOT-23	16vdc VD7	3d	Aat
156	DTA144VUA	Si-pnp-Digi	Sw, 50V, 100mA, 200mW, 250MHz, R1/R2=47k/10k	UMT3	16ta -	3a	Rhm
15A	MMBZ15VA	TVS	Dual, V _{rw} =12V, V _{br} =14.25..15.75V, 1.9A, 40W(1ms)	SOT-23	16dg -	3a	Wtr
15A	PZM15NB2A	Z-diode	Dual, 15V±2.5%, 300mW	SOT-346	16df -	3a	Phi
15B	CMBT9015	Si-pnp	GP, 30V, 100mA, 250mW, B=100..300, >125MHz	SOT-23	16ta -	3a	Cdi
15C	CMBT9015	Si-pnp	GP, 30V, 100mA, 250mW, B=200.600, >125MHz	SOT-23	16ta -	3a	Cdi
15C	MSCT15C	TVS	Dual, V _{rw} =15V, 300W (8/20μs), Bidirectional	SOT-23	16dp -	3a	Msp
15C	TVS2315PT	TVS	Dual, V _{br} =16.7V, V _{rw} =15V, 1A, 300W(1ms)	SOT-23	16df -	3a	Chm
15D	CMBT9015	Si-pnp	GP, 30V, 100mA, 250mW, B=400..1000, >125MHz	SOT-23	16ta -	3a	Cdi
15H	BZX84-C15-V	Z-diode	14.33..15.11V, I _{zt} =5mA, Z _{zt} =15Ω, 300mW	SOT-23	16dc -	3f	Kec
15H	MAZ3150-H	Z-diode	13.9..15.6V, I _f =100mA, Z _{zt} =30Ω, 200mW	SC-59	16dc -	3a	Pan
15L	MAZ3150-L	Z-diode	13.9..15.6V, I _f =100mA, Z _{zt} =30Ω, 200mW	SC-59	16dc -	3a	Pan
15M	MAZ3150-M	Z-diode	13.9..15.6V, I _f =100mA, Z _{zt} =30Ω, 200mW	SC-59	16dc -	3a	Pan
15s	BAS125-05	Si-diode	Dual, Schottky, 25V, 100mA, Vf<0.9V(35mA), Cd<1.1pF	SOT-23	16dg -	3c	Inf
15s	BAS125-05W	Si-diode	Dual, Schottky, 25V, 100mA, Vf<0.9V(35mA), Cd<1.1pF	SOT-323	16dg -	3c	Inf
15T	TK71515AS	LVR-IC	LDO, 1.5V±1.5%, 155mA	SOT-23	16cj VR1	3d	Tok
15V	CHPZ15VPT	Z-diode	Dual, 14.2..15.8V, I _{zt} =5mA, Z _{zt} =30Ω, 350mW	SOT-23	16df -	3a	Chm
15V	PZM15NB	Z-diode	15V±2.5%, 300mW	SOT-346	16dc -	3a	Phi
15W	CMSZDA43V	Z-diode	Dual, 40.0..46.0V, Z _{zt} =150Ω, 3.9mA, 275mW	SOT-323	16df -	3a	Cen
15X	02CZ15-X	Z-diode	13.8..14.63V, 200mW	SC-59	16dc -	3a	Tos
15X	TZT15XW	Z-diode	13.80..14.63V, I _{zt} =5mA, Z _{zt} =15Ω, 200mW	SOT-323	16dc -	3a	Ttr
15X	Z02W15VX	Z-diode	13.80..14.63V, I _{zt} =5mA, Z _{zt} =15Ω, 200mW	SOT-23	16dc -	3f	Kec
15Y	02CZ15-Y	Z-diode	14.33..15.11V, 200mW	SC-59	16dc -	3a	Tos



SMD code	Type	Function	Short description	Case	Pinout	Sch.	St.	Mnf.
15Y	TZT15YW	Z-diode	14.33..15.11V, Izt=5mA, Zzt=15Ω, 200mW	SOT-323	16dc	-	3a	Ttr
15Y	Z02W15VY	Z-diode	14.33..15.11V, Izt=5mA, Zzt=15Ω, 200mW	SOT-23	16dc	-	3f	Kec
15Z	02CZ15-Z	Z-diode	14.81..15.6V, 200mW	SC-59	16dc	-	3a	Tos
15Z	CZ1W15	Z-diode	15V±5%, 600mW	SOT-23	16dc	-	3a	Cdi
15Z	TZT15ZW	Z-diode	14.81..15.60V, Izt=5mA, Zzt=15Ω, 200mW	SOT-323	16dc	-	3a	Ttr
15Z	Z02W15VZ	Z-diode	14.81..15.60V, Izt=5mA, Zzt=15Ω, 200mW	SOT-23	16dc	-	3f	Kec
16	1PS95SB16	Si-diode	Dual, Schottky, Sw, Fast, 30V, 200mA, Vf<0.8V(100mA), <5ns	SC-59	16df	-	3a	Phi
16	DTA144EE	Si-pnp-Digi	Sw, 50V, 100mA, 150mW, 250MHz, R1/R2=47k/47k	SOT-416	16ta	-	3a	Rhm
16	DTA144EKA	Si-pnp-Digi	Sw, 50V, 100mA, 200mW, 250MHz, R1/R2=47k/47k	SOT-346	16ta	-	3a	Rhm
16	DTA144EM	Si-pnp-Digi	Sw, 50V, 100mA, 150mW, 250MHz, R1/R2=47k/47k	VMT3	18ta	-	3a	Rhm
16	DTA144EUA	Si-pnp-Digi	Sw, 50V, 100mA, 200mW, 250MHz, R1/R2=47k/47k	UMT3	16ta	-	3a	Rhm
16	ELM9816BB	LVR-IC	1.6V±2%, 200mA	SOT-23	16cg	VR1	3d	Elm
16	TZT16W	Z-diode	15.30..17.10V, Izt=5mA, Zzt=18Ω, 200mW	SOT-323	16dc	-	3a	Ttr
16	Z02W16V	Z-diode	15.30..17.10V, Izt=5mA, Zzt=18Ω, 200mW	SOT-23	16dc	-	3f	Kec
160	HZM16NB	Z-diode	15.37..17.09V, 200mW	SC-59A	16dc	-	3a	Ren
161	HZM16NB1	Z-diode	15.37..16.01V, 200mW	SC-59A	16dc	-	3a	Ren
161	PZM16NB1	Z-diode	16V±2.5%, 300mW	SOT-346	16dc	-	3a	Phi
162	HZM16NB2	Z-diode	15.85..16.51V, 200mW	SC-59A	16dc	-	3a	Ren
162	PZM16NB2	Z-diode	16V±2.5%, 300mW	SOT-346	16dc	-	3a	Phi
163	HZM16NB3	Z-diode	16.35..17.09V, 200mW	SC-59A	16dc	-	3a	Ren
163	PZM16NB3	Z-diode	16V±2.5%, 300mW	SOT-346	16dc	-	3a	Phi
166	DTC144VUA	Si-npn-Digi	Sw, 50V, 100mA, 200mW, 250MHz, R1/R2=47k/10k	UMT3	16ta	-	3a	Rhm
16H	BZX84-C16-V	Z-diode	15.80..16.60V, Izt=5mA, Zzt=18Ω, 300mW	SOT-23	16dc	-	3f	Kec
16H	MAZ3160-H	Z-diode	15.3..17.1V, If=100mA, Zzt=40Ω, 200mW	SC-59	16dc	-	3a	Pan
16L	MAZ3160-L	Z-diode	15.3..17.1V, If=100mA, Zzt=40Ω, 200mW	SC-59	16dc	-	3a	Pan
16M	MAZ3160-M	Z-diode	15.3..17.1V, If=100mA, Zzt=40Ω, 200mW	SC-59	16dc	-	3a	Pan
16N	STM1061N16W	Vdet-IC	1.6V±2%, -Reset ODO	SOT-323	16vda	VD6	3d	Ste
16N	STM1061N16WX	Vdet-IC	1.6V±2%, -Reset ODO	SOT-23	16vda	VD6	3d	Ste
16s	BAS125-06	Si-diode	Dual, Schottky, 25V, 100mA, Vf<0.9V(35mA), Cd<1.1pF	SOT-23	16df	-	3c	Inf
16s	BAS125-06W	Si-diode	Dual, Schottky, 25V, 100mA, Vf<0.9V(35mA), Cd<1.1pF	SOT-323	16df	-	3c	Inf
16T	TK71516AS	LVR-IC	LDO, 1.6V±1.5%, 155mA	SOT-23	16cj	VR1	3d	Tok
16V	CHPZ16VPT	Z-diode	Dual, 15.2..16.8V, Izt=5mA, Zzt=40Ω, 350mW	SOT-23	16df	-	3a	Chm
16V	PZM16NB	Z-diode	16V±2.5%, 300mW	SOT-346	16dc	-	3a	Phi
16W	CMSZDA47V	Z-diode	Dual, 44.0.50.0V, Zzt=170Ω, 3.5mA, 275mW	SOT-323	16df	-	3a	Cen
16X	02CZ16-X	Z-diode	15.3..16.1V, 200mW	SC-59	16dc	-	3a	Tos
16X	TZT16XW	Z-diode	15.30..16.10V, Izt=5mA, Zzt=18Ω, 200mW	SOT-323	16dc	-	3a	Ttr
16X	Z02W16VX	Z-diode	15.30..16.10V, Izt=5mA, Zzt=18Ω, 200mW	SOT-23	16dc	-	3f	Kec
16Y	02CZ16-Y	Z-diode	15.8..16.6V, 200mW	SC-59	16dc	-	3a	Tos
16Y	TZT16YW	Z-diode	15.80..16.60V, Izt=5mA, Zzt=18Ω, 200mW	SOT-323	16dc	-	3a	Ttr
16Y	Z02W16VY	Z-diode	15.80..16.60V, Izt=5mA, Zzt=18Ω, 200mW	SOT-23	16dc	-	3f	Kec
16Z	02CZ16-Z	Z-diode	16.3..17.1V, 200mW	SC-59	16dc	-	3a	Tos
16Z	CZ1W16	Z-diode	16V±5%, 600mW	SOT-23	16dc	-	3a	Cdi
16Z	TZT16ZW	Z-diode	16.30..17.10V, Izt=5mA, Zzt=18Ω, 200mW	SOT-323	16dc	-	3a	Ttr
16Z	Z02W16VZ	Z-diode	16.30..17.10V, Izt=5mA, Zzt=18Ω, 200mW	SOT-23	16dc	-	3f	Kec
17	ELM9817BB	LVR-IC	1.7V±2%, 200mA	SOT-23	16cg	VR1	3d	Elm
179	FMMT5179	Si-npn	GP, 20V, 50mA, 330mW, B=25..250, >1100MHz	SOT-23	16ta	-	3a	Zx
17C	BZX84-B17	Z-diode	16.66..17.34V, Zzt=40Ω, Izt=5mA, 410mW	SOT-23	16dc	-	3a	Pjt
17C	TZTC17WS	Z-diode	16.15..17.85V, Izt=5mA, Zzt=40Ω, 200mW	SOT-323	16dc	-	3a	Ttr
17N	STM1061N17W	Vdet-IC	1.7V±2%, -Reset ODO	SOT-323	16vda	VD6	3d	Ste
17N	STM1061N17WX	Vdet-IC	1.7V±2%, -Reset ODO	SOT-23	16vda	VD6	3d	Ste
17T	TK71517AS	LVR-IC	LDO, 1.7V±1.5%, 155mA	SOT-23	16cj	VR1	3d	Tok
17V	CHPZ17VPT	Z-diode	Dual, 16.1..17.9V, Izt=5mA, Zzt=40Ω, 350mW	SOT-23	16df	-	3a	Chm
18	ELM9818BB	LVR-IC	1.8V±2%, 200mA	SOT-23	16cg	VR1	3d	Elm
18	PDTC143ZK	Si-npn-Digi	Sw, 50V, 100mA, 250mW, R1/R2=4.7k/47k	SC-59	16ta	-	3a	Phi
18	TZT18W	Z-diode	16.80..19.10V, Izt=5mA, Zzt=20Ω, 200mW	SOT-323	16dc	-	3a	Ttr
18	Z02W18V	Z-diode	16.80..19.10V, Izt=5mA, Zzt=20Ω, 200mW	SOT-23	16dc	-	3f	Kec
180	HZM18NB	Z-diode	16.94..19.03V, 200mW	SC-59A	16dc	-	3a	Ren
181	HZM18NB1	Z-diode	16.94..17.7V, 200mW	SC-59A	16dc	-	3a	Ren
181	PZM18NB1	Z-diode	18V±2.5%, 300mW	SOT-346	16dc	-	3a	Phi
182	HZM18NB2	Z-diode	17.56..18.35V, 200mW	SC-59A	16dc	-	3a	Ren
182	PZM18NB2	Z-diode	18V±2.5%, 300mW	SOT-346	16dc	-	3a	Phi
18-2	UTC8118-2	Vdet-IC	1.8V, -Reset OCO	SOT-23	16vdy	VD6	3a	Utc
183	HZM18NB3	Z-diode	18.21..19.03V, 200mW	SC-59A	16dc	-	3a	Ren
183	PZM18NB3	Z-diode	18V±2.5%, 300mW	SOT-346	16dc	-	3a	Phi
18-3	UTC8118-3	Vdet-IC	1.8V, -Reset OCO	SOT-23	16vdb	VD6	3a	Utc
18-5	UTC8118-5	Vdet-IC	1.8V, -Reset OCO	SOT-23	16vdc	VD6	3a	Utc
18A	AAT60018A-S2	Vdet-IC	1.8V±2%, -Reset ODO	SOT-23	16vdy	VD6	3d	Aat
18A	CMPZ5221B	Z-diode	2.4V±2.5%, Izt=20mA, Zzt=30Ω, 350mW	SOT-23	16dc	-	3a	Cen
18A	FDZS2.4LT	Z-diode	2.28..2.52V, Izt=20mA, Zzt=30Ω, 225mW	SOT-23	16dc	-	3a	Fis
18A	HMBZ5221B	Z-diode	2.4V±5%, Izt=20mA, Zzt=30Ω, 225mW	SOT-23	16dc	-	3a	Hsn



SMD code	Type	Function	Short description	Case	Pinout	Sch.	St.	Mnf.
18A	MMBZ18VA	TVS	Dual, Vrwm=14.5V, Vbr=17.10..18.90V, 1.6A, 40W(1ms)	SOT-23	16dg	-	3a	Wtr
18A	MMBZ5221B	Z-diode	2.28..2.52V, Izt=20mA, Zzt=30Ω, 225mW	SOT-23	16dc	-	3a,3c	F,Mot
18A	ZD5221BN3	Z-diode	2.4V±5%, 20mA, Zzt=30Ω, 300mW	SOT-23	16dc	-	3a	Cys
18A-	MMCZ5221BPT	Z-diode	2.280..2.520V, Izt=5mA, Zzt=100Ω, 225mW	SOT-346	16dc	-	3a	Chm
18B	AAT60018B-S2	Vdet-IC	1.8V±2%, -Reset PPO	SOT-23	16vdb	VD7	3d	Aat
18B	CMPZ5222B	Z-diode	2.5V±2.5%, Izt=20mA, Zzt=30Ω, 350mW	SOT-23	16dc	-	3a	Cen
18B	FDZS2.5LT	Z-diode	2.37..2.63V, Izt=20mA, Zzt=30Ω, 225mW	SOT-23	16dc	-	3a	Fis
18B	HMBZ5222B	Z-diode	2.5V±5%, Izt=20mA, Zzt=30Ω, 225mW	SOT-23	16dc	-	3a	Hsn
18B	MMBZ5222B	Z-diode	2.38..2.63V, Zzt=30Ω, Izt=20mA, 225mW	SOT-23	16dc	-	3a,3c	F,Mot
18B	ZD5222BN3	Z-diode	2.5V±5%, 20mA, Zzt=30Ω, 300mW	SOT-23	16dc	-	3a	Cys
18B-	MMCZ5222BPT	Z-diode	2.375..2.625V, Izt=5mA, Zzt=100Ω, 225mW	SOT-346	16dc	-	3a	Chm
18C	AAT60018C-S2	Vdet-IC	1.8V±1%, -Reset ODO	SOT-23	16vdb	VD6	3d	Aat
18C	CMPZ5223B	Z-diode	2.7V±2.5%, Izt=20mA, Zzt=30Ω, 350mW	SOT-23	16dc	-	3a	Cen
18C	FDZS2.7LT	Z-diode	2.56..2.84V, Izt=20mA, Zzt=30Ω, 225mW	SOT-23	16dc	-	3a	Fis
18C	HMBZ5223B	Z-diode	2.7V±5%, Izt=20mA, Zzt=30Ω, 225mW	SOT-23	16dc	-	3a	Hsn
18C	MMBZ5223B	Z-diode	2.57..2.84V, Zzt=30Ω, Izt=20mA, 225mW	SOT-23	16dc	-	3a,3c	F,Mot
18C	ZD5223BN3	Z-diode	2.7V±5%, 20mA, Zzt=30Ω, 300mW	SOT-23	16dc	-	3a	Cys
18C-	MMCZ5223BPT	Z-diode	2.565..2.835V, Izt=5mA, Zzt=100Ω, 225mW	SOT-346	16dc	-	3a	Chm
18D	AAT60018D-S2	Vdet-IC	1.8V±1%, -Reset PPO	SOT-23	16vdb	VD7	3d	Aat
18D	CMPZ5224B	Z-diode	2.8V±2.5%, Izt=20mA, Zzt=30Ω, 350mW	SOT-23	16dc	-	3a	Cen
18D	FDZS2.8LT	Z-diode	2.66..2.94V, Izt=20mA, Zzt=30Ω, 225mW	SOT-23	16dc	-	3a	Fis
18D	HMBZ5224B	Z-diode	2.8V±5%, Izt=20mA, Zzt=30Ω, 225mW	SOT-23	16dc	-	3a	Hsn
18D	MMBZ5224B	Z-diode	2.8V±5%, Zzt=30Ω, 225mW	SOT-23	16dc	-	3a,3c	F,Mot
18D-	MMCZ5224BPT	Z-diode	2.660..2.940V, Izt=5mA, Zzt=100Ω, 225mW	SOT-346	16dc	-	3a	Chm
18E	CMPZ5225B	Z-diode	3.0V±2.5%, Izt=20mA, Zzt=29Ω, 350mW	SOT-23	16dc	-	3a	Cen
18E	FDZS3.0LT	Z-diode	2.85..3.15V, Izt=20mA, Zzt=29Ω, 225mW	SOT-23	16dc	-	3a	Fis
18E	HMBZ5225B	Z-diode	3V±5%, Izt=20mA, Zzt=29Ω, 225mW	SOT-23	16dc	-	3a	Hsn
18E	MMBZ5225B	Z-diode	3V±5%, Zzt=29Ω, 225mW	SOT-23	16dc	-	3a,3c	F,Mot
18E	ZD5225BN3	Z-diode	3.0V±5%, 20mA, Zzt=29Ω, 300mW	SOT-23	16dc	-	3a	Cys
18E-	MMCZ5225BPT	Z-diode	2.850..3.150V, Izt=5mA, Zzt=95Ω, 225mW	SOT-346	16dc	-	3a	Chm
18F	CMBZ5260B	Z-diode	43V±5%, Izt=3.0mA, Zzt=93Ω, 300mW	SOT-23	16dc	-	3a	Mei
18F	MMBZ5260B	Z-diode	43V±5%, Zzt=93Ω, 225mW	SOT-23	16dc	-	3g	Vs
18H	BZX84-C18-V	Z-diode	17.46..18.43V, Izt=5mA, Zzt=20Ω, 300mW	SOT-23	16dc	-	3f	Kec
18H	MAZ3180-H	Z-diode	16.9..19.1V, If=100mA, Zzt=45Ω, 200mW	SC-59	16dc	-	3a	Pan
18L	MAZ3180-L	Z-diode	16.9..19.1V, If=100mA, Zzt=45Ω, 200mW	SC-59	16dc	-	3a	Pan
18M	MAZ3180-M	Z-diode	16.9..19.1V, If=100mA, Zzt=45Ω, 200mW	SC-59	16dc	-	3a	Pan
18T	TK71518AS	LVR-IC	LDO, 1.8V±1.5%, 155mA	SOT-23	16cj	VR1	3d	Tok
18V	CHPZ18VPT	Z-diode	Dual, 17.1..18.9V, Izt=5mA, Zzt=45Ω, 350mW	SOT-23	16df	-	3a	Chm
18V	PZM18NB	Z-diode	18V±2.5%, 300mW	SOT-346	16dc	-	3a	Phi
18X	O2C18-X	Z-diode	16.8..17.76V, 200mW	SC-59	16dc	-	3a	Tos
18X	TZT18XW	Z-diode	16.80..17.76V, Izt=5mA, Zzt=20Ω, 200mW	SOT-323	16dc	-	3a	Ttr
18X	Z02W18VX	Z-diode	16.80..17.76V, Izt=5mA, Zzt=20Ω, 200mW	SOT-23	16dc	-	3f	Kec
18Y	O2C18-Y	Z-diode	17.46..18.43V, 200mW	SC-59	16dc	-	3a	Tos
18Y	TZT18YW	Z-diode	17.46..18.43V, Izt=5mA, Zzt=20Ω, 200mW	SOT-323	16dc	-	3a	Ttr
18Y	Z02W18VY	Z-diode	17.46..18.43V, Izt=5mA, Zzt=20Ω, 200mW	SOT-23	16dc	-	3f	Kec
18Z	O2C18-Z	Z-diode	18.13..19.1V, 200mW	SC-59	16dc	-	3a	Tos
18Z	CZ1W18	Z-diode	18V±5%, 600mW	SOT-23	16dc	-	3a	Cdi
18Z	TZT18ZW	Z-diode	18.13..19.10V, Izt=5mA, Zzt=20Ω, 200mW	SOT-323	16dc	-	3a	Ttr
18Z	Z02W18VZ	Z-diode	18.13..19.10V, Izt=5mA, Zzt=20Ω, 200mW	SOT-23	16dc	-	3f	Kec
19	DTA115EE	Si-pnp-Digi	Sw, 50V, 100mA, 150mW, 200MHz, R1/R2=100k/100k	SOT-416	16ta	-	3a	Rhm
19	DTA115EKA	Si-pnp-Digi	Sw, 50V, 100mA, 200mW, 200MHz, 100k/100k	SOT-346	16ta	-	3a	Rhm
19	DTA115EM	Si-pnp-Digi	Sw, 50V, 100mA, 150mW, 200MHz, R1/R2=100k/100k	VMT3	18ta	-	3a	Rhm
19	DTA115EUA	Si-pnp-Digi	Sw, 50V, 100mA, 200mW, 200MHz, 100k/100k	UMT3	16ta	-	3a	Rhm
19	ELM7619HAB	Vdet-IC	1.9V±2%, +Reset PPO, 250ms	SOT-23	16vdc	VD7	3d	Elm
19	ELM9819BB	LVR-IC	1.9V±2%, 200mA	SOT-23	16cg	VR1	3d	Elm
19	PDTA143ZK	Si-pnp-Digi	Sw, 50V, 100mA, 250mW, R1/R2=4.7k/47k	SOT-346	16ta	-	3a	Phi
19-2	UTC8119-2	Vdet-IC	1.9V, -Reset OCO	SOT-23	16vdy	VD6	3a	Utc
19-3	UTC8119-3	Vdet-IC	1.9V, -Reset OCO	SOT-23	16vdb	VD6	3a	Utc
19-5	UTC8119-5	Vdet-IC	1.9V, -Reset OCO	SOT-23	16vdc	VD6	3a	Utc
19A	AAT60019A-S2	Vdet-IC	1.9V±2%, -Reset ODO	SOT-23	16vdb	VD6	3d	Aat
19B	AAT60019B-S2	Vdet-IC	1.9V±2%, -Reset PPO	SOT-23	16vdb	VD7	3d	Aat
19C	AAT60019C-S2	Vdet-IC	1.9V±1%, -Reset ODO	SOT-23	16vdb	VD6	3d	Aat
19D	AAT60019D-S2	Vdet-IC	1.9V±1%, -Reset PPO	SOT-23	16vdb	VD7	3d	Aat
19N	STM1061N19W	Vdet-IC	1.9V±2%, -Reset ODO	SOT-323	16vda	VD6	3d	Ste
19N	STM1061N19WX	Vdet-IC	1.9V±2%, -Reset ODO	SOT-23	16vda	VD6	3d	Ste
19T	TK71519AS	LVR-IC	LDO, 1.9V±1.5%, 155mA	SOT-23	16cj	VR1	3d	Tok
19V	CHPZ19VPT	Z-diode	Dual, 18.0..20.0V, Izt=5mA, Zzt=45Ω, 350mW	SOT-23	16df	-	3a	Chm
1A	BC846A	Si-npn	GP, 80V, 100mA, 250mW, B=110..220, >100MHz	SOT-23	16ta	-	3a	PhH
1A	BC846AT	Si-npn	GP, 80V, 100mA, 150mW, B=110..220, >100MHz	SOT-416	16ta	-	3a	Phi
1A	BC846AW	Si-npn	GP, 80V, 100mA, 200mW, B=110..220, >100MHz	SOT-323	16ta	-	3a	PhH



SMD code	Type	Function	Short description	Case	Pinout	Sch.	St.	Mnf.
1A	CMBT3904	Si-npn	GP, 60V, 200mA, 250mW, B=100..300, >300MHz	SOT-23	16ta	-	3a	Cdi
1A	FMMT3904	Si-npn	GP, 60V, 0.1A, 200mW, B= 100..300, >300MHz	SOT-23	16ta	-	3a	Zx
1A	IRLML2402	n-MOSFET-e	V-MOS, LogL, 20V, 1.2A, <0.25Q	SOT-23	16fh	-	3a	Inr
1A	KST3904	Si-npn	GP, 60V, 0.1A, 200mW, B= 100..300, >300MHz	SOT-23	16ta	-	3a	Sam
1A	MMBT3904	Si-npn	GP, 60V, 100mA, 200mW, B= 100..300, >300MHz	SOT-23	16ta	-	3a	Nsc
1A	SMBT3904	Si-npn	GP, 60V, 0.1A, 200mW, B= 100..300, >300MHz	SOT-23	16ta	-	3c	Inf
1A	TMP3904	Si-npn	GP, 60V, 100mA, 200mW, B=100..300, >300MHz	SOT-23	16ta	-	3a	All
1A	YTS3904	Si-npn	GP, 60V, 0.1A, 200mW, B= 100..300, >300MHz	SOT-23	16ta	-	3a	Tos
-1A	PMST3904	Si-npn	GP, 60V, 200mA, 200mW, B=60..300, >300MHz	SOT-323	16ta	-	3a	PHH
1A5	TC591002ECB	LVR-IC	LDO, -1.0V±2%, 200mA	SOT-23	16cj	VR2	3d	Mcc
1A8	CMSZ5250B	Z-diode	20V±5%, 6.2mA, Zzt=25Q, 275mW	SOT-323	16dc	-	3a	Cen
1AC	CMST3904	Si-npn	GP, 60V, 200mA, 275mW, B=100..300, >300MHz	SOT-323	16ta	-	3a	Cen
1AC2	81C10-P-AE3-2	Vdet-IC	1.0V±2%, -Reset PPO, 50ms	SOT-23	16vdy	VD7	3a	Utc
1AC2G	81C10G-P-AE3-2	Vdet-IC	1.0V±2%, -Reset PPO, halogen free	SOT-23	16vdy	VD7	3a	Utc
1AC2L	81C10L-P-AE3-2	Vdet-IC	1.0V±2%, -Reset PPO, lead free	SOT-23	16vdy	VD7	3a	Utc
1AC3	81C10-P-AE3-3	Vdet-IC	1.0V±2%, -Reset PPO, 50ms	SOT-23	16vdb	VD7	3a	Utc
1AC3G	81C10G-P-AE3-3	Vdet-IC	1.0V±2%, -Reset PPO, halogen free	SOT-23	16vdb	VD7	3a	Utc
1AC3L	81C10L-P-AE3-3	Vdet-IC	1.0V±2%, -Reset PPO, lead free	SOT-23	16vdb	VD7	3a	Utc
1AC5	81C10-P-AE3-5	Vdet-IC	1.0V±2%, -Reset PPO, 50ms	SOT-23	16vdc	VD7	3a	Utc
1AC5G	81C10G-P-AE3-5	Vdet-IC	1.0V±2%, -Reset PPO, halogen free	SOT-23	16vdc	VD7	3a	Utc
1AC5L	81C10L-P-AE3-5	Vdet-IC	1.0V±2%, -Reset PPO, lead free	SOT-23	16vdc	VD7	3a	Utc
1AG	2SC3339-GR	Si-npn	GP, 60V, 150mA, 150mW, B=200..400, >80MHz	SOT-23	16ta	-	3a	Tos
1AL	2SC3339-BL	Si-npn	GP, 60V, 150mA, 150mW, B=350..700, >80MHz	SOT-23	16ta	-	3a	Tos
1AM	MMBT3904	Si-npn	GP, 60V, 100mA, 200mW, B= 100..300, >300MHz	SOT-23	16ta	-	3a	Mot
1AN2	81N10-P-AE3-2	Vdet-IC	1.0V±2%, -Reset ODO	SOT-23	16vdy	VD6	3a	Utc
1AN2G	81N10G-P-AE3-2	Vdet-IC	1.0V±2%, -Reset ODO, halogen free	SOT-23	16vdy	VD6	3a	Utc
1AN2L	81N10L-P-AE3-2	Vdet-IC	1.0V±2%, -Reset ODO, lead free	SOT-23	16vdy	VD6	3a	Utc
1AN3	81N10-P-AE3-3	Vdet-IC	1.0V±2%, -Reset ODO	SOT-23	16vdb	VD6	3a	Utc
1AN3G	81N10G-P-AE3-3	Vdet-IC	1.0V±2%, -Reset ODO, halogen free	SOT-23	16vdb	VD6	3a	Utc
1AN3L	81N10L-P-AE3-3	Vdet-IC	1.0V±2%, -Reset ODO, lead free	SOT-23	16vdb	VD6	3a	Utc
1AN5	81N10-P-AE3-5	Vdet-IC	1.0V±2%, -Reset ODO	SOT-23	16vdc	VD6	3a	Utc
1AN5G	81N10G-P-AE3-5	Vdet-IC	1.0V±2%, -Reset ODO, halogen free	SOT-23	16vdc	VD6	3a	Utc
1AN5L	81N10L-P-AE3-5	Vdet-IC	1.0V±2%, -Reset ODO, lead free	SOT-23	16vdc	VD6	3a	Utc
1AO	2SC3339-O	Si-npn	GP, 60V, 150mA, 150mW, B=70..140, >80MHz	SOT-23	16ta	-	3a	Tos
1Ap	BC846A	Si-npn	GP, 80V, 100mA, 250mW, B=110..220, >100MHz	SOT-23	16ta	-	3a	PHH
1Ap	BC846AW	Si-npn	GP, 80V, 100mA, 200mW, B=110..220, >100MHz	SOT-323	16ta	-	3a	PHH
1AQ	2SB1584-Q	Si-pnp	Lo-sat, 25V, 500mA, 150MHz, B=85..170	SOT-416	16ta	-	3a	Pan
1AQ	2SB779-Q	Si-pnp	AF-Drv, 25V, 500mA, 200mW, B=90..155, 150MHz	SC-59	16ta	-	3a	Pan
1AR	2SB1584-R	Si-pnp	Lo-sat, 25V, 500mA, 150MHz, B=120..240	SOT-416	16ta	-	3a	Pan
1AR	2SB779-R	Si-pnp	AF-Drv, 25V, 500mA, 200mW, B=130..220, 150MHz	SC-59	16ta	-	3a	Pan
1AS	2SB1584-S	Si-pnp	Lo-sat, 25V, 500mA, 150MHz, B=170..340	SOT-416	16ta	-	3a	Pan
1As	BC846A	Si-npn	GP, 80V, 100mA, 330mW, B=110..220, 250MHz	SOT-23	16ta	-	3a	Sie
1As	BC846AT	Si-npn	GP, 80V, 100mA, 250mW, B=110..220, >100MHz	SOT-416	16ta	-	3a	Inf
1As	BC846AW	Si-npn	GP, 80V, 100mA, 250mW, B=110..220, 250MHz	SOT-323	16ta	-	3c	Inf
1At	BC846A	Si-npn	GP, 80V, 100mA, 250mW, B=110..220, >100MHz	SOT-23	16ta	-	3a	PHM
1At	BC846AW	Si-npn	GP, 80V, 100mA, 200mW, B=110..220, >100MHz	SOT-323	16ta	-	3a	PHM
1AW	BC846A	Si-npn	GP, 80V, 100mA, 250mW, B=110..220, >100MHz	SOT-23	16ta	-	3a	PhC
1AW	BC846AW	Si-npn	GP, 80V, 100mA, 200mW, B=110..220, >100MHz	SOT-323	16ta	-	3a	PhC
1AY	2SC3339-Y	Si-npn	GP, 60V, 150mA, 150mW, B=120..240, >80MHz	SOT-23	16ta	-	3a	Tos
1B	2N2222	Si-npn	GP, 60V, 600mA, 330mW, B=100..300, >250MHz	SOT-23	16ta	-	3a	Nsc
1B	BC846B	Si-npn	GP, 80V, 100mA, 250mW, B=200..450, >100MHz	SOT-23	16ta	-	3a	PHH
1B	BC846B9	Si-npn	GP, 80V, 100mA, 250mW, B=200..450, >100MHz	SOT-23	16ta	-	3a	Di
1B	BC846BT	Si-npn	GP, 80V, 100mA, 150mW, B=200..450, >100MHz	SOT-416	16ta	-	3a	Phi
1B	BC846BW	Si-npn	GP, 80V, 100mA, 200mW, B=200..450, >100MHz	SOT-323	16ta	-	3a	PHH
1B	IRLML2803	n-MOSFET-e	V-MOS, LogL, 30V, 1.2A, <0.25Q	SOT-23	16fh	-	3a	Inr
1B	KST2222	Si-npn	GP, 60V, 600mA, 350mW, B=75, >250MHz	SOT-23	16ta	-	3a	Sam
1B	MMBT2222	Si-npn	GP, 60V, 600mA, 330mW, B=120..360, >300MHz	SOT-23	16ta	-	3a	Mot
1B	R3131N21EC	Vdet-IC	2.1V, +Reset ODO, 240ms	SOT-23	16vdc	VD6	3b	Ric
1B	SMBT2222	Si-npn	GP, 60V, 600mA, 330mW, B=120..360, >300MHz	SOT-23	16ta	-	3c	Inf
1B	TMP2222	Si-npn	GP, 60V, 0.8A, 200mW, B=100..300, >200MHz	SOT-23	16ta	-	3a	All
1B	UNRF1A3	Si-pnp-Digi	Sw, 50V, 80mA, 100mW, 80MHz, R1/R2=47k/47k	ML3	22ta	-	2b	Pan
1B	YTS2222	Si-npn	GP, 70V, 0.8A, 200mW, B=100..300, >200MHz	SOT-23	16ta	-	3a	Tos
-1B	PMST2222	Si-npn	Sw, 60V, 600mA, 200mW, B=120..300, >300MHz	SOT-323	16ta	-	3a	PHH
1B0	TC55RP112ECB	LVR-IC	LDO, 1.1V±2%, 250mA	SOT-23	16cq	VR1	3d	Mcc
1B5	TC591102ECB	LVR-IC	LDO, -1.1V±2%, 200mA	SOT-23	16cj	VR2	3d	Mcc
1B8	CMSZ5251B	Z-diode	22V±5%, 5.6mA, Zzt=29Q, 275mW	SOT-323	16dc	-	3a	Cen
1BC2	81C11-P-AE3-2	Vdet-IC	1.1V±2%, -Reset PPO	SOT-23	16vdy	VD7	3a	Utc
1BC2G	81C11G-P-AE3-2	Vdet-IC	1.1V±2%, -Reset PPO, halogen free	SOT-23	16vdy	VD7	3a	Utc
1BC2L	81C11L-P-AE3-2	Vdet-IC	1.1V±2%, -Reset PPO, lead free	SOT-23	16vdy	VD7	3a	Utc
1BC3	81C11-P-AE3-3	Vdet-IC	1.1V±2%, -Reset PPO	SOT-23	16vdb	VD7	3a	Utc



SMD code	Type	Function	Short description	Case	Pinout	Sch. St.	Mnf.
1BC3G	81C11G-P-AE3-3	Vdet-IC	1.1V±2%, -Reset PPO, halogen free	SOT-23	16vdb	VD7	3a Utc
1BC3L	81C11L-P-AE3-3	Vdet-IC	1.1V±2%, -Reset PPO, lead free	SOT-23	16vdb	VD7	3a Utc
1BC5	81C11-P-AE3-5	Vdet-IC	1.1V±2%, -Reset PPO	SOT-23	16vdc	VD7	3a Utc
1BC5G	81C11G-P-AE3-5	Vdet-IC	1.1V±2%, -Reset PPO, halogen free	SOT-23	16vdc	VD7	3a Utc
1BC5L	81C11L-P-AE3-5	Vdet-IC	1.1V±2%, -Reset PPO, lead free	SOT-23	16vdc	VD7	3a Utc
1BG	25C3340-GR	Si-npn	GP, 120V, 100mA, 150mW, B=200..400, 100MHz	SOT-23	16ta	-	3a Tos
1BL	25C3340-BL	Si-npn	GP, 120V, 100mA, 150mW, B=350..700, 100MHz	SOT-23	16ta	-	3a Tos
1BN2	81N11-P-AE3-2	Vdet-IC	1.1V±2%, -Reset ODO	SOT-23	16vdy	VD6	3a Utc
1BN2G	81N11G-P-AE3-2	Vdet-IC	1.1V±2%, -Reset ODO, halogen free	SOT-23	16vdy	VD6	3a Utc
1BN2L	81N11L-P-AE3-2	Vdet-IC	1.1V±2%, -Reset ODO, lead free	SOT-23	16vdy	VD6	3a Utc
1BN3	81N11-P-AE3-3	Vdet-IC	1.1V±2%, -Reset ODO	SOT-23	16vdb	VD6	3a Utc
1BN3G	81N11G-P-AE3-3	Vdet-IC	1.1V±2%, -Reset ODO, halogen free	SOT-23	16vdb	VD6	3a Utc
1BN3L	81N11L-P-AE3-3	Vdet-IC	1.1V±2%, -Reset ODO, lead free	SOT-23	16vdb	VD6	3a Utc
1BN5	81N11-P-AE3-5	Vdet-IC	1.1V±2%, -Reset ODO	SOT-23	16vdc	VD6	3a Utc
1BN5G	81N11G-P-AE3-5	Vdet-IC	1.1V±2%, -Reset ODO, halogen free	SOT-23	16vdc	VD6	3a Utc
1BN5L	81N11L-P-AE3-5	Vdet-IC	1.1V±2%, -Reset ODO, lead free	SOT-23	16vdc	VD6	3a Utc
1Bp	BC846B	Si-npn	GP, 80V, 100mA, 250mW, B=200..450, >100MHz	SOT-23	16ta	-	3a PHH
1Bp	BC846BW	Si-npn	GP, 80V, 100mA, 200mW, B=200..450, >100MHz	SOT-323	16ta	-	3a PHH
1Bs	BC846B	Si-npn	GP, 80V, 100mA, 330mW, B=200..450, 250MHz	SOT-23	16ta	-	3a Sie
1Bs	BC846BT	Si-npn	GP, 80V, 100mA, 330mW, B=200..450, 250MHz	SOT-416	16ta	-	3a Inf
1Bs	BC846BW	Si-npn	GP, 80V, 100mA, 250mW, B=200..450, 250MHz	SOT-323	16ta	-	3c Inf
1Bt	BC846B	Si-npn	GP, 80V, 100mA, 250mW, B=200..450, >100MHz	SOT-23	16ta	-	3a PHM
1Bt	BC846BW	Si-npn	GP, 80V, 100mA, 200mW, B=200..450, >100MHz	SOT-323	16ta	-	3a PhM
1BW	BC846B	Si-npn	GP, 80V, 100mA, 250mW, B=200..450, >100MHz	SOT-23	16ta	-	3a PhC
1BW	BC846BW	Si-npn	GP, 80V, 100mA, 200mW, B=200..450, >100MHz	SOT-323	16ta	-	3a PhC
1BZ	FMMT2222	Si-npn	GP, 60V, 600mA, 330mW, B=100..300, >250MHz	SOT-23	16ta	-	3a Zx
1C	BC846C	Si-npn	GP, 80V, 100mA, 300mW, B=110..220, >100MHz	SOT-23	16ta	-	3a Mot
1C	FMMT2A0	Si-npn	GP, 40V, 100mA, 330mW, B=40..400, >125MHz	SOT-23	16ta	-	3a Zx
1C	IRLML6302	p-MOSFET-e	V-MOS, LogL, 20V, 0.78A, <0.6Ω	SOT-23	16fh	-	3a Inr
1C	KST20	Si-npn	GP, 40V, 100mA, 350mW, B=40..400, >125MHz	SOT-23	16ta	-	3a Sam
1C	MMBTA20	Si-npn	GP, 40V, 100mA, 225mW, B40..400, >125MHz	SOT-23	16ta	-	3a Mot
1C	R3131N31EC	Vdet-IC	3.1V, +Reset ODO, 240ms	SOT-23	16vdc	VD6	3b Ric
1C	UNRF2AL	Si-npn-Digi	Sw, 50V, 80mA, 100mW, 150MHz, R1/R2=4k7/4k7	ML3	22ta	-	2b Pan
1C0	TC55RP122ECB	LVR-IC	LDO, 1.2V±2%, 250mA	SOT-23	16cq	VR1	3d Mcc
1C5	TC591202ECB	LVR-IC	LDO, -1.2V±2%, 200mA	SOT-23	16cj	VR2	3d Mcc
1C8	CMSZ5252B	Z-diode	24V±5%, 5.2mA, Zt=33Ω, 275mW	SOT-323	16dc	-	3a Cen
1CC2	81C12-P-AE3-2	Vdet-IC	1.2V±2%, -Reset PPO	SOT-23	16vdy	VD7	3a Utc
1CC2G	81C12G-P-AE3-2	Vdet-IC	1.2V±2%, -Reset PPO, halogen free	SOT-23	16vdy	VD7	3a Utc
1CC2L	81C12L-P-AE3-2	Vdet-IC	1.2V±2%, -Reset PPO, lead free	SOT-23	16vdy	VD7	3a Utc
1CC3	81C12-P-AE3-3	Vdet-IC	1.2V±2%, -Reset PPO	SOT-23	16vdb	VD7	3a Utc
1CC3G	81C12G-P-AE3-3	Vdet-IC	1.2V±2%, -Reset PPO, halogen free	SOT-23	16vdb	VD7	3a Utc
1CC3L	81C12L-P-AE3-3	Vdet-IC	1.2V±2%, -Reset PPO, lead free	SOT-23	16vdb	VD7	3a Utc
1CC5	81C12-P-AE3-5	Vdet-IC	1.2V±2%, -Reset PPO	SOT-23	16vdc	VD7	3a Utc
1CC5G	81C12G-P-AE3-5	Vdet-IC	1.2V±2%, -Reset PPO, halogen free	SOT-23	16vdc	VD7	3a Utc
1CC5L	81C12L-P-AE3-5	Vdet-IC	1.2V±2%, -Reset PPO, lead free	SOT-23	16vdc	VD7	3a Utc
1CL	25C4082-L	Si-npn	VHF/UHF, 30V, 50mA, 200mW, B=27..56, >1.5GHz	SOT-323	16ta	-	3a Rhm
1CM	25C4082-M	Si-npn	VHF/UHF, 30V, 50mA, 200mW, B=39..82, >1.5GHz	SOT-323	16ta	-	3a Rhm
1CN	25C4082-N	Si-npn	VHF/UHF, 30V, 50mA, 200mW, B=56..120, >1.5GHz	SOT-323	16ta	-	3a Rhm
1CN2	81N12-P-AE3-2	Vdet-IC	1.2V±2%, -Reset ODO	SOT-23	16vdy	VD6	3a Utc
1CN2G	81N12G-P-AE3-2	Vdet-IC	1.2V±2%, -Reset ODO, halogen free	SOT-23	16vdy	VD6	3a Utc
1CN2L	81N12L-P-AE3-2	Vdet-IC	1.2V±2%, -Reset ODO, lead free	SOT-23	16vdy	VD6	3a Utc
1CN3	81N12-P-AE3-3	Vdet-IC	1.2V±2%, -Reset ODO	SOT-23	16vdb	VD6	3a Utc
1CN3G	81N12G-P-AE3-3	Vdet-IC	1.2V±2%, -Reset ODO, halogen free	SOT-23	16vdb	VD6	3a Utc
1CN3L	81N12L-P-AE3-3	Vdet-IC	1.2V±2%, -Reset ODO, lead free	SOT-23	16vdb	VD6	3a Utc
1CN5	81N12-P-AE3-5	Vdet-IC	1.2V±2%, -Reset ODO	SOT-23	16vdc	VD6	3a Utc
1CN5G	81N12G-P-AE3-5	Vdet-IC	1.2V±2%, -Reset ODO, halogen free	SOT-23	16vdc	VD6	3a Utc
1CN5L	81N12L-P-AE3-5	Vdet-IC	1.2V±2%, -Reset ODO, lead free	SOT-23	16vdc	VD6	3a Utc
1CO	25C3341-O	Si-npn	AF, 35V, 500mA, 200mW, B=70..140, 300MHz	SOT-23	16ta	-	3a Tos
1CP	25C4082-P	Si-npn	VHF/UHF, 30V, 50mA, 200mW, B=82..180, >1.5GHz	SOT-323	16ta	-	3a Rhm
1Cp	BAP50-05	PIN-diode	Dual, RF, 50V, 50mA, 500mW, 0.3pF, 3CQ(10mA/100MHz)	SOT-23	16dg	-	3a PHH
1CQ	25C4082-Q	Si-npn	VHF/UHF, 30V, 50mA, 200mW, B=120..270, >1.5GHz	SOT-323	16ta	-	3a Rhm
1Ct	BAP50-05	PIN-diode	Dual, RF, 50V, 50mA, 500mW, 0.3pF, 3CQ(10mA/100MHz)	SOT-23	16dg	-	3a PhM
1CW	BAP50-05	PIN-diode	Dual, RF, 50V, 50mA, 500mW, 0.3pF, 3CQ(10mA/100MHz)	SOT-23	16dg	-	3a PhC
1CY	25C3341-Y	Si-npn	AF, 35V, 500mA, 200mW, B=120..240, 300MHz	SOT-23	16ta	-	3a Tos
1D	BC846	Si-npn	GP, 80V, 100mA, 250mW, B=110..450, >100MHz	SOT-23	16ta	-	3a PhH
1D	BC846W	Si-npn	GP, 80V, 100mA, 200mW, B=110..450, >100MHz	SOT-323	16ta	-	3a PhH
1D	IRLML5103	p-MOSFET-e	V-MOS, LogL, 30V, 0.76A, <0.6Ω	SOT-23	16fh	-	3a Inr
1D	KST42	Si-npn	Vid, 300/300V, 500mA, 350mW, B=40, >50MHz	SOT-23	16ta	-	3a Sam
1D	MBTA42	Si-npn	Vid, 300/300V, 500mA, 250mW, B=40, 50MHz	SOT-23	16ta	-	3a Tos
1D	MMBTA42	Si-npn	Vid, 300V, 200mA, 350mW, B>25, >50MHz	SOT-23	16ta	-	3a Ons



SMD code	Type	Function	Short description	Case	Pinout	Sch. St.	Mnf.
1D	MMBTA42L	Si-npn	Vid, 300V, 200mA, 350mW, B>25, >50MHz	SOT-23	16ta	-	3a Bel
1D	R3131N41EC	Vdet-IC	4.1V, +Reset ODO, 240ms	SOT-23	16vdc	VD6	3b Ric
1D	SMBTA20	Si-npn	GP, 40V, 100mA, 330mW, B=40, >125MHz	SOT-23	16ta	-	3g Vs
1D	SMBTA42	Si-npn	Vid, 300V, 500mA, 1W, B>40, >50MHz	SOT-23	16ta	-	3c Inf
1D	TMPTA42	Si-npn	Vid, 300/300V, 500mA, 350mW, B>40, >50MHz	SOT-23	16ta	-	3a All
-1D	PMSTA42	Si-npn	Vid, 300/300V, 100mA, 200mW, B>25, >50MHz	SOT-323	16ta	-	3a PHH
1D0	TC55RP132ECB	LVR-IC	LDO, 1.3V±2%, 250mA	SOT-23	16cq	VR1	3d Mcc
1D5	TC591302ECB	LVR-IC	LDO, -1.3V±2%, 200mA	SOT-23	16cj	VR2	3d Mcc
1D8	CMSZ5253B	Z-diode	25V±5%, 5.0mA, Zzt=35Ω, 275mW	SOT-323	16dc	-	3a Cen
1DC2	81C13-P-AE3-2	Vdet-IC	1.3V±2%, -Reset PPO	SOT-23	16vdy	VD7	3a Utc
1DC2G	81C13G-P-AE3-2	Vdet-IC	1.3V±2%, -Reset PPO, halogen free	SOT-23	16vdy	VD7	3a Utc
1DC2L	81C13L-P-AE3-2	Vdet-IC	1.3V±2%, -Reset PPO, lead free	SOT-23	16vdy	VD7	3a Utc
1DC3	81C13-P-AE3-3	Vdet-IC	1.3V±2%, -Reset PPO	SOT-23	16vdb	VD7	3a Utc
1DC3G	81C13G-P-AE3-3	Vdet-IC	1.3V±2%, -Reset PPO, halogen free	SOT-23	16vdb	VD7	3a Utc
1DC3L	81C13L-P-AE3-3	Vdet-IC	1.3V±2%, -Reset PPO, lead free	SOT-23	16vdb	VD7	3a Utc
1DC5	81C13-P-AE3-5	Vdet-IC	1.3V±2%, -Reset PPO	SOT-23	16vdc	VD7	3a Utc
1DC5G	81C13G-P-AE3-5	Vdet-IC	1.3V±2%, -Reset PPO, halogen free	SOT-23	16vdc	VD7	3a Utc
1DC5L	81C13L-P-AE3-5	Vdet-IC	1.3V±2%, -Reset PPO, lead free	SOT-23	16vdc	VD7	3a Utc
1DL	2SC4083-L	Si-npn	VHF/UHF, 20V, 50mA, 200mW, B=27.56, 3.2GHz	SOT-323	16ta	-	3a Rhm
1DM	2SC4083-M	Si-npn	VHF/UHF, 20V, 50mA, 200mW, B=39.82, 3.2GHz	SOT-323	16ta	-	3a Rhm
1DN	2SC4083-N	Si-npn	VHF/UHF, 20V, 50mA, 200mW, B=56.120, 3.2GHz	SOT-323	16ta	-	3a Rhm
1DN2	81N13-P-AE3-2	Vdet-IC	1.3V±2%, -Reset ODO	SOT-23	16vdy	VD6	3a Utc
1DN2G	81N13G-P-AE3-2	Vdet-IC	1.3V±2%, -Reset ODO, halogen free	SOT-23	16vdy	VD6	3a Utc
1DN2L	81N13L-P-AE3-2	Vdet-IC	1.3V±2%, -Reset ODO, lead free	SOT-23	16vdy	VD6	3a Utc
1DN3	81N13-P-AE3-3	Vdet-IC	1.3V±2%, -Reset ODO	SOT-23	16vdb	VD6	3a Utc
1DN3G	81N13G-P-AE3-3	Vdet-IC	1.3V±2%, -Reset ODO, halogen free	SOT-23	16vdb	VD6	3a Utc
1DN3L	81N13L-P-AE3-3	Vdet-IC	1.3V±2%, -Reset ODO, lead free	SOT-23	16vdb	VD6	3a Utc
1DN5	81N13-P-AE3-5	Vdet-IC	1.3V±2%, -Reset ODO	SOT-23	16vdc	VD6	3a Utc
1DN5G	81N13G-P-AE3-5	Vdet-IC	1.3V±2%, -Reset ODO, halogen free	SOT-23	16vdc	VD6	3a Utc
1DN5L	81N13L-P-AE3-5	Vdet-IC	1.3V±2%, -Reset ODO, lead free	SOT-23	16vdc	VD6	3a Utc
1DP	2SC4083-P	Si-npn	VHF/UHF, 20V, 50mA, 200mW, B=82.180, 3.2GHz	SOT-323	16ta	-	3a Rhm
1Dp	BC846	Si-npn	GP, 80V, 100mA, 250mW, B=110.450, >100MHz	SOT-23	16ta	-	3a PHH
1Dp	BC846W	Si-npn	GP, 80V, 100mA, 200mW, B=110.450, >100MHz	SOT-323	16ta	-	3a PhH
1DQ	2SC4083-Q	Si-npn	VHF/UHF, 20V, 50mA, 200mW, B=120.270, 3.2GHz	SOT-323	16ta	-	3a Rhm
1DR	2SD1328-R	Si-npn	AF-Amp, 25V, 500mA, 200mW, 200MHz, B=200.350	SC-59	16ta	-	3a Pan
1DR	MSD1328	Si-npn	GP, 25V, 500mA, 200mW, B=2200.350, <300µs	SOT-23	16ta	-	3a Wtr
1DR	MSD1328-R	Si-npn	GP, 25V, 500mA, 200mW, B=200.350	SOT-323	16ta	-	3a Mot
1DS	2SD1328-S	Si-npn	AF-Amp, 25V, 500mA, 200mW, 200MHz, B=300.500	SC-59	16ta	-	3a Pan
1DT	2SD1328-T	Si-npn	AF-Amp, 25V, 500mA, 200mW, 200MHz, B=400.800	SC-59	16ta	-	3a Pan
1Dt	BC846	Si-npn	GP, 80V, 100mA, 250mW, B=110.450, >100MHz	SOT-23	16ta	-	3a PHM
1Dt	BC846W	Si-npn	GP, 80V, 100mA, 200mW, B=110.450, >100MHz	SOT-323	16ta	-	3a PhM
1DW	BC846	Si-npn	GP, 80V, 100mA, 250mW, B=110.450, >100MHz	SOT-23	16ta	-	3a PhC
1DW	BC846W	Si-npn	GP, 80V, 100mA, 200mW, B=110.450, >100MHz	SOT-323	16ta	-	3a PhC
1E	BC847A	Si-npn	GP, 50V, 100mA, 250mW, B=110.220, >100MHz	SOT-23	16ta	-	3a PhH
1E	BC847AF	Si-npn	GP, 50V, 100mA, 250mW, B=110.220, 250MHz	SOT-490	18ta	-	3a Phi
1E	BC847AT	Si-npn	GP, 50V, 100mA, 150mW, B=110.220, >100MHz	SOT-416	16ta	-	3a Phi
1E	BC847AW	Si-npn	GP, 50V, 100mA, 200mW, B=110.220, >100MHz	SOT-323	16ta	-	3a PhH
1E	CM9NB847A	Si-npn	AF, Sw, 50V, 100mA, 200mW, B=110.220, 100MHz	SOT-23	16ta	-	3a Can
1E	CM9NB847AW	Si-npn	AF, Sw, 50V, 100mA, 150mW, B=110.220, 100MHz	SOT-323	16ta	-	3a Can
1E	FMMTA43	Si-npn	Vid, 200V, 200mA, 330mW, B=50.200, >50MHz	SOT-23	16ta	-	3a Zx
1E	KST43	Si-npn	Vid, 200V, 500mA, 350mW, B>40, >50MHz	SOT-23	16ta	-	3a Sam
1E	MMBTA43	Si-npn	Vid, 200V, 500mA, 300mW, B>40, >50MHz	SOT-23	16ta	-	3a Itt
1E	R3131N29EC3	Vdet-IC	2.9V, +Reset ODO, 240ms	SOT-23	16vdc	VD6	3b Ric
1E	SMBTA43	Si-npn	Vid, 200/200V, 200mA, 350mW, B>25, >50MHz	SOT-23	16ta	-	3c Inf
1E	TMPTA43	Si-npn	Vid, 200/200V, 200mA, 350mW, B>25, >50MHz	SOT-23	16ta	-	3a All
-1E	PMSTA43	Si-npn	Vid, 200/200V, 100mA, 200mW, B>25, >50MHz	SOT-323	16ta	-	3a PHH
1E0	TC55RP142ECB	LVR-IC	LDO, 1.4V±2%, 250mA	SOT-23	16cq	VR1	3d Mcc
1E5	TC591402ECB	LVR-IC	LDO, -1.4V±2%, 200mA	SOT-23	16cj	VR2	3d Mcc
1E8	CMSZ5254B	Z-diode	27V±5%, 4.6mA, Zzt=41Ω, 275mW	SOT-323	16dc	-	3a Cen
1EC2	81C14-P-AE3-2	Vdet-IC	1.4V±2%, -Reset PPO	SOT-23	16vdy	VD7	3a Utc
1EC2G	81C14G-P-AE3-2	Vdet-IC	1.4V±2%, -Reset PPO, halogen free	SOT-23	16vdy	VD7	3a Utc
1EC2L	81C14L-P-AE3-2	Vdet-IC	1.4V±2%, -Reset PPO, lead free	SOT-23	16vdy	VD7	3a Utc
1EC3	81C14-P-AE3-3	Vdet-IC	1.4V±2%, -Reset PPO	SOT-23	16vdb	VD7	3a Utc
1EC3G	81C14G-P-AE3-3	Vdet-IC	1.4V±2%, -Reset PPO, halogen free	SOT-23	16vdb	VD7	3a Utc
1EC3L	81C14L-P-AE3-3	Vdet-IC	1.4V±2%, -Reset PPO, lead free	SOT-23	16vdb	VD7	3a Utc
1EC5	81C14-P-AE3-5	Vdet-IC	1.4V±2%, -Reset PPO	SOT-23	16vdc	VD7	3a Utc
1EC5G	81C14G-P-AE3-5	Vdet-IC	1.4V±2%, -Reset PPO, halogen free	SOT-23	16vdc	VD7	3a Utc
1EC5L	81C14L-P-AE3-5	Vdet-IC	1.4V±2%, -Reset PPO, lead free	SOT-23	16vdc	VD7	3a Utc
1EL	2SC4084-L	Si-npn	VHF/UHF, 30V, 50mA, 150mW, >2GHz, B=27.56	SOT-323	16ta	-	3a Rhm
1EM	2SC4084-M	Si-npn	VHF/UHF, 30V, 50mA, 150mW, >2GHz, B=39.82	SOT-323	16ta	-	3a Rhm



SMD code	Type	Function	Short description	Case	Pinout	Sch. St.	Mnf.
1EN	2SC4084-N	Si-npn	VHF/UHF, 30V, 50mA, 150mW, >2GHz, B=56..120	SOT-323	16ta	- 3a	Rhm
1EN2	81N14-P-AE3-2	Vdet-IC	1.4V±2%, -Reset ODO	SOT-23	16vdy	VD6 3a	Utc
1EN2G	81N14G-P-AE3-2	Vdet-IC	1.4V±2%, -Reset ODO, halogen free	SOT-23	16vdy	VD6 3a	Utc
1EN2L	81N14L-P-AE3-2	Vdet-IC	1.4V±2%, -Reset ODO, lead free	SOT-23	16vdy	VD6 3a	Utc
1EN3	81N14-P-AE3-3	Vdet-IC	1.4V±2%, -Reset ODO	SOT-23	16vdb	VD6 3a	Utc
1EN3G	81N14G-P-AE3-3	Vdet-IC	1.4V±2%, -Reset ODO, halogen free	SOT-23	16vdb	VD6 3a	Utc
1EN3L	81N14L-P-AE3-3	Vdet-IC	1.4V±2%, -Reset ODO, lead free	SOT-23	16vdb	VD6 3a	Utc
1EN5	81N14-P-AE3-5	Vdet-IC	1.4V±2%, -Reset ODO	SOT-23	16vdc	VD6 3a	Utc
1EN5G	81N14G-P-AE3-5	Vdet-IC	1.4V±2%, -Reset ODO, halogen free	SOT-23	16vdc	VD6 3a	Utc
1EN5L	81N14L-P-AE3-5	Vdet-IC	1.4V±2%, -Reset ODO, lead free	SOT-23	16vdc	VD6 3a	Utc
1EP	2SC4084-P	Si-npn	VHF/UHF, 30V, 50mA, 150mW, >2GHz, B=82..180	SOT-323	16ta	- 3a	Rhm
1Ep	BC847A	Si-npn	GP, 50V, 100mA, 250mW, B=110..220, >100MHz	SOT-23	16ta	- 3a	PHH
1Ep	BC847AW	Si-npn	GP, 50V, 100mA, 200mW, B=110..220, >100MHz	SOT-323	16ta	- 3a	PHH
1EQ	2SC4084-Q	Si-npn	VHF/UHF, 30V, 50mA, 150mW, >2GHz, B=120..270	SOT-323	16ta	- 3a	Rhm
1Es	BC847A	Si-npn	GP, 50V, 100mA, 330mW, B=110..220, 250MHz	SOT-23	16ta	- 3a	Sie
1Es	BC847AT	Si-npn	GP, 50V, 100mA, 330mW, B=110..220, 250MHz	SOT-416	16ta	- 3a	Inf
1Es	BC847AW	Si-npn	GP, 50V, 100mA, 250mW, B=110..220, 250MHz	SOT-323	16ta	- 3c	Inf
1Et	BC847A	Si-npn	GP, 50V, 100mA, 250mW, B=110..220, >100MHz	SOT-23	16ta	- 3a	PHM
1Et	BC847AW	Si-npn	GP, 50V, 100mA, 200mW, B=110..220, >100MHz	SOT-323	16ta	- 3a	PHM
1EW	BC847A	Si-npn	GP, 50V, 100mA, 250mW, B=110..220, >100MHz	SOT-23	16ta	- 3a	PhC
1EW	BC847AW	Si-npn	GP, 50V, 100mA, 200mW, B=110..220, >100MHz	SOT-323	16ta	- 3a	PhC
1F	2SC5838	Si-npn	RF, LN, 15V, 80mA, 100mW, B=110..250, 6GHz	ML3-N2	22ta	- 2b	Pan
1F	BC847B	Si-npn	GP, 50V, 100mA, 250mW, B=200..450, >100MHz	SOT-23	16ta	- 3a	PHH
1F	BC847BF	Si-npn	GP, 50V, 100mA, 250mW, B=200..450, 250MHz	SOT-490	18ta	- 3a	Phi
1F	BC847BLP	Si-npn	GP, 50V, 100mA, 250mW, B=200..450, >100MHz	DFN1006-3	22ta	- 2a	Di
1F	BC847BT	Si-npn	GP, 50V, 100mA, 150mW, B=200..450, >100MHz	SOT-416	16ta	- 3a	Phi
1F	BC847BW	Si-npn	GP, 50V, 100mA, 200mW, B=200..450, >100MHz	SOT-323	16ta	- 3a	PHH
1F	CH847BPT-R	Si-npn	AF, Sw, 45V, 100mA, B=200..450, 200MHz	SOT-23	16ta	- 3a	Chm
1F	CM9NB847B	Si-npn	AF, Sw, 50V, 100mA, 200mW, B=200..450, 100MHz	SOT-23	16ta	- 3a	Can
1F	CM9NB847BW	Si-npn	AF, Sw, 50V, 100mA, 150mW, B=200..450, 100MHz	SOT-323	16ta	- 3a	Can
1F	KST5550	Si-npn	Vid, 160V, 600mA, 350mW, B=60..250, >150MHz	SOT-23	16ta	- 3a	Sam
-1F	PMST5550	Si-npn	HV, 160V, 300mA, 200mW, B=60..250, 100..300MHz	SOT-323	16ta	- 3a	PHH
1F0	TC55RP152ECB	LVR-IC	LDO, 1.5V±2%, 250mA	SOT-23	16cjq	VR1 3d	Mcc
1F5	TC591502ECB	LVR-IC	LDO, -1.5V±2%, 200mA	SOT-23	16cjq	VR2 3d	Mcc
1F8	CMSZ5255B	Z-diode	28V±5%, 4.5mA, Zzt=44Ω, 275mW	SOT-323	16dc	- 3a	Cen
1FC2	81C15-P-AE3-2	Vdet-IC	1.5V±2%, -Reset PPO	SOT-23	16vdy	VD7 3a	Utc
1FC2G	81C15G-P-AE3-2	Vdet-IC	1.5V±2%, -Reset PPO, halogen free	SOT-23	16vdy	VD7 3a	Utc
1FC2L	81C15L-P-AE3-2	Vdet-IC	1.5V±2%, -Reset PPO, lead free	SOT-23	16vdy	VD7 3a	Utc
1FC3	81C15-P-AE3-3	Vdet-IC	1.5V±2%, -Reset PPO	SOT-23	16vdb	VD7 3a	Utc
1FC3G	81C15G-P-AE3-3	Vdet-IC	1.5V±2%, -Reset PPO, halogen free	SOT-23	16vdb	VD7 3a	Utc
1FC3L	81C15L-P-AE3-3	Vdet-IC	1.5V±2%, -Reset PPO, lead free	SOT-23	16vdb	VD7 3a	Utc
1FC5	81C15-P-AE3-5	Vdet-IC	1.5V±2%, -Reset PPO	SOT-23	16vdc	VD7 3a	Utc
1FC5G	81C15G-P-AE3-5	Vdet-IC	1.5V±2%, -Reset PPO, halogen free	SOT-23	16vdc	VD7 3a	Utc
1FC5L	81C15L-P-AE3-5	Vdet-IC	1.5V±2%, -Reset PPO, lead free	SOT-23	16vdc	VD7 3a	Utc
1FF	CMPT5551	Si-npn	Sw, 180V, 600mA, 350mW, B=80..250, 100..300MHz	SOT-23	16ta	- 3a	Cen
1FN2	81N15-P-AE3-2	Vdet-IC	1.5V±2%, -Reset ODO	SOT-23	16vdy	VD6 3a	Utc
1FN2G	81N15G-P-AE3-2	Vdet-IC	1.5V±2%, -Reset ODO, halogen free	SOT-23	16vdy	VD6 3a	Utc
1FN2L	81N15L-P-AE3-2	Vdet-IC	1.5V±2%, -Reset ODO, lead free	SOT-23	16vdy	VD6 3a	Utc
1FN3	81N15-P-AE3-3	Vdet-IC	1.5V±2%, -Reset ODO	SOT-23	16vdb	VD6 3a	Utc
1FN3G	81N15G-P-AE3-3	Vdet-IC	1.5V±2%, -Reset ODO, halogen free	SOT-23	16vdb	VD6 3a	Utc
1FN3L	81N15L-P-AE3-3	Vdet-IC	1.5V±2%, -Reset ODO, lead free	SOT-23	16vdb	VD6 3a	Utc
1FN5	81N15-P-AE3-5	Vdet-IC	1.5V±2%, -Reset ODO	SOT-23	16vdc	VD6 3a	Utc
1FN5G	81N15G-P-AE3-5	Vdet-IC	1.5V±2%, -Reset ODO, halogen free	SOT-23	16vdc	VD6 3a	Utc
1FN5L	81N15L-P-AE3-5	Vdet-IC	1.5V±2%, -Reset ODO, lead free	SOT-23	16vdc	VD6 3a	Utc
1FP	2SK321-P	n-FET	Video-Cam, 15V, 50mA, 200mW, Idss=5..16mA, Up<3V	SOT-23	16fa	- 3a	Pan
1Fp	BC847B	Si-npn	GP, 50V, 100mA, 250mW, B=200..450, >100MHz	SOT-23	16ta	- 3a	PHH
1Fp	BC847BW	Si-npn	GP, 50V, 100mA, 200mW, B=200..450, >100MHz	SOT-323	16ta	- 3a	PHH
1FQ	2SK321-Q	n-FET	Video-Cam, 15V, 50mA, 200mW, Idss=14..24mA, Up<3V	SOT-23	16fa	- 3a	Pan
1FR	2SK321-R	n-FET	Video-Cam, 15V, 50mA, 200mW, Idss=20..32mA, Up<3V	SOT-23	16fa	- 3a	Pan
1FS	2SK321-S	n-FET	Video-Cam, 15V, 50mA, 200mW, Idss=28..42mA, Up<3V	SOT-23	16fa	- 3a	Pan
1Fs	BC847B	Si-npn	GP, 50V, 100mA, 330mW, B=200..450, 250MHz	SOT-23	16ta	- 3c	Inf
1Fs	BC847BT	Si-npn	GP, 50V, 100mA, 250mW, B=200..450, >100MHz	SOT-416	16ta	- 3a	Sie
1Fs	BC847BW	Si-npn	GP, 50V, 100mA, 250mW, B=200..450, 250MHz	SOT-323	16ta	- 3c	Inf
1Ft	BC847B	Si-npn	GP, 50V, 100mA, 250mW, B=200..450, >100MHz	SOT-23	16ta	- 3a	PHM
1Ft	BC847BW	Si-npn	GP, 50V, 100mA, 200mW, B=200..450, >100MHz	SOT-323	16ta	- 3a	PHM
1FW	BC847B	Si-npn	GP, 50V, 100mA, 250mW, B=200..450, >100MHz	SOT-23	16ta	- 3a	PhC
1FW	BC847BW	Si-npn	GP, 50V, 100mA, 200mW, B=200..450, >100MHz	SOT-323	16ta	- 3a	PhC
1FZ	FMBT5550	Si-npn	HV, 140V, 600mA, 225mW, B=80..250, >300MHz	SOT-23	16ta	- -	Zx
1G	BC847C	Si-npn	GP, 50V, 100mA, 250mW, B=420..800, >100MHz	SOT-23	16ta	- 3a	PHH
1G	BC847CF	Si-npn	GP, 50V, 100mA, 250mW, B=420..800, 250MHz	SOT-490	18ta	- 3a	Phi



SMD code	Type	Function	Short description	Case	Pinout	Sch.	St.	Mnf.
1G	BC847CT	Si-npn	GP, 50V, 100mA, 150mW, B=420..800, >100MHz	SOT-416	16ta	-	3a	Phi
1G	BC847CW	Si-npn	GP, 50V, 100mA, 200mW, B=420..800, >100MHz	SOT-323	16ta	-	3a	PHH
1G	CM9NB847C	Si-npn	AF, Sw, 50V, 100mA, 200mW, B=4520..800, 100MHz	SOT-23	16ta	-	3a	Can
1G	CM9NB847CW	Si-npn	AF, Sw, 50V, 100mA, 150mW, B=4520..800, 100MHz	SOT-323	16ta	-	3a	Can
1G	CMBTA06	Si-npn	GP, 80V, 500mA, 250mW, B>100, >100MHz	SOT-23	16ta	-	3a	Cdi
1G	CMBTA14	Si-npn-Darl	GP, 60V, 500mA, 250mW, B>10000, >125MHz	SOT-23	16ta	-	3a	Cdi
1G	FMMTA06	Si-npn	GP, 80V, 500mA, 350mW, B>100, >100MHz	SOT-23	16ta	-	3a	Zx
1G	KST06	Si-npn	AF-Drv, 80V, 500mA, 350mW, B>50, >100MHz	SOT-23	16ta	-	3a	Sam
1G	MMBTA06	Si-npn	GP, 80V, 500mA, 350mW, B>100, >100MHz	SOT-23	16ta	-	3g	Vs
1G	R3131N21EA	Vdet-IC	2.1V, +Reset PPO, 240ms	SOT-23	16vdc	VD7	3b	Ric
1G	SMBTA06	Si-npn	GP, 80V, 500mA, 350mW, B>100, >100MHz	SOT-23	16ta	-	3c	Inf
1G	TMPTA06	Si-npn	GP, 80V, 500mA, 350mW, B>100, >100MHz	SOT-23	16ta	-	3a	All
-1G	PMSTA06	Si-npn	GP, 80V, 500mA, 200mW, B>50, >100MHz	SOT-323	16ta	-	3a	PHH
1G8	CMSZ5256B	Z-diode	30V±5%, 4.2mA, Zzt=49Ω, 275mW	SOT-323	16dc	-	3a	Can
1GC2	81C16-P-AE3-2	Vdet-IC	1.6V±2%, -Reset PPO	SOT-23	16vdy	VD7	3a	Utc
1GC2G	81C16G-P-AE3-2	Vdet-IC	1.6V±2%, -Reset PPO, halogen free	SOT-23	16vdy	VD7	3a	Utc
1GC2L	81C16L-P-AE3-2	Vdet-IC	1.6V±2%, -Reset PPO, lead free	SOT-23	16vdy	VD7	3a	Utc
1GC3	81C16-P-AE3-3	Vdet-IC	1.6V±2%, -Reset PPO	SOT-23	16vdb	VD7	3a	Utc
1GC3G	81C16G-P-AE3-3	Vdet-IC	1.6V±2%, -Reset PPO, halogen free	SOT-23	16vdb	VD7	3a	Utc
1GC3L	81C16L-P-AE3-3	Vdet-IC	1.6V±2%, -Reset PPO, lead free	SOT-23	16vdb	VD7	3a	Utc
1GC5	81C16-P-AE3-5	Vdet-IC	1.6V±2%, -Reset PPO	SOT-23	16vdc	VD7	3a	Utc
1GC5G	81C16G-P-AE3-5	Vdet-IC	1.6V±2%, -Reset PPO, halogen free	SOT-23	16vdc	VD7	3a	Utc
1GC5L	81C16L-P-AE3-5	Vdet-IC	1.6V±2%, -Reset PPO, lead free	SOT-23	16vdc	VD7	3a	Utc
1GM	MMBTA06	Si-npn	GP, 80V, 500mA, 225mW, B>100, >100MHz	SOT-23	16ta	-	3a	Mot
1GN2	81N16-P-AE3-2	Vdet-IC	1.6V±2%, -Reset ODO	SOT-23	16vdy	VD6	3a	Utc
1GN2G	81N16G-P-AE3-2	Vdet-IC	1.6V±2%, -Reset ODO, halogen free	SOT-23	16vdy	VD6	3a	Utc
1GN2L	81N16L-P-AE3-2	Vdet-IC	1.6V±2%, -Reset ODO, lead free	SOT-23	16vdy	VD6	3a	Utc
1GN3	81N16-P-AE3-3	Vdet-IC	1.6V±2%, -Reset ODO	SOT-23	16vdb	VD6	3a	Utc
1GN3G	81N16G-P-AE3-3	Vdet-IC	1.6V±2%, -Reset ODO, halogen free	SOT-23	16vdb	VD6	3a	Utc
1GN3L	81N16L-P-AE3-3	Vdet-IC	1.6V±2%, -Reset ODO, lead free	SOT-23	16vdb	VD6	3a	Utc
1GN5	81N16-P-AE3-5	Vdet-IC	1.6V±2%, -Reset ODO	SOT-23	16vdc	VD6	3a	Utc
1GN5G	81N16G-P-AE3-5	Vdet-IC	1.6V±2%, -Reset ODO, halogen free	SOT-23	16vdc	VD6	3a	Utc
1GN5L	81N16L-P-AE3-5	Vdet-IC	1.6V±2%, -Reset ODO, lead free	SOT-23	16vdc	VD6	3a	Utc
1Gp	BC847C	Si-npn	GP, 50V, 100mA, 250mW, B=420..800, >100MHz	SOT-23	16ta	-	3a	PHH
1Gp	BC847CW	Si-npn	GP, 50V, 100mA, 200mW, B=420..800, >100MHz	SOT-323	16ta	-	3a	PHH
1Gs	BC847C	Si-npn	GP, 50V, 100mA, 330mW, B=420..800, 250MHz	SOT-23	16ta	-	3a	Sie
1Gs	BC847CT	Si-npn	GP, 50V, 100mA, 250mW, B=420..800, >100MHz	SOT-416	16ta	-	3a	Inf
1Gs	BC847CW	Si-npn	GP, 50V, 100mA, 250mW, B=420..800, 250MHz	SOT-323	16ta	-	3c	Inf
1Gt	BC847C	Si-npn	GP, 50V, 100mA, 250mW, B=420..800, >100MHz	SOT-23	16ta	-	3a	PHM
1Gt	BC847CW	Si-npn	GP, 50V, 100mA, 200mW, B=420..800, >100MHz	SOT-323	16ta	-	3a	PHM
1Gt	SOA06	Si-npn	GP, 80V, 500mA, 350mW, B>100, >100MHz	SOT-23	16ta	-	3a	StE
1GW	BC847C	Si-npn	GP, 50V, 100mA, 250mW, B=420..800, >100MHz	SOT-23	16ta	-	3a	PhC
1GW	BC847CW	Si-npn	GP, 50V, 100mA, 200mW, B=420..800, >100MHz	SOT-323	16ta	-	3a	PhC
1GZ	BC847C	Si-npn	GP, 50V, 100mA, 330mW, B=420..800, >300MHz	SOT-23	16ta	-	3a	Zx
1H	2SK123	n-FET	Imped-conv, 20V, 2mA, 100mW, Idss=95..480μA, 1.6ms	Mini3-G1	16fj	-	3a	Pan
1H	2SK123	n-FET	Imped-conv, 20V, 2mA, 100mW, Idss=95..480μA, 1.6ms	Mini3-G1	16fj	-	3a	Pan
1H	2SK1860	n-FET	AF imp-conv, 20V, 2mA, 150mW, Idss<0.48mA	Mini3-F1	16fj	-	3a	Pan
1H	BC847	Si-npn	GP, 50V, 100mA, 250mW, B=110..800, >100MHz	SOT-23	16ta	-	3a	PHH
1H	BC847W	Si-npn	GP, 50V, 100mA, 200mW, B=110..800, >100MHz	SOT-323	16ta	-	3a	PHH
1H	CMBTA05	Si-npn	GP, 60V, 500mA, 250mW, B>100, >100MHz	SOT-23	16ta	-	3a	Cdi
1H	CMBTA13	Si-npn-Darl	GP, 60V, 500mA, 250mW, B>5000, >125MHz	SOT-23	16ta	-	3a	Cdi
1H	FMMTA05	Si-npn	GP, 60V, 500mA, 350mW, B>100, >100MHz	SOT-23	16ta	-	3a	Zx
1H	KST05	Si-npn	AF-Drv, 60V, 500mA, 350mW, B>50, >100MHz	SOT-23	16ta	-	3a	Sam
1H	MMBTA05	Si-npn	GP, 60V, 500mA, 350mW, B>100, >100MHz	SOT-23	16ta	-	3g	Ons
1H	R3131N31EA	Vdet-IC	3.1V, +Reset PPO, 240ms	SOT-23	16vdc	VD7	3b	Ric
1H	SMBTA05	Si-npn	GP, 60V, 500mA, 350mW, B>100, >100MHz	SOT-23	16ta	-	3c	Inf
1H	TMPTA05	Si-npn	GP, 60V, 500mA, 350mW, B>100, >100MHz	SOT-23	16ta	-	3a	All
-1H	PMSTA05	Si-npn	GP, 60V, 500mA, 200mW, B>50, >100MHz	SOT-323	16ta	-	3a	PHH
1H0	TC55RP162ECB	LVR-IC	LDO, 1.6V±2%, 250mA	SOT-23	16cjq	VR1	3d	Mcc
1H5	TC591602ECB	LVR-IC	LDO, -1.6V±2%, 200mA	SOT-23	16cj	VR2	3d	Mcc
1H8	CMSZ5257B	Z-diode	33V±5%, 3.8mA, Zzt=58Ω, 275mW	SOT-323	16dc	-	3a	Can
1HC2	81C17-P-AE3-2	Vdet-IC	1.7V±2%, -Reset PPO	SOT-23	16vdy	VD7	3a	Utc
1HC2G	81C17G-P-AE3-2	Vdet-IC	1.7V±2%, -Reset PPO, halogen free	SOT-23	16vdy	VD7	3a	Utc
1HC2L	81C17L-P-AE3-2	Vdet-IC	1.7V±2%, -Reset PPO, lead free	SOT-23	16vdy	VD7	3a	Utc
1HC3	81C17-P-AE3-3	Vdet-IC	1.7V±2%, -Reset PPO	SOT-23	16vdb	VD7	3a	Utc
1HC3G	81C17G-P-AE3-3	Vdet-IC	1.7V±2%, -Reset PPO, halogen free	SOT-23	16vdb	VD7	3a	Utc
1HC3L	81C17L-P-AE3-3	Vdet-IC	1.7V±2%, -Reset PPO, lead free	SOT-23	16vdb	VD7	3a	Utc
1HC5	81C17-P-AE3-5	Vdet-IC	1.7V±2%, -Reset PPO	SOT-23	16vdc	VD7	3a	Utc
1HC5G	81C17G-P-AE3-5	Vdet-IC	1.7V±2%, -Reset PPO, halogen free	SOT-23	16vdc	VD7	3a	Utc
1HC5L	81C17L-P-AE3-5	Vdet-IC	1.7V±2%, -Reset PPO, lead free	SOT-23	16vdc	VD7	3a	Utc



SMD code	Type	Function	Short description	Case	Pinout	Sch. St.	Mnf.
1HD	L8550HQLT1	Si-npn	GP, 40V, 1.5A, 225mW, B=150..300	SOT-23	16ta	- 3a	Lrc
1HN2	81N17-P-AE3-2	Vdet-IC	1.7V±2%, -Reset ODO	SOT-23	16vdy	VD6 3a	Utc
1HN2G	81N17G-P-AE3-2	Vdet-IC	1.7V±2%, -Reset ODO, halogen free	SOT-23	16vdy	VD6 3a	Utc
1HN2L	81N17L-P-AE3-2	Vdet-IC	1.7V±2%, -Reset ODO, lead free	SOT-23	16vdy	VD6 3a	Utc
1HN3	81N17-P-AE3-3	Vdet-IC	1.7V±2%, -Reset ODO	SOT-23	16vdb	VD6 3a	Utc
1HN3G	81N17G-P-AE3-3	Vdet-IC	1.7V±2%, -Reset ODO, halogen free	SOT-23	16vdb	VD6 3a	Utc
1HN3L	81N17L-P-AE3-3	Vdet-IC	1.7V±2%, -Reset ODO, lead free	SOT-23	16vdb	VD6 3a	Utc
1HN5	81N17-P-AE3-5	Vdet-IC	1.7V±2%, -Reset ODO	SOT-23	16vdc	VD6 3a	Utc
1HN5G	81N17G-P-AE3-5	Vdet-IC	1.7V±2%, -Reset ODO, halogen free	SOT-23	16vdc	VD6 3a	Utc
1HN5L	81N17L-P-AE3-5	Vdet-IC	1.7V±2%, -Reset ODO, lead free	SOT-23	16vdc	VD6 3a	Utc
1Hp	BC847	Si-npn	GP, 50V, 100mA, 250mW, B=110..800, >100MHz	SOT-23	16ta	- 3a	PHH
1Hp	BC847W	Si-npn	GP, 50V, 100mA, 200mW, B=110..800, >100MHz	SOT-323	16ta	- 3a	PHH
1Ht	BC847	Si-npn	GP, 50V, 100mA, 250mW, B=110..800, >100MHz	SOT-23	16ta	- 3a	PHM
1Ht	BC847W	Si-npn	GP, 50V, 100mA, 200mW, B=110..800, >100MHz	SOT-323	16ta	- 3a	PHM
1HT	SOA05	Si-npn	GP, 60V, 500mA, 350mW, B=100, >100MHz	SOT-23	16ta	- 3a	Ste
1HW	BC847	Si-npn	GP, 50V, 100mA, 250mW, B=110..800, >100MHz	SOT-23	16ta	- 3a	PhC
1HW	BC847W	Si-npn	GP, 50V, 100mA, 200mW, B=110..800, >100MHz	SOT-323	16ta	- 3a	PhC
1J	BC848A	Si-npn	GP, 30V, 100mA, 150mW, B=110..220, 300MHz	SOT-23	16ta	- 3a	Di
1J	BC848AF	Si-npn	GP, 30V, 100mA, 200mW, B=110..220, 150MHz	SOT-490	18ta	- 3a	Phi
1J	BC848AT	Si-npn	GP, 30V, 100mA, 200mW, B=140, >100MHz	SOT-416	16ta	- 3a	Phi
1J	BC848AW	Si-npn	GP, 30V, 100mA, 310mW, B=110..220, >300MHz	SOT-323	16ta	- 3a	Ons
1J	FMMT2369	Si-npn	Sw, 40V, 200mA, 330mW, B=40..120	SOT-23	16ta	- 3a	Zx
1J	MMBT2369	Si-npn	Sw, 40V, 200mA, 330mW, B=40..120	SOT-23	16ta	- 3a	Mot
1J	R3131N41EA	Vdet-IC	4.1V, +Reset PPO, 240ms	SOT-23	16vdc	VD7 3b	Ric
-1J	PMST2369	Si-npn	Sw, 40V, 200mA, 330mW, B=40..120, >500MHz	SOT-323	16ta	- 3a	PHH
1J8	CMSZ5258B	Z-diode	36V±5%, 3.4mA, Zt=70Ω, 275mW	SOT-323	16dc	- 3a	Cen
1JA	MMBT2369A	Si-npn	Sw, 40V, 200mA, 330mW, B=40..120	SOT-23	16ta	- 3a	Mot
1JC2	81C18-P-AE3-2	Vdet-IC	1.8V±2%, -Reset PPO	SOT-23	16vdy	VD7 3a	Utc
1JC2G	81C18G-P-AE3-2	Vdet-IC	1.8V±2%, -Reset PPO, halogen free	SOT-23	16vdy	VD7 3a	Utc
1JC2L	81C18L-P-AE3-2	Vdet-IC	1.8V±2%, -Reset PPO, lead free	SOT-23	16vdy	VD7 3a	Utc
1JC3	81C18-P-AE3-3	Vdet-IC	1.8V±2%, -Reset PPO	SOT-23	16vdb	VD7 3a	Utc
1JC3G	81C18G-P-AE3-3	Vdet-IC	1.8V±2%, -Reset PPO, halogen free	SOT-23	16vdb	VD7 3a	Utc
1JC3L	81C18L-P-AE3-3	Vdet-IC	1.8V±2%, -Reset PPO, lead free	SOT-23	16vdb	VD7 3a	Utc
1JC5	81C18-P-AE3-5	Vdet-IC	1.8V±2%, -Reset PPO	SOT-23	16vdc	VD7 3a	Utc
1JCSG	81C18G-P-AE3-5	Vdet-IC	1.8V±2%, -Reset PPO, halogen free	SOT-23	16vdc	VD7 3a	Utc
1JCSL	81C18L-P-AE3-5	Vdet-IC	1.8V±2%, -Reset PPO, lead free	SOT-23	16vdc	VD7 3a	Utc
1JN2	81N18-P-AE3-2	Vdet-IC	1.8V±2%, -Reset ODO	SOT-23	16vdy	VD6 3a	Utc
1JN2G	81N18G-P-AE3-2	Vdet-IC	1.8V±2%, -Reset ODO, halogen free	SOT-23	16vdy	VD6 3a	Utc
1JN2L	81N18L-P-AE3-2	Vdet-IC	1.8V±2%, -Reset ODO, lead free	SOT-23	16vdy	VD6 3a	Utc
1JN3	81N18-P-AE3-3	Vdet-IC	1.8V±2%, -Reset ODO	SOT-23	16vdb	VD6 3a	Utc
1JN3G	81N18G-P-AE3-3	Vdet-IC	1.8V±2%, -Reset ODO, halogen free	SOT-23	16vdb	VD6 3a	Utc
1JN3L	81N18L-P-AE3-3	Vdet-IC	1.8V±2%, -Reset ODO, lead free	SOT-23	16vdb	VD6 3a	Utc
1JN5	81N18-P-AE3-5	Vdet-IC	1.8V±2%, -Reset ODO	SOT-23	16vdc	VD6 3a	Utc
1JN5G	81N18G-P-AE3-5	Vdet-IC	1.8V±2%, -Reset ODO, halogen free	SOT-23	16vdc	VD6 3a	Utc
1JN5L	81N18L-P-AE3-5	Vdet-IC	1.8V±2%, -Reset ODO, lead free	SOT-23	16vdc	VD6 3a	Utc
1Jp	BC848A	Si-npn	GP, 30V, 100mA, 250mW, B=110..220, >100MHz	SOT-23	16ta	- 3a	PHH
1Js	BC848A	Si-npn	GP, 30V, 100mA, 330mW, B=110..220, >300MHz	SOT-23	16ta	- 3a	Phi
1Js	BC848AT	Si-npn	GP, 30V, 100mA, 200mW, B=140, >100MHz	SOT-416	16ta	- 3a	Inf
1Js	BC848AW	Si-npn	GP, 30V, 100mA, 250mW, B=110..220, 250MHz	SOT-323	16ta	- 3c	Inf
1Jt	BC848AW	Si-npn	GP, 30V, 100mA, 310mW, B=110..220, >300MHz	SOT-323	16ta	- 3a	Phi
1JW	BC848A	Si-npn	GP, 30V, 100mA, 250mW, B=110..220, >100MHz	SOT-23	16ta	- 3a	PhC
1JZ	BC848A	Si-npn	GP, 30V, 100mA, 330mW, B=110..220, >300MHz	SOT-23	16ta	- 3a	Zx
1K	BC848B	Si-npn	GP, 30V, 100mA, 310mW, B=200..450, >300MHz	SOT-23	16ta	- 3a	Di
1K	BC848BF	Si-npn	GP, 30V, 100mA, 200mW, B=200..450, 250MHz	SOT-490	18ta	- 3a	Phi
1K	BC848BT	Si-npn	GP, 30V, 100mA, 200mW, B=250, >100MHz	SOT-416	16ta	- 3a	Phi
1K	BC848BW	Si-npn	GP, 30V, 100mA, 310mW, B=200..450, >300MHz	SOT-323	16ta	- 3a	Ons
1K	CH848BPT-Q	Si-npn	AF, Sw, 30V, 100mA, B=200..450, 300MHz	SOT-23	16ta	- 3a	Chm
1K	KST6428	Si-npn	GP, 60V, 200mA, 350mW, B=250..650, 100..700MHz	SOT-23	16ta	- 3a	Sam
1K	R3131N29EA3	Vdet-IC	2.9V, +Reset PPO, 240ms	SOT-23	16vdc	VD7 3b	Ric
-1K	PMST6428	Si-npn	GP, Hi-beta, 60V, 100mA, 200mW, B=250..650, 100..700MHz	SOT-323	16ta	- 3a	PHH
1K0	TC55RP172ECB	LVR-IC	LDO, 1.7V±2%, 250mA	SOT-23	16cq	VR1 3d	Mcc
1K5	TC591702ECB	LVR-IC	LDO, -1.7V±2%, 200mA	SOT-23	16cj	VR2 3d	Mcc
1K8	CMSZ5259B	Z-diode	39V±5%, 3.2mA, Zt=80Ω, 275mW	SOT-323	16dc	- 3a	Cen
1KC2	81C19-P-AE3-2	Vdet-IC	1.9V±2%, -Reset PPO	SOT-23	16vdy	VD7 3a	Utc
1KC2G	81C19G-P-AE3-2	Vdet-IC	1.9V±2%, -Reset PPO, halogen free	SOT-23	16vdy	VD7 3a	Utc
1KC2L	81C19L-P-AE3-2	Vdet-IC	1.9V±2%, -Reset PPO, lead free	SOT-23	16vdy	VD7 3a	Utc
1KC3	81C19-P-AE3-3	Vdet-IC	1.9V±2%, -Reset PPO	SOT-23	16vdb	VD7 3a	Utc
1KC3G	81C19G-P-AE3-3	Vdet-IC	1.9V±2%, -Reset PPO, halogen free	SOT-23	16vdb	VD7 3a	Utc
1KC3L	81C19L-P-AE3-3	Vdet-IC	1.9V±2%, -Reset PPO, lead free	SOT-23	16vdb	VD7 3a	Utc
1KC5	81C19-P-AE3-5	Vdet-IC	1.9V±2%, -Reset PPO	SOT-23	16vdc	VD7 3a	Utc



SMD code	Type	Function	Short description	Case	Pinout	Sch.	St.	Mnf.
1KCSG	81C19G-P-AE3-5	Vdet-IC	1.9V±2%, -Reset PPO, halogen free	SOT-23	16vdc	VD7	3a	Utc
1KCSL	81C19L-P-AE3-5	Vdet-IC	1.9V±2%, -Reset PPO, lead free	SOT-23	16vdc	VD7	3a	Utc
1KM	MMBT6428	Si-npn	AF, 60V, 200mA, 225mW, B=250..650, <700MHz	SOT-23	16ta	-	3a	Mot
1KN2	81N19-P-AE3-2	Vdet-IC	1.9V±2%, -Reset ODO	SOT-23	16vdy	VD6	3a	Utc
1KN2G	81N19G-P-AE3-2	Vdet-IC	1.9V±2%, -Reset ODO, halogen free	SOT-23	16vdy	VD6	3a	Utc
1KN2L	81N19L-P-AE3-2	Vdet-IC	1.9V±2%, -Reset ODO, lead free	SOT-23	16vdy	VD6	3a	Utc
1KN3	81N19-P-AE3-3	Vdet-IC	1.9V±2%, -Reset ODO	SOT-23	16vdb	VD6	3a	Utc
1KN3G	81N19G-P-AE3-3	Vdet-IC	1.9V±2%, -Reset ODO, halogen free	SOT-23	16vdb	VD6	3a	Utc
1KN3L	81N19L-P-AE3-3	Vdet-IC	1.9V±2%, -Reset ODO, lead free	SOT-23	16vdb	VD6	3a	Utc
1KN5	81N19-P-AE3-5	Vdet-IC	1.9V±2%, -Reset ODO	SOT-23	16vdc	VD6	3a	Utc
1KN5G	81N19G-P-AE3-5	Vdet-IC	1.9V±2%, -Reset ODO, halogen free	SOT-23	16vdc	VD6	3a	Utc
1KN5L	81N19L-P-AE3-5	Vdet-IC	1.9V±2%, -Reset ODO, lead free	SOT-23	16vdc	VD6	3a	Utc
1KP	2SK316-P	n-FET	V-cam, 10V, 50mA, 200mW, Idss=5..16mA, Up<3V	SOT-23	16fa	-	3a	Pan
1Kp	BC8488	Si-npn	GP, 30V, 100mA, 250mW, B=200..450, >100MHz	SOT-23	16ta	-	3a	PHH
1KQ	2SK316-Q	n-FET	V-cam, 10V, 50mA, 200mW, Idss=14..24mA, Up<3V	SOT-23	16fa	-	3a	Pan
1KR	BC848BR	Si-npn	GP, 30V, 100mA, 310mW, B=330, >300MHz	SOT-23	16ta	-	3a	Phi
1Ks	BC848B	Si-npn	GP, 30V, 100mA, 330mW, B=200..450, 250MHz	SOT-23	16ta	-	3a	Sie
1Ks	BC848BT	Si-npn	GP, 30V, 100mA, 200mW, B=250, >100MHz	SOT-416	16ta	-	3a	Inf
1Ks	BC848BW	Si-npn	GP, 30V, 100mA, 250mW, B=200..450, 250MHz	SOT-323	16ta	-	3c	Inf
1Kt	BC848BW	Si-npn	GP, 30V, 100mA, 310mW, B=200..450, >300MHz	SOT-323	16ta	-	3a	Phi
1KW	BC8488	Si-npn	GP, 30V, 100mA, 250mW, B=200..450, >100MHz	SOT-23	16ta	-	3a	PHC
1KZ	FMMT4400	Si-npn	AF, 60V, 600mA, 330mW, B=50..150, >200MHz	SOT-23	16ta	-	3a	Zx
1L	BC848C	Si-npn	GP, 30V, 100mA, 310mW, B=420..800, >300MHz	SOT-23	16ta	-	3a	Di
1L	BC848CF	Si-npn	GP, 30V, 100mA, 200mW, B=420..800, 150MHz	SOT-490	16ta	-	3a	Phi
1L	BC848CT	Si-npn	GP, 30V, 100mA, 200mW, B=480, >100MHz	SOT-416	16ta	-	3a	Phi
1L	BC848CW	Si-npn	GP, 30V, 100mA, 310mW, B=420..800, >300MHz	SOT-323	16ta	-	3a	Ons
1L	FMMT4401	Si-npn	AF, 60V, 600mA, 330mW, B=100..300, >250MHz	SOT-23	16ta	-	3a	Zx
1L	MMBT6429	Si-npn	AF, 55V, 200mA, 225mW, B=500..1250, <700MHz	SOT-23	16ta	-	3a	Mot
1L	R3131N44AC	Vdet-IC	4.4V, +Reset ODO, 50ms	SOT-23	16vdc	VD6	3b	Ric
-1L	PMST6429	Si-npn	GP, Hi-beta, 55V, 100mA, 200mW, B=250..650, 100..700MHz	SOT-323	16ta	-	3a	PHH
1L0	TC55RP182ECB	LVR-IC	LDO, 1.8V±2%, 250mA	SOT-23	16cq	VR1	3d	Mcc
1L5	TC591802ECB	LVR-IC	LDO, -1.8V±2%, 200mA	SOT-23	16cj	VR2	3d	Mcc
1L8	CMSZ5260B	Z-diode	43V±5%, 3.0mA, Zzt=93Ω, 275mW	SOT-323	16dc	-	3a	Cen
1LM	2SC4103-M	Si-npn	GP, 30V, 30mA, 200mW, B=39..82, >110MHz	SOT-323	16ta	-	3a	Rhm
1LN	2SC4103-N	Si-npn	GP, 30V, 30mA, 200mW, B=56..120, >110MHz	SOT-323	16ta	-	3a	Rhm
1LN	ELM7516CEB	Vdet-IC	1.6V±2%, +Reset PPO	SC-70	16vdb	VD7	3d	Elm
1LN	ELM7516NEB	Vdet-IC	1.6V±2%, +Reset ODO	SC-70	16vdb	VD6	3d	Elm
1LP	2SC4103-P	Si-npn	GP, 30V, 30mA, 200mW, B=82..180, >110MHz	SOT-323	16ta	-	3a	Rhm
1Lp	BC848C	Si-npn	GP, 30V, 100mA, 250mW, B=420..800, >100MHz	SOT-23	16ta	-	3a	PHH
1LQ	2SC4103-Q	Si-npn	GP, 30V, 30mA, 200mW, B=120..270, >110MHz	SOT-323	16ta	-	3a	Rhm
1Ls	BC848C	Si-npn	GP, 30V, 100mA, 330mW, B=420..800, 250MHz	SOT-23	16ta	-	3a	Sie
1Ls	BC848CT	Si-npn	GP, 30V, 100mA, 200mW, B=480, >100MHz	SOT-416	16ta	-	3a	Inf
1Ls	BC848CW	Si-npn	GP, 30V, 100mA, 250mW, B=420..800, 250MHz	SOT-323	16ta	-	3c	Inf
1Lt	BC848CW	Si-npn	GP, 30V, 100mA, 310mW, B=420..800, >300MHz	SOT-323	16ta	-	3a	Phi
1LW	BC848C	Si-npn	GP, 30V, 100mA, 250mW, B=420..800, >100MHz	SOT-23	16ta	-	3a	PHC
1M	BC807-16	Si-pnp	GP, 50V, 500mA, 350mW, B=100..250, >80MHz	SOT-23	16ta	-	3f	Kec
1M	BC807A-16	Si-pnp	GP, 50V, 500mA, 350mW, B=100..250, >80MHz	SOT-23	16ta	-	3f	Kec
1M	BC846T	Si-npn	GP, 80V, 100mA, 150mW, B=110..450, >100MHz	SOT-416	16ta	-	3a	Phi
1M	BC848	Si-npn	GP, 30V, 100mA, 250mW, B=110..800, >100MHz	SOT-23	16ta	-	3a	Cdi
1M	BC848W	Si-npn	GP, 30V, 100mA, 200mW, B=110..800, >100MHz	SOT-323	16ta	-	3a	Phi
1M	FMMTA13	Si-npn-Darl	GP, 40V, 300mA, 330mW, B=1000	SOT-23	16ta	-	3a	Zx
1M	IMBT3903	Si-npn	GP, 60V, 200mA, 250mW, B=50..150, >300MHz	SOT-23	16ta	-	3a	Itt
1M	KST13	Si-npn-Darl	GP, 30V, 300mA, 350mW, B=5000, >125MHz	SOT-23	16ta	-	3a	Sam
1M	MMBTA13	Si-npn-Darl	GP, 30V, 300mA, 225mW, B=5000, >125MHz	SOT-23	16ta	-	3a	Ons
1M	R3131N44BC	Vdet-IC	4.4V, +Reset ODO, 100ms	SOT-23	16vdc	VD6	3b	Ric
1M	SMBTA13	Si-npn-Darl	GP, 30V, 300mA, 300mW, B=5000, >125MHz	SOT-23	16ta	-	3c	Inf
1M0	TC55RP192ECB	LVR-IC	LDO, 1.9V±2%, 250mA	SOT-23	16cq	VR1	3d	Mcc
1M5	TC591902ECB	LVR-IC	LDO, -1.9V±2%, 200mA	SOT-23	16cj	VR2	3d	Mcc
1M8	CMSZ5261B	Z-diode	47V±5%, 2.7mA, Zzt=105Ω, 275mW	SOT-323	16dc	-	3a	Cen
1MN	2SC4128-N	Si-npn	GP, 40V, 100mA, 200mW, B=56..120, >230MHz	SOT-323	16ta	-	3a	Pan
1MP	2SC4128-P	Si-npn	GP, 40V, 100mA, 200mW, B=82..180, >230MHz	SOT-323	16ta	-	3a	Pan
1MP	2SJ84-P	p-FET	GP, 15V, 20mA, 200mW, Idss=0.5..3mA, Up<3V	SOT-23	16fa	-	3a	Pan
1Mp	BC848	Si-npn	GP, 30V, 100mA, 250mW, B=110..800, >100MHz	SOT-23	16ta	-	3a	PHH
1MQ	2SJ84-Q	p-FET	GP, 15V, 20mA, 200mW, Idss=2..6mA, Up<3V	SOT-23	16fa	-	3a	Pan
1MR	2SJ84-R	p-FET	GP, 15V, 20mA, 200mW, Idss=0.5..12mA, Up<3V	SOT-23	16fa	-	3a	Pan
1MW	BC848	Si-npn	GP, 30V, 100mA, 250mW, B=110..800, >100MHz	SOT-23	16ta	-	3a	PHC
1N	2SC5839	Si-npn	RF, LN, 9V, 30mA, 100mW, B=100..160, 10GHz	ML3-N2	22ta	-	2b	Pan
1N	BC807-25	Si-pnp	GP, 50V, 500mA, 350mW, B=160..400, >80MHz	SOT-23	16ta	-	3f	Kec
1N	BC807A-25	Si-pnp	GP, 50V, 500mA, 350mW, B=160..400, >80MHz	SOT-23	16ta	-	3f	Kec
1N	BC847T	Si-npn	GP, 50V, 100mA, 150mW, B=110..800, >100MHz	SOT-416	16ta	-	3a	Phi

Note: ELM75xxCBB series LN- lot number L=0...9 N=A to Z(I, O, X excepted); ELM75xxNBB series LN- lot number L=A to Z(I, O, X excepted) N=0...9



SMD code	Type	Function	Short description	Case	Pinout	Sch.	St.	Mnf.
1N	FMMTA14	Si-npn-Darl	GP, 40V, 300mA, 330mW, B>20000, >125MHz	SOT-23	16ta	-	3a	Zx
1N	IMBT3904	Si-npn	GP, 60V, 200mA, 250mW, B=100..300, >300MHz	SOT-23	16ta	-	3a	litt
1N	KST14	Si-npn-Darl	GP, 30V, 300mA, 350mW, B>10000, >125MHz	SOT-23	16ta	-	3a	Sam
1N	MMBT3904	Si-npn	GP, 60V, 100mA, 200mW, B= 100..300, >300MHz	SOT-23	16ta	-	3a	litt,Vs
1N	MMBT3904T	Si-npn	GP, 60V, 200mA, 250mW, B=100..300, >300MHz	SOT-23	16ta	-	3d	Di
1N	MMBTA14	Si-npn-Darl	GP, 30V, 300mA, 300mW, B>10000, >125MHz	SOT-23	16ta	-	3a,3g	Vs
1N	R3131N44DC	Vdet-IC	4.4V, +Reset ODO, 200ms	SOT-23	16vdc	VD6	3b	Ric
1N	SMBTA14	Si-npn-Darl	GP, 30V, 300mA, 300mW, B>10000, >125MHz	SOT-23	16ta	-	3c	Inf
1N	TMPTA14	Si-npn-Darl	GP, 30V, 500mA, 350mW, B>10000, >125MHz	SOT-23	16ta	-	3a	All
1N	GMBTA14	Si-npn-Darl	GP, 30V, 500mA, 225mW, B=10k..20k, 125MHz	SOT-23	16ta	-	3a	Gtm
1N5	ZXT11N15DFTA	Si-npn	Lo-sat, Sw, 40V, 3A, 625mW, B=200..900, 145MHz	SOT-23	16ta	-	3a	Zx
1N5	ZXT11N15DFTC	Si-npn	Lo-sat, Sw, 40V, 3A, 625mW, B=200..900, 145MHz	SOT-23	16ta	-	3a	Zx
1Np	BAP70-04W	PIN-diode	Dual RF, 50V, 100mA, 260mW, 0.6pF, 1.4C(100mA/100MHz)	SOT-323	16dl	-	3a	PhH
1Nt	BAP70-04W	PIN-diode	Dual RF, 50V, 100mA, 260mW, 0.6pF, 1.4C(100mA/100MHz)	SOT-323	16dl	-	3a	PhM
1NW	BAP70-04W	PIN-diode	Dual RF, 50V, 100mA, 260mW, 0.6pF, 1.4C(100mA/100MHz)	SOT-323	16dl	-	3a	PhC
1OP	2SK198-P	n-FET	AF, LN, 30V, ±20mA, 150mA, Idss=0.5..3mA, Up<1.5V	SOT-23	16fa	-	3a	Pan
1OP	2SK662-P	n-FET	Small Signal Amplifier, 30V, 20mA, 150mW, Idss=0.5..3mA, Up<0.8V	SOT-323	16fa	-	3a	Pan
1OQ	2SK198-Q	n-FET	AF, LN, 30V, ±20mA, 150mA, Idss=2..6mA, Up<1.5V	SOT-23	16fa	-	3a	Pan
1OQ	2SK662-Q	n-FET	Small Signal Amplifier, 30V, 20mA, 150mW, Idss=2..6mA, Up<0.8V	SOT-323	16fa	-	3a	Pan
1OR	2SK198-R	n-FET	AF, LN, 30V, ±20mA, 150mA, Idss=4..12mA, Up<1.5V	SOT-23	16fa	-	3a	Pan
1OR	2SK662-R	n-FET	Small Signal Amplifier, 30V, 20mA, 150mW, Idss=4..12mA, Up<0.8V	SOT-323	16fa	-	3a	Pan
1P	BC807-40	Si-pnp	GP, 50V, 500mA, 350mW, B=250..630, >80MHz	SOT-23	16ta	-	3f	Kec
1P	BC807A-40	Si-pnp	GP, 50V, 500mA, 350mW, B=250..630, >80MHz	SOT-23	16ta	-	3f	Kec
1P	FMMT2222A	Si-npn	GP, 75V, 600mA, 330mW, B=120..360, >300MHz	SOT-23	16ta	-	3a	Zx
1P	KST2222A	Si-npn	GP, 75V, 600mA, 350mW, B=75, >300MHz	SOT-23	16ta	-	3a	Sam
1P	MBT2222A	Si-npn	GP, 75V, 600mA, 250mW, B=40, 300MHz	SOT-23	16ta	-	3a	Tos
1P	MMBT2222A	Si-npn	GP, 75V, 800mA, 200mW, B=100..300, >200MHz	SOT-23	16ta	-	3a	Mot
1P	MMBT2222AT	Si-npn	GP, 75V, 800mA, 200mW, B=100..300, >200MHz	SOT-23	16ta	-	3d	Di
1P	MMBT2222AW	Si-npn	GP, 75V, 800mA, 200mW, B=100..300, >200MHz	SOT-323	16ta	-	3a	Mot
1P	R3131N44HC	Vdet-IC	4.4V, +Reset ODO, 400ms	SOT-23	16vdc	VD6	3b	Ric
1P	SMBT2222A	Si-npn	GP, 75V, 600mA, 330mW, B=120..360, >300MHz	SOT-23	16ta	-	3c	Inf
1P	TMPT2222A	Si-npn	GP, 75V, 0.8A, 200mW, B=100..300, >200MHz	SOT-23	16ta	-	3a	All
1P	UNRF1A1	Si-pnp-Digi	Sw, 50V, 80mA, 100mW, 80MHz, R1/R2=10k/10k	ML3	22ta	-	2b	Pan
1P	YTS2222A	Si-npn	GP, 75V, 0.8A, 200mW, B=100..300, >200MHz	SOT-23	16ta	-	3a	Tos
1P-	2SC2411KPT-R	Si-npn	AF, Sw, 32V, 500mA, B=180..390, 250MHz	SOT-23	16ta	-	3a	Chm
-1P	PMST2222A	Si-npn	Sw, 75V, 600mA, 200mW, B=120..300, >300MHz	SOT-323	16ta	-	3a	PhH
1Q	FMMT5088	Si-npn	GP, 35V, 50mA, 330mW, B=300..900, >50MHz	SOT-23	16ta	-	3a	Zx
1Q	KST5088	Si-npn	3GP, 5V, 50mA, 350mW, B=300..900, >50MHz	SOT-23	16ta	-	3a	Sam
1Q	MMBT5087	Si-pnp	GP, LN, 50V, 50mA, 225mW, B=250..800, >40MHz	SOT-23	16ta	-	3a	Mot
1Q	MMBT5088	Si-npn	GP, LN, 35V, 50mA, 225mW, B=300..900, >50MHz	SOT-23	16ta	-	3a	Mot
1Q	R3131N44AA	Vdet-IC	4.4V, +Reset PPO, 50ms	SOT-23	16vdc	VD7	3b	Ric
1Q	TMPT5088	Si-npn	GP, 35V, 50mA, 350mW, B=300..900, >50MHz	SOT-23	16ta	-	3a	All
-1Q	PMST5088	Si-npn	GP, 35V, 100mA, 200mW, B=300..900, >100MHz	SOT-323	16ta	-	3a	PhH
1R	FMMT5089	Si-npn	AF, 30V, 50mA, 330mW, B=400..1200, >50MHz	SOT-23	16ta	-	3a	Zx
1R	KST5089	Si-npn	GP, 35V, 50mA, 350mW, B=400..1200, >50MHz	SOT-23	16ta	-	3a	Sam
1R	MMBT5089	Si-npn	GP, LN, 30V, 50mA, 225mW, B=400..1200, >50MHz	SOT-23	16ta	-	3a	Mot
1R	R3131N44BA	Vdet-IC	4.4V, +Reset PPO, 100ms	SOT-23	16vdc	VD7	3b	Ric
1R	SRA2201E	Si-pnp-Digi	Sw, 50V, 100mA, 150mW, 200MHz, R1/R2=4.7/47k	SOT-523	16ta	-	3a	Auk
1R	SRA2201EF	Si-pnp-Digi	Sw, 50V, 100mA, 150mW, 200MHz, R1/R2=4.7/4.7k	SOT-523F	18ta	-	3a	Auk
1R	SRA2201U	Si-pnp-Digi	Sw, 50V, 100mA, 200mW, 200MHz, R1/R2=4.7/4.7k	SOT-323	16ta	-	3a	Auk
1R	SRA2201UF	Si-pnp-Digi	Sw, 50V, 100mA, 200mW, 200MHz, R1/R2=4.7/4.7k	SOT-323F	18ta	-	3a	Auk
1R	TMPT5089	Si-npn	AF, 30V, 50mA, 330mW, B=400..1200, >50MHz	SOT-23	16ta	-	3a	All
1R	UNRF1A0	Si-pnp-Digi	Sw, 50V, 80mA, 100mW, 80MHz, R1=47k	ML3	22ta	-	2b	Pan
-1R	PMST5089	Si-npn	GP, 30V, 100mA, 200mW, B=400..1200, >100MHz	SOT-323	16ta	-	3a	PhH
1RQ	2SB1585-Q	Si-pnp	Lo-sat, 15V, 500mA, 130MHz, B=85..170	SOT-416	16ta	-	3a	Pan
1RR	2SB1585-R	Si-pnp	Lo-sat, 15V, 500mA, 130MHz, B=120..240	SOT-416	16ta	-	3a	Pan
1RR	2SB970-R	Si-pnp	AF, 15V, 500mA, 200mW, B=130..220, 130MHz	SC-59	16ta	-	3a	Pan
1RS	2SB1585-S	Si-pnp	Lo-sat, 15V, 500mA, 130MHz, B=170..340	SOT-416	16ta	-	3a	Pan
1RS	2SB970-S	Si-pnp	AF, 15V, 500mA, 200mW, B=180..350, 130MHz	SC-59	16ta	-	3a	Pan
1S	MMBT2369A	Si-npn	Sw, 40V, 200mA, 330mW, B=40..120	SOT-23	16ta	-	3a	Nsc
1S	MSC3130	Si-npn	RF, 15V, 50mA, 200mW, B=75..400, >1.4GHz	SC-59	16ta	-	3a	Mot
1S	R3131N44DA	Vdet-IC	4.4V, +Reset PPO, 200ms	SOT-23	16vdc	VD7	3b	Ric
1S	UNRF1AM	Si-pnp-Digi	Sw, 50V, 80mA, 100mW, 80MHz, R1/R2=2k2/47k	ML3	22ta	-	2b	Pan
1S	UNRF1AT	Si-pnp-Digi	Sw, 50V, 80mA, 100mW, 80MHz, R1/R2=22k/47k	ML3	22ta	-	2b	Pan
1SP	2SC3130-P	Si-npn	HF-Amp/mix/osc, 15V, 50mA, 150mW, 1.9GHz, B=75..130	SC-59	16ta	-	3a	Pan
1SP	2SC3935-P	Si-npn	HF-Amp/osc, 15V, 50mA, 150mW, B=75..130, 1.9GHz	SOT-323	16ta	-	3a	Pan
1SP	2SC4809-P	Si-npn	HF Amp/osc/mix, 15V, 50mA, 125mW, B=75..130, 1.9GHz	SOT-416	16ta	-	3a	Pan
1SQ	2SC3130-Q	Si-npn	HF-Amp/mix/osc, 15V, 50mA, 150mW, 1.9GHz, B=110..220	SC-59	16ta	-	3a	Pan
1SQ	2SC3935-Q	Si-npn	HF-Amp/osc, 15V, 50mA, 150mW, B=110..220, 1.9GHz	SOT-323	16ta	-	3a	Pan
1SQ	2SC4809-Q	Si-npn	HF Amp/osc/mix, 15V, 50mA, 125mW, B=110..220, 1.9GHz	SOT-416	16ta	-	3a	Pan



SMD code	Type	Function	Short description	Case	Pinout	Sch. St.	Mnf.
1SR	2SC3130-R	Si-npn	HF-Amp/mix/osc, 15V, 50mA, 150mW, 1.9GHz, B=200..400	SC-59	16ta -	3a	Pan
1SR	2SC4809-R	Si-npn	HF Amp/osc/mix, 15V, 50mA, 125mW, B=200..400, 1.9GHz	SOT-416	16ta -	3a	Pan
1T	2SC3077	Si-npn	UHF-amp/mix, 30V, 20mA, 150mW, B=200..400, 1.1GHz	SC-59	16ta -	3a	Pan
1T	2SC3933	Si-npn	UHF-amp/mix, 30V, 20mA, 150mW, B=40..200, 1.1GHz	SOT-323	16ta -	3a	Pan
1T	R3131N44HA	Vdet-IC	4.4V, +Reset PPO, 400ms	SOT-23	16vdc	VD7	Ric
1T	UNRF2A1	Si-npn-Digi	Sw, 50V, 80mA, 100mW, 150MHz, R1/R2=10k/10k	ML3	22ta -	2b	Pan
1T1	MMST5101	Si-pnp	AF, 60V, 200mA, B=200..400, >125MHz	SOT-23	16ta -	3a	Rhm
1T1	SST5101	Si-pnp	GP, 60V, 200mA, >125MHz	SOT-23	16ta -	3a	Rhm
1TQ	2SC4773-Q	Si-npn	RF, Sw, 6V, 50mA, B=120..270, 800MHz	SOT-323	16ta -	3a	Rhm
1TR	2SC4773-R	Si-npn	RF, Sw, 6V, 50mA, B=180..390, 800MHz	SOT-323	16ta -	3a	Rhm
1TS	2SC4773-S	Si-npn	RF, Sw, 6V, 50mA, B=270..560, 800MHz	SOT-323	16ta -	3a	Rhm
1U	2SC3110	Si-npn	UHF, 15V, 30mA, 200mW, 4.5GHz, B>40	SC-59A	16ta -	3a	Pan
1U	2SC3934	Si-npn	HF, WB, LN, 15V, 50mA, 150mW, B>40, 4.5GHz	SOT-323	16ta -	3a	Pan
1U	KST2484	Si-npn	GP, 60V, 50mA, 350mW, B>250	SOT-23	16ta -	3a	Sam
1U	MMBT2484L	Si-npn	GP, 60V, 100mA, 300mW, B=250..800	SOT-23	16ta -	3a	Ons
1V	BF820	Si-npn	Vid, 300V, 50mA, 250mW, B>50, >60MHz	SOT-23	16ta -	3a	litt
1V	MMBT6427	Si-npn-Darl	AF, 40V, 1.2A, 350mW, B=10..100.00, >130MHz	SOT-23	16ta -	3a	Nsc
1V	TMPT6427	Si-npn-Darl	GP, 40V, 500mA, 350mW, B=10k..100k, >130MHz	SOT-23	16ta -	3a	All
1Vp	BF820	Si-npn	Vid, 300V, 50mA, 250mW, B>50, >60MHz	SOT-23	16ta -	3a	PHH
1VR	2SD1149-R	Si-npn	Hi-beta, LN, 100V, 20mA, 200mW, 200MHz, B=400..800	SC-59	16ta -	3a	Pan
1VR	2SD1824-R	Si-npn	AF-Amp, 100V, 50mA, 150mW, 90MHz, B=400..800	SOT-323	16ta -	3a	Pan
1VS	2SD1149-S	Si-npn	Hi-beta, LN, 100V, 20mA, 200mW, 200MHz, B=600..1200	SC-59	16ta -	3a	Pan
1VS	2SD1824-S	Si-npn	AF-Amp, 100V, 50mA, 150mW, 90MHz, B=600..1200	SOT-323	16ta -	3a	Pan
1VT	2SD1824-T	Si-npn	AF-Amp, 100V, 50mA, 150mW, 90MHz, B=1000..2000	SOT-323	16ta -	3a	Pan
1Vt	BF820	Si-npn	Vid, 300V, 50mA, 250mW, B>50, >60MHz	SOT-23	16ta -	3a	PHM
1Vt	BF820W	Si-npn	Vid, 300V, 100mA, 200mW, B>50, >60MHz	SOT-323	16ta -	3a	Phi
1VW	BF820	Si-npn	Vid, 300V, 50mA, 250mW, B>50, >60MHz	SOT-23	16ta -	3a	PhC
1W	BF821	Si-pnp	Vid, 300V, 50mA, 250mW, B>50, >60MHz	SOT-23	16ta -	3a	Cdi
1W	FMMT3903	Si-npn	GP, 60V, 200mA, 330mW, B=50..150, >250MHz	SOT-23	16ta -	3a	Zx
1W	UNRF2A3	Si-npn-Digi	Sw, 50V, 80mA, 100mW, 150MHz, R1/R2=47k/47k	ML3	22ta -	2b	Pan
1W-	BAP51-05W	PIN-diode	Dual, RF, 50V, 50mA, 240mW, 0.35pF, 2.5Ω(10mA/100MHz)	SOT-323	16dg -	3a	Phi
1Wp	BF821	Si-pnp	Vid, 300V, 50mA, 250mW, B>50, >60MHz	SOT-23	16ta -	3a	PHH
1Wt	BF821	Si-pnp	Vid, 300V, 50mA, 250mW, B>50, >60MHz	SOT-23	16ta -	3a	PHM
1Wt	BF822W	Si-npn	Vid, 250V, 100mA, 200mW, B>50, >60MHz	SOT-323	16ta -	3a	Phi
1WW	BF821	Si-pnp	Vid, 300V, 50mA, 250mW, B>50, >60MHz	SOT-23	16ta -	3a	PhC
1X	2SC2845	Si-npn	UHF, LN, 25V, 70mA, 200mW, B=40..200, 4.5GHz	SC-59	16ta -	3a	Pan
1X	BF822	Si-npn	Vid, 250V, 50mA, 250mW, B>50, >60MHz	SOT-23	16ta -	3a	litt
1X	MMBT930L	Si-npn	GP, 60V, 0.1A, 200mW, B= 100..300, >300MHz	SOT-23	16ta -	-	Mot
1X	UNRF2A5	Si-npn-Digi	Sw, 50V, 80mA, 100mW, 150MHz, R1=10k	ML3	22ta -	2b	Pan
1XB	2SC4780-B	Si-npn	UHF, LN, 25V, 50mA, 150mW, B=40..100, 4.5GHz	SOT-323	16ta -	3a	Pan
1XC	2SC4780-C	Si-npn	UHF, LN, 25V, 50mA, 150mW, B=80..200, 4.5GHz	SOT-323	16ta -	3a	Pan
1Xp	BF822	Si-npn	Vid, 250V, 50mA, 250mW, B>50, >60MHz	SOT-23	16ta -	3a	PHH
1Xt	BF822	Si-npn	Vid, 250V, 50mA, 250mW, B>50, >60MHz	SOT-23	16ta -	3a	PHM
1XW	BF822	Si-npn	Vid, 250V, 50mA, 250mW, B>50, >60MHz	SOT-23	16ta -	3a	PhC
1Y	BF823	Si-pnp	Vid, 250V, 50mA, 250mW, B>50, >60MHz	SOT-23	16ta -	3a	Cdi
1Y	CMBT3903	Si-npn	GP, 60V, 200mA, 250mW, B=50..150, >300MHz	SOT-23	16ta -	3a	Cdi
1Y	KST3903	Si-pnp	GP, 60V, 200mA, 350mW, B=50..150, >250MHz	SOT-23	16ta -	3a	Sam
1Y	MMBT3903	Si-npn	GP, 60V, 200mA, 250mW, B=50..150, >300MHz	SOT-23	16ta -	3a	Mot
1Y	UNRF2A6	Si-npn-Digi	Sw, 50V, 80mA, 100mW, 150MHz, R1=4k7	ML3	22ta -	2b	Pan
1Y	YTS3903	Si-npn	GP, 60V, 200mA, 250mW, B=50..150, >300MHz	SOT-23	16ta -	3a	Tos
1YD	L8550QLT1	Si-pnp	GP, 40V, 800mA, 225mW, B=150..300	SOT-23	16ta -	3a	Lrc
1Yp	BF823	Si-pnp	Vid, 250V, 50mA, 250mW, B>50, >60MHz	SOT-23	16ta -	3a	PHH
1Yt	BF823	Si-pnp	Vid, 250V, 50mA, 250mW, B>50, >60MHz	SOT-23	16ta -	3a	PHM
1YW	BF823	Si-pnp	Vid, 250V, 50mA, 250mW, B>50, >60MHz	SOT-23	16ta -	3a	PhC
1Z	BAS70-06	Si-diode	Dual, Schottky, 70V, 70mA, Vf<1V(15mA), <2pF, 5ns	SOT-23	16df -	3a	Zx
1Z	MMBT6517	Si-npn	Vid, 350V, 250mA, 225mW, B=30..200, <200MHz	SOT-23	16ta -	3a	Mot
1Z	UNRF2A7	Si-npn-Digi	Sw, 50V, 80mA, 100mW, 150MHz, R1=22k	ML3	22ta -	2b	Pan
1ZR	2SD1030-R	Si-npn	AF, 50V, 100mA, 200mW, 120MHz, B=400..800	SC-59	16ta -	3a	Pan
1ZR	2SD1823-R	Si-npn	AF-Amp, 50V, 100mA, 150mW, 120MHz, B=400..800	SOT-323	16ta -	3a	Pan
1ZR	2SD2345-R	Si-npn	AF, 50V, 100mA, 125mW, 120MHz, B=400..800	SOT-416	16ta -	3a	Pan
1ZS	2SD1030-S	Si-npn	AF, 50V, 100mA, 200mW, 120MHz, B=600..1200	SC-59	16ta -	3a	Pan
1ZS	2SD1823-S	Si-npn	AF-Amp, 50V, 100mA, 150mW, 120MHz, B=600..1200	SOT-323	16ta -	3a	Pan
1ZS	2SD2345J-S	Si-npn	AF, 50V, 50mA, 125mW, 120MHz, B=600..1200	SC-89	16ta -	3a	Pan
1ZS	2SD2345-S	Si-npn	AF, 50V, 100mA, 125mW, 120MHz, B=600..1200	SOT-416	16ta -	3a	Pan
1ZT	2SD1030-T	Si-npn	AF, 50V, 100mA, 200mW, 120MHz, B=1000..2000	SC-59	16ta -	3a	Pan
1ZT	2SD1823-T	Si-npn	AF-Amp, 50V, 100mA, 150mW, 120MHz, B=1000..2000	SOT-323	16ta -	3a	Pan
1ZT	2SD2345J-T	Si-npn	AF, 50V, 50mA, 125mW, 120MHz, B=1000..2000	SC-89	16ta -	3a	Pan
1ZT	2SD2345-T	Si-npn	AF, 50V, 100mA, 125mW, 120MHz, B=1000..2000	SOT-416	16ta -	3a	Pan
2	AX6904GA	Vdet-IC	2.25V±1.5%, +Reset PPO	SC-70	16vda	VD7	Axl
2.0	MAZ3020	Z-diode	1.88..2.12V, If=100mA, Zzt=100Ω, 200mW	SC-59	16dc -	3a	Pan



SMD code	Type	Function	Short description	Case	Pinout	Sch.	St.	Mnf.
2.2	MAZ3022	Z-diode	2.08..2.32V, If=100mA, Zzt=100Ω, 200mW	SC-59	16dc	-	3a	Pan
2.4	MAZ3024	Z-diode	2.28..2.6V, If=100mA, Zzt=100Ω, 200mW	SC-59	16dc	-	3a	Pan
2.7H	MAZ3027-H	Z-diode	2.5..2.9V, If=100mA, Zzt=110Ω, 200mW	SC-59	16dc	-	3a	Pan
2.7L	MAZ3027-L	Z-diode	2.5..2.9V, If=100mA, Zzt=110Ω, 200mW	SC-59	16dc	-	3a	Pan
2-0X	02CZ2.0-X	Z-diode	1.85..2.05V, 200mW	SC-59	16dc	-	3a	Tos
2-0Z	02CZ2.0-Z	Z-diode	1.95..2.15V, 200mW	SC-59	16dc	-	3a	Tos
2-2X	02CZ2.2-X	Z-diode	2.05..2.26V, 200mW	SC-59	16dc	-	3a	Tos
2-2Z	02CZ2.2-Z	Z-diode	2.16..2.38V, 200mW	SC-59	16dc	-	3a	Tos
2-4X	02CZ2.4-X	Z-diode	2.28..2.50V, 200mW	SC-59	16dc	-	3a	Tos
2-4Z	02CZ2.4-Z	Z-diode	2.4..2.60V, 200mW	SC-59	16dc	-	3a	Tos
2-7X	02CZ2.7-X	Z-diode	2.5..2.75V, 200mW	SC-59	16dc	-	3a	Tos
2-7Z	02CZ2.7-Z	Z-diode	2.65..2.9V, 200mW	SC-59	16dc	-	3a	Tos
20	1PS59SB20	Si-diode	Schottky, Sw, U-Fast, 40V, 500mA, Vf<0.55V(500mA), <5ns	SC-59	16dc	-	3a	Phi
20	BC849	Si-npn	GP, 30V, 100mA, 250mW, B=200..800, >100MHz	SOT-23	16ta	-	3a	Cdi
20	ELM9820BB	LVR-IC	2.0V±2%, 200mA	SOT-23	16cg	VR1	3d	Elm
20	TZT20W	Z-diode	18.80..21.20V, Izt=5mA, Zzt=25Ω, 200mW	SOT-323	16dc	-	3a	Ttr
20	Z02W20V	Z-diode	18.80..21.20V, Izt=5mA, Zzt=25Ω, 200mW	SOT-23	16dc	-	3f	Kec
20-	HZM2.0NB	Z-diode	1.9..2.2V, 200mW	SC-59A	16dc	-	3a	Ren
200	HZM20NB	Z-diode	18.86..21.08V, 200mW	SC-59A	16dc	-	3a	Ren
201	HZM20NB1	Z-diode	18.86..19.7V, 200mW	SC-59A	16dc	-	3a	Ren
201	PZM20NB1	Z-diode	20V±2.5%, 300mW	SOT-346	16dc	-	3a	Phi
202	HZM20NB2	Z-diode	19.52..20.39V, 200mW	SC-59A	16dc	-	3a	Ren
202	PZM20NB2	Z-diode	20V±2.5%, 300mW	SOT-346	16dc	-	3a	Phi
20-2	UTC8120-2	Vdet-IC	2V, -Reset OCO	SOT-23	16vdy	VD6	3a	Utc
203	HZM20NB3	Z-diode	20.21..21.08V, 200mW	SC-59A	16dc	-	3a	Ren
203	PZM20NB3	Z-diode	20V±2.5%, 300mW	SOT-346	16dc	-	3a	Phi
20-3	UTC8120-3	Vdet-IC	2V, -Reset OCO	SOT-23	16vdb	VD6	3a	Utc
20-5	UTC8120-5	Vdet-IC	2V, -Reset OCO	SOT-23	16vdc	VD6	3a	Utc
20A	AAT60020A-S2	Vdet-IC	2.0V±2%, -Reset ODO	SOT-23	16vdb	VD6	3d	Aat
20A	MAZ3200WA	Z-diode	Dual, 18.8..21.2V, If=100mA, Zzt=55Ω, 200mW	SC-59	16df	-	3a	Pan
20A	MMBZ20VA	TVS	Dual, Vrwm=17V, Vbr=19.0..21.0V, 1.4A, 40W(1ms)	SOT-23	16dg	-	3a	Wtr
20B	AAT60020B-S2	Vdet-IC	2.0V±2%, -Reset PPO	SOT-23	16vdb	VD7	3d	Aat
20C	AAT60020C-S2	Vdet-IC	2.0V±1%, -Reset ODO	SOT-23	16vdb	VD6	3d	Aat
20D	AAT60020D-S2	Vdet-IC	2.0V±1%, -Reset PPO	SOT-23	16vdb	VD7	3d	Aat
20H	BZX84-C20-V	Z-diode	19.48..20.46V, Izt=5mA, Zzt=25Ω, 300mW	SOT-23	16dc	-	3f	Kec
20H	MAZ3200-H	Z-diode	18.8..21.2V, If=100mA, Zzt=55Ω, 200mW	SC-59	16dc	-	3a	Pan
20L	MAZ3200-L	Z-diode	18.8..21.2V, If=100mA, Zzt=55Ω, 200mW	SC-59	16dc	-	3a	Pan
20M	MAZ3200-M	Z-diode	18.8..21.2V, If=100mA, Zzt=55Ω, 200mW	SC-59	16dc	-	3a	Pan
20T	TK71520AS	LVR-IC	LDO, 2V±1.5%, 155mA	SOT-23	16cj	VR1	3d	Tok
20V	CHP220VPT	Z-diode	Dual, 19.0..21.0V, Izt=5mA, Zzt=55Ω, 350mW	SOT-23	16df	-	3a	Chm
20V	PZM20NB	Z-diode	20V±2.5%, 300mW	SOT-346	16dc	-	3a	Phi
20X	02CZ20-X	Z-diode	18.8..19.78V, 200mW	SC-59	16dc	-	3a	Tos
20X	TZT20XW	Z-diode	18.80..19.78V, Izt=5mA, Zzt=25Ω, 200mW	SOT-323	16dc	-	3a	Ttr
20X	Z02W20VX	Z-diode	18.80..19.78V, Izt=5mA, Zzt=25Ω, 200mW	SOT-23	16dc	-	3f	Kec
20Y	02CZ20-Y	Z-diode	19.48..20.46V, 200mW	SC-59	16dc	-	3a	Tos
20Y	TZT20YW	Z-diode	19.48..20.46V, Izt=5mA, Zzt=25Ω, 200mW	SOT-323	16dc	-	3a	Ttr
20Y	Z02W20VY	Z-diode	19.48..20.46V, Izt=5mA, Zzt=25Ω, 200mW	SOT-23	16dc	-	3f	Kec
20Z	02CZ20-Z	Z-diode	20.16..21.2V, 200mW	SC-59	16dc	-	3a	Tos
20Z	CZ1W20	Z-diode	20V±5%, 600mW	SOT-23	16dc	-	3a	Cdi
20Z	TZT20ZW	Z-diode	20.16..21.20V, Izt=5mA, Zzt=25Ω, 200mW	SOT-323	16dc	-	3a	Ttr
20Z	Z02W20VZ	Z-diode	20.16..21.20V, Izt=5mA, Zzt=25Ω, 200mW	SOT-23	16dc	-	3f	Kec
21	1PS59SB21	Si-diode	Schottky, Sw, U-Fast, 40V, 200mA, Vf<0.55V(200mA), <5ns	SC-59	16dc	-	3a	Phi
21	CHP222MPT	Si-diode	Dual, Sw, 80V, 100mA, Vf<1.2V(100mA), 4ns	SOT-723	18df	-	3a	Chm
21	ELM9821BB	LVR-IC	2.1V±2%, 200mA	SOT-23	16cg	VR1	3d	Elm
210	KTY82/210	Tdet-IC	Sensor, Rs=1980..2020Ω(25°C, 1mA)	SOT-23	16ag	-	3a	Nxp
21-2	UTC8121-2	Vdet-IC	2.1V, -Reset OCO	SOT-23	16vdy	VD6	3a	Utc
21-3	UTC8121-3	Vdet-IC	2.1V, -Reset OCO	SOT-23	16vdb	VD6	3a	Utc
21-5	UTC8121-5	Vdet-IC	2.1V, -Reset OCO	SOT-23	16vdc	VD6	3a	Utc
21A	AAT60021A-S2	Vdet-IC	2.1V±2%, -Reset ODO	SOT-23	16vdb	VD6	3d	Aat
21A	APR3021-15A	Vdet-IC	1.5V, -Reset PPO	SOT-23	16vda	VD7	3b	Anp
21B	AAT60021B-S2	Vdet-IC	2.1V±2%, -Reset PPO	SOT-23	16vdb	VD7	3d	Aat
21B	APR3021-17A	Vdet-IC	1.75V, -Reset PPO	SOT-23	16vda	VD7	3b	Anp
21B	MMBZ5221BPT	Z-diode	2.280..2.520V, Izt=5mA, Zzt=100Ω, 225mW	SOT-23	16dc	-	3a	Chm
21C	AAT60021C-S2	Vdet-IC	2.1V±1%, -Reset ODO	SOT-23	16vdb	VD6	3d	Aat
21C	APR3021-23A	Vdet-IC	2.32V, -Reset PPO	SOT-23	16vda	VD7	3b	Anp
21D	AAT60021D-S2	Vdet-IC	2.1V±1%, -Reset PPO	SOT-23	16vdb	VD7	3d	Aat
21D	APR3021-26A	Vdet-IC	2.63V, -Reset PPO	SOT-23	16vda	VD7	3b	Anp
21E	APR3021-29A	Vdet-IC	2.93V, -Reset PPO	SOT-23	16vda	VD7	3b	Anp
21F	APR3021-30A	Vdet-IC	3.08V, -Reset PPO	SOT-23	16vda	VD7	3b	Anp
21G	APR3021-39A	Vdet-IC	3.9V, -Reset PPO	SOT-23	16vda	VD7	3b	Anp



SMD code	Type	Function	Short description	Case	Pinout	Sch.	St.	Mnf.
21H	APR3021-43A	Vdet-IC	4.38V, -Reset PPO	SOT-23	16vda	VD7	3b	Anp
21J	APR3021-46A	Vdet-IC	4.63V, -Reset PPO	SOT-23	16vda	VD7	3b	Anp
21N	DMN2170U	n-MOSFET-e*	Sw, 20V, 2.3A, 600mW, 50mQ(3A), 62pF	SOT-23	16fh	-	3c	Di
21N	STM1061N21W	Vdet-IC	2.1V±2%, -Reset ODO	SOT-323	16vda	VD6	3d	Ste
21N	STM1061N21WX	Vdet-IC	2.1V±2%, -Reset ODO	SOT-23	16vda	VD6	3d	Ste
21S	MMBZ5221SPT	Z-diode	2.352..2.448V, Izt=5mA, Zzt=100Ω, 225mW	SOT-23	16dc	-	3a	Chm
21S	MMBZ5221SPT	Z-diode	2.352..2.448V, Izt=5mA, Zzt=100Ω, 225mW	SOT-346	16dc	-	3a	Chm
21T	TK71521AS	LVR-IC	LDO, 2.1V±1.5%, 155mA	SOT-23	16cj	VR1	3d	Tok
22	CHN222M1PT	Si-diode	Dual, Sw, 80V, 100mA, Vf<1.2V(100mA), 4ns	FBPT-723	17dg	-	9d	Chm
22	CHN222MPT	Si-diode	Dual, Sw, 80V, 100mA, Vf<1.2V(100mA), 4ns	SOT-723	18dg	-	3a	Chm
22	DTC123EE	Si-npn-Digi	Sw, 50V, 100mA, 150mW, 250MHz, R1/R2=2k2/2k2	SOT-416	16ta	-	3a	Rhm
22	DTC123EKA	Si-npn-Digi	Sw, 50V, 100mA, 200mW, 250MHz, R1/R2=2k2/2k2	SOT-346	16ta	-	3a	Rhm
22	DTC123EM	Si-npn-Digi	Sw, 50V, 100mA, 150mW, 250MHz, R1/R2=2k2/2k2	VMT3	18ta	-	3a	Rhm
22	DTC123EUA	Si-npn-Digi	Sw, 50V, 100mA, 200mW, 250MHz, R1/R2=2k2/2k2	UMT3	16ta	-	3a	Rhm
22	ELM9822BB	LVR-IC	2.2V±2%, 200mA	SOT-23	16cg	VR1	3d	Elm
22	TZT22W	Z-diode	20.80..23.30V, Izt=5mA, Zzt=30Ω, 200mW	SOT-323	16dc	-	3a	Ttr
22	Z02W22V	Z-diode	20.80..23.30V, Izt=5mA, Zzt=30Ω, 200mW	SOT-23	16dc	-	3f	Kec
22-	HZM2.2NB	Z-diode	2.1..2.4V, 200mW	SC-59A	16dc	-	3a	Ren
220	HZM22NB	Z-diode	20.88..23.17V, 200mW	SC-59A	16dc	-	3a	Ren
220	KTY82220	Tdet-IC	Sensor, Rs=1960..2040Ω(25°C, 1mA)	SOT-23	16ag	-	3a	Nxp
221	HZM22NB1	Z-diode	20.88..21.77V, 200mW	SC-59A	16dc	-	3a	Ren
221	KTY82221	Tdet-IC	Sensor, Rs=1960..2000Ω(25°C, 1mA)	SOT-23	16ag	-	3a	Nxp
221	PZM22NB1	Z-diode	22V±2.5%, 300mW	SOT-346	16dc	-	3a	Phi
222	HZM22NB2	Z-diode	21.54..22.47V, 200mW	SC-59A	16dc	-	3a	Ren
222	KTY82222	Tdet-IC	Sensor, Rs=2000..2040Ω(25°C, 1mA)	SOT-23	16ag	-	3a	Nxp
222	PZM22NB2	Z-diode	22V±2.5%, 300mW	SOT-346	16dc	-	3a	Phi
22-2	UTC8122-2	Vdet-IC	2.2V, -Reset OCO	SOT-23	16vdy	VD6	3a	Utc
223	HZM22NB3	Z-diode	22.23..23.17V, 200mW	SC-59A	16dc	-	3a	Ren
223	PZM22NB3	Z-diode	22V±2.5%, 300mW	SOT-346	16dc	-	3a	Phi
22-3	UTC8122-3	Vdet-IC	2.2V, -Reset OCO	SOT-23	16vdb	VD6	3a	Utc
22-5	UTC8122-5	Vdet-IC	2.2V, -Reset OCO	SOT-23	16vdc	VD6	3a	Utc
22A	AAT60022A-S2	Vdet-IC	2.2V±2%, -Reset ODO	SOT-23	16vdb	VD6	3d	Aat
22A	APR3022-15A	Vdet-IC	1.5V, +Reset PPO	SOT-23	16vda	VD7	3b	Anp
22B	AAT60022B-S2	Vdet-IC	2.2V±2%, -Reset PPO	SOT-23	16vdb	VD7	3d	Aat
22B	APR3022-17A	Vdet-IC	1.75V, +Reset PPO	SOT-23	16vda	VD7	3b	Anp
22B	MMBZ5222BPT	Z-diode	2.375..2.625V, Izt=5mA, Zzt=100Ω, 225mW	SOT-23	16dc	-	3a	Chm
22C	AAT60022C-S2	Vdet-IC	2.2V±1%, -Reset ODO	SOT-23	16vdb	VD6	3d	Aat
22C	APR3022-23A	Vdet-IC	2.32V, +Reset PPO	SOT-23	16vda	VD7	3b	Anp
22D	AAT60022D-S2	Vdet-IC	2.2V±1%, -Reset PPO	SOT-23	16vdb	VD7	3d	Aat
22D	APR3022-26A	Vdet-IC	2.63V, +Reset PPO	SOT-23	16vda	VD7	3b	Anp
22E	APR3022-29A	Vdet-IC	2.93V, +Reset PPO	SOT-23	16vda	VD7	3b	Anp
22F	APR3022-30A	Vdet-IC	3.08V, +Reset PPO	SOT-23	16vda	VD7	3b	Anp
22G	APR3022-39A	Vdet-IC	3.9V, +Reset PPO	SOT-23	16vda	VD7	3b	Anp
22H	APR3022-43A	Vdet-IC	4.38V, +Reset PPO	SOT-23	16vda	VD7	3b	Anp
22H	BXZ84-C22-V	Z-diode	21.48..22.56V, Izt=5mA, Zzt=30Ω, 300mW	SOT-23	16dc	-	3f	Kec
22H	MAZ3220-H	Z-diode	20.8..23.3V, If=100mA, Zzt=55Ω, 200mW	SC-59	16dc	-	3a	Pan
22J	APR3022-46A	Vdet-IC	4.63V, +Reset PPO	SOT-23	16vda	VD7	3b	Anp
22L	MAZ3220-L	Z-diode	20.8..23.3V, If=100mA, Zzt=55Ω, 200mW	SC-59	16dc	-	3a	Pan
22M	MAZ3220-M	Z-diode	20.8..23.3V, If=100mA, Zzt=55Ω, 200mW	SC-59	16dc	-	3a	Pan
22N	DMN2230U	n-MOSFET-e	Sw, 20V, 2A, 600mW, 81mQ(2.5A), 8/19.6ns	SOT-23	16fh	-	3c	Di
22N	STM1061N22W	Vdet-IC	2.2V±2%, -Reset ODO	SOT-323	16vda	VD6	3d	Ste
22N	STM1061N22WX	Vdet-IC	2.2V±2%, -Reset ODO	SOT-23	16vda	VD6	3d	Ste
22S	MMBZ5222SPT	Z-diode	2.450..2.550V, Izt=5mA, Zzt=100Ω, 225mW	SOT-23	16dc	-	3a	Chm
22S	MMBZ5222SPT	Z-diode	2.450..2.550V, Izt=5mA, Zzt=100Ω, 225mW	SOT-346	16dc	-	3a	Chm
22T	TK71522AS	LVR-IC	LDO, 2.2V±1.5%, 155mA	SOT-23	16cj	VR1	3d	Tok
22V	CHPZ22VPT	Z-diode	Dual, 20.9..23.1V, Izt=5mA, Zzt=55Ω, 350mW	SOT-23	16df	-	3a	Chm
22V	PZM22NB	Z-diode	22V±2.5%, 300mW	SOT-346	16dc	-	3a	Phi
22X	02CZ22-X	Z-diode	20.80..21.88V, 200mW	SC-59	16dc	-	3a	Tos
22X	TZT22XW	Z-diode	20.80..21.88V, Izt=5mA, Zzt=30Ω, 200mW	SOT-323	16dc	-	3a	Ttr
22X	Z02W22VX	Z-diode	20.80..21.88V, Izt=5mA, Zzt=30Ω, 200mW	SOT-23	16dc	-	3f	Kec
22Y	02CZ22-Y	Z-diode	21.48..22.56V, 200mW	SC-59	16dc	-	3a	Tos
22Y	TZT22YW	Z-diode	21.48..22.56V, Izt=5mA, Zzt=30Ω, 200mW	SOT-323	16dc	-	3a	Ttr
22Y	Z02W22VY	Z-diode	21.48..22.56V, Izt=5mA, Zzt=30Ω, 200mW	SOT-23	16dc	-	3f	Kec
22Z	02CZ22-Z	Z-diode	22.16..23.3V, 200mW	SC-59	16dc	-	3a	Tos
22Z	CZ1W22	Z-diode	22V±5%, 600mW	SOT-23	16dc	-	3a	Cdi
22Z	TZT22ZW	Z-diode	22.16..23.30V, Izt=5mA, Zzt=30Ω, 200mW	SOT-323	16dc	-	3a	Ttr
22Z	Z02W22VZ	Z-diode	22.16..23.30V, Izt=5mA, Zzt=30Ω, 200mW	SOT-23	16dc	-	3f	Kec
23	CH221MSPT	Si-diode	Dual, Sw, 20V, 100mA, Vf<1V(10mA), 4ns	SOT-723	18dl	-	3a	Chm
23	DTC143EE	Si-npn-Digi	Sw, 50V, 100mA, 150mW, 250MHz, R1/R2=4k7/4k7	SOT-416	16ta	-	3a	Rhm
23	DTC143EKA	Si-npn-Digi	Sw, 50V, 100mA, 200mW, 250MHz, R1/R2=4k7/4k7	SOT-346	16ta	-	3a	Rhm



SMD code	Type	Function	Short description	Case	Pinout	Sch.	St.	Mnf.
23	DTC143EM	Si-npn-Digi	Sw, 50V, 100mA, 150mW, 250MHz, R1/R2=4k7/4k7	VMT3	18ta	-	3a	Rhm
23	DTC143EUA	Si-npn-Digi	Sw, 50V, 100mA, 200mW, 250MHz, R1/R2=4k7/4k7	UMT3	16ta	-	3a	Rhm
23	ELM9823BB	LVR-IC	2.3V±2%, 200mA	SOT-23	16cg	VR1	3d	Elm
23	MMBT3646	Si-npn	GP, 40V, 200mA, 350mW, B=30..120, >350MHz	SOT-23	16ta	-	3a	Nsc
23	PDTA114TK	Si-npn-Digi	Sw, 50V, 100mA, 250mW, R1=10k	SC-59	16ta	-	3a	Phi
-23	PDTA114TU	Si-npn-Digi	Sw, 50V, 100mA, 200mW, R1=10k	SOT-323	16ta	-	3a	PHH
23-2	UTC8123-2	Vdet-IC	2.3V, -Reset OCO	SOT-23	16vdy	VD6	3a	Utc
23-3	UTC8123-3	Vdet-IC	2.3V, -Reset OCO	SOT-23	16vdb	VD6	3a	Utc
23-5	UTC8123-5	Vdet-IC	2.3V, -Reset OCO	SOT-23	16vdc	VD6	3a	Utc
23A	AAT60023A-S2	Vdet-IC	2.3V±2%, -Reset ODO	SOT-23	16vdb	VD6	3d	Aat
23A	APR3023-15A	Vdet-IC	1.5V, -Reset ODO	SOT-23	16vdb	VD6	3b	Anp
23B	AAT60023B-S2	Vdet-IC	2.3V±2%, -Reset PPO	SOT-23	16vdb	VD7	3d	Aat
23B	APR3023-17A	Vdet-IC	1.75V, -Reset ODO	SOT-23	16vda	VD6	3b	Anp
23B	MMBZ5223BPT	Z-diode	2.565..2.835V, Izt=5mA, Zzt=100Ω, 225mW	SOT-23	16dc	-	3a	Chm
23C	AAT60023C-S2	Vdet-IC	2.3V±1%, -Reset ODO	SOT-23	16vdb	VD6	3d	Aat
23C	APR3023-23A	Vdet-IC	2.32V, -Reset ODO	SOT-23	16vda	VD6	3b	Anp
23D	AAT60023D-S2	Vdet-IC	2.3V±1%, -Reset PPO	SOT-23	16vdb	VD7	3d	Aat
23D	APR3023-26A	Vdet-IC	2.63V, -Reset ODO	SOT-23	16vda	VD6	3b	Anp
23E	APR3023-29A	Vdet-IC	2.93V, -Reset ODO	SOT-23	16vda	VD6	3b	Anp
23F	APR3023-30A	Vdet-IC	3.08V, -Reset ODO	SOT-23	16vda	VD6	3b	Anp
23G	APR3023-39A	Vdet-IC	3.9V, -Reset ODO	SOT-23	16vda	VD6	3b	Anp
23H	APR3023-43A	Vdet-IC	4.38V, -Reset ODO	SOT-23	16vda	VD6	3b	Anp
23J	APR3023-46A	Vdet-IC	4.63V, -Reset ODO	SOT-23	16vda	VD6	3b	Anp
23N	STM1061N23W	Vdet-IC	2.3V±2%, -Reset ODO	SOT-323	16vda	VD6	3d	Ste
23N	STM1061N23WX	Vdet-IC	2.3V±2%, -Reset ODO	SOT-23	16vda	VD6	3d	Ste
23S	MMBZ5223SPT	Z-diode	2.646..2.754V, Izt=5mA, Zzt=100Ω, 225mW	SOT-23	16dc	-	3a	Chm
23S	MMCZ5223SPT	Z-diode	2.646..2.754V, Izt=5mA, Zzt=100Ω, 225mW	SOT-346	16dc	-	3a	Chm
23T	TK71523AS	LVR-IC	LDO, 2.3V±1.5%, 155mA	SOT-23	16cj	VR1	3d	Tok
24	2SC5006-FB	Si-npn	VHF/UHF, 20V, 100mA, 125mW, 4.5GHz, B=80..160	SOT-323	16ta	-	3a	Nec
24	DTC114ECA	Si-npn-Digi	Sw, 50V, 100mA, 200mW, 250MHz, R1/R2=10/10k	SOT-23	16ta	-	3a	Rhm
24	DTC114EE	Si-npn-Digi	Sw, 50V, 100mA, 150mW, 250MHz, R1/R2=10/10k	SOT-416	16ta	-	3a	Rhm
24	DTC114EKA	Si-npn-Digi	Sw, 50V, 100mA, 200mW, 250MHz, R1/R2=10/10k	SOT-346	16ta	-	3a	Rhm
24	DTC114EM	Si-npn-Digi	Sw, 50V, 100mA, 150mW, 250MHz, R1/R2=10/10k	VMT3	18ta	-	3a	Rhm
24	DTC114EUA	Si-npn-Digi	Sw, 50V, 100mA, 200mW, 250MHz, R1/R2=10/10k	UMT3	16ta	-	3a	Rhm
24	ELM9824BB	LVR-IC	2.4V±2%, 200mA	SOT-23	16cg	VR1	3d	Elm
24	MSCT24	TVS	Vrwm=24V, 300W (8/20μs)	SOT-23	16dh	-	3a	Msp
24	NE85619-FB	Si-npn	VHF/UHF, 20V, 100mA, 125mW, 4.5GHz, B=80..160	SOT-323	16ta	-	3a	Cel
24	PDTC114TE	Si-npn-Digi	Sw, 50V, 100mA, 150mW, R1=10k	SOT-416	16ta	-	3a	Phi
24	PDTC114TK	Si-npn-Digi	Sw, 50V, 100mA, 250mW, R1=10k	SC-59	16ta	-	3a	Phi
24	TZT24W	Z-diode	22.80..25.60V, Izt=5mA, Zzt=40Ω, 200mW	SOT-323	16dc	-	3a	Ttr
24	Z02W24V	Z-diode	22.80..25.60V, Izt=5mA, Zzt=40Ω, 200mW	SOT-23	16dc	-	3f	Kec
24-	HZM2.4NB	Z-diode	2.3..2.6V, 200mW	SC-59A	16dc	-	3a	Ren
-24	PDTC114TU	Si-npn-Digi	Sw, 50V, 100mA, 200mW, R1=10k	SOT-323	16ta	-	3a	PHH
240	HZM24NB	Z-diode	22.93..25.57V, 200mW	SC-59A	16dc	-	3a	Ren
241	HZM24NB1	Z-diode	22.93..23.96V, 200mW	SC-59A	16dc	-	3a	Ren
241	PZM24NB	Z-diode	24V±2.5%, 300mW	SOT-346	16dc	-	3a	Phi
241	PZM24NB1	Z-diode	24V±2.5%, 300mW	SOT-346	16dc	-	3a	Phi
242	HZM24NB2	Z-diode	23.72..24.78V, 200mW	SC-59A	16dc	-	3a	Ren
242	PZM24NB	Z-diode	24V±2.5%, 300mW	SOT-346	16dc	-	3a	Phi
242	PZM24NB2	Z-diode	24V±2.5%, 300mW	SOT-346	16dc	-	3a	Phi
24-2	UTC8124-2	Vdet-IC	2.4V, -Reset OCO	SOT-23	16vdy	VD6	3a	Utc
243	HZM24NB3	Z-diode	24.54..25.57V, 200mW	SC-59A	16dc	-	3a	Ren
243	PZM20NB	Z-diode	24V±2.5%, 300mW	SOT-346	16dc	-	3a	Phi
243	PZM24NB3	Z-diode	24V±2.5%, 300mW	SOT-346	16dc	-	3a	Phi
24-3	UTC8124-3	Vdet-IC	2.4V, -Reset OCO	SOT-23	16vdb	VD6	3a	Utc
24-5	UTC8124-5	Vdet-IC	2.4V, -Reset OCO	SOT-23	16vdc	VD6	3a	Utc
24A	AAT60024A-S2	Vdet-IC	2.4V±2%, -Reset ODO	SOT-23	16vdb	VD6	3d	Aat
24B	AAT60024B-S2	Vdet-IC	2.4V±2%, -Reset PPO	SOT-23	16vdb	VD7	3d	Aat
24B	MMBZ5224BPT	Z-diode	2.660..2.940V, Izt=5mA, Zzt=100Ω, 225mW	SOT-23	16dc	-	3a	Chm
24C	AAT60024C-S2	Vdet-IC	2.4V±1%, -Reset ODO	SOT-23	16vdb	VD6	3d	Aat
24C	MSCT24C	TVS	Dual, Vrwm=24V, 300W (8/20μs), Bidirectional	SOT-23	16dp	-	3a	Msp
24C	TVS2324PT	TVS	Dual, Vbr=26.7V, Vrwm=24V, 1A, 300W(1ms)	SOT-23	16df	-	3a	Chm
24D	AAT60024D-S2	Vdet-IC	2.4V±1%, -Reset PPO	SOT-23	16vdb	VD7	3d	Aat
24H	BZX84-C24-V	Z-diode	23.61..24.92V, Izt=5mA, Zzt=40Ω, 300mW	SOT-23	16dc	-	3f	Kec
24H	MAZ3240-H	Z-diode	22.8..25.6V, If=100mA, Zzt=70Ω, 200mW	SC-59	16dc	-	3a	Pan
24K	XC6202P182MR	LVR-IC	LDO, 1.8V±2%, 150mA	SOT-23	16cj	VR1	3d	Tor
24L	MAZ3240-L	Z-diode	22.8..25.6V, If=100mA, Zzt=70Ω, 200mW	SC-59	16dc	-	3a	Pan
24L	XC6202P192MR	LVR-IC	LDO, 1.9V±2%, 150mA	SOT-23	16cj	VR1	3d	Tor
24M	MAZ3240-M	Z-diode	22.8..25.6V, If=100mA, Zzt=70Ω, 200mW	SC-59	16dc	-	3a	Pan
24M	XC6202P202MR	LVR-IC	LDO, 2V±2%, 150mA	SOT-23	16cj	VR1	3d	Tor



SMD code	Type	Function	Short description	Case	Pinout	Sch.	St.	Mnf.
24N	XC6202P212MR	LVR-IC	LDO, 2.1V±2%, 150mA	SOT-23	16cj	VR1	3d	Tor
24P	XC6202P222MR	LVR-IC	LDO, 2.2V±2%, 150mA	SOT-23	16cj	VR1	3d	Tor
24R	XC6202P232MR	LVR-IC	LDO, 2.3V±2%, 150mA	SOT-23	16cj	VR1	3d	Tor
24S	MMBZ5224SPT	Z-diode	2.774..2.856V, Izt=5mA, Zzt=100Q, 225mW	SOT-23	16dc	-	3a	Chm
24S	MMCZ5224SPT	Z-diode	2.774..2.856V, Izt=5mA, Zzt=100Q, 225mW	SOT-346	16dc	-	3a	Chm
24S	XC6202P242MR	LVR-IC	LDO, 2.4V±2%, 150mA	SOT-23	16cj	VR1	3d	Tor
24T	TK71524AS	LVR-IC	LDO, 2.4V±1.5%, 155mA	SOT-23	16cj	VR1	3d	Tok
24T	XC6202P252MR	LVR-IC	LDO, 2.5V±2%, 150mA	SOT-23	16cj	VR1	3d	Tor
24U	XC6202P262MR	LVR-IC	LDO, 2.6V±2%, 150mA	SOT-23	16cj	VR1	3d	Tor
24V	CHPZ24VPT	Z-diode	Dual, 22.8..25.2V, Izt=5mA, Zzt=70Q, 350mW	SOT-23	16df	-	3a	Chm
24V	PZM24NB	Z-diode	24V±2.5%, 300mW	SOT-346	16dc	-	3a	Phi
24V	XC6202P272MR	LVR-IC	LDO, 2.7V±2%, 150mA	SOT-23	16cj	VR1	3d	Tor
24X	02CZ24-X	Z-diode	22.8..24.11V, 200mW	SC-59	16dc	-	3a	Tos
24X	TZT24XW	Z-diode	22.80..23.61V, Izt=5mA, Zzt=40Q, 200mW	SOT-323	16dc	-	3a	TTr
24X	XC6202P282MR	LVR-IC	LDO, 2.8V±2%, 150mA	SOT-23	16cj	VR1	3d	Tor
24X	Z02W24VX	Z-diode	22.80..24.11V, Izt=5mA, Zzt=40Q, 200mW	SOT-23	16dc	-	3f	Kec
24Y	02CZ24-Y	Z-diode	23.61..24.92V, 200mW	SC-59	16dc	-	3a	Tos
24Y	XC6202P292MR	LVR-IC	LDO, 2.9V±2%, 150mA	SOT-23	16cj	VR1	3d	Tor
24Y	Z02W24VY	Z-diode	23.61..24.92V, Izt=5mA, Zzt=40Q, 200mW	SOT-23	16dc	-	3f	Kec
24Z	02CZ24-Z	Z-diode	24.42..25.6V, 200mW	SC-59	16dc	-	3a	Tos
24Z	CZ1W24	Z-diode	24V±5%, 600mW	SOT-23	16dc	-	3a	Cdi
24Z	TZT24ZW	Z-diode	24.92..25.60V, Izt=5mA, Zzt=40Q, 200mW	SOT-323	16dc	-	3a	TTr
24Z	XC6202P302MR	LVR-IC	LDO, 3V±2%, 150mA	SOT-23	16cj	VR1	3d	Tor
24Z	Z02W24VZ	Z-diode	24.42..25.60V, Izt=5mA, Zzt=40Q, 200mW	SOT-23	16dc	-	3f	Kec
25	DTC124EE	Si-npn-Digi	Sw, 50V, 100mA, 150mW, 250MHz, R1/R2=22k/22k	SOT-416	16ta	-	3a	Rhm
25	DTC124EKA	Si-npn-Digi	Sw, 50V, 100mA, 200mW, 250MHz, R1/R2=22k/22k	SOT-346	16ta	-	3a	Rhm
25	DTC124EM	Si-npn-Digi	Sw, 50V, 100mA, 150mW, 250MHz, R1/R2=22k/22k	VMT3	16ta	-	3a	Rhm
25	DTC124EUA	Si-npn-Digi	Sw, 50V, 100mA, 200mW, 250MHz, R1/R2=22k/22k	UMT3	16ta	-	3a	Rhm
25	ELM9825BB	LVR-IC	2.5V±2%, 200mA	SOT-23	16cg	VR1	3d	Elm
250	KTY82/250	Tdet-IC	Sensor, Rs=1900..2100Q(25°C, 1mA)	SOT-23	16ag	-	3a	Nxp
250	XC6202P312MR	LVR-IC	LDO, 3.1V±2%, 150mA	SOT-23	16cj	VR1	3d	Tor
251	KTY82/251	Tdet-IC	Sensor, Rs=1900..2000Q(25°C, 1mA)	SOT-23	16ag	-	3a	Nxp
251	XC6202P322MR	LVR-IC	LDO, 3.2V±2%, 150mA	SOT-23	16cj	VR1	3d	Tor
252	XC6202P332MR	LVR-IC	LDO, 3.3V±2%, 150mA	SOT-23	16cj	VR1	3d	Tor
25-2	UTC8125-2	Vdet-IC	2.5V, -Reset OCO	SOT-23	16vdy	VD6	3a	Utc
253	XC6202P342MR	LVR-IC	LDO, 3.4V±2%, 150mA	SOT-23	16cj	VR1	3d	Tor
25-3	UTC8125-3	Vdet-IC	2.5V, -Reset OCO	SOT-23	16vdb	VD6	3a	Utc
254	XC6202P352MR	LVR-IC	LDO, 3.5V±2%, 150mA	SOT-23	16cj	VR1	3d	Tor
255	KTY82/252	Tdet-IC	Sensor, Rs=2000..2100Q(25°C, 1mA)	SOT-23	16ag	-	3a	Nxp
255	XC6202P362MR	LVR-IC	LDO, 3.6V±2%, 150mA	SOT-23	16cj	VR1	3d	Tor
25-5	UTC8125-5	Vdet-IC	2.5V, -Reset OCO	SOT-23	16vdc	VD6	3a	Utc
256	XC6202P372MR	LVR-IC	LDO, 3.7V±2%, 150mA	SOT-23	16cj	VR1	3d	Tor
257	XC6202P382MR	LVR-IC	LDO, 3.8V±2%, 150mA	SOT-23	16cj	VR1	3d	Tor
258	XC6202P392MR	LVR-IC	LDO, 3.9V±2%, 150mA	SOT-23	16cj	VR1	3d	Tor
259	XC6202P402MR	LVR-IC	LDO, 4V±2%, 150mA	SOT-23	16cj	VR1	3d	Tor
25A	AAT60025A-S2	Vdet-IC	2.5V±2%, -Reset ODO	SOT-23	16vdb	VD6	3d	Aat
25A	XC6202P412MR	LVR-IC	LDO, 4.1V±2%, 150mA	SOT-23	16cj	VR1	3d	Tor
25B	AAT60025B-S2	Vdet-IC	2.5V±2%, -Reset PPO	SOT-23	16vdb	VD7	3d	Aat
25B	MMBZ5225BPT	Z-diode	2.850..3.150V, Izt=5mA, Zzt=95Q, 225mW	SOT-23	16dc	-	3a	Chm
25B	XC6202P422MR	LVR-IC	LDO, 4.2V±2%, 150mA	SOT-23	16cj	VR1	3d	Tor
25C	AAT60025C-S2	Vdet-IC	2.5V±1%, -Reset ODO	SOT-23	16vdb	VD6	3d	Aat
25C	XC6202P432MR	LVR-IC	LDO, 4.3V±2%, 150mA	SOT-23	16cj	VR1	3d	Tor
25D	AAT60025D-S2	Vdet-IC	2.5V±1%, -Reset PPO	SOT-23	16vdb	VD7	3d	Aat
25D	XC6202P442MR	LVR-IC	LDO, 4.4V±2%, 150mA	SOT-23	16cj	VR1	3d	Tor
25E	XC6202P452MR	LVR-IC	LDO, 4.5V±2%, 150mA	SOT-23	16cj	VR1	3d	Tor
25F	XC6202P462MR	LVR-IC	LDO, 4.6V±2%, 150mA	SOT-23	16cj	VR1	3d	Tor
25H	XC6202P472MR	LVR-IC	LDO, 4.7V±2%, 150mA	SOT-23	16cj	VR1	3d	Tor
25K	XC6202P482MR	LVR-IC	LDO, 4.8V±2%, 150mA	SOT-23	16cj	VR1	3d	Tor
25L	XC6202P492MR	LVR-IC	LDO, 4.9V±2%, 150mA	SOT-23	16cj	VR1	3d	Tor
25M	XC6202P502MR	LVR-IC	LDO, 5V±2%, 150mA	SOT-23	16cj	VR1	3d	Tor
25N	STM1061N25W	Vdet-IC	2.5V±2%, -Reset ODO	SOT-323	16vda	VD6	3d	Ste
25N	STM1061N25WX	Vdet-IC	2.5V±2%, -Reset ODO	SOT-23	16vda	VD6	3d	Ste
25N	XC6202P512MR	LVR-IC	LDO, 5.1V±2%, 150mA	SOT-23	16cj	VR1	3d	Tor
25P	XC6202P522MR	LVR-IC	LDO, 5.2V±2%, 150mA	SOT-23	16cj	VR1	3d	Tor
25R	XC6202P532MR	LVR-IC	LDO, 5.3V±2%, 150mA	SOT-23	16cj	VR1	3d	Tor
25S	MMBZ5225SPT	Z-diode	2.940..3.060V, Izt=5mA, Zzt=95Q, 225mW	SOT-23	16dc	-	3a	Chm
25S	MMCZ5225SPT	Z-diode	2.940..3.060V, Izt=5mA, Zzt=95Q, 225mW	SOT-346	16dc	-	3a	Chm
25S	XC6202P542MR	LVR-IC	LDO, 5.4V±2%, 150mA	SOT-23	16cj	VR1	3d	Tor
25T	TK71525AS	LVR-IC	LDO, 2.5V±1.5%, 155mA	SOT-23	16cj	VR1	3d	Tok
25T	XC6202P552MR	LVR-IC	LDO, 5.5V±2%, 150mA	SOT-23	16cj	VR1	3d	Tor



SMD code	Type	Function	Short description	Case	Pinout	Sch. St.	Mnf.
25U	XC6202P562MR	LVR-IC	LDO, 5.6V±2%, 150mA	SOT-23	16cj	VR1 3d	Tor
25V	CHPZ25VPT	Z-diode	Dual, 23.7..26.3V, Izt=5mA, Zzt=70Ω, 350mW	SOT-23	16df	- 3a	Chm
25V	XC6202P572MR	LVR-IC	LDO, 5.7V±2%, 150mA	SOT-23	16cj	VR1 3d	Tor
25X	XC6202P582MR	LVR-IC	LDO, 5.8V±2%, 150mA	SOT-23	16cj	VR1 3d	Tor
25Y	XC6202P592MR	LVR-IC	LDO, 5.9V±2%, 150mA	SOT-23	16cj	VR1 3d	Tor
25Z	XC6202P602MR	LVR-IC	LDO, 6V±2%, 150mA	SOT-23	16cj	VR1 3d	Tor
26	DTC144EE	Si-npn-Digi	Sw, 50V, 100mA, 150mW, 250MHz, R1/R2=47k/47k	SOT-416	16ta	- 3a	Rhm
26	DTC144EKA	Si-npn-Digi	Sw, 50V, 100mA, 200mW, 250MHz, R1/R2=47k/47k	SOT-346	16ta	- 3a	Rhm
26	DTC144EM	Si-npn-Digi	Sw, 50V, 100mA, 150mW, 250MHz, R1/R2=47k/47k	VMT3	18ta	- 3a	Rhm
26	DTC144EUA	Si-npn-Digi	Sw, 50V, 100mA, 200mW, 250MHz, R1/R2=47k/47k	UMT3	16ta	- 3a	Rhm
26	ELM9826BB	LVR-IC	2.6V±2%, 200mA	SOT-23	16cg	VR1 3d	Elm
260	2STR2160	Si-npn	Sw, 60V, 1A, 500mW, B=180..560, 220/500ms	SOT-23	16ta	- 3a	Ste
260	XC6202P612MR	LVR-IC	LDO, 6.1V±2%, 150mA	SOT-23	16cj	VR1 3d	Tor
261	XC6202P622MR	LVR-IC	LDO, 6.2V±2%, 150mA	SOT-23	16cj	VR1 3d	Tor
262	XC6202P632MR	LVR-IC	LDO, 6.3V±2%, 150mA	SOT-23	16cj	VR1 3d	Tor
26-2	UTC8126-2	Vdet-IC	2.6V, -Reset OCO	SOT-23	16vdy	VD6 3a	Utc
263	XC6202P642MR	LVR-IC	LDO, 6.4V±2%, 150mA	SOT-23	16cj	VR1 3d	Tor
26-3	UTC8126-3	Vdet-IC	2.6V, -Reset OCO	SOT-23	16vdb	VD6 3a	Utc
264	XC6202P652MR	LVR-IC	LDO, 6.5V±2%, 150mA	SOT-23	16cj	VR1 3d	Tor
265	XC6202P662MR	LVR-IC	LDO, 6.6V±2%, 150mA	SOT-23	16cj	VR1 3d	Tor
26-5	UTC8126-5	Vdet-IC	2.6V, -Reset OCO	SOT-23	16vdc	VD6 3a	Utc
266	XC6202P672MR	LVR-IC	LDO, 6.7V±2%, 150mA	SOT-23	16cj	VR1 3d	Tor
267	XC6202P682MR	LVR-IC	LDO, 6.8V±2%, 150mA	SOT-23	16cj	VR1 3d	Tor
268	XC6202P692MR	LVR-IC	LDO, 6.9V±2%, 150mA	SOT-23	16cj	VR1 3d	Tor
269	XC6202P702MR	LVR-IC	LDO, 7V±2%, 150mA	SOT-23	16cj	VR1 3d	Tor
26A	AAT60026A-S2	Vdet-IC	2.6V±2%, -Reset ODO	SOT-23	16vdb	VD6 3d	Aat
26A	XC6202P712MR	LVR-IC	LDO, 7.1V±2%, 150mA	SOT-23	16cj	VR1 3d	Tor
26B	AAT60026B-S2	Vdet-IC	2.6V±2%, -Reset PPO	SOT-23	16vdb	VD7 3d	Aat
26B	MMBZ5226BPT	Z-diode	3.135..3.465V, Izt=5mA, Zzt=95Ω, 225mW	SOT-23	16dc	- 3a	Chm
26B	XC6202P722MR	LVR-IC	LDO, 7.2V±2%, 150mA	SOT-23	16cj	VR1 3d	Tor
26C	AAT60026C-S2	Vdet-IC	2.6V±1%, -Reset ODO	SOT-23	16vdb	VD6 3d	Aat
26C	XC6202P732MR	LVR-IC	LDO, 7.3V±2%, 150mA	SOT-23	16cj	VR1 3d	Tor
26D	AAT60026D-S2	Vdet-IC	2.6V±1%, -Reset PPO	SOT-23	16vdb	VD7 3d	Aat
26D	XC6202P742MR	LVR-IC	LDO, 7.4V±2%, 150mA	SOT-23	16cj	VR1 3d	Tor
26E	XC6202P752MR	LVR-IC	LDO, 7.5V±2%, 150mA	SOT-23	16cj	VR1 3d	Tor
26F	XC6202P762MR	LVR-IC	LDO, 7.6V±2%, 150mA	SOT-23	16cj	VR1 3d	Tor
26H	XC6202P772MR	LVR-IC	LDO, 7.7V±2%, 150mA	SOT-23	16cj	VR1 3d	Tor
26K	XC6202P782MR	LVR-IC	LDO, 7.8V±2%, 150mA	SOT-23	16cj	VR1 3d	Tor
26L	XC6202P792MR	LVR-IC	LDO, 7.9V±2%, 150mA	SOT-23	16cj	VR1 3d	Tor
26M	XC6202P802MR	LVR-IC	LDO, 8V±2%, 150mA	SOT-23	16cj	VR1 3d	Tor
26N	STM1061N26V	Vdet-IC	2.6V±2%, -Reset ODO	SOT-323	16vda	VD6 3d	Ste
26N	STM1061N26WX	Vdet-IC	2.6V±2%, -Reset ODO	SOT-23	16vda	VD6 3d	Ste
26N	XC6202P812MR	LVR-IC	LDO, 8.1V±2%, 150mA	SOT-23	16cj	VR1 3d	Tor
26P	XC6202P822MR	LVR-IC	LDO, 8.2V±2%, 150mA	SOT-23	16cj	VR1 3d	Tor
26R	XC6202P832MR	LVR-IC	LDO, 8.3V±2%, 150mA	SOT-23	16cj	VR1 3d	Tor
26S	MMBZ5226SPT	Z-diode	3.234..3.366V, Izt=5mA, Zzt=95Ω, 225mW	SOT-23	16dc	- 3a	Chm
26S	MMCZ5226SPT	Z-diode	3.234..3.366V, Izt=5mA, Zzt=95Ω, 225mW	SOT-346	16dc	- 3a	Chm
26S	XC6202P842MR	LVR-IC	LDO, 8.4V±2%, 150mA	SOT-23	16cj	VR1 3d	Tor
26T	TK71526AS	LVR-IC	LDO, 2.6V±1.5%, 155mA	SOT-23	16cj	VR1 3d	Tok
26T	XC6202P852MR	LVR-IC	LDO, 8.5V±2%, 150mA	SOT-23	16cj	VR1 3d	Tor
26U	XC6202P862MR	LVR-IC	LDO, 8.6V±2%, 150mA	SOT-23	16cj	VR1 3d	Tor
26V	XC6202P872MR	LVR-IC	LDO, 8.7V±2%, 150mA	SOT-23	16cj	VR1 3d	Tor
26X	XC6202P882MR	LVR-IC	LDO, 8.8V±2%, 150mA	SOT-23	16cj	VR1 3d	Tor
26Y	XC6202P892MR	LVR-IC	LDO, 8.9V±2%, 150mA	SOT-23	16cj	VR1 3d	Tor
26Z	XC6202P902MR	LVR-IC	LDO, 9V±2%, 150mA	SOT-23	16cj	VR1 3d	Tor
27	BAS70-04	Si-diode	Dual, Schottky, 70V, 70mA, Vf<1V(15mA), <2pF, 5ns	SOT-23	16dl	- 3a	Zx
27	ELM9827BB	LVR-IC	2.7V±2%, 200mA	SOT-23	16cg	VR1 3d	Elm
27	PDTA123JE	Si-npn-Digi	Sw, 50V, 100mA, 150mW, R1/R2=2k2/47k	SOT-416	16ta	- 3a	Phi
27	PDTA123JEF	Si-npn-Digi	Sw, 50V, 100mA, 250mW, R1/R2=2k2/47k	SOT-490	18ta	- 3a	Phi
27-	HZM27NB	Z-diode	25.1..28.9V, 200mW	SC-59A	16dc	- 3a	Ren
270	HZM2.7NB	Z-diode	2.5..2.9V, 200mW	SC-59A	16dc	- 3a	Ren
270	XC6202P912MR	LVR-IC	LDO, 9.1V±2%, 150mA	SOT-23	16cj	VR1 3d	Tor
271	HZM2.7NB1	Z-diode	2.5..2.75V, 200mW	SC-59A	16dc	- 3a	Ren
271	PZM2.7NB1	Z-diode	2.7V±2.5%, 300mW	SOT-346	16dc	- 3a	Phi
271	XC6202P922MR	LVR-IC	LDO, 9.2V±2%, 150mA	SOT-23	16cj	VR1 3d	Tor
272	HZM2.7NB2	Z-diode	2.65..2.9V, 200mW	SC-59A	16dc	- 3a	Ren
272	PZM2.7NB2	Z-diode	2.7V±2.5%, 300mW	SOT-346	16dc	- 3a	Phi
272	XC6202P932MR	LVR-IC	LDO, 9.3V±2%, 150mA	SOT-23	16cj	VR1 3d	Tor
27-2	UTC8127-2	Vdet-IC	2.7V, -Reset OCO	SOT-23	16vdy	VD6 3a	Utc
273	XC6202P942MR	LVR-IC	LDO, 9.4V±2%, 150mA	SOT-23	16cj	VR1 3d	Tor



SMD code	Type	Function	Short description	Case	Pinout	Sch.	St.	Mnf.
27-3	UTC8127-3	Vdet-IC	2.7V, -Reset OCO	SOT-23	16vdb	VD6	3a	Utc
274	XC6202P952MR	LVR-IC	LDO, 9.5V±2%, 150mA	SOT-23	16cj	VR1	3d	Tor
275	XC6202P962MR	LVR-IC	LDO, 9.6V±2%, 150mA	SOT-23	16cj	VR1	3d	Tor
27-5	UTC8127-5	Vdet-IC	2.7V, -Reset OCO	SOT-23	16vdc	VD6	3a	Utc
276	XC6202P972MR	LVR-IC	LDO, 9.7V±2%, 150mA	SOT-23	16cj	VR1	3d	Tor
277	XC6202P982MR	LVR-IC	LDO, 9.8V±2%, 150mA	SOT-23	16cj	VR1	3d	Tor
278	XC6202P992MR	LVR-IC	LDO, 9.9V±2%, 150mA	SOT-23	16cj	VR1	3d	Tor
279	XC6202PA02MR	LVR-IC	LDO, 10V±2%, 150mA	SOT-23	16cj	VR1	3d	Tor
27A	AAT60027A-S2	Vdet-IC	2.7V±2%, -Reset ODO	SOT-23	16vdb	VD6	3d	Aat
27A	MMBZ27VA	TVS	Dual, Vrwm=22V, Vbr=25.65..28.35V, 1.0A, 40W(1ms)	SOT-23	16dg	-	3a	Wtr
27A	XC6202PA12MR	LVR-IC	LDO, 10.1V±2%, 150mA	SOT-23	16cj	VR1	3d	Tor
27B	AAT60027B-S2	Vdet-IC	2.7V±2%, -Reset PPO	SOT-23	16vdb	VD7	3d	Aat
27B	BZX84-C27-V	Z-diode	26.19..27.53V, Izt=2mA, Zzt=150Ω, 300mW	SOT-23	16dc	-	3f	Kec
27B	MMBZ5227BPT	Z-diode	3.420..3.780V, Izt=5mA, Zzt=90Ω, 225mW	SOT-23	16dc	-	3a	Chm
27B	XC6202PA22MR	LVR-IC	LDO, 10.2V±2%, 150mA	SOT-23	16cj	VR1	3d	Tor
27C	AAT60027C-S2	Vdet-IC	2.7V±1%, -Reset ODO	SOT-23	16vdb	VD6	3d	Aat
27C	XC6202PA32MR	LVR-IC	LDO, 10.3V±2%, 150mA	SOT-23	16cj	VR1	3d	Tor
27D	AAT60027D-S2	Vdet-IC	2.7V±1%, -Reset PPO	SOT-23	16vdb	VD7	3d	Aat
27D	XC6202PA42MR	LVR-IC	LDO, 10.4V±2%, 150mA	SOT-23	16cj	VR1	3d	Tor
27E	XC6202PA52MR	LVR-IC	LDO, 10.5V±2%, 150mA	SOT-23	16cj	VR1	3d	Tor
27F	XC6202PA62MR	LVR-IC	LDO, 10.6V±2%, 150mA	SOT-23	16cj	VR1	3d	Tor
27H	MAZ3270-H	Z-diode	25.1..28.9V, If=100mA, Zzt=80Ω, 200mW	SC-59	16dc	-	3a	Pan
27H	XC6202PA72MR	LVR-IC	LDO, 10.7V±2%, 150mA	SOT-23	16cj	VR1	3d	Tor
27K	XC6202PA82MR	LVR-IC	LDO, 10.8V±2%, 150mA	SOT-23	16cj	VR1	3d	Tor
27L	MAZ3270-L	Z-diode	25.1..28.9V, If=100mA, Zzt=80Ω, 200mW	SC-59	16dc	-	3a	Pan
27L	XC6202PA92MR	LVR-IC	LDO, 10.9V±2%, 150mA	SOT-23	16cj	VR1	3d	Tor
27M	MAZ3270-M	Z-diode	25.1..28.9V, If=100mA, Zzt=80Ω, 200mW	SC-59	16dc	-	3a	Pan
27M	XC6202PB02MR	LVR-IC	LDO, 11V±2%, 150mA	SOT-23	16cj	VR1	3d	Tor
27N	STM1061N27W	Vdet-IC	2.7V±2%, -Reset ODO	SOT-323	16vda	VD6	3d	Ste
27N	STM1061N27WX	Vdet-IC	2.7V±2%, -Reset ODO	SOT-23	16vda	VD6	3d	Ste
27N	XC6202PB12MR	LVR-IC	LDO, 11.1V±2%, 150mA	SOT-23	16cj	VR1	3d	Tor
27P	XC6202PB22MR	LVR-IC	LDO, 11.2V±2%, 150mA	SOT-23	16cj	VR1	3d	Tor
27R	XC6202PB32MR	LVR-IC	LDO, 11.3V±2%, 150mA	SOT-23	16cj	VR1	3d	Tor
27S	MMBZ5227SPT	Z-diode	3.528..3.762V, Izt=5mA, Zzt=90Ω, 225mW	SOT-23	16dc	-	3a	Chm
27S	MMCZ5227SPT	Z-diode	3.528..3.762V, Izt=5mA, Zzt=90Ω, 225mW	SOT-346	16dc	-	3a	Chm
27S	XC6202PB42MR	LVR-IC	LDO, 11.4V±2%, 150mA	SOT-23	16cj	VR1	3d	Tor
27T	TK71527AS	LVR-IC	LDO, 2.7V±1.5%, 155mA	SOT-23	16cj	VR1	3d	Tok
27T	XC6202PB52MR	LVR-IC	LDO, 11.5V±2%, 150mA	SOT-23	16cj	VR1	3d	Tor
27U	XC6202PB62MR	LVR-IC	LDO, 11.6V±2%, 150mA	SOT-23	16cj	VR1	3d	Tor
27V	CHPZ27VPT	Z-diode	Dual, 25.1..28.9V, Izt=2mA, Zzt=80Ω, 350mW	SOT-23	16df	-	3a	Chm
27V	PZM27NB	Z-diode	27V±2.5%, 300mW	SOT-346	16dc	-	3a	Phi
27V	XC6202PB72MR	LVR-IC	LDO, 11.7V±2%, 150mA	SOT-23	16cj	VR1	3d	Tor
27X	XC6202PB82MR	LVR-IC	LDO, 11.8V±2%, 150mA	SOT-23	16cj	VR1	3d	Tor
27Y	XC6202PB92MR	LVR-IC	LDO, 11.9V±2%, 150mA	SOT-23	16cj	VR1	3d	Tor
27Z	CZ1W27	Z-diode	27V±5%, 600mW	SOT-23	16dc	-	3a	Cdi
27Z	XC6202PC02MR	LVR-IC	LDO, 12V±2%, 150mA	SOT-23	16cj	VR1	3d	Tor
28	ELM9828BB	LVR-IC	2.8V±2%, 200mA	SOT-23	16cg	VR1	3d	Elm
28	PDTC123JE	Si-npn-Digi	Sw, 50V, 100mA, 150mW, R1/R2=2k2/47k	SOT-416	16ta	-	3a	Phi
28	PDTC123JEF	Si-npn-Digi	Sw, 50V, 100mA, 250mW, R1/R2=2k2/47k	SOT-490	18ta	-	3a	Phi
280	XC6202PC12MR	LVR-IC	LDO, 12.1V±2%, 150mA	SOT-23	16cj	VR1	3d	Tor
281	XC6202PC22MR	LVR-IC	LDO, 12.2V±2%, 150mA	SOT-23	16cj	VR1	3d	Tor
282	XC6202PC32MR	LVR-IC	LDO, 12.3V±2%, 150mA	SOT-23	16cj	VR1	3d	Tor
28-2	UTC8128-2	Vdet-IC	2.8V, -Reset OCO	SOT-23	16vdy	VD6	3a	Utc
283	XC6202PC42MR	LVR-IC	LDO, 12.4V±2%, 150mA	SOT-23	16cj	VR1	3d	Tor
28-3	UTC8128-3	Vdet-IC	2.8V, -Reset OCO	SOT-23	16vdb	VD6	3a	Utc
284	XC6202PC52MR	LVR-IC	LDO, 12.5V±2%, 150mA	SOT-23	16cj	VR1	3d	Tor
285	XC6202PC62MR	LVR-IC	LDO, 12.6V±2%, 150mA	SOT-23	16cj	VR1	3d	Tor
28-5	UTC8128-5	Vdet-IC	2.8V, -Reset OCO	SOT-23	16vdc	VD6	3a	Utc
286	XC6202PC72MR	LVR-IC	LDO, 12.7V±2%, 150mA	SOT-23	16cj	VR1	3d	Tor
287	XC6202PC82MR	LVR-IC	LDO, 12.8V±2%, 150mA	SOT-23	16cj	VR1	3d	Tor
288	XC6202PC92MR	LVR-IC	LDO, 12.9V±2%, 150mA	SOT-23	16cj	VR1	3d	Tor
289	XC6202PD02MR	LVR-IC	LDO, 13V±2%, 150mA	SOT-23	16cj	VR1	3d	Tor
28A	AAT60028A-S2	Vdet-IC	2.8V±2%, -Reset ODO	SOT-23	16vdb	VD6	3d	Aat
28A	XC6202PD12MR	LVR-IC	LDO, 13.1V±2%, 150mA	SOT-23	16cj	VR1	3d	Tor
28B	AAT60028B-S2	Vdet-IC	2.8V±2%, -Reset PPO	SOT-23	16vdb	VD7	3d	Aat
28B	MMBZ5228BPT	Z-diode	3.705..4.095V, Izt=5mA, Zzt=90Ω, 225mW	SOT-23	16dc	-	3a	Chm
28B	XC6202PD22MR	LVR-IC	LDO, 13.2V±2%, 150mA	SOT-23	16cj	VR1	3d	Tor
28C	AAT60028C-S2	Vdet-IC	2.8V±1%, -Reset ODO	SOT-23	16vdb	VD6	3d	Aat
28C	BZX84-B28	Z-diode	27.44..28.56V, Zzt=80Ω, Izt=5mA, 410mW	SOT-23	16dc	-	3a	Pjt
28C	TZTC28WS	Z-diode	26.60..29.40V, Izt=5mA, Zzt=80Ω, 200mW	SOT-323	16dc	-	3a	Ttr



SMD code	Type	Function	Short description	Case	Pinout	Sch.	St.	Mnf.
28C	XC6202PD32MR	LVR-IC	LDO, 13.3V±2%, 150mA	SOT-23	16cj	VR1	3d	Tor
28D	AAT60028D-S2	Vdet-IC	2.8V±1%, -Reset PPO	SOT-23	16vdb	VD7	3d	Aat
28D	XC6202PD42MR	LVR-IC	LDO, 13.4V±2%, 150mA	SOT-23	16cj	VR1	3d	Tor
28E	XC6202PD52MR	LVR-IC	LDO, 13.5V±2%, 150mA	SOT-23	16cj	VR1	3d	Tor
28F	XC6202PD62MR	LVR-IC	LDO, 13.6V±2%, 150mA	SOT-23	16cj	VR1	3d	Tor
28H	XC6202PD72MR	LVR-IC	LDO, 13.7V±2%, 150mA	SOT-23	16cj	VR1	3d	Tor
28K	XC6202PD82MR	LVR-IC	LDO, 13.8V±2%, 150mA	SOT-23	16cj	VR1	3d	Tor
28L	XC6202PD92MR	LVR-IC	LDO, 13.9V±2%, 150mA	SOT-23	16cj	VR1	3d	Tor
28M	XC6202PE02MR	LVR-IC	LDO, 14V±2%, 150mA	SOT-23	16cj	VR1	3d	Tor
28N	STM1061N28W	Vdet-IC	2.8V±2%, -Reset ODO	SOT-323	16vda	VD6	3d	Ste
28N	STM1061N28WX	Vdet-IC	2.8V±2%, -Reset ODO	SOT-23	16vda	VD6	3d	Ste
28N	XC6202PE12MR	LVR-IC	LDO, 14.1V±2%, 150mA	SOT-23	16cj	VR1	3d	Tor
28P	XC6202PE22MR	LVR-IC	LDO, 14.2V±2%, 150mA	SOT-23	16cj	VR1	3d	Tor
28R	XC6202PE32MR	LVR-IC	LDO, 14.3V±2%, 150mA	SOT-23	16cj	VR1	3d	Tor
28S	MMBZ5228SPT	Z-diode	3.822..3.987V, lzt=5mA, Zzt=90Q, 225mW	SOT-23	16dc	-	3a	Chm
28S	MMCZ5228SPT	Z-diode	3.822..3.987V, lzt=5mA, Zzt=90Q, 225mW	SOT-346	16dc	-	3a	Chm
28S	XC6202PE42MR	LVR-IC	LDO, 14.4V±2%, 150mA	SOT-23	16cj	VR1	3d	Tor
28T	TK71528AS	LVR-IC	LDO, 2.8V±1.5%, 155mA	SOT-23	16cj	VR1	3d	Tok
28T	XC6202PE52MR	LVR-IC	LDO, 14.5V±2%, 150mA	SOT-23	16cj	VR1	3d	Tor
28U	XC6202PE62MR	LVR-IC	LDO, 14.6V±2%, 150mA	SOT-23	16cj	VR1	3d	Tor
28V	CHPZ28VPT	Z-diode	Dual, 27.1..29.9V, lzt=2mA, Zzt=80Q, 350mW	SOT-23	16df	-	3a	Chm
28V	XC6202PE72MR	LVR-IC	LDO, 14.7V±2%, 150mA	SOT-23	16cj	VR1	3d	Tor
28X	XC6202PE82MR	LVR-IC	LDO, 14.8V±2%, 150mA	SOT-23	16cj	VR1	3d	Tor
28Y	XC6202PE92MR	LVR-IC	LDO, 14.9V±2%, 150mA	SOT-23	16cj	VR1	3d	Tor
28Z	XC6202PF02MR	LVR-IC	LDO, 15V±2%, 150mA	SOT-23	16cj	VR1	3d	Tor
29	DTC115EE	Si-npn-Digi	Sw, 50V, 100mA, 150mW, 250MHz, R1/R2=100k/100k	SOT-416	16ta	-	3a	Rhm
29	DTC115EKA	Si-npn-Digi	Sw, 50V, 100mA, 200mW, 250MHz, R1/R2=100k/100k	SOT-346	16ta	-	3a	Rhm
29	DTC115EM	Si-npn-Digi	Sw, 50V, 100mA, 150mW, 250MHz, R1/R2=100k/100k	VMT3	18ta	-	3a	Rhm
29	DTC115EUA	Si-npn-Digi	Sw, 50V, 100mA, 200mW, 250MHz, R1/R2=100k/100k	UMT3	16ta	-	3a	Rhm
29	ELM7619LAB	Vdet-IC	1.9V±2%, -Reset PPO, 250ms	SOT-23	16vdc	VD7	3d	Elm
29	ELM9829BB	LVR-IC	2.9V±2%, 200mA	SOT-23	16cg	VR1	3d	Elm
290	XC6202PF12MR	LVR-IC	LDO, 15.1V±2%, 150mA	SOT-23	16cj	VR1	3d	Tor
291	XC6202PF22MR	LVR-IC	LDO, 15.2V±2%, 150mA	SOT-23	16cj	VR1	3d	Tor
292	XC6202PF32MR	LVR-IC	LDO, 15.3V±2%, 150mA	SOT-23	16cj	VR1	3d	Tor
29-2	UTC8129-2	Vdet-IC	3.9V, -Reset OCO	SOT-23	16vdy	VD6	3a	Utc
293	XC6202PF42MR	LVR-IC	LDO, 15.4V±2%, 150mA	SOT-23	16cj	VR1	3d	Tor
29-3	UTC8129-3	Vdet-IC	3.9V, -Reset OCO	SOT-23	16vdb	VD6	3a	Utc
294	XC6202PF52MR	LVR-IC	LDO, 15.5V±2%, 150mA	SOT-23	16cj	VR1	3d	Tor
295	XC6202PF62MR	LVR-IC	LDO, 15.6V±2%, 150mA	SOT-23	16cj	VR1	3d	Tor
29-5	UTC8129-5	Vdet-IC	3.9V, -Reset OCO	SOT-23	16vdc	VD6	3a	Utc
296	XC6202PF72MR	LVR-IC	LDO, 15.7V±2%, 150mA	SOT-23	16cj	VR1	3d	Tor
297	XC6202PF82MR	LVR-IC	LDO, 15.8V±2%, 150mA	SOT-23	16cj	VR1	3d	Tor
298	XC6202PF92MR	LVR-IC	LDO, 15.9V±2%, 150mA	SOT-23	16cj	VR1	3d	Tor
299	XC6202PG02MR	LVR-IC	LDO, 16V±2%, 150mA	SOT-23	16cj	VR1	3d	Tor
29A	AAT60029A-S2	Vdet-IC	2.9V±2%, -Reset ODO	SOT-23	16vdb	VD6	3d	Aat
29A	XC6202PG12MR	LVR-IC	LDO, 16.1V±2%, 150mA	SOT-23	16cj	VR1	3d	Tor
29B	AAT60029B-S2	Vdet-IC	2.9V±2%, -Reset PPO	SOT-23	16vdb	VD7	3d	Aat
29B	MMBZ5229BPT	Z-diode	4.085..4.515V, lzt=5mA, Zzt=88Q, 225mW	SOT-23	16dc	-	3a	Chm
29B	XC6202PG22MR	LVR-IC	LDO, 16.2V±2%, 150mA	SOT-23	16cj	VR1	3d	Tor
29C	AAT60029C-S2	Vdet-IC	2.9V±1%, -Reset ODO	SOT-23	16vdb	VD6	3d	Aat
29C	XC6202PG32MR	LVR-IC	LDO, 16.3V±2%, 150mA	SOT-23	16cj	VR1	3d	Tor
29D	AAT60029D-S2	Vdet-IC	2.9V±1%, -Reset PPO	SOT-23	16vdb	VD7	3d	Aat
29D	XC6202PG42MR	LVR-IC	LDO, 16.4V±2%, 150mA	SOT-23	16cj	VR1	3d	Tor
29E	XC6202PG52MR	LVR-IC	LDO, 16.5V±2%, 150mA	SOT-23	16cj	VR1	3d	Tor
29F	XC6202PG62MR	LVR-IC	LDO, 16.6V±2%, 150mA	SOT-23	16cj	VR1	3d	Tor
29H	XC6202PG72MR	LVR-IC	LDO, 16.7V±2%, 150mA	SOT-23	16cj	VR1	3d	Tor
29K	XC6202PG82MR	LVR-IC	LDO, 16.8V±2%, 150mA	SOT-23	16cj	VR1	3d	Tor
29L	XC6202PG92MR	LVR-IC	LDO, 16.9V±2%, 150mA	SOT-23	16cj	VR1	3d	Tor
29M	XC6202PH02MR	LVR-IC	LDO, 17V±2%, 150mA	SOT-23	16cj	VR1	3d	Tor
29N	STM1061N29W	Vdet-IC	2.9V±2%, -Reset ODO	SOT-323	16vda	VD6	3d	Ste
29N	STM1061N29WX	Vdet-IC	2.9V±2%, -Reset ODO	SOT-23	16vda	VD6	3d	Ste
29N	XC6202PH12MR	LVR-IC	LDO, 17.1V±2%, 150mA	SOT-23	16cj	VR1	3d	Tor
29P	XC6202PH22MR	LVR-IC	LDO, 17.2V±2%, 150mA	SOT-23	16cj	VR1	3d	Tor
29R	XC6202PH32MR	LVR-IC	LDO, 17.3V±2%, 150mA	SOT-23	16cj	VR1	3d	Tor
29S	MMBZ5229SPT	Z-diode	4.214..4.386V, lzt=5mA, Zzt=88Q, 225mW	SOT-23	16dc	-	3a	Chm
29S	MMCZ5229SPT	Z-diode	4.214..4.386V, lzt=5mA, Zzt=88Q, 225mW	SOT-346	16dc	-	3a	Chm
29S	XC6202PH42MR	LVR-IC	LDO, 17.4V±2%, 150mA	SOT-23	16cj	VR1	3d	Tor
29T	TK71529AS	LVR-IC	LDO, 2.9V±1.5%, 155mA	SOT-23	16cj	VR1	3d	Tok
29T	XC6202PH52MR	LVR-IC	LDO, 17.5V±2%, 150mA	SOT-23	16cj	VR1	3d	Tor
29U	XC6202PH62MR	LVR-IC	LDO, 17.6V±2%, 150mA	SOT-23	16cj	VR1	3d	Tor



SMD code	Type	Function	Short description	Case	Pinout	Sch. St.	Mnf.
29V	XC6202PH72MR	LVR-IC	LDO, 17.7V±2%, 150mA	SOT-23	16cj	VR1 3d	Tor
29X	XC6202PH82MR	LVR-IC	LDO, 17.8V±2%, 150mA	SOT-23	16cj	VR1 3d	Tor
29Y	XC6202PH92MR	LVR-IC	LDO, 17.9V±2%, 150mA	SOT-23	16cj	VR1 3d	Tor
29Z	XC6202PJ02MR	LVR-IC	LDO, 18V±2%, 150mA	SOT-23	16cj	VR1 3d	Tor
2A	CMBT3906	Si-pnp	GP, 40V, 200mA, 250mW, B=60..300, >250MHz	SOT-23	16ta	- 3a	Cdi
2A	FMMT3906	Si-pnp	GP, 40V, 200mA, 330mW, B=100..300, >250MHz	SOT-23	16ta	- 3a	Zx
2A	KST3906	Si-pnp	GP, 40V, 200mA, 350mW, B=100..300, >250MHz	SOT-23	16ta	- 3a	Sam
2A	MMBT3906	Si-pnp	Sw, AF, 60/40V, 100mA, 200mW, B=100..300, >250MHz	SOT-23	16ta	- 3a	Nsc
2A	MMBT3906V	Si-pnp	Sw, AF, 60/40V, 100mA, 200mW, B=100..300, >250MHz	SOT-323	16ta	- 3a	Mot
2A	SMBT3906	Si-pnp	GP, 40V, 200mA 250MHz, B=100..300	SOT-23	16ta	- 3c	Inf
2A	TMPT3906	Si-pnp	Sw, AF, 40V, 100mA, 200mW, B=100..300, >250MHz	SOT-23	16ta	- 3a	All
2A	TZT2.0W	Z-diode	1.85..2.15V, Izt=5mA, Zzt=100Ω, 200mW	SOT-323	16dc	- 3a	Ttr
2A	YTS3906	Si-pnp	Sw, AF, 60/40V, 100mA, 200mW, B=100..300, >250MHz	SOT-23	16ta	- 3a	Tos
2A	Z02W2.0V	Z-diode	1.85..2.15V, Izt=5mA, Zzt=100Ω, 200mW	SOT-23	16dc	- 3f	Kec
-2A	PMST3906	Si-pnp	GP, 60V, 100mA, 200mW, B=60..300, >250MHz	SOT-323	16ta	- 3a	PhH
2A0	TC55RP202ECB	LVR-IC	LDO, 2.0V±2%, 250mA	SOT-23	16cq	VR1 3d	Mcc
2A0	XC62FP2002M	LVR-IC	2.0V±2%, 250mA	SOT-23	16cg	VR1 3d	Tor
2A4	PZM2.4NB2A	Z-diode	Dual, 2.4V±2.5%, 300mW	SOT-346	16df	- 3a	Phi
2A4	PZM2.4NBA	Z-diode	Dual, 2.4V±2.5%, 300mW	SOT-346	16df	- 3a	Phi
2A5	TC592002ECB	LVR-IC	LDO, -2.0V±2%, 200mA	SOT-23	16cj	VR2 3d	Mcc
2A7	PZM2.7NB2A	Z-diode	Dual, 2.7V±2.5%, 300mW	SOT-346	16df	- 3a	Phi
2AC	CMST3906	Si-pnp	GP, 40V, 200mA, 275mW, B=100..300, >250MHz	SOT-323	16ta	- 3a	Can
2AC2	81C20-P-AE3-2	Vdet-IC	2.0V±2%, -Reset PPO	SOT-23	16vdy	VD7 3a	Utc
2AC2G	81C20G-P-AE3-2	Vdet-IC	2.0V±2%, -Reset PPO, halogen free	SOT-23	16vdy	VD7 3a	Utc
2AC2L	81C20L-P-AE3-2	Vdet-IC	2.0V±2%, -Reset PPO, lead free	SOT-23	16vdy	VD7 3a	Utc
2AC3	81C20-P-AE3-3	Vdet-IC	2.0V±2%, -Reset PPO	SOT-23	16vdb	VD7 3a	Utc
2AC3G	81C20G-P-AE3-3	Vdet-IC	2.0V±2%, -Reset PPO, halogen free	SOT-23	16vdb	VD7 3a	Utc
2AC3L	81C20L-P-AE3-3	Vdet-IC	2.0V±2%, -Reset PPO, lead free	SOT-23	16vdb	VD7 3a	Utc
2AC5	81C20-P-AE3-5	Vdet-IC	2.0V±2%, -Reset PPO	SOT-23	16vdc	VD7 3a	Utc
2AC5G	81C20G-P-AE3-5	Vdet-IC	2.0V±2%, -Reset PPO, halogen free	SOT-23	16vdc	VD7 3a	Utc
2AC5L	81C20L-P-AE3-5	Vdet-IC	2.0V±2%, -Reset PPO, lead free	SOT-23	16vdc	VD7 3a	Utc
2AH	BZX84-C2V0-V	Z-diode	1.85..2.15V, Izt=5mA, Zzt=100Ω, 300mW	SOT-23	16dc	- 3f	Kec
2AN2	81N20-P-AE3-2	Vdet-IC	2.0V±2%, -Reset ODO	SOT-23	16vdy	VD6 3a	Utc
2AN2G	81N20G-P-AE3-2	Vdet-IC	2.0V±2%, -Reset ODO, halogen free	SOT-23	16vdy	VD6 3a	Utc
2AN2L	81N20L-P-AE3-2	Vdet-IC	2.0V±2%, -Reset ODO, lead free	SOT-23	16vdy	VD6 3a	Utc
2AN3	81N20-P-AE3-3	Vdet-IC	2.0V±2%, -Reset ODO	SOT-23	16vdb	VD6 3a	Utc
2AN3G	81N20G-P-AE3-3	Vdet-IC	2.0V±2%, -Reset ODO, halogen free	SOT-23	16vdb	VD6 3a	Utc
2AN3L	81N20L-P-AE3-3	Vdet-IC	2.0V±2%, -Reset ODO, lead free	SOT-23	16vdb	VD6 3a	Utc
2AN5	81N20-P-AE3-5	Vdet-IC	2.0V±2%, -Reset ODO	SOT-23	16vdc	VD6 3a	Utc
2AN5G	81N20G-P-AE3-5	Vdet-IC	2.0V±2%, -Reset ODO, halogen free	SOT-23	16vdc	VD6 3a	Utc
2AN5L	81N20L-P-AE3-5	Vdet-IC	2.0V±2%, -Reset ODO, lead free	SOT-23	16vdc	VD6 3a	Utc
2AQ	2SD1304-Q	Si-npn+Di	AF, 20V, 100mA, 200mW, 150MHz, B=160..260	SC-59	16ta	- 3a	Pan
2AR	2SD1304-R	Si-npn+Di	AF, 20V, 100mA, 200mW, 150MHz, B=210..340	SC-59	16ta	- 3a	Pan
2AS	2SD1304-S	Si-npn+Di	AF, 20V, 100mA, 200mW, 150MHz, B=290..460	SC-59	16ta	- 3a	Pan
2AX	TZT2.0XW	Z-diode	1.85..2.05V, Izt=5mA, Zzt=100Ω, 200mW	SOT-323	16dc	- 3a	Ttr
2AX	Z02W2.0VX	Z-diode	1.85..2.05V, Izt=5mA, Zzt=100Ω, 200mW	SOT-23	16dc	- 3f	Kec
2AZ	TZT2.0ZW	Z-diode	1.95..2.15V, Izt=5mA, Zzt=100Ω, 200mW	SOT-323	16dc	- 3a	Ttr
2AZ	Z02W2.0VZ	Z-diode	1.95..2.15V, Izt=5mA, Zzt=100Ω, 200mW	SOT-23	16dc	- 3f	Kec
2B	2N2907	Si-pnp	GP, 60V, 600mA, 330mW, B=100..300, >200MHz	SOT-23	16ta	- 3a	Nsc
2B	BC849B	Si-npn	GP, 30V, 100mA, 250mW, B=200..450, >100MHz	SOT-23	16ta	- 3a	PhM
2B	BC849BT	Si-npn	GP, 30V, 100mA, 200mW, B=250, >100MHz	SOT-416	16ta	- 3a	Phi
2B	BC849BW	Si-npn	GP, 30V, 100mA, 200mW, B=200..450, >100MHz	SOT-323	16ta	- 3a	PhH
2B	KST2907	Si-pnp	GP, 40V, 600mA, 350mW, B>75, >200MHz	SOT-23	16ta	- 3a	Sam
2B	MMBT2907	Si-pnp	GP, 40V, 500mA, 310mW, B=100..300, >200MHz	SOT-23	16ta	- 3g	Vs
2B	R3131N22EC	Vdet-IC	2.2V, +Reset ODO, 240ms	SOT-23	16vdc	VD6 3b	Ric
2B	SMBT2907	Si-pnp	GP, 40V, 500mA, 310mW, B=100..300, >200MHz	SOT-23	16ta	- 3c	Inf
2B	TMPT2907	Si-pnp	GP, 40/40V, 500mA, 310mW, B=100..300, >200MHz	SOT-23	16ta	- 3a	All
2B	TZT2.2W	Z-diode	2.05..2.38V, Izt=5mA, Zzt=100Ω, 200mW	SOT-323	16dc	- 3a	Ttr
2B	YTS2907	Si-pnp	GP, 40V, 600mA, 330mW, B=100..300, >200MHz	SOT-23	16ta	- 3a	Tos
2B	Z02W2.2V	Z-diode	2.05..2.38V, Izt=5mA, Zzt=100Ω, 200mW	SOT-23	16dc	- 3f	Kec
2B0	TC55RP212ECB	LVR-IC	LDO, 2.1V±2%, 250mA	SOT-23	16cq	VR1 3d	Mcc
2B0	XC62FP2102M	LVR-IC	2.1V±2%, 250mA	SOT-23	16cg	VR1 3d	Tor
2B5	TC592102ECB	LVR-IC	LDO, -2.1V±2%, 200mA	SOT-23	16cj	VR2 3d	Mcc
2B5	XC62KN212M	LVR-IC	LDO, -2.1V±2%, 100mA, 150mW	SOT-23	16cj	VR2 3d	Tor
2BC2	81C21-P-AE3-2	Vdet-IC	2.1V±2%, -Reset PPO	SOT-23	16vdy	VD7 3a	Utc
2BC2G	81C21G-P-AE3-2	Vdet-IC	2.1V±2%, -Reset PPO, halogen free	SOT-23	16vdy	VD7 3a	Utc
2BC2L	81C21L-P-AE3-2	Vdet-IC	2.1V±2%, -Reset PPO, lead free	SOT-23	16vdy	VD7 3a	Utc
2BC3	81C21-P-AE3-3	Vdet-IC	2.1V±2%, -Reset PPO	SOT-23	16vdb	VD7 3a	Utc
2BC3G	81C21G-P-AE3-3	Vdet-IC	2.1V±2%, -Reset PPO, halogen free	SOT-23	16vdb	VD7 3a	Utc
2BC3L	81C21L-P-AE3-3	Vdet-IC	2.1V±2%, -Reset PPO, lead free	SOT-23	16vdb	VD7 3a	Utc



SMD code	Type	Function	Short description	Case	Pinout	Sch.	St.	Mnf.
2BC5	81C21-P-AE3-5	Vdet-IC	2.1V±2%, -Reset PPO	SOT-23	16vdc	VD7	3a	Utc
2BC5G	81C21G-P-AE3-5	Vdet-IC	2.1V±2%, -Reset PPO, halogen free	SOT-23	16vdc	VD7	3a	Utc
2BC5L	81C21L-P-AE3-5	Vdet-IC	2.1V±2%, -Reset PPO, lead free	SOT-23	16vdc	VD7	3a	Utc
2BH	BZX84-C2V2-V	Z-diode	2.05..2.38V, Izt=5mA, Zzt=100Ω, 300mW	SOT-23	16dc	-	3f	Kec
2BN2	81N21-P-AE3-2	Vdet-IC	2.1V±2%, -Reset ODO	SOT-23	16vdy	VD6	3a	Utc
2BN2G	81N21G-P-AE3-2	Vdet-IC	2.1V±2%, -Reset ODO, halogen free	SOT-23	16vdy	VD6	3a	Utc
2BN2L	81N21L-P-AE3-2	Vdet-IC	2.1V±2%, -Reset ODO, lead free	SOT-23	16vdy	VD6	3a	Utc
2BN3	81N21-P-AE3-3	Vdet-IC	2.1V±2%, -Reset ODO	SOT-23	16vdb	VD6	3a	Utc
2BN3G	81N21G-P-AE3-3	Vdet-IC	2.1V±2%, -Reset ODO, halogen free	SOT-23	16vdb	VD6	3a	Utc
2BN3L	81N21L-P-AE3-3	Vdet-IC	2.1V±2%, -Reset ODO, lead free	SOT-23	16vdb	VD6	3a	Utc
2BN5	81N21-P-AE3-5	Vdet-IC	2.1V±2%, -Reset ODO	SOT-23	16vdc	VD6	3a	Utc
2BN5G	81N21G-P-AE3-5	Vdet-IC	2.1V±2%, -Reset ODO, halogen free	SOT-23	16vdc	VD6	3a	Utc
2BN5L	81N21L-P-AE3-5	Vdet-IC	2.1V±2%, -Reset ODO, lead free	SOT-23	16vdc	VD6	3a	Utc
2BP	2SK0374-P	n-FET	AF, Sw, 55V, 30mA, 200mW, Idss=1..3mA, Up<5V	SC-59	16fa	-	3a	Pan
2BP	2SK0663-P	n-FET	AF, Sw, 55V, 30mA, 200mW, Idss=1.3mA, Up<5V	SOT-323	16fa	-	3a	Pan
2BP	2SK2593-P	n-FET	AF, Sw, 55V, ±30mA, 125mW, Idss=1..3mA	SC-89	18fa	-	3a	Pan
2BP	2SK374-P	n-FET	AF, Sw, 55V, 30mA, 200mW, Idss=1..3mA, Up<5V	SC-59	16fa	-	3a	Pan
2BP	2SK663-P	n-FET	AF, Sw, 55V, 30mA, 200mW, Idss=1..3mA, Up<5V	SOT-323	16fa	-	3a	Pan
2Bp	BC849B	Si-npn	GP, 30V, 100mA, 250mW, B=200..450, >100MHz	SOT-23	16ta	-	3a	PHH
2BQ	2SK0374-Q	n-FET	AF, Sw, 55V, 30mA, 200mW, Idss=2..6.5mA, Up<5V	SC-59	16fa	-	3a	Pan
2BQ	2SK0663-Q	n-FET	AF, Sw, 55V, 30mA, 200mW, Idss=2..6.5mA, Up<5V	SOT-323	16fa	-	3a	Pan
2BQ	2SK2593-Q	n-FET	AF, Sw, 55V, ±30mA, 125mW, Idss=2..6.5mA	SC-89	18fa	-	3a	Pan
2BQ	2SK374-Q	n-FET	AF, Sw, 55V, 30mA, 200mW, Idss=2..6.5mA, Up<5V	SC-59	16fa	-	3a	Pan
2BQ	2SK663-Q	n-FET	AF, Sw, 55V, 30mA, 200mW, Idss=2..6.5mA, Up<5V	SOT-323	16fa	-	3a	Pan
2BR	2SK0374-R	n-FET	AF, Sw, 55V, 30mA, 200mW, Idss=5..12mA, Up<5V	SC-59	16fa	-	3a	Pan
2BR	2SK0663-R	n-FET	AF, Sw, 55V, 30mA, 200mW, Idss=5..12mA, Up<5V	SOT-323	16fa	-	3a	Pan
2BR	2SK2593-R	n-FET	AF, Sw, 55V, ±30mA, 125mW, Idss=5..12mA	SC-89	18fa	-	3a	Pan
2BR	2SK374-R	n-FET	AF, Sw, 55V, 30mA, 200mW, Idss=5..12mA, Up<5V	SC-59	16fa	-	3a	Pan
2BR	2SK663-R	n-FET	AF, Sw, 55V, 30mA, 200mW, Idss=5..12mA, Up<5V	SOT-323	16fa	-	3a	Pan
2BS	2SK0374-S	n-FET	AF, Sw, 55V, 30mA, 200mW, Idss=10..20mA, Up<5V	SC-59	16fa	-	3a	Pan
2BS	2SK2593-S	n-FET	AF, Sw, 55V, ±30mA, 125mW, Idss=10..20mA	SC-89	18fa	-	3a	Pan
2BS	2SK374-S	n-FET	AF, Sw, 55V, 30mA, 200mW, Idss=10..20mA, Up<5V	SC-59	16fa	-	3a	Pan
2Bs	BC849B	Si-npn	GP, 30V, 100mA, 330mW, B=200..450, 250MHz	SOT-23	16ta	-	3a	Sie
2Bs	BC849BT	Si-npn	GP, 30V, 100mA, 200mW, B=250, >100MHz	SOT-416	16ta	-	3a	Inf
2Bs	BC849BW	Si-npn	GP, 30V, 100mA, 250mW, B=200..450, 250MHz	SOT-323	16ta	-	3c	Inf
2Bt	BC849BW	Si-npn	GP, 30V, 100mA, 200mW, B=200..450, >100MHz	SOT-323	16ta	-	3a	PhM
2BW	BC849B	Si-npn	GP, 30V, 100mA, 250mW, B=200..450, >100MHz	SOT-23	16ta	-	3a	PHC
2BW	BC849BW	Si-npn	GP, 30V, 100mA, 200mW, B=200..450, >100MHz	SOT-323	16ta	-	3a	PhC
2BX	TZT2.2XW	Z-diode	2.05..2.26V, Izt=5mA, Zzt=100Ω, 200mW	SOT-323	16dc	-	3a	Ttr
2BX	Z02W2.2VX	Z-diode	2.05..2.26V, Izt=5mA, Zzt=100Ω, 200mW	SOT-23	16dc	-	3f	Kec
2BZ	FMMT2907	Si-pnp	GP, 40V, 600mA, 330mW, B=100..300, >200MHz	SOT-23	16ta	-	3a	Zx
2BZ	TZT2.2ZV	Z-diode	2.16..2.38V, Izt=5mA, Zzt=100Ω, 200mW	SOT-323	16dc	-	3a	Ttr
2BZ	Z02W2.2VZ	Z-diode	2.16..2.38V, Izt=5mA, Zzt=100Ω, 200mW	SOT-23	16dc	-	3f	Kec
2C	2SJ0536	p-MOSFET-e	V-MOS, LogL, 30V, 100mA, <75Ω	SOT-323	16fh	-	3a	Pan
2C	2SJ536	p-MOSFET	Sw, 30V, 100mA, 150mW, 50Q(10mA), 8ms	SOT-323	16fh	-	3a	Pan
2C	BC849C	Si-npn	GP, 30V, 100mA, 250mW, B=420..800, >100MHz	SOT-23	16ta	-	3a	PHM
2C	BC849CT	Si-npn	GP, 30V, 100mA, 200mW, B=480, >100MHz	SOT-416	16ta	-	3a	Phi
2C	BC849CW	Si-npn	GP, 30V, 100mA, 200mW, B=420..800, >100MHz	SOT-323	16ta	-	3a	PHH
2C	R3131N32EC	Vdet-IC	3.2V, +Reset ODO, 240ms	SOT-23	16vdc	VD6	3b	Ric
2C	SMBTA70	Si-pnp	GP, 40V, 100mA, 350mW, B=40..100, >125MHz	SOT-23	16ta	-	3c	Inf
2C	TMPA70	Si-pnp	GP, 40V, 100mA, 350mW, B=40..100, >125MHz	SOT-23	16ta	-	3a	All
2C	TZT2.4W	Z-diode	2.28..2.60V, Izt=5mA, Zzt=100Ω, 200mW	SOT-323	16dc	-	3a	Ttr
2C	UNRF2AN	Si-npn-Digi	Sw, 50V, 80mA, 100mW, 150MHz, R1/R2=4k7/47k	ML3	22ta	-	2b	Pan
2C	Z02W2.4V	Z-diode	2.28..2.60V, Izt=5mA, Zzt=100Ω, 200mW	SOT-23	16dc	-	3f	Kec
2C0	TC55RP222ECB	LVR-IC	LDO, 2.2V±2%, 250mA	SOT-23	16cq	VR1	3d	Mcc
2C0	XC62FP2202M	LVR-IC	2.2V±2%, 250mA	SOT-23	16cg	VR1	3d	Tor
2C5	TC592202ECB	LVR-IC	LDO, -2.2V±2%, 200mA	SOT-23	16cj	VR2	3d	Mcc
2C5	XC62KN222M	LVR-IC	LDO, -2.2V±2%, 100mA, 150mW	SOT-23	16cj	VR2	3d	Tor
2CC2	81C22-P-AE3-2	Vdet-IC	2.2V±2%, -Reset PPO	SOT-23	16vdy	VD7	3a	Utc
2CC2G	81C22G-P-AE3-2	Vdet-IC	2.2V±2%, -Reset PPO, halogen free	SOT-23	16vdy	VD7	3a	Utc
2CC2L	81C22L-P-AE3-2	Vdet-IC	2.2V±2%, -Reset PPO, lead free	SOT-23	16vdy	VD7	3a	Utc
2CC3	81C22-P-AE3-3	Vdet-IC	2.2V±2%, -Reset PPO	SOT-23	16vdb	VD7	3a	Utc
2CC3G	81C22G-P-AE3-3	Vdet-IC	2.2V±2%, -Reset PPO, halogen free	SOT-23	16vdb	VD7	3a	Utc
2CC3L	81C22L-P-AE3-3	Vdet-IC	2.2V±2%, -Reset PPO, lead free	SOT-23	16vdb	VD7	3a	Utc
2CC5	81C22-P-AE3-5	Vdet-IC	2.2V±2%, -Reset PPO	SOT-23	16vdc	VD7	3a	Utc
2CC5G	81C22G-P-AE3-5	Vdet-IC	2.2V±2%, -Reset PPO, halogen free	SOT-23	16vdc	VD7	3a	Utc
2CC5L	81C22L-P-AE3-5	Vdet-IC	2.2V±2%, -Reset PPO, lead free	SOT-23	16vdc	VD7	3a	Utc
2CH	BZX84-C2V4-V	Z-diode	2.28..2.60V, Izt=5mA, Zzt=100Ω, 300mW	SOT-23	16dc	-	3f	Kec
2CN2	81N22-P-AE3-2	Vdet-IC	2.2V±2%, -Reset ODO	SOT-23	16vdy	VD6	3a	Utc
2CN2G	81N22G-P-AE3-2	Vdet-IC	2.2V±2%, -Reset ODO, halogen free	SOT-23	16vdy	VD6	3a	Utc



SMD code	Type	Function	Short description	Case	Pinout	Sch.	St.	Mnf.
2CN2L	81N22L-P-AE3-2	Vdet-IC	2.2V±2%, -Reset ODO, lead free	SOT-23	16vdy	VD6	3a	Utc
2CN3	81N22-P-AE3-3	Vdet-IC	2.2V±2%, -Reset ODO	SOT-23	16vdb	VD6	3a	Utc
2CN3G	81N22G-P-AE3-3	Vdet-IC	2.2V±2%, -Reset ODO, halogen free	SOT-23	16vdb	VD6	3a	Utc
2CN3L	81N22L-P-AE3-3	Vdet-IC	2.2V±2%, -Reset ODO, lead free	SOT-23	16vdb	VD6	3a	Utc
2CN5	81N22-P-AE3-5	Vdet-IC	2.2V±2%, -Reset ODO	SOT-23	16vdc	VD6	3a	Utc
2CN5G	81N22G-P-AE3-5	Vdet-IC	2.2V±2%, -Reset ODO, halogen free	SOT-23	16vdc	VD6	3a	Utc
2CN5L	81N22L-P-AE3-5	Vdet-IC	2.2V±2%, -Reset ODO, lead free	SOT-23	16vdc	VD6	3a	Utc
2Cp	BC849C	Si-npn	GP, 30V, 100mA, 250mW, B=420..800, >100MHz	SOT-23	16ta	-	3a	PHH
2Cs	BC849C	Si-npn	GP, 30V, 100mA, 330mW, B=420..800, 250MHz	SOT-23	16ta	-	3a	Sie
2Cs	BC849CT	Si-npn	GP, 30V, 100mA, 200mW, B=480, >100MHz	SOT-416	16ta	-	3a	Inf
2Cs	BC849CW	Si-npn	GP, 30V, 100mA, 250mW, B=420..800, 250MHz	SOT-323	16ta	-	3c	Inf
2Ct	BC849CW	Si-npn	GP, 30V, 100mA, 200mW, B=420..800, >100MHz	SOT-323	16ta	-	3a	PHM
2CW	BC849C	Si-npn	GP, 30V, 100mA, 250mW, B=420..800, >100MHz	SOT-23	16ta	-	3a	PhC
2CW	BC849CW	Si-npn	GP, 30V, 100mA, 200mW, B=420..800, >100MHz	SOT-323	16ta	-	3a	PhC
2CX	TZT2.4XW	Z-diode	2.28..2.50V, Izt=5mA, Zzt=100Ω, 200mW	SOT-323	16dc	-	3a	Ttr
2CX	Z02W2.4VX	Z-diode	2.28..2.50V, Izt=5mA, Zzt=100Ω, 200mW	SOT-23	16dc	-	3f	Kec
2CZ	FMMTA70	Si-pnp	GP, 40V, 100mA, 330mW, B=400..400, >125MHz	SOT-23	16ta	-	3a	Zx
2CZ	TZT2.4ZV	Z-diode	2.40..2.60V, Izt=5mA, Zzt=100Ω, 200mW	SOT-323	16dc	-	3a	Ttr
2CZ	Z02W2.4VZ	Z-diode	2.40..2.60V, Izt=5mA, Zzt=100Ω, 200mW	SOT-23	16dc	-	3f	Kec
2D	2SK3064	n-MOSFET	Sw, 30V, 100mA, 150mW, 30Q(10mA), 150/35ns	SOT-323	16fh	-	3a	Pan
2D	KST92	Si-pnp	Vid, 300V, 500mA, 350mW, B>40, >50MHz	SOT-23	16ta	-	3a	Sam
2D	MBTA92	Si-pnp	Vid, 300/300V, 500mA, 250mW, B>40, >50MHz	SOT-23	16ta	-	3a	Tos
2D	MMBD914PT	Si-diode	Sw, 100V, 200mA, Vf<1V(10mA), 4ns	SOT-23	16dc	-	3a	Chm
2D	MMBT92	Si-pnp	300V, 500mA, 300mW, B>40, >50MHz	SOT-23	16ta	-	3g	Vs
2D	MMBT92	Si-pnp	Vid, 300V, 500mA, 330mW, B=25, >50MHz	SOT-23	16ta	-	3a	lIt,Vs
2D	R3131N42EC	Vdet-IC	4.2V, +Reset ODO, 240ms	SOT-23	16vdc	VD6	3b	Ric
2D	SMBTA92	Si-pnp	Vid, 300/300V, 500mA, 330mW, B=25, >50MHz	SOT-23	16ta	-	3c	Inf
2D	TZT2.7W	Z-diode	2.50..2.90V, Izt=5mA, Zzt=110Ω, 200mW	SOT-323	16dc	-	3a	Ttr
2D	Z02W2.7V	Z-diode	2.50..2.90V, Izt=5mA, Zzt=110Ω, 200mW	SOT-23	16dc	-	3f	Kec
-2D	PMSTA92	Si-pnp	Vid, 300/300V, 500mA, 200mW, B=25, >50MHz	SOT-323	16ta	-	3a	PHH
2D0	TC55RP232ECB	LVR-IC	LDO, 2.3V±2%, 250mA	SOT-23	16cq	VR1	3d	Mcc
2D0	XC62FP2302M	LVR-IC	2.3V±2%, 250mA	SOT-23	16cg	VR1	3d	Tor
2D5	TC592302ECB	LVR-IC	LDO, -2.3V±2%, 200mA	SOT-23	16cj	VR2	3d	Mcc
2D5	XC62KN232M	LVR-IC	LDO, -2.3V±2%, 100mA, 150mW	SOT-23	16cj	VR2	3d	Tor
2DC2	81C23-P-AE3-2	Vdet-IC	2.3V±2%, -Reset PPO	SOT-23	16vdy	VD7	3a	Utc
2DC2G	81C23G-P-AE3-2	Vdet-IC	2.3V±2%, -Reset PPO, halogen free	SOT-23	16vdy	VD7	3a	Utc
2DC2L	81C23L-P-AE3-2	Vdet-IC	2.3V±2%, -Reset PPO, lead free	SOT-23	16vdy	VD7	3a	Utc
2DC3	81C23-P-AE3-3	Vdet-IC	2.3V±2%, -Reset PPO	SOT-23	16vdb	VD7	3a	Utc
2DC3G	81C23G-P-AE3-3	Vdet-IC	2.3V±2%, -Reset PPO, halogen free	SOT-23	16vdb	VD7	3a	Utc
2DC3L	81C23L-P-AE3-3	Vdet-IC	2.3V±2%, -Reset PPO, lead free	SOT-23	16vdb	VD7	3a	Utc
2DC5	81C23-P-AE3-5	Vdet-IC	2.3V±2%, -Reset PPO	SOT-23	16vdc	VD7	3a	Utc
2DC5G	81C23G-P-AE3-5	Vdet-IC	2.3V±2%, -Reset PPO, halogen free	SOT-23	16vdc	VD7	3a	Utc
2DC5L	81C23L-P-AE3-5	Vdet-IC	2.3V±2%, -Reset PPO, lead free	SOT-23	16vdc	VD7	3a	Utc
2DH	BZX84-C2V7-V	Z-diode	2.50..2.90V, Izt=5mA, Zzt=100Ω, 300mW	SOT-23	16dc	-	3f	Kec
2DN2	81N23-P-AE3-2	Vdet-IC	2.3V±2%, -Reset ODO	SOT-23	16vdy	VD6	3a	Utc
2DN2G	81N23G-P-AE3-2	Vdet-IC	2.3V±2%, -Reset ODO, halogen free	SOT-23	16vdy	VD6	3a	Utc
2DN2L	81N23L-P-AE3-2	Vdet-IC	2.3V±2%, -Reset ODO, lead free	SOT-23	16vdy	VD6	3a	Utc
2DN3	81N23-P-AE3-3	Vdet-IC	2.3V±2%, -Reset ODO	SOT-23	16vdb	VD6	3a	Utc
2DN3G	81N23G-P-AE3-3	Vdet-IC	2.3V±2%, -Reset ODO, halogen free	SOT-23	16vdb	VD6	3a	Utc
2DN3L	81N23L-P-AE3-3	Vdet-IC	2.3V±2%, -Reset ODO, lead free	SOT-23	16vdb	VD6	3a	Utc
2DN5	81N23-P-AE3-5	Vdet-IC	2.3V±2%, -Reset ODO	SOT-23	16vdc	VD6	3a	Utc
2DN5G	81N23G-P-AE3-5	Vdet-IC	2.3V±2%, -Reset ODO, halogen free	SOT-23	16vdc	VD6	3a	Utc
2DN5L	81N23L-P-AE3-5	Vdet-IC	2.3V±2%, -Reset ODO, lead free	SOT-23	16vdc	VD6	3a	Utc
2Dp	BC849	Si-npn	GP, 30V, 100mA, 250mW, B=200..800, >100MHz	SOT-23	16ta	-	3a	PHH
2Dt	BC849W	Si-npn	GP, 30V, 100mA, 200mW, B=200..800, >100MHz	SOT-323	16ta	-	3a	Phi
2DW	BC849	Si-npn	GP, 30V, 100mA, 250mW, B=200..800, >100MHz	SOT-23	16ta	-	3a	PhC
2DX	TZT2.7XW	Z-diode	2.50..2.75V, Izt=5mA, Zzt=110Ω, 200mW	SOT-323	16dc	-	3a	Ttr
2DX	Z02W2.7VX	Z-diode	2.50..2.75V, Izt=5mA, Zzt=110Ω, 200mW	SOT-23	16dc	-	3f	Kec
2DZ	TZT2.7ZW	Z-diode	2.65..2.90V, Izt=5mA, Zzt=110Ω, 200mW	SOT-323	16dc	-	3a	Ttr
2DZ	Z02W2.7VZ	Z-diode	2.65..2.90V, Izt=5mA, Zzt=110Ω, 200mW	SOT-23	16dc	-	3f	Kec
2E	FMMTA93	Si-pnp	Vid, 200/200V, 500mA, 330mW, B=25, >50MHz	SOT-23	16ta	-	3a	Zx
2E	FT510Ea	LVR-IC	LDO, 2.8V±2%, 500mA	SOT-23	16cq	VR1	3d	Fmd
2E	KST93	Si-pnp	Vid, 200V, 500mA, 350mW, B>40, >50MHz	SOT-23	16ta	-	3a	Sam
2E	MMBT93	Si-pnp	Vid, 200V, 500mA, 300mW, B=25, >50MHz	SOT-23	16ta	-	3a	lIt
2E	R3131N30EC8	Vdet-IC	3V, +Reset ODO, 240ms	SOT-23	16vdc	VD6	3b	Ric
2E	SMBTA93	Si-pnp	Vid, 200/200V, 500mA, 330mW, B=25, >50MHz	SOT-23	16ta	-	3c	Inf
-2E	PMSTA93	Si-pnp	Vid, 200/200V, 500mA, 330mW, B=25, >50MHz	SOT-323	16ta	-	3a	PHH
2E0	TC55RP242ECB	LVR-IC	LDO, 2.4V±2%, 250mA	SOT-23	16cq	VR1	3d	Mcc
2E0	XC62FP2402M	LVR-IC	2.4V±2%, 250mA	SOT-23	16cg	VR1	3d	Tor
2E5	TC592402ECB	LVR-IC	LDO, -2.4V±2%, 200mA	SOT-23	16cj	VR2	3d	Mcc



SMD code	Type	Function	Short description	Case	Pinout	Sch. St.	Mnf.
2E5	XC62KN242M	LVR-IC	LDO, -2.4V±2%, 100mA, 150mW	SOT-23	16cj	VR2	3d Tor
2EC2	81C24-P-AE3-2	Vdet-IC	2.4V±2%, -Reset PPO	SOT-23	16vdy	VD7	3a Utc
2EC2G	81C24G-P-AE3-2	Vdet-IC	2.4V±2%, -Reset PPO, halogen free	SOT-23	16vdy	VD7	3a Utc
2EC2L	81C24L-P-AE3-2	Vdet-IC	2.4V±2%, -Reset PPO, lead free	SOT-23	16vdy	VD7	3a Utc
2EC3	81C24-P-AE3-3	Vdet-IC	2.4V±2%, -Reset PPO	SOT-23	16vdb	VD7	3a Utc
2EC3G	81C24G-P-AE3-3	Vdet-IC	2.4V±2%, -Reset PPO, halogen free	SOT-23	16vdb	VD7	3a Utc
2EC3L	81C24L-P-AE3-3	Vdet-IC	2.4V±2%, -Reset PPO, lead free	SOT-23	16vdb	VD7	3a Utc
2EC5	81C24-P-AE3-5	Vdet-IC	2.4V±2%, -Reset PPO	SOT-23	16vdc	VD7	3a Utc
2EC5G	81C24G-P-AE3-5	Vdet-IC	2.4V±2%, -Reset PPO, halogen free	SOT-23	16vdc	VD7	3a Utc
2EC5L	81C24L-P-AE3-5	Vdet-IC	2.4V±2%, -Reset PPO, lead free	SOT-23	16vdc	VD7	3a Utc
2EN2	81N24-P-AE3-2	Vdet-IC	2.4V±2%, -Reset ODO	SOT-23	16vdy	VD6	3a Utc
2EN2G	81N24G-P-AE3-2	Vdet-IC	2.4V±2%, -Reset ODO, halogen free	SOT-23	16vdy	VD6	3a Utc
2EN2L	81N24L-P-AE3-2	Vdet-IC	2.4V±2%, -Reset ODO, lead free	SOT-23	16vdy	VD6	3a Utc
2EN3	81N24-P-AE3-3	Vdet-IC	2.4V±2%, -Reset ODO	SOT-23	16vdb	VD6	3a Utc
2EN3G	81N24G-P-AE3-3	Vdet-IC	2.4V±2%, -Reset ODO, halogen free	SOT-23	16vdb	VD6	3a Utc
2EN3L	81N24L-P-AE3-3	Vdet-IC	2.4V±2%, -Reset ODO, lead free	SOT-23	16vdb	VD6	3a Utc
2EN5	81N24-P-AE3-5	Vdet-IC	2.4V±2%, -Reset ODO	SOT-23	16vdc	VD6	3a Utc
2EN5G	81N24G-P-AE3-5	Vdet-IC	2.4V±2%, -Reset ODO, halogen free	SOT-23	16vdc	VD6	3a Utc
2EN5L	81N24L-P-AE3-5	Vdet-IC	2.4V±2%, -Reset ODO, lead free	SOT-23	16vdc	VD6	3a Utc
2F	BC850B	Si-npn	GP, 50V, 100mA, 250mW, B=200..450, >100MHz	SOT-23	16ta	-	3a Cdi
2F	BC850BT	Si-npn	GP, 50V, 100mA, 200mW, B=250, >100MHz	SOT-416	16ta	-	3a Phi
2F	BC850BW	Si-npn	GP, 50V, 100mA, 200mW, B=200..450, >100MHz	SOT-323	16ta	-	3a PHH
2F	FMMT2907A	Si-pnp	GP, 60V, 600mA, 330mW, B=100..300, >200MHz	SOT-23	16ta	-	3a Zx
2F	FT510Fa	LVR-IC	LDO, 3.0V±2%, 500mA	SOT-23	16cqq	VR1	3d Fmd
2F	KST2907A	Si-pnp	GP, 60V, 600mA, 330mW, B=100..300, >200MHz	SOT-23	16ta	-	3a Sam
2F	MBT2907A	Si-pnp	GP, 60V, 600mA, 330mW, B=100..300, >200MHz	SOT-23	16ta	-	3a Tos
2F	MBTA2907A	Si-pnp	AF, 60V, 600mA, 250mW, B>50, >200MHz	SOT-23	16ta	-	3a Tos
2F	MMBT2907A	Si-pnp	GP, 60V, 500mA, 310mW, B=75..300, <200MHz	SOT-23	16ta	-	3a Mot
2F	MMBT2907AT	Si-pnp	GP, 60V, 500mA, 310mW, B=75..300, <200MHz	SOT-523	16ta	-	3d Di
2F	MMBT2907AW	Si-pnp	GP, 60V, 500mA, 310mW, B=75..300, <200MHz	SOT-323	16ta	-	3a Mot
2F	SMBT2907A	Si-pnp	GP, 60V, 500mA, 310mW, B=100..300, >200MHz	SOT-23	16ta	-	3c Inf
2F	TMPT2907A	Si-pnp	GP, 60V/60V, 600mA, 350mW, B=100..300, >200MHz	SOT-23	16ta	-	3a All
2F	YTS2907A	Si-pnp	GP, 60V, 600mA, 330mW, B=100..300, >200MHz	SOT-23	16ta	-	3a Tos
2F-	2SA1036KPT-R	Si-pnp	AF, Sw, 32V, 500mA, B=180..390, 200MHz	SOT-23	16ta	-	3a Chm
2F-	2SA1037KPT	Si-pnp	AF, Sw, 50V, 150mA, B=120..560, 140MHz	SOT-23	16ta	-	3a Chm
2F-	BC850B	Si-npn	GP, 50V, 100mA, 250mW, B=200..450, >100MHz	SOT-23	16ta	-	3a PhM
2F-	CHT2907APT	Si-pnp	AF, Sw, 60V, 600mA, B=100..300, 200MHz	SOT-23	16ta	-	3a Chm
2F-	CHT4403PT	Si-pnp	AF, Sw, 40V, 600mA, B=100..300, 200MHz	SOT-23	16ta	-	3a Chm
-2F	PMST2907A	Si-pnp	GP, 60V, 600mA, 330mW, B=100..300, >200MHz	SOT-323	16ta	-	3a PHH
2F0	XC5925P252ECB	LVR-IC	LDO, 2.5V±2%, 250mA	SOT-23	16cqq	VR1	3d Mcc
2F0	XC62FP2502M	LVR-IC	2.5V±2%, 250mA	SOT-23	16cgg	VR1	3d Tor
2F5	TC592502ECB	LVR-IC	LDO, -2.5V±2%, 200mA	SOT-23	16cj	VR2	3d Mcc
2F5	XC62KN252M	LVR-IC	LDO, -2.5V±2%, 100mA, 150mW	SOT-23	16cj	VR2	3d Tor
2FC2	81C25-P-AE3-2	Vdet-IC	2.5V±2%, -Reset PPO	SOT-23	16vdy	VD7	3a Utc
2FC2G	81C25G-P-AE3-2	Vdet-IC	2.5V±2%, -Reset PPO, halogen free	SOT-23	16vdy	VD7	3a Utc
2FC2L	81C25L-P-AE3-2	Vdet-IC	2.5V±2%, -Reset PPO, lead free	SOT-23	16vdy	VD7	3a Utc
2FC3	81C25-P-AE3-3	Vdet-IC	2.5V±2%, -Reset PPO	SOT-23	16vdb	VD7	3a Utc
2FC3G	81C25G-P-AE3-3	Vdet-IC	2.5V±2%, -Reset PPO, halogen free	SOT-23	16vdb	VD7	3a Utc
2FC3L	81C25L-P-AE3-3	Vdet-IC	2.5V±2%, -Reset PPO, lead free	SOT-23	16vdb	VD7	3a Utc
2FC5	81C25-P-AE3-5	Vdet-IC	2.5V±2%, -Reset PPO	SOT-23	16vdc	VD7	3a Utc
2FC5G	81C25G-P-AE3-5	Vdet-IC	2.5V±2%, -Reset PPO, halogen free	SOT-23	16vdc	VD7	3a Utc
2FC5L	81C25L-P-AE3-5	Vdet-IC	2.5V±2%, -Reset PPO, lead free	SOT-23	16vdc	VD7	3a Utc
2FN2	81N25-P-AE3-2	Vdet-IC	2.5V±2%, -Reset ODO	SOT-23	16vdy	VD6	3a Utc
2FN2G	81N25G-P-AE3-2	Vdet-IC	2.5V±2%, -Reset ODO, halogen free	SOT-23	16vdy	VD6	3a Utc
2FN2L	81N25L-P-AE3-2	Vdet-IC	2.5V±2%, -Reset ODO, lead free	SOT-23	16vdy	VD6	3a Utc
2FN3	81N25-P-AE3-3	Vdet-IC	2.5V±2%, -Reset ODO	SOT-23	16vdb	VD6	3a Utc
2FN3G	81N25G-P-AE3-3	Vdet-IC	2.5V±2%, -Reset ODO, halogen free	SOT-23	16vdb	VD6	3a Utc
2FN3L	81N25L-P-AE3-3	Vdet-IC	2.5V±2%, -Reset ODO, lead free	SOT-23	16vdb	VD6	3a Utc
2FN5	81N25-P-AE3-5	Vdet-IC	2.5V±2%, -Reset ODO	SOT-23	16vdc	VD6	3a Utc
2FN5G	81N25G-P-AE3-5	Vdet-IC	2.5V±2%, -Reset ODO, halogen free	SOT-23	16vdc	VD6	3a Utc
2FN5L	81N25L-P-AE3-5	Vdet-IC	2.5V±2%, -Reset ODO, lead free	SOT-23	16vdc	VD6	3a Utc
2Fp	BC850B	Si-npn	GP, 50V, 100mA, 250mW, B=200..450, >100MHz	SOT-23	16ta	-	3a PHH
2FQ	2SB1583-Q	Si-pnp	GP, 185V, 50mA, 200MHz, B=85..170	SOT-416	16ta	-	3a Pan
2FR	2SB1583-R	Si-pnp	GP, 185V, 50mA, 200MHz, B=120..240	SOT-416	16ta	-	3a Pan
2FR	2SB792A-R	Si-pnp	AF, LN, 185V, 50mA, 200mW, B=130..220, 200MHz	SC-59	16ta	-	3a Pan
2FS	2SB1583-S	Si-pnp	GP, 185V, 50mA, 200MHz, B=170..340	SOT-416	16ta	-	3a Pan
2FS	2SB792A-S	Si-pnp	AF, LN, 185V, 50mA, 200mW, B=185..330, 200MHz	SC-59	16ta	-	3a Pan
2Fs	BC850B	Si-npn	GP, 50V, 100mA, 330mW, B=200..450, 250MHz	SOT-23	16ta	-	3a Sie
2Fs	BC850BT	Si-npn	GP, 50V, 100mA, 200mW, B=250, >100MHz	SOT-416	16ta	-	3a Inf
2Ft	BC850BW	Si-npn	GP, 50V, 100mA, 200mW, B=200..450, >100MHz	SOT-323	16ta	-	3a PhM



SMD code	Type	Function	Short description	Case	Pinout	Sch. St.	Mnf.
2FW	BC850B	Si-npn	GP, 50V, 100mA, 250mW, B=200..450, >100MHz	SOT-23	16ta	-	3a PhC
2FW	BC850BW	Si-npn	GP, 50V, 100mA, 200mW, B=200..450, >100MHz	SOT-323	16ta	-	3a PhC
2FZ	BC850B	Si-npn	GP, 50V, 100mA, 330mW, B=200..450, >300MHz	SOT-23	16ta	-	3a Zx
2G	BC850C	Si-npn	GP, 50V, 100mA, 250mW, B=420..800, >100MHz	SOT-23	16ta	-	3a Cdi
2G	BC850CT	Si-npn	GP, 50V, 100mA, 200mW, B=480, >100MHz	SOT-416	16ta	-	3a Phi
2G	BC850CW	Si-npn	GP, 50V, 100mA, 200mW, B=420..800, >100MHz	SOT-323	16ta	-	3a PHH
2G	CMBTA56	Si-pnp	AF-Drv, 80V, 500mA, 250mW, B>100, >50MHz	SOT-23	16ta	-	3a Cdi
2G	FMMTA56	Si-pnp	AF-Drv, 80V, 500mA, 300mW, B>100, >50MHz	SOT-23	16ta	-	3a Zx
2G	FT510Ga	LVR-IC	LDO, 3.3V±2%, 500mA	SOT-23	16cq	VR1	3d Fmd
2G	KST56	Si-pnp	AF-Drv, 80V, 500mA, 350mW, B>50, >50MHz	SOT-23	16ta	-	3a Sam
2G	MMBTA56	Si-pnp	AF-Drv, 80V, 500mA, 300mW, B>100, >50MHz	SOT-23	16ta	-	3g Vs
2G	R3131N22EA	Vdet-IC	2.2V, +Reset PPO, 240ms	SOT-23	16vdc	VD7	3b Ric
2G	SMBTA56	Si-pnp	AF-Drv, 80V, 500mA, 300mW, B>100, >50MHz	SOT-23	16ta	-	3c Inf
2G	TMPTA56	Si-pnp	AF-Drv, 80V, 500mA, 300mW, B>100, >50MHz	SOT-23	16ta	-	3a All
2G-	BC850C	Si-npn	GP, 50V, 100mA, 250mW, B=420..800, >100MHz	SOT-23	16ta	-	3a PHM
-2G	PMSTA56	Si-pnp	AF-Drv, 80V, 500mA, 200mW, B>100, >50MHz	SOT-323	16ta	-	3a PhH
2GC2	81C26-P-AE3-2	Vdet-IC	2.6V±2%, -Reset PPO	SOT-23	16vdy	VD7	3a Utc
2GC2G	81C26G-P-AE3-2	Vdet-IC	2.6V±2%, -Reset PPO, halogen free	SOT-23	16vdy	VD7	3a Utc
2GC2L	81C26L-P-AE3-2	Vdet-IC	2.6V±2%, -Reset PPO, lead free	SOT-23	16vdy	VD7	3a Utc
2GC3	81C26-P-AE3-3	Vdet-IC	2.6V±2%, -Reset PPO	SOT-23	16vdb	VD7	3a Utc
2GC3G	81C26G-P-AE3-3	Vdet-IC	2.6V±2%, -Reset PPO, halogen free	SOT-23	16vdb	VD7	3a Utc
2GC3L	81C26L-P-AE3-3	Vdet-IC	2.6V±2%, -Reset PPO, lead free	SOT-23	16vdb	VD7	3a Utc
2GC5	81C26-P-AE3-5	Vdet-IC	2.6V±2%, -Reset PPO	SOT-23	16vdc	VD7	3a Utc
2GC5G	81C26G-P-AE3-5	Vdet-IC	2.6V±2%, -Reset PPO, halogen free	SOT-23	16vdc	VD7	3a Utc
2GC5L	81C26L-P-AE3-5	Vdet-IC	2.6V±2%, -Reset PPO, lead free	SOT-23	16vdc	VD7	3a Utc
2GM	MMBTA56	Si-pnp	AF-Drv, 80V, 500mA, 300mW, B>100, >50MHz	SOT-23	16ta	-	3a Ons
2GN2	81N26-P-AE3-2	Vdet-IC	2.6V±2%, -Reset ODO	SOT-23	16vdy	VD6	3a Utc
2GN2G	81N26G-P-AE3-2	Vdet-IC	2.6V±2%, -Reset ODO, halogen free	SOT-23	16vdy	VD6	3a Utc
2GN2L	81N26L-P-AE3-2	Vdet-IC	2.6V±2%, -Reset ODO, lead free	SOT-23	16vdy	VD6	3a Utc
2GN3	81N26-P-AE3-3	Vdet-IC	2.6V±2%, -Reset ODO	SOT-23	16vdb	VD6	3a Utc
2GN3G	81N26G-P-AE3-3	Vdet-IC	2.6V±2%, -Reset ODO, halogen free	SOT-23	16vdb	VD6	3a Utc
2GN3L	81N26L-P-AE3-3	Vdet-IC	2.6V±2%, -Reset ODO, lead free	SOT-23	16vdb	VD6	3a Utc
2GN5	81N26-P-AE3-5	Vdet-IC	2.6V±2%, -Reset ODO	SOT-23	16vdc	VD6	3a Utc
2GN5G	81N26G-P-AE3-5	Vdet-IC	2.6V±2%, -Reset ODO, halogen free	SOT-23	16vdc	VD6	3a Utc
2GN5L	81N26L-P-AE3-5	Vdet-IC	2.6V±2%, -Reset ODO, lead free	SOT-23	16vdc	VD6	3a Utc
2Gp	BC850C	Si-npn	GP, 50V, 100mA, 250mW, B=420..800, >100MHz	SOT-23	16ta	-	3a PhH
2Gs	BC850C	Si-npn	GP, 50V, 100mA, 330mW, B=420..800, 250MHz	SOT-23	16ta	-	3a Sie
2Gc	BC850CT	Si-npn	GP, 50V, 100mA, 200mW, B=480, >100MHz	SOT-416	16ta	-	3a Inf
2Gt	BC850CW	Si-npn	GP, 50V, 100mA, 200mW, B=420..800, >100MHz	SOT-323	16ta	-	3a PHM
2GT	SOA56	Si-pnp	AF-Drv, 80V, 500mA, 300mW, B>100, >50MHz	SOT-23	16ta	-	3a Ste
2GW	BC850C	Si-npn	GP, 50V, 100mA, 250mW, B=420..800, >100MHz	SOT-23	16ta	-	3a PhC
2GW	BC850CW	Si-npn	GP, 50V, 100mA, 200mW, B=420..800, >100MHz	SOT-323	16ta	-	3a PhC
2H	BC850	Si-npn	GP, 50V, 100mA, 250mW, B=200..800, >100MHz	SOT-23	16ta	-	3a Cdi
2H	CMBTA55	Si-pnp	AF-Drv, 60V, 500mA, 250mW, B>100, >50MHz	SOT-23	16ta	-	3a Cdi
2H	FMMTA55	Si-pnp	AF-Drv, 60V, 500mA, 300mW, B>100, >50MHz	SOT-23	16ta	-	3a Zx
2H	FT510Ha	LVR-IC	LDO, 3.6V±2%, 500mA	SOT-23	16cq	VR1	3d Fmd
2H	KST55	Si-pnp	GP, 60V, 500mA, 350mW, B>50, >50MHz	SOT-23	16ta	-	3a Sam
2H	MMBTA55	Si-pnp	AF-Drv, 60V, 500mA, 300mW, B>100, >50MHz	SOT-23	16ta	-	3a Ons
2H	R3131N32EA	Vdet-IC	3.2V, +Reset PPO, 240ms	SOT-23	16vdc	VD7	3b Ric
2H	SMBTA55	Si-pnp	AF-Drv, 60V, 500mA, 300mW, B>100, >50MHz	SOT-23	16ta	-	3c Inf
2H	TMPTA55	Si-pnp	AF-Drv, 60V, 500mA, 300mW, B>100, >50MHz	SOT-23	16ta	-	3a All
-2H	PMSTA55	Si-pnp	AF-Drv, 60V, 500mA, 200mW, B>100, >50MHz	SOT-323	16ta	-	3a PhH
2H0	TC59RP262ECB	LVR-IC	LDO, 2.6V±2%, 250mA	SOT-23	16cq	VR1	3d Mcc
2H0	XC62FP2602M	LVR-IC	2.6V±2%, 250mA	SOT-23	16cg	VR1	3d Tor
2H5	TC592602ECB	LVR-IC	LDO, -2.6V±2%, 200mA	SOT-23	16cj	VR2	3d Mcc
2H5	XC62KN262M	LVR-IC	LDO, -2.6V±2%, 100mA, 150mW	SOT-23	16cj	VR2	3d Tor
2HC2	81C27-P-AE3-2	Vdet-IC	2.7V±2%, -Reset PPO	SOT-23	16vdy	VD7	3a Utc
2HC2G	81C27G-P-AE3-2	Vdet-IC	2.7V±2%, -Reset PPO, halogen free	SOT-23	16vdy	VD7	3a Utc
2HC2L	81C27L-P-AE3-2	Vdet-IC	2.7V±2%, -Reset PPO, lead free	SOT-23	16vdy	VD7	3a Utc
2HC3	81C27-P-AE3-3	Vdet-IC	2.7V±2%, -Reset PPO	SOT-23	16vdb	VD7	3a Utc
2HC3G	81C27G-P-AE3-3	Vdet-IC	2.7V±2%, -Reset PPO, halogen free	SOT-23	16vdb	VD7	3a Utc
2HC3L	81C27L-P-AE3-3	Vdet-IC	2.7V±2%, -Reset PPO, lead free	SOT-23	16vdb	VD7	3a Utc
2HC5	81C27-P-AE3-5	Vdet-IC	2.7V±2%, -Reset PPO	SOT-23	16vdc	VD7	3a Utc
2HC5G	81C27G-P-AE3-5	Vdet-IC	2.7V±2%, -Reset PPO, halogen free	SOT-23	16vdc	VD7	3a Utc
2HC5L	81C27L-P-AE3-5	Vdet-IC	2.7V±2%, -Reset PPO, lead free	SOT-23	16vdc	VD7	3a Utc
2HN2	81N27-P-AE3-2	Vdet-IC	2.7V±2%, -Reset ODO	SOT-23	16vdy	VD6	3a Utc
2HN2G	81N27G-P-AE3-2	Vdet-IC	2.7V±2%, -Reset ODO, halogen free	SOT-23	16vdy	VD6	3a Utc
2HN2L	81N27L-P-AE3-2	Vdet-IC	2.7V±2%, -Reset ODO, lead free	SOT-23	16vdy	VD6	3a Utc
2HN3	81N27-P-AE3-3	Vdet-IC	2.7V±2%, -Reset ODO	SOT-23	16vdb	VD6	3a Utc
2HN3G	81N27G-P-AE3-3	Vdet-IC	2.7V±2%, -Reset ODO, halogen free	SOT-23	16vdb	VD6	3a Utc



SMD code	Type	Function	Short description	Case	Pinout	Sch.	St.	Mnf.
2HN3L	81N27L-P-AE3-3	Vdet-IC	2.7V±2%, -Reset ODO, lead free	SOT-23	16vdb	VD6	3a	Utc
2HN5	81N27-P-AE3-5	Vdet-IC	2.7V±2%, -Reset ODO	SOT-23	16vdc	VD6	3a	Utc
2HN5G	81N27G-P-AE3-5	Vdet-IC	2.7V±2%, -Reset ODO, halogen free	SOT-23	16vdc	VD6	3a	Utc
2HN5L	81N27L-P-AE3-5	Vdet-IC	2.7V±2%, -Reset ODO, lead free	SOT-23	16vdc	VD6	3a	Utc
2Hp	BC850	Si-npn	GP, 50V, 100mA, 250mW, B=200..800, >100MHz	SOT-23	16ta	-	3a	PHH
2HT	SOA55	Si-pnp	AF-Div, 80V, 500mA, 300mW, B>100, >50MHz	SOT-23	16ta	-	3a	Ste
2HW	BC850	Si-npn	GP, 50V, 100mA, 250mW, B=200..800, >100MHz	SOT-23	16ta	-	3a	PhC
2J	MMBT3640L	Si-pnp	HF, 12V, 80mA, 300mW, B=30..120, >500MHz	SOT-23	16ta	-	3a	Mot
2J	R3131N42EA	Vdet-IC	4.2V, +Reset PPO, 240ms	SOT-23	16vdc	VD7	3b	Ric
2JC2	81C28-P-AE3-2	Vdet-IC	2.8V±2%, -Reset PPO	SOT-23	16vdy	VD7	3a	Utc
2JC2G	81C28G-P-AE3-2	Vdet-IC	2.8V±2%, -Reset PPO, halogen free	SOT-23	16vdy	VD7	3a	Utc
2JC2L	81C28L-P-AE3-2	Vdet-IC	2.8V±2%, -Reset PPO, lead free	SOT-23	16vdy	VD7	3a	Utc
2JC3	81C28-P-AE3-3	Vdet-IC	2.8V±2%, -Reset PPO	SOT-23	16vdb	VD7	3a	Utc
2JC3G	81C28G-P-AE3-3	Vdet-IC	2.8V±2%, -Reset PPO, halogen free	SOT-23	16vdb	VD7	3a	Utc
2JC3L	81C28L-P-AE3-3	Vdet-IC	2.8V±2%, -Reset PPO, lead free	SOT-23	16vdb	VD7	3a	Utc
2JC5	81C28-P-AE3-5	Vdet-IC	2.8V±2%, -Reset PPO	SOT-23	16vdc	VD7	3a	Utc
2JC5G	81C28G-P-AE3-5	Vdet-IC	2.8V±2%, -Reset PPO, halogen free	SOT-23	16vdc	VD7	3a	Utc
2JC5L	81C28L-P-AE3-5	Vdet-IC	2.8V±2%, -Reset PPO, lead free	SOT-23	16vdc	VD7	3a	Utc
2JN2	81N28-P-AE3-2	Vdet-IC	2.8V±2%, -Reset ODO	SOT-23	16vdy	VD6	3a	Utc
2JN2G	81N28G-P-AE3-2	Vdet-IC	2.8V±2%, -Reset ODO, halogen free	SOT-23	16vdy	VD6	3a	Utc
2JN2L	81N28L-P-AE3-2	Vdet-IC	2.8V±2%, -Reset ODO, lead free	SOT-23	16vdy	VD6	3a	Utc
2JN3	81N28-P-AE3-3	Vdet-IC	2.8V±2%, -Reset ODO	SOT-23	16vdb	VD6	3a	Utc
2JN3G	81N28G-P-AE3-3	Vdet-IC	2.8V±2%, -Reset ODO, halogen free	SOT-23	16vdb	VD6	3a	Utc
2JN3L	81N28L-P-AE3-3	Vdet-IC	2.8V±2%, -Reset ODO, lead free	SOT-23	16vdb	VD6	3a	Utc
2JN5	81N28-P-AE3-5	Vdet-IC	2.8V±2%, -Reset ODO	SOT-23	16vdc	VD6	3a	Utc
2JN5G	81N28G-P-AE3-5	Vdet-IC	2.8V±2%, -Reset ODO, halogen free	SOT-23	16vdc	VD6	3a	Utc
2JN5L	81N28L-P-AE3-5	Vdet-IC	2.8V±2%, -Reset ODO, lead free	SOT-23	16vdc	VD6	3a	Utc
2K	BAT754	Si-diode	Schottky, Sw, U-Fst, 30V, 200mA, Vf<0.6V(0.1A), <0.3ns	SOT-23	16dc	-	3a	Phi
2K	DDZX22D	Z-diode	22V±2.5%, 500mW	SOT-23	16dc	-	3a	Di
2K	DDZX22DW	Z-diode	22V±2.5%, 200mW	SOT-323	16dc	-	3a	Di
2K	FMMT4402	Si-pnp	AF, 40V, 600mA, 330mW, B=50..150, >150MHz	SOT-23	16ta	-	3a	Zx
2K	R3131N30EA8	Vdet-IC	3V, +Reset PPO, 240ms	SOT-23	16vdc	VD7	3b	Ric
2K0	TC55RP272ECB	LVR-IC	LDO, 2.7V±2%, 250mA	SOT-23	16cq	VR1	3d	Mcc
2K0	XC62FP2702M	LVR-IC	LDO, 2.7V±2%, 250mA	SOT-23	16cj	VR1	3d	Tor
2K5	TC592702ECB	LVR-IC	LDO, -2.7V±2%, 200mA	SOT-23	16cj	VR2	3d	Mcc
2K5	XC62KN272M	LVR-IC	LDO, -2.7V±2%, 100mA, 150mW	SOT-23	16cj	VR2	3d	Tor
2KC2	81C29-P-AE3-2	Vdet-IC	2.9V±2%, -Reset PPO	SOT-23	16vdy	VD7	3a	Utc
2KC2G	81C29G-P-AE3-2	Vdet-IC	2.9V±2%, -Reset PPO, halogen free	SOT-23	16vdy	VD7	3a	Utc
2KC2L	81C29L-P-AE3-2	Vdet-IC	2.9V±2%, -Reset PPO, lead free	SOT-23	16vdy	VD7	3a	Utc
2KC3	81C29-P-AE3-3	Vdet-IC	2.9V±2%, -Reset PPO	SOT-23	16vdb	VD7	3a	Utc
2KC3G	81C29G-P-AE3-3	Vdet-IC	2.9V±2%, -Reset PPO, halogen free	SOT-23	16vdb	VD7	3a	Utc
2KC3L	81C29L-P-AE3-3	Vdet-IC	2.9V±2%, -Reset PPO, lead free	SOT-23	16vdb	VD7	3a	Utc
2KC5	81C29-P-AE3-5	Vdet-IC	2.9V±2%, -Reset PPO	SOT-23	16vdc	VD7	3a	Utc
2KC5G	81C29G-P-AE3-5	Vdet-IC	2.9V±2%, -Reset PPO, halogen free	SOT-23	16vdc	VD7	3a	Utc
2KC5L	81C29L-P-AE3-5	Vdet-IC	2.9V±2%, -Reset PPO, lead free	SOT-23	16vdc	VD7	3a	Utc
2KN2	81N29-P-AE3-2	Vdet-IC	2.9V±2%, -Reset ODO	SOT-23	16vdy	VD6	3a	Utc
2KN2G	81N29G-P-AE3-2	Vdet-IC	2.9V±2%, -Reset ODO, halogen free	SOT-23	16vdy	VD6	3a	Utc
2KN2L	81N29L-P-AE3-2	Vdet-IC	2.9V±2%, -Reset ODO, lead free	SOT-23	16vdy	VD6	3a	Utc
2KN3	81N29-P-AE3-3	Vdet-IC	2.9V±2%, -Reset ODO	SOT-23	16vdb	VD6	3a	Utc
2KN3G	81N29G-P-AE3-3	Vdet-IC	2.9V±2%, -Reset ODO, halogen free	SOT-23	16vdb	VD6	3a	Utc
2KN3L	81N29L-P-AE3-3	Vdet-IC	2.9V±2%, -Reset ODO, lead free	SOT-23	16vdb	VD6	3a	Utc
2KN5	81N29-P-AE3-5	Vdet-IC	2.9V±2%, -Reset ODO	SOT-23	16vdc	VD6	3a	Utc
2KN5G	81N29G-P-AE3-5	Vdet-IC	2.9V±2%, -Reset ODO, halogen free	SOT-23	16vdc	VD6	3a	Utc
2KN5L	81N29L-P-AE3-5	Vdet-IC	2.9V±2%, -Reset ODO, lead free	SOT-23	16vdc	VD6	3a	Utc
2L	BAT754A	Si-diode	Dual, Schottky, Sw, U-Fst, 30V, 0.2A, Vf<0.6V(0.1A), <0.3ns	SOT-23	16df	-	3a	Phi
2L	FMMT4403	Si-pnp	AF, 40V, 600mA, 330mW, B=100..300, >200MHz	SOT-23	16ta	-	3a	Zx
2L	KST5401	Si-pnp	Vid, 160V, 500mA, 350mW, B=60..240, >150MHz	SOT-23	16ta	-	3a	Sam
2L	MMBT5401	Si-pnp	HV, 160V, 200mA, 350mW, B=60..240, >100MHz	SOT-23	16ta	-	3a	Nsc
2L	R3131N26AC3	Vdet-IC	2.6V, +Reset ODO, 50ms	SOT-23	16vdc	VD6	3b	Ric
2L	TMPT5401	Si-pnp	GP, 160V, 200mA, 350mW, B=60..240, >100MHz	SOT-23	16ta	-	3a	All
-2L	PMST5401	Si-pnp	HV, 160V, 300mA, 200mW, B=60..240, 100..300MHz	SOT-323	16ta	-	3a	PHH
2L0	TC55RP282ECB	LVR-IC	LDO, 2.8V±2%, 250mA	SOT-23	16cq	VR1	3d	Mcc
2L0	XC62FP2802M	LVR-IC	LDO, 2.8V±2%, 250mA	SOT-23	16cj	VR1	3d	Tor
2L5	TC592802ECB	LVR-IC	LDO, -2.8V±2%, 200mA	SOT-23	16cj	VR2	3d	Mcc
2L5	XC62KN282M	LVR-IC	LDO, -2.8V±2%, 100mA, 150mW	SOT-23	16cj	VR2	3d	Tor
2LN	ELM7517CEB	Vdet-IC	1.7V±2%, +Reset PPO	SC-70	16vdb	VD7	3d	Elm
2LN	ELM7517NEB	Vdet-IC	1.7V±2%, +Reset ODO	SC-70	16vdb	VD6	3d	Elm
2M	BAT754C	Si-diode	Dual, Schottky, Sw, U-Fst, 30V, 0.2A, Vf<0.6V(0.1A), <0.3ns	SOT-23	16dg	-	3a	Phi
2M	BC817-16	Si-npn	GP, 50V, 500mA, 350mW, B=100..250, >80MHz	SOT-23	16ta	-	3f	Kec
2M	BC817A-16	Si-npn	GP, 50V, 500mA, 350mW, B=100..250, >80MHz	SOT-23	16ta	-	3f	Kec



SMD code	Type	Function	Short description	Case	Pinout	Sch.	St.	Mnf.
2M	DDZX27D	Z-diode	27V±2.5%, 500mW	SOT-23	16dc	-	3a	Di
2M	DDZX27DW	Z-diode	27V±2.5%, 200mW	SOT-323	16dc	-	3a	Di
2m	FMMT5087	Si-pnp	AF, 50V, 100mA, 330mW, B=250..800, >40MHz	SOT-23	16ta	-	3a	Zx
2M	R3131N26BC3	Vdet-IC	2.6V, +Reset ODO, 100ms	SOT-23	16vdc	VD6	3b	Ric
2M0	TC55RP292ECB	LVR-IC	LDO, 2.9V±2%, 250mA	SOT-23	16cq	VR1	3d	Mcc
2M0	XC62FP2902M	LVR-IC	2.9V±2%, 250mA	SOT-23	16cg	VR1	3d	Tor
2M5	TC592902ECB	LVR-IC	LDO, -2.9V±2%, 200mA	SOT-23	16cj	VR2	3d	Mcc
2M5	XC62KN292M	LVR-IC	LDO, -2.9V±2%, 100mA, 150mW	SOT-23	16cj	VR2	3d	Tor
2N	BAT754S	Si-diode	Dual, Schottky, Sw, U-Fst, 30V, 0.2A, Vf<0.6V(0.1A), <0.3ns	SOT-23	16dl	-	3a	Phi
2N	BC817-25	Si-npn	GP, 50V, 500mA, 350mW, B=160..400, >80MHz	SOT-23	16ta	-	3f	Kec
2N	BC817A-25	Si-npn	GP, 50V, 500mA, 350mW, B=160..400, >80MHz	SOT-23	16ta	-	3f	Kec
2N	DDZX30D	Z-diode	30V±2.5%, 500mW	SOT-23	16dc	-	3a	Di
2N	DDZX30DTS	Z-diode	30V±2.5%, 500mW	SOT-23	16dc	-	3a	Di
2N	DDZX30DW	Z-diode	30V±2.5%, 200mW	SOT-323	16dc	-	3a	Di
2N	MMBT404A	Si-pnp	Chopper, 40V, 150mA, 225mW, B=100..400, 180ns	SOT-23	16ta	-	3a	Mot
2N	R3131N26DC3	Vdet-IC	2.6V, +Reset ODO, 200ms	SOT-23	16vdc	VD6	3b	Ric
2N0	ZXT11N20DFTA	Si-npn	Lo-sat, Sw, 40V, 2.5A, 625mW, B=200..900, 160MHz	SOT-23	16ta	-	3a	Zx
2N0	ZXT11N20DFTC	Si-npn	Lo-sat, Sw, 40V, 2.5A, 625mW, B=200..900, 160MHz	SOT-23	16ta	-	3a	Zx
2NQ	2SD1478-Q	Si-npn-Darl	AF-Amp, 60V, 500mA, 200mW, 200MHz, B=4000..10000	SC-59	16ta	-	3a	Pan
2NR	2SD1478-R	Si-npn-Darl	AF-Amp, 60V, 500mA, 200mW, 200MHz, B=8000..20000	SC-59	16ta	-	3a	Pan
2OQ	2SD1478A-Q	Si-npn-Darl	AF-Amp, 50V, 500mA, 200mW, 200MHz, B=4000..10000	SC-59	16ta	-	3a	Pan
2OR	2SD1478A-R	Si-npn-Darl	AF-Amp, 50V, 500mA, 200mW, 200MHz, B=8000..20000	SC-59	16ta	-	3a	Pan
2P	BC817-40	Si-npn	GP, 50V, 500mA, 350mW, B=250..630, >80MHz	SOT-23	16ta	-	3f	Kec
2P	BC817A-40	Si-npn	GP, 50V, 500mA, 350mW, B=250..630, >80MHz	SOT-23	16ta	-	3f	Kec
2P	FMMT2222R	Si-npn	GP, 60V, 600mA, 330mW, B=120..360, >250MHz	SOT-23	16ta	-	3a	Zx
2P	KST5086	Si-pnp	GP, 50V, 50mA, 350mW, B=150..500, >40MHz	SOT-23	16ta	-	3a	Sam
2P	MMBT5086	Si-npn	GP, 50V, 50mA, 350mW, B=150..500, >40MHz	SOT-23	16ta	-	3a	Mot
2P	R3131N26HC3	Vdet-IC	2.6V, +Reset ODO, 400ms	SOT-23	16vdc	VD6	3b	Ric
2P	TMPT5086	Si-pnp	GP, 50V, 50mA, 350mW, B=150..500, >40MHz	SOT-23	16ta	-	3a	All
2Q	FMMT5209	Si-npn	GP, 50V, 50mA, 330mW, B=100..300, >30MHz	SOT-23	16ta	-	3a	Zx
2Q	KST5087	Si-pnp	GP, 50V, 50mA, 350mW, B=250..800, >40MHz	SOT-23	16ta	-	3a	Sam
2Q	R3131N26AA3	Vdet-IC	2.6V, +Reset PPO, 50ms	SOT-23	16vdc	VD7	3b	Ric
2Q	TMPT5087	Si-pnp	GP, 50V, 50mA, 350mW, B=250..800, >40MHz	SOT-23	16ta	-	3a	All
2R	2SD5632	Si-npn	HF-osc/Sw, 15V, 50mA, 150mW, B=100..350, 1.1GHz	SOT-323	16ta	-	3a	Pan
2R	FMMT5210	Si-npn	GP, 50V, 50mA, 330mW, B=200..600, >30MHz	SOT-23	16ta	-	3a	Zx
2R	R3131N26BA3	Vdet-IC	2.6V, +Reset PPO, 100ms	SOT-23	16vdc	VD7	3b	Ric
2R	SRA2202E	Si-pnp-Digi	Sw, 50V, 100mA, 150mW, 200MHz, R1/R2=10/10k	SOT-523	16ta	-	3a	Auk
2R	SRA2202EF	Si-pnp-Digi	Sw, 50V, 100mA, 150mW, 200MHz, R1/R2=10/10k	SOT-523F	18ta	-	3a	Rik
2R	SRA2202U	Si-pnp-Digi	Sw, 50V, 100mA, 200mW, 200MHz, R1/R2=10/10k	SOT-323	16ta	-	3a	Auk
2R	SRA2202UF	Si-pnp-Digi	Sw, 50V, 100mA, 200mW, 200MHz, R1/R2=10/10k	SOT-323F	18ta	-	3a	Auk
2S	2SD5654	Si-npn	DC/DC-Conv, 20V, 1A, 150mW, B=160..560, 180MHz	SOT-323	16ta	-	3a	Pan
2S	R3131N26DA3	Vdet-IC	2.6V, +Reset PPO, 200ms	SOT-23	16vdc	VD7	3b	Ric
2T	HT2	Si-npn	GP, 90V, 100mA, 300mW, <500/2000ns	SOT-23	16ta	-	3a	Fer
2T	KST4403	Si-pnp	GP, 60V, 600mA, 350mW, B=100..300, >200MHz	SOT-23	16ta	-	3a	Sam
2T	MMBT4403	Si-pnp	GP, 40V, 800mA, 200mW, B=100..300, >200MHz	SOT-23	16ta	-	3g	Vs
2T	MMBT4403T	Si-pnp	GP, 40V, 800mA, 200mW, B=100..300, >200MHz	SOT-23	16ta	-	3d	Di
2T	R3131N26HA3	Vdet-IC	2.6V, +Reset PPO, 400ms	SOT-23	16vdc	VD7	3b	Ric
2T	SO4403	Si-pnp	GP, 40V, 600mA, 225mW, B=30..100, 200MHz	SOT-23	16ta	-	3a	Ste
2T	TMPT4403	Si-pnp	GP, 40V, 600mA, 330mW, B=100..300, >200MHz	SOT-23	16ta	-	3a	All
2T	YTS4403	Si-pnp	GP, 40V, 600mA, 225mW, B=30..100, 200MHz	SOT-23	16ta	-	3a	Tos
-2T	PMST4403	Si-pnp	GP, 40V, 600mA, 200mW, B=100..300, >200MHz	SOT-323	16ta	-	3a	PHH
2T	GMBT4403	Si-pnp	GP, 40V, 600mA, 225mW, B=30..100, 200MHz	SOT-23	16ta	-	3a	Gtm
2T1H	S9012LT1-H	Si-pnp	GP, 40V, 500mA, 300mW, B=200..350, >150MHz	SOT-23	16ta	-	3a	Wtr
2T1L	S9012LT1-L	Si-pnp	GP, 40V, 500mA, 300mW, B=120..200, >150MHz	SOT-23	16ta	-	3a	Wtr
2U	KST63	Si-npn-Darl	GP, 30V, 500mA, 350mW, B>6000, >125MHz	SOT-23	16ta	-	3a	Sam
2U	MMBTA63	Si-pnp-Darl	GP, 30V, 500mA, 300mW, B>5000, >125MHz	SOT-23	16ta	-	3a	Mot
2U	SMBTA63	Si-pnp-Darl	GP, 30V, 500mA, 300mW, B>5000, >125MHz	SOT-23	16ta	-	3c	Inf
2V	KST64	Si-npn-Darl	GP, 30V, 500mA, 350mW, B>10000, >125MHz	SOT-23	16ta	-	3a	Sam
2V	MMBTA64	Si-pnp-Darl	GP, 30V, 500mA, 300mW, B>10000, >125MHz	SOT-23	16ta	-	3a	Mot
2V	SMBTA64	Si-pnp-Darl	GP, 30V, 500mA, 300mW, B>10000, >125MHz	SOT-23	16ta	-	3c	Inf
2V4	PZM2.4NB	Z-diode	2.4V±2.5%, 300mW	SOT-346	16dc	-	3a	Phi
2V7	PZM2.7NB	Z-diode	2.7V±2.5%, 300mW	SOT-346	16dc	-	3a	Phi
2VR	2SD2623-R	Si-npn	AF, 25V, 500mA, 250mW, B=200..350, 200MHz	SOT-323	16ta	-	3a	Pan
2VS	2SD2623-S	Si-npn	AF, 25V, 500mA, 250mW, B=300..500, 200MHz	SOT-323	16ta	-	3a	Pan
2VT	2SD2623-T	Si-npn	AF, 25V, 500mA, 250mW, B=400..800, 200MHz	SOT-323	16ta	-	3a	Pan
2W	2SC3704	Si-npn	UHF, LN, 15V, 80mA, 200mW, B=50..300, 6GHz	SC-59	16ta	-	3a	Pan
2W	2SC3937	Si-npn	UHF, 15V, 80mA, 150mW, B=80..200, 6GHz	SOT-323	16ta	-	3a	Pan
2W	FMMT3905	Si-pnp	GP, 40V, 200mA, 330mW, B=50..150, >200MHz	SOT-23	16ta	-	3a	Zx
2W	MMBT8599	Si-pnp	GP, 80V, 500mA, 300mW, B=100..300, >150MHz	SOT-23	16ta	-	3a	Mot
2W	RT1A3906	Si-pnp	AF, 60V, 200mA, 150mW, 250MHz, B=100..300	SC-59	16ta	-	3a	Mit



SMD code	Type	Function	Short description	Case	Pinout	Sch.	St.	Mnf.
2W	TMPT4402	Si-npn	GP, 40V, 600mA, 330mW, B=50..150, >150MHz	SOT-23	16ta	-	3a	All
2X	2SC3707	Si-npn	UHF, 10V, 10mA, 50mW, B=50..150, 4GHz	SC-59	16ta	-	3a	Pan
2X	2SC4410	Si-npn	UHF, 10V, 10mA, 50mW, B=50..200, 4GHz	SOT-323	16ta	-	3a	Pan
2X	KST4401	Si-npn	GP, 60V, 600mA, 350mW, B=100..300, >250MHz	SOT-23	16ta	-	3a	Sam
2X	MMBT4401	Si-npn	GP, 60V, 800mA, 200mW, B=100..300, >200MHz	SOT-23	16ta	-	3a	Nsc
2X	MMBT4401T	Si-npn	GP, 60V, 600mA, 300mW, B=100..300, >250MHz	SOT-523	16ta	-	3a	Di
2X	SO4401	Si-npn	GP, 60V, 800mA, 200mW, B=100..300, >200MHz	SOT-23	16ta	-	-	Ste
2X	TMPT4401	Si-npn	GP, 60V, 600mA, 350mW, B=100..300, >25MHz	SOT-23	16ta	-	3a	All
2X	UNRF1A5	Si-npn-Digi	Sw, 50V, 80mA, 100mW, 80MHz, R1=10k	ML3	22ta	-	2b	Pan
-2X	PMST4401	Si-npn	Sw, 60V, 600mA, 200mW, B=100..300, >250MHz	SOT-323	16ta	-	3a	PhH
2Y	CMBT3905	Si-npn	GP, 40V, 200mA, 250mW, B=50..150, >200MHz	SOT-23	16ta	-	3a	Cdi
2Y	UNRF2A4	Si-npn-Digi	Sw, 50V, 80mA, 100mW, 150MHz, R1/R2=10k47k	ML3	22ta	-	2b	Pan
2YQ	2SC3757-Q	Si-npn	Sw, Hi-speed, 15V, 50mA, 200mW, B=50..120, 1.5GHz	SC-59	16ta	-	3a	Pan
2YQ	2SC3938-Q	Si-npn	Sw, Hi-Sp, 40V, 300mA, 150mW, B=60..120, 450MHz	SOT-323	16ta	-	3a	Pan
2YQ	2SC4691J-Q	Si-npn	Sw, 40V, 100mA, 125mW, 450MHz, B=60..120	SC-89	18ta	-	3a	Pan
2YQ	2SC4691-Q	Si-npn	Sw, 40V, 300mA, 125mW, 450MHz, B=60..120	SOT-416	16ta	-	3a	Pan
2YR	2SC3757-R	Si-npn	Sw, Hi-speed, 15V, 50mA, 200mW, B=90..150, 1.5GHz	SC-59	16ta	-	3a	Pan
2YR	2SC3938-R	Si-npn	Sw, Hi-Sp, 40V, 300mA, 150mW, B=90..200, 450MHz	SOT-323	16ta	-	3a	Pan
2YR	2SC4691J-R	Si-npn	Sw, 40V, 100mA, 125mW, 450MHz, B=90..200	SC-89	18ta	-	3a	Pan
2YR	2SC4691-R	Si-npn	Sw, 40V, 300mA, 125mW, 450MHz, B=90..200	SOT-416	16ta	-	3a	Pan
2YS	2SC3757-S	Si-npn	Sw, Hi-speed, 15V, 50mA, 200mW, B=120..240, 1.5GHz	SC-59	16ta	-	3a	Pan
2Z	2SC4417	Si-npn	IF-TV, 45V, 50mA, 150mW, B=20..100, 200MHz	SOT-323	16ta	-	3a	Pan
2Z	MMBT6520	Si-npn	Vid, 350V, 250mA, 225mW, B=20..200, <200MHz	SOT-23	16ta	-	3a	Mot
2Z	UNRF2AM	Si-npn-Digi	Sw, 50V, 80mA, 100mW, 150MHz, R1/R2=2k2/47k	ML3	22ta	-	2b	Pan
2Z5	BAS70-05	Si-diode	Dual, Schottky, 70V, 70mA, Vf<1V(15mA), <2pF, 5ns	SOT-23	16dgy	-	3a	Zx
3.0H	MAZ3030-H	Z-diode	2.8..3.2V, If=100mA, Zzt=120Ω, 200mW	SC-59	16dc	-	3a	Pan
3.0L	MAZ3030-L	Z-diode	2.8..3.2V, If=100mA, Zzt=120Ω, 200mW	SC-59	16dc	-	3a	Pan
3.3H	MAZ3033-H	Z-diode	3.1..3.5V, If=100mA, Zzt=130Ω, 200mW	SC-59	16dc	-	3a	Pan
3.3L	MAZ3033-L	Z-diode	3.1..3.5V, If=100mA, Zzt=130Ω, 200mW	SC-59	16dc	-	3a	Pan
3.6H	MAZ3036-H	Z-diode	3.4..3.8V, If=100mA, Zzt=130Ω, 200mW	SC-59	16dc	-	3a	Pan
3.6L	MAZ3036-L	Z-diode	3.4..3.8V, If=100mA, Zzt=130Ω, 200mW	SC-59	16dc	-	3a	Pan
3.9H	MAZ3039-H	Z-diode	3.7..4.1V, If=100mA, Zzt=130Ω, 200mW	SC-59	16dc	-	3a	Pan
3.9L	MAZ3039-L	Z-diode	3.7..4.1V, If=100mA, Zzt=130Ω, 200mW	SC-59	16dc	-	3a	Pan
3-0X	02CZ3.0-X	Z-diode	2.8..3.05V, 200mW	SC-59	16dc	-	3a	Tos
3-0Z	02CZ3.0-Z	Z-diode	2.95..3.2V, 200mW	SC-59	16dc	-	3a	Tos
3-3X	02CZ3.3-X	Z-diode	3.1..3.35V, 200mW	SC-59	16dc	-	3a	Tos
3-3Z	02CZ3.3-Z	Z-diode	3.25..3.5V, 200mW	SC-59	16dc	-	3a	Tos
3-6X	02CZ3.6-X	Z-diode	3.4..3.65V, 200mW	SC-59	16dc	-	3a	Tos
3-6Z	02CZ3.6-Z	Z-diode	3.55..3.8V, 200mW	SC-59	16dc	-	3a	Tos
3-9X	02CZ3.9-X	Z-diode	3.7..3.97V, 200mW	SC-59	16dc	-	3a	Tos
3-9Z	02CZ3.9-Z	Z-diode	3.87..4.1V, 200mW	SC-59	16dc	-	3a	Tos
30	ELM9830BB	LVR-IC	3.0V±2%, 200mA	SOT-23	16cgy	VR1	3d	Elm
30	TZT3.0W	Z-diode	2.80..3.20V, Izt=5mA, Zzt=120Ω, 200mW	SOT-323	16dc	-	3a	Ttr
30	Z02W3.0V	Z-diode	2.80..3.20V, Izt=5mA, Zzt=120Ω, 200mW	SOT-23	16dc	-	3f	Kec
30-	HZM30NB	Z-diode	28..32V, 200mW	SC-59A	16dc	-	3a	Ren
300	HZM3.0NB	Z-diode	2.8..3.2V, 200mW	SC-59A	16dc	-	3a	Ren
301	HZM3.0NB1	Z-diode	2.8..3.05V, 200mW	SC-59A	16dc	-	3a	Ren
301	PZM3.0NB1	Z-diode	3.0V±2.5%, 300mW	SOT-346	16dc	-	3a	Phi
302	HZM3.0NB2	Z-diode	2.95..3.2V, 200mW	SC-59A	16dc	-	3a	Ren
302	PZM3.0NB2	Z-diode	3.0V±2.5%, 300mW	SOT-346	16dc	-	3a	Phi
30-2	UTC8130-2	Vdet-IC	3V, -Reset OCO	SOT-23	16vdy	VD6	3a	Utc
30-3	UTC8130-3	Vdet-IC	3V, -Reset OCO	SOT-23	16vdb	VD6	3a	Utc
305	AT-30533	Si-npn	UHF, 11V, 8mA, 100mW, B=70..300, 10GHz	SOT-23	16ta	-	3a	Agi
30-5	UTC8130-5	Vdet-IC	3V, -Reset OCO	SOT-23	16vdc	VD6	3a	Utc
309L	CMPT3090L	Si-npn	GP, Pow, 45V, 5A, 350mW, B>100, >100MHz	SOT-23F	18ta	-	3a	Cen
30A	AAT60030A-S2	Vdet-IC	3.0V±2%, -Reset ODO	SOT-23	16vdb	VD6	3d	Aat
30B	AAT60030B-S2	Vdet-IC	3.0V±2%, -Reset PPO	SOT-23	16vdb	VD7	3d	Aat
30B	BZX84-C30-V	Z-diode	29.19..30.69V, Izt=2mA, Zzt=200Ω, 300mW	SOT-23	16dc	-	3f	Kec
30B	MMBZ5230BPT	Z-diode	4.465..4.935V, Izt=5mA, Zzt=70Ω, 225mW	SOT-23	16dc	-	3a	Chm
30C	AAT60030C-S2	Vdet-IC	3.0V±1%, -Reset ODO	SOT-23	16vdb	VD6	3d	Aat
30D	AAT60030D-S2	Vdet-IC	3.0V±1%, -Reset PPO	SOT-23	16vdb	VD7	3d	Aat
30H	BZX84-C3V0-V	Z-diode	2.80..3.20V, Izt=5mA, Zzt=120Ω, 300mW	SOT-23	16dc	-	3f	Kec
30H	MAZ3300-H	Z-diode	28..32V, If=100mA, Zzt=80Ω, 200mW	SC-59	16dc	-	3a	Pan
30L	MAZ3300-L	Z-diode	28..32V, If=100mA, Zzt=80Ω, 200mW	SC-59	16dc	-	3a	Pan
30M	MAZ3300-M	Z-diode	28..32V, If=100mA, Zzt=80Ω, 200mW	SC-59	16dc	-	3a	Pan
30N	STM1061N30W	Vdet-IC	3.0V±2%, -Reset ODO	SOT-323	16vda	VD6	3d	Ste
30N	STM1061N30WX	Vdet-IC	3.0V±2%, -Reset ODO	SOT-23	16vda	VD6	3d	Ste
30S	MMBZ5230SPT	Z-diode	4.606..4.794V, Izt=5mA, Zzt=70Ω, 225mW	SOT-23	16dc	-	3a	Chm
30S	MMCZ5230SPT	Z-diode	4.606..4.794V, Izt=5mA, Zzt=70Ω, 225mW	SOT-346	16dc	-	3a	Chm
30T	TK71530AS	LVR-IC	LDO, 3V±1.5%, 155mA	SOT-23	16cj	VR1	3d	Tok



SMD code	Type	Function	Short description	Case	Pinout	Sch.	St.	Mnf.
30V	CHPZ30VPT	Z-diode	Dual, 28.0..32.0V, Izt=2mA, Zzt=80Ω, 350mW	SOT-23	16df	-	3a	Chm
30V	PZM30NB	Z-diode	30V±2.5%, 300mW	SOT-346	16dc	-	3a	Phi
30V	PZM30NB1	Z-diode	30V±2.5%, 300mW	SOT-346	16dc	-	3a	Phi
30X	TZT3.0XW	Z-diode	2.80..3.05V, Izt=5mA, Zzt=120Ω, 200mW	SOT-323	16dc	-	3a	Ttr
30X	Z02W3.0VX	Z-diode	2.80..3.05V, Izt=5mA, Zzt=120Ω, 200mW	SOT-23	16dc	-	3f	Kec
30Z	CZ1W30	Z-diode	30V±5%, 600mW	SOT-23	16dc	-	3a	Cdi
30Z	TZT3.0ZV	Z-diode	2.95..3.20V, Izt=5mA, Zzt=120Ω, 200mW	SOT-323	16dc	-	3a	Ttr
30Z	Z02W3.0VZ	Z-diode	2.95..3.20V, Izt=5mA, Zzt=120Ω, 200mW	SOT-23	16dc	-	3f	Kec
31	2SC5663PT	Si-npn	AF, Sw, 12V, 500mA, B=270..680, 320MHz	SOT-723	18ta	-	3a	Chm
31	2SC5663TPT	Si-npn	AF, Sw, 12V, 500mA, B=270..680, 320MHz	SOT-416	16ta	-	3a	Chm
31	CHT5663M1PT	Si-npn	AF, Sw, 12V, 500mA, B=270..680, 320MHz	FBPT-723	17ta	-	9a	Chm
31	ELM9831BB	LVR-IC	3.1V±2%, 200mA	SOT-23	16cg	VR1	3d	Elm
31	PDTA124XE	Si-pnp-Digi	Sw, 50V, 100mA, 200mW, R1/R2=22k/47k	SOT-416	16ta	-	3a	Phi
31	PDTA124XEF	Si-pnp-Digi	Sw, 50V, 100mA, 250mW, R1/R2=22k/47k	SOT-490	18ta	-	3a	Phi
310	AT-31033	Si-npn	UHF, 11V, 16mA, 0.15W, B=70..300, 10GHz	SOT-23	16ta	-	3a	Agi
31-2	UTC8131-2	Vdet-IC	3.1V, -Reset OCO	SOT-23	16vdy	VD6	3a	Utc
31-3	UTC8131-3	Vdet-IC	3.1V, -Reset OCO	SOT-23	16vdb	VD6	3a	Utc
31A	AAT60031A-S2	Vdet-IC	3.1V±2%, -Reset ODO	SOT-23	16vdb	VD6	3d	Aat
31-A	UTC8131-5	Vdet-IC	3.1V, -Reset OCO	SOT-23	16vdc	VD6	3a	Utc
31B	AAT60031B-S2	Vdet-IC	3.1V±2%, -Reset PPO	SOT-23	16vdb	VD7	3d	Aat
31B	MMBZ5231BPT	Z-diode	4.845..5.355V, Izt=5mA, Zzt=50Ω, 225mW	SOT-23	16dc	-	3a	Chm
31C	AAT60031C-S2	Vdet-IC	3.1V±1%, -Reset ODO	SOT-23	16vdb	VD6	3d	Aat
31D	AAT60031D-S2	Vdet-IC	3.1V±1%, -Reset PPO	SOT-23	16vdb	VD7	3d	Aat
31N	STM1061N31W	Vdet-IC	3.1V±2%, -Reset ODO	SOT-323	16vda	VD6	3d	Ste
31N	STM1061N31WX	Vdet-IC	3.1V±2%, -Reset ODO	SOT-23	16vda	VD6	3d	Ste
31p	BFR505	Si-npn	SATV, 20V, 18mA, 150mW, B=60..250, 9GHz	SOT-23	16ta	-	3a	NxH
31S	MMBZ5231SPT	Z-diode	4.998..5.202V, Izt=5mA, Zzt=50Ω, 225mW	SOT-23	16dc	-	3a	Chm
31S	MMCZ5231SPT	Z-diode	4.998..5.202V, Izt=5mA, Zzt=50Ω, 225mW	SOT-346	16dc	-	3a	Chm
31t	BFR505	Si-npn	SATV, 20V, 18mA, 150mW, B=60..250, 9GHz	SOT-23	16ta	-	3a	NxM
31T	TK71531AS	LVR-IC	LDO, 3.1V±1.5%, 155mA	SOT-23	16cj	VR1	3d	Tok
31W	BFR505	Si-npn	SATV, 20V, 18mA, 150mW, B=60..250, 9GHz	SOT-23	16ta	-	3a	NxC
32	CH3904M1PT	Si-npn	AF, Sw, 40V, 200mA, B=100..300, 300MHz	FBPT-723	17ta	-	9a	Chm
32	CH3904MPT	Si-npn	AF, Sw, 40V, 200mA, B=100..300, 300MHz	SOT-723	18ta	-	3a	Chm
32	ELM9832BB	LVR-IC	3.2V±2%, 200mA	SOT-23	16cg	VR1	3d	Elm
32	PDTC124XE	Si-npn-Digi	Sw, 50V, 100mA, 150mW, R1/R2=22k/47k	SOT-416	16ta	-	3a	Phi
32	PDTC124XEF	Si-npn-Digi	Sw, 50V, 100mA, 250mW, R1/R2=22k/47k	SOT-490	18ta	-	3a	Phi
320	AT-32033	Si-npn	UHF, 11V, 32mA, 0.2W, B=70..300, 10GHz	SOT-23	16ta	-	3a	Agi
32-2	UTC8132-2	Vdet-IC	3.2V, -Reset OCO	SOT-23	16vdy	VD6	3a	Utc
32-3	UTC8132-3	Vdet-IC	3.2V, -Reset OCO	SOT-23	16vdb	VD6	3a	Utc
32-5	UTC8132-5	Vdet-IC	3.2V, -Reset OCO	SOT-23	16vdc	VD6	3a	Utc
32A	AAT60032A-S2	Vdet-IC	3.2V±2%, -Reset ODO	SOT-23	16vdb	VD6	3d	Aat
32A	SP432AS23RG	Vref-IC	Precision, Shunt, adjustable 1.24...20V, 0.5%	SOT-23	16rb	RF1	3b	Syn
32B	AAT60032B-S2	Vdet-IC	3.2V±2%, -Reset PPO	SOT-23	16vdb	VD7	3d	Aat
32B	MMBZ5232BPT	Z-diode	5.320...5.880V, Izt=5mA, Zzt=25Ω, 225mW	SOT-23	16dc	-	3a	Chm
32B	SP432BS23RG	Vref-IC	Precision, Shunt, adjustable 1.24...20V, 1.0%	SOT-23	16rb	RF1	3b	Syn
32C	AAT60032C-S2	Vdet-IC	3.2V±1%, -Reset ODO	SOT-23	16vdb	VD6	3d	Aat
32D	AAT60032D-S2	Vdet-IC	3.2V±1%, -Reset PPO	SOT-23	16vdb	VD7	3d	Aat
32K	XC6203E182MR	LVR-IC	1.8V±2%, 400mA	SOT-23	16cg	VR1	3d	Tor
32L	XC6203E192MR	LVR-IC	1.9V±2%, 400mA	SOT-23	16cg	VR1	3d	Tor
32M	XC6203E202MR	LVR-IC	2V±2%, 400mA	SOT-23	16cg	VR1	3d	Tor
32N	XC6203E212MR	LVR-IC	2.1V±2%, 400mA	SOT-23	16cg	VR1	3d	Tor
32P	XC6203E222MR	LVR-IC	2.2V±2%, 400mA	SOT-23	16cg	VR1	3d	Tor
32R	XC6203E232MR	LVR-IC	2.3V±2%, 400mA	SOT-23	16cg	VR1	3d	Tor
32S	MMBZ5232SPT	Z-diode	5.488..5.712V, Izt=5mA, Zzt=25Ω, 225mW	SOT-23	16dc	-	3a	Chm
32S	MMCZ5232SPT	Z-diode	5.488..5.712V, Izt=5mA, Zzt=25Ω, 225mW	SOT-346	16dc	-	3a	Chm
32S	XC6203E242MR	LVR-IC	2.4V±2%, 400mA	SOT-23	16cg	VR1	3d	Tor
32T	TK71532AS	LVR-IC	LDO, 3.2V±1.5%, 155mA	SOT-23	16cj	VR1	3d	Tok
32T	XC6203E252MR	LVR-IC	2.5V±2%, 400mA	SOT-23	16cg	VR1	3d	Tor
32U	XC6203E262MR	LVR-IC	2.6V±2%, 400mA	SOT-23	16cg	VR1	3d	Tor
32V	XC6203E272MR	LVR-IC	2.7V±2%, 400mA	SOT-23	16cg	VR1	3d	Tor
32X	XC6203E282MR	LVR-IC	2.8V±2%, 400mA	SOT-23	16cg	VR1	3d	Tor
32Y	XC6203E292MR	LVR-IC	2.9V±2%, 400mA	SOT-23	16cg	VR1	3d	Tor
32Z	XC6203E302MR	LVR-IC	3V±2%, 400mA	SOT-23	16cg	VR1	3d	Tor
33	2SC2412MPT-Q	Si-npn	AF, Sw, 50V, 150mA, B=120..270, 180MHz	SOT-723	18ta	-	3a	Chm
33	DTA143XE	Si-pnp-Digi	Sw, 50V, 100mA, 150mW, 250MHz, R1/R2=4k7/10k	SOT-416	16ta	-	3a	Rhm
33	DTA143XKA	Si-pnp-Digi	Sw, 50V, 100mA, 200mW, 250MHz, R1/R2=4k7/10k	SOT-346	16ta	-	3a	Rhm
33	DTA143XM	Si-pnp-Digi	Sw, 50V, 100mA, 150mW, 250MHz, R1/R2=4k7/10k	VMT3	18ta	-	3a	Rhm
33	DTA143XUA	Si-pnp-Digi	Sw, 50V, 100mA, 200mW, 250MHz, R1/R2=4k7/10k	UMT3	16ta	-	3a	Rhm
33	ELM9833BB	LVR-IC	3.3V±2%, 200mA	SOT-23	16cg	VR1	3d	Elm
33	PDTC114YE	Si-npn-Digi	Sw, 50V, 100mA, 150mW, R1/R2=10k/47k	SOT-416	16ta	-	3a	PhM



SMD code	Type	Function	Short description	Case	Pinout	Sch.	St.	Mnf.
33	TZT3.3W	Z-diode	3.10..3.50V, Izt=5mA, Zzt=130Ω, 200mW	SOT-323	16dc	-	3a	Ttr
33	Z02W3.3V	Z-diode	3.10..3.50V, Izt=5mA, Zzt=130Ω, 200mW	SOT-23	16dc	-	3f	Kec
33-	HZM33NB	Z-diode	31..35V, 200mW	SC-59A	16dc	-	3a	Ren
330	HZM3.3NB	Z-diode	3.1..3.5V, 200mW	SC-59A	16dc	-	3a	Ren
330	XC6203E312MR	LVR-IC	3.1V±2%, 400mA	SOT-23	16cg	VR1	3d	Tor
331	HZM3.3NB1	Z-diode	3.1..3.35V, 200mW	SC-59A	16dc	-	3a	Ren
331	NDS331N	n-MOSFET-e	V-MOS, LogL, 20V, 1.3A, <0.16Ω	SOT-23	16fh	-	3a	Nsc
331	PZM3.3NB1	Z-diode	3.3V±2.5%, 300mW	SOT-346	16dc	-	3a	Phi
331	XC6203E322MR	LVR-IC	3.2V±2%, 400mA	SOT-23	16cg	VR1	3d	Tor
332	HZM3.3NB2	Z-diode	3.25..3.5V, 200mW	SC-59A	16dc	-	3a	Ren
332	NDS332P	p-MOSFET-e	V-MOS, LogL, 20V, 1A, <0.41Ω(5A)	SOT-23	16fh	-	3a	Nsc
332	PZM3.3NB2	Z-diode	3.3V±2.5%, 300mW	SOT-346	16dc	-	3a	Phi
332	XC6203E332MR	LVR-IC	3.3V±2%, 400mA	SOT-23	16cg	VR1	3d	Tor
33-2	UTC8133-2	Vdet-IC	3.3V, -Reset OCO	SOT-23	16vdy	VD6	3a	Utc
333	XC6203E342MR	LVR-IC	3.4V±2%, 400mA	SOT-23	16cg	VR1	3d	Tor
33-3	UTC8133-3	Vdet-IC	3.3V, -Reset OCO	SOT-23	16vdb	VD6	3a	Utc
334	XC6203E352MR	LVR-IC	3.5V±2%, 400mA	SOT-23	16cg	VR1	3d	Tor
335	NDS335N	n-MOSFET-e	V-MOS, LogL, 20V, 1.7A, <0.11Ω	SOT-23	16fh	-	3a	Nsc
335	XC6203E362MR	LVR-IC	3.6V±2%, 400mA	SOT-23	16cg	VR1	3d	Tor
33-5	UTC8133-5	Vdet-IC	3.3V, -Reset OCO	SOT-23	16vdc	VD6	3a	Utc
336	NDS336P	p-MOSFET-e	V-MOS, LogL, 20V, 1.2A, <0.27Ω	SOT-23	16fh	-	3a	Nsc
336	XC6203E372MR	LVR-IC	3.7V±2%, 400mA	SOT-23	16cg	VR1	3d	Tor
337	XC6203E382MR	LVR-IC	3.8V±2%, 400mA	SOT-23	16cg	VR1	3d	Tor
338	XC6203E392MR	LVR-IC	3.9V±2%, 400mA	SOT-23	16cg	VR1	3d	Tor
339	XC6203E402MR	LVR-IC	4V±2%, 400mA	SOT-23	16cg	VR1	3d	Tor
33A	AAT60033A-S2	Vdet-IC	3.3V±2%, -Reset ODO	SOT-23	16vdb	VD6	3d	Aat
33A	MMBZ33VA	TVS	Dual, Vrwm=26V, Vbr=31.35..34.65V, 0.87A, 40W(1ms)	SOT-23	16dg	-	3a	Wtr
33A	XC6203E412MR	LVR-IC	4.1V±2%, 400mA	SOT-23	16cg	VR1	3d	Tor
33AC	FM1233ACS3X	Vdet-IC	2.88V±1.5%, -Reset ODO	SOT-23	16vdc	VD6	3b	F
33AD	FM1233ADS3X	Vdet-IC	2.72V±1.5%, -Reset ODO	SOT-23	16vdc	VD6	3b	F
33B	AAT60033B-S2	Vdet-IC	3.3V±2%, -Reset PPO	SOT-23	16vdb	VD7	3d	Aat
33B	BZX84-C33-V	Z-diode	32.15..33.79V, Izt=2mA, Zzt=250Ω, 300mW	SOT-23	16dc	-	3f	Kec
33B	MMBZ5233BPT	Z-diode	5.700..6.300V, Izt=5mA, Zzt=25Ω, 225mW	SOT-23	16dc	-	3a	Chm
33B	XC6203E422MR	LVR-IC	4.2V±2%, 400mA	SOT-23	16cg	VR1	3d	Tor
33BA	FM1233ABAS3X	Vdet-IC	3.08V±1.5%, -Reset ODO	SOT-23	16vdc	VD6	3b	F
33C	AAT60033C-S2	Vdet-IC	3.3V±1%, -Reset ODO	SOT-23	16vdb	VD6	3d	Aat
33C	XC6203E432MR	LVR-IC	4.3V±2%, 400mA	SOT-23	16cg	VR1	3d	Tor
33D	AAT60033D-S2	Vdet-IC	3.3V±1%, -Reset PPO	SOT-23	16vdb	VD7	3d	Aat
33D	XC6203E442MR	LVR-IC	4.4V±2%, 400mA	SOT-23	16cg	VR1	3d	Tor
33E	XC6203E452MR	LVR-IC	4.5V±2%, 400mA	SOT-23	16cg	VR1	3d	Tor
33F	XC6203E462MR	LVR-IC	4.6V±2%, 400mA	SOT-23	16cg	VR1	3d	Tor
33H	BZX84-C3V3-V	Z-diode	3.10..3.50V, Izt=5mA, Zzt=130Ω, 300mW	SOT-23	16dc	-	3f	Kec
33H	MAZ3330-H	Z-diode	31..35V, If=100mA, Zzt=80Ω, 200mW	SC-59	16dc	-	3a	Pan
33H	XC6203E472MR	LVR-IC	4.7V±2%, 400mA	SOT-23	16cg	VR1	3d	Tor
33K	XC6203E482MR	LVR-IC	4.8V±2%, 400mA	SOT-23	16cg	VR1	3d	Tor
33L	MAZ3330-L	Z-diode	31..35V, If=100mA, Zzt=80Ω, 200mW	SC-59	16dc	-	3a	Pan
33L	XC6203E492MR	LVR-IC	4.9V±2%, 400mA	SOT-23	16cg	VR1	3d	Tor
33M	MAZ3330-M	Z-diode	31..35V, If=100mA, Zzt=80Ω, 200mW	SC-59	16dc	-	3a	Pan
33M	XC6203E502MR	LVR-IC	5V±2%, 400mA	SOT-23	16cg	VR1	3d	Tor
33N	XC6203E512MR	LVR-IC	5.1V±2%, 400mA	SOT-23	16cg	VR1	3d	Tor
33P	XC6203E522MR	LVR-IC	5.2V±2%, 400mA	SOT-23	16cg	VR1	3d	Tor
33R	XC6203E532MR	LVR-IC	5.3V±2%, 400mA	SOT-23	16cg	VR1	3d	Tor
33S	MMBZ5233SPT	Z-diode	5.880..6.120V, Izt=5mA, Zzt=25Ω, 225mW	SOT-23	16dc	-	3a	Chm
33S	MMCZ5233SPT	Z-diode	5.880..6.120V, Izt=5mA, Zzt=25Ω, 225mW	SOT-346	16dc	-	3a	Chm
33S	XC6203E542MR	LVR-IC	5.4V±2%, 400mA	SOT-23	16cg	VR1	3d	Tor
33T	TK71533AS	LVR-IC	LDO, 3.3V±1.5%, 155mA	SOT-23	16cj	VR1	3d	Tok
33T	XC6203E552MR	LVR-IC	5.5V±2%, 400mA	SOT-23	16cg	VR1	3d	Tor
33U	XC6203E562MR	LVR-IC	5.6V±2%, 400mA	SOT-23	16cg	VR1	3d	Tor
33V	CHPZ33VPT	Z-diode	Dual, 31.0..35.0V, Izt=2mA, Zzt=80Ω, 350mW	SOT-23	16df	-	3a	Chm
33V	PZM33NB	Z-diode	33V±2.5%, 300mW	SOT-346	16dc	-	3a	Phi
33V	PZM33NB1	Z-diode	33V±2.5%, 300mW	SOT-346	16dc	-	3a	Phi
33V	XC6203E572MR	LVR-IC	5.7V±2%, 400mA	SOT-23	16cg	VR1	3d	Tor
33X	TZT3.3XW	Z-diode	3.10..3.35V, Izt=5mA, Zzt=130Ω, 200mW	SOT-323	16dc	-	3a	Ttr
33X	XC6203E582MR	LVR-IC	5.8V±2%, 400mA	SOT-23	16cg	VR1	3d	Tor
33X	Z02W3.3VX	Z-diode	3.10..3.35V, Izt=5mA, Zzt=130Ω, 200mW	SOT-23	16dc	-	3f	Kec
33Y	XC6203E592MR	LVR-IC	5.9V±2%, 400mA	SOT-23	16cg	VR1	3d	Tor
33Z	CZ1W33	Z-diode	33V±5%, 600mW	SOT-23	16dc	-	3a	Cdi
33Z	TZT3.3ZW	Z-diode	3.25..3.50V, Izt=5mA, Zzt=130Ω, 200mW	SOT-323	16dc	-	3a	Ttr
33Z	XC6203E602MR	LVR-IC	6V±2%, 400mA	SOT-23	16cg	VR1	3d	Tor
33Z	Z02W3.3VZ	Z-diode	3.25..3.50V, Izt=5mA, Zzt=130Ω, 200mW	SOT-23	16dc	-	3f	Kec



SMD code	Type	Function	Short description	Case	Pinout	Sch.	St.	Mnf.
34	2SC2412MPT-R	Si-npn	AF, Sw, 50V, 150mA, B=180..390, 180MHz	SOT-723	18ta	-	3a	Chm
34	2SC5007-FB	Si-npn	UHfV/Hf, 20V, 65mA, 125mW, 7GHz, B=80..160	SOT-23	16ta	-	3a	Nec
34	ELM9834BB	LVR-IC	3.4V±2%, 200mA	SOT-23	16cg	VR1	3d	Elm
34	NE68119-FB	Si-npn	UHfV/Hf, 20V, 65mA, 125mW, 7GHz, B=80..160	SOT-23	16ta	-	3a	Cel
34	PDTC143XE	Si-npn-Digi	Sw, 50V, 100mA, 150mW, R1/R2=4.7k/10k	SOT-416	16ta	-	3a	Phi
34-2	UTC8134-2	Vdet-IC	3.4V, -Reset OCO	SOT-23	16vdy	VD6	3a	Utc
34-3	UTC8134-3	Vdet-IC	3.4V, -Reset OCO	SOT-23	16vdb	VD6	3a	Utc
34-5	UTC8134-5	Vdet-IC	3.4V, -Reset OCO	SOT-23	16vdc	VD6	3a	Utc
34A	AAT60034A-S2	Vdet-IC	3.4V±2%, -Reset ODO	SOT-23	16vdb	VD6	3d	Aat
34B	AAT60034B-S2	Vdet-IC	3.4V±2%, -Reset PPO	SOT-23	16vdb	VD7	3d	Aat
34B	MMBZ5234BPT	Z-diode	5.890..6.510V, Izt=5mA, Zzt=10Ω, 225mW	SOT-23	16dc	-	3a	Chm
34C	AAT60034C-S2	Vdet-IC	3.4V±1%, -Reset ODO	SOT-23	16vdb	VD6	3d	Aat
34D	AAT60034D-S2	Vdet-IC	3.4V±1%, -Reset PPO	SOT-23	16vdb	VD7	3d	Aat
34N	STM1061N34W	Vdet-IC	3.4V±2%, -Reset ODO	SOT-323	16vda	VD6	3d	Ste
34N	STM1061N34WX	Vdet-IC	3.4V±2%, -Reset ODO	SOT-23	16vda	VD6	3d	Ste
34S	MMBZ5234SPT	Z-diode	6.070..6.324V, Izt=5mA, Zzt=10Ω, 225mW	SOT-23	16dc	-	3a	Chm
34S	MMCZ5234SPT	Z-diode	6.070..6.324V, Izt=5mA, Zzt=10Ω, 225mW	SOT-346	16dc	-	3a	Chm
34T	TK71534AS	LVR-IC	LDO, 3.4V±1.5%, 155mA	SOT-23	16cj	VR1	3d	Tok
34X	XC6203E282AMR	LVR-IC	2.85V±2%, 400mA	SOT-23	16cg	VR1	3d	Tor
35	2SC2412MPT-S	Si-npn	AF, Sw, 50V, 150mA, B=270..560, 180MHz	SOT-723	18ta	-	3a	Chm
35	DTA124XE	Si-npn-Digi	Sw, 50V, 100mA, 150mW, 250MHz, R1/R2=22k/47k	SOT-416	16ta	-	3a	Rhm
35	DTA124XKA	Si-npn-Digi	Sw, 50V, 100mA, 200mW, 250MHz, R1/R2=22k/47k	SOT-346	16ta	-	3a	Rhm
35	DTA124XM	Si-npn-Digi	Sw, 50V, 100mA, 150mW, 250MHz, R1/R2=22k/47k	VMT3	18ta	-	3a	Rhm
35	DTA124XUA	Si-npn-Digi	Sw, 50V, 100mA, 200mW, 250MHz, R1/R2=22k/47k	UMT3	16ta	-	3a	Rhm
35	ELM9835BB	LVR-IC	3.5V±2%, 200mA	SOT-23	16cg	VR1	3d	Elm
35	PDTA143XE	Si-npn-Digi	Sw, 50V, 100mA, 150mW, R1/R2=4.7k/10k	SOT-416	16ta	-	3a	Phi
351	NDS351N	n-MOSFET-e	V-MOS, LogL, 30V, ±1.1A, <0.25Ω	SOT-23	16fh	-	3a	Nsc
352	NDS352P	p-MOSFET-e	V-MOS, LogL, 20V, ±0.85A, <0.5Ω	SOT-23	16fh	-	3a	Nsc
35-2	UTC8135-2	Vdet-IC	3.5V, -Reset OCO	SOT-23	16vdy	VD6	3a	Utc
35-3	UTC8135-3	Vdet-IC	3.5V, -Reset OCO	SOT-23	16vdb	VD6	3a	Utc
355	NDS355N	n-MOSFET-e	V-MOS, LogL, 30V, ±1.6A, <0.125Ω	SOT-23	16fh	-	3a	Nsc
35-5	UTC8135-5	Vdet-IC	3.5V, -Reset OCO	SOT-23	16vdc	VD6	3a	Utc
356	NDS356P	p-MOSFET-e	V-MOS, LogL, 20V, ±1.1A, <0.3Ω	SOT-23	16fh	-	3a	Nsc
35A	AAT60035A-S2	Vdet-IC	3.5V±2%, -Reset ODO	SOT-23	16vdb	VD6	3d	Aat
35B	AAT60035B-S2	Vdet-IC	3.5V±2%, -Reset PPO	SOT-23	16vdb	VD7	3d	Aat
35B	MMBZ5235BPT	Z-diode	6.460..7.140V, Izt=5mA, Zzt=8Ω, 225mW	SOT-23	16dc	-	3a	Chm
35C	AAT60035C-S2	Vdet-IC	3.5V±1%, -Reset ODO	SOT-23	16vdb	VD6	3d	Aat
35D	AAT60035D-S2	Vdet-IC	3.5V±1%, -Reset PPO	SOT-23	16vdb	VD7	3d	Aat
35K	XC6203P182MR	LVR-IC	1.8V±2%, 400mA, Internal current limiter	SOT-23	16cg	VR1	3d	Tor
35L	XC6203P192MR	LVR-IC	1.9V±2%, 400mA, Internal current limiter	SOT-23	16cg	VR1	3d	Tor
35M	XC6203P202MR	LVR-IC	2V±2%, 400mA, Internal current limiter	SOT-23	16cg	VR1	3d	Tor
35N	XC6203P212MR	LVR-IC	2.1V±2%, 400mA, Internal current limiter	SOT-23	16cg	VR1	3d	Tor
35P	XC6203P222MR	LVR-IC	2.2V±2%, 400mA, Internal current limiter	SOT-23	16cg	VR1	3d	Tor
35R	XC6203P232MR	LVR-IC	2.3V±2%, 400mA, Internal current limiter	SOT-23	16cg	VR1	3d	Tor
35S	MMBZ5235SPT	Z-diode	6.664..6.936V, Izt=5mA, Zzt=8Ω, 225mW	SOT-23	16dc	-	3a	Chm
35S	MMCZ5235SPT	Z-diode	6.664..6.936V, Izt=5mA, Zzt=8Ω, 225mW	SOT-346	16dc	-	3a	Chm
35S	XC6203P242MR	LVR-IC	2.4V±2%, 400mA, Internal current limiter	SOT-23	16cg	VR1	3d	Tor
35T	TK71535AS	LVR-IC	LDO, 3.5V±1.5%, 155mA	SOT-23	16cj	VR1	3d	Tok
35T	XC6203P252MR	LVR-IC	2.5V±2%, 400mA, Internal current limiter	SOT-23	16cg	VR1	3d	Tor
35U	XC6203P262MR	LVR-IC	2.6V±2%, 400mA, Internal current limiter	SOT-23	16cg	VR1	3d	Tor
35V	XC6203P272MR	LVR-IC	2.7V±2%, 400mA, Internal current limiter	SOT-23	16cg	VR1	3d	Tor
35X	XC6203P282MR	LVR-IC	2.8V±2%, 400mA, Internal current limiter	SOT-23	16cg	VR1	3d	Tor
35Y	XC6203P292MR	LVR-IC	2.9V±2%, 400mA, Internal current limiter	SOT-23	16cg	VR1	3d	Tor
35Z	XC6203P302MR	LVR-IC	3V±2%, 400mA, Internal current limiter	SOT-23	16cg	VR1	3d	Tor
36	2SA2030PT	Si-pnp	AF, Sw, 12V, 500mA, B=270..680, 260MHz	SOT-723	18ta	-	3a	Chm
36	CHT2030M1PT	Si-pnp	AF, Sw, 12V, 500mA, B=270..680, 260MHz	FBPT-723	17ta	-	9a	Chm
36	ELM9836BB	LVR-IC	3.6V±2%, 200mA	SOT-23	16cg	VR1	3d	Elm
36	TZT3.6W	Z-diode	3.40..3.80V, Izt=5mA, Zzt=130Ω, 200mW	SOT-323	16dc	-	3a	Ttr
36	Z02W3.6V	Z-diode	3.40..3.80V, Izt=5mA, Zzt=130Ω, 200mW	SOT-23	16dc	-	3f	Kec
36-	HZM36NB	Z-diode	34..38V, 200mW	SC-59A	16dc	-	3a	Ren
360	HZM3.6NB	Z-diode	3.4..3.8V, 200mW	SC-59A	16dc	-	3a	Ren
360	XC6203P312MR	LVR-IC	3.1V±2%, 400mA, Internal current limiter	SOT-23	16cg	VR1	3d	Tor
361	HZM3.6NB1	Z-diode	3.4..3.65V, 200mW	SC-59A	16dc	-	3a	Ren
361	PZM3.6NB1	Z-diode	3.6V±2.5%, 300mW	SOT-346	16dc	-	3a	Phi
361	XC6203P322MR	LVR-IC	3.2V±2%, 400mA, Internal current limiter	SOT-23	16cg	VR1	3d	Tor
362	HZM3.6NB2	Z-diode	3.55..3.8V, 200mW	SC-59A	16dc	-	3a	Ren
362	PZM3.6NB2	Z-diode	3.6V±2.5%, 300mW	SOT-346	16dc	-	3a	Phi
362	XC6203P332MR	LVR-IC	3.3V±2%, 400mA, Internal current limiter	SOT-23	16cg	VR1	3d	Tor
36-2	UTC8136-2	Vdet-IC	3.6V, -Reset OCO	SOT-23	16vdy	VD6	3a	Utc
363	XC6203P342MR	LVR-IC	3.4V±2%, 400mA, Internal current limiter	SOT-23	16cg	VR1	3d	Tor



SMD code	Type	Function	Short description	Case	Pinout	Sch.	St.	Mnf.
36-3	UTC8136-3	Vdet-IC	3.6V, -Reset OCO	SOT-23	16vdb	VD6	3a	Utc
364	XC6203P352MR	LVR-IC	3.5V±2%, 400mA, Internal current limiter	SOT-23	16cg	VR1	3d	Tor
365	XC6203P362MR	LVR-IC	3.6V±2%, 400mA, Internal current limiter	SOT-23	16cg	VR1	3d	Tor
36-5	UTC8136-5	Vdet-IC	3.6V, -Reset OCO	SOT-23	16vdc	VD6	3a	Utc
366	XC6203P372MR	LVR-IC	3.7V±2%, 400mA, Internal current limiter	SOT-23	16cg	VR1	3d	Tor
367	XC6203P382MR	LVR-IC	3.8V±2%, 400mA, Internal current limiter	SOT-23	16cg	VR1	3d	Tor
368	XC6203P392MR	LVR-IC	3.9V±2%, 400mA, Internal current limiter	SOT-23	16cg	VR1	3d	Tor
369	XC6203P402MR	LVR-IC	4V±2%, 400mA, Internal current limiter	SOT-23	16cg	VR1	3d	Tor
36A	AAT60036A-S2	Vdet-IC	3.6V±2%, -Reset ODO	SOT-23	16vdb	VD6	3d	Aat
36A	XC6203P412MR	LVR-IC	4.1V±2%, 400mA, Internal current limiter	SOT-23	16cg	VR1	3d	Tor
36B	AAT60036B-S2	Vdet-IC	3.6V±2%, -Reset PPO	SOT-23	16vdb	VD7	3d	Aat
36B	BZX84-C36-V	Z-diode	35.07..36.87V, Izt=2mA, Zzt=300Ω, 300mW	SOT-23	16dc	-	3f	Kec
36B	MMBZ5236BPT	Z-diode	7.125..7.875V, Izt=5mA, Zzt=7Ω, 225mW	SOT-23	16dc	-	3a	Chm
36B	XC6203P422MR	LVR-IC	4.2V±2%, 400mA, Internal current limiter	SOT-23	16cg	VR1	3d	Tor
36C	AAT60036C-S2	Vdet-IC	3.6V±1%, -Reset ODO	SOT-23	16vdb	VD6	3d	Aat
36C	TVS2336PT	TVS	Dual, Vbr=40V, Vrw=36V, 1A, 300W(1ms)	SOT-23	16df	-	3a	Chm
36C	XC6203P432MR	LVR-IC	4.3V±2%, 400mA, Internal current limiter	SOT-23	16cg	VR1	3d	Tor
36D	AAT60036D-S2	Vdet-IC	3.6V±1%, -Reset PPO	SOT-23	16vdb	VD7	3d	Aat
36D	XC6203P442MR	LVR-IC	4.4V±2%, 400mA, Internal current limiter	SOT-23	16cg	VR1	3d	Tor
36E	XC6203P452MR	LVR-IC	4.5V±2%, 400mA, Internal current limiter	SOT-23	16cg	VR1	3d	Tor
36F	XC6203P462MR	LVR-IC	4.6V±2%, 400mA, Internal current limiter	SOT-23	16cg	VR1	3d	Tor
36H	BZX84-C3V6-V	Z-diode	3.40..3.80V, Izt=5mA, Zzt=130Ω, 300mW	SOT-23	16dc	-	3f	Kec
36H	MAZ3360-H	Z-diode	34..38V, If=100mA, Zzt=90Ω, 200mW	SC-59	16dc	-	3a	Pan
36H	XC6203P472MR	LVR-IC	4.7V±2%, 400mA, Internal current limiter	SOT-23	16cg	VR1	3d	Tor
36K	XC6203P482MR	LVR-IC	4.8V±2%, 400mA, Internal current limiter	SOT-23	16cg	VR1	3d	Tor
36L	MAZ3360-L	Z-diode	34..38V, If=100mA, Zzt=90Ω, 200mW	SC-59	16dc	-	3a	Pan
36L	XC6203P492MR	LVR-IC	4.9V±2%, 400mA, Internal current limiter	SOT-23	16cg	VR1	3d	Tor
36M	MAZ3360-M	Z-diode	34..38V, If=100mA, Zzt=90Ω, 200mW	SC-59	16dc	-	3a	Pan
36M	XC6203P502MR	LVR-IC	5V±2%, 400mA, Internal current limiter	SOT-23	16cg	VR1	3d	Tor
36N	XC6203P512MR	LVR-IC	5.1V±2%, 400mA, Internal current limiter	SOT-23	16cg	VR1	3d	Tor
36P	XC6203P522MR	LVR-IC	5.2V±2%, 400mA, Internal current limiter	SOT-23	16cg	VR1	3d	Tor
36R	XC6203P532MR	LVR-IC	5.3V±2%, 400mA, Internal current limiter	SOT-23	16cg	VR1	3d	Tor
36S	MMBZ5236SPT	Z-diode	7.350..7.650V, Izt=5mA, Zzt=7Ω, 225mW	SOT-23	16dc	-	3a	Chm
36S	MMCZ5236SPT	Z-diode	7.350..7.650V, Izt=5mA, Zzt=7Ω, 225mW	SOT-346	16dc	-	3a	Chm
36S	XC6203P542MR	LVR-IC	5.4V±2%, 400mA, Internal current limiter	SOT-23	16cg	VR1	3d	Tor
36T	TK71536AS	LVR-IC	LDO, 3.6V±1.5%, 155mA	SOT-23	16cj	VR1	3d	Tok
36T	XC6203P552MR	LVR-IC	5.5V±2%, 400mA, Internal current limiter	SOT-23	16cg	VR1	3d	Tor
36U	XC6203P562MR	LVR-IC	5.6V±2%, 400mA, Internal current limiter	SOT-23	16cg	VR1	3d	Tor
36V	PZM36NB	Z-diode	36V±2.5%, 300mW	SOT-346	16dc	-	3a	Phi
36V	PZM36NB1	Z-diode	36V±2.5%, 300mW	SOT-346	16dc	-	3a	Phi
36V	XC6203P572MR	LVR-IC	5.7V±2%, 400mA, Internal current limiter	SOT-23	16cg	VR1	3d	Tor
36X	TZT3.6XW	Z-diode	3.40..3.55V, Izt=5mA, Zzt=130Ω, 200mW	SOT-323	16dc	-	3a	Ttr
36X	XC6203P582MR	LVR-IC	5.8V±2%, 400mA, Internal current limiter	SOT-23	16cg	VR1	3d	Tor
36X	Z02W3.6VX	Z-diode	3.40..3.65V, Izt=5mA, Zzt=130Ω, 200mW	SOT-23	16dc	-	3f	Kec
36Y	XC6203P592MR	LVR-IC	5.9V±2%, 400mA, Internal current limiter	SOT-23	16cg	VR1	3d	Tor
36Z	CZ1W36	Z-diode	36V±5%, 600mW	SOT-23	16dc	-	3a	Cdi
36Z	TZT3.6ZW	Z-diode	3.65..3.80V, Izt=5mA, Zzt=130Ω, 200mW	SOT-323	16dc	-	3a	Ttr
36Z	XC6203P602MR	LVR-IC	6V±2%, 400mA, Internal current limiter	SOT-23	16cg	VR1	3d	Tor
36Z	Z02W3.6VZ	Z-diode	3.55..3.80V, Izt=5mA, Zzt=130Ω, 200mW	SOT-23	16dc	-	3f	Kec
37	CH3906M1PT	Si-pnp	AF, Sw, 40V, 200mA, B=100..300, 250MHz	FBPT-723	17ta	-	9a	Chm
37	CH3906MPT	Si-pnp	AF, Sw, 40V, 200mA, B=100..300, 250MHz	SOT-723	18ta	-	3a	Chm
37	ELM9837BB	LVR-IC	3.7V±2%, 200mA	SOT-23	16cg	VR1	3d	Elm
37-2	UTC8137-2	Vdet-IC	3.7V, -Reset OCO	SOT-23	16vdy	VD6	3a	Utc
37-3	UTC8137-3	Vdet-IC	3.7V, -Reset OCO	SOT-23	16vdb	VD6	3a	Utc
37-5	UTC8137-5	Vdet-IC	3.7V, -Reset OCO	SOT-23	16vdc	VD6	3a	Utc
37A	AAT60037A-S2	Vdet-IC	3.7V±2%, -Reset ODO	SOT-23	16vdb	VD6	3d	Aat
37B	AAT60037B-S2	Vdet-IC	3.7V±2%, -Reset PPO	SOT-23	16vdb	VD7	3d	Aat
37B	MMBZ5237BPT	Z-diode	7.790..8.610V, Izt=5mA, Zzt=7Ω, 225mW	SOT-23	16dc	-	3a	Chm
37C	AAT60037C-S2	Vdet-IC	3.7V±1%, -Reset ODO	SOT-23	16vdb	VD6	3d	Aat
37D	AAT60037D-S2	Vdet-IC	3.7V±1%, -Reset PPO	SOT-23	16vdb	VD7	3d	Aat
37S	MMBZ5237SPT	Z-diode	8.036..8.364V, Izt=5mA, Zzt=7Ω, 225mW	SOT-23	16dc	-	3a	Chm
37S	MMCZ5237SPT	Z-diode	8.036..8.364V, Izt=5mA, Zzt=7Ω, 225mW	SOT-346	16dc	-	3a	Chm
37T	TK71537AS	LVR-IC	LDO, 3.7V±1.5%, 155mA	SOT-23	16cj	VR1	3d	Tok
37X	XC6203P28AMR	LVR-IC	2.85V±2%, 400mA, Internal current limiter	SOT-23	16cg	VR1	3d	Tor
38	2SA1037M1PT-Q	Si-pnp	AF, Sw, 50V, 150mA, B=120..270, 140MHz	FBPT-723	17ta	-	9a	Chm
38	2SA1037MPT-Q	Si-pnp	AF, Sw, 50V, 150mA, B=120..270, 140MHz	SOT-723	18ta	-	3a	Chm
38	ELM9838BB	LVR-IC	3.8V±2%, 200mA	SOT-23	16cg	VR1	3d	Elm
38-2	UTC8138-2	Vdet-IC	3.8V, -Reset OCO	SOT-23	16vdy	VD6	3a	Utc
38-3	UTC8138-3	Vdet-IC	3.8V, -Reset OCO	SOT-23	16vdb	VD6	3a	Utc
38-5	UTC8138-5	Vdet-IC	3.8V, -Reset OCO	SOT-23	16vdc	VD6	3a	Utc



SMD code	Type	Function	Short description	Case	Pinout	Sch. St.	Mnf.
38A	AAT60038A-S2	Vdet-IC	3.8V±2%, -Reset ODO	SOT-23	16vdb	VD6	3d Aat
38B	AAT60038B-S2	Vdet-IC	3.8V±2%, -Reset PPO	SOT-23	16vdb	VD7	3d Aat
38B	MMBZ5238BPT	Z-diode	8.265..9.135V, Izt=5mA, Zzt=7Ω, 225mW	SOT-23	16dc	-	3a Chm
38C	AAT60038C-S2	Vdet-IC	3.8V±1%, -Reset ODO	SOT-23	16vdb	VD6	3d Aat
38D	AAT60038D-S2	Vdet-IC	3.8V±1%, -Reset PPO	SOT-23	16vdb	VD7	3d Aat
38N	STM1061N38W	Vdet-IC	3.8V±2%, -Reset ODO	SOT-323	16vda	VD6	3d Ste
38N	STM1061N38WX	Vdet-IC	3.8V±2%, -Reset ODO	SOT-23	16vda	VD6	3d Ste
38S	MMBZ5238SPT	Z-diode	8.526..8.874V, Izt=5mA, Zzt=7Ω, 225mW	SOT-23	16dc	-	3a Chm
38S	MMCZ5238SPT	Z-diode	8.526..8.874V, Izt=5mA, Zzt=7Ω, 225mW	SOT-346	16dc	-	3a Chm
38T	TK71538AS	LVR-IC	LDO, 3.8V±1.5%, 155mA	SOT-23	16cj	VR1	3d Tok
39	2SA1037M1PT-R	Si-pnp	AF, Sw, 50V, 150mA, B=180..390, 140MHz	FBPT-723	17ta	-	9a Chm
39	2SA1037MPT-R	Si-pnp	AF, Sw, 50V, 150mA, B=180..390, 140MHz	SOT-723	18ta	-	3a Chm
39	ELM7619HBB	Vdet-IC	1.9V±2%, +Reset PPO, 500ms	SOT-23	16vdc	VD7	3d Elm
39	ELM9839BB	LVR-IC	3.9V±2%, 200mA	SOT-23	16cg	VR1	3d Elm
39	TZT3.9W	Z-diode	3.70..3.70V, Izt=5mA, Zzt=130Ω, 200mW	SOT-323	16dc	-	3a Ttr
39	Z02W3.9V	Z-diode	3.70..4.10V, Izt=5mA, Zzt=130Ω, 200mW	SOT-23	16dc	-	3f Kec
390	HZM3.9NB	Z-diode	3.7..4.1V, 200mW	SC-59A	16dc	-	3a Ren
391	HZM3.9NB1	Z-diode	3.7..3.97V, 200mW	SC-59A	16dc	-	3a Ren
391	PZM3.9NB1	Z-diode	3.9V±2.5%, 300mW	SOT-346	16dc	-	3a Phi
392	HZM3.9NB2	Z-diode	3.87..4.1V, 200mW	SC-59A	16dc	-	3a Ren
392	PZM3.9NB2	Z-diode	3.9V±2.5%, 300mW	SOT-346	16dc	-	3a Phi
39-2	UTC8139-2	Vdet-IC	3.9V, -Reset OCO	SOT-23	16vdy	VD6	3a Utc
39-3	UTC8139-3	Vdet-IC	3.9V, -Reset OCO	SOT-23	16vdb	VD6	3a Utc
39-5	UTC8139-5	Vdet-IC	3.9V, -Reset OCO	SOT-23	16vdc	VD6	3a Utc
39A	AAT60039A-S2	Vdet-IC	3.9V±2%, -Reset ODO	SOT-23	16vdb	VD6	3d Aat
39B	AAT60039B-S2	Vdet-IC	3.9V±2%, -Reset PPO	SOT-23	16vdb	VD7	3d Aat
39B	MMBZ5239BPT	Z-diode	8.645..9.555V, Izt=5mA, Zzt=10Ω, 225mW	SOT-23	16dc	-	3a Chm
39C	AAT60039C-S2	Vdet-IC	3.9V±1%, -Reset ODO	SOT-23	16vdb	VD6	3d Aat
39D	AAT60039D-S2	Vdet-IC	3.9V±1%, -Reset PPO	SOT-23	16vdb	VD7	3d Aat
39H	BZX84-C3V9-V	Z-diode	3.70..4.10V, Izt=5mA, Zzt=130Ω, 300mW	SOT-23	16dc	-	3f Kec
39S	MMBZ5239SPT	Z-diode	8.918..9.282V, Izt=5mA, Zzt=10Ω, 225mW	SOT-23	16dc	-	3a Chm
39S	MMCZ5239SPT	Z-diode	8.918..9.282V, Izt=5mA, Zzt=10Ω, 225mW	SOT-346	16dc	-	3a Chm
39T	TK71539AS	LVR-IC	LDO, 3.9V±1.5%, 155mA	SOT-23	16cj	VR1	3d Tok
39V	PZM39NB	Z-diode	3.9V±2.5%, 300mW	SOT-346	16dc	-	3a Phi
39V	PZM39NB1	Z-diode	3.9V±2.5%, 300mW	SOT-346	16dc	-	3a Phi
39X	TZT3.9XW	Z-diode	3.87..4.10V, Izt=5mA, Zzt=130Ω, 200mW	SOT-323	16dc	-	3a Ttr
39X	Z02W3.9VX	Z-diode	3.70..3.97V, Izt=5mA, Zzt=130Ω, 200mW	SOT-23	16dc	-	3f Kec
39Z	CZ1W39	Z-diode	3.9V±5%, 600mW	SOT-23	16dc	-	3a Cdi
39Z	TZT3.9ZW	Z-diode	3.97..4.10V, Izt=5mA, Zzt=130Ω, 200mW	SOT-323	16dc	-	3a Ttr
39Z	Z02W3.9VZ	Z-diode	3.87..4.10V, Izt=5mA, Zzt=130Ω, 200mW	SOT-23	16dc	-	3f Kec
3A	2SC5472	Si-npn	HF-osc, 9V, 30mA, 150mW, B=80..200, 12GHz	SOT-323	16ta	-	3a Pan
3A	2SC5474	Si-npn	HF-osc, 9V, 30mA, 150mW, B=80..200, 12GHz	SOT-416	16ta	-	3a Pan
3A	BC856A	Si-pnp	GP, 80V, 100mA, 310mW, B=125..250, >150MHz	SOT-23	16ta	-	3a Di
3A	BC856AT	Si-pnp	GP, 80V, 100mA, 250mW, B=125..250, >100MHz	SOT-416	16ta	-	3a Phi
3A	BC856AW	Si-pnp	GP, 80V, 100mA, 250mW, B=125..250, >100MHz	SOT-323	16ta	-	3a Ons
3A	CH706F-40PT	Si-diode	Dual, SBD, 45V, 30mA, Vf<0.37V(1mA)	SOT-323	16dl	-	3a Chm
3A	FT511Aa	LVR-IC	LDO, 1.2V±2%, 400mA	SOT-23	16cq	VR1	3d Fmd
3A	KST24	Si-npn	VHF-Mix., 40V, 100mA, 350mW, B>30, >620MHz	SOT-23	16ta	-	3a Sam
3A-	BC856AW	Si-pnp	GP, 80V, 100mA, 250mW, B=125..250, >100MHz	SOT-323	16ta	-	3a PhM
3A0	PZM3.0NB2A	Z-diode	Dual, 3.0V±2.5%, 300mW	SOT-346	16df	-	3a Phi
3A0	TC55RP302ECB	LVR-IC	LDO, 3.0V±2%, 250mA	SOT-23	16cq	VR1	3d Mcc
3A0	XC62FP3002M	LVR-IC	3.0V±2%, 250mA	SOT-23	16cg	VR1	3d Tor
3A3	PZM3.3NB2A	Z-diode	Dual, 3.3V±2.5%, 300mW	SOT-346	16df	-	3a Phi
3A5	TC593002ECB	LVR-IC	LDO, -3.0V±2%, 200mA	SOT-23	16cj	VR2	3d Mcc
3A5	XC62KN302M	LVR-IC	LDO, -3V±2%, 100mA, 150mW	SOT-23	16cj	VR2	3d Tor
3A6	PZM3.6NB2A	Z-diode	Dual, 3.6V±2.5%, 300mW	SOT-346	16df	-	3a Phi
3A9	PZM3.9NB2A	Z-diode	Dual, 3.9V±2.5%, 300mW	SOT-346	16df	-	3a Phi
3AC2	81C30-P-AE3-2	Vdet-IC	3.0V±2%, -Reset PPO	SOT-23	16vdy	VD7	3a Utc
3AC2G	81C30G-P-AE3-2	Vdet-IC	3.0V±2%, -Reset PPO, halogen free	SOT-23	16vdy	VD7	3a Utc
3AC2L	81C30L-P-AE3-2	Vdet-IC	3.0V±2%, -Reset PPO, lead free	SOT-23	16vdy	VD7	3a Utc
3AC3	81C30-P-AE3-3	Vdet-IC	3.0V±2%, -Reset PPO	SOT-23	16vdb	VD7	3a Utc
3AC3G	81C30G-P-AE3-3	Vdet-IC	3.0V±2%, -Reset PPO, halogen free	SOT-23	16vdb	VD7	3a Utc
3AC3L	81C30L-P-AE3-3	Vdet-IC	3.0V±2%, -Reset PPO, lead free	SOT-23	16vdb	VD7	3a Utc
3AC5	81C30-P-AE3-5	Vdet-IC	3.0V±2%, -Reset PPO	SOT-23	16vdc	VD7	3a Utc
3AC5G	81C30G-P-AE3-5	Vdet-IC	3.0V±2%, -Reset PPO, halogen free	SOT-23	16vdc	VD7	3a Utc
3AC5L	81C30L-P-AE3-5	Vdet-IC	3.0V±2%, -Reset PPO, lead free	SOT-23	16vdc	VD7	3a Utc
3AG	2SA1324-GR	Si-pnp	GP, 50V, 150mA, B=200..400, >80MHz	SOT-23	16te	-	3a Tos
3AN2	81N30-P-AE3-2	Vdet-IC	3.0V±2%, -Reset ODO	SOT-23	16vdy	VD6	3a Utc
3AN2G	81N30G-P-AE3-2	Vdet-IC	3.0V±2%, -Reset ODO, halogen free	SOT-23	16vdy	VD6	3a Utc
3AN2L	81N30L-P-AE3-2	Vdet-IC	3.0V±2%, -Reset ODO, lead free	SOT-23	16vdy	VD6	3a Utc



SMD code	Type	Function	Short description	Case	Pinout	Sch.	St.	Mnf.
3AN3	81N30-P-AE3-3	Vdet-IC	3.0V±2%, -Reset ODO	SOT-23	16vdb	VD6	3a	Utc
3AN3G	81N30G-P-AE3-3	Vdet-IC	3.0V±2%, -Reset ODO, halogen free	SOT-23	16vdb	VD6	3a	Utc
3AN3L	81N30L-P-AE3-3	Vdet-IC	3.0V±2%, -Reset ODO, lead free	SOT-23	16vdb	VD6	3a	Utc
3AN5	81N30-P-AE3-5	Vdet-IC	3.0V±2%, -Reset ODO	SOT-23	16vdc	VD6	3a	Utc
3AN5G	81N30G-P-AE3-5	Vdet-IC	3.0V±2%, -Reset ODO, halogen free	SOT-23	16vdc	VD6	3a	Utc
3AN5L	81N30L-P-AE3-5	Vdet-IC	3.0V±2%, -Reset ODO, lead free	SOT-23	16vdc	VD6	3a	Utc
3AO	2SA1324-O	Si-pnp	GP, 50V, 150mA, B=70..140, >80MHz	SOT-23	16te	-	3a	Tos
3Ap	BC856A	Si-pnp	GP, 80V, 100mA, 250mW, B=125..250, >100MHz	SOT-23	16ta	-	3a	PHH
3As	BC856A	Si-pnp	GP, 80V, 100mA, 330mW, B=125..250, 250MHz	SOT-23	16ta	-	3a	Sie
3At	BC856A	Si-pnp	GP, 80V, 100mA, 250mW, B=125..250, >100MHz	SOT-23	16ta	-	3a	PhM
3At	BC856AW	Si-pnp	GP, 80V, 100mA, 250mW, B=125..250, >100MHz	SOT-323	16ta	-	3a	PHH
3AW	BC856A	Si-pnp	GP, 80V, 100mA, 250mW, B=125..250, >100MHz	SOT-23	16ta	-	3a	PhC
3AW	BC856AW	Si-pnp	GP, 80V, 100mA, 250mW, B=125..250, >100MHz	SOT-323	16ta	-	3a	PhC
3AY	2SA1324-Y	Si-pnp	GP, 50V, 150mA, B=120..240, >80MHz	SOT-23	16te	-	3a	Tos
3B	2SD2620J	Si-npn	AF-Drv, 100V, 20mA, 125mW, 200MHz, B=200..400	SC-89	18ta	-	3a	Pan
3B	BC856B	Si-pnp	GP, 80V, 100mA, 310mW, B=220..475, >150MHz	SOT-23	16ta	-	3a	Di
3B	BC856BT	Si-pnp	GP, 80V, 100mA, 250mW, B=220..475, >100MHz	SOT-416	16ta	-	3a	Phi
3B	BC856BW	Si-pnp	GP, 80V, 100mA, 250mW, B=220..475, >100MHz	SOT-323	16ta	-	3c	Inf
3B	CH450FPT	Si-diode	SBD, 45V, 100mA, Vf<0.45V(10mA)	SOT-323	16dc	-	3a	Chm
3B	CMBT918	Si-npn	VHF/UHF, 30V, 350mA, 225mW, B>20, >600MHz	SOT-23	16ta	-	3a	Cdi
3B	FMMT918	Si-npn	GP, 30V, 100mA, 330mW, B>20, >600MHz	SOT-23	16ta	-	3a	Zx
3B	FT511Ba	LVR-IC	LDO, 1.5V±2%, 400mA	SOT-23	16cq	VR1	3d	Fmd
3B	R3131N23EC	Vdet-IC	2.3V, +Reset ODO, 240ms	SOT-23	16vdc	VD6	3b	Ric
3B	RB461F	Si-diode	SBR, 20V, 700mA, Vf<0.49V(700mA)	SOT-323	16dc	-	3a	Rhm
3B	TMPY918	Si-npn	VHF/UHF, 30V, 50mA, 350mW, B>20, >600MHz	SOT-23	16ta	-	3a	All
3B-	BC856BW	Si-pnp	GP, 80V, 100mA, 250mW, B=220..475, >100MHz	SOT-323	16ta	-	3a	PhM
3B0	TC55RP312ECB	LVR-IC	LDO, 3.1V±2%, 250mA	SOT-23	16cq	VR1	3d	Mcc
3B0	XC62FP3102M	LVR-IC	3.1V±2%, 250mA	SOT-23	16cg	VR1	3d	Tor
3B5	TC593102ECB	LVR-IC	LDO, -3.1V±2%, 200mA	SOT-23	16cj	VR2	3d	Mcc
3B5	XC62KN312M	LVR-IC	LDO, -3.1V±2%, 100mA, 150mW	SOT-23	16cj	VR2	3d	Tor
3BC2	81C31-P-AE3-2	Vdet-IC	3.1V±2%, -Reset PPO	SOT-23	16vdy	VD7	3a	Utc
3BC2G	81C31G-P-AE3-2	Vdet-IC	3.1V±2%, -Reset PPO, halogen free	SOT-23	16vdy	VD7	3a	Utc
3BC2L	81C31L-P-AE3-2	Vdet-IC	3.1V±2%, -Reset PPO, lead free	SOT-23	16vdy	VD7	3a	Utc
3BC3	81C31-P-AE3-3	Vdet-IC	3.1V±2%, -Reset PPO	SOT-23	16vdb	VD7	3a	Utc
3BC3G	81C31G-P-AE3-3	Vdet-IC	3.1V±2%, -Reset PPO, halogen free	SOT-23	16vdb	VD7	3a	Utc
3BC3L	81C31L-P-AE3-3	Vdet-IC	3.1V±2%, -Reset PPO, lead free	SOT-23	16vdb	VD7	3a	Utc
3BC5	81C31-P-AE3-5	Vdet-IC	3.1V±2%, -Reset PPO	SOT-23	16vdc	VD7	3a	Utc
3BC5G	81C31G-P-AE3-5	Vdet-IC	3.1V±2%, -Reset PPO, halogen free	SOT-23	16vdc	VD7	3a	Utc
3BC5L	81C31L-P-AE3-5	Vdet-IC	3.1V±2%, -Reset PPO, lead free	SOT-23	16vdc	VD7	3a	Utc
3BG	2SA1325-GR	Si-pnp	GP, 120V, 100mA, B=200..400, 100MHz	SOT-23	16te	-	3a	Tos
3BL	2SA1325-BL	Si-pnp	GP, 120V, 100mA, B=120..240, 100MHz	SOT-23	16ta	-	3a	Tos
3BN2	81N31-P-AE3-2	Vdet-IC	3.1V±2%, -Reset ODO	SOT-23	16vdy	VD6	3a	Utc
3BN2G	81N31G-P-AE3-2	Vdet-IC	3.1V±2%, -Reset ODO, halogen free	SOT-23	16vdy	VD6	3a	Utc
3BN2L	81N31L-P-AE3-2	Vdet-IC	3.1V±2%, -Reset ODO, lead free	SOT-23	16vdy	VD6	3a	Utc
3BN3	81N31-P-AE3-3	Vdet-IC	3.1V±2%, -Reset ODO	SOT-23	16vdb	VD6	3a	Utc
3BN3G	81N31G-P-AE3-3	Vdet-IC	3.1V±2%, -Reset ODO, halogen free	SOT-23	16vdb	VD6	3a	Utc
3BN3L	81N31L-P-AE3-3	Vdet-IC	3.1V±2%, -Reset ODO, lead free	SOT-23	16vdb	VD6	3a	Utc
3BN5	81N31-P-AE3-5	Vdet-IC	3.1V±2%, -Reset ODO	SOT-23	16vdc	VD6	3a	Utc
3BN5G	81N31G-P-AE3-5	Vdet-IC	3.1V±2%, -Reset ODO, halogen free	SOT-23	16vdc	VD6	3a	Utc
3BN5L	81N31L-P-AE3-5	Vdet-IC	3.1V±2%, -Reset ODO, lead free	SOT-23	16vdc	VD6	3a	Utc
3bp	BC856B	Si-pnp	GP, 80V, 100mA, 250mW, B=220..475, >100MHz	SOT-23	16ta	-	3a	PHH
3Bs	BC856B	Si-pnp	GP, 80V, 100mA, 330mW, B=220..475, 250MHz	SOT-23	16ta	-	3a	Sie
3bt	BC856B	Si-pnp	GP, 80V, 100mA, 250mW, B=220..475, >100MHz	SOT-23	16ta	-	3a	PHM
3bt	BC856BW	Si-pnp	GP, 80V, 100mA, 250mW, B=220..475, >100MHz	SOT-323	16ta	-	3a	PHH
3BW	BC856B	Si-pnp	GP, 80V, 100mA, 250mW, B=220..475, >100MHz	SOT-23	16ta	-	3a	PhC
3BW	BC856BW	Si-pnp	GP, 80V, 100mA, 250mW, B=220..475, >100MHz	SOT-323	16ta	-	3a	PhC
3C	CH451FPT	Si-diode	SBD, 40V, 100mA, Vf<0.55V(100mA)	SOT-323	16dc	-	3a	Chm
3C	FMMTA20R	Si-npn	GP, 40V, 100mA, 330mW, B=40..400, >125MHz	SOT-23	16te	-	3a	Zx
3C	FT511Ca	LVR-IC	LDO, 1.8V±2%, 400mA	SOT-23	16cq	VR1	3d	Fmd
3C	MMBT5179	Si-pnp	VHF, 20V, 500mW, 350mW, B>25, >900MHz	SOT-23	16ta	-	3a	Nsc
3C	R3131N33EC	Vdet-IC	3.3V, +Reset ODO, 240ms	SOT-23	16vdc	VD6	3b	Ric
3C0	TC55RP322ECB	LVR-IC	LDO, 3.2V±2%, 250mA	SOT-23	16cq	VR1	3d	Mcc
3C0	XC62FP3202M	LVR-IC	3.2V±2%, 250mA	SOT-23	16cg	VR1	3d	Tor
3C5	TC593202ECB	LVR-IC	LDO, -3.2V±2%, 200mA	SOT-23	16cj	VR2	3d	Mcc
3C5	XC62KN322M	LVR-IC	LDO, -3.2V±2%, 100mA, 150mW	SOT-23	16cj	VR2	3d	Tor
3CC2	81C32-P-AE3-2	Vdet-IC	3.2V±2%, -Reset PPO	SOT-23	16vdy	VD7	3a	Utc
3CC2G	81C32G-P-AE3-2	Vdet-IC	3.2V±2%, -Reset PPO, halogen free	SOT-23	16vdy	VD7	3a	Utc
3CC2L	81C32L-P-AE3-2	Vdet-IC	3.2V±2%, -Reset PPO, lead free	SOT-23	16vdy	VD7	3a	Utc
3CC3	81C32-P-AE3-3	Vdet-IC	3.2V±2%, -Reset PPO	SOT-23	16vdb	VD7	3a	Utc
3CC3G	81C32G-P-AE3-3	Vdet-IC	3.2V±2%, -Reset PPO, halogen free	SOT-23	16vdb	VD7	3a	Utc



SMD code	Type	Function	Short description	Case	Pinout	Sch. St.	Mnf.
3CC3L	81C32L-P-AE3-3	Vdet-IC	3.2V±2%, -Reset PPO, lead free	SOT-23	16vdb	VD7	3a Utc
3CC5	81C32-P-AE3-5	Vdet-IC	3.2V±2%, -Reset PPO	SOT-23	16vdc	VD7	3a Utc
3CC5G	81C32G-P-AE3-5	Vdet-IC	3.2V±2%, -Reset PPO, halogen free	SOT-23	16vdc	VD7	3a Utc
3CC5L	81C32L-P-AE3-5	Vdet-IC	3.2V±2%, -Reset PPO, lead free	SOT-23	16vdc	VD7	3a Utc
3CN2	81N32-P-AE3-2	Vdet-IC	3.2V±2%, -Reset ODO	SOT-23	16vdy	VD6	3a Utc
3CN2G	81N32G-P-AE3-2	Vdet-IC	3.2V±2%, -Reset ODO, halogen free	SOT-23	16vdy	VD6	3a Utc
3CN2L	81N32L-P-AE3-2	Vdet-IC	3.2V±2%, -Reset ODO, lead free	SOT-23	16vdy	VD6	3a Utc
3CN3	81N32-P-AE3-3	Vdet-IC	3.2V±2%, -Reset ODO	SOT-23	16vdb	VD6	3a Utc
3CN3G	81N32G-P-AE3-3	Vdet-IC	3.2V±2%, -Reset ODO, halogen free	SOT-23	16vdb	VD6	3a Utc
3CN3L	81N32L-P-AE3-3	Vdet-IC	3.2V±2%, -Reset ODO, lead free	SOT-23	16vdb	VD6	3a Utc
3CN5	81N32-P-AE3-5	Vdet-IC	3.2V±2%, -Reset ODO	SOT-23	16vdc	VD6	3a Utc
3CN5G	81N32G-P-AE3-5	Vdet-IC	3.2V±2%, -Reset ODO, halogen free	SOT-23	16vdc	VD6	3a Utc
3CN5L	81N32L-P-AE3-5	Vdet-IC	3.2V±2%, -Reset ODO, lead free	SOT-23	16vdc	VD6	3a Utc
3CO	2SA1326-O	Si-pnp	GP, 35V, 500mA, 200mW, B=70..140, 200MHz	SOT-23	16te	-	3a Tos
3CY	2SA1326-Y	Si-pnp	GP, 35V, 500mA, 200mW, B=120..240, 200MHz	SOT-23	16te	-	3a Tos
3D	BC856	Si-pnp	GP, 80V, 100mA, 250mW, B=125..800, >100MHz	SOT-23	16ta	-	3a Cdi
3D	CH715FPT	Si-diode	Dual, SBD, 40V, 30mA, Vf<0.37V(1mA)	SOT-323	16df	-	3a Chm
3D	FT511Da	LVR-IC	LDO, 2.5V±2%, 400mA	SOT-23	16cq	VR1	3d Fmd
3D	MMBT181	Si-pnp	UHF/VHF, 20V, 50mA, 225mW, B>60, >600MHz	SOT-23	16ta	-	3a Mot
3D	R3131N43EC	Vdet-IC	4.3V, +Reset ODO, 240ms	SOT-23	16vdc	VD6	3b Ric
3D	RB715F	Si-diode	Dual, Schottky Rectifier, 40V, 30mA, Vf<0.37V(1mA), 5pF	SOT-323	16dg	-	3a Rhm
3D	RB715W	Si-diode	Dual, Schottky Rectifier, 40V, 30mA, Vf<0.37V(1mA), 5pF	SOT-523	16dg	-	3a Rhm
3D-	BC856W	Si-pnp	GP, 80V, 100mA, 250mW, B=125..475, >100MHz	SOT-323	16ta	-	3a PhM
3D0	TC55RP332ECB	LVR-IC	LDO, 3.3V±2%, 250mA	SOT-23	16cq	VR1	3d Mcc
3D0	XC62FP3302M	LVR-IC	3.3V±2%, 250mA	SOT-23	16cg	VR1	3d Tor
3D5	TC593302ECB	LVR-IC	LDO, -3.3V±2%, 200mA	SOT-23	16cj	VR2	3d Mcc
3D5	XC62KN332M	LVR-IC	LDO, -3.3V±2%, 100mA, 150mW	SOT-23	16cj	VR2	3d Tor
3DC2	81C33-P-AE3-2	Vdet-IC	3.3V±2%, -Reset PPO	SOT-23	16vdy	VD7	3a Utc
3DC2G	81C33G-P-AE3-2	Vdet-IC	3.3V±2%, -Reset PPO, halogen free	SOT-23	16vdy	VD7	3a Utc
3DC2L	81C33L-P-AE3-2	Vdet-IC	3.3V±2%, -Reset PPO, lead free	SOT-23	16vdy	VD7	3a Utc
3DC3	81C33-P-AE3-3	Vdet-IC	3.3V±2%, -Reset PPO	SOT-23	16vdb	VD7	3a Utc
3DC3G	81C33G-P-AE3-3	Vdet-IC	3.3V±2%, -Reset PPO, halogen free	SOT-23	16vdb	VD7	3a Utc
3DC3L	81C33L-P-AE3-3	Vdet-IC	3.3V±2%, -Reset PPO, lead free	SOT-23	16vdb	VD7	3a Utc
3DC5	81C33-P-AE3-5	Vdet-IC	3.3V±2%, -Reset PPO	SOT-23	16vdc	VD7	3a Utc
3DC5G	81C33G-P-AE3-5	Vdet-IC	3.3V±2%, -Reset PPO, halogen free	SOT-23	16vdc	VD7	3a Utc
3DC5L	81C33L-P-AE3-5	Vdet-IC	3.3V±2%, -Reset PPO, lead free	SOT-23	16vdc	VD7	3a Utc
3DN2	81N33-P-AE3-2	Vdet-IC	3.3V±2%, -Reset ODO	SOT-23	16vdy	VD6	3a Utc
3DN2G	81N33G-P-AE3-2	Vdet-IC	3.3V±2%, -Reset ODO, halogen free	SOT-23	16vdy	VD6	3a Utc
3DN2L	81N33L-P-AE3-2	Vdet-IC	3.3V±2%, -Reset ODO, lead free	SOT-23	16vdy	VD6	3a Utc
3DN3	81N33-P-AE3-3	Vdet-IC	3.3V±2%, -Reset ODO	SOT-23	16vdb	VD6	3a Utc
3DN3G	81N33G-P-AE3-3	Vdet-IC	3.3V±2%, -Reset ODO, halogen free	SOT-23	16vdb	VD6	3a Utc
3DN3L	81N33L-P-AE3-3	Vdet-IC	3.3V±2%, -Reset ODO, lead free	SOT-23	16vdb	VD6	3a Utc
3DN5	81N33-P-AE3-5	Vdet-IC	3.3V±2%, -Reset ODO	SOT-23	16vdc	VD6	3a Utc
3DN5G	81N33G-P-AE3-5	Vdet-IC	3.3V±2%, -Reset ODO, halogen free	SOT-23	16vdc	VD6	3a Utc
3DN5L	81N33L-P-AE3-5	Vdet-IC	3.3V±2%, -Reset ODO, lead free	SOT-23	16vdc	VD6	3a Utc
3Dp	BC856	Si-pnp	GP, 80V, 100mA, 250mW, B=125..800, >100MHz	SOT-23	16ta	-	3a PhH
3Dt	BC856	Si-pnp	GP, 80V, 100mA, 250mW, B=125..800, >100MHz	SOT-23	16ta	-	3a PhM
3Dt	BC856W	Si-pnp	GP, 80V, 100mA, 250mW, B=125..475, >100MHz	SOT-323	16ta	-	3a PhH
3Dw	BC856	Si-pnp	GP, 80V, 100mA, 250mW, B=125..800, >100MHz	SOT-23	16ta	-	3a PhC
3Dw	BC856W	Si-pnp	GP, 80V, 100mA, 250mW, B=125..475, >100MHz	SOT-323	16ta	-	3a PhC
3E	2SA2021	Si-pnp	GP, 60V, 100mA, 100mW, B=180..390, 80MHz	SSSMini3	18ta	-	3a Pan
3E	BC857A	Si-pnp	GP, 50V, 100mA, 310mW, B=110..220, >150MHz	SOT-23	16ta	-	3f Ste
3E	BC857AF	Si-pnp	GP, 50V, 100mA, 250mW, B=125..250, >100MHz	SOT-490	18ta	-	3a Phi
3E	BC857AT	Si-pnp	GP, 50V, 100mA, 250mW, B=125..250, >100MHz	SOT-416	18ta	-	3a Phi
3E	BC857AW	Si-pnp	GP, 50V, 100mA, 250mW, B=125..250, >100MHz	SOT-323	16ta	-	3a Mot
3E	CH717FPT	Si-diode	Dual, SBD, 40V, 30mA, Vf<0.37V(1mA)	SOT-323	16dg	-	3a Chm
3E	CM9NB857A	Si-pnp	AF, Sw, 50V, 100mA, 200mW, B=110..220, 100MHz	SOT-23	16ta	-	3a Can
3E	CM9NB857AW	Si-pnp	AF, Sw, 50V, 100mA, 150mW, B=110..220, 100MHz	SOT-323	16ta	-	3a Can
3E	CMBTH10	Si-npn	GP, 30V, 25mA, 225mW, B>60, >650MHz	SOT-23	16ta	-	3a Cdi
3E	FMMTA42	Si-npn	Vid, 300/300V, 200mA, 330mW, B>40, >50MHz	SOT-23	16ta	-	3a Zx
3E	KST10	Si-npn	GP, 30V, 25mA, 330mW, B>60, >650MHz	SOT-23	16ta	-	3a Sam
3E	R3131N46EC5	Vdet-IC	4.6V, +Reset ODO, 240ms	SOT-23	16vdc	VD6	3b Ric
3E	RB717F	Si-diode	Dual, Schottky Rectifier, 40V, 30mA, Vf<0.37V(1mA), 5pF	SOT-323	16df	-	3a Rhm
3E-	BC857AW	Si-pnp	GP, 50V, 100mA, 250mW, B=125..250, >100MHz	SOT-323	16ta	-	3a PhM
3E0	TC55RP342ECB	LVR-IC	LDO, 3.4V±2%, 250mA	SOT-23	16cq	VR1	3d Mcc
3E0	XC62FP3402M	LVR-IC	3.4V±2%, 250mA	SOT-23	16cg	VR1	3d Tor
3E5	TC593402ECB	LVR-IC	LDO, -3.4V±2%, 200mA	SOT-23	16cj	VR2	3d Mcc
3E5	XC62KN342M	LVR-IC	LDO, -3.4V±2%, 100mA, 150mW	SOT-23	16cj	VR2	3d Tor
3EC2	81C34-P-AE3-2	Vdet-IC	3.4V±2%, -Reset PPO	SOT-23	16vdy	VD7	3a Utc
3EC2G	81C34G-P-AE3-2	Vdet-IC	3.4V±2%, -Reset PPO, halogen free	SOT-23	16vdy	VD7	3a Utc



SMD code	Type	Function	Short description	Case	Pinout	Sch.	St.	Mnf.
3EC2L	81C34L-P-AE3-2	Vdet-IC	3.4V±2%, -Reset PPO, lead free	SOT-23	16vdy	VD7	3a	Utc
3EC3	81C34-P-AE3-3	Vdet-IC	3.4V±2%, -Reset PPO	SOT-23	16vdb	VD7	3a	Utc
3EC3G	81C34G-P-AE3-3	Vdet-IC	3.4V±2%, -Reset PPO, halogen free	SOT-23	16vdb	VD7	3a	Utc
3EC3L	81C34L-P-AE3-3	Vdet-IC	3.4V±2%, -Reset PPO, lead free	SOT-23	16vdc	VD7	3a	Utc
3EC5	81C34-P-AE3-5	Vdet-IC	3.4V±2%, -Reset PPO	SOT-23	16vdc	VD7	3a	Utc
3EC5G	81C34G-P-AE3-5	Vdet-IC	3.4V±2%, -Reset PPO, halogen free	SOT-23	16vdc	VD7	3a	Utc
3EC5L	81C34L-P-AE3-5	Vdet-IC	3.4V±2%, -Reset PPO, lead free	SOT-23	16vdc	VD7	3a	Utc
3EM	MMBTH10	Si-npn	GP, 30V, 25mA, 225mW, B>60, >650MHz	SOT-23	16ta	-	3a	Ons
3EM	MMBTH10-4	Si-npn	GP, 30V, 25mA, 225mW, B>60, >650MHz	SOT-23	16ta	-	3a	Ons
3EN2	81N34-P-AE3-2	Vdet-IC	3.4V±2%, -Reset ODO	SOT-23	16vdy	VD6	3a	Utc
3EN2G	81N34G-P-AE3-2	Vdet-IC	3.4V±2%, -Reset ODO, halogen free	SOT-23	16vdy	VD6	3a	Utc
3EN2L	81N34L-P-AE3-2	Vdet-IC	3.4V±2%, -Reset ODO, lead free	SOT-23	16vdy	VD6	3a	Utc
3EN3	81N34-P-AE3-3	Vdet-IC	3.4V±2%, -Reset ODO	SOT-23	16vdb	VD6	3a	Utc
3EN3G	81N34G-P-AE3-3	Vdet-IC	3.4V±2%, -Reset ODO, halogen free	SOT-23	16vdb	VD6	3a	Utc
3EN3L	81N34L-P-AE3-3	Vdet-IC	3.4V±2%, -Reset ODO, lead free	SOT-23	16vdb	VD6	3a	Utc
3EN5	81N34-P-AE3-5	Vdet-IC	3.4V±2%, -Reset ODO	SOT-23	16vdc	VD6	3a	Utc
3EN5G	81N34G-P-AE3-5	Vdet-IC	3.4V±2%, -Reset ODO, halogen free	SOT-23	16vdc	VD6	3a	Utc
3EN5L	81N34L-P-AE3-5	Vdet-IC	3.4V±2%, -Reset ODO, lead free	SOT-23	16vdc	VD6	3a	Utc
3Ep	BC857A	Si-pnp	GP, 50V, 100mA, 250mW, B=125..250, >100MHz	SOT-23	16ta	-	3a	PHH
3ER	BC857AR	Si-pnp	GP, 45V, 100mA, 250mW, B=220, >150MHz	SOT-23	16te	-	3a	Phi
3Es	BC857A	Si-pnp	GP, 50V, 100mA, 330mW, B=125..250, 250MHz	SOT-23	16ta	-	3a	Sie
3Es	BC857AW	Si-pnp	GP, 50V, 100mA, 250mW, B=125..250, >100MHz	SOT-323	16ta	-	3a	Sie
3Et	BC857A	Si-pnp	GP, 50V, 100mA, 250mW, B=125..250, >100MHz	SOT-23	16ta	-	3a	PhM
3Et	BC857AW	Si-pnp	GP, 50V, 100mA, 250mW, B=125..250, >100MHz	SOT-323	16ta	-	3a	PHH
3EW	BC857A	Si-pnp	GP, 50V, 100mA, 250mW, B=125..250, >100MHz	SOT-23	16ta	-	3a	PhC
3EW	BC857AW	Si-pnp	GP, 50V, 100mA, 250mW, B=125..250, >100MHz	SOT-323	16ta	-	3a	PhC
3EZ	FMMTA10	Si-npn	Sw, 30V, 25mA, 330mW, B>60, >650MHz	SOT-23	16ta	-	3a	Zx
3EZ	FMMTH10	Si-npn	GP, 30V, 25mA, 330mW, B>60, >650MHz	SOT-23	16ta	-	3a	Zx
3F	2SD5609	Si-npn	AF-Amp, 60V, 100mA, 200mW, B=180..390, 80MHz	SSSMini3	18ta	-	3a	Pan
3F	BC857B	Si-pnp	GP, 50V, 100mA, 310mW, B=220..475, >150MHz	SOT-23	16ta	-	3f	Ste
3F	BC857BF	Si-pnp	GP, 50V, 100mA, 250mW, B=220..475, >100MHz	SOT-490	18ta	-	3a	Phi
3F	BC857BT	Si-pnp	GP, 50V, 100mA, 250mW, B=220..475, >100MHz	SOT-416	16ta	-	3a	Phi
3F	BC857BW	Si-pnp	GP, 50V, 100mA, 250mW, B=220..475, >100MHz	SOT-323	16ta	-	3a	Ons
3F	CH461FPT	Si-diode	SBD, 25V, 700mA, Vf<0.49V(700mA)	SOT-323	16dc	-	3a	Chm
3F	CM9NB857B	Si-pnp	AF, Sw, 50V, 100mA, 200mW, B=200..450, 100MHz	SOT-23	16ta	-	3a	Can
3F	CM9NB857BW	Si-pnp	AF, Sw, 50V, 100mA, 150mW, B=200..450, 100MHz	SOT-323	16ta	-	3a	Can
3F-	BC857BW	Si-pnp	GP, 50V, 100mA, 250mW, B=220..475, >100MHz	SOT-323	16ta	-	3a	PHM
3F0	TC55RP352ECB	LVR-IC	LDO, 3.5V±2%, 250mA	SOT-23	16cqq	VR1	3d	Mcc
3F0	XC62FP3502M	LVR-IC	3.5V±2%, 250mA	SOT-23	16cgg	VR1	3d	Tor
3F5	TC593502ECB	LVR-IC	LDO, -3.5V±2%, 200mA	SOT-23	16cjj	VR2	3d	Mcc
3F5	XC62KN352M	LVR-IC	LDO, -3.5V±2%, 100mA, 150mW	SOT-23	16cjj	VR2	3d	Tor
3FC2	81C35-P-AE3-2	Vdet-IC	3.5V±2%, -Reset PPO	SOT-23	16vdy	VD7	3a	Utc
3FC2G	81C35G-P-AE3-2	Vdet-IC	3.5V±2%, -Reset PPO, halogen free	SOT-23	16vdy	VD7	3a	Utc
3FC2L	81C35L-P-AE3-2	Vdet-IC	3.5V±2%, -Reset PPO, lead free	SOT-23	16vdy	VD7	3a	Utc
3FC3	81C35-P-AE3-3	Vdet-IC	3.5V±2%, -Reset PPO	SOT-23	16vdb	VD7	3a	Utc
3FC3G	81C35G-P-AE3-3	Vdet-IC	3.5V±2%, -Reset PPO, halogen free	SOT-23	16vdb	VD7	3a	Utc
3FC3L	81C35L-P-AE3-3	Vdet-IC	3.5V±2%, -Reset PPO, lead free	SOT-23	16vdb	VD7	3a	Utc
3FC5	81C35-P-AE3-5	Vdet-IC	3.5V±2%, -Reset PPO	SOT-23	16vdc	VD7	3a	Utc
3FC5G	81C35G-P-AE3-5	Vdet-IC	3.5V±2%, -Reset PPO, halogen free	SOT-23	16vdc	VD7	3a	Utc
3FC5L	81C35L-P-AE3-5	Vdet-IC	3.5V±2%, -Reset PPO, lead free	SOT-23	16vdc	VD7	3a	Utc
3FN2	81N35-P-AE3-2	Vdet-IC	3.5V±2%, -Reset ODO	SOT-23	16vdy	VD6	3a	Utc
3FN2G	81N35G-P-AE3-2	Vdet-IC	3.5V±2%, -Reset ODO, halogen free	SOT-23	16vdy	VD6	3a	Utc
3FN2L	81N35L-P-AE3-2	Vdet-IC	3.5V±2%, -Reset ODO, lead free	SOT-23	16vdy	VD6	3a	Utc
3FN3	81N35-P-AE3-3	Vdet-IC	3.5V±2%, -Reset ODO	SOT-23	16vdb	VD6	3a	Utc
3FN3G	81N35G-P-AE3-3	Vdet-IC	3.5V±2%, -Reset ODO, halogen free	SOT-23	16vdb	VD6	3a	Utc
3FN3L	81N35L-P-AE3-3	Vdet-IC	3.5V±2%, -Reset ODO, lead free	SOT-23	16vdb	VD6	3a	Utc
3FN5	81N35-P-AE3-5	Vdet-IC	3.5V±2%, -Reset ODO	SOT-23	16vdc	VD6	3a	Utc
3FN5G	81N35G-P-AE3-5	Vdet-IC	3.5V±2%, -Reset ODO, halogen free	SOT-23	16vdc	VD6	3a	Utc
3FN5L	81N35L-P-AE3-5	Vdet-IC	3.5V±2%, -Reset ODO, lead free	SOT-23	16vdc	VD6	3a	Utc
3Fp	BC857B	Si-pnp	GP, 50V, 100mA, 250mW, B=220..475, >100MHz	SOT-23	16ta	-	3a	PHH
3FR	BC857BR	Si-pnp	GP, 45V, 100mA, 200mW, B=220..475, >150MHz	SOT-23	16te	-	3a	Phi
3Fs	BC857B	Si-pnp	GP, 50V, 100mA, 330mW, B=220..475, 250MHz	SOT-23	16ta	-	3a	Sie
3Ft	BC857B	Si-pnp	GP, 50V, 100mA, 250mW, B=220..475, >100MHz	SOT-23	16ta	-	3a	PhM
3Ft	BC857BW	Si-pnp	GP, 50V, 100mA, 250mW, B=220..475, >100MHz	SOT-323	16ta	-	3a	PHH
3FW	BC857B	Si-pnp	GP, 50V, 100mA, 250mW, B=220..475, >100MHz	SOT-23	16ta	-	3a	PhC
3FW	BC857BW	Si-pnp	GP, 50V, 100mA, 250mW, B=220..475, >100MHz	SOT-323	16ta	-	3a	PhC
3G	BAT54WPT	Si-diode	SBD, 30V, 200mA, Vf<1V(100mA), 5ns	SOT-323	16dc	-	3a	Chm
3G	BC857C	Si-pnp	GP, 50V, 100mA, 310mW, B=420..800, >150MHz	SOT-23	16ta	-	3f	Di
3G	BC857CF	Si-pnp	GP, 50V, 100mA, 250mW, B=420..800, >100MHz	SOT-490	18ta	-	3a	Phi
3G	BC857CT	Si-pnp	GP, 50V, 100mA, 250mW, B=420..800, >100MHz	SOT-416	16ta	-	3a	Phi



SMD code	Type	Function	Short description	Case	Pinout	Sch.	St.	Mnf.
3G	BC857CW	Si-pnp	GP, 50V, 100mA, 250mW, B=420..800, >100MHz	SOT-323	16ta	-	3c	Inf
3G	CM9NB857C	Si-pnp	AF, Sw, 50V, 100mA, 200mW, B=4520..800, 100MHz	SOT-23	16ta	-	3a	Can
3G	CM9NB857CW	Si-pnp	AF, Sw, 50V, 100mA, 150mW, B=4520..800, 100MHz	SOT-323	16ta	-	3a	Can
3G	R3131N23EA	Vdet-IC	2.3V, +Reset PPO, 240ms	SOT-23	16vdc	VD7	3b	Ric
3G-	BC857CW	Si-pnp	GP, 50V, 100mA, 250mW, B=420..800, >100MHz	SOT-323	16ta	-	3a	PhM
3GC2	81C36-P-AE3-2	Vdet-IC	3.6V±2%, -Reset PPO	SOT-23	16vdy	VD7	3a	Utc
3GC2G	81C36G-P-AE3-2	Vdet-IC	3.6V±2%, -Reset PPO, halogen free	SOT-23	16vdy	VD7	3a	Utc
3GC2L	81C36L-P-AE3-2	Vdet-IC	3.6V±2%, -Reset PPO, lead free	SOT-23	16vdy	VD7	3a	Utc
3GC3	81C36-P-AE3-3	Vdet-IC	3.6V±2%, -Reset PPO	SOT-23	16vdb	VD7	3a	Utc
3GC3G	81C36G-P-AE3-3	Vdet-IC	3.6V±2%, -Reset PPO, halogen free	SOT-23	16vdb	VD7	3a	Utc
3GC3L	81C36L-P-AE3-3	Vdet-IC	3.6V±2%, -Reset PPO, lead free	SOT-23	16vdb	VD7	3a	Utc
3GC5	81C36-P-AE3-5	Vdet-IC	3.6V±2%, -Reset PPO	SOT-23	16vdc	VD7	3a	Utc
3GC5G	81C36G-P-AE3-5	Vdet-IC	3.6V±2%, -Reset PPO, halogen free	SOT-23	16vdc	VD7	3a	Utc
3GC5L	81C36L-P-AE3-5	Vdet-IC	3.6V±2%, -Reset PPO, lead free	SOT-23	16vdc	VD7	3a	Utc
3GN2	81N36-P-AE3-2	Vdet-IC	3.6V±2%, -Reset ODO	SOT-23	16vdy	VD6	3a	Utc
3GN2G	81N36G-P-AE3-2	Vdet-IC	3.6V±2%, -Reset ODO, halogen free	SOT-23	16vdy	VD6	3a	Utc
3GN2L	81N36L-P-AE3-2	Vdet-IC	3.6V±2%, -Reset ODO, lead free	SOT-23	16vdy	VD6	3a	Utc
3GN3	81N36-P-AE3-3	Vdet-IC	3.6V±2%, -Reset ODO	SOT-23	16vdb	VD6	3a	Utc
3GN3G	81N36G-P-AE3-3	Vdet-IC	3.6V±2%, -Reset ODO, halogen free	SOT-23	16vdb	VD6	3a	Utc
3GN3L	81N36L-P-AE3-3	Vdet-IC	3.6V±2%, -Reset ODO, lead free	SOT-23	16vdb	VD6	3a	Utc
3GN5	81N36-P-AE3-5	Vdet-IC	3.6V±2%, -Reset ODO	SOT-23	16vdc	VD6	3a	Utc
3GN5G	81N36G-P-AE3-5	Vdet-IC	3.6V±2%, -Reset ODO, halogen free	SOT-23	16vdc	VD6	3a	Utc
3GN5L	81N36L-P-AE3-5	Vdet-IC	3.6V±2%, -Reset ODO, lead free	SOT-23	16vdc	VD6	3a	Utc
3Gp	BC857C	Si-pnp	GP, 50V, 100mA, 250mW, B=420..800, >100MHz	SOT-23	16ta	-	3a	PHI
3Gr	BC857CR	Si-pnp	GP, 45V, 100mA, 200mW, B=420..800, >150MHz	SOT-23	16ta	-	3a	Phi
3Gs	BC857C	Si-pnp	GP, 50V, 100mA, 330mW, B=420..800, 250MHz	SOT-23	16ta	-	3a	Sie
3Gt	BC857C	Si-pnp	GP, 50V, 100mA, 250mW, B=420..800, >100MHz	SOT-23	16ta	-	3a	PhM
3Gt	BC857CW	Si-pnp	GP, 50V, 100mA, 250mW, B=420..800, >100MHz	SOT-323	16ta	-	3a	PHH
3GW	BC857C	Si-pnp	GP, 50V, 100mA, 250mW, B=420..800, >100MHz	SOT-23	16ta	-	3a	PhC
3GW	BC857CW	Si-pnp	GP, 50V, 100mA, 250mW, B=420..800, >100MHz	SOT-323	16ta	-	3a	PhC
3H	BAT54WAPT	Si-diode	Dual, SBD, 30V, 200mA, Vf<1V(100mA), 5ns	SOT-323	16df	-	3a	Chm
3H	BC857	Si-pnp	GP, 50V, 100mA, 250mW, B=125..800, >100MHz	SOT-23	16ta	-	3a	Cdi
3H	R3131N33EA	Vdet-IC	3.3V, +Reset PPO, 240ms	SOT-23	16vdc	VD7	3b	Ric
3H-	BC857W	Si-pnp	GP, 50V, 100mA, 250mW, B=125..800, >100MHz	SOT-323	16ta	-	3a	PhM
3H0	TC55RP362ECB	LVR-IC	LDO, 3.6V±2%, 250mA	SOT-23	16cq	VR1	3d	Mcc
3H0	XC62FP3602M	LVR-IC	3.6V±2%, 250mA	SOT-23	16cg	VR1	3d	Tor
3H5	TC593602ECB	LVR-IC	LDO, -3.6V±2%, 200mA	SOT-23	16cj	VR2	3d	Mcc
3H5	XC62KN362M	LVR-IC	LDO, -3.6V±2%, 100mA, 150mW	SOT-23	16cj	VR2	3d	Tor
3HC2	81C37-P-AE3-2	Vdet-IC	3.7V±2%, -Reset PPO	SOT-23	16vdy	VD7	3a	Utc
3HC2G	81C37G-P-AE3-2	Vdet-IC	3.7V±2%, -Reset PPO, halogen free	SOT-23	16vdy	VD7	3a	Utc
3HC2L	81C37L-P-AE3-2	Vdet-IC	3.7V±2%, -Reset PPO, lead free	SOT-23	16vdy	VD7	3a	Utc
3HC3	81C37-P-AE3-3	Vdet-IC	3.7V±2%, -Reset PPO	SOT-23	16vdb	VD7	3a	Utc
3HC3G	81C37G-P-AE3-3	Vdet-IC	3.7V±2%, -Reset PPO, halogen free	SOT-23	16vdb	VD7	3a	Utc
3HC3L	81C37L-P-AE3-3	Vdet-IC	3.7V±2%, -Reset PPO, lead free	SOT-23	16vdb	VD7	3a	Utc
3HC5	81C37-P-AE3-5	Vdet-IC	3.7V±2%, -Reset PPO	SOT-23	16vdc	VD7	3a	Utc
3HC5G	81C37G-P-AE3-5	Vdet-IC	3.7V±2%, -Reset PPO, halogen free	SOT-23	16vdc	VD7	3a	Utc
3HC5L	81C37L-P-AE3-5	Vdet-IC	3.7V±2%, -Reset PPO, lead free	SOT-23	16vdc	VD7	3a	Utc
3HN2	81N37-P-AE3-2	Vdet-IC	3.7V±2%, -Reset ODO	SOT-23	16vdy	VD6	3a	Utc
3HN2G	81N37G-P-AE3-2	Vdet-IC	3.7V±2%, -Reset ODO, halogen free	SOT-23	16vdy	VD6	3a	Utc
3HN2L	81N37L-P-AE3-2	Vdet-IC	3.7V±2%, -Reset ODO, lead free	SOT-23	16vdy	VD6	3a	Utc
3HN3	81N37-P-AE3-3	Vdet-IC	3.7V±2%, -Reset ODO	SOT-23	16vdb	VD6	3a	Utc
3HN3G	81N37G-P-AE3-3	Vdet-IC	3.7V±2%, -Reset ODO, halogen free	SOT-23	16vdb	VD6	3a	Utc
3HN3L	81N37L-P-AE3-3	Vdet-IC	3.7V±2%, -Reset ODO, lead free	SOT-23	16vdb	VD6	3a	Utc
3HN5	81N37-P-AE3-5	Vdet-IC	3.7V±2%, -Reset ODO	SOT-23	16vdc	VD6	3a	Utc
3HN5G	81N37G-P-AE3-5	Vdet-IC	3.7V±2%, -Reset ODO, halogen free	SOT-23	16vdc	VD6	3a	Utc
3HN5L	81N37L-P-AE3-5	Vdet-IC	3.7V±2%, -Reset ODO, lead free	SOT-23	16vdc	VD6	3a	Utc
3Hp	BC857	Si-pnp	GP, 50V, 100mA, 250mW, B=125..800, >100MHz	SOT-23	16ta	-	3a	PHH
3Ht	BC857	Si-pnp	GP, 50V, 100mA, 250mW, B=125..800, >100MHz	SOT-23	16ta	-	3a	PhM
3Ht	BC857CW	Si-pnp	GP, 50V, 100mA, 250mW, B=420..800, >100MHz	SOT-323	16ta	-	3a	Phi
3Ht	BC857W	Si-pnp	GP, 50V, 100mA, 250mW, B=125..800, >100MHz	SOT-323	16ta	-	3a	PHH
3HW	BC857	Si-pnp	GP, 50V, 100mA, 250mW, B=125..800, >100MHz	SOT-23	16ta	-	3a	PhC
3HW	BC857W	Si-pnp	GP, 50V, 100mA, 250mW, B=125..800, >100MHz	SOT-323	16ta	-	3a	PhC
3I	BAT54WCPT	Si-diode	Dual, SBD, 30V, 200mA, Vf<1V(100mA), 5ns	SOT-323	16dg	-	3a	Chm
3J	BAT54WSPT	Si-diode	Dual, SBD, 30V, 200mA, Vf<1V(100mA), 5ns	SOT-323	16dl	-	3a	Chm
3J	BC858A	Si-pnp	GP, 30V, 100mA, 310mW, B=110..220, >150MHz	SOT-23	16ta	-	3a	Ste
3J	BC858AT	Si-pnp	GP, 30V, 100mA, 250mW, B=125..250, >100MHz	SOT-416	16ta	-	3a	Phi
3J	BC858AW	Si-pnp	GP, 30V, 100mA, 250mW, B=125..250, >100MHz	SOT-323	16ta	-	3a	Ons
3J	R3131N43EA	Vdet-IC	4.3V, +Reset PPO, 240ms	SOT-23	16vdc	VD7	3b	Ric
3J	RB706F-40	Si-diode	Dual, Schottky Rectifier, 40V, 30mA, Vf<0.37V(1mA), 5pF	SOT-323	16dj	-	3a	Rhm
3J-	BC858AW	Si-pnp	GP, 30V, 100mA, 250mW, B=125..250, >100MHz	SOT-323	16ta	-	3a	PhM



SMD code	Type	Function	Short description	Case	Pinout	Sch. St.	Mnf.
3JC2	81C38-P-AE3-2	Vdet-IC	3.8V±2%, -Reset PPO	SOT-23	16vdy	VD7	3a Utc
3JC2G	81C38G-P-AE3-2	Vdet-IC	3.8V±2%, -Reset PPO, halogen free	SOT-23	16vdy	VD7	3a Utc
3JC2L	81C38L-P-AE3-2	Vdet-IC	3.8V±2%, -Reset PPO, lead free	SOT-23	16vdy	VD7	3a Utc
3JC3	81C38-P-AE3-3	Vdet-IC	3.8V±2%, -Reset PPO	SOT-23	16vdb	VD7	3a Utc
3JC3G	81C38G-P-AE3-3	Vdet-IC	3.8V±2%, -Reset PPO, halogen free	SOT-23	16vdb	VD7	3a Utc
3JC3L	81C38L-P-AE3-3	Vdet-IC	3.8V±2%, -Reset PPO, lead free	SOT-23	16vdb	VD7	3a Utc
3JC5	81C38-P-AE3-5	Vdet-IC	3.8V±2%, -Reset PPO	SOT-23	16vdc	VD7	3a Utc
3JC5G	81C38G-P-AE3-5	Vdet-IC	3.8V±2%, -Reset PPO, halogen free	SOT-23	16vdc	VD7	3a Utc
3JC5L	81C38L-P-AE3-5	Vdet-IC	3.8V±2%, -Reset PPO, lead free	SOT-23	16vdc	VD7	3a Utc
3JN2	81N38-P-AE3-2	Vdet-IC	3.8V±2%, -Reset ODO	SOT-23	16vdy	VD6	3a Utc
3JN2G	81N38G-P-AE3-2	Vdet-IC	3.8V±2%, -Reset ODO, halogen free	SOT-23	16vdy	VD6	3a Utc
3JN2L	81N38L-P-AE3-2	Vdet-IC	3.8V±2%, -Reset ODO, lead free	SOT-23	16vdy	VD6	3a Utc
3JN3	81N38-P-AE3-3	Vdet-IC	3.8V±2%, -Reset ODO	SOT-23	16vdb	VD6	3a Utc
3JN3G	81N38G-P-AE3-3	Vdet-IC	3.8V±2%, -Reset ODO, halogen free	SOT-23	16vdb	VD6	3a Utc
3JN3L	81N38L-P-AE3-3	Vdet-IC	3.8V±2%, -Reset ODO, lead free	SOT-23	16vdb	VD6	3a Utc
3JN5	81N38-P-AE3-5	Vdet-IC	3.8V±2%, -Reset ODO	SOT-23	16vdc	VD6	3a Utc
3JN5G	81N38G-P-AE3-5	Vdet-IC	3.8V±2%, -Reset ODO, halogen free	SOT-23	16vdc	VD6	3a Utc
3JN5L	81N38L-P-AE3-5	Vdet-IC	3.8V±2%, -Reset ODO, lead free	SOT-23	16vdc	VD6	3a Utc
3Jp	BC858A	Si-pnp	GP, 30V, 100mA, 250mW, B=125..250, >100MHz	SOT-23	16ta	-	3a PHH
3JR	BC858AR	Si-pnp	GP, 30V, 100mA, 250mW, B=220, >150MHz	SOT-23	16te	-	3a Phi
3Js	BC858A	Si-pnp	GP, 30V, 100mA, 330mW, B=125..250, 250MHz	SOT-23	16ta	-	3a Sie
3Js	BC858AW	Si-pnp	GP, 30V, 100mA, 250mW, B=125..250, >100MHz	SOT-323	16ta	-	3a Sie
3Jt	BC858AW	Si-pnp	GP, 30V, 100mA, 250mW, B=125..250, >100MHz	SOT-323	16ta	-	3a PhH
3JW	BC858A	Si-pnp	GP, 30V, 100mA, 250mW, B=125..250, >100MHz	SOT-23	16ta	-	3a PhC
3JW	BC858AW	Si-pnp	GP, 30V, 100mA, 250mW, B=125..250, >100MHz	SOT-323	16ta	-	3a PhC
3K	BC858B	Si-pnp	GP, 30V, 100mA, 310mW, B=200..450, >150MHz	SOT-23	16ta	-	3a Ste
3K	BC858BT	Si-pnp	GP, 30V, 100mA, 250mW, B=220..475, >100MHz	SOT-416	16ta	-	3a Phi
3K	BC858BW	Si-pnp	GP, 30V, 100mA, 250mW, B=220..475, >100MHz	SOT-323	16ta	-	3c Inf
3K	CH858BPT-R	Si-pnp	AF, Sw, 30V, 100mA, B=220..475, 200MHz	SOT-23	16ta	-	3a Chm
3K	R3131N46EA5	Vdet-IC	4.6V, +Reset PPO, 240ms	SOT-23	16vdc	VD7	3b Ric
3K	UNRF1AN	Si-pnp-Digi	Sw, 50V, 80mA, 100mW, 80MHz, R1/R2=4k7/47k	ML3	22ta	-	2b Pan
3K-	BC858BW	Si-pnp	GP, 30V, 100mA, 250mW, B=220..475, >100MHz	SOT-323	16ta	-	3a PHM
3K0	TC55RP372ECB	LVR-IC	LDO, 3.7V±2%, 250mA	SOT-23	16cq	VR1	3d Mcc
3K0	XC62FP3702M	LVR-IC	3.7V±2%, 250mA	SOT-23	16cg	VR1	3d Tor
3K5	TC593702ECB	LVR-IC	LDO, -3.7V±2%, 200mA	SOT-23	16cj	VR2	3d Mcc
3K5	XC62KN372M	LVR-IC	LDO, -3.7V±2%, 100mA, 150mW	SOT-23	16cj	VR2	3d Tor
3KC2	81C39-P-AE3-2	Vdet-IC	3.9V±2%, -Reset PPO	SOT-23	16vdy	VD7	3a Utc
3KC2G	81C39G-P-AE3-2	Vdet-IC	3.9V±2%, -Reset PPO, halogen free	SOT-23	16vdy	VD7	3a Utc
3KC2L	81C39L-P-AE3-2	Vdet-IC	3.9V±2%, -Reset PPO, lead free	SOT-23	16vdy	VD7	3a Utc
3KC3	81C39-P-AE3-3	Vdet-IC	3.9V±2%, -Reset PPO	SOT-23	16vdb	VD7	3a Utc
3KC3G	81C39G-P-AE3-3	Vdet-IC	3.9V±2%, -Reset PPO, halogen free	SOT-23	16vdb	VD7	3a Utc
3KC3L	81C39L-P-AE3-3	Vdet-IC	3.9V±2%, -Reset PPO, lead free	SOT-23	16vdb	VD7	3a Utc
3KC5	81C39-P-AE3-5	Vdet-IC	3.9V±2%, -Reset PPO	SOT-23	16vdc	VD7	3a Utc
3KC5G	81C39G-P-AE3-5	Vdet-IC	3.9V±2%, -Reset PPO, halogen free	SOT-23	16vdc	VD7	3a Utc
3KC5L	81C39L-P-AE3-5	Vdet-IC	3.9V±2%, -Reset PPO, lead free	SOT-23	16vdc	VD7	3a Utc
3KN2	81N39-P-AE3-2	Vdet-IC	3.9V±2%, -Reset ODO	SOT-23	16vdy	VD6	3a Utc
3KN2G	81N39G-P-AE3-2	Vdet-IC	3.9V±2%, -Reset ODO, halogen free	SOT-23	16vdy	VD6	3a Utc
3KN2L	81N39L-P-AE3-2	Vdet-IC	3.9V±2%, -Reset ODO, lead free	SOT-23	16vdy	VD6	3a Utc
3KN3	81N39-P-AE3-3	Vdet-IC	3.9V±2%, -Reset ODO	SOT-23	16vdb	VD6	3a Utc
3KN3G	81N39G-P-AE3-3	Vdet-IC	3.9V±2%, -Reset ODO, halogen free	SOT-23	16vdb	VD6	3a Utc
3KN3L	81N39L-P-AE3-3	Vdet-IC	3.9V±2%, -Reset ODO, lead free	SOT-23	16vdb	VD6	3a Utc
3KN5	81N39-P-AE3-5	Vdet-IC	3.9V±2%, -Reset ODO	SOT-23	16vdc	VD6	3a Utc
3KN5G	81N39G-P-AE3-5	Vdet-IC	3.9V±2%, -Reset ODO, halogen free	SOT-23	16vdc	VD6	3a Utc
3KN5L	81N39L-P-AE3-5	Vdet-IC	3.9V±2%, -Reset ODO, lead free	SOT-23	16vdc	VD6	3a Utc
3Kp	BC858B	Si-pnp	GP, 30V, 100mA, 250mW, B=220..475, >100MHz	SOT-23	16ta	-	3a PHH
3KR	BC858BR	Si-pnp	GP, 30V, 100mA, 200mW, B=475, >150MHz	SOT-23	16te	-	3a Phi
3Ks	BC858B	Si-pnp	GP, 30V, 100mA, 330mW, B=220..475, 250MHz	SOT-23	16ta	-	3a Sie
3Kt	BC858BW	Si-pnp	GP, 30V, 100mA, 250mW, B=220..475, >100MHz	SOT-323	16ta	-	3a PHH
3KW	BC858B	Si-pnp	GP, 30V, 100mA, 250mW, B=220..475, >100MHz	SOT-23	16ta	-	3a PhC
3KW	BC858BW	Si-pnp	GP, 30V, 100mA, 250mW, B=220..475, >100MHz	SOT-323	16ta	-	3a PhC
3L	BC858C	Si-pnp	GP, 30V, 100mA, 310mW, B=420..800, >150MHz	SOT-23	16ta	-	3a Di
3L	BC858CT	Si-pnp	GP, 30V, 100mA, 250mW, B=420..800, >100MHz	SOT-416	16ta	-	3a Phi
3L	BC858CW	Si-pnp	GP, 30V, 100mA, 300mW, B=420..800, >100MHz	SOT-323	16ta	-	3a Mot
3L	R3131N29AC3	Vdet-IC	2.9V, +Reset ODO, 50ms	SOT-23	16vdc	VD6	3b Ric
3L0	TC55RP382ECB	LVR-IC	LDO, 3.8V±2%, 250mA	SOT-23	16cq	VR1	3d Mcc
3L0	XC62FP3802M	LVR-IC	3.8V±2%, 250mA	SOT-23	16cg	VR1	3d Tor
3L5	TC593802ECB	LVR-IC	LDO, -3.8V±2%, 200mA	SOT-23	16cj	VR2	3d Mcc
3L5	XC62KN382M	LVR-IC	LDO, -3.8V±2%, 100mA, 150mW	SOT-23	16cj	VR2	3d Tor
3LN	ELM7518CEB	Vdet-IC	1.8V±2%, +Reset PPO	SC-70	16vdb	VD7	3d Elm
3LN	ELM7518NEB	Vdet-IC	1.8V±2%, +Reset ODO	SC-70	16vdb	VD6	3d Elm



SMD code	Type	Function	Short description	Case	Pinout	Sch.	St.	Mnf.
3LP	2SK608-P	n-FET	FM-Tuner, 30V, 20mA, 20mW, Idss=0.5..5mA, Up<3V	SOT-23	16fa	-	3a	Pan
3lp	BC858C	Si-pnp	GP, 30V, 100mA, 250mW, B=420..800, >100Hz	SOT-23	16ta	-	3a	PHH
3LQ	2SK608-Q	n-FET	FM-Tuner, 30V, 20mA, 20mW, Idss=4..10mA, Up<3V	SOT-23	16fa	-	3a	Pan
3LR	2SK608-R	n-FET	FM-Tuner, 30V, 20mA, 20mW, Idss=9..15mA, Up<3V	SOT-23	16fa	-	3a	Pan
3LR	BC858CR	Si-pnp	GP, 30V, 100mA, 250mW, B=800, >150MHz	SOT-23	16te	-	3a	Phi
3LS	2SK608-S	n-FET	FM-Tuner, 30V, 20mA, 20mW, Idss=14..20mA, Up<3V	SOT-23	16fa	-	3a	Pan
3Ls	BC858C	Si-pnp	GP, 30V, 100mA, 330mW, B=420..800, 250MHz	SOT-23	16ta	-	3a	Sie
3Ls	BC858CW	Si-pnp	GP, 30V, 100mA, 300mW, B=420..800, >100MHz	SOT-323	16ta	-	3a	Phi
3Lt	BC858CW	Si-pnp	GP, 30V, 100mA, 300mW, B=420..800, >100MHz	SOT-23	16ta	-	3a	Sie
3LW	BC858C	Si-pnp	GP, 30V, 100mA, 250mW, B=420..800, >100Hz	SOT-23	16ta	-	3a	PhC
3M	2SC3829	Si-npn	UHF, 15V, 80mA, 200mW, B=50..300, 6GHz	SC-59	16ta	-	3a	Pan
3M	2SC4808	Si-npn	UHF, LN, 15V, 80mA, 125mW, B=50..300, 6GHz	SOT-416	16ta	-	3a	Pan
3M	BC858	Si-pnp	GP, 30V, 100mA, 250mW, B=125..800, >100MHz	SOT-23	16ta	-	3a	Cdi
3M	CH715WPT	Si-diode	Dual, SBD, 40V, 30mA, Vf<0.37V(1mA)	SOT-416	16df	-	3a	Chm
3m	FMMT5087R	Si-pnp	AF, 50V, 100mA, 330mW, B=200..600, >40MHz	SOT-23	16te	-	3a	Zx
3M	NSF2250WT1	Si-npn	VHF/UHF Osc/Mix, 30V, 50mA, 200mW, B=150..250, 2.3GHz	SOT-323	16ta	-	3a	Ons
3M	R3131N29BC3	Vdet-IC	2.9V, +Reset ODO, 100ms	SOT-23	16vdc	VD6	3b	Ric
3M0	TC55RP392ECB	LVR-IC	LDO, 3.9V±2%, 250mA	SOT-23	16ccj	VR1	3d	Mcc
3M0	XC62FP3902M	LVR-IC	3.9V±2%, 250mA	SOT-23	16ccg	VR1	3d	Tor
3M3	CESD12VAP	ESDP-diode	Dual, Vbr=13.3..15.75V, Vrwm=12V, Ipp=11.2A, 300W(1ms)	SOT-23	16df	-	3a	Jce
3M3	CESD3V3AP	ESDP-diode	Dual, Vbr=5.0..5.9V, Vrwm=3.3V, Ipp=13.3A, 300W(1ms)	SOT-23	16df	-	3a	Jce
3M5	TC593902ECB	LVR-IC	LDO, -3.9V±2%, 200mA	SOT-23	16cj	VR2	3d	Mcc
3M5	XC62KN392M	LVR-IC	LDO, -3.9V±2%, 100mA, 150mW	SOT-23	16cj	VR2	3d	Tor
3Mp	BC858	Si-pnp	GP, 30V, 100mA, 250mW, B=125..800, >100MHz	SOT-23	16ta	-	3a	PHH
3Mq	2SC4835-Q	Si-npn	UHF, LN, 15V, 80mA, 150mW, B=50..100, 6GHz	SOT-323	16ta	-	3a	Pan
3MR	2SC4835-R	Si-npn	UHF, LN, 15V, 80mA, 150mW, B=80..130, 6GHz	SOT-323	16ta	-	3a	Pan
3MS	2SC4835-S	Si-npn	UHF, LN, 15V, 80mA, 150mW, B=100..200, 6GHz	SOT-323	16ta	-	3a	Pan
3Mt	BC858W	Si-pnp	GP, 30V, 100mA, 300mW, B=420..800, >100MHz	SOT-323	16ta	-	3a	Phi
3MW	BC858	Si-pnp	GP, 30V, 100mA, 250mW, B=125..800, >100MHz	SOT-23	16ta	-	3a	PhC
3N	2SK0620	n-MOSFET	Sw, 50V, 100mA, 150mW, <50Ω(20mA), Int.Di (S > G)	SC-59	16fh	-	3a	Pan
3N	2SK0664	n-MOSFET	Sw, 50V, 100mA, 150mW, <50Ω(20mA), 10/20ns	SOT-323	16fh	-	3a	Pan
3N	2SK620	n-MOSFET	Sw, 50V, 100mA, 150mW, <50Ω(20mA), Int.Di (S > G)	SC-59	16fh	-	3a	Pan
3N	2SK664	n-MOSFET	Sw, 50V, 100mA, 150mW, <50Ω(20mA), 10/20ns	SOT-323	16fh	-	3a	Pan
3N	CH548TSPT	Si-diode	Dual, SBD, 30V, 100mA, Vf<0.45V(10mA)	SOT-416	16dl	-	3a	Chm
3N	MMBT3906	Si-pnp	Sw, AF, 60/40V, 100mA, 200mW, B=100..300, >250MHz	SOT-23	16ta	-	3a	Itt,Vs
3N	MMBT3906T	Si-pnp	Sw, AF, 60/40V, 100mA, 200mW, B=100..300, >250MHz	SOT-323	16ta	-	3d	Di
3N	R3131N29DC3	Vdet-IC	2.9V, +Reset ODO, 200ms	SOT-23	16vdc	VD6	3b	Ric
3O	2SC4497-O	Si-npn	HV, 300V, 100mA, 200mW, B=50..150, 70MHz	SC-59	16ta	-	3a	Tos
3O	2SK0665	n-MOSFET	Sw, 20V, 100mA, 150mW, <50Ω(20mA), 1/1μs	SOT-323	16fh	-	3a	Pan
3O	2SK621	n-MOSFET-e	Int.Di+R (S > G), V-MOS, 20V, ±100mA	SOT-23	16fh	-	3a	Pan
3O	2SK665	n-MOSFET	Sw, 20V, 100mA, 150mW, <50Ω(20mA), 1/1μs	SOT-323	16fh	-	3a	Pan
3P	2N7002	n-MOSFET-e	TMOS, 60V, 115mA, 200mW, 1.2Ω(500mA), 20/20ns	SOT-23	16fh	-	3a	Gal
3P	FMMT2222AR	Si-npn	GP, 75V, 600mA, 330mW, B=120..360, >300MHz	SOT-23	16ta	-	3a	Zx
3P	R3131N29HC3	Vdet-IC	2.9V, +Reset ODO, 400ms	SOT-23	16vdc	VD6	3b	Ric
3Q	R3131N29AA3	Vdet-IC	2.9V, +Reset PPO, 50ms	SOT-23	16vdc	VD7	3b	Ric
3R	2SC4497-R	Si-npn	HV, 300V, 100mA, 200mW, B=30..90, 70MHz	SC-59	16ta	-	3a	Tos
3R	2SD5580	Si-npn	HF-osc/Sw, 15V, 50mA, 150mW, B=100..350, 1.1GHz	SOT-323	16ta	-	3a	Pan
3R	MMBT5751	Si-pnp	Sw, 15V, 200mA, 225mW, B=50..120, 15/20ns	SOT-23	16ta	-	3a	Nsc
3R	PDTA124EEF	Si-pnp-Digi	Sw, 50V, 100mA, 250mW, R1/R2=22k/22k	SOT-490	18ta	-	3a	Phi
3R	R3131N29BA3	Vdet-IC	2.9V, +Reset PPO, 100ms	SOT-23	16vdc	VD7	3b	Ric
3R	SRA2203E	Si-pnp-Digi	Sw, 50V, 100mA, 150mW, 200MHz, R1/R2=22/22k	SOT-523	16ta	-	3a	Auk
3R	SRA2203EF	Si-pnp-Digi	Sw, 50V, 100mA, 150mW, 200MHz, R1/R2=22/22k	SOT-523F	18ta	-	3a	Auk
3R	SRA2203U	Si-pnp-Digi	Sw, 50V, 100mA, 200mW, 200MHz, R1/R2=22/22k	SOT-323	16ta	-	3a	Auk
3R	SRA2203UF	Si-pnp-Digi	Sw, 50V, 100mA, 200mW, 200MHz, R1/R2=22/22k	SOT-323F	18ta	-	3a	Auk
3S	2SC3904	Si-npn	UHF-amp, 15V, 65mA, 200mW, B=50..300, 8.5GHz	SC-59	16ta	-	3a	Pan
3S	2SC4805	Si-npn	VHF/UHF, 15V, 65mA, 150mW, 8.5GHz, B=50..300	SOT-323	16ta	-	3a	Pan
3S	MMBT5551	Si-npn	HV, 180V, 200mA, 350mW, B=80..250, >300MHz	SOT-23	16ta	-	3a	Nsc
3S	R3131N29DA3	Vdet-IC	2.9V, +Reset PPO, 200ms	SOT-23	16vdc	VD7	3b	Ric
3S	UNRF1A2	Si-pnp-Digi	Sw, 50V, 80mA, 100mW, 80MHz, R1/R2=22k/22k	ML3	22ta	-	2b	Pan
3SQ	2SC4805-Q	Si-npn	VHF/UHF, 15V, 65mA, 150mW, 8.5GHz, B=50..120	SOT-323	16ta	-	3a	Pan
3SQ	2SC5295-Q	Si-npn	HF, LN, 15V, 65mA, 150mW, B=50..120, 8.5GHz	SOT-416	16ta	-	3a	Pan
3SR	2SC4805-R	Si-npn	VHF/UHF, 15V, 65mA, 150mW, 8.5GHz, B=100..170	SOT-323	16ta	-	3a	Pan
3SR	2SC5295-R	Si-npn	HF, LN, 15V, 65mA, 150mW, B=100..170, 8.5GHz	SOT-416	16ta	-	3a	Pan
3SS	2SC4805-S	Si-npn	VHF/UHF, 15V, 65mA, 150mW, 8.5GHz, B=150..300	SOT-323	16ta	-	3a	Pan
3SS	2SC5295-S	Si-npn	HF, LN, 15V, 65mA, 150mW, B=150..300, 8.5GHz	SOT-416	16ta	-	3a	Pan
3SS	MMBTA28	Si-npn-Darl	GP, 80V, 500mA, 500mW, B>10000, >100MHz	SOT-23	16ta	-	3a	Nsc
3T	HT3	Si-pnp	GP, 90V, 100mA, 300mW, <50Ω/2000ns	SOT-23	16ta	-	3a	Fer
3T	R3131N29HA3	Vdet-IC	2.9V, +Reset PPO, 400ms	SOT-23	16vdc	VD7	3b	Ric
3T	UNRF1A4	Si-pnp-Digi	Sw, 50V, 80mA, 100mW, 80MHz, R1/R2=10k/47k	ML3	22ta	-	2b	Pan
3U	2SC3967	Si-npn	UHF, 30V, 20mA, 200mW, B=40..200, 1.5GHz	SOT-23	16ta	-	3a	Pan



SMD code	Type	Function	Short description	Case	Pinout	Sch.	St.	Mnf.
3U	2SC4068	Si-npn	UHF, 30V, 20mA, ,150mW, B=40..200, 1.5GHz	SOT-323	16ta	-	3a	Pan
3V	BC857AT	Si-pnp	GP, 50V, 100mA, 250mW, B=125..250, >100MHz	SOT-416	16ta	-	3a	Di
3V0	PZM3.0NB	Z-diode	3.0V±2.5%, 300mW	SOT-346	16dc	-	3a	Phi
3V3	PZM3.3NB	Z-diode	3.3V±2.5%, 300mW	SOT-346	16dc	-	3a	Phi
3V6	CHPZ3V6PT	Z-diode	Dual, 3.4..3.8V, Izt=5mA, Zzt=95Ω, 350mW	SOT-23	16df	-	3a	Chm
3V6	PZM3.6NB	Z-diode	3.6V±2.5%, 300mW	SOT-346	16dc	-	3a	Phi
3V9	CHPZ3V9PT	Z-diode	Dual, 3.7..4.1V, Izt=5mA, Zzt=90Ω, 350mW	SOT-23	16df	-	3a	Chm
3V9	PZM3.9NB	Z-diode	3.9V±2.5%, 300mW	SOT-346	16dc	-	3a	Phi
3VR	2SB1679-R	Si-pnp	AF, 15V, 500mA, 150mW, B=130..220, 130MHz	SOT-323	16ta	-	3a	Pan
3VS	2SB1679-S	Si-pnp	AF, 15V, 500mA, 150mW, B=180..350, 130MHz	SOT-323	16ta	-	3a	Pan
3W	BC857BT	Si-pnp	GP, 50V, 100mA, 250mW, B=220..475, >100MHz	SOT-416	16ta	-	3d	Di
3W	FMMTA12	Si-npn-Darl	GP, 40V, 300mA, 350mW, B=50..150, 200MHz	SOT-23	16ta	-	-	Zx
3WS	2SD1979-S	Si-npn	AF, 50V, 500mA, 150mW, 80MHz, B=500..1500	SOT-323	16ta	-	3a	Pan
3WT	2SD1979-T	Si-npn	AF, 50V, 500mA, 150mW, 80MHz, B=800..2500	SOT-323	16ta	-	3a	Pan
3X	UNRF1A6	Si-pnp-Digi	Sw, 50V, 80mA, 100mW, 80MHz, R1=4k7	ML3	22ta	-	2b	Pan
3Y	2SC5190	Si-npn	HF, 9V, 30mA, 150mW, B=40..160, 10GHz	SOT-323	16ta	-	3a	Pan
3Y	2SC5363	Si-npn	HF, LN, 9V, 30mA, 125mW, B=40..160, 10GHz	SOT-416	16ta	-	3a	Pan
3Y	UNRF1A7	Si-pnp-Digi	Sw, 50V, 80mA, 100mW, 80MHz, R1=22k	ML3	22ta	-	2b	Pan
4.3	TZT4.3W	Z-diode	4.0..4.50V, Izt=5mA, Zzt=130Ω, 200mW	SOT-323	16dc	-	3a	Ttr
4.3	Z02W4.3V	Z-diode	4.0..4.50V, Izt=5mA, Zzt=130Ω, 200mW	SOT-23	16dc	-	3f	Kec
4.3H	BZX84-C4V3-V	Z-diode	4.13..4.35V, Izt=5mA, Zzt=130Ω, 300mW	SOT-23	16dc	-	3f	Kec
4.3H	MAZ3043-H	Z-diode	4.4.6V, If=100mA, Zzt=130Ω, 200mW	SC-59	16dc	-	3a	Pan
4.3L	MAZ3043-L	Z-diode	4.4.6V, If=100mA, Zzt=130Ω, 200mW	SC-59	16dc	-	3a	Pan
4.3M	MAZ3043-M	Z-diode	4.4.6V, If=100mA, Zzt=130Ω, 200mW	SC-59	16dc	-	3a	Pan
4.3X	TZT4.3XW	Z-diode	4.0..4.23V, Izt=5mA, Zzt=130Ω, 200mW	SOT-323	16dc	-	3a	Ttr
4.3X	Z02W4.3VX	Z-diode	4.0..4.23V, Izt=5mA, Zzt=130Ω, 200mW	SOT-23	16dc	-	3f	Kec
4.3Y	TZT4.3YW	Z-diode	4.13..4.35V, Izt=5mA, Zzt=130Ω, 200mW	SOT-323	16dc	-	3a	Ttr
4.3Y	Z02W4.3VY	Z-diode	4.13..4.35V, Izt=5mA, Zzt=130Ω, 200mW	SOT-23	16dc	-	3f	Kec
4.3Z	TZT4.3ZW	Z-diode	4.25..4.50V, Izt=5mA, Zzt=130Ω, 200mW	SOT-323	16dc	-	3a	Ttr
4.3Z	Z02W4.3VZ	Z-diode	4.25..4.50V, Izt=5mA, Zzt=130Ω, 200mW	SOT-23	16dc	-	3f	Kec
4.7	TZT4.7W	Z-diode	4.40..4.90V, Izt=5mA, Zzt=120Ω, 200mW	SOT-323	16dc	-	3a	Ttr
4.7	Z02W4.7V	Z-diode	4.40..4.90V, Izt=5mA, Zzt=120Ω, 200mW	SOT-23	16dc	-	3f	Kec
4.7H	BZX84-C4V7-V	Z-diode	4.53..4.76V, Izt=5mA, Zzt=120Ω, 300mW	SOT-23	16dc	-	3f	Kec
4.7H	MAZ3047-H	Z-diode	4.4..5V, If=100mA, Zzt=80Ω, 200mW	SC-59	16dc	-	3a	Pan
4.7L	MAZ3047-L	Z-diode	4.4..5V, If=100mA, Zzt=80Ω, 200mW	SC-59	16dc	-	3a	Pan
4.7M	MAZ3047-M	Z-diode	4.4..5V, If=100mA, Zzt=80Ω, 200mW	SC-59	16dc	-	3a	Pan
4.7X	TZT4.7XW	Z-diode	4.40..4.63V, Izt=5mA, Zzt=120Ω, 200mW	SOT-323	16dc	-	3a	Ttr
4.7X	Z02W4.7VX	Z-diode	4.40..4.63V, Izt=5mA, Zzt=120Ω, 200mW	SOT-23	16dc	-	3f	Kec
4.7Y	TZT4.7YW	Z-diode	4.53..4.76V, Izt=5mA, Zzt=120Ω, 200mW	SOT-323	16dc	-	3a	Ttr
4.7Y	Z02W4.7VY	Z-diode	4.53..4.76V, Izt=5mA, Zzt=120Ω, 200mW	SOT-23	16dc	-	3f	Kec
4.7Z	TZT4.7ZW	Z-diode	4.66..4.90V, Izt=5mA, Zzt=120Ω, 200mW	SOT-323	16dc	-	3a	Ttr
4.7Z	Z02W4.7VZ	Z-diode	4.66..4.90V, Izt=5mA, Zzt=120Ω, 200mW	SOT-23	16dc	-	3f	Kec
4-3X	02CZ4.3-X	Z-diode	4..4.23V, 200mW	SC-59	16dc	-	3a	Tos
4-3Y	02CZ4.3-Y	Z-diode	4.13..4.35V, 200mW	SC-59	16dc	-	3a	Tos
4-3Z	02CZ4.3-Z	Z-diode	4.25..4.5V, 200mW	SC-59	16dc	-	3a	Tos
4-7X	02CZ4.7-X	Z-diode	4.40..4.63V, 200mW	SC-59	16dc	-	3a	Tos
4-7Y	02CZ4.7-Y	Z-diode	4.53..4.76V, 200mW	SC-59	16dc	-	3a	Tos
4-7Z	02CZ4.7-Z	Z-diode	4.66..4.9V, 200mW	SC-59	16dc	-	3a	Tos
40	2SA1037M1PT-S	Si-pnp	AF, Sw, 50V, 150mA, B=270..560, 140MHz	FBPT-723	17ta	-	9a	Chm
40	2SA1037MPT-S	Si-pnp	AF, Sw, 50V, 150mA, B=270..560, 140MHz	SOT-723	18ta	-	3a	Chm
40	BC859	Si-pnp	GP, 30V, 100mA, 250mW, B=125..800, >100MHz	SOT-23	16ta	-	3a	Cdi
40	ELM9840BB	LVR-IC	4.0V±2%, 200mA	SOT-23	16cg	VR1	3d	Elm
40-2	UTC8140-2	Vdet-IC	4V, -Reset OCO	SOT-23	16vdy	VD6	3a	Utc
40-3	UTC8140-3	Vdet-IC	4V, -Reset OCO	SOT-23	16vdb	VD6	3a	Utc
40-5	UTC8140-5	Vdet-IC	4V, -Reset OCO	SOT-23	16vdc	VD6	3a	Utc
40A	AAT60040A-S2	Vdet-IC	4.0V±2%, -Reset ODO	SOT-23	16vdb	VD6	3d	Aat
40B	AAT60040B-S2	Vdet-IC	4.0V±2%, -Reset PPO	SOT-23	16vdb	VD7	3d	Aat
40B	MMBZ5240BPT	Z-diode	9.500..10.50V, Izt=5mA, Zzt=15Ω, 225mW	SOT-23	16dc	-	3a	Chm
40C	AAT60040C-S2	Vdet-IC	4.0V±1%, -Reset ODO	SOT-23	16vdb	VD6	3d	Aat
40D	AAT60040D-S2	Vdet-IC	4.0V±1%, -Reset PPO	SOT-23	16vdb	VD7	3d	Aat
40S	MMBZ5240SPT	Z-diode	9.800..10.20V, Izt=5mA, Zzt=15Ω, 225mW	SOT-23	16dc	-	3a	Chm
40S	MMBZ5240SPT	Z-diode	9.800..10.20V, Izt=5mA, Zzt=15Ω, 225mW	SOT-346	16dc	-	3a	Chm
40T	TK71540AS	LVR-IC	LDO, 4V±1.5%, 155mA	SOT-23	16cj	VR1	3d	Tok
41	CHDTC1147MPT	Si-npn-Digi	Sw, 50V, 100mA, 250MHz, R1=10k	SOT-723	18ta	-	3a	Chm
41	ELM9841BB	LVR-IC	4.1V±2%, 200mA	SOT-23	16cg	VR1	3d	Elm
41-2	UTC8141-2	Vdet-IC	4.1V, -Reset OCO	SOT-23	16vdy	VD6	3a	Utc
413	FMMT413	Si-npn	Avalanche, 150V, 100mA, 330mW, B>50, >150MHz	SOT-23	16ta	-	3a	Zx
41-3	UTC8141-3	Vdet-IC	4.1V, -Reset OCO	SOT-23	16vdb	VD6	3a	Utc
415	FMMT415	Si-npn	Avalanche, 260V, 500mA, 330mW, B>25, >40MHz	SOT-23	16ta	-	3a	Zx
41-5	UTC8141-5	Vdet-IC	4.1V, -Reset OCO	SOT-23	16vdc	VD6	3a	Utc



SMD code	Type	Function	Short description	Case	Pinout	Sch.	St.	Mnf.
417	FMMT417	Si-npn	Avalanche, 320V, 500mA, 330mW, B>25, >40MHz	SOT-23	16ta	-	3a	Zx
41A	AAT60041A-S2	Vdet-IC	4.1V±2%, -Reset ODO	SOT-23	16vdb	VD6	3d	Aat
41A	FMMT491A	Si-npn	AF, 80V, 1A, 500mW, B=100..300, >150MHz	SOT-23	16ta	-	3a	Zx
41B	AAT60041B-S2	Vdet-IC	4.1V±2%, -Reset PPO	SOT-23	16vdb	VD7	3d	Aat
41B	MMBZ5241BPT	Z-diode	10.45..11.55V, Izt=5mA, Zzt=18Ω, 225mW	SOT-23	16dc	-	3a	Chm
41C	AAT60041C-S2	Vdet-IC	4.1V±1%, -Reset ODO	SOT-23	16vdb	VD6	3d	Aat
41D	AAT60041D-S2	Vdet-IC	4.1V±1%, -Reset PPO	SOT-23	16vdb	VD7	3d	Aat
41S	MMBZ5241SPT	Z-diode	10.78..11.22V, Izt=5mA, Zzt=18Ω, 225mW	SOT-23	16dc	-	3a	Chm
41S	MMCZ5241SPT	Z-diode	10.78..11.22V, Izt=5mA, Zzt=18Ω, 225mW	SOT-346	16dc	-	3a	Chm
41T	TK71541AS	LVR-IC	LDO, 4.1V±1.5%, 155mA	SOT-23	16cj	VR1	3d	Tok
42	BAT54AW	Si-diode	Dual, Schottky Rectifier, 30V, 200mA, Vf<1V(100mA), <5ns	SOT-323	16df	-	3a	Phi
42	CHDTC115TMTPT	Si-npn-Digi	Sw, 50V, 100mA, 250MHz, R1=100k	SOT-723	18ta	-	3a	Chm
42	ELM9842BB	LVR-IC	4.2V±2%, 200mA	SOT-23	16cg	VR1	3d	Elm
42-2	UTC8142-2	Vdet-IC	4.2V, -Reset OCO	SOT-23	16vdy	VD6	3a	Utc
42-3	UTC8142-3	Vdet-IC	4.2V, -Reset OCO	SOT-23	16vdb	VD6	3a	Utc
42-5	UTC8142-5	Vdet-IC	4.2V, -Reset OCO	SOT-23	16vdc	VD6	3a	Utc
42A	AAT60042A-S2	Vdet-IC	4.2V±2%, -Reset ODO	SOT-23	16vdb	VD6	3d	Aat
42B	AAT60042B-S2	Vdet-IC	4.2V±2%, -Reset PPO	SOT-23	16vdb	VD7	3d	Aat
42B	MMBZ5242BPT	Z-diode	11.40..12.60V, Izt=5mA, Zzt=22Ω, 225mW	SOT-23	16dc	-	3a	Chm
42C	AAT60042C-S2	Vdet-IC	4.2V±1%, -Reset ODO	SOT-23	16vdb	VD6	3d	Aat
42D	AAT60042D-S2	Vdet-IC	4.2V±1%, -Reset PPO	SOT-23	16vdb	VD7	3d	Aat
42S	MMBZ5242SPT	Z-diode	11.76..12.24V, Izt=5mA, Zzt=22Ω, 225mW	SOT-23	16dc	-	3a	Chm
42S	MMCZ5242SPT	Z-diode	11.76..12.24V, Izt=5mA, Zzt=22Ω, 225mW	SOT-346	16dc	-	3a	Chm
42T	TK71542AS	LVR-IC	LDO, 4.2V±1.5%, 155mA	SOT-23	16cj	VR1	3d	Tok
43	1PS89SB15	Si-diode	Dual, SBD, U-Sp, 30V, 200mA, <10pF	SOT-490	18dg	-	3a	Phi
43	BAS40	Si-diode	Schottky, 40V, 200mA, 200mW, Cd<5pF, <5ns	SOT-23	16dc	-	3g	Vs
43	BAS40T	Si-diode	SBD, 40V, 200mA, Vf<1V(40mA), 5ns	SOT-523	16dc	-	3b	Di
43	BAT54CW	Si-diode	Dual, Schottky Rectifier, 30V, 200mA, Vf<1V(100mA), <5ns	SOT-323	16dg	-	3a	Phi
43	CHDTC123TMTPT	Si-npn-Digi	Sw, 50V, 100mA, 250MHz, R1=2.2k	SOT-723	18ta	-	3a	Chm
43	DTC143XE	Si-npn-Digi	Sw, 50V, 100mA, 150mW, 250MHz, R1/R2=4k7/10k	SOT-416	16ta	-	3a	Rhm
43	DTC143XKA	Si-npn-Digi	Sw, 50V, 100mA, 200mW, 250MHz, R1/R2=4k7/10k	SOT-346	16ta	-	3a	Rhm
43	DTC143XM	Si-npn-Digi	Sw, 50V, 100mA, 150mW, 250MHz, R1/R2=4k7/10k	VMT3	18ta	-	3a	Rhm
43	DTC143XUA	Si-npn-Digi	Sw, 50V, 100mA, 200mW, 250MHz, R1/R2=4k7/10k	UMT3	16ta	-	3a	Rhm
43	ELM9843BB	LVR-IC	4.3V±2%, 200mA	SOT-23	16cg	VR1	3d	Elm
431	HZM4.3NB1	Z-diode	4.01..4.21V, 200mW	SC-59A	16dc	-	3a	Ren
431	PZM4.3NB1	Z-diode	4.3V±2.5%, 300mW	SOT-346	16dc	-	3a	Phi
432	HZM4.3NB2	Z-diode	4.15..4.34V, 200mW	SC-59A	16dc	-	3a	Ren
432	PZM4.3NB2	Z-diode	4.3V±2.5%, 300mW	SOT-346	16dc	-	3a	Phi
43-2	UTC8143-2	Vdet-IC	4.3V, -Reset OCO	SOT-23	16vdy	VD6	3a	Utc
433	HZM4.3NB3	Z-diode	4.28..4.48V, 200mW	SC-59A	16dc	-	3a	Ren
433	PZM4.3NB3	Z-diode	4.3V±2.5%, 300mW	SOT-346	16dc	-	3a	Phi
43-3	UTC8143-3	Vdet-IC	4.3V, -Reset OCO	SOT-23	16vdb	VD6	3a	Utc
43-5	UTC8143-5	Vdet-IC	4.3V, -Reset OCO	SOT-23	16vdc	VD6	3a	Utc
43A	AAT60043A-S2	Vdet-IC	4.3V±2%, -Reset ODO	SOT-23	16vdb	VD6	3d	Aat
43B	AAT60043B-S2	Vdet-IC	4.3V±2%, -Reset PPO	SOT-23	16vdb	VD7	3d	Aat
43B	MMBZ5243BPT	Z-diode	12.35..13.65V, Izt=5mA, Zzt=25Ω, 225mW	SOT-23	16dc	-	3a	Chm
43C	AAT60043C-S2	Vdet-IC	4.3V±1%, -Reset ODO	SOT-23	16vdb	VD6	3d	Aat
43D	AAT60043D-S2	Vdet-IC	4.3V±1%, -Reset PPO	SOT-23	16vdb	VD7	3d	Aat
43p	BAS40	Si-diode	Schottky, 40V, 200mA, 200mW, Cd<5pF, <5ns	SOT-23	16dc	-	3a	PhH
43s	BAS40	Si-diode	Schottky, 40V, 200mA, 200mW, Cd<5pF, <5ns	SOT-23	16dc	-	3a	Sie
43S	MMBZ5243SPT	Z-diode	12.74..13.26V, Izt=5mA, Zzt=25Ω, 225mW	SOT-23	16dc	-	3a	Chm
43S	MMCZ5243SPT	Z-diode	12.74..13.26V, Izt=5mA, Zzt=25Ω, 225mW	SOT-346	16dc	-	3a	Chm
43t	BAS40	Si-diode	Schottky, 40V, 200mA, 200mW, Cd<5pF, <5ns	SOT-23	16dc	-	3a	PhM
43T	TK71543AS	LVR-IC	LDO, 4.3V±1.5%, 155mA	SOT-23	16cj	VR1	3d	Tok
43V	PZM43NB	Z-diode	4.3V±2.5%, 300mW	SOT-346	16dc	-	3a	Phi
43W	BAS40	Si-diode	Schottky, 40V, 200mA, 200mW, Cd<5pF, <5ns	SOT-23	16dc	-	3a	PhC
43Z	CZ1W43	Z-diode	4.3V±5%, 600mW	SOT-23	16dc	-	3a	Cdi
44	1PS89SB14	Si-diode	Dual, SBD, U-Sp, 30V, 200mA, <10pF	SOT-490	18dl	-	3a	Phi
44	2SC5008-FB	Si-npn	UHF-L-band, 20V, 35mA, 125mW, 8GHz, B=80..160	SOT-23	16ta	-	3a	Nec
44	BAS40-04	Si-diode	Dual, Schottky, 40V, 200mA, 200mW, Cd<5pF, <5ns	SOT-23	16dl	-	3g	Vs
44	BAS40-04W	Si-diode	Dual, Schottky, 40V, 200mA, 200mW, Cd<5pF, <5ns	SOT-323	16dl	-	3a	Sie
44	BAS40T-04	Si-diode	Dual, SBD, 40V, 200mA, Vf<1V(40mA), 5ns	SOT-523	16dl	-	3b	Di
44	BAT54SW	Si-diode	Dual, Schottky Rectifier, 30V, 200mA, Vf<1V(100mA), <5ns	SOT-323	16dl	-	3a	Phi
44	CHDTC124TMTPT	Si-npn-Digi	Sw, 50V, 100mA, 250MHz, R1=22k	SOT-723	18ta	-	3a	Chm
44	CHT44T1PT	Si-npn	Drv, 300V, 300mA, B=50..240, 50MHz	FBPT-523	17ta	-	9a	Chm
44	ELM9844BB	LVR-IC	4.4V±2%, 200mA	SOT-23	16cg	VR1	3d	Elm
44-2	UTC8144-2	Vdet-IC	4.4V, -Reset OCO	SOT-23	16vdy	VD6	3a	Utc
44-3	UTC8144-3	Vdet-IC	4.4V, -Reset OCO	SOT-23	16vdb	VD6	3a	Utc
44-5	UTC8144-5	Vdet-IC	4.4V, -Reset OCO	SOT-23	16vdc	VD6	3a	Utc
449	FMMT449	Si-npn	Lo-sat, 50V, 1A, 500mW, B=100..300, >150MHz	SOT-23	16ta	-	3a	Zx



SMD code	Type	Function	Short description	Case	Pinout	Sch. St.	Mnf.
44A	AAT60044A-S2	Vdet-IC	4.4V±2%, -Reset ODO	SOT-23	16vdb	VD6	3d Aat
44B	AAT60044B-S2	Vdet-IC	4.4V±2%, -Reset PPO	SOT-23	16vdb	VD7	3d Aat
44B	MMBZ5244BPT	Z-diode	13.30..14.70V, Izt=5mA, Zzt=25Ω, 225mW	SOT-23	16dc	-	3a Chm
44C	AAT60044C-S2	Vdet-IC	4.4V±1%, -Reset ODO	SOT-23	16vdb	VD6	3d Aat
44D	AAT60044D-S2	Vdet-IC	4.4V±1%, -Reset PPO	SOT-23	16vdb	VD7	3d Aat
44p	BAS40-04	Si-diode	Dual, Schottky, 40V, 200mA, 200mW, Cd<5pF, <5ns	SOT-23	16dl	-	3a PHH
44s	BAS40-04	Si-diode	Dual, Schottky, 40V, 200mA, 200mW, Cd<5pF, <5ns	SOT-23	16dl	-	3a Sie
44S	MMBZ5244SPT	Z-diode	13.72..14.28V, Izt=5mA, Zzt=25Ω, 225mW	SOT-23	16dc	-	3a Chm
44S	MMCZ5244SPT	Z-diode	13.72..14.28V, Izt=5mA, Zzt=25Ω, 225mW	SOT-346	16dc	-	3a Chm
44t	BAS40-04	Si-diode	Dual, Schottky, 40V, 200mA, 200mW, Cd<5pF, <5ns	SOT-23	16dl	-	3a PhM
44T	TK71544AS	LVR-IC	LDO, 4.4V±1.5%, 155mA	SOT-23	16cj	VR1	3d Tok
44W	BAS40-04	Si-diode	Dual, Schottky, 40V, 200mA, 200mW, Cd<5pF, <5ns	SOT-23	16dl	-	3a PhC
45	1PS75SB45	Si-diode	Dual, SBD, U-Sp, 40V, 120mA, <5pF	SOT-416	16dg	-	3a Phi
45	1PS89SB16	Si-diode	Dual, SBD, U-Sp, 30V, 200mA, <10pF	SOT-490	18df	-	3a Phi
45	BAS40-05	Si-diode	Dual, Schottky, 40V, 200mA, 200mW, Cd<5pF, <5ns	SOT-23	16dg	-	3g Vs
45	BAS40-05W	Si-diode	Dual, Schottky, 40V, 200mA, 200mW, Cd<5pF, <5ns	SOT-323	16dg	-	3a Sie
45	BAS40T-05	Si-diode	Dual, SBD, 40V, 200mA, Vf<1V(40mA), 5ns	SOT-523	16dg	-	3b Di
45	CHDTC143TMPT	Si-npn-Digi	Sw, 50V, 100mA, 250MHz, R1=4.7k	SOT-723	18ta	-	3a Chm
45	DTC124XE	Si-npn-Digi	Sw, 50V, 100mA, 150mW, 250MHz, R1/R2=22k/47k	SOT-416	16ta	-	3a Rhm
45	DTC124XKA	Si-npn-Digi	Sw, 50V, 100mA, 200mW, 250MHz, R1/R2=22k/47k	SOT-346	16ta	-	3a Rhm
45	DTC124XM	Si-npn-Digi	Sw, 50V, 100mA, 150mW, 250MHz, R1/R2=22k/47k	VMT3	18ta	-	3a Rhm
45	DTC124XUA	Si-npn-Digi	Sw, 50V, 100mA, 200mW, 250MHz, R1/R2=22k/47k	UMT3	16ta	-	3a Rhm
45	ELM9845BB	LVR-IC	4.5V±2%, 200mA	SOT-23	16cg	VR1	3d Elm
451	FMMT451	Si-npn	AF, 80V, 1A, 500mW, B=50..160, >150MHz	SOT-23	16ta	-	3a Zx
45-2	UTC8145-2	Vdet-IC	4.5V, -Reset OCO	SOT-23	16vdy	VD6	3a Utc
45-3	UTC8145-3	Vdet-IC	4.5V, -Reset OCO	SOT-23	16vdb	VD6	3a Utc
455	FMMT455	Si-npn	Vid, 160V, 1A, 500mW, B=100..300, >100MHz	SOT-23	16ta	-	3a Zx
45-5	UTC8145-5	Vdet-IC	4.5V, -Reset OCO	SOT-23	16vdc	VD6	3a Utc
458	FMMT458	Si-npn	Vid, 400V, 225mA, 500mW, B=100..300, >50MHz	SOT-23	16ta	-	3a Zx
459	TMPD459	Si-diode	GP, 200V, 500mA, Cd<6.0pF	SOT-23	16dc	-	3a All
45A	AAT60045A-S2	Vdet-IC	4.5V±2%, -Reset ODO	SOT-23	16vdb	VD6	3d Aat
45B	AAT60045B-S2	Vdet-IC	4.5V±2%, -Reset PPO	SOT-23	16vdb	VD7	3d Aat
45B	MMBZ5245BPT	Z-diode	14.25..15.75V, Izt=5mA, Zzt=32Ω, 225mW	SOT-23	16dc	-	3a Chm
45C	AAT60045C-S2	Vdet-IC	4.5V±1%, -Reset ODO	SOT-23	16vdb	VD6	3d Aat
45D	AAT60045D-S2	Vdet-IC	4.5V±1%, -Reset PPO	SOT-23	16vdb	VD7	3d Aat
45p	BAS40-05	Si-diode	Dual, Schottky, 40V, 200mA, 380mW, Cd<5pF, <5ns	SOT-23	16dg	-	3a PHH
45s	BAS40-05	Si-diode	Dual, Schottky, 40V, 200mA, 200mW, Cd<5pF, <5ns	SOT-23	16dg	-	3a Sie
45S	MMBZ5245SPT	Z-diode	14.70..15.30V, Izt=5mA, Zzt=32Ω, 225mW	SOT-23	16dc	-	3a Chm
45S	MMCZ5245SPT	Z-diode	14.70..15.30V, Izt=5mA, Zzt=32Ω, 225mW	SOT-346	16dc	-	3a Chm
45t	BAS40-05	Si-diode	Dual, Schottky, 40V, 200mA, 200mW, Cd<5pF, <5ns	SOT-23	16dg	-	3a PHM
45T	TK71545AS	LVR-IC	LDO, 4.5V±1.5%, 155mA	SOT-23	16cj	VR1	3d Tok
45W	BAS40-05	Si-diode	Dual, Schottky, 40V, 200mA, 200mW, Cd<5pF, <5ns	SOT-23	16dg	-	3a PhC
46	BAS40-06	Si-diode	Dual, Schottky, 40V, 200mA, 200mW, Cd<5pF, <5ns	SOT-23	16df	-	3g Vs
46	BAS40-06W	Si-diode	Dual, Schottky, 40V, 200mA, 200mW, Cd<5pF, <5ns	SOT-323	16dg	-	3a Sie
46	BAS40T-06	Si-diode	Dual, SBD, 40V, 200mA, Vf<1V(40mA), 5ns	SOT-523	16df	-	3b Di
46	CHDTC144TMPT	Si-npn-Digi	Sw, 50V, 100mA, 250MHz, R1=47k	SOT-723	18ta	-	3a Chm
46	ELM9846BB	LVR-IC	4.6V±2%, 200mA	SOT-23	16cg	VR1	3d Elm
46-2	UTC8146-2	Vdet-IC	4.6V, -Reset OCO	SOT-23	16vdy	VD6	3a Utc
46-3	UTC8146-3	Vdet-IC	4.6V, -Reset OCO	SOT-23	16vdb	VD6	3a Utc
46-5	UTC8146-5	Vdet-IC	4.6V, -Reset OCO	SOT-23	16vdc	VD6	3a Utc
46A	AAT60046A-S2	Vdet-IC	4.6V±2%, -Reset ODO	SOT-23	16vdb	VD6	3d Aat
46B	AAT60046B-S2	Vdet-IC	4.6V±2%, -Reset PPO	SOT-23	16vdb	VD7	3d Aat
46B	MMBZ5246BPT	Z-diode	15.20..16.80V, Izt=5mA, Zzt=36Ω, 225mW	SOT-23	16dc	-	3a Chm
46C	AAT60046C-S2	Vdet-IC	4.6V±1%, -Reset ODO	SOT-23	16vdb	VD6	3d Aat
46D	AAT60046D-S2	Vdet-IC	4.6V±1%, -Reset PPO	SOT-23	16vdb	VD7	3d Aat
46p	BAS40-06	Si-diode	Dual, Schottky, 40V, 200mA, 200mW, Cd<5pF, <5ns	SOT-23	16df	-	3a PHH
46s	BAS40-06	Si-diode	Dual, Schottky, 40V, 200mA, 200mW, Cd<5pF, <5ns	SOT-23	16df	-	3a Sie
46S	MMBZ5246SPT	Z-diode	15.68..16.32V, Izt=5mA, Zzt=36Ω, 225mW	SOT-23	16dc	-	3a Chm
46S	MMCZ5246SPT	Z-diode	15.68..16.32V, Izt=5mA, Zzt=36Ω, 225mW	SOT-346	16dc	-	3a Chm
46t	BAS40-06	Si-diode	Dual, Schottky, 40V, 200mA, 200mW, Cd<5pF, <5ns	SOT-23	16df	-	3a PhM
46T	TK71546AS	LVR-IC	LDO, 4.6V±1.5%, 155mA	SOT-23	16cj	VR1	3d Tok
46W	BAS40-06	Si-diode	Dual, Schottky, 40V, 200mA, 200mW, Cd<5pF, <5ns	SOT-23	16df	-	3a PhC
47	CHDTC114GMPT	Si-npn-Digi	Sw, 50V, 100mA, 250MHz, R2=10k	SOT-723	18ta	-	3a Chm
47	ELM9847BB	LVR-IC	4.7V±2%, 200mA	SOT-23	16cg	VR1	3d Elm
470	HZM4.7NB	Z-diode	4.42..4.9V, 200mW	SC-59A	16dc	-	3a Ren
471	HZM4.7NB1	Z-diode	4.42..4.61V, 200mW	SC-59A	16dc	-	3a Ren
471	PZM4.7NB1	Z-diode	4.7V±2.5%, 300mW	SOT-346	16dc	-	3a Phi
472	HZM4.7NB2	Z-diode	4.55..4.75V, 200mW	SC-59A	16dc	-	3a Ren
472	PZM4.7NB2	Z-diode	4.7V±2.5%, 300mW	SOT-346	16dc	-	3a Phi
473	HZM4.7NB3	Z-diode	4.69..4.9V, 200mW	SC-59A	16dc	-	3a Ren



SMD code	Type	Function	Short description	Case	Pinout	Sch. St.	Mnf.
473	PZM4.7NB3	Z-diode	4.7V±2.5%, 300mW	SOT-346	16dc	-	3a Phi
47A	AAT60047A-S2	Vdet-IC	4.7V±2%, -Reset ODO	SOT-23	16vdb	VD6	3d Aat
47B	AAT60047B-S2	Vdet-IC	4.7V±2%, -Reset PPO	SOT-23	16vdb	VD7	3d Aat
47B	MMBZ5247BPT	Z-diode	16.15..17.85V, Izt=5mA, Zzt=36Ω, 225mW	SOT-23	16dc	-	3a Chm
47C	AAT60047C-S2	Vdet-IC	4.7V±1%, -Reset ODO	SOT-23	16vdb	VD6	3d Aat
47D	AAT60047D-S2	Vdet-IC	4.7V±1%, -Reset PPO	SOT-23	16vdb	VD7	3d Aat
47S	MMBZ5247SPT	Z-diode	16.66..17.34V, Izt=5mA, Zzt=36Ω, 225mW	SOT-23	16dc	-	3a Chm
47S	MMCZ5247SPT	Z-diode	16.66..17.34V, Izt=5mA, Zzt=36Ω, 225mW	SOT-346	16dc	-	3a Chm
47T	TK71547AS	LVR-IC	LDO, 4.7V±1.5%, 155mA	SOT-23	16cj	VR1	3d Tok
47V	PZM47NB	Z-diode	47V±2.5%, 300mW	SOT-346	16dc	-	3a Phi
47Z	CZ1W47	Z-diode	47V±5%, 600mW	SOT-23	16dc	-	3a Cdi
48	CHDTC124GMPT	Si-npn-Digi	Sw, 50V, 100mA, 250MHz, R2=22k	SOT-723	18ta	-	3a Chm
48	ELM9846BB	LVR-IC	4.8V±2%, 200mA	SOT-23	16cg	VR1	3d Elm
489	FMMT489	Si-npn	Dr/Out, 50V, 1A, 500mW, B=100..300, >150MHz	SOT-23	16ta	-	3a Zx
48A	AAT60048A-S2	Vdet-IC	4.8V±2%, -Reset ODO	SOT-23	16vdb	VD6	3d Aat
48B	AAT60048B-S2	Vdet-IC	4.8V±2%, -Reset PPO	SOT-23	16vdb	VD7	3d Aat
48B	MMBZ5248BPT	Z-diode	17.10..18.90V, Izt=5mA, Zzt=42Ω, 225mW	SOT-23	16dc	-	3a Chm
48C	AAT60048C-S2	Vdet-IC	4.8V±1%, -Reset ODO	SOT-23	16vdb	VD6	3d Aat
48D	AAT60048D-S2	Vdet-IC	4.8V±1%, -Reset PPO	SOT-23	16vdb	VD7	3d Aat
48S	MMBZ5248SPT	Z-diode	17.64..18.36V, Izt=5mA, Zzt=42Ω, 225mW	SOT-23	16dc	-	3a Chm
48S	MMCZ5248SPT	Z-diode	17.64..18.36V, Izt=5mA, Zzt=42Ω, 225mW	SOT-346	16dc	-	3a Chm
48T	TK71548AS	LVR-IC	LDO, 4.8V±1.5%, 155mA	SOT-23	16cj	VR1	3d Tok
49	CHDTC144GMPT	Si-npn-Digi	Sw, 50V, 100mA, 250MHz, R2=47k	SOT-723	18ta	-	3a Chm
49	ELM7619LBB	Vdet-IC	1.9V±2%, -Reset PPO, 500ms	SOT-23	16vdc	VD7	3d Elm
49	ELM9849BB	LVR-IC	4.9V±2%, 200mA	SOT-23	16cg	VR1	3d Elm
491	CMMT491	Si-npn	AF-Drv, 80V, 1A, 700mW, B=100..300, >150MHz	SOT-23	16ta	-	3a Cdi
491	FMMT491	Si-npn	AF, 80V, 1A, 500mW, B=100..300, >150MHz	SOT-23	16ta	-	3a Zx
493	CMMT493	Si-npn	AF-Drv, 120V, 1A, 700mW, B=100..300, >150MHz	SOT-23	16ta	-	3a Cdi
493	FMMT493	Si-npn	AF-Drv, 120/100V, 1A, 500mW, B=100..300, >150MHz	SOT-23	16ta	-	3a Zx
494	FMMT494	Si-npn	Vid, 140V, 1A, 500mW, B=100..300, >100MHz	SOT-23	16ta	-	3a Zx
495	CMMT495	Si-npn	AF-Drv, 170V, 1A, 700mW, B=100..300, >100MHz	SOT-23	16ta	-	3a Cdi
495	FMMT495	Si-npn	Vid, 170V, 1A, 500mW, B=100..300, >100MHz	SOT-23	16ta	-	3a Zx
497	FMMT497	Si-npn	Sw, Vid, 300/300V, 500mA, 500mW, B=80..300, >75MHz	SOT-23	16ta	-	3a Zx
49A	AAT60049A-S2	Vdet-IC	4.9V±2%, -Reset ODO	SOT-23	16vdb	VD6	3d Aat
49B	AAT60049B-S2	Vdet-IC	4.9V±2%, -Reset PPO	SOT-23	16vdb	VD7	3d Aat
49B	MMBZ5249BPT	Z-diode	18.05..19.95V, Izt=5mA, Zzt=42Ω, 225mW	SOT-23	16dc	-	3a Chm
49C	AAT60049C-S2	Vdet-IC	4.9V±1%, -Reset ODO	SOT-23	16vdb	VD6	3d Aat
49D	AAT60049D-S2	Vdet-IC	4.9V±1%, -Reset PPO	SOT-23	16vdb	VD7	3d Aat
49S	MMBZ5249SPT	Z-diode	18.62..19.38V, Izt=5mA, Zzt=42Ω, 225mW	SOT-23	16dc	-	3a Chm
49S	MMCZ5249SPT	Z-diode	18.62..19.38V, Izt=5mA, Zzt=42Ω, 225mW	SOT-346	16dc	-	3a Chm
49T	TK71549AS	LVR-IC	LDO, 4.9V±1.5%, 155mA	SOT-23	16cj	VR1	3d Tok
4A	BC859A	Si-pnp	GP, 30V, 100mA, 310mW, B=110..220, >150MHz	SOT-23	16ta	-	3a Cdi
4A	FMMV109	C-diode	Tuning, 30V, 26..32pF, Q>250	SOT-23	16dc	-	3a Zx
4A0	TC55RP402ECB	LVR-IC	LDO, 4.0V±2%, 250mA	SOT-23	16cq	VR1	3d Mcc
4A0	XC62FP4002M	LVR-IC	4.0V±2%, 250mA	SOT-23	16cg	VR1	3d Tor
4A3	PZM4.3NB2A	Z-diode	Dual, 4.3V±2.5%, 300mW	SOT-346	16df	-	3a Phi
4A5	TC594002ECB	LVR-IC	LDO, -4.0V±2%, 200mA	SOT-23	16cj	VR2	3d Mcc
4A5	XC62KN402M	LVR-IC	LDO, -4V±2%, 100mA, 150mW	SOT-23	16cj	VR2	3d Tor
4A7	PZM4.7NB2A	Z-diode	Dual, 4.7V±2.5%, 300mW	SOT-346	16df	-	3a Phi
4AC2	81C40-P-AE3-2	Vdet-IC	4.0V±2%, -Reset PPO	SOT-23	16vdy	VD7	3a Utc
4AC2G	81C40G-P-AE3-2	Vdet-IC	4.0V±2%, -Reset PPO, halogen free	SOT-23	16vdy	VD7	3a Utc
4AC2L	81C40L-P-AE3-2	Vdet-IC	4.0V±2%, -Reset PPO, lead free	SOT-23	16vdy	VD7	3a Utc
4AC3	81C40-P-AE3-3	Vdet-IC	4.0V±2%, -Reset PPO	SOT-23	16vdb	VD7	3a Utc
4AC3G	81C40G-P-AE3-3	Vdet-IC	4.0V±2%, -Reset PPO, halogen free	SOT-23	16vdb	VD7	3a Utc
4AC3L	81C40L-P-AE3-3	Vdet-IC	4.0V±2%, -Reset PPO, lead free	SOT-23	16vdb	VD7	3a Utc
4AC5	81C40-P-AE3-5	Vdet-IC	4.0V±2%, -Reset PPO	SOT-23	16vdc	VD7	3a Utc
4AC5G	81C40G-P-AE3-5	Vdet-IC	4.0V±2%, -Reset PPO, halogen free	SOT-23	16vdc	VD7	3a Utc
4AC5L	81C40L-P-AE3-5	Vdet-IC	4.0V±2%, -Reset PPO, lead free	SOT-23	16vdc	VD7	3a Utc
4AN2	81N40-P-AE3-2	Vdet-IC	4.0V±2%, -Reset ODO	SOT-23	16vdy	VD6	3a Utc
4AN2G	81N40G-P-AE3-2	Vdet-IC	4.0V±2%, -Reset ODO, halogen free	SOT-23	16vdy	VD6	3a Utc
4AN2L	81N40L-P-AE3-2	Vdet-IC	4.0V±2%, -Reset ODO, lead free	SOT-23	16vdy	VD6	3a Utc
4AN3	81N40-P-AE3-3	Vdet-IC	4.0V±2%, -Reset ODO	SOT-23	16vdb	VD6	3a Utc
4AN3G	81N40G-P-AE3-3	Vdet-IC	4.0V±2%, -Reset ODO, halogen free	SOT-23	16vdb	VD6	3a Utc
4AN3L	81N40L-P-AE3-3	Vdet-IC	4.0V±2%, -Reset ODO, lead free	SOT-23	16vdb	VD6	3a Utc
4AN5	81N40-P-AE3-5	Vdet-IC	4.0V±2%, -Reset ODO	SOT-23	16vdc	VD6	3a Utc
4AN5G	81N40G-P-AE3-5	Vdet-IC	4.0V±2%, -Reset ODO, halogen free	SOT-23	16vdc	VD6	3a Utc
4AN5L	81N40L-P-AE3-5	Vdet-IC	4.0V±2%, -Reset ODO, lead free	SOT-23	16vdc	VD6	3a Utc
4Ap	BC859A	Si-pnp	GP, 30V, 100mA, 250mW, B=125..250, >100MHz	SOT-23	16ta	-	3a PhH
4AR	BC859AR	Si-pnp	GP, 30V, 100mA, 200mW, B=250, >150MHz	SOT-23	16te	-	3a Phi
4As	BC859A	Si-pnp	GP, 30V, 100mA, 330mW, B=125..250, 250MHz	SOT-23	16ta	-	3a Sie



SMD code	Type	Function	Short description	Case	Pinout	Sch.	St.	Mnf.
4As	BC859AW	Si-pnp	GP, 30V, 100mA, 310mW, B=110..220, >150MHz	SOT-23	16ta	-	3a	Sie
4At	BC859AW	Si-pnp	GP, 30V, 100mA, 310mW, B=110..220, >150MHz	SOT-23	16ta	-	3a	Phi
4AW	BC859A	Si-pnp	GP, 30V, 100mA, 250mW, B=125..250, >100MHz	SOT-23	16ta	-	3a	PhC
4B	2SC4238	Si-npn	VHF, 30V, 50mA, 200mW, 1.3GHz, B=100..350	SOT-323	16ta	-	3a	Pan
4B	2SC4670	Si-npn	UHF, 30V, 50mA, 150mW, B=100..350, 1.3GHz	SOT-323	16ta	-	3a	Pan
4B	BC859B	Si-pnp	GP, 30V, 100mA, 225mW, B=220..475, 300MHz	SOT-323	16ta	-	3a	Ons
4B	R3131N24EC	Vdet-IC	2.4V, +Reset ODO, 240ms	SOT-23	16vdc	VD6	3b	Ric
4B-	BC859BW	Si-pnp	GP, 30V, 100mA, 330mW, B=220..475, >300MHz	SOT-23	16ta	-	3a	Phi
4B0	TC55RP412ECB	LVR-IC	LDO, 4.1V±2%, 250mA	SOT-23	16cq	VR1	3d	Mcc
4B0	XC62FP4102M	LVR-IC	4.1V±2%, 250mA	SOT-23	16cg	VR1	3d	Tor
4B5	TC594102ECB	LVR-IC	LDO, -4.1V±2%, 200mA	SOT-23	16cj	VR2	3d	Mcc
4B5	XC62KN412M	LVR-IC	LDO, -4.1V±2%, 100mA, 150mW	SOT-23	16cj	VR2	3d	Tor
4BC2	81C41-P-AE3-2	Vdet-IC	4.1V±2%, -Reset PPO	SOT-23	16vdy	VD7	3a	Utc
4BC2G	81C41G-P-AE3-2	Vdet-IC	4.1V±2%, -Reset PPO, halogen free	SOT-23	16vdy	VD7	3a	Utc
4BC2L	81C41L-P-AE3-2	Vdet-IC	4.1V±2%, -Reset PPO, lead free	SOT-23	16vdy	VD7	3a	Utc
4BC3	81C41-P-AE3-3	Vdet-IC	4.1V±2%, -Reset PPO	SOT-23	16vdb	VD7	3a	Utc
4BC3G	81C41G-P-AE3-3	Vdet-IC	4.1V±2%, -Reset PPO, halogen free	SOT-23	16vdb	VD7	3a	Utc
4BC3L	81C41L-P-AE3-3	Vdet-IC	4.1V±2%, -Reset PPO, lead free	SOT-23	16vdb	VD7	3a	Utc
4BC5	81C41-P-AE3-5	Vdet-IC	4.1V±2%, -Reset PPO	SOT-23	16vdc	VD7	3a	Utc
4BC5G	81C41G-P-AE3-5	Vdet-IC	4.1V±2%, -Reset PPO, halogen free	SOT-23	16vdc	VD7	3a	Utc
4BC5L	81C41L-P-AE3-5	Vdet-IC	4.1V±2%, -Reset PPO, lead free	SOT-23	16vdc	VD7	3a	Utc
4BN2	81N41-P-AE3-2	Vdet-IC	4.1V±2%, -Reset ODO	SOT-23	16vdy	VD6	3a	Utc
4BN2G	81N41G-P-AE3-2	Vdet-IC	4.1V±2%, -Reset ODO, halogen free	SOT-23	16vdy	VD6	3a	Utc
4BN2L	81N41L-P-AE3-2	Vdet-IC	4.1V±2%, -Reset ODO, lead free	SOT-23	16vdy	VD6	3a	Utc
4BN3	81N41-P-AE3-3	Vdet-IC	4.1V±2%, -Reset ODO	SOT-23	16vdb	VD6	3a	Utc
4BN3G	81N41G-P-AE3-3	Vdet-IC	4.1V±2%, -Reset ODO, halogen free	SOT-23	16vdb	VD6	3a	Utc
4BN3L	81N41L-P-AE3-3	Vdet-IC	4.1V±2%, -Reset ODO, lead free	SOT-23	16vdb	VD6	3a	Utc
4BN5	81N41-P-AE3-5	Vdet-IC	4.1V±2%, -Reset ODO	SOT-23	16vdc	VD6	3a	Utc
4BN5G	81N41G-P-AE3-5	Vdet-IC	4.1V±2%, -Reset ODO, halogen free	SOT-23	16vdc	VD6	3a	Utc
4BN5L	81N41L-P-AE3-5	Vdet-IC	4.1V±2%, -Reset ODO, lead free	SOT-23	16vdc	VD6	3a	Utc
4Bp	BC859B	Si-pnp	GP, 30V, 100mA, 250mW, B=220..475, >100MHz	SOT-23	16ta	-	3a	PHH
4BR	BC859BR	Si-pnp	GP, 30V, 100mA, 200mW, B=475, >150MHz	SOT-23	16te	-	3a	Phi
4Bs	BC859B	Si-pnp	GP, 30V, 100mA, 330mW, B=220..475, 250MHz	SOT-23	16ta	-	3a	Sie
4Bs	BC859BW	Si-pnp	GP, 30V, 100mA, 330mW, B=220..475, >300MHz	SOT-323	16ta	-	3a	Sie
4Bt	BC859B	Si-pnp	GP, 30V, 100mA, 250mW, B=220..475, >150MHz	SOT-23	16ta	-	3a	Phi
4Bt	BC859BW	Si-pnp	GP, 30V, 100mA, 330mW, B=220..475, >300MHz	SOT-323	16ta	-	3a	Phi
4BW	BC859B	Si-pnp	GP, 30V, 100mA, 250mW, B=220..475, >100MHz	SOT-23	16ta	-	3a	PhC
4C	2SC4239	Si-npn	UHF/AF, 15V, 50mA, 2GHz	SOT-323	16ta	-	3a	Pan
4C	BC859C	Si-pnp	GP, 30V, 100mA, 330mW, B=420..800, >250MHz	SOT-23	16ta	-	3a	Ons
4C	FMMV3102	C-diode	Tuning, 30V, 20..25pF, Q>300	SOT-23	16dc	-	3a	Zx
4C	R3131N34EC	Vdet-IC	3.4V, +Reset ODO, 240ms	SOT-23	16vdc	VD6	3b	Ric
4C	UNRF1A9	Si-pnp-Digi	Sw, 50V, 80mA, 100mW, 80MHz, R1/R2=1k/10k	ML3	22ta	-	2b	Pan
4C-	BC859CW	Si-pnp	GP, 30V, 100mA, 330mW, B=420..800, 250MHz	SOT-23	16ta	-	3a	Phi
4C0	TC55RP422ECB	LVR-IC	LDO, 4.2V±2%, 250mA	SOT-23	16cq	VR1	3d	Mcc
4C0	XC62FP4202M	LVR-IC	4.2V±2%, 250mA	SOT-23	16cg	VR1	3d	Tor
4C5	TC594202ECB	LVR-IC	LDO, -4.2V±2%, 200mA	SOT-23	16cj	VR2	3d	Mcc
4C5	XC62KN422M	LVR-IC	LDO, -4.2V±2%, 100mA, 150mW	SOT-23	16cj	VR2	3d	Tor
4CC2	81C42-P-AE3-2	Vdet-IC	4.2V±2%, -Reset PPO	SOT-23	16vdy	VD7	3a	Utc
4CC2G	81C42G-P-AE3-2	Vdet-IC	4.2V±2%, -Reset PPO, halogen free	SOT-23	16vdy	VD7	3a	Utc
4CC2L	81C42L-P-AE3-2	Vdet-IC	4.2V±2%, -Reset PPO, lead free	SOT-23	16vdy	VD7	3a	Utc
4CC3	81C42-P-AE3-3	Vdet-IC	4.2V±2%, -Reset PPO	SOT-23	16vdb	VD7	3a	Utc
4CC3G	81C42G-P-AE3-3	Vdet-IC	4.2V±2%, -Reset PPO, halogen free	SOT-23	16vdb	VD7	3a	Utc
4CC3L	81C42L-P-AE3-3	Vdet-IC	4.2V±2%, -Reset PPO, lead free	SOT-23	16vdb	VD7	3a	Utc
4CC5	81C42-P-AE3-5	Vdet-IC	4.2V±2%, -Reset PPO	SOT-23	16vdc	VD7	3a	Utc
4CC5G	81C42G-P-AE3-5	Vdet-IC	4.2V±2%, -Reset PPO, halogen free	SOT-23	16vdc	VD7	3a	Utc
4CC5L	81C42L-P-AE3-5	Vdet-IC	4.2V±2%, -Reset PPO, lead free	SOT-23	16vdc	VD7	3a	Utc
4CN2	81N42-P-AE3-2	Vdet-IC	4.2V±2%, -Reset ODO	SOT-23	16vdy	VD6	3a	Utc
4CN2G	81N42G-P-AE3-2	Vdet-IC	4.2V±2%, -Reset ODO, halogen free	SOT-23	16vdy	VD6	3a	Utc
4CN2L	81N42L-P-AE3-2	Vdet-IC	4.2V±2%, -Reset ODO, lead free	SOT-23	16vdy	VD6	3a	Utc
4CN3	81N42-P-AE3-3	Vdet-IC	4.2V±2%, -Reset ODO	SOT-23	16vdb	VD6	3a	Utc
4CN3G	81N42G-P-AE3-3	Vdet-IC	4.2V±2%, -Reset ODO, halogen free	SOT-23	16vdb	VD6	3a	Utc
4CN3L	81N42L-P-AE3-3	Vdet-IC	4.2V±2%, -Reset ODO, lead free	SOT-23	16vdb	VD6	3a	Utc
4CN5	81N42-P-AE3-5	Vdet-IC	4.2V±2%, -Reset ODO	SOT-23	16vdc	VD6	3a	Utc
4CN5G	81N42G-P-AE3-5	Vdet-IC	4.2V±2%, -Reset ODO, halogen free	SOT-23	16vdc	VD6	3a	Utc
4CN5L	81N42L-P-AE3-5	Vdet-IC	4.2V±2%, -Reset ODO, lead free	SOT-23	16vdc	VD6	3a	Utc
4Cp	BC859C	Si-pnp	GP, 30V, 100mA, 250mW, B=420..800, >100MHz	SOT-23	16ta	-	3a	PHH
4Cr	BC859CR	Si-pnp	GP, 30V, 100mA, 200mW, B=800, >150MHz	SOT-23	16te	-	3a	Phi
4Cs	BC859C	Si-pnp	GP, 30V, 100mA, 330mW, B=420..800, 250MHz	SOT-23	16ta	-	3a	Sie
4Cs	BC859CW	Si-pnp	GP, 30V, 100mA, 330mW, B=420..800, 250MHz	SOT-323	16ta	-	3a	Sie
4Ct	BC859C	Si-pnp	GP, 30V, 100mA, 250mW, B=420..800, 250MHz	SOT-23	16ta	-	3a	Phi



SMD code	Type	Function	Short description	Case	Pinout	Sch.	St.	Mnf.
4Ct	BC859CW	Si-pnp	GP, 30V, 100mA, 330mW, B=420..800, 250MHz	SOT-323	16ta	-	3a	Phi
4CW	BC859C	Si-pnp	GP, 30V, 100mA, 250mW, B=420..800, >100MHz	SOT-23	16ta	-	3a	PhC
4D	2SJ146	p-MOSFET	Sw, 50V, 100mA, 150mW, <150Ω(10mA), <40/60ns	SC-59	16fh	-	3a	Pan
4D	HD3A	Si-diode	Fast Sw, 75V, 100mA, Cd<4.0pF, <6ns	SOT-23	16dc	-	3a	Zx
4D	R3131N44EC	Vdet-IC	4.4V, +Reset ODO, 240ms	SOT-23	16vdc	VD6	3b	Ric
4D	UNRF1AA	Si-pnp-Digi	Sw, 50V, 80mA, 100mW, 80MHz, R1/R2=100k/100k	ML3	22ta	-	2b	Pan
4D-	BC859W	Si-pnp	GP, 30V, 100mA, 330mW, B=420..800, 250MHz	SOT-23	16ta	-	3a	Phi
4D0	TC55RP432ECB	LVR-IC	LDO, 4.3V±2%, 250mA	SOT-23	16cq	VR1	3d	Mcc
4D0	XC62FP4302M	LVR-IC	4.3V±2%, 250mA	SOT-23	16cg	VR1	3d	Tor
4D5	TC594302ECB	LVR-IC	LDO, -4.3V±2%, 200mA	SOT-23	16cj	VR2	3d	Mcc
4D5	XC62KN432M	LVR-IC	LDO, -4.3V±2%, 100mA, 150mW	SOT-23	16cj	VR2	3d	Tor
4DC2	81C43-P-AE3-2	Vdet-IC	4.3V±2%, -Reset PPO	SOT-23	16vdy	VD7	3a	Utc
4DC2G	81C43G-P-AE3-2	Vdet-IC	4.3V±2%, -Reset PPO, halogen free	SOT-23	16vdy	VD7	3a	Utc
4DC2L	81C43L-P-AE3-2	Vdet-IC	4.3V±2%, -Reset PPO, lead free	SOT-23	16vdy	VD7	3a	Utc
4DC3	81C43-P-AE3-3	Vdet-IC	4.3V±2%, -Reset PPO	SOT-23	16vdb	VD7	3a	Utc
4DC3G	81C43G-P-AE3-3	Vdet-IC	4.3V±2%, -Reset PPO, halogen free	SOT-23	16vdb	VD7	3a	Utc
4DC3L	81C43L-P-AE3-3	Vdet-IC	4.3V±2%, -Reset PPO, lead free	SOT-23	16vdb	VD7	3a	Utc
4DC5	81C43-P-AE3-5	Vdet-IC	4.3V±2%, -Reset PPO	SOT-23	16vdc	VD7	3a	Utc
4DC5G	81C43G-P-AE3-5	Vdet-IC	4.3V±2%, -Reset PPO, halogen free	SOT-23	16vdc	VD7	3a	Utc
4DC5L	81C43L-P-AE3-5	Vdet-IC	4.3V±2%, -Reset PPO, lead free	SOT-23	16vdc	VD7	3a	Utc
4DN2	81N43-P-AE3-2	Vdet-IC	4.3V±2%, -Reset ODO	SOT-23	16vdy	VD6	3a	Utc
4DN2G	81N43G-P-AE3-2	Vdet-IC	4.3V±2%, -Reset ODO, halogen free	SOT-23	16vdy	VD6	3a	Utc
4DN2L	81N43L-P-AE3-2	Vdet-IC	4.3V±2%, -Reset ODO, lead free	SOT-23	16vdy	VD6	3a	Utc
4DN3	81N43-P-AE3-3	Vdet-IC	4.3V±2%, -Reset ODO	SOT-23	16vdb	VD6	3a	Utc
4DN3G	81N43G-P-AE3-3	Vdet-IC	4.3V±2%, -Reset ODO, halogen free	SOT-23	16vdb	VD6	3a	Utc
4DN3L	81N43L-P-AE3-3	Vdet-IC	4.3V±2%, -Reset ODO, lead free	SOT-23	16vdb	VD6	3a	Utc
4DN5	81N43-P-AE3-5	Vdet-IC	4.3V±2%, -Reset ODO	SOT-23	16vdc	VD6	3a	Utc
4DN5G	81N43G-P-AE3-5	Vdet-IC	4.3V±2%, -Reset ODO, halogen free	SOT-23	16vdc	VD6	3a	Utc
4DN5L	81N43L-P-AE3-5	Vdet-IC	4.3V±2%, -Reset ODO, lead free	SOT-23	16vdc	VD6	3a	Utc
4Dp	BC859	Si-pnp	GP, 30V, 100mA, 250mW, B=125..800, >100MHz	SOT-23	16ta	-	3a	PHH
4Dt	BC859W	Si-pnp	GP, 30V, 100mA, 330mW, B=420..800, 250MHz	SOT-23	16ta	-	3a	Phi
4DW	BC859	Si-pnp	GP, 30V, 100mA, 250mW, B=125..800, >100MHz	SOT-23	16ta	-	3a	PhC
4E	BC860A	Si-pnp	GP, 50V, 100mA, 250mW, B=125..250, >100MHz	SOT-23	16ta	-	3a	Cdi
4E	FMMTA92	Si-pnp	Vid, 300/300V, 200mA, 330mW, B>25, >50MHz	SOT-23	16ta	-	3a	Zx
4E0	TC55RP442ECB	LVR-IC	LDO, 4.4V±2%, 250mA	SOT-23	16cq	VR1	3d	Mcc
4E0	XC62FP4402M	LVR-IC	4.4V±2%, 250mA	SOT-23	16cg	VR1	3d	Tor
4E5	TC594402ECB	LVR-IC	LDO, -4.4V±2%, 200mA	SOT-23	16cj	VR2	3d	Mcc
4E5	XC62KN442M	LVR-IC	LDO, -4.4V±2%, 100mA, 150mW	SOT-23	16cj	VR2	3d	Tor
4EC2	81C44-P-AE3-2	Vdet-IC	4.4V±2%, -Reset PPO	SOT-23	16vdy	VD7	3a	Utc
4EC2G	81C44G-P-AE3-2	Vdet-IC	4.4V±2%, -Reset PPO, halogen free	SOT-23	16vdy	VD7	3a	Utc
4EC2L	81C44L-P-AE3-2	Vdet-IC	4.4V±2%, -Reset PPO, lead free	SOT-23	16vdy	VD7	3a	Utc
4EC3	81C44-P-AE3-3	Vdet-IC	4.4V±2%, -Reset PPO	SOT-23	16vdb	VD7	3a	Utc
4EC3G	81C44G-P-AE3-3	Vdet-IC	4.4V±2%, -Reset PPO, halogen free	SOT-23	16vdb	VD7	3a	Utc
4EC3L	81C44L-P-AE3-3	Vdet-IC	4.4V±2%, -Reset PPO, lead free	SOT-23	16vdb	VD7	3a	Utc
4EC5	81C44-P-AE3-5	Vdet-IC	4.4V±2%, -Reset PPO	SOT-23	16vdc	VD7	3a	Utc
4EC5G	81C44G-P-AE3-5	Vdet-IC	4.4V±2%, -Reset PPO, halogen free	SOT-23	16vdc	VD7	3a	Utc
4EC5L	81C44L-P-AE3-5	Vdet-IC	4.4V±2%, -Reset PPO, lead free	SOT-23	16vdc	VD7	3a	Utc
4EN2	81N44-P-AE3-2	Vdet-IC	4.4V±2%, -Reset ODO	SOT-23	16vdy	VD6	3a	Utc
4EN2G	81N44G-P-AE3-2	Vdet-IC	4.4V±2%, -Reset ODO, halogen free	SOT-23	16vdy	VD6	3a	Utc
4EN2L	81N44L-P-AE3-2	Vdet-IC	4.4V±2%, -Reset ODO, lead free	SOT-23	16vdy	VD6	3a	Utc
4EN3	81N44-P-AE3-3	Vdet-IC	4.4V±2%, -Reset ODO	SOT-23	16vdb	VD6	3a	Utc
4EN3G	81N44G-P-AE3-3	Vdet-IC	4.4V±2%, -Reset ODO, halogen free	SOT-23	16vdb	VD6	3a	Utc
4EN3L	81N44L-P-AE3-3	Vdet-IC	4.4V±2%, -Reset ODO, lead free	SOT-23	16vdb	VD6	3a	Utc
4EN5	81N44-P-AE3-5	Vdet-IC	4.4V±2%, -Reset ODO	SOT-23	16vdc	VD6	3a	Utc
4EN5G	81N44G-P-AE3-5	Vdet-IC	4.4V±2%, -Reset ODO, halogen free	SOT-23	16vdc	VD6	3a	Utc
4EN5L	81N44L-P-AE3-5	Vdet-IC	4.4V±2%, -Reset ODO, lead free	SOT-23	16vdc	VD6	3a	Utc
4Ep	BC860A	Si-pnp	GP, 50V, 100mA, 250mW, B=125..250, >100MHz	SOT-23	16ta	-	3a	PHH
4ER	BC860AR	Si-pnp	GP, 45V, 100mA, 200mW, B=250, >150MHz	SOT-23	16te	-	3a	Phi
4Et	BC860AW	Si-pnp	GP, LN, 50V, 100mA, 250mW, B=125..250, >100MHz	SOT-323	16ta	-	3a	Phi
4EW	BC860A	Si-pnp	GP, 50V, 100mA, 250mW, B=125..250, >100MHz	SOT-23	16ta	-	3a	PhC
4EZ	FMMV105G	C-diode	Tuning, 30V, 1.8..2.8pF, Q>350	SOT-23	16dc	-	3a	Zx
4F	2SC4444	Si-npn	VHF/IF, 45V, 50mA, 500MHz	SOT-23	16ta	-	3a	Pan
4F	BC860B	Si-pnp	GP, 50V, 100mA, 330mW, B=220..475, >300MHz	SOT-23	16ta	-	3a	Zx
4F-	BC860BW	Si-pnp	GP, LN, 50V, 100mA, 250mW, B=220..475, >100MHz	SOT-323	16ta	-	3a	Phi
4F0	TC55RP452ECB	LVR-IC	LDO, 4.5V±2%, 250mA	SOT-23	16cq	VR1	3d	Mcc
4F0	XC62FP4502M	LVR-IC	4.5V±2%, 250mA	SOT-23	16cg	VR1	3d	Tor
4F5	TC594502ECB	LVR-IC	LDO, -4.5V±2%, 200mA	SOT-23	16cj	VR2	3d	Mcc
4F5	XC62KN452M	LVR-IC	LDO, -4.5V±2%, 100mA, 150mW	SOT-23	16cj	VR2	3d	Tor
4FC2	81C45-P-AE3-2	Vdet-IC	4.5V±2%, -Reset PPO	SOT-23	16vdy	VD7	3a	Utc
4FC2G	81C45G-P-AE3-2	Vdet-IC	4.5V±2%, -Reset PPO, halogen free	SOT-23	16vdy	VD7	3a	Utc



SMD code	Type	Function	Short description	Case	Pinout	Sch.	St.	Mnf.
4FC2L	81C45L-P-AE3-2	Vdet-IC	4.5V±2%, -Reset PPO, lead free	SOT-23	16vdy	VD7	3a	Utc
4FC3	81C45-P-AE3-3	Vdet-IC	4.5V±2%, -Reset PPO	SOT-23	16vdb	VD7	3a	Utc
4FC3G	81C45G-P-AE3-3	Vdet-IC	4.5V±2%, -Reset PPO, halogen free	SOT-23	16vdb	VD7	3a	Utc
4FC3L	81C45L-P-AE3-3	Vdet-IC	4.5V±2%, -Reset PPO, lead free	SOT-23	16vdb	VD7	3a	Utc
4FC5	81C45-P-AE3-5	Vdet-IC	4.5V±2%, -Reset PPO	SOT-23	16vdc	VD7	3a	Utc
4FC5G	81C45G-P-AE3-5	Vdet-IC	4.5V±2%, -Reset PPO, halogen free	SOT-23	16vdc	VD7	3a	Utc
4FC5L	81C45L-P-AE3-5	Vdet-IC	4.5V±2%, -Reset PPO, lead free	SOT-23	16vdc	VD7	3a	Utc
4FN2	81N45-P-AE3-2	Vdet-IC	4.5V±2%, -Reset ODO	SOT-23	16vdy	VD6	3a	Utc
4FN2G	81N45G-P-AE3-2	Vdet-IC	4.5V±2%, -Reset ODO, halogen free	SOT-23	16vdy	VD6	3a	Utc
4FN2L	81N45L-P-AE3-2	Vdet-IC	4.5V±2%, -Reset ODO, lead free	SOT-23	16vdy	VD6	3a	Utc
4FN3	81N45-P-AE3-3	Vdet-IC	4.5V±2%, -Reset ODO	SOT-23	16vdb	VD6	3a	Utc
4FN3G	81N45G-P-AE3-3	Vdet-IC	4.5V±2%, -Reset ODO, halogen free	SOT-23	16vdb	VD6	3a	Utc
4FN3L	81N45L-P-AE3-3	Vdet-IC	4.5V±2%, -Reset ODO, lead free	SOT-23	16vdb	VD6	3a	Utc
4FN5	81N45-P-AE3-5	Vdet-IC	4.5V±2%, -Reset ODO	SOT-23	16vdc	VD6	3a	Utc
4FN5G	81N45G-P-AE3-5	Vdet-IC	4.5V±2%, -Reset ODO, halogen free	SOT-23	16vdc	VD6	3a	Utc
4FN5L	81N45L-P-AE3-5	Vdet-IC	4.5V±2%, -Reset ODO, lead free	SOT-23	16vdc	VD6	3a	Utc
4Fp	BC860B	Si-pnp	GP, 50V, 100mA, 250mW, B=220..475, >100MHz	SOT-23	16ta	-	3a	PHH
4FR	BC860BR	Si-pnp	GP, 45V, 100mA, 200mW, B=220..475, >150MHz	SOT-23	16te	-	3a	Phi
4Fs	BC850BW	Si-npn	GP, 50V, 100mA, 250mW, B=200..450, 250MHz	SOT-323	16ta	-	3c	Inf
4Fs	BC860B	Si-pnp	GP, 50V, 100mA, 330mW, B=220..475, 250MHz	SOT-23	16ta	-	3a	Sie
4Fs	BC860BW	Si-pnp	GP, LN, 50V, 100mA, 250mW, B=220..475, >100MHz	SOT-323	16ta	-	3a	Sie
4Ft	BC860B	Si-pnp	GP, 50V, 100mA, 250mW, B=220..475, >100MHz	SOT-23	16ta	-	3a	PHM
4Ft	BC860BW	Si-pnp	GP, LN, 50V, 100mA, 250mW, B=220..475, >100MHz	SOT-323	16ta	-	3a	Phi
4FW	BC860B	Si-pnp	GP, 50V, 100mA, 250mW, B=220..475, >100MHz	SOT-23	16ta	-	3a	PhC
4G	BC860C	Si-pnp	GP, 50V, 100mA, 250mW, B=420..800, >100MHz	SOT-23	16ta	-	3a	Cdi
4G	FMMT2484	Si-npn	AF, LN, 60V, 50mA, 330mW, B=100..500, >100MHz	SOT-23	16ta	-	3a	Zx
4G	R3131N24EA	Vdet-IC	2.4V, +Reset PPO, 240ms	SOT-23	16vdc	VD7	3b	Ric
4G-	BC860CW	Si-pnp	GP, LN, 50V, 100mA, 250mW, B=420..800, >100MHz	SOT-323	16ta	-	3a	Phi
4GC2	81C46-P-AE3-2	Vdet-IC	4.6V±2%, -Reset PPO	SOT-23	16vdy	VD7	3a	Utc
4GC2G	81C46G-P-AE3-2	Vdet-IC	4.6V±2%, -Reset PPO, halogen free	SOT-23	16vdy	VD7	3a	Utc
4GC2L	81C46L-P-AE3-2	Vdet-IC	4.6V±2%, -Reset PPO, lead free	SOT-23	16vdy	VD7	3a	Utc
4GC3	81C46-P-AE3-3	Vdet-IC	4.6V±2%, -Reset PPO	SOT-23	16vdb	VD7	3a	Utc
4GC3G	81C46G-P-AE3-3	Vdet-IC	4.6V±2%, -Reset PPO, halogen free	SOT-23	16vdb	VD7	3a	Utc
4GC3L	81C46L-P-AE3-3	Vdet-IC	4.6V±2%, -Reset PPO, lead free	SOT-23	16vdb	VD7	3a	Utc
4GC5	81C46-P-AE3-5	Vdet-IC	4.6V±2%, -Reset PPO	SOT-23	16vdc	VD7	3a	Utc
4GC5G	81C46G-P-AE3-5	Vdet-IC	4.6V±2%, -Reset PPO, halogen free	SOT-23	16vdc	VD7	3a	Utc
4GC5L	81C46L-P-AE3-5	Vdet-IC	4.6V±2%, -Reset PPO, lead free	SOT-23	16vdc	VD7	3a	Utc
4GN2	81N46-P-AE3-2	Vdet-IC	4.6V±2%, -Reset ODO	SOT-23	16vdy	VD6	3a	Utc
4GN2G	81N46G-P-AE3-2	Vdet-IC	4.6V±2%, -Reset ODO, halogen free	SOT-23	16vdy	VD6	3a	Utc
4GN2L	81N46L-P-AE3-2	Vdet-IC	4.6V±2%, -Reset ODO, lead free	SOT-23	16vdy	VD6	3a	Utc
4GN3	81N46-P-AE3-3	Vdet-IC	4.6V±2%, -Reset ODO	SOT-23	16vdb	VD6	3a	Utc
4GN3G	81N46G-P-AE3-3	Vdet-IC	4.6V±2%, -Reset ODO, halogen free	SOT-23	16vdb	VD6	3a	Utc
4GN3L	81N46L-P-AE3-3	Vdet-IC	4.6V±2%, -Reset ODO, lead free	SOT-23	16vdb	VD6	3a	Utc
4GN5	81N46-P-AE3-5	Vdet-IC	4.6V±2%, -Reset ODO	SOT-23	16vdc	VD6	3a	Utc
4GN5G	81N46G-P-AE3-5	Vdet-IC	4.6V±2%, -Reset ODO, halogen free	SOT-23	16vdc	VD6	3a	Utc
4GN5L	81N46L-P-AE3-5	Vdet-IC	4.6V±2%, -Reset ODO, lead free	SOT-23	16vdc	VD6	3a	Utc
4Gp	BC860C	Si-pnp	GP, 50V, 100mA, 250mW, B=420..800, >100MHz	SOT-23	16ta	-	3a	PHH
4GR	BC860CR	Si-pnp	GP, 45V, 100mA, 200mW, B=420..800, >150MHz	SOT-23	16te	-	3a	Phi
4Gs	BC850CW	Si-npn	GP, 50V, 100mA, 250mW, B=420..800, 250MHz	SOT-323	16ta	-	3c	Inf
4Gs	BC860C	Si-pnp	GP, 50V, 100mA, 330mW, B=420..800, >300MHz	SOT-23	16ta	-	3a	Sie
4Gs	BC860CW	Si-pnp	GP, LN, 50V, 100mA, 250mW, B=420..800, >100MHz	SOT-323	16ta	-	3a	Sie
4Gt	BC860C	Si-pnp	GP, 50V, 100mA, 250mW, B=420..800, >100MHz	SOT-23	16ta	-	3a	PHM
4Gt	BC860CW	Si-pnp	GP, LN, 50V, 100mA, 250mW, B=420..800, >100MHz	SOT-323	16ta	-	3a	Phi
4GW	BC860C	Si-pnp	GP, 50V, 100mA, 250mW, B=420..800, >100MHz	SOT-23	16ta	-	3a	PhC
4GZ	BC860C	Si-pnp	GP, 50V, 100mA, 330mW, B=420..800, >300MHz	SOT-23	16ta	-	3a	Zx
4H	BC860	Si-pnp	GP, 50V, 100mA, 250mW, B=125..800, >100MHz	SOT-23	16ta	-	3a	Cdi
4H	R3131N34EA	Vdet-IC	3.4V, +Reset PPO, 240ms	SOT-23	16vdc	VD7	3b	Ric
4H-	BC860W	Si-pnp	GP, LN, 50V, 100mA, 250mW, B=125..800, >100MHz	SOT-323	16ta	-	3a	PHM
4H0	TC55RP462ECB	LVR-IC	LDO, 4.6V±2%, 250mA	SOT-23	16cq	VR1	3d	Mcc
4H0	XC62FP4602M	LVR-IC	4.6V±2%, 250mA	SOT-23	16cg	VR1	3d	Tor
4H5	TC594602ECB	LVR-IC	LDO, -4.6V±2%, 200mA	SOT-23	16cj	VR2	3d	Mcc
4H5	XC62KN462M	LVR-IC	LDO, -4.6V±2%, 100mA, 150mW	SOT-23	16cj	VR2	3d	Tor
4HC2	81C47-P-AE3-2	Vdet-IC	4.7V±2%, -Reset PPO	SOT-23	16vdy	VD7	3a	Utc
4HC2G	81C47G-P-AE3-2	Vdet-IC	4.7V±2%, -Reset PPO, halogen free	SOT-23	16vdy	VD7	3a	Utc
4HC2L	81C47L-P-AE3-2	Vdet-IC	4.7V±2%, -Reset PPO, lead free	SOT-23	16vdy	VD7	3a	Utc
4HC3	81C47-P-AE3-3	Vdet-IC	4.7V±2%, -Reset PPO	SOT-23	16vdb	VD7	3a	Utc
4HC3G	81C47G-P-AE3-3	Vdet-IC	4.7V±2%, -Reset PPO, halogen free	SOT-23	16vdb	VD7	3a	Utc
4HC3L	81C47L-P-AE3-3	Vdet-IC	4.7V±2%, -Reset PPO, lead free	SOT-23	16vdb	VD7	3a	Utc
4HC5	81C47-P-AE3-5	Vdet-IC	4.7V±2%, -Reset PPO	SOT-23	16vdc	VD7	3a	Utc
4HC5G	81C47G-P-AE3-5	Vdet-IC	4.7V±2%, -Reset PPO, halogen free	SOT-23	16vdc	VD7	3a	Utc



SMD code	Type	Function	Short description	Case	Pinout	Sch. St.	Mnf.
4HC5L	81C47L-P-AE3-5	Vdet-IC	4.7V±2%, -Reset PPO, lead free	SOT-23	16vdc	VD7	3a Utc
4HN2	81N47-P-AE3-2	Vdet-IC	4.7V±2%, -Reset ODO	SOT-23	16vdy	VD6	3a Utc
4HN2G	81N47G-P-AE3-2	Vdet-IC	4.7V±2%, -Reset ODO, halogen free	SOT-23	16vdy	VD6	3a Utc
4HN2L	81N47L-P-AE3-2	Vdet-IC	4.7V±2%, -Reset ODO, lead free	SOT-23	16vdy	VD6	3a Utc
4HN3	81N47-P-AE3-3	Vdet-IC	4.7V±2%, -Reset ODO	SOT-23	16vdb	VD6	3a Utc
4HN3G	81N47G-P-AE3-3	Vdet-IC	4.7V±2%, -Reset ODO, halogen free	SOT-23	16vdb	VD6	3a Utc
4HN3L	81N47L-P-AE3-3	Vdet-IC	4.7V±2%, -Reset ODO, lead free	SOT-23	16vdb	VD6	3a Utc
4HN5	81N47-P-AE3-5	Vdet-IC	4.7V±2%, -Reset ODO	SOT-23	16vdc	VD6	3a Utc
4HN5G	81N47G-P-AE3-5	Vdet-IC	4.7V±2%, -Reset ODO, halogen free	SOT-23	16vdc	VD6	3a Utc
4HN5L	81N47L-P-AE3-5	Vdet-IC	4.7V±2%, -Reset ODO, lead free	SOT-23	16vdc	VD6	3a Utc
4Hp	BC860	Si-pnp	GP, 50V, 100mA, 250mW, B=125..800, >100MHz	SOT-23	16ta	-	3a PHH
4Ht	BC860W	Si-pnp	GP, LN, 50V, 100mA, 250mW, B=125..800, >100MHz	SOT-323	16ta	-	3a PHH
4HW	BC860	Si-pnp	GP, 50V, 100mA, 250mW, B=125..800, >100MHz	SOT-23	16ta	-	3a PhC
4HW	BC860W	Si-pnp	GP, LN, 50V, 100mA, 250mW, B=125..800, >100MHz	SOT-323	16ta	-	3a PhC
4J	FMMT38A	Si-npn	GP, 80V, 300mA, 330mW, B>500	SOT-23	16ta	-	3a Zx
4J	R3131N44EA	Vdet-IC	4.4V, +Reset PPO, 240ms	SOT-23	16vdc	VD7	3b Ric
4JC2	81C48-P-AE3-2	Vdet-IC	4.8V±2%, -Reset PPO	SOT-23	16vdy	VD7	3a Utc
4JC2G	81C48G-P-AE3-2	Vdet-IC	4.8V±2%, -Reset PPO, halogen free	SOT-23	16vdy	VD7	3a Utc
4JC2L	81C48L-P-AE3-2	Vdet-IC	4.8V±2%, -Reset PPO, lead free	SOT-23	16vdy	VD7	3a Utc
4JC3	81C48-P-AE3-3	Vdet-IC	4.8V±2%, -Reset PPO	SOT-23	16vdb	VD7	3a Utc
4JC3G	81C48G-P-AE3-3	Vdet-IC	4.8V±2%, -Reset PPO, halogen free	SOT-23	16vdb	VD7	3a Utc
4JC3L	81C48L-P-AE3-3	Vdet-IC	4.8V±2%, -Reset PPO, lead free	SOT-23	16vdb	VD7	3a Utc
4JC5	81C48-P-AE3-5	Vdet-IC	4.8V±2%, -Reset PPO	SOT-23	16vdc	VD7	3a Utc
4JC5G	81C48G-P-AE3-5	Vdet-IC	4.8V±2%, -Reset PPO, halogen free	SOT-23	16vdc	VD7	3a Utc
4JC5L	81C48L-P-AE3-5	Vdet-IC	4.8V±2%, -Reset PPO, lead free	SOT-23	16vdc	VD7	3a Utc
4JN2	81N48-P-AE3-2	Vdet-IC	4.8V±2%, -Reset ODO	SOT-23	16vdy	VD6	3a Utc
4JN2G	81N48G-P-AE3-2	Vdet-IC	4.8V±2%, -Reset ODO, halogen free	SOT-23	16vdy	VD6	3a Utc
4JN2L	81N48L-P-AE3-2	Vdet-IC	4.8V±2%, -Reset ODO, lead free	SOT-23	16vdy	VD6	3a Utc
4JN3	81N48-P-AE3-3	Vdet-IC	4.8V±2%, -Reset ODO	SOT-23	16vdb	VD6	3a Utc
4JN3G	81N48G-P-AE3-3	Vdet-IC	4.8V±2%, -Reset ODO, halogen free	SOT-23	16vdb	VD6	3a Utc
4JN3L	81N48L-P-AE3-3	Vdet-IC	4.8V±2%, -Reset ODO, lead free	SOT-23	16vdb	VD6	3a Utc
4JN5	81N48-P-AE3-5	Vdet-IC	4.8V±2%, -Reset ODO	SOT-23	16vdc	VD6	3a Utc
4JN5G	81N48G-P-AE3-5	Vdet-IC	4.8V±2%, -Reset ODO, halogen free	SOT-23	16vdc	VD6	3a Utc
4JN5L	81N48L-P-AE3-5	Vdet-IC	4.8V±2%, -Reset ODO, lead free	SOT-23	16vdc	VD6	3a Utc
4K	UNRF1AF	Si-pnp-Digi	Sw, 50V, 80mA, 100mW, 80MHz, R1/R2=4.7k/10k	ML3	22ta	-	2b Pan
4K0	TC55RP472ECB	LVR-IC	LDO, 4.7V±2%, 250mA	SOT-23	16cq	VR1	3d Mcc
4K0	XC62FP4702M	LVR-IC	4.7V±2%, 250mA	SOT-23	16cg	VR1	3d Tor
4K5	TC594702ECB	LVR-IC	LDO, -4.7V±2%, 200mA	SOT-23	16cj	VR2	3d Mcc
4K5	XC62KN472M	LVR-IC	LDO, -4.7V±2%, 100mA, 150mW	SOT-23	16cj	VR2	3d Tor
4KC2	81C49-P-AE3-2	Vdet-IC	4.9V±2%, -Reset PPO	SOT-23	16vdy	VD7	3a Utc
4KC2G	81C49G-P-AE3-2	Vdet-IC	4.9V±2%, -Reset PPO, halogen free	SOT-23	16vdy	VD7	3a Utc
4KC2L	81C49L-P-AE3-2	Vdet-IC	4.9V±2%, -Reset PPO, lead free	SOT-23	16vdy	VD7	3a Utc
4KC3	81C49-P-AE3-3	Vdet-IC	4.9V±2%, -Reset PPO	SOT-23	16vdb	VD7	3a Utc
4KC3G	81C49G-P-AE3-3	Vdet-IC	4.9V±2%, -Reset PPO, halogen free	SOT-23	16vdb	VD7	3a Utc
4KC3L	81C49L-P-AE3-3	Vdet-IC	4.9V±2%, -Reset PPO, lead free	SOT-23	16vdb	VD7	3a Utc
4KC5	81C49-P-AE3-5	Vdet-IC	4.9V±2%, -Reset PPO	SOT-23	16vdc	VD7	3a Utc
4KC5G	81C49G-P-AE3-5	Vdet-IC	4.9V±2%, -Reset PPO, halogen free	SOT-23	16vdc	VD7	3a Utc
4KC5L	81C49L-P-AE3-5	Vdet-IC	4.9V±2%, -Reset PPO, lead free	SOT-23	16vdc	VD7	3a Utc
4KN2	81N49-P-AE3-2	Vdet-IC	4.9V±2%, -Reset ODO	SOT-23	16vdy	VD6	3a Utc
4KN2G	81N49G-P-AE3-2	Vdet-IC	4.9V±2%, -Reset ODO, halogen free	SOT-23	16vdy	VD6	3a Utc
4KN2L	81N49L-P-AE3-2	Vdet-IC	4.9V±2%, -Reset ODO, lead free	SOT-23	16vdy	VD6	3a Utc
4KN3	81N49-P-AE3-3	Vdet-IC	4.9V±2%, -Reset ODO	SOT-23	16vdb	VD6	3a Utc
4KN3G	81N49G-P-AE3-3	Vdet-IC	4.9V±2%, -Reset ODO, halogen free	SOT-23	16vdb	VD6	3a Utc
4KN3L	81N49L-P-AE3-3	Vdet-IC	4.9V±2%, -Reset ODO, lead free	SOT-23	16vdb	VD6	3a Utc
4KN5	81N49-P-AE3-5	Vdet-IC	4.9V±2%, -Reset ODO	SOT-23	16vdc	VD6	3a Utc
4KN5G	81N49G-P-AE3-5	Vdet-IC	4.9V±2%, -Reset ODO, halogen free	SOT-23	16vdc	VD6	3a Utc
4KN5L	81N49L-P-AE3-5	Vdet-IC	4.9V±2%, -Reset ODO, lead free	SOT-23	16vdc	VD6	3a Utc
4Kp	BAP64-04	PIN-diode	Dual, RF, 175V, 100mA, 250mW, 0.35pF, 3.8Q(10mA/100MHz)	SOT-23	16dl	-	3a Phi
4L	R3131N30AC8	Vdet-IC	3V, +Reset ODO, 50ms	SOT-23	16vdc	VD6	3b Ric
4L	UNRF1AH	Si-pnp-Digi	Sw, 50V, 80mA, 100mW, 80MHz, R1/R2=2.2k/10k	ML3	22ta	-	2b Pan
4L0	TC55RP482ECB	LVR-IC	LDO, 4.8V±2%, 250mA	SOT-23	16cq	VR1	3d Mcc
4L0	XC62FP4802M	LVR-IC	4.8V±2%, 250mA	SOT-23	16cg	VR1	3d Tor
4L5	TC594802ECB	LVR-IC	LDO, -4.8V±2%, 200mA	SOT-23	16cj	VR2	3d Mcc
4L5	XC62KN482M	LVR-IC	LDO, -4.8V±2%, 100mA, 150mW	SOT-23	16cj	VR2	3d Tor
4LN	ELM7519CEB	Vdet-IC	1.9V±2%, +Reset PPO	SC-70	16vdb	VD7	3d Elm
4LN	ELM7519NEB	Vdet-IC	1.9V±2%, +Reset ODO	SC-70	16vdb	VD6	3d Elm
4L0	2SK1103-O	n-FET	Sw, 65V, 20mA, 150mW, Idss=0.2..1mA, Up<3.5V	SC-59	16fa	-	3a Pan
4LP	2SK1103-P	n-FET	Sw, 65V, 20mA, 150mW, Idss=0.6..1.5mA, Up<3.5V	SC-59	16fa	-	3a Pan
4Lp	BAP50-04	PIN-diode	Dual, RF, 50V, 50mA, 500mW, 0.3pF, 3Q(10mA/100MHz)	SOT-23	16dl	-	3a PHH
4LQ	2SK1103-Q	n-FET	Sw, 65V, 20mA, 150mW, Idss=1..3mA, Up<3.5V	SC-59	16fa	-	3a Pan



Note: ELM75xxCBB series LN- lot number L=0...9 N=A to Z(I, O, X excepted); ELM75xxNBB series LN- lot number L=A to Z(I, O, X excepted) N=0...9

SMD code	Type	Function	Short description	Case	Pinout	Sch.	St.	Mnf.
4LR	2SK1103-R	n-FET	Sw, 65V, 20mA, 150mW, Idss=2.5..6mA, Up<3.5V	SC-59	16fa	-	3a	Pan
4Ll	BAP50-04	PIN-diode	Dual, RF, 50V, 50mA, 500mW, 0.3pF, 3Q(10mA/100MHz)	SOT-23	16dl	-	3a	PhM
4LW	BAP50-04	PIN-diode	Dual, RF, 50V, 50mA, 500mW, 0.3pF, 3Q(10mA/100MHz)	SOT-23	16dl	-	3a	PhC
4M	MMBD101	Si-diode	Schottky, UHF-Mix, 7V, 10mA, 225mW, Vf<0.5V(10mA), <1pF	SOT-23	16dc	-	3a	Ons
4M	MMBD110	Si-diode	Schottky, UHF/HF-Det, 7V, 10mA, Vf<0.6V(10mA), <1pF	SOT-323	16dc	-	3a	Mot
4M	R3131N30BC8	Vdet-IC	3V, +Reset ODO, 100ms	SOT-23	16vdc	VD6	3b	Ric
4M0	TC55RP492ECB	LVR-IC	LDO, 4.9V±2%, 250mA	SOT-23	16cq	VR1	3d	Mcc
4M0	XC62FP4902M	LVR-IC	4.9V±2%, 250mA	SOT-23	16cg	VR1	3d	Tor
4M5	TC594902ECB	LVR-IC	LDO, -4.9V±2%, 200mA	SOT-23	16cj	VR2	3d	Mcc
4M5	XC62KN492M	LVR-IC	LDO, -4.9V±2%, 100mA, 150mW	SOT-23	16cj	VR2	3d	Tor
4MO	2SJ163-O	p-FET	Sw, 65V, 20mA, 150mW, Idss=0.2..1mA	SC-59	16fa	-	3a	Pan
4MO	2SJ364-O	p-FET	Sw, 65V, 20mA, 150mW, Idss=0.2..1mA	SOT-323	16fa	-	3a	Pan
4MP	2SJ163-P	p-FET	Sw, 65V, 20mA, 150mW, Idss=0.6..1.5mA	SC-59	16fa	-	3a	Pan
4MP	2SJ364-P	p-FET	Sw, 65V, 20mA, 150mW, Idss=0.6..1.5mA, 2.5ms	SOT-323	16fa	-	3a	Pan
4MQ	2SJ163-Q	p-FET	Sw, 65V, 20mA, 150mW, Idss=1..3mA	SC-59	16fa	-	3a	Pan
4MQ	2SJ364-Q	p-FET	Sw, 65V, 20mA, 150mW, Idss=1..3mA, 2.5ms	SOT-323	16fa	-	3a	Pan
4MR	2SJ163-R	p-FET	Sw, 65V, 20mA, 150mW, Idss=2.5..6mA	SC-59	16fa	-	3a	Pan
4MR	2SJ364-R	p-FET	Sw, 65V, 20mA, 150mW, Idss=2.5..6mA, 2.5ms	SOT-323	16fa	-	3a	Pan
4N	R3131N30DC8	Vdet-IC	3V, +Reset ODO, 200ms	SOT-23	16vdc	VD6	3b	Ric
4O	2SA1721-O	Si-pnp	Nix, Vid, 300V, 100mA, B=70..140, 55MHz	SOT-23	16ta	-	3a	Tos
4P	FMMT2907R	Si-pnp	GP, 40V, 600mA, 330mW, B=100..300, >200MHz	SOT-23	16te	-	3a	Zx
4P	R3131N30HC8	Vdet-IC	3V, +Reset ODO, 400ms	SOT-23	16vdc	VD6	3b	Ric
4P	UNRF1AL	Si-pnp-Digi	Sw, 50V, 80mA, 100mW, 80MHz, R1/R2=4k7/47k	ML3	22ta	-	2b	Pan
4Q	R3131N30AA8	Vdet-IC	3V, +Reset PPO, 50ms	SOT-23	16vdc	VD7	3b	Ric
4R	2SA1721-R	Si-pnp	Nix, Vid, 300V, 100mA, B=100..200, 55MHz	SOT-23	16ta	-	3a	Tos
4R	R3131N30BA8	Vdet-IC	3V, +Reset PPO, 100ms	SOT-23	16vdc	VD7	3b	Ric
4R	SRA2204E	Si-pnp-Digi	Sw, 50V, 100mA, 150mW, 200MHz, R1/R2=47/47k	SOT-523	16ta	-	3a	Auk
4R	SRA2204EF	Si-pnp-Digi	Sw, 50V, 100mA, 150mW, 200MHz, R1/R2=47/47k	SOT-523F	18ta	-	3a	Auk
4R	SRA2204U	Si-pnp-Digi	Sw, 50V, 100mA, 200mW, 200MHz, R1/R2=47/47k	SOT-323	16ta	-	3a	Auk
4R	SRA2204UF	Si-pnp-Digi	Sw, 50V, 100mA, 200mW, 200MHz, R1=47k, R2=47k	SOT-323F	18ta	-	3a	Auk
4S	R3131N30DA8	Vdet-IC	3V, +Reset PPO, 200ms	SOT-23	16vdc	VD7	3b	Ric
4T	2SK1216	n-FET	Video-Camera, 10V, 50mA, Idss>9.2mA	SOT-23	16fa	-	3a	Pan
4T	MMBD301	Si-diode	Schottky, UHF/VHF-Det, 30V, 200mW, <1.5pF	SOT-23	16dc	-	3a	Ons
4T	MMBD330	Si-diode	Schottky, UHF/VHF-Det, 70V, 10mA, Vf<0.6V(10mA), <1pF	SOT-323	16dc	-	3a	Ons
4T	R3131N30HA8	Vdet-IC	3V, +Reset PPO, 400ms	SOT-23	16vdc	VD7	3b	Ric
4V	2SK1228	n-MOSFET-e	Sw, 50V, ±50mA, <50Q(10mA)	SOT-23	16fh	-	3a	Pan
4V	2SK1374	n-MOSFET	Sw, 50V, 50mA, 150mW, 27Q(10mA), 0.2/0.2µs	SOT-323	16fh	-	3a	Pan
4V	BCW65AR	Si-npn	AF, 60V, 800mA, 330mW, B=100..250, >100MHz	SOT-23	16te	-	3a	Zx
4V3	CHPZ4V3PT	Z-diode	Dual, 4.0..4.6V, Izt=5mA, Zzt=90Q, 350mW	SOT-23	16df	-	3a	Chm
4V3	PZM4.3NB	Z-diode	4.3V±2.5%, 300mW	SOT-346	16df	-	3a	Phi
4V7	CHPZ4V7PT	Z-diode	Dual, 4.4..5.0V, Izt=5mA, Zzt=80Q, 350mW	SOT-23	16df	-	3a	Chm
4V7	PZM4.7NB	Z-diode	4.7V±2.5%, 300mW	SOT-346	16dc	-	3a	Phi
4W	BCW67AR	Si-pnp	AF, Sw, 45V, 800mA, 330mW, B=100..250, >100MHz	SOT-23	16ta	-	3a	Zx
4W-	BAP64-04W	PIN-diode	Dual, RF, 100V, 100mA, 250mW, 0.35pF, 3.8Q(10mA/100MHz)	SOT-323	16dl	-	3a	Phi
4X	UNRF2A0	Si-npn-Digi	Sw, 50V, 80mA, 100mW, 150MHz, R1=47k	ML3	22ta	-	2b	Pan
4Y	UNRF2A2	Si-npn-Digi	Sw, 50V, 80mA, 100mW, 150MHz, R/R2=22k/22k	ML3	22ta	-	2b	Pan
4Z	UNRF2A8	Si-npn-Digi	Sw, 50V, 80mA, 100mW, 150MHz, R1/R2=510R/5.1k	ML3	22ta	-	2b	Pan
4Z7	CZ1W4V7	Z-diode	4.7V±5%, 600mW	SOT-23	16dc	-	3a	Cdi
5.1	TZT5.1W	Z-diode	4.80..5.40V, Izt=5mA, Zzt=70Q, 200mW	SOT-323	16dc	-	3a	Ttr
5.1	Z02W5.1V	Z-diode	4.80..5.40V, Izt=5mA, Zzt=70Q, 200mW	SOT-23	16dc	-	3f	Kec
5.1H	BZX84-C5V1-V	Z-diode	4.97..5.24V, Izt=5mA, Zzt=70Q, 300mW	SOT-23	16dc	-	3f	Kec
5.1H	MAZ3051-H	Z-diode	4.8..5.4V, If=100mA, Zzt=60Q, 200mW	SC-59	16dc	-	3a	Pan
5.1L	MAZ3051-L	Z-diode	4.8..5.4V, If=100mA, Zzt=60Q, 200mW	SC-59	16dc	-	3a	Pan
5.1M	MAZ3051-M	Z-diode	4.8..5.4V, If=100mA, Zzt=60Q, 200mW	SC-59	16dc	-	3a	Pan
5.1X	TZT5.1XW	Z-diode	4.80..5.07V, Izt=5mA, Zzt=70Q, 200mW	SOT-323	16dc	-	3a	Ttr
5.1X	TZT5.12W	Z-diode	5.14..5.40V, Izt=5mA, Zzt=70Q, 200mW	SOT-323	16dc	-	3a	Ttr
5.1X	Z02W5.1VX	Z-diode	4.80..5.07V, Izt=5mA, Zzt=70Q, 200mW	SOT-23	16dc	-	3f	Kec
5.1Y	TZT5.1YW	Z-diode	4.97..5.24V, Izt=5mA, Zzt=70Q, 200mW	SOT-323	16dc	-	3a	Ttr
5.1Y	Z02W5.1VY	Z-diode	4.97..5.24V, Izt=5mA, Zzt=70Q, 200mW	SOT-23	16dc	-	3f	Kec
5.1Z	Z02W5.1VZ	Z-diode	5.14..5.40V, Izt=5mA, Zzt=70Q, 200mW	SOT-23	16dc	-	3f	Kec
5.6	TZT5.6W	Z-diode	5.30..6.0V, Izt=5mA, Zzt=40Q, 200mW	SOT-323	16dc	-	3a	Ttr
5.6	Z02W5.6V	Z-diode	5.30..6.0V, Izt=5mA, Zzt=40Q, 200mW	SOT-23	16dc	-	3f	Kec
5.6H	BZX84-C5V6-V	Z-diode	5.43..5.81V, Izt=5mA, Zzt=40Q, 300mW	SOT-23	16dc	-	3f	Kec
5.6H	MAZ3056-H	Z-diode	5.3..6V, If=100mA, Zzt=40Q, 200mW	SC-59	16dc	-	3a	Pan
5.6L	MAZ3056-L	Z-diode	5.3..6V, If=100mA, Zzt=40Q, 200mW	SC-59	16dc	-	3a	Pan
5.6M	MAZ3056-M	Z-diode	5.3..6V, If=100mA, Zzt=40Q, 200mW	SC-59	16dc	-	3a	Pan
5.6X	TZT5.6XW	Z-diode	5.30..5.63V, Izt=5mA, Zzt=40Q, 200mW	SOT-323	16dc	-	3a	Ttr
5.6X	Z02W5.6VX	Z-diode	5.30..5.63V, Izt=5mA, Zzt=40Q, 200mW	SOT-23	16dc	-	3f	Kec
5.6Y	TZT5.6YW	Z-diode	5.43..5.81V, Izt=5mA, Zzt=40Q, 200mW	SOT-323	16dc	-	3a	Ttr
5.6Y	Z02W5.6VY	Z-diode	5.43..5.81V, Izt=5mA, Zzt=40Q, 200mW	SOT-23	16dc	-	3f	Kec



SMD code	Type	Function	Short description	Case	Pinout	Sch. St.	Mnf.
5.6Z	MAZT056H	SA-Z-diode	Dual, 5.6V, 5mA, 150mW	SC-81	18df	-	3a Pan
5.6Z	TZT5.6ZW	Z-diode	5.61.6.0V, Izt=5mA, Zzt=40Ω, 200mW	SOT-323	16dc	-	3a Tlr
5.6Z	Z0ZV5.6VZ	Z-diode	5.61.6.0V, Izt=5mA, Zzt=40Ω, 200mW	SOT-23	16dc	-	3f Kec
5-1X	02CZ5.1-X	Z-diode	4.8.5.07V, 200mW	SC-59	16dc	-	3a Tos
5-1Y	02CZ5.1-Y	Z-diode	4.97.5.24V, 200mW	SC-59	16dc	-	3a Tos
5-1Z	02CZ5.1-Z	Z-diode	5.14.5.4V, 200mW	SC-59	16dc	-	3a Tos
5-6X	02CZ5.6-X	Z-diode	5.3.5.63V, 200mW	SC-59	16dc	-	3a Tos
5-6Y	02CZ5.6-Y	Z-diode	5.43.5.81V, 200mW	SC-59	16dc	-	3a Tos
5-6Z	02CZ5.6-Z	Z-diode	5.61.6V, 200mW	SC-59	16dc	-	3a Tos
50	BAS116T	Si-diode	Sw, 85V, 215mA, 225mW, Vf<1.25V(150mA), >3μs, 2pF	SOT-523	16dc	-	3b Di
50	CHDTC114EMPT	Si-npn-Digi	Sw, 50V, 50mA, 250MHz, R1/R2=10/10k	SOT-723	18ta	-	3a Chm
50	ELM9850BB	LVR-IC	5.0V±2%, 200mA	SOT-23	16cg	VR1	3d Elm
50-2	UTC8150-2	Vdet-IC	5V, -Reset OCO	SOT-23	16vdy	VD6	3a Utc
50-3	UTC8150-3	Vdet-IC	5V, -Reset OCO	SOT-23	16vdy	VD6	3a Utc
50-5	UTC8150-5	Vdet-IC	5V, -Reset OCO	SOT-23	16vdy	VD6	3a Utc
50A	AAT60050A-S2	Vdet-IC	5.0V±2%, -Reset ODO	SOT-23	16vdb	VD6	3d Aat
50B	AAT60050B-S2	Vdet-IC	5.0V±2%, -Reset PPO	SOT-23	16vdb	VD7	3d Aat
50B	MMBZ5250BPT	Z-diode	19.0.21.0V, Izt=5mA, Zzt=48Ω, 225mW	SOT-23	16dc	-	3a Chm
50C	AAT60050C-S2	Vdet-IC	5.0V±1%, -Reset ODO	SOT-23	16vdb	VD6	3d Aat
50D	AAT60050D-S2	Vdet-IC	5.0V±1%, -Reset PPO	SOT-23	16vdb	VD7	3d Aat
50S	MMBZ5250SPT	Z-diode	19.60.20.40V, Izt=5mA, Zzt=48Ω, 225mW	SOT-23	16dc	-	3a Chm
50S	MMBZ5250SPT	Z-diode	19.60.20.40V, Izt=5mA, Zzt=48Ω, 225mW	SOT-346	16dc	-	3a Chm
50T	TK71550AS	LVR-IC	LDO, 5V±1.5%, 155mA	SOT-23	16cj	VR1	3d Tok
51	BAV170T	Si-diode	Dual, Sw, 85V, 125mA, 225mW, Vf<1.25V(150mA), >3μs, 2pF	SOT-523	16dg	-	3b Di
51	CHDTC114YMPT	Si-npn-Digi	Sw, 50V, 70mA, 250MHz, R1/R2=10/47k	SOT-723	18ta	-	3a Chm
51	ELM9851BB	LVR-IC	5.1V±2%, 200mA	SOT-23	16cg	VR1	3d Elm
510	HZM5.1NB	Z-diode	4.84.5.37V, 200mW	SC-59A	16dc	-	3a Ren
511	HZM5.1NB1	Z-diode	4.84.5.04V, 200mW	SC-59A	16dc	-	3a Ren
511	PZM5.1NB1	Z-diode	5.1V±2.5%, 300mW	SOT-346	16dc	-	3a Phi
512	HZM5.1NB2	Z-diode	4.98.5.2V, 200mW	SC-59A	16dc	-	3a Ren
512	PZM5.1NB2	Z-diode	5.1V±2.5%, 300mW	SOT-346	16dc	-	3a Phi
513	HZM5.1NB3	Z-diode	5.14.5.37V, 200mW	SC-59A	16dc	-	3a Ren
513	PZM5.1NB3	Z-diode	5.1V±2.5%, 300mW	SOT-346	16dc	-	3a Phi
515	XC9111A151MR	DC/DC-IC	PFM step-up, 100kHz, 1.5V±2.5%, 400mA	SOT-23	16ss	DC2	3d Tor
516	XC9111A161MR	DC/DC-IC	PFM step-up, 100kHz, 1.6V±2.5%, 400mA	SOT-23	16ss	DC2	3d Tor
517	FMMT6517	Si-npn	Vid, 350/350V, 500mA, 330mW, B=30..200, >50MHz	SOT-23	16ta	-	3a Zx
517	XC9111A171MR	DC/DC-IC	PFM step-up, 100kHz, 1.7V±2.5%, 400mA	SOT-23	16ss	DC2	3d Tor
518	XC9111A181MR	DC/DC-IC	PFM step-up, 100kHz, 1.8V±2.5%, 400mA	SOT-23	16ss	DC2	3d Tor
519	XC9111A191MR	DC/DC-IC	PFM step-up, 100kHz, 1.9V±2.5%, 400mA	SOT-23	16ss	DC2	3d Tor
51A	AAT60051A-S2	Vdet-IC	5.1V±2%, -Reset ODO	SOT-23	16vdb	VD6	3d Aat
51B	AAT60051B-S2	Vdet-IC	5.1V±2%, -Reset PPO	SOT-23	16vdb	VD7	3d Aat
51B	MMBZ5251BPT	Z-diode	20.90.23.10V, Izt=5mA, Zzt=55Ω, 225mW	SOT-23	16dc	-	3a Chm
51C	AAT60051C-S2	Vdet-IC	5.1V±1%, -Reset ODO	SOT-23	16vdb	VD6	3d Aat
51D	AAT60051D-S2	Vdet-IC	5.1V±1%, -Reset PPO	SOT-23	16vdb	VD7	3d Aat
51S	MMBZ5251SPT	Z-diode	21.56.22.44V, Izt=5mA, Zzt=55Ω, 225mW	SOT-23	16dc	-	3a Chm
51S	MMBZ5251SPT	Z-diode	21.56.22.44V, Izt=5mA, Zzt=55Ω, 225mW	SOT-346	16dc	-	3a Chm
51V	PZM51NB	Z-diode	5.1V±2.5%, 300mW	SOT-346	16dc	-	3a Phi
52	BAV199T	Si-diode	Dual, Sw, 85V, 125mA, 225mW, Vf<1.25V(150mA), >3μs, 2pF	SOT-523	16dl	-	3b Di
52	CHDTC114WMPT	Si-npn-Digi	Sw, 50V, 100mA, 250MHz, R1/R2=10/4.7k	SOT-723	18ta	-	3a Chm
52	DTA123YE	Si-pnp-Digi	Sw, 50V, 100mA, 150mW, 220MHz, R1/R2=2k2/10k	SOT-416	16ta	-	3a Rhm
52	DTA123YKA	Si-pnp-Digi	Sw, 50V, 100mA, 200mW, 220MHz, R1/R2=2k2/10k	SOT-346	16ta	-	3a Rhm
52	DTA123YUA	Si-pnp-Digi	Sw, 50V, 100mA, 200mW, 220MHz, R1/R2=2k2/10k	UMT3	16ta	-	3a Rhm
52	ELM9852BB	LVR-IC	5.2V±2%, 200mA	SOT-23	16cg	VR1	3d Elm
520	FMMT6520	Si-pnp	Vid, 350/350V, 500mA, 330mW, B=30..200, >50MHz	SOT-23	16ta	-	3a Zx
520	XC9111A201MR	DC/DC-IC	PFM step-up, 100kHz, 2.0V±2.5%, 400mA	SOT-23	16ss	DC2	3d Tor
521	XC9111A211MR	DC/DC-IC	PFM step-up, 100kHz, 2.1V±2.5%, 400mA	SOT-23	16ss	DC2	3d Tor
522	XC9111A221MR	DC/DC-IC	PFM step-up, 100kHz, 2.2V±2.5%, 400mA	SOT-23	16ss	DC2	3d Tor
523	XC9111A231MR	DC/DC-IC	PFM step-up, 100kHz, 2.3V±2.5%, 400mA	SOT-23	16ss	DC2	3d Tor
524	XC9111A241MR	DC/DC-IC	PFM step-up, 100kHz, 2.4V±2.5%, 400mA	SOT-23	16ss	DC2	3d Tor
525	XC9111A251MR	DC/DC-IC	PFM step-up, 100kHz, 2.5V±2.5%, 400mA	SOT-23	16ss	DC2	3d Tor
526	XC9111A261MR	DC/DC-IC	PFM step-up, 100kHz, 2.6V±2.5%, 400mA	SOT-23	16ss	DC2	3d Tor
527	XC9111A271MR	DC/DC-IC	PFM step-up, 100kHz, 2.7V±2.5%, 400mA	SOT-23	16ss	DC2	3d Tor
528	XC9111A281MR	DC/DC-IC	PFM step-up, 100kHz, 2.8V±2.5%, 400mA	SOT-23	16ss	DC2	3d Tor
529	XC9111A291MR	DC/DC-IC	PFM step-up, 100kHz, 2.9V±2.5%, 400mA	SOT-23	16ss	DC2	3d Tor
52A	AAT60052A-S2	Vdet-IC	5.2V±2%, -Reset ODO	SOT-23	16vdb	VD6	3d Aat
52B	AAT60052B-S2	Vdet-IC	5.2V±2%, -Reset PPO	SOT-23	16vdb	VD7	3d Aat
52B	MMBZ5252BPT	Z-diode	22.80.25.20V, Izt=5mA, Zzt=62Ω, 225mW	SOT-23	16dc	-	3a Chm
52C	AAT60052C-S2	Vdet-IC	5.2V±1%, -Reset ODO	SOT-23	16vdb	VD6	3d Aat
52D	AAT60052D-S2	Vdet-IC	5.2V±1%, -Reset PPO	SOT-23	16vdb	VD7	3d Aat
52S	MMBZ5252SPT	Z-diode	23.52.24.48V, Izt=5mA, Zzt=62Ω, 225mW	SOT-23	16dc	-	3a Chm



SMD code	Type	Function	Short description	Case	Pinout	Sch.	St.	Mnf.
52S	MMCZ5252SPT	Z-diode	23.52..24.48V, Izt=5mA, Zzt=62Ω, 225mW	SOT-346	16dc	-	3a	Chm
53	BAT17	Si-diode	Schottky, UHF-Mix, 4V, 130mA, Vf<0.6V(10mA), Cd<0.75pF	SOT-23	16dc	-	3a	Sie
53	BAW156T	Si-diode	Dual, Sw, 85V, 125mA, 225mW, Vf<1.25V(150mA), >3μs, 2pF	SOT-523	16df	-	3b	Di
53	CHDTC115EMPT	Si-npn-Digi	Sw, 50V, 20mA, 250MHz, R1/R2=100/100k	SOT-723	18ta	-	3a	Chm
53	ELM9853BB	LVR-IC	5.3V±2%, 200mA	SOT-23	16cg	VR1	3d	Elm
530	XC9111A301MR	DC/DC-IC	PFM step-up, 100kHz, 3.0V±2.5%, 400mA	SOT-23	16ss	DC2	3d	Tor
531	XC9111A31MR	DC/DC-IC	PFM step-up, 100kHz, 3.1V±2.5%, 400mA	SOT-23	16ss	DC2	3d	Tor
532	XC9111A321MR	DC/DC-IC	PFM step-up, 100kHz, 3.2V±2.5%, 400mA	SOT-23	16ss	DC2	3d	Tor
533	XC9111A331MR	DC/DC-IC	PFM step-up, 100kHz, 3.3V±2.5%, 400mA	SOT-23	16ss	DC2	3d	Tor
534	XC9111A341MR	DC/DC-IC	PFM step-up, 100kHz, 3.4V±2.5%, 400mA	SOT-23	16ss	DC2	3d	Tor
535	XC9111A351MR	DC/DC-IC	PFM step-up, 100kHz, 3.5V±2.5%, 400mA	SOT-23	16ss	DC2	3d	Tor
536	XC9111A361MR	DC/DC-IC	PFM step-up, 100kHz, 3.6V±2.5%, 400mA	SOT-23	16ss	DC2	3d	Tor
537	XC9111A371MR	DC/DC-IC	PFM step-up, 100kHz, 3.7V±2.5%, 400mA	SOT-23	16ss	DC2	3d	Tor
538	XC9111A381MR	DC/DC-IC	PFM step-up, 100kHz, 3.8V±2.5%, 400mA	SOT-23	16ss	DC2	3d	Tor
539	XC9111A391MR	DC/DC-IC	PFM step-up, 100kHz, 3.9V±2.5%, 400mA	SOT-23	16ss	DC2	3d	Tor
53A	AAT60053A-S2	Vdet-IC	5.3V±2%, -Reset ODO	SOT-23	16vdb	VD6	3d	Aat
53B	AAT60053B-S2	Vdet-IC	5.3V±2%, -Reset PPO	SOT-23	16vdb	VD7	3d	Aat
53B	MMBZ5253BPT	Z-diode	23.75..26.25V, Izt=5mA, Zzt=62Ω, 225mW	SOT-23	16dc	-	3a	Chm
53C	AAT60053C-S2	Vdet-IC	5.3V±1%, -Reset ODO	SOT-23	16vdb	VD6	3d	Aat
53D	AAT60053D-S2	Vdet-IC	5.3V±1%, -Reset PPO	SOT-23	16vdb	VD7	3d	Aat
53S	MMBZ5253SPT	Z-diode	24.50..25.50V, Izt=5mA, Zzt=62Ω, 225mW	SOT-23	16dc	-	3a	Chm
53S	MMCZ5253SPT	Z-diode	24.50..25.50V, Izt=5mA, Zzt=62Ω, 225mW	SOT-346	16dc	-	3a	Chm
54	BAT17-04	Si-diode	Dual, Schottky, 4V, 130mA, Vf<0.6V(10mA), Cd<0.75pF	SOT-23	16dl	-	3a	Sie
54	CHDTC123EMPT	Si-npn-Digi	Sw, 50V, 100mA, 250MHz, R1/R2=2.2/2.2k	SOT-723	18ta	-	3a	Chm
54	DTA114YE	Si-pnp-Digi	Sw, 50V, 100mA, 200mW, 200MHz, R1/R2=10k/47k	SOT-416	16ta	-	3a	Rhm
54	DTA114YKA	Si-pnp-Digi	Sw, 50V, 100mA, 200mW, 200MHz, R1/R2=10k/47k	SOT-346	16ta	-	3a	Rhm
54	DTA114YAM	Si-pnp-Digi	Sw, 50V, 100mA, 150mW, 200MHz, R1/R2=10k/47k	VMT3	18ta	-	3a	Rhm
54	DTA114YUA	Si-pnp-Digi	Sw, 50V, 100mA, 200mW, 200MHz, R1/R2=10k/47k	UMT3	16ta	-	3a	Rhm
54	ELM9854BB	LVR-IC	5.4V±2%, 200mA	SOT-23	16cg	VR1	3d	Elm
54	ZMDC953TA	C-diode	Dual, Hyperabrupt varicap, 12V, 100mA, 45/37pF(0.5..1.5V)	SOT-323	16dg	-	3a	Zx
540	XC9111A401MR	DC/DC-IC	PFM step-up, 100kHz, 4.0V±2.5%, 400mA	SOT-23	16ss	DC2	3d	Tor
541	XC9111A411MR	DC/DC-IC	PFM step-up, 100kHz, 4.1V±2.5%, 400mA	SOT-23	16ss	DC2	3d	Tor
542	XC9111A421MR	DC/DC-IC	PFM step-up, 100kHz, 4.2V±2.5%, 400mA	SOT-23	16ss	DC2	3d	Tor
543	XC9111A431MR	DC/DC-IC	PFM step-up, 100kHz, 4.3V±2.5%, 400mA	SOT-23	16ss	DC2	3d	Tor
544	XC9111A441MR	DC/DC-IC	PFM step-up, 100kHz, 4.4V±2.5%, 400mA	SOT-23	16ss	DC2	3d	Tor
545	XC9111A451MR	DC/DC-IC	PFM step-up, 100kHz, 4.5V±2.5%, 400mA	SOT-23	16ss	DC2	3d	Tor
546	XC9111A461MR	DC/DC-IC	PFM step-up, 100kHz, 4.6V±2.5%, 400mA	SOT-23	16ss	DC2	3d	Tor
547	XC9111A471MR	DC/DC-IC	PFM step-up, 100kHz, 4.7V±2.5%, 400mA	SOT-23	16ss	DC2	3d	Tor
548	XC9111A481MR	DC/DC-IC	PFM step-up, 100kHz, 4.8V±2.5%, 400mA	SOT-23	16ss	DC2	3d	Tor
549	FMMT549	Si-pnp	GP, 35V, 1A, 500mW, B=100..300, >100MHz	SOT-23	16ta	-	3a	Zx
549	XC9111A491MR	DC/DC-IC	PFM step-up, 100kHz, 4.9V±2.5%, 400mA	SOT-23	16ss	DC2	3d	Tor
54A	AAT60054A-S2	Vdet-IC	5.4V±2%, -Reset ODO	SOT-23	16vdb	VD6	3d	Aat
54B	AAT60054B-S2	Vdet-IC	5.4V±2%, -Reset PPO	SOT-23	16vdb	VD7	3d	Aat
54B	MMBZ5254BPT	Z-diode	25.65..28.35V, Izt=5mA, Zzt=70Ω, 225mW	SOT-23	16dc	-	3a	Chm
54C	AAT60054C-S2	Vdet-IC	5.4V±1%, -Reset ODO	SOT-23	16vdb	VD6	3d	Aat
54D	AAT60054D-S2	Vdet-IC	5.4V±1%, -Reset PPO	SOT-23	16vdb	VD7	3d	Aat
54S	BAT17-04W	Si-diode	Dual, Schottky, 4V, 130mA, Vf<0.6V(10mA), Cd<0.75pF	SOT-323	16dl	-	3a	Sie
54S	MMBZ5254SPT	Z-diode	26.46..27.54V, Izt=5mA, Zzt=70Ω, 225mW	SOT-23	16dc	-	3a	Chm
54S	MMCZ5254SPT	Z-diode	26.46..27.54V, Izt=5mA, Zzt=70Ω, 225mW	SOT-346	16dc	-	3a	Chm
55	BAT17-05	Si-diode	Dual, Schottky, 4V, 130mA, Vf<0.6V(10mA), Cd<0.75pF	SOT-23	16dg	-	3a	Sie
55	CHDTC123JMPT	Si-npn-Digi	Sw, 50V, 100mA, 250MHz, R1/R2=2.2/47k	SOT-723	18ta	-	3a	Chm
55	ELM9855BB	LVR-IC	5.5V±2%, 200mA	SOT-23	16cg	VR1	3d	Elm
55	FSD273TA-A	C-diode	Dual, Hyperabrupt varicap, 12V, 100mA, 45/32.5pF(0.5..1.5V)	SOT-323	16dg	-	3a	Zx
550	XC9111A501MR	DC/DC-IC	PFM step-up, 100kHz, 5.0V±2.5%, 400mA	SOT-23	16ss	DC2	3d	Tor
551	FMMT551	Si-pnp	AF, 80V, 1A, 500mW, B=50..150, >150MHz	SOT-23	16ta	-	3a	Zx
551	XC9111A511MR	DC/DC-IC	PFM step-up, 100kHz, 5.1V±2.5%, 400mA	SOT-23	16ss	DC2	3d	Tor
552	XC9111A521MR	DC/DC-IC	PFM step-up, 100kHz, 5.2V±2.5%, 400mA	SOT-23	16ss	DC2	3d	Tor
553	XC9111A531MR	DC/DC-IC	PFM step-up, 100kHz, 5.3V±2.5%, 400mA	SOT-23	16ss	DC2	3d	Tor
554	XC9111A541MR	DC/DC-IC	PFM step-up, 100kHz, 5.4V±2.5%, 400mA	SOT-23	16ss	DC2	3d	Tor
555	FMMT555	Si-pnp	Vid, 160V, 1A, 500mW, B=50..300, >100MHz	SOT-23	16ta	-	3a	Zx
555	XC9111A551MR	DC/DC-IC	PFM step-up, 100kHz, 5.5V±2.5%, 400mA	SOT-23	16ss	DC2	3d	Tor
556	XC9111A561MR	DC/DC-IC	PFM step-up, 100kHz, 5.6V±2.5%, 400mA	SOT-23	16ss	DC2	3d	Tor
557	XC9111A571MR	DC/DC-IC	PFM step-up, 100kHz, 5.7V±2.5%, 400mA	SOT-23	16ss	DC2	3d	Tor
558	FMMT558	Si-pnp	Vid, 400V, 150mA, 500mW, B=100..300, >50MHz	SOT-23	16ta	-	3a	Zx
558	XC9111A581MR	DC/DC-IC	PFM step-up, 100kHz, 5.8V±2.5%, 400mA	SOT-23	16ss	DC2	3d	Tor
559	XC9111A591MR	DC/DC-IC	PFM step-up, 100kHz, 5.9V±2.5%, 400mA	SOT-23	16ss	DC2	3d	Tor
55A	AAT60055A-S2	Vdet-IC	5.5V±2%, -Reset ODO	SOT-23	16vdb	VD6	3d	Aat
55B	AAT60055B-S2	Vdet-IC	5.5V±2%, -Reset PPO	SOT-23	16vdb	VD7	3d	Aat
55B	MMBZ5255BPT	Z-diode	26.60..29.40V, Izt=5mA, Zzt=44Ω, 225mW	SOT-23	16dc	-	3a	Chm
55C	AAT60055C-S2	Vdet-IC	5.5V±1%, -Reset ODO	SOT-23	16vdb	VD6	3d	Aat



SMD code	Type	Function	Short description	Case	Pinout	Sch.	St.	Mnf.
55D	AAT60055D-S2	Vdet-IC	5.5V±1%, -Reset PPO	SOT-23	16vdb	VD7	3d	Aat
55s	BAT17-05W	Si-diode	Dual, Schottky, 4V, 130mA, Vf<0.6V(10mA), Cd<0.75pF	SOT-323	16df	-	3a	Sie
55S	MMBZ5255SPT	Z-diode	27.44..28.56V, Izt=5mA, Zzt=44Q, 225mW	SOT-23	16dc	-	3a	Chm
55S	MMCZ5255SPT	Z-diode	27.44..28.56V, Izt=5mA, Zzt=44Q, 225mW	SOT-346	16dc	-	3a	Chm
56	BAT17-06	Si-diode	Dual, Schottky, 4V, 130mA, Vf<0.6V(10mA), Cd<0.75pF	SOT-23	16df	-	3a	Sie
56	CHDTC123YMPT	Si-npn-Digi	Sw, 50V, 100mA, 250MHz, R1/R2=2.2/10k	SOT-723	18ta	-	3a	Chm
56	ELM9856BB	LVR-IC	5.6V±2%, 200mA	SOT-23	16cg	VR1	3d	Elm
56	FSD273TA-B	C-diode	Dual, Hyperabrupt varicap, 12V, 100mA, 45/34.7pF(0.5..1.5V)	SOT-323	16dg	-	3a	Zx
560	HZM5.6NB	Z-diode	5.31..5.92V, 200mW	SC-59A	16dc	-	3a	Ren
560	XC9111A601MR	DC/DC-IC	PFM step-up, 100kHz, 6.0V±2.5%, 400mA	SOT-23	16ss	DC2	3d	Tor
561	HZM5.6NB1	Z-diode	5.31..5.55V, 200mW	SC-59A	16dc	-	3a	Ren
561	PZM5.6NB1	Z-diode	5.6V±2.5%, 300mW	SOT-346	16dc	-	3a	Phi
561	XC9111A611MR	DC/DC-IC	PFM step-up, 100kHz, 6.1V±2.5%, 400mA	SOT-23	16ss	DC2	3d	Tor
562	HZM5.6NB2	Z-diode	5.49..5.73V, 200mW	SC-59A	16dc	-	3a	Ren
562	PZM5.6NB2	Z-diode	5.6V±2.5%, 300mW	SOT-346	16dc	-	3a	Phi
562	XC9111A621MR	DC/DC-IC	PFM step-up, 100kHz, 6.2V±2.5%, 400mA	SOT-23	16ss	DC2	3d	Tor
563	HZM5.6NB3	Z-diode	5.67..5.92V, 200mW	SC-59A	16dc	-	3a	Ren
563	PZM5.6NB3	Z-diode	5.6V±2.5%, 300mW	SOT-346	16dc	-	3a	Phi
563	XC9111A631MR	DC/DC-IC	PFM step-up, 100kHz, 6.3V±2.5%, 400mA	SOT-23	16ss	DC2	3d	Tor
564	XC9111A641MR	DC/DC-IC	PFM step-up, 100kHz, 6.4V±2.5%, 400mA	SOT-23	16ss	DC2	3d	Tor
565	XC9111A651MR	DC/DC-IC	PFM step-up, 100kHz, 6.5V±2.5%, 400mA	SOT-23	16ss	DC2	3d	Tor
566	XC9111A661MR	DC/DC-IC	PFM step-up, 100kHz, 6.6V±2.5%, 400mA	SOT-23	16ss	DC2	3d	Tor
567	XC9111A671MR	DC/DC-IC	PFM step-up, 100kHz, 6.7V±2.5%, 400mA	SOT-23	16ss	DC2	3d	Tor
568	XC9111A681MR	DC/DC-IC	PFM step-up, 100kHz, 6.8V±2.5%, 400mA	SOT-23	16ss	DC2	3d	Tor
569	XC9111A691MR	DC/DC-IC	PFM step-up, 100kHz, 6.9V±2.5%, 400mA	SOT-23	16ss	DC2	3d	Tor
56B	MMBZ5256BPT	Z-diode	28.50..31.50V, Izt=5mA, Zzt=78Q, 225mW	SOT-23	16dc	-	3a	Chm
56s	BAT17-06W	Si-diode	Dual, Schottky, 4V, 130mA, Vf<0.6V(10mA), Cd<0.75pF	SOT-323	16dg	-	3a	Sie
56S	MMBZ5256SPT	Z-diode	29.40..30.60V, Izt=5mA, Zzt=78Q, 225mW	SOT-23	16dc	-	3a	Chm
56S	MMCZ5256SPT	Z-diode	29.40..30.60V, Izt=5mA, Zzt=78Q, 225mW	SOT-346	16dc	-	3a	Chm
56V	PZM56NB	Z-diode	56V±2.5%, 300mW	SOT-346	16dc	-	3a	Phi
57	CHDTC124EMPT	Si-npn-Digi	Sw, 50V, 30mA, 250MHz, R1/R2=22/22k	SOT-723	18ta	-	3a	Chm
57	ELM9857BB	LVR-IC	5.7V±2%, 200mA	SOT-23	16cg	VR1	3d	Elm
57	FSD273TA-C	C-diode	Dual, Hyperabrupt varicap, 12V, 100mA, 45/37pF(0.5..1.5V)	SOT-323	16dg	-	3a	Zx
570	XC9111A701MR	DC/DC-IC	PFM step-up, 100kHz, 7.0V±2.5%, 400mA	SOT-23	16ss	DC2	3d	Tor
576	FMMT576	Si-pnp	Vid, 200V, 1A, 500mW, B=50..300, >100MHz	SOT-23	16ta	-	3a	Zx
57B	MMBZ5257BPT	Z-diode	31.35..34.65V, Izt=5mA, Zzt=88Q, 225mW	SOT-23	16dc	-	3a	Chm
57S	MMBZ5257SPT	Z-diode	32.34..33.66V, Izt=5mA, Zzt=88Q, 225mW	SOT-23	16dc	-	3a	Chm
57S	MMCZ5257SPT	Z-diode	32.34..33.66V, Izt=5mA, Zzt=88Q, 225mW	SOT-346	16dc	-	3a	Chm
58	CHDTC124XMPT	Si-npn-Digi	Sw, 50V, 100mA, 250MHz, R1/R2=22/47k	SOT-723	18ta	-	3a	Chm
58	ELM9858BB	LVR-IC	5.8V±2%, 200mA	SOT-23	16cg	VR1	3d	Elm
589	CHT589PT	Si-pnp	AF, Sw, 30V, 1A, B=100..300, 100MHz	SOT-23	16ta	-	3a	Chm
589	FMMT589	Si-pnp	AF, 50V, 1A, 500mW, B=100..300, >100MHz	SOT-23	16ta	-	3a	Zx
58B	MMBZ5258BPT	Z-diode	34.20..37.80V, Izt=5mA, Zzt=95Q, 225mW	SOT-23	16dc	-	3a	Chm
58S	MMBZ5258SPT	Z-diode	35.28..36.72V, Izt=5mA, Zzt=95Q, 225mW	SOT-23	16dc	-	3a	Chm
58S	MMCZ5258SPT	Z-diode	35.28..36.72V, Izt=5mA, Zzt=95Q, 225mW	SOT-346	16dc	-	3a	Chm
59	CHDTC143EMPT	Si-npn-Digi	Sw, 50V, 100mA, 250MHz, R1/R2=4.7/4.7k	SOT-723	18ta	-	3a	Chm
59	ELM7619HCB	Vdet-IC	1.9V±2%, +Reset PPO, 150ms	SOT-23	16vdb	VD7	3d	Elm
59	ELM9859BB	LVR-IC	5.9V±2%, 200mA	SOT-23	16cg	VR1	3d	Elm
591	CMMT591	Si-pnp	GP, 80V, 1A, 500mW, B=100..300, >150MHz	SOT-23	16ta	-	3a	Cdi
591	FMMT591	Si-pnp	AF, 80V, 1A, 500mW, B=100..300, >150MHz	SOT-23	16ta	-	3a	Zx
593	FMMT593	Si-pnp	AF, 120V, 1A, 500mW, B=100..300, >50MHz	SOT-23	16ta	-	3a	Zx
5946	CHT5946PT	Si-pnp	AF, 50V, 5A, B=200..560, 400MHz	SOT-23	16ta	-	3a	Chm
596	FMMT596	Si-pnp	Vid, 220V, 300mA, 500mW, B=85..300, >150MHz	SOT-23	16ta	-	3a	Zx
597	FMMT597	Si-pnp	Sw, Vid, 300/300V, 200mA, 500mW, B=100..300, >75MHz	SOT-23	16ta	-	3a	Zx
59A	CMMT591A	Si-pnp	GP, 40V, 1A, 500mW, B>300, >150MHz	SOT-23	16ta	-	3a	Cdi
59A	FMMT549A	Si-pnp	GP, 35V, 1A, 500mW, B=150..500, >100MHz	SOT-23	16ta	-	3a	Zx
59B	MMBZ5259BPT	Z-diode	37.05..40.95V, Izt=5mA, Zzt=130Q, 225mW	SOT-23	16dc	-	3a	Chm
59S	MMBZ5259SPT	Z-diode	38.22..39.78V, Izt=5mA, Zzt=130Q, 225mW	SOT-23	16dc	-	3a	Chm
59S	MMCZ5259SPT	Z-diode	38.22..39.78V, Izt=5mA, Zzt=130Q, 225mW	SOT-346	16dc	-	3a	Chm
5A	2SC5557	Si-npn	RF, LN, 9V, 30mA, 100mW, B=100..160, 12.5GHz	SSSMini3	18ta	-	3a	Pan
5A	2SC5938-A	Si-npn	AF, Sw, 50V, 200mA, 150mW, 30MHz, B=200..700	SC-59	16ta	-	3a	Ish
5A	2SC5996-A	Si-npn	AF, Sw, 50V, 200mA, 150mW, 30MHz, B=200..700	SOT-323	16ta	-	3a	Ish
5A	BC807-16	Si-pnp	GP, 50V, 500mA, 250mW, 80MHz, B=100..250	SOT-23	16ta	-	3a	PHH
5A	BC807-16W	Si-pnp	GP, 50V, 500mA, 200mW, 80MHz, B=100..250	SOT-323	16ta	-	3a	PHH
5A	FMMD6050	Si-diode	Fast Sw, 70V, 200mA, Vf<1.1V(100mA), <2.5pF, <5ns	SOT-23	16dc	-	3a	Zx
5A	LBC807-16LT1	Si-pnp	AF-Drv, 50V, 500mA, 225mW, B=100..250, 100MHz	SOT-23	16ta	-	3a	Lrc
5A	ST6205AS23	LVR-IC	LDO, 1.8V±2%, 150mA	SOT-323	16cg	VR1	3b	Sta
5A	ST6205AS32	LVR-IC	LDO, 1.8V±2%, 150mA	SOT-23	16cg	VR1	3b	Sta
5A~	MMBD4448PT	Si-diode	Sw, 80V, 250mA, Vf<1V(100mA), 4ns	SOT-23	16dc	-	3a	Chm
5A0	TC55RP502ECB	LVR-IC	LDO, 5.0V±2%, 250mA	SOT-23	16cq	VR1	3d	Mcc



SMD code	Type	Function	Short description	Case	Pinout	Sch. St.	Mnf.
5A0	XC62FP5002M	LVR-IC	5.0V±2%, 250mA	SOT-23	16cg	VR1	3d Tor
5A1	PZM5.1NB2A	Z-diode	5.1V±2.5%, 300mW	SOT-346	16df	-	3a Phi
5A5	TC595002ECB	LVR-IC	LDO, -5.0V±2%, 200mA	SOT-23	16cj	VR2	3d Mcc
5A5	XC62KN502M	LVR-IC	LDO, -5V±2%, 100mA, 150mW	SOT-23	16cj	VR2	3d Tor
5A6	MMBZ5V6A	TVS	Dual, Vrwm=3.0V, Vbr=5.32..5.88V, 3.0A, 24W(1ms)	SOT-23	16dg	-	3a Wtr
5A6	PZM5.6NB2A	Z-diode	Dual, 5.6V±2.5%, 300mW	SOT-346	16df	-	3a Phi
5AC2	81C50-P-AE3-2	Vdet-IC	5.0V±2%, -Reset PPO	SOT-23	16vdy	VD7	3a Utc
5AC2G	81C50G-P-AE3-2	Vdet-IC	5.0V±2%, -Reset PPO, halogen free	SOT-23	16vdy	VD7	3a Utc
5AC2L	81C50L-P-AE3-2	Vdet-IC	5.0V±2%, -Reset PPO, lead free	SOT-23	16vdy	VD7	3a Utc
5AC3	81C50-P-AE3-3	Vdet-IC	5.0V±2%, -Reset PPO	SOT-23	16vdb	VD7	3a Utc
5AC3G	81C50G-P-AE3-3	Vdet-IC	5.0V±2%, -Reset PPO, halogen free	SOT-23	16vdb	VD7	3a Utc
5AC3L	81C50L-P-AE3-3	Vdet-IC	5.0V±2%, -Reset PPO, lead free	SOT-23	16vdb	VD7	3a Utc
5AC5	81C50-P-AE3-5	Vdet-IC	5.0V±2%, -Reset PPO	SOT-23	16vdc	VD7	3a Utc
5AC5G	81C50G-P-AE3-5	Vdet-IC	5.0V±2%, -Reset PPO, halogen free	SOT-23	16vdc	VD7	3a Utc
5AC5L	81C50L-P-AE3-5	Vdet-IC	5.0V±2%, -Reset PPO, lead free	SOT-23	16vdc	VD7	3a Utc
5AN2	81N50-P-AE3-2	Vdet-IC	5.0V±2%, -Reset ODO	SOT-23	16vdy	VD6	3a Utc
5AN2G	81N50G-P-AE3-2	Vdet-IC	5.0V±2%, -Reset ODO, halogen free	SOT-23	16vdy	VD6	3a Utc
5AN2L	81N50L-P-AE3-2	Vdet-IC	5.0V±2%, -Reset ODO, lead free	SOT-23	16vdy	VD6	3a Utc
5AN3	81N50-P-AE3-3	Vdet-IC	5.0V±2%, -Reset ODO	SOT-23	16vdb	VD6	3a Utc
5AN3G	81N50G-P-AE3-3	Vdet-IC	5.0V±2%, -Reset ODO, halogen free	SOT-23	16vdb	VD6	3a Utc
5AN3L	81N50L-P-AE3-3	Vdet-IC	5.0V±2%, -Reset ODO, lead free	SOT-23	16vdb	VD6	3a Utc
5AN5	81N50-P-AE3-5	Vdet-IC	5.0V±2%, -Reset ODO	SOT-23	16vdc	VD6	3a Utc
5AN5G	81N50G-P-AE3-5	Vdet-IC	5.0V±2%, -Reset ODO, halogen free	SOT-23	16vdc	VD6	3a Utc
5AN5L	81N50L-P-AE3-5	Vdet-IC	5.0V±2%, -Reset ODO, lead free	SOT-23	16vdc	VD6	3a Utc
5Ap	BC807-16	Si-pnp	GP, 50V, 500mA, 250mW, 80MHz, B=100..250	SOT-23	16ta	-	3a PHH
5Ap	BC807-16W	Si-pnp	GP, 50V, 500mA, 200mW, 80MHz, B=100..250	SOT-323	16ta	-	3a PHH
5As	BC807-16	Si-pnp	GP, 50V, 500mA, 250mW, 80MHz, B=100..250	SOT-23	16ta	-	3a Sie
5As	BC807-16W	Si-pnp	GP, 50V, 500mA, 200mW, 80MHz, B=100..250	SOT-323	16ta	-	3a Sie
5At	BC807-16	Si-pnp	GP, 50V, 500mA, 250mW, 80MHz, B=100..250	SOT-23	16ta	-	3a PhM
5At	BC807-16W	Si-pnp	GP, 50V, 500mA, 200mW, 80MHz, B=100..250	SOT-323	16ta	-	3a PhM
5AW	BC807-16	Si-pnp	GP, 50V, 500mA, 250mW, 80MHz, B=100..250	SOT-23	16ta	-	3a PhC
5AW	BC807-16W	Si-pnp	GP, 50V, 500mA, 200mW, 80MHz, B=100..250	SOT-323	16ta	-	3a PhC
5AZ	BC807-16	Si-pnp	GP, 50V, 500mA, 250mW, 80MHz, B=100..250	SOT-23	16ta	-	3a Zx
5B	2SC5938-B	Si-npnp	AF, Sw, 50V, 200mA, 150mW, 30MHz, B=350..1200	SC-59	16ta	-	3a Ish
5B	2SC5996-B	Si-npnp	AF, Sw, 50V, 200mA, 150mW, 30MHz, B=350..1200	SOT-323	16ta	-	3a Ish
5B	BC807-25	Si-pnp	GP, 50V, 500mA, 250mW, 80MHz, B=160..400	SOT-23	16ta	-	3a PhH
5B	BC807-25W	Si-pnp	GP, 50V, 500mA, 200mW, 80MHz, B=160..400	SOT-323	16ta	-	3a PhH
5B	FMMD6100	C-diode	Dual, 70V, 200mA, Vf<1.1V, Cd<2.5pF, <5ns	SOT-23	16dg	-	3a Zx
5B	KST4123	Si-npnp	GP, 40V, 200mA, 350mW B=50..150, >250MHz	SOT-23	16ta	-	3a Sam
5B	LBC807-25LT1	Si-pnp	AF-Div, 50V, 500mA, 225mW, B=160..400, 100MHz	SOT-23	16ta	-	3a Lrc
5B	MMBT4123	Si-npnp	GP, 40V, 200mA, 350mW B=50..150, >250MHz	SOT-23	16ta	-	3a Mot
5B	R3131N25EC	Vdet-IC	2.5V, +Reset ODO, 240ms	SOT-23	16vdc	VD6	3b Ric
5B	ST6205BS23	LVR-IC	LDO, 2.5V±2%, 150mA	SOT-323	16cg	VR1	3b Sta
5B	ST6205BS32	LVR-IC	LDO, 2.5V±2%, 150mA	SOT-23	16cg	VR1	3b Sta
5B0	TC55RP512ECB	LVR-IC	LDO, 5.1V±2%, 250mA	SOT-23	16cq	VR1	3d Mcc
5B0	XC62FP5102M	LVR-IC	5.1V±2%, 250mA	SOT-23	16cg	VR1	3d Tor
5B5	TC595102ECB	LVR-IC	LDO, -5.1V±2%, 200mA	SOT-23	16cj	VR2	3d Mcc
5B5	XC62KN512M	LVR-IC	LDO, -5.1V±2%, 100mA, 150mW	SOT-23	16cj	VR2	3d Tor
5BC2	81C51-P-AE3-2	Vdet-IC	5.1V±2%, -Reset PPO	SOT-23	16vdy	VD7	3a Utc
5BC2G	81C51G-P-AE3-2	Vdet-IC	5.1V±2%, -Reset PPO, halogen free	SOT-23	16vdy	VD7	3a Utc
5BC2L	81C51L-P-AE3-2	Vdet-IC	5.1V±2%, -Reset PPO, lead free	SOT-23	16vdy	VD7	3a Utc
5BC3	81C51-P-AE3-3	Vdet-IC	5.1V±2%, -Reset PPO	SOT-23	16vdb	VD7	3a Utc
5BC3G	81C51G-P-AE3-3	Vdet-IC	5.1V±2%, -Reset PPO, halogen free	SOT-23	16vdb	VD7	3a Utc
5BC3L	81C51L-P-AE3-3	Vdet-IC	5.1V±2%, -Reset PPO, lead free	SOT-23	16vdb	VD7	3a Utc
5BC5	81C51-P-AE3-5	Vdet-IC	5.1V±2%, -Reset PPO	SOT-23	16vdc	VD7	3a Utc
5BC5G	81C51G-P-AE3-5	Vdet-IC	5.1V±2%, -Reset PPO, halogen free	SOT-23	16vdc	VD7	3a Utc
5BC5L	81C51L-P-AE3-5	Vdet-IC	5.1V±2%, -Reset PPO, lead free	SOT-23	16vdc	VD7	3a Utc
5BM	MMBD6100	Si-diode	Dual, Sw, 70V, 200mA, Vf<1.1V(100mA), <2.5pF	SOT-23	16dg	-	3a Ons
5BN2	81N51-P-AE3-2	Vdet-IC	5.1V±2%, -Reset ODO	SOT-23	16vdy	VD6	3a Utc
5BN2G	81N51G-P-AE3-2	Vdet-IC	5.1V±2%, -Reset ODO, halogen free	SOT-23	16vdy	VD6	3a Utc
5BN2L	81N51L-P-AE3-2	Vdet-IC	5.1V±2%, -Reset ODO, lead free	SOT-23	16vdy	VD6	3a Utc
5BN3	81N51-P-AE3-3	Vdet-IC	5.1V±2%, -Reset ODO	SOT-23	16vdb	VD6	3a Utc
5BN3G	81N51G-P-AE3-3	Vdet-IC	5.1V±2%, -Reset ODO, halogen free	SOT-23	16vdb	VD6	3a Utc
5BN3L	81N51L-P-AE3-3	Vdet-IC	5.1V±2%, -Reset ODO, lead free	SOT-23	16vdb	VD6	3a Utc
5BN5	81N51-P-AE3-5	Vdet-IC	5.1V±2%, -Reset ODO	SOT-23	16vdc	VD6	3a Utc
5BN5G	81N51G-P-AE3-5	Vdet-IC	5.1V±2%, -Reset ODO, halogen free	SOT-23	16vdc	VD6	3a Utc
5BN5L	81N51L-P-AE3-5	Vdet-IC	5.1V±2%, -Reset ODO, lead free	SOT-23	16vdc	VD6	3a Utc
5Bp	BC807-25	Si-pnp	GP, 50V, 500mA, 250mW, 80MHz, B=160..400	SOT-23	16ta	-	3a PHH
5Bp	BC807-25W	Si-pnp	GP, 50V, 500mA, 200mW, 80MHz, B=160..400	SOT-323	16ta	-	3a PHH
5Bs	BC807-25	Si-pnp	GP, 50V, 500mA, 250mW, 80MHz, B=160..400	SOT-23	16ta	-	3a Sie



SMD code	Type	Function	Short description	Case	Pinout	Sch.	St.	Mnf.
5Bs	BC807-25W	Si-pnp	GP, 50V, 500mA, 250mW, 80MHz, B=160..400	SOT-323	16ta	-	3a	Sie
5Bt	BC807-25	Si-pnp	GP, 50V, 500mA, 250mW, 80MHz, B=160..400	SOT-23	16ta	-	3a	PHM
5Bt	BC807-25W	Si-pnp	GP, 50V, 500mA, 200mW, 80MHz, B=160..400	SOT-323	16ta	-	3a	PHM
5BW	BC807-25	Si-pnp	GP, 50V, 500mA, 250mW, 80MHz, B=160..400	SOT-23	16ta	-	3a	PhC
5BW	BC807-25W	Si-pnp	GP, 50V, 500mA, 200mW, 80MHz, B=160..400	SOT-323	16ta	-	3a	PhC
5BZ	BC807-25	Si-pnp	GP, 50V, 500mA, 250mW, 80MHz, B=160..400	SOT-23	16ta	-	3a	Zx
5C	BC807-40	Si-pnp	GP, 50V, 500mA, 250mW, 80MHz, B=250..600	SOT-23	16ta	-	3a	PHH
5C	BC807-40W	Si-pnp	GP, 50V, 500mA, 200mW, 80MHz, B=250..600	SOT-323	16ta	-	3a	PHH
5C	FMMD7000	C-diode	Dual, 70V, 200mA, Vf<1.1V, Cd<2.5pF, <15ns	SOT-23	16dl	-	3a	Zx
5C	LBC807-40LT1	Si-pnp	AF-Drv, 50V, 500mA, 225mW, B=250..600, 100MHz	SOT-23	16ta	-	3a	Lrc
5C	R3131N35EC	Vdet-IC	3.5V, +Reset ODO, 240ms	SOT-23	16vdc	VD6	3b	Ric
5C	ST6205CS23	LVR-IC	LDO, 2.8V±2%, 150mA	SOT-323	16cg	VR1	3b	Sta
5C	ST6205CS32	LVR-IC	LDO, 2.8V±2%, 150mA	SOT-23	16cg	VR1	3b	Sta
5C	UNRF2A9	Si-npn-Digi	Sw, 50V, 80mA, 100mW, 150MHz, R1/R2=1k/10k	ML3	22ta	-	2b	Pan
5C0	TC55RP522ECB	LVR-IC	LDO, 5.2V±2%, 250mA	SOT-23	16cq	VR1	3d	Mcc
5C0	XC62FP5202M	LVR-IC	5.2V±2%, 250mA	SOT-23	16cg	VR1	3d	Tor
5C5	TC595202ECB	LVR-IC	LDO, -5.2V±2%, 200mA	SOT-23	16cj	VR2	3d	Mcc
5C5	XC62KN522M	LVR-IC	LDO, -5.2V±2%, 100mA, 150mW	SOT-23	16cj	VR2	3d	Tor
5CC2	81C52-P-AE3-2	Vdet-IC	5.2V±2%, -Reset PPO	SOT-23	16vdy	VD7	3a	Utc
5CC2G	81C52G-P-AE3-2	Vdet-IC	5.2V±2%, -Reset PPO, halogen free	SOT-23	16vdy	VD7	3a	Utc
5CC2L	81C52L-P-AE3-2	Vdet-IC	5.2V±2%, -Reset PPO, lead free	SOT-23	16vdy	VD7	3a	Utc
5CC3	81C52-P-AE3-3	Vdet-IC	5.2V±2%, -Reset PPO	SOT-23	16vdb	VD7	3a	Utc
5CC3G	81C52G-P-AE3-3	Vdet-IC	5.2V±2%, -Reset PPO, halogen free	SOT-23	16vdb	VD7	3a	Utc
5CC3L	81C52L-P-AE3-3	Vdet-IC	5.2V±2%, -Reset PPO, lead free	SOT-23	16vdb	VD7	3a	Utc
5CC5	81C52-P-AE3-5	Vdet-IC	5.2V±2%, -Reset PPO	SOT-23	16vdc	VD7	3a	Utc
5CC5G	81C52G-P-AE3-5	Vdet-IC	5.2V±2%, -Reset PPO, halogen free	SOT-23	16vdc	VD7	3a	Utc
5CC5L	81C52L-P-AE3-5	Vdet-IC	5.2V±2%, -Reset PPO, lead free	SOT-23	16vdc	VD7	3a	Utc
5CN2	81N52-P-AE3-2	Vdet-IC	5.2V±2%, -Reset ODO	SOT-23	16vdy	VD6	3a	Utc
5CN2G	81N52G-P-AE3-2	Vdet-IC	5.2V±2%, -Reset ODO, halogen free	SOT-23	16vdy	VD6	3a	Utc
5CN2L	81N52L-P-AE3-2	Vdet-IC	5.2V±2%, -Reset ODO, lead free	SOT-23	16vdy	VD6	3a	Utc
5CN3	81N52-P-AE3-3	Vdet-IC	5.2V±2%, -Reset ODO	SOT-23	16vdb	VD6	3a	Utc
5CN3G	81N52G-P-AE3-3	Vdet-IC	5.2V±2%, -Reset ODO, halogen free	SOT-23	16vdb	VD6	3a	Utc
5CN3L	81N52L-P-AE3-3	Vdet-IC	5.2V±2%, -Reset ODO, lead free	SOT-23	16vdb	VD6	3a	Utc
5CN5	81N52-P-AE3-5	Vdet-IC	5.2V±2%, -Reset ODO	SOT-23	16vdc	VD6	3a	Utc
5CN5G	81N52G-P-AE3-5	Vdet-IC	5.2V±2%, -Reset ODO, halogen free	SOT-23	16vdc	VD6	3a	Utc
5CN5L	81N52L-P-AE3-5	Vdet-IC	5.2V±2%, -Reset ODO, lead free	SOT-23	16vdc	VD6	3a	Utc
5Cp	BC807-40	Si-pnp	GP, 50V, 500mA, 250mW, 80MHz, B=250..600	SOT-23	16ta	-	3a	PHH
5Cp	BC807-40W	Si-pnp	GP, 50V, 500mA, 200mW, 80MHz, B=250..600	SOT-323	16ta	-	3a	PHH
5Cs	BC807-40	Si-pnp	GP, 50V, 500mA, 250mW, 80MHz, B=250..600	SOT-23	16ta	-	3a	Sie
5Cs	BC807-40W	Si-pnp	GP, 50V, 500mA, 200mW, 80MHz, B=250..600	SOT-323	16ta	-	3a	Sie
5Ct	BC807-40	Si-pnp	GP, 50V, 500mA, 250mW, 80MHz, B=250..600	SOT-23	16ta	-	3a	PHM
5Ct	BC807-40W	Si-pnp	GP, 50V, 500mA, 200mW, 80MHz, B=250..600	SOT-323	16ta	-	3a	PHM
5CW	BC807-40	Si-pnp	GP, 50V, 500mA, 250mW, 80MHz, B=250..600	SOT-23	16ta	-	3a	PhC
5CW	BC807-40W	Si-pnp	GP, 50V, 500mA, 200mW, 80MHz, B=250..600	SOT-323	16ta	-	3a	PhC
5CZ	BC807-40	Si-pnp	GP, 50V, 500mA, 250mW, 80MHz, B=250..600	SOT-23	16ta	-	3a	Zx
5D	BC807	Si-pnp	GP, 50V, 500mA, 250mW, B=100..600, 80MHz	SOT-23	16ta	-	3a	PHH
5D	BC807W	Si-pnp	GP, 50V, 500mA, 200mW, 80MHz, B=100..600	SOT-323	16ta	-	3a	PHH
5D	FMMD914	Si-diode	Fast Sw, 75V, 225mA, Vf<1V, Cd<4.0pF, <8ns	SOT-23	16dc	-	3a	Zx
5D	FT533Dh	LVR-IC	LDO, 1.8V±2%, 700mA	SOT-23	16cq	VR1	3d	Fmd
5D	HD2A	Si-diode	Dual, 35V, 100mA, Vf<1V, Cd<4pF, <6ns	SOT-23	16dg	-	3a	Zx
5D	MMBD914L	Si-diode	Sw, Fast, 100V, 200mA, 225mW, Vf<1V(10mA), <4ns	SOT-23	16dc	-	3a	Mot
5D	R3131N45EC	Vdet-IC	4.5V, +Reset ODO, 240ms	SOT-23	16vdc	VD6	3b	Ric
5D	ST6205DS23	LVR-IC	LDO, 3.3V±2%, 150mA	SOT-323	16cg	VR1	3b	Sta
5D	ST6205DS32	LVR-IC	LDO, 3.3V±2%, 150mA	SOT-23	16cg	VR1	3b	Sta
5D	TMPD4148	Si-diode	Sw, 100V, 600mA, Vf<1V, Cd<4pF, <4ns	SOT-23	16dc	-	3a	All
5D	TMPD914	Si-diode	Sw, 100V, 600mA, Vf<1V, Cd<6pF, <4ns	SOT-23	16dc	-	3a	All
5D0	TC55RP532ECB	LVR-IC	LDO, 5.3V±2%, 250mA	SOT-23	16cq	VR1	3d	Mcc
5D0	XC62FP5302M	LVR-IC	5.3V±2%, 250mA	SOT-23	16cg	VR1	3d	Tor
5D5	TC595302ECB	LVR-IC	LDO, -5.3V±2%, 200mA	SOT-23	16cj	VR2	3d	Mcc
5D5	XC62KN532M	LVR-IC	LDO, -5.3V±2%, 100mA, 150mW	SOT-23	16cj	VR2	3d	Tor
5DC2	81C53-P-AE3-2	Vdet-IC	5.3V±2%, -Reset PPO	SOT-23	16vdy	VD7	3a	Utc
5DC2G	81C53G-P-AE3-2	Vdet-IC	5.3V±2%, -Reset PPO, halogen free	SOT-23	16vdy	VD7	3a	Utc
5DC2L	81C53L-P-AE3-2	Vdet-IC	5.3V±2%, -Reset PPO, lead free	SOT-23	16vdy	VD7	3a	Utc
5DC3	81C53-P-AE3-3	Vdet-IC	5.3V±2%, -Reset PPO	SOT-23	16vdb	VD7	3a	Utc
5DC3G	81C53G-P-AE3-3	Vdet-IC	5.3V±2%, -Reset PPO, halogen free	SOT-23	16vdb	VD7	3a	Utc
5DC3L	81C53L-P-AE3-3	Vdet-IC	5.3V±2%, -Reset PPO, lead free	SOT-23	16vdb	VD7	3a	Utc
5DC5	81C53-P-AE3-5	Vdet-IC	5.3V±2%, -Reset PPO	SOT-23	16vdc	VD7	3a	Utc
5DC5G	81C53G-P-AE3-5	Vdet-IC	5.3V±2%, -Reset PPO, halogen free	SOT-23	16vdc	VD7	3a	Utc
5DC5L	81C53L-P-AE3-5	Vdet-IC	5.3V±2%, -Reset PPO, lead free	SOT-23	16vdc	VD7	3a	Utc
5Dg	FT533Dg	LVR-IC	LDO, 1.8V±2%, 700mA	SOT-23	16cq	VR1	3d	Fmd



SMD code	Type	Function	Short description	Case	Pinout	Sch.	St.	Mnf.
5DN2	81N53-P-AE3-2	Vdet-IC	5.3V±2%, -Reset ODO	SOT-23	16vdy	VD6	3a	Utc
5DN2G	81N53G-P-AE3-2	Vdet-IC	5.3V±2%, -Reset ODO, halogen free	SOT-23	16vdy	VD6	3a	Utc
5DN2L	81N53L-P-AE3-2	Vdet-IC	5.3V±2%, -Reset ODO, lead free	SOT-23	16vdy	VD6	3a	Utc
5DN3	81N53-P-AE3-3	Vdet-IC	5.3V±2%, -Reset ODO	SOT-23	16vdb	VD6	3a	Utc
5DN3G	81N53G-P-AE3-3	Vdet-IC	5.3V±2%, -Reset ODO, halogen free	SOT-23	16vdb	VD6	3a	Utc
5DN3L	81N53L-P-AE3-3	Vdet-IC	5.3V±2%, -Reset ODO, lead free	SOT-23	16vdb	VD6	3a	Utc
5DN5	81N53-P-AE3-5	Vdet-IC	5.3V±2%, -Reset ODO	SOT-23	16vdc	VD6	3a	Utc
5DN5G	81N53G-P-AE3-5	Vdet-IC	5.3V±2%, -Reset ODO, halogen free	SOT-23	16vdc	VD6	3a	Utc
5DN5L	81N53L-P-AE3-5	Vdet-IC	5.3V±2%, -Reset ODO, lead free	SOT-23	16vdc	VD6	3a	Utc
5Dp	BC807	Si-pnp	GP, 50V, 500mA, 250mW, B=100..600, 80MHz	SOT-23	16ta	-	3a	PhH
5Dp	BC807W	Si-pnp	GP, 50V, 500mA, 200mW, 80MHz, B=100..600	SOT-323	16ta	-	3a	PhH
5Dp	BC807R	Si-pnp	AF-Drv, 50V, 500mA, 250mW, 80MHz, B=100..600	SOT-23	16te	-	3a	Zx
5Dt	BC807	Si-pnp	GP, 50V, 500mA, 250mW, B=100..600, 80MHz	SOT-23	16ta	-	3a	PhM
5Dt	BC807W	Si-pnp	GP, 50V, 500mA, 200mW, 80MHz, B=100..600	SOT-323	16ta	-	3a	PhM
5DW	BC807	Si-pnp	GP, 50V, 500mA, 250mW, B=100..600, 80MHz	SOT-23	16ta	-	3a	PhC
5DW	BC807W	Si-pnp	GP, 50V, 500mA, 200mW, 80MHz, B=100..600	SOT-323	16ta	-	3a	PhC
5DZ	BC807	Si-pnp	GP, 50V, 500mA, 330mW, B=100..600, 100MHz	SOT-23	16ta	-	3a	Zx
5E	BC808-16	Si-pnp	AF-Drv, 30V, 500mA, 330mW, B=100..250, >100MHz	SOT-23	16ta	-	3a	Itt
5E	FMMTA43R	Si-npn	Vid, 200V, 200mA, 330mW, B=50..200, >50MHz	SOT-23	16te	-	3a	Zx
5E	FT533Eh	LVR-IC	LDO, 2.5V±2%, 700mA	SOT-23	16cq	VR1	3d	Fmd
5E0	TC55RP542ECB	LVR-IC	LDO, 5.4V±2%, 250mA	SOT-23	16cq	VR1	3d	Mcc
5E0	XC62FP5402M	LVR-IC	5.4V±2%, 250mA	SOT-23	16cg	VR1	3d	Tor
5E5	TC595402ECB	LVR-IC	LDO, -5.4V±2%, 200mA	SOT-23	16cj	VR2	3d	Mcc
5E5	XC62KN542M	LVR-IC	LDO, -5.4V±2%, 100mA, 150mW	SOT-23	16cj	VR2	3d	Tor
5EC2	81C54-P-AE3-2	Vdet-IC	5.4V±2%, -Reset PPO	SOT-23	16vdy	VD7	3a	Utc
5EC2G	81C54G-P-AE3-2	Vdet-IC	5.4V±2%, -Reset PPO, halogen free	SOT-23	16vdy	VD7	3a	Utc
5EC2L	81C54L-P-AE3-2	Vdet-IC	5.4V±2%, -Reset PPO, lead free	SOT-23	16vdy	VD7	3a	Utc
5EC3	81C54-P-AE3-3	Vdet-IC	5.4V±2%, -Reset PPO	SOT-23	16vdb	VD7	3a	Utc
5EC3G	81C54G-P-AE3-3	Vdet-IC	5.4V±2%, -Reset PPO, halogen free	SOT-23	16vdb	VD7	3a	Utc
5EC3L	81C54L-P-AE3-3	Vdet-IC	5.4V±2%, -Reset PPO, lead free	SOT-23	16vdb	VD7	3a	Utc
5EC5	81C54-P-AE3-5	Vdet-IC	5.4V±2%, -Reset PPO	SOT-23	16vdc	VD7	3a	Utc
5EC5G	81C54G-P-AE3-5	Vdet-IC	5.4V±2%, -Reset PPO, halogen free	SOT-23	16vdc	VD7	3a	Utc
5EC5L	81C54L-P-AE3-5	Vdet-IC	5.4V±2%, -Reset PPO, lead free	SOT-23	16vdc	VD7	3a	Utc
5Eg	FT533Eg	LVR-IC	LDO, 2.5V±2%, 700mA	SOT-23	16cq	VR1	3d	Fmd
5EN2	81N54-P-AE3-2	Vdet-IC	5.4V±2%, -Reset ODO	SOT-23	16vdy	VD6	3a	Utc
5EN2G	81N54G-P-AE3-2	Vdet-IC	5.4V±2%, -Reset ODO, halogen free	SOT-23	16vdy	VD6	3a	Utc
5EN2L	81N54L-P-AE3-2	Vdet-IC	5.4V±2%, -Reset ODO, lead free	SOT-23	16vdy	VD6	3a	Utc
5EN3	81N54-P-AE3-3	Vdet-IC	5.4V±2%, -Reset ODO	SOT-23	16vdb	VD6	3a	Utc
5EN3G	81N54G-P-AE3-3	Vdet-IC	5.4V±2%, -Reset ODO, halogen free	SOT-23	16vdb	VD6	3a	Utc
5EN3L	81N54L-P-AE3-3	Vdet-IC	5.4V±2%, -Reset ODO, lead free	SOT-23	16vdb	VD6	3a	Utc
5EN5	81N54-P-AE3-5	Vdet-IC	5.4V±2%, -Reset ODO	SOT-23	16vdc	VD6	3a	Utc
5EN5G	81N54G-P-AE3-5	Vdet-IC	5.4V±2%, -Reset ODO, halogen free	SOT-23	16vdc	VD6	3a	Utc
5EN5L	81N54L-P-AE3-5	Vdet-IC	5.4V±2%, -Reset ODO, lead free	SOT-23	16vdc	VD6	3a	Utc
5Ep	BC808-16	Si-pnp	AF-Drv, 30V, 500mA, 330mW, B=100..250, >100MHz	SOT-23	16ta	-	3a	PhH
5Es	BC808-16	Si-pnp	AF-Drv, 30V, 500mA, 330mW, B=100..250, >100MHz	SOT-23	16ta	-	3a	Sie
5Es	BC808-16W	Si-pnp	AF-Drv, 30V, 500mA, 330mW, B=100..250, >100MHz	SOT-323	16ta	-	3a	Sie
5Et	BC808-16W	Si-pnp	AF-Drv, 30V, 500mA, 330mW, B=100..250, >100MHz	SOT-323	16ta	-	3a	PhM
5EW	BC808-16	Si-pnp	AF-Drv, 30V, 500mA, 330mW, B=100..250, >100MHz	SOT-23	16ta	-	3a	PhC
5EZ	BC808-16	Si-pnp	AF-Drv, 30V, 500mA, 330mW, B=100..250, >100MHz	SOT-23	16ta	-	3a	Zx
5F	2SK3539	n-MOSFET*	Sw, 50V, 100mA, 150mW, 8Q(10mA), 200/200ns	SOT-23	16fh	-	3a	Pan
5F	2SK4072	n-MOSFET*	Sw, 25V, 100mA, 200mW, 8Q(10mA), 200/200ns	S-Mini3-G1	16fh	-	3a	Pan
5F	BC808-25	Si-pnp	AF-Drv, 30V, 500mA, 330mW, B=160..400, >100MHz	SOT-23	16ta	-	3a	Itt
5F	FT533Fh	LVR-IC	LDO, 2.7V±2%, 700mA	SOT-23	16cq	VR1	3d	Fmd
5F0	TC55RP552ECB	LVR-IC	LDO, 5.5V±2%, 250mA	SOT-23	16cq	VR1	3d	Mcc
5F0	XC62FP5502M	LVR-IC	5.5V±2%, 250mA	SOT-23	16cq	VR1	3d	Tor
5F5	TC595502ECB	LVR-IC	LDO, -5.5V±2%, 200mA	SOT-23	16cj	VR2	3d	Mcc
5F5	XC62KN552M	LVR-IC	LDO, -5.5V±2%, 100mA, 150mW	SOT-23	16cj	VR2	3d	Tor
5FC2	81C55-P-AE3-2	Vdet-IC	5.5V±2%, -Reset PPO	SOT-23	16vdy	VD7	3a	Utc
5FC2G	81C55G-P-AE3-2	Vdet-IC	5.5V±2%, -Reset PPO, halogen free	SOT-23	16vdy	VD7	3a	Utc
5FC2L	81C55L-P-AE3-2	Vdet-IC	5.5V±2%, -Reset PPO, lead free	SOT-23	16vdy	VD7	3a	Utc
5FC3	81C55-P-AE3-3	Vdet-IC	5.5V±2%, -Reset PPO	SOT-23	16vdb	VD7	3a	Utc
5FC3G	81C55G-P-AE3-3	Vdet-IC	5.5V±2%, -Reset PPO, halogen free	SOT-23	16vdb	VD7	3a	Utc
5FC3L	81C55L-P-AE3-3	Vdet-IC	5.5V±2%, -Reset PPO, lead free	SOT-23	16vdb	VD7	3a	Utc
5FC5	81C55-P-AE3-5	Vdet-IC	5.5V±2%, -Reset PPO	SOT-23	16vdc	VD7	3a	Utc
5FC5G	81C55G-P-AE3-5	Vdet-IC	5.5V±2%, -Reset PPO, halogen free	SOT-23	16vdc	VD7	3a	Utc
5FC5L	81C55L-P-AE3-5	Vdet-IC	5.5V±2%, -Reset PPO, lead free	SOT-23	16vdc	VD7	3a	Utc
5Fg	FT533Fg	LVR-IC	LDO, 2.7V±2%, 700mA	SOT-23	16cq	VR1	3d	Fmd
5FN2	81N55-P-AE3-2	Vdet-IC	5.5V±2%, -Reset ODO	SOT-23	16vdy	VD6	3a	Utc
5FN2G	81N55G-P-AE3-2	Vdet-IC	5.5V±2%, -Reset ODO, halogen free	SOT-23	16vdy	VD6	3a	Utc
5FN2L	81N55L-P-AE3-2	Vdet-IC	5.5V±2%, -Reset ODO, lead free	SOT-23	16vdy	VD6	3a	Utc



SMD code	Type	Function	Short description	Case	Pinout	Sch.	St.	Mnf.
5FN3	81N55-P-AE3-3	Vdet-IC	5.5V±2%, -Reset ODO	SOT-23	16vdb	VD6	3a	Utc
5FN3G	81N55G-P-AE3-3	Vdet-IC	5.5V±2%, -Reset ODO, halogen free	SOT-23	16vdb	VD6	3a	Utc
5FN3L	81N55L-P-AE3-3	Vdet-IC	5.5V±2%, -Reset ODO, lead free	SOT-23	16vdb	VD6	3a	Utc
5FN5	81N55-P-AE3-5	Vdet-IC	5.5V±2%, -Reset ODO	SOT-23	16vdc	VD6	3a	Utc
5FN5G	81N55G-P-AE3-5	Vdet-IC	5.5V±2%, -Reset ODO, halogen free	SOT-23	16vdc	VD6	3a	Utc
5FN5L	81N55L-P-AE3-5	Vdet-IC	5.5V±2%, -Reset ODO, lead free	SOT-23	16vdc	VD6	3a	Utc
5Fp	BC808-25	Si-pnp	AF-Drv, 30V, 500mA, 330mW, B=160..400, >100MHz	SOT-23	16ta	-	3a	PHH
5Fs	BC808-25	Si-pnp	AF-Drv, 30V, 500mA, 330mW, B=160..400, >100MHz	SOT-23	16ta	-	3a	Sie
5Fb	BC808-25W	Si-pnp	AF-Drv, 30V, 500mA, 330mW, B=160..400, >100MHz	SOT-323	16ta	-	3a	Sie
5Ft	BC808-25W	Si-pnp	AF-Drv, 30V, 500mA, 330mW, B=160..400, >100MHz	SOT-323	16ta	-	3a	Phi
5FW	BC808-25	Si-pnp	AF-Drv, 30V, 500mA, 330mW, B=160..400, >100MHz	SOT-23	16ta	-	3a	PhC
5FZ	BC808-25	Si-pnp	AF-Drv, 30V, 500mA, 330mW, B=160..400, >100MHz	SOT-23	16ta	-	3a	Zx
5G	BC808-40	Si-pnp	AF-Drv, 30V, 500mA, 330mW, B=250..630, >100MHz	SOT-23	16ta	-	3a	lIt
5G	FT533Gh	LVR-IC	LDO, 2.8V±2%, 700mA	SOT-23	16cq	VR1	3d	Fmd
5G	R3131N25EA	Vdet-IC	2.5V, +Reset PPO, 240ms	SOT-23	16vdc	VD7	3b	Ric
5GC2	81C56-P-AE3-2	Vdet-IC	5.6V±2%, -Reset PPO	SOT-23	16vdy	VD7	3a	Utc
5GC2G	81C56G-P-AE3-2	Vdet-IC	5.6V±2%, -Reset PPO, halogen free	SOT-23	16vdy	VD7	3a	Utc
5GC2L	81C56L-P-AE3-2	Vdet-IC	5.6V±2%, -Reset PPO, lead free	SOT-23	16vdy	VD7	3a	Utc
5GC3	81C56-P-AE3-3	Vdet-IC	5.6V±2%, -Reset PPO	SOT-23	16vdb	VD7	3a	Utc
5GC3G	81C56G-P-AE3-3	Vdet-IC	5.6V±2%, -Reset PPO, halogen free	SOT-23	16vdb	VD7	3a	Utc
5GC3L	81C56L-P-AE3-3	Vdet-IC	5.6V±2%, -Reset PPO, lead free	SOT-23	16vdb	VD7	3a	Utc
5GC5	81C56-P-AE3-5	Vdet-IC	5.6V±2%, -Reset PPO	SOT-23	16vdc	VD7	3a	Utc
5GC5G	81C56G-P-AE3-5	Vdet-IC	5.6V±2%, -Reset PPO, halogen free	SOT-23	16vdc	VD7	3a	Utc
5GC5L	81C56L-P-AE3-5	Vdet-IC	5.6V±2%, -Reset PPO, lead free	SOT-23	16vdc	VD7	3a	Utc
5Gg	FT533Gg	LVR-IC	LDO, 2.8V±2%, 700mA	SOT-23	16cq	VR1	3d	Fmd
5GN2	81N56-P-AE3-2	Vdet-IC	5.6V±2%, -Reset ODO	SOT-23	16vdy	VD6	3a	Utc
5GN2G	81N56G-P-AE3-2	Vdet-IC	5.6V±2%, -Reset ODO, halogen free	SOT-23	16vdy	VD6	3a	Utc
5GN2L	81N56L-P-AE3-2	Vdet-IC	5.6V±2%, -Reset ODO, lead free	SOT-23	16vdy	VD6	3a	Utc
5GN3	81N56-P-AE3-3	Vdet-IC	5.6V±2%, -Reset ODO	SOT-23	16vdb	VD6	3a	Utc
5GN3G	81N56G-P-AE3-3	Vdet-IC	5.6V±2%, -Reset ODO, halogen free	SOT-23	16vdb	VD6	3a	Utc
5GN3L	81N56L-P-AE3-3	Vdet-IC	5.6V±2%, -Reset ODO, lead free	SOT-23	16vdb	VD6	3a	Utc
5GN5	81N56-P-AE3-5	Vdet-IC	5.6V±2%, -Reset ODO	SOT-23	16vdc	VD6	3a	Utc
5GN5G	81N56G-P-AE3-5	Vdet-IC	5.6V±2%, -Reset ODO, halogen free	SOT-23	16vdc	VD6	3a	Utc
5GN5L	81N56L-P-AE3-5	Vdet-IC	5.6V±2%, -Reset ODO, lead free	SOT-23	16vdc	VD6	3a	Utc
5Gp	BC808-40	Si-pnp	AF-Drv, 30V, 500mA, 330mW, B=250..630, >100MHz	SOT-23	16ta	-	3a	PHH
5Gs	BC808-40	Si-pnp	AF-Drv, 30V, 500mA, 330mW, B=250..630, >100MHz	SOT-23	16ta	-	3a	Sie
5Gb	BC808-40W	Si-pnp	AF-Drv, 30V, 500mA, 330mW, B=250..630, >100MHz	SOT-323	16ta	-	3a	Sie
5Gt	BC808-40W	Si-pnp	AF-Drv, 30V, 500mA, 330mW, B=250..630, >100MHz	SOT-323	16ta	-	3a	Phi
5GW	BC808-40	Si-pnp	AF-Drv, 30V, 500mA, 330mW, B=250..630, >100MHz	SOT-23	16ta	-	3a	PhC
5GZ	BC808-40	Si-pnp	AF-Drv, 30V, 500mA, 330mW, B=250..630, >100MHz	SOT-23	16ta	-	3a	Zx
5H	BC808	Si-pnp	AF-Drv, 30V, 500mA, 330mW, B=100..600, >100MHz	SOT-23	16ta	-	3a	Cdi
5H	CHBD4148M1PT	Si-diode	Sw, 75V, 150mA, Vf<1V(10mA), 4ns	FBPT-723	17dc	-	9d	Chm
5H	CHBD4148T1PT	Si-diode	Sw, 75V, 250mA, Vf<1V(10mA), 4ns	FBPT-723	17dc	-	9d	Chm
5H	FT533Hh	LVR-IC	LDO, 2.85V±2%, 700mA	SOT-23	16cq	VR1	3d	Fmd
5H	MMBD4148	Si-diode	Sw, Fast, 75V, 200mA, 350mW, <4ns, 4pF	SOT-23	16dc	-	3a	F
5H	MMBD701	Si-diode	Schottky, UHF/VHF-Det, 70V, 10mA, Vf<1V(10mA), <1pF	SOT-23	16dc	-	3a	Ons
5H	MMBD770	Si-diode	Schottky, UHF/VHF-Det, 30V, 10mA, Vf<1V(10mA), <1pF	SOT-323	16dc	-	3a	Ons
5H	R3131N35EA	Vdet-IC	3.5V, +Reset PPO, 240ms	SOT-23	16vdc	VD7	3b	Ric
5H-	BD4148PT	Si-diode	Sw, 75V, 250mA, Vf<1V(10mA), 4ns	SOT-23	16dc	-	3a	Chm
5H0	TC55RP562ECB	LVR-IC	LDO, 5.6V±2%, 250mA	SOT-23	16cq	VR1	3d	Mcc
5H0	XC62FP5602M	LVR-IC	5.6V±2%, 250mA	SOT-23	16cg	VR1	3d	Tor
5H5	TC595602ECB	LVR-IC	LDO, -5.6V±2%, 200mA	SOT-23	16cj	VR2	3d	Mcc
5H5	XC62KN562M	LVR-IC	LDO, -5.6V±2%, 100mA, 150mW	SOT-23	16cj	VR2	3d	Tor
5HC2	81C57-P-AE3-2	Vdet-IC	5.7V±2%, -Reset PPO	SOT-23	16vdy	VD7	3a	Utc
5HC2G	81C57G-P-AE3-2	Vdet-IC	5.7V±2%, -Reset PPO, halogen free	SOT-23	16vdy	VD7	3a	Utc
5HC2L	81C57L-P-AE3-2	Vdet-IC	5.7V±2%, -Reset PPO, lead free	SOT-23	16vdy	VD7	3a	Utc
5HC3	81C57-P-AE3-3	Vdet-IC	5.7V±2%, -Reset PPO	SOT-23	16vdb	VD7	3a	Utc
5HC3G	81C57G-P-AE3-3	Vdet-IC	5.7V±2%, -Reset PPO, halogen free	SOT-23	16vdb	VD7	3a	Utc
5HC3L	81C57L-P-AE3-3	Vdet-IC	5.7V±2%, -Reset PPO, lead free	SOT-23	16vdb	VD7	3a	Utc
5HC5	81C57-P-AE3-5	Vdet-IC	5.7V±2%, -Reset PPO	SOT-23	16vdc	VD7	3a	Utc
5HC5G	81C57G-P-AE3-5	Vdet-IC	5.7V±2%, -Reset PPO, halogen free	SOT-23	16vdc	VD7	3a	Utc
5HC5L	81C57L-P-AE3-5	Vdet-IC	5.7V±2%, -Reset PPO, lead free	SOT-23	16vdc	VD7	3a	Utc
5Hg	FT533Hg	LVR-IC	LDO, 2.85V±2%, 700mA	SOT-23	16cq	VR1	3d	Fmd
5HN2	81N57-P-AE3-2	Vdet-IC	5.7V±2%, -Reset ODO	SOT-23	16vdy	VD6	3a	Utc
5HN2G	81N57G-P-AE3-2	Vdet-IC	5.7V±2%, -Reset ODO, halogen free	SOT-23	16vdy	VD6	3a	Utc
5HN2L	81N57L-P-AE3-2	Vdet-IC	5.7V±2%, -Reset ODO, lead free	SOT-23	16vdy	VD6	3a	Utc
5HN3	81N57-P-AE3-3	Vdet-IC	5.7V±2%, -Reset ODO	SOT-23	16vdb	VD6	3a	Utc
5HN3G	81N57G-P-AE3-3	Vdet-IC	5.7V±2%, -Reset ODO, halogen free	SOT-23	16vdb	VD6	3a	Utc
5HN3L	81N57L-P-AE3-3	Vdet-IC	5.7V±2%, -Reset ODO, lead free	SOT-23	16vdb	VD6	3a	Utc
5HN5	81N57-P-AE3-5	Vdet-IC	5.7V±2%, -Reset ODO	SOT-23	16vdc	VD6	3a	Utc



SMD code	Type	Function	Short description	Case	Pinout	Sch.	St.	Mnf.
5HN5G	81N57G-P-AE3-5	Vdet-IC	5.7V±2%, -Reset ODO, halogen free	SOT-23	16vdc	VD6	3a	Utc
5HN5L	81N57L-P-AE3-5	Vdet-IC	5.7V±2%, -Reset ODO, lead free	SOT-23	16vdc	VD6	3a	Utc
5Hp	BC808	Si-pnp	AF-Drv, 30V, 500mA, 330mW, B=100..600, >100MHz	SOT-23	16ta	-	3a	PHH
5Ht	BC808W	Si-pnp	AF-Drv, 30V, 500mA, 330mW, B=250..630, >80MHz	SOT-23	16ta	-	3a	Phi
5HW	BC808	Si-pnp	AF-Drv, 30V, 500mA, 330mW, B=100..600, >100MHz	SOT-23	16ta	-	3a	PhC
5HZ	BC808	Si-pnp	AF-Drv, 30V, 500mA, 330mW, B=100..600, >100MHz	SOT-23	16ta	-	3a	Zx
5I	FT533Ih	LVR-IC	LDO, 3.0V±2%, 700mA	SOT-23	16cq	VR1	3d	Fmd
5I-	BD4148APT	Si-diode	Dual, Sw, 75V, 150mA, Vf<1V(10mA), 4ns	SOT-23	16df	-	3a	Chm
5Ig	FT533Ilg	LVR-IC	LDO, 3.0V±2%, 700mA	SOT-23	16cq	VR1	3d	Fmd
5J	FMMT38B	Si-npn-Darl	GP, 50V, 300mA, 330mW, B>2000	SOT-23	16ta	-	3a	Zx
5J	FT533Jh	LVR-IC	LDO, 3.3V±2%, 700mA	SOT-23	16cq	VR1	3d	Fmd
5J	R3131N45EA	Vdet-IC	4.5V, +Reset PPO, 240ms	SOT-23	16vdc	VD7	3b	Ric
5J-	BD4148CPT	Si-diode	Dual, Sw, 75V, 150mA, Vf<1V(10mA), 4ns	SOT-23	16dg	-	3a	Chm
5JC2	81C58-P-AE3-2	Vdet-IC	5.8V±2%, -Reset PPO	SOT-23	16vdy	VD7	3a	Utc
5JC2G	81C58G-P-AE3-2	Vdet-IC	5.8V±2%, -Reset PPO, halogen free	SOT-23	16vdy	VD7	3a	Utc
5JC2L	81C58L-P-AE3-2	Vdet-IC	5.8V±2%, -Reset PPO, lead free	SOT-23	16vdy	VD7	3a	Utc
5JC3	81C58-P-AE3-3	Vdet-IC	5.8V±2%, -Reset PPO	SOT-23	16vdb	VD7	3a	Utc
5JC3G	81C58G-P-AE3-3	Vdet-IC	5.8V±2%, -Reset PPO, halogen free	SOT-23	16vdb	VD7	3a	Utc
5JC3L	81C58L-P-AE3-3	Vdet-IC	5.8V±2%, -Reset PPO, lead free	SOT-23	16vdb	VD7	3a	Utc
5JC5	81C58-P-AE3-5	Vdet-IC	5.8V±2%, -Reset PPO	SOT-23	16vdc	VD7	3a	Utc
5JC5G	81C58G-P-AE3-5	Vdet-IC	5.8V±2%, -Reset PPO, halogen free	SOT-23	16vdc	VD7	3a	Utc
5JC5L	81C58L-P-AE3-5	Vdet-IC	5.8V±2%, -Reset PPO, lead free	SOT-23	16vdc	VD7	3a	Utc
5Jg	FT533Jg	LVR-IC	LDO, 3.3V±2%, 700mA	SOT-23	16cq	VR1	3d	Fmd
5JN2	81N58-P-AE3-2	Vdet-IC	5.8V±2%, -Reset ODO	SOT-23	16vdy	VD6	3a	Utc
5JN2G	81N58G-P-AE3-2	Vdet-IC	5.8V±2%, -Reset ODO, halogen free	SOT-23	16vdy	VD6	3a	Utc
5JN2L	81N58L-P-AE3-2	Vdet-IC	5.8V±2%, -Reset ODO, lead free	SOT-23	16vdy	VD6	3a	Utc
5JN3	81N58-P-AE3-3	Vdet-IC	5.8V±2%, -Reset ODO	SOT-23	16vdb	VD6	3a	Utc
5JN3G	81N58G-P-AE3-3	Vdet-IC	5.8V±2%, -Reset ODO, halogen free	SOT-23	16vdb	VD6	3a	Utc
5JN3L	81N58L-P-AE3-3	Vdet-IC	5.8V±2%, -Reset ODO, lead free	SOT-23	16vdb	VD6	3a	Utc
5JN5	81N58-P-AE3-5	Vdet-IC	5.8V±2%, -Reset ODO	SOT-23	16vdc	VD6	3a	Utc
5JN5G	81N58G-P-AE3-5	Vdet-IC	5.8V±2%, -Reset ODO, halogen free	SOT-23	16vdc	VD6	3a	Utc
5JN5L	81N58L-P-AE3-5	Vdet-IC	5.8V±2%, -Reset ODO, lead free	SOT-23	16vdc	VD6	3a	Utc
5K	FT533Kh	LVR-IC	LDO, 3.6V±2%, 700mA	SOT-23	16cq	VR1	3d	Fmd
5K	MMBV809	C-diode	UHF-Tuning, 20V, 225mW, 4.5/6.1pF(2V, 1MHz)	SOT-23	16dc	-	3a	Ons
5K	UNRF2AF	Si-npn-Digi	Sw, 50V, 80mA, 100mW, 150MHz, R1/R2=4.7k/10k	ML3	22ta	-	2b	Pan
5K-	BD4148SPT	Si-diode	Dual, Sw, 75V, 150mA, Vf<1V(10mA), 4ns	SOT-23	16dl	-	3a	Chm
5K0	TC595P572ECB	LVR-IC	LDO, 5.7V±2%, 250mA	SOT-23	16cq	VR1	3d	Mcc
5K0	XC62FP5702M	LVR-IC	5.7V±2%, 250mA	SOT-23	16cg	VR1	3d	Tor
5K5	TC595702ECB	LVR-IC	LDO, -5.7V±2%, 200mA	SOT-23	16cj	VR2	3d	Mcc
5K5	XC62KN572M	LVR-IC	LDO, -5.7V±2%, 100mA, 150mW	SOT-23	16cj	VR2	3d	Tor
5KC2	81C59-P-AE3-2	Vdet-IC	5.9V±2%, -Reset PPO	SOT-23	16vdy	VD7	3a	Utc
5KC2G	81C59G-P-AE3-2	Vdet-IC	5.9V±2%, -Reset PPO, halogen free	SOT-23	16vdy	VD7	3a	Utc
5KC2L	81C59L-P-AE3-2	Vdet-IC	5.9V±2%, -Reset PPO, lead free	SOT-23	16vdy	VD7	3a	Utc
5KC3	81C59-P-AE3-3	Vdet-IC	5.9V±2%, -Reset PPO	SOT-23	16vdb	VD7	3a	Utc
5KC3G	81C59G-P-AE3-3	Vdet-IC	5.9V±2%, -Reset PPO, halogen free	SOT-23	16vdb	VD7	3a	Utc
5KC3L	81C59L-P-AE3-3	Vdet-IC	5.9V±2%, -Reset PPO, lead free	SOT-23	16vdb	VD7	3a	Utc
5KC5	81C59-P-AE3-5	Vdet-IC	5.9V±2%, -Reset PPO	SOT-23	16vdc	VD7	3a	Utc
5KC5G	81C59G-P-AE3-5	Vdet-IC	5.9V±2%, -Reset PPO, halogen free	SOT-23	16vdc	VD7	3a	Utc
5KC5L	81C59L-P-AE3-5	Vdet-IC	5.9V±2%, -Reset PPO, lead free	SOT-23	16vdc	VD7	3a	Utc
5Kg	FT533Kg	LVR-IC	LDO, 3.6V±2%, 700mA	SOT-23	16cq	VR1	3d	Fmd
5KN2	81N59-P-AE3-2	Vdet-IC	5.9V±2%, -Reset ODO	SOT-23	16vdy	VD6	3a	Utc
5KN2G	81N59G-P-AE3-2	Vdet-IC	5.9V±2%, -Reset ODO, halogen free	SOT-23	16vdy	VD6	3a	Utc
5KN2L	81N59L-P-AE3-2	Vdet-IC	5.9V±2%, -Reset ODO, lead free	SOT-23	16vdy	VD6	3a	Utc
5KN3	81N59-P-AE3-3	Vdet-IC	5.9V±2%, -Reset ODO	SOT-23	16vdb	VD6	3a	Utc
5KN3G	81N59G-P-AE3-3	Vdet-IC	5.9V±2%, -Reset ODO, halogen free	SOT-23	16vdb	VD6	3a	Utc
5KN3L	81N59L-P-AE3-3	Vdet-IC	5.9V±2%, -Reset ODO, lead free	SOT-23	16vdb	VD6	3a	Utc
5KN5	81N59-P-AE3-5	Vdet-IC	5.9V±2%, -Reset ODO	SOT-23	16vdc	VD6	3a	Utc
5KN5G	81N59G-P-AE3-5	Vdet-IC	5.9V±2%, -Reset ODO, halogen free	SOT-23	16vdc	VD6	3a	Utc
5KN5L	81N59L-P-AE3-5	Vdet-IC	5.9V±2%, -Reset ODO, lead free	SOT-23	16vdc	VD6	3a	Utc
5Kp	BAP64-05	PIN-diode	Dual, RF, 175V, 100mA, 250mW, 0.35pF, 3.8Ω(10mA/100MHz)	SOT-23	16dg	-	3a	Phi
5L	MMBV609	C-diode	Dual, FM-Tuning, 20V, 26/32pF(3V)	SOT-23	16dg	-	3a	Mot
5L	R3131N46AC5	Vdet-IC	4.6V, +Reset ODO, 50ms	SOT-23	16vdc	VD6	3b	Ric
5L	UNRF2AK	Si-npn-Digi	Sw, 50V, 80mA, 100mW, 150MHz, R1/R2=10k/4.7k	ML3	22ta	-	2b	Pan
5L0	TC595P582ECB	LVR-IC	LDO, 5.8V±2%, 250mA	SOT-23	16cq	VR1	3d	Mcc
5L0	XC62FP5802M	LVR-IC	5.8V±2%, 250mA	SOT-23	16cg	VR1	3d	Tor
5L5	TC595802ECB	LVR-IC	LDO, -5.8V±2%, 200mA	SOT-23	16cj	VR2	3d	Mcc
5L5	XC62KN582M	LVR-IC	LDO, -5.8V±2%, 100mA, 150mW	SOT-23	16cj	VR2	3d	Tor
5LN	ELM7542CEB	Vdet-IC	4.2V±2%, +Reset PPO	SC-70	16vdb	VD7	3d	Elm
5LN	ELM7542NEB	Vdet-IC	4.2V±2%, +Reset ODO	SC-70	16vdb	VD6	3d	Elm
5M	2SJ0672	p-MOSFET	Sw, 30V, 100mA, 100mW, 15Ω(10mA)	SSSMini3-F1	18fh	-	3a	Pan



SMD code	Type	Function	Short description	Case	Pinout	Sch.	St.	Mnf.
5M	CESD5V0AP	ESDP-diode	Dual, Vbr=6.2..7.3V, Vrrwm=5V, Ipp=12A, 300W(1ms)	SOT-23	16df	-	3a	Jce
5M	R3131N46BC5	Vdet-IC	4.6V, +Reset ODO, 100ms	SOT-23	16vdc	VD6	3b	Ric
5M0	TC55RP592ECB	LVR-IC	LDO, 5.9V±2%, 250mA	SOT-23	16cq	VR1	3d	Mcc
5M0	XC62FP5902M	LVR-IC	5.9V±2%, 250mA	SOT-23	16cg	VR1	3d	Tor
5M5	TC595902ECB	LVR-IC	LDO, -5.9V±2%, 200mA	SOT-23	16cj	VR2	3d	Mcc
5M5	XC62KN592M	LVR-IC	LDO, -5.9V±2%, 100mA, 150mW	SOT-23	16cj	VR2	3d	Tor
5N	IMBT3906	Si-pnp	GP, 40V, 200mA, 250mW, B=60..300, >250MHz	SOT-23	16ta	-	3a	lIt
5N	MMBD452	Si-diode	Dual, UHFV/HF-Det, 30V, 10mA, Vf<0.6V(10mA), <1.5pF	SOT-23	16dl	-	3a	Ons
5N	R3131N46DC5	Vdet-IC	4.6V, +Reset ODO, 200ms	SOT-23	16vdc	VD6	3b	Ric
5N	UNRF2AT	Si-npn-Digi	Sw, 50V, 80mA, 100mW, 150MHz, R1/R2=22k/47k	ML3	22ta	-	2b	Pan
5N	YTS4126	Si-pnp	GP, 25V, 200mA, 350mW, B=120..360, >250MHz	SOT-23	16ta	-	3a	Tos
5P	FMMT2907AR	Si-pnp	GP, 60V, 60mA, 330mW, B=100..300, >200MHz	SOT-23	16te	-	3a	Zx
5P	R3131N46HC5	Vdet-IC	4.6V, +Reset ODO, 400ms	SOT-23	16vdc	VD6	3b	Ric
5P	UNRF2AV	Si-npn-Digi	Sw, 50V, 80mA, 100mW, 150MHz, R1/R2=2.2k/2.2k	ML3	22ta	-	2b	Pan
5PMS	S5PMS	Si-diode	Rectifier, 1000V, 5A, Vf<1V(5A)	TO-277A	76dh	-	3o	Vs
5Q	DDZX39F	Z-diode	39V±2.5%, 500mW	SOT-23	16dc	-	3a	Di
5Q	DDZX39FW	Z-diode	39V±2.5%, 200mW	SOT-323	16dc	-	3a	Di
5Q	R3131N46AA5	Vdet-IC	4.6V, +Reset PPO, 50ms	SOT-23	16vdc	VD7	3b	Ric
5R	R3131N46BA5	Vdet-IC	4.6V, +Reset PPO, 100ms	SOT-23	16vdc	VD7	3b	Ric
5R	SRA2205E	Si-pnp-Digi	Sw, 50V, 100mA, 150mW, 200MHz, R1/R2=22/47k	SOT-523	16ta	-	3a	Auk
5R	SRA2205EF	Si-pnp-Digi	Sw, 50V, 100mA, 150mW, 200MHz, R1/R2=22/47k	SOT-523F	18ta	-	3a	Auk
5R	SRA2205U	Si-pnp-Digi	Sw, 50V, 100mA, 200mW, 200MHz, R1/R2=22/47k	SOT-323	16ta	-	3a	Auk
5R	SRA2205UF	Si-pnp-Digi	Sw, 50V, 100mA, 200mW, 200MHz, R1/R2=22/47k	SOT-323F	18ta	-	3a	Auk
5S	R3131N46DA5	Vdet-IC	4.6V, +Reset PPO, 200ms	SOT-23	16vdc	VD7	3b	Ric
5T	BCW66GR	Si-npn	AF, 75V, 800mA, 330mW, B=160..400, >100MHz	SOT-23	16te	-	3a	Zx
5T	BCW68GR	Si-pnp	AF, Sw, 60V, 800mA, 330mW, B=160..400, >100MHz	SOT-23	16ta	-	3a	Zx
5T	MSG33002	SiGe-npn	RF, LN, 9V, 60mA, 100mW, 19GHz, B=100..200	SSSMini3	18ta	-	3a	Pan
5T	R3131N46HA5	Vdet-IC	4.6V, +Reset PPO, 400ms	SOT-23	16vdc	VD7	3b	Ric
5V	BCW65BR	Si-npn	AF, 60V, 800mA, 330mW, B=160..400, >100MHz	SOT-23	16te	-	3a	Zx
5V1	CHPZ5V1PT	Z-diode	Dual, 4.8..5.4V, Izt=5mA, Zzt=60Ω, 350mW	SOT-23	16df	-	3a	Chm
5V1	PZM5.1NB	Z-diode	5.1V±2.5%, 300mW	SOT-346	16dc	-	3a	Phi
5V6	CHPZ5V6PT	Z-diode	Dual, 5.2..6.0V, Izt=5mA, Zzt=40Ω, 350mW	SOT-23	16df	-	3a	Chm
5V6	PZM5.6NB	Z-diode	5.6V±2.5%, 300mW	SOT-346	16dc	-	3a	Phi
5V	BCW67BR	Si-pnp	AF, Sw, 45V, 800mA, 330mW, B=160..400, >100MHz	SOT-23	16ta	-	3a	Zx
5V-	BAP64-05W	PIN-diode	Dual, RF, 100V, 100mA, 250mW, 0.35pF, 3.8Q(10mA/100MHz)	SOT-323	16dg	-	3a	Phi
5Z	2SK4029	n-MOSFET*	Sw, 25V, 1A, 500mW, 0.26Q(500mA), 8/30ns	S-Mini3-G1	16fh	-	3a	Pan
5Z1	CZ1W5V1	Z-diode	5.1V±5%, 600mW	SOT-23	16dc	-	3a	Cdi
5Z6	CZ1W5V6	Z-diode	5.6V±5%, 600mW	SOT-23	16dc	-	3a	Cdi
6.2	TZT6.2W	Z-diode	5.80..6.60V, Izt=5mA, Zzt=30Ω, 200mW	SOT-323	16dc	-	3a	Ttr
6.2	Z0ZV6.2V	Z-diode	5.80..6.60V, Izt=5mA, Zzt=30Ω, 200mW	SOT-23	16dc	-	3f	Kec
6.2A	MAZ3062WA	Z-diode	Dual, 6.2V, If=100mA, Zzt=20Ω, 200mW	SC-59	16df	-	3a	Pan
6.2C	MAZC062D	SA-Z-diode	Dual, 6.2V, Zzt=30Ω(5mA), 200mW	SC-59	16df	-	3a	Pan
6.2C	MAZE062D	SA-Z-diode	Dual, 6.2V, 5mA, 150mW	SOD-523	18df	-	3a	Pan
6.2H	BZX84-C6V2-V	Z-diode	6.0..6.39V, Izt=5mA, Zzt=30Ω, 300mW	SOT-23	16dc	-	3f	Kec
6.2H	MAZ3062-H	Z-diode	5.8..6.6V, If=100mA, Zzt=20Ω, 200mW	SC-59	16dc	-	3a	Pan
6.2L	MAZ3062-L	Z-diode	5.8..6.6V, If=100mA, Zzt=20Ω, 200mW	SC-59	16dc	-	3a	Pan
6.2M	MAZ3062-M	Z-diode	5.8..6.6V, If=100mA, Zzt=20Ω, 200mW	SC-59	16dc	-	3a	Pan
6.2X	TZT6.2XW	Z-diode	5.80..6.20V, Izt=5mA, Zzt=30Ω, 200mW	SOT-323	16dc	-	3a	Ttr
6.2X	Z0ZV6.2VX	Z-diode	5.80..6.20V, Izt=5mA, Zzt=30Ω, 200mW	SOT-23	16dc	-	3f	Kec
6.2Y	TZT6.2YW	Z-diode	6.0..6.39V, Izt=5mA, Zzt=30Ω, 200mW	SOT-323	16dc	-	3a	Ttr
6.2Y	Z0ZV6.2VY	Z-diode	6.0..6.39V, Izt=5mA, Zzt=30Ω, 200mW	SOT-23	16dc	-	3f	Kec
6.2Z	MAZ9062H	SA-Z-diode	Dual, 6.2V, Zzt=50Ω(5mA), 200mW	SC-59	16df	-	3a	Pan
6.2Z	MAZT062H	SA-Z-diode	Dual, 6.2V, 5mA, 150mW	SC-81	18df	-	3a	Pan
6.2Z	TZT6.2ZW	Z-diode	6.19..6.60V, Izt=5mA, Zzt=30Ω, 200mW	SOT-323	16dc	-	3a	Ttr
6.2Z	Z0ZV6.2VZ	Z-diode	6.19..6.60V, Izt=5mA, Zzt=30Ω, 200mW	SOT-23	16dc	-	3f	Kec
6.8	TZT6.8W	Z-diode	6.40..7.20V, Izt=5mA, Zzt=25Ω, 200mW	SOT-323	16dc	-	3a	Ttr
6.8	Z0ZV6.8V	Z-diode	6.40..7.20V, Izt=5mA, Zzt=25Ω, 200mW	SOT-23	16dc	-	3f	Kec
6.8H	BZX84-C6V8-V	Z-diode	6.60..7.02V, Izt=5mA, Zzt=25Ω, 300mW	SOT-23	16dc	-	3f	Kec
6.8H	MAZ3068-H	Z-diode	6.4..7.2V, If=100mA, Zzt=15Ω, 200mW	SC-59	16dc	-	3a	Pan
6.8L	MAZ3068-L	Z-diode	6.4..7.2V, If=100mA, Zzt=15Ω, 200mW	SC-59	16dc	-	3a	Pan
6.8M	MAZ3068-M	Z-diode	6.4..7.2V, If=100mA, Zzt=15Ω, 200mW	SC-59	16dc	-	3a	Pan
6.8X	TZT6.8XW	Z-diode	6.40..6.80V, Izt=5mA, Zzt=25Ω, 200mW	SOT-323	16dc	-	3a	Ttr
6.8X	Z0ZV6.8VX	Z-diode	6.40..6.80V, Izt=5mA, Zzt=25Ω, 200mW	SOT-23	16dc	-	3f	Kec
6.8Y	TZT6.8YW	Z-diode	6.60..7.02V, Izt=5mA, Zzt=25Ω, 200mW	SOT-323	16dc	-	3a	Ttr
6.8Y	Z0ZV6.8VY	Z-diode	6.60..7.02V, Izt=5mA, Zzt=25Ω, 200mW	SOT-23	16dc	-	3f	Kec
6.8Z	MAZ9068H	SA-Z-diode	Dual, 6.8V, Zzt=30Ω(5mA), 200mW	SC-59	18df	-	3a	Pan
6.8Z	MAZT068H	SA-Z-diode	Dual, 6.8V, 5mA, 150mW	SC-81	18df	-	3a	Pan
6.8Z	TZT6.8ZW	Z-diode	6.82..7.20V, Izt=5mA, Zzt=25Ω, 200mW	SOT-323	16dc	-	3a	Ttr
6.8Z	Z0ZV6.8VZ	Z-diode	6.82..7.20V, Izt=5mA, Zzt=25Ω, 200mW	SOT-23	16dc	-	3f	Kec
6-2X	02CZ6.2-X	Z-diode	5.8..6.2V, 200mW	SC-59	16dc	-	3a	Tos



SMD code	Type	Function	Short description	Case	Pinout	Sch.	St.	Mnf.
6-2Y	02CZ6.2-Y	Z-diode	6..6.39V, 200mW	SC-59	16dc	-	3a	Tos
6-2Z	02CZ6.2-Z	Z-diode	6.19..6.6V, 200mW	SC-59	16dc	-	3a	Tos
6-8X	02CZ6.8-X	Z-diode	6.4..6.8V, 200mW	SC-59	16dc	-	3a	Tos
6-8Y	02CZ6.8-Y	Z-diode	6.6..7.02V, 200mW	SC-59	16dc	-	3a	Tos
6-8Z	02CZ6.8-Z	Z-diode	6.82..7.20V, 200mW	SC-59	16dc	-	3a	Tos
60	CHDTC143XMPT	Si-npn-Digi	Sw, 50V, 100mA, 250MHz, R1/R2=4.7/10k	SOT-723	18ta	-	3a	Chm
60	ELM9860BB	LVR-IC	6.0V±2%, 200mA	SOT-23	16cg	VR1	3d	Elm
605	NDS0605	p-MOSFET-e	V-MOS, 60V, 0.18A, <5Q(0.5A)	SOT-23	16df	-	3a	Nsc
60B	MMBZ5260BPT	Z-diode	40.85..45.15V, Izt=3.0mA, Zzt=93Q, 225mW	SOT-23	16dc	-	3a	Chm
60S	MMBZ5260SPT	Z-diode	42.14..43.86V, Izt=3.0mA, Zzt=93Q, 225mW	SOT-23	16dc	-	3a	Chm
60S	MMBZ5260SPT	Z-diode	42.14..43.86V, Izt=3.0mA, Zzt=93Q, 225mW	SOT-346	16dc	-	3a	Chm
60T	TK71560AS	LVR-IC	LDO, 6V±1.5%, 155mA	SOT-23	16cj	VR1	3d	Tok
61	CHDTC143ZMPT	Si-npn-Digi	Sw, 50V, 100mA, 250MHz, R1/R2=4.7/47k	SOT-723	18ta	-	3a	Chm
610	KV1610S	C-diode	Dual, AM-Tunung, 26V, 50mA, 100mW, 194/46pF(8..1V)	SOT-23	16dg	-	3a	Tok
614	FMMT614	Si-npn-Darl	GP, 120/100V, 500mA, 500mW, B=15000	SOT-23	16ta	-	3a	Zx
615	XC9111B151MR	DC/DC-IC	PFM step-up, 100kHz, 1.5V±2.5%, 400mA	SOT-23	16sw	DC5	3d	Tor
616	XC9111B161MR	DC/DC-IC	PFM step-up, 100kHz, 1.6V±2.5%, 400mA	SOT-23	16sw	DC5	3d	Tor
617	FMMT617	Si-npn	Sw, Lo-sat, 15V, 3A, 625mW 120/160ns	SOT-23	16ta	-	3a	Zx
617	XC9111B171MR	DC/DC-IC	PFM step-up, 100kHz, 1.7V±2.5%, 400mA	SOT-23	16sw	DC5	3d	Tor
618	FMMT618	Si-npn	Sw, Lo-sat, 20V, 2.5A, 625mW, B=300..450, >140MHz	SOT-23	16ta	-	3a	Zx
618	XC9111B181MR	DC/DC-IC	PFM step-up, 100kHz, 1.8V±2.5%, 400mA	SOT-23	16sw	DC5	3d	Tor
619	FMMT619	Si-npn	Sw, Lo-sat, 50V, 2A, 625mW, B=300..450, >160MHz	SOT-23	16ta	-	3a	Zx
619	XC9111B191MR	DC/DC-IC	PFM step-up, 100kHz, 1.9V±2.5%, 400mA	SOT-23	16sw	DC5	3d	Tor
61B	MMBZ5261BPT	Z-diode	44.65..49.35V, Izt=2.7mA, Zzt=105Q, 225mW	SOT-23	16dc	-	3a	Chm
61S	MMBZ5261SPT	Z-diode	46.06..47.94V, Izt=2.7mA, Zzt=105Q, 225mW	SOT-23	16dc	-	3a	Chm
61S	MMBZ5261SPT	Z-diode	46.06..47.94V, Izt=2.7mA, Zzt=105Q, 225mW	SOT-346	16dc	-	3a	Chm
62	CHDTC144EMPT	Si-npn-Digi	Sw, 50V, 30mA, 250MHz, R1/R2=47/47k	SOT-723	18ta	-	3a	Chm
62	DTC123YE	Si-npn-Digi	Sw, 50V, 100mA, 150mW, 250MHz, R1/R2=2k2/10k	SOT-416	16ta	-	3a	Rhm
62	DTC123YKA	Si-npn-Digi	Sw, 50V, 100mA, 200mW, 250MHz, R1/R2=2k2/10k	SOT-346	16ta	-	3a	Rhm
62	DTC123YUA	Si-npn-Digi	Sw, 50V, 100mA, 200mW, 250MHz, R1/R2=2k2/10k	UMT3	16ta	-	3a	Rhm
62	MAZW062H	SA-Z-diode	Dual, 6.2V, 5mA, 150mW	SSSMini3	18df	-	3a	Pan
620	XC9111B201MR	DC/DC-IC	PFM step-up, 100kHz, 2.0V±2.5%, 400mA	SOT-23	16sw	DC5	3d	Tor
621	HZM6.2NB1	Z-diode	5.86..6.12V, 200mW	SC-59A	16dc	-	3a	Ren
621	PZM6.2NB1	Z-diode	6.2V±2.5%, 300mW	SOT-346	16dc	-	3a	Phi
621	XC9111B211MR	DC/DC-IC	PFM step-up, 100kHz, 2.1V±2.5%, 400mA	SOT-23	16sw	DC5	3d	Tor
622	HZM6.2NB2	Z-diode	6.06..6.33V, 200mW	SC-59A	16dc	-	3a	Ren
622	PZM6.2NB2	Z-diode	6.2V±2.5%, 300mW	SOT-346	16dc	-	3a	Phi
622	XC9111B221MR	DC/DC-IC	PFM step-up, 100kHz, 2.2V±2.5%, 400mA	SOT-23	16sw	DC5	3d	Tor
623	HZM6.2NB3	Z-diode	6.26..6.53V, 200mW	SC-59A	16dc	-	3a	Ren
623	PZM6.2NB3	Z-diode	6.2V±2.5%, 300mW	SOT-346	16dc	-	3a	Phi
623	XC9111B231MR	DC/DC-IC	PFM step-up, 100kHz, 2.3V±2.5%, 400mA	SOT-23	16sw	DC5	3d	Tor
624	FMMT624	Si-npn	Sw, Lo-sat, 125V, 1A, 625mW, B=300..450, >155MHz	SOT-23	16ta	-	3a	Zx
624	XC9111B241MR	DC/DC-IC	PFM step-up, 100kHz, 2.4V±2.5%, 400mA	SOT-23	16sw	DC5	3d	Tor
625	FMMT625	Si-npn	Sw, Lo-sat, 150V, 1A, 625mW, B=300..450, >135MHz	SOT-23	16ta	-	3a	Zx
625	XC9111B251MR	DC/DC-IC	PFM step-up, 100kHz, 2.5V±2.5%, 400mA	SOT-23	16sw	DC5	3d	Tor
626	XC9111B261MR	DC/DC-IC	PFM step-up, 100kHz, 2.6V±2.5%, 400mA	SOT-23	16sw	DC5	3d	Tor
627	XC9111B271MR	DC/DC-IC	PFM step-up, 100kHz, 2.7V±2.5%, 400mA	SOT-23	16sw	DC5	3d	Tor
628	XC9111B281MR	DC/DC-IC	PFM step-up, 100kHz, 2.8V±2.5%, 400mA	SOT-23	16sw	DC5	3d	Tor
629	XC9111B291MR	DC/DC-IC	PFM step-up, 100kHz, 2.9V±2.5%, 400mA	SOT-23	16sw	DC5	3d	Tor
62B	MMBZ5262BPT	Z-diode	48.45..53.35V, Izt=2.5mA, Zzt=125Q, 225mW	SOT-23	16dc	-	3a	Chm
62B	MMBZ5262BPT	Z-diode	48.45..53.35V, Izt=2.5mA, Zzt=125Q, 225mW	SOT-346	16dc	-	3a	Chm
62S	MMBZ5262SPT	Z-diode	49.98..52.02V, Izt=2.5mA, Zzt=125Q, 225mW	SOT-23	16dc	-	3a	Chm
62S	MMBZ5262SPT	Z-diode	49.98..52.02V, Izt=2.5mA, Zzt=125Q, 225mW	SOT-346	16dc	-	3a	Chm
62V	PZM62NB	Z-diode	62V±2.5%, 300mW	SOT-346	16dc	-	3a	Phi
62V	PZM62NB1	Z-diode	62V±2.5%, 300mW	SOT-346	16dc	-	3a	Phi
63	1PS70SB40	Si-diode	Schottky, Sw, Fast, 40V, 120mA, <100ps	SOT-323	16dc	-	3a	PHH
63	BAS40W	Si-diode	SBD, 40V, 200mA, 200mW, Cd<5pF, <5ns	SOT-323	16dc	-	3a	PHH
63	BAT64	Si-diode	SBD, Fast-Sw, 30V, 250mA, Vf<0.75V, Cd<6pF	SOT-23	16dc	-	3a	Cdi
63	CHDTC144VMPT	Si-npn-Digi	Sw, 50V, 30mA, 250MHz, R1/R2=47/10k	SOT-723	18ta	-	3a	Chm
63	CSA1163	Si-pnp	GP, 120V, 100mA, 150mW, B=200..700, 100MHz	SOT-23	16ta	-	3a	Cdi
630	XC9111B301MR	DC/DC-IC	PFM step-up, 100kHz, 3.0V±2.5%, 400mA	SOT-23	16sw	DC5	3d	Tor
631	XC9111B311MR	DC/DC-IC	PFM step-up, 100kHz, 3.1V±2.5%, 400mA	SOT-23	16sw	DC5	3d	Tor
632	XC9111B321MR	DC/DC-IC	PFM step-up, 100kHz, 3.2V±2.5%, 400mA	SOT-23	16sw	DC5	3d	Tor
633	XC9111B331MR	DC/DC-IC	PFM step-up, 100kHz, 3.3V±2.5%, 400mA	SOT-23	16sw	DC5	3d	Tor
634	XC9111B341MR	DC/DC-IC	PFM step-up, 100kHz, 3.4V±2.5%, 400mA	SOT-23	16sw	DC5	3d	Tor
635	XC9111B351MR	DC/DC-IC	PFM step-up, 100kHz, 3.5V±2.5%, 400mA	SOT-23	16sw	DC5	3d	Tor
636	XC9111B361MR	DC/DC-IC	PFM step-up, 100kHz, 3.6V±2.5%, 400mA	SOT-23	16sw	DC5	3d	Tor
637	XC9111B371MR	DC/DC-IC	PFM step-up, 100kHz, 3.7V±2.5%, 400mA	SOT-23	16sw	DC5	3d	Tor
638	XC9111B381MR	DC/DC-IC	PFM step-up, 100kHz, 3.8V±2.5%, 400mA	SOT-23	16sw	DC5	3d	Tor
639	XC9111B391MR	DC/DC-IC	PFM step-up, 100kHz, 3.9V±2.5%, 400mA	SOT-23	16sw	DC5	3d	Tor



SMD code	Type	Function	Short description	Case	Pinout	Sch.	St.	Mnf.
63B	MMBZ5263BPT	Z-diode	53.20..58.80V, Izt=2.2mA, Zzt=150Ω, 225mW	SOT-23	16dc	-	3a	Chm
63B	MMCZ5263BPT	Z-diode	53.20..58.80V, Izt=2.2mA, Zzt=150Ω, 225mW	SOT-346	16dc	-	3a	Chm
63G	CSA1163G	Si-pnp	GP, 120V, 100mA, 150mW, B=200..400, 100MHz	SOT-23	16ta	-	3a	Cdi
63L	CSA1163L	Si-pnp	GP, 120V, 100mA, 150mW, B=350..700, 100MHz	SOT-23	16ta	-	3a	Cdi
63s	BAT64	Si-diode	SBD, Fast-Sw, 30V, 250mA, Vf<0.75V, Cd<6pF	SOT-23	16dc	-	3c	Inf
63s	BAT64W	Si-diode	SBD, Fast-Sw, 30V, 250mA, Vf<0.75V, Cd<6pF	SOT-323	16dc	-	3c	Inf
63S	MMBZ5263SPT	Z-diode	54.88..57.12V, Izt=2.2mA, Zzt=150Ω, 225mW	SOT-23	16dc	-	3a	Chm
63S	MMCZ5263SPT	Z-diode	54.88..57.12V, Izt=2.2mA, Zzt=150Ω, 225mW	SOT-346	16dc	-	3a	Chm
63W	1PS70SB40	Si-diode	Schottky, Sw, Fast, 40V, 120mA, <100ps	SOT-323	16dc	-	3a	PHC
64	1PS70SB44	Si-diode	Dual, Schottky, Sw, Fast, 40V, 120mA, <100ps	SOT-323	16dl	-	3a	PHH
64	BAS40-04W	Si-diode	Dual, Schottky, 40V, 200mA, 200mW, Cd<5pF, <5ns	SOT-323	16dl	-	3a	Phi
64	BAT64-04	Si-diode	Dual, SBD, Fast-Sw, 30V, 250mA, Vf<0.75V, Cd<6pF	SOT-23	16dl	-	3a	Cdi
64	CHDTC144WMPPT	Si-npn-Digi	Sw, 50V, 30mA, 250MHz, R1/R2=47/22k	SOT-723	18ta	-	3a	Chm
64	DTC114YE	Si-npn-Digi	Sw, 50V, 100mA, 150mW, 250MHz, R1/R2=10/47k	SOT-416	16ta	-	3a	Rhm
64	DTC114YKA	Si-npn-Digi	Sw, 50V, 100mA, 200mW, 250MHz, R1/R2=10/47k	SOT-346	16ta	-	3a	Rhm
64	DTC114YM	Si-npn-Digi	Sw, 50V, 100mA, 150mW, 250MHz, R1/R2=10/47k	VMT3	18ta	-	3a	Rhm
64	DTC114YUA	Si-npn-Digi	Sw, 50V, 100mA, 200mW, 250MHz, R1/R2=10/47k	UMT3	16ta	-	3a	Rhm
640	XC9111B401MR	DC/DC-IC	PFM step-up, 100kHz, 4.0V±2.5%, 400mA	SOT-23	16sw	DC5	3d	Tor
641	XC9111B411MR	DC/DC-IC	PFM step-up, 100kHz, 4.1V±2.5%, 400mA	SOT-23	16sw	DC5	3d	Tor
642	XC9111B421MR	DC/DC-IC	PFM step-up, 100kHz, 4.2V±2.5%, 400mA	SOT-23	16sw	DC5	3d	Tor
643	XC9111B431MR	DC/DC-IC	PFM step-up, 100kHz, 4.3V±2.5%, 400mA	SOT-23	16sw	DC5	3d	Tor
644	XC9111B441MR	DC/DC-IC	PFM step-up, 100kHz, 4.4V±2.5%, 400mA	SOT-23	16sw	DC5	3d	Tor
645	XC9111B451MR	DC/DC-IC	PFM step-up, 100kHz, 4.5V±2.5%, 400mA	SOT-23	16sw	DC5	3d	Tor
646	XC9111B461MR	DC/DC-IC	PFM step-up, 100kHz, 4.6V±2.5%, 400mA	SOT-23	16sw	DC5	3d	Tor
647	XC9111B471MR	DC/DC-IC	PFM step-up, 100kHz, 4.7V±2.5%, 400mA	SOT-23	16sw	DC5	3d	Tor
648	XC9111B481MR	DC/DC-IC	PFM step-up, 100kHz, 4.8V±2.5%, 400mA	SOT-23	16sw	DC5	3d	Tor
649	XC9111B491MR	DC/DC-IC	PFM step-up, 100kHz, 4.9V±2.5%, 400mA	SOT-23	16sw	DC5	3d	Tor
64B	MMBZ5264BPT	Z-diode	57.0..63.0V, Izt=2.1mA, Zzt=170Ω, 225mW	SOT-23	16dc	-	3a	Chm
64B	MMCZ5264BPT	Z-diode	57.0..63.0V, Izt=2.1mA, Zzt=170Ω, 225mW	SOT-346	16dc	-	3a	Chm
64s	BAT64-04	Si-diode	Dual, SBD, Fast-Sw, 30V, 250mA, Vf<0.75V, Cd<6pF	SOT-23	16dl	-	3c	Inf
64s	BAT64-04W	Si-diode	Dual, SBD, Fast-Sw, 30V, 250mA, Vf<0.75V, Cd<6pF	SOT-323	16dl	-	3c	Inf
64S	MMBZ5264SPT	Z-diode	58.80..61.20V, Izt=2.1mA, Zzt=170Ω, 225mW	SOT-23	16dc	-	3a	Chm
64S	MMCZ5264SPT	Z-diode	58.80..61.20V, Izt=2.1mA, Zzt=170Ω, 225mW	SOT-346	16dc	-	3a	Chm
64W	1PS70SB44	Si-diode	Dual, Schottky, Sw, Fast, 40V, 120mA, <100ps	SOT-323	16dl	-	3a	PHC
65	1PS70SB45	Si-diode	Dual, Schottky, Sw, Fast, 40V, 120mA, <100ps	SOT-323	16dg	-	3a	PHH
65	BAS40-05W	Si-diode	Dual, Schottky, 40V, 200mA, 200mW, Cd<5pF, <5ns	SOT-323	16dg	-	3a	Phi
65	BAT64-05	Si-diode	Dual, SBD, Fast-Sw, 30V, 250mA, Vf<0.75V, Cd<6pF	SOT-23	16dg	-	3a	Cdi
650	XC6206P311MR	LVR-IC	LDO, 3.1V±2%, 250mA	SOT-23	16cg	VR1	3d	Tor
650	XC9111B501MR	DC/DC-IC	PFM step-up, 100kHz, 5.0V±2.5%, 400mA	SOT-23	16sw	DC5	3d	Tor
651	XC9111B511MR	DC/DC-IC	PFM step-up, 100kHz, 5.1V±2.5%, 400mA	SOT-23	16sw	DC5	3d	Tor
652	XC9111B521MR	DC/DC-IC	PFM step-up, 100kHz, 5.2V±2.5%, 400mA	SOT-23	16sw	DC5	3d	Tor
653	XC9111B531MR	DC/DC-IC	PFM step-up, 100kHz, 5.3V±2.5%, 400mA	SOT-23	16sw	DC5	3d	Tor
654	XC9111B541MR	DC/DC-IC	PFM step-up, 100kHz, 5.4V±2.5%, 400mA	SOT-23	16sw	DC5	3d	Tor
655	XC9111B551MR	DC/DC-IC	PFM step-up, 100kHz, 5.5V±2.5%, 400mA	SOT-23	16sw	DC5	3d	Tor
656	XC9111B561MR	DC/DC-IC	PFM step-up, 100kHz, 5.6V±2.5%, 400mA	SOT-23	16sw	DC5	3d	Tor
657	XC9111B571MR	DC/DC-IC	PFM step-up, 100kHz, 5.7V±2.5%, 400mA	SOT-23	16sw	DC5	3d	Tor
658	XC9111B581MR	DC/DC-IC	PFM step-up, 100kHz, 5.8V±2.5%, 400mA	SOT-23	16sw	DC5	3d	Tor
659	XC9111B591MR	DC/DC-IC	PFM step-up, 100kHz, 5.9V±2.5%, 400mA	SOT-23	16sw	DC5	3d	Tor
65B	MMBZ5265BPT	Z-diode	58.90..65.10V, Izt=2mA, Zzt=185Ω, 225mW	SOT-23	16dc	-	3a	Chm
65B	MMCZ5265BPT	Z-diode	58.90..65.10V, Izt=2mA, Zzt=185Ω, 225mW	SOT-346	16dc	-	3a	Chm
65B	XC6206P122MR	LVR-IC	LDO, 1.2V±2%, 250mA	SOT-23	16cg	VR1	3d	Tor
65C	XC6206P132MR	LVR-IC	LDO, 1.3V±2%, 250mA	SOT-23	16cg	VR1	3d	Tor
65D	XC6206P142MR	LVR-IC	LDO, 1.4V±2%, 250mA	SOT-23	16cg	VR1	3d	Tor
65E	XC6206P152MR	LVR-IC	LDO, 1.5V±2%, 250mA	SOT-23	16cg	VR1	3d	Tor
65F	XC6206P162MR	LVR-IC	LDO, 1.6V±2%, 250mA	SOT-23	16cg	VR1	3d	Tor
65H	XC6206P172MR	LVR-IC	LDO, 1.7V±2%, 250mA	SOT-23	16cg	VR1	3d	Tor
65K	XC6206P182MR	LVR-IC	LDO, 1.8V±2%, 250mA	SOT-23	16cg	VR1	3d	Tor
65L	XC6206P192MR	LVR-IC	LDO, 1.9V±2%, 250mA	SOT-23	16cg	VR1	3d	Tor
65M	XC6206P202MR	LVR-IC	LDO, 2.0V±2%, 250mA	SOT-23	16cg	VR1	3d	Tor
65N	XC6206P212MR	LVR-IC	LDO, 2.1V±2%, 250mA	SOT-23	16cg	VR1	3d	Tor
65P	XC6206P222MR	LVR-IC	LDO, 2.2V±2%, 250mA	SOT-23	16cg	VR1	3d	Tor
65R	XC6206P232MR	LVR-IC	LDO, 2.3V±2%, 250mA	SOT-23	16cg	VR1	3d	Tor
65s	BAT64-05	Si-diode	Dual, SBD, Fast-Sw, 30V, 250mA, Vf<0.75V, Cd<6pF	SOT-23	16dg	-	3c	Inf
65s	BAT64-05W	Si-diode	Dual, SBD, Fast-Sw, 30V, 250mA, Vf<0.75V, Cd<6pF	SOT-323	16dg	-	3c	Inf
65S	MMBZ5265SPT	Z-diode	60.76..63.24V, Izt=2mA, Zzt=185Ω, 225mW	SOT-23	16dc	-	3a	Chm
65S	MMCZ5265SPT	Z-diode	60.76..63.24V, Izt=2mA, Zzt=185Ω, 225mW	SOT-346	16dc	-	3a	Chm
65S	XC6206P242MR	LVR-IC	LDO, 2.4V±2%, 250mA	SOT-23	16cg	VR1	3d	Tor
65T	XC6206P252MR	LVR-IC	LDO, 2.5V±2%, 250mA	SOT-23	16cg	VR1	3d	Tor
65U	XC6206P262MR	LVR-IC	LDO, 2.6V±2%, 250mA	SOT-23	16cg	VR1	3d	Tor
65V	XC6206P272MR	LVR-IC	LDO, 2.7V±2%, 250mA	SOT-23	16cg	VR1	3d	Tor



SMD code	Type	Function	Short description	Case	Pinout	Sch.	St.	Mnf.
65W	1PS70SB45	Si-diode	Dual, Schottky, Sw, Fast, 40V, 120mA, <100ps	SOT-323	16dg	-	3a	PhC
65X	XC6206P282MR	LVR-IC	LDO, 2.8V±2%, 250mA	SOT-23	16cg	VR1	3d	Tor
65Y	XC6206P292MR	LVR-IC	LDO, 2.9V±2%, 250mA	SOT-23	16cg	VR1	3d	Tor
65Z	XC6206P302MR	LVR-IC	LDO, 3V±2%, 250mA	SOT-23	16cg	VR1	3d	Tor
66	1PS70SB46	Si-diode	Dual, Schottky, Sw, Fast, 40V, 120mA, <100ps	SOT-323	16df	-	3a	PHH
66	BAS40-06W	Si-diode	Dual, Schottky, 40V, 200mA, 200mW, Cd<5pF, <5ns	SOT-323	16dg	-	3a	Phi
66	BAT64-06	Si-diode	Dual, SBD, Fast-Sw, 30V, 250mA, Vf<0.75V, Cd<6pF	SOT-23	16df	-	3a	Cdi
660	XC9111B601MR	DC/DC-IC	PFM step-up, 100kHz, 6.0V±2.5%, 400mA	SOT-23	16sw	DC5	3d	Tor
661	XC6206P322MR	LVR-IC	LDO, 3.2V±2%, 250mA	SOT-23	16cg	VR1	3d	Tor
661	XC9111B611MR	DC/DC-IC	PFM step-up, 100kHz, 6.1V±2.5%, 400mA	SOT-23	16sw	DC5	3d	Tor
662	XC6206P332MR	LVR-IC	LDO, 3.3V±2%, 250mA	SOT-23	16cg	VR1	3d	Tor
662	XC9111B621MR	DC/DC-IC	PFM step-up, 100kHz, 6.2V±2.5%, 400mA	SOT-23	16sw	DC5	3d	Tor
663	XC6206P342MR	LVR-IC	LDO, 3.4V±2%, 250mA	SOT-23	16cg	VR1	3d	Tor
663	XC9111B631MR	DC/DC-IC	PFM step-up, 100kHz, 6.3V±2.5%, 400mA	SOT-23	16sw	DC5	3d	Tor
664	XC6206P352MR	LVR-IC	LDO, 3.5V±2%, 250mA	SOT-23	16cg	VR1	3d	Tor
664	XC9111B641MR	DC/DC-IC	PFM step-up, 100kHz, 6.4V±2.5%, 400mA	SOT-23	16sw	DC5	3d	Tor
665	XC6206P362MR	LVR-IC	LDO, 3.6V±2%, 250mA	SOT-23	16cg	VR1	3d	Tor
665	XC9111B651MR	DC/DC-IC	PFM step-up, 100kHz, 6.5V±2.5%, 400mA	SOT-23	16sw	DC5	3d	Tor
666	XC6206P372MR	LVR-IC	LDO, 3.7V±2%, 250mA	SOT-23	16cg	VR1	3d	Tor
666	XC9111B661MR	DC/DC-IC	PFM step-up, 100kHz, 6.6V±2.5%, 400mA	SOT-23	16sw	DC5	3d	Tor
667	XC6206P382MR	LVR-IC	LDO, 3.8V±2%, 250mA	SOT-23	16cg	VR1	3d	Tor
667	XC9111B671MR	DC/DC-IC	PFM step-up, 100kHz, 6.7V±2.5%, 400mA	SOT-23	16sw	DC5	3d	Tor
668	XC6206P392MR	LVR-IC	LDO, 3.9V±2%, 250mA	SOT-23	16cg	VR1	3d	Tor
668	XC9111B681MR	DC/DC-IC	PFM step-up, 100kHz, 6.8V±2.5%, 400mA	SOT-23	16sw	DC5	3d	Tor
669	XC6206P402MR	LVR-IC	LDO, 4V±2%, 250mA	SOT-23	16cg	VR1	3d	Tor
669	XC9111B691MR	DC/DC-IC	PFM step-up, 100kHz, 6.9V±2.5%, 400mA	SOT-23	16sw	DC5	3d	Tor
66A	XC6206P412MR	LVR-IC	LDO, 4.1V±2%, 250mA	SOT-23	16cg	VR1	3d	Tor
66B	MMBZ5266BPT	Z-diode	64.60..71.40V, Izt=1.8mA, Zzt=230Q, 225mW	SOT-23	16dc	-	3a	Chm
66B	MMBZ5266BPT	Z-diode	64.60..71.40V, Izt=1.8mA, Zzt=230Q, 225mW	SOT-346	16dc	-	3a	Chm
66B	XC6206P422MR	LVR-IC	LDO, 4.2V±2%, 250mA	SOT-23	16cg	VR1	3d	Tor
66C	XC6206P432MR	LVR-IC	LDO, 4.3V±2%, 250mA	SOT-23	16cg	VR1	3d	Tor
66D	XC6206P442MR	LVR-IC	LDO, 4.4V±2%, 250mA	SOT-23	16cg	VR1	3d	Tor
66E	XC6206P452MR	LVR-IC	LDO, 4.5V±2%, 250mA	SOT-23	16cg	VR1	3d	Tor
66G	XC6206P462MR	LVR-IC	LDO, 4.6V±2%, 250mA	SOT-23	16cg	VR1	3d	Tor
66H	XC6206P472MR	LVR-IC	LDO, 4.7V±2%, 250mA	SOT-23	16cg	VR1	3d	Tor
66K	XC6206P482MR	LVR-IC	LDO, 4.8V±2%, 250mA	SOT-23	16cg	VR1	3d	Tor
66L	XC6206P492MR	LVR-IC	LDO, 4.9V±2%, 250mA	SOT-23	16cg	VR1	3d	Tor
66M	XC6206P502MR	LVR-IC	LDO, 5V±2%, 250mA	SOT-23	16cg	VR1	3d	Tor
66s	BAT64-06	Si-diode	Dual, SBD, Fast-Sw, 30V, 250mA, Vf<0.75V, Cd<6pF	SOT-23	16df	-	3c	Inf
66s	BAT64-06W	Si-diode	Dual, SBD, Fast-Sw, 30V, 250mA, Vf<0.75V, Cd<6pF	SOT-323	16df	-	3c	Inf
66S	MMBZ5266SPT	Z-diode	66.64..69.36V, Izt=1.8mA, Zzt=230Q, 225mW	SOT-23	16dc	-	3a	Chm
66S	MMBZ5266SPT	Z-diode	66.64..69.36V, Izt=1.8mA, Zzt=230Q, 225mW	SOT-346	16dc	-	3a	Chm
66W	1PS70SB46	Si-diode	Dual, Schottky, Sw, Fast, 40V, 120mA, <100ps	SOT-323	16df	-	3a	PhC
670	XC9111B701MR	DC/DC-IC	PFM step-up, 100kHz, 7.0V±2.5%, 400mA	SOT-23	16sw	DC5	3d	Tor
67B	MMBZ5267BPT	Z-diode	71.25..78.75V, Izt=1.7mA, Zzt=270Q, 225mW	SOT-23	16dc	-	3a	Chm
67B	MMBZ5267BPT	Z-diode	71.25..78.75V, Izt=1.7mA, Zzt=270Q, 225mW	SOT-346	16dc	-	3a	Chm
67S	MMBZ5267SPT	Z-diode	73.50..76.50V, Izt=1.7mA, Zzt=270Q, 225mW	SOT-23	16dc	-	3a	Chm
67S	MMBZ5267SPT	Z-diode	73.50..76.50V, Izt=1.7mA, Zzt=270Q, 225mW	SOT-346	16dc	-	3a	Chm
68	MAZV068H	SA-Z-diode	Dual, 6.8V, 5mA, 150mW	SSSMini3	18df	-	3a	Pan
680	HZM6.8NB	Z-diode	6.47..7.14V, 200mW	SC-59A	16dc	-	3a	Ren
681	HZM6.8NB1	Z-diode	6.47..6.73V, 200mW	SC-59A	16dc	-	3a	Ren
681	PZM6.8NB1	Z-diode	6.8V±2.5%, 300mW	SOT-346	16dc	-	3a	Phi
682	HZM6.8NB2	Z-diode	6.65..6.93V, 200mW	SC-59A	16dc	-	3a	Ren
682	PZM6.8NB2	Z-diode	6.8V±2.5%, 300mW	SOT-346	16dc	-	3a	Phi
683	HZM6.8NB3	Z-diode	6.86..7.14V, 200mW	SC-59A	16dc	-	3a	Ren
683	PZM6.8NB3	Z-diode	6.8V±2.5%, 300mW	SOT-346	16dc	-	3a	Phi
686Ax	SS8037L263GT72	Vdet-IC	2.63V±1.5%, -Reset PPO	SOT-23	16vda	VD7	3a	Ssc
686Bx	SS8037L293GT72	Vdet-IC	2.93V±1.5%, -Reset PPO	SOT-23	16vda	VD7	3a	Ssc
686Cx	SS8037L308GT72	Vdet-IC	3.08V±1.5%, -Reset PPO	SOT-23	16vda	VD7	3a	Ssc
686Dx	SS8037L400GT72	Vdet-IC	4.0V±1.5%, -Reset PPO	SOT-23	16vda	VD7	3a	Ssc
686Ex	SS8037L438GT72	Vdet-IC	4.38V±1.5%, -Reset PPO	SOT-23	16vda	VD7	3a	Ssc
686Fx	SS8037L463GT72	Vdet-IC	4.63V±1.5%, -Reset PPO	SOT-23	16vda	VD7	3a	Ssc
686Gx	SS8037H263GT72	Vdet-IC	2.63V±1.5%, +Reset PPO	SOT-23	16vda	VD7	3a	Ssc
686Hx	SS8037H293GT72	Vdet-IC	2.93V±1.5%, +Reset PPO	SOT-23	16vda	VD7	3a	Ssc
686Ix	SS8037H308GT72	Vdet-IC	3.08V±1.5%, +Reset PPO	SOT-23	16vda	VD7	3a	Ssc
686Jx	SS8037H400GT72	Vdet-IC	4.0V±1.5%, +Reset PPO	SOT-23	16vda	VD7	3a	Ssc
686Kx	SS8037H438GT72	Vdet-IC	4.38V±1.5%, +Reset PPO	SOT-23	16vda	VD7	3a	Ssc
686Lx	SS8037H463GT72	Vdet-IC	4.63V±1.5%, +Reset PPO	SOT-23	16vda	VD7	3a	Ssc
687Ax	SS8038L263GT72	Vdet-IC	2.63V±1.5%, -Reset ODO	SOT-23	16vda	VD6	3a	Ssc
687Bx	SS8038L293GT72	Vdet-IC	2.93V±1.5%, -Reset ODO	SOT-23	16vda	VD6	3a	Ssc



SMD code	Type	Function	Short description	Case	Pinout	Sch.	St.	Mnf.
687Cx	SS8038L308GT72	Vdet-IC	3.08V±1.5%, -Reset ODO	SOT-23	16vda	VD6	3a	Ssc
687Dx	SS8038L400GT72	Vdet-IC	4.0V±1.5%, -Reset ODO	SOT-23	16vda	VD6	3a	Ssc
687Ex	SS8038L438GT72	Vdet-IC	4.38V±1.5%, -Reset ODO	SOT-23	16vda	VD6	3a	Ssc
687Fx	SS8038L463GT72	Vdet-IC	4.63V±1.5%, -Reset ODO	SOT-23	16vda	VD6	3a	Ssc
688Ax	SS8037L263GT71	Vdet-IC	2.63V±1.5%, -Reset PPO	SOT-23	16vdb	VD7	3a	Ssc
688Bx	SS8037L293GT71	Vdet-IC	2.93V±1.5%, -Reset PPO	SOT-23	16vdb	VD7	3a	Ssc
688Cx	SS8037L308GT71	Vdet-IC	3.08V±1.5%, -Reset PPO	SOT-23	16vdb	VD7	3a	Ssc
688Dx	SS8037L400GT71	Vdet-IC	4.0V±1.5%, -Reset PPO	SOT-23	16vdb	VD7	3a	Ssc
688Ex	SS8037L438GT71	Vdet-IC	4.38V±1.5%, -Reset PPO	SOT-23	16vdb	VD7	3a	Ssc
688Fx	SS8037L463GT71	Vdet-IC	4.63V±1.5%, -Reset PPO	SOT-23	16vdb	VD7	3a	Ssc
688Gx	SS8037H263GT71	Vdet-IC	2.63V±1.5%, +Reset PPO	SOT-23	16vdb	VD7	3a	Ssc
688Hx	SS8037H293GT71	Vdet-IC	2.93V±1.5%, +Reset PPO	SOT-23	16vdb	VD7	3a	Ssc
688Ix	SS8037H308GT71	Vdet-IC	3.08V±1.5%, +Reset PPO	SOT-23	16vdb	VD7	3a	Ssc
688Jx	SS8037H400GT71	Vdet-IC	4.0V±1.5%, +Reset PPO	SOT-23	16vdb	VD7	3a	Ssc
688Kx	SS8037H438GT71	Vdet-IC	4.38V±1.5%, +Reset PPO	SOT-23	16vdb	VD7	3a	Ssc
688Lx	SS8037H463GT71	Vdet-IC	4.63V±1.5%, +Reset PPO	SOT-23	16vdb	VD7	3a	Ssc
689Ax	SS8038L263GT71	Vdet-IC	2.63V±1.5%, -Reset ODO	SOT-23	16vdb	VD6	3a	Ssc
689Bx	SS8038L293GT71	Vdet-IC	2.93V±1.5%, -Reset ODO	SOT-23	16vdb	VD6	3a	Ssc
689Cx	SS8038L308GT71	Vdet-IC	3.08V±1.5%, -Reset ODO	SOT-23	16vdb	VD6	3a	Ssc
689Dx	SS8038L400GT71	Vdet-IC	4.0V±1.5%, -Reset ODO	SOT-23	16vdb	VD6	3a	Ssc
689Ex	SS8038L438GT71	Vdet-IC	4.38V±1.5%, -Reset ODO	SOT-23	16vdb	VD6	3a	Ssc
689Fx	SS8038L463GT71	Vdet-IC	4.63V±1.5%, -Reset ODO	SOT-23	16vdb	VD6	3a	Ssc
68B	MMBZ5268BPT	Z-diode	77.90..86.10V, Izt=1.5mA, Zzt=330Q, 225mW	SOT-23	16dc	-	3a	Chm
68B	MMBZ5268BPT	Z-diode	77.90..86.10V, Izt=1.5mA, Zzt=330Q, 225mW	SOT-346	16dc	-	3a	Chm
68S	MMBZ5268SPT	Z-diode	80.36..83.64V, Izt=1.5mA, Zzt=330Q, 225mW	SOT-23	16dc	-	3a	Chm
68S	MMBZ5268SPT	Z-diode	80.36..83.64V, Izt=1.5mA, Zzt=330Q, 225mW	SOT-346	16dc	-	3a	Chm
68V	PZM68NB	Z-diode	68V±2.5%, 300mW	SOT-346	16dc	-	3a	Phi
68V	PZM68NB1	Z-diode	68V±2.5%, 300mW	SOT-346	16dc	-	3a	Phi
69	ELM7619LCB	Vdet-IC	1.9V±2%, -Reset PPO, 150ms	SOT-23	16vdc	VD7	3d	Elm
690Ax	SS8037L263GT73	Vdet-IC	2.63V±1.5%, -Reset PPO	SOT-23	16vdc	VD7	3a	Ssc
690Bx	SS8037L293GT73	Vdet-IC	2.93V±1.5%, -Reset PPO	SOT-23	16vdc	VD7	3a	Ssc
690Cx	SS8037L308GT73	Vdet-IC	3.08V±1.5%, -Reset PPO	SOT-23	16vdc	VD7	3a	Ssc
690Dx	SS8037L400GT73	Vdet-IC	4.0V±1.5%, -Reset PPO	SOT-23	16vdc	VD7	3a	Ssc
690Ex	SS8037L438GT73	Vdet-IC	4.38V±1.5%, -Reset PPO	SOT-23	16vdc	VD7	3a	Ssc
690Fx	SS8037L463GT73	Vdet-IC	4.63V±1.5%, -Reset PPO	SOT-23	16vdc	VD7	3a	Ssc
690Gx	SS8037H263GT73	Vdet-IC	2.63V±1.5%, +Reset PPO	SOT-23	16vdc	VD7	3a	Ssc
690Hx	SS8037H293GT73	Vdet-IC	2.93V±1.5%, +Reset PPO	SOT-23	16vdc	VD7	3a	Ssc
690Ix	SS8037H308GT73	Vdet-IC	3.08V±1.5%, +Reset PPO	SOT-23	16vdc	VD7	3a	Ssc
690Jx	SS8037H400GT73	Vdet-IC	4.0V±1.5%, +Reset PPO	SOT-23	16vdc	VD7	3a	Ssc
690Kx	SS8037H438GT73	Vdet-IC	4.38V±1.5%, +Reset PPO	SOT-23	16vdc	VD7	3a	Ssc
690Lx	SS8037H463GT73	Vdet-IC	4.63V±1.5%, +Reset PPO	SOT-23	16vdc	VD7	3a	Ssc
691Ax	SS8038L263GT73	Vdet-IC	2.63V±1.5%, -Reset ODO	SOT-23	16vdc	VD6	3a	Ssc
691Bx	SS8038L293GT73	Vdet-IC	2.93V±1.5%, -Reset ODO	SOT-23	16vdc	VD6	3a	Ssc
691Cx	SS8038L308GT73	Vdet-IC	3.08V±1.5%, -Reset ODO	SOT-23	16vdc	VD6	3a	Ssc
691Dx	SS8038L400GT73	Vdet-IC	4.0V±1.5%, -Reset ODO	SOT-23	16vdc	VD6	3a	Ssc
691Ex	SS8038L438GT73	Vdet-IC	4.38V±1.5%, -Reset ODO	SOT-23	16vdc	VD6	3a	Ssc
691Fx	SS8038L463GT73	Vdet-IC	4.63V±1.5%, -Reset ODO	SOT-23	16vdc	VD6	3a	Ssc
69B	MMBZ5269BPT	Z-diode	82.65..91.35V, Izt=1.4mA, Zzt=370Q, 225mW	SOT-23	16dc	-	3a	Chm
69B	MMBZ5269BPT	Z-diode	82.65..91.35V, Izt=1.4mA, Zzt=370Q, 225mW	SOT-346	16dc	-	3a	Chm
69S	MMBZ5269SPT	Z-diode	85.26..88.74V, Izt=1.4mA, Zzt=370Q, 225mW	SOT-23	16dc	-	3a	Chm
69S	MMBZ5269SPT	Z-diode	85.26..88.74V, Izt=1.4mA, Zzt=370Q, 225mW	SOT-346	16dc	-	3a	Chm
6A	BC817-16	Si-npn	GP, 50V, 500mA, 250mW, B=100..250, 100MHz	SOT-23	16ta	-	3a	PhH
6A	BC817-16W	Si-npn	GP, 50V, 500mA, 200mW, B=100..250, 100MHz	SOT-323	16ta	-	3a	PHH
6A	DA121T	Si-diode	Sw, 80V, 200mA, 225mW, Vf<1.25V(150mA), <6ns	SOT-416	16dc	-	3b	Ons
6A	DTA114EE	Si-pnp-Digi	Sw, 50V, 100mA, 200mW, 200MHz, R1/R2=10k/10k	SOT-416	16ta	-	3a	Ons
6A	FT531Ah	LVR-IC	LDO, 1.3V±2%, 300mA	SOT-23	16cq	VR1	3d	Fmd
6A	KIA7019AT	Vdet-IC	1.9V, -Reset OCO	TSM	16vdb	VD6	3f	Kec
6A	MUN2111	Si-pnp-Digi	Sw, 50V, 100mA, 200mW, R1/R2=10/10k	SC-59	16ta	-	3a	Mot
6A	MUN5111	Si-pnp-Digi	Sw, 50V, 100mA, 200mW, R1/R2=10/10k	SOT-323	16ta	-	3a	Mot
6A	R3131N16EC	Vdet-IC	1.6V, +Reset ODO, 240ms	SOT-23	16vdc	VD6	3b	Ric
6A	UM28.2N	Z-diode	Dual, 7.76..8.64V, Zzt=60Q(5mA), 200mW	SOT-323	16df	-	3i	Rhm
6A	UN2111	Si-pnp-Digi	Sw, 50V, 100mA, 200mW, 80MHz, R1/R2=10k/10k	SC-59	16ta	-	3a	Pan
6A	UN5111	Si-pnp-Digi	Sw, 50V, 100mA, 150mW, 80MHz, R1/R2=10k/10k	SOT-23	16ta	-	3a	Pan
6A	UN9111J	Si-pnp-Digi	Sw, 50V, 100mA, 125mW, 80MHz, R1/R2=10k/10k	SC-89	18ta	-	3a	Pan
6A	UNR2111	Si-pnp-Digi	Sw, 50V, 100mA, 200mW, 80MHz, R1/R2=10k/10k	SC-59	16ta	-	3a	Pan
6A	UNR5111	Si-pnp-Digi	Sw, 50V, 100mA, 150mW, 80MHz, R1/R2=10k/10k	SOT-323	16ta	-	3a	Pan
6A	UNR9111J	Si-pnp-Digi	Sw, 50V, 100mA, 125mW, 80MHz, R1/R2=10k/10k	SC-89	18ta	-	3a	Pan
6A0	TC55RP602ECB	LVR-IC	LDO, 6.0V±2%, 250mA	SOT-23	16cq	VR1	3d	Mcc
6A0	XC62FP6002M	LVR-IC	6.0V±2%, 250mA	SOT-23	16cg	VR1	3d	Tor
6A2	MMBZ6V2A	TVS	Dual, Vrrwm=3.0V, Vbr=5.89..6.51V, 2.76A, 24W(1ms)	SOT-23	16dg	-	3a	Wtr



SMD code	Type	Function	Short description	Case	Pinout	Sch.	St.	Mnf.
6A2	PZM6.2NB2A	Z-diode	Dual, 6.2V±2.5%, 300mW	SOT-346	16df	-	3a	Phi
6A5	TC596002ECB	LVR-IC	LDO, -6.0V±2%, 200mA	SOT-23	16cj	VR2	3d	Mcc
6A5	XC62KN602M	LVR-IC	LDO, -6V±2%, 100mA, 150mW	SOT-23	16cj	VR2	3d	Tor
6A8	MMBZ6V8A	TVS	Dual, V _{rw} =4.5V, V _{br} =6.46..7.14V, 2.5A, 24W(1ms)	SOT-23	16dg	-	3a	Wtr
6A8	PZM6.8NB2A	Z-diode	Dual, 6.8V±2.5%, 300mW	SOT-346	16df	-	3a	Phi
6AC2	81C60-P-AE3-2	Vdet-IC	6.0V±2%, -Reset PPO	SOT-23	16vdy	VD7	3a	Utc
6AC2G	81C60G-P-AE3-2	Vdet-IC	6.0V±2%, -Reset PPO, halogen free	SOT-23	16vdy	VD7	3a	Utc
6AC2L	81C60L-P-AE3-2	Vdet-IC	6.0V±2%, -Reset PPO, lead free	SOT-23	16vdy	VD7	3a	Utc
6AC3	81C60-P-AE3-3	Vdet-IC	6.0V±2%, -Reset PPO	SOT-23	16vdb	VD7	3a	Utc
6AC3G	81C60G-P-AE3-3	Vdet-IC	6.0V±2%, -Reset PPO, halogen free	SOT-23	16vdb	VD7	3a	Utc
6AC3L	81C60L-P-AE3-3	Vdet-IC	6.0V±2%, -Reset PPO, lead free	SOT-23	16vdb	VD7	3a	Utc
6AC5	81C60-P-AE3-5	Vdet-IC	6.0V±2%, -Reset PPO	SOT-23	16vdc	VD7	3a	Utc
6AC5G	81C60G-P-AE3-5	Vdet-IC	6.0V±2%, -Reset PPO, halogen free	SOT-23	16vdc	VD7	3a	Utc
6AC5L	81C60L-P-AE3-5	Vdet-IC	6.0V±2%, -Reset PPO, lead free	SOT-23	16vdc	VD7	3a	Utc
6Ag	FT531Ag	LVR-IC	LDO, 1.3V±2%, 300mA	SOT-23	16cq	VR1	3d	Fmd
6AN2	81N60-P-AE3-2	Vdet-IC	6.0V±2%, -Reset ODO	SOT-23	16vdy	VD6	3a	Utc
6AN2G	81N60G-P-AE3-2	Vdet-IC	6.0V±2%, -Reset ODO, halogen free	SOT-23	16vdy	VD6	3a	Utc
6AN2L	81N60L-P-AE3-2	Vdet-IC	6.0V±2%, -Reset ODO, lead free	SOT-23	16vdy	VD6	3a	Utc
6AN3	81N60-P-AE3-3	Vdet-IC	6.0V±2%, -Reset ODO	SOT-23	16vdb	VD6	3a	Utc
6AN3G	81N60G-P-AE3-3	Vdet-IC	6.0V±2%, -Reset ODO, halogen free	SOT-23	16vdb	VD6	3a	Utc
6AN3L	81N60L-P-AE3-3	Vdet-IC	6.0V±2%, -Reset ODO, lead free	SOT-23	16vdb	VD6	3a	Utc
6AN5	81N60-P-AE3-5	Vdet-IC	6.0V±2%, -Reset ODO	SOT-23	16vdc	VD6	3a	Utc
6AN5G	81N60G-P-AE3-5	Vdet-IC	6.0V±2%, -Reset ODO, halogen free	SOT-23	16vdc	VD6	3a	Utc
6AN5L	81N60L-P-AE3-5	Vdet-IC	6.0V±2%, -Reset ODO, lead free	SOT-23	16vdc	VD6	3a	Utc
6Ap	BC817-16	Si-npn	GP, 50V, 500mA, 250mW, B=100..250, 100MHz	SOT-23	16ta	-	3a	PHH
6Ap	BC817-16W	Si-npn	GP, 50V, 500mA, 200mW, B=100..250, 100MHz	SOT-323	16ta	-	3a	PHH
6As	BC817-16	Si-npn	AF-Drv, 50V, 500mA, 330mW, B=100..250, >200MHz	SOT-23	16ta	-	3a	Sie
6At	BC817-16	Si-npn	GP, 50V, 500mA, 250mW, B=100..250, 100MHz	SOT-23	16ta	-	3a	PhM
6At	BC817-16W	Si-npn	GP, 50V, 500mA, 200mW, B=100..250, 100MHz	SOT-323	16ta	-	3a	PHH
6AW	BC817-16	Si-npn	GP, 50V, 500mA, 250mW, B=100..250, 100MHz	SOT-23	16ta	-	3a	PhC
6AW	BC817-16W	Si-npn	GP, 50V, 500mA, 200mW, B=100..250, 100MHz	SOT-323	16ta	-	3a	PhC
6AZ	BC817-16	Si-npn	AF-Drv, 50V, 500mA, 330mW, B=100..250, >200MHz	SOT-23	16ta	-	3a	Zx
6B	BC817-25	Si-npn	GP, 50V, 500mA, 250mW, B=160..400, 100MHz	SOT-23	16ta	-	3a	PHH
6B	BC817-25W	Si-npn	GP, 50V, 500mA, 200mW, B=160..400, 100MHz	SOT-323	16ta	-	3a	PHH
6B	DTA124EE	Si-pnp-Digi	Sw, 50V, 100mA, 200mW, 200MHz, R1/R2=22k/22k	SOT-416	16ta	-	3a	Ons
6B	FT531Bh	LVR-IC	LDO, 1.4V±2%, 300mA	SOT-23	16cq	VR1	3d	Fmd
6B	KIA7021AT	Vdet-IC	2.1V, -Reset OCO	TSM	16vdb	VD6	3f	Kec
6B	MMBF5484	n-FET	VHF-UHF-Amp, 25V, 10mA, 200mW, Up<3V	SOT-23	16fj	-	3a	Ons
6B	MUN2112	Si-pnp-Digi	Sw, 50V, 100mA, 200mW, R1/R2=22k/22k	SC-59	16ta	-	3a	Mot
6B	MUN5112	Si-pnp-Digi	Sw, 50V, 100mA, 200mW, R1/R2=22k/22k	SOT-323	16ta	-	3a	Mot
6B	R3131N26EC	Vdet-IC	2.6V, +Reset ODO, 240ms	SOT-23	16vdc	VD6	3b	Ric
6B	STZ6.2N	Z-diode	Dual, 5.81..6.4V, Zzt<60Q(5mA), 100mW	SOT-346	16df	-	3a	Rhm
6B	UN2112	Si-pnp-Digi	Sw, 50V, 100mA, 200mW, 80MHz, R1/R2=22k/22k	SC-59	16ta	-	3a	Pan
6B	UN5112	Si-pnp-Digi	Sw, 50V, 100mA, 150mW, 80MHz, R1/R2=22k/22k	SOT-23	16ta	-	3a	Pan
6B	UN9112J	Si-pnp-Digi	Sw, 50V, 100mA, 125mW, 80MHz, R1/R2=22k/22k	SC-89	18ta	-	3a	Pan
6B	UNR2112	Si-pnp-Digi	Sw, 50V, 100mA, 200mW, 80MHz, R1/R2=22k/22k	SC-59	16ta	-	3a	Pan
6B	UNR5112	Si-pnp-Digi	Sw, 50V, 100mA, 150mW, 80MHz, R1/R2=22k/22k	SOT-323	16ta	-	3a	Pan
6B	UNR9112J	Si-pnp-Digi	Sw, 50V, 100mA, 125mW, 80MHz, R1/R2=22k/22k	SC-89	18ta	-	3a	Pan
6B5	TC596102ECB	LVR-IC	LDO, -6.1V±2%, 200mA	SOT-23	16cj	VR2	3d	Mcc
6BG	CMPF4416A	n-FET	AF, 35V, I _{ds} =5..15mA, V _{gs} (off)=2.5..6.5V, Nf=2dB	SOT-23	16fk	-	3a	Cen
6BG	FT531Bg	LVR-IC	LDO, 1.4V±2%, 300mA	SOT-23	16cq	VR1	3d	Fmd
6Bp	BC817-25	Si-npn	GP, 50V, 500mA, 250mW, B=160..400, 100MHz	SOT-23	16ta	-	3a	PHH
6Bp	BC817-25W	Si-npn	GP, 50V, 500mA, 200mW, B=160..400, 100MHz	SOT-323	16ta	-	3a	PHH
6Bs	BC817-25	Si-npn	AF-Drv, 50V, 500mA, 330mW, B=160..400, >200MHz	SOT-23	16ta	-	3a	Sie
6Bs	BC817-25W	Si-npn	AF-Drv, 50V, 500mA, 330mW, B=160..400, >200MHz	SOT-323	16ta	-	3a	Sie
6Bt	BC817-25	Si-npn	GP, 50V, 500mA, 250mW, B=160..400, 100MHz	SOT-23	16ta	-	3a	PhM
6Bt	BC817-25W	Si-npn	GP, 50V, 500mA, 200mW, B=160..400, 100MHz	SOT-323	16ta	-	3a	PhM
6BW	BC817-25	Si-npn	GP, 50V, 500mA, 250mW, B=160..400, 100MHz	SOT-23	16ta	-	3a	PhC
6BW	BC817-25W	Si-npn	GP, 50V, 500mA, 200mW, B=160..400, 100MHz	SOT-323	16ta	-	3a	PhC
6BZ	BC817-25	Si-npn	AF-Drv, 50V, 500mA, 330mW, B=160..400, >200MHz	SOT-23	16ta	-	3a	Zx
6C	BC817-40	Si-npn	GP, 50V, 500mA, 250mW, B=250..600, 100MHz	SOT-23	16ta	-	3a	PHH
6C	BC817-40W	Si-npn	GP, 50V, 500mA, 200mW, B=250..600, 100MHz	SOT-323	16ta	-	3a	PHH
6C	DTA144EE	Si-pnp-Digi	Sw, 50V, 100mA, 200mW, 200MHz, R1/R2=47k/47k	SOT-416	16ta	-	3a	Ons
6C	EMZ6.8N	Z-diode	Dual, 6.47..7.14V, 150mW, <40Q(5mA)	SOT-23	16df	-	3a	Rhm
6C	FT531Ch	LVR-IC	LDO, 1.5V±2%, 300mA	SOT-23	16cq	VR1	3d	Fmd
6C	KIA7023AT	Vdet-IC	2.3V, -Reset OCO	TSM	16vdb	VD6	3f	Kec
6C	MUN2113	Si-pnp-Digi	Sw, 50V, 100mA, 200mW, R1/R2=47k/47k	SC-59	16ta	-	3a	Mot
6C	MUN5113T1	Si-pnp-Digi	Sw, 50V, 100mA, 200mW, R1/R2=47k/47k	SOT-323	16ta	-	3a	Mot
6C	R3131N36EC	Vdet-IC	3.6V, +Reset ODO, 240ms	SOT-23	16vdc	VD6	3b	Ric
6C	STZ6.8N	Z-diode	Dual, 6.47..7.14V, Zzt<40Q(5mA), 100mW	SOT-346	16df	-	3a	Rhm



SMD code	Type	Function	Short description	Case	Pinout	Sch.	St.	Mnf.
6C	UMZ6.8N	Z-diode	Dual, 6.47..7.14V, Zzt=40C(5mA), 200mW	SOT-323	16df	-	3i	Rhm
6C	UN2113	Si-pnp-Digi	Sw, 50V, 100mA, 200mW, 80MHz, R1/R2=47k/47k	SC-59	16ta	-	3a	Pan
6C	UN5113	Si-pnp-Digi	Sw, 50V, 100mA, 150mW, 80MHz, R1/R2=47k/47k	SOT-23	16ta	-	3a	Pan
6C	UN9113J	Si-pnp-Digi	Sw, 50V, 100mA, 125mW, 80MHz, R1/R2=47k/47k	SC-89	18ta	-	3a	Pan
6C	UNR2113	Si-pnp-Digi	Sw, 50V, 100mA, 200mW, 80MHz, R1/R2=47k/47k	SC-59	16ta	-	3a	Pan
6C	UNR3113	Si-pnp-Digi	Sw, 50V, 100mA, 100mW, 80MHz, R1/R2=47k/47k	SSSMini3	18ta	-	3a	Pan
6C	UNR5113	Si-pnp-Digi	Sw, 50V, 100mA, 150mW, 80MHz, R1/R2=47k/47k	SOT-323	16ta	-	3a	Pan
6C	UNR9113J	Si-pnp-Digi	Sw, 50V, 100mA, 125mW, 80MHz, R1/R2=47k/47k	SC-89	18ta	-	3a	Pan
6C5	TC596202ECB	LVR-IC	LDO, -6.2V±2%, 200mA	SOT-23	16cj	VR2	3d	Mcc
6Cg	FT531Cg	LVR-IC	LDO, 1.5V±2%, 300mA	SOT-23	16cq	VR1	3d	Fmd
6Cp	BC817-40	Si-npn	GP, 50V, 500mA, 250mW, B=250..600, 100MHz	SOT-23	16ta	-	3a	PHH
6Cp	BC817-40W	Si-npn	GP, 50V, 500mA, 200mW, B=250..600, 100MHz	SOT-323	16ta	-	3a	PHH
6Cs	BC817-40	Si-npn	AF-Drv, 50V, 500mA, 330mW, B=250..630, >200MHz	SOT-23	16ta	-	3a	Sie
6Cs	BC817-40W	Si-npn	AF-Drv, 50V, 500mA, 330mW, B=250..630, >200MHz	SOT-323	16ta	-	3a	Sie
6Ct	BC817-40	Si-npn	GP, 50V, 500mA, 250mW, B=250..600, 100MHz	SOT-23	16ta	-	3a	PHM
6Ct	BC817-40W	Si-npn	GP, 50V, 500mA, 200mW, B=250..600, 100MHz	SOT-323	16ta	-	3a	PHM
6CW	BC817-40	Si-npn	GP, 50V, 500mA, 250mW, B=250..600, 100MHz	SOT-23	16ta	-	3a	PhC
6CW	BC817-40W	Si-npn	GP, 50V, 500mA, 200mW, B=250..600, 100MHz	SOT-323	16ta	-	3a	PhC
6CZ	BC817-40	Si-npn	AF-Drv, 50V, 500mA, 330mW, B=250..630, >200MHz	SOT-23	16ta	-	3a	Zx
6D	BC817	Si-npn	GP, 50V, 500mA, 250mW, B=100..600, 100MHz	SOT-23	16ta	-	3a	PHH
6D	BC817W	Si-npn	GP, 50V, 500mA, 200mW, B=100..600, 100MHz	SOT-23	16ta	-	3a	PHH
6D	DTA114YE	Si-pnp-Digi	Sw, 50V, 100mA, 200mW, 200MHz, R1/R2=10k/47k	SOT-416	16ta	-	3a	Ons
6D	FT531Dh	LVR-IC	LDO, 1.8V±2%, 300mA	SOT-23	16cq	VR1	3d	Fmd
6D	KIA7025AT	Vdet-IC	2.5V, -Reset OCO	TSM	16vdb	VD6	3f	Kec
6D	MIMBF5457	n-FET	GP, 25V, 10mA, 225mW, Up<6V	SOT-23	16fj	-	3a	Ons
6D	MUN2114	Si-pnp-Digi	Sw, 50V, 100mA, 200mW, R1/R2=10/47k	SC-59	16ta	-	3a	Mot
6D	MUN5114	Si-pnp-Digi	Sw, 50V, 100mA, 200mW, R1/R2=10/47k	SOT-323	16ta	-	3a	Mot
6D	R3131N46EC	Vdet-IC	4.6V, +Reset ODO, 240ms	SOT-23	16vdc	VD6	3b	Ric
6D	UN2114	Si-pnp-Digi	Sw, 50V, 100mA, 200mW, 80MHz, R1/R2=10k/47k	SC-59	16ta	-	3a	Pan
6D	UN5114	Si-pnp-Digi	Sw, 50V, 100mA, 150mW, 80MHz, R1/R2=10k/47k	SOT-23	16ta	-	3a	Pan
6D	UN9114J	Si-pnp-Digi	Sw, 50V, 100mA, 125mW, 80MHz, R1/R2=10k/47k	SC-89	18ta	-	3a	Pan
6D	UNR2114	Si-pnp-Digi	Sw, 50V, 100mA, 200mW, 80MHz, R1/R2=10k/47k	SC-59	16ta	-	3a	Pan
6D	UNR5114	Si-pnp-Digi	Sw, 50V, 100mA, 150mW, 80MHz, R1/R2=10k/47k	SOT-323	16ta	-	3a	Pan
6D	UNR9114J	Si-pnp-Digi	Sw, 50V, 100mA, 125mW, 80MHz, R1/R2=10k/47k	SC-89	18ta	-	3a	Pan
6D5	TC596302ECB	LVR-IC	LDO, -6.3V±2%, 200mA	SOT-23	16cj	VR2	3d	Mcc
6Dg	FT531Dg	LVR-IC	LDO, 1.8V±2%, 300mA	SOT-23	16cq	VR1	3d	Fmd
6Dp	BC817	Si-npn	GP, 50V, 500mA, 250mW, B=100..600, 100MHz	SOT-23	16ta	-	3a	PHH
6Dp	BC817W	Si-npn	GP, 50V, 500mA, 200mW, B=100..600, 100MHz	SOT-23	16ta	-	3a	PHH
6Dt	BC817	Si-npn	GP, 50V, 500mA, 250mW, B=100..600, 100MHz	SOT-23	16ta	-	3a	PHM
6Dt	BC817W	Si-npn	GP, 50V, 500mA, 100mW, B=100..600, 100MHz	SOT-23	16ta	-	3a	PHM
6DW	BC817	Si-npn	GP, 50V, 500mA, 250mW, B=100..600, 100MHz	SOT-23	16ta	-	3a	PhC
6DW	BC817W	Si-npn	GP, 50V, 500mA, 100mW, B=100..600, 100MHz	SOT-23	16ta	-	3a	PhC
6DZ	BC817	Si-npn	AF-Drv, 50V, 500mA, 330mW, B=100..600, >200MHz	SOT-23	16ta	-	3a	Zx
6E	BC818-16	Si-npn	AF-Drv, 30V, 500mA, 330mW, B=100..250, >170MHz	SOT-23	16ta	-	3a	lIt
6E	DTA114TE	Si-pnp-Digi	Sw, 50V, 100mA, 200mW, 200MHz, R1=10k	SOT-416	16ta	-	3a	Ons
6E	FMMTA93R	Si-pnp	Vid, 200/200V, 500mA, 330mW, B=25, >50MHz	SOT-23	16te	-	3a	Zx
6E	FT531Eh	LVR-IC	LDO, 2.5V±2%, 300mA	SOT-23	16cq	VR1	3d	Fmd
6E	KIA7027AT	Vdet-IC	2.7V, -Reset OCO	TSM	16vdb	VD6	3f	Kec
6E	MIMBF5460	n-FET	GP, 40V, 10mA, 225mW, Up<6V	SOT-23	16fj	-	3a	Ons
6E	MUN2115	Si-pnp-Digi	Sw, 50V, 100mA, 200mW, R1=10k	SC-59	16ta	-	3a	Mot
6E	MUN5115	Si-pnp-Digi	Sw, 50V, 100mA, 200mW, B=100..250, R1=10k	SOT-323	16ta	-	3a	Mot
6E	UN2115	Si-pnp-Digi	Sw, 50V, 100mA, 200mW, 80MHz, R1=10k	SC-59	16ta	-	3a	Pan
6E	UN5115	Si-pnp-Digi	Sw, 50V, 100mA, 150mW, 80MHz, R1=10k	SOT-23	16ta	-	3a	Pan
6E	UN9115J	Si-pnp-Digi	Sw, 50V, 100mA, 125mW, 80MHz, R1=10k	SC-89	18ta	-	3a	Pan
6E	UNR2115	Si-pnp-Digi	Sw, 50V, 100mA, 200mW, 80MHz, R1=10k	SC-59	16ta	-	3a	Pan
6E	UNR5115	Si-pnp-Digi	Sw, 50V, 100mA, 150mW, 80MHz, R1=10k	SOT-323	16ta	-	3a	Pan
6E	UNR9115J	Si-pnp-Digi	Sw, 50V, 100mA, 125mW, 80MHz, R1=10k	SC-89	18ta	-	3a	Pan
6E5	TC596402ECB	LVR-IC	LDO, -6.4V±2%, 200mA	SOT-23	16cj	VR2	3d	Mcc
6Eg	FT531Eg	LVR-IC	LDO, 2.5V±2%, 300mA	SOT-23	16cq	VR1	3d	Fmd
6Ep	BC818-16	Si-npn	AF-Drv, 30V, 500mA, 250mW, B=100..250, >80MHz	SOT-23	16ta	-	3a	PHH
6Es	BC818-16	Si-npn	AF-Drv, 30V, 500mA, 330mW, B=100..250, 170MHz	SOT-23	16ta	-	3a	Sie
6Es	BC818-16W	Si-npn	AF-Drv, 30V, 500mA, 250mW, B=100..250, >170MHz	SOT-323	16ta	-	3a	Sie
6Et	BC818-16W	Si-npn	AF-Drv, 30V, 500mA, 250mW, B=100..250, >170MHz	SOT-323	16ta	-	3a	Phi
6EW	BC818-16	Si-npn	AF-Drv, 30V, 500mA, 250mW, B=100..250, >80MHz	SOT-23	16ta	-	3a	PhC
6EZ	BC818-16	Si-npn	AF-Drv, 30V, 500mA, 330mW, B=100..250, >200MHz	SOT-23	16ta	-	3a	Zx
6F	BC818-25	Si-npn	AF-Drv, 30V, 500mA, 330mW, B=160..400, >170MHz	SOT-23	16ta	-	3a	lIt
6F	DTA143TE	Si-pnp-Digi	Sw, 50V, 100mA, 200mW, 200MHz, R1=4k7	SOT-416	16ta	-	3a	Ons
6F	FT531Fh	LVR-IC	LDO, 2.7V±2%, 300mA	SOT-23	16cq	VR1	3d	Fmd
6F	KIA7029AT	Vdet-IC	2.9V, -Reset OCO	TSM	16vdb	VD6	3f	Kec
6F	MUN2116	Si-pnp-Digi	Sw, 50V, 100mA, 200mW, R1=4k7	SC-59	16ta	-	3a	Mot



SMD code	Type	Function	Short description	Case	Pinout	Sch.	St.	Mnf.
6F	MUN5116	Si-pnp-Digi	Sw, 50V, 100mA, 200mW, R1=4k7	SOT-323	16ta	-	3a	Mot
6F	R3131N16EA	Vdet-IC	1.6V, +Reset PPO, 240ms	SOT-23	16vdc	VD7	3b	Ric
6F	STZ5.6N	Z-diode	Dual, 5.31..5.92V, Zzt<60Q(5mA), 100mW	SOT-346	16df	-	3a	Rhm
6F	UN2116	Si-pnp-Digi	Sw, 50V, 100mA, 200mW, 80MHz, R1=4k7	SC-59	16ta	-	3a	Pan
6F	UN5116	Si-pnp-Digi	Sw, 50V, 100mA, 150mW, 80MHz, R1=4k7	SOT-23	16ta	-	3a	Pan
6F	UN9116J	Si-pnp-Digi	Sw, 50V, 100mA, 125mW, 80MHz, R1=4k7	SC-89	18ta	-	3a	Pan
6F	UNR2116	Si-pnp-Digi	Sw, 50V, 100mA, 200mW, 80MHz, R1=4k7	SC-59	16ta	-	3a	Pan
6F	UNR5116	Si-pnp-Digi	Sw, 50V, 100mA, 150mW, 80MHz, R1=4k7	SOT-323	16ta	-	3a	Pan
6F	UNR9116J	Si-pnp-Digi	Sw, 50V, 100mA, 125mW, 80MHz, R1=4k7	SC-89	18ta	-	3a	Pan
6F5	TC596502ECB	LVR-IC	LDO, -6.5V±2%, 200mA	SOT-23	16cj	VR2	3d	Mcc
6Fg	FT531Fg	LVR-IC	LDO, 2.7V±2%, 300mA	SOT-23	16cq	VR1	3d	Fmd
6Fp	BAP1321-04	PIN-diode	Dual, RF, 60V, 0.1A, 250mW, 0.45pF, 1.3Q(100mA/100MHz)	SOT-23	16dl	-	3a	PHH
6Fp	BC818-25	Si-npn	AF-Drv, 30V, 500mA, 250mW, B=160..400, >80MHz	SOT-23	16ta	-	3a	PHH
6Fs	BC818-25	Si-npn	AF-Drv, 30V, 500mA, 330mW, B= 160..400, 170MHz	SOT-23	16ta	-	3a	Sie
6Fs	BC818-25W	Si-npn	AF-Drv, 30V, 500mA, 250mW, B=160..400, >170MHz	SOT-323	16ta	-	3a	Sie
6Ft	BAP1321-04	PIN-diode	Dual, RF, 60V, 0.1A, 250mW, 0.45pF, 1.3Q(100mA/100MHz)	SOT-23	16dl	-	3a	PhM
6FW	BAP1321-04	PIN-diode	Dual, RF, 60V, 0.1A, 250mW, 0.45pF, 1.3Q(100mA/100MHz)	SOT-23	16dl	-	3a	PhC
6FW	BC818-25	Si-npn	AF-Drv, 30V, 500mA, 250mW, B=160..400, >80MHz	SOT-23	16ta	-	3a	PhC
6FZ	BC818-25	Si-npn	AF-Drv, 30V, 500mA, 330mW, B=160..400, >200MHz	SOT-23	16ta	-	3a	Zx
6G	BC818-40	Si-npn	AF-Drv, 30V, 500mA, 250mW, B=250..600, >80MHz	SOT-23	16ta	-	3a	lIt
6G	CMPF4393	n-FET	AF, 40V, Idss=5..30mA, Vgs(off)=-0.5..3V, Rds<100Q, <50ns	SOT-23	16fj	-	3a	Cen
6G	FMMV2103	C-diode	Tuning, 30V, 9..11pF, Q>400	SOT-23	16dc	-	3a	Zx
6G	FT531Gh	LVR-IC	LDO, 2.8V±2%, 300mA	SOT-23	16cq	VR1	3d	Fmd
6G	KIA7031AT	Vdet-IC	3.1V, -Reset OCO	TSM	16vdb	VD6	3f	Kec
6G	MMBF4393	n-FET	Sw, 30V, 50mA, 225mA, Rds=100Q (1mA)	SOT-23	16fj	-	3a	Ons
6G	MUN2130	Si-pnp-Digi	Sw, 50V, 100mA, 200mW, R1/R2=1k/1k0	SC-59	16ta	-	3a	Mot
6G	MUN5130	Si-pnp-Digi	Sw, 50V, 100mA, 200mW, R1/R2=1k/1k0	SOT-323	16ta	-	3a	Mot
6G	R3131N26EA	Vdet-IC	2.6V, +Reset PPO, 240ms	SOT-23	16vdc	VD7	3b	Ric
6G	UMZ30N	Z-diode	Dual, 29..19..30.69V, Zzt=100Q(5mA), 200mW	SOT-323	16df	-	3i	Rhm
6Gg	FT531Gg	LVR-IC	LDO, 2.8V±2%, 300mA	SOT-23	16cq	VR1	3d	Fmd
6Gp	BC818-40	Si-npn	AF-Drv, 30V, 500mA, 250mW, B=250..600, >80MHz	SOT-23	16ta	-	3a	PHH
6Gs	BC818-40	Si-npn	AF-Drv, 30V, 500mA, 330mW, B=250..630, >170MHz	SOT-23	16ta	-	3a	Sie
6Gs	BC818-40W	Si-npn	AF-Drv, 30V, 500mA, 250mW, B=250..630, >170MHz	SOT-323	16ta	-	3a	Sie
6Gt	BC818-40W	Si-npn	AF-Drv, 30V, 500mA, 250mW, B=250..630, >170MHz	SOT-323	16ta	-	3a	Phi
6GW	BC818-40	Si-npn	AF-Drv, 30V, 500mA, 250mW, B=250..600, >80MHz	SOT-23	16ta	-	3a	PhC
6GZ	BC818-40	Si-npn	AF-Drv, 30V, 500mA, 330mW, B=250..630, >200MHz	SOT-23	16ta	-	3a	Zx
6H	BC818	Si-npn	AF-Drv, 30V, 500mA, 250mW, B=100..600, >80MHz	SOT-23	16ta	-	3a	Cdi
6H	DTA123EE	Si-pnp-Digi	Sw, 50V, 100mA, 200mW, 200MHz, R1/R2=2k2/2k2	SOT-416	16ta	-	3a	Ons
6H	FMMV2104	C-diode	Tuning, 30V, 10.8..13.2pF, Q>400	SOT-23	16dc	-	3a	Zx
6H	FT531Hh	LVR-IC	LDO, 2.85V±2%, 300mA	SOT-23	16cq	VR1	3d	Fmd
6H	KIA7032AT	Vdet-IC	3.2V, -Reset OCO	TSM	16vdb	VD6	3f	Kec
6H	MMBF5486	n-FET	RF, LN, 25V, 10mA, 225mW, Up<4V	SOT-23	16fa	-	3a	Nsc
6H	MUN2131	Si-pnp-Digi	Sw, 50V, 100mA, 200mW, R1/R2=2k2/2k2	SC-59	16ta	-	3a	Mot
6H	MUN5131	Si-pnp-Digi	Sw, 50V, 100mA, 200mW, R1/R2=2k2/2k2	SOT-323	16ta	-	3a	Mot
6H	R3131N36EA	Vdet-IC	3.6V, +Reset PPO, 240ms	SOT-23	16vdc	VD7	3b	Ric
6H	UN2117	Si-pnp-Digi	Sw, 50V, 100mA, 200mW, 80MHz, R1=22k	SC-59	16ta	-	3a	Pan
6H	UN5117	Si-pnp-Digi	Sw, 50V, 100mA, 150mW, 80MHz, R1=22k	SOT-23	16ta	-	3a	Pan
6H	UN9117J	Si-pnp-Digi	Sw, 50V, 100mA, 125mW, 80MHz, R1=22k	SC-89	18ta	-	3a	Pan
6H	UNR2117	Si-pnp-Digi	Sw, 50V, 100mA, 200mW, 80MHz, R1=22k	SC-59	16ta	-	3a	Pan
6H	UNR5117	Si-pnp-Digi	Sw, 50V, 100mA, 150mW, 80MHz, R1=22k	SOT-323	16ta	-	3a	Pan
6H	UNR9117J	Si-pnp-Digi	Sw, 50V, 100mA, 125mW, 80MHz, R1/R2=2k2/2k2	SC-89	18ta	-	3a	Pan
6H5	TC596602ECB	LVR-IC	LDO, -6.6V±2%, 200mA	SOT-23	16cj	VR2	3d	Mcc
6Hg	FT531Hg	LVR-IC	LDO, 2.85V±2%, 300mA	SOT-23	16cq	VR1	3d	Fmd
6Hp	BC818	Si-npn	AF-Drv, 30V, 500mA, 250mW, B=100..600, >80MHz	SOT-23	16ta	-	3a	PHH
6Ht	BC818W	Si-npn	AF-Drv, 30V, 500mA, 250mW, 100..600, >170MHz	SOT-323	16ta	-	3a	Phi
6HW	BC818	Si-npn	AF-Drv, 30V, 500mA, 250mW, B=100..600, >80MHz	SOT-23	16ta	-	3a	PhC
6HZ	BC818	Si-npn	AF-Drv, 30V, 500mA, 330mW, B=100..600, >200MHz	SOT-23	16ta	-	3a	Zx
6I	FT531Ih	LVR-IC	LDO, 3.0V±2%, 300mA	SOT-23	16cq	VR1	3d	Fmd
6I	UN2118	Si-pnp-Digi	Sw, 50V, 100mA, 200mW, 80MHz, R1/R2=510R/5k1	SC-59	16ta	-	3a	Pan
6I	UN5118	Si-pnp-Digi	Sw, 50V, 100mA, 150mW, 80MHz, R1/R2=510R/5k1	SOT-23	16ta	-	3a	Pan
6I	UN9118J	Si-pnp-Digi	Sw, 50V, 100mA, 125mW, 80MHz, R1/R2=510R/5k1	SC-89	18ta	-	3a	Pan
6I	UNR2118	Si-pnp-Digi	Sw, 50V, 100mA, 200mW, 80MHz, R1/R2=510R/5k1	SC-59	16ta	-	3a	Pan
6I	UNR5118	Si-pnp-Digi	Sw, 50V, 100mA, 150mW, 80MHz, R1/R2=510R/5k1	SOT-323	16ta	-	3a	Pan
6I	UNR9118J	Si-pnp-Digi	Sw, 50V, 100mA, 125mW, 80MHz, R1/R2=510R/5k1	SC-89	18ta	-	3a	Pan
6Ig	FT531Ig	LVR-IC	LDO, 3.0V±2%, 300mA	SOT-23	16cq	VR1	3d	Fmd
6J	CMPF4391	n-FET	AF, 40V, Idss=50..150mA, Vgs(off)=4..10V, Rds<30Q, <20ns	SOT-23	16fk	-	3a	Cen
6J	DTA143EE	Si-pnp-Digi	Sw, 50V, 100mA, 200mW, 200MHz, R1/R2=4k7/4k7	SOT-416	16ta	-	3a	Ons
6J	FMMV2105	C-diode	Tuning, 30V, 13.5..16.5pF, Q>400	SOT-23	16dc	-	3a	Zx
6J	FT531Jh	LVR-IC	LDO, 3.3V±2%, 300mA	SOT-23	16cq	VR1	3d	Fmd
6J	KIA7033AT	Vdet-IC	3.3V, -Reset OCO	TSM	16vdb	VD6	3f	Kec



SMD code	Type	Function	Short description	Case	Pinout	Sch.	St.	Mnf.
6J	MMBF4391	n-FET	Sw, 30V, 50mA, 225mA, Rds=30Ω (1mA)	SOT-23	16jf	-	3a	Ons
6J	MUN2132	Si-pnp-Digi	Sw, 50V, 100mA, 200mW, R1/R2=4k/4k7	SC-59	16ta	-	3a	Mot
6J	MUN5132	Si-pnp-Digi	Sw, 50V, 100mA, 200mW, R1/R2=4k/4k7	SOT-323	16ta	-	3a	Mot
6J	R3131N46EA	Vdet-IC	4.6V, +Reset PPO, 240ms	SOT-23	16vdc	VD7	3b	Ric
6Jg	FT531Jg	LVR-IC	LDO, 3.3V±2%, 300mA	SOT-23	16cq	VR1	3d	Fmd
6K	2SJO675	p-MOSFET	Sw, 30V, 100mA, 100mW, 13Ω(10mA)	ML3-N2	22fg	-	2b	Pan
6K	CMPF4392	n-FET	AF, 40V, Idss=25..75mA, Vgs(off)=2..5V, Rds<60Ω, <35ns	SOT-23	16fk	-	3a	Cen
6K	DTA143ZE	Si-pnp-Digi	Sw, 50V, 100mA, 200mW, 200MHz, R1/R2=4k7/47k	SOT-416	16ta	-	3a	Ons
6K	FT531Kh	LVR-IC	LDO, 3.6V±2%, 300mA	SOT-23	16cq	VR1	3d	Fmd
6K	KIA7034AT	Vdet-IC	3.4V, -Reset OCO	TSM	16vdb	VD6	3f	Kec
6K	MMBF4392	n-FET	Sw, 30V, 50mA, 225mA, Rds=60Ω (1mA)	SOT-23	16jf	-	3a	Ons
6K	MUN2133	Si-pnp-Digi	Sw, 50V, 100mA, 200mW, R1/R2=4k7/47k	SC-59	16ta	-	3a	Mot
6K	MUN5133	Si-pnp-Digi	Sw, 50V, 100mA, 200mW, R1/R2=4k7/47k	SOT-323	16ta	-	3a	Mot
6K	UM25..1N	Z-diode	Dual, 4.84..5.37V, Zzt=40Ω(5mA), 200mW	SOT-323	16df	-	3i	Rhm
6K	UN2119	Si-pnp-Digi	Sw, 50V, 100mA, 200mW, 80MHz, R1/R2=1k/10k	SC-59	16ta	-	3a	Pan
6K	UN5119	Si-pnp-Digi	Sw, 50V, 100mA, 150mW, 80MHz, R1/R2=1k/10k	SOT-23	16ta	-	3a	Pan
6K	UN9119J	Si-pnp-Digi	Sw, 50V, 100mA, 125mW, 80MHz, R1/R2=1k/10k	SC-89	18ta	-	3a	Pan
6K	UNR2119	Si-pnp-Digi	Sw, 50V, 100mA, 200mW, 80MHz, R1/R2=1k/10k	SC-59	16ta	-	3a	Pan
6K	UNR5119	Si-pnp-Digi	Sw, 50V, 100mA, 150mW, 80MHz, R1/R2=1k/10k	SOT-323	16ta	-	3a	Pan
6K	UNR9119J	Si-pnp-Digi	Sw, 50V, 100mA, 125mW, 80MHz, R1/R2=1k/10k	SC-89	18ta	-	3a	Pan
6K5	TC596702ECB	LVR-IC	LDO, -6.7V±2%, 200mA	SOT-23	16cj	VR2	3d	Mcc
6Kg	FT531Kg	LVR-IC	LDO, 3.6V±2%, 300mA	SOT-23	16cq	VR1	3d	Fmd
6Kp	BAP64-06	PIN-diode	Dual, RF, 175V, 100mA, 250mW, 0.35pF, 3.8Ω(10mA/100MHz)	SOT-23	16df	-	3a	Phi
6L	DTA124XE	Si-pnp-Digi	Sw, 50V, 100mA, 200mW, 200MHz, R1/R2=22k/47k	SOT-416	16ta	-	3a	Ons
6L	FMMV2107	C-diode	Tuning, 30V, 19.8..24.2pF, Q>350	SOT-23	16dc	-	3a	Zx
6L	KIA7035AT	Vdet-IC	3.5V, -Reset OCO	TSM	16vdb	VD6	3f	Kec
6L	MUN2134	Si-pnp-Digi	Sw, 50V, 100mA, 200mW, R1/R2=22k/47k	SC-59	16ta	-	3a	Mot
6L	MUN5134	Si-pnp-Digi	Sw, 50V, 100mA, 200mW, R1/R2=22k/47k	SOT-323	16ta	-	3a	Mot
6L	UN2110	Si-pnp-Digi	Sw, 50V, 100mA, 200mW, 80MHz, R1=47k	SC-59	16ta	-	3a	Pan
6L	UN5110	Si-pnp-Digi	Sw, 50V, 100mA, 150mW, 80MHz, R1=47k	SOT-23	16ta	-	3a	Pan
6L	UN9110J	Si-pnp-Digi	Sw, 50V, 100mA, 125mW, 80MHz, R1=47k	SC-89	18ta	-	3a	Pan
6L	UNR2110	Si-pnp-Digi	Sw, 50V, 100mA, 200mW, 80MHz, R1=47k	SC-59	16ta	-	3a	Pan
6L	UNR5110	Si-pnp-Digi	Sw, 50V, 100mA, 150mW, 80MHz, R1=47k	SOT-323	16ta	-	3a	Pan
6L	UNR9110J	Si-pnp-Digi	Sw, 50V, 100mA, 125mW, 80MHz, R1=47k	SC-89	18ta	-	3a	Pan
6L5	TC596802ECB	LVR-IC	LDO, -6.8V±2%, 200mA	SOT-23	16cj	VR2	3d	Mcc
6LN	ELM7543CEB	Vdet-IC	4.3V±2%, +Reset PPO	SC-70	16vdb	VD7	3d	Elm
6LN	ELM7543NEB	Vdet-IC	4.3V±2%, +Reset ODO	SC-70	16vdb	VD6	3d	Elm
6M	DTA123JE	Si-pnp-Digi	Sw, 50V, 100mA, 200mW, 200MHz, R1/R2=2k2/47k	SOT-416	16ta	-	3a	Ons
6M	FMMV2108	C-diode	Tuning, 30V, 24.3..29.7pF, Q>300	SOT-23	16dc	-	3a	Zx
6M	KIA7036AT	Vdet-IC	3.6V, -Reset OCO	TSM	16vdb	VD6	3f	Kec
6M	MMBF5485	n-FET	RF, LN, 25V, 10mA, 225mW, Up<3V	SOT-23	16fa	-	3a	Nsc
6M	UN211D	Si-pnp-Digi	Sw, 50V, 100mA, 200mW, 80MHz, R2=10k	SC-59	16ta	-	3a	Pan
6M	UN511D	Si-pnp-Digi	Sw, 50V, 100mA, 150mW, 80MHz, R2=10k	SOT-23	16ta	-	3a	Pan
6M	UN911D.J	Si-pnp-Digi	Sw, 50V, 100mA, 125mW, 80MHz, R2=10k	SC-89	18ta	-	3a	Pan
6M	UNR211D	Si-pnp-Digi	Sw, 50V, 100mA, 200mW, 80MHz, R2=10k	SC-59	16ta	-	3a	Pan
6M	UNR511D	Si-pnp-Digi	Sw, 50V, 100mA, 150mW, 80MHz, R2=10k	SOT-323	16ta	-	3a	Pan
6M	UNR911D.J	Si-pnp-Digi	Sw, 50V, 100mA, 125mW, 80MHz, R2=10k	SC-89	18ta	-	3a	Pan
6M5	TC596902ECB	LVR-IC	LDO, -6.9V±2%, 200mA	SOT-23	16cj	VR2	3d	Mcc
6N	DTA115EE	Si-pnp-Digi	Sw, 50V, 100mA, 200mW, 200MHz, R1/R2=100k/100k	SOT-416	16ta	-	3a	Ons
6N	FMMV2109	C-diode	Tuning, 30V, 29.3..36.3pF, Q>280	SOT-23	16dc	-	3a	Zx
6N	KIA7039AT	Vdet-IC	3.9V, -Reset OCO	TSM	16vdb	VD6	3f	Kec
6N	MUN2136	Si-pnp-Digi	Sw, 50V, 100mA, 200mW, R1/R2=100k/100k	SC-59	16ta	-	3a	Mot
6N	MUN5136	Si-pnp-Digi	Sw, 50V, 100mA, 200mW, R1/R2=100k/100k	SOT-323	16ta	-	3a	Mot
6N	UN211E	Si-pnp-Digi	Sw, 50V, 100mA, 200mW, 80MHz, R1/R2=47k/22k	SC-59	16ta	-	3a	Pan
6N	UN511E	Si-pnp-Digi	Sw, 50V, 100mA, 150mW, 80MHz, R1/R2=47k/22k	SOT-23	16ta	-	3a	Pan
6N	UN911E.J	Si-pnp-Digi	Sw, 50V, 100mA, 125mW, 80MHz, R1/R2=47k/22k	SC-89	18ta	-	3a	Pan
6N	UNR211E	Si-pnp-Digi	Sw, 50V, 100mA, 200mW, 80MHz, R1/R2=47k/22k	SC-59	16ta	-	3a	Pan
6N	UNR511E	Si-pnp-Digi	Sw, 50V, 100mA, 150mW, 80MHz, R1/R2=47k/22k	SOT-323	16ta	-	3a	Pan
6N	UNR911E.J	Si-pnp-Digi	Sw, 50V, 100mA, 125mW, 80MHz, R1/R2=47k/22k	SC-89	18ta	-	3a	Pan
6O	UN211F	Si-pnp-Digi	Sw, 50V, 100mA, 200mW, 80MHz, R1/R2=4k7/10k	SC-59	16ta	-	3a	Pan
6O	UN511F	Si-pnp-Digi	Sw, 50V, 100mA, 150mW, 80MHz, R1/R2=4k7/10k	SOT-23	16ta	-	3a	Pan
6O	UN911F.J	Si-pnp-Digi	Sw, 50V, 100mA, 125mW, 80MHz, R1/R2=4k7/10k	SC-89	18ta	-	3a	Pan
6O	UNR211F	Si-pnp-Digi	Sw, 50V, 100mA, 200mW, 80MHz, R1/R2=4k7/10k	SC-59	16ta	-	3a	Pan
6O	UNR511F	Si-pnp-Digi	Sw, 50V, 100mA, 150mW, 80MHz, R1/R2=4k7/10k	SOT-323	16ta	-	3a	Pan
6O	UNR911F.J	Si-pnp-Digi	Sw, 50V, 100mA, 125mW, 80MHz, R1/R2=4k7/10k	SC-89	18ta	-	3a	Pan
6P	BCX71HR	Si-pnp	GP, 45V, 200mA, 330mW, B=180..310, >180MHz	SOT-23	16ta	-	3a	Zx
6P	BCX71RH	Si-pnp	GP, 45V, 200mA, 250mW, B=180..310, >100MHz	SOT-23	16ta	-	3a	Zx
6P	DTA144WE	Si-pnp-Digi	Sw, 50V, 100mA, 200mW, 200MHz, R1/R2=47k/22k	SOT-416	16ta	-	3a	Ons
6P	KIA7042AT	Vdet-IC	4.2V, -Reset OCO	TSM	16vdb	VD6	3f	Kec
6P	MUN2137	Si-pnp-Digi	Sw, 50V, 100mA, 200mW, R1/R2=47k/22k	SC-59	16ta	-	3a	Mot



SMD code	Type	Function	Short description	Case	Pinout	Sch.	St.	Mnf.
6P	MUN5137	Si-pnp-Digi	Sw, 50V, 100mA, 200mW, R1/R2=47k/22k	SOT-323	16ta	-	3a	Mot
6P	UMZ16N	Z-diode	Dual, 15.85..16.51V, Zzt=80Ω(5mA), 200mW	SOT-323	16df	-	3i	Rhm
6P	UNZ11H	Si-pnp-Digi	Sw, 50V, 100mA, 200mW, 80MHz, R1/R2=2k2/10k	SC-59	16ta	-	3a	Pan
6P	UN511K	Si-pnp-Digi	Sw, 50V, 100mA, 150mW, 80MHz, R1/R2=10k/4k7	SOT-23	16ta	-	3a	Pan
6P	UN911KJ	Si-pnp-Digi	Sw, 50V, 100mA, 125mW, 80MHz, R1/R2=10k/4k7	SC-89	18ta	-	3a	Pan
6P	UNR211H	Si-pnp-Digi	Sw, 50V, 100mA, 200mW, 80MHz, R1/R2=2k2/10k	SC-59	16ta	-	3a	Pan
6P	UNR511K	Si-pnp-Digi	Sw, 50V, 100mA, 150mW, 80MHz, R1/R2=10k/4k7	SOT-323	16ta	-	3a	Pan
6P	UNR911KJ	Si-pnp-Digi	Sw, 50V, 100mA, 125mW, 80MHz, R1/R2=10k/4k7	SC-89	18ta	-	3a	Pan
6Q	UN211L	Si-pnp-Digi	Sw, 50V, 100mA, 200mW, 80MHz, R1/R2=4k7/4k7	SC-59	16ta	-	3a	Pan
6Q	UN511L	Si-pnp-Digi	Sw, 50V, 100mA, 150mW, 80MHz, R1/R2=4k7/4k7	SOT-23	16ta	-	3a	Pan
6Q	UN911LJ	Si-pnp-Digi	Sw, 50V, 100mA, 125mW, 80MHz, R1/R2=4k4/4k7	SC-89	18ta	-	3a	Pan
6Q	UNR211L	Si-pnp-Digi	Sw, 50V, 100mA, 200mW, 80MHz, R1/R2=4k7/4k7	SC-59	16ta	-	3a	Pan
6Q	UNR511L	Si-pnp-Digi	Sw, 50V, 100mA, 150mW, 80MHz, R1/R2=4k7/4k7	SOT-323	16ta	-	3a	Pan
6Q	UNR911LJ	Si-pnp-Digi	Sw, 50V, 100mA, 125mW, 80MHz, R1/R2=4k4/4k7	SC-89	18ta	-	3a	Pan
6R	FMMV2101	C-diode	Tuning, 30V, 6.1..7.5pF, Q>450	SOT-23	16dc	-	3a	Zx
6R	KIA7045AT	Vdet-IC	4.5V, -Reset OCO	TSM	16vdb	VD6	3f	Kec
6R	SRA2206E	Si-pnp-Digi	Sw, 50V, 100mA, 150mW, 200MHz, R1/R2=4.7/47k	SOT-523	16ta	-	3a	Auk
6R	SRA2206EF	Si-pnp-Digi	Sw, 50V, 100mA, 150mW, 200MHz, R1/R2=4.7/47k	SOT-523F	18ta	-	3a	Auk
6R	SRA2206U	Si-pnp-Digi	Sw, 50V, 100mA, 200mW, 200MHz, R1/R2=4.7/47k	SOT-323	16ta	-	3a	Auk
6R	SRA2206UF	Si-pnp-Digi	Sw, 50V, 100mA, 200mW, 200MHz, R1/R2=4.7/47k	SOT-323F	18ta	-	3a	Auk
6R	UMZ8.2T	Z-diode	Dual, 7.76..8.64V, Zzt=30Ω(5mA), 200mW	SOT-323	16df	-	3i	Rhm
6S	UMZ27N	Z-diode	Dual, 26.19..27.53V, Zzt=100Ω(5mA), 200mW	SOT-323	16df	-	3i	Rhm
6T	BCW68RG	Si-pnp	AF, Sw, 60V, 800mA, 350mW, B>160, >100MHz	SOT-23	16ta	-	3a	Zx
6T	DTA144T	Si-pnp-Digi	Sw, 50V, 100mA, 230mW, 250MHz, R1=47k	SC-59	16ta	-	3a	Ons
6T	MUN2140	Si-pnp-Digi	Sw, 50V, 100mA, 200mW, R1=47k	SC-59	16ta	-	3a	Mot
6T3	1PS70SB40	Si-diode	Schottky, Sw, Fast, 40V, 120mA, <100ps	SOT-323	16dc	-	3a	PhM
6T4	1PS70SB44	Si-diode	Dual, Schottky, Sw, Fast, 40V, 120mA, <100ps	SOT-323	16dl	-	3a	PhM
6T5	1PS70SB45	Si-diode	Dual, Schottky, Sw, Fast, 40V, 120mA, <100ps	SOT-323	16dg	-	3a	PhM
6T6	1PS70SB46	Si-diode	Dual, Schottky, Sw, Fast, 40V, 120mA, <100ps	SOT-323	16df	-	3a	PhM
6V	BCW65CR	Si-npn	AF, 60V, 800mA, 330mW, B=250..630, >100MHz	SOT-23	16te	-	3a	Zx
6V	UMZ12N	Z-diode	Dual, 11.0..13.0V, Zzt=30Ω(5mA), 200mW	SOT-323	16df	-	3i	Rhm
6V0	CHPZ6VOPT	Z-diode	Dual, 5.6..6.4V, Izt=5mA, Zzt=20Ω, 350mW	SOT-23	16df	-	3a	Chm
6V2	CHPZ6V2PT	Z-diode	Dual, 5.8..6.6V, Izt=5mA, Zzt=10Ω, 350mW	SOT-23	16df	-	3a	Chm
6V2	PZM6.2NB	Z-diode	6.2V±2.5%, 300mW	SOT-346	16dc	-	3a	Phi
6V8	CHPZ6V8BPT	Z-diode	Dual, 6.4..7.2V, Izt=5mA, Zzt=15Ω, 350mW	SOT-23	16df	-	3a	Chm
6V8	PZM6.8NB	Z-diode	6.8V±2.5%, 300mW	SOT-346	16dc	-	3a	Phi
6V	BCW67CR	Si-pnp	AF, Sw, 45V, 800mA, 330mW, B=250..630, >100MHz	SOT-23	16ta	-	3a	Zx
6V-	BAP50-04W	PLIN-diode	Dual, RF, 50V, 50mA, 500mW, 0.3pF, 3Q(10mA/100MHz)	SOT-323	16dl	-	3a	Phi
6X	UNR311A	Si-pnp-Digi	Sw, 50V, 100mA, 100mW, 80MHz, R1/R2=100k/100k	SSSMini3	18ta	-	3a	Pan
6X	UNR911AJ	Si-pnp-Digi	Sw, 50V, 100mA, 125mW, 80MHz, R1/R2=100k/100k	SC-89	18ta	-	3a	Pan
6Y	UNR911BJ	Si-pnp-Digi	Sw, 50V, 100mA, 125mW, 80MHz, R1=100k	SC-89	18ta	-	3a	Pan
6Z	UNR911CJ	Si-pnp-Digi	Sw, 50V, 100mA, 125mW, 80MHz, R2=47k	SC-89	18ta	-	3a	Pan
6Z2	CZ1W6V2	Z-diode	6.2V±5%, 600mW	SOT-23	16dc	-	3a	Cdi
6Z8	CZ1W6V8	Z-diode	6.8V±5%, 600mW	SOT-23	16dc	-	3a	Cdi
7.5	TZT7.5W	Z-diode	7.0..7.90V, Izt=5mA, Zzt=23Ω, 200mW	SOT-323	16dc	-	3a	Ttr
7.5	Z02W7.5V	Z-diode	7.0..7.90V, Izt=5mA, Zzt=23Ω, 200mW	SOT-23	16dc	-	3f	Kec
7.5A	MAZ3075WA	Z-diode	Dual, 7.5V, If=100mA, Zzt=15Ω, 200mW	SC-59	16df	-	3a	Pan
7.5H	BZX84-C7V5-V	Z-diode	7.23..7.66V, Izt=5mA, Zzt=23Ω, 300mW	SOT-23	16dc	-	3f	Kec
7.5H	MAZ3075-H	Z-diode	7.7..9V, If=100mA, Zzt=15Ω, 200mW	SC-59	16dc	-	3a	Pan
7.5K	MAZ3075WK	Z-diode	Dual, 7.5V, If=100mA, Zzt=15Ω, 200mW	SC-59	16dg	-	3a	Pan
7.5L	MAZ3075-L	Z-diode	7.7..9V, If=100mA, Zzt=15Ω, 200mW	SC-59	16dc	-	3a	Pan
7.5M	MAZ3075-M	Z-diode	7.7..9V, If=100mA, Zzt=15Ω, 200mW	SC-59	16dc	-	3a	Pan
7.5X	TZT7.5XW	Z-diode	7.0..7.43V, Izt=5mA, Zzt=23Ω, 200mW	SOT-323	16dc	-	3a	Ttr
7.5X	Z02W7.5VX	Z-diode	7.0..7.43V, Izt=5mA, Zzt=23Ω, 200mW	SOT-23	16dc	-	3f	Kec
7.5Y	TZT7.5YW	Z-diode	7.23..7.66V, Izt=5mA, Zzt=23Ω, 200mW	SOT-323	16dc	-	3a	Ttr
7.5Y	Z02W7.5VY	Z-diode	7.23..7.66V, Izt=5mA, Zzt=23Ω, 200mW	SOT-23	16dc	-	3f	Kec
7.5Z	TZT7.5ZW	Z-diode	7.46..7.90V, Izt=5mA, Zzt=23Ω, 200mW	SOT-323	16dc	-	3a	Ttr
7.5Z	Z02W7.5VZ	Z-diode	7.46..7.90V, Izt=5mA, Zzt=23Ω, 200mW	SOT-23	16dc	-	3f	Kec
7-5X	02CZ7.5-X	Z-diode	7..7.43V, 200mW	SC-59	16dc	-	3a	Tos
7-5Y	02CZ7.5-Y	Z-diode	7.23..7.66V, 200mW	SC-59	16dc	-	3a	Tos
7-5Z	02CZ7.5-Z	Z-diode	7.46..7.9V, 200mW	SC-59	16dc	-	3a	Tos
7-8X	02CZ8.2-X	Z-diode	7.7..8.16V, 200mW	SC-59	16dc	-	3a	Tos
7-8Y	02CZ8.2-Y	Z-diode	7.96..8.43V, 200mW	SC-59	16dc	-	3a	Tos
7-8Z	02CZ8.2-Z	Z-diode	8.23..8.7V, 200mW	SC-59	16dc	-	3a	Tos
70	1PS70SB10	Si-diode	Schottky, Sw, Fast, 30V, 200mA, <5ns	SOT-323	16dc	-	3a	PhH
702	2N7002	n-MOSFET-e	TMOS, 60V, 300mA, 830mW, 5Q(500mA), 10/15ns	SOT-23	16fh	-	3a	Phi
702E	2N7002E	n-MOSFET-e*	TMOS, 60V, 385mA, 830mW, 3Q(500mA), 10/15ns	SOT-23	16fh	-	3a	Phi
702F	2N7002F	n-MOSFET-e*	TMOS, 60V, 475mA, 830mW, 2Q(500mA), 10/15ns	SOT-23	16fh	-	3a	Phi
702K	2N7002K	n-MOSFET-e*	TMOS, 60V, 340mA, 830mW, 3.9Q(500mA), 10/15ns	SOT-23	16fh	-	3a	Phi
702KA	2N7002KA	n-MOSFET-e*	TMOS, 60V, 320mA, 830mW, 4.4Q(500mA), 10/15ns	SOT-23	16fh	-	3a	Phi



SMD code	Type	Function	Short description	Case	Pinout	Sch.	St.	Mnf.
702T	2N7002T	n-MOSFET-e*	TMOS, 60V, 300mA, 830mW, 5Q(500mA), 10/15ns	SOT-23	16fh	-	3a	Phi
70B	MMBZ5270BPT	Z-diode	86.45..95.55V, Izt=1.4mA, Zzt=400Q, 225mW	SOT-23	16dc	-	3a	Chm
70B	MMBZ5270BPT	Z-diode	86.45..95.55V, Izt=1.4mA, Zzt=400Q, 225mW	SOT-346	16dc	-	3a	Chm
70LN	ELM7520CBB	Vdet-IC	2.0V±2%, +Reset PPO	SOT-23	16vdb	VD7	3d	Elm
70LN	ELM7520NBB	Vdet-IC	2.0V±2%, +Reset ODO	SOT-23	16vdb	VD6	3d	Elm
70S	MMBZ5270SPT	Z-diode	89.18..92.82V, Izt=1.4mA, Zzt=400Q, 225mW	SOT-23	16dc	-	3a	Chm
70S	MMBZ5270SPT	Z-diode	89.18..92.82V, Izt=1.4mA, Zzt=400Q, 225mW	SOT-346	16dc	-	3a	Chm
70T	TK71570AS	LVR-IC	LDO, 7V±1.5%, 155mA	SOT-23	16cj	VR1	3d	Tok
70W	1PS70SB10	Si-diode	Schottky, Sw, Fast, 30V, 200mA, <5ns	SOT-323	16dc	-	3a	PhC
71	CHDTA114TMPT	Si-pnp-Digi	Sw, 50V, 100mA, 250MHz, R1=10k	SOT-723	18ta	-	3a	Chm
712	NDS7002A	n-MOSFET-e	V-MOS, 60V, 0.28A, <2Q(0.5A)	SOT-23	16fh	-	3a	Nsc
717	FMMT717	Si-pnp	Sw, Lo-sat, 12V, 2.5A, 0.625W, 70/130ns	SOT-23	16ta	-	3a	Zx
718	FMMT718	Si-pnp	Sw, Lo-sat, 20V, 1.5A, 0.625W, 40/670ns	SOT-23	16ta	-	3a	Zx
71LN	ELM7521CBB	Vdet-IC	2.1V±2%, +Reset PPO	SOT-23	16vdb	VD7	3d	Elm
71LN	ELM7521NBB	Vdet-IC	2.1V±2%, +Reset ODO	SOT-23	16vdb	VD6	3d	Elm
72	1PS70SB20	Si-diode	Schottky, Sw, U-Fast, 40V, 500mA, Vf<0.55V(500mA)	SOT-323	16dc	-	3a	Phi
72	2N7002	n-MOSFET-e	TMOS, 60V, 250mA, 310mW, <7.5Q(500mA), 5/25ns	SOT-23	16fh	-	3a	Six
72	2N7002T	n-MOSFET-e*	TMOS, 60V, 150mA, 200mW, <7.5Q(500mA), 7/11ns	SOT-523	16fh	-	3a	Trs
72	CHDTA115TMPT	Si-pnp-Digi	Sw, 50V, 100mA, 250MHz, R1=100k	SOT-723	18ta	-	3a	Chm
720	FMMT720	Si-pnp	Sw, Lo-sat, 40V, 1.5A, 625mW, B=300..450, >190MHz	SOT-23	16ta	-	3a	Zx
722	FMMT722	Si-pnp	Sw, Lo-sat, 70V, 1.5A, 625mW, B=300..450, >200MHz	SOT-23	16ta	-	3a	Zx
723	FMMT723	Si-pnp	Sw, Lo-sat, 100V, -1A, 625mW, B=300..450, >200MHz	SOT-23	16ta	-	3a	Zx
723	S7123SF	Vdet-IC	2.3V, +Reset Open collector output	SOT-23F	18vdb	VD6	3b	Auk
725	MMBZ5225-V-G	Z-diode	3V±5%, Izt=20mA, Zzt=30Q, 225mW	SOT-23	16dc	-	3a	Vs
726	MMBZ5226-V-G	Z-diode	3.3V±5%, Izt=20mA, Zzt=28Q, 225mW	SOT-23	16dc	-	3a	Vs
727	MMBZ5227-V-G	Z-diode	3.6V±5%, Izt=20mA, Zzt=24Q, 225mW	SOT-23	16dc	-	3a	Vs
728	MMBZ5228-V-G	Z-diode	3.9V±5%, Izt=20mA, Zzt=23Q, 225mW	SOT-23	16dc	-	3a	Vs
729	MMBZ5229-V-G	Z-diode	4.3V±5%, Izt=20mA, Zzt=22Q, 225mW	SOT-23	16dc	-	3a	Vs
72A	KIA7219S	Vdet-IC	1.9V±2%, -Reset OCO	SOT-23	16vdy	VD6	3f	Kec
72B	KIA7221S	Vdet-IC	2.1V±2%, -Reset OCO	SOT-23	16vdy	VD6	3f	Kec
72C	KIA7223S	Vdet-IC	2.3V±2%, -Reset OCO	SOT-23	16vdy	VD6	3f	Kec
72D	KIA7225S	Vdet-IC	2.5V±2%, -Reset OCO	SOT-23	16vdy	VD6	3f	Kec
72E	KIA7227S	Vdet-IC	2.7V±2%, -Reset OCO	SOT-23	16vdy	VD6	3f	Kec
72F	KIA7229S	Vdet-IC	2.9V±2%, -Reset OCO	SOT-23	16vdy	VD6	3f	Kec
72G	KIA7231S	Vdet-IC	3.1V±2%, -Reset OCO	SOT-23	16vdy	VD6	3f	Kec
72H	KIA7232S	Vdet-IC	3.2V±2%, -Reset OCO	SOT-23	16vdy	VD6	3f	Kec
72J	KIA7233S	Vdet-IC	3.3V±2%, -Reset OCO	SOT-23	16vdy	VD6	3f	Kec
72K	KIA7234S	Vdet-IC	3.4V±2%, -Reset OCO	SOT-23	16vdy	VD6	3f	Kec
72L	KIA7235S	Vdet-IC	3.5V±2%, -Reset OCO	SOT-23	16vdy	VD6	3f	Kec
72LN	ELM7522CBB	Vdet-IC	2.2V±2%, +Reset PPO	SOT-23	16vdb	VD7	3d	Elm
72LN	ELM7522NBB	Vdet-IC	2.2V±2%, +Reset ODO	SOT-23	16vdb	VD6	3d	Elm
72M	KIA7236S	Vdet-IC	3.6V±2%, -Reset OCO	SOT-23	16vdy	VD6	3f	Kec
72N	KIA7239S	Vdet-IC	3.9V±2%, -Reset OCO	SOT-23	16vdy	VD6	3f	Kec
72P	KIA7242S	Vdet-IC	4.2V±2%, -Reset OCO	SOT-23	16vdy	VD6	3f	Kec
72R	KIA7245S	Vdet-IC	4.5V±2%, -Reset OCO	SOT-23	16vdy	VD6	3f	Kec
73	2SC5005-FB	Si-npn	UHF-Mix/Osc, 20V, 30mA, 100mW, 5.5GHz, B=60..120	SOT-23	16ta	-	3a	Nec
73	BAS70	Si-diode	Schottky, 70V, 70mA, Vf<1V(15mA), <2pF, 5ns	SOT-23	16dc	-	3g	Vs
73	BAS70W	Si-diode	Schottky, 70V, 70mA, Vf<1V(15mA), <2pF, 5ns	SOT-323	16dc	-	3a	PHH
73	CHDTA124TMPT	Si-pnp-Digi	Sw, 50V, 100mA, 250MHz, R1=22k	SOT-723	18ta	-	3a	Chm
730	MMBZ5230-V-G	Z-diode	4.7V±5%, Izt=20mA, Zzt=19Q, 225mW	SOT-23	16dc	-	3a	Vs
731	MMBZ5231-V-G	Z-diode	5.1V±5%, Izt=20mA, Zzt=17Q, 225mW	SOT-23	16dc	-	3a	Vs
732	MMBZ5232-V-G	Z-diode	5.6V±5%, Izt=20mA, Zzt=11Q, 225mW	SOT-23	16dc	-	3a	Vs
733	MMBZ5233-V-G	Z-diode	6V±5%, Izt=20mA, Zzt=7Q, 225mW	SOT-23	16dc	-	3a	Vs
734	MMBZ5234-V-G	Z-diode	6.2V±5%, Izt=20mA, Zzt=7Q, 225mW	SOT-23	16dc	-	3a	Vs
735	MMBZ5235-V-G	Z-diode	6.8V±5%, Izt=20mA, Zzt=5Q, 225mW	SOT-23	16dc	-	3a	Vs
736	MMBZ5236-V-G	Z-diode	7.5V±5%, Izt=20mA, Zzt=6Q, 225mW	SOT-23	16dc	-	3a	Vs
737	MMBZ5237-V-G	Z-diode	8.2V±5%, Izt=20mA, Zzt=8Q, 225mW	SOT-23	16dc	-	3a	Vs
738	MMBZ5238-V-G	Z-diode	8.7V±5%, Izt=20mA, Zzt=8Q, 225mW	SOT-23	16dc	-	3a	Vs
739	MMBZ5239-V-G	Z-diode	9.1V±5%, Izt=20mA, Zzt=10Q, 225mW	SOT-23	16dc	-	3a	Vs
73LN	ELM7523CBB	Vdet-IC	2.3V±2%, +Reset PPO	SOT-23	16vdb	VD7	3d	Elm
73LN	ELM7523NBB	Vdet-IC	2.3V±2%, +Reset ODO	SOT-23	16vdb	VD6	3d	Elm
73p	BAS70	Si-diode	Schottky, 70V, 70mA, Vf<1V(15mA), <2pF, 5ns	SOT-23	16dc	-	3a	PHH
73s	BAS70	Si-diode	Schottky, 70V, 70mA, Vf<1V(15mA), <2pF, 5ns	SOT-23	16dc	-	3c	Inf
73t	BAS70	Si-diode	Schottky, 70V, 70mA, Vf<1V(15mA), <2pF, 5ns	SOT-23	16dc	-	3a	PHM
73t	BAS70W	Si-diode	Schottky, 70V, 70mA, Vf<1V(15mA), <2pF, 5ns	SOT-323	16dc	-	3a	PhM
73W	BAS70	Si-diode	Schottky, 70V, 70mA, Vf<1V(15mA), <2pF, 5ns	SOT-23	16dc	-	3a	PhC
73W	BAS70W	Si-diode	Schottky, 70V, 70mA, Vf<1V(15mA), <2pF, 5ns	SOT-323	16dc	-	3a	PhC
74	1PS70SB14	Si-diode	Dual, Schottky, Sw, Fast, 30V, 200mA, <5ns	SOT-323	16dl	-	3a	PhH
74	BAS70-04	Si-diode	Dual, Schottky, 70V, 70mA, Vf<1V(15mA), <2pF, 5ns	SOT-23	16dl	-	3g	Vs
74	BAS70-04W	Si-diode	Dual, Schottky, 70V, 70mA, Vf<1V(15mA), <2pF, 5ns	SOT-323	16dl	-	3a	PHH



SMD code	Type	Function	Short description	Case	Pinout	Sch.	St.	Mnf.
74	CHDTA143TMPT	Si-pnp-Digi	Sw, 50V, 100mA, 250MHz, R1=4.7k	SOT-723	18ta	-	3a	Chm
74	DTA114WE	Si-pnp-Digi	Sw, 50V, 100mA, 150mW, 200MHz, R1/R2=10k/4k7	SOT-416	16ta	-	3a	Rhm
74	DTA114WKA	Si-pnp-Digi	Sw, 50V, 100mA, 200mW, 200MHz, R1/R2=10k/4k7	SOT-346	16ta	-	3a	Rhm
74	DTA114WUA	Si-pnp-Digi	Sw, 50V, 100mA, 200mW, 200MHz, R1/R2=10k/4k7	UMT3	16ta	-	3a	Rhm
740	MMBZ5240-V-G	Z-diode	10V±5%, Izt=20mA, Zzt=17Ω, 225mW	SOT-23	16dc	-	3a	Vs
741	MMBZ5241-V-G	Z-diode	11V±5%, Izt=20mA, Zzt=22Ω, 225mW	SOT-23	16dc	-	3a	Vs
742	MMBZ5242-V-G	Z-diode	12V±5%, Izt=20mA, Zzt=30Ω, 225mW	SOT-23	16dc	-	3a	Vs
743	MMBZ5243-V-G	Z-diode	13V±5%, Izt=9.5mA, Zzt=13Ω, 225mW	SOT-23	16dc	-	3a	Vs
744	MMBZ5244-V-G	Z-diode	14V±5%, Izt=9mA, Zzt=15Ω, 225mW	SOT-23	16dc	-	3a	Vs
745	MMBZ5245-V-G	Z-diode	15V±5%, Izt=8.5mA, Zzt=16Ω, 225mW	SOT-23	16dc	-	3a	Vs
746	MMBZ5246-V-G	Z-diode	16V±5%, Izt=7.8mA, Zzt=17Ω, 225mW	SOT-23	16dc	-	3a	Vs
747	MMBZ5247-V-G	Z-diode	17V±5%, Izt=7.4mA, Zzt=19Ω, 225mW	SOT-23	16dc	-	3a	Vs
748	MMBZ5248-V-G	Z-diode	18V±5%, Izt=7mA, Zzt=21Ω, 225mW	SOT-23	16dc	-	3a	Vs
749	MMBZ5249-V-G	Z-diode	19V±5%, Izt=6.6mA, Zzt=23Ω, 225mW	SOT-23	16dc	-	3a	Vs
74LN	ELM7524CBB	Vdet-IC	2.4V±2%, +Reset PPO	SOT-23	16vdb	VD7	3d	Elm
74LN	ELM7524NBB	Vdet-IC	2.4V±2%, +Reset ODO	SOT-23	16vdb	VD6	3d	Elm
74p	BAS70-04	Si-diode	Dual, Schottky, 70V, 70mA, Vf<1V(15mA), <2pF, 5ns	SOT-23	16dl	-	3a	PHH
74s	BAS70-04	Si-diode	Dual, Schottky, 70V, 70mA, Vf<1V(15mA), <2pF, 5ns	SOT-23	16dl	-	3c	Inf
74s	BAS70-04T	Si-diode	Dual, Schottky, 70V, 70mA, Vf<1V(15mA), <2pF, 5ns	SOT-416	16dl	-	3a	Di
74s	BAS70-04W	Si-diode	Dual, Schottky, 70V, 70mA, Vf<1V(15mA), <2pF, 5ns	SOT-323	16dl	-	3a	Di
74t	BAS70-04	Si-diode	Dual, Schottky, 70V, 70mA, Vf<1V(15mA), <2pF, 5ns	SOT-23	16dl	-	3a	PHM
74t	BAS70-04W	Si-diode	Dual, Schottky, 70V, 70mA, Vf<1V(15mA), <2pF, 5ns	SOT-323	16dl	-	3a	PHM
74W	1PS70SB14	Si-diode	Dual, Schottky, Sw, Fast, 30V, 200mA, <5ns	SOT-323	16dl	-	3a	PhC
74W	BAS70-04	Si-diode	Dual, Schottky, 70V, 70mA, Vf<1V(15mA), <2pF, 5ns	SOT-23	16dl	-	3a	PhC
74W	BAS70-04W	Si-diode	Dual, Schottky, 70V, 70mA, Vf<1V(15mA), <2pF, 5ns	SOT-323	16dl	-	3a	PhC
75	1PS70SB15	Si-diode	Dual, Schottky, Sw, Fast, 30V, 200mA, <5ns	SOT-323	16dg	-	3a	PHH
75	BAS70-05	Si-diode	Dual, Schottky, 70V, 70mA, Vf<1V(15mA), <2pF, 5ns	SOT-23	16dg	-	3g	Vs
75	BAS70-05W	Si-diode	Dual, Schottky, 70V, 70mA, Vf<1V(15mA), <2pF, 5ns	SOT-323	16dg	-	3a	Sme
75	CHDTA144TMPT	Si-pnp-Digi	Sw, 50V, 100mA, 250MHz, R1=4.7k	SOT-723	18ta	-	3a	Chm
75-	BAS70-05W	Si-diode	Dual, Schottky, 70V, 70mA, Vf<1V(15mA), <2pF, 5ns	SOT-323	16dg	-	3a	PHH
750	HZM7.5NB	Z-diode	7.06..7.84V, 200mW	SC-59A	16dc	-	3a	Ren
750	MMBZ5250-V-G	Z-diode	20V±5%, Izt=6.2mA, Zzt=25Ω, 225mW	SOT-23	16dc	-	3a	Vs
751	HZM7.5NB1	Z-diode	7.06..7.36V, 200mW	SC-59A	16dc	-	3a	Ren
751	MMBZ5251-V-G	Z-diode	22V±5%, Izt=5.6mA, Zzt=29Ω, 225mW	SOT-23	16dc	-	3a	Vs
751	PZM7.5NB1	Z-diode	7.5V±2.5%, 300mW	SOT-346	16dc	-	3a	Phi
752	HZM7.5NB2	Z-diode	7.28..7.6V, 200mW	SC-59A	16dc	-	3a	Ren
752	MMBZ5252-V-G	Z-diode	24V±5%, Izt=5.2mA, Zzt=33Ω, 225mW	SOT-23	16dc	-	3a	Vs
752	PZM7.5NB2	Z-diode	7.5V±2.5%, 300mW	SOT-346	16dc	-	3a	Phi
753	HZM7.5NB3	Z-diode	7.52..7.84V, 200mW	SC-59A	16dc	-	3a	Ren
753	MMBZ5253-V-G	Z-diode	25V±5%, Izt=5mA, Zzt=35Ω, 225mW	SOT-23	16dc	-	3a	Vs
753	PZM7.5NB3	Z-diode	7.5V±2.5%, 300mW	SOT-346	16dc	-	3a	Phi
754	MMBZ5254-V-G	Z-diode	27V±5%, Izt=4.6mA, Zzt=41Ω, 225mW	SOT-23	16dc	-	3a	Vs
755	MMBZ5255-V-G	Z-diode	28V±5%, Izt=4.5mA, Zzt=44Ω, 225mW	SOT-23	16dc	-	3a	Vs
756	MMBZ5256-V-G	Z-diode	30V±5%, Izt=4.2mA, Zzt=49Ω, 225mW	SOT-23	16dc	-	3a	Vs
757	MMBZ5257-V-G	Z-diode	33V±5%, Izt=3.8mA, Zzt=58Ω, 225mW	SOT-23	16dc	-	3a	Vs
758	MMBZ5258-V-G	Z-diode	36V±5%, Izt=3.4mA, Zzt=70Ω, 225mW	SOT-23	16dc	-	3a	Vs
759	MMBZ5259-V-G	Z-diode	39V±5%, Izt=3.2mA, Zzt=80Ω, 225mW	SOT-23	16dc	-	3a	Vs
75LN	ELM7525CBB	Vdet-IC	2.5V±2%, +Reset PPO	SOT-23	16vdb	VD7	3d	Elm
75LN	ELM7525NBB	Vdet-IC	2.5V±2%, +Reset ODO	SOT-23	16vdb	VD6	3d	Elm
75p	BAS70-05	Si-diode	Dual, Schottky, 70V, 70mA, Vf<1V(15mA), <2pF, 5ns	SOT-23	16dg	-	3a	PHH
75s	BAS70-05	Si-diode	Dual, Schottky, 70V, 70mA, Vf<1V(15mA), <2pF, 5ns	SOT-23	16dg	-	3c	Inf
75s	BAS70-05W	Si-diode	Dual, Schottky, 70V, 70mA, Vf<1V(15mA), <2pF, 5ns	SOT-323	16dg	-	3c	Inf
75t	BAS70-05	Si-diode	Dual, Schottky, 70V, 70mA, Vf<1V(15mA), <2pF, 5ns	SOT-23	16dg	-	3a	PHM
75t	BAS70-05W	Si-diode	Dual, Schottky, 70V, 70mA, Vf<1V(15mA), <2pF, 5ns	SOT-323	16dg	-	3a	PHM
75V	PZM75NB	Z-diode	75V±2.5%, 300mW	SOT-346	16dc	-	3a	Phi
75W	1PS70SB15	Si-diode	Dual, Schottky, Sw, Fast, 30V, 200mA, <5ns	SOT-323	16dg	-	3a	PhC
75W	BAS70-05	Si-diode	Dual, Schottky, 70V, 70mA, Vf<1V(15mA), <2pF, 5ns	SOT-23	16dg	-	3a	PhC
75W	BAS70-05W	Si-diode	Dual, Schottky, 70V, 70mA, Vf<1V(15mA), <2pF, 5ns	SOT-323	16dg	-	3a	PhC
76	1PS70SB16	Si-diode	Dual, Schottky, Sw, Fast, 30V, 200mA, <5ns	SOT-323	16df	-	3a	PHH
76	BAS70-06	Si-diode	Dual, Schottky, 70V, 70mA, Vf<1V(15mA), <2pF, 5ns	SOT-23	16df	-	3g	Vs
76	BAS70-06W	Si-diode	Dual, Schottky, 70V, 70mA, Vf<1V(15mA), <2pF, 5ns	SOT-323	16df	-	3a	PHH
76	CHDTA124GMPT	Si-pnp-Digi	Sw, 50V, 100mA, 250MHz, R2=22k	SOT-723	18ta	-	3a	Chm
76	DTA144WE	Si-pnp-Digi	Sw, 50V, 100mA, 150mW, 250MHz, R1/R2=47k/22k	SOT-416	16ta	-	3a	Rhm
76	DTA144WKA	Si-pnp-Digi	Sw, 50V, 100mA, 200mW, 250MHz, R1/R2=47k/22k	SOT-346	16ta	-	3a	Rhm
76	DTA144WUA	Si-pnp-Digi	Sw, 50V, 100mA, 200mW, 250MHz, R1/R2=47k/22k	UMT3	16ta	-	3a	Rhm
760	MMBZ5260-V-G	Z-diode	43V±5%, Izt=3mA, Zzt=93Ω, 225mW	SOT-23	16dc	-	3a	Vs
761	MMBZ5261-V-G	Z-diode	47V±5%, Izt=2.7mA, Zzt=105Ω, 225mW	SOT-23	16dc	-	3a	Vs
762	MMBZ5262-V-G	Z-diode	51V±5%, Izt=2.5mA, Zzt=125Ω, 225mW	SOT-23	16dc	-	3a	Vs
763	MMBZ5263-V-G	Z-diode	56V±5%, Izt=2.2mA, Zzt=150Ω, 225mW	SOT-23	16dc	-	3a	Vs
764	MMBZ5264-V-G	Z-diode	60V±5%, Izt=2.1mA, Zzt=170Ω, 225mW	SOT-23	16dc	-	3a	Vs

Note: ELM75xxCBB series LN- lot number L=0...9 N=A to Z(I, O, X excepted); ELM75xxNBB series LN- lot number L=A to Z(I, O, X excepted) N=0...9



SMD code	Type	Function	Short description	Case	Pinout	Sch.	St.	Mnf.
765	MMBZ5265-V-G	Z-diode	62V±5%, Izt=2mA, Zzt=185Ω, 225mW	SOT-23	16dc	-	3a	Vs
766	MMBZ5266-V-G	Z-diode	68V±5%, Izt=1.8mA, Zzt=230Ω, 225mW	SOT-23	16dc	-	3a	Vs
767	MMBZ5267-V-G	Z-diode	75V±5%, Izt=1.7mA, Zzt=270Ω, 225mW	SOT-23	16dc	-	3a	Vs
76LN	ELM7526CBB	Vdet-IC	2.6V±2%, +Reset PPO	SOT-23	16vdb	VD7	3d	Elm
76LN	ELM7526NBB	Vdet-IC	2.6V±2%, +Reset ODO	SOT-23	16vdb	VD6	3d	Elm
76p	BAS70-06	Si-diode	Dual, Schottky, 70V, 70mA, Vf<1V(15mA), <2pF, 5ns	SOT-23	16df	-	3a	PHH
76s	BAS70-06	Si-diode	Dual, Schottky, 70V, 70mA, Vf<1V(15mA), <2pF, 5ns	SOT-23	16df	-	3c	Inf
76s	BAS70-06W	Si-diode	Dual, Schottky, 70V, 70mA, Vf<1V(15mA), <2pF, 5ns	SOT-323	16df	-	3c	Inf
76t	BAS70-06	Si-diode	Dual, Schottky, 70V, 70mA, Vf<1V(15mA), <2pF, 5ns	SOT-23	16df	-	3a	PhM
76t	BAS70-06W	Si-diode	Dual, Schottky, 70V, 70mA, Vf<1V(15mA), <2pF, 5ns	SOT-323	16df	-	3a	PhM
76W	1PS705B16	Si-diode	Dual, Schottky, Sw, Fast, 30V, 200mA, <5ns	SOT-323	16df	-	3a	PhC
76W	BAS70-06	Si-diode	Dual, Schottky, 70V, 70mA, Vf<1V(15mA), <2pF, 5ns	SOT-23	16df	-	3a	PhC
76W	BAS70-06W	Si-diode	Dual, Schottky, 70V, 70mA, Vf<1V(15mA), <2pF, 5ns	SOT-323	16df	-	3a	PhC
77	2SC5004-FB	Si-npn	UHF-Mix/Osc, 20V, 60mA, 100mW, B=60..120, 5GHz	SOT-323	16ta	-	3a	Nec
77	CHDTA114GMPT	Si-pnp-Digi	Sw, 50V, 100mA, 250MHz, R2=10k	SOT-723	18ta	-	3a	Chm
77A	KIA7719S	Vdet-IC	1.9V±2%, -Reset OCO	SOT-23	16vdc	VD6	3f	Kec
77B	KIA7721S	Vdet-IC	2.1V±2%, -Reset OCO	SOT-23	16vdc	VD6	3f	Kec
77C	KIA7723S	Vdet-IC	2.3V±2%, -Reset OCO	SOT-23	16vdc	VD6	3f	Kec
77D	KIA7725S	Vdet-IC	2.5V±2%, -Reset OCO	SOT-23	16vdc	VD6	3f	Kec
77E	KIA7727S	Vdet-IC	2.7V±2%, -Reset OCO	SOT-23	16vdc	VD6	3f	Kec
77F	KIA7729S	Vdet-IC	2.9V±2%, -Reset OCO	SOT-23	16vdc	VD6	3f	Kec
77G	KIA7731S	Vdet-IC	3.1V±2%, -Reset OCO	SOT-23	16vdc	VD6	3f	Kec
77H	KIA7732S	Vdet-IC	3.2V±2%, -Reset OCO	SOT-23	16vdc	VD6	3f	Kec
77J	KIA7733S	Vdet-IC	3.3V±2%, -Reset OCO	SOT-23	16vdc	VD6	3f	Kec
77K	KIA7734S	Vdet-IC	3.4V±2%, -Reset OCO	SOT-23	16vdc	VD6	3f	Kec
77L	KIA7735S	Vdet-IC	3.5V±2%, -Reset OCO	SOT-23	16vdc	VD6	3f	Kec
77LN	ELM7527CBB	Vdet-IC	2.7V±2%, +Reset PPO	SOT-23	16vdb	VD7	3d	Elm
77LN	ELM7527NBB	Vdet-IC	2.7V±2%, +Reset ODO	SOT-23	16vdb	VD6	3d	Elm
77M	KIA7736S	Vdet-IC	3.6V±2%, -Reset OCO	SOT-23	16vdc	VD6	3f	Kec
77N	KIA7739S	Vdet-IC	3.9V±2%, -Reset OCO	SOT-23	16vdc	VD6	3f	Kec
77P	KIA7742S	Vdet-IC	4.2V±2%, -Reset OCO	SOT-23	16vdc	VD6	3f	Kec
77R	KIA7745S	Vdet-IC	4.5V±2%, -Reset OCO	SOT-23	16vdc	VD6	3f	Kec
78	CHDTA144GMPT	Si-pnp-Digi	Sw, 50V, 100mA, 250MHz, R2=47k	SOT-723	18ta	-	3a	Chm
78LN	ELM7528CBB	Vdet-IC	2.8V±2%, +Reset PPO	SOT-23	16vdb	VD7	3d	Elm
78LN	ELM7528NBB	Vdet-IC	2.8V±2%, +Reset ODO	SOT-23	16vdb	VD6	3d	Elm
79LN	ELM7529CBB	Vdet-IC	2.9V±2%, +Reset PPO	SOT-23	16vdb	VD7	3d	Elm
79LN	ELM7529NBB	Vdet-IC	2.9V±2%, +Reset ODO	SOT-23	16vdb	VD6	3d	Elm
7A	MMBR901	Si-npn	UHF, 25V, 30mA, 300mW, B=30..200, 4GHz	SOT-23	16ta	-	3a	lMot
7A	R3131N17EC	Vdet-IC	1.7V, +Reset ODO, 240ms	SOT-23	16vdc	VD6	3b	Ric
7A	UN2121	Si-pnp-Digi	Sw, 50V, 500mA, 200mW, 200MHz, R1/R2=2k2/2k2	SC-59	16ta	-	3a	Pan
7A	UNR2121	Si-pnp-Digi	Sw, 50V, 500mA, 200mW, 200MHz, R1/R2=2k2/2k2	SC-59	16ta	-	3a	Pan
7A5	PZM7.5NB2A	Z-diode	Dual, 7.5V±2.5%, 300mW	SOT-346	16df	-	3a	Phi
7A5	TC597002ECB	LVR-IC	LDO, -7.0V±2%, 200mA	SOT-23	16cj	VR2	3d	Mcc
7Ap	MMBT3904	Si-npn	GP, 60V, 200mA, 250mW, B=100..300, >300MHz	SOT-23	16ta	-	3a	PHH
7At	MMBT3904	Si-npn	GP, 60V, 200mA, 250mW, B=100..300, >300MHz	SOT-23	16ta	-	3a	PHM
7AW	MMBT3904	Si-npn	GP, 60V, 200mA, 250mW, B=100..300, >300MHz	SOT-23	16ta	-	3a	PhC
7B	MMBR920	Si-npn	UHF, 20V, 35mA, 268mW, B=25..250, 4.5GHz	SOT-23	16ta	-	3a	lMot
7B	R3131N27EC	Vdet-IC	2.7V, +Reset ODO, 240ms	SOT-23	16vdc	VD6	3b	Ric
7B	UN2122	Si-pnp-Digi	Sw, 50V, 500mA, 200mW, 200MHz, R1/R2=4k4/4k7	SC-59	16ta	-	3a	Pan
7B	UNR2122	Si-pnp-Digi	Sw, 50V, 500mA, 200mW, 200MHz, R1/R2=4k4/4k7	SC-59	16ta	-	3a	Pan
7B5	TC597102ECB	LVR-IC	LDO, -7.1V±2%, 200mA	SOT-23	16cj	VR2	3d	Mcc
7Bp	MMBT3906	Si-pnp	Sw, AF, 60/40V, 100mA, 250mW, B=100..300, >250MHz	SOT-23	16ta	-	3a	PHH
7Bt	MMBT3906	Si-pnp	Sw, AF, 60/40V, 100mA, 250mW, B=100..300, >250MHz	SOT-23	16ta	-	3a	PHM
7BW	MMBT3906	Si-pnp	Sw, AF, 60/40V, 100mA, 250mW, B=100..300, >250MHz	SOT-23	16ta	-	3a	PhC
7C	BAS70T	Si-diode	Schottky, 70V, 70mA, Vf<1V(15mA), <2pF, 5ns	SOT-523	16dc	-	3a	Di
7C	MMBR930	Si-npn	UHF, 15V, 35mA, 150mW, B=50..150, 5.5GHz	SOT-23	16ta	-	3a	lMot
7C	R3131N37EC	Vdet-IC	3.7V, +Reset ODO, 240ms	SOT-23	16vdc	VD6	3b	Ric
7C	UN2123	Si-pnp-Digi	Sw, 50V, 500mA, 200mW, 200MHz, R1/R2=10k/10k	SC-59	16ta	-	3a	Pan
7C	UNR2123	Si-pnp-Digi	Sw, 50V, 500mA, 200mW, 200MHz, R1/R2=10k/10k	SC-59	16ta	-	3a	Pan
7C	YTS4123	Si-npn	GP, 40V, 200mA, 350mW B=50..150, >250MHz	SOT-23	16ta	-	3a	Tos
7C5	TC597202ECB	LVR-IC	LDO, -7.2V±2%, 200mA	SOT-23	16cj	VR2	3d	Mcc
7Cp	MMBT2222A	Si-npn	GP, 75V, 800mA, 250mW, B=100..300, >300MHz	SOT-23	16ta	-	3a	PHH
7Ct	MMBT2222A	Si-npn	GP, 75V, 800mA, 250mW, B=100..300, >300MHz	SOT-23	16ta	-	3a	PHM
7CW	MMBT2222A	Si-npn	GP, 75V, 800mA, 250mW, B=100..300, >300MHz	SOT-23	16ta	-	3a	PhC
7D	BAS70-04T	Si-diode	Dual, Schottky, 70V, 70mA, Vf<1V(15mA), <2pF, 5ns	SOT-523	16df	-	3a	Di
7D	FT532Dh	LVR-IC	LDO, 1.8V±2%, 700mA	SOT-23	16cq	VR1	3d	Fmd
7D	HD4A	C-diode	Dual, 35V, 100mA, Vf<1V, Cd<4pF, <6ns	SOT-23	16df	-	3a	Zx
7D	MMBR931	Si-npn	UHF, 10V, 5mA, 150mW, B=50..150, 3GHz	SOT-23	16ta	-	3a	lMot
7D	R3131N47EC	Vdet-IC	4.7V, +Reset ODO, 240ms	SOT-23	16vdc	VD6	3b	Ric
7D	UN2124	Si-pnp-Digi	Sw, 50V, 500mA, 200mW, 200MHz, R1/R2=2k2/10k	SC-59	16ta	-	3a	Pan



SMD code	Type	Function	Short description	Case	Pinout	Sch.	St.	Mnf.
7D	UNR2124	Si-pnp-Digi	Sw, 50V, 500mA, 200mW, 200MHz, R1/R2=2k2/10k	SC-59	16ta	-	3a	Pan
7D5	TC597302ECB	LVR-IC	LDO, -7.3V±2%, 200mA	SOT-23	16cj	VR2	3d	Mcc
7Dg	FT532Dg	LVR-IC	LDO, 1.8V±2%, 700mA	SOT-23	16cq	VR1	3d	Fmd
7Dp	MMBTA42	Si-npn	Vid, 300V, 100mA, 250mW, B>25, >50MHz	SOT-23	16ta	-	3a	PHH
7Dt	MMBTA42	Si-npn	Vid, 300V, 100mA, 250mW, B>25, >50MHz	SOT-23	16ta	-	3a	PhM
7DW	MMBTA42	Si-npn	Vid, 300V, 100mA, 250mW, B>25, >50MHz	SOT-23	16ta	-	3a	PhC
7E	BAS70-05T	Si-diode	Dual, Schottky, 70V, 70mA, Vf<1V(15mA), <2pF, 5ns	SOT-523	16dl	-	3a	Di
7E	FMMTA42R	Si-npn	Vid, 300/300V, 200mA, 330mW, B>40, >50MHz	SOT-23	16te	-	3a	Zx
7E	FT532Eh	LVR-IC	LDO, 2.5V±2%, 700mA	SOT-23	16cq	VR1	3d	Fmd
7E	MMBR2060	Si-npn	UHF, 30V, 50mA, 1GHz	SOT-23	16ta	-	3a	Mot
7E	YTS2221	Si-npn	GP, 70V, 0.8A, 200mW, B>70, >200MHz	SOT-23	16ta	-	3a	Tos
7E5	TC597402ECB	LVR-IC	LDO, -7.4V±2%, 200mA	SOT-23	16cj	VR2	3d	Mcc
7Eg	FT532Eg	LVR-IC	LDO, 2.5V±2%, 700mA	SOT-23	16cq	VR1	3d	Fmd
7Ep	MMBTA92	Si-pnp	Vid, 300V, 100mA, 250mW, B=25, >50MHz	SOT-23	16ta	-	3a	PHH
7Et	MMBTA92	Si-pnp	Vid, 300V, 100mA, 250mW, B=25, >50MHz	SOT-23	16ta	-	3a	PhM
7EW	MMBTA92	Si-pnp	Vid, 300V, 100mA, 250mW, B=25, >50MHz	SOT-23	16ta	-	3a	PhC
7F	2SC6026-Y	Si-npn	GP, Amp, 60V, 100mA, 50mW, >60MHz, B=120..240	fSM	19ta	-	3a	Tos
7F	BAS70-06T	Si-diode	Dual, Schottky, 70V, 70mA, Vf<1V(15mA), <2pF, 5ns	SOT-523	16dg	-	3a	Di
7F	FT532Fh	LVR-IC	LDO, 2.7V±2%, 700mA	SOT-23	16cq	VR1	3d	Fmd
7F	MMBR4957	Si-npn	UHF, 30V, 30mA, 1.2GHz	SOT-23	16ta	-	3a	Mot
7F	R3131N17EA	Vdet-IC	1.7V, +Reset PPO, 240ms	SOT-23	16vdc	VD7	3b	Ric
7F	YTS2221A	Si-npn	GP, 75V, 0.8A, 200mW, B>40, >200MHz	SOT-23	16ta	-	3a	Tos
7F5	TC597502ECB	LVR-IC	LDO, -7.5V±2%, 200mA	SOT-23	16cj	VR2	3d	Mcc
7Fg	FT532Fg	LVR-IC	LDO, 2.7V±2%, 700mA	SOT-23	16cq	VR1	3d	Fmd
7Fg	FT532Gh	LVR-IC	LDO, 2.8V±2%, 700mA	SOT-23	16cq	VR1	3d	Fmd
7G	MMBR5031	Si-npn	UHF, 15V, 20mA, 300mW, B=25..300, 1GHz	SOT-23	16ta	-	3a	Mot
7G	R3131N27EA	Vdet-IC	2.7V, +Reset PPO, 240ms	SOT-23	16vdc	VD7	3b	Ric
7Gg	FT532Gg	LVR-IC	LDO, 2.8V±2%, 700mA	SOT-23	16cq	VR1	3d	Fmd
7H	2SC6026-GR	Si-npn	GP, Amp, 60V, 100mA, 50mW, >60MHz, B=200..400	fSM	19ta	-	3a	Tos
7H	FT532Hh	LVR-IC	LDO, 2.85V±2%, 700mA	SOT-23	16cq	VR1	3d	Fmd
7H	KST5179	Si-npn	GP, 20V, 50mA, 350mW, B>25, >900MHz	SOT-23	16ta	-	3a	Sam
7H	MMBR5179	Si-npn	UHF, 20V, 50mA, 375mW, B>25, 1.4GHz	SOT-23	16ta	-	3a	Mot
7H	R3131N37EA	Vdet-IC	3.7V, +Reset PPO, 240ms	SOT-23	16vdc	VD7	3b	Ric
7H5	TC597602ECB	LVR-IC	LDO, -7.6V±2%, 200mA	SOT-23	16cj	VR2	3d	Mcc
7Hg	FT532Hg	LVR-IC	LDO, 2.85V±2%, 700mA	SOT-23	16cq	VR1	3d	Fmd
7I	FT532Ih	LVR-IC	LDO, 3.0V±2%, 700mA	SOT-23	16cq	VR1	3d	Fmd
7I	UN212X	Si-pnp-Digi	Sw, 50V, 500mA, 200mW, 200MHz, R1/R2=270R/5k	SC-59	16ta	-	3a	Pan
7I	UNR212X	Si-pnp-Digi	Sw, 50V, 500mA, 200mW, 200MHz, R1/R2=270R/5k	SC-59	16ta	-	3a	Pan
7Ig	FT532Ig	LVR-IC	LDO, 3.0V±2%, 700mA	SOT-23	16cq	VR1	3d	Fmd
7J	FMMT38C	Si-npn-Darl	GP, 80V, 300mA, 330mW, B>5000	SOT-23	16ta	-	3a	Zx
7J	FT532Jh	LVR-IC	LDO, 3.3V±2%, 700mA	SOT-23	16cq	VR1	3d	Fmd
7J	R3131N47EA	Vdet-IC	4.7V, +Reset PPO, 240ms	SOT-23	16vdc	VD7	3b	Ric
7Jg	FT532Jg	LVR-IC	LDO, 3.3V±2%, 700mA	SOT-23	16cq	VR1	3d	Fmd
7K	FT532Kh	LVR-IC	LDO, 3.6V±2%, 700mA	SOT-23	16cq	VR1	3d	Fmd
7K	MMBR2857	Si-npn	UHF, 30V, 40mA, >1GHz	SOT-23	16ta	-	3a	Mot
7K5	TC597702ECB	LVR-IC	LDO, -7.7V±2%, 200mA	SOT-23	16cj	VR2	3d	Mcc
7Kg	FT532Kg	LVR-IC	LDO, 3.6V±2%, 700mA	SOT-23	16cq	VR1	3d	Fmd
7Kp	BAP65-05	PIN-diode	Dual, RF, 30V, 100mA, 250mW, 0.61pF, 0.3Ω(100mA/100MHz)	SOT-23	16dg	-	3a	Phi
7L	2SA2122	Si-pnp	GP, 60V, 100mA, 150mW, B=160..460, 80MHz	SOT-323	16ta	-	3a	Pan
7L5	TC597802ECB	LVR-IC	LDO, -7.8V±2%, 200mA	SOT-23	16cj	VR2	3d	Mcc
7LN	ELM7545CEB	Vdet-IC	4.5V±2%, +Reset PPO	SC-70	16vdb	VD7	3d	Elm
7LN	ELM7545NEB	Vdet-IC	4.5V±2%, +Reset ODO	SC-70	16vdb	VD6	3d	Elm
7M	2SD5950	Si-npn	AF-Amp, 60V, 100mA, 150mW, B=160..460, 100MHz	SOT-323	16ta	-	3a	Pan
7M	BCW66HR	Si-npn	AF, 75V, 800mA, 330mW, B=250..630, >100MHz	SOT-23	16ta	-	3a	Zx
7M	MMBR521	Si-pnp	UHF, 20V, 70mA, 333mW, B=25..125, 3.4GHz	SOT-23	16ta	-	3a	Mot
7M5	TC597902ECB	LVR-IC	LDO, -7.9V±2%, 200mA	SOT-23	16cj	VR2	3d	Mcc
7N	BCW68HR	Si-pnp	AF, Sw, 60V, 800mA, 330mW, B=250..630, >100MHz	SOT-23	16ta	-	3a	Zx
7N	MMBR941B	Si-npn	UHF, 20V, 50mA, 250mW, B=100..200, 8GHz	SOT-23	16ta	-	3a	Mot
7O	2SA1621-O	Si-pnp	GP, 35V, 800mA, 150mW, B=70..140, 120MHz	SOT-23	16ta	-	3a	Tos
7P	BCW66FR	Si-npn	AF, 75V, 800mA, 330mW, B=100..250, >100MHz	SOT-23	16te	-	3a	Zx
7P	MMBR911	Si-npn	UHF, 20V, 60mA, 300mW, B=30..200, 6GHz	SOT-23	16ta	-	3a	Mot
7P	UN21174	Si-pnp-Digi	Sw, 50V, 100mA, 150mW, 80MHz, R1/R2=10k/47k	SOT-523	18ta	-	3a	Pan
7P	UNR5174	Si-pnp-Digi	Sw, 50V, 100mA, 150mW, 80MHz, R1/R2=10k/47k	SOT-323	16ta	-	3a	Pan
7R	MMBR536	Si-npn	UHF, 15V, 30mA, 4.5MHz	SOT-23	16ta	-	3a	Mot
7R	SRA2207E	Si-pnp-Digi	Sw, 50V, 100mA, 150mW, 200MHz, R1/R2=10/47k	SOT-523	16ta	-	3a	Auk
7R	SRA2207EF	Si-pnp-Digi	Sw, 50V, 100mA, 150mW, 200MHz, R1/R2=10/47k	SOT-523F	18ta	-	3a	Auk
7R	SRA2207U	Si-pnp-Digi	Sw, 50V, 100mA, 200mW, 200MHz, R1/R2=10/47k	SOT-323	16ta	-	3a	Auk
7R	SRA2207UF	Si-pnp-Digi	Sw, 50V, 100mA, 200mW, 200MHz, R1/R2=10/47k	SOT-323F	18ta	-	3a	Auk
7R	UN22274	Si-npn-Digi	Sw, 50V, 100mA, 150mW, 150MHz, R1/R2=10k/47k	SOT-523	18ta	-	3a	Pan
7R	UNR5274	Si-npn-Digi	Sw, 50V, 100mA, 150mW, 150MHz, R1/R2=10k/47k	SOT-323	16ta	-	3a	Pan



SMD code	Type	Function	Short description	Case	Pinout	Sch.	St.	Mnf.
7T	BCW68FR	Si-pnp	AF, Sw, 60V, 800mA, 330mW, B=100..250, >100MHz	SOT-23	16te	-	3a	Zx
7I0	1PS70SB10	Si-diode	Schottky, Sw, Fast, 30V, 200mA, <5ns	SOT-323	16dc	-	3a	PhM
7I4	1PS70SB14	Si-diode	Dual, Schottky, Sw, Fast, 30V, 200mA, <5ns	SOT-323	16dl	-	3a	PhM
7I5	1PS70SB15	Si-diode	Dual, Schottky, Sw, Fast, 30V, 200mA, <5ns	SOT-323	16dg	-	3a	PhM
7I6	1PS70SB16	Si-diode	Dual, Schottky, Sw, Fast, 30V, 200mA, <5ns	SOT-323	16df	-	3a	PhM
7U	CH238UPT	Si-diode	Dual, Sw, 80V, 200mA, Vf<1.2V(200mA), 4ns	SOT-323	16dl	-	3a	Chm
7V5	CHPZ7V5PT	Z-diode	Dual, 7.1..7.9V, Izt=5mA, Zzt=15Ω, 350mW	SOT-23	16df	-	3a	Chm
7V5	PZM7.5NB	Z-diode	7.5V±2.5%, 300mW	SOT-346	16dc	-	3a	Phi
7X	MMBR571	Si-npn	UHF, 20V, 80mA, 330mW, B=50..300, 8GHz	SOT-23	16ta	-	3a	Mot
7Y	2SA1621-Y	Si-pnp	GP, 35V, 800mA, 150mW, B=120..240, 120MHz	SOT-23	16ta	-	3a	Tos
7Y	MMBR941	Si-npn	UHF, 20V, 50mA, 250mW, B=100..200, 8GHz	SOT-23	16ta	-	3a	Mot
7Y	UN212Y	Si-pnp-Digi	Sw, 50V, 500mA, 200mW, 200MHz, R1/R2=3.1k/4.6k	SC-59	16ta	-	3a	Pan
7Y	UNR212Y	Si-pnp-Digi	Sw, 50V, 500mA, 200mW, 200MHz, R1/R2=3.1k/4.6k	SC-59	16ta	-	3a	Pan
7Z	MMBR951	Si-npn	UHF, 20V, 100mA, 322mW, B=50..200, 8GHz	SOT-23	16ta	-	3a	Mot
7Z5	CZ1W7V5	Z-diode	7.5V±5%, 600mW	SOT-23	16dc	-	3a	Cdi
8.2	TZT8.2W	Z-diode	7.70..8.70V, Izt=5mA, Zzt=20Ω, 200mW	SOT-323	16dc	-	3a	Ttr
8.2	Z0ZW8.2V	Z-diode	7.70..8.70V, Izt=5mA, Zzt=20Ω, 200mW	SOT-23	16dc	-	3f	Kec
8.2A	MA4Z082WA	Z-diode	Dual, 8.2V, If=100mA, Zzt=20Ω(5mA), 200mW	SOT-323	16df	-	3a	Pan
8.2A	MAZ3082WA	Z-diode	Dual, 8.2V, If=100mA, Zzt=15Ω, 200mW	SC-59	16df	-	3a	Pan
8.2H	BZX84-C8V2-V	Z-diode	7.96..8.43V, Izt=5mA, Zzt=20Ω, 300mW	SOT-23	16dc	-	3f	Kec
8.2H	MAZ3082-H	Z-diode	7.7..8.7V, If=100mA, Zzt=15Ω, 200mW	SC-59	16dc	-	3a	Pan
8.2L	MAZ3082-L	Z-diode	7.7..8.7V, If=100mA, Zzt=15Ω, 200mW	SC-59	16dc	-	3a	Pan
8.2M	MAZ3082-M	Z-diode	7.7..8.7V, If=100mA, Zzt=15Ω, 200mW	SC-59	16dc	-	3a	Pan
8.2X	TZT8.2XW	Z-diode	7.70..8.16V, Izt=5mA, Zzt=20Ω, 200mW	SOT-323	16dc	-	3a	Ttr
8.2X	Z0ZW8.2VX	Z-diode	7.70..8.16V, Izt=5mA, Zzt=20Ω, 200mW	SOT-23	16dc	-	3f	Kec
8.2Y	TZT8.2YW	Z-diode	7.96..8.43V, Izt=5mA, Zzt=20Ω, 200mW	SOT-323	16dc	-	3a	Ttr
8.2Y	Z0ZW8.2VY	Z-diode	7.96..8.43V, Izt=5mA, Zzt=20Ω, 200mW	SOT-23	16dc	-	3f	Kec
8.2Z	MAZ9082H	SA-Z-diode	Dual, 8.2V, Zzt=30Ω(5mA), 200mW	SC-59	16df	-	3a	Pan
8.2Z	MAZT082H	SA-Z-diode	Dual, 8.2V, 5mA, 150mW	SC-81	18df	-	3a	Pan
8.2Z	MAZV082D	SA-Z-diode	Dual, 8.2V, Zzt=20Ω(5mA), 150mW	SOT-323	18df	-	3a	Pan
8.2Z	TZT8.2ZW	Z-diode	8.23..8.70V, Izt=5mA, Zzt=20Ω, 200mW	SOT-323	16dc	-	3a	Ttr
8.2Z	Z0ZW8.2VZ	Z-diode	8.23..8.70V, Izt=5mA, Zzt=20Ω, 200mW	SOT-23	16dc	-	3f	Kec
803L	SGM803-LXN3	Vdet-IC	4.63V±1.5%, -Reset ODO	SOT-23	16vdb	VD6	3a	Sgm
803M	SGM803-MXN3	Vdet-IC	4.38V±1.5%, -Reset ODO	SOT-23	16vdb	VD6	3a	Sgm
803R	SGM803-RXN3	Vdet-IC	2.63V±1.5%, -Reset ODO	SOT-23	16vdb	VD6	3a	Sgm
803S	SGM803-SXN3	Vdet-IC	2.93V±1.5%, -Reset ODO	SOT-23	16vdb	VD6	3a	Sgm
803T	SGM803-TXN3	Vdet-IC	3.08V±1.5%, -Reset ODO	SOT-23	16vdb	VD6	3a	Sgm
803Z	SGM803-ZXN3	Vdet-IC	2.32V±1.5%, -Reset ODO	SOT-23	16vdb	VD6	3a	Sgm
809J	SGM809-JXN3	Vdet-IC	4.0V±1.5%, -Reset PPO	SOT-23	16vdb	VD7	3a	Sgm
809L	SGM809-LXN3	Vdet-IC	4.63V±1.5%, -Reset PPO	SOT-23	16vdb	VD7	3a	Sgm
809M	MT809M-4.38S	Vdet-IC	4.38V±1.5%, -Reset PPO	SOT-23	16vdc	VD7	3b	Mam
809M	SGM809-MXN3	Vdet-IC	4.38V±1.5%, -Reset PPO	SOT-23	16vdb	VD7	3a	Sgm
809R	MT809S-2.63S	Vdet-IC	2.63V±1.5%, -Reset PPO	SOT-23	16vdc	VD7	3b	Mam
809R	SGM809-RXN3	Vdet-IC	2.63V±1.5%, -Reset PPO	SOT-23	16vdb	VD7	3a	Sgm
809S	MT809R-2.93S	Vdet-IC	2.93V±1.5%, -Reset PPO	SOT-23	16vdc	VD7	3b	Mam
809S	SGM809-SXN3	Vdet-IC	2.93V±1.5%, -Reset PPO	SOT-23	16vdb	VD7	3a	Sgm
809T	MT809T-3.08S	Vdet-IC	3.08V±1.5%, -Reset PPO	SOT-23	16vdc	VD7	3b	Mam
809T	SGM809-TXN3	Vdet-IC	3.08V±1.5%, -Reset PPO	SOT-23	16vdb	VD7	3a	Sgm
809Z	SGM809-ZXN3	Vdet-IC	2.32V±1.5%, -Reset PPO	SOT-23	16vdb	VD7	3a	Sgm
809ZL	SGM809-ZXN3L	Vdet-IC	2.32V±1.5%, -Reset PPO	SOT-23	16vdb	VD7	3a	Sgm
80LN	ELM7530CBB	Vdet-IC	3.0V±2%, +Reset PPO	SOT-23	16vdb	VD7	3d	Elm
80LN	ELM7530NBB	Vdet-IC	3.0V±2%, +Reset ODO	SOT-23	16vdb	VD6	3d	Elm
80T	TK71580AS	LVR-IC	LDO, 8V±1.5%, 155mA	SOT-23	6cj	VR1	3d	Tok
81	BAT7854W	Si-diode	Schottky, Sw, U-Fst, 40V, 200mA, Vf<0.55V(0.1A), <0.3ns	SOT-323	16dc	-	3a	Phi
810A	DS1810-5	Vdet-IC	5V±5%, -Reset PPO	SOT-23	16vdb	VD7	3a	Dal
810B	DS1810-10	Vdet-IC	5V±10%, -Reset PPO	SOT-23	16vdb	VD7	3a	Dal
810C	DS1810-15	Vdet-IC	5V±15%, -Reset PPO	SOT-23	16vdb	VD7	3a	Dal
810D	DS1810-20	Vdet-IC	5V±20%, -Reset PPO	SOT-23	16vdb	VD7	3a	Dal
810J	SGM810-JXN3	Vdet-IC	4.0V±1.5%, +Reset PPO	SOT-23	16vdb	VD7	3a	Sgm
810L	SGM810-LXN3	Vdet-IC	4.63V±1.5%, +Reset PPO	SOT-23	16vdb	VD7	3a	Sgm
810M	SGM810-MXN3	Vdet-IC	4.38V±1.5%, +Reset PPO	SOT-23	16vdb	VD7	3a	Sgm
810R	SGM810-RXN3	Vdet-IC	2.63V±1.5%, +Reset PPO	SOT-23	16vdb	VD7	3a	Sgm
810S	SGM810-SXN3	Vdet-IC	2.93V±1.5%, +Reset PPO	SOT-23	16vdb	VD7	3a	Sgm
810T	SGM810-TXN3	Vdet-IC	3.08V±1.5%, +Reset PPO	SOT-23	16vdb	VD7	3a	Sgm
810Z	SGM810-ZXN3	Vdet-IC	2.32V±1.5%, +Reset PPO	SOT-23	16vdb	VD7	3a	Sgm
811A	DS1811-5	Vdet-IC	5V±5%, -Reset ODO	SOT-23	16vdb	VD6	3a	Dal
811B	DS1811-10	Vdet-IC	5V±10%, -Reset ODO	SOT-23	16vdb	VD6	3a	Dal
811C	DS1811-15	Vdet-IC	5V±15%, -Reset ODO	SOT-23	16vdb	VD6	3a	Dal
811D	DS1811-20	Vdet-IC	5V±20%, -Reset ODO	SOT-23	16vdb	VD6	3a	Dal
812A	DS1812-5	Vdet-IC	5V±5%, +Reset PPO	SOT-23	16vdb	VD7	3a	Dal



SMD code	Type	Function	Short description	Case	Pinout	Sch.	St.	Mnf.
812B	DS1812-10	Vdet-IC	5V±10%, +Reset PPO	SOT-23	16vdb	VD7	3a	Dal
812C	DS1812-15	Vdet-IC	5V±15%, +Reset PPO	SOT-23	16vdb	VD7	3a	Dal
812D	DS1812-20	Vdet-IC	5V±20%, +Reset PPO	SOT-23	16vdb	VD7	3a	Dal
813A	DS1813-5	Vdet-IC	5V±5%, MR, +Reset ODO	SOT-23	16vdb	VD10	3a	Dal
813B	DS1813-10	Vdet-IC	5V±5%, MR, +Reset ODO	SOT-23	16vdb	VD10	3a	Dal
813C	DS1813-15	Vdet-IC	5V±5%, MR, +Reset ODO	SOT-23	16vdb	VD10	3a	Dal
813D	DS1813-20	Vdet-IC	5V±5%, MR, +Reset ODO	SOT-23	16vdb	VD10	3a	Dal
815A	DS1815-5	Vdet-IC	3.3V±5%, -Reset PPO	SOT-23	16vdb	VD7	3a	Dal
815B	DS1815-10	Vdet-IC	3.3V±5%, -Reset PPO	SOT-23	16vdb	VD7	3a	Dal
815C	DS1815-15	Vdet-IC	3.3V±5%, -Reset PPO	SOT-23	16vdb	VD7	3a	Dal
815D	DS1815-20	Vdet-IC	3.3V±5%, -Reset PPO	SOT-23	16vdb	VD7	3a	Dal
816A	DS1816-5	Vdet-IC	3.3V±5%, -Reset ODO	SOT-23	16vdb	VD6	3a	Dal
816B	DS1816-10	Vdet-IC	3.3V±5%, -Reset ODO	SOT-23	16vdb	VD6	3a	Dal
816C	DS1816-15	Vdet-IC	3.3V±5%, -Reset ODO	SOT-23	16vdb	VD6	3a	Dal
816D	DS1816-20	Vdet-IC	3.3V±5%, -Reset ODO	SOT-23	16vdb	VD6	3a	Dal
818A	DS1818-5	Vdet-IC	3.3V±5%, MR, -Reset ODO	SOT-23	16vdb	VD10	3a	Dal
818B	DS1818-10	Vdet-IC	3.3V±5%, MR, -Reset ODO	SOT-23	16vdb	VD10	3a	Dal
818C	DS1818-15	Vdet-IC	3.3V±5%, MR, -Reset ODO	SOT-23	16vdb	VD10	3a	Dal
818D	DS1818-20	Vdet-IC	3.3V±5%, MR, -Reset ODO	SOT-23	16vdb	VD10	3a	Dal
81A	CMBZ5250B	Z-diode	20V±5%, Izt=6.2mA, Zzt=25Q, 300mW	SOT-23	16dc	-	3a	Mei
81A	CMPZ5250B	Z-diode	20V±2.5%, Izt=6.2mA, Zzt=25Q, 350mW	SOT-23	16dc	-	3a	Cen
81A	FDZS20LT	Z-diode	19.0.21.0V, Izt=6.2mA, Zzt=25Q, 225mW	SOT-23	16dc	-	3a	Fis
81A	HMBZ5250B	Z-diode	20V±5%, Izt=6.2mA, Zzt=25Q, 225mW	SOT-23	16dc	-	3a	Hsn
81A	MMBZ5250B	Z-diode	20V±5%, Zzt=25Q, 225mW	SOT-23	16dc	-	3a,3c	F,Mot
81A	PMBZ5250B	Z-diode	20V±5%, 250mW	SOT-23	16dc	-	3a	Phi
81A	SMBZ5250B	Z-diode	20V±5%, 500mW	SOT-23	16dc	-	3a	Sur
81A	TMPZ5250	Z-diode	19.21V, Zzt<25Q, 250mW	SOT-23	16dc	-	3a	All
81A	TMPZ5250R	Z-diode	19.21V, Zzt<25Q, 250mW	SOT-23	16dr	-	3a	All
81A	ZD5250BN3	Z-diode	20V±5%, 6.2mA, Zzt=25Q, 300mW	SOT-23	16dc	-	3a	Cys
81A-	MMCZ5250BPT	Z-diode	19.0.21.0V, Izt=5mA, Zzt=48Q, 225mW	SOT-346	16dc	-	3a	Chm
81B	CMBZ5251B	Z-diode	22V±5%, Izt=5.6mA, Zzt=29Q, 300mW	SOT-23	16dc	-	3a	Mei
81B	CMPZ5251B	Z-diode	22V±2.5%, Izt=5.6mA, Zzt=29Q, 350mW	SOT-23	16dc	-	3a	Cen
81B	FDZS22LT	Z-diode	20.90.23.10V, Izt=5.6mA, Zzt=29Q, 225mW	SOT-23	16dc	-	3a	Fis
81B	HMBZ5251B	Z-diode	22V±5%, Izt=5.6mA, Zzt=29Q, 225mW	SOT-23	16dc	-	3a	Hsn
81B	MMBZ5251B	Z-diode	22V±5%, Zzt=29Q, 225mW	SOT-23	16dc	-	3a,3c	F,Mot
81B	PMBZ5251B	Z-diode	22V±5%, 250mW	SOT-23	16dc	-	3a	Phi
81B	SMBZ5251B	Z-diode	22V±5%, 500mW	SOT-23	16dc	-	3a	Sur
81B	TMPZ5251	Z-diode	20.9.23.1V, Zzt<29Q, 250mW	SOT-23	16dc	-	3a	All
81B	TMPZ5251R	Z-diode	20.9.23.1V, Zzt<29Q, 250mW	SOT-23	16dr	-	3a	All
81B	ZD5251BN3	Z-diode	22V±5%, 5.6mA, Zzt=29Q, 300mW	SOT-23	16dc	-	3a	Cys
81B-	MMCZ5251BPT	Z-diode	20.90.23.10V, Izt=5mA, Zzt=55Q, 225mW	SOT-346	16dc	-	3a	Chm
81C	CMBZ5252B	Z-diode	24V±5%, Izt=5.2mA, Zzt=33Q, 300mW	SOT-23	16dc	-	3a	Mei
81C	CMPZ5252B	Z-diode	24V±2.5%, Izt=5.2mA, Zzt=33Q, 350mW	SOT-23	16dc	-	3a	Cen
81C	FDZS24LT	Z-diode	22.80.25.20V, Izt=5.2mA, Zzt=33Q, 225mW	SOT-23	16dc	-	3a	Fis
81C	HMBZ5252B	Z-diode	24V±5%, Izt=5.2mA, Zzt=33Q, 225mW	SOT-23	16dc	-	3a	Hsn
81C	MMBZ5252B	Z-diode	24V±5%, Zzt=33Q, 225mW	SOT-23	16dc	-	3a,3c	F,Mot
81C	PMBZ5252B	Z-diode	24V±5%, 250mW	SOT-23	16dc	-	3a	Phi
81C	SMBZ5252B	Z-diode	24V±5%, 500mW	SOT-23	16dc	-	3a	Sur
81C	TMPZ5252	Z-diode	22.8.25.2V, Zzt<33Q, 250mW	SOT-23	16dc	-	3a	All
81C	TMPZ5252R	Z-diode	22.8.25.2V, Zzt<33Q, 250mW	SOT-23	16dr	-	3a	All
81C	ZD5252BN3	Z-diode	24V±5%, 5.2mA, Zzt=33Q, 300mW	SOT-23	16dc	-	3a	Cys
81C-	MMCZ5252BPT	Z-diode	22.80.25.20V, Izt=5mA, Zzt=62Q, 225mW	SOT-346	16dc	-	3a	Chm
81D	CMBZ5253B	Z-diode	25V±5%, Izt=5mA, Zzt=35Q, 300mW	SOT-23	16dc	-	3a	Mei
81D	CMPZ5253B	Z-diode	25V±2.5%, Izt=5mA, Zzt=35Q, 350mW	SOT-23	16dc	-	3a	Cen
81D	FDZS25LT	Z-diode	23.75.26.25V, Izt=5mA, Zzt=35Q, 225mW	SOT-23	16dc	-	3a	Fis
81D	HMBZ5253B	Z-diode	25V±5%, Izt=5mA, Zzt=35Q, 225mW	SOT-23	16dc	-	3a	Hsn
81D	MMBZ5253B	Z-diode	25V±5%, Zzt=35Q, 225mW	SOT-23	16dc	-	3a,3c	F,Mot
81D	PMBZ5253B	Z-diode	25V±5%, 250mW	SOT-23	16dc	-	3a	Phi
81D	SMBZ5253B	Z-diode	25V±5%, 500mW	SOT-23	16dc	-	3a	Sur
81D	TMPZ5253	Z-diode	23.8.26.3V, Zzt<35Q, 250mW	SOT-23	16dc	-	3a	All
81D	TMPZ5253R	Z-diode	23.8.26.3V, Zzt<35Q, 250mW	SOT-23	16dr	-	3a	All
81D	ZD5253BN3	Z-diode	25V±5%, 5mA, Zzt=35Q, 300mW	SOT-23	16dc	-	3a	Cys
81D-	MMCZ5253BPT	Z-diode	23.75.26.25V, Izt=5mA, Zzt=62Q, 225mW	SOT-346	16dc	-	3a	Chm
81E	CMBZ5254B	Z-diode	27V±5%, Izt=4.6mA, Zzt=41Q, 300mW	SOT-23	16dc	-	3a	Mei
81E	CMPZ5254B	Z-diode	27V±2.5%, Izt=4.6mA, Zzt=41Q, 350mW	SOT-23	16dc	-	3a	Cen
81E	FDZS27LT	Z-diode	25.65.28.35V, Izt=4.6mA, Zzt=41Q, 225mW	SOT-23	16dc	-	3a	Fis
81E	HMBZ5254B	Z-diode	27V±5%, Izt=4.6mA, Zzt=41Q, 225mW	SOT-23	16dc	-	3a	Hsn
81E	MMBZ5254B	Z-diode	27V±5%, Zzt=41Q, 225mW	SOT-23	16dc	-	3a,3c	F,Mot
81E	PMBZ5254B	Z-diode	27V±5%, 250mW	SOT-23	16dc	-	3a	Phi
81E	SMBZ5254B	Z-diode	27V±5%, 500mW	SOT-23	16dc	-	3a	Sur



SMD code	Type	Function	Short description	Case	Pinout	Sch.	St.	Mnf.
81E	TMPZ5254	Z-diode	25.7..28.4V, Zzt<41Ω, 250mW	SOT-23	16dc	-	3a	All
81E	TMPZ5254R	Z-diode	25.7..28.4V, Zzt<41Ω, 250mW	SOT-23	16dr	-	3a	All
81E	ZD5254BN3	Z-diode	27V±5%, 20mA, Zzt=41Ω, 300mW	SOT-23	16dc	-	3a	Cys
81E-	MMCZ5254BPT	Z-diode	25.65..28.35V, Izt=5mA, Zzt=70Ω, 225mW	SOT-346	16dc	-	3a	Chm
81F	CMBZ5255B	Z-diode	28V±5%, Izt=4.5mA, Zzt=44Ω, 300mW	SOT-23	16dc	-	3a	Mei
81F	CMPZ5255B	Z-diode	28V±2.5%, Izt=4.5mA, Zzt=44Ω, 350mW	SOT-23	16dc	-	3a	Cen
81F	FDZS28LT	Z-diode	26.60..29.40V, Izt=4.5mA, Zzt=44Ω, 225mW	SOT-23	16dc	-	3a	Fis
81F	HMBZ5255B	Z-diode	28V±5%, Izt=4.5mA, Zzt=44Ω, 225mW	SOT-23	16dc	-	3a	Hsn
81F	MMBZ5255B	Z-diode	28V±5%, Zzt=44Ω, 225mW	SOT-23	16dc	-	3a,3c	F,Mot
81F	PMBZ5255B	Z-diode	28V±5%, 250mW	SOT-23	16dc	-	3a	Phi
81F	SMBZ5255B	Z-diode	28V±5%, 500mW	SOT-23	16dc	-	3a	Sur
81F	TMPZ5255	Z-diode	26.6..29.4V, Zzt<44Ω, 250mW	SOT-23	16dc	-	3a	All
81F	TMPZ5255R	Z-diode	26.6..29.4V, Zzt<44Ω, 250mW	SOT-23	16dr	-	3a	All
81F	ZD5255BN3	Z-diode	28V±5%, 20mA, Zzt=44Ω, 300mW	SOT-23	16dc	-	3a	Cys
81F-	MMCZ5255BPT	Z-diode	26.60..29.40V, Izt=5mA, Zzt=44Ω, 225mW	SOT-346	16dc	-	3a	Chm
81G	CMBZ5256B	Z-diode	30V±5%, Izt=4.2mA, Zzt=49Ω, 300mW	SOT-23	16dc	-	3a	Mei
81G	CMPZ5256B	Z-diode	30V±2.5%, Izt=4.2mA, Zzt=49Ω, 350mW	SOT-23	16dc	-	3a	Cen
81G	FDZS30LT	Z-diode	28.50..31.50V, Izt=4.2mA, Zzt=49Ω, 225mW	SOT-23	16dc	-	3a	Fis
81G	HMBZ5256B	Z-diode	30V±5%, Izt=4.2mA, Zzt=49Ω, 225mW	SOT-23	16dc	-	3a	Hsn
81G	MMBZ5256B	Z-diode	30V±5%, Zzt=49Ω, 225mW	SOT-23	16dc	-	3a,3c	F,Mot
81G	PMBZ5256B	Z-diode	23V±5%, 250mW	SOT-23	16dc	-	3a	Phi
81G	SMBZ5256B	Z-diode	30V±5%, 500mW	SOT-23	16dc	-	3a	Sur
81G	TMPZ5256	Z-diode	28.5..31.5V, Zzt<49Ω, 250mW	SOT-23	16dc	-	3a	All
81G	TMPZ5256R	Z-diode	28.5..31.5V, Zzt<49Ω, 250mW	SOT-23	16dr	-	3a	All
81G	ZD5256BN3	Z-diode	30V±5%, 20mA, Zzt=49Ω, 300mW	SOT-23	16dc	-	3a	Cys
81G-	MMCZ5256BPT	Z-diode	28.50..31.50V, Izt=5mA, Zzt=78Ω, 225mW	SOT-346	16dc	-	3a	Chm
81H	CMBZ5257B	Z-diode	33V±5%, Izt=3.8mA, Zzt=58Ω, 300mW	SOT-23	16dc	-	3a	Mei
81H	CMPZ5257B	Z-diode	33V±2.5%, Izt=3.8mA, Zzt=58Ω, 350mW	SOT-23	16dc	-	3a	Cen
81H	FDZS33LT	Z-diode	31.35..34.65V, Izt=3.8mA, Zzt=58Ω, 225mW	SOT-23	16dc	-	3a	Fis
81H	HMBZ5257B	Z-diode	33V±5%, Izt=3.8mA, Zzt=58Ω, 225mW	SOT-23	16dc	-	3a	Hsn
81H	MMBZ5257B	Z-diode	33V±5%, Zzt=58Ω, 225mW	SOT-23	16dc	-	3a,3c	F,Mot
81H	PMBZ5257B	Z-diode	33V±5%, 250mW	SOT-23	16dc	-	3a	Phi
81H	SMBZ5257B	Z-diode	33V±5%, 500mW	SOT-23	16dc	-	3a	Sur
81H	TMPZ5257	Z-diode	31.4..34.7V, Zzt<58Ω, 250mW	SOT-23	16dc	-	3a	All
81H	TMPZ5257R	Z-diode	31.4..34.7V, Zzt<58Ω, 250mW	SOT-23	16dr	-	3a	All
81H	ZD5257BN3	Z-diode	33V±5%, 20mA, Zzt=58Ω, 300mW	SOT-23	16dc	-	3a	Cys
81H-	MMCZ5257BPT	Z-diode	31.35..34.65V, Izt=5mA, Zzt=88Ω, 225mW	SOT-346	16dc	-	3a	Chm
81J	CMBZ5258B	Z-diode	36V±5%, Izt=3.4mA, Zzt=70Ω, 300mW	SOT-23	16dc	-	3a	Mei
81J	CMPZ5258B	Z-diode	36V±2.5%, Izt=3.4mA, Zzt=70Ω, 350mW	SOT-23	16dc	-	3a	Cen
81J	FDZS36LT	Z-diode	34.20..37.80V, Izt=3.4mA, Zzt=70Ω, 225mW	SOT-23	16dc	-	3a	Fis
81J	HMBZ5258B	Z-diode	36V±5%, Izt=3.4mA, Zzt=70Ω, 225mW	SOT-23	16dc	-	3a	Hsn
81J	MMBZ5258B	Z-diode	36V±5%, Zzt=70Ω, 225mW	SOT-23	16dc	-	3a,3c	F,Mot
81J	ZD5258BN3	Z-diode	36V±5%, 3.4mA, Zzt=70Ω, 300mW	SOT-23	16dc	-	3a	Cys
81J-	MMCZ5258BPT	Z-diode	34.20..37.80V, Izt=5mA, Zzt=95Ω, 225mW	SOT-346	16dc	-	3a	Chm
81K	CMBZ5259B	Z-diode	39V±5%, Izt=3.2mA, Zzt=80Ω, 300mW	SOT-23	16dc	-	3a	Mei
81K	CMPZ5259B	Z-diode	39V±2.5%, Izt=3.2mA, Zzt=80Ω, 350mW	SOT-23	16dc	-	3a	Cen
81K	FDZS39LT	Z-diode	37.05..40.95V, Izt=3.2mA, Zzt=80Ω, 225mW	SOT-23	16dc	-	3a	Fis
81K	HMBZ5259B	Z-diode	39V±5%, Izt=3.2mA, Zzt=80Ω, 225mW	SOT-23	16dc	-	3a	Hsn
81K	MMBZ5259B	Z-diode	39V±5%, Zzt=80Ω, 225mW	SOT-23	16dc	-	3a,3c	F,Mot
81K-	MMCZ5259BPT	Z-diode	37.05..40.95V, Izt=5mA, Zzt=130Ω, 225mW	SOT-346	16dc	-	3a	Chm
81L	CMPZ5260B	Z-diode	43V±2.5%, Izt=3.0mA, Zzt=93Ω, 350mW	SOT-23	16dc	-	3a	Cen
81L	FDZS43LT	Z-diode	40.85..45.15V, Izt=3mA, Zzt=93Ω, 225mW	SOT-23	16dc	-	3a	Fis
81L	HMBZ5260B	Z-diode	43V±5%, Izt=3mA, Zzt=93Ω, 225mW	SOT-23	16dc	-	3a	Hsn
81L	MMBZ5260B	Z-diode	43V±5%, Zzt=93Ω, 225mW	SOT-23	16dc	-	3a,3c	F,Mot
81L-	MMCZ5260BPT	Z-diode	40.85..45.15V, Izt=3.0mA, Zzt=93Ω, 225mW	SOT-346	16dc	-	3a	Chm
81LN	ELM7531CBB	Vdet-IC	3.1V±2%, +Reset PPO	SOT-23	16vdb	VD7	3d	Elm
81LN	ELM7531NBB	Vdet-IC	3.1V±2%, +Reset ODO	SOT-23	16vdb	VD6	3d	Elm
81M	CMPZ5261B	Z-diode	47V±2.5%, Izt=2.7mA, Zzt=105Ω, 350mW	SOT-23	16dc	-	3a	Cen
81M	FDZS47LT	Z-diode	44.65..49.35V, Izt=2.7mA, Zzt=105Ω, 225mW	SOT-23	16dc	-	3a	Fis
81M	HMBZ5261B	Z-diode	47V±5%, Izt=2.7mA, Zzt=105Ω, 225mW	SOT-23	16dc	-	3a	Hsn
81M	MMBZ5261B	Z-diode	47V±5%, Zzt=105Ω, 225mW	SOT-23	16dc	-	3a,3c	F,Mot
81M-	MMCZ5261BPT	Z-diode	44.65..49.35V, Izt=2.7mA, Zzt=105Ω, 225mW	SOT-346	16dc	-	3a	Chm
81N	FDZS51LT	Z-diode	48.45..53.55V, Izt=2.5mA, Zzt=125Ω, 225mW	SOT-23	16dc	-	3a	Fis
81N	MMBZ5262B	Z-diode	51V±5%, Zzt=125Ω, 225mW	SOT-23	16dc	-	3a,3c	F,Mot
81P	FDZS56LT	Z-diode	53.20..58.80V, Izt=2.2mA, Zzt=150Ω, 225mW	SOT-23	16dc	-	3a	Fis
81P	MMBZ5263B	Z-diode	56V±5%, Zzt=150Ω, 225mW	SOT-23	16dc	-	3a,3c	F,Mot
81Q	FDZS60LT	Z-diode	57.0..63.0V, Izt=2.1mA, Zzt=170Ω, 225mW	SOT-23	16dc	-	3a	Fis
81Q	MMBZ5264B	Z-diode	60V±5%, Zzt=170Ω, 225mW	SOT-23	16dc	-	3a,3c	F,Mot
81R	FDZS62LT	Z-diode	58.90..65.10V, Izt=2mA, Zzt=185Ω, 225mW	SOT-23	16dc	-	3a	Fis
81R	MMBZ5265B	Z-diode	62V±5%, Zzt=185Ω, 225mW	SOT-23	16dc	-	3a,3c	F,Mot



SMD code	Type	Function	Short description	Case	Pinout	Sch.	St.	Mnf.
81S	FDZS68LT	Z-diode	64.60..71.40V, Izt=1.8mA, Zzt=230Ω, 225mW	SOT-23	16dc	-	3a	Fis
81S	MMBZ5266B	Z-diode	68V±5%, Zzt=230Ω, 225mW	SOT-23	16dc	-	3a,3c	F,Mot
81T	FDZS75LT	Z-diode	71.25..78.75V, Izt=1.7mA, Zzt=270Ω, 225mW	SOT-23	16dc	-	3a	Fis
81T	MMBZ5267B	Z-diode	75V±5%, Zzt=270Ω, 225mW	SOT-23	16dc	-	3a,3c	F,Mot
81U	FDZS82LT	Z-diode	77.90..86.10V, Izt=1.5mA, Zzt=330Ω, 225mW	SOT-23	16dc	-	3a	Fis
81U	MMBZ5268B	Z-diode	82V±5%, Zzt=330Ω, 225mW	SOT-23	16dc	-	3a,3c	F,Mot
81V	FDZS87LT	Z-diode	82.65..91.35V, Izt=1.4mA, Zzt=370Ω, 225mW	SOT-23	16dc	-	3a	Fis
81V	MMBZ5269B	Z-diode	87V±5%, Zzt=370Ω, 225mW	SOT-23	16dc	-	3a,3c	F,Mot
81W	FDZS91LT	Z-diode	86.45..95.55V, Izt=1.4mA, Zzt=400Ω, 225mW	SOT-23	16dc	-	3a	Fis
81W	MMBZ5270B	Z-diode	91V±5%, Zzt=400Ω, 225mW	SOT-23	16dc	-	3a,3c	F,Mot
82	2SC5009-FB	Si-npn	UHF-L-band, 9V, 10mA, 60mW, 12GHz, B=75..150	SOT-23	16ta	-	3a	Nec
82	BAT7854AW	Si-diode	Dual, Schottky, Sw, U-Fst, 40V, 0.2A, Vf<0.55V(0.1A), <0.3ns	SOT-323	16df	-	3a	Phi
82	CHDTA114YMPT	Si-pnp-Digi	Sw, 50V, 70mA, 250MHz, R1/R2=10/47k	SOT-723	18ta	-	3a	Chm
82	MAZW082H	SA-Z-diode	Dual, 8.2V, 5mA, 150mW	SSSMini3	18df	-	3a	Pan
820	HZM8.2NB	Z-diode	7.76..8.64V, 200mW	SC-59A	16dc	-	3a	Ren
821	HZM8.2NB1	Z-diode	7.76..8.1V, 200mW	SC-59A	16dc	-	3a	Ren
821	PZM8.2NB1	Z-diode	8.2V±2.5%, 300mW	SOT-346	16dc	-	3a	Phi
822	HZM8.2NB2	Z-diode	8.02..8.36V, 200mW	SC-59A	16dc	-	3a	Ren
822	HZM8.2NB3	Z-diode	8.28..8.64V, 200mW	SC-59A	16dc	-	3a	Ren
822	PZM8.2NB2	Z-diode	8.2V±2.5%, 300mW	SOT-346	16dc	-	3a	Phi
823	PZM8.2NB3	Z-diode	8.2V±2.5%, 300mW	SOT-346	16dc	-	3a	Phi
82LN	ELM7532CBB	Vdet-IC	3.2V±2%, +Reset PPO	SOT-23	16vdb	VD7	3d	Elm
82LN	ELM7532NBB	Vdet-IC	3.2V±2%, +Reset ODO	SOT-23	16vdb	VD6	3d	Elm
83	2SC5010	Si-npn	UHF/SHF, 9V, 30mA, 125mW, B=75..150, 12GHz	SOT-23	16ta	-	3a	Nec
83	BAT68	Si-diode	Schottky, VHF/UHF-Mix, Sw, 8V, 130mA, Vf<0.5V, Cd<1.0pF	SOT-23	16dc	-	3c	Inf
83	BAT7854CW	Si-diode	Dual, Schottky, Sw, U-Fst, 40V, 0.2A, Vf<0.55V(0.1A), <0.3ns	SOT-323	16dg	-	3a	Phi
83	CHDTA114EMPT	Si-pnp-Digi	Sw, 50V, 50mA, 250MHz, R1/R2=10/10k	SOT-723	18ta	-	3a	Chm
83LN	ELM7533CBB	Vdet-IC	3.3V±2%, +Reset PPO	SOT-23	16vdb	VD7	3d	Elm
83LN	ELM7533NBB	Vdet-IC	3.3V±2%, +Reset ODO	SOT-23	16vdb	VD6	3d	Elm
84	2SC5181-FB	Si-npn	μWave, LN, 5V, 10mA, 30mW, B=70..140, 13GHz	SOT-323	16ta	-	3a	Nec
84	BAT68-04	Si-diode	Dual, Schottky, 8V, 130mA, Vf<0.5V, Cd<1.0pF	SOT-23	16dl	-	3c	Phi
84	BAT7854SW	Si-diode	Dual, Schottky, Sw, U-Fst, 40V, 0.2A, Vf<0.55V(0.1A), <0.3ns	SOT-323	16dl	-	3a	Inf
84	CHDTA114WMPT	Si-pnp-Digi	Sw, 50V, 100mA, 250MHz, R1/R2=10/4.7k	SOT-723	18ta	-	3a	Chm
84	DTC114WE	Si-npn-Digi	Sw, 50V, 100mA, 150mW, 250MHz, R1/R2=10k/4k7	SOT-416	16ta	-	3a	Rhm
84	DTC114WKA	Si-npn-Digi	Sw, 50V, 100mA, 200mW, 250MHz, R1/R2=10k/4k7	SOT-346	16ta	-	3a	Rhm
84	DTC114WUA	Si-npn-Digi	Sw, 50V, 100mA, 200mW, 250MHz, R1/R2=10k/4k7	UMT3	16ta	-	3a	Rhm
84L	BSS84	p-MOSFET-e*	V-MOS, LogL, 50V, 130mA, 200mW, <10Q(130mA), 3/7ns	SOT-23	16fn	-	3a	Pjt
84LN	ELM7534CBB	Vdet-IC	3.4V±2%, +Reset PPO	SOT-23	16vdb	VD7	3d	Elm
84LN	ELM7534NBB	Vdet-IC	3.4V±2%, +Reset ODO	SOT-23	16vdb	VD6	3d	Elm
84W	BSS84W	p-MOSFET-e*	V-MOS, LogL, 50V, 130mA, 200mW, <10Q(130mA), 3/7ns	SOT-323	16fn	-	3a	Pjt
85	1PS70SB85	Si-diode	Dual, Schottky, UHF-Mix, 15V, 30mA, Vf<0.7V(30mA), 1pF	SOT-323	16dg	-	3a	Phi
85	BAT68-05	Si-diode	Dual, Schottky, 8V, 130mA, Vf<0.5V, Cd<1.0pF	SOT-23	16dg	-	3c	Inf
85	CHDTA115EMPT	Si-pnp-Digi	Sw, 50V, 20mA, 250MHz, R1/R2=100/100k	SOT-723	18ta	-	3a	Chm
85	MMBD1701	Si-diode	Fast, 30V, 150mA, 350mW, Vf<1.1V(50mA), 0.7ns	SOT-23	16dc	-	3a	F
852	S852T	Si-npn	RF, LN, 12V, 8mA, 40mW, B=40..150, 5.2GHz	SOT-23	16ta	-	3a	Tfk
85A	MMBD1701A	Si-diode	Fast, 30V, 150mA, 350mW, Vf<1.1V(50mA), 1ns	SOT-23	16dc	-	3a	F
85LN	ELM7535CBB	Vdet-IC	3.5V±2%, +Reset PPO	SOT-23	16vdb	VD7	3d	Elm
85LN	ELM7535NBB	Vdet-IC	3.5V±2%, +Reset ODO	SOT-23	16vdb	VD6	3d	Elm
85P	L8550PLT1	Si-pnp	GP, 40V, 800mA, 225mW, B=120..200	SOT-23	16ta	-	3a	Lrc
85R	L8550RLT1	Si-pnp	GP, 40V, 800mA, 225mW, B=200..400	SOT-23	16ta	-	3a	Lrc
85s	BAT68-05W	Si-diode	Dual, Schottky, 8V, 130mA, Vf<0.5V, Cd<1.0pF	SOT-323	16dg	-	3c	Inf
85S	L8550SLT1	Si-pnp	GP, 40V, 800mA, 225mW, B=300..600	SOT-23	16ta	-	3a	Lrc
86	1PS70SB86	Si-diode	Dual, Schottky, UHF-Mix, 15V, 30mA, Vf<0.7V(30mA), 1pF	SOT-323	16df	-	3a	Phi
86	2SC5186-FB	Si-npn	μWave, LN, 5V, 30mA, 90mW, B=70..140, 13GHz	SOT-323	16ta	-	3a	Nec
86	BAT68-06	Si-diode	Dual, Schottky, 8V, 130mA, Vf<0.5V, Cd<1.0pF	SOT-23	16df	-	3c	Inf
86	CHDTA123EMPT	Si-pnp-Digi	Sw, 50V, 100mA, 250MHz, R1/R2=2.2/2.2k	SOT-723	18ta	-	3a	Chm
86	DTC144WE	Si-npn-Digi	Sw, 50V, 100mA, 150mW, 250MHz, R1/R2=47k/22k	SOT-416	16ta	-	3a	Rhm
86	DTC144WKA	Si-npn-Digi	Sw, 50V, 100mA, 200mW, 250MHz, R1/R2=47k/22k	SOT-346	16ta	-	3a	Rhm
86	DTC144WUA	Si-npn-Digi	Sw, 50V, 100mA, 200mW, 250MHz, R1/R2=47k/22k	UMT3	16ta	-	3a	Rhm
86	MMBD1702	Si-diode	Fast, 30V, 150mA, 350mW, Vf<1.1V(50mA), 0.7ns	SOT-23	16dr	-	3a	Jgd
86LN	ELM7536CBB	Vdet-IC	3.6V±2%, +Reset PPO	SOT-23	16vdb	VD7	3d	Elm
86LN	ELM7536NBB	Vdet-IC	3.6V±2%, +Reset ODO	SOT-23	16vdb	VD6	3d	Elm
87	1PS70SB84	Si-diode	Dual, Schottky, UHF-Mix, 15V, 30mA, Vf<0.7V(30mA), 1pF	SOT-323	16dl	-	3a	Phi
87	CHDTA123JMPT	Si-pnp-Digi	Sw, 50V, 100mA, 250MHz, R1/R2=2.2/47k	SOT-723	18ta	-	3a	Chm
87	MMBD1703	Si-diode	Dual, Fast, 30V, 150mA, 350mW, Vf<1.1V(50mA), 0.7ns	SOT-23	16dl	-	3a	F
87A	MMBD1703A	Si-diode	Dual, Fast, 30V, 150mA, 350mW, Vf<1.1V(50mA), 1ns	SOT-23	16dl	-	3a	F
87C	BXZ84-B8V7	Z-diode	8.53..8.87V, Zzt=15Ω, Izt=5mA, 410mW	SOT-23	16dc	-	3a	Pjt
87C	TZTC8V7WS	Z-diode	8.27..9.14V, Izt=5mA, Zzt=15Ω, 200mW	SOT-323	16dc	-	3a	Ttr
87LN	ELM7537CBB	Vdet-IC	3.7V±2%, +Reset PPO	SOT-23	16vdb	VD7	3d	Elm
87LN	ELM7537NBB	Vdet-IC	3.7V±2%, +Reset ODO	SOT-23	16vdb	VD6	3d	Elm

Note: ELM75xxCBB series LN- lot number L=0...9 N=A to Z(I, O, X excepted); ELM75xxNBB series LN- lot number L=A to Z(I, O, X excepted) N=0...9



SMD code	Type	Function	Short description	Case	Pinout	Sch.	St.	Mnf.
88	1PS70SB82	Si-diode	Schottky, UHF-Mix, 15V, 30mA, Vf<0.7V(30mA), 1pF	SOT-323	16dc	-	3a	Phi
88	2SC5195-FB	Si-npn	μWave, LN, 9V, 100mA, 125mW, B=80, 160, 5GHz	SOT-323	16ta	-	3a	Nec
88	CHDTA123YMPT	Si-npn-Digi	Sw, 50V, 100mA, 250MHz, R1/R2=2.2/10k	SOT-723	18ta	-	3a	Chm
88	MMBD1704	Si-diode	Dual, Fast, 30V, 150mA, 350mW, Vf<1.1V(50mA), 0.7ns	SOT-23	16dg	-	3a	F
88A	MMBD1704A	Si-diode	Dual, Fast, 30V, 150mA, 350mW, Vf<1.1V(50mA), 1ns	SOT-23	16dg	-	3a	F
88LN	ELM7538CBB	Vdet-IC	3.8V±2%, +Reset PPO	SOT-23	16vdb	VD7	3d	Elm
88LN	ELM7538NBB	Vdet-IC	3.8V±2%, +Reset ODO	SOT-23	16vdb	VD6	3d	Elm
89	CHDTA124EMPT	Si-npn-Digi	Sw, 50V, 30mA, 250MHz, R1/R2=22/22k	SOT-723	18ta	-	3a	Chm
89	MMBD1705	Si-diode	Dual, Fast, 30V, 150mA, 350mW, Vf<1.1V(50mA), 0.7ns	SOT-23	16df	-	3a	F
89A	MMBD1705A	Si-diode	Dual, Fast, 30V, 150mA, 350mW, Vf<1.1V(50mA), 1ns	SOT-23	16df	-	3a	F
89LN	ELM7539CBB	Vdet-IC	3.9V±2%, +Reset PPO	SOT-23	16vdb	VD7	3d	Elm
89LN	ELM7539NBB	Vdet-IC	3.9V±2%, +Reset ODO	SOT-23	16vdb	VD6	3d	Elm
8A	2DA1774Q	Si-npn	GP, 60V 150mA, 150mW, B=120..270, >140MHz	SOT-523	16ta	-	3d	Di
8A	DTC114EE	Si-npn-Digi	Sw, 50V, 100mA, 200mW, 250MHz, R1/R2=10k/10k	SOT-416	16ta	-	3a	Ons
8A	FDZS3.3LT	Z-diode	3.13..3.47V, Izt=20mA, Zzt=28Ω, 225mW	SOT-23	16dc	-	3a	Fis
8A	HMBZ5226B	Z-diode	3.3V±5%, Izt=20mA, Zzt=28Ω, 225mW	SOT-23	16dc	-	3a	Hsn
8A	MMBZ5226B	Z-diode	3.14..3.47V, Izt=20mA, Zzt=28Ω, 225mW	SOT-23	16dc	-	3a,3c	F,Mot
8A	MUN2211	Si-npn-Digi	Sw, 50V, 100mA, 200mW, R1/R2=10/10k	SC-59	16ta	-	3a	Mot
8A	MUN5211	Si-npn-Digi	Sw, 50V, 100mA, 200mW, R1/R2=10/10k	SOT-323	16ta	-	3a	Mot
8A	R3131N18EC	Vdet-IC	1.8V, +Reset ODO, 240ms	SOT-23	16vdc	VD6	3b	Ric
8A	UN2211	Si-npn-Digi	Sw, 50V, 100mA, 200mW, 150MHz, R1/R2=10k/10k	SC-59	16ta	-	3a	Pan
8A	UN5211	Si-npn-Digi	Sw, 50V, 100mA, 150mW, 150MHz, R1/R2=10k/10k	SOT-23	16ta	-	3a	Pan
8A	UN9211J	Si-npn-Digi	Sw, 50V, 100mA, 125mW, 150MHz, R1/R2=10k/10k	SC-89	18ta	-	3a	Pan
8A	UNR2211	Si-npn-Digi	Sw, 50V, 100mA, 200mW, 150MHz, R1/R2=10k/10k	SC-59	16ta	-	3a	Pan
8A	UNR5211	Si-npn-Digi	Sw, 50V, 100mA, 150mW, 150MHz, R1/R2=10k/10k	SOT-323	16ta	-	3a	Pan
8A	UNR9211J	Si-npn-Digi	Sw, 50V, 100mA, 125mW, 150MHz, R1/R2=10k/10k	SC-89	18ta	-	3a	Pan
8A	ZD5226BN3	Z-diode	3.3V±5%, 20mA, Zzt=28Ω, 300mW	SOT-23	16dc	-	3a	Cys
8A-	MMCZ5226BPT	Z-diode	3.135..3.465V, Izt=5mA, Zzt=85Ω, 225mW	SOT-346	16dc	-	3a	Chm
8A1	CMSZ5221B	Z-diode	2.4V±5%, 20mA, Zzt=30Ω, 275mW	SOT-323	16dc	-	3a	Cen
8A2	PZM8.2NB2A	Z-diode	Dual, 8.2V±2.5%, 300mW	SOT-346	16df	-	3a	Phi
8A5	TC598002ECB	LVR-IC	LDO, -8.0V±2%, 200mA	SOT-23	16cj	VR2	3d	Mcc
8AA	BC846A	Si-npn	GP, 80V, 100mA, 310mW, B=110..220, >300MHz	SOT-23	16ta	-	3a	Sam
8AA	STM809L	Vdet-IC	4.63V±2%, -Reset PPO	SOT-23	16vdc	VD7	3b	Ste
8AB	BC846B	Si-npn	GP, 80V, 100mA, 310mW, B=200..450, >300MHz	SOT-23	16ta	-	3a	Sam
8AB	STM809M	Vdet-IC	4.38V±2%, -Reset PPO	SOT-23	16vdc	VD7	3b	Ste
8AC	BC846C	Si-npn	GP, 80V, 100mA, 310mW, B=420..800, >300MHz	SOT-23	16ta	-	3a	Sam
8AC	CMSZ5226B	Z-diode	3.3V±5%, 20mA, Zzt=28Ω, 275mW	SOT-323	16dc	-	3a	Cen
8AC	STM809T	Vdet-IC	3.08V±2%, -Reset PPO	SOT-23	16vdc	VD7	3b	Ste
8AD	STM809S	Vdet-IC	2.93V±2%, -Reset PPO	SOT-23	16vdc	VD7	3b	Ste
8AE	STM809R	Vdet-IC	2.63V±2%, -Reset PPO	SOT-23	16vdc	VD7	3b	Ste
8AF	STM810L	Vdet-IC	4.63V±2%, +Reset PPO	SOT-23	16vdc	VD7	3b	Ste
8AG	STM810M	Vdet-IC	4.38V±2%, +Reset PPO	SOT-23	16vdc	VD7	3b	Ste
8AH	STM810T	Vdet-IC	3.08V±2%, +Reset PPO	SOT-23	16vdc	VD7	3b	Ste
8AJ	STM810S	Vdet-IC	2.93V±2%, +Reset PPO	SOT-23	16vdc	VD7	3b	Ste
8AK	STM810R	Vdet-IC	2.63V±2%, +Reset PPO	SOT-23	16vdc	VD7	3b	Ste
8B	2DA1774R	Si-npn	GP, 60V 150mA, 150mW, B=180..390, >140MHz	SOT-523	16ta	-	3d	Di
8B	DTC124EE	Si-npn-Digi	Sw, 50V, 100mA, 200mW, 250MHz, R1/R2=22k/22k	SOT-416	16ta	-	3a	Ons
8B	FDZS3.6LT	Z-diode	3.42..3.78V, Izt=20mA, Zzt=24Ω, 225mW	SOT-23	16dc	-	3a	Fis
8B	HMBZ5227B	Z-diode	3.6V±5%, Izt=20mA, Zzt=24Ω, 225mW	SOT-23	16dc	-	3a	Hsn
8B	MMBZ5227B	Z-diode	3.42..3.78V, Zzt=24Ω, Izt=20mA, 225mW	SOT-23	16dc	-	3a,3c	F,Mot
8B	MUN2212	Si-npn-Digi	Sw, 50V, 100mA, 200mW, R1/R2=22/22k	SC-59	16ta	-	3a	Mot
8B	MUN5212	Si-npn-Digi	Sw, 50V, 100mA, 200mW, R1/R2=22/22k	SOT-323	16ta	-	3a	Mot
8B	R3131N28EC	Vdet-IC	2.8V, +Reset ODO, 240ms	SOT-23	16vdc	VD6	3b	Ric
8B	UN2212	Si-npn-Digi	Sw, 50V, 100mA, 200mW, 150MHz, R1/R2=22k/22k	SC-59	16ta	-	3a	Pan
8B	UN5212	Si-npn-Digi	Sw, 50V, 100mA, 150mW, 150MHz, R1/R2=22k/22k	SOT-23	16ta	-	3a	Pan
8B	UN9212J	Si-npn-Digi	Sw, 50V, 100mA, 125mW, 150MHz, R1/R2=22k/22k	SC-89	18ta	-	3a	Pan
8B	UNR2212	Si-npn-Digi	Sw, 50V, 100mA, 200mW, 150MHz, R1/R2=22k/22k	SC-59	16ta	-	3a	Pan
8B	UNR5212	Si-npn-Digi	Sw, 50V, 100mA, 150mW, 150MHz, R1/R2=22k/22k	SOT-323	16ta	-	3a	Pan
8B	UNR9212J	Si-npn-Digi	Sw, 50V, 100mA, 125mW, 150MHz, R1/R2=22k/22k	SC-89	18ta	-	3a	Pan
8B	ZD5227BN3	Z-diode	3.6V±5%, 20mA, Zzt=24Ω, 300mW	SOT-23	16dc	-	3a	Cys
8B-	MMCZ5227BPT	Z-diode	3.420..3.780V, Izt=5mA, Zzt=90Ω, 225mW	SOT-346	16dc	-	3a	Chm
8B1	CMSZ5222B	Z-diode	2.5V±5%, 20mA, Zzt=30Ω, 275mW	SOT-323	16dc	-	3a	Cen
8B5	TC598102ECB	LVR-IC	LDO, -8.1V±2%, 200mA	SOT-23	16cj	VR2	3d	Mcc
8BB	BC847B	Si-npn	GP, 50V, 100mA, 310mW, B=200..450, >300MHz	SOT-23	16ta	-	3a	Sam
8BC	CMSZ5227B	Z-diode	3.6V±5%, 20mA, Zzt=24Ω, 275mW	SOT-323	16dc	-	3a	Cen
8C	2DA1774S	Si-npn	GP, 60V 150mA, 150mW, B=270..560, >140MHz	SOT-523	16ta	-	3d	Di
8C	DTC144EE	Si-npn-Digi	Sw, 50V, 100mA, 200mW, 250MHz, R1/R2=47k/47k	SOT-416	16ta	-	3a	Ons
8C	FDZS3.9LT	Z-diode	3.70..4.10V, Izt=20mA, Zzt=23Ω, 225mW	SOT-23	16dc	-	3a	Fis
8C	HMBZ5228B	Z-diode	3.9V±5%, Izt=20mA, Zzt=23Ω, 225mW	SOT-23	16dc	-	3a	Hsn
8C	MMBZ5228B	Z-diode	3.71..4.10V, Izt=20mA, Zzt=23Ω, 225mW	SOT-23	16dc	-	3a,3c	F,Mot



SMD code	Type	Function	Short description	Case	Pinout	Sch.	St.	Mnf.
8C	MUN2213	Si-npn-Digi	Sw, 50V, 100mA, 200mW, R1/R2=47k/47k	SC-59	16ta	-	3a	Mot
8C	MUN5213	Si-npn-Digi	Sw, 50V, 100mA, 200mW, R1/R2=47k/47k	SOT-323	16ta	-	3a	Mot
8C	R3131N38EC	Vdet-IC	3.8V, +Reset ODO, 240ms	SOT-23	16vdc	VD6	3b	Ric
8C	UN2213	Si-npn-Digi	Sw, 50V, 100mA, 200mW, 150MHz, R1/R2=47k/47k	SC-59	16ta	-	3a	Pan
8C	UN5213	Si-npn-Digi	Sw, 50V, 100mA, 150mW, 150MHz, R1/R2=47k/47k	SOT-23	16ta	-	3a	Pan
8C	UN9213J	Si-npn-Digi	Sw, 50V, 100mA, 125mW, 150MHz, R1/R2=47k/47k	SC-89	18ta	-	3a	Pan
8C	UNR2213	Si-npn-Digi	Sw, 50V, 100mA, 200mW, 150MHz, R1/R2=47k/47k	SC-59	16ta	-	3a	Pan
8C	UNR3213	Si-npn-Digi	Sw, 50V, 100mA, 100mW, 150MHz, R1/R2=47k/47k	SSSMini3	18ta	-	3a	Pan
8C	UNR5213	Si-npn-Digi	Sw, 50V, 100mA, 150mW, 150MHz, R1/R2=47k/47k	SOT-323	16ta	-	3a	Pan
8C	UNR9213J	Si-npn-Digi	Sw, 50V, 100mA, 125mW, 150MHz, R1/R2=47k/47k	SC-89	18ta	-	3a	Pan
8C	ZD5228BN3	Z-diode	3.9V±5%, 20mA, Zzt=23Ω, 300mW	SOT-23	16dc	-	3a	Cys
8C-	MMCZ5228BPT	Z-diode	3.705..4.095V, Izt=5mA, Zzt=90Ω, 225mW	SOT-346	16dc	-	3a	Chm
8C1	CMSZ5223B	Z-diode	2.7V±5%, 20mA, Zzt=30Ω, 275mW	SOT-323	16dc	-	3a	Cen
8C5	TC598202ECB	LVR-IC	LDO, -8.2V±2%, 200mA	SOT-23	16cj	VR2	3d	Mcc
8CA	BC848A	Si-npn	GP, 30V, 100mA, 310mW, B=110..220, >300MHz	SOT-23	16ta	-	3a	Sam
8CB	BC848B	Si-npn	GP, 30V, 100mA, 310mW, B=200..450, >300MHz	SOT-23	16ta	-	3a	Sam
8CC	BC848C	Si-npn	GP, 30V, 100mA, 310mW, B=420..800, >300MHz	SOT-23	16ta	-	3a	Sam
8CC	CMSZ5228B	Z-diode	3.9V±5%, 20mA, Zzt=23Ω, 275mW	SOT-323	16dc	-	3a	Cen
8D	1SS398PT	Si-diode	Dual, Sw, 400V, 100mA, Vf<1.3V(100mA), 500ns	SOT-23	16dl	-	3a	Chm
8D	2DC4617Q	Si-npn	GP, 60V 150mA, 150mW, B=120..270, >180MHz	SOT-523	16ta	-	3d	Di
8D	DTC114YE	Si-npn-Digi	Sw, 50V, 100mA, 200mW, 250MHz, R1/R2=10k/47k	SOT-416	16ta	-	3a	Ons
8D	FDZS4.3LT	Z-diode	4.08..4.52V, Izt=20mA, Zzt=22Ω, 225mW	SOT-23	16dc	-	3a	Fis
8D	HMBZ5229B	Z-diode	4.3V±5%, Izt=20mA, Zzt=22Ω, 225mW	SOT-23	16dc	-	3a	Hsn
8D	MMBZ5229B	Z-diode	4.3V±5%, Zzt=22Ω, 225mW	SOT-23	16dc	-	3a,3c	F,Mot
8D	MUN2214	Si-npn-Digi	Sw, 50V, 100mA, 200mW, R1/R2=10/47k	SC-59	16ta	-	3a	Mot
8D	MUN5214	Si-npn-Digi	Sw, 50V, 100mA, 200mW, R1/R2=10/47k	SOT-323	16ta	-	3a	Mot
8D	R3131N48EC	Vdet-IC	4.8V, +Reset ODO, 240ms	SOT-23	16vdc	VD6	3b	Ric
8D	TMPZ5229	Z-diode	4..4.52V, Zzt<2Ω, 250mW	SOT-23	16dc	-	3a	All
8D	TMPZ5229R	Z-diode	4..4.52V, Zzt<2Ω, 250mW	SOT-23	16dr	-	3a	All
8D	UN2214	Si-npn-Digi	Sw, 50V, 100mA, 200mW, 150MHz, R1/R2=10k/47k	SC-59	16ta	-	3a	Pan
8D	UN5214	Si-npn-Digi	Sw, 50V, 100mA, 150mW, 150MHz, R1/R2=10k/47k	SOT-23	16ta	-	3a	Pan
8D	UN9214J	Si-npn-Digi	Sw, 50V, 100mA, 125mW, 150MHz, R1/R2=10k/47k	SC-89	18ta	-	3a	Pan
8D	UNR2214	Si-npn-Digi	Sw, 50V, 100mA, 200mW, 150MHz, R1/R2=10k/47k	SC-59	16ta	-	3a	Pan
8D	UNR5214	Si-npn-Digi	Sw, 50V, 100mA, 150mW, 150MHz, R1/R2=10k/47k	SOT-323	16ta	-	3a	Pan
8D	UNR9214J	Si-npn-Digi	Sw, 50V, 100mA, 125mW, 150MHz, R1/R2=10k/47k	SC-89	18ta	-	3a	Pan
8D	ZD5229BN3	Z-diode	4.3V±5%, 20mA, Zzt=22Ω, 300mW	SOT-23	16dc	-	3a	Cys
8D-	MMCZ5229BPT	Z-diode	4.085..4.515V, Izt=5mA, Zzt=88Ω, 225mW	SOT-346	16dc	-	3a	Chm
8D1	CMSZ5224B	Z-diode	2.8V±5%, 20mA, Zzt=30Ω, 275mW	SOT-323	16dc	-	3a	Cen
8D5	TC598302ECB	LVR-IC	LDO, -8.3V±2%, 200mA	SOT-23	16cj	VR2	3d	Mcc
8DA	BC849A	Si-npn	GP, 30V, 100mA, 310mW, B=110..220, >300MHz	SOT-23	16ta	-	3a	Sam
8DC	BC849C	Si-npn	GP, 30V, 100mA, 310mW, B=420..800, >300MHz	SOT-23	16ta	-	3a	Sam
8DC	CMSZ5229B	Z-diode	4.3V±5%, 20mA, Zzt=22Ω, 275mW	SOT-323	16dc	-	3a	Cen
8E	2DC4617R	Si-npn	GP, 60V 150mA, 150mW, B=180..390, >180MHz	SOT-523	16ta	-	3d	Di
8E	CMBZ5230B	Z-diode	4.7V±5%, Izt=20mA, Zzt=19Ω, 300mW	SOT-23	16dc	-	3a	Mei
8E	DTC114TE	Si-npn-Digi	Sw, 50V, 100mA, 200mW, 250MHz, R1=10k	SOT-416	16ta	-	3a	Ons
8E	FDZS4.7LT	Z-diode	4.46..4.94V, Izt=20mA, Zzt=19Ω, 225mW	SOT-23	16dc	-	3a	Fis
8E	FMMTA92R	Si-pnp	Vid, 300/300V, 200mA, 330mW, B>25, >50MHz	SOT-23	16te	-	3a	Zx
8E	HMBZ5230B	Z-diode	4.7V±5%, Izt=20mA, Zzt=19Ω, 225mW	SOT-23	16dc	-	3a	Hsn
8E	MMBZ5230B	Z-diode	4.7V±5%, Zzt=19Ω, 225mW	SOT-23	16dc	-	3a,3c	F,Mot
8E	MUN2215	Si-npn-Digi	Sw, 50V, 100mA, 200mW, R1=10k	SC-59	16ta	-	3a	Mot
8E	MUN5215	Si-npn-Digi	Sw, 50V, 100mA, 200mW, R1=10k	SOT-323	16ta	-	3a	Mot
8E	SMBZ5230B	Z-diode	4.7V±5%, 500mW	SOT-23	16dc	-	3a	Sur
8E	TMPZ5230	Z-diode	4.47..4.94V, Zzt<19Ω, 250mW	SOT-23	16dc	-	3a	All
8E	TMPZ5230R	Z-diode	4.47..4.94V, Zzt<19Ω, 250mW	SOT-23	16dr	-	3a	All
8E	UN2215	Si-npn-Digi	Sw, 50V, 100mA, 200mW, 150MHz, R1=10k	SC-59	16ta	-	3a	Pan
8E	UN5215	Si-npn-Digi	Sw, 50V, 100mA, 150mW, 150MHz, R1=10k	SOT-23	16ta	-	3a	Pan
8E	UN9215J	Si-npn-Digi	Sw, 50V, 100mA, 125mW, 150MHz, R1=10k	SC-89	18ta	-	3a	Pan
8E	UNR2215	Si-npn-Digi	Sw, 50V, 100mA, 200mW, 150MHz, R1=10k	SC-59	16ta	-	3a	Pan
8E	UNR5215	Si-npn-Digi	Sw, 50V, 100mA, 150mW, 150MHz, R1=10k	SOT-323	16ta	-	3a	Pan
8E	UNR9215J	Si-npn-Digi	Sw, 50V, 100mA, 125mW, 150MHz, R1=10k	SC-89	18ta	-	3a	Pan
8E	ZD5230BN3	Z-diode	4.7V±5%, 20mA, Zzt=19Ω, 300mW	SOT-23	16dc	-	3a	Cys
8E-	MMCZ5230BPT	Z-diode	4.465..4.935V, Izt=5mA, Zzt=70Ω, 225mW	SOT-346	16dc	-	3a	Chm
8E1	CMSZ5225B	Z-diode	3.0V±5%, 20mA, Zzt=29Ω, 275mW	SOT-323	16dc	-	3a	Cen
8E5	TC598402ECB	LVR-IC	LDO, -8.4V±2%, 200mA	SOT-23	16cj	VR2	3d	Mcc
8EA	BC850A	Si-npn	GP, 50V, 100mA, 310mW, B=110..220, >300MHz	SOT-23	16ta	-	3a	Sam
8EB	BC850B	Si-npn	GP, 50V, 100mA, 310mW, B=200..450, >300MHz	SOT-23	16ta	-	3a	Sam
8EC	CMSZ5230B	Z-diode	4.7V±5%, 20mA, Zzt=19Ω, 275mW	SOT-323	16dc	-	3a	Cen
8F	2DC4617S	Si-npn	GP, 60V 150mA, 150mW, B=270..560, >180MHz	SOT-523	16ta	-	3d	Di
8F	2SA2154-Y	Si-pnp	GP, Amp, 50V, 100mA, 50mW, B=120..240, >80MHz	fSM	19ta	-	3a	Tos
8F	CMBZ5231B	Z-diode	5.1V±5%, Izt=20mA, Zzt=17Ω, 300mW	SOT-23	16dc	-	3a	Mei



SMD code	Type	Function	Short description	Case	Pinout	Sch.	St.	Mnf.
8F	DTC143TE	Si-npn-Digi	Sw, 50V, 100mA, 200mW, 250MHz, R1=4k7	SOT-416	16ta	-	3a	Ons
8F	FDZS5.1LT	Z-diode	4.84..5.36V, Izt=20mA, Zzt=17Ω, 225mW	SOT-23	16dc	-	3a	Fis
8F	HMBZ5231B	Z-diode	5.1V±5%, Izt=20mA, Zzt=17Ω, 225mW	SOT-23	16dc	-	3a	Hsn
8F	MMBZ5231B	Z-diode	5.1V±5%, Zzt=17Ω, 225mW	SOT-23	16dc	-	3a,3c	F,Mot
8F	MUN2216	Si-npn-Digi	Sw, 50V, 100mA, 200mW, R1=4k7	SC-59	16ta	-	3a	Mot
8F	MUN5216	Si-npn-Digi	Sw, 50V, 100mA, 200mW, R1=4k7	SOT-323	16ta	-	3a	Mot
8F	R3131N18EA	Vdet-IC	1.8V, +Reset PPO, 240ms	SOT-23	16vdc	VD7	3b	Ric
8F	SMBZ5231B	Z-diode	5.1V±5%, 500mW	SOT-23	16dc	-	3a	Sur
8F	TMPZ5231	Z-diode	4.85..5.36V, Zzt<17Ω, 250mW	SOT-23	16dc	-	3a	All
8F	TMPZ5231R	Z-diode	4.85..5.36V, Zzt<17Ω, 250mW	SOT-23	16dr	-	3a	All
8F	UN2216	Si-npn-Digi	Sw, 50V, 100mA, 200mW, 150MHz, R1=4k7	SC-59	16ta	-	3a	Pan
8F	UN5216	Si-npn-Digi	Sw, 50V, 100mA, 150mW, 150MHz, R1=4k7	SOT-23	16ta	-	3a	Pan
8F	UN9216J	Si-npn-Digi	Sw, 50V, 100mA, 125mW, 150MHz, R1=4k7	SC-89	18ta	-	3a	Pan
8F	UNR2216	Si-npn-Digi	Sw, 50V, 100mA, 200mW, 150MHz, R1=4k7	SC-59	16ta	-	3a	Pan
8F	UNR3216	Si-npn-Digi	Sw, 50V, 100mA, 100mW, 150MHz, R1=4.7k	SSSMini3	18ta	-	3a	Pan
8F	UNR5216	Si-npn-Digi	Sw, 50V, 100mA, 150mW, 150MHz, R1=4k7	SOT-323	16ta	-	3a	Pan
8F	UNR9216J	Si-npn-Digi	Sw, 50V, 100mA, 125mW, 150MHz, R1=4k7	SC-89	18ta	-	3a	Pan
8F	ZD5231BN3	Z-diode	5.1V±5%, 20mA, Zzt=17Ω, 300mW	SOT-23	16dc	-	3a	Cys
8F-	MMCZ5231BPT	Z-diode	4.845..5.355V, Izt=5mA, Zzt=50Ω, 225mW	SOT-346	16dc	-	3a	Chm
8F5	TC598502ECB	LVR-IC	LDO, -8.5V±2%, 200mA	SOT-23	16cj	VR2	3d	Mcc
8FA	BC817-16	Si-npn	AF-Drv, 50V, 500mA, 330mW, B=100..250, >200MHz	SOT-23	16ta	-	3a	Sam
8FA	HBC817-16	Si-npn	AF-Drv, 50V, 500mA, 330mW, B=100..250, >200MHz	SOT-23	16ta	-	3a	Hsn
8FB	BC817-25	Si-npn	AF-Drv, 50V, 500mA, 330mW, B=160..400, >200MHz	SOT-23	16ta	-	3a	Sam
8FB	HBC817-25	Si-npn	AF-Drv, 50V, 500mA, 330mW, B=160..400, >200MHz	SOT-23	16ta	-	3a	Hsn
8FC	BC817-40	Si-npn	AF-Drv, 50V, 500mA, 330mW, B=250..630, >200MHz	SOT-23	16ta	-	3a	Sam
8FC	CMSZ5231B	Z-diode	5.1V±5%, 20mA, Zzt=17Ω, 275mW	SOT-323	16dc	-	3a	Cen
8FC	HBC817-40	Si-npn	AF-Drv, 50V, 500mA, 330mW, B=250..630, >200MHz	SOT-23	16ta	-	3a	Hsn
8G	CMBZ5232B	Z-diode	5.6V±5%, Izt=20mA, Zzt=11Ω, 300mW	SOT-23	16dc	-	3a	Mei
8G	FDZS5.6LT	Z-diode	5.32..5.88V, Izt=20mA, Zzt=11Ω, 225mW	SOT-23	16dc	-	3a	Fis
8G	HMBZ5232B	Z-diode	5.6V±5%, Izt=20mA, Zzt=11Ω, 225mW	SOT-23	16dc	-	3a	Hsn
8G	MMBZ5232B	Z-diode	5.6V±5%, Zzt=11Ω, 225mW	SOT-23	16dc	-	3a,3c	F,Mot
8G	MUN2230	Si-npn-Digi	Sw, 50V, 100mA, 200mW, R1/R2=1k/1k0	SC-59	16ta	-	3a	Mot
8G	MUN5230	Si-npn-Digi	Sw, 50V, 100mA, 200mW, R1/R2=1k/1k0	SOT-323	16ta	-	3a	Mot
8G	R3131N28EA	Vdet-IC	2.8V, +Reset PPO, 240ms	SOT-23	16vdc	VD7	3b	Ric
8G	SMBZ5232B	Z-diode	5.6V±5%, 500mW	SOT-23	16dc	-	3a	Sur
8G	TMPZ5232	Z-diode	5.32..5.88V, Zzt<11Ω, 250mW	SOT-23	16dc	-	3a	All
8G	TMPZ5232R	Z-diode	5.32..5.88V, Zzt<11Ω, 250mW	SOT-23	16dr	-	3a	All
8G	ZD5232BN3	Z-diode	5.6V±5%, 20mA, Zzt=11Ω, 300mW	SOT-23	16dc	-	3a	Cys
8G-	MMCZ5232BPT	Z-diode	5.320..5.880V, Izt=5mA, Zzt=25Ω, 225mW	SOT-346	16dc	-	3a	Chm
8GA	BC818-16	Si-npn	AF-Drv, 30V, 500mA, 330mW, B=100..250, >170MHz	SOT-23	16ta	-	3a	Sam
8GB	BC818-25	Si-npn	AF-Drv, 30V, 800mA, 310mW, B=160..400, 100MHz	SOT-23	16ta	-	3a	Sam
8GC	BC818-40	Si-npn	AF-Drv, 30V, 800mA, 310mW, B=250..630, 100MHz	SOT-23	16ta	-	3a	Sam
8GC	CMSZ5232B	Z-diode	5.6V±5%, 20mA, Zzt=11Ω, 275mW	SOT-323	16dc	-	3a	Cen
8H	2SA2154-GR	Si-npn	GP, Amp, 50V, 100mA, 50mW, B=200..400, >80MHz	fSM	19ta	-	3a	Tos
8H	CMBZ5233B	Z-diode	6.0V±5%, Izt=20mA, Zzt=7Ω, 300mW	SOT-23	16dc	-	3a	Mei
8H	DTC123EE	Si-npn-Digi	Sw, 50V, 100mA, 200mW, 250MHz, R1/R2=2k2/2k2	SOT-416	16ta	-	3a	Ons
8H	FDZS6.0LT	Z-diode	5.70..6.30V, Izt=20mA, Zzt=7Ω, 225mW	SOT-23	16dc	-	3a	Fis
8H	HMBZ5233B	Z-diode	6V±5%, Izt=20mA, Zzt=7Ω, 225mW	SOT-23	16dc	-	3a	Hsn
8H	MMBZ5233B	Z-diode	6V±5%, Zzt=7Ω, 225mW	SOT-23	16dc	-	3a,3c	F,Mot
8H	MUN2231	Si-npn-Digi	Sw, 50V, 100mA, 200mW, R1/R2=2k2/2k2	SC-59	16ta	-	3a	Mot
8H	MUN5231	Si-npn-Digi	Sw, 50V, 100mA, 200mW, R1/R2=2k2/2k2	SOT-323	16ta	-	3a	Mot
8H	R3131N38EA	Vdet-IC	3.8V, +Reset PPO, 240ms	SOT-23	16vdc	VD7	3b	Ric
8H	SMBZ5233B	Z-diode	6V±5%, 500mW	SOT-23	16dc	-	3a	Sur
8H	TMPZ5233	Z-diode	5.7..6.3V, Zzt<7Ω, 250mW	SOT-23	16dc	-	3a	All
8H	TMPZ5233R	Z-diode	5.7..6.3V, Zzt<7Ω, 250mW	SOT-23	16dr	-	3a	All
8H	UN2217	Si-npn-Digi	Sw, 50V, 100mA, 200mW, 150MHz, R1=22k	SC-59	16ta	-	3a	Pan
8H	UN5217	Si-npn-Digi	Sw, 50V, 100mA, 150mW, 150MHz, R1=22k	SOT-23	16ta	-	3a	Pan
8H	UN9217J	Si-npn-Digi	Sw, 50V, 100mA, 125mW, 150MHz, R1=22k	SC-89	18ta	-	3a	Pan
8H	UNR2217	Si-npn-Digi	Sw, 50V, 100mA, 200mW, 150MHz, R1=22k	SC-59	16ta	-	3a	Pan
8H	UNR5217	Si-npn-Digi	Sw, 50V, 100mA, 150mW, 150MHz, R1=22k	SOT-323	16ta	-	3a	Pan
8H	UNR9217J	Si-npn-Digi	Sw, 50V, 100mA, 125mW, 150MHz, R1=22k	SC-89	18ta	-	3a	Pan
8H	ZD5233BN3	Z-diode	6.0V±5%, 20mA, Zzt=7.0Ω, 300mW	SOT-23	16dc	-	3a	Cys
8H-	MMCZ5233BPT	Z-diode	5.700..6.300V, Izt=5mA, Zzt=25Ω, 225mW	SOT-346	16dc	-	3a	Chm
8H10	S8PH10	Si-diode	SBR, 100V, 4A, Vf<0.9V(4A)	TO-277A	76dh	-	3o	Vs
8H5	TC598602ECB	LVR-IC	LDO, -8.6V±2%, 200mA	SOT-23	16cj	VR2	3d	Mcc
8H9	S8PH9	Si-diode	SBR, 90V, 4A, Vf<0.9V(4A)	TO-277A	76dh	-	3o	Vs
8HC	CMSZ5233B	Z-diode	6.0V±5%, 20mA, Zzt=7.0Ω, 275mW	SOT-323	16dc	-	3a	Cen
8I	UN2218	Si-npn-Digi	Sw, 50V, 100mA, 200mW, 150MHz, R1/R2=510R/5k1	SC-59	16ta	-	3a	Pan
8I	UN5218	Si-npn-Digi	Sw, 50V, 100mA, 150mW, 150MHz, R1/R2=510R/5k1	SOT-23	16ta	-	3a	Pan
8I	UN9218J	Si-npn-Digi	Sw, 50V, 100mA, 125mW, 150MHz, R1/R2=510R/5k1	SC-89	18ta	-	3a	Pan



SMD code	Type	Function	Short description	Case	Pinout	Sch.	St.	Mnf.
8I	UNR2218	Si-npn-Digi	Sw, 50V, 100mA, 200mW, 150MHz, R1/R2=510R/5k1	SC-59	16ta	-	3a	Pan
8I	UNR5218	Si-npn-Digi	Sw, 50V, 100mA, 150mW, 150MHz, R1/R2=510R/5k1	SOT-323	16ta	-	3a	Pan
8I	UNR9218J	Si-npn-Digi	Sw, 50V, 100mA, 125mW, 150MHz, R1/R2=510R/5k1	SC-89	18ta	-	3a	Pan
8J	CMBZ5234B	Z-diode	6.2V±5%, Izt=20mA, Zzt=7Ω, 300mW	SOT-23	16dc	-	3a	Mei
8J	DTC143EE	Si-npn-Digi	Sw, 50V, 100mA, 200mW, 250MHz, R1/R2=4k7/4k7	SOT-416	16ta	-	3a	Ons
8J	FDZ56.2LT	Z-diode	5.89..6.51V, Izt=20mA, Zzt=7Ω, 225mW	SOT-23	16dc	-	3a	Fis
8J	HMBZ5234B	Z-diode	6.2V±5%, Izt=20mA, Zzt=7Ω, 225mW	SOT-23	16dc	-	3a	Hsn
8J	MMBZ5234B	Z-diode	6.2V±5%, Zzt=7Ω, 225mW	SOT-23	16dc	-	3a,3c	F,Mot
8J	MUN2232	Si-npn-Digi	Sw, 50V, 100mA, 200mW, R1/R2=4k/4k7	SC-59	16ta	-	3a	Mot
8J	MUN5232	Si-npn-Digi	Sw, 50V, 100mA, 200mW, R1/R2=4k/4k7	SOT-323	16ta	-	3a	Mot
8J	R3131N48EA	Vdet-IC	4.8V, +Reset PPO, 240ms	SOT-23	16vdc	VD7	3b	Ric
8J	SMBZ5234B	Z-diode	6.2V±5%, 500mW	SOT-23	16dc	-	3a	Sur
8J	TMPZ5234	Z-diode	5.98..6.51V, Zzt<7Ω, 250mW	SOT-23	16dc	-	3a	All
8J	TMPZ5234R	Z-diode	5.98..6.51V, Zzt<7Ω, 250mW	SOT-23	16dr	-	3a	All
8J	ZD5234BN3	Z-diode	6.2V±5%, 20mA, Zzt=7.0Ω, 300mW	SOT-23	16dc	-	3a	Cys
8J-	MMCZ5234BPT	Z-diode	5.890..6.510V, Izt=5mA, Zzt=10Ω, 225mW	SOT-346	16dc	-	3a	Chm
8JC	CMSZ5234B	Z-diode	6.2V±5%, 20mA, Zzt=7.0Ω, 275mW	SOT-323	16dc	-	3a	Cen
8K	CMBZ5235B	Z-diode	6.8V±5%, Izt=20mA, Zzt=5Ω, 300mW	SOT-23	16dc	-	3a	Mei
8K	CMBZ5236B	Z-diode	7.5V±5%, Izt=20mA, Zzt=6Ω, 300mW	SOT-23	16dc	-	3a	Mei
8K	DTC143ZE	Si-npn-Digi	Sw, 50V, 100mA, 200mW, 250MHz, R1/R2=4k7/4k7	SOT-416	16ta	-	3a	Ons
8K	FDZ56.8LT	Z-diode	6.46..7.14V, Izt=20mA, Zzt=5Ω, 225mW	SOT-23	16dc	-	3a	Fis
8K	HMBZ5235B	Z-diode	6.8V±5%, Izt=20mA, Zzt=5Ω, 225mW	SOT-23	16dc	-	3a	Hsn
8K	MMBZ5235B	Z-diode	6.8V±5%, Zzt=5Ω, 225mW	SOT-23	16dc	-	3a,3c	F,Mot
8K	MUN2233	Si-npn-Digi	Sw, 50V, 100mA, 200mW, R1/R2=4k7/4k7	SC-59	16ta	-	3a	Mot
8K	MUN5233	Si-npn-Digi	Sw, 50V, 100mA, 200mW, R1/R2=4k7/4k7	SOT-323	16ta	-	3a	Mot
8K	SMBZ5235B	Z-diode	6.8V±5%, 500mW	SOT-23	16dc	-	3a	Sur
8K	TMPZ5235	Z-diode	6.46..7.14V, Zzt<5Ω, 250mW	SOT-23	16dc	-	3a	All
8K	TMPZ5235R	Z-diode	6.46..7.14V, Zzt<5Ω, 250mW	SOT-23	16dr	-	3a	All
8K	UN2219	Si-npn-Digi	Sw, 50V, 100mA, 200mW, 150MHz, R1/R2=1k/10k	SC-59	16ta	-	3a	Pan
8K	UN5219	Si-npn-Digi	Sw, 50V, 100mA, 150mW, 150MHz, R1/R2=1k/10k	SOT-23	16ta	-	3a	Pan
8K	UN9219J	Si-npn-Digi	Sw, 50V, 100mA, 125mW, 150MHz, R1/R2=1k/10k	SC-89	18ta	-	3a	Pan
8K	UNR2219	Si-npn-Digi	Sw, 50V, 100mA, 200mW, 150MHz, R1/R2=1k/10k	SC-59	16ta	-	3a	Pan
8K	UNR5219	Si-npn-Digi	Sw, 50V, 100mA, 150mW, 150MHz, R1/R2=1k/10k	SOT-323	16ta	-	3a	Pan
8K	UNR9219J	Si-npn-Digi	Sw, 50V, 100mA, 125mW, 150MHz, R1/R2=1k/10k	SC-89	18ta	-	3a	Pan
8K	ZD5235BN3	Z-diode	6.8V±5%, 20mA, Zzt=5.0Ω, 300mW	SOT-23	16dc	-	3a	Cys
8K-	MMCZ5235BPT	Z-diode	6.460..7.140V, Izt=5mA, Zzt=8Ω, 225mW	SOT-346	16dc	-	3a	Chm
8KS	TC598702ECB	LVR-IC	LDO, -8.7V±2%, 200mA	SOT-23	16cj	VR2	3d	Mcc
8KC	CMSZ5235B	Z-diode	6.8V±5%, 20mA, Zzt=5.0Ω, 275mW	SOT-323	16dc	-	3a	Cen
8Kp	BAP70-05	PIN-diode	Dual RF, 50V, 100mA, 200mW, 0.6pF, 1.4Ω(100mA/100MHz)	SOT-23	16dg	-	3a	PhH
8Kt	BAP70-05	PIN-diode	Dual RF, 50V, 100mA, 200mW, 0.6pF, 1.4Ω(100mA/100MHz)	SOT-23	16dg	-	3a	PhM
8KW	BAP70-05	PIN-diode	Dual RF, 50V, 100mA, 200mW, 0.6pF, 1.4Ω(100mA/100MHz)	SOT-23	16df	-	3a	PhC
8L	DTC124XE	Si-npn-Digi	Sw, 50V, 100mA, 200mW, 250MHz, R1/R2=22k/47k	SOT-416	16ta	-	3a	Ons
8L	FDZ57.5LT	Z-diode	7.12..7.88V, Izt=20mA, Zzt=6Ω, 225mW	SOT-23	16dc	-	3a	Fis
8L	HMBZ5236B	Z-diode	7.5V±5%, Izt=20mA, Zzt=6Ω, 225mW	SOT-23	16dc	-	3a	Hsn
8L	MMBZ5236B	Z-diode	7.5V±5%, Zzt=6Ω, 225mW	SOT-23	16dc	-	3a,3c	F,Mot
8L	MUN2234	Si-npn-Digi	Sw, 50V, 100mA, 200mW, R1/R2=22k/47k	SC-59	16ta	-	3a	Mot
8L	MUN5234	Si-npn-Digi	Sw, 50V, 100mA, 200mW, R1/R2=22k/47k	SOT-323	16ta	-	3a	Mot
8L	SMBZ5236B	Z-diode	7.5V±5%, 500mW	SOT-23	16dc	-	3a	Sur
8L	TMPZ5236	Z-diode	7.13..7.88V, Zzt<6Ω, 250mW	SOT-23	16dc	-	3a	All
8L	TMPZ5236R	Z-diode	7.13..7.88V, Zzt<6Ω, 250mW	SOT-23	16dr	-	3a	All
8L	UN5210	Si-npn-Digi	Sw, 50V, 100mA, 150mW, 150MHz, R1=47k	SOT-23	16ta	-	3a	Pan
8L	UN9210J	Si-npn-Digi	Sw, 50V, 100mA, 125mW, 150MHz, R1=47k	SC-89	18ta	-	3a	Pan
8L	UNR2210	Si-npn-Digi	Sw, 50V, 100mA, 200mW, 150MHz, R1=47k	SC-59	16ta	-	3a	Pan
8L	UNR3210	Si-npn-Digi	Sw, 50V, 100mA, 100mW, 150MHz, R1=47k	SSSMini3	18ta	-	3a	Pan
8L	UNR5210	Si-npn-Digi	Sw, 50V, 100mA, 150mW, 150MHz, R1=47k	SOT-323	16ta	-	3a	Pan
8L	UNR9210J	Si-npn-Digi	Sw, 50V, 100mA, 125mW, 150MHz, R1=47k	SC-89	18ta	-	3a	Pan
8L	ZD5236BN3	Z-diode	7.5V±5%, 20mA, Zzt=6.0Ω, 300mW	SOT-23	16dc	-	3a	Cys
8L-	MMCZ5236BPT	Z-diode	7.125..7.875V, Izt=5mA, Zzt=7Ω, 225mW	SOT-346	16dc	-	3a	Chm
8L5	TC598802ECB	LVR-IC	LDO, -8.8V±2%, 200mA	SOT-23	16cj	VR2	3d	Mcc
8LC	CMSZ5236B	Z-diode	7.5V±5%, 20mA, Zzt=6.0Ω, 275mW	SOT-323	16dc	-	3a	Cen
8LN	ELM7550CEB	Vdet-IC	5.0V±2%, +Reset PPO	SC-70	16vdb	VD7	3d	Elm
8LN	ELM7550NEB	Vdet-IC	5.0V±2%, +Reset ODO	SC-70	16vdb	VD6	3d	Elm
8M	CMBZ5237B	Z-diode	8.2V±5%, Izt=20mA, Zzt=8Ω, 300mW	SOT-23	16dc	-	3a	Mei
8M	DTC123JE	Si-npn-Digi	Sw, 50V, 100mA, 200mW, 250MHz, R1/R2=2k2/47k	SOT-416	16ta	-	3a	Ons
8M	FDZ58.2LT	Z-diode	7.79..8.61V, Izt=20mA, Zzt=8Ω, 225mW	SOT-23	16dc	-	3a	Fis
8M	HMBZ5237B	Z-diode	8.2V±5%, Izt=20mA, Zzt=8Ω, 225mW	SOT-23	16dc	-	3a	Hsn
8M	MMBZ5237B	Z-diode	8.2V±5%, Zzt=8Ω, 225mW	SOT-23	16dc	-	3a,3c	F,Mot
8M	SMBZ5237B	Z-diode	8.2V±5%, 500mW	SOT-23	16dc	-	3a	Sur
8M	TMPZ5237	Z-diode	7.79..8.61V, Zzt<8Ω, 250mW	SOT-23	16dc	-	3a	All
8M	TMPZ5237R	Z-diode	7.79..8.61V, Zzt<8Ω, 250mW	SOT-23	16dr	-	3a	All



SMD code	Type	Function	Short description	Case	Pinout	Sch.	St.	Mnf.
8M	UN221D	Si-npn-Digi	Sw, 50V, 100mA, 200mW, 150MHz, R2=10k	SC-59	16ta	-	3a	Pan
8M	UN521D	Si-npn-Digi	Sw, 50V, 100mA, 150mW, 150MHz, R2=10k	SOT-23	16ta	-	3a	Pan
8M	UN921DJ	Si-npn-Digi	Sw, 50V, 100mA, 125mW, 150MHz, R2=10k	SC-89	18ta	-	3a	Pan
8M	UNR221D	Si-npn-Digi	Sw, 50V, 100mA, 200mW, 150MHz, R2=10k	SC-59	16ta	-	3a	Pan
8M	UNR521D	Si-npn-Digi	Sw, 50V, 100mA, 150mW, 150MHz, R2=10k	SOT-323	16ta	-	3a	Pan
8M	UNR921DJ	Si-npn-Digi	Sw, 50V, 100mA, 125mW, 150MHz, R2=10k	SC-89	18ta	-	3a	Pan
8M	ZD5237BN3	Z-diode	8.2V±5%, 20mA, Zzt=8.0Ω, 300mW	SOT-23	16dc	-	3a	Cys
8M-	MMCZ5237BPT	Z-diode	7.790..8.610V, Izt=5mA, Zzt=7Ω, 225mW	SOT-346	16dc	-	3a	Chm
8M5	TC598902ECB	LVR-IC	LDO, -8.9V±2%, 200mA	SOT-23	16cj	VR2	3d	Mcc
8MC	CMSZ5237B	Z-diode	8.2V±5%, 20mA, Zzt=8.0Ω, 275mW	SOT-323	16dc	-	3a	Cen
8N	CMBZ5238B	Z-diode	8.7V±5%, Izt=20mA, Zzt=8Ω, 300mW	SOT-23	16dc	-	3a	Mei
8N	DTC115EE	Si-npn-Digi	Sw, 50V, 100mA, 200mW, 250MHz, R1/R2=100k/100k	SOT-416	16ta	-	3a	Ons
8N	FDZS8.7LT	Z-diode	8.26..9.14V, Izt=20mA, Zzt=8Ω, 225mW	SOT-23	16dc	-	3a	Fis
8N	HMBZ5238B	Z-diode	8.7V±5%, Izt=20mA, Zzt=8Ω, 225mW	SOT-23	16dc	-	3a	Hsn
8N	MMBZ5238B	Z-diode	8.7V±5%, Zzt=8Ω, 225mW	SOT-23	16dc	-	3a,3c	F,Mot
8N	MUN2236	Si-npn-Digi	Sw, 50V, 100mA, 200mW, R1/R2=100k/100k	SC-59	16ta	-	3a	Mot
8N	MUN5236	Si-npn-Digi	Sw, 50V, 100mA, 200mW, R1/R2=100k/100k	SOT-323	16ta	-	3a	Mot
8N	SMBZ5238B	Z-diode	8.7V±5%, 500mW	SOT-23	16dc	-	3a	Sur
8N	TMPZ5238	Z-diode	8.26..9.14V, Zzt<8Ω, 250mW	SOT-23	16dc	-	3a	All
8N	TMPZ5238R	Z-diode	8.26..9.14V, Zzt<8Ω, 250mW	SOT-23	16dr	-	3a	All
8N	UN221E	Si-npn-Digi	Sw, 50V, 100mA, 200mW, 150MHz, R1/R2=47k/22k	SC-59	16ta	-	3a	Pan
8N	UN521E	Si-npn-Digi	Sw, 50V, 100mA, 150mW, 150MHz, R1/R2=47k/22k	SOT-23	16ta	-	3a	Pan
8N	UN921EJ	Si-npn-Digi	Sw, 50V, 100mA, 125mW, 150MHz, R1/R2=47k/22k	SC-89	18ta	-	3a	Pan
8N	UNR221E	Si-npn-Digi	Sw, 50V, 100mA, 200mW, 150MHz, R1/R2=47k/22k	SC-59	16ta	-	3a	Pan
8N	UNR521E	Si-npn-Digi	Sw, 50V, 100mA, 150mW, 150MHz, R1/R2=47k/22k	SOT-323	16ta	-	3a	Pan
8N	UNR921EJ	Si-npn-Digi	Sw, 50V, 100mA, 125mW, 150MHz, R1/R2=47k/22k	SC-89	18ta	-	3a	Pan
8N	ZD5238BN3	Z-diode	8.7V±5%, 20mA, Zzt=8.0Ω, 300mW	SOT-23	16dc	-	3a	Cys
8N-	MMCZ5238BPT	Z-diode	8.265..9.135V, Izt=5mA, Zzt=7Ω, 225mW	SOT-346	16dc	-	3a	Chm
8NC	CMSZ5238B	Z-diode	8.7V±5%, 20mA, Zzt=8.0Ω, 275mW	SOT-323	16dc	-	3a	Cen
8O	UN221F	Si-npn-Digi	Sw, 50V, 100mA, 200mW, 150MHz, R1/R2=4k7/10k	SC-59	16ta	-	3a	Pan
8O	UN521F	Si-npn-Digi	Sw, 50V, 100mA, 150mW, 150MHz, R1/R2=4k7/10k	SOT-23	16ta	-	3a	Pan
8O	UN921FJ	Si-npn-Digi	Sw, 50V, 100mA, 125mW, 150MHz, R1/R2=4k7/10k	SC-89	18ta	-	3a	Pan
8O	UNR221F	Si-npn-Digi	Sw, 50V, 100mA, 200mW, 150MHz, R1/R2=4k7/10k	SC-59	16ta	-	3a	Pan
8O	UNR521F	Si-npn-Digi	Sw, 50V, 100mA, 150mW, 150MHz, R1/R2=4k7/10k	SOT-323	16ta	-	3a	Pan
8O	UNR921FJ	Si-npn-Digi	Sw, 50V, 100mA, 125mW, 150MHz, R1/R2=4k7/10k	SC-89	18ta	-	3a	Pan
8P	CMBZ5239B	Z-diode	9.1V±5%, Izt=20mA, Zzt=10Ω, 300mW	SOT-23	16dc	-	3a	Mei
8P	DTC144WE	Si-npn-Digi	Sw, 50V, 100mA, 200mW, 250MHz, R1/R2=47k/22k	SOT-416	16ta	-	3a	Ons
8P	FDZS9.1LT	Z-diode	8.64..9.56V, Izt=20mA, Zzt=10Ω, 225mW	SOT-23	16dc	-	3a	Fis
8P	HMBZ5239B	Z-diode	9.1V±5%, Izt=20mA, Zzt=10Ω, 225mW	SOT-23	16dc	-	3a	Hsn
8P	MMBZ5239B	Z-diode	9.1V±5%, Zzt=10Ω, 225mW	SOT-23	16dc	-	3a,3c	F,Mot
8P	MUN2237	Si-npn-Digi	Sw, 50V, 100mA, 200mW, R1/R2=47k/22k	SC-59	16ta	-	3a	Mot
8P	MUN5237	Si-npn-Digi	Sw, 50V, 100mA, 200mW, R1/R2=47k/22k	SOT-323	16ta	-	3a	Mot
8P	SMBZ5239B	Z-diode	9.1V±5%, 500mW	SOT-23	16dc	-	3a	Sur
8P	TMPZ5239	Z-diode	8.65..9.56V, Zzt<10Ω, 250mW	SOT-23	16dc	-	3a	All
8P	TMPZ5239R	Z-diode	8.65..9.56V, Zzt<10Ω, 250mW	SOT-23	16dr	-	3a	All
8P	UN221H	Si-npn-Digi	Sw, 50V, 100mA, 200mW, 150MHz, R1/R2=2k2/10k	SC-59	16ta	-	3a	Pan
8P	UN521K	Si-npn-Digi	Sw, 50V, 100mA, 150mW, 150MHz, R1/R2=10k/4k7	SOT-23	16ta	-	3a	Pan
8P	UN921KJ	Si-npn-Digi	Sw, 50V, 100mA, 125mW, 150MHz, R1/R2=10k/4k7	SC-89	18ta	-	3a	Pan
8P	UNR221H	Si-npn-Digi	Sw, 50V, 100mA, 200mW, 150MHz, R1/R2=2k2/10k	SC-59	16ta	-	3a	Pan
8P	UNR521K	Si-npn-Digi	Sw, 50V, 100mA, 150mW, 150MHz, R1/R2=10k/4k7	SOT-323	16ta	-	3a	Pan
8P	UNR921KJ	Si-npn-Digi	Sw, 50V, 100mA, 125mW, 150MHz, R1/R2=10k/4k7	SC-89	18ta	-	3a	Pan
8P	ZD5239BN3	Z-diode	9.1V±5%, 20mA, Zzt=10Ω, 300mW	SOT-23	16dc	-	3a	Cys
8P-	MMCZ5239BPT	Z-diode	8.645..9.555V, Izt=5mA, Zzt=10Ω, 225mW	SOT-346	16dc	-	3a	Chm
8PC	CMSZ5239B	Z-diode	9.1V±5%, 20mA, Zzt=10Ω, 275mW	SOT-323	16dc	-	3a	Cen
8Q	CMBZ5240B	Z-diode	10V±5%, Izt=20mA, Zzt=17Ω, 300mW	SOT-23	16dc	-	3a	Mei
8Q	FDZS10LT	Z-diode	9.50..10.50V, Izt=20mA, Zzt=17Ω, 225mW	SOT-23	16dc	-	3a	Fis
8Q	HMBZ5240B	Z-diode	10V±5%, Izt=20mA, Zzt=17Ω, 225mW	SOT-23	16dc	-	3a	Hsn
8Q	MMBZ5240B	Z-diode	10V±5%, Zzt=17Ω, 225mW	SOT-23	16dc	-	3a,3c	F,Mot
8Q	SMBZ5240B	Z-diode	10V±5%, 500mW	SOT-23	16dc	-	3a	Sur
8Q	TMPZ5240	Z-diode	9.5..10.5V, Zzt<17Ω, 250mW	SOT-23	16dc	-	3a	All
8Q	TMPZ5240R	Z-diode	9.5..10.5V, Zzt<17Ω, 250mW	SOT-23	16dr	-	3a	All
8Q	UN221L	Si-npn-Digi	Sw, 50V, 100mA, 200mW, 150MHz, R1/R2=4k7/4k7	SC-59	16ta	-	3a	Pan
8Q	UN521L	Si-npn-Digi	Sw, 50V, 100mA, 150mW, 150MHz, R1/R2=4k7/4k7	SOT-23	16ta	-	3a	Pan
8Q	UN921LJ	Si-npn-Digi	Sw, 50V, 100mA, 125mW, 150MHz, R1/R2=4k4/4k7	SC-89	18ta	-	3a	Pan
8Q	UNR221L	Si-npn-Digi	Sw, 50V, 100mA, 200mW, 150MHz, R1/R2=4k7/4k7	SC-59	16ta	-	3a	Pan
8Q	UNR321L	Si-npn-Digi	Sw, 50V, 100mA, 100mW, 150MHz, R1/R2=4.7k/4.7k	SSSMini3	18ta	-	3a	Pan
8Q	UNR521L	Si-npn-Digi	Sw, 50V, 100mA, 150mW, 150MHz, R1/R2=4k7/4k7	SOT-323	16ta	-	3a	Pan
8Q	UNR921LJ	Si-npn-Digi	Sw, 50V, 100mA, 125mW, 150MHz, R1/R2=4k4/4k7	SC-89	18ta	-	3a	Pan
8Q	ZD5240BN3	Z-diode	10V±5%, 20mA, Zzt=17Ω, 300mW	SOT-23	16dc	-	3a	Cys
8Q-	MMCZ5240BPT	Z-diode	9.500..10.50V, Izt=5mA, Zzt=15Ω, 225mW	SOT-346	16dc	-	3a	Chm



SMD code	Type	Function	Short description	Case	Pinout	Sch.	St.	Mnf.
8QC	CMSZ5240B	Z-diode	10V±5%, 20mA, Zzt=17Ω, 275mW	SOT-323	16dc	-	3a	Cen
8R	CMBZ5241B	Z-diode	11V±5%, Izt=20mA, Zzt=22Ω, 300mW	SOT-23	16dc	-	3a	Mei
8R	FDZS11LT	Z-diode	10.4..11.55V, Izt=20mA, Zzt=22Ω, 225mW	SOT-23	16dc	-	3a	Fis
8R	HMBZ5241B	Z-diode	11V±5%, Izt=20mA, Zzt=22Ω, 225mW	SOT-23	16dc	-	3a	Hsn
8R	MMBZ5241B	Z-diode	11V±5%, Zzt=22Ω, 225mW	SOT-23	16dc	-	3a,3c	F,Mot
8R	SMBZ5241B	Z-diode	11V±5%, 500mW	SOT-23	16dc	-	3a	Sur
8R	TMPZ5241	Z-diode	10.5..11.6V, Zzt<22Ω, 250mW	SOT-23	16dc	-	3a	All
8R	TMPZ5241R	Z-diode	10.5..11.6V, Zzt<22Ω, 250mW	SOT-23	16dr	-	3a	All
8R	ZD5241BN3	Z-diode	11V±5%, 20mA, Zzt=22Ω, 300mW	SOT-23	16dc	-	3a	Cys
8R-	MMCZ5241BPT	Z-diode	10.45..11.55V, Izt=5mA, Zzt=18Ω, 225mW	SOT-346	16dc	-	3a	Chm
8RC	CMSZ5241B	Z-diode	11V±5%, 20mA, Zzt=22Ω, 275mW	SOT-323	16dc	-	3a	Cen
8S	CMBZ5242B	Z-diode	12V±5%, Izt=20mA, Zzt=30Ω, 300mW	SOT-23	16dc	-	3a	Mei
8S	FDZS12LT	Z-diode	11.40..12.60V, Izt=20mA, Zzt=30Ω, 225mW	SOT-23	16dc	-	3a	Fis
8S	HMBZ5242B	Z-diode	12V±5%, Izt=20mA, Zzt=30Ω, 225mW	SOT-23	16dc	-	3a	Hsn
8S	MMBZ5242B	Z-diode	12V±5%, Zzt=30Ω, 225mW	SOT-23	16dc	-	3a,3c	F,Mot
8S	SMBZ5242B	Z-diode	12V±5%, 500mW	SOT-23	16dc	-	3a	Sur
8S	TMPZ5242	Z-diode	11.4., 12.6V, Zzt<30Ω, 250mW	SOT-23	16dc	-	3a	All
8S	TMPZ5242R	Z-diode	11.4., 12.6V, Zzt<30Ω, 250mW	SOT-23	16dr	-	3a	All
8S	ZD5242BN3	Z-diode	12V±5%, 20mA, Zzt=30Ω, 300mW	SOT-23	16dc	-	3a	Cys
8S-	MMCZ5242BPT	Z-diode	11.40..12.60V, Izt=5mA, Zzt=22Ω, 225mW	SOT-346	16dc	-	3a	Chm
8SC	CMSZ5242B	Z-diode	12V±5%, 20mA, Zzt=30Ω, 275mW	SOT-323	16dc	-	3a	Cen
8TC	CMBZ5243B	Z-diode	13V±5%, Izt=9.5mA, Zzt=13Ω, 300mW	SOT-23	16dc	-	3a	Mei
8T	DTG144T	Si-npn-Digi	Sw, 50V, 100mA, 230mW, 250MHz, R1=47k	SC-59	16ta	-	3a	Ons
8T	FDZS13LT	Z-diode	12.35..13.65V, Izt=9.5mA, Zzt=13Ω, 225mW	SOT-23	16dc	-	3a	Fis
8T	HMBZ5243B	Z-diode	13V±5%, Izt=9.5mA, Zzt=13Ω, 225mW	SOT-23	16dc	-	3a	Hsn
8T	MMBZ5243B	Z-diode	13V±5%, Zzt=13Ω, 225mW	SOT-23	16dc	-	3a,3c	F,Mot
8T	MUN2240	Si-npn-Digi	Sw, 50V, 100mA, 200mW, R1=47k	SC-59	16ta	-	3a	Mot
8T	SMBZ5243B	Z-diode	13V±5%, 500mW	SOT-23	16dc	-	3a	Sur
8T	TMPZ5243	Z-diode	12.4..13.7V, Zzt<13Ω, 250mW	SOT-23	16dc	-	3a	All
8T	TMPZ5243R	Z-diode	12.4..13.7V, Zzt<13Ω, 250mW	SOT-23	16dr	-	3a	All
8T	ZD5243BN3	Z-diode	13V±5%, 9.5mA, Zzt=13Ω, 300mW	SOT-23	16dc	-	3a	Cys
8T-	MMCZ5243BPT	Z-diode	12.35..13.65V, Izt=5mA, Zzt=25Ω, 225mW	SOT-346	16dc	-	3a	Chm
8TC	CMSZ5243B	Z-diode	13V±5%, 9.5mA, Zzt=13Ω, 275mW	SOT-323	16dc	-	3a	Cen
8U	CMBZ5244B	Z-diode	14V±5%, Izt=9.0mA, Zzt=15Ω, 300mW	SOT-23	16dc	-	3a	Mei
8U	FDZS14LT	Z-diode	13.30..14.70V, Izt=9mA, Zzt=15Ω, 225mW	SOT-23	16dc	-	3a	Fis
8U	HMBZ5244B	Z-diode	14V±5%, Izt=9mA, Zzt=15Ω, 225mW	SOT-23	16dc	-	3a	Hsn
8U	MMBZ5244B	Z-diode	14V±5%, Zzt=15Ω, 225mW	SOT-23	16dc	-	3a,3c	F,Mot
8U	MUN2241	Si-npn-Digi	Sw, 50V, 100mA, 200mW, R1=100k	SC-59	16ta	-	3a	Mot
8U	SMBZ5244B	Z-diode	14V±5%, 500mW	SOT-23	16dc	-	3a	Sur
8U	TMPZ5244	Z-diode	13.3..14.7V, Zzt<15Ω, 250mW	SOT-23	16dc	-	3a	All
8U	TMPZ5244R	Z-diode	13.3..14.7V, Zzt<15Ω, 250mW	SOT-23	16dr	-	3a	All
8U	ZD5244BN3	Z-diode	14V±5%, 9mA, Zzt=15Ω, 300mW	SOT-23	16dc	-	3a	Cys
8U-	MMCZ5244BPT	Z-diode	13.30..14.70V, Izt=5mA, Zzt=25Ω, 225mW	SOT-346	16dc	-	3a	Chm
8UC	CMSZ5244B	Z-diode	14V±5%, 9.0mA, Zzt=15Ω, 275mW	SOT-323	16dc	-	3a	Cen
8V	CMBZ5245B	Z-diode	15V±5%, Izt=8.5mA, Zzt=16Ω, 300mW	SOT-23	16dc	-	3a	Mei
8V	FDZS15LT	Z-diode	14.25..15.75V, Izt=8.5mA, Zzt=16Ω, 225mW	SOT-23	16dc	-	3a	Fis
8V	HMBZ5245B	Z-diode	15V±5%, Izt=8.5mA, Zzt=16Ω, 225mW	SOT-23	16dc	-	3a	Hsn
8V	MMBZ5245B	Z-diode	15V±5%, Zzt=16Ω, 225mW	SOT-23	16dc	-	3a,3c	F,Mot
8V	SMBZ5245B	Z-diode	15V±5%, 500mW	SOT-23	16dc	-	3a	Sur
8V	TMPZ5245	Z-diode	14.3..15.8V, Zzt<16Ω, 250mW	SOT-23	16dc	-	3a	All
8V	TMPZ5245R	Z-diode	14.3..15.8V, Zzt<16Ω, 250mW	SOT-23	16dr	-	3a	All
8V	ZD5245BN3	Z-diode	15V±5%, 8.5mA, Zzt=16Ω, 300mW	SOT-23	16dc	-	3a	Cys
8V-	MMCZ5245BPT	Z-diode	14.25..15.75V, Izt=5mA, Zzt=32Ω, 225mW	SOT-346	16dc	-	3a	Chm
8V2	CHPZ8V2PT	Z-diode	Dual, 7.7..8.7V, Izt=5mA, Zzt=15Ω, 350mW	SOT-23	16df	-	3a	Chm
8V2	PZM8.2NB	Z-diode	8.2V±2.5%, 300mW	SOT-346	16dc	-	3a	Phi
8V7	CHPZ8V7PT	Z-diode	Dual, 8.2..9.2V, Izt=5mA, Zzt=15Ω, 350mW	SOT-23	16df	-	3a	Chm
8VC	CMSZ5245B	Z-diode	15V±5%, 8.5mA, Zzt=16Ω, 275mW	SOT-323	16dc	-	3a	Cen
8W	CMBZ5246B	Z-diode	16V±5%, Izt=7.8mA, Zzt=17Ω, 300mW	SOT-23	16dc	-	3a	Mei
8W	FDZS16LT	Z-diode	15.20..16.80V, Izt=7.8mA, Zzt=17Ω, 225mW	SOT-23	16dc	-	3a	Fis
8W	HMBZ5246B	Z-diode	16V±5%, Izt=7.8mA, Zzt=17Ω, 225mW	SOT-23	16dc	-	3a	Hsn
8W	MMBZ5246B	Z-diode	16V±5%, Zzt=17Ω, 225mW	SOT-23	16dc	-	3a,3c	F,Mot
8W	SMBZ5246B	Z-diode	16V±5%, 500mW	SOT-23	16dc	-	3a	Sur
8W	TMPZ5246	Z-diode	15.2..16.8V, Zzt<17Ω, 250mW	SOT-23	16dc	-	3a	All
8W	TMPZ5246R	Z-diode	15.2..16.8V, Zzt<17Ω, 250mW	SOT-23	16dr	-	3a	All
8W	ZD5246BN3	Z-diode	16V±5%, 7.8mA, Zzt=17Ω, 300mW	SOT-23	16dc	-	3a	Cys
8W-	MMCZ5246BPT	Z-diode	15.20..16.80V, Izt=5mA, Zzt=36Ω, 225mW	SOT-346	16dc	-	3a	Chm
8WC	CMSZ5246B	Z-diode	16V±5%, 7.8mA, Zzt=17Ω, 275mW	SOT-323	16dc	-	3a	Cen
8X	CMBZ5247B	Z-diode	17V±5%, Izt=7.4mA, Zzt=19Ω, 300mW	SOT-23	16dc	-	3a	Mei
8X	FDZS17LT	Z-diode	16.15..17.85V, Izt=7.4mA, Zzt=19Ω, 225mW	SOT-23	16dc	-	3a	Fis
8X	HMBZ5247B	Z-diode	17V±5%, Izt=7.4mA, Zzt=19Ω, 225mW	SOT-23	16dc	-	3a	Hsn



SMD code	Type	Function	Short description	Case	Pinout	Sch.	St.	Mnf.
8X	MMBZ5247B	Z-diode	17V±5%, Zzt=19Ω, 225mW	SOT-23	16dc	-	3a,3c	F,Mot
8X	SMBZ5247B	Z-diode	17V±5%, 500mW	SOT-23	16dc	-	3a	Sur
8X	TMPZ5247	Z-diode	16.2...17.9V, Zzt<19Ω, 250mW	SOT-23	16dc	-	3a	All
8X	TMPZ5247R	Z-diode	16.2...17.9V, Zzt<19Ω, 250mW	SOT-23	16dr	-	3a	All
8X	UNR921AJ	Si-pnp-Digi	Sw, 50V, 100mA, 125mW, 150MHz, R1/R2=100k/100k	SC-89	18ta	-	3a	Pan
8X	ZD5247BN3	Z-diode	17V±5%, 7.4mA, Zzt=19Ω, 300mW	SOT-23	16dc	-	3a	Cys
8X-	MMCZ5247BPT	Z-diode	16.15..17.85V, lzt=5mA, Zzt=36Ω, 225mW	SOT-346	16dc	-	3a	Chm
8XC	CMSZ5247B	Z-diode	17V±5%, 7.4mA, Zzt=19Ω, 275mW	SOT-323	16dc	-	3a	Ken
8Y	CMBZ5248B	Z-diode	18V±5%, lzt=7.0mA, Zzt=21Ω, 300mW	SOT-23	16dc	-	3a	Mei
8Y	FDZS18LT	Z-diode	17.10..18.90V, lzt=7mA, Zzt=21Ω, 225mW	SOT-23	16dc	-	3a	Fis
8Y	HMBZ5248B	Z-diode	18V±5%, lzt=7mA, Zzt=21Ω, 225mW	SOT-23	16dc	-	3a	Hsn
8Y	MMBZ5248B	Z-diode	18V±5%, Zzt=21Ω, 225mW	SOT-23	16dc	-	3a,3c	F,Mot
8Y	SMBZ5248B	Z-diode	18V±5%, 500mW	SOT-23	16dc	-	3a	Sur
8Y	TMPZ5248	Z-diode	17.1..18.9V, Zzt<21Ω, 250mW	SOT-23	16dc	-	3a	All
8Y	TMPZ5248R	Z-diode	17.1..18.9V, Zzt<21Ω, 250mW	SOT-23	16dr	-	3a	All
8Y	UNR921BJ	Si-pnp-Digi	Sw, 50V, 100mA, 125mW, 150MHz, R1=100k	SC-89	18ta	-	3a	Pan
8Y	ZD5248BN3	Z-diode	18V±5%, 7mA, Zzt=21Ω, 300mW	SOT-23	16dc	-	3a	Cys
8Y-	MMCZ5248BPT	Z-diode	17.10..18.90V, lzt=5mA, Zzt=42Ω, 225mW	SOT-346	16dc	-	3a	Chm
8YC	CMSZ5248B	Z-diode	18V±5%, 7.0mA, Zzt=21Ω, 275mW	SOT-323	16dc	-	3a	Ken
8Z	CMBZ5249B	Z-diode	19V±5%, lzt=6.6mA, Zzt=23Ω, 300mW	SOT-23	16dc	-	3a	Mei
8Z	FDZS19LT	Z-diode	18.05..19.95V, lzt=6.6mA, Zzt=23Ω, 225mW	SOT-23	16dc	-	3a	Fis
8Z	HMBZ5249B	Z-diode	19V±5%, lzt=6.6mA, Zzt=23Ω, 225mW	SOT-23	16dc	-	3a	Hsn
8Z	MMBZ5249B	Z-diode	19V±5%, Zzt=23Ω, 225mW	SOT-23	16dc	-	3a,3c	F,Mot
8Z	SMBZ5249B	Z-diode	19V±5%, 500mW	SOT-23	16dc	-	3a	Sur
8Z	TMPZ5249	Z-diode	18.1..20V, Zzt<23Ω, 250mW	SOT-23	16dc	-	3a	All
8Z	TMPZ5249R	Z-diode	18.1..20V, Zzt<23Ω, 250mW	SOT-23	16dr	-	3a	All
8Z	UNR921CJ	Si-pnp-Digi	Sw, 50V, 100mA, 125mW, 150MHz, R2=47k	SC-89	18ta	-	3a	Pan
8Z	ZD5249BN3	Z-diode	19V±5%, 6.6mA, Zzt=23Ω, 300mW	SOT-23	16dc	-	3a	Cys
8Z-	MMCZ5249BPT	Z-diode	18.05..19.95V, lzt=5mA, Zzt=42Ω, 225mW	SOT-346	16dc	-	3a	Chm
8ZZ	CZ1W8V2	Z-diode	8.2V±5%, 600mW	SOT-23	16dc	-	3a	Cdi
8ZC	CMSZ5249B	Z-diode	19V±5%, 6.6mA, Zzt=23Ω, 275mW	SOT-323	16dc	-	3a	Ken
9.1	TZT9.1W	Z-diode	8.50..9.60V, lzt=5mA, Zzt=18Ω, 200mW	SOT-323	16dc	-	3a	TTr
9.1	Z02W9.1V	Z-diode	8.50..9.60V, lzt=5mA, Zzt=18Ω, 200mW	SOT-23	16dc	-	3f	Kec
9.1H	BZX84-C9V1-V	Z-diode	8.80..9.30V, lzt=5mA, Zzt=18Ω, 300mW	SOT-23	16dc	-	3f	Kec
9.1H	MAZ3091-H	Z-diode	8.5..9.6V, If=100mA, Zzt=15Ω, 200mW	SC-59	16dc	-	3a	Pan
9.1K	MAZ3091WK	Z-diode	Dual, 9.1V, If=100mA, Zzt=15Ω, 200mW	SC-59	16dg	-	3a	Pan
9.1L	MAZ3091-L	Z-diode	8.5..9.6V, If=100mA, Zzt=15Ω, 200mW	SC-59	16dc	-	3a	Pan
9.1M	MAZ3091-M	Z-diode	8.5..9.6V, If=100mA, Zzt=15Ω, 200mW	SC-59	16dc	-	3a	Pan
9.1X	TZT9.1XW	Z-diode	8.50..9.0V, lzt=5mA, Zzt=18Ω, 200mW	SOT-323	16dc	-	3a	TTr
9.1X	Z02W9.1VX	Z-diode	8.50..9.0V, lzt=5mA, Zzt=18Ω, 200mW	SOT-23	16dc	-	3f	Kec
9.1Y	TZT9.1YW	Z-diode	8.80..9.30V, lzt=5mA, Zzt=18Ω, 200mW	SOT-323	16dc	-	3a	TTr
9.1Y	Z02W9.1VY	Z-diode	8.80..9.30V, lzt=5mA, Zzt=18Ω, 200mW	SOT-23	16dc	-	3f	Kec
9.1Z	TZT9.1ZW	Z-diode	9.10..9.60V, lzt=5mA, Zzt=18Ω, 200mW	SOT-323	16dc	-	3a	TTr
9.1Z	Z02W9.1VZ	Z-diode	9.10..9.60V, lzt=5mA, Zzt=18Ω, 200mW	SOT-23	16dc	-	3f	Kec
9.1X	O2CZ9.1-X	Z-diode	8.5..9V, 200mW	SC-59	16dc	-	3a	Tos
9.1Y	O2CZ9.1-Y	Z-diode	8.8..9.3V, 200mW	SC-59	16dc	-	3a	Tos
9.1Z	O2CZ9.1-Z	Z-diode	9.1..9.6V, 200mW	SC-59	16dc	-	3a	Tos
90	CHDTA124XMPT	Si-pnp-Digi	Sw, 50V, 100mA, 250MHz, R1/R2=22/47k	SOT-723	18ta	-	3a	Chm
90LN	ELM7540CBB	Vdet-IC	4.0V±2%, +Reset PPO	SOT-23	16vdb	VD7	3d	Elm
90LN	ELM7540NBB	Vdet-IC	4.0V±2%, +Reset ODO	SOT-23	16vdb	VD6	3d	Elm
90T	TK17590AS	LVR-IC	LDO, 9V±1.5%, 155mA	SOT-23	16cj	VR1	3d	Tok
91	2SK300-1	n-FET	GP, LN, 55V, 50mA, 150mW, Idss=9.5..14.8mA, Up<2V	SOT-23	16fa	-	3a	Pan
91	BZB784-C2V4	Z-diode	Dual, 2.4V±5%, Zzt=70Ω, 350mW	SOT-323	16df	-	3a	Phi
91	BZB984-C2V4	Z-diode	Dual, 2.4V±5%, If=200mA, 265mW	SOT-663	18df	-	3a	Phi
91	CHDTA143EMPT	Si-pnp-Digi	Sw, 50V, 100mA, 250MHz, R1/R2=4.7/4.7k	SOT-723	18ta	-	3a	Chm
91	DTA113TKA	Si-pnp-Digi	Sw, 50V, 100mA, 200mW, 200MHz, R1=1k	SOT-346	16ta	-	3a	Rhm
910	HZM9.1NB	Z-diode	8.56..9.55V, 200mW	SC-59A	16dc	-	3a	Ren
911	HZM9.1NB1	Z-diode	8.56..8.93V, 200mW	SC-59A	16dc	-	3a	Ren
911	PZM9.1NB1	Z-diode	9.1V±2.5%, 300mW	SOT-346	16dc	-	3a	Phi
912	HZM9.1NB2	Z-diode	8.85..9.23V, 200mW	SC-59A	16dc	-	3a	Ren
912	PZM9.1NB2	Z-diode	9.1V±2.5%, 300mW	SOT-346	16dc	-	3a	Phi
913	HZM9.1NB3	Z-diode	9.15..9.55V, 200mW	SC-59A	16dc	-	3a	Ren
913	PZM9.1NB3	Z-diode	9.1V±2.5%, 300mW	SOT-346	16dc	-	3a	Phi
91A	FMMT591A	Si-pnp	AF, 80V, 1A, 500mW, B=100..300, >150MHz	SOT-23	16ta	-	3a	Zx
91LN	ELM7541CBB	Vdet-IC	4.1V±2%, +Reset PPO	SOT-23	16vdb	VD7	3d	Elm
91LN	ELM7541NBB	Vdet-IC	4.1V±2%, +Reset ODO	SOT-23	16vdb	VD6	3d	Elm
92	2SK300-2	n-FET	GP, LN, 55V, 50mA, 150mW, Idss=13.4..21mA, Up<2V	SOT-23	16fa	-	3a	Pan
92	BZB784-C2V7	Z-diode	Dual, 2.7V±5%, Zzt=75Ω, 350mW	SOT-323	16df	-	3a	Phi
92	BZB984-C2V7	Z-diode	Dual, 2.7V±5%, If=200mA, 265mW	SOT-663	18df	-	3a	Phi
92	CHDTA143XMPT	Si-pnp-Digi	Sw, 50V, 100mA, 250MHz, R1/R2=4.7/10k	SOT-723	18ta	-	3a	Chm



SMD code	Type	Function	Short description	Case	Pinout	Sch. St.	Mnf.
926	KTF809T-2.63	Vdet-IC	2.63V±1.5%, -Reset PPO	SOT-23	16vdc	VD7 3a	lcm
929	KTF809T-2.93	Vdet-IC	2.93V±1.5%, -Reset PPO	SOT-23	16vdc	VD7 3a	lcm
92LN	ELM7542CBB	Vdet-IC	4.2V±2%, +Reset PPO	SOT-23	16vdb	VD7 3d	Elm
92LN	ELM7542NBB	Vdet-IC	4.2V±2%, +Reset ODO	SOT-23	16vdb	VD6 3d	Elm
93	2SK300-3	n-FET	GP, LN, 55V, 50mA, 150mW, Idss=19.30.2mA, Up<2V	SOT-23	16fa	- 3a	Pan
93	BZB784-C3V0	Z-diode	Dual, 3V±5%, Zzt=80Ω, 350mW	SOT-323	16df	- 3a	Phi
93	BZB984-C3V0	Z-diode	Dual, 3.0V±5%, If=200mA, 265mW	SOT-663	18df	- 3a	Phi
93	CHDTA143ZMPT	Si-pnp-Digi	Sw, 50V, 100mA, 250MHz, R1/R2=4.7/47k	SOT-723	18ta	- 3a	Chm
93	DTA143TE	Si-pnp-Digi	Sw, 50V, 100mA, 150mW, 250MHz, R1=4k7	SOT-416	16ta	- 3a	Rhm
93	DTA143TKA	Si-pnp-Digi	Sw, 50V, 100mA, 200mW, 250MHz, R1=4k7	SOT-346	16ta	- 3a	Rhm
93	DTA143TM	Si-pnp-Digi	Sw, 50V, 100mA, 150mW, 250MHz, R1=4k7	VMT3	18ta	- 3a	Rhm
93	DTA143TUA	Si-pnp-Digi	Sw, 50V, 100mA, 200mW, 250MHz, R1=4k7	UMT3	16ta	- 3a	Rhm
930	KTF809T-3.08	Vdet-IC	3.08V±1.5%, -Reset PPO	SOT-23	16vdc	VD7 3a	lcm
93LN	ELM7543CBB	Vdet-IC	4.3V±2%, +Reset PPO	SOT-23	16vdb	VD7 3d	Elm
93LN	ELM7543NBB	Vdet-IC	4.3V±2%, +Reset ODO	SOT-23	16vdb	VD6 3d	Elm
94	2SK300-4	n-FET	GP, LN, 55V, 50mA, 150mW, Idss=27.4.42mA, Up<2V	SOT-23	16fa	- 3a	Pan
94	BZB784-C3V3	Z-diode	Dual, 3.3V±5%, Zzt=85Ω, 350mW	SOT-323	16df	- 3a	Phi
94	BZB984-C3V3	Z-diode	Dual, 3.3V±5%, If=200mA, 265mW	SOT-663	18df	- 3a	Phi
94	CHDTA144EMPT	Si-pnp-Digi	Sw, 50V, 30mA, 250MHz, R1/R2=47/47k	SOT-723	18ta	- 3a	Chm
94	DTA114TE	Si-pnp-Digi	Sw, 50V, 100mA, 200mW, 200MHz, R1=10k	SOT-416	16ta	- 3a	Rhm
94	DTA114TKA	Si-pnp-Digi	Sw, 50V, 100mA, 200mW, 200MHz, R1=10k	SOT-346	16ta	- 3a	Rhm
94	DTA114TM	Si-pnp-Digi	Sw, 50V, 100mA, 200mW, 200MHz, R1=10k	VMT3	18ta	- 3a	Rhm
94	DTA114TUA	Si-pnp-Digi	Sw, 50V, 100mA, 200mW, 200MHz, R1=10k	UMT3	16ta	- 3a	Rhm
94	DTC114TE	Si-npn-Digi	Sw, 50V, 100mA, 150mW, 250MHz, R1=10k	SOT-416	16ta	- 3a	Rhm
94	DTC114TKA	Si-npn-Digi	Sw, 50V, 100mA, 200mW, 250MHz, R1=10k	SOT-346	16ta	- 3a	Rhm
94	DTC114TM	Si-npn-Digi	Sw, 50V, 100mA, 150W, 250MHz, R1=10k	VMT3	18ta	- 3a	Rhm
94	DTC114TUA	Si-npn-Digi	Sw, 50V, 100mA, 200mW, 250MHz, R1=10k	UMT3	16ta	- 3a	Rhm
940	KTF809T-4.00	Vdet-IC	4.0V±1.5%, -Reset PPO	SOT-23	16vdc	VD7 3a	lcm
943	KTF809T-4.38	Vdet-IC	4.38V±1.5%, -Reset PPO	SOT-23	16vdc	VD7 3a	lcm
946	KTF809T-4.63	Vdet-IC	4.63V±1.5%, -Reset PPO	SOT-23	16vdc	VD7 3a	lcm
94LN	ELM7544CBB	Vdet-IC	4.4V±2%, +Reset PPO	SOT-23	16vdb	VD7 3d	Elm
94LN	ELM7544NBB	Vdet-IC	4.4V±2%, +Reset ODO	SOT-23	16vdb	VD6 3d	Elm
95	BZB784-C3V6	Z-diode	Dual, 3.6V±5%, Zzt=85Ω, 350mW	SOT-323	16df	- 3a	Phi
95	BZB984-C3V6	Z-diode	Dual, 3.6V±5%, If=200mA, 265mW	SOT-663	18df	- 3a	Phi
95	CHDTA144VMPT	Si-pnp-Digi	Sw, 50V, 30mA, 250MHz, R1/R2=47/22k	SOT-723	18ta	- 3a	Chm
95	DTA124TE	Si-pnp-Digi	Sw, 50V, 100mA, 150mW, 250MHz, R2=22k	SOT-416	16ta	- 3a	Rhm
95	DTA124TKA	Si-pnp-Digi	Sw, 50V, 100mA, 200mW, 250MHz, R2=22k	SOT-346	16ta	- 3a	Rhm
95	DTA124TM	Si-pnp-Digi	Sw, 50V, 100mA, 150mW, 250MHz, R2=22k	VMT3	18ta	- 3a	Rhm
95	DTA124TUA	Si-pnp-Digi	Sw, 50V, 100mA, 200mW, 250MHz, R2=22k	UMT3	18ta	- 3a	Rhm
95LN	ELM7545CBB	Vdet-IC	4.5V±2%, +Reset PPO	SOT-23	16vdb	VD7 3d	Elm
95LN	ELM7545NBB	Vdet-IC	4.5V±2%, +Reset ODO	SOT-23	16vdb	VD6 3d	Elm
96	BZB784-C3V9	Z-diode	Dual, 3.9V±5%, Zzt=85Ω, 350mW	SOT-323	16df	- 3a	Phi
96	BZB984-C3V9	Z-diode	Dual, 3.9V±5%, If=200mA, 265mW	SOT-663	18df	- 3a	Phi
96	CHDTA144VMPT	Si-pnp-Digi	Sw, 50V, 30mA, 250MHz, R1/R2=47/10k	SOT-723	18ta	- 3a	Chm
96	DTA144TE	Si-pnp-Digi	Sw, 50V, 100mA, 150mW, 250MHz, R1=47k	SOT-416	16ta	- 3a	Rhm
96	DTA144TKA	Si-pnp-Digi	Sw, 50V, 100mA, 200mW, 250MHz, R1=47k	SOT-346	16ta	- 3a	Rhm
96	DTA144TM	Si-pnp-Digi	Sw, 50V, 100mA, 150mW, 250MHz, R1=47k	VMT3	18ta	- 3a	Rhm
96	DTA144TUA	Si-pnp-Digi	Sw, 50V, 100mA, 200mW, 250MHz, R1=47k	UMT3	16ta	- 3a	Rhm
96	DTC144TE	Si-npn-Digi	Sw, 50V, 100mA, 150mW, 250MHz, R1=47k	SOT-416	16ta	- 3a	Rhm
96	DTC144TKA	Si-npn-Digi	Sw, 50V, 100mA, 200mW, 250MHz, R1=47k	SOT-346	16ta	- 3a	Rhm
96	DTC144TM	Si-npn-Digi	Sw, 50V, 100mA, 150mW, 250MHz, R1=47k	VMT3	18ta	- 3a	Rhm
96	DTC144TUA	Si-npn-Digi	Sw, 50V, 100mA, 200mW, 250MHz, R1=47k	UMT3	16ta	- 3a	Rhm
96LN	ELM7546CBB	Vdet-IC	4.6V±2%, +Reset PPO	SOT-23	16vdb	VD7 3d	Elm
96LN	ELM7546NBB	Vdet-IC	4.6V±2%, +Reset ODO	SOT-23	16vdb	VD6 3d	Elm
97	BZB784-C4V3	Z-diode	Dual, 4.3V±5%, Zzt=80Ω, 350mW	SOT-323	16df	- 3a	Phi
97	BZB984-C4V3	Z-diode	Dual, 4.3V±5%, If=200mA, 265mW	SOT-663	18df	- 3a	Phi
97LN	ELM7547CBB	Vdet-IC	4.7V±2%, +Reset PPO	SOT-23	16vdb	VD7 3d	Elm
97LN	ELM7547NBB	Vdet-IC	4.7V±2%, +Reset ODO	SOT-23	16vdb	VD6 3d	Elm
98	BZB784-C4V7	Z-diode	Dual, 4.7V±5%, Zzt=50Ω, 350mW	SOT-323	16df	- 3a	Phi
98	BZB984-C4V7	Z-diode	Dual, 4.7V±5%, If=200mA, 265mW	SOT-663	18df	- 3a	Phi
98LN	ELM7548CBB	Vdet-IC	4.8V±2%, +Reset PPO	SOT-23	16vdb	VD7 3d	Elm
98LN	ELM7548NBB	Vdet-IC	4.8V±2%, +Reset ODO	SOT-23	16vdb	VD6 3d	Elm
99	BZB784-C5V1	Z-diode	Dual, 5.1V±5%, Zzt=40Ω, 350mW	SOT-323	16df	- 3a	Phi
99	BZB984-C5V1	Z-diode	Dual, 5.1V±5%, If=200mA, 265mW	SOT-663	18df	- 3a	Phi
99	DTA115TE	Si-pnp-Digi	Sw, 50V, 100mA, 150mW, 250MHz, R1=100k	SOT-416	16ta	- 3a	Rhm
99	DTA115TKA	Si-pnp-Digi	Sw, 50V, 100mA, 200mW, 250MHz, R1=100k	SOT-346	16ta	- 3a	Rhm
99	DTA115TM	Si-pnp-Digi	Sw, 50V, 100mA, 150mW, 250MHz, R1=100k	VMT3	18ta	- 3a	Rhm
99	DTA115TUA	Si-pnp-Digi	Sw, 50V, 100mA, 200mW, 250MHz, R1=100k	UMT3	16ta	- 3a	Rhm
99LN	ELM7549CBB	Vdet-IC	4.9V±2%, +Reset PPO	SOT-23	16vdb	VD7 3d	Elm
99LN	ELM7549NBB	Vdet-IC	4.9V±2%, +Reset ODO	SOT-23	16vdb	VD6 3d	Elm

Note: ELM75xxCBB series LN- lot number L=0...9 N=A to Z(I, O, X excepted); ELM75xxNBB series LN- lot number L=A to Z(I, O, X excepted) N=0...9



SMD code	Type	Function	Short description	Case	Pinout	Sch.	St.	Mnf.
9A	2SC5938A-A	Si-npn	AF, Sw, 50V, 200mA, 150mW, 30MHz, B=200..700	SC-59	16ta	-	3a	Ish
9A	2SC5966A-A	Si-npn	AF, Sw, 50V, 200mA, 150mW, 30MHz, B=200..700	SOT-323	16ta	-	3a	Ish
9A	BZB784-C5V6	Z-diode	Dual, 5.6V±5%, Zzt=15Ω, 350mW	SOT-323	16df	-	3a	Phi
9A	BZB984-C5V6	Z-diode	Dual, 5.6V±5%, If=200mA, 265mW	SOT-663	18df	-	3a	Phi
9A	DTA125TKA	Si-pnp-Digi	Sw, 50V, 100mA, 200mW, 250MHz, R1=200k	SOT-346	16ta	-	3a	Rhm
9A	DTA125TU	Si-pnp-Digi	Sw, 50V, 100mA, 200mW, B=100..600, >250MHz, R1=200k	SOT-323	16ta	-	3a	Rhm
9A	DTA125TUA	Si-pnp-Digi	Sw, 50V, 100mA, 200mW, 250MHz, R1=200k	UMT3	16ta	-	3a	Rhm
9A	FMMT2369AR	Si-npn	Sw, 40V, 200mA, 330mW, B=40..120	SOT-23	16ta	-	3a	Zx
9A	R3131N19EC	Vdet-IC	1.9V, +Reset ODO, 240ms	SOT-23	16vdc	VD6	3b	Ric
9A	UN2221	Si-npn-Digi	Sw, 50V, 500mA, 200mW, 250MHz, R1/R2=2k2/2k2	SC-59	16ta	-	3a	Pan
9A	UNR2221	Si-npn-Digi	Sw, 50V, 500mA, 200mW, 250MHz, R1/R2=2k2/2k2	SC-59	16ta	-	3a	Pan
9A1	MMBZ9V1A	TVS	Dual, Vrrwm=6.0V, Vbr=8.65..9.56V, 1.7A, 24W(1ms)	SOT-23	16dgy	-	3a	Wtr
9A1	PZM9.1NB2A	Z-diode	Dual, 9.1V±2.5%, 300mW	SOT-346	16df	-	3a	Phi
9A5	TC599002ECB	LVR-IC	LDO, -9.0V±2%, 200mA	SOT-23	16cj	VR2	3d	Mcc
9AA	BC856A	Si-pnp	GP, 80V, 100mA, 310mW, B=125..250, >150MHz	SOT-23	16ta	-	3a	Sam
9AA	STM1810L	Vdet-IC	4.62V±1.5%, -Reset PPO	SOT-23	16vda	VD7	3b	Ste
9AB	BC856B	Si-pnp	GP, 80V, 100mA, 310mW, B=220..475, >150MHz	SOT-23	16ta	-	3a	Sam
9AB	STM1810M	Vdet-IC	4.37V±1.5%, -Reset PPO	SOT-23	16vda	VD7	3b	Ste
9AC	BC856C	Si-pnp	GP, 80V, 100mA, 310mW, B=420..800, >150MHz	SOT-23	16ta	-	3a	Sam
9AH	STM1811L	Vdet-IC	4.62V±1.5%, -Reset ODO	SOT-23	16vda	VD6	3b	Ste
9AJ	STM1811M	Vdet-IC	4.37V±1.5%, -Reset ODO	SOT-23	16vda	VD6	3b	Ste
9Ap	PMMT491A	Si-npn	AF, 80V, 1A, 250mW, B=300..900, >150MHz	SOT-23	16ta	-	3a	PHH
9AQ	STM1812L	Vdet-IC	4.62V±1.5%, +Reset PPO	SOT-23	16vda	VD7	3b	Ste
9AR	STM1812M	Vdet-IC	4.37V±1.5%, +Reset PPO	SOT-23	16vda	VD7	3b	Ste
9At	PMMT491A	Si-npn	AF, 80V, 1A, 250mW, B=300..900, >150MHz	SOT-23	16ta	-	3a	PHM
9AW	PMMT491A	Si-npn	AF, 80V, 1A, 250mW, B=300..900, >150MHz	SOT-23	16ta	-	3a	PhC
9AX	STM1813L	Vdet-IC	4.62V±1.5%, +Reset ODO	SOT-23	16vda	VD6	3b	Ste
9AY	STM1813M	Vdet-IC	4.37V±1.5%, +Reset ODO	SOT-23	16vda	VD6	3b	Ste
9B	2SC5938A-B	Si-npn	AF, Sw, 50V, 200mA, 150mW, 30MHz, B=350..1200	SC-59	16ta	-	3a	Ish
9B	2SC5966A-B	Si-npn	AF, Sw, 50V, 200mA, 150mW, 30MHz, B=350..1200	SOT-323	16ta	-	3a	Ish
9B	BZB784-C6V2	Z-diode	Dual, 6.2V±5%, Zzt=6Ω, 350mW	SOT-323	16df	-	3a	Phi
9B	BZB984-C6V2	Z-diode	Dual, 6.2V±5%, If=200mA, 265mW	SOT-663	18df	-	3a	Phi
9B	R3131N29EC	Vdet-IC	2.9V, +Reset ODO, 240ms	SOT-23	16vdc	VD6	3b	Ric
9B	UN2222	Si-npn-Digi	Sw, 50V, 500mA, 200mW, 250MHz, R1/R2=4k4/4k7	SC-59	16ta	-	3a	Pan
9B	UNR2222	Si-npn-Digi	Sw, 50V, 500mA, 200mW, 250MHz, R1/R2=4k4/4k7	SC-59	16ta	-	3a	Pan
9BA	BC857A	Si-pnp	GP, 50V, 100mA, 310mW, B=110..220, >150MHz	SOT-23	16ta	-	3a	Sam
9BB	BC857B	Si-pnp	GP, 50V, 100mA, 310mW, B=220..475, >150MHz	SOT-23	16ta	-	3a	Sam
9BC	BC857C	Si-pnp	GP, 50V, 100mA, 310mW, B=420..800, >150MHz	SOT-23	16ta	-	3a	Sam
9BG	STM1815T	Vdet-IC	3.06V±1.5%, -Reset PPO	SOT-23	16vda	VD7	3b	Ste
9BH	STM1815S	Vdet-IC	2.88V±1.5%, -Reset PPO	SOT-23	16vda	VD7	3b	Ste
9BJ	STM1815R	Vdet-IC	2.55V±1.5%, -Reset PPO	SOT-23	16vda	VD7	3b	Ste
9Bp	PMMT591A	Si-pnp	AF, 80V, 1A, 250mW, B=300..800, >150MHz	SOT-23	16ta	-	3a	PHH
9BP	STM1816T	Vdet-IC	3.06V±1.5%, -Reset ODO	SOT-23	16vda	VD6	3b	Ste
9BQ	STM1816S	Vdet-IC	2.88V±1.5%, -Reset ODO	SOT-23	16vda	VD6	3b	Ste
9BR	STM1816R	Vdet-IC	2.55V±1.5%, -Reset ODO	SOT-23	16vda	VD6	3b	Ste
9Bt	PMMT591A	Si-pnp	AF, 80V, 1A, 250mW, B=300..800, >150MHz	SOT-23	16ta	-	3a	PHM
9BW	PMMT591A	Si-pnp	AF, 80V, 1A, 250mW, B=300..800, >150MHz	SOT-23	16ta	-	3a	PhC
9BW	STM1817T	Vdet-IC	3.06V±1.5%, +Reset PPO	SOT-23	16vda	VD7	3b	Ste
9BX	STM1817S	Vdet-IC	2.88V±1.5%, +Reset PPO	SOT-23	16vda	VD7	3b	Ste
9BY	STM1817R	Vdet-IC	2.55V±1.5%, +Reset PPO	SOT-23	16vda	VD7	3b	Ste
9C	BZB784-C6V8	Z-diode	Dual, 6.8V±5%, Zzt=6Ω, 350mW	SOT-323	16df	-	3a	Phi
9C	BZB984-C6V8	Z-diode	Dual, 6.8V±5%, If=200mA, 265mW	SOT-663	18df	-	3a	Phi
9C	R3131N39EC	Vdet-IC	3.9V, +Reset ODO, 240ms	SOT-23	16vdc	VD6	3b	Ric
9C	UN2223	Si-npn-Digi	Sw, 50V, 500mA, 200mW, 250MHz, R1/R2=10k/10k	SC-59	16ta	-	3a	Pan
9C	UNR2223	Si-npn-Digi	Sw, 50V, 500mA, 200mW, 250MHz, R1/R2=10k/10k	SC-59	16ta	-	3a	Pan
9CA	BC858A	Si-pnp	GP, 30V, 100mA, 310mW, B=110..220, >150MHz	SOT-23	16ta	-	3a	Sam
9CB	BC858B	Si-pnp	GP, 30V, 100mA, 310mW, B=200..450, >150MHz	SOT-23	16ta	-	3a	Sam
9CC	BC858C	Si-pnp	GP, 30V, 100mA, 310mW, B=420..800, >150MHz	SOT-23	16ta	-	3a	Sam
9CD	STM1818T	Vdet-IC	3.06V±1.5%, +Reset ODO	SOT-23	16vda	VD6	3b	Ste
9CE	STM1818S	Vdet-IC	2.88V±1.5%, +Reset ODO	SOT-23	16vda	VD6	3b	Ste
9CF	STM1818R	Vdet-IC	2.55V±1.5%, +Reset ODO	SOT-23	16vda	VD6	3b	Ste
9D	BZB784-C7V5	Z-diode	Dual, 7.5V±5%, Zzt=6Ω, 350mW	SOT-323	16df	-	3a	Phi
9D	BZB984-C7V5	Z-diode	Dual, 7.5V±5%, If=200mA, 265mW	SOT-663	18df	-	3a	Phi
9D	UN2224	Si-npn-Digi	Sw, 50V, 500mA, 200mW, 250MHz, R1/R2=2k2/10k	SC-59	16ta	-	3a	Pan
9D	UNR2224	Si-npn-Digi	Sw, 50V, 500mA, 200mW, 250MHz, R1/R2=2k2/10k	SC-59	16ta	-	3a	Pan
9DA	BC859A	Si-pnp	GP, 30V, 100mA, 310mW, B=110..220, >150MHz	SOT-23	16ta	-	3a	Sam
9DB	BC859B	Si-pnp	GP, 30V, 100mA, 310mW, B=200..450, >150MHz	SOT-23	16ta	-	3a	Sam
9DC	BC859C	Si-pnp	GP, 30V, 100mA, 310mW, B=420..800, >150MHz	SOT-23	16ta	-	3a	Sam
9E	BZB784-C8V2	Z-diode	Dual, 8.2V±5%, Zzt=6Ω, 350mW	SOT-323	16df	-	3a	Phi
9E	BZB984-C8V2	Z-diode	Dual, 8.2V±5%, If=200mA, 265mW	SOT-663	18df	-	3a	Phi



SMD code	Type	Function	Short description	Case	Pinout	Sch.	St.	Mnf.
9EA	BC860A	Si-pnp	GP, 50V, 100mA, 310mW, B=110..220, >150MHz	SOT-23	16ta	-	3a	Sam
9EB	BC860B	Si-pnp	GP, 50V, 100mA, 310mW, B=200..450, >150MHz	SOT-23	16ta	-	3a	Sam
9EC	BC860C	Si-pnp	GP, 50V, 100mA, 310mW, B=420..800, >150MHz	SOT-23	16ta	-	3a	Sam
9F	BZB784-C9V1	Z-diode	Dual, 9.1V±5%, Zzt=6Q, 350mW	SOT-323	16df	-	3a	Phi
9F	BZB984-C9V1	Z-diode	Dual, 9.1V±5%, If=200mA, 265mW	SOT-663	18df	-	3a	Phi
9F	R3131N19EA	Vdet-IC	1.9V, +Reset PPO, 240ms	SOT-23	16vdc	VD7	3b	Ric
9F	UNR521W	Si-npn-Digi	Sw, 50V, 100mA, 150mW, 100MHz, R2=100k	SOT-323	16ta	-	3a	Pan
9FA	BC807-16	Si-pnp	GP, 50V, 500mA, 250mW, 80MHz, B=100..250	SOT-23	16ta	-	3a	Sam
9FB	BC807-25	Si-pnp	GP, 50V, 500mA, 250mW, 80MHz, B=160..400	SOT-23	16ta	-	3a	Sam
9FC	BC807-40	Si-pnp	GP, 50V, 500mA, 250mW, 80MHz, B=250..600	SOT-23	16ta	-	3a	Sam
9G	BZB784-C10	Z-diode	Dual, 10V±5%, Zzt=8Q, 350mW	SOT-323	16df	-	3a	Phi
9G	BZB984-C10	Z-diode	Dual, 10V±5%, If=200mA, 265mW	SOT-663	18df	-	3a	Phi
9G	R3131N29EA	Vdet-IC	2.9V, +Reset PPO, 240ms	SOT-23	16vdc	VD7	3b	Ric
9GA	BC808-16	Si-pnp	AF-Drv, 30V, 500mA, 330mW, B=100..250, >100MHz	SOT-23	16ta	-	3a	Sam
9GB	BC808-25	Si-pnp	AF-Drv, 30V, 500mA, 330mW, B=160..400, >100MHz	SOT-23	16ta	-	3a	Sam
9GC	BC808-40	Si-pnp	AF-Drv, 30V, 500mA, 330mW, B=250..630, >100MHz	SOT-23	16ta	-	3a	Sam
9H	BZB784-C11	Z-diode	Dual, 11V±5%, Zzt=10Q, 350mW	SOT-323	16df	-	3a	Phi
9H	BZB984-C11	Z-diode	Dual, 11V±5%, If=200mA, 265mW	SOT-663	18df	-	3a	Phi
9H	R3131N39EA	Vdet-IC	3.9V, +Reset PPO, 240ms	SOT-23	16vdc	VD7	3b	Ric
9Ht	BC850W	Si-npn	GP, 50V, 100mA, 200mW, B=200..800, >100MHz	SOT-323	16ta	-	3a	Phi
9J	ADM809JART	Vdet-IC	4.0V±1.5%, -Reset PPO	SOT-23	16vdc	VD7	3a	Ad
9J	BZB784-C12	Z-diode	Dual, 12V±5%, Zzt=10Q, 350mW	SOT-323	16df	-	3a	Phi
9J	BZB984-C12	Z-diode	Dual, 12V±5%, If=200mA, 265mW	SOT-663	18df	-	3a	Phi
9K	BZB784-C13	Z-diode	Dual, 13V±5%, Zzt=10Q, 350mW	SOT-323	16df	-	3a	Phi
9K	BZB984-C13	Z-diode	Dual, 13V±5%, If=200mA, 265mW	SOT-663	18df	-	3a	Phi
9L	ADM809LART	Vdet-IC	4.63V±1.5%, -Reset PPO	SOT-23	16vdc	VD7	3a	Ad
9L	BZB784-C15	Z-diode	Dual, 15V±5%, Zzt=10Q, 350mW	SOT-323	16df	-	3a	Phi
9L	BZB984-C15	Z-diode	Dual, 15V±5%, If=200mA, 265mW	SOT-663	18df	-	3a	Phi
9LN	ELM7551CEB	Vdet-IC	5.1V±2%, +Reset PPO	SC-70	16vdb	VD7	3d	Elm
9LN	ELM7551NEB	Vdet-IC	5.1V±2%, +Reset ODO	SC-70	16vdb	VD6	3d	Elm
9M	ADM809MART	Vdet-IC	4.38V±1.5%, -Reset PPO	SOT-23	16vdc	VD7	3a	Ad
9P	BCX70HR	Si-npn	GP, 45V, 200mA, 330mW, B=180..310, >250MHz	SOT-23	16ta	-	3a	Zx
9R	ADM809RART	Vdet-IC	2.63V±1.5%, -Reset PPO	SOT-23	16vdc	VD7	3a	Ad
9R	FMMT2369R	Si-npn	Sw, 40V, 200mA, 330mW, B=40..120	SOT-23	16ta	-	3a	Zx
9T	ADM809TART	Vdet-IC	3.0V±1.5%, -Reset PPO	SOT-23	16vdc	VD7	3a	Ad
9V1	CHPZ9V1PT	Z-diode	Dual, 8.6..9.6V, Izt=5mA, Zzt=15Q, 350mW	SOT-23	16df	-	3a	Chm
9V1	PZM9-1NB	Z-diode	9.1V±2.5%, 300mW	SOT-346	16dc	-	3a	Phi
9Z1	CZ1W9V1	Z-diode	9.1V±5%, 600mW	SOT-23	16dc	-	3a	Cdi
a	AX6901AA	Vdet-IC	4.63V±1.5%, -Reset PPO	SC-70	16vdc	VD7	3b	Axl
A	MRF947	Si-npn	UHF, 20V, 50mA, 188mW, B>50, 8GHz	SOT-323	16ta	-	3a	Mot
A	MRF947T1	Si-npn	VHF/UHF, 20V, 50mA, 188mW, B>50, 8GHz	SOT-323	16ta	-	3a	Mot
A	SB01-05CP	Si-diode	SBR, HF, 50V, 100mA, Vf<0.55V(100mA), 4.4pF, 10ns	CP	16dc	-	3a	San
A	SB01-05Q	Si-diode	SBR, HF, 50V, 100mA, Vf<0.55V(100mA), 4.4pF, 10ns	MCP	16dc	-	3a	San
A0	BZX84-C43	Z-diode	40..46V, Zzt=150Q, Izt=20mA, 225mW	SOT-23	16dc	-	3a	Lge
A0	HSMS-2800	Si-diode	Schottky, RF, 70V, 1A, Vf<0.41V(1mA), <2pF, 35Q(5mA)	SOT-23	16dc	-	3a	Agj
A0	HSMS-280B	Si-diode	Schottky, RF, 70V, 1A, Vf<0.41V(1mA), <2pF, 35Q(5mA)	SOT-323	16dc	-	3a	Agj
A0	MC2837	Si-diode	2x Sw, Hi-sp, 80V, 100mA, Vf<1.2V(100mA), 0.9pF, <4ns	SC-59	16dl	-	3a	Mit
A0	RT9161-16CV	LVR-IC	LDO, 1.6V±2%, 300mA	SOT-23	16cg	VR1	3a	Rct
A0	RT9818C-20CU3	Vdet-IC	2.0V±1.5%, -Reset ODO, Td=220ms	SOT-323	16vdc	VD6	3a	Rct
A01	SST201	n-FET	AF, LN, 40V, 350mW, Idss=0.2..1mA, Up<1.5V	SOT-23	16fj	-	3a	Cal
A01	SST203	n-FET	AF, LN, 40V, 350mW, Idss=4..20mA, Up<10V	SOT-23	16fj	-	3a	Cal
A02	SST202	n-FET	AF, LN, 40V, 350mW, Idss=0.9..4.5mA, Up<4V	SOT-23	16fj	-	3a	Cal
A04	SST204	n-FET	AF, LN, 25V, 350mW, Idss=0.2..3mA, Up<2V	SOT-23	16fj	-	3a	Cal
A09	ELM9709NBB	Vdet-IC	0.9V±2.5%, +Reset ODO	SOT-23	16vdb	VD6	3d	Elm
A1	2SJ243	p-MOSFET-e*	V-MOS, Sw, 30V, ±0.1A, 200mW, 10/130ns, <25Q(10mA)	SOT-323	16fh	-	3a	Nec
A1	BAW56	Si-diode	Dual, Sw, 70V, 200mA, 250mW, Vf<1.25V, 2pF, <6ns	SOT-23	16df	-	3a	All
A1	BAW56L	Si-diode	Dual, Sw, 70V, 200mA, 250mW, Vf<1.25V, 2pF, <6ns	SOT-23	16df	-	3a	Ons
A1	BAW56PT	Si-diode	Dual, Sw, 85V, 150mA, Vf<1.25V(150mA), 4ns	SOT-23	16df	-	3a	Chm
A1	BAW56T	Si-diode	Dual, Sw, 70V, 200mA, 250mW, Vf<1.25V, 2pF, <6ns	SOT-416	16df	-	3a	Ons
A1	BAW56TPT	Si-diode	Dual, Sw, 85V, 150mA, Vf<1.25V(150mA), 4ns	SOT-416	16df	-	3a	Chm
A1	BAW56W	Si-diode	Dual, Hi-Speed, 70V, 200mA, 200mW, 2pF, 4ns	SOT-323	16df	-	3a	Ons
A1	CHP202KPT	Si-diode	Dual, Sw, 80V, 100mA, Vf<1.2V(100mA), 4ns	SOT-23	16df	-	3a	Chm
A1	CHP222PT	Si-diode	Dual, Sw, 80V, 100mA, Vf<1.2V(100mA), 4ns	SOT-416	16df	-	3a	Chm
A1	DSE015	Si-diode	Sw, Hi-sp, 75V, 150mA, Vf<1.2V(100mA), 8ns, 12.5MHz	MCP	16eb	-	3a	San
A1	MC2831	Si-diode	Sw, Hi-sp, 50V, 100mA, Vf<1.2V(100mA), 2.8pF, <4ns	SC-59	16eb	-	3a	Mit
A1	MC2841	Si-diode	Sw, Hi-sp, 50V, 100mA, Vf<1.2V(100mA), 2.8pF, <4ns	SOT-323	16eb	-	3a	Mit
A1	RT9161-17CV	LVR-IC	LDO, 1.7V±2%, 300mA	SOT-23	16cg	VR1	3a	Rct
A1	RT9818C-22CU3	Vdet-IC	2.2V±1.5%, -Reset ODO, Td=220ms	SOT-323	16vdc	VD6	3a	Rct
A1	Si2301DS	p-MOSFET-e	V-MOS, LogL, 12V, 2.3A, <0.19Q	SOT-23	16fh	-	3a	Six
A10	ELM9710NBB	Vdet-IC	1.0V±2.5%, +Reset ODO	SOT-23	16vdb	VD6	3d	Elm



SMD code	Type	Function	Short description	Case	Pinout	Sch.	St.	Mnf.
A11	AIC1747-11GJ3	LVR-IC	LDO, 1.1V±2%, 300mA	SOT-323	16cg	VR1	3a	Aic
A11	ELM9711NBB	Vdet-IC	1.1V±2.5%, +Reset ODO	SOT-23	16vdb	VD6	3d	Elm
A11	MMBD1501A	Si-diode	Sw 180V, 200mA, Vf<1.5V(300mA), <4pF	SOT-23	16dc	-	3a	Nsc
A11	MMBD1701A	Si-diode	Fast, 30V, 150mA, 350mW, Vf<1.1V(50mA), 1ns	SOT-23	16dc	-	3a	Nsc
A11	MMBD4148CC	Si-diode	Dual, Sw, Fast, 75V, 200mA, 350mW, <4ns, 4pF	SOT-23	16dg	-	3a	Nsc
A11A	ML6101C113M	Vdet-IC	1.1V±3%, +Reset PPO	SOT-23	16vdb	VD7	3a	Mlc
A12	AIC1747-12GJ3	LVR-IC	LDO, 1.2V±2%, 300mA	SOT-323	16cg	VR1	3a	Aic
A12	ELM9712NBB	Vdet-IC	1.2V±2.5%, +Reset ODO	SOT-23	16vdb	VD6	3d	Elm
A12A	ML6101C123M	Vdet-IC	1.2V±3%, +Reset PPO	SOT-23	16vdb	VD7	3a	Mlc
A13	1SS220	Si-diode	Sw, Fast, 70V, 100mA, <3ns	SOT-23	16dr	-	3a	Nec
A13	AIC1747-13GJ3	LVR-IC	LDO, 1.3V±2%, 300mA	SOT-323	16cg	VR1	3a	Aic
A13	ELM9713NBB	Vdet-IC	1.3V±2.5%, +Reset ODO	SOT-23	16vdb	VD6	3d	Elm
A13	MMBD1503A	Si-diode	Dual 180V, 200mA, Vf<1.5V(300mA), <4pF	SOT-23	16dl	-	3a	Nsc
A13	MMBD1703A	Si-diode	Dual, Fast, 30V, 150mA, 350mW, Vf<1.1V(50mA), 1ns	SOT-23	16dl	-	3a	Nsc
A13	MMBD4148SE	Si-diode	Dual, Sw, Fast, 75V, 200mA, 350mW, <4ns, 4pF	SOT-23	16dl	-	3a	Nsc
A13A	ML6101C133M	Vdet-IC	1.3V±3%, +Reset PPO	SOT-23	16vdb	VD7	3a	Mlc
A14	1SS221	Si-diode	Sw, Fast, 100V, 100mA, <3ns	SOT-23	16dr	-	3a	Nec
A14	ELM9714NBB	Vdet-IC	1.4V±2.5%, +Reset ODO	SOT-23	16vdb	VD6	3d	Elm
A14	MMBD1504A	Si-diode	Dual, Sw, 180V, 200mA, Vf<1.5V(300mA), <4pF	SOT-23	16dg	-	3a	Nsc
A14	MMBD1704A	Si-diode	Dual, Fast, 30V, 150mA, 350mW, Vf<1.1V(50mA), 1ns	SOT-23	16dg	-	3a	Nsc
A14A	ML6101C143M	Vdet-IC	1.4V±3%, +Reset PPO	SOT-23	16vdb	VD7	3a	Mlc
A15	1SS222	Si-diode	Sw, Fast, 70V, 100mA, <3ns	SOT-23	16ak	-	3b	Nec
A15	AIC1747-15GJ3	LVR-IC	LDO, 1.5V±2%, 300mA	SOT-323	16cg	VR1	3a	Aic
A15	ELM9715NBB	Vdet-IC	1.5V±2.5%, +Reset ODO	SOT-23	16vdb	VD6	3d	Elm
A15	MMBD1505A	Si-diode	Dual, Sw, 180V, 200mA, Vf<1.5V(300mA), <4pF	SOT-23	16df	-	3a	Nsc
A15	MMBD1705	Si-diode	Dual, Fast, 30V, 150mA, 350mW, Vf<1.1V(50mA), 0.7ns	SOT-23	16df	-	3a	Nsc
A15	XC31PNS0015AM	LVR-IC	Temperature Sensitive, -T*factor, 1.5V±5%, 50mA	SOT-23	16cg	VR1	3d	Tor
A15	XC31PPS0015AM	LVR-IC	Temperature Sensitive, +T*factor, 1.5V±5%, 50mA	SOT-23	16cg	VR1	3d	Tor
A15A	ML6101C153M	Vdet-IC	1.5V±3%, +Reset PPO	SOT-23	16vdb	VD7	3a	Mlc
A16	1SS223	Si-diode	Sw, Fast, 100V, 100mA, <3ns	SOT-23	16ak	-	3b	Nec
A16	ELM9716NBB	Vdet-IC	1.6V±2.5%, +Reset ODO	SOT-23	16vdb	VD6	3d	Elm
A16	XC31PNS0016AM	LVR-IC	Temperature Sensitive, -T*factor, 1.6V±5%, 50mA	SOT-23	16cg	VR1	3d	Tor
A16	XC31PPS0016AM	LVR-IC	Temperature Sensitive, +T*factor, 1.6V±5%, 50mA	SOT-23	16cg	VR1	3d	Tor
A16	ZC934ATA	C-diode	VHF-Tuning, 12V, 47/57.7pF(2.5V), Q>80	SOT-23	16dc	-	3a	Zx
A16A	ML6101C163M	Vdet-IC	1.6V±3%, +Reset PPO	SOT-23	16vdb	VD7	3a	Mlc
A17	2SK436-17	n-FET	RF-AM, LN, 15V, 20mA, 150mW, Ids=1.2..2.1mA	SOT-23	16fa	-	3a	San
A17	ELM9717NBB	Vdet-IC	1.7V±2.5%, +Reset ODO	SOT-23	16vdb	VD6	3d	Elm
A17	XC31PNS0017AM	LVR-IC	Temperature Sensitive, -T*factor, 1.7V±5%, 50mA	SOT-23	16cg	VR1	3d	Tor
A17	XC31PPS0017AM	LVR-IC	Temperature Sensitive, +T*factor, 1.7V±5%, 50mA	SOT-23	16cg	VR1	3d	Tor
A17	ZC933ATA	C-diode	VHF-Tuning, 12V, 20.25/24.75pF, Q>150	SOT-23	16dc	-	3a	Zx
A17A	ML6101C173M	Vdet-IC	1.7V±3%, +Reset PPO	SOT-23	16vdb	VD7	3a	Mlc
A18	2SK436-18	n-FET	RF-AM, LN, 15V, 20mA, 150mW, Ids=1.7..3mA	SOT-23	16fa	-	3a	San
A18	AIC1747-18GJ3	LVR-IC	LDO, 1.8V±2%, 300mA	SOT-323	16cg	VR1	3a	Aic
A18	ELM9718NBB	Vdet-IC	1.8V±2.5%, +Reset ODO	SOT-23	16vdb	VD6	3d	Elm
A18	XC31PNS0018AM	LVR-IC	Temperature Sensitive, -T*factor, 1.8V±5%, 50mA	SOT-23	16cg	VR1	3d	Tor
A18	XC31PPS0018AM	LVR-IC	Temperature Sensitive, +T*factor, 1.8V±5%, 50mA	SOT-23	16cg	VR1	3d	Tor
A18A	ML6101C183M	Vdet-IC	1.8V±3%, +Reset PPO	SOT-23	16vdb	VD7	3a	Mlc
A19	2SK436-19	n-FET	RF-AM, LN, 15V, 20mA, 150mW, Ids=2.5..4.2mA	SOT-23	16fa	-	3a	San
A19	ELM9719NBB	Vdet-IC	1.9V±2.5%, +Reset ODO	SOT-23	16vdb	VD6	3d	Elm
A19	XC31PNS0019AM	LVR-IC	Temperature Sensitive, -T*factor, 1.9V±5%, 50mA	SOT-23	16cg	VR1	3d	Tor
A19	XC31PPS0019AM	LVR-IC	Temperature Sensitive, +T*factor, 1.9V±5%, 50mA	SOT-23	16cg	VR1	3d	Tor
A19A	ML6101C193M	Vdet-IC	1.9V±3%, +Reset PPO	SOT-23	16vdb	VD7	3a	Mlc
A1p	BAW56	Si-diode	Dual, Sw, 70V, 200mA, 250mW, Vf<1.25V, 2pF, <6ns	SOT-23	16df	-	3a	PHH
A1s	BAW56	Si-diode	Dual, Sw, 70V, 200mA, 250mW, Vf<1.25V, 2pF, <6ns	SOT-23	16df	-	3a	Sie
A1s	BAW56W	Si-diode	Dual, Hi-Speed, 75V, 150mA, 200mW, 2pF, 4ns	SOT-323	16df	-	3a	Sie
A1t	BAW56	Si-diode	Dual, Sw, 70V, 200mA, 250mW, Vf<1.25V, 2pF, <6ns	SOT-23	16df	-	3a	PHM
A1W	BAW56	Si-diode	Dual, Sw, 70V, 200mA, 250mW, Vf<1.25V, 2pF, <6ns	SOT-23	16df	-	3a	PhC
A2	BAS16T	Si-diode	Sw, Fast, 75V, 155mA, 170mW, <6ns	SOT-416	16dc	-	3a	Di
A2	BAS16W	Si-diode	Sw, Fast, 75V, 300mA, Vf<1.25V(150mA), 4ns, 2pF	SOT-323	16dc	-	3a	Di
A2	BAS21PT	Si-diode	Sw, 250V, 250mA, Vf<1.25V(200mA), 50ns	SOT-23	16dc	-	3a	Chm
A2	BAT18	PIN-diode	Sw, 35V, 100mA, Vf<1.2V, Cd<1pF	SOT-23	16dc	-	3a	Phi
A2	DSB015	Si-diode	Sw, Hi-sp, 75V, 150mA, Vf<1.2V(100mA), 5ns, 20MHz	CP	16dc	-	3a	San
A2	DSH015	Si-diode	Sw, Hi-sp, 75V, 150mA, Vf<1.2V(100mA), 5ns, 20MHz	MCP	16dc	-	3a	San
A2	FMMD2B36	C-diode	Dual, 75V, 100mA, Cd<4pF, <6ns	SOT-23	16df	-	3a	Zx
A2	HSMS-2802	Si-diode	2x Schottky, RF, 70V, 1A, Vf<0.41V(1mA), <2pF, 35Ω(5mA)	SOT-23	16dl	-	3a	Agi
A2	HSMS-280C	Si-diode	2x Schottky, RF, 70V, 1A, Vf<0.41V(1mA), <2pF, 35Ω(5mA)	SOT-323	16dl	-	3a	Agi
A2	KV1520	C-diode	Dual, AM-Tuning, 20V, 50mA, 100mW, 143/35pF(6.5..1V)	SOT-23	16dg	-	3a	Tok
A2	MC2833	Si-diode	Sw, Hi-sp, 50V, 100mA, Vf<1.2V(100mA), 2.8pF, <4ns	SC-59	16ak	-	3a	Mit
A2	MC2843	Si-diode	Sw, Hi-sp, 50V, 100mA, Vf<1.2V(100mA), 2.8pF, <4ns	SOT-323	16ak	-	3a	Mit
A2	MIC803-40D2VC3	Vdet-IC	4.0V±2.5%, -Reset ODO, 20ms	SC-70	16vdc	VD7	3a	Mcr



SMD code	Type	Function	Short description	Case	Pinout	Sch.	St.	Mnf.
A2	MIC803-40D2VM3	Vdet-IC	4.0V±2.5%, -Reset ODO, 20ms	SOT-23	16vdc	VD7	3a	Mer
A2	MIMBD4148	Si-diode	Sw, Fast, 75V, 200mA, 350mW, <4ns, 4pF	SOT-23	16dc	-	3g	Pjt
A2	MIMBD4148W	Si-diode	Sw, Fast, 75V, 300mA, Vf<1.25V(150mA), <4ns, 2pF	SOT-323	16dc	-	3a	Di
A2	R3113D121A	Vdet-IC	1.2V±2%, -Reset, ODO	SON11408-3	18vda	VD6	3d	Ric
A2	RT9161-18CV	LVR-IC	LDO, 1.8V±2%, 300mA	SOT-23	16cg	VR1	3a	Rct
A2	SI2302DS	n-MOSFET-e	n-MOS, LogL, 20V, ±2.8A, <155mΩ	SOT-23	16fh	-	3a	Six
A2-	RT9161-18PV	LVR-IC	LDO, 1.8V±2%, 300mA	SOT-23	16cg	VR1	3a	Rct
A2-	RT9818C-29PU3	Vdet-IC	2.9V±1.5%, -Reset ODO, Td=220ms	SOT-323	16vdc	VD6	3a	Rct
A20	2SK1066-20	n-FET	GP, 15V, 20mA, 100mW, Idss=3.5.6mA, Up<1.5V	MCP	16fa	-	3a	San
A20	2SK436-20	n-FET	RF-AM, LN, 15V, 20mA, 150mW, Idss=3.5.6mA	SOT-23	16fa	-	3a	San
A20	AIC1747-20GJ3	LVR-IC	LDO, 2.0V±2%, 300mA	SOT-323	16cg	VR1	3a	Aic
A20	ELM9720NBB	Vdet-IC	2.0V±2.5%, +Reset ODO	SOT-23	16vdc	VD6	3d	Elm
A20	XC31PNS0020AM	LVR-IC	Temperature Sensitive, -T*factor, 2V±5%, 50mA	SOT-23	16cg	VR1	3d	Tor
A20	XC31PPS0020AM	LVR-IC	Temperature Sensitive, +T*factor, 2V±5%, 50mA	SOT-23	16cg	VR1	3d	Tor
A20A	ML6101C202M	Vdet-IC	2.0V±2%, +Reset PPO	SOT-23	16vdc	VD7	3a	Mlc
A21	2SK1066-21	n-FET	GP, 15V, 20mA, 100mW, Idss=5.8.5mA, Up<1.5V	MCP	16fa	-	3a	San
A21	2SK436-21	n-FET	RF-AM, LN, 15V, 20mA, 150mW, Idss=5.8.5mA	SOT-23	16fa	-	3a	San
A21	ELM9721NBB	Vdet-IC	2.1V±2.5%, +Reset ODO	SOT-23	16vdc	VD6	3d	Elm
A21	GS809C21EUA	Vdet-IC	2.1V, -Reset PPO, 1.5ms	SOT-23	16vdc	VD7	3g	Vs
A21	XC31PNS0021AM	LVR-IC	Temperature Sensitive, -T*factor, 2.1V±5%, 50mA	SOT-23	16cg	VR1	3d	Tor
A21	XC31PPS0021AM	LVR-IC	Temperature Sensitive, +T*factor, 2.1V±5%, 50mA	SOT-23	16cg	VR1	3d	Tor
A21A	ML6101C212M	Vdet-IC	2.1V±2%, +Reset PPO	SOT-23	16vdc	VD7	3a	Mlc
A22	2SK1066-22	n-FET	GP, 15V, 20mA, 100mW, Idss=7.3.12mA, Up<1.5V	MCP	16fa	-	3a	San
A22	2SK436-22	n-FET	RF-AM, LN, 15V, 20mA, 150mW, Idss=7.3.12mA	SOT-23	16fa	-	3a	San
A22	ELM9722NBB	Vdet-IC	2.2V±2.5%, +Reset ODO	SOT-23	16vdc	VD6	3d	Elm
A22	XC31PNS0022AM	LVR-IC	Temperature Sensitive, -T*factor, 2.2V±5%, 50mA	SOT-23	16cg	VR1	3d	Tor
A22	XC31PPS0022AM	LVR-IC	Temperature Sensitive, +T*factor, 2.2V±5%, 50mA	SOT-23	16cg	VR1	3d	Tor
A22A	ML6101C222M	Vdet-IC	2.2V±2%, +Reset PPO	SOT-23	16vdc	VD7	3a	Mlc
A23	ELM9723NBB	Vdet-IC	2.3V±2.5%, +Reset ODO	SOT-23	16vdc	VD6	3d	Elm
A23	XC31PNS0023AM	LVR-IC	Temperature Sensitive, -T*factor, 2.3V±5%, 50mA	SOT-23	16cg	VR1	3d	Tor
A23	XC31PPS0023AM	LVR-IC	Temperature Sensitive, +T*factor, 2.3V±5%, 50mA	SOT-23	16cg	VR1	3d	Tor
A23A	ML6101C232M	Vdet-IC	2.3V±2%, +Reset PPO	SOT-23	16vdc	VD7	3a	Mlc
A24	ELM9724NBB	Vdet-IC	2.4V±2.5%, +Reset ODO	SOT-23	16vdc	VD6	3d	Elm
A24	GS809C24EUA	Vdet-IC	2.4V, -Reset PPO, 1.5ms	SOT-23	16vdc	VD7	3g	Vs
A24	XC31PNS0024AM	LVR-IC	Temperature Sensitive, -T*factor, 2.4V±5%, 50mA	SOT-23	16cg	VR1	3d	Tor
A24	XC31PPS0024AM	LVR-IC	Temperature Sensitive, +T*factor, 2.4V±5%, 50mA	SOT-23	16cg	VR1	3d	Tor
A24A	ML6101C242M	Vdet-IC	2.4V±2%, +Reset PPO	SOT-23	16vdc	VD7	3a	Mlc
A25	AIC1747-25GJ3	LVR-IC	LDO, 2.5V±2%, 300mA	SOT-323	16cg	VR1	3a	Aic
A25	ELM9725NBB	Vdet-IC	2.5V±2.5%, +Reset ODO	SOT-23	16vdc	VD6	3d	Elm
A25	XC31PNS0025AM	LVR-IC	Temperature Sensitive, -T*factor, 2.5V±5%, 50mA	SOT-23	16cg	VR1	3d	Tor
A25	XC31PPS0025AM	LVR-IC	Temperature Sensitive, +T*factor, 2.5V±5%, 50mA	SOT-23	16cg	VR1	3d	Tor
A25A	ML6101C252M	Vdet-IC	2.5V±2%, +Reset PPO	SOT-23	16vdc	VD7	3a	Mlc
A26	ELM9726NBB	Vdet-IC	2.6V±2.5%, +Reset ODO	SOT-23	16vdc	VD6	3d	Elm
A26	GS809CREUA	Vdet-IC	2.63V, -Reset PPO, 1.5ms	SOT-23	16vdc	VD7	3g	Vs
A26	KTF810T-2.63	Vdet-IC	2.63V±1.5%, +Reset PPO	SOT-23	16vdc	VD7	3a	Icm
A26	XC31PNS0026AM	LVR-IC	Temperature Sensitive, -T*factor, 2.6V±5%, 50mA	SOT-23	16cg	VR1	3d	Tor
A26	XC31PPS0026AM	LVR-IC	Temperature Sensitive, +T*factor, 2.6V±5%, 50mA	SOT-23	16cg	VR1	3d	Tor
A26A	ML6101C262M	Vdet-IC	2.6V±2%, +Reset PPO	SOT-23	16vdc	VD7	3a	Mlc
A27	AIC1747-27GJ3	LVR-IC	LDO, 2.7V±2%, 300mA	SOT-323	16cg	VR1	3a	Aic
A27	ELM9727NBB	Vdet-IC	2.7V±2.5%, +Reset ODO	SOT-23	16vdc	VD6	3d	Elm
A27	GS809C27SEUA	Vdet-IC	2.7V, -Reset PPO, 1.5ms	SOT-23	16vdc	VD7	3g	Vs
A27	XC31PNS0027AM	LVR-IC	Temperature Sensitive, -T*factor, 2.7V±5%, 50mA	SOT-23	16cg	VR1	3d	Tor
A27	XC31PPS0027AM	LVR-IC	Temperature Sensitive, +T*factor, 2.7V±5%, 50mA	SOT-23	16cg	VR1	3d	Tor
A27A	ML6101C272M	Vdet-IC	2.7V±2%, +Reset PPO	SOT-23	16vdc	VD7	3a	Mlc
A28	ELM9728NBB	Vdet-IC	2.8V±2.5%, +Reset ODO	SOT-23	16vdc	VD6	3d	Elm
A28	XC31PNS0028AM	LVR-IC	Temperature Sensitive, -T*factor, 2.8V±5%, 50mA	SOT-23	16cg	VR1	3d	Tor
A28	XC31PPS0028AM	LVR-IC	Temperature Sensitive, +T*factor, 2.8V±5%, 50mA	SOT-23	16cg	VR1	3d	Tor
A28A	ML6101C282M	Vdet-IC	2.8V±2%, +Reset PPO	SOT-23	16vdc	VD7	3a	Mlc
A29	ELM9729NBB	Vdet-IC	2.9V±2.5%, +Reset ODO	SOT-23	16vdc	VD6	3d	Elm
A29	GS809CSEUA	Vdet-IC	2.93V, -Reset PPO, 1.5ms	SOT-23	16vdc	VD7	3g	Vs
A29	KTF810T-2.93	Vdet-IC	2.93V±1.5%, +Reset PPO	SOT-23	16vdc	VD7	3a	Icm
A29	XC31PNS0029AM	LVR-IC	Temperature Sensitive, -T*factor, 2.9V±5%, 50mA	SOT-23	16cg	VR1	3d	Tor
A29	XC31PPS0029AM	LVR-IC	Temperature Sensitive, +T*factor, 2.9V±5%, 50mA	SOT-23	16cg	VR1	3d	Tor
A29A	ML6101C292M	Vdet-IC	2.9V±2%, +Reset PPO	SOT-23	16vdc	VD7	3a	Mlc
A2J	AIC1747-285GJ3	LVR-IC	LDO, 2.85V±2%, 300mA	SOT-323	16cg	VR1	3a	Aic
A2X	MIMBD2836	Si-diode	Dual, Sw, 75V, 100mA, 225mW, Vf<1.2V(100mA), <15ns	SOT-23	16df	-	3a	Ons
A3	1PS300	Si-diode	Dual, Sw, Fast, 85V, 85mA, <4ns	SOT-323	16df	-	3a	Phi
A3	1S2835	Si-diode	Dual, Sw, Fast, 35V, 150mA, <4ms	SOT-23	16df	-	3a	Nec
A3	1SS181	Si-diode	Dual, Sw, U-Fst, 85V, 100mA, 150mW, Vf<1.2V(100mA), <4ns	SC-59	16df	-	3a	Tos
A3	1SS300	Si-diode	Dual, 80V, 100mA, Vf<1.2V(100mA), <4ns	SOT-323	16df	-	3a	Tos



SMD code	Type	Function	Short description	Case	Pinout	Sch. St.	Mnf.
A3	1SS360	Si-diode	Dual, Sw, U-Fast, 85V, 100mA, 150mW, Vf<1.2V(0.1A), <4ns	SOT-23	16df	-	3a Tos
A3	1SS360F	Si-diode	Dual, Sw, U-Fast, 85V, 100mA, 150mW, Vf<1.2V(0.1A), <4ns	SOT-23F	18df	-	3a Tos
A3	BAS16	Si-diode	Sw, Fast, 75V, 215mA, 250mW, <6ns	SOT-23	16dc	-	3a Zx
A3	HSMS-2803	Si-diode	Dual, Schottky, RF, 70V, 1A, Vf<0.41V(1mA), <2pF, 35Q(5mA)	SOT-23	16df	-	3a Agi
A3	HSMS-280E	Si-diode	Dual, Schottky, RF, 70V, 1A, Vf<0.41V(1mA), <2pF, 35Q(5mA)	SOT-323	16df	-	3a Agi
A3	MBT3906DW	Si-pnp	GP, 40V, 200mA, 250mW, B=60...300, >250MHz	SOT-363	16ta	-	3a Mot
A3	MC2832	Si-diode	Sw, Hi-sp, 50V, 100mA, Vf<1.2V(100mA), 1.3pF, <4ns	SC-59	16dc	-	3a Mit
A3	MC2842	Si-diode	Sw, Hi-sp, 50V, 100mA, Vf<1.2V(100mA), 1.3pF, <4ns	SOT-323	16dc	-	3a Mit
A3	MC2852	Si-diode	Sw, Hi-sp, 50V, 100mA, Vf<1.2V(100mA), 1.3pF, <4ns	SC-90	16dc	-	3a Mit
A3	MIC803-29D4VC3	Vdet-IC	2.93V±2.5%, -Reset ODO, 1120ms	SC-70	16vdc	VD7	3a Mcr
A3	MIC803-29D4VM3	Vdet-IC	2.93V±2.5%, -Reset ODO, 1120ms	SOT-23	16vdc	VD7	3a Mcr
A3	MMBD1005	Si-diode	Dual, Sw, 30V, 200mA, 225mW, Vf<0.95V(10mA), <2pF	SOT-23	16df	-	3a Mot
A3	MMBD4448	Si-diode	Sw, Fast, 80V, 500mA, Vf<1V(100mA), <4ns	SOT-23	16dc	-	3g Pjt
A3	MMBD4448HT	Si-diode	Sw, Fast, 75V, 500mA, Vf<1.25V(150mA), <4ns	SOT-523	16dc	-	3a Di
A3	R3113D131A	Vdet-IC	1.3V±2%, -Reset, ODO	SON1408-3	18vda	VD6	3d Ric
A3	RT9161-19CV	LVR-IC	LDO, 1.9V±2%, 300mA	SOT-23	16cg	VR1	3a Rct
A3	Si2303DS	p-MOSFET-e	V-MOS, LogL, 30V, 1.7A, <0.48Q	SOT-23	16fh	-	3a Six
A3-	RT9818B-25PU3	Vdet-IC	2.5V±1.5%, -Reset ODO, Td=55ms	SOT-323	16vdc	VD6	3a Rct
A30	AIC1747-30GJ3	LVR-IC	LDO, 3.0V±2%, 300mA	SOT-323	16cg	VR1	3a Aic
A30	ELM9730NBB	Vdet-IC	3.0V±2.5%, +Reset ODO	SOT-23	16vdb	VD6	3d Elm
A30	GS809CTEUA	Vdet-IC	3.08V, -Reset PPO, 1.5ms	SOT-23	16vdc	VD7	3g Vs
A30	KTF810T-3.08	Vdet-IC	3.08V±1.5%, +Reset PPO	SOT-23	16vdc	VD7	3a lcm
A30	XC31PNS0030AM	LVR-IC	Temperature Sensitive, -T*factor, 3V±5%, 50mA	SOT-23	16cg	VR1	3d Tor
A30	XC31PPS0030AM	LVR-IC	Temperature Sensitive, +T*factor, 3V±5%, 50mA	SOT-23	16cg	VR1	3d Tor
A30A	ML6101C302M	Vdet-IC	3.0V±2%, +Reset PPO	SOT-23	16vdb	VD7	3a Mic
A31	ELM9731NBB	Vdet-IC	3.1V±2.5%, +Reset ODO	SOT-23	16vdb	VD6	3d Elm
A31	XC31PNS0031AM	LVR-IC	Temperature Sensitive, -T*factor, 3.1V±5%, 50mA	SOT-23	16cg	VR1	3d Tor
A31	XC31PPS0031AM	LVR-IC	Temperature Sensitive, +T*factor, 3.1V±5%, 50mA	SOT-23	16cg	VR1	3d Tor
A31A	ML6101C312M	Vdet-IC	3.1V±2%, +Reset PPO	SOT-23	16vdb	VD7	3a Mic
A32	ELM9732NBB	Vdet-IC	3.2V±2.5%, +Reset ODO	SOT-23	16vdb	VD6	3d Elm
A32	XC31PNS0032AM	LVR-IC	Temperature Sensitive, -T*factor, 3.2V±5%, 50mA	SOT-23	16cg	VR1	3d Tor
A32	XC31PPS0032AM	LVR-IC	Temperature Sensitive, +T*factor, 3.2V±5%, 50mA	SOT-23	16cg	VR1	3d Tor
A32A	ML6101C322M	Vdet-IC	3.2V±2%, +Reset PPO	SOT-23	16vdb	VD7	3a Mic
A33	AIC1747-33GJ3	LVR-IC	LDO, 3.3V±2%, 300mA	SOT-323	16cg	VR1	3a Aic
A33	ELM9733NBB	Vdet-IC	3.3V±2.5%, +Reset ODO	SOT-23	16vdb	VD6	3d Elm
A33	XC31PNS0033AM	LVR-IC	Temperature Sensitive, -T*factor, 3.3V±5%, 50mA	SOT-23	16cg	VR1	3d Tor
A33	XC31PPS0033AM	LVR-IC	Temperature Sensitive, +T*factor, 3.3V±5%, 50mA	SOT-23	16cg	VR1	3d Tor
A33A	ML6101C332M	Vdet-IC	3.3V±2%, +Reset PPO	SOT-23	16vdb	VD7	3a Mic
A34	ELM9734NBB	Vdet-IC	3.4V±2.5%, +Reset ODO	SOT-23	16vdb	VD6	3d Elm
A34	XC31PNS0034AM	LVR-IC	Temperature Sensitive, -T*factor, 3.4V±5%, 50mA	SOT-23	16cg	VR1	3d Tor
A34	XC31PPS0034AM	LVR-IC	Temperature Sensitive, +T*factor, 3.4V±5%, 50mA	SOT-23	16cg	VR1	3d Tor
A34A	ML6101C342M	Vdet-IC	3.4V±2%, +Reset PPO	SOT-23	16vdb	VD7	3a Mic
A35	AIC1747-35GJ3	LVR-IC	LDO, 3.5V±2%, 300mA	SOT-323	16cg	VR1	3a Aic
A35	ELM9735NBB	Vdet-IC	3.5V±2.5%, +Reset ODO	SOT-23	16vdb	VD6	3d Elm
A35	XC31PNS0035AM	LVR-IC	Temperature Sensitive, -T*factor, 3.5V±5%, 50mA	SOT-23	16cg	VR1	3d Tor
A35	XC31PPS0035AM	LVR-IC	Temperature Sensitive, +T*factor, 3.5V±5%, 50mA	SOT-23	16cg	VR1	3d Tor
A35A	ML6101C352M	Vdet-IC	3.5V±2%, +Reset PPO	SOT-23	16vdb	VD7	3a Mic
A36	ELM9736NBB	Vdet-IC	3.6V±2.5%, +Reset ODO	SOT-23	16vdb	VD6	3d Elm
A36	XC31PNS0036AM	LVR-IC	Temperature Sensitive, -T*factor, 3.6V±5%, 50mA	SOT-23	16cg	VR1	3d Tor
A36	XC31PPS0036AM	LVR-IC	Temperature Sensitive, +T*factor, 3.6V±5%, 50mA	SOT-23	16cg	VR1	3d Tor
A36A	ML6101C362M	Vdet-IC	3.6V±2%, +Reset PPO	SOT-23	16vdb	VD7	3a Mic
A37	AIC1747-37GJ3	LVR-IC	LDO, 3.7V±2%, 300mA	SOT-323	16cg	VR1	3a Aic
A37	ELM9737NBB	Vdet-IC	3.7V±2.5%, +Reset ODO	SOT-23	16vdb	VD6	3d Elm
A37	XC31PNS0037AM	LVR-IC	Temperature Sensitive, -T*factor, 3.7V±5%, 50mA	SOT-23	16cg	VR1	3d Tor
A37	XC31PPS0037AM	LVR-IC	Temperature Sensitive, +T*factor, 3.7V±5%, 50mA	SOT-23	16cg	VR1	3d Tor
A37A	ML6101C372M	Vdet-IC	3.7V±2%, +Reset PPO	SOT-23	16vdb	VD7	3a Mic
A38	AIC1747-38GJ3	LVR-IC	LDO, 3.8V±2%, 300mA	SOT-323	16cg	VR1	3a Aic
A38	ELM9738NBB	Vdet-IC	3.8V±2.5%, +Reset ODO	SOT-23	16vdb	VD6	3d Elm
A38	XC31PNS0038AM	LVR-IC	Temperature Sensitive, -T*factor, 3.8V±5%, 50mA	SOT-23	16cg	VR1	3d Tor
A38	XC31PPS0038AM	LVR-IC	Temperature Sensitive, +T*factor, 3.8V±5%, 50mA	SOT-23	16cg	VR1	3d Tor
A38A	ML6101C382M	Vdet-IC	3.8V±2%, +Reset PPO	SOT-23	16vdb	VD7	3a Mic
A39	ELM9739NBB	Vdet-IC	3.9V±2.5%, +Reset ODO	SOT-23	16vdb	VD6	3d Elm
A39	XC31PNS0039AM	LVR-IC	Temperature Sensitive, -T*factor, 3.9V±5%, 50mA	SOT-23	16cg	VR1	3d Tor
A39	XC31PPS0039AM	LVR-IC	Temperature Sensitive, +T*factor, 3.9V±5%, 50mA	SOT-23	16cg	VR1	3d Tor
A39A	ML6101C392M	Vdet-IC	3.9V±2%, +Reset PPO	SOT-23	16vdb	VD7	3a Mic
A3p	BAT17	Si-diode	Schottky, UHF-Mix, 4V, 130mA, Vf<0.6V(10mA), Cd<0.75pF	SOT-23	16dc	-	3a Phi
A3T	1PS181	Si-diode	Dual, Hi-Speed, 85V, 215mA, 250mW, Vf<0.2pF, <4ns	SC-59	16df	-	3a PHH
A3t	BAT17	Si-diode	Schottky, UHF-Mix, 4V, 130mA, Vf<0.6V(10mA), Cd<0.75pF	SOT-23	16dc	-	3a PhiM
A3W	BAT17	Si-diode	Schottky, UHF-Mix, 4V, 130mA, Vf<0.6V(10mA), Cd<0.75pF	SOT-23	16dc	-	3a PhC
A3X	MMBD2835	Si-diode	Dual, Sw, 35V, 100mA, 225mW, Vf<1.2V(100mA), <15ns	SOT-23	16df	-	3a Ons



SMD code	Type	Function	Short description	Case	Pinout	Sch.	St.	Mnf.
A4	1S2836	Si-diode	Dual, Sw, Fast, 75V, 150mA, <4ms	SOT-23	16df	-	3a	Nec
A4	BAV70	Si-diode	Dual, Sw, 75V, 215mA, Vf<1.25V, <4ns	SOT-23	16dg	-	3a	Nsc
A4	BAV70PT	Si-diode	Dual, Sw, 75V, 250mA, Vf<1.25V(150mA), 4ns	SOT-23	16dg	-	3a	Chm
A4	BAV70T	Si-diode	Dual, Sw, 70V, 200mA, 225mW, Vf<1.25V, <4ns	SOT-416	16dg	-	3a	Ons
A4	BAV70TPT	Si-diode	Dual, Sw, 75V, 150mA, Vf<1.25V(150mA), 4ns	SOT-416	16dg	-	3a	Chm
A4	BAV70W	Si-diode	Dual, Sw, 75V, 215mA, 225mW, Vf<1.25V, <4ns	SOT-323	16dg	-	3a	Ons
A4	BB404A	C-diode	Dual, 10V, 43.5..27.5pF(2..8V), 100MHz	SOT-23	16dg	-	3a	lIt
A4	CHN202KPT	Si-diode	Dual, Sw, 80V, 100mA, Vf<1.2V(100mA), 4ns	SOT-23	16dg	-	3a	Chm
A4	CHN222PT	Si-diode	Dual, Sw, 80V, 100mA, Vf<1.2V(100mA), 4ns	SOT-416	16dg	-	3a	Chm
A4	CHN222T1PT	Si-diode	Dual, Sw, 80V, 100mA, Vf<1.2V(100mA), 4ns	FBPT-523	17dg	-	9d	Chm
A4	HSMS-2804	Si-diode	2x Schottky, RF, 70V, 1A, Vf<0.41V(1mA), <2pF, 35Ω(5mA)	SOT-23	16dg	-	3a	Agi
A4	HSMS-280F	Si-diode	2x Schottky, RF, 70V, 1A, Vf<0.41V(1mA), <2pF, 35Ω(5mA)	SOT-323	16dg	-	3a	Agi
A4	KA4A4M	Si-npn-Digi	Sw, 60V, 100mA, 200mW, R1/R2=10k/10k	SOT-416	16ta	-	3a	Nec
A4	MC2836	Si-diode	2x Sw, Hi-sp, 50V, 100mA, Vf<1.2V(100mA), 2.8pF, <4ns	SC-59	16df	-	3a	Mit
A4	MC2846	Si-diode	2x Sw, Hi-sp, 50V, 100mA, Vf<1.2V(100mA), 2.8pF, <4ns	SOT-323	16df	-	3a	Mit
A4	MC2856	Si-diode	2x Sw, Hi-sp, 50V, 100mA, Vf<1.2V(100mA), 2.8pF, <4ns	SC-90	16df	-	3a	Mit
A4	MIC803-31D3VC3	Vdet-IC	3.08V±2.5%, -Reset ODO, 140ms	SC-70	16vdc	VD7	3a	Mcr
A4	MIC803-31D3VM3	Vdet-IC	3.08V±2.5%, -Reset ODO, 140ms	SOT-23	16vdc	VD7	3a	Mcr
A4	R3113D141A	Vdet-IC	1.4V±2%, -Reset, ODO	SOM1408-3	18vda	VD6	3d	Ric
A4	RT9161-20CV	LVR-IC	LDO, 2.0V±2%, 300mA	SOT-23	16cg	VR1	3a	Rct
A4	Si2304DS	n-MOSFET-e	V-MOS, 30V, ±2.5A, <190mΩ(5A)	SOT-23	16fh	-	3a	Six
A4-	RT9161-20PV	LVR-IC	LDO, 2.0V±2%, 300mA	SOT-23	16cg	VR1	3a	Rct
A4-	RT9818A-38PU3	Vdet-IC	3.8V±1.5%, -Reset ODO	SOT-323	16vdc	VD6	3a	Rct
A40	ELM9740NBB	Vdet-IC	4.0V±2.5%, +Reset ODO	SOT-23	16vdc	VD6	3d	Elm
A40	GS809CJEUA	Vdet-IC	4V, -Reset PPO, 1.5ms	SOT-23	16vdc	VD7	3g	Vs
A40	KTF810T-4.00	Vdet-IC	4.0V±1.5%, +Reset PPO	SOT-23	16vdc	VD7	3a	lcm
A40	XC31PNS0040AM	LVR-IC	Temperature Sensitive, -T*factor, 4V±5%, 50mA	SOT-23	16cg	VR1	3d	Tor
A40	XC31PPS0040AM	LVR-IC	Temperature Sensitive, +T*factor, 4V±5%, 50mA	SOT-23	16cg	VR1	3d	Tor
A40A	ML6101C402M	Vdet-IC	4.0V±2%, +Reset PPO	SOT-23	16vdc	VD7	3a	Mlc
A41	ELM9741NBB	Vdet-IC	4.1V±2.5%, +Reset ODO	SOT-23	16vdc	VD6	3d	Elm
A41	XC31PNS0041AM	LVR-IC	Temperature Sensitive, -T*factor, 4.1V±5%, 50mA	SOT-23	16cg	VR1	3d	Tor
A41	XC31PPS0041AM	LVR-IC	Temperature Sensitive, +T*factor, 4.1V±5%, 50mA	SOT-23	16cg	VR1	3d	Tor
A41A	ML6101C412M	Vdet-IC	4.1V±2%, +Reset PPO	SOT-23	16vdc	VD7	3a	Mlc
A42	ELM9742NBB	Vdet-IC	4.2V±2.5%, +Reset ODO	SOT-23	16vdc	VD6	3d	Elm
A42	XC31PNS0042AM	LVR-IC	Temperature Sensitive, -T*factor, 4.2V±5%, 50mA	SOT-23	16cg	VR1	3d	Tor
A42	XC31PPS0042AM	LVR-IC	Temperature Sensitive, +T*factor, 4.2V±5%, 50mA	SOT-23	16cg	VR1	3d	Tor
A42A	ML6101C422M	Vdet-IC	4.2V±2%, +Reset PPO	SOT-23	16vdc	VD7	3a	Mlc
A43	ELM9743NBB	Vdet-IC	4.3V±2.5%, +Reset ODO	SOT-23	16vdc	VD6	3d	Elm
A43	GS809CMEUA	Vdet-IC	4.38V, -Reset PPO, 1.5ms	SOT-23	16vdc	VD7	3g	Vs
A43	KTF810T-4.38	Vdet-IC	4.38V±1.5%, +Reset PPO	SOT-23	16vdc	VD7	3a	lcm
A43	XC31PNS0043AM	LVR-IC	Temperature Sensitive, -T*factor, 4.3V±5%, 50mA	SOT-23	16cg	VR1	3d	Tor
A43	XC31PPS0043AM	LVR-IC	Temperature Sensitive, +T*factor, 4.3V±5%, 50mA	SOT-23	16cg	VR1	3d	Tor
A43A	ML6101C432M	Vdet-IC	4.3V±2%, +Reset PPO	SOT-23	16vdc	VD7	3a	Mlc
A44	ELM9744NBB	Vdet-IC	4.4V±2.5%, +Reset ODO	SOT-23	16vdc	VD6	3d	Elm
A44	XC31PNS0044AM	LVR-IC	Temperature Sensitive, -T*factor, 4.4V±5%, 50mA	SOT-23	16cg	VR1	3d	Tor
A44	XC31PPS0044AM	LVR-IC	Temperature Sensitive, +T*factor, 4.4V±5%, 50mA	SOT-23	16cg	VR1	3d	Tor
A44A	ML6101C442M	Vdet-IC	4.4V±2%, +Reset PPO	SOT-23	16vdc	VD7	3a	Mlc
A45	ELM9745NBB	Vdet-IC	4.5V±2.5%, +Reset ODO	SOT-23	16vdc	VD6	3d	Elm
A45	XC31PNS0045AM	LVR-IC	Temperature Sensitive, -T*factor, 4.5V±5%, 50mA	SOT-23	16cg	VR1	3d	Tor
A45	XC31PPS0045AM	LVR-IC	Temperature Sensitive, +T*factor, 4.5V±5%, 50mA	SOT-23	16cg	VR1	3d	Tor
A45A	ML6101C452M	Vdet-IC	4.5V±2%, +Reset PPO	SOT-23	16vdc	VD7	3a	Mlc
A46	BAR46A	Si-diode	Dual, Schottky, 100V, 150mA, 230mW, Vf<1V(250mA), 10pF	SOT-23	16df	-	3a	Ste
A46	BAT46A	Si-diode	Dual, SBD, 100V, 150mA, Vf<1V(250mA), 6pF	SOT-23	16df	-	3b	Ste
A46	ELM9746NBB	Vdet-IC	4.6V±2.5%, +Reset ODO	SOT-23	16vdc	VD6	3d	Elm
A46	GS809CLEUA	Vdet-IC	4.63V, -Reset PPO, 1.5ms	SOT-23	16vdc	VD7	3g	Vs
A46	KTF810T-4.63	Vdet-IC	4.63V±1.5%, +Reset PPO	SOT-23	16vdc	VD7	3a	lcm
A46	XC31PNS0046AM	LVR-IC	Temperature Sensitive, -T*factor, 4.6V±5%, 50mA	SOT-23	16cg	VR1	3d	Tor
A46	XC31PPS0046AM	LVR-IC	Temperature Sensitive, +T*factor, 4.6V±5%, 50mA	SOT-23	16cg	VR1	3d	Tor
A46A	ML6101C462M	Vdet-IC	4.6V±2%, +Reset PPO	SOT-23	16vdc	VD7	3a	Mlc
A47	ELM9747NBB	Vdet-IC	4.7V±2.5%, +Reset ODO	SOT-23	16vdc	VD6	3d	Elm
A47	XC31PNS0047AM	LVR-IC	Temperature Sensitive, -T*factor, 4.7V±5%, 50mA	SOT-23	16cg	VR1	3d	Tor
A47	XC31PPS0047AM	LVR-IC	Temperature Sensitive, +T*factor, 4.7V±5%, 50mA	SOT-23	16cg	VR1	3d	Tor
A47A	ML6101C472M	Vdet-IC	4.7V±2%, +Reset PPO	SOT-23	16vdc	VD7	3a	Mlc
A48	ELM9748NBB	Vdet-IC	4.8V±2.5%, +Reset ODO	SOT-23	16vdc	VD6	3d	Elm
A48	XC31PNS0048AM	LVR-IC	Temperature Sensitive, -T*factor, 4.8V±5%, 50mA	SOT-23	16cg	VR1	3d	Tor
A48	XC31PPS0048AM	LVR-IC	Temperature Sensitive, +T*factor, 4.8V±5%, 50mA	SOT-23	16cg	VR1	3d	Tor
A48A	ML6101C482M	Vdet-IC	4.8V±2%, +Reset PPO	SOT-23	16vdc	VD7	3a	Mlc
A49	ELM9749NBB	Vdet-IC	4.9V±2.5%, +Reset ODO	SOT-23	16vdc	VD6	3d	Elm
A49	XC31PNS0049AM	LVR-IC	Temperature Sensitive, -T*factor, 4.9V±5%, 50mA	SOT-23	16cg	VR1	3d	Tor
A49	XC31PPS0049AM	LVR-IC	Temperature Sensitive, +T*factor, 4.9V±5%, 50mA	SOT-23	16cg	VR1	3d	Tor



SMD code	Type	Function	Short description	Case	Pinout	Sch.	St.	Mnf.
A49A	ML6101C492M	Vdet-IC	4.9V±2%, +Reset PPO	SOT-23	16vdb	VD7	3a	Mic
A4p	BAV70	Si-diode	Dual, Sw, 75V, 215mA, Vf<1.25V, <4ns	SOT-23	16dg	-	3a	PHH
A4s	BAV70T	Si-diode	Dual, Sw, 75V, 150mA, 200mW, Vf<1.25V, <4ns	SOT-416	16dg	-	3a	Sie
A4t	BAV70W	Si-diode	Dual, Sw, 75V, 215mA, 225mW, Vf<1.25V, <4ns	SOT-323	16dg	-	3a	Sie
A4t	BAV70	Si-diode	Dual, Sw, 75V, 215mA, Vf<1.25V, <4ns	SOT-23	16dg	-	3a	PhM
A4W	BAV70	Si-diode	Dual, Sw, 75V, 215mA, Vf<1.25V, <4ns	SOT-23	16dg	-	3a	PhC
A5	1S2837	Si-diode	Dual, Sw, Fast, 35V, 150mA, <4ms	SOT-23	16dg	-	3a	Nec
A5	MC2834	Si-diode	Sw, Hi-sp, 50V, 100mA, Vf<1.2V(100mA), 1.3pF, <4ns	SC-59	16dr	-	3a	Mit
A5	MC2844	Si-diode	Sw, Hi-sp, 50V, 100mA, Vf<1.2V(100mA), 1.3pF, <4ns	SOT-323	16dr	-	3a	Mit
A5	MC2854	Si-diode	Sw, Hi-sp, 50V, 100mA, Vf<1.2V(100mA), 1.3pF, <4ns	SC-90	16dr	-	3a	Mit
A5	MIC803-40D3VC3	Vdet-IC	4.0V±2.5%, -Reset ODO, 140ms	SC-70	16vdc	VD7	3a	Mcr
A5	MIC803-40D3VM3	Vdet-IC	4.0V±2.5%, -Reset ODO, 140ms	SOT-23	16vdc	VD7	3a	Mcr
A5	MMBD2837	Si-diode	Dual, Sw, 30V, 150mA, 225mW, Vf>1.2V(100mA), <4ns	SOT-23	16dg	-	3a	Ons
A5	R3113D151A	Vdet-IC	1.5V±2%, -Reset, ODO	SON1408-3	18vda	VD6	3d	Ric
A5	RT9161-21CV	LVR-IC	LDO, 2.1V±2%, 300mA	SOT-23	16cg	VR1	3a	Rct
A5	Si2305DS	p-MOSFET-e	V-MOS, LogL, 8V, 3.5A, <108mΩ	SOT-23	16fh	-	3a	Six
A5	SP809NEK-4-0	Vdet-IC	4.0V±1.5%, -Reset ODO	SOT-23	16vdc	VD6	3b	Sip
A5-	RT9818A-41PU3	Vdet-IC	4.1V±1.5%, -Reset ODO	SOT-323	16vdc	VD6	3a	Rct
A50	ELM9750NBB	Vdet-IC	5.0V±2.5%, +Reset ODO	SOT-23	16vdb	VD6	3d	Elm
A50	XC31PNS0050AM	LVR-IC	Temperature Sensitive, -T*factor, 5V±5%, 50mA	SOT-23	16cg	VR1	3d	Tor
A50	XC31PPS0050AM	LVR-IC	Temperature Sensitive, +T*factor, 5V±5%, 50mA	SOT-23	16cg	VR1	3d	Tor
A50A	ML6101C502M	Vdet-IC	5.0V±2%, +Reset PPO	SOT-23	16vdb	VD7	3a	Mic
A51	ELM9751NBB	Vdet-IC	5.1V±2.5%, +Reset ODO	SOT-23	16vdb	VD6	3d	Elm
A51	XC31PNS0051AM	LVR-IC	Temperature Sensitive, -T*factor, 5.1V±5%, 50mA	SOT-23	16cg	VR1	3d	Tor
A51	XC31PPS0051AM	LVR-IC	Temperature Sensitive, +T*factor, 5.1V±5%, 50mA	SOT-23	16cg	VR1	3d	Tor
A51A	ML6101C512M	Vdet-IC	5.1V±2%, +Reset PPO	SOT-23	16vdb	VD7	3a	Mic
A52	ELM9752NBB	Vdet-IC	5.2V±2.5%, +Reset ODO	SOT-23	16vdb	VD6	3d	Elm
A52	XC31PNS0052AM	LVR-IC	Temperature Sensitive, -T*factor, 5.2V±5%, 50mA	SOT-23	16cg	VR1	3d	Tor
A52	XC31PPS0052AM	LVR-IC	Temperature Sensitive, +T*factor, 5.2V±5%, 50mA	SOT-23	16cg	VR1	3d	Tor
A52A	ML6101C522M	Vdet-IC	5.2V±2%, +Reset PPO	SOT-23	16vdb	VD7	3a	Mic
A53	ELM9753NBB	Vdet-IC	5.3V±2.5%, +Reset ODO	SOT-23	16vdb	VD6	3d	Elm
A53	XC31PNS0053AM	LVR-IC	Temperature Sensitive, -T*factor, 5.3V±5%, 50mA	SOT-23	16cg	VR1	3d	Tor
A53	XC31PPS0053AM	LVR-IC	Temperature Sensitive, +T*factor, 5.3V±5%, 50mA	SOT-23	16cg	VR1	3d	Tor
A53A	ML6101C532M	Vdet-IC	5.3V±2%, +Reset PPO	SOT-23	16vdb	VD7	3a	Mic
A54	ELM9754NBB	Vdet-IC	5.4V±2.5%, +Reset ODO	SOT-23	16vdb	VD6	3d	Elm
A54	XC31PNS0054AM	LVR-IC	Temperature Sensitive, -T*factor, 5.4V±5%, 50mA	SOT-23	16cg	VR1	3d	Tor
A54	XC31PPS0054AM	LVR-IC	Temperature Sensitive, +T*factor, 5.4V±5%, 50mA	SOT-23	16cg	VR1	3d	Tor
A54A	ML6101C542M	Vdet-IC	5.4V±2%, +Reset PPO	SOT-23	16vdb	VD7	3a	Mic
A55	ELM9755NBB	Vdet-IC	5.5V±2.5%, +Reset ODO	SOT-23	16vdb	VD6	3d	Elm
A55	XC31PNS0055AM	LVR-IC	Temperature Sensitive, -T*factor, 5.5V±5%, 50mA	SOT-23	16cg	VR1	3d	Tor
A55	XC31PPS0055AM	LVR-IC	Temperature Sensitive, +T*factor, 5.5V±5%, 50mA	SOT-23	16cg	VR1	3d	Tor
A55A	ML6101C552M	Vdet-IC	5.5V±2%, +Reset PPO	SOT-23	16vdb	VD7	3a	Mic
A56A	ML6101C562M	Vdet-IC	5.6V±2%, +Reset PPO	SOT-23	16vdb	VD7	3a	Mic
A57A	ML6101C572M	Vdet-IC	5.7V±2%, +Reset PPO	SOT-23	16vdb	VD7	3a	Mic
A58A	ML6101C582M	Vdet-IC	5.8V±2%, +Reset PPO	SOT-23	16vdb	VD7	3a	Mic
A59A	ML6101C592M	Vdet-IC	5.9V±2%, +Reset PPO	SOT-23	16vdb	VD7	3a	Mic
A6	1S2838	Si-diode	Dual, Sw, Fast, 75V, 150mA, <4ms	SOT-23	16dg	-	3a	Nec
A6	AP431W	Vref-IC	Adjustable, Precision, Shunt, 2.495V±1%	SOT-23-3L	16rc	RF1	3a	Ana
A6	BAS16L	Si-diode	Sw, Fast, 75V, 215mA, 250mW, <6ns	SOT-23	16dc	-	3a	Ons
A6	BAS16PT	Si-diode	Sw, 100V, 150mA, Vf<1.25V(150mA), 4ns	SOT-23	16dc	-	3a	Chm
A6	BAS16T	Si-diode	Sw, Fast, 75V, 155mA, 170mW, <6ns	SOT-416	16dc	-	3a	Ons
A6	BAS16W	Si-diode	Sw, Fast, 75V, 300mA, Vf<1.25V(150mA), 4ns, 2pF	SOT-323	16dc	-	3a	Ons
A6	DC0015	Si-diode	Dual, Hi-Speed-Sw, 75V, 100mA, Vf=1.2V(0.1A), 4pF, 5ns	MCP	16dg	-	3a	San
A6	MC2838	Si-diode	2x Sw, Hi-sp, 50V, 100mA, Vf<1.2V(100mA), 1.3pF, <3ns	SC-59	16dg	-	3a	Mit
A6	MC2848	Si-diode	2x Sw, Hi-sp, 50V, 100mA, Vf<1.2V(100mA), 1.3pF, <3ns	SOT-323	16dg	-	3a	Mit
A6	MC2858	Si-diode	2x Sw, Hi-sp, 50V, 100mA, Vf<1.2V(100mA), 1.3pF, <3ns	SC-90	16dg	-	3a	Mit
A6	MIC803-40D4VC3	Vdet-IC	4.0V±2.5%, -Reset ODO, 1120ms	SC-70	16vdc	VD7	3a	Mcr
A6	MIC803-40D4VM3	Vdet-IC	4.0V±2.5%, -Reset ODO, 1120ms	SOT-23	16vdc	VD7	3a	Mcr
A6	MMBD4448HTA	Si-diode	Dual, Sw, Fast, 75V, 500mA, Vf<1.25V(150mA), <4ns	SOT-523	16df	-	3a	Di
A6	R3113D161A	Vdet-IC	1.6V±2%, -Reset, ODO	SON1408-3	18vda	VD6	3d	Ric
A6	R3130N16EC	Vdet-IC	1.6V, -Reset ODO, 240ms	SOT-23	16vdc	VD6	3b	Ric
A6	RT9161-22CV	LVR-IC	LDO, 2.2V±2%, 300mA	SOT-23	16cg	VR1	3a	Rct
A6	Si2306DS	n-MOSFET-e	V-MOS, 30V, ±2.5A, <94mΩ(2.5A)	SOT-23	16fh	-	3a	Six
A6-	RT9818A-42PU3	Vdet-IC	4.2V±1.5%, -Reset ODO	SOT-323	16vdc	VD6	3a	Rct
A60A	ML6101C602M	Vdet-IC	6.0V±2%, +Reset PPO	SOT-23	16vdb	VD7	3a	Mic
A61	MC2838	Si-diode	Dual, Sw, 50V, 100mA, Vf<1.2V(100mA), 3ns, <4pF	SOT-23	16dg	-	3a	Jce
A63	FZTA63	Si-pnp-Darl	GP, 30V, 500mA, 300mW, B>5000, >125MHz	SOT-23	16ta	-	3a	Zx
A6A	MMUN2111	Si-pnp-Digi	Sw, 50V, 100mA, 250mW, R1/R2=10/10k	SOT-23	16ta	-	3a	Mot
A6B	MMUN2112	Si-pnp-Digi	Sw, 50V, 100mA, 250mW, R1/R2=22/22k	SOT-23	16ta	-	3a	Mot
A6C	MMUN2113	Si-pnp-Digi	Sw, 50V, 100mA, 250mW, R1/R2=47k/47k	SOT-23	16ta	-	3a	Mot



SMD code	Type	Function	Short description	Case	Pinout	Sch.	St.	Mnf.
A6D	MMUN2114	Si-pnp-Digi	Sw, 50V, 100mA, 250mW, R1/R2=10/47k	SOT-23	16ta	-	3a	Mot
A6E	MMUN2115	Si-pnp-Digi	Sw, 50V, 100mA, 250mW, R1=10k	SOT-23	16ta	-	3a	Mot
A6F	MMUN2116	Si-pnp-Digi	Sw, 50V, 100mA, 250mW, R1=4k7	SOT-23	16ta	-	3a	Mot
A6G	MMUN2130	Si-pnp-Digi	Sw, 50V, 100mA, 250mW, R1/R2=1k/1k0	SOT-23	16ta	-	3a	Mot
A6H	MMUN2131	Si-pnp-Digi	Sw, 50V, 100mA, 250mW, R1/R2=2k2/2k2	SOT-23	16ta	-	3a	Mot
A6J	MMUN2132	Si-pnp-Digi	Sw, 50V, 100mA, 250mW, R1/R2=4k/4k7	SOT-23	16ta	-	3a	Mot
A6K	MMUN2133	Si-pnp-Digi	Sw, 50V, 100mA, 250mW, R1/R2=4k7/47k	SOT-23	16ta	-	3a	Mot
A6L	MMUN2134	Si-pnp-Digi	Sw, 50V, 100mA, 250mW, R1/R2=22k/47k	SOT-23	16ta	-	3a	Mot
A6p	BAS16	Si-diode	Sw, Fast, 75V, 215mA, 250mW, <6ns	SOT-23	16dc	-	3a	PHH
A6s	BAS16	Si-diode	Sw, Fast, 75V, 215mA, 370mW, <6ns	SOT-23	16dc	-	3c	Inf
A6s	BAS16W	Si-diode	Sw, Fast, 75V, 300mA, Vf<1.25V(150mA), 4ns, 2pF	SOT-323	16dc	-	3c	Inf
A6t	BAS16	Si-diode	Sw, Fast, 75V, 215mA, 250mW, <6ns	SOT-23	16dc	-	3a	PhM
A6W	BAS16	Si-diode	Sw, Fast, 75V, 215mA, 250mW, <6ns	SOT-23	16dc	-	3a	PhC
A7	1S5123	Si-diode	Dual, Sw, Fast, 70V, 100mA, Vf<1.3V(100mA), <9ns	SOT-23	16dl	-	3a	Nec
A7	AP431AW	Vref-IC	Adjustable, Precision, Shunt, 2.495V±0.5%	SOT-23-3L	16rc	RF1	3a	Ana
A7	BAV99L	Si-diode	Dual, U-Sp, 70V, 215mA, Vf<1.2V(100mA), 0.5pF, 4ns	SOT-23	16dl	-	3b	Ons
A7	BAV99PT	Si-diode	Dual, Sw, 85V, 150mA, Vf<1.25V(150mA), 4ns	SOT-23	16dl	-	3a	Chm
A7	BAV99TPT	Si-diode	Dual, Sw, 85V, 150mA, Vf<1.25V(150mA), 4ns	SOT-416	16dl	-	3a	Chm
A7	BAV99U	Si-diode	Dual, U-Sp, 80V, 100mA, Vf<1.2V(100mA), 0.5pF, 4ns	SOT-323	16dl	-	3a	Rhm
A7	BAV99W	Si-diode	Dual, U-Sp, 70V, 215mA, Vf<1.2V(100mA), 0.5pF, 4ns	SOT-323	16dl	-	3a	Ons
A7	BAV99WPT	Si-diode	Dual, Sw, 85V, 150mA, Vf<1.25V(150mA), 4ns	SOT-323	16dl	-	3a	Chm
A7	CH204KPT	Si-diode	Dual, Sw, 20V, 100mA, Vf<1V(10mA), 4ns	SOT-23	16dl	-	3a	Chm
A7	CH204UPT	Si-diode	Dual, Sw, 20V, 100mA, Vf<1V(10mA), 4ns	SOT-323	16dl	-	3a	Chm
A7	CH221PT	Si-diode	Dual, Sw, 20V, 100mA, Vf<1V(10mA), 4ns	SOT-416	16dl	-	3a	Chm
A7	CH228UPT	Si-diode	Dual, Sw, 80V, 100mA, Vf<1.2V(100mA), 4ns	SOT-323	16dl	-	3a	Chm
A7	CHN217PT	Si-diode	Dual, Sw, 80V, 100mA, Vf<1.2V(100mA), 4ns	SOT-23	16dl	-	3a	Chm
A7	CHN217UPT	Si-diode	Dual, Sw, 80V, 100mA, Vf<1.2V(100mA), 4ns	SOT-323	16dl	-	3a	Chm
A7	DAN217U	Si-diode	Dual, U-Sp, 80V, 100mA, Vf<1.2V(100mA), 0.5pF, 4ns	UMD3	16dl	-	3i	Rhm
A7	KN4A4M	Si-pnp-Digi	Sw, 60V, 100mA, 150mW, R1/R2=10k/10k	SOT-416	16ta	-	3a	Nec
A7	MC2840	Si-diode	2x Sw, Hi-sp, 30V, 100mA, Vf<1.4V(100mA), <4ns	SC-59	16dl	-	3a	Mit
A7	MMBD4448HTC	Si-diode	Dual, Sw, Fast, 75V, 500mA, Vf<1.25V(150mA), <4ns	SOT-523	16dg	-	3a	Di
A7	R3113D171A	Vdet-IC	1.7V±2%, -Reset, ODO	SON1408-3	18vda	VD6	3d	Ric
A7	R3130N17EC	Vdet-IC	1.7V, -Reset ODO, 240ms	SOT-23	16vdc	VD6	3b	Ric
A7	RT9161-23CV	LVR-IC	LDO, 2.3V±2%, 300mA	SOT-23	16cg	VR1	3a	Rct
A7	Si2307DS	p-MOSFET-e	V-MOS, 30V, 3A, <140mΩ(2.5A)	SOT-23	16fh	-	3a	Six
A7-	RT9818A-25PU3	Vdet-IC	2.5V±1.5%, -Reset ODO	SOT-323	16vdc	VD6	3a	Rct
A7p	BAV99	Si-diode	Dual, U-Sp, 75V, 125mA, Vf<1.2V(100mA), 0.5pF, 4ns	SOT-23	16dl	-	3a	PHH
A7s	BAV99	Si-diode	Dual, U-Sp, 80V, 150mA, Vf<1.2V(100mA), 0.5pF, 4ns	SOT-23	16dl	-	3a	Sie
A7s	BAV99W	Si-diode	Dual, U-Sp, 75V, 125mA, Vf<1.2V(100mA), 0.5pF, 4ns	SOT-323	16dl	-	3a	Sie
A7t	BAV99	Si-diode	Dual, U-Sp, 75V, 125mA, Vf<1.2V(100mA), 0.5pF, 4ns	SOT-23	16dl	-	3a	PhM
A7W	BAV99	Si-diode	Dual, U-Sp, 75V, 125mA, Vf<1.2V(100mA), 0.5pF, 4ns	SOT-23	16dl	-	3a	PhC
A8	AP431R	Vref-IC	Adjustable, Precision, Shunt, 2.495V±1%	SOT-23-3L	16rd	RF1	3a	Ana
A8	BAS19	Si-diode	Sw, Fast, 120V, 250mA, Vf=1V(0.1A), 250mW, <50ns	SOT-23	16dc	-	3a	Zx
A8	MC2835	Si-diode	2x Sw, Hi-sp, 30V, 100mA, Vf<1.4V(100mA), <4ns	SC-59	16ea	-	3a	Mit
A8	MC2845	Si-diode	2x Sw, Hi-sp, 30V, 100mA, Vf<1.4V(100mA), <4ns	SOT-323	16ea	-	3a	Mit
A8	R3113D181A	Vdet-IC	1.8V±2%, -Reset, ODO	SON1408-3	18vda	VD6	3d	Ric
A8	R3130N18EC	Vdet-IC	1.8V, -Reset ODO, 240ms	SOT-23	16vdc	VD6	3b	Ric
A8	RT9161-24CV	LVR-IC	LDO, 2.4V±2%, 300mA	SOT-23	16cg	VR1	3a	Rct
A8	Si2308DS	n-MOSFET-e	V-MOS, 60V, ±2A, <220mΩ(1.5A)	SOT-23	16fh	-	3a	Six
A8	XC6GC0802ZHR	Vdet-IC	0.8V, +Reset PPO	USP-3	17vdc	VD3	9b	Tor
A80	BAS20	Si-diode	Sw, Fast, 150V, 250mA, Vf=1V(0.1A), 250mW, <50ns	SOT-23	16dc	-	3a	Pjt
A81	BAS20	Si-diode	Sw, Fast, 150V, 250mA, Vf=1V(0.1A), 250mW, <50ns	SOT-23	16dc	-	3a	Zx
A82	BAS21	Si-diode	Sw, Fast, 200V, 250mA, Vf=1V(0.1A), 250mW, <50ns	SOT-23	16dc	-	3a	Zx
A8A	MMUN2211	Si-npn-Digi	Sw, 50V, 100mA, 200mW, R1/R2=10/10k	SOT-23	16ta	-	3a	Mot
A8B	MMUN2212	Si-npn-Digi	Sw, 50V, 100mA, 200mW, R1/R2=22/22k	SOT-23	16ta	-	3a	Mot
A8C	MMUN2213	Si-npn-Digi	Sw, 50V, 100mA, 200mW, R1/R2=47k/47k	SOT-23	16ta	-	3a	Mot
A8D	MMUN2214	Si-npn-Digi	Sw, 50V, 100mA, 200mW, R1/R2=10/47k	SOT-23	16ta	-	3a	Mot
A8E	MMUN2215	Si-npn-Digi	Sw, 50V, 100mA, 200mW, R1=10k	SOT-23	16ta	-	3a	Mot
A8F	MMUN2216	Si-npn-Digi	Sw, 50V, 100mA, 200mW, R1=4k7	SOT-23	16ta	-	3a	Mot
A8G	MMUN2230	Si-npn-Digi	Sw, 50V, 100mA, 200mW, R1/R2=1k/1k0	SOT-23	16ta	-	3a	Mot
A8H	MMUN2231	Si-npn-Digi	Sw, 50V, 100mA, 200mW, R1/R2=2k2/2k2	SOT-23	16ta	-	3a	Mot
A8J	MMUN2232	Si-npn-Digi	Sw, 50V, 100mA, 200mW, R1/R2=4k/4k7	SOT-23	16ta	-	3a	Mot
A8K	MMUN2233	Si-npn-Digi	Sw, 50V, 100mA, 200mW, R1/R2=4k7/47k	SOT-23	16ta	-	3a	Mot
A8L	MMUN2234	Si-npn-Digi	Sw, 50V, 100mA, 200mW, R1/R2=22k/47k	SOT-23	16ta	-	3a	Mot
A8N	MMUN2236	Si-npn-Digi	Sw, 50V, 100mA, 200mW, R1/R2=100k/100k	SOT-23	16ta	-	3a	Mot
A8P	MMUN2237	Si-npn-Digi	Sw, 50V, 100mA, 200mW, R1/R2=47k/22k	SOT-23	16ta	-	3a	Mot
A8R	MMUN2238	Si-npn-Digi	Sw, 50V, 100mA, 200mW, R1=2k2	SOT-23	16ta	-	3a	Mot
A8U	MMUN2241	Si-npn-Digi	Sw, 50V, 100mA, 200mW, R1=100k	SOT-23	16ta	-	3a	Mot
A9	1S5294	Si-diode	Schottky, 45V, 100mA, Vf<0.6V(100mA)	SC-59	16dc	-	3a	Tos
A9	1S5322	Si-diode	Schottky, 40V, 0.1A	SOT-323	16dc	-	3a	Tos



SMD code	Type	Function	Short description	Case	Pinout	Sch. St.	Mnf.
A9	AP431AR	Vref-IC	Adjustable, Precision, Shunt, 2.495V±0.5%	SOT-23-3L	16rd	RF1 3a	Ana
A9	BZX84-C9V1	Z-diode	8.5..9.6V, Zzt=15Ω, Izt=20mA, 225mW	SOT-23	16dc	- 3a	Lge
A9	ELM9709NBB	Vdet-IC	0.9V±2.5%, +Reset ODO	SOT-23	16vdb	VD6 3d	Elm
A9	R3111N092A	Vdet-IC	0.9V±2%, -Reset PPO	SOT-23	16vdd	VD7 3d	Ric
A9	R3113D191A	Vdet-IC	1.9V±2%, -Reset, ODO	SON1408-3	18vda	VD6 3d	Ric
A9	R3130N19EC	Vdet-IC	1.9V, -Reset ODO, 240ms	SOT-23	16vdc	VD6 3b	Ric
A9	RT9161-26CV	LVR-IC	LDO, 2.6V±2%, 300mA	SOT-23	16cg	VR1 3a	Rct
A9	Si2309DS	p-MOSFET-e	V-MOS, 60V, 1.25A, <550mΩ(5A)	SOT-23	16fh	- 3a	Six
A9	XC6GC0902ZHR	Vdet-IC	0.9V, +Reset PPO	USP-3	17vdc	VD3 9b	Tor
A91	BAS17	Si-Stab	Stabistor, 5V, 200mA, 250mW, 140pF	SOT-23	16dc	- 3a	Phi
A91	CBAS17	Si-Stab	Stabistor, 5V, 250mA, 350mW, 140pF	SOT-23	16dc	- 3a	Cen
AA	2SA1864	Si-npn-Digi	Mute, 15V, 100mA, 150mW, 600MHz, R1/R2=4k7/4k7	SOT-23	16ta	- 3a	San
AA	BCW60A	Si-npn	GP, 32V, 200mA, 250mW, B=120..220, 250MHz	SOT-23	16ta	- 3a	Itt
AA	IMP809LEUR	Vdet-IC	4.63V±1.5%, -Reset PPO	SOT-23	16vdc	VD7 3a	Imp
AA	KRA351	Si-npn-Digi	Dual, Sw, 12V, 500mA, 100mW, R1/R2=1k/1k	USM	16ta	- 3f	Kec
AA	MIC803-26D2VC3	Vdet-IC	2.63V±2.5%, -Reset ODO, 20ms	SC-70	16vdc	VD7 3a	Mcr
AA	MIC803-26D2VM3	Vdet-IC	2.63V±2.5%, -Reset ODO, 20ms	SOT-23	16vdc	VD7 3a	Mcr
AA	MMBZ5225B	Z-diode	2.85..3.15V, Izt=20mA, Zzt=29Ω, 350mW	SOT-23	16dc	- 3a	Lge
AA	PT7M7809LT	Vdet-IC	4.63V±1.5%, -Reset PPO	SOT-23	16vdc	VD7 3b	Pti
AA	PT7M7809LTE	Vdet-IC	4.63V±1.5%, -Reset PPO, Lead free	SOT-23	16vdc	VD7 3b	Pti
AA	RT9161-28CV	LVR-IC	LDO, 2.8V±2%, 300mA	SOT-23	16cg	VR1 3a	Rct
AA-	RT9161-28PV	LVR-IC	LDO, 2.8V±2%, 300mA	SOT-23	16cg	VR1 3a	Rct
AA-	RT9818A-33PU3	Vdet-IC	3.3V±1.5%, -Reset ODO	SOT-323	16vdc	VD6 3a	Rct
AA1	FA4A4M	Si-npn-Digi	Sw, 60V, 100mA, 200mW, R1/R2=10k/10k	SC-59	16ta	- 3a	Nec
AA1	GA4A4M	Si-npn-Digi	Sw, 60V, 100mA, 200mW, R1/R2=10k/10k	SOT-323	16ta	- 3a	Nec
AAA	AME8800AEET	LVR-IC	LDO, 3.3V±1.5%, 300mA	SOT-23	16cq	VR1 3b	Ame
AAA	AME8800AEETL	LVR-IC	LDO, 3.3V±1.5%, 300mA	TSOT-23	16cq	VR1 3b	Ame
AAA	AME8800AEETY	LVR-IC	LDO, 3.3V±1.5%, 300mA	TSOT-23	16cq	VR1 3b	Ame
AAA	AME8800AEETZ	LVR-IC	LDO, 3.3V±1.5%, 300mA	SOT-23	16cq	VR1 3b	Ame
AAA	MAX6806XR46-T	Vdet-IC	4.6V±1.5%, -Reset PPO	SOT-323	16vdb	VD7 3b	Max
AAAA	HWD809LEU	Vdet-IC	4.63V±2%, -Reset PPO	SOT-23	16vdc	VD7 3a	Csm
AAAA	MAX809LUR	Vdet-IC	4.63V±1.5%, -Reset PPO	SOT-23	16vdc	VD7 3a	Max
AAB	AME8800BEET	LVR-IC	LDO, 3.0V±1.5%, 300mA	SOT-23	16cq	VR1 3b	Ame
AAB	AME8800BEETL	LVR-IC	LDO, 3.0V±1.5%, 300mA	TSOT-23	16cq	VR1 3b	Ame
AAB	AME8800BEETY	LVR-IC	LDO, 3.0V±1.5%, 300mA	TSOT-23	16cq	VR1 3b	Ame
AAB	AME8800BEETZ	LVR-IC	LDO, 3.0V±1.5%, 300mA	SOT-23	16cq	VR1 3b	Ame
AAB	MAX6806XR26-T	Vdet-IC	2.6V±1.5%, -Reset PPO	SOT-323	16vdb	VD7 3b	Max
AABA	HWD809MEU	Vdet-IC	4.38V±2%, -Reset PPO	SOT-23	16vdc	VD7 3a	Csm
AAC	AME8800CEET	LVR-IC	LDO, 2.8V±1.5%, 300mA	SOT-23	16cq	VR1 3b	Ame
AAC	AME8800CEETL	LVR-IC	LDO, 2.8V±1.5%, 300mA	TSOT-23	16cq	VR1 3b	Ame
AAC	AME8800CEETY	LVR-IC	LDO, 2.8V±1.5%, 300mA	TSOT-23	16cq	VR1 3b	Ame
AAC	AME8800CEETZ	LVR-IC	LDO, 2.8V±1.5%, 300mA	SOT-23	16cq	VR1 3b	Ame
AAC	MAX6806XR23-T	Vdet-IC	2.3V±1.5%, -Reset PPO	SOT-323	16vdb	VD7 3b	Max
AAC	PAM3101AAA150	LVR-IC	LDO, 1.5V±2%, 300mA	SOT-23	16cg	VR1 3b	Pam
AAC	PAM3101CAA150	LVR-IC	LDO, 1.5V±2%, 300mA	SOT-23	16ch	VR1 3b	Pam
AAC	PAM3101GAA150	LVR-IC	LDO, 1.5V±2%, 300mA	SOT-23	16vj	VR1 3b	Pam
AAC	PAM3101GUA150	LVR-IC	LDO, 1.5V±2%, 300mA	SC-70-3L	16vj	VR1 3b	Pam
AAD	AME8800DEET	LVR-IC	LDO, 2.5V±1.5%, 300mA	SOT-23	16cq	VR1 3b	Ame
AAD	AME8800DEETL	LVR-IC	LDO, 2.5V±1.5%, 300mA	TSOT-23	16cq	VR1 3b	Ame
AAD	AME8800DEETY	LVR-IC	LDO, 2.5V±1.5%, 300mA	TSOT-23	16cq	VR1 3b	Ame
AAD	AME8800DEETZ	LVR-IC	LDO, 2.5V±1.5%, 300mA	SOT-23	16cq	VR1 3b	Ame
AAD	MAX6807XR46-T	Vdet-IC	4.6V±1.5%, +Reset PPO	SOT-323	16vdb	VD7 3b	Max
AAE	AME8800EEET	LVR-IC	LDO, 3.8V±1.5%, 300mA	SOT-23	16cq	VR1 3b	Ame
AAE	AME8800EEETL	LVR-IC	LDO, 3.8V±1.5%, 300mA	TSOT-23	16cq	VR1 3b	Ame
AAE	AME8800EEETY	LVR-IC	LDO, 3.8V±1.5%, 300mA	TSOT-23	16cq	VR1 3b	Ame
AAE	AME8800EEETZ	LVR-IC	LDO, 3.8V±1.5%, 300mA	SOT-23	16cq	VR1 3b	Ame
AAE	MAX6807XR26-T	Vdet-IC	2.6V±1.5%, +Reset PPO	SOT-323	16vdb	VD7 3b	Max
AAE	PAM3101AAA180	LVR-IC	LDO, 1.8V±2%, 300mA	SOT-23	16cg	VR1 3b	Pam
AAE	PAM3101CAA180	LVR-IC	LDO, 1.8V±2%, 300mA	SOT-23	16ch	VR1 3b	Pam
AAE	PAM3101GAA180	LVR-IC	LDO, 1.8V±2%, 300mA	SOT-23	16vj	VR1 3b	Pam
AAE	PAM3101GUA180	LVR-IC	LDO, 1.8V±2%, 300mA	SC-70-3L	16vj	VR1 3b	Pam
AAF	MAX6808XR46-T	Vdet-IC	4.6V±1.5%, -Reset ODO	SOT-323	16vdb	VD6 3b	Max
AAG	MAX6808XR26-T	Vdet-IC	2.6V±1.5%, -Reset ODO	SOT-323	16vdb	VD6 3b	Max
AAG	MMBR951A	Si-npn	UHF, 20V, 100mA, 322mW, B=50..200, 8GHz	SOT-23	16ta	- 3a	Mot
AAG	PAM3101AAA250	LVR-IC	LDO, 2.5V±2%, 300mA	SOT-23	16cg	VR1 3b	Pam
AAG	PAM3101CAA250	LVR-IC	LDO, 2.5V±2%, 300mA	SOT-23	16ch	VR1 3b	Pam
AAG	PAM3101GAA250	LVR-IC	LDO, 2.5V±2%, 300mA	SOT-23	16vj	VR1 3b	Pam
AAG	PAM3101GUA250	LVR-IC	LDO, 2.5V±2%, 300mA	SC-70-3L	16vj	VR1 3b	Pam
AAH	MAX6326_R22-T	Vdet-IC	2.2V±1.5%, -Reset PPO	SOT-323	16vdc	VD7 3a	Max
AAH	PAM3101AAA280	LVR-IC	LDO, 2.8V±2%, 300mA	SOT-23	16cg	VR1 3b	Pam



SMD code	Type	Function	Short description	Case	Pinout	Sch.	St.	Mnf.
AAH	PAM310ICAA280	LVR-IC	LDO, 2.8V±2%, 300mA	SOT-23	16ch	VR1	3b	Pam
AAH	PAM310IGAA280	LVR-IC	LDO, 2.8V±2%, 300mA	SOT-23	16vj	VR1	3b	Pam
AAH	PAM310IGUA280	LVR-IC	LDO, 2.8V±2%, 300mA	SC-70-3L	16vj	VR1	3b	Pam
AAI	MAX6327XR22-T	Vdet-IC	2.2V±1.5%, +Reset PPO	SOT-323	16vdc	VD7	3a	Max
AAI	PAM310IAAA285	LVR-IC	LDO, 2.85V±2%, 300mA	SOT-23	16cg	VR1	3b	Pam
AAI	PAM310ICAA285	LVR-IC	LDO, 2.85V±2%, 300mA	SOT-23	16ch	VR1	3b	Pam
AAI	PAM310IGAA285	LVR-IC	LDO, 2.85V±2%, 300mA	SOT-23	16vj	VR1	3b	Pam
AAI	PAM310IGUA285	LVR-IC	LDO, 2.85V±2%, 300mA	SC-70-3L	16vj	VR1	3b	Pam
AAJ	MAX6328XR22-T	Vdet-IC	2.2V±1.5%, -Reset ODO	SOT-323	16vdc	VD6	3a	Max
AAJ	PAM310IAAA300	LVR-IC	LDO, 3.0V±2%, 300mA	SOT-23	16cg	VR1	3b	Pam
AAJ	PAM310ICAA300	LVR-IC	LDO, 3.0V±2%, 300mA	SOT-23	16ch	VR1	3b	Pam
AAJ	PAM310IGAA300	LVR-IC	LDO, 3.0V±2%, 300mA	SOT-23	16vj	VR1	3b	Pam
AAJ	PAM310IGUA300	LVR-IC	LDO, 3.0V±2%, 300mA	SC-70-3L	16vj	VR1	3b	Pam
AAK	PAM310IAAA330	LVR-IC	LDO, 3.3V±2%, 300mA	SOT-23	16cg	VR1	3b	Pam
AAK	PAM310ICAA330	LVR-IC	LDO, 3.3V±2%, 300mA	SOT-23	16ch	VR1	3b	Pam
AAK	PAM310IGAA330	LVR-IC	LDO, 3.3V±2%, 300mA	SOT-23	16vj	VR1	3b	Pam
AAK	PAM310IGUA330	LVR-IC	LDO, 3.3V±2%, 300mA	SC-70-3L	16vj	VR1	3b	Pam
AAM	PAM310IAAA400	LVR-IC	LDO, 4.0V±2%, 300mA	SOT-23	16cg	VR1	3b	Pam
AAM	PAM310ICAA400	LVR-IC	LDO, 4.0V±2%, 300mA	SOT-23	16ch	VR1	3b	Pam
AAM	PAM310IGAA400	LVR-IC	LDO, 4.0V±2%, 300mA	SOT-23	16vj	VR1	3b	Pam
AAM	PAM310IGUA400	LVR-IC	LDO, 4.0V±2%, 300mA	SC-70-3L	16vj	VR1	3b	Pam
AAN	HWD809LEX	Vdet-IC	4.63V±2%, -Reset PPO	SC-70	16vdc	VD7	3a	Csm
AAN	MAX809LXR	Vdet-IC	4.63V±1.5%, -Reset PPO	SOT-323	16vdc	VD7	3a	Max
AAO	2SA1979SF-O	Si-pnp	AF, 40V, 500mA, 200mW, B=70..140, 200MHz	SOT-23F	18ta	-	3a	Auk
AAO	2SA1979S-O	Si-pnp	AF, 40V, 500mA, 200mW, B=70..140, 200MHz	SOT-23	16ta	-	3a	Auk
AAO	HWD809MEX	Vdet-IC	4.38V±2%, -Reset PPO	SC-70	16vdc	VD7	3a	Csm
AAO	MAX809MXR	Vdet-IC	4.38V±1.5%, -Reset PPO	SOT-323	16vdc	VD7	3a	Max
AAO	PAM310IAAA380	LVR-IC	LDO, 3.8V±2%, 300mA	SOT-23	16cg	VR1	3b	Pam
AAO	PAM310ICAA380	LVR-IC	LDO, 3.8V±2%, 300mA	SOT-23	16ch	VR1	3b	Pam
AAO	PAM310IGAA380	LVR-IC	LDO, 3.8V±2%, 300mA	SOT-23	16vj	VR1	3b	Pam
AAO	PAM310IGUA380	LVR-IC	LDO, 3.8V±2%, 300mA	SC-70-3L	16vj	VR1	3b	Pam
AAP	HWD809TEX	Vdet-IC	3.08V±2%, -Reset PPO	SC-70	16vdc	VD7	3a	Csm
AAP	MAX809TXR	Vdet-IC	3.08V±1.5%, -Reset PPO	SOT-323	16vdc	VD7	3a	Max
AAP	PAM310IAAA310	LVR-IC	LDO, 3.1V±2%, 300mA	SOT-23	16cg	VR1	3b	Pam
AAP	PAM310ICAA310	LVR-IC	LDO, 3.1V±2%, 300mA	SOT-23	16ch	VR1	3b	Pam
AAP	PAM310IGAA310	LVR-IC	LDO, 3.1V±2%, 300mA	SOT-23	16vj	VR1	3b	Pam
AAP	PAM310IGUA310	LVR-IC	LDO, 3.1V±2%, 300mA	SC-70-3L	16vj	VR1	3b	Pam
AAQ	2SD1757K-Q	Si-npn	Lo-sat, Mute, 30V, 500mA, 200mW, B=120..270, 150MHz	SC-59	16ta	-	3a	Rhm
AAQ	HWD809SEX	Vdet-IC	2.93V±2%, -Reset PPO	SC-70	16vdc	VD7	3a	Csm
AAQ	MAX809SXR	Vdet-IC	2.93V±1.5%, -Reset PPO	SOT-323	16vdc	VD7	3a	Max
AAQ	PAM310IAAA290	LVR-IC	LDO, 2.9V±2%, 300mA	SOT-23	16cg	VR1	3b	Pam
AAQ	PAM310ICAA290	LVR-IC	LDO, 2.9V±2%, 300mA	SOT-23	16ch	VR1	3b	Pam
AAQ	PAM310IGAA290	LVR-IC	LDO, 2.9V±2%, 300mA	SOT-23	16vj	VR1	3b	Pam
AAQ	PAM310IGUA290	LVR-IC	LDO, 2.9V±2%, 300mA	SC-70-3L	16vj	VR1	3b	Pam
AAR	2SD1757K-R	Si-npn	Lo-sat, Mute, 30V, 500mA, 200mW, B=180..390, 150MHz	SC-59	16ta	-	3a	Rhm
AAR	MAX809RXR	Vdet-IC	2.63V±1.5%, -Reset PPO	SOT-323	16vdc	VD7	3a	Max
AAS	2SD1757K-S	Si-npn	Lo-sat, Mute, 30V, 500mA, 200mW, B=270..560, 150MHz	SC-59	16ta	-	3a	Rhm
AAs	BCW60A	Si-npn	GP, 32V, 200mA, 250mW, B=120..220, 250MHz	SOT-23	16ta	-	3a	Sie
AAS	HWD809ZEX	Vdet-IC	2.32V±2%, -Reset PPO	SC-70	16vdc	VD7	3a	Csm
AAS	MAX803ZXR	Vdet-IC	2.32V±1.5%, -Reset ODO	SOT-323	16vdc	VD6	3a	Max
AAT	HWD810LEX	Vdet-IC	4.63V±2%, +Reset PPO	SC-70	16vdc	VD7	3a	Csm
AAT	MAX810LXR	Vdet-IC	4.63V±1.5%, +Reset PPO	SOT-323	16vdc	VD7	3a	Max
AAT	PAM310IAAA475	LVR-IC	LDO, 4.75V±2%, 300mA	SOT-23	16cg	VR1	3b	Pam
AAT	PAM310ICAA475	LVR-IC	LDO, 4.75V±2%, 300mA	SOT-23	16ch	VR1	3b	Pam
AAT	PAM310IGAA475	LVR-IC	LDO, 4.75V±2%, 300mA	SOT-23	16vj	VR1	3b	Pam
AAT	PAM310IGUA475	LVR-IC	LDO, 4.75V±2%, 300mA	SC-70-3L	16vj	VR1	3b	Pam
AAU	HWD810MEX	Vdet-IC	4.38V±2%, +Reset PPO	SC-70	16vdc	VD7	3a	Csm
AAU	MAX810MXR	Vdet-IC	4.38V±1.5%, +Reset PPO	SOT-323	16vdc	VD7	3a	Max
AAV	AME8500AEETCF29	Vdet-IC	2.93V±1.5%, +Reset PPO, 210ms	SOT-23	16vdc	VD7	3b	Ame
AAV	AME8500AEETCF29Z	Vdet-IC	2.93V±1.5%, +Reset PPO, 210ms, lead free	SOT-23	16vdc	VD7	3b	Ame
AAV	HWD810TEX	Vdet-IC	3.08V±2%, +Reset PPO	SC-70	16vdc	VD7	3a	Csm
AAV	MAX810TXR	Vdet-IC	3.08V±1.5%, +Reset PPO	SOT-323	16vdc	VD7	3a	Max
AAW	HWD810REX	Vdet-IC	2.63V±2%, +Reset PPO	SC-70	16vdc	VD7	3a	Csm
AAW	MAX810RXR	Vdet-IC	2.63V±1.5%, +Reset PPO	SOT-323	16vdc	VD7	3a	Max
AAX	HWD810SEX	Vdet-IC	2.93V±2%, +Reset PPO	SC-70	16vdc	VD7	3a	Csm
AAX	MAX810SXR	Vdet-IC	2.93V±1.5%, +Reset PPO	SOT-323	16vdc	VD7	3a	Max
AAZ	2SA1979SF-Y	Si-pnp	AF, 40V, 500mA, 200mW, B=120..240, 200MHz	SOT-23F	18ta	-	3a	Auk
AAZ	2SA1979S-Y	Si-pnp	AF, 40V, 500mA, 200mW, B=120..240, 200MHz	SOT-23	16ta	-	3a	Auk
AAZ	HWD810ZEX	Vdet-IC	2.32V±2%, +Reset PPO	SC-70	16vdc	VD7	3a	Csm
AAZ	MAX810ZXR	Vdet-IC	2.32V±1.5%, +Reset PPO	SOT-323	16vdc	VD7	3a	Max



SMD code	Type	Function	Short description	Case	Pinout	Sch.	St.	Mnf.
AAZ	HWD803LEX	Vdet-IC	4.63V±2%, -Reset ODO	SC-70	16vdc	VD6	3a	Csm
AAZ	MAX803LXR	Vdet-IC	4.63V±1.5%, -Reset ODO	SOT-323	16vdc	VD6	3a	Max
AB	2SD1101B	Si-npn	GP, 25V, 700mA, 150mW, B=85...170	SC-59A	16ta	-	3a	Ren
AB	BCW60B	Si-npn	GP, 32V, 200mA, 250mW, B=150...310, 250MHz	SOT-23	16ta	-	3a	litt
AB	IMP809MEUR	Vdet-IC	4.38V±1.5%, -Reset PPO	SOT-23	16vdc	VD7	3a	Imp
AB	KRA352	Si-pnp-Digi	Dual, Sw, 12V, 500mA, 100mW, R1/R2=2.2k/2.2k	USM	16ta	-	3f	Kec
AB	MIC803-26D3VC3	Vdet-IC	2.63V±2.5%, -Reset ODO, 140ms	SC-70	16vdc	VD7	3a	Mcr
AB	MIC803-26D3VM3	Vdet-IC	2.63V±2.5%, -Reset ODO, 140ms	SOT-23	16vdc	VD7	3a	Mcr
AB	MMBD4448HTS	Si-diode	Dual, Sw, Fast, 75V, 500mA, Vf<1.25V(150mA), <4ns	SOT-523	16dl	-	3a	Di
AB	MMBZ5226B	Z-diode	3.14...3.47V, Izt=20mA, Zzt=28Ω, 350mW	SOT-23	16dc	-	3a	Lge
AB	PT7M7809MT	Vdet-IC	4.26V±1.5%, -Reset PPO	SOT-23	16vdc	VD7	3b	Pti
AB	PT7M7809MTE	Vdet-IC	4.26V±1.5%, -Reset PPO, Lead free	SOT-23	16vdc	VD7	3b	Pti
AB	RT9161-29CV	LVR-IC	LDO, 2.9V±2%, 300mA	SOT-23	16cg	VR1	3a	Rct
AB-	RT9818A-31PU3	Vdet-IC	3.1V±1.5%, -Reset ODO	SOT-323	16vdc	VD6	3a	Rct
AB1	FA4F4M	Si-npn-Digi	Sw, 60V, 100mA, 200mW, R1/R2=22k/22k	SC-59	16ta	-	3a	Nec
AB1	GA4F4M	Si-npn-Digi	Sw, 60V, 100mA, 200mW, R1/R2=22k/22k	SOT-323	16ta	-	3a	Nec
ABA	HWD803MEX	Vdet-IC	4.38V±2%, -Reset ODO	SC-70	16vdc	VD6	3a	Csm
ABA	MAX803TXR	Vdet-IC	3.08V±1.5%, -Reset ODO	SOT-323	16vdc	VD6	3a	Max
ABAA	MAX809MUR	Vdet-IC	4.38V±1.5%, -Reset PPO	SOT-23	16vdc	VD7	3a	Max
ABB	HWD803TEX	Vdet-IC	3.08V±2%, -Reset ODO	SC-70	16vdc	VD6	3a	Csm
ABB	MAX803MXR	Vdet-IC	4.38V±1.5%, -Reset ODO	SOT-323	16vdc	VD6	3a	Max
ABC	HWD803SEX	Vdet-IC	2.93V±2%, -Reset ODO	SC-70	16vdc	VD6	3a	Csm
ABC	MAX803SXR	Vdet-IC	2.93V±1.5%, -Reset ODO	SOT-323	16vdc	VD6	3a	Max
ABD	HWD803REX	Vdet-IC	2.63V±2%, -Reset ODO	SC-70	16vdc	VD6	3a	Csm
ABD	MAX803RXR	Vdet-IC	2.63V±1.5%, -Reset ODO	SOT-323	16vdc	VD6	3a	Max
ABE	HWD803ZEX	Vdet-IC	2.32V±2%, -Reset ODO	SC-70	16vdc	VD6	3a	Csm
ABE	MAX803ZXR	Vdet-IC	2.32V±1.5%, -Reset ODO	SOT-323	16vdc	VD6	3a	Max
ABG	2SA1312-GR	Si-pnp	AF, LN, 120V, 100mA, 150mW, B=200...400, 100MHz	SC-59	16ta	-	3a	Tos
ABL	2SA1312-BL	Si-pnp	AF, LN, 120V, 100mA, 150mW, B=350...700, 100MHz	SC-59	16ta	-	3a	Tos
ABN	AME8800FEET	LVR-IC	LDO, 3.6V±1.5%, 300mA	SOT-23	16cq	VR1	3b	Ame
ABN	AME8800FEETL	LVR-IC	LDO, 3.6V±1.5%, 300mA	TSOT-23	16cq	VR1	3b	Ame
ABN	AME8800FEETY	LVR-IC	LDO, 3.6V±1.5%, 300mA	TSOT-23	16cq	VR1	3b	Ame
ABN	AME8800FEETZ	LVR-IC	LDO, 3.6V±1.5%, 300mA	SOT-23	16cq	VR1	3b	Ame
ABp	BCW60B	Si-npn	GP, 32V, 200mA, 250mW, B=150...310, 250MHz	SOT-23	16ta	-	3a	PHH
ABs	BCW60B	Si-npn	GP, 32V, 200mA, 250mW, B=150...310, 250MHz	SOT-23	16ta	-	3c	Inf
ABt	BCW60B	Si-npn	GP, 32V, 200mA, 250mW, B=150...310, 250MHz	SOT-23	16ta	-	3a	PhM
ABW	BCW60B	Si-npn	GP, 32V, 200mA, 250mW, B=150...310, 250MHz	SOT-23	16ta	-	3a	PhC
AC	2SD1101C	Si-npn	GP, 25V, 700mA, 150mW, B=120...240	SC-59A	16ta	-	3a	Ren
AC	AP431IW	Vref-IC	Adjustable, Precision, Shunt, 2.495V±1%	SOT-23-3L	16rc	RF1	3a	Ana
AC	IMP809TEUR	Vdet-IC	3.08V±1.5%, -Reset PPO	SOT-23	16vdc	VD7	3a	Imp
AC	KRA353	Si-pnp-Digi	Dual, Sw, 12V, 500mA, 100mW, R1/R2=4.7k/4.7k	USM	16ta	-	3f	Kec
AC	MIC803-26D4VC3	Vdet-IC	2.63V±2.5%, -Reset ODO, 1120ms	SC-70	16vdc	VD7	3a	Mcr
AC	MIC803-26D4VM3	Vdet-IC	2.63V±2.5%, -Reset ODO, 1120ms	SOT-23	16vdc	VD7	3a	Mcr
AC	MMBZ5227B	Z-diode	3.42...3.78V, Izt=20mA, Zzt=24Ω, 350mW	SOT-23	16dc	-	3a	Lge
AC	MT3506S	Si-npn	VHF/UHF, 10V, 15mA, 10GHz	SOT-23	16ta	-	3a	Tos
AC	PT7M7809TT	Vdet-IC	3.08V±1.5%, -Reset PPO	SOT-23	16vdc	VD7	3b	Pti
AC	PT7M7809TTE	Vdet-IC	3.08V±1.5%, -Reset PPO, Lead free	SOT-23	16vdc	VD7	3b	Pti
AC	RT9161-31CV	LVR-IC	LDO, 3.1V±2%, 300mA	SOT-23	16cg	VR1	3a	Rct
AC-	RT9819B-28PU3	Vdet-IC	2.8V±1.5%, -Reset PPO, Td=55ms	SOT-323	16vdc	VD7	3a	Rct
AC1	FA4L4M	Si-npn-Digi	Sw, 60V, 100mA, 200mW, R1/R2=47k/47k	SC-59	16ta	-	3a	Nec
AC1	GA4L4M	Si-npn-Digi	Sw, 60V, 100mA, 200mW, R1/R2=47k/47k	SOT-323	16ta	-	3a	Nec
ACAA	HWD809TEU	Vdet-IC	3.08V±2%, -Reset PPO	SOT-23	16vdc	VD7	3a	Csm
ACAA	MAX809TUR	Vdet-IC	3.08V±1.5%, -Reset PPO	SOT-23	16vdc	VD7	3a	Max
ACD	AME8800GEET	LVR-IC	LDO, 3.5V±1.5%, 300mA	SOT-23	16cq	VR1	3b	Ame
ACD	AME8800GEETL	LVR-IC	LDO, 3.5V±1.5%, 300mA	TSOT-23	16cq	VR1	3b	Ame
ACD	AME8800GEETY	LVR-IC	LDO, 3.5V±1.5%, 300mA	TSOT-23	16cq	VR1	3b	Ame
ACD	AME8800GEETZ	LVR-IC	LDO, 3.5V±1.5%, 300mA	SOT-23	16cq	VR1	3b	Ame
ACD	MAX6808XR32-T	Vdet-IC	3.2V±1.5%, -Reset ODO	SOT-323	16vdc	VD6	3a	Max
ACE	MAX6326_R31-T	Vdet-IC	3.1V±1.5%, -Reset PPO	SOT-323	16vdc	VD7	3a	Max
ACF	MAX6347XR46-T	Vdet-IC	4.6V±1.5%, +Reset PPO	SOT-323	16vdc	VD7	3a	Max
ACG	KTA1517-GR	Si-pnp	AF, LN, 120V, 100mA, 150mW, B=200...400, 100MHz	SOT-23	16ta	-	3f	Kec
ACH	MAX6326_R23-T	Vdet-IC	2.3V±1.5%, -Reset PPO	SOT-323	16vdc	VD7	3a	Max
ACI	MAX6326_R26-T	Vdet-IC	2.6V±1.5%, -Reset PPO	SOT-323	16vdc	VD7	3a	Max
ACJ	MAX6328XR26-T	Vdet-IC	2.6V±1.5%, -Reset ODO	SOT-323	16vdc	VD6	3a	Max
ACK	MAX6346XR44-T	Vdet-IC	4.4V±1.5%, -Reset PPO	SOT-323	16vdc	VD7	3a	Max
ACL	2SC3837K-L	Si-npn	VHF/UHF, 30V, 50mA, 150mW, B=27...56, 1.5GHz	SOT-346	16ta	-	3a	Rhm
ACL	2SC4725-L	Si-npn	VHF/UHF, 30V, 50mA, 150mW, B=27...56, >1.5GHz	SC-75A	16ta	-	3a	Rhm
ACL	2SC5661-L	Si-npn	VHF/UHF, 30V, 50mA, 150mW, B=27...56, >1.5GHz	VMT3	18ta	-	3a	Rhm
ACL	KTA1517-BL	Si-pnp	AF, LN, 120V, 100mA, 150mW, B=350...700, 100MHz	SOT-23	16ta	-	3f	Kec
ACL	MAX6347XR44-T	Vdet-IC	4.4V±1.5%, +Reset PPO	SOT-323	16vdc	VD7	3a	Max



SMD code	Type	Function	Short description	Case	Pinout	Sch.	St.	Mnf.
ACM	2SC3837K-M	Si-npn	VHF/UHF, 30V, 50mA, 150mW, B=39..82, 1.5GHz	SOT-346	16ta	-	3a	Rhm
ACM	2SC4725-M	Si-npn	VHF/UHF, 30V, 50mA, 150mW, B=39..82, >1.5GHz	SC-75A	16ta	-	3a	Rhm
ACM	2SC5661-M	Si-npn	VHF/UHF, 30V, 50mA, 150mW, B=39..82, >1.5GHz	VMT3	18ta	-	3a	Rhm
ACM	MAX6348XR46-T	Vdet-IC	4.6V±1.5%, -Reset ODO	SOT-323	16vdc	VD6	3a	Max
ACN	2SC3837K-N	Si-npn	VHF/UHF, 30V, 50mA, 150mW, B=56..120, 1.5GHz	SOT-346	16ta	-	3a	Rhm
ACN	2SC4725-N	Si-npn	VHF/UHF, 30V, 50mA, 150mW, B=56..120, >1.5GHz	SC-75A	16ta	-	3a	Rhm
ACN	2SC5661-N	Si-npn	VHF/UHF, 30V, 50mA, 150mW, B=56..120, >1.5GHz	VMT3	18ta	-	3a	Rhm
ACN	MAX6348XR44-T	Vdet-IC	4.4V±1.5%, -Reset ODO	SOT-323	16vdc	VD6	3a	Max
ACO	2SA1313-O	Si-pnp	GP, 80V, 500mA, 200mW, B=70..140, 200MHz	SOT-23	16ta	-	3a	Tos
ACO	MAX6346XR46-T	Vdet-IC	4.6V±1.5%, -Reset PPO	SOT-323	16vdc	VD7	3a	Max
ACP	2SC3837K-P	Si-npn	VHF/UHF, 30V, 50mA, 150mW, B=82..180, 1.5GHz	SOT-346	16ta	-	3a	Rhm
ACP	2SC4725-P	Si-npn	VHF/UHF, 30V, 50mA, 150mW, B=82..180, >1.5GHz	SC-75A	16ta	-	3a	Rhm
ACP	2SC5661-P	Si-npn	VHF/UHF, 30V, 50mA, 150mW, B=82..180, >1.5GHz	VMT3	18ta	-	3a	Rhm
ACp	BCW60C	Si-npn	GP, 32V, 200mA, 250mW, B=250..480, 250MHz	SOT-23	16ta	-	3a	PHH
ACP	MAX6326_R29-T	Vdet-IC	2.9V±1.5%, -Reset PPO	SOT-323	16vdc	VD7	3a	Max
ACQ	2SC3837K-Q	Si-npn	VHF/UHF, 30V, 50mA, 150mW, B=120..270, 1.5GHz	SOT-346	16ta	-	3a	Rhm
ACQ	2SC4725-Q	Si-npn	VHF/UHF, 30V, 50mA, 150mW, B=120..270, >1.5GHz	SC-75A	16ta	-	3a	Rhm
ACQ	2SC5661-Q	Si-npn	VHF/UHF, 30V, 50mA, 150mW, B=120..270, >1.5GHz	VMT3	18ta	-	3a	Rhm
ACQ	MAX6327XR23-T	Vdet-IC	2.3V±1.5%, +Reset PPO	SOT-323	16vdc	VD7	3a	Max
ACR	MAX6327XR26-T	Vdet-IC	2.6V±1.5%, +Reset PPO	SOT-323	16vdc	VD7	3a	Max
ACs	BCW60C	Si-npn	GP, 32V, 200mA, 250mW, B=250..480, 250MHz	SOT-23	16ta	-	3c	Inf
ACS	MAX6327XR29-T	Vdet-IC	2.9V±1.5%, +Reset PPO	SOT-323	16vdc	VD7	3a	Max
ACt	BCW60C	Si-npn	GP, 32V, 200mA, 250mW, B=250..480, 250MHz	SOT-23	16ta	-	3a	PhM
ACT	MAX6327XR31-T	Vdet-IC	3.1V±1.5%, +Reset PPO	SOT-323	16vdc	VD7	3a	Max
ACU	MAX6328XR23-T	Vdet-IC	2.3V±1.5%, -Reset ODO	SOT-323	16vdc	VD6	3a	Max
ACV	MAX6328XR29-T	Vdet-IC	2.9V±1.5%, -Reset ODO	SOT-323	16vdc	VD6	3a	Max
ACW	BCW60C	Si-npn	GP, 32V, 200mA, 250mW, B=250..480, 250MHz	SOT-23	16ta	-	3a	PhC
ACW	MAX6328XR31-T	Vdet-IC	3.1V±1.5%, -Reset ODO	SOT-323	16vdc	VD6	3a	Max
ACX	MMBTA05	Si-npn	GP, 60V, 500mA, 350mW, B>100, >100MHz	SOT-323	16ta	-	3a	Kec
ACY	2SA1313-Y	Si-pnp	GP, 80V, 500mA, 200mW, B=120..240, 200MHz	SOT-23	16ta	-	3a	Tos
AD	12A02CH	Si-pnp	AF, GP, 15V, 1A, 700mW, B=300..700, 450MHz	CPH3	16ta	-	3a	San
AD	AP431IAW	Vref-IC	Adjustable, Precision, Shunt, 2.495V±0.5%	SOT-23-3L	16rc	RF1	3a	Ana
AD	GS6333UR15D1	Vdet-IC	1.5V, -Reset PPO, 1.5ms	SOT-23	16vdc	VD7	3g	Vs
AD	IMP809SEUR	Vdet-IC	2.93V±1.5%, -Reset PPO	SOT-23	16vdc	VD7	3a	Imp
AD	KRA354	Si-pnp-Digi	Dual, Sw, 12V, 500mA, 100mW, R1/R2=10k/10k	USM	16ta	-	3f	Kec
AD	MIC803-29D2VC3	Vdet-IC	2.93V±2.5%, -Reset ODO, 20ms	SC-70	16vdc	VD7	3a	Mcr
AD	MIC803-29D2VM3	Vdet-IC	2.93V±2.5%, -Reset ODO, 20ms	SOT-23	16vdc	VD7	3a	Mcr
AD	MMBZ5228B	Z-diode	3.71..4.10V, Izt=20mA, Zzt=23Ω, 350mW	SOT-23	16dc	-	3a	Lge
AD	MT3S07S	Si-npn	VHF/UHF, 10V, 25mA, 12GHz	SOT-23	16ta	-	3a	Tos
AD	PT7M7809ST	Vdet-IC	2.93V±1.5%, -Reset PPO	SOT-23	16vdc	VD7	3b	Pti
AD	PT7M7809STE	Vdet-IC	2.93V±1.5%, -Reset PPO, Lead free	SOT-23	16vdc	VD7	3b	Pti
AD	RT9161-32CV	LVR-IC	LDO, 3.2V±2%, 300mA	SOT-23	16cg	VR1	3a	Rct
AD	SiP6333R15D1	Vdet-IC	1.5V±1.5%, +Reset PPO 1.5ms	SOT-23	16vdc	VD7	3g	Vs
AD-	RT9818C-23PU3	Vdet-IC	2.3V±1.5%, -Reset ODO, Td=220ms	SOT-323	16vdc	VD6	3a	Rct
AD1	FA4L3M	Si-npn-Digi	Sw, 60V, 100mA, 200mW, R1/R2=4k7/4k7	SC-59	16ta	-	3a	Nec
AD1	GA4L3M	Si-npn-Digi	Sw, 60V, 100mA, 200mW, R1/R2=4k7/4k7	SOT-323	16ta	-	3a	Nec
ADAA	HWD809SEU	Vdet-IC	2.93V±2%, -Reset PPO	SOT-23	16vdc	VD7	3a	Csm
ADAA	MAX809SUR	Vdet-IC	2.93V±1.5%, -Reset PPO	SOT-23	16vdc	VD7	3a	Max
ADL	2SC3838K-L	Si-npn	VHF/UHF, 20V, 50mA, 200mW, B=27..56, 3.2GHz	SMT3	16ta	-	3a	Rhm
ADL	2SC4726-L	Si-npn	VHF/UHF, 20V, 50mA, 150mW, B=27..56, 3.2GHz	SC-75A	16ta	-	3a	Rhm
ADL	2SC5662-L	Si-npn	VHF/UHF, 20V, 50mA, 150mW, B=27..56, 3.2GHz	VMT3	16ta	-	3a	Rhm
ADM	2SC3838K-M	Si-npn	VHF/UHF, 20V, 50mA, 200mW, B=39..82, 3.2GHz	SMT3	16ta	-	3a	Rhm
ADM	2SC4726-M	Si-npn	VHF/UHF, 20V, 50mA, 150mW, B=39..82, 3.2GHz	SC-75A	16ta	-	3a	Rhm
ADM	2SC5662-M	Si-npn	VHF/UHF, 20V, 50mA, 150mW, B=39..82, 3.2GHz	VMT3	16ta	-	3a	Rhm
ADN	2SC3838K-N	Si-npn	VHF/UHF, 20V, 50mA, 200mW, B=56..120, 3.2GHz	SMT3	16ta	-	3a	Rhm
ADN	2SC4726-N	Si-npn	VHF/UHF, 20V, 50mA, 150mW, B=56..120, 3.2GHz	SC-75A	16ta	-	3a	Rhm
ADN	2SC5662-N	Si-npn	VHF/UHF, 20V, 50mA, 150mW, B=56..120, 3.2GHz	VMT3	16ta	-	3a	Rhm
ADP	2SC3838K-P	Si-npn	VHF/UHF, 20V, 50mA, 200mW, B=82..180, 3.2GHz	SMT3	16ta	-	3a	Rhm
ADP	2SC4726-P	Si-npn	VHF/UHF, 20V, 50mA, 150mW, B=82..180, 3.2GHz	SC-75A	16ta	-	3a	Rhm
ADP	2SC5662-P	Si-npn	VHF/UHF, 20V, 50mA, 150mW, B=82..180, 3.2GHz	VMT3	16ta	-	3a	Rhm
ADp	BCW60D	Si-npn	GP, 32V, 200mA, 250mW, B=380..630, 250MHz	SOT-23	16ta	-	3a	PHH
ADQ	2SC3838K-Q	Si-npn	VHF/UHF, 20V, 50mA, 200mW, B=120..270, 3.2GHz	SMT3	16ta	-	3a	Rhm
ADQ	2SC4726-Q	Si-npn	VHF/UHF, 20V, 50mA, 150mW, B=120..270, 3.2GHz	SC-75A	16ta	-	3a	Rhm
ADQ	2SC5662-Q	Si-npn	VHF/UHF, 20V, 50mA, 150mW, B=120..270, 3.2GHz	VMT3	16ta	-	3a	Rhm
ADs	BCW60D	Si-npn	GP, 32V, 200mA, 250mW, B=380..630, 250MHz	SOT-23	16ta	-	3c	Inf
ADt	BCW60D	Si-npn	GP, 32V, 200mA, 250mW, B=380..630, 250MHz	SOT-23	16ta	-	3a	PhM
ADW	BCW60D	Si-npn	GP, 32V, 200mA, 250mW, B=380..630, 250MHz	SOT-23	16ta	-	3a	PhC
ADX	MMBTA06	Si-npn	GP, 80V, 500mA, 350mW, B>100, >100MHz	SOT-23	16ta	-	3a	Kec
AE	2SA1365-E	Si-pnp	Relay-Drv, 25V, 1A, 150mW, B=150..300, 180MHz	SOT-23	16ta	-	3a	Mit
AE	AP431IR	Vref-IC	Adjustable, Precision, Shunt, 2.495V±1%	SOT-23-3L	16rd	RF1	3a	Ana



SMD code	Type	Function	Short description	Case	Pinout	Sch.	St.	Mnf.
AE	BCW60E	Si-npn	GP, 32V, 200mA, 0.33W, B=250..460, 250MHz	SOT-23	16ta	-	3a	Fer
AE	CPH3105	Si-pnp	Relay-Drv, 50V, 3A, 900mW, B=200..560, 360MHz	CPH3	16ta	-	3a	San
AE	GS6333UR15D2	Vdet-IC	1.5V, -Reset PPO, 30ms	SOT-23	16vdc	VD7	3g	Vs
AE	KRA355	Si-pnp-Digi	Dual, Sw, 12V, 500mA, 100mW, R1/R2=0.47k/10k	USM	16ta	-	3f	Kec
AE	MIC803-29D3VC3	Vdet-IC	2.93V±2.5%, -Reset ODO, 140ms	SC-70	16vdc	VD7	3a	Mcr
AE	MIC803-29D3VM3	Vdet-IC	2.93V±2.5%, -Reset ODO, 140ms	SOT-23	16vdc	VD7	3a	Mcr
AE	MMBZ5229B	Z-diode	4.09..4.52V, Izt=20mA, Zzt=22Ω, 350mW	SOT-23	16dc	-	3a	Lge
AE	MT3S04AS	Si-npn	VHF/UHF, 10V, 40mA, 7GHz	SOT-23	16ta	-	3a	Tos
AE	PT7M7809RT	Vdet-IC	2.63V±1.5%, -Reset PPO	SOT-23	16vdc	VD7	3b	Pti
AE	PT7M7809RTE	Vdet-IC	2.63V±1.5%, -Reset PPO, Lead free	SOT-23	16vdc	VD7	3b	Pti
AE	RT9161-34CV	LVR-IC	LDO, 3.4V±2%, 300mA	SOT-23	16cg	VR1	3a	Rct
AE	SiP6333R15D2	Vdet-IC	1.5V±1.5%, +Reset PPO 30ms	SOT-23	16vdc	VD7	3g	Vs
AE-	RT9819B-14PU3	Vdet-IC	1.4V±1.5%, -Reset PPO, Td=55ms	SOT-323	16vdc	VD7	3a	Rct
AE1	FA4L3N	Si-npn-Digi	Sw, 60V, 100mA, 200mW, R1/R2=4k7/10k	SC-59	16ta	-	3a	Nec
AE1	GA4L3N	Si-npn-Digi	Sw, 60V, 100mA, 200mW, R1/R2=4k7/10k	SOT-323	16ta	-	3a	Nec
AED	AME8800HEET	LVR-IC	LDO, 2.7V±1.5%, 300mA	SOT-23	16cq	VR1	3b	Ame
AED	AME8800HEETL	LVR-IC	LDO, 2.7V±1.5%, 300mA	TSOT-23	16cq	VR1	3b	Ame
ÆED	AME8800HEETY	LVR-IC	LDO, 2.7V±1.5%, 300mA	TSOT-23	16cq	VR1	3b	Ame
ÆED	AME8800HEETZ	LVR-IC	LDO, 2.7V±1.5%, 300mA	SOT-23	16cq	VR1	3b	Ame
AEG	2SA1362-GR	Si-pnp	Sw, AF-Amp, 15V, 800mA, 200mW, B=200..400, 120MHz	SOT-23	16ta	-	3a	Tos
AEK	MXD1810XR46	Vdet-IC	4.6V±2.5%, -Reset PPO	SOT-323	16vdy	VD7	3a	Max
AEL	2SA1362-BL	Si-pnp	Sw, AF-Amp, 15V, 800mA, 200mW, B=70..140, 120MHz	SOT-23	16ta	-	3a	Tos
AEL	2SC3839K-L	Si-npn	AF, 30V, 50mA, 150mW, B=27..56, >200MHz	SOT-346	16ta	-	3a	Rhm
AEL	AME8800IEET	LVR-IC	LDO, 3.4V±1.5%, 300mA	SOT-23	16cq	VR1	3b	Ame
AEL	AME8800IEETL	LVR-IC	LDO, 3.4V±1.5%, 300mA	TSOT-23	16cq	VR1	3b	Ame
ÆEL	AME8800IEETY	LVR-IC	LDO, 3.4V±1.5%, 300mA	TSOT-23	16cq	VR1	3b	Ame
ÆEL	AME8800IEETZ	LVR-IC	LDO, 3.4V±1.5%, 300mA	SOT-23	16cq	VR1	3b	Ame
AEL	MXD1811XR44	Vdet-IC	4.4V±2.5%, CMOS -Reset ODO	SOT-323	16vdy	VD9	3a	Max
AEM	2SC3839K-M	Si-npn	AF, 30V, 50mA, 150mW, B=39..82, >200MHz	SOT-346	16ta	-	3a	Rhm
AEM	MXD1812XR41	Vdet-IC	4.1V±2.5%, CMOS +PPO +Reset	SOT-323	16vdy	VD7	3a	Max
AEN	2SC3839K-N	Si-npn	AF, 30V, 50mA, 150mW, B=56..120, >200MHz	SOT-346	16ta	-	3a	Rhm
AEN	MXD1813XR46	Vdet-IC	4.6V±2.5%, MR, CMOS -Reset ODO	SOT-323	16vdy	VD10	3a	Max
AEO	MXD1815XR29	Vdet-IC	2.9V±2.5%, -Reset PPO	SOT-323	16vdy	VD7	3a	Max
AEP	2SC3839K-P	Si-npn	AF, 30V, 50mA, 150mW, B=82..180, >200MHz	SOT-346	16ta	-	3a	Rhm
AEP	MXD1816XR22	Vdet-IC	2.2V±2.5%, CMOS -Reset ODO	SOT-323	16vdy	VD9	3a	Max
AEQ	2SC3839K-Q	Si-npn	AF, 30V, 50mA, 150mW, B=120..270, >200MHz	SOT-346	16ta	-	3a	Rhm
AEQ	MXD1817XR31	Vdet-IC	3.1V±2.5%, CMOS +Reset PPO	SOT-323	16vdy	VD7	3a	Max
AER	MXD1818XR26	Vdet-IC	2.6V±2.5%, MR, CMOS +Reset ODO	SOT-323	16vdy	VD10	3a	Max
AEV	MXD1818XR22	Vdet-IC	2.2V±2.5%, MR, CMOS +Reset ODO	SOT-323	16vdy	VD10	3a	Max
AEW	MAX6138AEXR12-T	Vref-IC	Shunt, 1.225V, 0.1%	SOT-323	16dk	RF1	3a	Max
AEX	MAX6138BEXR12-T	Vref-IC	Shunt, 1.225V, 0.2%	SOT-323	16dk	RF1	3a	Max
AEY	2SA1362-Y	Si-pnp	Sw, AF-Amp, 15V, 800mA, 200mW, B=120..240, 120MHz	SOT-23	16ta	-	3a	Tos
AEY	MAX6138CEXR12-T	Vref-IC	Shunt, 1.225V, 0.5%	SOT-323	16dk	RF1	3a	Max
AF	2SA1365-F	Si-pnp	Relay-Drv, 25V, 1A, 150mW, B=250..500, 180MHz	SOT-23	16ta	-	3a	Mit
AF	AP431IAR	Vref-IC	Adjustable, Precision, Shunt, 2.495V±0.5%	SOT-23-3L	16rd	RF1	3a	Ana
AF	CPH3106	Si-pnp	DC/DC-Conv, 15V, 3A, 900mW, 280MHz, B=200..560	CPH3	16ta	-	3a	San
AF	IMP809REUR	Vdet-IC	2.63V±1.5%, -Reset PPO	SOT-23	16vdc	VD7	3a	Imp
AF	KRA356	Si-pnp-Digi	Dual, Sw, 12V, 500mA, 100mW, R1/R2=1k/10k	USM	16ta	-	3f	Kec
AF	MMBZ5230B	Z-diode	4.47..4.94V, Izt=20mA, Zzt=19Ω, 350mW	SOT-23	16dc	-	3a	Lge
AF	PT7M7809ZT	Vdet-IC	2.32V±1.5%, -Reset PPO	SOT-23	16vdc	VD7	3b	Pti
AF	PT7M7809ZTE	Vdet-IC	2.32V±1.5%, -Reset PPO, Lead free	SOT-23	16vdc	VD7	3b	Pti
AF-	RT9819D-20PU3	Vdet-IC	2.0V±1.5%, -Reset PPO, Td=450ms	SOT-23	16vdc	VD7	3a	Rct
AF1	FA4L3Z	Si-npn-Digi	Sw, 60V, 100mA, 200mW, R1=4k7	SC-59	16ta	-	3a	Nec
AF1	GA4L3Z	Si-npn-Digi	Sw, 60V, 100mA, 200mW, R1=4k7	SOT-323	16ta	-	3a	Nec
AFA	MAX6138AEXR21-T	Vref-IC	Shunt, 2.048V, 0.1%	SOT-323	16dk	RF1	3a	Max
AFAA	HWD809REU	Vdet-IC	2.63V±2%, -Reset PPO	SOT-23	16vdc	VD7	3a	Csm
AFAA	MAX809RUR	Vdet-IC	2.63V±1.5%, -Reset PPO	SOT-23	16vdc	VD7	3a	Max
AFB	MAX6138BEXR21-T	Vref-IC	Shunt, 2.048V, 0.2%	SOT-323	16dk	RF1	3a	Max
AFC	MAX6138CEXR21-T	Vref-IC	Shunt, 2.048V, 0.5%	SOT-323	16dk	RF1	3a	Max
AFE	MAX6138AEXR25-T	Vref-IC	Shunt, 2.5V, 0.1%	SOT-323	16dk	RF1	3a	Max
AFF	MAX6138BEXR25-T	Vref-IC	Shunt, 2.5V, 0.2%	SOT-323	16dk	RF1	3a	Max
AFG	MAX6138CEXR25-T	Vref-IC	Shunt, 2.5V, 0.5%	SOT-323	16dk	RF1	3a	Max
AFI	MAX6138AEXR30-T	Vref-IC	Shunt, 3V, 0.1%	SOT-323	16dk	RF1	3a	Max
AFJ	MAX6138BEXR30-T	Vref-IC	Shunt, 3V, 0.2%	SOT-323	16dk	RF1	3a	Max
AFK	MAX6138CEXR30-T	Vref-IC	Shunt, 3V, 0.5%	SOT-323	16dk	RF1	3a	Max
AFM	MAX6138AEXR41-T	Vref-IC	Shunt, 4.096V, 0.1%	SOT-323	16dk	RF1	3a	Max
AFN	MAX6138BEXR41-T	Vref-IC	Shunt, 4.096V, 0.2%	SOT-323	16dk	RF1	3a	Max
AFO	MAX6138CEXR41-T	Vref-IC	Shunt, 4.096V, 0.5%	SOT-323	16dk	RF1	3a	Max
AFP	2SD1781K-P	Si-npn	AF-Drv, 40V, 800mA, 200mW, B=82..180, >150MHz	SOT-346	16ta	-	3a	Rhm
AFQ	2SD1781K-Q	Si-npn	AF-Drv, 40V, 800mA, 200mW, B=120..270, >150MHz	SOT-346	16ta	-	3a	Rhm



SMD code	Type	Function	Short description	Case	Pinout	Sch. St.	Mnf.
AFQ	MAX6138AEXR50-T	Vref-IC	Shunt, 5.000V, 0.1%	SOT-323	16dk	RF1 3a	Max
AFR	2SD1781K-R	Si-npn	AF-Drv, 40V, 800mA, 200mW, B=180..390, >150MHz	SOT-346	16ta	- 3a	Rhm
AFR	MAX6138BEXR50-T	Vref-IC	Shunt, 5.000V, 0.2%	SOT-323	16dk	RF1 3a	Max
AFs	BCW60FF	Si-npn	GP, 32V, 200mA, 330mW, B=250..460, 250MHz	SOT-23	16ta	- 3c	Inf
AFS	MAX6138CEXR50-T	Vref-IC	Shunt, 5.0V, 0.5%	SOT-323	16dk	RF1 3a	Max
AG	2SA1365-G	Si-pnp	Relay-Drv, 25V, 1A, 150mW, B=400..800, 180MHz	SOT-23	16ta	- 3a	Mit
AG	2SA1980EF-G	Si-pnp	GP, 50V, 150mA, 150mW, B=200..400, 80MHz	SOT-523F	18ta	- 3a	Auk
AG	2SA1980E-G	Si-pnp	GP, 50V, 150mA, 150mW, B=200..400, 80MHz	SOT-523	16ta	- 3a	Auk
AG	CPH3107	Si-pnp	DC/DC-Conv, 15V, 6A, 900mW, 140MHz, B=200..560	CPH3	16ta	- 3a	San
AG	GS6333UR15D3	Vdet-IC	1.5V, -Reset PPO, 150ms	SOT-23	16vdc	VD7 3g	Vs
AG	IMP810LEUR	Vdet-IC	4.63V±1.5%, +Reset PPO	SOT-23	16vdc	VD7 3a	Imp
AG	KRA357	Si-pnp-Digi	Dual, Sw, 12V, 500mA, 100mW, R1/R2=2.2k/10k	USM	16ta	- 3f	Kec
AG	MIC803-31D2VC3	Vdet-IC	3.08V±2.5%, -Reset ODO, 20ms	SC-70	16vdc	VD7 3a	Mcr
AG	MIC803-31D2VM3	Vdet-IC	3.08V±2.5%, -Reset ODO, 20ms	SOT-23	16vdc	VD7 3a	Mcr
AG	PT7M7809YT	Vdet-IC	2.20V±1.5%, -Reset PPO	SOT-23	16vdc	VD7 3b	Pti
AG	PT7M7809YTE	Vdet-IC	2.20V±1.5%, -Reset PPO, Lead free	SOT-23	16vdc	VD7 3b	Pti
AG	RT9161-36CV	LVR-IC	LDO, 3.6V±2%, 300mA	SOT-23	16cg	VR1 3a	Rct
AG	SIP6333R15D3	Vdet-IC	1.5V±1.5%, +Reset PPO 150ms	SOT-23	16vdc	VD7 3g	Vs
AG-	RT9818C-16PU3	Vdet-IC	1.6V±1.5%, -Reset ODO, Td=220ms	SOT-323	16vdc	VD6 3a	Rct
AG1	FA4A3Q	Si-npn-Digi	Sw, 60V, 100mA, 200mW, R1/R2=1k/10k	SC-59	16ta	- 3a	Nec
AG1	GA4A3Q	Si-npn-Digi	Sw, 60V, 100mA, 200mW, R1/R2=1k/10k	SOT-323	16ta	- 3a	Nec
AGAA	HWD810LEU	Vdet-IC	4.63V±2%, +Reset PPO	SOT-23	16vdc	VD7 3a	Csm
AGAA	MAX810LUR	Vdet-IC	4.63V±1.5%, +Reset PPO	SOT-23	16vdc	VD7 3a	Max
AGN	AME8800JEET	LVR-IC	LDO, 2.85V±1.5%, 300mA	SOT-23	16cq	VR1 3b	Ame
AGN	AME8800JEETL	LVR-IC	LDO, 2.85V±1.5%, 300mA	TSOT-23	16cq	VR1 3b	Ame
AGN	AME8800JEETY	LVR-IC	LDO, 2.85V±1.5%, 300mA	TSOT-23	16cq	VR1 3b	Ame
AGN	AME8800JEETZ	LVR-IC	LDO, 2.85V±1.5%, 300mA	SOT-23	16cq	VR1 3b	Ame
AGp	BCX70G	Si-npn	GP, Sw, 45V, 100mA, 250mW, B=120..220, >100MHz	SOT-23	16ta	- 3a	PHM
AGs	BCW70G	Si-pnp	GP, 45V, 100mA, 200mW, B=120..220, >150MHz	SOT-23	16ta	- 3c	Inf
AGs	BCX70G	Si-npn	GP, Sw, 45V, 100mA, 250mW, B=120..220, >100MHz	SOT-23	16ta	- 3a	Sie
AGt	BCX70G	Si-npn	GP, Sw, 45V, 100mA, 250mW, B=120..220, >100MHz	SOT-23	16ta	- 3a	PhM
AGW	AME8500AEEETAD26	Vdet-IC	2.63V±1.5%, -Reset PPO, 30ms	SOT-23	16vdc	VD7 3b	Ame
AGW	AME8500AEEETAD26Z	Vdet-IC	2.63V±1.5%, -Reset PPO, 30ms, lead free	SOT-23	16vdc	VD7 3b	Ame
AGW	BCX70G	Si-npn	GP, Sw, 45V, 100mA, 250mW, B=120..220, >100MHz	SOT-23	16ta	- 3a	PhC
AH	1S5345	Si-diode	SBD, UHF-det/mix, 5V, 10mA, 150mW, 0.45pF	CP	16dc	- 3a	San
AH	GS6333UR16D1	Vdet-IC	1.6V, -Reset PPO, 1.5ms	SOT-23	16vdc	VD7 3g	Vs
AH	IMP810MEUR	Vdet-IC	4.38V±1.5%, +Reset PPO	SOT-23	16vdc	VD7 3a	Imp
AH	MMBZ5231B	Z-diode	4.85..5.36V, Izt=20mA, Zzt=17Ω, 350mW	SOT-23	16dc	- 3a	Lge
AH	PT7M7810LT	Vdet-IC	4.63V±1.5%, +Reset PPO	SOT-23	16vdc	VD7 3b	Pti
AH	PT7M7810LTE	Vdet-IC	4.63V±1.5%, +Reset PPO, Lead free	SOT-23	16vdc	VD7 3b	Pti
AH	RT9161-37CV	LVR-IC	LDO, 3.7V±2%, 300mA	SOT-23	16cg	VR1 3a	Rct
AH	SB01W05C	Si-diode	Dual, SBR, HF, 50V, 100mA, Vf<0.55V(100mA), 4.4pF, 10ns	CP	16dg	- 3a	San
AH	SIP6333R16D1	Vdet-IC	1.6V±1.5%, +Reset PPO 1.5ms	SOT-23	16vdc	VD7 3g	Vs
AH-	RT9819C-28PU3	Vdet-IC	2.8V±1.5%, -Reset PPO, Td=220ms	SOT-323	16vdc	VD7 3a	Rct
AH1	FA4A4P	Si-npn-Digi	Sw, 60V, 100mA, 200mW, R1/R2=10k/47k	SC-59	16ta	- 3a	Nec
AH1	GA4A4P	Si-npn-Digi	Sw, 60V, 100mA, 200mW, R1/R2=10k/47k	SOT-323	16ta	- 3a	Nec
AHAA	HWD810MEU	Vdet-IC	4.38V±2%, +Reset PPO	SOT-23	16vdc	VD7 3a	Csm
AHAA	MAX810MUR	Vdet-IC	4.38V±1.5%, +Reset PPO	SOT-23	16vdc	VD7 3a	Max
AHP	2SB1197K-P	Si-pnp	AF, 40V, 800mA, 200mW, B=82..180, 200MHz	SOT-23	16ta	- 3a	Rhm
AHP	AME8800KEET	LVR-IC	LDO, 3.7V±1.5%, 300mA	SOT-23	16cq	VR1 3b	Ame
AHP	AME8800KEETL	LVR-IC	LDO, 3.7V±1.5%, 300mA	TSOT-23	16cq	VR1 3b	Ame
AHP	AME8800KEETY	LVR-IC	LDO, 3.7V±1.5%, 300mA	TSOT-23	16cq	VR1 3b	Ame
AHP	AME8800KEETZ	LVR-IC	LDO, 3.7V±1.5%, 300mA	SOT-23	16cq	VR1 3b	Ame
AHp	BCX70H	Si-npn	GP, Sw, 45V, 100mA, 250mW, B=180..310, >100MHz	SOT-23	16ta	- 3a	PHH
AHQ	2SB1197K-Q	Si-pnp	AF, 40V, 800mA, 200mW, B=120..270, 200MHz	SOT-23	16ta	- 3a	Rhm
AHR	2SB1197K-R	Si-pnp	AF, 40V, 800mA, 200mW, B=180..390, 200MHz	SOT-23	16ta	- 3a	Rhm
AHs	BCW70H	Si-pnp	GP, 45V, 100mA, 200mW, B=180..310, >150MHz	SOT-23	16ta	- 3c	Inf
AHs	BCX70H	Si-npn	GP, Sw, 45V, 100mA, 250mW, B=180..310, >100MHz	SOT-23	16ta	- 3a	Sie
AHt	BCX70H	Si-npn	GP, Sw, 45V, 100mA, 250mW, B=180..310, >100MHz	SOT-23	16ta	- 3a	PhM
AHT	MXD1810XR41	Vdet-IC	4.1V±2.5%, -Reset PPO	SOT-323	16vdy	VD7 3a	Max
AHU	MXD1810XR44	Vdet-IC	4.4V±2.5%, -Reset PPO	SOT-323	16vdy	VD7 3a	Max
AHV	MXD1811XR41	Vdet-IC	4.1V±2.5%, CMOS -Reset ODO	SOT-323	16vdy	VD9 3a	Max
AHW	BCX70H	Si-npn	GP, Sw, 45V, 100mA, 250mW, B=180..310, >100MHz	SOT-23	16ta	- 3a	PhC
AHW	MXD1811XR46	Vdet-IC	4.6V±2.5%, CMOS -Reset ODO	SOT-323	16vdy	VD9 3a	Max
AHX	MXD1812XR44	Vdet-IC	4.4V±2.5%, CMOS +PPO +Reset	SOT-323	16vdy	VD7 3a	Max
AHY	MXD1812XR46	Vdet-IC	4.6V±2.5%, CMOS +PPO +Reset	SOT-323	16vdy	VD7 3a	Max
AHZ	MXD1813XR41	Vdet-IC	4.1V±2.5%, MR, CMOS -Reset ODO	SOT-323	16vdy	VD10 3a	Max
AI	GS6333UR16D2	Vdet-IC	1.6V, -Reset PPO, 30ms	SOT-23	16vdc	VD7 3g	Vs
AI	IMP810JEUR	Vdet-IC	4.0V±1.5%, +Reset PPO	SOT-23	16vdc	VD7 3a	Imp
AI	PT7M7810MT	Vdet-IC	4.26V±1.5%, +Reset PPO	SOT-23	16vdc	VD7 3b	Pti



SMD code	Type	Function	Short description	Case	Pinout	Sch.	St.	Mnf.
ĀI	PT7M7810MTE	Vdet-IC	4.26V±1.5%, +Reset PPO, Lead free	SOT-23	16vdc	VD7	3b	Pti
AI	SiP6333R16D2	Vdet-IC	1.6V±1.5%, +Reset PPO 30ms	SOT-23	16vdc	VD7	3g	Vs
AIa	MXD1813XR44	Vdet-IC	4.4V±2.5%, MR, CMOS -Reset ODO	SOT-323	16vdy	VD10	3a	Max
AIB	MXD1815XR22	Vdet-IC	2.2V±2.5%, -Reset PPO	SOT-323	16vdy	VD7	3a	Max
AIC	MXD1815XR23	Vdet-IC	2.3V±2.5%, -Reset PPO	SOT-323	16vdy	VD7	3a	Max
AID	MXD1815XR26	Vdet-IC	2.6V±2.5%, -Reset PPO	SOT-323	16vdy	VD7	3a	Max
AIE	MXD1815XR31	Vdet-IC	3.1V±2.5%, -Reset PPO	SOT-323	16vdy	VD7	3a	Max
AIF	MXD1816XR23	Vdet-IC	2.3V±2.5%, CMOS -Reset ODO	SOT-323	16vdy	VD9	3a	Max
AIG	MXD1816XR26	Vdet-IC	2.6V±2.5%, CMOS -Reset ODO	SOT-323	16vdy	VD9	3a	Max
AIH	MXD1816XR29	Vdet-IC	2.9V±2.5%, CMOS -Reset ODO	SOT-323	16vdy	VD9	3a	Max
AIi	MXD1816XR31	Vdet-IC	3.1V±2.5%, CMOS -Reset ODO	SOT-323	16vdy	VD9	3a	Max
AIJ	MXD1817XR22	Vdet-IC	2.2V±2.5%, CMOS +Reset PPO	SOT-323	16vdy	VD7	3a	Max
AIK	MXD1817XR23	Vdet-IC	2.3V±2.5%, CMOS +Reset PPO	SOT-323	16vdy	VD7	3a	Max
AIl	MXD1817XR26	Vdet-IC	2.6V±2.5%, CMOS +Reset PPO	SOT-323	16vdy	VD7	3a	Max
AIM	MXD1817XR29	Vdet-IC	2.9V±2.5%, CMOS +Reset PPO	SOT-323	16vdy	VD7	3a	Max
AIN	MXD1818XR23	Vdet-IC	2.3V±2.5%, MR, CMOS +Reset ODO	SOT-323	16vdy	VD10	3a	Max
AIO	MXD1818XR29	Vdet-IC	2.9V±2.5%, MR, CMOS +Reset ODO	SOT-323	16vdy	VD10	3a	Max
AIP	MXD1818XR31	Vdet-IC	3.1V±2.5%, MR, CMOS +Reset ODO	SOT-323	16vdy	VD10	3a	Max
AJ	ADM810JART	Vdet-IC	4.0V±1.5%, +Reset PPO	SOT-23	16vdc	VD7	3a	Ad
AJ	CPH3109	Si-pnp	DC/DC-Conv, 30V, 3A, 900mW, 380MHz, B=200..560	CPH3	16ta	-	3a	San
AJ	IMP810TEUR	Vdet-IC	3.08V±1.5%, +Reset PPO	SOT-23	16vdc	VD7	3a	Imp
AJ	MIC803-31D4VC3	Vdet-IC	3.08V±2.5%, -Reset ODO, 1120ms	SC-70	16vdc	VD7	3a	Mcr
AJ	MIC803-31D4VM3	Vdet-IC	3.08V±2.5%, -Reset ODO, 1120ms	SOT-23	16vdc	VD7	3a	Mcr
AJ	MMBZ5232B	Z-diode	5.32..5.88V, Izt=20mA, Zzt=11Ω, 350mW	SOT-23	16dc	-	3a	Lge
AJ	PT7M7810TT	Vdet-IC	3.08V±1.5%, +Reset PPO	SOT-23	16vdc	VD7	3b	Pti
ĀJ	PT7M7810TTE	Vdet-IC	3.08V±1.5%, +Reset PPO, Lead free	SOT-23	16vdc	VD7	3b	Pti
AJ	RT9161-38CV	LVR-IC	LDO, 3.8V±2%, 300mA	SOT-23	16cg	VR1	3a	Rct
AJ-	RT9818B-18PU3	Vdet-IC	1.8V±1.5%, -Reset ODO, Td=55ms	SOT-323	16vdc	VD6	3a	Rct
AJ=	RT9818B-18GU3	Vdet-IC	1.8V±1.5%, -Reset ODO, Td=55ms	SOT-323	16vdc	VD6	3a	Rct
AJ1	FA4F4N	Si-npn-Digi	Sw, 60V, 100mA, 200mW, R1/R2=22k/47k	SC-59	16ta	-	3a	Nec
AJ1	GA4F4N	Si-npn-Digi	Sw, 60V, 100mA, 200mW, R1/R2=22k/47k	SOT-323	16ta	-	3a	Nec
AJ5	2SK443-5	n-FET	V-cam amp, 15V, 50mA, 200mW, Idss=5..12mA	SOT-23	16fa	-	3a	San
AJ6	2SK443-6	n-FET	V-cam amp, 15V, 50mA, 200mW, Idss=10..24mA	SOT-23	16fa	-	3a	San
AJ7	2SK443-7	n-FET	V-cam amp, 15V, 50mA, 200mW, Idss=16..38mA	SOT-23	16fa	-	3a	San
AJAA	HWD810TEU	Vdet-IC	3.08V±2%, +Reset PPO	SOT-23	16vdc	VD7	3a	Csm
AJAA	MAX810TUR	Vdet-IC	3.08V±1.5%, +Reset PPO	SOT-23	16vdc	VD7	3a	Max
AJP	2SD1782K-P	Si-npn	AF-Drv, 80V, 500mA, 200mW, B=82..180, >180MHz	SOT-346	16ta	-	3a	Rhm
AJp	BCX70J	Si-npn	GP, Sw, 45V, 100mA, 250mW, B=250..460, >100MHz	SOT-23	16ta	-	3a	PHH
AJQ	2SD1782K-Q	Si-npn	AF-Drv, 80V, 500mA, 200mW, B=120..270, >180MHz	SOT-346	16ta	-	3a	Rhm
AJR	2SD1782K-R	Si-npn	AF-Drv, 80V, 500mA, 200mW, B=180..390, >180MHz	SOT-346	16ta	-	3a	Rhm
AJs	BCW70J	Si-pnp	GP, 45V, 100mA, 200mW, B=250..460, >150MHz	SOT-23	16ta	-	3c	Inf
AJs	BCX70J	Si-npn	GP, Sw, 45V, 100mA, 250mW, B=250..460, >100MHz	SOT-23	16ta	-	3a	Sie
AJt	BCX70J	Si-npn	GP, Sw, 45V, 100mA, 250mW, B=250..460, >100MHz	SOT-23	16ta	-	3a	PHM
AJW	AME8800LEET	LVR-IC	LDO, 1.5V±1.5%, 300mA	SOT-23	16cq	VR1	3b	Ame
AJW	AME8800LEETL	LVR-IC	LDO, 1.5V±1.5%, 300mA	TSOT-23	16cq	VR1	3b	Ame
ĀJW	AME8800LEETY	LVR-IC	LDO, 1.5V±1.5%, 300mA	TSOT-23	16cq	VR1	3b	Ame
ĀJW	AME8800LEETZ	LVR-IC	LDO, 1.5V±1.5%, 300mA	SOT-23	16cq	VR1	3b	Ame
AJW	BCX70J	Si-npn	GP, Sw, 45V, 100mA, 250mW, B=250..460, >100MHz	SOT-23	16ta	-	3a	PHC
AJX	AME8800MEET	LVR-IC	LDO, 1.8V±1.5%, 300mA	SOT-23	16cq	VR1	3b	Ame
AJX	AME8800MEETL	LVR-IC	LDO, 1.8V±1.5%, 300mA	TSOT-23	16cq	VR1	3b	Ame
ĀJX	AME8800MEETY	LVR-IC	LDO, 1.8V±1.5%, 300mA	TSOT-23	16cq	VR1	3b	Ame
ĀJX	AME8800MEETZ	LVR-IC	LDO, 1.8V±1.5%, 300mA	SOT-23	16cq	VR1	3b	Ame
AK	12A02MH	Si-pnp	AF, GP, 15V, 1A, 600mW, B=300..700, 450MHz	MCPH3	18ta	-	3a	San
AK	2SK2539	n-FET	FM/VHF, 15V, Idss=10..50mA, Up<3V	SOT-23	16fa	-	3a	San
AK	CPH3110	Si-pnp	DC/DC-Conv, 30V, 5A, 900mW, 250MHz, B=200..560	CPH3	16ta	-	3a	San
AK	GS6333UR16D3	Vdet-IC	1.6V, -Reset PPO, 150ms	SOT-23	16vdc	VD7	3g	Vs
AK	IMP810SEUR	Vdet-IC	2.93V±1.5%, +Reset PPO	SOT-23	16vdc	VD7	3a	Imp
AK	MIC803-41D2VC3	Vdet-IC	4.10V±2.5%, -Reset ODO, 20ms	SC-70	16vdc	VD7	3a	Mcr
AK	MIC803-41D2VM3	Vdet-IC	4.10V±2.5%, -Reset ODO, 20ms	SOT-23	16vdc	VD7	3a	Mcr
AK	MMBZ5233B	Z-diode	5.70..6.30V, Izt=20mA, Zzt=7Ω, 350mW	SOT-23	16dc	-	3a	Lge
AK	PT7M7810ST	Vdet-IC	2.93V±1.5%, +Reset PPO	SOT-23	16vdc	VD7	3b	Pti
ĀK	PT7M7810STE	Vdet-IC	2.93V±1.5%, +Reset PPO, Lead free	SOT-23	16vdc	VD7	3b	Pti
AK	RT9161-39CV	LVR-IC	LDO, 3.9V±2%, 300mA	SOT-23	16cg	VR1	3a	Rct
AK	SiP6333R16D3	Vdet-IC	1.6V±1.5%, +Reset PPO 150ms	SOT-23	16vdc	VD7	3g	Vs
AK-	RT9818E-18PU3	Vdet-IC	1.8V±1.5%, +Reset ODO	SOT-323	16vdc	VD6	3a	Rct
AK1	FA4L4L	Si-npn-Digi	Sw, 60V, 100mA, 200mW, R1/R2=47k/22k	SC-59	16ta	-	3a	Nec
AK1	GA4L4L	Si-npn-Digi	Sw, 60V, 100mA, 200mW, R1/R2=47k/22k	SOT-323	16ta	-	3a	Nec
AK6	2SK2539-6	n-FET	HF, Sw, 15V, 50mA, 200mW, Idss=10..20mA	SOT-23	16fa	-	3a	San
AK7	2SK2539-7	n-FET	HF, Sw, 15V, 50mA, 200mW, Idss=16..32mA	SOT-23	16fa	-	3a	San
AK8	2SK2539-8	n-FET	HF, Sw, 15V, 50mA, 200mW, Idss=25..50mA	SOT-23	16fa	-	3a	San



SMD code	Type	Function	Short description	Case	Pinout	Sch. St.	Mnf.
AKAA	HWD810SEU	Vdet-IC	2.93V±2%, +Reset PPO	SOT-23	16vdc	VD7	3a Csm
AKAA	MAX810SUR	Vdet-IC	2.93V±1.5%, +Reset PPO	SOT-23	16vdc	VD7	3a Max
AKG	AME8800NEET	LVR-IC	LDO, 2.9V±1.5%, 300mA	SOT-23	16cq	VR1	3b Ame
AKG	AME8800NEETL	LVR-IC	LDO, 2.9V±1.5%, 300mA	TSOT-23	16cq	VR1	3b Ame
ĀKG	AME8800NEETY	LVR-IC	LDO, 2.9V±1.5%, 300mA	TSOT-23	16cq	VR1	3b Ame
ĀKG	AME8800NEETZ	LVR-IC	LDO, 2.9V±1.5%, 300mA	SOT-23	16cq	VR1	3b Ame
AKH	AME8800OEET	LVR-IC	LDO, 3.1V±1.5%, 300mA	SOT-23	16cq	VR1	3b Ame
AKH	AME8800EETL	LVR-IC	LDO, 3.1V±1.5%, 300mA	TSOT-23	16cq	VR1	3b Ame
ĀKH	AME8800EETY	LVR-IC	LDO, 3.1V±1.5%, 300mA	TSOT-23	16cq	VR1	3b Ame
ĀKH	AME8800EETZ	LVR-IC	LDO, 3.1V±1.5%, 300mA	SOT-23	16cq	VR1	3b Ame
AKP	2SB1198K-P	Si-pnp	AF-Drv, 80V, 500mA, 200mW, B=82..180, >180MHz	SOT-346	16ta	-	3a Rhm
AKp	BCX70K	Si-npn	GP, Sw, 45V, 100mA, 250mW, B=380..630, >100MHz	SOT-23	16ta	-	3a PHH
AKQ	2SA1738-Q	Si-pnp	Sw, Hi-speed, 15V, 50mA, 200mW, B=50..120, 1.5GHz	SC-59	16ta	-	3a Pan
AKQ	2SA1806-Q	Si-pnp	Sw, 15V, 100mA, 125mW, 1.5GHz, B=50..120	SOT-416	16ta	-	3a Pan
AKQ	2SB1198K-Q	Si-pnp	AF-Drv, 80V, 500mA, 200mW, B=120..270, >180MHz	SOT-346	16ta	-	3a Rhm
AKR	2SA1738-R	Si-pnp	Sw, Hi-speed, 15V, 50mA, 200mW, B=90..150, 1.5GHz	SC-59	16ta	-	3a Pan
AKR	2SA1806-R	Si-pnp	Sw, 15V, 100mA, 125mW, 1.5GHz, B=90..150	SOT-416	16ta	-	3a Pan
AKR	2SB1198K-R	Si-pnp	AF-Drv, 80V, 500mA, 200mW, B=180..390, >180MHz	SOT-346	16ta	-	3a Rhm
AKs	BCW70K	Si-pnp	GP, 45V, 100mA, 200mW, B=380..630, >150MHz	SOT-23	16ta	-	3c Inf
AKs	BCX70K	Si-npn	GP, Sw, 45V, 100mA, 250mW, B=380..630, 250MHz	SOT-23	16ta	-	3a Sie
AKt	BCX70K	Si-npn	GP, Sw, 45V, 100mA, 250mW, B=380..630, >100MHz	SOT-23	16ta	-	3a PHM
AKV	MAX6461XR29-T	Vdet-IC	2.9V±2.5%, -Reset PPO	SOT-323	16vdc	VD7	3b Max
AKW	BCX70K	Si-npn	GP, Sw, 45V, 100mA, 250mW, B=380..630, >100MHz	SOT-23	16ta	-	3a PhC
AKW	MAX6462XR16-T	Vdet-IC	1.6V±2.5%, +Reset PPO	SOT-323	16vdc	VD6	3b Max
AKZ	MAX6465XR46-T	Vdet-IC	4.6V±2.5%, +Reset PPO, 150ms	SOT-323	16vdc	VD6	3b Max
AL	2SA1980EF-L	Si-pnp	GP, 50V, 150mA, 150mW, B=300..700, 80MHz	SOT-523F	18ta	-	3a Auk
AL	2SA1980E-L	Si-pnp	GP, 50V, 150mA, 150mW, B=300..700, 80MHz	SOT-523	16ta	-	3a Auk
AL	30A02CH	Si-pnp	AF, GP, 30V, 700mA, 700mW, B=200..500, 520MHz	CPH3	16ta	-	3a San
AL	30A02MH	Si-pnp	AF, GP, 30V, 700mA, 600mW, B=200..500, 520MHz	MCPH3	18ta	-	3a San
AL	ADM810LART	Vdet-IC	4.63V±1.5%, +Reset PPO	SOT-23	16vdc	VD7	3a Ad
AL	GS6333UR18D1	Vdet-IC	1.8V, -Reset PPO, 1.5ms	SOT-23	16vdc	VD7	3g Vs
AL	IMP810REUR	Vdet-IC	2.63V±1.5%, +Reset PPO	SOT-23	16vdc	VD7	3a Imp
AL	MMBTA55L	Si-pnp	AF-Drv, 60V, 500mA, 300mW, B>100, >50MHz	SOT-23	16ta	-	- Mot
AL	PT7M7810RT	Vdet-IC	2.63V±1.5%, +Reset PPO	SOT-23	16vdc	VD7	3b Pti
ĀL	PT7M7810RTE	Vdet-IC	2.63V±1.5%, +Reset PPO, Lead free	SOT-23	16vdc	VD7	3b Pti
AL	RT9161-40CV	LVR-IC	LDO, 4.0V±2%, 300mA	SOT-23	16cg	VR1	3a Rct
AL	SIP6333R18D1	Vdet-IC	1.8V±1.5%, +Reset PPO 1.5ms	SOT-23	16vdc	VD7	3g Vs
AL-	RT9818A-30PU3	Vdet-IC	3.0V±1.5%, -Reset ODO	SOT-323	16vdc	VD6	3a Rct
AL1	FA4A4Z	Si-npn-Digi	Sw, 60V, 100mA, 200mW, R1=10k	SC-59	16ta	-	3a Nec
AL1	GA4A4Z	Si-npn-Digi	Sw, 60V, 100mA, 200mW, R1=10k	SOT-323	16ta	-	3a Nec
AL4	2SA1338-4	Si-pnp	Sw, Hi-Sp, 60V, 500mA, 200mW, 200MHz, B=100..200	SOT-23	16ta	-	3a San
AL5	2SA1338-5	Si-pnp	Sw, Hi-Sp, 60V, 500mA, 200mW, 200MHz, B=140..280	SOT-23	16ta	-	3a San
AL6	2SA1338-6	Si-pnp	Sw, Hi-Sp, 60V, 500mA, 200mW, 200MHz, B=200..400	SOT-23	16ta	-	3a San
AL7	2SA1338-7	Si-pnp	Sw, Hi-Sp, 60V, 500mA, 200mW, 300MHz, B=280..560	SOT-23	16ta	-	3a San
ALA	MAX6466XR29-T	Vdet-IC	2.9V±2.5%, -Reset ODO, 150ms	SOT-323	16vdc	VD9	3b Max
ALAA	HWD810REU	Vdet-IC	2.63V±2%, +Reset PPO	SOT-23	16vdc	VD7	3a Csm
ALAA	MAX810RUR	Vdet-IC	2.63V±1.5%, +Reset PPO	SOT-23	16vdc	VD7	3a Max
ALB	MAX6466XR46-T	Vdet-IC	4.6V±2.5%, -Reset ODO, 150ms	SOT-323	16vdc	VD9	3b Max
ALM	2SC3802K-M	Si-npn	AF, 30V, 30mA, 200mW, B=39..82, >110MHz	SOT-346	16ta	-	3a Rhm
ALN	2SC3802K-N	Si-npn	AF, 30V, 30mA, 200mW, B=56..120, >110MHz	SOT-346	16ta	-	3a Rhm
ALN	ELM7522CEB	Vdet-IC	2.2V±2%, +Reset PPO	SC-70	16vdb	VD7	3d Elm
ALN	ELM7522NEB	Vdet-IC	2.2V±2%, +Reset ODO	SC-70	16vdb	VD6	3d Elm
ALP	2SC3802K-P	Si-npn	AF, 30V, 30mA, 200mW, B=82..180, >110MHz	SOT-346	16ta	-	3a Rhm
ALQ	2SA1747-Q	Si-pnp	GP, 50V, 50mA, 200mW, 250MHz, B=50..120	SOT-23	16ta	-	3a Pan
ALQ	2SA1748-Q	Si-pnp	HF, 50V, 50mA, 150mW, 250MHz, B=200..400	SOT-323	16ta	-	3a Pan
ALQ	2SA1791-Q	Si-pnp	HF, 50V, 50mA, 125mW, 250MHz, B=200..400	SOT-416	16ta	-	3a Pan
ALQ	2SC3802K-Q	Si-npn	AF, 30V, 30mA, 200mW, B=120..270, >110MHz	SOT-346	16ta	-	3a Rhm
ALR	2SA1747-R	Si-pnp	GP, 50V, 50mA, 200mW, 250MHz, B=90..150	SOT-23	16ta	-	3a Pan
ALR	2SA1748-R	Si-pnp	HF, 50V, 50mA, 150mW, 250MHz, B=250..500	SOT-323	16ta	-	3a Pan
ALR	2SA1791-R	Si-pnp	HF, 50V, 50mA, 125mW, 250MHz, B=250..500	SOT-416	16ta	-	3a Pan
ALU	AME8500AEETDF26	Vdet-IC	2.63V±1.5%, +Reset ODO, 210ms	SOT-23	16vdc	VD6	3b Ame
ĀLU	AME8500AEETDF26Z	Vdet-IC	2.63V±1.5%, +Reset ODO, 210ms, lead free	SOT-23	16vdc	VD6	3b Ame
ALV	AME8500AEETCF29	Vdet-IC	2.93V±1.5%, +Reset PPO, 210ms	SOT-23	16vdc	VD7	3b Ame
ĀLV	AME8500AEETCF29Z	Vdet-IC	2.93V±1.5%, +Reset PPO, 210ms, lead free	SOT-23	16vdc	VD7	3b Ame
ALX	AME8500AEETAD20	Vdet-IC	2V±1.5%, -Reset PPO, 30ms	SOT-23	16vdc	VD7	3b Ame
ĀLX	AME8500AEETAD20Z	Vdet-IC	2V±1.5%, -Reset PPO, 30ms, lead free	SOT-23	16vdc	VD7	3b Ame
ALY	AME8500AEETAE29	Vdet-IC	2.93V±1.5%, -Reset PPO, 150ms	SOT-23	16vdc	VD7	3b Ame
ĀLY	AME8500AEETAE29Z	Vdet-IC	2.93V±1.5%, -Reset PPO, 150ms, lead free	SOT-23	16vdc	VD7	3b Ame
ALZ	AME8500AEETCD20	Vdet-IC	2V±1.5%, +Reset PPO, 30ms	SOT-23	16vdc	VD7	3b Ame
ĀLZ	AME8500AEETCD20Z	Vdet-IC	2V±1.5%, +Reset PPO, 30ms, lead free	SOT-23	16vdc	VD7	3b Ame

Note: ELM75xxCBB series LN- lot number L=0...9 N=A to Z(I, O, X excepted); ELM75xxNBB series LN- lot number L=A to Z(I, O, X excepted) N=0...9



SMD code	Type	Function	Short description	Case	Pinout	Sch. St.	Mnf.
AM	2SJ284	p-MOSFET-e*	Sw, U-Sp, LogL, 30V, 300mA, 250mW, <3.3Ω(0.15A), 7/40ns	SOT-23	16fh	-	3a San
AM	50A02MH	Si-pnp	AF, GP, 50V, 500mA, 600mW, B=200..500, 690MHz	MCPH3	18ta	-	3a San
AM	ADM810MART	Vdet-IC	4.38V±1.5%, +Reset PPO	SOT-23	16vdc	VD7	3a Ad
AM	BSS64	Si-npn	GP, 120V, 100mA, 250mW, B>20, >60MHz	SOT-23	16ta	-	3a Ons
AM	CPH3112	Si-pnp	DC/DC-Corr, 50V, 5A, 900mW, 250MHz, B=200..560	CPH3	16ta	-	3a San
AM	GS6333UR18D2	Vdet-IC	1.8V, -Reset PPO, 30ms	SOT-23	16vdc	VD7	3g Vs
AM	MIC803-41D3VC3	Vdet-IC	4.10V±2.5%, -Reset ODO, 140ms	SC-70	16vdc	VD7	3a MCr
AM	MIC803-41D3VM3	Vdet-IC	4.10V±2.5%, -Reset ODO, 140ms	SOT-23	16vdc	VD7	3a MCr
AM	MMBT3904W	Si-npn	GP, 60V, 100mA, 200mW, B= 100..300, >300MHz	SOT-23	16ta	-	3a Mot
AM	MMBZ5234B	Z-diode	5.89..6.51V, Izt=20mA, Zzt=7.5V, 350mW	SOT-23	16dc	-	3a Lge
AM	PT7M7810ZT	Vdet-IC	2.32V±1.5%, +Reset PPO	SOT-23	16vdc	VD7	3b Pti
AM	PT7M7810ZTE	Vdet-IC	2.32V±1.5%, +Reset PPO, Lead free	SOT-23	16vdc	VD7	3b Pti
AM	RT9161-41CV	LVR-IC	LDO, 4.1V±2%, 300mA	SOT-23	16cg	VR1	3a Rct
AM	SiP6333R18D2	Vdet-IC	1.8V±1.5%, +Reset PPO 30ms	SOT-23	16vdc	VD7	3g Vs
AM-	RT9819B-24PU3	Vdet-IC	2.4V±1.5%, -Reset PPO, Td=55ms	SOT-323	16vdc	VD7	3a Rct
AM1	FA4F4Z	Si-npn-Digi	Sw, 60V, 100mA, 200mW, R1=22k	SC-59	16ta	-	3a Nec
AM1	GA4F4Z	Si-npn-Digi	Sw, 60V, 100mA, 200mW, R1=22k	SOT-323	16ta	-	3a Nec
AMB	MAX6461XR16-T	Vdet-IC	1.6V±2.5%, -Reset PPO	SOT-323	16vdc	VD7	3b Max
AMC	MAX6461XR22-T	Vdet-IC	2.2V±2.5%, -Reset PPO	SOT-323	16vdc	VD7	3b Max
AMD	MAX6461XR26-T	Vdet-IC	2.6V±2.5%, -Reset PPO	SOT-323	16vdc	VD7	3b Max
AME	MAX6461XR46-T	Vdet-IC	4.6V±2.5%, -Reset PPO	SOT-323	16vdc	VD7	3b Max
AMF	MAX6462XR22-T	Vdet-IC	2.2V±2.5%, +Reset PPO	SOT-323	16vdc	VD6	3b Max
AMG	MAX6462XR26-T	Vdet-IC	2.6V±2.5%, +Reset PPO	SOT-323	16vdc	VD6	3b Max
AMH	MAX6462XR29-T	Vdet-IC	2.9V±2.5%, +Reset PPO	SOT-323	16vdc	VD6	3b Max
AMI	MAX6462XR46-T	Vdet-IC	4.6V±2.5%, +Reset PPO	SOT-323	16vdc	VD6	3b Max
AMJ	MAX6463XR16-T	Vdet-IC	1.6V±2.5%, -Reset ODO	SOT-323	16vdc	VD9	3b Max
AMK	MAX6463XR22-T	Vdet-IC	2.2V±2.5%, -Reset ODO	SOT-323	16vdc	VD9	3b Max
AML	MAX6463XR26-T	Vdet-IC	2.6V±2.5%, -Reset ODO	SOT-323	16vdc	VD9	3b Max
AMM	MAX6463XR29-T	Vdet-IC	2.9V±2.5%, -Reset ODO	SOT-323	16vdc	VD9	3b Max
AMN	2SC4018K-N	Si-npn	AF, 40V, 100mA, 200mW, B=56..120, >230MHz	SOT-346	16ta	-	3a Rhm
AMN	MAX6463XR46-T	Vdet-IC	4.6V±2.5%, -Reset ODO	SOT-323	16vdc	VD9	3b Max
AMO	AME8500AEETAF29	Vdet-IC	2.93V±1.5%, -Reset PPO, 210ms	SOT-23	16vdc	VD7	3b Ame
AMO	AME8500AEETAF29Z	Vdet-IC	2.93V±1.5%, -Reset PPO, 210ms, lead free	SOT-23	16vdc	VD7	3b Ame
AMO	MAX6464XR16-T	Vdet-IC	1.6V±2.5%, -Reset PPO, 150ms	SOT-323	16vdc	VD7	3b Max
AMP	2SC4018K-P	Si-npn	AF, 40V, 100mA, 200mW, B=82..180, >230MHz	SOT-346	16ta	-	3a Rhm
AMP	AME8500AEETAF26	Vdet-IC	2.63V±1.5%, -Reset PPO, 210ms	SOT-23	16vdc	VD7	3b Ame
AMP	AME8500AEETAF26Z	Vdet-IC	2.63V±1.5%, -Reset PPO, 210ms, lead free	SOT-23	16vdc	VD7	3b Ame
AMp	BSS64	Si-npn	GP, 120V, 100mA, 250mW, B>20, >60MHz	SOT-23	16ta	-	3a PHH
AMP	MAX6464XR22-T	Vdet-IC	2.2V±2.5%, -Reset PPO, 150ms	SOT-323	16vdc	VD7	3b Max
AMQ	2SC4561-Q	Si-npn	GP, 50V, 50mA, 200mW, B=200..400, 250MHz	SOT-23	16ta	-	3a Pan
AMQ	2SC4562-Q	Si-npn	HF, 50V, 50mA, 150mW, B=200..400, 250MHz	SOT-323	16ta	-	3a Pan
AMQ	2SC4656-Q	Si-npn	HF, 50V, 50mA, 125mW, B=200..400, 250MHz	SOT-416	16ta	-	3a Pan
AMQ	MAX6464XR26-T	Vdet-IC	2.6V±2.5%, -Reset PPO, 150ms	SOT-323	16vdc	VD7	3b Max
AMR	2SC4561-R	Si-npn	GP, 50V, 50mA, 200mW, B=250..500, 250MHz	SOT-23	16ta	-	3a Pan
AMR	2SC4562-R	Si-npn	HF, 50V, 50mA, 150mW, B=250..500, 250MHz	SOT-323	16ta	-	3a Pan
AMR	2SC4656-R	Si-npn	HF, 50V, 50mA, 125mW, B=250..500, 250MHz	SOT-416	16ta	-	3a Pan
AMR	MAX6464XR29-T	Vdet-IC	2.9V±2.5%, -Reset PPO, 150ms	SOT-323	16vdc	VD7	3b Max
AMs	BSS64	Si-npn	GP, 120V, 100mA, 330mW, B=20..80, 100MHz	SOT-23	16ta	-	3a Sie
AMS	MAX6464XR46-T	Vdet-IC	4.6V±2.5%, -Reset PPO, 150ms	SOT-323	16vdc	VD7	3b Max
AMt	BSS64	Si-npn	GP, 120V, 100mA, 250mW, B>20, >60MHz	SOT-23	16ta	-	3a PHM
AMT	MAX6465XR16-T	Vdet-IC	1.6V±2.5%, +Reset PPO, 150ms	SOT-323	16vdc	VD6	3b Max
AMU	MAX6465XR22-T	Vdet-IC	2.2V±2.5%, +Reset PPO, 150ms	SOT-323	16vdc	VD6	3b Max
AMV	MAX6465XR26-T	Vdet-IC	2.6V±2.5%, +Reset PPO, 150ms	SOT-323	16vdc	VD6	3b Max
AMW	BSS64	Si-npn	GP, 120V, 100mA, 250mW, B>20, >60MHz	SOT-23	16ta	-	3a PhC
AMW	MAX6465XR29-T	Vdet-IC	2.9V±2.5%, +Reset PPO, 150ms	SOT-323	16vdc	VD6	3b Max
AMX	MAX6466XR16-T	Vdet-IC	1.6V±2.5%, -Reset ODO, 150ms	SOT-323	16vdc	VD9	3b Max
AMY	MAX6466XR22-T	Vdet-IC	2.2V±2.5%, -Reset ODO, 150ms	SOT-323	16vdc	VD9	3b Max
AMZ	MAX6466XR26-T	Vdet-IC	2.6V±2.5%, -Reset ODO, 150ms	SOT-323	16vdc	VD9	3b Max
AN	2SC2413K-N	Si-npn	HF-Amp, 40V, 50mA, 200mW, B=56..120, 300MHz	SOT-346	16ta	-	3a Rhm
AN	2SC2532	Si-npn-Darl	AF-Drv, 40V, 300mA, 150mW, B>5000	SC-59	16ta	-	3a Tos
AN	2SC4098-N	Si-npn	HF-Amp, 40V, 50mA, 200mW, B=56..120, >350MHz	SOT-323	16ta	-	3a Rhm
AN	2SC4618-N	Si-npn	HF-Amp, 40V, 50mA, 150mW, B=56..120, 300MHz	SOT-416	16ta	-	3a Rhm
AN	2SK3287	n-MOSFET-e*	V-MOS, LogL, 30V, 0.3A, <3.44Ω	SOT-23	16fh	-	3a Ren
AN	2SK3289	n-MOSFET-e*	GP, 30V, 300mA, 400mW, 2.8Ω(4V), 800/2200ns	SOT-323	16ft	-	3a Ren
AN	GS6333UR18D3	Vdet-IC	1.8V, -Reset PPO, 150ms	SOT-23	16vdc	VD7	3g Vs
AN	MIC803-41D4VC3	Vdet-IC	4.10V±2.5%, -Reset ODO, 1120ms	SC-70	16vdc	VD7	3a MCr
AN	MIC803-41D4VM3	Vdet-IC	4.10V±2.5%, -Reset ODO, 1120ms	SOT-23	16vdc	VD7	3a MCr
AN	MMBZ5235B	Z-diode	6.46..7.14V, Izt=20mA, Zzt=5.0V, 350mW	SOT-23	16dc	-	3a Lge
AN	PT7M7810YT	Vdet-IC	2.20V±1.5%, +Reset PPO	SOT-23	16vdc	VD7	3b Pti
AN	PT7M7810YTE	Vdet-IC	2.20V±1.5%, +Reset PPO, Lead free	SOT-23	16vdc	VD7	3b Pti



SMD code	Type	Function	Short description	Case	Pinout	Sch.	St.	Mnf.
AN	RT9161-42CV	LVR-IC	LDO, 4.2V±2%, 300mA	SOT-23	16cg	VR1	3a	Rct
AN	SiP6333R18D3	Vdet-IC	1.8V±1.5%, +Reset PPO 150ms	SOT-23	16vdc	VD7	3g	Vs
AN-	RT9819B-25PU3	Vdet-IC	2.5V±1.5%, -Reset PPO, Td=55ms	SOT-323	16vdc	VD7	3a	Rct
AN1	FA4L4Z	Si-npn-Digi	Sw, 60V, 100mA, 200mW, R1=47k	SC-59	16ta	-	3a	Nec
AN1	GA4L4Z	Si-npn-Digi	Sw, 60V, 100mA, 200mW, R1=47k	SOT-323	16ta	-	3a	Nec
ANN	2SC4061K-N	Si-npn	Vid, 300V, 100mA, 200mW, B=56..120, >100MHz	SC-59	16ta	-	3a	Rhm
ANP	2SC4061K-P	Si-npn	Vid, 300V, 100mA, 200mW, B=82..180, >100MHz	SC-59	16ta	-	3a	Rhm
ANs	BCW60FN	Si-npn	GP, 32V, 200mA, 330mW, B=380..630, 250MHz	SOT-23	16ta	-	3a	Fer
AO	2SA1980EF-O	Si-pnp	GP, 50V, 150mA, 150mW, B=70..140, 80MHz	SOT-523F	18ta	-	3a	Auk
AO	2SA1980E-O	Si-pnp	GP, 50V, 150mA, 150mW, B=70..140, 80MHz	SOT-523	16ta	-	3a	Auk
AO	2SC4210-O	Si-npn	AF, 35V, 800mA, 200mW, B=100..200, 120MHz	SC-59	16ta	-	3a	Tos
AO	BCW60AR	Si-npn	GP, 32V, 200mA, 250mW, B=120..220, 250MHz	SOT-23	16te	-	3a	lIt
AO	GS6333UR19D1	Vdet-IC	1.9V, -Reset PPO, 1.5ms	SOT-23	16vdc	VD7	3g	Vs
AO	SiP6333R19D1	Vdet-IC	1.9V±1.5%, +Reset PPO 1.5ms	SOT-23	16vdc	VD7	3g	Vs
AP	2SC2413K-P	Si-npn	HF-Amp, 40V, 50mA, 200mW, B=82..180, 300MHz	SOT-346	16ta	-	3a	Rhm
AP	2SC4098-P	Si-npn	HF-Amp, 40V, 50mA, 200mW, B=82..180, >350MHz	SOT-323	16ta	-	3a	Rhm
AP	2SC4618-P	Si-npn	HF-Amp, 40V, 50mA, 150mW, B=82..180, 300MHz	SOT-416	16ta	-	3a	Rhm
AP	2SJ575	p-MOSFET-e*	V-MOS, LogL, 30V, 0.1A, <7.9Ω	SOT-23	16fh	-	3a	Ren
AP	BCW60BR	Si-npn	GP, 32V, 200mA, 250mW, B=190..310, 250MHz	SOT-23	16te	-	3a	lIt
AP	CPH3114	Si-pnp	DC/DC-Conv, 15V, 1.5A, 900mW, 350MHz, B=200..560	CPH3	16ta	-	3a	San
AP	GS6333UR19D2	Vdet-IC	1.9V, -Reset PPO, 30ms	SOT-23	16vdc	VD7	3g	Vs
AP	MIC803-44D2VC3	Vdet-IC	4.38V±2.5%, -Reset ODO, 20ms	SC-70	16vdc	VD7	3a	Mcr
AP	MIC803-44D2VM3	Vdet-IC	4.38V±2.5%, -Reset ODO, 20ms	SOT-23	16vdc	VD7	3a	Mcr
AP	MMBZ5236B	Z-diode	7.13..7.88V, Izt=20mA, Zzt=6Ω, 350mW	SOT-23	16dc	-	3a	Lge
AP	RT9161-43CV	LVR-IC	LDO, 4.3V±2%, 300mA	SOT-23	16cg	VR1	3a	Rct
AP	SiP6333R19D2	Vdet-IC	1.9V±1.5%, +Reset PPO 30ms	SOT-23	16vdc	VD7	3g	Vs
AP-	RT9818B-14PU3	Vdet-IC	1.4V±1.5%, -Reset ODO, Td=55ms	SOT-323	16vdc	VD6	3a	Rct
AP_	2SC4074M	Si-npn	UHFVHF, 18V, 50mA, 150mW, B=270, >1.5GHz	SOT-346	16ta	-	3a	Rhm
AP1	FA4F3M	Si-npn-Digi	Sw, 60V, 100mA, 200mW, R1/R2=2k2/2k2	SC-59	16ta	-	3a	Nec
AP1	GA4F3M	Si-npn-Digi	Sw, 60V, 100mA, 200mW, R1/R2=2k2/2k2	SOT-323	16ta	-	3a	Nec
AQ	2PD1820AQ	Si-npn	GP, Sw, 60V, 500mA, 200mW, B=85..170, >150MHz	SOT-323	16ta	-	3a	PhH
AQ	2SA1979UF-Q	Si-pnp	AF, 40V, 500mA, 200mW, B=70..140, 200MHz	SOT-323F	18ta	-	3a	Auk
AQ	2SA1979U-Q	Si-pnp	AF, 40V, 500mA, 200mW, B=70..140, 200MHz	SOT-323	16ta	-	3a	Auk
AQ	2SB1218-Q	Si-pnp	AF, 25V, 100mA, 150mW, B=160..260, >80MHz	SOT-323	16ta	-	3a	Pan
AQ	2SB1462-Q	Si-pnp	GP, 60V, 100mA, 125mW, 80MHz, B=162..260	SOT-416	16ta	-	3a	Pan
AQ	2SB709-Q	Si-pnp	GP, AF, 50V, 600mA, B=160..260, 150MHz	SC-59	16ta	-	3a	Pan
AQ	2SC2413K-Q	Si-npn	HF-Amp, 40V, 50mA, 200mW, B=120..270, 300MHz	SOT-346	16ta	-	3a	Rhm
AQ	2SC4098-Q	Si-npn	HF-Amp, 40V, 50mA, 200mW, B=120..270, >350MHz	SOT-323	16ta	-	3a	Rhm
AQ	2SC4618-Q	Si-npn	HF-Amp, 40V, 50mA, 150mW, B=120..270, 300MHz	SOT-416	16ta	-	3a	Rhm
AQ	CPH3115	Si-pnp	DC/DC-Conv, 30V, 1.5A, 900mW, 450MHz, B=200..560	CPH3	16ta	-	3a	San
AQ	MIC803-44D3VC3	Vdet-IC	4.38V±2.5%, -Reset ODO, 140ms	SC-70	16vdc	VD7	3a	Mcr
AQ	MIC803-44D3VM3	Vdet-IC	4.38V±2.5%, -Reset ODO, 140ms	SOT-23	16vdc	VD7	3a	Mcr
AQ-	RT9818C-25PU3	Vdet-IC	2.5V±1.5%, -Reset ODO, Td=220ms	SOT-323	16vdc	VD6	3a	Rct
AQ1	FA4F3P	Si-npn-Digi	Sw, 60V, 100mA, 200mW, R1/R2=2k2/10k	SC-59	16ta	-	3a	Nec
AQ1	GA4F3P	Si-npn-Digi	Sw, 60V, 100mA, 200mW, R1/R2=2k2/10k	SOT-323	16ta	-	3a	Nec
AQP	2SB1051K-P	Si-pnp	AF-Drv, 40V, 1A, 200mW, B=82..180, >150MHz	SOT-346	16ta	-	3a	Rhm
AQQ	2SB1051K-Q	Si-pnp	AF-Drv, 40V, 1A, 200mW, B=120..270, >150MHz	SOT-346	16ta	-	3a	Rhm
AQR	2SB1051K-R	Si-pnp	AF-Drv, 40V, 1A, 200mW, B=180..390, >150MHz	SOT-346	16ta	-	3a	Rhm
ÄQV	AME8800SEETY	LVR-IC	LDO, 5.0V±1.5%, 300mA	TSOT-23	16cq	VR1	3b	Ame
ÄQV	AME8800SEETZ	LVR-IC	LDO, 5.0V±1.5%, 300mA	SOT-23	16cq	VR1	3b	Ame
AQW	2PD1820AQ	Si-npn	GP, Sw, 60V, 500mA, 200mW, B=85..170, >150MHz	SOT-323	16ta	-	3a	PhC
AR	2PD1820AR	Si-npn	GP, Sw, 60V, 500mA, 200mW, B=120..240, >150MHz	SOT-323	16ta	-	3a	PhH
AR	2SB1218-R	Si-pnp	AF, 25V, 100mA, 150mW, B=210..340, >80MHz	SOT-323	16ta	-	3a	Pan
AR	2SB1462-R	Si-pnp	GP, 60V, 100mA, 125mW, 80MHz, B=210..340	SOT-416	16ta	-	3a	Pan
AR	2SB709-R	Si-pnp	GP, AF, 50V, 600mA, B=210..340, 150MHz	SC-59	16ta	-	3a	Pan
AR	ADM810RART	Vdet-IC	2.63V±1.5%, +Reset PPO	SOT-23	16vdc	VD7	3a	Ad
AR	BCW60CR	Si-npn	GP, 32V, 200mA, 0.33V, B=250..460, 250MHz	SOT-23	16te	-	3a	Zx
AR	CPH3116	Si-pnp	DC/DC-Conv, 50V, 1A, 900mW, 420MHz, B=200..560	CPH3	16ta	-	3a	San
AR	GS6333UR19D3	Vdet-IC	1.9V, -Reset PPO, 150ms	SOT-23	16vdc	VD7	3g	Vs
AR	MIC803-44D4VC3	Vdet-IC	4.38V±2.5%, -Reset ODO, 1120ms	SC-70	16vdc	VD7	3a	Mcr
AR	MIC803-44D4VM3	Vdet-IC	4.38V±2.5%, -Reset ODO, 1120ms	SOT-23	16vdc	VD7	3a	Mcr
AR	MMBZ5237B	Z-diode	7.79..8.61V, Izt=20mA, Zzt=8Ω, 350mW	SOT-23	16dc	-	3a	Lge
AR	MSB709	Si-pnp	GP, 60V, 100mA, 200mW, B=210..340, <300µs	SOT-23	16ta	-	3a	Wtr
AR	MSB709-R	Si-pnp	GP, 60V, 100mA, 200mW, B=210..340, <300µs	SOT-323	16ta	-	3a	Mot
AR	RT9161-45CV	LVR-IC	LDO, 4.5V±2%, 300mA	SOT-23	16cg	VR1	3a	Rct
AR	SiP6333R19D3	Vdet-IC	1.9V±1.5%, +Reset PPO 150ms	SOT-23	16vdc	VD7	3g	Vs
AR	SRA2210E	Si-pnp-Digi	Sw, 50V, 100mA, 150mW, 200MHz, R1=4.7k	SOT-523	16ta	-	3a	Auk
AR	SRA2210EF	Si-pnp-Digi	Sw, 50V, 100mA, 150mW, 200MHz, R1=4.7k	SOT-523F	18ta	-	3a	Auk
AR	SRA2210U	Si-pnp-Digi	Sw, 50V, 100mA, 200mW, 200MHz, R1=4.7k	SOT-323	16ta	-	3a	Auk
AR	SRA2210UF	Si-pnp-Digi	Sw, 50V, 100mA, 200mW, 200MHz, R1=4.7k	SOT-323F	18ta	-	3a	Auk



SMD code	Type	Function	Short description	Case	Pinout	Sch.	St.	Mnf.
AR-	RT9819B-29PU3	Vdet-IC	2.9V±1.5%, -Reset PPO, Td=55ms	SOT-323	16vdc	VD7	3a	Rct
AR1	FA4F3R	Si-npn-Digi	Sw, 60V, 100mA, 200mW, R1/R2=2k2/47k	SC-59	16ta	-	3a	Nec
AR1	GA4F3R	Si-npn-Digi	Sw, 60V, 100mA, 200mW, R1/R2=2k2/47k	SOT-323	16ta	-	3a	Nec
AR3D	AR3PD	Si-diode	Rectifier, 200V, 3A, Vf<1.2V(3A)	TO-277A	76dh	-	3o	Vs
AR3G	AR3PG	Si-diode	Rectifier, 400V, 3A, Vf<1.2V(3A)	TO-277A	76dh	-	3o	Vs
AR3J	AR3PJ	Si-diode	Rectifier, 600V, 3A, Vf<1.2V(3A)	TO-277A	76dh	-	3o	Vs
AR3K	AR3PK	Si-diode	Rectifier, 800V, 3A, Vf<1.6V(3A)	TO-277A	76dh	-	3o	Vs
AR3M	AR3PM	Si-diode	Rectifier, 1000V, 3A, Vf<1.6V(3A)	TO-277A	76dh	-	3o	Vs
AR4D	AR4PD	Si-diode	Rectifier, 200V, 4A, Vf<1.2V(4A)	TO-277A	76dh	-	3o	Vs
AR4G	AR4PG	Si-diode	Rectifier, 400V, 4A, Vf<1.2V(4A)	TO-277A	76dh	-	3o	Vs
AR4J	AR4PJ	Si-diode	Rectifier, 600V, 4A, Vf<1.2V(4A)	TO-277A	76dh	-	3o	Vs
AR4K	AR4PK	Si-diode	Rectifier, 800V, 4A, Vf<1.6V(4A)	TO-277A	76dh	-	3o	Vs
AR4M	AR4PM	Si-diode	Rectifier, 1000V, 4A, Vf<1.6V(4A)	TO-277A	76dh	-	3o	Vs
ARI	AME8500AEETDF46	Vdet-IC	4.63V±1.5%, +Reset ODO, 210ms	SOT-23	16vdc	VD6	3b	Ame
ARI	AME8500AEETDF46Z	Vdet-IC	4.63V±1.5%, +Reset ODO, 210ms, lead free	SOT-23	16vdc	VD6	3b	Ame
ARJ	AME8500AEETCF46	Vdet-IC	4.63V±1.5%, +Reset PPO, 210ms	SOT-23	16vdc	VD7	3b	Ame
ARJ	AME8500AEETCF46Z	Vdet-IC	4.63V±1.5%, +Reset PPO, 210ms, lead free	SOT-23	16vdc	VD7	3b	Ame
ARK	AME8500AEETAF46	Vdet-IC	4.63V±1.5%, -Reset PPO, 210ms	SOT-23	16vdc	VD7	3b	Ame
ARK	AME8500AEETAF46Z	Vdet-IC	4.63V±1.5%, -Reset PPO, 210ms, lead free	SOT-23	16vdc	VD7	3b	Ame
ARL	AME8500BEETBA29	Vdet-IC	2.93V±1.5%, -Reset ODO, 1.5ms	SOT-23	16vdc	VD6	3b	Ame
ARL	AME8500BEETBA29Z	Vdet-IC	2.93V±1.5%, -Reset ODO, 1.5ms, lead free	SOT-23	16vdc	VD6	3b	Ame
ARM	AME8500BEETAA27	Vdet-IC	2.7V±1.5%, -Reset PPO, 1.5ms	SOT-23	16vdc	VD7	3b	Ame
ARM	AME8500BEETAA27Z	Vdet-IC	2.7V±1.5%, -Reset PPO, 1.5ms, lead free	SOT-23	16vdc	VD7	3b	Ame
ARN	AME8500AEETAF44	Vdet-IC	4.38V±1.5%, -Reset PPO, 210ms	SOT-23	16vdc	VD7	3b	Ame
ARN	AME8500AEETAF44Z	Vdet-IC	4.38V±1.5%, -Reset PPO, 210ms, lead free	SOT-23	16vdc	VD7	3b	Ame
ARQ	AME8500AEETBA30	Vdet-IC	3.0V±1.5%, -Reset ODO, 1.5ms	SOT-23	16vdc	VD6	3b	Ame
ARQ	AME8500AEETBA30Z	Vdet-IC	3.0V±1.5%, -Reset ODO, 1.5ms, lead free	SOT-23	16vdc	VD6	3b	Ame
ARR	2SA2009-R	Si-pnp	AF, 120V, 20mA, 150mW, B=180..360, 200MHz	SOT-323	16ta	-	3a	Pan
ARR	AME8500AEETBA24	Vdet-IC	2.40V±1.5%, -Reset ODO, 1.5ms	SOT-23	16vdc	VD6	3b	Ame
ARR	AME8500AEETBA24Z	Vdet-IC	2.40V±1.5%, -Reset ODO, 1.5ms, lead free	SOT-23	16vdc	VD6	3b	Ame
ARS	2SA2009-S	Si-pnp	AF, 120V, 20mA, 150mW, B=260..520, 200MHz	SOT-323	16ta	-	3a	Pan
ART	2SA2009-T	Si-pnp	AF, 120V, 20mA, 150mW, B=360..700, 200MHz	SOT-323	16ta	-	3a	Pan
ART	AME8500BEETAA21	Vdet-IC	2.1V±1.5%, -Reset PPO, 1.5ms	SOT-23	16vdc	VD7	3b	Ame
ART	AME8500BEETAA21Z	Vdet-IC	2.1V±1.5%, -Reset PPO, 1.5ms, lead free	SOT-23	16vdc	VD7	3b	Ame
ARW	2PD1820AR	Si-npn	GP, Sw, 60V, 500mA, 200mW, B=120..240, >150MHz	SOT-323	16ta	-	3a	PhC
ARW	AME8500CEETBF46	Vdet-IC	4.63V±1.5%, -Reset ODO, 210ms	SOT-23	16vdc	VD6	3b	Ame
ARW	AME8500CEETBF46Z	Vdet-IC	4.63V±1.5%, -Reset ODO, 210ms, lead free	SOT-23	16vdc	VD6	3b	Ame
ARY	AME8500AEETAD29	Vdet-IC	2.93V±1.5%, -Reset PPO, 30ms	SOT-23	16vdc	VD7	3b	Ame
ARY	AME8500AEETAD29Z	Vdet-IC	2.93V±1.5%, -Reset PPO, 30ms, lead free	SOT-23	16vdc	VD7	3b	Ame
ARZ	AME8500BEETAA29	Vdet-IC	2.93V±1.5%, -Reset PPO, 1.5ms	SOT-23	16vdc	VD7	3b	Ame
ARZ	AME8500BEETAA29Z	Vdet-IC	2.93V±1.5%, -Reset PPO, 1.5ms, lead free	SOT-23	16vdc	VD7	3b	Ame
AS	2PD1820AS	Si-npn	GP, Sw, 60V, 500mA, 200mW, B=170..340, >150MHz	SOT-323	16ta	-	3a	PhH
AS	2SA1655	Si-pnp-Digi	Sw, 50V, 100mA, 200mW, 200MHz, R1/R2=4.7k/4.7k	SOT-23	16ta	-	3a	San
AS	2SB1218-S	Si-pnp	AF, 25V, 100mA, 150mW, B=290..460, >80MHz	SOT-323	16ta	-	3a	Pan
AS	2SB1462-S	Si-pnp	GP, 60V, 100mA, 125mW, 80MHz, B=290..460	SOT-416	16ta	-	3a	Pan
AS	2SB709-S	Si-pnp	GP, AF, 50V, 600mA, B=290..460, 150MHz	SC-59	16ta	-	3a	Pan
AS	ADM810SART	Vdet-IC	2.93V±1.5%, +Reset PPO	SOT-23	16vdc	VD7	3a	Ad
AS	BAT18-05	PIN-diode	Dual, Sw, 35V, 0.1A, Vf<1.2V, Cd<1pF	SOT-23	16dg	-	3a	Sie
AS	GS6333UR20D1	Vdet-IC	2V, -Reset PPO, 30ms	SOT-23	16vdc	VD7	3g	Vs
AS	MIC803-46D2VC3	Vdet-IC	4.63V±2.5%, -Reset ODO, 20ms	SC-70	16vdc	VD7	3a	Mcr
AS	MIC803-46D2VM3	Vdet-IC	4.63V±2.5%, -Reset ODO, 20ms	SOT-23	16vdc	VD7	3a	Mcr
AS	SIP6333R20D1	Vdet-IC	2V±1.5%, +Reset PPO 1.5ms	SOT-23	16vdc	VD7	3g	Vs
AS-	RT9819C-13PU3	Vdet-IC	1.3V±1.5%, -Reset ODO, Td=220ms	SOT-323	16vdc	VD6	3a	Rct
AS1	FA4A4L	Si-npn-Digi	Sw, 60V, 100mA, 200mW, R1/R2=10k/4k7	SC-59	16ta	-	3a	Nec
AS1	GA4A4L	Si-npn-Digi	Sw, 60V, 100mA, 200mW, R1/R2=10k/4k7	SOT-323	16ta	-	3a	Nec
AS3D	AS3PD	Si-diode	Rectifier, 200V, 3A, Vf<0.95V(3A)	TO-277A	76dh	-	3o	Vs
AS3G	AS3PG	Si-diode	Rectifier, 400V, 3A, Vf<0.95V(3A)	TO-277A	76dh	-	3o	Vs
AS3J	AS3PJ	Si-diode	Rectifier, 600V, 3A, Vf<0.95V(3A)	TO-277A	76dh	-	3o	Vs
AS3K	AS3PK	Si-diode	Rectifier, 800V, 3A, Vf<0.95V(3A)	TO-277A	76dh	-	3o	Vs
AS3M	AS3PM	Si-diode	Rectifier, 1000V, 3A, Vf<0.95V(3A)	TO-277A	76dh	-	3o	Vs
AS4D	AS4PD	Si-diode	Rectifier, 200V, 4A, Vf<0.98V(3A)	TO-277A	76dh	-	3o	Vs
AS4G	AS4PG	Si-diode	Rectifier, 400V, 4A, Vf<0.98V(3A)	TO-277A	76dh	-	3o	Vs
AS4J	AS4PJ	Si-diode	Rectifier, 600V, 4A, Vf<0.98V(3A)	TO-277A	76dh	-	3o	Vs
AS4K	AS4PK	Si-diode	Rectifier, 800V, 4A, Vf<0.98V(3A)	TO-277A	76dh	-	3o	Vs
AS4M	AS4PM	Si-diode	Rectifier, 1000V, 4A, Vf<0.98V(3A)	TO-277A	76dh	-	3o	Vs
ASA	AME8500AEETAF31	Vdet-IC	3.08V±1.5%, -Reset PPO, 210ms	SOT-23	16vdc	VD7	3b	Ame
ASA	AME8500AEETAF31Z	Vdet-IC	3.08V±1.5%, -Reset PPO, 210ms, lead free	SOT-23	16vdc	VD7	3b	Ame
ASA	BC846UA	Si-npn	GP, 80V, 100mA, 200mW, B=110..220, >100MHz	SOT-323	16ta	-	3a	Auk
ASA	BC846UFA	Si-npn	GP, 80V, 100mA, 200mW, B=110..220, >100MHz	SOT-323F	18ta	-	3a	Auk
ASB	AME8500AEETAF40	Vdet-IC	4V±1.5%, -Reset PPO, 210ms	SOT-23	16vdc	VD7	3b	Ame



SMD code	Type	Function	Short description	Case	Pinout	Sch.	St.	Mnf.
ASB	AME8500AEETAF40Z	Vdet-IC	4V±1.5%, -Reset PPO, 210ms, lead free	SOT-23	16vdc	VD7	3b	Ame
ASB	BC846UB	Si-npn	GP, 80V, 100mA, 200mW, B=200..450, >100MHz	SOT-323	16ta	-	3a	Auk
ASB	BC846UBF	Si-npn	GP, 80V, 100mA, 200mW, B=200..450, >100MHz	SOT-323F	18ta	-	3a	Auk
ASB3	AS1903C31	Vdet-IC	3.08V±1.5%, +Reset PPO	SOT-23	16vdc	VD7	3a	Asm
ASBA	AS1901C23	Vdet-IC	2.32V±1.5%, -Reset ODO	SOT-23	16vdc	VD6	3a	Asm
ASBD	AS1901C26	Vdet-IC	2.63V±1.5%, -Reset ODO	SOT-23	16vdc	VD6	3a	Asm
ASBI	AS1901C31	Vdet-IC	3.08V±1.5%, -Reset ODO	SOT-23	16vdc	VD6	3a	Asm
ASBK	AS1902C23	Vdet-IC	2.32V±1.5%, -Reset PPO	SOT-23	16vdc	VD7	3a	Asm
ASBN	AS1902C26	Vdet-IC	2.63V±1.5%, -Reset PPO	SOT-23	16vdc	VD7	3a	Asm
ASBS	AS1902C31	Vdet-IC	3.08V±1.5%, -Reset PPO	SOT-23	16vdc	VD7	3a	Asm
ASBU	AS1903C23	Vdet-IC	2.32V±1.5%, +Reset PPO	SOT-23	16vdc	VD7	3a	Asm
ASBX	AS1903C26	Vdet-IC	2.63V±1.5%, +Reset PPO	SOT-23	16vdc	VD7	3a	Asm
ASC	AME8500BEETAA30	Vdet-IC	3.0V±1.5%, -Reset PPO, 1.5ms	SOT-23	16vdb	VD7	3b	Ame
ASC	AME8500BEETAA30Z	Vdet-IC	3.0V±1.5%, -Reset PPO, 1.5ms, lead free	SOT-23	16vdb	VD7	3b	Ame
ASC	BC846UC	Si-npn	GP, 80V, 100mA, 200mW, B=420..800, >100MHz	SOT-323	16ta	-	3a	Auk
ASC	BC846UFC	Si-npn	GP, 80V, 100mA, 200mW, B=420..800, >100MHz	SOT-323F	18ta	-	3a	Auk
ASDB	AS1904C26	Vdet-IC	2.63V±1.5%, -Reset PPO	SOT-23	16vdc	VD7	3a	Asm
ASDG	AS1904C31	Vdet-IC	3.08V±1.5%, -Reset PPO	SOT-23	16vdc	VD7	3a	Asm
ASDI	AS1905C23	Vdet-IC	2.32V±1.5%, +Reset PPO	SOT-23	16vdc	VD7	3a	Asm
ASDL	AS1905C26	Vdet-IC	2.63V±1.5%, +Reset PPO	SOT-23	16vdc	VD7	3a	Asm
ASDQ	AS1905C31	Vdet-IC	3.08V±1.5%, +Reset PPO	SOT-23	16vdc	VD7	3a	Asm
ASDS	AS1906C23	Vdet-IC	2.32V±1.5%, -Reset ODO	SOT-23	16vdc	VD6	3a	Asm
ASDV	AS1906C26	Vdet-IC	2.63V±1.5%, -Reset ODO	SOT-23	16vdc	VD6	3a	Asm
ASDX	AS1906C28	Vdet-IC	2.8V±1.5%, -Reset ODO	SOT-23	16vdc	VD6	3a	Asm
ASG	AME8500AEETAF30	Vdet-IC	3.0V±1.5%, -Reset PPO, 210ms	SOT-23	16vdc	VD7	3b	Ame
ASG	AME8500AEETAF30Z	Vdet-IC	3.0V±1.5%, -Reset PPO, 210ms, lead free	SOT-23	16vdc	VD7	3b	Ame
ASGI	KTA1504-GR	Si-pnp	GP, 50V, 150mA, 150mW, B=200..400, >80MHz	SOT-23	16ta	-	3f	Kec
ASGJ	AS1904C23	Vdet-IC	2.32V±1.5%, -Reset PPO	SOT-23	16vdc	VD7	3a	Asm
ASGK	AS1906C31	Vdet-IC	3.08V±1.5%, -Reset ODO	SOT-23	16vdc	VD6	3a	Asm
ASH	AME8500CEETAE26	Vdet-IC	2.63V±1.5%, -Reset PPO, 150ms	SOT-23	16vda	VD7	3b	Ame
ASH	AME8500CEETAE26Z	Vdet-IC	2.63V±1.5%, -Reset PPO, 150ms, lead free	SOT-23	16vda	VD7	3b	Ame
ASH1	AS1909C20-T	Vdet-IC	2.0V±1.5%, -Reset ODO	SOT-23	16vdc	VD6	3a	Asm
ASH2	AS1909C23-T	Vdet-IC	2.3V±1.5%, -Reset ODO	SOT-23	16vdc	VD6	3a	Asm
ASHP	AS1907C16-T	Vdet-IC	1.6V±1.5%, -Reset PPO	SOT-23	16vdc	VD7	3a	Asm
ASHQ	AS1907C18-T	Vdet-IC	1.8V±1.5%, -Reset PPO	SOT-23	16vdc	VD7	3a	Asm
ASHR	AS1907C20-T	Vdet-IC	2.0V±1.5%, -Reset PPO	SOT-23	16vdc	VD7	3a	Asm
ASHU	AS1908C18-T	Vdet-IC	1.8V±1.5%, +Reset PPO	SOT-23	16vdc	VD7	3a	Asm
ASHV	AS1908C20-T	Vdet-IC	2.0V±1.5%, +Reset PPO	SOT-23	16vdc	VD7	3a	Asm
ASHX	AS1907B23-T	Vdet-IC	2.3V±1.5%, -Reset PPO	SOT-23	16vdc	VD7	3a	Asm
ASHY	AS1909C16-T	Vdet-IC	1.6V±1.5%, -Reset ODO	SOT-23	16vdc	VD6	3a	Asm
ASHZ	AS1909C17-T	Vdet-IC	1.7V±1.5%, -Reset ODO	SOT-23	16vdc	VD6	3a	Asm
ASI	AME8500BEETBA42	Vdet-IC	4.2V±1.5%, -Reset ODO, 1.5ms	SOT-23	16vdb	VD6	3b	Ame
ASI	AME8500BEETBA42Z	Vdet-IC	4.2V±1.5%, -Reset ODO, 1.5ms, lead free	SOT-23	16vdb	VD6	3b	Ame
ASJ	AME8500AEETAE26	Vdet-IC	2.63V±1.5%, -Reset PPO, 150ms	SOT-23	16vdc	VD7	3b	Ame
ASJ	AME8500AEETAE26Z	Vdet-IC	2.63V±1.5%, -Reset PPO, 150ms, lead free	SOT-23	16vdc	VD7	3b	Ame
ASK	AME8500AEETAF21	Vdet-IC	2.1V±1.5%, -Reset PPO, 210ms	SOT-23	16vdc	VD7	3b	Ame
ASK	AME8500AEETAF21Z	Vdet-IC	2.1V±1.5%, -Reset PPO, 210ms, lead free	SOT-23	16vdc	VD7	3b	Ame
ASL	AME8500CEETAF29	Vdet-IC	2.93V±1.5%, -Reset PPO, 210ms	SOT-23	16vda	VD7	3b	Ame
ASL	AME8500CEETAF29Z	Vdet-IC	2.93V±1.5%, -Reset PPO, 210ms, lead free	SOT-23	16vda	VD7	3b	Ame
ASNB	AS1907C22-T	Vdet-IC	2.2V±1.5%, -Reset PPO	SOT-23	16vdc	VD7	3a	Asm
ASNC	AS1909C22-T	Vdet-IC	2.2V±1.5%, -Reset ODO	SOT-23	16vdc	VD6	3a	Asm
ASND	AS1909C18-T	Vdet-IC	1.8V±1.5%, -Reset ODO	SOT-23	16vdc	VD6	3a	Asm
ASO	KTA1504-O	Si-pnp	GP, 50V, 150mA, 150mW, B=70..140, >80MHz	SOT-23	16ta	-	3f	Kec
ASQ	AME8500BEETBA27	Vdet-IC	2.7V±1.5%, -Reset ODO, 1.5ms	SOT-23	16vdb	VD6	3b	Ame
ASQ	AME8500BEETBA27Z	Vdet-IC	2.7V±1.5%, -Reset ODO, 1.5ms, lead free	SOT-23	16vdb	VD6	3b	Ame
ASR	AME8500BEETAA28	Vdet-IC	2.8V±1.5%, -Reset PPO, 1.5ms	SOT-23	16vdb	VD7	3b	Ame
ASR	AME8500BEETAA28Z	Vdet-IC	2.8V±1.5%, -Reset PPO, 1.5ms, lead free	SOT-23	16vdb	VD7	3b	Ame
ASS	AME8500BEETBA28	Vdet-IC	2.8V±1.5%, -Reset ODO, 1.5ms	SOT-23	16vdb	VD6	3b	Ame
ASS	AME8500BEETBA28Z	Vdet-IC	2.8V±1.5%, -Reset ODO, 1.5ms, lead free	SOT-23	16vdb	VD6	3b	Ame
ASSB	AS1909C168-T	Vdet-IC	1.68V±1.5%, -Reset ODO	SOT-23	16vdc	VD6	3a	Asm
ASU	AME8500AEETCF31	Vdet-IC	3.08V±1.5%, +Reset PPO, 210ms	SOT-23	16vdc	VD7	3b	Ame
ASU	AME8500AEETCF31Z	Vdet-IC	3.08V±1.5%, +Reset PPO, 210ms, lead free	SOT-23	16vdc	VD7	3b	Ame
ASV	AME8500AEETAA21	Vdet-IC	2.1V±1.5%, -Reset PPO, 1.5ms	SOT-23	16vdc	VD7	3b	Ame
ASV	AME8500AEETAA21Z	Vdet-IC	2.1V±1.5%, -Reset PPO, 1.5ms, lead free	SOT-23	16vdc	VD7	3b	Ame
ASW	2PD1820AS	Si-npn	GP, Sw, 60V, 500mA, 200mW, B=170..340, >150MHz	SOT-323	16ta	-	3a	PhC
ASW	AME8500AEETCA21	Vdet-IC	2.1V±1.5%, +Reset PPO, 1.5ms	SOT-23	16vdc	VD7	3b	Ame
ASW	AME8500AEETCA21Z	Vdet-IC	2.1V±1.5%, +Reset PPO, 1.5ms, lead free	SOT-23	16vdc	VD7	3b	Ame
ASX	AME8500BEETCA21	Vdet-IC	2.1V±1.5%, +Reset PPO, 1.5ms	SOT-23	16vdb	VD7	3b	Ame
ASX	AME8500BEETCA21Z	Vdet-IC	2.1V±1.5%, +Reset PPO, 1.5ms, lead free	SOT-23	16vdb	VD7	3b	Ame
ASY	AME8500CEETAA21	Vdet-IC	2.1V±1.5%, -Reset PPO, 1.5ms	SOT-23	16vda	VD7	3b	Ame



SMD code	Type	Function	Short description	Case	Pinout	Sch.	St.	Mnf.
ĀSY	AME8500CEETA21Z	Vdet-IC	2.1V±1.5%, -Reset PPO, 1.5ms, lead free	SOT-23	16vda	VD7	3b	Ame
ASY	KTA1504-Y	Si-pnp	GP, 50V, 150mA, 150mW, B=120..240, >80MHz	SOT-23	16ta	-	3f	Kec
ĀSZ	AME8500CEETCA21	Vdet-IC	2.1V±1.5%, +Reset PPO, 1.5ms	SOT-23	16vda	VD7	3b	Ame
ASZ	AME8500CEETCA21Z	Vdet-IC	2.1V±1.5%, +Reset PPO, 1.5ms, lead free	SOT-23	16vda	VD7	3b	Ame
AT	2SA2028	Si-pnp	DC/DC-Corrv, 20V, 1A, 150mW, B=160..500, 170MHz	SOT-323	16ta	-	3a	Pan
AT	2SC4066	Si-npn	AF, GP, 50V, 100mA, 200mW, B=80, 250MHz	SOT-23	16ta	-	3a	San
AT	ADM810TART	Vdet-IC	3.08V±1.5%, +Reset PPO	SOT-23	16vdc	VD7	3a	Ad
AT	BAT18-06	PIN-diode	Dual, Sw, 35V, 0.1A, Vf<1.2V, Cd<1pF	SOT-23	16df	-	3a	Sie
AT	GS6333UR20D2	Vdet-IC	2V, -Reset PPO, 30ms	SOT-23	16vdc	VD7	3g	Vs
ĀI	MIC803-46D3VC3	Vdet-IC	4.63V±2.5%, -Reset ODO, 140ms	SC-70	16vdc	VD7	3a	Mcr
ĀI	MIC803-46D3VM3	Vdet-IC	4.63V±2.5%, -Reset ODO, 140ms	SOT-23	16vdc	VD7	3a	Mcr
AT	SiP633R20D2	Vdet-IC	2V±1.5%, +Reset PPO 30ms	SOT-23	16vdc	VD7	3g	Vs
AT=	RT9818C-27GU3	Vdet-IC	2.7V±1.5%, -Reset ODO, Td=220ms	SOT-323	16vdc	VD6	3a	Rct
AT1	FA4L4K	Si-npn-Digi	Sw, 60V, 100mA, 200mW, R1/R2=47k/10k	SC-59	16ta	-	3a	Nec
AT1	GA4L4K	Si-npn-Digi	Sw, 60V, 100mA, 200mW, R1/R2=47k/10k	SOT-323	16ta	-	3a	Nec
ATD	AME8500AEETAF15	Vdet-IC	1.5V±1.5%, -Reset PPO, 210ms	SOT-23	16vdc	VD7	3b	Ame
ĀD	AME8500AEETAF15Z	Vdet-IC	1.5V±1.5%, -Reset PPO, 210ms, lead free	SOT-23	16vdc	VD7	3b	Ame
ATE	AME8500AEETAF16	Vdet-IC	1.6V±1.5%, -Reset PPO, 210ms	SOT-23	16vdc	VD7	3b	Ame
ĀTE	AME8500AEETAF16Z	Vdet-IC	1.6V±1.5%, -Reset PPO, 210ms, lead free	SOT-23	16vdc	VD7	3b	Ame
ATO	AME8500BEETAF31	Vdet-IC	3.08V±1.5%, -Reset PPO, 210ms	SOT-23	16vdb	VD7	3b	Ame
ĀTO	AME8500BEETAF31Z	Vdet-IC	3.08V±1.5%, -Reset PPO, 210ms, lead free	SOT-23	16vdb	VD7	3b	Ame
ATP	AME8500BEETAA45	Vdet-IC	4.50V±1.5%, -Reset PPO, 1.5ms	SOT-23	16vdb	VD7	3b	Ame
ĀTP	AME8500BEETAA45Z	Vdet-IC	4.50V±1.5%, -Reset PPO, 1.5ms, lead free	SOT-23	16vdb	VD7	3b	Ame
AtQ	2PD1820AQ	Si-npn	GP, Sw, 60V, 500mA, 200mW, B=85..170, >150MHz	SOT-323	16ta	-	3a	PhM
ATQ	2SC4326K-Q	Si-npn	HF, 12V, 50mA, 150mW, B=120..270, >800MHz	SOT-346	16ta	-	3a	Rhm
ATQ	AME8500BEETAF40	Vdet-IC	4V±1.5%, -Reset PPO, 210ms	SOT-23	16vdb	VD7	3b	Ame
ĀTQ	AME8500BEETAF40Z	Vdet-IC	4V±1.5%, -Reset PPO, 210ms, lead free	SOT-23	16vdb	VD7	3b	Ame
AIR	2PD1820AR	Si-npn	GP, Sw, 60V, 500mA, 200mW, B=120..240, >150MHz	SOT-323	16ta	-	3a	PhM
ATR	2SC4326K-R	Si-npn	HF, 12V, 50mA, 150mW, B=180..390, >800MHz	SOT-346	16ta	-	3a	Rhm
ĀTR	AME8500AEETAF27	Vdet-IC	2.7V±1.5%, -Reset PPO, 210ms	SOT-23	16vdc	VD7	3b	Ame
ATR	AME8500AEETAF27Z	Vdet-IC	2.7V±1.5%, -Reset PPO, 210ms, lead free	SOT-23	16vdc	VD7	3b	Ame
AIS	2PD1820AS	Si-npn	GP, Sw, 60V, 500mA, 200mW, B=170..340, >150MHz	SOT-323	16ta	-	3a	PhM
ATS	2SC4326K-S	Si-npn	HF, 12V, 50mA, 150mW, B=270..560, >800MHz	SOT-346	16ta	-	3a	Rhm
ATS	AME8500AEETA46	Vdet-IC	4.63V±1.5%, -Reset PPO, 150ms	SOT-23	16vdc	VD7	3b	Ame
ĀTS	AME8500AEETA46Z	Vdet-IC	4.63V±1.5%, -Reset PPO, 150ms, lead free	SOT-23	16vdc	VD7	3b	Ame
ATT	AME8500AEETAF23	Vdet-IC	2.32V±1.5%, -Reset PPO, 210ms	SOT-23	16vdc	VD7	3b	Ame
ĀTT	AME8500AEETAF23Z	Vdet-IC	2.32V±1.5%, -Reset PPO, 210ms, lead free	SOT-23	16vdc	VD7	3b	Ame
ATY	AME8500AEETCF21	Vdet-IC	2.1V±1.5%, +Reset PPO, 210ms	SOT-23	16vdc	VD7	3b	Ame
ĀTY	AME8500AEETCF21Z	Vdet-IC	2.1V±1.5%, +Reset PPO, 210ms, lead free	SOT-23	16vdc	VD7	3b	Ame
AU	BAT18-04	PIN-diode	Dual, Sw, 35V, 0.1A, Vf<1.2V, Cd<1pF	SOT-23	16dl	-	3a	Sie
AU	BCW60GR	Si-npn	GP, 32V, 200mA, 0.33W, B=250..460, 250MHz	SOT-23	16te	-	3a	Fer
AU	BCX70RG	Si-npn	GP, 45V, 100mA, 330mW, B= 120..220, 250MHz	SOT-23	16ta	-	3a	Sie
ĀU	MIC803-46D4VC3	Vdet-IC	4.63V±2.5%, -Reset ODO, 1120ms	SC-70	16vdc	VD7	3a	Mcr
ĀU	MIC803-46D4VM3	Vdet-IC	4.63V±2.5%, -Reset ODO, 1120ms	SOT-23	16vdc	VD7	3a	Mcr
AU=	RT9818B-27GU3	Vdet-IC	2.7V±1.5%, -Reset PPO, Td=55ms	SOT-323	16vdc	VD6	3a	Rct
AU0	ELM9740CBB	Vdet-IC	4.0V±2.5%, +Reset PPO	SOT-23	16vdb	VD7	3d	Elm
AU1	ELM9741CBB	Vdet-IC	4.1V±2.5%, +Reset PPO	SOT-23	16vdb	VD7	3d	Elm
AU2	ELM9742CBB	Vdet-IC	4.2V±2.5%, +Reset PPO	SOT-23	16vdb	VD7	3d	Elm
AU2D	AU2PD	Si-diode	Rectifier, 200V, 2A, Vf<1.4V(2A)	TO-277A	76dh	-	3o	Vs
AU2G	AU2PG	Si-diode	Rectifier, 400V, 2A, Vf<1.4V(2A)	TO-277A	76dh	-	3o	Vs
AU2J	AU2PJ	Si-diode	Rectifier, 600V, 2A, Vf<1.4V(2A)	TO-277A	76dh	-	3o	Vs
AU2K	AU2PK	Si-diode	Rectifier, 800V, 2A, Vf<2V(2A)	TO-277A	76dh	-	3o	Vs
AU2M	AU2PM	Si-diode	Rectifier, 1000V, 2A, Vf<2V(2A)	TO-277A	76dh	-	3o	Vs
AU3	ELM9743CBB	Vdet-IC	4.3V±2.5%, +Reset PPO	SOT-23	16vdb	VD7	3d	Elm
AU3D	AU3PD	Si-diode	Rectifier, 200V, 3A, Vf<1.4V(3A)	TO-277A	76dh	-	3o	Vs
AU3G	AU3PG	Si-diode	Rectifier, 400V, 3A, Vf<1.4V(3A)	TO-277A	76dh	-	3o	Vs
AU3J	AU3PJ	Si-diode	Rectifier, 600V, 3A, Vf<1.4V(3A)	TO-277A	76dh	-	3o	Vs
AU3K	AU3PK	Si-diode	Rectifier, 800V, 3A, Vf<2V(3A)	TO-277A	76dh	-	3o	Vs
AU3M	AU3PM	Si-diode	Rectifier, 1000V, 3A, Vf<2V(3A)	TO-277A	76dh	-	3o	Vs
AU4	ELM9744CBB	Vdet-IC	4.4V±2.5%, +Reset PPO	SOT-23	16vdb	VD7	3d	Elm
AU5	ELM9745CBB	Vdet-IC	4.5V±2.5%, +Reset PPO	SOT-23	16vdb	VD7	3d	Elm
AU6	ELM9746CBB	Vdet-IC	4.6V±2.5%, +Reset PPO	SOT-23	16vdb	VD7	3d	Elm
AU7	ELM9747CBB	Vdet-IC	4.7V±2.5%, +Reset PPO	SOT-23	16vdb	VD7	3d	Elm
AU8	ELM9748CBB	Vdet-IC	4.8V±2.5%, +Reset PPO	SOT-23	16vdb	VD7	3d	Elm
AU9	ELM9749CBB	Vdet-IC	4.9V±2.5%, +Reset PPO	SOT-23	16vdb	VD7	3d	Elm
ĀUA	AME8500AEETA20	Vdet-IC	2V±1.5%, -Reset PPO, 150ms	SOT-23	16vdc	VD7	3b	Ame
AUA	AME8500AEETA20Z	Vdet-IC	2V±1.5%, -Reset PPO, 150ms, lead free	SOT-23	16vdc	VD7	3b	Ame
AUB	AME8500AEETA31	Vdet-IC	3.08V±1.5%, -Reset PPO, 150ms	SOT-23	16vdc	VD7	3b	Ame
ĀUB	AME8500AEETA31Z	Vdet-IC	3.08V±1.5%, -Reset PPO, 150ms, lead free	SOT-23	16vdc	VD7	3b	Ame
AUC	AME8500BEETAF27	Vdet-IC	2.7V±1.5%, -Reset PPO, 210ms	SOT-23	16vdb	VD7	3b	Ame



SMD code	Type	Function	Short description	Case	Pinout	Sch.	St.	Mnf.
ĀUC	AME8500BEETAF27Z	Vdet-IC	2.7V±1.5%, -Reset PPO, 210ms, lead free	SOT-23	16vdb	VD7	3b	Ame
ĀUT	AME8500AEETBF31	Vdet-IC	3.08V±1.5%, -Reset ODO, 210ms	SOT-23	16vdc	VD6	3b	Ame
ĀJT	AME8500AEETBF31Z	Vdet-IC	3.08V±1.5%, -Reset ODO, 210ms, lead free	SOT-23	16vdc	VD6	3b	Ame
ĀJU	AME8500AEETBF46	Vdet-IC	4.63V±1.5%, -Reset ODO, 210ms	SOT-23	16vdc	VD6	3b	Ame
ĀJU	AME8500AEETBF46Z	Vdet-IC	4.63V±1.5%, -Reset ODO, 210ms, lead free	SOT-23	16vdc	VD6	3b	Ame
ĀJV	AME8500BEETAF29	Vdet-IC	2.93V±1.5%, -Reset PPO, 210ms	SOT-23	16vdb	VD7	3b	Ame
ĀJV	AME8500BEETAF29Z	Vdet-IC	2.93V±1.5%, -Reset PPO, 210ms, lead free	SOT-23	16vdb	VD7	3b	Ame
ĀJW	AME8500BEETBA21	Vdet-IC	2.1V±1.5%, -Reset ODO, 1.5ms	SOT-23	16vdb	VD6	3b	Ame
ĀJW	AME8500BEETBA21Z	Vdet-IC	2.1V±1.5%, -Reset ODO, 1.5ms, lead free	SOT-23	16vdb	VD6	3b	Ame
ĀJX	AME8500BEETBA24	Vdet-IC	2.4V±1.5%, -Reset ODO, 1.5ms	SOT-23	16vdb	VD6	3b	Ame
ĀJX	AME8500BEETBA24Z	Vdet-IC	2.4V±1.5%, -Reset ODO, 1.5ms, lead free	SOT-23	16vdb	VD6	3b	Ame
ĀJY	AME8500AEETAF25	Vdet-IC	2.50V±1.5%, -Reset PPO, 210ms	SOT-23	16vdc	VD7	3b	Ame
ĀJY	AME8500AEETAF25Z	Vdet-IC	2.50V±1.5%, -Reset PPO, 210ms, lead free	SOT-23	16vdc	VD7	3b	Ame
ĀJZ	AME8500CEETA42	Vdet-IC	4.2V±1.5%, -Reset PPO, 150ms	SOT-23	16vda	VD7	3b	Ame
ĀJZ	AME8500CEETA42Z	Vdet-IC	4.2V±1.5%, -Reset PPO, 150ms, lead free	SOT-23	16vda	VD7	3b	Ame
AV	GS6333UR20D3	Vdet-IC	2V, -Reset PPO, 150ms	SOT-23	16vdc	VD7	3g	Vs
AV	MIC803-30D2VC3	Vdet-IC	3.0V±2.5%, -Reset ODO, 20ms	SC-70	16vdc	VD7	3a	Mcr
AV	MIC803-30D2VM3	Vdet-IC	3.0V±2.5%, -Reset ODO, 20ms	SOT-23	16vdc	VD7	3a	Mcr
AV	SiP6333R20D3	Vdet-IC	2V±1.5%, +Reset PPO 150ms	SOT-23	16vdc	VD7	3g	Vs
AV0	ELM9750CBB	Vdet-IC	5.0V±2.5%, +Reset PPO	SOT-23	16vdb	VD7	3d	Elm
AV1	ELM9751CBB	Vdet-IC	5.1V±2.5%, +Reset PPO	SOT-23	16vdb	VD7	3d	Elm
AV2	ELM9752CBB	Vdet-IC	5.2V±2.5%, +Reset PPO	SOT-23	16vdb	VD7	3d	Elm
AV3	ELM9753CBB	Vdet-IC	5.3V±2.5%, +Reset PPO	SOT-23	16vdb	VD7	3d	Elm
AV4	ELM9754CBB	Vdet-IC	5.4V±2.5%, +Reset PPO	SOT-23	16vdb	VD7	3d	Elm
AV5	ELM9755CBB	Vdet-IC	5.5V±2.5%, +Reset PPO	SOT-23	16vdb	VD7	3d	Elm
AVA	AME8500CEETBE42	Vdet-IC	4.2V±1.5%, -Reset ODO, 150ms	SOT-23	16vda	VD6	3b	Ame
AVA	AME8500CEETBE42Z	Vdet-IC	4.2V±1.5%, -Reset ODO, 150ms, lead free	SOT-23	16vda	VD6	3b	Ame
AVA	BC858UA	Si-pnp	GP, 30V, 100mA, 200mW, B=110..220, 150MHz	SOT-323	16ta	-	3a	Auk
AVA	BC858UFA	Si-pnp	GP, 30V, 100mA, 200mW, B=110..220, 150MHz	SOT-323F	18ta	-	3a	Auk
AVB	AME8500AEETCA27	Vdet-IC	2.7V±1.5%, +Reset PPO, 1.5ms	SOT-23	16vdc	VD7	3b	Ame
AVB	AME8500AEETCA27Z	Vdet-IC	2.7V±1.5%, +Reset PPO, 1.5ms, lead free	SOT-23	16vdc	VD7	3b	Ame
AVB	BC858UB	Si-pnp	GP, 30V, 100mA, 200mW, B=200..450, 150MHz	SOT-323	16ta	-	3a	Auk
AVB	BC858UFB	Si-pnp	GP, 30V, 100mA, 200mW, B=200..450, 150MHz	SOT-323F	18ta	-	3a	Auk
AVC	AME8500AEETCA46	Vdet-IC	4.63V±1.5%, +Reset PPO, 1.5ms	SOT-23	16vdc	VD7	3b	Ame
AVC	AME8500AEETCA46Z	Vdet-IC	4.63V±1.5%, +Reset PPO, 1.5ms, lead free	SOT-23	16vdc	VD7	3b	Ame
AVC	BC858UC	Si-pnp	GP, 30V, 100mA, 200mW, B=420..800, 150MHz	SOT-323	16ta	-	3a	Auk
AVC	BC858UFC	Si-pnp	GP, 30V, 100mA, 200mW, B=420..800, 150MHz	SOT-323F	18ta	-	3a	Auk
AVD	AME8500BEETBA22	Vdet-IC	2.2V±1.5%, -Reset ODO, 1.5ms	SOT-23	16vdb	VD6	3b	Ame
AVD	AME8500BEETBA22Z	Vdet-IC	2.2V±1.5%, -Reset ODO, 1.5ms, lead free	SOT-23	16vdb	VD6	3b	Ame
AVG	AME8500AEETA21	Vdet-IC	2.1V±1.5%, -Reset PPO, 150ms	SOT-23	16vdc	VD7	3b	Ame
AVG	AME8500AEETA21Z	Vdet-IC	2.1V±1.5%, -Reset PPO, 150ms, lead free	SOT-23	16vdc	VD7	3b	Ame
AVQ	AME8500BEETBA25	Vdet-IC	2.50V±1.5%, -Reset ODO, 1.5ms	SOT-23	16vdb	VD6	3b	Ame
AVQ	AME8500BEETBA25Z	Vdet-IC	2.50V±1.5%, -Reset ODO, 1.5ms, lead free	SOT-23	16vdb	VD6	3b	Ame
AVY	AME8500CEETBF31	Vdet-IC	3.08V±1.5%, -Reset ODO, 210ms	SOT-23	16vda	VD6	3b	Ame
AVY	AME8500CEETBF31Z	Vdet-IC	3.08V±1.5%, -Reset ODO, 210ms, lead free	SOT-23	16vda	VD6	3b	Ame
AW	BCX70HR	Si-npn	GP, 32V, 200mA, 250mW, B=380..630, 250MHz	SOT-23	16te	-	3a	Fer
AW	BCX70GR	Si-npn	AF, 45V, 200mA, 330mW, B=120..220, >250MHz	SOT-23	16ta	-	3a	Zx
AW	BCX70RH	Si-npn	GP, 45V, 200mA, 250mW, B=180..310, >100MHz	SOT-23	16ta	-	3a	Sie
AW	GS6333UR21D1	Vdet-IC	2.1V, -Reset PPO, 1.5ms	SOT-23	16vdc	VD7	3g	Vs
AW	RT9161-50CV	LVR-IC	LDO, 5.0V±2%, 300mA	SOT-23	16cg	VR1	3a	Rct
AW	SiP6333R21D1	Vdet-IC	2.1V±1.5%, +Reset PPO 1.5ms	SOT-23	16vdc	VD7	3g	Vs
AW-	RT9161-50PV	LVR-IC	LDO, 5.0V±2%, 300mA	SOT-23	16cg	VR1	3a	Rct
AW0	ELM9730CBB	Vdet-IC	3.0V±2.5%, +Reset PPO	SOT-23	16vdb	VD7	3d	Elm
AW1	ELM9731CBB	Vdet-IC	3.1V±2.5%, +Reset PPO	SOT-23	16vdb	VD7	3d	Elm
AW2	ELM9732CBB	Vdet-IC	3.2V±2.5%, +Reset PPO	SOT-23	16vdb	VD7	3d	Elm
AW3	ELM9733CBB	Vdet-IC	3.3V±2.5%, +Reset PPO	SOT-23	16vdb	VD7	3d	Elm
AW4	ELM9734CBB	Vdet-IC	3.4V±2.5%, +Reset PPO	SOT-23	16vdb	VD7	3d	Elm
AW5	ELM9735CBB	Vdet-IC	3.5V±2.5%, +Reset PPO	SOT-23	16vdb	VD7	3d	Elm
AW6	ELM9736CBB	Vdet-IC	3.6V±2.5%, +Reset PPO	SOT-23	16vdb	VD7	3d	Elm
AW7	ELM9737CBB	Vdet-IC	3.7V±2.5%, +Reset PPO	SOT-23	16vdb	VD7	3d	Elm
AW8	ELM9738CBB	Vdet-IC	3.8V±2.5%, +Reset PPO	SOT-23	16vdb	VD7	3d	Elm
AW9	ELM9739CBB	Vdet-IC	3.9V±2.5%, +Reset PPO	SOT-23	16vdb	VD7	3d	Elm
ĀWH	AME8550AEETA220L	Vdet-IC	2.2V±2%, -Reset PPO	SOT-23	16vdb	VD7	3b	Ame
ĀWH	AME8550AEETA220Y	Vdet-IC	2.2V±2%, -Reset PPO	TSOT-23	16vdb	VD7	3b	Ame
AWH	AME8550AEETA220Z	Vdet-IC	2.2V±2%, -Reset PPO	SOT-23	16vdb	VD7	3b	Ame
AWI	AME8550AEETA270L	Vdet-IC	2.7V±2%, -Reset PPO	SOT-23	16vdb	VD7	3b	Ame
AWI	AME8550AEETA270Y	Vdet-IC	2.7V±2%, -Reset PPO	TSOT-23	16vdb	VD7	3b	Ame
AWI	AME8550AEETA270Z	Vdet-IC	2.7V±2%, -Reset PPO	SOT-23	16vdb	VD7	3b	Ame
ĀWU	AME8550AEETB220L	Vdet-IC	2.2V±2%, -Reset ODO	SOT-23	16vdb	VD6	3b	Ame
AWU	AME8550AEETB220Y	Vdet-IC	2.2V±2%, -Reset ODO	TSOT-23	16vdb	VD6	3b	Ame



SMD code	Type	Function	Short description	Case	Pinout	Sch.	St.	Mnf.
AWU	AME8550AEETB220Z	Vdet-IC	2.2V±2%, -Reset ODO	SOT-23	16vdb	VD6	3b	Ame
AWV	AME8550AEETB270L	Vdet-IC	2.7V±2%, -Reset ODO	SOT-23	16vdb	VD6	3b	Ame
AWV	AME8550AEETB270Y	Vdet-IC	2.7V±2%, -Reset ODO	TSOT-23	16vdb	VD6	3b	Ame
AWV	AME8550AEETB270Z	Vdet-IC	2.7V±2%, -Reset ODO	SOT-23	16vdb	VD6	3b	Ame
AWX	AME8500AEETBE20	Vdet-IC	2.0V±1.5%, -Reset ODO, 150ms	SOT-23	16vdc	VD6	3b	Ame
AWX	AME8500AEETBE20Z	Vdet-IC	2.0V±1.5%, -Reset ODO, 150ms, lead free	SOT-23	16vdc	VD6	3b	Ame
AX	50A02CH	Si-pnp	AF, GP, 50V, 500mA, 700mW, B=200..500, 690MHz	CPH3	16ta	-	3a	San
AX	BCX70JR	Si-npn	GP, Sw, 45V, 100mA, 250mW, B=250..460, >100MHz	SOT-23	16ta	-	3a	Zx
AX	BCX70R	Si-npn	GP, Sw, 45V, 100mA, 250mW, B=250..460, >100MHz	SOT-23	16ta	-	3a	Sie
AX	GS6333UR21D2	Vdet-IC	2.1V, -Reset PPO, 30ms	SOT-23	16vdc	VD7	3g	Vs
AX	MIC803-30D3VC3	Vdet-IC	3.0V±2.5%, -Reset ODO, 140ms	SC-70	16vdc	VD7	3a	Mcr
AX	MIC803-30D3VM3	Vdet-IC	3.0V±2.5%, -Reset ODO, 140ms	SOT-23	16vdc	VD7	3a	Mcr
AX	MMBZ5238B	Z-diode	8.27..9.14V, Izt=20mA, Zzt=8Ω, 350mW	SOT-23	16dc	-	3a	Lge
AX	RT9809-49CV	Vdet-IC	4.9V±2%, -Reset PPO	SOT-23	16vdc	VD7	3a	Rct
AX	SiP6333R21D2	Vdet-IC	2.1V±1.5%, +Reset PPO 30ms	SOT-23	16vdc	VD7	3g	Vs
AXL	AME8500CEETBA26	Vdet-IC	2.63V±1.5%, -Reset ODO, 1.5ms	SOT-23	16vda	VD6	3b	Ame
AXL	AME8500CEETBA26Z	Vdet-IC	2.63V±1.5%, -Reset ODO, 1.5ms, lead free	SOT-23	16vda	VD6	3b	Ame
AXQ	2SA1739-Q	Si-pnp	Sw, Hi-speed, 15V, 50mA, 150mW, B=50..120, 1.5GHz	SOT-323	16ta	-	3a	Pan
AXQ	AME8550AEETB210L	Vdet-IC	2.1V±2%, -Reset ODO	SOT-23	16vdb	VD6	3b	Ame
AXQ	AME8550AEETB210Y	Vdet-IC	2.1V±2%, -Reset ODO	TSOT-23	16vdb	VD6	3b	Ame
AXQ	AME8550AEETB210Z	Vdet-IC	2.1V±2%, -Reset ODO	SOT-23	16vdb	VD6	3b	Ame
AXR	2SA1739-R	Si-pnp	Sw, Hi-speed, 15V, 50mA, 150mW, B=90..150, 1.5GHz	SOT-323	16ta	-	3a	Pan
AXT	AME8550AEETA240L	Vdet-IC	2.4V±2%, -Reset PPO	SOT-23	16vdb	VD7	3b	Ame
AXT	AME8550AEETA240Y	Vdet-IC	2.4V±2%, -Reset PPO	TSOT-23	16vdb	VD7	3b	Ame
AXT	AME8550AEETA240Z	Vdet-IC	2.4V±2%, -Reset PPO	SOT-23	16vdb	VD7	3b	Ame
AXV	AME8550AEETB240L	Vdet-IC	2.4V±2%, -Reset ODO	SOT-23	16vdb	VD6	3b	Ame
AXV	AME8550AEETB240Y	Vdet-IC	2.4V±2%, -Reset ODO	TSOT-23	16vdb	VD6	3b	Ame
AXV	AME8550AEETB240Z	Vdet-IC	2.4V±2%, -Reset ODO	SOT-23	16vdb	VD6	3b	Ame
AXZ	AME8550AEETB250L	Vdet-IC	2.5V±2%, -Reset ODO	SOT-23	16vdb	VD6	3b	Ame
AXZ	AME8550AEETB250Y	Vdet-IC	2.5V±2%, -Reset ODO	TSOT-23	16vdb	VD6	3b	Ame
AXZ	AME8550AEETB250Z	Vdet-IC	2.5V±2%, -Reset ODO	SOT-23	16vdb	VD6	3b	Ame
AY	2SA1979UF-Y	Si-pnp	AF, 40V, 500mA, 200mW, B=120..240, 200MHz	SOT-323F	16ta	-	3a	Auk
AY	2SA1979U-Y	Si-pnp	AF, 40V, 500mA, 200mW, B=120..240, 200MHz	SOT-323	16ta	-	3a	Auk
AY	2SA1980EF-Y	Si-pnp	GP, 50V, 150mA, 150mW, B=120..240, 80MHz	SOT-523F	16ta	-	3a	Auk
AY	2SA1980E-Y	Si-pnp	GP, 50V, 150mA, 150mW, B=120..240, 80MHz	SOT-523	16ta	-	3a	Auk
AY	2SC4210-Y	Si-npn	AF, 35V, 800mA, 200mW, B=160..320, 120MHz	SC-59	16ta	-	3a	Tos
AY	BCX70KR	Si-npn	GP, Sw, 45V, 100mA, 250mW, B=380..630, >100MHz	SOT-23	16te	-	3a	litt
AY	BCX70RK	Si-npn	GP, Sw, 45V, 100mA, 250mW, B=380..630, >100MHz	SOT-23	16ta	-	3a	Sie
AY	GS6333UR21D3	Vdet-IC	2.1V, -Reset PPO, 150ms	SOT-23	16vdc	VD7	3g	Vs
AY	MMBD1000	Si-diode	Sw, 30V, 200mA, 225mW, Vf<0.95V(10mA), <2pF	SOT-23	16dc	-	3a	Mot
AY	MMBZ5239B	Z-diode	8.65..9.56V, Izt=20mA, Zzt=10Ω, 350mW	SOT-23	16dc	-	3a	Lge
AY	SiP6333R21D3	Vdet-IC	2.1V±1.5%, +Reset PPO 150ms	SOT-23	16vdc	VD7	3g	Vs
AY0	ELM9720CBB	Vdet-IC	2.0V±2.5%, +Reset PPO	SOT-23	16vdb	VD7	3d	Elm
AY1	ELM9721CBB	Vdet-IC	2.1V±2.5%, +Reset PPO	SOT-23	16vdb	VD7	3d	Elm
AY2	ELM9722CBB	Vdet-IC	2.2V±2.5%, +Reset PPO	SOT-23	16vdb	VD7	3d	Elm
AY3	ELM9723CBB	Vdet-IC	2.3V±2.5%, +Reset PPO	SOT-23	16vdb	VD7	3d	Elm
AY4	2SC3392-4	Si-npn	Sw, Hi-Sp, 60V, 500mA, 200mW, 300MHz, B=100..200	SOT-23	16ta	-	3a	San
AY4	ELM9724CBB	Vdet-IC	2.4V±2.5%, +Reset PPO	SOT-23	16vdb	VD7	3d	Elm
AY5	2SC3392-5	Si-npn	Sw, Hi-Sp, 60V, 500mA, 200mW, 300MHz, B=140..280	SOT-23	16ta	-	3a	San
AY5	ELM9725CBB	Vdet-IC	2.5V±2.5%, +Reset PPO	SOT-23	16vdb	VD7	3d	Elm
AY6	2SC3392-6	Si-npn	Sw, Hi-Sp, 60V, 500mA, 200mW, 300MHz, B=200..400	SOT-23	16ta	-	3a	San
AY6	ELM9726CBB	Vdet-IC	2.6V±2.5%, +Reset PPO	SOT-23	16vdb	VD7	3d	Elm
AY7	2SC3392-7	Si-npn	Sw, Hi-Sp, 60V, 500mA, 200mW, 300MHz, B=280..560	SOT-23	16ta	-	3a	San
AY7	ELM9727CBB	Vdet-IC	2.7V±2.5%, +Reset PPO	SOT-23	16vdb	VD7	3d	Elm
AY8	ELM9728CBB	Vdet-IC	2.8V±2.5%, +Reset PPO	SOT-23	16vdb	VD7	3d	Elm
AY9	ELM9729CBB	Vdet-IC	2.9V±2.5%, +Reset PPO	SOT-23	16vdb	VD7	3d	Elm
AYB	AME8550AEETB280L	Vdet-IC	2.8V±2%, -Reset ODO	SOT-23	16vdb	VD6	3b	Ame
AYB	AME8550AEETB280Y	Vdet-IC	2.8V±2%, -Reset ODO	TSOT-23	16vdb	VD6	3b	Ame
AYB	AME8550AEETB280Z	Vdet-IC	2.8V±2%, -Reset ODO	SOT-23	16vdb	VD6	3b	Ame
AYF	AME8550AEETA300L	Vdet-IC	3.0V±2%, -Reset PPO	SOT-23	16vdb	VD7	3b	Ame
AYF	AME8550AEETA300Y	Vdet-IC	3.0V±2%, -Reset PPO	TSOT-23	16vdb	VD7	3b	Ame
AYF	AME8550AEETA300Z	Vdet-IC	3.0V±2%, -Reset PPO	SOT-23	16vdb	VD7	3b	Ame
AYH	AME8550AEETB340L	Vdet-IC	3.4V±2%, -Reset ODO	SOT-23	16vdb	VD6	3b	Ame
AYH	AME8550AEETB340Y	Vdet-IC	3.4V±2%, -Reset ODO	TSOT-23	16vdb	VD6	3b	Ame
AYH	AME8550AEETB340Z	Vdet-IC	3.4V±2%, -Reset ODO	SOT-23	16vdb	VD6	3b	Ame
AYL	AME8550AEETB440L	Vdet-IC	4.4V±2%, -Reset ODO	SOT-23	16vdb	VD6	3b	Ame
AYL	AME8550AEETB440Y	Vdet-IC	4.4V±2%, -Reset ODO	TSOT-23	16vdb	VD6	3b	Ame
AYL	AME8550AEETB440Z	Vdet-IC	4.4V±2%, -Reset ODO	SOT-23	16vdb	VD6	3b	Ame
AYR	AME8500AEETBF44	Vdet-IC	4.38V±1.5%, -Reset ODO, 210ms	SOT-23	16vdc	VD6	3b	Ame
AYR	AME8500AEETBF44Z	Vdet-IC	4.38V±1.5%, -Reset ODO, 210ms, lead free	SOT-23	16vdc	VD6	3b	Ame



SMD code	Type	Function	Short description	Case	Pinout	Sch. St.	Mnf.	
AZ	GS6333UR22D1	Vdet-IC	2.2V, -Reset PPO, 1.5ms	SOT-23	16vdc	VD7	3g	Vs
AZ	MIC803-30D4VC3	Vdet-IC	3.0V±2.5%, -Reset ODO, 1120ms	SC-70	16vdc	VD7	3a	Mcr
AZ	MIC803-30D4VM3	Vdet-IC	3.0V±2.5%, -Reset ODO, 1120ms	SOT-23	16vdc	VD7	3a	Mcr
AZ	MMBZ5240B	Z-diode	9.50..10.50V, Izt=20mA, Zzt=17Ω, 350mW	SOT-23	16dc	-	3a	Lge
AZ	RT9809-50CV	Vdet-IC	5.0V±2%, -Reset PPO	SOT-23	16vdc	VD7	3a	Rct
AZ	SiP6333R22D1	Vdet-IC	2.2V±1.5%, +Reset PPO 1.5ms	SOT-23	16vdc	VD7	3g	Vs
AZ6	ELM9716CBB	Vdet-IC	1.6V±2.5%, +Reset PPO	SOT-23	16vdb	VD7	3d	Elm
AZ7	ELM9717CBB	Vdet-IC	1.7V±2.5%, +Reset PPO	SOT-23	16vdb	VD7	3d	Elm
AZ8	ELM9718CBB	Vdet-IC	1.8V±2.5%, +Reset PPO	SOT-23	16vdb	VD7	3d	Elm
AZ9	ELM9719CBB	Vdet-IC	1.9V±2.5%, +Reset PPO	SOT-23	16vdb	VD7	3d	Elm
AZG	AME8500BEETBA35	Vdet-IC	3.50V±1.5%, -Reset ODO, 1.5ms	SOT-23	16vdb	VD6	3b	Ame
AZG	AME8500BEETBA35Z	Vdet-IC	3.50V±1.5%, -Reset ODO, 1.5ms, lead free	SOT-23	16vdb	VD6	3b	Ame
AZG	KTA1505S-GR	Si-pnp	GP, 35V, 500mA, 150mW, B=200..400, 200MHz	SOT-23	16ta	-	3f	Kec
AZM	AME8500AEECTCF26	Vdet-IC	2.63V±1.5%, +Reset PPO, 210ms	SOT-23	16vdc	VD7	3b	Ame
AZM	AME8500AEECTCF26Z	Vdet-IC	2.63V±1.5%, +Reset PPO, 210ms, lead free	SOT-23	16vdc	VD7	3b	Ame
AZO	KTA1505S-O	Si-pnp	GP, 35V, 500mA, 150mW, B=70..140, 200MHz	SOT-23	16ta	-	3f	Kec
AZY	KTA1505S-Y	Si-pnp	GP, 35V, 500mA, 150mW, B=120..240, 200MHz	SOT-23	16ta	-	3f	Kec
b	AX6901BA	Vdet-IC	4.38V±1.5%, -Reset PPO	SC-70	16vdc	VD7	3b	Axl
b	CH3904T1PT	Si-npn	AF, Sw, 40V, 200mA, B=100..300, 300MHz	FBPT-523	17ta	-	9a	Chm
b	CH3904TPT	Si-npn	AF, Sw, 40V, 200mA, B=100..300, 300MHz	SOT-416	16ta	-	3a	Chm
B	Si1013X	p-MOSFET-e	T-FET, Sw, 20V, 275mA, 250mW, <1.2Ω(350mA), 5/35ns	SC-89	16fh	-	3a	Six
B-W	2SC6046	Si-npn	GP, Drv, 75V, 600mA, 200mW, 250MHz, B=100..300	SC-89	16ta	-	3a	Ish
B0	BZX84-C47	Z-diode	44..50V, Zzt=170Ω, Izt=20mA, 225mW	SOT-23	16dc	-	3a	Lge
B0	ELM9710NBB	Vdet-IC	1.0V±2.5%, +Reset ODO	SOT-23	16vdb	VD6	3d	Elm
B0	HSMS-2810	Si-diode	Schottky, RF, 20V, 1A, Vf<0.4V(1mA), <1.2pF, 15Ω(5mA)	SOT-23	16dc	-	3a	Agi
B0	HSMS-281B	Si-diode	Schottky, RF, 20V, 1A, Vf<0.4V(1mA), <1.2pF, 15Ω(5mA)	SOT-323	16dc	-	3a	Agi
B0	R3111N102A	Vdet-IC	1V±2%, -Reset PPO	SOT-23	16vdd	VD7	3d	Ric
B0	R3113D201A	Vdet-IC	2V±2%, -Reset, ODO	SON1408-3	18vda	VD6	3d	Ric
B0	R3130N20EC	Vdet-IC	2V, -Reset ODO, 240ms	SOT-23	16vdc	VD6	3b	Ric
B0	XC6GC1002HR	Vdet-IC	1.0V, +Reset PPO	USP-3	17vdc	VD3	9b	Tor
B1	2SC4931-1	Si-npn	VHF/UHF, LN, 16V, 50mA, 100mW, B=60..120, 9GHz	SMCP	16ta	-	3a	San
B1	2SK1824	n-MOSFET-e*	V-MOS, LogL, 30V, ±0.1A, <8Ω(10mA)	SOT-23	16fh	-	3a	Nec
B1	BAS40L	Si-diode	Schottky, 40V, 200mA, 200mW, Cd<5pF, <5ns	SOT-23	16dc	-	3a	Ons
B1	BAS70PT	Si-diode	Schottky, 70V, 70mA, Vf<1V(15mA), <2pF, 5ns	SOT-23	16dc	-	3a	Chm
B1	ELM9711NBB	Vdet-IC	1.1V±2.5%, +Reset ODO	SOT-23	16vdb	VD6	3d	Elm
B1	R3111N112A	Vdet-IC	1.2V±2%, -Reset PPO	SOT-23	16vdd	VD7	3d	Ric
B1	R3113D211A	Vdet-IC	2.1V±2%, -Reset, ODO	SON1408-3	18vda	VD6	3d	Ric
B1	R3130N21EC	Vdet-IC	2.1V, -Reset ODO, 240ms	SOT-23	16vdc	VD6	3b	Ric
B1	RT9169-12CV	LVR-IC	LDO, 1.2V±2%, 100mA	SOT-23	16ch	VR1	3a	Rct
B1	XC6GC1102HR	Vdet-IC	1.1V, +Reset ODO	USP-3	17vdc	VD3	9b	Tor
B1-	RT9169-12PV	LVR-IC	LDO, 1.2V±2%, 100mA	SOT-23	16ch	VR1	3a	Rct
B10	2SK1068-10	n-FET	Impedance conv, 40V, 1mA, 100mW, Idss=30..80μA, Up<4V	MCP	16fa	-	3a	San
B10	2SK545-10	n-FET	Impedance-conv, 40V, 10mA, 125mW, Idss=30..80μA	SOT-23	16fa	-	3a	San
B11	2SK1068-11	n-FET	Impedance conv, 40V, 1mA, 100mW, Idss=60..180μA, Up<4V	MCP	16fa	-	3a	San
B11	2SK545-11	n-FET	Impedance-conv, 40V, 10mA, 125mW, Idss=60..180μA	SOT-23	16fa	-	3a	San
B11A	ML6101N113M	Vdet-IC	1.1V±3%, +Reset ODO	SOT-23	16vdb	VD6	3a	Mlc
B12	2SC3739-12	Si-npn	HF, Sw, 60V, 500mA, 200mW, 400MHz, B=75..150	SOT-23	16ta	-	3a	Nec
B12	2SC4173-12	Si-npn	Sw, 60V, 500mA, 150mW, B=75..150, >200MHz	SOT-323	16ta	-	3a	Nec
B12	2SK1068-12	n-FET	Impedance conv, 40V, 1mA, 100mW, Idss=150..300μA, Up<4V	MCP	16fa	-	3a	San
B12	2SK545-12	n-FET	Impedance-conv, 40V, 10mA, 125mW, Idss=150..300μA	SOT-23	16fa	-	3a	San
B12A	ML6101N123M	Vdet-IC	1.2V±3%, +Reset ODO	SOT-23	16vdb	VD6	3a	Mlc
B13	2SC3739-13	Si-npn	HF, Sw, 60V, 500mA, 200mW, 400MHz, B=100..200	SOT-23	16ta	-	3a	Nec
B13	2SC4173-13	Si-npn	Sw, 60V, 500mA, 150mW, B=100..200, >200MHz	SOT-323	16ta	-	3a	Nec
B13A	ML6101N133M	Vdet-IC	1.3V±3%, +Reset ODO	SOT-23	16vdb	VD6	3a	Mlc
B14	2SC3739-14	Si-npn	HF, Sw, 60V, 500mA, 200mW, 400MHz, B=150..300	SOT-23	16ta	-	3a	Nec
B14	2SC4173-14	Si-npn	Sw, 60V, 500mA, 150mW, B=150..300, >200MHz	SOT-323	16ta	-	3a	Nec
B14A	ML6101N143M	Vdet-IC	1.4V±3%, +Reset ODO	SOT-23	16vdb	VD6	3a	Mlc
B15	NTM2222A	Si-npn	GP, 75V, 600mA, 330mW, B=120..360, >300MHz	SOT-23	16ta	-	3a	Nec
B15A	ML6101N153M	Vdet-IC	1.5V±3%, +Reset ODO	SOT-23	16vdb	VD6	3a	Mlc
B16A	ML6101N163M	Vdet-IC	1.6V±3%, +Reset ODO	SOT-23	16vdb	VD6	3a	Mlc
B17A	ML6101N173M	Vdet-IC	1.7V±3%, +Reset ODO	SOT-23	16vdb	VD6	3a	Mlc
B18A	ML6101N183M	Vdet-IC	1.8V±3%, +Reset ODO	SOT-23	16vdb	VD6	3a	Mlc
B19A	ML6101N193M	Vdet-IC	1.9V±3%, +Reset ODO	SOT-23	16vdb	VD6	3a	Mlc
B10	KSC2715-O	Si-npn	AF, 35V, 50mA, 150mW, B=70..140, >150MHz	SOT-23	16ta	-	3a	Sam
B1R	KSC2715-R	Si-npn	AF, 35V, 50mA, 150mW, B=40..80, >150MHz	SOT-23	16ta	-	3a	Sam
B1Y	KSC2715-Y	Si-npn	AF, 35V, 50mA, 150mW, B=120..240, >150MHz	SOT-23	16ta	-	3a	Sam
B2	2SC1621-2	Si-npn	Sw, 40V, 200mA, 200mW, 500MHz, B=40..80	SOT-23	16ta	-	3a	Nec
B2	2SC4175-2	Si-npn	Sw, 40V, 200mA, 150mW, B=40..80, 12/18ns	SOT-323	16ta	-	3a	Nec
B2	2SC4931-2	Si-npn	VHF/UHF, LN, 16V, 50mA, 100mW, B=90..180, 9GHz	SMCP	16ta	-	3a	San
B2	BAS70APT	Si-diode	Dual, Schottky, 70V, 70mA, Vf<1V(15mA), <2pF, 5ns	SOT-23	16df	-	3a	Chm



SMD code	Type	Function	Short description	Case	Pinout	Sch.	St.	Mnf.
B2	BSV52	Si-npn	Sw, 20/12V, 100mA, 250mW, B=40..120, 500MHz	SOT-23	16ta	-	3a	Zx
B2	ELM9712NBB	Vdet-IC	1.2V±2.5%, +Reset ODO	SOT-23	16vdb	VD6	3d	Elm
B2	HSMS-2812	Si-diode	2x Schottky, RF, 20V, 1A, Vf<0.4V(1mA), <1.2pF, 15Ω(5mA)	SOT-23	16dl	-	3a	Agi
B2	HSMS-281C	Si-diode	2x Schottky, RF, 20V, 1A, Vf<0.4V(1mA), <1.2pF, 15Ω(5mA)	SOT-323	16dl	-	3a	Agi
B2	R3111N122A	Vdet-IC	1.2V±2%, -Reset PPO	SOT-23	16vdd	VD7	3d	Ric
B2	R3113D221A	Vdet-IC	2.2V±2%, -Reset, ODO	SON1408-3	18vda	VD6	3d	Ric
B2	R3130N22EC	Vdet-IC	2.2V, -Reset ODO, 240ms	SOT-23	16vdc	VD6	3b	Ric
B2	RT9169-13CV	LVR-IC	LDO, 1.3V±2%, 100mA	SOT-23	16ch	VR1	3a	Rct
B2	XC6GC1202HR	Vdet-IC	1.2V, +Reset PPO	USP-3	17vdc	VD3	9b	Tor
B20A	ML6101N202M	Vdet-IC	2.0V±2%, +Reset ODO	SOT-23	16vdb	VD6	3a	Mlc
B21A	ML6101N212M	Vdet-IC	2.1V±2%, +Reset ODO	SOT-23	16vdb	VD6	3a	Mlc
B22	2SC3734-22	Si-npn	Sw, 40V, 200mA, 200mW, B=75..150, >200MHz	SOT-23	16ta	-	3a	Nec
B22A	ML6101N222M	Vdet-IC	2.2V±2%, +Reset ODO	SOT-23	16vdb	VD6	3a	Mlc
B23	2SC3734-23	Si-npn	Sw, 40V, 200mA, 200mW, B=100..200, >200MHz	SOT-23	16ta	-	3a	Nec
B23A	ML6101N232M	Vdet-IC	2.3V±2%, +Reset ODO	SOT-23	16vdb	VD6	3a	Mlc
B24	2SC3734-24	Si-npn	Sw, 40V, 200mA, 200mW, B=150..300, >200MHz	SOT-23	16ta	-	3a	Nec
B24A	ML6101N242M	Vdet-IC	2.4V±2%, +Reset ODO	SOT-23	16vdb	VD6	3a	Mlc
B25	NTM3904	Si-npn	GP, 60V, 0.1A, 200mW, B= 100..300, >300MHz	SOT-23	16ta	-	-	Nec
B25A	ML6101N252M	Vdet-IC	2.5V±2%, +Reset ODO	SOT-23	16vdb	VD6	3a	Mlc
B26	BF570	Si-npn	TV-IF-Pre, 40V, 200mA, 250mW, B>40, >490MHz	SOT-23	16ta	-	3a	Phi
B26A	ML6101N262M	Vdet-IC	2.6V±2%, +Reset ODO	SOT-23	16vdb	VD6	3a	Mlc
B27A	ML6101N272M	Vdet-IC	2.7V±2%, +Reset ODO	SOT-23	16vdb	VD6	3a	Mlc
B28A	ML6101N282M	Vdet-IC	2.8V±2%, +Reset ODO	SOT-23	16vdb	VD6	3a	Mlc
B29A	ML6101N292M	Vdet-IC	2.9V±2%, +Reset ODO	SOT-23	16vdb	VD6	3a	Mlc
B2p	BSV52	Si-npn	Sw, 20/12V, 100mA, 250mW, B=40..120, 500MHz	SOT-23	16ta	-	3a	PH
B2t	BSV52	Si-npn	Sw, 20/12V, 100mA, 250mW, B=40..120, 500MHz	SOT-23	16ta	-	3a	PHM
B2W	BSV52	Si-npn	Sw, 20/12V, 100mA, 250mW, B=40..120, 500MHz	SOT-23	16ta	-	3a	PHC
B3	1PS301	Si-diode	Dual, Sw, Fast, 85V, 80mA, <4ns	SOT-323	16dg	-	3a	Phi
B3	1SS184	Si-diode	Dual, Sw, U-Fst, 85V, 100mA, 150mW, Vf<1.2V(100mA), <4ns	SC-59	16dg	-	3a	Tos
B3	1SS301	Si-diode	Dual, 80V, 100mA, Vf<1.2V(100mA), <4ns	SOT-323	16dg	-	3a	Tos
B3	1SS361	Si-diode	Dual, Sw, U-Fast, 85V, 100mA, 150mW, Vf<1.2V(0.1A), <4ns	SOT-23	18dg	-	3a	Tos
B3	1SS361F	Si-diode	Dual, Sw, U-Fast, 85V, 100mA, 150mW, Vf<1.2V(0.1A), <4ns	SOT-23F	16dg	-	3a	Tos
B3	2SC1621-3	Si-npn	Sw, 40V, 200mA, 200mW, 500MHz, B=60..120	SOT-23	16ta	-	3a	Nec
B3	2SC4175-3	Si-npn	Sw, 40V, 200mA, 150mW, B=60..120, 12/18ns	SOT-323	16ta	-	3a	Nec
B3	2SC4931-3	Si-npn	VHF/UHF, LN, 16V, 50mA, 100mW, B=135..270, 9GHz	SMCP	16ta	-	3a	San
B3	AP432W	Vref-IC	Adjustable, Precision, Shunt, 1.24V±1%	SOT-23-3L	16rc	RF1	3a	Ana
B3	BAS70CPT	Si-diode	Dual, Schottky, 70V, 70mA, Vf<1V(15mA), <2pF, 5ns	SOT-23	16db	-	3a	Chm
B3	ELM9713NBB	Vdet-IC	1.3V±2.5%, +Reset ODO	SOT-23	16vdb	VD6	3d	Elm
B3	HSMS-2813	Si-diode	Dual, Schottky, RF, 20V, 1A, Vf<0.4V(1mA), <1.2pF, 15Ω(5mA)	SOT-23	16df	-	3a	Agi
B3	HSMS-281E	Si-diode	Dual, Schottky, RF, 20V, 1A, Vf<0.4V(1mA), <1.2pF, 15Ω(5mA)	SOT-323	16df	-	3a	Agi
B3	MMBD717	Si-diode	Dual, Sw, 20mA, Vf<0.37V(1mA), <2.5pF	SOT-323	16df	-	3a	Ons
B3	R3111N132A	Vdet-IC	1.3V±2%, -Reset PPO	SOT-23	16vdd	VD7	3d	Ric
B3	R3113D231A	Vdet-IC	2.3V±2%, -Reset, ODO	SON1408-3	18vda	VD6	3d	Ric
B3	R3130N23EC	Vdet-IC	2.3V, -Reset ODO, 240ms	SOT-23	16vdc	VD6	3b	Ric
B3	RT9169-14CV	LVR-IC	LDO, 1.4V±2%, 100mA	SOT-23	16ch	VR1	3a	Rct
B3	XC6GC1302HR	Vdet-IC	1.3V, +Reset PPO	USP-3	17vdc	VD3	9b	Tor
B30A	ML6101N302M	Vdet-IC	3.0V±2%, +Reset ODO	SOT-23	16vdb	VD6	3a	Mlc
B31A	ML6101N312M	Vdet-IC	3.1V±2%, +Reset ODO	SOT-23	16vdb	VD6	3a	Mlc
B32A	ML6101N322M	Vdet-IC	3.2V±2%, +Reset ODO	SOT-23	16vdb	VD6	3a	Mlc
B33	2SC3735-33	Si-npn	Sw, 15V, 50mA, 200mW, B=50..100, >800MHz	SOT-23	16ta	-	3a	Nec
B33	2SC4176-33	Si-npn	Sw, 40V, 200mA, 150mW, B=40..80, >500MHz	SOT-323	16ta	-	3a	Nec
B33A	ML6101N332M	Vdet-IC	3.3V±2%, +Reset ODO	SOT-23	16vdb	VD6	3a	Mlc
B34	2SC3735-34	Si-npn	Sw, 15V, 50mA, 200mW, B=75..150, >800MHz	SOT-23	16ta	-	3a	Nec
B34	2SC4176-34	Si-npn	Sw, 40V, 200mA, 150mW, B=60..120, >500MHz	SOT-323	16ta	-	3a	Nec
B34A	ML6101N342M	Vdet-IC	3.4V±2%, +Reset ODO	SOT-23	16vdb	VD6	3a	Mlc
B35	2SC3735-35	Si-npn	Sw, 15V, 50mA, 200mW, B=100..200, >800MHz	SOT-23	16ta	-	3a	Nec
B35	2SC4176-35	Si-npn	Sw, 40V, 200mA, 150mW, B=90..180, >500MHz	SOT-323	16ta	-	3a	Nec
B35A	ML6101N352M	Vdet-IC	3.5V±2%, +Reset ODO	SOT-23	16vdb	VD6	3a	Mlc
B36A	ML6101N362M	Vdet-IC	3.6V±2%, +Reset ODO	SOT-23	16vdb	VD6	3a	Mlc
B37A	ML6101N372M	Vdet-IC	3.7V±2%, +Reset ODO	SOT-23	16vdb	VD6	3a	Mlc
B38A	ML6101N382M	Vdet-IC	3.8V±2%, +Reset ODO	SOT-23	16vdb	VD6	3a	Mlc
B39A	ML6101N392M	Vdet-IC	3.9V±2%, +Reset ODO	SOT-23	16vdb	VD6	3a	Mlc
B3T	1PS184	Si-diode	Dual, Hi-Speed, 85V, 215mA, 250mW, <1.5pF, <4ns	SC-59	16dg	-	3a	Phi
B4	2SC1621-4	Si-npn	Sw, 40V, 200mA, 200mW, 500MHz, B=90..180	SOT-23	16ta	-	3a	Nec
B4	2SC4175-4	Si-npn	Sw, 40V, 200mA, 150mW, B=90..180, 12/18ns	SOT-323	16ta	-	3a	Nec
B4	2SC4987-4	Si-npn	Sw, Hi-Sp, 40V, 200mA, 150mW, B=50..100, 750MHz	SMCP	16ta	-	3a	San
B4	AP432AW	Vref-IC	Adjustable, Precision, Shunt, 1.24V±0.5%	SOT-23-3L	16rc	RF1	3a	Ana
B4	BAS70SPT	Si-diode	Dual, Schottky, 70V, 70mA, Vf<1V(15mA), <2pF, 5ns	SOT-23	16dl	-	3a	Chm
B4	BAT54W	Si-diode	SBR, 30V, 200mA, Vf<0.52V(100mA), <5ns	SOT-323	16dc	-	3a	Ons
B4	BB404B	C-diode	Dual, 10V, 44.5..24.8pF(2..8V), 100MHz	SOT-23	16dg	-	3a	Itt



SMD code	Type	Function	Short description	Case	Pinout	Sch.	St.	Mnf.
B4	BSV52R	Si-npn	Sw, 20/12V, 100mA, 250mW, B=40..120, 500MHz	SOT-23	16te	-	3a	Zx
B4	ELM9714NBB	Vdet-IC	1.4V±2.5%, +Reset ODO	SOT-23	16vdb	VD6	3d	Elm
B4	HSMS-2814	Si-diode	2x Schottky, RF, 20V, 1A, Vf<0.4V(1mA), <1.2pF, 15Ω(5mA)	SOT-23	16dg	-	3a	Agi
B4	HSMS-281F	Si-diode	2x Schottky, RF, 20V, 1A, Vf<0.4V(1mA), <1.2pF, 15Ω(5mA)	SOT-323	16dg	-	3a	Agi
B4	KA4F4M	Si-npn-Digi	Sw, 60V, 100mA, 200mW, R1/R2=22k/22k	SOT-416	16ta	-	3a	Nec
B4	R3111N142A	Vdet-IC	1.4V±2%, -Reset PPO	SOT-23	16vdd	VD7	3d	Ric
B4	R3113D241A	Vdet-IC	2.4V±2%, -Reset, ODO	SON1408-3	18vda	VD6	3d	Ric
B4	R3130N24EC	Vdet-IC	2.4V, -Reset ODO, 240ms	SOT-23	16vdc	VD6	3b	Ric
B4	RT9169-15CV	LVR-IC	LDO, 1.5V±2%, 100mA	SOT-23	16ch	VR1	3a	Rct
B4	XC6GC1402HR	Vdet-IC	1.4V, +Reset PPO	USP-3	17vdc	VD3	9b	Tor
B40A	ML6101N402M	Vdet-IC	4.0V±2%, +Reset ODO	SOT-23	16vdb	VD6	3a	Mlc
B41A	ML6101N412M	Vdet-IC	4.1V±2%, +Reset ODO	SOT-23	16vdb	VD6	3a	Mlc
B42	2SB1475-42	Si-pnp	AF, 25V, 500mA, 150mW, B=110..240, >50MHz	SOT-323	16ta	-	3a	Nec
B42A	ML6101N422M	Vdet-IC	4.2V±2%, +Reset ODO	SOT-23	16vdb	VD6	3a	Mlc
B43	2SB1475-43	Si-pnp	AF, 25V, 500mA, 150mW, B=190..320, >50MHz	SOT-323	16ta	-	3a	Nec
B43A	ML6101N432M	Vdet-IC	4.3V±2%, +Reset ODO	SOT-23	16vdb	VD6	3a	Mlc
B44	2SB1475-44	Si-pnp	AF, 25V, 500mA, 150mW, B=270..400, >50MHz	SOT-323	16ta	-	3a	Nec
B44A	ML6101N442M	Vdet-IC	4.4V±2%, +Reset ODO	SOT-23	16vdb	VD6	3a	Mlc
B45A	ML6101N452M	Vdet-IC	4.5V±2%, +Reset ODO	SOT-23	16vdb	VD6	3a	Mlc
B46	BAT46S	Si-diode	Dual, SBD, 100V, 150mA, Vf<1V(250mA), 6pF	SOT-23	16dl	-	3b	Ste
B46	BAT46SW	Si-diode	Dual, SBD, 100V, 150mA, Vf<1V(250mA), 6pF	SOT-323	16dl	-	3b	Ste
B46A	ML6101N462M	Vdet-IC	4.6V±2%, +Reset ODO	SOT-23	16vdb	VD6	3a	Mlc
B47A	ML6101N472M	Vdet-IC	4.7V±2%, +Reset ODO	SOT-23	16vdb	VD6	3a	Mlc
B48A	ML6101N482M	Vdet-IC	4.8V±2%, +Reset ODO	SOT-23	16vdb	VD6	3a	Mlc
B49A	ML6101N492M	Vdet-IC	4.9V±2%, +Reset ODO	SOT-23	16vdb	VD6	3a	Mlc
B5	2SC4987-5	Si-npn	Sw, Hi-Sp, 40V, 200mA, 150mW, B=70..140, 750MHz	SMCP	16ta	-	3a	San
B5	AP432R	Vref-IC	Adjustable, Precision, Shunt, 1.24V±1%	SOT-23-3L	16rd	RF1	3a	Ana
B5	ELM9715NBB	Vdet-IC	1.5V±2.5%, +Reset ODO	SOT-23	16vdb	VD6	3d	Elm
B5	R3111N152A	Vdet-IC	1.5V±2%, -Reset PPO	SOT-23	16vdd	VD7	3d	Ric
B5	R3113D251A	Vdet-IC	2.5V±2%, -Reset, ODO	SON1408-3	18vda	VD6	3d	Ric
B5	R3130N25EC	Vdet-IC	2.5V, -Reset ODO, 240ms	SOT-23	16vdc	VD6	3b	Ric
B5	RT9169-16CV	LVR-IC	LDO, 1.6V±2%, 100mA	SOT-23	16ch	VR1	3a	Rct
B5	SP809NEK-4-4	Vdet-IC	4.4V±1.5%, -Reset ODO	SOT-23	16vdc	VD6	3b	Sip
B5	XC6GC1502HR	Vdet-IC	1.5V, +Reset PPO	USP-3	17vdc	VD3	9b	Tor
B50A	ML6101N502M	Vdet-IC	5.0V±2%, +Reset ODO	SOT-23	16vdb	VD6	3a	Mlc
B51	2SB736A-51	Si-pnp	AF, 80V, 300mA, 200mW, B=110..180, 100MHz	SOT-23	16ta	-	3a	Nec
B51A	ML6101N512M	Vdet-IC	5.1V±2%, +Reset ODO	SOT-23	16vdb	VD6	3a	Mlc
B52	2SB736A-52	Si-pnp	AF, 80V, 300mA, 200mW, B=135..220, 100MHz	SOT-23	16ta	-	3a	Nec
B52A	ML6101N522M	Vdet-IC	5.2V±2%, +Reset ODO	SOT-23	16vdb	VD6	3a	Mlc
B53	2SB736A-53	Si-pnp	AF, 80V, 300mA, 200mW, B=170..270, 100MHz	SOT-23	16ta	-	3a	Nec
B53A	ML6101N532M	Vdet-IC	5.3V±2%, +Reset ODO	SOT-23	16vdb	VD6	3a	Mlc
B54	2SB736A-54	Si-pnp	AF, 80V, 300mA, 200mW, B=200..320, 100MHz	SOT-23	16ta	-	3a	Nec
B54A	ML6101N542M	Vdet-IC	5.4V±2%, +Reset ODO	SOT-23	16vdb	VD6	3a	Mlc
B55	2SB736A-55	Si-pnp	AF, 80V, 300mA, 200mW, B=250..400, 100MHz	SOT-23	16ta	-	3a	Nec
B55A	ML6101N552M	Vdet-IC	5.5V±2%, +Reset ODO	SOT-23	16vdb	VD6	3a	Mlc
B56A	ML6101N562M	Vdet-IC	5.6V±2%, +Reset ODO	SOT-23	16vdb	VD6	3a	Mlc
B57A	ML6101N572M	Vdet-IC	5.7V±2%, +Reset ODO	SOT-23	16vdb	VD6	3a	Mlc
B58A	ML6101N582M	Vdet-IC	5.8V±2%, +Reset ODO	SOT-23	16vdb	VD6	3a	Mlc
B59A	ML6101N592M	Vdet-IC	5.9V±2%, +Reset ODO	SOT-23	16vdb	VD6	3a	Mlc
B5p	BSR12	Si-pnp	Sw, 15V, 100mA, 250mW, B=30..120, >1.5GHz	SOT-23	16ta	-	3a	Phi
B5s	BBY58-05W	C-diode	Dual, Tuning, VCO, 10V, 20mA, 17.5..19.3pF(4/1V)	SOT-323	16dg	-	3c	Inf
B6	2SB815-6	Si-pnp	AF-Amp, 20V, 700mA, 200mW, B=200..400, 250MHz	SOT-23	16ta	-	3a	San
B6	2SC4987-6	Si-npn	Sw, Hi-Sp, 40V, 200mA, 150mW, B=100..200, 750MHz	SMCP	16ta	-	3a	San
B6	AP432AR	Vref-IC	Adjustable, Precision, Shunt, 1.24V±0.5%	SOT-23-3L	16rd	RF1	3a	Ana
B6	BAT54A	Si-diode	Dual, Schottky Rectifier, 30V, 200mA, Vf<0.52V(0.1A), <5ns	SOT-23	16df	-	3a	Ons
B6	ELM9716NBB	Vdet-IC	1.6V±2.5%, +Reset ODO	SOT-23	16vdb	VD6	3d	Elm
B6	R3111N162A	Vdet-IC	1.6V±2%, -Reset PPO	SOT-23	16vdd	VD7	3d	Ric
B6	R3113D261A	Vdet-IC	2.6V±2%, -Reset, ODO	SON1408-3	18vda	VD6	3d	Ric
B6	R3130N26EC	Vdet-IC	2.6V, -Reset ODO, 240ms	SOT-23	16vdc	VD6	3b	Ric
B6	RT9169-17CV	LVR-IC	LDO, 1.7V±2%, 100mA	SOT-23	16ch	VR1	3a	Rct
B6	XC61CC1602M	Vdet-IC	1.6V±1%, +Reset PPO	SOT-23	16vdb	VD7	3d	Tor
B6	XC6GC1602HR	Vdet-IC	1.6V, +Reset PPO	USP-3	17vdc	VD3	9b	Tor
B60A	ML6101N602M	Vdet-IC	6.0V±2%, +Reset ODO	SOT-23	16vdb	VD6	3a	Mlc
B63	XE61CC1645MR	Vdet-IC	1.6V±2%, -Reset PPO	SOT-23	16vdb	VD7	3h	Tor
B65	XC61FC1612M	Vdet-IC	1.6V±2%, +Reset PPO, 200ms	SOT-23	16vdb	VD7	3d	Tor
B65	XC61HC1612MR	Vdet-IC	1.6V±2%, -Reset PPO, 50..200ms	SOT-23	16vdc	VD7	3d	Tor
B66	XC61FC1642M	Vdet-IC	1.6V±2%, +Reset PPO, 400ms	SOT-23	16vdb	VD7	3d	Tor
B66	XC61HC1642MR	Vdet-IC	1.6V±2%, -Reset PPO, 80..400ms	SOT-23	16vdc	VD7	3d	Tor
B67	XC61FC1652M	Vdet-IC	1.6V±2%, +Reset PPO, 50ms	SOT-23	16vdb	VD7	3d	Tor
B67	XC61HC1652MR	Vdet-IC	1.6V±2%, -Reset PPO, 1..50ms	SOT-23	16vdc	VD7	3d	Tor



SMD code	Type	Function	Short description	Case	Pinout	Sch.	St.	Mnf.
B6s	BBY58-06W	C-diode	Dual ,Tuning, VCO, 10V, 20mA, 17.5..19.3pF(4/1V)	SOT-323	16df	-	3c	Inf
B7	2SB815-7	Si-pnp	AF-Amp, 20V, 700mA, 200mW, B=300..400, 250MHz	SOT-23	16ta	-	3a	San
B7	ELM9717NBB	Vdet-IC	1.7V±2.5%, +Reset ODO	SOT-23	16vdb	VD6	3d	Elm
B7	KN4F4M	Si-pnp-Digi	Sw, 60V, 100mA, 150mW, R1/R2=22k/22k	SOT-416	16ta	-	3a	Nec
B7	R3111N172A	Vdet-IC	1.7V±2%, -Reset PPO	SOT-23	16vdd	VD7	3d	Ric
B7	R3113D271A	Vdet-IC	2.7V±2%, -Reset, ODO	SON1408-3	18vda	VD6	3d	Ric
B7	R3130N27EC	Vdet-IC	2.7V, -Reset ODO, 240ms	SOT-23	16vdc	VD6	3b	Ric
B7	RT9169-18CV	LVR-IC	LDO, 1.8V±2%, 100mA	SOT-23	16ch	VR1	3a	Rct
B7	XC61CC1702M	Vdet-IC	1.7V±1%, +Reset PPO	SOT-23	16vdb	VD7	3d	Tor
B7	XC6GC1702HR	Vdet-IC	1.7V, +Reset PPO	USP-3	17vdc	VD3	9b	Tor
B7-	RT9169-18PV	LVR-IC	LDO, 1.8V±2%, 100mA	SOT-23	16ch	VR1	3a	Rct
B73	XE61CC1745MR	Vdet-IC	1.7V±2%, -Reset PPO	SOT-23	16vdb	VD7	3h	Tor
B75	XC61FC1712M	Vdet-IC	1.7V±2%, +Reset PPO, 200ms	SOT-23	16vdb	VD7	3d	Tor
B75	XC61HC1712MR	Vdet-IC	1.7V±2%, -Reset PPO, 50..200ms	SOT-23	16vdc	VD7	3d	Tor
B76	XC61FC1742M	Vdet-IC	1.7V±2%, +Reset PPO, 400ms	SOT-23	16vdb	VD7	3d	Tor
B76	XC61HC1742MR	Vdet-IC	1.7V±2%, -Reset PPO, 80..400ms	SOT-23	16vdc	VD7	3d	Tor
B77	XC61FC1752M	Vdet-IC	1.7V±2%, +Reset PPO, 50ms	SOT-23	16vdb	VD7	3d	Tor
B77	XC61HC1752MR	Vdet-IC	1.7V±2%, -Reset PPO, 1..50ms	SOT-23	16vdc	VD7	3d	Tor
B8	A03438	n-MOSFET-e	Sw-PWM, 20V, 3A, 1.4W, Rds=62mΩ(4.5V), 2.5/21ns	SOT-23	16fh	-	3n	Aom
B8	A03438	n-MOSFET-e	Sw-PWM, 20V, 3A, 1.4W, Rds=62mΩ(4.5V), 2.5/21ns	SOT-23	16fh	-	3n	Aom
B8	BAT54SW	Si-diode	Dual, Schottky Rectifier, 30V, 200mA, Vf<0.52V(100mA), <5ns	SOT-323	16dl	-	3a	Ons
B8	CH0420LSPT	Si-diode	Dual, SBD, 20V, 400mA, Vf<0.43V(500mA)	SOT-23	16dl	-	3a	Chm
B8	ELM9718NBB	Vdet-IC	1.8V±2.5%, +Reset ODO	SOT-23	16vdb	VD6	3d	Elm
B8	R3111N182A	Vdet-IC	1.8V±2%, -Reset PPO	SOT-23	16vdd	VD7	3d	Ric
B8	R3113D281A	Vdet-IC	2.8V±2%, -Reset, ODO	SON1408-3	18vda	VD6	3d	Ric
B8	R3130N28EC	Vdet-IC	2.8V, -Reset ODO, 240ms	SOT-23	16vdc	VD6	3b	Ric
B8	RT9169-19CV	LVR-IC	LDO, 1.9V±2%, 100mA	SOT-23	16ch	VR1	3a	Rct
B8	XC61CC1802M	Vdet-IC	1.8V±1%, +Reset PPO	SOT-23	16vdb	VD7	3d	Tor
B8	XC6GC1802HR	Vdet-IC	1.8V, +Reset PPO	USP-3	17vdc	VD3	9b	Tor
B81	BSR12R	Si-pnp	Sw, 15V, 100mA, 250mW, B=30..120, >1.5GHz	SOT-23	16te	-	3a	Phi
B83	XE61CC1845MR	Vdet-IC	1.8V±2%, -Reset PPO	SOT-23	16vdb	VD7	3h	Tor
B85	XC61FC1812M	Vdet-IC	1.8V±2%, +Reset PPO, 200ms	SOT-23	16vdb	VD7	3d	Tor
B85	XC61HC1812MR	Vdet-IC	1.8V±2%, -Reset PPO, 50..200ms	SOT-23	16vdc	VD7	3d	Tor
B86	XC61FC1842M	Vdet-IC	1.8V±2%, +Reset PPO, 400ms	SOT-23	16vdb	VD7	3d	Tor
B86	XC61HC1842MR	Vdet-IC	1.8V±2%, -Reset PPO, 80..400ms	SOT-23	16vdc	VD7	3d	Tor
B87	XC61FC1852M	Vdet-IC	1.8V±2%, +Reset PPO, 50ms	SOT-23	16vdb	VD7	3d	Tor
B87	XC61HC1852MR	Vdet-IC	1.8V±2%, -Reset PPO, 1..50ms	SOT-23	16vdc	VD7	3d	Tor
B9	1SS311	Si-diode	Sw, 420V, 100mA, 1.5µs	SOT-23	16dr	-	3a	Tos
B9	1SS397	Si-diode	Rectifier, 420V, 100mA, 500ns	SOT-323	16dr	-	3a	Tos
B9	2SC4617	Si-npn	GP, 50V, 100mA, 150mW, B=120..560, 180MHz	SOT-416	16ta	-	3a	Ons
B9	BZX84-C10	Z-diode	9.4..10.6V, Zzt=20Ω, Izt=20mA, 225mW	SOT-23	16dc	-	3a	Lge
B9	ELM9719NBB	Vdet-IC	1.9V±2.5%, +Reset ODO	SOT-23	16vdb	VD6	3d	Elm
B9	R3111N192A	Vdet-IC	1.9V±2%, -Reset PPO	SOT-23	16vdd	VD7	3d	Ric
B9	R3113D291A	Vdet-IC	2.9V±2%, -Reset, ODO	SON1408-3	18vda	VD6	3d	Ric
B9	R3130N29EC	Vdet-IC	2.9V, -Reset ODO, 240ms	SOT-23	16vdc	VD6	3b	Ric
B9	RT9169-20CV	LVR-IC	LDO, 2.0V±2%, 100mA	SOT-23	16ch	VR1	3a	Rct
B9	XC61CC1902M	Vdet-IC	1.9V±1%, +Reset PPO	SOT-23	16vdb	VD7	3d	Tor
B9	XC6GC1902HR	Vdet-IC	1.9V, +Reset PPO	USP-3	17vdc	VD3	9b	Tor
B93	XE61CC1945MR	Vdet-IC	1.9V±2%, -Reset PPO	SOT-23	16vdb	VD7	3h	Tor
B95	XC61FC1912M	Vdet-IC	1.9V±2%, +Reset PPO, 200ms	SOT-23	16vdb	VD7	3d	Tor
B95	XC61HC1912MR	Vdet-IC	1.9V±2%, -Reset PPO, 50..200ms	SOT-23	16vdc	VD7	3d	Tor
B96	XC61FC1942M	Vdet-IC	1.9V±2%, +Reset PPO, 400ms	SOT-23	16vdb	VD7	3d	Tor
B96	XC61HC1942MR	Vdet-IC	1.9V±2%, -Reset PPO, 80..400ms	SOT-23	16vdc	VD7	3d	Tor
B97	XC61FC1952M	Vdet-IC	1.9V±2%, +Reset PPO, 50ms	SOT-23	16vdb	VD7	3d	Tor
B97	XC61HC1952MR	Vdet-IC	1.9V±2%, -Reset PPO, 1..50ms	SOT-23	16vdc	VD7	3d	Tor
BA	1SS154	Si-diode	Schottky, UHF-S-Band Mix/Det., 6V, 30mA, <0.8pF(1MHz)	SC-59	16dr	-	3a	Tos
BA	2SA1865	Si-pnp-Digi	Mute, 15V, 100mA, 150mW, 600MHz, R1/R2=10k/10k	SOT-23	16ta	-	3a	San
BA	BAS40PT	Si-diode	SBD, 40V, 200mA, Vf<1V(40mA), 5ns	SOT-23	16dc	-	3a	Chm
BA	BCW61A	Si-pnp	GP, 32V, 200mA, 330mW, B=120..220, >180MHz	SOT-23	16ta	-	3a	All
BA	DAN217	Si-diode	Dual, U-Sp, 80V, 100mA, Vf<1.2V(100mA), 0.5pF, 4ns	SMD3	16dl	-	3i	Rhm
BA	GS6333UR22D2	Vdet-IC	2.2V, -Reset PPO, 30ms	SOT-23	16vdc	VD7	3g	Vs
BA	MMBZ5241B	Z-diode	10.45..11.50V, Izt=20mA, Zzt=22Ω, 350mW	SOT-23	16dc	-	3a	Lge
BA	RT9169-21CV	LVR-IC	LDO, 2.1V±2%, 100mA	SOT-23	16ch	VR1	3a	Rct
BA	SiP6333R22D2	Vdet-IC	2.2V±1.5%, +Reset PPO 30ms	SOT-23	16vdc	VD7	3g	Vs
BAH	A1015LT1-H	Si-pnp	GP, 50V, 150mA, 200mW, >80MHz, B=200..400	SOT-23	16ta	-	3a	Wtr
BAL	A1015LT1-L	Si-pnp	GP, 50V, 150mA, 200mW, >80MHz, B=130..200	SOT-23	16ta	-	3a	Wtr
BAL	AME8500AEETB18	Vdet-IC	1.80V±1.5%, -Reset ODO, 150ms	SOT-23	16vdc	VD6	3b	Ame
BAL	AME8500AEETB18Z	Vdet-IC	1.80V±1.5%, -Reset ODO, 150ms, lead free	SOT-23	16vdc	VD6	3b	Ame
BAM	AME8500AEETBD18	Vdet-IC	1.80V±1.5%, -Reset ODO, 30ms	SOT-23	16vdc	VD6	3b	Ame
BAM	AME8500AEETBD18Z	Vdet-IC	1.80V±1.5%, -Reset ODO, 30ms, lead free	SOT-23	16vdc	VD6	3b	Ame



SMD code	Type	Function	Short description	Case	Pinout	Sch.	St.	Mnf.
BAO	2SC5342SF-Q	Si-npn	AF, 40V, 500mA, 200mW, B=70..140, 200MHz	SOT-23F	18ta	-	3a	Auk
BAO	2SC5342S-Q	Si-npn	AF, 40V, 500mA, 200mW, B=70..140, 200MHz	SOT-23	16ta	-	3a	Auk
BAp	BCW61A	Si-pnp	GP, 32V, 200mA, 250mW, B=120..220, >100MHz	SOT-23	16ta	-	3a	PhH
BAs	BCW61A	Si-pnp	GP, 32V, 100mA, 330mW, B=120..220, 250MHz	SOT-23	16ta	-	3a	Sie
BAt	BCW61A	Si-pnp	GP, 32V, 200mA, 250mW, B=120..220, >100MHz	SOT-23	16ta	-	3a	PhM
BAU	AME8500AEETAE23	Vdet-IC	2.32V±1.5%, -Reset PPO, 150ms	SOT-23	16vdc	VD7	3b	Ame
BAU	AME8500AEETAE23Z	Vdet-IC	2.32V±1.5%, -Reset PPO, 150ms, lead free	SOT-23	16vdc	VD7	3b	Ame
BAW	BCW61A	Si-pnp	GP, 32V, 200mA, 250mW, B=120..220, >100MHz	SOT-23	16ta	-	3a	PhC
BAX	AME8500CEETBE31	Vdet-IC	3.08V±1.5%, -Reset ODO, 150ms	SOT-23	16vda	VD6	3b	Ame
BAX	AME8500CEETBE31Z	Vdet-IC	3.08V±1.5%, -Reset ODO, 150ms, lead free	SOT-23	16vda	VD6	3b	Ame
BAY	2SC5342SF-Y	Si-npn	AF, 40V, 500mA, 200mW, B=120..240, 200MHz	SOT-23F	18ta	-	3a	Auk
BAY	2SC5342S-Y	Si-npn	AF, 40V, 500mA, 200mW, B=120..240, 200MHz	SOT-23	16ta	-	3a	Auk
BB	1SV128	PIN-diode	VHF/UHF, AGC, 50V, 0.05A, 0.25pF	SOT-23	16dc	-	3a	Tos
BB	2SB831-B	Si-pnp	AF-amp, 25V, 700mA, 150mW, B=85..170	MPAK	16ta	-	3a	Hit
BB	BAS40APT	Si-diode	Dual, SBD, 40V, 200mA, Vf<1V(40mA), 5ns	SOT-23	16df	-	3a	Chm
BB	BCW61B	Si-pnp	GP, 32V, 200mA, 330mW, B=180..310, >180MHz	SOT-23	16ta	-	3a	All
BB	GS6333UR22D3	Vdet-IC	2.2V, -Reset PPO, 150ms	SOT-23	16vdc	VD7	3g	Vs
BB	MMBZ5242B	Z-diode	11.40..12.60V, Izt=20mA, Zzt=30Ω, 350mW	SOT-23	16dc	-	3a	Lge
BB	RT9169-22CV	LVR-IC	LDO, 2.2V±2%, 100mA	SOT-23	16ch	VR1	3a	Rct
BB	SiP6333R22D3	Vdet-IC	2.2V±1.5%, +Reset PPO 150ms	SOT-23	16vdc	VD7	3g	Vs
BBD	AME8500BEETBE21	Vdet-IC	2.10V±1.5%, -Reset ODO, 150ms	SOT-23	16vdb	VD6	3b	Ame
BBD	AME8500BEETBE21Z	Vdet-IC	2.10V±1.5%, -Reset ODO, 150ms, lead free	SOT-23	16vdb	VD6	3b	Ame
BBD	KTC9012S-D	Si-pnp	GP, Sw, 40V, 500mA, 350mW, B=64..91, >150MHz	SOT-23	16ta	-	3f	Kec
BBE	KTC9012S-E	Si-pnp	GP, Sw, 40V, 500mA, 350mW, B=68..112, >150MHz	SOT-23	16ta	-	3f	Kec
BBF	KTC9012S-F	Si-pnp	GP, Sw, 40V, 500mA, 350mW, B=95..135, >150MHz	SOT-23	16ta	-	3f	Kec
BBG	KTC9012S-G	Si-pnp	GP, Sw, 40V, 500mA, 350mW, B=118..166, >150MHz	SOT-23	16ta	-	3f	Kec
BBH	KTC9012S-H	Si-pnp	GP, Sw, 40V, 500mA, 350mW, B=144..202, >150MHz	SOT-23	16ta	-	3f	Kec
BBI	KTC9012S-I	Si-pnp	GP, Sw, 40V, 500mA, 350mW, B=176..246, >150MHz	SOT-23	16ta	-	3f	Kec
BBp	BCW61B	Si-pnp	GP, 32V, 200mA, 250mW, B=180..310, >100MHz	SOT-23	16ta	-	3a	PhH
BBs	BCW61B	Si-pnp	GP, 32V, 100mA, 330mW, B=180..310, 250MHz	SOT-23	16ta	-	3a	Sie
BBt	BCW61B	Si-pnp	GP, 32V, 200mA, 250mW, B=180..310, >100MHz	SOT-23	16ta	-	3a	PhM
BBU	2SD2114K-U	Si-npn	AF, 25V, 500mA, 200mW, B=560..1200, >350MHz	SOT-346	16ta	-	3a	Rhm
BBV	2SD2114K-V	Si-npn	AF, 25V, 500mA, 200mW, B=820..1800, >350MHz	SOT-346	16ta	-	3a	Rhm
BBW	2SD2114K-W	Si-npn	AF, 25V, 500mA, 200mW, B=1200..2700, >350MHz	SOT-346	16ta	-	3a	Rhm
BBW	BCW61B	Si-pnp	GP, 32V, 200mA, 250mW, B=180..310, >100MHz	SOT-23	16ta	-	3a	PhC
BC	2SB831-C	Si-pnp	AF-amp, 25V, 700mA, 150mW, B=120..240	MPAK	16ta	-	3a	Hit
BC	AP432IW	Vref-IC	Adjustable, Precision, Shunt, 1.24V±1%	SOT-23-3L	16rc	RF1	3a	Ana
BC	BAS40CPT	Si-diode	Dual, SBD, 40V, 200mA, Vf<1V(40mA), 5ns	SOT-23	16dg	-	3a	Chm
BC	BCW61C	Si-pnp	GP, 32V, 200mA, 330mW, B=250..460, >180MHz	SOT-23	16ta	-	3a	All
BC	GS6333UR23D1	Vdet-IC	2.3V, -Reset PPO, 1.5ms	SOT-23	16vdc	VD7	3g	Vs
BC	MMBZ5243B	Z-diode	12.35..13.65V, Izt=9.5mA, Zzt=13Ω, 350mW	SOT-23	16dc	-	3a	Lge
BC	PT7M7803LT	Vdet-IC	4.63V±1.5%, -Reset ODO	SOT-23	16vdc	VD7	3b	Pti
BC	PT7M7803LTE	Vdet-IC	4.63V±1.5%, -Reset ODO, Lead free	SOT-23	16vdc	VD7	3b	Pti
BC	RT9169-23CV	LVR-IC	LDO, 2.3V±2%, 100mA	SOT-23	16ch	VR1	3a	Rct
BC	SiP6333R23D1	Vdet-IC	2.3V±1.5%, +Reset PPO 1.5ms	SOT-23	16vdc	VD7	3g	Vs
BCD	KTC9013S-D	Si-npn	GP, Sw, 40V, 500mA, 350mW, B=64..91, >140MHz	SOT-23	16ta	-	3f	Kec
BCE	KTC9013S-E	Si-npn	GP, Sw, 40V, 500mA, 350mW, B=68..112, >140MHz	SOT-23	16ta	-	3f	Kec
BCF	KTC9013S-F	Si-npn	GP, Sw, 40V, 500mA, 350mW, B=95..135, >140MHz	SOT-23	16ta	-	3f	Kec
BCG	AME8500AEETBF16	Vdet-IC	1.60V±1.5%, -Reset ODO, 210ms	SOT-23	16vdc	VD6	3b	Ame
BCG	AME8500AEETBF16Z	Vdet-IC	1.60V±1.5%, -Reset ODO, 210ms, lead free	SOT-23	16vdc	VD6	3b	Ame
BCG	KTC9013S-G	Si-npn	GP, Sw, 40V, 500mA, 350mW, B=118..166, >140MHz	SOT-23	16ta	-	3f	Kec
BCH	AME8500AEETAA16	Vdet-IC	1.60V±1.5%, -Reset PPO, 1.5ms	SOT-23	16vdc	VD7	3b	Ame
BCH	AME8500AEETAA16Z	Vdet-IC	1.60V±1.5%, -Reset PPO, 1.5ms, lead free	SOT-23	16vdc	VD7	3b	Ame
BCH	KTC9013S-H	Si-npn	GP, Sw, 40V, 500mA, 350mW, B=144..202, >140MHz	SOT-23	16ta	-	3f	Kec
BCI	KTC9013S-I	Si-npn	GP, Sw, 40V, 500mA, 350mW, B=176..246, >140MHz	SOT-23	16ta	-	3f	Kec
BCP	AME8500CEETAE40	Vdet-IC	4.0V±1.5%, -Reset PPO, 150ms	SOT-23	16vda	VD7	3b	Ame
BCP	AME8500CEETAE40Z	Vdet-IC	4.0V±1.5%, -Reset PPO, 150ms, lead free	SOT-23	16vda	VD7	3b	Ame
BCp	BCW61C	Si-pnp	GP, 32V, 200mA, 250mW, B=250..460, >100MHz	SOT-23	16ta	-	3a	PhH
BCQ	AME8500CEETAE28	Vdet-IC	2.80V±1.5%, -Reset PPO, 150ms	SOT-23	16vda	VD7	3b	Ame
BCQ	AME8500CEETAE28Z	Vdet-IC	2.80V±1.5%, -Reset PPO, 150ms, lead free	SOT-23	16vda	VD7	3b	Ame
BCR	AME8500CEETAE24	Vdet-IC	2.40V±1.5%, -Reset PPO, 150ms	SOT-23	16vda	VD7	3b	Ame
BCR	AME8500CEETAE24Z	Vdet-IC	2.40V±1.5%, -Reset PPO, 150ms, lead free	SOT-23	16vda	VD7	3b	Ame
BCS	AME8500AEETDE40	Vdet-IC	4.0V±1.5%, +Reset ODO, 150ms	SOT-23	16vdc	VD6	3b	Ame
BCS	AME8500AEETDE40Z	Vdet-IC	4.0V±1.5%, +Reset ODO, 150ms, lead free	SOT-23	16vdc	VD6	3b	Ame
BCs	BCW61C	Si-pnp	GP, 32V, 100mA, 330mW, B=250..460, 250MHz	SOT-23	16ta	-	3a	Sie
BCT	AME8500AEETDF27	Vdet-IC	2.70V±1.5%, +Reset ODO, 210ms	SOT-23	16vdc	VD6	3b	Ame
BCT	AME8500AEETDF27Z	Vdet-IC	2.70V±1.5%, +Reset ODO, 210ms, lead free	SOT-23	16vdc	VD6	3b	Ame
BCT	BCW61C	Si-pnp	GP, 32V, 200mA, 250mW, B=250..460, >100MHz	SOT-23	16ta	-	3a	PhM
BCU	AME8500AEETDF28	Vdet-IC	2.80V±1.5%, +Reset ODO, 210ms	SOT-23	16vdc	VD6	3b	Ame
BCU	AME8500AEETDF28Z	Vdet-IC	2.80V±1.5%, +Reset ODO, 210ms, lead free	SOT-23	16vdc	VD6	3b	Ame



SMD code	Type	Function	Short description	Case	Pinout	Sch.	St.	Mnf.
BCV	AME8500AEETDF30	Vdet-IC	3.0V±1.5%, +Reset ODO, 210ms	SOT-23	16vdc	VD6	3b	Ame
BCV	AME8500AEETDF30Z	Vdet-IC	3.0V±1.5%, +Reset ODO, 210ms, lead free	SOT-23	16vdc	VD6	3b	Ame
BCW	BCW61C	Si-pnp	GP, 32V, 200mA, 250mW, B=250..460, >100MHz	SOT-23	16ta	-	3a	PhC
BD	1S271	Si-diode	Dual, Schottky, VHF/UHF, 6V, 30mA, Vf<0.55V(10mA), <1pF	SOT-23	16ea	-	3a	Tos
BD	AP432IAW	Vref-IC	Adjustable, Precision, Shunt, 1.24V±0.5%	SOT-23-3L	16rc	RF1	3a	Ana
BD	BAS40SPT	Si-diode	Dual, SBD, 40V, 200mA, Vf<1V(40mA), 5ns	SOT-23	16dl	-	3a	Chm
BD	GS6333UR23D2	Vdet-IC	2.3V, -Reset PPO, 30ms	SOT-23	16vdc	VD7	3g	Vs
BD	PT7M7803MT	Vdet-IC	4.26V±1.5%, -Reset ODO	SOT-23	16vdc	VD7	3b	Pti
BD	PT7M7803MTE	Vdet-IC	4.26V±1.5%, -Reset ODO, Lead free	SOT-23	16vdc	VD7	3b	Pti
BD	RT9169-24CV	LVR-IC	LDO, 2.4V±2%, 100mA	SOT-23	16ch	VR1	3a	Rct
BD	SiP6333R23D2	Vdet-IC	2.3V±1.5%, +Reset PPO 30ms	SOT-23	16vdc	VD7	3g	Vs
BDB	AME88004EET	LVR-IC	LDO, 4.0V±1.5%, 300mA	SOT-23	16cq	VR1	3b	Ame
BDB	AME88004EETL	LVR-IC	LDO, 4.0V±1.5%, 300mA	TSOT-23	16cq	VR1	3b	Ame
BDB	AME88004EETY	LVR-IC	LDO, 4.0V±1.5%, 300mA	TSOT-23	16cq	VR1	3b	Ame
BDB	AME88004EETZ	LVR-IC	LDO, 4.0V±1.5%, 300mA	SOT-23	16cq	VR1	3b	Ame
BDC	AME8500CEETA31	Vdet-IC	3.08V±1.5%, -Reset PPO, 150ms	SOT-23	16vda	VD7	3b	Ame
BDC	AME8500CEETA31Z	Vdet-IC	3.08V±1.5%, -Reset PPO, 150ms, lead free	SOT-23	16vda	VD7	3b	Ame
BDD	KTC9014S-D	Si-npn	GP, Sw, 50V, 150mA, 350mW, B=64..91, >60MHz	SOT-23	16ta	-	3f	Kec
BDE	KTC9014S-E	Si-npn	GP, Sw, 50V, 150mA, 350mW, B=68..112, >60MHz	SOT-23	16ta	-	3f	Kec
BDF	KTC9014S-F	Si-npn	GP, Sw, 50V, 150mA, 350mW, B=95..135, >60MHz	SOT-23	16ta	-	3f	Kec
BDG	KTC9014S-G	Si-npn	GP, Sw, 50V, 150mA, 350mW, B=118..166, >60MHz	SOT-23	16ta	-	3f	Kec
BDH	KTC9014S-H	Si-npn	GP, Sw, 50V, 150mA, 350mW, B=144..202, >60MHz	SOT-23	16ta	-	3f	Kec
BDI	KTC9014S-I	Si-npn	GP, Sw, 50V, 150mA, 350mW, B=176..246, >60MHz	SOT-23	16ta	-	3f	Kec
BDK	AME8550AEETA390L	Vdet-IC	3.9V±2%, -Reset PPO	SOT-23	16vdb	VD7	3b	Ame
BDK	AME8550AEETA390Y	Vdet-IC	3.9V±2%, -Reset PPO	TSOT-23	16vdb	VD7	3b	Ame
BDK	AME8550AEETA390Z	Vdet-IC	3.9V±2%, -Reset PPO	SOT-23	16vdb	VD7	3b	Ame
BDM	2SA1733K-M	Si-pnp	Sw, 30V, 30mA, 200mW, B=39..82, >400MHz	SOT-346	16ta	-	3a	Rhm
BDM	2SA1808-M	Si-pnp	RF, 30V, 30mA, 200mW, B=39..82, >400MHz	SOT-323	16ta	-	3a	Rhm
BDM	2SA1821-M	Si-pnp	HF, 20V, 30mA, 150mW, >400MHz, B=39..82	SC-75A	16ta	-	3a	Rhm
BDM	AME8550AEETB330L	Vdet-IC	3.3V±2%, -Reset ODO	SOT-23	16vdb	VD6	3b	Ame
BDM	AME8550AEETB330Z	Vdet-IC	3.3V±2%, -Reset ODO	SOT-23	16vdb	VD6	3b	Ame
BDN	2SA1733K-N	Si-pnp	Sw, 30V, 30mA, 200mW, B=56..120, >400MHz	SOT-346	16ta	-	3a	Rhm
BDN	2SA1808-N	Si-pnp	RF, 30V, 30mA, 200mW, B=56..120, >400MHz	SOT-323	16ta	-	3a	Rhm
BDN	2SA1821-N	Si-pnp	HF, 20V, 30mA, 150mW, >400MHz, B=56..120	SC-75A	16ta	-	3a	Rhm
BDN	AME8500AEETBD29	Vdet-IC	2.93V±1.5%, -Reset ODO, 30ms	SOT-23	16vdc	VD6	3b	Ame
BDN	AME8500AEETBD29Z	Vdet-IC	2.93V±1.5%, -Reset ODO, 30ms, lead free	SOT-23	16vdc	VD6	3b	Ame
BDO	AME8500CEETBF29	Vdet-IC	2.93V±1.5%, -Reset ODO, 210ms	SOT-23	16vda	VD6	3b	Ame
BDO	AME8500CEETBF29Z	Vdet-IC	2.93V±1.5%, -Reset ODO, 210ms, lead free	SOT-23	16vda	VD6	3b	Ame
BDP	2SA1733K-P	Si-pnp	Sw, 30V, 30mA, 200mW, B=82..180, >400MHz	SOT-346	16ta	-	3a	Rhm
BDP	2SA1808-P	Si-pnp	RF, 30V, 30mA, 200mW, B=82..180, >400MHz	SOT-323	16ta	-	3a	Rhm
BDP	2SA1821-P	Si-pnp	HF, 20V, 30mA, 150mW, >400MHz, B=82..180	SC-75A	16ta	-	3a	Rhm
BDp	BCW61D	Si-pnp	GP, 32V, 200mA, 250mW, B=380..630, >100MHz	SOT-23	16ta	-	3a	PhH
BDS	BCW61D	Si-pnp	GP, 32V, 100mA, 330mW, B=380..630, 250MHz	SOT-23	16ta	-	3a	Sie
BDT	AME8500AEETA320	Vdet-IC	2.0V±1.5%, -Reset PPO, 210ms	SOT-23	16vdc	VD7	3b	Ame
BDT	AME8500AEETA320Z	Vdet-IC	2.0V±1.5%, -Reset PPO, 210ms, lead free	SOT-23	16vdc	VD7	3b	Ame
BDt	BCW61D	Si-pnp	GP, 32V, 200mA, 250mW, B=380..630, >100MHz	SOT-23	16ta	-	3a	PhM
BDU	AME8500BEETBE42	Vdet-IC	4.20V±1.5%, -Reset ODO, 150ms	SOT-23	16vdb	VD6	3b	Ame
BDU	AME8500BEETBE42Z	Vdet-IC	4.20V±1.5%, -Reset ODO, 150ms, lead free	SOT-23	16vdb	VD6	3b	Ame
BDW	BCW61D	Si-pnp	GP, 32V, 200mA, 250mW, B=380..630, >100MHz	SOT-23	16ta	-	3a	PhC
BDX	AME8500BEETBF45	Vdet-IC	4.50V±1.5%, -Reset ODO, 210ms	SOT-23	16vdb	VD6	3b	Ame
BDX	AME8500BEETBF45Z	Vdet-IC	4.50V±1.5%, -Reset ODO, 210ms, lead free	SOT-23	16vdb	VD6	3b	Ame
BE	1SV172	C-diode	Dual, VHF/UHF-B, 50V, 0.25pF(50V), Rs=7Ω(10mA), 100MHz	SOT-23	16dl	-	3a	Tos
BE	1SV252	PIN-diode	2x VHF/UHF-B, AGC, 50V, 0.25pF(50V), 7Ω(10mA, 100MHz)	SOT-23	16ea	-	3a	Tos
BE	2SC3440-E	Si-npn	Relay-Drv, 25V, 1A, 150mW, B=150..300, 180MHz	SC-59	16ta	-	3a	Mit
BE	AP432IR	Vref-IC	Adjustable, Precision, Shunt, 1.24V±1%	SOT-23-3L	16rd	RF1	3a	Ana
BE	BAS70	Si-diode	Schottky, 70V, 70mA, Vf<1V(15mA), <2pF, 5ns	SOT-23	16dc	-	3a	Ons
BE	BCW61E	Si-pnp	GP, 32V, 200mA, 250mW, B=450..900, >100MHz	SOT-23	16ta	-	3a	PhH
BE	GS6333UR23D3	Vdet-IC	2.3V, -Reset PPO, 150ms	SOT-23	16vdc	VD7	3g	Vs
BE	MMBZ5245B	Z-diode	14.25..15.75V, Izt=8.5mA, Zzt=16Ω, 350mW	SOT-23	16dc	-	3a	Lge
BE	PT7M7803TT	Vdet-IC	3.08V±1.5%, -Reset ODO	SOT-23	16vdc	VD7	3b	Pti
BE	PT7M7803TTE	Vdet-IC	3.08V±1.5%, -Reset ODO, Lead free	SOT-23	16vdc	VD7	3b	Pti
BE	RT9169-25CV	LVR-IC	LDO, 2.5V±2%, 100mA	SOT-23	16ch	VR1	3a	Rct
BE	SiP6333R23D3	Vdet-IC	2.3V±1.5%, +Reset PPO 150ms	SOT-23	16vdc	VD7	3g	Vs
BE-	RT9169-25PV	LVR-IC	LDO, 2.5V±2%, 100mA	SOT-23	16ch	VR1	3a	Rct
BEb	AME8500AEETBE40	Vdet-IC	4.0V±1.5%, -Reset ODO, 150ms	SOT-23	16vdc	VD6	3b	Ame
BEb	AME8500AEETBE40Z	Vdet-IC	4.0V±1.5%, -Reset ODO, 150ms, lead free	SOT-23	16vdc	VD6	3b	Ame
BED	KTC9015S-D	Si-pnp	GP, Sw, 50V, 150mA, 350mW, B=64..91, >60MHz	SOT-23	16ta	-	3f	Kec
BEE	AME8500AEETBE31	Vdet-IC	3.08V±1.5%, -Reset ODO, 150ms	SOT-23	16vdc	VD6	3b	Ame
BEE	AME8500AEETBE31Z	Vdet-IC	3.08V±1.5%, -Reset ODO, 150ms, lead free	SOT-23	16vdc	VD6	3b	Ame
BEE	KTC9015S-E	Si-pnp	GP, Sw, 50V, 150mA, 350mW, B=68..112, >60MHz	SOT-23	16ta	-	3f	Kec



SMD code	Type	Function	Short description	Case	Pinout	Sch.	St.	Mnf.
BEF	KTC9015S-F	Si-pnp	GP, Sw, 50V, 150mA, 350mW, B=95..135, >60MHz	SOT-23	16ta	-	3f	Kec
BEG	KTC9015S-G	Si-pnp	GP, Sw, 50V, 150mA, 350mW, B=118..166, >60MHz	SOT-23	16ta	-	3f	Kec
BEH	KTC9015S-H	Si-pnp	GP, Sw, 50V, 150mA, 350mW, B=144..202, >60MHz	SOT-23	16ta	-	3f	Kec
BEI	KTC9015S-I	Si-pnp	GP, Sw, 50V, 150mA, 350mW, B=176..246, >60MHz	SOT-23	16ta	-	3f	Kec
BEW	BCW61E	Si-pnp	GP, 32V, 200mA, 250mW, B=450..900, >100MHz	SOT-23	16ta	-	3a	PhC
BF	1SS268	Si-diode	Dual, VHF-Band-Sw, 30V, <1.2pF, <0.9Ω	SOT-23	16dg	-	3a	Tos
BF	1SS312	Si-diode	Dual, VHF-Band-Sw, 30V, <1.2pF, <0.9Ω	SOT-23	16df	-	3a	Tos
BF	1SS364	Si-diode	Dual, VHF-Band-Sw, 30V, <1.2pF, <0.9Ω	SOT-23	16dg	-	3a	Tos
BF	2SC3440-F	Si-npn	Relay-Drv, 25V, 1A, 150mW, B=250..500, 180MHz	SC-59	16ta	-	3a	Mit
BF	AP432IAR	Vref-IC	Adjustable, Precision, Shunt, 1.24V±0.5%	SOT-23-3L	16rd	RF1	3a	Ana
BF	KDS112	C-diode	Dual, VHF-Band-S, 30V, <1.2pF(6V)	SOT-323	16dg	-	3a	Kec
BF	MMBZ5246B	Z-diode	15.20..16.80V, Izt=7.8mA, Zzt=17Ω, 350mW	SOT-23	16dc	-	3a	Lge
BF	PT7M7803ST	Vdet-IC	2.93V±1.5%, -Reset ODO	SOT-23	16vdc	VD7	3b	Pti
BF	PT7M7803STE	Vdet-IC	2.93V±1.5%, -Reset ODO, Lead free	SOT-23	16vdc	VD7	3b	Pti
BF	RT9169-26CV	LVR-IC	LDO, 2.6V±2%, 100mA	SOT-23	16ch	VR1	3a	Rct
BF	XC62RP1502M	LVR-IC	LDO, 1.5V±2%, 6mA, 150mW	SOT-23	16cg	VR1	3d	Tor
BFR	2SC4642K-R	Si-npn	AF, 50V, 100mA, 200mW, B=180..390, >180MHz	SOT-346	16ta	-	3a	Rhm
BFR	2SC4723-R	Si-npn	AF, 50V, 100mA, 200mW, B=180..390, >180MHz	SOT-323	16ta	-	3a	Rhm
BFS	2SC4642K-S	Si-npn	AF, 50V, 100mA, 200mW, B=180..390, >180MHz	SOT-346	16ta	-	3a	Rhm
BFS	2SC4723-S	Si-npn	AF, 50V, 100mA, 200mW, B=180..390, >180MHz	SOT-323	16ta	-	3a	Rhm
BFs	BCW61FF	Si-pnp	GP, 32V, 100mA, 330mW, B=250..460, 250MHz	SOT-23	16ta	-	3a	Sie
BG	1SS269	Si-diode	Dual, VHF-Band-Sw, 30V, <1.2pF, <0.9Ω	SOT-23	16df	-	3a	Tos
BG	1SS313	Si-diode	Dual, VHF-Band-Sw, 30V, <1.2pF, <0.9Ω	SOT-23	16df	-	3a	Tos
BG	2SC3440-G	Si-npn	Relay-Drv, 25V, 1A, 150mW, B=400..800, 180MHz	SC-59	16ta	-	3a	Mit
BG	BAT54APT	Si-diode	Dual, SBD, 30V, 200mA, Vf<1V(100mA), 5ns	SOT-23	16df	-	3a	Chm
BG	BCW61G	Si-pnp	AF, 45V, 200mA, 250mW, B=120..220, >100MHz	SOT-23	16ta	-	3a	All
BG	GS6333UR24D1	Vdet-IC	2.4V, -Reset PPO, 1.5ms	SOT-23	16vdc	VD7	3g	Vs
BG	PT7M7803RT	Vdet-IC	2.63V±1.5%, -Reset ODO	SOT-23	16vdc	VD7	3b	Pti
B̄G	PT7M7803RTE	Vdet-IC	2.63V±1.5%, -Reset ODO, Lead free	SOT-23	16vdc	VD7	3b	Pti
BG	RT9169-27CV	LVR-IC	LDO, 2.7V±2%, 100mA	SOT-23	16ch	VR1	3a	Rct
BG	SIP6333R24D1	Vdet-IC	2.4V±1.5%, +Reset PPO 1.5ms	SOT-23	16vdc	VD7	3g	Vs
BG-	RT9169-27PV	LVR-IC	LDO, 2.7V±2%, 100mA	SOT-23	16ch	VR1	3a	Rct
BGp	BCW61G	Si-pnp	AF, 45V, 200mA, 250mW, B=120..220, >100MHz	SOT-23	16ta	-	3a	Phi
BGp	BCX71G	Si-pnp	GP, 45V, 200mA, 250mW, B=120..220, >100MHz	SOT-23	16ta	-	3a	PHH
BGs	BCW61G	Si-pnp	AF, 45V, 100mA, 330mW, B=120..220, 250MHz	SOT-23	16ta	-	3a	Sie
BGs	BCX71G	Si-pnp	GP, 45V, 100mA, 330mW, B=120..220, 250MHz	SOT-23	16ta	-	3a	Sie
BGt	BCX71G	Si-pnp	GP, 45V, 200mA, 250mW, B=120..220, >100MHz	SOT-23	16ta	-	3a	PHM
BGW	BCX71G	Si-pnp	GP, 45V, 200mA, 250mW, B=120..220, >100MHz	SOT-23	16ta	-	3a	PhC
BH	1SS295	Si-diode	Dual, Schottky, UHF-Mix, 4V, 50mA	SOT-23	16ea	-	3a	Tos
BH	1SS350	Si-diode	SBD, UHF-det/mix, 5V, 30mA, Vf<0.23V(1mA), 0.69pF	CP	16dc	-	3a	San
BH	GS6333UR24D2	Vdet-IC	2.4V, -Reset PPO, 30ms	SOT-23	16vdc	VD7	3g	Vs
BH	MMBZ5247B	Z-diode	16.15..17.85V, Izt=7.4mA, Zzt=19Ω, 350mW	SOT-23	16dc	-	3a	Lge
BH	PT7M7803ZT	Vdet-IC	2.32V±1.5%, -Reset ODO	SOT-23	16vdc	VD7	3b	Pti
B̄H	PT7M7803ZTE	Vdet-IC	2.32V±1.5%, -Reset ODO, Lead free	SOT-23	16vdc	VD7	3b	Pti
BH	RT9169-28CV	LVR-IC	LDO, 2.8V±2%, 100mA	SOT-23	16ch	VR1	3a	Rct
BH	SIP6333R24D2	Vdet-IC	2.4V±1.5%, +Reset PPO 30ms	SOT-23	16vdc	VD7	3g	Vs
BH	XC62RP1602M	LVR-IC	LDO, 1.6V±2%, 6mA, 150mW	SOT-23	16cg	VR1	3d	Tor
BHM	2SC4699K-M	Si-npn	AF, 25V, 200mA, 200mW, B=39..82, >250MHz	SOT-346	16ta	-	3a	Rhm
BHM	2SC4700-M	Si-npn	RF, Sw, 25V, 200mA, 150mW, B=39..82, >250MHz	SOT-323	16ta	-	3a	Rhm
BHN	2SC4699K-N	Si-npn	AF, 25V, 200mA, 200mW, B=56..120, >250MHz	SOT-346	16ta	-	3a	Rhm
BHN	2SC4700-N	Si-npn	RF, Sw, 25V, 200mA, 150mW, B=56..120, >250MHz	SOT-323	16ta	-	3a	Rhm
BHP	2SC4699K-P	Si-npn	AF, 25V, 200mA, 200mW, B=82..180, >250MHz	SOT-346	16ta	-	3a	Rhm
BHP	2SC4700-P	Si-npn	RF, Sw, 25V, 200mA, 150mW, B=82..180, >250MHz	SOT-323	16ta	-	3a	Rhm
Bhp	BCX71H	Si-pnp	GP, 45V, 200mA, 250mW, B=180..310, >100MHz	SOT-23	16ta	-	3a	PHH
BHs	BCX71H	Si-pnp	GP, 45V, 100mA, 330mW, B=180..310, 250MHz	SOT-23	16ta	-	3a	Sie
BHT	BCX71H	Si-pnp	GP, 45V, 200mA, 250mW, B=180..310, >100MHz	SOT-23	16ta	-	3a	PHM
BHW	BCX71H	Si-pnp	GP, 45V, 200mA, 250mW, B=180..310, >100MHz	SOT-23	16ta	-	3a	PhC
BI	GS6333UR24D3	Vdet-IC	2.4V, -Reset PPO, 150ms	SOT-23	16vdc	VD7	3g	Vs
BI	PT7M7803YT	Vdet-IC	2.20V±1.5%, -Reset ODO	SOT-23	16vdc	VD7	3b	Pti
BI	PT7M7803YTE	Vdet-IC	2.20V±1.5%, -Reset ODO, Lead free	SOT-23	16vdc	VD7	3b	Pti
BI	SIP6333R24D3	Vdet-IC	2.4V±1.5%, +Reset PPO 150ms	SOT-23	16vdc	VD7	3g	Vs
BIQ	2SK541-Q	n-FET	V-cam, 12V, ±50mA, 150mW, Idss=14..24mA, Up<2.5V	SOT-23	16fa	-	3a	Ren
BIR	2SK541-R	n-FET	V-cam, 12V, ±50mA, 150mW, Idss=20..32mA, Up<2.5V	SOT-23	16fa	-	3a	Ren
BIS	2SK541-S	n-FET	V-cam, 12V, ±50mA, 150mW, Idss=28..42mA, Up<2.5V	SOT-23	16fa	-	3a	Ren
BIZ	AME8550AEETA340L	Vdet-IC	3.4V±2%, -Reset PPO	SOT-23	16vdb	VD7	3b	Ame
BIZ	AME8550AEETA340Z	Vdet-IC	3.4V±2%, -Reset PPO	SOT-23	16vdb	VD7	3b	Ame
BJ	BCX71J	Si-pnp	GP, 45V, 100mA, 330mW, B=250..460, 250MHz	SOT-23	16ta	-	3a	All
BJ	MMBZ5248B	Z-diode	17.10..18.90V, Izt=7.0mA, Zzt=21Ω, 350mW	SOT-23	16dc	-	3a	Lge
BJ	RT9169-29CV	LVR-IC	LDO, 2.8V±2%, 100mA	SOT-23	16ch	VR1	3a	Rct
B̄JO	AME8570AEETA23L	Vdet-IC	2.32V±1.5%, -Reset PPO, lead free	SOT-23	16vdc	VD7	3b	Ame



SMD code	Type	Function	Short description	Case	Pinout	Sch.	St.	Mnf.
BJO	AME8570AEETAF23Y	Vdet-IC	2.32V±1.5%, -Reset PPO	TSOT-23	16vdc	VD7	3b	Ame
BJO	AME8570AEETAF23Z	Vdet-IC	2.32V±1.5%, -Reset PPO	SOT-23	16vdc	VD7	3b	Ame
BJP	AME8570AEITAF23L	Vdet-IC	2.32V±1.5%, -Reset PPO, lead free	SC-70-3	16vdc	VD7	3b	Ame
BJP	AME8570AEITAF23Z	Vdet-IC	2.32V±1.5%, -Reset PPO	SC-70-3	16vdc	VD7	3b	Ame
BJp	BCX71J	Si-pnp	GP, 45V, 200mA, 250mW, B=250..460, >100MHz	SOT-23	16ta	-	3a	PhH
BJR	AME8570AEETAF26L	Vdet-IC	2.63V±1.5%, -Reset PPO, lead free	SOT-23	16vdc	VD7	3b	Ame
BJR	AME8570AEETAF26Y	Vdet-IC	2.63V±1.5%, -Reset PPO	TSOT-23	16vdc	VD7	3b	Ame
BJR	AME8570AEETAF26Z	Vdet-IC	2.63V±1.5%, -Reset PPO	SOT-23	16vdc	VD7	3b	Ame
BJs	AME8570AEITAF26L	Vdet-IC	2.63V±1.5%, -Reset PPO, lead free	SC-70-3	16vdc	VD7	3b	Ame
BJs	AME8570AEITAF26Z	Vdet-IC	2.63V±1.5%, -Reset PPO	SC-70-3	16vdc	VD7	3b	Ame
BJs	BCX71J	Si-pnp	GP, 45V, 100mA, 330mW, B=250..460, 250MHz	SOT-23	16ta	-	3a	Sie
BJt	BCX71J	Si-pnp	GP, 45V, 200mA, 250mW, B=250..460, >100MHz	SOT-23	16ta	-	3a	PhM
BJU	AME8570AEETAF29L	Vdet-IC	2.93V±1.5%, -Reset PPO, lead free	SOT-23	16vdc	VD7	3b	Ame
BJU	AME8570AEETAF29Y	Vdet-IC	2.93V±1.5%, -Reset PPO	TSOT-23	16vdc	VD7	3b	Ame
BJU	AME8570AEETAF29Z	Vdet-IC	2.93V±1.5%, -Reset PPO	SOT-23	16vdc	VD7	3b	Ame
BJV	2SD2226K-V	Si-npn	AF, 60V, 150mA, 200mW, B=820..1800, 250MHz	SOT-346	16ta	-	3a	Rhm
BJV	2SD2351-V	Si-npn	Hi-beta, 60V, 150mA, 200mW, B=820..1800, 250MHz	UMT3	16ta	-	3a	Rhm
BJV	AME8570AEITAF29L	Vdet-IC	2.93V±1.5%, -Reset PPO, lead free	SC-70-3	16vdc	VD7	3b	Ame
BJV	AME8570AEITAF29Z	Vdet-IC	2.93V±1.5%, -Reset PPO	SC-70-3	16vdc	VD7	3b	Ame
BJW	2SD2226K-W	Si-npn	AF, 60V, 150mA, 200mW, B=1200..2700, 250MHz	SOT-346	16ta	-	3a	Rhm
BJW	2SD2227S-W	Si-npn	AF, 60V, 150mA, 300mW, B=1200..2700, 250MHz	SPT	16ta	-	3a	Rhm
BJW	2SD2351-W	Si-npn	Hi-beta, 60V, 150mA, 200mW, B=1200..2700, 250MHz	UMT3	16ta	-	3a	Rhm
BJW	BCX71J	Si-pnp	GP, 45V, 200mA, 250mW, B=250..460, >100MHz	SOT-23	16ta	-	3a	PhC
BJX	AME8570AEETCF29L	Vdet-IC	2.93V±1.5%, +Reset PPO, lead free	SOT-23	16vda	VD7	3b	Ame
BJX	AME8570AEETCF29Y	Vdet-IC	2.93V±1.5%, +Reset PPO	TSOT-23	16vda	VD7	3b	Ame
BJX	AME8570AEETCF29Z	Vdet-IC	2.93V±1.5%, +Reset PPO	SOT-23	16vda	VD7	3b	Ame
BJY	AME8570AEITCF29L	Vdet-IC	2.93V±1.5%, +Reset PPO, lead free	SC-70-3	16vda	VD6	3b	Ame
BJY	AME8570AEITCF29Z	Vdet-IC	2.93V±1.5%, +Reset PPO	SC-70-3	16vda	VD6	3b	Ame
BK	GS6333UR25D1	Vdet-IC	2.5V, -Reset PPO, 1.5ms	SOT-23	16vdc	VD7	3g	Vs
BK	MMBZ5249B	Z-diode	18.05..19.95V, Izt=6.6mA, Zzt=23Ω, 350mW	SOT-23	16dc	-	3a	Lge
BK	RT9169-30CV	LVR-IC	LDO, 3.0V±2%, 100mA	SOT-23	16ch	VR1	3a	Rct
BK	SiP6333R25D1	Vdet-IC	2.5V±1.5%, +Reset PPO 1.5ms	SOT-23	16vdc	VD7	3g	Vs
BK	XC62RP1702M	LVR-IC	LDO, 1.7V±2%, 6mA, 150mW	SOT-23	16cg	VR1	3d	Tor
BK-	RT9169-30PV	LVR-IC	LDO, 3.0V±2%, 100mA	SOT-23	16ch	VR1	3a	Rct
BKA	AME8570AEETAF31L	Vdet-IC	3.08V±1.5%, -Reset PPO, lead free	SOT-23	16vdc	VD7	3b	Ame
BKA	AME8570AEETAF31Y	Vdet-IC	3.08V±1.5%, -Reset PPO	TSOT-23	16vdc	VD7	3b	Ame
BKA	AME8570AEETAF31Z	Vdet-IC	3.08V±1.5%, -Reset PPO	SOT-23	16vdc	VD7	3b	Ame
BKB	AME8570AEITAF31L	Vdet-IC	3.08V±1.5%, -Reset PPO, lead free	SC-70-3	16vdc	VD7	3b	Ame
BKB	AME8570AEITAF31Z	Vdet-IC	3.08V±1.5%, -Reset PPO	SC-70-3	16vdc	VD7	3b	Ame
BKD	AME8570AEETBF31L	Vdet-IC	3.08V±1.5%, -Reset ODO, lead free	SOT-23	16vdb	VD6	3b	Ame
BKD	AME8570AEETBF31Y	Vdet-IC	3.08V±1.5%, -Reset ODO	TSOT-23	16vdb	VD6	3b	Ame
BKD	AME8570AEETBF31Z	Vdet-IC	3.08V±1.5%, -Reset ODO	SOT-23	16vdb	VD6	3b	Ame
BKE	AME8570AEITBF31L	Vdet-IC	3.08V±1.5%, -Reset ODO, lead free	SC-70-3	16vdb	VD6	3b	Ame
BKE	AME8570AEITBF31Z	Vdet-IC	3.08V±1.5%, -Reset ODO	SC-70-3	16vdb	VD6	3b	Ame
BKG	AME8570AEETAF46L	Vdet-IC	4.63V±1.5%, -Reset PPO, lead free	SOT-23	16vdc	VD7	3b	Ame
BKG	AME8570AEETAF46Y	Vdet-IC	4.63V±1.5%, -Reset PPO	TSOT-23	16vdc	VD7	3b	Ame
BKG	AME8570AEETAF46Z	Vdet-IC	4.63V±1.5%, -Reset PPO	SOT-23	16vdc	VD7	3b	Ame
BKH	AME8570AEITAF46L	Vdet-IC	4.63V±1.5%, -Reset PPO, lead free	SC-70-3	16vdc	VD7	3b	Ame
BKH	AME8570AEITAF46Z	Vdet-IC	4.63V±1.5%, -Reset PPO	SC-70-3	16vdc	VD7	3b	Ame
BKJ	AME8570AEETCF46L	Vdet-IC	4.63V±1.5%, +Reset PPO, lead free	SOT-23	16vda	VD7	3b	Ame
BKJ	AME8570AEETCF46Y	Vdet-IC	4.63V±1.5%, +Reset PPO	TSOT-23	16vda	VD7	3b	Ame
BKJ	AME8570AEETCF46Z	Vdet-IC	4.63V±1.5%, +Reset PPO	SOT-23	16vda	VD7	3b	Ame
BKK	AME8570AEITCF46L	Vdet-IC	4.63V±1.5%, +Reset PPO, lead free	SC-70-3	16vda	VD6	3b	Ame
BKK	AME8570AEITCF46Z	Vdet-IC	4.63V±1.5%, +Reset PPO	SC-70-3	16vda	VD6	3b	Ame
BKp	BCX71K	Si-pnp	GP, 45V, 200mA, 250mW, B=380..630, >100MHz	SOT-23	16ta	-	3a	PhH
BKQ	2SB1590K-Q	Si-pnp	Lo-sat, 15V, 1A, 200mW, B=120..270, 200MHz	SC-59	16ta	-	3a	Rhm
BKs	BCX71K	Si-pnp	GP, 45V, 100mA, 330mW, B=380..630, 250MHz	SOT-23	16ta	-	3a	Sie
BKt	BCX71K	Si-pnp	GP, 45V, 200mA, 250mW, B=380..630, >100MHz	SOT-23	16ta	-	3a	PhM
BKW	BCX71K	Si-pnp	GP, 45V, 200mA, 250mW, B=380..630, >100MHz	SOT-23	16ta	-	3a	PhC
BL	2SA1341	Si-pnp-Digi	Sw, 50V, 100mA, 200mW, 250MHz, R1/R2=47k/47k	CP	16ta	-	3a	San
BL	2SA1676	Si-pnp-Digi	Sw, 50V, 100mA, 200MHz, R1/R2=47k/47k	SOT-323	16ta	-	3a	San
BL	GS6333UR25D2	Vdet-IC	2.5V, -Reset PPO, 30ms	SOT-23	16vdc	VD7	3g	Vs
BL	RT9169-31CV	LVR-IC	LDO, 3.1V±2%, 100mA	SOT-23	16ch	VR1	3a	Rct
BL	SiP6333R25D2	Vdet-IC	2.5V±1.5%, +Reset PPO 30ms	SOT-23	16vdc	VD7	3g	Vs
BL	XC62RP1802M	LVR-IC	LDO, 1.8V±2%, 6mA, 150mW	SOT-23	16cg	VR1	3d	Tor
BLL	2SC4771K-L	Si-npn	HF, 30V, 50mA, 200mW, B=27..56, >600MHz	SOT-346	16ta	-	3a	Rhm
BLL	2SC4772-L	Si-npn	RF, 30V, 50mA, 150mW, B=27..56, >600MHz	SOT-323	16ta	-	3a	Rhm
BLM	2SC4771K-M	Si-npn	HF, 30V, 50mA, 200mW, B=39..82, >600MHz	SOT-346	16ta	-	3a	Rhm
BLM	2SC4772-M	Si-npn	RF, 30V, 50mA, 150mW, B=39..82, >600MHz	SOT-323	16ta	-	3a	Rhm
BLN	2SC4771K-N	Si-npn	HF, 30V, 50mA, 200mW, B=56..120, >600MHz	SOT-346	16ta	-	3a	Rhm



SMD code	Type	Function	Short description	Case	Pinout	Sch.	St.	Mnf.
BLN	2SC4772-N	Si-npn	RF, 30V, 50mA, 150mW, B=56..120, >600MHz	SOT-323	16ta	-	3a	Rhm
BLN	ELM7523CEB	Vdet-IC	2.3V±2%, +Reset PPO	SC-70	16vdb	VD7	3d	Elm
BLN	ELM7523NEB	Vdet-IC	2.3V±2%, +Reset ODO	SC-70	16vdb	VD6	3d	Elm
BLP	2SC4771K-P	Si-npn	HF, 30V, 50mA, 200mW, B=82..180, >600MHz	SOT-346	16ta	-	3a	Rhm
BLP	2SC4772-P	Si-npn	RF, 30V, 50mA, 150mW, B=82..180, >600MHz	SOT-323	16ta	-	3a	Rhm
BLY	AME8570AEETA26L	Vdet-IC	2.63V±1.5%, -Reset PPO, lead free	SOT-23	16vdc	VD7	3b	Ame
BLY	AME8570AEETA26Y	Vdet-IC	2.63V±1.5%, -Reset PPO	TSOT-23	16vdc	VD7	3b	Ame
BLY	AME8570AEETA26Z	Vdet-IC	2.63V±1.5%, -Reset PPO	SOT-23	16vdc	VD7	3b	Ame
BLZ	AME8570BEETA27L	Vdet-IC	2.70V±1.5%, -Reset PPO, lead free	SOT-23	16vdc	VD7	3b	Ame
BLZ	AME8570BEETA27Y	Vdet-IC	2.70V±1.5%, -Reset PPO	TSOT-23	16vdc	VD7	3b	Ame
BLZ	AME8570BEETA27Z	Vdet-IC	2.70V±1.5%, -Reset PPO	SOT-23	16vdc	VD7	3b	Ame
BM	GS6333UR25D3	Vdet-IC	2.5V, -Reset PPO, 150ms	SOT-23	16vdc	VD7	3g	Vs
BM	MMBZ5250B	Z-diode	19.0..21.0V, Izt=6.2mA, Zzt=25Ω, 350mW	SOT-23	16dc	-	3a	Lge
BM	RT9169-32CV	LVR-IC	LDO, 3.2V±2%, 100mA	SOT-23	16ch	VR1	3a	Rct
BM	SiP6333R25D3	Vdet-IC	2.5V±1.5%, +Reset PPO 150ms	SOT-23	16vdc	VD7	3g	Vs
BM	XC62RP1902M	LVR-IC	LDO, 1.9V±2%, 6mA, 150mW	SOT-23	16cg	VR1	3d	Tor
BM-	RT9169-32PV	LVR-IC	LDO, 3.2V±2%, 100mA	SOT-23	16ch	VR1	3a	Rct
BMA	AME8570BEETBA28L	Vdet-IC	2.80V±1.5%, -Reset ODO, lead free	SOT-23	16vdb	VD6	3b	Ame
BMA	AME8570BEETBA28Y	Vdet-IC	2.80V±1.5%, -Reset ODO	TSOT-23	16vdb	VD6	3b	Ame
BMA	AME8570BEETBA28Z	Vdet-IC	2.80V±1.5%, -Reset ODO	SOT-23	16vdb	VD6	3b	Ame
BMB	AME8570CEETBF29L	Vdet-IC	2.93V±1.5%, -Reset ODO, lead free	SOT-23	16vdb	VD6	3b	Ame
BMB	AME8570CEETBF29Y	Vdet-IC	2.93V±1.5%, -Reset ODO	TSOT-23	16vdb	VD6	3b	Ame
BMB	AME8570CEETBF29Z	Vdet-IC	2.93V±1.5%, -Reset ODO	SOT-23	16vdb	VD6	3b	Ame
BMC	AME8570AEETA16Y	Vdet-IC	1.60V±1.5%, -Reset PPO, lead free	SOT-23	16vdc	VD7	3b	Ame
BMC	AME8570AEETA16L	Vdet-IC	1.60V±1.5%, -Reset PPO	TSOT-23	16vdc	VD7	3b	Ame
BMC	AME8570AEETA16Z	Vdet-IC	1.60V±1.5%, -Reset PPO	SOT-23	16vdc	VD7	3b	Ame
BMD	AME8570BEETA16L	Vdet-IC	1.60V±1.5%, -Reset PPO, lead free	SOT-23	16vdc	VD7	3b	Ame
BMD	AME8570BEETA16Y	Vdet-IC	1.60V±1.5%, -Reset PPO	TSOT-23	16vdc	VD7	3b	Ame
BMD	AME8570BEETA16Z	Vdet-IC	1.60V±1.5%, -Reset PPO	SOT-23	16vdc	VD7	3b	Ame
BME	AME8570CEETA16L	Vdet-IC	1.60V±1.5%, -Reset PPO, lead free	SOT-23	16vdc	VD7	3b	Ame
BME	AME8570CEETA16Y	Vdet-IC	1.60V±1.5%, -Reset PPO	TSOT-23	16vdc	VD7	3b	Ame
BME	AME8570CEETA16Z	Vdet-IC	1.60V±1.5%, -Reset PPO	SOT-23	16vdc	VD7	3b	Ame
BMF	AME8570AETAA16L	Vdet-IC	1.60V±1.5%, -Reset PPO, lead free	SC-70-3	16vdc	VD7	3b	Ame
BMF	AME8570AETAA16Z	Vdet-IC	1.60V±1.5%, -Reset PPO	SC-70-3	16vdc	VD7	3b	Ame
BMH	AME8570AETBE20L	Vdet-IC	2.0V±1.5%, -Reset ODO, lead free	SOT-23	16vdb	VD6	3b	Ame
BMH	AME8570AETBE20Y	Vdet-IC	2.0V±1.5%, -Reset ODO	TSOT-23	16vdb	VD6	3b	Ame
BMH	AME8570AETBE20Z	Vdet-IC	2.0V±1.5%, -Reset ODO	SOT-23	16vdb	VD6	3b	Ame
BMI	AME8570BEETBE20L	Vdet-IC	2.0V±1.5%, -Reset ODO, lead free	SOT-23	16vdb	VD6	3b	Ame
BMI	AME8570BEETBE20Y	Vdet-IC	2.0V±1.5%, -Reset ODO	TSOT-23	16vdb	VD6	3b	Ame
BMI	AME8570BEETBE20Z	Vdet-IC	2.0V±1.5%, -Reset ODO	SOT-23	16vdb	VD6	3b	Ame
BMJ	AME8570CEETBE20L	Vdet-IC	2.0V±1.5%, -Reset ODO, lead free	SOT-23	16vdb	VD6	3b	Ame
BMJ	AME8570CEETBE20Y	Vdet-IC	2.0V±1.5%, -Reset ODO	TSOT-23	16vdb	VD6	3b	Ame
BMJ	AME8570CEETBE20Z	Vdet-IC	2.0V±1.5%, -Reset ODO	SOT-23	16vdb	VD6	3b	Ame
BMK	AME8570AETBE20L	Vdet-IC	2.0V±1.5%, -Reset ODO, lead free	SOT-23	16vdb	VD6	3b	Ame
BMK	AME8570AETBE20Y	Vdet-IC	2.0V±1.5%, -Reset ODO	SC-70-3	16vdb	VD6	3b	Ame
BMM	AME8570AETA21L	Vdet-IC	2.10V±1.5%, -Reset PPO, lead free	SOT-23	16vdc	VD7	3b	Ame
BMM	AME8570AETA21Y	Vdet-IC	2.10V±1.5%, -Reset PPO	TSOT-23	16vdc	VD7	3b	Ame
BMM	AME8570AETA21Z	Vdet-IC	2.10V±1.5%, -Reset PPO	SOT-23	16vdc	VD7	3b	Ame
BMN	AME8570BEETA21L	Vdet-IC	2.10V±1.5%, -Reset PPO, lead free	SOT-23	16vdc	VD7	3b	Ame
BMN	AME8570BEETA21Y	Vdet-IC	2.10V±1.5%, -Reset PPO	TSOT-23	16vdc	VD7	3b	Ame
BMN	AME8570BEETA21Z	Vdet-IC	2.10V±1.5%, -Reset PPO	SOT-23	16vdc	VD7	3b	Ame
BMO	AME8570CEETA21L	Vdet-IC	2.10V±1.5%, -Reset PPO, lead free	SOT-23	16vdc	VD7	3b	Ame
BMO	AME8570CEETA21Y	Vdet-IC	2.10V±1.5%, -Reset PPO	TSOT-23	16vdc	VD7	3b	Ame
BMO	AME8570CEETA21Z	Vdet-IC	2.10V±1.5%, -Reset PPO	SOT-23	16vdc	VD7	3b	Ame
BMP	AME8570AETA21L	Vdet-IC	2.10V±1.5%, -Reset PPO, lead free	SC-70-3	16vdc	VD7	3b	Ame
BMP	AME8570AETA21Z	Vdet-IC	2.10V±1.5%, -Reset PPO	SC-70-3	16vdc	VD7	3b	Ame
BMP	BSS63	Si-pnp	GP, 110V, 100mA, 250mW, B>30, >50MHz	SOT-23	16ta	-	3a	PHI
BMQ	2SC4713K-Q	Si-npn	RF, Sw, 12V, 50mA, 200mW, B=120..270, 800MHz	SC-59	16ta	-	3a	Rhm
BMQ	2SC4774-Q	Si-npn	RF, Sw, 12V, 50mA, 150mW, B=120..270, >800MHz	SOT-323	16ta	-	3a	Rhm
BMR	2SC4713K-R	Si-npn	RF, Sw, 12V, 50mA, 200mW, B=180..390, 800MHz	SC-59	16ta	-	3a	Rhm
BMR	2SC4774-R	Si-npn	RF, Sw, 12V, 50mA, 150mW, B=180..390, >800MHz	SOT-323	16ta	-	3a	Rhm
BMR	AME8570BEETA23L	Vdet-IC	2.32V±1.5%, -Reset PPO, lead free	SOT-23	16vdc	VD7	3b	Ame
BMR	AME8570BEETA23Y	Vdet-IC	2.32V±1.5%, -Reset PPO	TSOT-23	16vdc	VD7	3b	Ame
BMR	AME8570BEETA23Z	Vdet-IC	2.32V±1.5%, -Reset PPO	SOT-23	16vdc	VD7	3b	Ame
BMS	2SC4713K-S	Si-npn	RF, Sw, 12V, 50mA, 200mW, B=270..560, 800MHz	SC-59	16ta	-	3a	Rhm
BMS	2SC4774-S	Si-npn	RF, Sw, 12V, 50mA, 150mW, B=270..560, >800MHz	SOT-323	16ta	-	3a	Rhm
BMS	AME8570CEETA23L	Vdet-IC	2.32V±1.5%, -Reset PPO, lead free	SOT-23	16vdc	VD7	3b	Ame
BMS	AME8570CEETA23Y	Vdet-IC	2.32V±1.5%, -Reset PPO	TSOT-23	16vdc	VD7	3b	Ame
BMS	AME8570CEETA23Z	Vdet-IC	2.32V±1.5%, -Reset PPO	SOT-23	16vdc	VD7	3b	Ame
BMs	BSS63	Si-pnp	GP, 110V, 100mA, 330mW, B>30, >50MHz	SOT-23	16ta	-	3c	Inf



SMD code	Type	Function	Short description	Case	Pinout	Sch. St.	Mnf.
BM T	AME8570BEETA26L	Vdet-IC	2.63V±1.5%, -Reset PPO, lead free	SOT-23	16vdc	VD7	3b Ame
BMT	AME8570BEETA26Y	Vdet-IC	2.63V±1.5%, -Reset PPO	TSOT-23	16vdc	VD7	3b Ame
BMT	AME8570BEETA26Z	Vdet-IC	2.63V±1.5%, -Reset PPO	SOT-23	16vdc	VD7	3b Ame
BM I	BSS63	Si-pnp	GP, 110V, 100mA, 250mW, B>30, >50MHz	SOT-23	16ta	-	3a PhM
BM U	AME8570CEETA26L	Vdet-IC	2.63V±1.5%, -Reset PPO, lead free	SOT-23	16vdc	VD7	3b Ame
BMU	AME8570CEETA26Y	Vdet-IC	2.63V±1.5%, -Reset PPO	TSOT-23	16vdc	VD7	3b Ame
BMU	AME8570CEETA26Z	Vdet-IC	2.63V±1.5%, -Reset PPO	SOT-23	16vdc	VD7	3b Ame
BM V	AME8570AETA26L	Vdet-IC	2.63V±1.5%, -Reset PPO, lead free	SC-70-3	16vdc	VD7	3b Ame
BMV	AME8570AETA26Z	Vdet-IC	2.63V±1.5%, -Reset PPO	SC-70-3	16vdc	VD7	3b Ame
BM W	BSS63	Si-pnp	GP, 110V, 100mA, 250mW, B>30, >50MHz	SOT-23	16ta	-	3a PhC
BM X	AME8570BEETA26L	Vdet-IC	2.63V±1.5%, -Reset PPO, lead free	SOT-23	16vdc	VD7	3b Ame
BMX	AME8570BEETA26Y	Vdet-IC	2.63V±1.5%, -Reset PPO	TSOT-23	16vdc	VD7	3b Ame
BMX	AME8570BEETA26Z	Vdet-IC	2.63V±1.5%, -Reset PPO	SOT-23	16vdc	VD7	3b Ame
BM Y	AME8570CEETA26L	Vdet-IC	2.63V±1.5%, -Reset PPO, lead free	SOT-23	16vdc	VD7	3b Ame
BM Y	AME8570CEETA26Y	Vdet-IC	2.63V±1.5%, -Reset PPO	TSOT-23	16vdc	VD7	3b Ame
BM Y	AME8570CEETA26Z	Vdet-IC	2.63V±1.5%, -Reset PPO	SOT-23	16vdc	VD7	3b Ame
BM Z	AME8570AETA26L	Vdet-IC	2.70V±1.5%, -Reset PPO, lead free	SOT-23	16vdc	VD7	3b Ame
BMZ	AME8570AETA26Y	Vdet-IC	2.70V±1.5%, -Reset PPO	TSOT-23	16vdc	VD7	3b Ame
BMZ	AME8570AETA26Z	Vdet-IC	2.70V±1.5%, -Reset PPO	SOT-23	16vdc	VD7	3b Ame
BN	2SD2324	Si-pnp-Digi+Di	Motor-Drv, 20V, 800mA, 200mW, B>70, 150MHz, R2=1kΩ	SOT-23	16ta	-	3a San
BN	GS6332UR15D1	Vdet-IC	1.5V, +Reset PPO, 1.5ms	SOT-23	16vdc	VD7	3g Vs
BN	MMBZ5251B	Z-diode	20.90..23.10V, Izt=5.6mA, Zzt=29Ω, 350mW	SOT-23	16dc	-	3a Lge
BN	RT9169-33CV	LVR-IC	LDO, 3.3V±2%, 100mA	SOT-23	16ch	VR1	3a Rct
BN	SIP6332R15D1	Vdet-IC	1.5V±1.5%, -Reset PPO 1.5ms	SOT-23	16vdc	VD7	3g Vs
BN15	AIC1722A-15CU	LVR-IC	LDO, 1.5V±1%, 300mA	SOT-23	16vj	VR1	3a Aic
BN15P	AIC1722A-15PU	LVR-IC	LDO, 1.5V±1%, 300mA	SOT-23	16vj	VR1	3a Aic
BN18	AIC1722A-18CU	LVR-IC	LDO, 1.8V±1%, 300mA	SOT-23	16vj	VR1	3a Aic
BN18P	AIC1722A-18PU	LVR-IC	LDO, 1.8V±1%, 300mA	SOT-23	16vj	VR1	3a Aic
BN20	AIC1722A-20CU	LVR-IC	LDO, 2.0V±1%, 300mA	SOT-23	16vj	VR1	3a Aic
BN20P	AIC1722A-20PU	LVR-IC	LDO, 2.0V±1%, 300mA	SOT-23	16vj	VR1	3a Aic
BN25	AIC1722A-25CU	LVR-IC	LDO, 2.5V±1%, 300mA	SOT-23	16vj	VR1	3a Aic
BN25P	AIC1722A-25PU	LVR-IC	LDO, 2.5V±1%, 300mA	SOT-23	16vj	VR1	3a Aic
BN27	AIC1722A-27CU	LVR-IC	LDO, 2.7V±1%, 300mA	SOT-23	16vj	VR1	3a Aic
BN27P	AIC1722A-27PU	LVR-IC	LDO, 2.7V±1%, 300mA	SOT-23	16vj	VR1	3a Aic
BN30	AIC1722A-30CU	LVR-IC	LDO, 3.0V±1%, 300mA	SOT-23	16vj	VR1	3a Aic
BN30P	AIC1722A-30PU	LVR-IC	LDO, 3.0V±1%, 300mA	SOT-23	16vj	VR1	3a Aic
BN33	AIC1722A-33CU	LVR-IC	LDO, 3.3V±1%, 300mA	SOT-23	16vj	VR1	3a Aic
BN33P	AIC1722A-33PU	LVR-IC	LDO, 3.3V±1%, 300mA	SOT-23	16vj	VR1	3a Aic
BN35	AIC1722A-35CU	LVR-IC	LDO, 3.5V±1%, 300mA	SOT-23	16vj	VR1	3a Aic
BN35P	AIC1722A-35PU	LVR-IC	LDO, 3.5V±1%, 300mA	SOT-23	16vj	VR1	3a Aic
BN37	AIC1722A-37CU	LVR-IC	LDO, 3.7V±1%, 300mA	SOT-23	16vj	VR1	3a Aic
BN37P	AIC1722A-37PU	LVR-IC	LDO, 3.7V±1%, 300mA	SOT-23	16vj	VR1	3a Aic
BN38	AIC1722A-38CU	LVR-IC	LDO, 3.8V±1%, 300mA	SOT-23	16vj	VR1	3a Aic
BN38P	AIC1722A-38PU	LVR-IC	LDO, 3.8V±1%, 300mA	SOT-23	16vj	VR1	3a Aic
BN50	AIC1722A-50CU	LVR-IC	LDO, 5.0V±1%, 300mA	SOT-23	16vj	VR1	3a Aic
BN50P	AIC1722A-50PU	LVR-IC	LDO, 5.0V±1%, 300mA	SOT-23	16vj	VR1	3a Aic
BN52	AIC1722A-52CU	LVR-IC	LDO, 5.2V±1%, 300mA	SOT-23	16vj	VR1	3a Aic
BN52P	AIC1722A-52PU	LVR-IC	LDO, 5.2V±1%, 300mA	SOT-23	16vj	VR1	3a Aic
BN A	AME8570CEETA26L	Vdet-IC	2.70V±1.5%, -Reset PPO, lead free	SOT-23	16vdc	VD7	3b Ame
BNA	AME8570CEETA26Y	Vdet-IC	2.70V±1.5%, -Reset PPO	TSOT-23	16vdc	VD7	3b Ame
BNA	AME8570CEETA26Z	Vdet-IC	2.70V±1.5%, -Reset PPO	SOT-23	16vdc	VD7	3b Ame
BN B	AME8570AETA26L	Vdet-IC	2.70V±1.5%, -Reset PPO, lead free	SC-70-3	16vdc	VD7	3b Ame
BNB	AME8570AETA26Z	Vdet-IC	2.70V±1.5%, -Reset PPO	SC-70-3	16vdc	VD7	3b Ame
BN D	AME8570AETA26L	Vdet-IC	2.70V±1.5%, -Reset PPO, lead free	SOT-23	16vdc	VD7	3b Ame
BND	AME8570AETA26Y	Vdet-IC	2.70V±1.5%, -Reset PPO	TSOT-23	16vdc	VD7	3b Ame
BND	AME8570AETA26Z	Vdet-IC	2.70V±1.5%, -Reset PPO	SOT-23	16vdc	VD7	3b Ame
BN E	AME8570BEETA26L	Vdet-IC	2.70V±1.5%, -Reset PPO, lead free	SOT-23	16vdc	VD7	3b Ame
BNE	AME8570BEETA26Y	Vdet-IC	2.70V±1.5%, -Reset PPO	TSOT-23	16vdc	VD7	3b Ame
BNE	AME8570BEETA26Z	Vdet-IC	2.70V±1.5%, -Reset PPO	SOT-23	16vdc	VD7	3b Ame
BN F	AME8570CEETA26L	Vdet-IC	2.70V±1.5%, -Reset PPO, lead free	SOT-23	16vdc	VD7	3b Ame
BNF	AME8570CEETA26Y	Vdet-IC	2.70V±1.5%, -Reset PPO	TSOT-23	16vdc	VD7	3b Ame
BNF	AME8570CEETA26Z	Vdet-IC	2.70V±1.5%, -Reset PPO	SOT-23	16vdc	VD7	3b Ame
BN G	AME8570AETA26L	Vdet-IC	2.70V±1.5%, -Reset PPO, lead free	SC-70-3	16vdc	VD7	3b Ame
BNG	AME8570AETA26Z	Vdet-IC	2.70V±1.5%, -Reset PPO	SC-70-3	16vdc	VD7	3b Ame
BN I	AME8570AETBA28L	Vdet-IC	2.80V±1.5%, -Reset ODO, lead free	SOT-23	16vdb	VD6	3b Ame
BN I	AME8570AETBA28Y	Vdet-IC	2.80V±1.5%, -Reset ODO	TSOT-23	16vdb	VD6	3b Ame
BN I	AME8570AETBA28Z	Vdet-IC	2.80V±1.5%, -Reset ODO	SOT-23	16vdb	VD6	3b Ame
BN J	AME8570CEETBA28L	Vdet-IC	2.80V±1.5%, -Reset ODO, lead free	SOT-23	16vdb	VD6	3b Ame
BNJ	AME8570CEETBA28Y	Vdet-IC	2.80V±1.5%, -Reset ODO	TSOT-23	16vdb	VD6	3b Ame
BNJ	AME8570CEETBA28Z	Vdet-IC	2.80V±1.5%, -Reset ODO	SOT-23	16vdb	VD6	3b Ame



SMD code	Type	Function	Short description	Case	Pinout	Sch.	St.	Mnf.
BNK	AME8570AEITBA28L	Vdet-IC	2.80V±1.5%, -Reset ODO, lead free	SC-70-3	16vdb	VD6	3b	Ame
BNK	AME8570AEITBA28Z	Vdet-IC	2.80V±1.5%, -Reset ODO	SC-70-3	16vdb	VD6	3b	Ame
BNM	AME8570AEETA29L	Vdet-IC	2.93V±1.5%, -Reset PPO, lead free	SOT-23	16vdc	VD7	3b	Ame
BNM	AME8570AEETA29Y	Vdet-IC	2.93V±1.5%, -Reset PPO	TSOT-23	16vdc	VD7	3b	Ame
BNM	AME8570AEETA29Z	Vdet-IC	2.93V±1.5%, -Reset PPO	SOT-23	16vdc	VD7	3b	Ame
BNN	AME8570BEETA29L	Vdet-IC	2.93V±1.5%, -Reset PPO, lead free	SOT-23	16vdc	VD7	3b	Ame
BNN	AME8570BEETA29Y	Vdet-IC	2.93V±1.5%, -Reset PPO	TSOT-23	16vdc	VD7	3b	Ame
BNN	AME8570BEETA29Z	Vdet-IC	2.93V±1.5%, -Reset PPO	SOT-23	16vdc	VD7	3b	Ame
BNO	AME8570CEETA29L	Vdet-IC	2.93V±1.5%, -Reset PPO, lead free	SOT-23	16vdc	VD7	3b	Ame
BNO	AME8570CEETA29Y	Vdet-IC	2.93V±1.5%, -Reset PPO	TSOT-23	16vdc	VD7	3b	Ame
BNO	AME8570CEETA29Z	Vdet-IC	2.93V±1.5%, -Reset PPO	SOT-23	16vdc	VD7	3b	Ame
BNP	AME8570AEITAE29L	Vdet-IC	2.93V±1.5%, -Reset PPO, lead free	SC-70-3	16vdc	VD7	3b	Ame
BNP	AME8570AEITAE29Z	Vdet-IC	2.93V±1.5%, -Reset PPO	SC-70-3	16vdc	VD7	3b	Ame
BNR	AME8570BEETA29L	Vdet-IC	2.93V±1.5%, -Reset PPO, lead free	SOT-23	16vdc	VD7	3b	Ame
BNR	AME8570BEETA29Y	Vdet-IC	2.93V±1.5%, -Reset PPO	TSOT-23	16vdc	VD7	3b	Ame
BNR	AME8570BEETA29Z	Vdet-IC	2.93V±1.5%, -Reset PPO	SOT-23	16vdc	VD7	3b	Ame
BNS	AME8570CEETA29L	Vdet-IC	2.93V±1.5%, -Reset PPO, lead free	SOT-23	16vdc	VD7	3b	Ame
BNS	AME8570CEETA29Y	Vdet-IC	2.93V±1.5%, -Reset PPO	TSOT-23	16vdc	VD7	3b	Ame
BNS	AME8570CEETA29Z	Vdet-IC	2.93V±1.5%, -Reset PPO	SOT-23	16vdc	VD7	3b	Ame
BNS	BCW61FN	Si-npn	LN, 32V, 100mA, 330mW, B=380..630, 250MHz	SOT-23	16ta	-	3a	Sie
BNT	AME8570AEETBF29L	Vdet-IC	2.93V±1.5%, -Reset ODO, lead free	SOT-23	16vdb	VD6	3b	Ame
BNT	AME8570AEETBF29Y	Vdet-IC	2.93V±1.5%, -Reset ODO	TSOT-23	16vdb	VD6	3b	Ame
BNT	AME8570AEETBF29Z	Vdet-IC	2.93V±1.5%, -Reset ODO	SOT-23	16vdb	VD6	3b	Ame
BNU	AME8570BEETBF29L	Vdet-IC	2.93V±1.5%, -Reset ODO, lead free	SOT-23	16vdb	VD6	3b	Ame
BNU	AME8570BEETBF29Y	Vdet-IC	2.93V±1.5%, -Reset ODO	TSOT-23	16vdb	VD6	3b	Ame
BNU	AME8570BEETBF29Z	Vdet-IC	2.93V±1.5%, -Reset ODO	SOT-23	16vdb	VD6	3b	Ame
BNV	AME8570AEITBF29L	Vdet-IC	2.93V±1.5%, -Reset ODO, lead free	SC-70-3	16vdb	VD6	3b	Ame
BNV	AME8570AEITBF29Z	Vdet-IC	2.93V±1.5%, -Reset ODO	SC-70-3	16vdb	VD6	3b	Ame
BNW	AME8570BEETCF29L	Vdet-IC	2.93V±1.5%, +Reset PPO, lead free	SOT-23	16vda	VD7	3b	Ame
BNW	AME8570BEETCF29Y	Vdet-IC	2.93V±1.5%, +Reset PPO	TSOT-23	16vda	VD7	3b	Ame
BNW	AME8570BEETCF29Z	Vdet-IC	2.93V±1.5%, +Reset PPO	SOT-23	16vda	VD7	3b	Ame
BNX	AME8570CEETCF29L	Vdet-IC	2.93V±1.5%, +Reset PPO, lead free	SOT-23	16vda	VD7	3b	Ame
BNX	AME8570CEETCF29Y	Vdet-IC	2.93V±1.5%, +Reset PPO	TSOT-23	16vda	VD7	3b	Ame
BNX	AME8570CEETCF29Z	Vdet-IC	2.93V±1.5%, +Reset PPO	SOT-23	16vda	VD7	3b	Ame
BNY	AME8570BEETA31L	Vdet-IC	3.08V±1.5%, -Reset PPO, lead free	SOT-23	16vdc	VD7	3b	Ame
BNY	AME8570BEETA31Y	Vdet-IC	3.08V±1.5%, -Reset PPO	TSOT-23	16vdc	VD7	3b	Ame
BNY	AME8570BEETA31Z	Vdet-IC	3.08V±1.5%, -Reset PPO	SOT-23	16vdc	VD7	3b	Ame
BNZ	AME8570CEETA31L	Vdet-IC	3.08V±1.5%, -Reset PPO, lead free	SOT-23	16vdc	VD7	3b	Ame
BNZ	AME8570CEETA31Y	Vdet-IC	3.08V±1.5%, -Reset PPO	TSOT-23	16vdc	VD7	3b	Ame
BNZ	AME8570CEETA31Z	Vdet-IC	3.08V±1.5%, -Reset PPO	SOT-23	16vdc	VD7	3b	Ame
BO	2SC5342UF-Q	Si-npn	AF, 40V, 500mA, 200mW, B=70..140, 200MHz	SOT-323F	18ta	-	3a	Auk
BO	2SC5342U-Q	Si-npn	AF, 40V, 500mA, 200mW, B=70..140, 200MHz	SOT-323	16ta	-	3a	Auk
BO	GS6332UR15D2	Vdet-IC	1.5V, +Reset PPO, 30ms	SOT-23	16vdc	VD7	3g	Vs
BO	SIP6332R15D2	Vdet-IC	1.5V±1.5%, -Reset PPO 30ms	SOT-23	16vdc	VD7	3g	Vs
BOA	AME8570BEETBF31L	Vdet-IC	3.08V±1.5%, -Reset ODO, lead free	SOT-23	16vdb	VD6	3b	Ame
BOA	AME8570BEETBF31Y	Vdet-IC	3.08V±1.5%, -Reset ODO	TSOT-23	16vdb	VD6	3b	Ame
BOA	AME8570BEETBF31Z	Vdet-IC	3.08V±1.5%, -Reset ODO	SOT-23	16vdb	VD6	3b	Ame
BOB	AME8570CEETBF31L	Vdet-IC	3.08V±1.5%, -Reset ODO, lead free	SOT-23	16vdb	VD6	3b	Ame
BOB	AME8570CEETBF31Y	Vdet-IC	3.08V±1.5%, -Reset ODO	TSOT-23	16vdb	VD6	3b	Ame
BOB	AME8570CEETBF31Z	Vdet-IC	3.08V±1.5%, -Reset ODO	SOT-23	16vdb	VD6	3b	Ame
BOC	AME8570AEETBE31L	Vdet-IC	3.08V±1.5%, -Reset ODO, lead free	SOT-23	16vdb	VD6	3b	Ame
BOC	AME8570AEETBE31Y	Vdet-IC	3.08V±1.5%, -Reset ODO	TSOT-23	16vdb	VD6	3b	Ame
BOC	AME8570AEETBE31Z	Vdet-IC	3.08V±1.5%, -Reset ODO	SOT-23	16vdb	VD6	3b	Ame
BOD	AME8570BEETBE31L	Vdet-IC	3.08V±1.5%, -Reset ODO, lead free	SOT-23	16vdb	VD6	3b	Ame
BOD	AME8570BEETBE31Y	Vdet-IC	3.08V±1.5%, -Reset ODO	TSOT-23	16vdb	VD6	3b	Ame
BOD	AME8570BEETBE31Z	Vdet-IC	3.08V±1.5%, -Reset ODO	SOT-23	16vdb	VD6	3b	Ame
BOE	AME8570CEETBE31L	Vdet-IC	3.08V±1.5%, -Reset ODO, lead free	SOT-23	16vdb	VD6	3b	Ame
BOE	AME8570CEETBE31Y	Vdet-IC	3.08V±1.5%, -Reset ODO	TSOT-23	16vdb	VD6	3b	Ame
BOE	AME8570CEETBE31Z	Vdet-IC	3.08V±1.5%, -Reset ODO	SOT-23	16vdb	VD6	3b	Ame
BOF	AME8570AEITBE31L	Vdet-IC	3.08V±1.5%, -Reset ODO, lead free	SC-70-3	16vdb	VD6	3b	Ame
BOF	AME8570AEITBE31Z	Vdet-IC	3.08V±1.5%, -Reset ODO	SC-70-3	16vdb	VD6	3b	Ame
BOH	AME8570AEETCF31L	Vdet-IC	3.08V±1.5%, +Reset PPO, lead free	SOT-23	16vda	VD7	3b	Ame
BOH	AME8570AEETCF31Y	Vdet-IC	3.08V±1.5%, +Reset PPO	TSOT-23	16vda	VD7	3b	Ame
BOH	AME8570AEETCF31Z	Vdet-IC	3.08V±1.5%, +Reset PPO	SOT-23	16vda	VD7	3b	Ame
BOI	AME8570BEETCF31L	Vdet-IC	3.08V±1.5%, +Reset PPO, lead free	SOT-23	16vda	VD7	3b	Ame
BOI	AME8570BEETCF31Y	Vdet-IC	3.08V±1.5%, +Reset PPO	TSOT-23	16vda	VD7	3b	Ame
BOI	AME8570BEETCF31Z	Vdet-IC	3.08V±1.5%, +Reset PPO	SOT-23	16vda	VD7	3b	Ame
BOJ	AME8570CEETCF31L	Vdet-IC	3.08V±1.5%, +Reset PPO, lead free	SOT-23	16vda	VD7	3b	Ame
BOJ	AME8570CEETCF31Y	Vdet-IC	3.08V±1.5%, +Reset PPO	TSOT-23	16vda	VD7	3b	Ame
BOJ	AME8570CEETCF31Z	Vdet-IC	3.08V±1.5%, +Reset PPO	SOT-23	16vda	VD7	3b	Ame



SMD code	Type	Function	Short description	Case	Pinout	Sch.	St.	Mnf.
BOK	AME8570AETCF31L	Vdet-IC	3.08V±1.5%, +Reset PPO, lead free	SC-70-3	16vda	VD6	3b	Ame
BOK	AME8570AETCF31Z	Vdet-IC	3.08V±1.5%, +Reset PPO	SC-70-3	16vda	VD6	3b	Ame
BOM	AME8570AETAF40L	Vdet-IC	4.0V±1.5%, -Reset PPO, lead free	SOT-23	16vdc	VD7	3b	Ame
BOM	AME8570AETAF40Y	Vdet-IC	4.0V±1.5%, -Reset PPO	TSOT-23	16vdc	VD7	3b	Ame
BOM	AME8570AETAF40Z	Vdet-IC	4.0V±1.5%, -Reset PPO	SOT-23	16vdc	VD7	3b	Ame
BON	AME8570BEETAF40L	Vdet-IC	4.0V±1.5%, -Reset PPO, lead free	SOT-23	16vdc	VD7	3b	Ame
BON	AME8570BEETAF40Y	Vdet-IC	4.0V±1.5%, -Reset PPO	TSOT-23	16vdc	VD7	3b	Ame
BON	AME8570BEETAF40Z	Vdet-IC	4.0V±1.5%, -Reset PPO	SOT-23	16vdc	VD7	3b	Ame
BOO	AME8570CEETAF40L	Vdet-IC	4.0V±1.5%, -Reset PPO, lead free	SOT-23	16vdc	VD7	3b	Ame
BOO	AME8570CEETAF40Y	Vdet-IC	4.0V±1.5%, -Reset PPO	TSOT-23	16vdc	VD7	3b	Ame
BOO	AME8570CEETAF40Z	Vdet-IC	4.0V±1.5%, -Reset PPO	SOT-23	16vdc	VD7	3b	Ame
BOP	AME8570AETAF40L	Vdet-IC	4.0V±1.5%, -Reset PPO, lead free	SC-70-3	16vdc	VD7	3b	Ame
BOP	AME8570AETAF40Z	Vdet-IC	4.0V±1.5%, -Reset PPO	SC-70-3	16vdc	VD7	3b	Ame
BOR	AME8570AETAF44L	Vdet-IC	4.38V±1.5%, -Reset PPO, lead free	SOT-23	16vdc	VD7	3b	Ame
BOR	AME8570AETAF44Y	Vdet-IC	4.38V±1.5%, -Reset PPO	TSOT-23	16vdc	VD7	3b	Ame
BOR	AME8570AETAF44Z	Vdet-IC	4.38V±1.5%, -Reset PPO	SOT-23	16vdc	VD7	3b	Ame
BOS	AME8570BEETAF44L	Vdet-IC	4.38V±1.5%, -Reset PPO, lead free	SOT-23	16vdc	VD7	3b	Ame
BOS	AME8570BEETAF44Y	Vdet-IC	4.38V±1.5%, -Reset PPO	TSOT-23	16vdc	VD7	3b	Ame
BOS	AME8570BEETAF44Z	Vdet-IC	4.38V±1.5%, -Reset PPO	SOT-23	16vdc	VD7	3b	Ame
BOT	AME8570CEETAF44L	Vdet-IC	4.38V±1.5%, -Reset PPO, lead free	SOT-23	16vdc	VD7	3b	Ame
BOT	AME8570CEETAF44Y	Vdet-IC	4.38V±1.5%, -Reset PPO	TSOT-23	16vdc	VD7	3b	Ame
BOT	AME8570CEETAF44Z	Vdet-IC	4.38V±1.5%, -Reset PPO	SOT-23	16vdc	VD7	3b	Ame
BOU	AME8570AETAF44L	Vdet-IC	4.38V±1.5%, -Reset PPO, lead free	SC-70-3	16vdc	VD7	3b	Ame
BOU	AME8570AETAF44Z	Vdet-IC	4.38V±1.5%, -Reset PPO	SC-70-3	16vdc	VD7	3b	Ame
BOW	AME8570AETBF44L	Vdet-IC	4.38V±1.5%, -Reset ODO, lead free	SOT-23	16vdb	VD6	3b	Ame
BOW	AME8570AETBF44Y	Vdet-IC	4.38V±1.5%, -Reset ODO	TSOT-23	16vdb	VD6	3b	Ame
BOW	AME8570AETBF44Z	Vdet-IC	4.38V±1.5%, -Reset ODO	SOT-23	16vdb	VD6	3b	Ame
BOX	AME8570BEETBF44L	Vdet-IC	4.38V±1.5%, -Reset ODO, lead free	SOT-23	16vdb	VD6	3b	Ame
BOX	AME8570BEETBF44Y	Vdet-IC	4.38V±1.5%, -Reset ODO	TSOT-23	16vdb	VD6	3b	Ame
BOX	AME8570BEETBF44Z	Vdet-IC	4.38V±1.5%, -Reset ODO	SOT-23	16vdb	VD6	3b	Ame
BOY	AME8570CEETBF44L	Vdet-IC	4.38V±1.5%, -Reset ODO, lead free	SOT-23	16vdb	VD6	3b	Ame
BOY	AME8570CEETBF44Y	Vdet-IC	4.38V±1.5%, -Reset ODO	TSOT-23	16vdb	VD6	3b	Ame
BOY	AME8570CEETBF44Z	Vdet-IC	4.38V±1.5%, -Reset ODO	SOT-23	16vdb	VD6	3b	Ame
BOZ	AME8570AETBF44L	Vdet-IC	4.38V±1.5%, -Reset ODO, lead free	SC-70-3	16vdb	VD6	3b	Ame
BOZ	AME8570AETBF44Z	Vdet-IC	4.38V±1.5%, -Reset ODO	SC-70-3	16vdb	VD6	3b	Ame
BP	2SJ574	p-MOSFET-e*	V-MOS, LogL, 30V, 0.3A, <3.1Ω	SOT-23	16fh	-	3a	Ren
BP	GS6332UR15D3	Vdet-IC	1.5V, +Reset PPO, 150ms	SOT-23	16vdc	VD7	3g	Vs
BP	MMBZ5252B	Z-diode	22.80.25 20V, Izt=5.2mA, Zzt=33Ω, 350mW	SOT-23	16dc	-	3a	Lge
BP	RT9169-18CVL	LVR-IC	LDO, 1.8V±2%, 100mA	SOT-23	16cg	VR1	3a	Rct
BP	SiP6332R15D3	Vdet-IC	1.5V±1.5%, -Reset PPO 150ms	SOT-23	16vdc	VD7	3g	Vs
BP-	RT9169-18PVL	LVR-IC	LDO, 1.8V±2%, 100mA	SOT-23	16cg	VR1	3a	Rct
BPB	AME8570BEETAF46L	Vdet-IC	4.63V±1.5%, -Reset PPO, lead free	SOT-23	16vdc	VD7	3b	Ame
BPB	AME8570BEETAF46Y	Vdet-IC	4.63V±1.5%, -Reset PPO	TSOT-23	16vdc	VD7	3b	Ame
BPB	AME8570BEETAF46Z	Vdet-IC	4.63V±1.5%, -Reset PPO	SOT-23	16vdc	VD7	3b	Ame
BPB	AME8570CEETAF46L	Vdet-IC	4.63V±1.5%, -Reset PPO, lead free	SOT-23	16vdc	VD7	3b	Ame
BPC	AME8570CEETAF46Y	Vdet-IC	4.63V±1.5%, -Reset PPO	TSOT-23	16vdc	VD7	3b	Ame
BPC	AME8570CEETAF46Z	Vdet-IC	4.63V±1.5%, -Reset PPO	SOT-23	16vdc	VD7	3b	Ame
BPD	AME8570BEETCF46L	Vdet-IC	4.63V±1.5%, +Reset PPO, lead free	SOT-23	16vda	VD7	3b	Ame
BPD	AME8570BEETCF46Y	Vdet-IC	4.63V±1.5%, +Reset PPO	TSOT-23	16vda	VD7	3b	Ame
BPD	AME8570BEETCF46Z	Vdet-IC	4.63V±1.5%, +Reset PPO	SOT-23	16vda	VD7	3b	Ame
BPE	AME8570CEETCF46L	Vdet-IC	4.63V±1.5%, +Reset PPO, lead free	SOT-23	16vda	VD7	3b	Ame
BPE	AME8570CEETCF46Y	Vdet-IC	4.63V±1.5%, +Reset PPO	TSOT-23	16vda	VD7	3b	Ame
BPE	AME8570CEETCF46Z	Vdet-IC	4.63V±1.5%, +Reset PPO	SOT-23	16vda	VD7	3b	Ame
BQ	2PB709AQ	Si-pnp	GP, 45V, 100mA, 250mW, B=160..260, >60MHz	SC-59	16ta	-	3a	Phi
BQ	2SB1218A-Q	Si-pnp	AF, 45V, 100mA, 150mW, B=160..260, >80MHz	SOT-323	16ta	-	3a	Pan
BQ	2SB1627-Q	Si-pnp	Lo-sat, 45V, 100mA, 80MHz, B=85..170	SOT-416	16ta	-	3a	Pan
BQ	2SC2412K-Q	Si-npn	GP, 60V, 150mA, 200mW, 180MHz, B=120..270	SOT-346	16ta	-	3a	Rhm
BQ	2SC4081-Q	Si-npn	GP, 60V, 150mA, 200mW, 100MHz, B=120..270	SOT-323	16ta	-	3a	Rhm
BQ	2SC4617-Q	Si-npn	GP, 60V, 150mA, 150mW, B=120..270, 100MHz	SOT-416	16ta	-	3a	Rhm
BQ	2SC5658-Q	Si-npn	GP, 60V, 150mA, 150mW, 100MHz, B=120..270	VMT3	16ta	-	3a	Rhm
BQ	L2SC2412KQLT1	Si-npn	GP, 50V, 150mA, 200mW, 180MHz, B=120..270	SOT-23	16ta	-	3a	Lrc
BQ	RT9169-34CV	LVR-IC	LDO, 3.4V±2%, 100mA	SOT-23	16ch	VR1	3a	Rct
BR	2PB709AR	Si-pnp	GP, 45V, 100mA, 250mW, B=210..340, >70MHz	SC-59	16ta	-	3a	Phi
BR	2SB1218A-R	Si-pnp	AF, 45V, 100mA, 150mW, B=210..340, >80MHz	SOT-323	16ta	-	3a	Pan
BR	2SB1627-R	Si-pnp	Lo-sat, 45V, 100mA, 80MHz, B=120..240	SOT-416	16ta	-	3a	Pan
BR	2SC2412K-R	Si-npn	GP, 60V, 150mA, 200mW, 180MHz, B=180..390	SOT-346	16ta	-	3a	Rhm
BR	2SC4081-R	Si-npn	GP, 60V, 150mA, 200mW, 100MHz, B=180..390	SOT-323	16ta	-	3a	Rhm
BR	2SC4617-R	Si-npn	GP, 60V, 150mA, 150mW, B=180..390, 100MHz	SOT-416	16ta	-	3a	Rhm
BR	2SC5658-R	Si-npn	GP, 60V, 150mA, 150mW, 100MHz, B=180..390	VMT3	16ta	-	3a	Rhm
BR	BCW60DR	Si-npn	GP, 32V, 200mA, 300mW, B=380..630, 250MHz	SOT-23	16te	-	3a	Zx



SMD code	Type	Function	Short description	Case	Pinout	Sch.	St.	Mnf.
BR	GS6332UR16D1	Vdet-IC	1.6V, +Reset PPO, 1.5ms	SOT-23	16vdc	VD7	3g	Vs
BR	L2SC2412KRLT1	Si-npn	GP, 50V, 150mA, 200mW, 180MHz, B=180..390	SOT-23	16ta	-	3a	Lrc
BR	MMBZ5253B	Z-diode	23.75..26.25V, Izt=5mA, Zzt=35Q, 350mW	SOT-23	16dc	-	3a	Lge
BR	MSB1218A-R	Si-pnp	GP, 45V, 100mA, 150mW, B=210..340	SOT-323	16ta	-	3a	Mot
BR	RT9169-35CV	LVR-IC	LDO, 3.5V±2%, 100mA	SOT-23	16ch	VR1	3a	Rct
BR	SIP6332R16D1	Vdet-IC	1.6V±1.5%, -Reset PPO 1.5ms	SOT-23	16vdc	VD7	3g	Vs
BR	SRA2212E	Si-pnp-Digi	Sw, 50V, 100mA, 150mW, 200MHz, R1=100k	SOT-523	16ta	-	3a	Auk
BR	SRA2212EF	Si-pnp-Digi	Sw, 50V, 100mA, 150mW, 200MHz, R1=100k	SOT-523F	18ta	-	3a	Auk
BR	SRA2212U	Si-pnp-Digi	Sw, 50V, 100mA, 200mW, 200MHz, R1=100k	SOT-323	16ta	-	3a	Auk
BRQ	2SB709A-Q	Si-pnp	GP, AF, 60V, 600mA, B=160..260, 150MHz	SC-59	16ta	-	3a	Pan
BRR	2SB709A-R	Si-pnp	GP, AF, 60V, 600mA, B=210..340, 150MHz	SC-59	16ta	-	3a	Pan
BRS	2SB709A-S	Si-pnp	GP, AF, 60V, 600mA, B=290..460, 150MHz	SC-59	16ta	-	3a	Pan
BS	2PB709AS	Si-pnp	GP, 45V, 100mA, 250mW, B=290..460, >80MHz	SC-59	16ta	-	3a	Phi
BS	2SB1218A-S	Si-pnp	AF, 45V, 100mA, 150mW, B=210..340, >80MHz	SOT-323	16ta	-	3a	Pan
BS	2SB1627-S	Si-pnp	Lo-sat, 45V, 100mA, 80MHz, B=170..340	SOT-416	16ta	-	3a	Pan
BS	2SC2412K-S	Si-npn	GP, 60V, 150mA, 200mW, 180MHz, B=270..560	SOT-346	16ta	-	3a	Rhm
BS	2SC4081-S	Si-npn	GP, 60V, 150mA, 200mW, 100MHz, B=270..560	SOT-323	16ta	-	3a	Rhm
BS	2SC4617-S	Si-npn	GP, 60V, 150mA, 150mW, B=270..560, 100MHz	SOT-416	16ta	-	3a	Rhm
BS	2SC5658-S	Si-npn	GP, 60V, 150mA, 150mW, 100MHz, B=270..560	VMT3	16ta	-	3a	Rhm
BS	GS6332UR16D2	Vdet-IC	1.6V, +Reset PPO, 30ms	SOT-23	16vdc	VD7	3g	Vs
BS	MSB1218A-S	Si-pnp	GP, 45V, 100mA, 150mW, B=210..340	SOT-323	16ta	-	3a	Mot
BS	RT9169-36CV	LVR-IC	LDO, 3.6V±2%, 100mA	SOT-23	16ch	VR1	3a	Rct
BS	SIP6332R16D2	Vdet-IC	1.6V±1.5%, -Reset PPO 30ms	SOT-23	16vdc	VD7	3g	Vs
BSA	BC848UA	Si-npn	GP, 30V, 100mA, 200mW, B=110..220, 150MHz	SOT-323	16ta	-	3a	Auk
BSA	BC848UFA	Si-npn	GP, 30V, 100mA, 200mW, B=110..220, 150MHz	SOT-323F	18ta	-	3a	Auk
BSB	BC848UB	Si-npn	GP, 30V, 100mA, 200mW, B=200.450, 150MHz	SOT-323	16ta	-	3a	Auk
BSB	BC848UBF	Si-npn	GP, 30V, 100mA, 200mW, B=200.450, 150MHz	SOT-323F	18ta	-	3a	Auk
BSC	BC848UC	Si-npn	GP, 30V, 100mA, 200mW, B=420..800, 150MHz	SOT-323	16ta	-	3a	Auk
BSC	BC848UCF	Si-npn	GP, 30V, 100mA, 200mW, B=420..800, 150MHz	SOT-323F	18ta	-	3a	Auk
BSQ	2SD2444K-Q	Si-npn	Lo-sat, 15V, 1A, 200mW, B=120..270, 200MHz	SC-59	16ta	-	3a	Rhm
BT	2SC4069	Si-npn	AF, GP, 50V, 100mA, 200mW, B>70, 250MHz	SOT-23	16ta	-	3a	San
BT	GS6332UR16D3	Vdet-IC	1.6V, +Reset PPO, 150ms	SOT-23	16vdc	VD7	3g	Vs
BT	RT9169-37CV	LVR-IC	LDO, 3.7V±2%, 100mA	SOT-23	16ch	VR1	3a	Rct
BT	SIP6332R16D3	Vdet-IC	1.6V±1.5%, -Reset PPO 150ms	SOT-23	16vdc	VD7	3g	Vs
BT15P	AIC1723A-15PU	LVR-IC	LDO, 1.5V±1%, 500mA	SOT-23	16cg	VR1	3a	Aic
BT18P	AIC1723A-18PU	LVR-IC	LDO, 1.8V±1%, 500mA	SOT-23	16cg	VR1	3a	Aic
BT20P	AIC1723A-20PU	LVR-IC	LDO, 2.0V±1%, 500mA	SOT-23	16cg	VR1	3a	Aic
BT25P	AIC1723A-25PU	LVR-IC	LDO, 2.5V±1%, 500mA	SOT-23	16cg	VR1	3a	Aic
BT27P	AIC1723A-27PU	LVR-IC	LDO, 2.7V±1%, 500mA	SOT-23	16cg	VR1	3a	Aic
BT30P	AIC1723A-30PU	LVR-IC	LDO, 3.0V±1%, 500mA	SOT-23	16cg	VR1	3a	Aic
BT33P	AIC1723A-33PU	LVR-IC	LDO, 3.3V±1%, 500mA	SOT-23	16cg	VR1	3a	Aic
BT35P	AIC1723A-35PU	LVR-IC	LDO, 3.5V±1%, 500mA	SOT-23	16cg	VR1	3a	Aic
BT37P	AIC1723A-37PU	LVR-IC	LDO, 3.7V±1%, 500mA	SOT-23	16cg	VR1	3a	Aic
BT38P	AIC1723A-38PU	LVR-IC	LDO, 3.8V±1%, 500mA	SOT-23	16cg	VR1	3a	Aic
BT50P	AIC1723A-50PU	LVR-IC	LDO, 5.0V±1%, 500mA	SOT-23	16cg	VR1	3a	Aic
BT52P	AIC1723A-52PU	LVR-IC	LDO, 5.2V±1%, 500mA	SOT-23	16cg	VR1	3a	Aic
BTS	AME8570BEETBF27L	Vdet-IC	2.70V±1.5%, -Reset ODO, lead free	SOT-23	16vdb	VD6	3b	Ame
BTS	AME8570BEETBF27Z	Vdet-IC	2.70V±1.5%, -Reset ODO	SOT-23	16vdb	VD6	3b	Ame
BTY	AME8805AEETZ	LVR-IC	LDO, 3.3V±1.5%, 600mA	SOT-23	16vj	VR1	3b	Ame
BTZ	AME8805MEETZ	LVR-IC	LDO, 1.8V±1.5%, 600mA	SOT-23	16vj	VR1	3b	Ame
BU	BCX71GR	Si-pnp	GP, 45V, 100mA, 330mW, B= 120..220, 250MHz	SOT-23	16ta	-	3a	Phi
BU	BCX71RG	Si-pnp	GP, 45V, 100mA, 330mW, B= 120..220, 250MHz	SOT-23	16ta	-	3a	Sie
BU	DA228K	Si-diode	Dual, Sw, 80V, 200mA, 200mW, Vf<1V(10mA)	SOT-346	16dl	-	3i	Rhm
BU	DA228U	Si-diode	Dual, Sw, 80V, 200mA, 200mW, Vf<1V(10mA)	SOT-323	16dl	-	3i	Rhm
BU	RT9169-38CV	LVR-IC	LDO, 3.8V±2%, 100mA	SOT-23	16ch	VR1	3a	Rct
BUA	AME8570AEETAE18L	Vdet-IC	1.80V±1.5%, -Reset PPO, lead free	SOT-23	16vdc	VD7	3b	Ame
BUA	AME8570AEETAE18Z	Vdet-IC	1.80V±1.5%, -Reset PPO	SOT-23	16vdc	VD7	3b	Ame
BV	1SV233	PIN-diode	VHF/UHF-AGC, 50V, 50mA, 0.23pF, Rs=5Q(10mA, 100MHz)	SOT-23	16dc	-	3a	San
BV	1SV247	PIN-diode	VHF/UHF-AGC, 50V, 50mA, 0.23pF, Rs=5Q(10mA, 100MHz)	MCP	16dc	-	3a	San
BV	CSB624B	Si-pnp	GP, 30V, 700mA, 200mW, B=110..400, 160MHz	SOT-23	16ta	-	3a	Cdi
BV	GS6332UR18D1	Vdet-IC	1.8V, +Reset PPO, 1.5ms	SOT-23	16vdc	VD7	3g	Vs
BV	RT9169-39CV	LVR-IC	LDO, 3.9V±2%, 100mA	SOT-23	16ch	VR1	3a	Rct
BV	SIP6332R18D1	Vdet-IC	1.8V±1.5%, -Reset PPO 1.5ms	SOT-23	16vdc	VD7	3g	Vs
BV1	2SB624-BV1	Si-pnp	AF, 30V, 700mA, 200mW, B=110..180, 170MHz	SC-59	16ta	-	3a	Nec
BV1	CSB624B1	Si-pnp	GP, 30V, 700mA, 200mW, B=110..180, 160MHz	SOT-23	16ta	-	3a	Cdi
BV2	2SB624-BV2	Si-pnp	AF, 30V, 700mA, 200mW, B=135..220, 170MHz	SC-59	16ta	-	3a	Nec
BV2	CSB624B2	Si-pnp	GP, 30V, 700mA, 200mW, B=135..220, 160MHz	SOT-23	16ta	-	3a	Cdi
BV3	2SB624-BV3	Si-pnp	AF, 30V, 700mA, 200mW, B=170..270, 170MHz	SC-59	16ta	-	3a	Nec
BV3	CSB624B3	Si-pnp	GP, 30V, 700mA, 200mW, B=170..270, 160MHz	SOT-23	16ta	-	3a	Cdi
BV4	2SB624-BV4	Si-pnp	AF, 30V, 700mA, 200mW, B=200..320, 170MHz	SC-59	16ta	-	3a	Nec



SMD code	Type	Function	Short description	Case	Pinout	Sch.	St.	Mnf.
BV4	CSB624B4	Si-pnp	GP, 30V, 700mA, 200mW, B=200..320, 160MHz	SOT-23	16ta	-	3a	Cdi
BV5	2SB624-BV5	Si-pnp	AF, 30V, 700mA, 200mW, B=250..400, 170MHz	SC-59	16ta	-	3a	Nec
BV5	CSB624B5	Si-pnp	GP, 30V, 700mA, 200mW, B=250..400, 160MHz	SOT-23	16ta	-	3a	Cdi
BVA	BC857UA	Si-pnp	GP, 50V, 100mA, 200mW, B=110..220, 150MHz	SOT-323	16ta	-	3a	Auk
BVA	BC857UFA	Si-pnp	GP, 50V, 100mA, 200mW, B=110..220, 150MHz	SOT-323F	18ta	-	3a	Auk
BVB	BC857UB	Si-pnp	GP, 50V, 100mA, 200mW, B=200..450, 150MHz	SOT-323	16ta	-	3a	Auk
BVB	BC857UFB	Si-pnp	GP, 50V, 100mA, 200mW, B=200..450, 150MHz	SOT-323F	18ta	-	3a	Auk
BVC	BC857UC	Si-pnp	GP, 50V, 100mA, 200mW, B=420..800, 150MHz	SOT-323	16ta	-	3a	Auk
BVC	BC857UFC	Si-pnp	GP, 50V, 100mA, 200mW, B=420..800, 150MHz	SOT-323F	18ta	-	3a	Auk
BVN	2SC5274	Si-npn	GP, 150V, 50mA, 150mW, B=56..120, 120MHz	SC-75A	16ta	-	3a	Rhm
BW	2SA2018	Si-pnp	Sw, 15V, 500mA, 150mW, B=270..680, 260MHz	SC-75A	16ta	-	3a	Rhm
BW	2SA2018H	Si-pnp	Sw, 15V, 500mA, 150mW, B=270..680, 260MHz	SC-89	18ta	-	3a	Rhm
BW	2SA2030	Si-pnp	Sw, 15V, 500mA, 150mW, B=270..680, 260MHz	VMT3	18ta	-	3a	Rhm
BW	BCW71HR	Si-npn	AF, 50V, 100mA, 250mW, B=110..220, >100MHz	SOT-23	16ta	-	3a	Fer
BW	BCX71RH	Si-pnp	GP, 45V, 200mA, 250mW, B=180..310, >100MHz	SOT-23	16ta	-	3a	Sie
BW	GS6332UR18D2	Vdet-IC	1.8V, +Reset PPO, 30ms	SOT-23	16vdc	VD7	3g	Vs
BW	RT9169-40CV	LVR-IC	LDO, 4.0V±2%, 100mA	SOT-23	16ch	VR1	3a	Rct
BW1	2SB736-1	Si-pnp	AF, 60V, 300mA, 200mW, B=110..180, 100MHz	SOT-23	16ta	-	3a	Nec
BW2	2SB736-2	Si-pnp	AF, 60V, 300mA, 200mW, B=135..220, 100MHz	SOT-23	16ta	-	3a	Nec
BW3	2SB736-3	Si-pnp	AF, 60V, 300mA, 200mW, B=170..270, 100MHz	SOT-23	16ta	-	3a	Nec
BW4	2SB736-4	Si-pnp	AF, 60V, 300mA, 200mW, B=200..320, 100MHz	SOT-23	16ta	-	3a	Nec
BW5	2SB736-5	Si-pnp	AF, 60V, 300mA, 200mW, B=200..600, 100MHz	SOT-23	16ta	-	3a	Nec
BX	2SC5585	Si-npn	Sw, 15V, 500mA, 150mW, B=270..680, 320MHz	SC-75A	16ta	-	3a	Rhm
BX	2SC5663	Si-npn	Sw, 15V, 500mA, 150mW, B=270..680, 320MHz	VMT3	18ta	-	3a	Rhm
BX	BCW71JR	Si-npn	AF, 50V, 100mA, 250mW, B=200..600, >100MHz	SOT-23	16te	-	3a	Fer
BX	BCX71RJ	Si-pnp	GP, Sw, 45V, 100mA, 250mW, B=250..460, >100MHz	SOT-23	16ta	-	3a	Sie
BX	GS6332UR18D3	Vdet-IC	1.8V, +Reset PPO, 150ms	SOT-23	16vdc	VD7	3g	Vs
BX	MMBZ5254B	Z-diode	25.65..28.35V, Izt=4.6mA, Zzt=41Ω, 350mW	SOT-23	16dc	-	3a	Lge
BX	RT9169-41CV	LVR-IC	LDO, 4.1V±2%, 100mA	SOT-23	16ch	VR1	3a	Rct
BX	SiP6332R18D3	Vdet-IC	1.8V±1.5%, -Reset PPO 150ms	SOT-23	16vdc	VD7	3g	Vs
BY	2SC3395	Si-npn-Digi	Sw, 50V, 100mA, 200mW, 250MHz, R1/R2=47k/47k	CP	16ta	-	3a	San
BY	2SC4396	Si-npn-Digi	Sw, 50V, 100mA, 250MHz, R1=R2=47k	SOT-323	16ta	-	3a	San
BY	2SC5342UF-Y	Si-npn	AF, 40V, 500mA, 200mW, B=120..240, 200MHz	SOT-323F	18ta	-	3a	Auk
BY	2SC5342U-Y	Si-npn	AF, 40V, 500mA, 200mW, B=120..240, 200MHz	SOT-323	16ta	-	3a	Auk
BY	BCW71KR	Si-npn	AF, 50V, 100mA, 250mW, B=300..600, >100MHz	SOT-23	16te	-	3a	Fer
BY	BCX71RK	Si-pnp	GP, Sw, 45V, 100mA, 250mW, B=380..630, >100MHz	SOT-23	16ta	-	3a	Sie
BY	GS6332UR19D1	Vdet-IC	1.9V, +Reset PPO, 1.5ms	SOT-23	16vdc	VD7	3g	Vs
BY	MMBZ5255B	Z-diode	26.60..29.40V, Izt=4.5mA, Zzt=44Ω, 350mW	SOT-23	16dc	-	3a	Lge
BY	RT9169-42CV	LVR-IC	LDO, 4.2V±2%, 100mA	SOT-23	16ch	VR1	3a	Rct
BY	SiP6332R19D1	Vdet-IC	1.9V±1.5%, -Reset PPO 1.5ms	SOT-23	16vdc	VD7	3g	Vs
BY-	RT9169-42PV	LVR-IC	LDO, 4.2V±2%, 100mA	SOT-23	16ch	VR1	3a	Rct
BZ	GS6332UR19D2	Vdet-IC	1.9V, +Reset PPO, 30ms	SOT-23	16vdc	VD7	3g	Vs
BZ	MMBZ5256B	Z-diode	28.50..31.50V, Izt=4.2mA, Zzt=49Ω, 350mW	SOT-23	16dc	-	3a	Lge
BZ	RT9169-43CV	LVR-IC	LDO, 4.3V±2%, 100mA	SOT-23	16ch	VR1	3a	Rct
BZ	SiP6332R19D2	Vdet-IC	1.9V±1.5%, -Reset PPO 30ms	SOT-23	16vdc	VD7	3g	Vs
BZY	AME8550AEETB500L	Vdet-IC	5.0V±2%, -Reset ODO	SOT-23	16vdc	VD6	3b	Ame
BZY	AME8550AEETB500Z	Vdet-IC	5.0V±2%, -Reset ODO	SOT-23	16vdc	VD6	3b	Ame
c	AX6901CA	Vdet-IC	4.0V±1.5%, -Reset PPO	SC-70	16vdc	VD7	3b	Axl
c	CH3906T1PT	Si-pnp	AF, Sw, 40V, 200mA, B=100..300, 250MHz	FBPT-523	17ta	-	9a	Chm
c	CH3906TPT	Si-pnp	AF, Sw, 40V, 200mA, B=100..300, 250MHz	SOT-416	16ta	-	3a	Chm
C0	AP130-41TW	LVR-IC	LDO, 4.1V±2%, 300mA	TSOT23-3L	16vj	VR1	3b	Ana
C0	AP130-41W	LVR-IC	LDO, 4.1V±2%, 300mA	SOT-23	16vj	VR1	3b	Ana
C0	BZX84-C51	Z-diode	48..54V, Zzt=180Ω, Izt=20mA, 225mW	SOT-23	16dc	-	3a	Lge
C0	ELM9720NBB	Vdet-IC	2.0V±2.5%, +Reset ODO	SOT-23	16vdc	VD6	3d	Elm
C0	HSMS-2820	Si-diode	Schottky, RF, 15V, 1A, Vf<0.34V(1mA), <1pF, 12Q(5mA)	SOT-23	16dc	-	3a	Agi
C0	HSMS-282B	Si-diode	Schottky, RF, 15V, 1A, Vf<0.34V(1mA), <1pF, 12Q(5mA)	SOT-323	16dc	-	3a	Agi
C0	KV1700R	C-diode	2x FM-tun, 14V, 50mA, 27.4/79.93pF(8..2V), <0.3Q(100MHz)	SOT-23C-3	16gd	-	3a	Tok
C0	KV1700S	C-diode	2x FM-tun, 14V, 50mA, 27.4/79.93pF(8..2V), <0.3Q(100MHz)	SOT-23	16gd	-	3a	Tok
C0	KV1705R	C-diode	2x AM-up conv, 14V, 50mA, 52/148pF(8..2V), <0.5Q(100MHz)	SOT-23C-3	16gd	-	3a	Tok
C0	KV1705S	C-diode	2x AM-up conv, 14V, 50mA, 52/148pF(8..2V), <0.5Q(100MHz)	SOT-23	16gd	-	3a	Tok
C0	R3111N202A	Vdet-IC	2V±2%, -Reset PPO	SOT-23	16vdc	VD7	3d	Ric
C0	R3113D301A	Vdet-IC	3V±2%, -Reset, ODO	SON1408-3	18vdc	VD6	3d	Ric
C0	R3130N30EC	Vdet-IC	3V, -Reset ODO, 240ms	SOT-23	16vdc	VD6	3b	Ric
C0	XC61CC2002M	Vdet-IC	2V±1%, +Reset PPO	SOT-23	16vdc	VD7	3d	Tor
C0	XC6GC2002HR	Vdet-IC	2.0V, +Reset PPO	USP-3	17vdc	VD3	9b	Tor
C03	XE61CC2045MR	Vdet-IC	2.0V±2%, -Reset PPO	SOT-23	16vdc	VD7	3h	Tor
C05	KV1705R	C-diode	2x AM-up conv, 14V, 50mA, 52/148pF(8..2V), <0.5Q(100MHz)	SOT-23C-3	16gd	-	3a	Tok
C05	KV1705S	C-diode	2x AM-up conv, 14V, 50mA, 52/148pF(8..2V), <0.5Q(100MHz)	SOT-23	16gd	-	3a	Tok
C05	XC61FC2012M	Vdet-IC	2V±2%, +Reset PPO, 200ms	SOT-23	16vdc	VD7	3d	Tor
C05	XC61HC2012MR	Vdet-IC	2.0V±2%, -Reset PPO, 50..200ms	SOT-23	16vdc	VD7	3d	Tor



SMD code	Type	Function	Short description	Case	Pinout	Sch. St.	Mnf.
C06	XC61FC2042M	Vdet-IC	2V±2%, +Reset PPO, 400ms	SOT-23	16vdb	VD7	3d Tor
C06	XC61HC2042MR	Vdet-IC	2.0V±2%, -Reset PPO, 80..400ms	SOT-23	16vdc	VD7	3d Tor
C07	XC61FC2052M	Vdet-IC	2V±2%, +Reset PPO, 50ms	SOT-23	16vdb	VD7	3d Tor
C07	XC61HC2052MR	Vdet-IC	2.0V±2%, -Reset PPO, 1..50ms	SOT-23	16vdc	VD7	3d Tor
C1	2SJ559	p-MOSFET-e*	V-MOS, LogL, 30V, ±0.1A, <60Ω	SOT-23	16fh	-	3a Nec
C1	AP130-42TW	LVR-IC	LDO, 4.2V±2%, 300mA	TSOT23-3L	16vj	VR1	3b Ana
C1	AP130-42W	LVR-IC	LDO, 4.2V±2%, 300mA	SOT-23	16vj	VR1	3b Ana
C1	APE6812N-A	Vdet-IC	4.63V±2%, +Reset PPO	SOT-23	16vda	VD7	3b Ape
C1	APE6812U-A	Vdet-IC	4.63V±2%, +Reset PPO	SC-70	16vda	VD7	3b Ape
C1	AX6904AR	Vdet-IC	4.63V±1.5%, +Reset PPO	SOT-23	16vda	VD7	3b Axl
C1	BCW29	Si-pnp	GP, 20V, 100mA, 350mW, B=110..220, >100MHz	SOT-23	16ta	-	3a Rhm
C1	ELM9721NBB	Vdet-IC	2.1V±2.5%, +Reset ODO	SOT-23	16vdb	VD6	3d Elm
C1	MMBZ5221B	Z-diode	2.28..2.52V, Izt=20mA, Zzt=30Ω, 410mW	SOT-23	16dc	-	3a Pjt
C1	MMBZ5221BW	Z-diode	2.28..2.52V, Izt=20mA, Zzt=30Ω, 200mW	SOT-323	16dc	-	3a Pjt
C1	R3111N121A	Vdet-IC	2.1V±2%, -Reset PPO	SOT-23	16vdd	VD7	3d Ric
C1	R3113D311A	Vdet-IC	3.1V±2%, -Reset, ODO	SON1408-3	18vda	VD6	3d Ric
C1	R3130N31EC	Vdet-IC	3.1V, -Reset ODO, 240ms	SOT-23	16vdc	VD6	3b Ric
C1	RT9161-25CV	LVR-IC	LDO, 2.5V±2%, 300mA	SOT-23	16cg	VR1	3a Rct
C1	SST111	n-FET	Sw, 35V, 350mW, Idss=20mA, Rds(on)=30Ω, 2/6ns	SOT-23	16fj	-	3a Six
C1	TC54VC2102ECB	Vdet-IC	2.1V±2%, -Reset PPO	SOT-23	16vdb	VD7	3a Tcs
C1	XC61CC2102M	Vdet-IC	2.1V±1%, +Reset PPO	SOT-23	16vdb	VD7	3d Tor
C1	XC6GC2102HR	Vdet-IC	2.1V, +Reset PPO	USP-3	17vdc	VD3	9b Tor
C1-	RT9161-25PV	LVR-IC	LDO, 2.5V±2%, 300mA	SOT-23	16cg	VR1	3a Rct
C11	AIC1746-11GJ3	LVR-IC	LDO, 1.1V±2%, 150mA	SOT-323	16cg	VR1	3a Aic
C11	CM7P611C-11-T	Vdet-IC	1.1V±3%, -Reset PPO	SOT-23	16vdb	VD7	3a Can
C11	SST111	n-FET	Sw, 35V, 350mW, Idss=20mA, Rds(on)=30Ω, 2/6ns	SOT-23	16fj	-	3a Lns
C11B	ML61C113M	Vdet-IC	1.1V±3%, -Reset PPO	SOT-23	16vdb	VD7	3a Mic
C11C	CM7P62C-11-T	Vdet-IC	1.1V±3%, +Reset PPO	SOT-23	16vdb	VD7	3a Can
C11T	CM7P61C-11-T	Vdet-IC	1.1V±3%, +Reset PPO	SOT-23	16vdb	VD7	3a Can
C12	AIC1746-12GJ3	LVR-IC	LDO, 1.2V±2%, 150mA	SOT-323	16cg	VR1	3a Aic
C12	CM7P611C-12-T	Vdet-IC	1.2V±3%, -Reset PPO	SOT-23	16vdb	VD7	3a Can
C12	SST112	n-FET	Sw, 35V, 350mW, Idss=5mA, Rds(on)=50Ω, 2/6ns	SOT-23	16fj	-	3a Lns
C12B	ML61C123M	Vdet-IC	1.2V±3%, -Reset PPO	SOT-23	16vdb	VD7	3a Mic
C12C	CM7P62C-12-T	Vdet-IC	1.2V±3%, +Reset PPO	SOT-23	16vdb	VD7	3a Can
C12T	CM7P61C-12-T	Vdet-IC	1.2V±3%, +Reset PPO	SOT-23	16vdb	VD7	3a Can
C13	AIC1746-13GJ3	LVR-IC	LDO, 1.3V±2%, 150mA	SOT-323	16cg	VR1	3a Aic
C13	CM7P611C-13-T	Vdet-IC	1.3V±3%, -Reset PPO	SOT-23	16vdb	VD7	3a Can
C13	SST113	n-FET	Sw, 35V, 350mW, Idss=2mA, Rds(on)=100Ω, 2/6ns	SOT-23	16fj	-	3a Lns
C13	XE61CC2145MR	Vdet-IC	2.1V±2%, -Reset PPO	SOT-23	16vdb	VD7	3h Tor
C13B	ML61C133M	Vdet-IC	1.3V±3%, -Reset PPO	SOT-23	16vdb	VD7	3a Mic
C13C	CM7P62C-13-T	Vdet-IC	1.3V±3%, +Reset PPO	SOT-23	16vdb	VD7	3a Can
C13T	CM7P61C-13-T	Vdet-IC	1.3V±3%, +Reset PPO	SOT-23	16vdb	VD7	3a Can
C14	CM7P611C-14-T	Vdet-IC	1.4V±3%, -Reset PPO	SOT-23	16vdb	VD7	3a Can
C14B	ML61C143M	Vdet-IC	1.4V±3%, -Reset PPO	SOT-23	16vdb	VD7	3a Mic
C14C	CM7P62C-14-T	Vdet-IC	1.4V±3%, +Reset PPO	SOT-23	16vdb	VD7	3a Can
C14T	CM7P61C-14-T	Vdet-IC	1.4V±3%, +Reset PPO	SOT-23	16vdb	VD7	3a Can
C15	2SA1612-15	Si-pnp	AF, 120V, 50mA, 150mW, B=135..270, >50MHz	SOT-323	16ta	-	3a Nec
C15	2SA811A-15	Si-pnp	AF, Hi-beta, 120V, 50mA, 200mW, B=135..270, 90MHz	SOT-23	16ta	-	3a Nec
C15	AIC1746-15GJ3	LVR-IC	LDO, 1.5V±2%, 150mA	SOT-323	16cg	VR1	3a Aic
C15	CM7P611C-15-T	Vdet-IC	1.5V±3%, -Reset PPO	SOT-23	16vdb	VD7	3a Can
C15	XC61FC2112M	Vdet-IC	2.1V±2%, +Reset PPO, 200ms	SOT-23	16vdb	VD7	3d Tor
C15	XC61HC2112MR	Vdet-IC	2.1V±2%, -Reset PPO, 50..200ms	SOT-23	16vdc	VD7	3d Tor
C15B	ML61C153M	Vdet-IC	1.5V±3%, -Reset PPO	SOT-23	16vdb	VD7	3a Mic
C15C	CM7P62C-15-T	Vdet-IC	1.5V±3%, +Reset PPO	SOT-23	16vdb	VD7	3a Can
C15T	CM7P61C-15-T	Vdet-IC	1.5V±3%, +Reset PPO	SOT-23	16vdb	VD7	3a Can
C16	2SA1612-16	Si-pnp	AF, 120V, 50mA, 150mW, B=200..400, >50MHz	SOT-323	16ta	-	3a Nec
C16	2SA811A-16	Si-pnp	AF, Hi-beta, 120V, 50mA, 200mW, B=200..400, 90MHz	SOT-23	16ta	-	3a Nec
C16	CM7P611C-16-T	Vdet-IC	1.6V±3%, -Reset PPO	SOT-23	16vdb	VD7	3a Can
C16	XC61FC2142M	Vdet-IC	2.1V±2%, +Reset PPO, 400ms	SOT-23	16vdb	VD7	3d Tor
C16	XC61HC2142MR	Vdet-IC	2.1V±2%, -Reset PPO, 80..400ms	SOT-23	16vdc	VD7	3d Tor
C16B	ML61C163M	Vdet-IC	1.6V±3%, -Reset PPO	SOT-23	16vdb	VD7	3a Mic
C16C	CM7P62C-16-T	Vdet-IC	1.6V±3%, +Reset PPO	SOT-23	16vdb	VD7	3a Can
C16T	CM7P61C-16-T	Vdet-IC	1.6V±3%, +Reset PPO	SOT-23	16vdb	VD7	3a Can
C17	2SA1612-17	Si-pnp	AF, 120V, 50mA, 150mW, B=300..600, >50MHz	SOT-323	16ta	-	3a Nec
C17	2SA811A-17	Si-pnp	AF, Hi-beta, 120V, 50mA, 200mW, B=300..600, 90MHz	SOT-23	16ta	-	3a Nec
C17	CM7P611C-17-T	Vdet-IC	1.7V±3%, -Reset PPO	SOT-23	16vdb	VD7	3a Can
C17	XC61FC2152M	Vdet-IC	2.1V±2%, +Reset PPO, 50ms	SOT-23	16vdb	VD7	3d Tor
C17	XC61HC2152MR	Vdet-IC	2.1V±2%, -Reset PPO, 1..50ms	SOT-23	16vdc	VD7	3d Tor
C17B	ML61C173M	Vdet-IC	1.7V±3%, -Reset PPO	SOT-23	16vdb	VD7	3a Mic
C17C	CM7P62C-17-T	Vdet-IC	1.7V±3%, +Reset PPO	SOT-23	16vdb	VD7	3a Can



SMD code	Type	Function	Short description	Case	Pinout	Sch.	St.	Mnf.
C17T	CM7P61C-17-T	Vdet-IC	1.7V±3%, +Reset PPO	SOT-23	16vdb	VD7	3a	Can
C18	2SA1612-18	Si-pnp	AF, 120V, 50mA, 150mW, B=450..900, >50MHz	SOT-323	16ta	-	3a	Nec
C18	2SA811A-18	Si-pnp	AF, Hi-beta, 120V, 50mA, 200mW, B=450..900, 90MHz	SOT-23	16ta	-	3a	Nec
C18	AIC1746-18GJ3	LVR-IC	LDO, 1.8V±2%, 150mA	SOT-323	16cg	VR1	3a	Aic
C18	CM7P611C-18-T	Vdet-IC	1.8V±3%, -Reset PPO	SOT-23	16vdb	VD7	3a	Can
C18B	ML61C183M	Vdet-IC	1.8V±3%, -Reset PPO	SOT-23	16vdb	VD7	3a	Mic
C18C	CM7P62C-18-T	Vdet-IC	1.8V±3%, +Reset PPO	SOT-23	16vdb	VD7	3a	Can
C18T	CM7P61C-18-T	Vdet-IC	1.8V±3%, +Reset PPO	SOT-23	16vdb	VD7	3a	Can
C19	CM7P611C-19-T	Vdet-IC	1.9V±3%, -Reset PPO	SOT-23	16vdb	VD7	3a	Can
C19B	ML61C193M	Vdet-IC	1.9V±3%, -Reset PPO	SOT-23	16vdb	VD7	3a	Mic
C19C	CM7P62C-19-T	Vdet-IC	1.9V±3%, +Reset PPO	SOT-23	16vdb	VD7	3a	Can
C19T	CM7P61C-19-T	Vdet-IC	1.9V±3%, +Reset PPO	SOT-23	16vdb	VD7	3a	Can
C1A	CMPT3904	Si-npn	GP, 60V, 200mA, 350mW, B=100..300, >300MHz	SOT-23	16ta	-	3a	Can
C1D	CMPTA42	Si-npn	Vid, 300/300V, 500mA, 350mW, B>40, >50MHz	SOT-23	16ta	-	3a	Can
C1G	CMPTA06	Si-npn	GP, 80V, 500mA, 350mW, B>100, >100MHz	SOT-23	16ta	-	3a	Can
C1G	KSA1623-G	Si-npn	Sw, 60V, 100mA, 0.2W, B=200..400, >250MHz	SOT-23	16ta	-	3a	Sam
C1J	CMPT2369	Si-npn	GP, 40V, 500mA, 350mW, B=40..120, >500MHz	SOT-23	16ta	-	3a	Can
C1K	CMPT6428	Si-npn	GP, 60V, 200mA, 350mW, B=250..650, 100..700MHz	SOT-23	16ta	-	3a	Can
C1L	CMPT6429	Si-npn	GP, 55V, 200mA, 350mW, B=500..1250, 100..700MHz	SOT-23	16ta	-	3a	Can
C1L	KSA1623-L	Si-npn	Sw, 60V, 100mA, 0.2W, B=300..600, >250MHz	SOT-23	16ta	-	3a	Sam
C1M	CMPTA13	Si-npn-Darl	GP, 30V, 500mA, 350mW, B=5000, >125MHz	SOT-23	16ta	-	3a	Can
C1N	CMPTA14	Si-npn-Darl	GP, 30V, 500mA, 350mW, B=10000, >125MHz	SOT-23	16ta	-	3a	Can
C1O	KSA1623-O	Si-npn	Sw, 60V, 100mA, 0.2W, B=90..180, >250MHz	SOT-23	16ta	-	3a	Sam
C1p	BCW29	Si-pnp	GP, 32V, 100mA, 250mW, B=120..260, >100MHz	SOT-23	16ta	-	3a	PHH
C1P	CMPT2222A	Si-npn	AF, 75V, 600mA, 350mW, B<35, >300MHz	SOT-23	16ta	-	3a	Can
C1P	KSA1623-P	Si-npn	AF, 60V, 100mA, 200mW, B=90..180, >250MHz	SOT-23	16ta	-	3a	Sam
C1Q	CMPT5088	Si-npn	GP, 35V, 50mA, 350mW, B=300..900, >50MHz	SOT-23	16ta	-	3a	Can
C1R	CMPT5089	Si-npn	AF, 30V, 50mA, 350mW, B=400..1200, >50MHz	SOT-23	16ta	-	3a	Can
C1t	BCW29	Si-pnp	GP, 32V, 100mA, 250mW, B=120..260, >100MHz	SOT-23	16ta	-	3a	PhM
C1U	CMPT2484	Si-npn	GP, 60V, 50mA, 350mW, B=250..800	SOT-23	16ta	-	3a	Can
C1V	CMPT6427	Si-npn-Darl	GP, 40V, 500mA, 350mW, B=10k..100k, >130MHz	SOT-23	16ta	-	3a	Can
C1W	BCW29	Si-pnp	GP, 32V, 100mA, 250mW, B=120..260, >100MHz	SOT-23	16ta	-	3a	PhC
C1X	CMPT930	Si-npn	GP, 45V, 30mA, 350mW, B=100..300, >30MHz	SOT-23	16ta	-	3a	Can
C1Y	KSA1623-Y	Si-npn	Sw, 60V, 100mA, 0.2W, B=135..270, >250MHz	SOT-23	16ta	-	3a	Sam
C1Z	CMPT6517	Si-npn	Vid, 350/350V, 500mA, 350mW, B=20..200, 40..200MHz	SOT-23	16ta	-	3a	Can
C2	AP130-43TWT	LVR-IC	LDO, 4.3V±2%, 300mA	TSOT23-3L	16vj	VR1	3b	Ana
C2	AP130-43W	LVR-IC	LDO, 4.3V±2%, 300mA	SOT-23	16vj	VR1	3b	Ana
C2	APE6812N-B	Vdet-IC	4.38V±2%, +Reset PPO	SOT-23	16vda	VD7	3b	Ape
C2	APE6812U-B	Vdet-IC	4.38V±2%, +Reset PPO	SC-70	16vda	VD7	3b	Ape
C2	AX6904BR	Vdet-IC	4.38V±1.5%, +Reset PPO	SOT-23	16vda	VD7	3b	Axl
C2	BCW30	Si-pnp	GP, 32V, 100mA, 250mW, B=215..500, >100MHz	SOT-23	16ta	-	3a	Ste
C2	BFS38	Si-npn	AF/HF, 45V, 0.5A, >150MHz	SOT-323	16te	-	3a	Fer
C2	ELM9722NBB	Vdet-IC	2.2V±2.5%, +Reset ODO	SOT-23	16vdb	VD6	3d	Elm
C2	HSMS-2822	Si-diode	2x Schottky, RF, 15V, 1A, Vf<0.34V(1mA), <1pF, 12Ω(5mA)	SOT-23	16dl	-	3a	Agj
C2	HSMS-282C	Si-diode	2x Schottky, RF, 15V, 1A, Vf<0.34V(1mA), <1pF, 12Ω(5mA)	SOT-323	16dl	-	3a	Agj
C2	KV1720R	C-diode	2x FM-tun, 14V, 50mA, 21.34/46.48pF(8..2V), <0.3Ω (100MHz)	SOT-23C-3	16dg	-	3a	Tok
C2	KV1720S	C-diode	2x FM-tun, 14V, 50mA, 21.34/46.48pF(8..2V), <0.3Ω (100MHz)	SOT-23	16dg	-	3a	Tok
C2	MMBZ5222B	Z-diode	2.38..2.63V, Zzt=30Ω, Izt=20mA, 410mW	SOT-23	16dc	-	3a	Pjt
C2	MMBZ5222BW	Z-diode	2.38..2.63V, Zzt=30Ω, Izt=20mA, 200mW	SOT-323	16dc	-	3a	Pjt
C2	R3111N222A	Vdet-IC	2.2V±2%, -Reset PPO	SOT-23	16vdd	VD7	3d	Ric
C2	R3113D321A	Vdet-IC	3.2V±2%, -Reset, ODO	SON1408-3	18vda	VD6	3d	Ric
C2	R3130N32EC	Vdet-IC	3.2V, -Reset ODO, 240ms	SOT-23	16vdc	VD6	3b	Ric
C2	RT9161-27CV	LVR-IC	LDO, 2.7V±2%, 300mA	SOT-23	16cg	VR1	3a	Rct
C2	SST112	n-FET	Sw, 35V, 350mW, Idss=5mA, Rds(on)=50Ω, 2/6ns	SOT-23	16fj	-	3a	Six
C2	TC54VC2202ECB	Vdet-IC	2.2V±2%, -Reset PPO	SOT-23	16vdb	VD7	3a	Tcs
C2	XC61CC2202M	Vdet-IC	2.2V±1%, +Reset PPO	SOT-23	16vdb	VD7	3d	Tor
C2	XC6GC2202HR	Vdet-IC	2.2V, +Reset PPO	USP-3	17vdc	VD3	9b	Tor
C2-	RT9161-27PV	LVR-IC	LDO, 2.7V±2%, 300mA	SOT-23	16cg	VR1	3a	Rct
C20	2SK595-20	n-FET	Mic-preamp, 20V, 10mA, 100mW, Idss=110..170μA	2025	16fa	-	3a	San
C20	AIC1746-20GJ3	LVR-IC	LDO, 2.0V±2%, 150mA	SOT-323	16cg	VR1	3a	Aic
C20	CM7P611C-20-T	Vdet-IC	2.0V±2%, -Reset PPO	SOT-23	16vdb	VD7	3a	Can
C20	CPBT720	Si-pnp	Sw, 45V, 500mA, 350mW, B>300, >150MHz	SOT-23	16ta	-	3a	Cdi
C20B	ML61C202M	Vdet-IC	2.0V±2%, -Reset PPO	SOT-23	16vdb	VD7	3a	Mic
C20C	CM7P62C-20-T	Vdet-IC	2.0V±2%, +Reset PPO	SOT-23	16vdb	VD7	3a	Can
C20T	CM7P61C-20-T	Vdet-IC	2.0V±2%, +Reset PPO	SOT-23	16vdb	VD7	3a	Can
C21	2SK595-21	n-FET	Mic-preamp, 20V, 10mA, 100mW, Idss=150..240μA	2025	16fa	-	3a	San
C21	CM7P611C-21-T	Vdet-IC	2.1V±2%, -Reset PPO	SOT-23	16vdb	VD7	3a	Can
C21B	ML61C212M	Vdet-IC	2.1V±2%, -Reset PPO	SOT-23	16vdb	VD7	3a	Mic
C21C	CM7P62C-21-T	Vdet-IC	2.1V±2%, +Reset PPO	SOT-23	16vdb	VD7	3a	Can
C21T	CM7P61C-21-T	Vdet-IC	2.1V±2%, +Reset PPO	SOT-23	16vdb	VD7	3a	Can



SMD code	Type	Function	Short description	Case	Pinout	Sch. St.	Mnf.
C22	2SK595-22	n-FET	Mic-preamp, 20V, 10mA, 100mW, Idss=210..350µA	2025	16fa	-	3a San
C22	CM7P611C-22-T	Vdet-IC	2.2V±2%, -Reset PPO	SOT-23	16vdb	VD7	3a Can
C22B	ML61C222M	Vdet-IC	2.2V±2%, -Reset PPO	SOT-23	16vdb	VD7	3a Mic
C22C	CM7P62C-22-T	Vdet-IC	2.2V±2%, +Reset PPO	SOT-23	16vdb	VD7	3a Can
C22T	CM7P61C-22-T	Vdet-IC	2.2V±2%, +Reset PPO	SOT-23	16vdb	VD7	3a Can
C23	2SK595-23	n-FET	Mic-preamp, 20V, 10mA, 100mW, Idss=320..480µA	2025	16fa	-	3a San
C23	CM7P611C-23-T	Vdet-IC	2.3V±2%, -Reset PPO	SOT-23	16vdb	VD7	3a Can
C23	XE61CC2245MR	Vdet-IC	2.2V±2%, -Reset PPO	SOT-23	16vdb	VD7	3h Tor
C23B	ML61C232M	Vdet-IC	2.3V±2%, -Reset PPO	SOT-23	16vdb	VD7	3a Mic
C23C	CM7P62C-23-T	Vdet-IC	2.3V±2%, +Reset PPO	SOT-23	16vdb	VD7	3a Can
C23T	CM7P61C-23-T	Vdet-IC	2.3V±2%, +Reset PPO	SOT-23	16vdb	VD7	3a Can
C24	2SK595-24	n-FET	Mic-preamp, 20V, 10mA, 100mW, Idss=440..800µA	2025	16fa	-	3a San
C24	CM7P611C-24-T	Vdet-IC	2.4V±2%, -Reset PPO	SOT-23	16vdb	VD7	3a Can
C24B	ML61C242M	Vdet-IC	2.4V±2%, -Reset PPO	SOT-23	16vdb	VD7	3a Mic
C24C	CM7P62C-24-T	Vdet-IC	2.4V±2%, +Reset PPO	SOT-23	16vdb	VD7	3a Can
C24T	CM7P61C-24-T	Vdet-IC	2.4V±2%, +Reset PPO	SOT-23	16vdb	VD7	3a Can
C25	2SA1247-25	Si-pnp	GP, 120V, 50mA, 200mW, B=100..200, 100MHz	SOT-23	16ta	-	3a Nec
C25	AIC1746-25GJ3	LVR-IC	LDO, 2.5V±2%, 150mA	SOT-323	16cg	VR1	3a Aic
C25	CM7P611C-25-T	Vdet-IC	2.5V±2%, -Reset PPO	SOT-23	16vdb	VD7	3a Can
C25	XC61FC2212M	Vdet-IC	2.2V±2%, +Reset PPO, 200ms	SOT-23	16vdb	VD7	3d Tor
C25	XC61HC2212MR	Vdet-IC	2.2V±2%, -Reset PPO, 50..200ms	SOT-23	16vdc	VD7	3d Tor
C25B	ML61C252M	Vdet-IC	2.5V±2%, -Reset PPO	SOT-23	16vdb	VD7	3a Mic
C25C	CM7P62C-25-T	Vdet-IC	2.5V±2%, +Reset PPO	SOT-23	16vdb	VD7	3a Can
C25T	CM7P61C-25-T	Vdet-IC	2.5V±2%, +Reset PPO	SOT-23	16vdb	VD7	3a Can
C26	2SA1247-26	Si-pnp	GP, 120V, 50mA, 200mW, B=50..100, 100MHz	SOT-23	16ta	-	3a Nec
C26	CM7P611C-26-T	Vdet-IC	2.6V±2%, -Reset PPO	SOT-23	16vdb	VD7	3a Can
C26	XC61FC2242M	Vdet-IC	2.2V±2%, +Reset PPO, 400ms	SOT-23	16vdb	VD7	3d Tor
C26	XC61HC2242MR	Vdet-IC	2.2V±2%, -Reset PPO, 80..400ms	SOT-23	16vdc	VD7	3d Tor
C26B	ML61C262M	Vdet-IC	2.6V±2%, -Reset PPO	SOT-23	16vdb	VD7	3a Mic
C26C	CM7P62C-26-T	Vdet-IC	2.6V±2%, +Reset PPO	SOT-23	16vdb	VD7	3a Can
C26T	CM7P61C-26-T	Vdet-IC	2.6V±2%, +Reset PPO	SOT-23	16vdb	VD7	3a Can
C27	2SA1247-27	Si-pnp	GP, 120V, 50mA, 200mW, B=80..160, 100MHz	SOT-23	16ta	-	3a Nec
C27	AIC1746-27GJ3	LVR-IC	LDO, 2.7V±2%, 150mA	SOT-323	16cg	VR1	3a Aic
C27	CM7P611C-27-T	Vdet-IC	2.7V±2%, -Reset PPO	SOT-23	16vdb	VD7	3a Can
C27	XC61FC2252M	Vdet-IC	2.2V±2%, +Reset PPO, 50ms	SOT-23	16vdb	VD7	3d Tor
C27	XC61HC2252MR	Vdet-IC	2.2V±2%, -Reset PPO, 1..50ms	SOT-23	16vdc	VD7	3d Tor
C27B	ML61C272M	Vdet-IC	2.7V±2%, -Reset PPO	SOT-23	16vdb	VD7	3a Mic
C27C	CM7P62C-27-T	Vdet-IC	2.7V±2%, +Reset PPO	SOT-23	16vdb	VD7	3a Can
C27T	CM7P61C-27-T	Vdet-IC	2.7V±2%, +Reset PPO	SOT-23	16vdb	VD7	3a Can
C28	2SA1247-28	Si-pnp	GP, 120V, 50mA, 200mW, B=125..250, 100MHz	SOT-23	16ta	-	3a Nec
C28	CM7P611C-28-T	Vdet-IC	2.8V±2%, -Reset PPO	SOT-23	16vdb	VD7	3a Can
C28B	ML61C282M	Vdet-IC	2.8V±2%, -Reset PPO	SOT-23	16vdb	VD7	3a Mic
C28C	CM7P62C-28-T	Vdet-IC	2.8V±2%, +Reset PPO	SOT-23	16vdb	VD7	3a Can
C28T	CM7P61C-28-T	Vdet-IC	2.8V±2%, +Reset PPO	SOT-23	16vdb	VD7	3a Can
C29	CM7P611C-29-T	Vdet-IC	2.9V±2%, -Reset PPO	SOT-23	16vdb	VD7	3a Can
C29	CMPTA29	Si-npn-Darl	GP, 100V, 500mA, 350mW, B>10000, >125MHz	SOT-23	16ta	-	3a Cen
C29B	ML61C292M	Vdet-IC	2.9V±2%, -Reset PPO	SOT-23	16vdb	VD7	3a Mic
C29C	CM7P62C-29-T	Vdet-IC	2.9V±2%, +Reset PPO	SOT-23	16vdb	VD7	3a Can
C29T	CM7P61C-29-T	Vdet-IC	2.9V±2%, +Reset PPO	SOT-23	16vdb	VD7	3a Can
C2A	CMPT3906	Si-pnp	GP, 40V, 200mA, 350mW, B=100..300, >250MHz	SOT-23	16ta	-	3a Cen
C2A	ZDC833A	C-diode	Dual, 25V, 29.7/33.6pF, Q>200	SOT-23	16dg	-	3a Zx
C2A	ZDC833ATA	C-diode	Dual, VHF/UHF-Tuning, 25V, 330mW, 33pF(2V), ΔC ±10%	SOT-323	16dg	-	3a Zx
C2D	CMPTA92	Si-pnp	Vid, 300/300V, 500mA, 350mW, B>25, >50MHz	SOT-23	16ta	-	3a Cen
C2F	CMPT2907A	Si-pnp	GP, 60V, 600mA, 330mW, B=100..300, >200MHz	SOT-23	16ta	-	3a Cen
C2G	CMPTA56	Si-pnp	AF-Drv, 80V, 500mA, 300mW, B>100, >50MHz	SOT-23	16ta	-	3a Cen
C2J	AIC1746-285GJ3	LVR-IC	LDO, 2.85V±2%, 150mA	SOT-323	16cg	VR1	3a Aic
C2J	CMPT3640	Si-pnp	RF, 12V, 80mA, 350mW, B=30..120, >500MHz	SOT-23	16ta	-	3a Cen
C2L	CMPT5401	Si-pnp	GP, 160V, 500mA, 350mW, B=60..240, 100..300MHz	SOT-23	16ta	-	3a Cen
C2p	BCW30	Si-pnp	GP, 32V, 100mA, 250mW, B=215..500, >100MHz	SOT-23	16ta	-	3a PHH
C2P	CMPT5086	Si-pnp	GP, 50V, 50mA, 350mW, B=150..500, >40MHz	SOT-23	16ta	-	3a Cen
C2Q	CMPT5087	Si-pnp	GP, 50V, 50mA, 350mW, B=250..800, >40MHz	SOT-23	16ta	-	3a Cen
C2R	CMPT3646	Si-npn	GP, 40V, 200mA, 350mW, B=30..120, >350MHz	SOT-23	16ta	-	3a Cen
C2T	BCW30	Si-pnp	GP, 32V, 100mA, 250mW, B=215..500, >100MHz	SOT-23	16ta	-	3a PHM
C2t	CMPT4403	Si-pnp	GP, 40V, 600mA, 350mW, B=100..300, >200MHz	SOT-23	16ta	-	3a Cen
C2U	CMPTA63	Si-pnp-Darl	GP, 30V, 500mA, 350mW, B>10000, >125MHz	SOT-23	16ta	-	3a Cen
C2V	CMPTA64	Si-pnp-Darl	GP, 30V, 500mA, 350mW, B>20000, >125MHz	SOT-23	16ta	-	3a Cen
C2W	BCW30	Si-pnp	GP, 32V, 100mA, 250mW, B=215..500, >100MHz	SOT-23	16ta	-	3a PhC
C2W	CMPT8599	Si-pnp	GP, 80V, 500mA, 350mW, B=100..300, >150MHz	SOT-23	16ta	-	3a Cen
C2X	CMPT4401	Si-npn	GP, 60V, 600mA, 350mW, B=100..300, >25MHz	SOT-23	16ta	-	3a Cen
C2Z	CMPT6520	Si-pnp	Vid, 350/350V, 500mA, 350mW, B=20..200, >20MHz	SOT-23	16ta	-	3a Cen



SMD code	Type	Function	Short description	Case	Pinout	Sch. St.	Mnf.
C3	1PS302	Si-diode	Dual, Sw, Fast, 80V, 170mA, Vf<1.2V(100mA), <4ns	SOT-323	16dl	-	3a Phi
C3	1SS226	Si-diode	Dual, Sw, Fast, 85V, 100mA, <4ns	SOT-23	16ea	-	3a Tos
C3	1SS302	Si-diode	Dual, 80V, 100mA, Vf<1.2V(100mA), <4ns	SOT-323	16dg	-	3a Tos
C3	1SS362	Si-diode	Dual, Sw, U-Fast, 85V, 100mA, 150mW, Vf<1.2V(0.1A), <4ns	SOT-23	16ea	-	3a Tos
C3	2PD601ART	Si-npn	GP, Sw, 60V, 100mA, 250mW, B>90, >100MHz	SOT-23	16ta	-	3a PHH
C3	AP130-44TW	LVR-IC	LDO, 4.4V±2%, 300mA	TSOT23-3L	16vj	VR1	3b Ana
C3	AP130-44W	LVR-IC	LDO, 4.4V±2%, 300mA	SOT-23	16vj	VR1	3b Ana
C3	APE6812N-C	Vdet-IC	4.00V±2%, +Reset PPO	SOT-23	16vda	VD7	3b Ape
C3	APE6812U-C	Vdet-IC	4.00V±2%, +Reset PPO	SC-70	16vda	VD7	3b Ape
C3	AX6904CR	Vdet-IC	4.0V±1.5%, +Reset PPO	SOT-23	16vda	VD7	3b Axl
C3	ELM9723NBB	Vdet-IC	2.3V±2.5%, +Reset ODO	SOT-23	16vdb	VD6	3d Elm
C3	HSMS-2823	Si-diode	Dual, Schottky, RF, 15V, 1A, Vf<0.34V(1mA), <1pF, 12Ω(5mA)	SOT-23	16df	-	3a Agi
C3	HSMS-282E	Si-diode	Dual, Schottky, RF, 15V, 1A, Vf<0.34V(1mA), <1pF, 12Ω(5mA)	SOT-323	16df	-	3a Agi
C3	ILC50621C23X	Vdet-IC	2.3V±2%, -Reset PPO	SOT-323	16vdb	VD7	3a Imp
C3	ILC5062M23X	Vdet-IC	2.3V±2%, -Reset PPO	SOT-23	16vdb	VD7	3a Imp
C3	KST4126	Si-pnp	GP, 25V, 200mA, 350mW, B=120..360, >250MHz	SOT-23	16ta	-	3a Sam
C3	MMBT4126	Si-pnp	GP, 25V, 200mA, 350mW, B=120..360, >250MHz	SOT-23	16ta	-	3a Mot
C3	MMBZ5223B	Z-diode	2.57..2.84V, Zzt=30Ω, lzt=20mA, 410mW	SOT-23	16dc	-	3a Pjt
C3	MMBZ5223BW	Z-diode	2.57..2.84V, Zzt=30Ω, lzt=20mA, 200mW	SOT-323	16dc	-	3a Pjt
C3	R3111N232A	Vdet-IC	2.3V±2%, -Reset PPO	SOT-23	16vdd	VD7	3d Ric
C3	R3113D331A	Vdet-IC	3.3V±2%, -Reset, ODO	SON1408-3	18vda	VD6	3d Ric
C3	R3130N33EC	Vdet-IC	3.3V, -Reset ODO, 240ms	SOT-23	16vdc	VD6	3b Ric
C3	RT9161-15CV	LVR-IC	LDO, 1.5V±2%, 300mA	SOT-23	16cg	VR1	3a Rct
C3	SMBT4126	Si-pnp	GP, 25V, 200mA, 350mW, B=120..360, >250MHz	SOT-23	16ta	-	3a Sie
C3	SST113	n-FET	Sw, 35V, 350mW, Idss=2mA, Rds(on)=100Ω, 2/6ns	SOT-23	16jf	-	3a Six
C3	TC54VC2302ECB	Vdet-IC	2.3V±2%, -Reset PPO	SOT-23	16vdb	VD7	3a Tcs
C3	XC61CC2302M	Vdet-IC	2.3V±1%, +Reset PPO	SOT-23	16vdb	VD7	3d Tor
C3	XC6GC2302HR	Vdet-IC	2.3V, +Reset PPO	USP-3	17vdc	VD3	9b Tor
C30	AIC1746-30GJ3	LVR-IC	LDO, 3.0V±2%, 150mA	SOT-323	16cg	VR1	3a Aic
C30	CM7P611C-30-T	Vdet-IC	3.0V±2%, -Reset PPO	SOT-23	16vdb	VD7	3a Can
C30B	ML61C302M	Vdet-IC	3.0V±2%, -Reset PPO	SOT-23	16vdb	VD7	3a Mlc
C30C	CM7P62C-30-T	Vdet-IC	3.0V±2%, +Reset PPO	SOT-23	16vdb	VD7	3a Can
C30T	CM7P61C-30-T	Vdet-IC	3.0V±2%, +Reset PPO	SOT-23	16vdb	VD7	3a Can
C31	CM7P611C-31-T	Vdet-IC	3.1V±2%, -Reset PPO	SOT-23	16vdb	VD7	3a Can
C31B	ML61C312M	Vdet-IC	3.1V±2%, -Reset PPO	SOT-23	16vdb	VD7	3a Mlc
C31C	CM7P62C-31-T	Vdet-IC	3.1V±2%, +Reset PPO	SOT-23	16vdb	VD7	3a Can
C31T	CM7P61C-31-T	Vdet-IC	3.1V±2%, +Reset PPO	SOT-23	16vdb	VD7	3a Can
C32	CM7P611C-32-T	Vdet-IC	3.2V±2%, -Reset PPO	SOT-23	16vdb	VD7	3a Can
C32B	ML61C322M	Vdet-IC	3.2V±2%, -Reset PPO	SOT-23	16vdb	VD7	3a Mlc
C32C	CM7P62C-32-T	Vdet-IC	3.2V±2%, +Reset PPO	SOT-23	16vdb	VD7	3a Can
C32T	CM7P61C-32-T	Vdet-IC	3.2V±2%, +Reset PPO	SOT-23	16vdb	VD7	3a Can
C33	AIC1746-33GJ3	LVR-IC	LDO, 3.3V±2%, 150mA	SOT-323	16cg	VR1	3a Aic
C33	CM7P611C-33-T	Vdet-IC	3.3V±2%, -Reset PPO	SOT-23	16vdb	VD7	3a Can
C33	XE61CC2345MR	Vdet-IC	2.3V±2%, -Reset PPO	SOT-23	16vdb	VD7	3h Tor
C33B	ML61C332M	Vdet-IC	3.3V±2%, -Reset PPO	SOT-23	16vdb	VD7	3a Mlc
C33C	CM7P62C-33-T	Vdet-IC	3.3V±2%, +Reset PPO	SOT-23	16vdb	VD7	3a Can
C33T	CM7P61C-33-T	Vdet-IC	3.3V±2%, +Reset PPO	SOT-23	16vdb	VD7	3a Can
C34	CM7P611C-34-T	Vdet-IC	3.4V±2%, -Reset PPO	SOT-23	16vdb	VD7	3a Can
C34B	ML61C342M	Vdet-IC	3.4V±2%, -Reset PPO	SOT-23	16vdb	VD7	3a Mlc
C34C	CM7P62C-34-T	Vdet-IC	3.4V±2%, +Reset PPO	SOT-23	16vdb	VD7	3a Can
C34T	CM7P61C-34-T	Vdet-IC	3.4V±2%, +Reset PPO	SOT-23	16vdb	VD7	3a Can
C35	AIC1746-35GJ3	LVR-IC	LDO, 3.5V±2%, 150mA	SOT-323	16cg	VR1	3a Aic
C35	CM7P611C-35-T	Vdet-IC	3.5V±2%, -Reset PPO	SOT-23	16vdb	VD7	3a Can
C35	KV1735S	C-diode	2x FM-tun, 16V, 50mA, 22.25/77.74pF(8..2V), <0.3Ω (100MHz)	SOT-23	16dg	-	3a Tok
C35	XC61FC2312M	Vdet-IC	2.3V±2%, +Reset PPO, 200ms	SOT-23	16vdb	VD7	3d Tor
C35	XC61HC2312MR	Vdet-IC	2.3V±2%, -Reset PPO, 50..200ms	SOT-23	16vdc	VD7	3d Tor
C35B	ML61C352M	Vdet-IC	3.5V±2%, -Reset PPO	SOT-23	16vdb	VD7	3a Mlc
C35C	CM7P62C-35-T	Vdet-IC	3.5V±2%, +Reset PPO	SOT-23	16vdb	VD7	3a Can
C35T	CM7P61C-35-T	Vdet-IC	3.5V±2%, +Reset PPO	SOT-23	16vdb	VD7	3a Can
C36	CM7P611C-36-T	Vdet-IC	3.6V±2%, -Reset PPO	SOT-23	16vdb	VD7	3a Can
C36	XC61FC2342M	Vdet-IC	2.3V±2%, +Reset PPO, 400ms	SOT-23	16vdb	VD7	3d Tor
C36	XC61HC2342MR	Vdet-IC	2.3V±2%, -Reset PPO, 80..400ms	SOT-23	16vdc	VD7	3d Tor
C36B	ML61C362M	Vdet-IC	3.6V±2%, -Reset PPO	SOT-23	16vdb	VD7	3a Mlc
C36C	CM7P62C-36-T	Vdet-IC	3.6V±2%, +Reset PPO	SOT-23	16vdb	VD7	3a Can
C36T	CM7P61C-36-T	Vdet-IC	3.6V±2%, +Reset PPO	SOT-23	16vdb	VD7	3a Can
C37	AIC1746-37GJ3	LVR-IC	LDO, 3.7V±2%, 150mA	SOT-323	16cg	VR1	3a Aic
C37	CM7P611C-37-T	Vdet-IC	3.7V±2%, -Reset PPO	SOT-23	16vdb	VD7	3a Can
C37	XC61FC2352M	Vdet-IC	2.3V±2%, +Reset PPO, 50ms	SOT-23	16vdb	VD7	3d Tor
C37	XC61HC2352MR	Vdet-IC	2.3V±2%, -Reset PPO, 1..50ms	SOT-23	16vdc	VD7	3d Tor
C37B	ML61C372M	Vdet-IC	3.7V±2%, -Reset PPO	SOT-23	16vdb	VD7	3a Mlc



SMD code	Type	Function	Short description	Case	Pinout	Sch.	St.	Mnf.
C37C	CM7P62C-37-T	Vdet-IC	3.7V±2%, +Reset PPO	SOT-23	16vdb	VD7	3a	Can
C37T	CM7P61C-37-T	Vdet-IC	3.7V±2%, +Reset PPO	SOT-23	16vdb	VD7	3a	Can
C38	AIC1746-38GJ3	LVR-IC	LDO, 3.8V±2%, 150mA	SOT-323	16cg	VR1	3a	Aic
C38	CM7P611C-38-T	Vdet-IC	3.8V±2%, -Reset PPO	SOT-23	16vdb	VD7	3a	Can
C38B	ML61C382M	Vdet-IC	3.8V±2%, -Reset PPO	SOT-23	16vdb	VD7	3a	Mlc
C38C	CM7P62C-38-T	Vdet-IC	3.8V±2%, +Reset PPO	SOT-23	16vdb	VD7	3a	Can
C38T	CM7P61C-38-T	Vdet-IC	3.8V±2%, +Reset PPO	SOT-23	16vdb	VD7	3a	Can
C39	CM7P611C-39-T	Vdet-IC	3.9V±2%, -Reset PPO	SOT-23	16vdb	VD7	3a	Can
C39B	ML61C392M	Vdet-IC	3.9V±2%, -Reset PPO	SOT-23	16vdb	VD7	3a	Mlc
C39C	CM7P62C-39-T	Vdet-IC	3.9V±2%, +Reset PPO	SOT-23	16vdb	VD7	3a	Can
C39T	CM7P61C-39-T	Vdet-IC	3.9V±2%, +Reset PPO	SOT-23	16vdb	VD7	3a	Can
C3A	CMPT3019	Si-npn	Sw, 120V, 500mA, 350mW, B=100..300, >100MHz	SOT-23	16ta	-	3a	Cen
C3A	ILC5062AIC23X	Vdet-IC	2.3V±1%, -Reset PPO	SOT-323	16vdb	VD7	3a	Imp
C3A	ILC5062AM23X	Vdet-IC	2.3V±1%, -Reset PPO	SOT-23	16vdb	VD7	3a	Imp
C3B	CMPT918	Si-npn	VHF/UHF, 30V, 50mA, 350mW, B>20, >600MHz	SOT-23	16ta	-	3a	Cen
C3E	CMPTH10	Si-npn	GP, 30V, 25mA, 330mW, B>60, >650MHz	SOT-23	16ta	-	3a	Cen
C3p	2PD601ART	Si-npn	GP, Sw, 60V, 100mA, 250mW, B>90, >100MHz	SOT-23	16ta	-	3a	PHH
C3T	1PS226	Si-diode	Dual, Sw, Fast, 80V, 215mA, <4ns	SC-59	16dl	-	3a	Phi
C3t	2PD601ART	Si-npn	GP, Sw, 60V, 100mA, 250mW, B>90, >100MHz	SOT-23	16ta	-	3a	PHM
C3W	2PD601ART	Si-npn	GP, Sw, 60V, 100mA, 250mW, B>90, >100MHz	SOT-23	16ta	-	3a	PhC
C3Z	CMPTA44	Si-npn	450V, 300mA, 350mW, B=50..200, >20MHz	SOT-23	16ta	-	3a	Cen
C4	AP130-45TW	LVR-IC	LDO, 4.5V±2%, 300mA	TSOT23-3L	16vj	VR1	3b	Ana
C4	AP130-45W	LVR-IC	LDO, 4.5V±2%, 300mA	SOT-23	16vj	VR1	3b	Ana
C4	APE6812N-D	Vdet-IC	3.08V±2%, +Reset PPO	SOT-23	16vda	VD7	3b	Ape
C4	APE6812U-D	Vdet-IC	3.08V±2%, +Reset PPO	SC-70	16vda	VD7	3b	Ape
C4	AX6904DR	Vdet-IC	3.08V±1.5%, +Reset PPO	SOT-23	16vda	VD7	3b	Axl
C4	BB404C	C-diode	Dual, 10V, 45.5..22pF(2..8V), 100MHz	SOT-23	16dg	-	3a	lIt
C4	BCW29R	Si-pnp	GP, 32V, 100mA, 250mW, B=120..260, >100MHz	SOT-23	16dt	-	3a	Zx
C4	ELM9724NBB	Vdet-IC	2.4V±2.5%, +Reset ODO	SOT-23	16vdb	VD6	3d	Elm
C4	HSMS-2824	Si-diode	2x Schottky, RF, 15V, 1A, Vf<0.34V(1mA), <1pF, 12Ω(5mA)	SOT-23	16dg	-	3a	Agi
C4	HSMS-282F	Si-diode	2x Schottky, RF, 15V, 1A, Vf<0.34V(1mA), <1pF, 12Ω(5mA)	SOT-323	16dg	-	3a	Agi
C4	ILC5062IC24X	Vdet-IC	2.4V±2%, -Reset PPO	SOT-323	16vdb	VD7	3a	Imp
C4	ILC5062M24X	Vdet-IC	2.4V±2%, -Reset PPO	SOT-23	16vdb	VD7	3a	Imp
C4	KA4L4M	Si-npn-Digi	Sw, 60V, 100mA, 200mW, R1/R2=47k/47k	SOT-416	16ta	-	3a	Nec
C4	MC804	C-diode	Dual, TV, VHF-Band-S, 35V, 1pF(6V)	SOT-23	16dg	-	3a	Mit
C4	MMBZ5224B	Z-diode	2.66..2.94V, Zzt=30Ω, Izt=20mA, 410mW	SOT-23	16dc	-	3a	Pjt
C4	R3111N242A	Vdet-IC	2.4V±2%, -Reset PPO	SOT-23	16vdd	VD7	3d	Ric
C4	R3113D341A	Vdet-IC	3.4V±2%, -Reset, ODO	SON1408-3	18vda	VD6	3d	Ric
C4	R3130N34EC	Vdet-IC	3.4V, -Reset ODO, 240ms	SOT-23	16vdc	VD6	3b	Ric
C4	RT9161-30CV	LVR-IC	LDO, 3.0V±2%, 300mA	SOT-23	16cg	VR1	3a	Rct
C4	TC54V2C2402ECB	Vdet-IC	2.4V±2%, -Reset PPO	SOT-23	16vdb	VD7	3a	Tcs
C4	XC61CC2402M	Vdet-IC	2.4V±1%, +Reset PPO	SOT-23	16vdb	VD7	3d	Tor
C4	XC6GC2402HR	Vdet-IC	2.4V, +Reset PPO	USP-3	17vdc	VD3	9b	Tor
C4-	RT9161-30PV	LVR-IC	LDO, 3.0V±2%, 300mA	SOT-23	16cg	VR1	3a	Rct
C40	CM7P611C-40-T	Vdet-IC	4.0V±2%, -Reset PPO	SOT-23	16vdb	VD7	3a	Can
C40B	ML61C402M	Vdet-IC	4.0V±2%, -Reset PPO	SOT-23	16vdb	VD7	3a	Mlc
C40C	CM7P62C-40-T	Vdet-IC	4.0V±2%, +Reset PPO	SOT-23	16vdb	VD7	3a	Can
C40T	CM7P61C-40-T	Vdet-IC	4.0V±2%, +Reset PPO	SOT-23	16vdb	VD7	3a	Can
C41	CM7P611C-41-T	Vdet-IC	4.1V±2%, -Reset PPO	SOT-23	16vdb	VD7	3a	Can
C41	SST4091	n-FET	Sw, Chopper, 40..50V, Idss=30mA, Up<10V	SOT-23	16fa	-	3a	Lin
C41B	ML61C412M	Vdet-IC	4.1V±2%, -Reset PPO	SOT-23	16vdb	VD7	3a	Mlc
C41C	CM7P62C-41-T	Vdet-IC	4.1V±2%, +Reset PPO	SOT-23	16vdb	VD7	3a	Can
C41T	CM7P61C-41-T	Vdet-IC	4.1V±2%, +Reset PPO	SOT-23	16vdb	VD7	3a	Can
C42	CM7P611C-42-T	Vdet-IC	4.2V±2%, -Reset PPO	SOT-23	16vdb	VD7	3a	Can
C42	SST4092	n-FET	Sw, Chopper, 40..50V, Idss=15mA, Up<7V	SOT-23	16fa	-	3a	Lin
C42B	ML61C422M	Vdet-IC	4.2V±2%, -Reset PPO	SOT-23	16vdb	VD7	3a	Mlc
C42C	CM7P62C-42-T	Vdet-IC	4.2V±2%, +Reset PPO	SOT-23	16vdb	VD7	3a	Can
C42T	CM7P61C-42-T	Vdet-IC	4.2V±2%, +Reset PPO	SOT-23	16vdb	VD7	3a	Can
C43	CM7P611C-43-T	Vdet-IC	4.3V±2%, -Reset PPO	SOT-23	16vdb	VD7	3a	Can
C43	SST4093	n-FET	Sw, Chopper, 40..50V, Idss=8mA, Up<5V	SOT-23	16fa	-	3a	Lin
C43	XE61CC2445MR	Vdet-IC	2.4V±2%, -Reset PPO	SOT-23	16vdb	VD7	3h	Tor
C43B	ML61C432M	Vdet-IC	4.3V±2%, -Reset PPO	SOT-23	16vdb	VD7	3a	Mlc
C43C	CM7P62C-43-T	Vdet-IC	4.3V±2%, +Reset PPO	SOT-23	16vdb	VD7	3a	Can
C43T	CM7P61C-43-T	Vdet-IC	4.3V±2%, +Reset PPO	SOT-23	16vdb	VD7	3a	Can
C44	CM7P611C-44-T	Vdet-IC	4.4V±2%, -Reset PPO	SOT-23	16vdb	VD7	3a	Can
C44B	ML61C442M	Vdet-IC	4.4V±2%, -Reset PPO	SOT-23	16vdb	VD7	3a	Mlc
C44C	CM7P62C-44-T	Vdet-IC	4.4V±2%, +Reset PPO	SOT-23	16vdb	VD7	3a	Can
C44T	CM7P61C-44-T	Vdet-IC	4.4V±2%, +Reset PPO	SOT-23	16vdb	VD7	3a	Can
C45	CM7P611C-45-T	Vdet-IC	4.5V±2%, -Reset PPO	SOT-23	16vdb	VD7	3a	Can
C45	XC61FC2412M	Vdet-IC	2.4V±2%, +Reset PPO, 200ms	SOT-23	16vdb	VD7	3d	Tor



SMD code	Type	Function	Short description	Case	Pinout	Sch. St.	Mnf.
C45	XC61HC2412MR	Vdet-IC	2.4V±2%, -Reset PPO, 50..200ms	SOT-23	16vdc	VD7	3d Tor
C45B	ML61C452M	Vdet-IC	4.5V±2%, -Reset PPO	SOT-23	16vdb	VD7	3a Mlc
C45C	CM7P62C-45-T	Vdet-IC	4.5V±2%, +Reset PPO	SOT-23	16vdb	VD7	3a Can
C45T	CM7P61C-45-T	Vdet-IC	4.5V±2%, +Reset PPO	SOT-23	16vdb	VD7	3a Can
C46	BAT46C	Si-diode	Dual, SBD, 100V, 150mA, Vf<1V(250mA), 6pF	SOT-23	16df	-	3b Ste
C46	CM7P611C-46-T	Vdet-IC	4.6V±2%, -Reset PPO	SOT-23	16vdb	VD7	3a Can
C46	XC61FC2442M	Vdet-IC	2.4V±2%, +Reset PPO, 400ms	SOT-23	16vdb	VD7	3d Tor
C46	XC61HC2442MR	Vdet-IC	2.4V±2%, -Reset PPO, 80..400ms	SOT-23	16vdc	VD7	3d Tor
C46B	ML61C462M	Vdet-IC	4.6V±2%, -Reset PPO	SOT-23	16vdb	VD7	3a Mlc
C46C	CM7P62C-46-T	Vdet-IC	4.6V±2%, +Reset PPO	SOT-23	16vdb	VD7	3a Can
C46T	CM7P61C-46-T	Vdet-IC	4.6V±2%, +Reset PPO	SOT-23	16vdb	VD7	3a Can
C47	CM7P611C-47-T	Vdet-IC	4.7V±2%, -Reset PPO	SOT-23	16vdb	VD7	3a Can
C47	XC61FC2452M	Vdet-IC	2.4V±2%, +Reset PPO, 50ms	SOT-23	16vdb	VD7	3d Tor
C47	XC61HC2452MR	Vdet-IC	2.4V±2%, -Reset PPO, 1..50ms	SOT-23	16vdc	VD7	3d Tor
C47B	ML61C472M	Vdet-IC	4.7V±2%, -Reset PPO	SOT-23	16vdb	VD7	3a Mlc
C47C	CM7P62C-47-T	Vdet-IC	4.7V±2%, +Reset PPO	SOT-23	16vdb	VD7	3a Can
C47T	CM7P61C-47-T	Vdet-IC	4.7V±2%, +Reset PPO	SOT-23	16vdb	VD7	3a Can
C48	CM7P611C-48-T	Vdet-IC	4.8V±2%, -Reset PPO	SOT-23	16vdb	VD7	3a Can
C48B	ML61C482M	Vdet-IC	4.8V±2%, -Reset PPO	SOT-23	16vdb	VD7	3a Mlc
C48C	CM7P62C-48-T	Vdet-IC	4.8V±2%, +Reset PPO	SOT-23	16vdb	VD7	3a Can
C48T	CM7P61C-48-T	Vdet-IC	4.8V±2%, +Reset PPO	SOT-23	16vdb	VD7	3a Can
C49	CM7P611C-49-T	Vdet-IC	4.9V±2%, -Reset PPO	SOT-23	16vdb	VD7	3a Can
C49B	ML61C492M	Vdet-IC	4.9V±2%, -Reset PPO	SOT-23	16vdb	VD7	3a Mlc
C49C	CM7P62C-49-T	Vdet-IC	4.9V±2%, +Reset PPO	SOT-23	16vdb	VD7	3a Can
C49T	CM7P61C-49-T	Vdet-IC	4.9V±2%, +Reset PPO	SOT-23	16vdb	VD7	3a Can
C4A	CMPT4033	Si-pnp	GP, 80V, 500mA, 350mW, B=100..300, >100MHz	SOT-23	16ta	-	3a Cen
C4A	ILC5062A1C24X	Vdet-IC	2.4V±1%, -Reset PPO	SOT-323	16vdb	VD7	3a Imp
C4A	ILC5062AM24X	Vdet-IC	2.4V±1%, -Reset PPO	SOT-23	16vdb	VD7	3a Imp
C4G-	2SC2412KPT-R	Si-npn	AF, Sw, 50V, 150mA, B=180..390, 180MHz	SOT-23	16ta	-	3a Chm
C4G-	CHT846BPT-R	Si-npn	AF, Sw, 65V, 100mA, B=200..450, 200MHz	SOT-23	16ta	-	3a Chm
C5	2SA811-5	Si-pnp	AF, Hi-beta, 50V, 30mA, 200mW, B=135..270, 100MHz	SOT-23	16ta	-	3a Nec
C5	AP130-46TW	LVR-IC	LDO, 4.6V±2%, 300mA	TSOT23-3L	16vj	VR1	3b Ana
C5	AP130-46W	LVR-IC	LDO, 4.6V±2%, 300mA	SOT-23	16vj	VR1	3b Ana
C5	APE6812N-E	Vdet-IC	2.93V±2%, +Reset PPO	SOT-23	16vda	VD7	3b Ape
C5	APE6812U-E	Vdet-IC	2.93V±2%, +Reset PPO	SC-70	16vda	VD7	3b Ape
C5	AX6904ER	Vdet-IC	2.93V±1.5%, +Reset PPO	SOT-23	16vda	VD7	3b Axl
C5	BCW30R	Si-pnp	GP, 32V, 100mA, 250mW, B=215..500, >100MHz	SOT-23	16te	-	3a Zx
C5	BFS40	Si-pnp	AF/HF, 45V, 0.5A, >150MHz	SOT-323	16te	-	3a Fer
C5	ELM9725NBB	Vdet-IC	2.5V±2.5%, +Reset ODO	SOT-23	16vdb	VD6	3d Elm
C5	ILC50621C25X	Vdet-IC	2.5V±2%, -Reset PPO	SOT-323	16vdb	VD7	3a Imp
C5	ILC5062M25X	Vdet-IC	2.5V±2%, -Reset PPO	SOT-23	16vdb	VD7	3a Imp
C5	MMBA811C5	Si-pnp	AF, LN, 50V, 50mA, 350mW, B=135..270, >75MHz	SOT-23	16ta	-	3a Sam
C5	MMBZ5225B	Z-diode	2.85..3.15V, Zzt=30Ω, Izt=20mA, 410mW	SOT-23	16dc	-	3a Pjt
C5	MMBZ5225BW	Z-diode	3V±5%, Zzt=29Ω, 200mW	SOT-323	16dc	-	3a Pjt
C5	R3111N252A	Vdet-IC	2.5V±2%, -Reset PPO	SOT-23	16vdd	VD7	3d Ric
C5	R3113D351A	Vdet-IC	3.5V±2%, -Reset, ODO	SON1408-3	18vda	VD6	3d Ric
C5	R3130N35EC	Vdet-IC	3.5V, -Reset ODO, 240ms	SOT-23	16vdc	VD6	3b Ric
C5	RT9161-35CV	LVR-IC	LDO, 3.5V±2%, 300mA	SOT-23	16cg	VR1	3a Rct
C5	Si2315DS	p-MOSFET-e	V-MOS, LogL, 12V, 3.5A, <118ns	SOT-23	16fn	-	3a Six
C5	SP809NEK-4-6	Vdet-IC	4.6V±1.5%, -Reset ODO	SOT-23	16vdc	VD6	3b Sip
C5	TC54VC2502ECB	Vdet-IC	2.5V±2%, -Reset PPO	SOT-23	16vdb	VD7	3a Tcs
C5	XC61CC2502M	Vdet-IC	2.5V±1%, +Reset PPO	SOT-23	16vdb	VD7	3d Tor
C5	XC6GC2502HR	Vdet-IC	2.5V, +Reset PPO	USP-3	17vdc	VD3	9b Tor
C50	CM7P611C-50-T	Vdet-IC	5.0V±2%, -Reset PPO	SOT-23	16vdb	VD7	3a Can
C50B	ML61C502M	Vdet-IC	5.0V±2%, -Reset PPO	SOT-23	16vdb	VD7	3a Mlc
C50C	CM7P62C-50-T	Vdet-IC	5.0V±2%, +Reset PPO	SOT-23	16vdb	VD7	3a Can
C50T	CM7P61C-50-T	Vdet-IC	5.0V±2%, +Reset PPO	SOT-23	16vdb	VD7	3a Can
C51	CM7P611C-51-T	Vdet-IC	5.1V±2%, -Reset PPO	SOT-23	16vdb	VD7	3a Can
C51B	ML61C512M	Vdet-IC	5.1V±2%, -Reset PPO	SOT-23	16vdb	VD7	3a Mlc
C51C	CM7P62C-51-T	Vdet-IC	5.1V±2%, +Reset PPO	SOT-23	16vdb	VD7	3a Can
C51T	CM7P61C-51-T	Vdet-IC	5.1V±2%, +Reset PPO	SOT-23	16vdb	VD7	3a Can
C52	CM7P611C-52-T	Vdet-IC	5.2V±2%, -Reset PPO	SOT-23	16vdb	VD7	3a Can
C52B	ML61C522M	Vdet-IC	5.2V±2%, -Reset PPO	SOT-23	16vdb	VD7	3a Mlc
C52C	CM7P62C-52-T	Vdet-IC	5.2V±2%, +Reset PPO	SOT-23	16vdb	VD7	3a Can
C52T	CM7P61C-52-T	Vdet-IC	5.2V±2%, +Reset PPO	SOT-23	16vdb	VD7	3a Can
C53	CM7P611C-53-T	Vdet-IC	5.3V±2%, -Reset PPO	SOT-23	16vdb	VD7	3a Can
C53	XE61CC2545MR	Vdet-IC	2.5V±2%, -Reset PPO	SOT-23	16vdb	VD7	3h Tor
C53B	ML61C532M	Vdet-IC	5.3V±2%, -Reset PPO	SOT-23	16vdb	VD7	3a Mlc
C53C	CM7P62C-53-T	Vdet-IC	5.3V±2%, +Reset PPO	SOT-23	16vdb	VD7	3a Can
C53T	CM7P61C-53-T	Vdet-IC	5.3V±2%, +Reset PPO	SOT-23	16vdb	VD7	3a Can



SMD code	Type	Function	Short description	Case	Pinout	Sch.	St.	Mnf.
C54	CM7P611C-54-T	Vdet-IC	5.4V±2%, -Reset PPO	SOT-23	16vdb	VD7	3a	Can
C54B	ML61C542M	Vdet-IC	5.4V±2%, -Reset PPO	SOT-23	16vdb	VD7	3a	Mlc
C54C	CM7P62C-54-T	Vdet-IC	5.4V±2%, +Reset PPO	SOT-23	16vdb	VD7	3a	Can
C54T	CM7P61C-54-T	Vdet-IC	5.4V±2%, +Reset PPO	SOT-23	16vdb	VD7	3a	Can
C55	CM7P611C-55-T	Vdet-IC	5.5V±2%, -Reset PPO	SOT-23	16vdb	VD7	3a	Can
C55	XC61FC2512M	Vdet-IC	2.5V±2%, +Reset PPO, 200ms	SOT-23	16vdb	VD7	3d	Tor
C55	XC61HC2512MR	Vdet-IC	2.5V±2%, -Reset PPO, 50...200ms	SOT-23	16vdc	VD7	3d	Tor
C55B	ML61C552M	Vdet-IC	5.5V±2%, -Reset PPO	SOT-23	16vdb	VD7	3a	Mlc
C55C	CM7P62C-55-T	Vdet-IC	5.5V±2%, +Reset PPO	SOT-23	16vdb	VD7	3a	Can
C55T	CM7P61C-55-T	Vdet-IC	5.5V±2%, +Reset PPO	SOT-23	16vdb	VD7	3a	Can
C56	CM7P611C-56-T	Vdet-IC	5.6V±2%, -Reset PPO	SOT-23	16vdb	VD7	3a	Can
C56	XC61FC2542M	Vdet-IC	2.5V±2%, +Reset PPO, 400ms	SOT-23	16vdb	VD7	3d	Tor
C56	XC61HC2542MR	Vdet-IC	2.5V±2%, -Reset PPO, 80...400ms	SOT-23	16vdc	VD7	3d	Tor
C56B	ML61C562M	Vdet-IC	5.6V±2%, -Reset PPO	SOT-23	16vdb	VD7	3a	Mlc
C56C	CM7P62C-56-T	Vdet-IC	5.6V±2%, +Reset PPO	SOT-23	16vdb	VD7	3a	Can
C56T	CM7P61C-56-T	Vdet-IC	5.6V±2%, +Reset PPO	SOT-23	16vdb	VD7	3a	Can
C57	CM7P611C-57-T	Vdet-IC	5.7V±2%, -Reset PPO	SOT-23	16vdb	VD7	3a	Can
C57	XC61FC2552M	Vdet-IC	2.5V±2%, +Reset PPO, 50ms	SOT-23	16vdb	VD7	3d	Tor
C57	XC61HC2552MR	Vdet-IC	2.5V±2%, -Reset PPO, 1...50ms	SOT-23	16vdc	VD7	3d	Tor
C57B	ML61C572M	Vdet-IC	5.7V±2%, -Reset PPO	SOT-23	16vdb	VD7	3a	Mlc
C57C	CM7P62C-57-T	Vdet-IC	5.7V±2%, +Reset PPO	SOT-23	16vdb	VD7	3a	Can
C57T	CM7P61C-57-T	Vdet-IC	5.7V±2%, +Reset PPO	SOT-23	16vdb	VD7	3a	Can
C58	CM7P611C-58-T	Vdet-IC	5.8V±2%, -Reset PPO	SOT-23	16vdb	VD7	3a	Can
C58B	ML61C582M	Vdet-IC	5.8V±2%, -Reset PPO	SOT-23	16vdb	VD7	3a	Mlc
C58C	CM7P62C-58-T	Vdet-IC	5.8V±2%, +Reset PPO	SOT-23	16vdb	VD7	3a	Can
C58T	CM7P61C-58-T	Vdet-IC	5.8V±2%, +Reset PPO	SOT-23	16vdb	VD7	3a	Can
C59	CM7P611C-59-T	Vdet-IC	5.9V±2%, -Reset PPO	SOT-23	16vdb	VD7	3a	Can
C59B	ML61C592M	Vdet-IC	5.9V±2%, -Reset PPO	SOT-23	16vdb	VD7	3a	Mlc
C59C	CM7P62C-59-T	Vdet-IC	5.9V±2%, +Reset PPO	SOT-23	16vdb	VD7	3a	Can
C59T	CM7P61C-59-T	Vdet-IC	5.9V±2%, +Reset PPO	SOT-23	16vdb	VD7	3a	Can
C5A	ILC5062AIC25X	Vdet-IC	2.5V±1%, -Reset PPO	SOT-323	16vdb	VD7	3a	Imp
C5A	ILC5062AM25X	Vdet-IC	2.5V±1%, -Reset PPO	SOT-23	16vdb	VD7	3a	Imp
C5A	ZDC834ATA	C-diode	Dual, VHF/UHF-Tuning, 25V, 330mW, 47pF(2V), ΔC ±10%	SOT-323	16dg	-	3a	Zx
C6	2SA811-6	Si-pnp	AF, Hi-beta, 50V, 30mA, 200mW, B=200...400, 100MHz	SOT-23	16ta	-	3a	Nec
C6	AP130-47TW	LVR-IC	LDO, 4.7V±2%, 300mA	TSOT23-3L	16vj	VR1	3b	Ana
C6	AP130-47W	LVR-IC	LDO, 4.7V±2%, 300mA	SOT-23	16vj	VR1	3b	Ana
C6	APE6812N-F	Vdet-IC	2.63V±2%, +Reset PPO	SOT-23	16vda	VD7	3b	Ape
C6	APE6812U-F	Vdet-IC	2.63V±2%, +Reset PPO	SC-70	16vda	VD7	3b	Ape
C6	AX6904FR	Vdet-IC	2.63V±1.5%, +Reset PPO	SOT-23	16vda	VD7	3b	Axl
C6	ELM9726NBB	Vdet-IC	2.6V±2.5%, +Reset ODO	SOT-23	16vdb	VD6	3d	Elm
C6	ILC5062IC26X	Vdet-IC	2.6V±2%, -Reset PPO	SOT-323	16vdb	VD7	3a	Imp
C6	ILC5062M26X	Vdet-IC	2.6V±2%, -Reset PPO	SOT-23	16vdb	VD7	3a	Imp
C6	KTA2017-6	Si-pnp	AF, LN, 120V, 100mA, 100mW, B=200...400, 100MHz	USM	16ta	-	3a	Kec
C6	MMA811C6	Si-pnp	AF, LN, 50V, 50mA, 350mW, B=200...400, >75MHz	SOT-23	16ta	-	3a	Sam
C6	R3111N262A	Vdet-IC	2.6V±2%, -Reset PPO	SOT-23	16vdd	VD7	3d	Ric
C6	R3113D361A	Vdet-IC	3.6V±2%, -Reset, ODO	SON1408-3	18vda	VD6	3d	Ric
C6	R3130N36EC	Vdet-IC	3.6V, -Reset ODO, 240ms	SOT-23	16vdc	VD6	3b	Ric
C6	RT9161A-33CV	LVR-IC	LDO, 3.3V±2%, 500mA	SOT-23	16cg	VR1	3a	Rct
C6	TC54VC2602ECB	Vdet-IC	2.6V±2%, -Reset PPO	SOT-23	16vdb	VD7	3a	Tcs
C6	XC61CC2602M	Vdet-IC	2.6V±1%, +Reset PPO	SOT-23	16vdb	VD7	3d	Tor
C6	XC6GC2602HR	Vdet-IC	2.6V, +Reset PPO	USP-3	17vdc	VD3	9b	Tor
C6-	RT9161A-33PV	LVR-IC	LDO, 3.3V±2%, 500mA	SOT-23	16cg	VR1	3a	Rct
C60	CM7P611C-60-T	Vdet-IC	6.0V±2%, -Reset PPO	SOT-23	16vdb	VD7	3a	Can
C60B	ML61C602M	Vdet-IC	6.0V±2%, -Reset PPO	SOT-23	16vdb	VD7	3a	Mlc
C60C	CM7P62C-60-T	Vdet-IC	6.0V±2%, +Reset PPO	SOT-23	16vdb	VD7	3a	Can
C60T	CM7P61C-60-T	Vdet-IC	6.0V±2%, +Reset PPO	SOT-23	16vdb	VD7	3a	Can
C61	CM7P611C-61-T	Vdet-IC	6.1V±2%, -Reset PPO	SOT-23	16vdb	VD7	3a	Can
C61B	ML61C612M	Vdet-IC	6.1V±2%, -Reset PPO	SOT-23	16vdb	VD7	3a	Mlc
C61C	CM7P62C-61-T	Vdet-IC	6.1V±2%, +Reset PPO	SOT-23	16vdb	VD7	3a	Can
C61T	CM7P61C-61-T	Vdet-IC	6.1V±2%, +Reset PPO	SOT-23	16vdb	VD7	3a	Can
C62	CM7P611C-62-T	Vdet-IC	6.2V±2%, -Reset PPO	SOT-23	16vdb	VD7	3a	Can
C62B	ML61C622M	Vdet-IC	6.2V±2%, -Reset PPO	SOT-23	16vdb	VD7	3a	Mlc
C62C	CM7P62C-62-T	Vdet-IC	6.2V±2%, +Reset PPO	SOT-23	16vdb	VD7	3a	Can
C62T	CM7P61C-62-T	Vdet-IC	6.2V±2%, +Reset PPO	SOT-23	16vdb	VD7	3a	Can
C63	CM7P611C-63-T	Vdet-IC	6.3V±2%, -Reset PPO	SOT-23	16vdb	VD7	3a	Can
C63	XE61CC2645MR	Vdet-IC	2.6V±2%, -Reset PPO	SOT-23	16vdb	VD7	3h	Tor
C63B	ML61C632M	Vdet-IC	6.3V±2%, -Reset PPO	SOT-23	16vdb	VD7	3a	Mlc
C63C	CM7P62C-63-T	Vdet-IC	6.3V±2%, +Reset PPO	SOT-23	16vdb	VD7	3a	Can
C63T	CM7P61C-63-T	Vdet-IC	6.3V±2%, +Reset PPO	SOT-23	16vdb	VD7	3a	Can
C64	CM7P611C-64-T	Vdet-IC	6.4V±2%, -Reset PPO	SOT-23	16vdb	VD7	3a	Can



SMD code	Type	Function	Short description	Case	Pinout	Sch.	St.	Mnf.
C64B	ML61C642M	Vdet-IC	6.4V±2%, -Reset PPO	SOT-23	16vdb	VD7	3a	Mic
C64C	CM7P62C-64-T	Vdet-IC	6.4V±2%, +Reset PPO	SOT-23	16vdb	VD7	3a	Can
C64T	CM7P61C-64-T	Vdet-IC	6.4V±2%, +Reset PPO	SOT-23	16vdb	VD7	3a	Can
C65	CM7P611C-65-T	Vdet-IC	6.5V±2%, -Reset PPO	SOT-23	16vdb	VD7	3a	Can
C65	XC61FC2612M	Vdet-IC	2.6V±2%, +Reset PPO, 200ms	SOT-23	16vdb	VD7	3d	Tor
C65	XC61HC2612MR	Vdet-IC	2.6V±2%, -Reset PPO, 50..200ms	SOT-23	16vdc	VD7	3d	Tor
C65B	ML61C652M	Vdet-IC	6.5V±2%, -Reset PPO	SOT-23	16vdb	VD7	3a	Mic
C65C	CM7P62C-65-T	Vdet-IC	6.5V±2%, +Reset PPO	SOT-23	16vdb	VD7	3a	Can
C65T	CM7P61C-65-T	Vdet-IC	6.5V±2%, +Reset PPO	SOT-23	16vdb	VD7	3a	Can
C66	CM7P611C-66-T	Vdet-IC	6.6V±2%, -Reset PPO	SOT-23	16vdb	VD7	3a	Can
C66	XC61FC2642M	Vdet-IC	2.6V±2%, +Reset PPO, 400ms	SOT-23	16vdb	VD7	3d	Tor
C66	XC61HC2642MR	Vdet-IC	2.6V±2%, -Reset PPO, 80..400ms	SOT-23	16vdc	VD7	3d	Tor
C66B	ML61C662M	Vdet-IC	6.6V±2%, -Reset PPO	SOT-23	16vdb	VD7	3a	Mic
C66C	CM7P62C-66-T	Vdet-IC	6.6V±2%, +Reset PPO	SOT-23	16vdb	VD7	3a	Can
C66T	CM7P61C-66-T	Vdet-IC	6.6V±2%, +Reset PPO	SOT-23	16vdb	VD7	3a	Can
C67	CM7P611C-67-T	Vdet-IC	6.7V±2%, -Reset PPO	SOT-23	16vdb	VD7	3a	Can
C67	XC61FC2652M	Vdet-IC	2.6V±2%, +Reset PPO, 50ms	SOT-23	16vdb	VD7	3d	Tor
C67	XC61HC2652MR	Vdet-IC	2.6V±2%, -Reset PPO, 1..50ms	SOT-23	16vdc	VD7	3d	Tor
C67B	ML61C672M	Vdet-IC	6.7V±2%, -Reset PPO	SOT-23	16vdb	VD7	3a	Mic
C67C	CM7P62C-67-T	Vdet-IC	6.7V±2%, +Reset PPO	SOT-23	16vdb	VD7	3a	Can
C67T	CM7P61C-67-T	Vdet-IC	6.7V±2%, +Reset PPO	SOT-23	16vdb	VD7	3a	Can
C68	CM7P611C-68-T	Vdet-IC	6.8V±2%, -Reset PPO	SOT-23	16vdb	VD7	3a	Can
C68B	ML61C682M	Vdet-IC	6.8V±2%, -Reset PPO	SOT-23	16vdb	VD7	3a	Mic
C68C	CM7P62C-68-T	Vdet-IC	6.8V±2%, +Reset PPO	SOT-23	16vdb	VD7	3a	Can
C68T	CM7P61C-68-T	Vdet-IC	6.8V±2%, +Reset PPO	SOT-23	16vdb	VD7	3a	Can
C69	CM7P611C-69-T	Vdet-IC	6.9V±2%, -Reset PPO	SOT-23	16vdb	VD7	3a	Can
C69B	ML61C692M	Vdet-IC	6.9V±2%, -Reset PPO	SOT-23	16vdb	VD7	3a	Mic
C69C	CM7P62C-69-T	Vdet-IC	6.9V±2%, +Reset PPO	SOT-23	16vdb	VD7	3a	Can
C69T	CM7P61C-69-T	Vdet-IC	6.9V±2%, +Reset PPO	SOT-23	16vdb	VD7	3a	Can
C6A	ILC5062AIC26X	Vdet-IC	2.6V±1%, -Reset PPO	SOT-323	16vdb	VD7	3a	Imp
C6A	ILC5062AM26X	Vdet-IC	2.6V±1%, -Reset PPO	SOT-23	16vdb	VD7	3a	Imp
C7	2SA811-7	Si-pnp	AF, Hi-beta, 50V, 30mA, 200mW, B=300..600, 100MHz	SOT-23	16ta	-	3a	Nec
C7	2SC5231-7	Si-npn	VHF/UHF, LN, 20V, 70mA, 100mW, B=60..120, 7GHz	SMCP	16ta	-	3a	San
C7	AP130-48TW	LVR-IC	LDO, 4.8V±2%, 300mA	TSOT23-3L	16vj	VR1	3b	Ana
C7	AP130-48W	LVR-IC	LDO, 4.8V±2%, 300mA	SOT-23	16vj	VR1	3b	Ana
C7	APE6812N-G	Vdet-IC	2.25V±2%, +Reset PPO	SOT-23	16vda	VD7	3b	Ape
C7	APE6812U-G	Vdet-IC	2.25V±2%, +Reset PPO	SC-70	16vda	VD7	3b	Ape
C7	AX6904GR	Vdet-IC	2.25V±1.5%, +Reset PPO	SOT-23	16vda	VD7	3b	Axl
C7	ELM9727NBB	Vdet-IC	2.7V±2.5%, +Reset ODO	SOT-23	16vdb	VD6	3d	Elm
C7	ILC50621C27X	Vdet-IC	2.7V±2%, -Reset PPO	SOT-323	16vdb	VD7	3a	Imp
C7	ILC5062M27X	Vdet-IC	2.7V±2%, -Reset PPO	SOT-23	16vdb	VD7	3a	Imp
C7	KN4L4M	Si-pnp-Digi	Sw, 60V, 100mA, 150mW, R1/R2=47k/47k	SOT-416	16ta	-	3a	Nec
C7	MMBA811C7	Si-pnp	AF, LN, 50V, 50mA, 350mW, B=300..600, >75MHz	SOT-23	16ta	-	3a	Sam
C7	R3111N272A	Vdet-IC	2.7V±2%, -Reset PPO	SOT-23	16vdd	VD7	3d	Ric
C7	R3113D371A	Vdet-IC	3.7V±2%, -Reset, ODO	SON1408-3	18vda	VD6	3d	Ric
C7	R3130N37EC	Vdet-IC	3.7V, -Reset ODO, 240ms	SOT-23	16vdc	VD6	3b	Ric
C7	RT9161-165CV	LVR-IC	LDO, 1.6V±2%, 300mA	SOT-23	16cg	VR1	3a	Rct
C7	TC54VC2702ECB	Vdet-IC	2.7V±2%, -Reset PPO	SOT-23	16vdb	VD7	3a	Tcs
C7	XC61CC2702M	Vdet-IC	2.7V±1%, +Reset PPO	SOT-23	16vdb	VD7	3d	Tor
C7	XC6GC2702HR	Vdet-IC	2.7V, +Reset PPO	USP-3	17vdc	VD3	9b	Tor
C70	CM7P611C-70-T	Vdet-IC	7.0V±2%, -Reset PPO	SOT-23	16vdb	VD7	3a	Can
C70B	ML61C702M	Vdet-IC	7.0V±2%, -Reset PPO	SOT-23	16vdb	VD7	3a	Mic
C70C	CM7P62C-70-T	Vdet-IC	7.0V±2%, +Reset PPO	SOT-23	16vdb	VD7	3a	Can
C70T	CM7P61C-70-T	Vdet-IC	7.0V±2%, +Reset PPO	SOT-23	16vdb	VD7	3a	Can
C73	XE61CC2745MR	Vdet-IC	2.7V±2%, -Reset PPO	SOT-23	16vdb	VD7	3h	Tor
C75	XC61FC2712M	Vdet-IC	2.7V±2%, +Reset PPO, 200ms	SOT-23	16vdb	VD7	3d	Tor
C75	XC61HC2712MR	Vdet-IC	2.7V±2%, -Reset PPO, 50..200ms	SOT-23	16vdc	VD7	3d	Tor
C76	XC61FC2742M	Vdet-IC	2.7V±2%, +Reset PPO, 400ms	SOT-23	16vdb	VD7	3d	Tor
C76	XC61HC2742MR	Vdet-IC	2.7V±2%, -Reset PPO, 80..400ms	SOT-23	16vdc	VD7	3d	Tor
C77	XC61FC2752M	Vdet-IC	2.7V±2%, +Reset PPO, 50ms	SOT-23	16vdb	VD7	3d	Tor
C77	XC61HC2752MR	Vdet-IC	2.7V±2%, -Reset PPO, 1..50ms	SOT-23	16vdc	VD7	3d	Tor
C7A	ILC5062AIC27X	Vdet-IC	2.7V±1%, -Reset PPO	SOT-323	16vdb	VD7	3a	Imp
C7A	ILC5062AM27X	Vdet-IC	2.7V±1%, -Reset PPO	SOT-23	16vdb	VD7	3a	Imp
C7H	CMPT5179	Si-npn	VHF, 20V, 500mW, 350mW, B>25, >900MHz	SOT-23	16ta	-	3a	Can
C7p	BCF29	Si-pnp	GP, AF, LN, 32V, 200mA, 200mW, B=120..260, >100MHz	SOT-23	16ta	-	3a	Phi
C8	2SA811-8	Si-pnp	AF, Hi-beta, 50V, 30mA, 200mW, B=450..900, 100MHz	SOT-23	16ta	-	3a	Nec
C8	2SC5231-8	Si-npn	VHF/UHF, LN, 20V, 70mA, 100mW, B=90..180, 7GHz	SMCP	16ta	-	3a	San
C8	AP130-49TW	LVR-IC	LDO, 4.9V±2%, 300mA	TSOT23-3L	16vj	VR1	3b	Ana
C8	AP130-49W	LVR-IC	LDO, 4.9V±2%, 300mA	SOT-23	16vj	VR1	3b	Ana
C8	BCF30	Si-pnp	GP, AF, LN, 32V, 200mA, 200mW, B=215..500, >100MHz	SOT-23	16ta	-	3a	Ste



SMD code	Type	Function	Short description	Case	Pinout	Sch.	St.	Mnf.
C8	BZX84-C2V4	Z-diode	2.2..2.6V, Zzt=100Ω, Izt=20mA, 225mW	SOT-23	16dc	-	3a	Lge
C8	ELM9729NBB	Vdet-IC	2.8V±2.5%, +Reset ODO	SOT-23	16vdb	VD6	3d	Elm
C8	ILC50621C28X	Vdet-IC	2.8V±2%, -Reset PPO	SOT-323	16vdb	VD7	3a	Imp
C8	ILC5062M28X	Vdet-IC	2.8V±2%, -Reset PPO	SOT-23	16vdb	VD7	3a	Imp
C8	KTA2017-8	Si-pnp	AF, LN, 120V, 100mA, 100mW, B=350..700, 100MHz	USM	16ta	-	3a	Kec
C8	MMBA811C8	Si-pnp	AF, LN, 50V, 50mA, 350mW, B=450..900, >75MHz	SOT-23	16ta	-	3a	Sam
C8	R3111N282A	Vdet-IC	2.8V±2%, -Reset PPO	SOT-23	16vdd	VD7	3d	Ric
C8	R3113D381A	Vdet-IC	3.8V±2%, -Reset, ODO	SON1408-3	18vda	VD6	3d	Ric
C8	R3130N38EC	Vdet-IC	3.8V, -Reset ODO, 240ms	SOT-23	16vdc	VD6	3b	Ric
C8	TC54VC2802ECB	Vdet-IC	2.8V±2%, -Reset PPO	SOT-23	16vdb	VD7	3a	Tcs
C8	XC61CC2802M	Vdet-IC	2.8V±1%, +Reset PPO	SOT-23	16vdb	VD7	3d	Tor
C8	XC6GC2802HR	Vdet-IC	2.8V, +Reset PPO	USP-3	17vdc	VD3	9b	Tor
C8-	RT9161A-18PV	LVR-IC	LDO, 1.7V±2%, 500mA	SOT-23	16cg	VR1	3a	Rct
C809J	CYT809J	Vdet-IC	4.0V±1.5%, -Reset PPO	SOT-23	16vdc	VD7	3b	Cyt
C809L	CYT809L	Vdet-IC	4.63V±1.5%, -Reset PPO	SOT-23	16vdc	VD7	3b	Cyt
C809M	CYT809M	Vdet-IC	4.38V±1.5%, -Reset PPO	SOT-23	16vdc	VD7	3b	Cyt
C809R	CYT809R	Vdet-IC	2.93V±1.5%, -Reset PPO	SOT-23	16vdc	VD7	3b	Cyt
C809S	CYT809S	Vdet-IC	2.63V±1.5%, -Reset PPO	SOT-23	16vdc	VD7	3b	Cyt
C809T	CYT809T	Vdet-IC	3.08V±1.5%, -Reset PPO	SOT-23	16vdc	VD7	3b	Cyt
C83	XE61CC2845MR	Vdet-IC	2.8V±2%, -Reset PPO	SOT-23	16vdb	VD7	3h	Tor
C85	XC61FC2812M	Vdet-IC	2.8V±2%, +Reset PPO, 200ms	SOT-23	16vdb	VD7	3d	Tor
C85	XC61HC2812MR	Vdet-IC	2.8V±2%, -Reset PPO, 50..200ms	SOT-23	16vdc	VD7	3d	Tor
C86	XC61FC2842M	Vdet-IC	2.8V±2%, +Reset PPO, 400ms	SOT-23	16vdb	VD7	3d	Tor
C86	XC61HC2842MR	Vdet-IC	2.8V±2%, -Reset PPO, 80..400ms	SOT-23	16vdc	VD7	3d	Tor
C87	XC61FC2852M	Vdet-IC	2.8V±2%, +Reset PPO, 50ms	SOT-23	16vdb	VD7	3d	Tor
C87	XC61HC2852MR	Vdet-IC	2.8V±2%, -Reset PPO, 1..50ms	SOT-23	16vdc	VD7	3d	Tor
C8A	CMPZ5226B	Z-diode	3.3V±2.5%, Izt=20mA, Zzt=28Ω, 350mW	SOT-23	16dc	-	3a	Cen
C8A	ILC5062AIC28X	Vdet-IC	2.8V±1%, -Reset PPO	SOT-323	16vdb	VD7	3a	Imp
C8A	ILC5062AM28X	Vdet-IC	2.8V±1%, -Reset PPO	SOT-23	16vdb	VD7	3a	Imp
C8B	CMPZ5227B	Z-diode	3.6V±2.5%, Izt=20mA, Zzt=24Ω, 350mW	SOT-23	16dc	-	3a	Cen
C8C	CMPZ5228B	Z-diode	3.9V±2.5%, Izt=20mA, Zzt=23Ω, 350mW	SOT-23	16dc	-	3a	Cen
C8D	CMPZ5229B	Z-diode	4.3V±2.5%, Izt=20mA, Zzt=22Ω, 350mW	SOT-23	16dc	-	3a	Cen
C8E	CMPZ5230B	Z-diode	4.7V±2.5%, Izt=20mA, Zzt=19Ω, 350mW	SOT-23	16dc	-	3a	Cen
C8F	CMPZ5231B	Z-diode	5.1V±2.5%, Izt=20mA, Zzt=17Ω, 350mW	SOT-23	16dc	-	3a	Cen
C8G	CMPZ5232B	Z-diode	5.6V±2.5%, Izt=20mA, Zzt=11Ω, 350mW	SOT-23	16dc	-	3a	Cen
C8H	CMPZ5233B	Z-diode	6.0V±2.5%, Izt=20mA, Zzt=7Ω, 350mW	SOT-23	16dc	-	3a	Cen
C8J	CMPZ5234B	Z-diode	6.2V±2.5%, Izt=20mA, Zzt=7Ω, 350mW	SOT-23	16dc	-	3a	Cen
C8K	CMPZ5235B	Z-diode	6.8V±2.5%, Izt=20mA, Zzt=5Ω, 350mW	SOT-23	16dc	-	3a	Cen
C8L	CMPZ5236B	Z-diode	7.5V±2.5%, Izt=20mA, Zzt=6Ω, 350mW	SOT-23	16dc	-	3a	Cen
C8M	CMPZ5237B	Z-diode	8.2V±2.5%, Izt=20mA, Zzt=8Ω, 350mW	SOT-23	16dc	-	3a	Cen
C8N	CMPZ5238B	Z-diode	8.7V±2.5%, Izt=20mA, Zzt=8Ω, 350mW	SOT-23	16dc	-	3a	Cen
C8p	BCF30	Si-pnp	GP, AF, LN, 32V, 200mA, 200mW, B=215..500, >100MHz	SOT-23	16ta	-	3a	Phi
C8P	CMPZ5239B	Z-diode	9.1V±2.5%, Izt=20mA, Zzt=10Ω, 350mW	SOT-23	16dc	-	3a	Cen
C8Q	CMPZ5240B	Z-diode	10V±2.5%, Izt=20mA, Zzt=17Ω, 350mW	SOT-23	16dc	-	3a	Cen
C8R	CMPZ5241B	Z-diode	11V±2.5%, Izt=20mA, Zzt=12Ω, 350mW	SOT-23	16dc	-	3a	Cen
C8S	CMPZ5242B	Z-diode	12V±2.5%, Izt=20mA, Zzt=30Ω, 350mW	SOT-23	16dc	-	3a	Cen
C8T	CMPZ5243B	Z-diode	13V±2.5%, Izt=9.5mA, Zzt=13Ω, 350mW	SOT-23	16dc	-	3a	Cen
C8U	CMPZ5244B	Z-diode	14V±2.5%, Izt=9.0mA, Zzt=15Ω, 350mW	SOT-23	16dc	-	3a	Cen
C8V	CMPZ5245B	Z-diode	15V±2.5%, Izt=8.5mA, Zzt=16Ω, 350mW	SOT-23	16dc	-	3a	Cen
C8W	CMPZ5246B	Z-diode	16V±2.5%, Izt=7.8mA, Zzt=17Ω, 350mW	SOT-23	16dc	-	3a	Cen
C8X	CMPZ5247B	Z-diode	17V±2.5%, Izt=7.4mA, Zzt=19Ω, 350mW	SOT-23	16dc	-	3a	Cen
C8Y	CMPZ5248B	Z-diode	18V±2.5%, Izt=7.0mA, Zzt=21Ω, 350mW	SOT-23	16dc	-	3a	Cen
C8Z	CMPZ5249B	Z-diode	19V±2.5%, Izt=6.6mA, Zzt=23Ω, 350mW	SOT-23	16dc	-	3a	Cen
C9	1S307	Si-diode	Rectifier, 35V, 100mA, Vf<1.3V(100mA), <6pF	SOT-23	16dr	-	3a	Tos
C9	2SC5231-9	Si-npn	VHF/UHF, LN, 20V, 70mA, 100mW, B=135..270, 7GHz	SMCP	16ta	-	3a	San
C9	AP130-50TWT	LVR-IC	LDO, 5.0V±2%, 300mA	TSOT23-3L	16vj	VR1	3b	Ana
C9	AP130-50W	LVR-IC	LDO, 5.0V±2%, 300mA	SOT-23	16vj	VR1	3b	Ana
C9	BZX84-C11	Z-diode	10.4..11.6V, Zzt=20Ω, Izt=20mA, 225mW	SOT-23	16dc	-	3a	Lge
C9	ELM9729NBB	Vdet-IC	2.9V±2.5%, +Reset ODO	SOT-23	16vdb	VD6	3d	Elm
C9	ILC50621C29X	Vdet-IC	2.9V±2%, -Reset PPO	SOT-323	16vdb	VD7	3a	Imp
C9	ILC5062M29X	Vdet-IC	2.9V±2%, -Reset PPO	SOT-23	16vdb	VD7	3a	Imp
C9	R3111N292A	Vdet-IC	2.9V±2%, -Reset PPO	SOT-23	16vdd	VD7	3d	Ric
C9	R3113D391A	Vdet-IC	3.9V±2%, -Reset, ODO	SON1408-3	18vda	VD6	3d	Ric
C9	R3130N39EC	Vdet-IC	3.9V, -Reset ODO, 240ms	SOT-23	16vdc	VD6	3b	Ric
C9	TC54VC2902ECB	Vdet-IC	2.9V±2%, -Reset PPO	SOT-23	16vdb	VD7	3a	Tcs
C9	XC61CC2902M	Vdet-IC	2.9V±1%, +Reset PPO	SOT-23	16vdb	VD7	3d	Tor
C9	XC6GC2902HR	Vdet-IC	2.9V, +Reset PPO	USP-3	17vdc	VD3	9b	Tor
C91	SST4391	n-FET	Sw, Chopper, 40V, Idss=50mA, 350mW, Up<10V	SOT-23	16fa	-	3a	Lns
C92	SST4392	n-FET	Sw, Chopper, 40V, Idss=25mA, 350mW, Up<5V	SOT-23	16fa	-	3a	Lns
C93	SST4393	n-FET	Sw, Chopper, 40V, Idss=5mA, 350mW, Up<3V	SOT-23	16fa	-	3a	Lns



SMD code	Type	Function	Short description	Case	Pinout	Sch.	St.	Mnf.
C93	XE61CC2945MR	Vdet-IC	2.9V±2%, -Reset PPO	SOT-23	16vdb	VD7	3h	Tor
C95	XC61FC2912M	Vdet-IC	2.9V±2%, +Reset PPO, 200ms	SOT-23	16vdb	VD7	3d	Tor
C95	XC61HC2912MR	Vdet-IC	2.9V±2%, -Reset PPO, 50..200ms	SOT-23	16vdc	VD7	3d	Tor
C96	XC61FC2942M	Vdet-IC	2.9V±2%, +Reset PPO, 400ms	SOT-23	16vdb	VD7	3d	Tor
C96	XC61HC2942MR	Vdet-IC	2.9V±2%, -Reset PPO, 80..400ms	SOT-23	16vdc	VD7	3d	Tor
C97	XC61FC2952M	Vdet-IC	2.9V±2%, +Reset PPO, 50ms	SOT-23	16vdb	VD7	3d	Tor
C97	XC61HC2952MR	Vdet-IC	2.9V±2%, -Reset PPO, 1..50ms	SOT-23	16vdc	VD7	3d	Tor
C9A	ILC5062AIC29X	Vdet-IC	2.9V±1%, -Reset PPO	SOT-323	16vdb	VD7	3a	Imp
C9A	ILC5062AM29X	Vdet-IC	2.9V±1%, -Reset PPO	SOT-23	16vdb	VD7	3a	Imp
CA	2SA1866	Si-pnp-Digi	Mute, Drv, 15V, 50mA, 150mW, 600MHz, R1/R2=47k/47k	SMCP	16ta	-	3a	San
CA	AP130-15TW	LVR-IC	LDO, 1.5V±2%, 300mA	TSOT23-3L	16vj	VR1	3b	Ana
CA	AP130-15W	LVR-IC	LDO, 1.5V±2%, 300mA	SOT-23	16vj	VR1	3b	Ana
CA	AX6901AR	Vdet-IC	4.63V±1.5%, -Reset PPO	SOT-23	16vdc	VD7	3b	Axl
CA	BB510	C-diode	Dual, AM-Tuning, 10V, 440..600pF(1.9V)	SOT-23	16cz	-	3a	lft
CA	BCW61AR	Si-pnp	AF, 32V, 200mA, 330mW, B=120..220, >180MHz	SOT-23	16te	-	3a	Zx
CA	BFS18	Si-npn	HF, 30V, 30mA, 200MHz	SOT-23	16ta	-	3a	Sie
CA	FP6809-40NS3P	Vdet-IC	4.0V±1.5%, -Reset ODO	SOT-23	16vdc	VD6	3a	Fit
CA	GS6332UR19D3	Vdet-IC	1.9V, +Reset PPO, 150ms	SOT-23	16vdc	VD7	3g	Vs
CA	KRC451	Si-npn-Digi	Dual, Sw, 12V, 500mA, 100mW, R1/R2=1k/1k	USM	16ta	-	3f	Kec
CA	MMBZ4691	Z-diode	6.2V±5%, 350mW	SOT-23	16dc	-	3g	Vs
CA	MMBZ5257B	Z-diode	31.35..34.65V, Izt=3.8mA, Zzt=58Ω, 350mW	SOT-23	16dc	-	3a	Lge
CA	RN1444A	Si-npn-Digi	Mute, 50V, 300mA, 300mW, R1=5k2, B=200..700	SOT-346	16ta	-	3a	Tos
CA	RT9809-27CVL	Vdet-IC	2.7V±2%, -Reset PPO	SOT-23	16vdc	VD7	3a	Rct
CA	SiP6332R19D3	Vdet-IC	1.9V±1.5%, -Reset PPO 150ms	SOT-23	16vdc	VD7	3g	Vs
CA	SST4391	n-FET	Sw, Chopper, 40V, Idss=50mA, 350mW, Up<10V	SOT-23	16fa	-	3a	Six
CA	TS3809CXA	Vdet-IC	4.63V±1.5%, -Reset PPO	SOT-23	16vdc	VD7	3b	Tsc
CA	XC62RP2002M	LVR-IC	LDO, 2V±2%, 6mA, 150mW	SOT-23	16cg	VR1	3d	Tor
CA-	RT9809-27PVL	Vdet-IC	2.7V±2%, -Reset PPO	SOT-23	16vdc	VD7	3a	Rct
CA	APE6809N-A	Vdet-IC	4.63V±2%, -Reset PPO	SOT-23	16vdc	VD7	3b	Ape
Ca	APE6809N-H	Vdet-IC	2.70V±2%, -Reset PPO	SOT-23	16vdc	VD7	3b	Ape
CA	APE6809U-A	Vdet-IC	4.63V±2%, -Reset PPO	SC-70	16vdc	VD7	3b	Ape
Ca	APE6809U-H	Vdet-IC	2.25V±2%, -Reset PPO	SC-70	16vdc	VD7	3b	Ape
CA2	MMBD4448	Si-diode	Sw, Fast, 80V, 500mA, Vf<1V(100mA), <4ns	SOT-23	16dc	-	3g	Tlr
CAA	AME8550AEETA330L	Vdet-IC	3.3V±2%, -Reset PPO	SOT-23	16vdb	VD7	3b	Ame
CAA	AME8550AEETA330Z	Vdet-IC	3.3V±2%, -Reset PPO	SOT-23	16vdb	VD7	3b	Ame
CAG	2SA1980SF-G	Si-pnp	GP, 50V, 150mA, 200mW, B=200..400, 80MHz	SOT-23F	18ta	-	3a	Auk
CAG	2SA1980S-G	Si-pnp	GP, 50V, 150mA, 200mW, B=200..400, 80MHz	SOT-23	16ta	-	3a	Auk
CAL	2SA1980SF-L	Si-pnp	GP, 50V, 150mA, 200mW, B=300..700, 80MHz	SOT-23F	18ta	-	3a	Auk
CAL	2SA1980S-L	Si-pnp	GP, 50V, 150mA, 200mW, B=300..700, 80MHz	SOT-23	16ta	-	3a	Auk
CAO	2SA1980SF-O	Si-pnp	GP, 50V, 150mA, 200mW, B=70..140, 80MHz	SOT-23F	18ta	-	3a	Auk
CAO	2SA1980S-O	Si-pnp	GP, 50V, 150mA, 200mW, B=70..140, 80MHz	SOT-23	16ta	-	3a	Auk
CAR	AME8570BEETBF30L	Vdet-IC	3.0V±1.5%, -Reset ODO, lead free	SOT-23	16vdb	VD6	3b	Ame
CAR	AME8570BEETBF30Z	Vdet-IC	3.0V±1.5%, -Reset ODO	SOT-23	16vdb	VD6	3b	Ame
CAY	2SA1980SF-Y	Si-pnp	GP, 50V, 150mA, 200mW, B=120..240, 80MHz	SOT-23F	18ta	-	3a	Auk
CAY	2SA1980S-Y	Si-pnp	GP, 50V, 150mA, 200mW, B=120..240, 80MHz	SOT-23	16ta	-	3a	Auk
CB	2SC4997	Si-npn	HF/Sw, Hi-beta, 15V, 100mA, 150mW, B=560..2700, 240MHz	SOT-416	16ta	-	3a	Rhm
CB	2SC4998	Si-npn	HF/Sw, Hi-beta, 15V, 100mA, 200mW, B=560..2700, 240MHz	UMT3	16ta	-	3a	Rhm
CB	AP130-16TW	LVR-IC	LDO, 1.6V±2%, 300mA	TSOT23-3L	16vj	VR1	3b	Ana
CB	AP130-16W	LVR-IC	LDO, 1.6V±2%, 300mA	SOT-23	16vj	VR1	3b	Ana
CB	AX6901BR	Vdet-IC	4.38V±1.5%, -Reset PPO	SOT-23	16vdc	VD7	3b	Axl
CB	BCW61BR	Si-pnp	AF, 32V, 200mA, 330mW, B=180..310, >180MHz	SOT-23	16te	-	3a	Zx
CB	BFS19	Si-npn	RF, 30V, 30mA, 250mW, B=65..225, 260MHz	SOT-23	16ta	-	3a	Sie
CB	FP6809-44NS3P	Vdet-IC	4.38V±1.5%, -Reset ODO	SOT-23	16vdc	VD6	3a	Fit
CB	GS6332UR20D1	Vdet-IC	2V, +Reset PPO, 30ms	SOT-23	16vdc	VD7	3g	Vs
CB	KRC452	Si-npn-Digi	Dual, Sw, 12V, 500mA, 100mW, R1/R2=2.2k/2.2k	USM	16ta	-	3f	Kec
CB	MMBZ5258B	Z-diode	34.20..37.80V, Izt=3.4mA, Zzt=70Ω, 350mW	SOT-23	16dc	-	3a	Lge
CB	RN1444B	Si-npn-Digi	Mute, 50V, 300mA, 300mW, R1=5k2, B=350..1200	SOT-346	16ta	-	3a	Tos
CB	RT9169-15CVL	LVR-IC	LDO, 1.5V±2%, 100mA	SOT-23	16cg	VR1	3a	Rct
CB	SiP6332R20D1	Vdet-IC	2V±1.5%, -Reset PPO 1.5ms	SOT-23	16vdc	VD7	3g	Vs
CB	SST4392	n-FET	Sw, Chopper, 40V, Idss=25mA, 350mW, Up<5V	SOT-23	16fa	-	3a	Six
CB	TS3809CXB	Vdet-IC	4.38V±1.5%, -Reset PPO	SOT-23	16vdc	VD7	3b	Tsc
CB	XC62RP2102M	LVR-IC	LDO, 2.1V±2%, 6mA, 150mW	SOT-23	16cg	VR1	3d	Tor
CB-	RT9169-15PVL	LVR-IC	LDO, 1.5V±2%, 100mA	SOT-23	16cg	VR1	3a	Rct
CB	APE6809N-B	Vdet-IC	4.38V±2%, -Reset PPO	SOT-23	16vdc	VD7	3b	Ape
Cb	APE6809N-I	Vdet-IC	4.25V±2%, -Reset PPO	SOT-23	16vdc	VD7	3b	Ape
CB	APE6809U-B	Vdet-IC	4.38V±2%, -Reset PPO	SC-70	16vdc	VD7	3b	Ape
Cb	APE6809U-I	Vdet-IC	4.25V±2%, -Reset PPO	SC-70	16vdc	VD7	3b	Ape
CBG	2SC3324-GR	Si-npn	AF, LN, 120V, 100mA, 150mW, B=200..400, 100MHz	SC-59	16ta	-	3a	Tos
CBL	2SC3324-BL	Si-npn	AF, LN, 120V, 100mA, 150mW, B=350..700, 100MHz	SC-59	16ta	-	3a	Tos
CC	2SA1122-C	Si-pnp	GP, AF, 55V, 100mA, 150mW, B=160..320	SOT-23	16ta	-	3a	Ren



SMD code	Type	Function	Short description	Case	Pinout	Sch. St.	Mnf.
CC	AP130-17TW	LVR-IC	LDO, 1.7V±2%, 300mA	TSOT23-3L	16vj	VR1	3b Ana
CC	AP130-17W	LVR-IC	LDO, 1.7V±2%, 300mA	SOT-23	16vj	VR1	3b Ana
CC	AX6901CR	Vdet-IC	4.0V±1.5%, -Reset PPO	SOT-23	16vdc	VD7	3b Axl
CC	BCW61CR	Si-npn	AF, 32V, 200mA, 330mW, B=250..460, >180MHz	SOT-23	16te	-	3a Zx
CC	BF554	Si-npn	AF, 20V, 30mA, 280mW, B=60..280, >250MHz	SOT-23	16ta	-	3a Sie
CC	FP6809-46NS3P	Vdet-IC	4.63V±1.5%, -Reset ODO	SOT-23	16vdc	VD7	3a Fit
CC	GS6332UR20D2	Vdet-IC	2V, +Reset PPO, 30ms	SOT-23	16vdc	VD7	3g Vs
CC	KRC453	Si-npn-Digi	Dual, Sw, 12V, 500mA, 100mW, R1/R2=4.7k/4.7k	USM	16ta	-	3f Kec
CC	MMBZ5259B	Z-diode	37.05..40.95V, Izt=3.2mA, Zzt=80Ω, 350mW	SOT-23	16dc	-	3a Lge
CC	RT9169-21CVL	LVR-IC	LDO, 2.1V±2%, 100mA	SOT-23	16cg	VR1	3a Rct
CC	SiP6332R20D2	Vdet-IC	2V±1.5%, -Reset PPO 30ms	SOT-23	16vdc	VD7	3g Vs
CC	SST4393	n-FET	Sw, Chopper, 40V, Idss=5mA, 350mW, Up<3V	SOT-23	16fa	-	3a Six
CC	TS3809CXC	Vdet-IC	4.0V±1.5%, -Reset PPO	SOT-23	16vdc	VD7	3b Tsc
CC	XC62RP2202M	LVR-IC	LDO, 2.2V±2%, 6mA, 150mW	SOT-23	16cg	VR1	3d Tor
CC	ZMDC831BTA	C-diode	Dual, VHF/UHF-Tuning, 25V, 330mW, 15pF(2V), ΔC ±5%	SOT-23	16dg	-	3a Zx
CC	APE6809N-C	Vdet-IC	4.00V±2%, -Reset PPO	SOT-23	16vdc	VD7	3b Ape
CC	APE6809U-C	Vdet-IC	4.00V±2%, -Reset PPO	SC-70	16vdc	VD7	3b Ape
CC10	CMPZDC27V	Z-diode	Dual, 27V±5%, 350mW	SOT-23	16dg	-	3a Cen
CC11	CMPZDC30V	Z-diode	Dual, 30V±5%, 350mW	SOT-23	16dg	-	3a Cen
CC12	CMPZDC33V	Z-diode	Dual, 33V±5%, 350mW	SOT-23	16dg	-	3a Cen
CC13	CMPZDC36V	Z-diode	Dual, 36V±5%, 350mW	SOT-23	16dg	-	3a Cen
CC14	CMPZDC39V	Z-diode	Dual, 39V±5%, 350mW	SOT-23	16dg	-	3a Cen
CC15	CMPZDC43V	Z-diode	Dual, 43V±5%, 350mW	SOT-23	16dg	-	3a Cen
CC16	CMPZDC47V	Z-diode	Dual, 47V±5%, 350mW	SOT-23	16dg	-	3a Cen
CCA	2SC3326A	Si-npn	Muting, Sw, 50V, 300mA, 150mW, B=200..700, 30MHz	SC-59	16ta	-	3a Tos
CCB	2SC3326B	Si-npn	Muting, Sw, 50V, 300mA, 150mW, B=350..1200, 30MHz	SC-59	16ta	-	3a Tos
CCW3	CMPZDC2V4	Z-diode	Dual, 2.4V±5%, 350mW	SOT-23	16dg	-	3a Cen
CCW4	CMPZDC2V7	Z-diode	Dual, 2.7V±5%, 350mW	SOT-23	16dg	-	3a Cen
CCW5	CMPZDC3V0	Z-diode	Dual, 3.0V±5%, 350mW	SOT-23	16dg	-	3a Cen
CCW6	CMPZDC3V3	Z-diode	Dual, 3.3V±5%, 350mW	SOT-23	16dg	-	3a Cen
CCW7	CMPZDC3V6	Z-diode	Dual, 3.6V±5%, 350mW	SOT-23	16dg	-	3a Cen
CCW8	CMPZDC3V9	Z-diode	Dual, 3.9V±5%, 350mW	SOT-23	16dg	-	3a Cen
CCW9	CMPZDC4V3	Z-diode	Dual, 4.3V±5%, 350mW	SOT-23	16dg	-	3a Cen
CCY1	CMPZDC11V	Z-diode	Dual, 11V±5%, 350mW	SOT-23	16dg	-	3a Cen
CCY2	CMPZDC12V	Z-diode	Dual, 12V±5%, 350mW	SOT-23	16dg	-	3a Cen
CCY3	CMPZDC13V	Z-diode	Dual, 13V±5%, 350mW	SOT-23	16dg	-	3a Cen
CCY4	CMPZDC15V	Z-diode	Dual, 15V±5%, 350mW	SOT-23	16dg	-	3a Cen
CCY5	CMPZDC16V	Z-diode	Dual, 16V±5%, 350mW	SOT-23	16dg	-	3a Cen
CCY6	CMPZDC18V	Z-diode	Dual, 18V±5%, 350mW	SOT-23	16dg	-	3a Cen
CCY7	CMPZDC20V	Z-diode	Dual, 20V±5%, 350mW	SOT-23	16dg	-	3a Cen
CCY8	CMPZDC22V	Z-diode	Dual, 22V±5%, 350mW	SOT-23	16dg	-	3a Cen
CCY9	CMPZDC24V	Z-diode	Dual, 24V±5%, 350mW	SOT-23	16dg	-	3a Cen
CCZ1	CMPZDC4V7	Z-diode	Dual, 4.7V±5%, 350mW	SOT-23	16dg	-	3a Cen
CCZ2	CMPZDC5V1	Z-diode	Dual, 5.1V±5%, 350mW	SOT-23	16dg	-	3a Cen
CCZ3	CMPZDC5V6	Z-diode	Dual, 5.6V±5%, 350mW	SOT-23	16dg	-	3a Cen
CCZ4	CMPZDC6V2	Z-diode	Dual, 6.2V±5%, 350mW	SOT-23	16dg	-	3a Cen
CCZ5	CMPZDC6V8	Z-diode	Dual, 6.8V±5%, 350mW	SOT-23	16dg	-	3a Cen
CCZ6	CMPZDC7V5	Z-diode	Dual, 7.5V±5%, 350mW	SOT-23	16dg	-	3a Cen
CCZ7	CMPZDC8V2	Z-diode	Dual, 8.2V±5%, 350mW	SOT-23	16dg	-	3a Cen
CCZ8	CMPZDC9V1	Z-diode	Dual, 9.1V±5%, 350mW	SOT-23	16dg	-	3a Cen
CCZ9	CMPZDC10V	Z-diode	Dual, 10V±5%, 350mW	SOT-23	16dg	-	3a Cen
CD	15C02CH	Si-npn	AF, GP, 20V, 1A, 700mW, B=300..600, 440MHz	CPH3	16ta	-	3a San
CD	2SA1122-D	Si-npn	GP, AF, 55V, 100mA, 150mW, B=250..500	SOT-23	16ta	-	3a Ren
CD	2SA1366-D	Si-npn	Relay-Drv, 55V, 400mA, 150mW, B=90..180, 150MHz	SOT-23	16ta	-	3a Mit
CD	AP130-18TW	LVR-IC	LDO, 1.8V±2%, 300mA	TSOT23-3L	16vj	VR1	3b Ana
CD	AP130-18W	LVR-IC	LDO, 1.8V±2%, 300mA	SOT-23	16vj	VR1	3b Ana
CD	AX6901DR	Vdet-IC	3.08V±1.5%, -Reset PPO	SOT-23	16vdc	VD7	3b Axl
CD	BCW61DR	Si-npn	AF, 32V, 200mA, 330mW, B=380..630, >180MHz	SOT-23	16te	-	3a Zx
CD	FP6809-23CS3P	Vdet-IC	2.32V±1.5%, -Reset PPO	SOT-23	16vdc	VD7	3a Fit
CD	GS6332UR20D3	Vdet-IC	2V, +Reset PPO, 150ms	SOT-23	16vdc	VD7	3g Vs
CD	KRC454	Si-npn-Digi	Dual, Sw, 12V, 500mA, 100mW, R1/R2=10k/10k	USM	16ta	-	3f Kec
CD	MMBZ5260B	Z-diode	40.85..45.15V, Izt=3.0mA, Zzt=93Ω, 350mW	SOT-23	16dc	-	3a Lge
CD	RT9169-33CVL	LVR-IC	LDO, 3.3V±2%, 100mA	SOT-23	16cg	VR1	3a Rct
CD	SiP6332R20D3	Vdet-IC	2V±1.5%, -Reset PPO 150ms	SOT-23	16vdc	VD7	3g Vs
CD	TS3809CXD	Vdet-IC	3.08V±1.5%, -Reset PPO	SOT-23	16vdc	VD7	3b Tsc
CD	UNR31A0	Si-npn-Digi	Sw, 50V, 80mA, 100mW, 80MHz, R1=47k	SSSMini3	18ta	-	3a Pan
CD	XC62RP2302M	LVR-IC	LDO, 2.3V±2%, 6mA, 150mW	SOT-23	16cg	VR1	3d Tor
CD	ZMDC832BTA	C-diode	Dual, VHF/UHF-Tuning, 25V, 330mW, 22pF(2V), ΔC ±5%	SOT-23	16dg	-	3a Zx
CD-	RT9169-33PVL	LVR-IC	LDO, 3.3V±2%, 100mA	SOT-23	16cg	VR1	3a Rct
CD	APE6809N-D	Vdet-IC	3.08V±2%, -Reset PPO	SOT-23	16vdc	VD7	3b Ape



SMD code	Type	Function	Short description	Case	Pinout	Sch.	St.	Mnf.
CD	APE6809U-D	Vdet-IC	3.08V±2%, -Reset PPO	SC-70	16vdc	VD7	3b	Ape
Cd	APE6810N-H	Vdet-IC	2.25V±2%, +Reset PPO	SOT-23	16vdc	VD7	3b	Ape
Cd	APE6810U-H	Vdet-IC	2.25V±2%, +Reset PPO	SC-70	16vdc	VD7	3b	Ape
CD18	AIC1734-18CU	LVR-IC	LDO, 1.8V±1%, 300mA	SOT-23	16cg	VR1	3a	Aic
CD18G	AIC1734-18GU	LVR-IC	LDO, 1.8V±1%, 300mA	SOT-23	16cg	VR1	3a	Aic
CD18P	AIC1734-18PU	LVR-IC	LDO, 1.8V±1%, 300mA	SOT-23	16cg	VR1	3a	Aic
CD18P	SS6734-18GU	LVR-IC	LDO, 1.8V±2%, 500mA	SOT-23	16cg	VR1	3a	Ssc
CD20	AIC1734-20CU	LVR-IC	LDO, 2.0V±1%, 300mA	SOT-23	16cg	VR1	3a	Aic
CD20G	AIC1734-20GU	LVR-IC	LDO, 2.0V±1%, 300mA	SOT-23	16cg	VR1	3a	Aic
CD20P	AIC1734-20PU	LVR-IC	LDO, 2.0V±1%, 300mA	SOT-23	16cg	VR1	3a	Aic
CD20P	SS6734-20GU	LVR-IC	LDO, 2.0V±2%, 500mA	SOT-23	16cg	VR1	3a	Ssc
CD25	AIC1734-25CU	LVR-IC	LDO, 2.5V±1%, 300mA	SOT-23	16cg	VR1	3a	Aic
CD25G	AIC1734-25GU	LVR-IC	LDO, 2.5V±1%, 300mA	SOT-23	16cg	VR1	3a	Aic
CD25P	AIC1734-25PU	LVR-IC	LDO, 2.5V±1%, 300mA	SOT-23	16cg	VR1	3a	Aic
CD25P	SS6734-25GU	LVR-IC	LDO, 2.5V±2%, 500mA	SOT-23	16cg	VR1	3a	Ssc
CD27	AIC1734-27CU	LVR-IC	LDO, 2.7V±1%, 300mA	SOT-23	16cg	VR1	3a	Aic
CD27G	AIC1734-27GU	LVR-IC	LDO, 2.7V±1%, 300mA	SOT-23	16cg	VR1	3a	Aic
CD27P	AIC1734-27PU	LVR-IC	LDO, 2.7V±1%, 300mA	SOT-23	16cg	VR1	3a	Aic
CD27P	SS6734-27GU	LVR-IC	LDO, 2.7V±2%, 500mA	SOT-23	16cg	VR1	3a	Ssc
CD30	AIC1734-30CU	LVR-IC	LDO, 3.0V±1%, 300mA	SOT-23	16cg	VR1	3a	Aic
CD30G	AIC1734-30GU	LVR-IC	LDO, 3.0V±1%, 300mA	SOT-23	16cg	VR1	3a	Aic
CD30P	AIC1734-30PU	LVR-IC	LDO, 3.0V±1%, 300mA	SOT-23	16cg	VR1	3a	Aic
CD30P	SS6734-30GU	LVR-IC	LDO, 3.0V±2%, 500mA	SOT-23	16cg	VR1	3a	Ssc
CD33	AIC1734-33CU	LVR-IC	LDO, 3.3V±1%, 300mA	SOT-23	16cg	VR1	3a	Aic
CD33G	AIC1734-33GU	LVR-IC	LDO, 3.3V±1%, 300mA	SOT-23	16cg	VR1	3a	Aic
CD33P	AIC1734-33PU	LVR-IC	LDO, 3.3V±1%, 300mA	SOT-23	16cg	VR1	3a	Aic
CD33P	SS6734-33GU	LVR-IC	LDO, 3.3V±2%, 500mA	SOT-23	16cg	VR1	3a	Ssc
CD35	AIC1734-35CU	LVR-IC	LDO, 3.5V±1%, 300mA	SOT-23	16cg	VR1	3a	Aic
CD35G	AIC1734-35GU	LVR-IC	LDO, 3.5V±1%, 300mA	SOT-23	16cg	VR1	3a	Aic
CD35P	AIC1734-35PU	LVR-IC	LDO, 3.5V±1%, 300mA	SOT-23	16cg	VR1	3a	Aic
CD35P	SS6734-35GU	LVR-IC	LDO, 3.5V±2%, 500mA	SOT-23	16cg	VR1	3a	Ssc
CD37	AIC1734-37CU	LVR-IC	LDO, 3.7V±1%, 300mA	SOT-23	16cg	VR1	3a	Aic
CD37G	AIC1734-37GU	LVR-IC	LDO, 3.7V±1%, 300mA	SOT-23	16cg	VR1	3a	Aic
CD37P	AIC1734-37PU	LVR-IC	LDO, 3.7V±1%, 300mA	SOT-23	16cg	VR1	3a	Aic
CD37P	SS6734-37GU	LVR-IC	LDO, 3.7V±2%, 500mA	SOT-23	16cg	VR1	3a	Ssc
CD38	AIC1734-38CU	LVR-IC	LDO, 3.8V±1%, 300mA	SOT-23	16cg	VR1	3a	Aic
CD38G	AIC1734-38GU	LVR-IC	LDO, 3.8V±1%, 300mA	SOT-23	16cg	VR1	3a	Aic
CD38P	AIC1734-38PU	LVR-IC	LDO, 3.8V±1%, 300mA	SOT-23	16cg	VR1	3a	Aic
CD38P	SS6734-38GU	LVR-IC	LDO, 3.8V±2%, 500mA	SOT-23	16cg	VR1	3a	Ssc
CD50	AIC1734-50CU	LVR-IC	LDO, 5.0V±1%, 300mA	SOT-23	16cg	VR1	3a	Aic
CD50G	AIC1734-50GU	LVR-IC	LDO, 5.0V±1%, 300mA	SOT-23	16cg	VR1	3a	Aic
CD50P	AIC1734-50PU	LVR-IC	LDO, 5.0V±1%, 300mA	SOT-23	16cg	VR1	3a	Aic
CD50P	SS6734-50GU	LVR-IC	LDO, 5.0V±2%, 500mA	SOT-23	16cg	VR1	3a	Ssc
CD52	AIC1734-52CU	LVR-IC	LDO, 5.2V±1%, 300mA	SOT-23	16cg	VR1	3a	Aic
CD52G	AIC1734-52GU	LVR-IC	LDO, 5.2V±1%, 300mA	SOT-23	16cg	VR1	3a	Aic
CD52P	AIC1734-52PU	LVR-IC	LDO, 5.2V±1%, 300mA	SOT-23	16cg	VR1	3a	Aic
CD52P	SS6734-52GU	LVR-IC	LDO, 5.2V±2%, 500mA	SOT-23	16cg	VR1	3a	Ssc
CDs	BSS81B	Si-npn	Sw, 75V, 800mA, 330mW, B=40..120, 250MHz	SOT-23	16ta	-	3a	Sie
CE	2SA1122-E	Si-pnp	GP, AF, 55V, 100mA, 150mW, B=400..800	SOT-23	16ta	-	3a	Ren
CE	2SA1366-E	Si-pnp	Relay-Drv, 55V, 400mA, 150mW, B=150..300, 150MHz	SOT-23	16ta	-	3a	Mit
CE	2SK2552B-E	n-FET	GP, 20V, 10mA, 100mW, Idss=90..180µA	SOT-23	16fj	-	3a	Nec
CE	AP130-19TW	LVR-IC	LDO, 1.9V±2%, 300mA	TSOT23-3L	16vj	VR1	3b	Ana
CE	AP130-19W	LVR-IC	LDO, 1.9V±2%, 300mA	SOT-23	16vj	VR1	3b	Ana
CE	AX6901ER	Vdet-IC	2.93V±1.5%, -Reset PPO	SOT-23	16vdc	VD7	3b	Axl
CE	BCW61ER	Si-pnp	AF, 32V, 200mA, 330mW, B=450..900, >180MHz	SOT-23	16te	-	3a	Zx
CE	BSS79B	Si-npn	Sw, 75V, 800mA, 330mW, B=40..120, >250MHz	SOT-23	16ta	-	3a	Zx
CE	CPH3205	Si-npn	Relay-Drv, 100V, 3A, 900mW, B=200..560, 380MHz	CPH3	16ta	-	3a	San
CE	FP6809-26CS3P	Vdet-IC	2.63V±1.5%, -Reset PPO	SOT-23	16vdc	VD7	3a	Fit
CE	GS6332UR21D1	Vdet-IC	2.1V, +Reset PPO, 1.5ms	SOT-23	16vdc	VD7	3g	Vs
CE	KRC455	Si-npn-Digi	Dual, Sw, 12V, 500mA, 100mW, R1/R2=0.47k/10k	USM	16ta	-	3f	Kec
CE	MMBZ5261B	Z-diode	44.65..49.35V, Izt=2.7mA, Zzt=105Ω, 350mW	SOT-23	16dc	-	3a	Lge
CE	RT9169-30CVL	LVR-IC	LDO, 3.0V±2%, 100mA	SOT-23	16cg	VR1	3a	Rct
CE	SiP6332R21D1	Vdet-IC	2.1V±1.5%, -Reset PPO 1.5ms	SOT-23	16vdc	VD7	3g	Vs
CE	TS3809CXE	Vdet-IC	2.93V±1.5%, -Reset PPO	SOT-23	16vdc	VD7	3b	Tsc
CE	UNR31A1	Si-pnp-Digi	Sw, 50V, 80mA, 100mW, 80MHz, R1/R2=10k/10k	SSSMini3	18ta	-	3a	Pan
CE	XC62RP2402M	LVR-IC	LDO, 2.4V±2%, 6mA, 150mW	SOT-23	16cg	VR1	3d	Tor
CE-	RT9169-30PVL	LVR-IC	LDO, 3.0V±2%, 100mA	SOT-23	16cg	VR1	3a	Rct
CE	APE6809N-E	Vdet-IC	2.93V±2%, -Reset PPO	SOT-23	16vdc	VD7	3b	Ape
CE	APE6809U-E	Vdet-IC	2.93V±2%, -Reset PPO	SC-70	16vdc	VD7	3b	Ape
Ce	APE6810N-I	Vdet-IC	4.25V±2%, +Reset PPO	SOT-23	16vdc	VD7	3b	Ape



SMD code	Type	Function	Short description	Case	Pinout	Sch.	St.	Mnf.
CE	APE6810U-I	Vdet-IC	4.25V±2%, +Reset PPO	SC-70	16vdc	VD7	3b	Ape
CE15	AIC1735-15CU	LVR-IC	LDO, 1.5V±1%, 500mA	SOT-23	16cg	VR1	3a	Aic
CE15G	AIC1735-15GU	LVR-IC	LDO, 1.5V±1%, 500mA	SOT-23	16cg	VR1	3a	Aic
CE15P	AIC1735-15PU	LVR-IC	LDO, 1.5V±1%, 500mA	SOT-23	16cg	VR1	3a	Aic
CE18	AIC1735-18CU	LVR-IC	LDO, 1.8V±1%, 500mA	SOT-23	16cg	VR1	3a	Aic
CE18G	AIC1735-18GU	LVR-IC	LDO, 1.8V±1%, 500mA	SOT-23	16cg	VR1	3a	Aic
CE18P	AIC1735-18PU	LVR-IC	LDO, 1.8V±1%, 500mA	SOT-23	16cg	VR1	3a	Aic
CE18P	SS6735-18GU	LVR-IC	LDO, 1.8V±2%, 500mA	SOT-23	16cg	VR1	3a	Ssc
CE20	AIC1735-20CU	LVR-IC	LDO, 2.0V±1%, 500mA	SOT-23	16cg	VR1	3a	Aic
CE20G	AIC1735-20GU	LVR-IC	LDO, 2.0V±1%, 500mA	SOT-23	16cg	VR1	3a	Aic
CE20P	AIC1735-20PU	LVR-IC	LDO, 2.0V±1%, 500mA	SOT-23	16cg	VR1	3a	Aic
CE20P	SS6735-20GU	LVR-IC	LDO, 2.0V±2%, 500mA	SOT-23	16cg	VR1	3a	Ssc
CE25	AIC1735-25CU	LVR-IC	LDO, 2.5V±1%, 500mA	SOT-23	16cg	VR1	3a	Aic
CE25G	AIC1735-25GU	LVR-IC	LDO, 2.5V±1%, 500mA	SOT-23	16cg	VR1	3a	Aic
CE25P	AIC1735-25PU	LVR-IC	LDO, 2.5V±1%, 500mA	SOT-23	16cg	VR1	3a	Aic
CE25P	SS6735-25GU	LVR-IC	LDO, 2.5V±2%, 500mA	SOT-23	16cg	VR1	3a	Ssc
CE27	AIC1735-27CU	LVR-IC	LDO, 2.7V±1%, 500mA	SOT-23	16cg	VR1	3a	Aic
CE27G	AIC1735-27GU	LVR-IC	LDO, 2.7V±1%, 500mA	SOT-23	16cg	VR1	3a	Aic
CE27P	AIC1735-27PU	LVR-IC	LDO, 2.7V±1%, 500mA	SOT-23	16cg	VR1	3a	Aic
CE27P	SS6735-27GU	LVR-IC	LDO, 2.7V±2%, 500mA	SOT-23	16cg	VR1	3a	Ssc
CE30	AIC1735-30CU	LVR-IC	LDO, 3.0V±1%, 500mA	SOT-23	16cg	VR1	3a	Aic
CE30G	AIC1735-30GU	LVR-IC	LDO, 3.0V±1%, 500mA	SOT-23	16cg	VR1	3a	Aic
CE30P	AIC1735-30PU	LVR-IC	LDO, 3.0V±1%, 500mA	SOT-23	16cg	VR1	3a	Aic
CE30P	SS6735-30GU	LVR-IC	LDO, 3.0V±2%, 500mA	SOT-23	16cg	VR1	3a	Ssc
CE33	AIC1735-33CU	LVR-IC	LDO, 3.3V±1%, 500mA	SOT-23	16cg	VR1	3a	Aic
CE33G	AIC1735-33GU	LVR-IC	LDO, 3.3V±1%, 500mA	SOT-23	16cg	VR1	3a	Aic
CE33P	AIC1735-33PU	LVR-IC	LDO, 3.3V±1%, 500mA	SOT-23	16cg	VR1	3a	Aic
CE33P	SS6735-33GU	LVR-IC	LDO, 3.3V±2%, 500mA	SOT-23	16cg	VR1	3a	Ssc
CE35	AIC1735-35CU	LVR-IC	LDO, 3.5V±1%, 500mA	SOT-23	16cg	VR1	3a	Aic
CE35G	AIC1735-35GU	LVR-IC	LDO, 3.5V±1%, 500mA	SOT-23	16cg	VR1	3a	Aic
CE35P	AIC1735-35PU	LVR-IC	LDO, 3.5V±1%, 500mA	SOT-23	16cg	VR1	3a	Aic
CE35P	SS6735-35GU	LVR-IC	LDO, 3.5V±2%, 500mA	SOT-23	16cg	VR1	3a	Ssc
CE37	AIC1735-37CU	LVR-IC	LDO, 3.7V±1%, 500mA	SOT-23	16cg	VR1	3a	Aic
CE37G	AIC1735-37GU	LVR-IC	LDO, 3.7V±1%, 500mA	SOT-23	16cg	VR1	3a	Aic
CE37P	AIC1735-37PU	LVR-IC	LDO, 3.7V±1%, 500mA	SOT-23	16cg	VR1	3a	Aic
CE37P	SS6735-37GU	LVR-IC	LDO, 3.7V±2%, 500mA	SOT-23	16cg	VR1	3a	Ssc
CE38	AIC1735-38CU	LVR-IC	LDO, 3.8V±1%, 500mA	SOT-23	16cg	VR1	3a	Aic
CE38G	AIC1735-38GU	LVR-IC	LDO, 3.8V±1%, 500mA	SOT-23	16cg	VR1	3a	Aic
CE38P	AIC1735-38PU	LVR-IC	LDO, 3.8V±1%, 500mA	SOT-23	16cg	VR1	3a	Aic
CE38P	SS6735-38GU	LVR-IC	LDO, 3.8V±2%, 500mA	SOT-23	16cg	VR1	3a	Ssc
CE50	AIC1735-50CU	LVR-IC	LDO, 5.0V±1%, 500mA	SOT-23	16cg	VR1	3a	Aic
CE50G	AIC1735-50GU	LVR-IC	LDO, 5.0V±1%, 500mA	SOT-23	16cg	VR1	3a	Aic
CE50P	AIC1735-50PU	LVR-IC	LDO, 5.0V±1%, 500mA	SOT-23	16cg	VR1	3a	Aic
CE50P	SS6735-50GU	LVR-IC	LDO, 5.0V±2%, 500mA	SOT-23	16cg	VR1	3a	Ssc
CE52	AIC1735-52CU	LVR-IC	LDO, 5.2V±1%, 500mA	SOT-23	16cg	VR1	3a	Aic
CE52G	AIC1735-52GU	LVR-IC	LDO, 5.2V±1%, 500mA	SOT-23	16cg	VR1	3a	Aic
CE52P	AIC1735-52PU	LVR-IC	LDO, 5.2V±1%, 500mA	SOT-23	16cg	VR1	3a	Aic
CE52P	SS6735-52GU	LVR-IC	LDO, 5.2V±2%, 500mA	SOT-23	16cg	VR1	3a	Ssc
CEO	2SC3325-O	Si-npn	AF-Amp, 50V, 500mA, 200mW, B=70..140, 300MHz	SC-59	16ta	-	3a	Tos
CEs	BSS79B	Si-npn	Sw, 75V, 800mA, 330mW, B=40..120, 250MHz	SOT-23	16ta	-	3a	Sie
CEY	2SC3325-Y	Si-npn	AF-Amp, 50V, 500mA, 200mW, B=120..240, 300MHz	SC-59	16ta	-	3a	Tos
CF	2SA1366-F	Si-pnp	Relay-Drv, 55V, 400mA, 150mW, B=250..500, 150MHz	SOT-23	16ta	-	3a	Mit
CF	2SK2552B-F	n-FET	GP, 20V, 10mA, 100mW, Idss=150..240µA	SOT-23	16jf	-	3a	Nec
CF	AP130-20TW	LVR-IC	LDO, 2.0V±2%, 300mA	TSOT23-3L	16vj	VR1	3b	Ana
CF	AP130-20W	LVR-IC	LDO, 2.0V±2%, 300mA	SOT-23	16vj	VR1	3b	Ana
Cf	APE6811N-H	Vdet-IC	2.25V±2%, -Reset PPO	SOT-23	16vda	VD7	3b	Ape
Cf	APE6811U-H	Vdet-IC	2.25V±2%, -Reset PPO	SC-70	16vda	VD7	3b	Ape
CF	AX6901FR	Vdet-IC	2.63V±1.5%, -Reset PPO	SOT-23	16vdc	VD7	3b	Axl
CF	BSS79C	Si-npn	Sw, 75V, 800mA, 330mW, B=100..300, >250MHz	SOT-23	16ta	-	3a	Zx
CF	CPH3206	Si-npn	DC/DC-Conv, 15V, 3A, 900mW, 380MHz, B=200..560	CPH3	16ta	-	3a	San
CF	FP6809-29CS3P	Vdet-IC	2.93V±1.5%, -Reset PPO	SOT-23	16vdc	VD7	3a	Fit
CF	KRC456	Si-npn-Digi	Dual, Sw, 12V, 500mA, 100mW, R1/R2=1k/10k	USM	16ta	-	3f	Kec
CF	RT9169-12CVL	LVR-IC	LDO, 1.2V±2%, 100mA	SOT-23	16cg	VR1	3a	Rct
CF	TS3809CXF	Vdet-IC	2.63V±1.5%, -Reset PPO	SOT-23	16vdc	VD7	3b	Tsc
CF	UNR31A2	Si-pnp-Digi	Sw, 50V, 80mA, 100mW, 80MHz, R/R2=22k/22k	SSSMini3	18ta	-	3a	Pan
CF	XC62RP2502M	LVR-IC	LDO, 2.5V±2%, 6mA, 150mW	SOT-23	16cg	VR1	3d	Tor
CF	APE6809N-F	Vdet-IC	2.63V±2%, -Reset PPO	SOT-23	16vdc	VD7	3b	Ape
CF	APE6809U-F	Vdet-IC	2.63V±2%, -Reset PPO	SC-70	16vdc	VD7	3b	Ape
CFs	BSS79C	Si-npn	Sw, 75V, 800mA, 330mW, B=100..300, 250MHz	SOT-23	16ta	-	3a	Sie
CG	2SA1163-GR	Si-pnp	GP, AF, 120V, 100mA, 150mW, B=200..400, 100MHz	SOT-23	16ta	-	3a	Tos



SMD code	Type	Function	Short description	Case	Pinout	Sch.	St.	Mnf.
CG	2SA1587-G	Si-pnp	GP, LN, 120V, 120mA, 100mW, B=200..400, >100MHz	SOT-323	16ta	-	3a	Tos
CG	2SA1980UF-G	Si-pnp	GP, 50V, 150mA, 200mW, B=200..400, 80MHz	SOT-323F	18ta	-	3a	Auk
CG	2SA1980U-G	Si-pnp	GP, 50V, 150mA, 200mW, B=200..400, 80MHz	SOT-323	16ta	-	3a	Auk
CG	2SC5343EF-G	Si-npn	GP, 60V, 150mA, 150mW, >80MHz, B=200..400	SOT-523F	18ta	-	3a	Auk
CG	2SC5343E-G	Si-npn	GP, 60V, 150mA, 150mW, >80MHz, B=200..400	SOT-523	16ta	-	3a	Auk
CG	AP130-21TW	LVR-IC	LDO, 2.1V±2%, 300mA	TSOT23-3L	16vj	VR1	3b	Ana
CG	AP130-21W	LVR-IC	LDO, 2.1V±2%, 300mA	SOT-23	16vj	VR1	3b	Ana
Cg	APE6811N-I	Vdet-IC	4.25V±2%, -Reset PPO	SOT-23	16vda	VD7	3b	Ape
CG	AX6901GR	Vdet-IC	2.25V±1.5%, -Reset PPO	SOT-23	16vdc	VD7	3b	Axl
CG	BAS70-04	Si-diode	Dual, Schottky, 70V, 70mA, Vf<1V(15mA), <2pF, 5ns	SOT-23	16dl	-	3a	Ons
CG	BCX71GR	Si-pnp	GP, 45V, 100mA, 330mW, B= 120..220, 250MHz	SOT-23	16te	-	3a	Phi
CG	BCX71RG	Si-pnp	GP, 45V, 100mA, 330mW, B= 120..220, 250MHz	SOT-23	16ta	-	3a	Zx
CG	CPH3207	Si-npn	DC/DC-Corv, 15V, 6A, 900mW, 250MHz, B=200..560	CPH3	16ta	-	3a	San
CG	FP6809-31CS3P	Vdet-IC	3.08V±1.5%, -Reset PPO	SOT-23	16vdc	VD7	3a	Fit
CG	GS6332UR21D2	Vdet-IC	2.1V, +Reset PPO, 30ms	SOT-23	16vdc	VD7	3g	Vs
CG	KRC457	Si-npn-Digi	Dual, Sw, 12V, 500mA, 100mW, R1/R2=2.2k/10k	USM	16ta	-	3f	Kec
CG	KTA2017-GR	Si-pnp	AF, LN, 120V, 100mA, 100mW, B=350..700, 100MHz	USM	16ta	-	3a	Kec
CG	RT9169-20CVL	LVR-IC	LDO, 2.0V±2%, 100mA	SOT-23	16cg	VR1	3a	Rct
CG	SiP6332R21D2	Vdet-IC	2.1V±1.5%, -Reset PPO 30ms	SOT-23	16vdc	VD7	3g	Vs
CG	TS3809CXG	Vdet-IC	2.25V±1.5%, -Reset PPO	SOT-23	16vdc	VD7	3b	Tsc
CG	APE6809N-G	Vdet-IC	2.25V±2%, -Reset PPO	SOT-23	16vdc	VD7	3b	Ape
CG	APE6809U-G	Vdet-IC	2.25V±2%, -Reset PPO	SC-70	16vdc	VD7	3b	Ape
CGG	2SC3426-GR	Si-npn	GP, 15V, 800mA, 200mW, B=200..400, 120MHz	SOT-23	16ta	-	3a	Tos
COL	2SC3426-BL	Si-npn	GP, 15V, 800mA, 200mW, B=350..700, 120MHz	SOT-23	16ta	-	3a	Tos
CGs	BSS81C	Si-npn	Sw, 75V, 800mA, 330mW, B=100..300, 250MHz	SOT-23	16ta	-	3a	Sie
CGY	2SC3426-Y	Si-npn	GP, 15V, 800mA, 200mW, B=120..240, 120MHz	SOT-23	16ta	-	3a	Tos
CH	1S5351	Si-diode	Dual, SBD, UHF-det/mix., 5V, 30mA, Vf<0.23V(1mA), 0.69pF	CP	26d	-	3a	San
CH	2SK2552B-H	n-FET	GP, 20V, 10mA, 100mW, Idss=210..350µA	SOT-23	16fj	-	3a	Nec
CH	AP130-22TW	LVR-IC	LDO, 2.2V±2%, 300mA	TSOT23-3L	16vj	VR1	3b	Ana
CH	AP130-22W	LVR-IC	LDO, 2.2V±2%, 300mA	SOT-23	16vj	VR1	3b	Ana
Ch	APE6812N-H	Vdet-IC	2.25V±2%, +Reset PPO	SOT-23	16vda	VD7	3b	Ape
Ch	APE6812U-H	Vdet-IC	2.25V±2%, +Reset PPO	SC-70	16vda	VD7	3b	Ape
CH	AX6902AR	Vdet-IC	4.63V±1.5%, +Reset PPO	SOT-23	16vdc	VD7	3b	Axl
CH	BSS80B	Si-pnp	Sw, 60V, 800mA, 330mW, B=40..120, >200MHz	SOT-23	16ta	-	3a	Zx
CH	FP6809-40CS3P	Vdet-IC	4.0V±1.5%, -Reset PPO	SOT-23	16vdc	VD7	3a	Fit
CH	GS6332UR21D3	Vdet-IC	2.1V, +Reset PPO, 150ms	SOT-23	16vdc	-	3g	Vs
CH	MMBZ4682	Z-diode	2.7V±5%, 350mW	SOT-23	16dc	-	3g	Vs
CH	SiP6332R21D3	Vdet-IC	2.1V±1.5%, -Reset PPO 150ms	SOT-23	16vdc	VD7	3g	Vs
CH	TS3810CXA	Vdet-IC	4.63V±1.5%, +Reset PPO	SOT-23	16vdc	VD7	3b	Tsc
CH	UNR31A3	Si-pnp-Digi	Sw, 50V, 80mA, 100mW, 80MHz, R1/R2=47k/47k	SSSMini3	18ta	-	3a	Pan
CH	XC62RP2602M	LVR-IC	LDO, 2.6V±2%, 6mA, 150mW	SOT-23	16cg	VR1	3d	Tor
CH-	RT9169-25PVL	LVR-IC	LDO, 2.5V±2%, 100mA	SOT-23	16cg	VR1	3a	Rct
CH	APE6810N-A	Vdet-IC	4.63V±2%, +Reset PPO	SOT-23	16vdc	VD7	3b	Ape
CH	APE6810U-A	Vdet-IC	4.63V±2%, +Reset PPO	SC-70	16vdc	VD7	3b	Ape
CHO	2SC3437-O	Si-npn	Sw, 40V, 200mA, 150mW, 400MHz, B=70..140	SC-59	16ta	-	3a	Tos
CHO	2SC4667-O	Si-npn	Sw, 40V, 200mA, 100mW, 400MHz, B=40..80	SOT-323	16ta	-	3a	Tos
CHR	2SC3437-R	Si-npn	Sw, 40V, 200mA, 150mW, 400MHz, B=40..180	SC-59	16ta	-	3a	Tos
CHR	2SC4667-R	Si-npn	Sw, 40V, 200mA, 100mW, 400MHz, B=70..140	SOT-323	16ta	-	3a	Tos
CHs	BSS80B	Si-pnp	Sw, 60V, 800mA, 330mW, B=40..120, 250MHz	SOT-23	16ta	-	3a	Sie
CHY	2SC3437-Y	Si-npn	Sw, 40V, 200mA, 150mW, 400MHz, B=120..240	SC-59	16ta	-	3a	Tos
CHY	2SC4667-Y	Si-npn	Sw, 40V, 200mA, 100mW, 400MHz, B=120..240	SOT-323	16ta	-	3a	Tos
CI	AP130-23TW	LVR-IC	LDO, 2.3V±2%, 300mA	TSOT23-3L	16vj	VR1	3b	Ana
CI	AP130-23W	LVR-IC	LDO, 2.3V±2%, 300mA	SOT-23	16vj	VR1	3b	Ana
CI	AX6902BR	Vdet-IC	4.38V±1.5%, +Reset PPO	SOT-23	16vdc	VD7	3b	Axl
CI	GS6332UR22D1	Vdet-IC	2.2V, +Reset PPO, 1.5ms	SOT-23	16vdc	VD7	3g	Vs
CI	SiP6332R22D1	Vdet-IC	2.2V±1.5%, -Reset PPO 1.5ms	SOT-23	16vdc	VD7	3g	Vs
CI	TS3810CXB	Vdet-IC	4.38V±1.5%, +Reset PPO	SOT-23	16vdc	VD7	3b	Tsc
CI	APE6810N-B	Vdet-IC	4.38V±2%, +Reset PPO	SOT-23	16vdc	VD7	3b	Ape
CI	APE6810U-B	Vdet-IC	4.38V±2%, +Reset PPO	SC-70	16vdc	VD7	3b	Ape
CJ	2SK2552B-J	n-FET	GP, 20V, 10mA, 100mW, Idss=320..430µA	SOT-23	16fj	-	3a	Nec
CJ	AP130-24TW	LVR-IC	LDO, 2.4V±2%, 300mA	TSOT23-3L	16vj	VR1	3b	Ana
CJ	AP130-24W	LVR-IC	LDO, 2.4V±2%, 300mA	SOT-23	16vj	VR1	3b	Ana
CJ	AX6902CR	Vdet-IC	4.0V±1.5%, +Reset PPO	SOT-23	16vdc	VD7	3b	Axl
CJ	BSS80C	Si-pnp	Sw, 60V, 800mA, 330mW, B=100..300, >200MHz	SOT-23	16ta	-	3a	Zx
CJ	CPH3209	Si-npn	DC/DC-Corv, 40V, 3A, 900mW, 450MHz, B=200..560	CPH3	16ta	-	3a	San
CJ	FP6809-44CS3P	Vdet-IC	4.38V±1.5%, -Reset PPO	SOT-23	16vdc	VD7	3a	Fit
CJ	MMBZ4683	Z-diode	3.0V±5%, 350mW	SOT-23	16dc	-	3g	Vs
CJ	TS3810CXC	Vdet-IC	4.0V±1.5%, +Reset PPO	SOT-23	16vdc	VD7	3b	Tsc
CJ	APE6810N-C	Vdet-IC	4.00V±2%, +Reset PPO	SOT-23	16vdc	VD7	3b	Ape
CJ	APE6810U-C	Vdet-IC	4.00V±2%, +Reset PPO	SC-70	16vdc	VD7	3b	Ape



SMD code	Type	Function	Short description	Case	Pinout	Sch. St.	Mnf.
CJ3	2SK1067-3	n-MOSFET-d	VHF/FM, 16V, 30mA, 150mW, Idss=1.2..3mA, Up<2.5V	MCP	16fa -	3a	San
CJ3	2SK543-3	n-MOSFET-d	FM-Tun, VHF-amp, 20V, 30mA, 200mW, Idss=1.2..3mA	SOT-23	16fa -	3a	San
CJ4	2SK1067-4	n-MOSFET-d	VHF/FM, 16V, 30mA, 150mW, Idss=2.5..6mA, Up<2.5V	MCP	16fa -	3a	San
CJ4	2SK543-4	n-MOSFET-d	FM-Tun, VHF-amp, 20V, 30mA, 200mW, Idss=2.5..6mA	SOT-23	16fa -	3a	San
CJ5	2SK1067-5	n-MOSFET-d	VHF/FM, 16V, 30mA, 150mW, Idss=5..12mA, Up<2.5V	MCP	16fa -	3a	San
CJ5	2SK543-5	n-MOSFET-d	FM-Tun, VHF-amp, 20V, 30mA, 200mW, Idss=5..12mA	SOT-23	16fa -	3a	San
CJs	BSS80C	Si-pnp	Sw, 60V, 800mA, 330mW, B=100..300, 250MHz	SOT-23	16ta -	3a	Sie
CK	15C02MH	Si-npn	AF, GP, 20V, 1A, 600mW, B=300..600, 440MHz	MCPH3	18ta -	3a	San
CK	AP130-25TW	LVR-IC	LDO, 2.5V±2%, 300mA	TSOT23-3L	16vj VR1	3b	Ana
CK	AP130-25W	LVR-IC	LDO, 2.5V±2%, 300mA	SOT-23	16vj VR1	3b	Ana
CK	AX6902DR	Vdet-IC	3.08V±1.5%, +Reset PPO	SOT-23	16vdc VD7	3b	Axl
CK	BCX71JR	Si-pnp	GP, Sw, 45V, 100mA, 250mW, B=250..460, >100MHz	SOT-23	16te -	3a	Phi
CK	BCX71KR	Si-pnp	AF, 45V, 200mA, 330mW, B=380..630, >180MHz	SOT-23	16ta -	3a	Zx
CK	BCX71RK	Si-pnp	GP, Sw, 45V, 100mA, 250mW, B=380..630, >100MHz	SOT-23	16ta -	3a	Zx
CK	CPH3210	Si-npn	DC/DC-Conv, 40V, 5A, 900mW, 290MHz, B=200..560	CPH3	16ta -	3a	San
CK	FP6809-46CS3P	Vdet-IC	4.63V±1.5%, -Reset PPO	SOT-23	16vdc VD7	3a	Fit
CK	G56332UR22D2	Vdet-IC	2.2V, +Reset PPO, 30ms	SOT-23	16vdc VD7	3g	Vs
CK	MMBZ4684	Z-diode	3.3V±5%, 350mW	SOT-23	16dc -	3g	Vs
CK	SiP6332R22D2	Vdet-IC	2.2V±1.5%, -Reset PPO 30ms	SOT-23	16vdc VD7	3g	Vs
CK	TS3810CXD	Vdet-IC	3.08V±1.5%, +Reset PPO	SOT-23	16vdc VD7	3b	Tsc
CK	UNR31A4	Si-pnp-Digi	Sw, 50V, 80mA, 100mW, 80MHz, R1/R2=10k47k	SSSMini3	18ta -	3a	Pan
CK	XC62RP2702M	LVR-IC	LDO, 2.7V±2%, 6mA, 150mW	SOT-23	16cg VR1	3d	Tor
CK	APE6810N-D	Vdet-IC	3.08V±2%, +Reset PPO	SOT-23	16vdc VD7	3b	Ape
CK	APE6810U-D	Vdet-IC	3.08V±2%, +Reset PPO	SC-70	16vdc VD7	3b	Ape
CKB	CMPT8099	Si-npn	AF, 80V, 500mA, 350mW, B=100..300, >150MHz	SOT-23	16ta -	3a	Can
CL	2SA1163-BL	Si-pnp	GP, AF, 120V, 100mA, 150mW, B=350..700, 100MHz	SOT-23	16ta -	3a	Tos
CL	2SA1342	Si-pnp-Digi	Sw, 50V, 100mA, 200mW, 250MHz, R1/R2=22k/22k	CP	16ta -	3a	San
CL	2SA1587-B	Si-pnp	GP, LN, 120V, 120mA, 100mW, B=350..700, >100MHz	SOT-323	16ta -	3a	Tos
CL	2SA1677	Si-pnp-Digi	Sw, 50V, 100mA, 200MHz, R1/R2=22k/22k	SOT-323	16ta -	3a	San
CL	2SA1980UF-L	Si-pnp	GP, 50V, 150mA, 200mW, B=300..700, 80MHz	SOT-323F	18ta -	3a	Auk
CL	2SA1980U-L	Si-pnp	GP, 50V, 150mA, 200mW, B=300..700, 80MHz	SOT-323	16ta -	3a	Auk
CL	2SC5343EF-L	Si-npn	GP, 60V, 150mA, 150mW, >80MHz, B=300..700	SOT-523F	18ta -	3a	Auk
CL	2SC5343E-L	Si-npn	GP, 60V, 150mA, 150mW, >80MHz, B=300..700	SOT-523	16ta -	3a	Auk
CL	30C02CH	Si-npn	AF, GP, 40V, 700mA, 700mW, B=300..600, 540MHz	CPH3	16ta -	3a	San
CL	30C02MH	Si-npn	AF, GP, 40V, 700mA, 600mW, B=300..600, 540MHz	MCPH3	18ta -	3a	San
CL	AP130-26TW	LVR-IC	LDO, 2.6V±2%, 300mA	TSOT23-3L	16vj VR1	3b	Ana
CL	AP130-26W	LVR-IC	LDO, 2.6V±2%, 300mA	SOT-23	16vj VR1	3b	Ana
CL	AX6902ER	Vdet-IC	2.93V±1.5%, +Reset PPO	SOT-23	16vdc VD7	3b	Axl
CL	BSS82B	Si-pnp	Sw, 60V, 800mA, 330mW, B=40..120, >200MHz	SOT-23	16ta -	3a	Zx
CL	FP6810-23CS3P	Vdet-IC	2.32V±1.5%, +Reset PPO	SOT-23	16vdc VD7	3a	Fit
CL	G56332UR22D3	Vdet-IC	2.2V, +Reset PPO, 150ms	SOT-23	16vdc VD7	3g	Vs
CL	KTA2017-BL	Si-pnp	AF, LN, 120V, 100mA, 100mW, B=200..400, 100MHz	USM	16ta -	3a	Kec
CL	SiP6332R22D3	Vdet-IC	2.2V±1.5%, -Reset PPO 150ms	SOT-23	16vdc VD7	3g	Vs
CL	TS3810CXE	Vdet-IC	2.93V±1.5%, +Reset PPO	SOT-23	16vdc VD7	3b	Tsc
CL	UNR31A5	Si-pnp-Digi	Sw, 50V, 80mA, 100mW, 80MHz, R1=10k	SSSMini3	18ta -	3a	Pan
CL	XC62RP2802M	LVR-IC	LDO, 2.8V±2%, 6mA, 150mW	SOT-23	16cg VR1	3d	Tor
CL	APE6810N-E	Vdet-IC	2.93V±2%, +Reset PPO	SOT-23	16vdc VD7	3b	Ape
CL	APE6810U-E	Vdet-IC	2.93V±2%, +Reset PPO	SC-70	16vdc VD7	3b	Ape
CLN	ELM7524CEB	Vdet-IC	2.4V±2%, +Reset PPO	SC-70	16vdc VD7	3d	Elm
CLN	ELM7524NEB	Vdet-IC	2.4V±2%, +Reset ODO	SC-70	16vdc VD6	3d	Elm
CLs	BSS82B	Si-pnp	Sw, 60V, 800mA, 330mW, B=40..120, 250MHz	SOT-23	16ta -	3a	Sie
CM	50C02MH	Si-npn	AF, GP, 60V, 500mA, 600mW, B=300..800, 500MHz	MCPH3	18ta -	3a	San
CM	AP130-27TW	LVR-IC	LDO, 2.7V±2%, 300mA	TSOT23-3L	16vj VR1	3b	Ana
CM	AP130-27W	LVR-IC	LDO, 2.7V±2%, 300mA	SOT-23	16vj VR1	3b	Ana
CM	APE6812N-I	Vdet-IC	4.25V±2%, +Reset PPO	SOT-23	16vda VD7	3b	Ape
CM	APE6812U-I	Vdet-IC	4.25V±2%, +Reset PPO	SC-70	16vda VD7	3b	Ape
CM	AX6902FR	Vdet-IC	2.63V±1.5%, +Reset PPO	SOT-23	16vdc VD7	3b	Axl
CM	BSS82C	Si-pnp	Sw, 60V, 800mA, 330mW, B=100..300, >200MHz	SOT-23	16ta -	3a	Zx
CM	CPH3212	Si-npn	DC/DC-Conv, 60V, 5A, 900mW, 330MHz, B=200..560	CPH3	16ta -	3a	San
CM	FP6810-26CS3P	Vdet-IC	2.63V±1.5%, +Reset PPO	SOT-23	16vdc VD7	3a	Fit
CM	G56332UR23D1	Vdet-IC	2.3V, +Reset PPO, 1.5ms	SOT-23	16vdc VD7	3g	Vs
CM	MMBZ4685	Z-diode	3.6V±5%, 350mW	SOT-23	16dc -	3g	Vs
CM	SiP6332R23D1	Vdet-IC	2.3V±1.5%, -Reset PPO 1.5ms	SOT-23	16vdc VD7	3g	Vs
CM	TS3810CXF	Vdet-IC	2.63V±1.5%, +Reset PPO	SOT-23	16vdc VD7	3b	Tsc
CM	XC62RP2902M	LVR-IC	LDO, 2.9V±2%, 6mA, 150mW	SOT-23	16cg VR1	3d	Tor
CM	APE6810N-F	Vdet-IC	2.63V±2%, +Reset PPO	SOT-23	16vdc VD7	3b	Ape
CM	APE6810U-F	Vdet-IC	2.63V±2%, +Reset PPO	SC-70	16vdc VD7	3b	Ape
CMs	BSS82C	Si-pnp	Sw, 60V, 800mA, 330mW, B=100..300, 250MHz	SOT-23	16ta -	3a	Sie
CN	2SC5537	Si-npn	VHF/UHF, 12V, 15mA, 80mW, B=90..200, 5GHz	SSFP	18ta -	3a	San
CN	AP130-28TW	LVR-IC	LDO, 2.8V±2%, 300mA	TSOT23-3L	16vj VR1	3b	Ana



Note: ELM75xxCBB series LN- lot number L=0...9 N=A to Z(I, O, X excepted); ELM75xxNBB series LN- lot number L=A to Z(I, O, X excepted) N=0...9

SMD code	Type	Function	Short description	Case	Pinout	Sch.	St.	Mnf.
CN	AP130-28W	LVR-IC	LDO, 2.8V±2%, 300mA	SOT-23	16vj	VR1	3b	Ana
CN	AX6902GR	Vdet-IC	2.25V±1.5%, +Reset PPO	SOT-23	16vdc	VD7	3b	Axl
CN	FP6810-29CS3P	Vdet-IC	2.93V±1.5%, +Reset PPO	SOT-23	16vdc	VD7	3a	Fit
CN	GS6332UR23D2	Vdet-IC	2.3V, +Reset PPO, 30ms	SOT-23	16vdc	VD7	3g	Vs
CN	MMBZ4686	Z-diode	3.9V±5%, 350mW	SOT-23	16dc	-	3g	Vs
CN	SiP6332R23D2	Vdet-IC	2.3V±1.5%, -Reset PPO 30ms	SOT-23	16vdc	VD7	3g	Vs
CN	TS3810CXG	Vdet-IC	2.25V±1.5%, +Reset PPO	SOT-23	16vdc	VD7	3b	Tsc
CN	UNR31A6	Si-pnp-Digi	Sw, 50V, 80mA, 100mW, 80MHz, R1=4k7	SSSMini3	18ta	-	3a	Pan
CN	APE6810N-G	Vdet-IC	2.25V±2%, +Reset PPO	SOT-23	16vdc	VD7	3b	Ape
CN	APE6810U-G	Vdet-IC	2.25V±2%, +Reset PPO	SC-70	16vdc	VD7	3b	Ape
CN3	2SC4853-3	Si-npn	VHF/UHF, 12V, 15mA, 80mW, B=60..120, 5GHz	MCP	16ta	-	3a	San
CN3	2SC4854-3	Si-npn	VHF/UHF, 12V, 15mA, 80mW, B=60..120, 5GHz	CP	16ta	-	3a	San
CN4	2SC4853-4	Si-npn	VHF/UHF, 12V, 15mA, 80mW, B=90..180, 5GHz	MCP	16ta	-	3a	San
CN4	2SC4854-4	Si-npn	VHF/UHF, 12V, 15mA, 80mW, B=90..180, 5GHz	CP	16ta	-	3a	San
CN5	2SC4853-5	Si-npn	VHF/UHF, 12V, 15mA, 80mW, B=135..270, 5GHz	MCP	16ta	-	3a	San
CN5	2SC4854-5	Si-npn	VHF/UHF, 12V, 15mA, 80mW, B=60..120, 5GHz	CP	16ta	-	3a	San
CO	2SA1980UF-O	Si-pnp	GP, 50V, 150mA, 200mW, B=70..140, 80MHz	SOT-323F	18ta	-	3a	Auk
CO	2SA1980U-O	Si-pnp	GP, 50V, 150mA, 200mW, B=70..140, 80MHz	SOT-323	16ta	-	3a	Auk
CO	2SC4209-O	Si-npn	AF, Drv, 80V, 200mA, 200mW, B=70..140, 100MHz	SC-59	16ta	-	3a	Tos
CO	2SC5343EF-O	Si-npn	GP, 60V, 150mA, 150mW, >80MHz, B=70..140	SOT-523F	18ta	-	3a	Auk
CO	2SC5343E-O	Si-npn	GP, 60V, 150mA, 150mW, >80MHz, B=70..140	SOT-523	16ta	-	3a	Auk
CO	AP130-29TW	LVR-IC	LDO, 2.9V±2%, 300mA	TSOT23-3L	16vj	VR1	3b	Ana
CO	AP130-29W	LVR-IC	LDO, 2.9V±2%, 300mA	SOT-23	16vj	VR1	3b	Ana
CO	APE6811N-A	Vdet-IC	4.63V±2%, -Reset PPO	SOT-23	16vda	VD7	3b	Ape
CO	APE6811U-A	Vdet-IC	4.63V±2%, -Reset PPO	SC-70	16vda	VD7	3b	Ape
CO	AX6903AR	Vdet-IC	4.63V±1.5%, -Reset PPO	SOT-23	16vda	VD7	3b	Axl
CO	GS6332UR23D3	Vdet-IC	2.3V, +Reset PPO, 150ms	SOT-23	16vdc	VD7	3g	Vs
CO	SiP6332R23D3	Vdet-IC	2.3V±1.5%, -Reset PPO 150ms	SOT-23	16vdc	VD7	3g	Vs
CP	2SC2411K-P	Si-npn	AF, 40V, 500mA, 200mW, B=82..180, >250MHz	SC-59	16ta	-	3a	Rhm
CP	2SC4097-P	Si-npn	GP, 40V, 500mA, 200mW, B=82..180, >250MHz	SOT-323	16ta	-	3a	Rhm
CP	AP130-30TW	LVR-IC	LDO, 3.0V±2%, 300mA	TSOT23-3L	16vj	VR1	3b	Ana
CP	AP130-30W	LVR-IC	LDO, 3.0V±2%, 300mA	SOT-23	16vj	VR1	3b	Ana
CP	APE6811N-B	Vdet-IC	4.38V±2%, -Reset PPO	SOT-23	16vda	VD7	3b	Ape
CP	APE6811U-B	Vdet-IC	4.38V±2%, -Reset PPO	SC-70	16vda	VD7	3b	Ape
CP	AX6903BR	Vdet-IC	4.38V±1.5%, -Reset PPO	SOT-23	16vda	VD7	3b	Axl
CP	CPH3214	Si-npn	DC/DC-Conv, 15V, 1.5A, 900mW, 450MHz, B=200..560	CPH3	16ta	-	3a	San
CP	FP6810-31CS3P	Vdet-IC	3.08V±1.5%, +Reset PPO	SOT-23	16vdc	VD7	3a	Fit
CP	GS6332UR24D1	Vdet-IC	2.4V, +Reset PPO, 1.5ms	SOT-23	16vdc	VD7	3g	Vs
CP	L2SC2411KPLT1	Si-npn	GP, 40V, 500mA, 200mW, 250MHz, B=82..180	SOT-23	16ta	-	3a	Lrc
CP	MMBZ4687	Z-diode	4.3V±5%, 350mW	SOT-23	16dc	-	3g	Vs
CP	SiP6332R24D1	Vdet-IC	2.4V±1.5%, -Reset PPO 1.5ms	SOT-23	16vdc	VD7	3g	Vs
CP	UNR31A7	Si-pnp-Digi	Sw, 50V, 80mA, 100mW, 80MHz, R1=22k	SSSMini3	18ta	-	3a	Pan
CQ	2PB1219Q	Si-pnp	GP, 60V, 150mA, 200mW, B=85..170, 100MHz	SOT-323	16ta	-	3a	Phi
CQ	2PB710Q	Si-pnp	GP, 60V, 500mA, 250mW, B=85..170, >100MHz	SOT-23	16ta	-	3a	Phi
CQ	2SB1219-Q	Si-pnp	GP, 30V, 500mA, 150mW, B=85..170, 20MHz	SOT-323	16ta	-	3a	Phi
CQ	2SB1582-Q	Si-pnp	GP, 30V, 500mA, 200MHz, B=85..170	SOT-416	16ta	-	3a	Pan
CQ	2SB710-Q	Si-pnp	GP, AF, 50V, 500mA, 200mW, B=85..170, 200MHz	SC-59	16ta	-	3a	Pan
CQ	2SC2411K-Q	Si-npn	AF, 40V, 500mA, 200mW, B=120..270, >250MHz	SC-59	16ta	-	3a	Rhm
CQ	2SC4097-Q	Si-npn	GP, 40V, 500mA, 200mW, B=120..270, >250MHz	SOT-323	16ta	-	3a	Rhm
CQ	AP130-31TW	LVR-IC	LDO, 3.1V±2%, 300mA	TSOT23-3L	16vj	VR1	3b	Ana
CQ	AP130-31W	LVR-IC	LDO, 3.1V±2%, 300mA	SOT-23	16vj	VR1	3b	Ana
CQ	APE6811N-C	Vdet-IC	4.00V±2%, -Reset PPO	SOT-23	16vda	VD7	3b	Ape
CQ	APE6811U-C	Vdet-IC	4.00V±2%, -Reset PPO	SC-70	16vda	VD7	3b	Ape
Cq	APE6811U-I	Vdet-IC	4.25V±2%, -Reset PPO	SC-70	16vda	VD7	3b	Ape
CQ	AX6903CR	Vdet-IC	4.0V±1.5%, -Reset PPO	SOT-23	16vda	VD7	3b	Axl
CQ	CPH3215	Si-npn	DC/DC-Conv, 40V, 1.5A, 900mW, 500MHz, B=200..560	CPH3	16ta	-	3a	San
CQ	L2SC2411KQLT1	Si-npn	GP, 40V, 500mA, 200mW, 250MHz, B=120..270	SOT-23	16ta	-	3a	Lrc
CQ	MSB710-Q	Si-pnp	GP, 60V, 500mA, 200mW, B=85..170	SOT-323	16ta	-	3a	Mot
CR	2PB1219R	Si-pnp	GP, 60V, 150mA, 200mW, B=120..240, 120MHz	SOT-323	16ta	-	3a	Phi
CR	2PB710R	Si-pnp	GP, 60V, 500mA, 250mW, B=120..240, >120MHz	SOT-23	16ta	-	3a	Phi
CR	2SA1885-R	Si-pnp	HF, Sw, 15V, 100mA, 150mW, B=56..390, 650MHz	SOT-23	16ta	-	3a	Rhm
CR	2SA1886-R	Si-pnp	HF, Sw, 15V, 100mA, 150mW, B=56..390, 650MHz	SOT-323	16ta	-	3a	Rhm
CR	2SB1219-R	Si-pnp	GP, 30V, 500mA, 150mW, B=120..240, 20MHz	SOT-323	16ta	-	3a	Pan
CR	2SB1582-R	Si-pnp	GP, 30V, 500mA, 200MHz, B=120..240	SOT-416	16ta	-	3a	Pan
CR	2SB710-R	Si-pnp	GP, AF, 50V, 500mA, 200mW, B=120..240, 200MHz	SC-59	16ta	-	3a	Pan
CR	2SC2411K-R	Si-npn	AF, 40V, 500mA, 200mW, B=180..390, >250MHz	SC-59	16ta	-	3a	Rhm
CR	2SC4097-R	Si-npn	GP, 40V, 500mA, 200mW, B=180..390, >250MHz	SOT-323	16ta	-	3a	Rhm
CR	2SC4097-S	Si-npn	GP, 40V, 500mA, 200mW, B=270..560, >250MHz	SOT-323	16ta	-	3a	Rhm
CR	AP130-32TW	LVR-IC	LDO, 3.2V±2%, 300mA	TSOT23-3L	16vj	VR1	3b	Ana
CR	AP130-32W	LVR-IC	LDO, 3.2V±2%, 300mA	SOT-23	16vj	VR1	3b	Ana



SMD code	Type	Function	Short description	Case	Pinout	Sch.	St.	Mnf.
CR	APE6811N-D	Vdet-IC	3.08V±2%, -Reset PPO	SOT-23	16vda	VD7	3b	Ape
CR	APE6811U-D	Vdet-IC	3.08V±2%, -Reset PPO	SC-70	16vda	VD7	3b	Ape
CR	AX6903DR	Vdet-IC	3.08V±1.5%, -Reset PPO	SOT-23	16vda	VD7	3b	Axl
CR	CPH3216	Si-npn	DC/DC-Conv, 80V, 1A, 900mW, 420MHz, B=200..560	CPH3	16ta	-	3a	San
CR	FP6810-40CS3P	Vdet-IC	4.0V±1.5%, +Reset PPO	SOT-23	16vdc	VD7	3a	Fit
CR	GS6332UR24D2	Vdet-IC	2.4V, +Reset PPO, 30ms	SOT-23	16vdc	VD7	3g	Vs
CR	L2SC2411KRLT1	Si-npn	GP, 40V, 500mA, 200mW, 250MHz, B=180..390	SOT-23	16ta	-	3a	Lrc
CR	MSB710-R	Si-pnp	GP, 60V, 500mA, 200mW, B=120..240	SOT-323	16ta	-	3a	Mot
CR	SiP6332R24D2	Vdet-IC	2.4V±1.5%, -Reset PPO 30ms	SOT-23	16vdc	VD7	3g	Vs
CR	SRA2219E	Si-pnp-Digi	Sw, 50V, 100mA, 150mW, 200MHz, R1/R2=4.7/10k	SOT-523	16ta	-	3a	Auk
CR	SRA2219EF	Si-pnp-Digi	Sw, 50V, 100mA, 150mW, 200MHz, R1/R2=4.7/10k	SOT-523F	18ta	-	3a	Auk
CR	SRA2219U	Si-pnp-Digi	Sw, 50V, 100mA, 200mW, 200MHz, R1/R2=4.7/10k	SOT-323	16ta	-	3a	Auk
CR	SRA2219UF	Si-pnp-Digi	Sw, 50V, 100mA, 200mW, 200MHz, R1/R2=4.7/10k	SOT-323F	18ta	-	3a	Auk
CRH	C945LT1-H	Si-npn	AF-Amp, 60V, 150mA, 200mW, B=200..400, >150MHz	SOT-23	16ta	-	3a	Wtr
CRL	C945LT1-L	Si-npn	AF-Amp, 60V, 150mA, 200mW, B=130..200, >150MHz	SOT-23	16ta	-	3a	Wtr
CS	2PB1219S	Si-pnp	GP, 60V, 150mA, 200mW, B=170..340, 140MHz	SOT-323	16ta	-	3a	Phi
CS	2PB710S	Si-pnp	GP, 60V, 500mA, 250mW, B=170..340, >140MHz	SOT-23	16ta	-	3a	Phi
CS	2SA1885-S	Si-pnp	HF, Sw, 15V, 100mA, 150mW, B=270..560, 650MHz	SOT-23	16ta	-	3a	Rhm
CS	2SA1886-S	Si-pnp	HF, Sw, 15V, 100mA, 150mW, B=270..560, 650MHz	SOT-323	16ta	-	3a	Rhm
CS	2SB1219-S	Si-pnp	GP, 30V, 500mA, 150mW, B=170..340, 20MHz	SOT-323	16ta	-	3a	Pan
CS	2SB1582-S	Si-pnp	GP, 30V, 500mA, 200MHz, B=170..340	SOT-416	16ta	-	3a	Pan
CS	2SB710-S	Si-pnp	GP, AF, 50V, 500mA, 200mW, B=170..340, 200MHz	SC-59	16ta	-	3a	Pan
CS	2SC2411K-S	Si-npn	AF, 40V, 500mA, 200mW, B=270..560, >250MHz	SC-59	16ta	-	3a	Rhm
CS	AP130-33TW	LVR-IC	LDO, 3.3V±2%, 300mA	TSOT23-3L	16vj	VR1	3b	Ana
CS	AP130-33W	LVR-IC	LDO, 3.3V±2%, 300mA	SOT-23	16vj	VR1	3b	Ana
CS	APE6811N-E	Vdet-IC	2.93V±2%, -Reset PPO	SOT-23	16vda	VD7	3b	Ape
CS	APE6811U-E	Vdet-IC	2.93V±2%, -Reset PPO	SC-70	16vda	VD7	3b	Ape
CS	AX6903ER	Vdet-IC	2.93V±1.5%, -Reset PPO	SOT-23	16vda	VD7	3b	Axl
CS	FP6810-44CS3P	Vdet-IC	4.38V±1.5%, +Reset PPO	SOT-23	16vdc	VD7	3a	Fit
CS	GS6332UR24D3	Vdet-IC	2.4V, +Reset PPO, 150ms	SOT-23	16vdc	VD7	3g	Vs
CS	RT9169-46CV	LVR-IC	LDO, 4.6V±2%, 100mA	SOT-23	16ch	VR1	3a	Rct
CS	SiP6332R24D3	Vdet-IC	2.4V±1.5%, -Reset PPO 150ms	SOT-23	16vdc	VD7	3g	Vs
CS4	2SA1682-4	Si-pnp	HV-Driver, 300V, 50mA, 250mW, B=100..200, 70MHz	SOT-23	16ta	-	3a	San
CS5	2SA1682-5	Si-pnp	HV-Driver, 300V, 50mA, 250mW, B=160..320, 70MHz	SOT-23	16ta	-	3a	San
CSA	BC847UA	Si-npn	GP, 50V, 100mA, 200mW, B=110..220, >300MHz	SOT-323	16ta	-	3a	Auk
CSA	BC847UFA	Si-npn	GP, 50V, 100mA, 200mW, B=110..220, >300MHz	SOT-323F	16ta	-	3a	Auk
CSB	BC847UB	Si-npn	GP, 50V, 100mA, 200mW, B=200..450, >300MHz	SOT-323	16ta	-	3a	Auk
CSB	BC847UBF	Si-npn	GP, 50V, 100mA, 200mW, B=200..450, >300MHz	SOT-323F	18ta	-	3a	Auk
CSC	BC847UC	Si-npn	GP, 50V, 100mA, 200mW, B=420..800, >300MHz	SOT-323	16ta	-	3a	Auk
CSC	BC847UFC	Si-npn	GP, 50V, 100mA, 200mW, B=420..800, >300MHz	SOT-323F	18ta	-	3a	Auk
CSH	A733LT1-H	Si-pnp	GP, 50V, 150mA, 200mW, >50MHz, B=200..475	SOT-23	16ta	-	3a	Wtr
CSL	A733LT1-L	Si-pnp	GP, 50V, 150mA, 200mW, >50MHz, B=120..200	SOT-23	16ta	-	3a	Wtr
CT	AP130-34TW	LVR-IC	LDO, 3.4V±2%, 300mA	TSOT23-3L	16vj	VR1	3b	Ana
CT	AP130-34W	LVR-IC	LDO, 3.4V±2%, 300mA	SOT-23	16vj	VR1	3b	Ana
CT	APE6811N-F	Vdet-IC	2.63V±2%, -Reset PPO	SOT-23	16vda	VD7	3b	Ape
CT	APE6811U-F	Vdet-IC	2.63V±2%, -Reset PPO	SC-70	16vda	VD7	3b	Ape
CT	AX6903FR	Vdet-IC	2.63V±1.5%, -Reset PPO	SOT-23	16vda	VD7	3b	Axl
CT	FP6810-46CS3P	Vdet-IC	4.63V±1.5%, +Reset PPO	SOT-23	16vdc	VD7	3a	Fit
CT	GS6332UR25D1	Vdet-IC	2.5V, +Reset PPO, 1.5ms	SOT-23	16vdc	VD7	3g	Vs
CT	MMBZ4688	Z-diode	4.7V±5%, 350mW	SOT-23	16dc	-	3g	Vs
CT	RT9169-44CV	LVR-IC	LDO, 4.4V±2%, 100mA	SOT-23	16ch	VR1	3a	Rct
CT	SiP6332R25D1	Vdet-IC	2.5V±1.5%, -Reset PPO 1.5ms	SOT-23	16vdc	VD7	3g	Vs
CT5	2SD1935-5	Si-npn	AF-Drv, 15V, 800mA, 200mW, B=135..270, 200MHz	CP	16ta	-	3a	San
CT6	2SD1935-6	Si-npn	AF-Drv, 15V, 800mA, 200mW, B=200..400, 200MHz	CP	16ta	-	3a	San
CT7	2SD1935-7	Si-npn	AF-Drv, 15V, 800mA, 200mW, B=300..600, 200MHz	CP	16ta	-	3a	San
CT8	2SD1935-8	Si-npn	AF-Drv, 15V, 800mA, 200mW, B=450..900, 200MHz	CP	16ta	-	3a	San
CJ	AP130-35TW	LVR-IC	LDO, 3.5V±2%, 300mA	TSOT23-3L	16vj	VR1	3b	Ana
CJ	AP130-35W	LVR-IC	LDO, 3.5V±2%, 300mA	SOT-23	16vj	VR1	3b	Ana
CJ	APE6811N-G	Vdet-IC	2.25V±2%, -Reset PPO	SOT-23	16vda	VD7	3b	Ape
CJ	APE6811U-G	Vdet-IC	2.25V±2%, -Reset PPO	SC-70	16vda	VD7	3b	Ape
CJ	AX6903GR	Vdet-IC	2.25V±1.5%, -Reset PPO	SOT-23	16vda	VD7	3b	Axl
CJ	MMBZ4689	Z-diode	5.1V±5%, 350mW	SOT-23	16dc	-	3g	Vs
CJ	RT9169-45CV	LVR-IC	LDO, 4.5V±2%, 100mA	SOT-23	16ch	VR1	3a	Rct
CV	1SV234	PIN-diode	Dual, VHF/UHF, 50V, 50mA, 0.23pF, Rs=5Q(10mA, 100MHz)	SOT-23	16dl	-	3a	San
CV	1SV246	PIN-diode	Dual, VHF/UHF, 50V, 50mA, 0.23pF, Rs=5Q(10mA, 100MHz)	MCP	16dl	-	3a	San
CV	AP130-36TW	LVR-IC	LDO, 3.6V±2%, 300mA	TSOT23-3L	16vj	VR1	3b	Ana
CV	AP130-36W	LVR-IC	LDO, 3.6V±2%, 300mA	SOT-23	16vj	VR1	3b	Ana
CV	FP6809-23NS3P	Vdet-IC	2.32V±1.5%, -Reset ODO	SOT-23	16vdc	VD6	3a	Fit
CV	GS6332UR25D2	Vdet-IC	2.5V, +Reset PPO, 30ms	SOT-23	16vdc	VD7	3g	Vs
CV	MMBZ4690	Z-diode	5.6V±5%, 350mW	SOT-23	16dc	-	3g	Vs



SMD code	Type	Function	Short description	Case	Pinout	Sch.	St.	Mnf.
CV	RT9161-33CV	LVR-IC	LDO, 3.3V±2%, 300mA	SOT-23	16cg	VR1	3a	Rct
CV	SiP6332R25D2	Vdet-IC	2.5V±1.5%, -Reset PPO 30ms	SOT-23	16vdc	VD7	3g	Vs
CV-	RT9161-33PV	LVR-IC	LDO, 3.3V±2%, 300mA	SOT-23	16cg	VR1	3a	Rct
CVA	BC856UA	Si-pnp	GP, 80V, 100mA, 200mW, B=110..220, 150MHz	SOT-323	16ta	-	3a	Auk
CVA	BC856UFA	Si-pnp	GP, 80V, 100mA, 200mW, B=110..220, 150MHz	SOT-323F	18ta	-	3a	Auk
CVB	BC856UB	Si-pnp	GP, 80V, 100mA, 200mW, B=200..450, 150MHz	SOT-323	16ta	-	3a	Auk
CVB	BC856UFB	Si-pnp	GP, 80V, 100mA, 200mW, B=200..450, 150MHz	SOT-323F	18ta	-	3a	Auk
CVC	BC856UC	Si-pnp	GP, 80V, 100mA, 200mW, B=420..800, 150MHz	SOT-323	16ta	-	3a	Auk
CVC	BC856UFC	Si-pnp	GP, 80V, 100mA, 200mW, B=420..800, 150MHz	SOT-323F	18ta	-	3a	Auk
CW	AP130-37TW	LVR-IC	LDO, 3.7V±2%, 300mA	TSOT23-3L	16vj	VR1	3b	Ana
CW	AP130-37W	LVR-IC	LDO, 3.7V±2%, 300mA	SOT-23	16vj	VR1	3b	Ana
CW	CHT5401WPT	Si-pnp	AF, Drv, 150V, 200mA, B=60..240, 300MHz	SOT-323	16ta	-	3a	Chm
Cw	FP6809-26NS3P	Vdet-IC	2.63V±1.5%, -Reset ODO	SOT-23	16vdc	VD6	3a	Fit
CW	GS6332UR25D3	Vdet-IC	2.5V, +Reset PPO, 150ms	SOT-23	16vdc	VD7	3g	Vs
CW	IMP809JEUR	Vdet-IC	4.0V±1.5%, -Reset PPO	SOT-23	16vdc	VD7	3a	Imp
CW	MAZ6001UR	Vref-IC	Precision, 1.250V	SOT-23	16di	-	3a	Max
CW	RT9169-47CV	LVR-IC	LDO, 4.7V±2%, 100mA	SOT-23	16ch	VR1	3a	Rct
CW	SiP6332R25D3	Vdet-IC	2.5V±1.5%, -Reset PPO 150ms	SOT-23	16vdc	VD7	3g	Vs
CWAA	HWD809JEU	Vdet-IC	4.00V±2%, -Reset PPO	SOT-23	16vdc	VD7	3a	Csm
CWAA	MAX809JUR	Vdet-IC	4.0V±1.5%, -Reset PPO	SOT-23	16vdc	VD7	3a	Max
CX	50C02CH	Si-npn	AF, GP, 60V, 500mA, 700mW, B=300..800, 500MHz	CPH3	16ta	-	3a	San
CX	AP130-38TW	LVR-IC	LDO, 3.8V±2%, 300mA	TSOT23-3L	16vj	VR1	3b	Ana
CX	AP130-38W	LVR-IC	LDO, 3.8V±2%, 300mA	SOT-23	16vj	VR1	3b	Ana
Cx	FP6809-29NS3P	Vdet-IC	2.93V±1.5%, -Reset ODO	SOT-23	16vdc	VD6	3a	Fit
CX	MAZ6002UR	Vref-IC	Precision, 2.500V	SOT-23	16di	-	3a	Max
CX	MMBZ4692	Z-diode	6.8V±5%, 350mW	SOT-23	16dc	-	3g	Vs
CX	RT9169-48CV	LVR-IC	LDO, 4.8V±2%, 100mA	SOT-23	16ch	VR1	3a	Rct
CX=	RT9818A-21GU3	Vdet-IC	2.1V±1.5%, -Reset ODO	SOT-323	16vdc	VD6	3a	Rct
CXAA	MAX809LUR	Vdet-IC	4.63V±1.5%, -Reset PPO	SOT-23	16vdc	VD7	3a	Max
CY	2SA1980UF-Y	Si-pnp	GP, 50V, 150mA, 200mW, B=120..240, 80MHz	SOT-323F	18ta	-	3a	Auk
CY	2SA1980U-Y	Si-pnp	GP, 50V, 150mA, 200mW, B=120..240, 80MHz	SOT-323	16ta	-	3a	Auk
CY	2SC3396	Si-npn-Digi	Sw, 50V, 100mA, 200mW, 250MHz, R1/R2=22k/22k	CP	16ta	-	3a	San
CY	2SC4209-Y	Si-npn	AF, Drv, 80V, 200mA, 200mW, B=120..240, 100MHz	SC-59	16ta	-	3a	Tos
CY	2SC4397	Si-npn-Digi	Sw, 50V, 100mA, 250MHz, R1=R2=22k	SOT-323	16ta	-	3a	San
CY	2SC5343EF-Y	Si-npn	GP, 60V, 150mA, 150mW, >80MHz, B=120..240	SOT-523F	18ta	-	3a	Auk
CY	2SC5343E-Y	Si-npn	GP, 60V, 150mA, 150mW, >80MHz, B=120..240	SOT-523	16ta	-	3a	Auk
CY	AP130-39TW	LVR-IC	LDO, 3.9V±2%, 300mA	TSOT23-3L	16vj	VR1	3b	Ana
CY	AP130-39W	LVR-IC	LDO, 3.9V±2%, 300mA	SOT-23	16vj	VR1	3b	Ana
CY	BFS18R	Si-npn	RF, 30V, 30mA, 200MHz	SOT-23	16ta	-	3a	Sie
CY	MAZ6004UR	Vref-IC	Precision, 4.096V	SOT-23	16di	-	3a	Max
CY	MMBZ4693	Z-diode	7.5V±5%, 350mW	SOT-23	16dc	-	3g	Vs
CY	RT9169-49CV	LVR-IC	LDO, 4.9V±2%, 100mA	SOT-23	16ch	VR1	3a	Rct
CYQ	2SC4661-Q	Si-npn	UHF, 15V, 30mA, 150mW, B=50..100, 5GHz	SOT-323	16ta	-	3a	Pan
CYR	2SC4661-R	Si-npn	UHF, 15V, 30mA, 150mW, B=80..160, 5GHz	SOT-323	16ta	-	3a	Pan
CYS	2SC4661-S	Si-npn	UHF, 15V, 30mA, 150mW, B=125..250, 5GHz	SOT-323	16ta	-	3a	Pan
CZ	AP130-40TW	LVR-IC	LDO, 4.0V±2%, 300mA	TSOT23-3L	16vj	VR1	3b	Ana
CZ	AP130-40W	LVR-IC	LDO, 4.0V±2%, 300mA	SOT-23	16vj	VR1	3b	Ana
CZ	BFS19R	Si-npn	RF, 30V, 30mA, 250mW, B=65..225, 260MHz	SOT-23	16ta	-	3a	Sie
Cz	FP6809-31NS3P	Vdet-IC	3.08V±1.5%, -Reset ODO	SOT-23	16vdc	VD6	3a	Fit
CZ	MAZ6005UR	Vref-IC	Precision, 5.00V	SOT-23	16di	-	3a	Max
CZ	MMBZ4694	Z-diode	8.2V±5%, 350mW	SOT-23	16dc	-	3g	Vs
CZ	RT9169-50CV	LVR-IC	LDO, 5.0V±2%, 100mA	SOT-23	16ch	VR1	3a	Rct
CZ-	RT9169-50PV	LVR-IC	LDO, 5.0V±2%, 100mA	SOT-23	16ch	VR1	3a	Rct
d	AX6901DA	Vdet-IC	3.08V±1.5%, -Reset PPO	SC-70	16vdc	VD7	3b	Axl
D	Si1013R	p-MOSFET-e	T-FET, Sw, 20V, 275mA, 150mW, <1.2Ω(350mA), 5/35ns	SC-75A	16fh	-	3a	Six
D0	BZX84-C56	Z-diode	52..60V, Zzt=200Q, Izt=20mA, 225mW	SOT-23	16dc	-	3a	Lge
D0	ELM9730NBB	Vdet-IC	3.0V±2.5%, +Reset ODO	SOT-23	16vdb	VD6	3d	Elm
D0	HSMP-3800	PIN-diode	RF, 100V, 1A(1ms), <0.37pF, <2Q(100mA)	SOT-23	16dc	-	3a	Agj
D0	ILC5062IC30X	Vdet-IC	3V, ±2%, -Reset PPO	SOT-323	16vdb	VD7	3a	Imp
D0	ILC5062M30X	Vdet-IC	3V±2%, -Reset PPO	SOT-23	16vdb	VD7	3a	Imp
D0	R3111N302A	Vdet-IC	3V±2%, -Reset PPO	SOT-23	16vdd	VD7	3d	Ric
D0	R3113D401A	Vdet-IC	4V±2%, -Reset, ODO	SON1408-3	18vda	VD6	3d	Ric
D0	R3130N40EC	Vdet-IC	4V, -Reset ODO, 240ms	SOT-23	16vdc	VD6	3b	Ric
D0	RT9809-15CV	Vdet-IC	1.5V±2%, -Reset PPO	SOT-23	16vdc	VD7	3a	Rct
D0	Si2320DS	n-MOSFET-e	V-MOS, 200V, ±0.22A, <7Q(0.5A)	SOT-23	16fh	-	3a	Six
D0	TC54VC3002ECB	Vdet-IC	3.0V±2%, -Reset PPO	SOT-23	16vdb	VD7	3a	Tcs
D0	XC61CC3002M	Vdet-IC	3V±1%, +Reset PPO	SOT-23	16vdb	VD7	3d	Tor
D0	XC6GC3002HR	Vdet-IC	3.0V, +Reset PPO	USP-3	17vdc	VD3	9b	Tor
D03	XE61CC3045MR	Vdet-IC	3.0V±2%, -Reset PPO	SOT-23	16vdb	VD7	3h	Tor
D05	XC61FC3012M	Vdet-IC	3V±2%, +Reset PPO, 200ms	SOT-23	16vdb	VD7	3d	Tor



SMD code	Type	Function	Short description	Case	Pinout	Sch.	St.	Mnf.
D05	XC61HC3012MR	Vdet-IC	3.0V±2%, -Reset PPO, 50..200ms	SOT-23	16vdc	VD7	3d	Tor
D06	XC61FC3042M	Vdet-IC	3V±2%, +Reset PPO, 400ms	SOT-23	16vdb	VD7	3d	Tor
D06	XC61HC3042MR	Vdet-IC	3.0V±2%, -Reset PPO, 80..400ms	SOT-23	16vdc	VD7	3d	Tor
D07	XC61FC3052M	Vdet-IC	3V±2%, +Reset PPO, 50ms	SOT-23	16vdb	VD7	3d	Tor
D07	XC61HC3052MR	Vdet-IC	3.0V±2%, -Reset PPO, 1..50ms	SOT-23	16vdc	VD7	3d	Tor
D0A	ILC5062AIC30X	Vdet-IC	3V±1%, -Reset PPO,	SOT-323	16vdb	VD7	3a	Imp
D0A	ILC5062AM30X	Vdet-IC	3V±1%, -Reset PPO	SOT-23	16vdb	VD7	3a	Imp
D1	2SC5277-1	Si-npn	UHF-S-band, 20V, 30mA, 100mW, B=60..120, 11GHz	SMCP	16ta	-	3a	San
D1	2SK3107	n-MOSFET-e*	V-MOS, LogL, 30V, ±100mA, <15Q	SOT-23	16fh	-	3a	Nec
D1	AX1110R15	LVR-IC	LDO, 1.5V±2%, 350mA	SOT-23L	16vl	VR1	3b	Axl
D1	AZ23C2V7	Z-diode	Dual, 2.57..2.84V, Zzt=83Q, lzt=5mA, 300mW	SOT-23	16df	-	3c	Di
D1	BCW31	Si-npn	GP, 32V, 100mA, 250mW, B=110..220, >100MHz	SOT-23	16ta	-	3a	Rhm
D1	ELM9731NBB	Vdet-IC	3.1V±2.5%, +Reset ODO	SOT-23	16vdb	VD6	3d	Elm
D1	ILC5062IC31X	Vdet-IC	3.1V±2%, -Reset PPO	SOT-323	16vdb	VD7	3a	Imp
D1	ILC5062M31X	Vdet-IC	3.1V±2%, -Reset PPO	SOT-23	16vdb	VD7	3a	Imp
D1	MMBZ5226B	Z-diode	3.14..3.47V, lzt=20mA, Zzt=28Q, 410mW	SOT-23	16dc	-	3a	Pjt
D1	MMBZ5226BW	Z-diode	3.3V±5%, Zzt=28Q, 200mW	SOT-323	16dc	-	3a	Pjt
D1	R3111N312A	Vdet-IC	3.1V±2%, -Reset PPO	SOT-23	16vdd	VD7	3d	Ric
D1	R3113D411A	Vdet-IC	4.1V±2%, -Reset, ODO	SON11408-3	16vda	VD6	3d	Ric
D1	R3130N41EC	Vdet-IC	4.1V, -Reset ODO, 240ms	SOT-23	16vdc	VD6	3b	Ric
D1	RT9809-16CV	Vdet-IC	1.6V±2%, -Reset PPO	SOT-23	16vdc	VD7	3a	Rct
D1	TC54VC3102ECB	Vdet-IC	3.1V±2%, -Reset PPO	SOT-23	16vdb	VD7	3a	Tcs
D1	XC61CC3102M	Vdet-IC	3.1V±1%, +Reset PPO	SOT-23	16vdb	VD7	3d	Tor
D1	XC6GC3102HR	Vdet-IC	3.1V, +Reset PPO	USP-3	17vdc	VD3	9b	Tor
D10	AZ23C6V2	Z-diode	Dual, 5.89..6.51V, Zzt=10Q, lzt=5mA, 300mW	SOT-23	16df	-	3c	Di
D10	CZMA10	Z-diode	Dual, 10V±5%, 300mW	SOT-23	16df	-	3a	Cdi
D10	TZT10AW	Z-diode	Dual, 9.4..10.6V, lzt=5mA, Zzt=20Q, 300mW	SOT-23	16df	-	3a	Ttr
D11	AZ23C6V8	Z-diode	Dual, 6.46..7.14V, Zzt=8Q, lzt=5mA, 300mW	SOT-23	16df	-	3c	Pjt
D11	CZMA11	Z-diode	Dual, 11V±5%, 300mW	SOT-23	16df	-	3a	Cdi
D11	TZT11AW	Z-diode	Dual, 10.4..11.6V, lzt=5mA, Zzt=20Q, 300mW	SOT-23	16df	-	3a	Ttr
D11A	ML6102C113M	Vdet-IC	1.1V±3%, -Reset PPO	SOT-23	16vdb	VD7	3a	Mlc
D12	AZ23C7V5	Z-diode	Dual, 7.13..7.88V, Zzt=7Q, lzt=5mA, 300mW	SOT-23	16df	-	3c	Pjt
D12	CZMA12	Z-diode	Dual, 12V±5%, 300mW	SOT-23	16df	-	3a	Cdi
D12	TZT12AW	Z-diode	Dual, 11.4..12.7V, lzt=5mA, Zzt=25Q, 300mW	SOT-23	16df	-	3a	Ttr
D12A	ML6102C123M	Vdet-IC	1.2V±3%, -Reset PPO	SOT-23	16vdb	VD7	3a	Mlc
D13	AZ23C8V2	Z-diode	Dual, 7.79..8.61V, Zzt=7Q, lzt=5mA, 300mW	SOT-23	16df	-	3c	Pjt
D13	CZMA13	Z-diode	Dual, 13V±5%, 300mW	SOT-23	16df	-	3a	Cdi
D13	TZT13AW	Z-diode	Dual, 12.4..14.1V, lzt=5mA, Zzt=30Q, 300mW	SOT-23	16df	-	3a	Ttr
D13	XE61CC3145MR	Vdet-IC	3.1V±2%, -Reset PPO	SOT-23	16vdb	VD7	3h	Tor
D13A	ML6102C133M	Vdet-IC	1.3V±3%, -Reset PPO	SOT-23	16vdb	VD7	3a	Mlc
D14	AZ23C9V1	Z-diode	Dual, 8.65..9.56V, Zzt=10Q, lzt=5mA, 300mW	SOT-23	16df	-	3c	Pjt
D14A	ML6102C143M	Vdet-IC	1.4V±3%, -Reset PPO	SOT-23	16vdb	VD7	3a	Mlc
D15	2SC1622A-15	Si-npn	AF-Amp, 120V, 50mA, 200mW, 110MHz, B=130..270	SOT-23	16ta	-	3a	Nec
D15	2SC4180-15	Si-npn	AF, 120V, 50mA, 150mW, B=135..270, >50MHz	SOT-323	16ta	-	3a	Nec
D15	AZ23C10	Z-diode	Dual, 9.50..10.50V, Zzt=15Q, lzt=5mA, 300mW	SOT-23	16df	-	3c	Pjt
D15	CZMA15	Z-diode	Dual, 15V±5%, 300mW	SOT-23	16df	-	3a	Cdi
D15	TZT15AW	Z-diode	Dual, 13.8..15.6V, lzt=5mA, Zzt=30Q, 300mW	SOT-23	16df	-	3a	Ttr
D15	XC61FC3112M	Vdet-IC	3.1V±2%, +Reset PPO, 200ms	SOT-23	16vdb	VD7	3d	Tor
D15	XC61HC3112MR	Vdet-IC	3.1V±2%, -Reset PPO, 50..200ms	SOT-23	16vdc	VD7	3d	Tor
D15A	ML6102C153M	Vdet-IC	1.5V±3%, -Reset PPO	SOT-23	16vdb	VD7	3a	Mlc
D16	2SC1622A-16	Si-npn	AF-Amp, 120V, 50mA, 200mW, 110MHz, B=200..400	SOT-23	16ta	-	3a	Nec
D16	2SC4180-16	Si-npn	AF, 120V, 50mA, 150mW, B=200..400, >50MHz	SOT-323	16ta	-	3a	Nec
D16	AZ23C11	Z-diode	Dual, 10.45..11.55V, Zzt=20Q, lzt=5mA, 300mW	SOT-23	16df	-	3c	Pjt
D16	CZMA16	Z-diode	Dual, 16V±5%, 300mW	SOT-23	16df	-	3a	Cdi
D16	TZT16AW	Z-diode	Dual, 15.3..17.1V, lzt=5mA, Zzt=40Q, 300mW	SOT-23	16df	-	3a	Ttr
D16	XC61FC3142M	Vdet-IC	3.1V±2%, +Reset PPO, 400ms	SOT-23	16vdb	VD7	3d	Tor
D16	XC61HC3142MR	Vdet-IC	3.1V±2%, -Reset PPO, 80..400ms	SOT-23	16vdc	VD7	3d	Tor
D16A	ML6102C163M	Vdet-IC	1.6V±3%, -Reset PPO	SOT-23	16vdb	VD7	3a	Mlc
D17	2SC1622A-17	Si-npn	AF-Amp, 120V, 50mA, 200mW, 110MHz, B=300..600	SOT-23	16ta	-	3a	Nec
D17	2SC4180-17	Si-npn	AF, 120V, 50mA, 150mW, B=300..600, >50MHz	SOT-323	16ta	-	3a	Nec
D17	AZ23C12	Z-diode	Dual, 11.40..12.60V, Zzt=20Q, lzt=5mA, 300mW	SOT-23	16df	-	3c	Pjt
D17	XC61FC3152M	Vdet-IC	3.1V±2%, +Reset PPO, 50ms	SOT-23	16vdb	VD7	3d	Tor
D17	XC61HC3152MR	Vdet-IC	3.1V±2%, -Reset PPO, 1..50ms	SOT-23	16vdc	VD7	3d	Tor
D17A	ML6102C173M	Vdet-IC	1.7V±3%, -Reset PPO	SOT-23	16vdb	VD7	3a	Mlc
D18	2SC1622A-18	Si-npn	AF-Amp, 120V, 50mA, 200mW, 110MHz, B=450..900	SOT-23	16ta	-	3a	Nec
D18	2SC4180-18	Si-npn	AF, 120V, 50mA, 150mW, B=450..900, >50MHz	SOT-323	16ta	-	3a	Nec
D18	AZ23C13	Z-diode	Dual, 12.35..13.65V, Zzt=25Q, lzt=5mA, 300mW	SOT-23	16df	-	3c	Pjt
D18	CZMA18	Z-diode	Dual, 18V±5%, 300mW	SOT-23	16df	-	3a	Cdi
D18	TZT18AW	Z-diode	Dual, 16.8..19.1V, lzt=5mA, Zzt=45Q, 300mW	SOT-23	16df	-	3a	Ttr
D18A	ML6102C183M	Vdet-IC	1.8V±3%, -Reset PPO	SOT-23	16vdb	VD7	3a	Mlc



SMD code	Type	Function	Short description	Case	Pinout	Sch.	St.	Mnf.
D19	AZ23C15	Z-diode	Dual, 14.25..15.75V, Zzt=30Ω, Izt=5mA, 300mW	SOT-23	16df	-	3c	Pjt
D19A	ML6102C193M	Vdet-IC	1.9V±3%, -Reset PPO	SOT-23	16vdb	VD7	3a	Mlc
D1A	ILC5062AIC31X	Vdet-IC	3.1V±1%, -Reset PPO	SOT-323	16vdb	VD7	3a	Imp
D1A	ILC5062AM31X	Vdet-IC	3.1V±1%, -Reset PPO	SOT-23	16vdb	VD7	3a	Imp
D1G	KSA812-G	Si-pnp	AF, 60V, 100mA, 150mW, B=200..400, >180MHz	SOT-23	16ta	-	3a	Sam
D1L	KSA812-L	Si-pnp	AF, 60V, 100mA, 150mW, B=300..600, >180MHz	SOT-23	16ta	-	3a	Sam
D1O	KSA812-O	Si-pnp	AF, 60V, 100mA, 150mW, B=90..180, >180MHz	SOT-23	16ta	-	3a	Sam
D1p	BCW31	Si-pnp	GP, 32V, 100mA, 250mW, B=110..220, >100MHz	SOT-23	16ta	-	3a	PhH
D1t	BCW31	Si-pnp	GP, 32V, 100mA, 250mW, B=110..220, >100MHz	SOT-23	16ta	-	3a	PhM
D1W	BCW31	Si-pnp	GP, 32V, 100mA, 250mW, B=110..220, >100MHz	SOT-23	16ta	-	3a	PhC
D1Y	KSA812-Y	Si-pnp	AF, 60V, 100mA, 150mW, B=135..270, >180MHz	SOT-23	16ta	-	3a	Sam
D2	2SC5277-2	Si-npn	UHF-S-band, 20V, 30mA, 100mW, B=90..180, 11GHz	SMCP	16ta	-	3a	San
D2	AX1110R18	LVR-IC	LDO, 1.8V±2%, 350mA	SOT-23L	16vl	VR1	3b	Axl
D2	AZ23C3V0	Z-diode	Dual, 2.85..3.15V, Zzt=95Ω, Izt=5mA, 300mW	SOT-23	16df	-	3c	Di
D2	BCW32	Si-pnp	GP, 32V, 100mA, 250mW, B=200..450, >100MHz	SOT-23	16ta	-	3a	Rhm
D2	ELM9732NBB	Vdet-IC	3.2V±2.5%, +Reset ODO	SOT-23	16vdb	VD6	3d	Elm
D2	HSMF-3802	PIN-diode	Dual, RF, 100V, 1A(1ms), <0.37pF, <2Ω(100mA)	SOT-23	16dl	-	3a	Agi
D2	MMBZ5227B	Z-diode	3.42..3.78V, Zzt=24Ω, Izt=20mA, 410mW	SOT-23	16dc	-	3a	Pjt
D2	MMBZ5227BW	Z-diode	3.42..3.78V, Zzt=24Ω, Izt=20mA, 200mW	SOT-323	16dc	-	3a	Pjt
D2	R3111N322A	Vdet-IC	3.2V±2%, -Reset PPO	SOT-23	16vdd	VD7	3d	Ric
D2	R3113D421A	Vdet-IC	4.2V±2%, -Reset, ODO	SON1408-3	18vda	VD6	3d	Ric
D2	R3130N42EC	Vdet-IC	4.2V, -Reset ODO, 240ms	SOT-23	16vdc	VD6	3b	Ric
D2	RT9809-17CV	Vdet-IC	1.7V±2%, -Reset PPO	SOT-23	16vdc	VD7	3a	Rct
D2	TC54VC3202ECB	Vdet-IC	3.2V±2%, -Reset PPO	SOT-23	16vdb	VD7	3a	Tcs
D2	XC61CC3202M	Vdet-IC	3.2V±1%, +Reset PPO	SOT-23	16vdb	VD7	3d	Tor
D2	XC6GC3202HR	Vdet-IC	3.2V, +Reset PPO	USP-3	17vdc	VD3	9b	Tor
D20	AZ23C16	Z-diode	Dual, 15.20..16.80V, Zzt=40Ω, Izt=5mA, 300mW	SOT-23	16df	-	3c	Pjt
D20	CZMA20	Z-diode	Dual, 20V±5%, 300mW	SOT-23	16df	-	3a	Cdi
D20	TZT20AW	Z-diode	Dual, 18.8..21.2V, Izt=5mA, Zzt=55Ω, 300mW	SOT-23	16df	-	3a	Ttr
D20A	ML6102C202M	Vdet-IC	2.0V±2%, -Reset PPO	SOT-23	16vdb	VD7	3a	Mlc
D21	2SK2219-21	n-FET	Mic-preamp, 20V, 1mA, 100mW, Idss=140..240μA	MCP	16fa	-	3a	San
D21	2SK931-21	n-FET	GP, 30V, 50mA, 200mW, Idss=5..8.5mA, Up<2V	SOT-23	16fa	-	3a	San
D21	AZ23C18	Z-diode	Dual, 17.10..18.90V, Zzt=50Ω, Izt=5mA, 300mW	SOT-23	16df	-	3c	Pjt
D21	GS809C21EUD	Vdet-IC	2.1V, -Reset PPO, 30ms	SOT-23	16vdc	VD7	3g	Vs
D21A	ML6102C212M	Vdet-IC	2.1V±2%, -Reset PPO	SOT-23	16vdb	VD7	3a	Mlc
D22	2SK2219-22	n-FET	Mic-preamp, 20V, 1mA, 100mW, Idss=210..350μA	MCP	16fa	-	3a	San
D22	2SK931-22	n-FET	GP, 30V, 50mA, 200mW, Idss=7.3..12mA, Up<2V	SOT-23	16fa	-	3a	San
D22	AZ23C20	Z-diode	Dual, 19.0..21.00V, Zzt=50Ω, Izt=5mA, 300mW	SOT-23	16df	-	3c	Pjt
D22	CZMA22	Z-diode	Dual, 22V±5%, 300mW	SOT-23	16df	-	3a	Cdi
D22	TZT22AW	Z-diode	Dual, 20.8..23.3V, Izt=5mA, Zzt=55Ω, 300mW	SOT-23	16df	-	3a	Ttr
D22A	ML6102C222M	Vdet-IC	2.2V±2%, -Reset PPO	SOT-23	16vdb	VD7	3a	Mlc
D23	2SK2219-23	n-FET	Mic-preamp, 20V, 1mA, 100mW, Idss=320..500μA	MCP	16fa	-	3a	San
D23	2SK931-23	n-FET	GP, 30V, 50mA, 200mW, Idss=10..17mA, Up<2V	SOT-23	16fa	-	3a	San
D23	AZ23C22	Z-diode	Dual, 20.90..23.10V, Zzt=55Ω, Izt=5mA, 300mW	SOT-23	16df	-	3c	Pjt
D23	XE61CC3245MR	Vdet-IC	3.2V±2%, -Reset PPO	SOT-23	16vdb	VD7	3h	Tor
D23A	ML6102C232M	Vdet-IC	2.3V±2%, -Reset PPO	SOT-23	16vdb	VD7	3a	Mlc
D24	2SK931-24	n-FET	GP, 30V, 50mA, 200mW, Idss=14.5..24mA, Up<2V	SOT-23	16fa	-	3a	San
D24	AZ23C24	Z-diode	Dual, 22.80..25.20V, Zzt=80Ω, Izt=5mA, 300mW	SOT-23	16df	-	3c	Pjt
D24	CZMA24	Z-diode	Dual, 24V±5%, 300mW	SOT-23	16df	-	3a	Cdi
D24	GS809C24EUD	Vdet-IC	2.4V, -Reset PPO, 30ms	SOT-23	16vdc	VD7	3g	Vs
D24	TZT24AW	Z-diode	Dual, 22.8..25.6V, Izt=5mA, Zzt=70Ω, 300mW	SOT-23	16df	-	3a	Ttr
D24A	ML6102C242M	Vdet-IC	2.4V±2%, -Reset PPO	SOT-23	16vdb	VD7	3a	Mlc
D25	2SC3115-25	Si-npn	GP, 120V, 50mA, 200mA, B=135..270, 110MHz	SOT-23	16ta	-	3a	Nec
D25	2SK931-25	n-FET	GP, 30V, 50mA, 200mW, Idss=16..30mA, Up<2V	SOT-23	16fa	-	3a	San
D25	AZ23C27	Z-diode	Dual, 25.65..28.35V, Zzt=80Ω, Izt=5mA, 300mW	SOT-23	16df	-	3c	Pjt
D25	XC61FC3212M	Vdet-IC	3.2V±2%, +Reset PPO, 200ms	SOT-23	16vdb	VD7	3d	Tor
D25	XC61HC3212MR	Vdet-IC	3.2V±2%, -Reset PPO, 50..200ms	SOT-23	16vdc	VD7	3d	Tor
D25A	ML6102C252M	Vdet-IC	2.5V±2%, -Reset PPO	SOT-23	16vdb	VD7	3a	Mlc
D26	2SC3115-26	Si-npn	GP, 120V, 50mA, 200mA, B=200..400, 110MHz	SOT-23	16ta	-	3a	Nec
D26	AZ23C30	Z-diode	Dual, 28.50..31.50V, Zzt=80Ω, Izt=5mA, 300mW	SOT-23	16df	-	3c	Pjt
D26	GS809CREUD	Vdet-IC	2.63V, -Reset PPO, 30ms	SOT-23	16vdc	VD7	3g	Vs
D26	XC61FC3242M	Vdet-IC	3.2V±2%, +Reset PPO, 400ms	SOT-23	16vdb	VD7	3d	Tor
D26	XC61HC3242MR	Vdet-IC	3.2V±2%, -Reset PPO, 80..400ms	SOT-23	16vdc	VD7	3d	Tor
D26A	ML6102C262M	Vdet-IC	2.6V±2%, -Reset PPO	SOT-23	16vdb	VD7	3a	Mlc
D27	2SC3115-27	Si-npn	GP, 120V, 50mA, 200mA, B=300..600, 110MHz	SOT-23	16ta	-	3a	Nec
D27	AZ23C33	Z-diode	Dual, 31.35..34.65V, Zzt=80Ω, Izt=5mA, 300mW	SOT-23	16df	-	3c	Pjt
D27	CZMA27	Z-diode	Dual, 27V±5%, 300mW	SOT-23	16df	-	3a	Cdi
D27	GS809C27SEUD	Vdet-IC	2.7V, -Reset PPO, 30ms	SOT-23	16vdc	VD7	3g	Vs
D27	TZT27AW	Z-diode	Dual, 25.1..28.9V, Izt=2mA, Zzt=80Ω, 300mW	SOT-23	16df	-	3a	Ttr
D27	XC61FC3252M	Vdet-IC	3.2V±2%, +Reset PPO, 50ms	SOT-23	16vdb	VD7	3d	Tor



SMD code	Type	Function	Short description	Case	Pinout	Sch. St.	Mnf.
D27	XC61HC3252MR	Vdet-IC	3.2V±2%, -Reset PPO, 1..50ms	SOT-23	16vdc	VD7	3d Tor
D27A	ML6102C272M	Vdet-IC	2.7V±2%, -Reset PPO	SOT-23	16vdb	VD7	3a Mlc
D28	2SC3115-28	Si-npn	GP, 120V, 50mA, 200mA, B=450..900, 110MHz	SOT-23	16ta	-	3a Nec
D28	AZ23C36	Z-diode	Dual, 34.20..37.80V, Zzt=90Ω, lzt=5mA, 300mW	SOT-23	16df	-	3c Pjt
D28A	ML6102C282M	Vdet-IC	2.8V±2%, -Reset PPO	SOT-23	16vdb	VD7	3a Mlc
D29	AZ23C39	Z-diode	Dual, 37.05..40.95V, Zzt=90Ω, lzt=5mA, 300mW	SOT-23	16df	-	3c Pjt
D29	GS809CSEUD	Vdet-IC	2.93V, -Reset PPO, 30ms	SOT-23	16vdc	VD7	3g Vs
D29A	ML6102C292M	Vdet-IC	2.9V±2%, -Reset PPO	SOT-23	16vdb	VD7	3a Mlc
D2D	RB491D	Si-diode	SBR, 40V, 100mA, Vf<0.53V(1A)	SOT-23	16dc	-	3a Rhm
D2p	BCW32	Si-pnp	GP, 32V, 100mA, 250mW, B=200..450, >100MHz	SOT-23	16ta	-	3a Phi
D2t	BCW32	Si-pnp	GP, 32V, 100mA, 250mW, B=200..450, >100MHz	SOT-23	16ta	-	3a Phi
D3	1S5187	Si-diode	Sw, U-Fast, 85V, 100mA, 150mW, Vf<1.2V(100mA), <4ns	SC-59	16eb	-	3a Tos
D3	2SC5277-3	Si-npn	UHF-S-band, 20V, 30mA, 100mW, B=135..270, 11GHz	SMCP	16ta	-	3a San
D3	AX1110R25	LVR-IC	LDO, 2.5V±2%, 350mA	SOT-23L	16vl	VR1	3b Axl
D3	AZ23C3V3	Z-diode	Dual, 3.14..3.47V, Zzt=95Ω, lzt=5mA, 300mW	SOT-23	16df	-	3c Di
D3	BCW33	Si-pnp	GP, 32V, 100mA, 250mW, B=420..800, >100MHz	SOT-23	16ta	-	3a Rhm
D3	ELM9733NBB	Vdet-IC	3.3V±2.5%, +Reset ODO	SOT-23	16vdb	VD6	3d Elm
D3	KV1735R	C-diode	2x FM-tun, 16V, 50mA, 22.25/77.74pF(8..2V), <0.3Q (100MHz)	SOT-23C-3	16dg	-	3a Tok
D3	MMBZ5228B	Z-diode	3.71..4.10V, Zzt=23Ω, lzt=20mA, 410mW	SOT-23	16dc	-	3a Pjt
D3	MMBZ5228BW	Z-diode	3.71..4.10V, lzt=20mA, Zzt=23Ω, 200mW	SOT-323	16dc	-	3a Pjt
D3	R3111N332A	Vdet-IC	3.3V±2%, -Reset PPO	SOT-23	16vdd	VD7	3d Ric
D3	R3113D431A	Vdet-IC	4.3V±2%, -Reset, ODO	SON1408-3	18vda	VD6	3d Ric
D3	R3130N43EC	Vdet-IC	4.3V, -Reset ODO, 240ms	SOT-23	16vdc	VD6	3b Ric
D3	RT9809-18CV	Vdet-IC	1.8V±2%, -Reset PPO	SOT-23	16vdc	VD7	3a Ret
D3	TC54VC3302ECB	Vdet-IC	3.3V±2%, -Reset PPO	SOT-23	16vdb	VD7	3a Tcs
D3	XC61CC3302M	Vdet-IC	3.3V±1%, +Reset PPO	SOT-23	16vdb	VD7	3d Tor
D3	XC6GC3302HR	Vdet-IC	3.3V, +Reset PPO	USP-3	17vdc	VD3	9b Tor
D3.9	TZT3V9AW	Z-diode	Dual, 3.7..4.1V, lzt=5mA, Zzt=90Ω, 300mW	SOT-23	16df	-	3a Ttr
D30	AZ23C43	Z-diode	Dual, 40.85..45.15V, Zzt=100Ω, lzt=5mA, 300mW	SOT-23	16df	-	3c Pjt
D30	CZMA30	Z-diode	Dual, 30V±5%, 300mW	SOT-23	16df	-	3a Cdi
D30	GS809CTEUD	Vdet-IC	3.08V, -Reset PPO, 30ms	SOT-23	16vdc	VD7	3g Vs
D30	TZT30AW	Z-diode	Dual, 28.0..32.0V, lzt=2mA, Zzt=80Ω, 300mW	SOT-23	16df	-	3a Ttr
D30A	ML6102C302M	Vdet-IC	3.0V±2%, -Reset PPO	SOT-23	16vdb	VD7	3a Mlc
D31	AZ23C47	Z-diode	Dual, 44.65..49.35V, Zzt=100Ω, lzt=5mA, 300mW	SOT-23	16df	-	3c Pjt
D31A	ML6102C312M	Vdet-IC	3.1V±2%, -Reset PPO	SOT-23	16vdb	VD7	3a Mlc
D32	AZ23C51	Z-diode	Dual, 48.45..53.55V, Zzt=100Ω, lzt=5mA, 300mW	SOT-23	16df	-	3c Pjt
D32A	ML6102C322M	Vdet-IC	3.2V±2%, -Reset PPO	SOT-23	16vdb	VD7	3a Mlc
D33	CZMA33	Z-diode	Dual, 33V±5%, 300mW	SOT-23	16df	-	3a Cdi
D33	TZT33AW	Z-diode	Dual, 31.0..35.0V, lzt=2mA, Zzt=80Ω, 300mW	SOT-23	16df	-	3a Ttr
D33	XE61CC3345MR	Vdet-IC	3.3V±2%, -Reset PPO	SOT-23	16vdb	VD7	3h Tor
D33A	ML6102C332M	Vdet-IC	3.3V±2%, -Reset PPO	SOT-23	16vdb	VD7	3a Mlc
D34A	ML6102C342M	Vdet-IC	3.4V±2%, -Reset PPO	SOT-23	16vdb	VD7	3a Mlc
D35	XC61FC3312M	Vdet-IC	3.3V±2%, +Reset PPO, 200ms	SOT-23	16vdb	VD7	3d Tor
D35	XC61HC3312MR	Vdet-IC	3.3V±2%, -Reset PPO, 50..200ms	SOT-23	16vdc	VD7	3d Tor
D35A	ML6102C352M	Vdet-IC	3.5V±2%, -Reset PPO	SOT-23	16vdb	VD7	3a Mlc
D36	CZMA36	Z-diode	Dual, 36V±5%, 300mW	SOT-23	16df	-	3a Cdi
D36	TZT36AW	Z-diode	Dual, 34.0..38.0V, lzt=2mA, Zzt=90Ω, 300mW	SOT-23	16df	-	3a Ttr
D36	XC61FC3342M	Vdet-IC	3.3V±2%, +Reset PPO, 400ms	SOT-23	16vdb	VD7	3d Tor
D36	XC61HC3342MR	Vdet-IC	3.3V±2%, -Reset PPO, 80..400ms	SOT-23	16vdc	VD7	3d Tor
D36A	ML6102C362M	Vdet-IC	3.6V±2%, -Reset PPO	SOT-23	16vdb	VD7	3a Mlc
D37	XC61FC3352M	Vdet-IC	3.3V±2%, +Reset PPO, 50ms	SOT-23	16vdb	VD7	3d Tor
D37	XC61HC3352MR	Vdet-IC	3.3V±2%, -Reset PPO, 1..50ms	SOT-23	16vdc	VD7	3d Tor
D37A	ML6102C372M	Vdet-IC	3.7V±2%, -Reset PPO	SOT-23	16vdb	VD7	3a Mlc
D38A	ML6102C382M	Vdet-IC	3.8V±2%, -Reset PPO	SOT-23	16vdb	VD7	3a Mlc
D39	CZMA39	Z-diode	Dual, 39V±5%, 300mW	SOT-23	16df	-	3a Cdi
D39	TZT39AW	Z-diode	Dual, 37.0..41.0V, lzt=2mA, Zzt=130Ω, 300mW	SOT-23	16df	-	3a Ttr
D39A	ML6102C392M	Vdet-IC	3.9V±2%, -Reset PPO	SOT-23	16vdb	VD7	3a Mlc
D3A	RB400D	Si-diode	SBR, 40V, 500mA, Vf<0.55V(500mA), <20pF	SOT-23	16dc	-	3a Rhm
D3B	RB420D	Si-diode	SBR, 40V, 100mA, Vf<0.45V(10mA), <6pF	SOT-23	16dc	-	3a Rhm
D3C	RB421D	Si-diode	SBR, 40V, 100mA, Vf<0.55V(100mA), <6pF	SOT-23	16dc	-	3a Rhm
D3L	RB425D	Si-diode	Dual, Schottky Rectifier, 40V, 100mA, Vf<0.55V(100mA), <6pF	SOT-23	16dg	-	3a Rhm
D3p	BCW33	Si-pnp	GP, 32V, 100mA, 250mW, B=420..800, >100MHz	SOT-23	16ta	-	3a Phi
D3Q	RB495D	Si-diode	Dual, Schottky Rectifier, 40V, 400mA, Vf<0.5V(200mA)	SOT-23	16dg	-	3a Rhm
D3t	BCW33	Si-pnp	GP, 32V, 100mA, 250mW, B=420..800, >100MHz	SOT-23	16ta	-	3a Phi
D4	2SA1252-4	Si-pnp	AF, 60V, 150mA, 200mW, 100MHz, B=90..180	SOT-23	16ta	-	3a San
D4	AX1110R33	LVR-IC	LDO, 3.3V±2%, 350mA	SOT-23L	16vl	VR1	3b Axl
D4	AZ23C3V6	Z-diode	Dual, 3.42..3.78V, Zzt=95Ω, lzt=5mA, 300mW	SOT-23	16df	-	3c Di
D4	BB404D	C-diode	Dual, 10V, 46.5..22pF(2..8V), 100MHz	SOT-23	16dg	-	3a Itt
D4	BC847AM	Si-npn	GP, 50V, 100mA, 250mW, B=110..220, >100MHz	SOT-883	22ta	-	2a PHH
D4	BCW31R	Si-pnp	GP, 32V, 100mA, 250mW, B=110..220, >100MHz	SOT-23	16te	-	3a Phi



SMD code	Type	Function	Short description	Case	Pinout	Sch. St.	Mnf.
D4	ELM9734NBB	Vdet-IC	3.4V±2.5%, +Reset ODO	SOT-23	16vdb	VD6	3d Elm
D4	HSMP-3804	PIN-diode	Dual, RF, 100V, 1A(1ms), <0.37pF, <2Q(100mA)	SOT-23	16dg	-	3a Agi
D4	KA4L3M	Si-npn-Digi	Sw, 60V, 100mA, 200mW, R1/R2=4k7/4k7	SOT-416	16ta	-	3a Nec
D4	MMBD4148SE	Si-diode	Dual, Sw, Fast, 75V, 200mA, 350mW, <4ns, 4pF	SOT-23	16dl	-	3a F
D4	MMBZ5229B	Z-diode	4.09..4.52V, Zzt=22Q, lzt=20mA, 410mW	SOT-23	16dc	-	3a Pjt
D4	MMBZ5229BW	Z-diode	4.3V±5%, Zzt=22Q, 200mW	SOT-323	16dc	-	3a Pjt
D4	R3111N342A	Vdet-IC	3.4V±2%, -Reset PPO	SOT-23	16vdd	VD7	3d Ric
D4	R3113D441A	Vdet-IC	4.4V±2%, -Reset, ODO	SON1408-3	18vda	VD6	3d Ric
D4	R3130N44EC	Vdet-IC	4.4V, -Reset ODO, 240ms	SOT-23	16vdc	VD6	3b Ric
D4	RT9809-19CV	Vdet-IC	1.9V±2%, -Reset PPO	SOT-23	16vdc	VD7	3a Rct
D4	TC54VC3402ECB	Vdet-IC	3.4V±2%, -Reset PPO	SOT-23	16vdb	VD7	3a Tcs
D4	XC61CC3402M	Vdet-IC	3.4V±1%, +Reset PPO	SOT-23	16vdb	VD7	3d Tor
D4	XC6GC3402HR	Vdet-IC	3.4V, +Reset PPO	USP-3	17vdc	VD3	9b Tor
D4.3	CZMA4V3	Z-diode	Dual, 4.3V±5%, 300mW	SOT-23	16df	-	3a Cdi
D4.3	TZT4V3AW	Z-diode	Dual, 4.0..4.6V, lzt=5mA, Zzt=90Q, 300mW	SOT-23	16df	-	3a TTr
D4.7	CZMA4V7	Z-diode	Dual, 4.7V±5%, 300mW	SOT-23	16df	-	3a Cdi
D4.7	TZT4V7AW	Z-diode	Dual, 4.4..5.0V, lzt=5mA, Zzt=80Q, 300mW	SOT-23	16df	-	3a TTr
D40	GS809CJEUD	Vdet-IC	4V, -Reset PPO, 30ms	SOT-23	16vdc	VD7	3g Vs
D40A	ML6102C402M	Vdet-IC	4.0V±2%, -Reset PPO	SOT-23	16vdb	VD7	3a Mlc
D41A	ML6102C412M	Vdet-IC	4.1V±2%, -Reset PPO	SOT-23	16vdb	VD7	3a Mlc
D42	2SD2228-42	Si-npn	AF, 25V, 500mA, 150mW, >60MHz, B=110..240	SOT-323	16ta	-	3a Nec
D42A	ML6102C422M	Vdet-IC	4.2V±2%, -Reset PPO	SOT-23	16vdb	VD7	3a Mlc
D43	2SD2228-43	Si-npn	AF, 25V, 500mA, 150mW, >60MHz, B=190..320	SOT-323	16ta	-	3a Nec
D43	GS809CMEUD	Vdet-IC	4.38V, -Reset PPO, 30ms	SOT-23	16vdc	VD7	3g Vs
D43	TZT43AW	Z-diode	Dual, 40.0..46.0V, lzt=2mA, Zzt=150Q, 300mW	SOT-23	16df	-	3a TTr
D43	XE61CC3445MR	Vdet-IC	3.4V±2%, -Reset PPO	SOT-23	16vdb	VD7	3h Tor
D43A	ML6102C432M	Vdet-IC	4.3V±2%, -Reset PPO	SOT-23	16vdb	VD7	3a Mlc
D44	2SD2228-44	Si-npn	AF, 25V, 500mA, 150mW, >60MHz, B=270..400	SOT-323	16ta	-	3a Nec
D44A	ML6102C442M	Vdet-IC	4.4V±2%, -Reset PPO	SOT-23	16vdb	VD7	3a Mlc
D45	2SD2228-45	Si-npn	AF, 25V, 500mA, 150mW, >60MHz, B=350..600	SOT-323	16ta	-	3a Nec
D45	XC61FC3412M	Vdet-IC	3.4V±2%, +Reset PPO, 200ms	SOT-23	16vdb	VD7	3d Tor
D45	XC61HC3412MR	Vdet-IC	3.4V±2%, -Reset PPO, 50..200ms	SOT-23	16vdc	VD7	3d Tor
D45A	ML6102C452M	Vdet-IC	4.5V±2%, -Reset PPO	SOT-23	16vdb	VD7	3a Mlc
D46	BAT46W	Si-diode	SBD, 100V, 150mA, Vf<1V(250mA), 6pF	SOT-323	16dc	-	3b Ste
D46	GS809CLEUD	Vdet-IC	4.63V, -Reset PPO, 30ms	SOT-23	16vdc	VD7	3g Vs
D46	XC61FC3442M	Vdet-IC	3.4V±2%, +Reset PPO, 400ms	SOT-23	16vdb	VD7	3d Tor
D46	XC61HC3442MR	Vdet-IC	3.4V±2%, -Reset PPO, 80..400ms	SOT-23	16vdc	VD7	3d Tor
D46A	ML6102C462M	Vdet-IC	4.6V±2%, -Reset PPO	SOT-23	16vdb	VD7	3a Mlc
D47	BZX84-C3V9	Z-diode	3.9V±5%, 300mW	SOT-23	16dc	-	3a Ste
D47	TZT47AW	Z-diode	Dual, 44.0..50.0V, lzt=2mA, Zzt=170Q, 300mW	SOT-23	16df	-	3a TTr
D47	XC61FC3452M	Vdet-IC	3.4V±2%, +Reset PPO, 50ms	SOT-23	16vdb	VD7	3d Tor
D47	XC61HC3452MR	Vdet-IC	3.4V±2%, -Reset PPO, 1..50ms	SOT-23	16vdc	VD7	3d Tor
D47A	ML6102C472M	Vdet-IC	4.7V±2%, -Reset PPO	SOT-23	16vdb	VD7	3a Mlc
D48	BZX84-C4V3	Z-diode	4.3V±5%, 300mW	SOT-23	16dc	-	3a Ste
D48A	ML6102C482M	Vdet-IC	4.8V±2%, -Reset PPO	SOT-23	16vdb	VD7	3a Mlc
D49A	ML6102C492M	Vdet-IC	4.9V±2%, -Reset PPO	SOT-23	16vdb	VD7	3a Mlc
D4W	BC847AM	Si-npn	GP, 50V, 100mA, 250mW, B=110..220, >100MHz	SOT-883	22ta	-	2a PhC
D5	2SA1252-5	Si-pnp	AF, 60V, 150mA, 200mW, 100MHz, B=135..270	SOT-23	16ta	-	3a San
D5	2SA1687-5	Si-pnp	GP, AF, 60V, 150mA, 150mW, B=135..270, 130MHz	MCP	16ta	-	3a San
D5	AX1110R50	LVR-IC	LDO, 5.0V±2%, 350mA	SOT-23L	16vl	VR1	3b Axl
D5	AZ23C3V9	Z-diode	Dual, 3.71..4.10V, Zzt=95Q, lzt=5mA, 300mW	SOT-23	16df	-	3c Di
D5	BC847BM	Si-npn	GP, 50V, 100mA, 250mW, B=200..450, >100MHz	SOT-883	22ta	-	2a PhH
D5	BCW32R	Si-pnp	GP, 32V, 100mA, 250mW, B=200..450, >100MHz	SOT-23	16te	-	3a Phi
D5	ELM9735NBB	Vdet-IC	3.5V±2.5%, +Reset ODO	SOT-23	16vdb	VD6	3d Elm
D5	MMBD4148CC	Si-diode	Dual, Sw, Fast, 75V, 200mA, 350mW, <4ns, 4pF	SOT-23	16dg	-	3a F
D5	MMBZ5230B	Z-diode	4.47..4.94V, Zzt=19Q, lzt=20mA, 410mW	SOT-23	16dc	-	3a Pjt
D5	MMBZ5230BW	Z-diode	4.7V±5%, Zzt=19Q, 200mW	SOT-323	16dc	-	3a Pjt
D5	R3111N352A	Vdet-IC	3.5V±2%, -Reset PPO	SOT-23	16vdd	VD7	3d Ric
D5	R3113D451A	Vdet-IC	4.5V±2%, -Reset, ODO	SON1408-3	18vda	VD6	3d Ric
D5	R3130N45EC	Vdet-IC	4.5V, -Reset ODO, 240ms	SOT-23	16vdc	VD6	3b Ric
D5	RT9809-20CV	Vdet-IC	2.0V±2%, -Reset PPO	SOT-23	16vdc	VD7	3a Rct
D5	SP810EK-2-3	Vdet-IC	2.3V±1.5%, +Reset PPO	SOT-23	16vdc	VD7	3b Sip
D5	TC54VC3502ECB	Vdet-IC	3.5V±2%, -Reset PPO	SOT-23	16vdb	VD7	3a Tcs
D5	XC61CC3502M	Vdet-IC	3.5V±1%, +Reset PPO	SOT-23	16vdb	VD7	3d Tor
D5	XC6GC3502HR	Vdet-IC	3.5V, +Reset PPO	USP-3	17vdc	VD3	9b Tor
D5.1	CZMA5V1	Z-diode	Dual, 5.1V±5%, 300mW	SOT-23	16df	-	3a Cdi
D5.1	TZT5V1AW	Z-diode	Dual, 4.8..5.4V, lzt=5mA, Zzt=60Q, 300mW	SOT-23	16df	-	3a TTr
D5.6	CZMA5V6	Z-diode	Dual, 5.6V±5%, 300mW	SOT-23	16df	-	3a Cdi
D5.6	TZT5V6AW	Z-diode	Dual, 5.2..6.0V, lzt=5mA, Zzt=40Q, 300mW	SOT-23	16df	-	3a TTr
D50A	ML6102C502M	Vdet-IC	5.0V±2%, -Reset PPO	SOT-23	16vdb	VD7	3a Mlc



SMD code	Type	Function	Short description	Case	Pinout	Sch.	St.	Mnf.
D51	2SD780A-51	Si-npn	AF, 80V, 300mA, 200mW, B=110..180, 100MHz	SOT-23	16ta	-	3a	Nec
D51A	ML6102C512M	Vdet-IC	5.1V±2%, -Reset PPO	SOT-23	16vdb	VD7	3a	Mlc
D52	2SD780A-52	Si-npn	AF, 80V, 300mA, 200mW, B=135..220, 100MHz	SOT-23	16ta	-	3a	Nec
D52A	ML6102C522M	Vdet-IC	5.2V±2%, -Reset PPO	SOT-23	16vdb	VD7	3a	Mlc
D53	2SD780A-53	Si-npn	AF, 80V, 300mA, 200mW, B=170..270, 100MHz	SOT-23	16ta	-	3a	Nec
D53	XE61CC3545MR	Vdet-IC	3.5V±2%, -Reset PPO	SOT-23	16vdb	VD7	3h	Tor
D53A	ML6102C532M	Vdet-IC	5.3V±2%, -Reset PPO	SOT-23	16vdb	VD7	3a	Mlc
D54	2SD780A-54	Si-npn	AF, 80V, 300mA, 200mW, B=200..320, 100MHz	SOT-23	16ta	-	3a	Nec
D54	BZX84-C3V3	Z-diode	3.3V±5%, 300mW	SOT-23	16dc	-	3a	Ste
D54A	ML6102C542M	Vdet-IC	5.4V±2%, -Reset PPO	SOT-23	16vdb	VD7	3a	Mlc
D55	2SD780A-55	Si-npn	AF, 80V, 300mA, 200mW, B=250..400, 100MHz	SOT-23	16ta	-	3a	Nec
D55	XC61FC3512M	Vdet-IC	3.5V±2%, +Reset PPO, 200ms	SOT-23	16vdb	VD7	3d	Tor
D55	XC61HC3512MR	Vdet-IC	3.5V±2%, -Reset PPO, 50..200ms	SOT-23	16vdc	VD7	3d	Tor
D55A	ML6102C552M	Vdet-IC	5.5V±2%, -Reset PPO	SOT-23	16vdb	VD7	3a	Mlc
D56	XC61FC3542M	Vdet-IC	3.5V±2%, +Reset PPO, 400ms	SOT-23	16vdb	VD7	3d	Tor
D56	XC61HC3542MR	Vdet-IC	3.5V±2%, -Reset PPO, 80..400ms	SOT-23	16vdc	VD7	3d	Tor
D56A	ML6102C562M	Vdet-IC	5.6V±2%, -Reset PPO	SOT-23	16vdb	VD7	3a	Mlc
D57	XC61FC3552M	Vdet-IC	3.5V±2%, +Reset PPO, 50ms	SOT-23	16vdb	VD7	3d	Tor
D57	XC61HC3552MR	Vdet-IC	3.5V±2%, -Reset PPO, 1..50ms	SOT-23	16vdc	VD7	3d	Tor
D57A	ML6102C572M	Vdet-IC	5.7V±2%, -Reset PPO	SOT-23	16vdb	VD7	3a	Mlc
D58A	ML6102C582M	Vdet-IC	5.8V±2%, -Reset PPO	SOT-23	16vdb	VD7	3a	Mlc
D59A	ML6102C592M	Vdet-IC	5.9V±2%, -Reset PPO	SOT-23	16vdb	VD7	3a	Mlc
D5s	BBY57-05W	C-diode	Dual, VCO-Tuning, 10V, 20mA, 16.5/18.6pF(4/1V)	SOT-323	16dg	-	3c	Inf
D5W	BC847BM	Si-npn	GP, 50V, 100mA, 250mW, B=200..450, >100MHz	SOT-883	22ta	-	2a	PhC
D6	2SA1252-6	Si-npn	AF, 60V, 150mA, 200mW, 100MHz, B=200..400	SOT-23	16ta	-	3a	San
D6	2SA1687-7	Si-npn	GP, AF, 60V, 150mA, 150mW, B=300..600, 130MHz	MCP	16ta	-	3a	San
D6	AZ23CAV3	Z-diode	Dual, 4.09..4.52V, Zzt=95Q, Izt=5mA, 300mW	SOT-23	16df	-	3c	Di
D6	BC847CM	Si-npn	GP, 50V, 100mA, 250mW, B=420..800, >100MHz	SOT-883	22ta	-	2a	PHH
D6	BCW33R	Si-npn	GP, 32V, 100mA, 250mW, B=420..800, >100MHz	SOT-23	16te	-	3a	Phi
D6	ELM9736NBB	Vdet-IC	3.6V±2.5%, +Reset ODO	SOT-23	16vdb	VD6	3d	Elm
D6	MMBC1622D6	Si-npn	GP, AF, 40V, 100mA, 350mW, B=200..400, >100MHz	SOT-23	16ta	-	3a	Sam
D6	MMBD4148CA	Si-diode	Dual, Sw, Fast, 75V, 200mA, 350mW, <4ns, 4pF	SOT-23	16df	-	3a	F
D6	R3111N362A	Vdet-IC	3.6V±2%, -Reset PPO	SOT-23	16vdd	VD7	3d	Ric
D6	R3130N46EC	Vdet-IC	4.6V, -Reset ODO, 240ms	SOT-23	16vdc	VD6	3b	Ric
D6	RT9809-21CV	Vdet-IC	2.1V±2%, -Reset PPO	SOT-23	16vdc	VD7	3a	Rct
D6	TC54VC3602ECB	Vdet-IC	3.6V±2%, -Reset PPO	SOT-23	16vdb	VD7	3a	Tcs
D6	XC61CC3602M	Vdet-IC	3.6V±1%, +Reset PPO	SOT-23	16vdb	VD7	3d	Tor
D6	XC6GC3602HR	Vdet-IC	3.6V, +Reset PPO	USP-3	17vdc	VD3	9b	Tor
D6.2	CZMA6.2	Z-diode	Dual, 6.2V±5%, 300mW	SOT-23	16df	-	3a	Cdi
D6.2	TZT6V2AW	Z-diode	Dual, 5.8..6.6V, Izt=5mA, Zzt=10Q, 300mW	SOT-23	16df	-	3a	Ttr
D6.2	CZMA6V8	Z-diode	Dual, 6.8V±5%, 300mW	SOT-23	16df	-	3a	Cdi
D6.8	TZT6V8AW	Z-diode	Dual, 6.4..7.2V, Izt=5mA, Zzt=15Q, 300mW	SOT-23	16df	-	3a	Ttr
D60A	ML6102C602M	Vdet-IC	6.0V±2%, -Reset PPO	SOT-23	16vdb	VD7	3a	Mlc
D63	XE61CC3645MR	Vdet-IC	3.6V±2%, -Reset PPO	SOT-23	16vdb	VD7	3h	Tor
D64	BZX84-C3V6	Z-diode	3.6V±5%, 300mW	SOT-23	16dc	-	3a	Ste
D65	XC61FC3612M	Vdet-IC	3.6V±2%, +Reset PPO, 200ms	SOT-23	16vdb	VD7	3d	Tor
D65	XC61HC3612MR	Vdet-IC	3.6V±2%, -Reset PPO, 50..200ms	SOT-23	16vdc	VD7	3d	Tor
D66	XC61FC3642M	Vdet-IC	3.6V±2%, +Reset PPO, 400ms	SOT-23	16vdb	VD7	3d	Tor
D66	XC61HC3642MR	Vdet-IC	3.6V±2%, -Reset PPO, 80..400ms	SOT-23	16vdc	VD7	3d	Tor
D67	XC61FC3652M	Vdet-IC	3.6V±2%, +Reset PPO, 50ms	SOT-23	16vdb	VD7	3d	Tor
D67	XC61HC3652MR	Vdet-IC	3.6V±2%, -Reset PPO, 1..50ms	SOT-23	16vdc	VD7	3d	Tor
D6W	BC847CM	Si-npn	GP, 50V, 100mA, 250mW, B=420..800, >100MHz	SOT-883	22ta	-	2a	PhC
D7	2PC4617QM	Si-npn	GP, 50V, 100mA, 250mW, >100MHz, B=120..270	SOT-883	22ta	-	2a	PhC
D7	2SA1252-7	Si-npn	AF, 60V, 150mA, 200mW, 100MHz, B=300..600	SOT-23	16ta	-	3a	San
D7	2SA1687-6	Si-npn	GP, AF, 60V, 150mA, 150mW, B=200..400, 130MHz	MCP	16ta	-	3a	San
D7	AZ23CAV7	Z-diode	Dual, 4.47..4.94V, Zzt=78Q, Izt=5mA, 300mW	SOT-23	16df	-	3c	Di
D7	ELM9737NBB	Vdet-IC	3.7V±2.5%, +Reset ODO	SOT-23	16vdb	VD6	3d	Elm
D7	ILC50621C37X	Vdet-IC	3.7V±2%, -Reset PPO	SOT-323	16vdb	VD7	3a	Imp
D7	ILC5062M37X	Vdet-IC	3.7V±2%, -Reset PPO	SOT-23	16vdb	VD7	3a	Imp
D7	KN4L3M	Si-npn-Digi	Sw, 60V, 100mA, 150mW, R1/R2=4k7/4k7	SOT-416	16ta	-	3a	Nec
D7	MMBC1622D7	Si-npn	GP, AF, 40V, 100mA, 350mW, B=300..600, >100MHz	SOT-23	16ta	-	3a	Sam
D7	R3111N372A	Vdet-IC	3.7V±2%, -Reset PPO	SOT-23	16vdd	VD7	3d	Ric
D7	R3130N47EC	Vdet-IC	4.7V, -Reset ODO, 240ms	SOT-23	16vdc	VD6	3b	Ric
D7	RT9809-22CV	Vdet-IC	2.2V±2%, -Reset PPO	SOT-23	16vdc	VD7	3a	Rct
D7	TC54VC3702ECB	Vdet-IC	3.7V±2%, -Reset PPO	SOT-23	16vdb	VD7	3a	Tcs
D7	XC61CC3702M	Vdet-IC	3.7V±1%, +Reset PPO	SOT-23	16vdb	VD7	3d	Tor
D7	XC6GC3702HR	Vdet-IC	3.7V, +Reset PPO	USP-3	17vdc	VD3	9b	Tor
D7.5	CZMA7V5	Z-diode	Dual, 7.5V±5%, 300mW	SOT-23	16df	-	3a	Cdi
D7.5	TZT7V5AW	Z-diode	Dual, 7.0..7.9V, Izt=5mA, Zzt=15Q, 300mW	SOT-23	16df	-	3a	Ttr
D71	BCW60A	Si-npn	GP, 32V, 200mA, 250mW, B=120..220, 250MHz	SOT-23	16ta	-	3a	Phi



SMD code	Type	Function	Short description	Case	Pinout	Sch.	St.	Mnf.
D73	BA579A	PIN-diode	Dual, VHF/UHF, 30V, 20mA	SOT-23	16df	-	3a	Ste
D73	XE61CC3745MR	Vdet-IC	3.7V±2%, -Reset PPO	SOT-23	16vdb	VD7	3h	Tor
D74	BA579C	PIN-diode	Dual, VHF/UHF, 30V, 20mA, Vf<1V(20mA)	SOT-23	16df	-	3a	Ste
D74	BAT54AW	Si-diode	Dual, Schottky Rectifier, 30V, 200mA, Vf<1V(100mA), <5ns	SOT-323	16df	-	3a	Ste
D75	BA579S	PIN-diode	Dual, VHF/UHF, 30V, 20mA, Vf<1V(20mA)	SOT-23	16dl	-	3a	Ste
D75	XC61FC3712M	Vdet-IC	3.7V±2%, +Reset PPO, 200ms	SOT-23	16vdb	VD7	3d	Tor
D75	XC61HC3712MR	Vdet-IC	3.7V±2%, -Reset PPO, 50, 200ms	SOT-23	16vdc	VD7	3d	Tor
D76	BAR18	Si-diode	Schottky, 70V, 50mA, 250mW, <2pF	SOT-23	16dc	-	3a	Ste
D76	CMPD6263	Si-diode	Schottky, Sw, 70V, 15mA, Vf(If=1mA)<0.395..0.41V, <2pF	SOT-23	16dc	-	3a	Can
D76	XC61FC3742M	Vdet-IC	3.7V±2%, +Reset PPO, 400ms	SOT-23	16vdb	VD7	3d	Tor
D76	XC61HC3742MR	Vdet-IC	3.7V±2%, -Reset PPO, 80, 400ms	SOT-23	16vdc	VD7	3d	Tor
D77	BAT54CW	Si-diode	Dual, Schottky Rectifier, 30V, 200mA, Vf<1V(100mA), <5ns	SOT-323	16dg	-	3a	Ste
D77	BCF32R	Si-npn	GP, AF, LN, 32V, 100mA, 250mW, B=200..450, >100MHz	SOT-23	16te	-	3a	Phi
D77	XC61FC3752M	Vdet-IC	3.7V±2%, +Reset PPO, 50ms	SOT-23	16vdb	VD7	3d	Tor
D77	XC61HC3752MR	Vdet-IC	3.7V±2%, -Reset PPO, 1, 50ms	SOT-23	16vdc	VD7	3d	Tor
D78	BAT54SW	Si-diode	Dual, Schottky Rectifier, 30V, 200mA, Vf<1V(100mA), <5ns	SOT-323	16dl	-	3a	Ste
D7A	ILC5062AIC37X	Vdet-IC	3.7V±1%, -Reset PPO	SOT-323	16vdb	VD7	3a	Imp
D7A	ILC5062AM37X	Vdet-IC	3.7V±1%, -Reset PPO	SOT-23	16vdb	VD7	3a	Imp
D7p	BCF32	Si-npn	GP, AF, LN, 32V, 100mA, 250mW, B=200..450, >100MHz	SOT-23	16ta	-	3a	PHH
D7t	BCF32	Si-npn	GP, AF, LN, 32V, 100mA, 250mW, B=200..450, >100MHz	SOT-23	16ta	-	3a	PhM
D7W	BCF32	Si-npn	GP, AF, LN, 32V, 100mA, 250mW, B=200..450, >100MHz	SOT-23	16ta	-	3a	PhC
D8	2PC4617RM	Si-npn	GP, 50V, 100mA, 250mW, >100MHz, B=180..390	SOT-883	22ta	-	2a	Phi
D8	AZ23C5V1	Z-diode	Dual, 4.85..5.36V, Zzt=60Ω, lzt=5mA, 300mW	SOT-23	16df	-	3c	Di
D8	BZX84-C2V7	Z-diode	2.5..2.9V, Zzt=100Ω, lzt=20mA, 225mW	SOT-23	16dc	-	3a	Lge
D8	ELM9738NBB	Vdet-IC	3.8V±2.5%, +Reset ODO	SOT-23	16vdb	VD6	3d	Elm
D8	MMBC1622D8	Si-npn	GP, AF, 40V, 100mA, 350mW, B=450..900, >100MHz	SOT-23	16ta	-	3a	Sam
D8	R3111N382A	Vdet-IC	3.8V±2%, -Reset PPO	SOT-23	16vdd	VD7	3d	Ric
D8	R3130N48EC	Vdet-IC	4.8V, -Reset ODO, 240ms	SOT-23	16vdc	VD6	3b	Ric
D8	RT9809-23CV	Vdet-IC	2.3V±2%, -Reset PPO	SOT-23	16vdc	VD7	3a	Rct
D8	TC54VC3802ECB	Vdet-IC	3.8V±2%, -Reset PPO	SOT-23	16vdb	VD7	3a	Tcs
D8	XC61CC3802M	Vdet-IC	3.8V±1%, +Reset PPO	SOT-23	16vdb	VD7	3d	Tor
D8	XC6GC3802HR	Vdet-IC	3.8V, +Reset PPO	USP-3	17vdc	VD3	9b	Tor
D8-	RT9809-23PV	Vdet-IC	2.3V±2%, -Reset PPO	SOT-23	16vdc	VD7	3a	Rct
D8.2	CZMA8V2	Z-diode	Dual, 8.2V±5%, 300mW	SOT-23	16df	-	3a	Cdi
D8.2	TZT8V2AW	Z-diode	Dual, 7.7..8.7V, lzt=5mA, Zzt=15Ω, 300mW	SOT-23	16df	-	3a	Ttr
D81	BCF33R	Si-npn	GP, AF, LN, 32V, 0.1A, 300MHz	SOT-23	16te	-	3a	Phi
D83	XE61CC3845MR	Vdet-IC	3.8V±2%, -Reset PPO	SOT-23	16vdb	VD7	3h	Tor
D85	BAT17DS	Si-diode	Dual, Schottky, 4V, 130mA, Vf<0.6V(10mA), Cd<0.75pF	SOT-23	16dl	-	3a	Ste
D85	XC61FC3812M	Vdet-IC	3.8V±2%, +Reset PPO, 200ms	SOT-23	16vdb	VD7	3d	Tor
D85	XC61HC3812MR	Vdet-IC	3.8V±2%, -Reset PPO, 50, 200ms	SOT-23	16vdc	VD7	3d	Tor
D86	BAT54	Si-diode	SBR, 30V, 200mA, Vf<1V(100mA), <5ns	SOT-23	16dc	-	3a	Ste
D86	XC61FC3842M	Vdet-IC	3.8V±2%, +Reset PPO, 400ms	SOT-23	16vdb	VD7	3d	Tor
D86	XC61HC3842MR	Vdet-IC	3.8V±2%, -Reset PPO, 80, 400ms	SOT-23	16vdc	VD7	3d	Tor
D87	BAT54C	Si-diode	Dual, Schottky Rectifier, 30V, 200mA, Vf<1V(100mA), <5ns	SOT-23	16dg	-	3a	Ste
D87	XC61FC3852M	Vdet-IC	3.8V±2%, +Reset PPO, 50ms	SOT-23	16vdb	VD7	3d	Tor
D87	XC61HC3852MR	Vdet-IC	3.8V±2%, -Reset PPO, 1, 50ms	SOT-23	16vdc	VD7	3d	Tor
D88	BAT54S	Si-diode	Dual, Schottky Rectifier, 30V, 200mA, Vf<1V(100mA), <5ns	SOT-23	16dl	-	3a	Ste
D8p	BCF33	Si-npn	GP, AF, LN, 32V, 100mA, 250mW, B=270..560	SOT-23	16ta	-	3a	Phi
D9	1SS401	Si-diode	Schottky, Sw, 20V, 300mA, 100mW, Vf<0.45V(300mA), <46pF	SOT-323	16dc	-	3a	Tos
D9	2PC4617SM	Si-npn	GP, 50V, 100mA, 250mW, >100MHz, B=270..560	SOT-883	22ta	-	2a	Phi
D9	AZ23C5V6	Z-diode	Dual, 5.32..5.88V, Zzt=40Ω, lzt=5mA, 300mW	SOT-23	16df	-	3c	Di
D9	BZX84-C12	Z-diode	11.4..12.7V, Zzt=25Ω, lzt=20mA, 225mW	SOT-23	16dc	-	3a	Lge
D9	ELM9739NBB	Vdet-IC	3.9V±2.5%, +Reset ODO	SOT-23	16vdb	VD6	3d	Elm
D9	R3111N392A	Vdet-IC	3.9V±2%, -Reset PPO	SOT-23	16vdd	VD7	3d	Ric
D9	RT9809-24CV	Vdet-IC	2.4V±2%, -Reset PPO	SOT-23	16vdc	VD7	3a	Rct
D9	TC54VC3902ECB	Vdet-IC	3.9V±2%, -Reset PPO	SOT-23	16vdb	VD7	3a	Tcs
D9	XC61CC3902M	Vdet-IC	3.9V±1%, +Reset PPO	SOT-23	16vdb	VD7	3d	Tor
D9	XC6GC3902HR	Vdet-IC	3.9V, +Reset PPO	USP-3	17vdc	VD3	9b	Tor
D9.1	CZMA9.1	Z-diode	Dual, 9.1V±5%, 300mW	SOT-23	16df	-	3a	Cdi
D9.1	TZT9V1AW	Z-diode	Dual, 8.5..9.6V, lzt=5mA, Zzt=15Ω, 300mW	SOT-23	16df	-	3a	Ttr
D93	XE61CC3945MR	Vdet-IC	3.9V±2%, -Reset PPO	SOT-23	16vdb	VD7	3h	Tor
D94	BAR42	Si-diode	Schottky, 30V, 100mA, 250mW, Vf<1V(100mA), 7pF, <5ns	SOT-23	16dc	-	3a	F,Ste
D95	BAR43	Si-diode	Schottky, 30V, 100mA, 250mW, Vf<1V(100mA), 7pF, <5ns	SOT-23	16dc	-	3a	F,Ste
D95	XC61FC3912M	Vdet-IC	3.9V±2%, +Reset PPO, 200ms	SOT-23	16vdb	VD7	3d	Tor
D95	XC61HC3912MR	Vdet-IC	3.9V±2%, -Reset PPO, 50, 200ms	SOT-23	16vdc	VD7	3d	Tor
D96	BAS70-04	Si-diode	Dual, Schottky, 70V, 70mA, Vf<1V(15mA), <2pF, 5ns	SOT-23	16dl	-	3a	Ste
D96	CMPD6263S	Si-diode	Dual, Schottky, Sw, 70V, 15mA, Vf(If=1mA)<0.395..0.41V, <2pF	SOT-23	16dl	-	3a	Can
D96	XC61FC3942M	Vdet-IC	3.9V±2%, +Reset PPO, 400ms	SOT-23	16vdb	VD7	3d	Tor
D96	XC61HC3942MR	Vdet-IC	3.9V±2%, -Reset PPO, 80, 400ms	SOT-23	16vdc	VD7	3d	Tor
D97	BAS70-05	Si-diode	Dual, Schottky, 70V, 70mA, Vf<1V(15mA), <2pF, 5ns	SOT-23	16dg	-	3a	Ste



SMD code	Type	Function	Short description	Case	Pinout	Sch.	St.	Mnf.
D97	CMPD6263C	Si-diode	Dual, Schottky, Sw, 70V, 15mA, V _f (I _f =1mA)<0.395..0.41V, <2pF	SOT-23	16dl	-	3a	Cen
D97	XC61FC3952M	Vdet-IC	3.9V±2%, +Reset PPO, 50ms	SOT-23	16vdb	VD7	3d	Tor
D97	XC61HC3952MR	Vdet-IC	3.9V±2%, -Reset PPO, 1..50ms	SOT-23	16vdc	VD7	3d	Tor
D98	BAS70-06	Si-diode	Dual, Schottky, 70V, 70mA, V _f <1V(15mA), <2pF, 5ns	SOT-23	16df	-	3a	Ste
D98	CMPD6263A	Si-diode	Dual, Schottky, Sw, 70V, 15mA, V _f (I _f =1mA)<0.395..0.41V, <2pF	SOT-23	16df	-	3a	Cen
D9C	AV8050S-C	Si-npn	AF-Amp, 30V, 700mA, 1W, B=120..200, >100MHz	SOT-23	16ta	-	3a	Avi
D9C-	2SD1781KPT-Q	Si-npn	AF, Sw, 32V, 800mA, B=180..390, 150MHz	SOT-23	16ta	-	3a	Chm
D9D	AV8050S-D	Si-npn	AF-Amp, 30V, 700mA, 1W, B=160..300, >100MHz	SOT-23	16ta	-	3a	Avi
D9E	AV8050S-E	Si-npn	AF-Amp, 30V, 700mA, 1W, B=280..400, >100MHz	SOT-23	16ta	-	3a	Avi
DA	2SC4919	Si-npn	AF, Mute, 25V, 200mA, 150mW, B=800..3200, 240MHz	SMCP	16ta	-	3a	San
DA	AX1110R	LVR-IC	LDO, Adjustable 1.25..5V, 350mA	SOT-23L	16cm	VR20	3b	Axl
DA	AZ23C2V7	Z-diode	Dual, 2.57..2.84V, Zzt=83Ω, I _z t=5mA, 300mW	SOT-23	16df	-	3c	Pjt
DA	BCW67A	Si-npn	AF, Sw, 45V, 800mA, 330mW, B>100, >100MHz	SOT-23	16ta	-	3a	Ste
DA	MMBZ4708	Z-diode	22V±5%, 350mW	SOT-23	16dc	-	3g	Vs
DA	RT9809-25CV	Vdet-IC	2.5V±2%, -Reset PPO	SOT-23	16vdc	VD7	3a	Rct
DA	SSM3K03FE	n-MOSFET-e*	LogL, 20V, 100mA, <12Ω(10mA)	SOT-23	16fh	-	3a	Tos
DA	TC1275-5ENB	Vdet-IC	3.06V±2%, -Reset PPO	SOT-23	16vda	VD7	3d	Mcc
DA	XC62RP3002M	LVR-IC	LDO, 3V±2%, 6mA, 150mW	SOT-23	16cg	VR1	3d	Tor
DA5	BAR43S	Si-diode	Dual, Schottky, 30V, 100mA, V _f <1V(100mA), 7pF, <5ns	SOT-23	16dl	-	3a	F,Ste
DA5	CMPSH-3S	Si-diode	Dual, Schottky, 30V, 100mA, V _f (I _f =100mA)<1V, 2pF, <5ns	SOT-23	16dl	-	3a	Cen
DAG	2SC5343SF-G	Si-npn	GP, 60V, 150mA, 200mW, >80MHz, B=200..400	SOT-23F	18ta	-	3a	Auk
DAG	2SC5343S-G	Si-npn	GP, 60V, 150mA, 200mW, >80MHz, B=200..400	SOT-23	16ta	-	3a	Auk
DAL	2SC5343SF-L	Si-npn	GP, 60V, 150mA, 200mW, >80MHz, B=300..700	SOT-23F	18ta	-	3a	Auk
DAL	2SC5343S-L	Si-npn	GP, 60V, 150mA, 200mW, >80MHz, B=300..700	SOT-23	16ta	-	3a	Auk
DAO	2SC5343SF-O	Si-npn	GP, 60V, 150mA, 200mW, >80MHz, B=70..140	SOT-23F	18ta	-	3a	Auk
DAO	2SC5343S-O	Si-npn	GP, 60V, 150mA, 200mW, >80MHz, B=70..140	SOT-23	16ta	-	3a	Auk
DAY	2SC5343SF-Y	Si-npn	GP, 60V, 150mA, 200mW, >80MHz, B=120..240	SOT-23F	18ta	-	3a	Auk
DAY	2SC5343S-Y	Si-npn	GP, 60V, 150mA, 200mW, >80MHz, B=120..240	SOT-23	16ta	-	3a	Auk
DB	2SA1669	Si-npn	UHF, 20V, 50mA, 200mW, B>15, 3GHz	SOT-23	16ta	-	3a	San
DB	AZ23C3V0	Z-diode	Dual, 2.85..3.15V, Zzt=95Ω, I _z t=5mA, 300mW	SOT-23	16df	-	3c	Pjt
DB	BCW67B	Si-npn	AF, Sw, 45V, 800mA, 330mW, B>160, >100MHz	SOT-23	16ta	-	3a	Ste
DB	RT9809-26CV	Vdet-IC	2.6V±2%, -Reset PPO	SOT-23	16vdc	VD7	3a	Rct
DB	TC1275-10ENB	Vdet-IC	2.88V±2%, -Reset PPO	SOT-23	16vda	VD7	3d	Mcc
DB	XC62RP3102M	LVR-IC	LDO, 3.1V±2%, 6mA, 150mW	SOT-23	16cg	VR1	3d	Tor
DB-	RT9809-26PV	Vdet-IC	2.6V±2%, -Reset PPO	SOT-23	16vdc	VD7	3a	Rct
DB1	BAR43A	Si-diode	Dual, Schottky, 30V, 100mA, V _f <1V(100mA), 7pF, <5ns	SOT-23	16df	-	3a	F,Ste
DB1	CMPSH-3A	Si-diode	Dual, Schottky, 30V, 100mA, V _f (I _f =100mA)<1V, 2pF, <5ns	SOT-23	16df	-	3a	Cen
DB2	BAR43C	Si-diode	Dual, Schottky, 30V, 100mA, V _f <1V(100mA), 7pF, <5ns	SOT-23	16dg	-	3a	F,Ste
DB2	CMPSH-3C	Si-diode	Dual, Schottky, 30V, 100mA, V _f (I _f =100mA)<1V, 2pF, <5ns	SOT-23	16dg	-	3a	Cen
DB6	BAT46AW	Si-diode	Dual, SBD, 100V, 150mA, V _f <1V(250mA), 6pF	SOT-323	16df	-	3b	Ste
DB8	BAT46CW	Si-diode	Dual, SBD, 100V, 150mA, V _f <1V(250mA), 6pF	SOT-323	16df	-	3b	Ste
DB8	SDB310WKUF	Si-diode	Dual, Rectifier, 30V, 200mA, 150mW, <10pF, <5ns	SOT-323F	18dg	-	3a	Auk
DC	AZ23C3V3	Z-diode	Dual, 3.14..3.47V, Zzt=95Ω, I _z t=5mA, 300mW	SOT-23	16df	-	3c	Pjt
DC	BCW67C	Si-npn	AF, Sw, 45V, 800mA, 330mW, B>250, >100MHz	SOT-23	16ta	-	3a	Ste
DC	MMBZ4695	Z-diode	8.7V±5%, 350mW	SOT-23	16dc	-	3g	Vs
DC	RT9809-27CV	Vdet-IC	2.7V±2%, -Reset PPO	SOT-23	16vdc	VD7	3a	Rct
DC	SSM3K04FE	n-MOSFET-e*	LogL, 20V, 100mA, <12Ω(10mA)	SOT-23	16fh	-	3a	Tos
DC	TC1275-20ENB	Vdet-IC	2.55V±2%, -Reset PPO	SOT-23	16vda	VD7	3d	Mcc
DC	UNR31A9	Si-npn-Digi	Sw, 50V, 80mA, 100mW, 80MHz, R1/R2=1k/10k	SSSMini3	18ta	-	3a	Pan
DC	XC62RP3202M	LVR-IC	LDO, 3.2V±2%, 6mA, 150mW	SOT-23	16cg	VR1	3d	Tor
DC-	RT9809-27PV	Vdet-IC	2.7V±2%, -Reset PPO	SOT-23	16vdc	VD7	3a	Rct
DC4	DTC124XK	Si-npn-Digi	Sw, 50V, 100mA, 200mW, 250MHz, R1/R2=22k/47k	SOT-23	16ta	-	3a	lIt
DD	2SC2463-D	Si-npn	AF, 55V, 100mA, 150mW, B=250..500	SOT-23	16ta	-	3a	Ren
DD	2SC3441-D	Si-npn	Relay-Drv, 55V, 400mA, 150mW, B=90..180, 150MHz	SC-59	16ta	-	3a	Mit
DD	2SC4933-D	Si-npn	GP, 55V, 150mA, 150mW, 200MHz, B=135..270	SOT-323	16ta	-	3a	Ren
DD	AZ23C3V6	Z-diode	Dual, 3.42..3.78V, Zzt=95Ω, I _z t=5mA, 300mW	SOT-23	16df	-	3c	Pjt
DD	MMBZ4696	Z-diode	9.1V±5%, 350mW	SOT-23	16dc	-	3g	Vs
DD	RT9809-28CV	Vdet-IC	2.8V±2%, -Reset PPO	SOT-23	16vdc	VD7	3a	Rct
DD	SSM3J02F	p-MOSFET-e*	LogL, 30V, 600mA, <0.7Ω(500mA)	SOT-23	16fh	-	3a	Tos
DD	XC62RP3302M	LVR-IC	LDO, 3.3V±2%, 6mA, 150mW	SOT-23	16cg	VR1	3d	Tor
DDP	TPC6.8	TVS	Vbr=6.12..7.48V, V _{rw} =5.50V, I _{pp} =139.0A, 1500W(1ms)	TQ-277A	76bd	-	3o	Vs
DE	2SC2463-E	Si-npn	AF, 55V, 100mA, 150mW, B=400..800	SOT-23	16ta	-	3a	Ren
DE	2SC3441-E	Si-npn	Relay-Drv, 55V, 400mA, 150mW, B=150..300, 150MHz	SC-59	16ta	-	3a	Mit
DE	2SC4933-E	Si-npn	GP, 55V, 150mA, 150mW, 200MHz, B=200..400	SOT-323	16ta	-	3a	Ren
DE	AZ23C3V9	Z-diode	Dual, 3.71..4.10V, Zzt=95Ω, I _z t=5mA, 300mW	SOT-23	16df	-	3c	Pjt
DE	MMBZ4697	Z-diode	10V±5%, 350mW	SOT-23	16dc	-	3g	Vs
DE	RT9809-29CV	Vdet-IC	2.9V±2%, -Reset PPO	SOT-23	16vdc	VD7	3a	Rct
DE	SSM3J01F	p-MOSFET-e*	LogL, 30V, 700mA, <0.6Ω(350mA)	SOT-23	16fh	-	3a	Tos
DE	UNR31AA	Si-npn-Digi	Sw, 50V, 80mA, 100mW, 80MHz, R1/R2=100k/100k	SSSMini3	18ta	-	3a	Pan
DE	XC62RP3402M	LVR-IC	LDO, 3.4V±2%, 6mA, 150mW	SOT-23	16cg	VR1	3d	Tor



SMD code	Type	Function	Short description	Case	Pinout	Sch.	St.	Mnf.
DE-	RT9809-29PV	Vdet-IC	2.9V±2%, -Reset PPO	SOT-23	16vdc	VD7	3a	Rct
DEP	TPC6.8A	TVS	Vbr=6.45..7.14V, Vrwm=5.80V, Ipp=143.0A, 1500W(1ms)	TO-277A	76bd	-	3o	Vs
DF	2SC2463-F	Si-npn	AF, 55V, 100mA, 150mW, B=600..1200	SOT-23	16ta	-	3a	Ren
DF	2SC3441-F	Si-npn	Relay-Drv, 55V, 400mA, 150mW, B=250..500, 150MHz	SC-59	16ta	-	3a	Mit
DF	2SC4933-F	Si-npn	GP, 55V, 150mA, 150mW, 200MHz, B=300..600	SOT-323	16ta	-	3a	Ren
DF	AZ23CAV3	Z-diode	Dual, 4.09..4.52V, Zzt=95Ω, Izt=5mA, 300mW	SOT-23	16df	-	3c	Pjt
DF	BCW68F	Si-pnp	AF, Sw, 60V, 800mA, 350mW, B>100, >100MHz	SOT-23	16ta	-	3a	Ste
DF	MMBZ4698	Z-diode	11V±5%, 350mW	SOT-23	16dc	-	3g	Vs
DF	RT9809-30CV	Vdet-IC	3.0V±2%, -Reset PPO	SOT-23	16vdc	VD7	3a	Rct
DF	SSM3K05FU	n-MOSFET-e*	LogL, 20V, 500mA, <1.2Ω(500mA)	SOT-323	16fh	-	3a	Tos
DF	XC62RP3502M	LVR-IC	LDO, 3.5V±2%, 6mA, 150mW	SOT-23	16cg	VR1	3d	Tor
DF-	RT9809-30PV	Vdet-IC	3.0V±2%, -Reset PPO	SOT-23	16vdc	VD7	3a	Rct
DFFP	TPC7.5	TVS	Vbr=6.75..8.25V, Vrwm=6.05V, Ipp=128.0A, 1500W(1ms)	TO-277A	76bd	-	3o	Vs
DG	2SC2713-GR	Si-npn	GP, AF, 120V, 100mA, 150mW, B=200..400, 100MHz	SOT-23	16ta	-	3a	Tos
DG	2SC4117-GR	Si-npn	AF-Amp, 120V, 100mA, 100mW, 100MHz, B=200..400	SOT-323	16ta	-	3a	Tos
DG	2SC5343UF-G	Si-npn	GP, 60V, 150mA, 200mW, >80MHz, B=200..400	SOT-323F	18ta	-	3a	Auk
DG	2SC5343U-G	Si-npn	GP, 60V, 150mA, 200mW, >80MHz, B=200..400	SOT-323	16ta	-	3a	Auk
DG	AZ23CAV7	Z-diode	Dual, 4.47..4.94V, Zzt=78Ω, Izt=5mA, 300mW	SOT-23	16df	-	3c	Pjt
DG	BCW68G	Si-pnp	AF, Sw, 60V, 800mA, 350mW, B>160, >100MHz	SOT-23	16ta	-	3a	Ste
DG	RT9809-31CV	Vdet-IC	3.1V±2%, -Reset PPO	SOT-23	16vdc	VD7	3a	Rct
DGP	TPC7.5A	TVS	Vbr=7.13..7.88V, Vrwm=6.40V, Ipp=133.0A, 1500W(1ms)	TO-277A	76bd	-	3o	Vs
DH	1S5358	Si-diode	Dual, SBD, VHF/UHF-det/mix, 55V, 10mA, Vf<0.35V(1mA), 0.45pF	CP	16dl	-	3a	San
DH	AZ23C5V1	Z-diode	Dual, 4.85..5.36V, Zzt=60Ω, Izt=5mA, 300mW	SOT-23	16df	-	3c	Pjt
DH	BCW68H	Si-pnp	AF, Sw, 60V, 800mA, 350mW, B>250, >100MHz	SOT-23	16ta	-	3a	Ste
DH	MMBD2000	Si-diode	Sw, 30V, 200mA, 150mW, Vf<0.95V(10mA), <2pF	SOT-323	16dc	-	3a	Mot
DH	MMBZ4699	Z-diode	12V±5%, 350mW	SOT-23	16dc	-	3g	Vs
DH	RT9809-32CV	Vdet-IC	3.2V±2%, -Reset PPO	SOT-23	16vdc	VD7	3a	Rct
DH	SSM3J05FU	p-MOSFET-e*	LogL, 20V, 200mA, <4Ω(500mA)	SOT-323	16fh	-	3a	Tos
DHP	TPC8.2	TVS	Vbr=7.38..9.02V, Vrwm=6.63V, Ipp=120.0A, 1500W(1ms)	TO-277A	76bd	-	3o	Vs
DI	AZ23C5V6	Z-diode	Dual, 5.32..5.88V, Zzt=40Ω, Izt=5mA, 300mW	SOT-23	16df	-	3c	Pjt
DI	MMBD2005	Si-diode	Dual, Sw, 30V, 200mA, 150mW, Vf<0.95V(10mA), <2pF	SOT-323	16df	-	3a	Mot
DI	SIP809CREUADT	Vdet-IC	2.63V±1.5%, -Reset PPO 1.5ms	SOT-23	16vdc	VD7	3g	Vs
DI-	2SC3867	Si-npn	UHFVHF, 20V, 50mA, 150mW, B=20..200, >1.4GHz	SOT-346	16te	-	3a	Ren
DJ	AZ23C6V2	Z-diode	Dual, 5.89..6.51V, Zzt=10Ω, Izt=5mA, 300mW	SOT-23	16df	-	3c	Pjt
DJ	MMBZ4700	Z-diode	13V±5%, 350mW	SOT-23	16dc	-	3g	Vs
DJ	RT9809-33CV	Vdet-IC	3.3V±2%, -Reset PPO	SOT-23	16vdc	VD7	3a	Rct
DK	2SK2909	n-MOSFET-e*	V-MOS, LogL, 20V, 0.8A, <0.3Ω(0.5A)	SOT-23	16fh	-	3a	San
DK	AZ23C14	Z-diode	Dual, 13.30..14.70V, Zzt=25Ω, Izt=5mA, 300mW	SOT-23	16df	-	3c	Pjt
DK	MAZ6003UR	Vref-IC	Precision, 3.00V	SOT-23	16di	-	3a	Max
DK	MMBZ4701	Z-diode	14V±5%, 350mW	SOT-23	16dc	-	3g	Vs
DK	RT9809-34CV	Vdet-IC	3.4V±2%, -Reset PPO	SOT-23	16vdc	VD7	3a	Rct
DK	SIP809C27EUADT	Vdet-IC	2.7V±1.5%, -Reset PPO 1.5ms	SOT-23	16vdc	VD7	3g	Vs
DKP	TPC8.2A	TVS	Vbr=7.79..8.61V, Vrwm=7.02V, Ipp=124.0A, 1500W(1ms)	TO-277A	76bd	-	3o	Vs
Dks	BCX42	Si-pnp	AF, 125V, 800mA, 330mW, B=63, 150MHz	SOT-23	16ta	-	3c	Inf
DL	2SA1343	Si-pnp-Digi	Sw, 50V, 100mA, 200mW, 250MHz, R1/R2=47k/22k	CP	16ta	-	3a	San
DL	2SC2713-BL	Si-npn	GP, AF, 120V, 100mA, 150mW, B=350..700, 100MHz	SOT-23	16ta	-	3a	Tos
DL	2SC4117-BL	Si-npn	AF-Amp, 120V, 100mA, 100mW, 100MHz, B=350..700	SOT-323	16ta	-	3a	Tos
DL	2SC5343UF-L	Si-npn	GP, 60V, 150mA, 200mW, >80MHz, B=300..700	SOT-323F	18ta	-	3a	Auk
DL	2SC5343U-L	Si-npn	GP, 60V, 150mA, 200mW, >80MHz, B=300..700	SOT-323	16ta	-	3a	Auk
DL	AZ23C17	Z-diode	Dual, 16.15..17.85V, Zzt=40Ω, Izt=5mA, 300mW	SOT-23	16df	-	3c	Pjt
DL	RT9809-35CV	Vdet-IC	3.5V±2%, -Reset PPO	SOT-23	16vdc	VD7	3a	Rct
DL	SIP809C5EUADT	Vdet-IC	2.93V±1.5%, -Reset PPO 1.5ms	SOT-23	16vdc	VD7	3g	Vs
DL	UNR31AE	Si-pnp-Digi	Sw, 50V, 80mA, 100mW, 80MHz, R1/R2=47k/22k	SSSMini3	18ta	-	3a	Pan
DLN	ELM7525CEB	Vdet-IC	2.5V±2%, +Reset PPO	SC-70	16vdb	VD7	3d	Elm
DLN	ELM7525NEB	Vdet-IC	2.5V±2%, +Reset ODO	SC-70	16vdb	VD6	3d	Elm
DLP	TPC9.1	TVS	Vbr=8.19..10.0V, Vrwm=7.37V, Ipp=109.0A, 1500W(1ms)	TO-277A	76bd	-	3o	Vs
DM	AZ23C28	Z-diode	Dual, 26.60..29.40V, Zzt=80Ω, Izt=5mA, 300mW	SOT-23	16df	-	3c	Pjt
DM	MMBZ4702	Z-diode	15V±5%, 350mW	SOT-23	16dc	-	3g	Vs
DM	RT9809-36CV	Vdet-IC	3.6V±2%, -Reset PPO	SOT-23	16vdc	VD7	3a	Rct
DM	SIP809CTEUADT	Vdet-IC	3.08V±1.5%, -Reset PPO 1.5ms	SOT-23	16vdc	VD7	3g	Vs
DMP	TPC9.1A	TVS	Vbr=8.65..9.55V, Vrwm=7.78V, Ipp=112.0A, 1500W(1ms)	TO-277A	76bd	-	3o	Vs
DN	MMBZ4703	Z-diode	16V±5%, 350mW	SOT-23	16dc	-	3g	Vs
DN	RT9809-37CV	Vdet-IC	3.7V±2%, -Reset PPO	SOT-23	16vdc	VD7	3a	Rct
DN	SIP809CJEUADT	Vdet-IC	4V±1.5%, -Reset PPO 1.5ms	SOT-23	16vdc	VD7	3g	Vs
DN	UNR31AF	Si-pnp-Digi	Sw, 50V, 80mA, 100mW, 80MHz, R1/R2=47k/710k	SSSMini3	18ta	-	3a	Pan
DNP	TPC10	TVS	Vbr=9.0..11.0V, Vrwm=8.10V, Ipp=100.0A, 1500W(1ms)	TO-277A	76bd	-	3o	Vs
DO	2SA1620-O	Si-pnp	GP, 80V, 300mA, 150mW, B=70..140, 100MHz	SOT-23	16ta	-	3a	Tos
DO	2SC5343UF-O	Si-npn	GP, 60V, 150mA, 200mW, >80MHz, B=70..140	SOT-323F	18ta	-	3a	Auk
DO	2SC5343U-O	Si-npn	GP, 60V, 150mA, 200mW, >80MHz, B=70..140	SOT-323	16ta	-	3a	Auk
DO	AZ23C2V4	Z-diode	Dual, 2.28..2.52V, Zzt=85Ω, Izt=5mA, 300mW	SOT-23	16df	-	3c	Pjt



SMD code	Type	Function	Short description	Case	Pinout	Sch.	St.	Mnf.
DO	SiP809CMEUADT	Vdet-IC	4.38V±1.5%, -Reset PPO 1.5ms	SOT-23	16vdc	VD7	3g	Vs
DP	MAX809BJUR	Vdet-IC	4.0V±1.5%, -Reset PPO	SOT-23	16vdc	VD7	3a	Max
DP	MMBZ4704	Z-diode	17V±5%, 350mW	SOT-23	16dc	-	3g	Vs
DP	RT9809-38CV	Vdet-IC	3.8V±2%, -Reset PPO	SOT-23	16vdc	VD7	3a	Rct
DP	SiP809CLEUADT	Vdet-IC	4.63V±1.5%, -Reset PPO 1.5ms	SOT-23	16vdc	VD7	3g	Vs
DP	TPC10A	TVS	Vbr=9.50..10.5V, Vrwm=8.55V, Ipp=103.0A, 1500W(1ms)	TO-277A	76bd	-	3o	Vs
DQ	2PB1219AQ	Si-pnp	GP, 60V, 150mA, 200mW, B=85..170, 100MHz	SOT-323	16ta	-	3a	PHH
DQ	2PB710AQ	Si-pnp	GP, 60V, 500mA, 250mW, B=85..170, >100MHz	SC-59	16ta	-	3a	Phi
DQ	2SB1219A-Q	Si-pnp	GP, 60V, 500mA, 150mW, B=85..170, 200MHz	SOT-323	16ta	-	3a	Pan
DQ	2SB710A-Q	Si-pnp	GP, AF, 60V, 500mA, 200mW, B=85..170, 200MHz	SC-59	16ta	-	3a	Pan
DQ	MAX809BLUR	Vdet-IC	4.63V±1.5%, -Reset PPO	SOT-23	16vdc	VD7	3a	Max
DQ	RT9809-39CV	Vdet-IC	3.9V±2%, -Reset PPO	SOT-23	16vdc	VD7	3a	Rct
DQP	TPC11	TVS	Vbr=9.90..12.1V, Vrwm=8.92V, Ipp=92.6A, 1500W(1ms)	TO-277A	76bd	-	3o	Vs
DQW	2PB1219AQ	Si-pnp	GP, 60V, 150mA, 200mW, B=85..170, 100MHz	SOT-323	16ta	-	3a	PHC
DR	2PB1219AR	Si-pnp	GP, 60V, 150mA, 200mW, B=120..240, 100MHz	SOT-323	16ta	-	3a	PHH
DR	2PB710AR	Si-pnp	GP, 60V, 500mA, 250mW, B=120..240, >120MHz	SC-59	16ta	-	3a	Phi
DR	2SB1219A-R	Si-pnp	GP, 60V, 500mA, 150mW, B=120..240, 20MHz	SOT-323	16ta	-	3a	Pan
DR	2SB710A-R	Si-pnp	GP, AF, 60V, 500mA, 200mW, B=120..240, 200MHz	SC-59	16ta	-	3a	Pan
DR	MAX809BMUR	Vdet-IC	4.38V±1.5%, -Reset PPO	SOT-23	16vdc	VD7	3a	Max
DR	RT9809-40CV	Vdet-IC	4.0V±2%, -Reset PPO	SOT-23	16vdc	VD7	3a	Rct
DR	SRA2211E	Si-pnp-Digi	Sw, 50V, 100mA, 150mW, 200MHz, R1=10k	SOT-523	16ta	-	3a	Auk
DR	SRA2211EF	Si-pnp-Digi	Sw, 50V, 100mA, 150mW, 200MHz, R1=10k	SOT-523F	18ta	-	3a	Auk
DR	SRA2211U	Si-pnp-Digi	Sw, 50V, 100mA, 200mW, 200MHz, R1=10k	SOT-323	16ta	-	3a	Auk
DR	SRA2211UF	Si-pnp-Digi	Sw, 50V, 100mA, 200mW, 200MHz, R1=10k	SOT-323F	18ta	-	3a	Auk
DR	SRA2212UF	Si-pnp-Digi	Sw, 50V, 100mA, 200mW, 200MHz, R1=100k	SOT-323F	18ta	-	3a	Auk
DRP	TPC11A	TVS	Vbr=10.5..11.6V, Vrwm=9.40V, Ipp=96.2A, 1500W(1ms)	TO-277A	76bd	-	3o	Vs
DRW	2PB1219AR	Si-pnp	GP, 60V, 150mA, 200mW, B=120..240, 100MHz	SOT-323	16ta	-	3a	PHC
DS	2PB1219AS	Si-pnp	GP, 60V, 150mA, 200mW, B=170..340, 100MHz	SOT-323	16ta	-	3a	Phi
DS	2PB710AS	Si-pnp	GP, 60V, 500mA, 250mW, B=170..340, >140MHz	SC-59	16ta	-	3a	Phi
DS	2SB1219A-S	Si-pnp	GP, 60V, 500mA, 150mW, B=170..340, 20MHz	SOT-323	16ta	-	3a	Pan
DS	2SB710A-S	Si-pnp	GP, AF, 60V, 500mA, 200mW, B=170..340, 200MHz	SC-59	16ta	-	3a	Pan
DS	RT9809-41CV	Vdet-IC	4.1V±2%, -Reset PPO	SOT-23	16vdc	VD7	3a	Rct
DS	SiP809CREUDDT	Vdet-IC	2.63V±1.5%, -Reset PPO 30ms	SOT-23	16vdc	VD7	3g	Vs
DS3	2SA1728-3	Si-pnp	Sw, 50V, 500mA, 200mW, B=70..130, 350MHz, 60/170ns	SOT-23	16ta	-	3a	San
DS4	2SA1728-4	Si-pnp	Sw, 50V, 500mA, 200mW, B=100..200, 350MHz, 60/170ns	SOT-23	16ta	-	3a	San
DS5	2SA1728-5	Si-pnp	Sw, 50V, 500mA, 200mW, B=140..280, 350MHz, 60/170ns	SOT-23	16ta	-	3a	San
DSAA	MAX809BTUR	Vdet-IC	3.08V±1.5%, -Reset PPO	SOT-23	16vdc	VD7	3a	Max
DSPA	TPC12	TVS	Vbr=10.8..13.2V, Vrwm=9.72V, Ipp=86.7A, 1500W(1ms)	TO-277A	76bd	-	3o	Vs
DSW	2PB1219AS	Si-pnp	GP, 60V, 150mA, 200mW, B=170..340, 100MHz	SOT-323	16ta	-	3a	PHC
DT	BCW67RA	Si-pnp	AF, Sw, 45V, 800mA, 330mW, B>100, >100MHz	SOT-23	16ta	-	3a	Sie
DT	MMBZ4705	Z-diode	18V±5%, 350mW	SOT-23	16dc	-	3g	Vs
DT	RT9809-42CV	Vdet-IC	4.2V±2%, -Reset PPO	SOT-23	16vdc	VD7	3a	Rct
DT	SiP809C27EUDDT	Vdet-IC	2.7V±1.5%, -Reset PPO 30ms	SOT-23	16vdc	VD7	3g	Vs
DTAA	MAX809BSUR	Vdet-IC	2.93V±1.5%, -Reset PPO	SOT-23	16vdc	VD7	3a	Max
DTP	TPC12A	TVS	Vbr=11.4..12.6V, Vrwm=10.2V, Ipp=89.8A, 1500W(1ms)	TO-277A	76bd	-	3o	Vs
DIQ	2PB1219AQ	Si-pnp	GP, 60V, 150mA, 200mW, B=85..170, 100MHz	SOT-323	16ta	-	3a	PHM
DIR	2PB1219AR	Si-pnp	GP, 60V, 150mA, 200mW, B=120..240, 100MHz	SOT-323	16ta	-	3a	PHM
DIS	2PB1219AS	Si-pnp	GP, 60V, 150mA, 200mW, B=170..340, 100MHz	SOT-323	16ta	-	3a	PHM
DJ	BCW67RB	Si-pnp	AF, Sw, 45V, 800mA, 330mW, B>160, >100MHz	SOT-23	16ta	-	3a	Sie
DJ	MMBZ4706	Z-diode	19V±5%, 350mW	SOT-23	16dc	-	3g	Vs
DJ	RT9809-43CV	Vdet-IC	4.3V±2%, -Reset PPO	SOT-23	16vdc	VD7	3a	Rct
DJP	TPC13	TVS	Vbr=11.7..14.3V, Vrwm=10.5V, Ipp=78.9A, 1500W(1ms)	TO-277A	76bd	-	3o	Vs
DV	MAX809BRUR	Vdet-IC	2.63V±1.5%, -Reset PPO	SOT-23	16vdc	VD7	3a	Max
DV	MMBZ4707	Z-diode	20V±5%, 350mW	SOT-23	16dc	-	3g	Vs
DV	RT9809-44CV	Vdet-IC	4.4V±2%, -Reset PPO	SOT-23	16vdc	VD7	3a	Rct
DV	SiP809CSSEUDDT	Vdet-IC	2.93V±1.5%, -Reset PPO 30ms	SOT-23	16vdc	VD7	3g	Vs
DV1	2SD596-1	Si-npn	AF, 30V, 700mA, 200mW, B=110..180, 170MHz	SOT-23	16ta	-	3a	Nec
DV2	2SD596-2	Si-npn	AF, 30V, 700mA, 200mW, B=135..220, 170MHz	SOT-23	16ta	-	3a	Nec
DV3	2SD596-3	Si-npn	AF, 30V, 700mA, 200mW, B=170..270, 170MHz	SOT-23	16ta	-	3a	Nec
DV4	2SD596-4	Si-npn	AF, 30V, 700mA, 200mW, B=200..320, 170MHz	SOT-23	16ta	-	3a	Nec
DV5	2SD596-5	Si-npn	AF, 30V, 700mA, 200mW, B=250..400, 170MHz	SOT-23	16ta	-	3a	Nec
DVP	2SC4755-P	Si-npn	Hi-sp Sw, 25V, 300mA, 150mW, 500MHz, B=40..80	SOT-323	16ta	-	3a	Pan
DVP	2SC4782-P	Si-npn	Sw, Hi-sp, 25V, 200mA, 200mW, 500MHz, B=40..80	SC-59	16ta	-	3a	Pan
DVP	TPC13A	TVS	Vbr=12.4..13.7V, Vrwm=11.1V, Ipp=82.4A, 1500W(1ms)	TO-277A	76bd	-	3o	Vs
DVQ	2SC4755-Q	Si-npn	Hi-sp Sw, 25V, 300mA, 150mW, 500MHz, B=60..120	SOT-323	16ta	-	3a	Pan
DVQ	2SC4782-Q	Si-npn	Sw, Hi-sp, 25V, 200mA, 200mW, 500MHz, B=60..120	SC-59	16ta	-	3a	Pan
DVR	2SC4755-R	Si-npn	Hi-sp Sw, 25V, 300mA, 150mW, 500MHz, B=90..200	SOT-323	16ta	-	3a	Pan
DVR	2SC4782-R	Si-npn	Sw, Hi-sp, 25V, 200mA, 200mW, 500MHz, B=90..200	SC-59	16ta	-	3a	Pan
DW	BCW67RC	Si-pnp	AF, Sw, 45V, 800mA, 330mW, B>250, >100MHz	SOT-23	16ta	-	3a	Sie
DW	CHT4126WPT	Si-pnp	AF, Sw, 25V, 200mA, B=120..360, 250MHz	SOT-323	16ta	-	3a	Chm



SMD code	Type	Function	Short description	Case	Pinout	Sch. St.	Mnf.
DW	RT9809-45CV	Vdet-IC	4.5V±2%, -Reset PPO	SOT-23	16vdc	VD7	3a Rct
DW	SiP809CTEUDDT	Vdet-IC	3.08V±1.5%, -Reset PPO 30ms	SOT-23	16vdc	VD7	3g Vs
DW1	2SD780-1	Si-npn	AF, 60V, 300mA, 200mW, B=110..180, 100MHz	SOT-23	16ta	-	3a Nec
DW2	2SD780-2	Si-npn	AF, 60V, 300mA, 200mW, B=135..220, 100MHz	SOT-23	16ta	-	3a Nec
DW3	2SD780-3	Si-npn	AF, 60V, 300mA, 200mW, B=170..270, 100MHz	SOT-23	16ta	-	3a Nec
DW4	2SD780-4	Si-npn	AF, 60V, 300mA, 200mW, B=200..320, 100MHz	SOT-23	16ta	-	3a Nec
DW5	2SD780-5	Si-npn	AF, 60V, 300mA, 200mW, B=250..400, 100MHz	SOT-23	16ta	-	3a Nec
DWAA	MAX810BLUR	Vdet-IC	4.63V±1.5%, +Reset PPO	SOT-23	16vdc	VD7	3a Max
DWA	TPC15	TVS	Vbr=13.5..16.5V, Vrwm=12.1V, Ipp=68.2A, 1500W(1ms)	TO-277A	76bd	-	3o Vs
DX	BCW68RF	Si-pnp	AF, Sw, 60V, 800mA, 350mW, B>100, >100MHz	SOT-23	16ta	-	3a Sie
DX	RT9809-46CV	Vdet-IC	4.6V±2%, -Reset PPO	SOT-23	16vdc	VD7	3a Rct
DX	SiP809CJEUDDT	Vdet-IC	4V±1.5%, -Reset PPO 30ms	SOT-23	16vdc	VD7	3g Vs
DXAA	MAX810BMUR	Vdet-IC	4.38V±1.5%, +Reset PPO	SOT-23	16vdc	VD7	3a Max
DXP	TPC15A	TVS	Vbr=14.3..15.8V, Vrwm=12.8V, Ipp=70.8A, 1500W(1ms)	TO-277A	76bd	-	3o Vs
DY	2SA1620-Y	Si-pnp	GP, 80V, 300mA, 150mW, B=120..240, 100MHz	SOT-23	16ta	-	3a Tos
DY	2SC3397	Si-npn-Digi	Sw, 50V, 100mA, 200mW, 250MHz, R1/R2=47k/22k	CP	16ta	-	3a San
DY	2SC5343UF-Y	Si-npn	GP, 60V, 150mA, 200mW, >80MHz, B=120..240	SOT-323F	18ta	-	3a Auk
DY	2SC5343U-Y	Si-npn	GP, 60V, 150mA, 200mW, >80MHz, B=120..240	SOT-323	16ta	-	3a Auk
DY	BCW68RG	Si-pnp	AF, Sw, 60V, 800mA, 350mW, B>160, >100MHz	SOT-23	16ta	-	3a Sie
DY	MMBZ4710	Z-diode	25V±5%, 350mW	SOT-23	16dc	-	3g Vs
DY	RT9809-47CV	Vdet-IC	4.7V±2%, -Reset PPO	SOT-23	16vdc	VD7	3a Rct
DY	SiP809CMEUDDT	Vdet-IC	4.38V±1.5%, -Reset PPO 30ms	SOT-23	16vdc	VD7	3g Vs
DYAA	MAX810BTUR	Vdet-IC	3.08V±1.5%, +Reset PPO	SOT-23	16vdc	VD7	3a Max
DYP	TPC16	TVS	Vbr=14.4..17.6V, Vrwm=12.9V, Ipp=63.8A, 1500W(1ms)	TO-277A	76bd	-	3o Vs
DZ	BCW68RH	Si-pnp	AF, Sw, 60V, 800mA, 350mW, B>250, >100MHz	SOT-23	16ta	-	3a Sie
DZ	MMBZ4709	Z-diode	24V±5%, 350mW	SOT-23	16dc	-	3g Vs
DZ	RT9809-48CV	Vdet-IC	4.8V±2%, -Reset PPO	SOT-23	16vdc	VD7	3a Rct
DZ	SiP809CLEUDDT	Vdet-IC	4.63V±1.5%, -Reset PPO 30ms	SOT-23	16vdc	VD7	3g Vs
DZAA	MAX810BSUR	Vdet-IC	2.93V±1.5%, +Reset PPO	SOT-23	16vdc	VD7	3a Max
DZP	TPC16A	TVS	Vbr=15.2..16.8V, Vrwm=13.6V, Ipp=66.7A, 1500W(1ms)	TO-277A	76bd	-	3o Vs
e	AX6901EA	Vdet-IC	2.93V±1.5%, -Reset PPO	SC-70	16vdc	VD7	3b Axl
E	IMBT3904	Si-npn	GP, 60V, 200mA, 250mW, B=100..300, >300MHz	SOT-23	16ta	-	3a ltt
E	IMBT3906	Si-pnp	GP, 40V, 200mA, 250mW, B=60..300, >250MHz	SOT-23	16ta	-	3a ltt
E0	AP1702ATW	Vdet-IC	4.63V±1.5%, +Reset PPO	TSOT23-3L	16vdc	VD7	3b Ana
E0	AP1702AW	Vdet-IC	4.63V±1.5%, +Reset PPO	SOT-23-3L	16vdc	VD7	3b Ana
E0	BZX84-C62	Z-diode	58..66V, Zzt=215Ω, Izt=20mA, 225mW	SOT-23	16dc	-	3a Lge
E0	ELM9740NBB	Vdet-IC	4.0V±2.5%, +Reset ODO	SOT-23	16vdb	VD6	3d Elm
E0	HSMP-3810	PIN-diode	RF Att, 100V, 1A(1µs), <0.35pF, <3Ω(100mA), 3GHz	SOT-23	16dc	-	3a Agi
E0	HSMP-381B	PIN-diode	RF Att, 100V, 1A(1µs), <0.35pF, <3Ω(100mA), 3GHz	SOT-323	16dc	-	3a Agi
E0	R3111N402A	Vdet-IC	4V±2%, -Reset PPO	SOT-23	16vdd	VD7	3d Ric
E0	R3130N26EC3	Vdet-IC	2.6V, -Reset ODO, 240ms	SOT-23	16vdc	VD6	3b Ric
E0	TC54VC4002ECB	Vdet-IC	4.0V±2%, -Reset PPO	SOT-23	16vdb	VD7	3a Tcs
E0	TS810CXA	Vdet-IC	4.63V±1.5%, +Reset PPO	SOT-23	16vdc	VD7	3b Tsc
E0	XC61CC4002M	Vdet-IC	4V±1%, +Reset PPO	SOT-23	16vdb	VD7	3d Tor
E0	XC6GC4002HR	Vdet-IC	4.0V, +Reset PPO	USP-3	17vdc	VD3	9b Tor
E03	XE61CC4045MR	Vdet-IC	4.0V±2%, -Reset PPO	SOT-23	16vdb	VD7	3h Tor
E05	XC61FC4012M	Vdet-IC	4V±2%, +Reset PPO, 200ms	SOT-23	16vdb	VD7	3d Tor
E05	XC61HC4012MR	Vdet-IC	4.0V±2%, -Reset PPO, 50..200ms	SOT-23	16vdc	VD7	3d Tor
E06	XC61FC4042M	Vdet-IC	4V±2%, +Reset PPO, 400ms	SOT-23	16vdb	VD7	3d Tor
E06	XC61HC4042MR	Vdet-IC	4.0V±2%, -Reset PPO, 80..400ms	SOT-23	16vdc	VD7	3d Tor
E07	XC61FC4052M	Vdet-IC	4V±2%, +Reset PPO, 50ms	SOT-23	16vdb	VD7	3d Tor
E07	XC61HC4052MR	Vdet-IC	4.0V±2%, -Reset PPO, 1..50ms	SOT-23	16vdc	VD7	3d Tor
E1	BFS17L	Si-npn	VHF,UHF, 15V, 50mA, 200mW, B=20..150, >1GHz	SOT-23	16ta	-	3a Mot
E1	BFS17W	Si-npn	VHF/UHF, Mix/Osc, 25V, 25mA, 250mW, B=90, 1.6GHz	SOT-323	16ta	-	3a Phi
E1	ELM9741NBB	Vdet-IC	4.1V±2.5%, +Reset ODO	SOT-23	16vdb	VD6	3d Elm
E1	MMBZ5231B	Z-diode	4.85..5.36V, Zzt=17Ω, Izt=20mA, 410mW	SOT-23	16dc	-	3a Pjt
E1	MMBZ5231BW	Z-diode	5.1V±5%, Zzt=17Ω, 200mW	SOT-323	16dc	-	3a Pjt
E1	R3111N412A	Vdet-IC	4.1V±2%, -Reset PPO	SOT-23	16vdd	VD7	3d Ric
E1	R3130N29EC3	Vdet-IC	2.9V, -Reset ODO, 240ms	SOT-23	16vdc	VD6	3b Ric
E1	TC54VC4102ECB	Vdet-IC	4.1V±2%, -Reset PPO	SOT-23	16vdb	VD7	3a Tcs
E1	XC61CC4102M	Vdet-IC	4.1V±1%, +Reset PPO	SOT-23	16vdb	VD7	3d Tor
E1	XC6GC4102HR	Vdet-IC	4.1V, +Reset PPO	USP-3	17vdc	VD3	9b Tor
E11	DTA113ZE	Si-pnp-Digi	Sw, 50V, 100mA, 200mW, 200MHz, R1/R2=1k/10k	SOT-416	16ta	-	3a Rhm
E11	DTA113ZKA	Si-pnp-Digi	Sw, 50V, 100mA, 200mW, 200MHz, R1/R2=1k/10k	SOT-346	16ta	-	3a Rhm
E11A	ML6102N113M	Vdet-IC	1.1V±3%, -Reset ODO	SOT-23	16vdb	VD6	3a Mlc
E12A	ML6102N123M	Vdet-IC	1.2V±3%, -Reset ODO	SOT-23	16vdb	VD6	3a Mlc
E13	DTA143ZE	Si-pnp-Digi	Sw, 50V, 100mA, 150mW, 250MHz, R1/R2=4k7/47k	SOT-416	16ta	-	3a Rhm
E13	DTA143ZKA	Si-pnp-Digi	Sw, 50V, 100mA, 200mW, 250MHz, R1/R2=4k7/47k	SOT-346	16ta	-	3a Rhm
E13	DTA143ZM	Si-pnp-Digi	Sw, 50V, 100mA, 150mW, 250MHz, R1/R2=4k7/47k	VMT3	18ta	-	3a Rhm
E13	XE61CC4145MR	Vdet-IC	4.1V±2%, -Reset PPO	SOT-23	16vdb	VD7	3h Tor



SMD code	Type	Function	Short description	Case	Pinout	Sch. St.	Mnf.
E13A	ML6102N133M	Vdet-IC	1.3V±3%, -Reset ODO	SOT-23	16vdb	VD6	3a Mic
E14A	ML6102N143M	Vdet-IC	1.4V±3%, -Reset ODO	SOT-23	16vdb	VD6	3a Mic
E15	BF747	Si-npn	VHF/UHF TV-Tuner, 20V, 50mA, 300mW, N=40..250, >1.2GHz	SOT-23	16ta	-	3a Phi
E15	XC61FC4112M	Vdet-IC	4.1V±2%, +Reset PPO, 200ms	SOT-23	16vdb	VD7	3d Tor
E15	XC61HC4112MR	Vdet-IC	4.1V±2%, -Reset PPO, 50..200ms	SOT-23	16vdc	VD7	3d Tor
E15A	ML6102N153M	Vdet-IC	1.5V±3%, -Reset ODO	SOT-23	16vdb	VD6	3a Mic
E16	BF547	Si-npn	VHF/UHF-Mix/Osc, 30V, 30mA, 300mW, B=40..250, 1.6GHz	SOT-23	16ta	-	3a Phi
E16	XC61FC4142M	Vdet-IC	4.1V±2%, +Reset PPO, 400ms	SOT-23	16vdb	VD7	3d Tor
E16	XC61HC4142MR	Vdet-IC	4.1V±2%, -Reset PPO, 80..400ms	SOT-23	16vdc	VD7	3d Tor
E16A	ML6102N163M	Vdet-IC	1.6V±3%, -Reset ODO	SOT-23	16vdb	VD6	3a Mic
E17	XC61FC4152M	Vdet-IC	4.1V±2%, +Reset PPO, 50ms	SOT-23	16vdb	VD7	3d Tor
E17	XC61HC4152MR	Vdet-IC	4.1V±2%, -Reset PPO, 1..50ms	SOT-23	16vdc	VD7	3d Tor
E17A	ML6102N173M	Vdet-IC	1.7V±3%, -Reset ODO	SOT-23	16vdb	VD6	3a Mic
E18A	ML6102N183M	Vdet-IC	1.8V±3%, -Reset ODO	SOT-23	16vdb	VD6	3a Mic
E19A	ML6102N193M	Vdet-IC	1.9V±3%, -Reset ODO	SOT-23	16vdb	VD6	3a Mic
E1H	BFS17H	Si-npn	VHF UHF, 25V, 25mA, 330mW, B=70..200, >1GHz	SOT-23	16ta	-	3a Zx
E1L	BFS17L	Si-npn	VHF UHF, 25V, 25mA, 330mW, B=25..100, >1GHz	SOT-23	16ta	-	3a Zx
E1O	KSC2859-O	Si-npn	AF, 35V, 500mA, 150mW, B=70..140, >300MHz	SOT-23	16ta	-	3a Sam
E1p	BFS17	Si-npn	VHF/UHF, Mix/Osc, 25V, 25mA, 300mW, B=90, 1GHz	SOT-23	16ta	-	3a Phi
E1Y	KSC2859-Y	Si-npn	AF, 35V, 500mA, 150mW, B=120..240, >300MHz	SOT-23	16ta	-	3a Sam
E2	2SA1226-2	Si-pnp	HF, 40V, 30mA, 200mW, B=40..80, >250MHz	SOT-23	16ta	-	3a Nec
E2	AP1702BTW	Vdet-IC	4.38V±1.5%, +Reset PPO	TSOT23-3L	16vdc	VD7	3b Ana
E2	AP1702BW	Vdet-IC	4.38V±1.5%, +Reset PPO	SOT-23-3L	16vdc	VD7	3b Ana
E2	BAL99	Si-diode	Sw, Fast, 70V, 100mA, 330mW, <4ns	SOT-23	16dr	-	3a Zx
E2	BF547W	Si-npn	VHF/UHF-Mix/Osc, 30V, 50mA, 300mW, B=40..250, 1.6GHz	SOT-323	16ta	-	3a Phi
E2	BFS17A	Si-npn	VHF/UHF, Mix/Osc, 25V, 25mA, 200mW, B=20..150, 2.8GHz	SOT-23	16ta	-	3g Vs
E2	ELM9742NBB	Vdet-IC	4.2V±2%, +Reset ODO	SOT-23	16vdb	VD6	3d Elm
E2	HSMP-3812	PIN-diode	Dual, RF Att, 100V, 1A(1µs), <0.35pF, <3Ω(100mA), 3GHz	SOT-23	16dl	-	3a Agi
E2	HSMP-381C	PIN-diode	Dual, RF Att, 100V, 1A(1µs), <0.35pF, <3Ω(100mA), 3GHz	SOT-323	16dl	-	3a Agi
E2	MMBZ5232B	Z-diode	5.32..5.88V, Zzt=11Ω, Izt=20mA, 410mW	SOT-23	16dc	-	3a Pjt
E2	MMBZ5232BW	Z-diode	5.6V±5%, Zzt=11Ω, 200mW	SOT-323	16dc	-	3a Pjt
E2	R3111N422A	Vdet-IC	4.2V±2%, -Reset PPO	SOT-23	16vdd	VD7	3d Ric
E2	R3113D121C	Vdet-IC	1.2V±2%, -Reset, PPO	SON1408-3	18vda	VD7	3d Ric
E2	R3130N30EC8	Vdet-IC	3V, -Reset ODO, 240ms	SOT-23	16vdc	VD6	3b Ric
E2	SPE053S23RG	ESDP-diode	Dual, Vrrm=5V, Vbr=6..8.5V, 7A, 250W(1ms), Bidirectional	SOT-23	16dp	-	3b Syn
E2	TC54VC4202ECB	Vdet-IC	4.2V±2%, -Reset PPO	SOT-23	16vdb	VD7	3a Tcs
E2	TS810CXB	Vdet-IC	4.38V±1.5%, +Reset PPO	SOT-23	16vdc	VD7	3b Tsc
E2	XC61CC4202M	Vdet-IC	4.2V±1%, +Reset PPO	SOT-23	16vdb	VD7	3d Tor
E2	XC6GC4202HR	Vdet-IC	4.2V, +Reset PPO	USP-3	17vdc	VD3	9b Tor
E20A	ML6102N202M	Vdet-IC	2.0V±2%, -Reset ODO	SOT-23	16vdb	VD6	3a Mic
E21	2SK932-21	n-FET	RF, LN, 15V, 50mA, 200mW, Idss=5..8.5mA, Up<1.4V	SOT-23	16fa	-	3a San
E21	GS809C21EUE	Vdet-IC	2.1V, -Reset PPO, 150ms	SOT-23	16vdc	VD7	3g Vs
E21A	ML6102N212M	Vdet-IC	2.1V±2%, -Reset ODO	SOT-23	16vdb	VD6	3a Mic
E22	2SK932-22	n-FET	RF, LN, 15V, 50mA, 200mW, Idss=7.3..12mA, Up<1.4V	SOT-23	16fa	-	3a San
E22A	ML6102N222M	Vdet-IC	2.2V±2%, -Reset ODO	SOT-23	16vdb	VD6	3a Mic
E23	2SK932-23	n-FET	RF, LN, 15V, 50mA, 200mW, Idss=10..17mA, Up<1.4V	SOT-23	16fa	-	3a San
E23	DTC143ZE	Si-npn-Digi	Sw, 50V, 100mA, 150mW, 250MHz, R1/R2=4k/47k	SOT-416	16ta	-	3a Rhm
E23	DTC143ZKA	Si-npn-Digi	Sw, 50V, 100mA, 200mW, 250MHz, R1/R2=4k/47k	SOT-346	16ta	-	3a Rhm
E23	DTC143ZM	Si-npn-Digi	Sw, 50V, 100mA, 150mW, 250MHz, R1/R2=4k/47k	VMT3	18ta	-	3a Rhm
E23	DTC143ZUA	Si-npn-Digi	Sw, 50V, 100mA, 200mW, 250MHz, R1/R2=4k/47k	UMT3	16ta	-	3a Rhm
E23	XE61CC4245MR	Vdet-IC	4.2V±2%, -Reset PPO	SOT-23	16vdb	VD7	3h Tor
E23A	ML6102N232M	Vdet-IC	2.3V±2%, -Reset ODO	SOT-23	16vdb	VD6	3a Mic
E24	2SK932-24	n-FET	RF, LN, 15V, 50mA, 200mW, Idss=14.5..24mA, Up<1.4V	SOT-23	16fa	-	3a San
E24	GS809C24EUE	Vdet-IC	2.4V, -Reset PPO, 150ms	SOT-23	16vdc	VD7	3g Vs
E24A	ML6102N242M	Vdet-IC	2.4V±2%, -Reset ODO	SOT-23	16vdb	VD6	3a Mic
E25	XC61FC4212M	Vdet-IC	4.2V±2%, +Reset PPO, 200ms	SOT-23	16vdb	VD7	3d Tor
E25	XC61HC4212MR	Vdet-IC	4.2V±2%, -Reset PPO, 50..200ms	SOT-23	16vdc	VD7	3d Tor
E25A	ML6102N252M	Vdet-IC	2.5V±2%, -Reset ODO	SOT-23	16vdb	VD6	3a Mic
E26	GS809CREUE	Vdet-IC	2.63V, -Reset PPO, 150ms	SOT-23	16vdc	VD7	3g Vs
E26	XC61FC4242M	Vdet-IC	4.2V±2%, +Reset PPO, 400ms	SOT-23	16vdb	VD7	3d Tor
E26	XC61HC4242MR	Vdet-IC	4.2V±2%, -Reset PPO, 80..400ms	SOT-23	16vdc	VD7	3d Tor
E26A	ML6102N262M	Vdet-IC	2.6V±2%, -Reset ODO	SOT-23	16vdb	VD6	3a Mic
E27	GS809C27SEUE	Vdet-IC	2.7V, -Reset PPO, 150ms	SOT-23	16vdc	VD7	3g Vs
E27	XC61FC4252M	Vdet-IC	4.2V±2%, +Reset PPO, 50ms	SOT-23	16vdb	VD7	3d Tor
E27	XC61HC4252MR	Vdet-IC	4.2V±2%, -Reset PPO, 1..50ms	SOT-23	16vdc	VD7	3d Tor
E27A	ML6102N272M	Vdet-IC	2.7V±2%, -Reset ODO	SOT-23	16vdb	VD6	3a Mic
E28A	ML6102N282M	Vdet-IC	2.8V±2%, -Reset ODO	SOT-23	16vdb	VD6	3a Mic
E29	GS809CSEUE	Vdet-IC	2.93V, -Reset PPO, 150ms	SOT-23	16vdc	VD7	3g Vs
E29A	ML6102N292M	Vdet-IC	2.9V±2%, -Reset ODO	SOT-23	16vdb	VD6	3a Mic
E2p	BFS17A	Si-npn	VHF/UHF, Mix/Osc, 25V, 25mA, 200mW, B=20..150, 2.8GHz	SOT-23	16ta	-	3a Phi



SMD code	Type	Function	Short description	Case	Pinout	Sch. St.	Mnf.
E3	1SS190	Si-diode	Sw, U-Fast, 85V, 100mA, 150mW, Vf<1.2V(100mA), <4ns	SC-59	16ak	-	3b Tos
E3	2SA1226-3	Si-pnp	HF, 40V, 30mA, 200mW, B=60..120, >250MHz	SOT-23	16ta	-	3a Nec
E3	2SA1256-3	Si-pnp	HF Amp, 30V, 30mA, 150mW, B=60..120, >230MHz	SOT-23	16ta	-	3a San
E3	2SA1656-3	Si-pnp	GP, FM/RF, 30V, 30mA, 150mW, B=60..120, >320MHz	SOT-23	16ta	-	3a San
E3	2SA1688-3	Si-pnp	GP, FM/RF, 30V, 30mA, 150mW, B=60..120, >320MHz	MCP	16ta	-	3a San
E3	AP1702CTW	Vdet-IC	4.0V±1.5%, +Reset PPO	TSOT23-3L	16vdc	VD7	3b Ana
E3	AP1702CW	Vdet-IC	4.0V±1.5%, +Reset PPO	SOT-23-3L	16vdc	VD7	3b Ana
E3	BAR99	Si-diode	Sw, 70V, 100mA, 330mW, Vf<1.25V(150mA), <6ns	SOT-23	16dc	-	3a Zx
E3	ELM9743NBB	Vdet-IC	4.3V±2.5%, +Reset ODO	SOT-23	16vdb	VD6	3d Elm
E3	HSMP-3813	PIN-diode	Dual, RF Att, 100V, 1A(1µs), <0.35pF, <3Ω(100mA), 3GHz	SOT-23	16df	-	3a Agi
E3	HSMP-381E	PIN-diode	Dual, RF Att, 100V, 1A(1µs), <0.35pF, <3Ω(100mA), 3GHz	SOT-323	16df	-	3a Agi
E3	MMBZ5233B	Z-diode	5.70..6.30V, Zzt=7.0Ω, lzt=20mA, 410mW	SOT-23	16dc	-	3a Pjt
E3	R3111N432A	Vdet-IC	4.3V±2%, -Reset PPO	SOT-23	16vdd	VD7	3d Ric
E3	R3113D131C	Vdet-IC	1.3V±2%, -Reset, PPO	SON1408-3	18vda	VD7	3d Ric
E3	R3130N46EC5	Vdet-IC	4.6V, -Reset ODO, 240ms	SOT-23	16vdc	VD6	3b Ric
E3	TC54VC4302ECB	Vdet-IC	4.3V±2%, -Reset PPO	SOT-23	16vdb	VD7	3a Tcs
E3	TS810CXC	Vdet-IC	4.0V±1.5%, +Reset PPO	SOT-23	16vdc	VD7	3b Tsc
E3	XC61CC4302M	Vdet-IC	4.3V±1%, +Reset PPO	SOT-23	16vdb	VD7	3d Tor
E3	XC6GC4302HR	Vdet-IC	4.3V, +Reset PPO	USP-3	17vdc	VD3	9b Tor
E30	GS809CTEUE	Vdet-IC	3.08V, -Reset PPO, 150ms	SOT-23	16vdc	VD7	3g Vs
E30A	ML6102N302M	Vdet-IC	3.0V±2%, -Reset ODO	SOT-23	16vdb	VD6	3a Mlc
E31A	ML6102N312M	Vdet-IC	3.1V±2%, -Reset ODO	SOT-23	16vdb	VD6	3a Mlc
E32	DTA123JKA	Si-pnp-Digi	Sw, 50V, 100mA, 200mW, 250MHz, R1/R2=2k2/47k	SOT-346	16ta	-	3a Rhm
E32A	ML6102N322M	Vdet-IC	3.2V±2%, -Reset ODO	SOT-23	16vdb	VD6	3a Mlc
E33	XE61CC4345MR	Vdet-IC	4.3V±2%, -Reset PPO	SOT-23	16vdb	VD7	3h Tor
E33A	ML6102N332M	Vdet-IC	3.3V±2%, -Reset ODO	SOT-23	16vdb	VD6	3a Mlc
E34A	ML6102N342M	Vdet-IC	3.4V±2%, -Reset ODO	SOT-23	16vdb	VD6	3a Mlc
E35	XC61FC4312M	Vdet-IC	4.3V±2%, +Reset PPO, 200ms	SOT-23	16vdb	VD7	3d Tor
E35	XC61HC4312MR	Vdet-IC	4.3V±2%, -Reset PPO, 50..200ms	SOT-23	16vdc	VD7	3d Tor
E35A	ML6102N352M	Vdet-IC	3.5V±2%, -Reset ODO	SOT-23	16vdb	VD6	3a Mlc
E36	XC61FC4342M	Vdet-IC	4.3V±2%, +Reset PPO, 400ms	SOT-23	16vdb	VD7	3d Tor
E36	XC61HC4342MR	Vdet-IC	4.3V±2%, -Reset PPO, 80..400ms	SOT-23	16vdc	VD7	3d Tor
E36A	ML6102N362M	Vdet-IC	3.6V±2%, -Reset ODO	SOT-23	16vdb	VD6	3a Mlc
E37	XC61FC4352M	Vdet-IC	4.3V±2%, +Reset PPO, 50ms	SOT-23	16vdb	VD7	3d Tor
E37	XC61HC4352MR	Vdet-IC	4.3V±2%, -Reset PPO, 1..50ms	SOT-23	16vdc	VD7	3d Tor
E37A	ML6102N372M	Vdet-IC	3.7V±2%, -Reset ODO	SOT-23	16vdb	VD6	3a Mlc
E38A	ML6102N382M	Vdet-IC	3.8V±2%, -Reset ODO	SOT-23	16vdb	VD6	3a Mlc
E39A	ML6102N392M	Vdet-IC	3.9V±2%, -Reset ODO	SOT-23	16vdb	VD6	3a Mlc
E4	2SA1226-4	Si-pnp	HF, 40V, 30mA, 200mW, B=90..180, >250MHz	SOT-23	16ta	-	3a Nec
E4	2SA1256-4	Si-pnp	HF Amp, 30V, 30mA, 150mW, B=90..180, >230MHz	SOT-23	16ta	-	3a San
E4	2SA1656-4	Si-pnp	GP, FM/RF, 30mA, 150mW, B=90..180, >320MHz	SOT-23	16ta	-	3a San
E4	2SA1688-4	Si-pnp	GP, FM/RF, 30mA, 150mW, B=90..180, >320MHz	MCP	16ta	-	3a San
E4	AP1702DTW	Vdet-IC	3.08V±1.5%, +Reset PPO	TSOT23-3L	16vdc	VD7	3b Ana
E4	AP1702DW	Vdet-IC	3.08V±1.5%, +Reset PPO	SOT-23-3L	16vdc	VD7	3b Ana
E4	BB404E	C-diode	Dual, 10V, 47.5..18pF(2..8V), 100MHz	SOT-23	16dg	-	3a ltt
E4	CHN203KPT	Si-diode	Dual, Sw, 85V, 125mA, Vf<1.2V(100mA), 4ns	SOT-23	16dg	-	3a Chm
E4	ELM9744NBB	Vdet-IC	4.4V±2.5%, +Reset ODO	SOT-23	16vdb	VD6	3d Elm
E4	HSMP-3814	PIN-diode	Dual, RF Att, 100V, 1A(1µs), <0.35pF, <3Ω(100mA), 3GHz	SOT-23	16dg	-	3a Agi
E4	HSMP-381F	PIN-diode	Dual, RF Att, 100V, 1A(1µs), <0.35pF, <3Ω(100mA), 3GHz	SOT-323	16dg	-	3a Agi
E4	ILC50621C44X	Vdet-IC	4.4V±2%, -Reset PPO	SOT-323	16vdb	VD7	3a Imp
E4	ILC5062M44X	Vdet-IC	4.4V±2%, -Reset PPO	SOT-23	16vdb	VD7	3a Imp
E4	KA4L3N	Si-npn-Digi	Sw, 60V, 100mA, 200mW, R1/R2=4k7/10k	SOT-416	16ta	-	3a Nec
E4	MMBZ5233B	Z-diode	6V±5%, 410mW	SOT-23	16dc	-	3a Pjt
E4	MMBZ5234B	Z-diode	5.89..6.51V, Zzt=7Ω, lzt=20mA, 410mW	SOT-23	16dc	-	3a Pjt
E4	MMBZ5234BW	Z-diode	6.2V±5%, Zzt=7Ω, 200mW	SOT-323	16dc	-	3a Pjt
E4	R3111N442A	Vdet-IC	4.4V±2%, -Reset PPO	SOT-23	16vdd	VD7	3d Ric
E4	R3113D141C	Vdet-IC	1.4V±2%, -Reset, PPO	SON1408-3	18vda	VD7	3d Ric
E4	R3130N46EC3	Vdet-IC	4.6V, -Reset ODO, 240ms	SOT-23	16vdc	VD6	3b Ric
E4	TC54VC4402ECB	Vdet-IC	4.4V±2%, -Reset PPO	SOT-23	16vdb	VD7	3a Tcs
E4	TS810CXD	Vdet-IC	3.08V±1.5%, +Reset PPO	SOT-23	16vdc	VD7	3b Tsc
E4	XC61CC4402M	Vdet-IC	4.4V±1%, +Reset PPO	SOT-23	16vdb	VD7	3d Tor
E4	XC6GC4402HR	Vdet-IC	4.4V, +Reset PPO	USP-3	17vdc	VD3	9b Tor
E40	GS809CJEUE	Vdet-IC	4V, -Reset PPO, 150ms	SOT-23	16vdc	VD7	3g Vs
E40A	ML6102N402M	Vdet-IC	4.0V±2%, -Reset ODO	SOT-23	16vdb	VD6	3a Mlc
E41A	ML6102N412M	Vdet-IC	4.1V±2%, -Reset ODO	SOT-23	16vdb	VD6	3a Mlc
E42	DTC123JE	Si-npn-Digi	Sw, 50V, 100mA, 150mW, 250MHz, R1/R2=2k2/47k	SOT-416	16ta	-	3a Rhm
E42	DTC123JKA	Si-npn-Digi	Sw, 50V, 100mA, 200mW, 250MHz, R1/R2=2k2/47k	SOT-346	16ta	-	3a Rhm
E42	DTC123JM	Si-npn-Digi	Sw, 50V, 100mA, 150mW, 250MHz, R1/R2=2k2/47k	VMT3	18ta	-	3a Rhm
E42	DTC123JUA	Si-npn-Digi	Sw, 50V, 100mA, 200mW, 250MHz, R1/R2=2k2/47k	UMT3	16ta	-	3a Rhm
E42A	ML6102N422M	Vdet-IC	4.2V±2%, -Reset ODO	SOT-23	16vdb	VD6	3a Mlc



SMD code	Type	Function	Short description	Case	Pinout	Sch. St.	Mnf.
E43	GS809CMEUE	Vdet-IC	4.38V, -Reset PPO, 150ms	SOT-23	16vdc	VD7	3g Vs
E43	XE61CC4445MR	Vdet-IC	4.4V±2%, -Reset PPO	SOT-23	16vdc	VD7	3h Tor
E43A	ML6102N432M	Vdet-IC	4.3V±2%, -Reset ODO	SOT-23	16vdc	VD6	3a Mic
E44A	ML6102N442M	Vdet-IC	4.4V±2%, -Reset ODO	SOT-23	16vdc	VD6	3a Mic
E45	XC61FC4412M	Vdet-IC	4.4V±2%, +Reset PPO, 200ms	SOT-23	16vdc	VD7	3d Tor
E45	XC61HC4412MR	Vdet-IC	4.4V±2%, -Reset PPO, 50..200ms	SOT-23	16vdc	VD7	3d Tor
E45A	ML6102N452M	Vdet-IC	4.5V±2%, -Reset ODO	SOT-23	16vdc	VD6	3a Mic
E46	GS809CLEUE	Vdet-IC	4.63V, -Reset PPO, 150ms	SOT-23	16vdc	VD7	3g Vs
E46	XC61FC4442M	Vdet-IC	4.4V±2%, +Reset PPO, 400ms	SOT-23	16vdc	VD7	3d Tor
E46	XC61HC4442MR	Vdet-IC	4.4V±2%, -Reset PPO, 80..400ms	SOT-23	16vdc	VD7	3d Tor
E46A	ML6102N462M	Vdet-IC	4.6V±2%, -Reset ODO	SOT-23	16vdc	VD6	3a Mic
E47	XC61FC4452M	Vdet-IC	4.4V±2%, +Reset PPO, 50ms	SOT-23	16vdc	VD7	3d Tor
E47	XC61HC4452MR	Vdet-IC	4.4V±2%, -Reset PPO, 1..50ms	SOT-23	16vdc	VD7	3d Tor
E47A	ML6102N472M	Vdet-IC	4.7V±2%, -Reset ODO	SOT-23	16vdc	VD6	3a Mic
E48A	ML6102N482M	Vdet-IC	4.8V±2%, -Reset ODO	SOT-23	16vdc	VD6	3a Mic
E49A	ML6102N492M	Vdet-IC	4.9V±2%, -Reset ODO	SOT-23	16vdc	VD6	3a Mic
E4A	ILC5062AIC44X	Vdet-IC	4.4V±1%, -Reset PPO	SOT-323	16vdc	VD7	3a Imp
E4A	ILC5062AM44X	Vdet-IC	4.4V±1%, -Reset PPO	SOT-23	16vdc	VD7	3a Imp
E5	2SA1256-5	Si-pnp	HF Amp, 30V, 30mA, 150mW, B=135..280, 230MHz	SOT-23	16ta	-	3a San
E5	2SA1656-5	Si-pnp	GP, FM/RF, 30mA, 150mW, B=135..270, >320MHz	SOT-23	16ta	-	3a San
E5	2SA1688-5	Si-pnp	GP, FM/RF, 30mA, 150mW, B=135..270, >320MHz	MCP	16ta	-	3a San
E5	AP1702ETW	Vdet-IC	2.93V±1.5%, +Reset PPO	TSOT23-3L	16vdc	VD7	3b Ana
E5	AP1702EW	Vdet-IC	2.93V±1.5%, +Reset PPO	SOT-23-3L	16vdc	VD7	3b Ana
E5	BFS17AR	Si-npn	VHF/UHF, Mix/Osc, 25V, 25mA, 200mW, B=20..150, 2.8GHz	SOT-23	16te	-	3a Sil
E5	ELM9745NBB	Vdet-IC	4.5V±2.5%, +Reset ODO	SOT-23	16vdc	VD6	3d Elm
E5	MMBZ5235B	Z-diode	6.46..7.14V, Zzt=5Ω, Izt=20mA, 410mW	SOT-23	16dc	-	3a Pjt
E5	MMBZ5235BW	Z-diode	6.8V±5%, Zzt=5Ω, 200mW	SOT-323	16dc	-	3a Pjt
E5	R3111N452A	Vdet-IC	4.5V±2%, -Reset PPO	SOT-23	16vdc	VD7	3d Ric
E5	R3113D151C	Vdet-IC	1.5V±2%, -Reset, PPO	SON1408-3	18vda	VD7	3d Ric
E5	SP810EK-2-6	Vdet-IC	2.6V±1.5%, +Reset PPO	SOT-23	16vdc	VD7	3b Sip
E5	TC54VC4502ECB	Vdet-IC	4.5V±2%, -Reset PPO	SOT-23	16vdc	VD7	3a Tcs
E5	TS810CXE	Vdet-IC	2.93V±1.5%, +Reset PPO	SOT-23	16vdc	VD7	3b Tsc
E5	XC61CC4502M	Vdet-IC	4.5V±1%, +Reset PPO	SOT-23	16vdc	VD7	3d Tor
E5	XC6GC4502HR	Vdet-IC	4.5V, +Reset PPO	USP-3	17vdc	VD3	9b Tor
E50A	ML6102N502M	Vdet-IC	5.0V±2%, -Reset ODO	SOT-23	16vdc	VD6	3a Mic
E51A	ML6102N512M	Vdet-IC	5.1V±2%, -Reset ODO	SOT-23	16vdc	VD6	3a Mic
E52A	ML6102N522M	Vdet-IC	5.2V±2%, -Reset ODO	SOT-23	16vdc	VD6	3a Mic
E53	XE61CC4545MR	Vdet-IC	4.5V±2%, -Reset PPO	SOT-23	16vdc	VD7	3h Tor
E53A	ML6102N532M	Vdet-IC	5.3V±2%, -Reset ODO	SOT-23	16vdc	VD6	3a Mic
E54A	ML6102N542M	Vdet-IC	5.4V±2%, -Reset ODO	SOT-23	16vdc	VD6	3a Mic
E55	XC61FC4512M	Vdet-IC	4.5V±2%, +Reset PPO, 200ms	SOT-23	16vdc	VD7	3d Tor
E55	XC61HC4512MR	Vdet-IC	4.5V±2%, -Reset PPO, 50..200ms	SOT-23	16vdc	VD7	3d Tor
E55A	ML6102N552M	Vdet-IC	5.5V±2%, -Reset ODO	SOT-23	16vdc	VD6	3a Mic
E56	DTA144VKA	Si-pnp-Digi	Sw, 50V, 100mA, 200mW, 250MHz, R1/R2=47k/10k	SOT-346	16ta	-	3a Rhm
E56	XC61FC4542M	Vdet-IC	4.5V±2%, +Reset PPO, 400ms	SOT-23	16vdc	VD7	3d Tor
E56	XC61HC4542MR	Vdet-IC	4.5V±2%, -Reset PPO, 80..400ms	SOT-23	16vdc	VD7	3d Tor
E56A	ML6102N562M	Vdet-IC	5.6V±2%, -Reset ODO	SOT-23	16vdc	VD6	3a Mic
E57	XC61FC4552M	Vdet-IC	4.5V±2%, +Reset PPO, 50ms	SOT-23	16vdc	VD7	3d Tor
E57	XC61HC4552MR	Vdet-IC	4.5V±2%, -Reset PPO, 1..50ms	SOT-23	16vdc	VD7	3d Tor
E57A	ML6102N572M	Vdet-IC	5.7V±2%, -Reset ODO	SOT-23	16vdc	VD6	3a Mic
E58A	ML6102N582M	Vdet-IC	5.8V±2%, -Reset ODO	SOT-23	16vdc	VD6	3a Mic
E59A	ML6102N592M	Vdet-IC	5.9V±2%, -Reset ODO	SOT-23	16vdc	VD6	3a Mic
E6	AP1702FTW	Vdet-IC	2.63V±1.5%, +Reset PPO	TSOT23-3L	16vdc	VD7	3b Ana
E6	AP1702FW	Vdet-IC	2.63V±1.5%, +Reset PPO	SOT-23-3L	16vdc	VD7	3b Ana
E6	CHP203KPT	Si-diode	Dual, Sw, 85V, 125mA, Vf<1.2V(100mA), 4ns	SOT-23	16df	-	3a Chm
E6	ELM9746NBB	Vdet-IC	4.6V±2.5%, +Reset ODO	SOT-23	16vdc	VD6	3d Elm
E6	ILC5062IC46X	Vdet-IC	4.6V±2%, -Reset PPO	SOT-323	16vdc	VD7	3a Imp
E6	ILC5062M46X	Vdet-IC	4.6V±2%, -Reset PPO	SOT-23	16vdc	VD7	3a Imp
E6	R3111N462A	Vdet-IC	4.6V±2%, -Reset PPO	SOT-23	16vdc	VD7	3d Ric
E6	R3113D161C	Vdet-IC	1.6V±2%, -Reset, PPO	SON1408-3	18vda	VD7	3d Ric
E6	TC54VC4602ECB	Vdet-IC	4.6V±2%, -Reset PPO	SOT-23	16vdc	VD7	3a Tcs
E6	TS810CXF	Vdet-IC	2.63V±1.5%, +Reset PPO	SOT-23	16vdc	VD7	3b Tsc
E6	XC61CC4602M	Vdet-IC	4.6V±1%, +Reset PPO	SOT-23	16vdc	VD7	3d Tor
E6	XC6GC4602HR	Vdet-IC	4.6V, +Reset PPO	USP-3	17vdc	VD3	9b Tor
E60A	ML6102N602M	Vdet-IC	6.0V±2%, -Reset ODO	SOT-23	16vdc	VD6	3a Mic
E63	XE61CC4645MR	Vdet-IC	4.6V±2%, -Reset PPO	SOT-23	16vdc	VD7	3h Tor
E65	XC61FC4612M	Vdet-IC	4.6V±2%, +Reset PPO, 200ms	SOT-23	16vdc	VD7	3d Tor
E65	XC61HC4612MR	Vdet-IC	4.6V±2%, -Reset PPO, 50..200ms	SOT-23	16vdc	VD7	3d Tor
E66	DTC144VKA	Si-npn-Digi	Sw, 50V, 100mA, 200mW, 250MHz, R1/R2=47k/10k	SOT-346	16ta	-	3a Rhm
E66	XC61FC4642M	Vdet-IC	4.6V±2%, +Reset PPO, 400ms	SOT-23	16vdc	VD7	3d Tor



SMD code	Type	Function	Short description	Case	Pinout	Sch.	St.	Mnf.
E66	XC61HC4642MR	Vdet-IC	4.6V±2%, -Reset PPO, 80, 400ms	SOT-23	16vdc	VD7	3d	Tor
E67	XC61FC4652M	Vdet-IC	4.6V±2%, +Reset PPO, 50ms	SOT-23	16vdb	VD7	3d	Tor
E67	XC61HC4652MR	Vdet-IC	4.6V±2%, -Reset PPO, 1.50ms	SOT-23	16vdc	VD7	3d	Tor
E6A	ILC5062AIC46X	Vdet-IC	4.6V±1%, -Reset PPO	SOT-323	16vdb	VD7	3a	Imp
E6A	ILC5062AM46X	Vdet-IC	4.6V±1%, -Reset PPO	SOT-23	16vdb	VD7	3a	Imp
E7	AP1704ATW	Vdet-IC	4.63V±1.5%, +Reset PPO	TSOT23-3L	16vda	VD7	3b	Ana
E7	AP1704AW	Vdet-IC	4.63V±1.5%, +Reset PPO	SOT-23-3L	16vda	VD7	3b	Ana
E7	ELM9747NBB	Vdet-IC	4.7V±2.5%, +Reset ODO	SOT-23	16vdb	VD6	3d	Elm
E7	KN4L3N	Si-pnp-Digi	Sw, 60V, 100mA, 150mW, R1/R2=4k7/10k	SOT-416	16ta	-	3a	Nec
E7	R3111N472A	Vdet-IC	4.7V±2%, -Reset PPO	SOT-23	16vdd	VD7	3d	Ric
E7	R3113D171C	Vdet-IC	1.7V±2%, -Reset, PPO	SON1408-3	18vda	VD7	3d	Ric
E7	TC54VC4702ECB	Vdet-IC	4.7V±2%, -Reset PPO	SOT-23	16vdb	VD7	3a	Tcs
E7	TS810RCXA	Vdet-IC	4.63V±1.5%, +Reset PPO	SOT-23	16vdb	VD7	3b	Tsc
E7	XC61CC4702M	Vdet-IC	4.7V±1%, +Reset PPO	SOT-23	16vdb	VD7	3d	Tor
E7	XC6GC4702HR	Vdet-IC	4.7V, +Reset PPO	USP-3	17vdc	VD3	9b	Tor
E73	XE61CC4745MR	Vdet-IC	4.7V±2%, -Reset PPO	SOT-23	16vdb	VD7	3h	Tor
E75	XC61FC4712M	Vdet-IC	4.7V±2%, +Reset PPO, 200ms	SOT-23	16vdb	VD7	3d	Tor
E75	XC61HC4712MR	Vdet-IC	4.7V±2%, -Reset PPO, 50, 200ms	SOT-23	16vdc	VD7	3d	Tor
E76	XC61FC4742M	Vdet-IC	4.7V±2%, +Reset PPO, 400ms	SOT-23	16vdb	VD7	3d	Tor
E76	XC61HC4742MR	Vdet-IC	4.7V±2%, -Reset PPO, 80, 400ms	SOT-23	16vdc	VD7	3d	Tor
E77	XC61FC4752M	Vdet-IC	4.7V±2%, +Reset PPO, 50ms	SOT-23	16vdb	VD7	3d	Tor
E77	XC61HC4752MR	Vdet-IC	4.7V±2%, -Reset PPO, 1.50ms	SOT-23	16vdc	VD7	3d	Tor
E8	AP1704BTW	Vdet-IC	4.38V±1.5%, +Reset PPO	TSOT23-3L	16vda	VD7	3b	Ana
E8	AP1704BW	Vdet-IC	4.38V±1.5%, +Reset PPO	SOT-23-3L	16vda	VD7	3b	Ana
E8	BZX84-C3V0	Z-diode	2.8..3.2V, Zzt=95Ω, Izt=20mA, 225mW	SOT-23	16dc	-	3a	Lge
E8	ELM9748NBB	Vdet-IC	4.8V±2.5%, +Reset ODO	SOT-23	16vdb	VD6	3d	Elm
E8	R3111N482A	Vdet-IC	4.8V±2%, -Reset PPO	SOT-23	16vdd	VD7	3d	Ric
E8	R3113D181C	Vdet-IC	1.8V±2%, -Reset, PPO	SON1408-3	18vda	VD7	3d	Ric
E8	TC54VC4802ECB	Vdet-IC	4.8V±2%, -Reset PPO	SOT-23	16vdb	VD7	3a	Tcs
E8	TS810RCXB	Vdet-IC	4.38V±1.5%, +Reset PPO	SOT-23	16vdb	VD7	3b	Tsc
E8	XC61CC4802M	Vdet-IC	4.8V±1%, +Reset PPO	SOT-23	16vdb	VD7	3d	Tor
E8	XC6GC4802HR	Vdet-IC	4.8V, +Reset PPO	USP-3	17vdc	VD3	9b	Tor
E83	XE61CC4845MR	Vdet-IC	4.8V±2%, -Reset PPO	SOT-23	16vdb	VD7	3h	Tor
E85	XC61FC4812M	Vdet-IC	4.8V±2%, +Reset PPO, 200ms	SOT-23	16vdb	VD7	3d	Tor
E85	XC61HC4812MR	Vdet-IC	4.8V±2%, -Reset PPO, 50, 200ms	SOT-23	16vdc	VD7	3d	Tor
E86	XC61FC4842M	Vdet-IC	4.8V±2%, +Reset PPO, 400ms	SOT-23	16vdb	VD7	3d	Tor
E86	XC61HC4842MR	Vdet-IC	4.8V±2%, -Reset PPO, 80, 400ms	SOT-23	16vdc	VD7	3d	Tor
E87	XC61FC4852M	Vdet-IC	4.8V±2%, +Reset PPO, 50ms	SOT-23	16vdb	VD7	3d	Tor
E87	XC61HC4852MR	Vdet-IC	4.8V±2%, -Reset PPO, 1.50ms	SOT-23	16vdc	VD7	3d	Tor
E9	AP1704CTW	Vdet-IC	4.0V±1.5%, +Reset PPO	TSOT23-3L	16vda	VD7	3b	Ana
E9	AP1704CW	Vdet-IC	4.0V±1.5%, +Reset PPO	SOT-23-3L	16vda	VD7	3b	Ana
E9	BZX84-C13	Z-diode	12.4..14.1V, Zzt=30Ω, Izt=20mA, 225mW	SOT-23	16dc	-	3a	Lge
E9	ELM9749NBB	Vdet-IC	4.9V±2.5%, +Reset ODO	SOT-23	16vdb	VD6	3d	Elm
E9	R3111N492A	Vdet-IC	4.9V±2%, -Reset PPO	SOT-23	16vdd	VD7	3d	Ric
E9	R3113D191C	Vdet-IC	1.9V±2%, -Reset, PPO	SON1408-3	18vda	VD7	3d	Ric
E9	TC54VC4902ECB	Vdet-IC	4.9V±2%, -Reset PPO	SOT-23	16vdb	VD7	3a	Tcs
E9	TS810RCXC	Vdet-IC	4.0V±1.5%, +Reset PPO	SOT-23	16vdb	VD7	3b	Tsc
E9	XC61CC4902M	Vdet-IC	4.9V±1%, +Reset PPO	SOT-23	16vdb	VD7	3d	Tor
E9	XC6GC4902HR	Vdet-IC	4.9V, +Reset PPO	USP-3	17vdc	VD3	9b	Tor
E93	XE61CC4945MR	Vdet-IC	4.9V±2%, -Reset PPO	SOT-23	16vdb	VD7	3h	Tor
E94	DTB114TK	Si-pnp-Digi	Sw, 50V, 500mA, 200mW, 200MHz, R1=10k	SOT-346	16ta	-	3a	Rhm
E95	XC61FC4912M	Vdet-IC	4.9V±2%, +Reset PPO, 200ms	SOT-23	16vdb	VD7	3d	Tor
E95	XC61HC4912MR	Vdet-IC	4.9V±2%, -Reset PPO, 50, 200ms	SOT-23	16vdc	VD7	3d	Tor
E96	XC61FC4942M	Vdet-IC	4.9V±2%, +Reset PPO, 400ms	SOT-23	16vdb	VD7	3d	Tor
E96	XC61HC4942MR	Vdet-IC	4.9V±2%, -Reset PPO, 80, 400ms	SOT-23	16vdc	VD7	3d	Tor
E97	XC61FC4952M	Vdet-IC	4.9V±2%, +Reset PPO, 50ms	SOT-23	16vdb	VD7	3d	Tor
E97	XC61HC4952MR	Vdet-IC	4.9V±2%, -Reset PPO, 1.50ms	SOT-23	16vdc	VD7	3d	Tor
EA	2SA1532-A	Si-pnp	AF, 30V, 30mA, 150mW, B=50...100, 300MHz	SOT-323	16ta	-	3a	Pan
EA	2SC4920	Si-npn-Digi	Mute, Drv, 25V, 100mA, 150mW, 240MHz, R1=R2=4.7kΩ	SMCP	16ta	-	3a	San
EA	AP1701ATW	Vdet-IC	4.63V±1.5%, -Reset PPO	TSOT23-3L	16vdc	VD7	3b	Ana
EA	AP1701AW	Vdet-IC	4.63V±1.5%, -Reset PPO	SOT-23-3L	16vdc	VD7	3b	Ana
EA	BCW65A	Si-npn	AF, 60V, 800mA, 330mW, B=100..250, >100MHz	SOT-23	16ta	-	3a	All
EA	TC1276-5ENB	Vdet-IC	3.065V±2%, -Reset ODO	SOT-23	16vda	VD6	3d	Mcc
EA	TS809CXA	Vdet-IC	4.63V±1.5%, -Reset PPO	SOT-23	16vdc	VD7	3b	Tsc
EAAA	MAX810BRUR	Vdet-IC	2.63V±1.5%, +Reset PPO	SOT-23	16vdc	VD7	3a	Max
EAO	2SA1981SF-O	Si-pnp	AF, 35V, 800mA, 200mW, B=100..200, 120MHz	SOT-23F	18ta	-	3a	Auk
EAO	2SA1981S-O	Si-pnp	AF, 35V, 800mA, 200mW, B=100..200, 120MHz	SOT-23	16ta	-	3a	Auk
EAs	BCW65A	Si-npn	AF, 60V, 800mA, 330mW, B=100..250, 170MHz	SOT-23	16ta	-	3c	Inf
EAY	2SA1981SF-Y	Si-pnp	AF, 35V, 800mA, 200mW, B=160..320, 120MHz	SOT-23F	18ta	-	3a	Auk
EAY	2SA1981S-Y	Si-pnp	AF, 35V, 800mA, 200mW, B=160..320, 120MHz	SOT-23	16ta	-	3a	Auk



SMD code	Type	Function	Short description	Case	Pinout	Sch. St.	Mnf.
EB	2SA1022-B	Si-pnp	HF, 30V, 30mA, 200mW, B=70..140, 300MHz	SC-59	16ta	-	3a Pan
EB	2SA1532-B	Si-pnp	AF, 30V, 30mA, 150mW, B=70..140, 300MHz	SOT-323	16ta	-	3a Pan
EB	2SA1790-B	Si-pnp	HF, 30V, 30mA, 125mW, 300MHz, B=70..140	SOT-416	16ta	-	3a Pan
EB	2SA1790-JB	Si-pnp	HF, 30V, 30mA, 125mW, 300MHz, B=70..140	SC-89	18ta	-	3a Pan
EB	2SA1888-B	Si-pnp	FM-IF, 30V, 30mA, 300MHz, B=60..120	SOT-23	16te	-	3a Pan
EB	2SK1842	n-FET	IR-Sensor, 40V, Idss>30µA, Up<3V	SOT-23	16fa	-	3a Pan
EB	AAT35601GY-2.20	Vdet-IC	2.2V±1.5%, +Reset PPO	SOT-23	16vdc	VD7	3b Ant
EB	AP1701BTW	Vdet-IC	4.38V±1.5%, -Reset PPO	TSOT23-3L	16vdc	VD7	3b Ana
EB	AP1701BW	Vdet-IC	4.38V±1.5%, -Reset PPO	SOT-23-3L	16vdc	VD7	3b Ana
EB	BCW65B	Si-npn	AF, 60V, 800mA, 330mW, B=160..400, >100MHz	SOT-23	16ta	-	3a All
EB	H5MP-4810	PIN-diode	Dual, RF Att, 100V, 1A(1µs), <0.35pF, <3Ω(100mA), 3GHz	SOT-23	16dh	-	3a Agi
EB	H5MP-481B	PIN-diode	Dual, RF Att, 100V, 1A(1µs), <0.35pF, <3Ω(100mA), 3GHz	SOT-323	16df	-	3a Agi
EB	SIP809CREUEDT	Vdet-IC	2.63V±1.5%, -Reset PPO 150ms	SOT-23	16vdc	VD7	3g Vs
EB	TC1276-10ENB	Vdet-IC	2.88V±2%, -Reset ODO	SOT-23	16vda	VD6	3d Mcc
EB	TS809CXB	Vdet-IC	4.38V±1.5%, -Reset PPO	SOT-23	16vdc	VD7	3b Tsc
EBP	2SK1842-P	n-FET	AF imp-conv, 40V, 10mA, 150mW, Idss=30..75µA	SC-59	16fa	-	3a Pan
EBQ	2SK1842-Q	n-FET	AF imp-conv, 40V, 10mA, 150mW, Idss=50..100µA	SC-59	16fa	-	3a Pan
EBQ	2SK2380-Q	n-FET	AF imp-conv, 40V, 2mA, 125mW, Idss=50..100µA	SC-89	18fa	-	3a Pan
EBR	2SK1842-R	n-FET	AF imp-conv, 40V, 10mA, 150mW, Idss=70..130µA	SC-59	16fa	-	3a Pan
EBR	2SK2380-R	n-FET	AF imp-conv, 40V, 2mA, 125mW, Idss=70..130µA	SC-89	18fa	-	3a Pan
EBS	2SK1842-S	n-FET	AF imp-conv, 40V, 10mA, 150mW, Idss=100..200µA	SC-59	16fa	-	3a Pan
EBS	2SK2380-S	n-FET	AF imp-conv, 40V, 2mA, 125mW, Idss=100..200µA	SC-89	18fa	-	3a Pan
EBs	BCW65B	Si-npn	AF, 60V, 800mA, 330mW, B=160..400, 170MHz	SOT-23	16ta	-	3c Inf
EC	2SA1022-C	Si-pnp	HF, 30V, 30mA, 200mW, B=110..220, 300MHz	SC-59	16ta	-	3a Pan
EC	2SA1532-C	Si-pnp	AF, 30V, 30mA, 150mW, B=110..220, 300MHz	SOT-323	16ta	-	3a Pan
EC	2SA1790-C	Si-pnp	HF, 30V, 30mA, 125mW, 300MHz, B=110..220	SOT-416	16ta	-	3a Pan
EC	2SA1790-JC	Si-pnp	HF, 30V, 30mA, 125mW, 300MHz, B=110..220	SC-89	18ta	-	3a Pan
EC	2SA1888-C	Si-pnp	FM-IF, 30V, 30mA, 300MHz, B=100..200	SOT-23	16te	-	3a Pan
EC	2SC2732	Si-npn	UHF, 30V, 20mA, 150mW, B=60, 1GHz	SOT-23	16ta	-	3a Ren
EC	2SC4462	Si-npn	HF, 30V, 20mA, 150mW, B>30, >700MHz	SOT-323	16ta	-	3a Ren
EC	AAT35601GY-2.50	Vdet-IC	2.5V±1.5%, +Reset PPO	SOT-23	16vdc	VD7	3b Ant
EC	AP1701CTW	Vdet-IC	4.0V±1.5%, -Reset PPO	TSOT23-3L	16vdc	VD7	3b Ana
EC	AP1701CW	Vdet-IC	4.0V±1.5%, -Reset PPO	SOT-23-3L	16vdc	VD7	3b Ana
EC	BCW65C	Si-npn	AF, 60V, 800mA, 330mW, B=250..630, >100MHz	SOT-23	16ta	-	3a Zx
EC	MSA1022-C	Si-pnp	RF, 30V, 30mA, 200mW, B=110..220, >150MHz	SC-59	16ta	-	3a Mot
EC	SIP809C27EUEDT	Vdet-IC	2.7V±1.5%, -Reset PPO 150ms	SOT-23	16vdc	VD7	3g Vs
EC	TC1276-20ENB	Vdet-IC	2.55V±2%, -Reset ODO	SOT-23	16vda	VD6	3d Mcc
EC	TS809CXC	Vdet-IC	4.0V±1.5%, -Reset PPO	SOT-23	16vdc	VD7	3b Tsc
EC	UNR31AH	Si-pnp-Digi	Sw, 50V, 80mA, 100mW, 80MHz, R1/R2=2k2/10k	SSSMini3	18ta	-	3a Pan
EC4	DT1C14EK	Si-npn-Digi	Sw, 50V, 100mA, 200mW, 250MHz, R1/R2=10/10k	SOT-23	16ta	-	3a ltt
ECs	BCW65C	Si-npn	AF, 60V, 800mA, 330mW, B=250..630, 170MHz	SOT-23	16ta	-	3c Inf
ED	AP1701DTW	Vdet-IC	3.08V±1.5%, -Reset PPO	TSOT23-3L	16vdc	VD7	3b Ana
ED	AP1701DW	Vdet-IC	3.08V±1.5%, -Reset PPO	SOT-23-3L	16vdc	VD7	3b Ana
ED	SIP809CSEUEDT	Vdet-IC	2.93V±1.5%, -Reset PPO 150ms	SOT-23	16vdc	VD7	3g Vs
ED	TS809CXD	Vdet-IC	3.08V±1.5%, -Reset PPO	SOT-23	16vdc	VD7	3b Tsc
ED	UNR31AL	Si-pnp-Digi	Sw, 50V, 80mA, 100mW, 80MHz, R1/R2=4k7/4k7	SSSMini3	18ta	-	3a Pan
EDP	TPC18	TVS	Vbr=16.2..19.8V, Vrw=14.5V, Ipp=56.6A, 1500W(1ms)	TO-277A	76bd	-	3o Vs
EE	2SC5814-E	Si-npn	AF-Amp, 60V, 125mA, 150mW, 200MHz, B=150..300	SC-59	16ta	-	3a Ish
EE	2SC5815-E	Si-npn	AF-Amp, 60V, 125mA, 150mW, 200MHz, B=150..300	SOT-323	16ta	-	3a Ish
EE	2SC5816-E	Si-npn	AF-Amp, 60V, 125mA, 125mW, 200MHz, B=150..300	SC-75A	16ta	-	3a Ish
EE	2SC5817-E	Si-npn	AF-Amp, 60V, 125mA, 100mW, 200MHz, B=150..300	T-USM	18ta	-	3a Ish
EE	AP1701ETW	Vdet-IC	2.93V±1.5%, -Reset PPO	TSOT23-3L	16vdc	VD7	3b Ana
EE	AP1701EW	Vdet-IC	2.93V±1.5%, -Reset PPO	SOT-23-3L	16vdc	VD7	3b Ana
EE	SIP809CTEUEDT	Vdet-IC	3.08V±1.5%, -Reset PPO 150ms	SOT-23	16vdc	VD7	3g Vs
EE	TS809CXE	Vdet-IC	2.93V±1.5%, -Reset PPO	SOT-23	16vdc	VD7	3b Tsc
EE1	CHDTA123EEPT	Si-pnp-Digi	Sw, 50V, 100mA, 250MHz, R1/R2=2.2/2.2k	SOT-416	16ta	-	3a Chm
EE2	CHDTA143EEPT	Si-pnp-Digi	Sw, 50V, 100mA, 250MHz, R1/R2=4.7/4.7k	SOT-416	16ta	-	3a Chm
EE3	CHDTA114EEPT	Si-pnp-Digi	Sw, 50V, 50mA, 250MHz, R1/R2=10/10k	SOT-416	16ta	-	3a Chm
EE4	CHDTA124EEPT	Si-pnp-Digi	Sw, 50V, 30mA, 250MHz, R1/R2=22/22k	SOT-416	16ta	-	3a Chm
EE5	CHDTA115EEPT	Si-pnp-Digi	Sw, 50V, 20mA, 250MHz, R1/R2=100/100k	SOT-416	16ta	-	3a Chm
EEA	CHDTC123EEPT	Si-npn-Digi	Sw, 50V, 100mA, 250MHz, R1/R2=2.2/2.2k	SOT-416	16ta	-	3a Chm
EEB	CHDTC114EEPT	Si-npn-Digi	Sw, 50V, 50mA, 250MHz, R1/R2=10/10k	SOT-416	16ta	-	3a Chm
EEC	CHDTC124EEPT	Si-npn-Digi	Sw, 50V, 30mA, 250MHz, R1/R2=22/22k	SOT-416	16ta	-	3a Chm
EED	CHDTC115EEPT	Si-npn-Digi	Sw, 50V, 20mA, 250MHz, R1/R2=100/100k	SOT-416	16ta	-	3a Chm
EEP	TPC18A	TVS	Vbr=17.1..18.9V, Vrw=15.3V, Ipp=59.5A, 1500W(1ms)	TO-277A	76bd	-	3o Vs
EF	2SC5814-F	Si-npn	AF-Amp, 60V, 125mA, 150mW, 200MHz, B=250..500	SC-59	16ta	-	3a Ish
EF	2SC5815-F	Si-npn	AF-Amp, 60V, 125mA, 150mW, 200MHz, B=250..500	SOT-323	16ta	-	3a Ish
EF	2SC5816-F	Si-npn	AF-Amp, 60V, 125mA, 125mW, 200MHz, B=250..500	SC-75A	16ta	-	3a Ish
EF	2SC5817-F	Si-npn	AF-Amp, 60V, 125mA, 100mW, 200MHz, B=250..500	T-USM	18ta	-	3a Ish
EF	AP1701FTW	Vdet-IC	2.63V±1.5%, -Reset PPO	TSOT23-3L	16vdc	VD7	3b Ana



SMD code	Type	Function	Short description	Case	Pinout	Sch.	St.	Mnf.
EF	AP1701FW	Vdet-IC	2.63V±1.5%, -Reset PPO	SOT-23-3L	16vdc	VD7	3b	Ana
EF	BCW66F	Si-npn	AF, 75V, 800mA, 330mW, B=100..250, >100MHz	SOT-23	16ta	-	3a	Ste
EF	TS809CXF	Vdet-IC	2.63V±1.5%, -Reset PPO	SOT-23	16vdc	VD7	3b	Tsc
EF	UNR31AM	Si-pnp-Digi	Sw, 50V, 80mA, 100mW, 80MHz, R1/R2=2k2/47k	SSSMini3	18ta	-	3a	Pan
EF1	AP2121N-1.5TRE1	LVR-IC	LDO, 1.5V±2%, 200mA	SOT-23	16cg	VR1	3b	Bcd
EF3	AP2121N-1.8TRE1	LVR-IC	LDO, 1.8V±2%, 200mA	SOT-23	16cg	VR1	3b	Bcd
EF4	AP2121N-2.5TRE1	LVR-IC	LDO, 2.5V±2%, 200mA	SOT-23	16cg	VR1	3b	Bcd
EF5	AP2121N-2.8TRE1	LVR-IC	LDO, 2.8V±2%, 200mA	SOT-23	16cg	VR1	3b	Bcd
EF6	AP2121N-3.0TRE1	LVR-IC	LDO, 3.0V±2%, 200mA	SOT-23	16cg	VR1	3b	Bcd
EF7	AP2121N-3.2TRE1	LVR-IC	LDO, 3.2V±2%, 200mA	SOT-23	16cg	VR1	3b	Bcd
EF8	AP2121N-3.3TRE1	LVR-IC	LDO, 3.3V±2%, 200mA	SOT-23	16cg	VR1	3b	Bcd
EF9	AP2121N-1.2TRE1	LVR-IC	LDO, 1.2V±2%, 200mA	SOT-23	16cg	VR1	3b	Bcd
FFP	TPC20	TVS	Vbr=18.0..22.0V, Vrwm=16.2V, Ipp=51.5A, 1500W(1ms)	TO-277A	76bd	-	3o	Vs
EFs	BCW66F	Si-npn	AF, 75V, 800mA, 330mW, B=100..250, >170MHz	SOT-23	16ta	-	3c	Inf
EG	AP1703ATW	Vdet-IC	4.63V±1.5%, -Reset PPO	TSOT23-3L	16vda	VD7	3b	Ana
EG	AP1703AW	Vdet-IC	4.63V±1.5%, -Reset PPO	SOT-23-3L	16vda	VD7	3b	Ana
EG	BCW66G	Si-npn	AF, 75V, 800mA, 330mW, B=160..400, 170MHz	SOT-23	16ta	-	3a	Ste
EG	SIP809CJEUEDT	Vdet-IC	4V±1.5%, -Reset PPO 150ms	SOT-23	16vdc	VD7	3g	Vs
EG	TS809RCXA	Vdet-IC	4.63V±1.5%, -Reset PPO	SOT-23	16vdb	VD7	3b	Tsc
EG9	AP2121N-1.3TRE1	LVR-IC	LDO, 1.3V±2%, 200mA	SOT-23	16cg	VR1	3b	Bcd
EGP	TPC20A	TVS	Vbr=19.0..21.0V, Vrwm=17.1V, Ipp=54.2A, 1500W(1ms)	TO-277A	76bd	-	3o	Vs
EGs	BCW66G	Si-npn	AF, 75V, 800mA, 330mW, B=160..400, 170MHz	SOT-23	16ta	-	3c	Inf
EH	1SS365	Si-diode	SBD, VHF/UHF-del/mix, 10V, 35mA, Vf<0.42V(1mA), <0.85pF	CP	16dc	-	3a	San
EH	AP1703BTW	Vdet-IC	4.38V±1.5%, -Reset PPO	TSOT23-3L	16vda	VD7	3b	Ana
EH	AP1703BW	Vdet-IC	4.38V±1.5%, -Reset PPO	SOT-23-3L	16vda	VD7	3b	Ana
EH	BCW66H	Si-npn	AF, 75V, 800mA, 330mW, B=250..630, >100MHz	SOT-23	16ta	-	3a	Ste
EH	SIP809CMJEUEDT	Vdet-IC	4.38V±1.5%, -Reset PPO 150ms	SOT-23	16vdc	VD7	3g	Vs
EH	TS809RCXB	Vdet-IC	4.38V±1.5%, -Reset PPO	SOT-23	16vdb	VD7	3b	Tsc
EH1	AZ809ANSTR-E1	Vdet-IC	2.93V±1.5%, -Reset PPO	SOT-23	16vdc	VD7	3a	Bcd
EH6	AZ809ANSTR-E1	Vdet-IC	2.63V±1.5%, -Reset PPO	SOT-23	16vdc	VD7	3a	Bcd
EH7	AZ809ANLTR-E1	Vdet-IC	4.63V±1.5%, -Reset PPO	SOT-23	16vdc	VD7	3a	Bcd
EHAA	MAX6326_R22-T	Vdet-IC	2.2V±1.5%, -Reset PPO	SOT-23	16vdc	VD7	3a	Max
EHAA	MAX6326UR22	Vdet-IC	2.2V±1.5%, -Reset PPO	SOT-23	16vdc	VD7	3a	Max
EHP	TPC22	TVS	Vbr=19.8..24.2V, Vrwm=17.8V, Ipp=47.0A, 1500W(1ms)	TO-277A	76bd	-	3o	Vs
EHS	BCW66H	Si-npn	AF, 75V, 800mA, 330mW, B=250..630, >170MHz	SOT-23	16ta	-	3c	Inf
EI	AP1703CTW	Vdet-IC	4.0V±1.5%, -Reset PPO	TSOT23-3L	16vda	VD7	3b	Ana
EI	AP1703CW	Vdet-IC	4.0V±1.5%, -Reset PPO	SOT-23-3L	16vda	VD7	3b	Ana
EI	SIP809CLEUEDT	Vdet-IC	4.63V±1.5%, -Reset PPO 150ms	SOT-23	16vdc	VD7	3g	Vs
EI	TS809RCXC	Vdet-IC	4.0V±1.5%, -Reset PPO	SOT-23	16vdb	VD7	3b	Tsc
EI	UN211M	Si-pnp-Digi	Sw, 50V, 100mA, 200mW, 80MHz, R1/R2=2k2/47k	SC-59	16ta	-	3a	Pan
EI	UN511M	Si-pnp-Digi	Sw, 50V, 100mA, 150mW, 80MHz, R1/R2=2k2/47k	SOT-23	16ta	-	3a	Pan
EI	UNR211M	Si-pnp-Digi	Sw, 50V, 100mA, 200mW, 80MHz, R1/R2=2k2/47k	SC-59	16ta	-	3a	Pan
EI	UNR511M	Si-pnp-Digi	Sw, 50V, 100mA, 150mW, 80MHz, R1/R2=2k2/47k	SOT-323	16ta	-	3a	Pan
EI	UNR911MJ	Si-pnp-Digi	Sw, 50V, 100mA, 125mW, 80MHz, R1/R2=2k2/47k	SC-89	18ta	-	3a	Pan
EIAA	MAX6327UR22-T	Vdet-IC	2.2V±1.5%, +Reset PPO	SOT-23	16vdc	VD7	3a	Max
EJ	AP1703DTW	Vdet-IC	3.08V±1.5%, -Reset PPO	TSOT23-3L	16vda	VD7	3b	Ana
EJ	AP1703DW	Vdet-IC	3.08V±1.5%, -Reset PPO	SOT-23-3L	16vda	VD7	3b	Ana
EJ	TS809RCXD	Vdet-IC	3.08V±1.5%, -Reset PPO	SOT-23	16vdb	VD7	3b	Tsc
EJAA	MAX6328UR22-T	Vdet-IC	2.2V±1.5%, -Reset ODO	SOT-23	16vdc	VD6	3a	Max
EK	AP1703ETW	Vdet-IC	2.93V±1.5%, -Reset PPO	TSOT23-3L	16vda	VD7	3b	Ana
EK	AP1703EW	Vdet-IC	2.93V±1.5%, -Reset PPO	SOT-23-3L	16vda	VD7	3b	Ana
EK	BCX41	Si-npn	AF, 125V, 800mA, 330mW, B>63, >100MHz	SOT-23	16ta	-	3a	Zx
EK	ELM7619LDB	Vdet-IC	1.9V±2%, -Reset PPO, 50ms	SOT-23	16vdc	VD7	3d	Elm
EK	TS809RCXE	Vdet-IC	2.93V±1.5%, -Reset PPO	SOT-23	16vdb	VD7	3b	Tsc
EK	UNR31AN	Si-pnp-Digi	Sw, 50V, 80mA, 100mW, 80MHz, R1/R2=4k7/47k	SSSMini3	18ta	-	3a	Pan
EK0	CHDTB114EKPT	Si-pnp-Digi	Sw, 50V, 500mA, 200MHz, R1/R2=10/10k	SOT-23	16ta	-	3a	Chm
EK1	CHDTA123EKPT	Si-pnp-Digi	Sw, 50V, 100mA, 250MHz, R1/R2=2.2/2.2k	SOT-23	16ta	-	3a	Chm
EK2	CHDTA143EKPT	Si-pnp-Digi	Sw, 50V, 100mA, 250MHz, R1/R2=4.7/4.7k	SOT-23	16ta	-	3a	Chm
EK3	CHDTA114EKPT	Si-pnp-Digi	Sw, 50V, 50mA, 250MHz, R1/R2=10/10k	SOT-23	16ta	-	3a	Chm
EK4	CHDTA124EKPT	Si-pnp-Digi	Sw, 50V, 30mA, 250MHz, R1/R2=22/22k	SOT-23	16ta	-	3a	Chm
EK5	CHDTA144EKPT	Si-pnp-Digi	Sw, 50V, 30mA, 250MHz, R1/R2=4.7/4.7k	SOT-23	16ta	-	3a	Chm
EK6	CHDTA115EKPT	Si-pnp-Digi	Sw, 50V, 20mA, 250MHz, R1/R2=100/100k	SOT-23	16ta	-	3a	Chm
EK7	CHDTB113EKPT	Si-pnp-Digi	Sw, 50V, 500mA, 200MHz, R1/R2=1/1k	SOT-23	16ta	-	3a	Chm
EK8	CHDTB123EKPT	Si-pnp-Digi	Sw, 50V, 500mA, 200MHz, R1/R2=2.2/2.2k	SOT-23	16ta	-	3a	Chm
EK9	CHDTB143EKPT	Si-pnp-Digi	Sw, 50V, 500mA, 200MHz, R1/R2=4.7/4.7k	SOT-23	16ta	-	3a	Chm
EKA	CHDTC123EKPT	Si-npn-Digi	Sw, 50V, 100mA, 250MHz, R1/R2=2.2/2.2k	SOT-23	16ta	-	3a	Chm
EKB	CHDTC143EKPT	Si-npn-Digi	Sw, 50V, 100mA, 250MHz, R1/R2=4.7/4.7k	SOT-23	16ta	-	3a	Chm
EKD	CHDTC124EKPT	Si-npn-Digi	Sw, 50V, 30mA, 250MHz, R1/R2=22/22k	SOT-23	16ta	-	3a	Chm
EKE	CHDTC144EKPT	Si-npn-Digi	Sw, 50V, 30mA, 250MHz, R1/R2=4.7/4.7k	SOT-23	16ta	-	3a	Chm
EKF	CHDTC115EKPT	Si-npn-Digi	Sw, 50V, 20mA, 250MHz, R1/R2=100/100k	SOT-23	16ta	-	3a	Chm



SMD code	Type	Function	Short description	Case	Pinout	Sch. St.	Mnf.
EKG	CHDTD113EKPT	Si-npn-Digi	Sw, 50V, 500mA, 200MHz, R1/R2=1/1k	SOT-23	16ta -	3a	Chm
EKH	CHDTD123EKPT	Si-npn-Digi	Sw, 50V, 500mA, 200MHz, R1/R2=2.2/2.2k	SOT-23	16ta -	3a	Chm
EKI	CHDTD143EKPT	Si-npn-Digi	Sw, 50V, 500mA, 200MHz, R1/R2=4.7/4.7k	SOT-23	16ta -	3a	Chm
EKJ	CHDTD114EKPT	Si-npn-Digi	Sw, 50V, 500mA, 200MHz, R1/R2=10/10k	SOT-23	16ta -	3a	Chm
EKK	CHDTC363EKPT	Si-npn-Digi	Sw, 20V, 600mA, 200MHz, R1/R2=6.8/6.8k	SOT-23	16ta -	3a	Chm
EKL	CHDTC113ZKPT	Si-npn-Digi	Sw, 50V, 100mA, 250MHz, R1/R2=1/10k	SOT-23	16ta -	3a	Chm
EKM	CHDTC663EKPT	Si-npn-Digi	Sw, 20V, 600mA, 150MHz, R1/R2=6.8/6.8k	SOT-23	16ta -	3a	Chm
EKP	TPC22A	TVS	Vbr=20.9..23.1V, Vrwm=18.8V, lpp=49.0A, 1500W(1ms)	TO-277A	76bd -	3o	Vs
EKs	BCX41	Si-npn	AF, 125V, 800mA, 330mW, B=63, 100MHz	SOT-23	16ta -	3a	Sie
EL	2SA1344	Si-pnp-Digi	Sw, 50V, 100mA, 200mW, 250MHz, R1/R2=10k/10k	CP	16ta -	3a	San
EL	2SA1678	Si-pnp-Digi	Sw, 50V, 100mA, 200MHz, R1/R2=10k/10k	SOT-323	16ta -	3a	San
EL	AP1703FTW	Vdet-IC	2.63V±1.5%, -Reset PPO	TSOT23-3L	16vda VD7	3b	Ana
EL	AP1703FW	Vdet-IC	2.63V±1.5%, -Reset PPO	SOT-23-3L	16vda VD7	3b	Ana
EL	SiP809CREUDT	Vdet-IC	2.63V±1.5%, -Reset PPO 210ms	SOT-23	16vdc VD7	3g	Vs
EL	TS809RCXF	Vdet-IC	2.63V±1.5%, -Reset PPO	SOT-23	16vdc VD7	3b	Tsc
EL	UN221M	Si-npn-Digi	Sw, 50V, 100mA, 200mW, 150MHz, R1/R2=2k2/47k	SC-59	16ta -	3a	Pan
EL	UN521M	Si-npn-Digi	Sw, 50V, 100mA, 150mW, 150MHz, R1/R2=2k2/47k	SOT-23	16ta -	3a	Pan
EL	UNR221M	Si-npn-Digi	Sw, 50V, 100mA, 200mW, 150MHz, R1/R2=2k2/47k	SC-59	16ta -	3a	Pan
EL	UNR521M	Si-npn-Digi	Sw, 50V, 100mA, 150mW, 150MHz, R1/R2=2k2/47k	SOT-323	16ta -	3a	Pan
EL	UNR921MJ	Si-npn-Digi	Sw, 50V, 100mA, 125mW, 150MHz, R1/R2=2k2/47k	SC-89	18ta -	3a	Pan
ELN	ELM7526CEB	Vdet-IC	2.6V±2%, +Reset PPO	SC-70	16vdb VD7	3d	Elm
ELN	ELM7526NEB	Vdet-IC	2.6V±2%, +Reset ODO	SC-70	16vdb VD6	3d	Elm
ELP	TPC24	TVS	Vbr=21.6..26.4V, Vrwm=19.4V, lpp=43.2A, 1500W(1ms)	TO-277A	76bd -	3o	Vs
EM	2SJS501	p-MOSFET-e*	Sw, U-Sp, 20V, 500mA, 250mW, 10/30ns, <1Q(50mA)	SOT-23	16ftn -	3a	San
EM	AP1704DTW	Vdet-IC	3.08V±1.5%, +Reset PPO	TSOT23-3L	16vda VD7	3b	Ana
EM	AP1704DW	Vdet-IC	3.08V±1.5%, +Reset PPO	SOT-23-3L	16vda VD7	3b	Ana
EM	SiP809C27EUDT	Vdet-IC	2.7V±1.5%, -Reset PPO 210ms	SOT-23	16vdc VD7	3g	Vs
EM	TS810RCXD	Vdet-IC	3.08V±1.5%, +Reset PPO	SOT-23	16vdc VD7	3b	Tsc
EMP	TPC24A	TVS	Vbr=22.8..25.2V, Vrwm=20.5V, lpp=45.2A, 1500W(1ms)	TO-277A	76bd -	3o	Vs
EN	AP1704ETW	Vdet-IC	2.93V±1.5%, +Reset PPO	TSOT23-3L	16vda VD7	3b	Ana
EN	AP1704EW	Vdet-IC	2.93V±1.5%, +Reset PPO	SOT-23-3L	16vda VD7	3b	Ana
EN	SiP809CSEUDT	Vdet-IC	2.93V±1.5%, -Reset PPO 210ms	SOT-23	16vdc VD7	3g	Vs
EN	TS810RCXE	Vdet-IC	2.93V±1.5%, +Reset PPO	SOT-23	16vdc VD7	3b	Tsc
EN	UNR31AT	Si-pnp-Digi	Sw, 50V, 80mA, 100mW, 80MHz, R1/R2=22k/47k	SSSMini3	18ta -	3a	Pan
EN3	2SC4860-3	Si-npn	UHF, Osc, 20V, 30mA, 20mW, B=60..120, 6.5GHz	MCP	16ta -	3a	San
EN3	2SC4861-3	Si-npn	UHF, Osc, 20V, 30mA, 20mW, B=60..120, 6.5GHz	CP	16ta -	3a	San
EN4	2SC4860-4	Si-npn	UHF, Osc, 20V, 30mA, 20mW, B=90..180, 6.5GHz	MCP	16ta -	3a	San
EN4	2SC4861-4	Si-npn	UHF, Osc, 20V, 30mA, 20mW, B=90..180, 6.5GHz	CP	16ta -	3a	San
EN5	2SC4860-5	Si-npn	UHF, Osc, 20V, 30mA, 20mW, B=130..270, 6.5GHz	MCP	16ta -	3a	San
EN5	2SC4861-5	Si-npn	UHF, Osc, 20V, 30mA, 20mW, B=130..270, 6.5GHz	CP	16ta -	3a	San
ENP	TPC27	TVS	Vbr=24.3..29.7V, Vrwm=21.8V, lpp=38.4A, 1500W(1ms)	TO-277A	76bd -	3o	Vs
EO	2SC3265-0	Si-npn	AF, Sw, 30V, 800mA, 200mW, B=100..200, 120MHz	SC-59	16ta -	3a	Tos
EO	KTC3265-0	Si-npn	AF, 35V, 800mA, 200mW, B=100..200, 120MHz	SOT-23	16ta -	3f	Kec
EO	SiP809CTEUDT	Vdet-IC	3.08V±1.5%, -Reset PPO 210ms	SOT-23	16vdc VD7	3g	Vs
EP	AP1704FTW	Vdet-IC	2.63V±1.5%, +Reset PPO	TSOT23-3L	16vda VD7	3b	Ana
EP	AP1704FW	Vdet-IC	2.63V±1.5%, +Reset PPO	SOT-23-3L	16vda VD7	3b	Ana
EP	SiP809CJEUDT	Vdet-IC	4V±1.5%, -Reset PPO 210ms	SOT-23	16vdc VD7	3g	Vs
EP	TS810RCXF	Vdet-IC	2.63V±1.5%, +Reset PPO	SOT-23	16vdc VD7	3b	Tsc
EP	UNR31AV	Si-pnp-Digi	Sw, 50V, 80mA, 100mW, 80MHz, R1/R2=2k2/2k2	SSSMini3	18ta -	3a	Pan
EPP	TPC27A	TVS	Vbr=25.7..28.4V, Vrwm=23.1V, lpp=40.0A, 1500W(1ms)	TO-277A	76bd -	3o	Vs
EQ	2SC5814-Q	Si-npn	AF-Amp, 60V, 125mA, 150mW, 200MHz, B=120..270	SC-59	16ta -	3a	Ish
EQ	2SC5815-Q	Si-npn	AF-Amp, 60V, 125mA, 150mW, 200MHz, B=120..270	SOT-323	16ta -	3a	Ish
EQ	2SC5816-Q	Si-npn	AF-Amp, 60V, 125mA, 125mW, 200MHz, B=120..270	SC-75A	16ta -	3a	Ish
EQ	2SC5817-Q	Si-npn	AF-Amp, 60V, 125mA, 100mW, 200MHz, B=120..270	T-USM	18ta -	3a	Ish
EQP	TPC30	TVS	Vbr=27.0..33.0V, Vrwm=24.3V, lpp=34.5A, 1500W(1ms)	TO-277A	76bd -	3o	Vs
ER	2SC5814-R	Si-npn	AF-Amp, 60V, 125mA, 150mW, 200MHz, B=180..390	SC-59	16ta -	3a	Ish
ER	2SC5815-R	Si-npn	AF-Amp, 60V, 125mA, 150mW, 200MHz, B=180..390	SOT-323	16ta -	3a	Ish
ER	2SC5816-R	Si-npn	AF-Amp, 60V, 125mA, 125mW, 200MHz, B=180..390	SC-75A	16ta -	3a	Ish
ER	2SC5817-R	Si-npn	AF-Amp, 60V, 125mA, 100mW, 200MHz, B=180..390	T-USM	18ta -	3a	Ish
ER	SiP809CMEUDT	Vdet-IC	4.38V±1.5%, -Reset PPO 210ms	SOT-23	16vdc VD7	3g	Vs
ERP	TPC30A	TVS	Vbr=28.5..31.5V, Vrwm=25.6V, lpp=36.2A, 1500W(1ms)	TO-277A	76bd -	3o	Vs
ES	2SC5814-S	Si-npn	AF-Amp, 60V, 125mA, 150mW, 200MHz, B=270..560	SC-59	16ta -	3a	Ish
ES	2SC5815-S	Si-npn	AF-Amp, 60V, 125mA, 150mW, 200MHz, B=270..560	SOT-323	16ta -	3a	Ish
ES	2SC5816-S	Si-npn	AF-Amp, 60V, 125mA, 125mW, 200MHz, B=270..560	SC-75A	16ta -	3a	Ish
ES	2SC5817-S	Si-npn	AF-Amp, 60V, 125mA, 100mW, 200MHz, B=270..560	T-USM	18ta -	3a	Ish
ES	SiP809CLEUDT	Vdet-IC	4.63V±1.5%, -Reset PPO 210ms	SOT-23	16vdc VD7	3g	Vs
ES5	2SA1745-5	Si-pnp	AF, Lo-sat, 20V, 500mA, 150mW, B=135..270, 400MHz	SOT-323	16ta -	3a	San
ES5	2SA1753-5	Si-pnp	AF-Amp, 20V, 500mA, 200mW, 300MHz, B=135..270	SOT-23	16ta -	3a	San
ES6	2SA1745-6	Si-pnp	AF, Lo-sat, 20V, 500mA, 150mW, B=200..400, 400MHz	SOT-323	16ta -	3a	San
ES6	2SA1753-6	Si-pnp	AF-Amp, 20V, 500mA, 200mW, 300MHz, B=200..400	SOT-23	16ta -	3a	San

Note: ELM75xxCBB series LN- lot number L=0...9 N=A to Z(I, O, X excepted); ELM75xxNBB series LN- lot number L=A to Z(I, O, X excepted) N=0...9



SMD code	Type	Function	Short description	Case	Pinout	Sch.	St.	Mnf.
ES7	2SA1745-7	Si-pnp	AF, Lo-sat, 20V, 500mA, 150mW, B=300..600, 400MHz	SOT-323	16ta	-	3a	San
ES7	2SA1753-7	Si-pnp	AF-Amp, 20V, 500mA, 200mW, 300MHz, B=300..600	SOT-23	16ta	-	3a	San
ESP	TPC33	TVS	Vbr=29.7..36.3V, Vrwm=26.8V, Ipp=31.4A, 1500W(1ms)	TO-277A	76bd	-	3o	Vs
ET	BCW65RA	Si-npn	AF, 60V, 800mA, 330mW, B=100..250, >100MHz	SOT-23	16te	-	3a	Fer
ET8	XC6215P092HR	LVR-IC	LDO, 0.9V±2%, 200mA	USP-3	17vj	VR1	9b	Tor
ET9	XC6215P102HR	LVR-IC	LDO, 1V±2%, 200mA	USP-3	17vj	VR1	9b	Tor
ETA	XC6215P112HR	LVR-IC	LDO, 1.1V±2%, 200mA	USP-3	17vj	VR1	9b	Tor
ETB	XC6215P122HR	LVR-IC	LDO, 1.2V±2%, 200mA	USP-3	17vj	VR1	9b	Tor
ETC	XC6215P132HR	LVR-IC	LDO, 1.3V±2%, 200mA	USP-3	17vj	VR1	9b	Tor
ETD	XC6215P142HR	LVR-IC	LDO, 1.4V±2%, 200mA	USP-3	17vj	VR1	9b	Tor
ETE	XC6215P152HR	LVR-IC	LDO, 1.5V±2%, 200mA	USP-3	17vj	VR1	9b	Tor
ETF	XC6215P162HR	LVR-IC	LDO, 1.6V±2%, 200mA	USP-3	17vj	VR1	9b	Tor
ETH	XC6215P172HR	LVR-IC	LDO, 1.7V±2%, 200mA	USP-3	17vj	VR1	9b	Tor
ETK	XC6215P182HR	LVR-IC	LDO, 1.8V±2%, 200mA	USP-3	17vj	VR1	9b	Tor
ETL	XC6215P192HR	LVR-IC	LDO, 1.9V±2%, 200mA	USP-3	17vj	VR1	9b	Tor
ETM	XC6215P202HR	LVR-IC	LDO, 2V±2%, 200mA	USP-3	17vj	VR1	9b	Tor
ETN	XC6215P212HR	LVR-IC	LDO, 2.1V±2%, 200mA	USP-3	17vj	VR1	9b	Tor
ETP	TPC33A	TVS	Vbr=31.4..34.7V, Vrwm=28.2V, Ipp=32.8A, 1500W(1ms)	TO-277A	76bd	-	3o	Vs
ETP	XC6215P222HR	LVR-IC	LDO, 2.2V±2%, 200mA	USP-3	17vj	VR1	9b	Tor
ETR	XC6215P232HR	LVR-IC	LDO, 2.3V±2%, 200mA	USP-3	17vj	VR1	9b	Tor
ETS	XC6215P242HR	LVR-IC	LDO, 2.4V±2%, 200mA	USP-3	17vj	VR1	9b	Tor
ETT	XC6215P252HR	LVR-IC	LDO, 2.5V±2%, 200mA	USP-3	17vj	VR1	9b	Tor
ETU	XC6215P262HR	LVR-IC	LDO, 2.6V±2%, 200mA	USP-3	17vj	VR1	9b	Tor
ETV	XC6215P272HR	LVR-IC	LDO, 2.7V±2%, 200mA	USP-3	17vj	VR1	9b	Tor
ETX	XC6215P282HR	LVR-IC	LDO, 2.8V±2%, 200mA	USP-3	17vj	VR1	9b	Tor
ETY	XC6215P292HR	LVR-IC	LDO, 2.9V±2%, 200mA	USP-3	17vj	VR1	9b	Tor
ETZ	XC6215P302HR	LVR-IC	LDO, 3V±2%, 200mA	USP-3	17vj	VR1	9b	Tor
EU	BCW65RB	Si-npn	AF, 60V, 800mA, 330mW, B=160..400, >100MHz	SOT-23	16te	-	3a	Fer
EU0	XC6215P312HR	LVR-IC	LDO, 3.1V±2%, 200mA	USP-3	17vj	VR1	9b	Tor
EU1	CHDTA123EUPT	Si-pnp-Digi	Sw, 50V, 100mA, 250MHz, R1/R2=2.2/2.2k	SOT-323	16ta	-	3a	Chm
EU1	XC6215P322HR	LVR-IC	LDO, 3.2V±2%, 200mA	USP-3	17vj	VR1	9b	Tor
EU2	CHDTA143EUPT	Si-pnp-Digi	Sw, 50V, 100mA, 250MHz, R1/R2=4.7/4.7k	SOT-323	16ta	-	3a	Chm
EU2	XC6215P332HR	LVR-IC	LDO, 3.3V±2%, 200mA	USP-3	17vj	VR1	9b	Tor
EU3	CHDTA114EUPT	Si-pnp-Digi	Sw, 50V, 50mA, 250MHz, R1/R2=10/10k	SOT-323	16ta	-	3a	Chm
EU3	XC6215P342HR	LVR-IC	LDO, 3.4V±2%, 200mA	USP-3	17vj	VR1	9b	Tor
EU4	CHDTA124EUPT	Si-pnp-Digi	Sw, 50V, 30mA, 250MHz, R1/R2=22/22k	SOT-323	16ta	-	3a	Chm
EU4	XC6215P352HR	LVR-IC	LDO, 3.5V±2%, 200mA	USP-3	17vj	VR1	9b	Tor
EU5	CHDTA144EUPT	Si-pnp-Digi	Sw, 50V, 30mA, 250MHz, R1/R2=47/47k	SOT-323	16ta	-	3a	Chm
EU5	XC6215P362HR	LVR-IC	LDO, 3.6V±2%, 200mA	USP-3	17vj	VR1	9b	Tor
EU6	XC6215P372HR	LVR-IC	LDO, 3.7V±2%, 200mA	USP-3	17vj	VR1	9b	Tor
EU7	XC6215P382HR	LVR-IC	LDO, 3.8V±2%, 200mA	USP-3	17vj	VR1	9b	Tor
EU8	XC6215P392HR	LVR-IC	LDO, 3.9V±2%, 200mA	USP-3	17vj	VR1	9b	Tor
EU9	XC6215P402HR	LVR-IC	LDO, 4V±2%, 200mA	USP-3	17vj	VR1	9b	Tor
EU9A	CHDTC123EUPT	Si-npn-Digi	Sw, 50V, 100mA, 250MHz, R1/R2=2.2/2.2k	SOT-323	16ta	-	3a	Chm
EU9A	XC6215P412HR	LVR-IC	LDO, 4.1V±2%, 200mA	USP-3	17vj	VR1	9b	Tor
EUB	XC6215P422HR	LVR-IC	LDO, 4.2V±2%, 200mA	USP-3	17vj	VR1	9b	Tor
EUC	XC6215P432HR	LVR-IC	LDO, 4.3V±2%, 200mA	USP-3	17vj	VR1	9b	Tor
EUD	CHDTC124EUPT	Si-npn-Digi	Sw, 50V, 30mA, 250MHz, R1/R2=22/22k	SOT-323	16ta	-	3a	Chm
EUD	XC6215P442HR	LVR-IC	LDO, 4.4V±2%, 200mA	USP-3	17vj	VR1	9b	Tor
EUE	XC6215P452HR	LVR-IC	LDO, 4.5V±2%, 200mA	USP-3	17vj	VR1	9b	Tor
EUF	CHDTC115EUPT	Si-npn-Digi	Sw, 50V, 20mA, 250MHz, R1/R2=100/100k	SOT-323	16ta	-	3a	Chm
EUF	XC6215P462HR	LVR-IC	LDO, 4.6V±2%, 200mA	USP-3	17vj	VR1	9b	Tor
EUG	CHDTC363EUPT	Si-npn-Digi	Sw, 20V, 600mA, 200MHz, R1/R2=6.8/6.8k	SOT-323	16ta	-	3a	Chm
EUG	XC6215P472HR	LVR-IC	LDO, 4.7V±2%, 200mA	USP-3	17vj	VR1	9b	Tor
EUK	XC6215P482HR	LVR-IC	LDO, 4.8V±2%, 200mA	USP-3	17vj	VR1	9b	Tor
EUL	XC6215P492HR	LVR-IC	LDO, 4.9V±2%, 200mA	USP-3	17vj	VR1	9b	Tor
EUM	CHDTC663EUPT	Si-npn-Digi	Sw, 20V, 600mA, 150MHz, R1/R2=6.8/6.8k	SOT-323	16ta	-	3a	Chm
EUM	XC6215P502HR	LVR-IC	LDO, 5V±2%, 200mA	USP-3	17vj	VR1	9b	Tor
EUP	TPC36	TVS	Vbr=32.4..39.6V, Vrwm=29.1V, Ipp=28.8A, 1500W(1ms)	TO-277A	76bd	-	3o	Vs
EV	SIP810CREUADT	Vdet-IC	2.63V±1.5%, +Reset PPO 1.5ms	SOT-23	16vdc	VD7	3g	Vs
EV	UN2154	Si-pnp-Digi	Sw, 30V, 100mA, 200mW, 80MHz, R1/R2=10k/47k	SC-59	16ta	-	3a	Pan
EV	UN5154	Si-pnp-Digi	Sw, 30V, 100mA, 150mW, 80MHz, R1/R2=10k/47k	SOT-523	18ta	-	3a	Pan
EV	UNR2154	Si-pnp-Digi	Sw, 30V, 100mA, 200mW, 80MHz, R1/R2=10k/47k	SC-59	16ta	-	3a	Pan
EV	UNR5154	Si-pnp-Digi	Sw, 30V, 100mA, 150mW, 80MHz, R1/R2=10k/47k	SOT-323	16ta	-	3a	Pan
EVP	TPC36A	TVS	Vbr=34.2..37.8V, Vrwm=30.8V, Ipp=30.1A, 1500W(1ms)	TO-277A	76bd	-	3o	Vs
EW	BCW65RC	Si-npn	AF, 60V, 800mA, 330mW, B=250..630, 170MHz	SOT-23	16te	-	3a	Fer
EW	SIP810C27EUADT	Vdet-IC	2.7V±1.5%, +Reset PPO 1.5ms	SOT-23	16vdc	VD7	3g	Vs
EW	UN211N	Si-pnp-Digi	Sw, 50V, 100mA, 200mW, 80MHz, R1/R2=4k7/47k	SC-59	16ta	-	3a	Pan
EW	UN511N	Si-pnp-Digi	Sw, 50V, 100mA, 150mW, 80MHz, R1/R2=4k7/47k	SOT-23	16ta	-	3a	Pan
EW	UNR211N	Si-pnp-Digi	Sw, 50V, 100mA, 200mW, 80MHz, R1/R2=4k7/47k	SC-59	16ta	-	3a	Pan



SMD code	Type	Function	Short description	Case	Pinout	Sch.	St.	Mnf.
EW	UNR511N	Si-npn-Digi	Sw, 50V, 100mA, 150mW, 80MHz, R1/R2=4k7/47k	SOT-323	16ta	-	3a	Pan
EW	UNR911NJ	Si-npn-Digi	Sw, 50V, 100mA, 125mW, 80MHz, R1/R2=4k7/47k	SC-89	18ta	-	3a	Pan
EWAA	MAX6326_R23-T	Vdet-IC	2.3V±1.5%, -Reset PPO	SOT-23	16vdc	VD7	3a	Max
EWAA	MAX6326UR23	Vdet-IC	2.3V±1.5%, -Reset PPO	SOT-23	16vdc	VD7	3a	Max
EWP	TPC39	TVS	Vbr=35.1.42.9V, Vrw=31.6V, Ipp=26.6A, 1500W(1ms)	TO-277A	76bd	-	3a	Vs
EX	BCW65FR	Si-npn	AF, 60V, 800mA, 330mW, B=100.250, >100MHz	SOT-23	16te	-	3a	Fer
EX	BCW66RF	Si-npn	AF, 75V, 800mA, 330mW, B=100.250, >100MHz	SOT-23	16te	-	3a	Fer
EX	SIP810CSEUADT	Vdet-IC	2.93V±1.5%, +Reset PPO 1.5ms	SOT-23	16vdc	VD7	3g	Vs
EX	UN221N	Si-npn-Digi	Sw, 50V, 100mA, 200mW, 150MHz, R1/R2=4k7/47k	SC-59	16ta	-	3a	Pan
EX	UN521N	Si-npn-Digi	Sw, 50V, 100mA, 150mW, 150MHz, R1/R2=4k7/47k	SOT-23	16ta	-	3a	Pan
EX	UNR221N	Si-npn-Digi	Sw, 50V, 100mA, 200mW, 150MHz, R1/R2=4k7/47k	SOT-23	16ta	-	3a	Pan
EX	UNR321N	Si-npn-Digi	Sw, 50V, 100mA, 100mW, 150MHz, R1/R2=4.7k/47k	SSSMini3	18ta	-	3a	Pan
EX	UNR521N	Si-npn-Digi	Sw, 50V, 100mA, 150mW, 150MHz, R1/R2=4k7/47k	SOT-323	16ta	-	3a	Pan
EX	UNR921NJ	Si-npn-Digi	Sw, 50V, 100mA, 125mW, 150MHz, R1/R2=4k7/47k	SC-89	18ta	-	3a	Pan
EXAA	MAX6326_R24-T	Vdet-IC	2.4V±1.5%, -Reset PPO	SOT-23	16vdc	VD7	3a	Max
EXAA	MAX6326UR24	Vdet-IC	2.4V±1.5%, -Reset PPO	SOT-23	16vdc	VD7	3a	Max
EXP	TPC39A	TVS	Vbr=37.1.41.0V, Vrw=33.3V, Ipp=27.8A, 1500W(1ms)	TO-277A	76bd	-	3o	Vs
EY	2SC3265-Y	Si-npn	AF, Sw, 30V, 800mA, 200mW, B=160.320, 120MHz	SC-59	16ta	-	3a	Tos
EY	2SC3398	Si-npn-Digi	Sw, 50V, 100mA, 200mW, 250MHz, R1/R2=10k/10k	CP	16ta	-	3a	San
EY	2SC4398	Si-npn-Digi	Sw, 50V, 100mA, 250MHz, R1/R2=10k/10k	SOT-323	16ta	-	3a	San
EY	BCW65GR	Si-npn	AF, 60V, 800mA, 330mW, B=160.400, >100MHz	SOT-23	16te	-	3a	Fer
EY	BCW66RG	Si-npn	AF, 75V, 800mA, 330mW, B=160.400, 170MHz	SOT-23	16te	-	3a	Fer
EY	KTC3265-Y	Si-npn	AF, 35V, 800mA, 200mW, B=160.320, 120MHz	SOT-23	16ta	-	3f	Kec
EY	SIP810CTEUADT	Vdet-IC	3.08V±1.5%, +Reset PPO 1.5ms	SOT-23	16vdc	VD7	3g	Vs
EY	UN211T	Si-npn-Digi	Sw, 50V, 100mA, 200mW, 80MHz, R1/R2=22k/47k	SC-59	16ta	-	3a	Pan
EY	UN511T	Si-npn-Digi	Sw, 50V, 100mA, 150mW, 80MHz, R1/R2=22k/47k	SOT-23	16ta	-	3a	Pan
EY	UN911TJ	Si-npn-Digi	Sw, 50V, 100mA, 125mW, 80MHz, R1/R2=22k/47k	SC-89	18ta	-	3a	Pan
EY	UNR211T	Si-npn-Digi	Sw, 50V, 100mA, 200mW, 80MHz, R1/R2=22k/47k	SC-59	16ta	-	3a	Pan
EY	UNR311T	Si-npn-Digi	Sw, 50V, 100mA, 100mW, 80MHz, R1/R2=22k/47k	SSSMini3	18ta	-	3a	Pan
EY	UNR511T	Si-npn-Digi	Sw, 50V, 100mA, 150mW, 80MHz, R1/R2=22k/47k	SOT-323	16ta	-	3a	Pan
EY	UNR911TJ	Si-npn-Digi	Sw, 50V, 100mA, 125mW, 80MHz, R1/R2=22k/47k	SC-89	18ta	-	3a	Pan
EYAA	MAX6326_R25-T	Vdet-IC	2.5V±1.5%, -Reset PPO	SOT-23	16vdc	VD7	3a	Max
EYAA	MAX6326UR25	Vdet-IC	2.5V±1.5%, -Reset PPO	SOT-23	16vdc	VD7	3a	Max
EYP	TPC43	TVS	Vbr=38.7.47.3V, Vrw=34.8V, Ipp=24.2A, 1500W(1ms)	TO-277A	76bd	-	3a	Vs
EZ	BCW65HR	Si-npn	AF, 60V, 800mA, 330mW, B=250.630, 170MHz	SOT-23	16te	-	3a	Fer
EZ	BCW66RH	Si-npn	AF, 75V, 800mA, 330mW, B=160.400, 170MHz	SOT-23	16te	-	3a	Fer
EZ	SIP810CJEUADT	Vdet-IC	4V±1.5%, +Reset PPO 1.5ms	SOT-23	16vdc	VD7	3g	Vs
EZ	UN221T	Si-npn-Digi	Sw, 50V, 100mA, 200mW, 150MHz, R1/R2=22k/47k	SC-59	16ta	-	3a	Pan
EZ	UN521T	Si-npn-Digi	Sw, 50V, 100mA, 150mW, 150MHz, R1/R2=22k/47k	SOT-23	16ta	-	3a	Pan
EZ	UN921TJ	Si-npn-Digi	Sw, 50V, 100mA, 125mW, 150MHz, R1/R2=22k/47k	SC-89	18ta	-	3a	Pan
EZ	UNR221T	Si-npn-Digi	Sw, 50V, 100mA, 200mW, 150MHz, R1/R2=22k/47k	SC-59	16ta	-	3a	Pan
EZ	UNR521T	Si-npn-Digi	Sw, 50V, 100mA, 150mW, 150MHz, R1/R2=22k/47k	SOT-323	16ta	-	3a	Pan
EZ	UNR921TJ	Si-npn-Digi	Sw, 50V, 100mA, 125mW, 150MHz, R1/R2=22k/47k	SC-89	18ta	-	3a	Pan
EZAA	MAX6326_R26-T	Vdet-IC	2.6V±1.5%, -Reset PPO	SOT-23	16vdc	VD7	3a	Max
EZAA	MAX6326UR26	Vdet-IC	2.6V±1.5%, -Reset PPO	SOT-23	16vdc	VD7	3a	Max
EZP	TPC43A	TVS	Vbr=40.9.45.2V, Vrw=36.8V, Ipp=25.3A, 1500W(1ms)	TO-277A	76bd	-	3o	Vs
f	AX6901FA	Vdet-IC	2.63V±1.5%, -Reset PPO	SC-70	16vdc	VD7	3b	Axl
F	SB01-15CP	Si-diode	SBR, HF, 150V, 100mA, Vf<0.75V(100mA), 7pF, 10ns	CP	16dc	-	3a	San
F	UNR211W	Si-npn-Digi	Sw, 50V, 100mA, 200mW, 80MHz, R2=100k	SC-59	16ta	-	3a	Pan
F0	BZX84-C68	Z-diode	64.72V, Zzt=240Q, Izt=20mA, 225mW	SOT-23	16dc	-	3a	Lge
F0	ELM7620HBB	Vdet-IC	2.0V±2%, +Reset PPO, 500ms	SOT-23	16vdc	VD7	3d	Elm
F0	ELM9750NBB	Vdet-IC	5.0V±2.5%, +Reset ODO	SOT-23	16vdc	VD6	3d	Elm
F0	HSPM-3820	PIN-diode	RF, Sw, 50V, 1A(1µs), <0.75pF, <0.6Q(10mA), 3GHz	SOT-23	16dc	-	3a	Agi
F0	R3111N502A	Vdet-IC	5V±2%, -Reset PPO	SOT-23	16vdc	VD7	3d	Ric
F0	R3113D201C	Vdet-IC	2V±2%, -Reset, PPO	SON1408-3	18vda	VD7	3d	Ric
F0	RT9808-16CV	Vdet-IC	1.6V±2%, -Reset ODO	SOT-23	16vdc	VD6	3a	Rct
F0	TC54VC5002ECB	Vdet-IC	5.0V±2%, -Reset PPO	SOT-23	16vdc	VD7	3a	Tcs
F0	XC61CC5002M	Vdet-IC	5V±1%, +Reset PPO	SOT-23	16vdc	VD7	3d	Tor
F0	XC6GC5002ZHR	Vdet-IC	5.0V, +Reset PPO	USP-3	17vdc	VD3	9b	Tor
F0-	RT9808-16PV	Vdet-IC	1.6V±2%, -Reset ODO	SOT-23	16vdc	VD6	3a	Rct
F02	DTD123TK	Si-npn-Digi	Sw, 50V, 500mA, 200mW, 200MHz, R1=2k2	SOT-346	16ta	-	3a	Rhm
F03	DTD143TK	Si-npn-Digi	Sw, 50V, 500mA, 200mW, 200MHz, R1=4k7	SOT-346	16ta	-	3a	Rhm
F03	XE61CC5045MR	Vdet-IC	5.0V±2%, -Reset PPO	SOT-23	16vdc	VD7	3h	Tor
F05	XC61FC5012M	Vdet-IC	5V±2%, +Reset PPO, 200ms	SOT-23	16vdc	VD7	3d	Tor
F05	XC61HC5012MR	Vdet-IC	5.0V±2%, -Reset PPO, 50.200ms	SOT-23	16vdc	VD7	3d	Tor
F06	XC61FC5042M	Vdet-IC	5V±2%, +Reset PPO, 400ms	SOT-23	16vdc	VD7	3d	Tor
F06	XC61HC5042MR	Vdet-IC	5.0V±2%, -Reset PPO, 80.400ms	SOT-23	16vdc	VD7	3d	Tor
F07	XC61FC5052M	Vdet-IC	5V±2%, +Reset PPO, 50ms	SOT-23	16vdc	VD7	3d	Tor
F07	XC61HC5052MR	Vdet-IC	5.0V±2%, -Reset PPO, 1.50ms	SOT-23	16vdc	VD7	3d	Tor
F1	ELM7621HBB	Vdet-IC	2.1V±2%, +Reset PPO, 500ms	SOT-23	16vdc	VD7	3d	Elm



SMD code	Type	Function	Short description	Case	Pinout	Sch. St.	Mnf.
F1	ELM9751NBB	Vdet-IC	5.1V±2.5%, +Reset ODO	SOT-23	16vdb	VD6	3d Elm
F1	KST1009-F1	Si-npn	GP, 50V, 50mA, 350mW, B=60..120, >150MHz	SOT-23	16ta	-	3a Sam
F1	KTC1009F1	Si-npn	AF, 50V, 50mA, 350mW, B=30..60, >150MHz	SOT-23	16ta	-	3f Sam
F1	MMBC1009F1	Si-npn	AM/FM-RF Amp, 50V, 50mA, 350mW, B=30..60, >150MHz	SOT-23	16ta	-	3a Sam
F1	MMBZ5236B	Z-diode	7.13..7.88V, Zzt=6Ω, lzt=20mA, 410mW	SOT-23	16dc	-	3a Pjt
F1	MMBZ5236BW	Z-diode	7.5V±5%, Zzt=6Ω, 200mW	SOT-323	16dc	-	3a Pjt
F1	R3111N512A	Vdet-IC	5.1V±2%, -Reset PPO	SOT-23	16vdd	VD7	3d Ric
F1	R3113D211C	Vdet-IC	2.1V±2%, -Reset, PPO	SON1408-3	18vda	VD7	3d Ric
F1	RT9808-19CV	Vdet-IC	1.9V±2%, -Reset ODO	SOT-23	16vdb	VD6	3a Rct
F1	TC54VC5102ECB	Vdet-IC	5.1V±2%, -Reset PPO	SOT-23	16vdb	VD7	3a Tcs
F1	XC61CC5102M	Vdet-IC	5.1V±1%, +Reset PPO	SOT-23	16vdb	VD7	3d Tor
F11	DTB113EK	Si-pnp-Digi	Sw, 50V, 500mA, 200mW, 200MHz, R1/R2=1k/1k	SOT-346	16ta	-	3a Rhm
F12	2SC2223-12	Si-npn	HF, 30V, 20mA, 150mW, 600MHz, B=40..80	SOT-23	16ta	-	3a Nec
F12	2SC4178-12	Si-npn	HF, 30V, 20mA, 150mW, B=40..80, >600MHz	SOT-323	16ta	-	3a Nec
F12	DTB123EK	Si-pnp-Digi	Sw, 50V, 500mA, 200mW, 200MHz, R1/R2=2k2/2k2	SOT-346	16ta	-	3a Rhm
F13	2SC2223-13	Si-npn	HF, 30V, 20mA, 150mW, 600MHz, B=60..120	SOT-23	16ta	-	3a Nec
F13	2SC4178-13	Si-npn	HF, 30V, 20mA, 150mW, B=60..120, >600MHz	SOT-323	16ta	-	3a Nec
F13	DTB143EC	Si-pnp-Digi	Sw, 50V, 500mA, 200mW, 200MHz, R1/R2=4k7/4k7	SST3	16ta	-	3a Rhm
F13	DTB143EK	Si-pnp-Digi	Sw, 50V, 500mA, 200mW, 200MHz, R1/R2=4k7/4k7	SOT-346	16ta	-	3a Rhm
F13	XE61CC5145MR	Vdet-IC	5.1V±2%, -Reset PPO	SOT-23	16vdb	VD7	3h Tor
F14	2SC2223-14	Si-npn	HF, 30V, 20mA, 150mW, 600MHz, B=90..180	SOT-23	16ta	-	3a Nec
F14	2SC4178-14	Si-npn	HF, 30V, 20mA, 150mW, B=90..180, >600MHz	SOT-323	16ta	-	3a Nec
F14	DTB114EK	Si-pnp-Digi	Sw, 50V, 500mA, 200mW, 200MHz, R1/R2=10k/10k	SOT-346	16ta	-	3a Rhm
F15	XC61FC5112M	Vdet-IC	5.1V±2%, +Reset PPO, 200ms	SOT-23	16vdb	VD7	3d Tor
F15	XC61HC5112MR	Vdet-IC	5.1V±2%, -Reset PPO, 50..200ms	SOT-23	16vdc	VD7	3d Tor
F16	XC61FC5142M	Vdet-IC	5.1V±2%, +Reset PPO, 400ms	SOT-23	16vdb	VD7	3d Tor
F16	XC61HC5142MR	Vdet-IC	5.1V±2%, -Reset PPO, 80..400ms	SOT-23	16vdc	VD7	3d Tor
F17	XC61FC5152M	Vdet-IC	5.1V±2%, +Reset PPO, 50ms	SOT-23	16vdb	VD7	3d Tor
F17	XC61HC5152MR	Vdet-IC	5.1V±2%, -Reset PPO, 1..50ms	SOT-23	16vdc	VD7	3d Tor
F10	KSA1182-O	Si-pnp	AF, 35V, 500mA, 150mW, B=70..140, >200MHz	SOT-23	16ta	-	3a Sam
F1p	BFS18	Si-npn	RF, 30V, 30mA, 200MHz	SOT-23	16ta	-	3a PhH
F1t	BFS18	Si-npn	RF, 30V, 30mA, 200MHz	SOT-23	16ta	-	3a PhM
F1W	BFS18	Si-npn	RF, 30V, 30mA, 200MHz	SOT-23	16ta	-	3a PhC
F1Y	KSA1182-Y	Si-pnp	AF, 35V, 500mA, 150mW, B=120..240, >200MHz	SOT-23	16ta	-	3a Sam
F2	2SC2814-2	Si-npn	AF-Amp, 30V, 30mA, 150mW, 320MHz, B=40..80	SOT-23	16ta	-	3a San
F2	BFS19	Si-npn	RF, 30V, 30mA, 250mW, B=65..225, 260MHz	SOT-23	16ta	-	3a Ste
F2	ELM7622HBB	Vdet-IC	2.2V±2%, +Reset PPO, 500ms	SOT-23	16vdc	VD7	3d Elm
F2	ELM9752NBB	Vdet-IC	5.2V±2.5%, +Reset ODO	SOT-23	16vdb	VD6	3d Elm
F2	HSMP-3822	PIN-diode	Dual, RF, Sw, 50V, 1A(1μs), <0.75pF, <0.6Ω(10mA), 3GHz	SOT-23	16dl	-	3a Agi
F2	KST1009-F2	Si-npn	GP, 50V, 50mA, 350mW, B=90..180, >150MHz	SOT-23	16ta	-	3a Sam
F2	MMBC1009F2	Si-npn	AM/FM-RF Amp, 50V, 50mA, 350mW, B=40..80, >150MHz	SOT-23	16ta	-	3a Sam
F2	MMBZ5237B	Z-diode	7.79..8.61V, Zzt=8Ω, lzt=20mA, 410mW	SOT-23	16dc	-	3a Pjt
F2	MMBZ5237BW	Z-diode	8.2V±5%, Zzt=8Ω, 200mW	SOT-323	16dc	-	3a Pjt
F2	R3111N522A	Vdet-IC	5.2V±2%, -Reset PPO	SOT-23	16vdd	VD7	3d Ric
F2	R3113D221C	Vdet-IC	2.2V±2%, -Reset, PPO	SON1408-3	18vda	VD7	3d Ric
F2	RT9808-20CV	Vdet-IC	2.0V±2%, -Reset ODO	SOT-23	16vdb	VD6	3a Rct
F2	TC54VC5202ECB	Vdet-IC	5.2V±2%, -Reset PPO	SOT-23	16vdb	VD7	3a Tcs
F2	XC61CC5202M	Vdet-IC	5.2V±1%, +Reset PPO	SOT-23	16vdb	VD7	3d Tor
F2-	RT9808-20PV	Vdet-IC	2.0V±2%, -Reset ODO	SOT-23	16vdb	VD6	3a Rct
F21	DTD113EK	Si-npn-Digi	Sw, 50V, 500mA, 200mW, 200MHz, R1/R2=1k/1k	SOT-346	16ta	-	3a Rhm
F212G	UR6225G-12-AE3-3	LVR-IC	1.2V±2%, 100mA, halogen free	SOT-23	16cg	VR1	3a Utc
F212L	UR6225L-12-AE3-3	LVR-IC	1.2V±2%, 100mA, lead free	SOT-23	16cg	VR1	3a Utc
F213G	UR6225G-13-AE3-3	LVR-IC	1.3V±2%, 100mA, halogen free	SOT-23	16cg	VR1	3a Utc
F213L	UR6225L-13-AE3-3	LVR-IC	1.3V±2%, 100mA, lead free	SOT-23	16cg	VR1	3a Utc
F214G	UR6225G-14-AE3-3	LVR-IC	1.4V±2%, 100mA, halogen free	SOT-23	16cg	VR1	3a Utc
F214L	UR6225L-14-AE3-3	LVR-IC	1.4V±2%, 100mA, lead free	SOT-23	16cg	VR1	3a Utc
F215G	UR6225G-15-AE3-3	LVR-IC	1.5V±2%, 100mA, halogen free	SOT-23	16cg	VR1	3a Utc
F215L	UR6225L-15-AE3-3	LVR-IC	1.5V±2%, 100mA, lead free	SOT-23	16cg	VR1	3a Utc
F216G	UR6225G-16-AE3-3	LVR-IC	1.6V±2%, 100mA, halogen free	SOT-23	16cg	VR1	3a Utc
F216L	UR6225L-16-AE3-3	LVR-IC	1.6V±2%, 100mA, lead free	SOT-23	16cg	VR1	3a Utc
F217G	UR6225G-17-AE3-3	LVR-IC	1.7V±2%, 100mA, halogen free	SOT-23	16cg	VR1	3a Utc
F217L	UR6225L-17-AE3-3	LVR-IC	1.7V±2%, 100mA, lead free	SOT-23	16cg	VR1	3a Utc
F218G	UR6225G-18-AE3-3	LVR-IC	1.8V±2%, 100mA, halogen free	SOT-23	16cg	VR1	3a Utc
F218L	UR6225L-18-AE3-3	LVR-IC	1.8V±2%, 100mA, lead free	SOT-23	16cg	VR1	3a Utc
F219G	UR6225G-19-AE3-3	LVR-IC	1.9V±2%, 100mA, halogen free	SOT-23	16cg	VR1	3a Utc
F219L	UR6225L-19-AE3-3	LVR-IC	1.9V±2%, 100mA, lead free	SOT-23	16cg	VR1	3a Utc
F22	DTD123EK	Si-npn-Digi	Sw, 50V, 500mA, 200mW, 200MHz, R1/R2=2k2/2k2	SOT-346	16ta	-	3a Rhm
F220G	UR6225G-20-AE3-3	LVR-IC	2.0V±2%, 100mA, halogen free	SOT-23	16cg	VR1	3a Utc
F220L	UR6225L-20-AE3-3	LVR-IC	2.0V±2%, 100mA, lead free	SOT-23	16cg	VR1	3a Utc
F221G	UR6225G-21-AE3-3	LVR-IC	2.1V±2%, 100mA, halogen free	SOT-23	16cg	VR1	3a Utc



SMD code	Type	Function	Short description	Case	Pinout	Sch.	St.	Mnf.
F221L	UR6225L-21-AE3-3	LVR-IC	2.1V±2%, 100mA, lead free	SOT-23	16cg	VR1	3a	Utc
F222G	UR6225G-22-AE3-3	LVR-IC	2.2V±2%, 100mA, halogen free	SOT-23	16cg	VR1	3a	Utc
F222L	UR6225L-22-AE3-3	LVR-IC	2.2V±2%, 100mA, lead free	SOT-23	16cg	VR1	3a	Utc
F223G	UR6225G-23-AE3-3	LVR-IC	2.3V±2%, 100mA, halogen free	SOT-23	16cg	VR1	3a	Utc
F223L	UR6225L-23-AE3-3	LVR-IC	2.3V±2%, 100mA, lead free	SOT-23	16cg	VR1	3a	Utc
F224G	UR6225G-24-AE3-3	LVR-IC	2.4V±2%, 100mA, halogen free	SOT-23	16cg	VR1	3a	Utc
F224L	UR6225L-24-AE3-3	LVR-IC	2.4V±2%, 100mA, lead free	SOT-23	16cg	VR1	3a	Utc
F225G	UR6225G-25-AE3-3	LVR-IC	2.5V±2%, 100mA, halogen free	SOT-23	16cg	VR1	3a	Utc
F225L	UR6225L-25-AE3-3	LVR-IC	2.5V±2%, 100mA, lead free	SOT-23	16cg	VR1	3a	Utc
F226G	UR6225G-26-AE3-3	LVR-IC	2.6V±2%, 100mA, halogen free	SOT-23	16cg	VR1	3a	Utc
F226L	UR6225L-26-AE3-3	LVR-IC	2.6V±2%, 100mA, lead free	SOT-23	16cg	VR1	3a	Utc
F227G	UR6225G-27-AE3-3	LVR-IC	2.7V±2%, 100mA, halogen free	SOT-23	16cg	VR1	3a	Utc
F227L	UR6225L-27-AE3-3	LVR-IC	2.7V±2%, 100mA, lead free	SOT-23	16cg	VR1	3a	Utc
F228G	UR6225G-28-AE3-3	LVR-IC	2.8V±2%, 100mA, halogen free	SOT-23	16cg	VR1	3a	Utc
F228L	UR6225L-28-AE3-3	LVR-IC	2.8V±2%, 100mA, lead free	SOT-23	16cg	VR1	3a	Utc
F229G	UR6225G-29-AE3-3	LVR-IC	2.9V±2%, 100mA, halogen free	SOT-23	16cg	VR1	3a	Utc
F229L	UR6225L-29-AE3-3	LVR-IC	2.9V±2%, 100mA, lead free	SOT-23	16cg	VR1	3a	Utc
F23	DTD143EC	Si-npn-Digi	Sw, 50V, 500mA, 200mW, 200MHz, R1/R2=4k7/4k7	SST3	16ta	-	3a	Rhm
F23	DTD143EK	Si-npn-Digi	Sw, 50V, 500mA, 200mW, 200MHz, R1/R2=4k7/4k7	SOT-346	16ta	-	3a	Rhm
F23	XE61CC5245MR	Vdet-IC	5.2V±2%, -Reset PPO	SOT-23	16vdb	VD7	3h	Tor
F230G	UR6225G-30-AE3-3	LVR-IC	3.0V±2%, 100mA, halogen free	SOT-23	16cg	VR1	3a	Utc
F230L	UR6225L-30-AE3-3	LVR-IC	3.0V±2%, 100mA, lead free	SOT-23	16cg	VR1	3a	Utc
F231G	UR6225G-31-AE3-3	LVR-IC	3.1V±2%, 100mA, halogen free	SOT-23	16cg	VR1	3a	Utc
F231L	UR6225L-31-AE3-3	LVR-IC	3.1V±2%, 100mA, lead free	SOT-23	16cg	VR1	3a	Utc
F232G	UR6225G-32-AE3-3	LVR-IC	3.2V±2%, 100mA, halogen free	SOT-23	16cg	VR1	3a	Utc
F232L	UR6225L-32-AE3-3	LVR-IC	3.2V±2%, 100mA, lead free	SOT-23	16cg	VR1	3a	Utc
F233G	UR6225G-33-AE3-3	LVR-IC	3.3V±2%, 100mA, halogen free	SOT-23	16cg	VR1	3a	Utc
F233L	UR6225L-33-AE3-3	LVR-IC	3.3V±2%, 100mA, lead free	SOT-23	16cg	VR1	3a	Utc
F234G	UR6225G-34-AE3-3	LVR-IC	3.4V±2%, 100mA, halogen free	SOT-23	16cg	VR1	3a	Utc
F234L	UR6225L-34-AE3-3	LVR-IC	3.4V±2%, 100mA, lead free	SOT-23	16cg	VR1	3a	Utc
F235G	UR6225G-35-AE3-3	LVR-IC	3.5V±2%, 100mA, halogen free	SOT-23	16cg	VR1	3a	Utc
F235L	UR6225L-35-AE3-3	LVR-IC	3.5V±2%, 100mA, lead free	SOT-23	16cg	VR1	3a	Utc
F236G	UR6225G-36-AE3-3	LVR-IC	3.6V±2%, 100mA, halogen free	SOT-23	16cg	VR1	3a	Utc
F236L	UR6225L-36-AE3-3	LVR-IC	3.6V±2%, 100mA, lead free	SOT-23	16cg	VR1	3a	Utc
F237G	UR6225G-37-AE3-3	LVR-IC	3.7V±2%, 100mA, halogen free	SOT-23	16cg	VR1	3a	Utc
F237L	UR6225L-37-AE3-3	LVR-IC	3.7V±2%, 100mA, lead free	SOT-23	16cg	VR1	3a	Utc
F238G	UR6225G-38-AE3-3	LVR-IC	3.8V±2%, 100mA, halogen free	SOT-23	16cg	VR1	3a	Utc
F238L	UR6225L-38-AE3-3	LVR-IC	3.8V±2%, 100mA, lead free	SOT-23	16cg	VR1	3a	Utc
F239G	UR6225G-39-AE3-3	LVR-IC	3.9V±2%, 100mA, halogen free	SOT-23	16cg	VR1	3a	Utc
F239L	UR6225L-39-AE3-3	LVR-IC	3.9V±2%, 100mA, lead free	SOT-23	16cg	VR1	3a	Utc
F24	DTD114EK	Si-npn-Digi	Sw, 50V, 500mA, 200mW, 200MHz, R1/R2=10k/10k	SOT-346	16ta	-	3a	Rhm
F240G	UR6225G-40-AE3-3	LVR-IC	4.0V±2%, 100mA, halogen free	SOT-23	16cg	VR1	3a	Utc
F240L	UR6225L-40-AE3-3	LVR-IC	4.0V±2%, 100mA, lead free	SOT-23	16cg	VR1	3a	Utc
F241G	UR6225G-41-AE3-3	LVR-IC	4.1V±2%, 100mA, halogen free	SOT-23	16cg	VR1	3a	Utc
F241L	UR6225L-41-AE3-3	LVR-IC	4.1V±2%, 100mA, lead free	SOT-23	16cg	VR1	3a	Utc
F242G	UR6225G-42-AE3-3	LVR-IC	4.2V±2%, 100mA, halogen free	SOT-23	16cg	VR1	3a	Utc
F242L	UR6225L-42-AE3-3	LVR-IC	4.2V±2%, 100mA, lead free	SOT-23	16cg	VR1	3a	Utc
F243G	UR6225G-43-AE3-3	LVR-IC	4.3V±2%, 100mA, halogen free	SOT-23	16cg	VR1	3a	Utc
F243L	UR6225L-43-AE3-3	LVR-IC	4.3V±2%, 100mA, lead free	SOT-23	16cg	VR1	3a	Utc
F244G	UR6225G-44-AE3-3	LVR-IC	4.4V±2%, 100mA, halogen free	SOT-23	16cg	VR1	3a	Utc
F244L	UR6225L-44-AE3-3	LVR-IC	4.4V±2%, 100mA, lead free	SOT-23	16cg	VR1	3a	Utc
F245G	UR6225G-45-AE3-3	LVR-IC	4.5V±2%, 100mA, halogen free	SOT-23	16cg	VR1	3a	Utc
F245L	UR6225L-45-AE3-3	LVR-IC	4.5V±2%, 100mA, lead free	SOT-23	16cg	VR1	3a	Utc
F246G	UR6225G-46-AE3-3	LVR-IC	4.6V±2%, 100mA, halogen free	SOT-23	16cg	VR1	3a	Utc
F246L	UR6225L-46-AE3-3	LVR-IC	4.6V±2%, 100mA, lead free	SOT-23	16cg	VR1	3a	Utc
F247G	UR6225G-47-AE3-3	LVR-IC	4.7V±2%, 100mA, halogen free	SOT-23	16cg	VR1	3a	Utc
F247L	UR6225L-47-AE3-3	LVR-IC	4.7V±2%, 100mA, lead free	SOT-23	16cg	VR1	3a	Utc
F248G	UR6225G-48-AE3-3	LVR-IC	4.8V±2%, 100mA, halogen free	SOT-23	16cg	VR1	3a	Utc
F248L	UR6225L-48-AE3-3	LVR-IC	4.8V±2%, 100mA, lead free	SOT-23	16cg	VR1	3a	Utc
F249G	UR6225G-49-AE3-3	LVR-IC	4.9V±2%, 100mA, halogen free	SOT-23	16cg	VR1	3a	Utc
F249L	UR6225L-49-AE3-3	LVR-IC	4.9V±2%, 100mA, lead free	SOT-23	16cg	VR1	3a	Utc
F25	XC61FC5212M	Vdet-IC	5.2V±2%, +Reset PPO, 200ms	SOT-23	16vdb	VD7	3d	Tor
F25	XC61HC5212MR	Vdet-IC	5.2V±2%, -Reset PPO, 50..200ms	SOT-23	16vdc	VD7	3d	Tor
F250G	UR6225G-50-AE3-3	LVR-IC	5.0V±2%, 100mA, halogen free	SOT-23	16cg	VR1	3a	Utc
F250L	UR6225L-50-AE3-3	LVR-IC	5.0V±2%, 100mA, lead free	SOT-23	16cg	VR1	3a	Utc
F251G	UR6225G-51-AE3-3	LVR-IC	5.1V±2%, 100mA, halogen free	SOT-23	16cg	VR1	3a	Utc
F251L	UR6225L-51-AE3-3	LVR-IC	5.1V±2%, 100mA, lead free	SOT-23	16cg	VR1	3a	Utc
F252G	UR6225G-52-AE3-3	LVR-IC	5.2V±2%, 100mA, halogen free	SOT-23	16cg	VR1	3a	Utc
F252L	UR6225L-52-AE3-3	LVR-IC	5.2V±2%, 100mA, lead free	SOT-23	16cg	VR1	3a	Utc
F253G	UR6225G-53-AE3-3	LVR-IC	5.3V±2%, 100mA, halogen free	SOT-23	16cg	VR1	3a	Utc



SMD code	Type	Function	Short description	Case	Pinout	Sch. St.	Mnf.
F253L	UR6225L-53-AE3-3	LVR-IC	5.3V±2%, 100mA, lead free	SOT-23	16cg	VR1 3a	Utc
F254G	UR6225G-54-AE3-3	LVR-IC	5.4V±2%, 100mA, halogen free	SOT-23	16cg	VR1 3a	Utc
F254L	UR6225L-54-AE3-3	LVR-IC	5.4V±2%, 100mA, lead free	SOT-23	16cg	VR1 3a	Utc
F255G	UR6225G-55-AE3-3	LVR-IC	5.5V±2%, 100mA, halogen free	SOT-23	16cg	VR1 3a	Utc
F255L	UR6225L-55-AE3-3	LVR-IC	5.5V±2%, 100mA, lead free	SOT-23	16cg	VR1 3a	Utc
F256G	UR6225G-56-AE3-3	LVR-IC	5.6V±2%, 100mA, halogen free	SOT-23	16cg	VR1 3a	Utc
F256L	UR6225L-56-AE3-3	LVR-IC	5.6V±2%, 100mA, lead free	SOT-23	16cg	VR1 3a	Utc
F257G	UR6225G-57-AE3-3	LVR-IC	5.7V±2%, 100mA, halogen free	SOT-23	16cg	VR1 3a	Utc
F257L	UR6225L-57-AE3-3	LVR-IC	5.7V±2%, 100mA, lead free	SOT-23	16cg	VR1 3a	Utc
F258G	UR6225G-58-AE3-3	LVR-IC	5.8V±2%, 100mA, halogen free	SOT-23	16cg	VR1 3a	Utc
F258L	UR6225L-58-AE3-3	LVR-IC	5.8V±2%, 100mA, lead free	SOT-23	16cg	VR1 3a	Utc
F259G	UR6225G-59-AE3-3	LVR-IC	5.9V±2%, 100mA, halogen free	SOT-23	16cg	VR1 3a	Utc
F259L	UR6225L-59-AE3-3	LVR-IC	5.9V±2%, 100mA, lead free	SOT-23	16cg	VR1 3a	Utc
F26	XC61FC5242M	Vdet-IC	5.2V±2%, +Reset PPO, 400ms	SOT-23	16vdb	VD7 3d	Tor
F26	XC61HC5242MR	Vdet-IC	5.2V±2%, -Reset PPO, 80..400ms	SOT-23	16vdc	VD7 3d	Tor
F260G	UR6225G-60-AE3-3	LVR-IC	6.0V±2%, 100mA, halogen free	SOT-23	16cg	VR1 3a	Utc
F260L	UR6225L-60-AE3-3	LVR-IC	6.0V±2%, 100mA, lead free	SOT-23	16cg	VR1 3a	Utc
F27	XC61FC5252M	Vdet-IC	5.2V±2%, +Reset PPO, 50ms	SOT-23	16vdb	VD7 3d	Tor
F27	XC61HC5252MR	Vdet-IC	5.2V±2%, -Reset PPO, 1..50ms	SOT-23	16vdc	VD7 3d	Tor
F2JG	UR6225G-285-AE3-3	LVR-IC	2.85V±2%, 100mA, halogen free	SOT-23	16cg	VR1 3a	Utc
F2JL	UR6225L-285-AE3-3	LVR-IC	2.85V±2%, 100mA, lead free	SOT-23	16cg	VR1 3a	Utc
F2p	BFS19	Si-npn	RF, 30V, 30mA, 250mW, B=65..225, 260MHz	SOT-23	16ta	-	3a PHH
F2t	BFS19	Si-npn	RF, 30V, 30mA, 250mW, B=65..225, 260MHz	SOT-23	16ta	-	3a PhM
F2W	BFS19	Si-npn	RF, 30V, 30mA, 250mW, B=65..225, 260MHz	SOT-23	16ta	-	3a PhC
F3	1S5193	Si-diode	Sw, U-Fast, 85V, 100mA, 150mW, Vf<1.2V(100mA), <4ns	SC-59	16dc	-	3a Tos
F3	2SC2814-3	Si-npn	AF-Amp, 30V, 30mA, 150mW, 320MHz, B=60..120	SOT-23	16ta	-	3a San
F3	2SC4399-3	Si-npn	AF, 30V, 30mA, 150mW, B=60..120, 320MHz	SOT-323	16ta	-	3a San
F3	ELM7623HBB	Vdet-IC	2.3V±2%, +Reset PPO, 500ms	SOT-23	16vdc	VD7 3d	Elm
F3	ELM9753NBB	Vdet-IC	5.3V±2.5%, +Reset ODO	SOT-23	16vdb	VD6 3d	Elm
F3	HSMF-3823	PIN-diode	Dual, RF, Sw, 50V, 1A(1µs), <0.75pF, <0.6Ω(10mA), 3GHz	SOT-23	16df	-	3a Agi
F3	KST1009-F3	Si-npn	GP, 50V, 50mA, 350mW, B=135..270, >150MHz	SOT-23	16ta	-	3a Sam
F3	MMBC1009F3	Si-npn	AM/FM-RF Amp, 50V, 50mA, 350mW, B=50..130, >150MHz	SOT-23	16ta	-	3a Sam
F3	MMBZ5238B	Z-diode	8.27..9.14V, Zzt=8Ω, Izt=20mA, 410mW	SOT-23	16dc	-	3a Pjt
F3	R3111N532A	Vdet-IC	5.3V±2%, -Reset PPO	SOT-23	16vdb	VD7 3d	Ric
F3	R3113D231C	Vdet-IC	2.3V±2%, -Reset, PPO	SON11408-3	18vda	VD7 3d	Ric
F3	RT9808-21CV	Vdet-IC	2.1V±2%, -Reset ODO	SOT-23	16vdb	VD6 3a	Rct
F3	TC54VC5302ECB	Vdet-IC	5.3V±2%, -Reset PPO	SOT-23	16vdb	VD7 3a	Tcs
F3	XC61CC5302M	Vdet-IC	5.3V±1%, +Reset PPO	SOT-23	16vdb	VD7 3d	Tor
F3-	RT9808-21PV	Vdet-IC	2.1V±2%, -Reset ODO	SOT-23	16vdb	VD6 3a	Rct
F33	XE61CC5345MR	Vdet-IC	5.3V±2%, -Reset PPO	SOT-23	16vdb	VD7 3h	Tor
F35	XC61FC5312M	Vdet-IC	5.3V±2%, +Reset PPO, 200ms	SOT-23	16vdb	VD7 3d	Tor
F35	XC61HC5312MR	Vdet-IC	5.3V±2%, -Reset PPO, 50..200ms	SOT-23	16vdc	VD7 3d	Tor
F36	XC61FC5342M	Vdet-IC	5.3V±2%, +Reset PPO, 400ms	SOT-23	16vdb	VD7 3d	Tor
F36	XC61HC5342MR	Vdet-IC	5.3V±2%, -Reset PPO, 80..400ms	SOT-23	16vdc	VD7 3d	Tor
F37	XC61FC5352M	Vdet-IC	5.3V±2%, +Reset PPO, 50ms	SOT-23	16vdb	VD7 3d	Tor
F37	XC61HC5352MR	Vdet-IC	5.3V±2%, -Reset PPO, 1..50ms	SOT-23	16vdc	VD7 3d	Tor
F3T	1PS193	Si-diode	Sw, Fast, 80V, 215mA, <4ns	SC-59	16dc	-	3a Phi
F4	2SC2814-4	Si-npn	AF-Amp, 30V, 30mA, 150mW, 320MHz, B=90..180	SOT-23	16ta	-	3a San
F4	2SC4399-4	Si-npn	AF, 30V, 30mA, 150mW, B=90..180, 320MHz	SOT-323	16ta	-	3a San
F4	BFS18R	Si-npn	RF, 30V, 30mA, 200MHz	SOT-23	16ta	-	3a Ste
F4	ELM7624HBB	Vdet-IC	2.4V±2%, +Reset PPO, 500ms	SOT-23	16vdc	VD7 3d	Elm
F4	ELM9754NBB	Vdet-IC	5.4V±2.5%, +Reset ODO	SOT-23	16vdb	VD6 3d	Elm
F4	HSMF-3824	PIN-diode	Dual, RF, Sw, 50V, 1A(1µs), <0.75pF, <0.6Ω(10mA), 3GHz	SOT-23	16dg	-	3a Agi
F4	KA4L-3Z	Si-npn-Digi	Sw, 60V, 100mA, 200mW, R1=4k7	SOT-416	16ta	-	3a Nec
F4	KST1009-F4	Si-npn	GP, 50V, 50mA, 350mW, B=200..400, >150MHz	SOT-23	16ta	-	3a Sam
F4	KTA2013F-4	Si-npn	AF, Sw, 20V, 150mA, 50mW, B=120..240, >80MHz	TFSM	19ta	-	3f Kec
F4	MMBC1009F4	Si-npn	AM/FM-RF Amp, 50V, 50mA, 350mW, B=100..200, >150MHz	SOT-23	16ta	-	3a Sam
F4	MMBZ5239B	Z-diode	8.65..9.56V, Zzt=10Ω, Izt=20mA, 410mW	SOT-23	16dc	-	3a Pjt
F4	MMBZ5239BW	Z-diode	9.1V±5%, Zzt=10Ω, 200mW	SOT-323	16dc	-	3a Pjt
F4	R3111N542A	Vdet-IC	5.4V±2%, -Reset PPO	SOT-23	16vdb	VD7 3d	Ric
F4	R3113D241C	Vdet-IC	2.4V±2%, -Reset, PPO	SON11408-3	18vda	VD7 3d	Ric
F4	RT9808-27CV	Vdet-IC	2.7V±2%, -Reset ODO	SOT-23	16vdb	VD6 3a	Rct
F4	TC54VC5402ECB	Vdet-IC	5.4V±2%, -Reset PPO	SOT-23	16vdb	VD7 3a	Tcs
F4	XC61CC5402M	Vdet-IC	5.4V±1%, +Reset PPO	SOT-23	16vdb	VD7 3d	Tor
F4-	RT9808-27PV	Vdet-IC	2.7V±2%, -Reset ODO	SOT-23	16vdb	VD6 3a	Rct
F43	XE61CC5445MR	Vdet-IC	5.4V±2%, -Reset PPO	SOT-23	16vdb	VD7 3h	Tor
F45	XC61FC5412M	Vdet-IC	5.4V±2%, +Reset PPO, 200ms	SOT-23	16vdb	VD7 3d	Tor
F45	XC61HC5412MR	Vdet-IC	5.4V±2%, -Reset PPO, 50..200ms	SOT-23	16vdc	VD7 3d	Tor
F46	XC61FC5442M	Vdet-IC	5.4V±2%, +Reset PPO, 400ms	SOT-23	16vdb	VD7 3d	Tor
F46	XC61HC5442MR	Vdet-IC	5.4V±2%, -Reset PPO, 80..400ms	SOT-23	16vdc	VD7 3d	Tor



SMD code	Type	Function	Short description	Case	Pinout	Sch. St.	Mnf.
F47	XC61FC5452M	Vdet-IC	5.4V±2%, +Reset PPO, 50ms	SOT-23	16vdb	VD7	3d Tor
F47	XC61HC5452MR	Vdet-IC	5.4V±2%, -Reset PPO, 1.50ms	SOT-23	16vdc	VD7	3d Tor
F5	1SS250	Si-diode	Rectifier, 250V, 100mA, <60ns	SOT-23	16dr	-	3a Tos
F5	1SS370	Si-diode	Rectifier, 200V, 100mA, VF<1.2V(100mA), <60ns	SOT-323	16dc	-	3a Tos
F5	2SC2814-5	Si-npn	AF-Amp, 30V, 30mA, 150mW, 320MHz, B=135..270	SOT-23	16ta	-	3a San
F5	2SC4399-5	Si-npn	AF, 30V, 30mA, 150mW, B=135..270, 320MHz	SOT-323	16ta	-	3a San
F5	BFS19R	Si-npn	RF, 30V, 30mA, 250mW, B=65..225, 260MHz	SOT-23	16ta	-	3a Sil
F5	ELM7625HBB	Vdet-IC	2.5V±2%, +Reset PPO, 500ms	SOT-23	16vdb	VD7	3d Elm
F5	ELM9755NBB	Vdet-IC	5.5V±2.5%, +Reset ODO	SOT-23	16vdb	VD6	3d Elm
F5	KST1009-F5	Si-npn	GP, 50V, 50mA, 350mW, B=300..600, >150MHz	SOT-23	16ta	-	3a Sam
F5	MMBC1009F5	Si-npn	AM/FM-RF Amp, 50V, 50mA, 350mW, B=135..270, >150MHz	SOT-23	16ta	-	3a Sam
F5	MMBZ5240B	Z-diode	9.50..10.50V, Zzt=17Ω, Izt=20mA, 410mW	SOT-23	16dc	-	3a Pjt
F5	MMBZ5240BW	Z-diode	10V±5%, Zzt=17Ω, 200mW	SOT-323	16dc	-	3a Pjt
F5	R3111N552A	Vdet-IC	5.5V±2%, -Reset PPO	SOT-23	16vdd	VD7	3d Ric
F5	R3113D251C	Vdet-IC	2.5V±2%, -Reset, PPO	SON1408-3	18vda	VD7	3d Ric
F5	RT9808-29CV	Vdet-IC	2.9V±2%, -Reset ODO	SOT-23	16vdb	VD6	3a Rct
F5	SP810EK-2-9	Vdet-IC	2.9V±1.5%, +Reset PPO	SOT-23	16vdc	VD7	3b Sip
F5	TC54VC5502ECB	Vdet-IC	5.5V±2%, -Reset PPO	SOT-23	16vdb	VD7	3a Tcs
F5	XC61CC5502M	Vdet-IC	5.5V±1%, +Reset PPO	SOT-23	16vdb	VD7	3d Tor
F52	DTB123YC	Si-pnp-Digi	Sw, 50V, 500mA, 200mW, 200MHz, R1/R2=2k2/10k	SS3T	16ta	-	3a Rhm
F52	DTB123YK	Si-pnp-Digi	Sw, 50V, 500mA, 200mW, 200MHz, R1/R2=2k2/10k	SOT-346	16ta	-	3a Rhm
F53	XE61CC5545MR	Vdet-IC	5.5V±2%, -Reset PPO	SOT-23	16vdb	VD7	3h Tor
F55	XC61FC5512M	Vdet-IC	5.5V±2%, +Reset PPO, 200ms	SOT-23	16vdb	VD7	3d Tor
F55	XC61HC5512MR	Vdet-IC	5.5V±2%, -Reset PPO, 50..200ms	SOT-23	16vdc	VD7	3d Tor
F56	XC61FC5542M	Vdet-IC	5.5V±2%, +Reset PPO, 400ms	SOT-23	16vdb	VD7	3d Tor
F56	XC61HC5542MR	Vdet-IC	5.5V±2%, -Reset PPO, 80..400ms	SOT-23	16vdc	VD7	3d Tor
F57	XC61FC5552M	Vdet-IC	5.5V±2%, +Reset PPO, 50ms	SOT-23	16vdb	VD7	3d Tor
F57	XC61HC5552MR	Vdet-IC	5.5V±2%, -Reset PPO, 1..50ms	SOT-23	16vdc	VD7	3d Tor
F6	ELM7626HBB	Vdet-IC	2.6V±2%, +Reset PPO, 500ms	SOT-23	16vdc	VD7	3d Elm
F6	KTA2013F-6	Si-pnp	AF, Sw, 20V, 150mA, 50mW, B=200..400, >80MHz	TFSM	19ta	-	3f Kec
F6	R3111N562A	Vdet-IC	5.6V±2%, -Reset PPO	SOT-23	16vdd	VD7	3d Ric
F6	R3113D261C	Vdet-IC	2.6V±2%, -Reset, PPO	SON1408-3	18vda	VD7	3d Ric
F6	R3130N16EA	Vdet-IC	1.6V, -Reset PPO, 240ms	SOT-23	16vdc	VD7	3b Ric
F6	RT9808-30CV	Vdet-IC	3.0V±2%, -Reset ODO	SOT-23	16vdb	VD6	3a Rct
F6	TC54VC5602ECB	Vdet-IC	5.6V±2%, -Reset PPO	SOT-23	16vdb	VD7	3a Tcs
F6	XC61CC5602M	Vdet-IC	5.6V±1%, +Reset PPO	SOT-23	16vdb	VD7	3d Tor
F6-	RT9808-30PV	Vdet-IC	3.0V±2%, -Reset ODO	SOT-23	16vdb	VD6	3a Rct
F62	DTD123YK	Si-npn-Digi	Sw, 50V, 500mA, 200mW, 200MHz, R1/R2=2k2/10k	SOT-346	16ta	-	3a Rhm
F63	XE61CC5645MR	Vdet-IC	5.6V±2%, -Reset PPO	SOT-23	16vdb	VD7	3h Tor
F65	XC61FC5612M	Vdet-IC	5.6V±2%, +Reset PPO, 200ms	SOT-23	16vdb	VD7	3d Tor
F65	XC61HC5612MR	Vdet-IC	5.6V±2%, -Reset PPO, 50..200ms	SOT-23	16vdc	VD7	3d Tor
F66	XC61FC5642M	Vdet-IC	5.6V±2%, +Reset PPO, 400ms	SOT-23	16vdb	VD7	3d Tor
F66	XC61HC5642MR	Vdet-IC	5.6V±2%, -Reset PPO, 80..400ms	SOT-23	16vdc	VD7	3d Tor
F67	XC61FC5652M	Vdet-IC	5.6V±2%, +Reset PPO, 50ms	SOT-23	16vdb	VD7	3d Tor
F67	XC61HC5652MR	Vdet-IC	5.6V±2%, -Reset PPO, 1..50ms	SOT-23	16vdc	VD7	3d Tor
F7	BAV99RW	Si-diode	Dual, U-Sp, 70V, 215mA, Vf<1.2V(100mA), 0.5pF, 4ns	SOT-323	16ea	-	3a Ons
F7	ELM7627HBB	Vdet-IC	2.7V±2%, +Reset PPO, 500ms	SOT-23	16vdb	VD7	3d Elm
F7	KN4L3Z	Si-pnp-Digi	Sw, 60V, 100mA, 150mW, R1=4k7	SOT-416	16ta	-	3a Nec
F7	R3111N572A	Vdet-IC	5.7V±2%, -Reset PPO	SOT-23	16vdd	VD7	3d Ric
F7	R3113D271C	Vdet-IC	2.7V±2%, -Reset, PPO	SON1408-3	18vda	VD7	3d Ric
F7	R3130N17EA	Vdet-IC	1.7V, -Reset PPO, 240ms	SOT-23	16vdc	VD7	3b Ric
F7	RT9808-33CV	Vdet-IC	3.3V±2%, -Reset ODO	SOT-23	16vdb	VD6	3a Rct
F7	TC54VC5702ECB	Vdet-IC	5.7V±2%, -Reset PPO	SOT-23	16vdb	VD7	3a Tcs
F7	XC61CC5702M	Vdet-IC	5.7V±1%, +Reset PPO	SOT-23	16vdb	VD7	3d Tor
F7-	RT9808-33PV	Vdet-IC	3.3V±2%, -Reset ODO	SOT-23	16vdb	VD6	3a Rct
F73	XE61CC5745MR	Vdet-IC	5.7V±2%, -Reset PPO	SOT-23	16vdb	VD7	3h Tor
F75	XC61FC5712M	Vdet-IC	5.7V±2%, +Reset PPO, 200ms	SOT-23	16vdb	VD7	3d Tor
F75	XC61HC5712MR	Vdet-IC	5.7V±2%, -Reset PPO, 50..200ms	SOT-23	16vdc	VD7	3d Tor
F76	XC61FC5742M	Vdet-IC	5.7V±2%, +Reset PPO, 400ms	SOT-23	16vdb	VD7	3d Tor
F76	XC61HC5742MR	Vdet-IC	5.7V±2%, -Reset PPO, 80..400ms	SOT-23	16vdc	VD7	3d Tor
F77	XC61FC5752M	Vdet-IC	5.7V±2%, +Reset PPO, 50ms	SOT-23	16vdb	VD7	3d Tor
F77	XC61HC5752MR	Vdet-IC	5.7V±2%, -Reset PPO, 1..50ms	SOT-23	16vdc	VD7	3d Tor
F8	BZX84-C3V3	Z-diode	3.1..3.5V, Zzt=95Ω, Izt=20mA, 225mW	SOT-23	16dc	-	3a Lge
F8	ELM7628HBB	Vdet-IC	2.8V±2%, +Reset PPO, 500ms	SOT-23	16vdc	VD7	3d Elm
F8	R3111N582A	Vdet-IC	5.8V±2%, -Reset PPO	SOT-23	16vdd	VD7	3d Ric
F8	R3113D281C	Vdet-IC	2.8V±2%, -Reset, PPO	SON1408-3	18vda	VD7	3d Ric
F8	R3130N18EA	Vdet-IC	1.8V, -Reset PPO, 240ms	SOT-23	16vdc	VD7	3b Ric
F8	RT9808-35CV	Vdet-IC	3.5V±2%, -Reset ODO	SOT-23	16vdb	VD6	3a Rct
F8	TC54VC5802ECB	Vdet-IC	5.8V±2%, -Reset PPO	SOT-23	16vdb	VD7	3a Tcs
F8	XC61CC5802M	Vdet-IC	5.8V±1%, +Reset PPO	SOT-23	16vdb	VD7	3d Tor



SMD code	Type	Function	Short description	Case	Pinout	Sch.	St.	Mnf.
F83	XE61CC5845MR	Vdet-IC	5.8V±2%, -Reset PPO	SOT-23	16vdb	VD7	3h	Tor
F85	XC61FC5812M	Vdet-IC	5.8V±2%, +Reset PPO, 200ms	SOT-23	16vdb	VD7	3d	Tor
F85	XC61HC5812MR	Vdet-IC	5.8V±2%, -Reset PPO, 50..200ms	SOT-23	16vdc	VD7	3d	Tor
F86	XC61FC5842M	Vdet-IC	5.8V±2%, +Reset PPO, 400ms	SOT-23	16vdb	VD7	3d	Tor
F86	XC61HC5842MR	Vdet-IC	5.8V±2%, -Reset PPO, 80..400ms	SOT-23	16vdc	VD7	3d	Tor
F87	XC61FC5852M	Vdet-IC	5.8V±2%, +Reset PPO, 50ms	SOT-23	16vdb	VD7	3d	Tor
F87	XC61HC5852MR	Vdet-IC	5.8V±2%, -Reset PPO, 1..50ms	SOT-23	16vdc	VD7	3d	Tor
F8p	BF824	Si-pnp	FM RF, 30V, 25mA, 250mW, B>25, 450MHz	SOT-23	16ta	-	3a	PHH
F8p	BF824W	Si-pnp	FM RF, 30V, 25mA, 200mW, B>25, 450MHz	SOT-323	16ta	-	3a	PHH
F8p	BF828	Si-pnp	AF, 30V, 25mA, 250mW, 450MHz	SOT-23	16ta	-	3a	Phi
F8t	BF824	Si-pnp	FM RF, 30V, 25mA, 250mW, B>25, 450MHz	SOT-23	16ta	-	3a	PHM
F8t	BF824W	Si-pnp	FM RF, 30V, 25mA, 200mW, B>25, 450MHz	SOT-323	16ta	-	3a	PHM
F8W	BF824	Si-pnp	FM RF, 30V, 25mA, 250mW, B>25, 450MHz	SOT-23	16ta	-	3a	PhC
F8W	BF824W	Si-pnp	FM RF, 30V, 25mA, 200mW, B>25, 450MHz	SOT-323	16ta	-	3a	PhC
F9	1S5321	Si-diode	Dual, Schottky, 2x10V, 50mA	SC-59	16dg	-	3a	Tos
F9	2SA1774	Si-pnp	GP, 60V, 100mA, 150mW, B=150..560, 140MHz	SOT-416	16ta	-	3a	Ons
F9	BZX84-C15	Z-diode	13.8..15.6V, Zzt=30Q, Izt=20mA, 225mW	SOT-23	16dc	-	3a	Lge
F9	ELM7629HBB	Vdet-IC	2.9V±2%, +Reset PPO, 500ms	SOT-23	16vdc	VD7	3d	Elm
F9	R3111N592A	Vdet-IC	5.9V±2%, -Reset PPO	SOT-23	16vdd	VD7	3d	Ric
F9	R3113D291C	Vdet-IC	2.9V±2%, -Reset, PPO	SON1408-3	18vda	VD7	3d	Ric
F9	R3130N19EA	Vdet-IC	1.9V, -Reset PPO, 240ms	SOT-23	16vdc	VD7	3b	Ric
F9	RT9808-42CV	Vdet-IC	4.2V±2%, -Reset ODO	SOT-23	16vdb	VD6	3a	Rct
F9	TC54VC5901ECB	Vdet-IC	5.9V±2%, -Reset PPO	SOT-23	16vdb	VD7	3a	Tcs
F9	XC61CC5902M	Vdet-IC	5.9V±1%, +Reset PPO	SOT-23	16vdb	VD7	3d	Tor
F9-	RT9808-42PV	Vdet-IC	4.2V±2%, -Reset ODO	SOT-23	16vdb	VD6	3a	Rct
F92	DTB123TK	Si-pnp-Digi	Sw, 50V, 500mA, 200mW, 200MHz, R1=2k2	SOT-346	16ta	-	3a	Rhm
F93	DTB143TK	Si-pnp-Digi	Sw, 50V, 500mA, 200mW, 200MHz, R1=4k7	SOT-346	16ta	-	3a	Rhm
F93	XE61CC5945MR	Vdet-IC	5.9V±2%, -Reset PPO	SOT-23	16vdb	VD7	3h	Tor
F95	XC61FC5912M	Vdet-IC	5.9V±2%, +Reset PPO, 200ms	SOT-23	16vdb	VD7	3d	Tor
F95	XC61HC5912MR	Vdet-IC	5.9V±2%, -Reset PPO, 50..200ms	SOT-23	16vdc	VD7	3d	Tor
F96	XC61FC5942M	Vdet-IC	5.9V±2%, +Reset PPO, 400ms	SOT-23	16vdb	VD7	3d	Tor
F96	XC61HC5942MR	Vdet-IC	5.9V±2%, -Reset PPO, 80..400ms	SOT-23	16vdc	VD7	3d	Tor
F97	XC61FC5952M	Vdet-IC	5.9V±2%, +Reset PPO, 50ms	SOT-23	16vdb	VD7	3d	Tor
F97	XC61HC5952MR	Vdet-IC	5.9V±2%, -Reset PPO, 1..50ms	SOT-23	16vdc	VD7	3d	Tor
FA	2SC2619-A	Si-npn	AF, 100mA, 150mW, B=35..70, 230MHz	SOT-23	16ta	-	3a	Ren
FA	2SC4921	Si-npn-Digi	Mute, Drv, 25V, 100mA, 150mW, 240MHz, R1=R2=10kQ	SMCP	16ta	-	3a	San
FA	2SC5233-A	Si-npn	Sw, Muting, 15V, 500mA, 100mW, 130MHz, B=300..600	SOT-323	16ta	-	3a	Tos
FA	2SC5376-A	Si-npn	Sw, Muting, 15V, 400mA, 100mW, 130MHz, B=300..600	SOT-416	16ta	-	3a	Tos
FA	2SC5376F-A	Si-npn	Sw, Muting, 15V, 400mA, 100mW, 130MHz, B=300..600	SOT-490	18ta	-	3a	Tos
FA	2SC5376FV-A	Si-npn	Sw, Muting, 15V, 400mA, 150mW, 130MHz, B=300..600	SOT-723	18ta	-	3a	Tos
FA	ELM7620LDB	Vdet-IC	2.0V±2%, -Reset PPO, 50ms	SOT-23	16vdc	VD7	3d	Elm
FA	HSMP-4820	PLIN-diode	Dual, RF, Sw, 50V, 1A(1µs), <0.75pF, <0.6Q(10mA), 3GHz	SOT-323	16df	-	3a	Agi
FA	HSMP-482B	PLIN-diode	Dual, RF, Sw, 50V, 1A(1µs), <0.75pF, <0.6Q(10mA), 3GHz	SOT-323	16df	-	3a	Agi
FA	KRC151F	Si-npn-Digi	Sw, 20V, 50mA, 50mW, 200MHz, R1/R2=4.7/4.7k	TFSM	19ta	-	3k	Kec
FA	RT9808-44CV	Vdet-IC	4.4V±2%, -Reset ODO	SOT-23	16vdb	VD6	3a	Rct
FA	SiP810CMEUADT	Vdet-IC	4.38V±1.5%, +Reset PPO 1.5ms	SOT-23	16vdc	VD7	3g	Vs
FA	TC1277-5ENB	Vdet-IC	3.06V±2%, +Reset PPO	SOT-23	16vda	VD7	3d	Mcc
FA3	2SC1009A-3	Si-npn	FM/AM RF, 50V, 50mA, 150mW, 250MHz, B=60..120	SOT-23	16ta	-	3a	Nec
FA3	2SC4179-3	Si-npn	UHF, FM/AM, 50V, 50mA, 150mW, B=60..120, >150MHz	SOT-323	16ta	-	3a	Nec
FA4	2SC1009A-4	Si-npn	FM/AM RF, 50V, 50mA, 150mW, 250MHz, B=90..180	SOT-23	16ta	-	3a	Nec
FA4	2SC4179-4	Si-npn	UHF, FM/AM, 50V, 50mA, 150mW, B=90..180, >150MHz	SOT-323	16ta	-	3a	Nec
FAAA	MAX6326_R27-T	Vdet-IC	2.7V±1.5%, -Reset PPO	SOT-23	16vdc	VD7	3a	Max
FAAA	MAX6326UR27	Vdet-IC	2.7V±1.5%, -Reset PPO	SOT-23	16vdc	VD7	3a	Max
FAO	2SC5344SF-O	Si-npn	AF, 35V, 800mA, 200mW, 120MHz, B=100..200	SOT-23F	18ta	-	3a	Auk
FAO	2SC5344S-O	Si-npn	AF, 35V, 800mA, 200mW, 120MHz, B=100..200	SOT-23	16ta	-	3a	Auk
FAY	2SC5344SF-Y	Si-npn	AF, 35V, 800mA, 200mW, 120MHz, B=160..320	SOT-23F	18ta	-	3a	Auk
FAY	2SC5344S-Y	Si-npn	AF, 35V, 800mA, 200mW, 120MHz, B=160..320	SOT-23	16ta	-	3a	Auk
FB	2SC2619-B	Si-npn	AF, 100mA, 150mW, B=60..120, 230MHz	SOT-23	16ta	-	3a	Ren
FB	2SC3053-B	Si-npn	GP, AM/FM, 30V, 30mA, 150mW, B=35..70, 200MHz	SC-59	16ta	-	3a	Mit
FB	2SC4258-B	Si-npn	HF, AM/FM, 30V, 30mA, 150mW, 200MHz, B=35..70	SOT-323	16ta	-	3a	Mit
FB	2SC5016	Si-npn	VHF-Mix, 15V, 50mA, 1.3GHz	SOT-23	16te	-	3a	Pan
FB	2SC5216	Si-npn	VHF/UHF, 15V, 50mA, 200mW, 1.3GHz, B=100..350	SC-59	16ta	-	3a	Pan
FB	2SC5233-B	Si-npn	Sw, Muting, 15V, 500mA, 100mW, 130MHz, B=500..1000	SOT-323	16ta	-	3a	Tos
FB	2SC5376-B	Si-npn	Sw, Muting, 15V, 400mA, 100mW, 130MHz, B=500..1000	SOT-416	16ta	-	3a	Tos
FB	2SC5376F-B	Si-npn	Sw, Muting, 15V, 400mA, 100mW, 130MHz, B=500..1000	SOT-490	18ta	-	3a	Tos
FB	2SC5376FV-B	Si-npn	Sw, Muting, 15V, 400mA, 150mW, 130MHz, B=500..1000	SOT-723	18ta	-	3a	Tos
FB	2SC5384-B	Si-npn	HF, AM/FM, 30V, 30mA, 125mW, 200MHz, B=35..70	SC-75A	16ta	-	3a	Ish
FB	ELM7621LDB	Vdet-IC	2.1V±2%, -Reset PPO, 50ms	SOT-23	16vdc	VD7	3d	Elm
FB	KRC152F	Si-npn-Digi	Sw, 20V, 50mA, 50mW, 200MHz, R1/R2=10/10k	TFSM	19ta	-	3k	Kec
FB	RT9808-46CV	Vdet-IC	4.6V±2%, -Reset ODO	SOT-23	16vdb	VD6	3a	Rct



SMD code	Type	Function	Short description	Case	Pinout	Sch.	St.	Mnf.
FB	SiP810CLEUADT	Vdet-IC	4.63V±1.5%, +Reset PPO 1.5ms	SOT-23	16vdc	VD7	3g	Vs
FB	TC1277-10ENB	Vdet-IC	2.88V±2%, +Reset PPO	SOT-23	16vda	VD7	3d	Mcc
FBAA	MAX6326UR28	Vdet-IC	2.8V±1.5%, -Reset PPO	SOT-23	16vdc	VD7	3a	Max
FC	2SC2619-C	Si-npn	AF, 100mA, 150mW, B=100..200, 230MHz	SOT-23	16ta	-	3a	Ren
FC	2SC3053-C	Si-npn	GP, AM/FM, 30V, 30mA, 150mW, B=55..110, 200MHz	SC-59	16ta	-	3a	Mit
FC	2SC4258-C	Si-npn	HF, AM/FM, 30V, 30mA, 150mW, 200MHz, B=55..110	SOT-323	16ta	-	3a	Mit
FC	2SC5384-C	Si-npn	HF, AM/FM, 30V, 30mA, 125mW, 200MHz, B=55..110	SC-75A	16ta	-	3a	Ish
FC	ELM7622LDB	Vdet-IC	2.2V±2%, -Reset PPO, 50ms	SOT-23	16vdc	VD7	3d	Elm
FC	KRC153F	Si-npn-Digi	Sw, 20V, 50mA, 50mW, 200MHz, R1/R2=22/22k	TFSM	19ta	-	3k	Kec
FC	RT9808-22CV	Vdet-IC	2.2V±2%, -Reset ODO	SOT-23	16vdb	VD6	3a	Rct
FC	TC1277-20ENB	Vdet-IC	2.55V±2%, +Reset PPO	SOT-23	16vda	VD7	3d	Mcc
FC	UN211V	Si-pnp-Digi	Sw, 50V, 100mA, 200mW, 80MHz, R1/R2=2k2/2k2	SC-59	16ta	-	3a	Pan
FC	UN511V	Si-pnp-Digi	Sw, 50V, 100mA, 150mW, 80MHz, R1/R2=2k2/2k2	SOT-23	16ta	-	3a	Pan
FC	UNR211V	Si-pnp-Digi	Sw, 50V, 100mA, 200mW, 80MHz, R1/R2=2k2/2k2	SC-59	16ta	-	3a	Pan
FC	UNR511V	Si-pnp-Digi	Sw, 50V, 100mA, 150mW, 80MHz, R1/R2=2k2/2k2	SOT-323	16ta	-	3a	Pan
FC	UNR911VJ	Si-pnp-Digi	Sw, 50V, 100mA, 125mW, 80MHz, R1/R2=2k2/2k2	SC-89	18ta	-	3a	Pan
FC-	RT9808-22PV	Vdet-IC	2.2V±2%, -Reset ODO	SOT-23	16vdb	VD6	3a	Rct
FC11G	AIC1747-11GK3	LVR-IC	LDO, 1.1V±2%, 300mA	TSOT-23	16cg	VR1	3a	Aic
FC11P	AIC1747-11PK3	LVR-IC	LDO, 1.1V±2%, 300mA	TSOT-23	16cg	VR1	3a	Aic
FC12G	AIC1747-12GK3	LVR-IC	LDO, 1.2V±2%, 300mA	TSOT-23	16cg	VR1	3a	Aic
FC12P	AIC1747-12PK3	LVR-IC	LDO, 1.2V±2%, 300mA	TSOT-23	16cg	VR1	3a	Aic
FC13G	AIC1747-13GK3	LVR-IC	LDO, 1.3V±2%, 300mA	TSOT-23	16cg	VR1	3a	Aic
FC13P	AIC1747-13PK3	LVR-IC	LDO, 1.3V±2%, 300mA	TSOT-23	16cg	VR1	3a	Aic
FC15G	AIC1747-15GK3	LVR-IC	LDO, 1.5V±2%, 300mA	TSOT-23	16cg	VR1	3a	Aic
FC15P	AIC1747-15PK3	LVR-IC	LDO, 1.5V±2%, 300mA	TSOT-23	16cg	VR1	3a	Aic
FC18G	AIC1747-18GK3	LVR-IC	LDO, 1.8V±2%, 300mA	TSOT-23	16cg	VR1	3a	Aic
FC18P	AIC1747-18PK3	LVR-IC	LDO, 1.8V±2%, 300mA	TSOT-23	16cg	VR1	3a	Aic
FC20G	AIC1747-20GK3	LVR-IC	LDO, 2.0V±2%, 300mA	TSOT-23	16cg	VR1	3a	Aic
FC20P	AIC1747-20PK3	LVR-IC	LDO, 2.0V±2%, 300mA	TSOT-23	16cg	VR1	3a	Aic
FC25G	AIC1747-25GK3	LVR-IC	LDO, 2.5V±2%, 300mA	TSOT-23	16cg	VR1	3a	Aic
FC25P	AIC1747-25PK3	LVR-IC	LDO, 2.5V±2%, 300mA	TSOT-23	16cg	VR1	3a	Aic
FC27G	AIC1747-27GK3	LVR-IC	LDO, 2.7V±2%, 300mA	TSOT-23	16cg	VR1	3a	Aic
FC27P	AIC1747-27PK3	LVR-IC	LDO, 2.7V±2%, 300mA	TSOT-23	16cg	VR1	3a	Aic
FC2JG	AIC1747-285GK3	LVR-IC	LDO, 2.85V±2%, 300mA	TSOT-23	16cg	VR1	3a	Aic
FC2JP	AIC1747-285PK3	LVR-IC	LDO, 2.85V±2%, 300mA	TSOT-23	16cg	VR1	3a	Aic
FC30G	AIC1747-30GK3	LVR-IC	LDO, 3.0V±2%, 300mA	TSOT-23	16cg	VR1	3a	Aic
FC30P	AIC1747-30PK3	LVR-IC	LDO, 3.0V±2%, 300mA	TSOT-23	16cg	VR1	3a	Aic
FC33G	AIC1747-33GK3	LVR-IC	LDO, 3.3V±2%, 300mA	TSOT-23	16cg	VR1	3a	Aic
FC33P	AIC1747-33PK3	LVR-IC	LDO, 3.3V±2%, 300mA	TSOT-23	16cg	VR1	3a	Aic
FC35G	AIC1747-35GK3	LVR-IC	LDO, 3.5V±2%, 300mA	TSOT-23	16cg	VR1	3a	Aic
FC35P	AIC1747-35PK3	LVR-IC	LDO, 3.5V±2%, 300mA	TSOT-23	16cg	VR1	3a	Aic
FC37G	AIC1747-37GK3	LVR-IC	LDO, 3.7V±2%, 300mA	TSOT-23	16cg	VR1	3a	Aic
FC37P	AIC1747-37PK3	LVR-IC	LDO, 3.7V±2%, 300mA	TSOT-23	16cg	VR1	3a	Aic
FC38G	AIC1747-38GK3	LVR-IC	LDO, 3.8V±2%, 300mA	TSOT-23	16cg	VR1	3a	Aic
FC38P	AIC1747-38PK3	LVR-IC	LDO, 3.8V±2%, 300mA	TSOT-23	16cg	VR1	3a	Aic
FCAA	MAX6326_R29-T	Vdet-IC	2.9V±1.5%, -Reset PPO	SOT-23	16vdc	VD7	3a	Max
FCAA	MAX6326UR29	Vdet-IC	2.9V±1.5%, -Reset PPO	SOT-23	16vdc	VD7	3a	Max
FD	2SC3053-D	Si-npn	GP, AM/FM, 30V, 30mA, 150mW, B=90..180, 200MHz	SC-59	16ta	-	3a	Mit
FD	2SC4258-D	Si-npn	HF, AM/FM, 30V, 30mA, 150mW, 200MHz, B=90..180	SOT-323	16ta	-	3a	Mit
FD	2SC5384-D	Si-npn	HF, AM/FM, 30V, 30mA, 125mW, 200MHz, B=90..180	SC-75A	16ta	-	3a	Ish
FD	AAT3562IGY-2.70	Vdet-IC	2.7V±1.5%, -Reset ODO	SOT-23	16vdc	VD6	3b	Ant
FD	BCV26	Si-pnp-Darl	AF, 40V, 500mA, 300mW, 200MHz, B>4000	SOT-23	16ta	-	3a	Ste
FD	ELM7623LDB	Vdet-IC	2.3V±2%, -Reset PPO, 50ms	SOT-23	16vdc	VD7	3d	Elm
FD	KRC154F	Si-npn-Digi	Sw, 20V, 50mA, 50mW, 200MHz, R1/R2=47/47k	TFSM	19ta	-	3k	Kec
FD	RT9808-26CV	Vdet-IC	2.6V±2%, -Reset ODO	SOT-23	16vdb	VD6	3a	Rct
FD	SiP810CREUDDT	Vdet-IC	2.63V±1.5%, +Reset PPO 30ms	SOT-23	16vdc	VD7	3g	Vs
FD	UN221V	Si-npn-Digi	Sw, 50V, 100mA, 200mW, 150MHz, R1/R2=2k2/2k2	SC-59	16ta	-	3a	Pan
FD	UN521V	Si-npn-Digi	Sw, 50V, 100mA, 150mW, 150MHz, R1/R2=2k2/2k2	SOT-23	16ta	-	3a	Pan
FD	UNR221V	Si-npn-Digi	Sw, 50V, 100mA, 200mW, 150MHz, R1/R2=2k2/2k2	SC-59	16ta	-	3a	Pan
FD	UNR521V	Si-npn-Digi	Sw, 50V, 100mA, 150mW, 150MHz, R1/R2=2k2/2k2	SOT-323	16ta	-	3a	Pan
FD	UNR921VJ	Si-npn-Digi	Sw, 50V, 100mA, 125mW, 150MHz, R1/R2=2k2/2k2	SC-89	18ta	-	3a	Pan
FDA	MAX6326_R31-T	Vdet-IC	3.1V±1.5%, -Reset PPO	SOT-23	16vdc	VD7	3a	Max
FDA	MAX6326UR31	Vdet-IC	3.1V±1.5%, -Reset PPO	SOT-23	16vdc	VD7	3a	Max
FDp	BCV26	Si-pnp-Darl	AF, 40V, 500mA, 300mW, 200MHz, B>4000	SOT-23	16ta	-	3a	PHH
FDs	BCV26	Si-pnp-Darl	AF, 40V, 500mA, 300mW, 200MHz, B>4000	SOT-23	16ta	-	3c	Inf
FDt	BCV26	Si-pnp-Darl	AF, 40V, 500mA, 300mW, 200MHz, B>4000	SOT-23	16ta	-	3a	PHM
FDW	BCV26	Si-pnp-Darl	AF, 40V, 500mA, 300mW, 200MHz, B>4000	SOT-23	16ta	-	3a	PhC
FE	BCV46	Si-pnp-Darl	AF, 80V, 500mA, 300mW, 200MHz, B>2000	SOT-23	16ta	-	3a	Ste
FE	ELM7624LDB	Vdet-IC	2.4V±2%, -Reset PPO, 50ms	SOT-23	16vdc	VD7	3d	Elm
FE	SiP810C27EUDDT	Vdet-IC	2.7V±1.5%, +Reset PPO 30ms	SOT-23	16vdc	VD7	3g	Vs



SMD code	Type	Function	Short description	Case	Pinout	Sch.	St.	Mnf.
FE	UN211Z	Si-pnp-Digi	Sw, 50V, 100mA, 200mW, 80MHz, R1/R2=4k7/22k	SC-59	16ta	-	3a	Pan
FE	UN511Z	Si-pnp-Digi	Sw, 50V, 100mA, 150mW, 80MHz, R1/R2=4k7/22k	SOT-23	16ta	-	3a	Pan
FE	UNR211Z	Si-pnp-Digi	Sw, 50V, 100mA, 200mW, 80MHz, R1/R2=4k7/22k	SC-59	16ta	-	3a	Pan
FE	UNR511Z	Si-pnp-Digi	Sw, 50V, 100mA, 150mW, 80MHz, R1/R2=4k7/22k	SOT-323	16ta	-	3a	Pan
FE-	RT9808-25PV	Vdet-IC	2.5V±2%, -Reset ODO	SOT-23	16vdb	VD6	3a	Rct
FE11G	AIC1747-11GU3	LVR-IC	LDO, 1.1V±2%, 300mA	SOT-23	16cg	VR1	3a	Aic
FE11P	AIC1747-11PU3	LVR-IC	LDO, 1.1V±2%, 300mA	SOT-23	16cg	VR1	3a	Aic
FE12G	AIC1747-12GU3	LVR-IC	LDO, 1.2V±2%, 300mA	SOT-23	16cg	VR1	3a	Aic
FE12P	AIC1747-12PU3	LVR-IC	LDO, 1.2V±2%, 300mA	SOT-23	16cg	VR1	3a	Aic
FE13G	AIC1747-13GU3	LVR-IC	LDO, 1.3V±2%, 300mA	SOT-23	16cg	VR1	3a	Aic
FE13P	AIC1747-13PU3	LVR-IC	LDO, 1.3V±2%, 300mA	SOT-23	16cg	VR1	3a	Aic
FE15G	AIC1747-15GU3	LVR-IC	LDO, 1.5V±2%, 300mA	SOT-23	16cg	VR1	3a	Aic
FE15P	AIC1747-15PU3	LVR-IC	LDO, 1.5V±2%, 300mA	SOT-23	16cg	VR1	3a	Aic
FE18G	AIC1747-18GU3	LVR-IC	LDO, 1.8V±2%, 300mA	SOT-23	16cg	VR1	3a	Aic
FE18P	AIC1747-18PU3	LVR-IC	LDO, 1.8V±2%, 300mA	SOT-23	16cg	VR1	3a	Aic
FE20G	AIC1747-20GU3	LVR-IC	LDO, 2.0V±2%, 300mA	SOT-23	16cg	VR1	3a	Aic
FE20P	AIC1747-20PU3	LVR-IC	LDO, 2.0V±2%, 300mA	SOT-23	16cg	VR1	3a	Aic
FE25G	AIC1747-25GU3	LVR-IC	LDO, 2.5V±2%, 300mA	SOT-23	16cg	VR1	3a	Aic
FE25P	AIC1747-25PU3	LVR-IC	LDO, 2.5V±2%, 300mA	SOT-23	16cg	VR1	3a	Aic
FE27G	AIC1747-27GU3	LVR-IC	LDO, 2.7V±2%, 300mA	SOT-23	16cg	VR1	3a	Aic
FE27P	AIC1747-27PU3	LVR-IC	LDO, 2.7V±2%, 300mA	SOT-23	16cg	VR1	3a	Aic
FE2JG	AIC1747-285GU3	LVR-IC	LDO, 2.85V±2%, 300mA	SOT-23	16cg	VR1	3a	Aic
FE2JP	AIC1747-285PU3	LVR-IC	LDO, 2.85V±2%, 300mA	SOT-23	16cg	VR1	3a	Aic
FE30G	AIC1747-30GU3	LVR-IC	LDO, 3.0V±2%, 300mA	SOT-23	16cg	VR1	3a	Aic
FE30P	AIC1747-30PU3	LVR-IC	LDO, 3.0V±2%, 300mA	SOT-23	16cg	VR1	3a	Aic
FE33G	AIC1747-33GU3	LVR-IC	LDO, 3.3V±2%, 300mA	SOT-23	16cg	VR1	3a	Aic
FE33P	AIC1747-33PU3	LVR-IC	LDO, 3.3V±2%, 300mA	SOT-23	16cg	VR1	3a	Aic
FE35G	AIC1747-35GU3	LVR-IC	LDO, 3.5V±2%, 300mA	SOT-23	16cg	VR1	3a	Aic
FE35P	AIC1747-35PU3	LVR-IC	LDO, 3.5V±2%, 300mA	SOT-23	16cg	VR1	3a	Aic
FE37G	AIC1747-37GU3	LVR-IC	LDO, 3.7V±2%, 300mA	SOT-23	16cg	VR1	3a	Aic
FE37P	AIC1747-37PU3	LVR-IC	LDO, 3.7V±2%, 300mA	SOT-23	16cg	VR1	3a	Aic
FE38G	AIC1747-38GU3	LVR-IC	LDO, 3.8V±2%, 300mA	SOT-23	16cg	VR1	3a	Aic
FE38P	AIC1747-38PU3	LVR-IC	LDO, 3.8V±2%, 300mA	SOT-23	16cg	VR1	3a	Aic
FEAA	MAX6326_R30-T	Vdet-IC	3.0V±1.5%, -Reset PPO	SOT-23	16vdc	VD7	3a	Max
FEAA	MAX6326UR30	Vdet-IC	3.0V±1.5%, -Reset PPO	SOT-23	16vdc	VD7	3a	Max
FEp	BCV46	Si-pnp-Darl	AF, 80V, 500mA, 300mW, 200MHz, B>2000	SOT-23	16ta	-	3a	PhH
FEs	BCV46	Si-pnp-Darl	AF, 80V, 500mA, 300mW, 200MHz, B>2000	SOT-23	16ta	-	3c	Inf
FEt	BCV46	Si-pnp-Darl	AF, 80V, 500mA, 300mW, 200MHz, B>2000	SOT-23	16ta	-	3a	PhM
FEW	BCV46	Si-pnp-Darl	AF, 80V, 500mA, 300mW, 200MHz, B>2000	SOT-23	16ta	-	3a	PhC
FF	BCV27	Si-npn-Darl	AF, 40V, 300mA, 300mW, 200MHz, B>4000	SOT-23	16ta	-	3a	Ste
FF	ELM7625LDB	Vdet-IC	2.5V±2%, -Reset PPO, 50ms	SOT-23	16vdc	VD7	3d	Elm
FF	RT9808-17CV	Vdet-IC	1.7V±2%, -Reset ODO	SOT-23	16vdb	VD6	3a	Rct
FF	UN221Z	Si-npn-Digi	Sw, 50V, 100mA, 200mW, 150MHz, R1/R2=4k7/22k	SC-59	16ta	-	3a	Pan
FF	UN521Z	Si-npn-Digi	Sw, 50V, 100mA, 150mW, 150MHz, R1/R2=4k7/22k	SOT-23	16ta	-	3a	Pan
FF	UNR221Z	Si-npn-Digi	Sw, 50V, 100mA, 200mW, 150MHz, R1/R2=4k7/22k	SC-59	16ta	-	3a	Pan
FF	UNR521Z	Si-npn-Digi	Sw, 50V, 100mA, 150mW, 150MHz, R1/R2=4k7/22k	SOT-323	16ta	-	3a	Pan
FFAA	MAX6327UR23-T	Vdet-IC	2.3V±1.5%, +Reset PPO	SOT-23	16vdc	VD7	3a	Max
FFMA	MAX6327UR31-T	Vdet-IC	3.1V±1.5%, +Reset PPO	SOT-23	16vdc	VD7	3a	Max
FFNA	MAX6327UR30-T	Vdet-IC	3.0V±1.5%, +Reset PPO	SOT-23	16vdc	VD7	3a	Max
FFp	BCV27	Si-npn-Darl	AF, 40V, 500mA, 300mW, 200MHz, B>4000	SOT-23	16ta	-	3a	PhH
FFs	BCV27	Si-npn-Darl	AF, 40V, 500mA, 300mW, 200MHz, B>4000	SOT-23	16ta	-	3c	Inf
FFt	BCV27	Si-npn-Darl	AF, 40V, 500mA, 300mW, 200MHz, B>4000	SOT-23	16ta	-	3a	PhM
FFW	BCV27	Si-npn-Darl	AF, 40V, 500mA, 300mW, 200MHz, B>4000	SOT-23	16ta	-	3a	PhC
FG	ELM7626LDB	Vdet-IC	2.6V±2%, -Reset PPO, 50ms	SOT-23	16vdc	VD7	3d	Elm
FG	KRC157F	Si-npn-Digi	Sw, 20V, 50mA, 50mW, 200MHz, R1/R2=10/47k	TFSM	19ta	-	3k	Kec
FG	RT9808-24CV	Vdet-IC	2.4V±2%, -Reset ODO	SOT-23	16vdb	VD6	3a	Rct
FG	SIP810CSEUDDT	Vdet-IC	2.93V±1.5%, +Reset PPO 30ms	SOT-23	16vdc	VD7	3g	Vs
FG-	RT9808-24PV	Vdet-IC	2.4V±2%, -Reset ODO	SOT-23	16vdb	VD6	3a	Rct
FGAA	MAX6327UR24-T	Vdet-IC	2.4V±1.5%, +Reset PPO	SOT-23	16vdc	VD7	3a	Max
FGp	BCV47	Si-npn-Darl	AF, 80V, 500mA, 300mW, 200MHz, B>2000	SOT-23	16ta	-	3a	PhH
FGR	KTA2013F-GR	Si-pnp	AF, Sw, 20V, 150mA, 50mW, B=200..400, >80MHz	TFSM	19ta	-	3f	Kec
FGs	BCV47	Si-npn-Darl	AF, 80V, 500mA, 300mW, 200MHz, B>2000	SOT-23	16ta	-	3c	Inf
FGt	BCV47	Si-npn-Darl	AF, 80V, 500mA, 300mW, 200MHz, B>2000	SOT-23	16ta	-	3a	PhM
FGW	BCV47	Si-npn-Darl	AF, 80V, 500mA, 300mW, 200MHz, B>2000	SOT-23	16ta	-	3a	PhC
FH	1SS366	Si-diode	Dual, SBD, VHF/UHF-det/mix, 10V, 35mA, VF<0.42V(1mA), <0.85pF	CP	16dl	-	3a	San
FH	1SS375	Si-diode	Dual, SBD, VHF/UHF-det/mix, VF<0.42V(1mA), <0.85pF	MCP	16dl	-	3a	San
FH	ELM7627LDB	Vdet-IC	2.7V±2%, -Reset PPO, 50ms	SOT-23	16vdc	VD7	3d	Elm
FH	KRC158F	Si-npn-Digi	Sw, 20V, 50mA, 50mW, 200MHz, R1/R2=22/47k	TFSM	19ta	-	3k	Kec
FH	RT9808-45CV	Vdet-IC	4.5V±2%, -Reset ODO	SOT-23	16vdb	VD6	3a	Rct
FH	SIP810CTEUDDT	Vdet-IC	3.08V±1.5%, +Reset PPO 30ms	SOT-23	16vdc	VD7	3g	Vs



SMD code	Type	Function	Short description	Case	Pinout	Sch.	St.	Mnf.
FHAA	MAX6327UR25-T	Vdet-IC	2.5V±1.5%, +Reset PPO	SOT-23	16vdc	VD7	3a	Max
FHP	2SC5020-P	Si-npn	AM/FM, 30V, 15mA, 150mW, B=40..110, 650MHz	SOT-323	16ta	-	3a	Pan
FHQ	2SC5020-Q	Si-npn	AM/FM, 30V, 15mA, 150mW, B=65..160, 650MHz	SOT-323	16ta	-	3a	Pan
FHR	2SC5020-R	Si-npn	AM/FM, 30V, 15mA, 150mW, B=100..260, 650MHz	SOT-323	16ta	-	3a	Pan
FHs	BFN24	Si-npn	Vid, 250V, 200mA, 360mW, B>40, 70MHz	SOT-23	16ta	-	3a	Sie
FI	SiP810CJEUDDT	Vdet-IC	4V±1.5%, +Reset PPO 30ms	SOT-23	16vdc	VD7	3g	Vs
FIAA	MAX6327UR26-T	Vdet-IC	2.6V±1.5%, +Reset PPO	SOT-23	16vdc	VD7	3a	Max
FJ	ELM7628LDB	Vdet-IC	2.8V±2%, -Reset PPO, 50ms	SOT-23	16vdc	VD7	3d	Elm
FJ	KRC159F	Si-npn-Digi	Sw, 20V, 50mA, 50mW, 200MHz, R1/R2=47/22k	TFSM	19ta	-	3k	Kec
FJ	RT9808-50CV	Vdet-IC	5.0V±2%, -Reset ODO	SOT-23	16vdb	VD6	3a	Rct
FJ3	2SK1069-3	n-FET	GP, AF, 40V, 20mA, 150mW, Idss=1.2..3mA, Up<2V	MCP	16fa	-	3a	San
FJ3	2SK771-3	n-FET	AF-Amp, 40V, 20mA, 200mW, Idss=1.2..3mA	SOT-23	16fa	-	3a	San
FJ4	2SK1069-4	n-FET	GP, AF, 40V, 20mA, 150mW, Idss=2.5..6mA, Up<2V	MCP	16fa	-	3a	San
FJ4	2SK771-4	n-FET	AF-Amp, 40V, 20mA, 200mW, Idss=2.5..6mA	SOT-23	16fa	-	3a	San
FJ5	2SK1069-5	n-FET	GP, AF, 40V, 20mA, 150mW, Idss=5..12mA, Up<2V	MCP	16fa	-	3a	San
FJ5	2SK771-5	n-FET	AF-Amp, 40V, 20mA, 200mW, Idss=5..12mA	SOT-23	16fa	-	3a	San
FJAA	MAX6327UR27-T	Vdet-IC	2.7V±1.5%, +Reset PPO	SOT-23	16vdc	VD7	3a	Max
FJs	BFN26	Si-npn	Vid, 300V, 200mA, 360mW, B>30, 70MHz	SOT-23	16ta	-	3a	Sie
FK	ELM7629LDB	Vdet-IC	2.9V±2%, -Reset PPO, 50ms	SOT-23	16vdc	VD7	3d	Elm
FK	KRC160F	Si-npn-Digi	Sw, 20V, 50mA, 50mW, 200MHz, R1=4.7k	TFSM	19ta	-	3k	Kec
FK	RT9808-32CV	Vdet-IC	3.2V±2%, -Reset ODO	SOT-23	16vdb	VD6	3a	Rct
FK	SiP810CMEUDDT	Vdet-IC	4.38V±1.5%, +Reset PPO 30ms	SOT-23	16vdc	VD7	3g	Vs
FK	UNR32A1	Si-npn-Digi	Sw, 50V, 80mA, 100mW, 150MHz, R1/R2=10k/10k	SSSMini3	18ta	-	3a	Pan
FKAA	MAX6327UR28-T	Vdet-IC	2.8V±1.5%, +Reset PPO	SOT-23	16vdc	VD7	3a	Max
FKs	BFN25	Si-npn	Vid, 250V, 200mA, 360mW, B>40, 100MHz	SOT-23	16ta	-	3a	Sie
FL	2SA1434	Si-pnp	AF, Amp, 60V, 100mA, 200mW, B=500..1200, >100MHz	SOT-23	16ta	-	3a	San
FL	KRC161F	Si-npn-Digi	Sw, 20V, 50mA, 50mW, 200MHz, R1=10k	TFSM	19ta	-	3k	Kec
FL	SiP810CLEUDDT	Vdet-IC	4.63V±1.5%, +Reset PPO 30ms	SOT-23	16vdc	VD7	3g	Vs
FL	UNR32A2	Si-npn-Digi	Sw, 50V, 80mA, 100mW, 150MHz, R/R2=22k/22k	SSSMini3	18ta	-	3a	Pan
FL11G	AIC1746-11GK3	LVR-IC	LDO, 1.1V±2%, 150mA	TSOT-23	16cg	VR1	3a	Aic
FL11P	AIC1746-11PK3	LVR-IC	LDO, 1.1V±2%, 150mA	TSOT-23	16cg	VR1	3a	Aic
FL12G	AIC1746-12GK3	LVR-IC	LDO, 1.2V±2%, 150mA	TSOT-23	16cg	VR1	3a	Aic
FL12P	AIC1746-12PK3	LVR-IC	LDO, 1.2V±2%, 150mA	TSOT-23	16cg	VR1	3a	Aic
FL13G	AIC1746-13GK3	LVR-IC	LDO, 1.3V±2%, 150mA	TSOT-23	16cg	VR1	3a	Aic
FL13P	AIC1746-13PK3	LVR-IC	LDO, 1.3V±2%, 150mA	TSOT-23	16cg	VR1	3a	Aic
FL15G	AIC1746-15GK3	LVR-IC	LDO, 1.5V±2%, 150mA	TSOT-23	16cg	VR1	3a	Aic
FL15P	AIC1746-15PK3	LVR-IC	LDO, 1.5V±2%, 150mA	TSOT-23	16cg	VR1	3a	Aic
FL18G	AIC1746-18GK3	LVR-IC	LDO, 1.8V±2%, 150mA	TSOT-23	16cg	VR1	3a	Aic
FL18P	AIC1746-18PK3	LVR-IC	LDO, 1.8V±2%, 150mA	TSOT-23	16cg	VR1	3a	Aic
FL20G	AIC1746-20GK3	LVR-IC	LDO, 2.0V±2%, 150mA	TSOT-23	16cg	VR1	3a	Aic
FL20P	AIC1746-20PK3	LVR-IC	LDO, 2.0V±2%, 150mA	TSOT-23	16cg	VR1	3a	Aic
FL25G	AIC1746-25GK3	LVR-IC	LDO, 2.5V±2%, 150mA	TSOT-23	16cg	VR1	3a	Aic
FL25P	AIC1746-25PK3	LVR-IC	LDO, 2.5V±2%, 150mA	TSOT-23	16cg	VR1	3a	Aic
FL27G	AIC1746-27GK3	LVR-IC	LDO, 2.7V±2%, 150mA	TSOT-23	16cg	VR1	3a	Aic
FL27P	AIC1746-27PK3	LVR-IC	LDO, 2.7V±2%, 150mA	TSOT-23	16cg	VR1	3a	Aic
FL2JG	AIC1746-285GK3	LVR-IC	LDO, 2.85V±2%, 150mA	TSOT-23	16cg	VR1	3a	Aic
FL2JP	AIC1746-285PK3	LVR-IC	LDO, 2.85V±2%, 150mA	TSOT-23	16cg	VR1	3a	Aic
FL30G	AIC1746-30GK3	LVR-IC	LDO, 3.0V±2%, 150mA	TSOT-23	16cg	VR1	3a	Aic
FL30P	AIC1746-30PK3	LVR-IC	LDO, 3.0V±2%, 150mA	TSOT-23	16cg	VR1	3a	Aic
FL33G	AIC1746-33GK3	LVR-IC	LDO, 3.3V±2%, 150mA	TSOT-23	16cg	VR1	3a	Aic
FL33P	AIC1746-33PK3	LVR-IC	LDO, 3.3V±2%, 150mA	TSOT-23	16cg	VR1	3a	Aic
FL35G	AIC1746-35GK3	LVR-IC	LDO, 3.5V±2%, 150mA	TSOT-23	16cg	VR1	3a	Aic
FL35P	AIC1746-35PK3	LVR-IC	LDO, 3.5V±2%, 150mA	TSOT-23	16cg	VR1	3a	Aic
FL37G	AIC1746-37GK3	LVR-IC	LDO, 3.7V±2%, 150mA	TSOT-23	16cg	VR1	3a	Aic
FL37P	AIC1746-37PK3	LVR-IC	LDO, 3.7V±2%, 150mA	TSOT-23	16cg	VR1	3a	Aic
FL38G	AIC1746-38GK3	LVR-IC	LDO, 3.8V±2%, 150mA	TSOT-23	16cg	VR1	3a	Aic
FL38P	AIC1746-38PK3	LVR-IC	LDO, 3.8V±2%, 150mA	TSOT-23	16cg	VR1	3a	Aic
FLAA	MAX6327UR29-T	Vdet-IC	2.9V±1.5%, +Reset PPO	SOT-23	16vdc	VD7	3a	Max
FLN	ELM7527CEB	Vdet-IC	2.7V±2%, +Reset PPO	SC-70	16vdb	VD7	3d	Elm
FLN	ELM7527NEB	Vdet-IC	2.7V±2%, +Reset ODO	SC-70	16vdb	VD6	3d	Elm
FLs	BFN27	Si-pnp	Vid, 300V, 200mA, 360mW, B>30, 100MHz	SOT-23	16ta	-	3a	Sie
FM	2SJ502	p-MOSFET-e*	Sw, U-Sp, 30V, 500mA, 250mW, 8/40ns, <0.9Q(300mA)	SOT-23	16fh	-	3a	San
FM	RT9808-40CV	Vdet-IC	4.0V±2%, -Reset ODO	SOT-23	16vdb	VD6	3a	Rct
FM-	RT9808-40PV	Vdet-IC	4.0V±2%, -Reset ODO	SOT-23	16vdb	VD6	3a	Rct
FM0	BB804-0	C-diode	Dual, VHF, 18V, 50mA, 42/43.5pF	SOT-23	16dg	-	3g	Vs
FM1	BB804-1	C-diode	Dual, VHF, 18V, 50mA, 43/44.5pF	SOT-23	16dg	-	3g	Vs
FM2	BB804-2	C-diode	Dual, VHF, 18V, 50mA, 44/45.5pF	SOT-23	16dg	-	3g	Vs
FM3	BB804-3	C-diode	Dual, VHF, 18V, 50mA, 45/46.5pF	SOT-23	16dg	-	3g	Vs
FM4	BB804-4	C-diode	Dual, VHF, 18V, 50mA, 46/47.5pF	SOT-23	16dg	-	3g	Vs
FN	KRC163F	Si-npn-Digi	Sw, 20V, 50mA, 50mW, 200MHz, R1=22k	TFSM	19ta	-	3k	Kec



SMD code	Type	Function	Short description	Case	Pinout	Sch.	St.	Mnf.
FN	RT9808-15CV	Vdet-IC	1.5V±2%, -Reset ODO	SOT-23	16vdb	VD6	3a	Rct
FN	SiP810CREUEDT	Vdet-IC	2.63V±1.5%, +Reset PPO 150ms	SOT-23	16vdc	VD7	3g	Vs
FN	UNR32A3	Si-npn-Digi	Sw, 50V, 80mA, 100mW, 150MHz, R1/R2=47k/47k	SSSMini3	18ta	-	3a	Pan
FN11G	AIC1746-11GU3	LVR-IC	LDO, 1.1V±2%, 150mA	SOT-23	16cg	VR1	3a	Aic
FN11P	AIC1746-11PU3	LVR-IC	LDO, 1.1V±2%, 150mA	SOT-23	16cg	VR1	3a	Aic
FN12G	AIC1746-12GU3	LVR-IC	LDO, 1.2V±2%, 150mA	SOT-23	16cg	VR1	3a	Aic
FN12P	AIC1746-12PU3	LVR-IC	LDO, 1.2V±2%, 150mA	SOT-23	16cg	VR1	3a	Aic
FN13G	AIC1746-13GU3	LVR-IC	LDO, 1.3V±2%, 150mA	SOT-23	16cg	VR1	3a	Aic
FN13P	AIC1746-13PU3	LVR-IC	LDO, 1.3V±2%, 150mA	SOT-23	16cg	VR1	3a	Aic
FN15G	AIC1746-15GU3	LVR-IC	LDO, 1.5V±2%, 150mA	SOT-23	16cg	VR1	3a	Aic
FN15P	AIC1746-15PU3	LVR-IC	LDO, 1.5V±2%, 150mA	SOT-23	16cg	VR1	3a	Aic
FN18G	AIC1746-18GU3	LVR-IC	LDO, 1.8V±2%, 150mA	SOT-23	16cg	VR1	3a	Aic
FN18P	AIC1746-18PU3	LVR-IC	LDO, 1.8V±2%, 150mA	SOT-23	16cg	VR1	3a	Aic
FN20G	AIC1746-20GU3	LVR-IC	LDO, 2.0V±2%, 150mA	SOT-23	16cg	VR1	3a	Aic
FN20P	AIC1746-20PU3	LVR-IC	LDO, 2.0V±2%, 150mA	SOT-23	16cg	VR1	3a	Aic
FN25G	AIC1746-25GU3	LVR-IC	LDO, 2.5V±2%, 150mA	SOT-23	16cg	VR1	3a	Aic
FN25P	AIC1746-25PU3	LVR-IC	LDO, 2.5V±2%, 150mA	SOT-23	16cg	VR1	3a	Aic
FN27G	AIC1746-27GU3	LVR-IC	LDO, 2.7V±2%, 150mA	SOT-23	16cg	VR1	3a	Aic
FN27P	AIC1746-27PU3	LVR-IC	LDO, 2.7V±2%, 150mA	SOT-23	16cg	VR1	3a	Aic
FN2JG	AIC1746-285GU3	LVR-IC	LDO, 2.85V±2%, 150mA	SOT-23	16cg	VR1	3a	Aic
FN2JP	AIC1746-285PU3	LVR-IC	LDO, 2.85V±2%, 150mA	SOT-23	16cg	VR1	3a	Aic
FN3	2SC4863-3	Si-npn	VHF/UHF-Amp, 16V, 70mA, 200mW, B=60..120, 7GHz	MCP	16ta	-	3a	San
FN3	2SC4864-3	Si-npn	VHF/UHF-Amp, 16V, 70mA, 200mW, B=60..120, 7GHz	CP	16ta	-	3a	San
FN30G	AIC1746-30GU3	LVR-IC	LDO, 3.0V±2%, 150mA	SOT-23	16cg	VR1	3a	Aic
FN30P	AIC1746-30PU3	LVR-IC	LDO, 3.0V±2%, 150mA	SOT-23	16cg	VR1	3a	Aic
FN33G	AIC1746-33GU3	LVR-IC	LDO, 3.3V±2%, 150mA	SOT-23	16cg	VR1	3a	Aic
FN33P	AIC1746-33PU3	LVR-IC	LDO, 3.3V±2%, 150mA	SOT-23	16cg	VR1	3a	Aic
FN35G	AIC1746-35GU3	LVR-IC	LDO, 3.5V±2%, 150mA	SOT-23	16cg	VR1	3a	Aic
FN35P	AIC1746-35PU3	LVR-IC	LDO, 3.5V±2%, 150mA	SOT-23	16cg	VR1	3a	Aic
FN37G	AIC1746-37GU3	LVR-IC	LDO, 3.7V±2%, 150mA	SOT-23	16cg	VR1	3a	Aic
FN37P	AIC1746-37PU3	LVR-IC	LDO, 3.7V±2%, 150mA	SOT-23	16cg	VR1	3a	Aic
FN38G	AIC1746-38GU3	LVR-IC	LDO, 3.8V±2%, 150mA	SOT-23	16cg	VR1	3a	Aic
FN38P	AIC1746-38PU3	LVR-IC	LDO, 3.8V±2%, 150mA	SOT-23	16cg	VR1	3a	Aic
FN4	2SC4863-4	Si-npn	VHF/UHF-Amp, 16V, 70mA, 200mW, B=90..180, 7GHz	MCP	16ta	-	3a	San
FN4	2SC4864-4	Si-npn	VHF/UHF-Amp, 16V, 70mA, 200mW, B=90..180, 7GHz	CP	16ta	-	3a	San
FN5	2SC4863-5	Si-npn	VHF/UHF-Amp, 16V, 70mA, 200mW, B=90..180, 7GHz	MCP	16ta	-	3a	San
FN5	2SC4864-5	Si-npn	VHF/UHF-Amp, 16V, 70mA, 200mW, B=130..270, 7GHz	CP	16ta	-	3a	San
FO	2SC2716-O	Si-npn	HF/AF, 35V, 100mA, 150mW, B=40..80, 120MHz	SOT-23	16ta	-	3a	Tos
FO	2SC5344U-O	Si-npn	AF, 35V, 800mA, 200mW, 120MHz, B=100..200	SOT-323	18ta	-	3a	Auk
FOA	SiP810C27EUEdT	Vdet-IC	2.7V±1.5%, +Reset PPO 150ms	SOT-23	16vdc	VD7	3g	Vs
FOAA	MAX6328UR23-T	Vdet-IC	2.3V±1.5%, -Reset ODO	SOT-23	16vdc	VD6	3a	Max
FP	2SA1774EB-P	Si-pnp	AF, 60V, 150mA, 200mW, B=82..180, >140MHz	EMT3F	18ta	-	3a	Rhm
FP	KRC164F	Si-npn-Digi	Sw, 20V, 50mA, 50mW, 200MHz, R1=47k	TFSM	19ta	-	3k	Kec
FP	RT9808-23CV	Vdet-IC	2.3V±2%, -Reset ODO	SOT-23	16vdb	VD6	3a	Rct
FP	SiP810CSEUEdT	Vdet-IC	2.93V±1.5%, +Reset PPO 150ms	SOT-23	16vdc	VD7	3g	Vs
FP	UNR32A4	Si-npn-Digi	Sw, 50V, 80mA, 100mW, 150MHz, R1/R2=10k47k	SSSMini3	18ta	-	3a	Pan
FP-	RT9808-23PV	Vdet-IC	2.3V±2%, -Reset ODO	SOT-23	16vdb	VD6	3a	Rct
FPAA	MAX6328UR24-T	Vdet-IC	2.4V±1.5%, -Reset ODO	SOT-23	16vdc	VD6	3a	Max
FQ	2PA1576Q	Si-pnp	GP, 50V, 100mA, 200mW, >100MHz, B=120..270	SOT-323	16ta	-	3a	PhH
FQ	2SA1037AK-Q	Si-pnp	AF, 50V, 150mA, 200mW, B=120..270, >140MHz	SC-59	16ta	-	3a	Rhm
FQ	2SA1037-Q	Si-pnp	GP, 60V, 150mA, 200mW, B=120..270, >120MHz	SOT-23	16ta	-	3a	Rhm
FQ	2SA1576A-Q	Si-pnp	AF, 50V, 150mA, 200mW, B=120..270, >140MHz	SOT-323	16ta	-	3a	Rhm
FQ	2SA1576-Q	Si-pnp	GP, 60V, 100mA, 150mW, B=120..270, 140MHz	SOT-323	16ta	-	3a	Rhm
FQ	2SA1774EB-Q	Si-pnp	AF, 60V, 150mA, 200mW, B=120..270, >140MHz	EMT3F	18ta	-	3a	Rhm
FQ	2SA1774-Q	Si-pnp	GP, 60V, 100mA, 150mW, B=120..270, 140MHz	SC-75A	16ta	-	3a	Rhm
FQ	2SA2029-Q	Si-pnp	GP, 60V, 100mA, 150mW, B=120..270, 140MHz	VMT3	18ta	-	3a	Rhm
FQ	2SB1610	Si-pnp	Lo-sat, 10V, 500mA, 120MHz	SOT-23	16te	-	3a	Pan
FQ	2SB1618	Si-pnp	AF, Lo-sat, 10V, 500mA, 150mW, B=200..800, 120MHz	SOT-323	16ta	-	3a	Pan
FQ	L2SA1774QT1	Si-pnp	GP, 60V, 150mA, 150mW, B=120..270, 140MHz	SC-89	16ta	-	3a	Lrc
FQ	RT9818C-22CV	Vdet-IC	2.2V±1.5%, -Reset ODO, Td=220ms	SOT-23	16vda	VD6	3a	Rct
FOAA	MAX6328UR25-T	Vdet-IC	2.5V±1.5%, -Reset ODO	SOT-23	16vdc	VD6	3a	Max
FQW	2PA1576Q	Si-pnp	GP, 50V, 100mA, 200mW, >100MHz, B=120..270	SOT-323	16ta	-	3a	PhC
FR	2PA1576R	Si-pnp	GP, 50V, 100mA, 200mW, >100MHz, B=180..390	SOT-323	16ta	-	3a	PhH
FR	2SA1034-R	Si-pnp	AF, LN, 55V, 10mA, 200mW, B=180..360, 200MHz	SC-59	16ta	-	3a	Pan
FR	2SA1037AK-R	Si-pnp	AF, 50V, 150mA, 200mW, B=180..390, >140MHz	SC-59	16ta	-	3a	Rhm
FR	2SA1037-R	Si-pnp	GP, 60V, 150mA, 200mW, B=180..390, >120MHz	SOT-23	16ta	-	3a	Rhm
FR	2SA1531-R	Si-pnp	AF, LN, 35V, 50mA, 150mW, B=180..360, 80MHz	SOT-323	16ta	-	3a	Pan
FR	2SA1576A-R	Si-pnp	AF, 50V, 150mA, 200mW, B=180..390, >140MHz	SOT-323	16ta	-	3a	Rhm
FR	2SA1576-R	Si-pnp	GP, 60V, 100mA, 150mW, B=180..390, 140MHz	SOT-323	16ta	-	3a	Rhm
FR	2SA1774EB-R	Si-pnp	AF, 60V, 150mA, 200mW, B=180..390, >140MHz	EMT3F	18ta	-	3a	Rhm



SMD code	Type	Function	Short description	Case	Pinout	Sch.	St.	Mnf.
FR	2SA1774-R	Si-pnp	GP, 60V, 100mA, 150mW, B=180..390, 140MHz	SC-75A	16ta	-	3a	Rhm
FR	2SA2029-R	Si-pnp	GP, 60V, 100mA, 150mW, B=180..390, 140MHz	VMT3	18ta	-	3a	Rhm
FR	2SC2716-R	Si-npnp	HF/AF, 35V, 100mA, 150mW, B=70..140, 120MHz	SOT-23	16ta	-	3a	Tos
FR	2SD2472	Si-npnp	Lo-sat, 10V, 500mA, 200mW, B=200..800, 120MHz	SOT-23	16ta	-	3a	Pan
FR	L2SA1774RT1	Si-pnp	GP, 60V, 150mA, 150mW, B=180..390, 140MHz	SC-89	16ta	-	3a	Lrc
FR	RT9818C-29CV	Vdet-IC	2.9V±1.5%, -Reset ODO, Td=220ms	SOT-23	16vda	VD6	3a	Rct
FR	SIP810CTEUEDT	Vdet-IC	3.08V±1.5%, +Reset PPO 150ms	SOT-23	16vdc	VD7	3g	Vs
FR-	2SC5772	Si-npnp	UHF/VHF WB-amp, 15V, 75mA, 750mW, 9GHz, B=80..160	MPAK	16ta	-	3a	Ren
FR-	RT9818C-29PV	Vdet-IC	2.9V±1.5%, -Reset ODO, Td=220ms	SOT-23	16vda	VD6	3a	Rct
FR-	RT9818C-29GV	Vdet-IC	2.9V±1.5%, -Reset ODO, Td=220ms	SOT-23	16vda	VD6	3a	Rct
FRAA	MAX6328UR26-T	Vdet-IC	2.6V±1.5%, -Reset ODO	SOT-23	16vdc	VD6	3a	Max
FRWA	2PA1576R	Si-pnp	GP, 50V, 100mA, 200mW, >100MHz, B=180..390	SOT-323	16ta	-	3a	PhC
FS	2PA1576S	Si-pnp	GP, 50V, 100mA, 200mW, >100MHz, B=270..560	SOT-323	16ta	-	3a	PhH
FS	2SA1034-S	Si-pnp	AF, LN, 55V, 10mA, 200mW, B=260..520, 200MHz	SC-59	16ta	-	3a	Pan
FS	2SA1037AK-S	Si-pnp	AF, 50V, 150mA, 200mW, B=270..560, >140MHz	SC-59	16ta	-	3a	Rhm
FS	2SA1037-S	Si-pnp	GP, 60V, 150mA, 200mW, B=270..560, >120MHz	SOT-23	16ta	-	3a	Rhm
FS	2SA1531-S	Si-pnp	AF, LN, 35V, 50mA, 150mW, B=260..520, 80MHz	SOT-323	16ta	-	3a	Pan
FS	2SA1576A-S	Si-pnp	AF, 50V, 150mA, 200mW, B=270..560, >140MHz	SOT-323	16ta	-	3a	Rhm
FS	2SA1576-S	Si-pnp	GP, 60V, 100mA, 150mW, B=270..560, 140MHz	SOT-323	16ta	-	3a	Rhm
FS	2SA1763	Si-pnp	Sw, 15V, 200mA, 150mW, B=50..140, 1GHz	MCP	16ta	-	3a	San
FS	2SA1764	Si-pnp	Fast-Sw, 15V, 200mA, 200mW, B=50..140, 1GHz, 11/19ns	SOT-23	16ta	-	3a	San
FS	2SA1774EB-S	Si-pnp	AF, 60V, 150mA, 200mW, B=270..560, >140MHz	EMT3F	18ta	-	3a	Rhm
FS	2SA1774-S	Si-pnp	GP, 60V, 100mA, 150mW, B=270..560, 140MHz	SC-75A	16ta	-	3a	Rhm
FS	2SA2029-S	Si-pnp	GP, 60V, 100mA, 150mW, B=270..560, 140MHz	VMT3	18ta	-	3a	Rhm
FS	2SB1611	Si-pnp	Lo-sat, 20V, 500mA, 100MHz	SOT-23	16ta	-	3a	Pan
FS	2SB1619	Si-pnp	AF, Lo-sat, 20V, 500mA, 150mW, B=200..800, 100MHz	SOT-323	16ta	-	3a	Pan
FS	L2SA1774ST1	Si-pnp	GP, 60V, 150mA, 150mW, B=270..560, 140MHz	SC-89	16ta	-	3a	Lrc
FS	RT9818C-30CV	Vdet-IC	3.0V±1.5%, -Reset ODO, Td=220ms	SOT-23	16vda	VD6	3a	Rct
FS	SIP810CJEUEDT	Vdet-IC	4V±1.5%, +Reset PPO 150ms	SOT-23	16vdc	VD7	3g	Vs
FS-	2SC5990	Si-npnp	UHF/VHF WB-amp, 20V, 75mA, 750mW, 7.8GHz, B=100..200	MPAK	16ta	-	3a	Ren
FS-	RT9818C-30PV	Vdet-IC	3.0V±1.5%, -Reset ODO, Td=220ms	SOT-23	16vda	VD6	3a	Rct
FSA	MAX6328UR27-T	Vdet-IC	2.7V±1.5%, -Reset ODO	SOT-23	16vdc	VD6	3a	Max
FSW	2PA1576S	Si-pnp	GP, 50V, 100mA, 200mW, >100MHz, B=270..560	SOT-323	16ta	-	3a	PhC
FT	2SA1034-T	Si-pnp	AF, LN, 55V, 10mA, 200mW, B=360..700, 200MHz	SC-59	16ta	-	3a	Pan
FT	2SA1531-T	Si-pnp	AF, LN, 35V, 50mA, 150mW, B=360..700, 80MHz	SOT-323	16ta	-	3a	Pan
FT	2SD2473	Si-npnp	Lo-sat, 20V, 500mA	SOT-23	16ta	-	3a	Pan
FT	CHT551PT	Si-npnp	Drv, 160V, 600mA, B=80..250, 300MHz	SOT-23	16ta	-	3a	Chm
FT	RT9818C-40CV	Vdet-IC	4.0V±1.5%, -Reset ODO, Td=220ms	SOT-23	16vda	VD6	3a	Rct
FT	SIP810CMEUED	Vdet-IC	4.38V±1.5%, +Reset PPO 150ms	SOT-23	16vdc	VD7	3g	Vs
FTAA	MAX6328UR28-T	Vdet-IC	2.8V±1.5%, -Reset ODO	SOT-23	16vdc	VD6	3a	Max
FIQ	2PA1576Q	Si-pnp	GP, 50V, 100mA, 200mW, >100MHz, B=120..270	SOT-323	16ta	-	3a	PhM
FIR	2PA1576R	Si-pnp	GP, 50V, 100mA, 200mW, >100MHz, B=180..390	SOT-323	16ta	-	3a	PhM
FIS	2PA1576S	Si-pnp	GP, 50V, 100mA, 200mW, >100MHz, B=270..560	SOT-323	16ta	-	3a	PhM
FJ-	RT9819C-25PV	Vdet-IC	2.5V±1.5%, -Reset PPO, Td=220ms	SOT-23	16vdc	VD7	3a	Rct
FJAA	MAX6328UR29-T	Vdet-IC	2.9V±1.5%, -Reset ODO	SOT-23	16vdc	VD6	3a	Max
FV	1SV248	PIN-diode	VHF/UHF, 50V, 50mA, 0.23pF, 3.5Q(100MHz)	MCP	16dc	-	3a	San
FV	1SV250	PIN-diode	VHF/UHF, 50V, 50mA, 0.23pF, 3.5Q(100MHz)	SOT-23	16dc	-	3a	San
FV	SIP810CLEUDT	Vdet-IC	4.63V±1.5%, +Reset PPO 150ms	SOT-23	16vdc	VD7	3g	Vs
FV-	RT9819C-26PV	Vdet-IC	2.6V±1.5%, -Reset PPO, Td=220ms	SOT-23	16vdc	VD7	3a	Rct
FVAA	MAX6328UR31-T	Vdet-IC	3.1V±1.5%, -Reset ODO	SOT-23	16vdc	VD6	3a	Max
FW	AAT35621GY-2.20	Vdet-IC	2.2V±1.5%, -Reset ODO	SOT-23	16vdc	VD6	3b	Ant
FW	UN2227	Si-npn-Digi	Sw, 50V, 500mA, 200mW, 250MHz, R1/R2=6k8/6k8	SC-59	16ta	-	3a	Pan
FW	UNR2227	Si-npn-Digi	Sw, 50V, 500mA, 200mW, 250MHz, R1/R2=6k8/6k8	SC-59	16ta	-	3a	Pan
FW	UNR5227	Si-npn-Digi	Sw, 30V, 600mA, 150mW, 200MHz, R1/R2=6k8/6k8	SOT-323	16ta	-	3a	Pan
FW-	RT9819C-29PV	Vdet-IC	2.9V±1.5%, -Reset PPO, Td=220ms	SOT-23	16vdc	VD7	3a	Rct
FWAA	MAX6328UR30-T	Vdet-IC	3.0V±1.5%, -Reset ODO	SOT-23	16vdc	VD6	3a	Max
FX	AAT35621GY-2.30	Vdet-IC	2.3V±1.5%, -Reset ODO	SOT-23	16vdc	VD6	3b	Ant
FX	SIP810CREUDT	Vdet-IC	2.63V±1.5%, +Reset PPO 210ms	SOT-23	16vdc	VD7	3g	Vs
FX-	RT9819C-30PV	Vdet-IC	3.0V±1.5%, -Reset PPO, Td=220ms	SOT-23	16vdc	VD7	3a	Rct
FX-	RT9819C-30GV	Vdet-IC	3.0V±1.5%, -Reset PPO, Td=220ms	SOT-23	16vdc	VD7	3a	Rct
FY	2SC2716-Y	Si-npnp	HF/AF, 35V, 100mA, 150mW, B=120..240, 120MHz	SOT-23	16ta	-	3a	Tos
FY	2SC3661	Si-npnp	AF-Amp, 30V, 300mA, 200mW, B=800..3200, 250MHz	SOT-23	16ta	-	3a	San
FY	2SC5344U-Y	Si-pnp	AF, 35V, 800mA, 200mW, 120MHz, B=160..320	SOT-323	16ta	-	3a	Auk
FY	KTA2013F-Y	Si-pnp	AF, Sw, 20V, 150mA, 50mW, B=120..240, >80MHz	TFSM	19ta	-	3f	Kec
FY	SIP810C27EUDT	Vdet-IC	2.7V±1.5%, +Reset PPO 210ms	SOT-23	16vdc	VD7	3g	Vs
FY	UN2226	Si-npn-Digi	Sw, 50V, 500mA, 200mW, 250MHz, R1=4k7	SC-59	16ta	-	3a	Pan
FY	UNR2226	Si-npn-Digi	Sw, 50V, 500mA, 200mW, 250MHz, R1=4k7	SC-59	16ta	-	3a	Pan
FY	UNR5226	Si-npn-Digi	Sw, 30V, 600mA, 150mW, 200MHz, R1=4k7	SOT-323	16ta	-	3a	Pan
FZ	SIP810CSEUDT	Vdet-IC	2.93V±1.5%, +Reset PPO 210ms	SOT-23	16vdc	VD7	3g	Vs
FZ	UN2225	Si-npn-Digi	Sw, 50V, 500mA, 200mW, 250MHz, R1=10k	SC-59	16ta	-	3a	Pan



SMD code	Type	Function	Short description	Case	Pinout	Sch. St.	Mnf.
FZ	UNR2225	Si-npn-Digi	Sw, 50V, 500mA, 200mW, 250MHz, R1=10k	SC-59	16ta	-	3a Pan
FZ	UNR5225	Si-npn-Digi	Sw, 30V, 600mA, 150mW, 200MHz, R1=10k	SOT-323	16ta	-	3a Pan
FZ-	RT9819C-44PV	Vdet-IC	4.4V±1.5%, -Reset PPO, Td=220ms	SOT-23	16vdc	VD7	3a Rct
FZAP	MAX6012AUR	Vref-IC	Precision, 1.247V	SOT-23	16di	RF1	3a Max
FZAQ	MAX6025AUR	Vref-IC	Precision, 2.500V	SOT-23	16di	RF1	3a Max
FZAR	MAX6041AUR	Vref-IC	Precision, 4.096V	SOT-23	16di	RF1	3a Max
FZAS	MAX6045AUR	Vref-IC	Precision, 4.500V	SOT-23	16di	RF1	3a Max
FZAT	MAX6050AUR	Vref-IC	Precision, 5.00V	SOT-23	16di	RF1	3a Max
FZAU	MAX6021AUR	Vref-IC	Precision, 2.048V	SOT-23	16di	RF1	3a Max
FZAV	MAX6346UR33-T	Vdet-IC	3.3V±1.5%, -Reset PPO	SOT-23	16vdc	VD7	3a Max
FZAW	MAX6346UR34-T	Vdet-IC	3.4V±1.5%, -Reset PPO	SOT-23	16vdc	VD7	3a Max
FZAX	MAX6346UR35-T	Vdet-IC	3.5V±1.5%, -Reset PPO	SOT-23	16vdc	VD7	3a Max
FZAY	MAX6346UR36-T	Vdet-IC	3.6V±1.5%, -Reset PPO	SOT-23	16vdc	VD7	3a Max
FZAZ	MAX6346UR37-T	Vdet-IC	3.7V±1.5%, -Reset PPO	SOT-23	16vdc	VD7	3a Max
FZBA	MAX6346UR38-T	Vdet-IC	3.8V±1.5%, -Reset PPO	SOT-23	16vdc	VD7	3a Max
FZBB	MAX6346UR39-T	Vdet-IC	3.9V±1.5%, -Reset PPO	SOT-23	16vdc	VD7	3a Max
FZBC	MAX6346UR40-T	Vdet-IC	4.0V±1.5%, -Reset PPO	SOT-23	16vdc	VD7	3a Max
FZBD	MAX6346UR41-T	Vdet-IC	4.1V±1.5%, -Reset PPO	SOT-23	16vdc	VD7	3a Max
FZBE	MAX6346UR42-T	Vdet-IC	4.2V±1.5%, -Reset PPO	SOT-23	16vdc	VD7	3a Max
FZBF	MAX6346UR43-T	Vdet-IC	4.3V±1.5%, -Reset PPO	SOT-23	16vdc	VD7	3a Max
FZBG	MAX6346UR44-T	Vdet-IC	4.4V±1.5%, -Reset PPO	SOT-23	16vdc	VD7	3a Max
FZBH	MAX6346UR45-T	Vdet-IC	4.5V±1.5%, -Reset PPO	SOT-23	16vdc	VD7	3a Max
FZBI	MAX6346UR46-T	Vdet-IC	4.6V±1.5%, -Reset PPO	SOT-23	16vdc	VD7	3a Max
FZBJ	MAX6348UR33-T	Vdet-IC	3.3V±1.5%, +Reset PPO	SOT-23	16vdc	VD7	3a Max
FZBK	MAX6348UR34-T	Vdet-IC	3.4V±1.5%, +Reset PPO	SOT-23	16vdc	VD7	3a Max
FZBL	MAX6348UR35-T	Vdet-IC	3.5V±1.5%, +Reset PPO	SOT-23	16vdc	VD7	3a Max
FZBM	MAX6348UR36-T	Vdet-IC	3.6V±1.5%, +Reset PPO	SOT-23	16vdc	VD7	3a Max
FZBN	MAX6348UR37-T	Vdet-IC	3.7V±1.5%, +Reset PPO	SOT-23	16vdc	VD7	3a Max
FZBO	MAX6348UR38-T	Vdet-IC	3.8V±1.5%, +Reset PPO	SOT-23	16vdc	VD7	3a Max
FZBP	MAX6348UR39-T	Vdet-IC	3.9V±1.5%, +Reset PPO	SOT-23	16vdc	VD7	3a Max
FZBQ	MAX6348UR40-T	Vdet-IC	4.0V±1.5%, +Reset PPO	SOT-23	16vdc	VD7	3a Max
FZBR	MAX6348UR41-T	Vdet-IC	4.1V±1.5%, +Reset PPO	SOT-23	16vdc	VD7	3a Max
FZBS	MAX6348UR42-T	Vdet-IC	4.2V±1.5%, +Reset PPO	SOT-23	16vdc	VD7	3a Max
FZBT	MAX6348UR43-T	Vdet-IC	4.3V±1.5%, +Reset PPO	SOT-23	16vdc	VD7	3a Max
FZBU	MAX6348UR44-T	Vdet-IC	4.4V±1.5%, +Reset PPO	SOT-23	16vdc	VD7	3a Max
FZBV	MAX6348UR45-T	Vdet-IC	4.5V±1.5%, +Reset PPO	SOT-23	16vdc	VD7	3a Max
FZBW	MAX6348UR46-T	Vdet-IC	4.6V±1.5%, +Reset PPO	SOT-23	16vdc	VD7	3a Max
FZBX	MAX6348UR33-T	Vdet-IC	3.3V±1.5%, -Reset ODO	SOT-23	16vdc	VD6	3a Max
FZBY	MAX6348UR34-T	Vdet-IC	3.4V±1.5%, -Reset ODO	SOT-23	16vdc	VD6	3a Max
FZBZ	MAX6348UR35-T	Vdet-IC	3.5V±1.5%, -Reset ODO	SOT-23	16vdc	VD6	3a Max
FZCA	MAX6348UR36-T	Vdet-IC	3.6V±1.5%, -Reset ODO	SOT-23	16vdc	VD6	3a Max
FZCB	MAX6348UR37-T	Vdet-IC	3.7V±1.5%, -Reset ODO	SOT-23	16vdc	VD6	3a Max
FZCC	MAX6348UR38-T	Vdet-IC	3.8V±1.5%, -Reset ODO	SOT-23	16vdc	VD6	3a Max
FZCD	MAX6348UR39-T	Vdet-IC	3.9V±1.5%, -Reset ODO	SOT-23	16vdc	VD6	3a Max
FZCE	MAX6348UR40-T	Vdet-IC	4.0V±1.5%, -Reset ODO	SOT-23	16vdc	VD6	3a Max
FZCF	MAX6348UR41-T	Vdet-IC	4.1V±1.5%, -Reset ODO	SOT-23	16vdc	VD6	3a Max
FZCG	MAX6348UR42-T	Vdet-IC	4.2V±1.5%, -Reset ODO	SOT-23	16vdc	VD6	3a Max
FZCH	MAX6348UR43-T	Vdet-IC	4.3V±1.5%, -Reset ODO	SOT-23	16vdc	VD6	3a Max
FZCI	MAX6348UR44-T	Vdet-IC	4.4V±1.5%, -Reset ODO	SOT-23	16vdc	VD6	3a Max
FZCJ	MAX6348UR45-T	Vdet-IC	4.5V±1.5%, -Reset ODO	SOT-23	16vdc	VD6	3a Max
FZCK	MAX6348UR46-T	Vdet-IC	4.6V±1.5%, -Reset ODO	SOT-23	16vdc	VD6	3a Max
FZCL	MAX6332UR16D3	Vdet-IC	1.6V±1.5%, +Reset PPO	SOT-23	16vdc	VD7	3a Max
FZCM	MAX6332UR18D3	Vdet-IC	1.8V±1.5%, +Reset PPO	SOT-23	16vdc	VD7	3a Max
FZCN	MAX6332UR22D3	Vdet-IC	2.2V±1.5%, +Reset PPO	SOT-23	16vdc	VD7	3a Max
FZCO	MAX6333UR16D3	Vdet-IC	1.6V±1.5%, -Reset PPO	SOT-23	16vdc	VD7	3a Max
FZCP	MAX6333UR18D3	Vdet-IC	1.8V±1.5%, -Reset PPO	SOT-23	16vdc	VD7	3a Max
FZCQ	MAX6333UR20D3	Vdet-IC	2.0V±1.5%, -Reset PPO	SOT-23	16vdc	VD7	3a Max
FZCR	MAX6333UR22D3	Vdet-IC	2.2V±1.5%, -Reset PPO	SOT-23	16vdc	VD7	3a Max
FZCS	MAX6333UR23D3	Vdet-IC	2.3V±1.5%, -Reset PPO	SOT-23	16vdc	VD7	3a Max
FZCT	MAX6334UR16D3	Vdet-IC	1.6V±1.5%, -Reset ODO	SOT-23	16vdc	VD6	3a Max
FZCU	MAX6334UR18D3	Vdet-IC	1.8V±1.5%, -Reset ODO	SOT-23	16vdc	VD6	3a Max
FZCV	MAX6334UR22D3	Vdet-IC	2.2V±1.5%, -Reset ODO	SOT-23	16vdc	VD6	3a Max
FZCW	MAX6001EUR-T	Vref-IC	LDO, Shunt, 1.25V, 1%	SOT-23	16rd	RF1	3a Max
FZCX	MAX6002EUR-T	Vref-IC	LDO, Shunt, 2.5V, 1%	SOT-23	16rd	RF1	3a Max
FZCY	MAX6004EUR-T	Vref-IC	LDO, Shunt, 4.096V, 1%	SOT-23	16rd	RF1	3a Max
FZCZ	MAX6005EUR-T	Vref-IC	LDO, Shunt, 5V, 1%	SOT-23	16rd	RF1	3a Max
FZDA	MAX6012BUR	Vref-IC	Precision, 1.247V	SOT-23	16di	RF1	3a Max
FZDB	MAX6025BUR	Vref-IC	Precision, 2.500V	SOT-23	16di	RF1	3a Max
FZDC	MAX6041BUR	Vref-IC	Precision, 4.096V	SOT-23	16di	RF1	3a Max
FZDD	MAX6045BUR	Vref-IC	Precision, 4.500V	SOT-23	16di	RF1	3a Max



SMD code	Type	Function	Short description	Case	Pinout	Sch.	St.	Mnf.
FZDE	MAX6050BUR	Vref-IC	Precision, 5.00V	SOT-23	16di	RF1	3a	Max
FZDF	MAX6021BUR	Vref-IC	Precision, 2.048V	SOT-23	16di	RF1	3a	Max
FZDK	MAX6003EUR-T	Vref-IC	LDO, Shunt, 3V, 1%	SOT-23	16rd	RF1	3a	Max
FZDL	MAX6332UR20D3	Vdet-IC	2.0V±1.5%, +Reset PPO	SOT-23	16vdc	VD7	3a	Max
FZDM	MAX6332UR23D3	Vdet-IC	2.3V±1.5%, +Reset PPO	SOT-23	16vdc	VD7	3a	Max
FZDN	MAX6334UR20D3	Vdet-IC	2.0V±1.5%, -Reset ODO	SOT-23	16vdc	VD6	3a	Max
FZDO	MAX6334UR23D3	Vdet-IC	2.3V±1.5%, -Reset ODO	SOT-23	16vdc	VD6	3a	Max
FZDP	MAX6806UR46-T	Vdet-IC	4.6V±1.5%, -Reset PPO	SOT-23	16vdb	VD7	3b	Max
FZDQ	MAX6806UR26-T	Vdet-IC	2.6V±1.5%, -Reset PPO	SOT-23	16vdb	VD7	3b	Max
FZDR	MAX6806UR23-T	Vdet-IC	2.3V±1.5%, -Reset PPO	SOT-23	16vdb	VD7	3b	Max
FZDS	MAX6807UR46-T	Vdet-IC	4.6V±1.5%, +Reset PPO	SOT-23	16vdb	VD7	3b	Max
FZDT	MAX6807UR26-T	Vdet-IC	2.6V±1.5%, +Reset PPO	SOT-23	16vdb	VD7	3b	Max
FZDU	MAX6808UR46-T	Vdet-IC	4.6V±1.5%, -Reset ODO	SOT-23	16vdb	VD6	3b	Max
FZDV	MAX6808UR26-T	Vdet-IC	2.6V±1.5%, -Reset ODO	SOT-23	16vdb	VD6	3b	Max
FZDW	MAX6030AUR	Vref-IC	Precision, 3.00V	SOT-23	16di	RF1	3a	Max
FZDX	MAX6030BUR	Vref-IC	Precision, 3.00V	SOT-23	16di	RF1	3a	Max
FZEB	LM4041AIM3-1.2	Vref-IC	Precision, Shunt, 1.225V, 0.1%	SOT-23	16dk	RF1	3a	Max
FZEC	LM4041BIM3-1.2	Vref-IC	Precision, Shunt, 1.225V, 0.2%	SOT-23	16dk	RF1	3a	Max
FZED	LM4041DIM3-1.2	Vref-IC	Precision, Shunt, 1.225V, 0.5%	SOT-23	16dk	RF1	3a	Max
FZEE	LM4041DIM3-1.2	Vref-IC	Precision, Shunt, 1.225V, 1.5%	SOT-23	16dk	RF1	3a	Max
FZEF	LM4040AIM3-2.1	Vref-IC	Precision, Shunt, 2.048V, 0.1%	SOT-23	16dk	RF1	3a	Max
FZEG	LM4040BIM3-2.1	Vref-IC	Precision, Shunt, 2.048V, 0.2 %	SOT-23	16dk	RF1	3a	Max
FZEH	LM4040CIM3-2.1	Vref-IC	Shunt, 2.048V, 0.5%	SOT-23	16dk	RF1	3a	Max
FZEI	LM4040DIM3-2.1	Vref-IC	Shunt, 2.048V, 1%	SOT-23	16dk	RF1	3a	Max
FZEJ	LM4040AIM3-2.5	Vref-IC	Precision, Shunt, 2.500V, 0.1%	SOT-23	16dk	-	3a	Max
FZEK	LM4040BIM3-2.5	Vref-IC	Precision, Shunt, 2.500V, 0.2 %	SOT-23	16dk	RF1	3a	Max
FZEL	LM4040CIM3-2.5	Vref-IC	Shunt, 2.500V, 0.5%	SOT-23	16dk	RF1	3a	Max
FZEM	LM4040DIM3-2.5	Vref-IC	Shunt, 2.500V, 1%	SOT-23	16dk	RF1	3a	Max
FZEN	LM4040AIM3-3.0	Vref-IC	Precision, Shunt, 3.00V, 0.1%	SOT-23	16dk	RF1	3a	Max
FZEO	LM4040BIM3-3.0	Vref-IC	Precision, Shunt, 3.00V, 0.2 %	SOT-23	16dk	RF1	3a	Max
FZEP	LM4040CIM3-3.0	Vref-IC	Shunt, 3.00V, 0.5%	SOT-23	16dk	RF1	3a	Max
FZEQ	LM4040DIM3-3.0	Vref-IC	Shunt, 3.00V, 1%	SOT-23	16dk	RF1	3a	Max
FZER	LM4040AIM3-4.1	Vref-IC	Precision, Shunt, 4.096V, 0.1%	SOT-23	16dk	RF1	3a	Max
FZES	LM4040BIM3-4.1	Vref-IC	Precision, Shunt, 4.096V, 0.2 %	SOT-23	16dk	RF1	3a	Max
FZET	LM4040CIM3-4.1	Vref-IC	Shunt, 4.096V, 0.5%	SOT-23	16dk	RF1	3a	Max
FZEU	LM4040DIM3-4.1	Vref-IC	Shunt, 4.096V, 1%	SOT-23	16dk	RF1	3a	Max
FZEV	LM4040AIM3-5.0	Vref-IC	Precision, Shunt, 5.00V, 0.1%	SOT-23	16di	RF1	3a	Max
FZEW	LM4040BIM3-5.0	Vref-IC	Precision, Shunt, 5.00V, 0.2 %	SOT-23	16dk	RF1	3a	Max
FZEX	LM4040CIM3-5.0	Vref-IC	Shunt, 5.00V, 0.5%	SOT-23	16dk	RF1	3a	Max
FZEY	LM4040DIM3-5.0	Vref-IC	Shunt, 5.00V, 1%	SOT-23	16dk	RF1	3a	Max
FZFL	MAX6808UR32-T	Vdet-IC	3.2V±1.5%, -Reset ODO	SOT-23	16vdb	VD6	3b	Max
FZGH	MAX6006AEUR-T	Vref-IC	Precision, Shunt, 1.25V, 0.2%	SOT-23	16dk	RF1	3a	Max
FZGI	MAX6006BEUR-T	Vref-IC	Precision, Shunt, 1.25V, 0.5%	SOT-23	16dk	RF1	3a	Max
FZGK	MAX6007AEUR-T	Vref-IC	Precision, Shunt, 2.048V, 0.2%	SOT-23	16dk	RF1	3a	Max
FZGL	MAX6007BEUR-T	Vref-IC	Precision, Shunt, 2.048V, 0.5%	SOT-23	16dk	RF1	3a	Max
FZGN	MAX6008AEUR-T	Vref-IC	Precision, Shunt, 2.5V, 0.2%	SOT-23	16dk	RF1	3a	Max
FZGO	MAX6008BEUR-T	Vref-IC	Precision, Shunt, 2.5V, 0.5%	SOT-23	16dk	RF1	3a	Max
FZGQ	MAX6009AEUR-T	Vref-IC	Precision, Shunt, 3V, 0.2%	SOT-23	16dk	RF1	3a	Max
FZGR	MAX6009BEUR-T	Vref-IC	Precision, Shunt, 3V, 0.5%	SOT-23	16dk	RF1	3a	Max
FZIE	MAX6800UR26D3-T	Vdet-IC	2.63V±1.5%, +Reset PPO	SOT-23	16vdc	VD6	3b	Max
FZIF	MAX6800UR29D3-T	Vdet-IC	2.93V±1.5%, +Reset PPO	SOT-23	16vdc	VD6	3b	Max
FZIG	MAX6800UR31D3-T	Vdet-IC	3.08V±1.5%, +Reset PPO	SOT-23	16vdc	VD6	3b	Max
FZIH	MAX6800UR44D3-T	Vdet-IC	4.38V±1.5%, +Reset PPO	SOT-23	16vdc	VD6	3b	Max
FZII	MAX6800UR46D3-T	Vdet-IC	4.63V±1.5%, +Reset PPO	SOT-23	16vdc	VD6	3b	Max
FZIK	MAX6801UR26D3-T	Vdet-IC	2.63V±1.5%, -Reset PPO	SOT-23	16vdc	VD7	3b	Max
FZIM	MAX6801UR29D3-T	Vdet-IC	2.93V±1.5%, -Reset PPO	SOT-23	16vdc	VD7	3b	Max
FZIN	MAX6801UR31D3-T	Vdet-IC	3.08V±1.5%, -Reset PPO	SOT-23	16vdc	VD7	3b	Max
FZIO	MAX6801UR44D3-T	Vdet-IC	4.38V±1.5%, -Reset PPO	SOT-23	16vdc	VD7	3b	Max
FZIP	MAX6801UR46D3-T	Vdet-IC	4.63V±1.5%, -Reset PPO	SOT-23	16vdc	VD7	3b	Max
FZIQ	MAX6802UR26D3-T	Vdet-IC	2.63V±1.5%, -Reset ODO	SOT-23	16vdc	VD9	3b	Max
FZIR	MAX6802UR29D3-T	Vdet-IC	2.93V±1.5%, -Reset ODO	SOT-23	16vdc	VD9	3b	Max
FZIS	MAX6802UR31D3-T	Vdet-IC	3.08V±1.5%, -Reset ODO	SOT-23	16vdc	VD9	3b	Max
FZIU	MAX6802UR44D3-T	Vdet-IC	4.38V±1.5%, -Reset ODO	SOT-23	16vdc	VD9	3b	Max
FZIU	MAX6802UR46D3-T	Vdet-IC	4.63V±1.5%, -Reset ODO	SOT-23	16vdc	VD9	3b	Max
FZIV	MXD1810UR46	Vdet-IC	4.6V±2.5%, -Reset PPO	SOT-23	16vda	VD7	3a	Max
FZIW	MXD1811UR44	Vdet-IC	4.4V±2.5%, CMOS -Reset ODO	SOT-23	16vda	VD9	3a	Max
FZIX	MXD1812UR41	Vdet-IC	4.1V±2.5%, CMOS +PPO +Reset	SOT-23	16vda	VD7	3a	Max
FZIZ	MXD1813UR46	Vdet-IC	4.6V±2.5%, MR, CMOS -Reset ODO	SOT-23	16vda	VD10	3a	Max
FZIZ	MXD1815UR29	Vdet-IC	2.9V±2.5%, -Reset PPO	SOT-23	16vda	VD7	3a	Max
FZJA	MXD1816UR22	Vdet-IC	2.2V±2.5%, CMOS -Reset ODO	SOT-23	16vda	VD9	3a	Max



SMD code	Type	Function	Short description	Case	Pinout	Sch. St.	Mnf.
FZJB	MXD1817UR31	Vdet-IC	3.1V±2.5%, CMOS +Reset PPO	SOT-23	16vda	VD7	3a Max
FZJC	MXD1818UR26	Vdet-IC	2.6V±2.5%, MR, CMOS +Reset ODO	SOT-23	16vda	VD10	3a Max
FZJE	MXD1818UR22	Vdet-IC	2.2V±2.5%, MR, CMOS +Reset ODO	SOT-23	16vda	VD10	3a Max
FZKC	MXD1810UR41	Vdet-IC	4.1V±2.5%, -Reset PPO	SOT-23	16vda	VD7	3a Max
FZKD	MXD1810UR44	Vdet-IC	4.4V±2.5%, -Reset PPO	SOT-23	16vda	VD7	3a Max
FZKE	MXD1811UR41	Vdet-IC	4.1V±2.5%, CMOS -Reset ODO	SOT-23	16vda	VD9	3a Max
FZKF	MXD1811UR46	Vdet-IC	4.6V±2.5%, CMOS -Reset ODO	SOT-23	16vda	VD9	3a Max
FZKG	MXD1812UR44	Vdet-IC	4.4V±2.5%, CMOS +PPO +Reset	SOT-23	16vda	VD7	3a Max
FZKH	MXD1812UR46	Vdet-IC	4.6V±2.5%, CMOS +PPO +Reset	SOT-23	16vda	VD7	3a Max
FZKI	MXD1813UR41	Vdet-IC	4.1V±2.5%, MR, CMOS -Reset ODO	SOT-23	16vda	VD10	3a Max
FZKJ	MXD1813UR44	Vdet-IC	4.4V±2.5%, MR, CMOS -Reset ODO	SOT-23	16vda	VD10	3a Max
FZKK	MXD1815UR22	Vdet-IC	2.2V±2.5%, -Reset PPO	SOT-23	16vda	VD7	3a Max
FZKL	MXD1815UR23	Vdet-IC	2.3V±2.5%, -Reset PPO	SOT-23	16vda	VD7	3a Max
FZKM	MXD1815UR26	Vdet-IC	2.6V±2.5%, -Reset PPO	SOT-23	16vda	VD7	3a Max
FZKN	MXD1815UR31	Vdet-IC	3.1V±2.5%, -Reset PPO	SOT-23	16vda	VD7	3a Max
FZKO	MXD1816UR23	Vdet-IC	2.3V±2.5%, CMOS -Reset ODO	SOT-23	16vda	VD9	3a Max
FZKP	MXD1816UR26	Vdet-IC	2.6V±2.5%, CMOS -Reset ODO	SOT-23	16vda	VD9	3a Max
FZKQ	MXD1816UR29	Vdet-IC	2.9V±2.5%, CMOS -Reset ODO	SOT-23	16vda	VD9	3a Max
FZKR	MXD1816UR31	Vdet-IC	3.1V±2.5%, CMOS -Reset ODO	SOT-23	16vda	VD9	3a Max
FZKS	MXD1817UR22	Vdet-IC	2.2V±2.5%, CMOS +Reset PPO	SOT-23	16vda	VD7	3a Max
FZKT	MXD1817UR23	Vdet-IC	2.3V±2.5%, CMOS +Reset PPO	SOT-23	16vda	VD7	3a Max
FZKU	MXD1817UR26	Vdet-IC	2.6V±2.5%, CMOS +Reset PPO	SOT-23	16vda	VD7	3a Max
FZKV	MXD1817UR29	Vdet-IC	2.9V±2.5%, CMOS +Reset PPO	SOT-23	16vda	VD7	3a Max
FZKW	MXD1818UR23	Vdet-IC	2.3V±2.5%, MR, CMOS +Reset ODO	SOT-23	16vda	VD10	3a Max
FZKX	MXD1818UR29	Vdet-IC	2.9V±2.5%, MR, CMOS +Reset ODO	SOT-23	16vda	VD10	3a Max
FZKY	MXD1818UR31	Vdet-IC	3.1V±2.5%, MR, CMOS +Reset ODO	SOT-23	16vda	VD10	3a Max
g	AX6901GA	Vdet-IC	2.25V±1.5%, -Reset PPO	SC-70	16vdc	VD7	3b Axl
G	MRF947A	Si-npn	UHF, 20V, 50mA, 188mW, B>50, 8GHz	SOT-323	16ta	-	3a Mot
G	SB007-03Q	Si-diode	SBR, HF, 30V, 70mA, Vf<0.55V(70mA), 3pF, 10ms	MCP	16dc	-	3a San
G0	ELM7630HBB	Vdet-IC	3.0V±2%, +Reset PPO, 500ms	SOT-23	16vdc	VD7	3d Elm
G0	HSMP-3890	PIN-diode	RF, 100V, 1A, 250mW, Rs<2.5Ω, Cd<0.3pF	SOT-23	16dc	-	3a Agi
G0	HSMP-389B	PIN-diode	RF, 100V, 1A, Rs(typ)=2.5Ω, 0.3pF	SOT-323	16dc	-	3a Agi
G0	R3111N602A	Vdet-IC	6V±2%, -Reset PPO	SOT-23	16vdd	VD7	3d Ric
G0	R3113D301C	Vdet-IC	3V±2%, -Reset, PPO	SON1408-3	18vda	VD7	3d Ric
G0	R3130N20EA	Vdet-IC	2.2V, -Reset PPO, 240ms	SOT-23	16vdc	VD7	3b Ric
G06	DTD133HK	Si-npn-Digi	Sw, 50V, 500mA, 200mW, 200MHz, R1/R2=3k3/10k	SOT-346	16ta	-	3a Rhm
G1	ELM7631HBB	Vdet-IC	3.1V±2%, +Reset PPO, 500ms	SOT-23	16vdc	VD7	3d Elm
G1	MMBT5551	Si-npn	HV, 180V, 200mA, 350mW, B=80..250, >300MHz	SOT-23	16ta	-	3a Mot
G1	R3113D311C	Vdet-IC	3.1V±2%, -Reset, PPO	SON1408-3	18vda	VD7	3d Ric
G1	R3130N21EA	Vdet-IC	2.1V, -Reset PPO, 240ms	SOT-23	16vdc	VD7	3b Ric
G1	RT9166-33CVL	LVR-IC	LDO, 3.3V±2%, 300mA	SOT-23	16cg	VR1	3a Rct
G1-	RT9166-33PVL	LVR-IC	LDO, 3.3V±2%, 300mA	SOT-23	16cg	VR1	3a Rct
G11	DTB113ZK	Si-pnp-Digi	Sw, 50V, 500mA, 200mW, 200MHz, R1/R2=1k/10k	SOT-346	16ta	-	3a Rhm
G13	2SK1580	n-MOSFET-e*	V-MOS, LogL, 16V, ±0.1A, <10Ω(100mA)	SOT-323	16fh	-	3a Nec
G14	2SK1581	n-MOSFET-e*	V-MOS, LogL, 16V, ±0.2A, <3Ω(100mA)	SOT-23	16fh	-	3a Nec
G15	2SK1582	n-MOSFET-e*	V-MOS, LogL, 30V, ±0.2A, <3Ω(10mA)	SOT-23	16fh	-	3a Nec
G16	2SK1590	n-MOSFET-e*	V-MOS, LogL, 60V, ±0.2A, <3Ω	SOT-23	16fh	-	3a Nec
G17	2SK1589	n-MOSFET-e*	V-MOS, LogL, 100V, ±0.1A, <25Ω	SOT-23	16fh	-	3a Nec
G17	MMBZ4617	Z-diode	2.4V±5%, 350mW	SOT-23	16dc	-	3g Vs
G18	2SK1591	n-MOSFET-e*	V-MOS, LogL, 100V, ±0.2A, <6.5Ω	SOT-23	16fh	-	3a Nec
G18	MMBZ4618	Z-diode	2.7V±5%, 350mW	SOT-23	16dc	-	3g Vs
G19	MMBZ4619	Z-diode	3.0V±5%, 350mW	SOT-23	16dc	-	3g Vs
G1F	2SC2412K-Q	Si-npn	GP, 60V, 150mA, 200mW, 180MHz, B=120..270	SOT-23	16ta	-	3a Wtr
G1F	BC847B	Si-npn	GP, 50V, 100mA, 200mW, B=200..450, 200MHz	SOT-23	16ta	-	3a Rhm
G1F	L2SC2412KSLT1	Si-npn	GP, 50V, 150mA, 200mW, 180MHz, B=270..560	SOT-23	16ta	-	3a Lrc
G1K	BC848BW	Si-npn	GP, 30V, 100mA, 310mW, B=200..450, >300MHz	SOT-323	16ta	-	3a Rhm
G1p	BFS20	Si-npn	RF, 30V, 25mA, 250mW, B=85, 450MHz	SOT-23	16ta	-	3a PhH
G1t	BFS20	Si-npn	RF, 30V, 25mA, 250mW, B=85, 450MHz	SOT-23	16ta	-	3a PhM
G1W	BFS20	Si-npn	RF, 30V, 25mA, 250mW, B=85, 450MHz	SOT-23	16ta	-	3a PhC
G2	BF599	Si-npn	VHF, IF, 40V, 25mA, 200mW, B>40, 550MHz	SOT-23	16ta	-	3a Kec
G2	ELM7632HBB	Vdet-IC	3.2V±2%, +Reset PPO, 500ms	SOT-23	16vdc	VD7	3d Elm
G2	HSMP-389C	PIN-diode	Dual, RF, 100V, 1A, Rs(typ)=2.5Ω, 0.3pF	SOT-323	16dg	-	3a Agi
G2	R3113D321C	Vdet-IC	3.2V±2%, -Reset, PPO	SON1408-3	18vda	VD7	3d Ric
G2	R3130N22EA	Vdet-IC	2.2V, -Reset PPO, 240ms	SOT-23	16vdc	VD7	3b Ric
G2	RT9166-12CVL	LVR-IC	LDO, 1.2V±2%, 300mA	SOT-23	16cg	VR1	3a Rct
G2-	RT9166-12PVL	LVR-IC	LDO, 1.2V±2%, 300mA	SOT-23	16cg	VR1	3a Rct
G2=	RT9166-12GVL	LVR-IC	LDO, 1.2V±2%, 300mA	SOT-23	16cg	VR1	3a Rct
G20	MMBZ4620	Z-diode	3.3V±5%, 350mW	SOT-23	16dc	-	3g Vs
G21	2SK1958	n-MOSFET-e*	V-MOS, LogL, 16V, ±0.1A, <12Ω(10mA)	SOT-323	16fh	-	3a Nec
G21	MMBZ4621	Z-diode	3.6V±5%, 350mW	SOT-23	16dc	-	3g Vs



SMD code	Type	Function	Short description	Case	Pinout	Sch.	St.	Mnf.
G22	2SK2090	n-MOSFET-e*	V-MOS, LogL, 50V, ±100mA, <20Q(10mA)	SOT-323	16fh	-	3a	Nec
G22	DMN2075U	n-MOSFET-e	Sw, 20V, 4.2A, 800mW, 38mQ(3.6A), 7.4/28.1ns	SOT-23	16fh	-	3c	Di
G22	MMBZ4622	Z-diode	3.9V±5%, 350mW	SOT-23	16dc	-	3g	Vs
G23	2SK2158	n-MOSFET-e*	V-MOS, LogL, 50V, ±100mA, <15Q(10mA)	SOT-23	16fh	-	3a	Nec
G23	MMBZ4623	Z-diode	4.3V±5%, 350mW	SOT-23	16dc	-	3g	Vs
G24	2SK2858	n-MOSFET-e*	V-MOS, LogL, 30V, 0.1A, <15Q	SOT-323	16fh	-	3a	Nec
G24	GS809C21EU	Vdet-IC	2.1V, -Reset PPO, 210ms	SOT-23	16vdc	VD7	3g	Vs
G24	GS809C24EU	Vdet-IC	2.4V, -Reset PPO, 210ms	SOT-23	16vdc	VD7	3g	Vs
G24	MMBZ4624	Z-diode	4.7V±5%, 350mW	SOT-23	16dc	-	3g	Vs
G25	2SK3054	n-MOSFET-e*	V-MOS, LogL, 50V, ±0.1A, <40Q(10mA)	SOT-323	16fh	-	3a	Nec
G25	MMBZ4625	Z-diode	5.1V±5%, 350mW	SOT-23	16dc	-	3g	Vs
G26	GS809CREU	Vdet-IC	2.63V, -Reset PPO, 210ms	SOT-23	16vdc	VD7	3g	Vs
G26	MMBZ4626	Z-diode	5.6V±5%, 350mW	SOT-23	16dc	-	3g	Vs
G27	GS809C27SEU	Vdet-IC	2.7V, -Reset PPO, 210ms	SOT-23	16vdc	VD7	3g	Vs
G27	MMBZ4627	Z-diode	6.2V±5%, 350mW	SOT-23	16dc	-	3g	Vs
G29	GS809CSEU	Vdet-IC	2.93V, -Reset PPO, 210ms	SOT-23	16vdc	VD7	3g	Vs
G2F	2SC2412K-R	Si-npn	GP, 60V, 150mA, 200mW, 180MHz, B=180..390	SOT-23	16ta	-	3a	Wtr
G3	1SS196	Si-diode	Sw, U-Fast, 85V, 100mA, 150mW, Vf<1.2V(100mA), <4ns	SC-59	16dr	-	3a	Tos
G3	2SA1257-3	Si-npn	AF-Drv, 180V, 80mA, 200mW, 130MHz, B=60..120	SOT-23	16ta	-	3a	San
G3	2SC2107-3	Si-npn	GP, 60V, 100mA, 150mW, B=80..130, 300MHz	SOT-23	16ta	-	3a	Nec
G3	BAR63	PIN-diode	RF, 50V, 100mA, Vf(If=100mA)<1.2V, Ir<0.05µA, Cd<0.3pF	SOT-23	16dc	-	3a	Sie
G3	ELM7633HBB	Vdet-IC	3.3V±2%, +Reset PPO, 500ms	SOT-23	16vdc	VD7	3d	Elm
G3	HSMP-389E	PIN-diode	Dual, RF, 100V, 1A, Rs(typ)=2.5Q, 0.3pF	SOT-323	16df	-	3a	Agi
G3	R3113D331C	Vdet-IC	3.3V±2%, -Reset, PPO	SON1408-3	18vda	VD7	3d	Ric
G3	R3130N23EA	Vdet-IC	2.3V, -Reset PPO, 240ms	SOT-23	16vdc	VD7	3b	Ric
G3	RT9166-15CVL	LVR-IC	LDO, 1.5V±2%, 300mA	SOT-23	16cg	VR1	3a	Rct
G3-	RT9166-15PVL	LVR-IC	LDO, 1.5V±2%, 300mA	SOT-23	16cg	VR1	3a	Rct
G3-	PMST5551	Si-npn	HV, 180V, 300mA, 200mW, B=80..250, 100..300MHz	SOT-323	16ta	-	3a	PhH
G30	GS809CTEU	Vdet-IC	3.08V, -Reset PPO, 210ms	SOT-23	16vdc	VD7	3g	Vs
G3C	DTB122JK	Si-npn-Digi	Sw, 50V, 500mA, 200mW, 200MHz, R1/R2=220/470R	SOT-346	16ta	-	3a	Rhm
G3F	2SA1037AK-S	Si-npn	AF, 50V, 150mA, 200mW, B=270..560, >140MHz	SC-59	16ta	-	3a	Wtr
G3F	2SC2412K-S	Si-npn	GP, 60V, 150mA, 200mW, 180MHz, B=270..560	SOT-23	16ta	-	3a	Wtr
G3K	BC858BW	Si-npn	GP, 30V, 100mA, 250mW, B=220..475, >100MHz	UMT3	16ta	-	3a	Rhm
G4	2SA1257-4	Si-npn	AF-Drv, 180V, 80mA, 200mW, 130MHz, B=90..180	SOT-23	16ta	-	3a	San
G4	2SC2107-4	Si-npn	GP, 60V, 100mA, 150mW, B=110..170, 300MHz	SOT-23	16ta	-	3a	Nec
G4	BAR63	PIN-diode	RF, 50V, 100mA, Vf(If=100mA)<1.2V, Ir<0.05µA, Cd<0.3pF	SOT-23	16dc	-	3a	Sie
G4	BFS20R	Si-npn	RF, 30V, 25mA, 250mW, B=85, 450MHz	SOT-23	16ta	-	3a	Zx
G4	ELM7634HBB	Vdet-IC	3.4V±2%, +Reset PPO, 500ms	SOT-23	16vdc	VD7	3d	Elm
G4	HSMP-389F	PIN-diode	Dual, RF, 100V, 1A, Rs(typ)=2.5Q, 0.3pF	SOT-323	16dg	-	3a	Agi
G4	KA4A3Q	Si-npn-Digi	Sw, 60V, 100mA, 200mW, R1/R2=1k/10k	SOT-416	16ta	-	3a	Nec
G4	R3113D341C	Vdet-IC	3.4V±2%, -Reset, PPO	SON1408-3	18vda	VD7	3d	Ric
G4	R3130N24EA	Vdet-IC	2.4V, -Reset PPO, 240ms	SOT-23	16vdc	VD7	3b	Ric
G4	RT9166-18CVL	LVR-IC	LDO, 1.8V±2%, 300mA	SOT-23	16cg	VR1	3a	Rct
G4-	RT9166-18PVL	LVR-IC	LDO, 1.8V±2%, 300mA	SOT-23	16cg	VR1	3a	Rct
G4-	RT9166-18GVL	LVR-IC	LDO, 1.8V±2%, 300mA	SOT-23	16cg	VR1	3a	Rct
G40	GS809CJEU	Vdet-IC	4V, -Reset PPO, 210ms	SOT-23	16vdc	VD7	3g	Vs
G43	GS809CMEU	Vdet-IC	4.38V, -Reset PPO, 210ms	SOT-23	16vdc	VD7	3g	Vs
G46	GS809CLEU	Vdet-IC	4.63V, -Reset PPO, 210ms	SOT-23	16vdc	VD7	3g	Vs
G4C	DTD122JK	Si-npn-Digi	Sw, 50V, 500mA, 200mW, 200MHz, R1/R2=220R/470R	SOT-346	16ta	-	3a	Rhm
G4s	BAR63-04	PIN-diode	Dual, Sw, RF, 100V, 100mA, Vf<1.1V(50mA), < 0.3pF	SOT-23	16dl	-	3c	Inf
G4s	BAR63-04W	PIN-diode	Dual, Sw, RF, 100V, 100mA, Vf<1.1V(50mA), < 0.3pF	SOT-323	16dl	-	3c	Inf
G5	2SA1257-5	Si-npn	AF-Drv, 180V, 80mA, 200mW, 130MHz, B=135..270	SOT-23	16ta	-	3a	San
G5	2SC2107-5	Si-npn	GP, 60V, 100mA, 150mW, B=150..240, 300MHz	SOT-23	16ta	-	3a	Nec
G5	BF550R	Si-npn	HF/AF, 40V, 25mA, 200mW, B=50..125, 350MHz	SOT-23	16te	-	3a	Sil
G5	ELM7635HBB	Vdet-IC	3.5V±2%, +Reset PPO, 500ms	SOT-23	16vdc	VD7	3d	Elm
G5	R3113D351C	Vdet-IC	3.5V±2%, -Reset, PPO	SON1408-3	18vda	VD7	3d	Ric
G5	R3130N25EA	Vdet-IC	2.5V, -Reset PPO, 240ms	SOT-23	16vdc	VD7	3b	Ric
G5	RT9166-25CVL	LVR-IC	LDO, 2.5V±2%, 300mA	SOT-23	16cg	VR1	3a	Rct
G5	SP810EK-3-1	Vdet-IC	3.1V±1.5%, +Reset PPO	SOT-23	16vdc	VD7	3b	Sip
G5-	RT9166-25PVL	LVR-IC	LDO, 2.5V±2%, 300mA	SOT-23	16cg	VR1	3a	Rct
G5B	BC807-25	Si-npn	GP, 50V, 500mA, 250mW, 80MHz, B=160..400	SOT-23	16ta	-	3a	Rhm
G5s	BAR63-05	PIN-diode	Dual, Sw, RF, 100V, 100mA, Vf<1.1V(50mA), < 0.3pF	SOT-23	16dg	-	3c	Inf
G5s	BAR63-05W	PIN-diode	Dual, Sw, RF, 100V, 100mA, Vf<1.1V(50mA), < 0.3pF	SOT-323	16dg	-	3c	Inf
G6	2SC2107-6	Si-npn	GP, 60V, 100mA, 150mW, B=200..320, 300MHz	SOT-23	16ta	-	3a	Nec
G6	BF569	Si-npn	UHF-Mix/Osc, 40V, 30mA, 200mW, B=25..90, 1GHz	SOT-23	16ta	-	3a	Zx
G6	ELM7636HBB	Vdet-IC	3.6V±2%, +Reset PPO, 500ms	SOT-23	16vdc	VD7	3d	Elm
G6	R3113D361C	Vdet-IC	3.6V±2%, -Reset, PPO	SON1408-3	18vda	VD7	3d	Ric
G6	R3130N26EA	Vdet-IC	2.6V, -Reset PPO, 240ms	SOT-23	16vdc	VD7	3b	Ric
G6	RT9166-30CVL	LVR-IC	LDO, 3.0V±2%, 300mA	SOT-23	16cg	VR1	3a	Rct
G6-	RT9166-30PVL	LVR-IC	LDO, 3.0V±2%, 300mA	SOT-23	16cg	VR1	3a	Rct



SMD code	Type	Function	Short description	Case	Pinout	Sch. St.	Mnf.
G61	BF569R	Si-pnp	UHF-Mix/Osc, 40V, 30mA, 200mW, B=25..90, 1GHz	SOT-23	16te	-	3a Zx
G6s	BAR63-06	PIN-diode	Dual, Sw, RF, 100V, 100mA, Vf<1.1V(50mA), < 0.3pF	SOT-23	16df	-	3c Inf
G6s	BAR63-06W	PIN-diode	Dual, Sw, RF, 100V, 100mA, Vf<1.1V(50mA), < 0.3pF	SOT-323	16df	-	3c Inf
G7	BF579	Si-pnp	VHF/UHF, 20V, 25mA, 200mW, B=20..90, 1.75GHz	SOT-23	16ta	-	3a Sil
G7	ELM7637HBB	Vdet-IC	3.7V±2%, +Reset PPO, 500ms	SOT-23	16vdc	VD7	3d Elm
G7	KN4A3Q	Si-pnp-Digi	Sw, 60V, 100mA, 150mW, R1/R2=1k/10k	SOT-416	16ta	-	3a Nec
G7	R3113D371C	Vdet-IC	3.7V±2%, -Reset, PPO	SON1408-3	18vda	VD7	3d Ric
G7	R3130N27EA	Vdet-IC	2.7V, -Reset PPO, 240ms	SOT-23	16vdc	VD7	3b Ric
G7	RT9166A-28CVL	LVR-IC	LDO, 2.8V±2%, 600mA	SOT-23	16cg	VR1	3a Rct
G8	BF660	Si-pnp	VHF-Osc, 40V, 25mA, 650MHz	SOT-23	16ta	-	3a Sil
G8	ELM7638HBB	Vdet-IC	3.8V±2%, +Reset PPO, 500ms	SOT-23	16vdc	VD7	3d Elm
G8	R3113D381C	Vdet-IC	3.8V±2%, -Reset, PPO	SON1408-3	18vda	VD7	3d Ric
G8	R3130N28EA	Vdet-IC	2.8V, -Reset PPO, 240ms	SOT-23	16vdc	VD7	3b Ric
G8	RT9166-28CVL	LVR-IC	LDO, 2.8V±2%, 300mA	SOT-23	16cg	VR1	3a Rct
G8-	RT9166-28PVL	LVR-IC	LDO, 2.8V±2%, 300mA	SOT-23	16cg	VR1	3a Rct
G9	BF767	Si-pnp	VHF/UHF-LN, 950MHz	SOT-23	16ta	-	3a Phi
G9	ELM7639HBB	Vdet-IC	3.9V±2%, +Reset PPO, 500ms	SOT-23	16vdc	VD7	3d Elm
G9	R3113D391C	Vdet-IC	3.9V±2%, -Reset, PPO	SON1408-3	18vda	VD7	3d Ric
G9	R3130N29EA	Vdet-IC	2.9V, -Reset PPO, 240ms	SOT-23	16vdc	VD7	3b Ric
G9	RT9166-21CVL	LVR-IC	LDO, 2.1V±2%, 300mA	SOT-23	16cg	VR1	3a Rct
G9-	RT9166-21PVL	LVR-IC	LDO, 2.1V±2%, 300mA	SOT-23	16cg	VR1	3a Rct
G98	DTB133HKA	Si-pnp-Digi	Sw, 50V, 500mA, 200mW, 200MHz, R1/R2=3k3/10k	SOT-346	16ta	-	3a Rhm
GA	2SA1995FV-A	Si-pnp	GP, Sw, 15V, 400mA, 150mW, B=300..600, 130MHz	SOT-723	18ta	-	3a Tos
GA	2SC4922	Si-npn-Digi	Mute, Drv, 25V, 100mA, 150mW, 240MHz, R1=R2=47kΩ	SMCP	16ta	-	3a San
GA	ELM7630LDB	Vdet-IC	3.0V±2%, -Reset PPO, 50ms	SOT-23	16vdc	VD7	3d Elm
GA	HSMP-4890	PIN-diode	RF, 100V, 1A, 250mW, Rs<2.5Ω, Cd<0.375pF	SOT-23	16dh	-	3a Agi
GA	KRA151F	Si-pnp-Digi	Sw, 20V, 50mA, 50mW, 200MHz, R1/R2=4.7/4.7k	TFSM	19ta	-	3k Kec
GA	RT9166-35CVL	LVR-IC	LDO, 3.5V±2%, 300mA	SOT-23	16cg	VR1	3a Rct
GA-	RT9166-35PVL	LVR-IC	LDO, 3.5V±2%, 300mA	SOT-23	16cg	VR1	3a Rct
GAB	BCW60B	Si-npn	GP, 32V, 200mA, 250mW, B=150..310, 250MHz	SOT-23	16ta	-	3a Rhm
GAC	BCW60C	Si-npn	GP, 32V, 200mA, 250mW, B=250..480, 250MHz	SOT-23	16ta	-	3a Rhm
GAD	BCW60D	Si-npn	GP, 32V, 200mA, 250mW, B=380..630, 250MHz	SOT-23	16ta	-	3a Rhm
GAH	BXC70H	Si-npn	GP, Sw, 45V, 100mA, 250mW, B=180..310, >100MHz	SOT-23	16ta	-	3a Rhm
GB	2SA1995FV-B	Si-pnp	GP, Sw, 15V, 400mA, 150mW, B=000..1000, 130MHz	SOT-723	18ta	-	3a Tos
GB	ELM7631LDB	Vdet-IC	3.1V±2%, -Reset PPO, 50ms	SOT-23	16vdc	VD7	3d Elm
GB	KRA152F	Si-pnp-Digi	Sw, 20V, 50mA, 50mW, 200MHz, R1/R2=10/10k	TFSM	19ta	-	3k Kec
GB	RT9166A-25CVL	LVR-IC	LDO, 2.5V±2%, 600mA	SOT-23	16cg	VR1	3a Rct
GB	SiP810CJEUdT	Vdet-IC	4V±1.5%, +Reset PPO 210ms	SOT-23	16vdc	VD7	3g Vs
GC	2SC2734	Si-npn	UHF-conv/osc, 20V, 50mA, 150mW, B=20..200, 3.5GHz	SOT-23	16ta	-	3a Ren
GC	2SC4264	Si-npn	VHF/UHF, 20V, 50mA, 100mW, B=20..200, >1.4GHz	COMPACT	16ta	-	3a Ren
GC	ELM7632LDB	Vdet-IC	3.2V±2%, -Reset PPO, 50ms	SOT-23	16vdc	VD7	3d Elm
GC	KRA153F	Si-pnp-Digi	Sw, 20V, 50mA, 50mW, 200MHz, R1/R2=22/22k	TFSM	19ta	-	3k Kec
GC	SiP810CMEUdT	Vdet-IC	4.38V±1.5%, +Reset PPO 210ms	SOT-23	16vdc	VD7	3g Vs
GC-	RT9166-31PVL	LVR-IC	LDO, 3.1V±2%, 300mA	SOT-23	16cg	VR1	3a Rct
GD	ELM7633LDB	Vdet-IC	3.3V±2%, -Reset PPO, 50ms	SOT-23	16vdc	VD7	3d Elm
GD	KRA154F	Si-pnp-Digi	Sw, 20V, 50mA, 50mW, 200MHz, R1/R2=47/47k	TFSM	19ta	-	3k Kec
GD	SiP810CLEUdT	Vdet-IC	4.63V±1.5%, +Reset PPO 210ms	SOT-23	16vdc	VD7	3g Vs
GD-	RT9808-18PV	Vdet-IC	1.8V±2%, -Reset ODO	SOT-23	16vdb	VD6	3a Rct
GD08G	AIC1748-08GU3	LVR-IC	LDO, 0.8V±2%, 600mA	SOT-23	16cg	VR1	3a Aic
GD09G	AIC1748-09GU3	LVR-IC	LDO, 0.9V±2%, 600mA	SOT-23	16cg	VR1	3a Aic
GD10G	AIC1748-10GU3	LVR-IC	LDO, 1.0V±2%, 600mA	SOT-23	16cg	VR1	3a Aic
GD11G	AIC1748-11GU3	LVR-IC	LDO, 1.1V±2%, 600mA	SOT-23	16cg	VR1	3a Aic
GD12G	AIC1748-12GU3	LVR-IC	LDO, 1.2V±2%, 600mA	SOT-23	16cg	VR1	3a Aic
GD13G	AIC1748-13GU3	LVR-IC	LDO, 1.3V±2%, 600mA	SOT-23	16cg	VR1	3a Aic
GD14G	AIC1748-14GU3	LVR-IC	LDO, 1.4V±2%, 600mA	SOT-23	16cg	VR1	3a Aic
GD15G	AIC1748-15GU3	LVR-IC	LDO, 1.5V±2%, 600mA	SOT-23	16cg	VR1	3a Aic
GD16G	AIC1748-16GU3	LVR-IC	LDO, 1.6V±2%, 600mA	SOT-23	16cg	VR1	3a Aic
GD17G	AIC1748-17GU3	LVR-IC	LDO, 1.7V±2%, 600mA	SOT-23	16cg	VR1	3a Aic
GD18G	AIC1748-18GU3	LVR-IC	LDO, 1.8V±2%, 600mA	SOT-23	16cg	VR1	3a Aic
GD19G	AIC1748-19GU3	LVR-IC	LDO, 1.9V±2%, 600mA	SOT-23	16cg	VR1	3a Aic
GD20G	AIC1748-20GU3	LVR-IC	LDO, 2.0V±2%, 600mA	SOT-23	16cg	VR1	3a Aic
GD21G	AIC1748-21GU3	LVR-IC	LDO, 2.1V±2%, 600mA	SOT-23	16cg	VR1	3a Aic
GD22G	AIC1748-22GU3	LVR-IC	LDO, 2.2V±2%, 600mA	SOT-23	16cg	VR1	3a Aic
GD23G	AIC1748-23GU3	LVR-IC	LDO, 2.3V±2%, 600mA	SOT-23	16cg	VR1	3a Aic
GD24G	AIC1748-24GU3	LVR-IC	LDO, 2.4V±2%, 600mA	SOT-23	16cg	VR1	3a Aic
GD25G	AIC1748-25GU3	LVR-IC	LDO, 2.5V±2%, 600mA	SOT-23	16cg	VR1	3a Aic
GD26G	AIC1748-26GU3	LVR-IC	LDO, 2.6V±2%, 600mA	SOT-23	16cg	VR1	3a Aic
GD27G	AIC1748-27GU3	LVR-IC	LDO, 2.7V±2%, 600mA	SOT-23	16cg	VR1	3a Aic
GD28G	AIC1748-28GU3	LVR-IC	LDO, 2.8V±2%, 600mA	SOT-23	16cg	VR1	3a Aic
GD29G	AIC1748-29GU3	LVR-IC	LDO, 2.9V±2%, 600mA	SOT-23	16cg	VR1	3a Aic



SMD code	Type	Function	Short description	Case	Pinout	Sch. St.	Mnf.
GD2JG	AIC1748-285GU3	LVR-IC	LDO, 2.85V±2%, 600mA	SOT-23	16cg	VR1 3a	Aic
GD30G	AIC1748-30GU3	LVR-IC	LDO, 3.0V±2%, 600mA	SOT-23	16cg	VR1 3a	Aic
GD31G	AIC1748-32GU3	LVR-IC	LDO, 3.1V±2%, 600mA	SOT-23	16cg	VR1 3a	Aic
GD32G	AIC1748-33GU3	LVR-IC	LDO, 3.2V±2%, 600mA	SOT-23	16cg	VR1 3a	Aic
GD33G	AIC1748-33GU3	LVR-IC	LDO, 3.3V±2%, 600mA	SOT-23	16cg	VR1 3a	Aic
GDE	SMPc5.0A	TVS	Vbr=6.40..7.07V, Vrwm=5.0V, Ipp=150.0A, 1500W(1ms)	TO-277A	76bd	- 3o	Vs
GDG	SMPc6.0A	TVS	Vbr=6.67..7.37V, Vrwm=6.0V, Ipp=145.6A, 1500W(1ms)	TO-277A	76bd	- 3o	Vs
GDK	SMPc6.5A	TVS	Vbr=7.22..7.98V, Vrwm=6.5V, Ipp=133.9A, 1500W(1ms)	TO-277A	76bd	- 3o	Vs
GDM	SMPc7.0A	TVS	Vbr=7.78..8.60V, Vrwm=7.0V, Ipp=125.0A, 1500W(1ms)	TO-277A	76bd	- 3o	Vs
GDP	SMPc7.5A	TVS	Vbr=8.33..9.21V, Vrwm=7.5V, Ipp=116.3A, 1500W(1ms)	TO-277A	76bd	- 3o	Vs
GDR	SMPc8.0A	TVS	Vbr=8.89..9.83V, Vrwm=8.0V, Ipp=110.3A, 1500W(1ms)	TO-277A	76bd	- 3o	Vs
GDT	SMPc8.5A	TVS	Vbr=9.44..10.4V, Vrwm=8.5V, Ipp=104.2A, 1500W(1ms)	TO-277A	76bd	- 3o	Vs
GDV	SMPc9.0A	TVS	Vbr=10.0..11.1V, Vrwm=9.0V, Ipp=97.4A, 1500W(1ms)	TO-277A	76bd	- 3o	Vs
GDX	SMPc10A	TVS	Vbr=11.1..12.3V, Vrwm=10V, Ipp=88.2A, 1500W(1ms)	TO-277A	76bd	- 3o	Vs
GDZ	SMPc11A	TVS	Vbr=12.2..13.5V, Vrwm=11V, Ipp=82.4A, 1500W(1ms)	TO-277A	76bd	- 3o	Vs
GE	2SA1455K-E	Si-pnp	AF, 50V, 150mA, 200mW, B=390..820, >140MHz	SOT-346	16ta	- 3a	Rhm
GE	ELM7634LDB	Vdet-IC	3.4V±2%, -Reset PPO, 50ms	SOT-23	16vdc	VD7 3d	Elm
GE-	RT9198-18PV	LVR-IC	LDO, 1.8V±1%, 300mA	SOT-23	16cg	VR1 3a	Rct
GE=	RT9198-18GV	LVR-IC	LDO, 1.8V±1%, 300mA	SOT-23	16cg	VR1 3a	Rct
GEA	CHDTC144GEPT	Si-npn-Digi	Sw, 50V, 100mA, 250MHz, R2=47k	SOT-416	16ta	- 3a	Chm
GEE	SMPc12A	TVS	Vbr=13.3..14.7V, Vrwm=12V, Ipp=75.4A, 1500W(1ms)	TO-277A	76bd	- 3o	Vs
GEG	SMPc13A	TVS	Vbr=14.4..15.9V, Vrwm=13V, Ipp=69.8A, 1500W(1ms)	TO-277A	76bd	- 3o	Vs
GEK	SMPc14A	TVS	Vbr=15.6..17.2V, Vrwm=14V, Ipp=64.7A, 1500W(1ms)	TO-277A	76bd	- 3o	Vs
GEM	SMPc15A	TVS	Vbr=16.7..18.5V, Vrwm=15V, Ipp=61.5A, 1500W(1ms)	TO-277A	76bd	- 3o	Vs
GEP	SMPc16A	TVS	Vbr=17.8..19.7V, Vrwm=16V, Ipp=57.7A, 1500W(1ms)	TO-277A	76bd	- 3o	Vs
GER	SMPc17A	TVS	Vbr=18.9..20.9V, Vrwm=17V, Ipp=54.3A, 1500W(1ms)	TO-277A	76bd	- 3o	Vs
GEs	BFR35AP	Si-npn	VHF,UHF, 20V, 30mA, 280mW, B=40..200, 5GHz	SOT-23	16ta	- 3a	Sie
GET	SMPc18A	TVS	Vbr=20.0..22.1V, Vrwm=18V, Ipp=51.4A, 1500W(1ms)	TO-277A	76bd	- 3o	Vs
GEV	SMPc20A	TVS	Vbr=22.2..24.5V, Vrwm=20V, Ipp=46.3A, 1500W(1ms)	TO-277A	76bd	- 3o	Vs
GEX	SMPc22A	TVS	Vbr=24.4..26.9V, Vrwm=22V, Ipp=42.3A, 1500W(1ms)	TO-277A	76bd	- 3o	Vs
GEZ	SMPc24A	TVS	Vbr=26.7..29.5V, Vrwm=24V, Ipp=38.6A, 1500W(1ms)	TO-277A	76bd	- 3o	Vs
GF	BFN22	Si-npn	Vid, 250V, 20..50mA, >60MHz	SOT-23	16ta	- 3a	Ste
GF	ELM7635LDB	Vdet-IC	3.5V±2%, -Reset PPO, 50ms	SOT-23	16vdc	VD7 3d	Elm
GF-	RT9198-25PV	LVR-IC	LDO, 2.5V±1%, 300mA	SOT-23	16cg	VR1 3a	Rct
GF1	AP2121N-1.5TRG1	LVR-IC	LDO, 1.5V±2%, 200mA	SOT-23	16cg	VR1 3b	Bcd
GF3	AP2121N-1.8TRG1	LVR-IC	LDO, 1.8V±2%, 200mA	SOT-23	16cg	VR1 3b	Bcd
GF4	AP2121N-2.5TRG1	LVR-IC	LDO, 2.5V±2%, 200mA	SOT-23	16cg	VR1 3b	Bcd
GF5	AP2121N-2.8TRG1	LVR-IC	LDO, 2.8V±2%, 200mA	SOT-23	16cg	VR1 3b	Bcd
GF6	AP2121N-3.0TRG1	LVR-IC	LDO, 3.0V±2%, 200mA	SOT-23	16cg	VR1 3b	Bcd
GF7	AP2121N-3.2TRG1	LVR-IC	LDO, 3.2V±2%, 200mA	SOT-23	16cg	VR1 3b	Bcd
GF8	AP2121N-3.3TRG1	LVR-IC	LDO, 3.3V±2%, 200mA	SOT-23	16cg	VR1 3b	Bcd
GF9	AP2121N-1.2TRG1	LVR-IC	LDO, 1.2V±2%, 200mA	SOT-23	16cg	VR1 3b	Bcd
GFE	SMPc26A	TVS	Vbr=28.9..31.0V, Vrwm=26V, Ipp=35.6A, 1500W(1ms)	TO-277A	76bd	- 3o	Vs
GFG	SMPc28A	TVS	Vbr=31.1..34.4V, Vrwm=28V, Ipp=33.0A, 1500W(1ms)	TO-277A	76bd	- 3o	Vs
GFK	SMPc30A	TVS	Vbr=33.3..36.8V, Vrwm=30V, Ipp=31.0A, 1500W(1ms)	TO-277A	76bd	- 3o	Vs
GFM	SMPc33A	TVS	Vbr=36.7..40.6V, Vrwm=33V, Ipp=28.1A, 1500W(1ms)	TO-277A	76bd	- 3o	Vs
GFP	SMPc36A	TVS	Vbr=40.0..44.2V, Vrwm=36V, Ipp=25.8A, 1500W(1ms)	TO-277A	76bd	- 3o	Vs
GFs	BFR92P	Si-npn	UHF-A-Band, 20V, 25mA, 300mW, B>40, >5GHz	SOT-23	16ta	- 3a	Sie
GG	BF579R	Si-pnp	VHF/UHF, 20V, 25mA, 200mW, B=20..90, 1.75GHz	SOT-23	16te	- 3g	Vs
GG	BFR93P	Si-npn	UHF-A-Band, 15V, 30mA, 300mW, B>40, >5GHz	SOT-23	16ta	- 3a	Sie
GG	ELM7636LDB	Vdet-IC	3.6V±2%, -Reset PPO, 50ms	SOT-23	16vdc	VD7 3d	Elm
GG	KRA157F	Si-pnp-Digi	Sw, 20V, 50mA, 50mW, 200MHz, R1/R2=10/47k	TFSM	19ta	- 3k	Kec
GG-	RT9198-30PV	LVR-IC	LDO, 3.0V±1%, 300mA	SOT-23	16cg	VR1 3a	Rct
GG=	RT9198-30GV	LVR-IC	LDO, 3.0V±1%, 300mA	SOT-23	16cg	VR1 3a	Rct
GG9	AP2121N-1.3TRG1	LVR-IC	LDO, 1.3V±2%, 200mA	SOT-23	16cg	VR1 3b	Bcd
GH	ELM7637LDB	Vdet-IC	3.7V±2%, -Reset PPO, 50ms	SOT-23	16vdc	VD7 3d	Elm
GH	KRA158F	Si-pnp-Digi	Sw, 20V, 50mA, 50mW, 200MHz, R1/R2=22/47k	TFSM	19ta	- 3k	Kec
GH	MAZ6006AUR	Vref-IC	Shunt, 1.250V, 0.2%	SOT-23	16di	RF1 3a	Max
GH-	RT9198-33PV	LVR-IC	LDO, 3.3V±1%, 300mA	SOT-23	16cg	VR1 3a	Rct
GH1	AZ809ANSTR-G1	Vdet-IC	2.93V±1.5%, -Reset PPO	SOT-23	16vdc	VD7 3a	Bcd
GH1	BCW69	Si-pnp	GP, 50V, 100mA, 330mW, B=120..260, >150MHz	SOT-23	16ta	- 3a	Rhm
GH2	BCW70	Si-pnp	GP, 50V, 100mA, 330mW, B=215..500, >150MHz	SOT-23	16ta	- 3a	Rhm
GH6	AZ809ANSTR-G1	Vdet-IC	2.63V±1.5%, -Reset PPO	SOT-23	16vdc	VD7 3a	Bcd
GH7	AZ809ANLTR-G1	Vdet-IC	4.63V±1.5%, -Reset PPO	SOT-23	16vdc	VD7 3a	Bcd
GI	MAZ6006BUR	Vref-IC	Shunt, 1.250V, 0.5%	SOT-23	16di	RF1 3a	Max
GJ	ELM7638LDB	Vdet-IC	3.8V±2%, -Reset PPO, 50ms	SOT-23	16vdc	VD7 3d	Elm
GJ	KRA159F	Si-pnp-Digi	Sw, 20V, 50mA, 50mW, 200MHz, R1/R2=47/22k	TFSM	19ta	- 3k	Kec
GJ	MAZ6006CUR	Vref-IC	Shunt, 1.250V, 1%	SOT-23	16di	RF1 3a	Max
GJ=	RT9198-15GV	LVR-IC	LDO, 1.5V±1%, 300mA	SOT-23	16cg	VR1 3a	Rct
GJ2	2SK968-2	n-FET	FM, 20V, 20mA, 200mW, Idss=0.6..1.5mA, Up<2.5V	SOT-23	16fa	- 3a	San



SMD code	Type	Function	Short description	Case	Pinout	Sch.	St.	Mnf.
GJ3	2SK968-3	n-FET	FM, 20V, 20mA, 200mW, Idss=1.2..3mA, Up<2.5V	SOT-23	16fa	-	3a	San
GJ4	2SK968-4	n-FET	FM, 20V, 20mA, 200mW, Idss=2.5..4mA, Up<2.5V	SOT-23	16fa	-	3a	San
GJ5	2SK968-5	n-FET	FM, 20V, 20mA, 200mW, Idss=5..12mA, Up<2.5V	SOT-23	16fa	-	3a	San
GK	2SK2969	n-MOSFET-e*	V-MOS, LogL, 30V, 0.8A, <0.52Q, 20/50ns	SOT-23	16fh	-	3a	San
GK	ELM7639LDB	Vdet-IC	3.9V±2%, -Reset PPO, 50ms	SOT-23	16vdc	VD7	3d	Elm
GK	KRA160F	Si-pnp-Digi	Sw, 20V, 50mA, 50mW, 200MHz, R1=4.7k	TFSM	19ta	-	3k	Kec
GK	MAZ6007AUR	Vref-IC	Shunt, 2.480V, 0.2%	SOT-23	16di	RF1	3a	Max
GK-	RT9198-28PV	LVR-IC	LDO, 2.8V±1%, 300mA	SOT-23	16cg	VR1	3a	Rct
GK1	BCW71	Si-npn	AF, 50V, 100mA, 250mW, B=110..220, >100MHz	SOT-23	16ta	-	3a	Rhm
GK1	CHDTA114GKPT	Si-pnp-Digi	Sw, 50V, 100mA, 250MHz, R2=10k	SOT-23	16ta	-	3a	Chm
GK2	BCW72	Si-npn	AF, 50V, 100mA, 250mW, >100MHz, B=200..450	SOT-23	16ta	-	3a	Rhm
GK2	CHDTA124GKPT	Si-pnp-Digi	Sw, 50V, 100mA, 250MHz, R2=22k	SOT-23	16ta	-	3a	Chm
GK3	CHDTA144GKPT	Si-pnp-Digi	Sw, 50V, 100mA, 250MHz, R2=47k	SOT-23	16ta	-	3a	Chm
GK4	CHDTA115GKPT	Si-pnp-Digi	Sw, 50V, 100mA, 250MHz, R2=100k	SOT-23	16ta	-	3a	Chm
GKA	CHDTC114GKPT	Si-npn-Digi	Sw, 50V, 100mA, 250MHz, R2=10k	SOT-23	16ta	-	3a	Chm
GKB	CHDTC124GKPT	Si-npn-Digi	Sw, 50V, 100mA, 250MHz, R2=22k	SOT-23	16ta	-	3a	Chm
GKC	CHDTC144GKPT	Si-npn-Digi	Sw, 50V, 100mA, 250MHz, R2=47k	SOT-23	16ta	-	3a	Chm
GKD	CHDTC115GKPT	Si-npn-Digi	Sw, 50V, 100mA, 250MHz, R2=100k	SOT-23	16ta	-	3a	Chm
GKE	CHDTC114GKPT	Si-npn-Digi	Sw, 50V, 500mA, 250MHz, R2=10k	SOT-23	16ta	-	3a	Chm
GL	2SA1496	Si-pnp-Digi	Sw, 50V, 100mA, 200mW, 200MHz, B>100, R1=10k	CP	16ta	-	3a	San
GL	KRA161F	Si-pnp-Digi	Sw, 20V, 50mA, 50mW, 200MHz, R1=10k	TFSM	19ta	-	3k	Kec
GL	MAZ6007BUR	Vref-IC	Shunt, 2.480V, 0.5%	SOT-23	16di	RF1	3a	Max
GL	RT9166A-15CVL	LVR-IC	LDO, 1.5V±2%, 600mA	SOT-23	16cg	VR1	3a	Rct
GLN	ELM7528CEB	Vdet-IC	2.8V±2%, +Reset PPO	SC-70	16vdb	VD7	3d	Elm
GLN	ELM7528NEB	Vdet-IC	2.8V±2%, +Reset ODO	SC-70	16vdb	VD6	3d	Elm
GLP	MMBT1010	Si-npn	Lo-sat, 45V, 100mA, 225mW, B=300..600	SOT-23	16ta	-	3a	Mot
GLP	MSD1010	Si-npn	Lo-sat, 45V, 100mA, 225mW, B=300..600	SC-59	16ta	-	3a	Mot
GM	MAZ6007CUR	Vref-IC	Shunt, 2.480V, 1%	SOT-23	16di	RF1	3a	Max
GM	RT9166A-33CVL	LVR-IC	LDO, 3.3V±2%, 600mA	SOT-23	16cg	VR1	3a	Rct
GM-	RT9166A-33PVL	LVR-IC	LDO, 3.3V±2%, 600mA	SOT-23	16cg	VR1	3a	Rct
GMA	BFS17	Si-npn	VHF/UHF, Mix/Osc, 25V, 25mA, 300mW, B=90, 1GHz	SOT-23	16ta	-	3a	Rhm
GN	2SC5489	Si-npn	VHF/UHF LN, 16V, 50mA, 100mW, B=90..200, 9GHz	SSFP	18ta	-	3a	San
GN	KRA163F	Si-pnp-Digi	Sw, 20V, 50mA, 50mW, 200MHz, R1=22k	TFSM	19ta	-	3k	Kec
GN	MAZ6008AUR	Vref-IC	Shunt, 2.500V, 0.2%	SOT-23	16di	RF1	3a	Max
GN3	2SC4867-3	Si-npn	VHF/UHF-Amp, 16V, 50mA, 200mW, B=60..120, 9GHz	MCP	16ta	-	3a	San
GN3	2SC4868-3	Si-npn	VHF/UHF-Amp, 16V, 50mA, 200mW, B=60..120, 9GHz	SOT-23	16ta	-	3a	San
GN4	2SC4867-4	Si-npn	VHF/UHF-Amp, 16V, 50mA, 200mW, B=90..180, 9GHz	MCP	16ta	-	3a	San
GN4	2SC4868-4	Si-npn	VHF/UHF-Amp, 16V, 50mA, 200mW, B=90..180, 9GHz	SOT-23	16ta	-	3a	San
GN5	2SC4867-5	Si-npn	VHF/UHF-Amp, 16V, 50mA, 200mW, B=130..270, 9GHz	MCP	16ta	-	3a	San
GN5	2SC4868-5	Si-npn	VHF/UHF-Amp, 16V, 50mA, 200mW, B=130..270, 9GHz	SOT-23	16ta	-	3a	San
GO	2SC2996-O	Si-npn	FM/AM RF, 40V, 50mA, 150mW, B=40..80, 350MHz	SOT-23	16ta	-	3a	Tos
GO	AP130-15R	LVR-IC	LDO, 1.5V±2%, 300mA	SOT-23	16cg	VR1	3b	Ana
GO	MAZ6008BUR	Vref-IC	Shunt, 2.500V, 0.5%	SOT-23	16di	RF1	3a	Max
GP	AP130-16R	LVR-IC	LDO, 1.6V±2%, 300mA	SOT-23	16cg	VR1	3b	Ana
GP	KRA164F	Si-pnp-Digi	Sw, 20V, 50mA, 50mW, 200MHz, R1=47k	TFSM	19ta	-	3k	Kec
GP	MAZ6008CUR	Vref-IC	Shunt, 2.500V, 1%	SOT-23	16di	RF1	3a	Max
GQ	AP130-17R	LVR-IC	LDO, 1.7V±2%, 300mA	SOT-23	16cg	VR1	3b	Ana
GQ	MAZ6009AUR	Vref-IC	Shunt, 3.00V, 0.2%	SOT-23	16di	RF1	3a	Max
GR	2SA1455K-R	Si-pnp	AF, 50V, 150mA, 200mW, B=180..390, >140MHz	SOT-346	16ta	-	3a	Rhm
GR	2SC2996-R	Si-npn	FM/AM RF, 40V, 50mA, 150mW, B=70..140, 350MHz	SOT-23	16ta	-	3a	Tos
GR	AP130-18R	LVR-IC	LDO, 1.8V±2%, 300mA	SOT-23	16cg	VR1	3b	Ana
GR	MAZ6009BUR	Vref-IC	Shunt, 3.00V, 0.5%	SOT-23	16di	RF1	3a	Max
GR	RT9166A-13CVL	LVR-IC	LDO, 1.3V±2%, 600mA	SOT-23	16cg	VR1	3a	Rct
GS	2SA1455K-S	Si-pnp	AF, 50V, 150mA, 200mW, B=270..560, >140MHz	SOT-346	16ta	-	3a	Rhm
GS	AP130-19R	LVR-IC	LDO, 1.9V±2%, 300mA	SOT-23	16cg	VR1	3b	Ana
GS	MAZ6009CUR	Vref-IC	Shunt, 3.00V, 1%	SOT-23	16di	RF1	3a	Max
GS-	RT9818C-21PV	Vdet-IC	2.1V±1.5%, -Reset ODO, Td=220ms	SOT-23	16vda	VD6	3a	Rct
GT	2SC2412KPT-S	Si-npn	AF, Sw, 50V, 150mA, B=270..560, 180MHz	SOT-23	16ta	-	3a	Chm
GT	AP130-20R	LVR-IC	LDO, 2.0V±2%, 300mA	SOT-23	16cg	VR1	3b	Ana
GT-	RT9818C-25PV	Vdet-IC	2.5V±1.5%, -Reset ODO, Td=220ms	SOT-23	16vda	VD6	3a	Rct
GT=	RT9818C-25GV	Vdet-IC	2.5V±1.5%, -Reset ODO, Td=220ms	SOT-23	16vda	VD6	3a	Rct
GT0	BC857CT	Si-pnp	GP, 50V, 100mA, 250mW, B=420..800, >100MHz	SOT-523	16ta	-	3a	Phi
GT1	BC846AT	Si-npn	GP, 80V, 100mA, 150mW, B=110..220, >100MHz	SOT-523	16ta	-	3a	Cen
GT1	BCX17	Si-pnp	AF-Drv, 50V, 500mA, 250mW, B=100..600, >80MHz	SOT-23	18ta	-	3a	Rhm
GT2	BC846BT	Si-npn	GP, 80V, 100mA, 150mW, B=200..450, 250MHz	SOT-523	18ta	-	3a	Cen
GT2	BCX18	Si-pnp	AF-Drv, 30V, 500mA, 250mW, B=100..600, >80MHz	SOT-23	16ta	-	3a	Rhm
GT3	2SC4168-3	Si-npn	Sw, 40V, 150mA, 200mA, B=60..120, 700MHz	SOT-323	16ta	-	3a	San
GT3	2SC4443-3	Si-npn	Sw, 20V, 150mA, 150mW, B=60..120, 700MHz	SOT-323	16ta	-	3a	San
GT3	BC847AT	Si-npn	GP, 50V, 100mA, 330mW, B=110..220, 250MHz	SOT-523	18ta	-	3a	Cen
GT4	2SC4168-4	Si-npn	Sw, 40V, 150mA, 200mA, B=90..180, 700MHz	SOT-323	16ta	-	3a	San



SMD code	Type	Function	Short description	Case	Pinout	Sch. St.	Mnf.
GT4	2SC4443-4	Si-npn	Sw, 20V, 150mA, 150mW, B=90..180, 700MHz	SOT-323	16ta	-	3a San
GT4	BC847BT	Si-npn	GP, 50V, 100mA, 250mW, B=200..450, >100MHz	SOT-523	18ta	-	3a Cen
GT5	2SC4168-5	Si-npn	Sw, 40V, 150mA, 200mA, B=135..270, 700MHz	SOT-323	16ta	-	3a San
GT5	2SC4443-5	Si-npn	Sw, 20V, 150mA, 150mW, B=135..270, 700MHz	SOT-323	16ta	-	3a San
GT5	BC847CT	Si-npn	GP, 50V, 100mA, 150mW, B=420..800, >100MHz	SOT-523	18ta	-	3a Cen
GT6	BC856AT	Si-pnp	GP, 80V, 100mA, 250mW, B=125..250, >100MHz	SOT-523	18ta	-	3a Cen
GT7	BC856BT	Si-pnp	GP, 80V, 100mA, 250mW, B=220..475, >100MHz	SOT-523	18ta	-	3a Cen
GT8	BC857AT	Si-pnp	GP, 50V, 100mA, 250mW, B=125..250, >100MHz	SOT-523	18ta	-	3a Cen
GT9	BC857BT	Si-pnp	GP, 50V, 100mA, 250mW, B=220..475, >100MHz	SOT-523	18ta	-	3a Cen
GU	AP130-21R	LVR-IC	LDO, 2.1V±2%, 300mA	SOT-23	16cg	VR1	3b Ana
GU-	RT9818C-27PV	Vdet-IC	2.7V±1.5%, -Reset ODO, Td=220ms	SOT-23	16vda	VD6	3a Rct
GU=	RT9818C-27GV	Vdet-IC	2.7V±1.5%, -Reset ODO, Td=220ms	SOT-23	16vda	VD6	3a Rct
GU1	BCX19	Si-npn	AF-Drv, 50V, 500mA, 250mW, B=100..600, 200MHz	SOT-23	16ta	-	3a Rhm
GU1	CHDTA114GUPT	Si-pnp-Digi	Sw, 50V, 100mA, 250MHz, R2=10k	SOT-323	16ta	-	3a Chm
GU2	CHDTA144GUPT	Si-pnp-Digi	Sw, 50V, 100mA, 250MHz, R2=47k	SOT-323	16ta	-	3a Chm
GU3	CHDTA115GUPT	Si-pnp-Digi	Sw, 50V, 100mA, 250MHz, R2=100k	SOT-323	16ta	-	3a Chm
GU8	BSR14	Si-npn	HF/Sw, 75V, 800mA, 250mW, B=100..300, 300MHz	SOT-23	16ta	-	3a Rhm
GUA	CHDTC114GUPT	Si-npn-Digi	Sw, 50V, 100mA, 250MHz, R2=10k	SOT-323	16ta	-	3a Chm
GUB	CHDTC124GUPT	Si-npn-Digi	Sw, 50V, 100mA, 250MHz, R2=22k	SOT-323	16ta	-	3a Chm
GUC	CHDTC144GUPT	Si-npn-Digi	Sw, 50V, 100mA, 250MHz, R2=47k	SOT-323	16ta	-	3a Chm
GUD	CHDTC115GUPT	Si-npn-Digi	Sw, 50V, 100mA, 250MHz, R2=100k	SOT-323	16ta	-	3a Chm
GV	1SV249	PIN-diode	Dual, VHF/UHF, 50V, 50mA, 0.23pF, 3.5Ω(100MHz)	MCP	16dl	-	3a San
GV	1SV251	PIN-diode	Dual, VHF/UHF, 50V, 50mA, 0.23pF, 3.5Ω(100MHz)	SOT-23	16dl	-	3a San
GV	AP130-22R	LVR-IC	LDO, 2.2V±2%, 300mA	SOT-23	16cg	VR1	3b Ana
GV-	RT9198-31PV	LVR-IC	LDO, 3.1V±1%, 300mA	SOT-23	16cg	VR1	3a Rct
GW	2SC5619	Si-npn	UHF, TV-tun, 20V, 50mA, 150mW, 4.5GHz, B=50..250	SC-59	16ta	-	3a Ish
GW	2SC5620	Si-npn	UHF, TV-tun, 20V, 50mA, 125mW, 4.5GHz, B=50..250	SOT-323	16ta	-	3a Ish
GW	2SC5621	Si-npn	UHF, TV-tun, 20V, 50mA, 100mW, 4.5GHz, B=50..250	SC-75A	16ta	-	3a Ish
GW	AP130-23R	LVR-IC	LDO, 2.3V±2%, 300mA	SOT-23	16cg	VR1	3b Ana
GW	RT9166-36CVL	LVR-IC	LDO, 3.6V±2%, 300mA	SOT-23	16cg	VR1	3a Rct
GW-	RT9166-36PVL	LVR-IC	LDO, 3.6V±2%, 300mA	SOT-23	16cg	VR1	3a Rct
GX	AP130-24R	LVR-IC	LDO, 2.4V±2%, 300mA	SOT-23	16cg	VR1	3b Ana
GX	DDZX14	Z-diode	14V±2.5%, 500mW	SOT-23	16dc	-	3a Di
GX	DDZX14W	Z-diode	14V±2.5%, 200mW	SOT-323	16dc	-	3a Di
GX-	RT9818B-16PVL	Vdet-IC	1.6V±1.5%, -Reset ODO, Td=55ms	SOT-23	16vdc	VD6	3a Rct
GY	2SC2996-Y	Si-npn	FM/AM RF, 40V, 50mA, 150mW, B=120..240, 350MHz	SOT-23	16ta	-	3a Tos
GY	2SC3689	Si-npn	AF-Amp, GP, 60V, 199mA, 200mW, B=800..3200, 200MHz	SOT-23	16ta	-	3a San
GY	2SC4413	Si-npn	AF-Amp, 60V, 100mA, 150mW, B=800..3200, 200MHz	MCP	16ta	-	3a San
GY	AP130-25R	LVR-IC	LDO, 2.5V±2%, 300mA	SOT-23	16cg	VR1	3b Ana
GY	DDZX15	Z-diode	15V±2.5%, 500mW	SOT-23	16dc	-	3a Di
GY	DDZX15W	Z-diode	15V±2.5%, 200mW	SOT-323	16dc	-	3a Di
GY-	RT9818A-14PV	Vdet-IC	1.4V±1.5%, -Reset ODO	SOT-23	16vda	VD6	3a Rct
GZ	AP130-26R	LVR-IC	LDO, 2.6V±2%, 300mA	SOT-23	16cg	VR1	3b Ana
GZ	SiP810CTEUDT	Vdet-IC	3.08V±1.5%, +Reset PPO 210ms	SOT-23	16vdc	VD7	3g Vs
GZ-	RT9818A-16PV	Vdet-IC	1.6V±1.5%, -Reset ODO	SOT-23	16vda	VD6	3a Rct
H	2SK2076	n-FET	GP, 30V, Idss>0.4mA, Up<1.5V	SOT-23	16fa	-	3a San
h	AX6902AA	Vdet-IC	4.63V±1.5%, +Reset PPO	SC-70	16vdc	VD7	3b Axl
H	MRF947B	Si-npn	VHF/UHF, 20V, 50mA, 188mW, B=100..200, 8GHz	SOT-323	16ta	-	3a Mot
H	SB02-03Q	Si-diode	SBR, HF, 30V, 200mA, Vf<0.55V(200mA), 6.3pF, 10ns	MCP	16dc	-	3a San
H+Q	2SC3928A-Q	Si-npn	AF-Amp, 50V, 200mA, 200mW, B=120..270, 200MHz	SC-59	16ta	-	3a Mit
H+Q	2SC4155A-Q	Si-npn	AF-Amp, 50V, 200mA, 150mW, 200MHz, B=120..270	SOT-323	16ta	-	3a Mit
H+R	2SC3928A-R	Si-npn	AF-Amp, 50V, 200mA, 200mW, B=180..390, 200MHz	SC-59	16ta	-	3a Mit
H+R	2SC4155A-R	Si-npn	AF-Amp, 50V, 200mA, 150mW, 200MHz, B=180..390	SOT-323	16ta	-	3a Mit
H+S	2SC3928A-S	Si-npn	AF-Amp, 50V, 200mA, 200mW, B=270..560, 200MHz	SC-59	16ta	-	3a Mit
H+S	2SC4155A-S	Si-npn	AF-Amp, 50V, 200mA, 150mW, 200MHz, B=270..560	SOT-323	16ta	-	3a Mit
H+T	2SC3928A-T	Si-npn	AF-Amp, 50V, 200mA, 200mW, B=390..820, 200MHz	SC-59	16ta	-	3a Mit
H+T	2SC4155A-T	Si-npn	AF-Amp, 50V, 200mA, 150mW, 200MHz, B=390..820	SOT-323	16ta	-	3a Mit
H0	2SC4252	Si-npn	VHF-Osc, 20V, 30mA, 100mW, B=40..250, 2.1GHz	SOT-323	16ta	-	3a Tos
H0	2SC4255	Si-npn	TV-VHF, 20V, 30mA, 2GHz	SOT-23	16ta	-	3a Tos
H0	AP130-27R	LVR-IC	LDO, 2.7V±2%, 300mA	SOT-23	16cg	VR1	3b Ana
H0	BZX84-C75	Z-diode	70.79V, Zzt=25Ω, Izt=20mA, 225mW	SOT-23	16dc	-	3a Lge
H0	ELM7620HAB	Vdet-IC	2.0V±2%, +Reset PPO, 250ms	SOT-23	16vdc	VD7	3d Elm
H0	R3113D401C	Vdet-IC	4V±2%, -Reset, PPO	SON1408-3	18vda	VD7	3d Ric
H0	R3130N30EA	Vdet-IC	3V, -Reset PPO, 240ms	SOT-23	16vdc	VD7	3b Ric
H0	TC54VC6002ECB	Vdet-IC	6.0V±2%, -Reset PPO	SOT-23	16vdb	VD7	3a Tcs
H0	XC61CC6002M	Vdet-IC	6V±1%, +Reset PPO	SOT-23	16vdb	VD7	3d Tor
H02	DTC323TK	Si-npn-Digi	Mute, AF, 50V, 100mA, 200mW, 200MHz, R1=2k2	SOT-346	16ta	-	3a Rhm
H02	DTC323TU	Si-npn-Digi	Mute, AF, 50V, 100mA, 200mW, 200MHz, R1=2k2	UMT3	16ta	-	3a Rhm
H03	DTC343TK	Si-npn-Digi	Mute, AF, 50V, 100mA, 200mW, 200MHz, R1=4k7	SOT-346	16ta	-	3a Rhm
H03	XE61CC6045MR	Vdet-IC	6.0V±2%, -Reset PPO	SOT-23	16vdb	VD7	3h Tor



SMD code	Type	Function	Short description	Case	Pinout	Sch.	St.	Mnf.
H04	DTC314TK	Si-npn-Digi	Mute, AF, 50V, 100mA, 200mW, 250MHz, R1=10k	SOT-346	16ta	-	3a	Rhm
H04	DTC314TU	Si-npn-Digi	Mute, AF, 50V, 100mA, 200mW, 250MHz, R1=10k	UMT3	16ta	-	3a	Rhm
H05	XC61FC6012M	Vdet-IC	6V±2%, +Reset PPO, 200ms	SOT-23	16vdb	VD7	3d	Tor
H05	XC61HC6012MR	Vdet-IC	6.0V±2%, -Reset PPO, 50, 200ms	SOT-23	16vdc	VD7	3d	Tor
H06	XC61FC6042M	Vdet-IC	6V±2%, +Reset PPO, 400ms	SOT-23	16vdb	VD7	3d	Tor
H06	XC61HC6042MR	Vdet-IC	6.0V±2%, -Reset PPO, 80, 400ms	SOT-23	16vdc	VD7	3d	Tor
H07	DTC363TK	Si-npn-Digi	Sw, 50V, 100mA, 200mW, 200MHz, R1=6k8	SOT-346	16ta	-	3a	Rhm
H07	XC61FC6052M	Vdet-IC	6V±2%, +Reset PPO, 50ms	SOT-23	16vdb	VD7	3d	Tor
H07	XC61HC6052MR	Vdet-IC	6.0V±2%, -Reset PPO, 1.50ms	SOT-23	16vdc	VD7	3d	Tor
H1	AP130-28R	LVR-IC	LDO, 2.8V±2%, 300mA	SOT-23	16cg	VR1	3b	Ana
H1	BCW69	Si-pnp	GP, 50V, 100mA, 330mW, B=120..260, >150MHz	SOT-23	16ta	-	3a	Ste
H1	ELM7621HAB	Vdet-IC	2.1V±2%, +Reset PPO, 250ms	SOT-23	16vdc	VD7	3d	Elm
H1	HVM187VK	PIN-diode	Dual, HF-Attenuator, 60V, 50mA, 2.4pF, <5.5Q(10mA/100MHz)	SOT-23	16dg	-	3a	Ren
H1	MMBZ5241B	Z-diode	10.45..11.55V, Zzt=22Q, lzt=20mA, 410mW	SOT-23	16dc	-	3a	Pjt
H1	MMBZ5241BW	Z-diode	11V±5%, Zzt=22Q, 200mW	SOT-323	16dc	-	3a	Pjt
H1	R3113D411C	Vdet-IC	4.1V±2%, -Reset, PPO	SON1408-3	18vda	VD7	3d	Ric
H1	R3130N31EA	Vdet-IC	3.1V, -Reset PPO, 240ms	SOT-23	16vdc	VD7	3b	Ric
H1	SST4416	n-FET	VHF/UHF, 30V, 350mW, Idss=5..15mA, Up<6V, Rds=150Q	SOT-23	16jf	-	3a	Six
H11	2SJ166	p-MOSFET-e*	GP, 50V, ±100mA, 200mW, <50Q(20mA), 98/124ns	SOT-23	16fh	-	3a	Nec
H13	2SJ202	p-MOSFET-e*	V-MOS, Sw, 16V, ±0.1A, <30Q(10mA)	SOT-323	16fh	-	3a	Nec
H14	2SJ203	p-MOSFET-e*	V-MOS, Sw, 16V, ±0.2A, <10Q(10A)	SOT-23	16fh	-	3a	Nec
H15	2SJ204	p-MOSFET-e*	V-MOS, Sw, 30V, ±0.2A, <8Q(10mA)	SOT-23	16fh	-	3a	Nec
H16	2SJ210	p-MOSFET-e*	V-MOS, Sw, 60V, ±0.2A, <10Q(10mA)	SOT-23	16fh	-	3a	Nec
H17	2SJ209	p-MOSFET-e*	V-MOS, Sw, 100V, ±0.1A, <60Q(10mA)	SOT-23	16fh	-	3a	Nec
H18	2SJ211	p-MOSFET-e*	V-MOS, Sw, 100V, ±0.2A, <20Q(10mA)	SOT-23	16fh	-	3a	Nec
H19	SJ76H19S	Vdet-IC	1.9V±5%, +Reset OCO	SOT-23	16vda	VD6	3b	Kau
H10	KSC2755-O	Si-npn	HF, 30V, 20mA, 150mW, B=70..140, >600MHz	SOT-23	16ta	-	3a	Sam
H1p	BCW69	Si-pnp	GP, 50V, 100mA, 330mW, B=120..260, >150MHz	SOT-23	16ta	-	3a	PHH
H1R	KSC2755-R	Si-npn	HF, 30V, 20mA, 150mW, B=40..80, >600MHz	SOT-23	16ta	-	3a	Sam
H1t	BCW69	Si-pnp	GP, 50V, 100mA, 330mW, B=120..260, >150MHz	SOT-23	16ta	-	3a	PHM
H1W	BCW69	Si-pnp	GP, 50V, 100mA, 330mW, B=120..260, >150MHz	SOT-23	16ta	-	3a	PhC
H1Y	KSC2755-Y	Si-npn	HF, 30V, 20mA, 150mW, B=120..240, >600MHz	SOT-23	16ta	-	3a	Sam
H2	AP130-29R	LVR-IC	LDO, 2.9V±2%, 300mA	SOT-23	16cg	VR1	3b	Ana
H2	BCW70	Si-pnp	GP, 50V, 100mA, 330mW, B=125..500, >150MHz	SOT-23	16ta	-	3a	Ste
H2	ELM7622HAB	Vdet-IC	2.2V±2%, +Reset PPO, 250ms	SOT-23	16vdc	VD7	3d	Elm
H2	HVM13	PIN-diode	HF-Attenuator, 60V, 50mA	SOT-23	16dc	-	3a	Ren
H2	MMBZ5242B	Z-diode	11.40..12.60V, Zzt=30Q, lzt=20mA, 410mW	SOT-23	16dc	-	3a	Pjt
H2	MMBZ5242BW	Z-diode	12V±5%, Zzt=30Q, 200mW	SOT-323	16dc	-	3a	Pjt
H2	R3113D421C	Vdet-IC	4.2V±2%, -Reset, PPO	SON1408-3	18vda	VD7	3d	Ric
H2	R3130N32EA	Vdet-IC	3.2V, -Reset PPO, 240ms	SOT-23	16vdc	VD7	3b	Ric
H2-	RT9198-34PV	LVR-IC	LDO, 3.4V±1%, 300mA	SOT-23	16cg	VR1	3a	Rct
H21	SJ76H21S	Vdet-IC	2.1V±5%, +Reset OCO	SOT-23	16vda	VD6	3b	Kau
H23	SJ76H23S	Vdet-IC	2.3V±5%, +Reset OCO	SOT-23	16vda	VD6	3b	Kau
H25	SJ76H25S	Vdet-IC	2.5V±5%, +Reset OCO	SOT-23	16vda	VD6	3b	Kau
H27	DTC363EK	Si-npn-Digi	Sw, 50V, 100mA, 200mW, 200MHz, R1/R2=6k8/6k8	SOT-346	16ta	-	3a	Rhm
H27	DTC363EU	Si-npn-Digi	Sw, 50V, 100mA, 200mW, 200MHz, R1/R2=6k8/6k8	UMT3	16ta	-	3a	Rhm
H27	SJ76H27S	Vdet-IC	2.7V±5%, +Reset OCO	SOT-23	16vda	VD6	3b	Kau
H29	SJ76H29S	Vdet-IC	2.9V±5%, +Reset OCO	SOT-23	16vda	VD6	3b	Kau
H20	KSC2756-O	Si-npn	HF, 20V, 30mA, 150mW, B=90..180, >850MHz	SOT-23	16ta	-	3a	Sam
H2p	BCW70	Si-pnp	GP, 50V, 100mA, 330mW, B=215..500, >150MHz	SOT-23	16ta	-	3a	PHH
H2R	KSC2756-R	Si-npn	HF, 20V, 30mA, 150mW, B=60..120, >850MHz	SOT-23	16ta	-	3a	Sam
H2t	BCW70	Si-pnp	GP, 50V, 100mA, 330mW, B=215..500, >150MHz	SOT-23	16ta	-	3a	PHM
H2W	BCW70	Si-pnp	GP, 50V, 100mA, 330mW, B=215..500, >150MHz	SOT-23	16ta	-	3a	PhC
H2Y	KSC2756-Y	Si-npn	HF, 20V, 30mA, 150mW, B=120..240, >850MHz	SOT-23	16ta	-	3a	Sam
H3	2SA956-3	Si-pnp	AF-Amp, Sw, 6V, 100mA, 150mW, 280MHz, B=80..130	SOT-23	16ta	-	3a	Nec
H3	AP130-30R	LVR-IC	LDO, 3.0V±2%, 300mA	SOT-23	16cg	VR1	3b	Ana
H3	BCW89	Si-pnp	AF, 80V, 100mA, 250mW, B=120..260, >100MHz	SOT-23	16ta	-	3a	Zx
H3	ELM7623HAB	Vdet-IC	2.3V±2%, +Reset PPO, 250ms	SOT-23	16vdc	VD7	3d	Elm
H3	MMBZ5243B	Z-diode	12.35..13.65V, Zzt=13Q, lzt=9.5mA, 410mW	SOT-23	16dc	-	3a	Pjt
H3	MMBZ5243BW	Z-diode	13V±5%, Zzt=13Q, 200mW	SOT-323	16dc	-	3a	Pjt
H3	R3113D431C	Vdet-IC	4.3V±2%, -Reset, PPO	SON1408-3	18vda	VD7	3d	Ric
H3	R3130N33EA	Vdet-IC	3.3V, -Reset PPO, 240ms	SOT-23	16vdc	VD7	3b	Ric
H3-	RT9166-17PVL	LVR-IC	LDO, 1.7V±2%, 300mA	SOT-23	16cg	VR1	3a	Rct
H31	BCW89R	Si-pnp	AF, 60V, 100mA, 350mW, B=120..260, 150MHz	SOT-23	16te	-	3a	Phi
H31	SJ76H31S	Vdet-IC	3.1V±5%, +Reset OCO	SOT-23	16vda	VD6	3b	Kau
H32	SJ76H32S	Vdet-IC	3.2V±5%, +Reset OCO	SOT-23	16vda	VD6	3b	Kau
H33	SJ76H33S	Vdet-IC	3.3V±5%, +Reset OCO	SOT-23	16vda	VD6	3b	Kau
H34	SJ76H34S	Vdet-IC	3.4V±5%, +Reset OCO	SOT-23	16vda	VD6	3b	Kau
H35	SJ76H35S	Vdet-IC	3.5V±5%, +Reset OCO	SOT-23	16vda	VD6	3b	Kau
H36	SJ76H36S	Vdet-IC	3.6V±5%, +Reset OCO	SOT-23	16vda	VD6	3b	Kau



SMD code	Type	Function	Short description	Case	Pinout	Sch. St.	Mnf.
H39	SJ76H39S	Vdet-IC	3.9V±5%, +Reset OCO	SOT-23	16vda	VD6 3b	Kau
H30	KSC2757	Si-npn	AF, 30V, 50mA, 150mW, B=90..180, >1100MHz	SOT-23	16ta	- 3a	Sam
H3p	BCW89	Si-npn	AF, 80V, 100mA, 250mW, B=120..260, >150MHz	SOT-23	16ta	- 3a	Phi
H3R	KSC2757R	Si-npn	AF, 30V, 50mA, 150mW, B=60..120, >1100MHz	SOT-23	16ta	- 3a	Sam
H3Y	KSC2757Y	Si-npn	AF, 30V, 50mA, 150mW, B=120..240, >1100MHz	SOT-23	16ta	- 3a	Sam
H4	2SA956-4	Si-npn	AF-Amp, Sw, 6V, 100mA, 150mW, 280MHz, B=110..170	SOT-23	16ta	- 3a	Nec
H4	2SC3134-4	Si-npn	AF, 60V, 150mA, 200mW, 100MHz, B=90..180	SOT-23	16ta	- 3a	San
H4	AP130-31R	LVR-IC	LDO, 3.1V±2%, 300mA	SOT-23	16cg	VR1 3b	Ana
H4	BCW69R	Si-npn	GP, 50V, 100mA, 330mW, B=120..260, >150MHz	SOT-23	16te	- 3a	Zx
H4	ELM7624HAB	Vdet-IC	2.4V±2%, +Reset PPO, 250ms	SOT-23	16vdc	VD7 3d	Elm
H4	HVM121WK	PIN-diode	Dual, HF-Attenuator, 100V, 0.1A	SOT-23	16dg	- 3a	Ren
H4	KA4A4P	Si-npn-Digi	Sw, 60V, 100mA, 200mW, R1/R2=10k/47k	SOT-416	16ta	- 3a	Nec
H4	MMBZ5244B	Z-diode	13.30..14.70V, Zzt=15Ω, lzt=9.0mA, 410mW	SOT-23	16dc	- 3a	Pjt
H4	R3113D441C	Vdet-IC	4.4V±2%, -Reset, PPO	SON1408-3	18vda	VD7 3d	Ric
H4	R3130N34EA	Vdet-IC	3.4V, -Reset PPO, 240ms	SOT-23	16vdc	VD7 3b	Ric
H4	SST5484	n-FET	VHF/UHF, 25V, 350mW, Idss=1.5mA, Up<3V	SOT-23	16fj	- 3a	Six
H4-	RT9809-30PVL	Vdet-IC	3.0V±2%, -Reset PPO	SOT-23	16vdc	VD7 3a	Rct
H42	SJ76H42S	Vdet-IC	4.2V±5%, +Reset OCO	SOT-23	16vda	VD6 3b	Kau
H45	SJ76H45S	Vdet-IC	4.5V±5%, +Reset OCO	SOT-23	16vda	VD6 3b	Kau
H4BC	UH4PBC	Si-diode	Rectifier, 100V, 4A, Vf<1.05V(4A)	TO-277A	76dh	- 3o	Vs
H4CC	UH4PCC	Si-diode	Rectifier, 150V, 4A, Vf<1.05V(4A)	TO-277A	76dh	- 3o	Vs
H4CD	UH4PDC	Si-diode	Rectifier, 200V, 4A, Vf<1.05V(4A)	TO-277A	76dh	- 3o	Vs
H4Z	KSC2758	Si-npn	UHF, 30V, 20mA, 150mW, B=60..240, >1GHz	SOT-23	16ta	- 3a	Sam
H5	2SA956-5	Si-npn	AF-Amp, Sw, 6V, 100mA, 150mW, 280MHz, B=150..240	SOT-23	16ta	- 3a	Nec
H5	2SC3134-5	Si-npn	AF, 60V, 150mA, 200mW, 100MHz, B=135..270	SOT-23	16ta	- 3a	San
H5	2SC4446-6	Si-npn	GP, AF, 60V, 150mA, 150mW, B=200..400, 130MHz	SOT-323	16ta	- 3a	San
H5	AP130-32R	LVR-IC	LDO, 3.2V±2%, 300mA	SOT-23	16cg	VR1 3b	Ana
H5	BCW70R	Si-npn	GP, 50V, 100mA, 330mW, B=215..500, >150MHz	SOT-23	16te	- 3a	Zx
H5	ELM7625HAB	Vdet-IC	2.5V±2%, +Reset PPO, 250ms	SOT-23	16vdc	VD7 3d	Elm
H5	HVM14	PIN-diode	VHF/UHF-Attenuator, 50V, 50mA	SOT-23	16dc	- 3a	Ren
H5	MMBZ5245B	Z-diode	14.25..15.75V, Zzt=16Ω, lzt=8.5mA, 410mW	SOT-23	16dc	- 3a	Pjt
H5	MMBZ5245BW	Z-diode	15V±5%, Zzt=16Ω, 200mW	SOT-323	16dc	- 3a	Pjt
H5	R3113D451C	Vdet-IC	4.5V±2%, -Reset, PPO	SON1408-3	18vda	VD7 3d	Ric
H5	R3130N35EA	Vdet-IC	3.5V, -Reset PPO, 240ms	SOT-23	16vdc	VD7 3b	Ric
H5	SP810EK-4-0	Vdet-IC	4.0V±1.5%, +Reset PPO	SOT-23	16vdc	VD7 3b	Sip
H5	SST5485	n-FET	VHF/UHF, 25V, 350mW, Idss=4..10mA, Up<4V	SOT-23	16fj	- 3a	Six
H5-	RT9198-27PV	LVR-IC	LDO, 2.7V±1%, 300mA	SOT-23	16cg	VR1 3a	Rct
H5O	KSC2223-O	Si-npn	RF, 30V, 20mA, 150mW, B=60..120, >600MHz	SOT-23	16ta	- 3a	Sam
H5R	KSC2223-R	Si-npn	RF, 30V, 20mA, 150mW, B=40..80, >600MHz	SOT-23	16ta	- 3a	Sam
H5Y	KSC2223-Y	Si-npn	RF, 30V, 20mA, 150mW, B=90..180, >600MHz	SOT-23	16ta	- 3a	Sam
H6	2SA956-6	Si-npn	AF-Amp, Sw, 6V, 100mA, 150mW, 280MHz, B=200..230	SOT-23	16ta	- 3a	Nec
H6	2SC3134-6	Si-npn	AF, 60V, 150mA, 200mW, 100MHz, B=200..400	SOT-23	16ta	- 3a	San
H6	2SC4446-5	Si-npn	GP, AF, 60V, 150mA, 150mW, B=135..270, 130MHz	SOT-323	16ta	- 3a	San
H6	BCW89R	Si-npn	AF, 80V, 100mA, 330mW, B=120..260, >150MHz	SOT-23	16ta	- 3a	Zx
H6	ELM7626HAB	Vdet-IC	2.6V±2%, +Reset PPO, 250ms	SOT-23	16vdc	VD7 3d	Elm
H6	R3130N36EA	Vdet-IC	3.6V, -Reset PPO, 240ms	SOT-23	16vdc	VD7 3b	Ric
H6	SST5486	n-FET	VHF/UHF, 25V, 350mW, Idss=8..20mA, Up<6V	SOT-23	16fj	- 3a	Six
H6-	RT9818A-23PV	Vdet-IC	2.3V±1.5%, -Reset ODO	SOT-23	16vda	VD6 3a	Rct
H6D	UH6PD	Si-diode	Rectifier, 200V, 6A, Vf<1.05V(6A)	TO-277A	76dh	- 3o	Vs
H6O	KSC2759-O	Si-npn	UHF, 30V, 50mA, 150mW, B=60..120, >2GHz	SOT-23	16ta	- 3a	Sam
H6PJ	UH6PJ	Si-diode	Rectifier, 600V, 6A, Vf<3.0V(6A)	TO-277A	76dh	- 3o	Vs
H6R	KSC2759-R	Si-npn	UHF, 30V, 50mA, 150mW, B=40..80, >2GHz	SOT-23	16ta	- 3a	Sam
H6Y	KSC2759-Y	Si-npn	UHF, 30V, 50mA, 150mW, B=90..180, >2GHz	SOT-23	16ta	- 3a	Sam
H7	2SC3134-7	Si-npn	AF, 60V, 150mA, 200mW, 100MHz, B=300..600	SOT-23	16ta	- 3a	San
H7	2SC4446-7	Si-npn	GP, AF, 60V, 150mA, 150mW, B=300..600, 130MHz	SOT-323	16ta	- 3a	San
H7	ELM7627HAB	Vdet-IC	2.7V±2%, +Reset PPO, 250ms	SOT-23	16vdc	VD7 3d	Elm
H7	KN4A4P	Si-npn-Digi	Sw, 60V, 100mA, 150mW, R1/R2=10k/47k	SOT-416	16ta	- 3a	Nec
H7	R3130N37EA	Vdet-IC	3.7V, -Reset PPO, 240ms	SOT-23	16vdc	VD7 3b	Ric
H7-	RT9818A-24PV	Vdet-IC	2.4V±1.5%, -Reset ODO	SOT-23	16vda	VD6 3a	Rct
H71	BCF70R	Si-npn	AF, 45V, 100mA, 350mW, B=215..500, >100MHz	SOT-23	16te	- 3a	Phi
H7p	BCF70	Si-npn	AF, 50V, 100mA, 250mW, B=215..500, >100MHz	SOT-23	16ta	- 3a	Phi
H8	BZX84-C3V6	Z-diode	3.4..3.8V, Zzt=90Ω, lzt=20mA, 225mW	SOT-23	16dc	- 3a	Lge
H8	ELM7628HAB	Vdet-IC	2.8V±2%, +Reset PPO, 250ms	SOT-23	16vdc	VD7 3d	Elm
H8	R3130N38EA	Vdet-IC	3.8V, -Reset PPO, 240ms	SOT-23	16vdc	VD7 3b	Ric
H8-	RT9818A-25PV	Vdet-IC	2.5V±1.5%, -Reset ODO	SOT-23	16vda	VD6 3a	Rct
H8Z	KSC2734	Si-npn	AF, 20V, 50mA, 150mW, B=20..200, >3500MHz	SOT-23	16ta	- 3a	Sam
H9	1S344	Si-diode	Schottky, 20V, 0.5A	SOT-323	16dc	- 3a	Tos
H9	AP130-33R	LVR-IC	LDO, 3.3V±2%, 300mA	SOT-23	16cg	VR1 3b	Ana
H9	BZX84-C16	Z-diode	15.3..17.1V, Zzt=40Ω, lzt=20mA, 225mW	SOT-23	16dc	- 3a	Lge
H9	ELM7629HAB	Vdet-IC	2.9V±2%, +Reset PPO, 250ms	SOT-23	16vdc	VD7 3d	Elm



SMD code	Type	Function	Short description	Case	Pinout	Sch. St.	Mnf.
H9	R3111N092C	Vdet-IC	0.9V±2%, -Reset ODO	SOT-23	16vdd	VD6	3d Ric
H9	R3130N39EA	Vdet-IC	3.9V, -Reset PPO, 240ms	SOT-23	16vdc	VD7	3b Ric
H9-	RT9818A-27PV	Vdet-IC	2.7V±1.5%, -Reset ODO	SOT-23	16vda	VD6	3a Rct
H9=	RT9818A-27GV	Vdet-IC	2.7V±1.5%, -Reset ODO	SOT-23	16vda	VD6	3a Rct
H9Z	KSC3120	Si-npn	UHF, 30V, 50mA, 150mW, B=40..200, >2.4GHz	SOT-23	16ta	-	3a Sam
HA	2SA1883	Si-npn	Fast-Sw, 15V, 200mA, 150mW, B=50..140, 1GHz, 11/19ns	SOT-23	16ta	-	3a San
HA	2SC3119	Si-npn	UHF-TV-Tuner, AGC, 25V, 20mA, 150mW, B=25..100, 900MHz	SOT-23	16ta	-	3a Tos
HA	AP130-34R	LVR-IC	LDO, 3.4V±2%, 300mA	SOT-23	16cg	VR1	3b Ana
HA	DDZX9682	Z-diode	2.7V±5%, 500mW	SOT-23	16dc	-	3a Di
HA	DDZX9682W	Z-diode	2.7V±5%, 200mW	SOT-323	16dc	-	3a Di
HA	ELM7640LDB	Vdet-IC	4.0V±2%, -Reset PPO, 50ms	SOT-23	16vdc	VD7	3d Elm
HA-	RT9818B-30PV	Vdet-IC	3.0V±1.5%, -Reset ODO, Td=55ms	SOT-23	16vda	VD6	3a Rct
HAO	KSC3123-O	Si-npn	UHF, 30V, 50mA, 150mW, B=90..180, >1.4GHz	SOT-23	16ta	-	3a Sam
HAR	KSC3123-R	Si-npn	UHF, 30V, 50mA, 150mW, B=60..120, >1.4GHz	SOT-23	16ta	-	3a Sam
HAY	KSC3123-Y	Si-npn	UHF, 30V, 50mA, 150mW, B=120..240, >1.4GHz	SOT-23	16ta	-	3a Sam
HB	2SC3120	Si-npn	VHF/UHF-TV-Tuner, 30V, 50mA, 150mW, B=40..200, 2.4GHz	SC-59	16ta	-	3a Tos
HB	2SC4245	Si-npn	UHF-Mix, 30V, 50mA, 100mW, B=40..200, 2.4GHz	SOT-323	16ta	-	3a Tos
HB	AP130-35R	LVR-IC	LDO, 3.5V±2%, 300mA	SOT-23	16cg	VR1	3b Ana
HB	BFN22	Si-npn	Vid, 250V, 20..50mA, >60MHz	SOT-23	16ta	-	3a Ste
HB	DDZX9683	Z-diode	3V±5%, 500mW	SOT-23	16dc	-	3a Di
HB	DDZX9683W	Z-diode	3V±5%, 200mW	SOT-323	16dc	-	3a Di
HB	ELM7641LDB	Vdet-IC	4.1V±2%, -Reset PPO, 50ms	SOT-23	16vdc	VD7	3d Elm
HB-	RT9819C-30PVL	Vdet-IC	3.0V±1.5%, -Reset PPO, Td=220ms	SOT-23	16vda	VD7	3a Rct
HBs	BFN22	Si-npn	Vid, 250V, 20..50mA, >60MHz	SOT-23	16ta	-	3a Sie
HC	2SC2733	Si-npn	VHF, 30V, 50mA, 150mW, B>60, 1GHz	SOT-23	16ta	-	3a Ren
HC	2SC3121	Si-npn	VHF/UHF-TV-Tuner, 30V, 50mA, 150mW, B=60..320, 1.5GHz	SC-59	16ta	-	3a Tos
HC	2SC4246	Si-npn	UHF-Osc, 30V, 50mA, 100mW, B=60..320, 1.5GHz	SOT-323	16ta	-	3a Tos
HC	2SC4463	Si-npn	HF, 30V, 50mA, 100mW, B>60, >600MHz	SOT-323	16ta	-	3a Ren
HC	AP130-36R	LVR-IC	LDO, 3.6V±2%, 300mA	SOT-23	16cg	VR1	3b Ana
HC	DDZX9684	Z-diode	3.3V±5%, 500mW	SOT-23	16dc	-	3a Di
HC	DDZX9684W	Z-diode	3.3V±5%, 200mW	SOT-323	16dc	-	3a Di
HC	ELM7642LDB	Vdet-IC	4.2V±2%, -Reset PPO, 50ms	SOT-23	16vdc	VD7	3d Elm
HC	UNR32A5	Si-npn-Digi	Sw, 50V, 80mA, 100mW, 150MHz, R1=10k	SSSMini3	18ta	-	3a Pan
HC-	RT9819C-26PVL	Vdet-IC	2.6V±1.5%, -Reset PPO, Td=220ms	SOT-23	16vda	VD7	3a Rct
HCs	BFN23	Si-npn	Vid, 250V, 20..50mA, >60MHz	SOT-23	16ta	-	3a Sie
HD	2SC3122	Si-npn	VHF/UHF-TV-Tuner, 30V, 20mA, 150mW, B=60..300, 650MHz	SC-59	16ta	-	3a Tos
HD	2SC4249	Si-npn	VHF/UHF, 30V, 20mA, 100mW, B=60..300, 650MHz	SOT-323	16ta	-	3a Tos
HD	AP130-37R	LVR-IC	LDO, 3.7V±2%, 300mA	SOT-23	16cg	VR1	3b Ana
HD	DDZX9685	Z-diode	3.6V±5%, 500mW	SOT-23	16dc	-	3a Di
HD	DDZX9685W	Z-diode	3.6V±5%, 200mW	SOT-323	16dc	-	3a Di
HD	ELM7643LDB	Vdet-IC	4.3V±2%, -Reset PPO, 50ms	SOT-23	16vdc	VD7	3d Elm
HD	UNR32A6	Si-npn-Digi	Sw, 50V, 80mA, 100mW, 150MHz, R1=4k7	SSSMini3	18ta	-	3a Pan
HD-	RT9819B-18PVL	Vdet-IC	1.8V±1.5%, -Reset PPO, Td=55ms	SOT-23	16vda	VD7	3a Rct
HE	2SC3123	Si-npn	VHF, TV-Mix, 30V, 50mA, 150mW, B=40..300, 1.4GHz	SC-59	16ta	-	3a Tos
HE	2SC4250	Si-npn	VHF-Mix, 30V, 50mA, 100mW, B=40..300, 1.4GHz	SOT-323	16ta	-	3a Tos
HE	AP130-38R	LVR-IC	LDO, 3.8V±2%, 300mA	SOT-23	16cg	VR1	3b Ana
HE	DDZX9686	Z-diode	3.9V±5%, 500mW	SOT-23	16dc	-	3a Di
HE	DDZX9686W	Z-diode	3.9V±5%, 200mW	SOT-323	16dc	-	3a Di
HE	ELM7644LDB	Vdet-IC	4.4V±2%, -Reset PPO, 50ms	SOT-23	16vdc	VD7	3d Elm
HE	UNR32A7	Si-npn-Digi	Sw, 50V, 80mA, 100mW, 150MHz, R1=22k	SSSMini3	18ta	-	3a Pan
HE-	RT9818A-29PV	Vdet-IC	2.9V±1.5%, -Reset ODO	SOT-23	16vda	VD6	3a Rct
HF	2SC3124	Si-npn	VHF, TV-Tun, 30V, 50mA, 150mW, B=40..200, 1.1GHz	SC-59	16ta	-	3a Tos
HF	2SC4251	Si-npn	VHF-Osc, 30V, 50mA, 100mW, B=40..200, 1.1GHz	SOT-323	16ta	-	3a Tos
HF	AP130-39R	LVR-IC	LDO, 3.9V±2%, 300mA	SOT-23	16cg	VR1	3b Ana
HF	BFN23	Si-npn	Vid, 250V, 20..50mA, >60MHz	SOT-23	16ta	-	3a Sie
HF	DDZX9687	Z-diode	4.3V±5%, 500mW	SOT-23	16dc	-	3a Di
HF	DDZX9687W	Z-diode	4.3V±5%, 200mW	SOT-323	16dc	-	3a Di
HF	ELM7645LDB	Vdet-IC	4.5V±2%, -Reset PPO, 50ms	SOT-23	16vdc	VD7	3d Elm
HF	KTC3882	Si-npn	VHF-Osc, 30V, 50mA, 150mW, B=40..200, 1.1GHz	SOT-23	16ta	-	3f Kec
HF	UNR32A8	Si-npn-Digi	Sw, 50V, 80mA, 100mW, 150MHz, R1/R2=510R/5.1k	SSSMini3	18ta	-	3a Pan
HF-	RT9819C-33PV	Vdet-IC	3.3V±1.5%, -Reset PPO, Td=220ms	SOT-23	16vdc	VD7	3a Rct
HFH	C1815LT1-H	Si-npn	AF-Amp, 60V, 150mA, 200mW, B=200..400, >80MHz	SOT-23	16ta	-	3a Wtr
HFL	C1815LT1-L	Si-npn	AF-Amp, 60V, 150mA, 200mW, B=130..200, >80MHz	SOT-23	16ta	-	3a Wtr
HGL	2SC6026MFV-GR	Si-npn	GP, Amp, 60V, 150mA, 50mW, >60MHz, B=200..400	SOT-723	18ta	-	3a Tos
HG	AP130-40R	LVR-IC	LDO, 4.0V±2%, 300mA	SOT-23	16cg	VR1	3b Ana
HG	DDZX9688	Z-diode	4.7V±5%, 500mW	SOT-23	16dc	-	3a Di
HG	DDZX9688W	Z-diode	4.7V±5%, 200mW	SOT-323	16dc	-	3a Di
HG	ELM7646LDB	Vdet-IC	4.6V±2%, -Reset PPO, 50ms	SOT-23	16vdc	VD7	3d Elm
HG-	RT9819D-33PV	Vdet-IC	3.3V±1.5%, -Reset PPO, Td=450ms	SOT-23	16vdc	VD7	3a Rct
HH	2SC3125	Si-npn	TV-IF-Out, 30V, 50mA, 150mW, B=20..200, 600MHz	SC-59	16ta	-	3a Tos



SMD code	Type	Function	Short description	Case	Pinout	Sch.	St.	Mnf.
HH	2SC4253	Si-npn	TV-IF-Out, 30V, 50mA, 100mW, B=20..200, 600MHz	SOT-323	16ta	-	3a	Tos
HH	AP130-41R	LVR-IC	LDO, 4.1V±2%, 300mA	SOT-23	16cg	VR1	3b	Ana
HH	DDZX9689	Z-diode	5.1V±5%, 500mW	SOT-23	16dc	-	3a	Di
HH	DDZX9689W	Z-diode	5.1V±5%, 200mW	SOT-323	16dc	-	3a	Di
HH	ELM7647LDB	Vdet-IC	4.7V±2%, -Reset PPO, 50ms	SOT-23	16vdc	VD7	3d	Elm
HH-	RT9818B-25PV	Vdet-IC	2.5V±1.5%, -Reset ODO, Td=55ms	SOT-23	16vda	VD6	3a	Rct
HI	2SC3547A	Si-npn	TV-UHF-Osc, 12V, 30mA, 150mW, B=35..130, 4GHz	SOT-23	16ta	-	3a	Tos
HI	2SC4247	Si-npn	UHF-Osc, 20V, 30mA, 100mW, B=35..130, 4GHz	SOT-323	16ta	-	3a	Tos
HI	AP130-42R	LVR-IC	LDO, 4.2V±2%, 300mA	SOT-23	16cg	VR1	3b	Ana
HJ	AP130-43R	LVR-IC	LDO, 4.3V±2%, 300mA	SOT-23	16cg	VR1	3b	Ana
HJ	DDZX9690	Z-diode	5.6V±5%, 500mW	SOT-23	16dc	-	3a	Di
HJ	DDZX9690W	Z-diode	5.6V±5%, 200mW	SOT-323	16dc	-	3a	Di
HJ	ELM7648LDB	Vdet-IC	4.8V±2%, -Reset PPO, 50ms	SOT-23	16vdc	VD7	3d	Elm
HJ-	RT9818B-42PV	Vdet-IC	4.2V±1.5%, -Reset ODO, Td=55ms	SOT-23	16vda	VD6	3a	Rct
HJ-	RT9819C-27PV	Vdet-IC	2.7V±1.5%, -Reset PPO, Td=220ms	SOT-23	16vdc	VD7	3a	Rct
HK	AP130-44R	LVR-IC	LDO, 4.4V±2%, 300mA	SOT-23	16cg	VR1	3b	Ana
HK	DDZX9691	Z-diode	6.2V±5%, 500mW	SOT-23	16dc	-	3a	Di
HK	DDZX9691W	Z-diode	6.2V±5%, 200mW	SOT-323	16dc	-	3a	Di
HK	ELM7649LDB	Vdet-IC	4.9V±2%, -Reset PPO, 50ms	SOT-23	16vdc	VD7	3d	Elm
HK	UNR32A9	Si-npn-Digi	Sw, 50V, 80mA, 100mW, 150MHz, R1/R2=1k/10k	SSSMini3	18ta	-	3a	Pan
HK-	RT9819D-26PV	Vdet-IC	2.6V±1.5%, -Reset PPO, Td=450ms	SOT-23	16vdc	VD7	3a	Rct
HKA	CHDTD133HKPT	Si-npn-Digi	Sw, 50V, 500mA, 200MHz, R1/R2=3.3/10k	SOT-23	16ta	-	3a	Chm
HL	2SA1502	Si-pnp-Digi	Sw, 50V, 100mA, 200mW, 200MHz, B>50, R1/R2=2.2k/10k	CP	16ta	-	3a	San
HL	2SA1722	Si-pnp-Digi	Sw, 50V, 100mA, R/R2=2.2k/10k	SOT-323	16ta	-	3a	San
HL	2SC3862	Si-npn	TV-UHF-Tuner, 30V, 50mA, 2400MHz	SOT-23	16te	-	3a	Tos
HL	AP130-45R	LVR-IC	LDO, 4.5V±2%, 300mA	SOT-23	16cg	VR1	3b	Ana
HL	DDZX9692	Z-diode	6.8V±5%, 500mW	SOT-23	16dc	-	3a	Di
HL	DDZX9692W	Z-diode	6.8V±5%, 200mW	SOT-323	16dc	-	3a	Di
HL	UNR32AA	Si-npn-Digi	Sw, 50V, 80mA, 100mW, 150MHz, R1/R2=100k/100k	SSSMini3	18ta	-	3a	Pan
HL-	RT9819D-27PV	Vdet-IC	2.7V±1.5%, -Reset PPO, Td=450ms	SOT-23	16vdc	VD7	3a	Rct
HLN	ELM7529CEB	Vdet-IC	2.9V±2%, +Reset PPO	SC-70	16vdb	VD7	3d	Elm
HLN	ELM7529NEB	Vdet-IC	2.9V±2%, +Reset ODO	SC-70	16vdb	VD6	3d	Elm
HM	2SC3547B	Si-npn	TV-UHF-Osc, 12V, 30mA, 150mW, B=70..300, 4GHz	SOT-23	16ta	-	3a	Tos
HM	2SC4248	Si-npn	UHF-Osc, 20V, 30mA, 100mW, B=70..130, 4GHz	SOT-323	16ta	-	3a	Tos
HM	AP130-46R	LVR-IC	LDO, 4.6V±2%, 300mA	SOT-23	16cg	VR1	3b	Ana
HM	DDZX9693	Z-diode	7.5V±5%, 500mW	SOT-23	16dc	-	3a	Di
HM	DDZX9693W	Z-diode	7.5V±5%, 200mW	SOT-323	16dc	-	3a	Di
HM-	RT9819D-29PV	Vdet-IC	2.9V±1.5%, -Reset PPO, Td=450ms	SOT-23	16vdc	VD7	3a	Rct
HN	2SC4244	Si-npn	VHF/UHF, 25V, 20mA, 100mW, B=100, 850MHz	SOT-323	16ta	-	3a	Tos
HN	2SC5540	Si-npn	UHF-S-Band, LN, 16V, 20mA, 100mW, B=90..200, 10GHz	SSFP	18ta	-	3a	San
HN	AP130-47R	LVR-IC	LDO, 4.7V±2%, 300mA	SOT-23	16cg	VR1	3b	Ana
HN	DDZX9694	Z-diode	8.2V±5%, 500mW	SOT-23	16dc	-	3a	Di
HN	DDZX9694W	Z-diode	8.2V±5%, 200mW	SOT-323	16dc	-	3a	Di
HN	UNR32AB	Si-npn-Digi	Sw, 50V, 80mA, 100mW, 150MHz, R1=100k	SSSMini3	18ta	-	3a	Pan
HN-	RT9819D-30PV	Vdet-IC	3.0V±1.5%, -Reset PPO, Td=450ms	SOT-23	16vdc	VD7	3a	Rct
HN3	2SC4871-3	Si-npn	UHF-S-B, Amp, Osc, 16V, 20mA, 0.1W, B=60..120, 10GHz	MCP	16ta	-	3a	San
HN4	2SC4871-4	Si-npn	UHF-S-B, Amp, Osc, 16V, 20mA, 0.1W, B=90..180, 10GHz	MCP	16ta	-	3a	San
HN5	2SC4871-5	Si-npn	UHF-S-B, Amp, Osc, 16V, 20mA, 0.1W, B=130..270, 10GHz	MCP	16ta	-	3a	San
HO	AP130-48R	LVR-IC	LDO, 4.8V±2%, 300mA	SOT-23	16cg	VR1	3b	Ana
HP	2SA1036K-P	Si-pnp	GP, 40V, 500mA, 200mW, B=82..180, 200MHz	SC-59	16ta	-	3a	Rhm
HP	2SA1577-P	Si-pnp	GP, 40V, 500mA, 200mW, B=82..180, 200MHz	SOT-323	16ta	-	3a	Rhm
HP	2SC4527	Si-npn	TV-UHF-Tuner, 30V, 50mA, 1500MHz	SOT-23	16te	-	3a	Tos
HP	AP130-49R	LVR-IC	LDO, 4.9V±2%, 300mA	SOT-23	16cg	VR1	3b	Ana
HP	DDZX9696	Z-diode	9.1V±5%, 500mW	SOT-23	16dc	-	3a	Di
HP	DDZX9696W	Z-diode	9.1V±5%, 200mW	SOT-323	16dc	-	3a	Di
HP-	RT9818B-24PVL	Vdet-IC	2.4V±1.5%, -Reset ODO, Td=55ms	SOT-23	16vdc	VD6	3a	Rct
HQ	2SA1036K-Q	Si-pnp	GP, 40V, 500mA, 200mW, B=120..270, 200MHz	SC-59	16ta	-	3a	Rhm
HQ	2SA1577-Q	Si-pnp	GP, 40V, 500mA, 200mW, B=120..270, 200MHz	SOT-323	16ta	-	3a	Rhm
HQ	2SC3928-Q	Si-npn	AF-Amp, 30V, 100mA, 150mW, B=120..270, 200MHz	SC-59	16ta	-	3a	Mit
HQ	2SC4155A-Q	Si-npn	AF-Amp, 50V, 200mA, 150mW, 200MHz, B=120..270	SOT-323	16ta	-	3a	Mit
HQ	2SC4155-Q	Si-npn	AF-Amp, 50V, 100mA, 150mW, 200MHz, B=120..270	SOT-323	16ta	-	3a	Mit
HQ	AP130-50R	LVR-IC	LDO, 5.0V±2%, 300mA	SOT-23	16cg	VR1	3b	Ana
HQ	DDZX9697	Z-diode	10V±5%, 500mW	SOT-23	16dc	-	3a	Di
HQ	DDZX9697W	Z-diode	10V±5%, 200mW	SOT-323	16dc	-	3a	Di
HQ-	RT9818A-22PV	Vdet-IC	2.2V±1.5%, -Reset ODO	SOT-23	16vda	VD6	3a	Rct
HQ=	RT9818A-22GV	Vdet-IC	2.2V±1.5%, -Reset ODO	SOT-23	16vda	VD6	3a	Rct
HR	2SA1035-R	Si-pnp	AF, LN, 55V, 10mA, 200mW, B=180..360, 200MHz	SC-59	16ta	-	3a	Pan
HR	2SA1036K-R	Si-pnp	GP, 40V, 500mA, 200mW, B=180..390, 200MHz	SC-59	16ta	-	3a	Rhm
HR	2SA1531A-R	Si-pnp	AF, LN, 55V, 50mA, 150mW, B=180..360, 80MHz	SOT-323	16ta	-	3a	Pan
HR	2SA1577-R	Si-pnp	GP, 40V, 500mA, 200mW, B=180..390, 200MHz	SOT-323	16ta	-	3a	Rhm



SMD

SMD code	Type	Function	Short description	Case	Pinout	Sch.	St.	Mnf.
HR	2SC3928-R	Si-npn	AF-Amp, 30V, 100mA, 150mW, B=180..390, 200MHz	SC-59	16ta	-	3a	Mit
HR	2SC4155A-R	Si-npn	AF-Amp, 50V, 200mA, 150mW, 200MHz, B=180..390	SOT-323	16ta	-	3a	Mit
HR	2SC4155-R	Si-npn	AF-Amp, 50V, 100mA, 150mW, 200MHz, B=180..390	SOT-323	16ta	-	3a	Mit
HR	CAT809HTBI-GT3	Vdet-IC	4.55V±1.5%, -Reset PPO	SOT-23	16vdc	VD7	3b	Ons
HR	DDZX9698	Z-diode	11V±5%, 500mW	SOT-23	16dc	-	3a	Di
HR	DDZX9698W	Z-diode	11V±5%, 200mW	SOT-323	16dc	-	3a	Di
HR-	RT9819G-26PV	Vdet-IC	2.6V±1.5%, +PPO +Reset, Td=220ms	SOT-23	16vdc	VD7	3a	Rct
HS	2SA1035-S	Si-pnp	AF, LN, 55V, 10mA, 200mW, B=260..520, 200MHz	SC-59	16ta	-	3a	Pan
HS	2SA1531A-S	Si-pnp	AF, LN, 55V, 50mA, 150mW, B=260..520, 80MHz	SOT-323	16ta	-	3a	Pan
HS	2SC3928-S	Si-npn	AF-Amp, 30V, 100mA, 150mW, B=270..560, 200MHz	SC-59	16ta	-	3a	Mit
HS	2SC4155A-S	Si-npn	AF-Amp, 50V, 200mA, 150mW, 200MHz, B=270..560	SOT-323	16ta	-	3a	Mit
HS	2SC4155-S	Si-npn	AF-Amp, 50V, 100mA, 150mW, 200MHz, B=270..560	SOT-323	16ta	-	3a	Mit
HS	2SK2751	n-FET	LN, 40V, 10mA, 200mW, Up<3.5V	SC-59	16fa	-	3a	Pan
HS	2SK2988	n-FET	AF imp-conv, 40V, 10mA, 125mW, Idss<4.7mA, Up<3.5V	SC-78	16fa	-	3a	Pan
HS	DDZX9699	Z-diode	12V±5%, 500mW	SOT-23	16dc	-	3a	Di
HS	DDZX9699W	Z-diode	12V±5%, 200mW	SOT-323	16dc	-	3a	Di
HS-	RT9819E-28PV	Vdet-IC	2.8V±1.5%, +PPO +Reset	SOT-23	16vdc	VD7	3a	Rct
HS2	2SA1778-2	Si-pnp	VHF conv/osc, 15V, 50mA, 250mW, B=40..80, 1.2GHz	SOT-23	16ta	-	3a	San
HS3	2SA1778-3	Si-pnp	VHF conv/osc, 15V, 50mA, 250mW, B=60..120, 1.2GHz	SOT-23	16ta	-	3a	San
HS4	2SA1778-4	Si-pnp	VHF conv/osc, 15V, 50mA, 250mW, B=100..200, 1.2GHz	SOT-23	16ta	-	3a	San
HT	2SA1035-T	Si-pnp	AF, LN, 55V, 10mA, 200mW, B=360..700, 200MHz	SC-59	16ta	-	3a	Pan
HT	2SA1531A-T	Si-pnp	AF, LN, 55V, 50mA, 150mW, B=360..700, 80MHz	SOT-323	16ta	-	3a	Pan
HT	2SC3928-T	Si-npn	AF-Amp, 30V, 100mA, 150mW, B=390..820, 200MHz	SC-59	16ta	-	3a	Mit
HT	2SC4155A-T	Si-npn	AF-Amp, 50V, 200mA, 150mW, 200MHz, B=390..820	SOT-323	16ta	-	3a	Mit
HT	2SC4155-T	Si-npn	AF-Amp, 50V, 100mA, 150mW, 200MHz, B=390..820	SOT-323	16ta	-	3a	Mit
HT	CHT3019PT	Si-npn	AF, Sw, 80V, 1A, B=100..300, 100MHz	SOT-23	16ta	-	3a	Chm
HT	DDZX9700	Z-diode	13V±5%, 500mW	SOT-23	16dc	-	3a	Di
HT	DDZX9700W	Z-diode	13V±5%, 200mW	SOT-323	16dc	-	3a	Di
HT-	RT9818F-34PV	Vdet-IC	3.4V±1.5%, +Reset ODO, Td=55ms	SOT-23	16vda	VD6	3a	Rct
HTQ	2SC5378-Q	Si-npn	UHF, LN, 15V, 80mA, 150mW, B=80..115, 7GHz	SOT-323	16ta	-	3a	Pan
HTQ	2SC5379-Q	Si-npn	UHF, LN, 15V, 80mA, 125mW, B=80..115, 7GHz	SOT-416	16ta	-	3a	Pan
HTR	2SC5378-R	Si-npn	UHF, LN, 15V, 80mA, 150mW, B=95..155, 7GHz	SOT-323	16ta	-	3a	Pan
HTR	2SC5379-R	Si-npn	UHF, LN, 15V, 80mA, 125mW, B=90..155, 7GHz	SOT-416	16ta	-	3a	Pan
HTS	2SC5378-S	Si-npn	UHF, LN, 15V, 80mA, 150mW, B=135..200, 7GHz	SOT-323	16ta	-	3a	Pan
HTS	2SC5379-S	Si-npn	UHF, LN, 15V, 80mA, 125mW, B=125..200, 7GHz	SOT-416	16ta	-	3a	Pan
HU	DDZX9701	Z-diode	14V±5%, 500mW	SOT-23	16dc	-	3a	Di
HU	DDZX9701W	Z-diode	14V±5%, 200mW	SOT-323	16dc	-	3a	Di
HU-	RT9819F-36PV	Vdet-IC	3.6V±1.5%, +Reset ODO, Td=55ms	SOT-23	16vda	VD6	3a	Rct
HV	DDZX9702	Z-diode	15V±5%, 500mW	SOT-23	16dc	-	3a	Di
HV	DDZX9702W	Z-diode	15V±5%, 200mW	SOT-323	16dc	-	3a	Di
HV-	RT9818E-50PV	Vdet-IC	5.0V±1.5%, +Reset ODO	SOT-23	16vda	VD6	3a	Rct
HW	DDZX9703	Z-diode	16V±5%, 500mW	SOT-23	16dc	-	3a	Di
HW	DDZX9703W	Z-diode	16V±5%, 200mW	SOT-323	16dc	-	3a	Di
HW-	RT9818B-18PVL	Vdet-IC	1.8V±1.5%, -Reset ODO, Td=55ms	SOT-23	16vdc	VD6	3a	Rct
HX-	RT9819A-27PV	Vdet-IC	2.7V±1.5%, -Reset PPO	SOT-23	16vdc	VD7	3a	Rct
HY	2SC6026MFV-Y	Si-npn	GP, Amp, 60V, 150mA, 50mW, >60MHz, B=120..240	SOT-723	18ta	-	3a	Tos
HY	DDZX9705	Z-diode	18V±5%, 500mW	SOT-23	16dc	-	3a	Di
HY	DDZX9705W	Z-diode	18V±5%, 200mW	SOT-323	16dc	-	3a	Di
HY-	RT9818C-12PV	Vdet-IC	1.2V±1.5%, -Reset ODO, Td=220ms	SOT-23	16vda	VD6	3a	Rct
HZ-	RT9818C-33PV	Vdet-IC	3.3V±1.5%, -Reset ODO, Td=220ms	SOT-23	16vda	VD6	3a	Rct
i	AX6902BA	Vdet-IC	4.38V±1.5%, +Reset PPO	SC-70	16vdc	VD7	3b	Axl
I	MRF947R	Si-npn	VHF/UHF, 20V, 50mA, 188mW, B>50, 8GHz	SOT-323	16ta	-	3a	Mot
IO	EUP7968-15VI	LVR-IC	LDO, 1.5V±3%, 300mA	SOT-23	16cg	VR1	3b	Eut
IO8	SST108	n-FET	Sw, 25V, 350mW, Idss=80mA, Rds(on)=8Ω, 1/4ns	SOT-23	16fj	-	3a	Cal
IO9	SST109	n-FET	Sw, 25V, 350mW, Idss=40mA, Rds(on)=12Ω, 1/4ns	SOT-23	16fj	-	3a	Cal
I1	EUP7968-18VI	LVR-IC	LDO, 1.8V±3%, 300mA	SOT-23	16cg	VR1	3b	Eut
I10	SST110	n-FET	Sw, 25V, 350mW, Idss=10mA, Rds(on)=18Ω, 1/4ns	SOT-23	16fj	-	3a	Cal
I2	EUP7968-25VI	LVR-IC	LDO, 2.5V±3%, 300mA	SOT-23	16cg	VR1	3b	Eut
I3	EUP7968-33VI	LVR-IC	LDO, 3.3V±3%, 300mA	SOT-23	16cg	VR1	3b	Eut
I5	EUP7968-30VI	LVR-IC	LDO, 3.0V±3%, 300mA	SOT-23	16cg	VR1	3b	Eut
I6	EUP7968-28VI	LVR-IC	LDO, 2.8V±3%, 300mA	SOT-23	16cg	VR1	3b	Eut
I8	SST108	n-FET	Sw, 25V, 350mW, Idss=80mA, Rds(on)=8Ω, 1/4ns	SOT-23	16fj	-	3a	Six
I9	1SS336	Si-diode	Dual, Sw, 85V, 200mA, 7pf, <20ns	SOT-23	16df	-	3a	Tos
IC-	2SC3016	Si-npn	VHF/UHF-Osc, 10V, 50mA, 120mW, B=30..90, 1.45GHz	SOT-23	16ta	-	3a	Ren
ID-	2SC3127	Si-npn	UHF/VHF, 20V, 50mA, 150mW, B=30..900, 4.5GHz	SC-59A	16ta	-	3a	Ren
IE	2SC3722K-E	Si-npn	AF-Div, 120V, 50mA, 200mW, B=390..820, >140MHz	SOT-346	16ta	-	3a	Rhm
IFB	2SB973-B	Si-pnp	GP, 10V, 700mA, 150mW, B=100..200, 280MHz	SOT-23	16ta	-	3a	Ren
IFC	2SB973-C	Si-pnp	GP, 10V, 700mA, 150mW, B=160..320, 280MHz	SOT-23	16ta	-	3a	Ren
IGD	2SK1215-D	n-MOSFET-d	VHF, 20V, 30mA, 100mW, Idss=4..8mA, Up<2V	SOT-23	16fk	-	3a	Ren
IGD	2SK360-D	n-MOSFET-d	VHF Amp, 20V, 30mA, 150mW, Idss=4..6mA, 8/14ms	SOT-23	16fk	-	3a	Ren



SMD code	Type	Function	Short description	Case	Pinout	Sch. St.	Mnf.
IGE	2SK1215-E	n-MOSFET-d	VHF, 20V, 30mA, 100mW, Idss=6..10mA, Up<2V	SOT-23	16fk	-	3a Ren
IGE	2SK360-E	n-MOSFET-d	VHF Amp, 20V, 30mA, 150mW, Idss=6..8mA, 8/14ms	SOT-23	16fk	-	3a Ren
IGF	2SK1215-F	n-MOSFET-d	VHF, 20V, 30mA, 100mW, Idss=8..12mA, Up<2V	SOT-23	16fk	-	3a Ren
IGF	2SK360-F	n-MOSFET-d	VHF Amp, 20V, 30mA, 150mW, Idss=8..12mA, 8/14ms	SOT-23	16fk	-	3a Ren
IHC	2SK431-C	n-FET	AF, LN, 40V, 30mA, 150mW, Idss=2.5..5mA, Up<1.5V	MPAK	16fa	-	3a Ren
IHD	2SK431-D	n-FET	AF, LN, 40V, 30mA, 150mW, Idss=4..8mA, Up<1.5V	MPAK	16fa	-	3a Ren
IHE	2SK431-E	n-FET	AF, LN, 40V, 30mA, 150mW, Idss=6..12mA, Up<1.5V	MPAK	16fa	-	3a Ren
IHF	2SK431-F	n-FET	AF, LN, 40V, 30mA, 150mW, Idss=10..20mA, Up<1.5V	MPAK	16fa	-	3a Ren
IJ	ETC809JU	Vdet-IC	4V, -Reset PPO	SOT-23	16vdc	VD7	3a Etc
IJ	MIC809JU	Vdet-IC	4V, -Reset PPO	SOT-23	16vdc	VD7	3a Mcr
IJ-	2SC3374	Si-npn	Sw, 20V, 20mA, 150mW, B=20..200, >400MHz	SOT-346	16ta	-	3a Ren
IJ3	2SK1470-3	n-FET	AF, Sw, 40V, 75mA, 250mW, Idss=40..52mA	SOT-23	16fa	-	3a San
IJ4	2SK1470-4	n-FET	AF, Sw, 40V, 75mA, 250mW, Idss=48..63mA	SOT-23	16fa	-	3a San
IJ5	2SK1470-5	n-FET	AF, Sw, 40V, 75mA, 250mW, Idss=57..75mA	SOT-23	16fa	-	3a San
IKB	2SC3521-B	Si-npn	HF, Sw, 40V, 100mA, 100mW, B=45..90	MPAK	16ta	-	3a Ren
IKC	2SC3521-C	Si-npn	HF, Sw, 40V, 100mA, 100mW, B=80..160	MPAK	16ta	-	3a Ren
IL	ETC809LU	Vdet-IC	4.63V, -Reset PPO	SOT-23	16vdc	VD7	3a Etc
IL	MIC809LU	Vdet-IC	4.63V, -Reset PPO	SOT-23	16vdc	VD7	3a Mcr
IL-	2SC3493	Si-npn	VHF/UHF, 15V, 20mA, 150mW, B=30..200, >700MHz	SOT-346	16ta	-	3a Ren
IL-	2SC4263	Si-npn	HF, 15V, 20mA, 100mW, B=30..200, >700MHz	OMPAK	16ta	-	3a Ren
IM	ETC809MU	Vdet-IC	4.38V, -Reset PPO	SOT-23	16vdc	VD7	3a Etc
IM	MIC809MU	Vdet-IC	4.38V, -Reset PPO	SOT-23	16vdc	VD7	3a Mcr
INB	2SA1468-B	Si-pnp	HV, 180V, 100mA, 150mW, B=100..200, 200MHz	SOT-23	16ta	-	3a Ren
INC	2SA1468-C	Si-pnp	HV, 180V, 100mA, 150mW, B=160..320, 200MHz	SOT-23	16ta	-	3a Ren
IO	2SA1298-O	Si-pnp	AF, Sw, 30V, 800mA, 200mA, B=100..200, 120MHz	SC-59	16ta	-	3a Tos
IO	KTA1298-O	Si-pnp	AF, 35V, 800mA, 200mW, B=100..200, >80MHz	SOT-23	16ta	-	3f Kec
IO	WTA8921-O	Si-pnp	GP, 35V, 800mA, 200mW, B=100..200, >80MHz	SOT-23	16ta	-	3a Wtr
IP	AAT35621GY-2.50	Vdet-IC	2.5V±1.5%, -Reset ODO	SOT-23	16vdc	VD6	3b Ant
IP-	2SC3793	Si-npn	VHF/UHF, 20V, 50mA, 150mW, B=50..200, >1.4GHz	SOT-346	16ta	-	3a Ren
IP-	2SC4262	Si-npn	VHF/UHF, 20V, 50mA, 100mW, B=50..200, >1.4GHz	SOT-323	16ta	-	3a Ren
IR	2SB1220-R	Si-pnp	AF, LN, 150V, 100mA, 150mW, B=130..220, 200MHz	SOT-323	16ta	-	3a Pan
IR	2SB1463-R	Si-pnp	GP, 150V, 50mA, 125mW, 200MHz, B=130..220	SOT-416	16ta	-	3a Pan
IR	2SB792-R	Si-pnp	AF, LN, 150V, 50mA, 200mW, B=130..220, 200MHz	SC-59	16ta	-	3a Pan
IR	2SC3722K-R	Si-npn	AF-Drv, 120V, 50mA, 200mW, B=120..390, >140MHz	SOT-346	16ta	-	3a Rhm
IR	ETC809RU	Vdet-IC	2.63V, -Reset PPO	SOT-23	16vdc	VD7	3a Etc
IR	EUP7968-35V1	LVR-IC	LDO, 3.5V±3%, 300mA	SOT-23	16cg	VR1	3b Eut
IR	MIC809RU	Vdet-IC	2.63V, -Reset PPO	SOT-23	16vdc	VD7	3a Mcr
IRD	2SA1484-D	Si-pnp	GP, 90V, 100mA, B=60..120, 90MHz	SOT-23	16ta	-	3a Ren
IRE	2SA1484-E	Si-pnp	GP, 90V, 100mA, B=150..300, 90MHz	SOT-23	16ta	-	3a Ren
IS	2SB1220-S	Si-pnp	AF, LN, 150V, 100mA, 150mW, B=180..330, 200MHz	SOT-323	16ta	-	3a Pan
IS	2SB1463-S	Si-pnp	GP, 150V, 50mA, 125mW, 200MHz, B=185..330	SOT-416	16ta	-	3a Pan
IS	2SB792-S	Si-pnp	AF, LN, 150V, 50mA, 200mW, B=185..330, 200MHz	SC-59	16ta	-	3a Pan
IS	2SC3722K-S	Si-npn	AF-Drv, 120V, 50mA, 200mW, B=270..560, >140MHz	SOT-346	16ta	-	3a Rhm
IS	ETC809SU	Vdet-IC	2.93V, -Reset PPO	SOT-23	16vdc	VD7	3a Etc
IS	MIC809SU	Vdet-IC	2.93V, -Reset PPO	SOT-23	16vdc	VD7	3a Mcr
IS-	2SC3513	Si-npn	VHF/UHF, 15V, 50mA, 150mW, B=50..250, >4.5GHz	SOT-346	16ta	-	3a Ren
IS-	2SC4537	Si-npn	VHF/UHF, 15V, 50mA, 100mW, B=50..250, >4.5GHz	SOT-323	16ta	-	3a Ren
IS5	2SA1881-5	Si-pnp	AF, Amp, 15V, 200mA, 250mW, B=135..270, 300MHz	SOT-23	16ta	-	3a San
IS6	2SA1881-6	Si-pnp	AF, Amp, 15V, 200mA, 250mW, B=200..400, 300MHz	SOT-23	16ta	-	3a San
IS7	2SA1881-7	Si-pnp	AF, Amp, 15V, 200mA, 250mW, B=300..600, 300MHz	SOT-23	16ta	-	3a San
IT	2SB1220-T	Si-pnp	AF, LN, 150V, 100mA, 150mW, B=260..450, 200MHz	SOT-323	16ta	-	3a Pan
IT	2SB1463-T	Si-pnp	GP, 150V, 50mA, 125mW, 200MHz, B=260..450	SOT-416	16ta	-	3a Pan
IT	2SB792-T	Si-pnp	AF, LN, 150V, 50mA, 200mW, B=260..450, 200MHz	SC-59	16ta	-	3a Pan
IT	CHT817PT-R	Si-npn	AF, Sw, 45V, 500mA, B=160..400, 170MHz	SOT-23	16ta	-	3a Chm
IT	ETC809TU	Vdet-IC	3.08V, -Reset PPO	SOT-23	16vdc	VD7	3a Etc
IT	EUP7968-12V1	LVR-IC	LDO, 1.2V±3%, 300mA	SOT-23	16cg	VR1	3b Eut
IT	MIC809TU	Vdet-IC	3.08V, -Reset PPO	SOT-23	16vdc	VD7	3a Mcr
IX	MIC809-5S-U	Vdet-IC	3.3V, -Reset PPO	SOT-23	16vdc	VD7	3a Mcr
IY	2SA1298-Y	Si-pnp	AF, Sw, 30V, 800mA, 200mA, B=160..320, 120MHz	SC-59	16ta	-	3a Tos
IY	KTA1298-Y	Si-pnp	AF, 35V, 800mA, 200mW, B=160..320, >80MHz	SOT-23	16ta	-	3f Kec
IY	WTA8921-Y	Si-pnp	GP, 35V, 800mA, 200mW, B=160..320, >80MHz	SOT-23	16ta	-	3a Wtr
j	AX6902CA	Vdet-IC	4.0V±1.5%, +Reset PPO	SC-70	16vdc	VD7	3b Axl
JO	ELM7630HAB	Vdet-IC	3.0V±2%, +Reset PPO, 250ms	SOT-23	16vdc	VD7	3d Elm
JO	HSMS-270A	Si-diode	Schottky, 15V, 350mA, Vf<0.55V(350mA), Cd<6.7pF	SOT-23	16dc	-	3a Agi
JO	HSMS-270B	Si-diode	Schottky, 15V, 750mA, Vf<0.55V(350mA), Cd<6.7pF	SOT-323	16dc	-	3a Agi
JO	R3111N102C	Vdet-IC	1V±2%, -Reset ODO	SOT-23	16vdd	VD6	3d Ric
JO	R3130N40EA	Vdet-IC	4V, -Reset PPO, 240ms	SOT-23	16vdc	VD7	3b Ric
JO	SST110	n-FET	Sw, 25V, 350mW, Idss=10mA, Rds(on)=18Ω, 1/4ns	SOT-23	16fj	-	3a Six
JO-	RT9818B-14PV	Vdet-IC	1.4V±1.5%, -Reset ODO, Td=55ms	SOT-23	16vda	VD6	3a Rct
JO1	SO2906R	Si-pnp	GP, 60V, 600mA, 400mW, >200MHz, B>40	SOT-23	16te	-	Zx



SMD code	Type	Function	Short description	Case	Pinout	Sch.	St.	Mnf.
J03	SO2907AR	Si-pnp	GP, 60V, 600mA, 330mW, B=100..300, >200MHz	SOT-23	16te	-	3a	Zx
J05	SO2907R	Si-pnp	GP, 40V, 600mA, 330mW, B=100..300, >200MHz	SOT-23	16te	-	3a	Zx
J06	SO2894R	Si-pnp	Sw, 12V, 200mA, 360mW, 23/43ns	SOT-23	16te	-	-	Zx
J1	BSH101	n-MOSFET-e	V-MOS, LogL, 60V, 0.7A, <0.9Q	SOT-23	16fh	-	3a	Phi
J1	BSS138LT1	n-MOSFET-e*	SIPMOS, LogL, 50V, 200mA, 225mW, 3.5Q(220mA), 20/20ns	SOT-23	16fh	-	3m	Ons
J1	CHT9013PT-J	Si-npn	AF, Sw, 25V, 500mA, B=300..400, 150MHz	SOT-23	16ta	-	3a	Chm
J1	ELM7631HAB	Vdet-IC	3.1V±2%, +Reset PPO, 250ms	SOT-23	16vdc	VD7	3d	Elm
J1	MMBZ5246B	Z-diode	15.20..16.80V, Zzt=17Q, lzt=7.8mA, 410mW	SOT-23	16dc	-	3a	Pjt
J1	MMBZ5246BW	Z-diode	16V±5%, Zzt=17Q, 200mW	SOT-323	16dc	-	3a	Pjt
J1	R3111N112C	Vdet-IC	1.2V±2%, -Reset ODO	SOT-23	16vdd	VD6	3d	Ric
J1	R3130N41EA	Vdet-IC	4.1V, -Reset PPO, 240ms	SOT-23	16vdc	VD7	3b	Ric
J1	TCM809LELB	Vdet-IC	4.63V±2%, -Reset PPO	SC-70	16vdc	VD7	3b	Mcc
J1	TCM809LENB	Vdet-IC	4.63V±2%, -Reset PPO	SOT-23	16vdc	VD7	3b	Mcc
J1	ZC830	C-diode	VHF/UHF-Tuning, 25V, 330mW, 10pF(2V), ΔC ±20%	SOT-23	16dc	-	3a	Zx
J10	CHT856BPT-Q	Si-pnp	AF, Sw, 65V, 100mA, B=125..250, 200MHz	SOT-23	16ta	-	3a	Chm
J11	CHT856BPT-R	Si-pnp	AF, Sw, 65V, 100mA, B=220..475, 200MHz	SOT-23	16ta	-	3a	Chm
J12	CHT856BPT-S	Si-pnp	AF, Sw, 65V, 100mA, B=420..800, 200MHz	SOT-23	16ta	-	3a	Chm
J12	SO2906AR	Si-pnp	GP, 60V, 600mA, 400mW, >200MHz, B>40	SOT-23	16te	-	-	Zx
J13	CHT857BPT-Q	Si-pnp	AF, Sw, 45V, 100mA, B=125..250, 100MHz	SOT-23	16ta	-	3a	Chm
J14	CHT857BPT-R	Si-pnp	AF, Sw, 45V, 100mA, B=220..475, 100MHz	SOT-23	16ta	-	3a	Chm
J15	CHT857BPT-S	Si-pnp	AF, Sw, 45V, 100mA, B=420..800, 100MHz	SOT-23	16ta	-	3a	Chm
J16	CH848BPT-P	Si-npn	AF, Sw, 30V, 100mA, B=110..220, 300MHz	SOT-23	16ta	-	3a	Chm
J17	CH848BPT-Y	Si-npn	AF, Sw, 30V, 100mA, B=420..800, 300MHz	SOT-23	16ta	-	3a	Chm
J18	CH858BPT-Q	Si-pnp	AF, Sw, 30V, 100mA, B=125..250, 200MHz	SOT-23	16ta	-	3a	Chm
J19	CH858BPT-S	Si-pnp	AF, Sw, 30V, 100mA, B=420..800, 200MHz	SOT-23	16ta	-	3a	Chm
J1A	ZC830A	C-diode	VHF/UHF-Tuning, 25V, 330mW, 10pF(2V), ΔC ±10%	SOT-23	16dc	-	3a	Zx
J1B	ZC830B	C-diode	VHF/UHF-Tuning, 25V, 330mW, 10pF(2V), ΔC ±5%	SOT-23	16dc	-	3a	Zx
J10	KSA1298-O	Si-pnp	GP, AF, 30V, 800mA, 200mW, B=100..200, 120MHz	SOT-23	16ta	-	3a	Sam
J1Y	KSA1298-Y	Si-pnp	GP, AF, 30V, 800mA, 200mW, B=130..320, 120MHz	SOT-23	16ta	-	3a	Sam
J2	2SC3142-2	Si-npn	AF, GP, 25V, 30mA, 150mW, 750MHz, B=40..80	SOT-23	16ta	-	3a	San
J2	2SK67-2	n-FET	GP, 20V, 10mA, 80mW, Idss=0.02..0.04mA, Up<0.8V	SOT-23	16fh	-	3a	Nec
J2	BSH102	n-MOSFET-e	V-MOS, LogL, 30V, 0.85A, <0.6Q	SOT-23	16fh	-	3a	Phi
J2	CHT9013PT-H	Si-npn	AF, Sw, 25V, 500mA, B=200..350, 150MHz	SOT-23	16ta	-	3a	Chm
J2	ELM7632HAB	Vdet-IC	3.2V±2%, +Reset PPO, 250ms	SOT-23	16vdc	VD7	3d	Elm
J2	HSMS-2702	Si-diode	Dual, Schottky, 15V, 350mA, Vf<0.55V(350mA), Cd<6.7pF	SOT-23	16dl	-	3a	Agi
J2	HSMS-270C	Si-diode	Dual, Schottky, 15V, 750mA, Vf<0.55V(350mA), Cd<6.7pF	SOT-323	16dl	-	3a	Agi
J2	MAX809MTR	Vdet-IC	4.38V±1.5%, -Reset PPO	SOT-23	16vdc	VD7	3a	Ons
J2	MMBZ5247B	Z-diode	16.15..17.85V, Zzt=19Q, lzt=7.5mA, 410mW	SOT-23	16dc	-	3a	Pjt
J2	R3111N122C	Vdet-IC	1.2V±2%, -Reset ODO	SOT-23	16vdd	VD6	3d	Ric
J2	R3130N42EA	Vdet-IC	4.2V, -Reset PPO, 240ms	SOT-23	16vdc	VD7	3b	Ric
J2	TCM809MELB	Vdet-IC	4.38V±2%, -Reset PPO	SC-70	16vdc	VD7	3b	Mcc
J2	TCM809MENB	Vdet-IC	4.38V±2%, -Reset PPO	SOT-23	16vdc	VD7	3b	Mcc
J2	ZC833	C-diode	VHF/UHF-Tuning, 25V, 330mW, 33pF(2V), ΔC ±20%	SOT-23	16dc	-	3a	Zx
J22	CHT1198PT-Q	Si-pnp	AF, Sw, 80V, 500mA, B=120..390, 180MHz	SOT-23	16ta	-	3a	Chm
J23	CHT1198PT-R	Si-pnp	AF, Sw, 80V, 500mA, B=120..390, 180MHz	SOT-23	16ta	-	3a	Chm
J25	SO3906R	Si-pnp	Sw, AF, 60/40V, 100mA, 200mW, B=100..300, >250MHz	SOT-23	16te	-	-	Ste
J26	2SA2119PT	Si-pnp	AF, Sw, 12V, 500mA, B=270..680, 260MHz	SOT-23	16ta	-	3a	Chm
J2A	ZC833A	C-diode	VHF/UHF-Tuning, 25V, 330mW, 33pF(2V), ΔC ±10%	SOT-23	16dc	-	3a	Zx
J2B	ZC833B	C-diode	VHF/UHF-Tuning, 25V, 330mW, 33pF(2V), ΔC ±5%	SOT-23	16dc	-	3a	Zx
J3	2SC3142-3	Si-npn	AF, GP, 25V, 30mA, 150mW, 750MHz, B=60..120	SOT-23	16ta	-	3a	San
J3	2SK67-3	n-FET	GP, 20V, 10mA, 80mW, Idss=0.035..0.07mA, Up<0.8V	SOT-23	16fh	-	3a	Nec
J3	BSH103	n-MOSFET-e	V-MOS, LogL, 30V, 0.85A, <0.5Q	SOT-23	16fh	-	3a	Phi
J3	CHT9013PT-L	Si-npn	AF, Sw, 25V, 500mA, B=120..200, 150MHz	SOT-23	16ta	-	3a	Chm
J3	ELM7633HAB	Vdet-IC	3.3V±2%, +Reset PPO, 250ms	SOT-23	16vdc	VD7	3d	Elm
J3	MAX809TTR	Vdet-IC	3.08V±1.5%, -Reset PPO	SOT-23	16vdc	VD7	3a	Ons
J3	MMBZ5248B	Z-diode	17.10..18.90V, Zzt=21Q, lzt=7.0mA, 410mW	SOT-23	16dc	-	3a	Pjt
J3	MMBZ5248BW	Z-diode	18V±5%, Zzt=21Q, 200mW	SOT-323	16dc	-	3a	Pjt
J3	R3111N132C	Vdet-IC	1.3V±2%, -Reset ODO	SOT-23	16vdd	VD6	3d	Ric
J3	R3130N43EA	Vdet-IC	4.3V, -Reset PPO, 240ms	SOT-23	16vdc	VD7	3b	Ric
J3	TCM809TELB	Vdet-IC	3.08V±2%, -Reset PPO	SC-70	16vdc	VD7	3b	Mcc
J3	TCM809TENB	Vdet-IC	3.08V±2%, -Reset PPO	SOT-23	16vdc	VD7	3b	Mcc
J3	ZC831	C-diode	VHF/UHF-Tuning, 25V, 330mW, 15pF(2V), ΔC ±20%	SOT-23	16dc	-	3a	Zx
J3-	RT9818E-19PV	Vdet-IC	1.9V±1.5%, +Reset ODO	SOT-23	16vda	VD6	3a	Rct
J33	SO5401R	Si-pnp	GP, HV, 160V, 600mA, 200mW, B=50..240, 400MHz	SOT-23	16te	-	3a	Zx
J39	SO692R	Si-pnp	HV, Vid, 300V, 100mA, 310mW, B>25, 50MHz	SOT-23	16te	-	3a	Ste
J3A	ZC831A	C-diode	VHF/UHF-Tuning, 25V, 330mW, 15pF(2V), ΔC ±10%	SOT-23	16dc	-	3a	Zx
J3B	ZC831B	C-diode	VHF/UHF-Tuning, 25V, 330mW, 15pF(2V), ΔC ±5%	SOT-23	16dc	-	3a	Zx
J3H	S9013LT1-H	Si-npn	GP, 40V, 500mA, 300mW, B=200..350, >150MHz	SOT-23	16ta	-	3a	Wtr
J3L	S9013LT1-L	Si-npn	GP, 40V, 500mA, 300mW, B=120..200, >150MHz	SOT-23	16ta	-	3a	Wtr
J4	2SC3142-4	Si-npn	AF, GP, 25V, 30mA, 150mW, 750MHz, B=90..180	SOT-23	16ta	-	3a	San



SMD code	Type	Function	Short description	Case	Pinout	Sch. St.	Mnf.
J4	2SK67-4	n-FET	GP, 20V, 10mA, 80mW, Idss=0.06..0.12mA, Up<0.8V	SOT-23	16fh	-	3a Nec
J4	CHT807PT-Q	Si-pnp	AF, Sw, 45V, 500mA, B=100..250, 100MHz	SOT-23	16ta	-	3a Chm
J4	ELM7634HAB	Vdet-IC	3.4V±2%, +Reset PPO, 250ms	SOT-23	16vdc	VD7	3d Elm
J4	MMBZ5249B	Z-diode	18.05..19.95V, Zzt=23Ω, lzt=6.6mA, 410mW	SOT-23	16dc	-	3a Pjt
J4	R3111N142C	Vdet-IC	1.4V±2%, -Reset ODO	SOT-23	16vdd	VD6	3d Ric
J4	R3130N44EA	Vdet-IC	4.4V, -Reset PPO, 240ms	SOT-23	16vdc	VD7	3b Ric
J4	TCM809SELB	Vdet-IC	2.93V±2%, -Reset PPO	SC-70	16vdc	VD7	3b Mcc
J4	TCM809SENB	Vdet-IC	2.93V±2%, -Reset PPO	SOT-23	16vdc	VD7	3b Mcc
J4	ZC832	C-diode	VHF/UHF-Tuning, 25V, 330mW, 22pF(2V), ΔC ±20%	SOT-23	16dc	-	3a Zx
J4-	RT9818B-15PV	Vdet-IC	1.5V±1.5%, -Reset ODO, Td=55ms	SOT-23	16vda	VD6	3a Rct
J4A	ZC832A	C-diode	VHF/UHF-Tuning, 25V, 330mW, 22pF(2V), ΔC ±10%	SOT-23	16dc	-	3a Zx
J4B	ZC832B	C-diode	VHF/UHF-Tuning, 25V, 330mW, 22pF(2V), ΔC ±5%	SOT-23	16dc	-	3a Zx
J5	2SK67-5	n-FET	GP, 20V, 10mA, 80mW, Idss=0.1..0.2mA, Up<0.8V	SOT-23	16fh	-	3a Nec
J5	AH175W	H-IC	Hall-effect sensor IC, Vcc=3.5..20V, Iout=25mA, OCO	SOT-23	16ha	-	3a Ana
J5	CHT807PT-R	Si-pnp	AF, Sw, 45V, 500mA, B=160..400, 100MHz	SOT-23	16ta	-	3a Chm
J5	ELM7635HAB	Vdet-IC	3.5V±2%, +Reset PPO, 250ms	SOT-23	16vdc	VD7	3d Elm
J5	MAX809RTR	Vdet-IC	2.63V±1.5%, -Reset PPO	SOT-23	16vdc	VD7	3a Ons
J5	MMBZ5250B	Z-diode	19.0..21.0V, Zzt=25Ω, lzt=6.2mA, 410mW	SOT-23	16dc	-	3a Pjt
J5	MMBZ5250BW	Z-diode	20V±5%, Zzt=25Ω, 200mW	SOT-323	16dc	-	3a Pjt
J5	R3111N152C	Vdet-IC	1.5V±2%, -Reset ODO	SOT-23	16vdd	VD6	3d Ric
J5	R3130N45EA	Vdet-IC	4.5V, -Reset PPO, 240ms	SOT-23	16vdc	VD7	3b Ric
J5	SP810EK-4-4	Vdet-IC	4.4V±1.5%, +Reset PPO	SOT-23	16vdc	VD7	3b Sip
J5	TCM809RELB	Vdet-IC	2.63V±2%, -Reset PPO	SC-70	16vdc	VD7	3b Mcc
J5	TCM809RENB	Vdet-IC	2.63V±2%, -Reset PPO	SOT-23	16vdc	VD7	3b Mcc
J5	ZC834	C-diode	VHF/UHF-Tuning, 25V, 330mW, 47pF(2V), ΔC ±20%	SOT-23	16dc	-	3a Zx
J5-	RT9818B-16PV	Vdet-IC	1.6V±1.5%, -Reset ODO, Td=55ms	SOT-23	16vda	VD6	3a Rct
J5A	ZC834A	C-diode	VHF/UHF-Tuning, 25V, 330mW, 47pF(2V), ΔC ±10%	SOT-23	16dc	-	3a Zx
J5B	ZC834B	C-diode	VHF/UHF-Tuning, 25V, 330mW, 47pF(2V), ΔC ±5%	SOT-23	16dc	-	3a Zx
J6	2SK67-6	n-FET	GP, 20V, 10mA, 80mW, Idss=0.16..0.3mA, Up<0.8V	SOT-23	16fh	-	3a Nec
J6	CHT807PT-S	Si-pnp	AF, Sw, 45V, 500mA, B=250..600, 100MHz	SOT-23	16ta	-	3a Chm
J6	ELM7636HAB	Vdet-IC	3.6V±2%, +Reset PPO, 250ms	SOT-23	16vdc	VD7	3d Elm
J6	M1MA174	Si-diode	Sw, 100V, 200mA, 200mW, Vf<1.2V(100mA), <4pF	SOT-323	16dc	-	3a Ons
J6	MAX809JTR	Vdet-IC	4.0V±1.5%, -Reset PPO	SOT-23	16vdc	VD7	3a Ons
J6	R3111N162C	Vdet-IC	1.6V±2%, -Reset ODO	SOT-23	16vdd	VD6	3d Ric
J6	R3130N46EA	Vdet-IC	4.6V, -Reset PPO, 240ms	SOT-23	16vdc	VD7	3b Ric
J6	TCM809JELB	Vdet-IC	4.0V±2%, -Reset PPO	SC-70	16vdc	VD7	3b Mcc
J6	TCM809JENB	Vdet-IC	2.63V±2%, -Reset PPO	SOT-23	16vdc	VD7	3b Mcc
J6	ZC835	C-diode	VHF/UHF-Tuning, 25V, 330mW, 68pF(2V), ΔC ±20%	SOT-23	16dc	-	3a Zx
J6-	RT9818A-18PV	Vdet-IC	1.8V±1.5%, -Reset ODO	SOT-23	16vda	VD6	3a Rct
J6=	RT9818A-18GV	Vdet-IC	1.8V±1.5%, -Reset ODO	SOT-23	16vda	VD6	3a Rct
J6A	ZC835A	C-diode	VHF/UHF-Tuning, 25V, 330mW, 68pF(2V), ΔC ±10%	SOT-23	16dc	-	3a Zx
J6B	ZC835B	C-diode	VHF/UHF-Tuning, 25V, 330mW, 68pF(2V), ΔC ±5%	SOT-23	16dc	-	3a Zx
J6H	S9014LT1-H	Si-npn	GP, 50V, 100mA, 200mW, B=450..1000, >150MHz	SOT-23	16ta	-	3a Wtr
J6L	S9014LT1-L	Si-npn	GP, 50V, 100mA, 200mW, B=120..450, >150MHz	SOT-23	16ta	-	3a Wtr
J7	2SK67-7	n-FET	GP, 20V, 10mA, 80mW, Idss=0.27..0.54mA, Up<0.8V	SOT-23	16fh	-	3a Nec
J7	ATS177W	H-IC	Hall-effect sensor IC, Vcc=3.5..20V, Iout=25mA, OCO	SOT-23	16ha	-	3a Ana
J7	CHT846BPT-Q	Si-npn	AF, Sw, 65V, 100mA, B=110..220, 200MHz	SOT-23	16ta	-	3a Chm
J7	ELM7637HAB	Vdet-IC	3.7V±2%, +Reset PPO, 250ms	SOT-23	16vdc	VD7	3d Elm
J7	R3111N172C	Vdet-IC	1.7V±2%, -Reset ODO	SOT-23	16vdd	VD6	3d Ric
J7	R3130N47EA	Vdet-IC	4.7V, -Reset PPO, 240ms	SOT-23	16vdc	VD7	3b Ric
J7	TCM809ZELB	Vdet-IC	2.32V±2%, -Reset PPO	SC-70	16vdc	VD7	3b Mcc
J7	TCM809ZENB	Vdet-IC	2.32V±2%, -Reset PPO	SOT-23	16vdc	VD7	3b Mcc
J7	ZC836	C-diode	VHF/UHF-Tuning, 25V, 330mW, 100pF(2V), ΔC ±20%	SOT-23	16dc	-	3a Zx
J7-	RT9819A-27PVL	Vdet-IC	2.7V±1.5%, -Reset PPO	SOT-23	16vda	VD7	3a Rct
J7A	ZC836A	C-diode	VHF/UHF-Tuning, 25V, 330mW, 100pF(2V), ΔC ±10%	SOT-23	16dc	-	3a Zx
J7B	ZC836B	C-diode	VHF/UHF-Tuning, 25V, 330mW, 100pF(2V), ΔC ±5%	SOT-23	16dc	-	3a Zx
J7B	2SK67-8	n-FET	GP, 20V, 10mA, 80mW, Idss=0.1..1mA, Up<0.8V	SOT-23	16fh	-	3a Nec
J8	AV9018LT1	Si-npn	AF-Amp, 25V, 50mA, 200mW, B=70..190, >600MHz	SOT-23	16ta	-	3a Avi
J8	BCX71JR	Si-pnp	GP, Sw, 45V, 100mA, 250mW, B=250..460, >100MHz	SOT-23	16te	-	3a Phi
J8	BCX71RJ	Si-pnp	GP, Sw, 45V, 100mA, 250mW, B=250..460, >100MHz	SOT-23	16ta	-	3a Zx
J8	BZX84-C3V9	Z-diode	3.7..4.1V, Zzt=90Ω, lzt=20mA, 225mW	SOT-23	16dc	-	3a Lge
J8	ELM7638HAB	Vdet-IC	3.8V±2%, +Reset PPO, 250ms	SOT-23	16vdc	VD7	3d Elm
J8	R3111N182C	Vdet-IC	1.8V±2%, -Reset ODO	SOT-23	16vdd	VD6	3d Ric
J8	R3130N48EA	Vdet-IC	4.8V, -Reset PPO, 240ms	SOT-23	16vdc	VD7	3b Ric
J8	S9018LT1	Si-npn	GP, 25V, 50mA, 200mW, B=70..190, >600MHz	SOT-23	16ta	-	3a Wtr
J8-	RT9818C-23PVL	Vdet-IC	2.3V±1.5%, -Reset ODO, Td=220ms	SOT-23	16vda	VD6	3a Rct
J8H	S9018H	Si-npn	AM/FM-amp, 30V, 50mA, 200mW, B=105..190, >600MHz	SOT-23	16ta	-	3a Jce
J8L	S9018L	Si-npn	AM/FM-amp, 30V, 50mA, 200mW, B=70..105, >600MHz	SOT-23	16ta	-	3a Jce
J9	BZX84-C18	Z-diode	16.8..19.1V, Zzt=45Ω, lzt=20mA, 225mW	SOT-23	16dc	-	3a Lge
J9	CHT846BPT-S	Si-npn	AF, Sw, 65V, 100mA, B=420..800, 200MHz	SOT-23	16ta	-	3a Chm



SMD code	Type	Function	Short description	Case	Pinout	Sch.	St.	Mnf.
J9	ELM7639HAB	Vdet-IC	3.9V±2%, +Reset PPO, 250ms	SOT-23	16vdc	VD7	3d	Elm
J9	R3111N192C	Vdet-IC	1.9V±2%, -Reset ODO	SOT-23	16vdd	VD6	3d	Ric
J9	SST109	n-FET	Sw, 25V, 350mW, Idss=40mA, Rds(on)=12Ω, 1/4ns	SOT-23	16fj	-	3a	Six
J9	ZC829	C-diode	VHF/UHF-Tuning, 25V, 330mW, 8.2pF(2V), ΔC ±20%	SOT-23	16dc	-	3a	Zx
J9-	RT9818C-28PV	Vdet-IC	2.8V±1.5%, -Reset ODO, Td=220ms	SOT-23	16vda	VD6	3a	Rct
J9A	ZC829A	C-diode	VHF/UHF-Tuning, 25V, 330mW, 8.2pF(2V), ΔC ±10%	SOT-23	16dc	-	3a	Zx
J9B	ZC829B	C-diode	VHF/UHF-Tuning, 25V, 330mW, 8.2pF(2V), ΔC ±5%	SOT-23	16dc	-	3a	Zx
JA	2SK2170	n-FET	Conv, 30V, 20mA, 100mW, Idss=1.2..4.5mA, Up<2.5V	SOT-23	16fh	-	3a	San
JA	ATS137W	H-IC	Hall-effect sensor IC, Vcc=3.5..20V, Iout=25mA, OCO	SOT-23	16ha	-	3a	Ana
JA	BAV70	Si-diode	Dual, Sw, 75V, 215mA, Vf<1.25V, <4ns	SOT-23	16dg	-	3a	Pjt
JA	BAV70W	Si-diode	Dual, Sw, 75V, 215mA, 225mW, Vf<1.25V, <4ns	SOT-323	16dg	-	3a	Pjt
JA	BAV74	Si-diode	Dual, Hi-Speed, 50V, 200mA, Vf<1V(100mA), 2pF, 4ns	SOT-23	16dg	-	3a	Ons
JA-	RT9818C-34PV	Vdet-IC	3.4V±1.5%, -Reset ODO, Td=220ms	SOT-23	16vda	VD6	3a	Rct
JAp	BAV74	Si-diode	Dual, Hi-Speed, 50V, 215mA, Vf<1V(100mA), 1.5pF, 4ns	SOT-23	16dg	-	3a	PHH
JAT	BAV74	Si-diode	Dual, Hi-Speed, 50V, 215mA, Vf<1V(100mA), 1.5pF, 4ns	SOT-23	16dg	-	3a	PhM
JAW	BAV74	Si-diode	Dual, Hi-Speed, 50V, 215mA, Vf<1V(100mA), 1.5pF, 4ns	SOT-23	16dg	-	3a	PhC
JB-	RT9818C-35PV	Vdet-IC	3.5V±1.5%, -Reset ODO, Td=220ms	SOT-23	16vda	VD6	3a	Rct
JB=	RT9818C-35GV	Vdet-IC	3.5V±1.5%, -Reset ODO, Td=220ms	SOT-23	16vda	VD6	3a	Rct
JBp	BAV73	Si-diode	Dual, Hi-Speed, 200V, 200mA, Vf<1.25V(200mA), 5pF, 5ns	SOT-23	16dg	-	3a	Phi
JBs	BAR74	Si-diode	Sw, 50V, 250mA, 370mW, Vf<1V(100mA), <4ns	SOT-23	16dc	-	3c	Inf
JC	2SC2735	Si-npn	VHF/UHF-Osc, 30V, 50mA, 150mW, B>40, 1.2GHz	SOT-23	16ta	-	3a	Ren
JC	2SC4265	Si-npn	HF, 30V, 50mA, 100mW, B>40, >600MHz	COMPACT	16ta	-	3a	Ren
JC	2SJ125-C	p-FET	AF-Amp, 50V, Idss=1..3mA, 150mW, 4ms, Rds<220Ω	SC-59	16fa	-	3a	Mit
JC	2SJ145-C	p-FET	AF-Amp, 50V, Idss=1..3mA, 150mW, 4ms, Rds<200Ω	SOT-323	16fa	-	3a	Mit
JC	BAL74W	Si-diode	Sw, Fast, 50V, 0.25A, 250mW, <4ns	SOT-323	16dr	-	3a	Phi
JC	BAW56	Si-diode	Dual, Sw, 70V, 200mA, 250mW, Vf<1.25V, 2pF, <6ns	SOT-23	16df	-	3a	Pjt
JC	BAW56W	Si-diode	Dual, Hi-Speed, 75V, 150mA, 200mW, 2pF, 4ns	SOT-323	16df	-	3a	Pjt
JC	CPH3303	p-MOSFET*	Sw, LogL, 20V, 1.6A, 1W, 315mΩ(0.8A), 10/32ns	CPH3	16fa	-	3a	San
JC-	RT9818A-20PV	Vdet-IC	2.0V±1.5%, -Reset ODO	SOT-23	16vda	VD6	3a	Rct
JC=	RT9818A-20GV	Vdet-IC	2.0V±1.5%, -Reset ODO	SOT-23	16vda	VD6	3a	Rct
JCp	BAL74	Si-diode	Sw, Fast, 50V, 0.25A, 250mW, <4ns	SOT-23	16dr	-	3a	PHH
JCs	BAL74	Si-diode	Sw, Fast, 50V, 0.25A, 250mW, <4ns	SOT-23	16dr	-	3a	Sie
JCt	BAL74	Si-diode	Sw, Fast, 50V, 0.25A, 250mW, <4ns	SOT-23	16dr	-	3a	PhM
JCW	BAL74	Si-diode	Sw, Fast, 50V, 0.25A, 250mW, <4ns	SOT-23	16dr	-	3a	PhC
JD	2SJ125-D	p-FET	AF-Amp, 50V, Idss=2.5..6mA, 150mW, 4ms, Rds<220Ω	SC-59	16fa	-	3a	Mit
JD	2SJ145-D	p-FET	AF-Amp, 50V, Idss=2.5..6mA, 150mW, 4ms, Rds<200Ω	SOT-323	16fa	-	3a	Mit
JD	BAW56T	Si-diode	Dual, Hi-Speed, 85V, 150mA, 200mW, 2pF, 4ns	SOT-416	16df	-	3a	Di
JD-	RT9818A-30PV	Vdet-IC	3.0V±1.5%, -Reset ODO	SOT-23	16vda	VD6	3a	Rct
JD=	RT9818A-30GV	Vdet-IC	3.0V±1.5%, -Reset ODO	SOT-23	16vda	VD6	3a	Rct
JE	2SJ125-E	p-FET	AF-Amp, 50V, Idss=5..12mA, 150mW, 4ms, Rds<220Ω	SC-59	16fa	-	3a	Mit
JE	2SJ145-E	p-FET	AF-Amp, 50V, Idss=5..12mA, 150mW, 4ms, Rds<200Ω	SOT-323	16fa	-	3a	Mit
JE	CH228KPT	Si-diode	Dual, Sw, 80V, 100mA, Vf<1.2V(100mA), 4ns	SOT-23	16dl	-	3a	Chm
JE-	RT9818C-18PV	Vdet-IC	1.8V±1.5%, -Reset ODO, Td=220ms	SOT-23	16vda	VD6	3a	Rct
JE=	RT9818C-18GV	Vdet-IC	1.8V±1.5%, -Reset ODO, Td=220ms	SOT-23	16vda	VD6	3a	Rct
JE1	CHDTA123JEPT	Si-pnp-Digi	Sw, 50V, 100mA, 250MHz, R1/R2=2.2/47k	SOT-416	16ta	-	3a	Chm
JEA	CHDTC123JEPT	Si-npn-Digi	Sw, 50V, 100mA, 250MHz, R1/R2=2.2/47k	SOT-416	16ta	-	3a	Chm
JF	BAL99L	Si-diode	Sw, Fast, 75V, 0.25A, 250mW, <4ns	SOT-23	16dr	-	3a	Ons
JF	BAL99W	Si-diode	Sw, Fast, 75V, 150mA, 200mW, Vf<1.25V(150mA), <4ns	SOT-323	16dr	-	3a	Phi
JF-	RT9818F-20PVL	Vdet-IC	2.0V±1.5%, +Reset ODO, Td=55ms	SOT-23	16vdc	VD6	3a	Rct
JFp	BAL99	Si-diode	Sw, Fast, 75V, 0.25A, 250mW, <4ns	SOT-23	16dr	-	3a	PHH
JFs	BAL99	Si-diode	Sw, Fast, 75V, 0.25A, 250mW, <4ns	SOT-23	16dr	-	3a	Sie
JFt	BAL99	Si-diode	Sw, Fast, 75V, 0.25A, 250mW, <4ns	SOT-23	16dr	-	3a	PhM
JFW	BAL99	Si-diode	Sw, Fast, 75V, 0.25A, 250mW, <4ns	SOT-23	16dr	-	3a	PhC
JG	2SK208-GR	n-FET	AF-Amp, 50V, 10mA, 100mW, Idss=2..6..6.5mA	SOT-23	16fa	-	3a	Tos
JG	2SK879-GR	n-FET	AF-Amp, 50V, 10mA, 100mW, Idss=2.6..6.5mA, Up<5V	SOT-323	16fa	-	3a	Tos
JG	BAV99	Si-diode	Dual, U-Sp, 80V, 150mA, Vf<1.2V(100mA), 0.5pF, 4ns	SOT-23	16dl	-	3a	Pjt
JG	BAV99W	Si-diode	Dual, U-Sp, 75V, 125mA, Vf<1.2V(100mA), 0.5pF, 4ns	SOT-323	16dl	-	3a	Pjt
JG-	RT9818B-27PV	Vdet-IC	2.7V±1.5%, -Reset ODO, Td=55ms	SOT-23	16vda	VD6	3a	Rct
JGs	BAR99	Si-diode	Sw, 70V, 250mA, 370mW, Vf<1.25V(150mA), <6ns	SOT-23	16dc	-	3a	Sie
JH-	RT9818C-27PVL	Vdet-IC	2.7V±1.5%, -Reset ODO, Td=220ms	SOT-23	16vdc	VD6	3a	Rct
JH=	RT9818C-27GVL	Vdet-IC	2.7V±1.5%, -Reset ODO, Td=220ms	SOT-23	16vdc	VD6	3a	Rct
JID	2SA1566-D	Si-pnp	AF-Amp, 120V, 100mA, B=60..120, 120MHz	SOT-23	16ta	-	3a	Ren
JIE	2SA1566-E	Si-pnp	AF-Amp, 120V, 100mA, B=150..300, 120MHz	SOT-23	16ta	-	3a	Ren
JJ	2SK1839	n-MOSFET-e*	Sw, 30V, 100mA, 150mW, <15Ω(10mA), 12pF	MCP	16fi	-	3a	San
JJ	2SK1840	n-MOSFET-e*	Sw, 30V, 100mA, 200mW, <15Ω(10mA), 12pF	SOT-23	16fi	-	3a	San
JJ	BAV70	Si-diode	Dual, Sw, 75V, 215mA, Vf<1.25V, <4ns	SOT-23	16dg	-	3a	Sie
JJ	BAV70T	Si-diode	Dual, Sw, 75V, 150mA, 200mW, Vf<1.25V, <4ns	SOT-416	16dg	-	3a	Di
JJ	DZ23C2V7	Z-diode	Dual, 2.5..2.9V, Izt=5mA, Zzt=75Ω, 300mW	SOT-23	16dg	-	3a	Lge
JJ	ETC810JU	Vdet-IC	4V, +Reset PPO	SOT-23	16vdc	VD7	3a	Etc
JJ	MIC810JU	Vdet-IC	4V, +Reset PPO	SOT-23	16vdc	VD7	3a	Mcr



SMD code	Type	Function	Short description	Case	Pinout	Sch. St.	Mnf.
JJ-	RT9818D-27PVL	Vdet-IC	2.7V±1.5%, -Reset ODO, Td=450ms	SOT-23	16vdc	VD6	3a Rct
JK	DZ23C3V0	Z-diode	Dual, 2.8..3.2V, Izt=5mA, Zzt=80Ω, 300mW	SOT-23	16dg	-	3a Lge
JK	ELM7619HDB	Vdet-IC	1.9V±2%, +Reset PPO, 50ms	SOT-23	16vdc	VD7	3d Elm
JK-	RT9819A-33PV	Vdet-IC	3.3V±1.5%, -Reset PPO	SOT-23	16vdc	VD7	3a Rct
JK1	CHDTA123JKPT	Si-nnp-Digi	Sw, 50V, 100mA, 250MHz, R1/R2=2.2/47k	SOT-23	16ta	-	3a Chm
JK2	CHDTB122JKPT	Si-nnp-Digi	Sw, 50V, 500mA, 200MHz, R1/R2=220R/4.7k	SOT-23	16ta	-	3a Chm
JKA	CHDTC123JKPT	Si-nnp-Digi	Sw, 50V, 100mA, 250MHz, R1/R2=2.2/47k	SOT-23	16ta	-	3a Chm
JKB	CHDTD122JKPT	Si-nnp-Digi	Sw, 50V, 500mA, 250MHz, R1/R2=220R/4.7k	SOT-23	16ta	-	3a Chm
JL	2SA1508	Si-nnp-Digi	Sw, 50V, 100mA, 200mW, 200MHz, B>100, R1=47k	CP	16ta	-	3a San
JL	ETC810LU	Vdet-IC	4.63V, +Reset PPO	SOT-23	16vdc	VD7	3a Etc
JL	MIC810LU	Vdet-IC	4.63V, +Reset PPO	SOT-23	16vdc	VD7	3a Mcr
JL-	RT9818D-27PV	Vdet-IC	2.7V±1.5%, -Reset ODO, Td=450ms	SOT-23	16vda	VD6	3a Rct
JLN	ELM7530CEB	Vdet-IC	3.0V±2%, +Reset PPO	SC-70	16vdb	VD7	3d Elm
JLN	ELM7530NEB	Vdet-IC	3.0V±2%, +Reset ODO	SC-70	16vdb	VD6	3d Elm
JM	2SC2059K-M	Si-nnp	RF-amp, 25V, 20mA, 150mW, B=39..82, >500MHz	SC-59	16ta	-	3a Rhm
JM	2SC4099-M	Si-nnp	HF, 25V, 20mA, 150mW, B=39..82, >500MHz	SOT-323	16ta	-	3a Rhm
JM	2SC4649-M	Si-nnp	RF-amp, 25V, 20mA, 150mW, B=39..82, >500MHz	EM3	16ta	-	3a Rhm
JM	DZ23C3V3	Z-diode	Dual, 3.1..3.5V, Izt=5mA, Zzt=80Ω, 300mW	SOT-23	16dg	-	3a Lge
JM	ETC810MU	Vdet-IC	4.38V, +Reset PPO	SOT-23	16vdc	VD7	3a Etc
jm	MIC810MU	Vdet-IC	4.38V, +Reset PPO	SOT-23	16vdc	VD7	3a Mcr
Jm	PT7M7809JT	Vdet-IC	4.0V±1.5%, -Reset PPO	SOT-23	16vdc	VD7	3b Pti
jm	PT7M7809JTE	Vdet-IC	4.0V±1.5%, -Reset PPO, Lead free	SOT-23	16vdc	VD7	3b Pti
JM-	RT9818E-36PV	Vdet-IC	3.6V±1.5%, +Reset ODO	SOT-23	16vda	VD6	3a Rct
JN	2SC2059K-N	Si-nnp	RF-amp, 25V, 20mA, 150mW, B=56..120, >500MHz	SC-59	16ta	-	3a Rhm
JN	2SC4099-N	Si-nnp	HF, 25V, 20mA, 150mW, B=56..120, >500MHz	SOT-323	16ta	-	3a Rhm
JN	2SC4649-N	Si-nnp	RF-amp, 25V, 20mA, 150mW, B=56..120, >500MHz	EM3	16ta	-	3a Rhm
JN	2SC4909	Si-nnp-Digi	Mute, Div, 25V, 100mA, 200mW, 240MHz, R1/R2=47K/47K	MCP	16ta	-	3a San
JN	DZ23C3V6	Z-diode	Dual, 3.4..3.8V, Izt=5mA, Zzt=80Ω, 300mW	SOT-23	16dg	-	3a Lge
JN-	RT9819F-34PVL	Vdet-IC	3.4V±1.5%, +PPO +Reset, Td=55ms	SOT-23	16vda	VD7	3a Rct
JO	2SK208-O	n-FET	AF-Amp, 50V, 10mA, 100mW, Idss=0.6..1.4mA	SOT-23	16fa	-	3a Tos
JO	2SK879-O	n-FET	AF-Amp, 50V, 10mA, 100mW, Idss=0.6..1.4mA, Up<5V	SOT-323	16fa	-	3a Tos
JP	2SC2059K-P	Si-nnp	RF-amp, 25V, 20mA, 150mW, B=82..180, >500MHz	SC-59	16ta	-	3a Rhm
JP	2SC4099-P	Si-nnp	HF, 25V, 20mA, 150mW, B=82..180, >500MHz	SOT-323	16ta	-	3a Rhm
JP	2SC4649-P	Si-nnp	RF-amp, 25V, 20mA, 150mW, B=82..180, >500MHz	EM3	16ta	-	3a Rhm
JP	BAS19	Si-diode	Sw, Fast, 120V, 250mA, Vf=1V(0.1A), 250mW, <50ns	SOT-23	16dc	-	3a PHH
JP	DZ23C3V9	Z-diode	Dual, 3.7..4.1V, Izt=5mA, Zzt=80Ω, 300mW	SOT-23	16dg	-	3a Lge
JP-	RT9818D-29PV	Vdet-IC	2.9V±1.5%, -Reset ODO, Td=450ms	SOT-23	16vda	VD6	3a Rct
JPp	BAS19	Si-diode	Sw, Fast, 120V, 250mA, Vf=1V(0.1A), 250mW, <50ns	SOT-23	16dc	-	3a PHH
JPs	BAS19	Si-diode	Sw, Fast, 120V, 250mA, Vf=1V(0.1A), 250mW, <50ns	SOT-23	16dc	-	3a Sie
JPt	BAS19	Si-diode	Sw, Fast, 120V, 250mA, Vf=1V(0.1A), 250mW, <50ns	SOT-23	16dc	-	3a PHM
JPW	BAS19	Si-diode	Sw, Fast, 120V, 250mA, Vf=1V(0.1A), 250mW, <50ns	SOT-23	16dc	-	3a PhC
JQ-	RT9818D-42PV	Vdet-IC	4.2V±1.5%, -Reset ODO, Td=450ms	SOT-23	16vda	VD6	3a Rct
JR	2SK208-R	n-FET	AF-Amp, 50V, 10mA, 100mW, Idss=0.3..0.75mA	SOT-23	16fa	-	3a Tos
JR	2SK879-R	n-FET	AF-Amp, 50V, 10mA, 100mW, Idss=0.3..0.75mA, Up<5V	SOT-323	16fa	-	3a Tos
JR	BAS20	Si-diode	Sw, Fast, 150V, 250mA, Vf=1V(0.1A), 250mW, <50ns	SOT-23	16dc	-	3a Gal
JR	CAT809JSDI-GT3	Vdet-IC	4.0V±1.5%, -Reset PPO	SC-70	16vdc	VD7	3d Ons
JR	CAT809JTBI-GT3	Vdet-IC	4.0V±1.5%, -Reset PPO	SOT-23	16vdc	VD7	3b Ons
JR	DZ23C4V3	Z-diode	Dual, 4.0..4.6V, Izt=5mA, Zzt=80Ω, 300mW	SOT-23	16dg	-	3a Lge
JR	ETC810RU	Vdet-IC	2.63V, +Reset PPO	SOT-23	16vdc	VD7	3a Etc
JR	MIC810RU	Vdet-IC	2.63V, +Reset PPO	SOT-23	16vdc	VD7	3a Mcr
JR-	2SC5773	Si-nnp	UHfV/HF WB-amp, 15V, 80mA, 750mW, 10.8GHz, B=80..160	MPAK	16ta	-	3a Ren
JR-	RT9819C-12PV	Vdet-IC	1.2V±1.5%, -Reset PPO, Td=220ms	SOT-23	16vdc	VD7	3a Rct
JRp	BAS20	Si-diode	Sw, Fast, 150V, 250mA, Vf=1V(0.1A), 250mW, <50ns	SOT-23	16dc	-	3a PHH
JRs	BAS20	Si-diode	Sw, Fast, 150V, 250mA, Vf=1V(0.1A), 250mW, <50ns	SOT-23	16dc	-	3a Sie
JRt	BAS20	Si-diode	Sw, Fast, 150V, 250mA, Vf=1V(0.1A), 250mW, <50ns	SOT-23	16dc	-	3a PHM
JRW	BAS20	Si-diode	Sw, Fast, 150V, 250mA, Vf=1V(0.1A), 250mW, <50ns	SOT-23	16dc	-	3a PhC
JS	BAS21	Si-diode	Sw, Fast, 200V, 250mA, Vf=1V(0.1A), 250mW, <50ns	SOT-23	16dc	-	3a Gal
JS	BAS21S	Si-diode	Dual, Sw, Fast, 250V, 250mA, 250mW, <50ns	SOT-23	16dl	-	3b Ons
JS	CAT810JSDI-GT3	Vdet-IC	4.0V±1.5%, +Reset PPO	SC-70	16vdc	VD7	3d Ons
JS	CAT810JTBI-GT3	Vdet-IC	4.0V±1.5%, +Reset PPO	SOT-23	16vdc	VD7	3b Ons
JS	ETC810SU	Vdet-IC	2.93V, +Reset PPO	SOT-23	16vdc	VD7	3a Etc
JS	MIC810SU	Vdet-IC	2.93V, +Reset PPO	SOT-23	16vdc	VD7	3a Mcr
js	PT7M6218CLC3	Vdet-IC	1.8V±1.5%, -Reset PPO	SC-70	16vdc	VD7	3b Pti
js	PT7M6218CLC3E	Vdet-IC	1.8V±1.5%, -Reset PPO, Lead free	SC-70	16vdc	VD7	3b Pti
js	PT7M6218CLTA3	Vdet-IC	1.8V±1.5%, -Reset PPO	SOT-23	16vdb	VD7	3b Pti
js	PT7M6218CLTA3E	Vdet-IC	1.8V±1.5%, -Reset PPO, Lead free	SOT-23	16vdb	VD7	3b Pti
JS	TCM809ZVLB	Vdet-IC	2.32V±2%, -Reset PPO	SC-70	16vdc	VD7	3b Mcc
JS-	RT9818C-42PV	Vdet-IC	4.2V±1.5%, -Reset ODO, Td=220ms	SOT-23	16vda	VD6	3a Rct
JS-	RT9818C-42GV	Vdet-IC	4.2V±1.5%, -Reset ODO, Td=220ms	SOT-23	16vda	VD6	3a Rct
JS3	2SA1815-3	Si-nnp	RF, FM, IF-Amp, 15V, 50mA, 250mW, B=60..120, 750MHz	SOT-23	16ta	-	3a San



SMD code	Type	Function	Short description	Case	Pinout	Sch. St.	Mnf.
JS3	2SA1857-3	Si-pnp	RF, FM, IF-Amp, 15V, 50mA, 150mW, B=60..120, 750MHz	MCP	16ta -	3a	San
JS4	2SA1815-4	Si-pnp	RF, FM, IF-Amp, 15V, 50mA, 250mW, B=90..180, 750MHz	SOT-23	16ta -	3a	San
JS4	2SA1857-4	Si-pnp	RF, FM, IF-Amp, 15V, 50mA, 150mW, B=90..180, 750MHz	MCP	16ta -	3a	San
JS5	2SA1815-5	Si-pnp	RF, FM, IF-Amp, 15V, 50mA, 250mW, B=135..270, 750MHz	SOT-23	16ta -	3a	San
JS5	2SA1857-5	Si-pnp	RF, FM, IF-Amp, 15V, 50mA, 150mW, B=135..270, 750MHz	MCP	16ta -	3a	San
JSp	BAS21	Si-diode	Sw, Fast, 200V, 250mA, Vf=1V(0.1A), 250mW, <50ns	SOT-23	16dc -	3a	Phi
JSs	BAS21	Si-diode	Sw, Fast, 200V, 250mA, Vf=1V(0.1A), 250mW, <50ns	SOT-23	16dc -	3a	Sie
JSt	BAS21	Si-diode	Sw, Fast, 200V, 250mA, Vf=1V(0.1A), 250mW, <50ns	SOT-23	16dc -	3a	PHM
JT	ETC810TU	Vdet-IC	3.08V, +Reset PPO	SOT-23	16vdc VD7	3a	Etc
JT	MIC810TU	Vdet-IC	3.08V, +Reset PPO	SOT-23	16vdc VD7	3a	Mcr
jt	PT7M6218CHC3	Vdet-IC	1.8V±1.5%, +Reset PPO	SC-70	16vdc VD7	3b	Pti
jt	PT7M6218CHC3E	Vdet-IC	1.8V±1.5%, +Reset PPO, Lead free	SC-70	16vdc VD7	3b	Pti
jt	PT7M6218CHTA3	Vdet-IC	1.8V±1.5%, +Reset PPO	SOT-23	16vdb VD7	3b	Pti
jt	PT7M6218CHTA3E	Vdet-IC	1.8V±1.5%, +Reset PPO, Lead free	SOT-23	16vdb VD7	3b	Pti
JT	TCM809JVLB	Vdet-IC	4.0V±2%, -Reset PPO	SC-70	16vdc VD7	3b	Mcc
JT	TCM809JVNB	Vdet-IC	2.63V±2%, -Reset PPO	SOT-23	16vdc VD7	3b	Mcc
JT-	RT9818A-33PV	Vdet-IC	3.3V±1.5%, -Reset ODO	SOT-23	16vda VD6	3a	Rct
JT2	2SC4269-2	Si-npn	VHF/UHF-Osc, 30V, 50mA, 250mW, B=40..80, 1.2GHz	SOT-23	16ta -	3a	San
JT2	2SC4406-2	Si-npn	UHF, Mix/Osc, 30V, 50mA, 150mW, B=40..80, 1.2GHz	MCP	16ta -	3a	San
JT3	2SC4269-3	Si-npn	VHF/UHF-Osc, 30V, 50mA, 250mW, B=60..120, 1.2GHz	SOT-23	16ta -	3a	San
JT3	2SC4406-3	Si-npn	UHF, Mix/Osc, 30V, 50mA, 150mW, B=60..120, 1.2GHz	MCP	16ta -	3a	San
JT4	2SC4269-4	Si-npn	VHF/UHF-Osc, 30V, 50mA, 250mW, B=100..200, 1.2GHz	SOT-23	16ta -	3a	San
JT4	2SC4406-4	Si-npn	UHF, Mix/Osc, 30V, 50mA, 150mW, B=100..200, 1.2GHz	MCP	16ta -	3a	San
ju	PT7M6218NLC3	Vdet-IC	1.8V±1.5%, -Reset ODO	SC-70	16vdc VD6	3b	Pti
ju	PT7M6218NLC3E	Vdet-IC	1.8V±1.5%, -Reset ODO, Lead free	SC-70	16vdc VD6	3b	Pti
ju	PT7M6218NLTA3	Vdet-IC	1.8V±1.5%, -Reset ODO	SOT-23	16vdb VD6	3b	Pti
ju	PT7M6218NLTA3E	Vdet-IC	1.8V±1.5%, -Reset ODO, Lead free	SOT-23	16vdb VD6	3b	Pti
JU	TCM809RVLB	Vdet-IC	2.63V±2%, -Reset PPO	SC-70	16vdc VD7	3b	Mcc
JU	TCM809RVNB	Vdet-IC	2.63V±2%, -Reset PPO	SOT-23	16vdc VD7	3b	Mcc
JU-	RT9818D-30PV	Vdet-IC	3.0V±1.5%, -Reset ODO, Td=450ms	SOT-23	16vda VD6	3a	Rct
JU-	RT9818D-30GV	Vdet-IC	3.0V±1.5%, -Reset ODO, Td=450ms	SOT-23	16vda VD6	3a	Rct
JU1	CHDTA123JUPT	Si-pnp-Digi	Sw, 50V, 100mA, 250MHz, R1/R2=2.2/47k	SOT-323	16ta -	3a	Chm
JUA	CHDTC123JUPT	Si-npn-Digi	Sw, 50V, 100mA, 250MHz, R1/R2=2.2/47k	SOT-323	16ta -	3a	Chm
JV	1S2V63	PIN-diode	VHF/UHF-AGC, 50V, 50mA, 100mW, 0.23pF, 2.5Q(100MHz)	MCP	16dc -	3a	San
JV	1S2V66	PIN-diode	VHF/UHF-AGC, 50V, 50mA, 100mW, 0.23pF, 2.5Q(100MHz)	SOT-23	16dc -	3a	San
JV	BAS116L	Si-diode	Sw, 85V, 215mA, 225mW, Vf<1.25V(150mA), >3µs, 2pF	SOT-23	16dc -	3a	Ons
JV	CH751M1CPT	Si-diode	Dual, SBD, 40V, 30mA, Vf<0.37V(1mA)	FBPT-723	17df -	9c	Chm
jv	PT7M6219CLC3	Vdet-IC	1.9V±1.5%, -Reset PPO	SC-70	16vdc VD7	3b	Pti
jv	PT7M6219CLC3E	Vdet-IC	1.9V±1.5%, -Reset PPO, Lead free	SC-70	16vdc VD7	3b	Pti
jv	PT7M6219CLTA3	Vdet-IC	1.9V±1.5%, -Reset PPO	SOT-23	16vdb VD7	3b	Pti
jv	PT7M6219CLTA3E	Vdet-IC	1.9V±1.5%, -Reset PPO, Lead free	SOT-23	16vdb VD7	3b	Pti
JV	TCM809SVLB	Vdet-IC	2.93V±2%, -Reset PPO	SC-70	16vdc VD7	3b	Mcc
JV	TCM809SVNB	Vdet-IC	2.93V±2%, -Reset PPO	SOT-23	16vdc VD7	3b	Mcc
JV-	RT9818D-33PV	Vdet-IC	3.3V±1.5%, -Reset ODO, Td=450ms	SOT-23	16vda VD6	3a	Rct
JV=	RT9818D-33GV	Vdet-IC	3.3V±1.5%, -Reset ODO, Td=450ms	SOT-23	16vda VD6	3a	Rct
JV3	BAT54	Si-diode	SBR, 30V, 200mA, Vf<0.52V(100mA), <5ns	SOT-23	16dc -	3a	Ons
JVp	BAS116	Si-diode	Sw, 85V, 215mA, 225mW, Vf<1.25V(150mA), >3µs, 2pF	SOT-23	16dc -	3a	PHH
JVs	BAS116	Si-diode	Sw, 85V, 215mA, 225mW, Vf<1.25V(150mA), >3µs, 2pF	SOT-23	16dc -	3c	Inf
JVt	BAS116	Si-diode	Sw, 85V, 215mA, 225mW, Vf<1.25V(150mA), >3µs, 2pF	SOT-23	16dc -	3a	PHM
JVV	BAS116	Si-diode	Sw, 85V, 215mA, 225mW, Vf<1.25V(150mA), >3µs, 2pF	SOT-23	16dc -	3a	PHC
jw	PT7M6219CHC3	Vdet-IC	1.9V±1.5%, +Reset PPO	SC-70	16vdc VD7	3b	Pti
jw	PT7M6219CHC3E	Vdet-IC	1.9V±1.5%, +Reset PPO, Lead free	SC-70	16vdc VD7	3b	Pti
jw	PT7M6219CHTA3	Vdet-IC	1.9V±1.5%, +Reset PPO	SOT-23	16vdb VD7	3b	Pti
jw	PT7M6219CHTA3E	Vdet-IC	1.9V±1.5%, +Reset PPO, Lead free	SOT-23	16vdb VD7	3b	Pti
JW-	RT9819C-23PV	Vdet-IC	2.3V±1.5%, -Reset PPO, Td=220ms	SOT-23	16vdc VD7	3a	Rct
JX	DZ23C4V7	Z-diode	Dual, 4.4..5.0V, Izt=5mA, Zzt=70Q, 300mW	SOT-23	16dg -	3a	Lge
ix	PT7M6219NLC3	Vdet-IC	1.9V±1.5%, -Reset ODO	SC-70	16vdc VD6	3b	Pti
ix	PT7M6219NLC3E	Vdet-IC	1.9V±1.5%, -Reset ODO, Lead free	SC-70	16vdc VD6	3b	Pti
ix	PT7M6219NLTA3	Vdet-IC	1.9V±1.5%, -Reset ODO	SOT-23	16vdb VD6	3b	Pti
ix	PT7M6219NLTA3E	Vdet-IC	1.9V±1.5%, -Reset ODO, Lead free	SOT-23	16vdb VD6	3b	Pti
JX	TCM809TVLB	Vdet-IC	3.08V±2%, -Reset PPO	SC-70	16vdc VD7	3b	Mcc
JX	TCM809TVNB	Vdet-IC	3.08V±2%, -Reset PPO	SOT-23	16vdc VD7	3b	Mcc
JY	2SK208-Y	n-FET	AF-Amp, 50V, 10mA, 100mW, Idss=1.2..3mA	SOT-23	16fa -	3a	Tos
JY	2SK879-Y	n-FET	AF-Amp, 50V, 10mA, 100mW, Idss=1.2..3mA, Up<5V	SOT-323	16fa -	3a	Tos
JY	BAV199	Si-diode	Dual, Sw, 70V, 215mA, 225mW, <2pF, <3µs	SOT-23	16dl -	3a	Ons
JY	BAV199W	Si-diode	Dual, Sw, 70V, 135mA, 150mW, <2pF, <3µs	SOT-323	16dl -	3a	PHH
JY	DZ23C5V1	Z-diode	Dual, 4.8..5.4V, Izt=5mA, Zzt=30Q, 300mW	SOT-23	16dg -	3a	Lge
jy	PT7M6220CLC3	Vdet-IC	2.0V±1.5%, -Reset PPO	SC-70	16vdc VD7	3b	Pti
iy	PT7M6220CLC3E	Vdet-IC	2.0V±1.5%, -Reset PPO, Lead free	SC-70	16vdc VD7	3b	Pti
iy	PT7M6220CLTA3	Vdet-IC	2.0V±1.5%, -Reset PPO	SOT-23	16vdb VD7	3b	Pti



SMD code	Type	Function	Short description	Case	Pinout	Sch. St.	Mnf.
JY	PT7M6220CLTA3E	Vdet-IC	2.0V±1.5%, -Reset PPO, Lead free	SOT-23	16vdb	VD7	3b Pti
JY	TCM809MVLB	Vdet-IC	4.38V±2%, -Reset PPO	SC-70	16vdc	VD7	3b Mcc
JY	TCM809MVLNB	Vdet-IC	4.38V±2%, -Reset PPO	SOT-23	16vdc	VD7	3b Mcc
JY2	2SC3770-2	Si-npn	VHF/UHF, 30V, 30mA, 250mW, 1.2GHz, B=40..80	SOT-23	16ta	-	3a San
JY3	2SC3770-3	Si-npn	VHF/UHF, 30V, 30mA, 250mW, 1.2GHz, B=60..120	SOT-23	16ta	-	3a San
JY4	2SC3770-4	Si-npn	VHF/UHF, 30V, 30mA, 250mW, 1.2GHz, B=100..200	SOT-23	16ta	-	3a San
JYp	BAV199	Si-diode	Dual, Sw, 75V, 215mA, 225mW, <2pF, <3µs	SOT-23	16dl	-	3a PhH
JYt	BAV199	Si-diode	Dual, Sw, 75V, 215mA, 225mW, <2pF, <3µs	SOT-23	16dl	-	3a PhM
JYt	BAV199W	Si-diode	Dual, Sw, 75V, 135mA, 150mW, <2pF, <3µs	SOT-323	16dl	-	3a PhM
JYW	BAV199	Si-diode	Dual, Sw, 75V, 215mA, 225mW, <2pF, <3µs	SOT-23	16dl	-	3a PhC
JYW	BAV199W	Si-diode	Dual, Sw, 70V, 135mA, 150mW, <2pF, <3µs	SOT-323	16dl	-	3a PhC
JZ	BAW156	Si-diode	Dual, Sw, 82V, 160mA, 250mW, 3pF, 3µs	SOT-23	16df	-	3a Mot
JZ	DZ23C5V6	Z-diode	Dual, 5.2..6.0V, Izt=5mA, Zzt=10Ω, 300mW	SOT-23	16dg	-	3a Lge
JZ	PT7M6220CHC3	Vdet-IC	2.0V±1.5%, +Reset PPO	SC-70	16vdc	VD7	3b Pti
jz	PT7M6220CHC3E	Vdet-IC	2.0V±1.5%, +Reset PPO, Lead free	SC-70	16vdc	VD7	3b Pti
JZ	PT7M6220CHTA3	Vdet-IC	2.0V±1.5%, +Reset PPO	SOT-23	16vdb	VD7	3b Pti
jz	PT7M6220CHTA3E	Vdet-IC	2.0V±1.5%, +Reset PPO, Lead free	SOT-23	16vdb	VD7	3b Pti
JZ	TCM809LVLB	Vdet-IC	4.63V±2%, -Reset PPO	SC-70	16vdc	VD7	3b Mcc
JZ	TCM809LVNB	Vdet-IC	4.63V±2%, -Reset PPO	SOT-23	16vdc	VD7	3b Mcc
JZ-	RT9819B-25PVL	Vdet-IC	2.5V±1.5%, -Reset PPO, Td=55ms	SOT-23	16vda	VD7	3a Rct
JZp	BAW156	Si-diode	Dual, Sw, 82V, 160mA, 250mW, 3pF, 3µs	SOT-23	16df	-	3a PhH
JZt	BAW156	Si-diode	Dual, Sw, 82V, 160mA, 250mW, 3pF, 3µs	SOT-23	16df	-	3a PhM
JZW	BAW156	Si-diode	Dual, Sw, 82V, 160mA, 250mW, 3pF, 3µs	SOT-23	16df	-	3a PhC
k	AX6902DA	Vdet-IC	3.08V±1.5%, +Reset PPO	SC-70	16vdc	VD7	3b Axl
K	DA204K	Si-diode	Dual, Sw, 20V, 200mA, 200mW, Vf<1V(10mA)	SOT-346	16dl	-	3i Rhm
K	DA204U	Si-diode	Dual, Sw, 20V, 200mA, 200mW, Vf<1V(10mA)	UMD3	16dl	-	3i Rhm
K	DA221	Si-diode	Dual, Sw, 20V, 200mA, 150mW, Vf<1V(10mA)	SOT-416	16dl	-	3i Rhm
K	DA221M	Si-diode	Dual, Sw, 20V, 200mA, 150mW, Vf<1V(10mA)	VMD3	16dl	-	3j Rhm
K	SB007W03C	Si-diode	Dual, SBR, HF, 30V, 70mA, Vf<0.55V(70mA), 3pF, 10ns	CP	16dg	-	3a San
K	SB007W03Q	Si-diode	Dual, SBR, HF, 30V, 70mA, Vf<0.55V(70mA), 3pF, 10ns	MCP	16dg	-	3a San
K0	ELM7640HAB	Vdet-IC	4.0V±2%, +Reset PPO, 250ms	SOT-23	16vdc	VD7	3d Elm
K0	R3111N202C	Vdet-IC	2V±2%, -Reset ODO	SOT-23	16vdd	VD6	3d Ric
K0	R3130N26EA3	Vdet-IC	2.6V, -Reset PPO, 240ms	SOT-23	16vdc	VD7	3b Ric
K0-	RT9818C-29PVL	Vdet-IC	2.9V±1.5%, -Reset ODO, Td=220ms	SOT-23	16vda	VD6	3a Rct
K0=	RT9818C-29GVL	Vdet-IC	2.9V±1.5%, -Reset ODO, Td=220ms	SOT-23	16vdc	VD6	3a Rct
K1	2SK57-1	n-FET	GP, 20V, 20mA, 100mV, Idss=0.5..1.5mA, Up<4V	SOT-23	16fa	-	3a Nec
K1	A102WFT-3.3	LVR-IC	LDO, 3.3V±1.5%, 300mA	SOT-23	16cg	VR1	3b Adt
K1	ELM7641HAB	Vdet-IC	4.1V±2%, +Reset PPO, 250ms	SOT-23	16vdc	VD7	3d Elm
K1	MAX810LTR	Vdet-IC	4.63V±1.5%, +Reset PPO	SOT-23	16vdc	VD7	3a Ons
K1	MMBZ5251B	Z-diode	20.90..23.10V, Zzt=29Ω, Izt=5.6mA, 410mW	SOT-23	16dc	-	3a Pjt
K1	MMBZ5251BW	Z-diode	22V±5%, Zzt=29Ω, 200mW	SOT-323	16dc	-	3a Pjt
K1	R3111N212C	Vdet-IC	2.1V±2%, -Reset ODO	SOT-23	16vdd	VD6	3d Ric
K1	R3130N29EA3	Vdet-IC	2.9V, -Reset PPO, 240ms	SOT-23	16vdc	VD7	3b Ric
K1	TCM810LENB	Vdet-IC	4.63V±2%, +Reset PPO	SOT-23	16vdc	VD7	3b Mcc
K1-	RT9818E-30PV	Vdet-IC	3.0V±1.5%, +Reset ODO	SOT-23	16vda	VD6	3a Rct
K1=	RT9818E-30GV	Vdet-IC	3.0V±1.5%, +Reset ODO	SOT-23	16vda	VD6	3a Rct
K14	2SK238-14	n-FET	FM-VCO/Mix/Osc, 20V, 10mA, 150mW, Idss=0.5..1.5mA, Up<2.5V	SOT-23	16fi	-	3a Nec
K14	DTA114GE	Si-pnp-Digi	Sw, 50V, 100mA, 200mW, 200MHz, R2=10k	SOT-416	16ta	-	3a Rhm
K14	DTA114GKA	Si-pnp-Digi	Sw, 50V, 100mA, 200mW, 200MHz, R2=10k	SOT-346	16ta	-	3a Rhm
K14	DTA114GUA	Si-pnp-Digi	Sw, 50V, 100mA, 200mW, 200MHz, R2=10k	UMT3	16ta	-	3a Rhm
K15	2SK238-15	n-FET	FM-VCO/Mix/Osc, 20V, 10mA, 150mW, Idss=1..3mA, Up<2.5V	SOT-23	16fi	-	3a Nec
K15	DTA124GE	Si-pnp-Digi	Sw, 50V, 100mA, 150mW, 250MHz, R2=22k	SOT-416	16ta	-	3a Rhm
K15	DTA124GKA	Si-pnp-Digi	Sw, 50V, 100mA, 200mW, 250MHz, R2=22k	SOT-346	16ta	-	3a Rhm
K15	DTA124GUA	Si-pnp-Digi	Sw, 50V, 100mA, 200mW, B=56, >250MHz, R2=22k	SOT-323	16ta	-	3a Rhm
K16	2SK238-16	n-FET	FM-VCO/Mix/Osc, 20V, 10mA, 150mW, Idss=2..6mA, Up<2.5V	SOT-23	16fi	-	3a Nec
K16	DTA144GKA	Si-pnp-Digi	Sw, 50V, 100mA, 200mW, 250MHz, R2=47k	SOT-346	16ta	-	3a Rhm
K16	DTA144GUA	Si-pnp-Digi	Sw, 50V, 100mA, 200mW, 250MHz, R2=47k	UMT3	16ta	-	3a Rhm
K17	2SK238-17	n-FET	FM-VCO/Mix/Osc, 20V, 10mA, 150mW, Idss=4..12mA, Up<2.5V	SOT-23	16fi	-	3a Nec
K19	DTA115GKA	Si-pnp-Digi	Sw, 50V, 100mA, 200mW, 200MHz, R2=100k	SOT-346	16ta	-	3a Rhm
K19	DTA115GUA	Si-pnp-Digi	Sw, 50V, 100mA, 200mW, 200MHz, R2=100k	UMT3	16ta	-	3a Rhm
K1B	MMBT4124	Si-npn	Sw, 30V, 200mA, 330mW, B=120..360, >300MHz	SOT-23	16ta	-	3d Di
K1B	MMST4124	Si-npn	Sw, 30V, 200mA, 330mW, B=120..360, >300MHz	SC-59	16ta	-	3a Di
K1D	MMBT6427	Si-npn-Darl	AF, 40V, 500mA, 360mW, B=10.00..100.00, >130MHz	SOT-23	16ta	-	3d Di
K1D	MMST6427	Si-npn-Darl	AF, 40V, 500mA, 360mW, B=10k..100k, >130MHz	SOT-23	16ta	-	3a Di
K1E	BC847AW	Si-npn	GP, 50V, 100mA, 250mW, B=110..220, >100MHz	SOT-323	16ta	-	3d Di
K1E	BC848AW	Si-npn	GP, 30V, 100mA, 310mW, B=110..220, >300MHz	SOT-323	16ta	-	3d Di
K1F	BC847B	Si-npn	GP, 50V, 100mA, 200mW, B=200..450, 200MHz	SOT-23	16ta	-	3a Di
K1F	BC847BW	Si-npn	GP, 50V, 100mA, 250mW, B=200..450, >100MHz	SOT-323	16ta	-	3d Di
K1F	BC848BW	Si-npn	GP, 30V, 100mA, 310mW, B=200..450, >300MHz	SOT-323	16ta	-	3d Di
K1G	MMBTA05	Si-npn	GP, 60V, 500mA, 350mW, B>100, >100MHz	SOT-23	16ta	-	3a Di



SMD code	Type	Function	Short description	Case	Pinout	Sch.	St.	Mnf.
K1G	MMBTA06	Si-npn	GP, 80V, 500mA, 350mW, B>100, >100MHz	SOT-23	16ta	-	3a	Di
K1G	MMSTA05	Si-npn	GP, 60V, 500mA, 350mW, B>100, >100MHz	SC-59	16ta	-	3a	Di
K1G	MMSTA06	Si-npn	GP, 80V, 500mA, 350mW, B>100, >100MHz	SC-59	16ta	-	3a	Di
K1H	MMBTA05	Si-npn	GP, 60V, 500mA, 350mW, B>100, >100MHz	SOT-23	16ta	-	3a	Di
K1H	MMSTA05	Si-npn	GP, 60V, 500mA, 350mW, B>100, >100MHz	SC-59	16ta	-	3a	Di
K1J	BC848AW	Si-npn	GP, 30V, 100mA, 310mW, B=110..220, >300MHz	SOT-323	16ta	-	3d	Di
K1K	BC848BW	Si-npn	GP, 30V, 100mA, 310mW, B=200..450, >300MHz	SOT-323	16ta	-	3d	Di
K1L	BC848CW	Si-npn	GP, 30V, 100mA, 310mW, B=420..800, >300MHz	SOT-323	16ta	-	3d	Di
K1M	BC847CW	Si-npn	GP, 50V, 100mA, 250mW, B=420..800, >100MHz	SOT-323	16ta	-	3d	Di
K1M	BC848CW	Si-npn	GP, 30V, 100mA, 310mW, B=420..800, >300MHz	SOT-323	16ta	-	3d	Di
K1N	MMBT3904	Si-npn	GP, 60V, 100mA, 200mW, B= 100..300, >300MHz	SOT-23	16ta	-	3d	Di
K1O	KSA3265-O	Si-npn	AF, 30V, 800mA, 200mW, B=100..200, >120MHz	SOT-23	16ta	-	3a	Sam
K1p	BCW71	Si-npn	AF, 50V, 100mA, 250mW, B=110..220, >100MHz	SOT-23	16ta	-	3a	PhH
K1P	MMBT2222A	Si-npn	GP, 75V, 800mA, 200mW, B=100..300, >200MHz	SOT-23	16ta	-	3d	Di
K1Q	BC846AW	Si-npn	GP, 80V, 100mA, 330mW, B=110..220, 250MHz	SOT-323	16ta	-	3d	Di
K1Q	BC847AW	Si-npn	GP, 50V, 100mA, 250mW, B=110..220, >100MHz	SOT-323	16ta	-	3d	Di
K1Q	BC848AW	Si-npn	GP, 30V, 100mA, 310mW, B=110..220, >300MHz	SOT-323	16ta	-	3d	Di
K1R	BC846BW	Si-npn	GP, 80V, 100mA, 250mW, B=200..450, >100MHz	SOT-323	16ta	-	3d	Di
K1R	BC847BW	Si-npn	GP, 50V, 100mA, 250mW, B=200..450, >100MHz	SOT-323	16ta	-	3d	Di
K1R	BC848BW	Si-npn	GP, 30V, 100mA, 310mW, B=200..450, >300MHz	SOT-323	16ta	-	3d	Di
K1t	BCW71	Si-npn	AF, 50V, 100mA, 250mW, B=110..220, >100MHz	SOT-23	16ta	-	3a	PhM
K1W	BCW71	Si-npn	AF, 50V, 100mA, 250mW, B=110..220, >100MHz	SOT-23	16ta	-	3a	PhC
K1Y	KSA3265-Y	Si-npn	AF, 30V, 800mA, 200mW, B=160..320, >120MHz	SOT-23	16ta	-	3a	Sam
K2	2SK57-2	n-FET	GP, 20V, 20mA, 100mV, Idss=1..3mA, Up<4V	SOT-23	16fa	-	3a	Nec
K2	AH182W	H-IC	Hall-effect sensor IC, Vcc=2.5..5.5V, ODO	SOT-23	16ha	-	3a	Ana
K2	ELM7642HAB	Vdet-IC	4.2V±2%, +Reset PPO, 250ms	SOT-23	16vdc	VD7	3d	Elm
K2	HSMP-3832	PIN-diode	Dual, RF, 200V, 1A(1ms), <0.3pF, <1.5Ω(100mA)	SOT-23	16dl	-	3a	Agi
K2	MAX810MTR	Vdet-IC	4.38V±1.5%, +Reset PPO	SOT-23	16vdc	VD7	3a	Ons
K2	MMBZ5252B	Z-diode	22.80..25.20V, Zzt=33Ω, Izt=5.2mA, 410mW	SOT-23	16dc	-	3a	Pjt
K2	MMBZ5252BW	Z-diode	24V±5%, Zzt=33Ω, 200mW	SOT-323	16dc	-	3a	Pjt
K2	R3111N222C	Vdet-IC	2.2V±2%, -Reset ODO	SOT-23	16vdc	VD6	3d	Ric
K2	R3130N30EA8	Vdet-IC	3V, -Reset PPO, 240ms	SOT-23	16vdc	VD7	3b	Ric
K2	TCM810MENB	Vdet-IC	4.38V±2%, +Reset PPO	SOT-23	16vdc	VD7	3b	Mcc
K2-	RT9818E-35PV	Vdet-IC	3.5V±1.5%, +Reset ODO	SOT-23	16vdc	VD6	3a	Rct
K23	BSS123	n-MOSFET-e	V-MOS, LogL, 100V, 0.17A, 200mW, <6Ω, 10/22ns	SOT-23	16fh	-	3a	Di
K23	BSS123W	n-MOSFET-e	V-MOS, LogL, 100V, 0.17A, 200mW, <6Ω, 10/22ns	SOT-323	16fh	-	3a	Di
K24	2SK160A-24	n-FET	VHF, 30V, 20mA, 150mW, Idss=0.5..1.5mA, Up<4.5V	SOT-23	16fh	-	3a	Nec
K24	2SK853A-24	n-FET	GP, 50V, 10mA, 150mW, Idss=0.5..3mA, Up<4.5V	SOT-323	16fa	-	3a	Nec
K24	DTC114GKA	Si-npn-Digi	Sw, 50V, 100mA, 200mW, 250MHz, R2=22k	SOT-346	16ta	-	3a	Rhm
K24	DTC114GUA	Si-npn-Digi	Sw, 50V, 100mA, 200mW, 250MHz, R2=22k	UMT3	16ta	-	3a	Rhm
K25	2SK160A-25	n-FET	VHF, 30V, 20mA, 150mW, Idss=1..3mA, Up<4.5V	SOT-23	16fh	-	3a	Nec
K25	2SK853A-25	n-FET	GP, 50V, 10mA, 150mW, Idss=2..5mA, Up<4.5V	SOT-323	16fa	-	3a	Nec
K25	DTC124GUA	Si-npn-Digi	Sw, 50V, 100mA, 200mW, B=56, 250MHz, R2=22k	SOT-323	16ta	-	3a	Rhm
K26	2SK160A-26	n-FET	VHF, 30V, 20mA, 150mW, Idss=2..6mA, Up<4.5V	SOT-23	16fh	-	3a	Nec
K26	2SK853A-26	n-FET	GP, 50V, 10mA, 150mW, Idss=4..8mA, Up<4.5V	SOT-323	16fa	-	3a	Nec
K26	DTC144GE	Si-npn-Digi	Sw, 50V, 100mA, 200mW, 250MHz, R2=47k	SOT-416	16ta	-	3a	Rhm
K26	DTC144GKA	Si-npn-Digi	Sw, 50V, 100mA, 200mW, 250MHz, R2=47k	SOT-346	16ta	-	3a	Rhm
K26	DTC144GUA	Si-npn-Digi	Sw, 50V, 100mA, 200mW, 250MHz, R2=47k	UMT3	16ta	-	3a	Rhm
K27	2SK160A-27	n-FET	VHF, 30V, 20mA, 150mW, Idss=4..12mA, Up<4.5V	SOT-23	16fh	-	3a	Nec
K27	2SK853A-27	n-FET	GP, 50V, 10mA, 150mW, Idss=6..12mA, Up<4.5V	SOT-323	16fa	-	3a	Nec
K29	DTC115GKA	Si-npn-Digi	Sw, 50V, 100mA, 200mW, 250MHz, R2=100k	SOT-346	16ta	-	3a	Rhm
K29	DTC115GUA	Si-npn-Digi	Sw, 50V, 100mA, 200mW, 250MHz, R2=100k	UMT3	16ta	-	3a	Rhm
K2B	MMBT4126	Si-pnp	GP, 25V, 200mA, 350mW, B=120..360, >250MHz	SOT-23	16ta	-	3d	Di
K2B	MMST4126	Si-pnp	GP, 25V, 200mA, 350mW, B=120..360, >250MHz	SOT-323	16ta	-	3a	Di
K2D	MMBTA13	Si-npn-Darl	GP, 30V, 00mA, 300mW, B>5000, >125MHz	SOT-23	16ta	-	3a	Di
K2D	MMSTA13	Si-npn-Darl	GP, 30V, 300mA, 300mW, B>5000, >125MHz	SC-59	16ta	-	3a	Di
K2E	MMBTA63	Si-pnp-Darl	GP, 30V, 500mA, 300mW, B>5000, >125MHz	SOT-23	16ta	-	3d	Di
K2E	MMSTA63	Si-pnp-Darl	GP, 30V, 500mA, 300mW, B>5000, >125MHz	SC-59	16ta	-	3d	Di
K2F	MMBT2907A	Si-pnp	GP, 60V, 500mA, 310mW, B=75..300, <200MHz	SOT-23	16ta	-	3d	Di
K2G	MMBTA56	Si-pnp	AF-Drv, 80V, 500mA, 300mW, B>100, >50MHz	SOT-23	16ta	-	3d	Di
K2G	MMSTA55	Si-pnp	AF-Drv, 60V, 500mA, 300mW, B>100, >50MHz	SC-59	16ta	-	3a	Di
K2G	MMSTA56	Si-pnp	AF-Drv, 80V, 500mA, 300mW, B>100, >50MHz	SC-59	16ta	-	3d	Di
K2H	MMBTA55	Si-pnp	GP, 60V, 500mA, 225mW, B=50, >50MHz	SOT-23	16ta	-	3d	Di
K2H	MMSTA55	Si-pnp	AF-Drv, 60V, 500mA, 300mW, B>100, >50MHz	SC-59	16ta	-	3a	Di
K2N	MMST3904	Si-npn	GP, 60V, 200mA, 250mW, B=100..300, >300MHz	SOT-323	16ta	-	3d	Di
K2p	BCW72	Si-npn	AF, 50V, 100mA, 250mW, >100MHz, B=200..450	SOT-23	16ta	-	3a	Phi
K2t	BCW72	Si-npn	AF, 50V, 100mA, 250mW, >100MHz, B=200..450	SOT-23	16ta	-	3a	Phi
K2T	MMBT4403	Si-pnp	GP, 40V, 800mA, 200mW, B= 100..300, >200MHz	SOT-23	16ta	-	3a	Di
K2X	MMBT4401	Si-pnp	GP, 60V, 800mA, 200mW, B=100..300, >200MHz	SOT-23	16ta	-	3a	Di
K3	2SC3143-3	Si-npn	AF-Drv, 180V, 80mA, 200mW, 150MHz, B=60..120	SOT-23	16ta	-	3a	San



SMD code	Type	Function	Short description	Case	Pinout	Sch.	St.	Mnf.
K3	2SK57-3	n-FET	GP, 20V, 20mA, 100mV, Idss=2.6mA, Up<4V	SOT-23	16fa	-	3a	Nec
K3	AH183W	H-IC	Hall-effect sensor IC, Vcc=2.5-5.5V, ODO	SOT-23	16ha	-	3a	Ana
K3	ELM7643HAB	Vdet-IC	4.3V±2%, +Reset PPO, 250ms	SOT-23	16vdc	VD7	3d	Elm
K3	HSMP-3833	PIN-diode	Dual, RF, 200V, 1A(1ms), <0.3pF, <1.5Ω(100mA)	SOT-23	16df	-	3a	Agi
K3	MAX810TTR	Vdet-IC	3.08V±1.5%, +Reset PPO	SOT-23	16vdc	VD7	3a	Ons
K3	MMBZ5253B	Z-diode	23.75..26.25V, Zzt=35Ω, Izt=5mA, 410mW	SOT-23	16dc	-	3a	Pjt
K3	R3111N232C	Vdet-IC	2.3V±2%, -Reset ODO	SOT-23	16vdd	VD6	3d	Ric
K3	R3130N46EA5	Vdet-IC	4.6V, -Reset PPO, 240ms	SOT-23	16vdc	VD7	3b	Ric
K3	TCM810TENB	Vdet-IC	3.08V±2%, +Reset PPO	SOT-23	16vdc	VD7	3b	Mcc
K3-	RT9819C-15PV	Vdet-IC	1.5V±1.5%, -Reset PPO, Td=220ms	SOT-23	16vdc	VD7	3a	Rct
K31	BCW81R	Si-npn	AF, 50V, 100mA, 350mW, B=420..800, >300MHz	SOT-23	16te	-	3a	Phi
K38	BSS138	n-MOSFET-e*	SIPMOS, LogL, 50V, 200mA, 300mW, 3.5Ω(220mA), 20/20ns	SOT-23	16fh	-	3c	Di
K38	BSS138W	n-MOSFET-e*	SIPMOS, LogL, 50V, 200mA, 200mW, 3.5Ω(220mA), 20/20ns	SOT-323	16fh	-	3c	Di
K3A	BC856AW	Si-pnp	GP, 80V, 100mA, 250mW, B=125..250, >100MHz	SOT-323	16ta	-	3d	Di
K3A	BC857A	Si-pnp	GP, 50V, 100mA, 250mW, B=125..250, >100MHz	SOT-23	16ta	-	3d	Di
K3A	BC857AW	Si-pnp	GP, 50V, 100mA, 250mW, B=125..250, >100MHz	SOT-323	16ta	-	3d	Di
K3A	BC858AW	Si-pnp	GP, 30V, 100mA, 250mW, B=125..250, >100MHz	SOT-323	16ta	-	3d	Di
K3A	KDV804S	C-diode	Dual, 15V, 50nA, 45.7/25pF, Rs<0.3Ω	SOT-23	16dg	-	3a	Kec
K3B	BC856BW	Si-pnp	GP, 80V, 100mA, 250mW, B=220..475, >100MHz	SOT-323	16ta	-	3d	Di
K3B	BC857B	Si-pnp	GP, 50V, 100mA, 250mW, B=220..475, >100MHz	SOT-23	16ta	-	3d	Di
K3B	BC857BW	Si-pnp	GP, 50V, 100mA, 250mW, B=220..475, >100MHz	SOT-323	16ta	-	3d	Di
K3B	BC858BW	Si-pnp	GP, 30V, 100mA, 250mW, B=220..475, >100MHz	SOT-323	16ta	-	3d	Di
K3B	KDV804S	C-diode	Dual, 15V, 50nA, 45.7/25pF, Rs<0.3Ω	SOT-23	16dg	-	3a	Kec
K3C	KDV804S	C-diode	Dual, 15V, 50nA, 45.7/25pF, Rs<0.3Ω	SOT-23	16dg	-	3a	Kec
K3D	KDV804S	C-diode	Dual, 15V, 50nA, 45.7/25pF, Rs<0.3Ω	SOT-23	16dg	-	3a	Kec
K3D	MMBTA13	Si-npn-Darl	GP, 30V, 300mA, 300mW, B>5000, >125MHz	SOT-23	16ta	-	3a	Di
K3D	MMBTA14	Si-npn-Darl	GP, 30V, 300mA, 300mW, B>10000, >125MHz	SOT-23	16ta	-	3a	Di
K3D	MMSTA13	Si-npn-Darl	GP, 30V, 300mA, 300mW, B>5000, >125MHz	SC-59	16ta	-	3a	Di
K3D	MMSTA14	Si-npn-Darl	GP, 30V, 300mA, 300mW, B>10000, >125MHz	SC-59	16ta	-	3a	Di
K3E	KDV804S	C-diode	Dual, 15V, 50nA, 45.7/25pF, Rs<0.3Ω	SOT-23	16dg	-	3a	Kec
K3E	MMBTA64	Si-pnp-Darl	GP, 30V, 500mA, 300mW, B>10000, >125MHz	SOT-23	16ta	-	3d	Di
K3E	MMSTA63	Si-pnp-Darl	GP, 30V, 500mA, 300mW, B>5000, >125MHz	SC-59	16ta	-	3d	Di
K3E	MMSTA64	Si-pnp-Darl	GP, 30V, 500mA, 300mW, B>10000, >125MHz	SC-59	16ta	-	3d	Di
K3F	MMST2907A	Si-pnp	GP, 60V, 600mA, 330mW, B=100..300, >200MHz	SOT-323	16ta	-	3d	Di
K3G	BC857C	Si-pnp	GP, 50V, 100mA, 250mW, B=420..800, >100MHz	SOT-23	16ta	-	3d	Di
K3G	BC857CW	Si-pnp	GP, 50V, 100mA, 250mW, B=420..800, >100MHz	SOT-323	16ta	-	3d	Di
K3G	BC858C	Si-pnp	GP, 30V, 100mA, 310mW, B=420..800, >150MHz	SOT-23	16ta	-	3d	Di
K3G	BC858CW	Si-pnp	GP, 30V, 100mA, 300mW, B=420..800, >100MHz	SOT-23	16ta	-	3d	Di
K3H	MMBTH10	Si-npn	GP, 30V, 25mA, 330mW, B>60, >650MHz	SOT-23	16ta	-	3d	Di
K3J	BC858AW	Si-pnp	GP, 30V, 100mA, 250mW, B=125..250, >100MHz	SOT-323	16ta	-	3d	Di
K3K	BC858BW	Si-pnp	GP, 30V, 100mA, 250mW, B=220..475, >100MHz	SOT-323	16ta	-	3d	Di
K3L	BC858C	Si-pnp	GP, 30V, 100mA, 310mW, B=420..800, >150MHz	SOT-23	16ta	-	3d	Di
K3L	BC858CW	Si-pnp	GP, 30V, 100mA, 300mW, B=420..800, >100MHz	SC-59	16ta	-	3a	Di
K3M	MMBTA42	Si-npn	Vid, 300V, 200mA, 350mW, B>25, >50MHz	SOT-23	16ta	-	3d	Di
K3M	MMSTA42	Si-npn	Vid, 300/300V, 200mA, 350mW, B>25, >50MHz	SC-59	16ta	-	3a	Di
K3N	MMBT3906	Si-pnp	Sw, AF, 60/40V, 100mA, 200mW, B=100..300, >250MHz	SOT-23	16ta	-	3d	Di
K3p	BCW81	Si-npn	GP, 50V, 100mA, 200mW, B=420, >300MHz	SOT-23	16ta	-	3a	Phi
K3P	MMST2222A	Si-npn	GP, 75V, 600mA, 330mW, B=120..360, >300MHz	SOT-323	16ta	-	3d	Di
K3R	MMSTA92	Si-pnp	Vid, 300/300V, 500mA, 330mW, B=25, >50MHz	SC-59	16ta	-	3d	Di
K3t	BCW81	Si-npn	GP, 50V, 100mA, 200mW, B=420, >300MHz	SOT-23	16ta	-	3a	Phi
K3T	MMST4403	Si-pnp	Sw, 40V, 600mA, 200mW, B=100..300, >200MHz	SOT-323	16ta	-	3a	Di
K3V	BC857A	Si-pnp	GP, 50V, 100mA, 250mW, B=125..250, >100MHz	SOT-23	16ta	-	3d	Di
K3V	BC857AW	Si-pnp	GP, 50V, 100mA, 250mW, B=125..250, >100MHz	SOT-323	16ta	-	3d	Di
K3V	BC858AW	Si-pnp	GP, 30V, 100mA, 250mW, B=125..250, >100MHz	SOT-323	16ta	-	3d	Di
K3W	BC857B	Si-pnp	GP, 50V, 100mA, 250mW, B=220..475, >100MHz	SOT-23	16ta	-	3d	Di
K3W	BC857BW	Si-pnp	GP, 50V, 100mA, 250mW, B=220..475, >100MHz	SOT-323	16ta	-	3d	Di
K3W	BC858BW	Si-pnp	GP, 30V, 100mA, 250mW, B=220..475, >100MHz	SOT-323	16ta	-	3d	Di
K3X	MMST4401	Si-npn	Sw, 60V, 600mA, 200mW, B=100..300, >250MHz	SOT-323	16ta	-	3a	Di
K3Y	MMBTH10	Si-npn	GP, 30V, 25mA, 330mW, B>60, >650MHz	SOT-23	16ta	-	3d	Di
K4	2SC3143-4	Si-npn	AF-Drv, 180V, 80mA, 200mW, 150MHz, B=90..180	SOT-23	16ta	-	3a	San
K4	2SK160-4	n-FET	VHF, 30V, 20mA, 150mW, Idss=0.5..1.5mA, Up<4.5V	SC-59	16fh	-	3a	Nec
K4	2SK853-4	n-FET	GP, 30V, 10mA, 150mW, Idss=0.5..3mA, Up<4.5V	SOT-323	16fa	-	3a	Nec
K4	BCW71R	Si-npn	AF, 45V, 100mA, 350mW, B=110..220, >100MHz	SOT-23	16te	-	3a	Phi
K4	ELM7644HAB	Vdet-IC	4.4V±2%, +Reset PPO, 250ms	SOT-23	16vdc	VD7	3d	Elm
K4	HSMP-3834	PIN-diode	Dual, RF, 200V, 1A(1ms), <0.3pF, <1.5Ω(100mA)	SOT-23	16dg	-	3a	Agi
K4	KA4L4L	Si-npn-Digi	Sw, 60V, 100mA, 200mW, R1/R2=47k/22k	SOT-416	16ta	-	3a	Nec
K4	MAX810STR	Vdet-IC	2.93V±1.5%, +Reset PPO	SOT-23	16vdc	VD7	3a	Ons
K4	MMBZ5254B	Z-diode	25.65..28.35V, Zzt=41Ω, Izt=5mA, 410mW	SOT-23	16dc	-	3a	Pjt
K4	MMBZ5254BW	Z-diode	27V±5%, Zzt=41Ω, 200mW	SOT-323	16dc	-	3a	Pjt
K4	R3111N242C	Vdet-IC	2.4V±2%, -Reset ODO	SOT-23	16vdd	VD6	3d	Ric



SMD code	Type	Function	Short description	Case	Pinout	Sch.	St.	Mnf.
K4	TCM810SENB	Vdet-IC	2.93V±2%, +Reset PPO	SOT-23	16vdc	VD7	3b	Mcc
K4-	RT9819G-29PV	Vdet-IC	2.9V±1.5%, +PPO +Reset, Td=220ms	SOT-23	16vdc	VD7	3a	Rct
K41	2SK520-41	n-FET	GP, 30V, 50mA, 200mW, Idss=30..50mA, Up<9V	SOT-23	16fa	-	3a	Nec
K42	2SK520-42	n-FET	GP, 30V, 50mA, 200mW, Idss=45..65mA, Up<9V	SOT-23	16fa	-	3a	Nec
K43	2SK520-43	n-FET	GP, 30V, 50mA, 200mW, Idss=60..80mA, Up<9V	SOT-23	16fa	-	3a	Nec
K43	BAS40	Si-diode	Schottky, 40V, 200mA, 200mW, Cd<5pF, <5ns	SOT-23	16dc	-	3a	Di
K43	BAS40W	Si-diode	SBD, 40V, 200mA, Vf<1V(40mA), 5ns	SOT-323	16df	-	3b	Di
K44	2SK520-44	n-FET	GP, 30V, 50mA, 200mW, Idss=75..95mA, Up<9V	SOT-23	16fa	-	3a	Nec
K44	BAS40-04	Si-diode	Dual, Schottky, 40V, 200mA, 200mW, Cd<5pF, <5ns	SOT-23	16dl	-	3a	Di
K44	BAS40W-04	Si-diode	Dual, SBD, 40V, 200mA, Vf<1V(40mA), 5ns	SOT-323	16dl	-	3b	Di
K45	2SK520-45	n-FET	GP, 30V, 50mA, 200mW, Idss=90..110mA, Up<9V	SOT-23	16fa	-	3a	Nec
K45	BAS40-05	Si-diode	Dual, Schottky, 40V, 200mA, 200mW, Cd<5pF, <5ns	SOT-23	16dg	-	3a	Di
K45	BAS40W-05	Si-diode	Dual, SBD, 40V, 200mA, Vf<1V(40mA), 5ns	SOT-323	16dg	-	3b	Di
K46	BAS40-06	Si-diode	Dual, Schottky, 40V, 200mA, 200mW, Cd<5pF, <5ns	SOT-23	16df	-	3b	Di
K46	BAS40W-06	Si-diode	Dual, SBD, 40V, 200mA, Vf<1V(40mA), 5ns	SOT-323	16df	-	3b	Di
K4M	MMBT5401	Si-pnp	HV, 160V, 200mA, 350mW, B=60..240, >100MHz	SOT-23	16ta	-	3a	Di
K4N	MMBT5551	Si-npn	HV, 180V, 200mA, 350mW, B=80..250, >300MHz	SOT-23	16ta	-	3a	Di
K4N	MMST5551	Si-npn	GP, 180V, 200mA, 200mW, B=80..250, <300MHz	SOT-323	16ta	-	3a	Di
K5	2SC3143-5	Si-npn	AF-Drv, 180V, 80mA, 200mW, 150MHz, B=135..270	SOT-23	16ta	-	3a	San
K5	2SK160-5	n-FET	VHF, 30V, 20mA, 150mW, Idss=1..3mA, Up<4.5V	SC-59	16fh	-	3a	Nec
K5	2SK853-5	n-FET	GP, 30V, 10mA, 150mW, Idss=2..5mA, Up<4.5V	SOT-323	16fa	-	3a	Nec
K5	BCW72R	Si-npn	AF, 45V, 100mA, 350mW, B=200..450, >100MHz	SOT-23	16te	-	3a	Phi
K5	ELM7645HAB	Vdet-IC	4.5V±2%, +Reset PPO, 250ms	SOT-23	16vdc	VD7	3d	Elm
K5	MAX810RTR	Vdet-IC	2.63V±1.5%, +Reset PPO	SOT-23	16vdc	VD7	3a	Ons
K5	MMBZ5255B	Z-diode	26.60..29.40V, Zzt=44Ω, Izt=4.5mA, 410mW	SOT-23	16dc	-	3a	Pjt
K5	MMBZ5255BW	Z-diode	28V±5%, Zzt=44Ω, 200mW	SOT-323	16dc	-	3a	Pjt
K5	R3111N252C	Vdet-IC	2.5V±2%, -Reset ODO	SOT-23	16vdd	VD6	3d	Ric
K5	SP810EK-4-6	Vdet-IC	1.6V±1.5%, +Reset PPO	SOT-23	16vdc	VD7	3b	Sip
K5	TCM810RENB	Vdet-IC	2.63V±2%, +Reset PPO	SOT-23	16vdc	VD7	3b	Mcc
K5-	RT9819C-20PVL	Vdet-IC	2.0V±1.5%, -Reset PPO, Td=220ms	SOT-23	16vda	VD7	3a	Rct
K50	BAS116	Si-diode	Sw, 85V, 215mA, 225mW, Vf<1.25V(150mA), >3μs, 2pF	SOT-23	16dc	-	3a	Di
K51	2SK508-51	n-FET	GP, 15V, 50mA, 200mW, Idss=10..20mA, Up<3.5V	SOT-23	16fa	-	3a	Nec
K52	2SK508-52	n-FET	GP, 15V, 50mA, 200mW, Idss=15..30mA, Up<3.5V	SOT-23	16fa	-	3a	Nec
K52	BAV199	Si-diode	Dual, Sw, 70V, 215mA, 225mW, <2pF, <3μs	SOT-23	16dl	-	3a	Di
K53	2SK508-53	n-FET	GP, 15V, 50mA, 200mW, Idss=25..50mA, Up<3.5V	SOT-23	16fa	-	3a	Nec
K53	BAW156	Si-diode	Dual, Sw, 82V, 160mA, 250mW, 3pF, 3μs	SOT-23	16df	-	3a	Di
K54	BAS116	Si-diode	Sw, 85V, 215mA, 225mW, Vf<1.25V(150mA), >3μs, 2pF	SOT-23	16dc	-	3a	Di
K5A	BC807-16	Si-pnp	GP, 50V, 500mA, 250mW, 80MHz, B=100..250	SOT-23	16ta	-	3a	Di
K5B	BC807-25	Si-pnp	GP, 50V, 500mA, 250mW, 80MHz, B=160..400	SOT-23	16ta	-	3a	Di
K5C	BC807-40	Si-pnp	GP, 50V, 500mA, 250mW, 80MHz, B=250..600	SOT-23	16ta	-	3a	Di
K5D	MMDB914	Si-diode	Sw, Fast, 100V, 200mA, 225mW, Vf<1V(10mA), <4ns	SOT-23	16dc	-	3a	Di
K5N	MMST3906	Si-pnp	GP, 40V, 200mA, 250mW, B=60..300, >250MHz	SOT-323	16ta	-	3a	Di
K6	2SK160-6	n-FET	VHF, 30V, 20mA, 150mW, Idss=2..6mA, Up<4.5V	SC-59	16fh	-	3a	Nec
K6	2SK853-6	n-FET	GP, 30V, 10mA, 150mW, Idss=4..8mA, Up<4.5V	SOT-323	16fa	-	3a	Nec
K6	BCV71R	Si-npn	AF, Sw, 80V, 100mA, 250mW, >100MHz, B=110..220	SOT-23	16te	-	3a	Phi
K6	ELM7646HAB	Vdet-IC	4.6V±2%, +Reset PPO, 250ms	SOT-23	16vdc	VD7	3d	Elm
K6	R3111N262C	Vdet-IC	2.6V±2%, -Reset ODO	SOT-23	16vdd	VD6	3d	Ric
K6	TCM810ZENB	Vdet-IC	2.32V±2%, +Reset PPO	SOT-23	16vdc	VD7	3b	Mcc
K6-	RT9819C-27PVL	Vdet-IC	2.7V±1.5%, -Reset PPO, Td=220ms	SOT-23	16vda	VD7	3a	Rct
K6A	BC817-16	Si-npn	AF-Drv, 50V, 500mA, 330mW, B=100..250, >200MHz	SOT-23	16ta	-	3d	Di
K6B	BC817-25	Si-npn	AF-Drv, 50V, 500mA, 330mW, B=160..400, >200MHz	SOT-23	16ta	-	3d	Di
K6C	BC817-40	Si-npn	AF-Drv, 50V, 500mA, 330mW, B=250..630, >200MHz	SOT-23	16ta	-	3d	Di
K6R	MMBTA28	Si-npn-Darl	GP, 80V, 500mA, 500mW, B=10000, >100MHz	SOT-23	16ta	-	3a	Di
K7	2SK160-7	n-FET	VHF, 30V, 20mA, 150mW, Idss=4..12mA, Up<4.5V	SC-59	16fh	-	3a	Nec
K7	2SK853-7	n-FET	GP, 30V, 10mA, 150mW, Idss=6..12mA, Up<4.5V	SOT-323	16fa	-	3a	Nec
K7	ELM7647HAB	Vdet-IC	4.7V±2%, +Reset PPO, 250ms	SOT-23	16vdc	VD7	3d	Elm
K7	KN4L4L	Si-pnp-Digi	Sw, 60V, 100mA, 150mW, R1/R2=47k/22k	SOT-416	16ta	-	3a	Nec
K7	R3111N272C	Vdet-IC	2.7V±2%, -Reset ODO	SOT-23	16vdd	VD6	3d	Ric
K7-	RT9818C-30PVL	Vdet-IC	3.0V±1.5%, -Reset ODO, Td=220ms	SOT-23	16vdc	VD6	3a	Rct
K70	BS870	n-MOSFET-e	D-MOS, Sw, 60V, 250mA, 310mW, <3.5Ω(100mA), 5/25ns	SOT-23	16fh	-	3a	Di
K72	2N7002T	n-MOSFET-e*	TMOS, 60V, 150mA, 200mW, <7.5Ω(500mA), 7/11ns	SOT-323	16fh	-	3a	Trs
K72	2N7002W	n-MOSFET-e*	TMOS, 60V, 250mA, 310mW, <7.5Ω(500mA), 5/25ns	SOT-323	16fh	-	3a	Di
K73	BAS70	Si-diode	Schottky, 70V, 70mA, Vf<1V(15mA), <2pF, 5ns	SOT-23	16dc	-	3c	Di
K73	BAS70W	Si-diode	Schottky, 70V, 70mA, Vf<1V(15mA), <2pF, 5ns	SOT-323	16dc	-	3a	Trs
K74	BAS70-04	Si-diode	Dual, Schottky, 70V, 70mA, Vf<1V(15mA), <2pF, 5ns	SOT-23	16dl	-	3c	Di
K74	BAS70W-04	Si-diode	Dual, Schottky, 70V, 70mA, Vf<1V(15mA), <2pF, 5ns	SOT-323	16dl	-	3a	Trs
K75	BAS70-05	Si-diode	Dual, Schottky, 70V, 70mA, Vf<1V(15mA), <2pF, 5ns	SOT-23	16dg	-	3c	Di
K75	BAS70W-05	Si-diode	Dual, Schottky, 70V, 70mA, Vf<1V(15mA), <2pF, 5ns	SOT-323	16dg	-	3a	Trs
K76	BAS70-06	Si-diode	Dual, Schottky, 70V, 70mA, Vf<1V(15mA), <2pF, 5ns	SOT-23	16df	-	3c	Di
K76	BAS70W-06	Si-diode	Dual, Schottky, 70V, 70mA, Vf<1V(15mA), <2pF, 5ns	SOT-323	16df	-	3a	Trs



SMD code	Type	Function	Short description	Case	Pinout	Sch.	St.	Mnf.
K7B	2N7002E	n-MOSFET-e*	TMOS, 60V, 250mA, 310mW, <7.5Ω(500mA), 5/25ns	SOT-23	16fh	-	3a	Di
K7C	BAS70	Si-diode	Schottky, 70V, 70mA, Vf<1V(15mA), <2pF, 5ns	SOT-23	16dc	-	3c	Di
K7D	BAS70-04	Si-diode	Dual, Schottky, 70V, 70mA, Vf<1V(15mA), <2pF, 5ns	SOT-23	16dl	-	3c	Di
K7E	BAS70-05	Si-diode	Dual, Schottky, 70V, 70mA, Vf<1V(15mA), <2pF, 5ns	SOT-23	16dg	-	3c	Di
K7F	BAS70-06	Si-diode	Dual, Schottky, 70V, 70mA, Vf<1V(15mA), <2pF, 5ns	SOT-23	16df	-	3c	Di
K7p	BCV71	Si-npn	AF, Sw, 80V, 100mA, 250mW, >100MHz, B=110..220	SOT-23	16ta	-	3a	PHH
K7t	BCV71	Si-npn	AF, Sw, 80V, 100mA, 250mW, >100MHz, B=110..220	SOT-23	16ta	-	3a	PhM
K7W	BCV71	Si-npn	AF, Sw, 80V, 100mA, 250mW, >100MHz, B=110..220	SOT-23	16ta	-	3a	PhC
K8	BZX84-C4V3	Z-diode	4.0..4.6V, Zzt=90Ω, Izt=20mA, 225mW	SOT-23	16dc	-	3a	Lge
K8	ELM7648HAB	Vdet-IC	4.8V±2%, +Reset PPO, 250ms	SOT-23	16vdc	VD7	3d	Elm
K8	R3111N282C	Vdet-IC	2.8V±2%, -Reset ODO	SOT-23	16vdd	VD6	3d	Ric
K8	XC6GN0802HR	Vdet-IC	0.8V, +Reset ODO	USP-3	17vdc	VD1	9b	Tor
K8-	RT9818C-46PV	Vdet-IC	4.6V±1.5%, -Reset ODO, Td=220ms	SOT-23	16vda	VD6	3a	Rct
K8A	BSS84	p-MOSFET-e*	V-MOS, LogL, 50V, 130mA, 300mW, <10Ω(130mA), 10/18ns	SOT-23	16fh	-	3c	Di
K8p	BCV72	Si-npn	AF, Sw, 80V, 100mA, 250mW, >100MHz, B=200..450	SOT-23	16ta	-	3a	PHH
K8t	BCV72	Si-npn	AF, Sw, 80V, 100mA, 250mW, >100MHz, B=200..450	SOT-23	16ta	-	3a	PhM
K8W	BCV72	Si-npn	AF, Sw, 80V, 100mA, 250mW, >100MHz, B=200..450	SOT-23	16ta	-	3a	PhC
K9	1SS348	Si-diode	Schottky, 80V, 0.1A	SC-59	16dg	-	3a	Tos
K9	BCV72R	Si-npn	AF, Sw, 80V, 100mA, 250mW, >100MHz, B=200..450	SOT-23	16te	-	3a	Phi
K9	BZX84-C20	Z-diode	18.8..21.2V, Zzt=55Ω, Izt=20mA, 225mW	SOT-23	16dc	-	3a	Lge
K9	ELM7649HAB	Vdet-IC	4.9V±2%, +Reset PPO, 250ms	SOT-23	16vdc	VD7	3d	Elm
K9	R3111N292C	Vdet-IC	2.9V±2%, -Reset ODO	SOT-23	16vdd	VD6	3d	Ric
K9	XC6GN0902HR	Vdet-IC	0.9V, +Reset ODO	USP-3	17vdc	VD1	9b	Tor
K9-	RT9819A-36PVL	Vdet-IC	3.6V±1.5%, -Reset PPO	SOT-23	16vda	VD7	3a	Rct
K9I	BCF81R	Si-npn	GP, AF, 50V, 200mA, 250mW, B=420..80, >100MHz	SOT-23	16te	-	3a	Phi
K9A	MMBZ5V6AL	TVS	Dual, 5.6V, 3A, 40W(1ms)	SOT-23	16df	-	3a	Di
K9C	MMBZ6V8AL	TVS	Dual, 6.8V, 2.5A, 40W(1ms)	SOT-23	16df	-	3a	Di
K9D	MMBZ9V1AL	TVS	Dual, 9.1V, 1.7A, 40W(1ms)	SOT-23	16df	-	3a	Di
K9E	MMBZ10VAL	TVS	Dual, 10V, 1.7A, 40W(1ms)	SOT-23	16df	-	3a	Di
K9K	MMBZ15VAL	TVS	Dual, 15V, 1.9A, 40W(1ms)	SOT-23	16df	-	3a	Di
K9L	MMBZ18VAL	TVS	Dual, 18V, 1.6A, 40W(1ms)	SOT-23	16df	-	3a	Di
K9N	MMBZ20VAL	TVS	Dual, 20V, 1.4A, 40W(1ms)	SOT-23	16df	-	3a	Di
K9p	BCF81	Si-npn	GP, AF, 50V, 200mA, 250mW, B=420..80, >100MHz	SOT-23	16ta	-	3a	Phi
K9Q	MMBZ27VAL	TVS	Dual, 27V, 1A, 40W(1ms)	SOT-23	16df	-	3a	Di
K9T	MMBZ33VAL	TVS	Dual, 33V, 0.87A, 40W(1ms)	SOT-23	16df	-	3a	Di
KA	2SA1965	Si-pnp	Mute, 15V, 0.1A, 0.15W, B=200..600, 600MHz, Ron=1.2Ω	SOT-23	16ta	-	3a	San
KA	BFT75	Si-npn	UHF-A, LN, 20V, 50mA, 4.6GHz	SOT-23	16ta	-	3a	Sie
KA	DZ23C6V2	Z-diode	Dual, 5.8..6.6V, Izt=5mA, Zzt=4.8Ω, 300mW	SOT-23	16dg	-	3a	Lge
KA	ELM7620HDB	Vdet-IC	2.0V±2%, +Reset PPO, 50ms	SOT-23	16vdc	VD7	3d	Elm
ka	PT7M6220NLC3	Vdet-IC	2.0V±1.5%, -Reset ODO	SC-70	16vdc	VD6	3b	Pti
ka	PT7M6220NLC3E	Vdet-IC	2.0V±1.5%, -Reset ODO, Lead free	SC-70	16vdc	VD6	3b	Pti
ka	PT7M6220NLTA3	Vdet-IC	2.0V±1.5%, -Reset ODO	SOT-23	16vdb	VD6	3b	Pti
ka	PT7M6220NLTA3E	Vdet-IC	2.0V±1.5%, -Reset ODO, Lead free	SOT-23	16vdb	VD6	3b	Pti
KA	RN1441A	Si-npn-Digi	Mute, 50V, 300mA, 300mW, R1=5k6, B=200..700	SOT-346	16ta	-	3a	Tos
KA-	RT9819D-25PV	Vdet-IC	2.5V±1.5%, -Reset PPO, Td=450ms	SOT-23	16vdc	VD7	3a	Rct
KA1	MMBD4448HW	Si-diode	Sw, Fast, 75V, 500mA, Vf<1.25V(150mA), <4ns	SOT-323	16dc	-	3a	Di
KA2	BAS16W	Si-diode	Sw, Fast, 75V, 300mA, Vf<1.25V(150mA), <4ns, 2pF	SOT-323	16dc	-	3a	Di
KA2	MMBD4148	Si-diode	Sw, Fast, 75V, 200mA, 350mW, <4ns, 4pF	SOT-23	16dc	-	3a	Di
KA2	MMBD4148W	Si-diode	Sw, Fast, 75V, 300mA, Vf<1.25V(150mA), <4ns, 2pF	SOT-323	16dc	-	3a	Di
KA3	MMBD4448	Si-diode	Sw, Fast, 80V, 500mA, Vf<1V(100mA), <4ns	SOT-23	16dc	-	3g	Vs
KA3	MMBD4448H	Si-diode	Sw, Fast, 80V, 500mA, Vf<1.25V(150mA), <4ns	SOT-23	16dc	-	3a	Di
KA3	MMBD4448W	Si-diode	Sw, Fast, 75V, 500mA, Vf<1.25V(150mA), <4ns	SOT-323	16dc	-	3a	Di
KA6	BAS16	Si-diode	Sw, Fast, 75V, 215mA, 250mW, <6ns	SOT-23	16dc	-	3a	Di
KA8	BAS19	Si-diode	Sw, Fast, 120V, 250mA, 250mW, <50ns	SOT-23	16dc	-	3a	Di
KA8	BAS19W	Si-diode	Sw, Fast, 120V, 250mA, 250mW, <50ns	SOT-323	16dc	-	3a	Di
KAG	2SK368-GR	n-FET	GP, 100V, 10mA, 150mW, Idss=0.6..1.5mA, Up<3.5V	SOT-23	16fi	-	3a	Tos
KAO	2SK368-O	n-FET	GP, 100V, 10mA, 150mW, Idss=1.5..3mA, Up<3.5V	SOT-23	16fi	-	3a	Tos
KAY	2SK368-Y	n-FET	GP, 100V, 10mA, 150mW, Idss=3..6.5mA, Up<3.5V	SOT-23	16fi	-	3a	Tos
KB	2SC2778-B	Si-npn	RF, AM/FM, IF, 30V, 30mA, 200mW, B=70..160, 230MHz	SOT-23	16ta	-	3a	Pan
KB	2SC3936-B	Si-npn	RF, FM/AM, IF, 30V, 30mA, 150mW, B=70..160, 230MHz	SOT-323	16ta	-	3a	Pan
KB	2SC4655-B	Si-npn	HF, 30V, 30mA, 125mW, B=70..160, 230MHz	SOT-416	16ta	-	3a	Pan
KB	2SK323-B	n-FET	GP, 40V, 30mA, 150mW, Idss=1.6..3.2mA, Up<1.5V	SOT-23	16fa	-	3a	Ren
KB	2SK433-B	n-FET	AF-Amp, 50V, 150mW, Idss=0.6..1.5mA, Rds=250Ω(5mA)	SC-59	16fa	-	3a	Mit
KB	DZ23C6V8	Z-diode	Dual, 6.4..7.2V, Izt=5mA, Zzt=4.5Ω, 300mW	SOT-23	16dg	-	3a	Lge
KB	ELM7621HDB	Vdet-IC	2.1V±2%, +Reset PPO, 50ms	SOT-23	16vdc	VD7	3d	Elm
kb	PT7M6221CLC3	Vdet-IC	2.1V±1.5%, -Reset PPO	SC-70	16vdc	VD7	3b	Pti
kb	PT7M6221CLC3E	Vdet-IC	2.1V±1.5%, -Reset PPO, Lead free	SC-70	16vdc	VD7	3b	Pti
kb	PT7M6221CLTA3	Vdet-IC	2.1V±1.5%, -Reset PPO	SOT-23	16vdb	VD7	3b	Pti
kb	PT7M6221CLTA3E	Vdet-IC	2.1V±1.5%, -Reset PPO, Lead free	SOT-23	16vdb	VD7	3b	Pti
KB	RN1441B	Si-npn-Digi	Mute, 50V, 300mA, 300mW, R1=5k6, B=350..1200	SOT-346	16ta	-	3a	Tos



SMD code	Type	Function	Short description	Case	Pinout	Sch. St.	Mnf.
KB-	RT9818B-18PV	Vdet-IC	1.8V±1.5%, -Reset ODO, Td=55ms	SOT-23	16vda	VD6	3a Rct
KB=	RT9818B-18GV	Vdet-IC	1.8V±1.5%, -Reset ODO, Td=55ms	SOT-23	16vda	VD6	3a Rct
KC	2SC2778-C	Si-npn	RF, AM/FM, IF, 30V, 30mA, 200mW, B=110..250, 230MHz	SOT-23	16ta	-	3a Pan
KC	2SC3936-C	Si-npn	RF, FM/AM, IF, 30V, 30mA, 150mW, B=110..250, 230MHz	SOT-323	16ta	-	3a Pan
KC	2SC4655-C	Si-npn	HF, 30V, 30mA, 125mW, B=110..250, 230MHz	SOT-416	16ta	-	3a Pan
KC	2SK323-C	n-FET	GP, 40V, 30mA, 150mW, Idss=2.5..5mA, Up<1.5V	SOT-23	16fa	-	3a Ren
KC	2SK433-C	n-FET	AF-Amp, 50V, 150mW, Idss=1..3mA, Rds=250Q(5mA)	SC-59	16fa	-	3a Mit
KC	2SK930-C	n-FET	AF-Amp, 50V, 150mW, Idss=1..3mA, Rds=250Q(5mA)	SOT-323	16fa	-	3a Mit
KC	BFQ29P	Si-npn	VHF.UHF, 20V, 30mA, 280mW, B=50..250, 5GHZ	SOT-23	16ta	-	3a SIE
KC	DZ23C7V5	Z-diode	Dual, 7.0..7.9V, Izt=5mA, Zzt=4Q, 300mW	SOT-23	16dg	-	3a Lge
KC	ELM7622HDB	Vdet-IC	2.2V±2%, +Reset PPO, 50ms	SOT-23	16vdc	VD7	3d Elm
kc	PT7M6221CHC3	Vdet-IC	2.1V±1.5%, +Reset PPO	SC-70	16vdc	VD7	3b Pti
kc	PT7M6221CHC3E	Vdet-IC	2.1V±1.5%, +Reset PPO, Lead free	SC-70	16vdc	VD7	3b Pti
kc	PT7M6221CHTA3	Vdet-IC	2.1V±1.5%, +Reset PPO	SOT-23	16vdb	VD7	3b Pti
kc	PT7M6221CHTA3E	Vdet-IC	2.1V±1.5%, +Reset PPO, Lead free	SOT-23	16vdb	VD7	3b Pti
KC	UNR32AE	Si-npn-Digi	Sw, 50V, 80mA, 100mW, 150MHz, R1/R2=47k/22k	SSSMini3	18ta	-	3a Pan
KC-	RT9161A-50PV	LVR-IC	LDO, 5.0V±2%, 500mA	SOT-23	16cg	VR1	3a Rct
KC1	CZRT5221B-G	Z-diode	2.28..2.52V, Zzt=30Q, Izt=20.0mA, 350mW	SOT-23	16dc	-	3a Cmc
KC1	MMBZ5221B	Z-diode	2.28..2.52V, Izt=20mA, Zzt=30Q, 350mW	SOT-23	16dc	-	3a Di
KC1	MMBZ5221BT	Z-diode	2.28..2.52V, Izt=20mA, Zzt=30Q, 150mW	SOT-523	16dc	-	3a Di
KC1	MMBZ5221BW	Z-diode	2.28..2.52V, Izt=20mA, Zzt=30Q, 200mW	SOT-323	16dc	-	3a Di
KC2	CZRT5222B-G	Z-diode	2.38..2.63V, Zzt=30Q, Izt=20.0mA, 350mW	SOT-23	16dc	-	3a Cmc
KC3	CZRT5223B-G	Z-diode	2.57..2.84V, Zzt=30Q, Izt=20.0mA, 350mW	SOT-23	16dc	-	3a Cmc
KC3	MMBZ5223B	Z-diode	2.57..2.84V, Zzt=30Q, Izt=20mA, 350mW	SOT-23	16dc	-	3a Di
KC3	MMBZ5223BT	Z-diode	2.57..2.84V, Zzt=30Q, Izt=20mA, 150mW	SOT-523	16dc	-	3a Di
KC3	MMBZ5223BW	Z-diode	2.7V±5%, Zzt=30Q, 200mW	SOT-323	16dc	-	3a Di
KC5	CZRT5225B-G	Z-diode	2.85..3.15V, Zzt=30Q, Izt=20.0mA, 350mW	SOT-23	16dc	-	3a Cmc
KC5	MMBZ5225B	Z-diode	3V±5%, Zzt=29Q, 350mW	SOT-23	16dc	-	3a Di
KC5	MMBZ5225BT	Z-diode	3V±5%, Zzt=29Q, 150mW	SOT-523	16dc	-	3a Di
KC5	MMBZ5225BW	Z-diode	3V±5%, Zzt=29Q, 200mW	SOT-323	16dc	-	3a Di
KCG	2SK625-G	n-FET	Cond.-Microphone, 20V, 10mA, 100mW, Idss=0.25..0.5mA, Up<0.8V	SOT-23	16fa	-	3a Tos
KCK	AZ23C16	Z-diode	Dual, 15.20..16.80V, Zzt=40Q, Izt=5mA, 300mW	SOT-23	16df	-	3c Di
KCO	2SK625-O	n-FET	Cond.-Microphone, 20V, 10mA, 100mW, Idss=0.1..0.2mA, Up<0.8V	SOT-23	16fa	-	3a Tos
KCR	2SK625-R	n-FET	Cond.-Microphone, 20V, 10mA, 100mW, Idss=0.06..0.12mA, Up<0.8V	SOT-23	16fa	-	3a Tos
KCY	2SK625-Y	n-FET	Cond.-Microphone, 20V, 10mA, 100mW, Idss=0.15..0.3mA, Up<0.8V	SOT-23	16fa	-	3a Tos
KD	2SK323-D	n-FET	GP, 40V, 30mA, 150mW, Idss=4..8mA, Up<1.5V	SOT-23	16fa	-	3a Ren
KD	2SK433-D	n-FET	AF-Amp, 50V, 150mW, Idss=2.5..6mA, Rds=250Q(5mA)	SC-59	16fa	-	3a Mit
KD	2SK930-D	n-FET	AF-Amp, 50V, 150mW, Idss=2.5..6mA, Rds=250Q(5mA)	SOT-323	16fa	-	3a Mit
KD	DZ23C8V2	Z-diode	Dual, 7.7..8.7V, Izt=5mA, Zzt=4.5Q, 300mW	SOT-23	16dg	-	3a Lge
KD	ELM7623HDB	Vdet-IC	2.3V±2%, +Reset PPO, 50ms	SOT-23	16vdc	VD7	3d Elm
kd	PT7M6221NLC3	Vdet-IC	2.1V±1.5%, -Reset ODO	SC-70	16vdc	VD6	3b Pti
kd	PT7M6221NLC3E	Vdet-IC	2.1V±1.5%, -Reset ODO, Lead free	SC-70	16vdc	VD6	3b Pti
kd	PT7M6221NLTA3	Vdet-IC	2.1V±1.5%, -Reset ODO	SOT-23	16vdb	VD6	3b Pti
kd	PT7M6221NLTA3E	Vdet-IC	2.1V±1.5%, -Reset ODO, Lead free	SOT-23	16vdb	VD6	3b Pti
KD	UNR32AF	Si-npn-Digi	Sw, 50V, 80mA, 100mW, 150MHz, R1/R2=4.7k/10k	SSSMini3	18ta	-	3a Pan
KD-	RT9818A-36PV	Vdet-IC	3.6V±1.5%, -Reset ODO	SOT-23	16vda	VD6	3a Rct
KD1	AZ23C2V7	Z-diode	Dual, 2.57..2.84V, Zzt=83Q, Izt=5mA, 300mW	SOT-23	16df	-	3c Di
KD2	AZ23C3V0	Z-diode	Dual, 2.85..3.15V, Zzt=95Q, Izt=5mA, 300mW	SOT-23	16df	-	3c Di
KD3	AZ23C3V3	Z-diode	Dual, 3.14..3.47V, Zzt=95Q, Izt=5mA, 300mW	SOT-23	16df	-	3c Di
KD4	AZ23C3V6	Z-diode	Dual, 3.42..3.78V, Zzt=95Q, Izt=5mA, 300mW	SOT-23	16df	-	3c Di
KD5	AZ23C3V9	Z-diode	Dual, 3.71..4.10V, Zzt=95Q, Izt=5mA, 300mW	SOT-23	16df	-	3c Di
KD6	AZ23C4V3	Z-diode	Dual, 4.09..4.52V, Zzt=95Q, Izt=5mA, 300mW	SOT-23	16df	-	3c Di
KD7	AZ23C4V7	Z-diode	Dual, 4.47..4.94V, Zzt=78Q, Izt=5mA, 300mW	SOT-23	16df	-	3c Di
KD8	AZ23C5V1	Z-diode	Dual, 4.85..5.36V, Zzt=60Q, Izt=5mA, 300mW	SOT-23	16df	-	3c Di
KD9	AZ23C5V6	Z-diode	Dual, 5.32..5.88V, Zzt=40Q, Izt=5mA, 300mW	SOT-23	16df	-	3c Di
KD9	AZ23C5V6W	Z-diode	Dual, 5.32..5.88V, Zzt=40Q, Izt=5mA, 200mW	SOT-323	16df	-	3c Di
KDA	AZ23C6V2	Z-diode	Dual, 5.89..6.51V, Zzt=10Q, Izt=5mA, 300mW	SOT-23	16df	-	3c Di
KDB	AZ23C6V8	Z-diode	Dual, 6.46..7.14V, Zzt=8Q, Izt=5mA, 300mW	SOT-23	16df	-	3c Di
KDB	AZ23C6V8W	Z-diode	Dual, 6.46..7.14V, Zzt=8Q, Izt=5mA, 200mW	SOT-323	16df	-	3c Di
KDC	AZ23C7V5	Z-diode	Dual, 7.13..7.88V, Zzt=7Q, Izt=5mA, 300mW	SOT-23	16df	-	3c Di
KDD	AZ23C8V2	Z-diode	Dual, 7.79..8.61V, Zzt=7Q, Izt=5mA, 300mW	SOT-23	16df	-	3c Di
KDE	AZ23C9V1	Z-diode	Dual, 8.65..9.56V, Zzt=10Q, Izt=5mA, 300mW	SOT-23	16df	-	3c Di
KDF	AZ23C10	Z-diode	Dual, 9.50..10.50V, Zzt=15Q, Izt=5mA, 300mW	SOT-23	16df	-	3c Di
KDF	AZ23C10W	Z-diode	Dual, 9.50..10.50V, Zzt=15Q, Izt=5mA, 200mW	SOT-323	16df	-	3c Di
KDG	AZ23C11	Z-diode	Dual, 10.45..11.55V, Zzt=20Q, Izt=5mA, 300mW	SOT-23	16df	-	3c Di
KDH	AZ23C12	Z-diode	Dual, 11.40..12.60V, Zzt=20Q, Izt=5mA, 300mW	SOT-23	16df	-	3c Di
KDI	AZ23C13	Z-diode	Dual, 12.35..13.65V, Zzt=25Q, Izt=5mA, 300mW	SOT-23	16df	-	3c Di
KDJ	AZ23C15	Z-diode	Dual, 14.25..15.75V, Zzt=30Q, Izt=5mA, 300mW	SOT-23	16df	-	3c Di
KDL	AZ23C18	Z-diode	Dual, 17.10..18.90V, Zzt=50Q, Izt=5mA, 300mW	SOT-23	16df	-	3c Di
KDL	AZ23C18W	Z-diode	Dual, 17.10..18.90V, Zzt=50Q, Izt=5mA, 200mW	SOT-323	16df	-	3c Di



SMD code	Type	Function	Short description	Case	Pinout	Sch.	St.	Mnf.
KDM	AZ23C20	Z-diode	Dual, 19.0..21.00V, Zzt=50Ω, Izt=5mA, 300mW	SOT-23	16df	-	3c	Di
KDN	AZ23C22	Z-diode	Dual, 20.90..23.10V, Zzt=55Ω, Izt=5mA, 300mW	SOT-23	16df	-	3c	Di
KDO	AZ23C24	Z-diode	Dual, 22.80..25.20V, Zzt=80Ω, Izt=5mA, 300mW	SOT-23	16df	-	3c	Di
KDP	AZ23C27	Z-diode	Dual, 25.65..28.35V, Zzt=80Ω, Izt=5mA, 300mW	SOT-23	16df	-	3c	Di
KDQ	AZ23C30	Z-diode	Dual, 28.50..31.50V, Zzt=80Ω, Izt=5mA, 300mW	SOT-23	16df	-	3c	Di
KDR	AZ23C33	Z-diode	Dual, 31.35..34.65V, Zzt=80Ω, Izt=5mA, 300mW	SOT-23	16df	-	3c	Di
KDS	AZ23C36	Z-diode	Dual, 34.20..37.80V, Zzt=90Ω, Izt=5mA, 300mW	SOT-23	16df	-	3c	Di
KDT	AZ23C39	Z-diode	Dual, 37.05..40.95V, Zzt=90Ω, Izt=5mA, 300mW	SOT-23	16df	-	3c	Di
KDU	AZ23C43	Z-diode	Dual, 40.85..45.15V, Zzt=100Ω, Izt=5mA, 300mW	SOT-23	16df	-	3c	Di
KDV	AZ23C47	Z-diode	Dual, 44.65..49.35V, Zzt=100Ω, Izt=5mA, 300mW	SOT-23	16df	-	3c	Di
KDW	AZ23C51	Z-diode	Dual, 48.45..53.55V, Zzt=100Ω, Izt=5mA, 300mW	SOT-23	16df	-	3c	Di
KE	2SK1062	n-MOSFET	GP, 60V, 200mA, 200mW, I _{ds} =6..12mA, Up<1.5V	SOT-23	16fh	-	3a	Tos
KE	2SK323-E	n-FET	GP, 40V, 30mA, 150mW, I _{ds} =6..12mA, Up<1.5V	SOT-23	16fa	-	3a	Ren
KE	2SK433-E	n-FET	AF-Amp, 50V, 150mW, I _{ds} =5..12mA, R _{ds} =250Ω(5mA)	SC-59	16fa	-	3a	Mit
KE	2SK930-E	n-FET	AF-Amp, 50V, 150mW, I _{ds} =5..12mA, R _{ds} =250Ω(5mA)	SOT-323	16fa	-	3a	Mit
KE	A102WFT-1.5	LVR-IC	LDO, 1.5V±1.5%, 300mA	SOT-23	16cg	VR1	3b	Adt
KE	DZ23C9V1	Z-diode	Dual, 8.5..9.6V, Izt=5mA, Zzt=4.8Ω, 300mW	SOT-23	16dg	-	3a	Lge
KE	ELM7624HDB	Vdet-IC	2.4V±2%, +Reset PPO, 50ms	SOT-23	16vdc	VD7	3d	Elm
ke	PT7M6222CLC3	Vdet-IC	2.2V±1.5%, -Reset PPO	SC-70	16vdc	VD7	3b	Pti
ke	PT7M6222CLC3E	Vdet-IC	2.2V±1.5%, -Reset PPO, Lead free	SC-70	16vdc	VD7	3b	Pti
ke	PT7M6222CLTA3	Vdet-IC	2.2V±1.5%, -Reset PPO	SOT-23	16vdb	VD7	3b	Pti
ke	PT7M6222CLTA3E	Vdet-IC	2.2V±1.5%, -Reset PPO, Lead free	SOT-23	16vdb	VD7	3b	Pti
KE-	RT9818E-18PV	Vdet-IC	1.8V±1.5%, +Reset ODO	SOT-23	16vda	VD6	3a	Rct
KE1	CZRT5231B-G	Z-diode	4.85..5.36V, Zzt=17Ω, Izt=20.0mA, 350mW	SOT-23	16dc	-	3a	Cmc
KE1	MMBZ5231B	Z-diode	5.1V±5%, Zzt=17Ω, 350mW	SOT-23	16dc	-	3a	Di
KE1	MMBZ5231BT	Z-diode	5.1V±5%, Zzt=17Ω, 150mW	SOT-523	16dc	-	3a	Di
KE1	MMBZ5231BW	Z-diode	5.1V±5%, Zzt=17Ω, 200mW	SOT-323	16dc	-	3a	Di
KE2	CZRT5232B-G	Z-diode	5.32..5.88V, Zzt=11Ω, Izt=20.0mA, 350mW	SOT-23	16dc	-	3a	Cmc
KE2	MMBZ5232B	Z-diode	5.6V±5%, Zzt=11Ω, 350mW	SOT-23	16dc	-	3a	Di
KE2	MMBZ5232BT	Z-diode	5.6V±5%, Zzt=11Ω, 150mW	SOT-523	16dc	-	3a	Di
KE2	MMBZ5232BW	Z-diode	5.6V±5%, Zzt=11Ω, 200mW	SOT-323	16dc	-	3a	Di
KE3	MMBZ5233B	Z-diode	6V±5%, Zzt=7Ω, 350mW	SOT-23	16dc	-	3a	Di
KE4	CZRT5234B-G	Z-diode	5.89..6.51V, Zzt=7Ω, Izt=20.0mA, 350mW	SOT-23	16dc	-	3a	Cmc
KE4	MMBZ5234B	Z-diode	6.2V±5%, Zzt=7Ω, 350mW	SOT-23	16dc	-	3a	Di
KE4	MMBZ5234BT	Z-diode	6.2V±5%, Zzt=7Ω, 150mW	SOT-523	16dc	-	3a	Di
KE4	MMBZ5234BW	Z-diode	6.2V±5%, Zzt=7Ω, 200mW	SOT-323	16dc	-	3a	Di
KE5	CZRT5235B-G	Z-diode	6.46..7.14V, Zzt=5Ω, Izt=20.0mA, 350mW	SOT-23	16dc	-	3a	Cmc
KE5	MMBZ5235B	Z-diode	6.8V±5%, Zzt=5Ω, 350mW	SOT-23	16dc	-	3a	Di
KE5	MMBZ5235BT	Z-diode	6.8V±5%, Zzt=5Ω, 150mW	SOT-523	16dc	-	3a	Di
KE5	MMBZ5235BW	Z-diode	6.8V±5%, Zzt=5Ω, 200mW	SOT-323	16dc	-	3a	Di
KF	2SJ168	p-FET	Sw, 60V, 200mA, 400mW, 0.2Ω, 14/100ns	SOT-323	16fh	-	3a	Tos
KF	DZ23C10	Z-diode	Dual, 9.4..10.6V, Izt=5mA, Zzt=5.2Ω, 300mW	SOT-23	16dg	-	3a	Lge
KF	ELM7625HDB	Vdet-IC	2.5V±2%, +Reset PPO, 50ms	SOT-23	16vdc	VD7	3d	Elm
kf	PT7M6222CHC3	Vdet-IC	2.2V±1.5%, +Reset PPO	SC-70	16vdc	VD7	3b	Pti
kf	PT7M6222CHC3E	Vdet-IC	2.2V±1.5%, +Reset PPO, Lead free	SC-70	16vdc	VD7	3b	Pti
kf	PT7M6222CHTA3	Vdet-IC	2.2V±1.5%, +Reset PPO	SOT-23	16vdb	VD7	3b	Pti
kf	PT7M6222CHTA3E	Vdet-IC	2.2V±1.5%, +Reset PPO, Lead free	SOT-23	16vdb	VD7	3b	Pti
KF	UNR32AL	Si-npn-Digi	Sw, 50V, 80mA, 100mW, 150MHz, R1/R2=4.7k/4.7k	SSSMini3	18ta	-	3a	Pan
KF-	RT9198-35PV	LVR-IC	LDO, 3.5V±1%, 300mA	SOT-23	16cg	VR1	3a	Rct
KF1	CZRT5236B-G	Z-diode	7.13..7.88V, Zzt=6Ω, Izt=20.0mA, 350mW	SOT-23	16dc	-	3a	Cmc
KF1	MMBZ5236B	Z-diode	7.5V±5%, Zzt=6Ω, 350mW	SOT-23	16dc	-	3a	Di
KF1	MMBZ5236BT	Z-diode	7.5V±5%, Zzt=6Ω, 150mW	SOT-523	16dc	-	3a	Di
KF1	MMBZ5236BW	Z-diode	7.5V±5%, Zzt=6Ω, 200mW	SOT-323	16dc	-	3a	Di
KF2	CZRT5237B-G	Z-diode	7.79..8.61V, Zzt=8Ω, Izt=20.0mA, 350mW	SOT-23	16dc	-	3a	Cmc
KF2	MMBZ5237B	Z-diode	8.2V±5%, Zzt=8Ω, 350mW	SOT-23	16dc	-	3a	Di
KF2	MMBZ5237BT	Z-diode	8.2V±5%, Zzt=8Ω, 150mW	SOT-523	16dc	-	3a	Di
KF2	MMBZ5237BW	Z-diode	8.2V±5%, Zzt=8Ω, 200mW	SOT-323	16dc	-	3a	Di
KF3	MMBZ5238B	Z-diode	8.7V±5%, 350mW	SOT-23	16dc	-	3a	Di
KF4	CZRT5239B-G	Z-diode	8.65..9.56V, Zzt=10Ω, Izt=20.0mA, 350mW	SOT-23	16dc	-	3a	Cmc
KF4	MMBZ5239B	Z-diode	8.7V±5%, 350mW	SOT-23	16dc	-	3a	Di
KF4	MMBZ5239BT	Z-diode	9.1V±5%, Zzt=10Ω, 150mW	SOT-523	16dc	-	3a	Di
KF4	MMBZ5239BW	Z-diode	9.1V±5%, 200mW	SOT-323	16dc	-	3a	Di
KF5	CZRT5240B-G	Z-diode	9.50..10.50V, Zzt=17Ω, Izt=20.0mA, 350mW	SOT-23	16dc	-	3a	Cmc
KF5	MMBZ5240B	Z-diode	10V±5%, 350mW	SOT-23	16dc	-	3a	Di
KF5	MMBZ5240BT	Z-diode	10V±5%, Zzt=17Ω, 150mW	SOT-523	16dc	-	3a	Di
KF5	MMBZ5240BW	Z-diode	10V±5%, Zzt=17Ω, 200mW	SOT-323	16dc	-	3a	Di
KG	2SK881-GR	n-FET	FM/VHF, 18V, 10mA, 100mW, I _{ds} =5..10mA, Up<4V	SOT-323	16fk	-	3a	Tos
KG	ELM7626HDB	Vdet-IC	2.6V±2%, +Reset PPO, 50ms	SOT-23	16vdc	VD7	3d	Elm
kg	PT7M6222NLC3	Vdet-IC	2.2V±1.5%, -Reset ODO	SC-70	16vdc	VD6	3b	Pti
kg	PT7M6222NLC3E	Vdet-IC	2.2V±1.5%, -Reset ODO, Lead free	SC-70	16vdc	VD6	3b	Pti



SMD code	Type	Function	Short description	Case	Pinout	Sch.	St.	Mnf.
kg	PT7M6222NLTA3	Vdet-IC	2.2V±1.5%, -Reset ODO	SOT-23	16vdb	VD6	3b	Pti
kg	PT7M6222NLTA3E	Vdet-IC	2.2V±1.5%, -Reset ODO, Lead free	SOT-23	16vdb	VD6	3b	Pti
KG-	RT9818B-28PV	Vdet-IC	2.8V±1.5%, -Reset ODO, Td=55ms	SOT-23	16vda	VD6	3a	Rct
KG1	CZRT5226B-G	Z-diode	3.14..3.47V, Zzt=28Ω, Izt=20.0mA, 350mW	SOT-23	16dc	-	3a	Cmc
KG1	MMBZ5226B	Z-diode	3.14..3.47V, Izt=20mA, Zzt=28Ω, 350mW	SOT-23	16dc	-	3a	Di
KG1	MMBZ5226BT	Z-diode	3.3V±5%, Zzt=28Ω, 150mW	SOT-523	16dc	-	3a	Di
KG1	MMBZ5226BW	Z-diode	3.3V±5%, Zzt=28Ω, 200mW	SOT-323	16dc	-	3a	Di
KG2	CZRT5227B-G	Z-diode	3.42..3.78V, Zzt=24Ω, Izt=20.0mA, 350mW	SOT-23	16dc	-	3a	Cmc
KG2	MMBZ5227B	Z-diode	3.42..3.78V, Zzt=24Ω, Izt=20mA, 350mW	SOT-23	16dc	-	3a	Di
KG2	MMBZ5227BT	Z-diode	3.42..3.78V, Zzt=24Ω, Izt=20mA, 150mW	SOT-523	16dc	-	3a	Di
KG2	MMBZ5227BW	Z-diode	3.42..3.78V, Zzt=24Ω, Izt=20mA, 200mW	SOT-323	16dc	-	3a	Di
KG3	CZRT5228B-G	Z-diode	3.71..4.10V, Zzt=23Ω, Izt=20.0mA, 350mW	SOT-23	16dc	-	3a	Cmc
KG3	MMBZ5228B	Z-diode	3.71..4.10V, Izt=20mA, Zzt=23Ω, 350mW	SOT-23	16dc	-	3a	Di
KG3	MMBZ5228BT	Z-diode	3.71..4.10V, Izt=20mA, Zzt=23Ω, 150mW	SOT-523	16dc	-	3a	Di
KG3	MMBZ5228BW	Z-diode	3.71..4.10V, Izt=20mA, Zzt=23Ω, 200mW	SOT-323	16dc	-	3a	Di
KG4	CZRT5229B-G	Z-diode	4.09..4.52V, Zzt=22Ω, Izt=20.0mA, 350mW	SOT-23	16dc	-	3a	Cmc
KG4	MMBZ5229B	Z-diode	4.3V±5%, Zzt=22Ω, 350mW	SOT-23	16dc	-	3a	Di
KG4	MMBZ5229BT	Z-diode	4.3V±5%, Zzt=22Ω, 150mW	SOT-523	16dc	-	3a	Di
KG4	MMBZ5229BW	Z-diode	4.3V±5%, Zzt=22Ω, 200mW	SOT-323	16dc	-	3a	Di
KG5	CZRT5230B-G	Z-diode	4.47..4.94V, Zzt=19Ω, Izt=20.0mA, 350mW	SOT-23	16dc	-	3a	Cmc
KG5	MMBZ5230B	Z-diode	4.7V±5%, Zzt=19Ω, 350mW	SOT-23	16dc	-	3a	Di
KG5	MMBZ5230BT	Z-diode	4.7V±5%, Zzt=19Ω, 150mW	SOT-523	16dc	-	3a	Di
KG5	MMBZ5230BW	Z-diode	4.7V±5%, Zzt=19Ω, 200mW	SOT-323	16dc	-	3a	Di
KH	A102WFT-1.8	LVR-IC	LDO, 1.8V±1.5%, 300mA	SOT-23	16cg	VR1	3b	Adt
KH	D223C11	Z-diode	Dual, 10..4.11.6V, Izt=5mA, Zzt=6Ω, 300mW	SOT-23	16dg	-	3a	Lge
KH	ELM7627HDB	Vdet-IC	2.7V±2%, +Reset PPO, 50ms	SOT-23	16vdc	VD7	3d	Elm
KH	MMBZ5241BT	Z-diode	11V±5%, Zzt=22Ω, 200mW	SOT-523	16dc	-	3a	Di
kh	PT7M6223CLC3	Vdet-IC	2.3V±1.5%, -Reset PPO	SC-70	16vdc	VD7	3b	Pti
kh	PT7M6223CLC3E	Vdet-IC	2.3V±1.5%, -Reset PPO, Lead free	SC-70	16vdc	VD7	3b	Pti
kh	PT7M6223CLTA3	Vdet-IC	2.3V±1.5%, -Reset PPO	SOT-23	16vdb	VD7	3b	Pti
kh	PT7M6223CLTA3E	Vdet-IC	2.3V±1.5%, -Reset PPO, Lead free	SOT-23	16vdb	VD7	3b	Pti
KH	UNR32AM	Si-npn-Digi	Sw, 50V, 80mA, 100mW, 150MHz, R1/R2=2k2/47k	SSSMini3	18ta	-	3a	Pan
KH-	RT9818C-20PV	Vdet-IC	2.0V±1.5%, -Reset ODO, Td=220ms	SOT-23	16vda	VD6	3a	Rct
KH-	RT9818C-20GV	Vdet-IC	2.0V±1.5%, -Reset ODO, Td=220ms	SOT-23	16vda	VD6	3a	Rct
KH1	CZRT5241B-G	Z-diode	10.45..11.55V, Zzt=22Ω, Izt=20.0mA, 350mW	SOT-23	16dc	-	3a	Cmc
KH1	MMBZ5241B	Z-diode	11V±5%, Zzt=22Ω, 350mW	SOT-23	16dc	-	3a	Di
KH1	MMBZ5241BT	Z-diode	11V±5%, Zzt=22Ω, 150mW	SOT-523	16dc	-	3a	Di
KH1	MMBZ5241BW	Z-diode	11V±5%, Zzt=22Ω, 200mW	SOT-323	16dc	-	3a	Di
KH2	CZRT5242B-G	Z-diode	11.40..12.60V, Zzt=30Ω, Izt=20.0mA, 350mW	SOT-23	16dc	-	3a	Cmc
KH2	MMBZ5242B	Z-diode	12V±5%, Zzt=30Ω, 350mW	SOT-23	16dc	-	3a	Di
KH2	MMBZ5242BT	Z-diode	12V±5%, Zzt=30Ω, 150mW	SOT-523	16dc	-	3a	Di
KH2	MMBZ5242BW	Z-diode	12V±5%, Zzt=30Ω, 200mW	SOT-323	16dc	-	3a	Di
KH3	CZRT5243B-G	Z-diode	12.35..13.65V, Zzt=13Ω, Izt=9.5mA, 350mW	SOT-23	16dc	-	3a	Cmc
KH3	MMBZ5243B	Z-diode	13V±5%, Zzt=13Ω, 350mW	SOT-23	16dc	-	3a	Di
KH3	MMBZ5243BT	Z-diode	13V±5%, Zzt=13Ω, 150mW	SOT-523	16dc	-	3a	Di
KH3	MMBZ5243BW	Z-diode	13V±5%, Zzt=13Ω, 200mW	SOT-323	16dc	-	3a	Di
KH4	MMBZ5244B	Z-diode	14V±5%, Zzt=15Ω, 350mW	SOT-23	16dc	-	3a	Di
KH5	CZRT5245B-G	Z-diode	14.25..15.75V, Zzt=16Ω, Izt=8.5mA, 350mW	SOT-23	16dc	-	3a	Cmc
KH5	MMBZ5245B	Z-diode	15V±5%, Zzt=16Ω, 350mW	SOT-23	16dc	-	3a	Di
KH5	MMBZ5245BT	Z-diode	15V±5%, Zzt=16Ω, 150mW	SOT-523	16dc	-	3a	Di
KH5	MMBZ5245BW	Z-diode	15V±5%, Zzt=16Ω, 200mW	SOT-323	16dc	-	3a	Di
KI	2SK1828	n-MOSFET-e*	V-MOS +Di (S->G), 20V, 0.05A, <40Ω(10mA)	SOT-23	16fh	-	3a	Tos
ki	PT7M6223CHC3	Vdet-IC	2.3V±1.5%, +Reset PPO	SC-70	16vdc	VD7	3b	Pti
ki	PT7M6223CHC3E	Vdet-IC	2.3V±1.5%, +Reset PPO, Lead free	SC-70	16vdc	VD7	3b	Pti
ki	PT7M6223CHTA3	Vdet-IC	2.3V±1.5%, +Reset PPO	SOT-23	16vdb	VD7	3b	Pti
ki	PT7M6223CHTA3E	Vdet-IC	2.3V±1.5%, +Reset PPO, Lead free	SOT-23	16vdb	VD7	3b	Pti
KID	2SC4050-D	Si-npn	AF, Sw, 120V, 100mA, 150mW, B=250..500	MPAK	16ta	-	3a	Ren
KIE	2SC4050-E	Si-npn	AF, Sw, 120V, 100mA, 150mW, B=400..800	MPAK	16ta	-	3a	Ren
KJ	2SK1847	n-MOSFET*	Sw, 30V, 500mA, 250mW, <1.1Ω(250mA), 5/35nA	SOT-23	16fh	-	3a	San
KJ	2SK2036	n-MOSFET-e	V-MOS, +Di(S->G), 20V, 100mA, <6Ω(10mA)	SOT-23	16fh	-	3a	Tos
KJ	D223C12	Z-diode	Dual, 11.4..12.7V, Izt=5mA, Zzt=7Ω, 300mW	SOT-23	16dg	-	3a	Lge
KJ	ELM7628HDB	Vdet-IC	2.8V±2%, +Reset PPO, 50ms	SOT-23	16vdc	VD7	3d	Elm
kj	PT7M6223NLC3	Vdet-IC	2.3V±1.5%, -Reset ODO	SC-70	16vdc	VD6	3b	Pti
kj	PT7M6223NLC3E	Vdet-IC	2.3V±1.5%, -Reset ODO, Lead free	SC-70	16vdc	VD6	3b	Pti
kj	PT7M6223NLTA3	Vdet-IC	2.3V±1.5%, -Reset ODO	SOT-23	16vdb	VD6	3b	Pti
kj	PT7M6223NLTA3E	Vdet-IC	2.3V±1.5%, -Reset ODO, Lead free	SOT-23	16vdb	VD6	3b	Pti
KJ-	RT9818C-47PV	Vdet-IC	4.7V±1.5%, -Reset ODO, Td=220ms	SOT-23	16vda	VD6	3a	Rct
KJ1	CZRT5246B-G	Z-diode	15.20..16.80V, Zzt=17Ω, Izt=7.8mA, 350mW	SOT-23	16dc	-	3a	Cmc
KJ1	MMBZ5246B	Z-diode	16V±5%, Zzt=17Ω, 350mW	SOT-23	16dc	-	3a	Di
KJ1	MMBZ5246BT	Z-diode	16V±5%, Zzt=17Ω, 150mW	SOT-523	16dc	-	3a	Di



SMD code	Type	Function	Short description	Case	Pinout	Sch.	St.	Mnf.
KJ1	MMBZ5246BW	Z-diode	16V±5%, Zzt=17Ω, 200mW	SOT-323	16dc	-	3a	Di
KJ2	MMBZ5247B	Z-diode	17V±5%, Zzt=19Ω, 350mW	SOT-23	16dc	-	3a	Di
KJ3	CZRT5248B-G	Z-diode	17.10..18.90V, Zzt=21Ω, lzt=7.0mA, 350mW	SOT-23	16dc	-	3a	Cmc
KJ3	MMBZ5248B	Z-diode	18V±5%, Zzt=21Ω, 200mW	SOT-23	16dc	-	3a	Di
KJ3	MMBZ5248BT	Z-diode	18V±5%, Zzt=21Ω, 150mW	SOT-523	16dc	-	3a	Di
KJ3	MMBZ5248BW	Z-diode	18V±5%, Zzt=21Ω, 200mW	SOT-323	16dc	-	3a	Di
KJ4	MMBZ5249B	Z-diode	19V±5%, Zzt=23Ω, 350mW	SOT-23	16dc	-	3a	Di
KJ5	CZRT5250B-G	Z-diode	19.0..21.0V, Zzt=25Ω, lzt=6.2mA, 350mW	SOT-23	16dc	-	3a	Cmc
KJ5	MMBZ5250B	Z-diode	20V±5%, Zzt=25Ω, 350mW	SOT-23	16dc	-	3a	Di
KJ5	MMBZ5250BT	Z-diode	20V±5%, Zzt=25Ω, 150mW	SOT-523	16dc	-	3a	Di
KJ5	MMBZ5250BW	Z-diode	20V±5%, Zzt=25Ω, 200mW	SOT-323	16dc	-	3a	Di
KJA	BAV70W	Si-diode	Dual, Sw, 75V, 215mA, 225mW, Vf<1.25V, <4ns	SOT-323	16dg	-	3a	Di
KJC	BAW56W	Si-diode	Dual, Hi-Speed, 75V, 150mA, 200mW, 2pF, 4ns	SOT-323	16df	-	3a	Di
KJD	BAW56	Si-diode	Dual, Sw, 70V, 200mA, 250mW, Vf<1.25V, 2pF, <6ns	SOT-23	16df	-	3a	Di
KJE	BAV99	Si-diode	Dual, U-Sp, 80V, 150mA, Vf<1.2V(100mA), 0.5pF, 4ns	SOT-23	16dl	-	3a	Di
KJF	BAL99	Si-diode	Sw, Fast, 75V, 300mA, 250mW, <4ns	SOT-23	16dr	-	3a	Di
KJG	BAV99W	Si-diode	Dual, U-Sp, 75V, 125mA, Vf<1.2V(100mA), 0.5pF, 4ns	SOT-323	16dl	-	3a	Di
KJH	MMBD7000	Si-diode	Dual, Fast Sw, 100V, 300mA, 350mW, <15ns	SOT-23	16dl	-	3a	Di
KJJ	BAV70	Si-diode	Dual, Sw, 75V, 215mA, Vf<1.25V, <4ns	SOT-23	16dg	-	3g	Di
KK	A102WFT-2.0	LVR-IC	LDO, 2.0V±1.5%, 300mA	SOT-23	16cg	VR1	3b	Adt
KK	DZ23C13	Z-diode	Dual, 12.4..14.1V, lzt=5mA, Zzt=9Ω, 300mW	SOT-23	16dg	-	3a	Lge
KK	ELM7629HDB	Vdet-IC	2.9V±2%, +Reset PPO, 50ms	SOT-23	16vdc	VD7	3b	Elm
kk	PT7M6224CLC3	Vdet-IC	2.4V±1.5%, -Reset PPO	SC-70	16vdc	VD7	3b	Pti
kk̄	PT7M6224CLC3E	Vdet-IC	2.4V±1.5%, -Reset PPO, Lead free	SC-70	16vdc	VD7	3b	Pti
kk	PT7M6224CLTA3	Vdet-IC	2.4V±1.5%, -Reset PPO	SOT-23	16vdb	VD7	3b	Pti
kk̄	PT7M6224CLTA3E	Vdet-IC	2.4V±1.5%, -Reset PPO, Lead free	SOT-23	16vdb	VD7	3b	Pti
KK-	RT9818C-50PV	Vdet-IC	5.0V±1.5%, -Reset ODO, Td=220ms	SOT-23	16vda	VD6	3a	Rct
KK1	CZRT5251B-G	Z-diode	20.90..23.10V, Zzt=29Ω, Vf=5.6mA, 350mW	SOT-23	16dc	-	3a	Cmc
KK1	MMBZ5251B	Z-diode	22V±5%, Zzt=29Ω, 350mW	SOT-23	16dc	-	3a	Di
KK1	MMBZ5251BT	Z-diode	22V±5%, Zzt=29Ω, 150mW	SOT-523	16dc	-	3a	Di
KK1	MMBZ5251BW	Z-diode	22V±5%, Zzt=29Ω, 200mW	SOT-323	16dc	-	3a	Di
KK2	CZRT5252B-G	Z-diode	22.80..25.20V, Zzt=33Ω, lzt=5.2mA, 350mW	SOT-23	16dc	-	3a	Cmc
KK2	MMBZ5252B	Z-diode	24V±5%, Zzt=33Ω, 350mW	SOT-23	16dc	-	3a	Di
KK2	MMBZ5252BT	Z-diode	24V±5%, Zzt=33Ω, 150mW	SOT-523	16dc	-	3a	Di
KK2	MMBZ5252BW	Z-diode	24V±5%, Zzt=33Ω, 200mW	SOT-323	16dc	-	3a	Di
KK3	MMBZ5253B	Z-diode	25V±5%, Zzt=35Ω, 350mW	SOT-23	16dc	-	3a	Di
KK4	CZRT5254B-G	Z-diode	25.65..28.35V, Zzt=41Ω, lzt=5.0mA, 350mW	SOT-23	16dc	-	3a	Cmc
KK4	MMBZ5254B	Z-diode	27V±5%, Zzt=41Ω, 350mW	SOT-23	16dc	-	3a	Di
KK4	MMBZ5254BT	Z-diode	27V±5%, Zzt=41Ω, 150mW	SOT-523	16dc	-	3a	Di
KK4	MMBZ5254BW	Z-diode	27V±5%, Zzt=41Ω, 200mW	SOT-323	16dc	-	3a	Di
KK5	CZRT5255B-G	Z-diode	26.60..29.40V, Zzt=44Ω, lzt=4.5mA, 350mW	SOT-23	16dc	-	3a	Cmc
KK5	MMBZ5255B	Z-diode	28V±5%, Zzt=44Ω, 350mW	SOT-23	16dc	-	3a	Di
KK5	MMBZ5255BT	Z-diode	28V±5%, Zzt=44Ω, 150mW	SOT-523	16dc	-	3a	Di
KK5	MMBZ5255BW	Z-diode	28V±5%, Zzt=44Ω, 200mW	SOT-323	16dc	-	3a	Di
KL	2SA1510	Si-npn-Digi	Sw, 50V, 100mA, 200mW, 200MHz, B>100, R1=4.7k	CP	16ta	-	3a	San
KL	2SK2731	n-MOSFET-e*	V-MOS, LogL, 30V, 0.2A, <2.8Ω	SOT-23	16fh	-	3a	Rhm
kl	PT7M6224CHC3	Vdet-IC	2.4V±1.5%, +Reset PPO	SC-70	16vdc	VD7	3b	Pti
kl̄	PT7M6224CHC3E	Vdet-IC	2.4V±1.5%, +Reset PPO, Lead free	SC-70	16vdc	VD7	3b	Pti
kl	PT7M6224CHTA3	Vdet-IC	2.4V±1.5%, +Reset PPO	SOT-23	16vdb	VD7	3b	Pti
kl̄	PT7M6224CHTA3E	Vdet-IC	2.4V±1.5%, +Reset PPO, Lead free	SOT-23	16vdb	VD7	3b	Pti
KL	UNR32AN	Si-npn-Digi	Sw, 50V, 80mA, 100mW, 150MHz, R1/R2=4k7/47k	SSSMini3	18ta	-	3a	Pan
KL-	RT9818G-20PV	Vdet-IC	2.0V±1.5%, +Reset ODO, Td=220ms	SOT-23	16vda	VD6	3a	Rct
KL1	BAT54	Si-diode	SBR, 30V, 200mA, Vf<1V(100mA), <5ns	SOT-23	16dc	-	3a	Di
KL2	BAS54A	Si-diode	Dual, Schottky, 30V, 200mA, 200mW, <5ns	SOT-23	16df	-	3g	Vs
KL2	BAT54A	Si-diode	Dual, Schottky Rectifier, 30V, 200mA, Vf<1V(100mA), <5ns	SOT-23	16df	-	3a	Di
KL3	BAS54C	Si-diode	Dual, Schottky, 30V, 200mA, 200mW, <5ns	SOT-23	16dg	-	3g	Vs
KL3	BAT54B	Si-diode	Dual, Schottky, 30V, 200mA, Vf(If=100mA)<1V, <10pF, <5ns	SOT-23	16dg	-	3g	Vs
KL3	BAT54C	Si-diode	Dual, Schottky Rectifier, 30V, 200mA, Vf<1V(100mA), <5ns	SOT-23	16dg	-	3a	Di
KL3	BAT54CPT	Si-diode	Dual, SBD, 30V, 200mA, Vf<1V(100mA), 5ns	SOT-23	16dg	-	3a	Chm
KL31	BAV23S	Si-diode	Dual, GP, 200V, 225mA, Vs<1.25V(200mA), <50ns	SOT-23	16dl	-	3a	Di
KL4	BAS54C	Si-diode	Dual, Schottky, 30V, 200mA, 200mW, <5ns	SOT-23	16dl	-	3g	Vs
KL4	BAT54S	Si-diode	Dual, Schottky Rectifier, 30V, 200mA, Vf<1V(100mA), <5ns	SOT-23	16dl	-	3a	Di
KL4	CH425DPT	Si-diode	Dual, SBD, 40V, 100mA, Vf<0.55V(100mA)	SOT-23	16df	-	3a	Chm
KL5	CH705DPT	Si-diode	Dual, SBD, 40V, 30mA, Vf<0.37V(1mA)	SOT-23	16df	-	3a	Chm
KL6	BAT54AW	Si-diode	Dual, Schottky Rectifier, 30V, 200mA, Vf<1V(100mA), <5ns	SOT-323	16df	-	3a	Di
KL6	CHBD2004PT	Si-diode	Sw, 300V, 200mA, Vf<1V(100mA), 50ns	SOT-23	16dc	-	3a	Chm
KL7	BAT54CW	Si-diode	Dual, Schottky Rectifier, 30V, 200mA, Vf<1V(100mA), <5ns	SOT-323	16dg	-	3a	Di
KL7	CHBD2004APT	Si-diode	Dual, Sw, 300V, 200mA, Vf<1V(100mA), 50ns	SOT-23	16df	-	3a	Chm
KL8	BAT54SW	Si-diode	Dual, Schottky Rectifier, 30V, 200mA, Vf<1V(100mA), <5ns	SOT-323	16dl	-	3a	Di
KL9	CHBD2004SPT	Si-diode	Dual, Sw, 300V, 200mA, Vf<1V(100mA), 50ns	SOT-23	16dl	-	3a	Chm



SMD code	Type	Function	Short description	Case	Pinout	Sch.	St.	Mnf.
KLN	ELM7531CEB	Vdet-IC	3.1V±2%, +Reset PPO	SC-70	16vdb	VD7	3d	Elm
KLN	ELM7531NEB	Vdet-IC	3.1V±2%, +Reset ODO	SC-70	16vdb	VD6	3d	Elm
KLP	SDM20N40A	Si-diode	2x Schottky, 40V, 0.2A, 0.2W, Vf<0.55V(200mA), <50pF	SOT-23	16df	-	3c	Di
KM	2SK2009	n-MOSFET-e*	V-MOS, 30V, 0.2A, <2Q(50mA)	SOT-23	16fh	-	3a	Tos
KM	DDZX5V1B	Z-diode	5.1V±2.5%, 500mW	SOT-23	16dc	-	3a	Di
KM	DDZX5V1BW	Z-diode	5.1V±2.5%, 200mW	SOT-323	16dc	-	3a	Di
KM	DZ23C15	Z-diode	Dual, 13.8..15.6V, Izt=5mA, Zzt=11Q, 300mW	SOT-23	16dg	-	3a	Lge
km	PT7M6224NLC3	Vdet-IC	2.4V±1.5%, -Reset ODO	SC-70	16vdc	VD6	3b	Pti
km	PT7M6224NLC3E	Vdet-IC	2.4V±1.5%, -Reset ODO, Lead free	SC-70	16vdc	VD6	3b	Pti
km	PT7M6224NLTA3	Vdet-IC	2.4V±1.5%, -Reset ODO	SOT-23	16vdb	VD6	3b	Pti
km	PT7M6224NLTA3E	Vdet-IC	2.4V±1.5%, -Reset ODO, Lead free	SOT-23	16vdb	VD6	3b	Pti
KM-	RT9819C-20PV	Vdet-IC	2.0V±1.5%, -Reset PPO, Td=220ms	SOT-23	16vdc	VD7	3a	Rct
KM1	CZRT5256B-G	Z-diode	28.50..31.50V, Zzt=49Q, Izt=4.2mA, 350mW	SOT-23	16dc	-	3a	Cmc
KM1	MMBZ5256B	Z-diode	30V±5%, Zzt=49Q, 350mW	SOT-23	16dc	-	3a	Di
KM1	MMBZ5256BT	Z-diode	30V±5%, Zzt=49Q, 150mW	SOT-523	16dc	-	3a	Di
KM1	MMBZ5256BW	Z-diode	30V±5%, Zzt=49Q, 200mW	SOT-323	16dc	-	3a	Di
KM2	CZRT5257B-G	Z-diode	31.35..34.65V, Zzt=58Q, Izt=3.8mA, 350mW	SOT-23	16dc	-	3a	Cmc
KM2	MMBZ5257B	Z-diode	33V±5%, Zzt=58Q, 350mW	SOT-23	16dc	-	3a	Di
KM2	MMBZ5257BT	Z-diode	33V±5%, Zzt=58Q, 150mW	SOT-523	16dc	-	3a	Di
KM2	MMBZ5257BW	Z-diode	33V±5%, Zzt=58Q, 200mW	SOT-323	16dc	-	3a	Di
KM3	CZRT5258B-G	Z-diode	34.20..37.80V, Zzt=70Q, Izt=3.4mA, 350mW	SOT-23	16dc	-	3a	Cmc
KM3	MMBZ5258B	Z-diode	36V±5%, Zzt=70Q	SOT-23	16dc	-	3a	Di
KM3	MMBZ5258BT	Z-diode	36V±5%, Zzt=70Q, 150mW	SOT-523	16dc	-	3a	Di
KM3	MMBZ5258BW	Z-diode	36V±5%, Zzt=70Q, 200mW	SOT-323	16dc	-	3a	Di
KM4	CZRT5259B-G	Z-diode	37.05..40.95V, Zzt=80Q, Izt=3.2mA, 350mW	SOT-23	16dc	-	3a	Cmc
KM4	MMBZ5259B	Z-diode	39V±5%, Zzt=80Q, 350mW	SOT-23	16dc	-	3a	Di
KM4	MMBZ5259BT	Z-diode	39V±5%, Zzt=80Q, 150mW	SOT-523	16dc	-	3a	Di
KM4	MMBZ5259BW	Z-diode	39V±5%, Zzt=80Q, 200mW	SOT-323	16dc	-	3a	Di
KM5	CZRT5260B-G	Z-diode	40.85..45.15V, Zzt=93Q, Izt=3.0mA, 350mW	SOT-23	16dc	-	3a	Cmc
KN	2SC4983	Si-npn	AF, Amp, 15V, 200mA, 250mW, B=135..270, 200MHz	SOT-23	16ta	-	3a	Bel
KN	2SJ305	p-MOSFET-e*	V-MOS, 30V, 200mA, <4Q(0.05A)	SOT-23	16fh	-	3a	San
KN	2SK3018	n-MOSFET*	Sw, LogL, 30V, 0.1A, 200mW, 15/80ns, 5Q	UMT3	16fh	-	3a	Rhm
KN	2SK3019	n-MOSFET*	Sw, LogL, 30V, 0.1A, 200mW, 15/80ns, 5Q	SOT-416	16fh	-	3a	Rhm
KN	2SK3541	n-MOSFET*	Sw, LogL, 30V, 0.1A, 150mW, 15/80ns, 5Q	VMT3	16fh	-	3a	Rhm
KN	DDZX5V6B	Z-diode	5.6V±2.5%, 500mW	SOT-23	16dc	-	3a	Di
KN	DDZX5V6BW	Z-diode	5.6V±2.5%, 200mW	SOT-323	16dc	-	3a	Di
KN	DZ23C16	Z-diode	Dual, 15.3..17.1V, Izt=5mA, Zzt=13Q, 300mW	SOT-23	16dg	-	3a	Lge
kn	PT7M6225CLC3	Vdet-IC	2.5V±1.5%, -Reset PPO	SC-70	16vdc	VD7	3b	Pti
kn	PT7M6225CLC3E	Vdet-IC	2.5V±1.5%, -Reset PPO, Lead free	SC-70	16vdc	VD7	3b	Pti
kn	PT7M6225CLTA3	Vdet-IC	2.5V±1.5%, -Reset PPO	SOT-23	16vdb	VD7	3b	Pti
kn	PT7M6225CLTA3E	Vdet-IC	2.5V±1.5%, -Reset PPO, Lead free	SOT-23	16vdb	VD7	3b	Pti
KN-	RT9819C-22PV	Vdet-IC	2.2V±1.5%, -Reset PPO, Td=220ms	SOT-23	16vdc	VD7	3a	Rct
KN1	CZRT5261B-G	Z-diode	44.65..49.35V, Zzt=105Q, Izt=2.7mA, 350mW	SOT-23	16dc	-	3a	Cmc
KN2	CZRT5262B-G	Z-diode	48.45..53.55V, Zzt=125Q, Izt=2.5mA, 350mW	SOT-23	16dc	-	3a	Cmc
KN3	CZRT5263B-G	Z-diode	53.20..58.80V, Zzt=150Q, Izt=2.2mA, 350mW	SOT-23	16dc	-	3a	Cmc
KN4	CZRT5264B-G	Z-diode	57.0..63.0V, Zzt=170Q, Izt=2.1mA, 350mW	SOT-23	16dc	-	3a	Cmc
KN5	2SC4983-5	Si-npn	AF, Amp, 15V, 200mA, 250mW, B=135..270, 200MHz	SOT-23	16ta	-	3a	San
KN5	CZRT5265B-G	Z-diode	58.90..65.10V, Zzt=185Q, Izt=2.0mA, 350mW	SOT-23	16dc	-	3a	Cmc
KN6	2SC4983-6	Si-npn	AF, Amp, 15V, 200mA, 250mW, B=200..400, 200MHz	SOT-23	16ta	-	3a	San
KN7	2SC4983-7	Si-npn	AF, Amp, 15V, 200mA, 250mW, B=300..600, 200MHz	SOT-23	16ta	-	3a	San
KO	2SK881-O	n-FET	FM/VHF, 18V, 10mA, 100mW, Idss=1..3mA, Up<4V	SOT-323	16fk	-	3a	Tos
KO	AAT35621GY-3.10	Vdet-IC	3.1V±1.5%, -Reset ODO	SOT-23	16vdc	VD6	3b	Ant
KO	DDZX6V2B	Z-diode	6.2V±2.5%, 500mW	SOT-23	16dc	-	3a	Di
KO	DDZX6V2BW	Z-diode	6.2V±2.5%, 200mW	SOT-323	16dc	-	3a	Di
KO	HSMP-3830	PIN-diode	RF, 200V, 1A(1ms), <0.3pF, <1.5Q(100mA)	SOT-23	16dc	-	3a	Agi
ko	PT7M6225CHC3	Vdet-IC	2.5V±1.5%, +Reset PPO	SC-70	16vdc	VD7	3b	Pti
ko	PT7M6225CHC3E	Vdet-IC	2.5V±1.5%, +Reset PPO, Lead free	SC-70	16vdc	VD7	3b	Pti
ko	PT7M6225CHTA3	Vdet-IC	2.5V±1.5%, +Reset PPO	SOT-23	16vdb	VD7	3b	Pti
ko	PT7M6225CHTA3E	Vdet-IC	2.5V±1.5%, +Reset PPO, Lead free	SOT-23	16vdb	VD7	3b	Pti
KP	2SK2033	n-MOSFET-e	V-MOS, +Di(S>G), 20V, 100mA, <12Q(10mA)	SOT-23	16fh	-	3a	Tos
KP	2SK2034	n-MOSFET-e*	Sw, 20V, 100mA, 100mW, 8Q(10mA), 0.16/0/15µs	SC-70	16fh	-	3a	Tos
KP	2SK2035	n-MOSFET-e*	Sw, 20V, 100mA, 100mW, 8Q(10mA), 0.16/0/15µs	2-2H1B	16fh	-	3a	Tos
KP	DZ23C18	Z-diode	Dual, 16.8..19.1V, Izt=5mA, Zzt=18Q, 300mW	SOT-23	16dg	-	3a	Lge
kp	PT7M6225NLC3	Vdet-IC	2.5V±1.5%, -Reset ODO	SC-70	16vdc	VD6	3b	Pti
kp	PT7M6225NLC3E	Vdet-IC	2.5V±1.5%, -Reset ODO, Lead free	SC-70	16vdc	VD6	3b	Pti
kp	PT7M6225NLTA3	Vdet-IC	2.5V±1.5%, -Reset ODO	SOT-23	16vdb	VD6	3b	Pti
kp	PT7M6225NLTA3E	Vdet-IC	2.5V±1.5%, -Reset ODO, Lead free	SOT-23	16vdb	VD6	3b	Pti
KP	UNR32AV	Si-npn-Digi	Sw, 50V, 80mA, 100mW, 150MHz, R1/R2=2.2k/2.2k	SSSMini3	18ta	-	3a	Pan
KP-	RT9819B-26PV	Vdet-IC	2.6V±1.5%, -Reset PPO, Td=55ms	SOT-23	16vdc	VD7	3a	Rct
KP1	BZX84-C11W	Z-diode	11V±5%, 200mW	SOT-323	16dc	-	3a	Di



SMD code	Type	Function	Short description	Case	Pinout	Sch. St.	Mnf.
KP1	CZRT5266B-G	Z-diode	64.60..71.40V, Zzt=230Ω, Izt=1.8mA, 350mW	SOT-23	16dc	-	3a Cmc
KP1	CZRV3-55C11	Z-diode	11.0..11.60V, Zzt=20Ω, Izt=5mA, 200mW	SOT-323	18dc	-	3a Cmc
KP2	BZX84-C12W	Z-diode	12V±5%, 200mW	SOT-323	16dc	-	3a Di
KP2	CZRT5267B-G	Z-diode	71.25..78.75V, Zzt=270Ω, Izt=1.7mA, 350mW	SOT-23	16dc	-	3a Cmc
KP2	CZRV3-55C12	Z-diode	12.0..12.70V, Zzt=25Ω, Izt=5mA, 200mW	SOT-323	18dc	-	3a Cmc
KP3	BZX84-C13W	Z-diode	13V±5%, 200mW	SOT-323	16dc	-	3a Di
KP3	CZRV3-55C13	Z-diode	13.0..14.10V, Zzt=30Ω, Izt=5mA, 200mW	SOT-323	18dc	-	3a Cmc
KP4	BZX84-C15W	Z-diode	15V±5%, 200mW	SOT-323	16dc	-	3a Di
KP4	CZRV3-55C15	Z-diode	15.0..15.60V, Zzt=30Ω, Izt=5mA, 200mW	SOT-323	18dc	-	3a Cmc
KP5	BZX84-C16W	Z-diode	16V±5%, 200mW	SOT-323	16dc	-	3a Di
KP5	CZRV3-55C16	Z-diode	16.0..17.10V, Zzt=40Ω, Izt=5mA, 200mW	SOT-323	18dc	-	3a Cmc
KP6	BZX84-C18W	Z-diode	18V±5%, 200mW	SOT-323	16dc	-	3a Di
KP6	CZRV3-55C18	Z-diode	18.0..19.10V, Zzt=45Ω, Izt=5mA, 200mW	SOT-323	18dc	-	3a Cmc
KP7	BZX84-C20W	Z-diode	20V±5%, 200mW	SOT-323	16dc	-	3a Di
KP7	CZRV3-55C20	Z-diode	20.0..21.20V, Zzt=55Ω, Izt=5mA, 200mW	SOT-323	18dc	-	3a Cmc
KP8	BZX84-C22W	Z-diode	22V±5%, 200mW	SOT-323	16dc	-	3a Di
KP8	CZRV3-55C22	Z-diode	22.0..23.30V, Zzt=55Ω, Izt=5mA, 200mW	SOT-323	18dc	-	3a Cmc
KP9	BZX84-C24W	Z-diode	24V±5%, 200mW	SOT-323	16dc	-	3a Di
KP9	CZRV3-55C24	Z-diode	24.0..25.60V, Zzt=70Ω, Izt=5mA, 200mW	SOT-323	18dc	-	3a Cmc
KPA	BZX84-C27W	Z-diode	27V±5%, 200mW	SOT-323	16dc	-	3a Di
KPA	CZRV3-55C27	Z-diode	27.0..28.90V, Zzt=80Ω, Izt=2mA, 200mW	SOT-323	18dc	-	3a Cmc
KPB	BZX84-C30W	Z-diode	30V±5%, 200mW	SOT-323	16dc	-	3a Di
KPB	CZRV3-55C30	Z-diode	30.0..32.0V, Zzt=80Ω, Izt=2mA, 200mW	SOT-323	18dc	-	3a Cmc
KPC	BZX84-C33W	Z-diode	33V±5%, 200mW	SOT-323	16dc	-	3a Di
KPC	CZRV3-55C33	Z-diode	33.0..35.0V, Zzt=80Ω, Izt=2mA, 200mW	SOT-323	18dc	-	3a Cmc
KPD	BZX84-C36W	Z-diode	36V±5%, 200mW	SOT-323	16dc	-	3a Di
KPD	CZRV3-55C36	Z-diode	36.0..38.0V, Zzt=90Ω, Izt=2mA, 200mW	SOT-323	18dc	-	3a Cmc
KPE	BZX84-C39W	Z-diode	39V±5%, 200mW	SOT-323	16dc	-	3a Di
KPE	CZRV3-55C39	Z-diode	39.0..41.0V, Zzt=130Ω, Izt=2mA, 150mW	SOT-323	18dc	-	3a Cmc
KQ	2SJ343	p-MOSFET-e*	Sw, 50V, 50mA, 200mW, 20Ω, 0.15/0.13μs	SC-59	16fh	-	3a Tos
KQ	2SJ344	p-MOSFET-e*	Sw, 50V, 50mA, 100mW, 20Ω, 0.15/0.13μs	SOT-323	16fh	-	3a Tos
kq	PT7M6226CLC3	Vdet-IC	2.6V±1.5%, -Reset PPO	SC-70	16vdc	VD7	3b Pti
kq	PT7M6226CLC3E	Vdet-IC	2.6V±1.5%, -Reset PPO, Lead free	SC-70	16vdc	VD7	3b Pti
kq	PT7M6226CLTA3	Vdet-IC	2.6V±1.5%, -Reset PPO	SOT-23	16vdb	VD7	3b Pti
kq	PT7M6226CLTA3E	Vdet-IC	2.6V±1.5%, -Reset PPO, Lead free	SOT-23	16vdb	VD7	3b Pti
KQ-	RT9169-24PVL	LVR-IC	LDO, 2.4V±2%, 100mA	SOT-23	16cg	VR1	3a Rct
KR	A102WFT-2.5	LVR-IC	LDO, 2.5V±1.5%, 300mA	SOT-23	16cg	VR1	3b Adt
KR	DZ23C20	Z-diode	Dual, 18.8..21.2V, Izt=5mA, Zzt=20Ω, 300mW	SOT-23	16dg	-	3a Lge
kr	PT7M6226CHC3	Vdet-IC	2.6V±1.5%, +Reset PPO	SC-70	16vdc	VD7	3b Pti
kr	PT7M6226CHC3E	Vdet-IC	2.6V±1.5%, +Reset PPO, Lead free	SC-70	16vdc	VD7	3b Pti
kr	PT7M6226CHTA3	Vdet-IC	2.6V±1.5%, +Reset PPO	SOT-23	16vdb	VD7	3b Pti
kr	PT7M6226CHTA3E	Vdet-IC	2.6V±1.5%, +Reset PPO, Lead free	SOT-23	16vdb	VD7	3b Pti
KR-	RT9818A-15PV	Vdet-IC	1.5V±1.5%, -Reset ODO	SOT-23	16vda	VD6	3a Rct
KR1	BZX84-C47W	Z-diode	4.7V±5%, 200mW	SOT-323	16dc	-	3a Di
KR1	CZRV3-55C47	Z-diode	4.7..5.0V, Zzt=80Ω, Izt=5mA, 200mW	SOT-323	18dc	-	3a Cmc
KR2	BZX84-C51W	Z-diode	5.1V±5%, 200mW	SOT-323	16dc	-	3a Di
KR2	CZRV3-55C51	Z-diode	5.1..5.40V, Zzt=60Ω, Izt=5mA, 200mW	SOT-323	18dc	-	3a Cmc
KR3	BZX84-C56W	Z-diode	5.6V±5%, 200mW	SOT-323	16dc	-	3a Di
KR3	CZRV3-55C56	Z-diode	5.6..6.0V, Zzt=40Ω, Izt=5mA, 200mW	SOT-323	18dc	-	3a Cmc
KR4	BZX84-C62W	Z-diode	6.2V±5%, 200mW	SOT-323	16dc	-	3a Di
KR4	CZRV3-55C62	Z-diode	6.2..6.60V, Zzt=10Ω, Izt=5mA, 200mW	SOT-323	18dc	-	3a Cmc
KR5	BZX84-C68W	Z-diode	6.8V±5%, 200mW	SOT-323	16dc	-	3a Di
KR5	CZRV3-55C68	Z-diode	6.8..7.20V, Zzt=15Ω, Izt=5mA, 200mW	SOT-323	18dc	-	3a Cmc
KR6	BZX84-C75W	Z-diode	7.5V±5%, 200mW	SOT-323	16dc	-	3a Di
KR6	CZRV3-55C75	Z-diode	7.5..7.90V, Zzt=15Ω, Izt=5mA, 200mW	SOT-323	18dc	-	3a Cmc
KR7	BZX84-C82W	Z-diode	8.2V±5%, 200mW	SOT-323	16dc	-	3a Di
KR7	CZRV3-55C82	Z-diode	8.2..8.70V, Zzt=15Ω, Izt=5mA, 200mW	SOT-323	18dc	-	3a Cmc
KR8	BZX84-C91W	Z-diode	9.1V±5%, 200mW	SOT-323	16dc	-	3a Di
KR8	CZRV3-55C91	Z-diode	9.1..9.60V, Zzt=15Ω, Izt=5mA, 200mW	SOT-323	18dc	-	3a Cmc
KR9	BZX84-C10W	Z-diode	10V±5%, 200mW	SOT-323	16dc	-	3a Di
KR9	CZRV3-55C10	Z-diode	10.0..10.60V, Zzt=20Ω, Izt=5mA, 200mW	SOT-323	18dc	-	3a Cmc
KRB	BZX84-C2V4W	Z-diode	2.4V±5%, 200mW	SOT-323	16dc	-	3a Di
KRB	CZRV3-55C2V4	Z-diode	2.4..2.60V, Zzt=100Ω, Izt=5mA, 200mW	SOT-323	18dc	-	3a Cmc
KRC	BZX84-C2V7W	Z-diode	2.7V±5%, 200mW	SOT-323	16dc	-	3a Di
KRC	CZRV3-55C2V7	Z-diode	2.7..2.90V, Zzt=100Ω, Izt=5mA, 200mW	SOT-323	18dc	-	3a Cmc
KRD	BZX84-C3V0W	Z-diode	3V±5%, 200mW	SOT-323	16dc	-	3a Di
KRD	CZRV3-55C3V0	Z-diode	3.0..3.20V, Zzt=95Ω, Izt=5mA, 200mW	SOT-323	18dc	-	3a Cmc
KRE	BZX84-C3V3W	Z-diode	3.3V±5%, 200mW	SOT-323	16dc	-	3a Di
KRE	CZRV3-55C3V3	Z-diode	3.3..3.50V, Zzt=95Ω, Izt=5mA, 200mW	SOT-323	18dc	-	3a Cmc
KRF	BZX84-C3V6W	Z-diode	3.6V±5%, 200mW	SOT-323	16dc	-	3a Di



SMD code	Type	Function	Short description	Case	Pinout	Sch. St.	Mnf.
KRF	CZRV3-55C3V6	Z-diode	3.6..3.80V, Zzt=90Q, lzt=5mA, 200mW	SOT-323	18dc -	3a	Cmc
KRG	BZX84-C3V9W	Z-diode	3.9V±5%, 200mW	SOT-323	16dc -	3a	Di
KRG	CZRV3-55C3V9	Z-diode	3.9..4.10V, Zzt=90Q, lzt=5mA, 200mW	SOT-323	18dc -	3a	Cmc
KRH	BZX84-C4V3W	Z-diode	4.3V±5%, 200mW	SOT-323	16dc -	3a	Di
KRH	CZRV3-55C4V3	Z-diode	4.3..4.60V, Zzt=90Q, lzt=5mA, 200mW	SOT-323	18dc -	3a	Cmc
KS	2SA1813	Si-npn	AF-Drv, Mute, 30V, 150mA, 200mW, B=500..1200, 210MHz	MCP	16ta -	3a	San
KS	2SA1814	Si-pnp	AF, Mute, 30V, 150mA, 250mW, B=500..1200, 210MHz	SOT-23	16ta -	3a	San
KS	2SJ345	p-MOSFET-e	V-MOS, int.Di (G > S), 20V, 50MA, <40Q	SOT-23	16fh -	3a	Tos
ks	PT7M6226NLC3	Vdet-IC	2.6V±1.5%, -Reset ODO	SC-70	16vdc VD6	3b	Pti
ks	PT7M6226NLC3E	Vdet-IC	2.6V±1.5%, -Reset ODO, Lead free	SC-70	16vdc VD6	3b	Pti
ks	PT7M6226NLTA3	Vdet-IC	2.6V±1.5%, -Reset ODO	SOT-23	16vdb VD6	3b	Pti
ks	PT7M6226NLTA3E	Vdet-IC	2.6V±1.5%, -Reset ODO, Lead free	SOT-23	16vdb VD6	3b	Pti
KS	TCM810JVLB	Vdet-IC	4.0V±2%, +Reset PPO	SC-70	16vdc VD7	3b	Mcc
KS	TCM810JVNB	Vdet-IC	4.0V±2%, +Reset PPO	SOT-23	16vdc VD7	3b	Mcc
KS-	RT9819D-27PVL	Vdet-IC	2.7V±1.5%, -Reset PPO, Td=450ms	SOT-23	16vda VD7	3a	Rct
KSJ	BAT400D	Si-diode	SBR, 40V, 500mA, Vf<0.55V(500mA)	SOT-23	16dc -	3c	Di
KSS	SDM20E40C	Si-diode	2x Schottky, 40V, 0.4A, 0.4W, Vf<0.5V(200mA), <100pF	SC-59	16df -	3c	Di
KSW	SDM40E20LS	Si-diode	2x Schottky, Sw, 20V, 0.4A, Vf<0.43V(0.5A), 170pF	SOT-23	16dl -	3c	Di
KT	CHT4124PT	Si-npn	AF, Sw, 25V, 200mA, B=120..360, 300MHz	SOT-23	16ta -	3a	Chm
kt	PT7M6227CLC3	Vdet-IC	2.7V±1.5%, -Reset PPO	SC-70	16vdc VD7	3b	Pti
kt	PT7M6227CLC3E	Vdet-IC	2.7V±1.5%, -Reset PPO, Lead free	SC-70	16vdc VD7	3b	Pti
kt	PT7M6227CLTA3	Vdet-IC	2.7V±1.5%, -Reset PPO	SOT-23	16vdb VD7	3b	Pti
kt	PT7M6227CLTA3E	Vdet-IC	2.7V±1.5%, -Reset PPO, Lead free	SOT-23	16vdb VD7	3b	Pti
KT	TCM810ZVLB	Vdet-IC	2.32V±2%, +Reset PPO	SC-70	16vdc VD7	3b	Mcc
KT	UNR32A0	Si-npn-Digi	Sw, 50V, 80mA, 100mW, 150MHz, R1=47k	SSSMini3	18ta -	3a	Pan
KT1	BAS16W	Si-diode	Sw, Fast, 75V, 300mA, Vf<1.25V(150mA), <4ns, 2pF	SOT-323	16dc -	3a	Di
KT1	CHDTA144EKTPT	Si-pnp-Digi	Sw, 50V, 100mA, 250MHz, R1/R2=47/47k	SOT-23	16ta -	3a	Chm
KT1	MMBD4148W	Si-diode	Sw, Fast, 75V, 300mA, Vf<1.25V(150mA), <4ns, 2pF	SOT-323	16dc -	3a	Di
KT2	2SC4270-2	Si-npn	VHF/UHF-Osc, 25V, 50mA, 250mW, B=40..80, 3GHz	SOT-23	16ta -	3a	San
KT2	2SC4407-2	Si-npn	UHF, Mix/Osc, 25V, 50mA, 150mW, B=40..80, 3GHz	MCP	16ta -	3a	San
KT2	BAS19	Si-diode	Sw, Fast, 120V, 250mA, 250mW, <50ns	SOT-23	16dc -	3a	Di
KT2	BAS19W	Si-diode	Sw, Fast, 120V, 250mA, 250mW, <50ns	SOT-323	16dc -	3a	Di
KT2	BAS20	Si-diode	Sw, Fast, 150V, 250mA, 250mW, <50ns	SOT-23	16dc -	3a	Di
KT2	BAS20W	Si-diode	Sw, Fast, 150V, 250mA, 250mW, <50ns	SOT-323	16dc -	3a	Di
KT3	2SC4270-3	Si-npn	VHF/UHF-Osc, 25V, 50mA, 250mW, B=60..120, 3GHz	SOT-23	16ta -	3a	San
KT3	2SC4407-3	Si-npn	UHF, Mix/Osc, 25V, 50mA, 150mW, B=60..120, 3GHz	MCP	16ta -	3a	San
KT3	BAS19	Si-diode	Sw, Fast, 120V, 250mA, 250mW, <50ns	SOT-23	16dc -	3a	Di
KT3	BAS19W	Si-diode	Sw, Fast, 120V, 250mA, 250mW, <50ns	SOT-323	16dc -	3a	Di
KT3	BAS20	Si-diode	Sw, Fast, 150V, 250mA, 250mW, <50ns	SOT-23	16dc -	3a	Di
KT3	BAS20W	Si-diode	Sw, Fast, 150V, 250mA, 250mW, <50ns	SOT-323	16dc -	3a	Di
KT3	BAS21	Si-diode	Sw, Fast, 200V, 250mA, Vf=1V(0.1A), 250mW, <50ns	SOT-23	16dc -	3a	Di
KT3	BAS21W	Si-diode	Sw, Fast, 250V, 250mA, 250mW, <50ns	SOT-323	16dc -	3a	Di
KT4	2SC4270-4	Si-npn	VHF/UHF-Osc, 25V, 50mA, 250mW, B=100..200, 3GHz	SOT-23	16ta -	3a	San
KT4	2SC4407-4	Si-npn	UHF, Mix/Osc, 25V, 50mA, 150mW, B=100..200, 3GHz	MCP	16ta -	3a	San
KT6	BAV23C	Si-diode	Dual, GP, 200V, 225mA, Vs<1.25V(200mA), <50ns	SOT-23	16dg -	3a	Di
KT7	BAV23A	Si-diode	Dual, GP, 200V, 225mA, Vs<1.25V(200mA), <50ns	SOT-23	16df -	3a	Di
ku	PT7M6227CHC3	Vdet-IC	2.7V±1.5%, +Reset PPO	SC-70	16vdc VD7	3b	Pti
ku	PT7M6227CHC3E	Vdet-IC	2.7V±1.5%, +Reset PPO, Lead free	SC-70	16vdc VD7	3b	Pti
ku	PT7M6227CHTA3	Vdet-IC	2.7V±1.5%, +Reset PPO	SOT-23	16vdb VD7	3b	Pti
ku	PT7M6227CHTA3E	Vdet-IC	2.7V±1.5%, +Reset PPO, Lead free	SOT-23	16vdb VD7	3b	Pti
KJ	S3M3K02F	n-MOSFET-e*	LogL, 30V, 1A, <0.25Q(500mA)	SOT-23	16fh -	3a	Tos
KJ	TCM810RVLB	Vdet-IC	2.63V±2%, +Reset PPO	SC-70	16vdc VD7	3b	Mcc
KJ	TCM810RVNB	Vdet-IC	2.63V±2%, +Reset PPO	SOT-23	16vdc VD7	3b	Mcc
KJ-	RT9819E-27PV	Vdet-IC	2.7V±1.5%, +PPO +Reset	SOT-23	16vdc VD7	3a	Rct
KV	1SV264	PIN-diode	Dual, VHF/UHF, 50V, 50mA, 100mW, 0.23pF, 2.5Q(100MHz)	MCP	16dl -	3a	San
KV	1SV267	PIN-diode	Dual, VHF/UHF, 50V, 50mA, 100mW, 0.23pF, 2.5Q(100MHz)	SOT-23	16dl -	3a	San
KV	A102WFT-2.8	LVR-IC	LDO, 2.8V±1.5%, 300mA	SOT-23	16cg VR1	3b	Adt
kv	PT7M6227NLC3	Vdet-IC	2.7V±1.5%, -Reset ODO	SC-70	16vdc VD6	3b	Pti
kv	PT7M6227NLC3E	Vdet-IC	2.7V±1.5%, -Reset ODO, Lead free	SC-70	16vdc VD6	3b	Pti
kv	PT7M6227NLTA3	Vdet-IC	2.7V±1.5%, -Reset ODO	SOT-23	16vdb VD6	3b	Pti
kv	PT7M6227NLTA3E	Vdet-IC	2.7V±1.5%, -Reset ODO, Lead free	SOT-23	16vdb VD6	3b	Pti
KV	TCM810SVLB	Vdet-IC	2.93V±2%, +Reset PPO	SC-70	16vdc VD7	3b	Mcc
KV	TCM810SVNB	Vdet-IC	2.93V±2%, +Reset PPO	SOT-23	16vdc VD7	3b	Mcc
KV-	RT9819E-40PV	Vdet-IC	4.0V±1.5%, +PPO +Reset	SOT-23	16vdc VD7	3a	Rct
KV1	DZ23C2V7	Z-diode	Dual, 2.5..2.9V, lzt=5mA, Zzt=75Q, 300mW	SOT-23	16dg -	3c	Di
KV2	DZ23C3V0	Z-diode	Dual, 2.8..3.2V, lzt=5mA, Zzt=80Q, 300mW	SOT-23	16dg -	3c	Di
KV3	DZ23C3V3	Z-diode	Dual, 3.1..3.5V, lzt=5mA, Zzt=80Q, 300mW	SOT-23	16dg -	3c	Di
KV4	DZ23C3V6	Z-diode	Dual, 3.4..3.8V, lzt=5mA, Zzt=80Q, 300mW	SOT-23	16dg -	3c	Di
KV5	DZ23C3V9	Z-diode	Dual, 3.7..4.1V, lzt=5mA, Zzt=80Q, 300mW	SOT-23	16dg -	3c	Di
KV6	DZ23C4V3	Z-diode	Dual, 4.0..4.6V, lzt=5mA, Zzt=80Q, 300mW	SOT-23	16dg -	3c	Di



SMD code	Type	Function	Short description	Case	Pinout	Sch.	St.	Mnf.
KV7	DZ23C4V7	Z-diode	Dual, 4.4..5.0V, Izt=5mA, Zzt=70Ω, 300mW	SOT-23	16dg	-	3c	Di
KV8	DZ23C5V1	Z-diode	Dual, 4.8..5.4V, Izt=5mA, Zzt=30Ω, 300mW	SOT-23	16dg	-	3c	Di
KV9	DZ23C5V6	Z-diode	Dual, 5.2..6.0V, Izt=5mA, Zzt=10Ω, 300mW	SOT-23	16dg	-	3c	Di
KVA	DZ23C6V2	Z-diode	Dual, 5.8..6.6V, Izt=5mA, Zzt=4.8Ω, 300mW	SOT-23	16dg	-	3c	Di
KVB	DZ23C6V8	Z-diode	Dual, 6.4..7.2V, Izt=5mA, Zzt=4.5Ω, 300mW	SOT-23	16dg	-	3c	Di
KVC	DZ23C7V5	Z-diode	Dual, 7.0..7.9V, Izt=5mA, Zzt=4Ω, 300mW	SOT-23	16dg	-	3c	Di
KVD	DZ23C8V2	Z-diode	Dual, 7.7..8.7V, Izt=5mA, Zzt=4.5Ω, 300mW	SOT-23	16dg	-	3c	Di
KVE	DZ23C9V1	Z-diode	Dual, 8.5..9.6V, Izt=5mA, Zzt=4.8Ω, 300mW	SOT-23	16dg	-	3c	Di
KVF	DZ23C10	Z-diode	Dual, 9.4..10.6V, Izt=5mA, Zzt=5.2Ω, 300mW	SOT-23	16dg	-	3c	Di
KVG	DZ23C11	Z-diode	Dual, 10.4..11.6V, Izt=5mA, Zzt=6Ω, 300mW	SOT-23	16dg	-	3c	Di
KVH	DZ23C12	Z-diode	Dual, 11.4..12.7V, Izt=5mA, Zzt=7Ω, 300mW	SOT-23	16dg	-	3c	Di
KVI	DZ23C13	Z-diode	Dual, 12.4..14.1V, Izt=5mA, Zzt=9Ω, 300mW	SOT-23	16dg	-	3c	Di
KVJ	DZ23C15	Z-diode	Dual, 13.8..15.6V, Izt=5mA, Zzt=11Ω, 300mW	SOT-23	16dg	-	3c	Di
KVK	DZ23C16	Z-diode	Dual, 15.3..17.1V, Izt=5mA, Zzt=13Ω, 300mW	SOT-23	16dg	-	3c	Di
KVL	DZ23C18	Z-diode	Dual, 16.8..19.1V, Izt=5mA, Zzt=18Ω, 300mW	SOT-23	16dg	-	3c	Di
KVM	DZ23C20	Z-diode	Dual, 18.8..21.2V, Izt=5mA, Zzt=20Ω, 300mW	SOT-23	16dg	-	3c	Di
KVN	DZ23C22	Z-diode	Dual, 20.8..23.3V, Izt=5mA, Zzt=25Ω, 300mW	SOT-23	16dg	-	3c	Di
KVO	DZ23C24	Z-diode	Dual, 22.8..25.6V, Izt=5mA, Zzt=28Ω, 300mW	SOT-23	16dg	-	3c	Di
KVP	DZ23C27	Z-diode	Dual, 25.1..28.9V, Izt=5mA, Zzt=30Ω, 300mW	SOT-23	16dg	-	3c	Di
KVQ	DZ23C30	Z-diode	Dual, 28.0..32.0V, Izt=5mA, Zzt=35Ω, 300mW	SOT-23	16dg	-	3c	Di
KVR	DZ23C33	Z-diode	Dual, 31.0..35.0V, Izt=5mA, Zzt=40Ω, 300mW	SOT-23	16dg	-	3c	Di
KVS	DZ23C36	Z-diode	Dual, 34.0..38.0V, Izt=5mA, Zzt=40Ω, 300mW	SOT-23	16dg	-	3c	Di
KVT	DZ23C39	Z-diode	Dual, 37.0..41.0V, Izt=5mA, Zzt=50Ω, 300mW	SOT-23	16dg	-	3c	Di
KVU	DZ23C43	Z-diode	Dual, 40.0..46.0V, Izt=5mA, Zzt=60Ω, 300mW	SOT-23	16dg	-	3c	Di
KVV	DZ23C47	Z-diode	Dual, 44.0..50.0V, Izt=5mA, Zzt=70Ω, 300mW	SOT-23	16dg	-	3c	Di
KVW	DZ23C51	Z-diode	Dual, 48.0..54.0V, Izt=5mA, Zzt=70Ω, 300mW	SOT-23	16dg	-	3c	Di
KW	DDZX13B	Z-diode	13V±2.5%, 500mW	SOT-23	16dc	-	3a	Di
KW	DDZX13BW	Z-diode	13V±2.5%, 200mW	SOT-323	16dc	-	3a	Di
kw	PT7M6228CLC3	Vdet-IC	2.8V±1.5%, -Reset PPO	SC-70	16vdc	VD7	3b	Pti
kw	PT7M6228CLC3E	Vdet-IC	2.8V±1.5%, -Reset PPO, Lead free	SC-70	16vdc	VD7	3b	Pti
kw	PT7M6228CLTA3	Vdet-IC	2.8V±1.5%, -Reset PPO	SOT-23	16vdb	VD7	3b	Pti
kw	PT7M6228CLTA3E	Vdet-IC	2.8V±1.5%, -Reset PPO, Lead free	SOT-23	16vdb	VD7	3b	Pti
KW	SSM3K01F	n-MOSFET-e*	Logl, 30V, 1.3A, <0.15Q(0.650mA)	SOT-23	16fh	-	3a	Tos
KW-	RT9161-42PV	LVR-IC	LDO, 4.3V±2%, 300mA	SOT-23	16cg	VR1	3a	Rct
KX	A102WFT-3.0	LVR-IC	LDO, 3.0V±1.5%, 300mA	SOT-23	16cg	VR1	3b	Adt
KX	DZ23C22	Z-diode	Dual, 20.8..23.3V, Izt=5mA, Zzt=25Ω, 300mW	SOT-23	16dg	-	3a	Lge
kx	PT7M6228CHC3	Vdet-IC	2.8V±1.5%, +Reset PPO	SC-70	16vdc	VD7	3b	Pti
kx	PT7M6228CHC3E	Vdet-IC	2.8V±1.5%, +Reset PPO, Lead free	SC-70	16vdc	VD7	3b	Pti
kx	PT7M6228CHTA3	Vdet-IC	2.8V±1.5%, +Reset PPO	SOT-23	16vdb	VD7	3b	Pti
kx	PT7M6228CHTA3E	Vdet-IC	2.8V±1.5%, +Reset PPO, Lead free	SOT-23	16vdb	VD7	3b	Pti
KX	TCM810TVLB	Vdet-IC	3.08V±2%, +Reset PPO	SC-70	16vdc	VD7	3b	Mcc
KX	TCM810TVNB	Vdet-IC	3.08V±2%, +Reset PPO	SOT-23	16vdc	VD7	3b	Mcc
KX-	RT9819C-40PV	Vdet-IC	4.0V±1.5%, -Reset PPO, Td=220ms	SOT-23	16vdc	VD7	3a	Rct
KX2	MMTT2222A	Si-npn	GP, 75V, 600mA, 330mW, B=120..360, >300MHz	SOT-23	16ta	-	3d	Di
KY	25K881-Y	n-FET	FM/VHF, 18V, 10mA, 100mW, Idss=2.5..6mA, Up<4V	SOT-323	16fk	-	3a	Tos
KY	A102WFT-3.1	LVR-IC	LDO, 3.1V±1.5%, 300mA	SOT-23	16cg	VR1	3b	Adt
KY	DZ23C24	Z-diode	Dual, 22.8..25.6V, Izt=5mA, Zzt=28Ω, 300mW	SOT-23	16dg	-	3a	Lge
ky	PT7M6228NLC3	Vdet-IC	2.8V±1.5%, -Reset ODO	SC-70	16vdc	VD6	3b	Pti
ky	PT7M6228NLC3E	Vdet-IC	2.8V±1.5%, -Reset ODO, Lead free	SC-70	16vdc	VD6	3b	Pti
ky	PT7M6228NLTA3	Vdet-IC	2.8V±1.5%, -Reset ODO	SOT-23	16vdb	VD6	3b	Pti
ky	PT7M6228NLTA3E	Vdet-IC	2.8V±1.5%, -Reset ODO, Lead free	SOT-23	16vdb	VD6	3b	Pti
KY	TCM810MVLB	Vdet-IC	4.38V±2%, +Reset PPO	SC-70	16vdc	VD7	3b	Mcc
KY	TCM810MVNB	Vdet-IC	4.38V±2%, +Reset PPO	SOT-23	16vdc	VD7	3b	Mcc
KY1	BZX84-C11	Z-diode	11V±5%, 300mW	SOT-23	16dc	-	3a	Di
KY2	2SC3771-2	Si-npn	VHF/UHF, 30V, 30mA, 250mW, 2.2GHz, B=40..80	SOT-23	16ta	-	3a	San
KY2	BZX84-C12	Z-diode	12V±5%, 300mW	SOT-23	16dc	-	3a	Di
KY3	2SC3771-3	Si-npn	VHF/UHF, 30V, 30mA, 250mW, 2.2GHz, B=60..120	SOT-23	16ta	-	3a	San
KY3	BZX84-C13	Z-diode	13V±5%, 300mW	SOT-23	16dc	-	3a	Di
KY4	2SC3771-4	Si-npn	VHF/UHF, 30V, 30mA, 250mW, 2.2GHz, B=100..200	SOT-23	16ta	-	3a	San
KY4	BZX84-C15	Z-diode	15V±5%, 300mW	SOT-23	16dc	-	3a	Di
KY5	BZX84-C16	Z-diode	16V±5%, 300mW	SOT-23	16dc	-	3a	Di
KY6	BZX84-C18	Z-diode	18V±5%, 300mW	SOT-23	16dc	-	3a	Di
KY7	BZX84-C20	Z-diode	20V±5%, 300mW	SOT-23	16dc	-	3a	Di
KY8	BZX84-C22	Z-diode	20.8..23.3V, Zzt=55Ω, Izt=20mA, 300mW	SOT-23	16dc	-	3a	Di
KY9	BZX84-C24	Z-diode	24V±5%, 300mW	SOT-23	16dc	-	3a	Di
KYA	BZX84-C27	Z-diode	27V±5%, 300mW	SOT-23	16dc	-	3a	Di
KYB	BZX84-C30	Z-diode	30V±5%, 300mW	SOT-23	16dc	-	3a	Di
KYC	BZX84-C33	Z-diode	33V±5%, 300mW	SOT-23	16dc	-	3a	Di
KYD	BZX84-C36	Z-diode	36V±5%, 300mW	SOT-23	16dc	-	3a	Di
KYE	BZX84-C39	Z-diode	39V±5%, 300mW	SOT-23	16dc	-	3a	Di



SMD code	Type	Function	Short description	Case	Pinout	Sch. St.	Mnf.
KYF	BZX84-C43	Z-diode	43V±5%, 300mW	SOT-23	16dc	-	3a Di
KYG	BZX84-C47	Z-diode	47V±5%, 300mW	SOT-23	16dc	-	3a Di
KYH	BZX84-C51	Z-diode	51V±5%, 300mW	SOT-23	16dc	-	3a Di
KZ	DZ23C27	Z-diode	Dual, 25.1..28.9V, Izt=5mA, Zzt=30Ω, 300mW	SOT-23	16dg	-	3a Lge
kz	PT7M6229CLC3	Vdet-IC	2.9V±1.5%, -Reset PPO	SC-70	16vdc	VD7	3b Pti
kz	PT7M6229CLC3E	Vdet-IC	2.9V±1.5%, -Reset PPO, Lead free	SC-70	16vdc	VD7	3b Pti
kz	PT7M6229CLTA3	Vdet-IC	2.9V±1.5%, -Reset PPO	SOT-23	16vdb	VD7	3b Pti
kz	PT7M6229CLTA3E	Vdet-IC	2.9V±1.5%, -Reset PPO, Lead free	SOT-23	16vdb	VD7	3b Pti
KZ	TCM810VLVB	Vdet-IC	4.63V±2%, +Reset PPO	SC-70	16vdc	VD7	3b Mcc
KZ	TCM810LVNB	Vdet-IC	4.63V±2%, +Reset PPO	SOT-23	16vdc	VD7	3b Mcc
KZ	UNR3ZAT	Si-nprn-Digi	Sw, 50V, 80mA, 100mW, 150MHz, R1/R2=22k/47k	SSSMini3	18ta	-	3a Pan
KZ-	RT9818C-26PV	Vdet-IC	2.6V±1.5%, -Reset ODO, Td=220ms	SOT-23	16vda	VD6	3a Rct
KZ1	BZX84-C4V7	Z-diode	4.7V±5%, 300mW	SOT-23	16dc	-	3a Di
KZ2	BZX84-C5V1	Z-diode	5.1V±5%, 300mW	SOT-23	16dc	-	3a Di
KZ3	BZX84-C5V6	Z-diode	5.6V±5%, 300mW	SOT-23	16dc	-	3a Di
KZ4	BZX84-C6V2	Z-diode	6.2V±5%, 300mW	SOT-23	16dc	-	3a Di
KZ5	BZX84-C6V8	Z-diode	6.8V±5%, 300mW	SOT-23	16dc	-	3a Di
KZ6	BZX84-C7V5	Z-diode	7.5V±5%, 300mW	SOT-23	16dc	-	3a Di
KZ7	BZX84-C8V2	Z-diode	8.2V±5%, 300mW	SOT-23	16dc	-	3a Di
KZ8	BZX84-C9V1	Z-diode	9.1V±5%, 300mW	SOT-23	16dc	-	3a Di
KZ9	BZX84-C10	Z-diode	10V±5%, 300mW	SOT-23	16dc	-	3a Di
KZB	BZX84-C2V4	Z-diode	2.4V±5%, 300mW	SOT-23	16dc	-	3a Di
KZC	BZX84-C2V7	Z-diode	2.7V±5%, 300mW	SOT-23	16dc	-	3a Di
KZD	BZX84-C3V0	Z-diode	3V±5%, 300mW	SOT-23	16dc	-	3a Di
KZE	BZX84-C3V3	Z-diode	3.3V±5%, 300mW	SOT-23	16dc	-	3a Di
KZF	BZX84-C3V6	Z-diode	3.6V±5%, 300mW	SOT-23	16dc	-	3a Di
KZG	BZX84-C3V9	Z-diode	3.9V±5%, 300mW	SOT-23	16dc	-	3a Di
KZH	BZX84-C4V3	Z-diode	4.3V±5%, 300mW	SOT-23	16dc	-	3a Di
I	AX6902EA	Vdet-IC	2.93V±1.5%, +Reset PPO	SC-70	16vdc	VD7	3b Axl
L	SB02W03C	Si-diode	Dual, SBR, HF, 30V, 200mA, Vf<0.55V(200mA), 6.3pF, 10ns	CP	16dg	-	3a San
L0	BAT721S	Si-diode	Dual, Schottky, Sw, U-Fst, 40V, 0.2A, Vf<0.55V(0.2A), <0.3ns	SOT-23	16dl	-	3a PHH
L0	ELM7620LAB	Vdet-IC	2.0V±2%, -Reset PPO, 250ms	SOT-23	16vdc	VD7	3d Elm
L0	HSMF-386B	PIIN-diode	RF, 50V, 1A, Rs(typ)=3Ω, 0.2pF	SOT-323	16dc	-	3a Agi
L0	R3111N302C	Vdet-IC	3V±2%, -Reset ODO	SOT-23	16vdd	VD6	3d Ric
L0	R3130N40AC	Vdet-IC	4V, -Reset ODO, 50ms	SOT-23	16vdc	VD6	3b Ric
L0	RN1101FS	Si-nprn-Digi	Sw, 20V, 50mA, 50mW, R1/R2=4.7k/4.7k	fSM	19ta	-	3a Tos
L0	XC6GN1002HR	Vdet-IC	1.0V, +Reset ODO	USP-3	17vdc	VD1	9b Tor
L0-	RT9819B-29PV	Vdet-IC	2.9V±1.5%, -Reset PPO, Td=55ms	SOT-23	16vdc	VD7	3a Rct
L05	ZLLS500TA	Si-diode	SBR, 40V, 700mA, Vf<0.63V(750mA)	SOT-23	16dc	-	3a Zx
L05	ZLLS500TC	Si-diode	SBR, 40V, 700mA, Vf<0.63V(750mA)	SOT-23	16dc	-	3a Zx
L09	82C09-AE3-5	Vdet-IC	0.9V±2% -Reset PPO	SOT-23	16vdb	VD7	3a Utc
L09G	82C09G-AE3-5	Vdet-IC	0.9V±2% -Reset PPO, halogen free	SOT-23	16vdb	VD7	3a Utc
L09L	82C09L-AE3-5	Vdet-IC	0.9V±2% -Reset PPO, lead free	SOT-23	16vdb	VD7	3a Utc
L0A	LM3480IM3-3.3	LVR-IC	Quasi-LDO, 3.3V, 100mA	SOT-23	16cj	VR1	3d Nsc
L0B	LM3480IM3-5.0	LVR-IC	Quasi-LDO, 5V, 100mA	SOT-23	16cj	VR1	3d Nsc
L0C	LM3480IM3-12	LVR-IC	Quasi-LDO, 12V, 100mA	SOT-23	16cj	VR1	3d Nsc
L0D	LM3480IM3-15	LVR-IC	Quasi-LDO, 15V, 100mA	SOT-23	16cj	VR1	3d Nsc
L0p	BAT721S	Si-diode	Dual, Schottky, Sw, U-Fst, 40V, 0.2A, Vf<0.55V(0.2A), <0.3ns	SOT-23	16dl	-	3a PHH
L0t	BAT721S	Si-diode	Dual, Schottky, Sw, U-Fst, 40V, 0.2A, Vf<0.55V(0.2A), <0.3ns	SOT-23	16dl	-	3a PhM
L0W	BAT721S	Si-diode	Dual, Schottky, Sw, U-Fst, 40V, 0.2A, Vf<0.55V(0.2A), <0.3ns	SOT-23	16dl	-	3a PhC
L1	BFS36	Si-nprn	AF, LN, 45V, 0.5A, >30MHz	SOT-323	16te	-	3a Fer
L1	BSS85	Si-pnp	Sw, 12V, 100mA, 400MHz, <60/90ns	SOT-23	16ta	-	3a Fer
L1	ELM7621LAB	Vdet-IC	2.1V±2%, -Reset PPO, 250ms	SOT-23	16vdc	VD7	3d Elm
L1	R3111N312C	Vdet-IC	3.1V±2%, -Reset ODO	SOT-23	16vdd	VD6	3d Ric
L1	R3130N44AC	Vdet-IC	4.4V, -Reset ODO, 50ms	SOT-23	16vdc	VD6	3b Ric
L1	RN1102FS	Si-nprn-Digi	Sw, 20V, 50mA, 50mW, R1/R2=10k/10k	fSM	19ta	-	3a Tos
L1	RT9819E-23PV	Vdet-IC	2.3V±1.5%, +PPO +Reset	SOT-23	16vdc	VD7	3a Rct
L1	XC6GN1102HR	Vdet-IC	1.1V, +Reset ODO	USP-3	17vdc	VD1	9b Tor
L10	82C10-AE3-5	Vdet-IC	1.0V±2% -Reset PPO	SOT-23	16vdb	VD7	3a Utc
L10	ZLLS1000TA	Si-diode	SBR, 40V, 1.6A, Vf<0.66V(1.5A)	SOT-23	16dc	-	3a Zx
L10	ZLLS1000TC	Si-diode	SBR, 40V, 1.6A, Vf<0.66V(1.5A)	SOT-23	16dc	-	3a Zx
L10G	82C10G-AE3-5	Vdet-IC	1.0V±2% -Reset PPO, halogen free	SOT-23	16vdb	VD7	3a Utc
L10L	82C10L-AE3-5	Vdet-IC	1.0V±2% -Reset PPO, lead free	SOT-23	16vdb	VD7	3a Utc
L11	82C11-AE3-5	Vdet-IC	1.1V±2% -Reset PPO	SOT-23	16vdb	VD7	3a Utc
L11G	82C11G-AE3-5	Vdet-IC	1.1V±2% -Reset PPO, halogen free	SOT-23	16vdb	VD7	3a Utc
L11L	82C11L-AE3-5	Vdet-IC	1.1V±2% -Reset PPO, lead free	SOT-23	16vdb	VD7	3a Utc
L12	82C12-AE3-5	Vdet-IC	1.2V±2% -Reset PPO	SOT-23	16vdb	VD7	3a Utc
L12G	82C12G-AE3-5	Vdet-IC	1.2V±2% -Reset PPO, halogen free	SOT-23	16vdb	VD7	3a Utc
L12L	82C12L-AE3-5	Vdet-IC	1.2V±2% -Reset PPO, lead free	SOT-23	16vdb	VD7	3a Utc
L13	82C13-AE3-5	Vdet-IC	1.3V±2% -Reset PPO	SOT-23	16vdb	VD7	3a Utc



SMD code	Type	Function	Short description	Case	Pinout	Sch. St.	Mnf.
L13G	82C13G-AE3-5	Vdet-IC	1.3V±2% -Reset PPO, halogen free	SOT-23	16vdb	VD7	3a Utc
L13L	82C13L-AE3-5	Vdet-IC	1.3V±2% -Reset PPO, lead free	SOT-23	16vdb	VD7	3a Utc
L14	82C14-AE3-5	Vdet-IC	1.4V±2% -Reset PPO	SOT-23	16vdb	VD7	3a Utc
L14	DTB114GK	Si-npn-Digi	Sw, 50V, 500mA, 200mW, 200MHz, R2=10k	SOT-346	16ta	-	3a Rhm
L14G	82C14G-AE3-5	Vdet-IC	1.4V±2% -Reset PPO, halogen free	SOT-23	16vdb	VD7	3a Utc
L14L	82C14L-AE3-5	Vdet-IC	1.4V±2% -Reset PPO, lead free	SOT-23	16vdb	VD7	3a Utc
L15	25C3624A-15	Si-npn	AF-Amp, Sw, 60V, 150mA, 200mW, 250MHz, B=1000.2000	SOT-23	16ta	-	3a Nec
L15	25C4181A-15	Si-npn	AF, Sw, 60V, 150mA, 150mW, B=1000.2000, 250MHz	SOT-323	16ta	-	3a Nec
L15	82C15-AE3-5	Vdet-IC	1.5V±2% -Reset PPO	SOT-23	16vdb	VD7	3a Utc
L15G	82C15G-AE3-5	Vdet-IC	1.5V±2% -Reset PPO, halogen free	SOT-23	16vdb	VD7	3a Utc
L15L	82C15L-AE3-5	Vdet-IC	1.5V±2% -Reset PPO, lead free	SOT-23	16vdb	VD7	3a Utc
L16	25C3624A-16	Si-npn	AF-Amp, Sw, 60V, 150mA, 200mW, 250MHz, B=1600.3200	SOT-23	16ta	-	3a Nec
L16	25C4181A-16	Si-npn	AF, Sw, 60V, 150mA, 150mW, B=1600.3200, 250MHz	SOT-323	16ta	-	3a Nec
L16	82C16-AE3-5	Vdet-IC	1.6V±2% -Reset PPO	SOT-23	16vdb	VD7	3a Utc
L16G	82C16G-AE3-5	Vdet-IC	1.6V±2% -Reset PPO, halogen free	SOT-23	16vdb	VD7	3a Utc
L16L	82C16L-AE3-5	Vdet-IC	1.6V±2% -Reset PPO, lead free	SOT-23	16vdb	VD7	3a Utc
L17	25C3624-17	Si-npn	AF-Amp, Sw, 60V, 150mA, 200mW, 250MHz, B=1000.2000	SOT-23	16ta	-	3a Nec
L17	25C4181-17	Si-npn	AF, Sw, 60V, 150mA, 150mW, B=1000.2000, 250MHz	SOT-323	16ta	-	3a Nec
L17	82C17-AE3-5	Vdet-IC	1.7V±2% -Reset PPO	SOT-23	16vdb	VD7	3a Utc
L17G	82C17G-AE3-5	Vdet-IC	1.7V±2% -Reset PPO, halogen free	SOT-23	16vdb	VD7	3a Utc
L17L	82C17L-AE3-5	Vdet-IC	1.7V±2% -Reset PPO, lead free	SOT-23	16vdb	VD7	3a Utc
L18	25C3624-18	Si-npn	AF-Amp, Sw, 60V, 150mA, 200mW, 250MHz, B=160.3200	SOT-23	16ta	-	3a Nec
L18	25C4181-18	Si-npn	AF, Sw, 60V, 150mA, 150mW, B=1600.3200, 250MHz	SOT-323	16ta	-	3a Nec
L18	82C18-AE3-5	Vdet-IC	1.8V±2% -Reset PPO	SOT-23	16vdb	VD7	3a Utc
L18G	82C18G-AE3-5	Vdet-IC	1.8V±2% -Reset PPO, halogen free	SOT-23	16vdb	VD7	3a Utc
L18L	82C18L-AE3-5	Vdet-IC	1.8V±2% -Reset PPO, lead free	SOT-23	16vdb	VD7	3a Utc
L19	82C19-AE3-5	Vdet-IC	1.9V±2% -Reset PPO	SOT-23	16vdb	VD7	3a Utc
L19	SJ73L19S	Vdet-IC	1.9V±5% -Reset OCO	SOT-23	16vda	VD6	3b Kau
L19G	82C19G-AE3-5	Vdet-IC	1.9V±2% -Reset PPO, halogen free	SOT-23	16vdb	VD7	3a Utc
L19L	82C19L-AE3-5	Vdet-IC	1.9V±2% -Reset PPO, lead free	SOT-23	16vdb	VD7	3a Utc
L2	BAS40-06	Si-diode	Dual, Schottky, 40V, 200mA, 200mW, Cd<5pF, <5ns	SOT-23	16df	-	3a Ons
L2	BSS69	Si-npn	Sw, 40V, 100mA, 200MHz, <75/225ns, B>50	SOT-23	16ta	-	3a Fer
L2	ELM7622LAB	Vdet-IC	2.2V±2% -Reset PPO, 250ms	SOT-23	16vdc	VD7	3d Elm
L2	HSMP-3862	PIN-diode	Dual, RF, 50V, 1A(1ms), <0.2pF, <3Ω(100mA)	SOT-23	16dl	-	3a Agi
L2	HSMP-386C	PIN-diode	Dual, RF, 50V, 1A, Rs(typ)=3Ω, 0.2pF	SOT-323	16dgg	-	3a Agi
L2	KTC4075-2	Si-npn	AF, 60V, 150mA, 100mW, B=70.140, >80MHz	SOT-323	16ta	-	3f Kec
L2	R3111N322C	Vdet-IC	3.2V±2% -Reset ODO	SOT-23	16vdd	VD6	3d Ric
L2	R3130N26AC3	Vdet-IC	2.6V, -Reset ODO, 50ms	SOT-23	16vdc	VD6	3b Ric
L2	RN1103FS	Si-npn-Digi	Sw, 20V, 50mA, 50mW, R1/R2=22k/22k	fSM	19ta	-	3a Tos
L2	XC6GN1202HR	Vdet-IC	1.2V, +Reset ODO	USP-3	17vdc	VD1	9b Tor
L2-	RT9819E-24PV	Vdet-IC	2.4V±1.5%, +PPO +Reset	SOT-23	16vdc	VD7	3a Rct
L20	82C20-AE3-5	Vdet-IC	2.0V±2% -Reset PPO	SOT-23	16vdb	VD7	3a Utc
L20	BAS29	Si-diode	GP, Contr, Avalanche, 90V, 250mA, 250mW, 35pF, <50ns	SOT-23	16dc	-	3a Nsc
L20	KSK211	n-FET	VHF/FM, 18V, 200mW, Idss=1mA, Up<4V	SOT-23	16fk	-	3a Sam
L20G	82C20G-AE3-5	Vdet-IC	2.0V±2% -Reset PPO, halogen free	SOT-23	16vdb	VD7	3a Utc
L20L	82C20L-AE3-5	Vdet-IC	2.0V±2% -Reset PPO, lead free	SOT-23	16vdb	VD7	3a Utc
L21	82C21-AE3-5	Vdet-IC	2.1V±2% -Reset PPO	SOT-23	16vdb	VD7	3a Utc
L21	BAS31	Si-diode	Dual, GP, Contr, Aval., 90V, 250mA, 250mW, 35pF, <50ns	SOT-23	16dl	-	3a Nsc
L21	GS810C21EUA	Vdet-IC	2.1V, +Reset PPO, 1.5ms	SOT-23	16vdc	VD7	3g Vs
L21	SJ73L21S	Vdet-IC	2.1V±5% -Reset OCO	SOT-23	16vda	VD6	3b Kau
L21G	82C21G-AE3-5	Vdet-IC	2.1V±2% -Reset PPO, halogen free	SOT-23	16vdb	VD7	3a Utc
L21L	82C21L-AE3-5	Vdet-IC	2.1V±2% -Reset PPO, lead free	SOT-23	16vdb	VD7	3a Utc
L22	82C22-AE3-5	Vdet-IC	2.2V±2% -Reset PPO	SOT-23	16vdb	VD7	3a Utc
L22	BAS35	Si-diode	Dual, GP, Contr, Aval., 90V, 250mA, 250mW, 35pF, <50ns	SOT-23	16df	-	3a Nsc
L22G	82C22G-AE3-5	Vdet-IC	2.2V±2% -Reset PPO, halogen free	SOT-23	16vdb	VD7	3a Utc
L22L	82C22L-AE3-5	Vdet-IC	2.2V±2% -Reset PPO, lead free	SOT-23	16vdb	VD7	3a Utc
L23	82C23-AE3-5	Vdet-IC	2.3V±2% -Reset PPO	SOT-23	16vdb	VD7	3a Utc
L23	SJ73L23S	Vdet-IC	2.3V±5% -Reset OCO	SOT-23	16vda	VD6	3b Kau
L23G	82C23G-AE3-5	Vdet-IC	2.3V±2% -Reset PPO, halogen free	SOT-23	16vdb	VD7	3a Utc
L23L	82C23L-AE3-5	Vdet-IC	2.3V±2% -Reset PPO, lead free	SOT-23	16vdb	VD7	3a Utc
L24	82C24-AE3-5	Vdet-IC	2.4V±2% -Reset PPO	SOT-23	16vdb	VD7	3a Utc
L24	DTD114GK	Si-npn-Digi	Sw, 50V, 500mA, 200mW, 200MHz, R2=10k	SOT-346	16ta	-	3a Rhm
L24	GS810C24EUA	Vdet-IC	2.4V, +Reset PPO, 1.5ms	SOT-23	16vdc	VD7	3g Vs
L24G	82C24G-AE3-5	Vdet-IC	2.4V±2% -Reset PPO, halogen free	SOT-23	16vdb	VD7	3a Utc
L24L	82C24L-AE3-5	Vdet-IC	2.4V±2% -Reset PPO, lead free	SOT-23	16vdb	VD7	3a Utc
L25	82C25-AE3-5	Vdet-IC	2.5V±2% -Reset PPO	SOT-23	16vdb	VD7	3a Utc
L25	SJ73L25S	Vdet-IC	2.5V±5% -Reset OCO	SOT-23	16vda	VD6	3b Kau
L25G	82C25G-AE3-5	Vdet-IC	2.5V±2% -Reset PPO, halogen free	SOT-23	16vdb	VD7	3a Utc
L25L	82C25L-AE3-5	Vdet-IC	2.5V±2% -Reset PPO, lead free	SOT-23	16vdb	VD7	3a Utc
L26	82C26-AE3-5	Vdet-IC	2.6V±2% -Reset PPO	SOT-23	16vdb	VD7	3a Utc



SMD code	Type	Function	Short description	Case	Pinout	Sch. St.	Mnf.
L26	GS810CREUA	Vdet-IC	2.63V, +Reset PPO, 1.5ms	SOT-23	16vdc	VD7	3g Vs
L26G	82C26G-AE3-5	Vdet-IC	2.6V±2% -Reset PPO, halogen free	SOT-23	16vdb	VD7	3a Utc
L26L	82C26L-AE3-5	Vdet-IC	2.6V±2% -Reset PPO, lead free	SOT-23	16vdb	VD7	3a Utc
L27	82C27-AE3-5	Vdet-IC	2.7V±2% -Reset PPO	SOT-23	16vdc	VD7	3a Utc
L27	GS810C27SEUA	Vdet-IC	2.7V, +Reset PPO, 1.5ms	SOT-23	16vdc	VD7	3g Vs
L27	SJ73L27S	Vdet-IC	2.7V±5%, -Reset OCO	SOT-23	16vda	VD6	3b Kau
L27G	82C27G-AE3-5	Vdet-IC	2.7V±2% -Reset PPO, halogen free	SOT-23	16vdb	VD7	3a Utc
L27L	82C27L-AE3-5	Vdet-IC	2.7V±2% -Reset PPO, lead free	SOT-23	16vdb	VD7	3a Utc
L28	82C28-AE3-5	Vdet-IC	2.8V±2% -Reset PPO	SOT-23	16vdb	VD7	3a Utc
L28G	82C28G-AE3-5	Vdet-IC	2.8V±2% -Reset PPO, halogen free	SOT-23	16vdb	VD7	3a Utc
L28L	82C28L-AE3-5	Vdet-IC	2.8V±2% -Reset PPO, lead free	SOT-23	16vdb	VD7	3a Utc
L29	82C29-AE3-5	Vdet-IC	2.9V±2% -Reset PPO	SOT-23	16vdb	VD7	3a Utc
L29	GS810CSEUA	Vdet-IC	2.93V, +Reset PPO, 1.5ms	SOT-23	16vdc	VD7	3g Vs
L29	SJ73L29S	Vdet-IC	2.9V±5%, -Reset OCO	SOT-23	16vda	VD6	3b Kau
L29G	82C29G-AE3-5	Vdet-IC	2.9V±2% -Reset PPO, halogen free	SOT-23	16vdb	VD7	3a Utc
L29L	82C29L-AE3-5	Vdet-IC	2.9V±2% -Reset PPO, lead free	SOT-23	16vdb	VD7	3a Utc
L3	25C1623-3	Si-npn	GP, 60V, 100mA, 200mW, 250MHz, B=60..120	SOT-23	16ta	-	3a Nec
L3	BFS37	Si-npn	AF, LN, 45V, 0.5A, >30MHz	SOT-323	16te	-	3a Fer
L3	BSS70	Si-npn	Sw, 40V, 100mA, 330mW, B=100..300, >250MHz	SOT-23	16ta	-	3a Zx
L3	ELM7623LAB	Vdet-IC	2.3V±2%, -Reset PPO, 250ms	SOT-23	16vdc	VD7	3d Elm
L3	HSMP-3863	PIN-diode	Dual, RF, 50V, 1A(1ms), <0.2pF, <3Ω(100mA)	SOT-23	16df	-	3a Agi
L3	HSMP-386E	PIN-diode	Dual, RF, 50V, 1A, Rs(typ)=3Ω, 0.2pF	SOT-323	16df	-	3a Agi
L3	KST1623-L3	Si-npn	GP, 50V, 100mA, 350mW, B=60..120, >200MHz	SOT-23	16ta	-	3a Sam
L3	MMBC1623L3	Si-npn	GP, AF, 50V, 100mA, 350mW, B=60..120, >200MHz	SOT-23	16ta	-	3a Sam
L3	R3111N332C	Vdet-IC	3.3V±2%, -Reset ODO	SOT-23	16vdd	VD6	3d Ric
L3	R3130N29AC3	Vdet-IC	2.9V, -Reset ODO, 50ms	SOT-23	16vdc	VD6	3b Ric
L3	RN1104FS	Si-npn-Digi	Sw, 20V, 50mA, 50mW, R1/R2=47k/47k	fSM	19ta	-	3a Tos
L3	RT9819E-25PV	Vdet-IC	2.5V±1.5%, +PPO +Reset	SOT-23	16vdc	VD7	3a Rct
L3	XC6GN1302HR	Vdet-IC	1.3V, +Reset ODO	USP-3	17vdc	VD1	9b Tor
L30	82C30-AE3-5	Vdet-IC	3.0V±2% -Reset PPO	SOT-23	16vdb	VD7	3a Utc
L30	FA1L4L	Si-npn-Digi	Sw, 60V, 100mA, 200mW, R1/R2=10k/22k	SC-59	16ta	-	3a Nec
L30	GA1L4L	Si-npn-Digi	Sw, 60V, 100mA, 200mW, R1/R2=10k/22k	SOT-323	16ta	-	3a Nec
L30	GS810CTEUA	Vdet-IC	3.08V, +Reset PPO, 1.5ms	SOT-23	16vdc	VD7	3g Vs
L30G	82C30G-AE3-5	Vdet-IC	3.0V±2% -Reset PPO, halogen free	SOT-23	16vdb	VD7	3a Utc
L30L	82C30L-AE3-5	Vdet-IC	3.0V±2% -Reset PPO, lead free	SOT-23	16vdb	VD7	3a Utc
L31	82C31-AE3-5	Vdet-IC	3.1V±2% -Reset PPO	SOT-23	16vdb	VD7	3a Utc
L31	BAV23S	Si-diode	Dual, GP, 200V, 225mA, Vs<1.25V(200mA), <50ns	SOT-23	16dl	-	3a Phi
L31	FA1L4M	Si-npn-Digi	Sw, 60V, 100mA, 200mW, R1/R2=47k/47k	SC-59	16ta	-	3a Nec
L31	GA1L4M	Si-npn-Digi	Sw, 60V, 100mA, 200mW, R1/R2=47k/47k	SOT-323	16ta	-	3a Nec
L31	SJ73L31S	Vdet-IC	3.1V±5%, -Reset OCO	SOT-23	16vda	VD6	3b Kau
L31G	82C31G-AE3-5	Vdet-IC	3.1V±2% -Reset PPO, halogen free	SOT-23	16vdb	VD7	3a Utc
L31L	82C31L-AE3-5	Vdet-IC	3.1V±2% -Reset PPO, lead free	SOT-23	16vdb	VD7	3a Utc
L32	82C32-AE3-5	Vdet-IC	3.2V±2% -Reset PPO	SOT-23	16vdb	VD7	3a Utc
L32	FA1F4M	Si-npn-Digi	Sw, 60V, 100mA, 200mW, R1/R2=22k/22k	SC-59	16ta	-	3a Nec
L32	GA1F4M	Si-npn-Digi	Sw, 60V, 100mA, 200mW, R1/R2=22k/22k	SOT-323	16ta	-	3a Nec
L32	SJ73L32S	Vdet-IC	3.2V±5%, -Reset OCO	SOT-23	16vda	VD6	3b Kau
L32G	82C32G-AE3-5	Vdet-IC	3.2V±2% -Reset PPO, halogen free	SOT-23	16vdb	VD7	3a Utc
L32L	82C32L-AE3-5	Vdet-IC	3.2V±2% -Reset PPO, lead free	SOT-23	16vdb	VD7	3a Utc
L33	82C33-AE3-5	Vdet-IC	3.3V±2% -Reset PPO	SOT-23	16vdb	VD7	3a Utc
L33	FA1A4M	Si-npn-Digi	Sw, 60V, 100mA, 200mW, R1/R2=10k/10k	SC-59	16ta	-	3a Nec
L33	GA1A4M	Si-npn-Digi	Sw, 60V, 100mA, 200mW, R1/R2=10k/10k	SOT-323	16ta	-	3a Nec
L33	SJ73L33S	Vdet-IC	3.3V±5%, -Reset OCO	SOT-23	16vda	VD6	3b Kau
L33G	82C33G-AE3-5	Vdet-IC	3.3V±2% -Reset PPO, halogen free	SOT-23	16vdb	VD7	3a Utc
L33L	82C33L-AE3-5	Vdet-IC	3.3V±2% -Reset PPO, lead free	SOT-23	16vdb	VD7	3a Utc
L34	82C34-AE3-5	Vdet-IC	3.4V±2% -Reset PPO	SOT-23	16vdb	VD7	3a Utc
L34	FA1A4P	Si-npn-Digi	Sw, 60V, 100mA, 200mW, R1/R2=10k/47k	SC-59	16ta	-	3a Nec
L34	GA1A4P	Si-npn-Digi	Sw, 60V, 100mA, 200mW, R1/R2=10k/47k	SOT-323	16ta	-	3a Nec
L34	SJ73L34S	Vdet-IC	3.4V±5%, -Reset OCO	SOT-23	16vda	VD6	3b Kau
L34G	82C34G-AE3-5	Vdet-IC	3.4V±2% -Reset PPO, halogen free	SOT-23	16vdb	VD7	3a Utc
L34L	82C34L-AE3-5	Vdet-IC	3.4V±2% -Reset PPO, lead free	SOT-23	16vdb	VD7	3a Utc
L35	82C35-AE3-5	Vdet-IC	3.5V±2% -Reset PPO	SOT-23	16vdb	VD7	3a Utc
L35	FA1F4N	Si-npn-Digi	Sw, 60V, 100mA, 200mW, R1/R2=22k/47k	SC-59	16ta	-	3a Nec
L35	GA1F4N	Si-npn-Digi	Sw, 60V, 100mA, 200mW, R1/R2=22k/47k	SOT-323	16ta	-	3a Nec
L35	SJ73L35S	Vdet-IC	3.5V±5%, -Reset OCO	SOT-23	16vda	VD6	3b Kau
L35G	82C35G-AE3-5	Vdet-IC	3.5V±2% -Reset PPO, halogen free	SOT-23	16vdb	VD7	3a Utc
L35L	82C35L-AE3-5	Vdet-IC	3.5V±2% -Reset PPO, lead free	SOT-23	16vdb	VD7	3a Utc
L36	82C36-AE3-5	Vdet-IC	3.6V±2% -Reset PPO	SOT-23	16vdb	VD7	3a Utc
L36	FA1L3Z-K	Si-npn-Digi	Sw, 60V, 100mA, 200mW, R1=4k7, B=135..270	SC-59	16ta	-	3a Nec
L36	GA1L3Z-O	Si-npn-Digi	Sw, 60V, 100mA, 200mW, R1=4k7, B=200..400	SOT-323	16ta	-	3a Nec
L36	SJ73L36S	Vdet-IC	3.6V±5%, -Reset OCO	SOT-23	16vda	VD6	3b Kau



SMD code	Type	Function	Short description	Case	Pinout	Sch.	St.	Mnf.
L36G	82C36G-AE3-5	Vdet-IC	3.6V±2% -Reset PPO, halogen free	SOT-23	16vdb	VD7	3a	Utc
L36L	82C36L-AE3-5	Vdet-IC	3.6V±2% -Reset PPO, lead free	SOT-23	16vdb	VD7	3a	Utc
L37	82C37-AE3-5	Vdet-IC	3.7V±2% -Reset PPO	SOT-23	16vdb	VD7	3a	Utc
L37	FA1L3Z-P	Si-npn-Digi	Sw, 60V, 100mA, 200mW, R1=4k7, B=200..400	SC-59	16ta	-	3a	Nec
L37	GA1L3Z-P	Si-npn-Digi	Sw, 60V, 100mA, 200mW, R1=4k7, B=135..270	SOT-323	16ta	-	3a	Nec
L37G	82C37G-AE3-5	Vdet-IC	3.7V±2% -Reset PPO, halogen free	SOT-23	16vdb	VD7	3a	Utc
L37L	82C37L-AE3-5	Vdet-IC	3.7V±2% -Reset PPO, lead free	SOT-23	16vdb	VD7	3a	Utc
L38	82C38-AE3-5	Vdet-IC	3.8V±2% -Reset PPO	SOT-23	16vdb	VD7	3a	Utc
L38	FA1L3Z-Q	Si-npn-Digi	Sw, 60V, 100mA, 200mW, R1=4k7, B=300..600	SC-59	16ta	-	3a	Nec
L38	GA1L3Z-K	Si-npn-Digi	Sw, 60V, 100mA, 200mW, R1=4k7, B=135..270	SOT-323	16ta	-	3a	Nec
L38G	82C38G-AE3-5	Vdet-IC	3.8V±2% -Reset PPO, halogen free	SOT-23	16vdb	VD7	3a	Utc
L38L	82C38L-AE3-5	Vdet-IC	3.8V±2% -Reset PPO, lead free	SOT-23	16vdb	VD7	3a	Utc
L39	82C39-AE3-5	Vdet-IC	3.9V±2% -Reset PPO	SOT-23	16vdb	VD7	3a	Utc
L39	SJ73L39S	Vdet-IC	3.9V±5%, -Reset OCO	SOT-23	16vda	VD6	3b	Kau
L39G	82C39G-AE3-5	Vdet-IC	3.9V±2% -Reset PPO, halogen free	SOT-23	16vdb	VD7	3a	Utc
L39L	82C39L-AE3-5	Vdet-IC	3.9V±2% -Reset PPO, lead free	SOT-23	16vdb	VD7	3a	Utc
L4	25C1623-4	Si-npn	GP, 60V, 100mA, 200mW, 250MHz, B=90..180	SOT-23	16ta	-	3a	Nec
L4	25C1623A-4	Si-npn	GP, 60V, 100mA, 200mW, 250MHz, B=90..180	SOT-23	16ta	-	3a	Nec
L4	25C2812-4	Si-npn	GP, AF, 55V, 150mA, 200mW, B=90..180, 100MHz	CPA	16ta	-	3a	San
L4	25C4177-4	Si-npn	AF, 60V, 100mA, 150mW, B=90..180, 250MHz	SOT-323	16ta	-	3a	Nec
L4	25C4783-4	Si-npn	Hi-beta, 60V, 200mA, 200mW, 250MHz, B=90..180	SOT-416	16ta	-	3a	Nec
L4	BAT54	Si-diode	SBR, 30V, 200mA, Vf<1V(100mA), <5ns	SOT-23	16dc	-	3g	Vs
L4	BAT54W	Si-diode	SBR, 30V, 200mA, Vf<0.52V(100mA), <5ns	SOT-323	16dc	-	3a	Phi
L4	ELM7624LAB	Vdet-IC	2.4V±2%, -Reset PPO, 250ms	SOT-23	16vdc	VD7	3d	Elm
L4	HSMP-3864	PIN-diode	Dual, RF, 50V, 1A(1ms), <0.2pF, <3Ω(100mA)	SOT-23	16dg	-	3a	Agi
L4	HSMP-386F	PIN-diode	Dual, RF, 50V, 1A, Rs(typ)=3Ω, 0.2pF	SOT-323	16dg	-	3a	Agi
L4	KST1623-L4	Si-npn	GP, 50V, 100mA, 350mW, B=90..180, >200MHz	SOT-23	16ta	-	3a	Sam
L4	KTC4075-4	Si-npn	AF, 60V, 150mA, 100mW, B=120..240, >80MHz	SOT-323	16ta	-	3f	Kec
L4	MMBC1623L4	Si-npn	GP, AF, 50V, 100mA, 350mW, B=100..200, >200MHz	SOT-23	16ta	-	3a	Sam
L4	R3111N342C	Vdet-IC	3.4V±2%, -Reset ODO	SOT-23	16vdd	VD6	3d	Ric
L4	R3130N30AC8	Vdet-IC	3V, -Reset ODO, 50ms	SOT-23	16vdc	VD6	3b	Ric
L4	RN1105FS	Si-npn-Digi	Sw, 20V, 50mA, 50mW, R1/R2=2.2k/47k	f5M	19ta	-	3a	Tos
L4	RT9819E-26PV	Vdet-IC	2.6V±1.5%, +PPO +Reset	SOT-23	16vdc	VD7	3a	Rct
L4	XC6GN1402HR	Vdet-IC	1.4V, +Reset ODO	USP-3	17vdc	VD1	9b	Tor
L40	82C40-AE3-5	Vdet-IC	4.0V±2% -Reset PPO	SOT-23	16vdb	VD7	3a	Utc
L40	GS810CJEUA	Vdet-IC	4V, +Reset PPO, 1.5ms	SOT-23	16vdc	VD7	3g	Vs
L40G	82C40G-AE3-5	Vdet-IC	4.0V±2% -Reset PPO, halogen free	SOT-23	16vdb	VD7	3a	Utc
L40L	82C40L-AE3-5	Vdet-IC	4.0V±2% -Reset PPO, lead free	SOT-23	16vdb	VD7	3a	Utc
L41	82C41-AE3-5	Vdet-IC	4.1V±2% -Reset PPO	SOT-23	16vdb	VD7	3a	Utc
L41G	82C41G-AE3-5	Vdet-IC	4.1V±2% -Reset PPO, halogen free	SOT-23	16vdb	VD7	3a	Utc
L41L	82C41L-AE3-5	Vdet-IC	4.1V±2% -Reset PPO, lead free	SOT-23	16vdb	VD7	3a	Utc
L42	82C42-AE3-5	Vdet-IC	4.2V±2% -Reset PPO	SOT-23	16vdb	VD7	3a	Utc
L42	BAT54A	Si-diode	Dual, Schottky Rectifier, 30V, 200mA, Vf<1V(100mA), <5ns	SOT-23	16df	-	3a	Nsc
L42	SJ73L42S	Vdet-IC	4.2V±5%, -Reset OCO	SOT-23	16vda	VD6	3b	Kau
L42G	82C42G-AE3-5	Vdet-IC	4.2V±2% -Reset PPO, halogen free	SOT-23	16vdb	VD7	3a	Utc
L42L	82C42L-AE3-5	Vdet-IC	4.2V±2% -Reset PPO, lead free	SOT-23	16vdb	VD7	3a	Utc
L43	82C43-AE3-5	Vdet-IC	4.3V±2% -Reset PPO	SOT-23	16vdb	VD7	3a	Utc
L43	BAT54B	Si-diode	Dual, Schottky, 30V, 200mA, Vf(If=100mA)<1V, 10pF, <5ns	SOT-23	16dg	-	3g	Vs
L43	BAT54C	Si-diode	Dual, Schottky Rectifier, 30V, 200mA, Vf<1V(100mA), <5ns	SOT-23	16dg	-	3a	Nsc
L43	GS810CMEUA	Vdet-IC	4.38V, +Reset PPO, 1.5ms	SOT-23	16vdc	VD7	3g	Vs
L43G	82C43G-AE3-5	Vdet-IC	4.3V±2% -Reset PPO, halogen free	SOT-23	16vdb	VD7	3a	Utc
L43L	82C43L-AE3-5	Vdet-IC	4.3V±2% -Reset PPO, lead free	SOT-23	16vdb	VD7	3a	Utc
L44	82C44-AE3-5	Vdet-IC	4.4V±2% -Reset PPO	SOT-23	16vdb	VD7	3a	Utc
L44	BAT54S	Si-diode	Dual, Schottky Rectifier, 30V, 200mA, Vf<1V(100mA), <5ns	SOT-23	16dl	-	3a	Nsc
L44G	82C44G-AE3-5	Vdet-IC	4.4V±2% -Reset PPO, halogen free	SOT-23	16vdb	VD7	3a	Utc
L44L	82C44L-AE3-5	Vdet-IC	4.4V±2% -Reset PPO, lead free	SOT-23	16vdb	VD7	3a	Utc
L45	82C45-AE3-5	Vdet-IC	4.5V±2% -Reset PPO	SOT-23	16vdb	VD7	3a	Utc
L45	SJ73L45S	Vdet-IC	4.5V±5%, -Reset OCO	SOT-23	16vda	VD6	3b	Kau
L45G	82C45G-AE3-5	Vdet-IC	4.5V±2% -Reset PPO, halogen free	SOT-23	16vdb	VD7	3a	Utc
L45L	82C45L-AE3-5	Vdet-IC	4.5V±2% -Reset PPO, lead free	SOT-23	16vdb	VD7	3a	Utc
L46	82C46-AE3-5	Vdet-IC	4.6V±2% -Reset PPO	SOT-23	16vdb	VD7	3a	Utc
L46	GS810CLEUA	Vdet-IC	4.63V, +Reset PPO, 1.5ms	SOT-23	16vdc	VD7	3g	Vs
L46G	82C46G-AE3-5	Vdet-IC	4.6V±2% -Reset PPO, halogen free	SOT-23	16vdb	VD7	3a	Utc
L46L	82C46L-AE3-5	Vdet-IC	4.6V±2% -Reset PPO, lead free	SOT-23	16vdb	VD7	3a	Utc
L47	82C47-AE3-5	Vdet-IC	4.7V±2% -Reset PPO	SOT-23	16vdb	VD7	3a	Utc
L47G	82C47G-AE3-5	Vdet-IC	4.7V±2% -Reset PPO, halogen free	SOT-23	16vdb	VD7	3a	Utc
L47L	82C47L-AE3-5	Vdet-IC	4.7V±2% -Reset PPO, lead free	SOT-23	16vdb	VD7	3a	Utc
L48	82C48-AE3-5	Vdet-IC	4.8V±2% -Reset PPO	SOT-23	16vdb	VD7	3a	Utc
L48G	82C48G-AE3-5	Vdet-IC	4.8V±2% -Reset PPO, halogen free	SOT-23	16vdb	VD7	3a	Utc
L48L	82C48L-AE3-5	Vdet-IC	4.8V±2% -Reset PPO, lead free	SOT-23	16vdb	VD7	3a	Utc



SMD code	Type	Function	Short description	Case	Pinout	Sch.	St.	Mnf.
L49	82C49-AE3-5	Vdet-IC	4.9V±2% -Reset PPO	SOT-23	16vdb	VD7	3a	Utc
L49G	82C49G-AE3-5	Vdet-IC	4.9V±2% -Reset PPO, halogen free	SOT-23	16vdb	VD7	3a	Utc
L49L	82C49L-AE3-5	Vdet-IC	4.9V±2% -Reset PPO, lead free	SOT-23	16vdb	VD7	3a	Utc
L4p	BAT54	Si-diode	SBR, 30V, 200mA, Vf<1V(100mA), <5ns	SOT-23	16dc	-	3a	PHH
L4t	BAT54	Si-diode	SBR, 30V, 200mA, Vf<1V(100mA), <5ns	SOT-23	16dc	-	3a	PHM
L4w	BAT54	Si-diode	SBR, 30V, 200mA, Vf<1V(100mA), <5ns	SOT-23	16dc	-	3a	PHC
L4Z	BAT54	Si-diode	SBR, 30V, 200mA, Vf<1V(100mA), <5ns	SOT-23	16dc	-	3a	Zx
L5	2SC1623-5	Si-npn	GP, 60V, 100mA, 200mW, 250MHz, B=135..270	SOT-23	16ta	-	3a	Nec
L5	2SC1623A-5	Si-npn	GP, 60V, 100mA, 200mW, 250MHz, B=135..270	SOT-23	16ta	-	3a	Nec
L5	2SC2812-5	Si-npn	GP, AF, 55V, 150mA, 200mW, B=135..270, 100MHz	CPA	16ta	-	3a	San
L5	2SC4177-5	Si-npn	AF, 60V, 100mA, 150mW, B=135..270, 250MHz	SOT-323	16ta	-	3a	Nec
L5	2SC4211-5	Si-npn	GP, 55V, 150mA, 150mW, 200MHz, B=135..270	SOT-323	16ta	-	3a	Nec
L5	2SC4783-5	Si-npn	Hi-beta, 60V, 200mA, 200mW, 250MHz, B=135..270	SOT-416	16ta	-	3a	Nec
L5	BFT27	Si-npn	AF, 60V, 0.5A, >30MHz	SOT-323	16te	-	3a	Fer
L5	BSS85R	Si-npn	Switching, 12V, 100mA, 330mW, B=40..150, >400MHz	SOT-23	16te	-	3a	Zx
L5	ELM7625LAB	Vdet-IC	2.5V±2%, -Reset PPO, 250ms	SOT-23	16vdc	VD7	3d	Elm
L5	KST1623-L5	Si-npn	GP, 50V, 100mA, 350mW, B=135..270, >200MHz	SOT-23	16ta	-	3a	Sam
L5	MMBC1623L5	Si-npn	GP, AF, 50V, 100mA, 350mW, B=135..270, >200MHz	SOT-23	16ta	-	3a	Sam
L5	R3111N352C	Vdet-IC	3.5V±2%, -Reset ODO	SOT-23	16vdd	VD6	3d	Ric
L5	R3130N46AC5	Vdet-IC	4.6V, -Reset ODO, 50ms	SOT-23	16vdc	VD6	3b	Ric
L5	RN1106FS	Si-npn-Digi	Sw, 20V, 50mA, 50mW, R1/R2=4.7k/47k	fSM	19ta	-	3a	Tos
L5	XC6GN150ZHR	Vdet-IC	1.5V, +Reset ODO	USP-3	17vdc	VD1	9b	Tor
L5-	RT9818B-31PV	Vdet-IC	3.1V±1.5%, -Reset ODO, Td=55ms	SOT-23	16vda	VD6	3a	Rct
L50	82C50-AE3-5	Vdet-IC	5.0V±2% -Reset PPO	SOT-23	16vdb	VD7	3a	Utc
L50G	82C50G-AE3-5	Vdet-IC	5.0V±2% -Reset PPO, halogen free	SOT-23	16vdb	VD7	3a	Utc
L50L	82C50L-AE3-5	Vdet-IC	5.0V±2% -Reset PPO, lead free	SOT-23	16vdb	VD7	3a	Utc
L51	82C51-AE3-5	Vdet-IC	5.1V±2% -Reset PPO	SOT-23	16vdb	VD7	3a	Utc
L51G	82C51G-AE3-5	Vdet-IC	5.1V±2% -Reset PPO, halogen free	SOT-23	16vdb	VD7	3a	Utc
L51L	82C51L-AE3-5	Vdet-IC	5.1V±2% -Reset PPO, lead free	SOT-23	16vdb	VD7	3a	Utc
L52	82C52-AE3-5	Vdet-IC	5.2V±2% -Reset PPO	SOT-23	16vdb	VD7	3a	Utc
L52	BAS678	Si-diode	Sw, Fast, 80V, 250mA, Vf<1V(100mA), <6ns	SOT-23	16dc	-	3a	Phi
L52G	82C52G-AE3-5	Vdet-IC	5.2V±2% -Reset PPO, halogen free	SOT-23	16vdb	VD7	3a	Utc
L52L	82C52L-AE3-5	Vdet-IC	5.2V±2% -Reset PPO, lead free	SOT-23	16vdb	VD7	3a	Utc
L53	82C53-AE3-5	Vdet-IC	5.3V±2% -Reset PPO	SOT-23	16vdb	VD7	3a	Utc
L53G	82C53G-AE3-5	Vdet-IC	5.3V±2% -Reset PPO, halogen free	SOT-23	16vdb	VD7	3a	Utc
L53L	82C53L-AE3-5	Vdet-IC	5.3V±2% -Reset PPO, lead free	SOT-23	16vdb	VD7	3a	Utc
L54	82C54-AE3-5	Vdet-IC	5.4V±2% -Reset PPO	SOT-23	16vdb	VD7	3a	Utc
L54G	82C54G-AE3-5	Vdet-IC	5.4V±2% -Reset PPO, halogen free	SOT-23	16vdb	VD7	3a	Utc
L54L	82C54L-AE3-5	Vdet-IC	5.4V±2% -Reset PPO, lead free	SOT-23	16vdb	VD7	3a	Utc
L55	82C55-AE3-5	Vdet-IC	5.5V±2% -Reset PPO	SOT-23	16vdb	VD7	3a	Utc
L55G	82C55G-AE3-5	Vdet-IC	5.5V±2% -Reset PPO, halogen free	SOT-23	16vdb	VD7	3a	Utc
L55L	82C55L-AE3-5	Vdet-IC	5.5V±2% -Reset PPO, lead free	SOT-23	16vdb	VD7	3a	Utc
L56	82C56-AE3-5	Vdet-IC	5.6V±2% -Reset PPO	SOT-23	16vdb	VD7	3a	Utc
L56G	82C56G-AE3-5	Vdet-IC	5.6V±2% -Reset PPO, halogen free	SOT-23	16vdb	VD7	3a	Utc
L56L	82C56L-AE3-5	Vdet-IC	5.6V±2% -Reset PPO, lead free	SOT-23	16vdb	VD7	3a	Utc
L57	82C57-AE3-5	Vdet-IC	5.7V±2% -Reset PPO	SOT-23	16vdb	VD7	3a	Utc
L57G	82C57G-AE3-5	Vdet-IC	5.7V±2% -Reset PPO, halogen free	SOT-23	16vdb	VD7	3a	Utc
L57L	82C57L-AE3-5	Vdet-IC	5.7V±2% -Reset PPO, lead free	SOT-23	16vdb	VD7	3a	Utc
L58	82C58-AE3-5	Vdet-IC	5.8V±2% -Reset PPO	SOT-23	16vdb	VD7	3a	Utc
L58G	82C58G-AE3-5	Vdet-IC	5.8V±2% -Reset PPO, halogen free	SOT-23	16vdb	VD7	3a	Utc
L58L	82C58L-AE3-5	Vdet-IC	5.8V±2% -Reset PPO, lead free	SOT-23	16vdb	VD7	3a	Utc
L59	82C59-AE3-5	Vdet-IC	5.9V±2% -Reset PPO	SOT-23	16vdb	VD7	3a	Utc
L59G	82C59G-AE3-5	Vdet-IC	5.9V±2% -Reset PPO, halogen free	SOT-23	16vdb	VD7	3a	Utc
L59L	82C59L-AE3-5	Vdet-IC	5.9V±2% -Reset PPO, lead free	SOT-23	16vdb	VD7	3a	Utc
L5p	BAS55	Si-diode	Sw, U-Fast, 60V, 250mA, Vf<1V(200mA), <6ns	SOT-23	16dc	-	3a	Phi
L6	2SC1623-6	Si-npn	GP, 60V, 100mA, 200mW, 250MHz, B=200..400	SOT-23	16ta	-	3a	Nec
L6	2SC1623A-6	Si-npn	GP, 60V, 100mA, 200mW, 250MHz, B=200..400	SOT-23	16ta	-	3a	Nec
L6	2SC2812-6	Si-npn	GP, AF, 55V, 150mA, 200mW, B=150..300, 100MHz	CPA	16ta	-	3a	San
L6	2SC4177-6	Si-npn	AF, 60V, 100mA, 150mW, B=200..400, 250MHz	SOT-323	16ta	-	3a	Nec
L6	2SC4211-6	Si-npn	GP, 55V, 150mA, 150mW, 200MHz, B=200..400	SOT-323	16ta	-	3a	San
L6	2SC4783-6	Si-npn	Hi-beta, 60V, 200mA, 200mW, 250MHz, B=200..400	SOT-416	16ta	-	3a	Nec
L6	BAR17	PIN-diode	RF, 100V, 140mA, Vf(I=100mA)<1V, Ir<0.05µA, Cd<0.37pF	SOT-23	16dc	-	3a	Sie
L6	BSS47	Si-npn	Nix, 120V, 100mA	SOT-323	16te	-	3a	Fer
L6	BSS69R	Si-npn	Sw, 40V, 100mA, 200MHz, <75/225ns, B=50	SOT-23	16te	-	3a	Zx
L6	ELM7626LAB	Vdet-IC	2.6V±2%, -Reset PPO, 250ms	SOT-23	16vdc	VD7	3d	Elm
L6	KST1623-L6	Si-npn	GP, 50V, 100mA, 350mW, B=200..400, >200MHz	SOT-23	16ta	-	3a	Sam
L6	KTC4075-6	Si-npn	AF, 60V, 150mA, 100mW, B=200..400, >80MHz	SOT-323	16ta	-	3f	Kec
L6	MMBC1623L6	Si-npn	GP, AF, 50V, 100mA, 350mW, B=200..400, >200MHz	SOT-23	16ta	-	3a	Sam
L6	R3111N362C	Vdet-IC	3.6V±2%, -Reset ODO	SOT-23	16vdd	VD6	3d	Ric
L6	R3130N27AC	Vdet-IC	2.7V, -Reset ODO, 50ms	SOT-23	16vdc	VD6	3b	Ric



SMD code	Type	Function	Short description	Case	Pinout	Sch.	St.	Mnf.
L6	RN1107FS	Si-npn-Digi	Sw, 20V, 50mA, 50mW, R1/R2=10k/47k	fSM	19ta	-	3a	Tos
L6	XC61CN1602M	Vdet-IC	1.6V±1%, +Reset ODO	SOT-23	16vdb	VD6	3d	Tor
L6	XC6GN1602HR	Vdet-IC	1.6V, +Reset ODO	USP-3	17vdc	VD1	9b	Tor
L6-	RT9818B-30PVL	Vdet-IC	3.0V±1.5%, -Reset ODO, Td=55ms	SOT-23	16vda	VD6	3a	Rct
L60	82C60-AE3-5	Vdet-IC	6.0V±2% -Reset PPO	SOT-23	16vdb	VD7	3a	Utc
L60G	82C60G-AE3-5	Vdet-IC	6.0V±2% -Reset PPO, halogen free	SOT-23	16vdb	VD7	3a	Utc
L60L	82C60L-AE3-5	Vdet-IC	6.0V±2% -Reset PPO, lead free	SOT-23	16vdb	VD7	3a	Utc
L61	FA1L4Z-K	Si-npn-Digi	Sw, 60V, 100mA, 200mW, R1=47k, B=135..270	SC-59	16ta	-	3a	Nec
L61	GA1L4Z-Q	Si-npn-Digi	Sw, 60V, 100mA, 200mW, R1=4k7, B=300..600	SOT-323	16ta	-	3a	Nec
L62	FA1L4Z-P	Si-npn-Digi	Sw, 60V, 100mA, 200mW, R1=47k, B=200..400	SC-59	16ta	-	3a	Nec
L62	GA1L4Z-P	Si-npn-Digi	Sw, 60V, 100mA, 200mW, R1=4k7, B=200..400	SOT-323	16ta	-	3a	Nec
L63	FA1L4Z-Q	Si-npn-Digi	Sw, 60V, 100mA, 200mW, R1=47k, B=300..600	SC-59	16ta	-	3a	Nec
L63	GA1L4Z-K	Si-npn-Digi	Sw, 60V, 100mA, 200mW, R1=47k, B=135..270	SOT-323	16ta	-	3a	Nec
L63	XE61CN1645MR	Vdet-IC	1.6V±2%, -Reset ODO	SOT-23	16vdb	VD6	3h	Tor
L64	FA1F4Z-K	Si-npn-Digi	Sw, 60V, 100mA, 200mW, R1=22k, B=135..270	SC-59	16ta	-	3a	Nec
L64	GA1F4Z-Q	Si-npn-Digi	Sw, 60V, 100mA, 200mW, R1=22k, B=300..600	SOT-323	16ta	-	3a	Nec
L65	FA1F4Z-P	Si-npn-Digi	Sw, 60V, 100mA, 200mW, R1=22k, B=200..400	SC-59	16ta	-	3a	Nec
L65	GA1F4Z-P	Si-npn-Digi	Sw, 60V, 100mA, 200mW, R1=22k, B=200..400	SOT-323	16ta	-	3a	Nec
L65	XC61FN1612M	Vdet-IC	1.6V±2%, +Reset ODO, 200ms	SOT-23	16vdb	VD6	3d	Tor
L65	XC61HN1612MR	Vdet-IC	1.6V±2%, -Reset ODO, 50..200ms	SOT-23	16vdc	VD6	3d	Tor
L66	FA1F4Z-Q	Si-npn-Digi	Sw, 60V, 100mA, 200mW, R1=22k, B=300..600	SC-59	16ta	-	3a	Nec
L66	GA1F4Z-K	Si-npn-Digi	Sw, 60V, 100mA, 200mW, R1=22k, B=135..270	SOT-323	16ta	-	3a	Nec
L66	XC61FN1642M	Vdet-IC	1.6V±2%, +Reset ODO, 400ms	SOT-23	16vdb	VD6	3d	Tor
L66	XC61HN1642MR	Vdet-IC	1.6V±2%, -Reset ODO, 80..400ms	SOT-23	16vdc	VD6	3d	Tor
L67	FA1A4Z-K	Si-npn-Digi	Sw, 60V, 100mA, 200mW, R1=10k, B=135..270	SC-59	16ta	-	3a	Nec
L67	GA1A4Z-Q	Si-npn-Digi	Sw, 60V, 100mA, 200mW, R1=10k, B=300..600	SOT-323	16ta	-	3a	Nec
L67	XC61FN1652M	Vdet-IC	1.6V±2%, +Reset ODO, 50ms	SOT-23	16vdb	VD6	3d	Tor
L67	XC61HN1652MR	Vdet-IC	1.6V±2%, -Reset ODO, 1..50ms	SOT-23	16vdc	VD6	3d	Tor
L68	FA1A4Z-P	Si-npn-Digi	Sw, 60V, 100mA, 200mW, R1=10k, B=200..400	SC-59	16ta	-	3a	Nec
L68	GA1A4Z-P	Si-npn-Digi	Sw, 60V, 100mA, 200mW, R1=10k, B=200..400	SOT-323	16ta	-	3a	Nec
L69	FA1A4Z-Q	Si-npn-Digi	Sw, 60V, 100mA, 200mW, R1=10k, B=300..600	SC-59	16ta	-	3a	Nec
L69	GA1A4Z-K	Si-npn-Digi	Sw, 60V, 100mA, 200mW, R1=10k, B=135..270	SOT-323	16ta	-	3a	Nec
L6p	BAT720	Si-diode	Schottky, Sw, U-Fast, 40V, 500mA, Vf<0.55V(0.5A), <0.3ns	SOT-23	16dc	-	3a	PHH
L6t	BAT720	Si-diode	Schottky, Sw, U-Fast, 40V, 500mA, Vf<0.55V(0.5A), <0.3ns	SOT-23	16dc	-	3a	PHM
L6W	BAT720	Si-diode	Schottky, Sw, U-Fast, 40V, 500mA, Vf<0.55V(0.5A), <0.3ns	SOT-23	16dc	-	3a	PHC
L7	2SC1623-7	Si-npn	GP, 60V, 100mA, 200mW, 250MHz, B=300..600	SOT-23	16ta	-	3a	Nec
L7	2SC1623A-7	Si-npn	GP, 60V, 100mA, 200mW, 250MHz, B=300..600	SOT-23	16ta	-	3a	Nec
L7	2SC2812-7	Si-npn	GP, AF, 55V, 150mA, 200mW, B=175..350, 100MHz	CPA	16ta	-	3a	San
L7	2SC4177-7	Si-npn	AF, 60V, 100mA, 150mW, B=300..600, 250MHz	SOT-323	16ta	-	3a	Nec
L7	2SC4211-7	Si-npn	GP, 55V, 150mA, 150mW, 200MHz, B=300..600	SOT-323	16ta	-	3a	San
L7	2SC4783-7	Si-npn	Hi-beta, 60V, 200mA, 200mW, 250MHz, B=300..600	SOT-416	16ta	-	3a	Nec
L7	BAT721	Si-diode	Schottky, Sw, U-Fast, 40V, 200mA, Vf<0.55V(0.2A), <0.3ns	SOT-23	16dc	-	3a	PHH
L7	BSS56	Si-npn	Sw, Driver, 100V, 500mA, >80MHz	SOT-323	16te	-	3a	Fer
L7	BSS70R	Si-pnp	Sw, 40V, 100mA, 330mW, B=100..300, >250MHz	SOT-23	16ta	-	3a	Zx
L7	ELM7627LAB	Vdet-IC	2.7V±2%, -Reset PPO, 250ms	SOT-23	16vdc	VD7	3d	Elm
L7	KST1623-L7	Si-npn	GP, 50V, 100mA, 350mW, B=300..600, >200MHz	SOT-23	16ta	-	3a	Sam
L7	MMBC1623L7	Si-npn	GP, AF, 50V, 100mA, 350mW, B=300..600, >200MHz	SOT-23	16ta	-	3a	Sam
L7	R3111N372C	Vdet-IC	3.7V±2%, -Reset ODO	SOT-23	16vdd	VD6	3d	Ric
L7	RN1108FS	Si-npn-Digi	Sw, 20V, 50mA, 50mW, R1/R2=22k/47k	fSM	19ta	-	3a	Tos
L7	XC61CN1702M	Vdet-IC	1.7V±1%, +Reset ODO	SOT-23	16vdb	VD6	3d	Tor
L7	XC6GN1702HR	Vdet-IC	1.7V, +Reset ODO	USP-3	17vdc	VD1	9b	Tor
L7-	RT9818E-12PV	Vdet-IC	1.2V±1.5%, +Reset ODO	SOT-23	16vdc	VD6	3a	Rct
L73	XE61CN1745MR	Vdet-IC	1.7V±2%, -Reset ODO	SOT-23	16vdb	VD6	3h	Tor
L75	XC61FN1712M	Vdet-IC	1.7V±2%, +Reset ODO, 200ms	SOT-23	16vdb	VD6	3d	Tor
L75	XC61HN1712MR	Vdet-IC	1.7V±2%, -Reset ODO, 50..200ms	SOT-23	16vdc	VD6	3d	Tor
L76	XC61FN1742M	Vdet-IC	1.7V±2%, +Reset ODO, 400ms	SOT-23	16vdb	VD6	3d	Tor
L76	XC61HN1742MR	Vdet-IC	1.7V±2%, -Reset ODO, 80..400ms	SOT-23	16vdc	VD6	3d	Tor
L77	XC61FN1752M	Vdet-IC	1.7V±2%, +Reset ODO, 50ms	SOT-23	16vdb	VD6	3d	Tor
L77	XC61HN1752MR	Vdet-IC	1.7V±2%, -Reset ODO, 1..50ms	SOT-23	16vdc	VD6	3d	Tor
L7p	BAT721	Si-diode	Schottky, Sw, U-Fast, 40V, 200mA, Vf<0.55V(0.2A), <0.3ns	SOT-23	16dc	-	3a	PHH
L7s	BAR14-1	PN-diode	Dual, RF, 100V, 140mA, 250mW, Vf<1.25V(100mA), <0.5pF	SOT-23	16dl	-	3c	Inf
L7t	BAT721	Si-diode	Schottky, Sw, U-Fast, 40V, 200mA, Vf<0.55V(0.2A), <0.3ns	SOT-23	16dc	-	3a	PHM
L7W	BAT721	Si-diode	Schottky, Sw, U-Fast, 40V, 200mA, Vf<0.55V(0.2A), <0.3ns	SOT-23	16dc	-	3a	PHC
L8	BAT721A	Si-diode	Dual, Schottky, Sw, U-Fst, 40V, 0.2A, Vf<0.55V(0.2A), <0.3ns	SOT-23	16df	-	3a	PHH
L8	ELM7628LAB	Vdet-IC	2.8V±2%, -Reset PPO, 250ms	SOT-23	16vdc	VD7	3d	Elm
L8	KTC4075-8	Si-npn	AF, 60V, 150mA, 100mW, B=350..700, >80MHz	SOT-323	16ta	-	3f	Kec
L8	R3111N382C	Vdet-IC	3.8V±2%, -Reset ODO	SOT-23	16vdd	VD6	3d	Ric
L8	RN1109FS	Si-npn-Digi	Sw, 20V, 50mA, 50mW, R1/R2=47k/22k	fSM	19ta	-	3a	Tos
L8	XC61CN1802M	Vdet-IC	1.8V±1%, +Reset ODO	SOT-23	16vdb	VD6	3d	Tor
L8	XC6GN1802HR	Vdet-IC	1.8V, +Reset ODO	USP-3	17vdc	VD1	9b	Tor



SMD code	Type	Function	Short description	Case	Pinout	Sch. St.	Mnf.
L81	FA1L3M	Si-npn-Digi	Sw, 60V, 100mA, 200mW, R1/R2=4k7/4k7	SC-59	16ta -	3a	Nec
L81	GA1L3M	Si-npn-Digi	Sw, 60V, 100mA, 200mW, R1/R2=4k7/4k7	SOT-323	16ta -	3a	Nec
L82	FA1L3N	Si-npn-Digi	Sw, 60V, 100mA, 200mW, R1/R2=4k7/10k	SC-59	16ta -	3a	Nec
L82	GA1L3N	Si-npn-Digi	Sw, 60V, 100mA, 200mW, R1/R2=4k7/10k	SOT-323	16ta -	3a	Nec
L83	FA1A3Q	Si-npn-Digi	Sw, 60V, 100mA, 200mW, R1/R2=1k/10k	SC-59	16ta -	3a	Nec
L83	GA1A3Q	Si-npn-Digi	Sw, 60V, 100mA, 200mW, R1/R2=1k/10k	SOT-323	16ta -	3a	Nec
L83	XE61CN1845MR	Vdet-IC	1.8V±2%, -Reset ODO	SOT-23	16vdb VD6	3h	Tor
L85	XC61FN1812M	Vdet-IC	1.8V±2%, +Reset ODO, 200ms	SOT-23	16vdb VD6	3d	Tor
L85	XC61HN1812MR	Vdet-IC	1.8V±2%, -Reset ODO, 50..200ms	SOT-23	16vdc VD6	3d	Tor
L86	XC61FN1842M	Vdet-IC	1.8V±2%, +Reset ODO, 400ms	SOT-23	16vdb VD6	3d	Tor
L86	XC61HN1842MR	Vdet-IC	1.8V±2%, -Reset ODO, 80..400ms	SOT-23	16vdc VD6	3d	Tor
L87	XC61FN1852M	Vdet-IC	1.8V±2%, +Reset ODO, 50ms	SOT-23	16vdb VD6	3d	Tor
L87	XC61HN1852MR	Vdet-IC	1.8V±2%, -Reset ODO, 1..50ms	SOT-23	16vdc VD6	3d	Tor
L8p	BAT721A	Si-diode	Dual, Schottky, Sw, U-Fst, 40V, 0.2A, Vf<0.55V(0.2A), <0.3ns	SOT-23	16df -	3a	PHH
L8s	BAR15-1	PIN-diode	Dual, RF, 100V, 140mA, 250mW, Vf<1.25V (100mA), <0.5pF	SOT-23	16dg -	3c	Inf
L8t	BAT721A	Si-diode	Dual, Schottky, Sw, U-Fst, 40V, 0.2A, Vf<0.55V(0.2A), <0.3ns	SOT-23	16df -	3a	PhM
L8W	BAT721A	Si-diode	Dual, Schottky, Sw, U-Fst, 40V, 0.2A, Vf<0.55V(0.2A), <0.3ns	SOT-23	16df -	3a	PhC
L9	1SS349	Si-diode	Dual, Schottky, 2x20V, 1.0A	SC-59	16dc -	3a	Tos
L9	BAT721C	Si-diode	Dual, Schottky, Sw, U-Fst, 40V, 0.2A, Vf<0.55V(0.2A), <0.3ns	SOT-23	16dg -	3a	PHH
L9	ELM7629LAB	Vdet-IC	2.9V±2%, -Reset PPO, 250ms	SOT-23	16vdc VD7	3d	Elm
L9	R1100D091C	LVR-IC	U-low lcc, 0.9V±2%, 180mA	SON1408-3	18vj VR1	3d	Ric
L9	R3111N392C	Vdet-IC	3.9V±2%, -Reset ODO	SOT-23	16vdd VD6	3d	Ric
L9	RN1110FS	Si-npn-Digi	Sw, 20V, 50mA, 50mW, R1=4.7k	fSM	19ta -	3a	Tos
L9	XC61CN1902M	Vdet-IC	1.9V±1%, +Reset ODO	SOT-23	16vdb VD6	3d	Tor
L9	XC6GN1902HR	Vdet-IC	1.9V, +Reset ODO	USP-3	17vdc VD1	9b	Tor
L93	XE61CN1945MR	Vdet-IC	1.9V±2%, -Reset ODO	SOT-23	16vdb VD6	3h	Tor
L95	XC61FN1912M	Vdet-IC	1.9V±2%, +Reset ODO, 200ms	SOT-23	16vdb VD6	3d	Tor
L95	XC61HN1912MR	Vdet-IC	1.9V±2%, -Reset ODO, 50..200ms	SOT-23	16vdc VD6	3d	Tor
L96	XC61FN1942M	Vdet-IC	1.9V±2%, +Reset ODO, 400ms	SOT-23	16vdb VD6	3d	Tor
L96	XC61HN1942MR	Vdet-IC	1.9V±2%, -Reset ODO, 80..400ms	SOT-23	16vdc VD6	3d	Tor
L97	XC61FN1952M	Vdet-IC	1.9V±2%, +Reset ODO, 50ms	SOT-23	16vdb VD6	3d	Tor
L97	XC61HN1952MR	Vdet-IC	1.9V±2%, -Reset ODO, 1..50ms	SOT-23	16vdc VD6	3d	Tor
L9p	BAT721C	Si-diode	Dual, Schottky, Sw, U-Fst, 40V, 0.2A, Vf<0.55V(0.2A), <0.3ns	SOT-23	16dg -	3a	PHH
L9s	BAR16-1	PIN-diode	Dual, RF, 100V, 140mA, 250mW, Vf<1.25V (100mA), <0.5pF	SOT-23	16df -	3c	Inf
L9t	BAT721C	Si-diode	Dual, Schottky, Sw, U-Fst, 40V, 0.2A, Vf<0.55V(0.2A), <0.3ns	SOT-23	16dg -	3a	PhM
L9W	BAT721C	Si-diode	Dual, Schottky, Sw, U-Fst, 40V, 0.2A, Vf<0.55V(0.2A), <0.3ns	SOT-23	16dg -	3a	PhC
La	AX6601-33R	LVR-IC	LDO, 3.3V±2%, 300mA	SOT-23L	16cg VR1	3b	Axl
LA	BF550	Si-pnp	HF/AF, 40V, 25mA, 200mW, B=50..125, 350MHz	SOT-23	16ta -	3a	Sil
LA	ELM7630HDB	Vdet-IC	3.0V±2%, +Reset PPO, 50ms	SOT-23	16vdc VD7	3d	Elm
la	PT7M6229CHC3	Vdet-IC	2.9V±1.5%, +Reset PPO	SC-70	16vdc VD7	3b	Pti
lā	PT7M6229CHC3E	Vdet-IC	2.9V±1.5%, +Reset PPO, Lead free	SC-70	16vdc VD7	3b	Pti
la	PT7M6229CHTA3	Vdet-IC	2.9V±1.5%, +Reset PPO	SOT-23	16vdb VD7	3b	Pti
lā	PT7M6229CHTA3E	Vdet-IC	2.9V±1.5%, +Reset PPO, Lead free	SOT-23	16vdb VD7	3b	Pti
LA	RN1442A	Si-npn-Digi	Mute, 50V, 300mA, 300mW, R1=10k, B=200..700	SOT-346	16ta -	3a	Tos
LA	Si1303DL	p-MOSFET-e	V-MOS, LogL, 20V, ±0.67A, <0.7Q	SOT-323	16fh -	3a	Six
LAA	BC807-16	Si-pnp	GP, 50V, 800mA, 200mW, B=110..250, 100MHz	SOT-23	16ta -	3a	Auk
LAA	BC807F-16	Si-pnp	GP, 50V, 800mA, 200mW, B=110..250, 100MHz	SOT-23F	16ta -	3a	Auk
LAB	BC807-25	Si-pnp	GP, 50V, 800mA, 200mW, B=160..400, 100MHz	SOT-23	16ta -	3a	Auk
LAB	BC807F-25	Si-pnp	GP, 50V, 800mA, 200mW, B=160..400, 100MHz	SOT-23F	16ta -	3a	Auk
LAC	BC807-40	Si-pnp	GP, 50V, 800mA, 200mW, B=250..630, 100MHz	SOT-23	16ta -	3a	Auk
LAC	BC807F-40	Si-pnp	GP, 50V, 800mA, 200mW, B=250..630, 100MHz	SOT-23F	16ta -	3a	Auk
LAp	BF550	Si-pnp	HF/AF, 40V, 25mA, 200mW, B=50..125, 350MHz	SOT-23	16ta -	3a	PhH
LAs	BF550	Si-pnp	HF/AF, 40V, 25mA, 200mW, B=50..125, 350MHz	SOT-23	16ta -	3a	Sie
LAt	BF550	Si-pnp	HF/AF, 40V, 25mA, 200mW, B=50..125, 350MHz	SOT-23	16ta -	3a	PhM
LAW	BF550	Si-pnp	HF/AF, 40V, 25mA, 200mW, B=50..125, 350MHz	SOT-23	16ta -	3a	PhC
LB	2SC2462-B	Si-npn	AF, 50V, 100mA, 150mW, B=100..200	SOT-23	16ta -	3a	Ren
LB	2SC5850-B	Si-npn	GP, AF, 50V, 100mA, 150mW, >100MHz, B=100..200	SOT-23	16ta -	3a	Ren
LB	ELM7631HDB	Vdet-IC	3.1V±2%, +Reset PPO, 50ms	SOT-23	16vdc VD7	3d	Elm
lb	PT7M6229NLC3	Vdet-IC	2.9V±1.5%, -Reset ODO	SC-70	16vdc VD6	3b	Pti
lĪ	PT7M6229NLC3E	Vdet-IC	2.9V±1.5%, -Reset ODO, Lead free	SC-70	16vdc VD6	3b	Pti
lb	PT7M6229NLTA3	Vdet-IC	2.9V±1.5%, -Reset ODO	SOT-23	16vdb VD6	3b	Pti
lĪ	PT7M6229NLTA3E	Vdet-IC	2.9V±1.5%, -Reset ODO, Lead free	SOT-23	16vdb VD6	3b	Pti
LB	RN1442B	Si-npn-Digi	Mute, 50V, 300mA, 300mW, R1=10k, B=350..1200	SOT-346	16ta -	3a	Tos
LB	S525T	n-MOSFET-d	HF, LN, 20V, 30mA, 200mW, Idss=5..14mA	SOT-23	16fi -	3a	Tfk
LB	Si1305DL	p-MOSFET-e	V-MOS, LogL, 8V, ±0.86A, <0.53Q	SOT-323	16fh -	3a	Six
LB-	RT9818B-45PV	Vdet-IC	4.5V±1.5%, -Reset ODO, Td=55ms	SOT-23	16vda VD6	3a	Rct
LBL	KTC4075-L	Si-npn	AF, 60V, 150mA, 100mW, B=350..700, >80MHz	SOT-323	16ta -	3f	Kec
LC	2SC2462-C	Si-npn	AF, 50V, 100mA, 150mW, B=160..320	SOT-23	16ta -	3a	Ren
LC	2SC5850-C	Si-npn	GP, AF, 50V, 100mA, 150mW, >100MHz, B=160..320	SOT-23	16ta -	3a	Ren
LC	ELM7632HDB	Vdet-IC	3.2V±2%, +Reset PPO, 50ms	SOT-23	16vdc VD7	3d	Elm



SMD code	Type	Function	Short description	Case	Pinout	Sch.	St.	Mnf.
lc	PT7M6230CLC3	Vdet-IC	3.0V±1.5%, -Reset PPO	SC-70	16vdc	VD7	3b	Pti
lc	PT7M6230CLC3E	Vdet-IC	3.0V±1.5%, -Reset PPO, Lead free	SC-70	16vdc	VD7	3b	Pti
lc	PT7M6230CLTA3	Vdet-IC	3.0V±1.5%, -Reset PPO	SOT-23	16vdb	VD7	3b	Pti
lc	PT7M6230CLTA3E	Vdet-IC	3.0V±1.5%, -Reset PPO, Lead free	SOT-23	16vdb	VD7	3b	Pti
LC	Si1307DL	p-MOSFET-e	V-MOS, LogL, 12V, ±0.85A, <0.58Ω	SOT-323	16fh	-	3a	Six
LC-	RT9819A-40PV	Vdet-IC	4.0V±1.5%, -Reset PPO	SOT-23	16vdc	VD7	3a	Rct
LD	2SC2462-D	Si-npn	AF, 50V, 100mA, 150mW, B=250..500	SOT-23	16ta	-	3a	Ren
LD	2SC5850-D	Si-npn	GP, AF, 50V, 100mA, 150mW, >100MHz, B=250..500	SOT-23	16ta	-	3a	Ren
LD	AX6601-15R	LVR-IC	LDO, 1.5V±2%, 300mA	SOT-23L	16cg	VR1	3b	Axl
LD	BF543	n-MOSFET-d*	HF, 20V, 30mA, 200mW, Idss>1.5mA, Up<1.5V, 300MHz	SOT-23	16fi	-	3a	Sil
LD	ELM7633HDB	Vdet-IC	3.3V±2%, +Reset PPO, 50ms	SOT-23	16vdc	VD7	3d	Elm
ld	PT7M6230CHC3	Vdet-IC	3.0V±1.5%, +Reset PPO	SC-70	16vdc	VD7	3b	Pti
ld	PT7M6230CHC3E	Vdet-IC	3.0V±1.5%, +Reset PPO, Lead free	SC-70	16vdc	VD7	3b	Pti
ld	PT7M6230CHTA3	Vdet-IC	3.0V±1.5%, +Reset PPO	SOT-23	16vdb	VD7	3b	Pti
ld	PT7M6230CHTA3E	Vdet-IC	3.0V±1.5%, +Reset PPO, Lead free	SOT-23	16vdb	VD7	3b	Pti
LD-	RT9818A-28PV	Vdet-IC	2.8V±1.5%, -Reset ODO	SOT-23	16vda	VD6	3a	Rct
LD3	BAT54S	Si-diode	Dual, Schottky Rectifier, 30V, 200mA, Vf<0.52V(100mA), <5ns	SOT-23	16dl	-	3a	Ons
LD3	BAT54SPT	Si-diode	Dual, SBD, 30V, 200mA, Vf<1V(100mA), 5ns	SOT-23	16dl	-	3a	Chm
LD4	CH706D-40PT	Si-diode	Dual, SBD, 45V, 30mA, Vf<0.37V(1mA)	SOT-23	16dl	-	3a	Chm
LD6	CHBD3004PT	Si-diode	Sw, 350V, 225mA, Vf<1V(100mA), 50ns	SOT-23	16dc	-	3a	Chm
LD7	CHBD3004APT	Si-diode	Dual, Sw, 350V, 225mA, Vf<1V(100mA), 50ns	SOT-23	16df	-	3a	Chm
LD8	CHBD3004CPT	Si-diode	Dual, Sw, 350V, 225mA, Vf<1V(100mA), 50ns	SOT-23	16dg	-	3a	Chm
LD9	CHBD3004SPT	Si-diode	Dual, Sw, 350V, 225mA, Vf<1V(100mA), 50ns	SOT-23	16dl	-	3a	Chm
LDs	BF543	n-MOSFET-d*	HF, 20V, 30mA, 200mW, Idss>1.5mA, Up<1.5V, 300MHz	SOT-23	16fi	-	3a	Sie
LE	2SC3052-E	Si-npn	AF, 50V, 200mA, 150mW, B=150..300, 200MHz	SC-59	16ta	-	3a	Mit
LE	2SC4154-E	Si-npn	AF-Amp, 50V, 200mA, 150mW, 200MHz, B=150..300	SOT-323	16ta	-	3a	Mit
LE	2SC5383-E	Si-npn	AF-Amp, 50V, 200mA, 125mW, 200MHz, B=150..300	SC-75A	16ta	-	3a	Ish
LE	2SC5804-E	Si-npn	AF-Amp, 50V, 200mA, 100mW, 200MHz, B=150..300	T-USM	18ta	-	3a	Ish
LE	BF660W	Si-pnp	VHF-Osc, 40V, 25mA, 800MHz	SOT-323	16ta	-	3c	Inf
LE	ELM7634HDB	Vdet-IC	3.4V±2%, +Reset PPO, 50ms	SOT-23	16vdc	VD7	3d	Elm
le	PT7M6230NLC3	Vdet-IC	3.0V±1.5%, -Reset ODO	SC-70	16vdc	VD6	3b	Pti
le	PT7M6230NLC3E	Vdet-IC	3.0V±1.5%, -Reset ODO, Lead free	SC-70	16vdc	VD6	3b	Pti
le	PT7M6230NLTA3	Vdet-IC	3.0V±1.5%, -Reset ODO	SOT-23	16vdb	VD6	3b	Pti
le	PT7M6230NLTA3E	Vdet-IC	3.0V±1.5%, -Reset ODO, Lead free	SOT-23	16vdb	VD6	3b	Pti
LE-	RT9818F-38PV	Vdet-IC	3.8V±1.5%, +Reset ODO, Td=55ms	SOT-23	16vda	VD6	3a	Rct
LEp	BF660	Si-pnp	VHF-Osc, 40V, 25mA, 650MHz	SOT-23	16ta	-	3a	Phi
LEs	BF660W	Si-pnp	VHF-Osc, 40V, 25mA, 800MHz	SOT-323	16ta	-	3a	Sie
LF	2SC3052-F	Si-npn	AF, 50V, 200mA, 150mW, B=250..500, 200MHz	SC-59	16ta	-	3a	Mit
LF	2SC4154-F	Si-npn	AF-Amp, 50V, 200mA, 150mW, 200MHz, B=250..500	SOT-323	16ta	-	3a	Mit
LF	2SC5383-F	Si-npn	AF-Amp, 50V, 200mA, 125mW, 200MHz, B=250..500	SC-75A	16ta	-	3a	Ish
LF	2SC5804-F	Si-npn	AF-Amp, 50V, 200mA, 100mW, 200MHz, B=250..500	T-USM	18ta	-	3a	Ish
LF	ELM7635HDB	Vdet-IC	3.5V±2%, +Reset PPO, 50ms	SOT-23	16vdc	VD7	3d	Elm
lf	PT7M6231CLC3	Vdet-IC	3.1V±1.5%, -Reset PPO	SC-70	16vdc	VD7	3b	Pti
lf	PT7M6231CLC3E	Vdet-IC	3.1V±1.5%, -Reset PPO, Lead free	SC-70	16vdc	VD7	3b	Pti
lf	PT7M6231CLTA3	Vdet-IC	3.1V±1.5%, -Reset PPO	SOT-23	16vdb	VD7	3b	Pti
lf	PT7M6231CLTA3E	Vdet-IC	3.1V±1.5%, -Reset PPO, Lead free	SOT-23	16vdb	VD7	3b	Pti
LF	RN1111FS	Si-npn-Digi	Sw, 20V, 50mA, 50mW, R1=10k	fSM	19ta	-	3a	Tos
LF-	RT9818E-27PV	Vdet-IC	2.7V±1.5%, +Reset ODO	SOT-23	16vdc	VD6	3a	Rct
LG	2SC2712-GR	Si-npn	GP, AF, 50V, 150mA, 150mW, B=200..400, >80MHz	SOT-23	16ta	-	3a	Tos
LG	2SC3052-G	Si-npn	AF, 50V, 200mA, 150mW, B=400..800, 200MHz	SC-59	16ta	-	3a	Mit
LG	2SC4116-GR	Si-npn	GP, AF, 50V, 150mA, 100mW, B=200..400, >80MHz	SOT-323	16ta	-	3a	Tos
LG	2SC4154-G	Si-npn	AF-Amp, 50V, 200mA, 150mW, 200MHz, B=400..800	SOT-323	16ta	-	3a	Mit
LG	2SC4738F-GR	Si-npn	AF-Amp, 60V, 150mA, 100mW, >80MHz, B=200..400	SOT-490	18ta	-	3a	Tos
LG	2SC4738FT-GR	Si-npn	AF-Amp, 60V, 150mA, 100mW, >80MHz, B=200..400	TESM	18ta	-	3a	Tos
LG	2SC4738-GR	Si-npn	AF-Amp, 60V, 150mA, 100mW, >80MHz, B=200..400	SOT-23	16ta	-	3a	Tos
LG	2SC5383-G	Si-npn	AF-Amp, 50V, 200mA, 125mW, 200MHz, B=400..800	SC-75A	16ta	-	3a	Ish
LG	2SC5804-G	Si-npn	AF-Amp, 50V, 200mA, 100mW, 200MHz, B=400..800	T-USM	18ta	-	3a	Ish
LG	AX6601-18R	LVR-IC	LDO, 1.8V±2%, 300mA	SOT-23L	16cg	VR1	3b	Axl
LG	BF767	Si-pnp	VHF/UHF-LN, 950MHz	SOT-23	16ta	-	3a	Sie
LG	ELM7636HDB	Vdet-IC	3.6V±2%, +Reset PPO, 50ms	SOT-23	16vdc	VD7	3d	Elm
lg	PT7M6231CHC3	Vdet-IC	3.1V±1.5%, +Reset PPO	SC-70	16vdc	VD7	3b	Pti
lg	PT7M6231CHC3E	Vdet-IC	3.1V±1.5%, +Reset PPO, Lead free	SC-70	16vdc	VD7	3b	Pti
lg	PT7M6231CHTA3	Vdet-IC	3.1V±1.5%, +Reset PPO	SOT-23	16vdb	VD7	3b	Pti
lg	PT7M6231CHTA3E	Vdet-IC	3.1V±1.5%, +Reset PPO, Lead free	SOT-23	16vdb	VD7	3b	Pti
LG-	RT9819C-28PV	Vdet-IC	2.8V±1.5%, -Reset PPO, Td=220ms	SOT-23	16vdc	VD7	3a	Rct
LGR	KTC4075-R	Si-npn	AF, 60V, 150mA, 100mW, B=200..400, >80MHz	SOT-323	16ta	-	3f	Kec
LGS	BF775A	Si-npn	VHF/UHF, 25V, 30mA, 280mW, B=50..250, 5.8GHz	SOT-23	16ta	-	3a	Sie
LH	BF569	Si-pnp	UHF-Mix/Osc, 40V, 30mA, 200mW, B=25..90, 1GHz	SOT-23	16ta	-	3a	Sil
LH	ELM7637HDB	Vdet-IC	3.7V±2%, +Reset PPO, 50ms	SOT-23	16vdc	VD7	3d	Elm
lh	PT7M6231NLC3	Vdet-IC	3.1V±1.5%, -Reset ODO	SC-70	16vdc	VD6	3b	Pti



SMD code	Type	Function	Short description	Case	Pinout	Sch.	St.	Mnf.
<u>lh</u>	PT7M6231NLC3E	Vdet-IC	3.1V±1.5%, -Reset ODO, Lead free	SC-70	16vdc	VD6	3b	Pti
<u>lh</u>	PT7M6231NLT.A3	Vdet-IC	3.1V±1.5%, -Reset ODO	SOT-23	16vdb	VD6	3b	Pti
<u>lh</u>	PT7M6231NLT.A3E	Vdet-IC	3.1V±1.5%, -Reset ODO, Lead free	SOT-23	16vdb	VD6	3b	Pti
<u>LH</u>	RN1112FS	Si-nprn-Digi	Sw, 20V, 50mA, 50mW, R1=22k	fSM	19ta	-	3a	Tos
<u>LH-</u>	RT9819A-42PV	Vdet-IC	4.2V±1.5%, -Reset PPO	SOT-23	16vdc	VD7	3a	Rct
<u>LHp</u>	BF569	Si-nnp	UHF-Mix/Osc, 40V, 30mA, 200mW, B=25..90, 1GHz	SOT-23	16ta	-	3a	Phi
<u>LHs</u>	BF569	Si-nnp	UHF-Mix/Osc, 40V, 30mA, 200mW, B=25..90, 1GHz	SOT-23	16ta	-	3a	Sie
<u>LHs</u>	BF569W	Si-nnp	UHF-Mix/Osc, 40V, 30mA, 200mW, B=25..90, 1GHz	SOT-323	16ta	-	3a	Sie
<u>li</u>	PT7M6232CLC3	Vdet-IC	3.2V±1.5%, -Reset PPO	SC-70	16vdc	VD7	3b	Pti
<u>li</u>	PT7M6232CLC3E	Vdet-IC	3.2V±1.5%, -Reset PPO, Lead free	SC-70	16vdc	VD7	3b	Pti
<u>li</u>	PT7M6232CLTA3	Vdet-IC	3.2V±1.5%, -Reset PPO	SOT-23	16vdb	VD7	3b	Pti
<u>li</u>	PT7M6232CLTA3E	Vdet-IC	3.2V±1.5%, -Reset PPO, Lead free	SOT-23	16vdb	VD7	3b	Pti
<u>LJ</u>	2SK1848	n-MOSFET*	Sw, 60V, 400mA, 250mW, <1.6Q(200mA), 5/35nA	SOT-23	16fh	-	3a	San
<u>LJ</u>	ELM7638HDB	Vdet-IC	3.8V±2%, +Reset PPO, 50ms	SOT-23	16vdc	VD7	3d	Elm
<u>lj</u>	PT7M6232CHC3	Vdet-IC	3.2V±1.5%, +Reset PPO	SC-70	16vdc	VD7	3b	Pti
<u>lj</u>	PT7M6232CHC3E	Vdet-IC	3.2V±1.5%, +Reset PPO, Lead free	SC-70	16vdc	VD7	3b	Pti
<u>lj</u>	PT7M6232CHTA3	Vdet-IC	3.2V±1.5%, +Reset PPO	SOT-23	16vdb	VD7	3b	Pti
<u>lj</u>	PT7M6232CHTA3E	Vdet-IC	3.2V±1.5%, +Reset PPO, Lead free	SOT-23	16vdb	VD7	3b	Pti
<u>LJ</u>	RN1113FS	Si-nprn-Digi	Sw, 20V, 50mA, 50mW, R1=47k	fSM	19ta	-	3a	Tos
<u>Ljp</u>	BF579	Si-nnp	VHF/UHF, 20V, 25mA, 200mW, B=20..90, 1.75GHz	SOT-23	16ta	-	3a	Phi
<u>LK</u>	BF799	Si-nprn	TV-IF-Out, (SAW-Filter), 20V 35mA, 800..1100MHz	SOT-23	16ta	-	3a	Sie
<u>LK</u>	BF799W	Si-nprn	TV-IF-Out, (SAW-Filter), 20V 35mA, 800..1100MHz	SOT-323	16ta	-	3c	Inf
<u>LK</u>	ELM7639HDB	Vdet-IC	3.9V±2%, +Reset PPO, 50ms	SOT-23	16vdc	VD7	3d	Elm
<u>lk</u>	PT7M6232NLC3	Vdet-IC	3.2V±1.5%, -Reset ODO	SC-70	16vdc	VD6	3b	Pti
<u>lk</u>	PT7M6232NLC3E	Vdet-IC	3.2V±1.5%, -Reset ODO, Lead free	SC-70	16vdc	VD6	3b	Pti
<u>lk</u>	PT7M6232NLT.A3	Vdet-IC	3.2V±1.5%, -Reset ODO	SOT-23	16vdb	VD6	3b	Pti
<u>lk</u>	PT7M6232NLT.A3E	Vdet-IC	3.2V±1.5%, -Reset ODO, Lead free	SOT-23	16vdb	VD6	3b	Pti
<u>LK8</u>	CHBD2004CPT	Si-diode	Dual, Sw, 300V, 200mA, Vf<1V(100mA), 50ns	SOT-23	16dgd	-	3a	Chm
<u>LKs</u>	BF799	Si-nprn	TV-IF-Out, (SAW-Filter), 20V 35mA, 800..1100MHz	SOT-23	16ta	-	3a	Sie
<u>LKs</u>	BF799W	Si-nprn	TV-IF-Out, (SAW-Filter), 20V 35mA, 800..1100MHz	SOT-323	16ta	-	3a	Sie
<u>LL</u>	2SA1518	Si-nnp-Digi	Sw, 50V, 500mA, 200mW, 250MHz, R1/R2=10k/10k	SOT-23	16ta	-	3a	San
<u>LL</u>	2SC2712-BL	Si-nprn	GP, AF, 50V, 150mA, 150mW, B=350..700, >80MHz	SOT-23	16ta	-	3a	Tos
<u>LL</u>	2SC4116-BL	Si-nprn	GP, AF, 50V, 150mA, 100mW, B=350..700, >80MHz	SOT-323	16ta	-	3a	Tos
<u>LL</u>	2SC4738-BL	Si-nprn	AF-Amp, 60V, 150mA, 100mW, >80MHz, B=350..700	SOT-23	16ta	-	3a	Tos
<u>ll</u>	PT7M6233CLC3	Vdet-IC	3.3V±1.5%, -Reset PPO	SC-70	16vdc	VD7	3b	Pti
<u>ll</u>	PT7M6233CLC3E	Vdet-IC	3.3V±1.5%, -Reset PPO, Lead free	SC-70	16vdc	VD7	3b	Pti
<u>ll</u>	PT7M6233CLTA3	Vdet-IC	3.3V±1.5%, -Reset PPO	SOT-23	16vdb	VD7	3b	Pti
<u>ll</u>	PT7M6233CLTA3E	Vdet-IC	3.3V±1.5%, -Reset PPO, Lead free	SOT-23	16vdb	VD7	3b	Pti
<u>LLN</u>	ELM7532CEB	Vdet-IC	3.2V±2%, +Reset PPO	SC-70	16vdb	VD7	3d	Elm
<u>LLN</u>	ELM7532NEB	Vdet-IC	3.2V±2%, +Reset ODO	SC-70	16vdb	VD6	3d	Elm
<u>LM</u>	BF569R	Si-nnp	UHF-Mix/Osc, 40V, 30mA, 200mW, B=25..90, 1GHz	SOT-23	16te	-	3a	Sil
<u>lm</u>	PT7M6233CHC3	Vdet-IC	3.3V±1.5%, +Reset PPO	SC-70	16vdc	VD7	3b	Pti
<u>lm</u>	PT7M6233CHC3E	Vdet-IC	3.3V±1.5%, +Reset PPO, Lead free	SC-70	16vdc	VD7	3b	Pti
<u>lm</u>	PT7M6233CHTA3	Vdet-IC	3.3V±1.5%, +Reset PPO	SOT-23	16vdb	VD7	3b	Pti
<u>lm</u>	PT7M6233CHTA3E	Vdet-IC	3.3V±1.5%, +Reset PPO, Lead free	SOT-23	16vdb	VD7	3b	Pti
<u>LM-</u>	RT9819B-33PV	Vdet-IC	3.3V±1.5%, -Reset PPO, Td=55ms	SOT-23	16vdc	VD7	3a	Rct
<u>LN</u>	2SC5488	Si-nprn	VHF/UHF LN, 20V, 70mA, 100mW, B=90..200, 7GHz	SSFP	18ta	-	3a	San
<u>ln</u>	PT7M6233NLC3	Vdet-IC	3.3V±1.5%, -Reset ODO	SC-70	16vdc	VD6	3b	Pti
<u>ln</u>	PT7M6233NLC3E	Vdet-IC	3.3V±1.5%, -Reset ODO, Lead free	SC-70	16vdc	VD6	3b	Pti
<u>ln</u>	PT7M6233NLT.A3	Vdet-IC	3.3V±1.5%, -Reset ODO	SOT-23	16vdb	VD6	3b	Pti
<u>ln</u>	PT7M6233NLT.A3E	Vdet-IC	3.3V±1.5%, -Reset ODO, Lead free	SOT-23	16vdb	VD6	3b	Pti
<u>-LN</u>	ELM7548CEB	Vdet-IC	4.8V±2%, +Reset PPO	SC-70	16vdb	VD7	3d	Elm
<u>-LN</u>	ELM7548NEB	Vdet-IC	4.8V±2%, +Reset ODO	SC-70	16vdb	VD6	3d	Elm
<u>LN3</u>	2SC5226-3	Si-nprn	VHF/UHF, LN, 20V, 70mA, 150mW, B=60..120, 7GHz	MCP	16ta	-	3a	San
<u>LN3</u>	2SC5227-3	Si-nprn	VHF/UHF, LN, 20V, 70mA, 200mW, B=60..120, 7GHz	SOT-23	16ta	-	3a	San
<u>LN4</u>	2SC5226-4	Si-nprn	VHF/UHF, LN, 20V, 70mA, 150mW, B=90..180, 7GHz	MCP	16ta	-	3a	San
<u>LN4</u>	2SC5227-4	Si-nprn	VHF/UHF, LN, 20V, 70mA, 200mW, B=90..180, 7GHz	SOT-23	16ta	-	3a	San
<u>LN5</u>	2SC5226-5	Si-nprn	VHF/UHF, LN, 20V, 70mA, 150mW, B=135..270, 7GHz	MCP	16ta	-	3a	San
<u>LN5</u>	2SC5227-5	Si-nprn	VHF/UHF, LN, 20V, 70mA, 200mW, B=135..270, 7GHz	SOT-23	16ta	-	3a	San
<u>LO</u>	2SC2712-O	Si-nprn	GP, AF, 50V, 150mA, 150mW, B=70..140, >80MHz	SOT-23	16ta	-	3a	Tos
<u>LO</u>	2SC4116-O	Si-nprn	GP, AF, 50V, 150mA, 100mW, B=70..140, >80MHz	SOT-323	16ta	-	3a	Tos
<u>LO</u>	HSMF-3860	PIN-diode	RF, 50V, 1A(1ms), <0.2pF, <3Q(100mA)	SOT-23	16dc	-	3a	Agi
<u>lo</u>	PT7M6234CLC3	Vdet-IC	3.4V±1.5%, -Reset PPO	SC-70	16vdc	VD7	3b	Pti
<u>lo</u>	PT7M6234CLC3E	Vdet-IC	3.4V±1.5%, -Reset PPO, Lead free	SC-70	16vdc	VD7	3b	Pti
<u>lo</u>	PT7M6234CLTA3	Vdet-IC	3.4V±1.5%, -Reset PPO	SOT-23	16vdb	VD7	3b	Pti
<u>lo</u>	PT7M6234CLTA3E	Vdet-IC	3.4V±1.5%, -Reset PPO, Lead free	SOT-23	16vdb	VD7	3b	Pti
<u>LOs</u>	BF775	Si-nprn	VHF/UHF, 20V, 30mA, 280mW, B=40..250, 4.5GHz	SOT-23	16ta	-	3a	Sie
<u>LOs</u>	BF775W	Si-nprn	VHF/UHF, 20V, 30mA, 280mW, B>40..200, 5GHz	SOT-323	16ta	-	3a	Sie
<u>lp</u>	PT7M6234CHC3	Vdet-IC	3.4V±1.5%, +Reset PPO	SC-70	16vdc	VD7	3b	Pti
<u>lp</u>	PT7M6234CHC3E	Vdet-IC	3.4V±1.5%, +Reset PPO, Lead free	SC-70	16vdc	VD7	3b	Pti



SMD code	Type	Function	Short description	Case	Pinout	Sch. St.	Mnf.
lp	PT7M6234CHTA3	Vdet-IC	3.4V±1.5%, +Reset PPO	SOT-23	16vdb	VD7	3b Pti
lp	PT7M6234CHTA3E	Vdet-IC	3.4V±1.5%, +Reset PPO, Lead free	SOT-23	16vdb	VD7	3b Pti
LQ	2SD1821A-Q	Si-npn	AF, LN, 185V, 100mA, 150mW, B=85..170, 150MHz	SOT-323	16ta	-	3a Pan
LQ	2SD814A-Q	Si-npn	AF, LN, 185V, 50mA, 200mW, B=90..155, 150MHz	SC-59	16ta	-	3a Pan
LQ	AX6601-25R	LVR-IC	LDO, 2.5V±2%, 300mA	SOT-23L	16cgc	VR1	3b Axl
lq	PT7M6234NLC3	Vdet-IC	3.4V±1.5%, -Reset ODO	SC-70	16vdc	VD6	3b Pti
lq	PT7M6234NLC3E	Vdet-IC	3.4V±1.5%, -Reset ODO, Lead free	SC-70	16vdc	VD6	3b Pti
lq	PT7M6234NLTA3	Vdet-IC	3.4V±1.5%, -Reset ODO	SOT-23	16vdb	VD6	3b Pti
lq	PT7M6234NLTA3E	Vdet-IC	3.4V±1.5%, -Reset ODO, Lead free	SOT-23	16vdb	VD6	3b Pti
LQ-	RT9818C-23PV	Vdet-IC	2.3V±1.5%, -Reset ODO, Td=220ms	SOT-23	16vda	VD6	3a Rct
LR	2SD1821A-R	Si-npn	AF, LN, 185V, 100mA, 150mW, B=130..220, 150MHz	SOT-323	16ta	-	3a Pan
LR	2SD2240A-R	Si-npn	AF, LN, 185V, 100mA, 125mW, B=130..200, 150MHz	SOT-416	16ta	-	3a Pan
LR	2SD814A-R	Si-npn	AF, LN, 185V, 50mA, 200mW, B=130..220, 150MHz	SC-59	16ta	-	3a Pan
LR	CAT809LSDI-GT3	Vdet-IC	4.63V±1.5%, -Reset PPO	SC-70	16vdc	VD7	3d Ons
LR	CAT809LTBI-GT3	Vdet-IC	4.62V±1.5%, -Reset PPO	SOT-23	16vdc	VD7	3b Ons
lr	PT7M6235CLC3	Vdet-IC	3.5V±1.5%, -Reset PPO	SC-70	16vdc	VD7	3b Pti
lr	PT7M6235CLC3E	Vdet-IC	3.5V±1.5%, -Reset PPO, Lead free	SC-70	16vdc	VD7	3b Pti
lr	PT7M6235CLTA3	Vdet-IC	3.5V±1.5%, -Reset PPO	SOT-23	16vdb	VD7	3b Pti
lr	PT7M6235CLTA3E	Vdet-IC	3.5V±1.5%, -Reset PPO, Lead free	SOT-23	16vdb	VD7	3b Pti
LR-	RT9818C-13PV	Vdet-IC	1.3V±1.5%, -Reset ODO, Td=220ms	SOT-23	16vda	VD6	3a Rct
LRs	BF517	Si-npn	UHF-A/Osc, 20V, 25mA, 2.5GHz	SOT-23	16ta	-	3a Sie
LS	2SA1838	Si-pnp	Mute, 15V, 100mA, 200mW, B=200..600, 600MHz	MCP	16ta	-	3a San
LS	2SA1839	Si-pnp	Mute, 15V, 100mA, 200mW, B=200..600, 600MHz	SOT-23	16ta	-	3a San
LS	2SD1821A-S	Si-npn	AF, LN, 185V, 100mA, 150mW, B=185..330, 150MHz	SOT-323	16ta	-	3a Pan
LS	2SD2240A-S	Si-npn	AF, LN, 185V, 100mA, 125mW, B=185..330, 150MHz	SOT-416	16ta	-	3a Pan
LS	2SD814A-S	Si-npn	AF, LN, 185V, 50mA, 200mW, B=185..330, 150MHz	SC-59	16ta	-	3a Pan
LS	CAT810LSDI-GT3	Vdet-IC	4.63V±1.5%, +Reset PPO	SC-70	16vdc	VD7	3d Ons
LS	CAT810LTBI-GT3	Vdet-IC	4.63V±1.5%, +Reset PPO	SOT-23	16vdc	VD7	3b Ons
ls	PT7M6235CHC3	Vdet-IC	3.5V±1.5%, +Reset PPO	SC-70	16vdc	VD7	3b Pti
ls	PT7M6235CHC3E	Vdet-IC	3.5V±1.5%, +Reset PPO, Lead free	SC-70	16vdc	VD7	3b Pti
ls	PT7M6235CHTA3	Vdet-IC	3.5V±1.5%, +Reset PPO	SOT-23	16vdb	VD7	3b Pti
ls	PT7M6235CHTA3E	Vdet-IC	3.5V±1.5%, +Reset PPO, Lead free	SOT-23	16vdb	VD7	3b Pti
LS-	RT9819F-27PV	Vdet-IC	2.7V±1.5%, +PPO +Reset, Td=55ms	SOT-23	16vdc	VD7	3a Rct
LSs	BF770A	Si-npn	SATV-IF, 20V, 50mA, 6GHz	SOT-23	16ta	-	3a Sie
LT	2SD1821A-T	Si-npn	AF, LN, 185V, 100mA, 150mW, B=220..400, 150MHz	SOT-323	16ta	-	3a Pan
LT	2SD814A-T	Si-npn	AF, LN, 185V, 50mA, 200mW, B=220..400, 150MHz	SC-59	16ta	-	3a Pan
LT	AX6601-28R	LVR-IC	LDO, 2.8V±2%, 300mA	SOT-23L	16cgc	VR1	3b Axl
LT	CHT817PT-Q	Si-npn	AF, Sw, 45V, 500mA, B=100..250, 170MHz	SOT-23	16ta	-	3a Chm
lt	PT7M6235NLC3	Vdet-IC	3.5V±1.5%, -Reset ODO	SC-70	16vdc	VD6	3b Pti
lt	PT7M6235NLC3E	Vdet-IC	3.5V±1.5%, -Reset ODO, Lead free	SC-70	16vdc	VD6	3b Pti
lt	PT7M6235NLTA3	Vdet-IC	3.5V±1.5%, -Reset ODO	SOT-23	16vdb	VD6	3b Pti
lt	PT7M6235NLTA3E	Vdet-IC	3.5V±1.5%, -Reset ODO, Lead free	SOT-23	16vdb	VD6	3b Pti
LT-	RT9819A-36PV	Vdet-IC	3.6V±1.5%, -Reset PPO	SOT-23	16vdc	VD7	3a Rct
LT6	2SD2028-6	Si-npn	AF, 8V, 600mA, 200mW, B=200..400, 200MHz, Z-Di(B > C)	SOT-23	16ta	-	3a San
LT7	2SD2028-7	Si-npn	AF, 8V, 600mA, 200mW, B=300..600, 200MHz, Z-Di(B > C)	SOT-23	16ta	-	3a San
LT8	2SD2028-8	Si-npn	AF, 8V, 600mA, 200mW, B=450..900, 200MHz, Z-Di(B > C)	SOT-23	16ta	-	3a San
LTAC	LT1460HCS3-2.5	Vref-IC	µPower, Precision, Series, 2.5V, 0.075%	SOT-23	16vj	VR1	3a Ltc
LTAD	LT1460JCS3-2.5	Vref-IC	µPower, Precision, Series, 2.5V, 0.075%	SOT-23	16vj	VR1	3a Ltc
LTAE	LT1460KCS3-2.5	Vref-IC	µPower, Precision, Series, 2.5V, 0.075%	SOT-23	16vj	VR1	3a Ltc
LTAK	LT1460HCS3-5	Vref-IC	µPower, Precision, Series, 5.0V, 0.075%	SOT-23	16vj	VR1	3a Ltc
LTAL	LT1460JCS3-5	Vref-IC	µPower, Precision, Series, 5.0V, 0.075%	SOT-23	16vj	VR1	3a Ltc
LTAM	LT1460KCS3-5	Vref-IC	µPower, Precision, Series, 5.0V, 0.075%	SOT-23	16vj	VR1	3a Ltc
LTAN	LT1460HCS3-3	Vref-IC	µPower, Precision, Series, 3.0V, 0.075%	SOT-23	16vj	VR1	3a Ltc
LTAQ	LT1460JCS3-3	Vref-IC	µPower, Precision, Series, 3.0V, 0.075%	SOT-23	16vj	VR1	3a Ltc
LTAQ	LT1460KCS3-3	Vref-IC	µPower, Precision, Series, 3.0V, 0.075%	SOT-23	16vj	VR1	3a Ltc
LTAQ	LT1460HCS3-3.3	Vref-IC	µPower, Precision, Series, 3.3V, 0.075%	SOT-23	16vj	VR1	3a Ltc
LTAS	LT1460JCS3-3.3	Vref-IC	µPower, Precision, Series, 3.3V, 0.075%	SOT-23	16vj	VR1	3a Ltc
LTAQ	LT1460KCS3-3.3	Vref-IC	µPower, Precision, Series, 3.3V, 0.075%	SOT-23	16vj	VR1	3a Ltc
LTAU	LT1460HCS3-10	Vref-IC	µPower, Precision, Series, 10V, 0.075%	SOT-23	16vj	VR1	3a Ltc
LTAU	LT1460JCS3-10	Vref-IC	µPower, Precision, Series, 10V, 0.075%	SOT-23	16vj	VR1	3a Ltc
LTAU	LT1460KCS3-10	Vref-IC	µPower, Precision, Series, 10V, 0.075%	SOT-23	16vj	VR1	3a Ltc
LTH8	LT1460HCS3-2.5	Vref-IC	µPower, Precision, Series, 2.5V, 0.075%	SOT-23	16vj	VR1	3a Ltc
LTH8	LT1460JCS3-2.5	Vref-IC	µPower, Precision, Series, 2.5V, 0.075%	SOT-23	16vj	VR1	3a Ltc
LTH8	LT1460KCS3-2.5	Vref-IC	µPower, Precision, Series, 2.5V, 0.075%	SOT-23	16vj	VR1	3a Ltc
LTH9	LT1460HCS3-3	Vref-IC	µPower, Precision, Series, 3.0V, 0.075%	SOT-23	16vj	VR1	3a Ltc
LTH9	LT1460JCS3-3	Vref-IC	µPower, Precision, Series, 3.0V, 0.075%	SOT-23	16vj	VR1	3a Ltc
LTH9	LT1460KCS3-3	Vref-IC	µPower, Precision, Series, 3.0V, 0.075%	SOT-23	16vj	VR1	3a Ltc
LTH9	LT1460HCS3-3.3	Vref-IC	µPower, Precision, Series, 3.3V, 0.075%	SOT-23	16vj	VR1	3a Ltc
LTH9	LT1460JCS3-3.3	Vref-IC	µPower, Precision, Series, 3.3V, 0.075%	SOT-23	16vj	VR1	3a Ltc
LTH9	LT1460KCS3-3.3	Vref-IC	µPower, Precision, Series, 3.3V, 0.075%	SOT-23	16vj	VR1	3a Ltc



SMD code	Type	Function	Short description	Case	Pinout	Sch. St.	Mnf.
LTJ2	LT1460HCS3-5	Vref-IC	μPower, Precision, Series, 5.0V, 0.075%	SOT-23	16vj	VR1 3a	Ltc
LTJ2	LT1460JCS3-5	Vref-IC	μPower, Precision, Series, 5.0V, 0.075%	SOT-23	16vj	VR1 3a	Ltc
LTJ2	LT1460KCS3-5	Vref-IC	μPower, Precision, Series, 5.0V, 0.075%	SOT-23	16vj	VR1 3a	Ltc
LTJ3	LT1460HCS3-10	Vref-IC	μPower, Precision, Series, 10V, 0.075%	SOT-23	16vj	VR1 3a	Ltc
LTJ3	LT1460JCS3-10	Vref-IC	μPower, Precision, Series, 10V, 0.075%	SOT-23	16vj	VR1 3a	Ltc
LTJ3	LT1460KCS3-10	Vref-IC	μPower, Precision, Series, 10V, 0.075%	SOT-23	16vj	VR1 3a	Ltc
LTJN	LT1460BCS3-2.5	Vref-IC	μPower, Precision, Series, 2.5V, 0.075%	SOT-23	16vj	VR1 3a	Ltc
LTJP	LT1460BCS3-3.0	Vref-IC	μPower, Precision, Series, 3.0V, 0.075%	SOT-23	16vj	VR1 3a	Ltc
LTJQ	LT1460BCS3-3.3	Vref-IC	μPower, Precision, Series, 3.3V, 0.075%	SOT-23	16vj	VR1 3a	Ltc
LTJR	LT1460BCS3-5	Vref-IC	μPower, Precision, Series, 5.0V, 0.075%	SOT-23	16vj	VR1 3a	Ltc
LTJS	LT1460BCS3-10	Vref-IC	μPower, Precision, Series, 10V, 0.075%	SOT-23	16vj	VR1 3a	Ltc
LTJT	LT1460BIS3-2.5	Vref-IC	μPower, Precision, Series, 2.5V, 0.075%	SOT-23	16vj	VR1 3a	Ltc
LTJU	LT1460BIS3-3.0	Vref-IC	μPower, Precision, Series, 3.0V, 0.075%	SOT-23	16vj	VR1 3a	Ltc
LTJV	LT1460BIS3-3.3	Vref-IC	μPower, Precision, Series, 3.3V, 0.075%	SOT-23	16vj	VR1 3a	Ltc
LTJW	LT1460BIS3-5	Vref-IC	μPower, Precision, Series, 5.0V, 0.075%	SOT-23	16vj	VR1 3a	Ltc
LTJX	LT1460BIS3-10	Vref-IC	μPower, Precision, Series, 10V, 0.075%	SOT-23	16vj	VR1 3a	Ltc
lu	PT7M6236CLC3	Vdet-IC	3.6V±1.5%, -Reset PPO	SC-70	16vdc	VD7 3b	Pti
lu	PT7M6236CLC3E	Vdet-IC	3.6V±1.5%, -Reset PPO, Lead free	SC-70	16vdc	VD7 3b	Pti
lu	PT7M6236CLTA3	Vdet-IC	3.6V±1.5%, -Reset PPO	SOT-23	16vdc	VD7 3b	Pti
lu	PT7M6236CLTA3E	Vdet-IC	3.6V±1.5%, -Reset PPO, Lead free	SOT-23	16vdc	VD7 3b	Pti
LU-	RT9818C-16PV	Vdet-IC	1.6V±1.5%, -Reset ODO, Td=220ms	SOT-23	16vdc	VD6 3a	Rct
lv	PT7M6236CHC3	Vdet-IC	3.6V±1.5%, +Reset PPO	SC-70	16vdc	VD7 3b	Pti
lv	PT7M6236CHC3E	Vdet-IC	3.6V±1.5%, +Reset PPO, Lead free	SC-70	16vdc	VD7 3b	Pti
lv	PT7M6236CHTA3	Vdet-IC	3.6V±1.5%, +Reset PPO	SOT-23	16vdc	VD7 3b	Pti
lv	PT7M6236CHTA3E	Vdet-IC	3.6V±1.5%, +Reset PPO, Lead free	SOT-23	16vdc	VD7 3b	Pti
LV-	RT9166-13PVL	LVR-IC	LDO, 1.3V±2%, 300mA	SOT-23	16cg	VR1 3a	Rct
LV1	CH661DPT	Si-diode	SBD, 60V, 500mA, Vf<0.63V(500mA)	SOT-23	16dc	- 3a	Chm
LV3	BAT34PT	Si-diode	SBD, 30V, 100mA, Vf<1V(100mA), 5ns	SOT-23	16dc	- 3a	Chm
LV3	CH420DPT	Si-diode	SBD, 40V, 100mA, Vf<0.45V(10mA)	SOT-23	16dc	- 3a	Chm
LV4	BAT54PT	Si-diode	SBD, 30V, 200mA, Vf<1V(100mA), 5ns	SOT-23	16dc	- 3a	Chm
LV6	CH421DPT	Si-diode	SBD, 40V, 100mA, Vf<0.55V(100mA)	SOT-23	16dc	- 3a	Chm
LW	AX6601-30R	LVR-IC	LDO, 3.0V±2%, 300mA	SOT-23L	16cg	VR1 3b	Axl
lw	PT7M6236NLC3	Vdet-IC	3.6V±1.5%, -Reset ODO	SC-70	16vdc	VD6 3b	Pti
lw	PT7M6236NLC3E	Vdet-IC	3.6V±1.5%, -Reset ODO, Lead free	SC-70	16vdc	VD6 3b	Pti
lw	PT7M6236NLTA3	Vdet-IC	3.6V±1.5%, -Reset ODO	SOT-23	16vdc	VD6 3b	Pti
lw	PT7M6236NLTA3E	Vdet-IC	3.6V±1.5%, -Reset ODO, Lead free	SOT-23	16vdc	VD6 3b	Pti
LW-	RT9819B-15PV	Vdet-IC	1.5V±1.5%, -Reset PPO, Td=55ms	SOT-23	16vdc	VD7 3a	Rct
lx	PT7M6237CLC3	Vdet-IC	3.7V±1.5%, -Reset PPO	SC-70	16vdc	VD7 3b	Pti
lx	PT7M6237CLC3E	Vdet-IC	3.7V±1.5%, -Reset PPO, Lead free	SC-70	16vdc	VD7 3b	Pti
lx	PT7M6237CLTA3	Vdet-IC	3.7V±1.5%, -Reset PPO	SOT-23	16vdc	VD7 3b	Pti
lx	PT7M6237CLTA3E	Vdet-IC	3.7V±1.5%, -Reset PPO, Lead free	SOT-23	16vdc	VD7 3b	Pti
LX-	RT9161A-32PV	LVR-IC	LDO, 3.3V±2%, 500mA	SOT-23	16cg	VR1 3a	Rct
LY	2SC2712-Y	Si-npn	GP, AF, 50V, 150mA, 150mW, B=120..240, >80MHz	SOT-23	16ta	- 3a	Tos
LY	2SC4116-Y	Si-npn	GP, AF, 50V, 150mA, 100mW, B=120..240, >80MHz	SOT-323	16ta	- 3a	Tos
LY	2SC4738FT-Y	Si-npn	AF-Amp, 60V, 150mA, 100mW, >80MHz, B=120..240	TESM	18ta	- 3a	Tos
LY	2SC4738F-Y	Si-npn	AF-Amp, 60V, 150mA, 100mW, >80MHz, B=120..240	SOT-490	18ta	- 3a	Tos
LY	2SC4738-Y	Si-npn	AF-Amp, 60V, 150mA, 100mW, >80MHz, B=120..240	SOT-23	16ta	- 3a	Tos
LY	KTC4075-Y	Si-npn	AF, 60V, 150mA, 100mW, B>120..240, >80MHz	SOT-323	16ta	- 3f	Kec
ly	PT7M6237CHC3	Vdet-IC	3.7V±1.5%, +Reset PPO	SC-70	16vdc	VD7 3b	Pti
ly	PT7M6237CHC3E	Vdet-IC	3.7V±1.5%, +Reset PPO, Lead free	SC-70	16vdc	VD7 3b	Pti
ly	PT7M6237CHTA3	Vdet-IC	3.7V±1.5%, +Reset PPO	SOT-23	16vdc	VD7 3b	Pti
ly	PT7M6237CHTA3E	Vdet-IC	3.7V±1.5%, +Reset PPO, Lead free	SOT-23	16vdc	VD7 3b	Pti
LY=	RT9818D-12GV	Vdet-IC	1.2V±1.5%, -Reset ODO, Td=450ms	SOT-23	16vdc	VD6 3a	Rct
LY2	2SC3772-2	Si-npn	UHF, Osc-Mix, 25V, 70mA, 250mW, 3GHz, B=40..80	SOT-23	16ta	- 3a	San
LY2	2SC4403-2	Si-npn	UHF, Osc, 25V, 70mA, 150mW, B=40..80, 3GHz	MCP	16ta	- 3a	San
LY3	2SC3772-3	Si-npn	UHF, Osc-Mix, 25V, 70mA, 250mW, 3GHz, B=60..120	SOT-23	16ta	- 3a	San
LY3	2SC4403-3	Si-npn	UHF, Osc, 25V, 70mA, 150mW, B=60..120, 3GHz	MCP	16ta	- 3a	San
LY4	2SC3772-4	Si-npn	UHF, Osc-Mix, 25V, 70mA, 250mW, 3GHz, B=100..200	SOT-23	16ta	- 3a	San
LY4	2SC4403-4	Si-npn	UHF, Osc, 25V, 70mA, 150mW, B=100..200, 3GHz	MCP	16ta	- 3a	San
lz	PT7M6237NLC3	Vdet-IC	3.7V±1.5%, -Reset ODO	SC-70	16vdc	VD6 3b	Pti
lz	PT7M6237NLC3E	Vdet-IC	3.7V±1.5%, -Reset ODO, Lead free	SC-70	16vdc	VD6 3b	Pti
lz	PT7M6237NLTA3	Vdet-IC	3.7V±1.5%, -Reset ODO	SOT-23	16vdc	VD6 3b	Pti
lz	PT7M6237NLTA3E	Vdet-IC	3.7V±1.5%, -Reset ODO, Lead free	SOT-23	16vdc	VD6 3b	Pti
LZ=	RT9819D-13GV	Vdet-IC	1.3V±1.5%, -Reset PPO, Td=450ms	SOT-23	16vdc	VD7 3a	Rct
m	AX6902FA	Vdet-IC	2.63V±1.5%, +Reset PPO	SC-70	16vdc	VD7 3b	Axl
M-E	2SA1235A-E	Si-pnp	AF-Amp, 60V, 200mA, 200mW, 200MHz, B=150..300	SC-59	16ta	- 3a	Mit
M-E	2SA1602-E	Si-pnp	AF, 50V, 200mA, 150mW, 200MHz, B=150..300	SOT-323	16ta	- 3a	Mit
M-F	2SA1235A-F	Si-pnp	AF-Amp, 60V, 200mA, 200mW, 200MHz, B=250..500	SC-59	16ta	- 3a	Mit
M-F	2SA1602-F	Si-pnp	AF, 50V, 200mA, 150mW, 200MHz, B=250..500	SOT-323	16ta	- 3a	Mit
MO	ELM7630LAB	Vdet-IC	3.0V±2%, -Reset PPO, 250ms	SOT-23	16vdc	VD7 3d	Elm



SMD code	Type	Function	Short description	Case	Pinout	Sch. St.	Mnf.
M0	R1100D101C	LVR-IC	U-low lcc, 1V±2%, 180mA	SON1408-3	18vj	VR1	3d Ric
M0	R3111N402C	Vdet-IC	4V±2%, -Reset ODO	SOT-23	16vdd	VD6	3d Ric
M0	R3130N40BC	Vdet-IC	4V, -Reset ODO, 100ms	SOT-23	16vdc	VD6	3b Ric
M0	XC61CN2002M	Vdet-IC	2V±1%, +Reset ODO	SOT-23	16vdb	VD6	3d Tor
M0	XC6GN2002HR	Vdet-IC	2.0V, +Reset ODO	USP-3	17vdc	VD1	9b Tor
M0=	RT9161A-28GV	LVR-IC	LDO, 2.8V±2%, 500mA	SOT-23	16cg	VR1	3a Rct
M03	XE61CN2045MR	Vdet-IC	2.0V±2%, -Reset ODO	SOT-23	16vdb	VD6	3h Tor
M05	SM05	TVS	Dual, 5V, 17A, 300W(1ms)	SOT-23	16df	-	3a Smt
M05	XC61FN2012M	Vdet-IC	2V±2%, +Reset ODO, 200ms	SOT-23	16vdb	VD6	3d Tor
M05	XC61HN2012MR	Vdet-IC	2.0V±2%, -Reset ODO, 50..200ms	SOT-23	16vdc	VD6	3d Tor
M06	XC61FN2042M	Vdet-IC	2V±2%, +Reset ODO, 400ms	SOT-23	16vdb	VD6	3d Tor
M06	XC61HN2042MR	Vdet-IC	2.0V±2%, -Reset ODO, 80..400ms	SOT-23	16vdc	VD6	3d Tor
M07	XC61FN2052M	Vdet-IC	2V±2%, +Reset ODO, 50ms	SOT-23	16vdb	VD6	3d Tor
M07	XC61HN2052MR	Vdet-IC	2.0V±2%, -Reset ODO, 1..50ms	SOT-23	16vdc	VD6	3d Tor
M1	2SC5066-O	Si-npn	VHF/UHF, LN, 20V, 30mA, 100mW, 7GHz, B=80..160	SOT-323	16ta	-	3a Tos
M1	BFR30	n-FET	GP, 25V, 10mA, 225mW, Up<5V	SOT-23	16fj	-	3a Ons
M1	ELM7631LAB	Vdet-IC	3.1V±2%, -Reset PPO, 250ms	SOT-23	16vdc	VD7	3d Elm
M1	MAS3781	Si-diode	SBD, Sw, 30V, 30mA, Vf<1V(30mA), 1.5pF, 1ns	SSSMini3-F1	16dc	-	3a Pan
M1	MMBZ5256B	Z-diode	28.50..31.50V, Zzt=49Ω, Izt=4.2mA, 410mW	SOT-23	16dc	-	3a Pjt
M1	MMBZ5256BW	Z-diode	30V±5%, Zzt=49Ω, 200mW	SOT-323	16dc	-	3a Pjt
M1	R1100D111C	LVR-IC	U-low lcc, 1.1V±2%, 180mA	SON1408-3	18vj	VR1	3d Ric
M1	R3111N412C	Vdet-IC	4.1V±2%, -Reset ODO	SOT-23	16vdd	VD6	3d Ric
M1	R3130N44BC	Vdet-IC	4.4V, -Reset ODO, 100ms	SOT-23	16vdc	VD6	3b Ric
M1	TC54VN2102ECB	Vdet-IC	2.1V±2%, -Reset ODO	SOT-23	16vdb	VD6	3a Tcs
M1	XC61CN2102M	Vdet-IC	2.1V±1%, +Reset ODO	SOT-23	16vdb	VD6	3d Tor
M1	XC6GN2102HR	Vdet-IC	2.1V, +Reset ODO	USP-3	17vdc	VD1	9b Tor
M12	SM12	TVS	Dual, 12V, 12A, 300W(1ms)	SOT-23	16df	-	3a Smt
M13	XE61CN2145MR	Vdet-IC	2.1V±2%, -Reset ODO	SOT-23	16vdb	VD6	3h Tor
M15	2SA1411-15	Si-pnp	Sw, 25V, 150mA, 250mW, B=350..700	SOT-23	16ta	-	3a Nec
M15	2SA1613-15	Si-pnp	Hi-beta, 25V, 150mA, B=135..270	SOT-23	16ta	-	3a Nec
M15	SM15	TVS	Dual, 15V, 10A, 300W(1ms)	SOT-23	16df	-	3a Smt
M15	XC61FN2112M	Vdet-IC	2.1V±2%, +Reset ODO, 200ms	SOT-23	16vdb	VD6	3d Tor
M15	XC61HN2112MR	Vdet-IC	2.1V±2%, -Reset ODO, 50..200ms	SOT-23	16vdc	VD6	3d Tor
M16	2SA1411-16	Si-pnp	Sw, 25V, 150mA, 250mW, B=5000..1000	SOT-23	16ta	-	3a Nec
M16	2SA1613-16	Si-pnp	Hi-beta, 25V, 150mA, B=200..400	SOT-23	16ta	-	3a Nec
M16	XC61FN2142M	Vdet-IC	2.1V±2%, +Reset ODO, 400ms	SOT-23	16vdb	VD6	3d Tor
M16	XC61HN2142MR	Vdet-IC	2.1V±2%, -Reset ODO, 80..400ms	SOT-23	16vdc	VD6	3d Tor
M17	XC61FN2152M	Vdet-IC	2.1V±2%, +Reset ODO, 50ms	SOT-23	16vdb	VD6	3d Tor
M17	XC61HN2152MR	Vdet-IC	2.1V±2%, -Reset ODO, 1..50ms	SOT-23	16vdc	VD6	3d Tor
M1B	MMBT2222L	Si-npn	GP, 60V, 800mA, 200mW, B=100..300, >200MHz	SOT-23	16ta	-	3a Mot
M1E	MMBTA43	Si-npn	Vid, 200V, 500mA, 300mW, B>40, >50MHz	SOT-23	16ta	-	3a Mot
M1F	MMBT5550	Si-npn	HV, 140V, 600mA, 225mW, B=80..250, >300MHz	SOT-23	16ta	-	3a Mot
M1J	MMBT2369	Si-npn	Sw, 40V, 200mA, 330mW, B=40..120	SOT-23	16ta	-	3a Mot
M1P	BFR30	n-FET	GP, 25V, 10mA, 250mW, Up<5V	SOT-23	16fj	-	3a Phi
M1T	ADM1811-10AKS	Vdet-IC	4.35V, -Reset ODO	SOT-323	16vda	VD6	3a Ad
M1T	ADM1811-10ART	Vdet-IC	4.35V, -Reset ODO	SOT-23	16vda	VD6	3a Ad
M1V	ADM1811-5AKS	Vdet-IC	4.62V, -Reset ODO	SOT-323	16vda	VD6	3a Ad
M1V	ADM1811-5ART	Vdet-IC	4.62V, -Reset ODO	SOT-23	16vda	VD6	3a Ad
M1X	MA3X075D	Si-diode	Dual, Band-sw, 25V, 100mA, Vf=0.92V(100mA), 0.9pF	SC-59	16df	-	3a Pan
M1X	MA3Z080D	Si-diode	Dual, Band-sw, 35V, 100mA, Vf=0.92V(100mA), 0.9pF	SOT-323	16df	-	3a Pan
M1X	MA75WA	Si-diode	Dual, Band-sw, 25V, 100mA, Vf=0.92V(100mA), 0.9pF	SC-59	16df	-	3a Pan
M1X	MA80WA	Si-diode	Dual, Band-sw, 35V, 100mA, Vf=0.92V(100mA), 0.9pF	SOT-323	16df	-	3a Pan
M1Y	MA3X075E	Si-diode	Dual, Band-sw, 25V, 100mA, Vf=0.92V(100mA), 0.9pF	SC-59	16dg	-	3a Pan
M1Y	MA3Z080E	Si-diode	Dual, Band-sw, 35V, 100mA, Vf=0.92V(100mA), 0.9pF	SOT-323	16dg	-	3a Pan
M1Y	MA75WK	Si-diode	Dual, Band-sw, 25V, 100mA, Vf=0.92V(100mA), 0.9pF	SC-59	16dg	-	3a Pan
M1Y	MA80WK	Si-diode	Dual, Band-sw, 35V, 100mA, Vf=0.92V(100mA), 0.9pF	SOT-323	16dg	-	3a Pan
M2	2SC5066-Y	Si-npn	VHF/UHF, LN, 20V, 30mA, 100mW, 7GHz, B=120..240	SOT-323	16ta	-	3a Tos
M2	BFR31	n-FET	GP, 25V, 5mA, 225mW, Up<5V	SOT-23	16fj	-	3a Ons
M2	ELM7632LAB	Vdet-IC	3.2V±2%, -Reset PPO, 250ms	SOT-23	16vdc	VD7	3d Elm
M2	MMBZ5257B	Z-diode	31.35..34.65V, Zzt=58Ω, Izt=3.8mA, 410mW	SOT-23	16dc	-	3a Pjt
M2	MMBZ5257BW	Z-diode	33V±5%, Zzt=58Ω, 200mW	SOT-323	16dc	-	3a Pjt
M2	R1100D121C	LVR-IC	U-low lcc, 1.2V±2%, 180mA	SON1408-3	18vj	VR1	3d Ric
M2	R3111N422C	Vdet-IC	4.2V±2%, -Reset ODO	SOT-23	16vdd	VD6	3d Ric
M2	R3130N26BC3	Vdet-IC	2.6V, -Reset ODO, 100ms	SOT-23	16vdc	VD6	3b Ric
M2	TC54VN2202ECB	Vdet-IC	2.2V±2%, -Reset ODO	SOT-23	16vdb	VD6	3a Tcs
M2	XC61CN2202M	Vdet-IC	2.2V±1%, +Reset ODO	SOT-23	16vdb	VD6	3d Tor
M2	XC6GN2202HR	Vdet-IC	2.2V, +Reset ODO	USP-3	17vdc	VD1	9b Tor
M2=	RT9818C-33GVL	Vdet-IC	3.3V±1.5%, -Reset ODO, Td=220ms	SOT-23	16vdc	VD6	3a Rct
M23	XE61CN2245MR	Vdet-IC	2.2V±2%, -Reset ODO	SOT-23	16vdb	VD6	3h Tor
M24	SM24	TVS	2x 24V, 5A, 300W(1ms)	SOT-23	16df	-	3a Smt



SMD code	Type	Function	Short description	Case	Pinout	Sch.	St.	Mnf.
M25	XC61FN2212M	Vdet-IC	2.2V±2%, +Reset ODO, 200ms	SOT-23	16vdb	VD6	3d	Tor
M25	XC61HN2212MR	Vdet-IC	2.2V±2%, -Reset ODO, 50..200ms	SOT-23	16vdc	VD6	3d	Tor
M26	XC61FN2242M	Vdet-IC	2.2V±2%, +Reset ODO, 400ms	SOT-23	16vdb	VD6	3d	Tor
M26	XC61HN2242MR	Vdet-IC	2.2V±2%, -Reset ODO, 80..400ms	SOT-23	16vdc	VD6	3d	Tor
M27	XC61FN2252M	Vdet-IC	2.2V±2%, +Reset ODO, 50ms	SOT-23	16vdb	VD6	3d	Tor
M27	XC61HN2252MR	Vdet-IC	2.2V±2%, -Reset ODO, 1..50ms	SOT-23	16vdc	VD6	3d	Tor
M2A	MMBT2222A	Si-npn	GP, 75V, 600mA, 225mW, B=35..300, >200MHz	SOT-23	16ta	-	3a	Ctc
M2B	MMBT2907A	Si-pnp	GP, 60V, 500mA, 310mW, B=100..300, >200MHz	SOT-23	16ta	-	3a	Mot
M2B	MMBT2907L	Si-pnp	GP, 40V, 600mA, 330mW, B=100..300, >200MHz	SOT-23	16ta	-	3a	Mot
M2C	MMBT470	Si-pnp	GP, 40V, 100mA, 225mW, B=40..400, >125MHz	SOT-23	16ta	-	3a	Mot
M2F	MMBT2907A	Si-pnp	GP, 60V, 500mA, 310mW, B=75..300, <200MHz	SOT-23	16ta	-	3a	Bel
M2H	MA3X555	PIN-diode	Dual, UHF/SHF-AGC, 40V, 100mA, Vf=1V(100mA), 0.3pF	SC-59	16ea	-	3a	Pan
M2H	MA555	PIN-diode	Dual, UHF/SHF-AGC, 40V, 100mA, Vf=1V(100mA), 0.3pF	SC-59	16ea	-	3a	Pan
M2p	BFR31	n-FET	GP, 25V, 5mA, 250mW, Up<5V	SOT-23	16fj	-	3a	Phi
M2p	MA3X730	Si-diode	Dual, SBD UHF-mix, 5V, 100mA, Vf=0.25V(2mA), 0.85pF	SC-59	16dl	-	3a	Pan
M3	2SA812A-M3	Si-pnp	GP, AF, 60V, 100mA, 200mW, B=70..140, 180MHz	SOT-23	16ta	-	3a	Nec
M3	2SA812-M3	Si-pnp	GP, AF, 60V, 100mA, 200mW, B=70..140, 180MHz	SOT-23	16ta	-	3a	Nec
M3	ELM7633LAB	Vdet-IC	3.3V±2%, -Reset PPO, 250ms	SOT-23	16vdc	VD7	3d	Elm
M3	ILC5061C23X	Vdet-IC	2.3V±2%, -Reset ODO	SOT-323	16vdb	VD6	3a	Imp
M3	ILC5061M23X	Vdet-IC	2.3V±2%, -Reset ODO	SOT-23	16vdb	VD6	3a	Imp
M3	KST812-M3	Si-pnp	GP, 50V, 100mA, 350mW, B=60..120	SOT-23	16ta	-	3a	Sam
M3	MIMBA812M3	Si-pnp	GP, 50V, 100mA, 350mW, B=60..120	SOT-23	16ta	-	3a	Sam
M3	MMBZ5258B	Z-diode	34.20..37.80V, Zzt=70Ω, Izt=3.4mA, 410mW	SOT-23	16dc	-	3a	Pjt
M3	MMBZ5258BW	Z-diode	36V±5%, Zzt=70Ω, 200mW	SOT-323	16dc	-	3a	Pjt
M3	R1100D131C	LVR-IC	U-low lcc, 1.3V±2%, 180mA	SON1408-3	18vj	VR1	3d	Ric
M3	R3111N432C	Vdet-IC	4.3V±2%, -Reset ODO	SOT-23	16vdd	VD6	3d	Ric
M3	R3130N29BC3	Vdet-IC	2.9V, -Reset ODO, 100ms	SOT-23	16vdc	VD6	3b	Ric
M3	TC54VN2302ECB	Vdet-IC	2.3V±2%, -Reset ODO	SOT-23	16vdb	VD6	3a	Tcs
M3	XC61CN2302M	Vdet-IC	2.3V±1%, +Reset ODO	SOT-23	16vdb	VD6	3d	Tor
M3	XC6GN2302HR	Vdet-IC	2.3V, +Reset ODO	USP-3	17vdc	VD1	9b	Tor
M3=	RT9818D-13GV	Vdet-IC	1.3V±1.5%, -Reset ODO, Td=450ms	SOT-23	16vdc	VD6	3a	Rct
M30	FN1L4L	Si-pnp-Digi	Sw, 60V, 100mA, 200mW, R1/R2=10k/22k	SC-59	16ta	-	3a	Nec
M30	GN1L4L	Si-pnp-Digi	Sw, 60V, 100mA, 200mW, R1/R2=10k/22k	SOT-323	16ta	-	3a	Nec
M30	MA3X557	PIN-diode	Dual, UHF/SHF-AGC, 40V, 100mA, Vf=1V(100mA), 0.3pF	SC-59	16dl	-	3a	Pan
M30	MA557	PIN-diode	Dual, UHF/SHF-AGC, 40V, 100mA, Vf=1V(100mA), 0.3pF	SC-59	16dl	-	3a	Pan
M31	FN1L4M	Si-pnp-Digi	Sw, 60V, 100mA, 200mW, R1/R2=47k/47k	SC-59	16ta	-	3a	Nec
M31	GN1L4M	Si-pnp-Digi	Sw, 60V, 100mA, 200mW, R1/R2=47k/47k	SOT-323	16ta	-	3a	Nec
M32	FN1F4M	Si-pnp-Digi	Sw, 60V, 100mA, 200mW, R1/R2=22k/22k	SC-59	16ta	-	3a	Nec
M32	GN1F4M	Si-pnp-Digi	Sw, 60V, 100mA, 200mW, R1/R2=22k/22k	SOT-323	16ta	-	3a	Nec
M33	FN1A4M	Si-pnp-Digi	Sw, 60V, 100mA, 200mW, R1/R2=10k/10k	SC-59	16ta	-	3a	Nec
M33	GN1A4M	Si-pnp-Digi	Sw, 60V, 100mA, 200mW, R1/R2=10k/10k	SOT-323	16ta	-	3a	Nec
M33	XE61CN2345MR	Vdet-IC	2.3V±2%, -Reset ODO	SOT-23	16vdb	VD6	3h	Tor
M34	FN1A4P	Si-pnp-Digi	Sw, 60V, 100mA, 200mW, R1/R2=10k/47k	SC-59	16ta	-	3a	Nec
M34	GN1A4P	Si-pnp-Digi	Sw, 60V, 100mA, 200mW, R1/R2=10k/47k	SOT-323	16ta	-	3a	Nec
M35	FN1F4N	Si-pnp-Digi	Sw, 60V, 100mA, 200mW, R1/R2=22k/47k	SC-59	16ta	-	3a	Nec
M35	GN1F4N	Si-pnp-Digi	Sw, 60V, 100mA, 200mW, R1/R2=22k/47k	SOT-323	16ta	-	3a	Nec
M35	XC61FN2312M	Vdet-IC	2.3V±2%, +Reset ODO, 200ms	SOT-23	16vdb	VD6	3d	Tor
M35	XC61HN2312MR	Vdet-IC	2.3V±2%, -Reset ODO, 50..200ms	SOT-23	16vdc	VD6	3d	Tor
M36	FN1L3Z-Q	Si-pnp-Digi	Sw, 60V, 100mA, 200mW, R1=4k7, B=135..270	SC-59	16ta	-	3a	Nec
M36	GN1L3Z-Q	Si-pnp-Digi	Sw, 60V, 100mA, 200mW, R1=4k7, B=135..270	SOT-323	16ta	-	3a	Nec
M36	SM36	TVS	2x 36V, 4A, 300W(1ms)	SOT-23	16df	-	3a	Smt
M36	XC61FN2342M	Vdet-IC	2.3V±2%, +Reset ODO, 400ms	SOT-23	16vdb	VD6	3d	Tor
M36	XC61HN2342MR	Vdet-IC	2.3V±2%, -Reset ODO, 80..400ms	SOT-23	16vdc	VD6	3d	Tor
M37	FN1L3Z-P	Si-pnp-Digi	Sw, 60V, 100mA, 200mW, R1=4k7, B=200..400	SC-59	16ta	-	3a	Nec
M37	GN1L3Z-P	Si-pnp-Digi	Sw, 60V, 100mA, 200mW, R1=4k7, B=200..400	SOT-323	16ta	-	3a	Nec
M37	XC61FN2352M	Vdet-IC	2.3V±2%, +Reset ODO, 50ms	SOT-23	16vdb	VD6	3d	Tor
M37	XC61HN2352MR	Vdet-IC	2.3V±2%, -Reset ODO, 1..50ms	SOT-23	16vdc	VD6	3d	Tor
M38	FN1L3Z-K	Si-pnp-Digi	Sw, 60V, 100mA, 200mW, R1=4k7, B=135..270	SC-59	16ta	-	3a	Nec
M38	GN1L3Z-K	Si-pnp-Digi	Sw, 60V, 100mA, 200mW, R1=4k7, B=135..270	SOT-323	16ta	-	3a	Nec
M3A	ILC5061AIC23X	Vdet-IC	2.3V±1%, -Reset ODO	SOT-323	16vdb	VD6	3a	Imp
M3A	ILC5061AM23X	Vdet-IC	2.3V±1%, -Reset ODO	SOT-23	16vdb	VD6	3a	Imp
M3A	MMBTH24	Si-npn	40V, 50mA, 300mW, B>30, >400MHz	SOT-23	16ta	-	3a	Mot
M3B	MMBT918	Si-npn	VHF/UHF, 30V, 50mA, 225mW, B>20, 60MHz	SOT-23	16ta	-	3a	Mot
M3J	MMBTH69	Si-pnp	UHF/VHF, 15V, 50mA, 225mW, B=30..300, >2GHz	SOT-23	16ta	-	3a	Mot
M3p	BFT46	n-FET	AF/HF, 25V, 250mW, Idss>0.2mA, Up<1.2V, 0.5ms	SOT-23	16fj	-	3a	Phi
M3S	MA3Z070	Si-diode	Dual, Band-sw, 35V, 100mA, Vf=0.92V(100mA), 0.9pF	SOT-323	16dl	-	3a	Pan
M3S	MA70	Si-diode	Dual, Band-sw, 35V, 100mA, Vf=0.92V(100mA), 0.9pF	SOT-323	16dl	-	3a	Pan
M3T	ADM1813-10AKS	Vdet-IC	4.35V, -Reset ODO	SOT-323	16vda	VD6	3a	Ad
M3T	ADM1813-10ART	Vdet-IC	4.35V, -Reset ODO	SOT-23	16vda	VD6	3a	Ad
M3V	ADM1813-5AKS	Vdet-IC	4.62V, -Reset ODO	SOT-323	16vda	VD6	3a	Ad



SMD code	Type	Function	Short description	Case	Pinout	Sch. St.	Mnf.
M3V	ADM1813-5ART	Vdet-IC	4.62V, -Reset ODO	SOT-23	16vda	VD6	3a Ad
M4	2SA1179-4	Si-pnp	GP, AF, 55V, 150mA, 200mW, B=90..180, 180MHz	CPA	16ta	-	3a San
M4	2SA1611-4	Si-pnp	AF, 60V, 100mA, 150mW, B=90..180, 180MHz	SOT-323	16ta	-	3a Nec
M4	2SA1836-4	Si-pnp	AF, 60V, 100mA, 200mW, B=90..180, >50MHz	SOT-416	16ta	-	3a Nec
M4	2SA812A-M4	Si-pnp	GP, AF, 60V, 100mA, 200mW, B=90..180, 180MHz	SOT-23	16ta	-	3a Nec
M4	2SA812-M4	Si-pnp	GP, AF, 60V, 100mA, 200mW, B=90..180, 180MHz	SOT-23	16ta	-	3a Nec
M4	BSR56	n-FET	Sw, 40V, 250mW, Idss>50mA, Up<10V	SOT-23	16fj	-	3a Nsc
M4	ELM7634LAB	Vdet-IC	3.4V±2%, -Reset PPO, 250ms	SOT-23	16vdc	VD7	3d Elm
M4	KST812-M4	Si-pnp	GP, 50V, 100mA, 350mW, B=90..180	SOT-23	16ta	-	3a Sam
M4	MAS3781E	Si-diode	Dual, SBD, Sw, 30V, 30mA, Vf<1V(30mA), 1.5pF, 1ns	SSSMini3-F1	18dg	-	3a Pan
M4	MIBA812M4	Si-pnp	GP, 50V, 100mA, 350mW, B=90..180	SOT-23	16ta	-	3a Sam
M4	MMBZ5259B	Z-diode	37.05..40.95V, Zzt=80Ω, Izt=3.2mA, 410mW	SOT-23	16dc	-	3a Pjt
M4	MMBZ5259BW	Z-diode	39V±5%, Zzt=80Ω, 200mW	SOT-323	16dc	-	3a Pjt
M4	R1100D141C	LVR-IC	U-low lcc, 1.4V±2%, 180mA	SON1408-3	18vj	VR1	3d Ric
M4	R3111N442C	Vdet-IC	4.4V±2%, -Reset ODO	SOT-23	16vdd	VD6	3d Ric
M4	R3130N30BC8	Vdet-IC	3V, -Reset ODO, 100ms	SOT-23	16vdc	VD6	3b Ric
M4	TC54VN2402ECB	Vdet-IC	2.4V±2%, -Reset ODO	SOT-23	16vdb	VD6	3a Tcs
M4	XC61CN2402M	Vdet-IC	2.4V±1%, +Reset ODO	SOT-23	16vdb	VD6	3d Tor
M4	XC6GN2402HR	Vdet-IC	2.4V, +Reset ODO	USP-3	17vdc	VD1	9b Tor
M4=	RT9818C-15GV	Vdet-IC	1.5V±1.5%, -Reset ODO, Td=220ms	SOT-23	16vdc	VD6	3a Rct
M43	XE61CN2445MR	Vdet-IC	2.4V±2%, -Reset ODO	SOT-23	16vdb	VD6	3h Tor
M45	XC61FN2412M	Vdet-IC	2.4V±2%, +Reset ODO, 200ms	SOT-23	16vdb	VD6	3d Tor
M45	XC61HN2412MR	Vdet-IC	2.4V±2%, -Reset ODO, 50..200ms	SOT-23	16vdc	VD6	3d Tor
M46	XC61FN2442M	Vdet-IC	2.4V±2%, +Reset ODO, 400ms	SOT-23	16vdb	VD6	3d Tor
M46	XC61HN2442MR	Vdet-IC	2.4V±2%, -Reset ODO, 80..400ms	SOT-23	16vdc	VD6	3d Tor
M47	XC61FN2452M	Vdet-IC	2.4V±2%, +Reset ODO, 50ms	SOT-23	16vdb	VD6	3d Tor
M47	XC61HN2452MR	Vdet-IC	2.4V±2%, -Reset ODO, 1..50ms	SOT-23	16vdc	VD6	3d Tor
M4B	MMBV432	C-diode	Dual, FM-Tuning, 14V, 43/48.1pF(2V)	SOT-23	16dg	-	3a Mot
M4C	MA3X558	PIN-diode	Dual, UHF/SHF-AGC, 40V, 100mA, Vf=1V(100mA), 0.3pF	SC-59	16dg	-	3a Pan
M4C	MA558	PIN-diode	Dual, UHF/SHF-AGC, 40V, 100mA, Vf=1V(100mA), 0.3pF	SC-59	16dg	-	3a Pan
M4F	MMBD353	Si-diode	Dual, UHF-Mix, 7V, 10mA, Vf<0.6V(10mA), <1pF	SOT-23	16ea	-	3a Ons
M4L	MA200A	Si-diode	Sw, 80V, 100mA, Vf<1.2V(100mA), <100ns	SC-59	16eb	-	3a Pan
M4M	MA200K	Si-diode	Sw, 80V, 100mA, Vf<1.2V(100mA), <100ns	SC-59	16dc	-	3a Pan
M4P	BSR56	n-FET	Sw, 40V, 250mW, Idss>50mA, Up<10V	SOT-23	16fj	-	3a Phi
M5	2SA1179-5	Si-pnp	GP, AF, 55V, 150mA, 200mW, B=135..270, 180MHz	CPA	16ta	-	3a San
M5	2SA1611-5	Si-pnp	AF, 60V, 100mA, 150mW, B=135..270, 180MHz	SOT-323	16ta	-	3a Nec
M5	2SA1622-5	Si-pnp	GP, 55V, 150mA, 150mW, 180MHz, B=135..270	SOT-323	16ta	-	3a San
M5	2SA1836-5	Si-pnp	AF, 60V, 100mA, 200mW, B=135..270, >50MHz	SOT-416	16ta	-	3a Nec
M5	2SA812-M5	Si-pnp	GP, AF, 60V, 100mA, 200mW, B=135..270, 180MHz	SOT-23	16ta	-	3a Nec
M5	2SA81A-M5	Si-pnp	GP, AF, 60V, 100mA, 200mW, B=135..270, 180MHz	SOT-23	16ta	-	3a Nec
M5	2SC5086FT-O	Si-npn	VHF/UHF, LN, 20V, 80mA, 100mW, 7GHz, B=80..160	TESM	18ta	-	3a Tos
M5	2SC5086-O	Si-npn	VHF/UHF, LN, 20V, 80mA, 100mW, 7GHz, B=80..160	SOT-323	16ta	-	3a Tos
M5	ELM7635LAB	Vdet-IC	3.5V±2%, -Reset PPO, 250ms	SOT-23	16vdc	VD7	3d Elm
M5	ILC5061IC25X	Vdet-IC	2.5V±2%, -Reset ODO	SOT-323	16vdb	VD6	3a Imp
M5	ILC5061M25X	Vdet-IC	2.5V±2%, -Reset ODO	SOT-23	16vdb	VD6	3a Imp
M5	KST812-M5	Si-pnp	GP, 50V, 100mA, 350mW, B=135..270	SOT-23	16ta	-	3a Sam
M5	MAS3784	Si-diode	SBD, Sw, 30V, 100mA, Vf<0.55V(100mA), 20pF, 2ns	SSSMini3-F1	18dc	-	3a Pan
M5	MIBA812M5	Si-pnp	GP, 50V, 100mA, 350mW, B=135..270	SOT-23	16ta	-	3a Sam
M5	MMBD352W	Si-diode	Dual, UHF-Mix, 7V, 10mA, Vf<0.6V(10mA), <1pF	SOT-323	16dl	-	3a Ons
M5	MMBZ5260B	Z-diode	40.85..45.15V, Zzt=93Ω, Izt=3.0mA, 410mW	SOT-23	16dc	-	3a Pjt
M5	R1100D151C	LVR-IC	U-low lcc, 1.5V±2%, 180mA	SON1408-3	18vj	VR1	3d Ric
M5	R3111N452C	Vdet-IC	4.5V±2%, -Reset ODO	SOT-23	16vdd	VD6	3d Ric
M5	R3130N46BC5	Vdet-IC	4.6V, -Reset ODO, 100ms	SOT-23	16vdc	VD6	3b Ric
M5	TC54VN2502ECB	Vdet-IC	2.5V±2%, -Reset ODO	SOT-23	16vdb	VD6	3a Tcs
M5	XC61CN2502M	Vdet-IC	2.5V±1%, +Reset ODO	SOT-23	16vdb	VD6	3d Tor
M5	XC6GN2502HR	Vdet-IC	2.5V, +Reset ODO	USP-3	17vdc	VD1	9b Tor
M512	AMS5312	LVR-IC	LDO, 1.2V±2%, 500mA	SOT-23	16ch	VR1	3a Ams
M513	AMS5313	LVR-IC	LDO, 1.3V±2%, 500mA	SOT-23	16ch	VR1	3a Ams
M514	AMS5314	LVR-IC	LDO, 1.4V±2%, 500mA	SOT-23	16ch	VR1	3a Ams
M515	AMS5315	LVR-IC	LDO, 1.5V±2%, 500mA	SOT-23	16ch	VR1	3a Ams
M516	AMS5316	LVR-IC	LDO, 1.6V±2%, 500mA	SOT-23	16ch	VR1	3a Ams
M517	AMS5317	LVR-IC	LDO, 1.7V±2%, 500mA	SOT-23	16ch	VR1	3a Ams
M518	AMS5318	LVR-IC	LDO, 1.8V±2%, 500mA	SOT-23	16ch	VR1	3a Ams
M519	AMS5319	LVR-IC	LDO, 1.9V±2%, 500mA	SOT-23	16ch	VR1	3a Ams
M520	AMS5320	LVR-IC	LDO, 2.0V±2%, 500mA	SOT-23	16ch	VR1	3a Ams
M521	AMS5321	LVR-IC	LDO, 2.1V±2%, 500mA	SOT-23	16ch	VR1	3a Ams
M522	AMS5322	LVR-IC	LDO, 2.2V±2%, 500mA	SOT-23	16ch	VR1	3a Ams
M523	AMS5323	LVR-IC	LDO, 2.3V±2%, 500mA	SOT-23	16ch	VR1	3a Ams
M524	AMS5324	LVR-IC	LDO, 2.4V±2%, 500mA	SOT-23	16ch	VR1	3a Ams
M525	AMS5325	LVR-IC	LDO, 2.5V±2%, 500mA	SOT-23	16ch	VR1	3a Ams



SMD code	Type	Function	Short description	Case	Pinout	Sch.	St.	Mnf.
M526	AMS5326	LVR-IC	LDO, 2.6V±2%, 500mA	SOT-23	16ch	VR1	3a	Ams
M527	AMS5327	LVR-IC	LDO, 2.7V±2%, 500mA	SOT-23	16ch	VR1	3a	Ams
M528	AMS5328	LVR-IC	LDO, 2.8V±2%, 500mA	SOT-23	16ch	VR1	3a	Ams
M529	AMS5329	LVR-IC	LDO, 2.9V±2%, 500mA	SOT-23	16ch	VR1	3a	Ams
M53	XE61CN2545MR	Vdet-IC	2.5V±2%, -Reset ODO	SOT-23	16vdb	VD6	3h	Tor
M530	AMS5330	LVR-IC	LDO, 3.0V±2%, 500mA	SOT-23	16ch	VR1	3a	Ams
M531	AMS5331	LVR-IC	LDO, 3.1V±2%, 500mA	SOT-23	16ch	VR1	3a	Ams
M532	AMS5332	LVR-IC	LDO, 3.2V±2%, 500mA	SOT-23	16ch	VR1	3a	Ams
M533	AMS5333	LVR-IC	LDO, 3.3V±2%, 500mA	SOT-23	16ch	VR1	3a	Ams
M534	AMS5334	LVR-IC	LDO, 3.4V±2%, 500mA	SOT-23	16ch	VR1	3a	Ams
M535	AMS5335	LVR-IC	LDO, 3.5V±2%, 500mA	SOT-23	16ch	VR1	3a	Ams
M536	AMS5336	LVR-IC	LDO, 3.6V±2%, 500mA	SOT-23	16ch	VR1	3a	Ams
M537	AMS5337	LVR-IC	LDO, 3.7V±2%, 500mA	SOT-23	16ch	VR1	3a	Ams
M538	AMS5338	LVR-IC	LDO, 3.8V±2%, 500mA	SOT-23	16ch	VR1	3a	Ams
M539	AMS5339	LVR-IC	LDO, 3.9V±2%, 500mA	SOT-23	16ch	VR1	3a	Ams
M540	AMS5340	LVR-IC	LDO, 4.0V±2%, 500mA	SOT-23	16ch	VR1	3a	Ams
M541	AMS5341	LVR-IC	LDO, 4.1V±2%, 500mA	SOT-23	16ch	VR1	3a	Ams
M542	AMS5342	LVR-IC	LDO, 4.2V±2%, 500mA	SOT-23	16ch	VR1	3a	Ams
M543	AMS5343	LVR-IC	LDO, 4.3V±2%, 500mA	SOT-23	16ch	VR1	3a	Ams
M544	AMS5344	LVR-IC	LDO, 4.4V±2%, 500mA	SOT-23	16ch	VR1	3a	Ams
M545	AMS5345	LVR-IC	LDO, 4.5V±2%, 500mA	SOT-23	16ch	VR1	3a	Ams
M546	AMS5346	LVR-IC	LDO, 4.6V±2%, 500mA	SOT-23	16ch	VR1	3a	Ams
M547	AMS5347	LVR-IC	LDO, 4.7V±2%, 500mA	SOT-23	16ch	VR1	3a	Ams
M548	AMS5348	LVR-IC	LDO, 4.8V±2%, 500mA	SOT-23	16ch	VR1	3a	Ams
M549	AMS5349	LVR-IC	LDO, 4.9V±2%, 500mA	SOT-23	16ch	VR1	3a	Ams
M55	XC61FN2512M	Vdet-IC	2.5V±2%, +Reset ODO, 200ms	SOT-23	16vdb	VD6	3d	Tor
M55	XC61HN2512MR	Vdet-IC	2.5V±2%, -Reset ODO, 50..200ms	SOT-23	16vdc	VD6	3d	Tor
M550	AMS5350	LVR-IC	LDO, 5.0V±2%, 500mA	SOT-23	16ch	VR1	3a	Ams
M551	AMS5351	LVR-IC	LDO, 5.1V±2%, 500mA	SOT-23	16ch	VR1	3a	Ams
M552	AMS5352	LVR-IC	LDO, 5.2V±2%, 500mA	SOT-23	16ch	VR1	3a	Ams
M553	AMS5353	LVR-IC	LDO, 5.3V±2%, 500mA	SOT-23	16ch	VR1	3a	Ams
M554	AMS5354	LVR-IC	LDO, 5.4V±2%, 500mA	SOT-23	16ch	VR1	3a	Ams
M555	AMS5355	LVR-IC	LDO, 5.5V±2%, 500mA	SOT-23	16ch	VR1	3a	Ams
M556	AMS5356	LVR-IC	LDO, 5.6V±2%, 500mA	SOT-23	16ch	VR1	3a	Ams
M557	AMS5357	LVR-IC	LDO, 5.7V±2%, 500mA	SOT-23	16ch	VR1	3a	Ams
M558	AMS5358	LVR-IC	LDO, 5.8V±2%, 500mA	SOT-23	16ch	VR1	3a	Ams
M559	AMS5359	LVR-IC	LDO, 5.9V±2%, 500mA	SOT-23	16ch	VR1	3a	Ams
M56	XC61FN2542M	Vdet-IC	2.5V±2%, +Reset ODO, 400ms	SOT-23	16vdb	VD6	3d	Tor
M56	XC61HN2542MR	Vdet-IC	2.5V±2%, -Reset ODO, 80..400ms	SOT-23	16vdc	VD6	3d	Tor
M560	AMS5360	LVR-IC	LDO, 6.0V±2%, 500mA	SOT-23	16ch	VR1	3a	Ams
M561	AMS5361	LVR-IC	LDO, 6.1V±2%, 500mA	SOT-23	16ch	VR1	3a	Ams
M562	AMS5362	LVR-IC	LDO, 6.2V±2%, 500mA	SOT-23	16ch	VR1	3a	Ams
M563	AMS5363	LVR-IC	LDO, 6.3V±2%, 500mA	SOT-23	16ch	VR1	3a	Ams
M564	AMS5364	LVR-IC	LDO, 6.4V±2%, 500mA	SOT-23	16ch	VR1	3a	Ams
M565	AMS5365	LVR-IC	LDO, 6.5V±2%, 500mA	SOT-23	16ch	VR1	3a	Ams
M566	AMS5366	LVR-IC	LDO, 6.6V±2%, 500mA	SOT-23	16ch	VR1	3a	Ams
M567	AMS5367	LVR-IC	LDO, 6.7V±2%, 500mA	SOT-23	16ch	VR1	3a	Ams
M568	AMS5368	LVR-IC	LDO, 6.8V±2%, 500mA	SOT-23	16ch	VR1	3a	Ams
M569	AMS5369	LVR-IC	LDO, 6.9V±2%, 500mA	SOT-23	16ch	VR1	3a	Ams
M57	XC61FN2552M	Vdet-IC	2.5V±2%, +Reset ODO, 50ms	SOT-23	16vdb	VD6	3d	Tor
M57	XC61HN2552MR	Vdet-IC	2.5V±2%, -Reset ODO, 1..50ms	SOT-23	16vdc	VD6	3d	Tor
M570	AMS5370	LVR-IC	LDO, 7.0V±2%, 500mA	SOT-23	16ch	VR1	3a	Ams
M5A	ADM1815-20AKS	Vdet-IC	2.55V, -Reset PPO	SOT-323	16vda	VD7	3a	Ad
M5A	ADM1815-20ART	Vdet-IC	2.55V, -Reset PPO	SOT-23	16vda	VD7	3a	Ad
M5A	ILC5061AIC25X	Vdet-IC	2.5V±1%, -Reset ODO	SOT-323	16vdb	VD6	3a	Imp
M5A	ILC5061AM25X	Vdet-IC	2.5V±1%, -Reset ODO	SOT-23	16vdb	VD6	3a	Imp
M5B	ADM1815-R22AKS	Vdet-IC	2.18V, -Reset PPO	SOT-323	16vda	VD7	3a	Ad
M5B	ADM1815-R22ART	Vdet-IC	2.18V, -Reset PPO	SOT-23	16vda	VD7	3a	Ad
M5C	ADM1815-R23AKS	Vdet-IC	2.31V, -Reset PPO	SOT-323	16vda	VD7	3a	Ad
M5C	ADM1815-R23ART	Vdet-IC	2.31V, -Reset PPO	SOT-23	16vda	VD7	3a	Ad
M5C	MMBD7000	Si-diode	Dual, Sw, 100V, 200mA, Vf<1.1V(100mA), <1.5pF	SOT-23	16dl	-	3a	Ons
M5E	ADM1815-10AKS	Vdet-IC	2.88V, -Reset PPO	SOT-323	16vda	VD7	3a	Ad
M5E	ADM1815-10ART	Vdet-IC	2.88V, -Reset PPO	SOT-23	16vda	VD7	3a	Ad
M5G	MMBD352	Si-diode	Dual, UHF-Mix, 7V, 10mA, Vf<0.6V(10mA), <1pF	SOT-23	16dl	-	3a	Ons
M5H	MA3XD14E	Si-diode	Dual, SBD Sw, 20V, 100mA, Vf<0.4V(100mA), 25pF	SC-59	16dg	-	3a	Pan
M5K	ADM1815-5AKS	Vdet-IC	3.06V, -Reset PPO	SOT-323	16vda	VD7	3a	Ad
M5K	ADM1815-5ART	Vdet-IC	3.06V, -Reset PPO	SOT-23	16vda	VD7	3a	Ad
M5K	MA3XD17	Si-diode	SBR, HF, 100V, 300mA, Vf=0.5V(300mA), 25pF	SC-59	16dc	-	3a	Pan
M5M	MA3X200F	Si-diode	Dual, Sw, 80V, 100mA, Vf<1.2V(100mA), <100ns	SC-59	16dl	-	3a	Pan
M5P	BSR57	n-FET	Sw, 40V, 250mW, Idss>20mA, Up<6V	SOT-23	16fj	-	3a	Phi



SMD code	Type	Function	Short description	Case	Pinout	Sch. St.	Mnf.
M6	2SA1179-6	Si-pnp	GP, AF, 55V, 150mA, 200mW, B=150..300, 180MHz	CPA	16ta	-	3a San
M6	2SA1611-6	Si-pnp	AF, 60V, 100mA, 150mW, B=200..400, 180MHz	SOT-323	16ta	-	3a Nec
M6	2SA1622-6	Si-pnp	GP, 55V, 150mA, 150mW, 180MHz, B=200..400	SOT-323	16ta	-	3a San
M6	2SA1836-6	Si-pnp	AF, 60V, 100mA, 200mW, B=200..400, >50MHz	SOT-416	16ta	-	3a Nec
M6	2SA812A-M6	Si-pnp	GP, AF, 60V, 100mA, 200mW, B=200..400, 180MHz	SOT-23	16ta	-	3a Nec
M6	2SA812-M6	Si-pnp	GP, AF, 60V, 100mA, 200mW, B=200..400, 180MHz	SOT-23	16ta	-	3a Nec
M6	2SC5086FT-Y	Si-npn	VHF/UHF, LN, 20V, 80mA, 100mW, 7GHz, B=120..240	TESM	18ta	-	3a Tos
M6	2SC5086-Y	Si-npn	VHF/UHF, LN, 20V, 80mA, 100mW, 7GHz, B=120..240	SOT-323	16ta	-	3a Tos
M6	BSS66	Si-npn	Sw, 60V, 0.1A, 250MHz, <70/250ns, B>50	SOT-23	16ta	-	3a Fer
M6	ELM7636LAB	Vdet-IC	3.6V±2%, -Reset PPO, 250ms	SOT-23	16vdc	VD7	3d Elm
M6	ILC5061C26X	Vdet-IC	2.6V±2%, -Reset ODO	SOT-323	16vdc	VD6	3a Imp
M6	ILC5061M26X	Vdet-IC	2.6V±2%, -Reset ODO	SOT-23	16vdc	VD6	3a Imp
M6	KST812-M6	Si-pnp	GP, 50V, 100mA, 350mW, B=200..400	SOT-23	16ta	-	3a Sam
M6	MMB8A12M6	Si-pnp	GP, 50V, 100mA, 350mW, B=200..400	SOT-23	16ta	-	3a Sam
M6	R1100D161C	LVR-IC	U-low lcc, 1.6V±2%, 180mA	S0N1408-3	18vj	VR1	3d Ric
M6	R3111N462C	Vdet-IC	4.6V±2%, -Reset ODO	SOT-23	16vdd	VD6	3d Ric
M6	TC54VN2602ECB	Vdet-IC	2.6V±2%, -Reset ODO	SOT-23	16vdc	VD6	3a Tcs
M6	XC61CN2602M	Vdet-IC	2.6V±1%, +Reset ODO	SOT-23	16vdc	VD6	3d Tor
M6	XC6GN2602HR	Vdet-IC	2.6V, +Reset ODO	USP-3	17vdc	VD1	9b Tor
M6=	RT9818D-26GV	Vdet-IC	2.6V±1.5%, -Reset ODO, Td=450ms	SOT-23	16vdc	VD6	3a Rct
M61	FN1L4Z-Q	Si-pnp-Digi	Sw, 60V, 100mA, 200mW, R1=47k, B=300.600	SC-59	16ta	-	3a Nec
M61	GN1L4Z-Q	Si-pnp-Digi	Sw, 60V, 100mA, 200mW, R1=4k7, B=300.600	SOT-323	16ta	-	3a Nec
M62	FN1L4Z-P	Si-pnp-Digi	Sw, 60V, 100mA, 200mW, R1=47k, B=200..400	SC-59	16ta	-	3a Nec
M62	GN1L4Z-P	Si-pnp-Digi	Sw, 60V, 100mA, 200mW, R1=4k7, B=200..400	SOT-323	16ta	-	3a Nec
M63	FN1L4Z-K	Si-pnp-Digi	Sw, 60V, 100mA, 200mW, R1=47k, B=135..270	SC-59	16ta	-	3a Nec
M63	GN1L4Z-K	Si-pnp-Digi	Sw, 60V, 100mA, 200mW, R1=47k, B=135..270	SOT-323	16ta	-	3a Nec
M63	XE61CN2645MR	Vdet-IC	2.6V±2%, -Reset ODO	SOT-23	16vdc	VD6	3h Tor
M64	FN1F4Z-K	Si-pnp-Digi	Sw, 60V, 100mA, 200mW, R1=22k, B=135..270	SC-59	16ta	-	3a Nec
M64	GN1F4Z-Q	Si-pnp-Digi	Sw, 60V, 100mA, 200mW, R1=22k, B=300..600	SOT-323	16ta	-	3a Nec
M65	BF545A	n-FET	VHF Amp, osc, mix, 30V, 6.5mA, 250mW, Up<8V, 1GHz	SOT-23	16ta	-	3a Phi
M65	FN1F4Z-P	Si-pnp-Digi	Sw, 60V, 100mA, 200mW, R1=22k, B=200..400	SC-59	16ta	-	3a Nec
M65	GN1F4Z-P	Si-pnp-Digi	Sw, 60V, 100mA, 200mW, R1=22k, B=200..400	SOT-323	16ta	-	3a Nec
M65	XC61FN2612M	Vdet-IC	2.6V±2%, +Reset ODO, 200ms	SOT-23	16vdc	VD6	3d Tor
M65	XC61HN2612MR	Vdet-IC	2.6V±2%, -Reset ODO, 50..200ms	SOT-23	16vdc	VD6	3d Tor
M66	BF545B	n-FET	VHF Amp, osc, mix, 30V, 15mA, 250mW, Up<8V, 1GHz	SOT-23	16ta	-	3a Phi
M66	FN1F4Z-1	Si-pnp-Digi	Sw, 60V, 100mA, 200mW, R1=22k, B=300.600	SC-59	16ta	-	3a Nec
M66	GN1F4Z-K	Si-pnp-Digi	Sw, 60V, 100mA, 200mW, R1=22k, B=135..270	SOT-323	16ta	-	3a Nec
M66	XC61FN2642M	Vdet-IC	2.6V±2%, +Reset ODO, 400ms	SOT-23	16vdc	VD6	3d Tor
M66	XC61HN2642MR	Vdet-IC	2.6V±2%, -Reset ODO, 80..400ms	SOT-23	16vdc	VD6	3d Tor
M67	BF545C	n-FET	VHF Amp, osc, mix, 30V, 25mA, 250mW, Up<8V, 1GHz	SOT-23	16ta	-	3a Phi
M67	FN1A4Z-K	Si-pnp-Digi	Sw, 60V, 100mA, 200mW, R1=10k, B=135..270	SC-59	16ta	-	3a Nec
M67	GN1A4Z-Q	Si-pnp-Digi	Sw, 60V, 100mA, 200mW, R1=10k, B=300..600	SOT-323	16ta	-	3a Nec
M67	XC61FN2652M	Vdet-IC	2.6V±2%, +Reset ODO, 50ms	SOT-23	16vdc	VD6	3d Tor
M67	XC61HN2652MR	Vdet-IC	2.6V±2%, -Reset ODO, 1..50ms	SOT-23	16vdc	VD6	3d Tor
M68	FN1A4Z-P	Si-pnp-Digi	Sw, 60V, 100mA, 200mW, R1=10k, B=200..400	SC-59	16ta	-	3a Nec
M68	GN1A4Z-P	Si-pnp-Digi	Sw, 60V, 100mA, 200mW, R1=10k, B=200..400	SOT-323	16ta	-	3a Nec
M69	FN1A4Z-Q	Si-pnp-Digi	Sw, 60V, 100mA, 200mW, R1=10k, B=300..600	SC-59	16ta	-	3a Nec
M69	GN1A4Z-K	Si-pnp-Digi	Sw, 60V, 100mA, 200mW, R1=10k, B=135..270	SOT-323	16ta	-	3a Nec
M6A	ADM1816-20AKS	Vdet-IC	2.55V, -Reset ODO	SOT-323	16vda	VD6	3a Ad
M6A	ADM1816-20ART	Vdet-IC	2.55V, -Reset ODO	SOT-23	16vda	VD6	3a Ad
M6A	ILC5061AIC26X	Vdet-IC	2.6V±1%, -Reset ODO	SOT-323	16vdc	VD6	3a Imp
M6A	ILC5061AM26X	Vdet-IC	2.6V±1%, -Reset ODO	SOT-23	16vdc	VD6	3a Imp
M6A	MMBF4416	n-FET	VHF-UHF-Amp, 30V, 10mA, 225mW, Up<6V	SOT-23	16fj	-	3a Ons
M6B	ADM1816-R22AKS	Vdet-IC	2.18V, -Reset ODO	SOT-323	16vda	VD6	3a Ad
M6B	ADM1816-R22ART	Vdet-IC	2.18V, -Reset ODO	SOT-23	16vda	VD6	3a Ad
M6C	ADM1816-R23AKS	Vdet-IC	2.31V, -Reset ODO	SOT-323	16vda	VD6	3a Ad
M6C	ADM1816-R23ART	Vdet-IC	2.31V, -Reset ODO	SOT-23	16vda	VD6	3a Ad
M6E	ADM1816-10AKS	Vdet-IC	2.88V, -Reset ODO	SOT-323	16vda	VD6	3a Ad
M6E	ADM1816-10ART	Vdet-IC	2.88V, -Reset ODO	SOT-23	16vda	VD6	3a Ad
M6H	MMBD354	Si-diode	Dual, UHF-Mix, 7V, 10mA, Vf<0.6V(10mA), <1pF	SOT-23	16dg	-	3a Ons
M6H	S9015T1-H	Si-pnp	GP, 50V, 100mA, 200mW, B=450..1000, >150MHz	SOT-23	16ta	-	3a Wtr
M6K	ADM1816-5AKS	Vdet-IC	3.06V, -Reset ODO	SOT-323	16vda	VD6	3a Ad
M6K	ADM1816-5ART	Vdet-IC	3.06V, -Reset ODO	SOT-23	16vda	VD6	3a Ad
M6L	S9015T1-L	Si-pnp	GP, 50V, 100mA, 200mW, B=120..450, >150MHz	SOT-23	16ta	-	3a Wtr
M6P	BSR58	n-FET	Sw, 40V, 250mW, Idss>8mA, Up<4V	SOT-23	16fj	-	3a Phi
M7	2SA1179-7	Si-pnp	GP, AF, 55V, 150mA, 200mW, B=175..350, 180MHz	CPA	16ta	-	3a San
M7	2SA1611-7	Si-pnp	AF, 60V, 100mA, 150mW, B=300..600, 180MHz	SOT-323	16ta	-	3a Nec
M7	2SA1622-7	Si-pnp	GP, 55V, 150mA, 150mW, 180MHz, B=300..600	SOT-323	16ta	-	3a San
M7	2SA1836-7	Si-pnp	AF, 60V, 100mA, 200mW, B=300..600, >50MHz	SOT-416	16ta	-	3a Nec
M7	2SA812A-M7	Si-pnp	GP, AF, 60V, 100mA, 200mW, B=300..600, 180MHz	SOT-23	16ta	-	3a Nec



SMD code	Type	Function	Short description	Case	Pinout	Sch.	St.	Mnf.
M7	2SA812-M7	Si-pnp	GP, AF, 60V, 100mA, 200mW, B=300..600, 180MHz	SOT-23	16ta	-	3a	Nec
M7	2SC5091F-R	Si-npn	VHF/UHF, LN, 20V, 40mA, 100mW, 10GHz, B=50..100	TESM	18ta	-	3a	Tos
M7	2SC5091-R	Si-npn	VHF/UHF, LN, 20V, 40mA, 100mW, 10GHz, B=50..100	SOT-323	16ta	-	3a	Tos
M7	BSS67	Si-npn	Sw, 60V, 100mA, 330mW, B=100..300, >300MHz	SOT-23	16ta	-	3a	Zx
M7	ELM7637LAB	Vdet-IC	3.7V±2%, -Reset PPO, 250ms	SOT-23	16vdc	VD7	3d	Elm
M7	ILC5061C27X	Vdet-IC	2.7V±2%, -Reset ODO	SOT-323	16vdb	VD6	3a	Imp
M7	ILC5061M27X	Vdet-IC	2.7V±2%, -Reset ODO	SOT-23	16vdb	VD6	3a	Imp
M7	KST812-M7	Si-pnp	GP, 50V, 100mA, 350mW, B=300..600	SOT-23	16ta	-	3a	Sam
M7	M MBA812M7	Si-pnp	GP, 50V, 100mA, 350mW, B=300..600	SOT-23	16ta	-	3a	Sam
M7	R1100D171C	LVR-IC	U-low lcc, 1.7V±2%, 180mA	SON1408-3	18vj	VR1	3d	Ric
M7	R3111N472C	Vdet-IC	4.7V±2%, -Reset ODO	SOT-23	16vdd	VD6	3d	Ric
M7	TC54VN2702ECB	Vdet-IC	2.7V±2%, -Reset ODO	SOT-23	16vdb	VD6	3a	Tcs
M7	XC61CN2702M	Vdet-IC	2.7V±1%, +Reset ODO	SOT-23	16vdb	VD6	3d	Tor
M7	XC6GN2702HR	Vdet-IC	2.7V, +Reset ODO	USP-3	17vdc	VD1	9b	Tor
M7=	RT9818A-40GV	Vdet-IC	4.0V±1.5%, -Reset ODO	SOT-23	16vda	VD6	3a	Rct
M73	XE61CN2745MR	Vdet-IC	2.7V±2%, -Reset ODO	SOT-23	16vdb	VD6	3h	Tor
M75	XC61FN2712M	Vdet-IC	2.7V±2%, +Reset ODO, 200ms	SOT-23	16vdb	VD6	3d	Tor
M75	XC61HN2712MR	Vdet-IC	2.7V±2%, -Reset ODO, 50..200ms	SOT-23	16vdc	VD6	3d	Tor
M76	XC61FN2742M	Vdet-IC	2.7V±2%, +Reset ODO, 400ms	SOT-23	16vdb	VD6	3d	Tor
M76	XC61HN2742MR	Vdet-IC	2.7V±2%, -Reset ODO, 80..400ms	SOT-23	16vdc	VD6	3d	Tor
M77	XC61FN2752M	Vdet-IC	2.7V±2%, +Reset ODO, 50ms	SOT-23	16vdb	VD6	3d	Tor
M77	XC61HN2752MR	Vdet-IC	2.7V±2%, -Reset ODO, 1..50ms	SOT-23	16vdc	VD6	3d	Tor
M7A	ADM1817-20AKS	Vdet-IC	2.55V, +Reset PPO	SOT-323	16vda	VD7	3a	Ad
M7A	ADM1817-20ART	Vdet-IC	2.55V, +Reset PPO	SOT-23	16vda	VD7	3a	Ad
M7A	ILC5061AIC27X	Vdet-IC	2.7V±1%, -Reset ODO	SOT-323	16vdb	VD6	3a	Imp
M7A	ILC5061AM27X	Vdet-IC	2.7V±1%, -Reset ODO	SOT-23	16vdb	VD6	3a	Imp
M7B	ADM1817-R22AKS	Vdet-IC	2.18V, +Reset PPO	SOT-323	16vda	VD7	3a	Ad
M7B	ADM1817-R22ART	Vdet-IC	2.18V, +Reset PPO	SOT-23	16vda	VD7	3a	Ad
M7C	ADM1817-R23AKS	Vdet-IC	2.31V, +Reset PPO	SOT-323	16vda	VD7	3a	Ad
M7C	ADM1817-R23ART	Vdet-IC	2.31V, +Reset PPO	SOT-23	16vda	VD7	3a	Ad
M7E	ADM1817-10AKS	Vdet-IC	2.88V, +Reset PPO	SOT-323	16vda	VD7	3a	Ad
M7E	ADM1817-10ART	Vdet-IC	2.88V, +Reset PPO	SOT-23	16vda	VD7	3a	Ad
M7K	ADM1817-5AKS	Vdet-IC	3.06V, +Reset PPO	SOT-323	16vda	VD7	3a	Ad
M7K	ADM1817-5ART	Vdet-IC	3.06V, +Reset PPO	SOT-23	16vda	VD7	3a	Ad
M8	2SC5091F-O	Si-npn	VHF/UHF, LN, 20V, 40mA, 100mW, 10GHz, B=80..160	TESM	18ta	-	3a	Tos
M8	2SC5091-O	Si-npn	VHF/UHF, LN, 20V, 40mA, 100mW, 10GHz, B=80..160	SOT-323	16ta	-	3a	Tos
M8	BSH103	n-MOSFET-e	V-MOS, LogL, 30V, 0.85A, <0.5Ω	SOT-23	16fta	-	3a	Phi
M8	BSS66R	Si-npn	Sw, 60V, 100mA, 330mW, B=50..150, >250MHz	SOT-23	16ta	-	3a	Zx
M8	BZX84-C4V7	Z-diode	4.4..5.0V, Zzt=80Ω, Izt=20mA, 225mW	SOT-23	16dc	-	3a	Lge
M8	ELM7638LAB	Vdet-IC	3.8V±2%, -Reset PPO, 250ms	SOT-23	16vdc	VD7	3d	Elm
M8	ILC5061C28X	Vdet-IC	2.8V±2%, -Reset ODO	SOT-323	16vdb	VD6	3a	Imp
M8	ILC5061M28X	Vdet-IC	2.8V±2%, -Reset ODO	SOT-23	16vdb	VD6	3a	Imp
M8	R1100D181C	LVR-IC	U-low lcc, 1.8V±2%, 180mA	SON1408-3	18vj	VR1	3d	Ric
M8	R3111N482C	Vdet-IC	4.8V±2%, -Reset ODO	SOT-23	16vdd	VD6	3d	Ric
M8	TC54VN2802ECB	Vdet-IC	2.8V±2%, -Reset ODO	SOT-23	16vdb	VD6	3a	Tcs
M8	XC61CN2802M	Vdet-IC	2.8V±1%, +Reset ODO	SOT-23	16vdb	VD6	3d	Tor
M8	XC6GN2802HR	Vdet-IC	2.8V, +Reset ODO	USP-3	17vdc	VD1	9b	Tor
M81	FN1L3M	Si-pnp-Digi	Sw, 60V, 100mA, 200mW, R1/R2=4k7/4k7	SC-59	16ta	-	3a	Nec
M81	GN1L3M	Si-pnp-Digi	Sw, 60V, 100mA, 200mW, R1/R2=4k7/4k7	SOT-323	16ta	-	3a	Nec
M82	FN1L3N	Si-pnp-Digi	Sw, 60V, 100mA, 200mW, R1/R2=4k7/10k	SC-59	16ta	-	3a	Nec
M82	GN1L3N	Si-pnp-Digi	Sw, 60V, 100mA, 200mW, R1/R2=4k7/10k	SOT-323	16ta	-	3a	Nec
M83	FN1A3Q	Si-pnp-Digi	Sw, 60V, 100mA, 200mW, R1/R2=1k/10k	SC-59	16ta	-	3a	Nec
M83	GN1A3Q	Si-pnp-Digi	Sw, 60V, 100mA, 200mW, R1/R2=1k/10k	SOT-323	16ta	-	3a	Nec
M83	XE61CN2845MR	Vdet-IC	2.8V±2%, -Reset ODO	SOT-23	16vdb	VD6	3h	Tor
M84	BF556A	n-FET	VHF Amp, osc, mix, 30V, 7mA, 250mW, Up<7.5V, 1GHz	SOT-23	16fa	-	3a	Phi
M85	BF556B	n-FET	VHF Amp, osc, mix, 30V, 13mA, 250mW, Up<7.5V, 1GHz	SOT-23	16fa	-	3a	Phi
M85	XC61FN2812M	Vdet-IC	2.8V±2%, +Reset ODO, 200ms	SOT-23	16vdb	VD6	3d	Tor
M85	XC61HN2812MR	Vdet-IC	2.8V±2%, -Reset ODO, 50..200ms	SOT-23	16vdc	VD6	3d	Tor
M86	BF556C	n-FET	VHF Amp, osc, mix, 30V, 18mA, 250mW, Up<7.5V, 1GHz	SOT-23	16fa	-	3a	Phi
M86	XC61FN2842M	Vdet-IC	2.8V±2%, +Reset ODO, 400ms	SOT-23	16vdb	VD6	3d	Tor
M86	XC61HN2842MR	Vdet-IC	2.8V±2%, -Reset ODO, 80..400ms	SOT-23	16vdc	VD6	3d	Tor
M87	XC61FN2852M	Vdet-IC	2.8V±2%, +Reset ODO, 50ms	SOT-23	16vdb	VD6	3d	Tor
M87	XC61HN2852MR	Vdet-IC	2.8V±2%, -Reset ODO, 1..50ms	SOT-23	16vdc	VD6	3d	Tor
M8A	ADM1818-20AKS	Vdet-IC	2.55V, -Reset ODO	SOT-323	16vda	VD6	3a	Ad
M8A	ADM1818-20ART	Vdet-IC	2.55V, -Reset ODO	SOT-23	16vda	VD6	3a	Ad
M8A	ILC5061AIC28X	Vdet-IC	2.8V±1%, -Reset ODO	SOT-323	16vdb	VD6	3a	Imp
M8A	ILC5061AM28X	Vdet-IC	2.8V±1%, -Reset ODO	SOT-23	16vdb	VD6	3a	Imp
M8B	ADM1818-R22AKS	Vdet-IC	2.18V, -Reset ODO	SOT-323	16vda	VD6	3a	Ad
M8B	ADM1818-R22ART	Vdet-IC	2.18V, -Reset ODO	SOT-23	16vda	VD6	3a	Ad
M8C	ADM1818-R23AKS	Vdet-IC	2.31V, -Reset ODO	SOT-323	16vda	VD6	3a	Ad



SMD code	Type	Function	Short description	Case	Pinout	Sch.	St.	Mnf.
M8C	ADM1818-R23ART	Vdet-IC	2.31V, -Reset ODO	SOT-23	16vda	VD6	3a	Ad
M8E	ADM1818-10AKS	Vdet-IC	2.88V, -Reset ODO	SOT-323	16vda	VD6	3a	Ad
M8E	ADM1818-10ART	Vdet-IC	2.88V, -Reset ODO	SOT-23	16vda	VD6	3a	Ad
M8K	ADM1818-5AKS	Vdet-IC	3.06V, -Reset ODO	SOT-323	16vda	VD6	3a	Ad
M8K	ADM1818-5ART	Vdet-IC	3.06V, -Reset ODO	SOT-23	16vda	VD6	3a	Ad
M8p	BSN20	n-MOSFET-e*	Sw, LogL, 50V, 173mA, 830mW, 8/15ns, 15Ω(100mA)	SOT-23	16fh	-	3a	Phi
M8t	BSN20W	n-MOSFET-e*	Sw, LogL, 50V, 100mA, 830mW, 8/15ns, 15Ω(100mA)	SOT-323	16fh	-	3a	Phi
M9	2SC5096F-R	Si-npn	VHF/UHF, LN, 20V, 15mA, 100mW, 10GHz, B=50..100	TESM	18ta	-	3a	Tos
M9	2SC5096-R	Si-npn	VHF/UHF, LN, 20V, 15mA, 100mW, 10GHz, B=50..100	SOT-323	16ta	-	3a	Tos
M9	BSS67R	Si-npn	Sw, 60V, 100mA, 330mW, B=100..300, >300MHz	SOT-23	16ta	-	3a	Zx
M9	BZX84-C22	Z-diode	20.8..23.3V, Zzt=55Ω, Izt=20mA, 225mW	SOT-23	16dc	-	3a	Lge
M9	ELM7639LAB	Vdet-IC	3.9V±2%, -Reset PPO, 250ms	SOT-23	16vdc	VD7	3d	Elm
M9	ILC5061IC29X	Vdet-IC	2.9V±2%, -Reset ODO	SOT-323	16vdb	VD6	3a	Imp
M9	ILC5061M29X	Vdet-IC	2.9V±2%, -Reset ODO	SOT-23	16vdb	VD6	3a	Imp
M9	R1100D191C	LVR-IC	U-low Icc, 1.9V±2%, 180mA	SON1408-3	18vj	VR1	3d	Ric
M9	R3111N492C	Vdet-IC	4.9V±2%, -Reset ODO	SOT-23	16vdd	VD6	3d	Ric
M9	TC54VN2902ECB	Vdet-IC	2.9V±2%, -Reset ODO	SOT-23	16vdb	VD6	3a	Tcs
M9	XC61CN2902M	Vdet-IC	2.9V±1%, +Reset ODO	SOT-23	16vdb	VD6	3d	Tor
M9	XC6GN2902HR	Vdet-IC	2.9V, +Reset ODO	USP-3	17vdc	VD1	9b	Tor
M9=	RT9198-16GV	LVR-IC	LDO, 1.6V±1%, 300mA	SOT-23	16cg	VR1	3a	Rct
M93	XE61CN2945MR	Vdet-IC	2.9V±2%, -Reset ODO	SOT-23	16vdb	VD6	3h	Tor
M95	XC61FN2912M	Vdet-IC	2.9V±2%, +Reset ODO, 200ms	SOT-23	16vdb	VD6	3d	Tor
M95	XC61HN2912MR	Vdet-IC	2.9V±2%, -Reset ODO, 50..200ms	SOT-23	16vdc	VD6	3d	Tor
M96	XC61FN2942M	Vdet-IC	2.9V±2%, +Reset ODO, 400ms	SOT-23	16vdb	VD6	3d	Tor
M96	XC61HN2942MR	Vdet-IC	2.9V±2%, -Reset ODO, 80..400ms	SOT-23	16vdc	VD6	3d	Tor
M97	XC61FN2952M	Vdet-IC	2.9V±2%, +Reset ODO, 50ms	SOT-23	16vdb	VD6	3d	Tor
M97	XC61HN2952MR	Vdet-IC	2.9V±2%, -Reset ODO, 1..50ms	SOT-23	16vdc	VD6	3d	Tor
M9A	ILC5061AIC29X	Vdet-IC	2.9V±1%, -Reset ODO	SOT-323	16vdb	VD6	3a	Imp
M9A	ILC5061AM29X	Vdet-IC	2.9V±1%, -Reset ODO	SOT-23	16vdb	VD6	3a	Imp
MA	2SC3011	Si-npn	UHF, C-Band, 20V, 30mA, 150mW, B=30..120, 6.5GHz	SC-59	16ta	-	3a	Tos
MA	2SC4392	Si-npn	UHF, 20V, 30mA, 6.5GHz	SOT-323	16ta	-	3a	Tos
MA	2SC5096F-O	Si-npn	VHF/UHF, LN, 20V, 15mA, 100mW, 10GHz, B=80..160	TESM	18ta	-	3a	Tos
MA	2SC5096-O	Si-npn	VHF/UHF, LN, 20V, 15mA, 100mW, 10GHz, B=80..160	SOT-323	16ta	-	3a	Tos
MA	2SC5536	Si-npn	VHF LN, 20V, 50mA, 100mW, B=80..200, 1.7GHz	SSFP	18ta	-	3a	San
MA	BAS70WPT	Si-diode	Schottky, 70V, 70mA, Vf<1V(15mA), <2pF, 5ns	SOT-323	16dc	-	3a	Chm
MA	DZ23C30	Z-diode	Dual, 28.0..32.0V, Izt=5mA, Zzt=35Ω, 300mW	SOT-23	16dg	-	3a	Lge
MA	ELM7640HDB	Vdet-IC	4.0V±2%, +Reset PPO, 50ms	SOT-23	16vdc	VD7	3d	Elm
MA	FMMTA06R	Si-npn	AF, 80V, 500mA, 330mW, B>50, >100MHz	SOT-23	16te	-	3a	Zx
MA	M1MA151A	Si-diode	Sw, 40V, 100mA, 200mW, Vf<1.2V(100mA), <2pF	SC-59	16eb	-	3a	Ons
ma	PT7M6238CLC3	Vdet-IC	3.8V±1.5%, -Reset PPO	SC-70	16vdc	VD7	3b	Pti
mā	PT7M6238CLC3E	Vdet-IC	3.8V±1.5%, -Reset PPO, Lead free	SC-70	16vdc	VD7	3b	Pti
ma	PT7M6238CLTA3	Vdet-IC	3.8V±1.5%, -Reset PPO	SOT-23	16vdb	VD7	3b	Pti
mā	PT7M6238CLTA3E	Vdet-IC	3.8V±1.5%, -Reset PPO, Lead free	SOT-23	16vdb	VD7	3b	Pti
MA6	MMBD2838	Si-diode	Dual, Sw, 50V, 150mA, 225mW, Vf>1.2V(100mA), <4ns	SOT-23	16dg	-	3a	Ons
MAA	BC808-16	Si-npn	Sw, 30V, 800mA, 200mW, B=110..250, 100MHz	SOT-23	16ta	-	3a	Auk
MAA	BC808F-16	Si-pnp	Sw, 30V, 800mA, 200mW, B=110..250, 100MHz	SOT-23F	18ta	-	3a	Auk
MAB	BC808-25	Si-pnp	Sw, 30V, 800mA, 200mW, B=160..400, 100MHz	SOT-23	16ta	-	3a	Auk
MAB	BC808F-25	Si-pnp	Sw, 30V, 800mA, 200mW, B=160..400, 100MHz	SOT-23F	18ta	-	3a	Auk
MAC	BC808-40	Si-pnp	Sw, 30V, 800mA, 200mW, B=250..630, 100MHz	SOT-23	16ta	-	3a	Auk
MAC	BC808F-40	Si-pnp	Sw, 30V, 800mA, 200mW, B=250..630, 100MHz	SOT-23F	18ta	-	3a	Auk
MAO	2SC5064-O	Si-npn	VHF/UHF, LN, 20V, 30mA, 150mW, 7GHz, B=80..160	SC-59	16ta	-	3a	Tos
MAO	2SC5065-O	Si-npn	VHF/UHF, LN, 20V, 30mA, 100mW, 7GHz, B=80..160	SOT-323	16ta	-	3a	Tos
MAY	2SC5064-Y	Si-npn	VHF/UHF, LN, 20V, 30mA, 150mW, 7GHz, B=120..240	SC-59	16ta	-	3a	Tos
MAY	2SC5065-Y	Si-npn	VHF/UHF, LN, 20V, 30mA, 100mW, 7GHz, B=120..240	SOT-323	16ta	-	3a	Tos
MB	2SA1052-B	Si-pnp	GP, AF, 30V, 100mA, 150mW, B=100..200	SOT-23	16ta	-	3a	Ren
MB	2SC3098	Si-npn	UHF, C-Band, 30V, 50mA, 150mW, B=30..300, 3.5GHz	SC-59	16ta	-	3a	Tos
MB	2SC5108-O	Si-npn	VHF/UHF-VCO, 20V, 30mA, 100mW, 6GHz, B=80..160	SOT-323	16ta	-	3a	Tos
MB	BAS70WAPT	Si-diode	Dual, Schottky, 70V, 70mA, Vf<1V(15mA), <2pF, 5ns	SOT-323	16df	-	3a	Chm
MB	DZ23C33	Z-diode	Dual, 31.0..35.0V, Izt=5mA, Zzt=40Ω, 300mW	SOT-23	16dg	-	3a	Lge
MB	ELM7641HDB	Vdet-IC	4.1V±2%, +Reset PPO, 50ms	SOT-23	16vdc	VD7	3d	Elm
MB	FMMTA56R	Si-pnp	AF-Drv, 80V, 500mA, 330mW, B>50, >100MHz	SOT-23	16te	-	3a	Zx
MB	M1MA152A	Si-diode	Sw, 80V, 100mA, 200mW, Vf<1.2V(100mA), <2pF	SC-59	16eb	-	3a	Ons
MB	MBT3904DW9	Si-npn	GP, 60V, 200mA, 250mW, B=100..300, >300MHz	SOT-23	16ta	-	3a	Mot
mb	PT7M6238CHC3	Vdet-IC	3.8V±1.5%, +Reset PPO	SC-70	16vdc	VD7	3b	Pti
m̄b	PT7M6238CHC3E	Vdet-IC	3.8V±1.5%, +Reset PPO, Lead free	SC-70	16vdc	VD7	3b	Pti
mb	PT7M6238CHTA3	Vdet-IC	3.8V±1.5%, +Reset PPO	SOT-23	16vdb	VD7	3b	Pti
m̄b	PT7M6238CHTA3E	Vdet-IC	3.8V±1.5%, +Reset PPO, Lead free	SOT-23	16vdb	VD7	3b	Pti
MB=	RT9818G-30GVL	Vdet-IC	3.0V±1.5%, +Reset ODO, Td=220ms	SOT-23	16vda	VD6	3a	Rct
MC	2SA1052-C	Si-pnp	GP, AF, 30V, 100mA, 150mW, B=160..320	SOT-23	16ta	-	3a	Ren
MC	2SC3099	Si-npn	VHF/UHF, LN, 20V, 30mA, 150mW, B=30..250, 4GHz	SOT-23	16ta	-	3a	Tos



SMD code	Type	Function	Short description	Case	Pinout	Sch.	St.	Mnf.
MC	2SC5108-Y	Si-npn	VHF/UHF-VCO, 20V, 30mA, 100mW, 6GHz, B=120..240	SOT-323	16ta	-	3a	Tos
MC	BAS70WCPPT	Si-diode	Dual, Schottky, 70V, 70mA, Vf<1V(15mA), <2pF, 5ns	SOT-323	16dg	-	3a	Chm
MC	DZ23C36	Z-diode	Dual, 34.0..38.0V, Izt=5mA, Zzt=40Ω, 300mW	SOT-23	16dg	-	3a	Lge
MC	ELM7642HDB	Vdet-IC	4.2V±2%, +Reset PPO, 50ms	SOT-23	16vdc	VD7	3d	Elm
MC	MA3J143	Si-diode	Dual, Fast, Sw, 40V, 100mA, Vf<1.2V(100mA), <9ns	SOT-523	18dl	-	3a	Pan
mc	PT7M6238NLC3	Vdet-IC	3.8V±1.5%, -Reset ODO	SC-70	16vdc	VD6	3b	Pti
mc	PT7M6238NLC3E	Vdet-IC	3.8V±1.5%, -Reset ODO, Lead free	SC-70	16vdc	VD6	3b	Pti
mc	PT7M6238NLTA3	Vdet-IC	3.8V±1.5%, -Reset ODO	SOT-23	16vdb	VD6	3b	Pti
mc	PT7M6238NLTA3E	Vdet-IC	3.8V±1.5%, -Reset ODO, Lead free	SOT-23	16vdb	VD6	3b	Pti
MCO	2SC5084-O	Si-npn	VHF/UHF, LN, 20V, 80mA, 150mW, 7GHz, B=80..160	SC-59	16ta	-	3a	Tos
MCO	2SC5085-O	Si-npn	VHF/UHF, LN, 20V, 80mA, 100mW, 7GHz, B=80..160	SOT-323	16ta	-	3a	Tos
MCs	BFS17P	Si-npn	VHF UHF, 25V, 25mA, 280mW, B=20..150, 2.5GHz	SOT-23	16ta	-	3a	Sie
MCY	2SC5084-Y	Si-npn	VHF/UHF, LN, 20V, 80mA, 150mW, 7GHz, B=120..240	SC-59	16ta	-	3a	Tos
MCY	2SC5085-Y	Si-npn	VHF/UHF, LN, 20V, 80mA, 100mW, 7GHz, B=120..240	SOT-323	16ta	-	3a	Tos
MD	2SA1052-D	Si-pnp	GP, AF, 30V, 100mA, 150mW, B=240.500	SOT-23	16ta	-	3a	Ren
MD	2SA1245	Si-pnp	UHF, 15V, 30mA, 150mW, B>20, 4GHz	SC-59	16ta	-	3a	Tos
MD	2SC5111FT-O	Si-npn	VHF/UHF-VCO, 20V, 60mA, 100mW, 6GHz, B=80..160	TESM	18ta	-	3a	Tos
MD	2SC5111-O	Si-npn	VHF/UHF-VCO, 20V, 60mA, 100mW, 6GHz, B=80..160	SOT-323	16ta	-	3a	Tos
MD	BAS70WSPT	Si-diode	Dual, Schottky, 70V, 70mA, Vf<1V(15mA), <2pF, 5ns	SOT-323	16dl	-	3a	Chm
MD	DDZX9707	Z-diode	20V±5%, 500mW	SOT-23	16dc	-	3a	Di
MD	DDZX9707W	Z-diode	20V±5%, 200mW	SOT-323	16dc	-	3a	Di
MD	DZ23C39	Z-diode	Dual, 37.0..41.0V, Izt=5mA, Zzt=50Ω, 300mW	SOT-23	16dg	-	3a	Lge
MD	ELM7643HDB	Vdet-IC	4.3V±2%, +Reset PPO, 50ms	SOT-23	16vdc	VD7	3d	Elm
md	PT7M6239CLC3	Vdet-IC	3.9V±1.5%, -Reset PPO	SC-70	16vdc	VD7	3b	Pti
md	PT7M6239CLC3E	Vdet-IC	3.9V±1.5%, -Reset PPO, Lead free	SC-70	16vdc	VD7	3b	Pti
md	PT7M6239CLTA3	Vdet-IC	3.9V±1.5%, -Reset PPO	SOT-23	16vdb	VD7	3b	Pti
md	PT7M6239CLTA3E	Vdet-IC	3.9V±1.5%, -Reset PPO, Lead free	SOT-23	16vdb	VD7	3b	Pti
MDO	2SC5089-O	Si-npn	VHF/UHF, LN, 20V, 40mA, 150mW, 10GHz, B=80..160	SC-59	16ta	-	3a	Tos
MDO	2SC5090-O	Si-npn	VHF/UHF, LN, 20V, 40mA, 100mW, 10GHz, B=80..160	SOT-323	16ta	-	3a	Tos
MDR	2SC5089-R	Si-npn	VHF/UHF, LN, 20V, 40mA, 150mW, 10GHz, B=50..100	SC-59	16ta	-	3a	Tos
MDR	2SC5090-R	Si-npn	VHF/UHF, LN, 20V, 40mA, 100mW, 10GHz, B=50..100	SOT-323	16ta	-	3a	Tos
ME	2SA1235-E	Si-pnp	AF-Amp, 50V, 150mA, 200mW, 200MHz, B=150..300	SC-59	16ta	-	3a	Mit
ME	2SA1602-E	Si-pnp	AF, 50V, 200mA, 150mW, 200MHz, B=150..300	SOT-323	16ta	-	3a	Mit
ME	2SC3429	Si-npn	UHF/VHF, 17V, 70mA, 150mW, 5GHz, B>25	SOT-23	16ta	-	3a	Tos
ME	2SC4393	Si-npn	VHF/UHF, 17V, 70mA, 100mW, B>25, 5GHz	SOT-323	16ta	-	3a	Tos
ME	2SC5111FT-Y	Si-npn	VHF/UHF-VCO, 20V, 60mA, 100mW, 6GHz, B=120..240	TESM	18ta	-	3a	Tos
ME	2SC5111-Y	Si-npn	VHF/UHF-VCO, 20V, 60mA, 100mW, 6GHz, B=120..240	SOT-323	16ta	-	3a	Tos
ME	BAS40WPT	Si-diode	SBD, 40V, 200mA, Vf<1V(40mA), 5ns	SOT-323	16dc	-	3a	Chm
ME	DDZX9708	Z-diode	22V±5%, 500mW	SOT-23	16dc	-	3a	Di
ME	DDZX9708W	Z-diode	22V±5%, 200mW	SOT-323	16dc	-	3a	Di
ME	DZ23C43	Z-diode	Dual, 40.0..46.0V, Izt=5mA, Zzt=60Ω, 300mW	SOT-23	16dg	-	3a	Lge
ME	ELM7644HDB	Vdet-IC	4.4V±2%, +Reset PPO, 50ms	SOT-23	16vdc	VD7	3d	Elm
me	PT7M6239CHC3	Vdet-IC	3.9V±1.5%, +Reset PPO	SC-70	16vdc	VD7	3b	Pti
me	PT7M6239CHC3E	Vdet-IC	3.9V±1.5%, +Reset PPO, Lead free	SC-70	16vdc	VD7	3b	Pti
me	PT7M6239CHTA3	Vdet-IC	3.9V±1.5%, +Reset PPO	SOT-23	16vdb	VD7	3b	Pti
me	PT7M6239CHTA3E	Vdet-IC	3.9V±1.5%, +Reset PPO, Lead free	SOT-23	16vdb	VD7	3b	Pti
ME=	RT9818A-34GV	Vdet-IC	3.4V±1.5%, -Reset ODO	SOT-23	16vda	VD6	3a	Rct
MEO	2SC5094-O	Si-npn	VHF/UHF, LN, 20V, 15mA, 150mW, 10GHz, B=80..160	SC-59	16ta	-	3a	Tos
MEO	2SC5095-O	Si-npn	VHF/UHF, LN, 20V, 15mA, 100mW, 10GHz, B=80..160	SOT-323	16ta	-	3a	Tos
MER	2SC5094-R	Si-npn	VHF/UHF, LN, 20V, 15mA, 150mW, 10GHz, B=50..100	SC-59	16ta	-	3a	Tos
MER	2SC5095-R	Si-npn	VHF/UHF, LN, 20V, 15mA, 100mW, 10GHz, B=50..100	SOT-323	16ta	-	3a	Tos
MF	2SA1235-F	Si-pnp	AF-Amp, 50V, 150mA, 200mW, 200MHz, B=250..500	SC-59	16ta	-	3a	Mit
MF	2SA1602-F	Si-pnp	AF, 50V, 200mA, 150mW, 200MHz, B=250..500	SOT-323	16ta	-	3a	Mit
MF	2SC3445	Si-npn	UHF, 15V, 80mA, 150mW, B=30..200, 7GHz	SOT-23	16ta	-	3a	Tos
MF	BAS40WAPT	Si-diode	Dual, SBD, 40V, 200mA, Vf<1V(40mA), 5ns	SOT-323	16df	-	3a	Chm
MF	DDZX9709	Z-diode	24V±5%, 500mW	SOT-23	16dc	-	3a	Di
MF	DDZX9709W	Z-diode	24V±5%, 200mW	SOT-323	16dc	-	3a	Di
MF	DZ23C47	Z-diode	Dual, 44.0..50.0V, Izt=5mA, Zzt=70Ω, 300mW	SOT-23	16dg	-	3a	Lge
MF	ELM7645HDB	Vdet-IC	4.5V±2%, +Reset PPO, 50ms	SOT-23	16vdc	VD7	3d	Elm
mf	PT7M6239NLC3	Vdet-IC	3.9V±1.5%, -Reset ODO	SC-70	16vdc	VD6	3b	Pti
mf	PT7M6239NLC3E	Vdet-IC	3.9V±1.5%, -Reset ODO, Lead free	SC-70	16vdc	VD6	3b	Pti
mf	PT7M6239NLTA3	Vdet-IC	3.9V±1.5%, -Reset ODO	SOT-23	16vdb	VD6	3b	Pti
mf	PT7M6239NLTA3E	Vdet-IC	3.9V±1.5%, -Reset ODO, Lead free	SOT-23	16vdb	VD6	3b	Pti
MFO	2SC5106-O	Si-npn	VHF/UHF-VCO, 20V, 30mA, 150mW, 6GHz, B=80..160	SC-59	16ta	-	3a	Tos
MFO	2SC5107-O	Si-npn	VHF/UHF-VCO, 20V, 30mA, 100mW, 6GHz, B=80..160	SOT-323	16ta	-	3a	Tos
MFY	2SC5106-Y	Si-npn	VHF/UHF-VCO, 20V, 30mA, 150mW, 6GHz, B=120..240	SC-59	16ta	-	3a	Tos
MFY	2SC5107-Y	Si-npn	VHF/UHF-VCO, 20V, 30mA, 100mW, 6GHz, B=120..240	SOT-323	16ta	-	3a	Tos
MG	2SA1235-G	Si-pnp	AF-Amp, 50V, 150mA, 200mW, 200MHz, B=400..800	SC-59	16ta	-	3a	Mit
MG	2SA1602-G	Si-pnp	AF, 50V, 200mA, 150mW, 200MHz, B=400..800	SOT-323	16ta	-	3a	Mit
MG	BAS40WCPPT	Si-diode	Dual, SBD, 40V, 200mA, Vf<1V(40mA), 5ns	SOT-323	16dg	-	3a	Chm



SMD code	Type	Function	Short description	Case	Pinout	Sch. St.	Mnf.
MG	ELM7646HDB	Vdet-IC	4.6V±2%, +Reset PPO, 50ms	SOT-23	16vdc	VD7 3d	Elm
mg	PT7M6240CLC3	Vdet-IC	4.0V±1.5%, -Reset PPO	SC-70	16vdc	VD7 3b	Pti
mḡ	PT7M6240CLC3E	Vdet-IC	4.0V±1.5%, -Reset PPO, Lead free	SC-70	16vdc	VD7 3b	Pti
mg	PT7M6240CLTA3	Vdet-IC	4.0V±1.5%, -Reset PPO	SOT-23	16vdc	VD7 3b	Pti
mḡ	PT7M6240CLTA3E	Vdet-IC	4.0V±1.5%, -Reset PPO, Lead free	SOT-23	16vdc	VD7 3b	Pti
MGO	2SC5109-O	Si-npn	VHF/UHF-VCO, 20V, 60mA, 150mW, 6GHz, B=80..160	SC-59	16ta	-	3a Tos
MGO	2SC5110-O	Si-npn	VHF/UHF-VCO, 20V, 60mA, 100mW, 6GHz, B=80..160	SOT-323	16ta	-	3a Tos
MGY	2SC5109-Y	Si-npn	VHF/UHF-VCO, 20V, 60mA, 150mW, 6GHz, B=120..240	SC-59	16ta	-	3a Tos
MGY	2SC5110-Y	Si-npn	VHF/UHF-VCO, 20V, 60mA, 100mW, 6GHz, B=120..240	SOT-323	16ta	-	3a Tos
MH	2SC3606	Si-npn	VHF/UHF, LN, 20V, 80mA, 150mW, 7GHz, B=30..250	SC-59	16ta	-	3a Tos
MH	2SC4394	Si-npn	VHF/UHF, 20V, 80mA, 100mW, B=30..250, 7GHz	SOT-323	16ta	-	3a Tos
MH	2SC4839	Si-npn	VHF/UHF, LN, 20V, 80mA, 100mW, 7GHz, B=30..250	SOT-323	16ta	-	3a Tos
MH	BAS40WSPT	Si-diode	Dual, SBD, 40V, 200mA, Vf<1V(40mA), 5ns	SOT-323	16dl	-	3a Chm
MH	DDZX9711	Z-diode	27V±5%, 500mW	SOT-23	16dc	-	3a Di
MH	DDZX9711W	Z-diode	27V±5%, 200mW	SOT-323	16dc	-	3a Di
MH	DZ23C51	Z-diode	Dual, 48.0..54.0V, Izt=5mA, Zzt=70Ω, 300mW	SOT-23	16dg	-	3a Lge
MH	ELM7647HDB	Vdet-IC	4.7V±2%, +Reset PPO, 50ms	SOT-23	16vdc	VD7 3d	Elm
MH	M1MA141K	Si-diode	Sw, 40V, 100mA, 150mW, Vf<1.2V(100mA), <2pF	SOT-323	16dc	-	3a Ons
MH	M1MA151K	Si-diode	Sw, 40V, 100mA, 200mW, Vf<1.2V(100mA), <2pF	SC-59	16dc	-	3a Ons
mh	PT7M6240CHC3	Vdet-IC	4.0V±1.5%, +Reset PPO	SC-70	16vdc	VD7 3b	Pti
mḥ	PT7M6240CHC3E	Vdet-IC	4.0V±1.5%, +Reset PPO, Lead free	SC-70	16vdc	VD7 3b	Pti
mḥ	PT7M6240CHTA3	Vdet-IC	4.0V±1.5%, +Reset PPO	SOT-23	16vdc	VD7 3b	Pti
mḥ	PT7M6240CHTA3E	Vdet-IC	4.0V±1.5%, +Reset PPO, Lead free	SOT-23	16vdc	VD7 3b	Pti
MI	CH751WPT	Si-diode	SBD, 40V, 30mA, Vf<0.37V(1mA)	SOT-323	16dc	-	3a Chm
MI	M1MA142K	Si-diode	Sw, 80V, 100mA, 150mW, Vf<1.2V(100mA), <2pF	SOT-323	16dc	-	3a Ons
MI	M1MA152K	Si-diode	Sw, 80V, 100mA, 200mW, Vf<1.2V(100mA), <2pF	SC-59	16dc	-	3a Ons
mi	PT7M6240NLC3	Vdet-IC	4.0V±1.5%, -Reset ODO	SC-70	16vdc	VD6 3b	Pti
mī	PT7M6240NLC3E	Vdet-IC	4.0V±1.5%, -Reset ODO, Lead free	SC-70	16vdc	VD6 3b	Pti
mi	PT7M6240NLTA3	Vdet-IC	4.0V±1.5%, -Reset ODO	SOT-23	16vdc	VD6 3b	Pti
mī	PT7M6240NLTA3E	Vdet-IC	4.0V±1.5%, -Reset ODO, Lead free	SOT-23	16vdc	VD6 3b	Pti
MJ	2SK1849	n-MOSFET*	Sw, 100V, 250mA, 250mW, <4.2Ω(100mA), 5/40ns	SOT-23	16fh	-	3a San
MJ	2SK2273	n-MOSFET*	Sw, 20V, 500mA, 250mW, <0.75Ω(250mA), 8/35ns	SOT-23	16fh	-	3a San
MJ	DDZX9712	Z-diode	28V±5%, 500mW	SOT-23	16dc	-	3a Di
MJ	DDZX9712W	Z-diode	28V±5%, 200mW	SOT-323	16dc	-	3a Di
MJ	ELM7648HDB	Vdet-IC	4.8V±2%, +Reset PPO, 50ms	SOT-23	16vdc	VD7 3d	Elm
mj	PT7M6241CLC3	Vdet-IC	4.1V±1.5%, -Reset PPO	SC-70	16vdc	VD7 3b	Pti
mḡ	PT7M6241CLC3E	Vdet-IC	4.1V±1.5%, -Reset PPO, Lead free	SC-70	16vdc	VD7 3b	Pti
mj	PT7M6241CLTA3	Vdet-IC	4.1V±1.5%, -Reset PPO	SOT-23	16vdc	VD7 3b	Pti
mḡ	PT7M6241CLTA3E	Vdet-IC	4.1V±1.5%, -Reset PPO, Lead free	SOT-23	16vdc	VD7 3b	Pti
MJ1	MMBD355	Si-diode	Dual, UHF-Mix, 7V, 10mA, Vf<0.6V(10mA), <1pF	SOT-23	16df	-	3a Ons
MK	DDZX9713	Z-diode	30V±5%, 500mW	SOT-23	16dc	-	3a Di
MK	DDZX9713W	Z-diode	30V±5%, 200mW	SOT-323	16dc	-	3a Di
MK	ELM7649HDB	Vdet-IC	4.9V±2%, +Reset PPO, 50ms	SOT-23	16vdc	VD7 3d	Elm
mk	PT7M6241CHC3	Vdet-IC	4.1V±1.5%, +Reset PPO	SC-70	16vdc	VD7 3b	Pti
mḵ	PT7M6241CHC3E	Vdet-IC	4.1V±1.5%, +Reset PPO, Lead free	SC-70	16vdc	VD7 3b	Pti
mk	PT7M6241CHTA3	Vdet-IC	4.1V±1.5%, +Reset PPO	SOT-23	16vdc	VD7 3b	Pti
mḵ	PT7M6241CHTA3E	Vdet-IC	4.1V±1.5%, +Reset PPO, Lead free	SOT-23	16vdc	VD7 3b	Pti
ML	2SA1519	Si-npn-Digi	Sw, 50V, 500mA, 200mW, 250MHz, R1/R2=4k7/4k7	SOT-23	16ta	-	3a San
ML	CH751WSPT	Si-diode	Dual, SBD, 40V, 30mA, Vf<0.37V(1mA)	SOT-323	16dl	-	3a Chm
ML	DDZX9714	Z-diode	33V±5%, 500mW	SOT-23	16dc	-	3a Di
ML	DDZX9714W	Z-diode	33V±5%, 200mW	SOT-323	16dc	-	3a Di
ml	PT7M6241NLC3	Vdet-IC	4.1V±1.5%, -Reset ODO	SC-70	16vdc	VD6 3b	Pti
mī	PT7M6241NLC3E	Vdet-IC	4.1V±1.5%, -Reset ODO, Lead free	SC-70	16vdc	VD6 3b	Pti
ml	PT7M6241NLTA3	Vdet-IC	4.1V±1.5%, -Reset ODO	SOT-23	16vdc	VD6 3b	Pti
mī	PT7M6241NLTA3E	Vdet-IC	4.1V±1.5%, -Reset ODO, Lead free	SOT-23	16vdc	VD6 3b	Pti
ML	ZVP3306F	p-MOSFET-e	V-MOS, 60V, 0.09A, 0.625W, <14Ω(0.5A)	SOT-23	16fh	-	3a Zx
MLN	ELM7533CEB	Vdet-IC	3.3V±2%, +Reset PPO	SC-70	16vdc	VD7 3d	Elm
MLN	ELM7533NEB	Vdet-IC	3.3V±2%, +Reset ODO	SC-70	16vdc	VD6 3d	Elm
MM	DDZX9715	Z-diode	36V±5%, 500mW	SOT-23	16dc	-	3a Di
MM	DDZX9715W	Z-diode	36V±5%, 200mW	SOT-323	16dc	-	3a Di
mḡ	PT7M6242CLC3	Vdet-IC	4.2V±1.5%, -Reset PPO	SC-70	16vdc	VD7 3b	Pti
mm	PT7M6242CLC3E	Vdet-IC	4.2V±1.5%, -Reset PPO, Lead free	SC-70	16vdc	VD7 3b	Pti
mm	PT7M6242CLTA3	Vdet-IC	4.2V±1.5%, -Reset PPO	SOT-23	16vdc	VD7 3b	Pti
mḡ	PT7M6242CLTA3E	Vdet-IC	4.2V±1.5%, -Reset PPO, Lead free	SOT-23	16vdc	VD7 3b	Pti
MN	2SC4840	Si-npn	VHF-UHF, LN, 20V, 40mA, 100mW, B=50..250, 10GHz	2-2H1A	16ta	-	3a Tos
MN	2SC5490	Si-npn	UHF-S-band, LN, 20V, 30mA, 100mW, B=90..200, 11GHz	SSFP	18ta	-	3a San
MN	DDZX9716	Z-diode	39V±5%, 500mW	SOT-23	16dc	-	3a Di
MN	DDZX9716W	Z-diode	39V±5%, 200mW	SOT-323	16dc	-	3a Di
MN	M1MA141WA	Si-diode	Dual, Sw, 40V, 100mA, 150mW, Vf<1.2V(100mA), <15pF	SOT-323	16df	-	3a Ons
MN	M1MA151WA	Si-diode	Dual, Sw, 40V, 100mA, 200mW, Vf<1.2V(100mA), <15pF	SC-59	16df	-	3a Ons



Note: ELM75xxCBB series LN- lot number L=0...9 N=A to Z(I, O, X excepted); ELM75xxNBB series LN- lot number L=A to Z(I, O, X excepted) N=0...9

SMD code	Type	Function	Short description	Case	Pinout	Sch. St.	Mnf.
mn	PT7M6242CHC3	Vdet-IC	4.2V±1.5%, +Reset PPO	SC-70	16vdc	VD7 3b	Pti
mñ	PT7M6242CHC3E	Vdet-IC	4.2V±1.5%, +Reset PPO, Lead free	SC-70	16vdc	VD7 3b	Pti
mn	PT7M6242CHTA3	Vdet-IC	4.2V±1.5%, +Reset PPO	SOT-23	16vdb	VD7 3b	Pti
mñ	PT7M6242CHTA3E	Vdet-IC	4.2V±1.5%, +Reset PPO, Lead free	SOT-23	16vdb	VD7 3b	Pti
MN2	DMN2104L	n-MOSFET-e	Sw, 20V, 4.3A, 1.4W, 53mΩ(4.2A), 92pF	SOT-23	16fh	- 3c	Di
MN3	2SC5245-3	Si-npn	UHF-S-band, 20V, 30mA, 150mW, B=60..120, 11GHz	MCP	16ta	- 3a	San
MN3	2SC5275-3	Si-npn	UHF-S-band, 20V, 30mA, 200mW, B=60..120, 11GHz	SOT-23	16ta	- 3a	San
MN4	2SC5245-4	Si-npn	UHF-S-band, 20V, 30mA, 150mW, B=90..180, 11GHz	MCP	16ta	- 3a	San
MN4	2SC5275-4	Si-npn	UHF-S-band, 20V, 30mA, 200mW, B=90..180, 11GHz	SOT-23	16ta	- 3a	San
MN5	2SC5245-5	Si-npn	UHF-S-band, 20V, 30mA, 150mW, B=135..270, 11GHz	MCP	16ta	- 3a	San
MN5	2SC5275-5	Si-npn	UHF-S-band, 20V, 30mA, 200mW, B=135..270, 11GHz	SOT-23	16ta	- 3a	San
MO	2SC4322	Si-npn	VHF/UHF, LN, 20V, 15mA, 150mW, 10GHz, B=50..250	SC-59	16ta	- 3a	Tos
MO	2SC4841	Si-npn	VHF-UHF, LN, 20V, 15mA, 100mW, B=50..250, 10GHz	2-2H1A	16ta	- 3a	Tos
MO	BAW56WPT	Si-diode	Dual, Sw, 85V, 150mA, Vf<1.25V(150mA), 4ns	SOT-323	16df	- 3a	Chm
MO	CHP202UPT	Si-diode	Dual, Sw, 80V, 100mA, Vf<1.2V(100mA), 4ns	SOT-323	16df	- 3a	Chm
MO	M1MA142WA	Si-diode	Dual, Swi, 80V, 100mA, 150mW, Vf<1.2V(100mA), <15pF	SOT-323	16df	- 3a	Ons
MO	M1MA152WA	Si-diode	Dual, Sw, 80V, 100mA, 200mW, Vf<1.2V(100mA), <15pF	SC-59	16df	- 3a	Ons
MO	MA3X152D	Si-diode	Dual, Sw, 80V, 100mA, <10ns, 15pF	SOT-23	16df	- 3a	Pan
mo	PT7M6242NLC3	Vdet-IC	4.2V±1.5%, -Reset ODO	SC-70	16vdc	VD6 3b	Pti
mō	PT7M6242NLC3E	Vdet-IC	4.2V±1.5%, -Reset ODO, Lead free	SC-70	16vdc	VD6 3b	Pti
mo	PT7M6242NLTA3	Vdet-IC	4.2V±1.5%, -Reset ODO	SOT-23	16vdb	VD6 3b	Pti
mō	PT7M6242NLTA3E	Vdet-IC	4.2V±1.5%, -Reset ODO, Lead free	SOT-23	16vdb	VD6 3b	Pti
MP	2SC4470	Si-npn	UHF, 20V, 80mA, 7GHz	SOT-23	16te	- 3a	Tos
MP	MA3J143A	Si-diode	Dual, Fast, Sw, 80V, 100mA, Vf<1.2V(100mA), <9ns	SOT-523	18dl	- 3a	Pan
mp	PT7M6243CLC3	Vdet-IC	4.3V±1.5%, -Reset PPO	SC-70	16vdc	VD7 3b	Pti
mḡ	PT7M6243CLC3E	Vdet-IC	4.3V±1.5%, -Reset PPO, Lead free	SC-70	16vdc	VD7 3b	Pti
mp	PT7M6243CLTA3	Vdet-IC	4.3V±1.5%, -Reset PPO	SOT-23	16vdb	VD7 3b	Pti
mḡ	PT7M6243CLTA3E	Vdet-IC	4.3V±1.5%, -Reset PPO, Lead free	SOT-23	16vdb	VD7 3b	Pti
MP=	RT9818C-36GVL	Vdet-IC	4.6V±1.5%, -Reset ODO, Td=220ms	SOT-23	16vdc	VD6 3a	Rct
MQ	KRC281U	Si-npn-Digi	Sw, 50V, 300mA, 900mW, 300MHz, B=350..1200, R1=2.2k	SOT-323	16ta	- 3f	Kec
mḡ	PT7M6243CHC3	Vdet-IC	4.3V±1.5%, +Reset PPO	SC-70	16vdc	VD7 3b	Pti
mḡ	PT7M6243CHC3E	Vdet-IC	4.3V±1.5%, +Reset PPO, Lead free	SC-70	16vdc	VD7 3b	Pti
mḡ	PT7M6243CHTA3	Vdet-IC	4.3V±1.5%, +Reset PPO	SOT-23	16vdb	VD7 3b	Pti
mḡ	PT7M6243CHTA3E	Vdet-IC	4.3V±1.5%, +Reset PPO, Lead free	SOT-23	16vdb	VD7 3b	Pti
MQ=	RT9818C-41GVL	Vdet-IC	4.1V±1.5%, -Reset ODO, Td=220ms	SOT-23	16vdc	VD6 3a	Rct
MQA	KRC281SA	Si-npn-Digi	Sw, 50V, 300mA, 900mW, 300MHz, B=200..700, R1=2.2k	SOT-23	16ta	- 3f	Kec
MQB	KRC281SB	Si-npn-Digi	Sw, 50V, 300mA, 900mW, 300MHz, B=350..1200, R1=2.2k	SOT-23	16ta	- 3f	Kec
MR	CAT809MSDI-GT3	Vdet-IC	4.38V±1.5%, -Reset PPO	SC-70	16vdc	VD7 3d	Ons
MR	CAT809MTBI-GT3	Vdet-IC	4.38V±1.5%, -Reset PPO	SOT-23	16vdc	VD7 3b	Ons
MR	KRC282U	Si-npn-Digi	Sw, 50V, 300mA, 900mW, 300MHz, B=350..1200, R1=4.7k	SOT-323	16ta	- 3f	Kec
MR	MT3S03AS	Si-npn	VHF/UHF, 10V, 40mA, 10GHz	SOT-23	16ta	- 3a	Tos
mr	PT7M6243NLC3	Vdet-IC	4.3V±1.5%, -Reset ODO	SC-70	16vdc	VD6 3b	Pti
mḡ	PT7M6243NLC3E	Vdet-IC	4.3V±1.5%, -Reset ODO, Lead free	SC-70	16vdc	VD6 3b	Pti
mr	PT7M6243NLTA3	Vdet-IC	4.3V±1.5%, -Reset ODO	SOT-23	16vdb	VD6 3b	Pti
mḡ	PT7M6243NLTA3E	Vdet-IC	4.3V±1.5%, -Reset ODO, Lead free	SOT-23	16vdb	VD6 3b	Pti
MR	ZVP3310F	p-MOSFET-e	V-MOS, 100V, 0.14A, 0.175W, <20Q(0.15A)	SOT-23	16fh	- 3a	Zx
MR=	RT9818G-20GVL	Vdet-IC	2.0V±1.5%, +Reset ODO, Td=220ms	SOT-23	16vda	VD6 3a	Rct
MRA	KRC282SA	Si-npn-Digi	Sw, 50V, 300mA, 900mW, 300MHz, B=200..700, R1=4.7k	SOT-23	16ta	- 3f	Kec
MRB	KRC282SB	Si-npn-Digi	Sw, 50V, 300mA, 900mW, 300MHz, B=350..1200, R1=4.7k	SOT-23	16ta	- 3f	Kec
MS	CAT810MSDI-GT3	Vdet-IC	4.38V±1.5%, +Reset PPO	SC-70	16vdc	VD7 3d	Ons
MS	CAT810MTBI-GT3	Vdet-IC	4.38V±1.5%, +Reset PPO	SOT-23	16vdc	VD7 3b	Ons
MS	KRC283U	Si-npn-Digi	Sw, 50V, 300mA, 900mW, 300MHz, B=350..1200, R1=5.6k	SOT-323	16ta	- 3f	Kec
ms	PT7M6244CLC3	Vdet-IC	4.4V±1.5%, -Reset PPO	SC-70	16vdc	VD7 3b	Pti
mḡ	PT7M6244CLC3E	Vdet-IC	4.4V±1.5%, -Reset PPO, Lead free	SC-70	16vdc	VD7 3b	Pti
ms	PT7M6244CLTA3	Vdet-IC	4.4V±1.5%, -Reset PPO	SOT-23	16vdb	VD7 3b	Pti
mḡ	PT7M6244CLTA3E	Vdet-IC	4.4V±1.5%, -Reset PPO, Lead free	SOT-23	16vdb	VD7 3b	Pti
MS=	RT9818E-20GVL	Vdet-IC	2.0V±1.5%, +Reset ODO	SOT-23	16vda	VD6 3a	Rct
MS1	2SA1963-1	Si-pnp	HF, LN, U-Sp, Sw, 12V, 50mA, 200mW, B=20..50, 5GHz	SOT-23	16ta	- 3a	San
MS2	2SA1963-2	Si-pnp	HF, LN, U-Sp, Sw, 12V, 50mA, 200mW, B=40..80, 5GHz	SOT-23	16ta	- 3a	San
MS3	2SA1963-3	Si-pnp	HF, LN, U-Sp, Sw, 12V, 50mA, 200mW, B=60..120, 5GHz	SOT-23	16ta	- 3a	San
MSA	KRC283SA	Si-npn-Digi	Sw, 50V, 300mA, 900mW, 300MHz, B=200..700, R1=5.6k	SOT-23	16ta	- 3f	Kec
MSB	KRC283SB	Si-npn-Digi	Sw, 50V, 300mA, 900mW, 300MHz, B=350..1200, R1=5.6k	SOT-23	16ta	- 3f	Kec
MT	CHT817PT-S	Si-npn	AF, Sw, 45V, 500mA, B=250..600, 170MHz	SOT-23	16ta	- 3a	Chm
MT	KRC284U	Si-npn-Digi	Sw, 50V, 300mA, 900mW, 300MHz, B=350..1200, R1=6.8k	SOT-323	16ta	- 3f	Kec
MT	M1MA141WK	Si-diode	Dual, Sw, 40V, 100mA, 150mW, Vf<1.2V(100mA), <15pF	SOT-323	16dg	- 3a	Ons
MT	M1MA151WK	Si-diode	Dual, Sw, 40V, 100mA, 200mW, Vf<1.2V(100mA), <15pF	SC-59	16dg	- 3a	Ons
mt	PT7M6244CHC3	Vdet-IC	4.4V±1.5%, +Reset PPO	SC-70	16vdc	VD7 3b	Pti
mḡ	PT7M6244CHC3E	Vdet-IC	4.4V±1.5%, +Reset PPO, Lead free	SC-70	16vdc	VD7 3b	Pti
mt	PT7M6244CHTA3	Vdet-IC	4.4V±1.5%, +Reset PPO	SOT-23	16vdb	VD7 3b	Pti
mḡ	PT7M6244CHTA3E	Vdet-IC	4.4V±1.5%, +Reset PPO, Lead free	SOT-23	16vdb	VD7 3b	Pti



SMD code	Type	Function	Short description	Case	Pinout	Sch. St.	Mnf.
MT	ZVP1320F	p-MOSFET-e	V-MOS, 200V, 35mA, 0.625W, $-80\Omega(50mA)$	SOT-23	16fh	- 3a	Zx
MTA	KRC284SA	Si-npn-Digi	Sw, 50V, 300mA, 900mW, 300MHz, B=200..700, R1=6.8k	SOT-23	16ta	- 3f	Kec
MTB	KRC284SB	Si-npn-Digi	Sw, 50V, 300mA, 900mW, 300MHz, B=350..1200, R1=6.8k	SOT-23	16ta	- 3f	Kec
MTT	ADM1812-10AKS	Vdet-IC	4.35V, +Reset PPO	SOT-323	16vda	VD7 3a	Ad
MTT	ADM1812-10ART	Vdet-IC	4.35V, +Reset PPO	SOT-23	16vda	VD7 3a	Ad
MTV	ADM1812-5AKS	Vdet-IC	4.62V, +Reset PPO	SOT-323	16vda	VD7 3a	Ad
MTV	ADM1812-5ART	Vdet-IC	4.62V, +Reset PPO	SOT-23	16vda	VD7 3a	Ad
MU	BAV70WPT	Si-diode	Dual, Sw, 75V, 150mA, Vf<1.25V(150mA), 4ns	SOT-323	16dg	- 3a	Chm
MU	CHN202UPT	Si-diode	Dual, Sw, 80V, 100mA, Vf<1.2V(100mA), 4ns	SOT-323	16dg	- 3a	Chm
MU	KRC285U	Si-npn-Digi	Sw, 50V, 300mA, 900mW, 300MHz, B=350..1200, R1=10k	SOT-323	16ta	- 3f	Kec
MU	M1MA142WK	Si-diode	Dual, Sw, 80V, 100mA, 150mW, Vf<1.2V(100mA), <math><15pF</math>	SOT-323	16dg	- 3a	Ons
MU	M1MA152WK	Si-diode	Dual, Sw, 80V, 100mA, 200mW, Vf<1.2V(100mA), <math><15pF</math>	SC-59	16dg	- 3a	Ons
mu	PT7M6244NLC3	Vdet-IC	4.4V±1.5%, -Reset ODO	SC-70	16vdc	VD6 3b	Pti
mū	PT7M6244NLC3E	Vdet-IC	4.4V±1.5%, -Reset ODO, Lead free	SC-70	16vdc	VD6 3b	Pti
mu	PT7M6244NLT3	Vdet-IC	4.4V±1.5%, -Reset ODO	SOT-23	16vdb	VD6 3b	Pti
mū	PT7M6244NLT3E	Vdet-IC	4.4V±1.5%, -Reset ODO, Lead free	SOT-23	16vdb	VD6 3b	Pti
MU=	RT9818D-35GV	Vdet-IC	3.5V±1.5%, -Reset ODO, Td=450ms	SOT-23	16vda	VD6 3a	Rct
MJA	KRC285SA	Si-npn-Digi	Sw, 50V, 300mA, 900mW, 300MHz, B=200..700, R1=10k	SOT-23	16ta	- 3f	Kec
MJB	KRC285SB	Si-npn-Digi	Sw, 50V, 300mA, 900mW, 300MHz, B=350..1200, R1=10k	SOT-23	16ta	- 3f	Kec
MV	1SV272	PIN-diode	VHF/UHF, 50V, 100mA, 0.6pF, 0.5Q(470MHz)	SOT-23	16dc	- 3a	San
MV	KRC286U	Si-npn-Digi	Sw, 50V, 300mA, 900mW, 300MHz, B=350..1200, R1=22k	SOT-323	16ta	- 3f	Kec
mv	PT7M6245CLC3	Vdet-IC	4.5V±1.5%, -Reset PPO	SC-70	16vdc	VD7 3b	Pti
mṽ	PT7M6245CLC3E	Vdet-IC	4.5V±1.5%, -Reset PPO, Lead free	SC-70	16vdc	VD7 3b	Pti
mv	PT7M6245CLTA3	Vdet-IC	4.5V±1.5%, -Reset PPO	SOT-23	16vdb	VD7 3b	Pti
mṽ	PT7M6245CLTA3E	Vdet-IC	4.5V±1.5%, -Reset PPO, Lead free	SOT-23	16vdb	VD7 3b	Pti
MVA	KRC286SA	Si-npn-Digi	Sw, 50V, 300mA, 900mW, 300MHz, B=200..700, R1=22k	SOT-23	16ta	- 3f	Kec
MVB	KRC286SB	Si-npn-Digi	Sw, 50V, 300mA, 900mW, 300MHz, B=350..1200, R1=22k	SOT-23	16ta	- 3f	Kec
mw	PT7M6245CHC3	Vdet-IC	4.5V±1.5%, +Reset PPO	SC-70	16vdc	VD7 3b	Pti
mṽ	PT7M6245CHC3E	Vdet-IC	4.5V±1.5%, +Reset PPO, Lead free	SC-70	16vdc	VD7 3b	Pti
mw	PT7M6245CHTA3	Vdet-IC	4.5V±1.5%, +Reset PPO	SOT-23	16vdb	VD7 3b	Pti
mṽ	PT7M6245CHTA3E	Vdet-IC	4.5V±1.5%, +Reset PPO, Lead free	SOT-23	16vdb	VD7 3b	Pti
MX	MA3X057	C-diode	VHF-Band-Sw, 35V, 100mA, 1.3pF(15V), 0.78Q(100MHz)	SC-59	16dc	- 3a	Pan
MX	MA57	C-diode	VHF-Band-Sw, 35V, 100mA, 1.3pF(15V), 0.78Q(100MHz)	SC-59	16dc	- 3a	Pan
mx	PT7M6245NLC3	Vdet-IC	4.5V±1.5%, -Reset ODO	SC-70	16vdc	VD6 3b	Pti
mṁ	PT7M6245NLC3E	Vdet-IC	4.5V±1.5%, -Reset ODO, Lead free	SC-70	16vdc	VD6 3b	Pti
mx	PT7M6245NLT3	Vdet-IC	4.5V±1.5%, -Reset ODO	SOT-23	16vdb	VD6 3b	Pti
mṁ	PT7M6245NLT3E	Vdet-IC	4.5V±1.5%, -Reset ODO, Lead free	SOT-23	16vdb	VD6 3b	Pti
MY	MA3X551	PIN-diode	UHF/SHF-AGC, 40V, 100mA, Vf=1V(100mA), 0.3pF	SC-59	16dc	- 3a	Pan
MY	MA3Z551	PIN-diode	HF-alt, 40V, 100mA, 150mW, Vf=1V(100mA), 0.3pF	SOT-323	16dc	- 3a	Pan
MY	MA551	PIN-diode	UHF/SHF-AGC, 40V, 100mA, Vf=1V(100mA), 0.3pF	SC-59	16dc	- 3a	Pan
my	PT7M6246CLC3	Vdet-IC	4.6V±1.5%, -Reset PPO	SC-70	16vdc	VD7 3b	Pti
mṽ	PT7M6246CLC3E	Vdet-IC	4.6V±1.5%, -Reset PPO, Lead free	SC-70	16vdc	VD7 3b	Pti
my	PT7M6246CLTA3	Vdet-IC	4.6V±1.5%, -Reset PPO	SOT-23	16vdb	VD7 3b	Pti
mṽ	PT7M6246CLTA3E	Vdet-IC	4.6V±1.5%, -Reset PPO, Lead free	SOT-23	16vdb	VD7 3b	Pti
MY2	2SC3773-2	Si-npn	UHF, Osc-Mix, 25V, 50mA, 250mW, 3.5GHz, B=40..80	SOT-23	16ta	- 3a	San
MY3	2SC3773-3	Si-npn	UHF, Osc-Mix, 25V, 50mA, 250mW, 3.5GHz, B=60..120	SOT-23	16ta	- 3a	San
MY4	2SC3773-4	Si-npn	UHF, Osc-Mix, 25V, 50mA, 250mW, 3.5GHz, B=100..200	SOT-23	16ta	- 3a	San
mz	PT7M6246CHC3	Vdet-IC	4.6V±1.5%, +Reset PPO	SC-70	16vdc	VD7 3b	Pti
mṽ	PT7M6246CHC3E	Vdet-IC	4.6V±1.5%, +Reset PPO, Lead free	SC-70	16vdc	VD7 3b	Pti
mz	PT7M6246CHTA3	Vdet-IC	4.6V±1.5%, +Reset PPO	SOT-23	16vdb	VD7 3b	Pti
mṽ	PT7M6246CHTA3E	Vdet-IC	4.6V±1.5%, +Reset PPO, Lead free	SOT-23	16vdb	VD7 3b	Pti
MZ	ZVN4106F	n-MOSFET-e	V-MOS, 60V, 0.2A, <math><5\Omega(0.5A)</math>	SOT-23	16fh	- 3a	Zx
MZT	ADM1810-10AKS	Vdet-IC	4.35V, -Reset PPO	SOT-323	16vda	VD7 3a	Ad
MZT	ADM1810-10ART	Vdet-IC	4.35V, -Reset PPO	SOT-23	16vda	VD7 3a	Ad
MZV	ADM1810-5AKS	Vdet-IC	4.62V, -Reset PPO	SOT-323	16vda	VD7 3a	Ad
MZV	ADM1810-5ART	Vdet-IC	4.62V, -Reset PPO	SOT-23	16vda	VD7 3a	Ad
n	AX6902GA	Vdet-IC	2.25V±1.5%, +Reset PPO	SC-70	16vdc	VD7 3b	Axl
N	DAN202K	Si-diode	Dual, Sw, 80V, 300mA, 200mW, <math><1.5ns</math>	SC-59	16dg	- 3i	Rhm
N	DAN222	Si-diode	Dual, Sw, 80V, 300mA, 150mW, <math><1.5ns</math>	SOT-416	16dg	- 3i	Rhm
N	DAP202K	Si-diode	Dual, Sw, 80V, 300mA, 200mW, <math><1.5ns</math>	SC-59	16df	- 3i	Rhm
N	SB007T03Q	Si-diode	Dual, SBR, HF, 30V, 70mA, Vf<0.55V(70mA), 3pF, 10ns	MCP	16dl	- 3a	San
N0	BFR505T	Si-npn	SATV, 20V, 18mA, 150mW, B=60..250, 9GHz	SOT-416	16ta	- 3a	Phi
N0	ELM7640LAB	Vdet-IC	4.0V±2%, -Reset PPO, 250ms	SOT-23	16vdc	VD7 3d	Elm
N0	R1100D201C	LVR-IC	U-low lcc, 2V±2%, 180mA	SON1408-3	16jdc	VR1 3d	Ric
N0	R3111N502C	Vdet-IC	5V±2%, -Reset ODO	SOT-23	16vdd	VD6 3d	Ric
N0	R3130N40DC	Vdet-IC	4V, -Reset ODO, 200ms	SOT-23	16vdc	VD6 3b	Ric
N0	TC54VN3002ECB	Vdet-IC	3.0V±2%, -Reset ODO	SOT-23	16vdb	VD6 3a	Tcs
N0	TN0200T	n-MOSFET-e	V-MOS, LogL, 20V, 0.73A, <math><0.4\Omega</math>	SOT-23	16fh	- 3a	Six
N0	XC61CN3002M	Vdet-IC	3V±1%, +Reset ODO	SOT-23	16vdb	VD6 3d	Tor
N0	XC6GN3002HR	Vdet-IC	3.0V, +Reset ODO	USP-3	17vdc	VD1 9b	Tor



SMD code	Type	Function	Short description	Case	Pinout	Sch. St.	Mnf.
N01	DDTC113TCA	Si-npn-Digi	Sw, 50V, 100mA, 200mW, 250MHz, R1=1k	SOT-23	16ta	-	3d Di
N01	DDTC113TE	Si-npn-Digi	Sw, 50V, 100mA, 150mW, 250MHz, R1=1k	SOT-523	16ta	-	3d Di
N01	DDTC113TKA	Si-npn-Digi	Sw, 50V, 100mA, 200mW, 250MHz, R1=1k	SC-59	16ta	-	3d Di
N01	DDTC113TUA	Si-npn-Digi	Sw, 50V, 100mA, 200mW, 250MHz, R1=1k	SOT-323	16ta	-	3d Di
N01	SST4391	n-FET	Sw, Chopper, 40V, Idss=50mA, 350mW, Up<10V	SOT-23	16fa	-	3a Cal
N02	DDTC113KA	Si-npn-Digi	Sw, 50V, 100mA, 200mW, 250MHz, R1/R2=1k/10k	SC-59	16ta	-	3d Di
N02	DDTC113ZCA	Si-npn-Digi	Sw, 50V, 100mA, 200mW, 250MHz, R1/R2=1k/10k	SOT-23	16ta	-	3d Di
N02	DDTC113ZE	Si-npn-Digi	Sw, 50V, 100mA, 150mW, 250MHz, R1/R2=1k/10k	SOT-523	16ta	-	3d Di
N02	DDTC113ZKA	Si-npn-Digi	Sw, 50V, 100mA, 200mW, 250MHz, R1/R2=1k/10k	SC-59	16ta	-	3d Di
N02	DDTC113ZUA	Si-npn-Digi	Sw, 50V, 100mA, 200mW, 250MHz, R1/R2=1k/10k	SOT-323	16ta	-	3d Di
N02	SST4392	n-FET	Sw, Chopper, 40V, Idss=25mA, 350mW, Up<5V	SOT-23	16fa	-	3a Cal
N02	ZXM61N02F	n-MOSFET-e	V-MOS, LogL, 20V, 1.7A, <0.18Q	SOT-23	16fh	-	3a Zx
N03	DDTC123TCA	Si-npn-Digi	Sw, 50V, 100mA, 200mW, 250MHz, R1=2k2	SOT-23	16ta	-	3d Di
N03	DDTC123TE	Si-npn-Digi	Sw, 50V, 100mA, 150mW, 250MHz, R1=2k2	SOT-523	16ta	-	3d Di
N03	DDTC123TKA	Si-npn-Digi	Sw, 50V, 100mA, 200mW, 250MHz, R1=2k2	SC-59	16ta	-	3d Di
N03	DDTC123TUA	Si-npn-Digi	Sw, 50V, 100mA, 200mW, 250MHz, R1=2k2	SOT-323	16ta	-	3d Di
N03	SST4393	n-FET	Sw, Chopper, 40V, Idss=5mA, 350mW, Up<3V	SOT-23	16fa	-	3a Cal
N03	XE61CN3045MR	Vdet-IC	3.0V±2%, -Reset ODO	SOT-23	16vdb	VD6	3h Tor
N03	ZXM61N03F	n-MOSFET-e	V-MOS, LogL, 30V, 1.4A, <0.3Q	SOT-23	16fh	-	3a Zx
N04	DDTC123ECA	Si-npn-Digi	Sw, 50V, 100mA, 200mW, 250MHz, R1/R2=2k2/2k2	SOT-23	16ta	-	3d Di
N04	DDTC123EE	Si-npn-Digi	Sw, 50V, 100mA, 150mW, 250MHz, R1/R2=2k2/2k2	SOT-523	16ta	-	3d Di
N04	DDTC123EKA	Si-npn-Digi	Sw, 50V, 100mA, 200mW, 250MHz, R1/R2=2k2/2k2	SC-59	16ta	-	3d Di
N04	DDTC123EUA	Si-npn-Digi	Sw, 50V, 100mA, 200mW, 250MHz, R1/R2=2k2/2k2	SOT-323	16ta	-	3d Di
N05	DDTC123YCA	Si-npn-Digi	Sw, 50V, 100mA, 200mW, 250MHz, R1/R2=2k2/10k	SOT-23	16ta	-	3d Di
N05	DDTC123YE	Si-npn-Digi	Sw, 50V, 100mA, 150mW, 250MHz, R1/R2=2k2/10k	SOT-523	16ta	-	3d Di
N05	DDTC123YKA	Si-npn-Digi	Sw, 50V, 100mA, 200mW, 250MHz, R1/R2=2k2/10k	SC-59	16ta	-	3d Di
N05	DDTC123YUA	Si-npn-Digi	Sw, 50V, 100mA, 200mW, 250MHz, R1/R2=2k2/10k	SOT-323	16ta	-	3d Di
N05	SO2484	Si-npn	AF, LN, 60V, 50mA, 360mW, 100MHz, B>100	SOT-23	16ta	-	Ste
N05	XC61FN3012M	Vdet-IC	3V±2%, +Reset ODO, 200ms	SOT-23	16vdb	VD6	3d Tor
N05	XC61HN3012MR	Vdet-IC	3.0V±2%, -Reset ODO, 50..200ms	SOT-23	16vdc	VD6	3d Tor
N06	DDTC123JCA	Si-npn-Digi	Sw, 50V, 100mA, 200mW, 250MHz, R1/R2=2k2/47k	SOT-23	16ta	-	3d Di
N06	DDTC123JE	Si-npn-Digi	Sw, 50V, 100mA, 150mW, 250MHz, R1/R2=2k2/47k	SOT-523	16ta	-	3d Di
N06	DDTC123JKA	Si-npn-Digi	Sw, 50V, 100mA, 200mW, 250MHz, R1/R2=2k2/47k	SC-59	16ta	-	3d Di
N06	DDTC123JUA	Si-npn-Digi	Sw, 50V, 100mA, 200mW, 250MHz, R1/R2=2k2/47k	SOT-323	16ta	-	3d Di
N06	XC61FN3042M	Vdet-IC	3V±2%, +Reset ODO, 400ms	SOT-23	16vdb	VD6	3d Tor
N06	XC61HN3042MR	Vdet-IC	3.0V±2%, -Reset ODO, 80..400ms	SOT-23	16vdc	VD6	3d Tor
N07	DDTC143TCA	Si-npn-Digi	Sw, 50V, 100mA, 200mW, 250MHz, R1=4k7	SOT-23	16ta	-	3d Di
N07	DDTC143TE	Si-npn-Digi	Sw, 50V, 100mA, 150mW, 250MHz, R1=4k7	SOT-523	16ta	-	3d Di
N07	DDTC143TKA	Si-npn-Digi	Sw, 50V, 100mA, 200mW, 250MHz, R1=4k7	SC-59	16ta	-	3d Di
N07	DDTC143TUA	Si-npn-Digi	Sw, 50V, 100mA, 200mW, 250MHz, R1=4k7	SOT-323	16ta	-	3d Di
N07	XC61FN3052M	Vdet-IC	3V±2%, +Reset ODO, 50ms	SOT-23	16vdb	VD6	3d Tor
N07	XC61HN3052MR	Vdet-IC	3.0V±2%, -Reset ODO, 1..50ms	SOT-23	16vdc	VD6	3d Tor
N08	DDTC143ECA	Si-npn-Digi	Sw, 50V, 100mA, 200mW, 250MHz, R1/R2=4k7/4k7	SOT-23	16ta	-	3d Di
N08	DDTC143EE	Si-npn-Digi	Sw, 50V, 100mA, 150mW, 250MHz, R1/R2=4k7/4k7	SOT-523	16ta	-	3d Di
N08	DDTC143EKA	Si-npn-Digi	Sw, 50V, 100mA, 200mW, 250MHz, R1/R2=4k7/4k7	SC-59	16ta	-	3d Di
N08	DDTC143EUA	Si-npn-Digi	Sw, 50V, 100mA, 200mW, 250MHz, R1/R2=4k7/4k7	SOT-323	16ta	-	3d Di
N09	82N09-AE3-5	Vdet-IC	0.9V±2% -Reset ODO	SOT-23	16vdb	VD6	3a Utc
N09	DDTC123XCA	Si-npn-Digi	Sw, 50V, 100mA, 200mW, 250MHz, R1/R2=4k7/10k	SOT-23	16ta	-	3d Di
N09	DDTC123XE	Si-npn-Digi	Sw, 50V, 100mA, 150mW, 250MHz, R1/R2=4k7/10k	SOT-523	16ta	-	3a Di
N09	DDTC123XKA	Si-npn-Digi	Sw, 50V, 100mA, 200mW, 250MHz, R1/R2=4k7/10k	SC-59	16ta	-	3d Di
N09	DDTC123XUA	Si-npn-Digi	Sw, 50V, 100mA, 200mW, 250MHz, R1/R2=4k7/10k	SOT-323	16ta	-	3d Di
N09	DDTC143XCA	Si-npn-Digi	Sw, 50V, 100mA, 200mW, 250MHz, R1/R2=4k7/10k	SOT-23	16ta	-	3d Di
N09	DDTC143XE	Si-npn-Digi	Sw, 50V, 100mA, 150mW, 250MHz, R1/R2=4k7/10k	SOT-523	16ta	-	3d Di
N09	DDTC143XKA	Si-npn-Digi	Sw, 50V, 100mA, 200mW, 250MHz, R1/R2=4k7/10k	SC-59	16ta	-	3d Di
N09	DDTC143XUA	Si-npn-Digi	Sw, 50V, 100mA, 200mW, 250MHz, R1/R2=4k7/10k	SOT-323	16ta	-	3d Di
N09G	82N09G-AE3-5	Vdet-IC	0.9V±2% -Reset ODO, halogen free	SOT-23	16vdb	VD6	3a Utc
N09L	82N09L-AE3-5	Vdet-IC	0.9V±2% -Reset ODO, lead free	SOT-23	16vdb	VD6	3a Utc
N1	BFR53	Si-npn	UHF-A, 18V, 50mA, 2GHz	SOT-23	16ta	-	3a Ste
N1	ELM7641LAB	Vdet-IC	4.1V±2%, -Reset PPO, 250ms	SOT-23	16vdc	VD7	3d Elm
N1	ILC5061IC31X	Vdet-IC	3.1V±2%, -Reset ODO	SOT-323	16vdb	VD6	3a Imp
N1	ILC5061M31X	Vdet-IC	3.1V±2%, -Reset ODO	SOT-23	16vdb	VD6	3a Imp
N1	MMBZ5261B	Z-diode	44.65..49.35V, Zzt=105Ω, Izt=2.7mA, 410mW	SOT-23	16dc	-	3a Pjt
N1	R1100D211C	LVR-IC	U-low lcc, 2.1V±2%, 180mA	SON1408-3	18vj	VR1	3d Ric
N1	R3111N512C	Vdet-IC	5.1V±2%, -Reset ODO	SOT-23	16vdd	VD6	3d Ric
N1	R3130N44DC	Vdet-IC	4.4V, -Reset ODO, 200ms	SOT-23	16vdc	VD6	3b Ric
N1	RT1N141C	Si-npn-Digi	Sw, 50V, 100mA, 150mW, 200MHz, R1/R2=10k/10k	SC-59	16ta	-	3a Mit
N1	RT1N141M	Si-npn-Digi	Sw, 50V, 100mA, 150mW, 200MHz, R1/R2=10k/10k	SOT-323	16ta	-	3a Mit
N1	RT1N141T	Si-npn-Digi	Sw, 50V, 100mA, 125mW, 200MHz, R1/R2=10k/10k	T-USM	18ta	-	3a Mit
N1	RT1N141U	Si-npn-Digi	Sw, 50V, 100mA, 125mW, 200MHz, R1/R2=10k/10k	SC-75A	16ta	-	3a Mit
N1	TC54VN3102ECB	Vdet-IC	3.1V±2%, -Reset ODO	SOT-23	16vdb	VD6	3a Tcs



SMD code	Type	Function	Short description	Case	Pinout	Sch. St.	Mnf.
N1	TN0201T	n-MOSFET-e	V-MOS, 20V, 0.39A, <1Q(0.5A)	SOT-23	16fh	-	3a Six
N1	XC61CN3102M	Vdet-IC	3.1V±1%, +Reset ODO	SOT-23	16vdb	VD6	3d Tor
N1	XC6GN3102HR	Vdet-IC	3.1V, +Reset ODO	USP-3	17vdc	VD1	9b Tor
N1-	BFS20W	Si-npn	RF, 30V, 25mA, 200mW, B=85, 470MHz	SOT-323	16ta	-	3a Phi
N10	82N10-AE3-5	Vdet-IC	1.0V±2% -Reset ODO	SOT-23	16vdb	VD6	3a Utc
N10	DDTC143FCA	Si-npn-Digi	Sw, 50V, 100mA, 200mW, 250MHz, R1/R2=4k7/22k	SOT-23	16ta	-	3d Di
N10	DDTC143FE	Si-npn-Digi	Sw, 50V, 100mA, 150mW, 250MHz, R1/R2=4k7/22k	SOT-523	16ta	-	3d Di
N10	DDTC143FKA	Si-npn-Digi	Sw, 50V, 100mA, 200mW, 250MHz, R1/R2=4k7/22k	SC-59	16ta	-	3d Di
N10	DDTC143FUA	Si-npn-Digi	Sw, 50V, 100mA, 200mW, 250MHz, R1/R2=4k7/22k	SOT-323	16ta	-	3d Di
N10G	82N10G-AE3-5	Vdet-IC	1.0V±2% -Reset ODO, halogen free	SOT-23	16vdb	VD6	3a Utc
N10L	82N10L-AE3-5	Vdet-IC	1.0V±2% -Reset ODO, lead free	SOT-23	16vdb	VD6	3a Utc
N11	2SK334-11	n-FET	GP, 20V, 50mA, 100mW, Idss=0.06..0.18mA	SOT-23	16fa	-	3a San
N11	82N11-AE3-5	Vdet-IC	1.1V±2% -Reset ODO	SOT-23	16vdb	VD6	3a Utc
N11	DDTC143ZCA	Si-npn-Digi	Sw, 50V, 100mA, 200mW, 250MHz, R1/R2=4k7/47k	SOT-23	16ta	-	3d Di
N11	DDTC143ZE	Si-npn-Digi	Sw, 50V, 100mA, 150mW, 250MHz, R1/R2=4k7/47k	SOT-523	16ta	-	3d Di
N11	DDTC143ZKA	Si-npn-Digi	Sw, 50V, 100mA, 200mW, 250MHz, R1/R2=4k7/47k	SC-59	16ta	-	3d Di
N11	DDTC143ZUA	Si-npn-Digi	Sw, 50V, 100mA, 200mW, 250MHz, R1/R2=4k7/47k	SOT-323	16ta	-	3d Di
N11	SO2369	Si-npn	Sw, 40V, 200mA, 330mW, B=40..120, 400MHz	SOT-23	16ta	-	3a Ste
N11B	ML61N113M	Vdet-IC	1.1V±3%, -Reset ODO	SOT-23	16vdb	VD6	3a Mic
N11G	82N11G-AE3-5	Vdet-IC	1.1V±2% -Reset ODO, halogen free	SOT-23	16vdb	VD6	3a Utc
N11L	82N11L-AE3-5	Vdet-IC	1.1V±2% -Reset ODO, lead free	SOT-23	16vdb	VD6	3a Utc
N11T	CM7P61N-11-T	Vdet-IC	1.1V±3%, +Reset ODO	SOT-23	16vdb	VD6	3a Can
N12	2SK334-12	n-FET	GP, 20V, 50mA, 100mW, Idss=0.15..0.3mA	SOT-23	16fa	-	3a San
N12	82N12-AE3-5	Vdet-IC	1.2V±2% -Reset ODO	SOT-23	16vdb	VD6	3a Utc
N12	DDTC114TCA	Si-npn-Digi	Sw, 50V, 100mA, 200mW, 250MHz, R1=10k	SOT-23	16ta	-	3d Di
N12	DDTC114TE	Si-npn-Digi	Sw, 50V, 100mA, 150mW, 250MHz, R1=10k	SOT-523	16ta	-	3d Di
N12	DDTC114TKA	Si-npn-Digi	Sw, 50V, 100mA, 200mW, 250MHz, R1=10k	SC-59	16ta	-	3d Di
N12	DDTC114TUA	Si-npn-Digi	Sw, 50V, 100mA, 200mW, 250MHz, R1=10k	SOT-323	16ta	-	3d Di
N12	SO2221	Si-npn	GP, 60V, 800mA, 500mW, >250MHz, B>20	SOT-23	16ta	-	Ste
N12B	ML61N123M	Vdet-IC	1.2V±3%, -Reset ODO	SOT-23	16vdb	VD6	3a Mic
N12G	82N12G-AE3-5	Vdet-IC	1.2V±2% -Reset ODO, halogen free	SOT-23	16vdb	VD6	3a Utc
N12L	82N12L-AE3-5	Vdet-IC	1.2V±2% -Reset ODO, lead free	SOT-23	16vdb	VD6	3a Utc
N12T	CM7P61N-12-T	Vdet-IC	1.2V±3%, +Reset ODO	SOT-23	16vdb	VD6	3a Can
N13	2SK334-13	n-FET	GP, 20V, 50mA, 100mW, Idss=0.25..0.45mA	SOT-23	16fa	-	3a San
N13	82N13-AE3-5	Vdet-IC	1.3V±2% -Reset ODO	SOT-23	16vdb	VD6	3a Utc
N13	DDTC114ECA	Si-npn-Digi	Sw, 50V, 100mA, 200mW, 250MHz, R1/R2=10/10k	SOT-23	16ta	-	3d Di
N13	DDTC114EE	Si-npn-Digi	Sw, 50V, 100mA, 150mW, 250MHz, R1/R2=10k/10k	SOT-523	16ta	-	3d Di
N13	DDTC114EKA	Si-npn-Digi	Sw, 50V, 100mA, 200mW, 250MHz, R1/R2=10/10k	SC-59	16ta	-	3d Di
N13	DDTC114EUA	Si-npn-Digi	Sw, 50V, 100mA, 200mW, 250MHz, R1/R2=10/10k	SOT-323	16ta	-	3d Di
N13	SO2222	Si-npn	GP, 60V, 800mA, 350mW, B=100..300, >250MHz	SOT-23	16ta	-	3a Ste
N13	XE61CN3145MR	Vdet-IC	3.1V±2%, -Reset ODO	SOT-23	16vdb	VD6	3h Tor
N13B	ML61N133M	Vdet-IC	1.3V±3%, -Reset ODO	SOT-23	16vdb	VD6	3a Mic
N13G	82N13G-AE3-5	Vdet-IC	1.3V±2% -Reset ODO, halogen free	SOT-23	16vdb	VD6	3a Utc
N13L	82N13L-AE3-5	Vdet-IC	1.3V±2% -Reset ODO, lead free	SOT-23	16vdb	VD6	3a Utc
N13T	CM7P61N-13-T	Vdet-IC	1.3V±3%, +Reset ODO	SOT-23	16vdb	VD6	3a Can
N14	2SK334-14	n-FET	GP, 20V, 50mA, 100mW, Idss=0.4..0.8mA	SOT-23	16fa	-	3a San
N14	82N14-AE3-5	Vdet-IC	1.4V±2% -Reset ODO	SOT-23	16vdb	VD6	3a Utc
N14	DDTC114YCA	Si-npn-Digi	Sw, 50V, 100mA, 200mW, 250MHz, R1/R2=10/47k	SOT-23	16ta	-	3d Di
N14	DDTC114YE	Si-npn-Digi	Sw, 50V, 100mA, 150mW, 250MHz, R1/R2=10k/47k	SOT-523	16ta	-	3d Di
N14	DDTC114YKA	Si-npn-Digi	Sw, 50V, 100mA, 200mW, 250MHz, R1/R2=10/47k	SC-59	16ta	-	3d Di
N14	DDTC114YUA	Si-npn-Digi	Sw, 50V, 100mA, 200mW, 250MHz, R1/R2=10/47k	SOT-323	16ta	-	3d Di
N14B	ML61N143M	Vdet-IC	1.4V±3%, -Reset ODO	SOT-23	16vdb	VD6	3a Mic
N14G	82N14G-AE3-5	Vdet-IC	1.4V±2% -Reset ODO, halogen free	SOT-23	16vdb	VD6	3a Utc
N14L	82N14L-AE3-5	Vdet-IC	1.4V±2% -Reset ODO, lead free	SOT-23	16vdb	VD6	3a Utc
N14T	CM7P61N-14-T	Vdet-IC	1.4V±3%, +Reset ODO	SOT-23	16vdb	VD6	3a Can
N15	2SC3360-15	Si-npn	HV, Sw, 200V, 100mA, 200mW, 160MHz, B=90..180	SOT-23	16ta	-	3a Nec
N15	82N15-AE3-5	Vdet-IC	1.5V±2% -Reset ODO	SOT-23	16vdb	VD6	3a Utc
N15	DDTC114WCA	Si-npn-Digi	Sw, 50V, 100mA, 200mW, 250MHz, R1/R2=10/47k	SOT-23	16ta	-	3d Di
N15	DDTC114WE	Si-npn-Digi	Sw, 50V, 100mA, 150mW, 250MHz, R1/R2=10k/47k	SOT-523	16ta	-	3d Di
N15	DDTC114WKA	Si-npn-Digi	Sw, 50V, 100mA, 200mW, 250MHz, R1/R2=10/47k	SC-59	16ta	-	3d Di
N15	DDTC114WUA	Si-npn-Digi	Sw, 50V, 100mA, 200mW, 250MHz, R1/R2=10/47k	SOT-323	16ta	-	3d Di
N15	XC61FN3112M	Vdet-IC	3.1V±2%, +Reset ODO, 200ms	SOT-23	16vdb	VD6	3d Tor
N15	XC61HN3112MR	Vdet-IC	3.1V±2%, -Reset ODO, 50..200ms	SOT-23	16vdc	VD6	3d Tor
N15B	ML61N153M	Vdet-IC	1.5V±3%, -Reset ODO	SOT-23	16vdb	VD6	3a Mic
N15G	82N15G-AE3-5	Vdet-IC	1.5V±2% -Reset ODO, halogen free	SOT-23	16vdb	VD6	3a Utc
N15L	82N15L-AE3-5	Vdet-IC	1.5V±2% -Reset ODO, lead free	SOT-23	16vdb	VD6	3a Utc
N15T	CM7P61N-15-T	Vdet-IC	1.5V±3%, +Reset ODO	SOT-23	16vdb	VD6	3a Can
N16	2SC3360-16	Si-npn	HV, Sw, 200V, 100mA, 200mW, 160MHz, B=135..270	SOT-23	16ta	-	3a Nec
N16	82N16-AE3-5	Vdet-IC	1.6V±2% -Reset ODO	SOT-23	16vdb	VD6	3a Utc
N16	DDTC124TCA	Si-npn-Digi	Sw, 50V, 100mA, 200mW, 250MHz, R1=22k	SOT-23	16ta	-	3d Di



SMD code	Type	Function	Short description	Case	Pinout	Sch. St.	Mnf.
N16	DDTC124TE	Si-npn-Digi	Sw, 50V, 100mA, 200mW, 250MHz, R1=22k	SOT-523	16ta -	3d	Di
N16	DDTC124TKA	Si-npn-Digi	Sw, 50V, 100mA, 200mW, 250MHz, R1=22k	SC-59	16ta -	3d	Di
N16	DDTC124TUA	Si-npn-Digi	Sw, 50V, 100mA, 200mW, 250MHz, R1=22k	SOT-323	16ta -	3d	Di
N16	XC61FN3142M	Vdet-IC	3.1V±2%, +Reset ODO, 400ms	SOT-23	16vdb VD6	3d	Tor
N16	XC61HN3142MR	Vdet-IC	3.1V±2%, -Reset ODO, 80..400ms	SOT-23	16vdc VD6	3d	Tor
N16B	ML61N163M	Vdet-IC	1.6V±3%, -Reset ODO	SOT-23	16vdb VD6	3a	Mlc
N16G	82N16G-AE3-5	Vdet-IC	1.6V±2% -Reset ODO, halogen free	SOT-23	16vdb VD6	3a	Utc
N16L	82N16L-AE3-5	Vdet-IC	1.6V±2% -Reset ODO, lead free	SOT-23	16vdb VD6	3a	Utc
N16T	CM7P61N-16-T	Vdet-IC	1.6V±3%, +Reset ODO	SOT-23	16vdb VD6	3a	Can
N17	2SC3360-17	Si-npn	HV, Sw, 200V, 100mA, 200mW, 160MHz, B=200..450	SOT-23	16ta -	3a	Nec
N17	82N17-AE3-5	Vdet-IC	1.7V±2% -Reset ODO	SOT-23	16vdb VD6	3a	Utc
N17	DDTC124ECA	Si-npn-Digi	Sw, 50V, 100mA, 200mW, 250MHz, R1/R2=22k/22k	SOT-23	16ta -	3d	Di
N17	DDTC124EE	Si-npn-Digi	Sw, 50V, 100mA, 150mW, 250MHz, R1/R2=22k/22k	SOT-523	16ta -	3d	Di
N17	DDTC124EKA	Si-npn-Digi	Sw, 50V, 100mA, 200mW, 250MHz, R1/R2=22k/22k	SC-59	16ta -	3d	Di
N17	DDTC124EUA	Si-npn-Digi	Sw, 50V, 100mA, 200mW, 250MHz, R1/R2=22k/22k	SOT-323	16ta -	3d	Di
N17	XC61FN3152M	Vdet-IC	3.1V±2%, +Reset ODO, 50ms	SOT-23	16vdb VD6	3d	Tor
N17	XC61HN3152MR	Vdet-IC	3.1V±2%, -Reset ODO, 1..50ms	SOT-23	16vdc VD6	3d	Tor
N17B	ML61N173M	Vdet-IC	1.7V±3%, -Reset ODO	SOT-23	16vdb VD6	3a	Mlc
N17G	82N17G-AE3-5	Vdet-IC	1.7V±2% -Reset ODO, halogen free	SOT-23	16vdb VD6	3a	Utc
N17L	82N17L-AE3-5	Vdet-IC	1.7V±2% -Reset ODO, lead free	SOT-23	16vdb VD6	3a	Utc
N17T	CM7P61N-17-T	Vdet-IC	1.7V±3%, +Reset ODO	SOT-23	16vdb VD6	3a	Can
N18	82N18-AE3-5	Vdet-IC	1.8V±2% -Reset ODO	SOT-23	16vdb VD6	3a	Utc
N18	DDTC124XCA	Si-npn-Digi	Sw, 50V, 100mA, 200mW, 250MHz, R1/R2=22k/47k	SOT-23	16ta -	3d	Di
N18	DDTC124XE	Si-npn-Digi	Sw, 50V, 100mA, 150mW, 250MHz, R1/R2=22k/47k	SOT-523	16ta -	3d	Di
N18	DDTC124XKA	Si-npn-Digi	Sw, 50V, 100mA, 200mW, 250MHz, R1/R2=22k/47k	SC-59	16ta -	3d	Di
N18	DDTC124XUA	Si-npn-Digi	Sw, 50V, 100mA, 200mW, 250MHz, R1/R2=22k/47k	SOT-323	16ta -	3d	Di
N18	SO1711	Si-npn	GP, 75V, 1A, 1W, >70MHz	SOT-23	16ta -	-	Ste
N18B	ML61N183M	Vdet-IC	1.8V±3%, -Reset ODO	SOT-23	16vdb VD6	3a	Mlc
N18G	82N18G-AE3-5	Vdet-IC	1.8V±2% -Reset ODO, halogen free	SOT-23	16vdb VD6	3a	Utc
N18L	82N18L-AE3-5	Vdet-IC	1.8V±2% -Reset ODO, lead free	SOT-23	16vdb VD6	3a	Utc
N18T	CM7P61N-18-T	Vdet-IC	1.8V±3%, +Reset ODO	SOT-23	16vdb VD6	3a	Can
N19	82N19-AE3-5	Vdet-IC	1.9V±2% -Reset ODO	SOT-23	16vdb VD6	3a	Utc
N19	DDTC144TCA	Si-npn-Digi	Sw, 50V, 100mA, 200mW, 250MHz, R1=47k	SOT-23	16ta -	3d	Di
N19	DDTC144TE	Si-npn-Digi	Sw, 50V, 100mA, 150mW, 250MHz, R1=47k	SOT-523	16ta -	3d	Di
N19	DDTC144TKA	Si-npn-Digi	Sw, 50V, 100mA, 200mW, 250MHz, R1=47k	SC-59	16ta -	3d	Di
N19	DDTC144TUA	Si-npn-Digi	Sw, 50V, 100mA, 200mW, 250MHz, R1= 47k	SOT-323	16ta -	3d	Di
N19B	ML61N193M	Vdet-IC	1.9V±3%, -Reset ODO	SOT-23	16vdb VD6	3a	Mlc
N19G	82N19G-AE3-5	Vdet-IC	1.9V±2% -Reset ODO, halogen free	SOT-23	16vdb VD6	3a	Utc
N19L	82N19L-AE3-5	Vdet-IC	1.9V±2% -Reset ODO, lead free	SOT-23	16vdb VD6	3a	Utc
N19T	CM7P61N-19-T	Vdet-IC	1.9V±3%, +Reset ODO	SOT-23	16vdb VD6	3a	Can
N1A	ILC5061AIC31X	Vdet-IC	3.1V±1%, -Reset ODO	SOT-323	16vdb VD6	3a	Imp
N1A	ILC5061AM31X	Vdet-IC	3.1V±1%, -Reset ODO	SOT-23	16vdb VD6	3a	Imp
N1A	LM431CM3	Vref-IC	Adjust, Precision, Shunt, 2.44..2.55V, 0.5%, -40..+85°C	SOT-23	16ra -	3a	Nsc
N1B	LM431CCM3	Vref-IC	Adjust, Precision, Shunt, 2.44..2.55V, 0.5%, 0..+70°C	SOT-23	16ra -	3a	Nsc
N1C	LM431BM3	Vref-IC	Adjust, Precision, Shunt, 2.44..2.55V, 1%, -40..+85°C	SOT-23	16ra -	3a	Nsc
N1C	TN2124K1	n-MOSFET-e	V-MOS, LogL, 240V, 134mA, <15Q(0.12A), <12/22ns	SOT-23	16ft -	3a	Sbx
N1D	LM431BCM3	Vref-IC	Adjust, Precision, Shunt, 2.44..2.55V, 1%, 0..+70°C	SOT-23	16ra -	3a	Nsc
N1E	LM431AM3	Vref-IC	Adjust, Precision, Shunt, 2.44..2.55V, 2%, -40..+85°C	SOT-23	16ra -	3a	Nsc
N1F	LM431ACM3	Vref-IC	Adjust, Precision, Shunt, 2.44..2.55V, 2%, 0..+70°C	SOT-23	16ra -	3a	Nsc
N1L	TN2106K1	n-MOSFET-e	V-MOS, LogL, 60V, 280mA, <5Q(0.5A)	SOT-23	16ft -	3a	Sbx
N1p	BFR53	Si-npn	UHF-A, 18V, 50mA, 2GHz	SOT-23	16ta -	3a	Phi
N1t	BFS20W	Si-npn	RF, 30V, 25mA, 200mW, B=85, 470MHz	SOT-323	16ta -	3a	Phi
N1T	TN2130K1	n-MOSFET-e	V-MOS, LogL, 300V, 85mA, <25Q(0.12A), <17/27ns	SOT-23	16ft -	3a	Sbx
N1U	TN2101K1	n-MOSFET-e	V-MOS, LogL, 15V, 170mA, <7Q(50(A)	SOT-23	16ft -	3a	Sbx
N2	2SC1653-2	Si-npn	Sw, HV-drive, 150V, 50mA, 150mW, B=90..180, 120MHz	SOT-23	16ta -	3a	Nec
N2	BFR520T	Si-npn	RF, SATV, 20V, 70mA, 150mW, B=60..250, 9GHz	SOT-416	16ta -	3a	Phi
N2	ELM7642LAB	Vdet-IC	4.2V±2%, -Reset PPO, 250ms	SOT-23	16vdc VD7	3d	Elm
N2	ILC5061IC32X	Vdet-IC	3.2V±2%, -Reset ODO	SOT-323	16vdb VD6	3a	Imp
N2	ILC5061M32X	Vdet-IC	3.2V±2%, -Reset ODO	SOT-23	16vdb VD6	3a	Imp
N2	KRC116S	Si-npn-Digi	Sw, 50V, 100mA, 200mW, 200MHz, R1/R2=1k/10k	SOT-23	16ta -	3f	Kec
N2	KRC416	Si-npn-Digi	Sw, 50V, 100mA, 100mW, 200MHz, R1/R2=1k/10k	SOT-323	16ta -	3f	Kec
N2	KRC416E	Si-npn-Digi	Sw, 50V, 100mA, 100mW, 200MHz, R1/R2=1k/10k	SOT-490	18ta -	3f	Kec
N2	KRC416V	Si-npn-Digi	Sw, 50V, 100mA, 100mW, 200MHz, R1/R2=1k/10k	VSM	16ta -	3f	Kec
N2	MMBC1653N2	Si-npn	Switch, HV drive, 150V, 50mA, 150mW, B=50-130, 120MHz	SOT-23	18ta -	3a	Sam
N2	MMBT200	Si-pnp	GP, 75V, 500mA, 350mW, B=80..400, 250MHz	SOT-23	16ta -	3a	F
N2	MMBZ5262B	Z-diode	48.45..53.55V, Zzt=125Ω, Izt=2.5mA, 410mW	SOT-23	16dc -	3a	Pjt
N2	R1100D221C	LVR-IC	U-low lcc, 2.2V±2%, 180mA	SON1408-3	18yj VR1	3d	Ric
N2	R3111N522C	Vdet-IC	5.2V±2%, -Reset ODO	SOT-23	16vdd VD6	3d	Ric
N2	R3130N26D3C	Vdet-IC	2.6V, -Reset ODO, 200ms	SOT-23	16vdc VD6	3b	Ric
N2	RT1N241C	Si-npn-Digi	Sw, 50V, 100mA, 150mW, 200MHz, R1/R2=22k/22k	SC-59	16ta -	3a	Mit



SMD code	Type	Function	Short description	Case	Pinout	Sch.	St.	Mnf.
N2	RT1N241M	Si-npn-Digi	Sw, 50V, 100mA, 150mW, 200MHz, R1/R2=22k/22k	SOT-323	16ta	-	3a	Mit
N2	RT1N241U	Si-npn-Digi	Sw, 50V, 100mA, 125mW, 200MHz, R1/R2=22k/22k	SC-75A	16ta	-	3a	Mit
N2	TC54VN3202ECB	Vdet-IC	3.2V±2%, -Reset ODO	SOT-23	16vdb	VD6	3a	Tcs
N2	XC61CN3202M	Vdet-IC	3.2V±1%, +Reset ODO	SOT-23	16vdb	VD6	3d	Tor
N2	XC6GN3202HR	Vdet-IC	3.2V, +Reset ODO	USP-3	17vdc	VD1	9b	Tor
N20	82N20-AE3-5	Vdet-IC	2.0V±2% -Reset ODO	SOT-23	16vdb	VD6	3a	Utc
N20	DDTC124ECA	Si-npn-Digi	Sw, 50V, 100mA, 200mW, 250MHz, R1/R2=22/22k	SOT-23	16ta	-	3d	Di
N20	DDTC124EE	Si-npn-Digi	Sw, 50V, 100mA, 150mW, 250MHz, R1/R2=22k/22k	SOT-523	16ta	-	3d	Di
N20	DDTC124EKA	Si-npn-Digi	Sw, 50V, 100mA, 200mW, 250MHz, R1/R2=22k/22k	SC-59	16ta	-	3d	Di
N20	DDTC124EUA	Si-npn-Digi	Sw, 50V, 100mA, 200mW, 250MHz, R1/R2=22k/22k	SOT-323	16ta	-	3d	Di
N20	DDTC144ECA	Si-npn-Digi	Sw, 50V, 100mA, 200mW, 250MHz, R1/R2=47/47k	SOT-23	16ta	-	3d	Di
N20	DDTC144EE	Si-npn-Digi	Sw, 50V, 100mA, 150mW, 250MHz, R1/R2=47/47k	SOT-523	16ta	-	3d	Di
N20	DDTC144EKA	Si-npn-Digi	Sw, 50V, 100mA, 200mW, 250MHz, R1/R2=47/47k	SC-59	16ta	-	3d	Di
N20	DDTC144EUA	Si-npn-Digi	Sw, 50V, 100mA, 200mW, 250MHz, R1/R2=47/47k	SOT-323	16ta	-	3d	Di
N20	SO222A	Si-npn	GP, 75V, 800mA, 350mW, B=100..300, >300MHz	SOT-23	16ta	-	3a	Ste
N20B	ML61N202M	Vdet-IC	2.0V±2%, -Reset ODO	SOT-23	16vdb	VD6	3a	Mlc
N20G	82N20G-AE3-5	Vdet-IC	2.0V±2% -Reset ODO, halogen free	SOT-23	16vdb	VD6	3a	Utc
N20L	82N20L-AE3-5	Vdet-IC	2.0V±2% -Reset ODO, lead free	SOT-23	16vdb	VD6	3a	Utc
N20T	CM7P61N-20-T	Vdet-IC	2.0V±2%, +Reset ODO	SOT-23	16vdb	VD6	3a	Can
N21	82N21-AE3-5	Vdet-IC	2.1V±2% -Reset ODO	SOT-23	16vdb	VD6	3a	Utc
N21	DDTC144VCA	Si-npn-Digi	Sw, 50V, 100mA, 200mW, 250MHz, R1/R2=47k/10k	SOT-23	16ta	-	3d	Di
N21	DDTC144VE	Si-npn-Digi	Sw, 50V, 100mA, 150mW, 250MHz, R1/R2=47k/10k	SOT-523	16ta	-	3d	Di
N21	DDTC144VKA	Si-npn-Digi	Sw, 50V, 100mA, 200mW, 250MHz, R1/R2=47/10k	SC-59	16ta	-	3d	Di
N21	DDTC144VUA	Si-npn-Digi	Sw, 50V, 100mA, 200mW, 250MHz, R1/R2=47/10k	SOT-323	16ta	-	3d	Di
N21B	ML61N212M	Vdet-IC	2.1V±2%, -Reset ODO	SOT-23	16vdb	VD6	3a	Mlc
N21G	82N21G-AE3-5	Vdet-IC	2.1V±2% -Reset ODO, halogen free	SOT-23	16vdb	VD6	3a	Utc
N21L	82N21L-AE3-5	Vdet-IC	2.1V±2% -Reset ODO, lead free	SOT-23	16vdb	VD6	3a	Utc
N21T	CM7P61N-21-T	Vdet-IC	2.1V±2%, +Reset ODO	SOT-23	16vdb	VD6	3a	Can
N22	82N22-AE3-5	Vdet-IC	2.2V±2% -Reset ODO	SOT-23	16vdb	VD6	3a	Utc
N22	DDTC144WCA	Si-npn-Digi	Sw, 50V, 100mA, 200mW, 250MHz, R1/R2=47k/22k	SOT-23	16ta	-	3d	Di
N22	DDTC144WE	Si-npn-Digi	Sw, 50V, 100mA, 150mW, 250MHz, R1/R2=47k/22k	SOT-523	16ta	-	3d	Di
N22	DDTC144WKA	Si-npn-Digi	Sw, 50V, 100mA, 200mW, 250MHz, R1/R2=47k/22k	SC-59	16ta	-	3d	Di
N22	DDTC144WUA	Si-npn-Digi	Sw, 50V, 100mA, 200mW, 250MHz, R1/R2=47k/22k	SOT-323	16ta	-	3d	Di
N22B	ML61N222M	Vdet-IC	2.2V±2%, -Reset ODO	SOT-23	16vdb	VD6	3a	Mlc
N22G	82N22G-AE3-5	Vdet-IC	2.2V±2% -Reset ODO, halogen free	SOT-23	16vdb	VD6	3a	Utc
N22L	82N22L-AE3-5	Vdet-IC	2.2V±2% -Reset ODO, lead free	SOT-23	16vdb	VD6	3a	Utc
N22T	CM7P61N-22-T	Vdet-IC	2.2V±2%, +Reset ODO	SOT-23	16vdb	VD6	3a	Can
N23	82N23-AE3-5	Vdet-IC	2.3V±2% -Reset ODO	SOT-23	16vdb	VD6	3a	Utc
N23	DDTC115TCA	Si-npn-Digi	Sw, 50V, 100mA, 200mW, 250MHz, R1=100k	SOT-23	16ta	-	3d	Di
N23	DDTC115TE	Si-npn-Digi	Sw, 50V, 100mA, 150mW, 250MHz, R1=100k	SOT-523	16ta	-	3d	Di
N23	DDTC115TKA	Si-npn-Digi	Sw, 50V, 100mA, 200mW, 250MHz, R1=100k	SC-59	16ta	-	3d	Di
N23	DDTC115TUA	Si-npn-Digi	Sw, 50V, 100mA, 200mW, 250MHz, R1=100k	SOT-323	16ta	-	3d	Di
N23	S72N23SF	Vdet-IC	2.3V, +Reset Open collector output	SOT-23F	18vdc	VD6	3b	Auk
N23	S72N23UF	Vdet-IC	2.3V, +Reset Open collector output	SOT-323F	18vdc	VD6	3b	Auk
N23	XE61CN3245MR	Vdet-IC	3.2V±2%, -Reset ODO	SOT-23	16vdb	VD6	3h	Tor
N23B	ML61N232M	Vdet-IC	2.3V±2%, -Reset ODO	SOT-23	16vdb	VD6	3a	Mlc
N23G	82N23G-AE3-5	Vdet-IC	2.3V±2% -Reset ODO, halogen free	SOT-23	16vdb	VD6	3a	Utc
N23L	82N23L-AE3-5	Vdet-IC	2.3V±2% -Reset ODO, lead free	SOT-23	16vdb	VD6	3a	Utc
N23T	CM7P61N-23-T	Vdet-IC	2.3V±2%, +Reset ODO	SOT-23	16vdb	VD6	3a	Can
N24	82N24-AE3-5	Vdet-IC	2.4V±2% -Reset ODO	SOT-23	16vdb	VD6	3a	Utc
N24	DDTC115ECA	Si-npn-Digi	Sw, 50V, 100mA, 200mW, 250MHz, R1/R2=100/100k	SOT-23	16ta	-	3d	Di
N24	DDTC115EE	Si-npn-Digi	Sw, 50V, 100mA, 150mW, 250MHz, R1/R2=100k/100k	SOT-523	16ta	-	3d	Di
N24	DDTC115EKA	Si-npn-Digi	Sw, 50V, 100mA, 200mW, 250MHz, R1/R2=100/100k	SC-59	16ta	-	3d	Di
N24	DDTC115EUA	Si-npn-Digi	Sw, 50V, 100mA, 200mW, 250MHz, R1/R2=100/100k	SOT-323	16ta	-	3d	Di
N24B	ML61N242M	Vdet-IC	2.4V±2%, -Reset ODO	SOT-23	16vdb	VD6	3a	Mlc
N24G	82N24G-AE3-5	Vdet-IC	2.4V±2% -Reset ODO, halogen free	SOT-23	16vdb	VD6	3a	Utc
N24L	82N24L-AE3-5	Vdet-IC	2.4V±2% -Reset ODO, lead free	SOT-23	16vdb	VD6	3a	Utc
N24T	CM7P61N-24-T	Vdet-IC	2.4V±2%, +Reset ODO	SOT-23	16vdb	VD6	3a	Can
N25	82N25-AE3-5	Vdet-IC	2.5V±2% -Reset ODO	SOT-23	16vdb	VD6	3a	Utc
N25	DDTC125TCA	Si-npn-Digi	Sw, 50V, 100mA, 200mW, 250MHz, R1=200k	SOT-23	16ta	-	3d	Di
N25	DDTC125TE	Si-npn-Digi	Sw, 50V, 100mA, 150mW, 250MHz, R1=200k	SOT-523	16ta	-	3d	Di
N25	DDTC125TKA	Si-npn-Digi	Sw, 50V, 100mA, 200mW, 250MHz, R1=200k	SC-59	16ta	-	3d	Di
N25	DDTC125TUA	Si-npn-Digi	Sw, 50V, 100mA, 200mW, 250MHz, R1=200k	SOT-323	16ta	-	3d	Di
N25	S72N25UF	Vdet-IC	2.5V, +Reset Open collector output	SOT-323F	18vdc	VD6	3b	Auk
N25	XC61FN3212M	Vdet-IC	3.2V±2%, +Reset ODO, 200ms	SOT-23	16vdb	VD6	3d	Tor
N25	XC61HN3212MR	Vdet-IC	3.2V±2%, -Reset ODO, 50..200ms	SOT-23	16vdc	VD6	3d	Tor
N25B	ML61N252M	Vdet-IC	2.5V±2%, -Reset ODO	SOT-23	16vdb	VD6	3a	Mlc
N25G	82N25G-AE3-5	Vdet-IC	2.5V±2% -Reset ODO, halogen free	SOT-23	16vdb	VD6	3a	Utc
N25L	82N25L-AE3-5	Vdet-IC	2.5V±2% -Reset ODO, lead free	SOT-23	16vdb	VD6	3a	Utc
N25T	CM7P61N-25-T	Vdet-IC	2.5V±2%, +Reset ODO	SOT-23	16vdb	VD6	3a	Can



SMD code	Type	Function	Short description	Case	Pinout	Sch. St.	Mnf.
N26	82N26-AE3-5	Vdet-IC	2.6V±2% -Reset ODO	SOT-23	16vdb	VD6 3a	Utc
N26	DDTC114GCA	Si-nprn-Digi	Sw, 50V, 100mA, 200mW, B=100..600, 250MHz, R2=10k	SOT-23	16ta	- 3d	Di
N26	DDTC114GE	Si-nprn-Digi	Sw, 50V, 100mA, 200mW, B=100..600, 250MHz, R2=10k	SOT-523	16ta	- 3d	Di
N26	DDTC114GKA	Si-nprn-Digi	Sw, 50V, 100mA, 200mW, B=100..600, 250MHz, R2=10k	SC-59	16ta	- 3d	Di
N26	DDTC114GUA	Si-nprn-Digi	Sw, 50V, 100mA, 200mW, B=100..600, 250MHz, R2=10k	SOT-323	16ta	- 3d	Di
N26	XC61FN3242M	Vdet-IC	3.2V±2%, +Reset ODO, 400ms	SOT-23	16vdb	VD6 3d	Tor
N26	XC61HN3242MR	Vdet-IC	3.2V±2%, -Reset ODO, 80..400ms	SOT-23	16vdc	VD6 3d	Tor
N26B	ML61N262M	Vdet-IC	2.6V±2%, -Reset ODO	SOT-23	16vdb	VD6 3a	Mlc
N26G	82N26G-AE3-5	Vdet-IC	2.6V±2% -Reset ODO, halogen free	SOT-23	16vdb	VD6 3a	Utc
N26L	82N26L-AE3-5	Vdet-IC	2.6V±2% -Reset ODO, lead free	SOT-23	16vdb	VD6 3a	Utc
N26T	CM7P61N-26-T	Vdet-IC	2.6V±2%, +Reset ODO	SOT-23	16vdb	VD6 3a	Can
N27	82N27-AE3-5	Vdet-IC	2.7V±2% -Reset ODO	SOT-23	16vdb	VD6 3a	Utc
N27	DDTC124GCA	Si-nprn-Digi	Sw, 50V, 100mA, 200mW, B=100..600, 250MHz, R2=22k	SOT-23	16ta	- 3d	Di
N27	DDTC124GE	Si-nprn-Digi	Sw, 50V, 100mA, 150mW, 250MHz, R2=22k	SOT-523	16ta	- 3d	Di
N27	DDTC124GKA	Si-nprn-Digi	Sw, 50V, 100mA, 200mW, B=100..600, 250MHz, R2=22k	SC-59	16ta	- 3d	Di
N27	DDTC124GUA	Si-nprn-Digi	Sw, 50V, 100mA, 200mW, B=100..600, 250MHz, R2=22k	SOT-323	16ta	- 3d	Di
N27	S72N27SF	Vdet-IC	2.7V, +Reset Open collector output	SOT-23F	18vdc	VD6 3b	Auk
N27	S72N27UF	Vdet-IC	2.7V, +Reset Open collector output	SOT-323F	18vdc	VD6 3b	Auk
N27	SO1893	Si-nprn	AF, Sw, 120V, 500mA, 800mW, 70MHz	SOT-23	16ta	- -	Ste
N27	XC61FN3252M	Vdet-IC	3.2V±2%, +Reset ODO, 50ms	SOT-23	16vdb	VD6 3d	Tor
N27	XC61HN3252MR	Vdet-IC	3.2V±2%, -Reset ODO, 1..50ms	SOT-23	16vdc	VD6 3d	Tor
N27B	ML61N272M	Vdet-IC	2.7V±2%, -Reset ODO	SOT-23	16vdb	VD6 3a	Mlc
N27G	82N27G-AE3-5	Vdet-IC	2.7V±2% -Reset ODO, halogen free	SOT-23	16vdb	VD6 3a	Utc
N27L	82N27L-AE3-5	Vdet-IC	2.7V±2% -Reset ODO, lead free	SOT-23	16vdb	VD6 3a	Utc
N27T	CM7P61N-27-T	Vdet-IC	2.7V±2%, +Reset ODO	SOT-23	16vdb	VD6 3a	Can
N28	82N28-AE3-5	Vdet-IC	2.8V±2% -Reset ODO	SOT-23	16vdb	VD6 3a	Utc
N28	BFR520	Si-nprn	RF, SATV, 20V, 70mA, 300mW, B=60..250, 9GHz	SOT-23	16ta	- 3a	Phi
N28	DDTC144GCA	Si-nprn-Digi	Sw, 50V, 100mA, 200mW, B=100..600, 250MHz, R2=47k	SOT-23	16ta	- 3d	Di
N28	DDTC144GE	Si-nprn-Digi	Sw, 50V, 100mA, 150mW, 250MHz, R2=47k	SOT-523	16ta	- 3d	Di
N28	DDTC144GKA	Si-nprn-Digi	Sw, 50V, 100mA, 200mW, B=100..600, 250MHz, R2=47k	SC-59	16ta	- 3d	Di
N28	DDTC144GUA	Si-nprn-Digi	Sw, 50V, 100mA, 200mW, B=100..600, 250MHz, R2=47k	SOT-323	16ta	- 3d	Di
N28B	ML61N282M	Vdet-IC	2.8V±2%, -Reset ODO	SOT-23	16vdb	VD6 3a	Mlc
N28G	82N28G-AE3-5	Vdet-IC	2.8V±2% -Reset ODO, halogen free	SOT-23	16vdb	VD6 3a	Utc
N28L	82N28L-AE3-5	Vdet-IC	2.8V±2% -Reset ODO, lead free	SOT-23	16vdb	VD6 3a	Utc
N28T	CM7P61N-28-T	Vdet-IC	2.8V±2%, +Reset ODO	SOT-23	16vdb	VD6 3a	Can
N29	82N29-AE3-5	Vdet-IC	2.9V±2% -Reset ODO	SOT-23	16vdb	VD6 3a	Utc
N29	BFR540	Si-nprn	RF, SATV, 20V, 120mA, 250mW, B=100..250, 9GHz	SOT-23	16ta	- 3a	Phi
N29	DDTC115GCA	Si-nprn-Digi	Sw, 50V, 100mA, 200mW, B=100..600, 250MHz, R2=100k	SOT-23	16ta	- 3d	Di
N29	DDTC115GE	Si-nprn-Digi	Sw, 50V, 100mA, 150mW, 250MHz, R2=100k	SOT-523	16ta	- 3d	Di
N29	DDTC115GKA	Si-nprn-Digi	Sw, 50V, 100mA, 200mW, 250MHz, R2=100k	SC-59	16ta	- 3d	Di
N29	DDTC115GUA	Si-nprn-Digi	Sw, 50V, 100mA, 200mW, 250MHz, R2=100k	SOT-323	16ta	- 3d	Di
N29	S72N29SF	Vdet-IC	2.9V, +Reset Open collector output	SOT-23F	18vdc	VD6 3b	Auk
N29	S72N29UF	Vdet-IC	2.9V, +Reset Open collector output	SOT-323F	18vdc	VD6 3b	Auk
N29B	ML61N292M	Vdet-IC	2.9V±2%, -Reset ODO	SOT-23	16vdb	VD6 3a	Mlc
N29G	82N29G-AE3-5	Vdet-IC	2.9V±2% -Reset ODO, halogen free	SOT-23	16vdb	VD6 3a	Utc
N29L	82N29L-AE3-5	Vdet-IC	2.9V±2% -Reset ODO, lead free	SOT-23	16vdb	VD6 3a	Utc
N29T	CM7P61N-29-T	Vdet-IC	2.9V±2%, +Reset ODO	SOT-23	16vdb	VD6 3a	Can
N2A	ILC5061AIC32X	Vdet-IC	3.2V±1%, -Reset ODO	SOT-323	16vdb	VD6 3a	Imp
N2A	ILC5061AM32X	Vdet-IC	3.2V±1%, -Reset ODO	SOT-23	16vdb	VD6 3a	Imp
N2A	MMBT200A	Si-nprn	GP, 75V, 500mA, 350mW, B=240..600, 250MHz	SOT-23	16ta	- 3a	F
N3	2SC1653-3	Si-nprn	Sw, HV-drive, 150V, 50mA, 150mW, B=135..270, 120MHz	SOT-23	16ta	- 3a	Nec
N3	ELM7643LAB	Vdet-IC	4.3V±2%, -Reset PPO, 250ms	SOT-23	16vdc	VD7 3d	Elm
N3	MMBC1653N3	Si-nprn	Switch, HV drive, 150V, 50mA, 150mW, B=100-220, 120MHz	SOT-23	16ta	- 3a	Sam
N3	R1100D231C	LVR-IC	U-low lcc, 2.3V±2%, 180mA	SON1408-3	18vj	VR1 3d	Ric
N3	R3111N532C	Vdet-IC	5.3V±2%, -Reset ODO	SOT-23	16vdd	VD6 3d	Ric
N3	R3130N29DC3	Vdet-IC	2.9V, -Reset ODO, 200ms	SOT-23	16vdc	VD6 3b	Ric
N3	RT1N441C	Si-nprn-Digi	Sw, 50V, 100mA, 150mW, 200MHz, R1/R2=47k/47k	SC-59	16ta	- 3a	Mit
N3	RT1N441M	Si-nprn-Digi	Sw, 50V, 100mA, 150mW, 200MHz, R1/R2=47k/47k	SOT-323	16ta	- 3a	Mit
N3	RT1N441U	Si-nprn-Digi	Sw, 50V, 100mA, 125mW, 200MHz, R1/R2=47k/47k	SC-75A	16ta	- 3a	Mit
N3	TC54VN3302ECB	Vdet-IC	3.3V±2%, -Reset ODO	SOT-23	16vdb	VD6 3a	Tcs
N3	XC61CN3302M	Vdet-IC	3.3V±1%, +Reset ODO	SOT-23	16vdb	VD6 3d	Tor
N3	XC6GN3302ZHR	Vdet-IC	3.3V, +Reset ODO	USP-3	17vdc	VD1 9b	Tor
N30	82N30-AE3-5	Vdet-IC	3.0V±2% -Reset ODO	SOT-23	16vdb	VD6 3a	Utc
N30	BFR505	Si-nprn	SATV, 20V, 18mA, 150mW, B=60..250, 9GHz	SOT-23	16ta	- 3a	Phi
N30B	ML61N302M	Vdet-IC	3.0V±2%, -Reset ODO	SOT-23	16vdb	VD6 3a	Mlc
N30G	82N30G-AE3-5	Vdet-IC	3.0V±2% -Reset ODO, halogen free	SOT-23	16vdb	VD6 3a	Utc
N30L	82N30L-AE3-5	Vdet-IC	3.0V±2% -Reset ODO, lead free	SOT-23	16vdb	VD6 3a	Utc
N30T	CM7P61N-30-T	Vdet-IC	3.0V±2%, +Reset ODO	SOT-23	16vdb	VD6 3a	Can
N31	82N31-AE3-5	Vdet-IC	3.1V±2% -Reset ODO	SOT-23	16vdb	VD6 3a	Utc
N31	S72N31SF	Vdet-IC	3.1V, +Reset Open collector output	SOT-23F	18vdc	VD6 3b	Auk



SMD code	Type	Function	Short description	Case	Pinout	Sch.	St.	Mnf.
N31	S72N31UF	Vdet-IC	3.1V, +Reset Open collector output	SOT-323F	18vdc	VD6	3b	Auk
N31B	ML61N312M	Vdet-IC	3.1V±2%, -Reset ODO	SOT-23	16vdb	VD6	3a	Mlc
N31G	82N31G-AE3-5	Vdet-IC	3.1V±2% -Reset ODO, halogen free	SOT-23	16vdb	VD6	3a	Utc
N31L	82N31L-AE3-5	Vdet-IC	3.1V±2% -Reset ODO, lead free	SOT-23	16vdb	VD6	3a	Utc
N31T	CM7P61N-31-T	Vdet-IC	3.1V±2%, +Reset ODO	SOT-23	16vdb	VD6	3a	Can
N32	82N32-AE3-5	Vdet-IC	3.2V±2% -Reset ODO	SOT-23	16vdb	VD6	3a	Utc
N32B	ML61N322M	Vdet-IC	3.2V±2%, -Reset ODO	SOT-23	16vdb	VD6	3a	Mlc
N32G	82N32G-AE3-5	Vdet-IC	3.2V±2% -Reset ODO, halogen free	SOT-23	16vdb	VD6	3a	Utc
N32L	82N32L-AE3-5	Vdet-IC	3.2V±2% -Reset ODO, lead free	SOT-23	16vdb	VD6	3a	Utc
N32T	CM7P61N-32-T	Vdet-IC	3.2V±2%, +Reset ODO	SOT-23	16vdb	VD6	3a	Can
N33	82N33-AE3-5	Vdet-IC	3.3V±2% -Reset ODO	SOT-23	16vdb	VD6	3a	Utc
N33	S72N33SF	Vdet-IC	3.3V, +Reset Open collector output	SOT-323F	18vdc	VD6	3b	Auk
N33	S72N33UF	Vdet-IC	3.3V, +Reset Open collector output	SOT-323F	18vdc	VD6	3b	Auk
N33	XE61CN3345MR	Vdet-IC	3.3V±2%, -Reset ODO	SOT-23	16vdb	VD6	3h	Tor
N33B	ML61N332M	Vdet-IC	3.3V±2%, -Reset ODO	SOT-23	16vdb	VD6	3a	Mlc
N33G	82N33G-AE3-5	Vdet-IC	3.3V±2% -Reset ODO, halogen free	SOT-23	16vdb	VD6	3a	Utc
N33L	82N33L-AE3-5	Vdet-IC	3.3V±2% -Reset ODO, lead free	SOT-23	16vdb	VD6	3a	Utc
N33T	CM7P61N-33-T	Vdet-IC	3.3V±2%, +Reset ODO	SOT-23	16vdb	VD6	3a	Can
N34	82N34-AE3-5	Vdet-IC	3.4V±2% -Reset ODO	SOT-23	16vdb	VD6	3a	Utc
N34B	ML61N342M	Vdet-IC	3.4V±2%, -Reset ODO	SOT-23	16vdb	VD6	3a	Mlc
N34G	82N34G-AE3-5	Vdet-IC	3.4V±2% -Reset ODO, halogen free	SOT-23	16vdb	VD6	3a	Utc
N34L	82N34L-AE3-5	Vdet-IC	3.4V±2% -Reset ODO, lead free	SOT-23	16vdb	VD6	3a	Utc
N34T	CM7P61N-34-T	Vdet-IC	3.4V±2%, +Reset ODO	SOT-23	16vdb	VD6	3a	Can
N35	82N35-AE3-5	Vdet-IC	3.5V±2% -Reset ODO	SOT-23	16vdb	VD6	3a	Utc
N35	XC61FN3312M	Vdet-IC	3.3V±2%, +Reset ODO, 200ms	SOT-23	16vdb	VD6	3d	Tor
N35	XC61HN3312MR	Vdet-IC	3.3V±2%, -Reset ODO, 50..200ms	SOT-23	16vdc	VD6	3d	Tor
N35B	ML61N352M	Vdet-IC	3.5V±2%, -Reset ODO	SOT-23	16vdb	VD6	3a	Mlc
N35G	82N35G-AE3-5	Vdet-IC	3.5V±2% -Reset ODO, halogen free	SOT-23	16vdb	VD6	3a	Utc
N35L	82N35L-AE3-5	Vdet-IC	3.5V±2% -Reset ODO, lead free	SOT-23	16vdb	VD6	3a	Utc
N35T	CM7P61N-35-T	Vdet-IC	3.5V±2%, +Reset ODO	SOT-23	16vdb	VD6	3a	Can
N36	82N36-AE3-5	Vdet-IC	3.6V±2% -Reset ODO	SOT-23	16vdb	VD6	3a	Utc
N36	S72N36SF	Vdet-IC	3.6V, +Reset Open collector output	SOT-23F	18vdc	VD6	3b	Auk
N36	S72N36UF	Vdet-IC	3.6V, +Reset Open collector output	SOT-323F	18vdc	VD6	3b	Auk
N36	XC61FN3342M	Vdet-IC	3.3V±2%, +Reset ODO, 400ms	SOT-23	16vdb	VD6	3d	Tor
N36	XC61HN3342MR	Vdet-IC	3.3V±2%, -Reset ODO, 80..400ms	SOT-23	16vdc	VD6	3d	Tor
N36B	ML61N362M	Vdet-IC	3.6V±2%, -Reset ODO	SOT-23	16vdb	VD6	3a	Mlc
N36G	82N36G-AE3-5	Vdet-IC	3.6V±2% -Reset ODO, halogen free	SOT-23	16vdb	VD6	3a	Utc
N36L	82N36L-AE3-5	Vdet-IC	3.6V±2% -Reset ODO, lead free	SOT-23	16vdb	VD6	3a	Utc
N36T	CM7P61N-36-T	Vdet-IC	3.6V±2%, +Reset ODO	SOT-23	16vdb	VD6	3a	Can
N37	82N37-AE3-5	Vdet-IC	3.7V±2% -Reset ODO	SOT-23	16vdb	VD6	3a	Utc
N37	XC61FN3352M	Vdet-IC	3.3V±2%, +Reset ODO, 50ms	SOT-23	16vdb	VD6	3d	Tor
N37	XC61HN3352MR	Vdet-IC	3.3V±2%, -Reset ODO, 1..50ms	SOT-23	16vdc	VD6	3d	Tor
N37B	ML61N372M	Vdet-IC	3.7V±2%, -Reset ODO	SOT-23	16vdb	VD6	3a	Mlc
N37G	82N37G-AE3-5	Vdet-IC	3.7V±2% -Reset ODO, halogen free	SOT-23	16vdb	VD6	3a	Utc
N37L	82N37L-AE3-5	Vdet-IC	3.7V±2% -Reset ODO, lead free	SOT-23	16vdb	VD6	3a	Utc
N37T	CM7P61N-37-T	Vdet-IC	3.7V±2%, +Reset ODO	SOT-23	16vdb	VD6	3a	Can
N38	82N38-AE3-5	Vdet-IC	3.8V±2% -Reset ODO	SOT-23	16vdb	VD6	3a	Utc
N38B	ML61N382M	Vdet-IC	3.8V±2%, -Reset ODO	SOT-23	16vdb	VD6	3a	Mlc
N38G	82N38G-AE3-5	Vdet-IC	3.8V±2% -Reset ODO, halogen free	SOT-23	16vdb	VD6	3a	Utc
N38L	82N38L-AE3-5	Vdet-IC	3.8V±2% -Reset ODO, lead free	SOT-23	16vdb	VD6	3a	Utc
N38T	CM7P61N-38-T	Vdet-IC	3.8V±2%, +Reset ODO	SOT-23	16vdb	VD6	3a	Can
N39	82N39-AE3-5	Vdet-IC	3.9V±2% -Reset ODO	SOT-23	16vdb	VD6	3a	Utc
N39	S72N39SF	Vdet-IC	3.9V, +Reset Open collector output	SOT-23F	18vdc	VD6	3b	Auk
N39	S72N39UF	Vdet-IC	3.9V, +Reset Open collector output	SOT-323F	18vdc	VD6	3b	Auk
N39B	ML61N392M	Vdet-IC	3.9V±2%, -Reset ODO	SOT-23	16vdb	VD6	3a	Mlc
N39G	82N39G-AE3-5	Vdet-IC	3.9V±2% -Reset ODO, halogen free	SOT-23	16vdb	VD6	3a	Utc
N39L	82N39L-AE3-5	Vdet-IC	3.9V±2% -Reset ODO, lead free	SOT-23	16vdb	VD6	3a	Utc
N39T	CM7P61N-39-T	Vdet-IC	3.9V±2%, +Reset ODO	SOT-23	16vdb	VD6	3a	Can
N4	2SC1653-4	Si-npn	Sw, HV-drive, 150V, 50mA, 150mW, B=200..400, 120MHz	SOT-23	16ta	-	3a	Nec
N4	BFR53R	Si-npn	UHF-A, 18V, 50mA, 2GHz	SOT-23	16te	-	3a	Phi
N4	ELM7644LAB	Vdet-IC	4.4V±2%, -Reset PPO, 250ms	SOT-23	16vdc	VD7	3d	Elm
N4	ILC5061C34X	Vdet-IC	3.4V±2%, -Reset ODO	SOT-323	16vdb	VD6	3a	Imp
N4	ILC5061M34X	Vdet-IC	3.4V±2%, -Reset ODO	SOT-23	16vdb	VD6	3a	Imp
N4	KA4L4Z	Si-npn-Digi	Sw, 60V, 100mA, 200mW, R1=47k	SOT-416	16ta	-	3a	Nec
N4	KRC117S	Si-npn-Digi	Sw, 50V, 100mA, 200mW, 200MHz, R1/R2=2k2/2k2	SOT-23	16ta	-	3f	Kec
N4	KRC417	Si-npn-Digi	Sw, 50V, 100mA, 100mW, 200MHz, R1/R2=2k2/2k2	SOT-323	16ta	-	3f	Kec
N4	KRC417E	Si-npn-Digi	Sw, 50V, 100mA, 100mW, 200MHz, R1/R2=2k2/2k2	SOT-490	18ta	-	3f	Kec
N4	KRC417V	Si-npn-Digi	Sw, 50V, 100mA, 100mW, 200MHz, R1/R2=2k2/2k2	VSM	18ta	-	3f	Kec
N4	MMBC1653N4	Si-npn	Switch, HV drive, 150V, 50mA, 150mW, B=150-330, 120MHz	SOT-23	16ta	-	3a	Sam
N4	R1100D241C	LVR-IC	U-low lcc, 2.4V±2%, 180mA	SON1408-3	18vj	VR1	3d	Ric



SMD code	Type	Function	Short description	Case	Pinout	Sch. St.	Mnf.
N4	R3111N542C	Vdet-IC	5.4V±2%, -Reset ODO	SOT-23	16vdd	VD6	3d Ric
N4	R3130N30DC8	Vdet-IC	3V, -Reset ODO, 200ms	SOT-23	16vdc	VD6	3b Ric
N4	SP809EK-2-3	Vdet-IC	2.3V±1.5%, -Reset PPO	SOT-23	16vdc	VD7	3b Sip
N4	TC54VN3402ECB	Vdet-IC	3.4V±2%, -Reset ODO	SOT-23	16vdd	VD6	3a Tcs
N4	XC61CN3402M	Vdet-IC	3.4V±1%, +Reset ODO	SOT-23	16vdd	VD6	3d Tor
N4	XC6GN3402HR	Vdet-IC	3.4V, +Reset ODO	USP-3	17vdc	VD1	3b Tor
N40	82N40-AE3-5	Vdet-IC	4.0V±2% -Reset ODO	SOT-23	16vdd	VD6	3a Utc
N40B	ML61N402M	Vdet-IC	4.0V±2%, -Reset ODO	SOT-23	16vdd	VD6	3a Mlc
N40G	82N40G-AE3-5	Vdet-IC	4.0V±2% -Reset ODO, halogen free	SOT-23	16vdd	VD6	3a Utc
N40L	82N40L-AE3-5	Vdet-IC	4.0V±2% -Reset ODO, lead free	SOT-23	16vdd	VD6	3a Utc
N40T	CM7P61N-40-T	Vdet-IC	4.0V±2%, +Reset ODO	SOT-23	16vdd	VD6	3a Can
N41	82N41-AE3-5	Vdet-IC	4.1V±2% -Reset ODO	SOT-23	16vdd	VD6	3a Utc
N41B	ML61N412M	Vdet-IC	4.1V±2%, -Reset ODO	SOT-23	16vdd	VD6	3a Mlc
N41G	82N41G-AE3-5	Vdet-IC	4.1V±2% -Reset ODO, halogen free	SOT-23	16vdd	VD6	3a Utc
N41L	82N41L-AE3-5	Vdet-IC	4.1V±2% -Reset ODO, lead free	SOT-23	16vdd	VD6	3a Utc
N41T	CM7P61N-41-T	Vdet-IC	4.1V±2%, +Reset ODO	SOT-23	16vdd	VD6	3a Can
N42	82N42-AE3-5	Vdet-IC	4.2V±2% -Reset ODO	SOT-23	16vdd	VD6	3a Utc
N42	S72N42SF	Vdet-IC	4.2V, +Reset Open collector output	SOT-23F	18vdc	VD6	3b Auk
N42	S72N42UF	Vdet-IC	4.2V, +Reset Open collector output	SOT-323F	18vdc	VD6	3b Auk
N42B	ML61N422M	Vdet-IC	4.2V±2%, -Reset ODO	SOT-23	16vdd	VD6	3a Mlc
N42G	82N42G-AE3-5	Vdet-IC	4.2V±2% -Reset ODO, halogen free	SOT-23	16vdd	VD6	3a Utc
N42L	82N42L-AE3-5	Vdet-IC	4.2V±2% -Reset ODO, lead free	SOT-23	16vdd	VD6	3a Utc
N42T	CM7P61N-42-T	Vdet-IC	4.2V±2%, +Reset ODO	SOT-23	16vdd	VD6	3a Can
N43	82N43-AE3-5	Vdet-IC	4.3V±2% -Reset ODO	SOT-23	16vdd	VD6	3a Utc
N43	XE61CN3445MR	Vdet-IC	3.4V±2%, -Reset ODO	SOT-23	16vdd	VD6	3h Tor
N43B	ML61N432M	Vdet-IC	4.3V±2%, -Reset ODO	SOT-23	16vdd	VD6	3a Mlc
N43G	82N43G-AE3-5	Vdet-IC	4.3V±2% -Reset ODO, halogen free	SOT-23	16vdd	VD6	3a Utc
N43L	82N43L-AE3-5	Vdet-IC	4.3V±2% -Reset ODO, lead free	SOT-23	16vdd	VD6	3a Utc
N43T	CM7P61N-43-T	Vdet-IC	4.3V±2%, +Reset ODO	SOT-23	16vdd	VD6	3a Can
N44	82N44-AE3-5	Vdet-IC	4.4V±2% -Reset ODO	SOT-23	16vdd	VD6	3a Utc
N44B	ML61N442M	Vdet-IC	4.4V±2%, -Reset ODO	SOT-23	16vdd	VD6	3a Mlc
N44G	82N44G-AE3-5	Vdet-IC	4.4V±2% -Reset ODO, halogen free	SOT-23	16vdd	VD6	3a Utc
N44L	82N44L-AE3-5	Vdet-IC	4.4V±2% -Reset ODO, lead free	SOT-23	16vdd	VD6	3a Utc
N44T	CM7P61N-44-T	Vdet-IC	4.4V±2%, +Reset ODO	SOT-23	16vdd	VD6	3a Can
N45	82N45-AE3-5	Vdet-IC	4.5V±2% -Reset ODO	SOT-23	16vdd	VD6	3a Utc
N45	S72N45SF	Vdet-IC	4.5V, +Reset Open collector output	SOT-23F	18vdc	VD6	3b Auk
N45	S72N45UF	Vdet-IC	4.5V, +Reset Open collector output	SOT-323F	18vdc	VD6	3a Auk
N45	XC61FN3412M	Vdet-IC	3.4V±2%, +Reset ODO, 200ms	SOT-23	16vdd	VD6	3d Tor
N45	XC61HN3412MR	Vdet-IC	3.4V±2%, -Reset ODO, 50..200ms	SOT-23	16vdc	VD6	3d Tor
N45B	ML61N452M	Vdet-IC	4.5V±2%, -Reset ODO	SOT-23	16vdd	VD6	3a Mlc
N45G	82N45G-AE3-5	Vdet-IC	4.5V±2% -Reset ODO, halogen free	SOT-23	16vdd	VD6	3a Utc
N45L	82N45L-AE3-5	Vdet-IC	4.5V±2% -Reset ODO, lead free	SOT-23	16vdd	VD6	3a Utc
N45T	CM7P61N-45-T	Vdet-IC	4.5V±2%, +Reset ODO	SOT-23	16vdd	VD6	3a Can
N46	82N46-AE3-5	Vdet-IC	4.6V±2% -Reset ODO	SOT-23	16vdd	VD6	3a Utc
N46	XC61FN3442M	Vdet-IC	3.4V±2%, +Reset ODO, 400ms	SOT-23	16vdd	VD6	3d Tor
N46	XC61HN3442MR	Vdet-IC	3.4V±2%, -Reset ODO, 80..400ms	SOT-23	16vdc	VD6	3d Tor
N46B	ML61N462M	Vdet-IC	4.6V±2%, -Reset ODO	SOT-23	16vdd	VD6	3a Mlc
N46G	82N46G-AE3-5	Vdet-IC	4.6V±2% -Reset ODO, halogen free	SOT-23	16vdd	VD6	3a Utc
N46L	82N46L-AE3-5	Vdet-IC	4.6V±2% -Reset ODO, lead free	SOT-23	16vdd	VD6	3a Utc
N46T	CM7P61N-46-T	Vdet-IC	4.6V±2%, +Reset ODO	SOT-23	16vdd	VD6	3a Can
N47	82N47-AE3-5	Vdet-IC	4.7V±2% -Reset ODO	SOT-23	16vdd	VD6	3a Utc
N47	XC61FN3452M	Vdet-IC	3.4V±2%, +Reset ODO, 50ms	SOT-23	16vdd	VD6	3d Tor
N47	XC61HN3452MR	Vdet-IC	3.4V±2%, -Reset ODO, 1..50ms	SOT-23	16vdc	VD6	3d Tor
N47B	ML61N472M	Vdet-IC	4.7V±2%, -Reset ODO	SOT-23	16vdd	VD6	3a Mlc
N47G	82N47G-AE3-5	Vdet-IC	4.7V±2% -Reset ODO, halogen free	SOT-23	16vdd	VD6	3a Utc
N47L	82N47L-AE3-5	Vdet-IC	4.7V±2% -Reset ODO, lead free	SOT-23	16vdd	VD6	3a Utc
N47T	CM7P61N-47-T	Vdet-IC	4.7V±2%, +Reset ODO	SOT-23	16vdd	VD6	3a Can
N48	82N48-AE3-5	Vdet-IC	4.8V±2% -Reset ODO	SOT-23	16vdd	VD6	3a Utc
N48B	ML61N482M	Vdet-IC	4.8V±2%, -Reset ODO	SOT-23	16vdd	VD6	3a Mlc
N48G	82N48G-AE3-5	Vdet-IC	4.8V±2% -Reset ODO, halogen free	SOT-23	16vdd	VD6	3a Utc
N48L	82N48L-AE3-5	Vdet-IC	4.8V±2% -Reset ODO, lead free	SOT-23	16vdd	VD6	3a Utc
N48T	CM7P61N-48-T	Vdet-IC	4.8V±2%, +Reset ODO	SOT-23	16vdd	VD6	3a Can
N49	82N49-AE3-5	Vdet-IC	4.9V±2% -Reset ODO	SOT-23	16vdd	VD6	3a Utc
N49B	ML61N492M	Vdet-IC	4.9V±2%, -Reset ODO	SOT-23	16vdd	VD6	3a Mlc
N49G	82N49G-AE3-5	Vdet-IC	4.9V±2% -Reset ODO, halogen free	SOT-23	16vdd	VD6	3a Utc
N49L	82N49L-AE3-5	Vdet-IC	4.9V±2% -Reset ODO, lead free	SOT-23	16vdd	VD6	3a Utc
N49T	CM7P61N-49-T	Vdet-IC	4.9V±2%, +Reset ODO	SOT-23	16vdd	VD6	3a Can
N4A	ILC5061AIC34X	Vdet-IC	3.4V±1%, -Reset ODO	SOT-323	16vdd	VD6	3a Imp
N4A	ILC5061AM34X	Vdet-IC	3.4V±1%, -Reset ODO	SOT-23	16vdd	VD6	3a Imp
N5	2SC1654-5	Si-npn	Sw, HV-drive, 180V, 50mA, 150mW, B=90..180, 120MHz	SOT-23	16ta	-	3a Nec



SMD code	Type	Function	Short description	Case	Pinout	Sch. St.	Mnf.
N5	ELM7645LAB	Vdet-IC	4.5V±2%, -Reset PPO, 250ms	SOT-23	16vdc	VD7	3d Elm
N5	KRC118S	Si-npn-Digi	Sw, 50V, 100mA, 200mW, 200MHz, R1/R2=2k2/10k	SOT-23	16ta	-	3f Kec
N5	KRC418	Si-npn-Digi	Sw, 50V, 100mA, 100mW, 200MHz, R1/R2=2k2/10k	SOT-323	16ta	-	3f Kec
N5	KRC418E	Si-npn-Digi	Sw, 50V, 100mA, 100mW, 200MHz, R1/R2=2k2/10k	SOT-490	18ta	-	3f Kec
N5	KRC418V	Si-npn-Digi	Sw, 50V, 100mA, 100mW, 200MHz, R1/R2=2k2/10k	VSM	18ta	-	3f Kec
N5	MMBC1654N5	Si-npn	Switch, HV drive, 180V, 50mA, 150mW, B=50-130, 120MHz	SOT-23	16ta	-	3a Sam
N5	R1100D251C	LVR-IC	U-low lcc, 2.5V±2%, 180mA	SON1408-3	18vj	VR1	3d Ric
N5	R3111N552C	Vdet-IC	5.5V±2%, -Reset ODO	SOT-23	16vdd	VD6	3d Ric
N5	R3130N46DC5	Vdet-IC	4.6V, -Reset ODO, 200ms	SOT-23	16vdc	VD6	3b Ric
N5	RT1N144C	Si-npn-Digi	Sw, 50V, 100mA, 150mW, 200MHz, R1/R2=10/47k	SC-59	16ta	-	3a Mit
N5	RT1N144M	Si-npn-Digi	Sw, 50V, 100mA, 150mW, 200MHz, R1/R2=10/47k	SOT-323	16ta	-	3a Mit
N5	RT1N144U	Si-npn-Digi	Sw, 50V, 100mA, 125mW, 200MHz, R1/R2=10/47k	SC-75A	16ta	-	3a Mit
N5	TC54VN3502ECB	Vdet-IC	3.5V±2%, -Reset ODO	SOT-23	16vdb	VD6	3a Tcs
N5	XC61CN3502M	Vdet-IC	3.5V±1%, +Reset ODO	SOT-23	16vdb	VD6	3d Tor
N5	XC6GN3502HR	Vdet-IC	3.5V, +Reset ODO	USP-3	17vdc	VD1	9b Tor
N50	82N50-AE3-5	Vdet-IC	5.0V±2% -Reset ODO	SOT-23	16vdb	VD6	3a Utc
N50B	ML61N502M	Vdet-IC	5.0V±2%, -Reset ODO	SOT-23	16vdb	VD6	3a Mic
N50G	82N50G-AE3-5	Vdet-IC	5.0V±2% -Reset ODO, halogen free	SOT-23	16vdb	VD6	3a Utc
N50L	82N50L-AE3-5	Vdet-IC	5.0V±2% -Reset ODO, lead free	SOT-23	16vdb	VD6	3a Utc
N50T	CM7P61N-50-T	Vdet-IC	5.0V±2%, +Reset ODO	SOT-23	16vdb	VD6	3a Can
N51	82N51-AE3-5	Vdet-IC	5.1V±2% -Reset ODO	SOT-23	16vdb	VD6	3a Utc
N51B	ML61N512M	Vdet-IC	5.1V±2%, -Reset ODO	SOT-23	16vdb	VD6	3a Mic
N51G	82N51G-AE3-5	Vdet-IC	5.1V±2% -Reset ODO, halogen free	SOT-23	16vdb	VD6	3a Utc
N51L	82N51L-AE3-5	Vdet-IC	5.1V±2% -Reset ODO, lead free	SOT-23	16vdb	VD6	3a Utc
N51T	CM7P61N-51-T	Vdet-IC	5.1V±2%, +Reset ODO	SOT-23	16vdb	VD6	3a Can
N52	82N52-AE3-5	Vdet-IC	5.2V±2% -Reset ODO	SOT-23	16vdb	VD6	3a Utc
N52B	ML61N522M	Vdet-IC	5.2V±2%, -Reset ODO	SOT-23	16vdb	VD6	3a Mic
N52G	82N52G-AE3-5	Vdet-IC	5.2V±2% -Reset ODO, halogen free	SOT-23	16vdb	VD6	3a Utc
N52L	82N52L-AE3-5	Vdet-IC	5.2V±2% -Reset ODO, lead free	SOT-23	16vdb	VD6	3a Utc
N52T	CM7P61N-52-T	Vdet-IC	5.2V±2%, +Reset ODO	SOT-23	16vdb	VD6	3a Can
N53	82N53-AE3-5	Vdet-IC	5.3V±2% -Reset ODO	SOT-23	16vdb	VD6	3a Utc
N53	XE61CN3545MR	Vdet-IC	3.5V±2%, -Reset ODO	SOT-23	16vdb	VD6	3h Tor
N53B	ML61N532M	Vdet-IC	5.3V±2%, -Reset ODO	SOT-23	16vdb	VD6	3a Mic
N53G	82N53G-AE3-5	Vdet-IC	5.3V±2% -Reset ODO, halogen free	SOT-23	16vdb	VD6	3a Utc
N53L	82N53L-AE3-5	Vdet-IC	5.3V±2% -Reset ODO, lead free	SOT-23	16vdb	VD6	3a Utc
N53T	CM7P61N-53-T	Vdet-IC	5.3V±2%, +Reset ODO	SOT-23	16vdb	VD6	3a Can
N54	82N54-AE3-5	Vdet-IC	5.4V±2% -Reset ODO	SOT-23	16vdb	VD6	3a Utc
N54	SO2221A	Si-npn	GP, 75V, 800mA, 500mW, >250MHz, B>20	SOT-23	16ta	-	Ste
N54B	ML61N542M	Vdet-IC	5.4V±2%, -Reset ODO	SOT-23	16vdb	VD6	3a Mic
N54G	82N54G-AE3-5	Vdet-IC	5.4V±2% -Reset ODO, halogen free	SOT-23	16vdb	VD6	3a Utc
N54L	82N54L-AE3-5	Vdet-IC	5.4V±2% -Reset ODO, lead free	SOT-23	16vdb	VD6	3a Utc
N54T	CM7P61N-54-T	Vdet-IC	5.4V±2%, +Reset ODO	SOT-23	16vdb	VD6	3a Can
N55	82N55-AE3-5	Vdet-IC	5.5V±2% -Reset ODO	SOT-23	16vdb	VD6	3a Utc
N55	XC61FN3512M	Vdet-IC	3.5V±2%, +Reset ODO, 200ms	SOT-23	16vdb	VD6	3d Tor
N55	XC61HN3512MR	Vdet-IC	3.5V±2%, -Reset ODO, 50..200ms	SOT-23	16vdc	VD6	3d Tor
N55B	ML61N552M	Vdet-IC	5.5V±2%, -Reset ODO	SOT-23	16vdb	VD6	3a Mic
N55G	82N55G-AE3-5	Vdet-IC	5.5V±2% -Reset ODO, halogen free	SOT-23	16vdb	VD6	3a Utc
N55L	82N55L-AE3-5	Vdet-IC	5.5V±2% -Reset ODO, lead free	SOT-23	16vdb	VD6	3a Utc
N55T	CM7P61N-55-T	Vdet-IC	5.5V±2%, +Reset ODO	SOT-23	16vdb	VD6	3a Can
N56	82N56-AE3-5	Vdet-IC	5.6V±2% -Reset ODO	SOT-23	16vdb	VD6	3a Utc
N56	XC61FN3542M	Vdet-IC	3.5V±2%, +Reset ODO, 400ms	SOT-23	16vdb	VD6	3d Tor
N56	XC61HN3542MR	Vdet-IC	3.5V±2%, -Reset ODO, 80..400ms	SOT-23	16vdc	VD6	3d Tor
N56B	ML61N562M	Vdet-IC	5.6V±2%, -Reset ODO	SOT-23	16vdb	VD6	3a Mic
N56G	82N56G-AE3-5	Vdet-IC	5.6V±2% -Reset ODO, halogen free	SOT-23	16vdb	VD6	3a Utc
N56L	82N56L-AE3-5	Vdet-IC	5.6V±2% -Reset ODO, lead free	SOT-23	16vdb	VD6	3a Utc
N56T	CM7P61N-56-T	Vdet-IC	5.6V±2%, +Reset ODO	SOT-23	16vdb	VD6	3a Can
N57	82N57-AE3-5	Vdet-IC	5.7V±2% -Reset ODO	SOT-23	16vdb	VD6	3a Utc
N57	XC61FN3552M	Vdet-IC	3.5V±2%, +Reset ODO, 50ms	SOT-23	16vdb	VD6	3d Tor
N57	XC61HN3552MR	Vdet-IC	3.5V±2%, -Reset ODO, 1..50ms	SOT-23	16vdc	VD6	3d Tor
N57B	ML61N572M	Vdet-IC	5.7V±2%, -Reset ODO	SOT-23	16vdb	VD6	3a Mic
N57G	82N57G-AE3-5	Vdet-IC	5.7V±2% -Reset ODO, halogen free	SOT-23	16vdb	VD6	3a Utc
N57L	82N57L-AE3-5	Vdet-IC	5.7V±2% -Reset ODO, lead free	SOT-23	16vdb	VD6	3a Utc
N57T	CM7P61N-57-T	Vdet-IC	5.7V±2%, +Reset ODO	SOT-23	16vdb	VD6	3a Can
N58	82N58-AE3-5	Vdet-IC	5.8V±2% -Reset ODO	SOT-23	16vdb	VD6	3a Utc
N58B	ML61N582M	Vdet-IC	5.8V±2%, -Reset ODO	SOT-23	16vdb	VD6	3a Mic
N58G	82N58G-AE3-5	Vdet-IC	5.8V±2% -Reset ODO, halogen free	SOT-23	16vdb	VD6	3a Utc
N58L	82N58L-AE3-5	Vdet-IC	5.8V±2% -Reset ODO, lead free	SOT-23	16vdb	VD6	3a Utc
N58T	CM7P61N-58-T	Vdet-IC	5.8V±2%, +Reset ODO	SOT-23	16vdb	VD6	3a Can
N59	82N59-AE3-5	Vdet-IC	5.9V±2% -Reset ODO	SOT-23	16vdb	VD6	3a Utc
N59B	ML61N592M	Vdet-IC	5.9V±2%, -Reset ODO	SOT-23	16vdb	VD6	3a Mic



SMD code	Type	Function	Short description	Case	Pinout	Sch.	St.	Mnf.
N59G	82N59G-AE3-5	Vdet-IC	5.9V±2% -Reset ODO, halogen free	SOT-23	16vdb	VD6	3a	Utc
N59L	82N59L-AE3-5	Vdet-IC	5.9V±2% -Reset ODO, lead free	SOT-23	16vdb	VD6	3a	Utc
N59T	CM7P61N-59-T	Vdet-IC	5.9V±2%, +Reset ODO	SOT-23	16vdb	VD6	3a	Can
N6	2SC1654-6	Si-npn	Sw, HV-drive, 180V, 50mA, 150mW, B=135..270, 120MHz	SOT-23	16ta	-	3a	Nec
N6	BFS25A	Si-npn	UHF, 8V, 6.5mA, 32mW, 5GHz	SOT-323	16ta	-	3a	Phi
N6	ELM7646LAB	Vdet-IC	4.6V±2%, -Reset PPO, 250ms	SOT-23	16vdc	VD7	3d	Elm
N6	KRC119S	Si-npn-Digi	Sw, 50V, 100mA, 200mW, 200MHz, R1/R2=4k7k/10k	SOT-23	16ta	-	3f	Kec
N6	KRC419	Si-npn-Digi	Sw, 50V, 100mA, 100mW, 200MHz, R1/R2=4k7k/10k	SOT-323	16ta	-	3f	Kec
N6	KRC419E	Si-npn-Digi	Sw, 50V, 100mA, 100mW, 200MHz, R1/R2=4k7k/10k	SOT-490	18ta	-	3f	Kec
N6	KRC419V	Si-npn-Digi	Sw, 50V, 100mA, 100mW, 200MHz, R1/R2=4k7k/10k	VSM	18ta	-	3f	Kec
N6	MMBC1654N6	Si-npn	Switch, HV drive, 180V, 50mA, 150mW, B=50-130, 120MHz	SOT-23	16ta	-	3a	Sam
N6	R1100D261C	LVR-IC	U-low lcc, 2.6V±2%, 180mA	S0N1408-3	9vj	VR1	3d	Ric
N6	R3111N562C	Vdet-IC	5.6V±2%, -Reset ODO	SOT-23	16vdd	VD6	3d	Ric
N6	RT1N430C	Si-npn-Digi	Sw, 50V, 100mA, 150mW, 200MHz, R1=4k7	SC-59	16ta	-	3a	Mit
N6	RT1N430M	Si-npn-Digi	Sw, 50V, 100mA, 150mW, 200MHz, R1=4k7	SOT-323	16ta	-	3a	Mit
N6	RT1N430U	Si-npn-Digi	Sw, 50V, 100mA, 150mW, 200MHz, R1=4k7	SC-75A	16ta	-	3a	Mit
N6	TC54VN3602ECB	Vdet-IC	3.6V±2%, -Reset ODO	SOT-23	16vdb	VD6	3a	Tcs
N6	XC61CN3602M	Vdet-IC	3.6V±1%, +Reset ODO	SOT-23	16vdb	VD6	3d	Tor
N6	XC6GN3602HR	Vdet-IC	3.6V, +Reset ODO	USP-3	17vdc	VD1	9b	Tor
N60	82N60-AE3-5	Vdet-IC	6.0V±2% -Reset ODO	SOT-23	16vdb	VD6	3a	Utc
N60	DDTD113EC	Si-npn-Digi	Sw, 50V, 500mA, 200mW, 200MHz, R1/R2=1k/1k	SOT-23	16ta	-	3d	Di
N60	DDTD113EU	Si-npn-Digi	Sw, 50V, 500mA, 200mW, 200MHz, R1/R2=1k/1k	SOT-323	16ta	-	3d	Di
N60B	ML61N602M	Vdet-IC	6.0V±2%, -Reset ODO	SOT-23	16vdb	VD6	3a	Mlc
N60G	82N60G-AE3-5	Vdet-IC	6.0V±2% -Reset ODO, halogen free	SOT-23	16vdb	VD6	3a	Utc
N60L	82N60L-AE3-5	Vdet-IC	6.0V±2% -Reset ODO, lead free	SOT-23	16vdb	VD6	3a	Utc
N60T	CM7P61N-60-T	Vdet-IC	6.0V±2%, +Reset ODO	SOT-23	16vdb	VD6	3a	Can
N61	DDTD123EC	Si-npn-Digi	Sw, 50V, 500mA, 200mW, 200MHz, R1/R2=2.2k/2.2k	SOT-23	16ta	-	3d	Di
N61	DDTD123EU	Si-npn-Digi	Sw, 50V, 500mA, 200mW, 200MHz, R1/R2=2.2k/2.2k	SOT-323	16ta	-	3d	Di
N61B	ML61N612M	Vdet-IC	6.1V±2%, -Reset ODO	SOT-23	16vdb	VD6	3a	Mlc
N61T	CM7P61N-61-T	Vdet-IC	6.1V±2%, +Reset ODO	SOT-23	16vdb	VD6	3a	Can
N62	DDTD143EC	Si-npn-Digi	Sw, 50V, 500mA, 200mW, 200MHz, R1/R2=4.7k/4.7k	SOT-23	16ta	-	3d	Di
N62	DDTD143EU	Si-npn-Digi	Sw, 50V, 500mA, 200mW, 200MHz, R1/R2=4.7k/4.7k	SOT-323	16ta	-	3d	Di
N62B	ML61N622M	Vdet-IC	6.2V±2%, -Reset ODO	SOT-23	16vdb	VD6	3a	Mlc
N62T	CM7P61N-62-T	Vdet-IC	6.2V±2%, +Reset ODO	SOT-23	16vdb	VD6	3a	Can
N63	DDTD114EC	Si-npn-Digi	Sw, 50V, 500mA, 200mW, 200MHz, R1/R2=10k/10k	SOT-23	16ta	-	3d	Di
N63	DDTD114EU	Si-npn-Digi	Sw, 50V, 500mA, 200mW, 200MHz, R1/R2=10k/10k	SOT-323	16ta	-	3d	Di
N63	XE61CN3645MR	Vdet-IC	3.6V±2%, -Reset ODO	SOT-23	16vdb	VD6	3h	Tor
N63B	ML61N632M	Vdet-IC	6.3V±2%, -Reset ODO	SOT-23	16vdb	VD6	3a	Mlc
N63T	CM7P61N-63-T	Vdet-IC	6.3V±2%, +Reset ODO	SOT-23	16vdb	VD6	3a	Can
N64	DDTD122JC	Si-npn-Digi	Sw, 50V, 500mA, 200mW, 200MHz, R1/R2=0.22k/4.7k	SOT-23	16ta	-	3d	Di
N64	DDTD122JU	Si-npn-Digi	Sw, 50V, 500mA, 200mW, 200MHz, R1/R2=0.22k/4.7k	SOT-323	16ta	-	3d	Di
N64B	ML61N642M	Vdet-IC	6.4V±2%, -Reset ODO	SOT-23	16vdb	VD6	3a	Mlc
N64T	CM7P61N-64-T	Vdet-IC	6.4V±2%, +Reset ODO	SOT-23	16vdb	VD6	3a	Can
N65	DDTD113ZC	Si-npn-Digi	Sw, 50V, 500mA, 200mW, 200MHz, R1/R2=1k/10k	SOT-23	16ta	-	3d	Di
N65	DDTD113ZU	Si-npn-Digi	Sw, 50V, 500mA, 200mW, 200MHz, R1/R2=1k/10k	SOT-323	16ta	-	3d	Di
N65	XC61FN3612M	Vdet-IC	3.6V±2%, +Reset ODO, 200ms	SOT-23	16vdb	VD6	3d	Tor
N65	XC61HN3612MR	Vdet-IC	3.6V±2%, -Reset ODO, 50..200ms	SOT-23	16vdc	VD6	3d	Tor
N65B	ML61N652M	Vdet-IC	6.5V±2%, -Reset ODO	SOT-23	16vdb	VD6	3a	Mlc
N65T	CM7P61N-65-T	Vdet-IC	6.5V±2%, +Reset ODO	SOT-23	16vdb	VD6	3a	Can
N66	DDTD123YC	Si-npn-Digi	Sw, 50V, 500mA, 200mW, 200MHz, R1/R2=2.2k/10k	SOT-23	16ta	-	3d	Di
N66	DDTD123YU	Si-npn-Digi	Sw, 50V, 500mA, 200mW, 200MHz, R1/R2=2.2k/10k	SOT-323	16ta	-	3d	Di
N66	XC61FN3642M	Vdet-IC	3.6V±2%, +Reset ODO, 400ms	SOT-23	16vdb	VD6	3d	Tor
N66	XC61HN3642MR	Vdet-IC	3.6V±2%, -Reset ODO, 80..400ms	SOT-23	16vdc	VD6	3d	Tor
N66B	ML61N662M	Vdet-IC	6.6V±2%, -Reset ODO	SOT-23	16vdb	VD6	3a	Mlc
N66T	CM7P61N-66-T	Vdet-IC	6.6V±2%, +Reset ODO	SOT-23	16vdb	VD6	3a	Can
N67	DDTD133HC	Si-npn-Digi	Sw, 50V, 500mA, 200mW, 200MHz, R1/R2=3.3k/10k	SOT-23	16ta	-	3d	Di
N67	DDTD133HU	Si-npn-Digi	Sw, 50V, 500mA, 200mW, 200MHz, R1/R2=3.3k/10k	SOT-323	16ta	-	3d	Di
N67	XC61FN3652M	Vdet-IC	3.6V±2%, +Reset ODO, 50ms	SOT-23	16vdb	VD6	3d	Tor
N67	XC61HN3652MR	Vdet-IC	3.6V±2%, -Reset ODO, 1..50ms	SOT-23	16vdc	VD6	3d	Tor
N67B	ML61N672M	Vdet-IC	6.7V±2%, -Reset ODO	SOT-23	16vdb	VD6	3a	Mlc
N67T	CM7P61N-67-T	Vdet-IC	6.7V±2%, +Reset ODO	SOT-23	16vdb	VD6	3a	Can
N68B	ML61N682M	Vdet-IC	6.8V±2%, -Reset ODO	SOT-23	16vdb	VD6	3a	Mlc
N68T	CM7P61N-68-T	Vdet-IC	6.8V±2%, +Reset ODO	SOT-23	16vdb	VD6	3a	Can
N69	DDTD123TC	Si-npn-Digi	Sw, 50V, 500mA, 200mW, 200MHz, R1=2.2k	SOT-23	16ta	-	3d	Di
N69	DDTD123TU	Si-npn-Digi	Sw, 50V, 500mA, 200mW, 200MHz, R1=2.2k	SOT-323	16ta	-	3d	Di
N69B	ML61N692M	Vdet-IC	6.9V±2%, -Reset ODO	SOT-23	16vdb	VD6	3a	Mlc
N69T	CM7P61N-69-T	Vdet-IC	6.9V±2%, +Reset ODO	SOT-23	16vdb	VD6	3a	Can
N7	2SC1654-7	Si-npn	Sw, HV-drive, 180V, 50mA, 150mW, B=200..400, 120MHz	SOT-23	16ta	-	3a	Nec
N7	ELM7647LAB	Vdet-IC	4.7V±2%, -Reset PPO, 250ms	SOT-23	16vdc	VD7	3d	Elm
N7	ILC5061IC37X	Vdet-IC	3.7V±2%, -Reset ODO	SOT-323	16vdb	VD6	3a	Imp



SMD code	Type	Function	Short description	Case	Pinout	Sch. St.	Mnf.
N7	ILC5061M37X	Vdet-IC	3.7V±2%, -Reset ODO	SOT-23	16vdb	VD6	3a Imp
N7	KN4L4Z	Si-npn-Digi	Sw, 60V, 100mA, 150mW, R1=47k	SOT-416	16ta	-	3a Nec
N7	KRC120S	Si-npn-Digi	Sw, 50V, 100mA, 200mW, 200MHz, R1/R2=10k/4k7	SOT-23	16ta	-	3f Kec
N7	KRC420	Si-npn-Digi	Sw, 50V, 100mA, 100mW, 200MHz, R1/R2=10k/4k7	SOT-323	16ta	-	3f Kec
N7	KRC420E	Si-npn-Digi	Sw, 50V, 100mA, 100mW, 200MHz, R1/R2=10k/4k7	SOT-490	18ta	-	3f Kec
N7	KRC420V	Si-npn-Digi	Sw, 50V, 100mA, 100mW, 200MHz, R1/R2=10k/4k7	VSM	18ta	-	3f Kec
N7	MMBC1654N7	Si-npn	Switch, HV drive, 180V, 50mA, 150mW, B=100-220, 120MHz	SOT-23	16ta	-	3a Sam
N7	R1100D271C	LVR-IC	U-low lcc, 2.7V±2%, 180mA	SON1408-3	18vj	VR1	3d Ric
N7	R3111N572C	Vdet-IC	5.7V±2%, -Reset ODO	SOT-23	16vdd	VD6	3d Ric
N7	RT1N140C	Si-npn-Digi	Sw, 50V, 100mA, 150mW, 200MHz, R1=10k	SC-59	16ta	-	3a Mit
N7	RT1N140M	Si-npn-Digi	Sw, 50V, 100mA, 150mW, 200MHz, R1=10k	SOT-323	16ta	-	3a Mit
N7	RT1N140T	Si-npn-Digi	Sw, 50V, 100mA, 125mW, 200MHz, R1=10k	T-USM	18ta	-	3a Mit
N7	RT1N140U	Si-npn-Digi	Sw, 50V, 100mA, 125mW, 200MHz, R1=10k	SC-75A	16ta	-	3a Mit
N7	TC54VN3702ECB	Vdet-IC	3.7V±2%, -Reset ODO	SOT-23	16vdb	VD6	3a Tcs
N7	XC61CN3702M	Vdet-IC	3.7V±1%, +Reset ODO	SOT-23	16vdb	VD6	3d Tor
N7	XC6GN3702HR	Vdet-IC	3.7V, +Reset ODO	USP-3	17vdc	VD1	9b Tor
N70	DDTD143TC	Si-npn-Digi	Sw, 50V, 500mA, 200mW, 200MHz, R1=4.7k	SOT-23	16ta	-	3d Di
N70	DDTD143TU	Si-npn-Digi	Sw, 50V, 500mA, 200mW, 200MHz, R1=4.7k	SOT-323	16ta	-	3d Di
N70B	ML61N702M	Vdet-IC	7.0V±2%, -Reset ODO	SOT-23	16vdb	VD6	3a Mic
N70T	CM7P61N-70-T	Vdet-IC	7.0V±2%, +Reset ODO	SOT-23	16vdb	VD6	3a Can
N71	DDTD114TC	Si-npn-Digi	Sw, 50V, 500mA, 200mW, 200MHz, R1=10k	SOT-23	16ta	-	3d Di
N71	DDTD114TU	Si-npn-Digi	Sw, 50V, 500mA, 200mW, 200MHz, R1=4.7k	SOT-323	16ta	-	3d Di
N71	SO3904	Si-npn	GP, 60V, 100mA, 200mW, B= 100..300, >300MHz	SOT-23	16ta	-	- Ste
N72	DDTD114GC	Si-npn-Digi	Sw, 50V, 500mA, 200mW, 200MHz, R2=10k	SOT-23	16ta	-	3d Di
N72	DDTD114GU	Si-npn-Digi	Sw, 50V, 500mA, 200mW, 200MHz, R2=10k	SOT-323	16ta	-	3d Di
N72	SO3903	Si-npn	GP, 60V, 200mA, 250mW, B=50..150, >300MHz	SOT-23	16ta	-	3a Ste
N73	XE61CN3745MR	Vdet-IC	3.7V±2%, -Reset ODO	SOT-23	16vdb	VD6	3h Tor
N75	DDTD122LC	Si-npn-Digi	Sw, 50V, 500mA, 200mW, 200MHz, R1/R2=0.22k/10k	SOT-23	16ta	-	3d Di
N75	DDTD122LU	Si-npn-Digi	Sw, 50V, 500mA, 200mW, 200MHz, R1/R2=0.22k/10k	SOT-323	16ta	-	3d Di
N75	XC61FN3712M	Vdet-IC	3.7V±2%, +Reset ODO, 200ms	SOT-23	16vdb	VD6	3d Tor
N75	XC61HN3712MR	Vdet-IC	3.7V±2%, -Reset ODO, 50..200ms	SOT-23	16vdc	VD6	3d Tor
N76	DDTD142JC	Si-npn-Digi	Sw, 50V, 500mA, 200mW, 200MHz, R1/R2=0.47k/10k	SOT-23	16ta	-	3d Di
N76	DDTD142JU	Si-npn-Digi	Sw, 50V, 500mA, 200mW, 200MHz, R1/R2=0.47k/10k	SOT-323	16ta	-	3d Di
N76	XC61FN3742M	Vdet-IC	3.7V±2%, +Reset ODO, 400ms	SOT-23	16vdb	VD6	3d Tor
N76	XC61HN3742MR	Vdet-IC	3.7V±2%, -Reset ODO, 80..400ms	SOT-23	16vdc	VD6	3d Tor
N77	DDTD122TC	Si-npn-Digi	Sw, 50V, 500mA, 200mW, 200MHz, R1=0.22k	SOT-23	16ta	-	3d Di
N77	DDTD122TU	Si-npn-Digi	Sw, 50V, 500mA, 200mW, 200MHz, R1=0.22k	SOT-323	16ta	-	3d Di
N77	XC61FN3752M	Vdet-IC	3.7V±2%, +Reset ODO, 50ms	SOT-23	16vdb	VD6	3d Tor
N77	XC61HN3752MR	Vdet-IC	3.7V±2%, -Reset ODO, 1..50ms	SOT-23	16vdc	VD6	3d Tor
N78	DDTD142TC	Si-npn-Digi	Sw, 50V, 500mA, 200mW, 200MHz, R1=0.47k	SOT-23	16ta	-	3d Di
N78	DDTD142TU	Si-npn-Digi	Sw, 50V, 500mA, 200mW, 200MHz, R1=0.22k	SOT-323	16ta	-	3d Di
N79	SO5550	Si-npn	HV, 140V, 600mA, 225mW, B=80..250, >300MHz	SOT-23	16ta	-	- Ste
N7A	ILC5061AIC37X	Vdet-IC	3.7V±1%, -Reset ODO	SOT-323	16vdb	VD6	3a Imp
N7A	ILC5061AM37X	Vdet-IC	3.7V±1%, -Reset ODO	SOT-23	16vdb	VD6	3a Imp
N8	BZX84-C5V1	Z-diode	4.8..5.4V, Zzt=60Ω, Izt=20mA, 225mW	SOT-23	16dc	-	3a Lge
N8	DAP202U	Si-diode	Dual, Sw, 80V, 100mA, 200mW, <10ns	SOT-323	16df	-	3b Ons
N8	ELM7648LAB	Vdet-IC	4.8V±2%, -Reset PPO, 250ms	SOT-23	16vdc	VD7	3d Elm
N8	KRC121S	Si-npn-Digi	Sw, 50V, 100mA, 200mW, 200MHz, R1/R2=47k/10k	SOT-23	16ta	-	3f Kec
N8	KRC421	Si-npn-Digi	Sw, 50V, 100mA, 100mW, 200MHz, R1/R2=47k/10k	SOT-323	16ta	-	3f Kec
N8	KRC421E	Si-npn-Digi	Sw, 50V, 100mA, 100mW, 200MHz, R1/R2=47k/10k	SOT-490	18ta	-	3f Kec
N8	KRC421V	Si-npn-Digi	Sw, 50V, 100mA, 100mW, 200MHz, R1/R2=47k/10k	VSM	18ta	-	3f Kec
N8	R1100D281C	LVR-IC	U-low lcc, 2.8V±2%, 180mA	SON1408-3	18vj	VR1	3d Ric
N8	R3111N582C	Vdet-IC	5.8V±2%, -Reset ODO	SOT-23	16vdd	VD6	3d Ric
N8	TC54VN3802ECB	Vdet-IC	3.8V±2%, -Reset ODO	SOT-23	16vdb	VD6	3a Tcs
N8	XC61CN3802M	Vdet-IC	3.8V±1%, +Reset ODO	SOT-23	16vdb	VD6	3d Tor
N8	XC6GN3802HR	Vdet-IC	3.8V, +Reset ODO	USP-3	17vdc	VD1	9b Tor
N80	SO5551	Si-npn	GP, 180V, 200mA, 200mW, B=80..250, <300MHz	SOT-23	16ta	-	3a Ste
N81	DDTC122LE	Si-npn-Digi	Sw, 50V, 100mA, 150mW, 250MHz, R1/R2=0.22k/10k	SOT-523	16ta	-	3d Di
N81	DDTC122LU	Si-npn-Digi	Sw, 50V, 100mA, 200mW, 250MHz, R1/R2=0.22k/10k	SOT-23	16ta	-	3d Di
N81	SO2369A	Si-npn	Sw, 40V, 200mA, 330mW, B=40..120, 500MHz	SOT-23	16ta	-	3a Ste
N82	DDTC142JE	Si-npn-Digi	Sw, 50V, 100mA, 150mW, 250MHz, R1/R2=0.47k/10k	SOT-523	16ta	-	3d Di
N82	DDTC142JU	Si-npn-Digi	Sw, 50V, 100mA, 200mW, 250MHz, R1/R2=0.47k/10k	SOT-323	16ta	-	3d Di
N83	DDTC122TE	Si-npn-Digi	Sw, 50V, 100mA, 150mW, 250MHz, R1=2.2k	SOT-523	16ta	-	3d Di
N83	DDTC122TU	Si-npn-Digi	Sw, 50V, 100mA, 150mW, 250MHz, R1=2.2k	SOT-323	16ta	-	3d Di
N83	XE61CN3845MR	Vdet-IC	3.8V±2%, -Reset ODO	SOT-23	16vdb	VD6	3h Tor
N84	DDTC142TE	Si-npn-Digi	Sw, 50V, 100mA, 150mW, 250MHz, R1=0.47k	SOT-523	16ta	-	3d Di
N84	DDTC142TU	Si-npn-Digi	Sw, 50V, 100mA, 200mW, 250MHz, R1=0.47k	SOT-323	16ta	-	3d Di
N85	XC61FN3812M	Vdet-IC	3.8V±2%, +Reset ODO, 200ms	SOT-23	16vdb	VD6	3d Tor
N85	XC61HN3812MR	Vdet-IC	3.8V±2%, -Reset ODO, 50..200ms	SOT-23	16vdc	VD6	3d Tor
N86	XC61FN3842M	Vdet-IC	3.8V±2%, +Reset ODO, 400ms	SOT-23	16vdb	VD6	3d Tor



SMD code	Type	Function	Short description	Case	Pinout	Sch. St.	Mnf.
N86	XC61HN3842MR	Vdet-IC	3.8V±2%, -Reset ODO, 80, 400ms	SOT-23	16vdc	VD6 3d	Tor
N87	XC61FN3852M	Vdet-IC	3.8V±2%, +Reset ODO, 50ms	SOT-23	16vdc	VD6 3d	Tor
N87	XC61HN3852MR	Vdet-IC	3.8V±2%, -Reset ODO, 1..50ms	SOT-23	16vdc	VD6 3d	Tor
N9	1SS372	Si-diode	Dual, Schottky, 10V, 100mA	SOT-323	16dl	- 3a	Tos
N9	1SS374	Si-diode	Dual, Schottky, 10V, 100mA	SC-59	16dl	- 3a	Tos
N9	BZX84-C24	Z-diode	22.8..25.6V, Zzt=70Q, Izt=20mA, 225mW	SOT-23	16dc	- 3a	Lge
N9	DAN222	Si-diode	Dual, Sw, 80V, 100mA, 150mW, <4ns	SOT-416	16dg	- 3b	Ons
N9	ELM7649LAB	Vdet-IC	4.9V±2%, -Reset PPO, 250ms	SOT-23	16vdc	VD7 3d	Elm
N9	KRC122S	Si-npn-Digi	Sw, 50V, 100mA, 200mW, 200MHz, R1/R2=100k/100k	SOT-23	16ta	- 3f	Kec
N9	KRC422	Si-npn-Digi	Sw, 50V, 100mA, 100mW, 200MHz, R1/R2=100k/100k	SOT-323	16ta	- 3f	Kec
N9	KRC422E	Si-npn-Digi	Sw, 50V, 100mA, 100mW, 200MHz, R1/R2=100k/100k	SOT-490	18ta	- 3f	Kec
N9	KRC422V	Si-npn-Digi	Sw, 50V, 100mA, 100mW, 200MHz, R1/R2=100k/100k	VSM	18ta	- 3f	Kec
N9	R1100D291C	LVR-IC	U-low Icc, 2.9V±2%, 180mA	SON1408-3	10vj	VR1 3d	Ric
N9	R3111N592C	Vdet-IC	5.9V±2%, -Reset ODO	SOT-23	16vdd	VD6 3d	Ric
N9	TC54VN3902ECB	Vdet-IC	3.9V±2%, -Reset ODO	SOT-23	16vdc	VD6 3a	Tcs
N9	XC61CN3902M	Vdet-IC	3.9V±1%, +Reset ODO	SOT-23	16vdc	VD6 3d	Tor
N9	XC6GN3902HR	Vdet-IC	3.9V, +Reset ODO	USP-3	17vdc	VD1 9b	Tor
N91	SO642	Si-npn	HV, Vid, 300V, 100mA, 310mW, B>25, 50MHz	SOT-23	16ta	- 3a	Ste
N93	XE61CN3945MR	Vdet-IC	3.9V±2%, -Reset ODO	SOT-23	16vdc	VD6 3h	Tor
N95	S72N25SF	Vdet-IC	2.5V, +Reset Open collector output	SOT-23F	18vdc	VD6 3b	Auk
N95	XC61FN3912M	Vdet-IC	3.9V±2%, +Reset ODO, 200ms	SOT-23	16vdc	VD6 3d	Tor
N95	XC61HN3912MR	Vdet-IC	3.9V±2%, -Reset ODO, 50..200ms	SOT-23	16vdc	VD6 3d	Tor
N96	XC61FN3942M	Vdet-IC	3.9V±2%, +Reset ODO, 400ms	SOT-23	16vdc	VD6 3d	Tor
N96	XC61HN3942MR	Vdet-IC	3.9V±2%, -Reset ODO, 80..400ms	SOT-23	16vdc	VD6 3d	Tor
N97	XC61FN3952M	Vdet-IC	3.9V±2%, +Reset ODO, 50ms	SOT-23	16vdc	VD6 3d	Tor
N97	XC61HN3952MR	Vdet-IC	3.9V±2%, -Reset ODO, 1..50ms	SOT-23	16vdc	VD6 3d	Tor
NA	2SC5374	Si-npn	VHF/UHF Osc/Amp, 20V, 100mA, 100mW, B>110, 5.2GHz	SMCP	16ta	- 3a	San
NA	2SC5375	Si-npn	VHF/UHF Osc/Amp, 20V, 100mA, 150mW, B>110, 5.2GHz	MCP	16ta	- 3a	San
NA	2SC5538	Si-npn	VHF/UHF, 20V, 100mA, 100mW, B=110..200, 5.2GHz	SSFP	18ta	- 3a	San
NA	BFS20	Si-npn	RF, 30V, 25mA, 250mW, B=85, 450MHz	SOT-23	16ta	- 3a	Sil
NA	ETC1810-5U	Vdet-IC	4.62V, -Reset PPO	SOT-23	16vdc	VD7 3a	Etc
NA	FMMTA05R	Si-npn	GP, 60V, 500mA, 350mW, B>100, >100MHz	SOT-23	16te	- 3a	Zx
NA	KRC101S	Si-npn-Digi	Sw, 50V, 100mA, 200mW, 200MHz, R1/R2=4k7/4k7	SOT-23	16ta	- 3f	Kec
NA	KRC401	Si-npn-Digi	Sw, 50V, 100mA, 100mW, 200MHz, R1/R2=4k7/4k7	SOT-323	16ta	- 3f	Kec
NA	KRC401E	Si-npn-Digi	Sw, 50V, 100mA, 100mW, 200MHz, R1/R2=4k7/4k7	SOT-490	18ta	- 3f	Kec
NA	KRC401V	Si-npn-Digi	Sw, 50V, 100mA, 100mW, 200MHz, R1/R2=4k7/4k7	VSM	18ta	- 3f	Kec
NA	MIC1810-5U	Vdet-IC	4.62V, -Reset PPO	SOT-23	16vda	VD7 3d	Mcr
NA	MIC1810-5UY	Vdet-IC	4.62V, -Reset PPO	SOT-23	16vda	VD7 3d	Mcr
NA	MMBT100	Si-npn	GP, 75V, 500mA, 350mW, B=80..400, 250MHz	SOT-23	16ta	- 3a	F
na	PT7M6246NLC3	Vdet-IC	4.6V±1.5%, -Reset ODO	SC-70	16vdc	VD6 3b	Pti
na	PT7M6246NLC3E	Vdet-IC	4.6V±1.5%, -Reset ODO, Lead free	SC-70	16vdc	VD6 3b	Pti
na	PT7M6246NLTA3	Vdet-IC	4.6V±1.5%, -Reset ODO	SOT-23	16vdc	VD6 3b	Pti
na	PT7M6246NLTA3E	Vdet-IC	4.6V±1.5%, -Reset ODO, Lead free	SOT-23	16vdc	VD6 3b	Pti
NA	RN1443A	Si-npn-Digi	Mute, 50V, 300mA, 300mW, R1=22k, B=200..700	SOT-346	16ta	- 3a	Tos
NA1	FN4A4M	Si-pnp-Digi	Sw, 60V, 100mA, 200mW, R1/R2=10k/10k	SC-59	16ta	- 3a	Nec
NA1	GN4A4M	Si-pnp-Digi	Sw, 60V, 100mA, 200mW, R1/R2=10k/10k	SOT-323	16ta	- 3a	Nec
NA1	MMBT100A	Si-npn	GP, 75V, 500mA, 350mW, B=240..600, 250MHz	SOT-23	16ta	- 3a	F
NAA	BC817-16	Si-npn	Sw, 50V, 800mA, 200mW, B=110..250, 100MHz	SOT-23	16ta	- 3a	Auk
NAA	BC817F-16	Si-pnp	Sw, 50V, 800mA, 200mW, B=110..250, 100MHz	SOT-23F	18ta	- 3a	Auk
NAB	BC817-25	Si-pnp	Sw, 50V, 800mA, 200mW, B=160..400, 100MHz	SOT-23	16ta	- 3a	Auk
NAB	BC817F-25	Si-pnp	Sw, 50V, 800mA, 200mW, B=160..400, 100MHz	SOT-23F	18ta	- 3a	Auk
NAC	BC817-40	Si-pnp	Sw, 50V, 800mA, 200mW, B=250..630, 100MHz	SOT-23	16ta	- 3a	Auk
NAC	BC817F-40	Si-pnp	Sw, 50V, 800mA, 200mW, B=250..630, 100MHz	SOT-23F	18ta	- 3a	Auk
NB	BF599	Si-npn	VHF, IF, 40V, 25mA, 200mW, B>40, 550MHz	SOT-23	16ta	- 3a	Sie
NB	CHT42PT	Si-npn	Vid, 300V, 500mA, B=40..300, 50MHz	SOT-23	16ta	- 3a	Chm
NB	CHTA42LPT	Si-npn	Vid, 300V, 500mA, B>40, 50MHz	SOT-23	16ta	- 3a	Chm
NB	ETC1810-10U	Vdet-IC	4.37V, -Reset PPO	SOT-23	16vdc	VD7 3a	Etc
NB	FMMTA55R	Si-pnp	AF-Drv, 60V, 500mA, 300mW, B>100, >50MHz	SOT-23	16te	- 3a	Zx
NB	KRC102S	Si-npn-Digi	Sw, 50V, 100mA, 200mW, 200MHz, R1/R2=10k/10k	SOT-23	16ta	- 3f	Kec
NB	KRC402	Si-npn-Digi	Sw, 50V, 100mA, 100mW, 200MHz, R1/R2=10k/10k	SOT-323	16ta	- 3f	Kec
NB	KRC402E	Si-npn-Digi	Sw, 50V, 100mA, 100mW, 200MHz, R1/R2=10k/10k	SOT-490	18ta	- 3f	Kec
NB	KRC402V	Si-npn-Digi	Sw, 50V, 100mA, 100mW, 200MHz, R1/R2=10k/10k	VSM	18ta	- 3f	Kec
NB	MIC1810-10U	Vdet-IC	4.37V, -Reset PPO	SOT-23	16vda	VD7 3d	Mcr
NB	MIC1810-10UY	Vdet-IC	4.37V, -Reset PPO	SOT-23	16vda	VD7 3d	Mcr
nb	PT7M6247CLC3	Vdet-IC	4.7V±1.5%, -Reset PPO	SC-70	16vdc	VD7 3b	Pti
nb	PT7M6247CLC3E	Vdet-IC	4.7V±1.5%, -Reset PPO, Lead free	SC-70	16vdc	VD7 3b	Pti
nb	PT7M6247CLTA3	Vdet-IC	4.7V±1.5%, -Reset PPO	SOT-23	16vdc	VD7 3b	Pti
nb	PT7M6247CLTA3E	Vdet-IC	4.7V±1.5%, -Reset PPO, Lead free	SOT-23	16vdc	VD7 3b	Pti
NB	RN1443B	Si-npn-Digi	Mute, 50V, 300mA, 300mW, R1=22k, B=350..1200	SOT-346	16ta	- 3a	Tos
NB1	FN4F4M	Si-pnp-Digi	Sw, 60V, 100mA, 200mW, R1/R2=22k/22k	SC-59	16ta	- 3a	Nec



SMD code	Type	Function	Short description	Case	Pinout	Sch.	St.	Mnf.
NB1	GN4F4M	Si-npn-Digi	Sw, 60V, 100mA, 200mW, R1/R2=22k/22k	SOT-323	16ta	-	3a	Nec
NC	2SC2411KPT-Q	Si-npn	AF, Sw, 32V, 500mA, B=120..270, 250MHz	SOT-23	16ta	-	3a	Chm
NC	ETC1810-15U	Vdet-IC	4.12V, -Reset PPO	SOT-23	16vdb	VD7	3a	Etc
NC	KRC103S	Si-npn-Digi	Sw, 50V, 100mA, 200mW, 200MHz, R1/R2=22k/22k	SOT-23	16ta	-	3f	Kec
NC	KRC403	Si-npn-Digi	Sw, 50V, 100mA, 100mW, 200MHz, R1/R2=22k/22k	SOT-323	16ta	-	3f	Kec
NC	KRC403E	Si-npn-Digi	Sw, 50V, 100mA, 100mW, 200MHz, R1/R2=22k/22k	SOT-490	18ta	-	3f	Kec
NC	KRC403V	Si-npn-Digi	Sw, 50V, 100mA, 100mW, 200MHz, R1/R2=22k/22k	VSM	18ta	-	3f	Kec
NC	MIC1810-15U	Vdet-IC	4.12V, -Reset PPO	SOT-23	16vda	VD7	3d	Mcr
NC	MIC1810-15UY	Vdet-IC	4.12V, -Reset PPO	SOT-23	16vda	VD7	3d	Mcr
nc	PT7M6247CHC3	Vdet-IC	4.7V±1.5%, +Reset PPO	SC-70	16vdc	VD7	3b	Pti
nc	PT7M6247CHC3E	Vdet-IC	4.7V±1.5%, +Reset PPO, Lead free	SC-70	16vdc	VD7	3b	Pti
nc	PT7M6247CHTA3	Vdet-IC	4.7V±1.5%, +Reset PPO	SOT-23	16vdb	VD7	3b	Pti
nc	PT7M6247CHTA3E	Vdet-IC	4.7V±1.5%, +Reset PPO, Lead free	SOT-23	16vdb	VD7	3b	Pti
NC1	FN4L4M	Si-npn-Digi	Sw, 60V, 100mA, 200mW, R1/R2=47k/47k	SC-59	16ta	-	3a	Nec
NC1	GN4L4M	Si-npn-Digi	Sw, 60V, 100mA, 200mW, R1/R2=47k/47k	SOT-323	16ta	-	3a	Nec
NCp	BF840	Si-npn	AM/FM-RF, 40V, 25mA, 250mW, B=67..222, 380MHz	SOT-23	16ta	-	3a	PhH
NCs	BF840	Si-npn	AM/FM-RF, 40V, 25mA, 250mW, B=67..222, 380MHz	SOT-23	16ta	-	3a	Sie
NCt	BF840	Si-npn	AM/FM-RF, 40V, 25mA, 250mW, B=67..222, 380MHz	SOT-23	16ta	-	3a	PhM
NCW	BF840	Si-npn	AM/FM-RF, 40V, 25mA, 250mW, B=67..222, 380MHz	SOT-23	16ta	-	3a	PhC
ND	2SC2412KPT-Q	Si-npn	AF, Sw, 50V, 150mA, B=120..270, 180MHz	SOT-23	16ta	-	3a	Chm
ND	2SC5539	Si-npn	VHF/UHF, 20V, 100mA, 100mW, B=90..200, 7.5Hz	SSFP	18ta	-	3a	San
ND	2SD1306-D	Si-npn	AF, Mute, 30V, 700mA, 150mW, B=250..500	SC-59A	16ta	-	3a	Ren
ND	BF841	Si-npn	AF, 40V, 25mA, 280mW, B=35..125, >380MHz	SOT-23	16ta	-	3a	Sie
ND	KRC104S	Si-npn-Digi	Sw, 50V, 100mA, 200mW, 200MHz, R1/R2=47k/47k	SOT-23	16ta	-	3f	Kec
ND	KRC404	Si-npn-Digi	Sw, 50V, 100mA, 100mW, 200MHz, R1/R2=47k/47k	SOT-323	16ta	-	3f	Kec
ND	KRC404E	Si-npn-Digi	Sw, 50V, 100mA, 100mW, 200MHz, R1/R2=47k/47k	SOT-490	18ta	-	3f	Kec
ND	KRC404V	Si-npn-Digi	Sw, 50V, 100mA, 100mW, 200MHz, R1/R2=47k/47k	VSM	18ta	-	3f	Kec
ND	MIC1815-10U	Vdet-IC	2.88V, -Reset PPO	SOT-23	16vda	VD7	3d	Mcr
ND	MIC1815-10UY	Vdet-IC	2.88V, -Reset PPO	SOT-23	16vda	VD7	3d	Mcr
nd	PT7M6247NLC3	Vdet-IC	4.7V±1.5%, -Reset ODO	SC-70	16vdc	VD6	3b	Pti
nd	PT7M6247NLC3E	Vdet-IC	4.7V±1.5%, -Reset ODO, Lead free	SC-70	16vdc	VD6	3b	Pti
nd	PT7M6247NLTA3	Vdet-IC	4.7V±1.5%, -Reset ODO	SOT-23	16vdb	VD6	3b	Pti
nd	PT7M6247NLTA3E	Vdet-IC	4.7V±1.5%, -Reset ODO, Lead free	SOT-23	16vdb	VD6	3b	Pti
ND1	FN4L3M	Si-npn-Digi	Sw, 60V, 100mA, 200mW, R1/R2=4k7/4k7	SC-59	16ta	-	3a	Nec
ND1	GN4L3M	Si-npn-Digi	Sw, 60V, 100mA, 200mW, R1/R2=4k7/4k7	SOT-323	16ta	-	3a	Nec
NDp	BF841	Si-npn	AF, 40V, 25mA, 280mW, B=35..125, >380MHz	SOT-23	16ta	-	3a	Phi
NE	2SC4097PT-Q	Si-npn	AF, Sw, 32V, 500mA, B=120..270, 250MHz	SOT-323	16ta	-	3a	Chm
NE	2SD1306-E	Si-npn	AF, Mute, 30V, 700mA, 150mW, B=400..800	SC-59A	16ta	-	3a	Ren
NE	KRC105S	Si-npn-Digi	Sw, 50V, 100mA, 200mW, 200MHz, R1/R2=2K2/47k	SOT-23	16ta	-	3f	Kec
NE	KRC405	Si-npn-Digi	Sw, 50V, 100mA, 100mW, 200MHz, R1/R2=2K2/47k	SOT-323	16ta	-	3f	Kec
NE	KRC405E	Si-npn-Digi	Sw, 50V, 100mA, 100mW, 200MHz, R1/R2=2K2/47k	SOT-490	18ta	-	3f	Kec
NE	KRC405V	Si-npn-Digi	Sw, 50V, 100mA, 100mW, 200MHz, R1/R2=2K2/47k	VSM	18ta	-	3f	Kec
NE	MIC1815-20U	Vdet-IC	2.55V, -Reset PPO	SOT-23	16vda	VD7	3d	Mcr
NE	MIC1815-20UY	Vdet-IC	2.55V, -Reset PPO	SOT-23	16vda	VD7	3d	Mcr
ne	PT7M6248CLC3	Vdet-IC	4.8V±1.5%, -Reset PPO	SC-70	16vdc	VD7	3b	Pti
ne	PT7M6248CLC3E	Vdet-IC	4.8V±1.5%, -Reset PPO, Lead free	SC-70	16vdc	VD7	3b	Pti
ne	PT7M6248CLTA3	Vdet-IC	4.8V±1.5%, -Reset PPO	SOT-23	16vdb	VD7	3b	Pti
ne	PT7M6248CLTA3E	Vdet-IC	4.8V±1.5%, -Reset PPO, Lead free	SOT-23	16vdb	VD7	3b	Pti
NE1	FN4L3N	Si-npn-Digi	Sw, 60V, 100mA, 200mW, R1/R2=4k7/10k	SC-59	16ta	-	3a	Nec
NE1	GN4L3N	Si-npn-Digi	Sw, 60V, 100mA, 200mW, R1/R2=4k7/10k	SOT-323	16ta	-	3a	Nec
NF	2SC5645	Si-npn	UHF-S-band LN, 9V, 30mA, 100mW, B=100..160, 10GHz	SMCP	18ta	-	3a	San
NF	2SC5646	Si-npn	UHF-S-band LN, 9V, 30mA, 100mW, B=100..160, 10GHz	SSFP	18ta	-	3a	San
NF	KRC106S	Si-npn-Digi	Sw, 50V, 100mA, 200mW, 200MHz, R1/R2=4k7/47k	SOT-23	16ta	-	3f	Kec
NF	KRC406	Si-npn-Digi	Sw, 50V, 100mA, 100mW, 200MHz, R1/R2=4k7/47k	SOT-323	16ta	-	3f	Kec
NF	KRC406E	Si-npn-Digi	Sw, 50V, 100mA, 100mW, 200MHz, R1/R2=4k7/47k	SOT-490	18ta	-	3f	Kec
NF	KRC406V	Si-npn-Digi	Sw, 50V, 100mA, 100mW, 200MHz, R1/R2=4k7/47k	VSM	18ta	-	3f	Kec
nf	PT7M6248CHC3	Vdet-IC	4.8V±1.5%, +Reset PPO	SC-70	16vdc	VD7	3b	Pti
nf	PT7M6248CHC3E	Vdet-IC	4.8V±1.5%, +Reset PPO, Lead free	SC-70	16vdc	VD7	3b	Pti
nf	PT7M6248CHTA3	Vdet-IC	4.8V±1.5%, +Reset PPO	SOT-23	16vdb	VD7	3b	Pti
nf	PT7M6248CHTA3E	Vdet-IC	4.8V±1.5%, +Reset PPO, Lead free	SOT-23	16vdb	VD7	3b	Pti
NF1	FN4L3Z	Si-npn-Digi	Sw, 60V, 100mA, 200mW, R1=4k7	SC-59	16ta	-	3a	Nec
NF1	GN4L3Z	Si-npn-Digi	Sw, 60V, 100mA, 200mW, R1=4k7	SOT-323	16ta	-	3a	Nec
NG	CH3904N1PT	Si-npn	AF, Sw, 40V, 200mA, B=100..300, 300MHz	FBPT-923	17ta	-	9a	Chm
NG	CH3904WPT	Si-npn	AF, Sw, 40V, 200mA, B=100..300, 300MHz	SOT-323	16ta	-	3a	Chm
ng	PT7M6248NLC3	Vdet-IC	4.8V±1.5%, -Reset ODO	SC-70	16vdc	VD6	3b	Pti
ng	PT7M6248NLC3E	Vdet-IC	4.8V±1.5%, -Reset ODO, Lead free	SC-70	16vdc	VD6	3b	Pti
ng	PT7M6248NLTA3	Vdet-IC	4.8V±1.5%, -Reset ODO	SOT-23	16vdb	VD6	3b	Pti
ng	PT7M6248NLTA3E	Vdet-IC	4.8V±1.5%, -Reset ODO, Lead free	SOT-23	16vdb	VD6	3b	Pti
NG1	FN4A3Q	Si-npn-Digi	Sw, 60V, 100mA, 200mW, R1/R2=1k/10k	SC-59	16ta	-	3a	Nec
NG1	GN4A3Q	Si-npn-Digi	Sw, 60V, 100mA, 200mW, R1/R2=1k/10k	SOT-323	16ta	-	3a	Nec



SMD code	Type	Function	Short description	Case	Pinout	Sch.	St.	Mnf.
NH	KRC107S	Si-npn-Digi	Sw, 50V, 100mA, 200mW, 200MHz, R1/R2=10k/47k	SOT-23	16ta	-	3f	Kec
NH	KRC407	Si-npn-Digi	Sw, 50V, 100mA, 100mW, 200MHz, R1/R2=10k/47k	SOT-323	16ta	-	3f	Kec
NH	KRC407E	Si-npn-Digi	Sw, 50V, 100mA, 100mW, 200MHz, R1/R2=10k/47k	SOT-490	18ta	-	3f	Kec
NH	KRC407V	Si-npn-Digi	Sw, 50V, 100mA, 100mW, 200MHz, R1/R2=10k/47k	VSM	18ta	-	3f	Kec
nh	PT7M6249CLC3	Vdet-IC	4.9V±1.5%, -Reset PPO	SC-70	16vdc	VD7	3b	Pti
nh	PT7M6249CLC3E	Vdet-IC	4.9V±1.5%, -Reset PPO, Lead free	SC-70	16vdc	VD7	3b	Pti
nh	PT7M6249CLTA3	Vdet-IC	4.9V±1.5%, -Reset PPO	SOT-23	16vdb	VD7	3b	Pti
nh	PT7M6249CLTA3E	Vdet-IC	4.9V±1.5%, -Reset PPO, Lead free	SOT-23	16vdb	VD7	3b	Pti
NH1	FN4A4P	Si-pnp-Digi	Sw, 60V, 100mA, 200mW, R1/R2=10k/47k	SC-59	16ta	-	3a	Nec
NH1	GN4A4P	Si-pnp-Digi	Sw, 60V, 100mA, 200mW, R1/R2=10k/47k	SOT-323	16ta	-	3a	Nec
NI	CHBTA13PT	Si-npn-Darl	AF, Sw, 30V, 1.2A, B>10000, 125MHz	SOT-23	16ta	-	3a	Chm
NI	KRC108S	Si-npn-Digi	Sw, 50V, 100mA, 200mW, 200MHz, R1/R2=22k/47k	SOT-23	16ta	-	3f	Kec
NI	KRC408	Si-npn-Digi	Sw, 50V, 100mA, 100mW, 200MHz, R1/R2=22k/47k	SOT-323	16ta	-	3f	Kec
NI	KRC408E	Si-npn-Digi	Sw, 50V, 100mA, 100mW, 200MHz, R1/R2=22k/47k	SOT-490	18ta	-	3f	Kec
NI	KRC408V	Si-npn-Digi	Sw, 50V, 100mA, 100mW, 200MHz, R1/R2=22k/47k	VSM	18ta	-	3f	Kec
ni	PT7M6249CHC3	Vdet-IC	4.9V±1.5%, +Reset PPO	SC-70	16vdc	VD7	3b	Pti
ni	PT7M6249CHC3E	Vdet-IC	4.9V±1.5%, +Reset PPO, Lead free	SC-70	16vdc	VD7	3b	Pti
ni	PT7M6249CHTA3	Vdet-IC	4.9V±1.5%, +Reset PPO	SOT-23	16vdb	VD7	3b	Pti
ni	PT7M6249CHTA3E	Vdet-IC	4.9V±1.5%, +Reset PPO, Lead free	SOT-23	16vdb	VD7	3b	Pti
NJ	KRC109S	Si-npn-Digi	Sw, 50V, 100mA, 200mW, 200MHz, R1/R2=47k/22k	SOT-23	16ta	-	3f	Kec
NJ	KRC409	Si-npn-Digi	Sw, 50V, 100mA, 100mW, 200MHz, R1/R2=47k/22k	SOT-323	16ta	-	3f	Kec
NJ	KRC409E	Si-npn-Digi	Sw, 50V, 100mA, 100mW, 200MHz, R1/R2=47k/22k	SOT-490	18ta	-	3f	Kec
NJ	KRC409V	Si-npn-Digi	Sw, 50V, 100mA, 100mW, 200MHz, R1/R2=47k/22k	VSM	18ta	-	3f	Kec
nj	PT7M6249NLC3	Vdet-IC	4.9V±1.5%, -Reset ODO	SC-70	16vdc	VD6	3b	Pti
nj	PT7M6249NLC3E	Vdet-IC	4.9V±1.5%, -Reset ODO, Lead free	SC-70	16vdc	VD6	3b	Pti
nj	PT7M6249NLTA3	Vdet-IC	4.9V±1.5%, -Reset ODO	SOT-23	16vdb	VD6	3b	Pti
nj	PT7M6249NLTA3E	Vdet-IC	4.9V±1.5%, -Reset ODO, Lead free	SOT-23	16vdb	VD6	3b	Pti
NJ1	FN4F4N	Si-pnp-Digi	Sw, 60V, 100mA, 200mW, R1/R2=22k/47k	SC-59	16ta	-	3a	Nec
NJ1	GN4F4N	Si-pnp-Digi	Sw, 60V, 100mA, 200mW, R1/R2=22k/47k	SOT-323	16ta	-	3a	Nec
NK	KRC110S	Si-npn-Digi	Sw, 50V, 100mA, 200mW, 200MHz, R1=4k7	SOT-23	16ta	-	3f	Kec
NK	KRC410	Si-npn-Digi	Sw, 50V, 100mA, 100mW, 200MHz, R1=4k7	SOT-323	16ta	-	3f	Kec
NK	KRC410E	Si-npn-Digi	Sw, 50V, 100mA, 100mW, 200MHz, R1=4k7	SOT-490	18ta	-	3f	Kec
NK	KRC410V	Si-npn-Digi	Sw, 50V, 100mA, 100mW, 200MHz, R1=4k7	VSM	18ta	-	3f	Kec
nk	PT7M6250CLC3	Vdet-IC	5.0V±1.5%, -Reset PPO	SC-70	16vdc	VD7	3b	Pti
nk	PT7M6250CLC3E	Vdet-IC	5.0V±1.5%, -Reset PPO, Lead free	SC-70	16vdc	VD7	3b	Pti
nk	PT7M6250CLTA3	Vdet-IC	5.0V±1.5%, -Reset PPO	SOT-23	16vdb	VD7	3b	Pti
nk	PT7M6250CLTA3E	Vdet-IC	5.0V±1.5%, -Reset PPO, Lead free	SOT-23	16vdb	VD7	3b	Pti
NK1	FN4L4L	Si-pnp-Digi	Sw, 60V, 100mA, 200mW, R1/R2=47k/22k	SC-59	16ta	-	3a	Nec
NK1	GN4L4L	Si-pnp-Digi	Sw, 60V, 100mA, 200mW, R1/R2=47k/22k	SOT-323	16ta	-	3a	Nec
NL	2SA1520	Si-pnp-Digi	Sw, 50V, 500mA, 200mW, 250MHz, R1/R2=2k2/10k	SOT-23	16ta	-	3a	San
nl	PT7M6250CHC3	Vdet-IC	5.0V±1.5%, +Reset PPO	SC-70	16vdc	VD7	3b	Pti
nl	PT7M6250CHC3E	Vdet-IC	5.0V±1.5%, +Reset PPO, Lead free	SC-70	16vdc	VD7	3b	Pti
nl	PT7M6250CHTA3	Vdet-IC	5.0V±1.5%, +Reset PPO	SOT-23	16vdb	VD7	3b	Pti
nl	PT7M6250CHTA3E	Vdet-IC	5.0V±1.5%, +Reset PPO, Lead free	SOT-23	16vdb	VD7	3b	Pti
NL1	FN4A4Z	Si-pnp-Digi	Sw, 60V, 100mA, 200mW, R1=10k	SC-59	16ta	-	3a	Nec
NL1	GN4A4Z	Si-pnp-Digi	Sw, 60V, 100mA, 200mW, R1=10k	SOT-323	16ta	-	3a	Nec
NLN	ELM7534CEB	Vdet-IC	3.4V±2%, +Reset PPO	SC-70	16vdb	VD7	3d	Elm
NLN	ELM7534NEB	Vdet-IC	3.4V±2%, +Reset ODO	SC-70	16vdb	VD6	3d	Elm
NM	KRC111S	Si-npn-Digi	Sw, 50V, 100mA, 200mW, 200MHz, R1=10k	SOT-23	16ta	-	3f	Kec
NM	KRC411	Si-npn-Digi	Sw, 50V, 100mA, 100mW, 200MHz, R1=10k	SOT-323	16ta	-	3f	Kec
NM	KRC411E	Si-npn-Digi	Sw, 50V, 100mA, 100mW, 200MHz, R1=10k	SOT-490	18ta	-	3f	Kec
NM	KRC411V	Si-npn-Digi	Sw, 50V, 100mA, 100mW, 200MHz, R1=10k	VSM	18ta	-	3f	Kec
nm	PT7M6250NLC3	Vdet-IC	5.0V±1.5%, -Reset ODO	SC-70	16vdc	VD6	3b	Pti
nm	PT7M6250NLC3E	Vdet-IC	5.0V±1.5%, -Reset ODO, Lead free	SC-70	16vdc	VD6	3b	Pti
nm	PT7M6250NLTA3	Vdet-IC	5.0V±1.5%, -Reset ODO	SOT-23	16vdb	VD6	3b	Pti
nm	PT7M6250NLTA3E	Vdet-IC	5.0V±1.5%, -Reset ODO, Lead free	SOT-23	16vdb	VD6	3b	Pti
NM1	FN4F4Z	Si-pnp-Digi	Sw, 60V, 100mA, 200mW, R1=22k	SC-59	16ta	-	3a	Nec
NM1	GN4F4Z	Si-pnp-Digi	Sw, 60V, 100mA, 200mW, R1=22k	SOT-323	16ta	-	3a	Nec
NN	KRC112S	Si-npn-Digi	Sw, 50V, 100mA, 200mW, 200MHz, R1=100k	SOT-23	16ta	-	3f	Kec
NN	KRC412	Si-npn-Digi	Sw, 50V, 100mA, 100mW, 200MHz, R1=100k	SOT-323	16ta	-	3f	Kec
NN	KRC412E	Si-npn-Digi	Sw, 50V, 100mA, 100mW, 200MHz, R1=100k	SOT-490	18ta	-	3f	Kec
NN	KRC412V	Si-npn-Digi	Sw, 50V, 100mA, 100mW, 200MHz, R1=100k	VSM	18ta	-	3f	Kec
NN1	FN4L4Z	Si-pnp-Digi	Sw, 60V, 100mA, 200mW, R1=47k	SC-59	16ta	-	3a	Nec
NN1	GN4L4Z	Si-pnp-Digi	Sw, 60V, 100mA, 200mW, R1=47k	SOT-323	16ta	-	3a	Nec
NN5	2SC5310-5	Si-npn	DC/DC-Conv, 30V, 1A, 250mW, B=135..270, 150MHz	SOT-23	16ta	-	3a	San
NN6	2SC5310-6	Si-npn	DC/DC-Conv, 30V, 1A, 250mW, B=200..400, 150MHz	SOT-23	16ta	-	3a	San
NNA	KRC234S	Si-npn-Digi	Sw, 30V, 600mA, 200mW, 200MHz, R1=4.7k	SOT-23	16ta	-	3f	Kec
NNB	KRC235S	Si-npn-Digi	Sw, 30V, 600mA, 200mW, 200MHz, R1=6.8k	SOT-23	16ta	-	3f	Kec
NO	2SC3138-O	Si-npn	HV, Sw, 200V, 50mA, 150mW, 100MHz, B=70..140	SC-59	16ta	-	3a	Tos
NO	KRC113S	Si-npn-Digi	Sw, 50V, 100mA, 200mW, 200MHz, R1=22k	SOT-23	16ta	-	3f	Kec



SMD code	Type	Function	Short description	Case	Pinout	Sch.	St.	Mnf.
NO	KRC413	Si-nprn-Digi	Sw, 50V, 100mA, 100mW, 200MHz, R1=22k	SOT-323	16ta	-	3f	Kec
NO	KRC413E	Si-nprn-Digi	Sw, 50V, 100mA, 100mW, 200MHz, R1=22k	SOT-490	18ta	-	3f	Kec
NO	KRC413V	Si-nprn-Digi	Sw, 50V, 100mA, 100mW, 200MHz, R1=22k	VSM	18ta	-	3f	Kec
NP	KRC114S	Si-nprn-Digi	Sw, 50V, 100mA, 200mW, 200MHz, R1=47k	SOT-23	16ta	-	3f	Kec
NP	KRC414	Si-nprn-Digi	Sw, 50V, 100mA, 100mW, 200MHz, R1=47k	SOT-323	16ta	-	3f	Kec
NP	KRC414E	Si-nprn-Digi	Sw, 50V, 100mA, 100mW, 200MHz, R1=47k	SOT-490	18ta	-	3f	Kec
NP	KRC414V	Si-nprn-Digi	Sw, 50V, 100mA, 100mW, 200MHz, R1=47k	VSM	18ta	-	3f	Kec
NP1	FN4F3M	Si-pnp-Digi	Sw, 60V, 100mA, 200mW, R1/R2=2k2/2k2	SC-59	16ta	-	3a	Nec
NP1	GN4F3M	Si-pnp-Digi	Sw, 60V, 100mA, 200mW, R1/R2=2k2/2k2	SOT-323	16ta	-	3a	Nec
NQ	2SC6114-Q	Si-nprn	AF, 50V, 100mA, 150mW, B=120..270, 130MHz	VMN3	19ta	-	3k	Rhm
NQ	KRC241S	Si-nprn-Digi	Sw, 50V, 800mA, 200mW, 200MHz, R1/R2=1k/1k	SOT-23	16ta	-	3f	Kec
NQ1	FN4F3P	Si-pnp-Digi	Sw, 60V, 100mA, 200mW, R1/R2=2k2/10k	SC-59	16ta	-	3a	Nec
NQ1	GN4F3P	Si-pnp-Digi	Sw, 60V, 100mA, 200mW, R1/R2=2k2/10k	SOT-323	16ta	-	3a	Nec
NR	2SC6114-R	Si-nprn	AF, 50V, 100mA, 150mW, B=180..390, 130MHz	VMN3	19ta	-	3k	Rhm
NR	2SD1679-R	Si-nprn	AF, 18V, 500mA, 250mW, B=200..350, 170MHz	SC-59	16ta	-	3a	Pan
NR	KRC242S	Si-nprn-Digi	Sw, 50V, 800mA, 200mW, 200MHz, R1/R2=2.2k/2.2k	SOT-23	16ta	-	3f	Kec
NR1	FN4F3R	Si-pnp-Digi	Sw, 60V, 100mA, 200mW, R1/R2=2k2/47k	SC-59	16ta	-	3a	Nec
NR1	GN4F3R	Si-pnp-Digi	Sw, 60V, 100mA, 200mW, R1/R2=2k2/47k	SOT-323	16ta	-	3a	Nec
NS	2SB1527	Si-pnp-Digi+Di	Motor-Drv, 20V, 800mA, 200mW, B=200..350, Rbe=1kΩ	SOT-23	16ta	-	3a	San
NS	2SD1679-S	Si-nprn	AF, 18V, 500mA, 250mW, B=300..500, 170MHz	SC-59	16ta	-	3a	Pan
NS	KRC243S	Si-nprn-Digi	Sw, 50V, 800mA, 200mW, 200MHz, R1/R2=4.7k/4.7k	SOT-23	16ta	-	3f	Kec
NS	TN0200TS	n-MOSFET-e	V-MOS, LogL, 20V, 1.2A, <0.4Ω	SOT-23	16fh	-	3a	Six
NS1	FN4A4L	Si-pnp-Digi	Sw, 60V, 100mA, 200mW, R1/R2=10k/4k7	SC-59	16ta	-	3a	Nec
NS1	GN4A4L	Si-pnp-Digi	Sw, 60V, 100mA, 200mW, R1/R2=10k/4k7	SOT-323	16ta	-	3a	Nec
NS2	DMN2114SN	n-MOSFET-e*	Sw, 20V, 1.2A, 500mW, 0.1Ω(500mA), 10/50ns	SC-59	16fh	-	3c	Di
NS5	2SA1973-5	Si-pnp	DC/DC-Conv, 30V, 1A, 250mW, B=135..240, 150MHz	SOT-23	16ta	-	3a	San
NS6	2SA1973-6	Si-pnp	DC/DC-Conv, 30V, 1A, 250mW, B=200..400, 150MHz	SOT-23	16ta	-	3a	San
NT	2SD1679-T	Si-nprn	AF, 18V, 500mA, 250mW, B=400..800, 170MHz	SC-59	16ta	-	3a	Pan
NT	CHT2222T1PT	Si-nprn	AF, Sw, 40V, 600mA, B=100..300, 300MHz	FBPT-523	17ta	-	9a	Chm
NT	CHT2222T2PT	Si-nprn	AF, Sw, 40V, 600mA, B=100..300, 300MHz	SOT-416	16ta	-	3a	Chm
NT	CHT4401TPT	Si-nprn	AF, Sw, 40V, 600mA, B=100..300, 250MHz	SOT-416	16ta	-	3a	Chm
NT	KRC244S	Si-nprn-Digi	Sw, 50V, 800mA, 200mW, 200MHz, R1/R2=10k/10k	SOT-23	16ta	-	3f	Kec
NT1	FN4L4K	Si-pnp-Digi	Sw, 60V, 100mA, 200mW, R1/R2=47k/10k	SC-59	16ta	-	3a	Nec
NT1	GN4L4K	Si-pnp-Digi	Sw, 60V, 100mA, 200mW, R1/R2=47k/10k	SOT-323	16ta	-	3a	Nec
NU	2SD1781KPT-R	Si-nprn	AF, Sw, 32V, 800mA, B=180..390, 150MHz	SOT-23	16ta	-	3a	Chm
NU	KRC245S	Si-nprn-Digi	Sw, 50V, 800mA, 200mW, 200MHz, R1/R2=1k/10k	SOT-23	16ta	-	3f	Kec
NV	CH847BPT-Q	Si-nprn	AF, Sw, 45V, 100mA, B=110..220, 200MHz	SOT-23	16ta	-	3a	Chm
NV	KRC246S	Si-nprn-Digi	Sw, 50V, 800mA, 200mW, 200MHz, R1/R2=2.2k/10k	SOT-23	16ta	-	3f	Kec
NW	CH847BPT-S	Si-nprn	AF, Sw, 45V, 100mA, B=420..800, 200MHz	SOT-23	16ta	-	3a	Chm
NW	KRC231S	Si-nprn-Digi	Sw, 30V, 600mA, 200mW, 200MHz, R1=2.2k	SOT-23	16ta	-	3f	Kec
NY	2SC3138-Y	Si-nprn	HV, Sw, 200V, 50mA, 150mW, 100MHz, B=120..240	SC-59	16ta	-	3a	Tos
NY	KRC232S	Si-nprn-Digi	Sw, 30V, 600mA, 200mW, 200MHz, R1=5.6k	SOT-23	16ta	-	3f	Kec
NY2	2SC3774-2	Si-nprn	UHF, LN, 20V, 70mA, 250mW, 5GHz, B=40..80	SOT-23	16ta	-	3a	San
NY2	2SC4404-2	Si-nprn	UHF, Osc, 25V, 70mA, 150mW, B=40..80, 5GHz	MCP	16ta	-	3a	San
NY3	2SC3774-3	Si-nprn	UHF, LN, 20V, 70mA, 250mW, 5GHz, B=60..120	SOT-23	16ta	-	3a	San
NY3	2SC4404-3	Si-nprn	UHF, Osc, 25V, 70mA, 150mW, B=60..120, 5GHz	MCP	16ta	-	3a	San
NY4	2SC3774-4	Si-nprn	UHF, LN, 20V, 70mA, 250mW, 5GHz, B=100..200	SOT-23	16ta	-	3a	San
NY4	2SC4404-4	Si-nprn	UHF, Osc, 25V, 70mA, 150mW, B=100..200, 5GHz	MCP	16ta	-	3a	San
NZ	BFS20R	Si-nprn	RF, 30V, 25mA, 250mW, B=85, 450MHz	SOT-23	16ta	-	3a	Sie
NZ	KRC233S	Si-nprn-Digi	Sw, 30V, 600mA, 200mW, 200MHz, R1=10k	SOT-23	16ta	-	3f	Kec
o	AX6903AA	Vdet-IC	4.63V±1.5%, -Reset PPO	SC-70	16vda	VD7	3b	Axl
O15	2SA1609-15	Si-pnp	GP, 160V, 50mA, B=135..270, 80MHz	SOT-23	16ta	-	3a	Nec
O16	2SA1609-16	Si-pnp	GP, 160V, 50mA, B=200..400, 80MHz	SOT-23	16ta	-	3a	Nec
O17	2SA1609-17	Si-pnp	GP, 160V, 50mA, B=300..600, 80MHz	SOT-23	16ta	-	3a	Nec
O1s	BBY66-05-01	C-diode	Dual, VCO-Tuning, 12V, 50mA, 12.7..68.5pF(4.5..1V)	SOT-23	16dg	-	3c	Inf
O2s	BBY66-05-02	C-diode	Dual, VCO-Tuning, 12V, 50mA, 12.7..71.5pF(4.5..1V)	SOT-23	16dg	-	3c	Inf
O4	2SA1331-4	Si-pnp	Sw, Hi-Sp, 60V, 150mA, 150mW, 100MHz, B=100..200	SOT-23	16ta	-	3a	San
O5	2SA1330-5	Si-pnp	Sw, Amp, HV, 200V, 100mA, 200mW, 120MHz, B=90..180	SOT-23	16ta	-	3a	Nec
O5	2SA1331-5	Si-pnp	Sw, Hi-Sp, 60V, 150mA, 150mW, 100MHz, B=140..280	SOT-23	16ta	-	3a	San
O6	2SA1330-6	Si-pnp	Sw, Amp, HV, 200V, 100mA, 200mW, 120MHz, B=135..270	SOT-23	16ta	-	3a	Nec
O6	2SA1331-6	Si-pnp	Sw, Hi-Sp, 60V, 150mA, 150mW, 100MHz, B=200..400	SOT-23	16ta	-	3a	San
O7	2SA1330-7	Si-pnp	Sw, Amp, HV, 200V, 100mA, 200mW, 120MHz, B=200..450	SOT-23	16ta	-	3a	Nec
O72	SO3903R	Si-nprn	GP, 60V, 200mA, 250mW, B=50..150, >300MHz	SOT-23	16ta	-	3a	Ste
O80	SO5551R	Si-nprn	GP, 180V, 200mA, 200mW, B=80..250, <300MHz	SOT-23	16te	-	3a	Ste
O9	1SS377	Si-diode	Dual, Schottky, 10V, 100mA	SC-59	16dg	-	3a	Tos
O9	1SS378	Si-diode	Dual, Schottky, 10V, 100mA	SOT-323	16dg	-	3a	Tos
O9	1SS385	Si-diode	Dual, Schottky, 10V, 100mA	SOT-416	16dg	-	3a	Tos
O9	1SS385F	Si-diode	Dual, Schottky, 10V, 100mA	SOT-490	18dg	-	3a	Tos
OBs	BBY66-05W	C-diode	Dual, VCO-Tuning, 12V, 50mA, 12.7..68.7pF(4.5..1V)	SOT-323	16dg	-	3c	Inf
OCs	BAR50-05	PIN-diode	Dual, RF-Att, 50V, 100mA, 250mW, V<1.1V(50mA), <0.5pF	SOT-23	16dg	-	3c	Inf



SMD code	Type	Function	Short description	Case	Pinout	Sch. St.	Mnf.
OL	2SA1521	Si-pnp-Digi	Sw, 50V, 500mA, 200mW, 250MHz, R1/R2=2k2/2k2	SOT-23	16ta	-	3a San
OO	2SA1255-0	Si-pnp	HV, 200V, 50mA, 150mW, B=70..140, 100MHz	SC-59	16ta	-	3a Tos
OT2	2SC4364-2	Si-npn	UHF, Mix/Osc, 25V, 30mA, 250mW, B=40..80, 3GHz	CP	16ta	-	3a San
OT2	2SC4401-2	Si-npn	UHF, Mix/Osc, 25V, 30mA, 150mW, B=40..80, 3GHz	MCP	16ta	-	3a San
OT3	2SC4364-3	Si-npn	UHF, Mix/Osc, 25V, 30mA, 250mW, B=60..120, 3GHz	CP	16ta	-	3a San
OT3	2SC4401-3	Si-npn	UHF, Mix/Osc, 25V, 30mA, 150mW, B=60..120, 3GHz	MCP	16ta	-	3a San
OT4	2SC4364-4	Si-npn	UHF, Mix/Osc, 25V, 30mA, 250mW, B=100..200, 3GHz	CP	16ta	-	3a San
OT4	2SC4401-4	Si-npn	UHF, Mix/Osc, 25V, 30mA, 150mW, B=100..200, 3GHz	MCP	16ta	-	3a San
OY	2SA1255-Y	Si-pnp	HV, 200V, 50mA, 150mW, B=120..240, 100MHz	SC-59	16ta	-	3a Tos
OY2	2SC3775-2	Si-npn	UHF, LN, 20V, 100mA, 250mW, 5GHz, B=40..80	SOT-23	16ta	-	3a San
OY2	2SC4405-2	Si-npn	UHF, LN, 20V, 100mA, 150mW, B=40..80, 5GHz	MCP	16ta	-	3a San
OY3	2SC3775-3	Si-npn	UHF, LN, 20V, 100mA, 250mW, 5GHz, B=60..120	SOT-23	16ta	-	3a San
OY3	2SC4405-3	Si-npn	UHF, LN, 20V, 100mA, 150mW, B=60..120, 5GHz	MCP	16ta	-	3a San
OY4	2SC3775-4	Si-npn	UHF, LN, 20V, 100mA, 250mW, 5GHz, B=100..200	SOT-23	16ta	-	3a San
OY4	2SC4405-4	Si-npn	UHF, LN, 20V, 100mA, 150mW, B=100..200, 5GHz	MCP	16ta	-	3a San
P	2SB1197-P	Si-pnp	AF, 40V, 800mA, 200mW, B=82..180, >50MHz	SOT-23	16ta	-	3a Wtr
p	AX6903BA	Vdet-IC	4.38V±1.5%, -Reset PPO	SC-70	16vda	VD7	3b Axl
P	DAN202U	Si-diode	Dual, Sw, 80V, 300mA, 200mW, <1.5ns	SOT-323	16dg	-	3i Rhm
P	DAP202U	Si-diode	Dual, Sw, 80V, 300mA, 200mW, <1.5ns	SOT-323	16df	-	3i Rhm
P	DAP222	Si-diode	Dual, Sw, 80V, 300mA, 150mW, <1.5ns	SOT-416	16df	-	3i Rhm
P	SB05W05C	Si-diode	Dual, SBR, HF, 50V, 500mA, Vf<0.55V(500mA), 24pF, 10ns	CP	16dg	-	3a San
P0	ELM7620HCB	Vdet-IC	2.0V±2%, +Reset PPO, 150ms	SOT-23	16vdc	VD7	3d Elm
P0	ELM9720CBB	Vdet-IC	2.0V±2.5%, +Reset PPO	SOT-23	16vdb	VD7	3d Elm
P0	R1100D301C	LVR-IC	U-low lcc, 3V±2%, 180mA	SON1408-3	18vj	VR1	3d Ric
P0	R3111N602C	Vdet-IC	6V±2%, -Reset ODO	SOT-23	16vdd	VD6	3d Ric
P0	R3130N40HC	Vdet-IC	4V, -Reset ODO, 400ms	SOT-23	16vdc	VD6	3b Ric
P0	TC54VN4002ECB	Vdet-IC	4.0V±2%, -Reset ODO	SOT-23	16vdb	VD6	3a Tcs
P0	TP0101T	p-MOSFET-e	V-MOS, LogL, 12V, 3A, 1W, <0.65Ω	SOT-23	16fh	-	3a Six
P0	XC61CN4002M	Vdet-IC	4V±1%, +Reset ODO	SOT-23	16vdb	VD6	3d Tor
P0	XC6GN4002HR	Vdet-IC	4.0V, +Reset ODO	USP-3	17vdc	VD1	9b Tor
P01	DDTA113TCA	Si-pnp-Digi	Sw, 50V, 100mA, 200mW, 250MHz, R1=1k	SOT-23	16ta	-	3d Di
P01	DDTA113TE	Si-pnp-Digi	Sw, 50V, 100mA, 150mW, 250MHz, R1=1k	SOT-523	16ta	-	3d Di
P01	DDTA113TKA	Si-pnp-Digi	Sw, 50V, 100mA, 200mW, 250MHz, R1=1k	SC-59	16ta	-	3d Di
P01	DDTA113TUA	Si-pnp-Digi	Sw, 50V, 100mA, 200mW, 250MHz, R1=1k	SOT-323	16ta	-	3d Di
p01	PDTA143ET	Si-pnp-Digi	Sw, 50V, 100mA, 250mW, R1/R2=4.7k/4.7k	SOT-23	16ta	-	3a PhH
p01	PDTA143EU	Si-pnp-Digi	Sw, 50V, 100mA, 200mW, R1/R2=4.7k/4.7k	SOT-323	16ta	-	3a PhH
P01	SO2906	Si-pnp	GP, 60V, 600mA, 400mW, >200MHz, B=40	SOT-23	16ta	-	3d Ste
P02	DDTA113ZCA	Si-pnp-Digi	Sw, 50V, 100mA, 200mW, 250MHz, R1/R2=1k/10k	SOT-23	16ta	-	3d Di
P02	DDTA113ZE	Si-pnp-Digi	Sw, 50V, 100mA, 150mW, 250MHz, R1/R2=1k/10k	SOT-523	16ta	-	3d Di
P02	DDTA113ZKA	Si-pnp-Digi	Sw, 50V, 100mA, 200mW, 250MHz, R1/R2=1k/10k	SC-59	16ta	-	3d Di
P02	DDTA113ZUA	Si-pnp-Digi	Sw, 50V, 100mA, 200mW, 250MHz, R1/R2=1k/10k	SOT-323	16ta	-	3d Di
p02	PDTC143ET	Si-npn-Digi	Sw, 50V, 100mA, 250mW, R1/R2=4.7k/4.7k	SOT-23	16ta	-	3a PhH
p02	PDTC143EU	Si-npn-Digi	Sw, 50V, 100mA, 200mW, R1/R2=4.7k/4.7k	SOT-323	16ta	-	3a PhH
P02	ZXM61P02F	n-MOSFET-e	V-MOS, LogL, 20V, 0.9A, <0.6Ω	SOT-23	16fh	-	3a Zx
P03	DDTA123TCA	Si-pnp-Digi	Sw, 50V, 100mA, 200mW, 250MHz, R1=2k2	SOT-23	16ta	-	3d Di
P03	DDTA123TE	Si-pnp-Digi	Sw, 50V, 100mA, 150mW, 250MHz, R1=2k2	SOT-523	16ta	-	3d Di
P03	DDTA123TKA	Si-pnp-Digi	Sw, 50V, 100mA, 200mW, 250MHz, R1=2k2	SC-59	16ta	-	3d Di
P03	DDTA123TUA	Si-pnp-Digi	Sw, 50V, 100mA, 200mW, 250MHz, R1=2k2	SOT-323	16ta	-	3a Di
p03	PDTA114ET	Si-pnp-Digi	Sw, 50V, 100mA, 250mW, R1/R2=10k/10k	SOT-23	16ta	-	3a PhH
P03	SO2907A	Si-pnp	GP, 60V, 600mA, 330mW, B=100..300, >200MHz	SOT-23	16ta	-	3a Ste
P03	XE61CN4045MR	Vdet-IC	4.0V±2%, -Reset ODO	SOT-23	16vdb	VD6	3h Tor
P03	ZXM61P03F	n-MOSFET-e	V-MOS, LogL, 30V, 1.1A, <0.55Ω	SOT-23	16fh	-	3a Zx
p04	BZX84-A11	Z-diode	11V±1%, Izt=23mA, 350mW	SOT-23	16dc	-	3a PhH
P04	DDTA123ECA	Si-pnp-Digi	Sw, 50V, 100mA, 200mW, 250MHz, R1/R2=2.2k/2.2k	SOT-23	16ta	-	3a Di
P04	DDTA123EE	Si-pnp-Digi	Sw, 50V, 100mA, 150mW, 250MHz, R1/R2=2k2/2k2	SOT-523	16ta	-	3a Di
P04	DDTA123EKA	Si-pnp-Digi	Sw, 50V, 100mA, 200mW, 250MHz, R1/R2=2k2/2k2	SC-59	16ta	-	3a Di
P04	DDTA123EUA	Si-pnp-Digi	Sw, 50V, 100mA, 200mW, 250MHz, R1/R2=2k2/2k2	SOT-323	16ta	-	3d Di
P04	SST174	p-FET	Sw, 30V, 350mW, Idss=135mA, Rds(on)=85Ω, 15/20ns	SOT-23	16jf	-	3a Cal
P05	DDTA123YCA	Si-pnp-Digi	Sw, 50V, 100mA, 200mW, 250MHz, R1/R2=2k2/10k	SOT-23	16ta	-	3a Di
P05	DDTA123YE	Si-pnp-Digi	Sw, 50V, 100mA, 150mW, 250MHz, R1/R2=2k2/10k	SOT-523	16ta	-	3a Di
P05	DDTA123YKA	Si-pnp-Digi	Sw, 50V, 100mA, 200mW, 250MHz, R1/R2=2k2/10k	SC-59	16ta	-	3d Di
P05	DDTA123YUA	Si-pnp-Digi	Sw, 50V, 100mA, 200mW, 250MHz, R1/R2=2k2/10k	SOT-323	16ta	-	3d Di
p05	PDTA124ET	Si-pnp-Digi	Sw, 50V, 100mA, 250mW, R1/R2=22k/22k	SOT-23	16ta	-	3a PhH
p05	PDTA124EU	Si-pnp-Digi	Sw, 50V, 100mA, 200mW, R1/R2=22k/22k	SOT-323	16ta	-	3a PhH
P05	SO2907	Si-pnp	GP, 40V, 600mA, 330mW, B=100..300, >200MHz	SOT-23	16ta	-	3a Ste
P05	SST175	p-FET	Sw, 30V, 350mW, Idss=70mA, Rds(on)=125Ω, 15/20ns	SOT-23	16jf	-	3a Cal
P05	XC61FN4012M	Vdet-IC	4V±2%, +Reset ODO, 200ms	SOT-23	16vdb	VD6	3d Tor
P05	XC61HN4012MR	Vdet-IC	4.0V±2%, -Reset ODO, 50..200ms	SOT-23	16vdc	VD6	3d Tor
P06	DDTA123JCA	Si-pnp-Digi	Sw, 50V, 100mA, 200mW, 250MHz, R1/R2=2k2/47k	SOT-23	16ta	-	3d Di
P06	DDTA123JE	Si-pnp-Digi	Sw, 50V, 100mA, 150mW, 250MHz, R1/R2=2k2/47k	SOT-523	16ta	-	3d Di



SMD code	Type	Function	Short description	Case	Pinout	Sch.	St.	Mnf.
P06	DDTA123JKA	Si-pnp-Digi	Sw, 50V, 100mA, 200mW, 250MHz, R1/R2=2k2/47k	SC-59	16ta	-	3a	Di
P06	DDTA123JUA	Si-pnp-Digi	Sw, 50V, 100mA, 200mW, 250MHz, R1/R2=2k2/47k	SOT-323	16ta	-	3d	Di
p06	PDTC124ET	Si-npn-Digi	Sw, 50V, 100mA, 250mW, R1/R2=22k/22k	SOT-23	16ta	-	3a	PhH
p06	PDTC124EU	Si-npn-Digi	Sw, 50V, 100mA, 200mW, R1/R2=22k/22k	SOT-323	16ta	-	3a	PhH
P06	SO2894	Si-pnp	Sw, 12V, 200mA, 360mW, 23/43ns	SOT-23	16ta	-	-	Ste
P06	SST176	p-FET	Sw, 30V, 350mW, Idss=35mA, Rds(on)=250Q, 15/20ns	SOT-23	16fj	-	3a	Cal
P06	XC61FN4042M	Vdet-IC	4V±2%, +Reset ODO, 400ms	SOT-23	16vdb	VD6	3d	Tor
P06	XC61HN4042MR	Vdet-IC	4.0V±2%, -Reset ODO, 80.400ms	SOT-23	16vdc	VD6	3d	Tor
P07	DDTA143TCA	Si-pnp-Digi	Sw, 50V, 100mA, 200mW, 250MHz, R1=4k7	SOT-23	16ta	-	3d	Di
P07	DDTA143TE	Si-pnp-Digi	Sw, 50V, 100mA, 150mW, 250MHz, R1=4k7	SOT-523	16ta	-	3d	Di
P07	DDTA143TKA	Si-pnp-Digi	Sw, 50V, 100mA, 200mW, 250MHz, R1=4k7	SC-59	16ta	-	3d	Di
P07	DDTA143TUA	Si-pnp-Digi	Sw, 50V, 100mA, 200mW, 250MHz, R1=4k7	SOT-323	16ta	-	3d	Di
p07	PDTA144ET	Si-pnp-Digi	Sw, 50V, 100mA, 250mW, R1/R2=47k/47k	SOT-23	16ta	-	3a	PhH
p07	PDTA144EU	Si-pnp-Digi	Sw, 50V, 100mA, 200mW, R1/R2=47k/47k	SOT-323	16ta	-	3a	PhH
P07	SST177	p-FET	Sw, 30V, 350mW, Idss=20mA, Rds(on)=300Q, 15/20ns	SOT-23	16fj	-	3a	Cal
P07	XC61FN4052M	Vdet-IC	4V±2%, +Reset ODO, 50ms	SOT-23	16vdb	VD6	3d	Tor
P07	XC61HN4052MR	Vdet-IC	4.0V±2%, -Reset ODO, 1.50ms	SOT-23	16vdc	VD6	3d	Tor
P08	DDTA143ECA	Si-pnp-Digi	Sw, 50V, 100mA, 200mW, 250MHz, R1/R2=4k7/4k7	SOT-23	16ta	-	3d	Di
P08	DDTA143EE	Si-pnp-Digi	Sw, 50V, 100mA, 150mW, 250MHz, R1/R2=4k7/4k7	SOT-523	16ta	-	3d	Di
P08	DDTA143EKA	Si-pnp-Digi	Sw, 50V, 100mA, 200mW, 250MHz, R1/R2=4k7/4k7	SC-59	16ta	-	3d	Di
P08	DDTA143EUA	Si-pnp-Digi	Sw, 50V, 100mA, 200mW, 250MHz, R1/R2=4k7/4k7	SOT-323	16ta	-	3d	Di
p08	PDTC144ET	Si-npn-Digi	Sw, 50V, 100mA, 250mW, R1/R2=47k/47k	SOT-23	16ta	-	3a	PhH
p08	PDTC144EU	Si-npn-Digi	Sw, 50V, 100mA, 200mW, R1/R2=47k/47k	SOT-323	16ta	-	3a	PhH
P09	DDTA123XCA	Si-pnp-Digi	Sw, 50V, 100mA, 200mW, 250MHz, R1/R2=4k7/10k	SOT-23	16ta	-	3a	Di
P09	DDTA123XE	Si-pnp-Digi	Sw, 50V, 100mA, 150mW, 250MHz, R1/R2=4k7/10k	SOT-523	16ta	-	3d	Di
P09	DDTA123XKA	Si-pnp-Digi	Sw, 50V, 100mA, 200mW, 250MHz, R1/R2=4k7/10k	SC-59	16ta	-	3a	Di
P09	DDTA123XUA	Si-pnp-Digi	Sw, 50V, 100mA, 200mW, 250MHz, R1/R2=4k7/10k	SOT-323	16ta	-	3a	Di
P09	DDTA143XCA	Si-pnp-Digi	Sw, 50V, 100mA, 200mW, 250MHz, R1/R2=22k/47k	SOT-23	16ta	-	3d	Di
P09	DDTA143XE	Si-pnp-Digi	Sw, 50V, 100mA, 150mW, 250MHz, R1/R2=22k/47k	SOT-523	16ta	-	3d	Di
P09	DDTA143XKA	Si-pnp-Digi	Sw, 50V, 100mA, 200mW, 250MHz, R1/R2=22k/47k	SC-59	16ta	-	3d	Di
P09	DDTA143XUA	Si-pnp-Digi	Sw, 50V, 100mA, 200mW, 250MHz, R1/R2=22k/47k	SOT-323	16ta	-	3d	Di
p09	PDTB144ET	Si-pnp-Digi	Sw, 50V, 500mA, 250mW, R1/R2=10k/10k	SOT-23	16ta	-	3a	Phi
P1	2SK1577-1	n-FET	VHF/UHF, 35V, 100mA, 150mW, Idss=30.50mA, Up<5V	SOT-23	16ta	-	3a	Soy
P1	BFS42	Si-npn	AF/HF, 60/30V, 1A, >60MHz	SOT-323	16ta	-	3a	Fer
P1	BZK84-C11T	Z-diode	11V±5%, 150mW	SOT-523	16dc	-	3a	Di
P1	CZRH3-55C11	Z-diode	11.0..11.60V, Zzt=20Q, Izt=5mA, 150mW	SOT-523	18dc	-	3a	Cmc
P1	ELM7621HCB	Vdet-IC	2.1V±2%, +Reset PPO, 150ms	SOT-23	16vdc	VD7	3d	Elm
P1	ELM9721CBB	Vdet-IC	2.1V±2.5%, +Reset PPO	SOT-23	16vdb	VD7	3d	Elm
P1	R1100D311C	LVR-IC	U-low lcc, 3.1V±2%, 180mA	SON1408-3	18vj	VR1	3d	Ric
P1	R3130N44HC	Vdet-IC	4.4V, -Reset ODO, 400ms	SOT-23	16vdc	VD6	3b	Ric
P1	RT1P141C	Si-pnp-Digi	Sw, 50V, 100mA, 150mW, 200MHz, R1/R2=10k/10k	SC-59	16ta	-	3a	Mit
P1	RT1P141M	Si-pnp-Digi	Sw, 50V, 100mA, 150mW, 200MHz, R1/R2=10k/10k	SOT-323	16ta	-	3a	Mit
P1	RT1P141T	Si-pnp-Digi	Sw, 50V, 100mA, 125mW, 200MHz, R1/R2=10k/10k	T-USM	18ta	-	3a	Mit
P1	RT1P141U	Si-pnp-Digi	Sw, 50V, 100mA, 125mW, 200MHz, R1/R2=10k/10k	SC-75A	16ta	-	3a	Mit
P1	SST201	n-FET	AF, LN, 40V, 350mW, Idss=0.2..1mA, Up<1.5V	SOT-23	16fj	-	3a	Six
P1	TC54VN4102ECB	Vdet-IC	4.1V±2%, -Reset ODO	SOT-23	16vdb	VD6	3a	Tcs
P1	XC61CN4102M	Vdet-IC	4.1V±1%, +Reset ODO	SOT-23	16vdb	VD6	3d	Tor
P1	XC6GN4102HR	Vdet-IC	4.1V, +Reset ODO	USP-3	17vdc	VD1	9b	Tor
P10	DDTA143FCA	Si-pnp-Digi	Sw, 50V, 100mA, 200mW, 250MHz, R1/R2=4k7/22k	SOT-23	16ta	-	3d	Di
P10	DDTA143FE	Si-pnp-Digi	Sw, 50V, 100mA, 150mW, 250MHz, R1/R2=4k7/22k	SOT-523	16ta	-	3d	Di
P10	DDTA143FKA	Si-pnp-Digi	Sw, 50V, 100mA, 200mW, 250MHz, R1/R2=4k7/22k	SC-59	16ta	-	3d	Di
P10	DDTA143FUA	Si-pnp-Digi	Sw, 50V, 100mA, 200mW, 250MHz, R1/R2=4k7/22k	SOT-323	16ta	-	3d	Di
p10	PDTD114ET	Si-npn-Digi	Sw, 50V, 500mA, 250mW, R1/R2=10k/10k	SOT-23	16ta	-	3a	Phi
P11	DDTA143ZCA	Si-pnp-Digi	Sw, 50V, 100mA, 200mW, 250MHz, R1/R2=4k7/47k	SOT-23	16ta	-	3d	Di
P11	DDTA143ZE	Si-pnp-Digi	Sw, 50V, 100mA, 150mW, 250MHz, R1/R2=4k7/47k	SOT-523	16ta	-	3d	Di
P11	DDTA143ZKA	Si-pnp-Digi	Sw, 50V, 100mA, 200mW, 250MHz, R1/R2=4k7/47k	SC-59	16ta	-	3d	Di
P11	DDTA143ZUA	Si-pnp-Digi	Sw, 50V, 100mA, 200mW, 250MHz, R1/R2=4k7/47k	SOT-323	16ta	-	3d	Di
p11	PDTA114TT	Si-pnp-Digi	Sw, 50V, 100mA, 200mW, R1=10k	SOT-23	16ta	-	3a	PhH
P12	DDTA114TCA	Si-pnp-Digi	Sw, 50V, 100mA, 200mW, 250MHz, R1=10k	SOT-23	16ta	-	3d	Di
P12	DDTA114TE	Si-pnp-Digi	Sw, 50V, 100mA, 150mW, 250MHz, R1=10k	SOT-523	16ta	-	3d	Di
P12	DDTA114TKA	Si-pnp-Digi	Sw, 50V, 100mA, 200mW, 250MHz, R1=10k	SC-59	16ta	-	3d	Di
P12	DDTA114TUA	Si-pnp-Digi	Sw, 50V, 100mA, 200mW, 250MHz, R1=10k	SOT-323	16ta	-	3d	Di
p12	PDTC114TT	Si-npn-Digi	Sw, 50V, 100mA, 250mW, R1=10k	SOT-23	16ta	-	3a	PhH
P12	SO2906A	Si-pnp	GP, 60V, 600mA, 400mW, >200MHz, B>40	SOT-23	16ta	-	-	Ste
P13	DDTA114ECA	Si-pnp-Digi	Sw, 50V, 100mA, 200mW, 250MHz, R1/R2=10k/10k	SOT-23	16ta	-	3d	Di
P13	DDTA114EE	Si-pnp-Digi	Sw, 50V, 100mA, 150mW, 250MHz, R1/R2=10k/10k	SOT-523	16ta	-	3d	Di
P13	DDTA114EKA	Si-pnp-Digi	Sw, 50V, 100mA, 200mW, 250MHz, R1/R2=10k/10k	SC-59	16ta	-	3d	Di
P13	DDTA114EUA	Si-pnp-Digi	Sw, 50V, 100mA, 200mW, 250MHz, R1/R2=10k/10k	SOT-323	16ta	-	3d	Di
P13	XE61CN4145MR	Vdet-IC	4.1V±2%, -Reset ODO	SOT-23	16vdb	VD6	3h	Tor
P14	DDTA114YCA	Si-pnp-Digi	Sw, 50V, 100mA, 200mW, 250MHz, R1/R2=10k/47k	SOT-23	16ta	-	3d	Di



SMD code	Type	FUNCTION	Short description	Case	Pinout	Sch.	St.	Mnf.
P14	DDTA114YE	Si-pnp-Digi	Sw, 50V, 100mA, 150mW, 250MHz, R1/R2=10k/47k	SOT-523	16ta	-	3d	Di
P14	DDTA114YKA	Si-pnp-Digi	Sw, 50V, 100mA, 200mW, 250MHz, R1/R2=10k/47k	SC-59	16ta	-	3d	Di
P14	DDTA114YUA	Si-pnp-Digi	Sw, 50V, 100mA, 200mW, 250MHz, R1/R2=10k/47k	SOT-323	16ta	-	3d	Di
P15	DDTA114WCA	Si-pnp-Digi	Sw, 50V, 100mA, 200mW, 250MHz, R1/R2=10k/47k	SOT-23	16ta	-	3d	Di
P15	DDTA114WE	Si-pnp-Digi	Sw, 50V, 100mA, 150mW, 250MHz, R1/R2=10k/47k	SOT-523	16ta	-	3d	Di
P15	DDTA114WKA	Si-pnp-Digi	Sw, 50V, 100mA, 200mW, 250MHz, R1/R2=10k/47k	SC-59	16ta	-	3d	Di
P15	DDTA114WUA	Si-pnp-Digi	Sw, 50V, 100mA, 200mW, 250MHz, R1/R2=10k/47k	SOT-323	16ta	-	3d	Di
P15	XC61FN4112M	Vdet-IC	4.1V±2%, +Reset ODO, 200ms	SOT-23	16vdb	VD6	3d	Tor
P15	XC61HN4112MR	Vdet-IC	4.1V±2%, -Reset ODO, 50..200ms	SOT-23	16vdc	VD6	3d	Tor
P16	DDTA124TCA	Si-pnp-Digi	Sw, 50V, 100mA, 200mW, 250MHz, R1=22k	SOT-23	16ta	-	3d	Di
P16	DDTA124TE	Si-pnp-Digi	Sw, 50V, 100mA, 150mW, 250MHz, R1=22k	SOT-523	16ta	-	3d	Di
P16	DDTA124TKA	Si-pnp-Digi	Sw, 50V, 100mA, 200mW, 250MHz, R1=22k	SC-59	16ta	-	3d	Di
P16	DDTA124TUA	Si-pnp-Digi	Sw, 50V, 100mA, 200mW, 250MHz, R1=22k	SOT-323	16ta	-	3d	Di
p16	PDTC114ET	Si-npn-Digi	Sw, 50V, 100mA, 250mW, R1/R2=10k/10k	SOT-23	16ta	-	3a	PHH
P16	XC61FN4142M	Vdet-IC	4.1V±2%, +Reset ODO, 400ms	SOT-23	16vdb	VD6	3d	Tor
P16	XC61HN4142MR	Vdet-IC	4.1V±2%, -Reset ODO, 80..400ms	SOT-23	16vdc	VD6	3d	Tor
P17	DDTA124ECA	Si-pnp-Digi	Sw, 50V, 100mA, 200mW, 250MHz, R1/R2=22k/22k	SOT-23	16ta	-	3d	Di
P17	DDTA124EE	Si-pnp-Digi	Sw, 50V, 100mA, 150mW, 250MHz, R1/R2=22k/22k	SOT-523	16ta	-	3d	Di
P17	DDTA124EKA	Si-pnp-Digi	Sw, 50V, 100mA, 200mW, 250MHz, R1/R2=22k/22k	SC-59	16ta	-	3d	Di
P17	DDTA124EUA	Si-pnp-Digi	Sw, 50V, 100mA, 200mW, 250MHz, R1/R2=22k/22k	SOT-323	16ta	-	3d	Di
P17	XC61FN4152M	Vdet-IC	4.1V±2%, +Reset ODO, 50ms	SOT-23	16vdb	VD6	3d	Tor
P17	XC61HN4152MR	Vdet-IC	4.1V±2%, -Reset ODO, 1..50ms	SOT-23	16vdc	VD6	3d	Tor
P18	DDTA124XCA	Si-pnp-Digi	Sw, 50V, 100mA, 200mW, 250MHz, R1/R2=22k/47k	SOT-23	16ta	-	3d	Di
P18	DDTA124XE	Si-pnp-Digi	Sw, 50V, 100mA, 150mW, 250MHz, R1/R2=22k/47k	SOT-523	16ta	-	3d	Di
P18	DDTA124XKA	Si-pnp-Digi	Sw, 50V, 100mA, 200mW, 250MHz, R1/R2=22k/47k	SC-59	16ta	-	3d	Di
P18	DDTA124XUA	Si-pnp-Digi	Sw, 50V, 100mA, 200mW, 250MHz, R1/R2=22k/47k	SOT-323	16ta	-	3d	Di
p18	PDTC143ZT	Si-npn-Digi	Sw, 50V, 100mA, 250mW, R1/R2=4.7k/47k	SOT-23	16ta	-	3a	PHH
P19	DDTA144TCA	Si-pnp-Digi	Sw, 50V, 100mA, 200mW, 250MHz, R1=47k	SOT-23	16ta	-	3d	Di
P19	DDTA144TE	Si-pnp-Digi	Sw, 50V, 100mA, 150mW, 250MHz, R1=47k	SOT-523	16ta	-	3d	Di
P19	DDTA144TKA	Si-pnp-Digi	Sw, 50V, 100mA, 200mW, 250MHz, R1=47k	SC-59	16ta	-	3d	Di
P19	DDTA144TUA	Si-pnp-Digi	Sw, 50V, 100mA, 200mW, 250MHz, R1=47k	SOT-323	16ta	-	3d	Di
p19	PDTA143ZT	Si-pnp-Digi	Sw, 50V, 100mA, 250mW, R1/R2=4.7k/47k	SOT-23	16ta	-	3a	PHH
p1A	PMBT3904	Si-npn	Sw, 60V, 100mA, 250mW, B=100..300, >300MHz	SOT-23	16ta	-	3a	PHH
p1A	PMMT3904	Si-npn	GP, 60V, 200mA, 350mW, B=100..300, >300MHz	SOT-23	16ta	-	-	Phi
P1A	VP2110K1	p-MOSFET-e	V-MOS, 100V, 120mA, B=120Ω(0.5A)	SOT-23	16fh	-	3a	Sbx
p1B	PMBT2222	Si-npn	Sw, 60V, 600mA, 330mW, B=120..360, >300MHz	SOT-23	16ta	-	3a	PhM
p1D	PMBA42	Si-npn	Vid, 300/300V, 100mA, 250mW, B>25, >50MHz	SOT-23	16ta	-	3a	PhM
p1E	PMBTA43	Si-npn	Vid, 200/200V, 100mA, 250mW, B>25, >50MHz	SOT-23	16ta	-	3a	PhM
p1F	PMBT5550	Si-npn	HV, 160V, 300mA, 250mW, B=60..250, 100..300MHz	SOT-23	16ta	-	3a	PhM
p1G	PMBA06	Si-npn	GP, 80V, 500mA, 250mW, B=100, >100MHz	SOT-23	16ta	-	3a	PhM
p1G	PMMTA06	Si-npn	GP, 80V, 500mA, 350mW, B=100, >100MHz	SOT-23	16ta	-	-	Phi
p1H	PMBTA05	Si-npn	GP, 60V, 500mA, 250mW, B>100, >100MHz	SOT-23	16ta	-	3a	PhM
p1J	PMBT2369	Si-npn	Sw, 40V, 200mA, 330mW, B=40..120, >500MHz	SOT-23	16ta	-	3a	PhM
p1K	PMBT6428	Si-npn	GP, AF, 60V, 100mA, 250mW, B=250..650, 100..700MHz	SOT-23	16ta	-	3a	PhM
p1L	PMBT6429	Si-npn	GP, AF, 55V, 100mA, 250mW, B=500..1250, 100..700MHz	SOT-23	16ta	-	3a	PhM
p1M	PMBTA13	Si-npn-Darl	GP, 30V, 500mA, 250mW, B=5000, >125MHz	SOT-23	16ta	-	3a	PhM
p1N	PMBTA12	Si-npn-Darl	GP, 30V, 300mA, 250mW, B=10000, >125MHz	SOT-23	16ta	-	3a	Phi
p1N	PMBTA14	Si-npn-Darl	GP, 30V, 500mA, 250mW, B=10000, >125MHz	SOT-23	16ta	-	3a	PhM
P1p	BFR92	Si-npn	UHF-A-Band, 20V, 25mA, 300mW, B>40, >5GHz	SOT-23	16ta	-	3a	Phi
p1P	PMBT2222A	Si-npn	Sw, 75V, 600mA, 330mW, B=120..360, >300MHz	SOT-23	16ta	-	3a	PhM
p1Q	PMBT5088	Si-npn	GP, AF, 30V, 200mA, 325mW, B=500, 160MHz	SOT-23	16ta	-	3a	PhM
P1s	BFR92AW	Si-npn	UHF-A-Band, 20V, 25mA, 300mW, B>40, >5GHz	SOT-323	16ta	-	3c	Inf
P1s	BFR92W	Si-npn	UHF-A-Band, 20V, 25mA, 300mW, B>40, >5GHz	SOT-323	16ta	-	3a	Sie
P1Y	PMBT3903	Si-npn	GP, 60V, 200mA, 250mW, B=50..150, >300MHz	SOT-23	16ta	-	3a	Phi
P2	2SK1577-2	n-FET	VHF/UHF, 35V, 100mA, 150mW, Idss=45..65mA, Up<6V	SOT-23	16fa	-	3a	Soy
P2	BFR92AL	Si-npn	VHF/UHF, 20V, 25mA, 273mW, B>40, 4.5GHz	SOT-23	16ta	-	3a	Mat
P2	BFR92AT	Si-npn	UHF-A-Band, 20V, 25mA, 300mW, B>40, >5GHz	SOT-416	16ta	-	3a	Phi
P2	BZX84-C12T	Z-diode	12V±5%, 150mW	SOT-523	16dc	-	3a	Di
P2	CZRH3-55C12	Z-diode	12.0..12.70V, Zzt=25Ω, Izt=5mA, 150mW	SOT-523	18dc	-	3a	Cmc
P2	ELM7622HCB	Vdet-IC	2.2V±2%, +Reset PPO, 150ms	SOT-23	16vdc	VD7	3d	Elm
P2	ELM9722CBB	Vdet-IC	2.2V±2.5%, +Reset PPO	SOT-23	16vdb	VD7	3d	Elm
P2	KRA116S	Si-pnp-Digi	Sw, 50V, 100mA, 200mW, 200MHz, R1/R2=1k/10k	SOT-23	16ta	-	3f	Kec
P2	KRA316	Si-pnp-Digi	Sw, 50V, 100mA, 100mW, 200MHz, R1/R2=1k/10k	SOT-323	16ta	-	3f	Kec
P2	KRA316E	Si-pnp-Digi	Sw, 50V, 100mA, 100mW, 200MHz, R1/R2=1k/10k	SOT-490	18ta	-	3f	Kec
P2	KRA316V	Si-pnp-Digi	Sw, 50V, 100mA, 100mW, 200MHz, R1/R2=1k/10k	VSM	18ta	-	3f	Kec
P2	R1100D321C	LVR-IC	U-low lcc, 3.2V±2%, 180mA	SON1408-3	18vj	VR1	3d	Ric
P2	R3130N26HC3	Vdet-IC	2.6V, -Reset ODO, 400ms	SOT-23	16vdc	VD6	3b	Ric
P2	RT1P241C	Si-pnp-Digi	Sw, 50V, 100mA, 150mW, 200MHz, R1/R2=22k/22k	SC-59	16ta	-	3a	Mit
P2	RT1P241M	Si-pnp-Digi	Sw, 50V, 100mA, 150mW, 200MHz, R1/R2=22k/22k	SOT-323	16ta	-	3a	Mit
P2	RT1P241U	Si-pnp-Digi	Sw, 50V, 100mA, 125mW, 200MHz, R1/R2=22k/22k	SC-75A	16ta	-	3a	Mit



SMD code	Type	Function	Short description	Case	Pinout	Sch. St.	Mnf.
P2	SST202	n-FET	AF, LN, 40V, 350mW, Idss=0.9..4.5mA, Up<4V	SOT-23	16fj	-	3a Six
P2	TC54VN4202ECB	Vdet-IC	4.2V±2%, -Reset ODO	SOT-23	16vdb	VD6	3a Tcs
P2	XC61CN4202M	Vdet-IC	4.2V±1%, +Reset ODO	SOT-23	16vdb	VD6	3d Tor
P2	XC6GN4202HR	Vdet-IC	4.2V, +Reset ODO	USP-3	17vdc	VD1	9b Tor
P20	DDTA124ECA	Si-pnp-Digi	Sw, 50V, 100mA, 200mW, 250MHz, R1/R2=22k/22k	SOT-23	16ta	-	3a Di
P20	DDTA124EE	Si-pnp-Digi	Sw, 50V, 100mA, 150mW, 250MHz, R1/R2=22k/22k	SOT-523	16ta	-	3d Di
P20	DDTA124EKA	Si-pnp-Digi	Sw, 50V, 100mA, 200mW, 250MHz, R1/R2=22k/22k	SC-59	16ta	-	3d Di
P20	DDTA124EUA	Si-pnp-Digi	Sw, 50V, 100mA, 200mW, 250MHz, R1/R2=22k/22k	SOT-323	16ta	-	3d Di
P20	DDTA144ECA	Si-pnp-Digi	Sw, 50V, 100mA, 200mW, 250MHz, R1/R2=47/47k	SOT-23	16ta	-	3d Di
P20	DDTA144EE	Si-pnp-Digi	Sw, 50V, 100mA, 150mW, 250MHz, R1/R2=47/47k	SOT-523	16ta	-	3d Di
P20	DDTA144EKA	Si-pnp-Digi	Sw, 50V, 100mA, 150mW, 250MHz, R1/R2=47/47k	SC-59	16ta	-	3d Di
P20	DDTA144EUA	Si-pnp-Digi	Sw, 50V, 100mA, 150mW, 250MHz, R1/R2=47/47k	SOT-323	16ta	-	3d Di
p20	PDTC144WT	Si-npn-Digi	Sw, 50V, 100mA, 250mW, R1/R2=47k/22k	SOT-23	16ta	-	3a PhH
p20	PDTC144WU	Si-npn-Digi	Sw, 50V, 100mA, 200mW, R1/R2=47k/22k	SOT-323	16ta	-	3a PhH
P20	SST270	n-FET	AF, LN, 30V, 350mW, Idss=2..15mA, Up<2V	SOT-23	16fj	-	3a Cal
P21	DDTA144VCA	Si-pnp-Digi	Sw, 50V, 100mA, 200mW, 250MHz, R1/R2=47k/10k	SOT-23	16ta	-	3d Di
P21	DDTA144VE	Si-pnp-Digi	Sw, 50V, 100mA, 150mW, 250MHz, R1/R2=47k/10k	SOT-523	16ta	-	3d Di
P21	DDTA144VKA	Si-pnp-Digi	Sw, 50V, 100mA, 200mW, 250MHz, R1/R2=47k/10k	SC-59	16ta	-	3d Di
P21	DDTA144VUA	Si-pnp-Digi	Sw, 50V, 100mA, 200mW, 250MHz, R1/R2=47k/10k	SOT-323	16ta	-	3d Di
p21	PDTA123ET	Si-pnp-Digi	Sw, 50V, 100mA, 250mW, R1/R2=2k2/2k2	SOT-23	16ta	-	3a PhH
P22	DDTA144WCA	Si-pnp-Digi	Sw, 50V, 100mA, 200mW, 250MHz, R1/R2=47k/22k	SOT-23	16ta	-	3d Di
P22	DDTA144WE	Si-pnp-Digi	Sw, 50V, 100mA, 150mW, 250MHz, R1/R2=47k/22k	SOT-523	16ta	-	3d Di
P22	DDTA144WKA	Si-pnp-Digi	Sw, 50V, 100mA, 200mW, 250MHz, R1/R2=47k/22k	SC-59	16ta	-	3d Di
P22	DDTA144WUA	Si-pnp-Digi	Sw, 50V, 100mA, 200mW, 250MHz, R1/R2=47k/22k	SOT-323	16ta	-	3d Di
P23	DDTA115TCA	Si-pnp-Digi	Sw, 50V, 100mA, 200mW, 250MHz, R1=100k	SOT-23	16ta	-	3a Di
P23	DDTA115TE	Si-pnp-Digi	Sw, 50V, 100mA, 150mW, 250MHz, R1=100k	SOT-523	16ta	-	3a Di
P23	DDTA115TKA	Si-pnp-Digi	Sw, 50V, 100mA, 200mW, 250MHz, R1=100k	SC-59	16ta	-	3a Di
P23	DDTA115TUA	Si-pnp-Digi	Sw, 50V, 100mA, 200mW, 250MHz, R1=100k	SOT-323	16ta	-	3a Di
p23	PDTA123JT	Si-pnp-Digi	Sw, 50V, 100mA, 250mW, R1/R2=2k2/47k	SOT-23	16ta	-	3a PhH
P23	XE61CN4245MR	Vdet-IC	4.2V±2%, -Reset ODO	SOT-23	16vdb	VD6	3h Tor
P24	DDTA115ECA	Si-pnp-Digi	Sw, 50V, 100mA, 200mW, 250MHz, R1/R2=100k/100k	SOT-23	16ta	-	3d Di
P24	DDTA115EE	Si-pnp-Digi	Sw, 50V, 100mA, 150mW, 250MHz, R1/R2=100k/100k	SOT-523	16ta	-	3d Di
P24	DDTA115EKA	Si-pnp-Digi	Sw, 50V, 100mA, 200mW, 250MHz, R1/R2=100k/100k	SC-59	16ta	-	3d Di
P24	DDTA115EUA	Si-pnp-Digi	Sw, 50V, 100mA, 200mW, 250MHz, R1/R2=100k/100k	SOT-323	16ta	-	3d Di
P25	DDTA125TCA	Si-pnp-Digi	Sw, 50V, 100mA, 200mW, 250MHz, R1=200k	SOT-23	16ta	-	3d Di
P25	DDTA125TE	Si-pnp-Digi	Sw, 50V, 100mA, 150mW, 250MHz, R1=200k	SOT-523	16ta	-	3d Di
P25	DDTA125TKA	Si-pnp-Digi	Sw, 50V, 100mA, 200mW, 250MHz, R1=200k	SC-59	16ta	-	3d Di
P25	DDTA125TUA	Si-pnp-Digi	Sw, 50V, 100mA, 200mW, 250MHz, R1=200k	SOT-323	16ta	-	3d Di
p25	PDTC123JT	Si-npn-Digi	Sw, 50V, 100mA, 250mW, R1/R2=2k2/47k	SOT-23	16ta	-	3a PhH
P25	SC3906	Si-pnp	Sw, AF, 60/40V, 100mA, 200mW, B=100..300, >250MHz	SOT-23	16ta	-	Ste
P25	XC61FN4212M	Vdet-IC	4.2V±2%, +Reset ODO, 200ms	SOT-23	16vdb	VD6	3d Tor
P25	XC61HN4212MR	Vdet-IC	4.2V±2%, -Reset ODO, 50..200ms	SOT-23	16vdc	VD6	3d Tor
P26	DDTA114GCA	Si-pnp-Digi	Sw, 50V, 100mA, 200mW, B=100..600, 250MHz, R2=10k	SOT-23	16ta	-	3d Di
P26	DDTA114GE	Si-pnp-Digi	Sw, 50V, 100mA, 200mW, B=100..600, 250MHz, R2=10k	SOT-523	16ta	-	3d Di
P26	DDTA114GKA	Si-pnp-Digi	Sw, 50V, 100mA, 200mW, B=100..600, 250MHz, R2=10k	SC-59	16ta	-	3d Di
P26	DDTA114GUA	Si-pnp-Digi	Sw, 50V, 100mA, 200mW, B=100..600, 250MHz, R2=10k	SOT-323	16ta	-	3d Di
P26	DDTA114KA	Si-pnp-Digi	Sw, 50V, 100mA, 200mW, B=100..600, 250MHz, R2=10k	SC-59	16ta	-	3d Di
p26	PDTC123ET	Si-npn-Digi	Sw, 50V, 100mA, 250mW, R1/R2=2k2/2k2	SOT-23	16ta	-	3a PhH
P26	SC3905	Si-pnp	GP, 40V, 200mA, 250mW, B=50..150, >200MHz	SOT-23	16ta	-	Ste
P26	XC61FN4242M	Vdet-IC	4.2V±2%, +Reset ODO, 400ms	SOT-23	16vdb	VD6	3d Tor
P26	XC61HN4242MR	Vdet-IC	4.2V±2%, -Reset ODO, 80..400ms	SOT-23	16vdc	VD6	3d Tor
P27	DDTA124GCA	Si-pnp-Digi	Sw, 50V, 100mA, 200mW, B=100..600, 250MHz, R2=22k	SOT-23	16ta	-	3d Di
P27	DDTA124GE	Si-pnp-Digi	Sw, 50V, 100mA, 150mW, 250MHz, R2=22k	SOT-523	16ta	-	3d Di
P27	DDTA124GKA	Si-pnp-Digi	Sw, 50V, 100mA, 200mW, B=100..600, 250MHz, R2=22k	SC-59	16ta	-	3d Di
P27	DDTA124GUA	Si-pnp-Digi	Sw, 50V, 100mA, 200mW, B=100..600, 250MHz, R2=22k	SOT-323	16ta	-	3d Di
P27	DDTA124KA	Si-pnp-Digi	Sw, 50V, 100mA, 200mW, B=100..600, 250MHz, R2=22k	SC-59	16ta	-	3d Di
p27	PDTC114YT	Si-npn-Digi	Sw, 50V, 100mA, 250mW, R1/R2=10k/47k	SOT-23	16ta	-	3a PhH
P27	XC61FN4252M	Vdet-IC	4.2V±2%, +Reset ODO, 50ms	SOT-23	16vdb	VD6	3d Tor
P27	XC61HN4252MR	Vdet-IC	4.2V±2%, -Reset ODO, 1..50ms	SOT-23	16vdc	VD6	3d Tor
P28	DDTA144GCA	Si-pnp-Digi	Sw, 50V, 100mA, 200mW, B=100..600, 250MHz, R2=47k	SOT-23	16ta	-	3d Di
P28	DDTA144GE	Si-pnp-Digi	Sw, 50V, 100mA, 150mW, 250MHz, R2=47k	SOT-523	16ta	-	3d Di
P28	DDTA144GKA	Si-pnp-Digi	Sw, 50V, 100mA, 200mW, B=100..600, 250MHz, R2=47k	SC-59	16ta	-	3d Di
P28	DDTA144GUA	Si-pnp-Digi	Sw, 50V, 100mA, 200mW, B=100..600, 250MHz, R2=47k	SOT-323	16ta	-	3d Di
P28	DDTA144KA	Si-pnp-Digi	Sw, 50V, 100mA, 200mW, B=100..600, 250MHz, R2=47k	SC-59	16ta	-	3d Di
p28	PDTA144WU	Si-pnp-Digi	Sw, 50V, 100mA, 200mW, R1/R2=47k/22k	SOT-323	16ta	-	3a PhH
P29	DDTA115GCA	Si-pnp-Digi	Sw, 50V, 100mA, 200mW, 250MHz, R2=100k	SOT-23	16ta	-	3d Di
P29	DDTA115GE	Si-pnp-Digi	Sw, 50V, 100mA, 150mW, 250MHz, R2=100k	SOT-523	16ta	-	3d Di
P29	DDTA115GKA	Si-pnp-Digi	Sw, 50V, 100mA, 200mW, 250MHz, R2=100k	SC-59	16ta	-	3a Di
P29	DDTA115GUA	Si-pnp-Digi	Sw, 50V, 100mA, 200mW, 250MHz, R2=100k	SOT-323	16ta	-	3a Di
P29	DDTA115KA	Si-pnp-Digi	Sw, 50V, 100mA, 200mW, 250MHz, R2=100k	SC-59	16ta	-	3a Di



SMD code	Type	Function	Short description	Case	Pinout	Sch.	St.	Mnf.
p29	PDTA114YT	Si-pnp-Digi	Sw, 50V, 100mA, 250mW, R1/R2=10k/47k	SOT-23	16ta	-	3a	PHH
p2A	PMBT3906	Si-pnp	Sw, 40V, 100mA, 250mW, B=100..300, >250MHz	SOT-23	16ta	-	3a	PHH
p2B	PMBT2907	Si-pnp	GP, 40V, 600mA, 330mW, B=100..300, >200MHz	SOT-23	16ta	-	3a	PhM
p2D	PMBTA92	Si-pnp	Vid, 300/300V, 500mA, 250mW, B=25, >50MHz	SOT-23	16ta	-	3a	PhM
p2E	PMBTA93	Si-pnp	Vid, 200/200V, 500mA, 250mW, B=25, >50MHz	SOT-23	16ta	-	3a	PhM
p2F	PMBT2907A	Si-pnp	GP, 60V, 600mA, 330mW, B=100..300, >200MHz	SOT-23	16ta	-	3a	PHM
p2G	PMBTA56	Si-pnp	AF-Drv, 80V, 500mA, 250mW, B>100, >50MHz	SOT-23	16ta	-	3a	PhM
p2H	PMBTA55	Si-pnp	AF-Drv, 60V, 500mA, 250mW, B>100, >50MHz	SOT-23	16ta	-	3a	PhM
p2L	PMBT5401	Si-pnp	HV, 160V, 300mA, 250mW, B=60..240, 100..300MHz	SOT-23	16ta	-	3a	PhM
P2p	BFR92A	Si-npn	UHF-A-Band, 20V, 25mA, 300mW, B>40, >5GHz	SOT-23	16ta	-	3a	Phi
P2p	BFR92AW	Si-npn	UHF-A-Band, 20V, 25mA, 300mW, B>40, >5GHz	SOT-323	16ta	-	3a	Phi
p2T	PMBT4403	Si-pnp	Sw, 40V, 600mA, 250mW, B=100..300, >250MHz	SOT-23	16ta	-	3a	PHH
p2U	PMBT463	Si-pnp-Darl	GP, 30V, 500mA, 250mW, B>5000, >125MHz	SOT-23	16ta	-	3a	PhM
p2V	PMBT464	Si-pnp-Darl	GP, 30V, 500mA, 250mW, B>10000, >125MHz	SOT-23	16ta	-	3a	PhM
p2X	PMBT4401	Si-npn	Sw, 60V, 600mA, 250mW, B=100..300, >250MHz	SOT-23	16ta	-	3a	PHH
P3	2SK1577-3	n-FET	VHF/UHF, 35V, 100mA, 150mW, Idss=60..80mA, Up<6V	SOT-23	16fa	-	3a	Soy
P3	BFS44	Si-pnp	AF/HF, 60/30V, 1A, >60MHz	SOT-323	16dc	-	3a	Fer
P3	BZX84-C13T	Z-diode	13V±5%, 150mW	SOT-523	16dc	-	3a	Di
P3	CZRH3-55C13	Z-diode	13.0..14.10V, Zzt=30Ω, Izt=5mA, 150mW	SOT-523	18dc	-	3a	Cmc
P3	ELM7623HCB	Vdet-IC	2.3V±2%, +Reset PPO, 150ms	SOT-23	16vdc	VD7	3d	Elm
P3	ELM9723CBB	Vdet-IC	2.3V±2.5%, +Reset PPO	SOT-23	16vdc	VD7	3d	Elm
P3	HVM132	PIN-diode	HF-Attenuator, 60V, 100mA	SOT-23	16dc	-	3a	Ren
P3	R1100D331C	LVR-IC	U-low lcc, 3.3V±2%, 180mA	SON1408-3	18vj	VR1	3d	Ric
P3	R3130N29HC3	Vdet-IC	2.9V, -Reset ODO, 400ms	SOT-23	16vdc	VD6	3b	Ric
P3	RT1P441C	Si-pnp-Digi	Sw, 50V, 100mA, 150mW, 200MHz, R1/R2=47k/47k	SC-59	16ta	-	3a	Mit
P3	RT1P441M	Si-pnp-Digi	Sw, 50V, 100mA, 150mW, 200MHz, R1/R2=47k/47k	SOT-323	16ta	-	3a	Mit
P3	RT1P441U	Si-pnp-Digi	Sw, 50V, 100mA, 125mW, 200MHz, R1/R2=47k/47k	SC-75A	16ta	-	3a	Mit
P3	TC54VN4302ECB	Vdet-IC	4.3V±2%, -Reset ODO	SOT-23	16vdc	VD6	3a	Tcs
P3	TP0202T	p-MOSFET-e	V-MOS, 20V, 310mA, <1.4Ω(0.2A)	SOT-23	16fh	-	3a	Sbx
P3	XC61CN4302M	Vdet-IC	4.3V±1%, +Reset ODO	SOT-23	16vdc	VD6	3d	Tor
P3	XC6GN4302HR	Vdet-IC	4.3V, +Reset ODO	USP-3	17vdc	VD1	9b	Tor
P30	FB1A4A	Si-npn-Digi	Sw, 30V, 700mA, 200mW, R2=10k	SC-59	16ta	-	3a	Nec
p30	PDTC114YU	Si-npn-Digi	Sw, 50V, 100mA, 200mW, R1/R2=10k/47k	SOT-323	16ta	-	3a	PHH
P31	FB1L2Q	Si-npn-Digi	Sw, 30V, 700mA, 200mW, R1/R2=0k47/4k7	SC-59	16ta	-	3a	Nec
P31	SST271	n-FET	AF, LN, 30V, 350mW, Idss=6..50mA, Up<4.5V	SOT-23	16fj	-	3a	Cal
P32	FB1A3M	Si-npn-Digi	Sw, 30V, 700mA, 200mW, R1/R2=1k/1k	SC-59	16ta	-	3a	Nec
p32	PDTC143XT	Si-npn-Digi	Sw, 50V, 100mA, 250mW, R1/R2=4.7k/10k	SOT-23	16ta	-	3a	PHH
P33	FB1F3P	Si-npn-Digi	Sw, 30V, 700mA, 200mW, R1/R2=2k2/10k	SC-59	16ta	-	3a	Nec
p33	PDTC143TT	Si-npn-Digi	Sw, 50V, 100mA, 250mW, R1=4.7k	SOT-323	16ta	-	3a	PHH
P33	SO5401	Si-pnp	GP, HV, 160V, 600mA, 200mW, B=50..240, 400MHz	SOT-23	16ta	-	3a	Ste
P33	XE61CN4345MR	Vdet-IC	4.3V±2%, -Reset ODO	SOT-23	16vdc	VD6	3h	Tor
P34	FB1L3N	Si-npn-Digi	Sw, 30V, 700mA, 200mW, R1/R2=4k7/10k	SC-59	16ta	-	3a	Nec
P35	FB1A4M	Si-npn-Digi	Sw, 30V, 700mA, 200mW, R1/R2=10k/10k	SC-59	16ta	-	3a	Nec
P35	FB1L3N	Si-npn-Digi	Sw, 30V, 700mA, 200mW, R1/R2=10k/10k	SC-59	16ta	-	3a	Nec
p35	PDTA143XT	Si-pnp-Digi	Sw, 50V, 100mA, 250mW, R1/R2=4.7k/10k	SOT-23	16ta	-	3a	PHH
P35	XC61FN4312M	Vdet-IC	4.3V±2%, +Reset ODO, 200ms	SOT-23	16vdc	VD6	3d	Tor
P35	XC61HN4312MR	Vdet-IC	4.3V±2%, -Reset ODO, 50..200ms	SOT-23	16vdc	VD6	3d	Tor
P36	FB1J3P	Si-npn-Digi	Sw, 30V, 700mA, 200mW, R1/R2=3k3/10k	SC-59	16ta	-	3a	Nec
P36	XC61FN4342M	Vdet-IC	4.3V±2%, +Reset ODO, 400ms	SOT-23	16vdc	VD6	3d	Tor
P36	XC61HN4342MR	Vdet-IC	4.3V±2%, -Reset ODO, 80..400ms	SOT-23	16vdc	VD6	3d	Tor
P37	XC61FN4352M	Vdet-IC	4.3V±2%, +Reset ODO, 50ms	SOT-23	16vdc	VD6	3d	Tor
P37	XC61HN4352MR	Vdet-IC	4.3V±2%, -Reset ODO, 1..50ms	SOT-23	16vdc	VD6	3d	Tor
P38	SST4338	n-FET	GP, Low-Noise, 50V, Idss=0.2mA, Up<1V	SOT-23	16fa	-	3a	Lns
P39	SO692	Si-pnp	HV, Vid, 300V, 100mA, 310mW, B>25, 50MHz	SOT-23	16ta	-	3a	Ste
P39	SST4339	n-FET	GP, Low-Noise, 50V, Idss=0.5mA, Up<1.8V	SOT-23	16fa	-	3a	Lns
P4	2SD1161-P4	Si-npn	GP, 30V, 0.03A, Emitter-R=130Ω	SOT-23	16ta	-	3a	San
P4	BFR92R	Si-npn	UHF-A-Band, 20V, 25mA, 300mW, B>40, >5GHz	SOT-23	16ta	-	3a	Mot
P4	BZX84-C15T	Z-diode	15V±5%, 150mW	SOT-523	16dc	-	3a	Di
P4	CZRH3-55C15	Z-diode	15.0..15.60V, Zzt=30Ω, Izt=5mA, 150mW	SOT-523	18dc	-	3a	Cmc
P4	ELM7624HCB	Vdet-IC	2.4V±2%, +Reset PPO, 150ms	SOT-23	16vdc	VD7	3d	Elm
P4	ELM9724CBB	Vdet-IC	2.4V±2.5%, +Reset PPO	SOT-23	16vdc	VD7	3d	Elm
P4	ILC5061C44X	Vdet-IC	4.4V±2%, -Reset ODO	SOT-323	16vdc	VD6	3a	Imp
P4	ILC5061M44X	Vdet-IC	4.4V±2%, -Reset ODO	SOT-23	16vdc	VD6	3a	Imp
P4	KA4F3M	Si-npn-Digi	Sw, 60V, 100mA, 200mW, R1/R2=2k2/2k2	SOT-416	16ta	-	3a	Nec
P4	KRA117S	Si-pnp-Digi	Sw, 50V, 100mA, 200mW, 200MHz, R1/R2=2k2/2k2	SOT-23	16ta	-	3f	Kec
P4	KRA317	Si-pnp-Digi	Sw, 50V, 100mA, 100mW, 200MHz, R1/R2=2k2/2k2	SOT-323	16ta	-	3f	Kec
P4	KRA317E	Si-pnp-Digi	Sw, 50V, 100mA, 100mW, 200MHz, R1/R2=2k2/2k2	SOT-490	18ta	-	3f	Kec
P4	KRA317V	Si-pnp-Digi	Sw, 50V, 100mA, 100mW, 200MHz, R1/R2=2k2/2k2	VSM	18ta	-	3f	Kec
P4	R1100D341C	LVR-IC	U-low lcc, 3.4V±2%, 180mA	SON1408-3	18vj	VR1	3d	Ric
P4	R3130N30HC8	Vdet-IC	3V, -Reset ODO, 400ms	SOT-23	16vdc	VD6	3b	Ric



SMD code	Type	Function	Short description	Case	Pinout	Sch. St.	Mnf.	
P4	SP809EK-2-6	Vdet-IC	2.6V±1.5%, -Reset PPO	SOT-23	16vdc	VD7	3b	Sip
P4	SST204	n-FET	AF, LN, 25V, 350mW, Idss=0.2..3mA, Up<2V	SOT-23	16fj	-	3a	Six
P4	TC54VN4402ECB	Vdet-IC	4.4V±2%, -Reset ODO	SOT-23	16vdb	VD6	3a	Tcs
P4	XC61CN4402M	Vdet-IC	4.4V±1%, +Reset ODO	SOT-23	16vdb	VD6	3d	Tor
P4	XC6GN4402HR	Vdet-IC	4.4V, +Reset ODO	USP-3	17vdc	VD1	9b	Tor
P40	SST4340	n-FET	GP, Low-Noise, 50V, Idss=1.2mA, Up<3V	SOT-23	16fa	-	3a	Lns
P41	SST4341	n-FET	GP, Low-Noise, 50V, Idss=3mA, Up<6V	SOT-23	16fa	-	3a	Lns
P43	XE61CN4445MR	Vdet-IC	4.4V±2%, -Reset ODO	SOT-23	16vdb	VD6	3h	Tor
P45	XC61FN4412M	Vdet-IC	4.4V±2%, +Reset ODO, 200ms	SOT-23	16vdb	VD6	3d	Tor
P45	XC61HN4412MR	Vdet-IC	4.4V±2%, -Reset ODO, 50..200ms	SOT-23	16vdc	VD6	3d	Tor
P46	XC61FN4442M	Vdet-IC	4.4V±2%, +Reset ODO, 400ms	SOT-23	16vdb	VD6	3d	Tor
P46	XC61HN4442MR	Vdet-IC	4.4V±2%, -Reset ODO, 80..400ms	SOT-23	16vdc	VD6	3d	Tor
P47	XC61FN4452M	Vdet-IC	4.4V±2%, +Reset ODO, 50ms	SOT-23	16vdb	VD6	3d	Tor
P47	XC61HN4452MR	Vdet-IC	4.4V±2%, -Reset ODO, 1..50ms	SOT-23	16vdc	VD6	3d	Tor
P4A	ILC5061AIC44X	Vdet-IC	4.4V±1%, -Reset ODO	SOT-323	16vdb	VD6	3a	Imp
P4A	ILC5061AM44X	Vdet-IC	4.4V±1%, -Reset ODO	SOT-23	16vdb	VD6	3a	Imp
p4F	PMBD353	Si-diode	Dual, Schottky Barrier, 4V, 30mA, Vf<600mV(10mA), <1pF	SOT-23	16ea	-	3a	PHH
P5	2SD1161-P5	Si-npn	GP, 30V, 0.03A, Emitter-R=130Ω	SOT-23	16ta	-	3a	San
P5	BFR92AR	Si-npn	UHF-A-Band, 20V, 25mA, 300mW, B>40, >5GHz	SOT-23	16te	-	3a	Phi
P5	BZX84-C16T	Z-diode	16V±5%, 150mW	SOT-523	16dc	-	3a	Di
P5	CZRH3-55C16	Z-diode	16.0..17.10V, Zzt=40Ω, Izt=5mA, 150mW	SOT-523	18dc	-	3a	Cmc
P5	ELM7625HCB	Vdet-IC	2.5V±2%, +Reset PPO, 150ms	SOT-23	16vdc	VD7	3d	Elm
P5	ELM9725CBB	Vdet-IC	2.5V±2.5%, +Reset PPO	SOT-23	16vdb	VD7	3d	Elm
P5	FMMT2369A	Si-npn	Sw, 40V, 200mA, 330mW, B=40..120	SOT-23	16ta	-	3a	Zx
P5	KRA118S	Si-pnp-Digi	Sw, 50V, 100mA, 200mW, 200MHz, R1/R2=2k2/10k	SOT-23	16ta	-	3f	Kec
P5	KRA318	Si-pnp-Digi	Sw, 50V, 100mA, 100mW, 200MHz, R1/R2=2k2/10k	SOT-323	16ta	-	3f	Kec
P5	KRA318E	Si-pnp-Digi	Sw, 50V, 100mA, 100mW, 200MHz, R1/R2=2k2/10k	SOT-490	18ta	-	3f	Kec
P5	KRA318V	Si-pnp-Digi	Sw, 50V, 100mA, 100mW, 200MHz, R1/R2=2k2/10k	VSM	18ta	-	3f	Kec
P5	R1100D351C	LVR-IC	U-low lcc, 3.5V±2%, 180mA	SON1408-3	18vj	VR1	3d	Ric
P5	R3130N46HC5	Vdet-IC	4.6V, -Reset ODO, 400ms	SOT-23	16vdc	VD6	3b	Ric
P5	RT1P144C	Si-pnp-Digi	Sw, 50V, 100mA, 150mW, 200MHz, R1/R2=10/47k	SC-59	16ta	-	3a	Mit
P5	RT1P144M	Si-pnp-Digi	Sw, 50V, 100mA, 150mW, 200MHz, R1/R2=10/47k	SOT-323	16ta	-	3a	Mit
P5	RT1P144U	Si-pnp-Digi	Sw, 50V, 100mA, 125mW, 200MHz, R1/R2=10/47k	SC-75A	16ta	-	3a	Mit
P5	TC54VN44502ECB	Vdet-IC	4.5V±2%, -Reset ODO	SOT-23	16vdb	VD6	3a	Tcs
P5	XC61CN4502M	Vdet-IC	4.5V±1%, +Reset ODO	SOT-23	16vdb	VD6	3d	Tor
P5	XC6GN4502HR	Vdet-IC	4.5V, +Reset ODO	USP-3	17vdc	VD1	9b	Tor
p50	BZX84-A2V4	Z-diode	2.4V±1%, 300mW	SOT-23	16dc	-	3a	PHH
p51	BZX84-A2V7	Z-diode	2.7V±1%, 300mW	SOT-23	16dc	-	3a	PHH
p52	BZX84-A3V0	Z-diode	3V±1%, 300mW	SOT-23	16dc	-	3a	PHH
P53	XE61CN4545MR	Vdet-IC	4.5V±2%, -Reset ODO	SOT-23	16vdb	VD6	3h	Tor
p55	BZX84-A3V9	Z-diode	3.9V±1%, 300mW	SOT-23	16dc	-	3a	PHH
P55	XC61FN4512M	Vdet-IC	4.5V±2%, +Reset ODO, 200ms	SOT-23	16vdb	VD6	3d	Tor
P55	XC61HN4512MR	Vdet-IC	4.5V±2%, -Reset ODO, 50..200ms	SOT-23	16vdc	VD6	3d	Tor
p56	BZX84-A4V3	Z-diode	4.3V±1%, 300mW	SOT-23	16dc	-	3a	PHH
P56	XC61FN4542M	Vdet-IC	4.5V±2%, +Reset ODO, 400ms	SOT-23	16vdb	VD6	3d	Tor
P56	XC61HN4542MR	Vdet-IC	4.5V±2%, -Reset ODO, 80..400ms	SOT-23	16vdc	VD6	3d	Tor
p57	BZX84-A4V7	Z-diode	4.7V±1%, 300mW	SOT-23	16dc	-	3a	PHH
P57	XC61FN4552M	Vdet-IC	4.5V±2%, +Reset ODO, 50ms	SOT-23	16vdb	VD6	3d	Tor
P57	XC61HN4552MR	Vdet-IC	4.5V±2%, -Reset ODO, 1..50ms	SOT-23	16vdc	VD6	3d	Tor
p58	BZX84-A5V1	Z-diode	5.1V±1%, 300mW	SOT-23	16dc	-	3a	PHH
p59	BZX84-A5V6	Z-diode	5.6V±1%, 300mW	SOT-23	16dc	-	3a	PHH
p5A	PMBD6050	Si-diode	Sw, Hi-sp, 75V, 215mA, Vf<1.25V(150mA), <4ns	SOT-23	16dc	-	3a	PHH
p5B	PMBD6100	Si-diode	Dual, Sw, Hi-sp, 70V, 215mA, Vf<1.1V(100mA), <4ns	SOT-23	16dg	-	3a	PHH
p5C	PMBD7000	Si-diode	Dual, Sw, Hi-sp, 100V, 215mA, Vf<1.25V(150mA), <4ns	SOT-23	16dl	-	3a	PHH
p5D	PMBD914	Si-diode	Sw, Fast, 70V, 215mA, 250mW, <4ns	SOT-23	16dc	-	3a	PHH
p5G	PMBD352	Si-diode	Dual, Sw, Fast, 4V, 30mA, Vf<0.6V(10mA), <1pF	SOT-23	16dl	-	3a	Phi
P6	2SD1161-P6	Si-npn	GP, 30V, 0.03A, Emitter-R=130Ω	SOT-23	16ta	-	3a	San
P6	BZX84-C18T	Z-diode	18V±5%, 150mW	SOT-523	16dc	-	3a	Di
P6	CZRH3-55C18	Z-diode	18.0..19.10V, Zzt=45Ω, Izt=5mA, 150mW	SOT-523	18dc	-	3a	Cmc
P6	ELM7626HCB	Vdet-IC	2.6V±2%, +Reset PPO, 150ms	SOT-23	16vdc	VD7	3d	Elm
P6	ELM9726CBB	Vdet-IC	2.6V±2.5%, +Reset PPO	SOT-23	16vdb	VD7	3d	Elm
P6	ILC50611C46X	Vdet-IC	4.6V±2%, -Reset ODO	SOT-323	16vdb	VD6	3a	Imp
P6	ILC5061M46X	Vdet-IC	4.6V±2%, -Reset ODO	SOT-23	16vdb	VD6	3a	Imp
P6	KRA119S	Si-pnp-Digi	Sw, 50V, 100mA, 200mW, 200MHz, R1/R2=4k7k/10k	SOT-23	16ta	-	3f	Kec
P6	KRA319	Si-pnp-Digi	Sw, 50V, 100mA, 100mW, 200MHz, R1/R2=4k7k/10k	SOT-323	16ta	-	3f	Kec
P6	KRA319E	Si-pnp-Digi	Sw, 50V, 100mA, 100mW, 200MHz, R1/R2=4k7k/10k	SOT-490	18ta	-	3f	Kec
P6	KRA319V	Si-pnp-Digi	Sw, 50V, 100mA, 100mW, 200MHz, R1/R2=4k7k/10k	VSM	18ta	-	3f	Kec
P6	R1100D361C	LVR-IC	U-low lcc, 3.6V±2%, 180mA	SON1408-3	18vj	VR1	3d	Ric
P6	RT1P430C	Si-pnp-Digi	Sw, 50V, 100mA, 150mW, 200MHz, R1=4k7	SC-59	16ta	-	3a	Mit
P6	RT1P430M	Si-pnp-Digi	Sw, 50V, 100mA, 150mW, 200MHz, R1=4k7	SOT-323	16ta	-	3a	Mit



SMD code	Type	Function	Short description	Case	Pinout	Sch. St.	Mnf.
P6	RT1P430U	Si-pnp-Digi	Sw, 50V, 100mA, 150mW, 200MHz, R1=4k7	SC-75A	16ta	-	3a Mit
P6	TC54VN4602ECB	Vdet-IC	4.6V±2%, -Reset ODO	SOT-23	16vdb	VD6	3a Tcs
P6	XC61CN4602M	Vdet-IC	4.6V±1%, +Reset ODO	SOT-23	16vdb	VD6	3d Tor
P6	XC6GN4602HR	Vdet-IC	4.6V, +Reset ODO	USP-3	17vdc	VD1	9b Tor
p60	BZX84-A6V2	Z-diode	6.2V±1%, 300mW	SOT-23	16dc	-	3a PhH
P60	DDTB113EC	Si-pnp-Digi	Sw, 50V, 100mA, 200mW, 250MHz, R1/R2=1k/1k	SOT-23	16ta	-	3d Di
P60	DDTB113EU	Si-pnp-Digi	Sw, 50V, 100mA, 200mW, 250MHz, R1/R2=1k/1k	SOT-323	16ta	-	3d Di
p61	BZX84-A6V8	Z-diode	6.8V±1%, 300mW	SOT-23	16dc	-	3a PhH
P61	DDTB123EC	Si-pnp-Digi	Sw, 50V, 100mA, 200mW, 250MHz, R1/R2=2.2k/2.2k	SOT-23	16ta	-	3d Di
P61	DDTB123EU	Si-pnp-Digi	Sw, 50V, 100mA, 200mW, 250MHz, R1/R2=2.2k/2.2k	SOT-323	16ta	-	3d Di
p62	BZX84-A7V5	Z-diode	7.5V±1%, 300mW	SOT-23	16dc	-	3a PhH
P62	DDTB143EC	Si-pnp-Digi	Sw, 50V, 100mA, 200mW, 250MHz, R1/R2=4.7k/4.7k	SOT-23	16ta	-	3d Di
P62	DDTB143EU	Si-pnp-Digi	Sw, 50V, 100mA, 200mW, 250MHz, R1/R2=4.7k/4.7k	SOT-323	16ta	-	3d Di
p63	BZX84-ABV2	Z-diode	8.2V±1%, 300mW	SOT-23	16dc	-	3a PhH
P63	DDTB114EC	Si-pnp-Digi	Sw, 50V, 100mA, 200mW, 250MHz, R1/R2=10k/10k	SOT-23	16ta	-	3d Di
P63	DDTB114EU	Si-pnp-Digi	Sw, 50V, 100mA, 200mW, 250MHz, R1/R2=10k/10k	SOT-323	16ta	-	3d Di
P63	XE61CN4645MR	Vdet-IC	4.6V±2%, -Reset ODO	SOT-23	16vdb	VD6	3h Tor
p64	BZX84-A9V1	Z-diode	9.1V±1%, 300mW	SOT-23	16dc	-	3a PhH
P64	DDTB122JC	Si-pnp-Digi	Sw, 50V, 100mA, 200mW, 250MHz, R1/R2=0.22k/4.7k	SOT-23	16ta	-	3d Di
P64	DDTB122JU	Si-pnp-Digi	Sw, 50V, 100mA, 200mW, 250MHz, R1/R2=0.22k/4.7k	SOT-323	16ta	-	3d Di
p65	BZX84-A10	Z-diode	10V±1%, Izt=25mA, 350mW	SOT-23	16dc	-	3a PhH
P65	DDTB113ZC	Si-pnp-Digi	Sw, 50V, 100mA, 200mW, 250MHz, R1/R2=1k/10k	SOT-23	16ta	-	3d Di
P65	DDTB113ZU	Si-pnp-Digi	Sw, 50V, 100mA, 200mW, 250MHz, R1/R2=1k/10k	SOT-323	16ta	-	3d Di
P65	XC61FN4612M	Vdet-IC	4.6V±2%, +Reset ODO, 200ms	SOT-23	16vdb	VD6	3d Tor
P65	XC61HN4612MR	Vdet-IC	4.6V±2%, -Reset ODO, 50..200ms	SOT-23	16vdc	VD6	3d Tor
p66	BZX84-B10	Z-diode	10V±2%, 300mW	SOT-23	16dc	-	3a PhH
P66	DDTB123YC	Si-pnp-Digi	Sw, 50V, 100mA, 200mW, 250MHz, R1/R2=2.2k/10k	SOT-23	16ta	-	3d Di
P66	DDTB123YU	Si-pnp-Digi	Sw, 50V, 100mA, 200mW, 250MHz, R1/R2=2.2k/10k	SOT-323	16ta	-	3d Di
P66	XC61FN4642M	Vdet-IC	4.6V±2%, +Reset ODO, 400ms	SOT-23	16vdb	VD6	3d Tor
P66	XC61HN4642MR	Vdet-IC	4.6V±2%, -Reset ODO, 80..400ms	SOT-23	16vdc	VD6	3d Tor
p67	BZX84-A12	Z-diode	12V±1%, Izt=21mA, 300mW	SOT-23	16dc	-	3a PhH
P67	DDTB133HC	Si-pnp-Digi	Sw, 50V, 100mA, 200mW, 250MHz, R1/R2=3.3k/10k	SOT-23	16ta	-	3d Di
P67	DDTB133HU	Si-pnp-Digi	Sw, 50V, 100mA, 200mW, 250MHz, R1/R2=3.3k/10k	SOT-323	16ta	-	3d Di
P67	XC61FN4652M	Vdet-IC	4.6V±2%, +Reset ODO, 50ms	SOT-23	16vdb	VD6	3d Tor
P67	XC61HN4652MR	Vdet-IC	4.6V±2%, -Reset ODO, 1..1.50ms	SOT-23	16vdc	VD6	3d Tor
p69	BZX84-A15	Z-diode	15V±1%, 300mW	SOT-23	16dc	-	3a PhH
P69	DDTB123TC	Si-pnp-Digi	Sw, 50V, 100mA, 200mW, 250MHz, R1=2.2k	SOT-23	16ta	-	3d Di
P69	DDTB123TU	Si-pnp-Digi	Sw, 50V, 100mA, 200mW, 250MHz, R1=2.2k	SOT-323	16ta	-	3d Di
P6A	ILC5061AIC46X	Vdet-IC	4.6V±1%, -Reset ODO	SOT-323	16vdb	VD6	3a Imp
P6A	ILC5061AM46X	Vdet-IC	4.6V±1%, -Reset ODO	SOT-23	16vdb	VD6	3a Imp
p6D	2PD601AQW	Si-npn	GP, Sw, 60V, 100mA, 200mW, B=160..260, >100MHz	SOT-323	16ta	-	3a PhH
p6E	2PD601ARW	Si-npn	GP, Sw, 60V, 100mA, 200mW, B=210..340, >120MHz	SOT-323	16ta	-	3a PhH
p6F	2PD601ASW	Si-npn	GP, Sw, 60V, 100mA, 200mW, B=290..460, >140MHz	SOT-323	16ta	-	3a PhH
p6G	PMBF4393	n-FET	Sw, 30V, 50mA, 225mA, Rds=30Q (1mA)	SOT-23	16fj	-	3a Phi
p6J	PMBF4391	n-FET	Sw, 30V, 50mA, 225mA, Rds=30Q (1mA)	SOT-23	16fj	-	3a Phi
p6K	PMBF4392	n-FET	Sw, 30V, 50mA, 225mA, Rds=60Q (1mA)	SOT-23	16fj	-	3a Phi
P7	BZX84-C20T	Z-diode	20V±5%, 150mW	SOT-523	16dc	-	3a Di
P7	CZRH3-55C20	Z-diode	20.0..21.20V, Zzt=55Q, Izt=5mA, 150mW	SOT-523	18dc	-	3a Cmc
P7	ELM7627HCB	Vdet-IC	2.7V±2%, +Reset PPO, 150ms	SOT-23	16vdc	VD7	3d Elm
P7	ELM9727CBB	Vdet-IC	2.7V±2.5%, +Reset PPO	SOT-23	16vdb	VD7	3d Elm
P7	KN4F3M	Si-pnp-Digi	Sw, 60V, 100mA, 150mW, R1/R2=2k2/2k2	SOT-416	16ta	-	3a Nec
P7	KRA120S	Si-pnp-Digi	Sw, 50V, 100mA, 200mW, 200MHz, R1/R2=10k/4k7	SOT-23	16ta	-	3f Kec
P7	KRA320	Si-pnp-Digi	Sw, 50V, 100mA, 100mW, 200MHz, R1/R2=10k/4k7	SOT-323	16ta	-	3f Kec
P7	KRA320E	Si-pnp-Digi	Sw, 50V, 100mA, 100mW, 200MHz, R1/R2=10k/4k7	SOT-490	18ta	-	3f Kec
P7	KRA320V	Si-pnp-Digi	Sw, 50V, 100mA, 100mW, 200MHz, R1/R2=10k/4k7	VSM	18ta	-	3f Kec
P7	R1100D371C	LVR-IC	U-low Icc, 3.7V±2%, 180mA	SON1408-3	18vj	VR1	3d Ric
P7	RT1P140C	Si-pnp-Digi	Sw, 50V, 100mA, 150mW, 200MHz, R1=10k	SC-59	16ta	-	3a Mit
P7	RT1P140M	Si-pnp-Digi	Sw, 50V, 100mA, 150mW, 200MHz, R1=10k	SOT-323	16ta	-	3a Mit
P7	RT1P140T	Si-pnp-Digi	Sw, 50V, 100mA, 125mW, 200MHz, R1=10k	T-USM	18ta	-	3a Mit
P7	RT1P140U	Si-pnp-Digi	Sw, 50V, 100mA, 125mW, 200MHz, R1=10k	SC-75A	16ta	-	3a Mit
P7	TC54VN4702ECB	Vdet-IC	4.7V±2%, -Reset ODO	SOT-23	16vdb	VD6	3a Tcs
P7	XC61CN4702M	Vdet-IC	4.7V±1%, +Reset ODO	SOT-23	16vdb	VD6	3d Tor
P7	XC6GN4702HR	Vdet-IC	4.7V, +Reset ODO	USP-3	17vdc	VD1	9b Tor
p70	BZX84-B16	Z-diode	16V±2%, 300mW	SOT-23	16dc	-	3a PhH
P70	DDTB143TC	Si-pnp-Digi	Sw, 50V, 100mA, 200mW, 250MHz, R1=4.7k	SOT-23	16ta	-	3d Di
P70	DDTB143TU	Si-pnp-Digi	Sw, 50V, 100mA, 200mW, 250MHz, R1=4.7k	SOT-323	16ta	-	3d Di
p71	BZX84-B18	Z-diode	18V±2%, 300mW	SOT-23	16dc	-	3a PhH
P71	DDTB114TC	Si-pnp-Digi	Sw, 50V, 100mA, 200mW, 250MHz, R1=10k	SOT-23	16ta	-	3d Di
P71	DDTB114TU	Si-pnp-Digi	Sw, 50V, 100mA, 200mW, 250MHz, R1=10k	SOT-323	16ta	-	3d Di
p72	BZX84-B20	Z-diode	20V±2%, 300mW	SOT-23	16dc	-	3a PhH



SMD code	Type	Function	Short description	Case	Pinout	Sch.	St.	Mnf.
P72	DDTB114GC	Si-pnp-Digi	Sw, 50V, 100mA, 200mW, B=100..600, 250MHz, R2=10k	SOT-23	16ta	-	3d	Di
P72	DDTB114GU	Si-pnp-Digi	Sw, 50V, 100mA, 200mW, B=100..600, 250MHz, R2=10k	SOT-323	16ta	-	3d	Di
p73	BZX84-B22	Z-diode	22V±2%, 300mW	SOT-23	16dc	-	3a	PhH
P73	XE61CN4745MR	Vdet-IC	4.7V±2%, -Reset ODO	SOT-23	16vdb	VD6	3h	Tor
p74	BZX84-B24	Z-diode	24V±2%, 300mW	SOT-23	16dc	-	3a	PhH
p75	BZX84-A27	Z-diode	27V±1%, 300mW	SOT-23	16dc	-	3a	PHH
P75	DDTB122LC	Si-pnp-Digi	Sw, 50V, 100mA, 200mW, 250MHz, R1/R2=0.22k/10k	SOT-23	16ta	-	3d	Di
P75	DDTB122LU	Si-pnp-Digi	Sw, 50V, 100mA, 200mW, 250MHz, R1/R2=0.22k/10k	SOT-323	16ta	-	3d	Di
P75	XC61FN4712M	Vdet-IC	4.7V±2%, +Reset ODO, 200ms	SOT-23	16vdb	VD6	3d	Tor
P75	XC61HN4712MR	Vdet-IC	4.7V±2%, -Reset ODO, 50..200ms	SOT-23	16vdc	VD6	3d	Tor
P76	DDTB142JC	Si-pnp-Digi	Sw, 50V, 100mA, 200mW, 250MHz, R1/R2=0.47k/10k	SOT-23	16ta	-	3d	Di
P76	DDTB142JU	Si-pnp-Digi	Sw, 50V, 100mA, 200mW, 250MHz, R1/R2=0.47k/10k	SOT-323	16ta	-	3d	Di
P76	XC61FN4742M	Vdet-IC	4.7V±2%, +Reset ODO, 400ms	SOT-23	16vdb	VD6	3d	Tor
P76	XC61HN4742MR	Vdet-IC	4.7V±2%, -Reset ODO, 80..400ms	SOT-23	16vdc	VD6	3d	Tor
P77	DDTB122TC	Si-pnp-Digi	Sw, 50V, 100mA, 200mW, 250MHz, R1=0.22k	SOT-23	16ta	-	3d	Di
P77	DDTB122TU	Si-pnp-Digi	Sw, 50V, 100mA, 200mW, 250MHz, R1=0.22k	SOT-323	16ta	-	3d	Di
P77	XC61FN4752M	Vdet-IC	4.7V±2%, +Reset ODO, 50ms	SOT-23	16vdb	VD6	3d	Tor
P77	XC61HN4752MR	Vdet-IC	4.7V±2%, -Reset ODO, 1..50ms	SOT-23	16vdc	VD6	3d	Tor
P78	DDTB142TC	Si-pnp-Digi	Sw, 50V, 100mA, 200mW, 250MHz, R1=0.47k	SOT-23	16ta	-	3d	Di
P78	DDTB142TU	Si-pnp-Digi	Sw, 50V, 100mA, 200mW, 250MHz, R1=0.47k	SOT-323	16ta	-	3d	Di
P8	BZX84-C22T	Z-diode	22V±5%, 150mW	SOT-523	16dc	-	3a	Di
P8	BZX84-C5V6	Z-diode	5.2..6.0V, Zzt=40Ω, Izt=20mA, 225mW	SOT-23	16dc	-	3a	Lge
P8	CZRH3-55C22	Z-diode	22.0..23.30V, Zzt=55Ω, Izt=5mA, 150mW	SOT-523	18dc	-	3a	Cmc
P8	ELM7628HCB	Vdet-IC	2.8V±2%, +Reset PPO, 150ms	SOT-23	16vdc	VD7	3d	Elm
P8	ELM9728CBB	Vdet-IC	2.8V±2.5%, +Reset PPO	SOT-23	16vdb	VD7	3d	Elm
P8	KRA121S	Si-pnp-Digi	Sw, 50V, 100mA, 200mW, 200MHz, R1/R2=47k/10k	SOT-23	16ta	-	3f	Kec
P8	KRA321	Si-pnp-Digi	Sw, 50V, 100mA, 100mW, 200MHz, R1/R2=47k/10k	SOT-323	16ta	-	3f	Kec
P8	KRA321E	Si-pnp-Digi	Sw, 50V, 100mA, 100mW, 200MHz, R1/R2=47k/10k	SOT-490	18ta	-	3f	Kec
P8	KRA321V	Si-pnp-Digi	Sw, 50V, 100mA, 100mW, 200MHz, R1/R2=47k/10k	VSM	18ta	-	3f	Kec
P8	R1100D381C	LVR-IC	U-low lcc, 3.8V±2%, 180mA	SON11408-3	18vj	VR1	3d	Ric
P8	TC54VN4802ECB	Vdet-IC	4.8V±2%, -Reset ODO	SOT-23	16vdb	VD6	3a	Tcs
P8	XC61CN4802M	Vdet-IC	4.8V±1%, +Reset ODO	SOT-23	16vdb	VD6	3d	Tor
P8	XC6GN4802HR	Vdet-IC	4.8V, +Reset ODO	USP-3	17vdc	VD1	9b	Tor
P81	DDTA122LE	Si-pnp-Digi	Sw, 50V, 100mA, 150mW, 250MHz, R1/R2=0.22k/100k	SOT-523	16ta	-	3a	Di
P81	DDTA122LU	Si-pnp-Digi	Sw, 50V, 100mA, 200mW, 250MHz, R1/R2=0.22k/100k	SOT-23	16ta	-	3a	Di
P82	DDTA142JE	Si-pnp-Digi	Sw, 50V, 100mA, 150mW, 250MHz, R1/R2=0.47k/10k	SOT-523	16ta	-	3d	Di
P82	DDTA142JU	Si-pnp-Digi	Sw, 50V, 100mA, 200mW, 250MHz, R1/R2=0.47k/10k	SOT-23	16ta	-	3d	Di
P83	DDTA122TE	Si-pnp-Digi	Sw, 50V, 100mA, 150mW, 250MHz, R1=0.22k	SOT-523	16ta	-	3a	Di
P83	DDTA122TU	Si-pnp-Digi	Sw, 50V, 100mA, 200mW, 250MHz, R1=0.22k	SOT-323	16ta	-	3a	Di
P83	XE61CN4845MR	Vdet-IC	4.8V±2%, -Reset ODO	SOT-23	16vdb	VD6	3h	Tor
P84	DDTA142TE	Si-pnp-Digi	Sw, 50V, 100mA, 150mW, 250MHz, R1=0.47k	SOT-523	16ta	-	3d	Di
P84	DDTA142TU	Si-pnp-Digi	Sw, 50V, 100mA, 200mW, 250MHz, R1=0.47k	SOT-323	16ta	-	3d	Di
P85	XC61FN4812M	Vdet-IC	4.8V±2%, +Reset ODO, 200ms	SOT-23	16vdb	VD6	3d	Tor
P85	XC61HN4812MR	Vdet-IC	4.8V±2%, -Reset ODO, 50..200ms	SOT-23	16vdc	VD6	3d	Tor
p86	BZX84-A75	Z-diode	75V±1%, 300mW	SOT-23	16dc	-	3a	PHH
P86	XC61FN4842M	Vdet-IC	4.8V±2%, +Reset ODO, 400ms	SOT-23	16vdb	VD6	3d	Tor
P86	XC61HN4842MR	Vdet-IC	4.8V±2%, -Reset ODO, 80..400ms	SOT-23	16vdc	VD6	3d	Tor
P87	XC61FN4852M	Vdet-IC	4.8V±2%, +Reset ODO, 50ms	SOT-23	16vdb	VD6	3d	Tor
P87	XC61HN4852MR	Vdet-IC	4.8V±2%, -Reset ODO, 1..50ms	SOT-23	16vdc	VD6	3d	Tor
p8A	PMBZ5226B	Z-diode	3.3V±5%, 250mW	SOT-23	16dc	-	3a	PhH
p8B	PMBZ5227B	Z-diode	3.6V±5%, 250mW	SOT-23	16dc	-	3a	PhH
p8C	PMBZ5228B	Z-diode	3.9V±5%, 250mW	SOT-23	16dc	-	3a	PhH
p8D	PMBZ5229B	Z-diode	4.3V±5%, 250mW	SOT-23	16dc	-	3a	PhH
p8E	PMBZ5230B	Z-diode	4.7V±5%, 250mW	SOT-23	16dc	-	3a	PhH
p8F	PMBZ5231B	Z-diode	5.1V±5%, 250mW	SOT-23	16dc	-	3a	PhH
p8G	PMBZ5232B	Z-diode	5.6V±5%, 250mW	SOT-23	16dc	-	3a	PhH
p8H	PMBZ5233B	Z-diode	6V±5%, 250mW	SOT-23	16dc	-	3a	PhH
p8J	PMBZ5234B	Z-diode	6.2V±5%, 250mW	SOT-23	16dc	-	3a	PhH
p8K	PMBZ5235B	Z-diode	6.8V±5%, 250mW	SOT-23	16dc	-	3a	PhH
p8L	PMBZ5236B	Z-diode	7.5V±5%, 250mW	SOT-23	16dc	-	3a	PhH
p8M	PMBZ5237B	Z-diode	8.2V±5%, 250mW	SOT-23	16dc	-	3a	PhH
p8N	PMBZ5238B	Z-diode	8.7V±5%, 250mW	SOT-23	16dc	-	3a	PhH
p8P	PMBZ5239B	Z-diode	9.1V±5%, 250mW	SOT-23	16dc	-	3a	PhH
p8Q	PMBZ5240B	Z-diode	10V±5%, 250mW	SOT-23	16dc	-	3a	PhH
p8R	PMBZ5241B	Z-diode	11V±5%, 250mW	SOT-23	16dc	-	3a	PhH
p8S	PMBZ5242B	Z-diode	12V±5%, 250mW	SOT-23	16dc	-	3a	PhH
p8T	PMBZ5243B	Z-diode	13V±5%, 250mW	SOT-23	16dc	-	3a	PhH
P8U	LP0801K1	p-MOSFET-e	V-MOS, LogL, 16.5V, 0.1A, <12Ω	SOT-23	16fh	-	3a	Sbx
p8U	PMBZ5244B	Z-diode	14V±5%, 250mW	SOT-23	16dc	-	3a	PhH
p8V	PMBZ5245B	Z-diode	15V±5%, 250mW	SOT-23	16dc	-	3a	PhH



SMD code	Type	Function	Short description	Case	Pinout	Sch.	St.	Mnf.
p8W	PMBZ5246B	Z-diode	16V±5%, 250mW	SOT-23	16dc	-	3a	PHH
p8X	PMBZ5247B	Z-diode	17V±5%, 250mW	SOT-23	16dc	-	3a	PHH
p8Y	PMBZ5248B	Z-diode	18V±5%, 250mW	SOT-23	16dc	-	3a	PHH
p8Z	PMBZ5249B	Z-diode	19V±5%, 250mW	SOT-23	16dc	-	3a	PHH
P9	1SS379	Si-diode	Dual, Schottky, Sw, 15V, 100mA	SOT-23	16ea	-	3a	Tos
P9	BCX70KR	Si-npn	GP, Sw, 45V, 100mA, 250mW, B=380..630, >100MHz	SOT-23	16te	-	3a	Phi
P9	BCX70RK	Si-npn	GP, Sw, 45V, 100mA, 250mW, B=380..630, >100MHz	SOT-23	16ta	-	3a	Zx
P9	BZX84-C24T	Z-diode	24V±5%, 150mW	SOT-523	16dc	-	3a	Di
P9	BZX84-C27	Z-diode	25.1.28.90V, Zzt=80Ω, Izt=20mA, 225mW	SOT-23	16dc	-	3a	Lge
P9	CZRH3-55C24	Z-diode	24.0..25.60V, Zzt=70Ω, Izt=5mA, 150mW	SOT-523	18dc	-	3a	Cmc
P9	DAP222	Si-diode	Dual, Sw, 80V, 100mA, 150mW, <4ns	SOT-416	16df	-	3b	Ons
P9	ELM7629HCB	Vdet-IC	2.9V±2%, +Reset PPO, 150ms	SOT-23	16vdc	VD7	3d	Elm
P9	ELM9729CBB	Vdet-IC	2.9V±2.5%, +Reset PPO	SOT-23	16vdb	VD7	3d	Elm
P9	KRA122S	Si-pnp-Digi	Sw, 50V, 100mA, 200mW, 200MHz, R1/R2=100k/100k	SOT-23	16ta	-	3f	Kec
P9	KRA322	Si-pnp-Digi	Sw, 50V, 100mA, 100mW, 200MHz, R1/R2=100k/100k	SOT-323	16ta	-	3f	Kec
P9	KRA322E	Si-pnp-Digi	Sw, 50V, 100mA, 100mW, 200MHz, R1/R2=100k/100k	SOT-490	18ta	-	3f	Kec
P9	KRA322V	Si-pnp-Digi	Sw, 50V, 100mA, 100mW, 200MHz, R1/R2=100k/100k	VSM	18ta	-	3f	Kec
P9	R1100D391C	LVR-IC	U-low lcc, 3.9V±2%, 180mA	SON1408-3	18vj	VR1	3d	Ric
P9	TC54VN4902ECB	Vdet-IC	4.9V±2%, -Reset ODO	SOT-23	16vdb	VD6	3a	Tcs
P9	XC61CN4902M	Vdet-IC	4.9V±1%, +Reset ODO	SOT-23	16vdb	VD6	3d	Tor
P9	XC6GN4902HR	Vdet-IC	4.9V, +Reset ODO	USP-3	17vdc	VD1	9b	Tor
P93	XE61CN4945MR	Vdet-IC	4.9V±2%, -Reset ODO	SOT-23	16vdb	VD6	3h	Tor
P95	XC61FN4912M	Vdet-IC	4.9V±2%, +Reset ODO, 200ms	SOT-23	16vdb	VD6	3d	Tor
P95	XC61HN4912MR	Vdet-IC	4.9V±2%, -Reset ODO, 50..200ms	SOT-23	16vdb	VD6	3d	Tor
P96	XC61FN4942M	Vdet-IC	4.9V±2%, +Reset ODO, 400ms	SOT-23	16vdb	VD6	3d	Tor
P96	XC61HN4942MR	Vdet-IC	4.9V±2%, -Reset ODO, 80..400ms	SOT-23	16vdc	VD6	3d	Tor
P97	XC61FN4952M	Vdet-IC	4.9V±2%, +Reset ODO, 50ms	SOT-23	16vdb	VD6	3d	Tor
P97	XC61HN4952MR	Vdet-IC	4.9V±2%, -Reset ODO, 1..50ms	SOT-23	16vdc	VD6	3d	Tor
p9A	PLVA650A	Z-diode	Avalanshe regulator, 5V, 250mA, 250mW	SOT-23	16dc	-	3a	PHH
p9B	PLVA653A	Z-diode	Avalanshe regulator, 5.3V, 250mA, 250mW	SOT-23	16dc	-	3a	PHH
p9C	PLVA656A	Z-diode	Avalanshe regulator, 5.6V, 250mA, 250mW	SOT-23	16dc	-	3a	PHH
p9D	PLVA659A	Z-diode	Avalanshe regulator, 5.9V, 250mA, 250mW	SOT-23	16dc	-	3a	PHH
p9E	PLVA662A	Z-diode	Avalanshe regulator, 6.2V, 250mA, 250mW	SOT-23	16dc	-	3a	PHH
p9F	PLVA665A	Z-diode	Avalanshe regulator, 6.5V, 250mA, 250mW	SOT-23	16dc	-	3a	PHH
p9G	PLVA668A	Z-diode	Avalanshe regulator, 6.8V, 250mA, 250mW	SOT-23	16dc	-	3a	PHH
p9J	PLVA2650A	Z-diode	Dual, Avalanshe regulator, 5V, 250mA, 250mW	SOT-23	16df	-	3a	PHH
p9K	PLVA2653A	Z-diode	Dual, Avalanshe regulator, 5.3V, 250mA, 250mW	SOT-23	16df	-	3a	PHH
p9L	PLVA2656A	Z-diode	Dual, Avalanshe regulator, 5.6V, 250mA, 250mW	SOT-23	16df	-	3a	PHH
p9M	PLVA2659A	Z-diode	Dual, Avalanshe regulator, 5.9V, 250mA, 250mW	SOT-23	16df	-	3a	PHH
p9N	PLVA2662A	Z-diode	Dual, Avalanshe regulator, 6.2V, 250mA, 250mW	SOT-23	16df	-	3a	PHM
p9O	PLVA2665A	Z-diode	Dual, Avalanshe regulator, 6.5V, 250mA, 250mW	SOT-23	16df	-	3a	PHH
p9P	PLVA2668A	Z-diode	Dual, Avalanshe regulator, 6.8V, 250mA, 250mW	SOT-23	16df	-	3a	PHH
PA	2PA1774RM	Si-pnp	LN, 50V, 100mA, 250mW, >100MHz, B=180..390	SOT-883	22ta	-	2a	Phi
PA	2SC3295-A	Si-npn	AF-Amp, Sw, 50V, 150mA, 150mW, B=600..1800, 250MHz	SC-59	16ta	-	3a	Tos
PA	2SC4666A	Si-npn	AF, 50V, 150mA, 100mW, B=600..1800, 250MHz	SOT-323	16ta	-	3a	Tos
PA	BA885	PIN-diode	UHF TV-sat, 50V, 50mA, Vf<1.1V(50mA), 0.22pF, <2GHz	SOT-23	16dc	-	3c	Inf
PA	BZX84-C27T	Z-diode	27V±5%, 150mW	SOT-523	16dc	-	3a	Di
PA	CHT92T1PT	Si-pnp	Vid, Drv, 300V, 300mA, B=50..240, 50MHz	FBPT-523	17ta	-	9a	Chm
PA	CHTA92LPT	Si-pnp	Vid, Drv, 300V, 500mA, B>25, 50MHz	SOT-23	16ta	-	3a	Chm
PA	CZRH3-55C27	Z-diode	27.0..28.90V, Zzt=80Ω, Izt=2mA, 150mW	SOT-523	18dc	-	3a	Cmc
PA	KRA101S	Si-pnp-Digi	Sw, 50V, 100mA, 200mW, 200MHz, R1/R2=4k7/4k7	SOT-23	16ta	-	3f	Kec
PA	KRA301	Si-pnp-Digi	Sw, 50V, 100mA, 100mW, 200MHz, R1/R2=4k7/4k7	SOT-323	16ta	-	3f	Kec
PA	KRA301E	Si-pnp-Digi	Sw, 50V, 100mA, 100mW, 200MHz, R1/R2=4k7/4k7	SOT-490	18ta	-	3f	Kec
PA	KRA301V	Si-pnp-Digi	Sw, 50V, 100mA, 100mW, 200MHz, R1/R2=4k7/4k7	VSM	18ta	-	3f	Kec
PA	TC1278-5ENB	Vdet-IC	4.62V, +Reset PPO	SOT-23	16vdb	VD7	3d	Mcc
pA1	BZX84-C75	Z-diode	75V±5%, 300mW	SOT-23	16dc	-	3a	PHH
pA2	PMBD2836	Si-diode	Dual, Sw, Hi-sp, 75V, 215mA, Vf<1.25V(150mA), <4ns	SOT-23	16df	-	3a	Phi
pA3	PMBD2835	Si-diode	Dual, Sw, Hi-sp, 35V, 215mA, Vf<1.25V(150mA), <4ns	SOT-23	16df	-	3a	Phi
pA5	PMBD2837	Si-diode	Dual, Sw, Hi-sp, 35V, 215mA, Vf<1.25V(150mA), <4ns	SOT-23	16dg	-	3a	Phi
pA6	PMBD2838	Si-diode	Dual, Sw, Hi-sp, 75V, 215mA, Vf<1.25V(150mA), <4ns	SOT-23	16dg	-	3a	Phi
PAA	BC818-16	Si-npn	Sw, 30V, 800mA, 200mW, B=110..250, 100MHz	SOT-23	16ta	-	3a	Auk
PAA	BC818F-16	Si-pnp	Sw, 30V, 800mA, 200mW, B=110..250, 100MHz	SOT-23F	18ta	-	3a	Auk
PAB	BC818-25	Si-pnp	Sw, 30V, 800mA, 200mW, B=160..400, 100MHz	SOT-23	16ta	-	3a	Auk
PAB	BC818F-25	Si-pnp	Sw, 30V, 800mA, 200mW, B=160..400, 100MHz	SOT-23F	18ta	-	3a	Auk
PAC	BC818-40	Si-pnp	Sw, 30V, 800mA, 200mW, B=250..630, 100MHz	SOT-23	16ta	-	3a	Auk
PAC	BC818F-40	Si-pnp	Sw, 30V, 800mA, 200mW, B=250..630, 100MHz	SOT-23F	18ta	-	3a	Auk
PAB	2PA1774QM	Si-pnp	LN, 50V, 100mA, 250mW, >100MHz, B=120..270	SOT-883	22ta	-	2a	Phi
PB	2SC3295-B	Si-npn	AF-Amp, Sw, 50V, 150mA, 150mW, B=1200..3600, 250MHz	SC-59	16ta	-	3a	Tos
PB	2SC4666B	Si-npn	AF, 50V, 150mA, 100mW, B>1200..3600, 250MHz	SOT-323	16ta	-	3a	Tos
PB	BZX84-C30T	Z-diode	30V±5%, 150mW	SOT-523	16dc	-	3a	Di



SMD code	Type	Function	Short description	Case	Pinout	Sch. St.	Mnf.
PB	CZRH3-55C30	Z-diode	30.0..32.0V, Zzt=80Ω, Izt=2mA, 150mW	SOT-523	18dc	-	3a Cmc
PB	KRA102S	Si-pnp-Digi	Sw, 50V, 100mA, 200mW, 200MHz, R1/R2=10k/10k	SOT-23	16ta	-	3f Kec
PB	KRA302	Si-pnp-Digi	Sw, 50V, 100mA, 100mW, 200MHz, R1/R2=10k/10k	SOT-323	16ta	-	3f Kec
PB	KRA302E	Si-pnp-Digi	Sw, 50V, 100mA, 100mW, 200MHz, R1/R2=10k/10k	SOT-490	18ta	-	3f Kec
PB	KRA302V	Si-pnp-Digi	Sw, 50V, 100mA, 100mW, 200MHz, R1/R2=10k/10k	VSM	18ta	-	3f Kec
PB	TC1278-10ENB	Vdet-IC	4.37V, +Reset PPO	SOT-23	16vdb	VD7	3d Mcc
PB-	BZB84-C16	Z-diode	Dual, 16V±5%, If=200mA, 300mW	SOT-23	16df	-	3a PhH
pB0	BZX84-C68	Z-diode	68V±5%, 300mW	SOT-23	16dc	-	3a PhH
pB1	BZX84-C3V3	Z-diode	3.3V±5%, 300mW	SOT-23	16dc	-	3a PhH
pB2	BZX84-C3V6	Z-diode	3.6V±5%, 300mW	SOT-23	16dc	-	3a PhH
pB3	BZX84-C3V9	Z-diode	3.9V±5%, 300mW	SOT-23	16dc	-	3a PhH
pB4	BZX84-C43	Z-diode	43V±5%, 300mW	SOT-23	16dc	-	3a PhH
pB5	BZX84-C47	Z-diode	47V±5%, 300mW	SOT-23	16dc	-	3a PhH
pB6	BZX84-C4V3	Z-diode	4.3V±5%, 300mW	SOT-23	16dc	-	3a PhH
pB7	BZX84-C51	Z-diode	51V±5%, 300mW	SOT-23	16dc	-	3a PhH
pB8	BZX84-C56	Z-diode	56V±5%, 300mW	SOT-23	16dc	-	3a PhH
pB9	BZX84-C62	Z-diode	62V±5%, 300mW	SOT-23	16dc	-	3a PhH
PBp	BZB84-C16	Z-diode	Dual, 16V±5%, If=200mA, 300mW	SOT-23	16df	-	3a PhH
PBt	BZB84-C16	Z-diode	Dual, 16V±5%, If=200mA, 300mW	SOT-23	16df	-	3a PhM
PBW	BZB84-C16	Z-diode	Dual, 16V±5%, If=200mA, 300mW	SOT-23	16df	-	3a PhC
PC	2PA1774SM	Si-pnp	LN, 50V, 100mA, 250mW, >100MHz, B=270..560	SOT-883	22ta	-	2a Phi
PC	2SA1577PT-Q	Si-pnp	AF, Sw, 32V, 500mA, B=120..270, 200MHz	SOT-323	16ta	-	3a Chm
PC	BA886	PIN-diode	RF, 50V, 50mA, Vf(If=10mA)<1.15V, C<0.2pF	SOT-23	16dc	-	3a Sie
PC	BZX84-C33T	Z-diode	33V±5%, 150mW	SOT-523	16dc	-	3a Di
PC	CZRH3-55C33	Z-diode	33.0..35.0V, Zzt=80Ω, Izt=2mA, 150mW	SOT-523	18dc	-	3a Cmc
PC	KRA103S	Si-pnp-Digi	Sw, 50V, 100mA, 200mW, 200MHz, R1/R2=22k/22k	SOT-23	16ta	-	3f Kec
PC	KRA303	Si-pnp-Digi	Sw, 50V, 100mA, 100mW, 200MHz, R1/R2=22k/22k	SOT-323	16ta	-	3f Kec
PC	KRA303E	Si-pnp-Digi	Sw, 50V, 100mA, 100mW, 200MHz, R1/R2=22k/22k	SOT-490	18ta	-	3f Kec
PC	KRA303V	Si-pnp-Digi	Sw, 50V, 100mA, 100mW, 200MHz, R1/R2=22k/22k	VSM	18ta	-	3f Kec
PC	TC1278-15ENB	Vdet-IC	4.12V, +Reset PPO	SOT-23	18vdb	VD7	3d Mcc
PC-	BZB84-C18	Z-diode	Dual, 18V±5%, If=200mA, 300mW	SOT-23	16df	-	3a PhH
pC0	BZX84-A13	Z-diode	13V±1%, 300mW	SOT-23	16dc	-	3a PhH
pC1	BZX84-A3V6	Z-diode	3.6V±1%, 300mW	SOT-23	16dc	-	3a PhH
pC2	BZX84-A20	Z-diode	20V±1%, 300mW	SOT-23	16dc	-	3a PhH
pC3	BZX84-A36	Z-diode	36V±1%, 300mW	SOT-23	16dc	-	3a PhH
pC4	BZX84-A39	Z-diode	39V±1%, 300mW	SOT-23	16dc	-	3a PhH
pC5	BZX84-A43	Z-diode	43V±1%, 300mW	SOT-23	16dc	-	3a PhH
pC6	BZX84-A51	Z-diode	51V±1%, 300mW	SOT-23	16dc	-	3a PhH
PCp	BZB84-C18	Z-diode	Dual, 18V±5%, If=200mA, 300mW	SOT-23	16df	-	3a PhH
PCt	BZB84-C18	Z-diode	Dual, 18V±5%, If=200mA, 300mW	SOT-23	16df	-	3a PhM
PCW	BZB84-C18	Z-diode	Dual, 18V±5%, If=200mA, 300mW	SOT-23	16df	-	3a PhC
PD	2SA1171-D	Si-pnp	AF, 90V, 50mA, 150mW, B=250..500, 200MHz	SOT-23	16ta	-	3a Ren
PD	BSS84	p-MOSFET-e*	V-MOS, LogL, 50V, 130mA, 200mW, <10Ω(130mA), 3/7ns	SOT-23	16dc	-	3b Ons
PD	BZX84-C36T	Z-diode	36V±5%, 150mW	SOT-523	16dc	-	3a Di
PD	CZRH3-55C36	Z-diode	36.0..38.0V, Zzt=90Ω, Izt=2mA, 150mW	SOT-523	18dc	-	3a Cmc
PD	KRA104S	Si-pnp-Digi	Sw, 50V, 100mA, 200mW, 200MHz, R1/R2=47k/47k	SOT-23	16ta	-	3f Kec
PD	KRA304	Si-pnp-Digi	Sw, 50V, 100mA, 100mW, 200MHz, R1/R2=47k/47k	SOT-323	16ta	-	3f Kec
PD	KRA304E	Si-pnp-Digi	Sw, 50V, 100mA, 100mW, 200MHz, R1/R2=47k/47k	SOT-490	18ta	-	3f Kec
PD	KRA304V	Si-pnp-Digi	Sw, 50V, 100mA, 100mW, 200MHz, R1/R2=47k/47k	VSM	18ta	-	3f Kec
PD-	BZB84-C22	Z-diode	Dual, 22V±5%, If=200mA, 300mW	SOT-23	16df	-	3a PhH
PDp	BZB84-C22	Z-diode	Dual, 22V±5%, If=200mA, 300mW	SOT-23	16df	-	3a PhH
PDs	BA887	PIN-diode	RF, 50V, 100mA, Ir<0.02μA, C<0.27pF	SOT-23	16dc	-	3a Sie
PDt	BZB84-C22	Z-diode	Dual, 22V±5%, If=200mA, 300mW	SOT-23	16df	-	3a PhM
PDW	BZB84-C22	Z-diode	Dual, 22V±5%, If=200mA, 300mW	SOT-23	16df	-	3a PhC
PE	2SA1171-E	Si-pnp	AF, 90V, 50mA, 150mW, B=400..800, 200MHz	SOT-23	16ta	-	3a Ren
PE	BZX84-C39T	Z-diode	39V±5%, 150mW	SOT-523	16dc	-	3a Di
PE	CZRH3-55C39	Z-diode	39.0..41.0V, Zzt=130Ω, Izt=2mA, 150mW	SOT-523	18dc	-	3a Cmc
PE	KRA105S	Si-pnp-Digi	Sw, 50V, 100mA, 200mW, 200MHz, R1/R2=2K2/47k	SOT-23	16ta	-	3f Kec
PE	KRA305	Si-pnp-Digi	Sw, 50V, 100mA, 100mW, 200MHz, R1/R2=2K2/47k	SOT-323	16ta	-	3f Kec
PE	KRA305E	Si-pnp-Digi	Sw, 50V, 100mA, 100mW, 200MHz, R1/R2=2K2/47k	SOT-490	18ta	-	3f Kec
PE	KRA305V	Si-pnp-Digi	Sw, 50V, 100mA, 100mW, 200MHz, R1/R2=2K2/47k	VSM	18ta	-	3f Kec
PE-	BZB84-C24	Z-diode	Dual, 24V±5%, If=200mA, 300mW	SOT-23	16df	-	3a PhH
PEp	BZB84-C24	Z-diode	Dual, 24V±5%, If=200mA, 300mW	SOT-23	16df	-	3a PhH
PEt	BZB84-C24	Z-diode	Dual, 24V±5%, If=200mA, 300mW	SOT-23	16df	-	3a PhM
PEW	BZB84-C24	Z-diode	Dual, 24V±5%, If=200mA, 300mW	SOT-23	16df	-	3a PhC
PF	KRA106S	Si-pnp-Digi	Sw, 50V, 100mA, 200mW, 200MHz, R1/R2=4k7/47k	SOT-23	16ta	-	3f Kec
PF	KRA306	Si-pnp-Digi	Sw, 50V, 100mA, 100mW, 200MHz, R1/R2=4k7/47k	SOT-323	16ta	-	3f Kec
PF	KRA306E	Si-pnp-Digi	Sw, 50V, 100mA, 100mW, 200MHz, R1/R2=4k7/47k	SOT-490	18ta	-	3f Kec
PF	KRA306V	Si-pnp-Digi	Sw, 50V, 100mA, 100mW, 200MHz, R1/R2=4k7/47k	VSM	18ta	-	3f Kec
PF-	BZB84-C27	Z-diode	Dual, 27V±5%, If=200mA, 300mW	SOT-23	16df	-	3a PhH



SMD code	Type	Function	Short description	Case	Pinout	Sch.	St.	Mnf.
PFp	BZB84-C27	Z-diode	Dual, 27V±5%, If=200mA, 300mW	SOT-23	16df	-	3a	PHH
PFt	BZB84-C27	Z-diode	Dual, 27V±5%, If=200mA, 300mW	SOT-23	16df	-	3a	PHM
PFw	BZB84-C27	Z-diode	Dual, 27V±5%, If=200mA, 300mW	SOT-23	16df	-	3a	PhC
PG	2SA2154MFV-GR	Si-pnp	GP, Amp, 50V, 150mA, 150mW, B=200..400, >80MHz	SOT-723	18ta	-	3a	Tos
PG-	BZB84-C30	Z-diode	Dual, 30V±5%, If=200mA, 300mW	SOT-23	16df	-	3a	PHH
pG1	PMBT5551	Si-npn	GP, 180V, 300mA, 250mW, B=80..250, 100..300MHz	SOT-23	16ta	-	3a	PHM
PGp	BZB84-C30	Z-diode	Dual, 30V±5%, If=200mA, 300mW	SOT-23	16df	-	3a	PHH
PGt	BZB84-C30	Z-diode	Dual, 30V±5%, If=200mA, 300mW	SOT-23	16df	-	3a	PHM
PGW	BZB84-C30	Z-diode	Dual, 30V±5%, If=200mA, 300mW	SOT-23	16df	-	3a	PhC
PH	KRA107S	Si-pnp-Digi	Sw, 50V, 100mA, 200mW, 200MHz, R1/R2=10k/47k	SOT-23	16ta	-	3f	Kec
PH	KRA307	Si-pnp-Digi	Sw, 50V, 100mA, 100mW, 200MHz, R1/R2=10k/47k	SOT-323	16ta	-	3f	Kec
PH	KRA307E	Si-pnp-Digi	Sw, 50V, 100mA, 100mW, 200MHz, R1/R2=10k/47k	SOT-490	18ta	-	3f	Kec
PH	KRA307V	Si-pnp-Digi	Sw, 50V, 100mA, 100mW, 200MHz, R1/R2=10k/47k	VSM	18ta	-	3f	Kec
PH-	BZB84-C33	Z-diode	Dual, 33V±5%, If=200mA, 300mW	SOT-23	16df	-	3a	PHH
PH2	SST4302	n-FET	GP, Low-Noise, 30V, Idss=0.5mA, Up<5V	SOT-23	16fa	-	3a	Lns
PH3	SST4303	n-FET	GP, Low-Noise, 30V, Idss=4mA, Up<6V	SOT-23	16fa	-	3a	Lns
PH4	SST4304	n-FET	GP, Low-Noise, 30V, Idss=0.5mA, Up<10V	SOT-23	16fa	-	3a	Lns
PHp	BZB84-C33	Z-diode	Dual, 33V±5%, If=200mA, 300mW	SOT-23	16df	-	3a	PHH
PHt	BZB84-C33	Z-diode	Dual, 33V±5%, If=200mA, 300mW	SOT-23	16df	-	3a	PHM
PHW	BZB84-C33	Z-diode	Dual, 33V±5%, If=200mA, 300mW	SOT-23	16df	-	3a	PhC
PI	KRA108S	Si-pnp-Digi	Sw, 50V, 100mA, 200mW, 200MHz, R1/R2=22k/47k	SOT-23	16ta	-	3f	Kec
PI	KRA308	Si-pnp-Digi	Sw, 50V, 100mA, 100mW, 200MHz, R1/R2=22k/47k	SOT-323	16ta	-	3f	Kec
PI	KRA308E	Si-pnp-Digi	Sw, 50V, 100mA, 100mW, 200MHz, R1/R2=22k/47k	SOT-490	18ta	-	3f	Kec
PI	KRA308V	Si-pnp-Digi	Sw, 50V, 100mA, 100mW, 200MHz, R1/R2=22k/47k	VSM	18ta	-	3f	Kec
PIB	2SK1070-B	n-FET	AF/HF, 22V, 50mA, 150mW, Idss=6..14mA, Up<2.5V	SC-59A	16fa	-	3a	Ren
PIC	2SK1070-C	n-FET	AF/HF, 22V, 50mA, 150mW, Idss=12..22mA, Up<2.5V	SC-59A	16fa	-	3a	Ren
PID	2SK1070-D	n-FET	AF/HF, 22V, 50mA, 150mW, Idss=18..30mA, Up<2.5V	SC-59A	16fa	-	3a	Ren
PIE	2SK1070-E	n-FET	AF/HF, 22V, 50mA, 150mW, Idss=27..40mA, Up<2.5V	SC-59A	16fa	-	3a	Ren
PJ	CHDTA114YKPT	Si-pnp-Digi	Sw, 50V, 70mA, 250MHz, R1/R2=10/47k	SOT-23	16ta	-	3a	Chm
PJ	DDZX20C	Z-diode	20V±2.5%, 500mW	SOT-23	16dc	-	3a	Di
PJ	DDZX20CW	Z-diode	20V±2.5%, 200mW	SOT-323	16dc	-	3a	Di
PJ	KRA109S	Si-pnp-Digi	Sw, 50V, 100mA, 200mW, 200MHz, R1/R2=47k/22k	SOT-23	16ta	-	3f	Kec
PJ	KRA309	Si-pnp-Digi	Sw, 50V, 100mA, 100mW, 200MHz, R1/R2=47k/22k	SOT-323	16ta	-	3f	Kec
PJ	KRA309E	Si-pnp-Digi	Sw, 50V, 100mA, 100mW, 200MHz, R1/R2=47k/22k	SOT-490	18ta	-	3f	Kec
PJ	KRA309V	Si-pnp-Digi	Sw, 50V, 100mA, 100mW, 200MHz, R1/R2=47k/22k	VSM	18ta	-	3f	Kec
PJ	MCP130-270I	Vdet-IC	2.62V, -Reset ODO	SOT-23	16vdb	VD6	3a	Mcc
PJ	MCP130T-270I	Vdet-IC	2.62V, -Reset ODO	SOT-23	16vdb	VD6	3a	Mcc
PJ-	BZB84-C36	Z-diode	Dual, 36V±5%, If=200mA, 300mW	SOT-23	16df	-	3a	PHH
pJ1	BSH101	n-MOSFET-e	V-MOS, LogL, 60V, 0.7A, <0.9Ω	SOT-23	16fh	-	3a	Phi
pJ2	BSH102	n-MOSFET-e	V-MOS, LogL, 30V, 0.85A, <0.6Ω	SOT-23	16fh	-	3a	Phi
pJ3	BSH103	n-MOSFET-e	V-MOS, LogL, 30V, 0.85A, <0.5Ω	SOT-23	16fh	-	3a	Phi
PJp	BZB84-C36	Z-diode	Dual, 36V±5%, If=200mA, 300mW	SOT-23	16df	-	3a	PHH
PJt	BZB84-C36	Z-diode	Dual, 36V±5%, If=200mA, 300mW	SOT-23	16df	-	3a	PHM
PJW	BZB84-C36	Z-diode	Dual, 36V±5%, If=200mA, 300mW	SOT-23	16df	-	3a	PhC
PK	BAT400D	Si-diode	SBR, 40V, 500mA, Vf<0.55V(500mA)	SOT-23	16dc	-	3c	Sme
PK	KRA110S	Si-pnp-Digi	Sw, 50V, 100mA, 200mW, 200MHz, R1=4k7	SOT-23	16ta	-	3f	Kec
PK	KRA310	Si-pnp-Digi	Sw, 50V, 100mA, 100mW, 200MHz, R1=4k7	SOT-323	16ta	-	3f	Kec
PK	KRA310E	Si-pnp-Digi	Sw, 50V, 100mA, 100mW, 200MHz, R1=4k7	SOT-490	18ta	-	3f	Kec
PK	KRA310V	Si-pnp-Digi	Sw, 50V, 100mA, 100mW, 200MHz, R1=4k7	VSM	18ta	-	3f	Kec
PK	MCP130-300I	Vdet-IC	2.92V, -Reset ODO	SOT-23	16vdb	VD6	3a	Mcc
PK	MCP130T-300I	Vdet-IC	2.92V, -Reset ODO	SOT-23	16vdb	VD6	3a	Mcc
PK-	BZB84-C39	Z-diode	Dual, 39V±5%, If=200mA, 300mW	SOT-23	16df	-	3a	PHH
PKp	BZB84-C39	Z-diode	Dual, 39V±5%, If=200mA, 300mW	SOT-23	16df	-	3a	PHM
PKt	BZB84-C39	Z-diode	Dual, 39V±5%, If=200mA, 300mW	SOT-23	16df	-	3a	PhC
PKW	BZB84-C39	Z-diode	Dual, 39V±5%, If=200mA, 300mW	SOT-23	16df	-	3a	PhC
pKX	PMBF170	n-MOSFET-e	T-MOS, LogL, 60V, 300mA, 830mW, <25Ω(500mA)	SOT-23	16fh	-	3a	Phi
pKZ	PMBF107	n-MOSFET-e	V-MOS, LogL, 200V, 100mA, 250mW, <28Ω(20mA)	SOT-23	16fh	-	3a	Phi
PL	2SB1234	Si-pnp-Dar	AF-Drv, 80V, 200mA, 200mW, B=5000	SOT-23	16ta	-	3a	San
PL	DDZX24C	Z-diode	24V±2.5%, 500mW	SOT-23	16dc	-	3a	Di
PL	DDZX24CW	Z-diode	24V±2.5%, 200mW	SOT-323	16dc	-	3a	Di
PL	MCP130-315I	Vdet-IC	3.07V, -Reset ODO	SOT-23	16vdb	VD6	3a	Mcc
PL	MCP130T-315I	Vdet-IC	3.07V, -Reset ODO	SOT-23	16vdb	VD6	3a	Mcc
PL-	BZB84-C43	Z-diode	Dual, 43V±5%, If=200mA, 300mW	SOT-23	16df	-	3a	PHH
PLN	ELM7535CEB	Vdet-IC	3.5V±2%, +Reset PPO	SC-70	16vdb	VD7	3d	Elm
PLN	ELM7535NEB	Vdet-IC	3.5V±2%, +Reset ODO	SC-70	16vdb	VD6	3d	Elm
PLp	BZB84-C43	Z-diode	Dual, 43V±5%, If=200mA, 300mW	SOT-23	16df	-	3a	PHH
PLt	BZB84-C43	Z-diode	Dual, 43V±5%, If=200mA, 300mW	SOT-23	16df	-	3a	PHM
PLW	BZB84-C43	Z-diode	Dual, 43V±5%, If=200mA, 300mW	SOT-23	16df	-	3a	PhC
PM	KRA111S	Si-pnp-Digi	Sw, 50V, 100mA, 200mW, 200MHz, R1=10k	SOT-23	16ta	-	3f	Kec
PM	KRA311	Si-pnp-Digi	Sw, 50V, 100mA, 100mW, 200MHz, R1=10k	SOT-323	16ta	-	3f	Kec



SMD code	Type	Function	Short description	Case	Pinout	Sch. St.	Mnf.
PM	KRA311E	Si-pnp-Digi	Sw, 50V, 100mA, 100mW, 200MHz, R1=10k	SOT-490	18ta	- 3f	Kec
PM	KRA311V	Si-pnp-Digi	Sw, 50V, 100mA, 100mW, 200MHz, R1=10k	VSM	18ta	- 3f	Kec
PM	MCP130-450I	Vdet-IC	4.37V, -Reset ODO	SOT-23	16vdb	VD6 3a	Mcc
PM	MCP130T-450I	Vdet-IC	4.37V, -Reset ODO	SOT-23	16vdb	VD6 3a	Mcc
PM-	BZB84-C47	Z-diode	Dual, 47V±5%, If=200mA, 300mW	SOT-23	16df	- 3a	PHH
PMp	BZB84-C47	Z-diode	Dual, 47V±5%, If=200mA, 300mW	SOT-23	16df	- 3a	PHH
PMs	BAR66	PIN-diode	Dual, 150V, 200mA, 250mW, Vf<1.2V(50mA), <0.9pF	SOT-23	16dl	- 3c	Inf
PMt	BZB84-C47	Z-diode	Dual, 47V±5%, If=200mA, 300mW	SOT-23	16df	- 3a	PHM
PMW	BZB84-C47	Z-diode	Dual, 47V±5%, If=200mA, 300mW	SOT-23	16df	- 3a	PhC
PN	2SB1197KPT-Q	Si-pnp	AF, Sw, 32V, 800mA, B=120..270, 200MHz	SOT-23	16ta	- 3a	Chm
PN	BA779	PIN-diode	HF-Att, 30V, 50mA, 0.5pF, Rf=50Ω, 1GHz	SOT-23	16dc	- 3a	Sil
PN	KRA112S	Si-pnp-Digi	Sw, 50V, 100mA, 200mW, 200MHz, R1=100k	SOT-23	16ta	- 3f	Kec
PN	KRA312	Si-pnp-Digi	Sw, 50V, 100mA, 100mW, 200MHz, R1=100k	SOT-323	16ta	- 3f	Kec
PN	KRA312E	Si-pnp-Digi	Sw, 50V, 100mA, 100mW, 200MHz, R1=100k	SOT-490	18ta	- 3f	Kec
PN	KRA312V	Si-pnp-Digi	Sw, 50V, 100mA, 100mW, 200MHz, R1=100k	VSM	18ta	- 3f	Kec
PN	MCP130-460I	Vdet-IC	4.47V, -Reset ODO	SOT-23	16vdb	VD6 3a	Mcc
PN	MCP130T-460I	Vdet-IC	4.47V, -Reset ODO	SOT-23	16vdb	VD6 3a	Mcc
PN-	BZB84-C51	Z-diode	Dual, 51V±5%, If=200mA, 300mW	SOT-23	16df	- 3a	PHH
PNp	BZB84-C51	Z-diode	Dual, 51V±5%, If=200mA, 300mW	SOT-23	16df	- 3a	PHH
PNt	BZB84-C51	Z-diode	Dual, 51V±5%, If=200mA, 300mW	SOT-23	16df	- 3a	PHM
PNW	BZB84-C51	Z-diode	Dual, 51V±5%, If=200mA, 300mW	SOT-23	16df	- 3a	PhC
PO	2SA1712-O	Si-pnp	Sw, 29V, 30mA, 200mW, B=70..140, 15/110ns	SOT-23	16ta	- 3a	Tos
PO	KRA113S	Si-pnp-Digi	Sw, 50V, 100mA, 200mW, 200MHz, R1=22k	SOT-23	16ta	- 3f	Kec
PO	KRA313	Si-pnp-Digi	Sw, 50V, 100mA, 100mW, 200MHz, R1=22k	SOT-323	16ta	- 3f	Kec
PO	KRA313E	Si-pnp-Digi	Sw, 50V, 100mA, 100mW, 200MHz, R1=22k	SOT-490	18ta	- 3f	Kec
PO	KRA313V	Si-pnp-Digi	Sw, 50V, 100mA, 100mW, 200MHz, R1=22k	VSM	18ta	- 3f	Kec
PO	MCP130-475I	Vdet-IC	4.62V, -Reset ODO	SOT-23	16vdb	VD6 3a	Mcc
PO	MCP130T-475I	Vdet-IC	4.62V, -Reset ODO	SOT-23	16vdb	VD6 3a	Mcc
pO4	PMBS3904	Si-npn	Sw, 40V, 100mA, 250mW, B=100..300, >180MHz	SOT-23	16ta	- 3a	PHH
pO6	PMBS3906	Si-pnp	Sw, 40V, 100mA, 250mW, B=100..300, >150MHz	SOT-23	16ta	- 3a	PHH
POs	BAR64	PIN-diode	GP, Sw, 200V, 100mA, Vf<1.1V(50mA), 0.35pF, ..3GHz	SOT-23	16dc	- 3c	Inf
PP	KRA114S	Si-pnp-Digi	Sw, 50V, 100mA, 200mW, 200MHz, R1=47k	SOT-23	16ta	- 3f	Kec
PP	KRA314	Si-pnp-Digi	Sw, 50V, 100mA, 100mW, 200MHz, R1=47k	SOT-323	16ta	- 3f	Kec
PP	KRA314E	Si-pnp-Digi	Sw, 50V, 100mA, 100mW, 200MHz, R1=47k	SOT-490	18ta	- 3f	Kec
PP	KRA314V	Si-pnp-Digi	Sw, 50V, 100mA, 100mW, 200MHz, R1=47k	VSM	18ta	- 3f	Kec
PP	MCP130-485I	Vdet-IC	4.72V, -Reset ODO	SOT-23	16vdb	VD6 3a	Mcc
PP	MCP130T-485I	Vdet-IC	4.72V, -Reset ODO	SOT-23	16vdb	VD6 3a	Mcc
PP-	BZB84-C56	Z-diode	Dual, 56V±5%, If=200mA, 300mW	SOT-23	16df	- 3a	PHH
PPp	BZB84-C56	Z-diode	Dual, 56V±5%, If=200mA, 300mW	SOT-23	16df	- 3a	PHH
PPs	BAR64-04	PIN-diode	Dual, Sw, RF-Att, 150V, 100mA, Vf<1.1V(50mA), <0.35pF	SOT-23	16dl	- 3c	Inf
PPs	BAR64-04T	PIN-diode	Dual, Sw, RF-Att, 150V, 100mA, Vf<1.1V(50mA), <0.35pF	SOT-416	16dl	- 3a	Inf
PPs	BAR64-04W	PIN-diode	Dual, Sw, RF-Att, 150V, 100mA, Vf<1.1V(50mA), <0.35pF	SOT-323	16dl	- 3c	Inf
PPt	BZB84-C56	Z-diode	Dual, 56V±5%, If=200mA, 300mW	SOT-23	16df	- 3a	PHM
PPW	BZB84-C56	Z-diode	Dual, 56V±5%, If=200mA, 300mW	SOT-23	16df	- 3a	PhC
PQ	2SA2199-Q	Si-pnp	AF, 50V, 100mA, 150mW, B=120..270, 110MHz	VMN3	19ta	- 3k	Rhm
PQ	2SD1821-Q	Si-npn	AF, LN, 150V, 100mA, 150mW, B=85..170, 150MHz	SOT-323	16ta	- 3a	Pan
PQ	2SD814-Q	Si-npn	AF, LN, 150V, 50mA, 200mW, B=90..155, 150MHz	SC-59	16ta	- 3a	Pan
PQ	KRA221S	Si-pnp-Digi	Sw, 50V, 800mA, 200mW, 200MHz, R1/R2=1k/1k	SOT-23	16ta	- 3f	Kec
PQ-	BZB84-C62	Z-diode	Dual, 62V±5%, If=200mA, 300mW	SOT-23	16df	- 3a	PHH
PQp	BZB84-C62	Z-diode	Dual, 62V±5%, If=200mA, 300mW	SOT-23	16df	- 3a	PHH
PQt	BZB84-C62	Z-diode	Dual, 62V±5%, If=200mA, 300mW	SOT-23	16df	- 3a	PHM
PQW	BZB84-C62	Z-diode	Dual, 62V±5%, If=200mA, 300mW	SOT-23	16df	- 3a	PhC
PR	2SA1712-R	Si-pnp	Sw, 29V, 30mA, 200mW, B=100..200, 15/110ns	SOT-23	16ta	- 3a	Tos
PR	2SA2199-R	Si-pnp	AF, 50V, 100mA, 150mW, B=120..390, 110MHz	VMN3	19ta	- 3k	Rhm
PR	2SD1821-R	Si-npn	AF, LN, 150V, 100mA, 150mW, B=130..220, 150MHz	SOT-323	16ta	- 3a	Pan
PR	2SD2240-R	Si-npn	AF, LN, 150V, 100mA, 125mW, B=130..200, 150MHz	SOT-416	16ta	- 3a	Pan
PR	2SD814-R	Si-npn	AF, LN, 150V, 50mA, 200mW, B=130..220, 150MHz	SC-59	16ta	- 3a	Pan
PR	KRA222S	Si-pnp-Digi	Sw, 50V, 800mA, 200mW, 200MHz, R1/R2=2.2k/2.2k	SOT-23	16ta	- 3f	Kec
PR-	BZB84-C68	Z-diode	Dual, 68V±5%, If=200mA, 300mW	SOT-23	16df	- 3a	PHH
pR0	BZX84-B56	Z-diode	56V±2%, 300mW	SOT-23	16dc	- 3a	PHH
pR1	BZX84-B5V1	Z-diode	5.1V±2%, 300mW	SOT-23	16dc	- 3a	PHH
pR2	BZX84-B5V6	Z-diode	5.6V±2%, 300mW	SOT-23	16dc	- 3a	PHH
pR3	BZX84-B62	Z-diode	62V±2%, 300mW	SOT-23	16dc	- 3a	PHH
pR4	BZX84-B68	Z-diode	68V±2%, 300mW	SOT-23	16dc	- 3a	PHH
pR5	BZX84-B6V2	Z-diode	6.2V±2%, 300mW	SOT-23	16dc	- 3a	PHH
pR6	BZX84-B6V8	Z-diode	6.8V±2%, 300mW	SOT-23	16dc	- 3a	PHH
pR7	BZX84-B75	Z-diode	75V±2%, 300mW	SOT-23	16dc	- 3a	PHH
pR8	BZX84-B7V5	Z-diode	7.5V±2%, 300mW	SOT-23	16dc	- 3a	PHH
pR9	BZX84-B8V2	Z-diode	8.2V±2%, 300mW	SOT-23	16dc	- 3a	PHH
PRp	BZB84-C68	Z-diode	Dual, 68V±5%, If=200mA, 300mW	SOT-23	16df	- 3a	PHH



SMD code	Type	Function	Short description	Case	Pinout	Sch.	St.	Mnf.
PRs	BAR64-05	PIN-diode	Dual, Sw, RF-Att, 150V, 100mA, Vf<1.1V(50mA), < 0.35pF	SOT-23	16dg	-	3c	Inf
PRs	BAR64-05W	PIN-diode	Dual, Sw, RF-Att, 150V, 100mA, Vf<1.1V(50mA), < 0.35pF	SOT-323	16dg	-	3c	Inf
PRt	BZB84-C68	Z-diode	Dual, 68V±5%, If=200mA, 300mW	SOT-23	16df	-	3a	PhM
PRW	BZB84-C68	Z-diode	Dual, 68V±5%, If=200mA, 300mW	SOT-23	16df	-	3a	PhC
PS	2SD1821-S	Si-npn	AF, LN, 150V, 100mA, 150mW, B=185..330, 150MHz	SOT-323	16ta	-	3a	Pan
PS	2SD2240-S	Si-npn	AF, LN, 150V, 100mA, 125mW, B=185..330, 150MHz	SOT-416	16ta	-	3a	Pan
PS	2SD814-S	Si-npn	AF, LN, 150V, 50mA, 200mW, B=185..330, 150MHz	SC-59	16ta	-	3a	Pan
PS	KRA223S	Si-pnp-Digi	Sw, 50V, 800mA, 200mW, 200MHz, R1/R2=4.7k/4.7k	SOT-23	16ta	-	3f	Kec
PS	TP0101TS	p-MOSFET-e	V-MOS, LogL, 20V, 1A, 1W, <0.85Q	SOT-23	16fh	-	3a	Six
PS-	BZB84-C75	Z-diode	Dual, 75V±5%, If=200mA, 300mW	SOT-23	16df	-	3a	PhH
pS0	BZX84-B39	Z-diode	39V±2%, 300mW	SOT-23	16dc	-	3a	PhH
pS1	BZX84-B3V0	Z-diode	3V±2%, 300mW	SOT-23	16dc	-	3a	PhH
pS2	BZX84-B3V3	Z-diode	3.3V±2%, 300mW	SOT-23	16dc	-	3a	PhH
pS2	BZX84-B3V6	Z-diode	3.6V±2%, 300mW	SOT-23	16dc	-	3a	PhH
pS4	BZX84-B3V9	Z-diode	3.9V±2%, 300mW	SOT-23	16dc	-	3a	PhH
pS5	BZX84-B43	Z-diode	43V±2%, 300mW	SOT-23	16dc	-	3a	PhH
pS6	BZX84-B47	Z-diode	47V±2%, 300mW	SOT-23	16dc	-	3a	PhH
pS7	BZX84-B4V3	Z-diode	4.3V±2%, 300mW	SOT-23	16dc	-	3a	PhH
pS8	BZX84-B4V7	Z-diode	4.7V±2%, 300mW	SOT-23	16dc	-	3a	PhH
pS9	BZX84-B51	Z-diode	51V±2%, 300mW	SOT-23	16dc	-	3a	PhH
PSp	BZB84-C75	Z-diode	Dual, 75V±5%, If=200mA, 300mW	SOT-23	16df	-	3a	PhH
PSs	BAR64-06	PIN-diode	Dual, Sw, RF-Att, 150V, 100mA, Vf<1.1V(50mA), < 0.35pF	SOT-23	16df	-	3c	Inf
PSs	BAR64-06W	PIN-diode	Dual, Sw, RF-Att, 150V, 100mA, Vf<1.1V(50mA), < 0.35pF	SOT-323	16df	-	3c	Inf
PSt	BZB84-C75	Z-diode	Dual, 75V±5%, If=200mA, 300mW	SOT-23	16df	-	3a	PhM
PSW	BZB84-C75	Z-diode	Dual, 75V±5%, If=200mA, 300mW	SOT-23	16df	-	3a	PhC
PT	2SC2411KPT-P	Si-npn	AF, Sw, 32V, 500mA, B=82..180, 250MHz	SOT-23	16ta	-	3a	Chm
PT	2SD1821-T	Si-npn	AF, LN, 150V, 100mA, 150mW, B=220..400, 150MHz	SOT-323	16ta	-	3a	Pan
PT	2SD814-T	Si-npn	AF, LN, 150V, 50mA, 200mW, B=220..400, 150MHz	SC-59	16ta	-	3a	Pan
PT	CHT2907T1PT	Si-pnp	AF, Sw, 60V, 600mA, B=100..300, 200MHz	FBPT-523	17ta	-	9a	Chm
PT	CHT2907TPT	Si-pnp	AF, Sw, 60V, 600mA, B=100..300, 200MHz	SOT-416	16ta	-	3a	Chm
PT	CHT4403TPT	Si-pnp	AF, Sw, 40V, 600mA, B=100..300, 200MHz	SOT-416	16ta	-	3a	Chm
PT	KRA224S	Si-pnp-Digi	Sw, 50V, 800mA, 200mW, 200MHz, R1/R2=10k/10k	SOT-23	16ta	-	3f	Kec
PT-	BZB84-B16	Z-diode	Dual, 16V±2%, If=200mA, 300mW	SOT-23	16df	-	3a	PhH
pT1	BZX84-B9V1	Z-diode	9.1V±2%, 300mW	SOT-23	16dc	-	3a	PhH
PT2	2SC4365-2	Si-npn	UHF, Mix/Osc, 25V, 50mA, 250mW, B=40..80, 3GHz	CP	16ta	-	3a	San
PT2	2SC4402-2	Si-npn	UHF, Mix/Osc, 25V, 50mA, 150mW, B=40..80, 3GHz	MCP	16ta	-	3a	San
pT2	BZX84-C27	Z-diode	27V±5%, 300mW	SOT-23	16dc	-	3a	PhH
PT3	2SC4365-3	Si-npn	UHF, Mix/Osc, 25V, 50mA, 250mW, B=60..120, 3GHz	CP	16ta	-	3a	San
PT3	2SC4402-3	Si-npn	UHF, Mix/Osc, 25V, 50mA, 150mW, B=60..120, 3GHz	MCP	16ta	-	3a	San
pT3	BZX84-C2V4	Z-diode	2.4V±5%, 300mW	SOT-23	16dc	-	3a	PhH
PT4	2SC4365-4	Si-npn	UHF, Mix/Osc, 25V, 50mA, 250mW, B=100..200, 3GHz	CP	16ta	-	3a	San
PT4	2SC4402-4	Si-npn	UHF, Mix/Osc, 25V, 50mA, 150mW, B=100..200, 3GHz	MCP	16ta	-	3a	San
pT4	BZX84-C2V7	Z-diode	2.7V±5%, 300mW	SOT-23	16dc	-	3a	PhH
pT5	BZX84-C30	Z-diode	30V±5%, 300mW	SOT-23	16dc	-	3a	PhH
pT6	BZX84-C33	Z-diode	33V±5%, 300mW	SOT-23	16dc	-	3a	PhH
pT7	BZX84-C36	Z-diode	36V±5%, 300mW	SOT-23	16dc	-	3a	PhH
pT8	BZX84-C39	Z-diode	39V±5%, 300mW	SOT-23	16dc	-	3a	PhH
pT9	BZX84-C3V0	Z-diode	3.0V±5%, 300mW	SOT-23	16dc	-	3a	PhH
PTp	BZB84-B16	Z-diode	Dual, 16V±2%, If=200mA, 300mW	SOT-23	16df	-	3a	PhH
PTt	BZB84-B16	Z-diode	Dual, 16V±2%, If=200mA, 300mW	SOT-23	16df	-	3a	PhM
PTW	BZB84-B16	Z-diode	Dual, 16V±2%, If=200mA, 300mW	SOT-23	16df	-	3a	PhC
PU	2SA2119TPT	Si-pnp	AF, Sw, 12V, 500mA, B=270..680, 260MHz	SOT-416	16ta	-	3a	Chm
PU	KRA225S	Si-pnp-Digi	Sw, 50V, 800mA, 200mW, 200MHz, R1/R2=1k/10k	SOT-23	16ta	-	3f	Kec
PU-	BZB84-B18	Z-diode	Dual, 18V±2%, If=200mA, 300mW	SOT-23	16df	-	3a	PhH
PUp	BZB84-B18	Z-diode	Dual, 18V±2%, If=200mA, 300mW	SOT-23	16df	-	3a	PhH
PUt	BZB84-B18	Z-diode	Dual, 18V±2%, If=200mA, 300mW	SOT-23	16df	-	3a	PhM
PUW	BZB84-B18	Z-diode	Dual, 18V±2%, If=200mA, 300mW	SOT-23	16df	-	3a	PhC
PV	1SV294	PIN-diode	VHF/UHF Var, Res, Att, 50V, 0.05A, 0.23pF, 7Q(100MHz)	SOT-23	16dc	-	3a	San
PV	KRA226S	Si-pnp-Digi	Sw, 50V, 800mA, 200mW, 200MHz, R1/R2=2.2k/10k	SOT-23	16ta	-	3f	Kec
PV-	BZB84-B22	Z-diode	Dual, 22V±2%, If=200mA, 300mW	SOT-23	16df	-	3a	PhH
pV1	BAS31	Si-diode	Dual, GP, Contr, Aval., 90V, 250mA, 250mW, 35pF, <50ns	SOT-23	16dl	-	3a	PhH
pV2	BAS35	Si-diode	Dual, GP, Contr, Aval., 90V, 250mA, 250mW, 35pF, <50ns	SOT-23	16df	-	3a	PhH
pV3	BAT54A	Si-diode	Dual, Schottky Rectifier, 30V, 200mA, Vf<1V(100mA), <5ns	SOT-23	16df	-	3a	PhH
pV4	BAT54S	Si-diode	Dual, Schottky Rectifier, 30V, 200mA, Vf<1V(100mA), <5ns	SOT-23	16dl	-	3a	PhH
pV5	BAV23S	Si-diode	Dual, GP, 200V, 225mA, Vs<1.25V(200mA), <50ns	SOT-23	16dl	-	3a	PhH
PVp	BZB84-B22	Z-diode	Dual, 22V±2%, If=200mA, 300mW	SOT-23	16df	-	3a	PhH
PVt	BZB84-B22	Z-diode	Dual, 22V±2%, If=200mA, 300mW	SOT-23	16df	-	3a	PhM
PWW	BZB84-B22	Z-diode	Dual, 22V±2%, If=200mA, 300mW	SOT-23	16df	-	3a	PhC
PW	CHDTA115EUPT	Si-pnp-Digi	Sw, 50V, 20mA, 250MHz, R1/R2=100/100k	SOT-323	16ta	-	3a	Chm
PW-	BZB84-B24	Z-diode	Dual, 24V±2%, If=200mA, 300mW	SOT-23	16df	-	3a	PhH



SMD code	Type	Function	Short description	Case	Pinout	Sch.	St.	Mnf.
PWp	BZB84-B24	Z-diode	Dual, 24V±2%, If=200mA, 300mW	SOT-23	16df	-	3a	PhH
PWt	BZB84-B24	Z-diode	Dual, 24V±2%, If=200mA, 300mW	SOT-23	16df	-	3a	PhM
PWW	BZB84-B24	Z-diode	Dual, 24V±2%, If=200mA, 300mW	SOT-23	16df	-	3a	PhC
PX-	BZB84-B27	Z-diode	Dual, 27V±2%, If=200mA, 300mW	SOT-23	16df	-	3a	PhH
PXp	BZB84-B27	Z-diode	Dual, 27V±2%, If=200mA, 300mW	SOT-23	16df	-	3a	PhH
PXt	BZB84-B27	Z-diode	Dual, 27V±2%, If=200mA, 300mW	SOT-23	16df	-	3a	PhM
PXW	BZB84-B27	Z-diode	Dual, 27V±2%, If=200mA, 300mW	SOT-23	16df	-	3a	PhC
PY	2SA2154MFV-Y	Si-npn	GP, Amp, 50V, 150mA, 150mW, B=120..240, >80MHz	SOT-723	18ta	-	3a	Tos
PY	2SC3859	Si-npn-Digi	Sw, 50V, 100mA, 200mW, 250MHz, B>100, R1=10k	CP	16ta	-	3a	San
PY-	BZB84-B30	Z-diode	Dual, 30V±2%, If=200mA, 300mW	SOT-23	16df	-	3a	PhH
pY1	BZX84-B33	Z-diode	33V±2%, 300mW	SOT-23	16dc	-	3a	PhH
pY2	BZX84-B36	Z-diode	36V±2%, 300mW	SOT-23	16dc	-	3a	PhH
PYp	BZB84-B30	Z-diode	Dual, 30V±2%, If=200mA, 300mW	SOT-23	16df	-	3a	PhH
PYt	BZB84-B30	Z-diode	Dual, 30V±2%, If=200mA, 300mW	SOT-23	16df	-	3a	PhM
PYW	BZB84-B30	Z-diode	Dual, 30V±2%, If=200mA, 300mW	SOT-23	16df	-	3a	PhC
PZ-	BZB84-B33	Z-diode	Dual, 33V±2%, If=200mA, 300mW	SOT-23	16df	-	3a	PhH
pZ0	BZX84-B2V4	Z-diode	2.4V±2%, 300mW	SOT-23	16dc	-	3a	PhH
pZ1	BZX84-B2V7	Z-diode	2.7V±2%, 300mW	SOT-23	16dc	-	3a	PhH
pZ4	BZX84-B30	Z-diode	30V±2%, 300mW	SOT-23	16dc	-	3a	PhH
pZ5	BZX84-B27	Z-diode	27V±2%, 300mW	SOT-23	16dc	-	3a	PhH
pZ6	BZX84-B11	Z-diode	11V±2%, 300mW	SOT-23	16dc	-	3a	PhH
pZ7	BZX84-B12	Z-diode	12V±2%, 300mW	SOT-23	16dc	-	3a	PhH
pZ8	BZX84-B13	Z-diode	13V±2%, 300mW	SOT-23	16dc	-	3a	PhH
pZ9	BZX84-B15	Z-diode	15V±2%, 300mW	SOT-23	16dc	-	3a	PhH
PZp	BZB84-B33	Z-diode	Dual, 33V±2%, If=200mA, 300mW	SOT-23	16df	-	3a	PhH
PZt	BZB84-B33	Z-diode	Dual, 33V±2%, If=200mA, 300mW	SOT-23	16df	-	3a	PhM
PZW	BZB84-B33	Z-diode	Dual, 33V±2%, If=200mA, 300mW	SOT-23	16df	-	3a	PhC
Q	2SB1197-Q	Si-npn	AF, 40V, 800mA, 200mW, B=120..270, >50MHz	SOT-23	16ta	-	3a	Wtr
q	AX6903CA	Vdet-IC	4.0V±1.5%, -Reset PPO	SC-70	16vda	VD7	3b	Axl
Q	SB05-03C	Si-diode	SBR, HF, 30V, 500mA, Vf<0.55V(500mA), 16pF, 10ns	CP	16dc	-	3a	San
Q	SB05-03Q	Si-diode	SBR, HF, 30V, 500mA, Vf<0.55V(500mA), 16pF, 10ns	MCP	16dc	-	3a	San
Q0	ELM7640HBB	Vdet-IC	4.0V±2%, +Reset PPO, 500ms	SOT-23	16vdc	VD7	3d	Elm
Q0	R1100D401C	LVR-IC	U-low lcc, 4V±2%, 180mA	SON11408-3	18bj	VR1	3d	Ric
Q0	R3130N40AA	Vdet-IC	4V, -Reset PPO, 50ms	SOT-23	16vdc	VD7	3b	Ric
Q1	ELM7641HBB	Vdet-IC	4.1V±2%, +Reset PPO, 500ms	SOT-23	16vdc	VD7	3d	Elm
Q1	R3130N44AA	Vdet-IC	4.4V, -Reset PPO, 50ms	SOT-23	16vdc	VD7	3b	Ric
Q17	CHT817WPT-Q	Si-npn	AF, Sw, 45V, 500mA, B=100..250, 170MHz	SOT-323	16ta	-	3a	Chm
Q2	2SC1321-2	Si-npn	UHF, 30V, 10mA, 100mW, B=40..80, 900MHz	SOT-23	16ta	-	3a	Nec
Q2	2SC2813-2	Si-npn	RF, GP, 25V, 30mA, 150mW, B=40..80, 600MHz	CP	16ta	-	3a	San
Q2	ELM7642HBB	Vdet-IC	4.2V±2%, +Reset PPO, 500ms	SOT-23	16vdc	VD7	3d	Elm
Q2	R3130N26AA3	Vdet-IC	2.6V, -Reset PPO, 50ms	SOT-23	16vdc	VD7	3b	Ric
Q21	GS810C21EUD	Vdet-IC	2.1V, +Reset PPO, 30ms	SOT-23	16vdc	VD7	3g	Vs
Q24	GS810C24EUD	Vdet-IC	2.4V, +Reset PPO, 30ms	SOT-23	16vdc	VD7	3g	Vs
Q26	GS810CREUD	Vdet-IC	2.63V, +Reset PPO, 30ms	SOT-23	16vdc	VD7	3g	Vs
Q27	GS810C27SEUD	Vdet-IC	2.7V, +Reset PPO, 30ms	SOT-23	16vdc	VD7	3g	Vs
Q29	GS810CSEUD	Vdet-IC	2.93V, +Reset PPO, 30ms	SOT-23	16vdc	VD7	3g	Vs
Q3	2SC1321-3	Si-npn	UHF, 30V, 10mA, 100mW, B=60..120, 900MHz	SOT-23	16ta	-	3a	Nec
Q3	2SC2813-3	Si-npn	RF, GP, 25V, 30mA, 150mW, B=60..120, 600MHz	CP	16ta	-	3a	San
Q3	ELM7643HBB	Vdet-IC	4.3V±2%, +Reset PPO, 500ms	SOT-23	16vdc	VD7	3d	Elm
Q3	R3130N29AA3	Vdet-IC	2.9V, -Reset PPO, 50ms	SOT-23	16vdc	VD7	3b	Ric
Q30	GS810CTEUD	Vdet-IC	3.08V, +Reset PPO, 30ms	SOT-23	16vdc	VD7	3g	Vs
Q4	2SC1321-4	Si-npn	UHF, 30V, 10mA, 100mW, B=90..180, 900MHz	SOT-23	16ta	-	3a	Nec
Q4	2SC2813-4	Si-npn	RF, GP, 25V, 30mA, 150mW, B=90..180, 600MHz	CP	16ta	-	3a	San
Q4	ELM7644HBB	Vdet-IC	4.4V±2%, +Reset PPO, 500ms	SOT-23	16vdc	VD7	3d	Elm
Q4	KA4F3P	Si-npn-Digi	Sw, 60V, 100mA, 200mW, R1/R2=2k2/10k	SOT-416	16ta	-	3a	Nec
Q4	R3130N30AA8	Vdet-IC	3V, -Reset PPO, 50ms	SOT-23	16vdc	VD7	3b	Ric
Q4	SP809EK-2-9	Vdet-IC	2.9V±1.5%, -Reset PPO	SOT-23	16vdc	VD7	3b	Sip
Q40	GS810CJEUD	Vdet-IC	4V, +Reset PPO, 30ms	SOT-23	16vdc	VD7	3g	Vs
Q43	GS810CMEUD	Vdet-IC	4.38V, +Reset PPO, 30ms	SOT-23	16vdc	VD7	3g	Vs
Q46	GS810CLEUD	Vdet-IC	4.63V, +Reset PPO, 30ms	SOT-23	16vdc	VD7	3g	Vs
Q5	2SC1321-5	Si-npn	UHF, 30V, 10mA, 100mW, B=135..270, 900MHz	SOT-23	16ta	-	3a	Nec
Q5	2SC2813-5	Si-npn	RF, GP, 25V, 30mA, 150mW, B=135..270, 600MHz	CP	16ta	-	3a	San
Q5	ELM7645HBB	Vdet-IC	4.5V±2%, +Reset PPO, 500ms	SOT-23	16vdc	VD7	3d	Elm
Q5	R3130N46AA5	Vdet-IC	4.6V, -Reset PPO, 50ms	SOT-23	16vdc	VD7	3b	Ric
Q6	ELM7646HBB	Vdet-IC	4.6V±2%, +Reset PPO, 500ms	SOT-23	16vdc	VD7	3d	Elm
Q6	R3130N23AA	Vdet-IC	2.3V, -Reset PPO, 50ms	SOT-23	16vdc	VD7	3b	Ric
Q7	ELM7647HBB	Vdet-IC	4.7V±2%, +Reset PPO, 500ms	SOT-23	16vdc	VD7	3d	Elm
Q7	KN4F3P	Si-npn-Digi	Sw, 60V, 100mA, 150mW, R1/R2=2k2/10k	SOT-416	16ta	-	3a	Nec
Q7	R3130N28AA	Vdet-IC	2.8V, -Reset PPO, 50ms	SOT-23	16vdc	VD7	3b	Ric
Q8	ELM7648HBB	Vdet-IC	4.8V±2%, +Reset PPO, 500ms	SOT-23	16vdc	VD7	3d	Elm



SMD code	Type	Function	Short description	Case	Pinout	Sch. St.	Mnf.
Q9	ELM7649HBB	Vdet-IC	4.9V±2%, +Reset PPO, 500ms	SOT-23	16vdc	VD7	3d Elm
QA	2SC2620-A	Si-npn	VHF Mix, Osc, 30V, 20mA, 100mW, B=35..70, 940MHz	SOT-23	16ta	-	3a Ren
QA	RN1321A	Si-npn-Digi	Mute, 15V, 500mA, 300mW, R1/R2=1k/1k	SOT-323	16ta	-	3a Tos
QA	RN1421	Si-npn-Digi	Mute, 50V, 800mA, 300mW, R1/R2=1k/1k	SOT-346	16ta	-	3a Tos
QAA	BC846A	Si-npn	GP, 80V, 100mA, 200mW, B=110..220, >300MHz	SOT-23	16ta	-	3a Auk
QAA	BC846FA	Si-npn	GP, 80V, 100mA, 200mW, B=110..220, 250MHz	SOT-23F	18ta	-	3a Auk
QAB	BC846B	Si-npn	GP, 80V, 100mA, 200mW, B=200..450, >300MHz	SOT-23	16ta	-	3a Auk
QAB	BC846FB	Si-npn	GP, 80V, 100mA, 200mW, B=200..450, 250MHz	SOT-23F	18ta	-	3a Auk
QAC	BC846C	Si-npn	GP, 80V, 100mA, 200mW, B=200..800, >300MHz	SOT-23	16ta	-	3a Auk
QAC	BC846FC	Si-npn	GP, 80V, 100mA, 200mW, B=420..800, 250MHz	SOT-23F	18ta	-	3a Auk
QB	2SC2620-B	Si-npn	VHF Mix, Osc, 30V, 20mA, 100mW, B=60..120, 940MHz	SOT-23	16ta	-	3a Ren
QB	RN1322A	Si-npn-Digi	Mute, 15V, 500mA, 300mW, R1/R2=2k2/2k2	SOT-323	16ta	-	3a Tos
QB	RN1422	Si-npn-Digi	Mute, 50V, 800mA, 300mW, R1/R2=2.2k/2.2k	SOT-346	16ta	-	3a Tos
QC	2SC2620-C	Si-npn	VHF Mix, Osc, 30V, 20mA, 100mW, B=100..200, 940MHz	SOT-23	16ta	-	3a Ren
QC	RN1323A	Si-npn-Digi	Mute, 15V, 500mA, 300mW, R1/R2=4k7/4k7	SOT-323	16ta	-	3a Tos
QC	RN1423	Si-npn-Digi	Mute, 50V, 800mA, 300mW, R1/R2=4.7k/4.7k	SOT-346	16ta	-	3a Tos
QD	RN1324A	Si-npn-Digi	Mute, 15V, 500mA, 300mW, R1/R2=10k/10k	SOT-323	16ta	-	3a Tos
QD	RN1424	Si-npn-Digi	Mute, 50V, 800mA, 300mW, R1/R2=10k/10k	SOT-346	16ta	-	3a Tos
QE	RN1325A	Si-npn-Digi	Mute, 15V, 500mA, 300mW, R1/R2=0k47/10k	SOT-323	16ta	-	3a Tos
QE	RN1425	Si-npn-Digi	Mute, 50V, 800mA, 300mW, R1/R2=0k47/10k	SOT-346	16ta	-	3a Tos
QF	RN1326A	Si-npn-Digi	Mute, 15V, 500mA, 300mW, R1/R2=1k/10k	SOT-323	16ta	-	3a Tos
QF	RN1426	Si-npn-Digi	Mute, 50V, 800mA, 300mW, R1/R2=1k/10k	SOT-346	16ta	-	3a Tos
QG	RN1327A	Si-npn-Digi	Mute, 15V, 500mA, 300mW, R1/R2=2k2/10k	SOT-323	16ta	-	3a Tos
QG	RN1427	Si-npn-Digi	Mute, 50V, 800mA, 300mW, R1/R2=2.2k/10k	SOT-346	16ta	-	3a Tos
QH	2SC1496	Si-npn	UHF-Osc, 25V, 50mA, 150mW, B=50..180, 2.4GHz	SC-59A	16ta	-	3a Ren
QH	2SC4261	Si-npn	VHF/UHF, 25V, 50mA, 100mW, B=50..180, >1.8GHz	SOT-323	16ta	-	3a Ren
QJ	MCP100T-270I	Vdet-IC	2.7V, -Reset PPO	SOT-23	16vdc	VD7	3a Mcc
QJY	FM803JP3X	Vdet-IC	4.0V±1.5%, -Reset ODO	SC-70	16vdc	VD6	3a F
QK	MCP100T-300I	Vdet-IC	3V, -Reset PPO	SOT-23	16vdc	VD7	3a Mcc
QL	MCP100T-315I	Vdet-IC	3.15V, -Reset PPO	SOT-23	16vdc	VD7	3a Mcc
QL3	2SA1580-3	Si-pnp	Vid, 70V, 50mA, 200mW, B=60..120, 700MHz	SOT-23	16ta	-	3a San
QL4	2SA1580-4	Si-pnp	Vid, 70V, 50mA, 200mW, B=90..180, 700MHz	SOT-23	16ta	-	3a San
QL5	2SA1580-5	Si-pnp	Vid, 70V, 50mA, 200mW, B=60..120, 700MHz	SOT-23	16ta	-	3a San
QLN	ELM7536CEB	Vdet-IC	3.6V±2%, +Reset PPO	SC-70	16vdc	VD7	3d Elm
QLN	ELM7536NEB	Vdet-IC	3.6V±2%, +Reset ODO	SC-70	16vdc	VD6	3d Elm
QLY	FM803LP3X	Vdet-IC	4.63V±1.5%, -Reset ODO	SC-70	16vdc	VD6	3a F
QM	MCP100T-450I	Vdet-IC	4.5V, -Reset PPO	SOT-23	16vdc	VD7	3a Mcc
QMY	FM803MP3X	Vdet-IC	4.38V±1.5%, -Reset ODO	SC-70	16vdc	VD6	3a F
QN	MCP100T-460I	Vdet-IC	4.6V, -Reset PPO	SOT-23	16vdc	VD7	3a Mcc
QO	2SC2714-O	Si-npn	VHF Mix/Osc, 40V, 20mA, 100mW, B=40..80, 550MHz	SC-59	16ta	-	3a Tos
QO	2SC4215-O	Si-npn	RF, FM/AM, 40V, 20mA, 100mW, B=70..140, 550MHz	SOT-323	16ta	-	3a Tos
QO	2SC4915-O	Si-npn	FM, RF, Mix, IF, 40V, 20mA, 100mW, 550MHz, B=70..140	SOT-23	16ta	-	3a Tos
QO	KTC4080-O	Si-npn	GP, 50V, 20mA, 100mW, B=70..140, >550MHz	SOT-323	16ta	-	3f Kec
QP	MCP100T-475I	Vdet-IC	4.75V, -Reset PPO	SOT-23	16vdc	VD7	3a Mcc
QP	MCP100T-485I	Vdet-IC	4.85V, -Reset PPO	SOT-23	16vdc	VD7	3a Mcc
QR	2SC2714-R	Si-npn	VHF Mix/Osc, 40V, 20mA, 100mW, B=70..140, 550MHz	SC-59	16ta	-	3a Tos
QR	2SC4215-R	Si-npn	RF, FM/AM, 40V, 20mA, 100mW, B=40..80, 550MHz	SOT-323	16ta	-	3a Tos
QR	2SC4915-R	Si-npn	FM, RF, Mix, IF, 40V, 20mA, 100mW, 550MHz, B=40..80	SOT-23	16ta	-	3a Tos
QR	KTC4080-R	Si-npn	GP, 50V, 20mA, 100mW, B=40..80, >550MHz	SOT-323	16ta	-	3f Kec
QRY	FM803RP3X	Vdet-IC	2.63V±1.5%, -Reset ODO	SC-70	16vdc	VD6	3a F
QSY	FM803SP3X	Vdet-IC	2.93V±1.5%, -Reset ODO	SC-70	16vdc	VD6	3a F
QT	CHT4126PT	Si-pnp	AF, Sw, 25V, 200mA, B=120..360, 250MHz	SOT-23	16ta	-	3a Chm
QT4	2SC4412-4	Si-npn	CTV-Vid, 300V, 50mA, 250mW, B=100..200, 70MHz	CP	16ta	-	3a San
QT5	2SC4412-5	Si-npn	CTV-Vid, 300V, 50mA, 250mW, B=160..320, 70MHz	CP	16ta	-	3a San
QTY	FM803TP3X	Vdet-IC	3.08V±1.5%, -Reset ODO	SC-70	16vdc	VD6	3a F
QY	2SC2714-Y	Si-npn	VHF Mix/Osc, 40V, 20mA, 100mW, B=120..240, 550MHz	SC-59	16ta	-	3a Tos
QY	2SC3863	Si-npn-Digi	Sw, 50V, 100mA, 200mW, 200MHz, B>50, R1/R2=2.2k/10k	CP	16ta	-	3a San
QY	2SC4215-Y	Si-npn	RF, FM/AM, 40V, 20mA, 100mW, B=100..200, 550MHz	SOT-323	16ta	-	3a Tos
QY	2SC4498	Si-npn-Digi	Sw, 50V, 100mA, R1=2.2kΩ, R2=10kΩ	SOT-323	16ta	-	3a San
QY	2SC4915-Y	Si-npn	FM, RF, Mix, IF, 40V, 20mA, 100mW, 550MHz, B=100..200	SOT-23	16ta	-	3a Tos
QY	KTC4080-Y	Si-npn	GP, 50V, 20mA, 100mW, B=100..200, >550MHz	SOT-323	16ta	-	3f Kec
R	2SB1197-R	Si-pnp	AF, 40V, 800mA, 200mW, B=180..390, >50MHz	SOT-23	16ta	-	3a Wtr
r	2SC2480	Si-npn	VHF/UHF, 30V, 50mA, 150mW, B=800..1600, 1.3GHz	SC-59	16ta	-	3a Pan
R	AX6903DA	Vdet-IC	3.08V±1.5%, -Reset PPO	SC-70	16vda	VD7	3b Axl
R0	ELM7630LCB	Vdet-IC	3.0V±2%, -Reset PPO, 150ms	SOT-23	16vdc	VD7	3d Elm
R0	ELM9730CBB	Vdet-IC	3.0V±2.5%, +Reset PPO	SOT-23	16vdc	VD7	3d Elm
R0	R3130N40BA	Vdet-IC	4V, -Reset PPO, 100ms	SOT-23	16vdc	VD7	3b Ric
R0	TC54VN5002ECB	Vdet-IC	5.0V±2%, -Reset ODO	SOT-23	16vdc	VD6	3a Tcs
R0	XC61CN5002M	Vdet-IC	5V±1%, +Reset ODO	SOT-23	16vdc	VD6	3d Tor
R0	XC6GN5002HR	Vdet-IC	5.0V, +Reset ODO	USP-3	17vdc	VD1	9b Tor



SMD code	Type	Function	Short description	Case	Pinout	Sch. St.	Mnf.
R01	CHRT5993TPT	Si-npn	UHF, 11V, 50mA, B=56..270, 3.2GHz	SOT-416	16ta -	3a	Chm
R01	CHRT5993WTPPT	Si-npn	UHF, Sw, 11V, 50mA, B=56..270, 3.2GHz	SOT-323	16ta -	3a	Chm
R01	KSR1101	Si-npn-Digi	Sw, 50V, 100mA, 20mW, 250MHz, R1/R2=4k7/4k7	SOT-23	16ta -	3a	Sam
R02	KSR1102	Si-npn-Digi	Sw, 50V, 100mA, 20mW, 250MHz, R1/R2=10k/10k	SOT-23	16ta -	3a	Sam
R03	KSR1103	Si-npn-Digi	Sw, 50V, 100mA, 20mW, 250MHz, R1/R2=22k/22k	SOT-23	16ta -	3a	Sam
R03	XE61CN5045MR	Vdet-IC	5.0V±2%, -Reset ODO	SOT-23	16vdb	VD6	3h Tor
R04	KSR1104	Si-npn-Digi	Sw, 50V, 100mA, 20mW, 250MHz, R1/R2=47k/47k	SOT-23	16ta -	3a	Sam
R05	KSR1105	Si-npn-Digi	Sw, 50V, 100mA, 20mW, 250MHz, R1/R2=4k7/10k	SOT-23	16ta -	3a	Sam
R05	XC61FN5012M	Vdet-IC	5V±2%, +Reset ODO, 200ms	SOT-23	16vdb	VD6	3d Tor
R05	XC61HN5012MR	Vdet-IC	5.0V±2%, -Reset ODO, 50..200ms	SOT-23	16vdc	VD6	3d Tor
R06	KSR1106	Si-npn-Digi	Sw, 50V, 100mA, 20mW, 250MHz, R1/R2=10k/47k	SOT-23	16ta -	3a	Sam
R06	XC61FN5042M	Vdet-IC	5V±2%, +Reset ODO, 400ms	SOT-23	16vdb	VD6	3d Tor
R06	XC61HN5042MR	Vdet-IC	5.0V±2%, -Reset ODO, 80..400ms	SOT-23	16vdc	VD6	3d Tor
R07	KSR1107	Si-npn-Digi	Sw, 50V, 100mA, 20mW, 250MHz, R1/R2=22k/47k	SOT-23	16ta -	3a	Sam
R07	XC61FN5052M	Vdet-IC	5V±2%, +Reset ODO, 50ms	SOT-23	16vdb	VD6	3d Tor
R07	XC61HN5052MR	Vdet-IC	5.0V±2%, -Reset ODO, 1..50ms	SOT-23	16vdc	VD6	3d Tor
R08	KSR1108	Si-npn-Digi	Sw, 50V, 100mA, 20mW, 250MHz, R1/R2=47k/22k	SOT-23	16ta -	3a	Sam
R09	KSR1109	Si-npn-Digi	Sw, 50V, 100mA, 20mW, 250MHz, R1=4k7	SOT-23	16ta -	3a	Sam
ROA	LM4040AIM3-10.0	Vref-IC	Precision, Shunt, 10.0V, 0.1%	SOT-23	16dk	RF1	3a Nsc
ROA	LM4040AIM3X-10.0	Vref-IC	Precision, Shunt, 10.0V, 0.1%	SOT-23	16dk	RF1	3a Nsc
ROB	LM4040BIM3-10.0	Vref-IC	Precision, Shunt, 10.0V, 0.2%	SOT-23	16dk	RF1	3a Nsc
ROB	LM4040BIM3X-10.0	Vref-IC	Precision, Shunt, 10.0V, 0.2%	SOT-23	16dk	RF1	3a Nsc
ROC	LM4040CIM3-10.0	Vref-IC	Precision, Shunt, 10.0V, 0.5%	SOT-23	16dk	RF1	3a Nsc
ROC	LM4040CIM3X-10.0	Vref-IC	Precision, Shunt, 10.0V, 0.5%	SOT-23	16dk	RF1	3a Nsc
ROD	LM4040DIM3-10.0	Vref-IC	Precision, Shunt, 10.0V, 1%	SOT-23	16dk	RF1	3a Nsc
ROD	LM4040DIM3X-10.0	Vref-IC	Precision, Shunt, 10.0V, 1%	SOT-23	16dk	RF1	3a Nsc
R1	BFR93	Si-npn	UHF-A-Band, 15V, 30mA, 300mW, B>40, >5GHz	SOT-23	16ta -	3a	Ste
R1	BZX84-C4V7T	Z-diode	4.7V±5%, 150mW	SOT-523	16dc -	3a	Di
R1	CHDTA113TKPT	Si-npn-Digi	Sw, 50V, 100mA, 250MHz, R1=1k	SOT-23	16ta -	3a	Chm
R1	CZRH3-55C4V7	Z-diode	4.7..5.0V, Zzt=80Q, Izt=5mA, 150mW	SOT-523	18dc -	3a	Cmc
R1	ELM7631LCB	Vdet-IC	3.1V±2%, -Reset PPO, 150ms	SOT-23	16vdc	VD7	3d Elm
R1	ELM79731CBB	Vdet-IC	3.1V±2.5%, +Reset PPO	SOT-23	16vdb	VD7	3d Elm
R1	R3130N44BA	Vdet-IC	4.4V, -Reset PPO, 100ms	SOT-23	16vdc	VD7	3b Ric
R1	SRC1201E	Si-npn-Digi	Sw, 50V, 100mA, 150mW, 200MHz, R1/R2=4.7/4.7k	SOT-523	16ta -	3a	Auk
R1	SRC1201EF	Si-npn-Digi	Sw, 50V, 100mA, 150mW, 200MHz, R1/R2=4.7/4.7k	SOT-523F	18ta -	3a	Auk
R1	SRC1201U	Si-npn-Digi	Sw, 50V, 100mA, 200mW, 200MHz, R1/R2=4.7/4.7k	SOT-323	16ta -	3a	Auk
R1	SRC1201UF	Si-npn-Digi	Sw, 50V, 100mA, 200mW, 200MHz, R1/R2=4.7/4.7k	SOT-323F	18ta -	3a	Auk
R1	TC54VN5102ECB	Vdet-IC	5.1V±2%, -Reset ODO	SOT-23	16vdb	VD6	3a Tcs
R1	TN2010T	n-MOSFET-e	V-MOS, 200V, 120mA, 360mW, <9.5Q(0.5A)	SOT-23	16fh -	3a	Six
R1	XC61CN5012M	Vdet-IC	5.1V±1%, +Reset ODO	SOT-23	16vdb	VD6	3d Tor
R10	KSR1110	Si-npn-Digi	Sw, 50V, 100mA, 20mW, 250MHz, R1=10k	SOT-23	16ta -	3a	Sam
R11	CM7R250-11B-T	LVR-IC	LDO, 1.1V±3%, 150mA	SOT-23	16cg	VR1	3a Can
R11	KSR1111	Si-npn-Digi	Sw, 50V, 100mA, 20mW, 250MHz, R1=22k	SOT-23	16ta -	3a	Sam
R11	LM385M3-1.2	Vref-IC	µPower, 1.2V	SOT-23	16dk -	3a	Nsc
R11A	REF1112A	Vref-IC	Prec. Shunt, 1.25V, 0.2%, <10ppm°C	SOT-23	16dk -	3a	Bb
R11B	ML62113M	LVR-IC	1.1V±3%, 250mA	SOT-23	16cg	VR1	3a Mic
R12	CM7R250-12B-T	LVR-IC	LDO, 1.2V±3%, 150mA	SOT-23	16cg	VR1	3a Can
R12	KSR1112	Si-npn-Digi	Sw, 50V, 100mA, 20mW, 250MHz, R1=47k	SOT-23	16ta -	3a	Sam
R12	LM385M3-2.5	Vref-IC	µPower, 2.5V	SOT-23	16dk -	3a	Nsc
R12B	ML62123M	LVR-IC	1.2V±3%, 250mA	SOT-23	16cg	VR1	3a Mic
R13	25C4885	Si-npn	UHF-Osc, 25V, 50mA, 120mW, 3.5GHz, B=60..150	SOT-323	16ta -	3a	Nec
R13	CM7R250-13B-T	LVR-IC	LDO, 1.3V±3%, 150mA	SOT-23	16cg	VR1	3a Can
R13	KSR1113	Si-npn-Digi	Sw, 50V, 100mA, 20mW, 250MHz, R1/R2=2k2/47k	SOT-23	16ta -	3a	Sam
R13	XE61CN5145MR	Vdet-IC	5.1V±2%, -Reset ODO	SOT-23	16vdb	VD6	3h Tor
R13B	ML62133M	LVR-IC	1.3V±3%, 250mA	SOT-23	16cg	VR1	3a Mic
R14	CM7R250-14B-T	LVR-IC	LDO, 1.4V±3%, 150mA	SOT-23	16cg	VR1	3a Can
R14	KSR1114	Si-npn-Digi	Sw, 50V, 100mA, 20mW, 250MHz, R1/R2=4k7/47k	SOT-23	16ta -	3a	Sam
R14B	ML62143M	LVR-IC	1.4V±3%, 250mA	SOT-23	16cg	VR1	3a Mic
R15	CM7R250-15B-T	LVR-IC	LDO, 1.5V±3%, 150mA	SOT-23	16cg	VR1	3a Can
R15	XC61FN5112M	Vdet-IC	5.1V±2%, +Reset ODO, 200ms	SOT-23	16vdb	VD6	3d Tor
R15	XC61HN5112MR	Vdet-IC	5.1V±2%, -Reset ODO, 50..200ms	SOT-23	16vdc	VD6	3d Tor
R15B	ML62153M	LVR-IC	1.5V±3%, 250mA	SOT-23	16cg	VR1	3a Mic
R16	CM7R250-16B-T	LVR-IC	LDO, 1.6V±3%, 150mA	SOT-23	16cg	VR1	3a Can
R16	XC61FN5142M	Vdet-IC	5.1V±2%, +Reset ODO, 400ms	SOT-23	16vdb	VD6	3d Tor
R16	XC61HN5142MR	Vdet-IC	5.1V±2%, -Reset ODO, 80..400ms	SOT-23	16vdc	VD6	3d Tor
R16B	ML62163M	LVR-IC	1.6V±3%, 250mA	SOT-23	16cg	VR1	3a Mic
R17	CHT817WPT-R	Si-npn	AF, Sw, 45V, 500mA, B=160..400, 170MHz	SOT-323	16ta -	3a	Chm
R17	CM7R250-17B-T	LVR-IC	LDO, 1.7V±3%, 150mA	SOT-23	16cg	VR1	3a Can
R17	XC61FN5152M	Vdet-IC	5.1V±2%, +Reset ODO, 50ms	SOT-23	16vdb	VD6	3d Tor
R17	XC61HN5152MR	Vdet-IC	5.1V±2%, -Reset ODO, 1..50ms	SOT-23	16vdc	VD6	3d Tor



SMD code	Type	Function	Short description	Case	Pinout	Sch.	St.	Mnf.
R17B	ML62173M	LVR-IC	LDO, 1.7V±3%, 250mA	SOT-23	16cg	VR1	3a	Mic
R18	CM7R250-18B-T	LVR-IC	LDO, 1.8V±3%, 150mA	SOT-23	16cg	VR1	3a	Can
R18B	ML62183M	LVR-IC	LDO, 1.8V±3%, 250mA	SOT-23	16cg	VR1	3a	Mic
R19	CM7R250-19B-T	LVR-IC	LDO, 1.9V±3%, 150mA	SOT-23	16cg	VR1	3a	Can
R19B	ML62193M	LVR-IC	LDO, 1.9V±3%, 250mA	SOT-23	16cg	VR1	3a	Mic
R1A	LM4041AIM3-1.2	Vref-IC	Precision, Shunt, 1.225V, 0.1%	SOT-23	16dk	RF1	3a	Nsc
R1A	MMST3904	Si-npn	GP, 60V, 200mA, 250mW, B=100..300, >300MHz	SC-59	16ta	-	3a	Rhm
R1A	SST3904	Si-npn	GP, 60V, 100mA, 200mW, B= 100..300, >300MHz	SOT-23	16ta	-	3a	Rhm
R1A	UMT3904	Si-npn	GP, 60V, 100mA, 200mW, B= 100..300, >300MHz	SOT-323	16ta	-	-	Rhm
R1B	CM7R250-11A-T	LVR-IC	LDO, 1.15V±3%, 150mA	SOT-23	16cg	VR1	3a	Can
R1B	LM4041BIM3-1.2	Vref-IC	Precision, Shunt, 1.225V, 0.2%	SOT-23	16dk	RF1	3a	Nsc
R1B	MMST2222	Si-npn	GP, 60V, 600mA, 330mW, B=120..360, >300MHz	SOT-23	16ta	-	3a	Rhm
R1B	SST2222	Si-npn	GP, 60V, 600mA, 330mW, B=100..300, >250MHz	SOT-23	16ta	-	3a	Rhm
R1C	CM7R250-12A-T	LVR-IC	LDO, 1.25V±3%, 150mA	SOT-23	16cg	VR1	3a	Can
R1C	LM4041CEM3-1.2	Vref-IC	Precision, Shunt, 1.20V	SOT-23	16dk	RF1	3a	Nsc
R1C	MMSTA20	Si-npn	GP, 40V, 100mA, 600mW, B=40..400, >125MHz	SC-59	16ta	-	3a	Rhm
R1C	SSTA20	Si-npn	AF, 40V, 200mA, B>120, >125MHz	SOT-23	16ta	-	3a	Rhm
R1D	CM7R250-13A-T	LVR-IC	LDO, 1.35V±3%, 150mA	SOT-23	16cg	VR1	3a	Can
R1D	LM4041DEM3-1.2	Vref-IC	Precision, Shunt, 1.20V	SOT-23	16dk	RF1	3a	Nsc
R1E	CM7R250-14A-T	LVR-IC	LDO, 1.45V±3%, 150mA	SOT-23	16cg	VR1	3a	Can
R1E	LM4041EEM3-1.2	Vref-IC	Precision, Shunt, 1.20V, 1.5%	SOT-23	16dk	RF1	3a	Nsc
R1E	LM4041EIM3-1.2	Vref-IC	Precision, Shunt, 1.20V, 1.5%	SOT-23	16dk	RF1	3a	Nsc
R1F	CM7R250-15A-T	LVR-IC	LDO, 1.55V±3%, 150mA	SOT-23	16cg	VR1	3a	Can
R1G	CM7R250-16A-T	LVR-IC	LDO, 1.65V±3%, 150mA	SOT-23	16cg	VR1	3a	Can
R1G	MMSTA06	Si-npn	GP, 80V, 500mA, 350mW, B>100, >100MHz	SC-59	16ta	-	3a	Rhm
R1G	SSTA06	Si-npn	AF, 80V, 500mA, B>100, >100MHz	SOT-23	16ta	-	3a	Rhm
R1H	CM7R250-17A-T	LVR-IC	LDO, 1.75V±3%, 150mA	SOT-23	16cg	VR1	3a	Can
R1H	SSTA05	Si-npn	GP, 60V, 500mA, 350mW, B>100, >100MHz	SOT-23	16ta	-	3a	Rhm
R1I	CM7R250-18A-T	LVR-IC	LDO, 1.85V±3%, 150mA	SOT-23	16cg	VR1	3a	Can
R1J	CM7R250-19A-T	LVR-IC	LDO, 1.95V±3%, 150mA	SOT-23	16cg	VR1	3a	Can
R1J	SST6427	Si-npn-Darl	AF, 40V, 500mA, 360mW, B=10k..100k, >130MHz	SOT-23	16ta	-	3a	Rhm
R1K	MMST6428	Si-npn	GP, 60V, 200mA, 350mW, B=250..650, 100..700MHz	SOT-23	16ta	-	3a	Rhm
R1K	SST6428	Si-npn	AF, 60V, 200mA, B=250..650, >100MHz	SOT-23	16ta	-	3a	Rhm
R1M	2SD2142K	Si-npn-Darl	GP, 40V, 300mA, 200MHz, B>5000	SOT-23	16ta	-	3a	Rhm
R1M	MMSTA13	Si-npn-Darl	GP, 30V, 300mA, 300mW, B=5000, >125MHz	SC-59	16ta	-	3a	Rhm
R1M	SSTA13	Si-npn-Darl	AF, 30V, 500mA, B>10000, >125MHz	SOT-23	16ta	-	3a	Rhm
R1N	MMSTA14	Si-npn-Darl	GP, 30V, 300mA, 300mW, B>10000, >125MHz	SC-59	16ta	-	3a	Rhm
R1N	SSTA14	Si-npn-Darl	AF, 30V, 500mA, B>20000, >125MHz	SOT-23	16ta	-	3a	Rhm
R1O	MMST5088	Si-npn	GP, 35V, 50mA, 350mW, B=300..900, >50MHz	SOT-23	16ta	-	3a	Rhm
R1p	BFR93	Si-npn	UHF-A-Band, 15V, 30mA, 300mW, B>40, >5GHz	SOT-23	16ta	-	3a	Phi
R1P	MMST2222A	Si-npn	GP, 75V, 600mA, 330mW, B=120..360, >300MHz	SC-59	16ta	-	3a	Rhm
R1P	SST2222A	Si-npn	GP, 75V, 600mA, 330mW, B=120..360, >300MHz	SOT-23	16ta	-	3a	Rhm
R1P	UMT2222A	Si-npn	GP, 75V, 600mA, 330mW, B=120..360, >300MHz	SOT-323	16ta	-	3a	Rhm
R1Q	SST5088	Si-npn	AF, 35V, 200mA, B=300..900, >50MHz	SOT-23	16ta	-	3a	Rhm
R1R	MMST5089	Si-npn	AF, 30V, 50mA, 350mW, B=400..1200, >50MHz	SOT-23	16ta	-	3a	Rhm
R1R	SST5089	Si-npn	AF, 30V, 200mA, B=400..1200, >50MHz	SOT-23	16ta	-	3a	Rhm
R2	2SC2351-2	Si-npn	Fast-Sw, UHF, 20V, 70mA, 200mW, B=40..120, 4.5Hz	SOT-23	16ta	-	3a	Nec
R2	2SC2351-P	Si-npn	Fast-Sw, UHF, 20V, 70mA, 200mW, B=40..120, 4.5Hz	SOT-23	16ta	-	3a	Nec
R2	2SC4225-2	Si-npn	VHF/UHF, 25V, 70mA, 160mW, B=40..120, 4GHz	SOT-323	16ta	-	3a	Nec
R2	BFR93AL	Si-npn	VHF UHF, 15V, 35mA, 306mW, B>40, >3GHz	SOT-23	16ta	-	3a	Mot
R2	BFR93AT	Si-npn	UHF-A-Band, 15V, 30mA, 300mW, B>40, >5GHz	SOT-416	16ta	-	3a	Phi
R2	BFR93AW	Si-npn	UHF-A-Band, 15V, 30mA, 300mW, B>40, >5GHz	SOT-323	16ta	-	3a	Phi
R2	BZX84-C5V1T	Z-diode	5.1V±5%, 150mW	SOT-523	16dc	-	3a	Di
R2	CZRH3-55C5V1	Z-diode	5.1..5.40V, Zzt=60Ω, Izt=5mA, 150mW	SOT-523	16dc	-	3a	Cmc
R2	ELM7632LCB	Vdet-IC	3.2V±2%, -Reset PPO, 150ms	SOT-23	16vdc	VD7	3d	Elm
R2	ELM9732CBB	Vdet-IC	3.2V±2.5%, +Reset PPO	SOT-23	16vdb	VD7	3d	Elm
R2	NE02133-2	Si-npn	Fast-Sw, UHF, 25V, 70mA, 200mW, B=40..120, 4.5Hz	SOT-23	16ta	-	3a	Cel
R2	NE02133-P	Si-npn	Fast-Sw, UHF, 25V, 70mA, 200mW, B=40..120, 4.5Hz	SOT-23	16ta	-	3a	Cel
R2	R3130N26BA3	Vdet-IC	2.6V, -Reset PPO, 100ms	SOT-23	16vdc	VD7	3b	Ric
R2	SRC1202E	Si-npn-Digi	Sw, 50V, 100mA, 150mW, 200MHz, R1/R2=10/10k	SOT-523	16ta	-	3a	Auk
R2	SRC1202EF	Si-npn-Digi	Sw, 50V, 100mA, 150mW, 200MHz, R1/R2=10/10k	SOT-523F	18ta	-	3a	Auk
R2	SRC1202U	Si-npn-Digi	Sw, 50V, 100mA, 200mW, 200MHz, R1/R2=10/10k	SOT-323	16ta	-	3a	Auk
R2	SRC1202UF	Si-npn-Digi	Sw, 50V, 100mA, 200mW, 200MHz, R1/R2=10/10k	SOT-323F	18ta	-	3a	Auk
R2	TC54VN5202ECB	Vdet-IC	5.2V±2%, -Reset ODO	SOT-23	16vdb	VD6	3a	Tcs
R2	XC61CN5202M	Vdet-IC	5.2V±1%, +Reset ODO	SOT-23	16vdb	VD6	3d	Tor
R20	CM7R250-20B-T	LVR-IC	LDO, 2.0V±2%, 150mA	SOT-23	16cg	VR1	3a	Can
R20B	ML62202M	LVR-IC	LDO, 2.0V±2%, 250mA	SOT-23	16cg	VR1	3a	Mic
R21	CM7R250-21B-T	LVR-IC	LDO, 2.1V±2%, 150mA	SOT-23	16cg	VR1	3a	Can
R21	GS810C21EUE	Vdet-IC	2.1V, +Reset PPO, 150ms	SOT-23	16vdc	VD7	3g	Vs
R21B	ML62212M	LVR-IC	LDO, 2.1V±2%, 250mA	SOT-23	16cg	VR1	3a	Mic



SMD code	Type	Function	Short description	Case	Pinout	Sch. St.	Mnf.
R22	2SC4226-22	Si-npn	VHF/UHF, 20V, 100mA, 150mW, B=30..60, 4.5GHz	SOT-323	16ta	-	3a Nec
R22	CM7R250-22B-T	LVR-IC	LDO, 2.2V±2%, 150mA	SOT-23	16cg	VR1	3a Can
R22	NE85630-22	Si-npn	VHF/UHF, 20V, 100mA, 150mW, B=30..60, 4.5GHz	SOT-323	16ta	-	3a Cel
R22B	ML62222M	LVR-IC	2.2V±2%, 250mA	SOT-23	16cg	VR1	3a Mic
R23	2SC3356-Q	Si-npn	VHF/UHF, CATV, 20V, 100mA, 200mW, B=50..100, 7GHz	SOT-23	16ta	-	3a Nec
R23	2SC4226-23	Si-npn	VHF/UHF, 20V, 100mA, 150mW, B=40..80, 4.5GHz	SOT-323	16ta	-	3a Nec
R23	CM7R250-23B-T	LVR-IC	LDO, 2.3V±2%, 150mA	SOT-23	16cg	VR1	3a Can
R23	NE85630-23	Si-npn	VHF/UHF, 20V, 100mA, 150mW, B=40..80, 4.5GHz	SOT-323	16ta	-	3a Cel
R23	NE85633-23	Si-npn	VHF/UHF, CATV, 20V, 100mA, 200mW, B=50..100, 7GHz	SOT-23	16ta	-	3a Cel
R23	NE85633-Q	Si-npn	VHF/UHF, CATV, 20V, 100mA, 200mW, B=50..100, 7GHz	SOT-23	16ta	-	3a Cel
R23	XE61CN5245MR	Vdet-IC	5.2V±2%, -Reset ODO	SOT-23	16vdb	VD6	3h Tor
R23B	ML62232M	LVR-IC	2.3V±2%, 250mA	SOT-23	16cg	VR1	3a Mic
R24	2SC3356-R	Si-npn	VHF/UHF, CATV, 20V, 100mA, 200mW, B=80..160, 7GHz	SOT-23	16ta	-	3a Nec
R24	2SC4226-24	Si-npn	VHF/UHF, 20V, 100mA, 150mW, B=70..140, 4.5GHz	SOT-323	16ta	-	3a Nec
R24	CM7R250-24B-T	LVR-IC	LDO, 2.4V±2%, 150mA	SOT-23	16cg	VR1	3a Can
R24	GS810C24EUE	Vdet-IC	2.4V, +Reset PPO, 150ms	SOT-23	16vdc	VD7	3g Vs
R24	NE85630-24	Si-npn	VHF/UHF, 20V, 100mA, 150mW, B=70..140, 4.5GHz	SOT-323	16ta	-	3a Cel
R24	NE85633-24	Si-npn	VHF/UHF, CATV, 20V, 100mA, 200mW, B=80..160, 7GHz	SOT-23	16ta	-	3a Cel
R24	NE85633-R	Si-npn	VHF/UHF, CATV, 20V, 100mA, 200mW, B=80..160, 7GHz	SOT-23	16ta	-	3a Cel
R24	SST5424	Si-npn	VHF/UHF, 30V, 50mA, >600MHz	SOT-23	16ta	-	3a Rhm
R24B	ML62242M	LVR-IC	2.4V±2%, 250mA	SOT-23	16cg	VR1	3a Mic
R25	2SC3356-S	Si-npn	VHF/UHF, CATV, 20V, 100mA, 200mW, B=125..250, 7GHz	SOT-23	16ta	-	3a Nec
R25	2SC3838Q	Si-npn	HF, TV-Tun, 11V, 50mA, 200mW, 3.2GHz, B=120..270	SC-59	16ta	-	3a Wtr
R25	2SC4226-25	Si-npn	VHF/UHF, 20V, 100mA, 150mW, B=125..250, 4.5GHz	SOT-323	16ta	-	3a Nec
R25	CM7R250-25B-T	LVR-IC	LDO, 2.5V±2%, 150mA	SOT-23	16cg	VR1	3a Can
R25	NE85630-25	Si-npn	VHF/UHF, 20V, 100mA, 150mW, B=125..250, 4.5GHz	SOT-323	16ta	-	3a Cel
R25	NE85633-25	Si-npn	VHF/UHF, CATV, 20V, 100mA, 200mW, B=125..250, 7GHz	SOT-23	16ta	-	3a Cel
R25	NE85633-S	Si-npn	VHF/UHF, CATV, 20V, 100mA, 200mW, B=125..250, 7GHz	SOT-23	16ta	-	3a Cel
R25	XC61FN5212M	Vdet-IC	5.2V±2%, +Reset ODO, 200ms	SOT-23	16vdb	VD6	3d Tor
R25	XC61HN5212MR	Vdet-IC	5.2V±2%, -Reset ODO, 50..200ms	SOT-23	16vdc	VD6	3d Tor
R25B	ML62252M	LVR-IC	2.5V±2%, 250mA	SOT-23	16cg	VR1	3a Mic
R26	CM7R250-26B-T	LVR-IC	LDO, 2.6V±2%, 150mA	SOT-23	16cg	VR1	3a Can
R26	GS810CREUE	Vdet-IC	2.63V, +Reset PPO, 150ms	SOT-23	16vdc	VD7	3g Vs
R26	XC61FN5242M	Vdet-IC	5.2V±2%, +Reset ODO, 400ms	SOT-23	16vdb	VD6	3d Tor
R26	XC61HN5242MR	Vdet-IC	5.2V±2%, -Reset ODO, 80..400ms	SOT-23	16vdc	VD6	3d Tor
R26B	ML62262M	LVR-IC	2.6V±2%, 250mA	SOT-23	16cg	VR1	3a Mic
R27	CM7R250-27B-T	LVR-IC	LDO, 2.7V±2%, 150mA	SOT-23	16cg	VR1	3a Can
R27	GS810C27SEUE	Vdet-IC	2.7V, +Reset PPO, 150ms	SOT-23	16vdc	VD7	3g Vs
R27	XC61FN5252M	Vdet-IC	5.2V±2%, +Reset ODO, 50ms	SOT-23	16vdb	VD6	3d Tor
R27	XC61HN5252MR	Vdet-IC	5.2V±2%, -Reset ODO, 1..50ms	SOT-23	16vdc	VD6	3d Tor
R27B	ML62272M	LVR-IC	2.7V±2%, 250mA	SOT-23	16cg	VR1	3a Mic
R28	CM7R250-28B-T	LVR-IC	LDO, 2.8V±2%, 150mA	SOT-23	16cg	VR1	3a Can
R28B	ML62282M	LVR-IC	2.8V±2%, 250mA	SOT-23	16cg	VR1	3a Mic
R29	CM7R250-29B-T	LVR-IC	LDO, 2.9V±2%, 150mA	SOT-23	16cg	VR1	3a Can
R29	GS810CSEUE	Vdet-IC	2.93V, +Reset PPO, 150ms	SOT-23	16vdc	VD7	3g Vs
R29B	ML62292M	LVR-IC	2.9V±2%, 250mA	SOT-23	16cg	VR1	3a Mic
R2A	CM7R250-20A-T	LVR-IC	LDO, 2.05V±2%, 150mA	SOT-23	16cg	VR1	3a Can
R2A	LM4040AIM3X-2.5	Vref-IC	Precision, Shunt, 2.50V, 0.1%	SOT-23	16dk	RF1	3a Nsc
R2A	MMST3906	Si-pnp	GP, 40V, 200mA, 250mW, B=60..300, >250MHz	SC-59	16ta	-	3a Rhm
R2A	SST3906	Si-pnp	GP, 40V, 200mA, 330mW, B=100..300, >250MHz	SOT-23	16ta	-	3a Rhm
R2A	UMT3906	Si-pnp	Sw, AF, 60/40V, 100mA, 250mW, B=100..300, >250MHz	SOT-323	16ta	-	Rhm
R2B	CM7R250-21A-T	LVR-IC	LDO, 2.15V±2%, 150mA	SOT-23	16cg	VR1	3a Can
R2B	LM4040BIM3X-2.5	Vref-IC	Precision, Shunt, 2.50V, 0.2%	SOT-23	16dk	RF1	3a Nsc
R2B	MMST2907	Si-pnp	GP, 40V, 600mA, 330mW, B=100..300, >200MHz	SC-59	16ta	-	3a Rhm
R2B	SST2907	Si-pnp	GP, 40V, 600mA, 330mW, B=100..300, >200MHz	SOT-23	16ta	-	3a Rhm
R2C	CM7R250-22A-T	LVR-IC	LDO, 2.25V±2%, 150mA	SOT-23	16cg	VR1	3a Can
R2C	LM4040CIM3X-2.5	Vref-IC	Precision, Shunt, 2.50V, 0.5%	SOT-23	16dk	RF1	3a Nsc
R2C	MMSTA70	Si-pnp	GP, 40V, 100mA, 350mW, B=40..100, >125MHz	SC-59	16ta	-	3a Rhm
R2D	CM7R250-23A-T	LVR-IC	LDO, 2.35V±2%, 150mA	SOT-23	16cg	VR1	3a Can
R2D	LM4040DEM3-2.5	Vref-IC	Precision, Shunt, 2.50V, 1.0%	SOT-23	16dk	RF1	3a Nsc
R2D	LM4040DIM3X-2.5	Vref-IC	Precision, Shunt, 2.50V, 1%	SOT-23	16dk	RF1	3a Nsc
R2E	CM7R250-24A-T	LVR-IC	LDO, 2.45V±2%, 150mA	SOT-23	16cg	VR1	3a Can
R2E	LM4040EEM3-2.5	Vref-IC	Precision, Shunt, 2.50V	SOT-23	16dk	RF1	3a Nsc
R2E	LM4040EIM3-2.5	Vref-IC	Precision, Shunt, 2.50V, 2%	SOT-23	16dk	RF1	3a Nsc
R2E	LM4040EIM3X-2.5	Vref-IC	Precision, Shunt, 2.50V, 2%	SOT-23	16dk	RF1	3a Nsc
R2F	CM7R250-25A-T	LVR-IC	LDO, 2.55V±2%, 150mA	SOT-23	16cg	VR1	3a Can
R2F	MMST2907A	Si-pnp	GP, 60V, 600mA, 330mW, B=100..300, >200MHz	SC-59	16ta	-	3a Rhm
R2F	SST2907A	Si-pnp	GP, 60V, 600mA, 330mW, B=100..300, >200MHz	SOT-23	16ta	-	3a Rhm
R2F	UMT2907A	Si-pnp	GP, 60V, 600mA, 330mW, B=100..300, >200MHz	SOT-323	16ta	-	3a Rhm
R2G	CM7R250-26A-T	LVR-IC	LDO, 2.65V±2%, 150mA	SOT-23	16cg	VR1	3a Can



SMD code	Type	Function	Short description	Case	Pinout	Sch.	St.	Mnf.
R2G	MMSTA56	Si-pnp	AF-Drv, 80V, 500mA, 300mW, B>100, >50MHz	SC-59	16ta	-	3a	Rhm
R2G	SSTA56	Si-pnp	AF-Drv, 80V, 500mA, 300mW, B>100, >50MHz	SOT-23	16ta	-	3a	Rhm
R2H	CM7R250-27A-T	LVR-IC	LDO, 2.75V±2%, 150mA	SOT-23	16cg	VR1	3a	Can
R2H	SSTA55	Si-pnp	AF, 60V, 500mA, B>100, >50MHz	SOT-23	16ta	-	3a	Rhm
R2I	CM7R250-28A-T	LVR-IC	LDO, 2.85V±2%, 150mA	SOT-23	16cg	VR1	3a	Can
R2J	CM7R250-29A-T	LVR-IC	LDO, 2.95V±2%, 150mA	SOT-23	16cg	VR1	3a	Can
R2K	MMST8598	Si-pnp	AF, 60V, 200mA, B=100..300, >150MHz	SOT-23	16ta	-	3a	Rhm
R2p	BFR93A	Si-npn	UHF-A-Band, 15V, 30mA, 300mW, B=40, >5GHz	SOT-23	16ta	-	3a	Phi
R2P	MMST5086	Si-pnp	AF, 50V, 200mA, B=150..500, >40MHz	SOT-23	16ta	-	3a	Rhm
R2Q	MMST5087	Si-pnp	AF, 50V, 200mA, B=250..800, >40MHz	SOT-23	16ta	-	3a	Rhm
R2s	SST7157	Si-pnp	GP, 60V, 200mA	SOT-23	16ta	-	3a	Rhm
R2Q	BFR93W	Si-npn	UHF-A-Band, 15V, 30mA, 300mW, B>40, >5GHz	SOT-323	16ta	-	3a	Sie
R2T	MMST4403	Si-pnp	Sw, 40V, 600mA, 200mW, B=100..300, >200MHz	SC-59	16ta	-	3a	Rhm
R2T	SST4403	Si-pnp	Sw, 40V, 600mA, 200mW, B=100..300, >200MHz	SST3	16ta	-	3a	Rhm
R2T	UMT4403	Si-pnp	GP, 40V, 600mA, 225mW, B=30..100, 200MHz	SOT-323	16ta	-	3a	Rhm
R2U	MMSTA63	Si-pnp-Darl	GP, 30V, 500mA, 300mW, B>5000, >125MHz	SC-59	16ta	-	3a	Rhm
R2U	SSTA63	Si-pnp-Darl	GP, 30V, 500mA, 300mW, B>5000, >125MHz	SOT-23	16ta	-	3a	Rhm
R2V	MMSTA64	Si-pnp-Darl	GP, 30V, 500mA, 300mW, B>10000, >125MHz	SC-59	16ta	-	3a	Rhm
R2V	SSTA64	Si-pnp-Digi	GP, 30V, 500mA, 300mW, B>10000, >125MHz	SOT-23	16ta	-	3a	Rhm
R2X	MMST4401	Si-npn	Sw, 60V, 600mA, 200mW, B=100..300, >250MHz	SC-59	16ta	-	3a	Rhm
R2X	SST4401	Si-npn	Sw, 60V, 600mA, 200mW, B=100..300, >250MHz	SST3	16ta	-	3a	Rhm
R2X	UMT4401	Si-npn	Sw, 60V, 600mA, 200mW, B=100..300, >250MHz	SOT-323	16ta	-	3a	Rhm
R2Z	SST4400	Si-npn	AF, 60V, 600mA, B=50..150, >200MHz	SOT-23	16ta	-	3a	Rhm
R3	2SC2351-3	Si-npn	Fast-Sw, UHF, 20V, 70mA, 200mW, B=80..160, 4.5Hz	SOT-23	16ta	-	3a	Nec
R3	2SC2351-Q	Si-npn	Fast-Sw, UHF, 20V, 70mA, 200mW, B=100..200, 4.5Hz	SOT-23	16ta	-	3a	Nec
R3	2SC4225-3	Si-npn	VHF/UHF, 25V, 70mA, 160mW, B=100..200, 4GHz	SOT-323	16ta	-	3a	Nec
R3	2SK283-3	n-FET	AF-Amp, 80V, 50mA, 150mW, Idss=1.2..3mA, Up=0.75V	SOT-23	16ta	-	3a	San
R3	BZX84-C5V6T	Z-diode	5.6V±5%, 150mW	SOT-523	16dc	-	3a	Di
R3	CZRH3-55C5V6	Z-diode	5.6..6.0V, Zzt=40Ω, Izt=5mA, 150mW	SOT-523	18dc	-	3a	Cmc
R3	ELM7633LCB	Vdet-IC	3.3V±2%, -Reset PPO, 150ms	SOT-23	16vdc	VD7	3d	Elm
R3	ELM9733CBB	Vdet-IC	3.3V±2.5%, +Reset PPO	SOT-23	16vdc	VD7	3d	Elm
R3	NE02133-Q	Si-npn	Fast-Sw, UHF, 25V, 70mA, 200mW, B=80..160, 4.5Hz	SOT-23	16ta	-	3a	Cel
R3	NE02133-Q	Si-npn	Fast-Sw, UHF, 25V, 70mA, 200mW, B=100..200, 4.5Hz	SOT-23	16ta	-	3a	Cel
R3	R3130N29BA3	Vdet-IC	2.9V, -Reset PPO, 100ms	SOT-23	16vdc	VD7	3b	Ric
R3	SRC1203E	Si-npn-Digi	Sw, 50V, 100mA, 150mW, 200MHz, R1/R2=22/22k	SOT-523	16ta	-	3a	Auk
R3	SRC1203EF	Si-npn-Digi	Sw, 50V, 100mA, 150mW, 200MHz, R1/R2=22/22k	SOT-523F	18ta	-	3a	Auk
R3	SRC1203U	Si-npn-Digi	Sw, 50V, 100mA, 200mW, 200MHz, R1/R2=22/22k	SOT-323	16ta	-	3a	Auk
R3	SRC1203UF	Si-npn-Digi	Sw, 50V, 100mA, 200mW, 200MHz, R1/R2=22/22k	SOT-323F	18ta	-	3a	Auk
R3	TC54VN5302ECB	Vdet-IC	5.3V±2%, -Reset ODO	SOT-23	16vdb	VD6	3a	Tcs
R3	XC61CN5302M	Vdet-IC	5.3V±1%, +Reset ODO	SOT-23	16vdb	VD6	3d	Tor
R30	CM7R250-30B-T	LVR-IC	LDO, 3.0V±2%, 150mA	SOT-23	16cg	VR1	3a	Can
R30	GS810CTEUE	Vdet-IC	3.08V, +Reset PPO, 150ms	SOT-23	16vdc	VD7	3g	Vs
R30B	ML62302M	LVR-IC	3.0V±2%, 250mA	SOT-23	16cg	VR1	3a	Mic
R31	CM7R250-31B-T	LVR-IC	LDO, 3.1V±2%, 150mA	SOT-23	16cg	VR1	3a	Can
R31A	REF3112A	Vref-IC	Prec. LDO, Series, 1.25V, 0.2%, <15ppm/°C	SOT-23	16vj	VR1	3a	Bb
R31B	ML62312M	LVR-IC	3.1V±2%, 250mA	SOT-23	16cg	VR1	3a	Mic
R31B	REF3120A	Vref-IC	Prec. LDO, Series, 2.048V, 0.2%, <15ppm/°C	SOT-23	16vj	VR1	3a	Bb
R31C	REF3125A	Vref-IC	Prec. LDO, Series, 2.5V, 0.2%, <15ppm/°C	SOT-23	16vj	VR1	3a	Bb
R31D	REF3140A	Vref-IC	Prec. LDO, Series, 4.096V, 0.2%, <15ppm/°C	SOT-23	16vj	VR1	3a	Bb
R31E	REF3130A	Vref-IC	Prec. LDO, Series, 3V, 0.2%, <15ppm/°C	SOT-23	16vj	VR1	3a	Bb
R31F	REF3133A	Vref-IC	Prec. LDO, Series, 3.3V, 0.2%, <15ppm/°C	SOT-23	16vj	VR1	3a	Bb
R32	2SC3583-P	Si-npn	VHF/UHF, LN, 20V, 65mA, 200mW, B=40..80, 9GHz	SOT-23	16ta	-	3a	Nec
R32	2SC4227-32	Si-npn	VHF/UHF, 20V, 65mA, 150mW, B=30..60, 7GHz	SOT-323	16ta	-	3a	Nec
R32	CM7R250-32B-T	LVR-IC	LDO, 3.2V±2%, 150mA	SOT-23	16cg	VR1	3a	Can
R32	NE68130-32	Si-npn	VHF/UHF, 20V, 65mA, 150mW, B=30..60, 7GHz	SOT-323	16ta	-	3a	Cel
R32	NE68133-P	Si-npn	VHF/UHF, LN, 20V, 65mA, 200mW, B=40..80, 9GHz	SOT-23	16ta	-	3a	Cel
R32B	ML62322M	LVR-IC	3.2V±2%, 250mA	SOT-23	16cg	VR1	3a	Mic
R33	2SC3583-33	Si-npn	VHF/UHF, LN, 20V, 35mA, 200mW, B=50..100, 9GHz	SOT-23	16ta	-	3a	Nec
R33	2SC3583-Q	Si-npn	VHF/UHF, LN, 20V, 35mA, 200mW, B=50..100, 9GHz	SOT-23	16ta	-	3a	Nec
R33	2SC4227-33	Si-npn	VHF/UHF, 20V, 65mA, 150mW, B=40..80, 7GHz,	SOT-323	16ta	-	3a	Nec
R33	CM7R250-33B-T	LVR-IC	LDO, 3.3V±2%, 150mA	SOT-23	16cg	VR1	3a	Can
R33	NE68130-33	Si-npn	VHF/UHF, 20V, 65mA, 150mW, B=40..80, 7GHz,	SOT-323	16ta	-	3a	Cel
R33	NE68133-33	Si-npn	VHF/UHF, LN, 20V, 35mA, 200mW, B=50..100, 9GHz	SOT-23	16ta	-	3a	Cel
R33	NE68133-Q	Si-npn	VHF/UHF, LN, 20V, 35mA, 200mW, B=50..100, 9GHz	SOT-23	16ta	-	3a	Cel
R33	XE61CN5345MR	Vdet-IC	5.3V±2%, -Reset ODO	SOT-23	16vdb	VD6	3h	Tor
R33B	ML62332M	LVR-IC	3.3V±2%, 250mA	SOT-23	16cg	VR1	3a	Mic
R34	2SC3583-34	Si-npn	VHF/UHF, LN, 20V, 35mA, 200mW, B=80..160, 9GHz	SOT-23	16ta	-	3a	Nec
R34	2SC3583-R	Si-npn	VHF/UHF, LN, 20V, 35mA, 200mW, B=80..160, 9GHz	SOT-23	16ta	-	3a	Nec
R34	2SC4227-34	Si-npn	VHF/UHF, 20V, 65mA, 150mW, B=70..140, 7GHz,	SOT-323	16ta	-	3a	Nec
R34	CM7R250-34B-T	LVR-IC	LDO, 3.4V±2%, 150mA	SOT-23	16cg	VR1	3a	Can



SMD code	Type	Function	Short description	Case	Pinout	Sch.	St.	Mnf.
R34	NE68130-34	Si-npn	VHF/UHF, 20V, 65mA, 150mW, B=70..140, 7GHz,	SOT-323	16ta	-	3a	Cel
R34	NE68133-34	Si-npn	VHF/UHF, LN, 20V, 35mA, 200mW, B=80..160, 9GHz	SOT-23	16ta	-	3a	Cel
R34	NE68133-R	Si-npn	VHF/UHF, LN, 20V, 35mA, 200mW, B=80..160, 9GHz	SOT-23	16ta	-	3a	Cel
R34B	ML62342M	LVR-IC	3.4V±2%, 250mA	SOT-23	16cg	VR1	3a	Mic
R35	2SC3583-35	Si-npn	VHF/UHF, LN, 20V, 35mA, 200mW, B=125..250, 9GHz	SOT-23	16ta	-	3a	Nec
R35	2SC3583-S	Si-npn	VHF/UHF, LN, 20V, 35mA, 200mW, B=125..250, 9GHz	SOT-23	16ta	-	3a	Nec
R35	2SC4227-35	Si-npn	VHF/UHF, 20V, 65mA, 150mW, B=125..250, 7GHz,	SOT-323	16ta	-	3a	Nec
R35	CM7R250-35B-T	LVR-IC	LDO, 3.5V±2%, 150mA	SOT-23	16cg	VR1	3a	Can
R35	NE68130-35	Si-npn	VHF/UHF, 20V, 65mA, 150mW, B=125..250, 7GHz,	SOT-323	16ta	-	3a	Cel
R35	NE68133-35	Si-npn	VHF/UHF, LN, 20V, 35mA, 200mW, B=125..250, 9GHz	SOT-23	16ta	-	3a	Cel
R35	NE68133-S	Si-npn	VHF/UHF, LN, 20V, 35mA, 200mW, B=125..250, 9GHz	SOT-23	16ta	-	3a	Cel
R35	XC61FN5312M	Vdet-IC	5.3V±2%, +Reset ODO, 200ms	SOT-23	16vdb	VD6	3d	Tor
R35	XC61HN5312MR	Vdet-IC	5.3V±2%, -Reset ODO, 50..200ms	SOT-23	16vdc	VD6	3d	Tor
R35B	ML62352M	LVR-IC	3.5V±2%, 250mA	SOT-23	16cg	VR1	3a	Mic
R36	CM7R250-36B-T	LVR-IC	LDO, 3.6V±2%, 150mA	SOT-23	16cg	VR1	3a	Can
R36	XC61FN5342M	Vdet-IC	5.3V±2%, +Reset ODO, 400ms	SOT-23	16vdb	VD6	3d	Tor
R36	XC61HN5342MR	Vdet-IC	5.3V±2%, -Reset ODO, 80..400ms	SOT-23	16vdc	VD6	3d	Tor
R36B	ML62362M	LVR-IC	3.6V±2%, 250mA	SOT-23	16cg	VR1	3a	Mic
R37	CM7R250-37B-T	LVR-IC	LDO, 3.7V±2%, 150mAV	SOT-23	16cg	VR1	3a	Can
R37	XC61FN5352M	Vdet-IC	5.3V±2%, +Reset ODO, 50ms	SOT-23	16vdb	VD6	3d	Tor
R37	XC61HN5352MR	Vdet-IC	5.3V±2%, -Reset ODO, 1..50ms	SOT-23	16vdc	VD6	3d	Tor
R37B	ML62372M	LVR-IC	3.7V±2%, 250mA	SOT-23	16cg	VR1	3a	Mic
R38	CM7R250-38B-T	LVR-IC	LDO, 3.8V±2%, 150mA	SOT-23	16cg	VR1	3a	Can
R38B	ML62382M	LVR-IC	3.8V±2%, 250mA	SOT-23	16cg	VR1	3a	Mic
R39	CM7R250-39B-T	LVR-IC	LDO, 3.9V±2%, 150mA	SOT-23	16cg	VR1	3a	Can
R39	SST1139	Si-npn	VHF/UHF, 30V, 30mA, >850MHz	SOT-23	16ta	-	3a	Rhm
R39B	ML62392M	LVR-IC	3.9V±2%, 250mA	SOT-23	16cg	VR1	3a	Mic
R3A	CM7R250-30A-T	LVR-IC	LDO, 3.05V±2%, 150mA	SOT-23	16cg	VR1	3a	Can
R3B	CM7R250-31A-T	LVR-IC	LDO, 3.15V±2%, 150mA	SOT-23	16cg	VR1	3a	Can
R3B	SST8245	Si-npn	VHF/UHF, 30V, 50mA, >600MHz	SOT-23	16ta	-	3a	Rhm
R3C	CM7R250-32A-T	LVR-IC	LDO, 3.25V±2%, 150mA	SOT-23	16cg	VR1	3a	Can
R3D	CM7R250-33A-T	LVR-IC	LDO, 3.35V±2%, 150mA	SOT-23	16cg	VR1	3a	Can
R3E	CM7R250-34A-T	LVR-IC	LDO, 3.45V±2%, 150mA	SOT-23	16cg	VR1	3a	Can
R3F	CM7R250-35A-T	LVR-IC	LDO, 3.55V±2%, 150mA	SOT-23	16cg	VR1	3a	Can
R3G	CM7R250-36A-T	LVR-IC	LDO, 3.65V±2%, 150mA	SOT-23	16cg	VR1	3a	Can
R3H	CM7R250-37A-T	LVR-IC	LDO, 3.75V±2%, 150mA	SOT-23	16cg	VR1	3a	Can
R3I	CM7R250-38A-T	LVR-IC	LDO, 3.85V±2%, 150mA	SOT-23	16cg	VR1	3a	Can
R3J	CM7R250-39A-T	LVR-IC	LDO, 3.95V±2%, 150mA	SOT-23	16cg	VR1	3a	Can
R4	2SK283-4	n-FET	AF-Amp, 80V, 50mA, 150mW, Idss=2.5..6mA, Up=0.75V	SOT-23	16fa	-	3a	San
R4	BFR93R	Si-npn	UHF-A-Band, 15V, 30mA, 300mW, B>40, >5GHz	SOT-23	16ta	-	3a	Mot
R4	BZX84-C6V2T	Z-diode	6.2V±5%, 150mW	SOT-523	16dc	-	3a	Di
R4	CZRH3-55C6V2	Z-diode	6.2..6.60V, Zzt=10Ω, Izt=5mA, 150mW	SOT-523	18dc	-	3a	Omc
R4	ELM7634LCB	Vdet-IC	3.4V±2%, -Reset PPO, 150ms	SOT-23	16vdc	VD7	3d	Elm
R4	ELM9734CBB	Vdet-IC	3.4V±2.5%, +Reset PPO	SOT-23	16vdb	VD7	3d	Elm
R4	KA4F3R	Si-npn-Digi	Sw, 60V, 100mA, 200mW, R1/R2=2k2/47k	SOT-416	16ta	-	3a	Nec
R4	R3130N30BA8	Vdet-IC	3V, -Reset PPO, 100ms	SOT-23	16vdc	VD7	3b	Ric
R4	SP809EK-3-1	Vdet-IC	3.1V±1.5%, -Reset PPO	SOT-23	16vdc	VD7	3b	Sip
R4	SRC1204E	Si-npn-Digi	Sw, 50V, 100mA, 150mW, 200MHz, R1/R2=47/47k	SOT-523	16ta	-	3a	Auk
R4	SRC1204EF	Si-npn-Digi	Sw, 50V, 100mA, 150mW, 200MHz, R1/R2=47/47k	SOT-523F	18ta	-	3a	Auk
R4	SRC1204U	Si-npn-Digi	Sw, 50V, 100mA, 200mW, 200MHz, R1/R2=47/47k	SOT-323	16ta	-	3a	Auk
R4	SRC1204UF	Si-npn-Digi	Sw, 50V, 100mA, 200mW, 200MHz, R1/R2=47/47k	SOT-323F	18ta	-	3a	Auk
R4	TC54VN5402ECB	Vdet-IC	5.4V±2%, -Reset ODO	SOT-23	16vdb	VD6	3a	Tcs
R4	XC61CN5402M	Vdet-IC	5.4V±1%, +Reset ODO	SOT-23	16vdb	VD6	3d	Tor
R40	CM7R250-40B-T	LVR-IC	LDO, 4.0V±2%, 150mA	SOT-23	16cg	VR1	3a	Can
R40	GS810CJEUE	Vdet-IC	4V, +Reset PPO, 150ms	SOT-23	16vdc	VD7	3g	Vs
R40B	ML62402M	LVR-IC	4.0V±2%, 250mA	SOT-23	16cg	VR1	3a	Mic
R41	CM7R250-41B-T	LVR-IC	LDO, 4.1V±2%, 150mA	SOT-23	16cg	VR1	3a	Can
R41B	ML62412M	LVR-IC	4.1V±2%, 250mA	SOT-23	16cg	VR1	3a	Mic
R42	2SC4228-42	Si-npn	VHF/UHF, 20V, 35mA, 150mW, B=30..80, 8.5GHz,	SOT-323	16ta	-	3a	Nec
R42	CM7R250-42B-T	LVR-IC	LDO, 4.2V±2%, 150mA	SOT-23	16cg	VR1	3a	Can
R42B	ML62422M	LVR-IC	4.2V±2%, 250mA	SOT-23	16cg	VR1	3a	Mic
R43	2SC3585-43	Si-npn	VHF/UHF, 20V, 35mA, 200mW, 10GHz, B=50..100	SOT-23	16ta	-	3a	Nec
R43	2SC3585-Q	Si-npn	VHF/UHF, 20V, 35mA, 200mW, 10GHz, B=50..100	SOT-23	16ta	-	3a	Nec
R43	2SC4228-43	Si-npn	VHF/UHF, 20V, 35mA, 150mW, B=50..100, 8.5GHz,	SOT-323	16ta	-	3a	Nec
R43	CM7R250-43B-T	LVR-IC	LDO, 4.3V±2%, 150mA	SOT-23	16cg	VR1	3a	Can
R43	GS810CMEUE	Vdet-IC	4.38V, +Reset PPO, 150ms	SOT-23	16vdc	VD7	3g	Vs
R43	XE61CN5445MR	Vdet-IC	5.4V±2%, -Reset ODO	SOT-23	16vdb	VD6	3h	Tor
R43B	ML62432M	LVR-IC	4.3V±2%, 250mA	SOT-23	16cg	VR1	3a	Mic
R44	2SC3585-44	Si-npn	VHF/UHF, 20V, 35mA, 200mW, 10GHz, B=80..160	SOT-23	16ta	-	3a	Nec
R44	2SC3585-R	Si-npn	VHF/UHF, 20V, 35mA, 200mW, 10GHz, B=80..160	SOT-23	16ta	-	3a	Nec



SMD code	Type	Function	Short description	Case	Pinout	Sch. St.	Mnf.
R44	2SC4228-44	Si-npn	VHF/UHF, 20V, 35mA, 150mW, B=80..160, 8.5GHz,	SOT-323	16ta	-	3a Nec
R44	CM7R250-44B-T	LVR-IC	LDO, 4.4V±2%, 150mA	SOT-23	16cg	VR1	3a Can
R44B	ML62442M	LVR-IC	4.4V±2%, 250mA	SOT-23	16cg	VR1	3a Mic
R45	2SC3585-45	Si-npn	VHF/UHF, 20V, 35mA, 200mW, 10GHz, B=125..250	SOT-23	16ta	-	3a Nec
R45	2SC3585-S	Si-npn	VHF/UHF, 20V, 35mA, 200mW, 10GHz, B=125..250	SOT-23	16ta	-	3a Nec
R45	2SC4228-45	Si-npn	VHF/UHF, 20V, 35mA, 150mW, B=125..250, 8.5GHz,	SOT-323	16ta	-	3a Nec
R45	CM7R250-45B-T	LVR-IC	LDO, 4.5V±2%, 150mA	SOT-23	16cg	VR1	3a Can
R45	XC61FN5412M	Vdet-IC	5.4V±2%, +Reset ODO, 200ms	SOT-23	16vdb	VD6	3d Tor
R45	XC61HN5412MR	Vdet-IC	5.4V±2%, -Reset ODO, 50..200ms	SOT-23	16vdc	VD6	3d Tor
R45B	ML62452M	LVR-IC	4.5V±2%, 250mA	SOT-23	16cg	VR1	3a Mic
R46	CM7R250-46B-T	LVR-IC	LDO, 4.6V±2%, 150mA	SOT-23	16cg	VR1	3a Can
R46	GS810CLEUE	Vdet-IC	4.63V, +Reset PPO, 150ms	SOT-23	16vdc	VD7	3g Vs
R46	XC61FN5442M	Vdet-IC	5.4V±2%, +Reset ODO, 400ms	SOT-23	16vdb	VD6	3d Tor
R46	XC61HN5442MR	Vdet-IC	5.4V±2%, -Reset ODO, 80..400ms	SOT-23	16vdc	VD6	3d Tor
R46B	ML62462M	LVR-IC	4.6V±2%, 250mA	SOT-23	16cg	VR1	3a Mic
R47	CM7R250-47B-T	LVR-IC	LDO, 4.7V±2%, 150mA	SOT-23	16cg	VR1	3a Can
R47	XC61FN5452M	Vdet-IC	5.4V±2%, +Reset ODO, 50ms	SOT-23	16vdb	VD6	3d Tor
R47	XC61HN5452MR	Vdet-IC	5.4V±2%, -Reset ODO, 1..50ms	SOT-23	16vdc	VD6	3d Tor
R47B	ML62472M	LVR-IC	4.7V±2%, 250mA	SOT-23	16cg	VR1	3a Mic
R48	CM7R250-48B-T	LVR-IC	LDO, 4.8V±2%, 150mA	SOT-23	16cg	VR1	3a Can
R48B	ML62482M	LVR-IC	4.8V±2%, 250mA	SOT-23	16cg	VR1	3a Mic
R49	CM7R250-49B-T	LVR-IC	LDO, 4.9V±2%, 150mA	SOT-23	16cg	VR1	3a Can
R49B	ML62492M	LVR-IC	4.9V±2%, 250mA	SOT-23	16cg	VR1	3a Mic
R4A	CM7R250-40A-T	LVR-IC	LDO, 4.05V±2%, 150mA	SOT-23	16cg	VR1	3a Can
R4A	LM4040AIM3X-4.1	Vref-IC	Precision, Shunt, 4.10V, 0.1%	SOT-23	16dk	RF1	3a Nsc
R4B	CM7R250-41A-T	LVR-IC	LDO, 4.15V±2%, 150mA	SOT-23	16cg	VR1	3a Can
R4B	LM4040BIM3X-4.1	Vref-IC	Precision, Shunt, 4.10V, 0.2%	SOT-23	16dk	RF1	3a Nsc
R4C	CM7R250-42A-T	LVR-IC	LDO, 4.25V±2%, 150mA	SOT-23	16cg	VR1	3a Can
R4C	LM4040CIM3X-4.1	Vref-IC	Precision, Shunt, 4.10V, 0.5%	SOT-23	16dk	RF1	3a Nsc
R4D	CM7R250-43A-T	LVR-IC	LDO, 4.35V±2%, 150mA	SOT-23	16cg	VR1	3a Can
R4D	LM4040DIM3X-4.1	Vref-IC	Precision, Shunt, 4.10V, 1%	SOT-23	16dk	RF1	3a Nsc
R4E	CM7R250-44A-T	LVR-IC	LDO, 4.45V±2%, 150mA	SOT-23	16cg	VR1	3a Can
R4F	CM7R250-45A-T	LVR-IC	LDO, 4.55V±2%, 150mA	SOT-23	16cg	VR1	3a Can
R4G	CM7R250-46A-T	LVR-IC	LDO, 4.65V±2%, 150mA	SOT-23	16cg	VR1	3a Can
R4H	CM7R250-47A-T	LVR-IC	LDO, 4.75V±2%, 150mA	SOT-23	16cg	VR1	3a Can
R4I	CM7R250-48A-T	LVR-IC	LDO, 4.85V±2%, 150mA	SOT-23	16cg	VR1	3a Can
R4J	CM7R250-49A-T	LVR-IC	LDO, 4.95V±2%, 150mA	SOT-23	16cg	VR1	3a Can
R5	2SK283-5	n-FET	AF-Amp, 80V, 50mA, 150mW, Idss=5..12mA, Up=0.75V	SOT-23	16fa	-	3a San
R5	BFR93AR	Si-npn	UHF-A-Band, 15V, 30mA, 300mW, B>40, >5GHz	SOT-23	16te	-	3a Ste
R5	BZX84-C6V8T	Z-diode	6.8V±5%, 150mW	SOT-523	18dc	-	3a Di
R5	CZRH3-55C6V8	Z-diode	6.8..7.20V, Zzt=15Ω, Izt=5mA, 150mW	SOT-523	18dc	-	3a Cmc
R5	ELM7635LCB	Vdet-IC	3.5V±2%, -Reset PPO, 150ms	SOT-23	16vdc	VD7	3d Elm
R5	ELM9735CBB	Vdet-IC	3.5V±2.5%, +Reset PPO	SOT-23	16vdb	VD7	3d Elm
R5	R3130N46BA5	Vdet-IC	4.6V, -Reset PPO, 100ms	SOT-23	16vdc	VD7	3b Ric
R5	SRC1205E	Si-npn-Digi	Sw, 50V, 100mA, 150mW, 200MHz, R1/R2=22/47k	SOT-523	16ta	-	3a Auk
R5	SRC1205EF	Si-npn-Digi	Sw, 50V, 100mA, 150mW, 200MHz, R1/R2=22/47k	SOT-523F	18ta	-	3a Auk
R5	SRC1205U	Si-npn-Digi	Sw, 50V, 100mA, 200mW, 200MHz, R1/R2=22/47k	SOT-323	16ta	-	3a Auk
R5	SRC1205UF	Si-npn-Digi	Sw, 50V, 100mA, 200mW, 200MHz, R1/R2=22/47k	SOT-323F	18ta	-	3a Auk
R5	TC54VN5502ECB	Vdet-IC	5.5V±2%, -Reset ODO	SOT-23	16vdb	VD6	3a Tcs
R5	XC61CN5502M	Vdet-IC	5.5V±1%, +Reset ODO	SOT-23	16vdb	VD6	3d Tor
R50	CM7R250-50B-T	LVR-IC	LDO, 5.0V±2%, 150mA	SOT-23	16cg	VR1	3a Can
R50B	ML62502M	LVR-IC	5.0V±2%, 250mA	SOT-23	16cg	VR1	3a Mic
R51	CM7R250-51B-T	LVR-IC	LDO, 5.1V±2%, 150mA	SOT-23	16cg	VR1	3a Can
R51	KSR2101	Si-pnp-Digi	Sw, 50V, 100mA, 20mW, 250MHz, R1/R2=4k7/4k7	SOT-23	16ta	-	3a Sam
R51B	ML62512M	LVR-IC	5.1V±2%, 250mA	SOT-23	16cg	VR1	3a Mic
R52	CM7R250-52B-T	LVR-IC	LDO, 5.2V±2%, 150mA	SOT-23	16cg	VR1	3a Can
R52	KSR2102	Si-pnp-Digi	Sw, 50V, 100mA, 20mW, 250MHz, R1/R2=10k/10k	SOT-23	16ta	-	3a Sam
R52B	ML62522M	LVR-IC	5.2V±2%, 250mA	SOT-23	16cg	VR1	3a Mic
R53	CM7R250-53B-T	LVR-IC	LDO, 5.3V±2%, 150mA	SOT-23	16cg	VR1	3a Can
R53	KSR2103	Si-pnp-Digi	Sw, 50V, 100mA, 20mW, 250MHz, R1/R2=22k/22k	SOT-23	16ta	-	3a Sam
R53	XE61CN5545MR	Vdet-IC	5.5V±2%, -Reset ODO	SOT-23	16vdb	VD6	3h Tor
R53B	ML62532M	LVR-IC	5.3V±2%, 250mA	SOT-23	16cg	VR1	3a Mic
R54	CM7R250-54B-T	LVR-IC	LDO, 5.4V±2%, 150mA	SOT-23	16cg	VR1	3a Can
R54	KSR2104	Si-pnp-Digi	Sw, 50V, 100mA, 20mW, 250MHz, R1/R2=47k/47k	SOT-23	16ta	-	3a Sam
R54B	ML62542M	LVR-IC	5.4V±2%, 250mA	SOT-23	16cg	VR1	3a Mic
R55	CM7R250-55B-T	LVR-IC	LDO, 5.5V±2%, 150mA	SOT-23	16cg	VR1	3a Can
R55	KSR2105	Si-pnp-Digi	Sw, 50V, 100mA, 20mW, 250MHz, R1/R2=10k/47k	SOT-23	16ta	-	3a Sam
R55	XC61FN5512M	Vdet-IC	5.5V±2%, +Reset ODO, 200ms	SOT-23	16vdb	VD6	3d Tor
R55	XC61HN5512MR	Vdet-IC	5.5V±2%, -Reset ODO, 50..200ms	SOT-23	16vdc	VD6	3d Tor
R55B	ML62552M	LVR-IC	5.5V±2%, 250mA	SOT-23	16cg	VR1	3a Mic



SMD code	Type	Function	Short description	Case	Pinout	Sch.	St.	Mnf.
R56	CM7R250-56B-T	LVR-IC	LDO, 5.6V±2%, 150mA	SOT-23	16cg	VR1	3a	Can
R56	KSR2106	Si-pnp-Digi	Sw, 50V, 100mA, 20mW, 250MHz, R1/R2=22k/47k	SOT-23	16ta	-	3a	Sam
R56	XC61FN5542M	Vdet-IC	5.5V±2%, +Reset ODO, 400ms	SOT-23	16vdb	VD6	3d	Tor
R56	XC61HN5542MR	Vdet-IC	5.5V±2%, -Reset ODO, 80..400ms	SOT-23	16vdc	VD6	3d	Tor
R56B	ML62562M	LVR-IC	5.6V±2%, 250mA	SOT-23	16cg	VR1	3a	Mlc
R57	CM7R250-57B-T	LVR-IC	LDO, 5.7V±2%, 150mA	SOT-23	16cg	VR1	3a	Can
R57	KSR2107	Si-pnp-Digi	Sw, 50V, 100mA, 20mW, 250MHz, R1/R2=22k/47k	SOT-23	16ta	-	3a	Sam
R57	XC61FN5552M	Vdet-IC	5.5V±2%, +Reset ODO, 50ms	SOT-23	16vdb	VD6	3d	Tor
R57	XC61HN5552MR	Vdet-IC	5.5V±2%, -Reset ODO, 1..150ms	SOT-23	16vdc	VD6	3d	Tor
R57B	ML62572M	LVR-IC	5.7V±2%, 250mA	SOT-23	16cg	VR1	3a	Mlc
R58	CM7R250-58B-T	LVR-IC	LDO, 5.8V±2%, 150mA	SOT-23	16cg	VR1	3a	Can
R58	KSR2108	Si-pnp-Digi	Sw, 50V, 100mA, 20mW, 250MHz, R1/R2=47k/22k	SOT-23	16ta	-	3a	Sam
R58B	ML62582M	LVR-IC	5.8V±2%, 250mA	SOT-23	16cg	VR1	3a	Mlc
R59	CM7R250-59B-T	LVR-IC	LDO, 5.9V±2%, 150mA	SOT-23	16cg	VR1	3a	Can
R59	KSR2109	Si-pnp-Digi	Sw, 50V, 100mA, 20mW, 250MHz, R1=4k7	SOT-23	16ta	-	3a	Sam
R59B	ML62592M	LVR-IC	5.9V±2%, 250mA	SOT-23	16cg	VR1	3a	Mlc
R5A	CM7R250-50A-T	LVR-IC	LDO, 5.05V±2%, 150mA	SOT-23	16cg	VR1	3a	Can
R5A	LM4040AIM3X-5.0	Vref-IC	Precision, Shunt, 5.0V, 0.1%	SOT-23	16dk	RF1	3a	Nsc
R5B	CM7R250-51A-T	LVR-IC	LDO, 5.15V±2%, 150mA	SOT-23	16cg	VR1	3a	Can
R5B	LM4040BIM3X-5.0	Vref-IC	Precision, Shunt, 5.0V, 0.2%	SOT-23	16dk	RF1	3a	Nsc
R5C	CM7R250-52A-T	LVR-IC	LDO, 5.25V±2%, 150mA	SOT-23	16cg	VR1	3a	Can
R5C	LM4040CIM3X-5.0	Vref-IC	Precision, Shunt, 5.0V, 0.5%	SOT-23	16dk	RF1	3a	Nsc
R5D	CM7R250-53A-T	LVR-IC	LDO, 5.35V±2%, 150mA	SOT-23	16cg	VR1	3a	Can
R5D	LM4040DEM3-5.0	Vref-IC	Precision, Shunt, 5.0V, 1.0%	SOT-23	16dk	RF1	3a	Nsc
R5D	LM4040DIM3X-5.0	Vref-IC	Precision, Shunt, 5.0V, 1%	SOT-23	16dk	RF1	3a	Nsc
R5E	CM7R250-54A-T	LVR-IC	LDO, 5.45V±2%, 150mA	SOT-23	16cg	VR1	3a	Can
R5F	CM7R250-55A-T	LVR-IC	LDO, 5.55V±2%, 150mA	SOT-23	16cg	VR1	3a	Can
R5G	CM7R250-56A-T	LVR-IC	LDO, 5.65V±2%, 150mA	SOT-23	16cg	VR1	3a	Can
R5H	CM7R250-57A-T	LVR-IC	LDO, 5.75V±2%, 150mA	SOT-23	16cg	VR1	3a	Can
R5I	CM7R250-58A-T	LVR-IC	LDO, 5.85V±2%, 150mA	SOT-23	16cg	VR1	3a	Can
R5J	CM7R250-59A-T	LVR-IC	LDO, 5.95V±2%, 150mA	SOT-23	16cg	VR1	3a	Can
R6	2SK283-6	n-FET	AF-Amp, 80V, 50mA, 150mW, Idss=10..17mA, Up=0.75V	SOT-23	16fa	-	3a	San
R6	BZX84-C7V5T	Z-diode	7.5V±5%, 150mW	SOT-523	16dc	-	3a	Di
R6	CZRH3-55C7V5	Z-diode	7.5..7.90V, Zzt=15Ω, Izt=5mA, 150mW	SOT-523	18dc	-	3a	Cmc
R6	ELM763LCB	Vdet-IC	3.6V±2%, -Reset PPO, 150ms	SOT-23	16vdc	VD7	3d	Elm
R6	ELM9736CBB	Vdet-IC	3.6V±2.5%, +Reset PPO	SOT-23	16vdb	VD7	3d	Elm
R6	SRC1206E	Si-npn-Digi	Sw, 50V, 100mA, 150mW, 200MHz, R1/R2=4.7/47k	SOT-523	16ta	-	3a	Auk
R6	SRC1206EF	Si-npn-Digi	Sw, 50V, 100mA, 150mW, 200MHz, R1/R2=4.7/47k	SOT-523F	18ta	-	3a	Auk
R6	SRC1206U	Si-npn-Digi	Sw, 50V, 100mA, 200mW, 200MHz, R1/R2=4.7/47k	SOT-323	16ta	-	3a	Auk
R6	SRC1206UF	Si-npn-Digi	Sw, 50V, 100mA, 200mW, 200MHz, R1/R2=4.7/47k	SOT-323F	18ta	-	3a	Auk
R6	TC54VN5602ECB	Vdet-IC	5.6V±2%, -Reset ODO	SOT-23	16vdb	VD6	3a	Tcs
R6	XC61CN5602M	Vdet-IC	5.6V±1%, +Reset ODO	SOT-23	16vdb	VD6	3d	Tor
R60	CM7R250-60B-T	LVR-IC	LDO, 6.0V±2%, 150mA	SOT-23	16cg	VR1	3a	Can
R60	KSR2110	Si-pnp-Digi	Sw, 50V, 100mA, 20mW, 250MHz, R1=10k	SOT-23	16ta	-	3a	Sam
R60B	ML62602M	LVR-IC	6.0V±2%, 250mA	SOT-23	16cg	VR1	3a	Mlc
R61	KSR2111	Si-pnp-Digi	Sw, 50V, 100mA, 20mW, 250MHz, R1=22k	SOT-23	16ta	-	3a	Sam
R62	2SC3663	Si-npn	UHF, LN, 15V, 5mA, 50mW, B=50..250, 4GHz	SOT-23	16ta	-	3a	Nec
R62	KSR2112	Si-pnp-Digi	Sw, 50V, 100mA, 20mW, 250MHz, R1=47k	SOT-23	16ta	-	3a	Sam
R63	KSR2113	Si-pnp-Digi	Sw, 50V, 100mA, 20mW, 250MHz, R1/R2=2k2/47k	SOT-23	16ta	-	3a	Sam
R63	XE61CN5645MR	Vdet-IC	5.6V±2%, -Reset ODO	SOT-23	16vdb	VD6	3h	Tor
R64	KSR2114	Si-pnp-Digi	Sw, 50V, 100mA, 20mW, 250MHz, R1/R2=4k7/47k	SOT-23	16ta	-	3a	Sam
R65	SSTA65	Si-npn-Darl	AF, 30V, 300mA, B>50000, >100MHz	SOT-23	16ta	-	3a	Rhm
R65	XC61FN5612M	Vdet-IC	5.6V±2%, +Reset ODO, 200ms	SOT-23	16vdb	VD6	3d	Tor
R65	XC61HN5612MR	Vdet-IC	5.6V±2%, -Reset ODO, 50..200ms	SOT-23	16vdc	VD6	3d	Tor
R66	XC61FN5642M	Vdet-IC	5.6V±2%, +Reset ODO, 400ms	SOT-23	16vdb	VD6	3d	Tor
R66	XC61HN5642MR	Vdet-IC	5.6V±2%, -Reset ODO, 80..400ms	SOT-23	16vdc	VD6	3d	Tor
R67	XC61FN5652M	Vdet-IC	5.6V±2%, +Reset ODO, 50ms	SOT-23	16vdb	VD6	3d	Tor
R67	XC61HN5652MR	Vdet-IC	5.6V±2%, -Reset ODO, 1..150ms	SOT-23	16vdc	VD6	3d	Tor
R6A	2SC4187-A	Si-npn	UHF, 15V, 5mA, 150mW, B=50..100, 4GHz	SOT-323	16ta	-	3a	Nec
R6B	2SC4187-B	Si-npn	UHF, 15V, 5mA, 150mW, B=80..160, 4GHz	SOT-323	16ta	-	3a	Nec
R6C	2SC4187-C	Si-npn	UHF, 15V, 5mA, 150mW, B=125..250, 4GHz	SOT-323	16ta	-	3a	Nec
R6D	LM4040DIM3-6.0	Vref-IC	Precision, Shunt, 6.0V, 1%	SOT-23	16dk	RF1	3a	Nsc
R7	BZX84-C8V2T	Z-diode	8.2V±5%, 150mW	SOT-523	16dc	-	3a	Di
R7	CZRH3-55C8V2	Z-diode	8.2..8.70V, Zzt=15Ω, Izt=5mA, 150mW	SOT-523	18dc	-	3a	Cmc
R7	ELM763LCB	Vdet-IC	3.7V±2%, -Reset PPO, 150ms	SOT-23	16vdc	VD7	3d	Elm
R7	ELM9737CBB	Vdet-IC	3.7V±2.5%, +Reset PPO	SOT-23	16vdb	VD7	3d	Elm
R7	KN4F3R	Si-pnp-Digi	Sw, 60V, 100mA, 150mW, R1/R2=2k2/47k	SOT-416	16ta	-	3a	Nec
R7	SRC1207E	Si-npn-Digi	Sw, 50V, 100mA, 150mW, 200MHz, R1/R2=10/47k	SOT-523	16ta	-	3a	Auk
R7	SRC1207EF	Si-npn-Digi	Sw, 50V, 100mA, 150mW, 200MHz, R1/R2=10/47k	SOT-523F	18ta	-	3a	Auk
R7	SRC1207U	Si-npn-Digi	Sw, 50V, 100mA, 200mW, 200MHz, R1/R2=10/47k	SOT-323	16ta	-	3a	Auk



SMD code	Type	Function	Short description	Case	Pinout	Sch. St.	Mnf.
R7	SRC1207UF	Si-npn-Digi	Sw, 50V, 100mA, 200mW, 200MHz, R1/R2=10/47k	SOT-323F	18ta	-	3a Auk
R7	TC54VN5702ECB	Vdet-IC	5.7V±2%, -Reset ODO	SOT-23	16vdb	VD6	3a Tcs
R7	XC61CN5702M	Vdet-IC	5.7V±1%, +Reset ODO	SOT-23	16vdb	VD6	3d Tor
R73	XE61CN5745MR	Vdet-IC	5.7V±2%, -Reset ODO	SOT-23	16vdb	VD6	3h Tor
R75	XC61FN5712M	Vdet-IC	5.7V±2%, +Reset ODO, 200ms	SOT-23	16vdb	VD6	3d Tor
R75	XC61HN5712MR	Vdet-IC	5.7V±2%, -Reset ODO, 50..200ms	SOT-23	16vdc	VD6	3d Tor
R76	XC61FN5742M	Vdet-IC	5.7V±2%, +Reset ODO, 400ms	SOT-23	16vdb	VD6	3d Tor
R76	XC61HN5742MR	Vdet-IC	5.7V±2%, -Reset ODO, 80..400ms	SOT-23	16vdc	VD6	3d Tor
R77	XC61FN5752M	Vdet-IC	5.7V±2%, +Reset ODO, 50ms	SOT-23	16vdb	VD6	3d Tor
R77	XC61HN5752MR	Vdet-IC	5.7V±2%, -Reset ODO, 1..50ms	SOT-23	16vdc	VD6	3d Tor
R7p	BFR106	Si-npn	VHF/UHF-A-Band, 20V, 100mA, 500mW, B=80, 5GHz	SOT-23	16ta	-	3a Phi
R7s	BFR106	Si-npn	VHF/UHF-A-Band, 20V, 100mA, 500mW, B=80, 5GHz	SOT-23	16ta	-	3a Sie
R8	BZX84-C6V2	Z-diode	5.8..6.6V, Zzt=10Q, Izt=20mA, 225mW	SOT-23	16dc	-	3a Lge
R8	BZX84-C9V1T	Z-diode	9.1V±5%, 150mW	SOT-523	16dc	-	3a Di
R8	CZRH3-55C9V1	Z-diode	9.1..9.60V, Zzt=15Q, Izt=5mA, 150mW	SOT-523	18dc	-	3a Cmc
R8	ELM7638LCB	Vdet-IC	3.8V±2%, -Reset PPO, 150ms	SOT-23	16vdc	VD7	3d Elm
R8	ELM9738CBB	Vdet-IC	3.8V±2.5%, +Reset PPO	SOT-23	16vdb	VD7	3d Elm
R8	TC54VN5802ECB	Vdet-IC	5.8V±2%, -Reset ODO	SOT-23	16vdb	VD6	3a Tcs
R8	XC61CN5802M	Vdet-IC	5.8V±1%, +Reset ODO	SOT-23	16vdb	VD6	3d Tor
R83	XE61CN5845MR	Vdet-IC	5.8V±2%, -Reset ODO	SOT-23	16vdb	VD6	3h Tor
R85	XC61FN5812M	Vdet-IC	5.8V±2%, +Reset ODO, 200ms	SOT-23	16vdb	VD6	3d Tor
R85	XC61HN5812MR	Vdet-IC	5.8V±2%, -Reset ODO, 50..200ms	SOT-23	16vdc	VD6	3d Tor
R86	XC61FN5842M	Vdet-IC	5.8V±2%, +Reset ODO, 400ms	SOT-23	16vdb	VD6	3d Tor
R86	XC61HN5842MR	Vdet-IC	5.8V±2%, -Reset ODO, 80..400ms	SOT-23	16vdc	VD6	3d Tor
R87	XC61FN5852M	Vdet-IC	5.8V±2%, +Reset ODO, 50ms	SOT-23	16vdb	VD6	3d Tor
R87	XC61HN5852MR	Vdet-IC	5.8V±2%, -Reset ODO, 1..50ms	SOT-23	16vdc	VD6	3d Tor
R8A	LM4040AIM3X-8.2	Vref-IC	Precision, Shunt, 8.192V, 0.1%	SOT-23	16dk	RF1	3a Nsc
R8A	LM4040AIM3X-8.2	Vref-IC	Precision, Shunt, 8.192V, 0.1%	SOT-23	16dk	RF1	3a Nsc
R8B	LM4040BIM3-8.2	Vref-IC	Precision, Shunt, 8.192V, 0.2%	SOT-23	16dk	RF1	3a Nsc
R8B	LM4040BIM3X-8.2	Vref-IC	Precision, Shunt, 8.192V, 0.2%	SOT-23	16dk	RF1	3a Nsc
R8C	LM4040CIM3-8.2	Vref-IC	Precision, Shunt, 8.192V, 0.5%	SOT-23	16dk	RF1	3a Nsc
R8C	LM4040CIM3X-8.2	Vref-IC	Precision, Shunt, 8.192V, 0.5%	SOT-23	16dk	RF1	3a Nsc
R8D	LM4040DIM3-8.2	Vref-IC	Precision, Shunt, 8.192V, 1%	SOT-23	16dk	RF1	3a Nsc
R8D	LM4040DIM3X-8.2	Vref-IC	Precision, Shunt, 8.192V, 1%	SOT-23	16dk	RF1	3a Nsc
R9	1SS392	Si-diode	Dual, Schottky, 40V, 100mA	SC-59	16dg	-	3a Tos
R9	1SS393	Si-diode	Dual, Schottky, 40V, 100mA	SOT-323	16dg	-	3a Tos
R9	BZX84-C10T	Z-diode	10V±5%, 150mW	SOT-523	16dc	-	3a Di
R9	BZX84-C30	Z-diode	28..32V, Zzt=80Q, Izt=20mA, 225mW	SOT-23	16dc	-	3a Lge
R9	CZRH3-55C10	Z-diode	10.0..10.60V, Zzt=20Q, Izt=5mA, 150mW	SOT-523	18dc	-	3a Cmc
R9	ELM7639LCB	Vdet-IC	3.9V±2%, -Reset PPO, 150ms	SOT-23	16vdc	VD7	3d Elm
R9	ELM9739CBB	Vdet-IC	3.9V±2.5%, +Reset PPO	SOT-23	16vdb	VD7	3d Elm
R9	TC54VN5902ECB	Vdet-IC	5.9V±2%, -Reset ODO	SOT-23	16vdb	VD6	3a Tcs
R9	XC61CN5902M	Vdet-IC	5.9V±1%, +Reset ODO	SOT-23	16vdb	VD6	3d Tor
R93	XE61CN5945MR	Vdet-IC	5.9V±2%, -Reset ODO	SOT-23	16vdb	VD6	3h Tor
R95	XC61FN5912M	Vdet-IC	5.9V±2%, +Reset ODO, 200ms	SOT-23	16vdb	VD6	3d Tor
R95	XC61HN5912MR	Vdet-IC	5.9V±2%, -Reset ODO, 50..200ms	SOT-23	16vdc	VD6	3d Tor
R96	XC61FN5942M	Vdet-IC	5.9V±2%, +Reset ODO, 400ms	SOT-23	16vdb	VD6	3d Tor
R96	XC61HN5942MR	Vdet-IC	5.9V±2%, -Reset ODO, 80..400ms	SOT-23	16vdc	VD6	3d Tor
R97	SSTT197	Si-npn	AF, 60V, 200mA, B=250..700	SOT-23	16ta	-	3a Rhm
R97	XC61FN5952M	Vdet-IC	5.9V±2%, +Reset ODO, 50ms	SOT-23	16vdb	VD6	3d Tor
R97	XC61HN5952MR	Vdet-IC	5.9V±2%, -Reset ODO, 1..50ms	SOT-23	16vdc	VD6	3d Tor
RA	2SC4097PT-R	Si-npn	AF, Sw, 32V, 500mA, B=180..390, 250MHz	SOT-323	16ta	-	3a Chm
RA	ASM1810R-5	Vdet-IC	4.62V, -Reset PPO	SOT-23	16vda	VD6	3a Ali
RA	BF081	Si-npn	UHF-A, LN, 25V, 0.03A, 4.2GHz	SOT-23	16ta	-	3a Sil
RA	RN2321A	Si-npn-Digi	Mute, 15V, 500mA, 300mW, R1/R2=1k/1k	SOT-323	16ta	-	3a Tos
RA	RN2421	Si-npn-Digi	Mute, 50V, 800mA, 200mW, R1/R2=1k/1k	SC-59	16ta	-	3a Tos
RA	SRC1210E	Si-npn-Digi	Sw, 50V, 100mA, 150mW, 200MHz, R1=4.7k	SOT-523	16ta	-	3a Auk
RA	SRC1210EF	Si-npn-Digi	Sw, 50V, 100mA, 150mW, 200MHz, R1=4.7k	SOT-523F	18ta	-	3a Auk
RA	SRC1210U	Si-npn-Digi	Sw, 50V, 100mA, 200mW, 200MHz, R1=4.7k	SOT-323	16ta	-	3a Auk
RA	SRC1210UF	Si-npn-Digi	Sw, 50V, 100mA, 200mW, 200MHz, R1=4.7k	SOT-323F	18ta	-	3a Auk
RA	TC1279-5ENB	Vdet-IC	4.62V, -Reset PPO	SOT-23	16vdb	VD7	3d Mcc
RA-	BZB84-B36	Z-diode	Dual, 36V±2%, If=200mA, 300mW	SOT-23	16df	-	3a PHH
RA1	SRA2201S	Si-npn-Digi	Sw, 50V, 100mA, 200mW, 200MHz, R1/R2=4.7/4.7k	SOT-23	16ta	-	3a Auk
RA1	SRA2201SF	Si-npn-Digi	Sw, 50V, 100mA, 200mW, 200MHz, R1/R2=4.7/4.7k	SOT-23F	18ta	-	3a Auk
RA2	SRA2202S	Si-npn-Digi	Sw, 50V, 100mA, 200mW, 200MHz, R1/R2=10/10k	SOT-23	16ta	-	3a Auk
RA2	SRA2202SF	Si-npn-Digi	Sw, 50V, 100mA, 200mW, 200MHz, R1/R2=10/10k	SOT-23F	18ta	-	3a Auk
RA23P	PCS809PIURF	Vdet-IC	2.3V±1.5%, -Reset PPO	SOT-23	16vdc	VD7	3a Pcr
RA26P	PCS809RIURF	Vdet-IC	2.63V±1.5%, -Reset PPO	SOT-23	16vdc	VD7	3a Pcr
RA29P	PCS809SIURF	Vdet-IC	2.93V±1.5%, -Reset PPO	SOT-23	16vdc	VD7	3a Pcr
RA3	SRA2203S	Si-npn-Digi	Sw, 50V, 100mA, 200mW, 200MHz, R1/R2=22/22k	SOT-23	16ta	-	3a Auk



SMD code	Type	Function	Short description	Case	Pinout	Sch.	St.	Mnf.
RA3	SRA2203SF	Si-pnp-Digi	Sw, 50V, 100mA, 200mW, 200MHz, R1/R2=22/22k	SOT-23F	18ta	-	3a	Auk
RA31P	PCS809TIURF	Vdet-IC	3.08V±1.5%, -Reset PPO	SOT-23	16vdc	VD7	3a	Pcr
RA4	BAV70	Si-diode	Dual, Sw, 75V, 215mA, Vf<1.25V, <4ns	SOT-23	16dg	-	3a	Rhm
RA4	SRA2204S	Si-pnp-Digi	Sw, 50V, 100mA, 200mW, 200MHz, R1/R2=47/47k	SOT-23	16ta	-	3a	Auk
RA4	SRA2204SF	Si-pnp-Digi	Sw, 50V, 100mA, 200mW, 200MHz, R1/R2=47/47k	SOT-23F	18ta	-	3a	Auk
RA40P	PCS809JIURF	Vdet-IC	4.0V±1.5%, -Reset PPO	SOT-23	16vdc	VD7	3a	Pcr
RA44P	PCS809MIURF	Vdet-IC	4.38V±1.5%, -Reset PPO	SOT-23	16vdc	VD7	3a	Pcr
RA46P	PCS809LIURF	Vdet-IC	4.63V±1.5%, -Reset PPO	SOT-23	16vdc	VD7	3a	Pcr
RA5	SRA2205S	Si-pnp-Digi	Sw, 50V, 100mA, 200mW, 200MHz, R1/R2=22/47k	SOT-23	16ta	-	3a	Auk
RA5	SRA2205SF	Si-pnp-Digi	Sw, 50V, 100mA, 200mW, 200MHz, R1/R2=22/47k	SOT-23F	18ta	-	3a	Auk
RA6	SRA2206S	Si-pnp-Digi	Sw, 50V, 100mA, 200mW, 200MHz, R1/R2=4.7/47k	SOT-23	16ta	-	3a	Auk
RA6	SRA2206SF	Si-pnp-Digi	Sw, 50V, 100mA, 200mW, 200MHz, R1/R2=4.7/47k	SOT-23F	18ta	-	3a	Auk
RA7	SRA2207S	Si-pnp-Digi	Sw, 50V, 100mA, 200mW, 200MHz, R1/R2=10/47k	SOT-23	16ta	-	3a	Auk
RA7	SRA2207SF	Si-pnp-Digi	Sw, 50V, 100mA, 200mW, 200MHz, R1/R2=10/47k	SOT-23F	18ta	-	3a	Auk
RAA	SRA2210S	Si-pnp-Digi	Sw, 50V, 100mA, 200mW, 200MHz, R1=4.7k	SOT-23	16ta	-	3a	Auk
RAA	SRA2210SF	Si-pnp-Digi	Sw, 50V, 100mA, 200mW, 200MHz, R1=4.7k	SOT-23F	18ta	-	3a	Auk
RAB	MMD4448	Si-diode	Sw, Fast, 80V, 500mA, Vf<1V(100mA), <4ns	SOT-23	16dc	-	3g	Vs
RAB	SRA2212S	Si-pnp-Digi	Sw, 50V, 100mA, 200mW, 200MHz, R1=100k	SOT-23	16ta	-	3a	Auk
RAB	SRA2212SF	Si-pnp-Digi	Sw, 50V, 100mA, 200mW, 200MHz, R1=100k	SOT-23F	18ta	-	3a	Auk
RAC	LM4041CEM3-ADJ	Vref-IC	Precision, Shunt, Adjustable	SOT-23	16du	RF1	3a	Nsc
RAC	LM4041CIM3-ADJ	Vref-IC	Precision, Shunt, Adjustable	SOT-23	16du	RF1	3a	Nsc
RAC	SRA2219S	Si-pnp-Digi	Sw, 50V, 100mA, 200mW, 200MHz, R1/R2=4.7/10k	SOT-23	16ta	-	3a	Auk
RAC	SRA2219SF	Si-pnp-Digi	Sw, 50V, 100mA, 200mW, 200MHz, R1/R2=4.7/10k	SOT-23F	18ta	-	3a	Auk
RAD	LM4041DEM3-ADJ	Vref-IC	Precision, Shunt, Adjustable	SOT-23	16du	RF1	3a	Nsc
RAD	LM4041DIM3-ADJ	Vref-IC	Precision, Shunt, Adjustable	SOT-23	16du	RF1	3d	Mcr
RAD	SRA2211S	Si-pnp-Digi	Sw, 50V, 100mA, 200mW, 200MHz, R1=10k	SOT-23	16ta	-	3a	Auk
RAD	SRA2211SF	Si-pnp-Digi	Sw, 50V, 100mA, 200mW, 200MHz, R1=10k	SOT-23F	18ta	-	3a	Auk
RAF	SSTA29	Si-npn-Darl	AF, 100V, 500mA, B>10000, >125MHz	SOT-23	16ta	-	3a	Rhm
RAO	2SC3718-O	Si-npn	VHF, RF-Mix, 30V, 50mA, 150mW, 500MHz, B=70..140	SC-59	16ta	-	3a	Tos
RAp	BZB84-B36	Z-diode	Dual, 36V±2%, If=200mA, 300mW	SOT-23	16df	-	3a	PHH
RAs	BFQ81	Si-npn	UHF-A, LN, 25V, 0.03A, 4.2GHz	SOT-23	16ta	-	3a	Sie
RAt	BZB84-B36	Z-diode	Dual, 36V±2%, If=200mA, 300mW	SOT-23	16df	-	3a	PHM
RAT	MMSTA28	Si-npn-Darl	GP, 80V, 500mA, 500mW, B>10000, >100MHz	SC-59	16ta	-	3a	Rhm
RAT	SSTA28	Si-npn-Darl	GP, 80V, 500mA, 500mW, B>10000, >100MHz	SOT-23	16ta	-	3a	Rhm
RAW	BZB84-B36	Z-diode	Dual, 36V±2%, If=200mA, 300mW	SOT-23	16df	-	3a	PHC
RAY	2SC3718-Y	Si-npn	VHF, RF-Mix, 30V, 50mA, 150mW, 500MHz, B=130..240	SC-59	16ta	-	3a	Tos
RB	2SA1577PT-R	Si-pnp	AF, Sw, 32V, 500mA, B=180..390, 200MHz	SOT-323	16ta	-	3a	Chm
RB	2SC2618-B	Si-npn	GP, AF, 35V, 500mA, 150mW, B=60..120	SOT-23	16ta	-	3a	Ren
RB	ASM1810R-10	Vdet-IC	4.37V, -Reset PPO	SOT-23	16vda	VD6	3a	Ali
RB	BZX84-C2V4T	Z-diode	2.4V±5%, 150mW	SOT-523	16dc	-	3a	Di
RB	CH3906WPT	Si-pnp	AF, Sw, 40V, 200mA, B=100..300, 250MHz	SOT-323	16ta	-	3a	Chm
RB	CZRH3-55C2V4	Z-diode	2.4..2.60V, Zzt=100Ω, Izt=5mA, 150mW	SOT-523	18dc	-	3a	Omc
RB	RN2322A	Si-pnp-Digi	Mute, 15V, 500mA, 300mW, R1/R2=2k2/2k2	SOT-323	16ta	-	3a	Tos
RB	RN2422	Si-pnp-Digi	Mute, 50V, 800mA, 200mW, R1/R2=2k2/2k2	SC-59	16ta	-	3a	Tos
RB	SRC1212E	Si-npn-Digi	Sw, 50V, 100mA, 150mW, 200MHz, R1=100k	SOT-523	16ta	-	3a	Auk
RB	SRC1212EF	Si-npn-Digi	Sw, 50V, 100mA, 150mW, 200MHz, R1=100k	SOT-523F	18ta	-	3a	Auk
RB	SRC1212U	Si-npn-Digi	Sw, 50V, 100mA, 200mW, 200MHz, R1=100k	SOT-323	16ta	-	3a	Auk
RB	SRC1212UF	Si-npn-Digi	Sw, 50V, 100mA, 200mW, 200MHz, R1=100k	SOT-323F	18ta	-	3a	Auk
RB	TC1279-10ENB	Vdet-IC	4.37V, -Reset PPO	SOT-23	16vdb	VD7	3d	Mcc
RB-	BZB84-B39	Z-diode	Dual, 39V±2%, If=200mA, 300mW	SOT-23	16df	-	3a	PHH
RB23P	PCS809NPIURF	Vdet-IC	2.3V±1.5%, -Reset ODO	SOT-23	16vdc	VD6	3a	Pcr
RB26P	PCS809NRIURF	Vdet-IC	2.63V±1.5%, -Reset ODO	SOT-23	16vdc	VD6	3a	Pcr
RB29P	PCS809NSIURF	Vdet-IC	2.93V±1.5%, -Reset ODO	SOT-23	16vdc	VD6	3a	Pcr
RB31P	PCS809NTIURF	Vdet-IC	3.08V±1.5%, -Reset ODO	SOT-23	16vdc	VD6	3a	Pcr
RB40P	PCS809NJIURF	Vdet-IC	4.0V±1.5%, -Reset ODO	SOT-23	16vdc	VD6	3a	Pcr
RB44P	PCS809NMIURF	Vdet-IC	4.38V±1.5%, -Reset ODO	SOT-23	16vdc	VD6	3a	Pcr
RB46P	PCS809NLIURF	Vdet-IC	4.63V±1.5%, -Reset ODO	SOT-23	16vdc	VD6	3a	Pcr
RBG	2SK711-GR	n-FET	GP, 20V, 10mA, 300mW, Idss=6..12mA	SOT-23	16fa	-	3a	Tos
RBL	2SK711-BL	n-FET	GP, 20V, 10mA, 300mW, Idss=10..20mA	SOT-23	16fa	-	3a	Tos
Rbp	BZB84-B39	Z-diode	Dual, 39V±2%, If=200mA, 300mW	SOT-23	16df	-	3a	PHH
RBQ	SST7208	Si-npn	GP, 60V, 100mA, 180MHz	SOT-23	16ta	-	3a	Rhm
RB R	SST6838	Si-npn	GP, Hi-beta, 50V, 0.2A, 200mW, 180MHz, B=100..1000	SST	18ta	-	3a	Rhm
RBs	BF771	Si-npn	SATV/VTR-Tuner, 20V, 80mA, 8GHz	SOT-23	16ta	-	3a	Sie
RBs	BF771W	Si-npn	SATV/VTR-Tuner, 20V, 80mA, 8GHz	SOT-323	16ta	-	3a	Sie
RBt	BZB84-B39	Z-diode	Dual, 39V±2%, If=200mA, 300mW	SOT-23	16df	-	3a	PHM
RBV	2SK711-V	n-FET	GP, 20V, 10mA, 300mW, Idss=16..32mA	SOT-23	16fa	-	3a	Tos
RBW	BZB84-B39	Z-diode	Dual, 39V±2%, If=200mA, 300mW	SOT-23	16df	-	3a	PHC
RC	2SB1197KPT-R	Si-pnp	AF, Sw, 32V, 800mA, B=180..390, 200MHz	SOT-23	16ta	-	3a	Chm
RC	2SC2618-C	Si-npn	GP, AF, 35V, 500mA, 150mW, B=100..200	SOT-23	16ta	-	3a	Ren
RC	ASM1810R-15	Vdet-IC	4.12V, -Reset PPO	SOT-23	16vda	VD6	3a	Ali



SMD code	Type	Function	Short description	Case	Pinout	Sch.	St.	Mnf.
RC	BFR193T	Si-npn	UHF, 20V, 80mA, 400mW, 8GHz	SOT-416	16ta	-	3a	Sil
RC	BZK84-C2V7T	Z-diode	2.7V±5%, 150mW	SOT-523	16dc	-	3a	Di
RC	CZRH3-55C2V7	Z-diode	2.7..2.90V, Zzt=100Ω, Izt=5mA, 150mW	SOT-523	18dc	-	3a	Cmc
RC	RN2323A	Si-npn-Digi	Mute, 15V, 500mA, 300mW, R1/R2=4K7/4K7	SOT-323	16ta	-	3a	Tos
RC	RN2423	Si-npn-Digi	Mute, 50V, 800mA, 200mW, R1/R2=4.7K/4.7K	SC-59	16ta	-	3a	Tos
RC	SRC1219E	Si-npn-Digi	Sw, 50V, 100mA, 150mW, 200MHz, R1/R2=4.7/10k	SOT-523	16ta	-	3a	Auk
RC	SRC1219EF	Si-npn-Digi	Sw, 50V, 100mA, 150mW, 200MHz, R1/R2=4.7/10k	SOT-523F	18ta	-	3a	Auk
RC	SRC1219U	Si-npn-Digi	Sw, 50V, 100mA, 200mW, 200MHz, R1/R2=4.7/10k	SOT-323	16ta	-	3a	Auk
RC	SRC1219UF	Si-npn-Digi	Sw, 50V, 100mA, 200mW, 200MHz, R1/R2=4.7/10k	SOT-323F	18ta	-	3a	Auk
RC	TC1279-15ENB	Vdet-IC	4.12V, -Reset PPO	SOT-23	16vdb	VD7	3d	Mcc
RC-	BZB84-B43	Z-diode	Dual, 43V±2%, If=200mA, 300mW	SOT-23	16df	-	3a	PHH
RC1	SRC1201S	Si-npn-Digi	Sw, 50V, 100mA, 200mW, 200MHz, R1/R2=4.7/4.7k	SOT-23	16ta	-	3a	Auk
RC1	SRC1201SF	Si-npn-Digi	Sw, 50V, 100mA, 200mW, 200MHz, R1/R2=4.7/4.7k	SOT-23F	18ta	-	3a	Auk
RC2	SRC1202S	Si-npn-Digi	Sw, 50V, 100mA, 200mW, 200MHz, R1/R2=10/10k	SOT-23	16ta	-	3a	Auk
RC2	SRC1202SF	Si-npn-Digi	Sw, 50V, 100mA, 200mW, 200MHz, R1/R2=10/10k	SOT-23F	18ta	-	3a	Auk
RC3	SRC1203S	Si-npn-Digi	Sw, 50V, 100mA, 200mW, 200MHz, R1/R2=22/22k	SOT-23	16ta	-	3a	Auk
RC3	SRC1203SF	Si-npn-Digi	Sw, 50V, 100mA, 200mW, 200MHz, R1/R2=22/22k	SOT-23F	18ta	-	3a	Auk
RC4	SRC1204S	Si-npn-Digi	Sw, 50V, 100mA, 200mW, 200MHz, R1/R2=47/47k	SOT-23	16ta	-	3a	Auk
RC4	SRC1204SF	Si-npn-Digi	Sw, 50V, 100mA, 200mW, 200MHz, R1=47k, R2=47k	SOT-23F	18ta	-	3a	Auk
RC5	SRC1205S	Si-npn-Digi	Sw, 50V, 100mA, 200mW, 200MHz, R1/R2=22/47k	SOT-23	16ta	-	3a	Auk
RC5	SRC1205SF	Si-npn-Digi	Sw, 50V, 100mA, 200mW, 200MHz, R1/R2=22/47k	SOT-23F	18ta	-	3a	Auk
RC6	SRC1206S	Si-npn-Digi	Sw, 50V, 100mA, 200mW, 200MHz, R1/R2=4.7/47k	SOT-23	16ta	-	3a	Auk
RC6	SRC1206SF	Si-npn-Digi	Sw, 50V, 100mA, 200mW, 200MHz, R1/R2=4.7/47k	SOT-23F	18ta	-	3a	Auk
RC7	SRC1207S	Si-npn-Digi	Sw, 50V, 100mA, 200mW, 200MHz, R1/R2=10/47k	SOT-23	16ta	-	3a	Auk
RC7	SRC1207SF	Si-npn-Digi	Sw, 50V, 100mA, 200mW, 200MHz, R1/R2=10/47k	SOT-23F	18ta	-	3a	Auk
RCA	LM4050AIM3-2.5	Vref-IC	Precision, Shunt, 2.50V, 0.1%	SOT-23	16dk	RF1	3a	Nsc
RCA	SRC1210S	Si-npn-Digi	Sw, 50V, 100mA, 200mW, 200MHz, R1=4.7k	SOT-23	16ta	-	3a	Auk
RCA	SRC1210SF	Si-npn-Digi	Sw, 50V, 100mA, 200mW, 200MHz, R1=4.7k	SOT-23F	18ta	-	3a	Auk
RCB	LM4050BIM3-2.5	Vref-IC	Precision, Shunt, 2.50V, 0.2%	SOT-23	16dk	RF1	3a	Nsc
RCB	SRC1212S	Si-npn-Digi	Sw, 50V, 100mA, 200mW, 200MHz, R1=100k	SOT-23	16ta	-	3a	Auk
RCB	SRC1212SF	Si-npn-Digi	Sw, 50V, 100mA, 200mW, 200MHz, R1=100k	SOT-23F	18ta	-	3a	Auk
RCC	LM4050CIM3-2.5	Vref-IC	Precision, Shunt, 2.50V, 0.5%	SOT-23	16dk	RF1	3a	Nsc
RCC	SRC1219S	Si-npn-Digi	Sw, 50V, 100mA, 200mW, 200MHz, R1/R2=4.7/10k	SOT-23	16ta	-	3a	Auk
RCC	SRC1219SF	Si-npn-Digi	Sw, 50V, 100mA, 200mW, 200MHz, R1/R2=4.7/10k	SOT-23F	18ta	-	3a	Auk
RCD	SRC1211S	Si-npn-Digi	Sw, 50V, 100mA, 200mW, 200MHz, R1=10k	SOT-23	16ta	-	3a	Auk
RCD	SRC1211SF	Si-npn-Digi	Sw, 50V, 100mA, 200mW, 200MHz, R1=10k	SOT-23F	18ta	-	3a	Auk
RCp	BZB84-B43	Z-diode	Dual, 43V±2%, If=200mA, 300mW	SOT-23	16df	-	3a	PHH
RCs	BFR193	Si-npn	UHF, 20V, 80mA, 0.4W, 8GHz	SOT-23	16ta	-	3a	Sie
RCs	BFR193T	Si-npn	UHF, 20V, 80mA, 400mW, 8GHz	SOT-416	16ta	-	3a	Sie
RCs	BFR193W	Si-npn	UHF, 20V, 80mA, 400mW, 8GHz	SOT-323	16ta	-	3a	Sie
RCt	BZB84-B43	Z-diode	Dual, 43V±2%, If=200mA, 300mW	SOT-23	16df	-	3a	PHM
RCW	BZB84-B43	Z-diode	Dual, 43V±2%, If=200mA, 300mW	SOT-23	16df	-	3a	PhC
RD	2SA1037WPT	Si-pnp	AF, Sw, 50V, 150mA, B=120..560, 140MHz	SOT-323	16ta	-	3a	Chm
RD	2SC2618-D	Si-npn	GP, AF, 35V, 500mA, 150mW, B=120..240	SOT-23	16ta	-	3a	Ren
RD	BZK84-C3V0T	Z-diode	3.0V±5%, 150mW	SOT-523	16dc	-	3a	Di
RD	CZRH3-55C3V0	Z-diode	3.0..3.20V, Zzt=95Ω, Izt=5mA, 150mW	SOT-523	18dc	-	3a	Cmc
RD	RN2324A	Si-npn-Digi	Mute, 15V, 500mA, 300mW, R1/R2=10k/10k	SOT-323	16ta	-	3a	Tos
RD	RN2424	Si-npn-Digi	Mute, 50V, 800mA, 200mW, R1/R2=10k/10k	SC-59	16ta	-	3a	Tos
RD	SRC1211E	Si-npn-Digi	Sw, 50V, 100mA, 150mW, 200MHz, R1=10k	SOT-523	16ta	-	3a	Auk
RD	SRC1211EF	Si-npn-Digi	Sw, 50V, 100mA, 150mW, 200MHz, R1=10k	SOT-523F	18ta	-	3a	Auk
RD	SRC1211U	Si-npn-Digi	Sw, 50V, 100mA, 200mW, 200MHz, R1=10k	SOT-323	16ta	-	3a	Auk
RD	SRC1211UF	Si-npn-Digi	Sw, 50V, 100mA, 200mW, 200MHz, R1=10k	SOT-323F	18ta	-	3a	Auk
RD-	BZB84-B47	Z-diode	Dual, 47V±2%, If=200mA, 300mW	SOT-23	16df	-	3a	PHH
RD23P	PCS810PIURF	Vdet-IC	2.3V±1.5%, +Reset PPO	SOT-23	16vdc	VD7	3a	Pcr
RD26P	PCS810RIURF	Vdet-IC	2.63V±1.5%, +Reset PPO	SOT-23	16vdc	VD7	3a	Pcr
RD29P	PCS810SIURF	Vdet-IC	2.93V±1.5%, +Reset PPO	SOT-23	16vdc	VD7	3a	Pcr
RD31P	PCS810TIURF	Vdet-IC	3.08V±1.5%, +Reset PPO	SOT-23	16vdc	VD7	3a	Pcr
RD40P	PCS810JIURF	Vdet-IC	4.0V±1.5%, +Reset PPO	SOT-23	16vdc	VD7	3a	Pcr
RD44P	PCS810MIURF	Vdet-IC	4.38V±1.5%, +Reset PPO	SOT-23	16vdc	VD7	3a	Pcr
RD46P	PCS810LIURF	Vdet-IC	4.63V±1.5%, +Reset PPO	SOT-23	16vdc	VD7	3a	Pcr
RDA	LM4050AIM3-4.1	Vref-IC	Precision, Shunt, 4.10V, 0.1%	SOT-23	16dk	RF1	3a	Nsc
RDB	LM4050BIM3-4.1	Vref-IC	Precision, Shunt, 4.10V, 0.2%	SOT-23	16dk	RF1	3a	Nsc
RDC	LM4050CIM3-4.1	Vref-IC	Precision, Shunt, 4.10V, 0.5%	SOT-23	16dk	RF1	3a	Nsc
RDp	BZB84-B47	Z-diode	Dual, 47V±2%, If=200mA, 300mW	SOT-23	16df	-	3a	PHH
RDs	BFR180	Si-npn	VHF/UHF, 10V, 4mA, 30mW, B=30..200, 6.2GHz	SOT-23	16ta	-	3a	Sie
RDs	BFR180W	Si-npn	VHF/UHF, 10V, 4mA, 30mW, B=30..200, 7GHz	SOT-323	16ta	-	3a	Sie
RDt	BZB84-B47	Z-diode	Dual, 47V±2%, If=200mA, 300mW	SOT-23	16df	-	3a	PHM
RDW	BZB84-B47	Z-diode	Dual, 47V±2%, If=200mA, 300mW	SOT-23	16df	-	3a	PhC
RE	2SA1514K-E	Si-pnp	GP, 120V, 50mA, 200mW, B=120..270, 140MHz	SOT-346	16ta	-	3a	Rhm
RE	2SA1579-E	Si-pnp	GP, 120V, 50mA, 200mW, B=120..270, 140MHz	SOT-323	16ta	-	3a	Rhm



SMD code	Type	Function	Short description	Case	Pinout	Sch.	St.	Mnf.
RE	2SC2412WPT-Q	Si-npn	AF, Sw, 50V, 150mA, B=120..270, 180MHz	SOT-323	16ta	-	3a	Chm
RE	BZX84-C2V4T	Z-diode	3.3V±5%, 150mW	SOT-523	16dc	-	3a	Di
RE	BZX84-C3V3T	Z-diode	3.3V±5%, 150mW	SOT-523	16dc	-	3a	Di
RE	CZRH3-55C3V3	Z-diode	3.3..3.50V, Zzt=95Ω, Izt=5mA, 150mW	SOT-523	18dc	-	3a	Cmc
RE	RN2325A	Si-pnp-Digi	Mute, 15V, 500mA, 300mW, R1/R2=0k47/10k	SOT-323	16ta	-	3a	Tos
RE	RN2425	Si-pnp-Digi	Mute, 50V, 800mA, 200mW, R1/R2=0k47/10k	SC-59	16ta	-	3a	Tos
RE-	BZB84-B51	Z-diode	Dual, 51V±2%, If=200mA, 300mW	SOT-23	16df	-	3a	PHH
REA	LM4050AIM3-5.0	Vref-IC	Precision, Shunt, 5.0V, 0.1%	SOT-23	16dk	RF1	3a	Nsc
REB	LM4050BIM3-5.0	Vref-IC	Precision, Shunt, 5.0V, 0.2%	SOT-23	16dk	RF1	3a	Nsc
REC	LM4050CIM3-5.0	Vref-IC	Precision, Shunt, 5V, 0.5%	SOT-23	16dk	RF1	3a	Nsc
REP	BZB84-B51	Z-diode	Dual, 51V±2%, If=200mA, 300mW	SOT-23	16df	-	3a	PHH
Ret	BZB84-B51	Z-diode	Dual, 51V±2%, If=200mA, 300mW	SOT-23	16df	-	3a	PHM
REW	BZB84-B51	Z-diode	Dual, 51V±2%, If=200mA, 300mW	SOT-23	16df	-	3a	PhC
RF	2SC2412WPT-R	Si-npn	AF, Sw, 50V, 150mA, B=180..390, 180MHz	SOT-323	16ta	-	3a	Chm
RF	BZX84-C3V6T	Z-diode	3.6V±5%, 150mW	SOT-523	16dc	-	3a	Di
RF	CZRH3-55C3V6	Z-diode	3.6..3.80V, Zzt=90Ω, Izt=5mA, 150mW	SOT-523	18dc	-	3a	Cmc
RF	RN2326A	Si-pnp-Digi	Mute, 15V, 500mA, 300mW, R1/R2=1k/10k	SOT-323	16ta	-	3a	Tos
RF	RN2426	Si-pnp-Digi	Mute, 50V, 800mA, 200mW, R1/R2=1k/10k	SC-59	16ta	-	3a	Tos
RF-	BZB84-B56	Z-diode	Dual, 56V±2%, If=200mA, 300mW	SOT-23	16df	-	3a	PHH
RFA	LM4050AIM3-8.2	Vref-IC	Precision, Shunt, 8.20V, 0.1%	SOT-23	16dk	RF1	3a	Nsc
RFB	LM4050BIM3-8.2	Vref-IC	Precision, Shunt, 8.20V, 0.2%	SOT-23	16dk	RF1	3a	Nsc
RFC	LM4050CIM3-8.2	Vref-IC	Precision, Shunt, 8.20V, 0.5%	SOT-23	16dk	RF1	3a	Nsc
RFp	BZB84-B56	Z-diode	Dual, 56V±2%, If=200mA, 300mW	SOT-23	16df	-	3a	PHH
RFQ	SST6839	Si-pnp	GP, Hi-beta, 50V, 0.2A, 200mW, 140MHz, B=100..1000	SST	18ta	-	3a	Rhm
RFs	BFR181	Si-npn	VHF/UHF, 20V, 20mA, 175mW, B=50..200, 8GHz	SOT-23	16ta	-	3a	Sie
RFs	BFR181W	Si-npn	VHF/UHF, 20V, 20mA, 175mW, B=50..200, 8GHz	SOT-323	16ta	-	3a	Sie
RFt	BZB84-B56	Z-diode	Dual, 56V±2%, If=200mA, 300mW	SOT-23	16df	-	3a	PHM
RFW	BZB84-B56	Z-diode	Dual, 56V±2%, If=200mA, 300mW	SOT-23	16df	-	3a	PhC
RG	2SC2412WPT-S	Si-npn	AF, Sw, 50V, 150mA, B=270..560, 180MHz	SOT-323	16ta	-	3a	Chm
RG	BZX84-C3V9T	Z-diode	3.9V±5%, 150mW	SOT-523	16dc	-	3a	Di
RG	CZRH3-55C3V9	Z-diode	3.9..4.10V, Zzt=90Ω, Izt=5mA, 150mW	SOT-523	18dc	-	3a	Cmc
RG	RN2327A	Si-pnp-Digi	Mute, 15V, 500mA, 300mW, R1/R2=2k2/10k	SOT-323	16ta	-	3a	Tos
RG	RN2427	Si-pnp-Digi	Mute, 50V, 800mA, 200mW, R1/R2=2.2k/10k	SC-59	16ta	-	3a	Tos
RG-	BZB84-B62	Z-diode	Dual, 62V±2%, If=200mA, 300mW	SOT-23	16df	-	3a	PHH
RGA	LM4050AIM3-10	Vref-IC	Precision, Shunt, 10.0V, 0.1%	SOT-23	16dk	RF1	3a	Nsc
RGB	LM4050BIM3-10	Vref-IC	Precision, Shunt, 10.0V, 0.2%	SOT-23	16dk	RF1	3a	Nsc
RGC	LM4050CIM3-10	Vref-IC	Precision, Shunt, 10V, 0.5%	SOT-23	16dk	RF1	3a	Nsc
Rgp	BZB84-B62	Z-diode	Dual, 62V±2%, If=200mA, 300mW	SOT-23	16df	-	3a	PHH
RGs	BFR182	Si-npn	VHF/UHF, 20V, 35mA, 250mW, B=50..200, 8GHz	SOT-23	16ta	-	3a	Sie
RGs	BFR182W	Si-npn	VHF/UHF, 20V, 35mA, 250mW, B=50..200, 8GHz	SOT-323	16ta	-	3a	Sie
RGt	BZB84-B62	Z-diode	Dual, 62V±2%, If=200mA, 300mW	SOT-23	16df	-	3a	PHM
RGW	BZB84-B62	Z-diode	Dual, 62V±2%, If=200mA, 300mW	SOT-23	16df	-	3a	PhC
RH	BZX84-C4V3T	Z-diode	4.3V±5%, 150mW	SOT-523	16dc	-	3a	Di
RH	CHT846BWPT-Q	Si-npn	AF, Sw, 65V, 100mA, B=110..220, 200MHz	SOT-323	16ta	-	3a	Chm
RH	CZRH3-55C4V3	Z-diode	4.3..4.60V, Zzt=90Ω, Izt=5mA, 150mW	SOT-523	18dc	-	3a	Cmc
RH-	BZB84-B68	Z-diode	Dual, 68V±2%, If=200mA, 300mW	SOT-23	16df	-	3a	PHH
RHp	BZB84-B68	Z-diode	Dual, 68V±2%, If=200mA, 300mW	SOT-23	16df	-	3a	PHH
RHs	BFR183	Si-npn	VHF/UHF, 20V, 65mA, 450mW, B=50..200, 8GHz	SOT-23	16ta	-	3a	Sie
RHs	BFR183W	Si-npn	VHF/UHF, 20V, 65mA, 450mW, B=50..200, 8GHz	SOT-323	16ta	-	3a	Sie
RHt	BZB84-B68	Z-diode	Dual, 68V±2%, If=200mA, 300mW	SOT-23	16df	-	3a	PHM
RHW	BZB84-B68	Z-diode	Dual, 68V±2%, If=200mA, 300mW	SOT-23	16df	-	3a	PhC
RI	CHT846BWPT-R	Si-npn	AF, Sw, 65V, 100mA, B=200..450, 200MHz	SOT-323	16ta	-	3a	Chm
RJ	CAT803JSDI-GT3	Vdet-IC	4.0V±1.5%, -Reset ODO	SC-70	16vdc	VD6	3d	Ons
RJ	CAT803JTBI-GT3	Vdet-IC	4.0V±1.5%, -Reset ODO	SOT-23	16vdc	VD6	3b	Ons
RJ	CHT846BWPT-S	Si-npn	AF, Sw, 65V, 100mA, B=420..800, 200MHz	SOT-323	16ta	-	3a	Chm
RJ	MCP101T-270I	Vdet-IC	2.7V, +Reset PPO	SOT-23	16vab	VD7	3a	Mcc
RJ-	BZB84-B75	Z-diode	Dual, 75V±2%, If=200mA, 300mW	SOT-23	16df	-	3a	PHH
RJA	LM4040AIM3-2.0	Vref-IC	Precision, Shunt, 2.048V, 0.1%	SOT-23	16dk	RF1	3a	Nsc
RJA	LM4040AIM3X-2.0	Vref-IC	Precision, Shunt, 2.048V, 0.1%	SOT-23	16dk	RF1	3a	Nsc
RJB	LM4040BIM3-2.0	Vref-IC	Precision, Shunt, 2.048V, 0.2%	SOT-23	16dk	RF1	3a	Nsc
RJB	LM4040BIM3X-2.0	Vref-IC	Precision, Shunt, 2.048V, 0.2%	SOT-23	16dk	RF1	3a	Nsc
RJC	LM4040CIM3-2.0	Vref-IC	Precision, Shunt, 2.048V, 0.5%	SOT-23	16dk	RF1	3a	Nsc
RJC	LM4040CIM3X-2.0	Vref-IC	Precision, Shunt, 2.048V, 0.5%	SOT-23	16dk	RF1	3a	Nsc
RJD	LM4040DIM3-2.0	Vref-IC	Precision, Shunt, 2.048V, 1%	SOT-23	16dk	RF1	3a	Nsc
RJD	LM4040DIM3X-2.0	Vref-IC	Precision, Shunt, 2.048V, 1%	SOT-23	16dk	RF1	3a	Nsc
RJE	LM4040EIM3-2.0	Vref-IC	Precision, Shunt, 2.048V, 2%	SOT-23	16dk	RF1	3a	Nsc
RJE	LM4040EIM3X-2.0	Vref-IC	Precision, Shunt, 2.048V, 2%	SOT-23	16dk	RF1	3a	Nsc
RJp	BZB84-B75	Z-diode	Dual, 75V±2%, If=200mA, 300mW	SOT-23	16df	-	3a	PHH
RJt	BZB84-B75	Z-diode	Dual, 75V±2%, If=200mA, 300mW	SOT-23	16df	-	3a	PHM
RJW	BZB84-B75	Z-diode	Dual, 75V±2%, If=200mA, 300mW	SOT-23	16df	-	3a	PhC



SMD code	Type	Function	Short description	Case	Pinout	Sch.	St.	Mnf.
RK	CHT847BWPT-Q	Si-npn	AF, Sw, 45V, 100mA, B=110..220, 200MHz	SOT-323	16ta	-	3a	Chm
RK	MCP101T-300I	Vdet-IC	3V, +Reset PPO	SOT-23	16vdb	VD7	3a	Mcc
RKA	LM4040AIM3X-3.0	Vref-IC	Precision, Shunt, 3.00V, 0.1%	SOT-23	16dk	RF1	3a	Nsc
RKB	LM4040BIM3X-3.0	Vref-IC	Precision, Shunt, 3.0V, 0.2%	SOT-23	16dk	RF1	3a	Nsc
RKC	LM4040CIM3X-3.0	Vref-IC	Precision, Shunt, 3V, 0.5%	SOT-23	16dk	RF1	3a	Nsc
RKD	LM4040DIM3X-3.0	Vref-IC	Precision, Shunt, 3.0V, 1%	SOT-23	16dk	RF1	3a	Nsc
RKE	LM4040EIM3X-3.0	Vref-IC	Precision, Shunt, 3.0V, 2%	SOT-23	16dk	RF1	3a	Nsc
RKE	LM4040EIM3X-3.0	Vref-IC	Precision, Shunt, 3.0V, 2%	SOT-23	16dk	RF1	3a	Nsc
RKM	RK7002	n-MOSFET-E*	V-MOS, LogL, 60V, 0.115A, <7.5Ω	SOT-23	16fh	-	3a	Rhm
RKs	BFR194	Si-pnp	UHF-A, ..1.5GHz, 20V, 0.1A, 5GHz	SOT-23	16ta	-	3a	Sie
RL	2SA1563	Si-pnp-Digi	Sw, 50V, 100mA, 200mW, 200MHz, B>70, R1/R2=10k/47k	CP	16ta	-	3a	San
RL	CAT803LSDI-GT3	Vdet-IC	4.63V±1.5%, -Reset ODO	SC-70	16vdc	VD6	3d	Ons
RL	CAT803LTBI-GT3	Vdet-IC	4.63V±1.5%, -Reset ODO	SOT-23	16vdc	VD6	3b	Ons
RL	CHT847BWPT-R	Si-npn	AF, Sw, 45V, 100mA, B=200..450, 200MHz	SOT-323	16ta	-	3a	Chm
RL	MCP101T-315I	Vdet-IC	3.15V, +Reset PPO	SOT-23	16vdb	VD7	3a	Mcc
RLN	ELM7537CEB	Vdet-IC	3.7V±2%, +Reset PPO	SC-70	16vdb	VD7	3d	Elm
RLN	ELM7537NEB	Vdet-IC	3.7V±2%, +Reset ODO	SC-70	16vdb	VD6	3d	Elm
RM	CAT803MSDI-GT3	Vdet-IC	4.38V±1.5%, -Reset ODO	SC-70	16vdc	VD6	3d	Ons
RM	CAT803MTBI-GT3	Vdet-IC	4.38V±1.5%, -Reset ODO	SOT-23	16vdc	VD6	3b	Ons
RM	CHT847BWPT-S	Si-npn	AF, Sw, 45V, 100mA, B=420..800, 200MHz	SOT-323	16ta	-	3a	Chm
RM	MCP101T-450I	Vdet-IC	4.5V, +Reset PPO	SOT-23	16vdb	VD7	3a	Mcc
RN	CHT848BWPT-P	Si-npn	AF, Sw, 30V, 100mA, B=110..220, 300MHz	SOT-323	16ta	-	3a	Chm
RN	MCP101T-460I	Vdet-IC	4.6V, +Reset PPO	SOT-23	16vdb	VD7	3a	Mcc
RO	2SC2715-O	Si-npn	VHF Mix/Osc, 35V, 50mA, 150mW, B=40..80, 100..400MHz	SC-59	16ta	-	3a	Tos
RO	CHT848BWPT-Q	Si-npn	AF, Sw, 30V, 100mA, B=200..450, 300MHz	SOT-323	16ta	-	3a	Chm
RO	MCP101T-475I	Vdet-IC	4.75V, +Reset PPO	SOT-23	16vdb	VD7	3a	Mcc
RP	CHT848BWPT-R	Si-npn	AF, Sw, 30V, 100mA, B=420..800, 300MHz	SOT-323	16ta	-	3a	Chm
RP	DDZX33	Z-diode	33V±2.5%, 500mW	SOT-23	16dc	-	3a	Di
RP	DDZX33W	Z-diode	33V±2.5%, 200mW	SOT-323	16dc	-	3a	Di
RP	MCP101T-485I	Vdet-IC	4.85V, +Reset PPO	SOT-23	16vdb	VD7	3a	Mcc
RP-	BZB84-B20	Z-diode	Dual, 20V±2%, If=200mA, 300mW	SOT-23	16df	-	3a	PhH
RPp	BZB84-B20	Z-diode	Dual, 20V±2%, If=200mA, 300mW	SOT-23	16df	-	3a	PhH
RPt	BZB84-B20	Z-diode	Dual, 20V±2%, If=200mA, 300mW	SOT-23	16df	-	3a	PhM
RPW	BZB84-B20	Z-diode	Dual, 20V±2%, If=200mA, 300mW	SOT-23	16df	-	3a	PhC
RQ	CHT856BWPT-Q	Si-pnp	AF, Sw, 65V, 100mA, B=125..250, 200MHz	SOT-323	16ta	-	3a	Chm
RQ-	BZB84-C20	Z-diode	Dual, 20V±5%, If=200mA, 300mW	SOT-23	16df	-	3a	PhH
RQp	BZB84-C20	Z-diode	Dual, 20V±5%, If=200mA, 300mW	SOT-23	16df	-	3a	PhH
RQt	BZB84-C20	Z-diode	Dual, 20V±5%, If=200mA, 300mW	SOT-23	16df	-	3a	PhM
RQW	BZB84-C20	Z-diode	Dual, 20V±5%, If=200mA, 300mW	SOT-23	16df	-	3a	PhC
RR	2SA1514K-R	Si-pnp	GP, 120V, 50mA, 200mW, B=180..390, 140MHz	SOT-346	16ta	-	3a	Rhm
RR	2SA1579-R	Si-pnp	GP, 120V, 50mA, 200mW, B=180..390, 140MHz	SOT-323	16ta	-	3a	Rhm
RR	2SC2715-R	Si-npn	VHF Mix/Osc, 35V, 50mA, 150mW, B=70..140, 100..400MHz	SC-59	16ta	-	3a	Tos
RR	BFR93P	Si-npn	UHF-A-Band, 15V, 30mA, 300mW, B>40, >5GHz	SOT-23	16ta	-	3a	Sie
RR	CAT803RSDI-GT3	Vdet-IC	2.63V±1.5%, -Reset ODO	SC-70	16vdc	VD6	3d	Ons
RR	CAT803RTBI-GT3	Vdet-IC	2.63V±1.5%, -Reset ODO	SOT-23	16vdc	VD6	3b	Ons
RR	CAT809RSDI-GT3	Vdet-IC	2.63V±1.5%, -Reset PPO	SC-70	16vdc	VD7	3d	Ons
RR	CAT809RTBI-GT3	Vdet-IC	2.63V±1.5%, -Reset PPO	SOT-23	16vdc	VD7	3b	Ons
RR	CHT856BWPT-R	Si-pnp	AF, Sw, 65V, 100mA, B=220..475, 200MHz	SOT-323	16ta	-	3a	Chm
RRA	BC847A	Si-npn	GP, 50V, 100mA, 200mW, B=110..220, 250MHz	SOT-23	16ta	-	3a	Auk
RRA	BC847FA	Si-npn	GP, 50V, 100mA, 200mW, B=110..220, 250MHz	SOT-23F	16ta	-	3a	Auk
RRB	BC847B	Si-npn	GP, 50V, 100mA, 200mW, B=200..450, 250MHz	SOT-23	18ta	-	3a	Auk
RRB	BC847FB	Si-npn	GP, 50V, 100mA, 200mW, B=200..450, 250MHz	SOT-23F	18ta	-	3a	Auk
RRC	BC847C	Si-npn	GP, 50V, 100mA, 200mW, B=420..800, 250MHz	SOT-23	16ta	-	3a	Auk
RRC	BC847FC	Si-npn	GP, 50V, 100mA, 200mW, B=420..800, 250MHz	SOT-23F	18ta	-	3a	Auk
RS	2SA1514K-S	Si-pnp	GP, 120V, 50mA, 200mW, B=270..560, 140MHz	SOT-346	16ta	-	3a	Rhm
RS	2SA1579-S	Si-pnp	GP, 120V, 50mA, 200mW, B=270..560, 140MHz	SOT-323	16ta	-	3a	Rhm
RS	2SC2480-S	Si-npn	VHF/UHF, 30V, 50mA, 150mW, B=1000..1600, 1.3GHz	SC-59	16ta	-	3a	Pan
RS	2SC3932-S	Si-npn	HF-Amp, Osc, 30V, 50mA, 150mW, B=800..1400, >800MHz	SOT-323	16ta	-	3a	Pan
RS	CAT803SSDI-GT3	Vdet-IC	2.93V±1.5%, -Reset ODO	SC-70	16vdc	VD6	3d	Ons
RS	CAT803STBI-GT3	Vdet-IC	2.93V±1.5%, -Reset ODO	SOT-23	16vdc	VD6	3b	Ons
RS	CAT810RSDI-GT3	Vdet-IC	2.63V±1.5%, +Reset PPO	SC-70	16vdc	VD7	3d	Ons
RS	CAT810RTBI-GT3	Vdet-IC	2.63V±1.5%, +Reset PPO	SOT-23	16vdc	VD7	3b	Ons
RS	CHT856BWPT-S	Si-pnp	AF, Sw, 65V, 100mA, B=420..800, 200MHz	SOT-323	16ta	-	3a	Chm
RSR	SST5210	Si-npn	AF, 50V, 200mA, B=200..600, >30MHz	SOT-23	16ta	-	3a	Rhm
RT	2SC2480-T	Si-npn	VHF/UHF, 30V, 50mA, 150mW, B=800..1400, 1.3GHz	SC-59	16ta	-	3a	Pan
RT	2SC3932-T	Si-npn	HF-Amp, Osc, 30V, 50mA, 150mW, B=1000..1600, >800MHz	SOT-323	16ta	-	3a	Pan
RT	CAT803TSDI-GT3	Vdet-IC	3.08V±1.5%, -Reset ODO	SC-70	16vdc	VD6	3d	Ons
RT	CAT803TTBI-GT3	Vdet-IC	3.08V±1.5%, -Reset ODO	SOT-23	16vdc	VD6	3b	Ons
RT	CHT857BWPT-Q	Si-pnp	AF, Sw, 45V, 100mA, B=125..250, 100MHz	SOT-323	16ta	-	3a	Chm
RT3	2SC4400-3	Si-npn	VHF, FP, 40V, 50mA, 150mW, B=60..120, 750MHz	SOT-23	16ta	-	3a	San



SMD code	Type	Function	Short description	Case	Pinout	Sch. St.	Mnf.
RT3	2SC4432-3	Si-npn	FM/VHF, 40V, 50mA, 250mW, B=60..120, 750MHz	CP	16ta	-	3a San
RT4	2SC4400-4	Si-npn	VHF, GP, 40V, 50mA, 150mW, B=90..180, 750MHz	SOT-23	16ta	-	3a San
RT4	2SC4432-4	Si-npn	FM/VHF, 40V, 50mA, 250mW, B=90..180, 750MHz	CP	16ta	-	3a San
RT5	2SC4400-5	Si-npn	VHF, GP, 40V, 50mA, 150mW, B=135..270, 750MHz	SOT-23	16ta	-	3a San
RT5	2SC4432-5	Si-npn	FM/VHF, 40V, 50mA, 250mW, B=135..270, 750MHz	CP	16ta	-	3a San
RU	CHT857BWPT-R	Si-pnp	AF, Sw, 45V, 100mA, B=220..475, 100MHz	SOT-323	16ta	-	3a Chm
RV	CHT857BWPT-S	Si-pnp	AF, Sw, 45V, 100mA, B=420..800, 100MHz	SOT-323	16ta	-	3a Chm
RVZ	MMST4126	Si-pnp	GP, 25V, 200mA, 350mW, B=120..360, >250MHz	SC-59	16ta	-	3a Rhm
RVZ	SST4126	Si-pnp	GP, 25V, 200mA, 350mW, B=120..360, >250MHz	SOT-23	16ta	-	3a Rhm
RW	BFR194	Si-pnp	UHF-A, ..1.5GHz, 20V, 0.1A, 5GHz	SOT-23	16ta	-	3a Sie
RW	CHT858BWPT-Q	Si-pnp	AF, Sw, 30V, 100mA, B=125..250, 200MHz	SOT-323	16ta	-	3a Chm
RX	CHT858BWPT-R	Si-pnp	AF, Sw, 30V, 100mA, B=220..475, 200MHz	SOT-323	16ta	-	3a Chm
RX7	SST6426	Si-npn-Darl	AF, 40V, 500mA, B=300..300000	SOT-23	16ta	-	3a Rhm
RY	2SC2715-Y	Si-npn	VHF Mix/Osc, 35V, 50mA, 150mW, B=120..240, 100..400MHz	SC-59	16ta	-	3a Tos
RY	2SC3898	Si-npn-Digi	Sw, 50V, 100mA, 200mW, 250MHz, B>100, R1=47k	CP	16ta	-	3a San
RY	2SC5541	Si-npn	UHF-S-Band, LN, 9V, 30mA, 100mW, B=90..200, 13GHz	SSFP	18ta	-	3a San
RY	CHT858BWPT-S	Si-pnp	AF, Sw, 30V, 100mA, B=420..800, 200MHz	SOT-323	16ta	-	3a Chm
RZ	CAT803ZSDI-GT3	Vdet-IC	2.32V±1.5%, -Reset ODO	SC-70	16vdc	VD6	3d Ons
RZ	CAT803ZTBI-GT3	Vdet-IC	2.32V±1.5%, -Reset ODO	SOT-23	16vdc	VD6	3b Ons
RZC	MMST4124	Si-npn	Sw, 30V, 200mA, 330mW, B=120..360, >300MHz	SC-59	16ta	-	3a Rhm
RZC	SST4124	Si-npn	Sw, 30V, 200mA, 330mW, B=120..360, >300MHz	SOT-23	16ta	-	3a Rhm
RZQ	MMST7157	Si-pnp	AF, 60V, 200mA, B>100	SOT-23	16ta	-	3a Rhm
s	AX6903EA	Vdet-IC	2.93V±1.5%, -Reset PPO	SC-70	16vda	VD7	3b Axl
S	SB10-015C	Si-diode	SBR, HF, 15V, 1A, Vf<0.55V(500mA), 30pF, 10ns	CP	16dc	-	3a San
S0	ELM7630HCB	Vdet-IC	3.0V±2%, +Reset PPO, 150ms	SOT-23	16vdc	VD7	3d Elm
S0	ELM9740CBB	Vdet-IC	4.0V±2.5%, +Reset PPO	SOT-23	16vdb	VD7	3d Elm
S0	HSPM-3880	PIN-diode	RF, 100V, 1A, 250mW, Rs<6.5Ω, Ccd<0.4pF	SOT-23	16dc	-	3a Agi
S0	R3130N40DA	Vdet-IC	4V, -Reset PPO, 200ms	SOT-23	16vdc	VD7	3b Ric
S0	SST270	n-FET	AF, LN, 30V, 350mW, Idss=2..15mA, Up<2V	SOT-23	16fj	-	3a Six
S0	TC54VN6002ECB	Vdet-IC	6.0V±2%, -Reset ODO	SOT-23	16vdb	VD6	3a Tcs
S0	XC61CN6002M	Vdet-IC	6V±1%, +Reset ODO	SOT-23	16vdb	VD6	3d Tor
S03	XE61CN6045MR	Vdet-IC	6.0V±2%, -Reset ODO	SOT-23	16vdb	VD6	3h Tor
S05	XC61FN6012M	Vdet-IC	6V±2%, +Reset ODO, 200ms	SOT-23	16vdb	VD6	3d Tor
S05	XC61HN6012MR	Vdet-IC	6.0V±2%, -Reset ODO, 50..200ms	SOT-23	16vdb	VD6	3d Tor
S06	XC61FN6042M	Vdet-IC	6V±2%, +Reset ODO, 400ms	SOT-23	16vdb	VD6	3d Tor
S06	XC61HN6042MR	Vdet-IC	6.0V±2%, -Reset ODO, 80..400ms	SOT-23	16vdc	VD6	3d Tor
S07	XC61FN6052M	Vdet-IC	6V±2%, +Reset ODO, 50ms	SOT-23	16vdb	VD6	3d Tor
S07	XC61HN6052MR	Vdet-IC	6.0V±2%, -Reset ODO, 1..50ms	SOT-23	16vdc	VD6	3d Tor
S09	BS809	n-MOSFET-e	D-MOS, Sw, 400V, 100mA, 310mW, <18Ω(100mA), 10/50ns	SOT-23	16fh	-	3a Itt
S1	BBY31	C-diode	VCO, 30V, 20mA, 1.6/16.5pF(28/1V), 1MHz, <1.2Ω	SOT-23	16dc	-	3a Phi
S1	ELM7631HCB	Vdet-IC	3.1V±2%, +Reset PPO, 150ms	SOT-23	16vdc	VD7	3d Elm
S1	ELM9741CBB	Vdet-IC	4.1V±2.5%, +Reset PPO	SOT-23	16vdb	VD7	3d Elm
S1	R3130N44DA	Vdet-IC	4.4V, -Reset PPO, 200ms	SOT-23	16vdc	VD7	3b Ric
S1	SST271	n-FET	AF, LN, 30V, 350mW, Idss=6..50mA, Up<4.5V	SOT-23	16fj	-	3a Six
S1023L	SS10P3CL	Si-diode	Dual SBR, 30V, 5A, Vf<0.52V(5A)	TO-277A	76dg	-	3o Vs
S102CL	SS10P2CL	Si-diode	Dual SBR, 20V, 5A, Vf<0.52V(5A)	TO-277A	76dg	-	3o Vs
S103	SS10P3	Si-diode	SBR, 30V, 10A, Vf<0.56V(10A)	TO-277A	76dh	-	3o Vs
S103C	SS10P3C	Si-diode	Dual SBR, 20V, 5A, Vf<0.53V(5A)	TO-277A	76dg	-	3o Vs
S104	SS10P4	Si-diode	SBR, 40V, 10A, Vf<0.56V(10A)	TO-277A	76dh	-	3o Vs
S1043	SS10P4C	Si-diode	Dual SBR, 30V, 5A, Vf<0.53V(5A)	TO-277A	76dg	-	3o Vs
S105	SS10P5	Si-diode	SBR, 50V, 10A, Vf<0.59V(10A)	TO-277A	76dh	-	3o Vs
S106	SS10P6	Si-diode	SBR, 60V, 10A, Vf<0.59V(10A)	TO-277A	76dh	-	3o Vs
S12	BBY39	C-diode	Dual, Satellite-TV-Tuning, 30V, 20mA, 1.6..2/16.5pF(28/1V)	SOT-23	16dg	-	3a Phi
S122	SS12P2L	Si-diode	SBR, 20V, 12A, Vf<0.56V(10A)	TO-277A	76dh	-	3o Vs
S123	SS12P3L	Si-diode	SBR, 30V, 12A, Vf<0.56V(10A)	TO-277A	76dh	-	3o Vs
S124C	SS12P4C	Si-diode	Dual, SBR, 40V, 6A, Vf<0.52V(10A)	TO-277A	76dc	-	3o Vs
S16	ZHCS1006	Si-diode	Schottky, 60V, 300mA, Vf<0.6V(300mA)	SOT-23	16dc	-	3a Zx
S17	CHT817WPT-S	Si-npn	AF, Sw, 45V, 500mA, B=250..600, 170MHz	SOT-323	16ta	-	3a Chm
S1A	CH3904PT	Si-npn	AF, Sw, 40V, 300mA, B=100..300, 300MHz	SOT-23	16ta	-	3a Chm
s1A	SMBT3904	Si-npn	GP, 60V, 0.1A, 200mW, B= 100..300, >300MHz	SOT-23	16ta	-	3a Sie
s1A	SMBT3904S	Si-npn	GP, 60V, 0.1A, 200mW, B= 100..300, >300MHz	SOT-363	16ta	-	3a Sie
s1B	SMBT2222	Si-npn	GP, 60V, 600mA, 330mW, B=120..360, >300MHz	SOT-23	16ta	-	3a Sie
s1D	SMBTA42	Si-npn	Vid, 300V, 500mA, 1W, B>40, >50MHz	SOT-23	16ta	-	3a Sie
s1D	SMBTA42M	Si-npn	Vid, 300/300V, 200mA, 350mW, B>25, >50MHz	SOT-23	16ta	-	3a Sie
s1E	SMBTA43	Si-npn	Vid, 200/200V, 200mA, 350mW, B>25, >50MHz	SOT-23	16ta	-	3a Sie
s1G	SMBTA06	Si-npn	GP, 80V, 500mA, 350mW, B>100, >100MHz	SOT-23	16ta	-	3a Sie
s1H	SMBTA05	Si-npn	GP, 60V, 500mA, 350mW, B>100, >100MHz	SOT-23	16ta	-	3a Sie
s1K	SMBT6428	Si-npn	GP, 60V, 200mA, 330mW, B=250..650, 200MHz	SOT-23	16ta	-	3a Sie
s1L	SMBT6429	Si-npn	GP, 55V, 200mA, 330mW, B=500..1250, 200MHz	SOT-23	16ta	-	3a Sie
s1M	SMBTA13	Si-npn-Darl	GP, 30V, 300mA, 300mW, B>5000, >125MHz	SOT-23	16ta	-	3a Sie



SMD code	Type	Function	Short description	Case	Pinout	Sch. St.	Mnf.
s1N	SMBTA14	Si-npn-Darl	GP, 30V, 300mA, 300mW, B>10000, >125MHz	SOT-23	16ta -	3a	Sie
S1P	CHT2222APT	Si-npn	AF, Sw, 40V, 600mA, B=100..300, 300MHz	SOT-23	16ta -	3a	Chm
S1P	CHT4401PT	Si-npn	AF, Sw, 40V, 600mA, B=100..300, 250MHz	SOT-23	16ta -	3a	Chm
s1P	MMBT2222A	Si-npn	GP, 75V, 600mA, 330mW, B=100..300, >200MHz	SOT-23	16ta -	3c	Inf
s1P	SMBT2222A	Si-npn	GP, 75V, 600mA, 330mW, B=120..360, >300MHz	SOT-23	16ta -	3c	Inf
s1V	SMBT6427	Si-npn-Darl	AF, 40V, 500mA, 360mW, B=10k..100k, >130MHz	SOT-23	16ta -	3a	Sie
S2	2SA813-2	Si-pnp	GP, 60V, 200mA, 150mW, B=60..120, 200MHz	SOT-23	16ta -	3a	Nec
S2	BBQ31	Si-npn	HF, 30V, 100mA, 330mW, B>20, >600MHz	SOT-23	16ta -	3a	Zx
S2	BFQ31	Si-npn	VHF, 30V, 100mA, 200mW, B>20, >600MHz	SOT-23	16ta -	3a	Zx
S2	BSV35	Si-npn	Fast-Sw, 40V, 500mA, <12/18ns	SOT-323	16te -	3a	Fer
S2	ELM7632HCB	Vdet-IC	3.2V±2%, +Reset PPO, 150ms	SOT-23	16vdc	VD7	3d Elm
S2	ELM9742CBB	Vdet-IC	4.2V±2.5%, +Reset PPO	SOT-23	16vdb	VD7	3d Elm
S2	KTA2014-2	Si-pnp	GP, 50V, 150mA, 100mW, B=70..140, >80MHz	USM	16ta -	3f	Kec
S2	KTA2014E-2	Si-pnp	GP, 50V, 150mA, 100mW, B=70..140, >80MHz	ESM	18ta -	3f	Kec
S2	KTA2014F-2	Si-pnp	GP, 50V, 150mA, 100mW, B=70..140, >80MHz	TFSM	19ta -	3f	Kec
S2	KTA2014V-2	Si-pnp	GP, 50V, 150mA, 100mW, B=70..140, >80MHz	VSM	18ta -	3f	Kec
S2	R3130N26DA3	Vdet-IC	2.6V, -Reset PPO, 200ms	SOT-23	16vdc	VD7	3b Ric
S21	GS810C21EU	Vdet-IC	2.1V, +Reset PPO, 210ms	SOT-23	16vdc	VD7	3g Vs
S24	GS810C24EU	Vdet-IC	2.4V, +Reset PPO, 210ms	SOT-23	16vdc	VD7	3g Vs
S26	GS810CREU	Vdet-IC	2.63V, +Reset PPO, 210ms	SOT-23	16vdc	VD7	3g Vs
S27	GS810C27SEU	Vdet-IC	2.7V, +Reset PPO, 210ms	SOT-23	16vdc	VD7	3g Vs
S28	BS828	n-MOSFET-e	D-MOS, Sw, 240V, 230mA, 310mW, <5.5Ω(100mA), 5/50ns	SOT-23	16fh -	3a	Itt
S29	BS829	p-MOSFET-e	D-MOS, Sw, 400V, 70mA, 350mW, <40Ω(100mA), 10/50ns	SOT-23	16fh -	3a	Itt
S29	GS810CSEU	Vdet-IC	2.93V, +Reset PPO, 210ms	SOT-23	16vdc	VD7	3g Vs
S2A	CH3906PT	Si-pnp	AF, Sw, 40V, 200mA, B=100..300, 250MHz	SOT-23	16ta -	3a	Chm
s2A	SMBT3906	Si-pnp	GP, 40V, 200mA 250MHz, B=100..300	SOT-23	16ta -	3a	Sie
s2A	SMBT3906S	Si-pnp	GP, 40V, 200mA, 330mW, B=100..300, >250MHz	SOT-363	16ta -	3a	Sie
s2C	SMBT470	Si-pnp	GP, 40V, 100mA, 350mW, B=40..100, >125MHz	SOT-23	16ta -	3a	Sie
s2D	SMBTA92	Si-pnp	Vid, 300/300V, 500mA, 330mW, B=25, >50MHz	SOT-23	16ta -	3a	Sie
s2D	SMBTA92M	Si-pnp	Vid, 300/300V, 500mA, 330mW, B=25, >50MHz	SOT-23	16ta -	3a	Sie
s2E	SMBTA93	Si-pnp	Vid, 200/200V, 500mA, 330mW, B=25, >50MHz	SOT-23	16ta -	3a	Sie
s2F	SMBT2907A	Si-pnp	GP, 60V, 500mA, 310mW, B=100..300, >200MHz	SOT-23	16ta -	3a	Sie
s2G	SMBTA56	Si-pnp	AF-Drv, 80V, 500mA, 300mW, B>100, >50MHz	SOT-23	16ta -	3a	Sie
s2G	SMBTA56M	Si-pnp	AF-Drv, 80V, 500mA, 300mW, B>100, >50MHz	SOT-23	16ta -	3a	Sie
s2H	SMBTA55	Si-pnp	AF-Drv, 60V, 500mA, 300mW, B>100, >50MHz	SOT-23	16ta -	3a	Sie
s2P	SMBT5086	Si-pnp	GP, 50V, 50mA, 330mW, B=150..500, >40MHz	SOT-23	16ta -	3a	Sie
s2Q	SMBT5087	Si-pnp	GP, 50V, 50mA, 330mW, B=250..800, >40MHz	SOT-23	16ta -	3a	Sie
s2U	SMBTA63	Si-pnp-Darl	GP, 30V, 500mA, 300mW, B>5000, >125MHz	SOT-23	16ta -	3a	Sie
s2V	SMBTA64	Si-pnp-Darl	GP, 30V, 500mA, 300mW, B>10000, >125MHz	SOT-23	16ta -	3a	Sie
S3	2SA813-3	Si-pnp	GP, 60V, 200mA, 150mW, B=80..160, 200MHz	SOT-23	16ta -	3a	Nec
S3	APX803-46SR	Vdet-IC	4.63V±1.5%, -Reset ODO	SOT-23	16vdb	VD6	3b Di
S3	BBQ31R	Si-npn	HF, 30V, 100mA, 330mW, B>20, >600MHz	SOT-23	16ta -	3a	Zx
S3	BBY51	C-diode	Dual, Tuning, VCO, 7V, 4.5/6.1pF(4/1V)	SOT-23	16dg -	3a	Sie
S3	BSV36	Si-npn	Sw, 15V, 500mA, <20/15ns	SOT-323	16te -	3a	Fer
S3	ELM7633HCB	Vdet-IC	3.3V±2%, +Reset PPO, 150ms	SOT-23	16vdc	VD7	3d Elm
S3	ELM9743CBB	Vdet-IC	4.3V±2.5%, +Reset PPO	SOT-23	16vdb	VD7	3d Elm
S3	R3130N29DA3	Vdet-IC	2.9V, -Reset PPO, 200ms	SOT-23	16vdc	VD7	3b Ric
S30	FP1A4A	Si-pnp-Digi	Sw, 25V, 700mA, 200mW, R2=10k	SC-59	16ta -	3a	Nec
S30	GS810CTEU	Vdet-IC	3.08V, +Reset PPO, 210ms	SOT-23	16vdc	VD7	3g Vs
S31	FP1L2Q	Si-pnp-Digi	Sw, 25V, 700mA, 200mW, R1/R2=0k47/4k7	SC-59	16ta -	3a	Nec
S32	FP1A3M	Si-pnp-Digi	Sw, 25V, 700mA, 200mW, R1/R2=1k/1k	SC-59	16ta -	3a	Nec
S33	FP1F3P	Si-pnp-Digi	Sw, 25V, 700mA, 200mW, R1/R2=2k2/10k	SC-59	16ta -	3a	Nec
S33	SS3P3L	Si-diode	SBR, 30V, 3A, Vf<0.47V(3A)	TO-277A	76dh -	3o	Vs
S34	FP1L3N	Si-pnp-Digi	Sw, 25V, 700mA, 200mW, R1/R2=4k7/10k	SC-59	16ta -	3a	Nec
S34	SS3P4L	Si-diode	SBR, 40V, 3A, Vf<0.47V(3A)	TO-277A	76dh -	3o	Vs
S35	FP1A4M	Si-pnp-Digi	Sw, 30V, 700mA, 200mW, R1/R2=10k/10k	SC-59	16ta -	3a	Nec
S35	FP1L3N	Si-pnp-Digi	Sw, 25V, 700mA, 200mW, R1/R2=10k/10k	SC-59	16ta -	3a	Nec
S35	SS3P5L	Si-diode	SBR, 50V, 3A, Vf<0.54V(3A)	TO-277A	76dh -	3o	Vs
S36	FP1J3P	Si-pnp-Digi	Sw, 25V, 700mA, 200mW, R1/R2=3k3/10k	SC-59	16ta -	3a	Nec
S36	SS3P6L	Si-diode	SBR, 60V, 3A, Vf<0.54V(3A)	TO-277A	76dh -	3o	Vs
S3B	LM809M3-2.63	Vdet-IC	2.63V±1.5%, -Reset PPO	SOT-23	16vdc	VD7	3a Nsc
S4	1PS89SS04	Si-diode	Dual, SBD, U-Sp, 85V, 200mA, <1.5pF	SOT-490	18dl -	3a	Phi
S4	2SA813-4	Si-pnp	GP, 60V, 200mA, 150mW, B=120..240, 200MHz	SOT-23	16ta -	3a	Nec
S4	2SC3361-4	Si-npn	Sw, Hi-Sp, 60V, 150mA, 150mW, 100MHz, B=100..200	SOT-23	16ta -	3a	San
S4	APX803-44SR	Vdet-IC	4.38V±1.5%, -Reset ODO	SOT-23	16vdb	VD6	3b Di
S4	BBQ31A	Si-npn	HF, 30V, 100mA, 330mW, B>100, >600MHz	SOT-23	16ta -	3a	Zx
S4	BFQ31A	Si-npn	VHF, 30V, 100mA, 200mW, B>20, >600MHz	SOT-23	16ta -	3a	Zx
S4	BSV37	Si-pnp	Sw, 12V, 500mA, <60/90ns	SOT-323	16te -	3a	Fer
S4	ELM7634HCB	Vdet-IC	3.4V±2%, +Reset PPO, 150ms	SOT-23	16vdc	VD7	3d Elm
S4	ELM9744CBB	Vdet-IC	4.4V±2.5%, +Reset PPO	SOT-23	16vdb	VD7	3d Elm



SMD code	Type	Function	Short description	Case	Pinout	Sch.	St.	Mnf.
S4	KA4A4L	Si-npn-Digi	Sw, 60V, 100mA, 200mW, R1/R2=10k/4k7	SOT-416	16ta	-	3a	Nec
S4	KTA2014-4	Si-pnp	GP, 50V, 150mA, 100mW, B=120..240, >80MHz	USM	16ta	-	3f	Kec
S4	KTA2014E-4	Si-pnp	GP, 50V, 150mA, 100mW, B=120..240, >80MHz	ESM	18ta	-	3f	Kec
S4	KTA2014F-4	Si-pnp	GP, 50V, 150mA, 100mW, B=120..240, >80MHz	TFSM	19ta	-	3f	Kec
S4	KTA2014V-4	Si-pnp	GP, 50V, 150mA, 100mW, B=120..240, >80MHz	VSM	18ta	-	3f	Kec
S4	R3130N30DA8	Vdet-IC	3V, -Reset PPO, 200ms	SOT-23	16vdc	VD7	3b	Ric
S4	SP809EK-4-0	Vdet-IC	4.0V±1.5%, -Reset PPO	SOT-23	16vdc	VD7	3b	Sip
S4	SST174	p-FET	Sw, 30V, 350mW, Idss=135mA, Rds(on)=85Q, 15/20ns	SOT-23	16fj	-	3a	Six
S40	GS810CJEU	Vdet-IC	4V, +Reset PPO, 210ms	SOT-23	16vdc	VD7	3g	Vs
S43	GS810CMEU	Vdet-IC	4.38V, +Reset PPO, 210ms	SOT-23	16vdc	VD7	3g	Vs
S46	BAR46	Si-diode	SBR, 100V, 150mA, 230mW, Vf<1V(250mA), 10pF	SOT-23	16dc	-	3a	Ste
S46	BAT46	Si-diode	SBD, 100V, 150mA, Vf<1V(250mA), 6pF	SOT-23	16dc	-	3b	Ste
S46	GS810CLEU	Vdet-IC	4.63V, +Reset PPO, 210ms	SOT-23	16vdc	VD7	3g	Vs
S4B	LM809M3-2.93	Vdet-IC	2.93V±1.5%, -Reset PPO	SOT-23	16vdc	VD7	3a	Nsc
S5	1PS89SS05	Si-diode	Dual, SBD, U-Sp, 85V, 200mA, <1.5pF	SOT-490	18dg	-	3a	Phi
S5	2SC3361-5	Si-npn	Sw, Hi-Sp, 60V, 150mA, 150mW, 100MHz, B=140..280	SOT-23	16ta	-	3a	San
S5	APX803-40SR	Vdet-IC	4.0V±1.5%, -Reset ODO	SOT-23	16vdb	VD6	3b	Di
S5	BBQ31AR	Si-npn	HF, 30V, 100mA, 330mW, B>100, >600MHz	SOT-23	16ta	-	3a	Zx
S5	BFQ31AR	Si-npn	VHF, 30V, 100mA, 200mW, B>20, >600MHz	SOT-23	16te	-	3a	Zx
S5	ELM7635HCB	Vdet-IC	3.5V±2%, +Reset PPO, 150ms	SOT-23	16vdc	VD7	3d	Elm
S5	ELM9745CBB	Vdet-IC	4.5V±2.5%, +Reset PPO	SOT-23	16vdb	VD7	3d	Elm
S5	R3130N46DA5	Vdet-IC	4.6V, -Reset PPO, 200ms	SOT-23	16vdc	VD7	3b	Ric
S5	SST175	p-FET	Sw, 30V, 350mW, Idss=70mA, Rds(on)=125Q, 15/20ns	SOT-23	16fj	-	3a	Six
S50	BS850	p-MOSFET-e	D-MOS, Sw, 60V, 250mA, 310mW, <3.5Q(100mA), 5/25ns	SOT-23	16fh	-	3a	lIt
S510	SS5P10	Si-diode	SBR, 100V, 5A, Vf<0.88V(5A)	TO-277A	76dh	-	3o	Vs
S53	SS5P3	Si-diode	SBR, 30V, 5A, Vf<0.52V(5A)	TO-277A	76dh	-	3o	Vs
S54	SS5P4	Si-diode	SBR, 40V, 5A, Vf<0.52V(5A)	TO-277A	76dh	-	3o	Vs
S55	SS5P5	Si-diode	SBR, 50V, 5A, Vf<0.69V(5A)	TO-277A	76dh	-	3o	Vs
S56	SS5P6	Si-diode	SBR, 60V, 5A, Vf<0.69V(5A)	TO-277A	76dh	-	3o	Vs
S56	ZHC5506	Si-diode	Schottky, 60V, 500mA, Vf<0.63V(500mA)	SOT-23	16dc	-	3a	Zx
S59	SS5P9	Si-diode	SBR, 90V, 5A, Vf<0.88V(5A)	TO-277A	76dh	-	3o	Vs
s5A	SMBD6050	Si-diode	Sw, 70V, 250mA, 370mW, Vf<1.1V(100mA), <10ns	SOT-23	16dc	-	3a	Sie
S5B	LM809M3-3.08	Vdet-IC	3.08V±1.5%, -Reset PPO	SOT-23	16vdc	VD7	3a	Nsc
s5B	SMBD6100	Si-diode	Dual, Sw, 70V, 200mA, 250mW, Vf<1.1V(0.1A), <10ns	SOT-23	16dg	-	3a	Sie
s5C	SMBD7000	Si-diode	Dual, Sw, 100V, 200mA, 330mW, Vf<1.1V(0.1A), <15ns	SOT-23	16dl	-	3a	Sie
s5D	MMBD914	Si-diode	Sw, 100V, 250mA, 370mW, Vf<1.25V(150mA), <4ns	SOT-23	16dc	-	3a	Sie
s5D	SMBD914	Si-diode	Sw, 100V, 250mA, 370mW, Vf<1.25V(150mA), <4ns	SOT-23	16dc	-	3a	Sie
S5s	BAT15-05W	Si-diode	Dual, Schottky, DBS-mix, 4V, 100mA, <12GHz, <0.35pF	SOT-323	16dg	-	3c	Inf
S5s	BBY52	C-diode	Dual, VCO-Tuning, 7V, 20mA, 1.4..2.2pF(41V)	SOT-23	16dg	-	3c	Sie
S6	1PS89SS06	Si-diode	Dual, SBD, U-Sp, 85V, 200mA, <2pF	SOT-490	18df	-	3a	Phi
S6	2SC3361-6	Si-npn	Sw, Hi-Sp, 60V, 150mA, 150mW, 100MHz, B=200..400	SOT-23	16ta	-	3a	San
S6	APX803-31SR	Vdet-IC	3.08V±1.5%, -Reset ODO	SOT-23	16vdb	VD6	3b	Di
S6	ELM7635HCB	Vdet-IC	3.6V±2%, +Reset PPO, 150ms	SOT-23	16vdc	VD7	3d	Elm
S6	ELM9746CBB	Vdet-IC	4.6V±2.5%, +Reset PPO	SOT-23	16vdb	VD7	3d	Elm
S6	KTA2014-6	Si-pnp	GP, 50V, 150mA, 100mW, B=200..400, >80MHz	USM	16ta	-	3f	Kec
S6	KTA2014E-6	Si-pnp	GP, 50V, 150mA, 100mW, B=200..400, >80MHz	ESM	18ta	-	3f	Kec
S6	KTA2014F-6	Si-pnp	GP, 50V, 150mA, 100mW, B=200..400, >80MHz	TFSM	19ta	-	3f	Kec
S6	KTA2014V-6	Si-pnp	GP, 50V, 150mA, 100mW, B=200..400, >80MHz	VSM	18ta	-	3f	Kec
S6	SST176	p-FET	Sw, 30V, 350mW, Idss=35mA, Rds(on)=250Q, 15/20ns	SOT-23	16fj	-	3a	Lns
S64C	SS6P4C	Si-diode	Dual, SBR, 40V, 6A, Vf<0.65V(4A)	TO-277A	76dg	-	3o	Vs
S6B	LM809M3-4.00	Vdet-IC	4.0V±1.5%, -Reset PPO	SOT-23	16vdc	VD7	3a	Nsc
S6p	BF510	n-FET	VHF-LN, 2V, 30(3)mA, 250mW, 0.3pF	SOT-23	16fi	-	3a	Phi
S7	1PS89SB74	Si-diode	Dual, SBD, U-Sp, 70V, 70mA, <2pF	SOT-490	18dl	-	3a	Phi
S7	APX803-29SR	Vdet-IC	2.93V±1.5%, -Reset ODO	SOT-23	16vdb	VD6	3b	Di
S7	ELM7637HCB	Vdet-IC	3.7V±2%, +Reset PPO, 150ms	SOT-23	16vdc	VD7	3d	Elm
S7	ELM9747CBB	Vdet-IC	4.7V±2.5%, +Reset PPO	SOT-23	16vdb	VD7	3d	Elm
S7	KN4A4L	Si-pnp-Digi	Sw, 60V, 100mA, 150mW, R1/R2=10k/4k7	SOT-416	16ta	-	3a	Nec
S7	SST177	p-FET	Sw, 30V, 350mW, Idss=20mA, Rds(on)=300Q, 15/20ns	SOT-23	16fj	-	3a	Six
S70	BS870	n-MOSFET-e	D-MOS, Sw, 60V, 250mA, 310mW, <3.5Q(100mA), 5/25ns	SOT-23	16fh	-	3a	lIt
S72	2N7002	n-MOSFET-e	TMOS, 60V, 250mA, 310mW, <7.5Q(500mA), 5/25ns	SOT-23	16fh	-	3a	lIt
S76	SST176	p-FET	Sw, 30V, 350mW, Idss=35mA, Rds(on)=250Q, 15/20ns	SOT-23	16fj	-	3a	Lns
S76	ZHC5756	Si-diode	Schottky, 60V, 750mA, Vf<0.61V(750mA)	SOT-23	16dc	-	3a	Zx
S77	SST177	p-FET	Sw, 30V, 350mW, Idss=20mA, Rds(on)=300Q, 15/20ns	SOT-23	16fj	-	3a	Lns
S7B	LM809M3-4.38	Vdet-IC	4.38V±1.5%, -Reset PPO	SOT-23	16vdc	VD7	3a	Nsc
S7p	BF511	n-FET	VHF-LN, 2V, 30(7)mA, 250mW, 0.3pF	SOT-23	16fi	-	3a	Phi
S7s	BBY53	C-diode	Dual, VCO-Tuning, 6V, 20mA, 3.1..5.8pF(3.1V)	SOT-23	16dg	-	3c	Sie
S7s	BBY53-05W	C-diode	Dual, VCO-Tuning, 6V, 20mA, 3.1..5.8pF(3.1V)	SOT-323	16dg	-	3c	Sie
S8	APX803-26SR	Vdet-IC	2.63V±1.5%, -Reset ODO	SOT-23	16vdb	VD6	3b	Di
S8	ELM7638HCB	Vdet-IC	3.8V±2%, +Reset PPO, 150ms	SOT-23	16vdc	VD7	3d	Elm
S8	ELM9748CBB	Vdet-IC	4.8V±2.5%, +Reset PPO	SOT-23	16vdb	VD7	3d	Elm



SMD code	Type	Function	Short description	Case	Pinout	Sch.	St.	Mnf.
S809J*	EC49809JB-F	Vdet-IC	4.0V±1.5%, -Reset PPO	SOT-23	16vdc	VD7	3b	Ecm
S809J*	S809JS	Vdet-IC	4.0V±1.5%, -Reset PPO	SOT-23	16vdc	VD7	3b	Sew
S809L*	EC49809LB-F	Vdet-IC	4.63V±1.5%, -Reset PPO	SOT-23	16vdc	VD7	3b	Ecm
S809L*	S809LS	Vdet-IC	4.63V±1.5%, -Reset PPO	SOT-23	16vdc	VD7	3b	Sew
S809M*	EC49809MB-F	Vdet-IC	4.38V±1.5%, -Reset PPO	SOT-23	16vdc	VD7	3b	Ecm
S809M*	S809MS	Vdet-IC	4.38V±1.5%, -Reset PPO	SOT-23	16vdc	VD7	3b	Sew
S809R*	EC49809RB-F	Vdet-IC	2.63V±1.5%, -Reset PPO	SOT-23	16vdc	VD7	3b	Ecm
S809R*	S809RS	Vdet-IC	2.63V±1.5%, -Reset PPO	SOT-23	16vdc	VD7	3b	Sew
S809S*	EC49809SB-F	Vdet-IC	2.93V±1.5%, -Reset PPO	SOT-23	16vdc	VD7	3b	Ecm
S809S*	S809SS	Vdet-IC	2.93V±1.5%, -Reset PPO	SOT-23	16vdc	VD7	3b	Sew
S809T*	EC49809TB-F	Vdet-IC	3.08V±1.5%, -Reset PPO	SOT-23	16vdc	VD7	3b	Ecm
S809T*	S809TS	Vdet-IC	3.08V±1.5%, -Reset PPO	SOT-23	16vdc	VD7	3b	Sew
S82	SS8P2L	Si-diode	SBR, 20V, 8A, Vf<0.57V(8A)	TO-277A	76dh	-	3o	Vs
S82CL	SS8P2CL	Si-diode	Dual, SBR, 20V, 4A, Vf<0.54V(4A)	TO-277A	76dg	-	3o	Vs
S83	SS8P3L	Si-diode	SBR, 30V, 8A, Vf<0.57V(8A)	TO-277A	76dh	-	3o	Vs
S83C	SS8P3C	Si-diode	Dual, SBR, 30V, 4A, Vf<0.58V(4A)	TO-277A	76dg	-	3o	Vs
S83CL	SS8P3CL	Si-diode	Dual, SBR, 30V, 4A, Vf<0.54V(4A)	TO-277A	76dg	-	3o	Vs
S84C	SS8P4C	Si-diode	Dual, SBR, 40V, 4A, Vf<0.58V(4A)	TO-277A	76dh	-	3o	Vs
S85C	SS8P5C	Si-diode	Dual, SBR, 50V, 4A, Vf<0.7V(4A)	TO-277A	76dg	-	3o	Vs
S86C	SS8P6C	Si-diode	Dual, SBR, 60V, 4A, Vf<0.7V(4A)	TO-277A	76dg	-	3o	Vs
S8B	LM809M3-4.63	Vdet-IC	4.63V±1.5%, -Reset PPO	SOT-23	16vdc	VD7	3a	Nsc
S8p	BF512	n-FET	VHF-LN, 2V, 30(12)mA, 250mW, 0.3pF	SOT-23	16fi	-	3a	Phi
S8s	BAT15-04W	Si-diode	Dual, Schottky, DBS-mix, 4V, 100mA, <12GHz, <0.35pF	SOT-323	16dl	-	3c	Inf
S9	1S5394	Si-diode	Schottky, 10V, 100mA	SC-59	16dc	-	3a	Tos
S9	1S5395	Si-diode	Schottky, 10V, 100mA	SOT-323	16dc	-	3a	Tos
S9	APX803-23SR	Vdet-IC	2.25V±1.5%, -Reset ODO	SOT-23	16vdb	VD6	3b	Di
S9	ELM7639HCB	Vdet-IC	3.9V±2%, +Reset PPO, 150ms	SOT-23	16vdc	VD7	3d	Elm
S9	ELM9749CBB	Vdet-IC	4.9V±2.5%, +Reset PPO	SOT-23	16vdc	VD7	3d	Elm
S9B	LM810M3-2.63	Vdet-IC	2.63V±1.5%, +Reset PPO	SOT-23	16vdc	VD7	3a	Nsc
S9p	BF513	n-FET	VHF-LN, 2V, 30(18)mA, 250mW, 0.3pF	SOT-23	16fi	-	3a	Phi
SA	ASM809LEUR	Vdet-IC	4.63V±1.5%, -Reset PPO	SOT-23	16vdc	VD7	3d	Ali
SA	BSS123	n-MOSFET-e	V-MOS, LogL, 100V, 0.17A, 200mW, <6Q, 10/22ns	SOT-23	16fh	-	3a	Ons
-SA	BSS123	n-MOSFET-e	V-MOS, LogL, 100V, 0.17A, 200mW, <6Q, 10/22ns	SOT-23	16fh	-	3a	Zx
sA2	SMBD2836	Si-diode	Dual, Sw, 50V, 200mA, 250mW, Vf<1.2V(100mA), <6ns	SOT-23	16df	-	3a	Sie
sA3	SMBD2835	Si-diode	Dual, Sw, 30V, 200mA, 250mW, Vf<1.2V(100mA), <6ns	SOT-23	16df	-	3a	Sie
sA4	SMBD2838	Si-diode	Dual, Sw, 50V, 200mA, 250mW, Vf<1.2V(100mA), <6ns	SOT-23	16dg	-	3a	Sie
sA5	SMBD2837	Si-diode	Dual, Sw, 30V, 200mA, 250mW, Vf<1.2V(100mA), <6ns	SOT-23	16dg	-	3a	Sie
SAA	BC848A	Si-npn	GP, 30V, 100mA, 200mW, B=110..220, >300MHz	SOT-23	16ta	-	3a	Auk
SAA	BC848FA	Si-npn	GP, 30V, 100mA, 200mW, B=110..220, 150MHz	SOT-23F	18ta	-	3a	Auk
SAA	MAX809SN160	Vdet-IC	1.6V±1.5%, -Reset PPO	SOT-23	16vdc	VD7	3a	Ons
SAA	MAX809SN160T1	Vdet-IC	1.60V±1.5%, -Reset PPO	SOT-23	16vdc	VD7	3b	Ons
SAA	S-1206B12-M3T1G	LVR-IC	LDO, 1.2V±15mV, 250mA	SOT-23	16eu	VR1	3d	Sii
-SAA	BSS123A	n-MOSFET-e	V-MOS, LogL, 100V, 0.17A, 360mW, <6Q, 10/15ns	SOT-23	16fh	-	3a	Zx
SAB	BC848B	Si-npn	GP, 30V, 100mA, 200mW, B=200..450, 250MHz	SOT-23	16ta	-	3a	Auk
SAB	BC848FB	Si-npn	GP, 30V, 100mA, 200mW, B=200.450, 150MHz	SOT-23F	16ta	-	3a	Auk
SAB	LM810M3-2.93	Vdet-IC	2.93V±1.5%, +Reset PPO	SOT-23	16vdc	VD7	3a	Nsc
SAB	S-1206B13-M3T1G	LVR-IC	LDO, 1.3V±15mV, 250mA	SOT-23	16eu	VR1	3d	Sii
SAC	BC848C	Si-npn	GP, 30V, 100mA, 200mW, B=420..800, 250MHz	SOT-23	16ta	-	3a	Auk
SAC	BC848FC	Si-npn	GP, 30V, 100mA, 200mW, B=420..800, 150MHz	SOT-23F	16ta	-	3a	Auk
SAC	S-1206B14-M3T1G	LVR-IC	LDO, 1.4V±15mV, 250mA	SOT-23	16eu	VR1	3d	Sii
SAD	S-1206B15-M3T1G	LVR-IC	LDO, 1.5V±1.0%, 250mA	SOT-23	16eu	VR1	3d	Sii
SAE	S-1206B16-M3T1G	LVR-IC	LDO, 1.6V±1.0%, 250mA	SOT-23	16eu	VR1	3d	Sii
SAF	S-1206B17-M3T1G	LVR-IC	LDO, 1.7V±1.0%, 250mA	SOT-23	16eu	VR1	3d	Sii
SAG	S-1206B18-M3T1G	LVR-IC	LDO, 1.8V±1.0%, 250mA	SOT-23	16eu	VR1	3d	Sii
SAH	S-1206B1J-M3T1G	LVR-IC	LDO, 1.85V±1.0%, 250mA	SOT-23	16eu	VR1	3d	Sii
SAI	S-1206B19-M3T1G	LVR-IC	LDO, 1.9V±1.0%, 250mA	SOT-23	16eu	VR1	3d	Sii
SAJ	S-1206B20-M3T1G	LVR-IC	LDO, 2.0V±1.0%, 250mA	SOT-23	16eu	VR1	3d	Sii
SAK	S-1206B21-M3T1G	LVR-IC	LDO, 2.1V±1.0%, 250mA	SOT-23	16eu	VR1	3d	Sii
SAL	S-1206B22-M3T1G	LVR-IC	LDO, 2.2V±1.0%, 250mA	SOT-23	16eu	VR1	3d	Sii
SAM	S-1206B23-M3T1G	LVR-IC	LDO, 2.3V±1.0%, 250mA	SOT-23	16eu	VR1	3d	Sii
SAN	S-1206B24-M3T1G	LVR-IC	LDO, 2.4V±1.0%, 250mA	SOT-23	16eu	VR1	3d	Sii
SAO	S-1206B25-M3T1G	LVR-IC	LDO, 2.5V±1.0%, 250mA	SOT-23	16eu	VR1	3d	Sii
SAP	S-1206B26-M3T1G	LVR-IC	LDO, 2.6V±1.0%, 250mA	SOT-23	16eu	VR1	3d	Sii
SAQ	S-1206B27-M3T1G	LVR-IC	LDO, 2.7V±1.0%, 250mA	SOT-23	16eu	VR1	3d	Sii
SAR	KTA1531T-R	Si-pnp	AF, 20V, 1A, 900mW, B=120..240 >180MHz	TSM	16ta	-	3f	Kec
SAR	S-1206B28-M3T1G	LVR-IC	LDO, 2.8V±1.0%, 250mA	SOT-23	16eu	VR1	3d	Sii
SAS	KTA1531T-S	Si-pnp	AF, 20V, 1A, 900mW, B=150..300 >180MHz	TSM	16ta	-	3f	Kec
SAS	S-1206B2J-M3T1G	LVR-IC	LDO, 2.85V±1.0%, 250mA	SOT-23	16eu	VR1	3d	Sii
SAT	KTA1531T-T	Si-pnp	AF, 20V, 1A, 900mW, B=120..240 >180MHz	TSM	16ta	-	3f	Kec
SAT	S-1206B29-M3T1G	LVR-IC	LDO, 2.9V±1.0%, 250mA	SOT-23	16eu	VR1	3d	Sii



SMD code	Type	Function	Short description	Case	Pinout	Sch.	St.	Mnf.
SAU	S-1206B30-M3T1G	LVR-IC	LDO, 3.0V±1.0%, 250mA	SOT-23	16eu	VR1	3d	Sii
SAV	S-1206B31-M3T1G	LVR-IC	LDO, 3.1V±1.0%, 250mA	SOT-23	16eu	VR1	3d	Sii
SAW	S-1206B32-M3T1G	LVR-IC	LDO, 3.2V±1.0%, 250mA	SOT-23	16eu	VR1	3d	Sii
SAX	S-1206B33-M3T1G	LVR-IC	LDO, 3.3V±1.0%, 250mA	SOT-23	16eu	VR1	3d	Sii
SAY	S-1206B34-M3T1G	LVR-IC	LDO, 3.4V±1.0%, 250mA	SOT-23	16eu	VR1	3d	Sii
SAZ	S-1206B35-M3T1G	LVR-IC	LDO, 3.5V±1.0%, 250mA	SOT-23	16eu	VR1	3d	Sii
SB	2SA1121-B	Si-pnp	GP, AF, 35V, 500mA, 150mW, B=60..120	SOT-23	16ta	-	3a	Ren
SB	ASM809MEUR	Vdet-IC	4.38V±1.5%, -Reset PPO	SOT-23	16vdc	VD7	3d	Ali
SB	KTA1532T	Si-pnp	AF, 20V, 1A, 900mW, B=200..560 >210MHz	TSM	16ta	-	3f	Kec
SB	SMBT2222	Si-npn	GP, 60V, 600mA, 330mW, B=120..360, >300MHz	SOT-23	16ta	-	3a	Sie
SBA	S-1206B36-M3T1G	LVR-IC	LDO, 3.6V±1.0%, 250mA	SOT-23	16eu	VR1	3d	Sii
SBB	LM810M3-3.08	Vdet-IC	3.08V±1.5%, +Reset PPO	SOT-23	16vdc	VD7	3a	Nsc
SBB	S-1206B37-M3T1G	LVR-IC	LDO, 3.7V±1.0%, 250mA	SOT-23	16eu	VR1	3d	Sii
SBC	BC847C	Si-npn	GP, 50V, 100mA, 30mW, B=420..800, >300MHz	SOT-23	16ta	-	3a	Sam
SBC	S-1206B38-M3T1G	LVR-IC	LDO, 3.8V±1.0%, 250mA	SOT-23	16eu	VR1	3d	Sii
SBD	MAX809HTR	Vdet-IC	4.55V±1.5%, -Reset PPO	SOT-23	16vdc	VD7	3b	Ons
SBD	S-1206B39-M3T1G	LVR-IC	LDO, 3.9V±1.0%, 250mA	SOT-23	16eu	VR1	3d	Sii
SBE	S-1206B40-M3T1G	LVR-IC	LDO, 4.0V±1.0%, 250mA	SOT-23	16eu	VR1	3d	Sii
SBF	S-1206B41-M3T1G	LVR-IC	LDO, 4.1V±1.0%, 250mA	SOT-23	16eu	VR1	3d	Sii
SBG	S-1206B42-M3T1G	LVR-IC	LDO, 4.2V±1.0%, 250mA	SOT-23	16eu	VR1	3d	Sii
SBH	MAX809SN490	Vdet-IC	4.9V±1.5%, -Reset PPO	SOT-23	16vdc	VD7	3a	Ons
SBH	MAX809SN490T1	Vdet-IC	4.9V±1.5%, -Reset PPO	SOT-23	16vdc	VD7	3b	Ons
SBH	S-1206B43-M3T1G	LVR-IC	LDO, 4.3V±1.0%, 250mA	SOT-23	16eu	VR1	3d	Sii
SBI	S-1206B44-M3T1G	LVR-IC	LDO, 4.4V±1.0%, 250mA	SOT-23	16eu	VR1	3d	Sii
SBJ	S-1206B45-M3T1G	LVR-IC	LDO, 4.5V±1.0%, 250mA	SOT-23	16eu	VR1	3d	Sii
SBK	S-1206B46-M3T1G	LVR-IC	LDO, 4.6V±1.0%, 250mA	SOT-23	16eu	VR1	3d	Sii
SBL	S-1206B47-M3T1G	LVR-IC	LDO, 4.7V±1.0%, 250mA	SOT-23	16eu	VR1	3d	Sii
SBM	S-1206B48-M3T1G	LVR-IC	LDO, 4.8V±1.0%, 250mA	SOT-23	16eu	VR1	3d	Sii
SBN	S-1206B49-M3T1G	LVR-IC	LDO, 4.9V±1.0%, 250mA	SOT-23	16eu	VR1	3d	Sii
SBO	S-1206B50-M3T1G	LVR-IC	LDO, 5.0V±1.0%, 250mA	SOT-23	16eu	VR1	3d	Sii
SBP	S-1206B51-M3T1G	LVR-IC	LDO, 5.1V±1.0%, 250mA	SOT-23	16eu	VR1	3d	Sii
SBQ	S-1206B52-M3T1G	LVR-IC	LDO, 5.2V±1.0%, 250mA	SOT-23	16eu	VR1	3d	Sii
SBs	BSS145	n-MOSFET-e*	V-MOS, 65V, 220mA, <3.5Ω, 11/27ns	SOT-23	16fh	-	3a	Sie
SC	2SA1121-C	Si-pnp	GP, AF, 35V, 500mA, 150mW, B=100..200	SOT-23	16ta	-	3a	Ren
SC	ASM809EUR	Vdet-IC	4.0V±1.5%, -Reset PPO	SOT-23	16vdc	VD7	3d	Ali
sc	PT7M7803JT	Vdet-IC	4.0V±1.5%, -Reset ODO	SOT-23	16vdc	VD7	3b	Pti
sc	PT7M7803JTE	Vdet-IC	4.0V±1.5%, -Reset ODO, Lead free	SOT-23	16vdc	VD7	3b	Pti
SC	SMBT2222A	Si-npn	GP, 75V, 600mA, 330mW, B=120..360, >300MHz	SOT-23	16ta	-	3a	Sie
sC3	SMBT4126	Si-pnp	GP, 25V, 200mA, 350mW, B=120..360, >250MHz	SOT-23	16ta	-	3c	Inf
SCB	LM810M3-4.00	Vdet-IC	4.0V±1.5%, +Reset PPO	SOT-23	16vdc	VD7	3a	Nsc
SCQ	NCP803SN160T1	Vdet-IC	1.60V±1.5%, -Reset ODO	SOT-23	16vdc	VD6	3b	Ons
SD	2SA1121-D	Si-pnp	GP, AF, 35V, 500mA, 150mW, B=160..320	SOT-23	16ta	-	3a	Ren
SD	ASM809TEUR	Vdet-IC	3.08V±1.5%, -Reset PPO	SOT-23	16vdc	VD7	3d	Ali
SD	BSS145	n-MOSFET-e*	V-MOS, 65V, 220mA, <3.5Ω, 11/27ns	SOT-23	16fh	-	3a	Sie
SD	BSS284	p-MOSFET-e	V-MOS, LogL, 50V, 130mA, 19/30ns	SOT-23	16fh	-	3a	Sie
SD	SMBT2907	Si-pnp	GP, 40V, 500mA, 310mW, B=100..300, >200MHz	SOT-23	16ta	-	3a	Sie
SDB	LM810M3-4.38	Vdet-IC	4.38V±1.5%, +Reset PPO	SOT-23	16vdc	VD7	3a	Nsc
Sds	BSS284	p-MOSFET-e	V-MOS, LogL, 50V, 130mA, 19/30ns	SOT-23	16fh	-	3a	Sie
SE	ASM809SEUR	Vdet-IC	2.93V±1.5%, -Reset PPO	SOT-23	16vdc	VD7	3d	Ali
se	PT7M7810JT	Vdet-IC	4.0V±1.5%, +Reset PPO	SOT-23	16vdc	VD7	3b	Pti
se	PT7M7810JTE	Vdet-IC	4.0V±1.5%, +Reset PPO, Lead free	SOT-23	16vdc	VD7	3b	Pti
SE	SMBT2907A	Si-pnp	GP, 60V, 500mA, 310mW, B=100..300, >200MHz	SOT-23	16ta	-	3a	Sie
SEB	LM810M3-4.63	Vdet-IC	4.63V±1.5%, +Reset PPO	SOT-23	16vdc	VD7	3a	Nsc
SEs	BSS159	n-MOSFET-d	V-MOS, 50V, 160mA, <8Ω(70mA)	SOT-23	16fh	-	3a	Sie
SF	ASM809REUR	Vdet-IC	2.63V±1.5%, -Reset PPO	SOT-23	16vdc	VD7	3d	Ali
SF	SBMTA13	Si-npn-Darl	GP, 30V, 300mA, 300mW, B=5000, >125MHz	SOT-23	16ta	-	3a	Sie
SF0	BB804-0	C-diode	Dual, VHF, 18V, 50mA, 42/43.5pF	SOT-23	16dg	-	3a	Sie
SF0	BB804F0	C-diode	Dual, 18V, <50mA, Rs<0.2Ω, 42/43.pF	SOT-23	16dg	-	3a	Sie
SF1	BB804-1	C-diode	Dual, VHF, 18V, 50mA, 43/44.5pF	SOT-23	16dg	-	3a	Sie
SF1	BB804F1	C-diode	Dual, 18V, <50mA, 43/44.5pF	SOT-23	16dg	-	3a	Sie
SF2	BB804-2	C-diode	Dual, VHF, 18V, 50mA, 44/45.5pF	SOT-23	16dg	-	3a	Sie
SF2	BB804F2	C-diode	Dual, 18V, <50mA, 44/45.5pF	SOT-23	16dg	-	3a	Sie
SF2	BB804W	C-diode	Dual, VHF, 18V, 50mA, 45/26pF	SOT-23	16dg	-	3a	Phi
SF3	BB804-3	C-diode	Dual, VHF, 18V, 50mA, 45/46.5pF	SOT-23	16dg	-	3a	Sie
SF3	BB804F3	C-diode	Dual, 18V, <50mA, 45/46.5pF	SOT-23	16dg	-	3a	Sie
SF4	BB804-4	C-diode	Dual, VHF, 18V, 50mA, 46/47.5pF	SOT-23	16dg	-	3a	Sie
SF4	BB804F4	C-diode	Dual, 18V, <50mA, 46/47.5pF	SOT-23	16dg	-	3a	Sie
SF5	BB804	C-diode	Dual, VHF, 18V, 50mA, 45/26pF	SOT-23	16dg	-	3a	Phi
SFB	LM809M3-2.45	Vdet-IC	2.45V±1.5%, -Reset PPO	SOT-23	16vdc	VD7	3a	Nsc
SFs	BB804	C-diode	Dual, VHF, 18V, 50mA, 42/43.5pF	SOT-23	16dg	-	3a	Sie



SMD code	Type	Function	Short description	Case	Pinout	Sch.	St.	Mnf.
SFs	BSS169	n-MOSFET-d	V-MOS, 100V, 120mA, <12Q(0.5A)	SOT-23	16fh	-	3a	Sie
SG	2SA1162-GR	Si-pnp	GP, AF, 50V, 150mA, 150mW, B=200..400, >80MHz	SOT-23	16ta	-	3a	Tos
SG	2SA1586-GR	Si-pnp	GP, AF, 50V, 150mA, 100mW, B=200..400, >70MHz	SOT-323	16ta	-	3a	Tos
SG	2SA1832FT-GR	Si-pnp	GP, 50V, 150mA, 100mW, B=200..400, 80MHz	TESM	18ta	-	3a	Tos
SG	ASM810LEUR	Vdet-IC	4.63V±1.5%, +Reset PPO	SOT-23	16vdc	VD7	3d	Ali
SG	SMBA14	Si-npn-Darl	GP, 30V, 300mA, 300mW, B>10000, >125MHz	SOT-23	16ta	-	3a	Sie
SGB	MCP810M3-2.63	Vdet-IC	2.63V±1.5%, +Reset PPO	SOT-23	16vda	VD7	3a	Nsc
SGR	KTA2014E-GR	Si-pnp	AF, Sw, 50V, 150mA, 100mW, B=200..400, >80MHz	ESM	18ta	-	3f	Kec
SGR	KTA2014F-GR	Si-pnp	AF, Sw, 50V, 150mA, 100mW, B=200..400, >80MHz	TFSM	19ta	-	3f	Kec
SGR	KTA2014-GR	Si-pnp	AF, Sw, 50V, 150mA, 100mW, B=200..400, >80MHz	USM	16ta	-	3f	Kec
SGR	KTA2014V-GR	Si-pnp	AF, Sw, 50V, 150mA, 100mW, B=200..400, >80MHz	VSM	18ta	-	3f	Kec
SH	ASM810MEUR	Vdet-IC	4.238V±1.5%, +Reset PPO	SOT-23	16vdc	VD7	3d	Ali
SH	BSS119	n-MOSFET-e	V-MOS, 100V, 0.17A, <6Q, 9/24ns	SOT-23	16fh	-	3a	Sie
SH1	BB814	C-diode	Dual, FM/VHF, 18V, 50mA, 21.9/43pF(8V..2V, 1MHz)	SOT-23	16dg	-	3c	Inf
SH1	BB814H1	C-diode	Dual, 18V, <50mA, 43/45pF	SOT-23	16dg	-	3a	Sie
SH2	BB814	C-diode	Dual, FM/VHF, 18V, 50mA, 22.7/44.5pF(8V..2V, 1MHz)	SOT-23	16dg	-	3c	Inf
SH2	BB814H2	C-diode	Dual, 18V, <50mA, 44.5/46.5pF	SOT-23	16dg	-	3a	Sie
SHB	MCP810M3-2.93	Vdet-IC	2.93V±1.5%, +Reset PPO	SOT-23	16vda	VD7	3a	Nsc
SI	ASM810JEUR	Vdet-IC	4.0V±1.5%, +Reset PPO	SOT-23	16vdc	VD7	3d	Ali
SJ	1N5817	Si-diode	SBR, 20V, 1A, Vf<0.45V(1A), 120pF	SOT-23	16dc	-	3a	Trs
SJ	ASM810TEUR	Vdet-IC	3.08V±1.5%, +Reset PPO	SOT-23	16vdc	VD7	3d	Ali
SJ	MCP120-270I	Vdet-IC	2.62V, -Reset ODO	SOT-23	16vdb	VD6	3a	Mcc
SJ	MCP120T-270I	Vdet-IC	2.62V, -Reset ODO	SOT-23	16vdb	VD6	3a	Mcc
SJ	SMBA29	Si-pnp	Vid, 300/300V, 500mA, 330mW, B=25, >50MHz	SOT-23	16ta	-	3a	Sie
SJB	MCP810M3-3.08	Vdet-IC	3.08V±1.5%, +Reset PPO	SOT-23	16vda	VD7	3a	Nsc
SK	ASM810SEUR	Vdet-IC	2.93V±1.5%, +Reset PPO	SOT-23	16vdc	VD7	3d	Ali
SK	MCP120-300I	Vdet-IC	2.92V, -Reset ODO	SOT-23	16vdb	VD6	3a	Mcc
SK	MCP120T-300I	Vdet-IC	2.92V, -Reset ODO	SOT-23	16vdb	VD6	3a	Mcc
SK	SMBA93	Si-pnp	Vid, 200/200V, 500mA, 330mW, B=25, >50MHz	SOT-23	16ta	-	3a	Sie
SKB	MCP810M3-4.00	Vdet-IC	4.0V±1.5%, +Reset PPO	SOT-23	16vda	VD7	3a	Nsc
SKs	BSS138N	n-MOSFET-e*	SIPMOS, LogL, 60V, 220mA, 360mW, 3.5Q(220mA), 5/12ns	SOT-23	16fh	-	3c	Inf
SL	1N5819	Si-diode	SBR, 40V, 1A, Vf<0.6V(1A), 120pF	SOT-23	16dc	-	3a	Trs
SL	2SA1571	Si-pnp-Digi	Sw, 50V, 100mA, 200mW, 200MHz, R1=47k	SOT-23	16ta	-	3a	San
SL	ASM810REUR	Vdet-IC	2.63V±1.5%, +Reset PPO	SOT-23	16vdc	VD7	3d	Ali
SL	MCP120-315I	Vdet-IC	3.07V, -Reset ODO	SOT-23	16vdb	VD6	3a	Mcc
SL	MCP120T-315I	Vdet-IC	3.07V, -Reset ODO	SOT-23	16vdb	VD6	3a	Mcc
SL	SMBA42	Si-npn	Vid, 300V, 500mA, 1W, B>40, >50MHz	SOT-23	16ta	-	3a	Sie
SLB	MCP810M3-4.38	Vdet-IC	4.38V±1.5%, +Reset PPO	SOT-23	16vda	VD7	3a	Nsc
SLN	ELM7538CEB	Vdet-IC	3.8V±2%, +Reset PPO	SC-70	16vdb	VD7	3d	Elm
SLN	ELM7538NEB	Vdet-IC	3.8V±2%, +Reset ODO	SC-70	16vdb	VD6	3d	Elm
SM	2SC3082K-M	Si-npn	AF, 30V, 50mA, 200mW, B=39..82, >110MHz	SOT-346	16ta	-	3a	Rhm
SM	2SC4100-M	Si-npn	AF, 30V, 50mA, 200mW, B=39..82, >110MHz	SOT-323	16ta	-	3a	Rhm
SM	2SC4619-M	Si-npn	HF-Amp, 30V, 50mA, 150mW, B=39..82, 110MHz	SOT-416	16ta	-	3a	Rhm
SM	BB914	C-diode	Dual, FM-Tuning, 20V, 42.5/45pF(8/2V)	SOT-23	16dg	-	3a	Sie
SM	MCP120-450I	Vdet-IC	4.37V, -Reset ODO	SOT-23	16vdb	VD6	3a	Mcc
SM	MCP120T-450I	Vdet-IC	4.37V, -Reset ODO	SOT-23	16vdb	VD6	3a	Mcc
SM	SDMP0340LT	Si-diode	Schottky, Sw, 40V, 200mA, 150mW, 2pF	SOT-523	16dc	-	3b	Di
SM	SMBA43	Si-npn	Vid, 200/200V, 200mA, 350mW, B>25, >50MHz	SOT-23	16ta	-	3a	Sie
SMs	BB914	C-diode	Dual, FM-Tuning, 20V, 42.5/45pF(8/2V)	SOT-23	16dg	-	3a	Sie
SN	2SC3082K-N	Si-npn	AF, 30V, 50mA, 200mW, B=56..120, >110MHz	SOT-346	16ta	-	3a	Rhm
SN	2SC4100-N	Si-npn	AF, 30V, 50mA, 200mW, B=56..120, >110MHz	SOT-323	16ta	-	3a	Rhm
SN	2SC4619-N	Si-npn	GP, 30V, 50mA, 150mW, B=56..120, 110MHz	SOT-416	16ta	-	3a	Rhm
SN	MCP120-460I	Vdet-IC	4.47V, -Reset ODO	SOT-23	16vdb	VD6	3a	Mcc
SN	MCP120T-460I	Vdet-IC	4.47V, -Reset ODO	SOT-23	16vdb	VD6	3a	Mcc
SN	SDMP0340LST	Si-diode	2x Schottky, Sw, 40V, 200mA, 150mW, 2pF	SOT-523	16dl	-	3b	Di
SN	SMBT3904	Si-npn	GP, 60V, 0.1A, 200mW, B=100..300, >300MHz	SOT-23	16ta	-	3a	Sie
SNB	MCP810M3-4.63	Vdet-IC	4.63V±1.5%, +Reset PPO	SOT-23	16vda	VD7	3a	Nsc
SO	2SA1162-O	Si-pnp	GP, AF, 50V, 150mA, 150mW, B=70..140, >80MHz	SOT-23	16ta	-	3a	Tos
SO	2SA1586-O	Si-pnp	GP, AF, 50V, 150mA, 100mW, B=70..140, >70MHz	SOT-323	16ta	-	3a	Tos
SO	KTA2014E-O	Si-pnp	AF, Sw, 50V, 150mA, 100mW, B=70..140, >80MHz	ESM	18ta	-	3f	Kec
SO	KTA2014F-O	Si-pnp	AF, Sw, 50V, 150mA, 100mW, B=70..140, >80MHz	TFSM	19ta	-	3f	Kec
SO	KTA2014-O	Si-pnp	AF, Sw, 50V, 150mA, 100mW, B=70..140, >80MHz	USM	16ta	-	3f	Kec
SO	KTA2014V-O	Si-pnp	AF, Sw, 50V, 150mA, 100mW, B=70..140, >80MHz	VSM	18ta	-	3f	Kec
SO	MCP120-475I	Vdet-IC	4.62V, -Reset ODO	SOT-23	16vdb	VD6	3a	Mcc
SO	MCP120T-475I	Vdet-IC	4.62V, -Reset ODO	SOT-23	16vdb	VD6	3a	Mcc
SO	SMBT3906	Si-pnp	GP, 40V, 200mA 250MHz, B=100..300	SOT-23	16ta	-	3a	Sie
SP	2SC3082K-P	Si-npn	AF, 30V, 50mA, 200mW, B=82..180, >110MHz	SOT-346	16ta	-	3a	Rhm
SP	2SC4100-P	Si-npn	AF, 30V, 50mA, 200mW, B=82..180, >110MHz	SOT-323	16ta	-	3a	Rhm
SP	2SC4619-P	Si-npn	GP, 30V, 50mA, 150mW, B=82..180, 110MHz	SOT-416	16ta	-	3a	Rhm
SP	BSS84	p-MOSFET-e*	V-MOS, LogL, 50V, 130mA, 250mW, <10Q(130mA), 3/7ns	SOT-23	16fh	-	3a	Phi



SMD code	Type	Function	Short description	Case	Pinout	Sch.	St.	Mnf.
SP	MCP120-485I	Vdet-IC	4.72V, -Reset ODO	SOT-23	16vdb	VD6	3a	Mcc
SP	MCP120T-485I	Vdet-IC	4.72V, -Reset ODO	SOT-23	16vdb	VD6	3a	Mcc
SP	SDMP0340LCT	Si-diode	2x Schottky, Sw, 40V, 200mA, 150mW, 2pF	SOT-523	16dg	-	3b	Di
SPB	MCP809M3-2.63	Vdet-IC	2.63V±1.5%, -Reset PPO	SOT-23	16vda	VD7	3a	Nsc
SPR	MAX809JTR	Vdet-IC	4.0V±1.5%, -Reset PPO	SOT-23	16vdc	VD7	3b	Ons
SPs	BSS84	p-MOSFET-e*	V-MOS, LogL, 50V, 130mA, 250mW, <10Q(130mA), 3/7ns	SOT-23	16fh	-	3c	Inf
SPS	MAX809RTR	Vdet-IC	2.63V±1.5%, -Reset PPO	SOT-23	16vdc	VD7	3b	Ons
SPT	MAX809STR	Vdet-IC	2.93V±1.5%, -Reset PPO	SOT-23	16vdc	VD7	3b	Ons
SPU	MAX809TTR	Vdet-IC	3.08V±1.5%, -Reset PPO	SOT-23	16vdc	VD7	3b	Ons
SPV	MAX809MTR	Vdet-IC	4.38V±1.5%, -Reset PPO	SOT-23	16vdc	VD7	3b	Ons
SPW	MAX809LTR	Vdet-IC	4.63V±1.5%, -Reset PPO	SOT-23	16vdc	VD7	3b	Ons
SPX	MAX810RTR	Vdet-IC	2.63V±1.5%, +Reset PPO	SOT-23	16vdc	VD7	3b	Ons
SPY	MAX810STR	Vdet-IC	2.93V±1.5%, +Reset PPO	SOT-23	16vdc	VD7	3b	Ons
SPZ	MAX810TTR	Vdet-IC	3.08V±1.5%, +Reset PPO	SOT-23	16vdc	VD7	3b	Ons
SQ	2SC3082K-Q	Si-npn	AF, 30V, 50mA, 200mW, B=120..270, >110MHz	SOT-346	16ta	-	3a	Rhm
SQ	2SC4100-Q	Si-npn	AF, 30V, 50mA, 200mW, B=120..270, >110MHz	SOT-323	16ta	-	3a	Rhm
SQ	2SC4619-Q	Si-npn	GP, 30V, 50mA, 150mW, B=120..270, 110MHz	SOT-416	16ta	-	3a	Rhm
SQ	SDMP0340LAT	Si-diode	2x Schottky, Sw, 40V, 200mA, 150mW, 2pF	SOT-523	16df	-	3b	Di
SQA	MAX810MTR	Vdet-IC	4.38V±1.5%, +Reset PPO	SOT-23	16vdc	VD7	3b	Ons
SQB	MAX810LTR	Vdet-IC	4.63V±1.5%, +Reset PPO	SOT-23	16vdc	VD7	3b	Ons
SQC	NCP803SN263T1	Vdet-IC	2.63V±1.5%, -Reset ODO	SOT-23	16vdc	VD6	3b	Ons
SQD	NCP803SN293T1	Vdet-IC	2.93V±1.5%, -Reset ODO	SOT-23	16vdc	VD6	3b	Ons
SQD	NCP803SN293T3	Vdet-IC	2.93V±1.5%, -Reset ODO	SOT-23	16vdc	VD6	3b	Ons
SQE	NCP803SN308T1	Vdet-IC	3.08V±1.5%, -Reset ODO	SOT-23	16vdc	VD6	3b	Ons
SQF	NCP803SN438T1	Vdet-IC	4.38V±1.5%, -Reset ODO	SOT-23	16vdc	VD6	3b	Ons
SQG	NCP803SN463T1	Vdet-IC	4.63V±1.5%, -Reset ODO	SOT-23	16vdc	VD6	3b	Ons
SQP	MAX809SN232	Vdet-IC	2.32V±1.5%, -Reset PPO	SOT-23	16vdc	VD7	3a	Ons
SQP	MAX809SN232T1	Vdet-IC	2.32V±1.5%, -Reset PPO	SOT-23	16vdc	VD7	3b	Ons
SQR	NCP803SN232T1	Vdet-IC	2.32V±1.5%, -Reset ODO	SOT-23	16vdc	VD6	3b	Ons
SR	2SC2405-R	Si-npn	AF, LN, 55V, 10mA, 200mW, B=180..360, 200MHz	SOT-23	16ta	-	3a	Pan
SR	2SC3929-R	Si-npn	AF, LN, 35V, 50mA, 150mW, B=180..360, 80MHz	SOT-323	16ta	-	3a	Pan
SR	CAT809SSDI-GT3	Vdet-IC	2.93V±1.5%, -Reset PPO	SC-70	16vdc	VD7	3d	Ons
SR	CAT809STBI-GT3	Vdet-IC	2.93V±1.5%, -Reset PPO	SOT-23	16vdc	VD7	3b	Ons
SRB	MCP809M3-2.93	Vdet-IC	2.93V±1.5%, -Reset PPO	SOT-23	16vda	VD7	3a	Nsc
SRs	BSS131	n-MOSFET-e*	SIPMOS, LogL, 240V, 100mA, 360mW, <16Q(100mA), 5/12ms	SOT-23	16fh	-	3c	Inf
SS	2SC2405-S	Si-npn	AF, LN, 55V, 10mA, 200mW, B=260..520, 200MHz	SOT-23	16ta	-	3a	Pan
SS	2SC3929-S	Si-npn	AF, LN, 35V, 50mA, 150mW, B=260..520, 80MHz	SOT-323	16ta	-	3a	Pan
SS	CAT810SSDI-GT3	Vdet-IC	2.93V±1.5%, +Reset PPO	SC-70	16vdc	VD7	3d	Ons
SS	CAT810STBI-GT3	Vdet-IC	2.93V±1.5%, +Reset PPO	SOT-23	16vdc	VD7	3b	Ons
-SS	BSS138	n-MOSFET-e*	SIPMOS, LogL, 50V, 200mA, 360mW, 3.5Q(200mA), 10/15ns	SOT-23	16fh	-	3a	Zx
SSB	MCP809M3-3.08	Vdet-IC	3.08V±1.5%, -Reset PPO	SOT-23	16vda	VD7	3a	Nsc
sSH	BSS119	n-MOSFET-e*	V-MOS, 100V, 0.17A, <6Q, 9/24ns	SOT-23	16fh	-	3a	Sie
sSJ	BSS7728	n-MOSFET-e	V-MOS, 60V, 150mA, 11/27ns	SOT-23	16fh	-	3a	Sie
SSO	MAX809SN120T1G	Vdet-IC	1.2V±1.5%, -Reset PPO	SOT-23	16vdc	VD7	3b	Ons
SSP	MAX809SN293D1T1G	Vdet-IC	2.93V±1.5%, 1ms, -Reset PPO	SOT-23	16vdc	VD7	3b	Ons
SSQ	MAX809SN293D2T1G	Vdet-IC	2.93V±1.5%, 20ms, -Reset PPO	SOT-23	16vdc	VD7	3b	Ons
SSR	MAX809SN293D3T1G	Vdet-IC	2.93V±1.5%, 100ms, -Reset PPO	SOT-23	16vdc	VD7	3b	Ons
SSs	BSS138	n-MOSFET-e*	SIPMOS, LogL, 50V, 220mA, 360mW, 3.5Q(220mA), 5/12ns	SOT-23	16fh	-	3c	Inf
SSS	MAX810SN120T1G	Vdet-IC	1.2V±1.5%, +Reset PPO	SOT-23	16vdc	VD7	3b	Ons
SST	MAX810SN293D1T1G	Vdet-IC	2.93V±1.5%, +Reset PPO	SOT-23	16vdc	VD7	3b	Ons
SSU	MAX810SN293D2T1G	Vdet-IC	2.93V±1.5%, +Reset PPO	SOT-23	16vdc	VD7	3b	Ons
SSZ	MAX810SN293D3T1G	Vdet-IC	2.93V±1.5%, +Reset PPO	SOT-23	16vdc	VD7	3b	Ons
ST	2SA1036KPT-P	Si-pnp	AF, Sw, 32V, 500mA, B=82..180, 200MHz	SOT-23	16ta	-	3a	Chm
ST	2SC2405-T	Si-npn	AF, LN, 55V, 10mA, 200mW, B=360..700, 200MHz	SOT-23	16ta	-	3a	Pan
ST	2SC3929-T	Si-npn	AF, LN, 35V, 50mA, 150mW, B=360..700, 80MHz	SOT-323	16ta	-	3a	Pan
ST	BSS139	n-MOSFET-d	V-MOS, 250V, 40mA, <100Q, 14/25ns	SOT-23	16fh	-	3a	Sie
ST2	2SC4452-2	Si-npn	Sw, Hi-Sp, 40V, 200mA, 150mW, 750MHz, B=50..100	MCP	16ta	-	3a	San
ST2	2SC4453-2	Si-npn	Sw, Hi-Sp, 40V, 200mA, 200mW, 750MHz, B=50..100	CP	16ta	-	3a	San
ST2N	2N7002	n-MOSFET-e*	TMOS, 60V, 350mA, 1W, <5Q(350mA), 5/7ns	SOT-23-3L	16fh	-	3b	Ste
ST3	2SC4452-3	Si-npn	Sw, Hi-Sp, 40V, 200mA, 150mW, 750MHz, B=70..140	MCP	16ta	-	3a	San
ST3	2SC4453-3	Si-npn	Sw, Hi-Sp, 40V, 200mA, 200mW, 750MHz, B=70..140	CP	16ta	-	3a	San
ST4	2SC4452-4	Si-npn	Sw, Hi-Sp, 40V, 200mA, 150mW, 750MHz, B=100..200	MCP	16ta	-	3a	San
ST4	2SC4453-4	Si-npn	Sw, Hi-Sp, 40V, 200mA, 200mW, 750MHz, B=100..200	CP	16ta	-	3a	San
STB	MCP809M3-4.00	Vdet-IC	4.0V±1.5%, -Reset PPO	SOT-23	16vda	VD7	3a	Nsc
STs	BSS139	n-MOSFET-d	V-MOS, 250V, 40mA, <100Q, 14/25ns	SOT-23	16fh	-	3a	Sie
SUB	MCP809M3-4.38	Vdet-IC	4.38V±1.5%, -Reset PPO	SOT-23	16vda	VD7	3a	Nsc
SV	SVC233	C-diode	Dual, FM-band pager, 16V, 50mA, Vf=0.95V(50mA), 0.25pF	CP	16dl	-	3a	San
SVB	MCP809M3-4.63	Vdet-IC	4.63V±1.5%, -Reset PPO	SOT-23	16vda	VD7	3a	Nsc
SW	2SC5477	Si-npn	HF, 30V, 50mA, 150mW, 1.1GHz, B~148	SC-59	16ta	-	3a	Ish
SW	2SC5626	Si-npn	HF-Amp, 30V, 50mA, 150mW, 1.1GHz, B~148	SOT-323	16ta	-	3a	Ish



SMD code	Type	Function	Short description	Case	Pinout	Sch.	St.	Mnf.
SWs	BSS138W	n-MOSFET-e*	SIPMOS, LogL, 60V, 280mA, 360mW, 3.5Ω(200mA), 2.2/6.7ns	SOT-323	16fh	-	3c	Inf
SY	2SA1162-Y	Si-pnp	GP, AF, 50V, 150mA, 150mW, B=120..240, >80MHz	SOT-23	16ta	-	3a	Tos
SY	2SA1586-Y	Si-pnp	GP, AF, 50V, 150mA, 100mW, B=120..240, >70MHz	SOT-323	16ta	-	3a	Tos
SY	2SA1832FT-Y	Si-pnp	GP, 50V, 150mA, 100mW, B=120..240, 80MHz	TESM	18ta	-	3a	Tos
SY	2SC3900	Si-npn-Digi	Sw, 50V, 100mA, 200mW, 250MHz, B>100, R1=4.7k	CP	16ta	-	3a	San
SY	KTA2014E-Y	Si-pnp	AF, Sw, 50V, 150mA, 100mW, B=120..240, >80MHz	ESM	18ta	-	3f	Kec
SY	KTA2014F-Y	Si-pnp	AF, Sw, 50V, 150mA, 100mW, B=120..240, >80MHz	TFSM	19ta	-	3f	Kec
SY	KTA2014V-Y	Si-pnp	AF, Sw, 50V, 150mA, 100mW, B=120..240, >80MHz	VSM	18ta	-	3f	Kec
SY	KTA2014-Y	Si-pnp	AF, Sw, 50V, 150mA, 100mW, B=120..240, >80MHz	USM	16ta	-	3f	Kec
SZ	KTA2012E	Si-pnp	GP, 15V, 500mA, 100mW, B=270..680, 260MHz	ESM	18ta	-	3a	Kec
SZ	KTA2012V	Si-pnp	GP, 15V, 500mA, 100mW, B=270..680, 260MHz	VSM	18ta	-	3a	Kec
SZ	MAX809SQ400T1G	Vdet-IC	4.0V±1.5%, -Reset PPO	SC-70	16vdc	VD7	3b	Ons
sZC	MMBT4124	Si-npn	Sw, 30V, 200mA, 330mW, B=120..360, >300MHz	SOT-23	16ta	-	3a	Sie
sZC	SMBT4124	Si-npn	Sw, 30V, 200mA, 330mW, B=120..360, >300MHz	SOT-23	16ta	-	3a	Sie
t	AX6903FA	Vdet-IC	2.63V±1.5%, -Reset PPO	SC-70	16vda	VD7	3b	Axd
T-Q	2SA1603A-Q	Si-pnp	AF, 60V, 150mA, 150mW, 200MHz, B=120..270	SOT-323	16ta	-	3a	Mit
T-R	2SA1603A-R	Si-pnp	AF, 60V, 150mA, 150mW, 200MHz, B=180..390	SOT-323	16ta	-	3a	Mit
T-S	2SA1603A-S	Si-pnp	AF, 60V, 150mA, 150mW, 200MHz, B=270..560	SOT-323	16ta	-	3a	Mit
T0	ELM7640HCB	Vdet-IC	4.0V±2%, +Reset PPO, 150ms	SOT-23	16vdc	VD7	3d	Elm
T0	ELM9750CBB	Vdet-IC	5.0V±2.5%, +Reset PPO	SOT-23	16vdb	VD7	3d	Elm
T0	R3130N40HA	Vdet-IC	4V, -Reset PPO, 400ms	SOT-23	16vdc	VD7	3b	Ric
T01	PDTA143ET	Si-pnp-Digi	Sw, 50V, 100mA, 250mW, R1/R2=4.7k/4.7k	SOT-23	16ta	-	3a	PhM
T01	PDTA143EU	Si-pnp-Digi	Sw, 50V, 100mA, 200mW, R1/R2=4.7k/4.7k	SOT-323	16ta	-	3a	PhM
T02	CHDTC143EUPT	Si-npn-Digi	Sw, 50V, 100mA, 250MHz, R1/R2=4.7/4.7k	SOT-323	16ta	-	3a	Chm
T02	PDTC143ET	Si-npn-Digi	Sw, 50V, 100mA, 250mW, R1/R2=4.7k/4.7k	SOT-23	16ta	-	3a	PhM
T02	PDTC143EU	Si-npn-Digi	Sw, 50V, 100mA, 200mW, R1/R2=4.7k/4.7k	SOT-323	16ta	-	3a	PhM
T03	PDTA114ET	Si-pnp-Digi	Sw, 50V, 100mA, 250mW, R1/R2=10k/10k	SOT-23	16ta	-	3a	PhM
T03	PDTA114EU	Si-pnp-Digi	Sw, 50V, 100mA, 200mW, R1/R2=10k/10k	SOT-323	16ta	-	3a	PhM
T04	BZX84-A11	Z-diode	11V±1%, Izt=23mA, 350mW	SOT-23	16dc	-	3a	PhM
T04	PMSS3904	Si-npn	GP, 60V, 100mA, 200mW, B=100..300, >180MHz	SOT-323	16ta	-	3a	PhM
T05	CHT05PT	Si-npn	AF, Sw, 60V, 500mA, B>100, 80MHz	SOT-23	16ta	-	3a	Chm
T05	PDTA124ET	Si-pnp-Digi	Sw, 50V, 100mA, 250mW, R1/R2=22k/22k	SOT-23	16ta	-	3a	PhM
T05	PDTA124EU	Si-pnp-Digi	Sw, 50V, 100mA, 200mW, R1/R2=22k/22k	SOT-323	16ta	-	3a	PhM
T06	PDTC124ET	Si-npn-Digi	Sw, 50V, 100mA, 250mW, R1/R2=22k/22k	SOT-23	16ta	-	3a	PhM
T06	PDTC124EU	Si-npn-Digi	Sw, 50V, 100mA, 200mW, R1/R2=22k/22k	SOT-323	16ta	-	3a	PhM
T06	PMSS3906	Si-pnp	GP, 60V, 100mA, 200mW, B=100..300, >150MHz	SOT-323	16ta	-	3a	PhM
T07	PDTA144ET	Si-pnp-Digi	Sw, 50V, 100mA, 250mW, R1/R2=47k/47k	SOT-23	16ta	-	3a	PhM
T07	PDTA144EU	Si-pnp-Digi	Sw, 50V, 100mA, 200mW, R1/R2=47k/47k	SOT-323	16ta	-	3a	PhM
T08	PDTC144ET	Si-npn-Digi	Sw, 50V, 100mA, 250mW, R1/R2=47k/47k	SOT-23	16ta	-	3a	PhM
T08	PDTC144EU	Si-npn-Digi	Sw, 50V, 100mA, 200mW, R1/R2=47k/47k	SOT-323	16ta	-	3a	PhM
T09	CHDTC114EUPT	Si-npn-Digi	Sw, 50V, 50mA, 250MHz, R1/R2=10/10k	SOT-323	16ta	-	3a	Chm
T09	PDTC114EU	Si-npn-Digi	Sw, 50V, 100mA, 200mW, R1/R2=10k/10k	SOT-323	16ta	-	3a	PhM
T1	BCX17	Si-pnp	AF-Drv, 50V, 500mA, 300mW, B=100..600, >80MHz	SOT-23	16ta	-	3a	Ste
T1	BSS63	Si-pnp	GP, 110V, 100mA, 250mW, B>30, >50MHz	SOT-23	16ta	-	3a	Ons
T1	BTC5181WC3	Si-npn	HF, 5V, 10mA, 30mW, B=70..140, 12GHz	SOT-23	16ta	-	3a	Cys
T1	ELM7641HCB	Vdet-IC	4.1V±2%, +Reset PPO, 150ms	SOT-23	16vdc	VD7	3d	Elm
T1	ELM9751CBB	Vdet-IC	5.1V±2.5%, +Reset PPO	SOT-23	16vdb	VD7	3d	Elm
T1	HSM5-2862	Si-diode	Dual, Schottky, 5V, Vf(I _F =30mA)<0.6V, Ct<0.3pF, Rd=10Ω	SOT-23	16dl	-	3a	Agj
T1	R3130N44HA	Vdet-IC	4.4V, -Reset PPO, 400ms	SOT-23	16vdc	VD7	3b	Ric
T106	DTD1132U	Si-npn-Digi	Sw, 50V, 500mA, 200mW, 200MHz, R1/R2=1k/10k	UMT3	16ta	-	3a	Rhm
T11	PDTA114TT	Si-pnp-Digi	Sw, 50V, 100mA, 200mW, R1=10k	SOT-23	16ta	-	3a	PhM
T12	PDTC114TT	Si-npn-Digi	Sw, 50V, 100mA, 250mW, R1=10k	SOT-23	16ta	-	3a	PhM
T146	DTD1132K	Si-npn-Digi	Sw, 50V, 500mA, 200mW, 200MHz, R1/R2=1k/10k	SOT-346	16ta	-	3a	Rhm
T16	PDTC114ET	Si-npn-Digi	Sw, 50V, 100mA, 250mW, R1/R2=10k/10k	SOT-23	16ta	-	3a	PhM
T17	SST4117	n-FET	AF, 40V, 50mA, 300mW, Id _{ss} =0.03..0.09mA, Up<1.8V	SOT-23	16fj	-	3a	Cal
T18	PDTC143ZT	Si-npn-Digi	Sw, 50V, 100mA, 250mW, R1/R2=4.7k/47k	SOT-23	16ta	-	3a	PhM
T18	SST4118	n-FET	AF, 40V, 50mA, 300mW, Id _{ss} =0.08..0.24mA, Up<3V	SOT-23	16fj	-	3a	Cal
T19	PDTA143ZT	Si-pnp-Digi	Sw, 50V, 100mA, 250mW, R1/R2=4.7k/47k	SOT-23	16ta	-	3a	PhM
T19	SST4119	n-FET	AF, 40V, 50mA, 300mW, Id _{ss} =0.2..0.6mA, Up<6V	SOT-23	16fj	-	3a	Cal
T19	TK71519S	LVR-IC	LDO, 1.9V±1.5%, 155mA	SOT-23	16cj	VR1	3d	Tok
T1A	PMBT3904	Si-npn	Sw, 60V, 100mA, 250mW, B=100..300, >300MHz	SOT-23	16ta	-	3a	PhM
T1A	PMMT3904	Si-npn	GP, 60V, 200mA, 350mW, B=100..300, >300MHz	SOT-23	16ta	-	-	Phi
T1A	PMST3904	Si-npn	GP, 60V, 200mA, 200mW, B=60..300, >300MHz	SOT-323	16ta	-	3a	PhM
T1B	PMBT2222	Si-npn	Sw, 60V, 600mA, 330mW, B=120..360, >300MHz	SOT-23	16ta	-	3a	PhM
T1B	PMST2222	Si-npn	Sw, 60V, 600mA, 200mW, B=120..300, >300MHz	SOT-23	16ta	-	3a	PhM
T1D	PMBTA42	Si-npn	Vid, 300/300V, 100mA, 250mW, B>25, >50MHz	SOT-23	16ta	-	3a	PHH
T1D	PMSTA42	Si-npn	Vid, 300/300V, 100mA, 200mW, B>25, >50MHz	SOT-323	16ta	-	3a	PHM
T1E	PMBTA43	Si-npn	Vid, 200/200V, 100mA, 250mW, B>25, >50MHz	SOT-23	16ta	-	3a	PHH
T1E	PMSTA43	Si-npn	Vid, 200/200V, 100mA, 200mW, B>25, >50MHz	SOT-323	16ta	-	3a	PHM
T1F	PMBT5550	Si-npn	HV, 160V, 300mA, 250mW, B=60..250, 100..300MHz	SOT-23	16ta	-	3a	PHH



SMD code	Type	Function	Short description	Case	Pinout	Sch.	St.	Mnf.
T1F	PMST5550	Si-npn	HV, 160V, 300mA, 200mW, B=60..250, 100..300MHz	SOT-323	16ta	-	3a	PhM
T1G	PMBTA06	Si-npn	GP, 80V, 500mA, 250mW, B>100, >100MHz	SOT-23	16ta	-	3a	PhH
T1G	PMMTA06	Si-npn	GP, 80V, 500mA, 350mW, B>100, >100MHz	SOT-23	16ta	-	-	Phi
T1G	PMSTA06	Si-npn	GP, 80V, 500mA, 200mW, B>50, >100MHz	SOT-323	16ta	-	3a	PhM
T1H	MMBTA05	Si-npn	GP, 60V, 500mA, 350mW, B>100, >100MHz	SOT-323	16ta	-	3a	Phi
T1H	PMBTA05	Si-npn	GP, 60V, 500mA, 250mW, B>100, >100MHz	SOT-23	16ta	-	3a	PhH
T1H	PMSTA05	Si-npn	GP, 60V, 500mA, 200mW, B>50, >100MHz	SOT-323	16ta	-	3a	PhM
T1J	PMBT2369	Si-npn	Sw, 40V, 200mA, 330mW, B=40..120, >500MHz	SOT-23	16ta	-	3a	PhH
T1J	PMST2369	Si-npn	Sw, 40V, 200mA, 200mW, B=40..120, >500MHz	SOT-323	16ta	-	3a	PhM
T1K	PMBT6428	Si-npn	GP, AF, 60V, 100mA, 250mW, B>250..650, 100..700MHz	SOT-23	16ta	-	3a	PhH
T1K	PMST6428	Si-npn	GP, Hi-beta, 60V, 100mA, 200mW, B=250..650, 100..700MHz	SOT-323	16ta	-	3a	PhM
T1L	PMBT6429	Si-npn	GP, AF, 55V, 100mA, 250mW, B=500..1250, 100..700MHz	SOT-23	16ta	-	3a	PhH
T1L	PMST6429	Si-npn	GP, Hi-beta, 55V, 100mA, 200mW, B=250..650, 100..700MHz	SOT-323	16ta	-	3a	PhM
T1M	PMBTA13	Si-npn-Darl	GP, 30V, 500mA, 250mW, B>5000, >125MHz	SOT-23	16ta	-	3a	PhH
T1N	PMBTA14	Si-npn-Darl	GP, 30V, 500mA, 250mW, B>10000, >125MHz	SOT-23	16ta	-	3a	PhH
T1p	BCX17	Si-pnp	AF-Drv, 50V, 500mA, 250mW, B=100..600, >80MHz	SOT-23	16ta	-	3a	PhH
T1P	PMBT2222A	Si-npn	Sw, 75V, 600mA, 330mW, B=120..360, >300MHz	SOT-23	16ta	-	3a	PhH
T1P	PMST2222A	Si-npn	Sw, 75V, 600mA, 200mW, B=120..300, >300MHz	SOT-323	16ta	-	3a	PhM
T1Q	PMBT5088	Si-npn	GP, AF, 30V, 200mA, 325mW, B=500, 160MHz	SOT-23	16ta	-	3a	PhH
T1Q	PMST5088	Si-npn	GP, 35V, 100mA, 200mW, B=300..900, >100MHz	SOT-323	16ta	-	3a	PhM
T1R	PMST5089	Si-npn	GP, 30V, 100mA, 200mW, B=400..1200, >100MHz	SOT-323	16ta	-	3a	PhM
T1t	BCX17	Si-pnp	AF-Drv, 50V, 500mA, 250mW, B=100..600, >80MHz	SOT-23	16ta	-	3a	PhH
T1W	BCX17	Si-pnp	AF-Drv, 50V, 500mA, 250mW, B=100..600, >80MHz	SOT-23	16ta	-	3a	PhC
T2	25K242-2	n-FET	AF-Amp, 20V, 20mA, 250mW, Idss=0.6..1.5mA, Ciss=4pF	SOT-23	16fi	-	3a	San
T2	ELM7642HCB	Vdet-IC	4.2V±2%, +Reset PPO, 150ms	SOT-23	16vdc	VD7	3d	Elm
T2	ELM9752CBB	Vdet-IC	5.2V±2.5%, +Reset PPO	SOT-23	16vdb	VD7	3d	Elm
T2	R3130N26HA3	Vdet-IC	2.6V, -Reset PPO, 400ms	SOT-23	16vdc	VD7	3b	Ric
I20	PDTC144WT	Si-npn-Digi	Sw, 50V, 100mA, 250mW, R1/R2=47k/22k	SOT-23	16ta	-	3a	PhM
I20	PDTC144WU	Si-npn-Digi	Sw, 50V, 100mA, 200mW, R1/R2=47k/22k	SOT-323	16ta	-	3a	PhM
T20	TK71520S	LVR-IC	LDO, 2V±1.5%, 155mA	SOT-23	16cj	VR1	3d	Tok
I21	PDTA123ET	Si-pnp-Digi	Sw, 50V, 100mA, 250mW, R1/R2=2k2/2k2	SOT-23	16ta	-	3a	PhM
T21	TK71521S	LVR-IC	LDO, 2.1V±1.5%, 155mA	SOT-23	16cj	VR1	3d	Tok
T22	TK71522S	LVR-IC	LDO, 2.2V±1.5%, 155mA	SOT-23	16cj	VR1	3d	Tok
I23	PDTA114TU	Si-pnp-Digi	Sw, 50V, 100mA, 200mW, R1=10k	SOT-323	16ta	-	3a	PhM
I23	PDTA123JT	Si-pnp-Digi	Sw, 50V, 100mA, 250mW, R1/R2=2k2/47k	SOT-23	16ta	-	3a	PhM
T23	TK71523S	LVR-IC	LDO, 2.3V±1.5%, 155mA	SOT-23	16cj	VR1	3d	Tok
I24	PDTC114TU	Si-npn-Digi	Sw, 50V, 100mA, 200mW, R1=10k	SOT-323	16ta	-	3a	PhM
T24	TK71524S	LVR-IC	LDO, 2.4V±1.5%, 155mA	SOT-23	16cj	VR1	3d	Tok
I25	PDTC123JT	Si-npn-Digi	Sw, 50V, 100mA, 250mW, R1/R2=2k2/47k	SOT-23	16ta	-	3a	PhM
T25	TK71525S	LVR-IC	LDO, 2.5V±1.5%, 155mA	SOT-23	16cj	VR1	3d	Tok
I26	PDTC123ET	Si-npn-Digi	Sw, 50V, 100mA, 250mW, R1/R2=2k2/2k2	SOT-23	16ta	-	3a	PhM
T26	TK71526S	LVR-IC	LDO, 2.6V±1.5%, 155mA	SOT-23	16cj	VR1	3d	Tok
I27	PDTC114YT	Si-npn-Digi	Sw, 50V, 100mA, 250mW, R1/R2=10k/47k	SOT-23	16ta	-	3a	PhM
T27	TK71527S	LVR-IC	LDO, 2.7V±1.5%, 155mA	SOT-23	16cj	VR1	3d	Tok
I28	PDTA144WU	Si-pnp-Digi	Sw, 50V, 100mA, 200mW, R1/R2=47k/22k	SOT-323	16ta	-	3a	PhM
T28	TK71528S	LVR-IC	LDO, 2.8V±1.5%, 155mA	SOT-23	16cj	VR1	3d	Tok
I29	PDTA114YT	Si-pnp-Digi	Sw, 50V, 100mA, 250mW, R1/R2=10k/47k	SOT-23	16ta	-	3a	PhM
T29	TK71529S	LVR-IC	LDO, 2.9V±1.5%, 155mA	SOT-23	16cj	VR1	3d	Tok
I2A	PMBT3906	Si-pnp	Sw, 40V, 100mA, 250mW, B=100..300, >250MHz	SOT-23	16ta	-	3a	PhM
I2A	PMST3906	Si-pnp	GP, 60V, 100mA, 200mW, B=60..300, >250MHz	SOT-323	16ta	-	3a	PhM
I2B	PMBT2907	Si-pnp	GP, 40V, 600mA, 330mW, B=100..300, >200MHz	SOT-23	16ta	-	3a	PhH
I2D	PMBTA92	Si-pnp	Vid, 300/300V, 500mA, 250mW, B=25, >50MHz	SOT-23	16ta	-	3a	PhH
I2D	PMSTA92	Si-pnp	Vid, 300/300V, 100mA, 200mW, B=40, >50MHz	SOT-323	16ta	-	3a	PhM
I2E	PMBTA93	Si-pnp	Vid, 200/200V, 500mA, 250mW, B=25, >50MHz	SOT-23	16ta	-	3a	PhH
I2E	PMSTA93	Si-pnp	Vid, 200/200V, 500mA, 330mW, B=25, >50MHz	SOT-323	16ta	-	3a	PhM
I2F	PMBT2907A	Si-pnp	GP, 60V, 600mA, 330mW, B=100..300, >200MHz	SOT-23	16ta	-	3a	PhH
I2F	PMST2907A	Si-pnp	GP, 60V, 600mA, 330mW, B=100..300, >200MHz	SOT-323	16ta	-	3a	PhM
I2G	PMBTA56	Si-pnp	AF-Drv, 80V, 500mA, 250mW, B>100, >50MHz	SOT-23	16ta	-	3a	PhH
I2G	PMSTA56	Si-pnp	AF-Drv, 80V, 500mA, 200mW, B>100, >50MHz	SOT-323	16ta	-	3a	PhM
I2H	PMBTA55	Si-pnp	AF-Drv, 60V, 500mA, 250mW, B>100, >50MHz	SOT-23	16ta	-	3a	PhH
I2H	PMSTA55	Si-pnp	AF-Drv, 60V, 500mA, 200mW, B>100, >50MHz	SOT-323	16ta	-	3a	PhM
I2L	PMBT5401	Si-pnp	HV, 160V, 300mA, 250mW, B=60..240, 100..300MHz	SOT-23	16ta	-	3a	PhH
I2L	PMST5401	Si-pnp	HV, 160V, 300mA, 200mW, B=60..240, 100..300MHz	SOT-323	16ta	-	3a	PhM
T2p	BCX18	Si-pnp	GP, 30V, 500mA, 250mW, B=100..600, >80MHz	SOT-23	16ta	-	3a	PhH
T2t	BCX18	Si-pnp	GP, 30V, 500mA, 250mW, B=100..600, >80MHz	SOT-23	16ta	-	3a	PhM
I2T	PMBT4403	Si-pnp	Sw, 40V, 600mA, 250mW, B=100..300, >250MHz	SOT-23	16ta	-	3a	PhM
I2T	PMST4403	Si-pnp	GP, 40V, 600mA, 200mW, B=100..300, >200MHz	SOT-323	16ta	-	3a	PhM
I2U	PMBTA63	Si-pnp-Darl	GP, 30V, 500mA, 250mW, B>5000, >125MHz	SOT-23	16ta	-	3a	PhH
I2V	PMBTA64	Si-pnp-Darl	GP, 30V, 500mA, 250mW, B>10000, >125MHz	SOT-23	16te	-	3a	PhH
T2W	BCX18	Si-pnp	GP, 30V, 500mA, 250mW, B=100..600, >80MHz	SOT-23	16ta	-	3a	PhC



SMD code	Type	Function	Short description	Case	Pinout	Sch.	St.	Mnf.
I2X	PMBT4401	Si-npn	Sw, 60V, 600mA, 250mW, B=100..300, >250MHz	SOT-23	16ta	-	3a	PHM
I2X	PMST4401	Si-npn	Sw, 60V, 600mA, 200mW, B=100..300, >250MHz	SOT-323	16ta	-	3a	PHM
T3	2SK1065-3	n-FET	GP, 20V, 20mA, 100mW, Idss=1.2..3mA, Up<2.5V	MCP	16fa	-	3a	San
T3	2SK242-3	n-FET	AF-Amp, 20V, 20mA, 250mW, Idss=1.2..3mA, Ciss=4pF	SOT-23	16fi	-	3a	San
T3	BAS21T	Si-diode	Sw, Fast, 250V, 250mA, 250mW, <50ns	SOT-416	16dc	-	3a	Di
T3	BSS63	Si-pnp	GP, 110V, 100mA, 200mW, B>30, >50MHz	SOT-23	16te	-	3a	Ste
T3	ELM7643HCB	Vdet-IC	4.3V±2%, +Reset PPO, 150ms	SOT-23	16vdc	VD7	3d	Elm
T3	ELM9753CBB	Vdet-IC	5.3V±2.5%, +Reset PPO	SOT-23	16vdb	VD7	3d	Elm
T3	HSMS-2863	Si-diode	Dual, Schottky, 5V, Vf(If=30mA)<0.6V, Ct<0.3pF, Rd=10Ω	SOT-23	16df	-	3a	Agi
T3	HVM16	C-diode	Dual, FM-Tuning, 14V, 24.6/43pF(8..2V/1MHz)	SOT-23	16dg	-	3a	Ren
T3	R3130N29HA3	Vdet-IC	2.9V, -Reset PPO, 400ms	SOT-23	16vdc	VD7	3b	Ric
I30	PDTC114YU	Si-npn-Digi	Sw, 50V, 100mA, 200mW, R1/R2=10k/47k	SOT-323	16ta	-	3a	PHM
T30	TK71530S	LVR-IC	LDO, 3V±1.5%, 155mA	SOT-23	16cj	VR1	3d	Tok
T31	TK71531S	LVR-IC	LDO, 3.1V±1.5%, 155mA	SOT-23	16cj	VR1	3d	Tok
T32	2SC2757-32	Si-npn	RF-amp, 15V, 50mA, 150mW, B=60..120, 800MHz	SOT-23	16ta	-	3a	Nec
T32	2SC4182-32	Si-npn	UHF/VHF-Osc, Mix, 30V, 50mA, 160mW, B=60..105, 1.1GHz	SOT-323	16ta	-	3a	Nec
I32	PDTC143XT	Si-npn-Digi	Sw, 50V, 100mA, 250mW, R1/R2=4.7k/10k	SOT-23	16ta	-	3a	PHM
T32	TK71532S	LVR-IC	LDO, 3.2V±1.5%, 155mA	SOT-23	16cj	VR1	3d	Tok
T33	2SC2757-33	Si-npn	RF-amp, 15V, 50mA, 150mW, B=90..180, 800MHz	SOT-23	16ta	-	3a	Nec
T33	2SC4182-33	Si-npn	UHF/VHF-Osc, Mix, 30V, 50mA, 160mW, B=85..150, 1.1GHz	SOT-323	16ta	-	3a	Nec
I33	PDTC143TT	Si-npn-Digi	Sw, 50V, 100mA, 250mW, R1=4.7k	SOT-323	16ta	-	3a	PHM
T33	TK71533S	LVR-IC	LDO, 3.3V±1.5%, 155mA	SOT-23	16cj	VR1	3d	Tok
T34	2SC2757-34	Si-npn	RF-amp, 15V, 50mA, 150mW, B=120..240, 800MHz	SOT-23	16ta	-	3a	Nec
T34	2SC4182-34	Si-npn	UHF/VHF-Osc, Mix, 30V, 50mA, 160mW, B=120..220, 1.1GHz	SOT-323	16ta	-	3a	Nec
T34	TK71534S	LVR-IC	LDO, 3.4V±1.5%, 155mA	SOT-23	16cj	VR1	3d	Tok
T35	BSR20	Si-pnp	HF/Sw, 130V, 300mA, 250mW, B=40..180, 400MHz	SOT-23	16ta	-	3a	Phi
I35	PDTA143XT	Si-pnp-Digi	Sw, 50V, 100mA, 250mW, R1/R2=4.7k/10k	SOT-23	16ta	-	3a	PHM
T35	TK71535S	LVR-IC	LDO, 3.5V±1.5%, 155mA	SOT-23	16cj	VR1	3d	Tok
T36	BSR20A	Si-pnp	Sw, 160V, 600mA, 250mW, B=60..240, 300MHz	SOT-23	16ta	-	3a	Phi
T36	TK71536S	LVR-IC	LDO, 3.6V±1.5%, 155mA	SOT-23	16cj	VR1	3d	Tok
T37	TK71537S	LVR-IC	LDO, 3.7V±1.5%, 155mA	SOT-23	16cj	VR1	3d	Tok
T38	TK71538S	LVR-IC	LDO, 3.8V±1.5%, 155mA	SOT-23	16cj	VR1	3d	Tok
T39	TK71539S	LVR-IC	LDO, 3.9V±1.5%, 155mA	SOT-23	16cj	VR1	3d	Tok
T4	2SK1065-4	n-FET	GP, 20V, 20mA, 100mW, Idss=2.5..6mA, Up<2.5V	MCP	16fa	-	3a	San
T4	2SK242-4	n-FET	AF-Amp, 20V, 20mA, 250mW, Idss=2.5..6mA, Ciss=4pF	SOT-23	16fi	-	3a	San
T4	BCX17R	Si-pnp	AF-Drv, 50V, 500mA, 250mW, B=100..600, >80MHz	SOT-23	16te	-	3a	Zx
T4	ELM7644HCB	Vdet-IC	4.4V±2%, +Reset PPO, 150ms	SOT-23	16vdc	VD7	3d	Elm
T4	ELM9754CBB	Vdet-IC	5.4V±2.5%, +Reset PPO	SOT-23	16vdb	VD7	3d	Elm
T4	HSMS-2864	Si-diode	Dual, Schottky, 5V, Vf(If=30mA)<0.6V, Ct<0.3pF, Rd=10Ω	SOT-23	16dg	-	3a	Agi
T4	HVM11	C-diode	UHF/SHF-Tuning, 35V, 3.6..5.6pF(1V)	SOT-23	16dc	-	3a	Ren
T4	KA4L4K	Si-npn-Digi	Sw, 60V, 100mA, 200mW, R1/R2=47k/10k	SOT-416	16ta	-	3a	Nec
T4	R3130N30HA8	Vdet-IC	3V, -Reset PPO, 400ms	SOT-23	16vdc	VD7	3b	Ric
T4	SP809EK-4-4	Vdet-IC	4.4V±1.5%, -Reset PPO	SOT-23	16vdc	VD7	3b	Sip
T40	TK71540S	LVR-IC	LDO, 4V±1.5%, 155mA	SOT-23	16cj	VR1	3d	Tok
T41	TK71541S	LVR-IC	LDO, 4.1V±1.5%, 155mA	SOT-23	16cj	VR1	3d	Tok
T42	2SC3545-M	Si-npn	UHF/RF, Osc/Mix, 30V, 50mA, 150mW, 2GHz, B=50..100	SOT-23	16ta	-	3a	Nec
T42	2SC3545-P	Si-npn	UHF/RF, Osc/Mix, 30V, 50mA, 150mW, 2GHz, B=50..100	SOT-23	16ta	-	3a	Nec
T42	2SC4184-42	Si-npn	UHF/VHF-Osc, Mix, 30V, 50mA, 160mW, B=40..80, 1.8GHz	SOT-323	16ta	-	3a	Nec
T42	TK71542S	LVR-IC	LDO, 4.2V±1.5%, 155mA	SOT-23	16cj	VR1	3d	Tok
T43	2SC3545-L	Si-npn	UHF/RF, Osc/Mix, 30V, 50mA, 150mW, 2GHz, B=70..140	SOT-23	16ta	-	3a	Nec
T43	2SC3545-Q	Si-npn	UHF/RF, Osc/Mix, 30V, 50mA, 150mW, 2GHz, B=70..140	SOT-23	16ta	-	3a	Nec
T43	2SC4184-43	Si-npn	UHF/VHF-Osc, Mix, 30V, 50mA, 160mW, B=60..120, 1.8GHz	SOT-323	16ta	-	3a	Nec
T43	TK71543S	LVR-IC	LDO, 4.3V±1.5%, 155mA	SOT-23	16cj	VR1	3d	Tok
T44	2SC3545-K	Si-npn	UHF/RF, Osc/Mix, 30V, 50mA, 150mW, 2GHz, B=120..250	SOT-23	16ta	-	3a	Nec
T44	2SC3545-R	Si-npn	UHF/RF, Osc/Mix, 30V, 50mA, 150mW, 2GHz, B=120..250	SOT-23	16ta	-	3a	Nec
T44	2SC4184-44	Si-npn	UHF/VHF-Osc, Mix, 30V, 50mA, 160mW, B=100..200, 1.8GHz	SOT-323	16ta	-	3a	Nec
T44	CHT44PT	Si-npn	Vid, 400V, 300mA, B=50..240, 50MHz	SOT-23	16ta	-	3a	Chm
T44	TK71544S	LVR-IC	LDO, 4.4V±1.5%, 155mA	SOT-23	16cj	VR1	3d	Tok
T45	TK71545S	LVR-IC	LDO, 4.5V±1.5%, 155mA	SOT-23	16cj	VR1	3d	Tok
T46	TK71546S	LVR-IC	LDO, 4.6V±1.5%, 155mA	SOT-23	16cj	VR1	3d	Tok
T47	TK71547S	LVR-IC	LDO, 4.7V±1.5%, 155mA	SOT-23	16cj	VR1	3d	Tok
T48	TK71548S	LVR-IC	LDO, 4.8V±1.5%, 155mA	SOT-23	16cj	VR1	3d	Tok
T49	TK71549S	LVR-IC	LDO, 4.9V±1.5%, 155mA	SOT-23	16cj	VR1	3d	Tok
I4F	PM8D353	Si-diode	Dual, Schottky Barrier, 4V, 30mA, Vf<600mV(10mA), <1pF	SOT-23	16ea	-	3a	PHM
T5	1SV153A	C-diode	VHF/UHF-Tuning, 35V, 2.11/2.43pF, <0.55Q(470MHz)	SOT-23	16dr	-	3a	Nec
T5	2SK1065-5	n-FET	GP, 20V, 20mA, 100mW, Idss=5..12mA, Up<2.5V	MCP	16fa	-	3a	San
T5	2SK242-4	n-FET	AF-Amp, 20V, 20mA, 250mW, Idss=5..12mA, Ciss=4pF	SOT-23	16fi	-	3a	San
T5	BCX18R	Si-pnp	GP, 30V, 500mA, 250mW, B=100..600, >80MHz	SOT-23	16te	-	3a	Zx
T5	ELM7645HCB	Vdet-IC	4.5V±2%, +Reset PPO, 150ms	SOT-23	16vdc	VD7	3d	Elm
T5	ELM9755CBB	Vdet-IC	5.5V±2.5%, +Reset PPO	SOT-23	16vdb	VD7	3d	Elm



SMD code	Type	Function	Short description	Case	Pinout	Sch.	St.	Mnf.
T5	HVM27WK	C-diode	Dual, FM-Tuning, 20V, 24/52pF(8..1V/1MHz)	SOT-23	16dg	-	3a	Ren
T5	R3130N46HA5	Vdet-IC	4.6V, -Reset PPO, 400ms	SOT-23	16vdc	VD7	3b	Ric
I50	BZX84-A2V4	Z-diode	2.4V±1%, 300mW	SOT-23	16dc	-	3a	PhM
T50	TK71550S	LVR-IC	LDO, 5V±1.5%, 155mA	SOT-23	16cj	VR1	3d	Tok
I51	BZX84-A2V7	Z-diode	2.7V±1%, 300mW	SOT-23	16dc	-	3a	PhM
I52	BZX84-A3V0	Z-diode	3V±1%, 300mW	SOT-23	16dc	-	3a	PhM
I55	BZX84-A3V9	Z-diode	3.9V±1%, 300mW	SOT-23	16dc	-	3a	PhM
T55	CHT55PT	Si-pnp	AF, Sw, 60V, 500mA, B>100, 50MHz	SOT-23	16ta	-	3a	Chm
I56	BZX84-A4V3	Z-diode	4.3V±1%, 300mW	SOT-23	16dc	-	3a	PhM
I57	BZX84-A4V7	Z-diode	4.7V±1%, 300mW	SOT-23	16dc	-	3a	PhM
I58	BZX84-A5V1	Z-diode	5.1V±1%, 300mW	SOT-23	16dc	-	3a	PhM
I59	BZX84-A5V6	Z-diode	5.6V±1%, 300mW	SOT-23	16dc	-	3a	PhM
I5A	PMBD6050	Si-diode	Sw, Hi-sp, 75V, 215mA, Vf<1.25V(150mA), <4ns	SOT-23	16dc	-	3a	PhM
I5B	PMBD6100	Si-diode	Dual, Sw, Hi-sp, 70V, 215mA, Vf<1.1V(100mA), <4ns	SOT-23	16dg	-	3a	PhM
I5C	PMBD7000	Si-diode	Dual, Sw, Hi-sp, 100V, 215mA, Vf<1.25V(150mA), <4ns	SOT-23	16dl	-	3a	PhM
I5D	PMBD914	Si-diode	Sw, Fast, 70V, 215mA, 250mW, <4ns	SOT-23	16dc	-	3a	PhM
T6	BSS63	Si-pnp	GP, 110V, 100mA, 200mW, B>30, >50MHz	SOT-23	16ta	-	3f	Kec
T6	BSS63R	Si-pnp	GP, 110V, 100mA, 200mW, B>30, >50MHz	SOT-23	16te	-	3a	Zx
T6	ELM764HCB	Vdet-IC	4.6V±2%, +Reset PPO, 150ms	SOT-23	16vdc	VD7	3d	Elm
T6	HVM17	C-diode	Dual, FM-Tuning, 15V, 50/85pF(1V)	SOT-23	16dg	-	3a	Ren
I60	BZX84-A6V2	Z-diode	6.2V±1%, 300mW	SOT-23	16dc	-	3a	PhM
T60	TK71560S	LVR-IC	LDO, 6V±1.5%, 155mA	SOT-23	16cj	VR1	3d	Tok
I61	BZX84-A6V8	Z-diode	6.8V±1%, 300mW	SOT-23	16dc	-	3a	PhM
T61	ZUMT617	Si-npn	Sw, Lo-sat, 15V, 1.5A, 180MHz	SOT-323	16ta	-	3a	Zx
T62	2SC3841-62	Si-npn	UHF-Mix, Osc, 25V, 30mA, 200mW, B=40..80, 4GHz	SOT-23	16ta	-	3a	Nec
T62	2SC3841-P	Si-npn	UHF-Mix, Osc, 25V, 30mA, 200mW, B=40..80, 4GHz	SOT-23	16ta	-	3a	Nec
T62	2SC4186-62	Si-npn	UHF-Mix, 25V, 30mA, 150mW, B=40..80, 4GHz	SOT-323	16ta	-	3a	Nec
I62	BZX84-A7V5	Z-diode	7.5V±1%, 300mW	SOT-23	16dc	-	3a	PhM
T62	ZUMT618	Si-npn	Sw, Lo-sat, 20V, 1.25A, 210MHz	SOT-323	16ta	-	3a	Zx
T63	2SC3841-63	Si-npn	UHF-Mix, Osc, 25V, 30mA, 200mW, B=60..120, 4GHz	SOT-23	16ta	-	3a	Nec
T63	2SC3841-Q	Si-npn	UHF-Mix, Osc, 25V, 30mA, 200mW, B=60..120, 4GHz	SOT-23	16ta	-	3a	Nec
T63	2SC4186-63	Si-npn	UHF-Mix, 25V, 30mA, 150mW, B=60..120, 4GHz	SOT-323	16ta	-	3a	Nec
I63	BZX84-A8V2	Z-diode	8.2V±1%, 300mW	SOT-23	16dc	-	3a	PhM
T63	ZUMT619	Si-npn	Sw, Lo-sat, 50V, 1A, 215MHz	SOT-323	16ta	-	3a	Zx
T64	2SC3841-64	Si-npn	UHF-Mix, Osc, 25V, 30mA, 200mW, B=100..200, 4GHz	SOT-23	16ta	-	3a	Nec
T64	2SC3841-R	Si-npn	UHF-Mix, Osc, 25V, 30mA, 200mW, B=100..200, 4GHz	SOT-23	16ta	-	3a	Nec
T64	2SC4186-64	Si-npn	UHF-Mix, 25V, 30mA, 150mW, B=100..200, 4GHz	SOT-323	16ta	-	3a	Nec
I64	BZX84-A9V1	Z-diode	9.1V±1%, 300mW	SOT-23	16dc	-	3a	PhM
I65	BZX84-A10	Z-diode	10V±1%, Izt=25mA, 350mW	SOT-23	16dc	-	3a	PhM
I66	BZX84-B10	Z-diode	10V±2%, 300mW	SOT-23	16dc	-	3a	PhM
I67	BZX84-A12	Z-diode	12V±1%, Izt=21mA, 300mW	SOT-23	16dc	-	3a	PhM
I69	BZX84-A15	Z-diode	15V±1%, 300mW	SOT-23	16dc	-	3a	PhM
I6D	2PD601AQW	Si-npn	GP, Sw, 60V, 100mA, 200mW, B=160..260, >100MHz	SOT-323	16ta	-	3a	PhM
I6E	2PD601ARW	Si-npn	GP, Sw, 60V, 100mA, 200mW, B=210..340, >120MHz	SOT-323	16ta	-	3a	PhM
I6F	2PD601ASW	Si-npn	GP, Sw, 60V, 100mA, 200mW, B=290..460, >140MHz	SOT-323	16ta	-	3a	PhM
T7	BSR15	Si-pnp	HF/Sw, 60V, 600mA, 250mW, B=100..300, 200MHz	SOT-23	16ta	-	3a	Ste
T7	ELM764HCB	Vdet-IC	4.7V±2%, +Reset PPO, 150ms	SOT-23	16vdc	VD7	3d	Elm
T7	KN4L4K	Si-pnp-Digi	Sw, 60V, 100mA, 150mW, R1/R2=47k/10k	SOT-416	16ta	-	3a	Nec
T7	SST4117	n-FET	AF, 40V, 50mA, 300mW, Idss=0.03..0.09mA, Up<1.8V	SOT-23	16fj	-	3a	Six
I70	BZX84-B16	Z-diode	16V±2%, 300mW	SOT-23	16dc	-	3a	PhM
T70	TK71570S	LVR-IC	LDO, 7V±1.5%, 155mA	SOT-23	16cj	VR1	3d	Tok
T71	BSR15R	Si-npn	HF/Sw, 60V, 600mA, 250mW, B=100..300, 200MHz	SOT-23	16te	-	3a	Ste
I71	BZX84-B18	Z-diode	18V±2%, 300mW	SOT-23	16dc	-	3a	PhM
T71	ZUMT717	Si-pnp	Sw, Lo-sat, 12V, 1.25A, 220MHz	SOT-323	16ta	-	3a	Zx
T72	2SC4568-72	Si-npn	UHF-Mix/Osc, 20V, 30mA, B=40..80, 5.5GHz	SOT-23	16ta	-	3a	Nec
T72	2SC4570-72	Si-npn	VHF/UHF, 20V, 30mA, 120mW, B=40..80, 5.5GHz	SOT-323	16ta	-	3a	Nec
I72	BZX84-B20	Z-diode	20V±2%, 300mW	SOT-23	16dc	-	3a	PhM
T72	ZUMT718	Si-pnp	Sw, Lo-sat, 20V, 1A, 0.5W, 210MHz	SOT-323	16ta	-	3a	Zx
T73	2SC4568-73	Si-npn	UHF-Mix/Osc, 20V, 30mA, B=60..120, 5.5GHz	SOT-23	16ta	-	3a	Nec
T73	2SC4570-73	Si-npn	VHF/UHF, 20V, 30mA, 120mW, B=60..120, 5.5GHz	SOT-323	16ta	-	3a	Nec
I73	BZX84-B22	Z-diode	22V±2%, 300mW	SOT-23	16dc	-	3a	PhM
T73	ZUMT720	Si-pnp	Sw, Lo-sat, 40V, 0.75A, 220MHz	SOT-323	16ta	-	3a	Zx
T74	2SC4568-74	Si-npn	UHF-Mix/Osc, 20V, 30mA, B=100..200, 5.5GHz	SOT-23	16ta	-	3a	Nec
T74	2SC4570-74	Si-npn	VHF/UHF, 20V, 30mA, 120mW, B=100..200, 5.5GHz	SOT-323	16ta	-	3a	Nec
I74	BZX84-B24	Z-diode	24V±2%, 300mW	SOT-23	16dc	-	3a	PhM
T75	2SC4569-75	Si-npn	UHF, TV-tun/Osc/Mix, 20V, 60mA, 150mW, 5GHz, B=40..80	SOT-23	16ta	-	3a	Nec
T75	2SC4571-75	Si-npn	UHF-Mix/Osc, 20V, 60mA, B=40-80, 5GHz	SOT-323	16ta	-	3a	Nec
I75	BZX84-A27	Z-diode	27V±1%, 300mW	SOT-23	16dc	-	3a	PhM
T76	2SC4569-76	Si-npn	UHF, TV-tun/Osc/Mix, 20V, 60mA, 150mW, 5GHz, B=60..120	SOT-23	16ta	-	3a	Nec
T76	2SC4571-76	Si-npn	UHF-Mix/Osc, 20V, 60mA, B=60-120, 5GHz	SOT-323	16ta	-	3a	Nec



SMD code	Type	Function	Short description	Case	Pinout	Sch.	St.	Mnf.
T77	2SC4569-77	Si-npn	UHF, TV-tun, Osc/Mix, 20V, 60mA, 150mW, 5GHz, B=100..200	SOT-23	16ta	-	3a	Nec
T78	XC6218P09H	LVR-IC	LDO, 0.9V±2%, 200mA	USP-3	17vj	VR1	9b	Tor
T79	XC6218P10H	LVR-IC	LDO, 1V±2%, 200mA	USP-3	17vj	VR1	9b	Tor
T7A	XC6218P11H	LVR-IC	LDO, 1.1V±2%, 200mA	USP-3	17vj	VR1	9b	Tor
T7B	XC6218P12H	LVR-IC	LDO, 1.2V±2%, 200mA	USP-3	17vj	VR1	9b	Tor
T7C	XC6218P13H	LVR-IC	LDO, 1.3V±2%, 200mA	USP-3	17vj	VR1	9b	Tor
T7D	XC6218P14H	LVR-IC	LDO, 1.4V±2%, 200mA	USP-3	17vj	VR1	9b	Tor
T7E	XC6218P15H	LVR-IC	LDO, 1.5V±2%, 200mA	USP-3	17vj	VR1	9b	Tor
T7F	XC6218P16H	LVR-IC	LDO, 1.6V±2%, 200mA	USP-3	17vj	VR1	9b	Tor
T7H	XC6218P17H	LVR-IC	LDO, 1.7V±2%, 200mA	USP-3	17vj	VR1	9b	Tor
T7K	XC6218P18H	LVR-IC	LDO, 1.8V±2%, 200mA	USP-3	17vj	VR1	9b	Tor
T7L	XC6218P19H	LVR-IC	LDO, 1.9V±2%, 200mA	USP-3	17vj	VR1	9b	Tor
T7M	XC6218P20H	LVR-IC	LDO, 2V±2%, 200mA	USP-3	17vj	VR1	9b	Tor
T7N	XC6218P21H	LVR-IC	LDO, 2.1V±2%, 200mA	USP-3	17vj	VR1	9b	Tor
T7p	BSR15	Si-pnp	HF/Sw, 60V, 600mA, 250mW, B=100..300, 200MHz	SOT-23	16ta	-	3a	Phi
T7P	XC6218P22H	LVR-IC	LDO, 2.2V±2%, 200mA	USP-3	17vj	VR1	9b	Tor
T7R	XC6218P23H	LVR-IC	LDO, 2.3V±2%, 200mA	USP-3	17vj	VR1	9b	Tor
T7S	XC6218P24H	LVR-IC	LDO, 2.4V±2%, 200mA	USP-3	17vj	VR1	9b	Tor
T7T	XC6218P25H	LVR-IC	LDO, 2.5V±2%, 200mA	USP-3	17vj	VR1	9b	Tor
T7U	XC6218P26H	LVR-IC	LDO, 2.6V±2%, 200mA	USP-3	17vj	VR1	9b	Tor
T7V	XC6218P27H	LVR-IC	LDO, 2.7V±2%, 200mA	USP-3	17vj	VR1	9b	Tor
T7X	XC6218P28H	LVR-IC	LDO, 2.8V±2%, 200mA	USP-3	17vj	VR1	9b	Tor
T7Y	XC6218P29H	LVR-IC	LDO, 2.9V±2%, 200mA	USP-3	17vj	VR1	9b	Tor
T7Z	XC6218P30H	LVR-IC	LDO, 3V±2%, 200mA	USP-3	17vj	VR1	9b	Tor
T8	BSR16	Si-pnp	Sw, 60V, 600mA, 250mW, B100..300, 200MHz	SOT-23	16ta	-	3a	Cdi
T8	ELM7648HCB	Vdet-IC	4.8V±2%, +Reset PPO, 150ms	SOT-23	16vdc	VD7	3d	Elm
T8	HVM25	C-diode	Dual, FM-Tuning, 16V, 36/45pF(3V)	SOT-23	16dg	-	3a	Ren
T8	SST4118	n-FET	AF, 40V, 50mA, 300mW, Idss=0.08..0.24mA, Up<3V	SOT-23	16fj	-	3a	Six
T80	TK71580S	LVR-IC	LDO, 8V±1.5%, 155mA	SOT-23	16cj	VR1	3d	Tok
T80	XC6218P31H	LVR-IC	LDO, 3.1V±2%, 200mA	USP-3	17vj	VR1	9b	Tor
T81	BSR16R	Si-pnp	Sw, 60V, 600mA, 250mW, B100..300, 200MHz	SOT-23	16te	-	3a	Phi
T81	XC6218P32H	LVR-IC	LDO, 3.2V±2%, 200mA	USP-3	17vj	VR1	9b	Tor
T82	2SC4954	Si-npn	UHF/SHF, 9V, 10mA, 60mW, B=75..150, 12GHz	SOT-23	16ta	-	3a	Nec
T82	2SC4958	Si-npn	LN, HF, 9V, 10mA, 60mW, B=75..150, 12GHz	SOT-323	16ta	-	3a	Nec
T82	XC6218P33H	LVR-IC	LDO, 3.3V±2%, 200mA	USP-3	17vj	VR1	9b	Tor
T83	2SC4955	Si-npn	UHF/SHF, 9V, 30mA, 100mW, B=75..150, 12GHz	SOT-23	16ta	-	3a	Nec
T83	XC6218P34H	LVR-IC	LDO, 3.4V±2%, 200mA	USP-3	17vj	VR1	9b	Tor
T84	2SC5177	Si-npn	UHF, LN, 5V, 10mA, 30mW, B=70..140, 13GHz	SC-59	16ta	-	3a	Nec
T84	2SC5177-FB	Si-npn	µWave, LN, 5V, 10mA, 30mW, B=70..140, 13GHz	SC-59	16ta	-	3a	Nec
T84	2SC5179-FB	Si-npn	µWave, LN, 5V, 10mA, 30mW, B=70..140, 13GHz	SOT-323	16ta	-	3a	Nec
T84	XC6218P35H	LVR-IC	LDO, 3.5V±2%, 200mA	USP-3	17vj	VR1	9b	Tor
T85	XC6218P36H	LVR-IC	LDO, 3.6V±2%, 200mA	USP-3	17vj	VR1	9b	Tor
T86	2SC5182-FB	Si-npn	µWave, LN, 5V, 30mA, 90mW, B=70..140, 12GHz	SC-59	16ta	-	3a	Nec
T86	2SC5184-FB	Si-npn	µWave, LN, 5V, 30mA, 90mW, B=70..140, 13GHz	SOT-323	16ta	-	3a	Nec
I86	BZX84-A75	Z-diode	75V±1%, 300mW	SOT-23	16dc	-	3a	PhM
T86	XC6218P37H	LVR-IC	LDO, 3.7V±2%, 200mA	USP-3	17vj	VR1	9b	Tor
T87	XC6218P38H	LVR-IC	LDO, 3.8V±2%, 200mA	USP-3	17vj	VR1	9b	Tor
T88	2SC5191-FB	Si-npn	µWave, LN, 9V, 100mA, 200mW, B=80..160, 4.5GHz	SOT-23	16ta	-	3a	Nec
T88	2SC5193-FB	Si-npn	µWave, LN, 9V, 100mA, 150mW, B=80..160, 4.5GHz	SOT-23	16ta	-	3a	Nec
T88	XC6218P39H	LVR-IC	LDO, 3.9V±2%, 200mA	USP-3	17vj	VR1	9b	Tor
T89	XC6218P40H	LVR-IC	LDO, 4V±2%, 200mA	USP-3	17vj	VR1	9b	Tor
I8A	PMBZ5226B	Z-diode	3.3V±5%, 250mW	SOT-23	16dc	-	3a	PhM
I8B	PMBZ5227B	Z-diode	3.6V±5%, 250mW	SOT-23	16dc	-	3a	PhM
I8C	PMBZ5228B	Z-diode	3.9V±5%, 250mW	SOT-23	16dc	-	3a	PhM
I8D	PMBZ5229B	Z-diode	4.3V±5%, 250mW	SOT-23	16dc	-	3a	PhM
I8E	PMBZ5230B	Z-diode	4.7V±5%, 250mW	SOT-23	16dc	-	3a	PhM
I8F	PMBZ5231B	Z-diode	5.1V±5%, 250mW	SOT-23	16dc	-	3a	PhM
I8G	PMBZ5232B	Z-diode	5.6V±5%, 250mW	SOT-23	16dc	-	3a	PhM
I8H	PMBZ5233B	Z-diode	6V±5%, 250mW	SOT-23	16dc	-	3a	PhM
I8J	PMBZ5234B	Z-diode	6.2V±5%, 250mW	SOT-23	16dc	-	3a	PhM
I8K	PMBZ5235B	Z-diode	6.8V±5%, 250mW	SOT-23	16dc	-	3a	PhM
I8L	PMBZ5236B	Z-diode	7.5V±5%, 250mW	SOT-23	16dc	-	3a	PhM
I8M	PMBZ5237B	Z-diode	8.2V±5%, 250mW	SOT-23	16dc	-	3a	PhM
I8N	PMBZ5238B	Z-diode	8.7V±5%, 250mW	SOT-23	16dc	-	3a	PhM
T8p	BSR16	Si-pnp	Sw, 60V, 600mA, 250mW, B100..300, 200MHz	SOT-23	16ta	-	3a	Phi
I8P	PMBZ5239B	Z-diode	9.1V±5%, 250mW	SOT-23	16dc	-	3a	PhM
I8Q	PMBZ5240B	Z-diode	10V±5%, 250mW	SOT-23	16dc	-	3a	PhM
I8R	PMBZ5241B	Z-diode	11V±5%, 250mW	SOT-23	16dc	-	3a	PhM
I8S	PMBZ5242B	Z-diode	12V±5%, 250mW	SOT-23	16dc	-	3a	PhM
I8T	PMBZ5243B	Z-diode	13V±5%, 250mW	SOT-23	16dc	-	3a	PhM



SMD code	Type	Function	Short description	Case	Pinout	Sch.	St.	Mnf.
18U	PMBZ5244B	Z-diode	14V±5%, 250mW	SOT-23	16dc	-	3a	PhM
18V	PMBZ5245B	Z-diode	15V±5%, 250mW	SOT-23	16dc	-	3a	PhM
18W	PMBZ5246B	Z-diode	16V±5%, 250mW	SOT-23	16dc	-	3a	PhM
18X	PMBZ5247B	Z-diode	17V±5%, 250mW	SOT-23	16dc	-	3a	PhM
18Y	PMBZ5248B	Z-diode	18V±5%, 250mW	SOT-23	16dc	-	3a	PhM
18Z	PMBZ5249B	Z-diode	19V±5%, 250mW	SOT-23	16dc	-	3a	PhM
T9	1SS396	Si-diode	Dual, Schottky, 40V, 100mA	SC-59	16dg	-	3a	Tos
T9	BSR18	Si-pnp	Sw, 40V, 200mA, 250mW, B=50..150, >200MHz	SOT-23	16ta	-	3a	Phi
T9	ELM7649HCB	Vdet-IC	4.9V±2%, +Reset PPO, 150ms	SOT-23	16vdc	VD7	3d	Elm
T9	HVM306	C-diode	Dual, Filter, Tuning, 30V, 32pF(2V)	SOT-23	16dg	-	3a	Ren
T9	SST4119	n-FET	AF, 40V, 50mA, 300mW, Idss=0.2..0.6mA, Up<6V	SOT-23	16fj	-	3a	Six
T90	TK71590S	LVR-IC	LDO, 9V±1.5%, 155mA	SOT-23	16cj	VR1	3d	Tok
T91	BSR18R	Si-pnp	Sw, 40V, 200mA, 250mW, B=50..150, >200MHz	SOT-23	16te	-	3a	Phi
T92	2SA1977-FB	Si-pnp	Fast-Sw, UHF, 20V, 50mA, 200mW, B=20..100, 8.5GHz	SOT-23	16ta	-	3a	Nec
T92	BSR18A	Si-pnp	Sw, 40V, 200mA, 250mW, B=100..300, >250MHz	SOT-23	16ta	-	3a	Phi
T92	NE97733	Si-pnp	Fast-Sw, UHF, 20V, 50mA, 200mW, B=20..100, 8.5GHz	SOT-23	16ta	-	3a	Cel
T93	2SA1978-FB	Si-pnp	Fast-Sw, UHF, 20V, 50mA, 200mW, B=20..100, 5.5Hz	SOT-23	16ta	-	3a	Nec
T93	BSR18AR	Si-pnp	Sw, 40V, 200mA, 250mW, B=100..300, >250MHz	SOT-23	16te	-	3a	Phi
T93	NE97833	Si-pnp	Fast-Sw, UHF, 20V, 50mA, 200mW, B=20..100, 5.5Hz	SOT-23	16ta	-	3a	Cel
19A	PLVA650A	Z-diode	Avalanshe regulator, 5V, 250mA, 250mW	SOT-23	16dc	-	3a	PhM
19B	PLVA653A	Z-diode	Avalanshe regulator, 5.3V, 250mA, 250mW	SOT-23	16dc	-	3a	PhM
19C	PLVA656A	Z-diode	Avalanshe regulator, 5.6V, 250mA, 250mW	SOT-23	16dc	-	3a	PhM
19D	PLVA659A	Z-diode	Avalanshe regulator, 5.9V, 250mA, 250mW	SOT-23	16dc	-	3a	PhM
19E	PLVA662A	Z-diode	Avalanshe regulator, 6.2V, 250mA, 250mW	SOT-23	16dc	-	3a	PhM
19F	PLVA665A	Z-diode	Avalanshe regulator, 6.5V, 250mA, 250mW	SOT-23	16dc	-	3a	PhM
19G	PLVA668A	Z-diode	Avalanshe regulator, 6.8V, 250mA, 250mW	SOT-23	16dc	-	3a	PhM
19J	PLVA2650A	Z-diode	Dual, Avalanshe regulator, 5V, 250mA, 250mW	SOT-23	16df	-	3a	PhM
19K	PLVA2653A	Z-diode	Dual, Avalanshe regulator, 5.3V, 250mA, 250mW	SOT-23	16df	-	3a	PhH
19L	PLVA2656A	Z-diode	Dual, Avalanshe regulator, 5.6V, 250mA, 250mW	SOT-23	16df	-	3a	PhM
19M	PLVA2659A	Z-diode	Dual, Avalanshe regulator, 5.9V, 250mA, 250mW	SOT-23	16df	-	3a	PhM
19N	PLVA2662A	Z-diode	Dual, Avalanshe regulator, 6.2V, 250mA, 250mW	SOT-23	16df	-	3a	PhM
19O	PLVA2665A	Z-diode	Dual, Avalanshe regulator, 6.5V, 250mA, 250mW	SOT-23	16df	-	3a	PhM
19P	PLVA2668A	Z-diode	Dual, Avalanshe regulator, 6.8V, 250mA, 250mW	SOT-23	16df	-	3a	PhM
TA	2SC5431-EB	Si-npn	UHF-tun, Mix/Osc, 20V, 60mA, 100mW, 4.3GHz, B=60..90	SOT-523	18ta	-	3a	Nec
TA	BAS16TPT	Si-diode	Sw, 100V, 150mA, Vf<1.25V(150mA), 4ns	SOT-416	16dc	-	3a	Chm
TA	KTC3295A	Si-npn	AF, 60V, 150mA, 150mW, B=600..1800, >250MHz	SOT-23	16ta	-	3f	Kec
TA1	BZX84-C75	Z-diode	75V±5%, 300mW	SOT-23	16dc	-	3a	PhM
TAA	BC856A	Si-pnp	GP, 80V, 100mA, 200mW, B=110..220, 150MHz	SOT-23	16ta	-	3a	Auk
TAA	BC856FA	Si-pnp	GP, 80V, 100mA, 200mW, B=110..220, 150MHz	SOT-23F	18ta	-	3a	Auk
TAB	BC856B	Si-pnp	GP, 80V, 100mA, 200mW, B=200..450, 150MHz	SOT-23	16ta	-	3a	Auk
TAB	BC856FB	Si-pnp	GP, 80V, 100mA, 200mW, B=200..450, 150MHz	SOT-23F	18ta	-	3a	Auk
TAC	BC856C	Si-pnp	GP, 80V, 100mA, 200mW, B=420..800, 150MHz	SOT-23	16ta	-	3a	Auk
TAC	BC856FC	Si-pnp	GP, 80V, 100mA, 200mW, B=420..800, 150MHz	SOT-23F	18ta	-	3a	Auk
TB	2SC5431-FB	Si-npn	UHF-tun, Mix/Osc, 20V, 60mA, 100mW, 4.3GHz, B=80..120	SOT-523	18ta	-	3a	Nec
TB	KTC3295B	Si-npn	AF, 60V, 150mA, 150mW, B=1200..3600, >250MHz	SOT-23	16ta	-	3f	Kec
1B0	BZX84-C68	Z-diode	68V±5%, 300mW	SOT-23	16dc	-	3a	PhM
1B1	BZX84-C3V3	Z-diode	3.3V±5%, 300mW	SOT-23	16dc	-	3a	PhM
1B2	BZX84-C3V6	Z-diode	3.6V±5%, 300mW	SOT-23	16dc	-	3a	PhM
1B3	BZX84-C3V9	Z-diode	3.9V±5%, 300mW	SOT-23	16dc	-	3a	PhM
1B4	BZX84-C43	Z-diode	43V±5%, 300mW	SOT-23	16dc	-	3a	PhM
1B5	BZX84-C47	Z-diode	47V±5%, 300mW	SOT-23	16dc	-	3a	PhM
1B6	BZX84-C4V3	Z-diode	4.3V±5%, 300mW	SOT-23	16dc	-	3a	PhM
1B7	BZX84-C51	Z-diode	51V±5%, 300mW	SOT-23	16dc	-	3a	PhM
1B8	BZX84-C56	Z-diode	56V±5%, 300mW	SOT-23	16dc	-	3a	PhM
1B9	BZX84-C62	Z-diode	62V±5%, 300mW	SOT-23	16dc	-	3a	PhM
TC	2SC2736	Si-npn	VHF/UHF-Osc, 30V, 50mA, 150mW, B=30..200, 2.2GHz	SOT-23	16ta	-	3a	Ren
TC	2SC5432-EB	Si-npn	VHF/UHF, 12V, 100mA, 100mW, 4.5GHz, B=60..90	SOT-523	18ta	-	3a	Nec
1C0	BZX84-A13	Z-diode	13V±1%, 300mW	SOT-23	16dc	-	3a	PhM
1C2	BZX84-A20	Z-diode	20V±1%, 300mW	SOT-23	16dc	-	3a	PhM
1C3	BZX84-A36	Z-diode	36V±1%, 300mW	SOT-23	16dc	-	3a	PhM
1C4	BZX84-A39	Z-diode	39V±1%, 300mW	SOT-23	16dc	-	3a	PhM
1C5	BZX84-A43	Z-diode	43V±1%, 300mW	SOT-23	16dc	-	3a	PhM
1C6	BZX84-A51	Z-diode	51V±1%, 300mW	SOT-23	16dc	-	3a	PhM
1Cq	BZX84-A3V6	Z-diode	3.6V±1%, 300mW	SOT-23	16dc	-	3a	PhM
TD	2SC5432-FB	Si-npn	VHF/UHF, 12V, 100mA, 100mW, 4.5GHz, B=80..120	SOT-523	18ta	-	3a	Nec
TE	2SC5433-EB	Si-npn	VHF/UHF, 10V, 65mA, 100mW, 7GHz, B=60..90	SOT-523	18ta	-	3a	Nec
TE	BAS21TPT	Si-diode	Sw, 250V, 200mA, Vf<1.25V(200mA), 50ns	SOT-416	16dc	-	3a	Chm
TE1	CHDTA143TEPT	Si-pnp-Digi	Sw, 50V, 100mA, 250MHz, R1=47k	SOT-416	16ta	-	3a	Chm
TE2	CHDTA114TEPT	Si-pnp-Digi	Sw, 50V, 100mA, 250MHz, R1=10k	SOT-416	16ta	-	3a	Chm
TE3	CHDTA124TEPT	Si-pnp-Digi	Sw, 50V, 100mA, 250MHz, R1=22k	SOT-416	16ta	-	3a	Chm



SMD code	Type	Function	Short description	Case	Pinout	Sch.	St.	Mnf.
TE4	CHDTA144TEPT	Si-npn-Digi	Sw, 50V, 100mA, 250MHz, R1=4.7k	SOT-416	16ta	-	3a	Chm
TE5	CHDTA115TEPT	Si-npn-Digi	Sw, 50V, 100mA, 250MHz, R1=100k	SOT-416	16ta	-	3a	Chm
TEA	CHDTC143TEPT	Si-npn-Digi	Sw, 50V, 100mA, 250MHz, R1=4.7k	SOT-416	16ta	-	3a	Chm
TEB	CHDTC114TEPT	Si-npn-Digi	Sw, 50V, 100mA, 250MHz, R1=10k	SOT-416	16ta	-	3a	Chm
TEC	CHDTC124TEPT	Si-npn-Digi	Sw, 50V, 100mA, 250MHz, R1=22k	SOT-416	16ta	-	3a	Chm
TED	CHDTC144TEPT	Si-npn-Digi	Sw, 50V, 100mA, 250MHz, R1=47k	SOT-416	16ta	-	3a	Chm
TEE	CHDTC115TEPT	Si-npn-Digi	Sw, 50V, 100mA, 250MHz, R1=100k	SOT-416	16ta	-	3a	Chm
TF	2SC5433-FB	Si-npn	VHF/UHF, 10V, 65mA, 100mW, 7GHz, B=80..120	SOT-523	18ta	-	3a	Nec
TF	BAL99	Si-diode	Sw, Fast, 75V, 0.25A, 250mW, <4ns	SOT-23	16dr	-	3a	Trs
TG	2SK302-GR	n-FET	VHF, 20V, 30mA, 200mW, Idss=6..14mA	SOT-23	16fk	-	3a	Tos
TG	2SK882-GR	n-FET	FM/VHF, 20V, 30mA, 100mW, Idss=6..14mA, Up<2.5V	SOT-323	16fk	-	3a	Tos
TG	CH715TPT	Si-diode	SBD, 40V, 30mA, Vf<0.37V(1mA)	SOT-416	16dc	-	3a	Chm
IG1	PMBT5551	Si-npn	GP, 180V, 300mA, 250mW, B=80..250, 100..300MHz	SOT-23	16ta	-	3a	PhH
IG3	PMST5551	Si-npn	HV, 180V, 300mA, 200mW, B=80..250, 100..300MHz	SOT-323	16ta	-	3a	PhM
TH	2SC5434-EB	Si-npn	VHF/UHF, 10V, 35mA, 100mW, 8GHz, B=60..90	SOT-523	18ta	-	3a	Nec
TH	CH715TAPT	Si-diode	Dual, SBD, 40V, 30mA, Vf<0.37V(1mA)	SOT-416	16dg	-	3a	Chm
TI	CH715TSPT	Si-diode	Dual, SBD, 40V, 30mA, Vf<0.37V(1mA)	SOT-416	16dl	-	3a	Chm
TI-	2SC4197	Si-npn	UHF-F-Conv, 25V, 50mA, 150mW, B=50..180, 3.8GHz	SOT-323	16ta	-	3a	Ren
TI-	2SC4260	Si-npn	VHF/UHF, 25V, 50mA, 100mW, B=50..180, >3GHz	COMPACT	16ta	-	3a	Ren
TI-	2SC5136	Si-npn	VHF/UHF, 25V, 50mA, 80mW, B=50..180, 3.8GHz	SMPACK	16ta	-	3a	Ren
TJ	2SC5434-FB	Si-npn	VHF/UHF, 10V, 35mA, 100mW, 8GHz, B=80..120	SOT-523	18ta	-	3a	Nec
TJ	MMBD4448TPT	Si-diode	Sw, 80V, 250mA, Vf<1V(100mA), 4ns	SOT-416	16dc	-	3a	Chm
TK	2SC5435-EB	Si-npn	VHF/UHF, 9V, 30mA, 100mW, 12GHz, B=60..90	SOT-523	18ta	-	3a	Nec
TK	MMBD4448TAPT	Si-diode	Dual, Sw, 80V, 250mA, Vf<1V(100mA), 4ns	SOT-416	16df	-	3a	Chm
TK0	CHDTB114TKPT	Si-npn-Digi	Sw, 50V, 500mA, 250MHz, R1=10k	SOT-23	16ta	-	3a	Chm
TK2	CHDTA143TKPT	Si-npn-Digi	Sw, 50V, 100mA, 250MHz, R1=4.7k	SOT-23	16ta	-	3a	Chm
TK3	CHDTA114TKPT	Si-npn-Digi	Sw, 50V, 100mA, 250MHz, R1=10k	SOT-23	16ta	-	3a	Chm
TK4	CHDTA124TKPT	Si-npn-Digi	Sw, 50V, 100mA, 250MHz, R1=22k	SOT-23	16ta	-	3a	Chm
TK5	CHDTA144TKPT	Si-npn-Digi	Sw, 50V, 100mA, 250MHz, R1=47k	SOT-23	16ta	-	3a	Chm
TK6	CHDTA115TKPT	Si-npn-Digi	Sw, 50V, 100mA, 250MHz, R1=100k	SOT-23	16ta	-	3a	Chm
TK7	CHDTA125TKPT	Si-npn-Digi	Sw, 50V, 100mA, 250MHz, R1=200k	SOT-23	16ta	-	3a	Chm
TK8	CHDTB123TKPT	Si-npn-Digi	Sw, 40V, 500mA, 250MHz, R1=2.2k	SOT-23	16ta	-	3a	Chm
TK9	CHDTB143TKPT	Si-npn-Digi	Sw, 40V, 500mA, 250MHz, R1=4.7k	SOT-23	16ta	-	3a	Chm
TKA	CHDTC123TKPT	Si-npn-Digi	Sw, 50V, 100mA, 250MHz, R1=2.2k	SOT-23	16ta	-	3a	Chm
TKB	CHDTC143TKPT	Si-npn-Digi	Sw, 50V, 100mA, 250MHz, R1=4.7k	SOT-23	16ta	-	3a	Chm
TKC	CHDTC114TKPT	Si-npn-Digi	Sw, 50V, 100mA, 250MHz, R1=10k	SOT-23	16ta	-	3a	Chm
TKD	CHDTC124TKPT	Si-npn-Digi	Sw, 50V, 100mA, 250MHz, R1=22k	SOT-23	16ta	-	3a	Chm
TKE	CHDTC144TKPT	Si-npn-Digi	Sw, 50V, 100mA, 250MHz, R1=47k	SOT-23	16ta	-	3a	Chm
TKF	CHDTC115TKPT	Si-npn-Digi	Sw, 50V, 100mA, 250MHz, R1=100k	SOT-23	16ta	-	3a	Chm
TKG	CHDTC125TKPT	Si-npn-Digi	Sw, 50V, 100mA, 250MHz, R1=200k	SOT-23	16ta	-	3a	Chm
TKH	CHDTC123TKPT	Si-npn-Digi	Sw, 50V, 100mA, 250MHz, R1=2.2k	SOT-23	16ta	-	3a	Chm
TKI	CHDTC143TKPT	Si-npn-Digi	Sw, 50V, 100mA, 250MHz, R1=4.7k	SOT-23	16ta	-	3a	Chm
TKJ	CHDTC323TKPT	Si-npn-Digi	Sw, 15V, 600mA, 200MHz, R1=2.2k	SOT-23	16ta	-	3a	Chm
TKK	CHDTC343TKPT	Si-npn-Digi	Sw, 15V, 600mA, 200MHz, R1=4.7k	SOT-23	16ta	-	3a	Chm
TKL	CHDTC363TKPT	Si-npn-Digi	Sw, 15V, 600mA, 200MHz, R1=6.8k	SOT-23	16ta	-	3a	Chm
TKM	CHDTC314TKPT	Si-npn-Digi	Sw, 15V, 600mA, 200MHz, R1=10k	SOT-23	16ta	-	3a	Chm
TKN	CHDTC614TKPT	Si-npn-Digi	Sw, 20V, 600mA, 150MHz, R1=10k	SOT-23	16ta	-	3a	Chm
TKO	CHDTC623TKPT	Si-npn-Digi	Sw, 20V, 600mA, 150MHz, R1=2.5k	SOT-23	16ta	-	3a	Chm
TKP	CHDTC643TKPT	Si-npn-Digi	Sw, 20V, 600mA, 150MHz, R1=4.7k	SOT-23	16ta	-	3a	Chm
TL	2SA1573	Si-npn-Digi	Sw, 50V, 100mA, 200mW, 200MHz, R1=22k	SOT-23	16ta	-	3a	San
TL	2SC5435-FB	Si-npn	VHF/UHF, 9V, 30mA, 100mW, 12GHz, B=80..120	SOT-523	18ta	-	3a	Nec
TL	MMBD4448TCPT	Si-diode	Dual, Sw, 80V, 250mA, Vf<1V(100mA), 4ns	SOT-416	16dg	-	3a	Chm
TLN	ELM7539CEB	Vdet-IC	3.9V±2%, +Reset PPO	SC-70	16vdb	VD7	3d	Elm
TLN	ELM7539NEB	Vdet-IC	3.9V±2%, +Reset ODO	SC-70	16vdb	VD6	3d	Elm
TM	MMBD4448TSPT	Si-diode	Dual, Sw, 80V, 250mA, Vf<1V(100mA), 4ns	SOT-416	16dl	-	3a	Chm
TN	2SC5436-EB	Si-npn	VHF/UHF, 5V, 30mA, 100mW, 14GHz, B=60..90	SOT-523	18ta	-	3a	Nec
TN	CH145TPT	Si-diode	SBD, 45V, 100mA, Vf<0.6V(50mA)	SOT-416	16dc	-	3a	Chm
TO	2SK302-O	n-FET	VHF, 20V, 30mA, 200mW, Idss=1.5..3.5mA	SOT-23	16fk	-	3a	Tos
TO	BAS40TPT	Si-diode	SBD, 40V, 200mA, Vf<1V(40mA), 5ns	SOT-416	16dc	-	3a	Chm
IO4	PMBS3904	Si-npn	Sw, 60V, 200mA, 250mW, B=100..300, >180MHz	SOT-23	16ta	-	3a	PhM
IO6	PMBS3906	Si-npn	Sw, 40V, 100mA, 250mW, B=100..200, >150MHz	SOT-23	16ta	-	3a	PhM
TP	2SC5436-FB	Si-npn	VHF/UHF, 5V, 30mA, 100mW, 14GHz, B=80..120	SOT-523	18ta	-	3a	Nec
TP	BAS40TAPT	Si-diode	Dual, SBD, 40V, 200mA, Vf<1V(40mA), 5ns	SOT-416	16df	-	3a	Chm
TQ	2SA1530A-Q	Si-npn	AF, 60V, 150mA, 200mW, B=120..270, 200MHz	SOT-23	16ta	-	3a	Pan
TQ	2SA1603-Q	Si-npn	AF, 50V, 100mA, 150mW, 200MHz, B=120..270	SOT-323	16ta	-	3a	Mit
TQ	2SA1989-Q	Si-npn	AF, 50V, 100mA, 150mW, B=120..270, 200MHz	SC-75A	16ta	-	3a	Mit
TQ	BAS40TCPT	Si-diode	Dual, SBD, 40V, 200mA, Vf<1V(40mA), 5ns	SOT-416	16dg	-	3a	Chm
TR	2SA1530A-R	Si-npn	AF, 60V, 150mA, 200mW, B=180..390, 200MHz	SOT-23	16ta	-	3a	Pan
TR	2SA1603-R	Si-npn	AF, 50V, 100mA, 150mW, 200MHz, B=180..390	SOT-323	16ta	-	3a	Mit
TR	2SA1989-R	Si-npn	AF, 50V, 100mA, 150mW, B=180..390, 200MHz	SC-75A	16ta	-	3a	Mit



SMD code	Type	Function	Short description	Case	Pinout	Sch.	St.	Mnf.
TR	2SC2406-R	Si-npn	AF, LN, 55V, 10mA, 200mW, B=180..360, 200MHz	SOT-23	16ta	-	3a	Pan
TR	2SC3906K-R	Si-npn	AF-Drv, 120V, 50mA, 200mW, B=390..820, 140MHz	SC-59	16ta	-	3a	Rhm
TR	2SC3929A-R	Si-npn	AF, LN, 55V, 50mA, 150mW, B=180..360, 80MHz	SOT-323	16ta	-	3a	Pan
TR	2SC4102-R	Si-npn	AF, 120V, 50mA, 200mW, B=180..390, >140MHz	SOT-323	16ta	-	3a	Rhm
TR	BAS40TSPT	Si-diode	Dual, SBD, 40V, 200mA, Vf<1V(40mA), 5ns	SOT-416	16dl	-	3a	Chm
TR	CAT809TSDI-GT3	Vdet-IC	3.08V±1.5%, -Reset PPO	SC-70	16vdc	VD7	3d	Ons
TR	CAT809TTBI-GT3	Vdet-IC	3.08V±1.5%, -Reset PPO	SOT-23	16vdc	VD7	3b	Ons
IR0	BZX84-B56	Z-diode	5.6V±2%, 300mW	SOT-23	16dc	-	3a	PhM
IR1	BZX84-B5V1	Z-diode	5.1V±2%, 300mW	SOT-23	16dc	-	3a	PhM
IR2	BZX84-B5V6	Z-diode	5.6V±2%, 300mW	SOT-23	16dc	-	3a	PhM
IR3	BZX84-B62	Z-diode	6.2V±2%, 300mW	SOT-23	16dc	-	3a	PhM
IR4	BZX84-B68	Z-diode	6.8V±2%, 300mW	SOT-23	16dc	-	3a	PhM
IR5	BZX84-B6V2	Z-diode	6.2V±2%, 300mW	SOT-23	16dc	-	3a	PhM
IR6	BZX84-B6V8	Z-diode	6.8V±2%, 300mW	SOT-23	16dc	-	3a	PhM
IR7	BZX84-B75	Z-diode	7.5V±2%, 300mW	SOT-23	16dc	-	3a	PhM
IR8	BZX84-B7V5	Z-diode	7.5V±2%, 300mW	SOT-23	16dc	-	3a	PhM
IR9	BZX84-B8V2	Z-diode	8.2V±2%, 300mW	SOT-23	16dc	-	3a	PhM
TS	2SA1530A-S	Si-pnp	AF, 60V, 150mA, 200mW, B=270..560, 200MHz	SOT-23	16ta	-	3a	Pan
TS	2SA1603-S	Si-pnp	AF, 50V, 100mA, 150mW, 200MHz, B=270..560	SOT-323	16ta	-	3a	Mit
TS	2SA1989-S	Si-pnp	AF, 50V, 100mA, 150mW, B=270..560, 200MHz	SC-75A	16ta	-	3a	Mit
TS	2SC2406-S	Si-npn	AF, LN, 55V, 10mA, 200mW, B=260..520, 200MHz	SOT-23	16ta	-	3a	Pan
TS	2SC3906K-S	Si-npn	AF-Drv, 120V, 50mA, 200mW, B=270..560, 140MHz	SC-59	16ta	-	3a	Rhm
TS	2SC3929A-S	Si-npn	AF, LN, 55V, 50mA, 150mW, B=260..520, 80MHz	SOT-323	16ta	-	3a	Pan
TS	2SC4102-S	Si-npn	AF, 120V, 50mA, 200mW, B=270..560, >140MHz	SOT-323	16ta	-	3a	Rhm
TS	2SC5437-EB	Si-npn	VHF/UHF, 9V, 50mA, 100mW, 9.5Hz, B=60..90	SOT-523	18ta	-	3a	Nec
TS	BAT54TPT	Si-diode	SBD, 30V, 200mA, Vf<1V(100mA), 5ns	SOT-416	16dc	-	3a	Chm
TS	CAT810TSDI-GT3	Vdet-IC	3.08V±1.5%, +Reset PPO	SC-70	16vdc	VD7	3d	Ons
TS	CAT810TTBI-GT3	Vdet-IC	3.08V±1.5%, +Reset PPO	SOT-23	16vdc	VD7	3b	Ons
IS0	BZX84-B39	Z-diode	3.9V±2%, 300mW	SOT-23	16dc	-	3a	PhM
IS1	BZX84-B3V0	Z-diode	3V±2%, 300mW	SOT-23	16dc	-	3a	PhM
IS2	BZX84-B3V3	Z-diode	3.3V±2%, 300mW	SOT-23	16dc	-	3a	PhM
IS2	BZX84-B3V6	Z-diode	3.6V±2%, 300mW	SOT-23	16dc	-	3a	PhM
IS4	BZX84-B3V9	Z-diode	3.9V±2%, 300mW	SOT-23	16dc	-	3a	PhM
IS5	BZX84-B43	Z-diode	4.3V±2%, 300mW	SOT-23	16dc	-	3a	PhM
IS6	BZX84-B47	Z-diode	4.7V±2%, 300mW	SOT-23	16dc	-	3a	PhM
IS7	BZX84-B4V3	Z-diode	4.3V±2%, 300mW	SOT-23	16dc	-	3a	PhM
IS8	BZX84-B4V7	Z-diode	4.7V±2%, 300mW	SOT-23	16dc	-	3a	PhM
IS9	BZX84-B51	Z-diode	5.1V±2%, 300mW	SOT-23	16dc	-	3a	PhM
TT	2SA1036KPT-Q	Si-pnp	AF, Sw, 32V, 500mA, B=120..270, 200MHz	SOT-23	16ta	-	3a	Chm
TT	2SA1530A-T	Si-pnp	AF, 60V, 150mA, 200mW, B=360..700, 200MHz	SOT-23	16ta	-	3a	Pan
TT	2SA1603-T	Si-pnp	AF, 50V, 100mA, 150mW, 200MHz, B=390..820	SOT-323	16ta	-	3a	Mit
TT	2SA1989-T	Si-pnp	AF, 50V, 100mA, 150mW, B=390..820, 200MHz	SC-75A	16ta	-	3a	Mit
TT	2SC2406-T	Si-npn	AF, LN, 55V, 10mA, 200mW, B=360..700, 200MHz	SOT-23	16ta	-	3a	Pan
TT	2SC3929A-T	Si-npn	AF, LN, 55V, 50mA, 150mW, B=360..700, 80MHz	SOT-323	16ta	-	3a	Pan
TT	2SC5437-FB	Si-npn	VHF/UHF, 9V, 50mA, 100mW, 9.5Hz, B=80..120	SOT-523	18ta	-	3a	Nec
TT	BAT54TAPT	Si-diode	Dual, SBD, 30V, 200mA, Vf<1V(100mA), 5ns	SOT-416	16df	-	3a	Chm
IT1	BZX84-B9V1	Z-diode	9.1V±2%, 300mW	SOT-23	16dc	-	3a	PhM
IT2	BZX84-C27	Z-diode	2.7V±5%, 300mW	SOT-23	16dc	-	3a	PhM
IT3	BZX84-C2V4	Z-diode	2.4V±5%, 300mW	SOT-23	16dc	-	3a	PhM
TT4	2SC4519-4	Si-npn	Sw, Hi-Sp, 60V, 500mA, 200mW, B=100..200, 350MHz	CP	16ta	-	3a	San
IT4	BZX84-C2V7	Z-diode	2.7V±5%, 300mW	SOT-23	16dc	-	3a	PhM
TT5	2SC4519-5	Si-npn	Sw, Hi-Sp, 60V, 500mA, 200mW, B=140..280, 350MHz	CP	16ta	-	3a	San
IT5	BZX84-C30	Z-diode	3.0V±5%, 300mW	SOT-23	16dc	-	3a	PhM
TT6	2SC4519-6	Si-npn	Sw, Hi-Sp, 60V, 500mA, 200mW, B=200..400, 350MHz	CP	16ta	-	3a	San
IT6	BZX84-C33	Z-diode	3.3V±5%, 300mW	SOT-23	16dc	-	3a	PhM
IT7	BZX84-C36	Z-diode	3.6V±5%, 300mW	SOT-23	16dc	-	3a	PhM
IT8	BZX84-C39	Z-diode	3.9V±5%, 300mW	SOT-23	16dc	-	3a	PhM
IT9	BZX84-C3V0	Z-diode	3.0V±5%, 300mW	SOT-23	16dc	-	3a	PhM
TU	BAT54TCPT	Si-diode	Dual, SBD, 30V, 200mA, Vf<1V(100mA), 5ns	SOT-416	16dg	-	3a	Chm
TU1	CHDTA113TUPT	Si-pnp-Digi	Sw, 50V, 100mA, 250MHz, R1=1k	SOT-323	16ta	-	3a	Chm
TU1	CHDTA143TUPT	Si-pnp-Digi	Sw, 50V, 100mA, 250MHz, R1=4.7k	SOT-323	16ta	-	3a	Chm
TU2	CHDTA114TUPT	Si-pnp-Digi	Sw, 50V, 100mA, 250MHz, R1=10k	SOT-323	16ta	-	3a	Chm
TU3	CHDTA124TUPT	Si-pnp-Digi	Sw, 50V, 100mA, 250MHz, R1=22k	SOT-323	16ta	-	3a	Chm
TU4	CHDTA144TUPT	Si-pnp-Digi	Sw, 50V, 100mA, 250MHz, R1=47k	SOT-323	16ta	-	3a	Chm
TU5	CHDTA115TUPT	Si-pnp-Digi	Sw, 50V, 100mA, 250MHz, R1=100k	SOT-323	16ta	-	3a	Chm
TU6	CHDTA125TUPT	Si-pnp-Digi	Sw, 50V, 100mA, 250MHz, R1=200k	SOT-323	16ta	-	3a	Chm
TUA	CHDTC143TUPT	Si-npn-Digi	Sw, 50V, 100mA, 250MHz, R1=4.7k	SOT-323	16ta	-	3a	Chm
TUB	CHDTC114TUPT	Si-npn-Digi	Sw, 50V, 100mA, 250MHz, R1=10k	SOT-323	16ta	-	3a	Chm
TUC	CHDTC124TUPT	Si-npn-Digi	Sw, 50V, 100mA, 250MHz, R1=22k	SOT-323	16ta	-	3a	Chm
TUD	CHDTC144TUPT	Si-npn-Digi	Sw, 50V, 100mA, 250MHz, R1=47k	SOT-323	16ta	-	3a	Chm



SMD code	Type	Function	Short description	Case	Pinout	Sch.	St.	Mnf.
TUE	CHDTC115TUPT	Si-npn-Digi	Sw, 50V, 100mA, 250MHz, R1=100k	SOT-323	16ta	-	3a	Chm
TUF	CHDTC125TUPT	Si-npn-Digi	Sw, 50V, 100mA, 250MHz, R1=200k	SOT-323	16ta	-	3a	Chm
TUG	CHDTC323TUPT	Si-npn-Digi	Sw, 15V, 600mA, 200MHz, R1=2.2k	SOT-323	16ta	-	3a	Chm
TUH	CHDTC314TUPT	Si-npn-Digi	Sw, 15V, 600mA, 200MHz, R1=10k	SOT-323	16ta	-	3a	Chm
TUI	CHDTC614TUPT	Si-npn-Digi	Sw, 20V, 600mA, 150MHz, R1=10k	SOT-323	16ta	-	3a	Chm
TUJ	CHDTC623TUPT	Si-npn-Digi	Sw, 20V, 600mA, 150MHz, R1=2.5k	SOT-323	16ta	-	3a	Chm
TUK	CHDTC643TUPT	Si-npn-Digi	Sw, 20V, 600mA, 150MHz, R1=4.7k	SOT-323	16ta	-	3a	Chm
TV	2SC5599	Si-npn	VHF/UHF, 9V, 100mA, 200mW, B=80..160, 6.5GHz	SOT-23	16ta	-	3a	Nec
TV	2SC5600	Si-npn	VHF/UHF, 9V, 100mA, 200mW, B=80..160, 6.5GHz	SOT-523	18ta	-	3a	Nec
TV	BAT54TSP	Si-diode	Dual, SBD, 30V, 200mA, Vf<1V(100mA), 5ns	SOT-416	16dl	-	3a	Chm
IV1	BAS31	Si-diode	Dual, GP, Contr, Aval., 90V, 250mA, 250mW, 35pF, <50ns	SOT-23	16dl	-	3a	PhM
IV2	BAS35	Si-diode	Dual, GP, Contr, Aval., 90V, 250mA, 250mW, 35pF, <50ns	SOT-23	16df	-	3a	PhM
IV3	BAT54A	Si-diode	Dual, Schottky Rectifier, 30V, 200mA, Vf<1V(100mA), <5ns	SOT-23	16df	-	3a	PhM
IV4	BAT54S	Si-diode	Dual, Schottky Rectifier, 30V, 200mA, Vf<1V(100mA), <5ns	SOT-23	16dl	-	3a	PhM
IV5	BAV23S	Si-diode	Dual, GP, 200V, 225mA, Vs<1.25V(200mA), <50ns	SOT-23	16dl	-	3a	PhM
TW	2SC5602	Si-npn	RF, LN, 15V, 35mA, 200mW, 13.5GHz, B=60..120	SC-59	16ta	-	3a	Nec
TW	2SC5603	Si-npn	VHF/UHF, 15V, 35mA, 200mW, B=60..120, 13.5GHz	SOT-523	18ta	-	3a	Nec
TW	BAS70TPT	Si-diode	Schottky, 70V, 70mA, Vf<1V(15mA), <2pF, 5ns	SOT-416	16dc	-	3a	Chm
TX	BAS70TAPT	Si-diode	Dual, Schottky, 70V, 70mA, Vf<1V(15mA), <2pF, 5ns	SOT-416	16df	-	3a	Chm
TY	2SC3912	Si-npn-Digi	Sw, 50V, 500mA, 200mW, 250MHz, R1/R2=10k/10k	SOT-23	16ta	-	3a	San
TY	2SK302-Y	n-FET	VHF, 20V, 30mA, 200mW, Idss=3..7mA	SOT-23	16fk	-	3a	Tos
TY	2SK882	n-MOSFET*	VHF, 20V, Idss=3..14mA, Up<2.5V	SOT-323	16fk	-	3a	Tos
TY	2SK882-Y	n-FET	FM/VHF, 20V, 30mA, 100mW, Idss=3..7mA, Up<2.5V	SOT-323	16fk	-	3a	Tos
TY	BAS70TCPT	Si-diode	Dual, Schottky, 70V, 70mA, Vf<1V(15mA), <2pF, 5ns	SOT-416	16dg	-	3a	Chm
IY1	BZX84-B33	Z-diode	33V±2%, 300mW	SOT-23	16dc	-	3a	PhM
IY2	BZX84-B36	Z-diode	36V±2%, 300mW	SOT-23	16dc	-	3a	PhM
TZ	BAS70TSPT	Si-diode	Dual, Schottky, 70V, 70mA, Vf<1V(15mA), <2pF, 5ns	SOT-416	16dl	-	3a	Chm
IZ0	BZX84-B2V4	Z-diode	2.4V±2%, 300mW	SOT-23	16dc	-	3a	PhM
IZ1	BZX84-B2V7	Z-diode	2.7V±2%, 300mW	SOT-23	16dc	-	3a	PhM
IZ4	BZX84-B30	Z-diode	30V±2%, 300mW	SOT-23	16dc	-	3a	PhM
IZ5	BZX84-B27	Z-diode	27V±2%, 300mW	SOT-23	16dc	-	3a	PhM
IZ6	BZX84-B11	Z-diode	11V±2%, 300mW	SOT-23	16dc	-	3a	PhM
IZ7	BZX84-B12	Z-diode	12V±2%, 300mW	SOT-23	16dc	-	3a	PhM
IZ8	BZX84-B13	Z-diode	13V±2%, 300mW	SOT-23	16dc	-	3a	PhM
IZ9	BZX84-B15	Z-diode	15V±2%, 300mW	SOT-23	16dc	-	3a	PhM
u	AX6903GA	Vdet-IC	2.25V±1.5%, -Reset PPO	SC-70	16vda	VD7	3b	Axl
U0	ELM7620LCB	Vdet-IC	2.0V±2%, -Reset PPO, 150ms	SOT-23	16vda	VD7	3d	Elm
U0	RN2101FS	Si-pnp-Digi	Sw, 20V, 50mA, 50mW, R1/R2=4.7k/4.7k	fSM	19ta	-	3a	Tos
U1	BCX19	Si-npn	AF-Drv, 50V, 500mA, 250mW, B=100..600, 200MHz	SOT-23	16ta	-	3a	Ste
U1	ELM7621LCB	Vdet-IC	2.1V±2%, -Reset PPO, 150ms	SOT-23	16vdc	VD7	3d	Elm
U1	RN2102FS	Si-pnp-Digi	Sw, 20V, 50mA, 50mW, R1/R2=10k/10k	fSM	19ta	-	3a	Tos
U12	2SC2758-12	Si-npn	RF-amp, 25V, 20mA, 150mW, B=60..120, 750MHz	SOT-23	16ta	-	3a	Nec
U13	2SC2758-13	Si-npn	RF-amp, 25V, 20mA, 150mW, B=90..180, 750MHz	SOT-23	16ta	-	3a	Nec
U14	2SC2758-14	Si-npn	RF-amp, 25V, 20mA, 150mW, B=120..240, 750MHz	SOT-23	16ta	-	3a	Nec
U16	2SC4183-16	Si-npn	UHF TV-Tuner, 30V, 20mA, 150mW, B=60..120, 1GHz	SOT-323	16ta	-	3a	Nec
U16C	SS6680C-16CU	Vdet-IC	1.6V±2.5%, +Reset PPO	SOT-23	16vda	VD7	3a	Ssc
U16N	SS6680N-16CU	Vdet-IC	1.6V±2.5%, +Reset ODO	SOT-23	16vda	VD6	3a	Ssc
U16P	SS6680P-16CU	Vdet-IC	1.6V±2.5%, -Reset ODO	SOT-23	16vda	VD6	3a	Ssc
U17	2SC4183-17	Si-npn	UHF TV-Tuner, 30V, 20mA, 150mW, B=90..180, 1GHz	SOT-323	16ta	-	3a	Nec
U17C	SS6680C-17CU	Vdet-IC	1.7V±2.5%, +Reset PPO	SOT-23	16vda	VD7	3a	Ssc
U17N	SS6680N-17CU	Vdet-IC	1.7V±2.5%, +Reset ODO	SOT-23	16vda	VD6	3a	Ssc
U17P	SS6680P-17CU	Vdet-IC	1.7V±2.5%, -Reset ODO	SOT-23	16vda	VD6	3a	Ssc
U18	2SC4183-18	Si-npn	UHF TV-Tuner, 30V, 20mA, 150mW, B=120..240, 1GHz	SOT-323	16ta	-	3a	Nec
U18C	SS6680C-18CU	Vdet-IC	1.8V±2.5%, +Reset PPO	SOT-23	16vda	VD7	3a	Ssc
U18N	SS6680N-18CU	Vdet-IC	1.8V±2.5%, +Reset ODO	SOT-23	16vda	VD6	3a	Ssc
U18P	SS6680P-18CU	Vdet-IC	1.8V±2.5%, -Reset ODO	SOT-23	16vda	VD6	3a	Ssc
U19C	SS6680C-19CU	Vdet-IC	1.9V±2.5%, +Reset PPO	SOT-23	16vda	VD7	3a	Ssc
U19N	SS6680N-19CU	Vdet-IC	1.9V±2.5%, +Reset ODO	SOT-23	16vda	VD6	3a	Ssc
U19P	SS6680P-19CU	Vdet-IC	1.9V±2.5%, -Reset ODO	SOT-23	16vda	VD6	3a	Ssc
U1p	BCX19	Si-npn	AF-Drv, 50V, 500mA, 250mW, B=100..600, 200MHz	SOT-23	16ta	-	3a	PHH
U1t	BCX19	Si-npn	AF-Drv, 50V, 500mA, 250mW, B=100..600, 200MHz	SOT-23	16ta	-	3a	PhM
U2	2SK613-2	n-FET	V-CAM, 15V, 50mA, 150mW, Idss=13.4..21, Up<1.26V	SOT-23	16fa	-	3a	Soy
U2	BCX20	Si-npn	AF, 30V, 500mA, 250mW, B=100..600, >100MHz	SOT-23	16ta	-	3a	Ste
U2	ELM7622LCB	Vdet-IC	2.2V±2%, -Reset PPO, 150ms	SOT-23	16vdc	VD7	3d	Elm
U2	RN2103FS	Si-pnp-Digi	Sw, 20V, 50mA, 50mW, R1/R2=22k/22k	fSM	19ta	-	3a	Tos
U20C	SS6680C-20CU	Vdet-IC	2.0V±2.5%, +Reset PPO	SOT-23	16vda	VD7	3a	Ssc
U20N	SS6680N-20CU	Vdet-IC	2.0V±2.5%, +Reset ODO	SOT-23	16vda	VD6	3a	Ssc
U20P	SS6680P-20CU	Vdet-IC	2.0V±2.5%, -Reset ODO	SOT-23	16vda	VD6	3a	Ssc
U21	2SC2759-21	Si-npn	RF-amp, 14V, 50mA, 150mW, B=40..80, 1.5GHz	SOT-23	16ta	-	3a	Nec
U21	2SC4185-21	Si-npn	UHF-Mix, Osc, 30V, 50mA, 160mW, B=40..80, 2GHz	SOT-323	16ta	-	3a	Nec



SMD code	Type	Function	Short description	Case	Pinout	Sch.	St.	Mnf.
U21C	SS6680C-21CU	Vdet-IC	2.1V±2.5%, +Reset PPO	SOT-23	16vda	VD7	3a	Ssc
U21N	SS6680N-21CU	Vdet-IC	2.1V±2.5%, +Reset ODO	SOT-23	16vda	VD6	3a	Ssc
U21P	SS6680P-21CU	Vdet-IC	2.1V±2.5%, -Reset ODO	SOT-23	16vda	VD6	3a	Ssc
U22	2SC2759-22	Si-npn	RF-amp, 14V, 50mA, 150mW, B=60..120, 1.5GHz	SOT-23	16ta	-	3a	Nec
U22	2SC4185-22	Si-npn	UHF-Mix, Osc, 30V, 50mA, 160mW, B=60..120, 2GHz	SOT-323	16ta	-	3a	Nec
U22C	SS6680C-22CU	Vdet-IC	2.2V±2.5%, +Reset PPO	SOT-23	16vda	VD7	3a	Ssc
U22N	SS6680N-22CU	Vdet-IC	2.2V±2.5%, +Reset ODO	SOT-23	16vda	VD6	3a	Ssc
U22P	SS6680P-22CU	Vdet-IC	2.2V±2.5%, -Reset ODO	SOT-23	16vda	VD6	3a	Ssc
U23	2SC2759-23	Si-npn	RF-amp, 14V, 50mA, 150mW, B=90..180, 1.5GHz	SOT-23	16ta	-	3a	Nec
U23	2SC4185-23	Si-npn	UHF-Mix, Osc, 30V, 50mA, 160mW, B=90..180, 2GHz	SOT-323	16ta	-	3a	Nec
U23C	SS6680C-23CU	Vdet-IC	2.3V±2.5%, +Reset PPO	SOT-23	16vda	VD7	3a	Ssc
U23N	SS6680N-23CU	Vdet-IC	2.3V±2.5%, +Reset ODO	SOT-23	16vda	VD6	3a	Ssc
U23P	SS6680P-23CU	Vdet-IC	2.3V±2.5%, -Reset ODO	SOT-23	16vda	VD6	3a	Ssc
U24C	SS6680C-24CU	Vdet-IC	2.4V±2.5%, +Reset PPO	SOT-23	16vda	VD7	3a	Ssc
U24N	SS6680N-24CU	Vdet-IC	2.4V±2.5%, +Reset ODO	SOT-23	16vda	VD6	3a	Ssc
U24P	SS6680P-24CU	Vdet-IC	2.4V±2.5%, -Reset ODO	SOT-23	16vda	VD6	3a	Ssc
U25C	SS6680C-25CU	Vdet-IC	2.5V±2.5%, +Reset PPO	SOT-23	16vda	VD7	3a	Ssc
U25N	SS6680N-25CU	Vdet-IC	2.5V±2.5%, +Reset ODO	SOT-23	16vda	VD6	3a	Ssc
U25P	SS6680P-25CU	Vdet-IC	2.5V±2.5%, -Reset ODO	SOT-23	16vda	VD6	3a	Ssc
U26C	SS6680C-26CU	Vdet-IC	2.6V±2.5%, +Reset PPO	SOT-23	16vda	VD7	3a	Ssc
U26N	SS6680N-26CU	Vdet-IC	2.6V±2.5%, +Reset ODO	SOT-23	16vda	VD6	3a	Ssc
U26P	SS6680P-26CU	Vdet-IC	2.6V±2.5%, -Reset ODO	SOT-23	16vda	VD6	3a	Ssc
U27C	SS6680C-27CU	Vdet-IC	2.7V±2.5%, +Reset PPO	SOT-23	16vda	VD7	3a	Ssc
U27N	SS6680N-27CU	Vdet-IC	2.7V±2.5%, +Reset ODO	SOT-23	16vda	VD6	3a	Ssc
U27P	SS6680P-27CU	Vdet-IC	2.7V±2.5%, -Reset ODO	SOT-23	16vda	VD6	3a	Ssc
U28C	SS6680C-28CU	Vdet-IC	2.8V±2.5%, +Reset PPO	SOT-23	16vda	VD7	3a	Ssc
U28N	SS6680N-28CU	Vdet-IC	2.8V±2.5%, +Reset ODO	SOT-23	16vda	VD6	3a	Ssc
U28P	SS6680P-28CU	Vdet-IC	2.8V±2.5%, -Reset ODO	SOT-23	16vda	VD6	3a	Ssc
U29C	SS6680C-29CU	Vdet-IC	2.9V±2.5%, +Reset PPO	SOT-23	16vda	VD7	3a	Ssc
U29N	SS6680N-29CU	Vdet-IC	2.9V±2.5%, +Reset ODO	SOT-23	16vda	VD6	3a	Ssc
U29P	SS6680P-29CU	Vdet-IC	2.9V±2.5%, -Reset ODO	SOT-23	16vda	VD6	3a	Ssc
U2p	BCX20	Si-pnp	AF, 30V, 500mA, 250mW, B=100..600, >100MHz	SOT-23	16ta	-	3a	Phi
U3	2SK613-3	n-FET	V-CAM, 15V, 50mA, 150mW, Idss=19..30.2, Up<1.26V	SOT-23	16fa	-	3a	Soy
U3	ELM7623LCB	Vdet-IC	2.3V±2%, -Reset PPO, 150ms	SOT-23	16vdc	VD7	3d	Elm
U3	RN2104FS	Si-pnp-Digi	Sw, 20V, 50mA, 50mW, R1/R2=47k/47k	fSM	19ta	-	3a	Tos
U30C	SS6680C-30CU	Vdet-IC	3.0V±2.5%, +Reset PPO	SOT-23	16vda	VD7	3a	Ssc
U30N	SS6680N-30CU	Vdet-IC	3.0V±2.5%, +Reset ODO	SOT-23	16vda	VD6	3a	Ssc
U30P	SS6680P-30CU	Vdet-IC	3.0V±2.5%, -Reset ODO	SOT-23	16vda	VD6	3a	Ssc
U31C	SS6680C-31CU	Vdet-IC	3.1V±2.5%, +Reset PPO	SOT-23	16vda	VD7	3a	Ssc
U31N	SS6680N-31CU	Vdet-IC	3.1V±2.5%, +Reset ODO	SOT-23	16vda	VD6	3a	Ssc
U31P	SS6680P-31CU	Vdet-IC	3.1V±2.5%, -Reset ODO	SOT-23	16vda	VD6	3a	Ssc
U32C	SS6680C-32CU	Vdet-IC	3.2V±2.5%, +Reset PPO	SOT-23	16vda	VD7	3a	Ssc
U32N	SS6680N-32CU	Vdet-IC	3.2V±2.5%, +Reset ODO	SOT-23	16vda	VD6	3a	Ssc
U32P	SS6680P-32CU	Vdet-IC	3.2V±2.5%, -Reset ODO	SOT-23	16vda	VD6	3a	Ssc
U33C	SS6680C-33CU	Vdet-IC	3.3V±2.5%, +Reset PPO	SOT-23	16vda	VD7	3a	Ssc
U33N	SS6680N-33CU	Vdet-IC	3.3V±2.5%, +Reset ODO	SOT-23	16vda	VD6	3a	Ssc
U33P	SS6680P-33CU	Vdet-IC	3.3V±2.5%, -Reset ODO	SOT-23	16vda	VD6	3a	Ssc
U34C	SS6680C-34CU	Vdet-IC	3.4V±2.5%, +Reset PPO	SOT-23	16vda	VD7	3a	Ssc
U34N	SS6680N-34CU	Vdet-IC	3.4V±2.5%, +Reset ODO	SOT-23	16vda	VD6	3a	Ssc
U34P	SS6680P-34CU	Vdet-IC	3.4V±2.5%, -Reset ODO	SOT-23	16vda	VD6	3a	Ssc
U35	BSR19	Si-npn	Sw, 160V, 300mA, 250mW, B=60..250, 100MHz	SOT-23	16ta	-	3a	Phi
U35C	SS6680C-35CU	Vdet-IC	3.5V±2.5%, +Reset PPO	SOT-23	16vda	VD7	3a	Ssc
U35N	SS6680N-35CU	Vdet-IC	3.5V±2.5%, +Reset ODO	SOT-23	16vda	VD6	3a	Ssc
U35P	SS6680P-35CU	Vdet-IC	3.5V±2.5%, -Reset ODO	SOT-23	16vda	VD6	3a	Ssc
U36	BSR19A	Si-npn	Sw, 180V, 300mA, 250mW, B=80..250, 100MHz	SOT-23	16ta	-	3a	Phi
U36C	SS6680C-36CU	Vdet-IC	3.6V±2.5%, +Reset PPO	SOT-23	16vda	VD7	3a	Ssc
U36N	SS6680N-36CU	Vdet-IC	3.6V±2.5%, +Reset ODO	SOT-23	16vda	VD6	3a	Ssc
U36P	SS6680P-36CU	Vdet-IC	3.6V±2.5%, -Reset ODO	SOT-23	16vda	VD6	3a	Ssc
U37C	SS6680C-37CU	Vdet-IC	3.7V±2.5%, +Reset PPO	SOT-23	16vda	VD7	3a	Ssc
U37N	SS6680N-37CU	Vdet-IC	3.7V±2.5%, +Reset ODO	SOT-23	16vda	VD6	3a	Ssc
U37P	SS6680P-37CU	Vdet-IC	3.7V±2.5%, -Reset ODO	SOT-23	16vda	VD6	3a	Ssc
U38C	SS6680C-38CU	Vdet-IC	3.8V±2.5%, +Reset PPO	SOT-23	16vda	VD7	3a	Ssc
U38N	SS6680N-38CU	Vdet-IC	3.8V±2.5%, +Reset ODO	SOT-23	16vda	VD6	3a	Ssc
U38P	SS6680P-38CU	Vdet-IC	3.8V±2.5%, -Reset ODO	SOT-23	16vda	VD6	3a	Ssc
U39C	SS6680C-39CU	Vdet-IC	3.9V±2.5%, +Reset PPO	SOT-23	16vda	VD7	3a	Ssc
U39N	SS6680N-39CU	Vdet-IC	3.9V±2.5%, +Reset ODO	SOT-23	16vda	VD6	3a	Ssc
U39P	SS6680P-39CU	Vdet-IC	3.9V±2.5%, -Reset ODO	SOT-23	16vda	VD6	3a	Ssc
U4	2SK613-4	n-FET	V-CAM, 15V, 50mA, 150mW, Idss=24.7..42, Up<1.26V	SOT-23	16fa	-	3a	Soy
U4	BCR114L3	Si-npn-Digi	Sw, 50V, 100mA, 250mW, R1/R2=4.7k/10k, 160MHz	TSLP-3	22ta	-	2a	Inf
U4	BCX19R	Si-npn	AF-Drv, 50V, 500mA, 250mW, B=100..600, 200MHz	SOT-23	16te	-	3a	Zx



SMD code	Type	Function	Short description	Case	Pinout	Sch.	St.	Mnf.
U4	ELM7624LCB	Vdet-IC	2.4V±2%, -Reset PPO, 150ms	SOT-23	16vdc	VD7	3d	Elm
U4	RN2105FS	Si-nnp-Digi	Sw, 20V, 50mA, 50mW, R1/R2=2.2k/47k	fSM	19ta	-	3a	Tos
U4	SP809EK-4-6	Vdet-IC	4.6V±1.5%, -Reset PPO	SOT-23	16vdc	VD7	3b	Sip
U40C	SS6680C-40CU	Vdet-IC	4.0V±2.5%, +Reset PPO	SOT-23	16vda	VD7	3a	Ssc
U40N	SS6680N-40CU	Vdet-IC	4.0V±2.5%, +Reset ODO	SOT-23	16vda	VD6	3a	Ssc
U40P	SS6680P-40CU	Vdet-IC	4.0V±2.5%, -Reset ODO	SOT-23	16vda	VD6	3a	Ssc
U41C	SS6680C-41CU	Vdet-IC	4.1V±2.5%, +Reset PPO	SOT-23	16vda	VD7	3a	Ssc
U41N	SS6680N-41CU	Vdet-IC	4.1V±2.5%, +Reset ODO	SOT-23	16vda	VD6	3a	Ssc
U41P	SS6680P-41CU	Vdet-IC	4.1V±2.5%, -Reset ODO	SOT-23	16vda	VD6	3a	Ssc
U42C	SS6680C-42CU	Vdet-IC	4.2V±2.5%, +Reset PPO	SOT-23	16vda	VD7	3a	Ssc
U42N	SS6680N-42CU	Vdet-IC	4.2V±2.5%, +Reset ODO	SOT-23	16vda	VD6	3a	Ssc
U42P	SS6680P-42CU	Vdet-IC	4.2V±2.5%, -Reset ODO	SOT-23	16vda	VD6	3a	Ssc
U43C	SS6680C-43CU	Vdet-IC	4.3V±2.5%, +Reset PPO	SOT-23	16vda	VD7	3a	Ssc
U43N	SS6680N-43CU	Vdet-IC	4.3V±2.5%, +Reset ODO	SOT-23	16vda	VD6	3a	Ssc
U43P	SS6680P-43CU	Vdet-IC	4.3V±2.5%, -Reset ODO	SOT-23	16vda	VD6	3a	Ssc
U44C	SS6680C-44CU	Vdet-IC	4.4V±2.5%, +Reset PPO	SOT-23	16vda	VD7	3a	Ssc
U44N	SS6680N-44CU	Vdet-IC	4.4V±2.5%, +Reset ODO	SOT-23	16vda	VD6	3a	Ssc
U44P	SS6680P-44CU	Vdet-IC	4.4V±2.5%, -Reset ODO	SOT-23	16vda	VD6	3a	Ssc
U45C	SS6680C-45CU	Vdet-IC	4.5V±2.5%, +Reset PPO	SOT-23	16vda	VD7	3a	Ssc
U45N	SS6680N-45CU	Vdet-IC	4.5V±2.5%, +Reset ODO	SOT-23	16vda	VD6	3a	Ssc
U45P	SS6680P-45CU	Vdet-IC	4.5V±2.5%, -Reset ODO	SOT-23	16vda	VD6	3a	Ssc
U46C	SS6680C-46CU	Vdet-IC	4.6V±2.5%, +Reset PPO	SOT-23	16vda	VD7	3a	Ssc
U46N	SS6680N-46CU	Vdet-IC	4.6V±2.5%, +Reset ODO	SOT-23	16vda	VD6	3a	Ssc
U46P	SS6680P-46CU	Vdet-IC	4.6V±2.5%, -Reset ODO	SOT-23	16vda	VD6	3a	Ssc
U47C	SS6680C-47CU	Vdet-IC	4.7V±2.5%, +Reset PPO	SOT-23	16vda	VD7	3a	Ssc
U47N	SS6680N-47CU	Vdet-IC	4.7V±2.5%, +Reset ODO	SOT-23	16vda	VD6	3a	Ssc
U47P	SS6680P-47CU	Vdet-IC	4.7V±2.5%, -Reset ODO	SOT-23	16vda	VD6	3a	Ssc
U48C	SS6680C-48CU	Vdet-IC	4.8V±2.5%, +Reset PPO	SOT-23	16vda	VD7	3a	Ssc
U48N	SS6680N-48CU	Vdet-IC	4.8V±2.5%, +Reset ODO	SOT-23	16vda	VD6	3a	Ssc
U48P	SS6680P-48CU	Vdet-IC	4.8V±2.5%, -Reset ODO	SOT-23	16vda	VD6	3a	Ssc
U49C	SS6680C-49CU	Vdet-IC	4.9V±2.5%, +Reset PPO	SOT-23	16vda	VD7	3a	Ssc
U49N	SS6680N-49CU	Vdet-IC	4.9V±2.5%, +Reset ODO	SOT-23	16vda	VD6	3a	Ssc
U49P	SS6680P-49CU	Vdet-IC	4.9V±2.5%, -Reset ODO	SOT-23	16vda	VD6	3a	Ssc
U4s	BCR114F	Si-npn-Digi	Sw, 50V, 100mA, 250mW, R1/R2=4.7k/10k, 160MHz	TSFP-3	18ta	-	3a	Inf
U4s	BCR114T	Si-npn-Digi	Sw, 50V, 100mA, 250mW, R1/R2=4.7k/10k, 160MHz	SOT-416	16ta	-	3a	Inf
U5	BCX20R	Si-npn	AF, 30V, 500mA, 330mW, B=100..600, >200MHz	SOT-23	16ta	-	3a	Zx
U5	ELM7625LCB	Vdet-IC	2.5V±2%, -Reset PPO, 150ms	SOT-23	16vdc	VD7	3d	Elm
U5	RN2106FS	Si-nnp-Digi	Sw, 20V, 50mA, 50mW, R1/R2=4.7k/47k	fSM	19ta	-	3a	Tos
U50C	SS6680C-50CU	Vdet-IC	5.0V±2.5%, +Reset PPO	SOT-23	16vda	VD7	3a	Ssc
U50N	SS6680N-50CU	Vdet-IC	5.0V±2.5%, +Reset ODO	SOT-23	16vda	VD6	3a	Ssc
U50P	SS6680P-50CU	Vdet-IC	5.0V±2.5%, -Reset ODO	SOT-23	16vda	VD6	3a	Ssc
U51C	SS6680C-51CU	Vdet-IC	5.1V±2.5%, +Reset PPO	SOT-23	16vda	VD7	3a	Ssc
U51N	SS6680N-51CU	Vdet-IC	5.1V±2.5%, +Reset ODO	SOT-23	16vda	VD6	3a	Ssc
U51P	SS6680P-51CU	Vdet-IC	5.1V±2.5%, -Reset ODO	SOT-23	16vda	VD6	3a	Ssc
U52C	SS6680C-52CU	Vdet-IC	5.2V±2.5%, +Reset PPO	SOT-23	16vda	VD7	3a	Ssc
U52N	SS6680N-52CU	Vdet-IC	5.2V±2.5%, +Reset ODO	SOT-23	16vda	VD6	3a	Ssc
U52P	SS6680P-52CU	Vdet-IC	5.2V±2.5%, -Reset ODO	SOT-23	16vda	VD6	3a	Ssc
U53C	SS6680C-53CU	Vdet-IC	5.3V±2.5%, +Reset PPO	SOT-23	16vda	VD7	3a	Ssc
U53N	SS6680N-53CU	Vdet-IC	5.3V±2.5%, +Reset ODO	SOT-23	16vda	VD6	3a	Ssc
U53P	SS6680P-53CU	Vdet-IC	5.3V±2.5%, -Reset ODO	SOT-23	16vda	VD6	3a	Ssc
U54C	SS6680C-54CU	Vdet-IC	5.4V±2.5%, +Reset PPO	SOT-23	16vda	VD7	3a	Ssc
U54N	SS6680N-54CU	Vdet-IC	5.4V±2.5%, +Reset ODO	SOT-23	16vda	VD6	3a	Ssc
U54P	SS6680P-54CU	Vdet-IC	5.4V±2.5%, -Reset ODO	SOT-23	16vda	VD6	3a	Ssc
U55C	SS6680C-55CU	Vdet-IC	5.5V±2.5%, +Reset PPO	SOT-23	16vda	VD7	3a	Ssc
U55N	SS6680N-55CU	Vdet-IC	5.5V±2.5%, +Reset ODO	SOT-23	16vda	VD6	3a	Ssc
U55P	SS6680P-55CU	Vdet-IC	5.5V±2.5%, -Reset ODO	SOT-23	16vda	VD6	3a	Ssc
U56C	SS6680C-56CU	Vdet-IC	5.6V±2.5%, +Reset PPO	SOT-23	16vda	VD7	3a	Ssc
U56N	SS6680N-56CU	Vdet-IC	5.6V±2.5%, +Reset ODO	SOT-23	16vda	VD6	3a	Ssc
U56P	SS6680P-56CU	Vdet-IC	5.6V±2.5%, -Reset ODO	SOT-23	16vda	VD6	3a	Ssc
U57C	SS6680C-57CU	Vdet-IC	5.7V±2.5%, +Reset PPO	SOT-23	16vda	VD7	3a	Ssc
U57N	SS6680N-57CU	Vdet-IC	5.7V±2.5%, +Reset ODO	SOT-23	16vda	VD6	3a	Ssc
U57P	SS6680P-57CU	Vdet-IC	5.7V±2.5%, -Reset ODO	SOT-23	16vda	VD6	3a	Ssc
U58C	SS6680C-58CU	Vdet-IC	5.8V±2.5%, +Reset PPO	SOT-23	16vda	VD7	3a	Ssc
U58N	SS6680N-58CU	Vdet-IC	5.8V±2.5%, +Reset ODO	SOT-23	16vda	VD6	3a	Ssc
U58P	SS6680P-58CU	Vdet-IC	5.8V±2.5%, -Reset ODO	SOT-23	16vda	VD6	3a	Ssc
U59C	SS6680C-59CU	Vdet-IC	5.9V±2.5%, +Reset PPO	SOT-23	16vda	VD7	3a	Ssc
U59N	SS6680N-59CU	Vdet-IC	5.9V±2.5%, +Reset ODO	SOT-23	16vda	VD6	3a	Ssc
U59P	SS6680P-59CU	Vdet-IC	5.9V±2.5%, -Reset ODO	SOT-23	16vda	VD6	3a	Ssc
U6	BCR164L3	Si-nnp-Digi	Sw, 50V, 100mA, 250mW, R1/R2=4.7k/10k, 160MHz	TSLP-3	22ta	-	2a	Inf
U6	BSS64	Si-npn	GP, 80V, 100mA, 200mW, B=20..80, 100MHz	SOT-23	16ta	-	3a	Kec



SMD code	Type	Function	Short description	Case	Pinout	Sch.	St.	Mnf.
U6	ELM7626LCB	Vdet-IC	2.6V±2%, -Reset PPO, 150ms	SOT-23	16vdc	VD7	3d	Elm
U6	ELM9716CBB	Vdet-IC	1.6V±2.5%, +Reset PPO	SOT-23	16vdb	VD7	3d	Elm
U6	RN2107FS	Si-pnp-Digi	Sw, 20V, 50mA, 50mW, R1/R2=10k/47k	fSM	19ta	-	3a	Tos
U60C	SS6680C-60CU	Vdet-IC	6.0V±2.5%, +Reset PPO	SOT-23	16vda	VD7	3a	Ssc
U60N	SS6680N-60CU	Vdet-IC	6.0V±2.5%, +Reset ODO	SOT-23	16vda	VD6	3a	Ssc
U60P	SS6680P-60CU	Vdet-IC	6.0V±2.5%, -Reset ODO	SOT-23	16vda	VD6	3a	Ssc
U6s	BCR164F	Si-pnp-Digi	Sw, 50V, 100mA, 250mW, R1/R2=4.7k/10k, 160MHz	TSFP-3	18ta	-	3a	Inf
U6s	BCR164T	Si-pnp-Digi	Sw, 50V, 100mA, 250mW, R1/R2=4.7k/10k, 160MHz	SOT-416	16ta	-	3a	Inf
U7	BSR13	Si-npn	HF/Sw, 60V, 800mA, 250mW, B=100...300, 250MHz	SOT-23	16ta	-	3a	Ste
U7	ELM7627LCB	Vdet-IC	2.7V±2%, -Reset PPO, 150ms	SOT-23	16vdc	VD7	3d	Elm
U7	ELM9717CBB	Vdet-IC	1.7V±2.5%, +Reset PPO	SOT-23	16vdb	VD7	3d	Elm
U7	RN2108FS	Si-pnp-Digi	Sw, 20V, 50mA, 50mW, R1/R2=22k/47k	fSM	19ta	-	3a	Tos
U71	BSR13R	Si-npn	HF/Sw, 60V, 800mA, 250mW, B=100...300, 250MHz	SOT-23	16te	-	3a	Ste
U7p	BSR13	Si-npn	HF/Sw, 60V, 800mA, 250mW, B=100...300, 250MHz	SOT-23	16ta	-	3a	Phi
U7t	BSR13	Si-npn	HF/Sw, 60V, 800mA, 250mW, B=100...300, 250MHz	SOT-23	16ta	-	3a	Phi
U8	BSR14	Si-npn	HF/Sw, 75V, 800mA, 250mW, B=100...300, 300MHz	SOT-23	16ta	-	3a	Ste
U8	ELM7628LCB	Vdet-IC	2.8V±2%, -Reset PPO, 150ms	SOT-23	16vdc	VD7	3d	Elm
U8	ELM9718CBB	Vdet-IC	1.8V±2.5%, +Reset PPO	SOT-23	16vdb	VD7	3d	Elm
U8	RN2109FS	Si-pnp-Digi	Sw, 20V, 50mA, 50mW, R1/R2=47k/22k	fSM	19ta	-	3a	Tos
U81	BSR14R	Si-npn	HF/Sw, 75V, 800mA, 250mW, B=100...300, 300MHz	SOT-23	16te	-	3a	Ste
U8p	BSR14	Si-npn	HF/Sw, 75V, 800mA, 250mW, B=100...300, 300MHz	SOT-23	16ta	-	3a	Phi
U8t	BSR14	Si-npn	HF/Sw, 75V, 800mA, 250mW, B=100...300, 300MHz	SOT-23	16ta	-	3a	Phi
U9	BSR17	Si-pnp	Sw, 60V, 200mA, 250mW, B=50...150, 300MHz	SOT-23	16ta	-	3a	Phi
U9	ELM7629LCB	Vdet-IC	2.9V±2%, -Reset PPO, 150ms	SOT-23	16vdc	VD7	3d	Elm
U9	ELM9719CBB	Vdet-IC	1.9V±2.5%, +Reset PPO	SOT-23	16vdb	VD7	3d	Elm
U9-	BZB84-C2V4	Z-diode	Dual, 2.4V±5%, If=200mA, 300mW	SOT-23	16df	-	3a	PhH
U91	BSR17R	Si-npn	Sw, 60V, 200mA, 250mW, B=50...150, 300MHz	SOT-23	16te	-	3a	Phi
U92	BSR17A	Si-npn	Sw, 60V, 200mA, 355mW, B=100...300, 300MHz	SOT-23	16ta	-	3a	Phi
U93	BSR17AR	Si-npn	Sw, 60V, 200mA, 355mW, B=100...300, 300MHz	SOT-23	16te	-	3a	Phi
U9p	BZB84-C2V4	Z-diode	Dual, 2.4V±5%, If=200mA, 300mW	SOT-23	16df	-	3a	PhH
U9t	BZB84-C2V4	Z-diode	Dual, 2.4V±5%, If=200mA, 300mW	SOT-23	16df	-	3a	PhM
U9W	BZB84-C2V4	Z-diode	Dual, 2.4V±5%, If=200mA, 300mW	SOT-23	16df	-	3a	PhC
UA	2SB852K-A	Si-pnp	AF, 40V, 300mA, 200mW, B>1000, >200MHz	SOT-346	16ta	-	3a	Rhm
UA	BCR149L3	Si-npn-Digi	Sw, 50V, 70mA, 250mW, R1=47k, 150MHz	TSLP-3	22ta	-	2a	Inf
UA	CHT4401WPPT	Si-npn	AF, Sw, 40V, 600mA, B=100...300, 250MHz	SOT-323	16ta	-	3a	Chm
UA	MMBTA517	Si-npn-Darl	GP, 40V, 400mA, 220MHz, B>30000	SOT-23	16ta	-	-	Kec
UA-	BZB84-C2V7	Z-diode	Dual, 2.7V±5%, If=200mA, 300mW	SOT-23	16df	-	3a	PhH
UAA	BC857A	Si-pnp	GP, 50V, 100mA, 200mW, B=110...220, 150MHz	SOT-23	16ta	-	3a	Auk
UAA	BC857FA	Si-pnp	GP, 50V, 100mA, 200mW, B=110...220, 150MHz	SOT-23F	18ta	-	3a	Auk
UAB	BC857B	Si-pnp	GP, 50V, 100mA, 200mW, B=200...450, 150MHz	SOT-23	16ta	-	3a	Auk
UAB	BC857FB	Si-pnp	GP, 50V, 100mA, 200mW, B=200...450, 150MHz	SOT-23F	18ta	-	3a	Auk
UAC	BC857C	Si-pnp	GP, 50V, 100mA, 200mW, B=420...800, 150MHz	SOT-23	16ta	-	3a	Auk
UAC	BC857FC	Si-pnp	GP, 50V, 100mA, 200mW, B=420...800, 150MHz	SOT-23F	18ta	-	3a	Auk
UALL	MIC809L-LBM3	Vdet-IC	5V±5%, -Reset PPO	SOT-23	16vdc	VD7	3a	Mcr
UALM	MIC809L-MBM3	Vdet-IC	5V±10%, -Reset PPO	SOT-23	16vdc	VD7	3a	Mcr
UALR	MIC809L-RBM3	Vdet-IC	2.85V±5%, -Reset PPO	SOT-23	16vdc	VD7	3a	Mcr
UALS	MIC809L-SBM3	Vdet-IC	3.3V±10%, -Reset PPO	SOT-23	16vdc	VD7	3a	Mcr
UALT	MIC809L-TBM3	Vdet-IC	3.3V±5%, -Reset PPO	SOT-23	16vdc	VD7	3a	Mcr
UANL	MIC809N-LBM3	Vdet-IC	5V±5%, -Reset ODO	SOT-23	16vdc	VD6	3a	Mcr
UANM	MIC809N-MBM3	Vdet-IC	5V±10%, -Reset ODO	SOT-23	16vdc	VD6	3a	Mcr
UANR	MIC809N-RBM3	Vdet-IC	2.85V±5%, -Reset ODO	SOT-23	16vdc	VD6	3a	Mcr
UANS	MIC809N-SBM3	Vdet-IC	3.3V±10%, -Reset ODO	SOT-23	16vdc	VD6	3a	Mcr
UANT	MIC809N-TBM3	Vdet-IC	3.3V±5%, -Reset ODO	SOT-23	16vdc	VD6	3a	Mcr
UAp	BZB84-C2V7	Z-diode	Dual, 2.7V±5%, If=200mA, 300mW	SOT-23	16df	-	3a	PhH
UAs	BCR149F	Si-npn-Digi	Sw, 50V, 70mA, 250mW, R1=47k, 150MHz	TSFP-3	18ta	-	3a	Inf
UAs	BCR149T	Si-npn-Digi	Sw, 50V, 70mA, 250mW, R1=47k, 150MHz	SOT-416	16ta	-	3a	Inf
UAt	BZB84-C2V7	Z-diode	Dual, 2.7V±5%, If=200mA, 300mW	SOT-23	16df	-	3a	PhM
UAW	BZB84-C2V7	Z-diode	Dual, 2.7V±5%, If=200mA, 300mW	SOT-23	16df	-	3a	PhC
UB	2SB852K	Si-pnp-Darl	40V, 300mA, 200mW, 200MHz, B>5000	SC-59	16ta	-	3a	Rhm
UB	2SB852K-B	Si-pnp	AF, 40V, 300mA, 200mW, B>5000, >200MHz	SOT-346	16ta	-	3a	Rhm
UB	2SC2404-B	Si-npn	RF, AM-FM, 30V, 15mA, 150mW, 650MHz, B=40...110	SC-59	16ta	-	3a	Pan
UB	2SC4627-B	Si-npn	FM/AM RF, 30V, 15mA, 125mW, 650MHz, B=40...110	SOT-416	16ta	-	3a	Pan
UB	BCR199L3	Si-pnp-Digi	Sw, 50V, 70mA, 250mW, R1=47k, 150MHz	TSLP-3	22ta	-	2a	Inf
UB	CHT2907WPPT	Si-pnp	AF, Sw, 60V, 600mA, B=100...300, 200MHz	SOT-323	16ta	-	3a	Chm
UB	CHT4403WPPT	Si-pnp	AF, Sw, 40V, 600mA, B=100...300, 200MHz	SOT-323	16ta	-	3a	Chm
UB-	BZB84-C3V0	Z-diode	Dual, 3.0V±5%, If=200mA, 300mW	SOT-23	16df	-	3a	PhH
UBHL	MIC810H-LBM3	Vdet-IC	5V±5%, -Reset PPO	SOT-23	16vdc	VD7	3a	Mcr
UBHM	MIC810H-MBM3	Vdet-IC	5V±10%, -Reset PPO	SOT-23	16vdc	VD7	3a	Mcr
UBHR	MIC810H-RBM3	Vdet-IC	2.85V±5%, -Reset PPO	SOT-23	16vdc	VD7	3a	Mcr
UBHS	MIC810H-SBM3	Vdet-IC	3.3V±10%, -Reset PPO	SOT-23	16vdc	VD7	3a	Mcr



SMD code	Type	Function	Short description	Case	Pinout	Sch.	St.	Mnf.
UBHT	MIC810H-TBM3	Vdet-IC	3.3V±5%, -Reset PPO	SOT-23	16vdc	VD7	3a	Mc
UBp	BZB84-C3V0	Z-diode	Dual, 3.0V±5%, If=200mA, 300mW	SOT-23	16df	-	3a	PhH
UBPL	MIC810P-LBM3	Vdet-IC	5V±5%, +Reset ODO	SOT-23	16vdc	VD6	3a	Mc
UBPM	MIC810P-MBM3	Vdet-IC	5V±10%, +Reset ODO	SOT-23	16vdc	VD6	3a	Mc
UBPR	MIC810P-RBM3	Vdet-IC	2.85V±5%, +Reset ODO	SOT-23	16vdc	VD6	3a	Mc
UBPS	MIC810P-SBM3	Vdet-IC	3.3V±10%, +Reset ODO	SOT-23	16vdc	VD6	3a	Mc
UBPT	MIC810P-TBM3	Vdet-IC	3.3V±5%, +Reset ODO	SOT-23	16vdc	VD6	3a	Mc
UBs	BCR199F	Si-pnp-Digi	Sw, 50V, 70mA, 250mW, R1=47k, 150MHz	TSFP-3	18ta	-	3a	Inf
UBs	BCR199T	Si-pnp-Digi	Sw, 50V, 70mA, 250mW, R1=47k, 150MHz	SOT-416	16ta	-	3a	Inf
UBt	BZB84-C3V0	Z-diode	Dual, 3.0V±5%, If=200mA, 300mW	SOT-23	16df	-	3a	PhM
UBW	BZB84-C3V0	Z-diode	Dual, 3.0V±5%, If=200mA, 300mW	SOT-23	16df	-	3a	PhC
UC	2SC2404-C	Si-npn	RF, AM-FM, 30V, 15mA, 150mW, 650MHz, B=65..160	SC-59	16ta	-	3a	Pan
UC	2SC3931-C	Si-npn	RF, FM/AM, 30V, 15mA, 150mW, B=65..160, 650MHz	SOT-323	16ta	-	3a	Pan
UC	2SC4097PT-P	Si-npn	AF, Sw, 32V, 500mA, B=82..180, 250MHz	SOT-323	16ta	-	3a	Chm
UC	2SC4627-C	Si-npn	FM/AM RF, 30V, 15mA, 125mW, 650MHz, B=65..160	SOT-416	16ta	-	3a	Pan
UC	2SC4627-J	Si-npn	FM/AM RF, 30V, 15mA, 125mW, 650MHz, B=65..160	SC-89	18ta	-	3a	Pan
UC	BCR101L3	Si-npn-Digi	Sw, 50V, 100mA, 250mW, R1/R2=100k/100k, 100MHz	TSLP-3	22ta	-	2a	Inf
UC	CHT857BTPT-Q	Si-pnp	AF, Sw, 45V, 100mA, B=125..250, 100MHz	SOT-416	16ta	-	3a	Chm
UC-	BZB84-C3V3	Z-diode	Dual, 3.3V±5%, If=200mA, 300mW	SOT-23	16df	-	3a	PhH
UCp	BZB84-C3V3	Z-diode	Dual, 3.3V±5%, If=200mA, 300mW	SOT-23	16df	-	3a	PhH
UCs	BCR101F	Si-npn-Digi	Sw, 50V, 100mA, 250mW, R1/R2=100k/100k, 100MHz	TSFP-3	18ta	-	3a	Inf
UCs	BCR101T	Si-npn-Digi	Sw, 50V, 100mA, 250mW, R1/R2=100k/100k, 100MHz	SOT-416	16ta	-	3a	Inf
UCt	BZB84-C3V3	Z-diode	Dual, 3.3V±5%, If=200mA, 300mW	SOT-23	16df	-	3a	PhM
UCW	BZB84-C3V3	Z-diode	Dual, 3.3V±5%, If=200mA, 300mW	SOT-23	16df	-	3a	PhC
UD	2SC2404-D	Si-npn	RF, AM-FM, 30V, 15mA, 150mW, 650MHz, B=100..260	SC-59	16ta	-	3a	Pan
UD	2SC2821-D	Si-npn	GP, 20V, 50mA, 150mW, B=250..500, 230MHz	SOT-23	16ta	-	3a	Ren
UD	2SC3931-D	Si-npn	RF, FM/AM, 30V, 15mA, 150mW, B=100..260, 650MHz	SOT-323	16ta	-	3a	Pan
UD	2SC4627-D	Si-npn	FM/AM RF, 30V, 15mA, 125mW, 650MHz, B=100..260	SOT-416	16ta	-	3a	Pan
UD	BCR151L3	Si-pnp-Digi	Sw, 50V, 100mA, 250mW, R1/R2=100k/100k, 120MHz	TSLP-3	22ta	-	2a	Inf
UD-	BZB84-C3V6	Z-diode	Dual, 3.6V±5%, If=200mA, 300mW	SOT-23	16df	-	3a	PhH
UDp	BZB84-C3V6	Z-diode	Dual, 3.6V±5%, If=200mA, 300mW	SOT-23	16df	-	3a	PhH
UDs	BCR151F	Si-pnp-Digi	Sw, 50V, 100mA, 250mW, R1/R2=100k/100k, 120MHz	TSFP-3	18ta	-	3a	Inf
UDs	BCR151T	Si-pnp-Digi	Sw, 50V, 100mA, 250mW, R1/R2=100k/100k, 120MHz	SOT-416	16ta	-	3a	Inf
UDt	BZB84-C3V6	Z-diode	Dual, 3.6V±5%, If=200mA, 300mW	SOT-23	16df	-	3a	PhM
UDW	BZB84-C3V6	Z-diode	Dual, 3.6V±5%, If=200mA, 300mW	SOT-23	16df	-	3a	PhC
UE	2SA1577PT-P	Si-pnp	AF, Sw, 32V, 500mA, B=82..180, 200MHz	SOT-323	16ta	-	3a	Chm
UE	2SC2821-E	Si-npn	GP, 20V, 50mA, 150mW, B=400..800, 230MHz	SOT-23	16ta	-	3a	Ren
UE-	BZB84-C3V9	Z-diode	Dual, 3.9V±5%, If=200mA, 300mW	SOT-23	16df	-	3a	PhH
UEp	BZB84-C3V9	Z-diode	Dual, 3.9V±5%, If=200mA, 300mW	SOT-23	16df	-	3a	PhH
UEt	BZB84-C3V9	Z-diode	Dual, 3.9V±5%, If=200mA, 300mW	SOT-23	16df	-	3a	PhM
UEW	BZB84-C3V9	Z-diode	Dual, 3.9V±5%, If=200mA, 300mW	SOT-23	16df	-	3a	PhC
UF	2SC2821-F	Si-npn	GP, 20V, 50mA, 150mW, B=600..1200, 230MHz	SOT-23	16ta	-	3a	Ren
UF-	BZB84-C4V3	Z-diode	Dual, 4.3V±5%, If=200mA, 300mW	SOT-23	16df	-	3a	PhH
UFp	BZB84-C4V3	Z-diode	Dual, 4.3V±5%, If=200mA, 300mW	SOT-23	16df	-	3a	PhH
Uft	BZB84-C4V3	Z-diode	Dual, 4.3V±5%, If=200mA, 300mW	SOT-23	16df	-	3a	PhM
UFW	BZB84-C4V3	Z-diode	Dual, 4.3V±5%, If=200mA, 300mW	SOT-23	16df	-	3a	PhC
UG-	BZB84-C4V7	Z-diode	Dual, 4.7V±5%, If=200mA, 300mW	SOT-23	16df	-	3a	PhH
UGp	BZB84-C4V7	Z-diode	Dual, 4.7V±5%, If=200mA, 300mW	SOT-23	16df	-	3a	PhH
UGt	BZB84-C4V7	Z-diode	Dual, 4.7V±5%, If=200mA, 300mW	SOT-23	16df	-	3a	PhM
UGW	BZB84-C4V7	Z-diode	Dual, 4.7V±5%, If=200mA, 300mW	SOT-23	16df	-	3a	PhC
UH-	BZB84-C5V1	Z-diode	Dual, 5.1V±5%, If=200mA, 300mW	SOT-23	16df	-	3a	PhH
UHp	BZB84-C5V1	Z-diode	Dual, 5.1V±5%, If=200mA, 300mW	SOT-23	16df	-	3a	PhH
UHT	BZB84-C5V1	Z-diode	Dual, 5.1V±5%, If=200mA, 300mW	SOT-23	16df	-	3a	PhM
UHW	BZB84-C5V1	Z-diode	Dual, 5.1V±5%, If=200mA, 300mW	SOT-23	16df	-	3a	PhC
UI-	2SC4229	Si-npn	HF, 30V, 20mA, 150mW, B=50..180, >700MHz	SOT-346	16ta	-	3a	Ren
UI-	2SC4259	Si-npn	HF, 30V, 20mA, 100mW, B=50..180, >700MHz	SOT-323	16ta	-	3a	Ren
UK-	BZB84-C5V6	Z-diode	Dual, 5.6V±5%, If=200mA, 300mW	SOT-23	16df	-	3a	PhH
UKp	BZB84-C5V6	Z-diode	Dual, 5.6V±5%, If=200mA, 300mW	SOT-23	16df	-	3a	PhH
UKt	BZB84-C5V6	Z-diode	Dual, 5.6V±5%, If=200mA, 300mW	SOT-23	16df	-	3a	PhM
UKW	BZB84-C5V6	Z-diode	Dual, 5.6V±5%, If=200mA, 300mW	SOT-23	16df	-	3a	PhC
UL-	BZB84-C6V2	Z-diode	Dual, 6.2V±5%, If=200mA, 300mW	SOT-23	16df	-	3a	PhH
UL5	2SB1295-5	Si-pnp	AF-Amp, 15V, 800mA, 200mW, B=135..270, 200MHz	SOT-23	16ta	-	3a	San
UL6	2SB1295-6	Si-pnp	AF-Amp, 15V, 800mA, 200mW, B=200..400, 200MHz	SOT-23	16ta	-	3a	San
UL7	2SB1295-7	Si-pnp	AF-Amp, 15V, 800mA, 200mW, B=300..600, 200MHz	SOT-23	16ta	-	3a	San
ULN	ELM7540CEB	Vdet-IC	4.0V±2%, +Reset PPO	SC-70	16vdb	VD7	3d	Elm
ULN	ELM7540NEB	Vdet-IC	4.0V±2%, +Reset ODO	SC-70	16vdb	VD6	3d	Elm
ULp	BZB84-C6V2	Z-diode	Dual, 6.2V±5%, If=200mA, 300mW	SOT-23	16df	-	3a	PhH
ULt	BZB84-C6V2	Z-diode	Dual, 6.2V±5%, If=200mA, 300mW	SOT-23	16df	-	3a	PhM
ULW	BZB84-C6V2	Z-diode	Dual, 6.2V±5%, If=200mA, 300mW	SOT-23	16df	-	3a	PhC
UM-	BZB84-C6V8	Z-diode	Dual, 6.8V±5%, If=200mA, 300mW	SOT-23	16df	-	3a	PhH



SMD code	Type	Function	Short description	Case	Pinout	Sch.	St.	Mnf.
UMP	BZB84-C6V8	Z-diode	Dual, 6.8V±5%, If=200mA, 300mW	SOT-23	16df	-	3a	PhH
UMt	BZB84-C6V8	Z-diode	Dual, 6.8V±5%, If=200mA, 300mW	SOT-23	16df	-	3a	PhM
UMW	BZB84-C6V8	Z-diode	Dual, 6.8V±5%, If=200mA, 300mW	SOT-23	16df	-	3a	PhC
UN-	BZB84-C7V5	Z-diode	Dual, 7.5V±5%, If=200mA, 300mW	SOT-23	16df	-	3a	PhH
UNp	BZB84-C7V5	Z-diode	Dual, 7.5V±5%, If=200mA, 300mW	SOT-23	16df	-	3a	PhH
UNt	BZB84-C7V5	Z-diode	Dual, 7.5V±5%, If=200mA, 300mW	SOT-23	16df	-	3a	PhM
UNW	BZB84-C7V5	Z-diode	Dual, 7.5V±5%, If=200mA, 300mW	SOT-23	16df	-	3a	PhC
UP-	BZB84-C8V2	Z-diode	Dual, 8.2V±5%, If=200mA, 300mW	SOT-23	16df	-	3a	PhH
UPp	BZB84-C8V2	Z-diode	Dual, 8.2V±5%, If=200mA, 300mW	SOT-23	16df	-	3a	PhH
UPt	BZB84-C8V2	Z-diode	Dual, 8.2V±5%, If=200mA, 300mW	SOT-23	16df	-	3a	PhM
UPW	BZB84-C8V2	Z-diode	Dual, 8.2V±5%, If=200mA, 300mW	SOT-23	16df	-	3a	PhC
UR-	BZB84-C9V1	Z-diode	Dual, 9.2V±5%, If=200mA, 300mW	SOT-23	16df	-	3a	PhH
URp	BZB84-C9V1	Z-diode	Dual, 9.2V±5%, If=200mA, 300mW	SOT-23	16df	-	3a	PhH
URt	BZB84-C9V1	Z-diode	Dual, 9.2V±5%, If=200mA, 300mW	SOT-23	16df	-	3a	PhM
URW	BZB84-C9V1	Z-diode	Dual, 9.2V±5%, If=200mA, 300mW	SOT-23	16df	-	3a	PhC
US-	BZB84-C10	Z-diode	Dual, 10V±5%, If=200mA, 300mW	SOT-23	16df	-	3a	PhH
USp	BZB84-C10	Z-diode	Dual, 10V±5%, If=200mA, 300mW	SOT-23	16df	-	3a	PhH
USt	BZB84-C10	Z-diode	Dual, 10V±5%, If=200mA, 300mW	SOT-23	16df	-	3a	PhM
USW	BZB84-C10	Z-diode	Dual, 10V±5%, If=200mA, 300mW	SOT-23	16df	-	3a	PhC
UT	2SA1020PT-O	Si-pnp	AF, Sw, 50V, 500mA, B=70..140, 120MHz	SOT-23	16ta	-	3a	Chm
UT-	BZB84-C11	Z-diode	Dual, 11V±5%, If=200mA, 300mW	SOT-23	16df	-	3a	PhH
UT5	2SC4555-5	Si-npn	AF, Lo-sat, 20V, 500mA, 150mW, B=135..270, 400MHz	MCP	16ta	-	3a	San
UT5	2SC4577-5	Si-npn	AF-Amp, 20V, 500mA, 200mW, B=135..270, 300MHz	SOT-23	16ta	-	3a	San
UT6	2SC4555-6	Si-npn	AF, Lo-sat, 20V, 500mA, 150mW, B=200..400, 400MHz	MCP	16ta	-	3a	San
UT6	2SC4577-6	Si-npn	AF-Amp, 20V, 500mA, 200mW, B=200..400, 300MHz	SOT-23	16ta	-	3a	San
UT7	2SC4555-7	Si-npn	AF, Lo-sat, 20V, 500mA, 150mW, B=300..600, 400MHz	MCP	16ta	-	3a	San
UT7	2SC4577-7	Si-npn	AF-Amp, 20V, 500mA, 200mW, B=300..600, 300MHz	SOT-23	16ta	-	3a	San
UTp	BZB84-C11	Z-diode	Dual, 11V±5%, If=200mA, 300mW	SOT-23	16df	-	3a	PhH
UTt	BZB84-C11	Z-diode	Dual, 11V±5%, If=200mA, 300mW	SOT-23	16df	-	3a	PhM
UTW	BZB84-C11	Z-diode	Dual, 11V±5%, If=200mA, 300mW	SOT-23	16df	-	3a	PhC
UU-	BZB84-C12	Z-diode	Dual, 12V±5%, If=200mA, 300mW	SOT-23	16df	-	3a	PhH
UUp	BZB84-C12	Z-diode	Dual, 12V±5%, If=200mA, 300mW	SOT-23	16df	-	3a	PhH
UUt	BZB84-C12	Z-diode	Dual, 12V±5%, If=200mA, 300mW	SOT-23	16df	-	3a	PhM
UuW	BZB84-C12	Z-diode	Dual, 12V±5%, If=200mA, 300mW	SOT-23	16df	-	3a	PhC
UV	1SV315	Si-diode	Dual, Var.-res, att, 50V, 50mA, 100mW, 0.23pF, 6Q(100MHz)	MCP	16dl	-	3a	San
UV	1SV316	Si-diode	Dual, Var.-res, att, 50V, 50mA, 100mW, 0.23pF, 6Q(100MHz)	SOT-23	16dl	-	3a	San
UV-	BZB84-C13	Z-diode	Dual, 13V±5%, If=200mA, 300mW	SOT-23	16df	-	3a	PhH
Uvp	BZB84-C13	Z-diode	Dual, 13V±5%, If=200mA, 300mW	SOT-23	16df	-	3a	PhH
UVt	BZB84-C13	Z-diode	Dual, 13V±5%, If=200mA, 300mW	SOT-23	16df	-	3a	PhM
UVW	BZB84-C13	Z-diode	Dual, 13V±5%, If=200mA, 300mW	SOT-23	16df	-	3a	PhC
UW	2SC4774PT	Si-npn	RF, Sw, 6V, 50mA, B=270..560, 800	SOT-323	16ta	-	3a	Chm
UW-	BZB84-C15	Z-diode	Dual, 15V±5%, If=200mA, 300mW	SOT-23	16df	-	3a	PhH
UWp	BZB84-C15	Z-diode	Dual, 15V±5%, If=200mA, 300mW	SOT-23	16df	-	3a	PhH
UWt	BZB84-C15	Z-diode	Dual, 15V±5%, If=200mA, 300mW	SOT-23	16df	-	3a	PhM
UWW	BZB84-C15	Z-diode	Dual, 15V±5%, If=200mA, 300mW	SOT-23	16df	-	3a	PhC
UX	2SC4617PT-Q	Si-npn	AF, Sw, 50V, 150mA, 150mW, B=120..270, 180MHz	SOT-416	16ta	-	3a	Chm
UY	2SC3913	Si-npn-Digi	Sw, 50V, 500mA, 200mW, 250MHz, R1/R2=4k7/4k7	SOT-23	16ta	-	3a	San
UY	2SC4617PT-R	Si-npn	AF, Sw, 50V, 150mA, 150mW, B=180..390, 180MHz	SOT-416	16ta	-	3a	Chm
UZ	2SC4617PT-S	Si-npn	AF, Sw, 50V, 150mA, 150mW, B=270..560, 180MHz	SOT-416	16ta	-	3a	Chm
v	AX6904AA	Vdet-IC	4.63V±1.5%, +Reset PPO	SC-70	16vda	VD7	3b	Axl
V0	DZ23C2V4	Z-diode	Dual, 2.28..2.52V, Zzt=85Q, lzt=5mA, 410mW	SOT-23	16dg	-	3a	Pjt
V0	ELM7620LBB	Vdet-IC	2.0V±2%, -Reset PPO, 500ms	SOT-23	16vdc	VD7	3d	Elm
V0	HBAT-5400	Si-diode	Schottky, TVS, 30V, 220mA, 250mW, <3pF	SOT-23	16dc	-	3a	Agi
V0	HBAT-540B	Si-diode	Schottky, TVS, 30V, 430mA, 825mW, <3pF	SOT-323	16dc	-	3a	Agi
V0	PRF947	Si-npn	UHF, LN, 20V, 50mA, 250mW, B=50..200, 8.5GHz	SOT-323	16ta	-	3a	Phi
V0	PRF949	Si-npn	UHF, LN, 20V, 50mA, 150mW, B=100..200, 9GHz	SOT-416	16ta	-	3a	Phi
V02	VN0605T	n-MOSFET-e	V-MOS, 60V, 0.18A, <5Q, <20/20ns	SOT-23	16fh	-	3g	Vs
V1	1SV160	C-diode	FM-AFC, 15V, 7/14pF(4V), <1.2Q	SC-59	16dg	-	3a	Tos
V1	2SD596-1	Si-npn	AF, 30V, 700mA, 200mW, B=110..180, 170MHz	SOT-23	16ta	-	3a	Nec
V1	2SD596A-1	Si-npn	AF, 30V, 700mA, 200mW, B=110..180, 170MHz	SOT-23	16ta	-	3a	Nec
V1	2SD780-1	Si-npn	AF, 60V, 300mA, 200mW, B=110..180, 100MHz	SOT-23	16ta	-	3a	Nec
V1	DZ23C2V7	Z-diode	Dual, 2.5..2.9V, lzt=5mA, Zzt=75Q, 300mW	SOT-23	16dg	-	3g	Vs
V1	DZ23C2V7-V	Z-diode	Dual, 2.5..2.9V, Zzt=75Q, lzt=5mA, 300mW	SOT-23	16dg	-	3a	Vs
V1	ELM7621LBB	Vdet-IC	2.1V±2%, -Reset PPO, 500ms	SOT-23	16vdc	VD7	3d	Elm
V10	BFT25A	Si-npn	UHF-A, 8V, 6.5mA, 30mW, B=50..200, >3.5GHz	SOT-23	16ta	-	3a	Phi
V10	DZ23C6V2	Z-diode	Dual, 5.8..6.6V, lzt=5mA, Zzt=4.8Q, 300mW	SOT-23	16dg	-	3g	Vs
V10	DZ23C6V2-V	Z-diode	Dual, 5.8..6.6V, Zzt=4.8Q, lzt=5mA, 300mW	SOT-23	16dg	-	3a	Vs
V1010	V10P10	Si-diode	TMBSR, 100V, 10A, Vf<0.68V(10A)	TO-277A	76dh	-	3o	Vs
V1012	V10P12	Si-diode	TMBSR, 120V, 10A, Vf<0.82V(10A)	TO-277A	76dh	-	3o	Vs
V1045	V10P45	Si-diode	TMBSR, 450V, 10A, Vf<0.57V(10A)	TO-277A	76dh	-	3o	Vs



SMD code	Type	Function	Short description	Case	Pinout	Sch.	St.	Mnf.
V1045S	V10P45S	Si-diode	TMBSR, 450V, 10A, Vf<0.57V(10A)	TO-277A	76dh	-	3o	Vs
V11	DZ23C6V8	Z-diode	Dual, 6.4..7.2V, lzt=5mA, Zzt=4.5Ω, 300mW	SOT-23	16dg	-	3g	Vs
V11	DZ23C6V8-V	Z-diode	Dual, 6.4..7.2V, Zzt=4.5Ω, lzt=5mA, 300mW	SOT-23	16dg	-	3a	Vs
V12	DZ23C7V5	Z-diode	Dual, 7.0..7.9V, lzt=5mA, Zzt=4Ω, 300mW	SOT-23	16dg	-	3g	Vs
V12	DZ23C7V5-V	Z-diode	Dual, 7..7.9V, Zzt=4Ω, lzt=5mA, 300mW	SOT-23	16dg	-	3a	Vs
V1210	V12P10	Si-diode	TMBSR, 100V, 12A, Vf<0.7V(12A)	TO-277A	76dh	-	3o	Vs
V1212	V12P12	Si-diode	TMBSR, 120V, 12A, Vf<0.7V(12A)	TO-277A	76dh	-	3o	Vs
V13	DZ23C8V2	Z-diode	Dual, 7.7..8.7V, lzt=5mA, Zzt=4.5Ω, 300mW	SOT-23	16dg	-	3g	Vs
V13	DZ23C8V2-V	Z-diode	Dual, 7.7..8.7V, Zzt=4.5Ω, lzt=5mA, 300mW	SOT-23	16dg	-	3a	Vs
V13	ZC932TA	C-diode	VHF-Tuning, 12V, 8.5/10.5pF(2.5V)	SOT-23	16dc	-	3a	Zx
V14	DZ23C9V1	Z-diode	Dual, 8.5..9.6V, lzt=5mA, Zzt=4.8Ω, 300mW	SOT-23	16dg	-	3g	Vs
V14	DZ23C9V1-V	Z-diode	Dual, 8.5..9.6V, Zzt=4.8Ω, lzt=5mA, 300mW	SOT-23	16dg	-	3a	Vs
V14	ZC931TA	C-diode	VHF-Tuning, 12V, 6.5/7.8pF(2.5V)	SOT-23	16dc	-	3a	Zx
V15	DZ23C10	Z-diode	Dual, 9.50..10.50V, Zzt=15Ω, lzt=5mA, 410mW	SOT-23	16dg	-	3a	Pjt
V15	DZ23C10-V	Z-diode	Dual, 9.4..10.6V, lzt=5mA, Zzt=5.2Ω, 300mW	SOT-23	16dg	-	3	Vs
V15	ZC930TA	C-diode	VHF-Tuning, 12V, 4.3/5.5pF(2.5V)	SOT-23	16dc	-	3a	Zx
V1545	V15P45	Si-diode	TMBSR, 45V, 15A, Vf<0.58V(15A)	TO-277A	76dh	-	3o	Vs
V1545S	V15P45S	Si-diode	TMBSR, 45V, 15A, Vf<0.58V(15A)	TO-277A	76dh	-	3o	Vs
V16	DZ23C11	Z-diode	Dual, 10.4..11.6V, lzt=5mA, Zzt=6Ω, 300mW	SOT-23	16dg	-	3c	Vs
V16	DZ23C11-V	Z-diode	Dual, 10.4..11.6V, Zzt=6Ω, lzt=5mA, 300mW	SOT-23	16dg	-	3a	Vs
V16	ZC934TA	C-diode	VHF-Tuning, 12V, 40/65pF(2.5V)	SOT-23	16dc	-	3a	Zx
V17	DZ23C12	Z-diode	Dual, 11.4..12.7V, lzt=5mA, Zzt=7Ω, 300mW	SOT-23	16dg	-	3c	Vs
V17	DZ23C12-V	Z-diode	Dual, 11.4..12.7V, Zzt=7Ω, lzt=5mA, 300mW	SOT-23	16dg	-	3a	Vs
V17	ZC933TA	C-diode	VHF-Tuning, 12V, 18/27pF(2.5V)	SOT-23	16dc	-	3a	Zx
V18	DZ23C13	Z-diode	Dual, 12.4..14.1V, lzt=5mA, Zzt=9Ω, 300mW	SOT-23	16dg	-	3c	Vs
V18	DZ23C13-V	Z-diode	Dual, 12.4..14.1V, Zzt=9Ω, lzt=5mA, 300mW	SOT-23	16dg	-	3a	Vs
V19	DZ23C15	Z-diode	Dual, 13.8..15.6V, lzt=5mA, Zzt=11Ω, 300mW	SOT-23	16dg	-	3c	Vs
V19	DZ23C15-V	Z-diode	Dual, 13.8..15.6V, Zzt=11Ω, lzt=5mA, 300mW	SOT-23	16dg	-	3a	Vs
V1p	BFT25	Si-npn	UHF-A, 8V, 6.5mA, 30mW, B>20, >2.3GHz	SOT-23	16ta	-	3a	Phi
V2	2SD596-2	Si-npn	AF, 30V, 700mA, 200mW, B=135..220, 170MHz	SOT-23	16ta	-	3a	Nec
V2	2SD596A-2	Si-npn	AF, 30V, 700mA, 200mW, B=135..220, 170MHz	SOT-23	16ta	-	3a	Nec
V2	2SD780-2	Si-npn	AF, 60V, 300mA, 200mW, B=135..220, 100MHz	SOT-23	16ta	-	3a	Nec
V2	2SK1332-2	n-FET	AF-Amp, 30V, 20mA, 150mW, Idss=0.6..1.5mA	MCP	16fa	-	3a	San
V2	2SK303-2	n-FET	AF-Amp, 30V, 20mA, 200mW, Idss=0.6..1.5mA, Ciss=5pF	SOT-23	16fa	-	3a	San
V2	BFQ67	Si-npn	UHF-A, LN, 20V, 50mA, 200mW, B=65..150, 7.5GHz	SOT-23	16ta	-	3a	Sil
V2	BFQ67F	Si-npn	UHF-A, LN, 20V, 50mA, 200mW, B=65..150, 7.5GHz	SOT-490	18ta	-	3g	Vs
V2	BFQ67W	Si-npn	UHF-A, LN, 20V, 50mA, 200mW, B=65..150, 7.5GHz	SOT-323	16ta	-	3a	Sil
V2	DZ23C3V0	Z-diode	Dual, 2.8..3.2V, lzt=5mA, Zzt=80Ω, 300mW	SOT-23	16dg	-	3g	Vs
V2	DZ23C3V0-V	Z-diode	Dual, 2.8..3.2V, Zzt=80Ω, lzt=5mA, 300mW	SOT-23	16dg	-	3a	Vs
V2	ELM7622LBB	Vdet-IC	2.2V±2%, -Reset PPO, 500ms	SOT-23	16vdc	VD7	3d	Elm
V2	HBAT-5402	Si-diode	Dual, Schottky, TVS, 30V, 220mA(1A..1μs), 250mW, <3pF	SOT-23	16dl	-	3a	Agj
V2	HBAT-540C	Si-diode	Dual, Schottky, TVS, 30V, 430mA(1A..1μs), 825mW, <3pF	SOT-323	16dl	-	3a	Agj
V2	VN0605T	n-MOSFET-e	V-MOS, 60V, 0.18A, <5Q, <20/20ns	SOT-23	16fh	-	3a	Six
V20	DZ23C16	Z-diode	Dual, 15.3..17.1V, lzt=5mA, Zzt=13Ω, 300mW	SOT-23	16dg	-	3c	Vs
V20	DZ23C16-V	Z-diode	Dual, 15.3..17.1V, Zzt=13Ω, lzt=5mA, 300mW	SOT-23	16dg	-	3a	Vs
V21	DZ23C18	Z-diode	Dual, 16.8..19.1V, lzt=5mA, Zzt=18Ω, 300mW	SOT-23	16dg	-	3c	Vs
V21	DZ23C18-V	Z-diode	Dual, 16.8..19.1V, Zzt=18Ω, lzt=5mA, 300mW	SOT-23	16dg	-	3a	Vs
V22	DZ23C20	Z-diode	Dual, 18.8..21.2V, lzt=5mA, Zzt=20Ω, 300mW	SOT-23	16dg	-	3g	Vs
V22	DZ23C20-V	Z-diode	Dual, 18.8..21.2V, Zzt=20Ω, lzt=5mA, 300mW	SOT-23	16dg	-	3a	Vs
V23	DZ23C22	Z-diode	Dual, 20.8..23.3V, lzt=5mA, Zzt=25Ω, 300mW	SOT-23	16dg	-	3g	Vs
V23	DZ23C22-V	Z-diode	Dual, 20.8..23.3V, Zzt=25Ω, lzt=5mA, 300mW	SOT-23	16dg	-	3a	Vs
V24	DZ23C24	Z-diode	Dual, 22.8..25.6V, lzt=5mA, Zzt=28Ω, 300mW	SOT-23	16dg	-	3g	Vs
V24	DZ23C24-V	Z-diode	Dual, 22.8..25.6V, Zzt=28Ω, lzt=5mA, 300mW	SOT-23	16dg	-	3a	Vs
V25	DZ23C27	Z-diode	Dual, 25.1..28.9V, lzt=5mA, Zzt=30Ω, 300mW	SOT-23	16dg	-	3g	Vs
V25	DZ23C27-V	Z-diode	Dual, 25.1..28.9V, Zzt=30Ω, lzt=5mA, 300mW	SOT-23	16dg	-	3a	Vs
V25	PMBT3640	Si-pnp	HF, Sw, 12V, 80mA, 350mW, B=30..120, >500MHz	SOT-23	16ta	-	3a	Phi
V26	DZ23C30	Z-diode	Dual, 28.0..32.0V, lzt=5mA, Zzt=35Ω, 300mW	SOT-23	16dg	-	3g	Vs
V26	DZ23C30-V	Z-diode	Dual, 28..32V, Zzt=35Ω, lzt=5mA, 300mW	SOT-23	16dg	-	3a	Vs
V27	DZ23C33	Z-diode	Dual, 31.0..35.0V, lzt=5mA, Zzt=40Ω, 300mW	SOT-23	16dg	-	3g	Vs
V27	DZ23C33-V	Z-diode	Dual, 31..35V, Zzt=40Ω, lzt=5mA, 300mW	SOT-23	16dg	-	3a	Vs
V28	DZ23C36	Z-diode	Dual, 34.0..38.0V, lzt=5mA, Zzt=40Ω, 300mW	SOT-23	16dg	-	3g	Vs
V28	DZ23C36-V	Z-diode	Dual, 34..38V, Zzt=40Ω, lzt=5mA, 300mW	SOT-23	16dg	-	3a	Vs
V29	DZ23C39	Z-diode	Dual, 37.0..41.0V, lzt=5mA, Zzt=50Ω, 300mW	SOT-23	16dg	-	3g	Vs
V29	DZ23C39-V	Z-diode	Dual, 37..41V, Zzt=50Ω, lzt=5mA, 300mW	SOT-23	16dg	-	3a	Vs
V2p	BFQ67	Si-npn	UHF-A, LN, 20V, 50mA, 200mW, B=65..150, 7.5GHz	SOT-23	16ta	-	3a	Phi
V3	1SV25	C-diode	Dual, FM-Tuning, 32V, 6.6/7.7pF(30V)	SOT-346	16dg	-	3a	Toc
V3	2SD596-3	Si-npn	AF, 30V, 700mA, 200mW, B=170..270, 170MHz	SOT-23	16ta	-	3a	Nec
V3	2SD596A-3	Si-npn	AF, 30V, 700mA, 200mW, B=170..270, 170MHz	SOT-23	16ta	-	3a	Nec
V3	2SD780-3	Si-npn	AF, 60V, 300mA, 200mW, B=170..270, 100MHz	SOT-23	16ta	-	3a	Nec
V3	2SK1332-3	n-FET	AF-Amp, 30V, 20mA, 150mW, Idss=1.2..3mA	MCP	16fa	-	3a	San



SMD code	Type	Function	Short description	Case	Pinout	Sch.	St.	Mnf.
V3	2SK303-3	n-FET	AF-Amp, 30V, 20mA, 200mW, Idss=1.2..3mA, Ciss=5pF	SOT-23	16fa	-	3a	San
V3	APX803-46SA	Vdet-IC	4.63V±1.5%, -Reset ODO	SOT-23	16vdc	VD6	3b	Di
V3	DZ23C3V3	Z-diode	Dual, 3.1..3.5V, Izt=5mA, Zzt=80Ω, 300mW	SOT-23	16dg	-	3g	Vs
V3	DZ23C3V3-V	Z-diode	Dual, 3.1..3.5V, Zzt=80Ω, Izt=5mA, 300mW	SOT-23	16dg	-	3a	Vs
V3	ELM7623LBB	Vdet-IC	2.3V±2%, -Reset PPO, 500ms	SOT-23	16vdc	VD7	3d	Elm
V3	HBAT-540E	Si-diode	Dual, Schottky, TVS, 30V, 430mA(1A..1μs), 825mW, <3pF	SOT-323	16df	-	3a	Agi
V30	DZ23C43	Z-diode	Dual, 40.0..46.0V, Izt=5mA, Zzt=60Ω, 300mW	SOT-23	16dg	-	3g	Vs
V30	DZ23C43-V	Z-diode	Dual, 40..46V, Zzt=60Ω, Izt=5mA, 300mW	SOT-23	16dg	-	3a	Vs
V30	PMBT10	Si-npn	UHF, Sw, 20V, 40mA, 400mW, B>60, 1GHz, <0.7pF	SOT-23	16ta	-	3a	Phi
V31	DZ23C47	Z-diode	Dual, 44.0..50.0V, Izt=5mA, Zzt=70Ω, 300mW	SOT-23	16dg	-	3g	Vs
V31	DZ23C47-V	Z-diode	Dual, 44..50V, Zzt=70Ω, Izt=5mA, 300mW	SOT-23	16dg	-	3a	Vs
V31	PMBT10	Si-npn	UHF, Sw, 30V, 40mA, 400mW, B>60, 1GHz, <0.7pF	SOT-23	16ta	-	3a	Phi
V32	DZ23C51	Z-diode	Dual, 48.0..54.0V, Izt=5mA, Zzt=70Ω, 300mW	SOT-23	16dg	-	3g	Vs
V32	DZ23C51-V	Z-diode	Dual, 48..54V, Zzt=70Ω, Izt=5mA, 300mW	SOT-23	16dg	-	3a	Vs
V33	DZ23C56	Z-diode	Dual, 53.20..58.80V, Zzt=135Ω, Izt=2.5mA, 410mW	SOT-23	16dg	-	3a	Pjt
V34	DZ23C62	Z-diode	Dual, 58.90..65.10V, Zzt=150Ω, Izt=2.5mA, 410mW	SOT-23	16dg	-	3a	Pjt
V35	DZ23C68	Z-diode	Dual, 64.60..71.40V, Zzt=200Ω, Izt=2.5mA, 410mW	SOT-23	16dg	-	3a	Pjt
V36	DZ23C75	Z-diode	Dual, 71.25..78.75V, Zzt=250Ω, Izt=2.5mA, 410mW	SOT-23	16dg	-	3a	Pjt
V4	15V228	C-diode	Dual, FM-Tuning, 15V, 12.7pF(8V)	SOT-346	16dg	-	3a	Tos
V4	2SD596-4	Si-npn	AF, 30V, 700mA, 200mW, B=200..320, 170MHz	SOT-23	16ta	-	3a	Nec
V4	2SD596A-4	Si-npn	AF, 30V, 700mA, 200mW, B=200..320, 170MHz	SOT-23	16ta	-	3a	Nec
V4	2SD780-4	Si-npn	AF, 60V, 300mA, 200mW, B=200..320, 100MHz	SOT-23	16ta	-	3a	Nec
V4	2SK1332-4	n-FET	AF-Amp, 30V, 20mA, 150mW, Idss=2.5..6mA	MCP	16fa	-	3a	San
V4	2SK303-4	n-FET	AF-Amp, 30V, 20mA, 200mW, Idss=2.5..6mA, Ciss=5pF	SOT-23	16fa	-	3a	San
V4	APX803-44SA	Vdet-IC	4.38V±1.5%, -Reset ODO	SOT-23	16vdc	VD6	3b	Di
V4	BFT25R	Si-npn	UHF-A, 8V, 6.5mA, 30mW, B>20, >2.3GHz	SOT-23	16ta	-	3a	Phi
V4	DZ23C3V6	Z-diode	Dual, 3.4..3.8V, Izt=5mA, Zzt=80Ω, 300mW	SOT-23	16dg	-	3g	Vs
V4	DZ23C3V6-V	Z-diode	Dual, 3.4..3.8V, Zzt=80Ω, Izt=5mA, 300mW	SOT-23	16dg	-	3a	Vs
V4	ELM7624LBB	Vdet-IC	2.4V±2%, -Reset PPO, 500ms	SOT-23	16vdc	VD7	3d	Elm
V4	HBAT-540F	Si-diode	Dual, Schottky, TVS, 30V, 430mA(1A..1μs), 825mW, <3pF	SOT-323	16dg	-	3a	Agi
V4	SP809NEK-2-3	Vdet-IC	2.3V±1.5%, -Reset ODO	SOT-23	16vdc	VD6	3b	Sip
V4	BAP64-06W	PIN-diode	Dual, RF, 100V, 100mA, 250mW, 0.35pF, 3.8Ω(10mA/100MHz)	SOT-323	16df	-	3a	Phi
V5	15V242	C-diode	Dual, VHF/UHF-Tuning, 35V, 2.43/3pF(28V)	SOT-346	16dg	-	3a	Tos
V5	2SD596-5	Si-npn	AF, 30V, 700mA, 200mW, B=250..400, 170MHz	SOT-23	16ta	-	3a	Nec
V5	2SD596A-5	Si-npn	AF, 30V, 700mA, 200mW, B=250..400, 170MHz	SOT-23	16ta	-	3a	Nec
V5	2SD780-5	Si-npn	AF, 60V, 300mA, 200mW, B=250..400, 100MHz	SOT-23	16ta	-	3a	Nec
V5	2SK303-5	n-FET	AF-Amp, 30V, 20mA, 200mW, Idss=5..12mA, Ciss=5pF	SOT-23	16fa	-	3a	San
V5	APX803-40SA	Vdet-IC	4.0V±1.5%, -Reset ODO	SOT-23	16vdc	VD6	3b	Di
V5	DZ23C3V9	Z-diode	Dual, 3.7..4.1V, Izt=5mA, Zzt=80Ω, 300mW	SOT-23	16dg	-	3g	Vs
V5	DZ23C3V9-V	Z-diode	Dual, 3.7..4.1V, Zzt=80Ω, Izt=5mA, 300mW	SOT-23	16dg	-	3a	Vs
V5	ELM7625LBB	Vdet-IC	2.5V±2%, -Reset PPO, 500ms	SOT-23	16vdc	VD7	3d	Elm
V6	APX803-31SA	Vdet-IC	3.08V±1.5%, -Reset ODO	SOT-23	16vdc	VD6	3b	Di
V6	DZ23C4V3	Z-diode	Dual, 4.0..4.6V, Izt=5mA, Zzt=80Ω, 300mW	SOT-23	16dg	-	3g	Vs
V6	DZ23C4V3-V	Z-diode	Dual, 4.0..4.6V, Zzt=80Ω, Izt=5mA, 300mW	SOT-23	16dg	-	3a	Vs
V6	ELM7626LBB	Vdet-IC	2.6V±2%, -Reset PPO, 500ms	SOT-23	16vdc	VD7	3d	Elm
V6	BAP65-05W	PIN-diode	Dual, RF, 30V, 100mA, 240mW, 0.61pF, 0.3Ω(100mA/100MHz)	SOT-323	16dg	-	3a	Phi
V7	APX803-29SA	Vdet-IC	2.93V±1.5%, -Reset ODO	SOT-23	16vdc	VD6	3b	Di
V7	DZ23C4V7	Z-diode	Dual, 4.4..5.0V, Izt=5mA, Zzt=70Ω, 300mW	SOT-23	16dg	-	3g	Vs
V7	DZ23C4V7-V	Z-diode	Dual, 4.4..5V, Zzt=70Ω, Izt=5mA, 300mW	SOT-23	16dg	-	3a	Vs
V7	ELM7627LBB	Vdet-IC	2.7V±2%, -Reset PPO, 500ms	SOT-23	16vdc	VD7	3d	Elm
V8	APX803-26SA	Vdet-IC	2.63V±1.5%, -Reset ODO	SOT-23	16vdc	VD6	3b	Di
V8	DZ23C5V1	Z-diode	Dual, 4.8..5.4V, Izt=5mA, Zzt=30Ω, 300mW	SOT-23	16dg	-	3g	Vs
V8	DZ23C5V1-V	Z-diode	Dual, 4.8..5.4V, Zzt=30Ω, Izt=5mA, 300mW	SOT-23	16dg	-	3a	Vs
V8	ELM7628LBB	Vdet-IC	2.8V±2%, -Reset PPO, 500ms	SOT-23	16vdc	VD7	3d	Elm
V810	V8P10	Si-diode	TMBSR, 100V, 8A, Vf<0.69V(8A)	TO-277A	76dh	-	3o	Vs
V812	V8P12	Si-diode	TMBSR, 120V, 8A, Vf<0.84V(8A)	TO-277A	76dh	-	3o	Vs
V9	APX803-23SA	Vdet-IC	2.25V±1.5%, -Reset ODO	SOT-23	16vdc	VD6	3b	Di
V9	DZ23C5V6	Z-diode	Dual, 5.2..6.0V, Izt=5mA, Zzt=10Ω, 300mW	SOT-23	16dg	-	3g	Vs
V9	DZ23C5V6-V	Z-diode	Dual, 5.2..6V, Zzt=10Ω, Izt=5mA, 300mW	SOT-23	16dg	-	3a	Vs
V9	ELM7629LBB	Vdet-IC	2.9V±2%, -Reset PPO, 500ms	SOT-23	16vdc	VD7	3d	Elm
V9	BZB84-B2V4	Z-diode	Dual, 2.4V±2%, If=200mA, 300mW	SOT-23	16df	-	3a	PHH
V9p	BZB84-B2V4	Z-diode	Dual, 2.4V±2%, If=200mA, 300mW	SOT-23	16df	-	3a	PHH
V9t	BZB84-B2V4	Z-diode	Dual, 2.4V±2%, If=200mA, 300mW	SOT-23	16df	-	3a	PHM
V9W	BZB84-B2V4	Z-diode	Dual, 2.4V±2%, If=200mA, 300mW	SOT-23	16df	-	3a	PHC
VA	2SC2776-A	Si-npn	VHF Mix, Osc, 30V, 30mA, 100mW, B=35..70, 320MHz	SOT-23	16ta	-	3a	Ren
VA	DZ23C14	Z-diode	Dual, 13.30..14.70V, Zzt=25Ω, Izt=5mA, 410mW	SOT-23	16dg	-	3a	Pjt
VA	BZB84-B2V7	Z-diode	Dual, 2.4V±2%, If=200mA, 300mW	SOT-23	16df	-	3a	PHH
VAA	BC858A	Si-npn	GP, 30V, 100mA, 200mW, B=110..220, 150MHz	SOT-23	16ta	-	3a	Auk
VAA	BC858FA	Si-npn	GP, 30V, 100mA, 200mW, B=110..220, 150MHz	SOT-23F	18ta	-	3a	Auk
VAB	BC858B	Si-npn	GP, 30V, 100mA, 200mW, B=200..450, 150MHz	SOT-23	16ta	-	3a	Auk



SMD code	Type	Function	Short description	Case	Pinout	Sch.	St.	Mnf.
VAB	BC858FB	Si-pnp	GP, 30V, 100mA, 200mW, B=200..450, 150MHz	SOT-23F	18ta	-	3a	Auk
VAC	BC858C	Si-pnp	GP, 30V, 100mA, 200mW, B=420..800, 150MHz	SOT-23	16ta	-	3a	Auk
VAC	BC858FC	Si-pnp	GP, 30V, 100mA, 200mW, B=420..800, 150MHz	SOT-23F	18ta	-	3a	Auk
VAp	BZB84-B2V7	Z-diode	Dual, 2.4V±2%, If=200mA, 300mW	SOT-23	16df	-	3a	PHH
VAt	BZB84-B2V7	Z-diode	Dual, 2.4V±2%, If=200mA, 300mW	SOT-23	16df	-	3a	PhM
VAW	BZB84-B2V7	Z-diode	Dual, 2.4V±2%, If=200mA, 300mW	SOT-23	16df	-	3a	PhC
VB	2SC2295-B	Si-npn	HF, 30V, 30mA, 200mW, B=70..140, 300MHz	SOT-23	16ta	-	3a	Pan
VB	2SC2776-B	Si-npn	VHF Mix, Osc, 30V, 30mA, 100mW, B=60..120, 320MHz	SOT-23	16ta	-	3a	Ren
VB	2SC3930-B	Si-npn	RF, FM/AM, 30V, 30mA, 150mW, B=70..140, 250MHz	SOT-323	16ta	-	3a	Pan
VB	2SC4626-B	Si-npn	HF, 30V, 30mA, 125mW, 250MHz, B=70..140	SOT-416	16ta	-	3a	Pan
VB	DZ23C17	Z-diode	Dual, 16.15..17.85V, Zzt=40Ω, Izt=5mA, 410mW	SOT-23	16dg	-	3a	Pjt
VB	MSC2295-B	Si-npn	GP, 30V, 30mA, 200mW, B=70..140, >150MHz	SC-59	16ta	-	3a	Mot
VB-	BZB84-B3V0	Z-diode	Dual, 3.0V±2%, If=200mA, 300mW	SOT-23	16df	-	3a	PhH
VBp	BZB84-B3V0	Z-diode	Dual, 3.0V±2%, If=200mA, 300mW	SOT-23	16df	-	3a	PhH
VBt	BZB84-B3V0	Z-diode	Dual, 3.0V±2%, If=200mA, 300mW	SOT-23	16df	-	3a	PhM
VBW	BZB84-B3V0	Z-diode	Dual, 3.0V±2%, If=200mA, 300mW	SOT-23	16df	-	3a	PhC
VC	2SC2295-C	Si-npn	HF, 30V, 30mA, 200mW, B=110..220, 300MHz	SOT-23	16ta	-	3a	Pan
VC	2SC2776-C	Si-npn	VHF Mix, Osc, 30V, 30mA, 100mW, B=100..200, 320MHz	SOT-23	16ta	-	3a	Ren
VC	2SC3930-C	Si-npn	RF, FM/AM, 30V, 30mA, 150mW, B=110..220, 250MHz	SOT-323	16ta	-	3a	Pan
VC	2SC4626-C	Si-npn	HF, 30V, 30mA, 125mW, 250MHz, B=110..220	SOT-416	16ta	-	3a	Pan
VC	CHT857BTPT-R	Si-pnp	AF, Sw, 45V, 100mA, B=220..475, 100MHz	SOT-416	16ta	-	3a	Chm
VC	DZ23C28	Z-diode	Dual, 26.60..29.40V, Zzt=80Ω, Izt=5mA, 410mW	SOT-23	16dg	-	3a	Pjt
VC	MSC2295-C	Si-npn	GP, 30V, 30mA, 200mW, B=110..220, >150MHz	SC-59	16ta	-	3a	Mot
VC-	BZB84-B3V3	Z-diode	Dual, 3.3V±2%, If=200mA, 300mW	SOT-23	16df	-	3a	PhH
VCp	BZB84-B3V3	Z-diode	Dual, 3.3V±2%, If=200mA, 300mW	SOT-23	16df	-	3a	PhH
VCt	BZB84-B3V3	Z-diode	Dual, 3.3V±2%, If=200mA, 300mW	SOT-23	16df	-	3a	PhM
VCW	BZB84-B3V3	Z-diode	Dual, 3.3V±2%, If=200mA, 300mW	SOT-23	16df	-	3a	PhC
VD-	BZB84-B3V6	Z-diode	Dual, 3.6V±2%, If=200mA, 300mW	SOT-23	16df	-	3a	PhH
VDp	BZB84-B3V6	Z-diode	Dual, 3.6V±2%, If=200mA, 300mW	SOT-23	16df	-	3a	PhH
VDt	BZB84-B3V6	Z-diode	Dual, 3.6V±2%, If=200mA, 300mW	SOT-23	16df	-	3a	PhM
VDW	BZB84-B3V6	Z-diode	Dual, 3.6V±2%, If=200mA, 300mW	SOT-23	16df	-	3a	PhC
VE-	BZB84-B3V9	Z-diode	Dual, 3.9V±2%, If=200mA, 300mW	SOT-23	16df	-	3a	PhH
VEp	BZB84-B3V9	Z-diode	Dual, 3.9V±2%, If=200mA, 300mW	SOT-23	16df	-	3a	PhH
VEt	BZB84-B3V9	Z-diode	Dual, 3.9V±2%, If=200mA, 300mW	SOT-23	16df	-	3a	PhM
VEW	BZB84-B3V9	Z-diode	Dual, 3.9V±2%, If=200mA, 300mW	SOT-23	16df	-	3a	PhC
VF-	BZB84-B4V3	Z-diode	Dual, 4.3V±2%, If=200mA, 300mW	SOT-23	16df	-	3a	PhH
VFp	BZB84-B4V3	Z-diode	Dual, 4.3V±2%, If=200mA, 300mW	SOT-23	16df	-	3a	PhH
VFt	BZB84-B4V3	Z-diode	Dual, 4.3V±2%, If=200mA, 300mW	SOT-23	16df	-	3a	PhM
VFW	BZB84-B4V3	Z-diode	Dual, 4.3V±2%, If=200mA, 300mW	SOT-23	16df	-	3a	PhC
VG	2SJ106-GR	p-FET	AF, Sw, 50V, Ig=10mA, 150mW, Idss=2.6..6.5mA	SC-59	16fa	-	3a	Tos
VG	2SJ144-GR	p-FET	AF, Sw, 50V, Ig=10mA, 100mW, Idss=2.6..6.5mA	SOT-323	16fa	-	3a	Tos
VG-	BZB84-B4V7	Z-diode	Dual, 4.7V±2%, If=200mA, 300mW	SOT-23	16df	-	3a	PhH
VGp	BZB84-B4V7	Z-diode	Dual, 4.7V±2%, If=200mA, 300mW	SOT-23	16df	-	3a	PhH
VGt	BZB84-B4V7	Z-diode	Dual, 4.7V±2%, If=200mA, 300mW	SOT-23	16df	-	3a	PhM
VGW	BZB84-B4V7	Z-diode	Dual, 4.7V±2%, If=200mA, 300mW	SOT-23	16df	-	3a	PhC
VH-	BZB84-B5V1	Z-diode	Dual, 5.1V±2%, If=200mA, 300mW	SOT-23	16df	-	3a	PhH
VHp	BZB84-B5V1	Z-diode	Dual, 5.1V±2%, If=200mA, 300mW	SOT-23	16df	-	3a	PhH
VHt	BZB84-B5V1	Z-diode	Dual, 5.1V±2%, If=200mA, 300mW	SOT-23	16df	-	3a	PhM
VHW	BZB84-B5V1	Z-diode	Dual, 5.1V±2%, If=200mA, 300mW	SOT-23	16df	-	3a	PhC
VIB	2SA1617-B	Si-pnp	GP, 55V, 100mA, B=100..200, 280MHz	SOT-23	16ta	-	3a	Ren
VIC	2SA1617-C	Si-pnp	GP, 55V, 100mA, B=160..320, 280MHz	SOT-23	16ta	-	3a	Ren
VJY	FM809JP3X	Vdet-IC	4.0V±1.5%, -Reset PPO	SOT-323	16vdc	VD7	3a	F
VK-	BZB84-B5V6	Z-diode	Dual, 5.6V±2%, If=200mA, 300mW	SOT-23	16df	-	3a	PhH
VK1	CHDTA144VKPT	Si-pnp-Digi	Sw, 50V, 30mA, 250MHz, R1/R2=47/10k	SOT-23	16ta	-	3a	Chm
VKA	CHDTC144VKPT	Si-npn-Digi	Sw, 50V, 30mA, 250MHz, R1/R2=47/10k	SOT-23	16ta	-	3a	Chm
VKp	BZB84-B5V6	Z-diode	Dual, 5.6V±2%, If=200mA, 300mW	SOT-23	16df	-	3a	PhH
VKt	BZB84-B5V6	Z-diode	Dual, 5.6V±2%, If=200mA, 300mW	SOT-23	16df	-	3a	PhM
VKW	BZB84-B5V6	Z-diode	Dual, 5.6V±2%, If=200mA, 300mW	SOT-23	16df	-	3a	PhC
VL	2SA1581	Si-pnp-Digi	Sw, 50V, 100mA, 200mW, 200MHz, R1=2.2k	SOT-23	16ta	-	3a	San
VL	2SJ106-BL	p-FET	AF, Sw, 50V, Ig=10mA, 150mW, Idss=6..14mA	SC-59	16fa	-	3a	Tos
VL	2SJ144-BL	p-FET	AF, Sw, 50V, Ig=10mA, 100mW, Idss=6..14mA	SOT-323	16fa	-	3a	Tos
VL-	BZB84-B6V2	Z-diode	Dual, 6.2V±2%, If=200mA, 300mW	SOT-23	16df	-	3a	PhH
VLN	ELM7520CEB	Vdet-IC	2.0V±2%, +Reset PPO	SC-70	16vdb	VD7	3d	Elm
VLN	ELM7520NEB	Vdet-IC	2.0V±2%, +Reset ODO	SC-70	16vdb	VD6	3d	Elm
VLp	BZB84-B6V2	Z-diode	Dual, 6.2V±2%, If=200mA, 300mW	SOT-23	16df	-	3a	PhH
VLQ	2SC5866-Q	Si-npn	Sw, 60V, 2A, 500mW, B=120..270, 200MHz	TSMIT3	16ta	-	3a	Rhm
VLr	2SC5866-R	Si-npn	Sw, 60V, 2A, 500mW, B=180..390, 200MHz	TSMT3	16ta	-	3a	Rhm
VLt	BZB84-B6V2	Z-diode	Dual, 6.2V±2%, If=200mA, 300mW	SOT-23	16df	-	3a	PhM
VLW	BZB84-B6V2	Z-diode	Dual, 6.2V±2%, If=200mA, 300mW	SOT-23	16df	-	3a	PhC
VLY	FM809LP3X	Vdet-IC	4.63V±1.5%, -Reset PPO	SOT-323	16vdc	VD7	3a	F



SMD code	Type	Function	Short description	Case	Pinout	Sch.	St.	Mnf.
VM-	BZB84-B6V8	Z-diode	Dual, 6.8V±2%, If=200mA, 300mW	SOT-23	16df	-	3a	PhH
VmP	BZB84-B6V8	Z-diode	Dual, 6.8V±2%, If=200mA, 300mW	SOT-23	16df	-	3a	PhH
VmIt	BZB84-B6V8	Z-diode	Dual, 6.8V±2%, If=200mA, 300mW	SOT-23	16df	-	3a	PhM
VmW	BZB84-B6V8	Z-diode	Dual, 6.8V±2%, If=200mA, 300mW	SOT-23	16dfc	-	3a	PhC
VmY	FM809MP3X	Vdet-IC	4.38V±1.5%, -Reset PPO	SOT-323	16vdc	VD7	3a	F
VN-	BZB84-B7V5	Z-diode	Dual, 7.5V±2%, If=200mA, 300mW	SOT-23	16df	-	3a	PhH
VNp	BZB84-B7V5	Z-diode	Dual, 7.5V±2%, If=200mA, 300mW	SOT-23	16df	-	3a	PhH
VnIt	BZB84-B7V5	Z-diode	Dual, 7.5V±2%, If=200mA, 300mW	SOT-23	16df	-	3a	PhM
VnW	BZB84-B7V5	Z-diode	Dual, 7.5V±2%, If=200mA, 300mW	SOT-23	16df	-	3a	PhC
VP-	BZB84-B8V2	Z-diode	Dual, 8.2V±2%, If=200mA, 300mW	SOT-23	16df	-	3a	PhH
VpP	BZB84-B8V2	Z-diode	Dual, 8.2V±2%, If=200mA, 300mW	SOT-23	16df	-	3a	PhH
VpIt	BZB84-B8V2	Z-diode	Dual, 8.2V±2%, If=200mA, 300mW	SOT-23	16df	-	3a	PhM
VpW	BZB84-B8V2	Z-diode	Dual, 8.2V±2%, If=200mA, 300mW	SOT-23	16df	-	3a	PhC
VR	CAT809VTBI-GT3	Vdet-IC	1.60V±1.5%, -Reset PPO	SOT-23	16vdc	VD7	3b	Ons
VR-	BZB84-B9V1	Z-diode	Dual, 9.1V±2%, If=200mA, 300mW	SOT-23	16df	-	3a	PhH
VRp	BZB84-B9V1	Z-diode	Dual, 9.1V±2%, If=200mA, 300mW	SOT-23	16df	-	3a	PhH
VrIt	BZB84-B9V1	Z-diode	Dual, 9.1V±2%, If=200mA, 300mW	SOT-23	16df	-	3a	PhM
VrW	BZB84-B9V1	Z-diode	Dual, 9.1V±2%, If=200mA, 300mW	SOT-23	16df	-	3a	PhC
VRY	FM809RP3X	Vdet-IC	2.63V±1.5%, -Reset PPO	SOT-323	16vdc	VD7	3a	F
VS-	BZB84-B10	Z-diode	Dual, 10V±2%, If=200mA, 300mW	SOT-23	16df	-	3a	PhH
VSp	BZB84-B10	Z-diode	Dual, 10V±2%, If=200mA, 300mW	SOT-23	16df	-	3a	PhH
VSQ	2SC5868 -Q	Si-npn	Sw, 60V, 500mA, 500mW, B=120..270, 300MHz	TSMT3	16ta	-	3a	Rhm
VSQ	2SC5876-Q	Si-npn	Sw, 60V, 500mA, 200mW, B=120..270, 300MHz	UMT3	16ta	-	3a	Rhm
VSR	2SC5868 -R	Si-npn	Sw, 60V, 500mA, 500mW, B=180..390, 300MHz	TSMT3	16ta	-	3a	Rhm
VSR	2SC5876-R	Si-npn	Sw, 60V, 500mA, 200mW, B=180..390, 300MHz	UMT3	16ta	-	3a	Rhm
VSt	BZB84-B10	Z-diode	Dual, 10V±2%, If=200mA, 300mW	SOT-23	16df	-	3a	PhM
VSW	BZB84-B10	Z-diode	Dual, 10V±2%, If=200mA, 300mW	SOT-23	16df	-	3a	PhC
VSY	FM809SP3X	Vdet-IC	2.93V±1.5%, -Reset PPO	SOT-323	16vdc	VD7	3a	F
VT	CHT5401PT	Si-pnp	AF, Drv, 150V, 200mA, B=60..240, 300MHz	SOT-23	16ta	-	3a	Chm
VT-	BZB84-B11	Z-diode	Dual, 11V±2%, If=200mA, 300mW	SOT-23	16df	-	3a	PhH
VTp	BZB84-B11	Z-diode	Dual, 11V±2%, If=200mA, 300mW	SOT-23	16df	-	3a	PhH
VtIt	BZB84-B11	Z-diode	Dual, 11V±2%, If=200mA, 300mW	SOT-23	16df	-	3a	PhM
VtW	BZB84-B11	Z-diode	Dual, 11V±2%, If=200mA, 300mW	SOT-23	16df	-	3a	PhC
VTY	FM809TP3X	Vdet-IC	3.08V±1.5%, -Reset PPO	SOT-323	16vdc	VD7	3a	F
VU-	BZB84-B12	Z-diode	Dual, 12V±2%, If=200mA, 300mW	SOT-23	16df	-	3a	PhH
VUA	CHDTC144VUPT	Si-npn-Digi	Sw, 50V, 30mA, 250MHz, R1/R2=47/10k	SOT-323	16ta	-	3a	Chm
VUp	BZB84-B12	Z-diode	Dual, 12V±2%, If=200mA, 300mW	SOT-23	16df	-	3a	PhH
VUQ	2SC5865 -Q	Si-npn	Sw, 60V, 1A, 500mW, B=120..270, 250MHz	TSMT3	16ta	-	3a	Rhm
VUR	2SC5865 -R	Si-npn	Sw, 60V, 1A, 500mW, B=180..390, 250MHz	TSMT3	16ta	-	3a	Rhm
VUt	BZB84-B12	Z-diode	Dual, 12V±2%, If=200mA, 300mW	SOT-23	16df	-	3a	PhM
VUW	BZB84-B12	Z-diode	Dual, 12V±2%, If=200mA, 300mW	SOT-23	16df	-	3a	PhC
VV-	BZB84-B13	Z-diode	Dual, 13V±2%, If=200mA, 300mW	SOT-23	16df	-	3a	PhH
VVp	BZB84-B13	Z-diode	Dual, 13V±2%, If=200mA, 300mW	SOT-23	16df	-	3a	PhH
VvIt	BZB84-B13	Z-diode	Dual, 13V±2%, If=200mA, 300mW	SOT-23	16df	-	3a	PhM
VvW	BZB84-B13	Z-diode	Dual, 13V±2%, If=200mA, 300mW	SOT-23	16df	-	3a	PhC
VW	SiP6332R18D2	Vdet-IC	1.8V±1.5%, -Reset PPO 30ms	SOT-23	16vdc	VD7	3g	Vs
VW-	BZB84-B15	Z-diode	Dual, 15V±2%, If=200mA, 300mW	SOT-23	16df	-	3a	PhH
VWp	BZB84-B15	Z-diode	Dual, 15V±2%, If=200mA, 300mW	SOT-23	16df	-	3a	PhH
VvIt	BZB84-B15	Z-diode	Dual, 15V±2%, If=200mA, 300mW	SOT-23	16df	-	3a	PhM
VvW	BZB84-B15	Z-diode	Dual, 15V±2%, If=200mA, 300mW	SOT-23	16df	-	3a	PhC
VY	2SC3914	Si-npn-Digi	Sw, 50V, 500mA, 200mW, 250MHz, R1/R2=2k2/10k	SOT-23	16ta	-	3a	San
VY	2SJ106-Y	p-FET	AF, Sw, 50V, Ig=10mA, 150mW, Idss=1.2..3mA	SC-59	16fa	-	3a	Tos
VY	2SJ144-Y	p-FET	AF, Sw, 50V, Ig=10mA, 100mW, Idss=1.2..3mA	SOT-323	16fa	-	3a	Tos
w	AX6904BA	Vdet-IC	4.38V±1.5%, +Reset PPO	SC-70	16vda	VD7	3b	Axd
W0	ELM7630LBB	Vdet-IC	3.0V±2%, -Reset PPO, 500ms	SOT-23	16vdc	VD7	3d	Elm
W01	PDTA143ET	Si-pnp-Digi	Sw, 50V, 100mA, 250mW, R1/R2=4.7k/4.7k	SOT-23	16ta	-	3a	PhC
W01	PDTA143EU	Si-pnp-Digi	Sw, 50V, 100mA, 200mW, R1/R2=4.7k/4.7k	SOT-323	16ta	-	3a	PhC
W02	PDTC143ET	Si-npn-Digi	Sw, 50V, 100mA, 250mW, R1/R2=4.7k/4.7k	SOT-23	16ta	-	3a	PhC
W02	PDTC143EU	Si-npn-Digi	Sw, 50V, 100mA, 200mW, R1/R2=4.7k/4.7k	SOT-323	16ta	-	3a	PhC
W03	PDTA114ET	Si-pnp-Digi	Sw, 50V, 100mA, 250mW, R1/R2=10k/10k	SOT-23	16ta	-	3a	PhC
W03	PDTA114EU	Si-pnp-Digi	Sw, 50V, 100mA, 200mW, R1/R2=10k/10k	SOT-323	16ta	-	3a	PhC
W04	BZX84-A11	Z-diode	11V±1%, Izt=23mA, 350mW	SOT-23	16dc	-	3a	PhC
W04	PMSS3904	Si-npn	GP, 60V, 100mA, 200mW, B=100..300, >180MHz	SOT-323	16ta	-	3a	PhC
W05	PDTA124ET	Si-pnp-Digi	Sw, 50V, 100mA, 250mW, R1/R2=22k/22k	SOT-23	16ta	-	3a	PhC
W05	PDTA124EU	Si-pnp-Digi	Sw, 50V, 100mA, 200mW, R1/R2=22k/22k	SOT-323	16ta	-	3a	PhC
W06	PDTC124ET	Si-npn-Digi	Sw, 50V, 100mA, 250mW, R1/R2=22k/22k	SOT-23	16ta	-	3a	PhC
W06	PDTC124EU	Si-npn-Digi	Sw, 50V, 100mA, 200mW, R1/R2=22k/22k	SOT-323	16ta	-	3a	PhC
W06	PMSS3906	Si-pnp	GP, 60V, 100mA, 200mW, B=100..300, >150MHz	SOT-323	16ta	-	3a	PhC
W07	PDTA144ET	Si-pnp-Digi	Sw, 50V, 100mA, 250mW, R1/R2=47k/47k	SOT-23	16ta	-	3a	PhC
W07	PDTA144EU	Si-pnp-Digi	Sw, 50V, 100mA, 200mW, R1/R2=47k/47k	SOT-323	16ta	-	3a	PhC



SMD code	Type	Function	Short description	Case	Pinout	Sch.	St.	Mnf.
W08	PDTC144ET	Si-npn-Digi	Sw, 50V, 100mA, 250mW, R1/R2=47k/47k	SOT-23	16ta	-	3a	PhC
W08	PDTC144EU	Si-npn-Digi	Sw, 50V, 100mA, 200mW, R1/R2=47k/47k	SOT-323	16ta	-	3a	PhC
W09	PDTC114EU	Si-npn-Digi	Sw, 50V, 100mA, 200mW, R1/R2=10k/10k	SOT-323	16ta	-	3a	PhC
W1	AP1701GTW	Vdet-IC	2.25V±1.5%, -Reset PPO	TSOT23-3L	16vdc	VD7	3b	Ana
W1	AP1701GW	Vdet-IC	2.25V±1.5%, -Reset PPO	SOT-23-3L	16vdc	VD7	3b	Ana
W1	BFT92W	Si-pnp	UHF-A, 20V, 25mA, 5GHz	SOT-323	16ta	-	3a	Phi
W1	BZX84-B2V4	Z-diode	2.35..2.45V, Zzt=100Ω, Izt=5mA, 410mW	SOT-23	16dc	-	3a	Pjt
W1	BZX84-C2V4	Z-diode	2.4V±5%, 300mW	SOT-23	16dc	-	3a	Wte
W1	BZX84-C2V4W	Z-diode	2.4V±5%, 200mW	SOT-323	16dc	-	3a	Mco
W1	ELM7631LBB	Vdet-IC	3.1V±2%, -Reset PPO, 500ms	SOT-23	16vdc	VD7	3d	Elm
W1	TZTC2V4WS	Z-diode	2.28..2.52V, Izt=5mA, Zzt=100Ω, 200mW	SOT-323	16dc	-	3a	Ttr
W10	CMPZDA27V	Z-diode	Dual, 27V±2.5%, 350mW	SOT-23	16df	-	3a	Cen
W11	CMPZDA30V	Z-diode	Dual, 30V±2.5%, 350mW	SOT-23	16df	-	3a	Cen
W11	PDTA114TT	Si-pnp-Digi	Sw, 50V, 100mA, 200mW, R1=10k	SOT-23	16ta	-	3a	PhC
W12	CMPZDA33V	Z-diode	Dual, 33V±2.5%, 350mW	SOT-23	16df	-	3a	Cen
W12	PDTC114TT	Si-npn-Digi	Sw, 50V, 100mA, 250mW, R1=10k	SOT-23	16ta	-	3a	PhC
W13	CMPZDA36V	Z-diode	Dual, 36V±2.5%, 350mW	SOT-23	16df	-	3a	Cen
W14	CMPZDA39V	Z-diode	Dual, 39V±2.5%, 350mW	SOT-23	16df	-	3a	Cen
W15	CMPZDA43V	Z-diode	Dual, 43V±2.5%, 350mW	SOT-23	16df	-	3a	Cen
W16	CMPZDA47V	Z-diode	Dual, 47V±2.5%, 350mW	SOT-23	16df	-	3a	Cen
W16	PDTC114ET	Si-npn-Digi	Sw, 50V, 100mA, 250mW, R1/R2=10k/10k	SOT-23	16ta	-	3a	PhC
W18	PDTC143ZT	Si-npn-Digi	Sw, 50V, 100mA, 250mW, R1/R2=4.7k/47k	SOT-23	16ta	-	3a	PhC
W19	PDTA143ZT	Si-pnp-Digi	Sw, 50V, 100mA, 250mW, R1/R2=4.7k/47k	SOT-23	16ta	-	3a	PhC
W1A	PMBT3904	Si-npn	Sw, 60V, 100mA, 250mW, B=100..300, >300MHz	SOT-23	16ta	-	3a	PhC
W1A	PMST3904	Si-npn	GP, 60V, 200mA, 200mW, B=60..300, >300MHz	SOT-323	16ta	-	3a	PhC
W1B	PMBT2222	Si-npn	Sw, 60V, 600mA, 330mW, B=120..360, >300MHz	SOT-23	16ta	-	3a	PhC
W1B	PMST2222	Si-npn	Sw, 60V, 600mA, 200mW, B=120..300, >300MHz	SOT-323	16ta	-	3a	PhC
W1D	PMBTA42	Si-npn	Vid, 300/300V, 100mA, 250mW, B>25, >50MHz	SOT-23	16ta	-	3a	PhC
W1D	PMSTA42	Si-npn	Vid, 300/300V, 100mA, 200mW, B>25, >50MHz	SOT-323	16ta	-	3a	PhC
W1E	PMBTA43	Si-npn	Vid, 200/200V, 100mA, 250mW, B>25, >50MHz	SOT-23	16ta	-	3a	PhC
W1E	PMSTA43	Si-npn	Vid, 200/200V, 100mA, 200mW, B>25, >50MHz	SOT-323	16ta	-	3a	PhC
W1F	PMBT5550	Si-npn	HV, 160V, 300mA, 250mW, B=60..250, 100..300MHz	SOT-23	16ta	-	3a	PhC
W1F	PMST5550	Si-npn	HV, 160V, 300mA, 200mW, B=60..250, 100..300MHz	SOT-323	16ta	-	3a	PhC
W1G	PMBTA06	Si-npn	GP, 80V, 500mA, 250mW, B>100, >100MHz	SOT-23	16ta	-	3a	PhC
W1G	PMSTA06	Si-npn	GP, 80V, 500mA, 200mW, B>50, >100MHz	SOT-323	16ta	-	3a	PhC
W1H	PMBTA05	Si-npn	GP, 60V, 500mA, 250mW, B>100, >100MHz	SOT-23	16ta	-	3a	PhC
W1H	PMSTA05	Si-npn	GP, 60V, 500mA, 200mW, B>50, >100MHz	SOT-323	16ta	-	3a	PhC
W1J	PMBT2369	Si-npn	Sw, 40V, 200mA, 330mW, B=40..120, >500MHz	SOT-23	16ta	-	3a	PhC
W1J	PMST2369	Si-npn	Sw, 40V, 200mA, 200mW, B=40..120, >500MHz	SOT-323	16ta	-	3a	PhC
W1K	PMBT6428	Si-npn	GP, AF, 60V, 100mA, 250mW, B>250..650, 100..700MHz	SOT-23	16ta	-	3a	PhC
W1K	PMST6428	Si-npn	GP, Hi-beta, 60V, 100mA, 200mW, B=250..650, 100..700MHz	SOT-323	16ta	-	3a	PhC
W1L	PMBT6429	Si-npn	GP, AF, 55V, 100mA, 250mW, B>500..1250, 100..700MHz	SOT-23	16ta	-	3a	PhC
W1L	PMST6429	Si-npn	GP, Hi-beta, 55V, 100mA, 200mW, B=250..650, 100..700MHz	SOT-323	16ta	-	3a	PhC
W1M	PMBTA13	Si-npn-Darl	GP, 30V, 500mA, 250mW, B>5000, >125MHz	SOT-23	16ta	-	3a	PhC
W1N	PMBTA14	Si-npn-Darl	GP, 30V, 500mA, 250mW, B>10000, >125MHz	SOT-23	16ta	-	3a	PhC
W1p	BFT92	Si-pnp	UHF-A, 20V, 25mA, 5GHz	SOT-23	16ta	-	3a	Phi
W1P	PMBT2222A	Si-npn	Sw, 75V, 600mA, 330mW, B=120..360, >300MHz	SOT-23	16ta	-	3a	PhC
W1P	PMST2222A	Si-npn	Sw, 75V, 600mA, 200mW, B=120..300, >300MHz	SOT-323	16ta	-	3a	PhC
W1Q	PMBT5088	Si-npn	GP, AF, 30V, 200mA, 325mW, B>500, 160MHz	SOT-23	16ta	-	3a	PhC
W1Q	PMST5088	Si-npn	GP, 35V, 100mA, 200mW, B=300..900, >100MHz	SOT-323	16ta	-	3a	PhC
W1R	PMST5089	Si-npn	GP, 30V, 100mA, 200mW, B=400..1200, >100MHz	SOT-323	16ta	-	3a	PhC
W1s	BFT92W	Si-pnp	UHF-A, 20V, 25mA, 5GHz	SOT-323	16ta	-	3a	Sie
W2	AP1702GTW	Vdet-IC	2.25V±1.5%, +Reset PPO	TSOT23-3L	16vdc	VD7	3b	Ana
W2	AP1702GW	Vdet-IC	2.25V±1.5%, +Reset PPO	SOT-23-3L	16vdc	VD7	3b	Ana
W2	BCR189L3	Si-pnp-Digi	Sw, 50V, 100mA, 250mW, R1=22k, 150MHz	TSLP-3	22ta	-	2a	Inf
W2	BZX84-B2V7	Z-diode	2.64..2.75V, Zzt=100Ω, Izt=5mA, 410mW	SOT-23	16dc	-	3a	Pjt
W2	BZX84-C2V7	Z-diode	2.7V±5%, 300mW	SOT-23	16dc	-	3a	Wte
W2	BZX84-C2V7W	Z-diode	2.7V±5%, 200mW	SOT-323	16dc	-	3a	Mco
W2	ELM7632LBB	Vdet-IC	3.2V±2%, -Reset PPO, 500ms	SOT-23	16vdc	VD7	3d	Elm
W2	PRF957	Si-npn	UHF, LN, 20V, 100mA, 270mW, B=50..200, 8.5GHz	SOT-323	16ta	-	3a	Phi
W2	TZTC2V7WS	Z-diode	2.57..2.84V, Izt=5mA, Zzt=100Ω, 200mW	SOT-323	16dc	-	3a	Ttr
W20	PDTC144WT	Si-npn-Digi	Sw, 50V, 100mA, 250mW, R1/R2=47k/22k	SOT-23	16ta	-	3a	PhC
W20	PDTC144WU	Si-npn-Digi	Sw, 50V, 100mA, 200mW, R1/R2=47k/22k	SOT-323	16ta	-	3a	PhC
W21	PDTA123ET	Si-pnp-Digi	Sw, 50V, 100mA, 250mW, R1/R2=2k2/2k2	SOT-23	16ta	-	3a	PhC
W23	PDTA114TU	Si-pnp-Digi	Sw, 50V, 100mA, 200mW, R1=10k	SOT-323	16ta	-	3a	PhC
W23	PDTA123JT	Si-pnp-Digi	Sw, 50V, 100mA, 250mW, R1/R2=2k2/47k	SOT-23	16ta	-	3a	PhC
W24	PDTC114TU	Si-npn-Digi	Sw, 50V, 100mA, 200mW, R1=10k	SOT-323	16ta	-	3a	PhC
W25	PDTC123JT	Si-npn-Digi	Sw, 50V, 100mA, 250mW, R1/R2=2k2/47k	SOT-23	16ta	-	3a	PhC
W26	PDTC123ET	Si-npn-Digi	Sw, 50V, 100mA, 250mW, R1/R2=2k2/2k2	SOT-23	16ta	-	3a	PhC
W27	PDTC114YT	Si-npn-Digi	Sw, 50V, 100mA, 250mW, R1/R2=10k/47k	SOT-23	16ta	-	3a	PhC



SMD code	Type	Function	Short description	Case	Pinout	Sch.	St.	Mnf.
W28	PDTA144WU	Si-pnp-Digi	Sw, 50V, 100mA, 200mW, R1/R2=47k/22k	SOT-323	16ta	-	3a	PhC
W29	PDTA114YT	Si-pnp-Digi	Sw, 50V, 100mA, 250mW, R1/R2=10k/47k	SOT-23	16ta	-	3a	PhC
W2A	PMBT3906	Si-pnp	Sw, 40V, 100mA, 250mW, B=100..300, >250MHz	SOT-23	16ta	-	3a	PhC
W2A	PMST3906	Si-pnp	GP, 60V, 100mA, 200mW, B=60..300, >250MHz	SOT-323	16ta	-	3a	PhC
W2B	PMBT2907	Si-pnp	GP, 40V, 600mA, 330mW, B=100..300, >200MHz	SOT-23	16ta	-	3a	PhC
W2D	PMBTA92	Si-pnp	Vid, 300/300V, 500mA, 250mW, B=25, >50MHz	SOT-23	16ta	-	3a	PhC
W2D	PMSTA92	Si-pnp	Vid, 300/300V, 500mA, 200mW, B=25, >50MHz	SOT-323	16ta	-	3a	PhC
W2E	PMBTA93	Si-pnp	Vid, 200/200V, 500mA, 250mW, B=25, >50MHz	SOT-23	16ta	-	3a	PhC
W2E	PMSTA93	Si-pnp	Vid, 200/200V, 500mA, 330mW, B=25, >50MHz	SOT-323	16ta	-	3a	PhC
W2F	PMBT2907A	Si-pnp	GP, 60V, 600mA, 330mW, B=100..300, >200MHz	SOT-23	16ta	-	3a	PhC
W2F	PMST2907A	Si-pnp	GP, 60V, 600mA, 330mW, B=100..300, >200MHz	SOT-323	16ta	-	3a	PhC
W2G	PMBTA56	Si-pnp	AF-Drv, 80V, 500mA, 250mW, B>100, >50MHz	SOT-23	16ta	-	3a	PhC
W2G	PMSTA56	Si-pnp	AF-Drv, 80V, 500mA, 200mW, B>100, >50MHz	SOT-323	16ta	-	3a	PhC
W2H	PMBTA55	Si-pnp	AF-Drv, 60V, 500mA, 250mW, B>100, >50MHz	SOT-23	16ta	-	3a	PhC
W2H	PMSTA55	Si-pnp	AF-Drv, 60V, 500mA, 200mW, B>100, >50MHz	SOT-323	16ta	-	3a	PhC
W2L	PMBT5401	Si-pnp	HV, 160V, 300mA, 250mW, B=60..240, 100..300MHz	SOT-23	16ta	-	3a	PhC
W2L	PMST5401	Si-pnp	HV, 160V, 300mA, 200mW, B=60..240, 100..300MHz	SOT-323	16ta	-	3a	PhC
W2s	BCR189	Si-pnp-Digi	Sw, 50V, 100mA, 200mW, R1=22k, 200MHz	SOT-23	16ta	-	3c	Inf
W2s	BCR189F	Si-pnp-Digi	Sw, 50V, 100mA, 250mW, R1=22k, 150MHz	TSFP-3	18ta	-	3a	Inf
W2s	BCR189T	Si-pnp-Digi	Sw, 50V, 100mA, 250mW, R1/R2=22k, 150MHz	SOT-416	16ta	-	3a	Inf
W2T	PMBT4403	Si-pnp	Sw, 40V, 600mA, 250mW, B=100..300, >250MHz	SOT-23	16ta	-	3a	PhC
W2T	PMST4403	Si-pnp	GP, 40V, 600mA, 200mW, B=100..300, >200MHz	SOT-323	16ta	-	3a	PhC
W2U	PMBTA63	Si-pnp-Darl	GP, 30V, 500mA, 250mW, B>5000, >125MHz	SOT-23	16ta	-	3a	PhC
W2V	PMBTA64	Si-pnp-Darl	GP, 30V, 500mA, 250mW, B>10000, >125MHz	SOT-23	16ta	-	3a	PhC
W2X	PMBT4401	Si-npn	Sw, 60V, 600mA, 250mW, B=100..300, >250MHz	SOT-23	16ta	-	3a	PhC
W2X	PMST4401	Si-npn	Sw, 60V, 600mA, 200mW, B=100..300, >250MHz	SOT-323	16ta	-	3a	PhC
W3	AP1703GTW	Vdet-IC	2.25V±1.5%, -Reset PPO	TSOT23-3L	16vda	VD7	3b	Ana
W3	AP1703GW	Vdet-IC	2.25V±1.5%, -Reset PPO	SOT-23-3L	16vda	VD7	3b	Ana
W3	BZX84-A2V4	Z-diode	2.4V±1%, Izt=104mA, 350mW	SOT-23	16dc	-	3a	Cen
W3	BZX84-B2V4	Z-diode	2.4V±2%, Izt=104mA, 350mW	SOT-23	16dc	-	3a	Cen
W3	BZX84-B3	Z-diode	2.94..3.06V, Zzt=95Ω, Izt=5mA, 410mW	SOT-23	16dc	-	3a	Pjt
W3	BZX84-C2V4	Z-diode	2.4V±5%, Izt=104mA, 350mW	SOT-23	16dc	-	3a	Cen
W3	BZX84-C3	Z-diode	3V±5%, 300mW	SOT-23	16dc	-	3a	Wte
W3	BZX84-C3W	Z-diode	3V±5%, 200mW	SOT-323	16dc	-	3a	Mco
W3	ELM7633LBB	Vdet-IC	3.3V±2%, -Reset PPO, 500ms	SOT-23	16vdc	VD7	3d	Elm
W3	KDV1471	C-diode	FM-Tuning, 16V, 32/37pF(1V)	SOT-23	16dc	-	3a	Kec
W3	TZTC3V0WS	Z-diode	2.85..3.15V, Izt=5mA, Zzt=95Ω, 200mW	SOT-323	16dc	-	3a	Ttr
W30	PDTC114YU	Si-npn-Digi	Sw, 50V, 100mA, 200mW, R1/R2=10k/47k	SOT-323	16ta	-	3a	PhC
W32	PDTC143XT	Si-npn-Digi	Sw, 50V, 100mA, 250mW, R1/R2=4.7k/10k	SOT-23	16ta	-	3a	PhC
W33	PDTC143TT	Si-npn-Digi	Sw, 50V, 100mA, 250mW, R1=4.7k	SOT-323	16ta	-	3a	PhC
W35	PDTA143XT	Si-pnp-Digi	Sw, 50V, 100mA, 250mW, R1/R2=4.7k/10k	SOT-23	16ta	-	3a	PhC
W3W	CMSZDA2V4	Z-diode	Dual, 2.2..2.6V, Zzt=100Ω, 63mA, 275mW	SOT-323	16df	-	3a	Cen
W4	AP1704GTW	Vdet-IC	2.25V±1.5%, +Reset PPO	TSOT23-3L	16vda	VD7	3b	Ana
W4	AP1704GW	Vdet-IC	2.25V±1.5%, +Reset PPO	SOT-23-3L	16vda	VD7	3b	Ana
W4	BZX84-A2V7	Z-diode	2.7V±1%, Izt=92mA, 350mW	SOT-23	16dc	-	3a	Cen
W4	BZX84-B2V7	Z-diode	2.7V±2%, Izt=92mA, 350mW	SOT-23	16dc	-	3a	Cen
W4	BZX84-B3V3	Z-diode	3.23..3.37V, Zzt=95Ω, Izt=5mA, 410mW	SOT-23	16dc	-	3a	Pjt
W4	BZX84-C2V7	Z-diode	2.7V±5%, Izt=92mA, 350mW	SOT-23	16dc	-	3a	Cen
W4	BZX84-C3V3	Z-diode	3.3V±5%, 300mW	SOT-23	16dc	-	3a	Wte
W4	BZX84-C3V3W	Z-diode	3.3V±5%, 200mW	SOT-323	16dc	-	3a	Mco
W4	BZX88-C2V7	Z-diode	2.7V±5%, 200mW	SOT-323	16dc	-	3a	Zx
W4	ELM7634LBB	Vdet-IC	3.4V±2%, -Reset PPO, 500ms	SOT-23	16vdc	VD7	3d	Elm
W4	SP809NEK-2-6	Vdet-IC	2.6V±1.5%, -Reset ODO	SOT-23	16vdc	VD6	3b	Sip
W4	TZTC3V3WS	Z-diode	3.14..3.47V, Izt=5mA, Zzt=95Ω, 200mW	SOT-323	16dc	-	3a	Ttr
W4-	BAP50-05W	PIN-diode	Dual, RF, 50V, 50mA, 500mW, 0.3pF, 3Q(10mA/100MHz)	SOT-323	16dg	-	3a	Phi
W4F	PMBD353	Si-diode	Dual, Schottky Barrier, 4V, 30mA, Vf=600mV(10mA), <1pF	SOT-23	16ea	-	3a	PhC
W4W	BAP50-05W	PIN-diode	Dual, RF, 50V, 50mA, 500mW, 0.3pF, 3Q(10mA/100MHz)	SOT-323	16dg	-	3a	PhC
W4W	CMSZDA2V7	Z-diode	Dual, 2.5..2.9V, Zzt=100Ω, 57mA, 275mW	SOT-323	16df	-	3a	Cen
W5	BZX84-A3V0	Z-diode	3V±1%, Izt=83mA, 350mW	SOT-23	16dc	-	3a	Cen
W5	BZX84-B3V0	Z-diode	3V±2%, Izt=83mA, 350mW	SOT-23	16dc	-	3a	Cen
W5	BZX84-B3V6	Z-diode	3.52..3.67V, Zzt=90Ω, Izt=5mA, 410mW	SOT-23	16dc	-	3a	Pjt
W5	BZX84-C3V0	Z-diode	3V±5%, Izt=83mA, 350mW	SOT-23	16dc	-	3a	Cen
W5	BZX84-C3V6	Z-diode	3.6V±5%, 300mW	SOT-23	16dc	-	3a	Wte
W5	BZX84-C3V6W	Z-diode	3.6V±5%, 200mW	SOT-323	16dc	-	3a	Mco
W5	BZX88-C3V0	Z-diode	3V±5%, 200mW	SOT-323	16dc	-	3a	Zx
W5	ELM7635LBB	Vdet-IC	3.5V±2%, -Reset PPO, 500ms	SOT-23	16vdc	VD7	3d	Elm
W5	TZTC3V6WS	Z-diode	3.42..3.78V, Izt=5mA, Zzt=90Ω, 200mW	SOT-323	16dc	-	3a	Ttr
W50	BZX84-A2V4	Z-diode	2.4V±1%, 300mW	SOT-23	16dc	-	3a	PhC
W51	BZX84-A2V7	Z-diode	2.7V±1%, 300mW	SOT-23	16dc	-	3a	PhC
W52	BZX84-A3V0	Z-diode	3V±1%, 300mW	SOT-23	16dc	-	3a	PhC



SMD code	Type	Function	Short description	Case	Pinout	Sch. St.	Mnf.
W52	S852TW	Si-npn	RF, LN, 12V, 8mA, 40mW, B=40..150, 5.2GHz	SOT-323	16ta	-	3a Tfk
W55	BZX84-A3V9	Z-diode	3.9V±1%, 300mW	SOT-23	16dc	-	3a PhC
W56	BZX84-A4V3	Z-diode	4.3V±1%, 300mW	SOT-23	16dc	-	3a PhC
W57	BZX84-A4V7	Z-diode	4.7V±1%, 300mW	SOT-23	16dc	-	3a PhC
W58	BZX84-A5V1	Z-diode	5.1V±1%, 300mW	SOT-23	16dc	-	3a PhC
W59	BZX84-A5V6	Z-diode	5.6V±1%, 300mW	SOT-23	16dc	-	3a PhC
W5A	PMBD6050	Si-diode	Sw, Hi-sp, 75V, 215mA, Vf<1.25V(150mA), <4ns	SOT-23	16dc	-	3a PhC
W5B	PMBD6100	Si-diode	Dual, Sw, Hi-sp, 70V, 215mA, Vf<1.1V(100mA), <4ns	SOT-23	16dg	-	3a PhC
W5C	PMBD7000	Si-diode	Dual, Sw, Hi-sp, 100V, 215mA, Vf<1.25V(150mA), <4ns	SOT-23	16dl	-	3a PhC
W5D	PMBD914	Si-diode	Sw, Fast, 70V, 215mA, 250mW, <4ns	SOT-23	16dc	-	3a PhC
W5W	CMSZDA3V0	Z-diode	Dual, 2.8..3.2V, Zzt=95Ω, 54mA, 275mW	SOT-323	16df	-	3a Cen
W6	BZX84-A3V3	Z-diode	3.3V±1%, lzt=76mA, 350mW	SOT-23	16dc	-	3a Cen
W6	BZX84-B3V3	Z-diode	3.3V±2%, lzt=76mA, 350mW	SOT-23	16dc	-	3a Cen
W6	BZX84-B3V9	Z-diode	3.82..3.98V, Zzt=90Ω, lzt=5mA, 410mW	SOT-23	16dc	-	3a Pjt
W6	BZX84-C3V3	Z-diode	3.3V±5%, lzt=76mA, 350mW	SOT-23	16dc	-	3a Cen
W6	BZX84-C3V9	Z-diode	3.9V±5%, 300mW	SOT-23	16dc	-	3a Wte
W6	BZX84-C3V9W	Z-diode	3.9V±5%, 200mW	SOT-23	16dc	-	3a Mco
W6	BZX88-C3V3	Z-diode	3.3V±5%, 200mW	SOT-323	16dc	-	3a Zx
W6	DCC010	Si-diode	Dual, Hi-Speed-Sw, 65V, 100mA, Vf=1.2V(0.1A), 3pF, 4ns	MCP	16dg	-	3a San
W6	ECG505SM	Z-diode	3.3V±5%, 300mW	SOT-23	16dc	-	3a Ecg
W6	ELM7636LBB	Vdet-IC	3.6V±2%, -Reset PPO, 500ms	SOT-23	16vdc	VD7	3d Elm
W6	NTE505SM	Z-diode	3.3V±5%, 300mW	SOT-23	16dc	-	3a Nte
W6	TZTC3V9WS	Z-diode	3.71..4.10V, lzt=5mA, Zzt=90Ω, 200mW	SOT-323	16dc	-	3a Ttr
W6-	PBHV8115T	Si-npn	HV, 150V, 1A, 30mW, B>100, 30MHz	SOT-23	16ta	-	3a Phi
W60	BZX84-A6V2	Z-diode	6.2V±1%, 300mW	SOT-23	16dc	-	3a PhC
W61	BZX84-A6V8	Z-diode	6.8V±1%, 300mW	SOT-23	16dc	-	3a PhC
W62	BZX84-A7V5	Z-diode	7.5V±1%, 300mW	SOT-23	16dc	-	3a PhC
W63	BZX84-A8V2	Z-diode	8.2V±1%, 300mW	SOT-23	16dc	-	3a PhC
W64	BZX84-A9V1	Z-diode	9.1V±1%, 300mW	SOT-23	16dc	-	3a PhC
W65	BZX84-A10	Z-diode	10V±1%, lzt=25mA, 350mW	SOT-23	16dc	-	3a PhC
W66	BZX84-B10	Z-diode	10V±2%, 300mW	SOT-23	16dc	-	3a PhC
W67	BZX84-A12	Z-diode	12V±1%, lzt=21mA, 300mW	SOT-23	16dc	-	3a PhC
W69	BZX84-A15	Z-diode	15V±1%, 300mW	SOT-23	16dc	-	3a PhC
W6D	2PD601AQW	Si-npn	GP, Sw, 60V, 100mA, 200mW, B=160..260, >100MHz	SOT-323	16ta	-	3a PhC
W6E	2PD601ARW	Si-npn	GP, Sw, 60V, 100mA, 200mW, B=210..340, >120MHz	SOT-323	16ta	-	3a PhC
W6F	2PD601ASW	Si-npn	GP, Sw, 60V, 100mA, 200mW, B=290..460, >140MHz	SOT-323	16ta	-	3a PhC
W6p	PBHV8115T	Si-npn	HV, 150V, 1A, 30mW, B>100, 30MHz	SOT-23	16ta	-	3a PHH
W6t	PBHV8115T	Si-npn	HV, 150V, 1A, 30mW, B>100, 30MHz	SOT-23	16ta	-	3a PHM
W6W	CMSZDA3V3	Z-diode	Dual, 3.1..3.5V, Zzt=95Ω, 47mA, 275mW	SOT-323	16df	-	3a Cen
W6W	PBHV8115T	Si-npn	HV, 150V, 1A, 30mW, B>100, 30MHz	SOT-23	16ta	-	3a PhC
W7	BZX84-A3V6	Z-diode	3.6V±1%, lzt=69mA, 350mW	SOT-23	16dc	-	3a Cen
W7	BZX84-B3V6	Z-diode	3.6V±2%, lzt=69mA, 350mW	SOT-23	16dc	-	3a Cen
W7	BZX84-B4V3	Z-diode	4.21..4.39V, Zzt=90Ω, lzt=5mA, 410mW	SOT-23	16dc	-	3a Pjt
W7	BZX84-C3V6	Z-diode	3.6V±5%, lzt=69mA, 350mW	SOT-23	16dc	-	3a Cen
W7	BZX84-C4V3	Z-diode	4.3V±5%, 300mW	SOT-23	16dc	-	3a Wte
W7	BZX88-C3V6	Z-diode	3.6V±5%, 200mW	SOT-323	16dc	-	3a Zx
W7	DCC010	Si-diode	Dual, Hi-Speed-Sw, 65V, 100mA, Vf=1.2V(0.1A), 3pF, 4ns	MCP	16dl	-	3a San
W7	ECG506SM	Z-diode	3.6V±5%, 300mW	SOT-23	16dc	-	3a Ecg
W7	ELM7637LBB	Vdet-IC	3.7V±2%, -Reset PPO, 500ms	SOT-23	16vdc	VD7	3d Elm
W7	NTE506SM	Z-diode	3.6V±5%, 300mW	SOT-23	16dc	-	3a Nte
W7	TZTC4V3WS	Z-diode	4.09..4.52V, lzt=5mA, Zzt=90Ω, 200mW	SOT-323	16dc	-	3a Ttr
W70	BZX84-B16	Z-diode	16V±2%, 300mW	SOT-23	16dc	-	3a PhC
W71	BZX84-B18	Z-diode	18V±2%, 300mW	SOT-23	16dc	-	3a PhC
W72	BZX84-B20	Z-diode	20V±2%, 300mW	SOT-23	16dc	-	3a PhC
W73	BZX84-B22	Z-diode	22V±2%, 300mW	SOT-23	16dc	-	3a PhC
W74	BZX84-B24	Z-diode	24V±2%, 300mW	SOT-23	16dc	-	3a PhC
W75	BZX84-A27	Z-diode	27V±1%, 300mW	SOT-23	16dc	-	3a PhC
W7W	CMSZDA3V6	Z-diode	Dual, 3.4..3.8V, Zzt=95Ω, 45mA, 275mW	SOT-323	16df	-	3a Cen
W8	BZX84-A3V9	Z-diode	3.9V±1%, lzt=64mA, 350mW	SOT-23	16dc	-	3a Cen
W8	BZX84-B3V9	Z-diode	3.9V±2%, lzt=64mA, 350mW	SOT-23	16dc	-	3a Cen
W8	BZX84-B4V7	Z-diode	4.61..4.79V, Zzt=80Ω, lzt=5mA, 410mW	SOT-23	16dc	-	3a Pjt
W8	BZX84-C3V9	Z-diode	3.9V±5%, lzt=64mA, 350mW	SOT-23	16dc	-	3a Cen
W8	BZX84-C4V7	Z-diode	4.7V±5%, 300mW	SOT-23	16dc	-	3a Wte
W8	BZX84-C4V7W	Z-diode	4.7V±5%, 200mW	SOT-323	16dc	-	3a Mco
W8	BZX88-C3V9	Z-diode	3.9V±5%, 200mW	SOT-323	16dc	-	3a Zx
W8	ECG507SM	Z-diode	3.9V±5%, 300mW	SOT-23	16dc	-	3a Ecg
W8	ELM7638LBB	Vdet-IC	3.8V±2%, -Reset PPO, 500ms	SOT-23	16vdc	VD7	3d Elm
W8	NTE507SM	Z-diode	3.9V±5%, 300mW	SOT-23	16dc	-	3a Nte
W8	TZTC4V7WS	Z-diode	4.47..4.94V, lzt=5mA, Zzt=80Ω, 200mW	SOT-323	16dc	-	3a Ttr
W86	BZX84-A75	Z-diode	75V±1%, 300mW	SOT-23	16dc	-	3a PhC



SMD code	Type	Function	Short description	Case	Pinout	Sch. St.	Mnf.
W8W	CMSZDA3V9	Z-diode	Dual, 3.7..4.1V, Zzt=90Ω, 43mA, 275mW	SOT-323	16df	-	3a Cen
W9	BZX84-A4V3	Z-diode	4.3V±1%, Izt=58mA, 350mW	SOT-23	16dc	-	3a Cen
W9	BZX84-B4V3	Z-diode	4.3V±2%, Izt=58mA, 350mW	SOT-23	16dc	-	3a Cen
W9	BZX84-B5V1	Z-diode	5.0..5.20V, Zzt=60Ω, Izt=5mA, 410mW	SOT-23	16dc	-	3a Pjt
W9	BZX84-C4V3	Z-diode	4.3V±5%, Izt=58mA, 350mW	SOT-23	16dc	-	3a Cen
W9	BZX84-C5V1	Z-diode	5.1V±5%, 300mW	SOT-23	16dc	-	3a Wte
W9	BZX84-C5V1W	Z-diode	5.1V±5%, 200mW	SOT-323	16dc	-	3a Mco
W9	BZX88-C4V3	Z-diode	4.3V±5%, 200mW	SOT-323	16dc	-	3a Zx
W9	DPA05	PIN-diode	Dual, FM/AM-tun, AGC, 50V, 50mA, Vf=0.95V(50mA), 0.25pF	CP	16dl	-	3a San
W9	ECG508SM	Z-diode	4.3V±5%, 300mW	SOT-23	16dc	-	3a Ecg
W9	ELM7639LBB	Vdet-IC	3.9V±2%, -Reset PPO, 500ms	SOT-23	16vdu	VD7	3d Elm
W9	NTE508SM	Z-diode	4.3V±5%, 300mW	SOT-23	16dc	-	3a Nte
W9	TZTC5V1WS	Z-diode	4.85..5.36V, Izt=5mA, Zzt=60Ω, 200mW	SOT-323	16dc	-	3a Ttr
W9-	BAP63-05W	PIN-diode	Dual, RF, 50V, 100mA, 240mW, 0.35pF, 1.8Ω(10mA/100MHz)	SOT-323	16dg	-	3a Phi
W9W	CMSZDA4V3	Z-diode	Dual, 4.0..4.6V, Zzt=90Ω, 40mA, 275mW	SOT-323	16df	-	3a Cen
WA	2N7002	n-MOSFET-e	TMOS, 60V, 300mA, 300mW, 1.2Ω(500mA), 8.8/14.8ns	SOT-23	16fh	-	3f Kec
WA	2SD1383K-A	Si-npn-Darl	AF, 40V, 300mA, 300mW, B>1000, >250MHz	SOT-346	16ta	-	3a Rhm
WA	BAS16WPT	Si-diode	Sw, 100V, 150mA, Vf<1.25V(150mA), 4ns	SOT-323	16dc	-	3a Chm
WA	BCR103L3	Si-npn-Digi	Sw, 50V, 100mA, 250mW, R1/R2=2.2k/2.2k, 140MHz	TSLP-3	22ta	-	2a Inf
WA	BZX84-B5V6	Z-diode	5.49..5.71V, Zzt=40Ω, Izt=5mA, 410mW	SOT-23	16dc	-	3a Pjt
WA	BZX84-C5V6	Z-diode	5.6V±5%, 300mW	SOT-23	16dc	-	3a Wte
WA	BZX84-C5V6W	Z-diode	5.6V±5%, 200mW	SOT-323	16dc	-	3a Mco
WA	TZTC5V6WS	Z-diode	5.32..5.88V, Izt=5mA, Zzt=40Ω, 200mW	SOT-323	16dc	-	3a Ttr
WA1	BZX84-C75	Z-diode	75V±5%, 300mW	SOT-23	16dc	-	3a PhC
WAs	BCR103	Si-npn-Digi	Sw, 50V, 100mA, 250mW, R1/R2=2.2k/2.2k, 140MHz	SOT-23	16ta	-	3c Inf
WAs	BCR103F	Si-npn-Digi	Sw, 50V, 100mA, 250mW, R1/R2=2.2k/2.2k, 140MHz	TSFP-3	18ta	-	3a Inf
WAs	BCR103T	Si-npn-Digi	Sw, 50V, 100mA, 250mW, R1/R2=2.2k/2.2k, 140MHz	SOT-416	16ta	-	3a Inf
WB	2N7002A	n-MOSFET-e*	TMOS, 60V, 115mA, 200mW, 1.8Ω(500mA), 20/20ns	SOT-23	16fh	-	3f Kec
WB	2SD1383K-B	Si-npn-Darl	AF, 40V, 300mA, 200mW, B>5000, >250MHz	SOT-346	16ta	-	3a Rhm
WB	BAS21WPT	Si-diode	Sw, 250V, 200mA, Vf<1.25V(100mA), 50ns	SOT-323	16dc	-	3a Chm
WB	BCR153L3	Si-pnp-Digi	Sw, 50V, 100mA, 250mW, R1/R2=2.2k/2.2k, 200MHz	TSLP-3	22ta	-	2a Inf
WB	BZX84-B6V2	Z-diode	6.08..6.32V, Zzt=10Ω, Izt=5mA, 410mW	SOT-23	16dc	-	3a Pjt
WB	BZX84-C6V2	Z-diode	6.2V±5%, 300mW	SOT-23	16dc	-	3a Wte
WB	BZX84-C6V2W	Z-diode	6.2V±5%, 200mW	SOT-323	16dc	-	3a Mco
WB	TZTC6V2WS	Z-diode	5.89..6.51V, Izt=5mA, Zzt=10Ω, 200mW	SOT-323	16dc	-	3a Ttr
WB0	BZX84-C68	Z-diode	68V±5%, 300mW	SOT-23	16dc	-	3a PhC
WB1	BZX84-C3V3	Z-diode	3.3V±5%, 300mW	SOT-23	16dc	-	3a PhC
WB2	BZX84-C3V6	Z-diode	3.6V±5%, 300mW	SOT-23	16dc	-	3a PhC
WB3	BZX84-C3V9	Z-diode	3.9V±5%, 300mW	SOT-23	16dc	-	3a PhC
WB4	BZX84-C43	Z-diode	43V±5%, 300mW	SOT-23	16dc	-	3a PhC
WB5	BZX84-C47	Z-diode	47V±5%, 300mW	SOT-23	16dc	-	3a PhC
WB6	BZX84-C4V3	Z-diode	4.3V±5%, 300mW	SOT-23	16dc	-	3a PhC
WB7	BZX84-C51	Z-diode	51V±5%, 300mW	SOT-23	16dc	-	3a PhC
WB8	BZX84-C56	Z-diode	56V±5%, 300mW	SOT-23	16dc	-	3a PhC
WB9	BZX84-C62	Z-diode	62V±5%, 300mW	SOT-23	16dc	-	3a PhC
WBs	BCR153	Si-pnp-Digi	Sw, 50V, 100mA, 200mW, R1/R2=2.2k/2.2k, 200MHz	SOT-23	16ta	-	3c Inf
WBs	BCR153F	Si-pnp-Digi	Sw, 50V, 100mA, 250mW, R1/R2=2.2k/2.2k, 200MHz	TSFP-3	18ta	-	3a Inf
WBs	BCR153T	Si-pnp-Digi	Sw, 50V, 100mA, 250mW, R1/R2=2.2k/2.2k, 200MHz	SOT-416	16ta	-	3a Inf
WC	2N7002K	n-MOSFET-e*	TMOS, 60V, 300mA, 300mW, 1.2Ω(500mA), 11.1/22.5ns	SOT-23	16fh	-	3f Kec
WC	BCR133L3	Si-npn-Digi	Sw, 50V, 100mA, 250mW, R1/R2=10k/10k, 130MHz	TSLP-3	22ta	-	2a Inf
WC	BZX84-B6V8	Z-diode	6.66..6.94V, Zzt=15Ω, Izt=5mA, 410mW	SOT-23	16dc	-	3a Pjt
WC	BZX84-C6V8	Z-diode	6.8V±5%, 300mW	SOT-23	16dc	-	3a Wte
WC	BZX84-C6V8W	Z-diode	6.8V±5%, 200mW	SOT-323	16dc	-	3a Mco
WC	CHDTC114EKPT	Si-npn-Digi	Sw, 50V, 50mA, 250MHz, R1/R2=10/10k	SOT-23	16ta	-	3a Chm
WC	CHT857BTPT-S	Si-pnp	AF, Sw, 45V, 100mA, B=420..800, 100MHz	SOT-416	16ta	-	3a Chm
WC	TZTC6V8WS	Z-diode	6.46..7.14V, Izt=5mA, Zzt=15Ω, 200mW	SOT-323	16dc	-	3a Ttr
WC0	BZX84-A13	Z-diode	13V±1%, 300mW	SOT-23	16dc	-	3a PhC
WC1	BZX84-A3V6	Z-diode	3.6V±1%, 300mW	SOT-23	16dc	-	3a PhC
WC2	BZX84-A20	Z-diode	20V±1%, 300mW	SOT-23	16dc	-	3a PhC
WC3	BZX84-A36	Z-diode	36V±1%, 300mW	SOT-23	16dc	-	3a PhC
WC4	BZX84-A39	Z-diode	39V±1%, 300mW	SOT-23	16dc	-	3a PhC
WC5	BZX84-A43	Z-diode	43V±1%, 300mW	SOT-23	16dc	-	3a PhC
WC6	BZX84-A51	Z-diode	51V±1%, 300mW	SOT-23	16dc	-	3a PhC
WCs	BCR133	Si-npn-Digi	Sw, 50V, 100mA, 330mW, R1/R2=10k/10k, 130MHz	SOT-23	16ta	-	3c Inf
WCs	BCR133F	Si-npn-Digi	Sw, 50V, 100mA, 250mW, R1/R2=10k/10k, 130MHz	TSFP-3	18ta	-	3a Inf
WCs	BCR133T	Si-npn-Digi	Sw, 50V, 100mA, 250mW, R1/R2=10k/10k, 130MHz	SOT-416	16ta	-	3a Inf
WCs	BCR133W	Si-npn-Digi	Sw, 50V, 100mA, 250mW, R1/R2=10k/10k, 130MHz	SOT-323	16ta	-	3c Inf
WD	BCR141L3	Si-npn-Digi	Sw, 50V, 100mA, 250mW, R1/R2=22k/22k, 130MHz	TSLP-3	22ta	-	2a Inf
WD	BZX84-B7V5	Z-diode	7.35..7.65V, Zzt=15Ω, Izt=5mA, 410mW	SOT-23	16dc	-	3a Pjt
WD	BZX84-C7V5	Z-diode	7.5V±5%, 300mW	SOT-23	16dc	-	3a Wte



SMD code	Type	Function	Short description	Case	Pinout	Sch.	St.	Mnf.
WD	BZX84-C7V5W	Z-diode	7.5V±5%, 200mW	SOT-323	16dc	-	3a	Mco
WD	MMBD4448WPT	Si-diode	Sw, 80V, 250mA, Vf<1V(100mA), 4ns	SOT-323	16dc	-	3a	Chm
WD	TZTC7V5WS	Z-diode	7.13..7.88V, Izt=5mA, Zzt=15Ω, 200mW	SOT-323	16dc	-	3a	Ttr
WDs	BCR141	Si-npn-Digi	Sw, 50V, 100mA, 200mW, R1/R2=22k/22k, 130MHz	SOT-23	16ta	-	3c	Inf
WDs	BCR141F	Si-npn-Digi	Sw, 50V, 100mA, 250mW, R1/R2=22k/22k, 130MHz	TSFP-3	18ta	-	3a	Inf
WDs	BCR141T	Si-npn-Digi	Sw, 50V, 100mA, 250mW, R1/R2=22k/22k, 130MHz	SOT-416	16ta	-	3a	Inf
WDs	BCR141W	Si-npn-Digi	Sw, 50V, 100mA, 250mW, R1/R2=22k/22k, 130MHz	SOT-323	16ta	-	3c	Inf
WE	2SK322-E	n-FET	HF, 15V, 50mA, 150mW, Ids=6..12mA, Up<3V	SOT-23	16fa	-	3a	Ren
WE	BCR148L3	Si-npn-Digi	Sw, 50V, 70mA, 250mW, R1/R2=47k/47k, 100MHz	TSLP-3	22ta	-	2a	Inf
WE	BZX84-B8V2	Z-diode	8.04..8.36V, Zzt=15Ω, Izt=5mA, 410mW	SOT-23	16dc	-	3a	Pjt
WE	BZX84-C8V2	Z-diode	8.2V±5%, 300mW	SOT-23	16dc	-	3a	Wte
WE	BZX84-C8V2W	Z-diode	8.2V±5%, 200mW	SOT-323	16dc	-	3a	Mco
WE	CHDTC144EEPT	Si-npn-Digi	Sw, 50V, 30mA, 250MHz, R1/R2=47/47k	SOT-416	16ta	-	3a	Chm
WE	CHDTC144EUPT	Si-npn-Digi	Sw, 50V, 30mA, 250MHz, R1/R2=47/47k	SOT-323	16ta	-	3a	Chm
WE	TZTC8V2WS	Z-diode	7.79..8.61V, Izt=5mA, Zzt=15Ω, 200mW	SOT-323	16dc	-	3a	Ttr
WE1	BFS17W	Si-npn	VHF/UHF, Mix/Osc, 25V, 25mA, 250mW, B=90, 1.6GHz	SOT-23	16ta	-	3a	Sil
WE1	CHDTA114WEPT	Si-pnp-Digi	Sw, 50V, 100mA, 250MHz, R1/R2=10/4.7k	SOT-416	16ta	-	3a	Chm
WE2	BFS17AW	Si-npn	VHF/UHF, Mix/Osc, 25V, 25mA, 200mW, B=20..150, 2.8GHz	SOT-323	16ta	-	3a	Sil
WE2	CHDTA144WEPT	Si-pnp-Digi	Sw, 50V, 30mA, 250MHz, R1/R2=47/22k	SOT-416	16ta	-	3a	Chm
WEA	CHDTC114WEPT	Si-npn-Digi	Sw, 50V, 100mA, 250MHz, R1/R2=10/4.7k	SOT-416	16ta	-	3a	Chm
WEB	CHDTC144WEPT	Si-npn-Digi	Sw, 50V, 30mA, 250MHz, R1/R2=47/22k	SOT-416	16ta	-	3a	Chm
WEs	BCR148	Si-npn-Digi	Sw, 50V, 70mA, 200mW, R1/R2=47k/47k, 100MHz	SOT-23	16ta	-	3c	Inf
WEs	BCR148F	Si-npn-Digi	Sw, 50V, 70mA, 250mW, R1/R2=47k/47k, 100MHz	TSFP-3	18ta	-	3a	Inf
WEs	BCR148T	Si-npn-Digi	Sw, 50V, 70mA, 250mW, R1/R2=47k/47k, 100MHz	SOT-416	16ta	-	3a	Inf
WEs	BCR148W	Si-npn-Digi	Sw, 50V, 70mA, 250mW, R1/R2=47k/47k, 100MHz	SOT-323	16ta	-	3c	Inf
WF	2SK322-F	n-FET	HF, 15V, 50mA, 150mW, Ids=10..20mA, Up<3V	SOT-23	16fa	-	3a	Ren
WF	BCR112L3	Si-npn-Digi	Sw, 50V, 100mA, 250mW, R1/R2=4.7k/4.7k, 140MHz	TSLP-3	22ta	-	2a	Inf
WF	BZX84-B9V1	Z-diode	8.92..9.28V, Zzt=15Ω, Izt=5mA, 410mW	SOT-23	16dc	-	3a	Pjt
WF	BZX84-C9V1	Z-diode	9.1V±5%, 300mW	SOT-23	16dc	-	3a	Wte
WF	BZX84-C9V1W	Z-diode	9.1V±5%, 200mW	SOT-323	16dc	-	3a	Mco
WF	CHDTC143EEPT	Si-npn-Digi	Sw, 50V, 100mA, 250MHz, R1/R2=4.7/4.7k	SOT-416	16ta	-	3a	Chm
WF	TZTC9V1WS	Z-diode	8.65..9.56V, Izt=5mA, Zzt=15Ω, 200mW	SOT-323	16dc	-	3a	Ttr
WFs	BCR112	Si-npn-Digi	Sw, 50V, 100mA, 200mW, R1/R2=4.7k/4.7k, 140MHz	SOT-23	16ta	-	3c	Inf
WFs	BCR112F	Si-npn-Digi	Sw, 50V, 100mA, 250mW, R1/R2=4.7k/4.7k, 140MHz	TSFP-3	18ta	-	3a	Inf
WFs	BCR112T	Si-npn-Digi	Sw, 50V, 100mA, 250mW, R1/R2=4.7k/4.7k, 140MHz	SOT-416	16ta	-	3a	Inf
WFs	BCR112W	Si-npn-Digi	Sw, 50V, 100mA, 200mW, R1/R2=4.7k/4.7k, 140MHz	SOT-323	16ta	-	3c	Inf
WG	2SK322-G	n-FET	HF, 15V, 50mA, 150mW, Ids=16..32mA, Up<3V	SOT-23	16fa	-	3a	Ren
WG	BCR116L3	Si-npn-Digi	Sw, 50V, 100mA, 250mW, R1/R2=4.7k/47k, 150MHz	TSLP-3	22ta	-	2a	Inf
WG	BZX84-B10	Z-diode	9.80..10.20V, Zzt=20Ω, Izt=5mA, 410mW	SOT-23	16dc	-	3a	Pjt
WG	BZX84-C10	Z-diode	10V±5%, 300mW	SOT-23	16dc	-	3a	Wte
WG	BZX84-C10W	Z-diode	10V±5%, 200mW	SOT-323	16dc	-	3a	Mco
WG	CHDTC143ZEPT	Si-npn-Digi	Sw, 50V, 100mA, 250MHz, R1/R2=4.7/47k	SOT-416	16ta	-	3a	Chm
WG	CHDTC143ZKPT	Si-npn-Digi	Sw, 50V, 100mA, 250MHz, R1/R2=4.7/47k	SOT-23	16ta	-	3a	Chm
WG	CHDTC143ZUPT	Si-npn-Digi	Sw, 50V, 100mA, 250MHz, R1/R2=4.7/47k	SOT-323	16ta	-	3a	Chm
WG	KTC3876S-GR	Si-npn	GP, 35V, 500mA, 150mW, B=200..400, 200MHz	SOT-23	16ta	-	3f	Kec
WG	TZTC10WS	Z-diode	9.50..10.50V, Izt=5mA, Zzt=20Ω, 200mW	SOT-323	16dc	-	3a	Ttr
WG1	PMBT5551	Si-npn	GP, 180V, 300mA, 250mW, B=80..250, 100..300MHz	SOT-23	16ta	-	3a	PhC
WG3	PMT5551	Si-npn	HV, 180V, 300mA, 200mW, B=80..250, 100..300MHz	SOT-323	16ta	-	3a	PhC
WGs	BCR116	Si-npn-Digi	Sw, 50V, 100mA, 200mW, R1/R2=4.7k/47k, 160MHz	SOT-23	16ta	-	3c	Inf
WGs	BCR116F	Si-npn-Digi	Sw, 50V, 100mA, 250mW, R1/R2=4.7k/47k, 150MHz	TSFP-3	18ta	-	3a	Inf
WGs	BCR116T	Si-npn-Digi	Sw, 50V, 100mA, 250mW, R1/R2=4.7k/47k, 150MHz	SOT-416	16ta	-	3a	Inf
WGs	BCR116W	Si-npn-Digi	Sw, 50V, 100mA, 250mW, R1/R2=4.7k/47k, 160MHz	SOT-323	16ta	-	3c	Inf
WH	2SK322-H	n-FET	HF, 15V, 50mA, 150mW, Ids=25..50mA, Up<3V	SOT-23	16fa	-	3a	Ren
WH	BCR108L3	Si-npn-Digi	Sw, 50V, 100mA, 250mW, R1/R2=2.2k/47k, 170MHz	TSLP-3	22ta	-	2a	Inf
WH	BZX84-B11	Z-diode	10.78..11.22V, Zzt=20Ω, Izt=5mA, 410mW	SOT-23	16dc	-	3a	Pjt
WH	BZX84-C11	Z-diode	11V±5%, 300mW	SOT-23	16dc	-	3a	Wte
WH	BZX84-C11W	Z-diode	11V±5%, 200mW	SOT-323	16dc	-	3a	Mco
WH	TZTC11WS	Z-diode	10.45..11.55V, Izt=5mA, Zzt=20Ω, 200mW	SOT-323	16dc	-	3a	Ttr
WHs	BCR108	Si-npn-Digi	Sw, 50V, 100mA, 200mW, R1/R2=2.2k/47k, 170MHz	SOT-23	16ta	-	3c	Inf
WHs	BCR108F	Si-npn-Digi	Sw, 50V, 100mA, 250mW, R1/R2=2.2k/47k, 170MHz	TSFP-3	18ta	-	3a	Inf
WHs	BCR108T	Si-npn-Digi	Sw, 50V, 100mA, 250mW, R1/R2=2.2k/47k, 170MHz	SOT-416	16ta	-	3a	Inf
WHs	BCR108W	Si-npn-Digi	Sw, 50V, 100mA, 250mW, R1/R2=2.2k/47k, 170MHz	SOT-323	16ta	-	3c	Inf
WI	BCR158L3	Si-pnp-Digi	Sw, 50V, 100mA, 250mW, R1/R2=2.2k/47k, 170MHz	TSLP-3	22ta	-	2a	Inf
WI	BZX84-B12	Z-diode	11.76..12.24V, Zzt=25Ω, Izt=5mA, 410mW	SOT-23	16dc	-	3a	Pjt
WI	BZX84-C12	Z-diode	12V±5%, 300mW	SOT-23	16dc	-	3a	Wte
WI	BZX84-C12W	Z-diode	12V±5%, 200mW	SOT-323	16dc	-	3a	Mco
WI	TZTC12WS	Z-diode	11.40..12.60V, Izt=5mA, Zzt=25Ω, 200mW	SOT-323	16dc	-	3a	Ttr
WIs	BCR158	Si-pnp-Digi	Sw, 50V, 100mA, 200mW, R1/R2=2.2k/47k, 200MHz	SOT-23	16ta	-	3c	Inf
WIs	BCR158F	Si-pnp-Digi	Sw, 50V, 100mA, 250mW, R1/R2=2.2k/47k, 170MHz	TSFP-3	18ta	-	3a	Inf
WIs	BCR158T	Si-pnp-Digi	Sw, 50V, 100mA, 250mW, R1/R2=2.2k/47k, 170MHz	SOT-416	16ta	-	3a	Inf



SMD code	Type	Function	Short description	Case	Pinout	Sch.	St.	Mnf.
WIs	BCR158W	Si-pnp-Digi	Sw, 50V, 100mA, 250mW, R1/R2=2.2k/47k, 200MHz	SOT-323	16ta	-	3c	Inf
WJ	BCR135L3	Si-npn-Digi	Sw, 50V, 100mA, 250mW, R1/R2=10k/47k, 150MHz	TSLP-3	22ta	-	2a	Inf
WJ	BZX84-B14	Z-diode	13.72..14.28V, Zzt=30Ω, Izt=5mA, 410mW	SOT-23	16dc	-	3a	Pjt
WJ	CHDTC114YEPT	Si-npn-Digi	Sw, 50V, 70mA, 250MHz, R1/R2=10/47k	SOT-416	16ta	-	3a	Chm
WJ	CHDTC114YKPT	Si-npn-Digi	Sw, 50V, 70mA, 250MHz, R1/R2=10/47k	SOT-23	16ta	-	3a	Chm
WJ	CHDTC114YUPT	Si-npn-Digi	Sw, 50V, 70mA, 250MHz, R1/R2=10/47k	SOT-323	16ta	-	3a	Chm
WJ	TZTC14WS	Z-diode	13.30..14.70V, Izt=5mA, Zzt=30Ω, 200mW	SOT-323	16dc	-	3a	Ttr
WJs	BCR135	Si-npn-Digi	Sw, 50V, 100mA, 200mW, R1/R2=10k/47k, 150MHz	SOT-23	16ta	-	3c	Inf
WJs	BCR135F	Si-npn-Digi	Sw, 50V, 100mA, 250mW, R1/R2=10k/47k, 150MHz	TSFP-3	18ta	-	3a	Inf
WJs	BCR135T	Si-npn-Digi	Sw, 50V, 100mA, 250mW, R1/R2=10k/47k, 150MHz	SOT-416	16ta	-	3a	Inf
WJs	BCR135W	Si-npn-Digi	Sw, 50V, 100mA, 250mW, R1/R2=10k/47k, 150MHz	SOT-323	16ta	-	3c	Inf
WK	BCR119L3	Si-npn-Digi	Sw, 50V, 100mA, 250mW, R1=4.7k, 150MHz	TSLP-3	22ta	-	2a	Inf
WK	BZX84-B13	Z-diode	12.74..13.26V, Zzt=30Ω, Izt=5mA, 410mW	SOT-23	16dc	-	3a	Pjt
WK	BZX84-C13	Z-diode	13.6V±5%, 300mW	SOT-23	16dc	-	3a	Wte
WK	BZX84-C13W	Z-diode	13V±5%, 200mW	SOT-323	16dc	-	3a	Mco
WK	TZTC13WS	Z-diode	12.35..13.65V, Izt=5mA, Zzt=30Ω, 200mW	SOT-323	16dc	-	3a	Ttr
WK1	CHDTA114WKPT	Si-pnp-Digi	Sw, 50V, 100mA, 250MHz, R1/R2=10/4.7k	SOT-23	16ta	-	3a	Chm
WK2	CHDTA144WKPT	Si-pnp-Digi	Sw, 50V, 30mA, 250MHz, R1/R2=47/22k	SOT-23	16ta	-	3a	Chm
WKA	CHDTC114WKPT	Si-npn-Digi	Sw, 50V, 100mA, 250MHz, R1/R2=10/4.7k	SOT-23	16ta	-	3a	Chm
WKB	CHDTC144WKPT	Si-npn-Digi	Sw, 50V, 30mA, 250MHz, R1/R2=47/22k	SOT-23	16ta	-	3a	Chm
Wks	BCR119	Si-npn-Digi	Sw, 50V, 100mA, 200mW, R1=4.7k, 150MHz	SOT-23	16ta	-	3c	Inf
Wks	BCR119F	Si-npn-Digi	Sw, 50V, 100mA, 250mW, R1=4.7k, 150MHz	TSFP-3	18ta	-	3a	Inf
Wks	BCR119T	Si-npn-Digi	Sw, 50V, 100mA, 250mW, R1=4.7k, 150MHz	SOT-416	16ta	-	3a	Inf
Wks	BCR119W	Si-npn-Digi	Sw, 50V, 100mA, 200mW, R1=4.7k, 150MHz	SOT-323	16ta	-	3c	Inf
WL	2SA1589	Si-pnp-Digi	Sw, 50V, 100mA, 200mW, R1=22k	SOT-23	16ta	-	3a	San
WL	BCR146L3	Si-npn-Digi	Sw, 50V, 70mA, 250mW, R1/R2=47k/22k, 150MHz	TSLP-3	22ta	-	2a	Inf
WL	BZX84-B15	Z-diode	14.70..15.30V, Zzt=30Ω, Izt=5mA, 410mW	SOT-23	16dc	-	3a	Pjt
WL	BZX84-C15	Z-diode	15V±5%, 300mW	SOT-23	16dc	-	3a	Wte
WL	BZX84-C15W	Z-diode	15V±5%, 200mW	SOT-323	16dc	-	3a	Mco
WL	TZTC15WS	Z-diode	14.25..15.75V, Izt=5mA, Zzt=30Ω, 200mW	SOT-323	16dc	-	3a	Ttr
WLN	ELM7521CEB	Vdet-IC	2.1V±2%, +Reset PPO	SC-70	16vdb	VD7	3d	Elm
WLN	ELM7521NEB	Vdet-IC	2.1V±2%, +Reset ODO	SC-70	16vdb	VD6	3d	Elm
WLS	BCR146	Si-npn-Digi	Sw, 50V, 70mA, 200mW, R1/R2=47k/22k, 150MHz	SOT-23	16ta	-	3c	Inf
WLS	BCR146F	Si-npn-Digi	Sw, 50V, 70mA, 250mW, R1/R2=47k/22k, 150MHz	TSFP-3	18ta	-	3a	Inf
WLS	BCR146T	Si-npn-Digi	Sw, 50V, 70mA, 250mW, R1/R2=47k/22k, 150MHz	SOT-416	16ta	-	3a	Inf
WLS	BCR146W	Si-npn-Digi	Sw, 50V, 70mA, 250mW, R1/R2=47k/22k, 150MHz	SOT-323	16ta	-	3c	Inf
WM	BCR183L3	Si-pnp-Digi	Sw, 50V, 100mA, 250mW, R1/R2=10k/10k, 130MHz	TSLP-3	22ta	-	2a	Inf
WM	BZX84-B16	Z-diode	15.68..16.32V, Zzt=40Ω, Izt=5mA, 410mW	SOT-23	16dc	-	3a	Pjt
WM	BZX84-C16	Z-diode	16V±5%, 300mW	SOT-23	16dc	-	3a	Wte
WM	BZX84-C16W	Z-diode	16V±5%, 200mW	SOT-323	16dc	-	3a	Mco
WM	TZTC16WS	Z-diode	15.20..16.80V, Izt=5mA, Zzt=40Ω, 200mW	SOT-323	16dc	-	3a	Ttr
WMs	BCR183	Si-pnp-Digi	Sw, 50V, 100mA, 200mW, R1/R2=10k/10k, 200MHz	SOT-23	16ta	-	3c	Inf
WMs	BCR183F	Si-pnp-Digi	Sw, 50V, 100mA, 250mW, R1/R2=10k/10k, 130MHz	TSFP-3	18ta	-	3a	Inf
WMs	BCR183T	Si-pnp-Digi	Sw, 50V, 100mA, 250mW, R1/R2=10k/10k, 130MHz	SOT-416	16ta	-	3a	Inf
WMs	BCR183W	Si-pnp-Digi	Sw, 50V, 100mA, 200mW, R1/R2=10k/10k, 200MHz	SOT-323	16ta	-	3c	Inf
WN	2SC6061	Si-npn	Sw, 180V, 1A, 1W, 0.1/0.2μs, B=120..300	SOT-23	16ta	-	3a	Tos
WN	BCR185L3	Si-pnp-Digi	Sw, 50V, 100mA, 250mW, R1/R2=10k/47k, 150MHz	TSLP-3	22ta	-	2a	Inf
WN	BZX84-B18	Z-diode	17.64..18.36V, Zzt=45Ω, Izt=5mA, 410mW	SOT-23	16dc	-	3a	Pjt
WN	BZX84-C18	Z-diode	18V±5%, 300mW	SOT-23	16dc	-	3a	Wte
WN	BZX84-C18W	Z-diode	18V±5%, 200mW	SOT-323	16dc	-	3a	Mco
WN	CHDTA114YUPT	Si-pnp-Digi	Sw, 50V, 70mA, 250MHz, R1/R2=10/47k	SOT-323	16ta	-	3a	Chm
WN	TZTC18WS	Z-diode	17.10..18.90V, Izt=5mA, Zzt=45Ω, 200mW	SOT-323	16dc	-	3a	Ttr
WNs	BCR185	Si-pnp-Digi	Sw, 50V, 100mA, 200mW, R1/R2=10k/47k, 200MHz	SOT-23	16ta	-	3c	Inf
WNs	BCR185F	Si-pnp-Digi	Sw, 50V, 100mA, 250mW, R1/R2=10k/47k, 150MHz	TSFP-3	18ta	-	3a	Inf
WNs	BCR185T	Si-pnp-Digi	Sw, 50V, 100mA, 250mW, R1/R2=10k/47k, 150MHz	SOT-416	16ta	-	3a	Inf
WNs	BCR185W	Si-pnp-Digi	Sw, 50V, 100mA, 250mW, R1/R2=10k/47k, 200MHz	SOT-323	16ta	-	3c	Inf
WO	2SC2859-O	Si-npn	AF, 35V, 500mA, 150mW, B=70..140, 200MHz	SC-59	16ta	-	3a	Tos
WO	2SC4118-O	Si-npn	AF-Drv, Sw, 35V, 500mA, 100mW, B=70..140, 200MHz	SOT-323	16ta	-	3a	Tos
WO	BCR191L3	Si-pnp-Digi	Sw, 50V, 100mA, 250mW, R1/R2=22k/22k, 130MHz	TSLP-3	22ta	-	2a	Inf
WO	BZX84-B20	Z-diode	19.60..20.40V, Zzt=55Ω, Izt=5mA, 410mW	SOT-23	16dc	-	3a	Pjt
WO	BZX84-C20	Z-diode	20V±5%, 300mW	SOT-23	16dc	-	3a	Wte
WO	BZX84-C20W	Z-diode	20V±5%, 200mW	SOT-323	16dc	-	3a	Mco
WO	KTC3876S-O	Si-npn	GP, 35V, 500mA, 150mW, B=70..140, 200MHz	SOT-23	16ta	-	3f	Kec
WO	TZTC20WS	Z-diode	19.0..21.0V, Izt=5mA, Zzt=55Ω, 200mW	SOT-323	16dc	-	3a	Ttr
WO4	PMBS3904	Si-npn	Sw, 40V, 100mA, 250mW, B=100..300, >180MHz	SOT-23	16ta	-	3a	PhC
WO6	PMBS3906	Si-pnp	Sw, 40V, 100mA, 250mW, B=100..300, >150MHz	SOT-23	16ta	-	3a	PhC
WOs	BCR191	Si-pnp-Digi	Sw, 50V, 100mA, 200mW, R1/R2=22k/22k, 200MHz	SOT-23	16ta	-	3c	Inf
WOs	BCR191F	Si-pnp-Digi	Sw, 50V, 100mA, 250mW, R1/R2=22k/22k, 130MHz	TSFP-3	18ta	-	3a	Inf
WOs	BCR191T	Si-pnp-Digi	Sw, 50V, 100mA, 250mW, R1/R2=22k/22k, 130MHz	SOT-416	16ta	-	3a	Inf
WOs	BCR191W	Si-pnp-Digi	Sw, 50V, 100mA, 200mW, R1/R2=22k/22k, 200MHz	SOT-323	16ta	-	3c	Inf



SMD code	Type	Function	Short description	Case	Pinout	Sch.	St.	Mnf.
WP	2SK322-P	n-FET	HF, 15V, 50mA, 150mW, Ids=5..15mA, Up<3V	SOT-23	16fa	-	3a	Ren
WP	BCR192L3	Si-pnp-Digi	Sw, 50V, 100mA, 250mW, R1/R2=22k/47k, 150MHz	TSLP-3	22ta	-	2a	Inf
WP	BZX84-B22	Z-diode	21.56..22.44V, Zzt=55Ω, Izt=5mA, 410mW	SOT-23	16dc	-	3a	Pjt
WP	BZX84-C22	Z-diode	20.8..23.3V, Zzt=55Ω, Izt=20mA, 300mW	SOT-23	16dc	-	3a	Wte
WP	BZX84-C22W	Z-diode	22V±5%, 200mW	SOT-323	16dc	-	3a	Mco
WP	TZTC22WS	Z-diode	20.90..23.10V, Izt=5mA, Zzt=55Ω, 200mW	SOT-323	16dc	-	3a	Ttr
WPs	BCR192	Si-pnp-Digi	Sw, 50V, 100mA, 330mW, R1/R2=22k/47k, 200MHz	SOT-23	16ta	-	3c	Inf
WPs	BCR192F	Si-pnp-Digi	Sw, 50V, 100mA, 250mW, R1/R2=22k/47k, 150MHz	TSFP-3	18ta	-	3a	Inf
WPs	BCR192T	Si-pnp-Digi	Sw, 50V, 100mA, 250mW, R1/R2=22k/47k, 150MHz	SOT-416	16ta	-	3a	Inf
WPs	BCR192W	Si-pnp-Digi	Sw, 50V, 100mA, 250mW, R1/R2=22k/47k, 200MHz	SOT-323	16ta	-	3c	Inf
WQ	2PD602Q	Si-npn	GP, Sw, 60V, 500mA, 250mW, B=85..170, >140MHz	SOT-23	16ta	-	3a	Phi
WQ	2SD1820-Q	Si-npn	GP, 30V, 500mA, 150mW, B=85..170, 20MHz	SOT-323	16ta	-	3a	Pan
WQ	2SD602-Q	Si-npn	GP, AF, 50V, 500mA, 200mW, B=85..170, 200MHz	SC-59	16ta	-	3a	Pan
WQ	2SK322-Q	n-FET	HF, 15V, 50mA, 150mW, Ids=14..24mA, Up<3V	SOT-23	16fa	-	3a	Ren
WR	2PD602R	Si-npn	GP, Sw, 60V, 500mA, 250mW, B=120..240, >160MHz	SOT-23	16ta	-	3a	Phi
WR	2SD1820-R	Si-npn	GP, 30V, 500mA, 150mW, B=120..240, 20MHz	SOT-323	16ta	-	3a	Pan
WR	2SD602-R	Si-npn	GP, AF, 50V, 500mA, 200mW, B=120..240, 200MHz	SC-59	16ta	-	3a	Pan
WR	2SK322-R	n-FET	HF, 15V, 50mA, 150mW, Ids=20..32mA, Up<3V	SOT-23	16fa	-	3a	Ren
WR	BCR198L3	Si-pnp-Digi	Sw, 50V, 70mA, 250mW, R1/R2=47k/47k, 100MHz	TSLP-3	22ta	-	2a	Inf
WR	BZX84-B24	Z-diode	23.52..24.48V, Zzt=70Ω, Izt=5mA, 410mW	SOT-23	16dc	-	3a	Pjt
WR	BZX84-C24	Z-diode	24V±5%, 300mW	SOT-23	16dc	-	3a	Wte
WR	BZX84-C24W	Z-diode	24V±5%, 200mW	SOT-323	16dc	-	3a	Mco
WR	CHDTA144EEPT	Si-pnp-Digi	Sw, 50V, 30mA, 250MHz, R1/R2=47/47k	SOT-416	16ta	-	3a	Chm
WR	MSD602-R	Si-npn	GP, 60V, 500mA, 200mW, B=120..240	SOT-323	16ta	-	3a	Mot
WR	TZTC24WS	Z-diode	22.80..25.20V, Izt=5mA, Zzt=70Ω, 200mW	SOT-323	16dc	-	3a	Ttr
WR0	BZX84-B56	Z-diode	56V±2%, 300mW	SOT-23	16dc	-	3a	PhC
WR1	BZX84-B5V1	Z-diode	5.1V±2%, 300mW	SOT-23	16dc	-	3a	PhC
WR2	BFR93AW	Si-npn	UHF-A-Band, 15V, 30mA, 300mW, B>40, >5GHz	SOT-323	16ta	-	3a	Sil
WR2	BZX84-B5V6	Z-diode	5.6V±2%, 300mW	SOT-23	16dc	-	3a	PhC
WR3	BZX84-B62	Z-diode	62V±2%, 300mW	SOT-23	16dc	-	3a	PhC
WR4	BZX84-B68	Z-diode	68V±2%, 300mW	SOT-23	16dc	-	3a	PhC
WR5	BZX84-B6V2	Z-diode	6.2V±2%, 300mW	SOT-23	16dc	-	3a	PhC
WR6	BZX84-B6V8	Z-diode	6.8V±2%, 300mW	SOT-23	16dc	-	3a	PhC
WR7	BZX84-B75	Z-diode	75V±2%, 300mW	SOT-23	16dc	-	3a	PhC
WR8	BZX84-B7V5	Z-diode	7.5V±2%, 300mW	SOT-23	16dc	-	3a	PhC
WR9	BZX84-B8V2	Z-diode	8.2V±2%, 300mW	SOT-23	16dc	-	3a	PhC
WRC	BFR193TRW	Si-npn	UHF, 20V, 80mA, 400mW, 8GHz	SOT-323	16ta	-	3a	Sil
WRs	BCR198	Si-pnp-Digi	Sw, 50V, 70mA, 200mW, R1/R2=47k/47k, 190MHz	SOT-23	16ta	-	3c	Inf
WRs	BCR198F	Si-pnp-Digi	Sw, 50V, 70mA, 250mW, R1/R2=47k/47k, 100MHz	TSFP-3	18ta	-	3a	Inf
WRs	BCR198T	Si-pnp-Digi	Sw, 50V, 70mA, 250mW, R1/R2=47k/47k, 100MHz	SOT-416	16ta	-	3a	Inf
WRs	BCR198W	Si-pnp-Digi	Sw, 50V, 70mA, 250mW, R1/R2=47k/47k, 190MHz	SOT-323	16ta	-	3c	Inf
WS	2PD602S	Si-npn	GP, Sw, 60V, 500mA, 250mW, B=85..170, >140MHz	SOT-23	16ta	-	3a	Phi
WS	2SD1820-S	Si-npn	GP, 30V, 500mA, 150mW, B=170..340, 20MHz	SOT-323	16ta	-	3a	Pan
WS	2SD602-S	Si-npn	GP, AF, 50V, 500mA, 200mW, B=170..340, 200MHz	SC-59	16ta	-	3a	Pan
WS	2SK322-S	n-FET	HF, 15V, 50mA, 150mW, Ids=18..42mA, Up<3V	SOT-23	16fa	-	3a	Ren
WS	BCR169L3	Si-pnp-Digi	Sw, 50V, 100mA, 250mW, R1=4.7k, 150MHz	TSLP-3	22ta	-	2a	Inf
WS	BZX84-B27	Z-diode	26.46..27.54V, Zzt=80Ω, Izt=5mA, 410mW	SOT-23	16dc	-	3a	Pjt
WS	BZX84-C27	Z-diode	27V±5%, 300mW	SOT-23	16dc	-	3a	Wte
WS	BZX84-C27W	Z-diode	27V±5%, 200mW	SOT-323	16dc	-	3a	Mco
WS	TZTC27WS	Z-diode	25.65..28.35V, Izt=5mA, Zzt=80Ω, 200mW	SOT-323	16dc	-	3a	Ttr
WS0	BZX84-B39	Z-diode	39V±2%, 300mW	SOT-23	16dc	-	3a	PhC
WS1	BZX84-B3V0	Z-diode	3V±2%, 300mW	SOT-23	16dc	-	3a	PhC
WS2	BZX84-B3V3	Z-diode	3.3V±2%, 300mW	SOT-23	16dc	-	3a	PhC
WS2	BZX84-B3V6	Z-diode	3.6V±2%, 300mW	SOT-23	16dc	-	3a	PhC
WS4	BZX84-B3V9	Z-diode	3.9V±2%, 300mW	SOT-23	16dc	-	3a	PhC
WS5	BZX84-B43	Z-diode	43V±2%, 300mW	SOT-23	16dc	-	3a	PhC
WS6	BZX84-B47	Z-diode	47V±2%, 300mW	SOT-23	16dc	-	3a	PhC
WS7	BZX84-B4V3	Z-diode	4.3V±2%, 300mW	SOT-23	16dc	-	3a	PhC
WS8	BZX84-B4V7	Z-diode	4.7V±2%, 300mW	SOT-23	16dc	-	3a	PhC
WS9	BZX84-B51	Z-diode	51V±2%, 300mW	SOT-23	16dc	-	3a	PhC
WSs	BCR169	Si-pnp-Digi	Sw, 50V, 100mA, 200mW, R1=4.7k, 200MHz	SOT-23	16ta	-	3c	Inf
WSs	BCR169F	Si-pnp-Digi	Sw, 50V, 100mA, 250mW, R1=4.7k, 150MHz	TSFP-3	18ta	-	3a	Inf
WSs	BCR169T	Si-pnp-Digi	Sw, 50V, 100mA, 250mW, R1=4.7k, 150MHz	SOT-416	16ta	-	3a	Inf
WSs	BCR169W	Si-pnp-Digi	Sw, 50V, 100mA, 200mW, R1=4.7k, 200MHz	SOT-323	16ta	-	3c	Inf
WT	2SA1020PT-Y	Si-pnp	AF, Sw, 50V, 500mA, B=120..240, 120MHz	SOT-23	16ta	-	3a	Chm
WT	2SC4694	Si-npn	AF, Mute, 50V, 500mA, 150mW, B=300..1200, 250MHz	MCP	16ta	-	3a	San
WT	2SC4695	Si-npn	AF, Mute, 50V, 500mA, 250mW, B=300..1200, 250MHz	CP	16ta	-	3a	San
WT	2SK322-T	n-FET	HF, 15V, 50mA, 150mW, Ids=36..50mA, Up<3V	SOT-23	16fa	-	3a	Ren
WT	BCR166L3	Si-pnp-Digi	Sw, 50V, 100mA, 250mW, R1/R2=4.7k/47k, 150MHz	TSLP-3	22ta	-	2a	Inf
WT	BZX84-B30	Z-diode	29.40..30.60V, Zzt=80Ω, Izt=5mA, 410mW	SOT-23	16dc	-	3a	Pjt



SMD code	Type	Function	Short description	Case	Pinout	Sch.	St.	Mnf.
WT	BZX84-C30	Z-diode	30V±5%, 300mW	SOT-23	16dc	-	3a	Wte
WT	BZX84-C30W	Z-diode	30V±5%, 200mW	SOT-323	16dc	-	3a	Mco
WT	TZTC30WS	Z-diode	28.50..31.50V, Izt=5mA, Zzt=80Ω, 200mW	SOT-323	16dc	-	3a	Ttr
WT1	BZX84-B9V1	Z-diode	9.1V±2%, 300mW	SOT-23	16dc	-	3a	PhC
WT2	BZX84-C27	Z-diode	27V±5%, 300mW	SOT-23	16dc	-	3a	PhC
WT3	BZX84-C2V4	Z-diode	2.4V±5%, 300mW	SOT-23	16dc	-	3a	PhC
WT4	BZX84-C2V7	Z-diode	2.7V±5%, 300mW	SOT-23	16dc	-	3a	PhC
WT5	BZX84-C30	Z-diode	30V±5%, 300mW	SOT-23	16dc	-	3a	PhC
WT6	BZX84-C33	Z-diode	33V±5%, 300mW	SOT-23	16dc	-	3a	PhC
WT7	BZX84-C36	Z-diode	36V±5%, 300mW	SOT-23	16dc	-	3a	PhC
WT8	BZX84-C39	Z-diode	39V±5%, 300mW	SOT-23	16dc	-	3a	PhC
WT9	BZX84-C3V0	Z-diode	3.0V±5%, 300mW	SOT-23	16dc	-	3a	PhC
WTs	BCR166	Si-pnp-Digi	Sw, 50V, 100mA, 200mW, R1/R2=4.7k/47k, 160MHz	SOT-23	16ta	-	3c	Inf
WTs	BCR166F	Si-pnp-Digi	Sw, 50V, 100mA, 250mW, R1/R2=4.7k/47k, 150MHz	TSFP-3	18ta	-	3a	Inf
WTs	BCR166T	Si-pnp-Digi	Sw, 50V, 100mA, 250mW, R1/R2=4.7k/47k, 150MHz	SOT-416	16ta	-	3a	Inf
WTs	BCR166W	Si-pnp-Digi	Sw, 50V, 100mA, 250mW, R1/R2=4.7k/47k, 160MHz	SOT-323	16ta	-	3c	Inf
WU	BCR162L3	Si-pnp-Digi	Sw, 50V, 100mA, 250mW, R1/R2=4.7k/4.7k, 140MHz	TSLP-3	22ta	-	2a	Inf
WU	BZX84-B33	Z-diode	32.34..33.66V, Zzt=80Ω, Izt=5mA, 410mW	SOT-23	16dc	-	3a	Pjt
WU	BZX84-C33	Z-diode	33V±5%, 300mW	SOT-23	16dc	-	3a	Wte
WU	BZX84-C33W	Z-diode	33V±5%, 200mW	SOT-323	16dc	-	3a	Mco
WU	TZTC33WS	Z-diode	31.35..34.65V, Izt=5mA, Zzt=80Ω, 200mW	SOT-323	16dc	-	3a	Ttr
WU1	CHDTA114WUPT	Si-pnp-Digi	Sw, 50V, 100mA, 250MHz, R1/R2=10/4.7k	SOT-323	16ta	-	3a	Chm
WU2	CHDTA144WUPT	Si-pnp-Digi	Sw, 50V, 30mA, 250MHz, R1/R2=47/22k	SOT-323	16ta	-	3a	Chm
WU4	CHDTC114WUPT	Si-npn-Digi	Sw, 50V, 100mA, 250MHz, R1/R2=10/4.7k	SOT-323	16ta	-	3a	Chm
WUB	CHDTC144WUPT	Si-npn-Digi	Sw, 50V, 30mA, 250MHz, R1/R2=47/22k	SOT-323	16ta	-	3a	Chm
WUs	BCR162	Si-pnp-Digi	Sw, 50V, 100mA, 200mW, R1/R2=4.7k/4.7k, 200MHz	SOT-23	16ta	-	3c	Inf
WUs	BCR162F	Si-pnp-Digi	Sw, 50V, 100mA, 250mW, R1/R2=4.7k/4.7k, 140MHz	TSFP-3	18ta	-	3a	Inf
WUs	BCR162T	Si-pnp-Digi	Sw, 50V, 100mA, 250mW, R1/R2=4.7k/4.7k, 140MHz	SOT-416	16ta	-	3a	Inf
WV	BCR129L3	Si-npn-Digi	Sw, 50V, 100mA, 250mW, R1=10k, 150MHz	TSLP-3	22ta	-	2a	Inf
WV1	BAS31	Si-diode	Dual, GP, Contr, Aval., 90V, 250mA, 250mW, 35pF, <50ns	SOT-23	16dl	-	3a	PhC
WV2	BAS35	Si-diode	Dual, GP, Contr, Aval., 90V, 250mA, 250mW, 35pF, <50ns	SOT-23	16df	-	3a	PhC
WV2	BF067W	Si-npn	UHF-A, LN, 20V, 50mA, 200mW, B=65..150, 7.5GHz	SOT-323	16ta	-	3a	Sil
WV3	BAT54A	Si-diode	Dual, Schottky Rectifier, 30V, 200mA, Vf<1V(100mA), <5ns	SOT-23	16df	-	3a	PhC
WV4	BAT54S	Si-diode	Dual, Schottky Rectifier, 30V, 200mA, Vf<1V(100mA), <5ns	SOT-23	16dl	-	3a	PhC
WV5	BAV23S	Si-diode	Dual, GP, 200V, 225mA, Vs<1.25V(200mA), <50ns	SOT-23	16dl	-	3a	PhC
WVs	BCR129	Si-npn-Digi	Sw, 50V, 100mA, 200mW, R1=10k, 150MHz	SOT-23	16ta	-	3c	Inf
WVs	BCR129F	Si-npn-Digi	Sw, 50V, 100mA, 250mW, R1=10k, 150MHz	TSFP-3	18ta	-	3a	Inf
WVs	BCR129T	Si-npn-Digi	Sw, 50V, 100mA, 250mW, R1=10k, 150MHz	SOT-416	16ta	-	3a	Inf
WVW	BCR179L3	Si-pnp-Digi	Sw, 50V, 100mA, 250mW, R1=10k, 150MHz	TSLP-3	22ta	-	2a	Inf
WV	BZX84-B36	Z-diode	35.28..36.72V, Zzt=90Ω, Izt=5mA, 410mW	SOT-23	16dc	-	3a	Pjt
WV	BZX84-C36	Z-diode	36V±5%, 300mW	SOT-23	16dc	-	3a	Wte
WV	BZX84-C36W	Z-diode	36V±5%, 200mW	SOT-323	16dc	-	3a	Mco
WV	TZTC36WS	Z-diode	34.20..37.80V, Izt=5mA, Zzt=90Ω, 200mW	SOT-323	16dc	-	3a	Ttr
WV3	CMPZDA2V4	Z-diode	Dual, 2.4V±2.5%, 350mW	SOT-23	16df	-	3a	Cen
WV4	CMPZDA2V7	Z-diode	Dual, 2.7V±2.5%, 350mW	SOT-23	16df	-	3a	Cen
WV5	CMPZDA3V0	Z-diode	Dual, 3V±2.5%, 350mW	SOT-23	16df	-	3a	Cen
WV6	CMPZDA3V3	Z-diode	Dual, 3.3V±2.5%, 350mW	SOT-23	16df	-	3a	Cen
WV7	CMPZDA3V6	Z-diode	Dual, 3.6V±2.5%, 350mW	SOT-23	16df	-	3a	Cen
WV8	CMPZDA3V9	Z-diode	Dual, 3.9V±2.5%, 350mW	SOT-23	16df	-	3a	Cen
WV9	CMPZDA4V3	Z-diode	Dual, 4.3V±2.5%, 350mW	SOT-23	16df	-	3a	Cen
WVs	BCR179F	Si-pnp-Digi	Sw, 50V, 100mA, 250mW, R1=10k, 150MHz	TSFP-3	18ta	-	3a	Inf
WVs	BCR179T	Si-pnp-Digi	Sw, 50V, 100mA, 250mW, R1=10k, 150MHz	SOT-416	16ta	-	3a	Inf
WX	2SC6033	Si-npn	Sw, 100V, 2.5A, 1W, 25/470ns, B=250...400	SOT-23	16ta	-	3a	Tos
WX	BCR196L3	Si-pnp-Digi	Sw, 50V, 70mA, 250mW, R1/R2=47k/22k, 150MHz	TSLP-3	22ta	-	2a	Inf
WX	BZX84-B39	Z-diode	38.22..39.78V, Zzt=130Ω, Izt=5mA, 410mW	SOT-23	16dc	-	3a	Pjt
WX	BZX84-C39	Z-diode	39V±5%, 300mW	SOT-23	16dc	-	3a	Wte
WX	BZX84-C39W	Z-diode	39V±5%, 200mW	SOT-323	16dc	-	3a	Mco
WX	TZTC39WS	Z-diode	37.05..40.95V, Izt=5mA, Zzt=130Ω, 200mW	SOT-323	16dc	-	3a	Ttr
Wxs	BCR196	Si-pnp-Digi	Sw, 50V, 70mA, 200mW, R1/R2=47k/22k, 150MHz	SOT-23	16ta	-	3c	Inf
Wxs	BCR196F	Si-pnp-Digi	Sw, 50V, 70mA, 250mW, R1/R2=47k/22k, 150MHz	TSFP-3	18ta	-	3a	Inf
Wxs	BCR196T	Si-pnp-Digi	Sw, 50V, 70mA, 250mW, R1/R2=47k/22k, 150MHz	SOT-416	16ta	-	3a	Inf
Wxs	BCR196W	Si-pnp-Digi	Sw, 50V, 70mA, 200mW, R1/R2=47k/22k, 150MHz	SOT-323	16ta	-	3c	Inf
WY	2SC2859-GR	Si-npn	AF, 35V, 500mA, 150mW, B=200..400, 200MHz	SC-59	16ta	-	3a	Tos
WY	2SC2859-Y	Si-npn	AF, 35V, 500mA, 150mW, B=120..240, 200MHz	SC-59	16ta	-	3a	Tos
WY	2SC3915	Si-npn-Digi	Sw, 50V, 500mA, 200mW, 250MHz, R1/R2=2k2/2k2	SOT-23	16ta	-	3a	San
WY	2SC4118-Y	Si-npn	AF-Div, Sw, 35V, 500mA, 100mW, B=120..240, 200MHz	SOT-323	16ta	-	3a	Tos
WY	BCR139L3	Si-npn-Digi	Sw, 50V, 100mA, 250mW, R1=22k, 150MHz	TSLP-3	22ta	-	2a	Inf
WY	BZX84-B43	Z-diode	42.14..43.86V, Zzt=150Ω, Izt=5mA, 410mW	SOT-23	16dc	-	3a	Pjt
WY	KTC3876S-Y	Si-npn	GP, 35V, 500mA, 150mW, B=120..240, 200MHz	SOT-23	16ta	-	3f	Kec
WY	TZTC43WS	Z-diode	40.85..45.15V, Izt=5mA, Zzt=150Ω, 200mW	SOT-323	16dc	-	3a	Ttr



SMD code	Type	Function	Short description	Case	Pinout	Sch.	St.	Mnf.
WY1	BZX84-B33	Z-diode	33V±2%, 300mW	SOT-23	16dc	-	3a	PhC
WY2	BZX84-B36	Z-diode	36V±2%, 300mW	SOT-23	16dc	-	3a	PhC
WYs	BCR139	Si-npn-Digi	Sw, 50V, 100mA, 200mW, R1=22k, 150MHz	SOT-23	16ta	-	3c	Inf
WYs	BCR139F	Si-npn-Digi	Sw, 50V, 100mA, 250mW, R1=22k, 150MHz	TSFP-3	18ta	-	3a	Inf
WYs	BCR139T	Si-npn-Digi	Sw, 50V, 100mA, 250mW, R1=22k, 150MHz	SOT-416	16ta	-	3a	Inf
WZ	BCR142L3	Si-npn-Digi	Sw, 50V, 100mA, 250mW, R1/R2=22k/47k, 150MHz	TSLP-3	22ta	-	2a	Inf
WZ	BZX84-B47	Z-diode	46.06..47.94V, Zzt=170Ω, Izt=5mA, 410mW	SOT-23	16dc	-	3a	Pjt
WZ	TZTC47WS	Z-diode	44.65..49.35V, Izt=5mA, Zzt=170Ω, 200mW	SOT-323	16dc	-	3a	Ttr
WZ0	BZX84-B2V4	Z-diode	2.4V±2%, 300mW	SOT-23	16dc	-	3a	PhC
WZ1	BZX84-B2V7	Z-diode	2.7V±2%, 300mW	SOT-23	16dc	-	3a	PhC
WZ4	BZX84-B30	Z-diode	30V±2%, 300mW	SOT-23	16dc	-	3a	PhC
WZ5	BZX84-B27	Z-diode	27V±2%, 300mW	SOT-23	16dc	-	3a	PhC
WZ6	BZX84-B11	Z-diode	11V±2%, 300mW	SOT-23	16dc	-	3a	PhC
WZ7	BZX84-B12	Z-diode	12V±2%, 300mW	SOT-23	16dc	-	3a	PhC
WZ8	BZX84-B13	Z-diode	13V±2%, 300mW	SOT-23	16dc	-	3a	PhC
WZ9	BZX84-B15	Z-diode	15V±2%, 300mW	SOT-23	16dc	-	3a	PhC
WZs	BCR142	Si-npn-Digi	Sw, 50V, 100mA, 200mW, R1/R2=22k/47k, 150MHz	SOT-23	16ta	-	3c	Inf
WZs	BCR142F	Si-npn-Digi	Sw, 50V, 100mA, 250mW, R1/R2=22k/47k, 150MHz	TSFP-3	18ta	-	3a	Inf
WZs	BCR142T	Si-npn-Digi	Sw, 50V, 100mA, 250mW, R1/R2=22k/47k, 150MHz	SOT-416	16ta	-	3a	Inf
WZs	BCR142W	Si-npn-Digi	Sw, 50V, 100mA, 250mW, R1/R2=22k/47k, 150MHz	SOT-323	16ta	-	3c	Inf
x	AX6904CA	Vdet-IC	4.0V±1.5%, +Reset PPO	SC-70	16vda	VD7	3b	Axl
X_	2SB1051K	Si-npn	AF-Drv, 32V, 1A, 200mW, B=390, 150MHz	SOT-346	16ta	-	3a	Rhm
X0LN	ELM7550CBB	Vdet-IC	5.0V±2%, +Reset PPO	SOT-23	16vdb	VD7	3d	Elm
X0LN	ELM7550NBB	Vdet-IC	5.0V±2%, +Reset ODO	SOT-23	16vdb	VD6	3d	Elm
X1	2SK852-X1	n-FET	GP, 50V, 10mA, 150mW, Idss=0.5..3mA, Up<1.5V	SOT-323	16fa	-	3a	Nec
X1	2SK94-1	n-FET	GP, 50V, 20mA, 150mW, Idss=0.5..1.5mA, Up<1.5V	SOT-23	16fa	-	3a	Nec
X1	BFT93	Si-npn	UHF-A, 15V, 35mA, 5GHz	SOT-23	16ta	-	3a	Sie
X1	BZX84-C27	Z-diode	27V±5%, 300mW	SOT-23	16dc	-	3a	Sie
X1	BZX88-C27	Z-diode	27V±5%, 200mW	SOT-323	16dc	-	3a	Zx
X1	TC1272-10ENB	Vdet-IC	4.37V, -Reset PPO	SOT-23	16vdb	VD7	3d	Mcc
X11	2SK425-11	n-FET	AF, 50V, 30mA, 200mW, Idss=1.4mA, Up<1.2V	SOT-23	16fa	-	3a	Nec
X12	2SK425-12	n-FET	AF, 50V, 30mA, 200mW, Idss=3..6mA, Up<1.2V	SOT-23	16fa	-	3a	Nec
X13	2SK425-13	n-FET	AF, 50V, 30mA, 200mW, Idss=5..8mA, Up<1.2V	SOT-23	16fa	-	3a	Nec
X14	2SK425-14	n-FET	AF, 50V, 30mA, 200mW, Idss=7..10mA, Up<1.2V	SOT-23	16fa	-	3a	Nec
X15	2SK425-15	n-FET	AF, 50V, 30mA, 200mW, Idss=9..12mA, Up<1.2V	SOT-23	16fa	-	3a	Nec
X16	2SK425-16	n-FET	AF, 50V, 30mA, 200mW, Idss=11..14mA, Up<1.2V	SOT-23	16fa	-	3a	Nec
X17	2SK425-17	n-FET	AF, 50V, 30mA, 200mW, Idss=13..16mA, Up<1.2V	SOT-23	16fa	-	3a	Nec
X18	2SK425-18	n-FET	AF, 50V, 30mA, 200mW, Idss=15..18mA, Up<1.2V	SOT-23	16fa	-	3a	Nec
X1LN	ELM7551CBB	Vdet-IC	5.1V±2%, +Reset PPO	SOT-23	16vdb	VD7	3d	Elm
X1LN	ELM7551NBB	Vdet-IC	5.1V±2%, +Reset ODO	SOT-23	16vdb	VD6	3d	Elm
X1p	BFT93	Si-npn	UHF-A, 15V, 35mA, 5GHz	SOT-23	16ta	-	3a	Phi
X2	2SK852-X2	n-FET	GP, 50V, 10mA, 150mW, Idss=2..5mA, Up<1.5V	SOT-323	16fa	-	3a	Nec
X2	2SK94-2	n-FET	GP, 50V, 20mA, 150mW, Idss=1..3mA, Up<1.5V	SOT-23	16fa	-	3a	Nec
X2	APX809-46SA	Vdet-IC	4.63V±1.5%, -Reset PPO	SOT-23	16vdc	VD7	3b	Di
X2	BZX84-B56	Z-diode	54.88..57.12V, Zzt=135Ω, Izt=2.5mA, 410mW	SOT-23	16dc	-	3a	Pjt
X2	BZX84-C30	Z-diode	30V±5%, 300mW	SOT-23	16dc	-	3a	Sie
X2	BZX88-C30	Z-diode	30V±5%, 200mW	SOT-323	16dc	-	3a	Zx
X2	BZX99-C13	Z-diode	13V±5%, 300mW	SOT-23	16dc	-	3a	Phi
X2	TC1272-15ENB	Vdet-IC	4.12V, -Reset PPO	SOT-23	16vdb	VD7	3d	Mcc
X21	2SK426-21	n-FET	AF, LN, 50V, 30mA, 200mW, Idss=1..4mA, Up<1.2V	SOT-23	16fa	-	3a	Nec
X22	2SK426-22	n-FET	AF, LN, 50V, 30mA, 200mW, Idss=3..6mA, Up<1.2V	SOT-23	16fa	-	3a	Nec
X23	2SK426-23	n-FET	AF, LN, 50V, 30mA, 200mW, Idss=5..8mA, Up<1.2V	SOT-23	16fa	-	3a	Nec
X24	2SK426-24	n-FET	AF, LN, 50V, 30mA, 200mW, Idss=7..10mA, Up<1.2V	SOT-23	16fa	-	3a	Nec
X25	2SK426-25	n-FET	AF, LN, 50V, 30mA, 200mW, Idss=9..12mA, Up<1.2V	SOT-23	16fa	-	3a	Nec
X26	2SK426-26	n-FET	AF, LN, 50V, 30mA, 200mW, Idss=11..14mA, Up<1.2V	SOT-23	16fa	-	3a	Nec
X27	2SK426-27	n-FET	AF, LN, 50V, 30mA, 200mW, Idss=13..16mA, Up<1.2V	SOT-23	16fa	-	3a	Nec
X28	2SK426-28	n-FET	AF, LN, 50V, 30mA, 200mW, Idss=15..18mA, Up<1.2V	SOT-23	16fa	-	3a	Nec
X2LN	ELM7552CBB	Vdet-IC	5.2V±2%, +Reset PPO	SOT-23	16vdb	VD7	3d	Elm
X2LN	ELM7552NBB	Vdet-IC	5.2V±2%, +Reset ODO	SOT-23	16vdb	VD6	3d	Elm
X3	2SK852-X3	n-FET	GP, 50V, 10mA, 150mW, Idss=4..8mA, Up<1.5V	SOT-323	16fa	-	3a	Nec
X3	2SK94-3	n-FET	GP, 50V, 20mA, 150mW, Idss=2..6mA, Up<1.5V	SOT-23	16fa	-	3a	Nec
X3	APX809-44SA	Vdet-IC	4.38V±1.5%, -Reset PPO	SOT-23	16vdc	VD7	3b	Di
X3	BZX84-B62	Z-diode	60.76..63.24V, Zzt=150Ω, Izt=2.5mA, 410mW	SOT-23	16dc	-	3a	Pjt
X3	BZX84-C33	Z-diode	33V±5%, 300mW	SOT-23	16dc	-	3a	Sie
X3	BZX88-C33	Z-diode	33V±5%, 200mW	SOT-323	16dc	-	3a	Zx
X3	BZX99-C15	Z-diode	15V±5%, 300mW	SOT-23	16dc	-	3a	Phi
X3	RN1131F	Si-npn-Digi	Sw, 50V, 100mA, 100mW, R1=100k	SOT-490	18ta	-	3a	Tos
X3	RN1131FV	Si-npn-Digi	Sw, 50V, 100mA, 150mW, R1=100k	SOT-723	18ta	-	3a	Tos
X3	TC1272-5ENB	Vdet-IC	4.62V, -Reset PPO	SOT-23	16vdb	VD7	3d	Mcc
X31	2SK515-31	n-FET	Analog Sw, 50V, 20mA, 250mW, Idss=1..2mA, Up<4.5V	SOT-23	16fa	-	3a	Nec



SMD code	Type	Function	Short description	Case	Pinout	Sch.	St.	Mnf.
X32	2SK515-32	n-FET	Analog Sw, 50V, 20mA, 250mW, Idss=1.5..3mA, Up<4.5V	SOT-23	16fa	-	3a	Nec
X33	2SK515-33	n-FET	Analog Sw, 50V, 20mA, 250mW, Idss=2.5..5mA, Up<4.5V	SOT-23	16fa	-	3a	Nec
X34	2SK515-34	n-FET	Analog Sw, 50V, 20mA, 250mW, Idss=4..8mA, Up<4.5V	SOT-23	16fa	-	3a	Nec
X35	2SK515-35	n-FET	Analog Sw, 50V, 20mA, 250mW, Idss=6..12mA, Up<4.5V	SOT-23	16fa	-	3a	Nec
X3LN	ELM7553CBB	Vdet-IC	5.3V±2%, +Reset PPO	SOT-23	16vdb	VD7	3d	Elm
X3LN	ELM7553NBB	Vdet-IC	5.3V±2%, +Reset ODO	SOT-23	16vdb	VD6	3d	Elm
X4	2SK852-X4	n-FET	GP, 50V, 10mA, 150mW, Idss=6..12mA, Up<1.5V	SOT-323	16fa	-	3a	Nec
X4	2SK94-4	n-FET	GP, 50V, 20mA, 150mW, Idss=4..12mA, Up<1.5V	SOT-23	16fa	-	3a	Nec
X4	APX809-40SA	Vdet-IC	4.0V±1.5%, -Reset PPO	SOT-23	16vdc	VD7	3b	Di
X4	BZX84-B68	Z-diode	66.64..69.36V, Zzt=200Q, Izt=2.5mA, 410mW	SOT-23	16dc	-	3a	Pjt
X4	BZX84-C36	Z-diode	36V±5%, 300mW	SOT-23	16dc	-	3a	Sie
X4	BZX88-C36	Z-diode	36V±5%, 200mW	SOT-323	16dc	-	3a	Zx
X4	KA4F4N	Si-npn-Digi	Sw, 60V, 100mA, 200mW, R1/R2=22k/47k	SOT-416	16ta	-	3a	Nec
X4	RN1132F	Si-npn-Digi	Sw, 50V, 100mA, 100mW, R1=200k	SOT-490	18ta	-	3a	Tos
X4	RN1132FV	Si-npn-Digi	Sw, 50V, 100mA, 150mW, R1=200k	SOT-723	18ta	-	3a	Tos
X4	SP809NEK-2-9	Vdet-IC	2.9V±1.5%, -Reset ODO	SOT-23	16vdc	VD6	3b	Sip
X41	2SK1001-41	n-FET	AM-tuner, 22V, 50mA, 250mW, Idss=10..20mA, Vr<30mQ	SOT-23	16fa	-	3a	Nec
X42	2SK1001-42	n-FET	AM-tuner, 22V, 50mA, 250mW, Idss=150..30mA, Vr<30mQ	SOT-23	16fa	-	3a	Nec
X43	2SK1001-43	n-FET	AM-tuner, 22V, 50mA, 250mW, Idss=25..50mA, Vr<30mQ	SOT-23	16fa	-	3a	Nec
X4LN	ELM7554CBB	Vdet-IC	5.4V±2%, +Reset PPO	SOT-23	16vdb	VD7	3d	Elm
X4LN	ELM7554NBB	Vdet-IC	5.4V±2%, +Reset ODO	SOT-23	16vdb	VD6	3d	Elm
X5	APX809-31SA	Vdet-IC	3.08V±1.5%, -Reset PPO	SOT-23	16vdc	VD7	3b	Di
X5	BZX84-B75	Z-diode	73.50..76.50V, Zzt=250Q, Izt=2.5mA, 410mW	SOT-23	16dc	-	3a	Pjt
X5	BZX84-C39	Z-diode	39V±5%, 300mW	SOT-23	16dc	-	3a	Sie
X5	BZX88-C39	Z-diode	39V±5%, 200mW	SOT-323	16dc	-	3a	Zx
X5LN	ELM7555CAB	Vdet-IC	5.5V±2%, +Reset PPO	SOT-89	16vda	VD7	4a	Elm
X5LN	ELM7555CBB	Vdet-IC	5.5V±2%, +Reset PPO	SOT-23	16vdb	VD7	3d	Elm
X5LN	ELM7555NBB	Vdet-IC	5.5V±2%, +Reset ODO	SOT-23	16vdb	VD6	3d	Elm
X6	2SD1048-6	Si-npn	AF-Amp, 20V, 700mA, 200mW, B=200..400, 250MHz	SOT-23	16ta	-	3a	San
X6	APX809-29SA	Vdet-IC	2.93V±1.5%, -Reset PPO	SOT-23	16vdc	VD7	3b	Di
X6	BZX84-C43	Z-diode	43V±5%, 300mW	SOT-23	16dc	-	3a	Sie
X6	BZX88-C43	Z-diode	43V±5%, 200mW	SOT-323	16dc	-	3a	Zx
X7	2SD1048-7	Si-npn	AF-Amp, 20V, 700mA, 200mW, B=300..400, 250MHz	SOT-23	16ta	-	3a	San
X7	APX809-26SA	Vdet-IC	2.63V±1.5%, -Reset PPO	SOT-23	16vdc	VD7	3b	Di
X7	BZX84-C47	Z-diode	47V±5%, 300mW	SOT-23	16dc	-	3a	Sie
X7	BZX88-C47	Z-diode	47V±5%, 200mW	SOT-323	16dc	-	3a	Zx
X7	KN4F4N	Si-npn-Digi	Sw, 60V, 100mA, 150mW, R1/R2=22k/47k	SOT-416	16ta	-	3a	Nec
X8	2SD1048-8	Si-npn	AF-Amp, 20V, 700mA, 200mW, B=450..900, 250MHz	SOT-23	16ta	-	3a	San
X8	APX809-23SA	Vdet-IC	2.25V±1.5%, -Reset PPO	SOT-23	16vdc	VD7	3b	Di
X8	BZX84-C6V8	Z-diode	6.4..7.2V, Zzt=15Q, Izt=20mA, 225mW	SOT-23	16dc	-	3a	Lge
X9	1S398	Si-diode	Dual, Rect, 420V, 100mA, 500ns	SOT-23	16ea	-	3a	Tos
X9	BZX84-C33	Z-diode	31..35V, Zzt=80Q, Izt=20mA, 225mW	SOT-23	16dc	-	3a	Lge
XA	2SK3105	n-MOSFET-e*	V-MOS, LogL, 30V, ±2.5A, <0.15Q	SOT-23	16fh	-	3a	Nec
XA	2SK3408	n-MOSFET-e*	V-MOS, LogL, 43±5V, ±1A, <0.26Q(0.5A), 32/153ns	SOT-23	16fh	-	3a	Nec
XA	APX810-46SA	Vdet-IC	4.63V±1.5%, +Reset PPO	SOT-23	16vdc	VD7	3b	Di
XA	BZX84-B51	Z-diode	49.98..52.02V, Zzt=100Q, Izt=5mA, 410mW	SOT-23	16dc	-	3a	Pjt
XA	BZX99-CAV7	Z-diode	4.7V±5%, 300mW	SOT-23	16dc	-	3a	Phi
XA	RN1101	Si-npn-Digi	Sw, 50V, 100mA, 100mW, R1/R2=4.7k/4.7k	SOT-416	16ta	-	3a	Tos
XA	RN1101F	Si-npn-Digi	Sw, 50V, 100mA, 100mW, R1/R2=4.7k/4.7k	SOT-490	18ta	-	3a	Tos
XA	RN1101FT	Si-npn-Digi	Sw, 50V, 100mA, 100mW, R1/R2=4.7k/4.7k	TESM	18ta	-	3a	Tos
XA	RN1101FV	Si-npn-Digi	Sw, 50V, 100mA, 150mW, R1/R2=4.7k/4.7k	SOT-723	18ta	-	3a	Tos
XA	RN1301	Si-npn-Digi	Sw, 50V, 100mA, 400mW, R1/R2=4.7k/4.7k	SOT-323	16ta	-	3a	Tos
XA	RN1401	Si-npn-Digi	Sw, 50V, 100mA, 400mW, R1/R2=4.7k/4.7k	SOT-346	16ta	-	3a	Tos
XA	TZTC51WS	Z-diode	48.45..53.55V, Izt=5mA, Zzt=100Q, 200mW	SOT-323	16dc	-	3a	Thr
XAF	2SK980-F	n-FET	Video frequency, LN, 12V, 40mA, 150mW, Idss=8..20mA, Up<2.5V	SOT-23	16fa	-	3a	Ren
XAG	2SK980-G	n-FET	Video frequency, LN, 12V, 40mA, 150mW, Idss=16..32mA, Up<2.5V	SOT-23	16fa	-	3a	Ren
XAs	BCR503	Si-npn-Digi	Sw, 50V, 500mA, 330mW, R1/R2=2.2k/2.2k, 100MHz	SOT-23	16ta	-	3c	Inf
XB	2SJ557	p-MOSFET-e*	V-MOS, LogL, 30V, ±2.5A, <0.29Q	SOT-23	16fh	-	3a	Nec
XB	5LP01C	p-MOSFET*	Sw, U-Hi-Sp, 50V, 70mA, 250mW, 20/250ns	SOT-23	16fh	-	3a	San
XB	5LP01M	p-MOSFET*	Sw, U-Hi-Sp, 50V, 70mA, 150mW, 20/250ns	MCP3	16fh	-	3a	San
XB	5LP01S	p-MOSFET*	Sw, U-Hi-Sp, 50V, 70mA, 150mW, 20/250ns	SMCP	16fh	-	3a	San
XB	5LP01SS	p-MOSFET*	Sw, U-Hi-Sp, 50V, 70mA, 150mW, 20/250ns	SSFP	18fh	-	3a	San
XB	APX810-44SA	Vdet-IC	4.38V±1.5%, +Reset PPO	SOT-23	16vdc	VD7	3b	Di
XB	BZX99-CSV1	Z-diode	5.1V±5%, 300mW	SOT-23	16dc	-	3a	Phi
XB	RN1102	Si-npn-Digi	Sw, 50V, 100mA, 100mW, R1/R2=10k/10k	SOT-416	16ta	-	3a	Tos
XB	RN1102F	Si-npn-Digi	Sw, 50V, 100mA, 100mW, R1/R2=10k/10k	SOT-490	18ta	-	3a	Tos
XB	RN1102FT	Si-npn-Digi	Sw, 50V, 100mA, 100mW, R1/R2=10k/10k	TESM	18ta	-	3a	Tos
XB	RN1102FV	Si-npn-Digi	Sw, 50V, 100mA, 150mW, R1/R2=10k/10k	SOT-723	18ta	-	3a	Tos
XB	RN1302	Si-npn-Digi	Sw, 50V, 100mA, 400mW, R1/R2=10k/10k	SOT-323	16ta	-	3a	Tos
XB	RN1402	Si-npn-Digi	Sw, 50V, 100mA, 400mW, R1/R2=10k/10k	SOT-346	16ta	-	3a	Tos



SMD code	Type	Function	Short description	Case	Pinout	Sch.	St.	Mnf.
XB	2SC4416	Si-npn	UHF/VHF, 25V, 50mA, 150mW, B=50..180, 3GHz	SOT-346	16te	-	3a	Ren
XBs	BCR553	Si-pnp-Digi	Sw, 50V, 500mA, 330mW, R1/R2=2.2k/2.2k, 150MHz	SOT-23	16ta	-	3c	Inf
XC	2SK492-C	n-FET	AF-Amp, 50V, 150mW, Idss=1..3mA, Rds=70Q(5mA)	SC-59	16fa	-	3a	Mit
XC	APX810-40SA	Vdet-IC	4.0V±1.5%, +Reset PPO	SOT-23	16vdc	VD7	3b	Di
XC	BZX99-C5V6	Z-diode	5.6V±5%, 300mW	SOT-23	16dc	-	3a	Phi
XC	CHT847BM1PT-Q	Si-npn	AF, Sw, 45V, 100mA, B=110..220, 200MHz	FBPT-723	17ta	-	9a	Chm
XC	CHT847BTPT-Q	Si-npn	AF, Sw, 45V, 100mA, B=110..220, 200MHz	SOT-416	16ta	-	3a	Chm
XC	RN1103	Si-npn-Digi	Sw, 50V, 100mA, 100mW, R1/R2=22k/22k	SOT-416	16ta	-	3a	Tos
XC	RN1103F	Si-npn-Digi	Sw, 50V, 100mA, 100mW, R1/R2=22k/22k	SOT-490	18ta	-	3a	Tos
XC	RN1103FT	Si-npn-Digi	Sw, 50V, 100mA, 100mW, R1/R2=22k/22k	TESM	18ta	-	3a	Tos
XC	RN1103FV	Si-npn-Digi	Sw, 50V, 100mA, 150mW, R1/R2=22k/22k	SOT-723	18ta	-	3a	Tos
XC	RN1303	Si-npn-Digi	Sw, 50V, 100mA, 400mW, R1/R2=22k/22k	SOT-323	16ta	-	3a	Tos
XC	RN1403	Si-npn-Digi	Sw, 50V, 100mA, 400mW, R1/R2=22k/22k	SOT-346	16ta	-	3a	Tos
XCAV	YB1210ST23R120	LVR-IC	LDO, ULN, 1.2V±2%, 300mA	SOT-23	16cg	VR1	3a	Ybn
XCBV	YB1210ST23R130	LVR-IC	LDO, ULN, 1.3V±2%, 300mA	SOT-23	16cg	VR1	3a	Ybn
XCCV	YB1210ST23R140	LVR-IC	LDO, ULN, 1.4V±2%, 300mA	SOT-23	16cg	VR1	3a	Ybn
XCDV	YB1210ST23R150	LVR-IC	LDO, ULN, 1.5V±2%, 300mA	SOT-23	16cg	VR1	3a	Ybn
XCEV	YB1210ST23R160	LVR-IC	LDO, ULN, 1.6V±2%, 300mA	SOT-23	16cg	VR1	3a	Ybn
XCFV	YB1210ST23R170	LVR-IC	LDO, ULN, 1.7V±2%, 300mA	SOT-23	16cg	VR1	3a	Ybn
XCGV	YB1210ST23R180	LVR-IC	LDO, ULN, 1.8V±2%, 300mA	SOT-23	16cg	VR1	3a	Ybn
XCHV	YB1210ST23R190	LVR-IC	LDO, ULN, 1.9V±2%, 300mA	SOT-23	16cg	VR1	3a	Ybn
XCVI	YB1210ST23R200	LVR-IC	LDO, ULN, 2.0V±2%, 300mA	SOT-23	16cg	VR1	3a	Ybn
XCJV	YB1210ST23R210	LVR-IC	LDO, ULN, 2.1V±2%, 300mA	SOT-23	16cg	VR1	3a	Ybn
XCKV	YB1210ST23R220	LVR-IC	LDO, ULN, 2.2V±2%, 300mA	SOT-23	16cg	VR1	3a	Ybn
XCLV	YB1210ST23R230	LVR-IC	LDO, ULN, 2.3V±2%, 300mA	SOT-23	16cg	VR1	3a	Ybn
XCMV	YB1210ST23R240	LVR-IC	LDO, ULN, 2.4V±2%, 300mA	SOT-23	16cg	VR1	3a	Ybn
XCNV	YB1210ST23R250	LVR-IC	LDO, ULN, 2.5V±2%, 300mA	SOT-23	16cg	VR1	3a	Ybn
XCOV	YB1210ST23R260	LVR-IC	LDO, ULN, 2.6V±2%, 300mA	SOT-23	16cg	VR1	3a	Ybn
XCPV	YB1210ST23R270	LVR-IC	LDO, ULN, 2.7V±2%, 300mA	SOT-23	16cg	VR1	3a	Ybn
XCQV	YB1210ST23R280	LVR-IC	LDO, ULN, 2.8V±2%, 300mA	SOT-23	16cg	VR1	3a	Ybn
XCRV	YB1210ST23R290	LVR-IC	LDO, ULN, 2.9V±2%, 300mA	SOT-23	16cg	VR1	3a	Ybn
XCs	BCR533	Si-npn-Digi	Sw, 50V, 500mA, 330mW, R1/R2=10k/10k, 100MHz	SOT-23	16ta	-	3c	Inf
XGSV	YB1210ST23R300	LVR-IC	LDO, ULN, 3.0V±2%, 300mA	SOT-23	16cg	VR1	3a	Ybn
XCTV	YB1210ST23R310	LVR-IC	LDO, ULN, 3.1V±2%, 300mA	SOT-23	16cg	VR1	3a	Ybn
XCUV	YB1210ST23R320	LVR-IC	LDO, ULN, 3.2V±2%, 300mA	SOT-23	16cg	VR1	3a	Ybn
XCVV	YB1210ST23R330	LVR-IC	LDO, ULN, 3.3V±2%, 300mA	SOT-23	16cg	VR1	3a	Ybn
XGwV	YB1210ST23R340	LVR-IC	LDO, ULN, 3.4V±2%, 300mA	SOT-23	16cg	VR1	3a	Ybn
XCXV	YB1210ST23R350	LVR-IC	LDO, ULN, 3.5V±2%, 300mA	SOT-23	16cg	VR1	3a	Ybn
XCyV	YB1210ST23R360	LVR-IC	LDO, ULN, 3.6V±2%, 300mA	SOT-23	16cg	VR1	3a	Ybn
XD	2SK492-D	n-FET	AF-Amp, 50V, 150mW, Idss=2.5..6mA, Rds=70Q(5mA)	SC-59	16fa	-	3a	Mit
XD	APX810-31SA	Vdet-IC	3.08V±1.5%, +Reset PPO	SOT-23	16vdc	VD7	3b	Di
XD	BZX99-C6V2	Z-diode	6.2V±5%, 300mW	SOT-23	16dc	-	3a	Phi
XD	RN1104	Si-npn-Digi	Sw, 50V, 100mA, 100mW, R1/R2=47k/47k	SOT-416	16ta	-	3a	Tos
XD	RN1104F	Si-npn-Digi	Sw, 50V, 100mA, 100mW, R1/R2=47k/47k	SOT-490	18ta	-	3a	Tos
XD	RN1104FT	Si-npn-Digi	Sw, 50V, 100mA, 100mW, R1/R2=47k/47k	TESM	18ta	-	3a	Tos
XD	RN1104FV	Si-npn-Digi	Sw, 50V, 100mA, 150mW, R1/R2=47k/47k	SOT-723	18ta	-	3a	Tos
XD	RN1304	Si-npn-Digi	Sw, 50V, 100mA, 400mW, R1/R2=47k/47k	SOT-323	16ta	-	3a	Tos
XD	RN1404	Si-npn-Digi	Sw, 50V, 100mA, 400mW, R1/R2=47k/47k	SOT-346	16ta	-	3a	Tos
XDB	2SK1031-B	n-FET	AF, 50V, 10mA, 100mW, Idss=0.6..1.4mA, Up<5V	SOT-23	16fa	-	3a	Ren
XDB	2SK1532-B	n-FET	AF, Sw, 50V, 19mA, 100mW, Idss=0.6..1.4mA	CMPAK	16fa	-	3a	Hit
XDC	2SK1031-C	n-FET	AF, 50V, 10mA, 100mW, Idss=1.2..3mA, Up<5V	SOT-23	16fa	-	3a	Ren
XDC	2SK1532-C	n-FET	AF, Sw, 50V, 19mA, 100mW, Idss=1.2..3mA	CMPAK	16fa	-	3a	Hit
XDD	2SK1031-D	n-FET	AF, 50V, 10mA, 100mW, Idss=2.6..6.5mA, Up<5V	SOT-23	16fa	-	3a	Ren
XDD	2SK1532-D	n-FET	AF, Sw, 50V, 19mA, 100mW, Idss=2.6..6.5mA	CMPAK	16fa	-	3a	Hit
XDs	BCR555	Si-pnp-Digi	Sw, 50V, 500mA, 330mW, R1/R2=2.2k/10k, 100MHz	SOT-23	16ta	-	3c	Inf
XE	2SK492-E	n-FET	AF-Amp, 50V, 150mW, Idss=5..12mA, Rds=70Q(5mA)	SC-59	16fa	-	3a	Mit
XE	5LP02C	p-MOSFET*	Sw, U-Hi-Sp, 50V, 140mA, 250mW, 20/250ns	SOT-23	16fa	-	3a	San
XE	APX810-29SA	Vdet-IC	2.93V±1.5%, +Reset PPO	SOT-23	16vdc	VD7	3b	Di
XE	BZX99-C6V8	Z-diode	6.8V±5%, 300mW	SOT-23	16dc	-	3a	Phi
XE	RN1105	Si-npn-Digi	Sw, 50V, 100mA, 100mW, R1/R2=2.2k/47k	SOT-416	16ta	-	3a	Tos
XE	RN1105F	Si-npn-Digi	Sw, 50V, 100mA, 100mW, R1/R2=2.2k/47k	SOT-490	18ta	-	3a	Tos
XE	RN1105FT	Si-npn-Digi	Sw, 50V, 100mA, 100mW, R1/R2=2.2k/47k	TESM	18ta	-	3a	Tos
XE	RN1105FV	Si-npn-Digi	Sw, 50V, 100mA, 150mW, R1/R2=2.2k/47k	SOT-723	18ta	-	3a	Tos
XE	RN1305	Si-npn-Digi	Sw, 50V, 100mA, 400mW, R1/R2=2.2k/47k	SOT-323	16ta	-	3a	Tos
XE	RN1405	Si-npn-Digi	Sw, 50V, 100mA, 400mW, R1/R2=2.2k/47k	SOT-346	16ta	-	3a	Tos
XE1	CHDTA143XEPT	Si-pnp-Digi	Sw, 50V, 100mA, 250MHz, R1/R2=4.7/10k	SOT-416	16ta	-	3a	Chm
XE2	CHDTA124XEPT	Si-pnp-Digi	Sw, 50V, 100mA, 250MHz, R1/R2=22/47k	SOT-416	16ta	-	3a	Chm
XEa	CHDTC143XEPT	Si-npn-Digi	Sw, 50V, 100mA, 250MHz, R1/R2=4.7/10k	SOT-416	16ta	-	3a	Chm
XEAV	YB1230ST23X180	LVR-IC	LDO, 1.8V±2%, 600mA	SOT-23	16cg	VR1	3a	Ybn
XEB	CHDTC124XEPT	Si-npn-Digi	Sw, 50V, 100mA, 250MHz, R1/R2=22/47k	SOT-416	16ta	-	3a	Chm



SMD code	Type	Function	Short description	Case	Pinout	Sch.	St.	Mnf.
XEBV	YB1230ST23X190	LVR-IC	LDO, 1.9V±2%, 600mA	SOT-23	16cg	VR1	3a	Ybn
XECV	YB1230ST23X200	LVR-IC	LDO, 2.0V±2%, 600mA	SOT-23	16cg	VR1	3a	Ybn
XEDV	YB1230ST23X210	LVR-IC	LDO, 2.1V±2%, 600mA	SOT-23	16cg	VR1	3a	Ybn
XEEV	YB1230ST23X220	LVR-IC	LDO, 2.2V±2%, 600mA	SOT-23	16cg	VR1	3a	Ybn
XEFV	YB1230ST23X230	LVR-IC	LDO, 2.3V±2%, 600mA	SOT-23	16cg	VR1	3a	Ybn
XEGV	YB1230ST23X240	LVR-IC	LDO, 2.4V±2%, 600mA	SOT-23	16cg	VR1	3a	Ybn
XEHV	YB1230ST23X250	LVR-IC	LDO, 2.5V±2%, 600mA	SOT-23	16cg	VR1	3a	Ybn
XEIV	YB1230ST23X260	LVR-IC	LDO, 2.6V±2%, 600mA	SOT-23	16cg	VR1	3a	Ybn
XEJV	YB1230ST23X270	LVR-IC	LDO, 2.7V±2%, 600mA	SOT-23	16cg	VR1	3a	Ybn
XEKV	YB1230ST23X280	LVR-IC	LDO, 2.8V±2%, 600mA	SOT-23	16cg	VR1	3a	Ybn
XELV	YB1230ST23X290	LVR-IC	LDO, 2.9V±2%, 600mA	SOT-23	16cg	VR1	3a	Ybn
XEMV	YB1230ST23X300	LVR-IC	LDO, 3.0V±2%, 600mA	SOT-23	16cg	VR1	3a	Ybn
XENV	YB1230ST23X310	LVR-IC	LDO, 3.1V±2%, 600mA	SOT-23	16cg	VR1	3a	Ybn
XF	5HP02C	p-MOSFET*	Sw, U-Hi-Sp, 50V, 140mA, 250mW, 13/190ns, 4.7Q(70mA)	SOT-23	16fh	-	3a	San
XF	5HP02M	p-MOSFET*	Sw, U-Hi-Sp, 50V, 140mA, 150mW, 13/190ns, 4.7Q(70mA)	MCP3	16fh	-	3a	San
XF	APX810-26SA	Vdet-IC	2.63V±1.5%, +Reset PPO	SOT-23	16vdc	VD7	3b	Di
XF	RN1106	Si-npn-Digi	Sw, 50V, 100mA, 100mW, R1/R2=4.7k/47k	SOT-416	16ta	-	3a	Tos
XF	RN1106F	Si-npn-Digi	Sw, 50V, 100mA, 100mW, R1/R2=4.7k/47k	SOT-490	18ta	-	3a	Tos
XF	RN1106FT	Si-npn-Digi	Sw, 50V, 100mA, 100mW, R1/R2=4.7k/47k	TESM	18ta	-	3a	Tos
XF	RN1106FV	Si-npn-Digi	Sw, 50V, 100mA, 150mW, R1/R2=4.7k/47k	SOT-723	18ta	-	3a	Tos
XF	RN1306	Si-npn-Digi	Sw, 50V, 100mA, 400mW, R1/R2=4.7k/47k	SOT-323	16ta	-	3a	Tos
XF	RN1406	Si-npn-Digi	Sw, 50V, 100mA, 400mW, R1/R2=4.7k/47k	SOT-346	16ta	-	3a	Tos
XF-	2SC4464	Si-npn	VHF/UHF, 15V, 5mA, 50mW, B=40.250, >2.5GHz	SOT-323	16ta	-	3a	Ren
XF _s	BCR512	Si-npn-Digi	Sw, 50V, 500mA, 330mW, R1/R2=4.7k/4.7k, 100MHz	SOT-23	16ta	-	3c	Inf
XG	2SK209-GR	n-FET	GP, 50V, 10mA, 150mW, Idss=2.6..6.5mA	SOT-23	16fa	-	3a	Tos
XG	2SK880-GR	n-FET	AF-Amp, 50V, 10mA, 100mW, Idss=2.6..6.5mA, Up<1.5V	SOT-323	16fa	-	3a	Tos
XG	APX810-23SA	Vdet-IC	2.25V±1.5%, +Reset PPO	SOT-23	16vdc	VD7	3b	Di
XGs	BCR523	Si-npn-Digi	Sw, 50V, 500mA, 330mW, R1/R2=1k/10k, 100MHz	SOT-23	16ta	-	3c	Inf
XH	RN1107	Si-npn-Digi	Sw, 50V, 100mA, 100mW, R1/R2=10k/47k	SOT-416	16ta	-	3a	Tos
XH	RN1107F	Si-npn-Digi	Sw, 50V, 100mA, 100mW, R1/R2=10k/47k	SOT-490	18ta	-	3a	Tos
XH	RN1107FT	Si-npn-Digi	Sw, 50V, 100mA, 100mW, R1/R2=10k/47k	TESM	18ta	-	3a	Tos
XH	RN1107FV	Si-npn-Digi	Sw, 50V, 100mA, 150mW, R1/R2=10k/47k	SOT-723	18ta	-	3a	Tos
XH	RN1307	Si-npn-Digi	Sw, 50V, 100mA, 400mW, R1/R2=10k/47k	SOT-323	16ta	-	3a	Tos
XH	RN1407	Si-npn-Digi	Sw, 50V, 100mA, 400mW, R1/R2=10k/47k	SOT-346	16ta	-	3a	Tos
XH	RN2107FT	Si-pnp-Digi	Sw, 50V, 100mA, 100mW, R1/R2=10k/47k	TESM	18ta	-	3a	Tos
XH	RN2107FV	Si-pnp-Digi	Sw, 50V, 100mA, 150mW, R1/R2=10k/47k	SOT-723	18ta	-	3a	Tos
XH _s	BCR573	Si-pnp-Digi	Sw, 50V, 500mA, 330mW, R1/R2=1k/10k, 100MHz	SOT-23	16ta	-	3c	Inf
XI	RN1108	Si-npn-Digi	Sw, 50V, 100mA, 100mW, R1/R2=22k/47k	SOT-416	16ta	-	3a	Tos
XI	RN1108F	Si-npn-Digi	Sw, 50V, 100mA, 100mW, R1/R2=22k/47k	SOT-490	18ta	-	3a	Tos
XI	RN1108FT	Si-npn-Digi	Sw, 50V, 100mA, 100mW, R1/R2=22k/47k	TESM	18ta	-	3a	Tos
XI	RN1108FV	Si-npn-Digi	Sw, 50V, 100mA, 150mW, R1/R2=22k/47k	SOT-723	18ta	-	3a	Tos
XI	RN1308	Si-npn-Digi	Sw, 50V, 100mA, 400mW, R1/R2=22k/47k	SOT-323	16ta	-	3a	Tos
XI	RN1408	Si-npn-Digi	Sw, 50V, 100mA, 400mW, R1/R2=22k/47k	SOT-346	16ta	-	3a	Tos
XI	RN2108F	Si-pnp-Digi	Sw, 50V, 100mA, 100mW, R1/R2=22k/47k	SOT-490	18ta	-	3a	Tos
XI	RN2108FT	Si-pnp-Digi	Sw, 50V, 100mA, 100mW, R1/R2=22k/47k	TESM	18ta	-	3a	Tos
XI	RN2108FV	Si-pnp-Digi	Sw, 50V, 100mA, 150mW, R1/R2=22k/47k	SOT-723	18ta	-	3a	Tos
XJ	2SK2273	n-MOSFET-e*	V-MOS, LogL, 20V, 500mA, <0.75Q	SOT-23	16fh	-	3a	San
XJ	RN1109	Si-npn-Digi	Sw, 50V, 100mA, 100mW, R1/R2=47k/22k	SOT-416	16ta	-	3a	Tos
XJ	RN1109F	Si-npn-Digi	Sw, 50V, 100mA, 100mW, R1/R2=47k/22k	SOT-490	18ta	-	3a	Tos
XJ	RN1109FT	Si-npn-Digi	Sw, 50V, 100mA, 100mW, R1/R2=47k/22k	TESM	18ta	-	3a	Tos
XJ	RN1109FV	Si-npn-Digi	Sw, 50V, 100mA, 150mW, R1/R2=47k/22k	SOT-723	18ta	-	3a	Tos
XJ	RN1309	Si-npn-Digi	Sw, 50V, 100mA, 400mW, R1/R2=47k/22k	SOT-323	16ta	-	3a	Tos
XJ	RN1409	Si-npn-Digi	Sw, 50V, 100mA, 400mW, R1/R2=47k/22k	SOT-346	16ta	-	3a	Tos
XJ	RN2109F	Si-pnp-Digi	Sw, 50V, 100mA, 100mW, R1/R2=47k/22k	SOT-490	18ta	-	3a	Tos
XJ	RN2109FT	Si-pnp-Digi	Sw, 50V, 100mA, 100mW, R1/R2=47k/22k	TESM	18ta	-	3a	Tos
XJ	RN2109FV	Si-pnp-Digi	Sw, 50V, 100mA, 150mW, R1/R2=47k/22k	SOT-723	18ta	-	3a	Tos
XJCV	YB1231ST23X320	LVR-IC	LDO, 3.2V±2%, 600mA	SOT-23	16cg	VR1	3a	Ybn
XJDV	YB1231ST23X330	LVR-IC	LDO, 3.3V±2%, 600mA	SOT-23	16cg	VR1	3a	Ybn
XJFV	YB1231ST23X340	LVR-IC	LDO, 3.4V±2%, 600mA	SOT-23	16cg	VR1	3a	Ybn
XJGV	YB1231ST23X350	LVR-IC	LDO, 3.5V±2%, 600mA	SOT-23	16cg	VR1	3a	Ybn
XJHV	YB1231ST23X360	LVR-IC	LDO, 3.6V±2%, 600mA	SOT-23	16cg	VR1	3a	Ybn
XJIV	YB1231ST23X370	LVR-IC	LDO, 3.7V±2%, 600mA	SOT-23	16cg	VR1	3a	Ybn
XJIV	YB1231ST23X380	LVR-IC	LDO, 3.8V±2%, 600mA	SOT-23	16cg	VR1	3a	Ybn
XJIV	YB1231ST23X390	LVR-IC	LDO, 3.9V±2%, 600mA	SOT-23	16cg	VR1	3a	Ybn
XJKV	YB1231ST23X400	LVR-IC	LDO, 4.0V±2%, 600mA	SOT-23	16cg	VR1	3a	Ybn
XJLV	YB1231ST23X410	LVR-IC	LDO, 4.1V±2%, 600mA	SOT-23	16cg	VR1	3a	Ybn
XJMV	YB1231ST23X420	LVR-IC	LDO, 4.2V±2%, 600mA	SOT-23	16cg	VR1	3a	Ybn
XJNV	YB1231ST23X430	LVR-IC	LDO, 4.3V±2%, 600mA	SOT-23	16cg	VR1	3a	Ybn
XJOV	YB1231ST23X440	LVR-IC	LDO, 4.4V±2%, 600mA	SOT-23	16cg	VR1	3a	Ybn
XJPV	YB1231ST23X450	LVR-IC	LDO, 4.5V±2%, 600mA	SOT-23	16cg	VR1	3a	Ybn



SMD code	Type	Function	Short description	Case	Pinout	Sch.	St.	Mnf.
XK	12A02S	Si-pnp	AF, GP, 15V, 500mA, 200mW, B=300..700, 450MHz	SMCP	16ta	-	3a	San
XK	12A02SS	Si-pnp	AF, GP, 15V, 500mA, 200mW, B=300..700, 450MHz	SSFP	18ta	-	3a	San
XK	RN1110	Si-npn-Digi	Sw, 50V, 100mA, 100mW, R1=4.7k	SOT-416	16ta	-	3a	Tos
XK	RN1110F	Si-npn-Digi	Sw, 50V, 100mA, 100mW, R1=4.7k	SOT-490	18ta	-	3a	Tos
XK	RN1110FT	Si-npn-Digi	Sw, 50V, 100mA, 100mW, R1=4.7k	TESM	18ta	-	3a	Tos
XK	RN1110FV	Si-npn-Digi	Sw, 50V, 100mA, 150mW, R1=4.7k	SOT-723	18ta	-	3a	Tos
XK	RN1310	Si-npn-Digi	Sw, 50V, 100mA, 400mW, R1=4.7k	SOT-323	16ta	-	3a	Tos
XK	RN1410	Si-npn-Digi	Sw, 50V, 100mA, 400mW, R1=4.7k	SOT-346	16ta	-	3a	Tos
XK	RN2110F	Si-pnp-Digi	Sw, 50V, 100mA, 100mW, R1=4.7k	SOT-490	18ta	-	3a	Tos
XK	RN2110FS	Si-pnp-Digi	Sw, 20V, 50mA, 50mW, R1=4.7k	fSM	19ta	-	3a	Tos
XK	RN2110FV	Si-pnp-Digi	Sw, 50V, 100mA, 150mW, R1=4.7k	SOT-723	18ta	-	3a	Tos
XK1	CHDTA143XKPT	Si-pnp-Digi	Sw, 50V, 100mA, 250MHz, R1/R2=4.7/10k	SOT-23	16ta	-	3a	Chm
XK2	CHDTA124XKPT	Si-pnp-Digi	Sw, 50V, 100mA, 250MHz, R1/R2=22/47k	SOT-23	16ta	-	3a	Chm
XKA	CHDTC143XKPT	Si-npn-Digi	Sw, 50V, 100mA, 250MHz, R1/R2=4.7/10k	SOT-23	16ta	-	3a	Chm
XKB	CHDTC124XKPT	Si-npn-Digi	Sw, 50V, 100mA, 250MHz, R1/R2=22/47k	SOT-23	16ta	-	3a	Chm
XKs	BCR519	Si-npn-Digi	Sw, 50V, 500mA, 330mW, R1=4.7k, 100MHz	SOT-23	16ta	-	3c	Inf
XL	2SA1597	Si-pnp-Digi	Sw, 50V, 100mA, 200mW, 200MHz, R1/R2=4.7k/47k	SOT-23	16ta	-	3a	San
XL	2SK209-BL	n-FET	GP, 50V, 10mA, 150mW, Idss=6..14mA	SOT-23	16fa	-	3a	Tos
XL	2SK880-BL	n-FET	AF-Amp, 50V, 10mA, 100mW, Idss=6..14mA, Up<1.5V	SOT-323	16fa	-	3a	Tos
XL	BZX99-C2V4	Z-diode	2.4V±5%, 300mW	SOT-23	16dc	-	3a	Phi
XLN	ELM7555CEB	Vdet-IC	5.5V±2%, +Reset PPO	SC-70	16vdb	VD7	3d	Elm
XLN	ELM7555NEB	Vdet-IC	5.5V±2%, +Reset ODO	SC-70	16vdb	VD6	3d	Elm
XLs	BCR569	Si-pnp-Digi	Sw, 50V, 500mA, 330mWmW, R1=4.7k, 150MHz	SOT-23	16ta	-	3c	Inf
XM	1SS294	Si-diode	SBD, 45V, 100mA, Vf<0.6V(100mA)	SOT-23	16dc	-	3a	Sme
XM	30A02S	Si-pnp	AF, GP, 30V, 600mA, 200mW, B=200..500, 520MHz	SMCP	16ta	-	3a	San
XM	30A02SS	Si-pnp	AF, GP, 30V, 600mA, 200mW, B=200..500, 520MHz	SSFP	18ta	-	3a	San
XM	BZX99-C2V7	Z-diode	2.7V±5%, 300mW	SOT-23	16dc	-	3a	Phi
XM	RN1111	Si-npn-Digi	Sw, 50V, 100mA, 100mW, R1=10k	SOT-416	16ta	-	3a	Tos
XM	RN1111F	Si-npn-Digi	Sw, 50V, 100mA, 100mW, R1=10k	SOT-490	18ta	-	3a	Tos
XM	RN1111FT	Si-npn-Digi	Sw, 50V, 100mA, 100mW, R1=10k	TESM	18ta	-	3a	Tos
XM	RN1111FV	Si-npn-Digi	Sw, 50V, 100mA, 150mW, R1=10k	SOT-723	18ta	-	3a	Tos
XM	RN1311	Si-npn-Digi	Sw, 50V, 100mA, 400mW, R1=10k	SOT-323	16ta	-	3a	Tos
XM	RN1411	Si-npn-Digi	Sw, 50V, 100mA, 400mW, R1=10k	SOT-346	16ta	-	3a	Tos
XM	RN2111F	Si-pnp-Digi	Sw, 50V, 100mA, 100mW, R1=10k	SOT-490	18ta	-	3a	Tos
XM	RN2111FS	Si-pnp-Digi	Sw, 20V, 50mA, 50mW, R1=10k	fSM	19ta	-	3a	Tos
XM	RN2111FV	Si-pnp-Digi	Sw, 50V, 100mA, 150mW, R1=10k	SOT-723	18ta	-	3a	Tos
XM-	2SC4593	Si-npn	VHF/UHF, 15V, 50mA, 100mW, B=40..250, >6.5GHz	SOT-323	16ta	-	3a	Ren
XM-	2SC4591	Si-npn	UHF/VHF, 15V, 50mA, 150mW, B=40..250, >6.5GHz	SOT-346	16ta	-	3a	Ren
XMs	BCR583	Si-pnp-Digi	Sw, 50V, 500mA, 330mW, R1/R2=10k/10k, 150MHz	SOT-23	16ta	-	3c	Inf
XN	50A02S	Si-pnp	AF, GP, 50V, 400mA, 200mW, B=200..500, 690MHz	SMCP	16ta	-	3a	San
XN	50A02SS	Si-pnp	AF, GP, 50V, 400mA, 200mW, B=200..500, 690MHz	SSFP	18ta	-	3a	San
XN	BZX99-C3V0	Z-diode	3V±5%, 300mW	SOT-23	16dc	-	3a	Phi
XN	RN1112	Si-npn-Digi	Sw, 50V, 100mA, 100mW, R1=22k	SOT-416	16ta	-	3a	Tos
XN	RN1112F	Si-npn-Digi	Sw, 50V, 100mA, 100mW, R1=22k	SOT-490	18ta	-	3a	Tos
XN	RN1112FT	Si-npn-Digi	Sw, 50V, 100mA, 100mW, R1=22k	TESM	18ta	-	3a	Tos
XN	RN1112FV	Si-npn-Digi	Sw, 50V, 100mA, 150mW, R1=22k	SOT-723	18ta	-	3a	Tos
XN	RN1312	Si-npn-Digi	Sw, 50V, 100mA, 400mW, R1=22k	SOT-323	16ta	-	3a	Tos
XN	RN1412	Si-npn-Digi	Sw, 50V, 100mA, 400mW, R1=22k	SOT-346	16ta	-	3a	Tos
XN	RN2112F	Si-pnp-Digi	Sw, 50V, 100mA, 100mW, R1=22k	SOT-490	18ta	-	3a	Tos
XN	RN2112FS	Si-pnp-Digi	Sw, 20V, 50mA, 50mW, R1=22k	fSM	19ta	-	3a	Tos
XN	RN2112FV	Si-pnp-Digi	Sw, 50V, 100mA, 150mW, R1=22k	SOT-723	18ta	-	3a	Tos
XN	RN2412	Si-pnp-Digi	Sw, 50V, 100mA, 400mW, R1=22k	SOT-346	16ta	-	3a	Tos
XO	2SK209-O	n-FET	GP, 50V, 10mA, 150mW, Idss=0.6..1.4mA	SOT-23	16fa	-	3a	Tos
XP	12A01C	Si-pnp	AF, GP, 15V, 500mA, 300mW, B=300..700, 490MHz	CP	16ta	-	3a	San
XP	12A01M	Si-pnp	AF, GP, 15V, 500mA, 300mW, B=300..700, 490MHz	MCP	16ta	-	3a	San
XP	12A01S	Si-pnp	AF, GP, 15V, 500mA, 200mW, B=300..700, 490MHz	SMCP	16ta	-	3a	San
XP	12A01SS	Si-pnp	AF, GP, 15V, 500mA, 200mW, B=300..700, 490MHz	SSFP	18ta	-	3a	San
XP	BZX99-C3V3	Z-diode	3.3V±5%, 300mW	SOT-23	16dc	-	3a	Phi
XP	MIMBDB3000	Si-diode	Sw, 30V, 200mA, 225mW, Vf<0.95V(10mA), <2pF	SOT-346	16dc	-	3a	Mot
XP	RN1113	Si-npn-Digi	Sw, 50V, 100mA, 100mW, R1=47k	SOT-416	16ta	-	3a	Tos
XP	RN1113F	Si-npn-Digi	Sw, 50V, 100mA, 100mW, R1=47k	SOT-490	18ta	-	3a	Tos
XP	RN1113FT	Si-npn-Digi	Sw, 50V, 100mA, 100mW, R1=47k	TESM	18ta	-	3a	Tos
XP	RN1113FV	Si-npn-Digi	Sw, 50V, 100mA, 150mW, R1=47k	SOT-723	18ta	-	3a	Tos
XP	RN1313	Si-npn-Digi	Sw, 50V, 100mA, 400mW, R1=47k	SOT-323	16ta	-	3a	Tos
XP	RN1413	Si-npn-Digi	Sw, 50V, 100mA, 400mW, R1=47k	SOT-346	16ta	-	3a	Tos
XP	RN2113F	Si-pnp-Digi	Sw, 50V, 100mA, 100mW, R1=47k	SOT-490	18ta	-	3a	Tos
XP	RN2113FS	Si-pnp-Digi	Sw, 20V, 50mA, 50mW, R1=47k	fSM	19ta	-	3a	Tos
XP	RN2113FV	Si-pnp-Digi	Sw, 50V, 100mA, 150mW, R1=47k	SOT-723	18ta	-	3a	Tos
XP	RN2413	Si-pnp-Digi	Sw, 50V, 100mA, 400mW, R1=47k	SOT-346	16ta	-	3a	Tos
XQ	2PD602AQ	Si-npn	GP, Sw, 60V, 500mA, 250mW, B=85..170, >140MHz	SC-59	16ta	-	3a	Phi



Note: ELM75xxCEB series LN- lot number L=0...9 N=A to Z(I, O, X excepted); ELM75xxNEB series LN- lot number L=A to Z(I, O, X excepted) N=0...9

SMD code	Type	Function	Short description	Case	Pinout	Sch.	St.	Mnf.
XQ	2SD1820A-Q	Si-npn	GP, 60V, 500mA, 150mW, B=85..170, 20MHz	SOT-323	16ta	-	3a	Pan
XQ	2SD602A-Q	Si-npn	GP, AF, 60V, 500mA, 200mW, B=85..170, 200MHz	SC-59	16ta	-	3a	Pan
XQ	30A01C	Si-pnp	AF, GP, 30V, 300mA, 300mW, B=200..500, 520MHz	CP	16ta	-	3a	San
XQ	30A01M	Si-pnp	AF, GP, 30V, 300mA, 300mW, B=200..500, 520MHz	MCP	16ta	-	3a	San
XQ	30A01S	Si-pnp	AF, GP, 30V, 300mA, 200mW, B=200..500, 520MHz	SMCP	16ta	-	3a	San
XQ	30A01SS	Si-pnp	AF, GP, 30V, 300mA, 200mW, B=200..500, 520MHz	SSFP	18ta	-	3a	San
XQ	MMD3005	Si-diode	Dual, Sw, 30V, 200mA, 225mW, Vf<0.95V(10mA), <2pF	SOT-346	16df	-	3a	Mot
XQ	RN1114	Si-npn-Digi	Sw, 50V, 100mA, 100mW, R1/R2=1k/10k	SOT-416	16ta	-	3a	Tos
XQ	RN1114F	Si-npn-Digi	Sw, 50V, 100mA, 100mW, R1/R2=1k/10k	SOT-490	18ta	-	3a	Tos
XQ	RN1114FT	Si-npn-Digi	Sw, 50V, 100mA, 100mW, R1/R2=1k/10k	TESM	18ta	-	3a	Tos
XQ	RN1114FV	Si-npn-Digi	Sw, 50V, 100mA, 150mW, R1/R2=1k/10k	SOT-723	18ta	-	3a	Tos
XQ	RN1314	Si-npn-Digi	Sw, 50V, 100mA, 400mW, R1/R2=1k/10k	SOT-323	16ta	-	3a	Tos
XQ	RN1414	Si-npn-Digi	Sw, 50V, 100mA, 400mW, R1/R2=1k/10k	SOT-346	16ta	-	3a	Tos
XQ	RN2114F	Si-pnp-Digi	Sw, 50V, 100mA, 100mW, R1/R2=1k/10k	SOT-490	18ta	-	3a	Tos
XQ	RN2114FT	Si-pnp-Digi	Sw, 50V, 100mA, 100mW, R1/R2=1k/10k	TESM	18ta	-	3a	Tos
XR	2PD602AR	Si-npn	GP, Sw, 60V, 500mA, 250mW, B=120..240, >160MHz	SC-59	16ta	-	3a	Phi
XR	2SD1820A-R	Si-npn	GP, 60V, 500mA, 150mW, B=120..240, 20MHz	SOT-323	16ta	-	3a	Pan
XR	2SD602A-R	Si-npn	GP, AF, 60V, 500mA, 200mW, B=120..240, 200MHz	SC-59	16ta	-	3a	Pan
XR	BZX99-C3V6	Z-diode	3.6V±5%, 300mW	SOT-23	16dc	-	3a	Phi
XS	2PD602AS	Si-npn	GP, Sw, 60V, 500mA, 250mW, B=170..340, >180MHz	SC-59	16ta	-	3a	Phi
XS	2SD1820A-S	Si-npn	GP, 60V, 500mA, 150mW, B=170..340, 20MHz	SOT-323	16ta	-	3a	Pan
XS	2SD602A-S	Si-npn	GP, AF, 60V, 500mA, 200mW, B=170..340, 200MHz	SC-59	16ta	-	3a	Pan
XS	BZX99-C3V9	Z-diode	3.9V±5%, 300mW	SOT-23	16dc	-	3a	Phi
XS	RN1115	Si-npn-Digi	Sw, 50V, 100mA, 100mW, R1/R2=2.2k/10k	SOT-416	16ta	-	3a	Tos
XS	RN1115F	Si-npn-Digi	Sw, 50V, 100mA, 100mW, R1/R2=2.2k/10k	SOT-490	18ta	-	3a	Tos
XS	RN1115FT	Si-npn-Digi	Sw, 50V, 100mA, 100mW, R1/R2=2.2k/10k	TESM	18ta	-	3a	Tos
XS	RN1115FV	Si-npn-Digi	Sw, 50V, 100mA, 150mW, R1/R2=2.2k/10k	SOT-723	18ta	-	3a	Tos
XS	RN1315	Si-npn-Digi	Sw, 50V, 100mA, 400mW, R1/R2=2.2k/10k	SOT-323	16ta	-	3a	Tos
XS	RN1415	Si-npn-Digi	Sw, 50V, 100mA, 400mW, R1/R2=2.2k/10k	SOT-346	16ta	-	3a	Tos
XS	RN2115F	Si-pnp-Digi	Sw, 50V, 100mA, 100mW, R1/R2=2.2k/10k	SOT-490	18ta	-	3a	Tos
XS	RN2115FT	Si-pnp-Digi	Sw, 50V, 100mA, 100mW, R1/R2=2.2k/10k	TESM	18ta	-	3a	Tos
XT	BZX99-C4V3	Z-diode	4.3V±5%, 300mW	SOT-23	16dc	-	3a	Phi
XT	RN1116	Si-npn-Digi	Sw, 50V, 100mA, 100mW, R1/R2=4.7k/10k	SOT-416	16ta	-	3a	Tos
XT	RN1116F	Si-npn-Digi	Sw, 50V, 100mA, 100mW, R1/R2=4.7k/10k	SOT-490	18ta	-	3a	Tos
XT	RN1116FT	Si-npn-Digi	Sw, 50V, 100mA, 100mW, R1/R2=4.7k/10k	TESM	18ta	-	3a	Tos
XT	RN1116FV	Si-npn-Digi	Sw, 50V, 100mA, 150mW, R1/R2=4.7k/10k	SOT-723	18ta	-	3a	Tos
XT	RN1316	Si-npn-Digi	Sw, 50V, 100mA, 400mW, R1/R2=4.7k/10k	SOT-323	16ta	-	3a	Tos
XT	RN1416	Si-npn-Digi	Sw, 50V, 100mA, 400mW, R1/R2=4.7k/10k	SOT-346	16ta	-	3a	Tos
XT	RN2116F	Si-pnp-Digi	Sw, 50V, 100mA, 100mW, R1/R2=4.7k/10k	SOT-490	18ta	-	3a	Tos
XT	RN2116FT	Si-pnp-Digi	Sw, 50V, 100mA, 100mW, R1/R2=4.7k/10k	TESM	18ta	-	3a	Tos
XT	RN2116FV	Si-pnp-Digi	Sw, 50V, 100mA, 150mW, R1/R2=4.7k/10k	SOT-723	18ta	-	3a	Tos
XT-	2SC4674	Si-npn	VHF/UHF, 12V, 8mA, 50mW, B=50..250, >4GHz	SOT-323	16ta	-	3a	Ren
XU	BZX99-C7V5	Z-diode	7.5V±5%, 300mW	SOT-23	16dc	-	3a	Phi
XU	RN1117	Si-npn-Digi	Sw, 50V, 100mA, 100mW, R1/R2=10k/4.7k	SOT-416	16ta	-	3a	Tos
XU	RN1117F	Si-npn-Digi	Sw, 50V, 100mA, 100mW, R1/R2=10k/4.7k	SOT-490	18ta	-	3a	Tos
XU	RN1117FT	Si-npn-Digi	Sw, 50V, 100mA, 100mW, R1/R2=10k/4.7k	TESM	18ta	-	3a	Tos
XU	RN1117FV	Si-npn-Digi	Sw, 50V, 100mA, 150mW, R1/R2=10k/4.7k	SOT-723	18ta	-	3a	Tos
XU	RN1317	Si-npn-Digi	Sw, 50V, 100mA, 400mW, R1/R2=10k/4.7k	SOT-323	16ta	-	3a	Tos
XU	RN1417	Si-npn-Digi	Sw, 50V, 100mA, 400mW, R1/R2=10k/4.7k	SOT-346	16ta	-	3a	Tos
XU	RN2117F	Si-pnp-Digi	Sw, 50V, 100mA, 100mW, R1/R2=10k/4.7k	SOT-490	18ta	-	3a	Tos
XU	RN2117FT	Si-pnp-Digi	Sw, 50V, 100mA, 100mW, R1/R2=10k/4.7k	TESM	18ta	-	3a	Tos
XU_	2SC4680	Si-npn	UHF/VHF, 12V, 50mA, 150mW, B>100	SOT-346	16ta	-	3a	Ren
XU1	CHDTA143XUPT	Si-pnp-Digi	Sw, 50V, 100mA, 250MHz, R1/R2=4.7/10k	SOT-323	16ta	-	3a	Chm
XU2	CHDTA124XUPT	Si-pnp-Digi	Sw, 50V, 100mA, 250MHz, R1/R2=22/47k	SOT-323	16ta	-	3a	Chm
XUA	CHDTC143XUPT	Si-npn-Digi	Sw, 50V, 100mA, 250MHz, R1/R2=4.7/10k	SOT-323	16ta	-	3a	Chm
XUB	CHDTC124XUPT	Si-npn-Digi	Sw, 50V, 100mA, 250MHz, R1/R2=22/47k	SOT-323	16ta	-	3a	Chm
XUs	BCR562	Si-pnp-Digi	Sw, 50V, 500mA, 330mW, R1/R2=4.7k/4.7k, 150MHz	SOT-23	16ta	-	3c	Inf
XV	BZX99-C8V2	Z-diode	8.2V±5%, 300mW	SOT-23	16dc	-	3a	Phi
XV-	2SC4702	Si-npn	AF, Vid, 300/300V, 50mA, 150mW, 80MHz, B=60..150	SOT-23	16ta	-	3a	Ren
XVs	BCR521	Si-npn-Digi	Sw, 50V, 500mA, 330mW, R1/R2=1k/1k, 100MHz	SOT-23	16ta	-	3c	Inf
XV	BZX99-C9V1	Z-diode	9.1V±5%, 300mW	SOT-23	16dc	-	3a	Phi
XW	CHT4124WPT	Si-npn	AF, Sw, 25V, 200mA, B=120..360, 300MHz	SOT-323	16ta	-	3a	Chm
XW	RN1118	Si-npn-Digi	Sw, 50V, 100mA, 100mW, R1/R2=47k/10k	SOT-416	16ta	-	3a	Tos
XW	RN1118F	Si-npn-Digi	Sw, 50V, 100mA, 100mW, R1/R2=47k/10k	SOT-490	18ta	-	3a	Tos
XW	RN1118FT	Si-npn-Digi	Sw, 50V, 100mA, 100mW, R1/R2=47k/10k	TESM	18ta	-	3a	Tos
XW	RN1118FV	Si-npn-Digi	Sw, 50V, 100mA, 150mW, R1/R2=47k/10k	SOT-723	18ta	-	3a	Tos
XW	RN1318	Si-npn-Digi	Sw, 50V, 100mA, 400mW, R1/R2=47k/10k	SOT-323	16ta	-	3a	Tos
XW	RN1418	Si-npn-Digi	Sw, 50V, 100mA, 400mW, R1/R2=47k/10k	SOT-346	16ta	-	3a	Tos
XW	RN2118F	Si-pnp-Digi	Sw, 50V, 100mA, 100mW, R1/R2=47k/10k	SOT-490	18ta	-	3a	Tos
XW	RN2118FT	Si-pnp-Digi	Sw, 50V, 100mA, 100mW, R1/R2=47k/10k	TESM	18ta	-	3a	Tos



SMD code	Type	Function	Short description	Case	Pinout	Sch.	St.	Mnf.
XWs	BCR505	Si-npn-Digi	Sw, 50V, 500mA, 330mW, R1/R2=2.2k/10k, 100MHz	SOT-23	16ta	-	3c	Inf
XX	BZX99-C10	Z-diode	10V±5%, 300mW	SOT-23	16dc	-	3a	Phi
XXs	BCR571	Si-pnp-Digi	Sw, 50V, 500mA, 330mW, R1/R2=1k/1k, 150MHz	SOT-23	16ta	-	3c	Inf
XY	2SD1851	Si-npn-Darl	AF-Drv, 80V, 200mA, 200mW, B>5000	SOT-23	16ta	-	3a	San
XY	2SK209-Y	n-FET	GP, 50V, 10mA, 150mW, Idss=1.2..3mA	SOT-23	16fa	-	3a	Tos
XY	2SK880-Y	n-FET	AF-Amp, 50V, 10mA, 100mW, Idss=1.2..3mA, Up<1.5V	SOT-323	16fa	-	3a	Tos
XY	BZX99-C11	Z-diode	11V±5%, 300mW	SOT-23	16dc	-	3a	Phi
XZ	BZX99-C12	Z-diode	12V±5%, 300mW	SOT-23	16dc	-	3a	Phi
y	AX6904DA	Vdet-IC	3.08V±1.5%, +Reset PPO	SC-70	16vda	VD7	3b	Axl
Y0	ELM7640LBB	Vdet-IC	4.0V±2%, -Reset PPO, 500ms	SOT-23	16vdc	VD7	3d	Elm
Y0	MMBZ5221B	Z-diode	2.28..2.52V, Izt=20mA, Zzt=30Ω, 350mW	SOT-23	16dc	-	3a	Lge
Y1	BZX84-A11	Z-diode	11V±1%, Izt=23mA, 350mW	SOT-23	16dc	-	3a	Cen
Y1	BZX84-B11	Z-diode	11V±2%, Izt=23mA, 350mW	SOT-23	16dc	-	3a	Cen
Y1	BZX84-C11	Z-diode	10.4..11.6V, Izt=5mA, Zzt=20Ω, 350mW	SOT-23	16eb	-	3a	TTr
Y1	BZX84-C11-V	Z-diode	11V±5%, Zzt=10Ω(20mA), 300mW	SOT-23	16dc	-	3a,3g	Cen,F
Y1	CZRT55C11	Z-diode	10.4..11.6V, Zzt=20Ω, Izt=5mA, 350mW	SOT-23	16dc	-	3a	Cmc
Y1	ELM7641LBB	Vdet-IC	4.1V±2%, -Reset PPO, 500ms	SOT-23	16vdc	VD7	3d	Elm
Y1	TC1273-10ENB	Vdet-IC	4.37V, -Reset ODO	SOT-23	16vdb	VD6	3d	Mcc
Y1	TC1273-15ENB	Vdet-IC	4.12V, -Reset ODO	SOT-23	16vdb	VD6	3d	Mcc
Y10	BZX84-A27	Z-diode	27V±1%, Izt=9mA, 350mW	SOT-23	16dc	-	3a	Cen
Y10	BZX84-B27	Z-diode	27V±2%, Izt=9mA, 350mW	SOT-23	16dc	-	3a	Cen
Y10	BZX84-C27	Z-diode	25.1..28.9V, Izt=2mA, Zzt=80Ω, 350mW	SOT-23	16eb	-	3a	TTr
Y10	BZX84-C27-V	Z-diode	27V±5%, Zzt=25Ω(80mA), 300mW	SOT-23	16dc	-	3a,3g	F,Vs
Y10	CZRT55C27	Z-diode	25.1..28.9V, Zzt=80Ω, Izt=2mA, 350mW	SOT-23	16dc	-	3a	Cmc
Y11	BZX84-A30	Z-diode	30V±1%, Izt=8mA, 350mW	SOT-23	16dc	-	3a	Cen
Y11	BZX84-B30	Z-diode	30V±2%, Izt=8mA, 350mW	SOT-23	16dc	-	3a	Cen
Y11	BZX84-C30	Z-diode	28.0..32.0V, Izt=2mA, Zzt=80Ω, 350mW	SOT-23	16eb	-	3a	TTr
Y11	BZX84-C30-V	Z-diode	30V±5%, Zzt=30Ω(80mA), 300mW	SOT-23	16dc	-	3a,3g	Cen,F
Y11	CZRT55C30	Z-diode	28.0..32.0V, Zzt=80Ω, Izt=2mA, 350mW	SOT-23	16dc	-	3a	Cmc
Y12	2SA1464-Y12	Si-pnp	AF, Sw, 60V, 500mA, 200mW, 400MHz, B=75..150	SOT-23-3L	16te	-	3a	Trs
Y12	2SA1608-12	Si-pnp	HF, Sw, 60V, 500mA, 150mW, B=75..150, 400MHz	SOT-23	16ta	-	3a	Nec
Y12	BZX84-A33	Z-diode	33V±1%, Izt=7mA, 350mW	SOT-23	16dc	-	3a	Cen
Y12	BZX84-B33	Z-diode	33V±2%, Izt=7mA, 350mW	SOT-23	16dc	-	3a	Cen
Y12	BZX84-C33	Z-diode	31.0..35.0V, Izt=2mA, Zzt=80Ω, 350mW	SOT-23	16eb	-	3a	TTr
Y12	BZX84-C33-V	Z-diode	33V±5%, Zzt=35Ω(80mA), 300mW	SOT-23	16dc	-	3a,3g	Cen,F
Y12	CZRT55C33	Z-diode	31.0..35.0V, Zzt=80Ω, Izt=2mA, 350mW	SOT-23	16dc	-	3a	Cmc
Y13	2SA1464-Y13	Si-pnp	AF, Sw, 60V, 500mA, 200mW, 400MHz, B=100..200	SOT-23-3L	16te	-	3a	Trs
Y13	2SA1608-13	Si-pnp	HF, Sw, 60V, 500mA, 150mW, B=100..200, 400MHz	SOT-23	16ta	-	3a	Nec
Y13	BZX84-A36	Z-diode	36V±1%, Izt=6.9mA, 350mW	SOT-23	16dc	-	3a	Cen
Y13	BZX84-B36	Z-diode	36V±2%, Izt=6.9mA, 350mW	SOT-23	16dc	-	3a	Cen
Y13	BZX84-C36	Z-diode	34.0..38.0V, Izt=2mA, Zzt=90Ω, 350mW	SOT-23	16eb	-	3a	TTr
Y13	BZX84-C36-V	Z-diode	36V±5%, Zzt=35Ω(90mA), 300mW	SOT-23	16dc	-	3a,3g	Cen,F
Y13	CZRT55C36	Z-diode	34.0..38.0V, Zzt=90Ω, Izt=2mA, 350mW	SOT-23	16dc	-	3a	Cmc
Y14	2SA1464-Y14	Si-pnp	AF, Sw, 60V, 500mA, 200mW, 400MHz, B=150..300	SOT-23-3L	16te	-	3a	Trs
Y14	2SA1608-14	Si-pnp	HF, Sw, 60V, 500mA, 150mW, B=150..300, 400MHz	SOT-23	16ta	-	3a	Nec
Y14	BZX84-A39	Z-diode	39V±1%, Izt=6.4mA, 350mW	SOT-23	16dc	-	3a	Cen
Y14	BZX84-B39	Z-diode	39V±2%, Izt=6.4mA, 350mW	SOT-23	16dc	-	3a	Cen
Y14	BZX84-C39	Z-diode	37.0..41.0V, Izt=2mA, Zzt=130Ω, 350mW	SOT-23	16eb	-	3a	TTr
Y14	BZX84-C39-V	Z-diode	39V±5%, Zzt=40Ω(130mA), 300mW	SOT-23	16dc	-	3a,3g	Cen,F
Y14	CZRT55C39	Z-diode	37.0..41.0V, Zzt=130Ω, Izt=2mA, 350mW	SOT-23	16dc	-	3a	Cmc
Y15	BZX84-A43	Z-diode	43V±1%, Izt=5.8mA, 350mW	SOT-23	16dc	-	3a	Cen
Y15	BZX84-B43	Z-diode	43V±2%, Izt=5.8mA, 350mW	SOT-23	16dc	-	3a	Cen
Y15	BZX84-C43	Z-diode	40.0..46.0V, Izt=2mA, Zzt=150Ω, 350mW	SOT-23	16eb	-	3a	TTr
Y15	BZX84-C43-V	Z-diode	43V±5%, Zzt=45Ω(150mA), 300mW	SOT-23	16dc	-	3a,3g	Cen,Di
Y15A	ML6206S153M	LVR-IC	1.5V±3%, 250mA	SOT-23	16cg	VR1	3a	Mlc
Y16	BZX84-A47	Z-diode	47V±1%, Izt=5.3mA, 350mW	SOT-23	16dc	-	3a	Cen
Y16	BZX84-B47	Z-diode	47V±2%, Izt=5.3mA, 350mW	SOT-23	16dc	-	3a	Cen
Y16	BZX84-C47	Z-diode	44.0..50.0V, Izt=2mA, Zzt=70Ω, 350mW	SOT-23	16eb	-	3a	TTr
Y16	BZX84-C47-V	Z-diode	47V±5%, Zzt=50Ω(170mA), 300mW	SOT-23	16dc	-	3a,3c	Cen,Di
Y16A	ML6206S163M	LVR-IC	1.6V±3%, 250mA	SOT-23	16cg	VR1	3a	Mlc
Y17	BZX84-C51	Z-diode	48.0..54.0V, Izt=2mA, Zzt=180Ω, 350mW	SOT-23	16eb	-	3a	TTr
Y17	BZX84-C51-V	Z-diode	51V±5%, Zzt=60Ω(180mA), 300mW	SOT-23	16dc	-	3d,3g	Di
Y17A	ML6206S173M	LVR-IC	1.7V±3%, 250mA	SOT-23	16cg	VR1	3a	Mlc
Y18	BZX84-C56	Z-diode	52.0..60.0V, Izt=2mA, Zzt=200Ω, 350mW	SOT-23	16eb	-	3a	TTr
Y18	BZX84-C56-V	Z-diode	56V±5%, Zzt=70Ω(200mA), 300mW	SOT-23	16dc	-	3a,3g	Phi
Y18A	ML6206S183M	LVR-IC	1.8V±3%, 250mA	SOT-23	16cg	VR1	3a	Mlc
Y19	BZX84-C62	Z-diode	58.0..66.0V, Izt=2mA, Zzt=215Ω, 350mW	SOT-23	16eb	-	3a	TTr
Y19	BZX84-C62-V	Z-diode	62V±5%, Zzt=80Ω(215mA), 300mW	SOT-23	16dc	-	3a,3g	Phi
Y19A	ML6206S193M	LVR-IC	1.9V±3%, 250mA	SOT-23	16cg	VR1	3a	Mlc
Y1H	SS8050LT1-H	Si-npn	GP, 40V, 1.5A, 625mW, B=200..350, >100MHz	SOT-23	16ta	-	3a	Wtr



SMD code	Type	Function	Short description	Case	Pinout	Sch.	St.	Mnf.
Y1L	SS8050LT1-L	Si-npn	GP, 40V, 1.5A, 625mW, B=120..200, >100MHz	SOT-23	16ta	-	3a	Wtr
Y1p	BZX84-C11	Z-diode	11V±5%, 300mW	SOT-23	16dc	-	3a	PHH
Y1t	BZX84-C11	Z-diode	11V±5%, 300mW	SOT-23	16dc	-	3a	PhM
Y1W	BZX84-C11	Z-diode	11V±5%, 300mW	SOT-23	16dc	-	3a	PhC
Y1Y	CMSZDA11V	Z-diode	Dual, 10.4..11.6V, Zzt=20Ω, 15mA, 275mW	SOT-323	16df	-	3a	Cen
Y2	APX809-46SR	Vdet-IC	4.63V±1.5%, -Reset PPO	SOT-23	16vdb	VD7	3b	Di
Y2	BZX84-A12	Z-diode	12V±1%, lzt=21mA, 350mW	SOT-23	16dc	-	3a	Cen
Y2	BZX84-B12	Z-diode	12V±2%, lzt=21mA, 350mW	SOT-23	16dc	-	3a	Cen
Y2	BZX84-C12	Z-diode	11.4..12.7V, lzt=5mA, Zzt=25Ω, 350mW	SOT-23	16eb	-	3a	TTr
Y2	BZX84-C12-V	Z-diode	12V±5%, Zzt=10Ω(25mA), 300mW	SOT-23	16dc	-	3a,3g	Cen,F
Y2	CZRT55C12	Z-diode	11.4..12.7V, Zzt=25Ω, lzt=5mA, 350mW	SOT-23	16dc	-	3a	Cmc
Y2	ECG5021SM	Z-diode	12V±5%, 300mW	SOT-23	16dc	-	3a	Ecq
Y2	ELM7642LBB	Vdet-IC	4.2V±2%, -Reset PPO, 500ms	SOT-23	16vdc	VD7	3d	Elm
Y2	NTE5021SM	Z-diode	12V±5%, 300mW	SOT-23	16dc	-	3a	Nte
Y2	RN2130F	Si-pnp-Digi	Sw, 50V, 100mA, 100mW, R1/R2=100k/100k	SOT-490	18ta	-	3a	Tos
Y20	BZX84-C68	Z-diode	64.0..72.0V, lzt=2mA, Zzt=240Ω, 350mW	SOT-23	16eb	-	3a	TTr
Y20	BZX84-C68-V	Z-diode	68V±5%, Zzt=90Ω(240mA), 300mW	SOT-23	16dc	-	3a,3g	Phi
Y20A	ML6206S202M	LVR-IC	2.0V±2%, 250mA	SOT-23	16cg	VR1	3a	Mlc
Y21	BZX84-C75	Z-diode	70.0..79.0V, lzt=2mA, Zzt=255Ω, 350mW	SOT-23	16eb	-	3a	TTr
Y21	BZX84-C75-V	Z-diode	75V±5%, 300mW	SOT-23	16dc	-	3a,3g	Phi
Y21A	ML6206S212M	LVR-IC	2.1V±2%, 250mA	SOT-23	16cg	VR1	3a	Mlc
Y22	2SA1461-22	Si-pnp	Sw, 40V, 200mA, 200mW, B=75..150, >200MHz	SOT-23	16ta	-	3a	Nec
Y22A	ML6206S222M	LVR-IC	2.2V±2%, 250mA	SOT-23	16cg	VR1	3a	Mlc
Y23	2SA1461-23	Si-pnp	Sw, 40V, 200mA, 200mW, B=100..200, >200MHz	SOT-23	16ta	-	3a	Nec
Y23A	ML6206S232M	LVR-IC	2.3V±2%, 250mA	SOT-23	16cg	VR1	3a	Mlc
Y24	2SA1461-24	Si-pnp	Sw, 40V, 200mA, 200mW, B=150..300, >200MHz	SOT-23	16ta	-	3a	Nec
Y24A	ML6206S242M	LVR-IC	2.4V±2%, 250mA	SOT-23	16cg	VR1	3a	Mlc
Y25	NTM3906	Si-pnp	GP, 40V, 200mA, 330mW, B=100..300, >250MHz	SOT-23	16ta	-	-	Nec
Y25A	ML6206S252M	LVR-IC	2.5V±2%, 250mA	SOT-23	16cg	VR1	3a	Mlc
Y26A	ML6206S262M	LVR-IC	2.6V±2%, 250mA	SOT-23	16cg	VR1	3a	Mlc
Y27A	ML6206S272M	LVR-IC	2.7V±2%, 250mA	SOT-23	16cg	VR1	3a	Mlc
Y28A	ML6206S282M	LVR-IC	2.8V±2%, 250mA	SOT-23	16cg	VR1	3a	Mlc
Y29A	ML6206S292M	LVR-IC	2.9V±2%, 250mA	SOT-23	16cg	VR1	3a	Mlc
Y2H	SS8550LT1-H	Si-pnp	GP, 40V, 1.5A, 625mW, B=200..350, >100MHz	SOT-23	16ta	-	3a	Wtr
Y2L	SS8550LT1-L	Si-pnp	GP, 40V, 1.5A, 625mW, B=120..200, >100MHz	SOT-23	16ta	-	3a	Wtr
Y2p	BZX84-C12	Z-diode	12V±5%, 300mW	SOT-23	16dc	-	3a	PhH
Y2t	BZX84-C12	Z-diode	12V±5%, 300mW	SOT-23	16dc	-	3a	PhM
Y2W	BZX84-C12	Z-diode	12V±5%, 300mW	SOT-23	16dc	-	3a	PhC
Y2Y	CMSZDA12V	Z-diode	Dual, 11.4..12.7V, Zzt=25Ω, 13mA, 275mW	SOT-323	16df	-	3a	Cen
Y3	APX809-44SR	Vdet-IC	4.38V±1.5%, -Reset PPO	SOT-23	16vdb	VD7	3b	Di
Y3	BZX84-A13	Z-diode	13V±1%, lzt=18mA, 350mW	SOT-23	16dc	-	3a	Cen
Y3	BZX84-B13	Z-diode	13V±2%, lzt=18mA, 350mW	SOT-23	16dc	-	3a	Cen
Y3	BZX84-C13	Z-diode	13V±5%, Zzt=10Ω(30mA), 300mW	SOT-23	16dc	-	3a,3g	Cen,F
Y3	BZX84-C13-V	Z-diode	13V±5%, Zzt=10Ω(30mA), 300mW	SOT-23	16dc	-	3g	Vs
Y3	BZX88-C13	Z-diode	13V±5%, 200mW	SOT-323	16dc	-	3a	Zx
Y3	CZRT55C13	Z-diode	12.4..14.1V, Zzt=30Ω, lzt=5mA, 350mW	SOT-23	16dc	-	3a	Cmc
Y3	ELM7643LBB	Vdet-IC	4.3V±2%, -Reset PPO, 500ms	SOT-23	16vdc	VD7	3d	Elm
Y3	RN2131F	Si-pnp-Digi	Sw, 50V, 100mA, 100mW, R1=100k	SOT-490	18ta	-	3a	Tos
Y3	TC1273-5ENB	Vdet-IC	4.62V, -Reset ODO	SOT-23	16vdb	VD6	3d	Mcc
Y30A	ML6206S302M	LVR-IC	3.0V±2%, 250mA	SOT-23	16cg	VR1	3a	Mlc
Y31A	ML6206S312M	LVR-IC	3.1V±2%, 250mA	SOT-23	16cg	VR1	3a	Mlc
Y32A	ML6206S322M	LVR-IC	3.2V±2%, 250mA	SOT-23	16cg	VR1	3a	Mlc
Y33	2SA1462-33	Si-pnp	Sw, 15V, 50mA, 200mW, B=50..100, >800MHz	SOT-23	16ta	-	3a	Nec
Y33	2SA1610-33	Si-pnp	Sw, 15V, 50mA, 150mW, B=50..100, 1.8GHz, 20/40ns	SOT-23	16ta	-	3a	Nec
Y33A	ML6206S332M	LVR-IC	3.3V±2%, 250mA	SOT-23	16cg	VR1	3a	Mlc
Y34	2SA1462-34	Si-pnp	Sw, 15V, 50mA, 200mW, B=75..150, >800MHz	SOT-23	16ta	-	3a	Nec
Y34	2SA1610-34	Si-pnp	Sw, 15V, 50mA, 150mW, B=75..150, 1.8GHz, 20/40ns	SOT-23	16ta	-	3a	Nec
Y34A	ML6206S342M	LVR-IC	3.4V±2%, 250mA	SOT-23	16cg	VR1	3a	Mlc
Y35A	ML6206S352M	LVR-IC	3.5V±2%, 250mA	SOT-23	16cg	VR1	3a	Mlc
Y36A	ML6206S362M	LVR-IC	3.6V±2%, 250mA	SOT-23	16cg	VR1	3a	Mlc
Y37A	ML6206S372M	LVR-IC	3.7V±2%, 250mA	SOT-23	16cg	VR1	3a	Mlc
Y38A	ML6206S382M	LVR-IC	3.8V±2%, 250mA	SOT-23	16cg	VR1	3a	Mlc
Y39A	ML6206S392M	LVR-IC	3.9V±2%, 250mA	SOT-23	16cg	VR1	3a	Mlc
Y3p	BZX84-C13	Z-diode	13V±5%, 300mW	SOT-23	16dc	-	3a	PHH
Y3t	BZX84-C13	Z-diode	13.6V±5%, 300mW	SOT-23	16dc	-	3a	PhM
Y3W	BZX84-C13	Z-diode	13.6V±5%, 300mW	SOT-23	16dc	-	3a	PhC
Y3Y	CMSZDA13V	Z-diode	Dual, 12.4..14.1V, Zzt=30Ω, 12mA, 275mW	SOT-323	16df	-	3a	Cen
Y4	APX809-40SR	Vdet-IC	4.0V±1.5%, -Reset PPO	SOT-23	16vdb	VD7	3b	Di
Y4	BZX84-A15	Z-diode	15V±1%, lzt=17mA, 350mW	SOT-23	16dc	-	3a	Cen
Y4	BZX84-B15	Z-diode	15V±2%, lzt=17mA, 350mW	SOT-23	16dc	-	3a	Cen



SMD code	Type	Function	Short description	Case	Pinout	Sch.	St.	Mnf.
Y4	BZX84-C15	Z-diode	13.8..15.6V, Izt=5mA, Zzt=30Ω, 350mW	SOT-23	16eb	-	3a	Ttr
Y4	BZX84-C15-V	Z-diode	15V±5%, Zzt=10Ω(30mA), 300mW	SOT-23	16dc	-	3a,3g	Gen,F
Y4	BZX88-C15	Z-diode	15V±5%, 200mW	SOT-323	16dc	-	3a	Zx
Y4	CZRT55C15	Z-diode	13.8..15.6V, Zzt=30Ω, Izt=5mA, 350mW	SOT-23	16dc	-	3a	Cmc
Y4	ECG5024SM	Z-diode	15V±5%, 300mW	SOT-23	16dc	-	3a	Ecg
Y4	ELM7644LBB	Vdet-IC	4.4V±2%, -Reset PPO, 500ms	SOT-23	16vdc	VD7	3d	Elm
Y4	KA4A4Z	Si-npn-Digi	Sw, 60V, 100mA, 200mW, R1=10k	SOT-416	16ta	-	3a	Nec
Y4	NTE5024SM	Z-diode	15V±5%, 300mW	SOT-23	16dc	-	3a	Nte
Y4	RN2132F	Si-npn-Digi	Sw, 50V, 100mA, 100mW, R1=200k	SOT-490	18ta	-	3a	Tos
Y4	SP809NEK-3-1	Vdet-IC	3.1V±1.5%, -Reset ODO	SOT-23	16vdc	VD6	3b	Sip
Y40A	ML6206S402M	LVR-IC	4.0V±2%, 250mA	SOT-23	16cg	VR1	3a	Mlc
Y41A	ML6206S412M	LVR-IC	4.1V±2%, 250mA	SOT-23	16cg	VR1	3a	Mlc
Y42A	ML6206S422M	LVR-IC	4.2V±2%, 250mA	SOT-23	16cg	VR1	3a	Mlc
Y43A	ML6206S432M	LVR-IC	4.3V±2%, 250mA	SOT-23	16cg	VR1	3a	Mlc
Y44A	ML6206S442M	LVR-IC	4.4V±2%, 250mA	SOT-23	16cg	VR1	3a	Mlc
Y45A	ML6206S452M	LVR-IC	4.5V±2%, 250mA	SOT-23	16cg	VR1	3a	Mlc
Y46A	ML6206S462M	LVR-IC	4.6V±2%, 250mA	SOT-23	16cg	VR1	3a	Mlc
Y47A	ML6206S472M	LVR-IC	4.7V±2%, 250mA	SOT-23	16cg	VR1	3a	Mlc
Y48A	ML6206S482M	LVR-IC	4.8V±2%, 250mA	SOT-23	16cg	VR1	3a	Mlc
Y49A	ML6206S492M	LVR-IC	4.9V±2%, 250mA	SOT-23	16cg	VR1	3a	Mlc
Y4p	BZX84-C15	Z-diode	15V±5%, 300mW	SOT-23	16dc	-	3a	PhH
Y4t	BZX84-C15	Z-diode	15V±5%, 300mW	SOT-23	16dc	-	3a	PhM
Y4W	BZX84-C15	Z-diode	15V±5%, 300mW	SOT-23	16dc	-	3a	PhC
Y4Y	CMSZDA15V	Z-diode	Dual, 13.8..15.6V, Zzt=30Ω, 11mA, 275mW	SOT-323	16df	-	3a	Cen
Y5	APX809-31SR	Vdet-IC	3.08V±1.5%, -Reset PPO	SOT-23	16vdb	VD7	3b	Di
Y5	BZX84-A16	Z-diode	16V±1%, Izt=16mA, 350mW	SOT-23	16dc	-	3a	Cen
Y5	BZX84-B16	Z-diode	16V±2%, 16mA, 350mW	SOT-23	16dc	-	3a	Cen
Y5	BZX84-C16	Z-diode	15.3..17.1V, Izt=5mA, Zzt=40Ω, 350mW	SOT-23	16eb	-	3a	Ttr
Y5	BZX84-C16-V	Z-diode	16V±5%, Zzt=10Ω(40mA), 300mW	SOT-23	16dc	-	3a,3g	Gen,F
Y5	BZX88-C16	Z-diode	16V±5%, 200mW	SOT-323	16dc	-	3a	Zx
Y5	CZRT55C16	Z-diode	15.3..17.1V, Zzt=40Ω, Izt=5mA, 350mW	SOT-23	16dc	-	3a	Cmc
Y5	ELM7645LBB	Vdet-IC	4.5V±2%, -Reset PPO, 500ms	SOT-23	16vdc	VD7	3d	Elm
Y50	BZX84-A2V4	Z-diode	2.4V±1%, 300mW	SOT-23	16dc	-	3a	Phi
Y50A	ML6206S502M	LVR-IC	5.0V±2%, 250mA	SOT-23	16cg	VR1	3a	Mlc
Y51	BZX84-A2V7	Z-diode	2.7V±1%, 300mW	SOT-23	16dc	-	3a	Phi
Y52	BZX84-A3V0	Z-diode	3V±1%, 300mW	SOT-23	16dc	-	3a	Phi
Y53	BZX84-A3V3	Z-diode	3.3V±1%, 300mW	SOT-23	16dc	-	3a	Phi
Y54	BZX84-A3V6	Z-diode	3.6V±1%, 300mW	SOT-23	16dc	-	3a	Phi
Y55	BZX84-A3V9	Z-diode	3.9V±1%, 300mW	SOT-23	16dc	-	3a	Phi
Y56	BZX84-A4V3	Z-diode	4.3V±1%, 300mW	SOT-23	16dc	-	3a	Phi
Y57	BZX84-A4V7	Z-diode	4.7V±1%, 300mW	SOT-23	16dc	-	3a	Phi
Y58	BZX84-A5V1	Z-diode	5.1V±1%, 300mW	SOT-23	16dc	-	3a	Phi
Y59	BZX84-A5V6	Z-diode	5.6V±1%, 300mW	SOT-23	16dc	-	3a	Phi
Y5p	BZX84-C16	Z-diode	16V±5%, 300mW	SOT-23	16dc	-	3a	PhH
Y5t	BZX84-C16	Z-diode	16V±5%, 300mW	SOT-23	16dc	-	3a	PhM
Y5W	BZX84-C16	Z-diode	16V±5%, 300mW	SOT-23	16dc	-	3a	PhC
Y5Y	CMSZDA16V	Z-diode	Dual, 15.3..17.1V, Zzt=40Ω, 10mA, 275mW	SOT-323	16df	-	3a	Cen
Y6	APX809-29SR	Vdet-IC	2.93V±1.5%, -Reset PPO	SOT-23	16vdb	VD7	3b	Di
Y6	BZX84-A18	Z-diode	18V±1%, Izt=14mA, 350mW	SOT-23	16dc	-	3a	Cen
Y6	BZX84-B18	Z-diode	18V±2%, 14mA, 350mW	SOT-23	16dc	-	3a	Cen
Y6	BZX84-C18	Z-diode	16.8..19.1V, Izt=5mA, Zzt=45Ω, 350mW	SOT-23	16eb	-	3a	Ttr
Y6	BZX84-C18-V	Z-diode	18V±5%, Zzt=10Ω(45mA), 300mW	SOT-23	16dc	-	3a,3g	Gen,F
Y6	BZX88-C18	Z-diode	18V±5%, 200mW	SOT-323	16dc	-	3a	Zx
Y6	CZRT55C18	Z-diode	16.8..19.1V, Zzt=45Ω, Izt=5mA, 350mW	SOT-23	16dc	-	3a	Cmc
Y6	ECG5027SM	Z-diode	18V±5%, 300mW	SOT-23	16dc	-	3a	Ecg
Y6	ELM7646LBB	Vdet-IC	4.6V±2%, -Reset PPO, 500ms	SOT-23	16vdc	VD7	3d	Elm
Y6	NTE5027SM	Z-diode	18V±5%, 300mW	SOT-23	16dc	-	3a	Nte
Y60	BZX84-A6V2	Z-diode	6.2V±1%, 300mW	SOT-23	16dc	-	3a	Phi
Y61	BZX84-A6V8	Z-diode	6.8V±1%, 300mW	SOT-23	16dc	-	3a	Phi
Y62	BZX84-A7V5	Z-diode	7.5V±1%, 300mW	SOT-23	16dc	-	3a	Phi
Y63	BZX84-A8V2	Z-diode	8.2V±1%, 300mW	SOT-23	16dc	-	3a	Phi
Y64	BZX84-A9V1	Z-diode	9.1V±1%, 300mW	SOT-23	16dc	-	3a	Phi
Y65	BZX84-A10	Z-diode	10V±1%, Izt=25mA, 350mW	SOT-23	16dc	-	3a	Phi
Y66	BZX84-A11	Z-diode	12V±1%, Izt=21mA, 300mW	SOT-23	16dc	-	3a	Phi
Y67	BZX84-A12	Z-diode	12V±1%, Izt=21mA, 300mW	SOT-23	16dc	-	3a	Phi
Y68	BZX84-A13	Z-diode	13V±1%, 300mW	SOT-23	16dc	-	3a	Phi
Y69	BZX84-A15	Z-diode	15V±1%, 300mW	SOT-23	16dc	-	3a	Phi
Y6p	BZX84-C18	Z-diode	18V±5%, 300mW	SOT-23	16dc	-	3a	PhH
Y6t	BZX84-C18	Z-diode	18V±5%, 300mW	SOT-23	16dc	-	3a	PhM
Y6W	BZX84-C18	Z-diode	18V±5%, 300mW	SOT-23	16dc	-	3a	PhC
Y6Y	CMSZDA18V	Z-diode	Dual, 16.8..19.1V, Zzt=45Ω, 9.2mA, 275mW	SOT-323	16df	-	3a	Cen



SMD code	Type	Function	Short description	Case	Pinout	Sch.	St.	Mnf.
Y7	APX809-26SR	Vdet-IC	2.63V±1.5%, -Reset PPO	SOT-23	16vdb	VD7	3b	Di
Y7	BZX84-A20	Z-diode	20V±1%, Izt=12mA, 350mW	SOT-23	16dc	-	3a	Cen
Y7	BZX84-B20	Z-diode	20V±2%, Izt=12mA, 350mW	SOT-23	16dc	-	3a	Cen
Y7	BZX84-C20	Z-diode	18.8..21.2V, Izt=5mA, Zzt=55Ω, 350mW	SOT-23	16eb	-	3a	Ttr
Y7	BZX84-C20-V	Z-diode	20V±5%, Zzt=15Ω(55mA), 300mW	SOT-23	16dc	-	3a,3g	Cen,F
Y7	BZX88-C20	Z-diode	20V±5%, 200mW	SOT-323	16dc	-	3a	Zx
Y7	CZRT55C20	Z-diode	18.8..21.2V, Zzt=55Ω, Izt=5mA, 350mW	SOT-23	16dc	-	3a	Cmc
Y7	ELM7647LBB	Vdet-IC	4.7V±2%, -Reset PPO, 500ms	SOT-23	16vdc	VD7	3d	Elm
Y7	KN4A4Z	Si-pnp-Digi	Sw, 60V, 100mA, 150mW, R1=10k	SOT-416	16ta	-	3a	Nec
Y70	BZX84-A16	Z-diode	16V±1%, 300mW	SOT-23	16dc	-	3a	Phi
Y71	BZX84-A18	Z-diode	18V±1%, 300mW	SOT-23	16dc	-	3a	Phi
Y72	BZX84-A20	Z-diode	20V±1%, 300mW	SOT-23	16dc	-	3a	Phi
Y73	BZX84-A22	Z-diode	22V±1%, 300mW	SOT-23	16dc	-	3a	Phi
Y74	BZX84-A24	Z-diode	24V±1%, 300mW	SOT-23	16dc	-	3a	Phi
Y75	BZX84-A27	Z-diode	27V±1%, 300mW	SOT-23	16dc	-	3a	Phi
Y76	BZX84-A30	Z-diode	30V±1%, 300mW	SOT-23	16dc	-	3a	Phi
Y77	BZX84-A33	Z-diode	33V±1%, 300mW	SOT-23	16dc	-	3a	Phi
Y78	BZX84-A36	Z-diode	36V±1%, 300mW	SOT-23	16dc	-	3a	Phi
Y79	BZX84-A39	Z-diode	39V±1%, 300mW	SOT-23	16dc	-	3a	Phi
Y7p	BZX84-C20	Z-diode	20V±5%, 300mW	SOT-23	16dc	-	3a	PHM
Y7t	BZX84-C20	Z-diode	20V±5%, 300mW	SOT-23	16dc	-	3a	PHH
Y7W	BZX84-C20	Z-diode	20V±5%, 300mW	SOT-23	16dc	-	3a	PhC
Y7Y	CMSZDA20V	Z-diode	Dual, 18.8..21.2V, Zzt=55Ω, 8.3mA, 275mW	SOT-323	16df	-	3a	Cen
Y8	APX809-23SR	Vdet-IC	2.25V±1.5%, -Reset PPO	SOT-23	16vdb	VD7	3b	Di
Y8	BZX84-A22	Z-diode	22V±1%, Izt=11mA, 350mW	SOT-23	16dc	-	3a	Cen
Y8	BZX84-B22	Z-diode	22V±2%, Izt=11mA, 350mW	SOT-23	16dc	-	3a	Cen
Y8	BZX84-C22	Z-diode	20.8..23.3V, Izt=5mA, Zzt=55Ω, 350mW	SOT-23	16eb	-	3a	Ttr
Y8	BZX84-C22-V	Z-diode	22V±5%, Zzt=20Ω(55mA), 300mW	SOT-23	16dc	-	3a,3g	Cen,F
Y8	BZX84-C7V5	Z-diode	7.0..7.9V, Zzt=15Ω, Izt=20mA, 225mW	SOT-23	16dc	-	3a	Lge
Y8	BZX88-C22	Z-diode	22V±5%, 200mW	SOT-323	16dc	-	3a	Zx
Y8	CZRT55C22	Z-diode	20.8..23.3V, Zzt=55Ω, Izt=5mA, 350mW	SOT-23	16dc	-	3a	Cmc
Y8	ELM7648LBB	Vdet-IC	4.8V±2%, -Reset PPO, 500ms	SOT-23	16vdc	VD7	3d	Elm
Y80	BZX84-A43	Z-diode	43V±1%, 300mW	SOT-23	16dc	-	3a	Phi
Y81	BZX84-A47	Z-diode	47V±1%, 300mW	SOT-23	16dc	-	3a	Phi
Y82	BZX84-A51	Z-diode	51V±1%, 300mW	SOT-23	16dc	-	3a	Phi
Y83	BZX84-A56	Z-diode	56V±1%, 300mW	SOT-23	16dc	-	3a	Phi
Y84	BZX84-A62	Z-diode	62V±1%, 300mW	SOT-23	16dc	-	3a	Phi
Y85	BZX84-A68	Z-diode	68V±1%, 300mW	SOT-23	16dc	-	3a	Phi
Y86	BZX84-A75	Z-diode	75V±1%, 300mW	SOT-23	16dc	-	3a	Phi
Y8p	BZX84-C22	Z-diode	20.8..23.3V, Zzt=55Ω, Izt=20mA, 300mW	SOT-23	16dc	-	3a	PHH
Y8t	BZX84-C22	Z-diode	20.8..23.3V, Zzt=55Ω, Izt=20mA, 300mW	SOT-23	16dc	-	3a	PHM
Y8W	BZX84-C22	Z-diode	20.8..23.3V, Zzt=55Ω, Izt=20mA, 300mW	SOT-23	16dc	-	3a	PhC
Y8Y	CMSZDA22V	Z-diode	Dual, 20.8..23.3V, Zzt=55Ω, 7.6mA, 275mW	SOT-323	16df	-	3a	Cen
Y9	BZX84-A24	Z-diode	24V±1%, Izt=10mA, 350mW	SOT-23	16dc	-	3a	Cen
Y9	BZX84-B24	Z-diode	24V±2%, Izt=10mA, 350mW	SOT-23	16dc	-	3a	Cen
Y9	BZX84-C24	Z-diode	22.8..25.6V, Izt=2mA, Zzt=70Ω, 350mW	SOT-23	16eb	-	3a	Ttr
Y9	BZX84-C24-V	Z-diode	24V±5%, Zzt=25Ω(70mA), 300mW	SOT-23	16dc	-	3a,3g	Cen,F
Y9	BZX84-C36	Z-diode	34..38V, Zzt=90Ω, Izt=20mA, 225mW	SOT-23	16dc	-	3a	Lge
Y9	BZX88-C24	Z-diode	24V±5%, 200mW	SOT-323	16dc	-	3a	Zx
Y9	CZRT55C24	Z-diode	22.8..25.6V, Zzt=70Ω, Izt=5mA, 350mW	SOT-23	16dc	-	3a	Cmc
Y9	ECG5031SM	Z-diode	24V±5%, 300mW	SOT-23	16dc	-	3a	Ecog
Y9	ELM7649LBB	Vdet-IC	4.9V±2%, -Reset PPO, 500ms	SOT-23	16vdc	VD7	3d	Elm
Y9	NTE5031SM	Z-diode	24V±5%, 300mW	SOT-23	16dc	-	3a	Nte
Y9p	BZX84-C24	Z-diode	24V±5%, 300mW	SOT-23	16dc	-	3a	PHH
Y9t	BZX84-C24	Z-diode	24V±5%, 300mW	SOT-23	16dc	-	3a	PHM
Y9W	BZX84-C24	Z-diode	24V±5%, 300mW	SOT-23	16dc	-	3a	PhC
Y9Y	CMSZDA24V	Z-diode	Dual, 22.8..25.6V, Zzt=70Ω, 7.0mA, 275mW	SOT-323	16df	-	3a	Cen
YA	3LN01C	n-MOSFET*	Sw, U-Hi-Sp, 30V, 150mA, 250mW, 19/155ns, 3.7Ω (50mA)	SOT-23	16fh	-	3a	San
YA	3LN01M	n-MOSFET*	Sw, U-Hi-Sp, 30V, 150mA, 150mW, 19/155ns, 3.7Ω (50mA)	MCP	16fh	-	3a	San
YA	3LN01S	n-MOSFET*	Sw, U-Hi-Sp, 30V, 150mA, 150mW, 19/155ns, 3.7Ω (50mA)	SMCP	16fh	-	3a	San
YA	3LN01SS	n-MOSFET*	Sw, U-Hi-Sp, 30V, 150mA, 150mW, 19/155ns, 3.7Ω (50mA)	SSFP	18fh	-	3a	San
YA	APX810-46SR	Vdet-IC	4.63V±1.5%, +Reset PPO	SOT-23	16vdb	VD7	3b	Di
YA	RN1119FV	Si-npn-Digi	Sw, 50V, 100mA, 150mW, R1=1k	SOT-723	18ta	-	3a	Tos
YA	RN2101	Si-pnp-Digi	Sw, 50V, 100mA, 100mW, R1/R2=4.7k/4.7k	SOT-416	16ta	-	3a	Tos
YA	RN2101F	Si-pnp-Digi	Sw, 50V, 100mA, 100mW, R1/R2=4.7k/4.7k	SOT-490	18ta	-	3a	Tos
YA	RN2101FT	Si-pnp-Digi	Sw, 50V, 100mA, 100mW, R1/R2=4.7k/4.7k	TESM	18ta	-	3a	Tos
YA	RN2101FV	Si-pnp-Digi	Sw, 50V, 100mA, 150mW, R1/R2=4.7k/4.7k	SOT-723	18ta	-	3a	Tos
YA	RN2119FV	Si-pnp-Digi	Sw, 50V, 100mA, 150mW, R1=1k	SOT-723	18ta	-	3a	Tos
YA	RN2301	Si-pnp-Digi	Sw, 50V, 100mA, 400mW, R1/R2=4.7k/4.7k	SOT-346	16ta	-	3a	Tos
YA	RN2401	Si-pnp-Digi	Sw, 50V, 100mA, 400mW, R1/R2=4.7k/4.7k	SOT-346	16ta	-	3a	Tos
YA-	2SC4784	Si-npn	VHF/UHF, 15V, 20mA, 100mW, 10GHz, B=50..250	SOT-323	16ta	-	3a	Ren



SMD code	Type	Function	Short description	Case	Pinout	Sch.	St.	Mnf.
YA-	2SC5049	Si-npn	VHF/UHF, LN, 15V, 20mA, 150mW, B=50..250, 10GHz	SC-59A	16ta	-	3a	Ren
YA-	2SC5137	Si-npn	VHF/UHF, 15V, 20mA, 80mW, B=50..250, 10GHz	SMPAK	16ta	-	3a	Ren
YAs	BSS83P	p-MOSFET-e	V-MOS, LogL, 60V, 330mA, <3Ω	SOT-23	16fh	-	3a	Sie
YB	5LN01C	n-MOSFET*	Sw, U-Hi-Sp, 50V, 100mA, 250mW, 25/350ns	SOT-23	16fh	-	3a	San
YB	5LN01M	n-MOSFET*	Sw, U-Hi-Sp, 50V, 100mA, 150mW, 25/350ns	MCP	16fh	-	3a	San
YB	5LN01S	n-MOSFET*	Sw, U-Hi-Sp, 50V, 100mA, 150mW, 25/350ns	SMCP	16fh	-	3a	San
YB	5LN01SS	n-MOSFET*	Sw, U-Hi-Sp, 50V, 100mA, 150mW, 25/350ns	SSFP	18fh	-	3a	San
YB	APX810-44SR	Vdet-IC	4.38V±1.5%, +Reset PPO	SOT-23	16vdb	VD7	3b	Di
YB	CZMK13	Z-diode	Dual, 13V±5%, 300mW	SOT-23	16dg	-	3a	Cdi
YB	RN2102	Si-pnp-Digi	Sw, 50V, 100mA, 100mW, R1/R2=10k/10k	SOT-416	16ta	-	3a	Tos
YB	RN2102F	Si-pnp-Digi	Sw, 50V, 100mA, 100mW, R1/R2=10k/10k	SOT-490	18ta	-	3a	Tos
YB	RN2102FT	Si-pnp-Digi	Sw, 50V, 100mA, 100mW, R1/R2=10k/10k	TESM	18ta	-	3a	Tos
YB	RN2102FV	Si-pnp-Digi	Sw, 50V, 100mA, 150mW, R1/R2=10k/10k	SOT-723	18ta	-	3a	Tos
YB	RN2302	Si-pnp-Digi	Sw, 50V, 100mA, 400mW, R1/R2=10k/10k	SOT-346	16ta	-	3a	Tos
YB	RN2402	Si-pnp-Digi	Sw, 50V, 100mA, 400mW, R1/R2=10k/10k	SOT-346	16ta	-	3a	Tos
YB	TZT13CW	Z-diode	Dual, 12.4..14.1V, lzt=5mA, Zzt=30Ω, 300mW	SOT-23	16dg	-	3a	Ttr
YBs	BSS84P	p-MOSFET-e*	V-MOS, LogL, 60V, 130mA, 250mW, <10Ω(130mA), 3/7ns	SOT-23	16fh	-	3c	Inf
YBs	BSS84PW	p-MOSFET-e*	V-MOS, LogL, 60V, 130mA, 250mW, <10Ω(130mA), 3/7ns	SOT-23	16fh	-	3c	Inf
YC	5HN01C	n-MOSFET*	Sw, U-Hi-Sp, 50V, 100mA, 250mW, 10/105ns, 5.8Ω (50mA)	SOT-23	16fh	-	3a	San
YC	5HN01M	n-MOSFET*	Sw, U-Hi-Sp, 50V, 100mA, 150mW, 10/105ns, 5.8Ω (50mA)	MCP	16fh	-	3a	San
YC	5HN01S	n-MOSFET*	Sw, U-Hi-Sp, 50V, 100mA, 150mW, 10/105ns, 5.8Ω (50mA)	SMCP	16fh	-	3a	San
YC	5HN01SS	n-MOSFET*	Sw, U-Hi-Sp, 50V, 100mA, 150mW, 10/105ns, 5.8Ω (50mA)	SMCP	18fh	-	3a	San
YC	APX810-40SR	Vdet-IC	4.0V±1.5%, +Reset PPO	SOT-23	16vdb	VD7	3b	Di
YC	CHT847BM1PT-R	Si-npn	AF, Sw, 45V, 100mA, B=200..450, 200MHz	FBPT-723	17ta	-	9a	Chm
YC	CHT847BTPT-R	Si-npn	AF, Sw, 45V, 100mA, B=200..450, 200MHz	SOT-416	16ta	-	3a	Chm
YC	CZMK15	Z-diode	Dual, 15V±5%, 300mW	SOT-23	16dg	-	3a	Cdi
YC	RN2103	Si-pnp-Digi	Sw, 50V, 100mA, 100mW, R1/R2=22k/22k	SOT-416	16ta	-	3a	Tos
YC	RN2103F	Si-pnp-Digi	Sw, 50V, 100mA, 100mW, R1/R2=22k/22k	SOT-490	18ta	-	3a	Tos
YC	RN2103FT	Si-pnp-Digi	Sw, 50V, 100mA, 100mW, R1/R2=22k/22k	TESM	18ta	-	3a	Tos
YC	RN2103FV	Si-pnp-Digi	Sw, 50V, 100mA, 150mW, R1/R2=22k/22k	SOT-723	18ta	-	3a	Tos
YC	RN2303	Si-pnp-Digi	Sw, 50V, 100mA, 400mW, R1/R2=22k/22k	SOT-346	16ta	-	3a	Tos
YC	RN2403	Si-pnp-Digi	Sw, 50V, 100mA, 400mW, R1/R2=22k/22k	SOT-346	16ta	-	3a	Tos
YC	TZT15CW	Z-diode	Dual, 13.8..15.6V, lzt=5mA, Zzt=30Ω, 300mW	SOT-23	16dg	-	3a	Ttr
YC-	2SC5998	Si-npn	UHF/VHFamp, 13V, 500mA, 700mW, 11GHz, B=110..190	MPAK	16tb	-	3a	Ren
YD	APX810-31SR	Vdet-IC	3.08V±1.5%, +Reset PPO	SOT-23	16vdb	VD7	3b	Di
YD	CZMK16	Z-diode	Dual, 16V±5%, 300mW	SOT-23	16dg	-	3a	Cdi
YD	RN2104	Si-pnp-Digi	Sw, 50V, 100mA, 100mW, R1/R2=47k/47k	SOT-416	16ta	-	3a	Tos
YD	RN2104F	Si-pnp-Digi	Sw, 50V, 100mA, 100mW, R1/R2=47k/47k	SOT-490	18ta	-	3a	Tos
YD	RN2104FT	Si-pnp-Digi	Sw, 50V, 100mA, 100mW, R1/R2=47k/47k	TESM	18ta	-	3a	Tos
YD	RN2104FV	Si-pnp-Digi	Sw, 50V, 100mA, 150mW, R1/R2=47k/47k	SOT-723	18ta	-	3a	Tos
YD	RN2304	Si-pnp-Digi	Sw, 50V, 100mA, 400mW, R1/R2=47k/47k	SOT-346	16ta	-	3a	Tos
YD	RN2404	Si-pnp-Digi	Sw, 50V, 100mA, 400mW, R1/R2=47k/47k	SOT-346	16ta	-	3a	Tos
YD	TZT16CW	Z-diode	Dual, 15.3..17.1V, lzt=5mA, Zzt=40Ω, 300mW	SOT-23	16dg	-	3a	Ttr
YDAV	YB1253ST23X120	LVR-IC	LDO, 1.2V±2%, 300mA	SOT-23	16cg	VR1	3a	Ybn
YDBV	YB1253ST23X130	LVR-IC	LDO, 1.3V±2%, 300mA	SOT-23	16cg	VR1	3a	Ybn
YDCV	YB1253ST23X140	LVR-IC	LDO, 1.4V±2%, 300mA	SOT-23	16cg	VR1	3a	Ybn
YDDV	YB1253ST23X150	LVR-IC	LDO, 1.5V±2%, 300mA	SOT-23	16cg	VR1	3a	Ybn
YDEV	YB1253ST23X160	LVR-IC	LDO, 1.6V±2%, 300mA	SOT-23	16cg	VR1	3a	Ybn
YDFV	YB1253ST23X170	LVR-IC	LDO, 1.7V±2%, 300mA	SOT-23	16cg	VR1	3a	Ybn
YDGV	YB1253ST23X180	LVR-IC	LDO, 1.8V±2%, 300mA	SOT-23	16cg	VR1	3a	Ybn
YDHV	YB1253ST23X190	LVR-IC	LDO, 1.9V±2%, 300mA	SOT-23	16cg	VR1	3a	Ybn
YDIV	YB1253ST23X200	LVR-IC	LDO, 2.0V±2%, 300mA	SOT-23	16cg	VR1	3a	Ybn
YDJV	YB1253ST23X210	LVR-IC	LDO, 2.1V±2%, 300mA	SOT-23	16cg	VR1	3a	Ybn
YDKV	YB1253ST23X220	LVR-IC	LDO, 2.2V±2%, 300mA	SOT-23	16cg	VR1	3a	Ybn
YDLV	YB1253ST23X230	LVR-IC	LDO, 2.3V±2%, 300mA	SOT-23	16cg	VR1	3a	Ybn
YDMV	YB1253ST23X240	LVR-IC	LDO, 2.4V±2%, 300mA	SOT-23	16cg	VR1	3a	Ybn
YDNV	YB1253ST23X250	LVR-IC	LDO, 2.5V±2%, 300mA	SOT-23	16cg	VR1	3a	Ybn
YDOV	YB1253ST23X260	LVR-IC	LDO, 2.6V±2%, 300mA	SOT-23	16cg	VR1	3a	Ybn
YDPV	YB1253ST23X270	LVR-IC	LDO, 2.7V±2%, 300mA	SOT-23	16cg	VR1	3a	Ybn
YDQV	YB1253ST23X280	LVR-IC	LDO, 2.8V±2%, 300mA	SOT-23	16cg	VR1	3a	Ybn
YDRV	YB1253ST23X290	LVR-IC	LDO, 2.9V±2%, 300mA	SOT-23	16cg	VR1	3a	Ybn
YDSV	YB1253ST23X300	LVR-IC	LDO, 3.0V±2%, 300mA	SOT-23	16cg	VR1	3a	Ybn
YDTV	YB1253ST23X310	LVR-IC	LDO, 3.1V±2%, 300mA	SOT-23	16cg	VR1	3a	Ybn
YDUV	YB1253ST23X320	LVR-IC	LDO, 3.2V±2%, 300mA	SOT-23	16cg	VR1	3a	Ybn
YDVV	YB1253ST23X330	LVR-IC	LDO, 3.3V±2%, 300mA	SOT-23	16cg	VR1	3a	Ybn
YDWW	YB1253ST23X340	LVR-IC	LDO, 3.4V±2%, 300mA	SOT-23	16cg	VR1	3a	Ybn
YDXV	YB1253ST23X350	LVR-IC	LDO, 3.5V±2%, 300mA	SOT-23	16cg	VR1	3a	Ybn
YDYV	YB1253ST23X360	LVR-IC	LDO, 3.6V±2%, 300mA	SOT-23	16cg	VR1	3a	Ybn
YE	5LN02C	n-MOSFET*	Sw, U-Hi-Sp, 50V, 200mA, 250mW, 25/350ns	SOT-23	16fh	-	3a	San
YE	5LN02M	n-MOSFET*	Sw, U-Hi-Sp, 50V, 200mA, 150mW, 25/350ns	MCP	16fh	-	3a	San
YE	APX810-29SR	Vdet-IC	2.93V±1.5%, +Reset PPO	SOT-23	16vdb	VD7	3b	Di



SMD code	Type	Function	Short description	Case	Pinout	Sch. St.	Mnf.
YE	CZMK18	Z-diode	Dual, 18V±5%, 300mW	SOT-23	16dg	-	3a Cdi
YE	RN2105	Si-pnp-Digi	Sw, 50V, 100mA, 100mW, R1/R2=2.2k/47k	SOT-416	16ta	-	3a Tos
YE	RN2105F	Si-pnp-Digi	Sw, 50V, 100mA, 100mW, R1/R2=2.2k/47k	SOT-490	18ta	-	3a Tos
YE	RN2105FT	Si-pnp-Digi	Sw, 50V, 100mA, 100mW, R1/R2=2.2k/47k	TESM	18ta	-	3a Tos
YE	RN2105FV	Si-pnp-Digi	Sw, 50V, 100mA, 150mW, R1/R2=2.2k/47k	SOT-723	18ta	-	3a Tos
YE	RN2305	Si-pnp-Digi	Sw, 50V, 100mA, 400mW, R1/R2=2.2k/47k	SOT-346	16ta	-	3a Tos
YE	RN2405	Si-pnp-Digi	Sw, 50V, 100mA, 400mW, R1/R2=2.2k/47k	SOT-346	16ta	-	3a Tos
YE	TZT18CW	Z-diode	Dual, 16.8..19.1V, lzt=5mA, Zzt=45Ω, 300mW	SOT-23	16dg	-	3a Ttr
YE1	CHDTA123YEPT	Si-pnp-Digi	Sw, 50V, 100mA, 250MHz, R1/R2=2.2/10k	SOT-416	16ta	-	3a Chm
YE2	CHDTA114YEPT	Si-pnp-Digi	Sw, 50V, 70mA, 250MHz, R1/R2=10/47k	SOT-416	16ta	-	3a Chm
YEA	CHDTC123YEPT	Si-npn-Digi	Sw, 50V, 100mA, 250MHz, R1/R2=2.2/10k	SOT-416	16ta	-	3a Chm
YF	APX810-26SR	Vdet-IC	2.63V±1.5%, +Reset PPO	SOT-23	16vdb	VD7	3b Di
YF	CZMK20	Z-diode	Dual, 20V±5%, 300mW	SOT-23	16dg	-	3a Cdi
YF	RN2106	Si-pnp-Digi	Sw, 50V, 100mA, 100mW, R1/R2=4.7k/47k	SOT-416	16ta	-	3a Tos
YF	RN2106F	Si-pnp-Digi	Sw, 50V, 100mA, 100mW, R1/R2=4.7k/47k	SOT-490	18ta	-	3a Tos
YF	RN2106FT	Si-pnp-Digi	Sw, 50V, 100mA, 100mW, R1/R2=4.7k/47k	TESM	18ta	-	3a Tos
YF	RN2106FV	Si-pnp-Digi	Sw, 50V, 100mA, 150mW, R1/R2=4.7k/47k	SOT-723	18ta	-	3a Tos
YF	RN2306	Si-pnp-Digi	Sw, 50V, 100mA, 400mW, R1/R2=4.7k/47k	SOT-346	16ta	-	3a Tos
YF	RN2406	Si-pnp-Digi	Sw, 50V, 100mA, 400mW, R1/R2=4.7k/47k	SOT-346	16ta	-	3a Tos
YF	TZT20CW	Z-diode	Dual, 18.8..21.2V, lzt=5mA, Zzt=55Ω, 300mW	SOT-23	16dg	-	3a Ttr
YFB	2SC4932-B	Si-npn	AF, GP, 20V, 500mA, 150mW, B=135..270, 300MHz	SOT-323	16ta	-	3a Ren
YFC	2SC4932-C	Si-npn	AF, GP, 20V, 500mA, 150mW, B=200..400, 300MHz	SOT-323	16ta	-	3a Ren
YFD	2SC4932-D	Si-npn	AF, GP, 20V, 500mA, 150mW, B=300..600, 300MHz	SOT-323	16ta	-	3a Ren
YG	APX810-23SR	Vdet-IC	2.25V±1.5%, +Reset PPO	SOT-23	16vdb	VD7	3b Di
YG	BCX71RG	Si-pnp	GP, 45V, 100mA, 330mW, B=120..220, 250MHz	SOT-23	16ta	-	3a Sil
YG	CZMK22	Z-diode	Dual, 22V±5%, 300mW	SOT-23	16dg	-	3a Cdi
YG	TZT22CW	Z-diode	Dual, 20.8..23.3V, lzt=5mA, Zzt=55Ω, 300mW	SOT-23	16dg	-	3a Ttr
YH	BCX71RH	Si-pnp	GP, 45V, 200mA, 250mW, B=180..310, >100MHz	SOT-23	16ta	-	3a Sil
YH	CZMK24	Z-diode	Dual, 24V±5%, 300mW	SOT-23	16dg	-	3a Cdi
YH	RN2107	Si-pnp-Digi	Sw, 50V, 100mA, 100mW, R1/R2=10k/47k	SOT-416	16ta	-	3a Tos
YH	RN2107F	Si-pnp-Digi	Sw, 50V, 100mA, 100mW, R1/R2=10k/47k	SOT-490	18ta	-	3a Tos
YH	RN2307	Si-pnp-Digi	Sw, 50V, 100mA, 400mW, R1/R2=10k/47k	SOT-346	16ta	-	3a Tos
YH	RN2407	Si-pnp-Digi	Sw, 50V, 100mA, 400mW, R1/R2=10k/47k	SOT-346	16ta	-	3a Tos
YH	TZT24CW	Z-diode	Dual, 22.8..25.6V, lzt=5mA, Zzt=70Ω, 300mW	SOT-23	16dg	-	3a Ttr
YH-	2SC4899	Si-npn	VHF/UHF, 15V, 20mA, 100mW, 9GHz, B=50..250	SOT-323	16ta	-	3a Ren
YH-	2SC5140	Si-npn	VHF/UHF, 15V, 20mA, 80mW, B=50..250, 9GHz	SOT-23	16ta	-	3a Ren
YI	RN2108	Si-pnp-Digi	Sw, 50V, 100mA, 100mW, R1/R2=22k/47k	SOT-416	16ta	-	3a Tos
YI	RN2308	Si-pnp-Digi	Sw, 50V, 100mA, 400mW, R1/R2=22k/47k	SOT-346	16ta	-	3a Tos
YI	RN2408	Si-pnp-Digi	Sw, 50V, 100mA, 400mW, R1/R2=22k/47k	SOT-346	16ta	-	3a Tos
YI-	2SA1666	Si-pnp	HF/Sw, 20V, 200mA, 35/70ns	SOT-23	16ta	-	3a Ren
YJ	BCX71RJ	Si-pnp	GP, Sw, 45V, 100mA, 250mW, B=250..460, >100MHz	SOT-23	16ta	-	3a Sil
YJ	CZMK27	Z-diode	Dual, 27V±5%, 300mW	SOT-23	16dg	-	3a Cdi
YJ	RN2109	Si-pnp-Digi	Sw, 50V, 100mA, 100mW, R1/R2=47k/22k	SOT-416	16ta	-	3a Tos
YJ	RN2309	Si-pnp-Digi	Sw, 50V, 100mA, 400mW, R1/R2=47k/22k	SOT-346	16ta	-	3a Tos
YJ	RN2409	Si-pnp-Digi	Sw, 50V, 100mA, 400mW, R1/R2=47k/22k	SOT-346	16ta	-	3a Tos
YJ	TZT27CW	Z-diode	Dual, 25.1..28.9V, lzt=2mA, Zzt=80Ω, 300mW	SOT-23	16dg	-	3a Ttr
YJ5	2SK2394-5	n-FET	LN, HF, 15V, 50mA, 200mW, Idss=6..12mA	CP	16fa	-	3a San
YJ6	2SK2394-6	n-FET	LN, HF, 15V, 50mA, 200mW, Idss=10..20mA	CP	16fa	-	3a San
YJ7	2SK2394-7	n-FET	LN, HF, 15V, 50mA, 200mW, Idss=16..32mA	CP	16fa	-	3a San
YK	15C025	Si-npn	AF, GP, 20V, 800mA, 200mW, B=300..600, 440MHz	SMCP	16ta	-	3a San
YK	15C02SS	Si-npn	AF, GP, 20V, 800mA, 200mW, B=300..600, 440MHz	SSFP	18ta	-	3a San
YK	BCX71RK	Si-pnp	GP, Sw, 45V, 100mA, 250mW, B=380..630, >100MHz	SOT-23	16ta	-	3a Sil
YK	CZMK30	Z-diode	Dual, 30V±5%, 300mW	SOT-23	16dg	-	3a Cdi
YK	RN2110	Si-pnp-Digi	Sw, 50V, 100mA, 100mW, R1=4.7k	SOT-416	16ta	-	3a Tos
YK	RN2110FT	Si-pnp-Digi	Sw, 50V, 100mA, 100mW, R1=4.7k	TESM	18ta	-	3a Tos
YK	RN2310	Si-pnp-Digi	Sw, 50V, 100mA, 400mW, R1=4.7k	SOT-346	16ta	-	3a Tos
YK	RN2410	Si-pnp-Digi	Sw, 50V, 100mA, 400mW, R1=4.7k	SOT-346	16ta	-	3a Tos
YK	TZT30CW	Z-diode	Dual, 28.0..32.0V, lzt=2mA, Zzt=80Ω, 300mW	SOT-23	16dg	-	3a Ttr
YK-	2SC4901	Si-npn	UHF/VHF WB-amp, 15V, 50mA, 150mW, 9GHz, B=50..250	COMPACT	16ta	-	3a Ren
YK-	2SC5218	Si-npn	VHF/UHF, 15V, 50mA, 9GHz	SOT-23	16ta	-	3a Ren
YK1	CHDTA123YKPT	Si-pnp-Digi	Sw, 50V, 100mA, 250MHz, R1/R2=2.2/10k	SOT-23	16ta	-	3a Chm
YK3	CHDTB123YKPT	Si-pnp-Digi	Sw, 50V, 500mA, 200MHz, R1/R2=2.2/10k	SOT-23	16ta	-	3a Chm
YKA	CHDTC123YKPT	Si-npn-Digi	Sw, 50V, 100mA, 250MHz, R1/R2=2.2/10k	SOT-23	16ta	-	3a Chm
YKC	CHDTD123YKPT	Si-npn-Digi	Sw, 50V, 500mA, 200MHz, R1/R2=2.2/10k	SOT-23	16ta	-	3a Chm
YL	CZMK33	Z-diode	Dual, 33V±5%, 300mW	SOT-23	16dg	-	3a Cdi
YL	TZT33CW	Z-diode	Dual, 31.0..35.0V, lzt=2mA, Zzt=80Ω, 300mW	SOT-23	16dg	-	3a Ttr
YL-	2SC4902	Si-npn	VHF/UHF, 20V, 30mA, 150mW, B=50..250, 6GHz	SOT-23	16ta	-	3a Ren
YL-	2SC4903	Si-npn	VHF/UHF, LN, 20V, 30mA, 100mW, B=50..250, 6GHz	SOT-323	16ta	-	3a Ren
YL-	2SC5138	Si-npn	VHF/UHF, 20V, 30mA, 80mW, B=50..250, 6GHz	SOT-23	16ta	-	3a Ren
YL09	SGM2021-09YN3G	LVR-IC	LDO, 0.9V±2.2%, 300mA	SOT-23	16cq	VR1	3a Sgm
YL12	SGM2021-1.2YN3G	LVR-IC	LDO, 1.2V±2.2%, 300mA	SOT-23	16cq	VR1	3a Sgm



SMD code	Type	Function	Short description	Case	Pinout	Sch.	St.	Mnf.
YL13	SGM2021-1.3YN3G	LVR-IC	LDO, 1.3V±2.2%, 300mA	SOT-23	16cq	VR1	3a	Sgm
YL15	SGM2021-1.5YN3G	LVR-IC	LDO, 1.5V±2.2%, 300mA	SOT-23	16cq	VR1	3a	Sgm
YL18	SGM2021-1.8YN3G	LVR-IC	LDO, 1.8V±2.2%, 300mA	SOT-23	16cq	VR1	3a	Sgm
YL21	SGM2021-2.1YN3G	LVR-IC	LDO, 2.1V±2.2%, 300mA	SOT-23	16cq	VR1	3a	Sgm
YL25	SGM2021-2.5YN3G	LVR-IC	LDO, 2.5V±2.2%, 300mA	SOT-23	16cq	VR1	3a	Sgm
YL26	SGM2021-2.6YN3G	LVR-IC	LDO, 2.6V±2.2%, 300mA	SOT-23	16cq	VR1	3a	Sgm
YL27	SGM2021-2.7YN3G	LVR-IC	LDO, 2.7V±2.2%, 300mA	SOT-23	16cq	VR1	3a	Sgm
YL28	SGM2021-2.8YN3G	LVR-IC	LDO, 2.8V±2.2%, 300mA	SOT-23	16cq	VR1	3a	Sgm
YL29	SGM2021-2.9YN3G	LVR-IC	LDO, 2.9V±2.2%, 300mA	SOT-23	16cq	VR1	3a	Sgm
YL2J	SGM2021-2.85YN3G	LVR-IC	LDO, 2.85V±2.2%, 300mA	SOT-23	16cq	VR1	3a	Sgm
YL3	2SA1607-3	Si-pnp	Sw, 40V, 150mA, 200mA, B=60..120, 700MHz	SOT-23	16ta	-	3a	San
YL3	2SA1685-3	Si-pnp	Sw, 20V, 150mA, 150mW, B=60..120, 700MHz	MCP	16ta	-	3a	San
YL30	SGM2021-3.0YN3G	LVR-IC	LDO, 3.0V±2.2%, 300mA	SOT-23	16cq	VR1	3a	Sgm
YL31	SGM2021-3.1YN3G	LVR-IC	LDO, 3.1V±2.2%, 300mA	SOT-23	16cq	VR1	3a	Sgm
YL32	SGM2021-3.2YN3G	LVR-IC	LDO, 3.2V±2.2%, 300mA	SOT-23	16cq	VR1	3a	Sgm
YL33	SGM2021-3.3YN3G	LVR-IC	LDO, 3.3V±2.2%, 300mA	SOT-23	16cq	VR1	3a	Sgm
YL36	SGM2021-3.6YN3G	LVR-IC	LDO, 3.6V±2.2%, 300mA	SOT-23	16cq	VR1	3a	Sgm
YL4	2SA1607-4	Si-pnp	Sw, 40V, 150mA, 200mA, B=90..180, 700MHz	SOT-23	16ta	-	3a	San
YL4	2SA1685-4	Si-pnp	Sw, 20V, 150mA, 150mW, B=90..180, 700MHz	MCP	16ta	-	3a	San
YL42	SGM2021-4.2YN3G	LVR-IC	LDO, 4.2V±2.2%, 300mA	SOT-23	16cq	VR1	3a	Sgm
YL50	SGM2021-5.0YN3G	LVR-IC	LDO, 5.0V±2.2%, 300mA	SOT-23	16cq	VR1	3a	Sgm
YLN	ELM7514CEB	Vdet-IC	1.4V±2%, +Reset PPO	SC-70	16vdb	VD7	3d	Elm
YLN	ELM7514NEB	Vdet-IC	1.4V±2%, +Reset ODO	SC-70	16vdb	VD6	3d	Elm
YM	30C02S	Si-npn	AF, GP, 40V, 600mA, 200mW, B=300..600, 540MHz	SMCP	16ta	-	3a	San
YM	30C02SS	Si-npn	AF, GP, 40V, 600mA, 200mW, B=300..600, 540MHz	SSFP	18ta	-	3a	San
YM	CZMK36	Z-diode	Dual, 36V±5%, 300mW	SOT-23	16dg	-	3a	Cdi
YM	RN2111	Si-pnp-Digi	Sw, 50V, 100mA, 100mW, R1=10k	SOT-416	16ta	-	3a	Tos
YM	RN2111FT	Si-pnp-Digi	Sw, 50V, 100mA, 100mW, R1=10k	TESM	18ta	-	3a	Tos
YM	RN2311	Si-pnp-Digi	Sw, 50V, 100mA, 400mW, R1=10k	SOT-346	16ta	-	3a	Tos
YM	RN2411	Si-pnp-Digi	Sw, 50V, 100mA, 400mW, R1=10k	SOT-346	16ta	-	3a	Tos
YM	TZT36CW	Z-diode	Dual, 34.0..38.0V, Izt=2mA, Zzt=130Ω, 300mW	SOT-23	16dg	-	3a	Ttr
YM-	2SC4904	Si-npn	VHF/UHF, 20V, 50mA, 150mW, B=50..250, 5.8GHz	SOT-23	16ta	-	3a	Ren
YM-	2SC4905	Si-npn	VHF/UHF, LN, 20V, 50mA, 100mW, B=50..250, 5.8GHz	SOT-323	16ta	-	3a	Ren
YN	50C02S	Si-npn	AF, GP, 60V, 400mA, 200mW, B=300..800, 500MHz	SMCP	16ta	-	3a	San
YN	50C02SS	Si-npn	AF, GP, 60V, 400mA, 200mW, B=300..800, 500MHz	SSFP	18ta	-	3a	San
YN	CZMK39	Z-diode	Dual, 39V±5%, 300mW	SOT-23	16dg	-	3a	Cdi
YN	RN2112	Si-pnp-Digi	Sw, 50V, 100mA, 100mW, R1=22k	SOT-416	16ta	-	3a	Tos
YN	RN2112FT	Si-pnp-Digi	Sw, 50V, 100mA, 100mW, R1=22k	TESM	18ta	-	3a	Tos
YN	RN2312	Si-pnp-Digi	Sw, 50V, 100mA, 400mW, R1=22k	SOT-346	16ta	-	3a	Tos
YN	TZT39CW	Z-diode	Dual, 37.0..41.0V, Izt=2mA, Zzt=130Ω, 300mW	SOT-23	16dg	-	3a	Ttr
YN-	2SC4906	Si-npn	VHF/UHF, LN, 20V, 50mA, 100mW, B=50..250, 5.8GHz	SOT-323	16ta	-	3a	Ren
YN-	2SC5141	Si-npn	VHF/UHF, 20V, 50mA, 80mW, B=50..250, 5.8GHz	SOT-23	16ta	-	3a	Ren
YP	15C01C	Si-npn	AF, GP, 20V, 700mA, 300mW, B=300..600, 330MHz	CP	16ta	-	3a	San
YP	15C01M	Si-npn	AF, GP, 20V, 700mA, 300mW, B=300..600, 330MHz	MCP	16ta	-	3a	San
YP	15C01S	Si-npn	AF, GP, 20V, 600mA, 200mW, B=300..600, 330MHz	SMCP	16ta	-	3a	San
YP	15C01SS	Si-npn	AF, GP, 20V, 600mA, 200mW, B=300..600, 330MHz	SSFP	18ta	-	3a	San
YP	2SD1484K-P	Si-npn	AF-Drv, 50V, 500mA, 200mW, B=82..180, >250MHz	SOT-346	16ta	-	3a	Rhm
YP	2SD1949K-P	Si-npn	AF-Drv, 50V, 500mA, 200mW, B=82..180, >250MHz	SOT-323	16ta	-	3a	Rhm
YP	2SD1949-P	Si-npn	AF, 50V, 500mA, 200mW, B=82..180, >250MHz	SOT-323	16ta	-	3a	Rhm
YP	DDZx6V8C	Z-diode	6.8V±2.5%, 500mW	SOT-23	16dc	-	3a	Di
YP	DDZx6V8CW	Z-diode	6.8V±2.5%, 200mW	SOT-323	16dc	-	3a	Di
YP	RN2113	Si-pnp-Digi	Sw, 50V, 100mA, 100mW, R1=47k	SOT-416	16ta	-	3a	Tos
YP	RN2113FT	Si-pnp-Digi	Sw, 50V, 100mA, 100mW, R1=47k	TESM	18ta	-	3a	Tos
YP	RN2313	Si-pnp-Digi	Sw, 50V, 100mA, 400mW, R1=47k	SOT-346	16ta	-	3a	Tos
YQ	2PA1774Q	Si-pnp	LN, 50V, 100mA, 150mW, >100MHz, B=120..270	SOT-416	16ta	-	3a	Phi
YQ	2PA1774QJ	Si-pnp	LN, 50V, 100mA, 250mW, >100MHz, B=120..270	SOT-490	18ta	-	3a	Phi
YQ	2PD601Q	Si-npn	GP, Sw, 60V, 100mA, 250mW, B=160..260, >100MHz	SOT-23	16ta	-	3a	Phi
YQ	2SD1484K-Q	Si-npn	AF-Drv, 50V, 500mA, 200mW, B=120..270, >250MHz	SOT-346	16ta	-	3a	Rhm
YQ	2SD1949K-Q	Si-npn	AF-Drv, 50V, 500mA, 200mW, B=120..270, >250MHz	SOT-323	16ta	-	3a	Rhm
YQ	2SD1949-Q	Si-npn	AF, 50V, 500mA, 200mW, B=120..270, >250MHz	SOT-323	16ta	-	3a	Rhm
YQ	2SD2216-Q	Si-npn	GP, 60V, 200mA, 125mW, 150MHz, B=160..260	SOT-416	16ta	-	3a	Pan
YQ	2SD601-Q	Si-npn	GP, AF, 50V, 600mA, B=160..260, 150MHz	SC-59	16ta	-	3a	Pan
YQ	30C01C	Si-npn	AF, GP, 40V, 400mA, 300mW, B=300..600, 380MHz	CP	16ta	-	3a	San
YQ	30C01M	Si-npn	AF, GP, 40V, 400mA, 300mW, B=300..600, 380MHz	MCP	16ta	-	3a	San
YQ	30C01S	Si-npn	AF, GP, 40V, 400mA, 200mW, B=300..600, 380MHz	SMCP	16ta	-	3a	San
YQ	30C01SS	Si-npn	AF, GP, 40V, 400mA, 200mW, B=300..600, 380MHz	SSFP	18ta	-	3a	San
YQ	DDZx7V5C	Z-diode	7.5V±2.5%, 500mW	SOT-23	16dc	-	3a	Di
YQ	DDZx7V5CW	Z-diode	7.5V±2.5%, 200mW	SOT-323	16dc	-	3a	Di
YQ	RN2114	Si-pnp-Digi	Sw, 50V, 100mA, 100mW, R1/R2=1k/10k	SOT-416	16ta	-	3a	Tos
YQ	RN2114FV	Si-pnp-Digi	Sw, 50V, 100mA, 150mW, R1/R2=1k/10k	SOT-723	18ta	-	3a	Tos
YQ	RN2314	Si-pnp-Digi	Sw, 50V, 100mA, 400mW, R1/R2=1k/10k	SOT-346	16ta	-	3a	Tos



SMD code	Type	Function	Short description	Case	Pinout	Sch.	St.	Mnf.
YQ	RN2414	Si-pnp-Digi	Sw, 50V, 100mA, 400mW, R1/R2=1k/10k	SOT-346	16ta	-	3a	Tos
YQB	2SA1867-B	Si-pnp	GP, AF, 20V, 500mA, 100mW, B=60..120	SOT-23	16ta	-	3a	Hit
YQC	2SA1867-C	Si-pnp	GP, AF, 20V, 500mA, 100mW, B=100..200	SOT-23	16ta	-	3a	Hit
YQD	2SA1867-D	Si-pnp	GP, AF, 20V, 500mA, 100mW, B=120..240	SOT-23	16ta	-	3a	Hit
YR	2PA1774R	Si-pnp	LN, 50V, 100mA, 150mW, >100MHz, B=180..390	SOT-416	16ta	-	3a	Phi
YR	2PA1774RJ	Si-pnp	LN, 50V, 100mA, 250mW, >100MHz, B=180..390	SOT-490	18ta	-	3a	Phi
YR	2PD601R	Si-npn	GP, Sw, 60V, 100mA, 250mW, B=210..340, >120MHz	SOT-23	16ta	-	3a	Phi
YR	2SD1484K-R	Si-npn	AF-Drv, 50V, 500mA, 200mW, B=180..390, >250MHz	SOT-346	16ta	-	3a	Tos
YR	2SD1949K-R	Si-npn	AF-Drv, 50V, 500mA, 200mW, B=180..390, >250MHz	SOT-323	16ta	-	3a	Rhm
YR	2SD1949-R	Si-npn	AF, 50V, 500mA, 200mW, B=180..390, >250MHz	SOT-323	16ta	-	3a	Rhm
YR	2SD2216-R	Si-npn	GP, 60V, 200mA, 125mW, 150MHz, B=210..340	SOT-416	16ta	-	3a	Pan
YR	2SD601-R	Si-npn	GP, AF, 50V, 600mA, B=210..340, 150MHz	SC-59	16ta	-	3a	Pan
YR	DDZX8V2C	Z-diode	8.2V±2.5%, 500mW	SOT-23	16dc	-	3a	Di
YR	DDZX8V2CW	Z-diode	8.2V±2.5%, 200mW	SOT-323	16dc	-	3a	Di
YR	MSD601-R	Si-npn	GP, 60V, 100mA, 200mW, B=210..340	SOT-323	16ta	-	3a	Mot
YS	2PA1774S	Si-pnp	LN, 50V, 100mA, 150mW, >100MHz, B=270..560	SOT-416	16ta	-	3a	Phi
YS	2PA1774SJ	Si-pnp	LN, 50V, 100mA, 250mW, >100MHz, B=270..560	SOT-490	18ta	-	3a	Phi
YS	2PD601S	Si-npn	GP, Sw, 60V, 100mA, 250mW, B=290..460, >140MHz	SOT-23	16ta	-	3a	Phi
YS	2SD2216-S	Si-npn	GP, 60V, 200mA, 125mW, 150MHz, B=290..460	SOT-416	16ta	-	3a	Pan
YS	2SD601-S	Si-npn	GP, AF, 50V, 600mA, B=290..460, 150MHz	SC-59	16ta	-	3a	Pan
YS	DDZX9V1C	Z-diode	9.1V±2.5%, 500mW	SOT-23	16dc	-	3a	Di
YS	DDZX9V1CW	Z-diode	9.1V±2.5%, 200mW	SOT-323	16dc	-	3a	Di
YS	MSD601-S	Si-npn	GP, 60V, 100mA, 200mW, B=290..460	SOT-323	16ta	-	3a	Mot
YS	RN2115	Si-pnp-Digi	Sw, 50V, 100mA, 100mW, R1/R2=2.2k/10k	SOT-416	16ta	-	3a	Tos
YS	RN2115FV	Si-pnp-Digi	Sw, 50V, 100mA, 150mW, R1/R2=2.2k/10k	SOT-723	18ta	-	3a	Tos
YS	RN2315	Si-pnp-Digi	Sw, 50V, 100mA, 400mW, R1/R2=2.2k/10k	SOT-346	16ta	-	3a	Tos
YS	RN2415	Si-pnp-Digi	Sw, 50V, 100mA, 400mW, R1/R2=2.2k/10k	SOT-346	16ta	-	3a	Tos
YT	08C025S	Si-npn	AF, GP, 15V, 800mA, 200mW, B=300..800, 400MHz	SSFP	18ta	-	3a	San
YT	2SC4851	Si-npn	Mute, 25V, 0.1A, 0.2W, B=800..3200, 240MHz, Ron<0.9Ω	MCP	16ta	-	3a	San
YT	2SC4852	Si-npn	Mute, 25V, 0.1A, 0.25W, B=800..3200, 240MHz, Ron=0.9Ω	CP	16ta	-	3a	San
YT	DDZX10C	Z-diode	10V±2.5%, 500mW	SOT-23	16dc	-	3a	Di
YT	DDZX10CW	Z-diode	10V±2.5%, 200mW	SOT-323	16dc	-	3a	Di
YT	RN2116	Si-pnp-Digi	Sw, 50V, 100mA, 100mW, R1/R2=4.7k/10k	SOT-416	16ta	-	3a	Tos
YT	RN2316	Si-pnp-Digi	Sw, 50V, 100mA, 400mW, R1/R2=4.7k/10k	SOT-346	16ta	-	3a	Tos
YT	RN2416	Si-pnp-Digi	Sw, 50V, 100mA, 400mW, R1/R2=4.7k/10k	SOT-346	16ta	-	3a	Tos
YU	DDZX11C	Z-diode	11V±2.5%, 500mW	SOT-23	16dc	-	3a	Di
YU	DDZX11CW	Z-diode	11V±2.5%, 200mW	SOT-23	16dc	-	3a	Di
YU	RN2117	Si-pnp-Digi	Sw, 50V, 100mA, 100mW, R1/R2=10k/4.7k	SOT-416	16ta	-	3a	Tos
YU	RN2117FV	Si-pnp-Digi	Sw, 50V, 100mA, 150mW, R1/R2=10k/4.7k	SOT-723	18ta	-	3a	Tos
YU	RN2317	Si-pnp-Digi	Sw, 50V, 100mA, 400mW, R1/R2=10k/4.7k	SOT-346	16ta	-	3a	Tos
YU	RN2417	Si-pnp-Digi	Sw, 50V, 100mA, 400mW, R1/R2=10k/4.7k	SOT-346	16ta	-	3a	Tos
YU1	CHDTA123YUPT	Si-pnp-Digi	Sw, 50V, 100mA, 250MHz, R1/R2=2.2/10k	SOT-323	16ta	-	3a	Chm
YUA	CHDTC123YUPT	Si-npn-Digi	Sw, 50V, 100mA, 250MHz, R1/R2=2.2/10k	SOT-323	16ta	-	3a	Chm
YV	DDZX12C	Z-diode	12V±2.5%, 500mW	SOT-23	16dc	-	3a	Di
YV	DDZX12CW	Z-diode	12V±2.5%, 200mW	SOT-323	16dc	-	3a	Di
YV-	2SC4964	Si-npn	UHFV/HF, 12V, 100mA, 100mW, B=100..600	SOT-23	16ta	-	3a	Ren
YV-	2SC4965	Si-npn	UHFV/HF, 12V, 100mA, 100mW, B=100..600	SOT-323	16ta	-	3a	Ren
YW	CHT5551WPT	Si-npn	Drv, 160V, 200mA, B=80..250, 300MHz	SOT-323	16ta	-	3a	Chm
YW	RN2118	Si-pnp-Digi	Sw, 50V, 100mA, 100mW, R1/R2=47k/10k	SOT-416	16ta	-	3a	Tos
YW	RN2118FV	Si-pnp-Digi	Sw, 50V, 100mA, 150mW, R1/R2=47k/10k	SOT-723	18ta	-	3a	Tos
YW	RN2318	Si-pnp-Digi	Sw, 50V, 100mA, 400mW, R1/R2=47k/10k	SOT-346	16ta	-	3a	Tos
YW	RN2418	Si-pnp-Digi	Sw, 50V, 100mA, 400mW, R1/R2=47k/10k	SOT-346	16ta	-	3a	Tos
YW-	2SC4966	Si-npn	VHF/UHF, 12V, 100mA, 150mW, B=100..600	SOT-23	16ta	-	3a	Ren
YW-	2SC4967	Si-npn	VHF/UHF Ant.-Sw, 12V, 100mA, 100mW, B=100..600	SOT-323	16ta	-	3a	Ren
YY	DDZX16	Z-diode	16V±2.5%, 500mW	SOT-23	16dc	-	3a	Di
YY	DDZX16W	Z-diode	16V±2.5%, 200mW	SOT-323	16dc	-	3a	Di
YY1	CMPZDA11V	Z-diode	Dual, 11V±2.5%, 350mW	SOT-23	16df	-	3a	Cen
YY2	CMPZDA12V	Z-diode	Dual, 12V±2.5%, 350mW	SOT-23	16df	-	3a	Cen
YY3	2SC4104-3	Si-npn	Vid, 70V, 50mA, 200mW, B=60..120, 700MHz	SOT-23	16ta	-	3a	San
YY3	CMPZDA13V	Z-diode	Dual, 13V±2.5%, 350mW	SOT-23	16df	-	3a	Cen
YY4	2SC4104-4	Si-npn	Vid, 70V, 50mA, 200mW, B=90..180, 700MHz	SOT-23	16ta	-	3a	San
YY4	CMPZDA15V	Z-diode	Dual, 15V±2.5%, 350mW	SOT-23	16df	-	3a	Cen
YY5	2SC4104-5	Si-npn	Vid, 70V, 50mA, 200mW, B=135..270, 700MHz	SOT-23	16ta	-	3a	San
YY5	CMPZDA16V	Z-diode	Dual, 16V±2.5%, 350mW	SOT-23	16df	-	3a	Cen
YY6	CMPZDA18V	Z-diode	Dual, 18V±2.5%, 350mW	SOT-23	16df	-	3a	Cen
YY7	CMPZDA20V	Z-diode	Dual, 20V±2.5%, 350mW	SOT-23	16df	-	3a	Cen
YY8	CMPZDA22V	Z-diode	Dual, 22V±2.5%, 350mW	SOT-23	16df	-	3a	Cen
YY9	CMPZDA24V	Z-diode	Dual, 24V±2.5%, 350mW	SOT-23	16df	-	3a	Cen
YZ	DDZX18C	Z-diode	18V±2.5%, 500mW	SOT-23	16dc	-	3a	Di
YZ	DDZX18CW	Z-diode	18V±2.5%, 200mW	SOT-323	16dc	-	3a	Di
YZ-	2SC5050	Si-npn	VHF/UHF, LN, 15V, 50mA, 150mW, B=50..250, 11GHz	SC-59A	16ta	-	3a	Ren



SMD code	Type	Function	Short description	Case	Pinout	Sch.	St.	Mnf.
YZ-	2SC5051	Si-npn	VHF/UHF, LN, 15V, 50mA, 100mW, B=50..250, 11GHz	CMPAK	16ta	-	3a	Ren
YZ-	2SC5139	Si-npn	VHF/UHF, 15V, 50mA, 80mW, B=50..250, 11GHz	SMPAK	16ta	-	3a	Ren
z	AX6904EA	Vdet-IC	2.93V±1.5%, +Reset PPO	SC-70	16vda	VD7	3b	Axl
Z0	ELM7640LCB	Vdet-IC	4.0V±2%, -Reset PPO, 150ms	SOT-23	16vdc	VD7	3d	Elm
Z0	MMBZ5223B	Z-diode	2.57..2.84V, Izt=20mA, Zzt=30Q, 350mW	SOT-23	16dc	-	3a	Lge
Z0	SST310	n-FET	UHF/VHF-Amp/Mix/Osc, 25V, 350mW, Idss=24..60mA, Up<6.5V	SOT-23	16fj	-	3a	Six
Z08	SST308	n-FET	UHF/VHF-Amp/Mix/Osc, 25V, 350mW, Idss=12..60mA, Up<6.5V	SOT-23	16fj	-	3a	Cal
Z09	SST309	n-FET	UHF/VHF-Amp/Mix/Osc, 25V, 350mW, Idss=12..30mA, Up<4.1V	SOT-23	16fj	-	3a	Cal
Z1	BZX84-A4V7	Z-diode	4.7V±1%, Izt=53mA, 350mW	SOT-23	16dc	-	3a	Cen
Z1	BZX84-B4V7	Z-diode	4.7V±2%, Izt=53mA, 350mW	SOT-23	16dc	-	3a	Cen
Z1	BZX84-C4V7	Z-diode	4.4..5.0V, Izt=5mA, Zzt=80Q, 350mW	SOT-23	16eb	-	3a	TTr
Z1	BZX84-C4V7-V	Z-diode	4.7V±5%, 53mA, 350mW	SOT-23	16dc	-	3a,3g	Cen,F
Z1	BZX88-C4V7	Z-diode	4.7V±5%, 200mW	SOT-323	16dc	-	3a	Zx
Z1	CZRT55C4V7	Z-diode	4.4..5.0V, Zzt=80Q, Izt=5mA, 350mW	SOT-23	16dc	-	3a	Cmc
Z1	ELM7641LCB	Vdet-IC	4.1V±2%, -Reset PPO, 150ms	SOT-23	16vdc	VD7	3d	Elm
Z1	SSTJ211	n-FET	UHF/VHF-Amp/Mix/Osc, 25V, 360mW, Idss=7..20mA	SOT-23	16fj	-	3a	Lns
Z1	TC1274-10ENB	Vdet-IC	4.37V, +Reset PPO	SOT-23	16vdb	VD7	3d	Mcc
Z10	SST310	n-FET	UHF/VHF-Amp/Mix/Osc, 25V, 350mW, Idss=24..60mA, Up<6.5V	SOT-23	16fj	-	3a	Cal
Z10	SSTJ210	n-FET	UHF/VHF-Amp/Mix/Osc, 25V, 360mW, Idss=15..40mA	SOT-23	16fj	-	3a	Cal
Z11	BZX84-C2V4	Z-diode	2.2..2.6V, Izt=5mA, Zzt=100Q, 300mW	SOT-23	16eb	-	3a	TTr
Z11	BZX84-C2V4-V	Z-diode	2.4V±5%, Zzt=70Q(100mA), 300mW	SOT-23	16dc	-	3a,3g	Phi
Z11	CZRT55C2V4	Z-diode	2.2..2.6V, Zzt=100Q, Izt=5mA, 350mW	SOT-23	16dc	-	3a	Cmc
Z11	SSTJ211	n-FET	UHF/VHF-Amp/Mix/Osc, 25V, 360mW, Idss=7..20mA	SOT-23	16fj	-	3a	Cal
Z12	BZX84-C2V7	Z-diode	2.5..2.9V, Izt=5mA, Zzt=100Q, 350mW	SOT-23	16eb	-	3a	TTr
Z12	BZX84-C2V7-V	Z-diode	2.7V±5%, Zzt=75Q(100mA), 300mW	SOT-23	16dc	-	3a,3g	Phi
Z12	CZRT55C2V7	Z-diode	2.5..2.9V, Zzt=100Q, Izt=5mA, 350mW	SOT-23	16dc	-	3a	Cmc
Z12	SSTJ212	n-FET	UHF/VHF-Amp/Mix/Osc, 25V, 360mW, Idss=7..20mA	SOT-23	16fj	-	3a	Cal
Z13	BZX84-C3V0	Z-diode	2.8..3.2V, Izt=5mA, Zzt=95Q, 350mW	SOT-23	16eb	-	3a	TTr
Z13	BZX84-C3V0-V	Z-diode	3.0V±5%, Zzt=80Q(95mA), 300mW	SOT-23	16dc	-	3a,3g	Phi
Z13	CZRT55C3	Z-diode	2.8..3.2V, Zzt=95Q, Izt=5mA, 350mW	SOT-23	16dc	-	3a	Cmc
Z14	BZX84-C3V3	Z-diode	3.1..3.5V, Izt=5mA, Zzt=95Q, 350mW	SOT-23	16eb	-	3a	TTr
Z14	BZX84-C3V3-V	Z-diode	3.3V±5%, Zzt=85Q(95mA), 300mW	SOT-23	16dc	-	3a,3g	F,Phi
Z14	CZRT55C3V3	Z-diode	3.1..3.5V, Zzt=95Q, Izt=5mA, 350mW	SOT-23	16dc	-	3a	Cmc
Z15	BZX84-C3V6	Z-diode	3.4..3.8V, Izt=5mA, Zzt=90Q, 350mW	SOT-23	16eb	-	3a	TTr
Z15	BZX84-C3V6-V	Z-diode	3.6V±5%, Zzt=85Q(90mA), 300mW	SOT-23	16dc	-	3a,3g	F,Phi
Z15	CZRT55C3V6	Z-diode	3.4..3.8V, Zzt=90Q, Izt=5mA, 350mW	SOT-23	16dc	-	3a	Cmc
Z15A	ML6206P153M	LVR-IC	1.5V±3%, 250mA	SOT-23	16cg	VR1	3a	Mlc
Z16	BZX84-C3V9	Z-diode	3.7..4.1V, Izt=5mA, Zzt=90Q, 350mW	SOT-23	16eb	-	3a	TTr
Z16	BZX84-C3V9-V	Z-diode	3.9V±5%, Zzt=85Q(90mA), 300mW	SOT-23	16dc	-	3a,3g	F,Vs
Z16	CZRT55C3V9	Z-diode	3.7..4.1V, Zzt=90Q, Izt=5mA, 350mW	SOT-23	16dc	-	3a	Cmc
Z16A	ML6206P163M	LVR-IC	1.6V±3%, 250mA	SOT-23	16cg	VR1	3a	Mlc
Z17	BZX84-C4V3	Z-diode	4.0..4.6V, Izt=5mA, Zzt=90Q, 350mW	SOT-23	16eb	-	3a	TTr
Z17	BZX84-C4V3-V	Z-diode	4.3V±5%, Zzt=80Q(90mA), 300mW	SOT-23	16dc	-	3a,3g	F,Vs
Z17	CZRT55C4V3	Z-diode	4.0..4.6V, Zzt=90Q, Izt=5mA, 350mW	SOT-23	16dc	-	3a	Cmc
Z17A	ML6206P173M	LVR-IC	1.7V±3%, 250mA	SOT-23	16cg	VR1	3a	Mlc
Z18A	ML6206P183M	LVR-IC	1.8V±3%, 250mA	SOT-23	16cg	VR1	3a	Mlc
Z19A	ML6206P193M	LVR-IC	1.9V±3%, 250mA	SOT-23	16cg	VR1	3a	Mlc
Z1p	BZX84-C4V7	Z-diode	4.7V±5%, 300mW	SOT-23	16dc	-	3a	PHH
Z1t	BZX84-C4V7	Z-diode	4.7V±5%, 300mW	SOT-23	16dc	-	3a	PhiM
Z1W	BZX84-C4V7	Z-diode	4.7V±5%, 300mW	SOT-23	16dc	-	3a	PhC
Z1Z	CMSZDA4V7	Z-diode	Dual, 4.4..5.0V, Zzt=80Q, 38mA, 275mW	SOT-323	16df	-	3a	Cen
Z2	BZX84-A5V1	Z-diode	5.1V±1%, Izt=49mA, 350mW	SOT-23	16dc	-	3a	Cen
Z2	BZX84-B5V1	Z-diode	5.1V±2%, Izt=49mA, 350mW	SOT-23	16dc	-	3a	Cen
Z2	BZX84-C5V1	Z-diode	4.8..5.4V, Izt=5mA, Zzt=60Q, 350mW	SOT-23	16eb	-	3a	TTr
Z2	BZX84-C5V1-V	Z-diode	5.1V±5%, Zzt=40Q(60mA), 300mW	SOT-23	16dc	-	3a,3g	Phi
Z2	BZX88-C5V1	Z-diode	5.1V±5%, 200mW	SOT-323	16dc	-	3a	Zx
Z2	CZRT55C5V1	Z-diode	4.8..5.4V, Zzt=60Q, Izt=5mA, 350mW	SOT-23	16dc	-	3a	Cmc
Z2	ECG5010SM	Z-diode	5.1V±5%, 300mW	SOT-23	16dc	-	3a	Ecg
Z2	ELM7642LCB	Vdet-IC	4.2V±2%, -Reset PPO, 150ms	SOT-23	16vdc	VD7	3d	Elm
Z2	KTA2015-2	Si-pnp	AF, Sw, 35V, 500mA, 100mW, B=40..120, 200MHz	USM	16ta	-	3f	Kec
Z2	NTE5010SM	Z-diode	5.1V±5%, 300mW	SOT-23	16dc	-	3a	Nte
Z2	SSTJ212	n-FET	UHF/VHF-Amp/Mix/Osc, 25V, 360mW, Idss=7..20mA	SOT-23	16fj	-	3a	Lns
Z2	TC1274-15ENB	Vdet-IC	4.12V, +Reset PPO	SOT-23	16vdb	VD7	3d	Mcc
Z20A	ML6206P202M	LVR-IC	2.0V±2%, 250mA	SOT-23	16cg	VR1	3a	Mlc
Z21	DTC113ZKA	Si-npn-Digi	Sw, 50V, 100mA, 200mW, 250MHz, R1/R2=1k/10k	SOT-346	16ta	-	3a	Rhm
Z21A	ML6206P212M	LVR-IC	2.1V±2%, 250mA	SOT-23	16cg	VR1	3a	Mlc
Z22A	ML6206P222M	LVR-IC	2.2V±2%, 250mA	SOT-23	16cg	VR1	3a	Mlc
Z23A	ML6206P232M	LVR-IC	2.3V±2%, 250mA	SOT-23	16cg	VR1	3a	Mlc
Z24A	ML6206P242M	LVR-IC	2.4V±2%, 250mA	SOT-23	16cg	VR1	3a	Mlc
Z25A	ML6206P252M	LVR-IC	2.5V±2%, 250mA	SOT-23	16cg	VR1	3a	Mlc
Z26A	ML6206P262M	LVR-IC	2.6V±2%, 250mA	SOT-23	16cg	VR1	3a	Mlc



SMD code	Type	Function	Short description	Case	Pinout	Sch.	St.	Mnf.
Z27A	ML6206P272M	LVR-IC	2.7V±2%, 250mA	SOT-23	16cg	VR1	3a	Mic
Z28A	ML6206P282M	LVR-IC	2.8V±2%, 250mA	SOT-23	16cg	VR1	3a	Mic
Z29A	ML6206P292M	LVR-IC	2.9V±2%, 250mA	SOT-23	16cg	VR1	3a	Mic
Z2p	BZX84-C5V1	Z-diode	5.1V±5%, 300mW	SOT-23	16dc	-	3a	PHH
Z2t	BZX84-C5V1	Z-diode	5.1V±5%, 300mW	SOT-23	16dc	-	3a	PHM
Z2U	FMMTA63	Si-pnp-Darl	GP, 30V, 500mA, 300mW, B>5000, >125MHz	SOT-23	16ta	-	3a	Zx
Z2V	FMMTA64	Si-pnp-Darl	GP, 30V, 500mA, 300mW, B>10000, >125MHz	SOT-23	16ta	-	3a	Zx
Z2W	BZX84-C5V1	Z-diode	5.1V±5%, 300mW	SOT-23	16dc	-	3a	PhC
Z2Z	CMSZDA5V1	Z-diode	Dual, 4.8..5.4V, Zzt=60Q, 35mA, 275mW	SOT-323	16df	-	3a	Cen
Z3	BZX84-A5V6	Z-diode	5.6V±1%, 45mA, 350mW	SOT-23	16dc	-	3a	Cen
Z3	BZX84-B5V6	Z-diode	5.6V±2%, Izt=45mA, 350mW	SOT-23	16dc	-	3a	Cen
Z3	BZX84-C5V6	Z-diode	5.2..6.0V, Izt=5mA, Zzt=40Q, 350mW	SOT-23	16eb	-	3a	Ttr
Z3	BZX84-C5V6-V	Z-diode	5.6V±5%, Zzt=15Q(40mA), 300mW	SOT-23	16dc	-	3a,3g	Cen,F
Z3	BZX88-C5V6	Z-diode	5.6V±5%, 200mW	SOT-323	16dc	-	3a	Zx
Z3	CZRT55C5V6	Z-diode	5.2..6.0V, Zzt=40Q, Izt=5mA, 350mW	SOT-23	16dc	-	3a	Cmc
Z3	ECG5011SM	Z-diode	5.6V±5%, 300mW	SOT-23	16dc	-	3a	Ecg
Z3	ELM7643LCB	Vdet-IC	4.3V±2%, -Reset PPO, 150ms	SOT-23	16vdc	VD7	3d	Elm
Z3	NTE5011SM	Z-diode	5.6V±5%, 300mW	SOT-23	16dc	-	3a	Nte
Z3	TC1274-5ENB	Vdet-IC	4.62V, +Reset PPO	SOT-23	16vdb	VD7	3d	Mcc
Z30A	ML6206P302M	LVR-IC	3.0V±2%, 250mA	SOT-23	16cg	VR1	3a	Mic
Z31A	ML6206P312M	LVR-IC	3.1V±2%, 250mA	SOT-23	16cg	VR1	3a	Mic
Z32A	ML6206P322M	LVR-IC	3.2V±2%, 250mA	SOT-23	16cg	VR1	3a	Mic
Z33A	ML6206P332M	LVR-IC	3.3V±2%, 250mA	SOT-23	16cg	VR1	3a	Mic
Z34A	ML6206P342M	LVR-IC	3.4V±2%, 250mA	SOT-23	16cg	VR1	3a	Mic
Z35A	ML6206P352M	LVR-IC	3.5V±2%, 250mA	SOT-23	16cg	VR1	3a	Mic
Z36A	ML6206P362M	LVR-IC	3.6V±2%, 250mA	SOT-23	16cg	VR1	3a	Mic
Z37A	ML6206P372M	LVR-IC	3.7V±2%, 250mA	SOT-23	16cg	VR1	3a	Mic
Z38A	ML6206P382M	LVR-IC	3.8V±2%, 250mA	SOT-23	16cg	VR1	3a	Mic
Z39A	ML6206P392M	LVR-IC	3.9V±2%, 250mA	SOT-23	16cg	VR1	3a	Mic
Z3p	BZX84-C5V6	Z-diode	5.6V±5%, 300mW	SOT-23	16dc	-	3a	PHH
Z3t	BZX84-C5V6	Z-diode	5.6V±5%, 300mW	SOT-23	16dc	-	3a	PHM
Z3W	BZX84-C5V6	Z-diode	5.6V±5%, 300mW	SOT-23	16dc	-	3a	PhC
Z3Z	CMSZDA5V6	Z-diode	Dual, 5.2..6.0V, Zzt=40Q, 32mA, 275mW	SOT-323	16df	-	3a	Cen
Z4	BZX84-A6V2	Z-diode	6.2V±1%, Izt=40mA, 350mW	SOT-23	16dc	-	3a	Cen
Z4	BZX84-B6V2	Z-diode	6.2V±2%, Izt=40mA, 350mW	SOT-23	16dc	-	3a	Cen
Z4	BZX84-C6V2	Z-diode	5.8..6.6V, Izt=5mA, Zzt=10Q, 350mW	SOT-23	16eb	-	3a	Ttr
Z4	BZX84-C6V2-V	Z-diode	6.2V±5%, Zzt=6.0Q(10mA), 300mW	SOT-23	16dc	-	3a,3g	Cen,F
Z4	BZX88-C6V2	Z-diode	6.2V±5%, 200mW	SOT-323	16dc	-	3a	Zx
Z4	CZRT55C6V2	Z-diode	5.8..6.6V, Zzt=10Q, Izt=5mA, 350mW	SOT-23	16dc	-	3a	Cmc
Z4	ECG5013SM	Z-diode	6.2V±5%, 300mW	SOT-23	16dc	-	3a	Ecg
Z4	ELM7644LCB	Vdet-IC	4.4V±2%, -Reset PPO, 150ms	SOT-23	16vdc	VD7	3d	Elm
Z4	KA4F4Z	Si-npn-Digi	Sw, 60V, 100mA, 200mW, R1=22k	SOT-416	16ta	-	3a	Nec
Z4	KTA2015-4	Si-pnp	AF, Sw, 35V, 500mA, 100mW, B=120..240, 200MHz	USM	16ta	-	3f	Kec
Z4	NTE5013SM	Z-diode	6.2V±5%, 300mW	SOT-23	16dc	-	3a	Nte
Z40A	ML6206P402M	LVR-IC	4.0V±2%, 250mA	SOT-23	16cg	VR1	3a	Mic
Z41A	ML6206P412M	LVR-IC	4.1V±2%, 250mA	SOT-23	16cg	VR1	3a	Mic
Z42A	ML6206P422M	LVR-IC	4.2V±2%, 250mA	SOT-23	16cg	VR1	3a	Mic
Z43A	ML6206P432M	LVR-IC	4.3V±2%, 250mA	SOT-23	16cg	VR1	3a	Mic
Z44A	ML6206P442M	LVR-IC	4.4V±2%, 250mA	SOT-23	16cg	VR1	3a	Mic
Z45A	ML6206P452M	LVR-IC	4.5V±2%, 250mA	SOT-23	16cg	VR1	3a	Mic
Z46A	ML6206P462M	LVR-IC	4.6V±2%, 250mA	SOT-23	16cg	VR1	3a	Mic
Z47A	ML6206P472M	LVR-IC	4.7V±2%, 250mA	SOT-23	16cg	VR1	3a	Mic
Z48A	ML6206P482M	LVR-IC	4.8V±2%, 250mA	SOT-23	16cg	VR1	3a	Mic
Z49A	ML6206P492M	LVR-IC	4.9V±2%, 250mA	SOT-23	16cg	VR1	3a	Mic
Z4p	BZX84-C6V2	Z-diode	6.2V±5%, 300mW	SOT-23	16dc	-	3a	PHH
Z4t	BZX84-C6V2	Z-diode	6.2V±5%, 300mW	SOT-23	16dc	-	3a	PHM
Z4W	BZX84-C6V2	Z-diode	6.2V±5%, 300mW	SOT-23	16dc	-	3a	PhC
Z4Z	CMSZDA6V2	Z-diode	Dual, 5.8..6.6V, Zzt=10Q, 28mA, 275mW	SOT-323	16df	-	3a	Cen
Z5	BZX84-A6V8	Z-diode	6.8V±1%, Izt=37mA, 350mW	SOT-23	16dc	-	3a	Cen
Z5	BZX84-B6V8	Z-diode	6.8V±2%, Izt=37mA, 350mW	SOT-23	16dc	-	3a	Cen
Z5	BZX84-C6V8	Z-diode	6.4..7.2V, Izt=5mA, Zzt=15Q, 350mW	SOT-23	16eb	-	3a	Ttr
Z5	BZX84-C6V8-V	Z-diode	6.8V±5%, Zzt=6.0Q(15mA), 300mW	SOT-23	16dc	-	3a,3g	Cen,F
Z5	BZX88-C6V8	Z-diode	6.8V±5%, 200mW	SOT-323	16dc	-	3a	Zx
Z5	CZRT55C6V8	Z-diode	6.4..7.2V, Zzt=15Q, Izt=5mA, 350mW	SOT-23	16dc	-	3a	Cmc
Z5	ECG5014SM	Z-diode	6.8V±5%, 300mW	SOT-23	16dc	-	3a	Ecg
Z5	ELM7645LCB	Vdet-IC	4.5V±2%, -Reset PPO, 150ms	SOT-23	16vdc	VD7	3d	Elm
Z5	NTE5014SM	Z-diode	6.8V±5%, 300mW	SOT-23	16dc	-	3a	Nte
Z50	BZX84-B2V4-V	Z-diode	2.4V±2%, Zzt=70Q(Izt=100mA), 300mW	SOT-23	16dc	-	3a,3g	Phi
Z50A	ML6206P502M	LVR-IC	5.0V±2%, 250mA	SOT-23	16cg	VR1	3a	Mic
Z51	BZX84-B2V7-V	Z-diode	2.7V±2%, Zzt=75Q(Izt=100mA), 300mW	SOT-23	16dc	-	3a,3g	Phi
Z52	BZX84-B3V0-V	Z-diode	3.0V±2%, Zzt=80Q(95mA), 300mW	SOT-23	16dc	-	3a,3g	Phi



SMD code	Type	Function	Short description	Case	Pinout	Sch.	St.	Mnf.
Z53	BZX84-B3V3-V	Z-diode	3.3V±2%, Zzt=85Q(95mA), 300mW	SOT-23	16dc	-	3a,3g	Phi
Z54	BZX84-B3V6-V	Z-diode	3.6V±2%, Zzt=85Q(90mA), 300mW	SOT-23	16dc	-	3a,3g	Phi
Z55	BZX84-B3V9-V	Z-diode	3.9V±2%, Zzt=85Q(zt=90mA), 300mW	SOT-23	16dc	-	3a,3g	Phi
Z56	BZX84-B4V3-V	Z-diode	4.3V±2%, Zzt=80Q(zt=90mA), 300mW	SOT-23	16dc	-	3a,3g	Phi
Z57	BZX84-B4V7-V	Z-diode	4.7V±2%, Zzt=50Q(zt=80mA), 300mW	SOT-23	16dc	-	3a,3g	Phi
Z58	BZX84-B5V1-V	Z-diode	5.1V±2%, Zzt=40Q(zt=60mA), 300mW	SOT-23	16dc	-	3a,3g	Phi
Z59	BZX84-B5V6-V	Z-diode	5.6V±2%, Zzt=15Q(40mA), 300mW	SOT-23	16dc	-	3a,3g	Phi
Z5p	BZX84-C6V8	Z-diode	6.8V±5%, 300mW	SOT-23	16dc	-	3a	PhH
Z5t	BZX84-C6V8	Z-diode	6.8V±5%, 300mW	SOT-23	16dc	-	3a	PhM
Z5W	BZX84-C6V8	Z-diode	6.8V±5%, 300mW	SOT-23	16dc	-	3a	PhC
Z5Z	CMSZDA6V8	Z-diode	Dual, 6.5..7.2V, Zzt=15Q, 25mA, 275mW	SOT-323	16df	-	3a	Cen
Z6	BZX84-A7V5	Z-diode	7.5V±1%, lzt=33mA, 350mW	SOT-23	16dc	-	3a	Cen
Z6	BZX84-B7V5	Z-diode	7.5V±2%, lzt=33mA, 350mW	SOT-23	16dc	-	3a	Cen
Z6	BZX84-C7V5	Z-diode	7.0..7.9V, lzt=5mA, Zzt=15Q, 350mW	SOT-23	16eb	-	3a	Ttr
Z6	BZX84-C7V5-V	Z-diode	7.5V±5%, 33mA, 350mW	SOT-23	16dc	-	3a,3g	Cen,F
Z6	BZX88-C7V5	Z-diode	7.5V±5%, 200mW	SOT-323	16dc	-	3a	Zx
Z6	CZRT55C7V5	Z-diode	7.0..7.9V, Zzt=15Q, lzt=5mA, 350mW	SOT-23	16dc	-	3a	Cmc
Z6	ECG5015SM	Z-diode	7.5V±5%, 300mW	SOT-23	16dc	-	3a	Ecq
Z6	ELM764LCB	Vdet-IC	4.6V±2%, -Reset PPO, 150ms	SOT-23	16vdc	VD7	3d	Elm
Z6	NTE5015SM	Z-diode	7.5V±5%, 300mW	SOT-23	16dc	-	3a	Nte
Z60	BZX84-B6V2-V	Z-diode	6.2V±2%, Zzt=6.0Q(10mA), 300mW	SOT-23	16dc	-	3a,3g	Phi
Z61	BZX84-B6V8-V	Z-diode	6.8V±2%, Zzt=6.0Q(15mA), 300mW	SOT-23	16dc	-	3a,3g	Phi
Z62	BZX84-B7V5-V	Z-diode	7.5V±2%, Zzt=6.0Q(15mA), 300mW	SOT-23	16dc	-	3a,3g	Phi
Z63	BZX84-B8V2-V	Z-diode	8.2V±2%, Zzt=6.0Q(15mA), 300mW	SOT-23	16dc	-	3a,3g	Phi
Z64	BZX84-B9V1-V	Z-diode	9.1V±2%, Zzt=6.0Q(15mA), 300mW	SOT-23	16dc	-	3a,3g	Phi
Z65	BZX84-B10-V	Z-diode	10V±2%, Zzt=8.0Q(zt=20mA), 300mW	SOT-23	16dc	-	3a,3g	Phi
Z66	BZX84-B11-V	Z-diode	11V±2%, Zzt=10Q(zt=20mA), 300mW	SOT-23	16dc	-	3a,3g	Phi
Z67	BZX84-B12-V	Z-diode	12V±2%, Zzt=10Q(zt=25mA), 300mW	SOT-23	16dc	-	3a,3g	Phi
Z68	BZX84-B13-V	Z-diode	13V±2%, Zzt=10Q(zt=30mA), 300mW	SOT-23	16dc	-	3a,3g	Phi
Z69	BZX84-B15-V	Z-diode	15V±2%, Zzt=10Q(zt=30mA), 300mW	SOT-23	16dc	-	3a,3g	Phi
Z6p	BZX84-C7V5	Z-diode	7.5V±5%, 300mW	SOT-23	16dc	-	3a	PhH
Z6t	BZX84-C7V5	Z-diode	7.5V±5%, 300mW	SOT-23	16dc	-	3a	PhM
Z6W	BZX84-C7V5	Z-diode	7.5V±5%, 300mW	SOT-23	16dc	-	3a	PhC
Z6Z	CMSZDA7V5	Z-diode	Dual, 7.0..7.9V, Zzt=15Q, 23mA, 275mW	SOT-323	16df	-	3a	Cen
Z7	BZX84-A8V2	Z-diode	8.2V±1%, lzt=30mA, 350mW	SOT-23	16dc	-	3a	Cen
Z7	BZX84-B8V2	Z-diode	8.2V±2%, lzt=30mA, 350mW	SOT-23	16dc	-	3a	Cen
Z7	BZX84-C8V2	Z-diode	7.7..8.7V, lzt=5mA, Zzt=15Q, 350mW	SOT-23	16eb	-	3a	Ttr
Z7	BZX84-C8V2-V	Z-diode	8.2V±5%, 30mA, 350mW	SOT-23	16dc	-	3a,3g	Cen,F
Z7	BZX88-C8V2	Z-diode	8.2V±5%, 200mW	SOT-323	16dc	-	3a	Zx
Z7	CZRT55C8V2	Z-diode	7.7..8.7V, Zzt=15Q, lzt=5mA, 350mW	SOT-23	16dc	-	3a	Cmc
Z7	ELM764LCB	Vdet-IC	4.7V±2%, -Reset PPO, 150ms	SOT-23	16vdc	VD7	3d	Elm
Z7	KN4F4Z	Si-pnp-Digi	Sw, 60V, 100mA, 150mW, R1=22k	SOT-416	16ta	-	3a	Nec
Z70	BZX84-B16-V	Z-diode	16V±2%, Zzt=10Q(zt=40mA), 300mW	SOT-23	16dc	-	3a,3g	Phi
Z71	BZX84-B18-V	Z-diode	18V±2%, Zzt=10Q(zt=45mA), 300mW	SOT-23	16dc	-	3a,3g	Phi
Z72	BZX84-B20-V	Z-diode	20V±2%, Zzt=15Q(zt=55mA), 300mW	SOT-23	16dc	-	3a,3g	Phi
Z73	BZX84-B22	Z-diode	22V±2%, Zzt=20Q(zt=55mA), 300mW	SOT-23	16dc	-	3g	Vs
Z74	BZX84-B24-V	Z-diode	24V±2%, Zzt=25Q(zt=70mA), 300mW	SOT-23	16dc	-	3a,3g	Phi
Z75	BZX84-B27-V	Z-diode	27V±2%, Zzt=25Q(zt=80mA), 300mW	SOT-23	16dc	-	3a,3g	Phi
Z76	BZX84-B30-V	Z-diode	30V±2%, Zzt=30Q(zt=80mA), 300mW	SOT-23	16dc	-	3a,3g	Phi
Z77	BZX84-B33-V	Z-diode	33V±2%, Zzt=35Q(zt=80mA), 300mW	SOT-23	16dc	-	3a,3g	Phi
Z78	BZX84-B36-V	Z-diode	36V±2%, Zzt=35Q(90mA), 300mW	SOT-23	16dc	-	3a,3g	Phi
Z79	BZX84-B39-V	Z-diode	39V±2%, Zzt=40Q(130mA), 300mW	SOT-23	16dc	-	3a,3g	Phi
Z7p	BZX84-C8V2	Z-diode	8.2V±5%, 300mW	SOT-23	16dc	-	3a	PhH
Z7t	BZX84-C8V2	Z-diode	8.2V±5%, 300mW	SOT-23	16dc	-	3a	PhM
Z7W	BZX84-C8V2	Z-diode	8.2V±5%, 300mW	SOT-23	16dc	-	3a	PhC
Z7Z	CMSZDA8V2	Z-diode	Dual, 7.7..8.7V, Zzt=15Q, 21mA, 275mW	SOT-323	16df	-	3a	Cen
Z8	BZX84-A9V1	Z-diode	9.1V±1%, lzt=27mA, 350mW	SOT-23	16dc	-	3a	Cen
Z8	BZX84-B9V1	Z-diode	9.1V±2%, lzt=27mA, 350mW	SOT-23	16dc	-	3a	Cen
Z8	BZX84-C8V2	Z-diode	7.7..8.7V, Zzt=15Q, lzt=20mA, 225mW	SOT-23	16dc	-	3a	Lge
Z8	BZX84-C9V1	Z-diode	8.5..9.6V, lzt=5mA, Zzt=15Q, 350mW	SOT-23	16eb	-	3a	Ttr
Z8	BZX84-C9V1-V	Z-diode	9.1V±5%, 27mA, 350mW	SOT-23	16dc	-	3a,3g	Cen,F
Z8	BZX88-C9V1	Z-diode	9.1V±5%, 200mW	SOT-323	16dc	-	3a	Zx
Z8	CZRT55C9V1	Z-diode	8.5..9.6V, Zzt=15Q, lzt=5mA, 350mW	SOT-23	16dc	-	3a	Cmc
Z8	ECG5018SM	Z-diode	9.1V±5%, 300mW	SOT-23	16dc	-	3a	Ecq
Z8	ELM7648LCB	Vdet-IC	4.8V±2%, -Reset PPO, 150ms	SOT-23	16vdc	VD7	3d	Elm
Z8	NTE5018SM	Z-diode	9.1V±5%, 300mW	SOT-23	16dc	-	3a	Nte
Z8	SST308	n-FET	UHFF/HF-Amp/Mix/Osc, 25V, 350mW, Idss=12..60mA, Up<6.5V	SOT-23	16fj	-	3a	Six
Z80	BZX84-B43-V	Z-diode	43V±2%, Zzt=45Q(zt=150mA), 300mW	SOT-23	16dc	-	3a,3g	Phi
Z81	BZX84-B47-V	Z-diode	47V±2%, Zzt=50Q(zt=170mA), 300mW	SOT-23	16dc	-	3g	Vs
Z82	BZX84-B51-V	Z-diode	51V±2%, Zzt=60Q(zt=180mA), 300mW	SOT-23	16dc	-	3a,3g	Phi
Z83	BZX84-B56-V	Z-diode	56V±2%, Zzt=70Q(zt=200mA), 300mW	SOT-23	16dc	-	3a,3g	Phi



SMD code	Type	Function	Short description	Case	Pinout	Sch.	St.	Mnf.
Z84	BZX84-B62-V	Z-diode	62V±2%, Zzt=80Ω(215mA), 300mW	SOT-23	16dc	-	3a,3g	Phi
Z85	BZX84-B68-V	Z-diode	68V±2%, Zzt=90Ω(240mA), 300mW	SOT-23	16dc	-	3a,3g	Phi
Z86	BZX84-B75-V	Z-diode	75V±2%, Zzt=95Ω(255mA), 300mW	SOT-23	16dc	-	3a,3g	Phi
Z8p	BZX84-C9V1	Z-diode	9.1V±5%, 300mW	SOT-23	16dc	-	3a	PHH
Z8t	BZX84-C9V1	Z-diode	9.1V±5%, 300mW	SOT-23	16dc	-	3a	PHM
Z8W	BZX84-C9V1	Z-diode	9.1V±5%, 300mW	SOT-23	16dc	-	3a	PhC
Z8Z	CMSZDA9V1	Z-diode	Dual, 8.5..9.6V, Zzt=15Ω, 18mA, 275mW	SOT-323	16df	-	3a	Cen
Z9	BZX84-A10	Z-diode	10V±1%, lzt=25mA, 350mW	SOT-23	16dc	-	3a	Cen
Z9	BZX84-B10	Z-diode	10V±2%, lzt=25mA, 350mW	SOT-23	16dc	-	3a	Cen
Z9	BZX84-C10	Z-diode	10V±5%, Zzt=8.0Ω(20mA), 300mW	SOT-23	16dc	-	3a,3g	Cen,F
Z9	BZX84-C10-V	Z-diode	10V±5%, Zzt=8.0Ω(20mA), 300mW	SOT-23	16dc	-	3g	Vs
Z9	BZX84-C39	Z-diode	37.41V, Zzt=130Ω, lzt=20mA, 225mW	SOT-23	16dc	-	3a	Lge
Z9	BZX88-C10	Z-diode	10V±5%, 200mW	SOT-323	16dc	-	3a	Zx
Z9	CZRT55C10	Z-diode	9.4..10.6V, Zzt=20Ω, lzt=5mA, 350mW	SOT-23	16dc	-	3a	Cmc
Z9	ELM7649LCB	Vdet-IC	4.9V±2%, -Reset PPO, 150ms	SOT-23	16vdc	VD7	3d	Elm
Z9	SST309	n-FET	UHF/VHF-Amp/Mix/Osc, 25V, 350mW, Idss=12..30mA, Up<1.4V	SOT-23	16fj	-	3a	Six
Z9p	BZX84-C10	Z-diode	10V±5%, 300mW	SOT-23	16dc	-	3a	PHH
Z9t	BZX84-C10	Z-diode	10V±5%, 300mW	SOT-23	16dc	-	3a	PhM
Z9W	BZX84-C10	Z-diode	10V±5%, 300mW	SOT-23	16dc	-	3a	PhC
Z9Z	CMSZDA10V	Z-diode	Dual, 9.4..10.6V, Zzt=20Ω, 16mA, 275mW	SOT-323	16df	-	3a	Cen
ZA	2N3906S	Si-pnp	GP, 40V, 200mA, 350mW, B=60..300, >250MHz	SOT-23	16ta	-	3f	Kec
ZA	2N3906U	Si-pnp	GP, 40V, 200mA, 100mW, B=60..300, >250MHz	USM	18ta	-	3a	Kec
ZA	RT9809-27CB	Vdet-IC	2.7V±2%, -Reset PPO	SOT-23	16vdc	VD7	3a	Rct
ZAA	KN3906S	Si-pnp	GP, 40V, 200mA, 250mW, B=60..300, >250MHz	SOT-23	16ta	-	3a	Kec
ZB	FMMT4123	Si-npn	GP, 40V, 200mA, 350mW B=50..150, >250MHz	SOT-23	16ta	-	3a	Zx
ZB	KTN2222S	Si-npn	GP, 60V, 600mA, 330mW, B=120..360, >300MHz	SOT-23	16ta	-	3f	Kec
ZB	KTN2222U	Si-npn	GP, 60V, 600mA, 330mW, B=120..360, >300MHz	SOT-323	16ta	-	3f	Kec
ZB	MAX810SQ270T1G	Vdet-IC	2.70V±1.5%, +Reset PPO	SC-70	16vdc	VD7	3b	Ons
ZBA	KN2222S	Si-npn	GP, 60V, 600mA, 330mW, B=120..360, >300MHz	SOT-23	16ta	-	3a	Kec
ZC	2N3904S	Si-npn	GP, 60V, 200mA, 350mW, B=100..300, >300MHz	SOT-23	16ta	-	3f	Kec
ZC	2N3904U	Si-npn	GP, 60V, 200mA, 100mW, B=100..300, >300MHz	USM	18ta	-	3a	Kec
ZC	2SK217-C	n-FET	VHF, 30V, 20mA, 150mA, Idss=2.5..5mA, Up<2.5V	SOT-23	16fk	-	3a	Ren
ZC	CHT847BM1PT-S	Si-npn	AF, Sw, 45V, 100mA, B=420..800, 200MHz	FBPT-723	17ta	-	9a	Chm
ZC	CHT847BTPT-S	Si-npn	AF, Sw, 45V, 100mA, B=420..800, 200MHz	SOT-416	16ta	-	3a	Chm
ZC	FMMT4124	Si-npn	Sw, 30V, 200mA, 330mW, B=120..360, >300MHz	SOT-23	16ta	-	3a	Zx
ZC	KST4124	Si-npn	Sw, 30V, 200mA, 330mW, B=120..360, >300MHz	SOT-23	16ta	-	3a	Sam
ZC	MAX810SQ400T1G	Vdet-IC	4.0V±1.5%, +Reset PPO	SC-70	16vdc	VD7	3b	Ons
ZC	MMBT4124	Si-npn	Sw, 30V, 200mA, 330mW, B=120..360, >300MHz	SOT-23	16ta	-	3a	Nsc
ZC	YTS4124	Si-npn	Sw, 30V, 200mA, 330mW, B=120..360, >300MHz	SOT-23	16ta	-	3a	Tos
ZC-	2SC5246	Si-npn	VHF/UHF, 15V, 20mA, 12GHz	SOT-23	16ta	-	3a	Ren
ZCA	KN3904S	Si-npn	GP, 60V, 200mA, 250mW, B=100..300, >300MHz	SOT-23	16ta	-	3a	Kec
ZD	2SK217-D	n-FET	VHF, 30V, 20mA, 150mA, Idss=4..8mA, Up<2.5V	SOT-23	16fk	-	3a	Ren
ZD	FMMT4125	Si-pnp	GP, 30V, 200mA, 350mW, B=50..150, 200MHz	SOT-23	16ta	-	-	Zx
ZD	KST4125	Si-pnp	AF, 30V, 200mA, 350mW, B=50..150, >200MHz	SOT-23	16ta	-	3a	Sam
ZD	KTN2907S	Si-pnp	GP, 40V, 600mA, 330mW, B=100..300, >200MHz	SOT-23	16ta	-	3f	Kec
ZD	KTN2907U	Si-pnp	GP, 40V, 600mA, 330mW, B=100..300, >200MHz	SOT-323	16te	-	3f	Kec
ZD	MAX809SQ120T1G	Vdet-IC	1.2V±1.5%, -Reset PPO	SC-70	16vdc	VD7	3b	Ons
ZD	MMBT4125	Si-pnp	GP, 30V, 200mA, 350mW, B=50..150, 200MHz	SOT-23	16ta	-	3a	Sam
ZD-	2SC5247	Si-npn	VHF/UHF, 15V, 50mA, 13.5GHz	SOT-23	16ta	-	3a	Ren
ZDA	KN2907S	Si-pnp	GP, 40V, 600mA, 330mW, B=100..300, >200MHz	SOT-23	16ta	-	3a	Kec
ZE	2N5401S	Si-pnp	GP, 150V, 600mA, 350mW, B=60..240, >100MHz	SOT-23	16ta	-	3f	Kec
ZE	2SK217-E	n-FET	VHF, 30V, 20mA, 150mA, Idss=6..12mA, Up<2.5V	SOT-23	16fk	-	3a	Ren
ZE	FMMT4126	Si-pnp	GP, 25V, 200mA, 350mW, B=120..360, >250MHz	SOT-23	16ta	-	3a	Zx
ZE	MAX809SQ232T1G	Vdet-IC	2.32V±1.5%, -Reset PPO	SC-70	16vdc	VD7	3b	Ons
ZE	MMBT4123	Si-npn	GP, 40V, 200mA, 350mW B=50..150, >250MHz	SOT-23	16ta	-	3a	Nsc
ZE-	2SK2373	n-MOSFET-e*	V-MOS, LogL, 30V, 200mA, <1.4C(10mA), integr, Rgate	SOT-23	16fh	-	3a	Ren
ZE1	CHDTA113ZEPT	Si-pnp-Digi	Sw, 50V, 100mA, 250MHz, R1/R2=1/10k	SOT-416	16ta	-	3a	Chm
ZE2	CHDTA143ZEPT	Si-pnp-Digi	Sw, 50V, 100mA, 250MHz, R1/R2=4.7/47k	SOT-416	16ta	-	3a	Chm
ZF	2N5551S	Si-npn	GP, 160V, 600mA, 350mW, B=80..250, >100MHz	SOT-23	16ta	-	3f	Kec
ZF	CZMK3.3	Z-diode	Dual, 4.3V±5%, 300mW	SOT-23	16dg	-	3a	Cdi
ZF	MAX809SQ263T1G	Vdet-IC	2.63V±1.5%, -Reset PPO	SC-70	16vdc	VD7	3b	Ons
ZF	MMBT4126	Si-pnp	GP, 25V, 200mA, 350mW, B=120..360, >250MHz	SOT-23	16ta	-	3a	Nsc
ZF	TZT3V3CW	Z-diode	Dual, 3.1..3.5V, lzt=5mA, Zzt=95Ω, 300mW	SOT-23	16dg	-	3a	Ttr
ZF-	2SJ399	p-MOSFET-e*	V-MOS, LogL, 30V, 0.2A, <7Q(100mA), integr, Rgate	SOT-23	16fh	-	3a	Ren
ZG	BCX70RG	Si-npn	GP, 45V, 100mA, 330mW, B=120..220, 250MHz	SOT-23	16ta	-	3a	Sil
ZG	CZMK3.6	Z-diode	Dual, 4.3V±5%, 300mW	SOT-23	16dg	-	3a	Cdi
ZG	KTN2222AS	Si-npn	GP, 75V, 600mA, 330mW, B=120..360, >300MHz	SOT-23	16ta	-	3f	Kec
ZG	KTN2222AU	Si-npn	GP, 75V, 600mA, 330mW, B=120..360, >300MHz	SOT-323	16ta	-	3f	Kec
ZG	MAX809SQ293T1G	Vdet-IC	2.93V±1.5%, -Reset PPO	SC-70	16vdc	VD7	3b	Ons
ZG	TZT3V6CW	Z-diode	Dual, 3.4..3.8V, lzt=5mA, Zzt=90Ω, 300mW	SOT-23	16dg	-	3a	Ttr
ZGA	KN2222AS	Si-npn	GP, 75V, 600mA, 330mW, B=120..360, >300MHz	SOT-23	16ta	-	3a	Kec



SMD code	Type	Function	Short description	Case	Pinout	Sch.	St.	Mnf.
ZH	BCX70RH	Si-npn	GP, 45V, 200mA, 250mW, B=180..310, >100MHz	SOT-23	16ta	-	3a	Sil
ZH	CZMK3.9	Z-diode	Dual, 4.3V±5%, 300mW	SOT-23	16dg	-	3a	Cdi
ZH	KTN2907AS	Si-pnp	GP, 60V, 600mA, 330mW, B=100..300, >200MHz	SOT-23	16ta	-	3f	Kec
ZH	KTN2907AU	Si-pnp	GP, 60V, 600mA, 330mW, B=100..300, >200MHz	SOT-323	16ta	-	3f	Kec
ZH	MAX809SQ308T1G	Vdet-IC	3.08V±1.5%, -Reset PPO	SC-70	16vdc	VD7	3b	Ons
ZH	TZT3V9CW	Z-diode	Dual, 3.7..4.1V, Izt=5mA, Zzt=90Ω, 300mW	SOT-23	16dg	-	3a	TTr
ZHA	KN2907AS	Si-pnp	GP, 60V, 600mA, 330mW, B=100..300, >200MHz	SOT-23	16ta	-	3a	Kec
ZI	KTN2369S	Si-npn	Sw, 40V, 200mA, 330mW, B=40..120	SOT-23	16ta	-	3f	Kec
ZI	KTN2369U	Si-npn	Sw, 40V, 200mA, 330mW, B=40..120	SOT-323	16ta	-	3f	Kec
ZI	MAX809SQ438T1G	Vdet-IC	4.38V±1.5%, -Reset PPO	SC-70	16vdc	VD7	3b	Ons
ZJ	BCX70RJ	Si-npn	GP, Sw, 45V, 100mA, 250mW, B=250..460, >100MHz	SOT-23	16ta	-	3a	Sil
ZJ	CZMK4V3	Z-diode	Dual, 4.3V±5%, 300mW	SOT-23	16dg	-	3a	Cdi
ZJ	MAX809SQ463T1G	Vdet-IC	4.63V±1.5%, -Reset PPO	SC-70	16vdc	VD7	3b	Ons
ZJ	TZT4V3CW	Z-diode	Dual, 4.0..4.6V, Izt=5mA, Zzt=90Ω, 300mW	SOT-23	16dg	-	3a	TTr
ZJY	FM810JP3X	Vdet-IC	4.0V±1.5%, +Reset PPO	SOT-323	16vdc	VD7	3a	F
ZK	BCX70RK	Si-npn	GP, Sw, 45V, 100mA, 250mW, B=380..630, >100MHz	SOT-23	16ta	-	3a	Sie
ZK	CZMK4V7	Z-diode	Dual, 4.7V±5%, 300mW	SOT-23	16dg	-	3a	Cdi
ZK	KTN2369AS	Si-npn	Sw, 40V, 200mA, 330mW, B=40..120	SOT-23	16ta	-	3f	Kec
ZK	KTN2369AU	Si-npn	Sw, 40V, 200mA, 330mW, B=40..120	SOT-323	16ta	-	3f	Kec
ZK	MAX809SQ293D1T1G	Vdet-IC	2.93V±1.5%, 1ms, -Reset PPO	SC-70	16vdc	VD7	3b	Ons
ZK	TZT4V7CW	Z-diode	Dual, 4.4..5.0V, Izt=5mA, Zzt=80Ω, 300mW	SOT-23	16dg	-	3a	TTr
ZK-	2SJ451	p-MOSFET-e*	V-MOS, LogL, 20V, 0.2A, <3.5Ω(0.1A), integr, Rgate	SOT-23	16fh	-	3a	Ren
ZK1	CHDTA113ZKPT	Si-pnp-Digi	Sw, 50V, 100mA, 250MHz, R1/R2=1/10k	SOT-23	16ta	-	3a	Chm
ZK2	CHDTA143ZKPT	Si-pnp-Digi	Sw, 50V, 100mA, 250MHz, R1/R2=4.7/47k	SOT-23	16ta	-	3a	Chm
ZK3	CHDTB113ZKPT	Si-pnp-Digi	Sw, 50V, 500mA, 200MHz, R1/R2=1/10k	SOT-23	16ta	-	3a	Chm
ZKB	CHDTD113ZKPT	Si-npn-Digi	Sw, 50V, 500mA, 200MHz, R1/R2=1/10k	SOT-23	16ta	-	3a	Chm
ZL	2SA1653	Si-pnp-Digi	Sw, 50V, 100mA, 200mW, 200MHz, R1/R2=4.7k/10k	SOT-23	16ta	-	3a	San
ZL	CZMK5V1	Z-diode	Dual, 5.1V±5%, 300mW	SOT-23	16dg	-	3a	Cdi
ZL	MAX809SQ293D2T1G	Vdet-IC	2.93V±1.5%, 20ms, -Reset PPO	SC-70	16vdc	VD7	3b	Ons
ZL	TZT5V1CW	Z-diode	Dual, 4.8..5.4V, Izt=5mA, Zzt=60Ω, 300mW	SOT-23	16dg	-	3a	TTr
ZL-	2SK2570	n-MOSFET-e*	V-MOS, LogL, 20V, 0.2A, <1.1Ω, integr, Rgate	SOT-23	16fh	-	3a	Ren
ZLN	ELM7515CEB	Vdet-IC	1.5V±2%, +Reset PPO	SC-70	16vdb	VD7	3d	Elm
ZLN	ELM7515NEB	Vdet-IC	1.5V±2%, +Reset ODO	SC-70	16vdb	VD6	3d	Elm
ZLY	FM810LP3X	Vdet-IC	4.63V±1.5%, +Reset PPO	SOT-323	16vdc	VD7	3a	F
ZM	CZMK5V6	Z-diode	Dual, 5.6V±5%, 300mW	SOT-23	16dg	-	3a	Cdi
ZM	MAX809SQ293D3T1G	Vdet-IC	2.93V±1.5%, 100ms, -Reset PPO	SC-70	16vdc	VD7	3b	Ons
ZM	TZT5V6CW	Z-diode	Dual, 5.2..6.0V, Izt=5mA, Zzt=40Ω, 300mW	SOT-23	16dg	-	3a	TTr
ZM-	2SJ452	p-MOSFET-e*	V-MOS, LogL, 50V, 0.2A, <7Ω(0.1A), integr, Rgate	SOT-23	16fh	-	3a	Ren
ZMY	FM810MP3X	Vdet-IC	4.38V±1.5%, +Reset PPO	SOT-323	16vdc	VD7	3a	F
ZN	2N5400S	Si-pnp	GP, 120V, 600mA, 350mW, B=40..180, >100MHz	SOT-23	16ta	-	3f	Kec
ZN	CZMK6V2	Z-diode	Dual, 6.2V±5%, 300mW	SOT-23	16dg	-	3a	Cdi
ZN	MAX810SQ120T1G	Vdet-IC	1.20V±1.5%, +Reset PPO	SC-70	16vdc	VD7	3b	Ons
ZN	TZT6V2CW	Z-diode	Dual, 5.8..6.6V, Izt=5mA, Zzt=10Ω, 300mW	SOT-23	16dg	-	3a	TTr
ZN-	2SK2569	n-MOSFET-e*	V-MOS, LogL, 50V, 0.2A, <2.6Ω(0.1A), integr, Rgate	SOT-23	16fh	-	3a	Ren
ZO	2SA1182-O	Si-pnp	AF, 35V, 500mA, 150mW, B=70..140, 200MHz	SOT-23	16ta	-	3a	Tos
ZO	2SA1588-O	Si-pnp	AF-Drv, Sw, 35V, 500mA, 100mW, B=70..140, 200MHz	SOT-323	16ta	-	3a	Tos
ZO	KTA2015-O	Si-pnp	AF, Sw, 35V, 500mA, 100mW, B=40..120, 200MHz	USM	16ta	-	3f	Kec
ZO	MAX810SQ263T1G	Vdet-IC	2.63V±1.5%, +Reset PPO	SC-70	16vdc	VD7	3b	Ons
ZOP	STZ8 T	Z-diode	Dual, 6.47..7.14V, Zzt<40Ω(5mA), 100mW	SOT-346	16df	-	3a	Rhm
ZP	2N5550S	Si-npn	GP, 140V, 600mA, 350mW, B=60..250, >100MHz	SOT-23	16ta	-	3f	Kec
ZP	CZMK6V8	Z-diode	Dual, 6.8V±5%, 300mW	SOT-23	16dg	-	3a	Cdi
ZP	MAX810SQ293T1G	Vdet-IC	2.93V±1.5%, +Reset PPO	SC-70	16vdc	VD7	3b	Ons
ZP	TZT6V8CW	Z-diode	Dual, 6.4..7.2V, Izt=5mA, Zzt=15Ω, 300mW	SOT-23	16dg	-	3a	TTr
ZQ	2PC4081Q	Si-npn	GP, 50V, 100mA, 200mW, B=120..270, >100MHz	SOT-323	16ta	-	3a	PHH
ZQ	2PC4617Q	Si-npn	GP, 50V, 100mA, 150mW, >100MHz, B=120..270	SOT-416	16ta	-	3a	Phi
ZQ	2PC4617QJ	Si-npn	GP, 50V, 100mA, 250mW, >100MHz, B=120..270	SOT-490	18ta	-	3a	Phi
ZQ	2PD601AQ	Si-npn	GP, Sw, 60V, 100mA, 250mW, B=160..260, >100MHz	SC-59	16ta	-	3a	Phi
ZQ	2SD1819A-Q	Si-npn	GP, 60V, 200mA, 150mW, 150MHz, B=160..260	SOT-323	16ta	-	3a	Pan
ZQ	2SD2496-Q	Si-npn	GP, 60V, 100mA, 150MHz, B=60..120	SOT-23	16ta	-	3a	Pan
ZQ	2SD601A-Q	Si-npn	GP, AF, 60V, 600mA, B=160..260, 150MHz	SC-59	16ta	-	3a	Pan
ZQ	DDZK36	Z-diode	36V±2.5%, 500mW	SOT-23	16dc	-	3a	Di
ZQ	DDZK36W	Z-diode	36V±2.5%, 200mW	SOT-323	16dc	-	3a	Di
ZQ	MAX810SQ438T1G	Vdet-IC	4.38V±1.5%, +Reset PPO	SC-70	16vdc	VD7	3b	Ons
ZQw	2PC4081Q	Si-npn	GP, 50V, 100mA, 200mW, B=120..270, >100MHz	SOT-323	16ta	-	3a	PhC
ZR	2PC4081R	Si-npn	GP, 50V, 100mA, 200mW, B=180..390, >100MHz	SOT-323	16ta	-	3a	PHH
ZR	2PC4617R	Si-npn	GP, 50V, 100mA, 150mW, >100MHz, B=180..390	SOT-416	16ta	-	3a	Phi
ZR	2PC4617RJ	Si-npn	GP, 50V, 100mA, 250mW, >100MHz, B=180..390	SOT-490	18ta	-	3a	Phi
ZR	2PD601AR	Si-npn	GP, Sw, 60V, 100mA, 250mW, B=210..340, >120MHz	SC-59	16ta	-	3a	Phi
ZR	2SD1819A-R	Si-npn	GP, 60V, 200mA, 150mW, 150MHz, B=210..340	SOT-323	16ta	-	3a	Pan
ZR	2SD2496-R	Si-npn	GP, 60V, 100mA, 150MHz, B=90..180	SOT-23	16ta	-	3a	Pan
ZR	2SD601A-R	Si-npn	GP, AF, 60V, 600mA, B=210..340, 150MHz	SC-59	16ta	-	3a	Pan

Note: ELM75xxCEB series LN- lot number L=0...9 N=A to Z(I, O, X excepted); ELM75xxNEB series LN- lot number L=A to Z(I, O, X excepted) N=0...9



SMD code	Type	Function	Short description	Case	Pinout	Sch.	St.	Mnf.
ZR	CAT809ZSDI-GT3	Vdet-IC	2.32V±1.5%, -Reset PPO	SC-70	16vdc	VD7	3d	Ons
ZR	CAT809ZTBI-GT3	Vdet-IC	2.32V±1.5%, -Reset PPO	SOT-23	16vdc	VD7	3b	Ons
ZR	DDZX43	Z-diode	43V±2.5%, 500mW	SOT-23	16dc	-	3a	Di
ZR	DDZX43W	Z-diode	43V±2.5%, 500mW	SOT-323	16dc	-	3a	Di
ZR	MAX810SQ463T1G	Vdet-IC	4.63V±1.5%, +Reset PPO	SC-70	16vdc	VD7	3b	Ons
ZR	MSD1819A-R	Si-npn	GP, 60V, 100mA, 150mW, B=210..340	SOT-323	16ta	-	3a	Mot
ZRA	KN3903S	Si-npn	GP, 60V, 200mA, 250mW, B=50..150, >300MHz	SOT-23	16ta	-	3a	Kec
ZRw	2PC4081R	Si-npn	GP, 50V, 100mA, 200mW, B=180..390, >100MHz	SOT-323	16ta	-	3a	PhC
ZRY	FM810RP3X	Vdet-IC	2.63V±1.5%, +Reset PPO	SOT-323	16vdc	VD7	3a	F
ZS	2PC4081S	Si-npn	GP, 50V, 100mA, 200mW, B=270..560, >100MHz	SOT-323	16ta	-	3a	PhH
ZS	2PC4617S	Si-npn	GP, 50V, 100mA, 150mW, >100MHz, B=270..560	SOT-416	16ta	-	3a	Phi
ZS	2PC4617SJ	Si-npn	GP, 50V, 100mA, 250mW, >100MHz, B=270..560	SOT-490	18ta	-	3a	Phi
ZS	2PD601AS	Si-npn	GP, Sw, 60V, 100mA, 250mW, B=290..460, >140MHz	SC-59	16ta	-	3a	Phi
ZS	2SD1819A-S	Si-npn	GP, 60V, 200mA, 150mW, 150MHz, B=290..460	SOT-323	16ta	-	3a	Pan
ZS	2SD2496-S	Si-npn	GP, 60V, 100mA, 150MHz, B=120..240	SOT-23	16ta	-	3a	Pan
ZS	2SD601A-S	Si-npn	GP, AF, 60V, 600mA, B=290..460, 150MHz	SC-59	16ta	-	3a	Pan
ZS	CAT810ZSDI-GT3	Vdet-IC	2.32V±1.5%, +Reset PPO	SC-70	16vdc	VD7	3d	Ons
ZS	CAT810ZTBI-GT3	Vdet-IC	2.32V±1.5%, +Reset PPO	SOT-23	16vdc	VD7	3b	Ons
ZS	DDZX47W	Z-diode	47V±2.5%, 200mW	SOT-323	16dc	-	3a	Di
ZS	MAX810SQ293D1T1G	Vdet-IC	2.93V±1.5%, 1ms, +Reset PPO	SC-70	16vdc	VD7	3b	Ons
ZS	MSD1819A-S	Si-npn	GP, 60V, 100mA, 150mW, B=290..460	SOT-323	16ta	-	3a	Mot
ZS1	ZHCS1000	Si-diode	Schottky, 30V, 1A, Vf<0.5V(1)	SOT-23	16dc	-	3a	Zx
ZS2	ZHCS2000	Si-diode	Schottky, 40V, 2A	SOT-23	16dc	-	3a	Zx
ZS5	ZHCS500	Si-diode	Schottky, 40V, 500mA, Vf<0.55V(500mA)	SOT-23	16dc	-	3a	Zx
ZS7	ZHCS750	Si-diode	Schottky, 30V, 750mA, Vf<0.54V(750mA)	SOT-23	16dc	-	3a	Zx
ZSw	2PC4081S	Si-npn	GP, 50V, 100mA, 200mW, B=270..560, >100MHz	SOT-323	16ta	-	3a	PhC
ZSY	FM810SP3X	Vdet-IC	2.93V±1.5%, +Reset PPO	SOT-323	16vdc	VD7	3a	F
ZT	CZMK7V5	Z-diode	Dual, 7.5V±5%, 300mW	SOT-23	16dg	-	3a	Cdi
ZT	MAX810SQ293D2T1G	Vdet-IC	2.93V±1.5%, 20ms, +Reset PPO	SC-70	16vdc	VD7	3b	Ons
ZT	TZT7V5CW	Z-diode	Dual, 7.0..7.9V, Izt=5mA, Zzt=15Ω, 300mW	SOT-23	16dg	-	3a	Ttr
ZTA	KN4400S	Si-npn	GP, Sw, 60V, 600mA, 350mW, B=50..150, 200MHz	SOT-23	16ta	-	16ta	Kec
ZIQ	2PC4081Q	Si-npn	GP, 50V, 100mA, 200mW, B=120..270, >100MHz	SOT-323	16ta	-	3a	PhM
ZIR	2PC4081R	Si-npn	GP, 50V, 100mA, 200mW, B=180..390, >100MHz	SOT-323	16ta	-	3a	PhM
ZIS	2PC4081S	Si-npn	GP, 50V, 100mA, 200mW, B=270..560, >100MHz	SOT-323	16ta	-	3a	PhM
ZTY	FM810TP3X	Vdet-IC	3.08V±1.5%, +Reset PPO	SOT-323	16vdc	VD7	3a	F
ZU	MAX810SQ293D3T1G	Vdet-IC	2.93V±1.5%, 100ms, +Reset PPO	SC-70	16vdc	VD7	3b	Ons
ZU-	2SJ486	p-MOSFET-e*	V-MOS, LogL, 30V, 0.3A, <0.65Ω, integr, Rgate	SOT-23	16fh	-	3a	Ren
ZU1	CHDTA143ZUPT	Si-pnp-Digi	Sw, 50V, 100mA, 250MHz, R1/R2=4.7/47k	SOT-323	16ta	-	3a	Chm
ZU2	CHDTA113ZUPT	Si-pnp-Digi	Sw, 50V, 100mA, 250MHz, R1/R2=1/10k	SOT-323	16ta	-	3a	Chm
ZUA	CHDTC113ZUPT	Si-npn-Digi	Sw, 50V, 100mA, 250MHz, R1/R2=1/2k	SOT-323	16ta	-	3a	Chm
ZUA	KN4401S	Si-npn	GP, Sw, 60V, 600mA, 350mW, B=100..300, 250MHz	SOT-23	16ta	-	16ta	Kec
ZUB	CHDTD113ZUPT	Si-npn-Digi	Sw, 50V, 500mA, 200MHz, R1/R2=1/10k	SOT-323	16ta	-	3a	Chm
ZV	CZMK8V2	Z-diode	Dual, 8.2V±5%, 300mW	SOT-23	16dg	-	3a	Cdi
ZV	TZT8V2CW	Z-diode	Dual, 7.7..8.7V, Izt=5mA, Zzt=15Ω, 300mW	SOT-23	16dg	-	3a	Ttr
ZV-	2SK2802	n-MOSFET-e*	V-MOS, LogL, 30V, 0.5A, <0.28Ω, integr, Rgate	SOT-23	16fh	-	3a	Ren
ZVA	KN4402S	Si-pnp	GP, Sw, 40V, 600mA, 350mW, B=50..150, 250MHz	SOT-23	16ta	-	16ta	Kec
ZW	CZMK9V1	Z-diode	Dual, 9.1V±5%, 300mW	SOT-23	16dg	-	3a	Cdi
ZW	TZT9V1CW	Z-diode	Dual, 8.5..9.6V, Izt=5mA, Zzt=15Ω, 300mW	SOT-23	16dg	-	3a	Ttr
ZWA	KN4403S	Si-pnp	GP, Sw, 40V, 600mA, 350mW, B=100..300, 250MHz	SOT-23	16ta	-	16ta	Kec
ZX	CZMK10	Z-diode	Dual, 10V±5%, 300mW	SOT-23	16dg	-	3a	Cdi
ZX	TZT10CW	Z-diode	Dual, 9.4..10.6V, Izt=5mA, Zzt=20Ω, 300mW	SOT-23	16dg	-	3a	Ttr
ZY	2SA1182-Y	Si-pnp	AF, 35V, 500mA, 150mW, B=120..240, 200MHz	SOT-23	16ta	-	3a	Tos
ZY	2SA1588-Y	Si-pnp	AF-Div, Sw, 35V, 500mA, 100mW, B=120..240, 200MHz	SOT-323	16ta	-	3a	Tos
ZY	2SC4047	Si-npn-Digi	Sw, 50V, 100mA, 200mW, 250MHz, B>70, R1/R2=10k/47k	CP	16ta	-	3a	San
ZY	CZMK11	Z-diode	Dual, 11V±5%, 300mW	SOT-23	16dg	-	3a	Cdi
ZY	KTA2015-Y	Si-pnp	AF, Sw, 35V, 500mA, 100mW, B=120..240, 200MHz	USM	16ta	-	3f	Kec
ZY	TZT11CW	Z-diode	Dual, 10.4..11.6V, Izt=5mA, Zzt=20Ω, 300mW	SOT-23	16dg	-	3a	Ttr
ZY-	2SK3000	n-MOSFET-e*	V-MOS, LogL, 40V, 1A, <0.5Ω(0.45A), In, Rgate	SOT-23	16fh	-	3a	Ren
ZZ	CZMK12	Z-diode	Dual, 12V±5%, 300mW	SOT-23	16dg	-	3a	Cdi
ZZ	TZT12CW	Z-diode	Dual, 11.4..12.7V, Izt=5mA, Zzt=25Ω, 300mW	SOT-23	16dg	-	3a	Ttr
ZZ-	2SK2980	n-MOSFET-e*	V-MOS, LogL, 30V, 1A, <0.28Ω(0.5A)	MPAK	16fh	-	3a	Ren
ZZ1	CMPZDA4V7	Z-diode	Dual, 4.7V±2.5%, 350mW	SOT-23	16df	-	3a	Cen
ZZ2	CMPZDA5V1	Z-diode	Dual, 5.1V±2.5%, 350mW	SOT-23	16df	-	3a	Cen
ZZ3	CMPZDA5V6	Z-diode	Dual, 5.6V±2.5%, 350mW	SOT-23	16df	-	3a	Cen
ZZ4	CMPZDA6V2	Z-diode	Dual, 6.2V±2.5%, 350mW	SOT-23	16df	-	3a	Cen
ZZ5	CMPZDA6V8	Z-diode	Dual, 6.8V±2.5%, 350mW	SOT-23	16df	-	3a	Cen
ZZ6	CMPZDA7V5	Z-diode	Dual, 7.5V±2.5%, 350mW	SOT-23	16df	-	3a	Cen
ZZ7	CMPZDA8V2	Z-diode	Dual, 8.2V±2.5%, 350mW	SOT-23	16df	-	3a	Cen
ZZ8	CMPZDA9V1	Z-diode	Dual, 9.1V±2.5%, 350mW	SOT-23	16df	-	3a	Cen
ZZ9	CMPZDA10V	Z-diode	Dual, 10V±2.5%, 350mW	SOT-23	16df	-	3a	Cen
ZZR	HWD809REX	Vdet-IC	2.63V±2%, -Reset PPO	SC-70	16vdc	VD7	3a	Csm



SECTION 4
SOT-223 CASE SMD SEMICONDUCTOR COMPONENTS



SMD code	Type	Function	Short description	Case	Pinout	Sch.	St.	Mnf.
01N60C3	SPN01N60C3	n-MOSFET	HV, LogL, 650V, 300mA, 1.8W, 5.5Q(500mA), 45/60ns	SOT-223	21f2	-	4k	Inf
02N60C3	SPN02N60C3	n-MOSFET	HV, LogL, 600V, 400mA, 1.8W, 2.0Q(1.1A), 6/68ns	SOT-223	21f2	-	4k	Inf
02N60S5	SPN02N60S5	n-MOSFET	HV, LogL, 600V, 400mA, 1.8W, 2.5Q(1.1A), 30/110ns	SOT-223	21f2	-	4k	Inf
03N60C3	SPN03N60C3	n-MOSFET	HV, LogL, 650V, 700mA, 1.8W, 1.2Q(2A), 7/64ns	SOT-223	21f2	-	4k	Inf
03N60S5	SPN03N60S5	n-MOSFET	HV, LogL, 600V, 700mA, 1.8W, 1.2Q(2A), 35/120ns	SOT-223	21f2	-	4k	Inf
04N60S5	SPN04N60S5	n-MOSFET	HV, LogL, 600V, 800mA, 1.8W, 0.8Q(2.8A), 40/130ns	SOT-223	21f2	-	4k	Inf
103MN	Z0103MN	Triac	600V, 1A, 1W, V _{tm} <1.56V, <lg>3mA	SOT-223	21hz	-	4s	Ons
107MN	Z0107MN	Triac	600V, 1A, 1W, V _{tm} <1.56V, lgt>5mA	SOT-223	21hz	-	4s	Ons
109MN	Z0109MN	Triac	600V, 1A, 1W, V _{tm} <1.56V, lgt>10mA	SOT-223	21hz	-	4s	Ons
1117	LT1117CST	LVR-IC	LDO, Adjustable 1.5..15V, 800mA	SOT-223	21wc	VR20	4r	Ltc
11172	LT1117CST-2.85	LVR-IC	LDO, 2.85±1%V, 800mA	SOT-223	21wb	VR1	4r	Ltc
11173	LT1117CST-3.3	LVR-IC	LDO, 3.3V±1%, 800mA	SOT-223	21wb	VR1	4r	Ltc
11175	LT1117CST-5	LVR-IC	LDO, 5V±1%, 800mA	SOT-223	21wb	VR1	4r	Ltc
1172	NCP1117ST20T3	LVR-IC	LDO, 2V±1%, 800mA	SOT-223	21wb	VR1	4s	Ons
1172V	NGV1117ST20T3	LVR-IC	LDO, 2V±1%, 800mA	SOT-223	21wb	VR1	4s	Ons
1175	NCP1117ST50T3	LVR-IC	LDO, 5V±1%, 800mA	SOT-223	21wb	VR1	4s	Ons
117A	NCP1117STAT3	LVR-IC	LDO, Adjustable 2..12V, 800mA	SOT-223	21wc	VR20	4s	Ons
117AV	NGV1117STAT3	LVR-IC	LDO, Adjustable 2..12V, 800mA	SOT-223	21wc	VR20	4s	Ons
1712	NCP1117ST12T3	LVR-IC	LDO, 12V±1%, 800mA	SOT-223	21wb	VR1	4s	Ons
1712V	NGV1117ST12T3	LVR-IC	LDO, 12V±1%, 800mA	SOT-223	21wb	VR1	4s	Ons
1715	NCP1117ST15T3	LVR-IC	LDO, 1.5V±1%, 800mA	SOT-223	21wb	VR1	4s	Ons
1715V	NGV1117ST15T3	LVR-IC	LDO, 1.5V±1%, 800mA	SOT-223	21wb	VR1	4s	Ons
1718	NCP1117ST18T3	LVR-IC	LDO, 1.8V±1%, 800mA	SOT-223	21wb	VR1	4s	Ons
1718V	NGV1117ST18T3	LVR-IC	LDO, 1.8V±1%, 800mA	SOT-223	21wb	VR1	4s	Ons
1719	NCP1117ST19T3	LVR-IC	LDO, 1.9V±1%, 800mA	SOT-223	21wb	VR1	4s	Ons
1725	NCP1117ST25T3	LVR-IC	LDO, 2.5V±1%, 800mA	SOT-223	21wb	VR1	4s	Ons
1725V	NGV1117ST25T3	LVR-IC	LDO, 2.5V±1%, 800mA	SOT-223	21wb	VR1	4s	Ons
1733	NCP1117ST33T3	LVR-IC	LDO, 3.3V±1%, 800mA	SOT-223	21wb	VR1	4s	Ons
1733V	NGV1117ST33T3	LVR-IC	LDO, 3.3V±1%, 800mA	SOT-223	21wb	VR1	4s	Ons
1AM	PZT3904	Si-npn	Sw, 60V, 100mA, 1.2W, B=100..300, >300MHz	SOT-223	21tm	-	4s	Ons
1C200	NSS1C200MZ4	Si-npn	GP, 100V, 2A, 2W, B=150..360, 120MHz	SOT-223	21tm	-	4s	Ons
1N10	MMFT1N10E	n-MOSFET-e	V-MOS, 100V, 1A, <0.25Q(500mA)	SOT-223	21f2	-	4s	Mot
24K	XC6202P182FR	LVR-IC	LDO, 1.8V±2%, 150mA	SOT-223	21ch	VR1	4k	Tor
24L	XC6202P192FR	LVR-IC	LDO, 1.9V±2%, 150mA	SOT-223	21ch	VR1	4k	Tor
24M	XC6202P202FR	LVR-IC	LDO, 2V±2%, 150mA	SOT-223	21ch	VR1	4k	Tor
24M	XC6216D202FR	LVR-IC	2.0V±2%, 150mA	SOT-223	21ch	VR1	4k	Tor
24N	XC6202P212FR	LVR-IC	LDO, 2.1V±2%, 150mA	SOT-223	21ch	VR1	4k	Tor
24N	XC6216D212FR	LVR-IC	2.1V±2%, 150mA	SOT-223	21ch	VR1	4k	Tor
24P	XC6202P222FR	LVR-IC	LDO, 2.2V±2%, 150mA	SOT-223	21ch	VR1	4k	Tor
24P	XC6216D222FR	LVR-IC	2.2V±2%, 150mA	SOT-223	21ch	VR1	4k	Tor
24R	XC6202P232FR	LVR-IC	LDO, 2.3V±2%, 150mA	SOT-223	21ch	VR1	4k	Tor
24R	XC6216D232FR	LVR-IC	2.3V±2%, 150mA	SOT-223	21ch	VR1	4k	Tor
24S	XC6202P242FR	LVR-IC	LDO, 2.4V±2%, 150mA	SOT-223	21ch	VR1	4k	Tor
24S	XC6216D242FR	LVR-IC	2.4V±2%, 150mA	SOT-223	21ch	VR1	4k	Tor
24T	XC6202P252FR	LVR-IC	LDO, 2.5V±2%, 150mA	SOT-223	21ch	VR1	4k	Tor
24T	XC6216D252FR	LVR-IC	2.5V±2%, 150mA	SOT-223	21ch	VR1	4k	Tor
24U	XC6202P262FR	LVR-IC	LDO, 2.6V±2%, 150mA	SOT-223	21ch	VR1	4k	Tor
24U	XC6216D262FR	LVR-IC	2.6V±2%, 150mA	SOT-223	21ch	VR1	4k	Tor
24V	XC6202P272FR	LVR-IC	LDO, 2.7V±2%, 150mA	SOT-223	21ch	VR1	4k	Tor
24V	XC6216D272FR	LVR-IC	2.7V±2%, 150mA	SOT-223	21ch	VR1	4k	Tor
24X	XC6202P282FR	LVR-IC	LDO, 2.8V±2%, 150mA	SOT-223	21ch	VR1	4k	Tor
24X	XC6216D282FR	LVR-IC	2.8V±2%, 150mA	SOT-223	21ch	VR1	4k	Tor
24Y	XC6202P292FR	LVR-IC	LDO, 2.9V±2%, 150mA	SOT-223	21ch	VR1	4k	Tor
24Y	XC6216D292FR	LVR-IC	2.9V±2%, 150mA	SOT-223	21ch	VR1	4k	Tor
24Z	XC6202P302FR	LVR-IC	LDO, 3V±2%, 150mA	SOT-223	21ch	VR1	4k	Tor
24Z	XC6216D302FR	LVR-IC	3.0V±2%, 150mA	SOT-223	21ch	VR1	4k	Tor
250	XC6202P312FR	LVR-IC	LDO, 3.1V±2%, 150mA	SOT-223	21ch	VR1	4k	Tor
250	XC6216D312FR	LVR-IC	3.1V±2%, 150mA	SOT-223	21ch	VR1	4k	Tor
251	XC6202P322FR	LVR-IC	LDO, 3.2V±2%, 150mA	SOT-223	21ch	VR1	4k	Tor
251	XC6216D322FR	LVR-IC	3.2V±2%, 150mA	SOT-223	21ch	VR1	4k	Tor
252	XC6202P332FR	LVR-IC	LDO, 3.3V±2%, 150mA	SOT-223	21ch	VR1	4k	Tor
252	XC6216D332FR	LVR-IC	3.3V±2%, 150mA	SOT-223	21ch	VR1	4k	Tor
253	XC6202P342FR	LVR-IC	LDO, 3.4V±2%, 150mA	SOT-223	21ch	VR1	4k	Tor
253	XC6216D342FR	LVR-IC	3.4V±2%, 150mA	SOT-223	21ch	VR1	4k	Tor
254	XC6202P352FR	LVR-IC	LDO, 3.5V±2%, 150mA	SOT-223	21ch	VR1	4k	Tor
254	XC6216D352FR	LVR-IC	3.5V±2%, 150mA	SOT-223	21ch	VR1	4k	Tor
255	XC6202P362FR	LVR-IC	LDO, 3.6V±2%, 150mA	SOT-223	21ch	VR1	4k	Tor
255	XC6216D362FR	LVR-IC	3.6V±2%, 150mA	SOT-223	21ch	VR1	4k	Tor
256	XC6202P372FR	LVR-IC	LDO, 3.7V±2%, 150mA	SOT-223	21ch	VR1	4k	Tor
256	XC6216D372FR	LVR-IC	3.7V±2%, 150mA	SOT-223	21ch	VR1	4k	Tor



SMD code	Type	Function	Short description	Case	Pinout	Sch.	St.	Mnf.
257	XC6202P382FR	LVR-IC	LDO, 3.8V±2%, 150mA	SOT-223	21ch	VR1	4k	Tor
257	XC6216D382FR	LVR-IC	3.8V±2%, 150mA	SOT-223	21ch	VR1	4k	Tor
258	XC6202P392FR	LVR-IC	LDO, 3.9V±2%, 150mA	SOT-223	21ch	VR1	4k	Tor
258	XC6216D392FR	LVR-IC	3.9V±2%, 150mA	SOT-223	21ch	VR1	4k	Tor
259	XC6202P402FR	LVR-IC	LDO, 4.0V±2%, 150mA	SOT-223	21ch	VR1	4k	Tor
259	XC6216D402FR	LVR-IC	4.0V±2%, 150mA	SOT-223	21ch	VR1	4k	Tor
25A	XC6202P412FR	LVR-IC	LDO, 4.1V±2%, 150mA	SOT-223	21ch	VR1	4k	Tor
25A	XC6216D412FR	LVR-IC	4.1V±2%, 150mA	SOT-223	21ch	VR1	4k	Tor
25B	XC6202P422FR	LVR-IC	LDO, 4.2V±2%, 150mA	SOT-223	21ch	VR1	4k	Tor
25B	XC6216D422FR	LVR-IC	4.2V±2%, 150mA	SOT-223	21ch	VR1	4k	Tor
25C	XC6202P432FR	LVR-IC	LDO, 4.3V±2%, 150mA	SOT-223	21ch	VR1	4k	Tor
25C	XC6216D432FR	LVR-IC	4.3V±2%, 150mA	SOT-223	21ch	VR1	4k	Tor
25D	XC6202P442FR	LVR-IC	LDO, 4.4V±2%, 150mA	SOT-223	21ch	VR1	4k	Tor
25D	XC6216D442FR	LVR-IC	4.4V±2%, 150mA	SOT-223	21ch	VR1	4k	Tor
25E	XC6202P452FR	LVR-IC	LDO, 4.5V±2%, 150mA	SOT-223	21ch	VR1	4k	Tor
25E	XC6216D452FR	LVR-IC	4.5V±2%, 150mA	SOT-223	21ch	VR1	4k	Tor
25F	XC6202P462FR	LVR-IC	LDO, 4.6V±2%, 150mA	SOT-223	21ch	VR1	4k	Tor
25F	XC6216D462FR	LVR-IC	4.6V±2%, 150mA	SOT-223	21ch	VR1	4k	Tor
25H	XC6202P472FR	LVR-IC	LDO, 4.7V±2%, 150mA	SOT-223	21ch	VR1	4k	Tor
25H	XC6216D472FR	LVR-IC	4.7V±2%, 150mA	SOT-223	21ch	VR1	4k	Tor
25K	XC6202P482FR	LVR-IC	LDO, 4.8V±2%, 150mA	SOT-223	21ch	VR1	4k	Tor
25K	XC6216D482FR	LVR-IC	4.8V±2%, 150mA	SOT-223	21ch	VR1	4k	Tor
25L	XC6202P492FR	LVR-IC	LDO, 4.9V±2%, 150mA	SOT-223	21ch	VR1	4k	Tor
25L	XC6216D492FR	LVR-IC	4.9V±2%, 150mA	SOT-223	21ch	VR1	4k	Tor
25M	XC6202P502FR	LVR-IC	LDO, 5.0V±2%, 150mA	SOT-223	21ch	VR1	4k	Tor
25M	XC6216D502FR	LVR-IC	5.0V±2%, 150mA	SOT-223	21ch	VR1	4k	Tor
25N	XC6202P512FR	LVR-IC	LDO, 5.1V±2%, 150mA	SOT-223	21ch	VR1	4k	Tor
25N	XC6216D512FR	LVR-IC	5.1V±2%, 150mA	SOT-223	21ch	VR1	4k	Tor
25P	XC6202P522FR	LVR-IC	LDO, 5.2V±2%, 150mA	SOT-223	21ch	VR1	4k	Tor
25P	XC6216D522FR	LVR-IC	5.2V±2%, 150mA	SOT-223	21ch	VR1	4k	Tor
25R	XC6202P532FR	LVR-IC	LDO, 5.3V±2%, 150mA	SOT-223	21ch	VR1	4k	Tor
25R	XC6216D532FR	LVR-IC	5.3V±2%, 150mA	SOT-223	21ch	VR1	4k	Tor
25S	XC6202P542FR	LVR-IC	LDO, 5.4V±2%, 150mA	SOT-223	21ch	VR1	4k	Tor
25S	XC6216D542FR	LVR-IC	5.4V±2%, 150mA	SOT-223	21ch	VR1	4k	Tor
25T	XC6202P552FR	LVR-IC	LDO, 5.5V±2%, 150mA	SOT-223	21ch	VR1	4k	Tor
25T	XC6216D552FR	LVR-IC	5.5V±2%, 150mA	SOT-223	21ch	VR1	4k	Tor
25U	XC6202P562FR	LVR-IC	LDO, 5.6V±2%, 150mA	SOT-223	21ch	VR1	4k	Tor
25U	XC6216D562FR	LVR-IC	5.6V±2%, 150mA	SOT-223	21ch	VR1	4k	Tor
25V	XC6202P572FR	LVR-IC	LDO, 5.7V±2%, 150mA	SOT-223	21ch	VR1	4k	Tor
25V	XC6216D572FR	LVR-IC	5.7V±2%, 150mA	SOT-223	21ch	VR1	4k	Tor
25X	XC6202P582FR	LVR-IC	LDO, 5.8V±2%, 150mA	SOT-223	21ch	VR1	4k	Tor
25X	XC6216D582FR	LVR-IC	5.8V±2%, 150mA	SOT-223	21ch	VR1	4k	Tor
25Y	XC6202P592FR	LVR-IC	LDO, 5.9V±2%, 150mA	SOT-223	21ch	VR1	4k	Tor
25Y	XC6216D592FR	LVR-IC	5.9V±2%, 150mA	SOT-223	21ch	VR1	4k	Tor
25Z	XC6202P602FR	LVR-IC	LDO, 6.0V±2%, 150mA	SOT-223	21ch	VR1	4k	Tor
25Z	XC6216D602FR	LVR-IC	6.0V±2%, 150mA	SOT-223	21ch	VR1	4k	Tor
260	XC6202P612FR	LVR-IC	LDO, 6.1V±2%, 150mA	SOT-223	21ch	VR1	4k	Tor
260	XC6216D612FR	LVR-IC	6.1V±2%, 150mA	SOT-223	21ch	VR1	4k	Tor
261	XC6202P622FR	LVR-IC	LDO, 6.2V±2%, 150mA	SOT-223	21ch	VR1	4k	Tor
261	XC6216D622FR	LVR-IC	6.2V±2%, 150mA	SOT-223	21ch	VR1	4k	Tor
262	XC6202P632FR	LVR-IC	LDO, 6.3V±2%, 150mA	SOT-223	21ch	VR1	4k	Tor
262	XC6216D632FR	LVR-IC	6.3V±2%, 150mA	SOT-223	21ch	VR1	4k	Tor
263	XC6202P642FR	LVR-IC	LDO, 6.4V±2%, 150mA	SOT-223	21ch	VR1	4k	Tor
263	XC6216D642FR	LVR-IC	6.4V±2%, 150mA	SOT-223	21ch	VR1	4k	Tor
264	XC6202P652FR	LVR-IC	LDO, 6.5V±2%, 150mA	SOT-223	21ch	VR1	4k	Tor
264	XC6216D652FR	LVR-IC	6.5V±2%, 150mA	SOT-223	21ch	VR1	4k	Tor
265	XC6202P662FR	LVR-IC	LDO, 6.6V±2%, 150mA	SOT-223	21ch	VR1	4k	Tor
265	XC6216D662FR	LVR-IC	6.6V±2%, 150mA	SOT-223	21ch	VR1	4k	Tor
266	XC6202P672FR	LVR-IC	LDO, 6.7V±2%, 150mA	SOT-223	21ch	VR1	4k	Tor
266	XC6216D672FR	LVR-IC	6.7V±2%, 150mA	SOT-223	21ch	VR1	4k	Tor
267	XC6202P682FR	LVR-IC	LDO, 6.8V±2%, 150mA	SOT-223	21ch	VR1	4k	Tor
267	XC6216D682FR	LVR-IC	6.8V±2%, 150mA	SOT-223	21ch	VR1	4k	Tor
268	XC6202P692FR	LVR-IC	LDO, 6.9V±2%, 150mA	SOT-223	21ch	VR1	4k	Tor
268	XC6216D692FR	LVR-IC	6.9V±2%, 150mA	SOT-223	21ch	VR1	4k	Tor
269	XC6202P702FR	LVR-IC	LDO, 7.0V±2%, 150mA	SOT-223	21ch	VR1	4k	Tor
269	XC6216D702FR	LVR-IC	7.0V±2%, 150mA	SOT-223	21ch	VR1	4k	Tor
269.3	MC33269ST-3.3T3	LVR-IC	LDO, 3.3V±2%, 800mA	SOT-223	21cg	VR1	4s	Ons
26A	XC6202P712FR	LVR-IC	LDO, 7.1V±2%, 150mA	SOT-223	21ch	VR1	4k	Tor
26A	XC6216D712FR	LVR-IC	7.1V±2%, 150mA	SOT-223	21ch	VR1	4k	Tor
26B	XC6202P722FR	LVR-IC	LDO, 7.2V±2%, 150mA	SOT-223	21ch	VR1	4k	Tor



SMD code	Type	Function	Short description	Case	Pinout	Sch.	St.	Mnf.
26B	XC6216D722FR	LVR-IC	7.2V±2%, 150mA	SOT-223	21ch	VR1	4k	Tor
26C	XC6202P732FR	LVR-IC	LDO, 7.3V±2%, 150mA	SOT-223	21ch	VR1	4k	Tor
26C	XC6216D732FR	LVR-IC	7.3V±2%, 150mA	SOT-223	21ch	VR1	4k	Tor
26D	XC6202P742FR	LVR-IC	LDO, 7.4V±2%, 150mA	SOT-223	21ch	VR1	4k	Tor
26D	XC6216D742FR	LVR-IC	7.4V±2%, 150mA	SOT-223	21ch	VR1	4k	Tor
26E	XC6202P752FR	LVR-IC	LDO, 7.5V±2%, 150mA	SOT-223	21ch	VR1	4k	Tor
26E	XC6216D752FR	LVR-IC	7.5V±2%, 150mA	SOT-223	21ch	VR1	4k	Tor
26F	XC6202P762FR	LVR-IC	LDO, 7.6V±2%, 150mA	SOT-223	21ch	VR1	4k	Tor
26F	XC6216D762FR	LVR-IC	7.6V±2%, 150mA	SOT-223	21ch	VR1	4k	Tor
26H	XC6202P772FR	LVR-IC	LDO, 7.7V±2%, 150mA	SOT-223	21ch	VR1	4k	Tor
26H	XC6216D772FR	LVR-IC	7.7V±2%, 150mA	SOT-223	21ch	VR1	4k	Tor
26K	XC6202P782FR	LVR-IC	LDO, 7.8V±2%, 150mA	SOT-223	21ch	VR1	4k	Tor
26K	XC6216D782FR	LVR-IC	7.8V±2%, 150mA	SOT-223	21ch	VR1	4k	Tor
26L	XC6202P792FR	LVR-IC	LDO, 7.9V±2%, 150mA	SOT-223	21ch	VR1	4k	Tor
26L	XC6216D792FR	LVR-IC	7.9V±2%, 150mA	SOT-223	21ch	VR1	4k	Tor
26M	XC6202P802FR	LVR-IC	LDO, 8V±2%, 150mA	SOT-223	21ch	VR1	4k	Tor
26M	XC6216D802FR	LVR-IC	8.0V±2%, 150mA	SOT-223	21ch	VR1	4k	Tor
26N	XC6202P812FR	LVR-IC	LDO, 8.1V±2%, 150mA	SOT-223	21ch	VR1	4k	Tor
26N	XC6216D812FR	LVR-IC	8.1V±2%, 150mA	SOT-223	21ch	VR1	4k	Tor
26P	XC6202P822FR	LVR-IC	LDO, 8.2V±2%, 150mA	SOT-223	21ch	VR1	4k	Tor
26P	XC6216D822FR	LVR-IC	8.2V±2%, 150mA	SOT-223	21ch	VR1	4k	Tor
26R	XC6202P832FR	LVR-IC	LDO, 8.3V±2%, 150mA	SOT-223	21ch	VR1	4k	Tor
26R	XC6216D832FR	LVR-IC	8.3V±2%, 150mA	SOT-223	21ch	VR1	4k	Tor
26S	XC6202P842FR	LVR-IC	LDO, 8.4V±2%, 150mA	SOT-223	21ch	VR1	4k	Tor
26S	XC6216D842FR	LVR-IC	8.4V±2%, 150mA	SOT-223	21ch	VR1	4k	Tor
26T	XC6202P852FR	LVR-IC	LDO, 8.5V±2%, 150mA	SOT-223	21ch	VR1	4k	Tor
26T	XC6216D852FR	LVR-IC	8.5V±2%, 150mA	SOT-223	21ch	VR1	4k	Tor
26U	XC6202P862FR	LVR-IC	LDO, 8.6V±2%, 150mA	SOT-223	21ch	VR1	4k	Tor
26U	XC6216D862FR	LVR-IC	8.6V±2%, 150mA	SOT-223	21ch	VR1	4k	Tor
26V	XC6202P872FR	LVR-IC	LDO, 8.7V±2%, 150mA	SOT-223	21ch	VR1	4k	Tor
26V	XC6216D872FR	LVR-IC	8.7V±2%, 150mA	SOT-223	21ch	VR1	4k	Tor
26X	XC6202P882FR	LVR-IC	LDO, 8.8V±2%, 150mA	SOT-223	21ch	VR1	4k	Tor
26X	XC6216D882FR	LVR-IC	8.8V±2%, 150mA	SOT-223	21ch	VR1	4k	Tor
26Y	XC6202P892FR	LVR-IC	LDO, 8.9V±2%, 150mA	SOT-223	21ch	VR1	4k	Tor
26Y	XC6216D892FR	LVR-IC	8.9V±2%, 150mA	SOT-223	21ch	VR1	4k	Tor
26Z	XC6202P902FR	LVR-IC	LDO, 9V±2%, 150mA	SOT-223	21ch	VR1	4k	Tor
26Z	XC6216D902FR	LVR-IC	9.0V±2%, 150mA	SOT-223	21ch	VR1	4k	Tor
270	XC6202P912FR	LVR-IC	LDO, 9.1V±2%, 150mA	SOT-223	21ch	VR1	4k	Tor
270	XC6216D912FR	LVR-IC	9.1V±2%, 150mA	SOT-223	21ch	VR1	4k	Tor
271	XC6202P922FR	LVR-IC	LDO, 9.2V±2%, 150mA	SOT-223	21ch	VR1	4k	Tor
271	XC6216D922FR	LVR-IC	9.2V±2%, 150mA	SOT-223	21ch	VR1	4k	Tor
272	XC6202P932FR	LVR-IC	LDO, 9.3V±2%, 150mA	SOT-223	21ch	VR1	4k	Tor
272	XC6216D932FR	LVR-IC	9.3V±2%, 150mA	SOT-223	21ch	VR1	4k	Tor
273	XC6202P942FR	LVR-IC	LDO, 9.4V±2%, 150mA	SOT-223	21ch	VR1	4k	Tor
273	XC6216D942FR	LVR-IC	9.4V±2%, 150mA	SOT-223	21ch	VR1	4k	Tor
274	XC6202P952FR	LVR-IC	LDO, 9.5V±2%, 150mA	SOT-223	21ch	VR1	4k	Tor
274	XC6216D952FR	LVR-IC	9.5V±2%, 150mA	SOT-223	21ch	VR1	4k	Tor
275	XC6202P962FR	LVR-IC	LDO, 9.6V±2%, 150mA	SOT-223	21ch	VR1	4k	Tor
275	XC6216D962FR	LVR-IC	9.6V±2%, 150mA	SOT-223	21ch	VR1	4k	Tor
27525	MC33275ST-2.5T3	LVR-IC	LDO, 2.5V±1%, 300mA	SOT-223	21hn	VR1	4s	Ons
27525G	MC33275ST-2.5T3	LVR-IC	LDO, 2.5V±1%, 300mA, Pb-free	SOT-223	21hn	VR1	4s	Ons
27530	MC33275ST-3.0T3	LVR-IC	LDO, 3.0V±1%, 300mA	SOT-223	21hn	VR1	4s	Ons
27530G	MC33275ST-3.0T3	LVR-IC	LDO, 3.0V±1%, 300mA, Pb-free	SOT-223	21hn	VR1	4s	Ons
27533	MC33275ST-3.3T3	LVR-IC	LDO, 3.3V±1%, 300mA	SOT-223	21hn	VR1	4s	Ons
27533G	MC33275ST-3.3T3	LVR-IC	LDO, 3.3V±1%, 300mA, Pb-free	SOT-223	21hn	VR1	4s	Ons
27533V	NCV33275ST-3.3T3	LVR-IC	LDO, 3.3V±1%, 300mA	SOT-223	21hn	VR1	4s	Ons
27533VG	NCV33275ST-3.3T3	LVR-IC	LDO, 3.3V±1%, 300mA, Pb-free	SOT-223	21hn	VR1	4s	Ons
27550	MC33275ST-5.0T3	LVR-IC	LDO, 5.0V±1%, 300mA	SOT-223	21hn	VR1	4s	Ons
27550G	MC33275ST-5.0T3	LVR-IC	LDO, 5.0V±1%, 300mA, Pb-free	SOT-223	21hn	VR1	4s	Ons
27550V	NCV33275ST-5.0T3	LVR-IC	LDO, 5.0V±1%, 300mA	SOT-223	21hn	VR1	4s	Ons
27550VG	NCV33275ST-5.0T3	LVR-IC	LDO, 5.0V±1%, 300mA, Pb-free	SOT-223	21hn	VR1	4s	Ons
276	XC6202P972FR	LVR-IC	LDO, 9.7V±2%, 150mA	SOT-223	21ch	VR1	4k	Tor
276	XC6216D972FR	LVR-IC	9.7V±2%, 150mA	SOT-223	21ch	VR1	4k	Tor
277	XC6202P982FR	LVR-IC	LDO, 9.8V±2%, 150mA	SOT-223	21ch	VR1	4k	Tor
277	XC6216D982FR	LVR-IC	9.8V±2%, 150mA	SOT-223	21ch	VR1	4k	Tor
278	XC6202P992FR	LVR-IC	LDO, 9.9V±2%, 150mA	SOT-223	21ch	VR1	4k	Tor
278	XC6216D992FR	LVR-IC	9.9V±2%, 150mA	SOT-223	21ch	VR1	4k	Tor
279	XC6202PA02FR	LVR-IC	LDO, 10V±2%, 150mA	SOT-223	21ch	VR1	4k	Tor
279	XC6216DA02FR	LVR-IC	10.0V±2%, 150mA	SOT-223	21ch	VR1	4k	Tor
27A	XC6202PA12FR	LVR-IC	LDO, 10.1V±2%, 150mA	SOT-223	21ch	VR1	4k	Tor



SMD code	Type	Function	Short description	Case	Pinout	Sch.	St.	Mnf.
27A	XC6216DA12FR	LVR-IC	10.1V±2%, 150mA	SOT-223	21ch	VR1	4k	Tor
27B	XC6202PA22FR	LVR-IC	LDO, 10.2V±2%, 150mA	SOT-223	21ch	VR1	4k	Tor
27B	XC6216DA22FR	LVR-IC	10.2V±2%, 150mA	SOT-223	21ch	VR1	4k	Tor
27C	XC6202PA32FR	LVR-IC	LDO, 10.3V±2%, 150mA	SOT-223	21ch	VR1	4k	Tor
27C	XC6216DA32FR	LVR-IC	10.3V±2%, 150mA	SOT-223	21ch	VR1	4k	Tor
27D	XC6202PA42FR	LVR-IC	LDO, 10.4V±2%, 150mA	SOT-223	21ch	VR1	4k	Tor
27D	XC6216DA42FR	LVR-IC	10.4V±2%, 150mA	SOT-223	21ch	VR1	4k	Tor
27E	XC6202PA52FR	LVR-IC	LDO, 10.5V±2%, 150mA	SOT-223	21ch	VR1	4k	Tor
27E	XC6216DA52FR	LVR-IC	10.5V±2%, 150mA	SOT-223	21ch	VR1	4k	Tor
27F	XC6202PA62FR	LVR-IC	LDO, 10.6V±2%, 150mA	SOT-223	21ch	VR1	4k	Tor
27F	XC6216DA62FR	LVR-IC	10.6V±2%, 150mA	SOT-223	21ch	VR1	4k	Tor
27H	XC6202PA72FR	LVR-IC	LDO, 10.7V±2%, 150mA	SOT-223	21ch	VR1	4k	Tor
27H	XC6216DA72FR	LVR-IC	10.7V±2%, 150mA	SOT-223	21ch	VR1	4k	Tor
27K	XC6202PA82FR	LVR-IC	LDO, 10.8V±2%, 150mA	SOT-223	21ch	VR1	4k	Tor
27K	XC6216DA82FR	LVR-IC	10.8V±2%, 150mA	SOT-223	21ch	VR1	4k	Tor
27L	XC6202PA92FR	LVR-IC	LDO, 10.9V±2%, 150mA	SOT-223	21ch	VR1	4k	Tor
27L	XC6216DA92FR	LVR-IC	10.9V±2%, 150mA	SOT-223	21ch	VR1	4k	Tor
27M	XC6202PB02FR	LVR-IC	LDO, 11V±2%, 150mA	SOT-223	21ch	VR1	4k	Tor
27M	XC6216DB02FR	LVR-IC	11.0V±2%, 150mA	SOT-223	21ch	VR1	4k	Tor
27N	XC6202PB12FR	LVR-IC	LDO, 11.1V±2%, 150mA	SOT-223	21ch	VR1	4k	Tor
27N	XC6216DB12FR	LVR-IC	11.1V±2%, 150mA	SOT-223	21ch	VR1	4k	Tor
27P	XC6202PB22FR	LVR-IC	LDO, 11.2V±2%, 150mA	SOT-223	21ch	VR1	4k	Tor
27P	XC6216DB22FR	LVR-IC	11.2V±2%, 150mA	SOT-223	21ch	VR1	4k	Tor
27R	XC6202PB32FR	LVR-IC	LDO, 11.3V±2%, 150mA	SOT-223	21ch	VR1	4k	Tor
27R	XC6216DB32FR	LVR-IC	11.3V±2%, 150mA	SOT-223	21ch	VR1	4k	Tor
27S	XC6202PB42FR	LVR-IC	LDO, 11.4V±2%, 150mA	SOT-223	21ch	VR1	4k	Tor
27S	XC6216DB42FR	LVR-IC	11.4V±2%, 150mA	SOT-223	21ch	VR1	4k	Tor
27T	XC6202PB52FR	LVR-IC	LDO, 11.5V±2%, 150mA	SOT-223	21ch	VR1	4k	Tor
27T	XC6216DB52FR	LVR-IC	11.5V±2%, 150mA	SOT-223	21ch	VR1	4k	Tor
27U	XC6202PB62FR	LVR-IC	LDO, 11.6V±2%, 150mA	SOT-223	21ch	VR1	4k	Tor
27U	XC6216DB62FR	LVR-IC	11.6V±2%, 150mA	SOT-223	21ch	VR1	4k	Tor
27V	XC6202PB72FR	LVR-IC	LDO, 11.7V±2%, 150mA	SOT-223	21ch	VR1	4k	Tor
27V	XC6216DB72FR	LVR-IC	11.7V±2%, 150mA	SOT-223	21ch	VR1	4k	Tor
27X	XC6202PB82FR	LVR-IC	LDO, 11.8V±2%, 150mA	SOT-223	21ch	VR1	4k	Tor
27X	XC6216DB82FR	LVR-IC	11.8V±2%, 150mA	SOT-223	21ch	VR1	4k	Tor
27Y	XC6202PB92FR	LVR-IC	LDO, 11.9V±2%, 150mA	SOT-223	21ch	VR1	4k	Tor
27Y	XC6216DB92FR	LVR-IC	11.9V±2%, 150mA	SOT-223	21ch	VR1	4k	Tor
27Z	XC6202PC02FR	LVR-IC	LDO, 12V±2%, 150mA	SOT-223	21ch	VR1	4k	Tor
27Z	XC6216DC02FR	LVR-IC	12.0V±2%, 150mA	SOT-223	21ch	VR1	4k	Tor
280	XC6202PC12FR	LVR-IC	LDO, 12.1V±2%, 150mA	SOT-223	21ch	VR1	4k	Tor
281	XC6202PC22FR	LVR-IC	LDO, 12.2V±2%, 150mA	SOT-223	21ch	VR1	4k	Tor
282	XC6202PC32FR	LVR-IC	LDO, 12.3V±2%, 150mA	SOT-223	21ch	VR1	4k	Tor
283	XC6202PC42FR	LVR-IC	LDO, 12.4V±2%, 150mA	SOT-223	21ch	VR1	4k	Tor
284	XC6202PC52FR	LVR-IC	LDO, 12.5V±2%, 150mA	SOT-223	21ch	VR1	4k	Tor
285	XC6202PC62FR	LVR-IC	LDO, 12.6V±2%, 150mA	SOT-223	21ch	VR1	4k	Tor
286	XC6202PC72FR	LVR-IC	LDO, 12.7V±2%, 150mA	SOT-223	21ch	VR1	4k	Tor
287	XC6202PC82FR	LVR-IC	LDO, 12.8V±2%, 150mA	SOT-223	21ch	VR1	4k	Tor
288	XC6202PC92FR	LVR-IC	LDO, 12.9V±2%, 150mA	SOT-223	21ch	VR1	4k	Tor
289	XC6202PD02FR	LVR-IC	LDO, 13V±2%, 150mA	SOT-223	21ch	VR1	4k	Tor
28A	XC6202PD12FR	LVR-IC	LDO, 13.1V±2%, 150mA	SOT-223	21ch	VR1	4k	Tor
28B	XC6202PD22FR	LVR-IC	LDO, 13.2V±2%, 150mA	SOT-223	21ch	VR1	4k	Tor
28C	XC6202PD32FR	LVR-IC	LDO, 13.3V±2%, 150mA	SOT-223	21ch	VR1	4k	Tor
28D	XC6202PD42FR	LVR-IC	LDO, 13.4V±2%, 150mA	SOT-223	21ch	VR1	4k	Tor
28E	XC6202PD52FR	LVR-IC	LDO, 13.5V±2%, 150mA	SOT-223	21ch	VR1	4k	Tor
28F	XC6202PD62FR	LVR-IC	LDO, 13.6V±2%, 150mA	SOT-223	21ch	VR1	4k	Tor
28H	XC6202PD72FR	LVR-IC	LDO, 13.7V±2%, 150mA	SOT-223	21ch	VR1	4k	Tor
28K	XC6202PD82FR	LVR-IC	LDO, 13.8V±2%, 150mA	SOT-223	21ch	VR1	4k	Tor
28L	XC6202PD92FR	LVR-IC	LDO, 13.9V±2%, 150mA	SOT-223	21ch	VR1	4k	Tor
28M	XC6202PE02FR	LVR-IC	LDO, 14V±2%, 150mA	SOT-223	21ch	VR1	4k	Tor
28N	XC6202PE12FR	LVR-IC	LDO, 14.1V±2%, 150mA	SOT-223	21ch	VR1	4k	Tor
28P	XC6202PE22FR	LVR-IC	LDO, 14.2V±2%, 150mA	SOT-223	21ch	VR1	4k	Tor
28R	XC6202PE32FR	LVR-IC	LDO, 14.3V±2%, 150mA	SOT-223	21ch	VR1	4k	Tor
28S	XC6202PE42FR	LVR-IC	LDO, 14.4V±2%, 150mA	SOT-223	21ch	VR1	4k	Tor
28T	XC6202PE52FR	LVR-IC	LDO, 14.5V±2%, 150mA	SOT-223	21ch	VR1	4k	Tor
28U	XC6202PE62FR	LVR-IC	LDO, 14.6V±2%, 150mA	SOT-223	21ch	VR1	4k	Tor
28V	XC6202PE72FR	LVR-IC	LDO, 14.7V±2%, 150mA	SOT-223	21ch	VR1	4k	Tor
28X	XC6202PE82FR	LVR-IC	LDO, 14.8V±2%, 150mA	SOT-223	21ch	VR1	4k	Tor
28Y	XC6202PE92FR	LVR-IC	LDO, 14.9V±2%, 150mA	SOT-223	21ch	VR1	4k	Tor
28Z	XC6202PF02FR	LVR-IC	LDO, 15V±2%, 150mA	SOT-223	21ch	VR1	4k	Tor
290	XC6202PF12FR	LVR-IC	LDO, 15.1V±2%, 150mA	SOT-223	21ch	VR1	4k	Tor



SMD
code

Type

Function

Short description

Case

Pinout

Sch.

St.

Mnf.

2907A	PZT2907A	Si-nip	Sw, 60V, 600mA, 1.5W, B=100...300, >200MHz	SOT-223	21tm	-	4k	Wtr
291	XC6202PF22FR	LVR-IC	LDO, 15.2V±2%, 150mA	SOT-223	21ch	VR1	4k	Tor
292	XC6202PF32FR	LVR-IC	LDO, 15.3V±2%, 150mA	SOT-223	21ch	VR1	4k	Tor
293	XC6202PF42FR	LVR-IC	LDO, 15.4V±2%, 150mA	SOT-223	21ch	VR1	4k	Tor
294	XC6202PF52FR	LVR-IC	LDO, 15.5V±2%, 150mA	SOT-223	21ch	VR1	4k	Tor
295	XC6202PF62FR	LVR-IC	LDO, 15.6V±2%, 150mA	SOT-223	21ch	VR1	4k	Tor
2955	MMFT2955E	p-MOSFET-e	V-MOS, 60V, 1.2A, <0.3Q(500mA)	SOT-223	21f2	-	4s	Mot
296	XC6202PF72FR	LVR-IC	LDO, 15.7V±2%, 150mA	SOT-223	21ch	VR1	4k	Tor
297	XC6202PF82FR	LVR-IC	LDO, 15.8V±2%, 150mA	SOT-223	21ch	VR1	4k	Tor
298	XC6202PF92FR	LVR-IC	LDO, 15.9V±2%, 150mA	SOT-223	21ch	VR1	4k	Tor
299	XC6202PG02FR	LVR-IC	LDO, 16V±2%, 150mA	SOT-223	21ch	VR1	4k	Tor
29A	XC6202PG12FR	LVR-IC	LDO, 16.1V±2%, 150mA	SOT-223	21ch	VR1	4k	Tor
29B	XC6202PG22FR	LVR-IC	LDO, 16.2V±2%, 150mA	SOT-223	21ch	VR1	4k	Tor
29C	XC6202PG32FR	LVR-IC	LDO, 16.3V±2%, 150mA	SOT-223	21ch	VR1	4k	Tor
29D	XC6202PG42FR	LVR-IC	LDO, 16.4V±2%, 150mA	SOT-223	21ch	VR1	4k	Tor
29E	XC6202PG52FR	LVR-IC	LDO, 16.5V±2%, 150mA	SOT-223	21ch	VR1	4k	Tor
29F	XC6202PG62FR	LVR-IC	LDO, 16.6V±2%, 150mA	SOT-223	21ch	VR1	4k	Tor
29H	XC6202PG72FR	LVR-IC	LDO, 16.7V±2%, 150mA	SOT-223	21ch	VR1	4k	Tor
29K	XC6202PG82FR	LVR-IC	LDO, 16.8V±2%, 150mA	SOT-223	21ch	VR1	4k	Tor
29L	XC6202PG92FR	LVR-IC	LDO, 16.9V±2%, 150mA	SOT-223	21ch	VR1	4k	Tor
29M	XC6202PH02FR	LVR-IC	LDO, 17V±2%, 150mA	SOT-223	21ch	VR1	4k	Tor
29N	XC6202PH12FR	LVR-IC	LDO, 17.1V±2%, 150mA	SOT-223	21ch	VR1	4k	Tor
29P	XC6202PH22FR	LVR-IC	LDO, 17.2V±2%, 150mA	SOT-223	21ch	VR1	4k	Tor
29R	XC6202PH32FR	LVR-IC	LDO, 17.3V±2%, 150mA	SOT-223	21ch	VR1	4k	Tor
29S	XC6202PH42FR	LVR-IC	LDO, 17.4V±2%, 150mA	SOT-223	21ch	VR1	4k	Tor
29T	XC6202PH52FR	LVR-IC	LDO, 17.5V±2%, 150mA	SOT-223	21ch	VR1	4k	Tor
29U	XC6202PH62FR	LVR-IC	LDO, 17.6V±2%, 150mA	SOT-223	21ch	VR1	4k	Tor
29V	XC6202PH72FR	LVR-IC	LDO, 17.7V±2%, 150mA	SOT-223	21ch	VR1	4k	Tor
29X	XC6202PH82FR	LVR-IC	LDO, 17.8V±2%, 150mA	SOT-223	21ch	VR1	4k	Tor
29Y	XC6202PH92FR	LVR-IC	LDO, 17.9V±2%, 150mA	SOT-223	21ch	VR1	4k	Tor
29Z	XC6202PJ02FR	LVR-IC	LDO, 18V±2%, 150mA	SOT-223	21ch	VR1	4k	Tor
2CJQE	20CJQ030	Si-diode	Dual, Schottky Rectifier, 30V, 2A, Vf<0.42V(1A)	SOT-223	21bs	-	4k	Inr
2N02L	MMFT2N02EL	n-MOSFET-e	V-MOS, LogL, 20V, 1.6A, <0.15Q	SOT-223	21f2	-	4s	Mot
2N603L	BSP603S2L	n-MOSFET-e	OptiMOS, LogL, 55V, 5.2A, 1.8W, 33mQ(2.6A), 10.8/28ns	SOT-223	21f2	-	4k	Inf
2N615L	BSF615S2L	n-MOSFET-e	OptiMOS, LogL, 55V, 2.8A, 1.8W, 90mQ(1.4A), 7.8/22ns	SOT-223	21f2	-	4k	Inf
3055	NTF3055-100	n-MOSFET-e	V-MOS, LogL, 60V, 3A, 2.1W, 88mQ(1.5A), 9.4/21ns	SOT-223	21f2	-	4s	Ons
3055L	NTF3055L108	n-MOSFET-e	V-MOS, LogL, 60V, 3A, 2.1W, 92mQ(1.5A), 11/22ns	SOT-223	21f2	-	4s	Ons
32K	XC6203E182FR	LVR-IC	1.8V±2%, 400mA	SOT-223	21vl	VR1	4k	Tor
32L	XC6203E192FR	LVR-IC	1.9V±2%, 400mA	SOT-223	21vl	VR1	4k	Tor
32M	XC6203E202FR	LVR-IC	2V±2%, 400mA	SOT-223	21vl	VR1	4k	Tor
32N	XC6203E212FR	LVR-IC	2.1V±2%, 400mA	SOT-223	21vl	VR1	4k	Tor
32P	XC6203E222FR	LVR-IC	2.2V±2%, 400mA	SOT-223	21vl	VR1	4k	Tor
32R	XC6203E232FR	LVR-IC	2.3V±2%, 400mA	SOT-223	21vl	VR1	4k	Tor
32S	XC6203E242FR	LVR-IC	2.4V±2%, 400mA	SOT-223	21vl	VR1	4k	Tor
32T	XC6203E252FR	LVR-IC	2.5V±2%, 400mA	SOT-223	21vl	VR1	4k	Tor
32U	XC6203E262FR	LVR-IC	2.6V±2%, 400mA	SOT-223	21vl	VR1	4k	Tor
32V	XC6203E272FR	LVR-IC	2.7V±2%, 400mA	SOT-223	21vl	VR1	4k	Tor
32X	XC6203E282FR	LVR-IC	2.8V±2%, 400mA	SOT-223	21vl	VR1	4k	Tor
32Y	XC6203E292FR	LVR-IC	2.9V±2%, 400mA	SOT-223	21vl	VR1	4k	Tor
32Z	XC6203E302FR	LVR-IC	3V±2%, 400mA	SOT-223	21vl	VR1	4k	Tor
330	XC6203E312FR	LVR-IC	3.1V±2%, 400mA	SOT-223	21vl	VR1	4k	Tor
331	XC6203E322FR	LVR-IC	3.2V±2%, 400mA	SOT-223	21vl	VR1	4k	Tor
332	XC6203E332FR	LVR-IC	3.3V±2%, 400mA	SOT-223	21vl	VR1	4k	Tor
333	XC6203E342FR	LVR-IC	3.4V±2%, 400mA	SOT-223	21vl	VR1	4k	Tor
334	XC6203E352FR	LVR-IC	3.5V±2%, 400mA	SOT-223	21vl	VR1	4k	Tor
335	XC6203E362FR	LVR-IC	3.6V±2%, 400mA	SOT-223	21vl	VR1	4k	Tor
336	XC6203E372FR	LVR-IC	3.7V±2%, 400mA	SOT-223	21vl	VR1	4k	Tor
337	XC6203E382FR	LVR-IC	3.8V±2%, 400mA	SOT-223	21vl	VR1	4k	Tor
338	XC6203E392FR	LVR-IC	3.9V±2%, 400mA	SOT-223	21vl	VR1	4k	Tor
339	XC6203E402FR	LVR-IC	4V±2%, 400mA	SOT-223	21vl	VR1	4k	Tor
33A	XC6203E412FR	LVR-IC	4.1V±2%, 400mA	SOT-223	21vl	VR1	4k	Tor
33B	XC6203E422FR	LVR-IC	4.2V±2%, 400mA	SOT-223	21vl	VR1	4k	Tor
33C	XC6203E432FR	LVR-IC	4.3V±2%, 400mA	SOT-223	21vl	VR1	4k	Tor
33D	XC6203E442FR	LVR-IC	4.4V±2%, 400mA	SOT-223	21vl	VR1	4k	Tor
33E	XC6203E452FR	LVR-IC	4.5V±2%, 400mA	SOT-223	21vl	VR1	4k	Tor
33F	XC6203E462FR	LVR-IC	4.6V±2%, 400mA	SOT-223	21vl	VR1	4k	Tor
33H	XC6203E472FR	LVR-IC	4.7V±2%, 400mA	SOT-223	21vl	VR1	4k	Tor
33K	XC6203E482FR	LVR-IC	4.8V±2%, 400mA	SOT-223	21vl	VR1	4k	Tor
33L	XC6203E492FR	LVR-IC	4.9V±2%, 400mA	SOT-223	21vl	VR1	4k	Tor
33M	XC6203E502FR	LVR-IC	5V±2%, 400mA	SOT-223	21vl	VR1	4k	Tor



SMD code	Type	Function	Short description	Case	Pinout	Sch.	St.	Mnf.
33N	XC6203E512FR	LVR-IC	5.1V±2%, 400mA	SOT-223	21vl	VR1	4k	Tor
33P	XC6203E522FR	LVR-IC	5.2V±2%, 400mA	SOT-223	21vl	VR1	4k	Tor
33R	XC6203E532FR	LVR-IC	5.3V±2%, 400mA	SOT-223	21vl	VR1	4k	Tor
33S	XC6203E542FR	LVR-IC	5.4V±2%, 400mA	SOT-223	21vl	VR1	4k	Tor
33T	XC6203E552FR	LVR-IC	5.5V±2%, 400mA	SOT-223	21vl	VR1	4k	Tor
33U	XC6203E562FR	LVR-IC	5.6V±2%, 400mA	SOT-223	21vl	VR1	4k	Tor
33V	XC6203E572FR	LVR-IC	5.7V±2%, 400mA	SOT-223	21vl	VR1	4k	Tor
33X	XC6203E582FR	LVR-IC	5.8V±2%, 400mA	SOT-223	21vl	VR1	4k	Tor
33Y	XC6203E592FR	LVR-IC	5.9V±2%, 400mA	SOT-223	21vl	VR1	4k	Tor
33Z	XC6203E602FR	LVR-IC	6V±2%, 400mA	SOT-223	21vl	VR1	4k	Tor
34X	XC6203E28AFR	LVR-IC	2.85V±2%, 400mA	SOT-223	21vl	VR1	4k	Tor
35K	XC6203P182FR	LVR-IC	1.8V±2%, 400mA, Internal current limiter	SOT-223	21vl	VR1	4k	Tor
35L	XC6203P192FR	LVR-IC	1.9V±2%, 400mA, Internal current limiter	SOT-223	21vl	VR1	4k	Tor
35M	XC6203P202FR	LVR-IC	2V±2%, 400mA, Internal current limiter	SOT-223	21vl	VR1	4k	Tor
35N	XC6203P212FR	LVR-IC	2.1V±2%, 400mA, Internal current limiter	SOT-223	21vl	VR1	4k	Tor
35P	XC6203P222FR	LVR-IC	2.2V±2%, 400mA, Internal current limiter	SOT-223	21vl	VR1	4k	Tor
35R	XC6203P232FR	LVR-IC	2.3V±2%, 400mA, Internal current limiter	SOT-223	21vl	VR1	4k	Tor
35S	XC6203P242FR	LVR-IC	2.4V±2%, 400mA, Internal current limiter	SOT-223	21vl	VR1	4k	Tor
35T	XC6203P252FR	LVR-IC	2.5V±2%, 400mA, Internal current limiter	SOT-223	21vl	VR1	4k	Tor
35U	XC6203P262FR	LVR-IC	2.6V±2%, 400mA, Internal current limiter	SOT-223	21vl	VR1	4k	Tor
35V	XC6203P272FR	LVR-IC	2.7V±2%, 400mA, Internal current limiter	SOT-223	21vl	VR1	4k	Tor
35X	XC6203P282FR	LVR-IC	2.8V±2%, 400mA, Internal current limiter	SOT-223	21vl	VR1	4k	Tor
35Y	XC6203P292FR	LVR-IC	2.9V±2%, 400mA, Internal current limiter	SOT-223	21vl	VR1	4k	Tor
35Z	XC6203P302FR	LVR-IC	3V±2%, 400mA, Internal current limiter	SOT-223	21vl	VR1	4k	Tor
360	XC6203P312FR	LVR-IC	3.1V±2%, 400mA, Internal current limiter	SOT-223	21vl	VR1	4k	Tor
361	XC6203P322FR	LVR-IC	3.2V±2%, 400mA, Internal current limiter	SOT-223	21vl	VR1	4k	Tor
362	XC6203P332FR	LVR-IC	3.3V±2%, 400mA, Internal current limiter	SOT-223	21vl	VR1	4k	Tor
363	XC6203P342FR	LVR-IC	3.4V±2%, 400mA, Internal current limiter	SOT-223	21vl	VR1	4k	Tor
364	XC6203P352FR	LVR-IC	3.5V±2%, 400mA, Internal current limiter	SOT-223	21vl	VR1	4k	Tor
365	XC6203P362FR	LVR-IC	3.6V±2%, 400mA, Internal current limiter	SOT-223	21vl	VR1	4k	Tor
366	XC6203P372FR	LVR-IC	3.7V±2%, 400mA, Internal current limiter	SOT-223	21vl	VR1	4k	Tor
367	XC6203P382FR	LVR-IC	3.8V±2%, 400mA, Internal current limiter	SOT-223	21vl	VR1	4k	Tor
368	XC6203P392FR	LVR-IC	3.9V±2%, 400mA, Internal current limiter	SOT-223	21vl	VR1	4k	Tor
369	XC6203P402FR	LVR-IC	4V±2%, 400mA, Internal current limiter	SOT-223	21vl	VR1	4k	Tor
36A	XC6203P412FR	LVR-IC	4.1V±2%, 400mA, Internal current limiter	SOT-223	21vl	VR1	4k	Tor
36B	XC6203P422FR	LVR-IC	4.2V±2%, 400mA, Internal current limiter	SOT-223	21vl	VR1	4k	Tor
36C	XC6203P432FR	LVR-IC	4.3V±2%, 400mA, Internal current limiter	SOT-223	21vl	VR1	4k	Tor
36D	XC6203P442FR	LVR-IC	4.4V±2%, 400mA, Internal current limiter	SOT-223	21vl	VR1	4k	Tor
36E	XC6203P452FR	LVR-IC	4.5V±2%, 400mA, Internal current limiter	SOT-223	21vl	VR1	4k	Tor
36F	XC6203P462FR	LVR-IC	4.6V±2%, 400mA, Internal current limiter	SOT-223	21vl	VR1	4k	Tor
36H	XC6203P472FR	LVR-IC	4.7V±2%, 400mA, Internal current limiter	SOT-223	21vl	VR1	4k	Tor
36K	XC6203P482FR	LVR-IC	4.8V±2%, 400mA, Internal current limiter	SOT-223	21vl	VR1	4k	Tor
36L	XC6203P492FR	LVR-IC	4.9V±2%, 400mA, Internal current limiter	SOT-223	21vl	VR1	4k	Tor
36M	XC6203P502FR	LVR-IC	5V±2%, 400mA, Internal current limiter	SOT-223	21vl	VR1	4k	Tor
36N	XC6203P512FR	LVR-IC	5.1V±2%, 400mA, Internal current limiter	SOT-223	21vl	VR1	4k	Tor
36P	XC6203P522FR	LVR-IC	5.2V±2%, 400mA, Internal current limiter	SOT-223	21vl	VR1	4k	Tor
36R	XC6203P532FR	LVR-IC	5.3V±2%, 400mA, Internal current limiter	SOT-223	21vl	VR1	4k	Tor
36S	XC6203P542FR	LVR-IC	5.4V±2%, 400mA, Internal current limiter	SOT-223	21vl	VR1	4k	Tor
36T	XC6203P552FR	LVR-IC	5.5V±2%, 400mA, Internal current limiter	SOT-223	21vl	VR1	4k	Tor
36U	XC6203P562FR	LVR-IC	5.6V±2%, 400mA, Internal current limiter	SOT-223	21vl	VR1	4k	Tor
36V	XC6203P572FR	LVR-IC	5.7V±2%, 400mA, Internal current limiter	SOT-223	21vl	VR1	4k	Tor
36X	XC6203P582FR	LVR-IC	5.8V±2%, 400mA, Internal current limiter	SOT-223	21vl	VR1	4k	Tor
36Y	XC6203P592FR	LVR-IC	5.9V±2%, 400mA, Internal current limiter	SOT-223	21vl	VR1	4k	Tor
36Z	XC6203P602FR	LVR-IC	6V±2%, 400mA, Internal current limiter	SOT-223	21vl	VR1	4k	Tor
37518	MC33375ST-1.8T3	LVR-IC	LDO, 1.8V±1%, 300mA, +CE	SOT-223	21hy	VR4	4s	Ons
37525	MC33375ST-2.5T3	LVR-IC	LDO, 2.5V±1%, 300mA, +CE	SOT-223	21hy	VR4	4s	Ons
37530	MC33375ST-3.0T3	LVR-IC	LDO, 3.0V±1%, 300mA, +CE	SOT-223	21hy	VR4	4s	Ons
37533	MC33375ST-3.3T3	LVR-IC	LDO, 3.3V±1%, 300mA, +CE	SOT-223	21hy	VR4	4s	Ons
37550	MC33375ST-5.0T3	LVR-IC	LDO, 5.0V±1%, 300mA, +CE	SOT-223	21hy	VR4	4s	Ons
37X	XC6203P28AFR	LVR-IC	2.85V±2%, 400mA, Internal current limiter	SOT-223	21vl	VR1	4k	Tor
3904	PZT3904	Si-npn	Sw, 60V, 100mA, 1.2W, B=100..300, >300MHz	SOT-223	21tm	-	4k	Ste
3906	PZT3906	Si-npn	Sw, 60V, 200mA, 1W, B=100..300, >250MHz	SOT-223	21tm	-	4k	Ste
40300	NSS40300MZ4	Si-npn	Drv, 40V, 3A, 2W, B=200..350, 126MHz	SOT-223	21tm	-	4s	Ons
40301	NSS40301MZ4	Si-npn	Drv, 40V, 3A, 2W, B=220..500, 215MHz	SOT-223	21tm	-	4s	Ons
4030P	NJT4030P	Si-npn	GP, 40V, 1A, 2W, B=220..400, 160MHz	SOT-223	21tm	-	4s	Ons
44	PZTA44	Si-npn	Vid, 500/400V, 300mA, 2W, B=400..300	SOT-223	21tm	-	4r	Wtr
5551A	PZT5551A	Si-npn	Drv, 180V, 600mA, 1.5W, B=80..200, <300MHz	SOT-223	21tm	-	4r	Wtr
5551B	PZT5551B	Si-npn	Drv, 180V, 600mA, 1.5W, B=100..250, <300MHz	SOT-223	21tm	-	4r	Wtr
5551C	PZT5551C	Si-npn	Drv, 180V, 600mA, 1.5W, B=160..400, <300MHz	SOT-223	21tm	-	4r	Wtr
56512	NCP56512T3	LVR-IC	LDO, 1.2V±1%, 1.5A	SOT-223	21wb	VR1	4s	Ons



SMD code	Type	Function	Short description	Case	Pinout	Sch.	St.	Mnf.
56512V	NCV565ST12T3	LVR-IC	LDO, 1.2V±1%, 1.5A	SOT-223	21wb	VR1	4s	Ons
5888	CHT5988ZPT	Si-pnp	AF, Sw, 60V, 5A, B=120..300, 100MHz	SOT-223	21fb	-	4r	Chm
5L175	NTF3055L175	n-MOSFET-e	V-MOS, LogL, 60V, 2A, 2.1W, 155mΩ(1A), 10.2/14.3ns	SOT-223	21f2	-	4s	Ons
5P03	NTF5P03T3	p-MOSFET-e	V-MOS, LogL, 30V, 5.2A, 1.5W, 56mΩ(5.2A), 10/38ns	SOT-223	21f2	-	4s	Ons
60600	NSS60600MZ4	Si-pnp	Drv, 100V, 6A, 800mW, B=150..360, 100MHz	SOT-223	21fm	-	4s	Ons
60601	NSS60601MZ4	Si-npn	Drv, 100V, 6A, 800mW, B=150..360, 100MHz	SOT-223	21fm	-	4s	Ons
642	NCV4264-2ST33T3G	LVR-IC	LDO, 3.3V±2%, 100mA	SOT-223	21eu	VR1	4s	Ons
642x	NCV4264-2ST50T3G	LVR-IC	LDO, 5.0V±2%, 100mA	SOT-223	21eu	VR1	4s	Ons
651	PZT651	Si-npn	GP, 80V, 2A, 800mW, B>75, >75MHz	SOT-223	21fm	-	4s	Ons
7285	NCP1117ST285T3	LVR-IC	LDO, 2.85V±1%, 800mA	SOT-223	21wb	VR1	4s	Ons
74-25G	NCV4274ST25T3G	LVR-IC	LDO, 2.5V±2%, 100mA	SOT-223	21hn	VR1	4s	Ons
74-33G	NCV4274ST33T3G	LVR-IC	LDO, 3.3V±2%, 100mA	SOT-223	21hn	VR1	4s	Ons
74A-25G	NCV4274AST25T3G	LVR-IC	LDO, 2.5V±1%, 100mA	SOT-223	21hn	VR1	4s	Ons
74A-33G	NCV4274AST33T3G	LVR-IC	LDO, 3.3V±1%, 100mA	SOT-223	21hn	VR1	4s	Ons
772	2SB772ZPT	Si-pnp	AF, Sw, 30V, 3A, B=100..500, 100MHz	SOT-223	21fb	-	4r	Chm
84K	XC6701D18FR	LVR-IC	1.8V±2%, 150mA	SOT-223	21ch	VR1	4k	Tor
84L	XC6701D19FR	LVR-IC	1.9V±2%, 150mA	SOT-223	21ch	VR1	4k	Tor
84M	XC6701D20FR	LVR-IC	2.0V±2%, 150mA	SOT-223	21ch	VR1	4k	Tor
84N	XC6701D21FR	LVR-IC	2.1V±2%, 150mA	SOT-223	21ch	VR1	4k	Tor
84P	XC6701D22FR	LVR-IC	2.2V±2%, 150mA	SOT-223	21ch	VR1	4k	Tor
84R	XC6701D23FR	LVR-IC	2.3V±2%, 150mA	SOT-223	21ch	VR1	4k	Tor
84S	XC6701D24FR	LVR-IC	2.4V±2%, 150mA	SOT-223	21ch	VR1	4k	Tor
84T	XC6701D25FR	LVR-IC	2.5V±2%, 150mA	SOT-223	21ch	VR1	4k	Tor
84U	XC6701D26FR	LVR-IC	2.6V±2%, 150mA	SOT-223	21ch	VR1	4k	Tor
84V	XC6701D27FR	LVR-IC	2.7V±2%, 150mA	SOT-223	21ch	VR1	4k	Tor
84X	XC6701D28FR	LVR-IC	2.8V±2%, 150mA	SOT-223	21ch	VR1	4k	Tor
84Y	XC6701D29FR	LVR-IC	2.9V±2%, 150mA	SOT-223	21ch	VR1	4k	Tor
84Z	XC6701D30FR	LVR-IC	3.0V±2%, 150mA	SOT-223	21ch	VR1	4k	Tor
850	XC6701D31FR	LVR-IC	3.1V±2%, 150mA	SOT-223	21ch	VR1	4k	Tor
851	XC6701D32FR	LVR-IC	3.2V±2%, 150mA	SOT-223	21ch	VR1	4k	Tor
852	XC6701D33FR	LVR-IC	3.3V±2%, 150mA	SOT-223	21ch	VR1	4k	Tor
853	XC6701D34FR	LVR-IC	3.4V±2%, 150mA	SOT-223	21ch	VR1	4k	Tor
854	XC6701D35FR	LVR-IC	3.5V±2%, 150mA	SOT-223	21ch	VR1	4k	Tor
855	XC6701D36FR	LVR-IC	3.6V±2%, 150mA	SOT-223	21ch	VR1	4k	Tor
856	XC6701D37FR	LVR-IC	3.7V±2%, 150mA	SOT-223	21ch	VR1	4k	Tor
857	XC6701D38FR	LVR-IC	3.8V±2%, 150mA	SOT-223	21ch	VR1	4k	Tor
858	XC6701D39FR	LVR-IC	3.9V±2%, 150mA	SOT-223	21ch	VR1	4k	Tor
859	XC6701D40FR	LVR-IC	4.0V±2%, 150mA	SOT-223	21ch	VR1	4k	Tor
85A	XC6701D41FR	LVR-IC	4.1V±2%, 150mA	SOT-223	21ch	VR1	4k	Tor
85B	XC6701D42FR	LVR-IC	4.2V±2%, 150mA	SOT-223	21ch	VR1	4k	Tor
85C	XC6701D43FR	LVR-IC	4.3V±2%, 150mA	SOT-223	21ch	VR1	4k	Tor
85C	XC6701D58FR	LVR-IC	5.8V±2%, 150mA	SOT-223	21ch	VR1	4k	Tor
85D	XC6701D44FR	LVR-IC	4.4V±2%, 150mA	SOT-223	21ch	VR1	4k	Tor
85E	XC6701D45FR	LVR-IC	4.5V±2%, 150mA	SOT-223	21ch	VR1	4k	Tor
85F	XC6701D46FR	LVR-IC	4.6V±2%, 150mA	SOT-223	21ch	VR1	4k	Tor
85H	XC6701D47FR	LVR-IC	4.7V±2%, 150mA	SOT-223	21ch	VR1	4k	Tor
85K	XC6701D48FR	LVR-IC	4.8V±2%, 150mA	SOT-223	21ch	VR1	4k	Tor
85L	XC6701D49FR	LVR-IC	4.9V±2%, 150mA	SOT-223	21ch	VR1	4k	Tor
85M	XC6701D50FR	LVR-IC	5.0V±2%, 150mA	SOT-223	21ch	VR1	4k	Tor
85N	XC6701D51FR	LVR-IC	5.1V±2%, 150mA	SOT-223	21ch	VR1	4k	Tor
85P	XC6701D52FR	LVR-IC	5.2V±2%, 150mA	SOT-223	21ch	VR1	4k	Tor
85R	XC6701D53FR	LVR-IC	5.3V±2%, 150mA	SOT-223	21ch	VR1	4k	Tor
85S	XC6701D54FR	LVR-IC	5.4V±2%, 150mA	SOT-223	21ch	VR1	4k	Tor
85T	XC6701D55FR	LVR-IC	5.5V±2%, 150mA	SOT-223	21ch	VR1	4k	Tor
85U	XC6701D56FR	LVR-IC	5.6V±2%, 150mA	SOT-223	21ch	VR1	4k	Tor
85V	XC6701D57FR	LVR-IC	5.7V±2%, 150mA	SOT-223	21ch	VR1	4k	Tor
85Y	XC6701D59FR	LVR-IC	5.9V±2%, 150mA	SOT-223	21ch	VR1	4k	Tor
85Z	XC6701D60FR	LVR-IC	6.0V±2%, 150mA	SOT-223	21ch	VR1	4k	Tor
860	XC6701D61FR	LVR-IC	6.1V±2%, 150mA	SOT-223	21ch	VR1	4k	Tor
861	XC6701D62FR	LVR-IC	6.2V±2%, 150mA	SOT-223	21ch	VR1	4k	Tor
862	XC6701D63FR	LVR-IC	6.3V±2%, 150mA	SOT-223	21ch	VR1	4k	Tor
863	XC6701D64FR	LVR-IC	6.4V±2%, 150mA	SOT-223	21ch	VR1	4k	Tor
864	XC6701D65FR	LVR-IC	6.5V±2%, 150mA	SOT-223	21ch	VR1	4k	Tor
865	XC6701D66FR	LVR-IC	6.6V±2%, 150mA	SOT-223	21ch	VR1	4k	Tor
866	XC6701D67FR	LVR-IC	6.7V±2%, 150mA	SOT-223	21ch	VR1	4k	Tor
867	XC6701D68FR	LVR-IC	6.8V±2%, 150mA	SOT-223	21ch	VR1	4k	Tor
868	XC6701D69FR	LVR-IC	6.9V±2%, 150mA	SOT-223	21ch	VR1	4k	Tor
869	XC6701D70FR	LVR-IC	7.0V±2%, 150mA	SOT-223	21ch	VR1	4k	Tor
86A	XC6701D71FR	LVR-IC	7.1V±2%, 150mA	SOT-223	21ch	VR1	4k	Tor
86B	XC6701D72FR	LVR-IC	7.2V±2%, 150mA	SOT-223	21ch	VR1	4k	Tor



SMD
code

Type

Function

Short description

Case

Pinout

Sch.

St.

Mnf.

SMD code	Type	Function	Short description	Case	Pinout	Sch.	St.	Mnf.
86C	XC6701D73FR	LVR-IC	7.3V±2%, 150mA	SOT-223	21ch	VR1	4k	Tor
86D	XC6701D74FR	LVR-IC	7.4V±2%, 150mA	SOT-223	21ch	VR1	4k	Tor
86E	XC6701D75FR	LVR-IC	7.5V±2%, 150mA	SOT-223	21ch	VR1	4k	Tor
86F	XC6701D76FR	LVR-IC	7.6V±2%, 150mA	SOT-223	21ch	VR1	4k	Tor
86H	XC6701D77FR	LVR-IC	7.7V±2%, 150mA	SOT-223	21ch	VR1	4k	Tor
86K	XC6701D78FR	LVR-IC	7.8V±2%, 150mA	SOT-223	21ch	VR1	4k	Tor
86L	XC6701D79FR	LVR-IC	7.9V±2%, 150mA	SOT-223	21ch	VR1	4k	Tor
86M	XC6701D80FR	LVR-IC	8.0V±2%, 150mA	SOT-223	21ch	VR1	4k	Tor
86N	XC6701D81FR	LVR-IC	8.1V±2%, 150mA	SOT-223	21ch	VR1	4k	Tor
86P	XC6701D82FR	LVR-IC	8.2V±2%, 150mA	SOT-223	21ch	VR1	4k	Tor
86R	XC6701D83FR	LVR-IC	8.3V±2%, 150mA	SOT-223	21ch	VR1	4k	Tor
86S	XC6701D84FR	LVR-IC	8.4V±2%, 150mA	SOT-223	21ch	VR1	4k	Tor
86T	XC6701D85FR	LVR-IC	8.5V±2%, 150mA	SOT-223	21ch	VR1	4k	Tor
86U	XC6701D86FR	LVR-IC	8.6V±2%, 150mA	SOT-223	21ch	VR1	4k	Tor
86V	XC6701D87FR	LVR-IC	8.7V±2%, 150mA	SOT-223	21ch	VR1	4k	Tor
86X	XC6701D88FR	LVR-IC	8.8V±2%, 150mA	SOT-223	21ch	VR1	4k	Tor
86Y	XC6701D89FR	LVR-IC	8.9V±2%, 150mA	SOT-223	21ch	VR1	4k	Tor
86Z	XC6701D90FR	LVR-IC	9.0V±2%, 150mA	SOT-223	21ch	VR1	4k	Tor
870	XC6701D91FR	LVR-IC	9.1V±2%, 150mA	SOT-223	21ch	VR1	4k	Tor
871	XC6701D92FR	LVR-IC	9.2V±2%, 150mA	SOT-223	21ch	VR1	4k	Tor
872	XC6701D93FR	LVR-IC	9.3V±2%, 150mA	SOT-223	21ch	VR1	4k	Tor
873	XC6701D94FR	LVR-IC	9.4V±2%, 150mA	SOT-223	21ch	VR1	4k	Tor
874	XC6701D95FR	LVR-IC	9.5V±2%, 150mA	SOT-223	21ch	VR1	4k	Tor
875	XC6701D96FR	LVR-IC	9.6V±2%, 150mA	SOT-223	21ch	VR1	4k	Tor
876	XC6701D97FR	LVR-IC	9.7V±2%, 150mA	SOT-223	21ch	VR1	4k	Tor
877	XC6701D98FR	LVR-IC	9.8V±2%, 150mA	SOT-223	21ch	VR1	4k	Tor
878	XC6701D99FR	LVR-IC	9.9V±2%, 150mA	SOT-223	21ch	VR1	4k	Tor
879	XC6701DA0FR	LVR-IC	10.0V±2%, 150mA	SOT-223	21ch	VR1	4k	Tor
87A	XC6701DA1FR	LVR-IC	10.1V±2%, 150mA	SOT-223	21ch	VR1	4k	Tor
87B	XC6701DA2FR	LVR-IC	10.2V±2%, 150mA	SOT-223	21ch	VR1	4k	Tor
87C	XC6701DA3FR	LVR-IC	10.3V±2%, 150mA	SOT-223	21ch	VR1	4k	Tor
87D	XC6701DA4FR	LVR-IC	10.4V±2%, 150mA	SOT-223	21ch	VR1	4k	Tor
87E	XC6701DA5FR	LVR-IC	10.5V±2%, 150mA	SOT-223	21ch	VR1	4k	Tor
87F	XC6701DA6FR	LVR-IC	10.6V±2%, 150mA	SOT-223	21ch	VR1	4k	Tor
87H	XC6701DA7FR	LVR-IC	10.7V±2%, 150mA	SOT-223	21ch	VR1	4k	Tor
87K	XC6701DA8FR	LVR-IC	10.8V±2%, 150mA	SOT-223	21ch	VR1	4k	Tor
87L	XC6701DA9FR	LVR-IC	10.9V±2%, 150mA	SOT-223	21ch	VR1	4k	Tor
87M	XC6701DB0FR	LVR-IC	11.0V±2%, 150mA	SOT-223	21ch	VR1	4k	Tor
87N	XC6701DB1FR	LVR-IC	11.1V±2%, 150mA	SOT-223	21ch	VR1	4k	Tor
87P	XC6701DB2FR	LVR-IC	11.2V±2%, 150mA	SOT-223	21ch	VR1	4k	Tor
87R	XC6701DB3FR	LVR-IC	11.3V±2%, 150mA	SOT-223	21ch	VR1	4k	Tor
87S	XC6701DB4FR	LVR-IC	11.4V±2%, 150mA	SOT-223	21ch	VR1	4k	Tor
87T	XC6701DB5FR	LVR-IC	11.5V±2%, 150mA	SOT-223	21ch	VR1	4k	Tor
87U	XC6701DB6FR	LVR-IC	11.6V±2%, 150mA	SOT-223	21ch	VR1	4k	Tor
87V	XC6701DB7FR	LVR-IC	11.7V±2%, 150mA	SOT-223	21ch	VR1	4k	Tor
87X	XC6701DB8FR	LVR-IC	11.8V±2%, 150mA	SOT-223	21ch	VR1	4k	Tor
87Y	XC6701DB9FR	LVR-IC	11.9V±2%, 150mA	SOT-223	21ch	VR1	4k	Tor
87Z	XC6701DC0FR	LVR-IC	12.0V±2%, 150mA	SOT-223	21ch	VR1	4k	Tor
882	2SD882ZPT	Si-npn	AF, Sw, 30V, 3A, B=100..500, 100MHz	SOT-223	21fb	-	4r	Chm
8C0	XC6701DC1FR	LVR-IC	12.1V±2%, 150mA	SOT-223	21ch	VR1	4k	Tor
8C1	XC6701DC2FR	LVR-IC	12.2V±2%, 150mA	SOT-223	21ch	VR1	4k	Tor
8C2	XC6701DC3FR	LVR-IC	12.3V±2%, 150mA	SOT-223	21ch	VR1	4k	Tor
8C3	XC6701DC4FR	LVR-IC	12.4V±2%, 150mA	SOT-223	21ch	VR1	4k	Tor
8C4	XC6701DC5FR	LVR-IC	12.5V±2%, 150mA	SOT-223	21ch	VR1	4k	Tor
8C5	XC6701DC6FR	LVR-IC	12.6V±2%, 150mA	SOT-223	21ch	VR1	4k	Tor
8C6	XC6701DC7FR	LVR-IC	12.7V±2%, 150mA	SOT-223	21ch	VR1	4k	Tor
8C7	XC6701DC8FR	LVR-IC	12.8V±2%, 150mA	SOT-223	21ch	VR1	4k	Tor
8C8	XC6701DC9FR	LVR-IC	12.9V±2%, 150mA	SOT-223	21ch	VR1	4k	Tor
8C9	XC6701DD0FR	LVR-IC	13.0V±2%, 150mA	SOT-223	21ch	VR1	4k	Tor
8CA	XC6701DD1FR	LVR-IC	13.1V±2%, 150mA	SOT-223	21ch	VR1	4k	Tor
8CB	XC6701DD2FR	LVR-IC	13.2V±2%, 150mA	SOT-223	21ch	VR1	4k	Tor
8CC	XC6701DD3FR	LVR-IC	13.3V±2%, 150mA	SOT-223	21ch	VR1	4k	Tor
8CD	XC6701DD4FR	LVR-IC	13.4V±2%, 150mA	SOT-223	21ch	VR1	4k	Tor
8CE	XC6701DD5FR	LVR-IC	13.5V±2%, 150mA	SOT-223	21ch	VR1	4k	Tor
8CF	XC6701DD6FR	LVR-IC	13.6V±2%, 150mA	SOT-223	21ch	VR1	4k	Tor
8CH	XC6701DD7FR	LVR-IC	13.7V±2%, 150mA	SOT-223	21ch	VR1	4k	Tor
8CK	XC6701DD8FR	LVR-IC	13.8V±2%, 150mA	SOT-223	21ch	VR1	4k	Tor
8CL	XC6701DD9FR	LVR-IC	13.9V±2%, 150mA	SOT-223	21ch	VR1	4k	Tor
8CM	XC6701DE0FR	LVR-IC	14.0V±2%, 150mA	SOT-223	21ch	VR1	4k	Tor
8CN	XC6701DE1FR	LVR-IC	14.1V±2%, 150mA	SOT-223	21ch	VR1	4k	Tor



SMD code	Type	Function	Short description	Case	Pinout	Sch.	St.	Mnf.
8CP	XC6701DE2FR	LVR-IC	14.2V±2%, 150mA	SOT-223	21ch	VR1	4k	Tor
8CR	XC6701DE3FR	LVR-IC	14.3V±2%, 150mA	SOT-223	21ch	VR1	4k	Tor
8CS	XC6701DE4FR	LVR-IC	14.4V±2%, 150mA	SOT-223	21ch	VR1	4k	Tor
8CT	XC6701DE5FR	LVR-IC	14.5V±2%, 150mA	SOT-223	21ch	VR1	4k	Tor
8CU	XC6701DE6FR	LVR-IC	14.6V±2%, 150mA	SOT-223	21ch	VR1	4k	Tor
8CV	XC6701DE7FR	LVR-IC	14.7V±2%, 150mA	SOT-223	21ch	VR1	4k	Tor
8CX	XC6701DE8FR	LVR-IC	14.8V±2%, 150mA	SOT-223	21ch	VR1	4k	Tor
8CY	XC6701DE9FR	LVR-IC	14.9V±2%, 150mA	SOT-223	21ch	VR1	4k	Tor
8CZ	XC6701DF0FR	LVR-IC	15.0V±2%, 150mA	SOT-223	21ch	VR1	4k	Tor
8D0	XC6701DF1FR	LVR-IC	15.1V±2%, 150mA	SOT-223	21ch	VR1	4k	Tor
8D1	XC6701DF2FR	LVR-IC	15.2V±2%, 150mA	SOT-223	21ch	VR1	4k	Tor
8D2	XC6701DF3FR	LVR-IC	15.3V±2%, 150mA	SOT-223	21ch	VR1	4k	Tor
8D3	XC6701DF4FR	LVR-IC	15.4V±2%, 150mA	SOT-223	21ch	VR1	4k	Tor
8D4	XC6701DF5FR	LVR-IC	15.5V±2%, 150mA	SOT-223	21ch	VR1	4k	Tor
8D5	XC6701DF6FR	LVR-IC	15.6V±2%, 150mA	SOT-223	21ch	VR1	4k	Tor
8D6	XC6701DF7FR	LVR-IC	15.7V±2%, 150mA	SOT-223	21ch	VR1	4k	Tor
8D7	XC6701DF8FR	LVR-IC	15.8V±2%, 150mA	SOT-223	21ch	VR1	4k	Tor
8D8	XC6701DF9FR	LVR-IC	15.9V±2%, 150mA	SOT-223	21ch	VR1	4k	Tor
8D9	XC6701DG0FR	LVR-IC	16.0V±2%, 150mA	SOT-223	21ch	VR1	4k	Tor
8DA	XC6701DG1FR	LVR-IC	16.1V±2%, 150mA	SOT-223	21ch	VR1	4k	Tor
8DB	XC6701DG2FR	LVR-IC	16.2V±2%, 150mA	SOT-223	21ch	VR1	4k	Tor
8DC	XC6701DG3FR	LVR-IC	16.3V±2%, 150mA	SOT-223	21ch	VR1	4k	Tor
8DD	XC6701DG4FR	LVR-IC	16.4V±2%, 150mA	SOT-223	21ch	VR1	4k	Tor
8DE	XC6701DG5FR	LVR-IC	16.5V±2%, 150mA	SOT-223	21ch	VR1	4k	Tor
8DF	XC6701DG6FR	LVR-IC	16.6V±2%, 150mA	SOT-223	21ch	VR1	4k	Tor
8DH	XC6701DG7FR	LVR-IC	16.7V±2%, 150mA	SOT-223	21ch	VR1	4k	Tor
8DK	XC6701DG8FR	LVR-IC	16.8V±2%, 150mA	SOT-223	21ch	VR1	4k	Tor
8DL	XC6701DG9FR	LVR-IC	16.9V±2%, 150mA	SOT-223	21ch	VR1	4k	Tor
8DM	XC6701DH0FR	LVR-IC	17.0V±2%, 150mA	SOT-223	21ch	VR1	4k	Tor
8DN	XC6701DH1FR	LVR-IC	17.1V±2%, 150mA	SOT-223	21ch	VR1	4k	Tor
8DP	XC6701DH2FR	LVR-IC	17.2V±2%, 150mA	SOT-223	21ch	VR1	4k	Tor
8DR	XC6701DH3FR	LVR-IC	17.3V±2%, 150mA	SOT-223	21ch	VR1	4k	Tor
8DS	XC6701DH4FR	LVR-IC	17.4V±2%, 150mA	SOT-223	21ch	VR1	4k	Tor
8DT	XC6701DH5FR	LVR-IC	17.5V±2%, 150mA	SOT-223	21ch	VR1	4k	Tor
8DU	XC6701DH6FR	LVR-IC	17.6V±2%, 150mA	SOT-223	21ch	VR1	4k	Tor
8DV	XC6701DH7FR	LVR-IC	17.7V±2%, 150mA	SOT-223	21ch	VR1	4k	Tor
8DX	XC6701DH8FR	LVR-IC	17.8V±2%, 150mA	SOT-223	21ch	VR1	4k	Tor
8DY	XC6701DH9FR	LVR-IC	17.9V±2%, 150mA	SOT-223	21ch	VR1	4k	Tor
8DZ	XC6701DJ0FR	LVR-IC	18.0V±2%, 150mA	SOT-223	21ch	VR1	4k	Tor
9435Z	CHT9435ZPT	Si-pnp	AF, Sw, 30V, 3A, B=125..220, 110MHz	SOT-223	21tb	-	4r	Chm
A42	PZTA42	Si-pnp	Vid, 300/300V, 500mA, 2W, B>25, >50MHz	SOT-223	21tm	-	4r	Wtr
Ā8819AB	AME8819AEGT330Z	LVR-IC	LDO, 3.3V±1.5%, 600mA	SOT-223	21eu	VR1	4q	Ame
Ā8819AC	AME8819AEGT310Z	LVR-IC	LDO, 3.1V±1.5%, 600mA	SOT-223	21eu	VR1	4q	Ame
Ā8819AD	AME8819AEGT300Z	LVR-IC	LDO, 3.0V±1.5%, 600mA	SOT-223	21eu	VR1	4q	Ame
Ā8819AG	AME8819AEGT250Z	LVR-IC	LDO, 2.5V±1.5%, 600mA	SOT-223	21eu	VR1	4q	Ame
Ā8819AJ	AME8819AEGT180Z	LVR-IC	LDO, 1.8V±1.5%, 600mA	SOT-223	21eu	VR1	4q	Ame
Ā8819AJ	AME8819AEGT150Z	LVR-IC	LDO, 1.5V±1.5%, 600mA	SOT-223	21eu	VR1	4q	Ame
Ā8819AK	AME8819AEGT120Z	LVR-IC	LDO, 1.2V±1.5%, 600mA	SOT-223	21eu	VR1	4q	Ame
Ā8819BB	AME8819BEGT330Z	LVR-IC	LDO, 3.3V±1.5%, 600mA	SOT-223	21eu	VR1	4q	Ame
Ā8819BD	AME8819BEGT300Z	LVR-IC	LDO, 3.0V±1.5%, 600mA	SOT-223	21eu	VR1	4q	Ame
Ā8819BG	AME8819BEGT250Z	LVR-IC	LDO, 2.5V±1.5%, 600mA	SOT-223	21eu	VR1	4q	Ame
Ā8819BI	AME8819BEGT180Z	LVR-IC	LDO, 1.8V±1.5%, 600mA	SOT-223	21eu	VR1	4q	Ame
Ā8819BJ	AME8819BEGT150Z	LVR-IC	LDO, 1.5V±1.5%, 600mA	SOT-223	21eu	VR1	4q	Ame
Ā8819BK	AME8819BEGT120Z	LVR-IC	LDO, 1.2V±1.5%, 600mA	SOT-223	21eu	VR1	4q	Ame
Ā8827AB	AME8827-AGT330	LVR-IC	LDO, 3.3V±1.5%, 1A	SOT-223	21eu	VR1	4q	Ame
Ā8827AG	AME8827-AGT250	LVR-IC	LDO, 2.5V±1.5%, 1A	SOT-223	21eu	VR1	4q	Ame
Ā8827AI	AME8827-AGT180	LVR-IC	LDO, 1.8V±1.5%, 1A	SOT-223	21eu	VR1	4q	Ame
Ā8827AK	AME8827-AGT120	LVR-IC	LDO, 1.2V±1.5%, 1A	SOT-223	21eu	VR1	4q	Ame
Ā8827EB	AME8827-BGT330	LVR-IC	LDO, 3.3V±1.5%, 1A	SOT-223	21cq	VR1	4q	Ame
Ā8827EG	AME8827-BGT250	LVR-IC	LDO, 2.5V±1.5%, 1A	SOT-223	21cq	VR1	4q	Ame
Ā8827EJ	AME8827-BGT180	LVR-IC	LDO, 1.8V±1.5%, 1A	SOT-223	21cq	VR1	4q	Ame
Ā8827EJ	AME8827-BGT150	LVR-IC	LDO, 1.5V±1.5%, 1A	SOT-223	21cq	VR1	4q	Ame
Ā8827EK	AME8827-BGT120	LVR-IC	LDO, 1.2V±1.5%, 1A	SOT-223	21cq	VR1	4q	Ame
AA	BCP51	Si-pnp	AF, 45V, 1A, 1.3W, B=63..250, 115MHz	SOT-223	21tm	-	4k	Phi
AC	BCP51-10	Si-pnp	AF, 45V, 1A, 1.3W, B=63..160, 115MHz	SOT-223	21tm	-	4k	Phi
AD	BCP51-16	Si-pnp	AF, 45V, 1A, 1.3W, B=100, 250, 115MHz	SOT-223	21tm	-	4k	Phi
ADB	AME8805AEGT	LVR-IC	LDO, 3.3V±1.5%, 600mA	SOT-223	21eu	VR1	4q	Ame
ĀDB	AME8805AEGTZ	LVR-IC	LDO, 3.3V±1.5%, 600mA	SOT-223	21eu	VR1	4q	Ame
ADC	AME8805BEGT	LVR-IC	LDO, 3.0V±1.5%, 600mA	SOT-223	21eu	VR1	4q	Ame
ĀDC	AME8805BEGTZ	LVR-IC	LDO, 3.0V±1.5%, 600mA	SOT-223	21eu	VR1	4q	Ame



SMD
code

Type

Function

Short description

Case

Pinout

Sch.

St.

Mnf.

SMD code	Type	Function	Short description	Case	Pinout	Sch.	St.	Mnf.
ADD	AME8805CEGT	LVR-IC	LDO, 2.8V±1.5%, 600mA	SOT-223	21eu	VR1	4q	Ame
ADD	AME8805CEGTZ	LVR-IC	LDO, 2.8V±1.5%, 600mA	SOT-223	21eu	VR1	4q	Ame
ADE	AME8805DEGT	LVR-IC	LDO, 2.5V±1.5%, 600mA	SOT-223	21eu	VR1	4q	Ame
ADE	AME8805DEGTZ	LVR-IC	LDO, 2.5V±1.5%, 600mA	SOT-223	21eu	VR1	4q	Ame
ADF	AME8805EEGT	LVR-IC	LDO, 3.8V±1.5%, 600mA	SOT-223	21eu	VR1	4q	Ame
ADF	AME8805EEGTZ	LVR-IC	LDO, 3.8V±1.5%, 600mA	SOT-223	21eu	VR1	4q	Ame
ADH	AME8805GEGT	LVR-IC	LDO, 3.5V±1.5%, 600mA	SOT-223	21eu	VR1	4q	Ame
ADH	AME8805GEGTZ	LVR-IC	LDO, 3.5V±1.5%, 600mA	SOT-223	21eu	VR1	4q	Ame
AE	BCP52	Si-pnp	AF, 60V, 1A, 1.3W, B=63..250, 115MHz	SOT-223	21tm	-	4k	Phi
AE	TSB1424ACW	Si-pnp	Lo-sat, 50V, 30A, 500mW, B=180..560, 240MHz	SOT-223	21tm	-	4k	Tsc
AEJ	AME8805HEGT	LVR-IC	LDO, 2.7V±1.5%, 600mA	SOT-223	21eu	VR1	4q	Ame
AEJ	AME8805HEGTZ	LVR-IC	LDO, 2.7V±1.5%, 600mA	SOT-223	21eu	VR1	4q	Ame
AER	AME8805IEGT	LVR-IC	LDO, 3.4V±1.5%, 600mA	SOT-223	21eu	VR1	4q	Ame
AER	AME8805IEGTZ	LVR-IC	LDO, 3.4V±1.5%, 600mA	SOT-223	21eu	VR1	4q	Ame
AET	AME8808AEGT	LVR-IC	LDO, 3.3V±1.5%, 750mA	SOT-223	21cq	VR1	4q	Ame
AET	AME8808AEGTZ	LVR-IC	LDO, 3.3V±1.5%, 750mA	SOT-223	21cq	VR1	4q	Ame
AEV	AME8808BEGT	LVR-IC	LDO, 3.0V±1.5%, 750mA	SOT-223	21cq	VR1	4q	Ame
AEV	AME8808BEGTZ	LVR-IC	LDO, 3.0V±1.5%, 750mA	SOT-223	21cq	VR1	4q	Ame
AEW	AME8808CEGT	LVR-IC	LDO, 2.8V±1.5%, 750mA	SOT-223	21cq	VR1	4q	Ame
AEW	AME8808CEGTZ	LVR-IC	LDO, 2.5V±1.5%, 750mA	SOT-223	21cq	VR1	4q	Ame
ĀEX	AME8808EGTZ	LVR-IC	LDO, 3.8V±1.5%, 750mA	SOT-223	21cq	VR1	4q	Ame
ĀEY	AME8808FEGTZ	LVR-IC	LDO, 3.6V±1.5%, 750mA	SOT-223	21cq	VR1	4q	Ame
ĀEZ	AME8808GEGTZ	LVR-IC	LDO, 3.5V±1.5%, 750mA	SOT-223	21cq	VR1	4q	Ame
ĀFA	AME8808HEGTZ	LVR-IC	LDO, 2.7V±1.5%, 750mA	SOT-223	21cq	VR1	4q	Ame
ĀFB	AME8808IEGTZ	LVR-IC	LDO, 3.4V±1.5%, 750mA	SOT-223	21cq	VR1	4q	Ame
AG	BCP52-10	Si-pnp	AF, 60V, 1A, 1.3W, B=63..160, 115MHz	SOT-223	21tm	-	4k	Phi
AGT	AME8805JEGT	LVR-IC	LDO, 2.85V±1.5%, 600mA	SOT-223	21eu	VR1	4q	Ame
ĀGT	AME8805JEGTZ	LVR-IC	LDO, 2.85V±1.5%, 600mA	SOT-223	21eu	VR1	4q	Ame
ĀGU	AME8808JEGTZ	LVR-IC	LDO, 2.85V±1.5%, 750mA	SOT-223	21cq	VR1	4q	Ame
AH	BCP53	Si-pnp	AF, 100V, 1A, 1.3W, B=63..250, 115MHz	SOT-223	21tm	-	4k	Ons
AH-10	BCP53-10	Si-pnp	AF, 100V, 1.5A, 1.5W, B=63..160, 115MHz	SOT-223	21tm	-	4s	Ons
AH-16	BCP53-16	Si-pnp	AF, 100V, 1.5A, 1.5W, B=100..250, 115MHz	SOT-223	21tm	-	4s	Ons
AHV	AME8805KEGT	LVR-IC	LDO, 3.7V±1.5%, 600mA	SOT-223	21eu	VR1	4q	Ame
ĀHV	AME8805KEGTZ	LVR-IC	LDO, 3.7V±1.5%, 600mA	SOT-223	21eu	VR1	4q	Ame
ĀHW	AME8808KEGTZ	LVR-IC	LDO, 3.7V±1.5%, 750mA	SOT-223	21cq	VR1	4q	Ame
ĀJG	AME8808LEGTZ	LVR-IC	LDO, 1.5V±1.5%, 750mA	SOT-223	21cq	VR1	4q	Ame
ĀJH	AME8808MEGTZ	LVR-IC	LDO, 1.8V±1.5%, 750mA	SOT-223	21cq	VR1	4q	Ame
AJI	AME8805LEGT	LVR-IC	LDO, 1.5V±1.5%, 600mA	SOT-223	21eu	VR1	4q	Ame
ĀJI	AME8805LEGTZ	LVR-IC	LDO, 1.5V±1.5%, 600mA	SOT-223	21eu	VR1	4q	Ame
AJJ	AME8805MEGT	LVR-IC	LDO, 1.8V±1.5%, 600mA	SOT-223	21eu	VR1	4q	Ame
ĀJJ	AME8805MEGTZ	LVR-IC	LDO, 1.8V±1.5%, 600mA	SOT-223	21eu	VR1	4q	Ame
AJY	AME8815BEGT150	LVR-IC	LDO, 1.50V±1.5%, 1.5A	SOT-223	21cq	VR1	4q	Ame
ĀJY	AME8815BEGT150Z	LVR-IC	LDO, 1.50V±1.5%, 1.5A	SOT-223	21cq	VR1	4q	Ame
AJZ	AME8815BEGT180	LVR-IC	LDO, 1.80V±1.5%, 1.5A	SOT-223	21cq	VR1	4q	Ame
ĀJZ	AME8815BEGT180Z	LVR-IC	LDO, 1.80V±1.5%, 1.5A	SOT-223	21cq	VR1	4q	Ame
AK	BCP53-10	Si-pnp	AF, 100V, 1A, 1.3W, B=63..160, 115MHz	SOT-223	21tm	-	4k	Phi
AKB	AME8815BEGT250	LVR-IC	LDO, 2.50V±1.5%, 1.5A	SOT-223	21cq	VR1	4q	Ame
ĀKB	AME8815BEGT250Z	LVR-IC	LDO, 2.50V±1.5%, 1.5A	SOT-223	21cq	VR1	4q	Ame
AKC	AME8815AEGT330	LVR-IC	LDO, 3.30V±1.5%, 1.5A	SOT-223	21eu	VR1	4q	Ame
ĀKC	AME8815AEGT330Z	LVR-IC	LDO, 3.30V±1.5%, 1.5A	SOT-223	21eu	VR1	4q	Ame
AKD	AME8815BEGT330	LVR-IC	LDO, 3.30V±1.5%, 1.5A	SOT-223	21cq	VR1	4q	Ame
ĀKD	AME8815BEGT330Z	LVR-IC	LDO, 3.30V±1.5%, 1.5A	SOT-223	21cq	VR1	4q	Ame
AKS	AME8805NEGT	LVR-IC	LDO, 2.9V±1.5%, 600mA	SOT-223	21eu	VR1	4q	Ame
ĀKS	AME8805NEGTZ	LVR-IC	LDO, 2.9V±1.5%, 600mA	SOT-223	21eu	VR1	4q	Ame
ĀKT	AME8805OEGT	LVR-IC	LDO, 3.1V±1.5%, 600mA	SOT-223	21eu	VR1	4q	Ame
AKT	AME8805OEGTZ	LVR-IC	LDO, 3.1V±1.5%, 600mA	SOT-223	21eu	VR1	4q	Ame
ĀKU	AME8808NEGTZ	LVR-IC	LDO, 2.9V±1.5%, 750mA	SOT-223	21cq	VR1	4q	Ame
ĀKV	AME8808OEGTZ	LVR-IC	LDO, 3.1V±1.5%, 750mA	SOT-223	21cq	VR1	4q	Ame
AL	BCP53-16	Si-pnp	AF, 100V, 1A, 1.3W, B=100..250, 115MHz	SOT-223	21tm	-	4k	Phi
AM	BCP52-16	Si-pnp	AF, 60V, 1A, 1.3W, B=100..250, 115MHz	SOT-223	21tm	-	4k	Phi
AMN	AME8815BEGT475	LVR-IC	LDO, 4.75V±1.5%, 1.5A	SOT-223	21cq	VR1	4q	Ame
ĀMN	AME8815BEGT475Z	LVR-IC	LDO, 4.75V±1.5%, 1.5A	SOT-223	21cq	VR1	4q	Ame
APR	AME8815AEGT250	LVR-IC	LDO, 2.50V±1.5%, 1.5A	SOT-223	21eu	VR1	4q	Ame
ĀPR	AME8815AEGT250Z	LVR-IC	LDO, 2.50V±1.5%, 1.5A	SOT-223	21eu	VR1	4q	Ame
AQQ	AME8815BEGT390	LVR-IC	LDO, 3.90V±1.5%, 1.5A	SOT-223	21cq	VR1	4q	Ame
ĀQQ	AME8815BEGT390Z	LVR-IC	LDO, 3.90V±1.5%, 1.5A	SOT-223	21cq	VR1	4q	Ame
AQR	AME8815AEGT475	LVR-IC	LDO, 4.75V±1.5%, 1.5A	SOT-223	21eu	VR1	4q	Ame
ĀQR	AME8815AEGT475Z	LVR-IC	LDO, 4.75V±1.5%, 1.5A	SOT-223	21eu	VR1	4q	Ame
AQS	AME8815AEGT500	LVR-IC	LDO, 5.00V±1.5%, 1.5A	SOT-223	21eu	VR1	4q	Ame
ĀQS	AME8815AEGT500Z	LVR-IC	LDO, 5.00V±1.5%, 1.5A	SOT-223	21eu	VR1	4q	Ame
AQT	AME8815BEGT500	LVR-IC	LDO, 5.00V±1.5%, 1.5A	SOT-223	21cq	VR1	4q	Ame



SMD code	Type	Function	Short description	Case	Pinout	Sch.	St.	Mnf.
ĀQU	AME8815BEGT500Z	LVR-IC	LDO, 5.00V±1.5%, 1.5A	SOT-223	21cq	VR1	4q	Ame
AQU	AME8815AEGT180	LVR-IC	LDO, 1.80V±1.5%, 1.5A	SOT-223	21eu	VR1	4q	Ame
ĀQU	AME8815AEGT180Z	LVR-IC	LDO, 1.80V±1.5%, 1.5A	SOT-223	21eu	VR1	4q	Ame
AR2	BSP41	Si-npn	AF, Sw, 70V, 1A, 1.3W, B=30..300, >100MHz	SOT-223	21tm	-	4k	Phi
AR3	BSP42	Si-npn	AF, Sw, 90V, 1A, 1.3W, B=10..120, >100MHz	SOT-223	21tm	-	4k	Phi
AR4	BSP43	Si-npn	AF, Sw, 90V, 1A, 1.3W, B=30..300, >100MHz	SOT-223	21tm	-	4k	Phi
AS1	BSP50	Si-npn-Darl	AF, 60V, 1A, 1.25W, B>1000, >200MHz	SOT-223	21tm	-	4k	Phi
AS2	BSP51	Si-npn-Darl	AF, 80V, 1A, 1.25W, B>1000, >200MHz	SOT-223	21tm	-	4k	Phi
AS3	BSP52	Si-npn-Darl	AF, 90V, 1A, 1.25W, B>1000, >200MHz	SOT-223	21tm	-	4k	Phi
ASP	AME8815AEGT150	LVR-IC	LDO, 1.50V±1.5%, 1.5A	SOT-223	21eu	VR1	4q	Ame
ĀSP	AME8815AEGT150Z	LVR-IC	LDO, 1.50V±1.5%, 1.5A	SOT-223	21eu	VR1	4q	Ame
AT1	BSP19	Si-npn	AF, Sw, Vid, 400V, 100mA, 1.2W, B>40, >15MHz	SOT-223	21tm	-	4k	Phi
AT120A	BAT120A	Si-diode	Dual, Schottky, Fast, 25V, 1A, Vf<0.45V(1A), <300µs	SOT-223	21bt	-	4k	Phi
AT120C	BAT120C	Si-diode	Dual, Schottky, Fast, 25V, 1A, Vf<0.45V(1A), <300µs	SOT-223	21bu	-	4k	Phi
AT120S	BAT120S	Si-diode	Dual, Schottky, Fast, 25V, 1A, Vf<0.45V(1A), <300µs	SOT-223	21bv	-	4k	Phi
AT140A	BAT140A	Si-diode	Dual, Schottky, Fast, 40V, 1A, Vf<0.5V(1A), <300µs	SOT-223	21bt	-	4k	Phi
AT140C	BAT140C	Si-diode	Dual, Schottky, Fast, 40V, 1A, Vf<0.5V(1A), <300µs	SOT-223	21bu	-	4k	Phi
AT140S	BAT140S	Si-diode	Dual, Schottky, Fast, 40V, 1A, Vf<0.5V(1A), <300µs	SOT-223	21bv	-	4k	Phi
AT160A	BAT160A	Si-diode	Dual, Schottky, Fast, 60V, 1A, Vf<0.65V(1A), <300µs	SOT-223	21bt	-	4k	Phi
AT160C	BAT160C	Si-diode	Dual, Schottky, Fast, 60V, 1A, Vf<0.65V(1A), <300µs	SOT-223	21bu	-	4k	Phi
AT160S	BAT160S	Si-diode	Dual, Schottky, Fast, 60V, 1A, Vf<0.65V(1A), <300µs	SOT-223	21bv	-	4k	Phi
AT2	BSP20	Si-npn	AF, Sw, Vid, 300V, 100mA, 1.2W, B>40, >15MHz	SOT-223	21tm	-	4k	Phi
AWF	AME8843AEGT250	LVR-IC	LDO, 2.5V±1.5%, 750mA	SOT-223	21eu	VR1	4q	Ame
ĀWF	AME8843AEGT250Z	LVR-IC	LDO, 2.5V±1.5%, 750mA	SOT-223	21eu	VR1	4q	Ame
AWL	AME88051EGT	LVR-IC	LDO, 1.3V±1.5%, 600mA	SOT-223	21eu	VR1	4q	Ame
ĀWL	AME88051EGTZ	LVR-IC	LDO, 1.3V±1.5%, 600mA	SOT-223	21eu	VR1	4q	Ame
AWZ	AME8843AEGT180	LVR-IC	LDO, 1.8V±1.5%, 750mA	SOT-223	21eu	VR1	4q	Ame
ĀWZ	AME8843AEGT180Z	LVR-IC	LDO, 1.8V±1.5%, 750mA	SOT-223	21eu	VR1	4q	Ame
AZS	AME8845AEGT250	LVR-IC	LDO, 2.50V±1.5%, 3A	SOT-223	21eu	VR1	4q	Ame
ĀZS	AME8845AEGT250Z	LVR-IC	LDO, 2.50V±1.5%, 3A	SOT-223	21eu	VR1	4q	Ame
BA	BCP54	Si-npn	AF, 45V, 1A, 1.3W, B=63..250, 115MHz	SOT-223	21tm	-	4k	Phi
BAY	AME8815AEGT190	LVR-IC	LDO, 1.90V±1.5%, 1.5A	SOT-223	21eu	VR1	4q	Ame
ĀAY	AME8815AEGT190Z	LVR-IC	LDO, 1.90V±1.5%, 1.5A	SOT-223	21eu	VR1	4q	Ame
BAZ	AME8845AEGT180	LVR-IC	LDO, 1.80V±1.5%, 3A	SOT-223	21eu	VR1	4q	Ame
ĀAZ	AME8845AEGT180Z	LVR-IC	LDO, 1.80V±1.5%, 3A	SOT-223	21eu	VR1	4q	Ame
BC	BCP54-10	Si-npn	AF, 45V, 1A, 1.3W, B=63..160, 115MHz	SOT-223	21tm	-	4k	Phi
ĀCI	AME8805YEGTZ	LVR-IC	LDO, 1.9V±1.5%, 600mA	SOT-223	21eu	VR1	4q	Ame
BCP56	CHT3019ZPT	Si-npn	AF, Sw, 80V, 1A B=100..300, 100MHz	SOT-223	21tb	-	4r	Chm
BD	BCP54-16	Si-npn	AF, 45V, 1A, 1.3W, B=100..250, 115MHz	SOT-223	21tm	-	4k	Phi
ĀDF	AME8845AEGT330Z	LVR-IC	LDO, 3.30V±1.5%, 3A	SOT-223	21eu	VR1	4q	Ame
BE	BCP55	Si-npn	AF, 60V, 1A, 1.3W, B=63..250, 115MHz	SOT-223	21tm	-	4k	Phi
ĀFW	AME8847AEGT330Z	LVR-IC	LDO, 3.3V±1.5%, 800mA	SOT-223	21cq	VR1	4q	Ame
BG	BCP55-10	Si-npn	AF, 60V, 1A, 1.3W, B=63..160, 115MHz	SOT-223	21tm	-	4k	Phi
ĀGI	AME8845AEGT150Z	LVR-IC	LDO, 1.50V±1.5%, 3A	SOT-223	21eu	VR1	4q	Ame
BH	BCP56	Si-npn	AF, 80V, 1A, 1.3W, B=63..250, 115MHz	SOT-223	21tm	-	4k	Phi
BH-10	BCP56-10	Si-npn	AF, 80V, 1A, 1.5W, B=63..160, 115MHz	SOT-223	21tm	-	4s	Ons
BH-16	BCP56-16	Si-npn	AF, 80V, 1A, 1.5W, B=100..250, 115MHz	SOT-223	21tm	-	4s	Ons
BHI	AME8847AEGT180Z	LVR-IC	LDO, 1.8V±1.5%, 800mA	SOT-223	21cq	VR1	4q	Ame
ĀHJ	AME8847AEGT250Z	LVR-IC	LDO, 2.5V±1.5%, 800mA	SOT-223	21cq	VR1	4q	Ame
BK	BCP56-10	Si-npn	AF, 80V, 1A, 1.3W, B=63..160, 115MHz	SOT-223	21tm	-	4k	Phi
BL	BCP56-16	Si-npn	AF, 80V, 1A, 1.3W, B=100..250, 115MHz	SOT-223	21tm	-	4k	Phi
ĀLI	AME8848AEGT180Z	LVR-IC	LDO, 1.8V±1.5%, 1A	SOT-223	21eu	VR1	4q	Ame
ĀLJ	AME8848AEGT250Z	LVR-IC	LDO, 2.5V±1.5%, 1A	SOT-223	21eu	VR1	4q	Ame
ĀLK	AME8848AEGT330Z	LVR-IC	LDO, 3.3V±1.5%, 1A	SOT-223	21eu	VR1	4q	Ame
BM	BCP55-16	Si-npn	AF, 60V, 1A, 1.3W, B=100..250, 115MHz	SOT-223	21tm	-	4k	Phi
BR2	BSP31	Si-npn	AF, Sw, 70V, 1A, 1.3W, B=30..300, >100MHz	SOT-223	21tm	-	4k	Phi
BR3	BSP32	Si-npn	AF, Sw, 90V, 1A, 1.3W, B=10..120, >100MHz	SOT-223	21tm	-	4k	Phi
BR4	BSP33	Si-npn	AF, Sw, 90V, 1A, 1.3W, B=30..300, >100MHz	SOT-223	21tm	-	4k	Phi
BS1	BSP60	Si-npn-Darl	AF, 60V, 1A, 1.25W, B>1000, >200MHz	SOT-223	21tm	-	4k	Phi
BS2	BSP61	Si-npn-Darl	AF, 80V, 1A, 1.25W, B>1000, >200MHz	SOT-223	21tm	-	4k	Phi
BS3	BSP62	Si-npn-Darl	AF, 90V, 1A, 1.25W, B>1000, >200MHz	SOT-223	21tm	-	4k	Phi
BT1	BSP15	Si-npn	AF, Sw, Vid, 200V, 200mA, 1.2W, B=30..120, >15MHz	SOT-223	21tm	-	4k	Phi
BT2	BSP16	Si-npn	AF, Sw, Vid, 350V, 200mA, 1.2W, B=30..120, >15MHz	SOT-223	21tm	-	4k	Phi
BU15G	AIC1723A-15GY	LVR-IC	LDO, 1.5V±1%, 500mA	SOT-223	21ch	VR1	4k	Aic
BU15P	AIC1723A-15PY	LVR-IC	LDO, 1.5V±1%, 500mA	SOT-223	21ch	VR1	4k	Aic
BU18G	AIC1723A-18GY	LVR-IC	LDO, 1.8V±1%, 500mA	SOT-223	21ch	VR1	4k	Aic
BU18P	AIC1723A-18PY	LVR-IC	LDO, 1.8V±1%, 500mA	SOT-223	21ch	VR1	4k	Aic
BU20G	AIC1723A-20GY	LVR-IC	LDO, 2.0V±1%, 500mA	SOT-223	21ch	VR1	4k	Aic
BU20P	AIC1723A-20PY	LVR-IC	LDO, 2.0V±1%, 500mA	SOT-223	21ch	VR1	4k	Aic
BU25G	AIC1723A-25GY	LVR-IC	LDO, 2.5V±1%, 500mA	SOT-223	21ch	VR1	4k	Aic



SMD code	Type	Function	Short description	Case	Pinout	Sch.	St.	Mnf.
BU25P	AIC1723A-25PY	LVR-IC	LDO, 2.5V±1%, 500mA	SOT-223	21ch	VR1	4k	Aic
BU27G	AIC1723A-27GY	LVR-IC	LDO, 2.7V±1%, 500mA	SOT-223	21ch	VR1	4k	Aic
BU27P	AIC1723A-27PY	LVR-IC	LDO, 2.7V±1%, 500mA	SOT-223	21ch	VR1	4k	Aic
BU30G	AIC1723A-30GY	LVR-IC	LDO, 3.0V±1%, 500mA	SOT-223	21ch	VR1	4k	Aic
BU30P	AIC1723A-30PY	LVR-IC	LDO, 3.0V±1%, 500mA	SOT-223	21ch	VR1	4k	Aic
BU33G	AIC1723A-33GY	LVR-IC	LDO, 3.3V±1%, 500mA	SOT-223	21ch	VR1	4k	Aic
BU33P	AIC1723A-33PY	LVR-IC	LDO, 3.3V±1%, 500mA	SOT-223	21ch	VR1	4k	Aic
BU35G	AIC1723A-35GY	LVR-IC	LDO, 3.5V±1%, 500mA	SOT-223	21ch	VR1	4k	Aic
BU35P	AIC1723A-35PY	LVR-IC	LDO, 3.5V±1%, 500mA	SOT-223	21ch	VR1	4k	Aic
BU37G	AIC1723A-37GY	LVR-IC	LDO, 3.7V±1%, 500mA	SOT-223	21ch	VR1	4k	Aic
BU37P	AIC1723A-37PY	LVR-IC	LDO, 3.7V±1%, 500mA	SOT-223	21ch	VR1	4k	Aic
BU38G	AIC1723A-38GY	LVR-IC	LDO, 3.8V±1%, 500mA	SOT-223	21ch	VR1	4k	Aic
BU38P	AIC1723A-38PY	LVR-IC	LDO, 3.8V±1%, 500mA	SOT-223	21ch	VR1	4k	Aic
BU50G	AIC1723A-50GY	LVR-IC	LDO, 5.0V±1%, 500mA	SOT-223	21ch	VR1	4k	Aic
BU50P	AIC1723A-50PY	LVR-IC	LDO, 5.0V±1%, 500mA	SOT-223	21ch	VR1	4k	Aic
BU52G	AIC1723A-52GY	LVR-IC	LDO, 5.2V±1%, 500mA	SOT-223	21ch	VR1	4k	Aic
BU52P	AIC1723A-52PY	LVR-IC	LDO, 5.2V±1%, 500mA	SOT-223	21ch	VR1	4k	Aic
CA	BCP68	Si-npn	AF, 32V, 1A, 1.3W, B=50..375, >40MHz	SOT-223	21tm	-	4k	Phi
CAG	AME8815BEGT190Z	LVR-IC	LDO, 1.90V±1.5%, 1.5A	SOT-223	21cq	VR1	4q	Amc
CB	BCP68-16	Si-npn	AF, 32V, 1A, 1.3W, B=100..250, >40MHz	SOT-223	21tm	-	4k	Phi
CC	BCP68-25	Si-npn	AF, 32V, 1A, 1.3W, B=160..375, >40MHz	SOT-223	21tm	-	4k	Phi
CC15	AIC1735-15CY	LVR-IC	LDO, 1.5V±1%, 500mA	SOT-223	21ch	VR1	4k	Aic
CC15G	AIC1735-15GY	LVR-IC	LDO, 1.5V±1%, 500mA	SOT-223	21ch	VR1	4k	Aic
CC15P	AIC1735-15PY	LVR-IC	LDO, 1.5V±1%, 500mA	SOT-223	21ch	VR1	4k	Aic
CC18	AIC1735-18CY	LVR-IC	LDO, 1.8V±1%, 500mA	SOT-223	21ch	VR1	4k	Aic
CC18G	AIC1735-18GY	LVR-IC	LDO, 1.8V±1%, 500mA	SOT-223	21ch	VR1	4k	Aic
CC18P	AIC1735-18PY	LVR-IC	LDO, 1.8V±1%, 500mA	SOT-223	21ch	VR1	4k	Aic
CC18P	SS6735-18GY	LVR-IC	LDO, 1.8V±2%, 500mA	SOT-223	21ch	VR1	4r	Ssc
CC20	AIC1735-20CY	LVR-IC	LDO, 2.0V±1%, 500mA	SOT-223	21ch	VR1	4k	Aic
CC20G	AIC1735-20GY	LVR-IC	LDO, 2.0V±1%, 500mA	SOT-223	21ch	VR1	4k	Aic
CC20P	AIC1735-20PY	LVR-IC	LDO, 2.0V±1%, 500mA	SOT-223	21ch	VR1	4k	Aic
CC20P	SS6735-20GY	LVR-IC	LDO, 2.0V±2%, 500mA	SOT-223	21ch	VR1	4r	Ssc
CC25	AIC1735-25CY	LVR-IC	LDO, 2.5V±1%, 500mA	SOT-223	21ch	VR1	4k	Aic
CC25G	AIC1735-25GY	LVR-IC	LDO, 2.5V±1%, 500mA	SOT-223	21ch	VR1	4k	Aic
CC25P	AIC1735-25PY	LVR-IC	LDO, 2.5V±1%, 500mA	SOT-223	21ch	VR1	4k	Aic
CC25P	SS6735-25GY	LVR-IC	LDO, 2.5V±2%, 500mA	SOT-223	21ch	VR1	4r	Ssc
CC27	AIC1735-27CY	LVR-IC	LDO, 2.7V±1%, 500mA	SOT-223	21ch	VR1	4k	Aic
CC27G	AIC1735-27GY	LVR-IC	LDO, 2.7V±1%, 500mA	SOT-223	21ch	VR1	4k	Aic
CC27P	AIC1735-27PY	LVR-IC	LDO, 2.7V±1%, 500mA	SOT-223	21ch	VR1	4k	Aic
CC27P	SS6735-27GY	LVR-IC	LDO, 2.7V±2%, 500mA	SOT-223	21ch	VR1	4r	Ssc
CC30	AIC1735-30CY	LVR-IC	LDO, 3.0V±1%, 500mA	SOT-223	21ch	VR1	4k	Aic
CC30G	AIC1735-30GY	LVR-IC	LDO, 3.0V±1%, 500mA	SOT-223	21ch	VR1	4k	Aic
CC30P	AIC1735-30PY	LVR-IC	LDO, 3.0V±1%, 500mA	SOT-223	21ch	VR1	4k	Aic
CC30P	SS6735-30GY	LVR-IC	LDO, 3.0V±2%, 500mA	SOT-223	21ch	VR1	4r	Ssc
CC33	AIC1735-33CY	LVR-IC	LDO, 3.3V±1%, 500mA	SOT-223	21ch	VR1	4k	Aic
CC33G	AIC1735-33GY	LVR-IC	LDO, 3.3V±1%, 500mA	SOT-223	21ch	VR1	4k	Aic
CC33P	AIC1735-33PY	LVR-IC	LDO, 3.3V±1%, 500mA	SOT-223	21ch	VR1	4k	Aic
CC33P	SS6735-33GY	LVR-IC	LDO, 3.3V±2%, 500mA	SOT-223	21ch	VR1	4r	Ssc
CC35	AIC1735-35CY	LVR-IC	LDO, 3.5V±1%, 500mA	SOT-223	21ch	VR1	4k	Aic
CC35G	AIC1735-35GY	LVR-IC	LDO, 3.5V±1%, 500mA	SOT-223	21ch	VR1	4k	Aic
CC35P	AIC1735-35PY	LVR-IC	LDO, 3.5V±1%, 500mA	SOT-223	21ch	VR1	4k	Aic
CC35P	SS6735-35GY	LVR-IC	LDO, 3.5V±2%, 500mA	SOT-223	21ch	VR1	4r	Ssc
CC37	AIC1735-37CY	LVR-IC	LDO, 3.7V±1%, 500mA	SOT-223	21ch	VR1	4k	Aic
CC37G	AIC1735-37GY	LVR-IC	LDO, 3.7V±1%, 500mA	SOT-223	21ch	VR1	4k	Aic
CC37P	AIC1735-37PY	LVR-IC	LDO, 3.7V±1%, 500mA	SOT-223	21ch	VR1	4k	Aic
CC37P	SS6735-37GY	LVR-IC	LDO, 3.7V±2%, 500mA	SOT-223	21ch	VR1	4r	Ssc
CC38	AIC1735-38CY	LVR-IC	LDO, 3.8V±1%, 500mA	SOT-223	21ch	VR1	4k	Aic
CC38G	AIC1735-38GY	LVR-IC	LDO, 3.8V±1%, 500mA	SOT-223	21ch	VR1	4k	Aic
CC38P	AIC1735-38PY	LVR-IC	LDO, 3.8V±1%, 500mA	SOT-223	21ch	VR1	4k	Aic
CC38P	SS6735-38GY	LVR-IC	LDO, 3.8V±2%, 500mA	SOT-223	21ch	VR1	4r	Ssc
CC50	AIC1735-50CY	LVR-IC	LDO, 5.0V±1%, 500mA	SOT-223	21ch	VR1	4k	Aic
CC50G	AIC1735-50GY	LVR-IC	LDO, 5.0V±1%, 500mA	SOT-223	21ch	VR1	4k	Aic
CC50P	AIC1735-50PY	LVR-IC	LDO, 5.0V±1%, 500mA	SOT-223	21ch	VR1	4k	Aic
CC50P	SS6735-50GY	LVR-IC	LDO, 5.0V±2%, 500mA	SOT-223	21ch	VR1	4r	Ssc
CC52	AIC1735-52CY	LVR-IC	LDO, 5.2V±1%, 500mA	SOT-223	21ch	VR1	4k	Aic
CC52G	AIC1735-52GY	LVR-IC	LDO, 5.2V±1%, 500mA	SOT-223	21ch	VR1	4k	Aic
CC52P	AIC1735-52PY	LVR-IC	LDO, 5.2V±1%, 500mA	SOT-223	21ch	VR1	4k	Aic
CC52P	SS6735-52GY	LVR-IC	LDO, 5.2V±2%, 500mA	SOT-223	21ch	VR1	4r	Ssc
CE	BCP69	Si-npn	AF, 32V, 1A, 1.3W, B=100..375, >40MHz	SOT-223	21tm	-	4k	Phi
CF	BCP69-16	Si-npn	AF, 32V, 1A, 1.3W, B=100..250, >40MHz	SOT-223	21tm	-	4k	Phi



SMD code	Type	Function	Short description	Case	Pinout	Sch.	St.	Mnf.
CG	BCP69-25	Si-npn	AF, 32V, 1A, 1.3W, B=160...375, >40MHz	SOT-223	21tm	-	4k	Phi
CHP69	CHP69PT	Si-npn	AF, Sw, 20V, 1A, B=85...375, 40MHz	SOT-223	21fb	-	4r	Chm
DA	BF722	Si-npn	Vid, 250V, 100mA, 1.2W, B>50, >60MHz	SOT-223	21tb	-	4k	Phi
DB	BF723	Si-npn	Vid, 250V, 100mA, 1.2W, B>50, >60MHz	SOT-223	21tb	-	4k	Phi
DC	BF720	Si-npn	Vid, 300V, 100mA, 1.5W, B>50, >60MHz	SOT-223	21tb	-	4s	Ons
DF	BF721	Si-npn	Vid, 300V, 100mA, 1.5W, B>50, >60MHz	SOT-223	21tb	-	4s	Ons
FT107	MMFT107T1	n-MOSFET-e	T-MOS, LogL, 200V, 250mA, 800mW, 14Q(200mA), 60pF	SOT-223	21fz	-	4q	Mot
FT960	MMFT960T1	n-MOSFET-e	V-MOS, LogL, 60V, 300mA, 800mW, 1.7Q(1A), Qg=3.2ns	SOT-223	21fz	-	4s	Ons
GK08G	AIC1748-08GY3A	LVR-IC	LDO, 0.8V±2%, 600mA	SOT-223	21cg	VR1	4r	Aic
GK09G	AIC1748-09GY3A	LVR-IC	LDO, 0.9V±2%, 600mA	SOT-223	21cg	VR1	4r	Aic
GK10G	AIC1748-10GY3A	LVR-IC	LDO, 1.0V±2%, 600mA	SOT-223	21cg	VR1	4r	Aic
GK11G	AIC1748-11GY3A	LVR-IC	LDO, 1.1V±2%, 600mA	SOT-223	21cg	VR1	4r	Aic
GK12G	AIC1748-12GY3A	LVR-IC	LDO, 1.2V±2%, 600mA	SOT-223	21cg	VR1	4r	Aic
GK13G	AIC1748-13GY3A	LVR-IC	LDO, 1.3V±2%, 600mA	SOT-223	21cg	VR1	4r	Aic
GK14G	AIC1748-14GY3A	LVR-IC	LDO, 1.4V±2%, 600mA	SOT-223	21cg	VR1	4r	Aic
GK15G	AIC1748-15GY3A	LVR-IC	LDO, 1.5V±2%, 600mA	SOT-223	21cg	VR1	4r	Aic
GK16G	AIC1748-16GY3A	LVR-IC	LDO, 1.6V±2%, 600mA	SOT-223	21cg	VR1	4r	Aic
GK17G	AIC1748-17GY3A	LVR-IC	LDO, 1.7V±2%, 600mA	SOT-223	21cg	VR1	4r	Aic
GK18G	AIC1748-18GY3A	LVR-IC	LDO, 1.8V±2%, 600mA	SOT-223	21cg	VR1	4r	Aic
GK19G	AIC1748-19GY3A	LVR-IC	LDO, 1.9V±2%, 600mA	SOT-223	21cg	VR1	4r	Aic
GK20G	AIC1748-20GY3A	LVR-IC	LDO, 2.0V±2%, 600mA	SOT-223	21cg	VR1	4r	Aic
GK21G	AIC1748-21GY3A	LVR-IC	LDO, 2.1V±2%, 600mA	SOT-223	21cg	VR1	4r	Aic
GK22G	AIC1748-22GY3A	LVR-IC	LDO, 2.2V±2%, 600mA	SOT-223	21cg	VR1	4r	Aic
GK23G	AIC1748-23GY3A	LVR-IC	LDO, 2.3V±2%, 600mA	SOT-223	21cg	VR1	4r	Aic
GK24G	AIC1748-24GY3A	LVR-IC	LDO, 2.4V±2%, 600mA	SOT-223	21cg	VR1	4r	Aic
GK25G	AIC1748-25GY3A	LVR-IC	LDO, 2.5V±2%, 600mA	SOT-223	21cg	VR1	4r	Aic
GK26G	AIC1748-26GY3A	LVR-IC	LDO, 2.6V±2%, 600mA	SOT-223	21cg	VR1	4r	Aic
GK27G	AIC1748-27GY3A	LVR-IC	LDO, 2.7V±2%, 600mA	SOT-223	21cg	VR1	4r	Aic
GK28G	AIC1748-28GY3A	LVR-IC	LDO, 2.8V±2%, 600mA	SOT-223	21cg	VR1	4r	Aic
GK29G	AIC1748-29GY3A	LVR-IC	LDO, 2.9V±2%, 600mA	SOT-223	21cg	VR1	4r	Aic
GK2JG	AIC1748-285GY3A	LVR-IC	LDO, 2.85V±2%, 600mA	SOT-223	21cg	VR1	4r	Aic
GK30G	AIC1748-30GY3A	LVR-IC	LDO, 3.0V±2%, 600mA	SOT-223	21cg	VR1	4r	Aic
GK31G	AIC1748-32GY3A	LVR-IC	LDO, 3.1V±2%, 600mA	SOT-223	21cg	VR1	4r	Aic
GK32G	AIC1748-33GY3A	LVR-IC	LDO, 3.2V±2%, 600mA	SOT-223	21cg	VR1	4r	Aic
GK33G	AIC1748-33GY3A	LVR-IC	LDO, 3.3V±2%, 600mA	SOT-223	21cg	VR1	4r	Aic
GL08G	AIC1748-08GY3T	LVR-IC	LDO, 0.8V±2%, 600mA	SOT-223	21ch	VR1	4r	Aic
GL09G	AIC1748-09GY3T	LVR-IC	LDO, 0.9V±2%, 600mA	SOT-223	21ch	VR1	4r	Aic
GL10G	AIC1748-10GY3T	LVR-IC	LDO, 1.0V±2%, 600mA	SOT-223	21ch	VR1	4r	Aic
GL11G	AIC1748-11GY3T	LVR-IC	LDO, 1.1V±2%, 600mA	SOT-223	21ch	VR1	4r	Aic
GL12G	AIC1748-12GY3T	LVR-IC	LDO, 1.2V±2%, 600mA	SOT-223	21ch	VR1	4r	Aic
GL13G	AIC1748-13GY3T	LVR-IC	LDO, 1.3V±2%, 600mA	SOT-223	21ch	VR1	4r	Aic
GL14G	AIC1748-14GY3T	LVR-IC	LDO, 1.4V±2%, 600mA	SOT-223	21ch	VR1	4r	Aic
GL15G	AIC1748-15GY3T	LVR-IC	LDO, 1.5V±2%, 600mA	SOT-223	21ch	VR1	4r	Aic
GL16G	AIC1748-16GY3T	LVR-IC	LDO, 1.6V±2%, 600mA	SOT-223	21ch	VR1	4r	Aic
GL17G	AIC1748-17GY3T	LVR-IC	LDO, 1.7V±2%, 600mA	SOT-223	21ch	VR1	4r	Aic
GL18G	AIC1748-18GY3T	LVR-IC	LDO, 1.8V±2%, 600mA	SOT-223	21ch	VR1	4r	Aic
GL19G	AIC1748-19GY3T	LVR-IC	LDO, 1.9V±2%, 600mA	SOT-223	21ch	VR1	4r	Aic
GL20G	AIC1748-20GY3T	LVR-IC	LDO, 2.0V±2%, 600mA	SOT-223	21ch	VR1	4r	Aic
GL21G	AIC1748-21GY3T	LVR-IC	LDO, 2.1V±2%, 600mA	SOT-223	21ch	VR1	4r	Aic
GL22G	AIC1748-22GY3T	LVR-IC	LDO, 2.2V±2%, 600mA	SOT-223	21ch	VR1	4r	Aic
GL23G	AIC1748-23GY3T	LVR-IC	LDO, 2.3V±2%, 600mA	SOT-223	21ch	VR1	4r	Aic
GL24G	AIC1748-24GY3T	LVR-IC	LDO, 2.4V±2%, 600mA	SOT-223	21ch	VR1	4r	Aic
GL25G	AIC1748-25GY3T	LVR-IC	LDO, 2.5V±2%, 600mA	SOT-223	21ch	VR1	4r	Aic
GL26G	AIC1748-26GY3T	LVR-IC	LDO, 2.6V±2%, 600mA	SOT-223	21ch	VR1	4r	Aic
GL27G	AIC1748-27GY3T	LVR-IC	LDO, 2.7V±2%, 600mA	SOT-223	21ch	VR1	4r	Aic
GL28G	AIC1748-28GY3T	LVR-IC	LDO, 2.8V±2%, 600mA	SOT-223	21ch	VR1	4r	Aic
GL29G	AIC1748-29GY3T	LVR-IC	LDO, 2.9V±2%, 600mA	SOT-223	21ch	VR1	4r	Aic
GL2JG	AIC1748-285GY3T	LVR-IC	LDO, 2.85V±2%, 600mA	SOT-223	21ch	VR1	4r	Aic
GL30G	AIC1748-30GY3T	LVR-IC	LDO, 3.0V±2%, 600mA	SOT-223	21ch	VR1	4r	Aic
GL31G	AIC1748-32GY3T	LVR-IC	LDO, 3.1V±2%, 600mA	SOT-223	21ch	VR1	4r	Aic
GL32G	AIC1748-33GY3T	LVR-IC	LDO, 3.2V±2%, 600mA	SOT-223	21ch	VR1	4r	Aic
GL33G	AIC1748-33GY3T	LVR-IC	LDO, 3.3V±2%, 600mA	SOT-223	21ch	VR1	4r	Aic
HB08G	AIC1190-08GY3	LVR-IC	LDO, 0.8V±2%, 1A	SOT-223	21hn	VR1	4r	Aic
HB08P	AIC1190-08PY3	LVR-IC	LDO, 0.8V±2%, 1A	SOT-223	21hn	VR1	4r	Aic
HB10G	AIC1190-10GY3	LVR-IC	LDO, 1.0V±2%, 1A	SOT-223	21hn	VR1	4r	Aic
HB10P	AIC1190-10PY3	LVR-IC	LDO, 1.0V±2%, 1A	SOT-223	21hn	VR1	4r	Aic
HB12G	AIC1190-12GY3	LVR-IC	LDO, 1.2V±2%, 1A	SOT-223	21hn	VR1	4r	Aic
HB12P	AIC1190-12PY3	LVR-IC	LDO, 1.2V±2%, 1A	SOT-223	21hn	VR1	4r	Aic
HB15G	AIC1190-15GY3	LVR-IC	LDO, 1.5V±2%, 1A	SOT-223	21hn	VR1	4r	Aic
HB15P	AIC1190-15PY3	LVR-IC	LDO, 1.5V±2%, 1A	SOT-223	21hn	VR1	4r	Aic



SMD code	Type	Function	Short description	Case	Pinout	Sch.	St.	Mnf.
HB18G	AIC1190-18GY3	LVR-IC	LDO, 1.8V±2%, 1A	SOT-223	21hn	VR1	4r	Aic
HB18P	AIC1190-18PY3	LVR-IC	LDO, 1.8V±2%, 1A	SOT-223	21hn	VR1	4r	Aic
HB20G	AIC1190-20GY3	LVR-IC	LDO, 2.0V±2%, 1A	SOT-223	21hn	VR1	4r	Aic
HB20P	AIC1190-20PY3	LVR-IC	LDO, 2.0V±2%, 1A	SOT-223	21hn	VR1	4r	Aic
HB25G	AIC1190-25GY3	LVR-IC	LDO, 2.5V±2%, 1A	SOT-223	21hn	VR1	4r	Aic
HB25P	AIC1190-25PY3	LVR-IC	LDO, 2.5V±2%, 1A	SOT-223	21hn	VR1	4r	Aic
HB27G	AIC1190-27GY3	LVR-IC	LDO, 2.7V±2%, 1A	SOT-223	21hn	VR1	4r	Aic
HB27P	AIC1190-27PY3	LVR-IC	LDO, 2.7V±2%, 1A	SOT-223	21hn	VR1	4r	Aic
HB30G	AIC1190-30GY3	LVR-IC	LDO, 3.0V±2%, 1A	SOT-223	21hn	VR1	4r	Aic
HB30P	AIC1190-30PY3	LVR-IC	LDO, 3.0V±2%, 1A	SOT-223	21hn	VR1	4r	Aic
HB33G	AIC1190-33GY3	LVR-IC	LDO, 3.3V±2%, 1A	SOT-223	21hn	VR1	4r	Aic
HB33P	AIC1190-33PY3	LVR-IC	LDO, 3.3V±2%, 1A	SOT-223	21hn	VR1	4r	Aic
HB35G	AIC1190-35GY3	LVR-IC	LDO, 3.5V±2%, 1A	SOT-223	21hn	VR1	4r	Aic
HB35P	AIC1190-35PY3	LVR-IC	LDO, 3.5V±2%, 1A	SOT-223	21hn	VR1	4r	Aic
HB37G	AIC1190-37GY3	LVR-IC	LDO, 3.7V±2%, 1A	SOT-223	21hn	VR1	4r	Aic
HB37P	AIC1190-37PY3	LVR-IC	LDO, 3.7V±2%, 1A	SOT-223	21hn	VR1	4r	Aic
HB38G	AIC1190-38GY3	LVR-IC	LDO, 3.8V±2%, 1A	SOT-223	21hn	VR1	4r	Aic
HB38P	AIC1190-38PY3	LVR-IC	LDO, 3.8V±2%, 1A	SOT-223	21hn	VR1	4r	Aic
HD1	HDP01-0512N	LIN-IC	HDD/FDD/CD-R Power supply protection 5V/12V	SOT-223	21	-	4r	Ste
LOEB	LM2940IMP-9.0	LVR-IC	LDO, 9V±2%, 1A	SOT-223	21hn	VR1	4k	Nsc
L53B	LM2940IMP-5.0	LVR-IC	LDO, 5V±2%, 1A	SOT-223	21hn	VR1	4k	Nsc
L54B	LM2940IMP-8.0	LVR-IC	LDO, 8V±2%, 1A	SOT-223	21hn	VR1	4k	Nsc
L55B	LM2940IMP-10	LVR-IC	LDO, 10V±2%, 1A	SOT-223	21hn	VR1	4k	Nsc
L56B	LM2940IMP-12	LVR-IC	LDO, 12V±2%, 1A	SOT-223	21hn	VR1	4k	Nsc
L68B	LM2937IMP-2.5	LVR-IC	LDO, 2.5V±2%, 400mA	SOT-223	21hn	VR1	4k	Nsc
L69B	LM2937IMP-3.3	LVR-IC	LDO, 3.3V±2%, 400mA	SOT-223	21hn	VR1	4k	Nsc
L70B	LM2940IMP-15	LVR-IC	LDO, 15V±2%, 1A	SOT-223	21hn	VR1	4k	Nsc
L71B	LM2937IMP-5.0	LVR-IC	LDO, 5V±2%, 500mA	SOT-223	21hn	VR1	4k	Nsc
L72B	LM2937IMP-8.0	LVR-IC	LDO, 8V±2%, 500mA	SOT-223	21hn	VR1	4k	Nsc
L73B	LM2937IMP-10	LVR-IC	LDO, 10V±2%, 500mA	SOT-223	21hn	VR1	4k	Nsc
L74B	LM2937IMP-12	LVR-IC	LDO, 12V±2%, 500mA	SOT-223	21hn	VR1	4k	Nsc
L75B	LM2937IMP-15	LVR-IC	LDO, 15V±2%, 500mA	SOT-223	21hn	VR1	4k	Nsc
LS00	LMS8117AMP-1.8	LVR-IC	LDO, 1.8V±1%, 1A	SOT-223	21wb	VR1	4k	Nsc
LS01	LMS8117AMP-3.3	LVR-IC	LDO, 3.3V±1%, 1A	SOT-223	21wb	VR1	4k	Nsc
LS0A	LMS8117AMP-ADJ	LVR-IC	LDO, Adjustable 1.25..13.8V, 0.8A, 0..+125°	SOT-223	21wc	VR20	4k	Nsc
N00A	LM340MP-5.0	LVR-IC	LDO, 5.0V±2%, 1A	SOT-223	21hn	VR1	4r	Nsc
N02A	LM337IMP	LVR-IC	LDO, Adjustable -1.2V..-37V, 1A	SOT-223	21cy	VR20	4r	Nsc
N03A	LM1117MP-ADJ	LVR-IC	LDO, Adjustable 1.25..13.8V, 0.8A, 0..+125°	SOT-223	21wc	VR20	4k	Nsc
N03B	LM1117MPX-ADJ	LVR-IC	LDO, Adjustable 1.25..13.8V, 0.8A, -40..+125°	SOT-223	21wc	VR20	4k	Nsc
N04A	LM1117MP-2.85	LVR-IC	LDO, 2.85V, 0.8A, 0..+125°	SOT-223	21wb	VR1	4k	Nsc
N05A	LM1117MP-3.3	LVR-IC	LDO, 3.3V, 0.8A, 0..+125°	SOT-223	21wb	VR1	4k	Nsc
N05B	LM1117MPX-3.3	LVR-IC	LDO, 3.3V, 0.8A, -40..+125°	SOT-223	21wb	VR1	4k	Nsc
N06A	LM1117MP-5.0	LVR-IC	LDO, 5V, 0.8A, 0..+125°	SOT-223	21wb	VR1	4k	Nsc
N06B	LM1117MPX-5.0	LVR-IC	LDO, 5V, 0.8A, -40..+125°	SOT-223	21wb	VR1	4k	Nsc
N07A	LM317AEMP	LVR-IC	LDO, Adjustable 3..37V, 1.5A	SOT-223	21wc	VR20	4r	Nsc
N12A	LM1117MPX-1.8	LVR-IC	LDO, 1.8V, 0.8A, 0..+125°	SOT-223	21wb	VR1	4k	Nsc
N13A	LM1117MPX-2.5	LVR-IC	LDO, 2.5V, 0.8A, 0..+125°	SOT-223	21wb	VR1	4k	Nsc
P1A	PZT3904	Si-npn	Sw, 60V, 100mA, 1.5W, B=100..300, >300MHz	SOT-223	21tm	-	4s	Mot
P1D	PZTA42	Si-npn	Vid, 300/300V, 200mA, 1.5W, B=25, >50MHz	SOT-223	21tm	-	4s	Ons
P1E	PZTA43	Si-npn	Vid, 200/200V, 200mA, 1.5W, B=25, >50MHz	SOT-223	21tm	-	4s	Ons
P1F	PZT2222A	Si-npn	Sw, 75V, 600mA, 1.5W, B=100..300, >300MHz	SOT-223	21tm	-	4s	Ons
P1M	PZTA13	Si-npn-Darl	GP, 30V, 300mA, 1.5W, B>5000, >125MHz	SOT-223	21tm	-	4s	Ons
P1N	PZTA14	Si-npn-Darl	GP, 30V, 300mA, 1.5W, B>10000, >125MHz	SOT-223	21tm	-	4s	Ons
P2A	PZT3906	Si-npn	Sw, 60V, 100mA, 1.2W, B=100..300, >250MHz	SOT-223	21tm	-	4s	Mot
P2D	PZTA92	Si-npn	Vid, 300/300V, 500mA, 1.5W, B=25, >50MHz	SOT-223	21tm	-	4s	Ons
P2E	PZTA93	Si-npn	Vid, 200/200V, 500mA, 1.5W, B=25, >50MHz	SOT-223	21tm	-	4s	Mot
P2F	PZT2907A	Si-npn	Sw, 60V, 600mA, 1.5W, B=100..300, >200MHz	SOT-223	21tm	-	4s	Ons
P2U	PZTA63	Si-npn-Darl	GP, 30V, 500mA, 1.5W, B>5000, >125MHz	SOT-223	21tm	-	4s	Ons
P2V	PZTA64	Si-npn-Darl	GP, 30V, 500mA, 1.5W, B>10000, >125MHz	SOT-223	21tm	-	4s	Ons
S12	STPS120E	Si-diode	SBR, 20V, 1A, Vf<0.55V(1A)	SOT-223	21rt	-	4k	Ste
S13	STPS130E	Si-diode	SBR, 30V, 1A, Vf<0.55V(1A)	SOT-223	21rt	-	4k	Ste
S14	STPS140E	Si-diode	SBR, 40V, 1A, Vf<0.55V(1A)	SOT-223	21rt	-	4k	Ste
S16	STPS160E	Si-diode	SBR, 60V, 1A, Vf<0.55V(1A)	SOT-223	21rt	-	4k	Ste
SP19A	BSP19A	Si-npn	AF, Sw, Vid, 400V, 1A, 1.5W, B>40, >70MHz	SOT-223	21tm	-	4s	Ons
T22	STPS220CE	Si-diode	Dual, SBR, 20V, 1A, Vf<0.55V(1A)	SOT-223	21bs	-	4k	Ste
T23	STPS230CE	Si-diode	Dual, SBR, 30V, 1A, Vf<0.55V(1A)	SOT-223	21bs	-	4k	Ste
T24	STPS240CE	Si-diode	Dual, SBR, 40V, 1A, Vf<0.55V(1A)	SOT-223	21bs	-	4k	Ste
T26	STPS260CE	Si-diode	Dual, SBR, 60V, 1A, Vf<0.55V(1A)	SOT-223	21bs	-	4k	Ste
T350	MMJT350T1	Si-npn	Sw, Vid, 300V, 500mA, 2.75W, B=30..240	SOT-223	21tm	-	4s	Ons
TBD	NTF5P03T3	p-MOSFET-e	V-MOS, LogL, 30V, 5.2A, 1.5W, 56mΩ(5.2A), 10/38ns	SOT-223	21f2	-	4t	Ons



SMD code	Type	Function	Short description	Case	Pinout	Sch.	St.	Mnf.
TM1101	PZTM1101	Si-npn	Sw, 60V, 200mA, 500mW, >250MHz, int, SBD, 40V, 1A	SOT-223	21to	-	4k	Phi
TM1102	PZTM1102	Si-npn	Sw, 40V, 200mA, 500mW, >250MHz, int, SBD, 40V, 1A	SOT-223	21fn	-	4k	Phi
V6643	NCV8664ST33T3G	LVR-IC	LDO, 3.3V±2%, 150mA	SOT-223	21hn	VR1	4s	Ons
V6645	NCV8664ST50T3G	LVR-IC	LDO, 5.0V±2%, 150mA	SOT-223	21hn	VR1	4s	Ons
Z06	Z0110MN	Triac	600V, 1A, 1W, V _{tm} <1.56V, <I _{gt} >25mA	SOT-223	21hz	-	4r	Ste
Z07	Z0110SN	Triac	700V, 1A, 1W, V _{tm} <1.56V, <I _{gt} >25mA	SOT-223	21hz	-	4r	Ste
Z08	Z0110NN	Triac	800V, 1A, 1W, V _{tm} <1.56V, <I _{gt} >25mA	SOT-223	21hz	-	4r	Ste
Z0D	Z0110DN	Triac	400V, 1A, 1W, V _{tm} <1.56V, <I _{gt} >25mA	SOT-223	21hz	-	4r	Ste
Z0M	Z0110MN	Triac	600V, 1A, 1W, V _{tm} <1.56V, <I _{gt} >25mA	SOT-223	21hz	-	4r	Ste
Z0N	Z0110NN	Triac	800V, 1A, 1W, V _{tm} <1.56V, <I _{gt} >25mA	SOT-223	21hz	-	4r	Ste
Z0S	Z0110SN	Triac	700V, 1A, 1W, V _{tm} <1.56V, <I _{gt} >25mA	SOT-223	21hz	-	4r	Ste
Z1	CHS04ZPT	Si-diode	SBD, 40V, 2A, V _f <0.6V(2A)	SOT-223	21dm	-	4r	Chm
Z36	Z0103MN	Triac	600V, 1A, 1W, V _{tm} <1.56V, <I _{gt} >3mA	SOT-223	21hz	-	4r	Ste
Z37	Z0103SN	Triac	700V, 1A, 1W, V _{tm} <1.56V, <I _{gt} >3mA	SOT-223	21hz	-	4r	Ste
Z38	Z0103NN	Triac	800V, 1A, 1W, V _{tm} <1.56V, <I _{gt} >3mA	SOT-223	21hz	-	4r	Ste
Z3D	Z0103DN	Triac	400V, 1A, 1W, V _{tm} <1.56V, <I _{gt} >3mA	SOT-223	21hz	-	4r	Ste
Z3M	Z0103MN	Triac	600V, 1A, 1W, V _{tm} <1.56V, <I _{gt} >3mA	SOT-223	21hz	-	4r	Ste
Z3N	Z0103NN	Triac	800V, 1A, 1W, V _{tm} <1.56V, <I _{gt} >3mA	SOT-223	21hz	-	4r	Ste
Z3S	Z0103SN	Triac	700V, 1A, 1W, V _{tm} <1.56V, <I _{gt} >3mA	SOT-223	21hz	-	4r	Ste
Z76	Z0107MN	Triac	600V, 1A, 1W, V _{tm} <1.56V, <I _{gt} >5mA	SOT-223	21hz	-	4r	Ste
Z77	Z0107SN	Triac	700V, 1A, 1W, V _{tm} <1.56V, <I _{gt} >5mA	SOT-223	21hz	-	4r	Ste
Z78	Z0107NN	Triac	800V, 1A, 1W, V _{tm} <1.56V, <I _{gt} >5mA	SOT-223	21hz	-	4r	Ste
Z7D	Z0107DN	Triac	400V, 1A, 1W, V _{tm} <1.56V, <I _{gt} >5mA	SOT-223	21hz	-	4r	Ste
Z7M	Z0107MN	Triac	600V, 1A, 1W, V _{tm} <1.56V, <I _{gt} >5mA	SOT-223	21hz	-	4r	Ste
Z7N	Z0107NN	Triac	800V, 1A, 1W, V _{tm} <1.56V, <I _{gt} >5mA	SOT-223	21hz	-	4r	Ste
Z7S	Z0107SN	Triac	700V, 1A, 1W, V _{tm} <1.56V, <I _{gt} >5mA	SOT-223	21hz	-	4r	Ste
Z96	Z0109MN	Triac	600V, 1A, 1W, V _{tm} <1.56V, <I _{gt} >10mA	SOT-223	21hz	-	4r	Ste
Z97	Z0109SN	Triac	700V, 1A, 1W, V _{tm} <1.56V, <I _{gt} >10mA	SOT-223	21hz	-	4r	Ste
Z98	Z0109NN	Triac	800V, 1A, 1W, V _{tm} <1.56V, <I _{gt} >10mA	SOT-223	21hz	-	4r	Ste
Z9D	Z0109DN	Triac	400V, 1A, 1W, V _{tm} <1.56V, <I _{gt} >10mA	SOT-223	21hz	-	4r	Ste
Z9M	Z0109MN	Triac	600V, 1A, 1W, V _{tm} <1.56V, <I _{gt} >10mA	SOT-223	21hz	-	4r	Ste
Z9N	Z0110NN	Triac	800V, 1A, 1W, V _{tm} <1.56V, <I _{gt} >10mA	SOT-223	21hz	-	4r	Ste
Z9S	Z0109SN	Triac	700V, 1A, 1W, V _{tm} <1.56V, <I _{gt} >10mA	SOT-223	21hz	-	4r	Ste
ZAN	CHT31CZPT	Si-npn	AF, Sw, 100V, 3A B=10..100, 3MHz	SOT-223	21fb	-	4r	Chm
ZAP	CHT32CZPT	Si-npn	AF, Sw, 100V, 3A, B=10..100, 3MHz	SOT-223	21fb	-	4r	Chm
ZBN	CHT122ZPT	Si-npn-Darl	AF, Drv, 100V, 5A B>1000, 4MHz	SOT-223	21fb	-	4r	Chm
ZBP	CHT127ZPT	Si-npn-Darl	AF, Sw, 100V, 5A, B>1000, 4MHz	SOT-223	21fb	-	4r	Chm
ZCN	CHT222ZPT	Si-npn	AF, Sw, 40V, 600mA B=100..300, 300MHz	SOT-223	21fb	-	4r	Chm
ZCP	CHT2907ZPT	Si-npn	AF, Sw, 60V, 600mA, B=100..300, 200MHz	SOT-223	21fb	-	4r	Chm
ZDN	CHT3055ZPT	Si-npn	AF, Sw, 60V, 6A B=20..70, 2.5MHz	SOT-223	21fb	-	4r	Chm
ZDP	CHT2955ZPT	Si-npn	AF, Sw, 60V, 6A, B=20..70, 2.5MHz	SOT-223	21fb	-	4r	Chm
ZEP	CHT4033ZPT	Si-npn	AF, Sw, 80V, 1A, B=100..300, 100MHz	SOT-223	21fb	-	4r	Chm
ZFN	CHT5551ZPT	Si-npn	AF, Drv, 160V, 600mA B=80..250, 300MHz	SOT-223	21fb	-	4r	Chm
ZFP	CHT5401ZPT	Si-npn	AF, Drv, 150V, 600mA, B=60..240, 100MHz	SOT-223	21fb	-	4r	Chm
ZGN	CHTA14ZPT	Si-npn-Darl	AF, Sw, 30V, 1A B>20000, 125MHz	SOT-223	21fb	-	4r	Chm
ZGP	CHTA64ZPT	Si-npn-Darl	AF, Sw, 30V, 1A, B>20000, 125MHz	SOT-223	21fb	-	4r	Chm
ZHN	CHTA42ZPT	Si-npn	Vid, Drv, 300V, 300mA B>40, 50MHz	SOT-223	21fb	-	4r	Chm
ZHP	CHTA92ZPT	Si-npn	Vid, Drv, 300V, 500mA, B>40, 50MHz	SOT-223	21fb	-	4r	Chm
ZIN	CH3904ZPT	Si-npn	AF, Sw, 40V, 200mA B=100..300, 300MHz	SOT-223	21fb	-	4r	Chm
ZIP	CH3906ZPT	Si-npn	AF, Sw, 40V, 200mA, B=100..300, 250MHz	SOT-223	21fb	-	4r	Chm
ZJN	CHTA44ZPT	Si-npn	Vid, Drv, 400V, 300mA B=50..200, 50MHz	SOT-223	21fb	-	4r	Chm
ZKN	CHTA27ZPT	Si-npn-Darl	AF, Sw, 60V, 500mA B>10000, 125MHz	SOT-223	21fb	-	4r	Chm
ZLN	CHT5338ZPT	Si-npn	AF, Drv, 100V, 5A B=30..120, 300MHz	SOT-223	21fb	-	4r	Chm
ZMN	CHT2000ZPT	Si-npn-Darl	Vid, Drv, 200V, 600mA B>3000	SOT-223	21fb	-	4r	Chm
ZT2222	PZT2222	Si-npn	Sw, 60V, 600mA, 1.5W, B=100..300, >300MHz	SOT-223	21fm	-	4k	Sie
ZT2222A	PZT2222A	Si-npn	Sw, 75V, 600mA, 1.5W, B=100..300, >300MHz	SOT-223	21fm	-	4k	Sie
ZT2907	PZT2907	Si-npn	Sw, 60V, 600mA, 1.5W, B=100..300, >200MHz	SOT-223	21fm	-	4k	Sie
ZT2907A	PZT2907A	Si-npn	Sw, 60V, 600mA, 1.5W, B=100..300, >200MHz	SOT-223	21fm	-	4k	Sie
ZT3904	PZT3904	Si-npn	Sw, 60V, 100mA, 1.2W, B=100..300, >300MHz	SOT-223	21fm	-	4k	Sie
ZT3906	PZT3906	Si-npn	Sw, 60V, 200mA, 1.5W, B=100..300, >250MHz	SOT-223	21fm	-	4k	Sie
ZT4401	PZT4401	Si-npn	Sw, 60V, 600mA, 1.15W, B=20..30, >250MHz	SOT-223	21fm	-	4k	Phi
ZT4403	PZT4403	Si-npn	Sw, 40V, 600mA, 1.15W, B=30..30, >200MHz	SOT-223	21fm	-	4k	Phi
ZT651	PZT651	Si-npn	GP, 80V, 2A, 800mW, B>75, >75MHz	SOT-223	21fm	-	4s	Mot
ZT751	PZT751	Si-npn	GP, 80V, 2A, 800mW, B>75, >75MHz	SOT-223	21fm	-	4s	Ons
ZTA96	PZTA96S	Si-npn	Vid, 450/450V, 500mA, 1.5W, B>25, >50MHz	SOT-223	21fm	-	4s	Ons



SECTION 5
SOT-89 CASE SMD SEMICONDUCTOR COMPONENTS



SMD
code

Type

Function

Short description

Case Pinout Sch. St. Mnf.

SMD code	Type	Function	Short description	Case	Pinout	Sch.	St.	Mnf.
000	ELM85101A	LVR-IC	LDO, 1.0V±2%, 800mA	SOT-89	20vl	VR1	4c	Elm
008	ELM85081A	LVR-IC	LDO, 0.8V±2%, 800mA	SOT-89	20vl	VR1	4c	Elm
009	ELM85091A	LVR-IC	LDO, 0.9±2%, 800mA	SOT-89	20vl	VR1	4c	Elm
00A	ELM85111A	LVR-IC	LDO, 1.1±2%, 800mA	SOT-89	20vl	VR1	4c	Elm
00B	ELM85121A	LVR-IC	LDO, 1.2±2%, 800mA	SOT-89	20vl	VR1	4c	Elm
00C	ELM85131A	LVR-IC	LDO, 1.3±2%, 800mA	SOT-89	20vl	VR1	4c	Elm
00D	ELM85141A	LVR-IC	LDO, 1.4±2%, 800mA	SOT-89	20vl	VR1	4c	Elm
00E	ELM85151A	LVR-IC	LDO, 1.5±2%, 800mA	SOT-89	20vl	VR1	4c	Elm
00F	ELM85161A	LVR-IC	LDO, 1.6±2%, 800mA	SOT-89	20vl	VR1	4c	Elm
00G	ELM85171A	LVR-IC	LDO, 1.7±2%, 800mA	SOT-89	20vl	VR1	4c	Elm
00H	ELM85181A	LVR-IC	LDO, 1.8±2%, 800mA	SOT-89	20vl	VR1	4c	Elm
00J	ELM85191A	LVR-IC	LDO, 1.9±2%, 800mA	SOT-89	20vl	VR1	4c	Elm
00K	ELM85201A	LVR-IC	LDO, 2.0±2%, 800mA	SOT-89	20vl	VR1	4c	Elm
00L	ELM85211A	LVR-IC	LDO, 2.1±2%, 800mA	SOT-89	20vl	VR1	4c	Elm
00M	ELM85221A	LVR-IC	LDO, 2.2±2%, 800mA	SOT-89	20vl	VR1	4c	Elm
00N	ELM85231A	LVR-IC	LDO, 2.3±2%, 800mA	SOT-89	20vl	VR1	4c	Elm
00P	ELM85241A	LVR-IC	LDO, 2.4±2%, 800mA	SOT-89	20vl	VR1	4c	Elm
00Q	ELM85251A	LVR-IC	LDO, 2.5±2%, 800mA	SOT-89	20vl	VR1	4c	Elm
00R	ELM85261A	LVR-IC	LDO, 2.6±2%, 800mA	SOT-89	20vl	VR1	4c	Elm
00S	ELM85271A	LVR-IC	LDO, 2.7±2%, 800mA	SOT-89	20vl	VR1	4c	Elm
00T	ELM85281A	LVR-IC	LDO, 2.8±2%, 800mA	SOT-89	20vl	VR1	4c	Elm
00U	ELM85291A	LVR-IC	LDO, 2.9±2%, 800mA	SOT-89	20vl	VR1	4c	Elm
00V	ELM85301A	LVR-IC	LDO, 3.0±2%, 800mA	SOT-89	20vl	VR1	4c	Elm
01	Gali-1	MMIC	RF amplifier, DC..3GHz, 11dB (50Ω)	SOT-89	20aa	A1	4b	Mc
010	ELM85401A	LVR-IC	LDO, 4.0±2%, 800mA	SOT-89	20vl	VR1	4c	Elm
011	ELM85311A	LVR-IC	LDO, 3.1±2%, 800mA	SOT-89	20vl	VR1	4c	Elm
012	ELM85321A	LVR-IC	LDO, 3.2±2%, 800mA	SOT-89	20vl	VR1	4c	Elm
013	ELM85331A	LVR-IC	LDO, 3.3±2%, 800mA	SOT-89	20vl	VR1	4c	Elm
014	ELM85341A	LVR-IC	LDO, 3.4±2%, 800mA	SOT-89	20vl	VR1	4c	Elm
015	ELM85351A	LVR-IC	LDO, 3.5±2%, 800mA	SOT-89	20vl	VR1	4c	Elm
016	ELM85361A	LVR-IC	LDO, 3.6±2%, 800mA	SOT-89	20vl	VR1	4c	Elm
017	ELM85371A	LVR-IC	LDO, 3.7±2%, 800mA	SOT-89	20vl	VR1	4c	Elm
018	ELM85381A	LVR-IC	LDO, 3.8±2%, 800mA	SOT-89	20vl	VR1	4c	Elm
019	ELM85391A	LVR-IC	LDO, 3.9±2%, 800mA	SOT-89	20vl	VR1	4c	Elm
01A	APR3001-15D	Vdet-IC	1.5V, -Reset PPO	SOT-89	20vda	VD7	4b	Anp
01A	ELM85411A	LVR-IC	LDO, 4.1±2%, 800mA	SOT-89	20vl	VR1	4c	Elm
01B	APR3001-17D	Vdet-IC	1.75V, -Reset PPO	SOT-89	20vda	VD7	4b	Anp
01B	ELM85421A	LVR-IC	LDO, 4.2±2%, 800mA	SOT-89	20vl	VR1	4c	Elm
01C	APR3001-23D	Vdet-IC	2.32V, -Reset PPO	SOT-89	20vda	VD7	4b	Anp
01C	ELM85431A	LVR-IC	LDO, 4.3±2%, 800mA	SOT-89	20vl	VR1	4c	Elm
01D	APR3001-26D	Vdet-IC	2.63V, -Reset PPO	SOT-89	20vda	VD7	4b	Anp
01D	ELM85441A	LVR-IC	LDO, 4.4±2%, 800mA	SOT-89	20vl	VR1	4c	Elm
01E	APR3001-29D	Vdet-IC	2.93V, -Reset PPO	SOT-89	20vda	VD7	4b	Anp
01E	ELM85451A	LVR-IC	LDO, 4.5±2%, 800mA	SOT-89	20vl	VR1	4c	Elm
01F	APR3001-30D	Vdet-IC	3.08V, -Reset PPO	SOT-89	20vda	VD7	4b	Anp
01F	ELM85461A	LVR-IC	LDO, 4.6±2%, 800mA	SOT-89	20vl	VR1	4c	Elm
01G	APR3001-39D	Vdet-IC	3.9V, -Reset PPO	SOT-89	20vda	VD7	4b	Anp
01G	ELM85471A	LVR-IC	LDO, 4.7±2%, 800mA	SOT-89	20vl	VR1	4c	Elm
01H	APR3001-43D	Vdet-IC	4.38V, -Reset PPO	SOT-89	20vda	VD7	4b	Anp
01H	ELM85481A	LVR-IC	LDO, 4.8±2%, 800mA	SOT-89	20vl	VR1	4c	Elm
01J	APR3001-46D	Vdet-IC	4.63V, -Reset PPO	SOT-89	20vda	VD7	4b	Anp
01J	ELM85491A	LVR-IC	LDO, 4.9±2%, 800mA	SOT-89	20vl	VR1	4c	Elm
01K	ELM85501A	LVR-IC	LDO, 5.0±2%, 800mA	SOT-89	20vl	VR1	4c	Elm
02	Gali-2	MMIC	RF amplifier, DC..3GHz, 15.1dB (50Ω)	SOT-89	20aa	A1	4b	Mc
02A	APR3002-15D	Vdet-IC	1.5V, +Reset PPO	SOT-89	20vda	VD7	4b	Anp
02B	APR3002-17D	Vdet-IC	1.75V, +Reset PPO	SOT-89	20vda	VD7	4b	Anp
02C	APR3002-23D	Vdet-IC	2.32V, +Reset PPO	SOT-89	20vda	VD7	4b	Anp
02D	APR3002-26D	Vdet-IC	2.63V, +Reset PPO	SOT-89	20vda	VD7	4b	Anp
02E	APR3002-29D	Vdet-IC	2.93V, +Reset PPO	SOT-89	20vda	VD7	4b	Anp
02F	APR3002-30D	Vdet-IC	3.08V, +Reset PPO	SOT-89	20vda	VD7	4b	Anp
02G	APR3002-39D	Vdet-IC	3.9V, +Reset PPO	SOT-89	20vda	VD7	4b	Anp
02H	APR3002-43D	Vdet-IC	4.38V, +Reset PPO	SOT-89	20vda	VD7	4b	Anp
02J	APR3002-46D	Vdet-IC	4.63V, +Reset PPO	SOT-89	20vda	VD7	4b	Anp
03	Gali-3	MMIC	RF amplifier, DC..3GHz, 15.8dB (50Ω)	SOT-89	20aa	A1	4b	Mc
03A	APR3003-15D	Vdet-IC	1.5V, -Reset ODO	SOT-89	20vda	VD6	4b	Anp
03B	APR3003-17D	Vdet-IC	1.75V, -Reset ODO	SOT-89	20vda	VD6	4b	Anp
03C	APR3003-23D	Vdet-IC	2.32V, -Reset ODO	SOT-89	20vda	VD6	4b	Anp
03D	APR3003-26D	Vdet-IC	2.63V, -Reset ODO	SOT-89	20vda	VD6	4b	Anp
03E	APR3003-29D	Vdet-IC	2.93V, -Reset ODO	SOT-89	20vda	VD6	4b	Anp
03F	APR3003-30D	Vdet-IC	3.08V, -Reset ODO	SOT-89	20vda	VD6	4b	Anp



SMD
code

Type

Function

Short description

Case Pinout Sch. St. Mnf.

SMD code	Type	Function	Short description	Case	Pinout	Sch.	St.	Mnf.
03G	APR3003-39D	Vdet-IC	3.9V, -Reset ODO	SOT-89	20vda	VD6	4b	Anp
03H	APR3003-43D	Vdet-IC	4.38V, -Reset ODO	SOT-89	20vda	VD6	4b	Anp
03J	APR3003-46D	Vdet-IC	4.63V, -Reset ODO	SOT-89	20vda	VD6	4b	Anp
04	Gali-4	MMIC	RF amplifier, DC. 4GHz, 13.1dB (50Ω)	SOT-89	20aa	A1	4b	Mc
047	FCX1047A	Si-npn	Hi-beta, Lo-sat, 35V, 4A, 2W, B=450..1200, 150MHz	SOT-89	20tb	-	4b	Zx
04F	Gali-4F	MMIC	RF amplifier, DC. 4GHz, 13.2dB (50Ω)	SOT-89	20aa	A1	4b	Mc
05	Gali-5	MMIC	RF amplifier, DC. 4GHz, 15.1dB (50Ω)	SOT-89	20aa	A1	4b	Mc
051	FCX1051A	Si-npn	Hi-beta, Lo-sat, 150V, 3A, 2W, B=450..1200, 155MHz	SOT-89	20tb	-	4b	Zx
053	FCX1053A	Si-npn	Hi-beta, Lo-sat, 150V, 3A, 1W, B=100..1200, 140MHz	SOT-89	20tb	-	4b	Zx
05F	Gali-5F	MMIC	RF amplifier, DC. 4GHz, 15.1dB (50Ω)	SOT-89	20aa	A1	4b	Mc
06	Gali-6	MMIC	RF amplifier, DC. 4GHz, 12.3dB (50Ω)	SOT-89	20aa	A1	4b	Mc
06F	Gali-6F	MMIC	RF amplifier, DC. 4GHz, 12.3dB (50Ω)	SOT-89	20aa	A1	4b	Mc
0B	RH5RL20AA	LVR-IC	2V±2.5%, 150mA	SOT-89	20vl	VR1	4c	Ric
0C	MC78LC30HT1	LVR-IC	Low Iq, 3V±2.5%, 80mA	SOT-89	20vl	VR1	4b	Ons
0C	RH5RL30AA	LVR-IC	3V±2.5%, 150mA	SOT-89	20vl	VR1	4c	Ric
0D	RH5RL40AA	LVR-IC	4V±2.5%, 150mA	SOT-89	20vl	VR1	4c	Ric
0E	RH5RL50AA	LVR-IC	5V±2.5%, 150mA	SOT-89	20vl	VR1	4c	Ric
0F	RH5RL60AA	LVR-IC	6V±2.5%, 150mA	SOT-89	20vl	VR1	4c	Ric
0J	RH5RE20AA	LVR-IC	Ultra-LDO, 2V±2.5%, 300mA	SOT-89	20vl	VR1	4c	Ric
0K	RH5RE30AA	LVR-IC	Ultra-LDO, 3V±2.5%, 300mA	SOT-89	20vl	VR1	4c	Ric
0L	RH5RE40AA	LVR-IC	Ultra-LDO, 4V±2.5%, 300mA	SOT-89	20vl	VR1	4c	Ric
0M	RH5RE50AA	LVR-IC	Ultra-LDO, 5V±2.5%, 300mA	SOT-89	20vl	VR1	4c	Ric
0N	RH5RE60AA	LVR-IC	Ultra-LDO, 6V±2.5%, 300mA	SOT-89	20vl	VR1	4c	Ric
100	XC6503P121PR-G	LVR-IC	LDO, 1.2V±20mV, 500mA	SOT-89	20ch	VR1	4a	Tor
101	XC6503P131PR-G	LVR-IC	LDO, 1.3V±20mV, 500mA	SOT-89	20ch	VR1	4a	Tor
1019G	EC1019B-G	MMIC	Buff/amp, DC. 4GHz, 18.5dB (2GHz, 50Ω)	SOT-89	20aa	A1	4i	Wjc
102	XC6503P141PR-G	LVR-IC	LDO, 1.4V±20mV, 500mA	SOT-89	20ch	VR1	4a	Tor
103	XC6503P151PR-G	LVR-IC	LDO, 1.5V±20mV, 500mA	SOT-89	20ch	VR1	4a	Tor
104	XC6503P161PR-G	LVR-IC	LDO, 1.6V±20mV, 500mA	SOT-89	20ch	VR1	4a	Tor
105	XC6503P171PR-G	LVR-IC	LDO, 1.7V±20mV, 500mA	SOT-89	20ch	VR1	4a	Tor
106	XC6503P181PR-G	LVR-IC	LDO, 1.8V±20mV, 500mA	SOT-89	20ch	VR1	4a	Tor
107	XC6503P191PR-G	LVR-IC	LDO, 1.9V±20mV, 500mA	SOT-89	20ch	VR1	4a	Tor
1078G	EC1078B-G	MMIC	Buff/amp, DC. 3.5GHz, 20dB (1GHz, 50Ω)	SOT-89	20aa	A1	4i	Wjc
108	XC6503P201PR-G	LVR-IC	LDO, 2.0V±1%, 500mA	SOT-89	20ch	VR1	4a	Tor
109	XC6503P211PR-G	LVR-IC	LDO, 2.1V±1%, 500mA	SOT-89	20ch	VR1	4a	Tor
10A	XC6503P221PR-G	LVR-IC	LDO, 2.2V±1%, 500mA	SOT-89	20ch	VR1	4a	Tor
10B	XC6503P231PR-G	LVR-IC	LDO, 2.3V±1%, 500mA	SOT-89	20ch	VR1	4a	Tor
10C	XC6503P241PR-G	LVR-IC	LDO, 2.4V±1%, 500mA	SOT-89	20ch	VR1	4a	Tor
10D	XC6503P251PR-G	LVR-IC	LDO, 2.5V±1%, 500mA	SOT-89	20ch	VR1	4a	Tor
10E	XC6503P261PR-G	LVR-IC	LDO, 2.6V±1%, 500mA	SOT-89	20ch	VR1	4a	Tor
10F	XC6503P271PR-G	LVR-IC	LDO, 2.7V±1%, 500mA	SOT-89	20ch	VR1	4a	Tor
10H	XC6503P281PR-G	LVR-IC	LDO, 2.8V±1%, 500mA	SOT-89	20ch	VR1	4a	Tor
10K	XC6503P291PR-G	LVR-IC	LDO, 2.9V±1%, 500mA	SOT-89	20ch	VR1	4a	Tor
10L	XC6503P301PR-G	LVR-IC	LDO, 3.0V±1%, 500mA	SOT-89	20ch	VR1	4a	Tor
10M	XC6503P311PR-G	LVR-IC	LDO, 3.1V±1%, 500mA	SOT-89	20ch	VR1	4a	Tor
10N	XC6503P321PR-G	LVR-IC	LDO, 3.2V±1%, 500mA	SOT-89	20ch	VR1	4a	Tor
10P	XC6503P331PR-G	LVR-IC	LDO, 3.3V±1%, 500mA	SOT-89	20ch	VR1	4a	Tor
10R	XC6503P341PR-G	LVR-IC	LDO, 3.4V±1%, 500mA	SOT-89	20ch	VR1	4a	Tor
10S	XC6503P351PR-G	LVR-IC	LDO, 3.5V±1%, 500mA	SOT-89	20ch	VR1	4a	Tor
10T	XC6503P361PR-G	LVR-IC	LDO, 3.6V±1%, 500mA	SOT-89	20ch	VR1	4a	Tor
10U	XC6503P371PR-G	LVR-IC	LDO, 3.7V±1%, 500mA	SOT-89	20ch	VR1	4a	Tor
10V	XC6503P381PR-G	LVR-IC	LDO, 3.8V±1%, 500mA	SOT-89	20ch	VR1	4a	Tor
10X	XC6503P391PR-G	LVR-IC	LDO, 3.9V±1%, 500mA	SOT-89	20ch	VR1	4a	Tor
10Y	BZV49-C10	Z-diode	10V±5%, Izt=5mA, 1W	SOT-89	20dm	-	4b	Phi
10Y	XC6503P401PR-G	LVR-IC	LDO, 4.0V±1%, 500mA	SOT-89	20ch	VR1	4a	Tor
10Z	XC6503P411PR-G	LVR-IC	LDO, 4.1V±1%, 500mA	SOT-89	20ch	VR1	4a	Tor
110	XC6503P421PR-G	LVR-IC	LDO, 4.2V±1%, 500mA	SOT-89	20ch	VR1	4a	Tor
111	XC6503P431PR-G	LVR-IC	LDO, 4.3V±1%, 500mA	SOT-89	20ch	VR1	4a	Tor
112	XC6503P441PR-G	LVR-IC	LDO, 4.4V±1%, 500mA	SOT-89	20ch	VR1	4a	Tor
113	XC6503P451PR-G	LVR-IC	LDO, 4.5V±1%, 500mA	SOT-89	20ch	VR1	4a	Tor
114	XC6503P461PR-G	LVR-IC	LDO, 4.6V±1%, 500mA	SOT-89	20ch	VR1	4a	Tor
115	XC6503P471PR-G	LVR-IC	LDO, 4.7V±1%, 500mA	SOT-89	20ch	VR1	4a	Tor
116	XC6503P481PR-G	LVR-IC	LDO, 4.8V±1%, 500mA	SOT-89	20ch	VR1	4a	Tor
117	XC6503P491PR-G	LVR-IC	LDO, 4.9V±1%, 500mA	SOT-89	20ch	VR1	4a	Tor
118	XC6503P501PR-G	LVR-IC	LDO, 5.0V±1%, 500mA	SOT-89	20ch	VR1	4a	Tor
11A	APR3011-15D	Vdet-IC	1.5V, -Reset PPO	SOT-89	20vde	VD7	4b	Anp
11B	APR3011-17D	Vdet-IC	1.75V, -Reset PPO	SOT-89	20vde	VD7	4b	Anp
11C	APR3011-23D	Vdet-IC	2.32V, -Reset PPO	SOT-89	20vde	VD7	4b	Anp
11D	APR3011-26D	Vdet-IC	2.63V, -Reset PPO	SOT-89	20vde	VD7	4b	Anp
11E	APR3011-29D	Vdet-IC	2.93V, -Reset PPO	SOT-89	20vde	VD7	4b	Anp



SMD
code

Type

Function

Short description

Case Pinout Sch. St. Mnf.

SMD code	Type	Function	Short description	Case	Pinout	Sch.	St.	Mnf.
11F	APR3011-30D	Vdet-IC	3.08V, -Reset PPO	SOT-89	20vde	VD7	4b	Anp
11G	APR3011-39D	Vdet-IC	3.9V, -Reset PPO	SOT-89	20vde	VD7	4b	Anp
11H	APR3011-43D	Vdet-IC	4.38V, -Reset PPO	SOT-89	20vde	VD7	4b	Anp
11J	APR3011-46D	Vdet-IC	4.63V, -Reset PPO	SOT-89	20vde	VD7	4b	Anp
11Y	BZV49-C11	Z-diode	11V±5%, Izt=5mA, 1W	SOT-89	20dm	-	4b	Phi
120	XC6372A201P	DC/DC-IC	PWM/PFM step-up, 100kHz, 2.0V±2.5%, 100mA	SOT-89	20bq	DC2	4c	Tor
120	XC6503P12APR-G	LVR-IC	LDO, 1.25V±20mV, 500mA	SOT-89	20ch	VR1	4a	Tor
1203O	KSA1203-O	Si-pnp	AF, 30V, 1.5A, 500mW, B=100..200, 20MHz	SOT-89	20tb	-	4n	F
1203Y	KSA1203-Y	Si-pnp	AF, 30V, 1.5A, 500mW, B=160..320, 20MHz	SOT-89	20tb	-	4n	F
121	XC6372A202P	DC/DC-IC	PWM/PFM step-up, 180kHz, 2.0V±2.5%, 100mA	SOT-89	20bq	DC2	4c	Tor
121	XC6503P13APR-G	LVR-IC	LDO, 1.35V±20mV, 500mA	SOT-89	20ch	VR1	4a	Tor
122	XC6372A221P	DC/DC-IC	PWM/PFM step-up, 100kHz, 2.2V±2.5%, 100mA	SOT-89	20bq	DC2	4c	Tor
122	XC6503P14APR-G	LVR-IC	LDO, 1.45V±20mV, 500mA	SOT-89	20ch	VR1	4a	Tor
123	XC6372A231P	DC/DC-IC	PWM/PFM step-up, 100kHz, 2.3V±2.5%, 100mA	SOT-89	20bq	DC2	4c	Tor
123	XC6503P15APR-G	LVR-IC	LDO, 1.55V±20mV, 500mA	SOT-89	20ch	VR1	4a	Tor
124	XC6372A241P	DC/DC-IC	PWM/PFM step-up, 100kHz, 2.4V±2.5%, 100mA	SOT-89	20bq	DC2	4c	Tor
124	XC6503P16APR-G	LVR-IC	LDO, 1.65V±20mV, 500mA	SOT-89	20ch	VR1	4a	Tor
125	XC6372A251P	DC/DC-IC	PWM/PFM step-up, 100kHz, 2.5V±2.5%, 100mA	SOT-89	20bq	DC2	4c	Tor
125	XC6503P17APR-G	LVR-IC	LDO, 1.75V±20mV, 500mA	SOT-89	20ch	VR1	4a	Tor
126	XC6372A261P	DC/DC-IC	PWM/PFM step-up, 100kHz, 2.6V±2.5%, 100mA	SOT-89	20bq	DC2	4c	Tor
126	XC6503P18APR-G	LVR-IC	LDO, 1.85V±20mV, 500mA	SOT-89	20ch	VR1	4a	Tor
127	XC6372A271P	DC/DC-IC	PWM/PFM step-up, 100kHz, 2.7V±2.5%, 100mA	SOT-89	20bq	DC2	4c	Tor
127	XC6503P19APR-G	LVR-IC	LDO, 1.95V±20mV, 500mA	SOT-89	20ch	VR1	4a	Tor
128	XC6372A281P	DC/DC-IC	PWM/PFM step-up, 100kHz, 2.8V±2.5%, 100mA	SOT-89	20bq	DC2	4c	Tor
128	XC6503P20APR-G	LVR-IC	LDO, 2.05V±1%, 500mA	SOT-89	20ch	VR1	4a	Tor
129	XC6372A291P	DC/DC-IC	PWM/PFM step-up, 100kHz, 2.9V±2.5%, 100mA	SOT-89	20bq	DC2	4c	Tor
129	XC6503P21APR-G	LVR-IC	LDO, 2.15V±1%, 500mA	SOT-89	20ch	VR1	4a	Tor
12A	APR3012-15D	Vdet-IC	1.5V, +Reset PPO	SOT-89	20vde	VD7	4b	Anp
12A	XC6372A211P	DC/DC-IC	PWM/PFM step-up, 100kHz, 2.1V±2.5%, 100mA	SOT-89	20bq	DC2	4c	Tor
12A	XC6503P22APR-G	LVR-IC	LDO, 2.25V±1%, 500mA	SOT-89	20ch	VR1	4a	Tor
12B	APR3012-17D	Vdet-IC	1.75V, +Reset PPO	SOT-89	20vde	VD7	4b	Anp
12B	XC6372A212P	DC/DC-IC	PWM/PFM step-up, 180kHz, 2.1V±2.5%, 100mA	SOT-89	20bq	DC2	4c	Tor
12B	XC6503P23APR-G	LVR-IC	LDO, 2.35V±1%, 500mA	SOT-89	20ch	VR1	4a	Tor
12C	APR3012-23D	Vdet-IC	2.32V, +Reset PPO	SOT-89	20vde	VD7	4b	Anp
12C	XC6372A222P	DC/DC-IC	PWM/PFM step-up, 180kHz, 2.2V±2.5%, 100mA	SOT-89	20bq	DC2	4c	Tor
12C	XC6503P24APR-G	LVR-IC	LDO, 2.45V±1%, 500mA	SOT-89	20ch	VR1	4a	Tor
12D	APR3012-26D	Vdet-IC	2.63V, +Reset PPO	SOT-89	20vde	VD7	4b	Anp
12D	XC6372A232P	DC/DC-IC	PWM/PFM step-up, 180kHz, 2.3V±2.5%, 100mA	SOT-89	20bq	DC2	4c	Tor
12D	XC6503P25APR-G	LVR-IC	LDO, 2.55V±1%, 500mA	SOT-89	20ch	VR1	4a	Tor
12E	APR3012-29D	Vdet-IC	2.93V, +Reset PPO	SOT-89	20vde	VD7	4b	Anp
12E	XC6372A242P	DC/DC-IC	PWM/PFM step-up, 180kHz, 2.4V±2.5%, 100mA	SOT-89	20bq	DC2	4c	Tor
12E	XC6503P26APR-G	LVR-IC	LDO, 2.65V±1%, 500mA	SOT-89	20ch	VR1	4a	Tor
12F	APR3012-30D	Vdet-IC	3.08V, +Reset PPO	SOT-89	20vde	VD7	4b	Anp
12F	XC6372A252P	DC/DC-IC	PWM/PFM step-up, 180kHz, 2.5V±2.5%, 100mA	SOT-89	20bq	DC2	4c	Tor
12F	XC6503P27APR-G	LVR-IC	LDO, 2.75V±1%, 500mA	SOT-89	20ch	VR1	4a	Tor
12G	APR3012-39D	Vdet-IC	3.9V, +Reset PPO	SOT-89	20vde	VD7	4b	Anp
12G	APR3012-43D	Vdet-IC	4.38V, +Reset PPO	SOT-89	20vde	VD7	4b	Anp
12H	XC6372A262P	DC/DC-IC	PWM/PFM step-up, 180kHz, 2.6V±2.5%, 100mA	SOT-89	20bq	DC2	4c	Tor
12H	XC6503P28APR-G	LVR-IC	LDO, 2.85V±1%, 500mA	SOT-89	20ch	VR1	4a	Tor
12J	APR3012-46D	Vdet-IC	4.63V, +Reset PPO	SOT-89	20vde	VD7	4b	Anp
12J	XC6372A272P	DC/DC-IC	PWM/PFM step-up, 180kHz, 2.7V±2.5%, 100mA	SOT-89	20bq	DC2	4c	Tor
12K	XC6503P29APR-G	LVR-IC	LDO, 2.95V±1%, 500mA	SOT-89	20ch	VR1	4a	Tor
12L	XC6372A282P	DC/DC-IC	PWM/PFM step-up, 180kHz, 2.8V±2.5%, 100mA	SOT-89	20bq	DC2	4c	Tor
12L	XC6503P30APR-G	LVR-IC	LDO, 3.05V±1%, 500mA	SOT-89	20ch	VR1	4a	Tor
12M	XC6372A292P	DC/DC-IC	PWM/PFM step-up, 180kHz, 2.9V±2.5%, 100mA	SOT-89	20bq	DC2	4c	Tor
12M	XC6503P31APR-G	LVR-IC	LDO, 3.15V±1%, 500mA	SOT-89	20ch	VR1	4a	Tor
12N	XC6503P32APR-G	LVR-IC	LDO, 3.25V±1%, 500mA	SOT-89	20ch	VR1	4a	Tor
12P	XC6503P33APR-G	LVR-IC	LDO, 3.35V±1%, 500mA	SOT-89	20ch	VR1	4a	Tor
12R	XC6503P34APR-G	LVR-IC	LDO, 3.45V±1%, 500mA	SOT-89	20ch	VR1	4a	Tor
12S	XC6503P35APR-G	LVR-IC	LDO, 3.55V±1%, 500mA	SOT-89	20ch	VR1	4a	Tor
12T	XC6503P36APR-G	LVR-IC	LDO, 3.65V±1%, 500mA	SOT-89	20ch	VR1	4a	Tor
12U	XC6503P37APR-G	LVR-IC	LDO, 3.75V±1%, 500mA	SOT-89	20ch	VR1	4a	Tor
12V	XC6503P38APR-G	LVR-IC	LDO, 3.85V±1%, 500mA	SOT-89	20ch	VR1	4a	Tor
12X	XC6503P39APR-G	LVR-IC	LDO, 3.95V±1%, 500mA	SOT-89	20ch	VR1	4a	Tor
12Y	BZV49-C12	Z-diode	12V±5%, Izt=5mA, 1W	SOT-89	20dm	-	4b	Phi
12Y	XC6503P40APR-G	LVR-IC	LDO, 4.05V±1%, 500mA	SOT-89	20ch	VR1	4a	Tor
12Z	XC6503P41APR-G	LVR-IC	LDO, 4.15V±1%, 500mA	SOT-89	20ch	VR1	4a	Tor
130	XC6372A301P	DC/DC-IC	PWM/PFM step-up, 100kHz, 3.0V±2.5%, 100mA	SOT-89	20bq	DC2	4c	Tor
130	XC6503P42APR-G	LVR-IC	LDO, 4.25V±1%, 500mA	SOT-89	20ch	VR1	4a	Tor
131	XC6372A311P	DC/DC-IC	PWM/PFM step-up, 100kHz, 3.1V±2.5%, 100mA	SOT-89	20bq	DC2	4c	Tor



SMD
code

Type

Function

Short description

Case Pinout Sch. St. Mnf.

SMD code	Type	Function	Short description	Case	Pinout	Sch.	St.	Mnf.
131	XC6503P43APR-G	LVR-IC	LDO, 4.35V±1%, 500mA	SOT-89	20ch	VR1	4a	Tor
132	XC6372A321P	DC/DC-IC	PWM/PFM step-up, 100kHz, 3.2V±2.5%, 100mA	SOT-89	20bq	DC2	4c	Tor
132	XC6503P44APR-G	LVR-IC	LDO, 4.45V±1%, 500mA	SOT-89	20ch	VR1	4a	Tor
133	XC6372A331P	DC/DC-IC	PWM/PFM step-up, 100kHz, 3.3V±2.5%, 100mA	SOT-89	20bq	DC2	4c	Tor
133	XC6503P45APR-G	LVR-IC	LDO, 4.55V±1%, 500mA	SOT-89	20ch	VR1	4a	Tor
134	XC6372A341P	DC/DC-IC	PWM/PFM step-up, 100kHz, 3.4V±2.5%, 100mA	SOT-89	20bq	DC2	4c	Tor
134	XC6503P46APR-G	LVR-IC	LDO, 4.65V±1%, 500mA	SOT-89	20ch	VR1	4a	Tor
135	XC6372A351P	DC/DC-IC	PWM/PFM step-up, 100kHz, 3.5V±2.5%, 100mA	SOT-89	20bq	DC2	4c	Tor
135	XC6503P47APR-G	LVR-IC	LDO, 4.75V±1%, 500mA	SOT-89	20ch	VR1	4a	Tor
136	XC6372A361P	DC/DC-IC	PWM/PFM step-up, 100kHz, 3.6V±2.5%, 100mA	SOT-89	20bq	DC2	4c	Tor
136	XC6503P48APR-G	LVR-IC	LDO, 4.85V±1%, 500mA	SOT-89	20ch	VR1	4a	Tor
137	XC6372A371P	DC/DC-IC	PWM/PFM step-up, 100kHz, 3.7V±2.5%, 100mA	SOT-89	20bq	DC2	4c	Tor
137	XC6503P49APR-G	LVR-IC	LDO, 4.95V±1%, 500mA	SOT-89	20ch	VR1	4a	Tor
138	XC6372A381P	DC/DC-IC	PWM/PFM step-up, 100kHz, 3.8V±2.5%, 100mA	SOT-89	20bq	DC2	4c	Tor
139	XC6372A391P	DC/DC-IC	PWM/PFM step-up, 100kHz, 3.9V±2.5%, 100mA	SOT-89	20bq	DC2	4c	Tor
13A	APR3013-15D	Vdet-IC	1.5V, -Reset ODO	SOT-89	20vde	VD6	4b	Anp
13A	XC6372A302P	DC/DC-IC	PWM/PFM step-up, 180kHz, 3.0V±2.5%, 100mA	SOT-89	20bq	DC2	4c	Tor
13B	APR3013-17D	Vdet-IC	1.75V, -Reset ODO	SOT-89	20vde	VD6	4b	Anp
13B	XC6372A312P	DC/DC-IC	PWM/PFM step-up, 180kHz, 3.1V±2.5%, 100mA	SOT-89	20bq	DC2	4c	Tor
13C	APR3013-23D	Vdet-IC	2.32V, -Reset ODO	SOT-89	20vde	VD6	4b	Anp
13C	XC6372A322P	DC/DC-IC	PWM/PFM step-up, 180kHz, 3.2V±2.5%, 100mA	SOT-89	20bq	DC2	4c	Tor
13D	APR3013-26D	Vdet-IC	2.63V, -Reset ODO	SOT-89	20vde	VD6	4b	Anp
13D	XC6372A332P	DC/DC-IC	PWM/PFM step-up, 180kHz, 3.3V±2.5%, 100mA	SOT-89	20bq	DC2	4c	Tor
13E	APR3013-29D	Vdet-IC	2.93V, -Reset ODO	SOT-89	20vde	VD6	4b	Anp
13E	XC6372A342P	DC/DC-IC	PWM/PFM step-up, 180kHz, 3.4V±2.5%, 100mA	SOT-89	20bq	DC2	4c	Tor
13F	APR3013-30D	Vdet-IC	3.08V, -Reset ODO	SOT-89	20vde	VD6	4b	Anp
13F	XC6372A352P	DC/DC-IC	PWM/PFM step-up, 180kHz, 3.5V±2.5%, 100mA	SOT-89	20bq	DC2	4c	Tor
13G	APR3013-39D	Vdet-IC	3.9V, -Reset ODO	SOT-89	20vde	VD6	4b	Anp
13H	APR3013-43D	Vdet-IC	4.38V, -Reset ODO	SOT-89	20vde	VD6	4b	Anp
13H	XC6372A362P	DC/DC-IC	PWM/PFM step-up, 180kHz, 3.6V±2.5%, 100mA	SOT-89	20bq	DC2	4c	Tor
13J	APR3013-46D	Vdet-IC	4.63V, -Reset ODO	SOT-89	20vde	VD6	4b	Anp
13K	XC6372A372P	DC/DC-IC	PWM/PFM step-up, 180kHz, 3.7V±2.5%, 100mA	SOT-89	20bq	DC2	4c	Tor
13L	XC6372A382P	DC/DC-IC	PWM/PFM step-up, 180kHz, 3.8V±2.5%, 100mA	SOT-89	20bq	DC2	4c	Tor
13M	XC6372A392P	DC/DC-IC	PWM/PFM step-up, 180kHz, 3.9V±2.5%, 100mA	SOT-89	20bq	DC2	4c	Tor
13Y	BZV49-C13	Z-diode	13V±5%, Izt=5mA, 1W	SOT-89	20dim	-	4b	Phi
140	XC6372A401P	DC/DC-IC	PWM/PFM step-up, 100kHz, 4.0V±2.5%, 100mA	SOT-89	20bq	DC2	4c	Tor
141	XC6372A411P	DC/DC-IC	PWM/PFM step-up, 100kHz, 4.1V±2.5%, 100mA	SOT-89	20bq	DC2	4c	Tor
142	XC6372A421P	DC/DC-IC	PWM/PFM step-up, 100kHz, 4.2V±2.5%, 100mA	SOT-89	20bq	DC2	4c	Tor
143	XC6372A431P	DC/DC-IC	PWM/PFM step-up, 100kHz, 4.3V±2.5%, 100mA	SOT-89	20bq	DC2	4c	Tor
144	XC6372A441P	DC/DC-IC	PWM/PFM step-up, 100kHz, 4.4V±2.5%, 100mA	SOT-89	20bq	DC2	4c	Tor
145	XC6372A451P	DC/DC-IC	PWM/PFM step-up, 100kHz, 4.5V±2.5%, 100mA	SOT-89	20bq	DC2	4c	Tor
146	XC6372A461P	DC/DC-IC	PWM/PFM step-up, 100kHz, 4.6V±2.5%, 100mA	SOT-89	20bq	DC2	4c	Tor
147	FCX1147A	Si-pnp	Lo-sat, 15V, 3A, 2W, B=250..850, 115MHz	SOT-89	20tb	-	4b	Zx
147	XC6372A471P	DC/DC-IC	PWM/PFM step-up, 100kHz, 4.7V±2.5%, 100mA	SOT-89	20bq	DC2	4c	Tor
148	XC6372A481P	DC/DC-IC	PWM/PFM step-up, 100kHz, 4.8V±2.5%, 100mA	SOT-89	20bq	DC2	4c	Tor
149	FCX1149A	Si-pnp	Sw, 30V, 3A, 2W, B=250..850, 135MHz	SOT-89	20tb	-	4b	Zx
149	XC6372A491P	DC/DC-IC	PWM/PFM step-up, 100kHz, 4.9V±2.5%, 100mA	SOT-89	20bq	DC2	4c	Tor
14A	XC6372A402P	DC/DC-IC	PWM/PFM step-up, 180kHz, 4.0V±2.5%, 100mA	SOT-89	20bq	DC2	4c	Tor
14B	XC6372A412P	DC/DC-IC	PWM/PFM step-up, 180kHz, 4.1V±2.5%, 100mA	SOT-89	20bq	DC2	4c	Tor
14C	XC6372A422P	DC/DC-IC	PWM/PFM step-up, 180kHz, 4.2V±2.5%, 100mA	SOT-89	20bq	DC2	4c	Tor
14D	XC6372A432P	DC/DC-IC	PWM/PFM step-up, 180kHz, 4.3V±2.5%, 100mA	SOT-89	20bq	DC2	4c	Tor
14E	XC6372A442P	DC/DC-IC	PWM/PFM step-up, 180kHz, 4.4V±2.5%, 100mA	SOT-89	20bq	DC2	4c	Tor
14F	XC6372A452P	DC/DC-IC	PWM/PFM step-up, 180kHz, 4.5V±2.5%, 100mA	SOT-89	20bq	DC2	4c	Tor
14H	XC6372A462P	DC/DC-IC	PWM/PFM step-up, 180kHz, 4.6V±2.5%, 100mA	SOT-89	20bq	DC2	4c	Tor
14K	XC6372A472P	DC/DC-IC	PWM/PFM step-up, 180kHz, 4.7V±2.5%, 100mA	SOT-89	20bq	DC2	4c	Tor
14L	XC6372A482P	DC/DC-IC	PWM/PFM step-up, 180kHz, 4.8V±2.5%, 100mA	SOT-89	20bq	DC2	4c	Tor
14M	XC6372A492P	DC/DC-IC	PWM/PFM step-up, 180kHz, 4.9V±2.5%, 100mA	SOT-89	20bq	DC2	4c	Tor
150	XC6372A501P	DC/DC-IC	PWM/PFM step-up, 100kHz, 5.0V±2.5%, 100mA	SOT-89	20bq	DC2	4c	Tor
151	FCX1151A	Si-pnp	Lo-sat, 45V, 3A, 2W, B=250..800, 145MHz	SOT-89	20tb	-	4b	Zx
151	XC6372A511P	DC/DC-IC	PWM/PFM step-up, 100kHz, 5.1V±2.5%, 100mA	SOT-89	20bq	DC2	4c	Tor
152	XC6372A521P	DC/DC-IC	PWM/PFM step-up, 100kHz, 5.2V±2.5%, 100mA	SOT-89	20bq	DC2	4c	Tor
153	XC6372A531P	DC/DC-IC	PWM/PFM step-up, 100kHz, 5.3V±2.5%, 100mA	SOT-89	20bq	DC2	4c	Tor
154	XC6372A541P	DC/DC-IC	PWM/PFM step-up, 100kHz, 5.4V±2.5%, 100mA	SOT-89	20bq	DC2	4c	Tor
155	XC6372A551P	DC/DC-IC	PWM/PFM step-up, 100kHz, 5.5V±2.5%, 100mA	SOT-89	20bq	DC2	4c	Tor
156	XC6372A561P	DC/DC-IC	PWM/PFM step-up, 100kHz, 5.6V±2.5%, 100mA	SOT-89	20bq	DC2	4c	Tor
157	XC6372A571P	DC/DC-IC	PWM/PFM step-up, 100kHz, 5.7V±2.5%, 100mA	SOT-89	20bq	DC2	4c	Tor
158	XC6372A581P	DC/DC-IC	PWM/PFM step-up, 100kHz, 5.8V±2.5%, 100mA	SOT-89	20bq	DC2	4c	Tor
159	XC6372A591P	DC/DC-IC	PWM/PFM step-up, 100kHz, 5.9V±2.5%, 100mA	SOT-89	20bq	DC2	4c	Tor
15A	XC6372A502P	DC/DC-IC	PWM/PFM step-up, 180kHz, 5.0V±2.5%, 100mA	SOT-89	20bq	DC2	4c	Tor
15B	XC6372A512P	DC/DC-IC	PWM/PFM step-up, 180kHz, 5.1V±2.5%, 100mA	SOT-89	20bq	DC2	4c	Tor



SMD
code

Type

Function

Short description

Case Pinout Sch. St. Mnf.

SMD code	Type	Function	Short description	Case	Pinout	Sch.	St.	Mnf.
15C	XC6201P132PR	LVR-IC	1.3V±2%, 250mA	SOT-89	20ch	VR1	4c	Tor
15C	XC6372A522P	DC/DC-IC	PWM/PFM step-up, 180kHz, 5.2V±2.5%, 100mA	SOT-89	20bq	DC2	4c	Tor
15D	XC6201P142PR	LVR-IC	1.4V±2%, 250mA	SOT-89	20ch	VR1	4c	Tor
15D	XC6372A532P	DC/DC-IC	PWM/PFM step-up, 180kHz, 5.3V±2.5%, 100mA	SOT-89	20bq	DC2	4c	Tor
15E	XC6201P152PR	LVR-IC	1.5V±2%, 250mA	SOT-89	20ch	VR1	4c	Tor
15E	XC6372A542P	DC/DC-IC	PWM/PFM step-up, 180kHz, 5.4V±2.5%, 100mA	SOT-89	20bq	DC2	4c	Tor
15F	XC6201P162PR	LVR-IC	1.6V±2%, 250mA	SOT-89	20ch	VR1	4c	Tor
15F	XC6372A552P	DC/DC-IC	PWM/PFM step-up, 180kHz, 5.5V±2.5%, 100mA	SOT-89	20bq	DC2	4c	Tor
15H	XC6201P172PR	LVR-IC	1.7V±2%, 250mA	SOT-89	20ch	VR1	4c	Tor
15H	XC6372A562P	DC/DC-IC	PWM/PFM step-up, 180kHz, 5.6V±2.5%, 100mA	SOT-89	20bq	DC2	4c	Tor
15K	XC6201P182PR	LVR-IC	1.8V±2%, 250mA	SOT-89	20ch	VR1	4c	Tor
15K	XC6372A572P	DC/DC-IC	PWM/PFM step-up, 180kHz, 5.7V±2.5%, 100mA	SOT-89	20bq	DC2	4c	Tor
15L	XC6201P192PR	LVR-IC	1.9V±2%, 250mA	SOT-89	20ch	VR1	4c	Tor
15L	XC6372A582P	DC/DC-IC	PWM/PFM step-up, 180kHz, 5.8V±2.5%, 100mA	SOT-89	20bq	DC2	4c	Tor
15M	XC6201P202PR	LVR-IC	2.0V±2%, 250mA	SOT-89	20ch	VR1	4c	Tor
15M	XC6372A592P	DC/DC-IC	PWM/PFM step-up, 180kHz, 5.9V±2.5%, 100mA	SOT-89	20bq	DC2	4c	Tor
15N	XC6201P212PR	LVR-IC	2.1V±2%, 250mA	SOT-89	20ch	VR1	4c	Tor
15P	XC6201P222PR	LVR-IC	2.2V±2%, 250mA	SOT-89	20ch	VR1	4c	Tor
15R	XC6201P232PR	LVR-IC	2.3V±2%, 250mA	SOT-89	20ch	VR1	4c	Tor
15S	XC6201P242PR	LVR-IC	2.4V±2%, 250mA	SOT-89	20ch	VR1	4c	Tor
15T	XC6201P252PR	LVR-IC	2.5V±2%, 250mA	SOT-89	20ch	VR1	4c	Tor
15U	XC6201P262PR	LVR-IC	2.6V±2%, 250mA	SOT-89	20ch	VR1	4c	Tor
15V	XC6201P272PR	LVR-IC	2.7V±2%, 250mA	SOT-89	20ch	VR1	4c	Tor
15X	XC6201P282PR	LVR-IC	2.8V±2%, 250mA	SOT-89	20ch	VR1	4c	Tor
15Y	BZV49-C15	Z-diode	15V±5%, Izt=5mA, 1W	SOT-89	20dm	-	4b	Phi
15Y	XC6201P292PR	LVR-IC	2.9V±2%, 250mA	SOT-89	20ch	VR1	4c	Tor
160	XC6201P312PR	LVR-IC	3.1V±2%, 250mA	SOT-89	20ch	VR1	4c	Tor
160	XC6372A601P	DC/DC-IC	PWM/PFM step-up, 100kHz, 6.0V±2.5%, 100mA	SOT-89	20bq	DC2	4c	Tor
161	XC6201P322PR	LVR-IC	3.2V±2%, 250mA	SOT-89	20ch	VR1	4c	Tor
161	XC6372A611P	DC/DC-IC	PWM/PFM step-up, 100kHz, 6.1V±2.5%, 100mA	SOT-89	20bq	DC2	4c	Tor
162	XC6201P332PR	LVR-IC	3.3V±2%, 250mA	SOT-89	20ch	VR1	4c	Tor
162	XC6372A621P	DC/DC-IC	PWM/PFM step-up, 100kHz, 6.2V±2.5%, 100mA	SOT-89	20bq	DC2	4c	Tor
163	XC6201P342PR	LVR-IC	3.4V±2%, 250mA	SOT-89	20ch	VR1	4c	Tor
163	XC6372A631P	DC/DC-IC	PWM/PFM step-up, 100kHz, 6.3V±2.5%, 100mA	SOT-89	20bq	DC2	4c	Tor
164	XC6201P352PR	LVR-IC	3.5V±2%, 250mA	SOT-89	20ch	VR1	4c	Tor
164	XC6372A641P	DC/DC-IC	PWM/PFM step-up, 100kHz, 6.4V±2.5%, 100mA	SOT-89	20bq	DC2	4c	Tor
165	XC6201P362PR	LVR-IC	3.6V±2%, 250mA	SOT-89	20ch	VR1	4c	Tor
165	XC6372A651P	DC/DC-IC	PWM/PFM step-up, 100kHz, 6.5V±2.5%, 100mA	SOT-89	20bq	DC2	4c	Tor
166	XC6201P372PR	LVR-IC	3.7V±2%, 250mA	SOT-89	20ch	VR1	4c	Tor
166	XC6372A661P	DC/DC-IC	PWM/PFM step-up, 100kHz, 6.6V±2.5%, 100mA	SOT-89	20bq	DC2	4c	Tor
167	XC6201P382PR	LVR-IC	3.8V±2%, 250mA	SOT-89	20ch	VR1	4c	Tor
167	XC6372A671P	DC/DC-IC	PWM/PFM step-up, 100kHz, 6.7V±2.5%, 100mA	SOT-89	20bq	DC2	4c	Tor
168	XC6201P392PR	LVR-IC	3.9V±2%, 250mA	SOT-89	20ch	VR1	4c	Tor
168	XC6372A681P	DC/DC-IC	PWM/PFM step-up, 100kHz, 6.8V±2.5%, 100mA	SOT-89	20bq	DC2	4c	Tor
169	XC6201P402PR	LVR-IC	4.0V±2%, 250mA	SOT-89	20ch	VR1	4c	Tor
169	XC6372A691P	DC/DC-IC	PWM/PFM step-up, 100kHz, 6.9V±2.5%, 100mA	SOT-89	20bq	DC2	4c	Tor
16A	XC6201P412PR	LVR-IC	4.1V±2%, 250mA	SOT-89	20ch	VR1	4c	Tor
16A	XC6372A602P	DC/DC-IC	PWM/PFM step-up, 180kHz, 6.0V±2.5%, 100mA	SOT-89	20bq	DC2	4c	Tor
16B	XC6201P422PR	LVR-IC	4.2V±2%, 250mA	SOT-89	20ch	VR1	4c	Tor
16B	XC6372A612P	DC/DC-IC	PWM/PFM step-up, 180kHz, 6.1V±2.5%, 100mA	SOT-89	20bq	DC2	4c	Tor
16C	XC6201P432PR	LVR-IC	4.3V±2%, 250mA	SOT-89	20ch	VR1	4c	Tor
16C	XC6372A622P	DC/DC-IC	PWM/PFM step-up, 180kHz, 6.2V±2.5%, 100mA	SOT-89	20bq	DC2	4c	Tor
16D	XC6201P442PR	LVR-IC	4.4V±2%, 250mA	SOT-89	20ch	VR1	4c	Tor
16D	XC6372A632P	DC/DC-IC	PWM/PFM step-up, 180kHz, 6.3V±2.5%, 100mA	SOT-89	20bq	DC2	4c	Tor
16E	XC6201P452PR	LVR-IC	4.5V±2%, 250mA	SOT-89	20ch	VR1	4c	Tor
16E	XC6372A642P	DC/DC-IC	PWM/PFM step-up, 180kHz, 6.4V±2.5%, 100mA	SOT-89	20bq	DC2	4c	Tor
16F	XC6201P462PR	LVR-IC	4.6V±2%, 250mA	SOT-89	20ch	VR1	4c	Tor
16F	XC6372A652P	DC/DC-IC	PWM/PFM step-up, 180kHz, 6.5V±2.5%, 100mA	SOT-89	20bq	DC2	4c	Tor
16H	XC6201P472PR	LVR-IC	4.7V±2%, 250mA	SOT-89	20ch	VR1	4c	Tor
16H	XC6372A662P	DC/DC-IC	PWM/PFM step-up, 180kHz, 6.6V±2.5%, 100mA	SOT-89	20bq	DC2	4c	Tor
16K	XC6201P482PR	LVR-IC	4.8V±2%, 250mA	SOT-89	20ch	VR1	4c	Tor
16K	XC6372A672P	DC/DC-IC	PWM/PFM step-up, 180kHz, 6.7V±2.5%, 100mA	SOT-89	20bq	DC2	4c	Tor
16L	XC6201P492PR	LVR-IC	4.9V±2%, 250mA	SOT-89	20ch	VR1	4c	Tor
16L	XC6372A682P	DC/DC-IC	PWM/PFM step-up, 180kHz, 6.8V±2.5%, 100mA	SOT-89	20bq	DC2	4c	Tor
16M	XC6201P502PR	LVR-IC	5.0V±2%, 250mA	SOT-89	20ch	VR1	4c	Tor
16M	XC6372A692P	DC/DC-IC	PWM/PFM step-up, 180kHz, 6.9V±2.5%, 100mA	SOT-89	20bq	DC2	4c	Tor
16N	XC6201P512PR	LVR-IC	5.1V±2%, 250mA	SOT-89	20ch	VR1	4c	Tor
16P	XC6201P522PR	LVR-IC	5.2V±2%, 250mA	SOT-89	20ch	VR1	4c	Tor
16R	XC6201P532PR	LVR-IC	5.3V±2%, 250mA	SOT-89	20ch	VR1	4c	Tor
16S	XC6201P542PR	LVR-IC	5.4V±2%, 250mA	SOT-89	20ch	VR1	4c	Tor



SMD
code

Type

Function

Short description

Case Pinout Sch. St. Mnf.

16T	XC6201P552PR	LVR-IC	5.5V±2%, 250mA	SOT-89	20ch	VR1	4c	Tor
16U	XC6201P562PR	LVR-IC	5.6V±2%, 250mA	SOT-89	20ch	VR1	4c	Tor
16V	XC6201P572PR	LVR-IC	5.7V±2%, 250mA	SOT-89	20ch	VR1	4c	Tor
16X	XC6201P582PR	LVR-IC	5.8V±2%, 250mA	SOT-89	20ch	VR1	4c	Tor
16Y	BZV49-C16	Z-diode	16V±5%, Izt=5mA, 1W	SOT-89	20dm	-	4b	Phi
16Y	XC6201P592PR	LVR-IC	5.9V±2%, 250mA	SOT-89	20ch	VR1	4c	Tor
16Z	XC6201P302PR	LVR-IC	3V±2%, 250mA	SOT-89	20ch	VR1	4c	Tor
16Z	XC6201P602PR	LVR-IC	6V±2%, 250mA	SOT-89	20ch	VR1	4c	Tor
170	XC6372A701P	DC/DC-IC	PWM/PFM step-up, 100kHz, 7.0V±2.5%, 100mA	SOT-89	20bq	DC2	4c	Tor
1766	2SC1766PT-P	Si-npn	AF, Sw, 50V, 2A, B=82..180, 120MHz	SOT-89	20tb	-	4b	Chm
17A	XC6372A702P	DC/DC-IC	PWM/PFM step-up, 180kHz, 7.0V±2.5%, 100mA	SOT-89	20bq	DC2	4c	Tor
18	UTC8118	Vdet-IC	1.8V, -Reset OCO	SOT-89	20vdd	VD6	4b	Utc
18A	AAT60018A-S16	Vdet-IC	1.8V±2%, -Reset ODO	SOT-89	20vda	VD6	4p	Aat
18B	AAT60018B-S16	Vdet-IC	1.8V±2%, -Reset PPO	SOT-89	20vda	VD7	4p	Aat
18C	AAT60018C-S16	Vdet-IC	1.8V±1%, -Reset ODO	SOT-89	20vda	VD6	4p	Aat
18D	AAT60018D-S16	Vdet-IC	1.8V±1%, -Reset PPO	SOT-89	20vda	VD7	4p	Aat
18Y	BZV49-C18	Z-diode	18V±5%, Izt=5mA, 1W	SOT-89	20dm	-	4b	Phi
19	Gali-19	MMIC	RF amplifier, DC..7GHz, 11dB (50Ω)	SOT-89	20aa	A1	4b	Mc
19	UTC8119	Vdet-IC	1.9V, -Reset OCO	SOT-89	20vdd	VD6	4b	Utc
19A	AAT60019A-S16	Vdet-IC	1.9V±2%, -Reset ODO	SOT-89	20vda	VD6	4p	Aat
19B	AAT60019B-S16	Vdet-IC	1.9V±2%, -Reset PPO	SOT-89	20vda	VD7	4p	Aat
19C	AAT60019C-S16	Vdet-IC	1.9V±1%, -Reset ODO	SOT-89	20vda	VD6	4p	Aat
19D	AAT60019D-S16	Vdet-IC	1.9V±1%, -Reset PPO	SOT-89	20vda	VD7	4p	Aat
1A	2T664A9	Si-npn	GP, 120V, 1A, 300mW, B=40..250, 140MHz	SOT-89	20tb	-	4g	Rus
1A	PXT3904	Si-npn	Sw, 60V, 100mA, 1.2W, B=100..300, >300MHz	SOT-89	20tb	-	4a	Kex
1A	SXT3904	Si-npn	GP, 60V, 0.1A, 200mW, B= 100..300, >300MHz	SOT-89	20tb	-	4b	Sie
1B	RH5RL21AA	LVR-IC	2.1V±2.5%, 150mA	SOT-89	20vl	VR1	4c	Ric
1B0	TC55RP112EMB	LVR-IC	LDO, 1.1V±2%, 250mA	SOT-89	20vl	VR1	4h	Mcc
1C	RH5RL31AA	LVR-IC	3.1V±2.5%, 150mA	SOT-89	20vl	VR1	4c	Ric
1C0	TC55RP122EMB	LVR-IC	LDO, 1.2V±2%, 250mA	SOT-89	20vl	VR1	4h	Mcc
1C0	XC6372A200P	DC/DC-IC	PWM/PFM step-up, 50kHz, 2.0V±2.5%, 100mA	SOT-89	20bq	DC2	4c	Tor
1C1	XC6372A210P	DC/DC-IC	PWM/PFM step-up, 50kHz, 2.1V±2.5%, 100mA	SOT-89	20bq	DC2	4c	Tor
1C2	XC6372A220P	DC/DC-IC	PWM/PFM step-up, 50kHz, 2.2V±2.5%, 100mA	SOT-89	20bq	DC2	4c	Tor
1C3	XC6372A230P	DC/DC-IC	PWM/PFM step-up, 50kHz, 2.3V±2.5%, 100mA	SOT-89	20bq	DC2	4c	Tor
1C4	XC6372A240P	DC/DC-IC	PWM/PFM step-up, 50kHz, 2.4V±2.5%, 100mA	SOT-89	20bq	DC2	4c	Tor
1C5	XC6372A250P	DC/DC-IC	PWM/PFM step-up, 50kHz, 2.5V±2.5%, 100mA	SOT-89	20bq	DC2	4c	Tor
1C6	XC6372A260P	DC/DC-IC	PWM/PFM step-up, 50kHz, 2.6V±2.5%, 100mA	SOT-89	20bq	DC2	4c	Tor
1C7	XC6372A270P	DC/DC-IC	PWM/PFM step-up, 50kHz, 2.7V±2.5%, 100mA	SOT-89	20bq	DC2	4c	Tor
1C8	XC6372A280P	DC/DC-IC	PWM/PFM step-up, 50kHz, 2.8V±2.5%, 100mA	SOT-89	20bq	DC2	4c	Tor
1C9	XC6372A290P	DC/DC-IC	PWM/PFM step-up, 50kHz, 2.9V±2.5%, 100mA	SOT-89	20bq	DC2	4c	Tor
1D	RH5RL41AA	LVR-IC	4.1V±2.5%, 150mA	SOT-89	20vl	VR1	4c	Ric
1D	SXTA42	Si-npn	Vid, 300V, 500mA, 1W, B>40, >50MHz	SOT-89	20tb	-	4b	Sie
1D0	TC55RP132EMB	LVR-IC	LDO, 1.3V±2%, 250mA	SOT-89	20vl	VR1	4h	Mcc
1D0	XC6372A300P	DC/DC-IC	PWM/PFM step-up, 50kHz, 3.0V±2.5%, 100mA	SOT-89	20bq	DC2	4c	Tor
1D1	XC6372A310P	DC/DC-IC	PWM/PFM step-up, 50kHz, 3.1V±2.5%, 100mA	SOT-89	20bq	DC2	4c	Tor
1D2	XC6372A320P	DC/DC-IC	PWM/PFM step-up, 50kHz, 3.2V±2.5%, 100mA	SOT-89	20bq	DC2	4c	Tor
1D3	XC6372A330P	DC/DC-IC	PWM/PFM step-up, 50kHz, 3.3V±2.5%, 100mA	SOT-89	20bq	DC2	4c	Tor
1D4	XC6372A340P	DC/DC-IC	PWM/PFM step-up, 50kHz, 3.4V±2.5%, 100mA	SOT-89	20bq	DC2	4c	Tor
1D5	XC6372A350P	DC/DC-IC	PWM/PFM step-up, 50kHz, 3.5V±2.5%, 100mA	SOT-89	20bq	DC2	4c	Tor
1D6	XC6372A360P	DC/DC-IC	PWM/PFM step-up, 50kHz, 3.6V±2.5%, 100mA	SOT-89	20bq	DC2	4c	Tor
1D7	XC6372A370P	DC/DC-IC	PWM/PFM step-up, 50kHz, 3.7V±2.5%, 100mA	SOT-89	20bq	DC2	4c	Tor
1D8	XC6372A380P	DC/DC-IC	PWM/PFM step-up, 50kHz, 3.8V±2.5%, 100mA	SOT-89	20bq	DC2	4c	Tor
1D9	XC6372A390P	DC/DC-IC	PWM/PFM step-up, 50kHz, 3.9V±2.5%, 100mA	SOT-89	20bq	DC2	4c	Tor
1E	RH5RL51AA	LVR-IC	5.1V±2.5%, 150mA	SOT-89	20vl	VR1	4c	Ric
1E	SXTA43	Si-npn	Vid, 200V, 500mA, 1W, B>40, >50MHz	SOT-89	20tb	-	4b	Sie
1E0	TC55RP142EMB	LVR-IC	LDO, 1.4V±2%, 250mA	SOT-89	20vl	VR1	4h	Mcc
1E0	XC6372A400P	DC/DC-IC	PWM/PFM step-up, 50kHz, 4.0V±2.5%, 100mA	SOT-89	20bq	DC2	4c	Tor
1E1	XC6372A410P	DC/DC-IC	PWM/PFM step-up, 50kHz, 4.1V±2.5%, 100mA	SOT-89	20bq	DC2	4c	Tor
1E2	XC6372A420P	DC/DC-IC	PWM/PFM step-up, 50kHz, 4.2V±2.5%, 100mA	SOT-89	20bq	DC2	4c	Tor
1E3	XC6372A430P	DC/DC-IC	PWM/PFM step-up, 50kHz, 4.3V±2.5%, 100mA	SOT-89	20bq	DC2	4c	Tor
1E4	XC6372A440P	DC/DC-IC	PWM/PFM step-up, 50kHz, 4.4V±2.5%, 100mA	SOT-89	20bq	DC2	4c	Tor
1E5	XC6372A450P	DC/DC-IC	PWM/PFM step-up, 50kHz, 4.5V±2.5%, 100mA	SOT-89	20bq	DC2	4c	Tor
1E6	XC6372A460P	DC/DC-IC	PWM/PFM step-up, 50kHz, 4.6V±2.5%, 100mA	SOT-89	20bq	DC2	4c	Tor
1E7	XC6372A470P	DC/DC-IC	PWM/PFM step-up, 50kHz, 4.7V±2.5%, 100mA	SOT-89	20bq	DC2	4c	Tor
1E8	XC6372A480P	DC/DC-IC	PWM/PFM step-up, 50kHz, 4.8V±2.5%, 100mA	SOT-89	20bq	DC2	4c	Tor
1E9	XC6372A490P	DC/DC-IC	PWM/PFM step-up, 50kHz, 4.9V±2.5%, 100mA	SOT-89	20bq	DC2	4c	Tor
1F	2SC4543	Si-npn	Vid, 110V, 300mA, 1W, B>20, 350MHz	SOT-89	20tb	-	4b	Pan
1F0	TC55RP152EMB	LVR-IC	LDO, 1.5V±2%, 250mA	SOT-89	20vl	VR1	4h	Mcc
1F0	XC6372A500P	DC/DC-IC	PWM/PFM step-up, 50kHz, 5.0V±2.5%, 100mA	SOT-89	20bq	DC2	4c	Tor
1F1	XC6372A510P	DC/DC-IC	PWM/PFM step-up, 50kHz, 5.1V±2.5%, 100mA	SOT-89	20bq	DC2	4c	Tor



SMD
code

Type

Function

Short description

Case Pinout Sch. St. Mnf.

1F2	XC6372A520P	DC/DC-IC	PWM/PFM step-up, 50kHz, 5.2V±2.5%, 100mA	SOT-89	20bq	DC2	4c	Tor
1F3	XC6372A530P	DC/DC-IC	PWM/PFM step-up, 50kHz, 5.3V±2.5%, 100mA	SOT-89	20bq	DC2	4c	Tor
1F4	XC6372A540P	DC/DC-IC	PWM/PFM step-up, 50kHz, 5.4V±2.5%, 100mA	SOT-89	20bq	DC2	4c	Tor
1F5	XC6372A550P	DC/DC-IC	PWM/PFM step-up, 50kHz, 5.5V±2.5%, 100mA	SOT-89	20bq	DC2	4c	Tor
1F6	XC6372A560P	DC/DC-IC	PWM/PFM step-up, 50kHz, 5.6V±2.5%, 100mA	SOT-89	20bq	DC2	4c	Tor
1F7	XC6372A570P	DC/DC-IC	PWM/PFM step-up, 50kHz, 5.7V±2.5%, 100mA	SOT-89	20bq	DC2	4c	Tor
1F8	XC6372A580P	DC/DC-IC	PWM/PFM step-up, 50kHz, 5.8V±2.5%, 100mA	SOT-89	20bq	DC2	4c	Tor
1F9	XC6372A590P	DC/DC-IC	PWM/PFM step-up, 50kHz, 5.9V±2.5%, 100mA	SOT-89	20bq	DC2	4c	Tor
1H0	TC55RP162EMB	LVR-IC	LDO, 1.6V±2%, 250mA	SOT-89	20vl	VR1	4h	Mcc
1H0	XC6372A600P	DC/DC-IC	PWM/PFM step-up, 50kHz, 6.0V±2.5%, 100mA	SOT-89	20bq	DC2	4c	Tor
1H1	XC6372A610P	DC/DC-IC	PWM/PFM step-up, 50kHz, 6.1V±2.5%, 100mA	SOT-89	20bq	DC2	4c	Tor
1H2	XC6372A620P	DC/DC-IC	PWM/PFM step-up, 50kHz, 6.2V±2.5%, 100mA	SOT-89	20bq	DC2	4c	Tor
1H3	XC6372A630P	DC/DC-IC	PWM/PFM step-up, 50kHz, 6.3V±2.5%, 100mA	SOT-89	20bq	DC2	4c	Tor
1H4	XC6372A640P	DC/DC-IC	PWM/PFM step-up, 50kHz, 6.4V±2.5%, 100mA	SOT-89	20bq	DC2	4c	Tor
1H5	XC6372A650P	DC/DC-IC	PWM/PFM step-up, 50kHz, 6.5V±2.5%, 100mA	SOT-89	20bq	DC2	4c	Tor
1H6	XC6372A660P	DC/DC-IC	PWM/PFM step-up, 50kHz, 6.6V±2.5%, 100mA	SOT-89	20bq	DC2	4c	Tor
1H7	XC6372A670P	DC/DC-IC	PWM/PFM step-up, 50kHz, 6.7V±2.5%, 100mA	SOT-89	20bq	DC2	4c	Tor
1H8	XC6372A680P	DC/DC-IC	PWM/PFM step-up, 50kHz, 6.8V±2.5%, 100mA	SOT-89	20bq	DC2	4c	Tor
1H9	XC6372A690P	DC/DC-IC	PWM/PFM step-up, 50kHz, 6.9V±2.5%, 100mA	SOT-89	20bq	DC2	4c	Tor
1HR	2SD2185-R	Si-npn	AF-Drv, 50V, 3A, 1W, B=120..240, 120MHz	SOT-89	20tb	-	4g	Pan
1HS	2SD2185-S	Si-npn	AF-Drv, 50V, 3A, 1W, B=170..340, 120MHz	SOT-89	20tb	-	4g	Pan
1IR	2SB1440-R	Si-npn	AF-Amp, 50V, 2A, 1W, B=120..240, 150MHz	SOT-89	20tb	-	4b	Pan
1IS	2SB1440-S	Si-npn	AF-Amp, 50V, 2A, 1W, B=170..340, 150MHz	SOT-89	20tb	-	4b	Pan
1J	RH5RE21AA	LVR-IC	Ultra-LDO, 2.1V±2.5%, 300mA	SOT-89	20vl	VR1	4c	Ric
1K	RH5RE31AA	LVR-IC	Ultra-LDO, 3.1V±2.5%, 300mA	SOT-89	20vl	VR1	4c	Ric
1K0	TC55RP172EMB	LVR-IC	LDO, 1.7V±2%, 250mA	SOT-89	20vl	VR1	4h	Mcc
1K0	XC6372A700P	DC/DC-IC	PWM/PFM step-up, 50kHz, 7.0V±2.5%, 100mA	SOT-89	20bq	DC2	4c	Tor
1L	2SB1537	Si-npn	AF, Lo-sat, 10V, 1A, 1W, B=200..800, 120MHz	SOT-89	20tb	-	4b	Pan
1L	RH5RE41AA	LVR-IC	Ultra-LDO, 4.1V±2.5%, 300mA	SOT-89	20vl	VR1	4c	Ric
1L0	TC55RP182EMB	LVR-IC	LDO, 1.8V±2%, 250mA	SOT-89	20vl	VR1	4h	Mcc
1M	2SD2357	Si-npn	AF, Lo-sat, 10V, 1A, 1W, B=200..800, 100MHz	SOT-89	20tb	-	4b	Pan
1M	RH5RE51AA	LVR-IC	Ultra-LDO, 5.1V±2.5%, 300mA	SOT-89	20vl	VR1	4c	Ric
1M0	TC55RP192EMB	LVR-IC	LDO, 1.9V±2%, 250mA	SOT-89	20vl	VR1	4h	Mcc
1M3	ZXTP19100CZ	Si-npn	Drv, 100V, 2A, 2.4W, B=200..500, 142MHz	SOT-89	20tb	-	4g	Zx
1N	2SB1539	Si-npn	AF, Lo-sat, 20V, 1A, 1W, B=200..800, 120MHz	SOT-89	20tb	-	4b	Pan
1O	2SD2359	Si-npn	AF, Lo-sat, 20V, 1A, 1W, B=200..800, 100MHz	SOT-89	20tb	-	4b	Pan
1P	PX12222A	Si-npn	GP, 75V, 600mA, 1.25W, B=100..300, >300MHz	SOT-89	20tb	-	4a	Kex
1P	WTM2222A	Si-npn	Sw, 75V, 600mA, 1.2W, B=35..300, >300MHz	SOT-89	20tb	-	4b	Wtr
1R	2SC4929	Si-npn	Sw, 500/400V, 800mA, 80MHz	SOT-89	20tb	-	4b	Pan
1S	2SD2413	Si-npn	AF-Drv, 400V, 100mA, 1W, B>30, 40MHz	SOT-89	20tb	-	4b	Pan
1T	2SD2416	Si-npn-Darl+Di	Sw, 60V, 1A, 150MHz, B=6.5k. 40k, Z-Di (E->C)	SOT-89	20tb	-	4b	Pan
1V	2SD2441	Si-npn	Lo-sat, 10V, 2A, 1W, B=200..700, 190MHz	SOT-89	20tb	-	4b	Pan
1W	2SC5019	Si-npn	UHF, LN, 15V, 80mA, 1W, B=80..250, 6GHz	SOT-89	20tb	-	4b	Pan
1XP	2SB1599-P	Si-npn	AF, 50V, 1.5A, 1W, B=50..100, 150MHz	SOT-89	20tb	-	4b	Pan
1XQ	2SB1599-Q	Si-npn	AF, 50V, 1.5A, 1W, B=80..160, 150MHz	SOT-89	20tb	-	4b	Pan
1XR	2SB1599-R	Si-npn	AF, 50V, 1.5A, 1W, B=100..220, 150MHz	SOT-89	20tb	-	4b	Pan
1YP	2SD2457-P	Si-npn	AF, 50V, 1.5A, 1W, B=60..120, 150MHz	SOT-89	20tb	-	4b	Pan
1YQ	2SD2457-Q	Si-npn	AF, 50V, 1.5A, 1W, B=80..160, 150MHz	SOT-89	20tb	-	4b	Pan
1YR	2SD2457-R	Si-npn	AF, 50V, 1.5A, 1W, B=120..240, 150MHz	SOT-89	20tb	-	4b	Pan
1ZQ	2SA1890-Q	Si-npn	AF-Drv, 80V, 1A, 1W, B=120..240, 120MHz	SOT-89	20tb	-	4b	Pan
1ZR	2SA1890-R	Si-npn	AF-Drv, 80V, 1A, 1W, B=270..340, 120MHz	SOT-89	20tb	-	4b	Pan
1B	2T66459	Si-npn	GP, 100V, 1A, 300mW, B=40..250, 140MHz	SOT-89	20tb	-	4g	Rus
20	UTC8120	Vdet-IC	2V, -Reset OCO	SOT-89	20vdd	VD6	4b	Utc
20A	AAT60020A-S16	Vdet-IC	2.0V±2%, -Reset ODO	SOT-89	20vda	VD6	4p	Aat
20B	AAT60020B-S16	Vdet-IC	2.0V±2%, -Reset PPO	SOT-89	20vda	VD7	4p	Aat
20C	AAT60020C-S16	Vdet-IC	2.0V±1%, -Reset ODO	SOT-89	20vda	VD6	4p	Aat
20D	AAT60020D-S16	Vdet-IC	2.0V±1%, -Reset PPO	SOT-89	20vda	VD7	4p	Aat
20Y	BZV49-C20	Z-diode	20V±5%, Izt=5mA, 1W	SOT-89	20dim	-	4b	Phi
21	Gali-21	MMIC	RF amplifier, DC..8GHz, 12.4dB (50Ω)	SOT-89	20aa	A1	4b	Mc
21	UTC8121	Vdet-IC	2.1V, -Reset OCO	SOT-89	20vdd	VD6	4b	Utc
21A	AAT60021A-S16	Vdet-IC	2.1V±2%, -Reset ODO	SOT-89	20vda	VD6	4p	Aat
21A	APR3021-15D	Vdet-IC	1.5V, -Reset PPO	SOT-89	20vdb	VD7	4b	Anp
21B	AAT60021B-S16	Vdet-IC	2.1V±2%, -Reset PPO	SOT-89	20vda	VD7	4p	Aat
21B	APR3021-17D	Vdet-IC	1.75V, -Reset PPO	SOT-89	20vdb	VD7	4b	Anp
21C	AAT60021C-S16	Vdet-IC	2.1V±1%, -Reset ODO	SOT-89	20vda	VD6	4p	Aat
21C	APR3021-23D	Vdet-IC	2.32V, -Reset PPO	SOT-89	20vdb	VD7	4b	Anp
21D	AAT60021D-S16	Vdet-IC	2.1V±1%, -Reset PPO	SOT-89	20vda	VD7	4p	Aat
21D	APR3021-26D	Vdet-IC	2.63V, -Reset PPO	SOT-89	20vdb	VD7	4b	Anp
21E	APR3021-29D	Vdet-IC	2.93V, -Reset PPO	SOT-89	20vdb	VD7	4b	Anp
21F	APR3021-30D	Vdet-IC	3.08V, -Reset PPO	SOT-89	20vdb	VD7	4b	Anp



SMD
code

Type

Function

Short description

Case Pinout Sch. St. Mnf.

SMD code	Type	Function	Short description	Case	Pinout	Sch.	St.	Mnf.
21G	APR3021-39D	Vdet-IC	3.9V, -Reset PPO	SOT-89	20vdb	VD7	4b	Anp
21H	APR3021-43D	Vdet-IC	4.38V, -Reset PPO	SOT-89	20vdb	VD7	4b	Anp
21J	APR3021-46D	Vdet-IC	4.63V, -Reset PPO	SOT-89	20vdb	VD7	4b	Anp
22	UTC8122	Vdet-IC	2.2V, -Reset OCO	SOT-89	20vdd	VD6	4b	Utc
2222A	WTM2222A	Si-nprn	Sw, 75V, 600mA, 1.2W, B=35..300, >300MHz	SOT-89	20tb	-	4b	Wtr
22A	AAT60022A-S16	Vdet-IC	2.2V±2%, -Reset ODO	SOT-89	20vda	VD6	4b	Aat
22A	APR3022-15D	Vdet-IC	1.5V, +Reset PPO	SOT-89	20vdb	VD7	4b	Anp
22B	AAT60022B-S16	Vdet-IC	2.2V±2%, -Reset PPO	SOT-89	20vda	VD7	4p	Aat
22B	APR3022-17D	Vdet-IC	1.75V, +Reset PPO	SOT-89	20vdb	VD7	4b	Anp
22C	AAT60022C-S16	Vdet-IC	2.2V±1%, -Reset ODO	SOT-89	20vda	VD6	4p	Aat
22C	APR3022-23D	Vdet-IC	2.32V, +Reset PPO	SOT-89	20vdb	VD7	4b	Anp
22D	AAT60022D-S16	Vdet-IC	2.2V±1%, -Reset PPO	SOT-89	20vda	VD7	4p	Aat
22D	APR3022-26D	Vdet-IC	2.63V, +Reset PPO	SOT-89	20vdb	VD7	4b	Anp
22E	APR3022-29D	Vdet-IC	2.93V, +Reset PPO	SOT-89	20vdb	VD7	4b	Anp
22F	APR3022-30D	Vdet-IC	3.08V, +Reset PPO	SOT-89	20vdb	VD7	4b	Anp
22G	APR3022-39D	Vdet-IC	3.9V, +Reset PPO	SOT-89	20vdb	VD7	4b	Anp
22H	APR3022-43D	Vdet-IC	4.38V, +Reset PPO	SOT-89	20vdb	VD7	4b	Anp
22J	APR3022-46D	Vdet-IC	4.63V, +Reset PPO	SOT-89	20vdb	VD7	4b	Anp
22Y	BZV49-C22	Z-diode	22V±5%, Izt=5mA, 1W	SOT-89	20dm	-	4b	Phi
23	UTC8123	Vdet-IC	2.3V, -Reset OCO	SOT-89	20vdd	VD6	4b	Utc
23A	AAT60023A-S16	Vdet-IC	2.3V±2%, -Reset ODO	SOT-89	20vda	VD6	4p	Aat
23A	APR3023-15D	Vdet-IC	1.5V, -Reset ODO	SOT-89	20vdb	VD6	4b	Anp
23B	AAT60023B-S16	Vdet-IC	2.3V±2%, -Reset PPO	SOT-89	20vda	VD7	4p	Aat
23B	APR3023-17D	Vdet-IC	1.75V, -Reset ODO	SOT-89	20vdb	VD6	4b	Anp
23C	AAT60023C-S16	Vdet-IC	2.3V±1%, -Reset ODO	SOT-89	20vda	VD6	4p	Aat
23C	APR3023-23D	Vdet-IC	2.32V, -Reset ODO	SOT-89	20vdb	VD6	4b	Anp
23D	AAT60023D-S16	Vdet-IC	2.3V±1%, -Reset PPO	SOT-89	20vda	VD7	4p	Aat
23D	APR3023-26D	Vdet-IC	2.63V, -Reset ODO	SOT-89	20vdb	VD6	4b	Anp
23E	APR3023-29D	Vdet-IC	2.93V, -Reset ODO	SOT-89	20vdb	VD6	4b	Anp
23F	APR3023-30D	Vdet-IC	3.08V, -Reset ODO	SOT-89	20vdb	VD6	4b	Anp
23G	APR3023-39D	Vdet-IC	3.9V, -Reset ODO	SOT-89	20vdb	VD6	4b	Anp
23H	APR3023-43D	Vdet-IC	4.38V, -Reset ODO	SOT-89	20vdb	VD6	4b	Anp
23J	APR3023-46D	Vdet-IC	4.63V, -Reset ODO	SOT-89	20vdb	VD6	4b	Anp
24	UTC8124	Vdet-IC	2.4V, -Reset OCO	SOT-89	20vdd	VD6	4b	Utc
24A	AAT60024A-S16	Vdet-IC	2.4V±2%, -Reset ODO	SOT-89	20vda	VD6	4p	Aat
24B	AAT60024B-S16	Vdet-IC	2.4V±2%, -Reset PPO	SOT-89	20vda	VD7	4p	Aat
24C	AAT60024C-S16	Vdet-IC	2.4V±1%, -Reset ODO	SOT-89	20vda	VD6	4p	Aat
24D	AAT60024D-S16	Vdet-IC	2.4V±1%, -Reset PPO	SOT-89	20vda	VD7	4p	Aat
24K	XC6202P182PR	LVR-IC	LDO, 1.8V±2%, 150mA	SOT-89	20ch	VR1	4c	Tor
24L	XC6202P192PR	LVR-IC	LDO, 1.9V±2%, 150mA	SOT-89	20ch	VR1	4c	Tor
24M	XC6202P202PR	LVR-IC	LDO, 2.0V±2%, 150mA	SOT-89	20ch	VR1	4c	Tor
24M	XC6216D202PR	LVR-IC	2.0V±2%, 150mA	SOT-89	20ch	VR1	4a	Tor
24N	XC6202P212PR	LVR-IC	LDO, 2.1V±2%, 150mA	SOT-89	20ch	VR1	4c	Tor
24N	XC6216D212PR	LVR-IC	2.1V±2%, 150mA	SOT-89	20ch	VR1	4a	Tor
24P	XC6202P222PR	LVR-IC	LDO, 2.2V±2%, 150mA	SOT-89	20ch	VR1	4c	Tor
24P	XC6216D222PR	LVR-IC	2.2V±2%, 150mA	SOT-89	20ch	VR1	4a	Tor
24R	XC6202P232PR	LVR-IC	LDO, 2.3V±2%, 150mA	SOT-89	20ch	VR1	4c	Tor
24R	XC6216D232PR	LVR-IC	2.3V±2%, 150mA	SOT-89	20ch	VR1	4a	Tor
24S	XC6202P242PR	LVR-IC	LDO, 2.4V±2%, 150mA	SOT-89	20ch	VR1	4c	Tor
24S	XC6216D242PR	LVR-IC	2.4V±2%, 150mA	SOT-89	20ch	VR1	4a	Tor
24T	XC6202P252PR	LVR-IC	LDO, 2.5V±2%, 150mA	SOT-89	20ch	VR1	4c	Tor
24T	XC6216D252PR	LVR-IC	2.5V±2%, 150mA	SOT-89	20ch	VR1	4a	Tor
24U	XC6202P262PR	LVR-IC	LDO, 2.6V±2%, 150mA	SOT-89	20ch	VR1	4c	Tor
24U	XC6216D262PR	LVR-IC	2.6V±2%, 150mA	SOT-89	20ch	VR1	4a	Tor
24V	XC6202P272PR	LVR-IC	LDO, 2.7V±2%, 150mA	SOT-89	20ch	VR1	4c	Tor
24V	XC6216D272PR	LVR-IC	2.7V±2%, 150mA	SOT-89	20ch	VR1	4a	Tor
24X	XC6202P282PR	LVR-IC	LDO, 2.8V±2%, 150mA	SOT-89	20ch	VR1	4c	Tor
24X	XC6216D282PR	LVR-IC	2.8V±2%, 150mA	SOT-89	20ch	VR1	4a	Tor
24Y	BZV49-C24	Z-diode	24V±5%, Izt=5mA, 1W	SOT-89	20dm	-	4b	Phi
24Y	XC6202P292PR	LVR-IC	LDO, 2.9V±2%, 150mA	SOT-89	20ch	VR1	4c	Tor
24Y	XC6216D292PR	LVR-IC	2.9V±2%, 150mA	SOT-89	20ch	VR1	4a	Tor
24Z	XC6202P302PR	LVR-IC	LDO, 3.0V±2%, 150mA	SOT-89	20ch	VR1	4c	Tor
24Z	XC6216D302PR	LVR-IC	3.0V±2%, 150mA	SOT-89	20ch	VR1	4a	Tor
25	UTC8125	Vdet-IC	2.5V, -Reset OCO	SOT-89	20vdd	VD6	4b	Utc
250	XC6202P312PR	LVR-IC	LDO, 3.1V±2%, 150mA	SOT-89	20ch	VR1	4c	Tor
250	XC6216D312PR	LVR-IC	3.1V±2%, 150mA	SOT-89	20ch	VR1	4a	Tor
251	XC6202P322PR	LVR-IC	LDO, 3.2V±2%, 150mA	SOT-89	20ch	VR1	4c	Tor
251	XC6216D322PR	LVR-IC	3.2V±2%, 150mA	SOT-89	20ch	VR1	4a	Tor
252	XC6202P332PR	LVR-IC	LDO, 3.3V±2%, 150mA	SOT-89	20ch	VR1	4c	Tor
252	XC6216D332PR	LVR-IC	3.3V±2%, 150mA	SOT-89	20ch	VR1	4a	Tor



SMD
code

Type

Function

Short description

Case Pinout Sch. St. Mnf.

SMD code	Type	Function	Short description	Case	Pinout	Sch.	St.	Mnf.
253	XC6202P342PR	LVR-IC	LDO, 3.4V±2%, 150mA	SOT-89	20ch	VR1	4c	Tor
253	XC6216D342PR	LVR-IC	3.4V±2%, 150mA	SOT-89	20ch	VR1	4a	Tor
254	XC6202P352PR	LVR-IC	LDO, 3.5V±2%, 150mA	SOT-89	20ch	VR1	4c	Tor
254	XC6216D352PR	LVR-IC	3.5V±2%, 150mA	SOT-89	20ch	VR1	4a	Tor
255	XC6202P362PR	LVR-IC	LDO, 3.6V±2%, 150mA	SOT-89	20ch	VR1	4c	Tor
255	XC6216D362PR	LVR-IC	3.6V±2%, 150mA	SOT-89	20ch	VR1	4a	Tor
256	XC6202P372PR	LVR-IC	LDO, 3.7V±2%, 150mA	SOT-89	20ch	VR1	4c	Tor
256	XC6216D372PR	LVR-IC	3.7V±2%, 150mA	SOT-89	20ch	VR1	4a	Tor
257	XC6202P382PR	LVR-IC	LDO, 3.8V±2%, 150mA	SOT-89	20ch	VR1	4c	Tor
257	XC6216D382PR	LVR-IC	3.8V±2%, 150mA	SOT-89	20ch	VR1	4a	Tor
258	XC6202P392PR	LVR-IC	LDO, 3.9V±2%, 150mA	SOT-89	20ch	VR1	4c	Tor
258	XC6216D392PR	LVR-IC	3.9V±2%, 150mA	SOT-89	20ch	VR1	4a	Tor
259	XC6202P402PR	LVR-IC	LDO, 4V±2%, 150mA	SOT-89	20ch	VR1	4c	Tor
259	XC6216D402PR	LVR-IC	4.0V±2%, 150mA	SOT-89	20ch	VR1	4a	Tor
25A	AAT60025A-S16	Vdet-IC	2.5V±2%, -Reset ODO	SOT-89	20vda	VD6	4c	Aat
25A	XC6202P412PR	LVR-IC	LDO, 4.1V±2%, 150mA	SOT-89	20ch	VR1	4c	Tor
25A	XC6216D412PR	LVR-IC	4.1V±2%, 150mA	SOT-89	20ch	VR1	4a	Tor
25B	AAT60025B-S16	Vdet-IC	2.5V±2%, -Reset PPO	SOT-89	20vda	VD7	4c	Aat
25B	XC6202P422PR	LVR-IC	LDO, 4.2V±2%, 150mA	SOT-89	20ch	VR1	4c	Tor
25B	XC6216D422PR	LVR-IC	4.2V±2%, 150mA	SOT-89	20ch	VR1	4a	Tor
25C	AAT60025C-S16	Vdet-IC	2.5V±1%, -Reset ODO	SOT-89	20vda	VD6	4c	Aat
25C	XC6202P432PR	LVR-IC	LDO, 4.3V±2%, 150mA	SOT-89	20ch	VR1	4c	Tor
25C	XC6216D432PR	LVR-IC	4.3V±2%, 150mA	SOT-89	20ch	VR1	4a	Tor
25D	AAT60025D-S16	Vdet-IC	2.5V±1%, -Reset PPO	SOT-89	20vda	VD7	4c	Aat
25D	XC6202P442PR	LVR-IC	LDO, 4.4V±2%, 150mA	SOT-89	20ch	VR1	4c	Tor
25D	XC6216D442PR	LVR-IC	4.4V±2%, 150mA	SOT-89	20ch	VR1	4a	Tor
25E	XC6202P452PR	LVR-IC	LDO, 4.5V±2%, 150mA	SOT-89	20ch	VR1	4c	Tor
25E	XC6216D452PR	LVR-IC	4.5V±2%, 150mA	SOT-89	20ch	VR1	4a	Tor
25F	XC6202P462PR	LVR-IC	LDO, 4.6V±2%, 150mA	SOT-89	20ch	VR1	4c	Tor
25F	XC6216D462PR	LVR-IC	4.6V±2%, 150mA	SOT-89	20ch	VR1	4a	Tor
25H	XC6202P472PR	LVR-IC	LDO, 4.7V±2%, 150mA	SOT-89	20ch	VR1	4c	Tor
25H	XC6216D472PR	LVR-IC	4.7V±2%, 150mA	SOT-89	20ch	VR1	4a	Tor
25K	XC6202P482PR	LVR-IC	LDO, 4.8V±2%, 150mA	SOT-89	20ch	VR1	4c	Tor
25K	XC6216D482PR	LVR-IC	4.8V±2%, 150mA	SOT-89	20ch	VR1	4a	Tor
25L	XC6202P492PR	LVR-IC	LDO, 4.9V±2%, 150mA	SOT-89	20ch	VR1	4c	Tor
25L	XC6216D492PR	LVR-IC	4.9V±2%, 150mA	SOT-89	20ch	VR1	4a	Tor
25M	XC6202P502PR	LVR-IC	LDO, 5V±2%, 150mA	SOT-89	20ch	VR1	4c	Tor
25M	XC6216D502PR	LVR-IC	5.0V±2%, 150mA	SOT-89	20ch	VR1	4a	Tor
25N	XC6202P512PR	LVR-IC	LDO, 5.1V±2%, 150mA	SOT-89	20ch	VR1	4c	Tor
25N	XC6216D512PR	LVR-IC	5.1V±2%, 150mA	SOT-89	20ch	VR1	4a	Tor
25P	XC6202P522PR	LVR-IC	LDO, 5.2V±2%, 150mA	SOT-89	20ch	VR1	4c	Tor
25P	XC6216D522PR	LVR-IC	5.2V±2%, 150mA	SOT-89	20ch	VR1	4a	Tor
25R	XC6202P532PR	LVR-IC	LDO, 5.3V±2%, 150mA	SOT-89	20ch	VR1	4c	Tor
25R	XC6216D532PR	LVR-IC	5.3V±2%, 150mA	SOT-89	20ch	VR1	4a	Tor
25S	XC6202P542PR	LVR-IC	LDO, 5.4V±2%, 150mA	SOT-89	20ch	VR1	4c	Tor
25S	XC6216D542PR	LVR-IC	5.4V±2%, 150mA	SOT-89	20ch	VR1	4a	Tor
25T	XC6202P552PR	LVR-IC	LDO, 5.5V±2%, 150mA	SOT-89	20ch	VR1	4c	Tor
25T	XC6216D552PR	LVR-IC	5.5V±2%, 150mA	SOT-89	20ch	VR1	4a	Tor
25U	XC6202P562PR	LVR-IC	LDO, 5.6V±2%, 150mA	SOT-89	20ch	VR1	4c	Tor
25U	XC6216D562PR	LVR-IC	5.6V±2%, 150mA	SOT-89	20ch	VR1	4a	Tor
25V	XC6202P572PR	LVR-IC	LDO, 5.7V±2%, 150mA	SOT-89	20ch	VR1	4c	Tor
25V	XC6216D572PR	LVR-IC	5.7V±2%, 150mA	SOT-89	20ch	VR1	4a	Tor
25X	XC6202P582PR	LVR-IC	LDO, 5.8V±2%, 150mA	SOT-89	20ch	VR1	4c	Tor
25X	XC6216D582PR	LVR-IC	5.8V±2%, 150mA	SOT-89	20ch	VR1	4a	Tor
25Y	XC6202P592PR	LVR-IC	LDO, 5.9V±2%, 150mA	SOT-89	20ch	VR1	4c	Tor
25Y	XC6216D592PR	LVR-IC	5.9V±2%, 150mA	SOT-89	20ch	VR1	4a	Tor
25Z	XC6202P602PR	LVR-IC	LDO, 6V±2%, 150mA	SOT-89	20ch	VR1	4c	Tor
25Z	XC6216D602PR	LVR-IC	6.0V±2%, 150mA	SOT-89	20ch	VR1	4a	Tor
26	UTC8126	Vdet-IC	2.6V, -Reset OCO	SOT-89	20vdd	VD6	4b	Utc
260	XC6202P612PR	LVR-IC	LDO, 6.1V±2%, 150mA	SOT-89	20ch	VR1	4c	Tor
260	XC6216D612PR	LVR-IC	6.1V±2%, 150mA	SOT-89	20ch	VR1	4a	Tor
261	XC6202P622PR	LVR-IC	LDO, 6.2V±2%, 150mA	SOT-89	20ch	VR1	4c	Tor
261	XC6216D622PR	LVR-IC	6.2V±2%, 150mA	SOT-89	20ch	VR1	4a	Tor
262	XC6202P632PR	LVR-IC	LDO, 6.3V±2%, 150mA	SOT-89	20ch	VR1	4c	Tor
262	XC6216D632PR	LVR-IC	6.3V±2%, 150mA	SOT-89	20ch	VR1	4a	Tor
263	XC6202P642PR	LVR-IC	LDO, 6.4V±2%, 150mA	SOT-89	20ch	VR1	4c	Tor
263	XC6216D642PR	LVR-IC	6.4V±2%, 150mA	SOT-89	20ch	VR1	4a	Tor
264	XC6202P652PR	LVR-IC	LDO, 6.5V±2%, 150mA	SOT-89	20ch	VR1	4c	Tor
264	XC6216D652PR	LVR-IC	6.5V±2%, 150mA	SOT-89	20ch	VR1	4a	Tor
265	XC6202P662PR	LVR-IC	LDO, 6.6V±2%, 150mA	SOT-89	20ch	VR1	4c	Tor



SMD
code

Type

Function

Short description

Case Pinout Sch. St. Mnf.

SMD code	Type	Function	Short description	Case	Pinout	Sch.	St.	Mnf.
265	XC6216D662PR	LVR-IC	6.6V±2%, 150mA	SOT-89	20ch	VR1	4a	Tor
266	XC6202P672PR	LVR-IC	LDO, 6.7V±2%, 150mA	SOT-89	20ch	VR1	4c	Tor
266	XC6216D672PR	LVR-IC	6.7V±2%, 150mA	SOT-89	20ch	VR1	4a	Tor
267	XC6202P682PR	LVR-IC	LDO, 6.8V±2%, 150mA	SOT-89	20ch	VR1	4c	Tor
267	XC6216D682PR	LVR-IC	6.8V±2%, 150mA	SOT-89	20ch	VR1	4a	Tor
268	XC6202P692PR	LVR-IC	LDO, 6.9V±2%, 150mA	SOT-89	20ch	VR1	4c	Tor
268	XC6216D692PR	LVR-IC	6.9V±2%, 150mA	SOT-89	20ch	VR1	4a	Tor
269	XC6202P702PR	LVR-IC	LDO, 7V±2%, 150mA	SOT-89	20ch	VR1	4c	Tor
269	XC6216D702PR	LVR-IC	7.0V±2%, 150mA	SOT-89	20ch	VR1	4a	Tor
26A	AAT60026A-S16	Vdet-IC	2.6V±2%, -Reset ODO	SOT-89	20vda	VD6	4p	Aat
26A	XC6202P712PR	LVR-IC	LDO, 7.1V±2%, 150mA	SOT-89	20ch	VR1	4c	Tor
26A	XC6216D712PR	LVR-IC	7.1V±2%, 150mA	SOT-89	20ch	VR1	4a	Tor
26B	AAT60026B-S16	Vdet-IC	2.6V±2%, -Reset PPO	SOT-89	20vda	VD7	4p	Aat
26B	XC6202P722PR	LVR-IC	LDO, 7.2V±2%, 150mA	SOT-89	20ch	VR1	4c	Tor
26B	XC6216D722PR	LVR-IC	7.2V±2%, 150mA	SOT-89	20ch	VR1	4a	Tor
26C	AAT60026C-S16	Vdet-IC	2.6V±1%, -Reset ODO	SOT-89	20vda	VD6	4p	Aat
26C	XC6202P732PR	LVR-IC	LDO, 7.3V±2%, 150mA	SOT-89	20ch	VR1	4c	Tor
26C	XC6216D732PR	LVR-IC	7.3V±2%, 150mA	SOT-89	20ch	VR1	4a	Tor
26D	AAT60026D-S16	Vdet-IC	2.6V±1%, -Reset PPO	SOT-89	20vda	VD7	4p	Aat
26D	XC6202P742PR	LVR-IC	LDO, 7.4V±2%, 150mA	SOT-89	20ch	VR1	4c	Tor
26D	XC6216D742PR	LVR-IC	7.4V±2%, 150mA	SOT-89	20ch	VR1	4a	Tor
26E	XC6202P752PR	LVR-IC	LDO, 7.5V±2%, 150mA	SOT-89	20ch	VR1	4c	Tor
26E	XC6216D752PR	LVR-IC	7.5V±2%, 150mA	SOT-89	20ch	VR1	4a	Tor
26F	XC6202P762PR	LVR-IC	LDO, 7.6V±2%, 150mA	SOT-89	20ch	VR1	4c	Tor
26F	XC6216D762PR	LVR-IC	7.6V±2%, 150mA	SOT-89	20ch	VR1	4a	Tor
26H	XC6202P772PR	LVR-IC	LDO, 7.7V±2%, 150mA	SOT-89	20ch	VR1	4c	Tor
26H	XC6216D772PR	LVR-IC	7.7V±2%, 150mA	SOT-89	20ch	VR1	4a	Tor
26K	XC6202P782PR	LVR-IC	LDO, 7.8V±2%, 150mA	SOT-89	20ch	VR1	4c	Tor
26K	XC6216D782PR	LVR-IC	7.8V±2%, 150mA	SOT-89	20ch	VR1	4a	Tor
26L	XC6202P792PR	LVR-IC	LDO, 7.9V±2%, 150mA	SOT-89	20ch	VR1	4c	Tor
26L	XC6216D792PR	LVR-IC	7.9V±2%, 150mA	SOT-89	20ch	VR1	4a	Tor
26M	XC6202P802PR	LVR-IC	LDO, 8V±2%, 150mA	SOT-89	20ch	VR1	4c	Tor
26M	XC6216D802PR	LVR-IC	8.0V±2%, 150mA	SOT-89	20ch	VR1	4a	Tor
26N	XC6202P812PR	LVR-IC	LDO, 8.1V±2%, 150mA	SOT-89	20ch	VR1	4c	Tor
26N	XC6216D812PR	LVR-IC	8.1V±2%, 150mA	SOT-89	20ch	VR1	4a	Tor
26P	XC6202P822PR	LVR-IC	LDO, 8.2V±2%, 150mA	SOT-89	20ch	VR1	4c	Tor
26P	XC6216D822PR	LVR-IC	8.2V±2%, 150mA	SOT-89	20ch	VR1	4a	Tor
26R	XC6202P832PR	LVR-IC	LDO, 8.3V±2%, 150mA	SOT-89	20ch	VR1	4c	Tor
26R	XC6216D832PR	LVR-IC	8.3V±2%, 150mA	SOT-89	20ch	VR1	4a	Tor
26S	XC6202P842PR	LVR-IC	LDO, 8.4V±2%, 150mA	SOT-89	20ch	VR1	4c	Tor
26S	XC6216D842PR	LVR-IC	8.4V±2%, 150mA	SOT-89	20ch	VR1	4a	Tor
26T	XC6202P852PR	LVR-IC	LDO, 8.5V±2%, 150mA	SOT-89	20ch	VR1	4c	Tor
26T	XC6216D852PR	LVR-IC	8.5V±2%, 150mA	SOT-89	20ch	VR1	4a	Tor
26U	XC6202P862PR	LVR-IC	LDO, 8.6V±2%, 150mA	SOT-89	20ch	VR1	4c	Tor
26U	XC6216D862PR	LVR-IC	8.6V±2%, 150mA	SOT-89	20ch	VR1	4a	Tor
26V	XC6202P872PR	LVR-IC	LDO, 8.7V±2%, 150mA	SOT-89	20ch	VR1	4c	Tor
26V	XC6216D872PR	LVR-IC	8.7V±2%, 150mA	SOT-89	20ch	VR1	4a	Tor
26X	XC6202P882PR	LVR-IC	LDO, 8.8V±2%, 150mA	SOT-89	20ch	VR1	4c	Tor
26X	XC6216D882PR	LVR-IC	8.8V±2%, 150mA	SOT-89	20ch	VR1	4a	Tor
26Y	XC6202P892PR	LVR-IC	LDO, 8.9V±2%, 150mA	SOT-89	20ch	VR1	4c	Tor
26Y	XC6216D892PR	LVR-IC	8.9V±2%, 150mA	SOT-89	20ch	VR1	4a	Tor
26Z	XC6202P902PR	LVR-IC	LDO, 9V±2%, 150mA	SOT-89	20ch	VR1	4c	Tor
26Z	XC6216D902PR	LVR-IC	9.0V±2%, 150mA	SOT-89	20ch	VR1	4a	Tor
27	UTC8127	Vdet-IC	2.7V, -Reset OCO	SOT-89	20vdd	VD6	4b	Ufc
270	XC6202P912PR	LVR-IC	LDO, 9.1V±2%, 150mA	SOT-89	20ch	VR1	4c	Tor
270	XC6216D912PR	LVR-IC	9.1V±2%, 150mA	SOT-89	20ch	VR1	4a	Tor
271	XC6202P922PR	LVR-IC	LDO, 9.2V±2%, 150mA	SOT-89	20ch	VR1	4c	Tor
271	XC6216D922PR	LVR-IC	9.2V±2%, 150mA	SOT-89	20ch	VR1	4a	Tor
272	XC6202P932PR	LVR-IC	LDO, 9.3V±2%, 150mA	SOT-89	20ch	VR1	4c	Tor
272	XC6216D932PR	LVR-IC	9.3V±2%, 150mA	SOT-89	20ch	VR1	4a	Tor
273	XC6202P942PR	LVR-IC	LDO, 9.4V±2%, 150mA	SOT-89	20ch	VR1	4c	Tor
273	XC6216D942PR	LVR-IC	9.4V±2%, 150mA	SOT-89	20ch	VR1	4a	Tor
274	XC6202P952PR	LVR-IC	LDO, 9.5V±2%, 150mA	SOT-89	20ch	VR1	4c	Tor
274	XC6216D952PR	LVR-IC	9.5V±2%, 150mA	SOT-89	20ch	VR1	4a	Tor
275	XC6202P962PR	LVR-IC	LDO, 9.6V±2%, 150mA	SOT-89	20ch	VR1	4c	Tor
275	XC6216D962PR	LVR-IC	9.6V±2%, 150mA	SOT-89	20ch	VR1	4a	Tor
276	XC6202P972PR	LVR-IC	LDO, 9.7V±2%, 150mA	SOT-89	20ch	VR1	4c	Tor
276	XC6216D972PR	LVR-IC	9.7V±2%, 150mA	SOT-89	20ch	VR1	4a	Tor
277	XC6202P982PR	LVR-IC	LDO, 9.8V±2%, 150mA	SOT-89	20ch	VR1	4c	Tor
277	XC6216D982PR	LVR-IC	9.8V±2%, 150mA	SOT-89	20ch	VR1	4a	Tor



SMD
code

Type

Function

Short description

Case Pinout Sch. St. Mnf.

SMD code	Type	Function	Short description	Case	Pinout	Sch.	St.	Mnf.
278	XC6202P992PR	LVR-IC	LDO, 9.9V±2%, 150mA	SOT-89	20ch	VR1	4c	Tor
278	XC6216D992PR	LVR-IC	9.9V±2%, 150mA	SOT-89	20ch	VR1	4a	Tor
279	XC6202PA02PR	LVR-IC	LDO, 10V±2%, 150mA	SOT-89	20ch	VR1	4c	Tor
279	XC6216DA02PR	LVR-IC	10.0V±2%, 150mA	SOT-89	20ch	VR1	4a	Tor
27A	AAT60027A-S16	Vdet-IC	2.7V±2%, -Reset ODO	SOT-89	20vda	VD6	4p	Aat
27A	XC6202PA12PR	LVR-IC	LDO, 10.1V±2%, 150mA	SOT-89	20ch	VR1	4c	Tor
27A	XC6216DA12PR	LVR-IC	10.1V±2%, 150mA	SOT-89	20ch	VR1	4a	Tor
27B	AAT60027B-S16	Vdet-IC	2.7V±2%, -Reset PPO	SOT-89	20vda	VD7	4p	Aat
27B	XC6202PA22PR	LVR-IC	LDO, 10.2V±2%, 150mA	SOT-89	20ch	VR1	4c	Tor
27B	XC6216DA22PR	LVR-IC	10.2V±2%, 150mA	SOT-89	20ch	VR1	4a	Tor
27C	AAT60027C-S16	Vdet-IC	2.7V±1%, -Reset ODO	SOT-89	20vda	VD6	4p	Aat
27C	XC6202PA32PR	LVR-IC	LDO, 10.3V±2%, 150mA	SOT-89	20ch	VR1	4c	Tor
27C	XC6216DA32PR	LVR-IC	10.3V±2%, 150mA	SOT-89	20ch	VR1	4a	Tor
27D	AAT60027D-S16	Vdet-IC	2.7V±1%, -Reset PPO	SOT-89	20vda	VD7	4p	Aat
27D	XC6202PA42PR	LVR-IC	LDO, 10.4V±2%, 150mA	SOT-89	20ch	VR1	4c	Tor
27D	XC6216DA42PR	LVR-IC	10.4V±2%, 150mA	SOT-89	20ch	VR1	4a	Tor
27E	XC6202PA52PR	LVR-IC	LDO, 10.5V±2%, 150mA	SOT-89	20ch	VR1	4c	Tor
27E	XC6216DA52PR	LVR-IC	10.5V±2%, 150mA	SOT-89	20ch	VR1	4a	Tor
27F	XC6202PA62PR	LVR-IC	LDO, 10.6V±2%, 150mA	SOT-89	20ch	VR1	4c	Tor
27F	XC6216DA62PR	LVR-IC	10.6V±2%, 150mA	SOT-89	20ch	VR1	4a	Tor
27H	XC6202PA72PR	LVR-IC	LDO, 10.7V±2%, 150mA	SOT-89	20ch	VR1	4c	Tor
27H	XC6216DA72PR	LVR-IC	10.7V±2%, 150mA	SOT-89	20ch	VR1	4a	Tor
27K	XC6202PA82PR	LVR-IC	LDO, 10.8V±2%, 150mA	SOT-89	20ch	VR1	4c	Tor
27K	XC6216DA82PR	LVR-IC	10.8V±2%, 150mA	SOT-89	20ch	VR1	4a	Tor
27L	XC6202PA92PR	LVR-IC	LDO, 10.9V±2%, 150mA	SOT-89	20ch	VR1	4c	Tor
27L	XC6216DA92PR	LVR-IC	10.9V±2%, 150mA	SOT-89	20ch	VR1	4a	Tor
27M	XC6202PB02PR	LVR-IC	LDO, 11V±2%, 150mA	SOT-89	20ch	VR1	4c	Tor
27M	XC6216DB02PR	LVR-IC	11.0V±2%, 150mA	SOT-89	20ch	VR1	4a	Tor
27N	XC6202PB12PR	LVR-IC	LDO, 11.1V±2%, 150mA	SOT-89	20ch	VR1	4c	Tor
27N	XC6216DB12PR	LVR-IC	11.1V±2%, 150mA	SOT-89	20ch	VR1	4a	Tor
27P	XC6202PB22PR	LVR-IC	LDO, 11.2V±2%, 150mA	SOT-89	20ch	VR1	4c	Tor
27P	XC6216DB22PR	LVR-IC	11.2V±2%, 150mA	SOT-89	20ch	VR1	4a	Tor
27R	XC6202PB32PR	LVR-IC	LDO, 11.3V±2%, 150mA	SOT-89	20ch	VR1	4c	Tor
27R	XC6216DB32PR	LVR-IC	11.3V±2%, 150mA	SOT-89	20ch	VR1	4a	Tor
27S	XC6202PB42PR	LVR-IC	LDO, 11.4V±2%, 150mA	SOT-89	20ch	VR1	4c	Tor
27S	XC6216DB42PR	LVR-IC	11.4V±2%, 150mA	SOT-89	20ch	VR1	4a	Tor
27T	XC6202PB52PR	LVR-IC	LDO, 11.5V±2%, 150mA	SOT-89	20ch	VR1	4c	Tor
27T	XC6216DB52PR	LVR-IC	11.5V±2%, 150mA	SOT-89	20ch	VR1	4a	Tor
27U	XC6202PB62PR	LVR-IC	LDO, 11.6V±2%, 150mA	SOT-89	20ch	VR1	4c	Tor
27U	XC6216DB62PR	LVR-IC	11.6V±2%, 150mA	SOT-89	20ch	VR1	4a	Tor
27V	XC6202PB72PR	LVR-IC	LDO, 11.7V±2%, 150mA	SOT-89	20ch	VR1	4c	Tor
27V	XC6216DB72PR	LVR-IC	11.7V±2%, 150mA	SOT-89	20ch	VR1	4a	Tor
27X	XC6202PB82PR	LVR-IC	LDO, 11.8V±2%, 150mA	SOT-89	20ch	VR1	4c	Tor
27X	XC6216DB82PR	LVR-IC	11.8V±2%, 150mA	SOT-89	20ch	VR1	4a	Tor
27Y	BZV49-C27	Z-diode	27V±5%, Izt=2mA, 1W	SOT-89	20dm	-	4b	Phi
27Y	XC6202PB92PR	LVR-IC	LDO, 11.9V±2%, 150mA	SOT-89	20ch	VR1	4c	Tor
27Y	XC6216DB92PR	LVR-IC	11.9V±2%, 150mA	SOT-89	20ch	VR1	4a	Tor
27Z	XC6202PC02PR	LVR-IC	LDO, 12V±2%, 150mA	SOT-89	20ch	VR1	4c	Tor
27Z	XC6216DC02PR	LVR-IC	12.0V±2%, 150mA	SOT-89	20ch	VR1	4a	Tor
28	UTC8128	Vdet-IC	2.8V, -Reset OCO	SOT-89	20vdd	VD6	4b	Utc
280	XC6202PC12PR	LVR-IC	LDO, 12.1V±2%, 150mA	SOT-89	20ch	VR1	4c	Tor
281	XC6202PC22PR	LVR-IC	LDO, 12.2V±2%, 150mA	SOT-89	20ch	VR1	4c	Tor
282	XC6202PC32PR	LVR-IC	LDO, 12.3V±2%, 150mA	SOT-89	20ch	VR1	4c	Tor
283	XC6202PC42PR	LVR-IC	LDO, 12.4V±2%, 150mA	SOT-89	20ch	VR1	4c	Tor
284	XC6202PC52PR	LVR-IC	LDO, 12.5V±2%, 150mA	SOT-89	20ch	VR1	4c	Tor
285	XC6202PC62PR	LVR-IC	LDO, 12.6V±2%, 150mA	SOT-89	20ch	VR1	4c	Tor
286	XC6202PC72PR	LVR-IC	LDO, 12.7V±2%, 150mA	SOT-89	20ch	VR1	4c	Tor
287	XC6202PC82PR	LVR-IC	LDO, 12.8V±2%, 150mA	SOT-89	20ch	VR1	4c	Tor
288	XC6202PC92PR	LVR-IC	LDO, 12.9V±2%, 150mA	SOT-89	20ch	VR1	4c	Tor
289	XC6202PD02PR	LVR-IC	LDO, 13V±2%, 150mA	SOT-89	20ch	VR1	4c	Tor
28A	AAT60028A-S16	Vdet-IC	2.8V±2%, -Reset ODO	SOT-89	20vda	VD6	4p	Aat
28A	XC6202PD12PR	LVR-IC	LDO, 13.1V±2%, 150mA	SOT-89	20ch	VR1	4c	Tor
28B	AAT60028B-S16	Vdet-IC	2.8V±2%, -Reset PPO	SOT-89	20vda	VD7	4p	Aat
28B	XC6202PD22PR	LVR-IC	LDO, 13.2V±2%, 150mA	SOT-89	20ch	VR1	4c	Tor
28C	AAT60028C-S16	Vdet-IC	2.8V±1%, -Reset ODO	SOT-89	20vda	VD6	4p	Aat
28C	XC6202PD32PR	LVR-IC	LDO, 13.3V±2%, 150mA	SOT-89	20ch	VR1	4c	Tor
28D	AAT60028D-S16	Vdet-IC	2.8V±1%, -Reset PPO	SOT-89	20vda	VD7	4p	Aat
28D	XC6202PD42PR	LVR-IC	LDO, 13.4V±2%, 150mA	SOT-89	20ch	VR1	4c	Tor
28E	XC6202PD52PR	LVR-IC	LDO, 13.5V±2%, 150mA	SOT-89	20ch	VR1	4c	Tor
28F	XC6202PD62PR	LVR-IC	LDO, 13.6V±2%, 150mA	SOT-89	20ch	VR1	4c	Tor



SMD
code

Type

Function

Short description

Case Pinout Sch. St. Mnf.

SMD code	Type	Function	Short description	Case	Pinout	Sch.	St.	Mnf.
28H	XC6202PD72PR	LVR-IC	LDO, 13.7V±2%, 150mA	SOT-89	20ch	VR1	4c	Tor
28K	XC6202PD82PR	LVR-IC	LDO, 13.8V±2%, 150mA	SOT-89	20ch	VR1	4c	Tor
28L	XC6202PD92PR	LVR-IC	LDO, 13.9V±2%, 150mA	SOT-89	20ch	VR1	4c	Tor
28M	XC6202PE02PR	LVR-IC	LDO, 14V±2%, 150mA	SOT-89	20ch	VR1	4c	Tor
28N	XC6202PE12PR	LVR-IC	LDO, 14.1V±2%, 150mA	SOT-89	20ch	VR1	4c	Tor
28P	XC6202PE22PR	LVR-IC	LDO, 14.2V±2%, 150mA	SOT-89	20ch	VR1	4c	Tor
28R	XC6202PE32PR	LVR-IC	LDO, 14.3V±2%, 150mA	SOT-89	20ch	VR1	4c	Tor
28S	XC6202PE42PR	LVR-IC	LDO, 14.4V±2%, 150mA	SOT-89	20ch	VR1	4c	Tor
28T	XC6202PE52PR	LVR-IC	LDO, 14.5V±2%, 150mA	SOT-89	20ch	VR1	4c	Tor
28U	XC6202PE62PR	LVR-IC	LDO, 14.6V±2%, 150mA	SOT-89	20ch	VR1	4c	Tor
28V	XC6202PE72PR	LVR-IC	LDO, 14.7V±2%, 150mA	SOT-89	20ch	VR1	4c	Tor
28X	XC6202PE82PR	LVR-IC	LDO, 14.8V±2%, 150mA	SOT-89	20ch	VR1	4c	Tor
28Y	XC6202PE92PR	LVR-IC	LDO, 14.9V±2%, 150mA	SOT-89	20ch	VR1	4c	Tor
28Z	XC6202PF02PR	LVR-IC	LDO, 15V±2%, 150mA	SOT-89	20ch	VR1	4c	Tor
29	Gali-29	MMIC	RF amplifier, DC..7GHz, 14.2dB (50Ω)	SOT-89	20aa	A1	4b	Mc
29	UTC8129	Vdet-IC	3.9V, -Reset OCO	SOT-89	20vdd	VD6	4b	Utc
290	XC6202PF12PR	LVR-IC	LDO, 15.1V±2%, 150mA	SOT-89	20ch	VR1	4c	Tor
2907A	WTM2907A	Si-pp	GP, 60V, 600mA, 1.2W, B=100..300, >200MHz	SOT-89	20tb	-	4b	Wtr
291	XC6202PF22PR	LVR-IC	LDO, 15.2V±2%, 150mA	SOT-89	20ch	VR1	4c	Tor
292	XC6202PF32PR	LVR-IC	LDO, 15.3V±2%, 150mA	SOT-89	20ch	VR1	4c	Tor
293	XC6202PF42PR	LVR-IC	LDO, 15.4V±2%, 150mA	SOT-89	20ch	VR1	4c	Tor
294	XC6202PF52PR	LVR-IC	LDO, 15.5V±2%, 150mA	SOT-89	20ch	VR1	4c	Tor
295	XC6202PF62PR	LVR-IC	LDO, 15.6V±2%, 150mA	SOT-89	20ch	VR1	4c	Tor
296	XC6202PF72PR	LVR-IC	LDO, 15.7V±2%, 150mA	SOT-89	20ch	VR1	4c	Tor
297	XC6202PF82PR	LVR-IC	LDO, 15.8V±2%, 150mA	SOT-89	20ch	VR1	4c	Tor
298	XC6202PF92PR	LVR-IC	LDO, 15.9V±2%, 150mA	SOT-89	20ch	VR1	4c	Tor
299	XC6202PG02PR	LVR-IC	LDO, 16V±2%, 150mA	SOT-89	20ch	VR1	4c	Tor
29A	AAT60029A-S16	Vdet-IC	2.9V±2%, -Reset ODO	SOT-89	20vda	VD6	4c	Aat
29A	XC6202PG12PR	LVR-IC	LDO, 16.1V±2%, 150mA	SOT-89	20ch	VR1	4c	Tor
29B	AAT60029B-S16	Vdet-IC	2.9V±2%, -Reset PPO	SOT-89	20vda	VD7	4p	Aat
29B	XC6202PG22PR	LVR-IC	LDO, 16.2V±2%, 150mA	SOT-89	20ch	VR1	4c	Tor
29C	AAT60029C-S16	Vdet-IC	2.9V±1%, -Reset ODO	SOT-89	20vda	VD6	4c	Aat
29C	XC6202PG32PR	LVR-IC	LDO, 16.3V±2%, 150mA	SOT-89	20ch	VR1	4c	Tor
29D	AAT60029D-S16	Vdet-IC	2.9V±1%, -Reset PPO	SOT-89	20vda	VD7	4p	Aat
29D	XC6202PG42PR	LVR-IC	LDO, 16.4V±2%, 150mA	SOT-89	20ch	VR1	4c	Tor
29E	XC6202PG52PR	LVR-IC	LDO, 16.5V±2%, 150mA	SOT-89	20ch	VR1	4c	Tor
29F	XC6202PG62PR	LVR-IC	LDO, 16.6V±2%, 150mA	SOT-89	20ch	VR1	4c	Tor
29H	XC6202PG72PR	LVR-IC	LDO, 16.7V±2%, 150mA	SOT-89	20ch	VR1	4c	Tor
29K	XC6202PG82PR	LVR-IC	LDO, 16.8V±2%, 150mA	SOT-89	20ch	VR1	4c	Tor
29L	XC6202PG92PR	LVR-IC	LDO, 16.9V±2%, 150mA	SOT-89	20ch	VR1	4c	Tor
29M	XC6202PH02PR	LVR-IC	LDO, 17V±2%, 150mA	SOT-89	20ch	VR1	4c	Tor
29N	XC6202PH12PR	LVR-IC	LDO, 17.1V±2%, 150mA	SOT-89	20ch	VR1	4c	Tor
29P	XC6202PH22PR	LVR-IC	LDO, 17.2V±2%, 150mA	SOT-89	20ch	VR1	4c	Tor
29P	XC6202PH32PR	LVR-IC	LDO, 17.3V±2%, 150mA	SOT-89	20ch	VR1	4c	Tor
29S	XC6202PH42PR	LVR-IC	LDO, 17.4V±2%, 150mA	SOT-89	20ch	VR1	4c	Tor
29T	XC6202PH52PR	LVR-IC	LDO, 17.5V±2%, 150mA	SOT-89	20ch	VR1	4c	Tor
29U	XC6202PH62PR	LVR-IC	LDO, 17.6V±2%, 150mA	SOT-89	20ch	VR1	4c	Tor
29V	XC6202PH72PR	LVR-IC	LDO, 17.7V±2%, 150mA	SOT-89	20ch	VR1	4c	Tor
29X	CHTA29XPT	Si-npn-Darl	AF, Sw, 40V, 500mA, B>20000, 220MHz	SOT-89	20tb	-	4b	Chm
29X	XC6202PH82PR	LVR-IC	LDO, 17.8V±2%, 150mA	SOT-89	20ch	VR1	4c	Tor
29Y	XC6202PH92PR	LVR-IC	LDO, 17.9V±2%, 150mA	SOT-89	20ch	VR1	4c	Tor
29Z	XC6202PJ02PR	LVR-IC	LDO, 18V±2%, 150mA	SOT-89	20ch	VR1	4c	Tor
2A	ZT665A9	Si-npn	GP, 120V, 1A, 300mW, B=40..250, 200MHz	SOT-89	20tb	-	4g	Rus
2A	KIA7219F	Vdet-IC	1.9V±2%, -Reset OCO	SOT-89	20vdd	VD6	4a	Kec
2A	PXT3906	Si-ppn	Sw, 40V, 100mA, 1.2W, B=100..300, >250MHz	SOT-89	20tb	-	4a	Kex
2A	SXT3906	Si-ppn	Sw, 40V, 200mA, 1W, B=100..300, >250MHz	SOT-89	20tb	-	4b	Sie
2A0	TC55RP202EMB	LVR-IC	LDO, 2.0V±2%, 250mA	SOT-89	20vl	VR1	4h	Mcc
2A0	XC62FP2002P	LVR-IC	2.0V±2%, 250mA	SOT-89	20vl	VR1	4c	Tor
2AR	2SC5026-R	Si-npn	AF-Drv, 80V, 1A, 1W, B=120..240, 120MHz	SOT-89	20tb	-	4b	Pan
2AS	2SC5026-S	Si-npn	AF-Drv, 80V, 1A, 1W, B=270..340, 120MHz	SOT-89	20tb	-	4b	Pan
2B	KIA7221F	Vdet-IC	2.1V±2%, -Reset OCO	SOT-89	20vdd	VD6	4a	Kec
2B	RH5RL22AA	LVR-IC	2.2V±2.5%, 150mA	SOT-89	20vl	VR1	4c	Ric
2B0	TC55RP212EMB	LVR-IC	LDO, 2.1V±2%, 250mA	SOT-89	20vl	VR1	4h	Mcc
2B0	XC62FP2102P	LVR-IC	2.1V±2%, 250mA	SOT-89	20vl	VR1	4c	Tor
2B5	XC62KN212P	LVR-IC	LDO, -2.1V±2%, 100mA, 500mW	SOT-89	20ch	VR2	4c	Tor
2C	KIA7223F	Vdet-IC	2.3V±2%, -Reset OCO	SOT-89	20vdd	VD6	4a	Kec
2C	RH5RL32AA	LVR-IC	3.2V±2.5%, 150mA	SOT-89	20vl	VR1	4c	Ric
2C0	TC55RP222EMB	LVR-IC	LDO, 2.2V±2%, 250mA	SOT-89	20vl	VR1	4h	Mcc
2C0	XC62FP2202P	LVR-IC	2.2V±2%, 250mA	SOT-89	20vl	VR1	4c	Tor
2C5	XC62KN222P	LVR-IC	LDO, -2.2V±2%, 100mA, 500mW	SOT-89	20ch	VR2	4c	Tor



SMD
code

Type

Function

Short description

Case Pinout Sch. St. Mnf.

2D	KIA7225F	Vdet-IC	2.5V±2%, -Reset OCO	SOT-89	20vdd	VD6	4a	Kec
2D	RH5RL42AA	LVR-IC	4.2V±2.5%, 150mA	SOT-89	20vl	VR1	4c	Ric
2D	SXTA92	Si-pnp	Vid, 300V, 500mA, 1W, B>25, >50MHz	SOT-89	20tb	-	4b	Sie
2D0	TC55RP232EMB	LVR-IC	LDO, 2.3V±2%, 250mA	SOT-89	20vl	VR1	4h	Mcc
2D0	XC62FP2302P	LVR-IC	2.3V±2%, 250mA	SOT-89	20vl	VR1	4c	Tor
2D5	XC62KN232P	LVR-IC	LDO, -2.3V±2%, 100mA, 500mW	SOT-89	20ch	VR2	4c	Tor
2E	KIA7227F	Vdet-IC	2.7V±2%, -Reset OCO	SOT-89	20vdd	VD6	4a	Kec
2E	RH5RL52AA	LVR-IC	5.2V±2.5%, 150mA	SOT-89	20vl	VR1	4c	Ric
2E	SXTA93	Si-pnp	Vid, 200V, 500mA, 1W, B>25, >50MHz	SOT-89	20tb	-	4b	Sie
2E0	TC55RP242EMB	LVR-IC	LDO, 2.4V±2%, 250mA	SOT-89	20vl	VR1	4h	Mcc
2E0	XC62FP2402P	LVR-IC	2.4V±2%, 250mA	SOT-89	20vl	VR1	4c	Tor
2E5	XC62KN242P	LVR-IC	LDO, -2.4V±2%, 100mA, 500mW	SOT-89	20ch	VR2	4c	Tor
2Eb	FT510Eb	LVR-IC	LDO, 2.8V±2%, 500mA	SOT-89	20vl	VR1	4k	Fmd
2Ec	FT510Ec	LVR-IC	LDO, 2.8V±2%, 500mA	SOT-89	20ch	VR1	4k	Fmd
2ER	2SD2459-R	Si-npn	AF, 150V, 1A, 1W, B=140..240, 90MHz	SOT-89	20tb	-	4b	Pan
2ES	2SD2459-S	Si-npn	AF, 150V, 1A, 1W, B=170..340, 90MHz	SOT-89	20tb	-	4b	Pan
2F	2SB1612	Si-pnp	AF, Lo-sat, 10V, 2A, 1W, B=200..800, 60MHz	SOT-89	20tb	-	4b	Pan
2F	KIA7229F	Vdet-IC	2.9V±2%, -Reset OCO	SOT-89	20vdd	VD6	4a	Kec
2F	SXT2907A	Si-pnp	GP, 60V, 600mA, 1W, B=100..300, >200MHz	SOT-89	20tb	-	4b	Sie
2F0	TC55RP252EMB	LVR-IC	LDO, 2.5V±2%, 250mA	SOT-89	20vl	VR1	4h	Mcc
2F0	XC62FP2502P	LVR-IC	2.5V±2%, 250mA	SOT-89	20vl	VR1	4c	Tor
2F5	XC62KN252P	LVR-IC	LDO, -2.5V±2%, 100mA, 500mW	SOT-89	20ch	VR2	4c	Tor
2Fb	FT510Fb	LVR-IC	LDO, 3.0V±2%, 500mA	SOT-89	20vl	VR1	4k	Fmd
2Fc	FT510Fc	LVR-IC	LDO, 3.0V±2%, 500mA	SOT-89	20ch	VR1	4k	Fmd
2G	KIA7231F	Vdet-IC	3.1V±2%, -Reset OCO	SOT-89	20vdd	VD6	4a	Kec
2Gb	FT510Gb	LVR-IC	LDO, 3.3V±2%, 500mA	SOT-89	20vl	VR1	4k	Fmd
2Gc	FT510Gc	LVR-IC	LDO, 3.3V±2%, 500mA	SOT-89	20ch	VR1	4k	Fmd
2Gc	KIA7232F	Vdet-IC	3.2V±2%, -Reset OCO	SOT-89	20vdd	VD6	4a	Kec
2H0	TC55RP262EMB	LVR-IC	LDO, 2.6V±2%, 250mA	SOT-89	20vl	VR1	4h	Mcc
2H0	XC62FP2602P	LVR-IC	2.6V±2%, 250mA	SOT-89	20vl	VR1	4c	Tor
2H5	XC62KN262P	LVR-IC	LDO, -2.6V±2%, 100mA, 500mW	SOT-89	20ch	VR2	4c	Tor
2Hb	FT510Hb	LVR-IC	LDO, 3.6V±2%, 500mA	SOT-89	20vl	VR1	4k	Fmd
2Hc	FT510Hc	LVR-IC	LDO, 3.6V±2%, 500mA	SOT-89	20ch	VR1	4k	Fmd
2I	2SD2474	Si-npn	AF, Lo-sat, 10V, 2A, 1W, B=200..800, 180MHz	SOT-89	20tb	-	4b	Pan
2J	KIA7233F	Vdet-IC	3.3V±2%, -Reset OCO	SOT-89	20vdd	VD6	4a	Kec
2J	RH5RE22AA	LVR-IC	Ultra-LDO, 2.2V±2.5%, 300mA	SOT-89	20vl	VR1	4c	Ric
2K	2SB1614	Si-pnp	AF, 20V, 2A, 1W, B=200..800, 60MHz	SOT-89	20tb	-	4b	Pan
2K	KIA7234F	Vdet-IC	3.4V±2%, -Reset OCO	SOT-89	20vdd	VD6	4a	Kec
2K	RH5RE32AA	LVR-IC	Ultra-LDO, 3.2V±2.5%, 300mA	SOT-89	20vl	VR1	4c	Ric
2K0	TC55RP272EMB	LVR-IC	LDO, 2.7V±2%, 250mA	SOT-89	20vl	VR1	4h	Mcc
2K0	XC62FP2702P	LVR-IC	2.7V±2%, 250mA	SOT-89	20vl	VR1	4c	Tor
2K5	XC62KN272P	LVR-IC	LDO, -2.7V±2%, 100mA, 500mW	SOT-89	20ch	VR2	4c	Tor
2KP	2SB1678-P	Si-pnp	AF-Drv, 10V, 3A, 1W, B=90..135, 120MHz	SOT-89	20tb	-	4b	Pan
2KQ	2SB1678-Q	Si-pnp	AF-Drv, 10V, 3A, 1W, B=120..205, 120MHz	SOT-89	20tb	-	4b	Pan
2KR	2SB1678-R	Si-pnp	AF-Drv, 10V, 3A, 1W, B=180..625, 120MHz	SOT-89	20tb	-	4b	Pan
2L	KIA7235F	Vdet-IC	3.5V±2%, -Reset OCO	SOT-89	20vdd	VD6	4a	Kec
2L	RH5RE42AA	LVR-IC	Ultra-LDO, 4.2V±2.5%, 300mA	SOT-89	20vl	VR1	4c	Ric
2L0	TC55RP282EMB	LVR-IC	LDO, 2.8V±2%, 250mA	SOT-89	20vl	VR1	4h	Mcc
2L0	XC62FP2802P	LVR-IC	2.8V±2%, 250mA	SOT-89	20vl	VR1	4c	Tor
2L5	XC62KN282P	LVR-IC	LDO, -2.8V±2%, 100mA, 500mW	SOT-89	20ch	VR2	4c	Tor
2M	2SK2211	n-MOSFET-e*	V-MOS, LogL, 30V, ±1A, <0.6Ω(0.5A), 12/220ns, int, Rgate	SOT-89	20fa	-	4b	Pan
2M	KIA7236F	Vdet-IC	3.6V±2%, -Reset OCO	SOT-89	20vdd	VD6	4a	Kec
2M	RH5RE52AA	LVR-IC	Ultra-LDO, 5.2V±2.5%, 300mA	SOT-89	20vl	VR1	4c	Ric
2M0	TC55RP292EMB	LVR-IC	LDO, 2.9V±2%, 250mA	SOT-89	20vl	VR1	4h	Mcc
2M0	XC62FP2902P	LVR-IC	2.9V±2%, 250mA	SOT-89	20vl	VR1	4c	Tor
2M5	XC62KN292P	LVR-IC	LDO, -2.9V±2%, 100mA, 500mW	SOT-89	20ch	VR2	4c	Tor
2N	KIA7239F	Vdet-IC	3.9V±2%, -Reset OCO	SOT-89	20vdd	VD6	4a	Kec
2P	KIA7242F	Vdet-IC	4.2V±2%, -Reset OCO	SOT-89	20vdd	VD6	4a	Kec
2P	SXT2222A	Si-npn	GP, 40V, 600mA, 1W, B=100..300, >300MHz	SOT-89	20tb	-	4b	Sie
2R	KIA7245F	Vdet-IC	4.5V±2%, -Reset OCO	SOT-89	20vdd	VD6	4a	Kec
2X	PXT4401	Si-npn	Sw, 60V, 600mA, 1.3W, B=20..30, >250MHz	SOT-89	20tb	-	4a	Kex
2Y4	BZV49-C2V4	Z-diode	2.4V±5%, Izt=5mA, 1W	SOT-89	20dm	-	4b	Phi
2Y7	BZV49-C2V7	Z-diode	2.7V±5%, Izt=5mA, 1W	SOT-89	20dm	-	4b	Phi
25	2T66559	Si-npn	GP, 100V, 1A, 300mW, B=40..250, 200MHz	SOT-89	20tb	-	4g	Rus
30	UTC8130	Vdet-IC	3V, -Reset OCO	SOT-89	20vdd	VD6	4b	Utc
301	MC33463H-30K	DC/DC-IC	PFM, 3V±2.5%, 80..120kHz	SOT-89	20bq	-	4b	Ons
302B	MC33466H-30	DC/DC-IC	PWM, 3V±2.5%, 100kHz	SOT-89	20br	-	4b	Ons
30A	AAT60030A-S16	Vdet-IC	3.0V±2%, -Reset ODO	SOT-89	20vda	VD6	4p	Aat
30B	AAT60030B-S16	Vdet-IC	3.0V±2%, -Reset PPO	SOT-89	20vda	VD7	4p	Aat
30C	AAT60030C-S16	Vdet-IC	3.0V±1%, -Reset ODO	SOT-89	20vda	VD6	4p	Aat



SMD
code

Type

Function

Short description

Case Pinout Sch. St. Mnf.

SMD code	Type	Function	Short description	Case	Pinout	Sch.	St.	Mnf.
30D	AAT60030D-S16	Vdet-IC	3.0V±1%, -Reset PPO	SOT-89	20vda	VD7	4p	Aat
30Y	BZV49-C30	Z-diode	30V±5%, Izt=2mA, 1W	SOT-89	20dm	-	4b	Phi
31	UTC8131	Vdet-IC	3.1V, -Reset OCO	SOT-89	20vdd	VD6	4b	Utc
31A	AAT60031A-S16	Vdet-IC	3.1V±2%, -Reset ODO	SOT-89	20vda	VD6	4p	Aat
31B	AAT60031B-S16	Vdet-IC	3.1V±2%, -Reset PPO	SOT-89	20vda	VD7	4p	Aat
31C	AAT60031C-S16	Vdet-IC	3.1V±1%, -Reset ODO	SOT-89	20vda	VD6	4p	Aat
31D	AAT60031D-S16	Vdet-IC	3.1V±1%, -Reset PPO	SOT-89	20vda	VD7	4p	Aat
32	UTC8132	Vdet-IC	3.2V, -Reset OCO	SOT-89	20vdd	VD6	4b	Utc
32A	AAT60032A-S16	Vdet-IC	3.2V±2%, -Reset ODO	SOT-89	20vda	VD6	4p	Aat
32B	AAT60032B-S16	Vdet-IC	3.2V±2%, -Reset PPO	SOT-89	20vda	VD7	4p	Aat
32C	AAT60032C-S16	Vdet-IC	3.2V±1%, -Reset ODO	SOT-89	20vda	VD6	4p	Aat
32D	AAT60032D-S16	Vdet-IC	3.2V±1%, -Reset PPO	SOT-89	20vda	VD7	4p	Aat
32K	XC6203E182PR	LVR-IC	1.8V±2%, 400mA	SOT-89	20vl	VR1	4c	Tor
32L	XC6203E192PR	LVR-IC	1.9V±2%, 400mA	SOT-89	20vl	VR1	4c	Tor
32M	XC6203E202PR	LVR-IC	2V±2%, 400mA	SOT-89	20vl	VR1	4c	Tor
32N	XC6203E212PR	LVR-IC	2.1V±2%, 400mA	SOT-89	20vl	VR1	4c	Tor
32P	XC6203E222PR	LVR-IC	2.2V±2%, 400mA	SOT-89	20vl	VR1	4c	Tor
32R	XC6203E232PR	LVR-IC	2.3V±2%, 400mA	SOT-89	20vl	VR1	4c	Tor
32S	XC6203E242PR	LVR-IC	2.4V±2%, 400mA	SOT-89	20vl	VR1	4c	Tor
32T	XC6203E252PR	LVR-IC	2.5V±2%, 400mA	SOT-89	20vl	VR1	4c	Tor
32V	XC6203E272PR	LVR-IC	2.7V±2%, 400mA	SOT-89	20vl	VR1	4c	Tor
32X	XC6203E282PR	LVR-IC	2.8V±2%, 400mA	SOT-89	20vl	VR1	4c	Tor
32Y	XC6203E292PR	LVR-IC	2.9V±2%, 400mA	SOT-89	20vl	VR1	4c	Tor
32Z	XC6203E302PR	LVR-IC	3V±2%, 400mA	SOT-89	20vl	VR1	4c	Tor
33	Gali-33	MMIC	RF amplifier, DC, 4GHz, 15.8dB (50Ω)	SOT-89	20aa	A1	4b	Mc
33	UTC8133	Vdet-IC	3.3V, -Reset OCO	SOT-89	20vdd	VD6	4b	Utc
330	XC6203E312PR	LVR-IC	3.1V±2%, 400mA	SOT-89	20vl	VR1	4c	Tor
331	XC6203E322PR	LVR-IC	3.2V±2%, 400mA	SOT-89	20vl	VR1	4c	Tor
332	XC6203E332PR	LVR-IC	3.3V±2%, 400mA	SOT-89	20vl	VR1	4c	Tor
333	XC6203E342PR	LVR-IC	3.4V±2%, 400mA	SOT-89	20vl	VR1	4c	Tor
334	XC6203E352PR	LVR-IC	3.5V±2%, 400mA	SOT-89	20vl	VR1	4c	Tor
335	XC6203E362PR	LVR-IC	3.6V±2%, 400mA	SOT-89	20vl	VR1	4c	Tor
336	XC6203E372PR	LVR-IC	3.7V±2%, 400mA	SOT-89	20vl	VR1	4c	Tor
337	XC6203E382PR	LVR-IC	3.8V±2%, 400mA	SOT-89	20vl	VR1	4c	Tor
338	XC6203E392PR	LVR-IC	3.9V±2%, 400mA	SOT-89	20vl	VR1	4c	Tor
339	XC6203E402PR	LVR-IC	4V±2%, 400mA	SOT-89	20vl	VR1	4c	Tor
33A	AAT60033A-S16	Vdet-IC	3.3V±2%, -Reset ODO	SOT-89	20vda	VD6	4p	Aat
33A	XC6203E412PR	LVR-IC	4.1V±2%, 400mA	SOT-89	20vl	VR1	4c	Tor
33B	AAT60033B-S16	Vdet-IC	3.3V±2%, -Reset PPO	SOT-89	20vda	VD7	4p	Aat
33B	XC6203E422PR	LVR-IC	4.2V±2%, 400mA	SOT-89	20vl	VR1	4c	Tor
33C	AAT60033C-S16	Vdet-IC	3.3V±1%, -Reset ODO	SOT-89	20vda	VD6	4p	Aat
33C	XC6203E432PR	LVR-IC	4.3V±2%, 400mA	SOT-89	20vl	VR1	4c	Tor
33D	AAT60033D-S16	Vdet-IC	3.3V±1%, -Reset PPO	SOT-89	20vda	VD7	4p	Aat
33D	XC6203E442PR	LVR-IC	4.4V±2%, 400mA	SOT-89	20vl	VR1	4c	Tor
33E	XC6203E452PR	LVR-IC	4.5V±2%, 400mA	SOT-89	20vl	VR1	4c	Tor
33F	XC6203E462PR	LVR-IC	4.6V±2%, 400mA	SOT-89	20vl	VR1	4c	Tor
33H	XC6203E472PR	LVR-IC	4.7V±2%, 400mA	SOT-89	20vl	VR1	4c	Tor
33K	XC6203E482PR	LVR-IC	4.8V±2%, 400mA	SOT-89	20vl	VR1	4c	Tor
33L	XC6203E492PR	LVR-IC	4.9V±2%, 400mA	SOT-89	20vl	VR1	4c	Tor
33M	XC6203E502PR	LVR-IC	5V±2%, 400mA	SOT-89	20vl	VR1	4c	Tor
33N	XC6203E512PR	LVR-IC	5.1V±2%, 400mA	SOT-89	20vl	VR1	4c	Tor
33P	XC6203E522PR	LVR-IC	5.2V±2%, 400mA	SOT-89	20vl	VR1	4c	Tor
33R	XC6203E532PR	LVR-IC	5.3V±2%, 400mA	SOT-89	20vl	VR1	4c	Tor
33S	XC6203E542PR	LVR-IC	5.4V±2%, 400mA	SOT-89	20vl	VR1	4c	Tor
33T	XC6203E552PR	LVR-IC	5.5V±2%, 400mA	SOT-89	20vl	VR1	4c	Tor
33U	XC6203E562PR	LVR-IC	5.6V±2%, 400mA	SOT-89	20vl	VR1	4c	Tor
33V	XC6203E572PR	LVR-IC	5.7V±2%, 400mA	SOT-89	20vl	VR1	4c	Tor
33X	XC6203E582PR	LVR-IC	5.8V±2%, 400mA	SOT-89	20vl	VR1	4c	Tor
33Y	BZV49-C33	Z-diode	33V±5%, Izt=2mA, 1W	SOT-89	20dm	-	4b	Phi
33Y	XC6203E592PR	LVR-IC	5.9V±2%, 400mA	SOT-89	20vl	VR1	4c	Tor
33Z	XC6203E602PR	LVR-IC	6V±2%, 400mA	SOT-89	20vl	VR1	4c	Tor
34	UTC8134	Vdet-IC	3.4V, -Reset OCO	SOT-89	20vdd	VD6	4b	Utc
349B	AAT60039B-S16	Vdet-IC	3.9V±2%, -Reset PPO	SOT-89	20vda	VD7	4p	Aat
34A	AAT60034A-S16	Vdet-IC	3.4V±2%, -Reset ODO	SOT-89	20vda	VD6	4p	Aat
34B	AAT60034B-S16	Vdet-IC	3.4V±2%, -Reset PPO	SOT-89	20vda	VD7	4p	Aat
34C	AAT60034C-S16	Vdet-IC	3.4V±1%, -Reset ODO	SOT-89	20vda	VD6	4p	Aat
34D	AAT60034D-S16	Vdet-IC	3.4V±1%, -Reset PPO	SOT-89	20vda	VD7	4p	Aat
34X	XC6203E28APR	LVR-IC	2.85V±2%, 400mA	SOT-89	20vl	VR1	4c	Tor
35	UTC8135	Vdet-IC	3.5V, -Reset OCO	SOT-89	20vdd	VD6	4b	Utc
351	MC33463H-35K	DC/DC-IC	PFM, 3.5V±2.5%, 80..120kHz	SOT-89	20bq	-	4b	Ons



SMD
code

Type

Function

Short description

Case Pinout Sch. St. Mnf.

SMD code	Type	Function	Short description	Case	Pinout	Sch.	St.	Mnf.
351A	MC33466H-35J	DC/DC-IC	PWM, 3.5V±2.5%, 50kHz	SOT-89	20bq	-	4b	Ons
351A	SD42351NA	LDR-IC	White LED driver 3.6V, 335mA	SOT-89	20ch	LD4	4g	Sln
351B	SD42351NB	LDR-IC	White LED driver 3.6V, 305mA	SOT-89	20ch	LD4	4g	Sln
351C	SD42351NC	LDR-IC	White LED driver 3.6V, 270mA	SOT-89	20ch	LD4	4g	Sln
351D	SD42351ND	LDR-IC	White LED driver 3.6V, 245mA	SOT-89	20ch	LD4	4g	Sln
351E	SD42351NE	LDR-IC	White LED driver 3.6V, 215mA	SOT-89	20ch	LD4	4g	Sln
351G	SD42351NG	LDR-IC	White LED driver 3.6V, 170mA	SOT-89	20ch	LD4	4g	Sln
351H	SD42351NH	LDR-IC	White LED driver 3.6V, 150mA	SOT-89	20ch	LD4	4g	Sln
351L	SD42351NL	LDR-IC	White LED driver 3.6V, 110mA	SOT-89	20ch	LD4	4g	Sln
352B	MC33466H-35	DC/DC-IC	PWM, 3.5V±2.5%, 100kHz	SOT-89	20br	-	4b	Ons
35A	AAT60035A-S16	Vdet-IC	3.5V±2%, -Reset ODO	SOT-89	20vda	VD6	4p	Aat
35B	AAT60035B-S16	Vdet-IC	3.5V±2%, -Reset PPO	SOT-89	20vda	VD7	4p	Aat
35C	AAT60035C-S16	Vdet-IC	3.5V±1%, -Reset ODO	SOT-89	20vda	VD6	4p	Aat
35D	AAT60035D-S16	Vdet-IC	3.5V±1%, -Reset PPO	SOT-89	20vda	VD7	4p	Aat
35K	XC6203P182PR	LVR-IC	1.8V±2%, 400mA, Internal current limiter	SOT-89	20vl	VR1	4c	Tor
35L	XC6203P192PR	LVR-IC	1.9V±2%, 400mA, Internal current limiter	SOT-89	20vl	VR1	4c	Tor
35M	XC6203P202PR	LVR-IC	2V±2%, 400mA, Internal current limiter	SOT-89	20vl	VR1	4c	Tor
35N	XC6203P212PR	LVR-IC	2.1V±2%, 400mA, Internal current limiter	SOT-89	20vl	VR1	4c	Tor
35P	XC6203P222PR	LVR-IC	2.2V±2%, 400mA, Internal current limiter	SOT-89	20vl	VR1	4c	Tor
35R	XC6203P232PR	LVR-IC	2.3V±2%, 400mA, Internal current limiter	SOT-89	20vl	VR1	4c	Tor
35S	XC6203P242PR	LVR-IC	2.4V±2%, 400mA, Internal current limiter	SOT-89	20vl	VR1	4c	Tor
35T	XC6203P252PR	LVR-IC	2.5V±2%, 400mA, Internal current limiter	SOT-89	20vl	VR1	4c	Tor
35U	XC6203P262PR	LVR-IC	2.6V±2%, 400mA, Internal current limiter	SOT-89	20vl	VR1	4c	Tor
35V	XC6203P272PR	LVR-IC	2.7V±2%, 400mA, Internal current limiter	SOT-89	20vl	VR1	4c	Tor
35X	XC6203P282PR	LVR-IC	2.8V±2%, 400mA, Internal current limiter	SOT-89	20vl	VR1	4c	Tor
35Y	XC6203P292PR	LVR-IC	2.9V±2%, 400mA, Internal current limiter	SOT-89	20vl	VR1	4c	Tor
35Z	XC6203P302PR	LVR-IC	3V±2%, 400mA, Internal current limiter	SOT-89	20vl	VR1	4c	Tor
36	UTC8136	Vdet-IC	3.6V, -Reset OCO	SOT-89	20vdd	VD6	4b	Utc
360	XC6203P312PR	LVR-IC	3.1V±2%, 400mA, Internal current limiter	SOT-89	20vl	VR1	4c	Tor
361	XC6203P322PR	LVR-IC	3.2V±2%, 400mA, Internal current limiter	SOT-89	20vl	VR1	4c	Tor
362	XC6203P332PR	LVR-IC	3.3V±2%, 400mA, Internal current limiter	SOT-89	20vl	VR1	4c	Tor
363	XC6203P342PR	LVR-IC	3.4V±2%, 400mA, Internal current limiter	SOT-89	20vl	VR1	4c	Tor
364	XC6203P352PR	LVR-IC	3.5V±2%, 400mA, Internal current limiter	SOT-89	20vl	VR1	4c	Tor
365	XC6203P362PR	LVR-IC	3.6V±2%, 400mA, Internal current limiter	SOT-89	20vl	VR1	4c	Tor
366	XC6203P372PR	LVR-IC	3.7V±2%, 400mA, Internal current limiter	SOT-89	20vl	VR1	4c	Tor
367	XC6203P382PR	LVR-IC	3.8V±2%, 400mA, Internal current limiter	SOT-89	20vl	VR1	4c	Tor
368	XC6203P392PR	LVR-IC	3.9V±2%, 400mA, Internal current limiter	SOT-89	20vl	VR1	4c	Tor
369	XC6203P402PR	LVR-IC	4V±2%, 400mA, Internal current limiter	SOT-89	20vl	VR1	4c	Tor
36A	AAT60036A-S16	Vdet-IC	3.6V±2%, -Reset ODO	SOT-89	20vda	VD6	4p	Aat
36A	XC6203P412PR	LVR-IC	4.1V±2%, 400mA, Internal current limiter	SOT-89	20vl	VR1	4c	Tor
36B	AAT60036B-S16	Vdet-IC	3.6V±2%, -Reset PPO	SOT-89	20vda	VD7	4p	Aat
36B	XC6203P422PR	LVR-IC	4.2V±2%, 400mA, Internal current limiter	SOT-89	20vl	VR1	4c	Tor
36C	AAT60036C-S16	Vdet-IC	3.6V±1%, -Reset ODO	SOT-89	20vda	VD6	4p	Aat
36C	XC6203P432PR	LVR-IC	4.3V±2%, 400mA, Internal current limiter	SOT-89	20vl	VR1	4c	Tor
36D	AAT60036D-S16	Vdet-IC	3.6V±1%, -Reset PPO	SOT-89	20vda	VD7	4p	Aat
36D	XC6203P442PR	LVR-IC	4.4V±2%, 400mA, Internal current limiter	SOT-89	20vl	VR1	4c	Tor
36E	XC6203P452PR	LVR-IC	4.5V±2%, 400mA, Internal current limiter	SOT-89	20vl	VR1	4c	Tor
36F	XC6203P462PR	LVR-IC	4.6V±2%, 400mA, Internal current limiter	SOT-89	20vl	VR1	4c	Tor
36H	XC6203P472PR	LVR-IC	4.7V±2%, 400mA, Internal current limiter	SOT-89	20vl	VR1	4c	Tor
36K	XC6203P482PR	LVR-IC	4.8V±2%, 400mA, Internal current limiter	SOT-89	20vl	VR1	4c	Tor
36L	XC6203P492PR	LVR-IC	4.9V±2%, 400mA, Internal current limiter	SOT-89	20vl	VR1	4c	Tor
36M	XC6203P502PR	LVR-IC	5V±2%, 400mA, Internal current limiter	SOT-89	20vl	VR1	4c	Tor
36N	XC6203P512PR	LVR-IC	5.1V±2%, 400mA, Internal current limiter	SOT-89	20vl	VR1	4c	Tor
36P	XC6203P522PR	LVR-IC	5.2V±2%, 400mA, Internal current limiter	SOT-89	20vl	VR1	4c	Tor
36R	XC6203P532PR	LVR-IC	5.3V±2%, 400mA, Internal current limiter	SOT-89	20vl	VR1	4c	Tor
36S	XC6203P542PR	LVR-IC	5.4V±2%, 400mA, Internal current limiter	SOT-89	20vl	VR1	4c	Tor
36T	XC6203P552PR	LVR-IC	5.5V±2%, 400mA, Internal current limiter	SOT-89	20vl	VR1	4c	Tor
36U	XC6203P562PR	LVR-IC	5.6V±2%, 400mA, Internal current limiter	SOT-89	20vl	VR1	4c	Tor
36V	XC6203P572PR	LVR-IC	5.7V±2%, 400mA, Internal current limiter	SOT-89	20vl	VR1	4c	Tor
36X	XC6203P582PR	LVR-IC	5.8V±2%, 400mA, Internal current limiter	SOT-89	20vl	VR1	4c	Tor
36Y	BZV49-C36	Z-diode	36V±5%, Izt=2mA, 1W	SOT-89	20dm	-	4b	Phi
36Y	XC6203P592PR	LVR-IC	5.9V±2%, 400mA, Internal current limiter	SOT-89	20vl	VR1	4c	Tor
36Z	XC6203P602PR	LVR-IC	6V±2%, 400mA, Internal current limiter	SOT-89	20vl	VR1	4c	Tor
37	UTC8137	Vdet-IC	3.7V, -Reset OCO	SOT-89	20vdd	VD6	4b	Utc
37A	AAT60037A-S16	Vdet-IC	3.7V±2%, -Reset ODO	SOT-89	20vda	VD6	4p	Aat
37B	AAT60037B-S16	Vdet-IC	3.7V±2%, -Reset PPO	SOT-89	20vda	VD7	4p	Aat
37C	AAT60037C-S16	Vdet-IC	3.7V±1%, -Reset ODO	SOT-89	20vda	VD6	4p	Aat
37D	AAT60037D-S16	Vdet-IC	3.7V±1%, -Reset PPO	SOT-89	20vda	VD7	4p	Aat
37X	XC6203P28APR	LVR-IC	2.85V±2%, 400mA, Internal current limiter	SOT-89	20vl	VR1	4c	Tor
38	UTC8138	Vdet-IC	3.8V, -Reset OCO	SOT-89	20vdd	VD6	4b	Utc



SMD
code

Type

Function

Short description

Case Pinout Sch. St. Mnf.

38A	AAT60038A-S16	Vdet-IC	3.8V±2%, -Reset ODO	SOT-89	20vda	VD6	4p	Aat
38B	AAT60038B-S16	Vdet-IC	3.8V±2%, -Reset PPO	SOT-89	20vda	VD7	4p	Aat
38C	AAT60038C-S16	Vdet-IC	3.8V±1%, -Reset ODO	SOT-89	20vda	VD6	4p	Aat
38D	AAT60038D-S16	Vdet-IC	3.8V±1%, -Reset PPO	SOT-89	20vda	VD7	4p	Aat
39	Gali-39	MMIC	RF amplifier, DC..7GHz, 17.6dB (50Ω)	SOT-89	20aa	A1	4b	Mc
39	UTC8139	Vdet-IC	3.9V, -Reset OCO	SOT-89	20vdd	VD6	4b	Utc
39A	AAT60039A-S16	Vdet-IC	3.9V±2%, -Reset ODO	SOT-89	20vda	VD6	4p	Aat
39C	AAT60039C-S16	Vdet-IC	3.9V±1%, -Reset ODO	SOT-89	20vda	VD6	4p	Aat
39D	AAT60039D-S16	Vdet-IC	3.9V±1%, -Reset PPO	SOT-89	20vda	VD7	4p	Aat
39U	XC6203E262PR	LVR-IC	2.6V±2%, 400mA	SOT-89	20vl	VR1	4c	Tor
39Y	BZV49-C39	Z-diode	39V±5%, Izt=2mA, 1W	SOT-89	20dm	-	4b	Phi
3A	2SB1699	Si-pnp	AF-Drv, 60V, 2A, 1W, B=80..250, 180MHz	SOT-89	20tb	-	4b	Pan
3A	BGA6289	MMIC	RF amp, DC..1.95GHz, 13dB (50Ω), Vcc=4.1V	SOT-89	20aa	A1	4g	Nxp
3A0	TC55RP302EMB	LVR-IC	LDO, 3.0V±2%, 250mA	SOT-89	20vl	VR1	4h	Mcc
3A0	XC62FP3002P	LVR-IC	3.0V±2%, 250mA	SOT-89	20vl	VR1	4c	Tor
3A5	XC62KN302P	LVR-IC	LDO, -3V±2%, 100mA, 500mW	SOT-89	20ch	VR2	4c	Tor
3Ab	FT511Ab	LVR-IC	LDO, 1.2V±2%, 400mA	SOT-89	20vl	VR1	4k	Fmd
3Ac	FT511Ac	LVR-IC	LDO, 1.2V±2%, 400mA	SOT-89	20ch	VR1	4k	Fmd
3B	RH5RL23AA	LVR-IC	2.3V±2.5%, 150mA	SOT-89	20vl	VR1	4c	Ric
3B0	TC55RP312EMB	LVR-IC	LDO, 3.1V±2%, 250mA	SOT-89	20vl	VR1	4h	Mcc
3B0	XC62FP3102P	LVR-IC	3.1V±2%, 250mA	SOT-89	20vl	VR1	4c	Tor
3B5	XC62KN312P	LVR-IC	LDO, -3.1V±2%, 100mA, 500mW	SOT-89	20ch	VR2	4c	Tor
3Bb	FT511Bb	LVR-IC	LDO, 1.5V±2%, 400mA	SOT-89	20vl	VR1	4k	Fmd
3Bc	FT511Bc	LVR-IC	LDO, 1.5V±2%, 400mA	SOT-89	20ch	VR1	4k	Fmd
3C	MC78LC33HT1	LVR-IC	Low Iq, 3.3V±2.5%, 80mA	SOT-89	20vl	VR1	4b	Ons
3C	RH5RL33AA	LVR-IC	3.3V±2.5%, 150mA	SOT-89	20vl	VR1	4c	Ric
3C0	TC55RP322EMB	LVR-IC	LDO, 3.2V±2%, 250mA	SOT-89	20vl	VR1	4h	Mcc
3C0	XC62FP3202P	LVR-IC	3.2V±2%, 250mA	SOT-89	20vl	VR1	4c	Tor
3C5	XC62KN322P	LVR-IC	LDO, -3.2V±2%, 100mA, 500mW	SOT-89	20ch	VR2	4c	Tor
3Cb	FT511Cb	LVR-IC	LDO, 1.8V±2%, 400mA	SOT-89	20vl	VR1	4k	Fmd
3Cc	FT511Cc	LVR-IC	LDO, 1.8V±2%, 400mA	SOT-89	20ch	VR1	4k	Fmd
3D	RH5RL43AA	LVR-IC	4.3V±2.5%, 150mA	SOT-89	20vl	VR1	4c	Ric
3D0	TC55RP332EMB	LVR-IC	LDO, 3.3V±2%, 250mA	SOT-89	20vl	VR1	4h	Mcc
3D0	XC62FP3302P	LVR-IC	3.3V±2%, 250mA	SOT-89	20vl	VR1	4c	Tor
3D5	XC62KN332P	LVR-IC	LDO, -3.3V±2%, 100mA, 500mW	SOT-89	20ch	VR2	4c	Tor
3Db	FT511Db	LVR-IC	LDO, 2.5V±2%, 400mA	SOT-89	20vl	VR1	4k	Fmd
3Dc	FT511Dc	LVR-IC	LDO, 2.5V±2%, 400mA	SOT-89	20ch	VR1	4k	Fmd
3E	RH5RL53AA	LVR-IC	5.3V±2.5%, 150mA	SOT-89	20vl	VR1	4c	Ric
3E0	TC55RP342EMB	LVR-IC	LDO, 3.4V±2%, 250mA	SOT-89	20vl	VR1	4h	Mcc
3E0	XC62FP3402P	LVR-IC	3.4V±2%, 250mA	SOT-89	20vl	VR1	4c	Tor
3E5	XC62KN342P	LVR-IC	LDO, -3.4V±2%, 100mA, 500mW	SOT-89	20ch	VR2	4c	Tor
3F0	TC55RP352EMB	LVR-IC	LDO, 3.5V±2%, 250mA	SOT-89	20vl	VR1	4h	Mcc
3F0	XC62FP3502P	LVR-IC	3.5V±2%, 250mA	SOT-89	20vl	VR1	4c	Tor
3F5	XC62KN352P	LVR-IC	LDO, -3.5V±2%, 100mA, 500mW	SOT-89	20ch	VR2	4c	Tor
3H0	TC55RP362EMB	LVR-IC	LDO, 3.6V±2%, 250mA	SOT-89	20vl	VR1	4h	Mcc
3H0	XC62FP3602P	LVR-IC	3.6V±2%, 250mA	SOT-89	20vl	VR1	4c	Tor
3H5	XC62KN362P	LVR-IC	LDO, -3.6V±2%, 100mA, 500mW	SOT-89	20ch	VR2	4c	Tor
3J	RH5RE23AA	LVR-IC	Ultra-LDO, 2.3V±2.5%, 300mA	SOT-89	20vl	VR1	4c	Ric
3K	RH5RE33AA	LVR-IC	Ultra-LDO, 3.3V±2.5%, 300mA	SOT-89	20vl	VR1	4c	Ric
3K0	TC55RP372EMB	LVR-IC	LDO, 3.7V±2%, 250mA	SOT-89	20vl	VR1	4h	Mcc
3K0	XC62FP3702P	LVR-IC	3.7V±2%, 250mA	SOT-89	20vl	VR1	4c	Tor
3K5	XC62KN372P	LVR-IC	LDO, -3.7V±2%, 100mA, 500mW	SOT-89	20ch	VR2	4c	Tor
3L	RH5RE43AA	LVR-IC	Ultra-LDO, 4.3V±2.5%, 300mA	SOT-89	20vl	VR1	4c	Ric
3L0	TC55RP382EMB	LVR-IC	LDO, 3.8V±2%, 250mA	SOT-89	20vl	VR1	4h	Mcc
3L0	XC62FP3802P	LVR-IC	3.8V±2%, 250mA	SOT-89	20vl	VR1	4c	Tor
3L5	XC62KN382P	LVR-IC	LDO, -3.8V±2%, 100mA, 500mW	SOT-89	20ch	VR2	4c	Tor
3M	RH5RE53AA	LVR-IC	Ultra-LDO, 5.3V±2.5%, 300mA	SOT-89	20vl	VR1	4c	Ric
3M0	TC55RP392EMB	LVR-IC	LDO, 3.9V±2%, 250mA	SOT-89	20vl	VR1	4h	Mcc
3M0	XC62FP3902P	LVR-IC	3.9V±2%, 250mA	SOT-89	20vl	VR1	4c	Tor
3M5	XC62KN392P	LVR-IC	LDO, -3.9V±2%, 100mA, 500mW	SOT-89	20ch	VR2	4c	Tor
3Y0	BZV49-C3V0	Z-diode	3V±5%, Izt=5mA, 1W	SOT-89	20dm	-	4b	Phi
3Y3	BZV49-C3V3	Z-diode	3.3V±5%, Izt=5mA, 1W	SOT-89	20dm	-	4b	Phi
3Y6	BZV49-C3V6	Z-diode	3.6V±5%, Izt=5mA, 1W	SOT-89	20dm	-	4b	Phi
3Y9	BZV49-C3V9	Z-diode	3.9V±5%, Izt=5mA, 1W	SOT-89	20dm	-	4b	Phi
40	UTC8140	Vdet-IC	4V, -Reset OCO	SOT-89	20vdd	VD6	4b	Utc
40A	AAT60040A-S16	Vdet-IC	4.0V±2%, -Reset ODO	SOT-89	20vda	VD6	4p	Aat
40B	AAT60040B-S16	Vdet-IC	4.0V±2%, -Reset PPO	SOT-89	20vda	VD7	4p	Aat
40C	AAT60040C-S16	Vdet-IC	4.0V±1%, -Reset ODO	SOT-89	20vda	VD6	4p	Aat
40D	AAT60040D-S16	Vdet-IC	4.0V±1%, -Reset PPO	SOT-89	20vda	VD7	4p	Aat
41	UTC8141	Vdet-IC	4.1V, -Reset OCO	SOT-89	20vdd	VD6	4b	Utc



SMD
code

Type

Function

Short description

Case Pinout Sch. St. Mnf.

41A	AAT60041A-S16	Vdet-IC	4.1V±2%, -Reset ODO	SOT-89	20vda	VD6	4p	Aat
41B	AAT60041B-S16	Vdet-IC	4.1V±2%, -Reset PPO	SOT-89	20vda	VD7	4p	Aat
41C	AAT60041C-S16	Vdet-IC	4.1V±1%, -Reset ODO	SOT-89	20vda	VD6	4p	Aat
41D	AAT60041D-S16	Vdet-IC	4.1V±1%, -Reset PPO	SOT-89	20vda	VD7	4p	Aat
42	UTC8142	Vdet-IC	4.2V, -Reset OCO	SOT-89	20vdd	VD6	4b	Utc
42A	AAT60042A-S16	Vdet-IC	4.2V±2%, -Reset ODO	SOT-89	20vda	VD6	4p	Aat
42B	AAT60042B-S16	Vdet-IC	4.2V±2%, -Reset PPO	SOT-89	20vda	VD7	4p	Aat
42C	AAT60042C-S16	Vdet-IC	4.2V±1%, -Reset ODO	SOT-89	20vda	VD6	4p	Aat
42D	AAT60042D-S16	Vdet-IC	4.2V±1%, -Reset PPO	SOT-89	20vda	VD7	4p	Aat
43	UTC8143	Vdet-IC	4.3V, -Reset OCO	SOT-89	20vdd	VD6	4b	Utc
43A	AAT60043A-S16	Vdet-IC	4.3V±2%, -Reset ODO	SOT-89	20vda	VD6	4p	Aat
43B	AAT60043B-S16	Vdet-IC	4.3V±2%, -Reset PPO	SOT-89	20vda	VD7	4p	Aat
43C	AAT60043C-S16	Vdet-IC	4.3V±1%, -Reset ODO	SOT-89	20vda	VD6	4p	Aat
43D	AAT60043D-S16	Vdet-IC	4.3V±1%, -Reset PPO	SOT-89	20vda	VD7	4p	Aat
43Y	BZV49-C43	Z-diode	43V±5%, Izt=2mA, 1W	SOT-89	20dm	-	4b	Phi
44	UTC8144	Vdet-IC	4.4V, -Reset OCO	SOT-89	20vdd	VD6	4b	Utc
44A	AAT60044A-S16	Vdet-IC	4.4V±2%, -Reset ODO	SOT-89	20vda	VD6	4p	Aat
44B	AAT60044B-S16	Vdet-IC	4.4V±2%, -Reset PPO	SOT-89	20vda	VD7	4p	Aat
44C	AAT60044C-S16	Vdet-IC	4.4V±1%, -Reset ODO	SOT-89	20vda	VD6	4p	Aat
44D	AAT60044D-S16	Vdet-IC	4.4V±1%, -Reset PPO	SOT-89	20vda	VD7	4p	Aat
45	UTC8145	Vdet-IC	4.5V, -Reset OCO	SOT-89	20vdd	VD6	4b	Utc
45A	AAT60045A-S16	Vdet-IC	4.5V±2%, -Reset ODO	SOT-89	20vda	VD6	4p	Aat
45B	AAT60045B-S16	Vdet-IC	4.5V±2%, -Reset PPO	SOT-89	20vda	VD7	4p	Aat
45C	AAT60045C-S16	Vdet-IC	4.5V±1%, -Reset ODO	SOT-89	20vda	VD6	4p	Aat
45D	AAT60045D-S16	Vdet-IC	4.5V±1%, -Reset PPO	SOT-89	20vda	VD7	4p	Aat
46	UTC8146	Vdet-IC	4.6V, -Reset OCO	SOT-89	20vdd	VD6	4b	Utc
46A	AAT60046A-S16	Vdet-IC	4.6V±2%, -Reset ODO	SOT-89	20vda	VD6	4p	Aat
46B	AAT60046B-S16	Vdet-IC	4.6V±2%, -Reset PPO	SOT-89	20vda	VD7	4p	Aat
46C	AAT60046C-S16	Vdet-IC	4.6V±1%, -Reset ODO	SOT-89	20vda	VD6	4p	Aat
46D	AAT60046D-S16	Vdet-IC	4.6V±1%, -Reset PPO	SOT-89	20vda	VD7	4p	Aat
47A	AAT60047A-S16	Vdet-IC	4.7V±2%, -Reset ODO	SOT-89	20vda	VD6	4p	Aat
47B	AAT60047B-S16	Vdet-IC	4.7V±2%, -Reset PPO	SOT-89	20vda	VD7	4p	Aat
47C	AAT60047C-S16	Vdet-IC	4.7V±1%, -Reset ODO	SOT-89	20vda	VD6	4p	Aat
47D	AAT60047D-S16	Vdet-IC	4.7V±1%, -Reset PPO	SOT-89	20vda	VD7	4p	Aat
47Y	BZV49-C47	Z-diode	47V±5%, Izt=2mA, 1W	SOT-89	20dm	-	4b	Phi
48A	AAT60048A-S16	Vdet-IC	4.8V±2%, -Reset ODO	SOT-89	20vda	VD6	4p	Aat
48B	AAT60048B-S16	Vdet-IC	4.8V±2%, -Reset PPO	SOT-89	20vda	VD7	4p	Aat
48C	AAT60048C-S16	Vdet-IC	4.8V±1%, -Reset ODO	SOT-89	20vda	VD6	4p	Aat
48D	AAT60048D-S16	Vdet-IC	4.8V±1%, -Reset PPO	SOT-89	20vda	VD7	4p	Aat
49	Gali-49	MMIC	RF amplifier, DC..5GHz, 10.7dB (50Ω)	SOT-89	20aa	A1	4b	Mcc
49A	AAT60049A-S16	Vdet-IC	4.9V±2%, -Reset ODO	SOT-89	20vda	VD6	4p	Aat
49B	AAT60049B-S16	Vdet-IC	4.9V±2%, -Reset PPO	SOT-89	20vda	VD7	4p	Aat
49C	AAT60049C-S16	Vdet-IC	4.9V±1%, -Reset ODO	SOT-89	20vda	VD6	4p	Aat
49D	AAT60049D-S16	Vdet-IC	4.9V±1%, -Reset PPO	SOT-89	20vda	VD7	4p	Aat
4A	BGA6489	MMIC	RF amp, DC..1.95GHz, 16dB (50Ω), Vcc=5.1V	SOT-89	20aa	A1	4g	Nxp
4A	KIA7419F	Vdet-IC	1.9V, +Reset OCO	SOT-89	20vdd	VD6	4a	Kec
4A0	TC55RP402EMB	LVR-IC	LDO, 4.0V±2%, 250mA	SOT-89	20vl	VR1	4h	Mcc
4A0	XC62FP4002P	LVR-IC	LDO, 4.0V±2%, 250mA	SOT-89	20vl	VR1	4c	Tor
4A5	XC62KN402P	LVR-IC	LDO, -4V±2%, 100mA, 500mW	SOT-89	20ch	VR2	4c	Tor
4B	KIA7421F	Vdet-IC	2.1V, +Reset OCO	SOT-89	20vdd	VD6	4a	Kec
4B	RH5RL24AA	LVR-IC	2.4V±2.5%, 150mA	SOT-89	20vl	VR1	4c	Ric
4B0	TC55RP412EMB	LVR-IC	LDO, 4.1V±2%, 250mA	SOT-89	20vl	VR1	4h	Mcc
4B0	XC62FP4102P	LVR-IC	LDO, 4.1V±2%, 250mA	SOT-89	20vl	VR1	4c	Tor
4B5	XC62KN412P	LVR-IC	LDO, -4.1V±2%, 100mA, 500mW	SOT-89	20ch	VR2	4c	Tor
4C	KIA7423F	Vdet-IC	2.3V, +Reset OCO	SOT-89	20vdd	VD6	4a	Kec
4C	RH5RL34AA	LVR-IC	3.4V±2.5%, 150mA	SOT-89	20vl	VR1	4c	Ric
4C0	TC55RP422EMB	LVR-IC	LDO, 4.2V±2%, 250mA	SOT-89	20vl	VR1	4h	Mcc
4C0	XC62FP4202P	LVR-IC	LDO, 4.2V±2%, 250mA	SOT-89	20vl	VR1	4c	Tor
4C5	XC62KN422P	LVR-IC	LDO, -4.2V±2%, 100mA, 500mW	SOT-89	20ch	VR2	4c	Tor
4D	KIA7425F	Vdet-IC	2.5V, +Reset OCO	SOT-89	20vdd	VD6	4a	Kec
4D	RH5RL44AA	LVR-IC	4.4V±2.5%, 150mA	SOT-89	20vl	VR1	4c	Ric
4D0	TC55RP432EMB	LVR-IC	LDO, 4.3V±2%, 250mA	SOT-89	20vl	VR1	4h	Mcc
4D0	XC62FP4302P	LVR-IC	LDO, 4.3V±2%, 250mA	SOT-89	20vl	VR1	4c	Tor
4D5	XC62KN432P	LVR-IC	LDO, -4.3V±2%, 100mA, 500mW	SOT-89	20ch	VR2	4c	Tor
4E	KIA7427F	Vdet-IC	2.7V, +Reset OCO	SOT-89	20vdd	VD6	4a	Kec
4E	RH5RL54AA	LVR-IC	5.4V±2.5%, 150mA	SOT-89	20vl	VR1	4c	Ric
4E0	TC55RP442EMB	LVR-IC	LDO, 4.4V±2%, 250mA	SOT-89	20vl	VR1	4h	Mcc
4E0	XC62FP4402P	LVR-IC	LDO, 4.4V±2%, 250mA	SOT-89	20vl	VR1	4c	Tor
4E5	XC62KN442P	LVR-IC	LDO, -4.4V±2%, 100mA, 500mW	SOT-89	20ch	VR2	4c	Tor
4F	KIA7429F	Vdet-IC	2.9V, +Reset OCO	SOT-89	20vdd	VD6	4a	Kec



SMD
code

Type

Function

Short description

Case Pinout Sch. St. Mnf.

SMD code	Type	Function	Short description	Case	Pinout	Sch.	St.	Mnf.
4F0	TC55RP452EMB	LVR-IC	LDO, 4.5V±2%, 250mA	SOT-89	20vl	VR1	4h	Mcc
4F0	XC62FP4502P	LVR-IC	4.5V±2%, 250mA	SOT-89	20vl	VR1	4c	Tor
4F5	XC62KN452P	LVR-IC	LDO, -4.5V±2%, 100mA, 500mW	SOT-89	20ch	VR2	4c	Tor
4G	KIA7431F	Vdet-IC	3.1V, +Reset OCO	SOT-89	20vdd	VD6	4a	Kec
4H	KIA7432F	Vdet-IC	3.2V, +Reset OCO	SOT-89	20vdd	VD6	4a	Kec
4H0	TC55RP462EMB	LVR-IC	LDO, 4.6V±2%, 250mA	SOT-89	20vl	VR1	4h	Mcc
4H0	XC62FP4602P	LVR-IC	4.6V±2%, 250mA	SOT-89	20vl	VR1	4c	Tor
4H5	XC62KN462P	LVR-IC	LDO, -4.6V±2%, 100mA, 500mW	SOT-89	20ch	VR2	4c	Tor
4J	KIA7433F	Vdet-IC	3.3V, +Reset OCO	SOT-89	20vdd	VD6	4a	Kec
4J	RH5RE24AA	LVR-IC	Ultra-LDO, 2.4V±2.5%, 300mA	SOT-89	20vl	VR1	4c	Ric
4K	KIA7434F	Vdet-IC	3.4V, +Reset OCO	SOT-89	20vdd	VD6	4a	Kec
4K	RH5RE34AA	LVR-IC	Ultra-LDO, 3.4V±2.5%, 300mA	SOT-89	20vl	VR1	4c	Ric
4K0	TC55RP472EMB	LVR-IC	LDO, 4.7V±2%, 250mA	SOT-89	20vl	VR1	4h	Mcc
4K0	XC62FP4702P	LVR-IC	4.7V±2%, 250mA	SOT-89	20vl	VR1	4c	Tor
4K5	XC62KN472P	LVR-IC	LDO, -4.7V±2%, 100mA, 500mW	SOT-89	20ch	VR2	4c	Tor
4L	KIA7435F	Vdet-IC	3.5V, +Reset OCO	SOT-89	20vdd	VD6	4a	Kec
4L	RH5RE44AA	LVR-IC	Ultra-LDO, 4.4V±2.5%, 300mA	SOT-89	20vl	VR1	4c	Ric
4L0	TC55RP482EMB	LVR-IC	LDO, 4.8V±2%, 250mA	SOT-89	20vl	VR1	4h	Mcc
4L0	XC62FP4802P	LVR-IC	4.8V±2%, 250mA	SOT-89	20vl	VR1	4c	Tor
4L5	XC62KN482P	LVR-IC	LDO, -4.8V±2%, 100mA, 500mW	SOT-89	20ch	VR2	4c	Tor
4M	KIA7436F	Vdet-IC	3.6V, +Reset OCO	SOT-89	20vdd	VD6	4a	Kec
4M	RH5RE54AA	LVR-IC	Ultra-LDO, 5.4V±2.5%, 300mA	SOT-89	20vl	VR1	4c	Ric
4M0	TC55RP492EMB	LVR-IC	LDO, 4.9V±2%, 250mA	SOT-89	20vl	VR1	4h	Mcc
4M0	XC62FP4902P	LVR-IC	4.9V±2%, 250mA	SOT-89	20vl	VR1	4c	Tor
4M5	XC62KN492P	LVR-IC	LDO, -4.9V±2%, 100mA, 500mW	SOT-89	20ch	VR2	4c	Tor
4N	KIA7439F	Vdet-IC	3.9V, +Reset OCO	SOT-89	20vdd	VD6	4a	Kec
4P	KIA7442F	Vdet-IC	4.2V, +Reset OCO	SOT-89	20vdd	VD6	4a	Kec
4R	KIA7445F	Vdet-IC	4.5V, +Reset OCO	SOT-89	20vdd	VD6	4a	Kec
4Y3	BZV49-C4V3	Z-diode	4.3V±5%, Izt=5mA, 1W	SOT-89	20dm	-	4b	Phi
4Y7	BZV49-C4V7	Z-diode	4.7V±5%, Izt=5mA, 1W	SOT-89	20dm	-	4b	Phi
50	UTC8150	Vdet-IC	5V, -Reset OCO	SOT-89	20vdd	VD6	4b	Utc
501	MC33463H-50K	DC/DC-IC	PFM, 5V±2.5%, 80...120kHz	SOT-89	20bq	-	4b	Ons
501A	MC33466H-50J	DC/DC-IC	PWM, 5V±2.5%, 50kHz	SOT-89	20bq	-	4b	Ons
502B	MC33466H-50	DC/DC-IC	PWM, 5V±2.5%, 100kHz	SOT-89	20br	-	4b	Ons
50A	AAT60050A-S16	Vdet-IC	5.0V±2%, -Reset ODO	SOT-89	20vda	VD6	4p	Aat
50B	AAT60050B-S16	Vdet-IC	5.0V±2%, -Reset PPO	SOT-89	20vda	VD7	4p	Aat
50C	AAT60050C-S16	Vdet-IC	5.0V±1%, -Reset ODO	SOT-89	20vda	VD6	4p	Aat
50D	AAT60050D-S16	Vdet-IC	5.0V±1%, -Reset PPO	SOT-89	20vda	VD7	4p	Aat
51	Gali-51	MMIC	RF amplifier, DC..4GHz, 13.4dB (50Ω)	SOT-89	20aa	A1	4b	Mc
5130Ax	G5130-25T21U	DC/DC-IC	PSM step-up, 2.5V±2%	SOT-89	20bq	DC2	4p	Gmt
5130Bx	G5130-26T21U	DC/DC-IC	PSM step-up, 2.6V±2%	SOT-89	20bq	DC2	4p	Gmt
5130Cx	G5130-27T21U	DC/DC-IC	PSM step-up, 2.7V±2%	SOT-89	20bq	DC2	4p	Gmt
5130Dx	G5130-28T21U	DC/DC-IC	PSM step-up, 2.8V±2%	SOT-89	20bq	DC2	4p	Gmt
5130Ex	G5130-29T21U	DC/DC-IC	PSM step-up, 2.9V±2%	SOT-89	20bq	DC2	4p	Gmt
5130Fx	G5130-30T21U	DC/DC-IC	PSM step-up, 3.0V±2%	SOT-89	20bq	DC2	4p	Gmt
5130Gx	G5130-31T21U	DC/DC-IC	PSM step-up, 3.1V±2%	SOT-89	20bq	DC2	4p	Gmt
5130Hx	G5130-32T21U	DC/DC-IC	PSM step-up, 3.2V±2%	SOT-89	20bq	DC2	4p	Gmt
5130Ix	G5130-33T21U	DC/DC-IC	PSM step-up, 3.3V±2%	SOT-89	20bq	DC2	4p	Gmt
5130Jx	G5130-34T21U	DC/DC-IC	PSM step-up, 3.4V±2%	SOT-89	20bq	DC2	4p	Gmt
5130Kx	G5130-35T21U	DC/DC-IC	PSM step-up, 3.5V±2%	SOT-89	20bq	DC2	4p	Gmt
5130Lx	G5130-36T21U	DC/DC-IC	PSM step-up, 3.6V±2%	SOT-89	20bq	DC2	4p	Gmt
5130Mx	G5130-37T21U	DC/DC-IC	PSM step-up, 3.7V±2%	SOT-89	20bq	DC2	4p	Gmt
5130Nx	G5130-38T21U	DC/DC-IC	PSM step-up, 3.8V±2%	SOT-89	20bq	DC2	4p	Gmt
5130Ox	G5130-39T21U	DC/DC-IC	PSM step-up, 3.9V±2%	SOT-89	20bq	DC2	4p	Gmt
5130Px	G5130-40T21U	DC/DC-IC	PSM step-up, 4.0V±2%	SOT-89	20bq	DC2	4p	Gmt
5130Qx	G5130-41T21U	DC/DC-IC	PSM step-up, 4.1V±2%	SOT-89	20bq	DC2	4p	Gmt
5130Rx	G5130-42T21U	DC/DC-IC	PSM step-up, 4.2V±2%	SOT-89	20bq	DC2	4p	Gmt
5130Sx	G5130-43T21U	DC/DC-IC	PSM step-up, 4.3V±2%	SOT-89	20bq	DC2	4p	Gmt
5130Tx	G5130-44T21U	DC/DC-IC	PSM step-up, 4.4V±2%	SOT-89	20bq	DC2	4p	Gmt
5130Ux	G5130-45T21U	DC/DC-IC	PSM step-up, 4.5V±2%	SOT-89	20bq	DC2	4p	Gmt
5130Vx	G5130-46T21U	DC/DC-IC	PSM step-up, 4.6V±2%	SOT-89	20bq	DC2	4p	Gmt
5130Wx	G5130-47T21U	DC/DC-IC	PSM step-up, 4.7V±2%	SOT-89	20bq	DC2	4p	Gmt
5130Xx	G5130-48T21U	DC/DC-IC	PSM step-up, 4.8V±2%	SOT-89	20bq	DC2	4p	Gmt
5130Yx	G5130-49T21U	DC/DC-IC	PSM step-up, 4.9V±2%	SOT-89	20bq	DC2	4p	Gmt
5130Zx	G5130-50T21U	DC/DC-IC	PSM step-up, 5.0V±2%	SOT-89	20bq	DC2	4p	Gmt
5131Ax	G5131-25T21U	DC/DC-IC	PSM step-up, 2.5V±2%, ext, transistor	SOT-89	20br	DC5	4p	Gmt
5131Bx	G5131-26T21U	DC/DC-IC	PSM step-up, 2.6V±2%, ext, transistor	SOT-89	20br	DC5	4p	Gmt
5131Cx	G5131-27T21U	DC/DC-IC	PSM step-up, 2.7V±2%, ext, transistor	SOT-89	20br	DC5	4p	Gmt
5131Dx	G5131-28T21U	DC/DC-IC	PSM step-up, 2.8V±2%, ext, transistor	SOT-89	20br	DC5	4p	Gmt
5131Ex	G5131-29T21U	DC/DC-IC	PSM step-up, 2.9V±2%, ext, transistor	SOT-89	20br	DC5	4p	Gmt



SMD
code

Type

Function

Short description

Case Pinout Sch. St. Mnf.

SMD code	Type	Function	Short description	Case	Pinout	Sch.	St.	Mnf.
5131Fx	G5131-30T21U	DC/DC-IC	PSM step-up, 3.0V±2%, ext, transistor	SOT-89	20br	DC5	4p	Gmt
5131Gx	G5131-31T21U	DC/DC-IC	PSM step-up, 3.1V±2%, ext, transistor	SOT-89	20br	DC5	4p	Gmt
5131Hx	G5131-32T21U	DC/DC-IC	PSM step-up, 3.2V±2%, ext, transistor	SOT-89	20br	DC5	4p	Gmt
5131Ix	G5131-33T21U	DC/DC-IC	PSM step-up, 3.3V±2%, ext, transistor	SOT-89	20br	DC5	4p	Gmt
5131Jx	G5131-34T21U	DC/DC-IC	PSM step-up, 3.4V±2%, ext, transistor	SOT-89	20br	DC5	4p	Gmt
5131Kx	G5131-35T21U	DC/DC-IC	PSM step-up, 3.5V±2%, ext, transistor	SOT-89	20br	DC5	4p	Gmt
5131Lx	G5131-36T21U	DC/DC-IC	PSM step-up, 3.6V±2%, ext, transistor	SOT-89	20br	DC5	4p	Gmt
5131Mx	G5131-37T21U	DC/DC-IC	PSM step-up, 3.7V±2%, ext, transistor	SOT-89	20br	DC5	4p	Gmt
5131Nx	G5131-38T21U	DC/DC-IC	PSM step-up, 3.8V±2%, ext, transistor	SOT-89	20br	DC5	4p	Gmt
5131Ox	G5131-39T21U	DC/DC-IC	PSM step-up, 3.9V±2%, ext, transistor	SOT-89	20br	DC5	4p	Gmt
5131Px	G5131-40T21U	DC/DC-IC	PSM step-up, 4.0V±2%, ext, transistor	SOT-89	20br	DC5	4p	Gmt
5131Qx	G5131-41T21U	DC/DC-IC	PSM step-up, 4.1V±2%, ext, transistor	SOT-89	20br	DC5	4p	Gmt
5131Rx	G5131-42T21U	DC/DC-IC	PSM step-up, 4.2V±2%, ext, transistor	SOT-89	20br	DC5	4p	Gmt
5131Sx	G5131-43T21U	DC/DC-IC	PSM step-up, 4.3V±2%, ext, transistor	SOT-89	20br	DC5	4p	Gmt
5131Tx	G5131-44T21U	DC/DC-IC	PSM step-up, 4.4V±2%, ext, transistor	SOT-89	20br	DC5	4p	Gmt
5131Ux	G5131-45T21U	DC/DC-IC	PSM step-up, 4.5V±2%, ext, transistor	SOT-89	20br	DC5	4p	Gmt
5131Vx	G5131-46T21U	DC/DC-IC	PSM step-up, 4.6V±2%, ext, transistor	SOT-89	20br	DC5	4p	Gmt
5131Wx	G5131-47T21U	DC/DC-IC	PSM step-up, 4.7V±2%, ext, transistor	SOT-89	20br	DC5	4p	Gmt
5131Xx	G5131-48T21U	DC/DC-IC	PSM step-up, 4.8V±2%, ext, transistor	SOT-89	20br	DC5	4p	Gmt
5131Yx	G5131-49T21U	DC/DC-IC	PSM step-up, 4.9V±2%, ext, transistor	SOT-89	20br	DC5	4p	Gmt
5131Zx	G5131-50T21U	DC/DC-IC	PSM step-up, 5.0V±2%, ext, transistor	SOT-89	20br	DC5	4p	Gmt
515	XC9111A151PR	DC/DC-IC	PFM step-up, 100kHz, 1.5V±2.5%, 400mA	SOT-89	20bq	DC2	4c	Tor
516	XC9111A161PR	DC/DC-IC	PFM step-up, 100kHz, 1.6V±2.5%, 400mA	SOT-89	20bq	DC2	4c	Tor
517	XC9111A171PR	DC/DC-IC	PFM step-up, 100kHz, 1.7V±2.5%, 400mA	SOT-89	20bq	DC2	4c	Tor
518	XC9111A181PR	DC/DC-IC	PFM step-up, 100kHz, 1.8V±2.5%, 400mA	SOT-89	20bq	DC2	4c	Tor
519	XC9111A191PR	DC/DC-IC	PFM step-up, 100kHz, 1.9V±2.5%, 400mA	SOT-89	20bq	DC2	4c	Tor
51A	AAT60051A-S16	Vdet-IC	5.1V±2%, -Reset PPO	SOT-89	20vda	VD6	4p	Aat
51B	AAT60051B-S16	Vdet-IC	5.1V±2%, -Reset PPO	SOT-89	20vda	VD7	4p	Aat
51C	AAT60051C-S16	Vdet-IC	5.1V±1%, -Reset ODO	SOT-89	20vda	VD6	4p	Aat
51D	AAT60051D-S16	Vdet-IC	5.1V±1%, -Reset PPO	SOT-89	20vda	VD7	4p	Aat
51F	Gali-51F	MMIC	RF amplifier, DC, .4GHz, 13.3dB (50Ω)	SOT-89	20aa	A1	4b	Mc
51Y	BZV49-C51	Z-diode	51V±5%, Izt=5mA, 1W	SOT-89	20dm	-	4b	Phi
52	Gali-52	MMIC	RF amplifier, DC, 2GHz, 14.4dB (50Ω)	SOT-89	20aa	A1	4b	Mc
520	XC9111A201PR	DC/DC-IC	PFM step-up, 100kHz, 2.0V±2.5%, 400mA	SOT-89	20bq	DC2	4c	Tor
521	XC9111A211PR	DC/DC-IC	PFM step-up, 100kHz, 2.1V±2.5%, 400mA	SOT-89	20bq	DC2	4c	Tor
522	XC9111A221PR	DC/DC-IC	PFM step-up, 100kHz, 2.2V±2.5%, 400mA	SOT-89	20bq	DC2	4c	Tor
523	XC9111A231PR	DC/DC-IC	PFM step-up, 100kHz, 2.3V±2.5%, 400mA	SOT-89	20bq	DC2	4c	Tor
524	XC9111A241PR	DC/DC-IC	PFM step-up, 100kHz, 2.4V±2.5%, 400mA	SOT-89	20bq	DC2	4c	Tor
525	XC9111A251PR	DC/DC-IC	PFM step-up, 100kHz, 2.5V±2.5%, 400mA	SOT-89	20bq	DC2	4c	Tor
526	XC9111A261PR	DC/DC-IC	PFM step-up, 100kHz, 2.6V±2.5%, 400mA	SOT-89	20bq	DC2	4c	Tor
527	XC9111A271PR	DC/DC-IC	PFM step-up, 100kHz, 2.7V±2.5%, 400mA	SOT-89	20bq	DC2	4c	Tor
528	XC9111A281PR	DC/DC-IC	PFM step-up, 100kHz, 2.8V±2.5%, 400mA	SOT-89	20bq	DC2	4c	Tor
529	XC9111A291PR	DC/DC-IC	PFM step-up, 100kHz, 2.9V±2.5%, 400mA	SOT-89	20bq	DC2	4c	Tor
52A	AAT60052A-S16	Vdet-IC	5.2V±2%, -Reset ODO	SOT-89	20vda	VD6	4p	Aat
52B	AAT60052B-S16	Vdet-IC	5.2V±2%, -Reset PPO	SOT-89	20vda	VD7	4p	Aat
52C	AAT60052C-S16	Vdet-IC	5.2V±1%, -Reset ODO	SOT-89	20vda	VD6	4p	Aat
52D	AAT60052D-S16	Vdet-IC	5.2V±1%, -Reset PPO	SOT-89	20vda	VD7	4p	Aat
530	XC9111A301PR	DC/DC-IC	PFM step-up, 100kHz, 3.0V±2.5%, 400mA	SOT-89	20bq	DC2	4c	Tor
531	XC9111A311PR	DC/DC-IC	PFM step-up, 100kHz, 3.1V±2.5%, 400mA	SOT-89	20bq	DC2	4c	Tor
532	XC9111A321PR	DC/DC-IC	PFM step-up, 100kHz, 3.2V±2.5%, 400mA	SOT-89	20bq	DC2	4c	Tor
533	XC9111A331PR	DC/DC-IC	PFM step-up, 100kHz, 3.3V±2.5%, 400mA	SOT-89	20bq	DC2	4c	Tor
534	XC9111A341PR	DC/DC-IC	PFM step-up, 100kHz, 3.4V±2.5%, 400mA	SOT-89	20bq	DC2	4c	Tor
535	XC9111A351PR	DC/DC-IC	PFM step-up, 100kHz, 3.5V±2.5%, 400mA	SOT-89	20bq	DC2	4c	Tor
536	XC9111A361PR	DC/DC-IC	PFM step-up, 100kHz, 3.6V±2.5%, 400mA	SOT-89	20bq	DC2	4c	Tor
537	XC9111A371PR	DC/DC-IC	PFM step-up, 100kHz, 3.7V±2.5%, 400mA	SOT-89	20bq	DC2	4c	Tor
538	XC9111A381PR	DC/DC-IC	PFM step-up, 100kHz, 3.8V±2.5%, 400mA	SOT-89	20bq	DC2	4c	Tor
539	XC9111A391PR	DC/DC-IC	PFM step-up, 100kHz, 3.9V±2.5%, 400mA	SOT-89	20bq	DC2	4c	Tor
53A	AAT60053A-S16	Vdet-IC	5.3V±2%, -Reset ODO	SOT-89	20vda	VD6	4p	Aat
53B	AAT60053B-S16	Vdet-IC	5.3V±2%, -Reset PPO	SOT-89	20vda	VD7	4p	Aat
53C	AAT60053C-S16	Vdet-IC	5.3V±1%, -Reset ODO	SOT-89	20vda	VD6	4p	Aat
53D	AAT60053D-S16	Vdet-IC	5.3V±1%, -Reset PPO	SOT-89	20vda	VD7	4p	Aat
540	XC9111A401PR	DC/DC-IC	PFM step-up, 100kHz, 4.0V±2.5%, 400mA	SOT-89	20bq	DC2	4c	Tor
541	XC9111A411PR	DC/DC-IC	PFM step-up, 100kHz, 4.1V±2.5%, 400mA	SOT-89	20bq	DC2	4c	Tor
542	XC9111A421PR	DC/DC-IC	PFM step-up, 100kHz, 4.2V±2.5%, 400mA	SOT-89	20bq	DC2	4c	Tor
543	XC9111A431PR	DC/DC-IC	PFM step-up, 100kHz, 4.3V±2.5%, 400mA	SOT-89	20bq	DC2	4c	Tor
544	XC9111A441PR	DC/DC-IC	PFM step-up, 100kHz, 4.4V±2.5%, 400mA	SOT-89	20bq	DC2	4c	Tor
545	XC9111A451PR	DC/DC-IC	PFM step-up, 100kHz, 4.5V±2.5%, 400mA	SOT-89	20bq	DC2	4c	Tor
546	XC9111A461PR	DC/DC-IC	PFM step-up, 100kHz, 4.6V±2.5%, 400mA	SOT-89	20bq	DC2	4c	Tor
547	XC9111A471PR	DC/DC-IC	PFM step-up, 100kHz, 4.7V±2.5%, 400mA	SOT-89	20bq	DC2	4c	Tor
548	XC9111A481PR	DC/DC-IC	PFM step-up, 100kHz, 4.8V±2.5%, 400mA	SOT-89	20bq	DC2	4c	Tor



SMD
code

Type

Function

Short description

Case Pinout Sch. St. Mnf.

SMD code	Type	Function	Short description	Case	Pinout	Sch.	St.	Mnf.
549	XC9111A491PR	DC/DC-IC	PFM step-up, 100kHz, 4.9V±2.5%, 400mA	SOT-89	20bq	DC2	4c	Tor
54A	AAT60054A-S16	Vdet-IC	5.4V±2%, -Reset ODO	SOT-89	20vda	VD6	4p	Aat
54B	AAT60054B-S16	Vdet-IC	5.4V±2%, -Reset PPO	SOT-89	20vda	VD7	4p	Aat
54C	AAT60054C-S16	Vdet-IC	5.4V±1%, -Reset ODO	SOT-89	20vda	VD6	4p	Aat
54D	AAT60054D-S16	Vdet-IC	5.4V±1%, -Reset PPO	SOT-89	20vda	VD7	4p	Aat
55	Gali-55	MMIC	RF amplifier, DC..4GHz, 15.7dB (50Ω)	SOT-89	20aa	A1	4b	Mc
550	XC9111A501PR	DC/DC-IC	PFM step-up, 100kHz, 5.0V±2.5%, 400mA	SOT-89	20bq	DC2	4c	Tor
551	XC9111A511PR	DC/DC-IC	PFM step-up, 100kHz, 5.1V±2.5%, 400mA	SOT-89	20bq	DC2	4c	Tor
552	XC9111A521PR	DC/DC-IC	PFM step-up, 100kHz, 5.2V±2.5%, 400mA	SOT-89	20bq	DC2	4c	Tor
553	XC9111A531PR	DC/DC-IC	PFM step-up, 100kHz, 5.3V±2.5%, 400mA	SOT-89	20bq	DC2	4c	Tor
554	XC9111A541PR	DC/DC-IC	PFM step-up, 100kHz, 5.4V±2.5%, 400mA	SOT-89	20bq	DC2	4c	Tor
555	FCX555	Si-ppn	Dr/Out, 180V, 750mA, 1.5W, B=100..300, 100MHz	SOT-89	20tb	-	4b	Zx
555	XC9111A551PR	DC/DC-IC	PFM step-up, 100kHz, 5.5V±2.5%, 400mA	SOT-89	20bq	DC2	4c	Tor
556	XC9111A561PR	DC/DC-IC	PFM step-up, 100kHz, 5.6V±2.5%, 400mA	SOT-89	20bq	DC2	4c	Tor
5564	CHT5564XPT	Si-ppn	AF, Sw, 15V, 6A, B>250, 380MHz	SOT-89	20tb	-	4b	Chm
557	XC9111A571PR	DC/DC-IC	PFM step-up, 100kHz, 5.7V±2.5%, 400mA	SOT-89	20bq	DC2	4c	Tor
558	XC9111A581PR	DC/DC-IC	PFM step-up, 100kHz, 5.8V±2.5%, 400mA	SOT-89	20bq	DC2	4c	Tor
559	XC9111A591PR	DC/DC-IC	PFM step-up, 100kHz, 5.9V±2.5%, 400mA	SOT-89	20bq	DC2	4c	Tor
55A	AAT60055A-S16	Vdet-IC	5.5V±2%, -Reset ODO	SOT-89	20vda	VD6	4p	Aat
55B	AAT60055B-S16	Vdet-IC	5.5V±2%, -Reset PPO	SOT-89	20vda	VD7	4p	Aat
55C	AAT60055C-S16	Vdet-IC	5.5V±1%, -Reset ODO	SOT-89	20vda	VD6	4p	Aat
55D	AAT60055D-S16	Vdet-IC	5.5V±1%, -Reset PPO	SOT-89	20vda	VD7	4p	Aat
560	XC9111A601PR	DC/DC-IC	PFM step-up, 100kHz, 6.0V±2.5%, 400mA	SOT-89	20bq	DC2	4c	Tor
561	XC9111A611PR	DC/DC-IC	PFM step-up, 100kHz, 6.1V±2.5%, 400mA	SOT-89	20bq	DC2	4c	Tor
562	XC9111A621PR	DC/DC-IC	PFM step-up, 100kHz, 6.2V±2.5%, 400mA	SOT-89	20bq	DC2	4c	Tor
563	XC9111A631PR	DC/DC-IC	PFM step-up, 100kHz, 6.3V±2.5%, 400mA	SOT-89	20bq	DC2	4c	Tor
564	XC9111A641PR	DC/DC-IC	PFM step-up, 100kHz, 6.4V±2.5%, 400mA	SOT-89	20bq	DC2	4c	Tor
565	XC9111A651PR	DC/DC-IC	PFM step-up, 100kHz, 6.5V±2.5%, 400mA	SOT-89	20bq	DC2	4c	Tor
566	XC9111A661PR	DC/DC-IC	PFM step-up, 100kHz, 6.6V±2.5%, 400mA	SOT-89	20bq	DC2	4c	Tor
567	XC9111A671PR	DC/DC-IC	PFM step-up, 100kHz, 6.7V±2.5%, 400mA	SOT-89	20bq	DC2	4c	Tor
568	XC9111A681PR	DC/DC-IC	PFM step-up, 100kHz, 6.8V±2.5%, 400mA	SOT-89	20bq	DC2	4c	Tor
569	XC9111A691PR	DC/DC-IC	PFM step-up, 100kHz, 6.9V±2.5%, 400mA	SOT-89	20bq	DC2	4c	Tor
56Y	BZV49-C56	Z-diode	56V±5%, Izt=2mA, 1W	SOT-89	20dm	-	4b	Phi
570	XC9111A701PR	DC/DC-IC	PFM step-up, 100kHz, 7.0V±2.5%, 400mA	SOT-89	20bq	DC2	4c	Tor
5824	CHT5824XPT	Si-ppn	AF, Sw, 60V, 3A, B=120..390, 200MHz	SOT-89	20tb	-	4b	Chm
59	Gali-59	MMIC	RF amplifier, DC..5GHz, 10.2dB (50Ω)	SOT-89	20aa	A1	4b	Mc
5A	BGA6589	MMIC	RF amp, DC..1.95GHz, 17dB (50Ω), Vcc=4.8V	SOT-89	20aa	A1	4g	Nxp
5A0	TC55RP502EMB	LVR-IC	LDO, 5.0V±2%, 250mA	SOT-89	20vl	VR1	4h	Mcc
5A0	XC62FP5002P	LVR-IC	LDO, 5.0V±2%, 250mA	SOT-89	20vl	VR1	4c	Tor
5A5	XC62KN502P	LVR-IC	LDO, -5V±2%, 100mA, 500mW	SOT-89	20ch	VR2	4c	Tor
5B	RH5RL25AA	LVR-IC	LDO, 2.5V±2.5%, 150mA	SOT-89	20vl	VR1	4c	Ric
5B0	TC55RP512EMB	LVR-IC	LDO, 5.1V±2%, 250mA	SOT-89	20vl	VR1	4h	Mcc
5B0	XC62FP5102P	LVR-IC	LDO, 5.1V±2%, 250mA	SOT-89	20vl	VR1	4c	Tor
5B5	XC62KN512P	LVR-IC	LDO, -5.1V±2%, 100mA, 500mW	SOT-89	20ch	VR2	4c	Tor
5C	RH5RL35AA	LVR-IC	LDO, 3.5V±2.5%, 150mA	SOT-89	20vl	VR1	4c	Ric
5C0	TC55RP522EMB	LVR-IC	LDO, 5.2V±2%, 250mA	SOT-89	20vl	VR1	4h	Mcc
5C0	XC62FP5202P	LVR-IC	LDO, 5.2V±2%, 250mA	SOT-89	20vl	VR1	4c	Tor
5C5	XC62KN522P	LVR-IC	LDO, -5.2V±2%, 100mA, 500mW	SOT-89	20ch	VR2	4c	Tor
5D	FT533Di	LVR-IC	LDO, 1.8V±2%, 700mA	SOT-89	20vl	VR1	4k	Fmd
5D	RH5RL45AA	LVR-IC	LDO, 4.5V±2.5%, 150mA	SOT-89	20vl	VR1	4c	Ric
5D0	TC55RP532EMB	LVR-IC	LDO, 5.3V±2%, 250mA	SOT-89	20vl	VR1	4h	Mcc
5D0	XC62FP5302P	LVR-IC	LDO, 5.3V±2%, 250mA	SOT-89	20vl	VR1	4c	Tor
5D5	XC62KN532P	LVR-IC	LDO, -5.3V±2%, 100mA, 500mW	SOT-89	20ch	VR2	4c	Tor
5E	FT533Ei	LVR-IC	LDO, 2.5V±2%, 700mA	SOT-89	20vl	VR1	4k	Fmd
5E	RH5RL55AA	LVR-IC	LDO, 5.5V±2.5%, 150mA	SOT-89	20vl	VR1	4c	Ric
5E0	TC55RP542EMB	LVR-IC	LDO, 5.4V±2%, 250mA	SOT-89	20vl	VR1	4h	Mcc
5E0	XC62FP5402P	LVR-IC	LDO, 5.4V±2%, 250mA	SOT-89	20vl	VR1	4c	Tor
5E5	XC62KN542P	LVR-IC	LDO, -5.4V±2%, 100mA, 500mW	SOT-89	20ch	VR2	4c	Tor
5F	FT533Fi	LVR-IC	LDO, 2.7V±2%, 700mA	SOT-89	20vl	VR1	4k	Fmd
5F0	TC55RP552EMB	LVR-IC	LDO, 5.5V±2%, 250mA	SOT-89	20vl	VR1	4h	Mcc
5F0	XC62FP5502P	LVR-IC	LDO, 5.5V±2%, 250mA	SOT-89	20vl	VR1	4c	Tor
5F5	XC62KN552P	LVR-IC	LDO, -5.5V±2%, 100mA, 500mW	SOT-89	20ch	VR2	4c	Tor
5G	FT533Gi	LVR-IC	LDO, 2.8V±2%, 700mA	SOT-89	20vl	VR1	4k	Fmd
5H	FT533Hi	LVR-IC	LDO, 2.85V±2%, 700mA	SOT-89	20vl	VR1	4k	Fmd
5H0	TC55RP562EMB	LVR-IC	LDO, 5.6V±2%, 250mA	SOT-89	20vl	VR1	4h	Mcc
5H0	XC62FP5602P	LVR-IC	LDO, 5.6V±2%, 250mA	SOT-89	20vl	VR1	4c	Tor
5H5	XC62KN562P	LVR-IC	LDO, -5.6V±2%, 100mA, 500mW	SOT-89	20ch	VR2	4c	Tor
5I	FT533Ii	LVR-IC	LDO, 3.0V±2%, 700mA	SOT-89	20vl	VR1	4k	Fmd
5J	FT533Ji	LVR-IC	LDO, 3.3V±2%, 700mA	SOT-89	20vl	VR1	4k	Fmd
5J	RH5RE25AA	LVR-IC	Ultra-LDO, 2.5V±2.5%, 300mA	SOT-89	20vl	VR1	4c	Ric



SMD
code

Type

Function

Short description

Case Pinout Sch. St. Mnf.

SMD code	Type	Function	Short description	Case	Pinout	Sch.	St.	Mnf.
5K	FT533Ki	LVR-IC	LDO, 3.6V±2%, 700mA	SOT-89	20vl	VR1	4k	Fmd
5K	RH5RE35AA	LVR-IC	Ultra-LDO, 3.5V±2.5%, 300mA	SOT-89	20vl	VR1	4c	Ric
5K0	TC55RP572EMB	LVR-IC	LDO, 5.7V±2%, 250mA	SOT-89	20vl	VR1	4h	Mcc
5K0	XC62FP5702P	LVR-IC	5.7V±2%, 250mA	SOT-89	20vl	VR1	4c	Tor
5K5	XC62KN572P	LVR-IC	LDO, -5.7V±2%, 100mA, 500mW	SOT-89	20ch	VR2	4c	Tor
5L	RH5RE45AA	LVR-IC	Ultra-LDO, 4.5V±2.5%, 300mA	SOT-89	20vl	VR1	4c	Ric
5L0	TC55RP582EMB	LVR-IC	LDO, 5.8V±2%, 250mA	SOT-89	20vl	VR1	4h	Mcc
5L0	XC62FP5802P	LVR-IC	5.8V±2%, 250mA	SOT-89	20vl	VR1	4c	Tor
5L5	XC62KN582P	LVR-IC	LDO, -5.8V±2%, 100mA, 500mW	SOT-89	20ch	VR2	4c	Tor
5M	RH5RE55AA	LVR-IC	Ultra-LDO, 5.5V±2.5%, 300mA	SOT-89	20vl	VR1	4c	Ric
5M0	TC55RP592EMB	LVR-IC	LDO, 5.9V±2%, 250mA	SOT-89	20vl	VR1	4h	Mcc
5M0	XC62FP5902P	LVR-IC	5.9V±2%, 250mA	SOT-89	20vl	VR1	4c	Tor
5M5	XC62KN592P	LVR-IC	LDO, -5.9V±2%, 100mA, 500mW	SOT-89	20ch	VR2	4c	Tor
5Y1	BZV49-C5V1	Z-diode	5.1V±5%, Izt=5mA, 1W	SOT-89	20dm	-	4b	Phi
5Y6	BZV49-C5V6	Z-diode	5.6V±5%, Izt=5mA, 1W	SOT-89	20dm	-	4b	Phi
605	FCX605	Si-npn-Darl	GP, 140V, 1A, 1W, B=5k, >150MHz	SOT-89	20tb	-	4b	Zx
60LN	ELM7520CAB	Vdet-IC	2.0V±2%, +Reset PPO	SOT-89	20vda	VD7	4a	Elm
60LN	ELM7520NAB	Vdet-IC	2.0V±2%, +Reset ODO	SOT-89	20vda	VD6	4a	Elm
615	XC9111B151PR	DC/DC-IC	PFM step-up, 100kHz, 1.5V±2.5%, 400mA	SOT-89	20br	DC5	4c	Tor
616	XC9111B161PR	DC/DC-IC	PFM step-up, 100kHz, 1.6V±2.5%, 400mA	SOT-89	20br	DC5	4c	Tor
617	FCX617	Si-npn	Sw, 15V, 3A, 2W, B=200.415, >120MHz	SOT-89	20tb	-	4b	Zx
617	FCX619	Si-npn	Sw, 50V, 3A, 2W, B=100.200, 165MHz	SOT-89	20tb	-	4b	Zx
617	XC9111B171PR	DC/DC-IC	PFM step-up, 100kHz, 1.7V±2.5%, 400mA	SOT-89	20br	DC5	4c	Tor
618	XC9111B181PR	DC/DC-IC	PFM step-up, 100kHz, 1.8V±2.5%, 400mA	SOT-89	20br	DC5	4c	Tor
619	XC9111B191PR	DC/DC-IC	PFM step-up, 100kHz, 1.9V±2.5%, 400mA	SOT-89	20br	DC5	4c	Tor
61LN	ELM7521CAB	Vdet-IC	2.1V±2%, +Reset PPO	SOT-89	20vda	VD7	4a	Elm
61LN	ELM7521NAB	Vdet-IC	2.1V±2%, +Reset ODO	SOT-89	20vda	VD6	4a	Elm
620	XC9111B201PR	DC/DC-IC	PFM step-up, 100kHz, 2.0V±2.5%, 400mA	SOT-89	20br	DC5	4c	Tor
621	XC9111B211PR	DC/DC-IC	PFM step-up, 100kHz, 2.1V±2.5%, 400mA	SOT-89	20br	DC5	4c	Tor
622	XC9111B221PR	DC/DC-IC	PFM step-up, 100kHz, 2.2V±2.5%, 400mA	SOT-89	20br	DC5	4c	Tor
623	XC9111B231PR	DC/DC-IC	PFM step-up, 100kHz, 2.3V±2.5%, 400mA	SOT-89	20br	DC5	4c	Tor
624	XC9111B241PR	DC/DC-IC	PFM step-up, 100kHz, 2.4V±2.5%, 400mA	SOT-89	20br	DC5	4c	Tor
625	XC9111B251PR	DC/DC-IC	PFM step-up, 100kHz, 2.5V±2.5%, 400mA	SOT-89	20br	DC5	4c	Tor
626	XC9111B261PR	DC/DC-IC	PFM step-up, 100kHz, 2.6V±2.5%, 400mA	SOT-89	20br	DC5	4c	Tor
627	BST62-70	Si-npn-Darl+Di	AF, 85V, 500mA, 1W, B>2000, 350MHz	SOT-89	20tb	-	4g	X
627	XC9111B271PR	DC/DC-IC	PFM step-up, 100kHz, 2.7V±2.5%, 400mA	SOT-89	20br	DC5	4c	Tor
628	XC9111B281PR	DC/DC-IC	PFM step-up, 100kHz, 2.8V±2.5%, 400mA	SOT-89	20br	DC5	4c	Tor
629	XC9111B291PR	DC/DC-IC	PFM step-up, 100kHz, 2.9V±2.5%, 400mA	SOT-89	20br	DC5	4c	Tor
62LN	ELM7522CAB	Vdet-IC	2.2V±2%, +Reset PPO	SOT-89	20vda	VD7	4a	Elm
62LN	ELM7522NAB	Vdet-IC	2.2V±2%, +Reset ODO	SOT-89	20vda	VD6	4a	Elm
62Y	BZV49-C62	Z-diode	62V±5%, Izt=2mA, 1W	SOT-89	20dm	-	4b	Phi
630	TK11630U	LVR-IC	LDO, 3V±1.5%, 190mA	SOT-89	20hn	VR1	4d	Tok
630	XC9111B301PR	DC/DC-IC	PFM step-up, 100kHz, 3.0V±2.5%, 400mA	SOT-89	20br	DC5	4c	Tor
631	XC9111B311PR	DC/DC-IC	PFM step-up, 100kHz, 3.1V±2.5%, 400mA	SOT-89	20br	DC5	4c	Tor
632	XC9111B321PR	DC/DC-IC	PFM step-up, 100kHz, 3.2V±2.5%, 400mA	SOT-89	20br	DC5	4c	Tor
633	TK11633U	LVR-IC	LDO, 3.3V±1.5%, 190mA	SOT-89	20hn	VR1	4d	Tok
633	XC9111B331PR	DC/DC-IC	PFM step-up, 100kHz, 3.3V±2.5%, 400mA	SOT-89	20br	DC5	4c	Tor
634	XC9111B341PR	DC/DC-IC	PFM step-up, 100kHz, 3.4V±2.5%, 400mA	SOT-89	20br	DC5	4c	Tor
635	XC9111B351PR	DC/DC-IC	PFM step-up, 100kHz, 3.5V±2.5%, 400mA	SOT-89	20br	DC5	4c	Tor
636	XC9111B361PR	DC/DC-IC	PFM step-up, 100kHz, 3.6V±2.5%, 400mA	SOT-89	20br	DC5	4c	Tor
637	XC9111B371PR	DC/DC-IC	PFM step-up, 100kHz, 3.7V±2.5%, 400mA	SOT-89	20br	DC5	4c	Tor
638	XC9111B381PR	DC/DC-IC	PFM step-up, 100kHz, 3.8V±2.5%, 400mA	SOT-89	20br	DC5	4c	Tor
639	XC9111B391PR	DC/DC-IC	PFM step-up, 100kHz, 3.9V±2.5%, 400mA	SOT-89	20br	DC5	4c	Tor
63LN	ELM7523CAB	Vdet-IC	2.3V±2%, +Reset PPO	SOT-89	20vda	VD7	4a	Elm
63LN	ELM7523NAB	Vdet-IC	2.3V±2%, +Reset ODO	SOT-89	20vda	VD6	4a	Elm
640	XC9111B401PR	DC/DC-IC	PFM step-up, 100kHz, 4.0V±2.5%, 400mA	SOT-89	20br	DC5	4c	Tor
641	XC9111B411PR	DC/DC-IC	PFM step-up, 100kHz, 4.1V±2.5%, 400mA	SOT-89	20br	DC5	4c	Tor
642	XC9111B421PR	DC/DC-IC	PFM step-up, 100kHz, 4.2V±2.5%, 400mA	SOT-89	20br	DC5	4c	Tor
643	XC9111B431PR	DC/DC-IC	PFM step-up, 100kHz, 4.3V±2.5%, 400mA	SOT-89	20br	DC5	4c	Tor
644	XC9111B441PR	DC/DC-IC	PFM step-up, 100kHz, 4.4V±2.5%, 400mA	SOT-89	20br	DC5	4c	Tor
645	XC9111B451PR	DC/DC-IC	PFM step-up, 100kHz, 4.5V±2.5%, 400mA	SOT-89	20br	DC5	4c	Tor
646	XC9111B461PR	DC/DC-IC	PFM step-up, 100kHz, 4.6V±2.5%, 400mA	SOT-89	20br	DC5	4c	Tor
647	XC9111B471PR	DC/DC-IC	PFM step-up, 100kHz, 4.7V±2.5%, 400mA	SOT-89	20br	DC5	4c	Tor
648	XC9111B481PR	DC/DC-IC	PFM step-up, 100kHz, 4.8V±2.5%, 400mA	SOT-89	20br	DC5	4c	Tor
649	XC9111B491PR	DC/DC-IC	PFM step-up, 100kHz, 4.9V±2.5%, 400mA	SOT-89	20br	DC5	4c	Tor
649AB	WTM649A-B	Si-npn	GP, 180V, 1.5A, 1W, B=60.120, 140MHz	SOT-89	20tb	-	4b	Wtr
649AC	WTM649A-C	Si-npn	GP, 180V, 1.5A, 1W, B=100.200, 140MHz	SOT-89	20tb	-	4b	Wtr
64LN	ELM7524CAB	Vdet-IC	2.4V±2%, +Reset PPO	SOT-89	20vda	VD7	4a	Elm
64LN	ELM7524NAB	Vdet-IC	2.4V±2%, +Reset ODO	SOT-89	20vda	VD6	4a	Elm
650	TK11650U	LVR-IC	LDO, 5V±1.5%, 190mA	SOT-89	20hn	VR1	4d	Tok

Note: ELM75xxCAB series LN- lot number L=0...9 N=A to Z(I, O, X excepted); ELM75xxNAB series LN- lot number L=A to Z(I, O, X excepted) N=0...9



SMD
code

Type

Function

Short description

Case Pinout Sch. St. Mnf.



650	XC6206P311PR	LVR-IC	LDO, 3.1V±2%, 250mA	SOT-89	20vl	VR1	4c	Tor
650	XC9111B501PR	DC/DC-IC	PFM step-up, 100kHz, 5.0V±2.5%, 400mA	SOT-89	20br	DC5	4c	Tor
651	XC9111B511PR	DC/DC-IC	PFM step-up, 100kHz, 5.1V±2.5%, 400mA	SOT-89	20br	DC5	4c	Tor
652	XC9111B521PR	DC/DC-IC	PFM step-up, 100kHz, 5.2V±2.5%, 400mA	SOT-89	20br	DC5	4c	Tor
653	XC9111B531PR	DC/DC-IC	PFM step-up, 100kHz, 5.3V±2.5%, 400mA	SOT-89	20br	DC5	4c	Tor
654	XC9111B541PR	DC/DC-IC	PFM step-up, 100kHz, 5.4V±2.5%, 400mA	SOT-89	20br	DC5	4c	Tor
655	XC9111B551PR	DC/DC-IC	PFM step-up, 100kHz, 5.5V±2.5%, 400mA	SOT-89	20br	DC5	4c	Tor
656	XC9111B561PR	DC/DC-IC	PFM step-up, 100kHz, 5.6V±2.5%, 400mA	SOT-89	20br	DC5	4c	Tor
657	XC9111B571PR	DC/DC-IC	PFM step-up, 100kHz, 5.7V±2.5%, 400mA	SOT-89	20br	DC5	4c	Tor
658	XC9111B581PR	DC/DC-IC	PFM step-up, 100kHz, 5.8V±2.5%, 400mA	SOT-89	20br	DC5	4c	Tor
659	XC9111B591PR	DC/DC-IC	PFM step-up, 100kHz, 5.9V±2.5%, 400mA	SOT-89	20br	DC5	4c	Tor
65A	FCX658A	Si-npn	Dr/Out, 400V, 1A, 1W, B=100.170, >50MHz	SOT-89	20tb	-	4b	Zx
65B	XC6206P122PR	LVR-IC	LDO, 1.2V±2%, 250mA	SOT-89	20vl	VR1	4c	Tor
65C	XC6206P132PR	LVR-IC	LDO, 1.3V±2%, 250mA	SOT-89	20vl	VR1	4c	Tor
65D	XC6206P142PR	LVR-IC	LDO, 1.4V±2%, 250mA	SOT-89	20vl	VR1	4c	Tor
65E	XC6206P152PR	LVR-IC	LDO, 1.5V±2%, 250mA	SOT-89	20vl	VR1	4c	Tor
65F	XC6206P162PR	LVR-IC	LDO, 1.6V±2%, 250mA	SOT-89	20vl	VR1	4c	Tor
65H	XC6206P172PR	LVR-IC	LDO, 1.7V±2%, 250mA	SOT-89	20vl	VR1	4c	Tor
65K	XC6206P182PR	LVR-IC	LDO, 1.8V±2%, 250mA	SOT-89	20vl	VR1	4c	Tor
65L	XC6206P192PR	LVR-IC	LDO, 1.9V±2%, 250mA	SOT-89	20vl	VR1	4c	Tor
65LN	ELM7525CAB	Vdet-IC	2.5V±2%, +Reset PPO	SOT-89	20vda	VD7	4a	Elm
65LN	ELM7525NAB	Vdet-IC	2.5V±2%, +Reset ODO	SOT-89	20vda	VD6	4a	Elm
65M	XC6206P202PR	LVR-IC	LDO, 2V±2%, 250mA	SOT-89	20vl	VR1	4c	Tor
65N	XC6206P212PR	LVR-IC	LDO, 2.1V±2%, 250mA	SOT-89	20vl	VR1	4c	Tor
65P	XC6206P222PR	LVR-IC	LDO, 2.2V±2%, 250mA	SOT-89	20vl	VR1	4c	Tor
65R	XC6206P232PR	LVR-IC	LDO, 2.3V±2%, 250mA	SOT-89	20vl	VR1	4c	Tor
65S	XC6206P242PR	LVR-IC	LDO, 2.4V±2%, 250mA	SOT-89	20vl	VR1	4c	Tor
65T	XC6206P252PR	LVR-IC	LDO, 2.5V±2%, 250mA	SOT-89	20vl	VR1	4c	Tor
65U	XC6206P262PR	LVR-IC	LDO, 2.6V±2%, 250mA	SOT-89	20vl	VR1	4c	Tor
65V	XC6206P272PR	LVR-IC	LDO, 2.7V±2%, 250mA	SOT-89	20vl	VR1	4c	Tor
65X	XC6206P282PR	LVR-IC	LDO, 2.8V±2%, 250mA	SOT-89	20vl	VR1	4c	Tor
65Y	XC6206P292PR	LVR-IC	LDO, 2.9V±2%, 250mA	SOT-89	20vl	VR1	4c	Tor
65Z	XC6206P302PR	LVR-IC	LDO, 3V±2%, 250mA	SOT-89	20vl	VR1	4c	Tor
66	Gali-S66	MMIC	RF amplifier, DC..3GHz, 15.5dB (50Ω)	SOT-89	20aa	A1	4b	Mc
660	XC9111B601PR	DC/DC-IC	PFM step-up, 100kHz, 6.0V±2.5%, 400mA	SOT-89	20br	DC5	4c	Tor
6601A	AX6601-15F	LVR-IC	LDO, 1.5V±2%, 300mA	SOT-89-3L	20vl	VR1	4n	Axl
6601B	AX6601-18F	LVR-IC	LDO, 1.8V±2%, 300mA	SOT-89-3L	20vl	VR1	4n	Axl
6601C	AX6601-25F	LVR-IC	LDO, 2.5V±2%, 300mA	SOT-89-3L	20vl	VR1	4n	Axl
6601D	AX6601-28F	LVR-IC	LDO, 2.8V±2%, 300mA	SOT-89-3L	20vl	VR1	4n	Axl
6601E	AX6601-30F	LVR-IC	LDO, 3.0V±2%, 300mA	SOT-89-3L	20vl	VR1	4n	Axl
6601F	AX6601-33F	LVR-IC	LDO, 3.3V±2%, 300mA	SOT-89-3L	20vl	VR1	4n	Axl
661	XC6206P322PR	LVR-IC	LDO, 3.2V±2%, 250mA	SOT-89	20vl	VR1	4c	Tor
661	XC9111B611PR	DC/DC-IC	PFM step-up, 100kHz, 6.1V±2.5%, 400mA	SOT-89	20br	DC5	4c	Tor
662	XC6206P332PR	LVR-IC	LDO, 3.3V±2%, 250mA	SOT-89	20vl	VR1	4c	Tor
662	XC9111B621PR	DC/DC-IC	PFM step-up, 100kHz, 6.2V±2.5%, 400mA	SOT-89	20br	DC5	4c	Tor
663	XC6206P342PR	LVR-IC	LDO, 3.4V±2%, 250mA	SOT-89	20vl	VR1	4c	Tor
663	XC9111B631PR	DC/DC-IC	PFM step-up, 100kHz, 6.3V±2.5%, 400mA	SOT-89	20br	DC5	4c	Tor
6630a	AX6630-360F	LVR-IC	LDO, 3.6V±2%, 1.2A	SOT-89	20eu	VR1	4n	Axl
6630A	AX6630-120F	LVR-IC	LDO, 1.2V±2%, 1.2A	SOT-89	20eu	VR1	4n	Axl
6630Aa	AX6630A-360F	LVR-IC	LDO, 3.6V±2%, 1.2A	SOT-89	20cq	VR1	4n	Axl
6630AA	AX6630A-120F	LVR-IC	LDO, 1.2V±2%, 1.2A	SOT-89	20cq	VR1	4n	Axl
6630Ab	AX6630A-370F	LVR-IC	LDO, 3.7V±2%, 1.2A	SOT-89	20cq	VR1	4n	Axl
6630AB	AX6630A-130F	LVR-IC	LDO, 1.3V±2%, 1.2A	SOT-89	20cq	VR1	4n	Axl
6630AC	AX6630A-140F	LVR-IC	LDO, 1.4V±2%, 1.2A	SOT-89	20cq	VR1	4n	Axl
6630Ad	AX6630A-380F	LVR-IC	LDO, 3.8V±2%, 1.2A	SOT-89	20cq	VR1	4n	Axl
6630AD	AX6630A-150F	LVR-IC	LDO, 1.5V±2%, 1.2A	SOT-89	20cq	VR1	4n	Axl
6630Ae	AX6630A-390F	LVR-IC	LDO, 3.9V±2%, 1.2A	SOT-89	20cq	VR1	4n	Axl
6630AE	AX6630A-160F	LVR-IC	LDO, 1.6V±2%, 1.2A	SOT-89	20cq	VR1	4n	Axl
6630Af	AX6630A-400F	LVR-IC	LDO, 4.0V±2%, 1.2A	SOT-89	20cq	VR1	4n	Axl
6630AF	AX6630A-170F	LVR-IC	LDO, 1.7V±2%, 1.2A	SOT-89	20cq	VR1	4n	Axl
6630Ag	AX6630A-410F	LVR-IC	LDO, 4.1V±2%, 1.2A	SOT-89	20cq	VR1	4n	Axl
6630AG	AX6630A-180F	LVR-IC	LDO, 1.8V±2%, 1.2A	SOT-89	20cq	VR1	4n	Axl
6630Ah	AX6630A-420F	LVR-IC	LDO, 4.2V±2%, 1.2A	SOT-89	20cq	VR1	4n	Axl
6630AH	AX6630A-190F	LVR-IC	LDO, 1.9V±2%, 1.2A	SOT-89	20cq	VR1	4n	Axl
6630AJ	AX6630A-200F	LVR-IC	LDO, 2.0V±2%, 1.2A	SOT-89	20cq	VR1	4n	Axl
6630AK	AX6630A-210F	LVR-IC	LDO, 2.1V±2%, 1.2A	SOT-89	20cq	VR1	4n	Axl
6630AL	AX6630A-220F	LVR-IC	LDO, 2.2V±2%, 1.2A	SOT-89	20cq	VR1	4n	Axl
6630Am	AX6630A-430F	LVR-IC	LDO, 4.3V±2%, 1.2A	SOT-89	20cq	VR1	4n	Axl
6630AM	AX6630A-230F	LVR-IC	LDO, 2.3V±2%, 1.2A	SOT-89	20cq	VR1	4n	Axl
6630An	AX6630A-440F	LVR-IC	LDO, 4.4V±2%, 1.2A	SOT-89	20cq	VR1	4n	Axl

SMD
code

Type

Function

Short description

Case Pinout Sch. St. Mnf.

SMD code	Type	Function	Short description	Case	Pinout	Sch.	St.	Mnf.
6630AN	AX6630A-240F	LVR-IC	LDO, 2.4V±2%, 1.2A	SOT-89	20cq	VR1	4n	Axl
6630Ao	AX6630A-450F	LVR-IC	LDO, 4.5V±2%, 1.2A	SOT-89	20cq	VR1	4n	Axl
6630AP	AX6630A-250F	LVR-IC	LDO, 2.5V±2%, 1.2A	SOT-89	20cq	VR1	4n	Axl
6630Aq	AX6630A-460F	LVR-IC	LDO, 4.6V±2%, 1.2A	SOT-89	20cq	VR1	4n	Axl
6630AQ	AX6630A-260F	LVR-IC	LDO, 2.6V±2%, 1.2A	SOT-89	20cq	VR1	4n	Axl
6630Ar	AX6630A-470F	LVR-IC	LDO, 4.7V±2%, 1.2A	SOT-89	20cq	VR1	4n	Axl
6630AR	AX6630A-270F	LVR-IC	LDO, 2.7V±2%, 1.2A	SOT-89	20cq	VR1	4n	Axl
6630AS	AX6630A-280F	LVR-IC	LDO, 2.8V±2%, 1.2A	SOT-89	20cq	VR1	4n	Axl
6630At	AX6630A-480F	LVR-IC	LDO, 4.8V±2%, 1.2A	SOT-89	20cq	VR1	4n	Axl
6630AT	AX6630A-290F	LVR-IC	LDO, 2.9V±2%, 1.2A	SOT-89	20cq	VR1	4n	Axl
6630Au	AX6630A-490F	LVR-IC	LDO, 4.9V±2%, 1.2A	SOT-89	20cq	VR1	4n	Axl
6630AU	AX6630A-300F	LVR-IC	LDO, 3.0V±2%, 1.2A	SOT-89	20cq	VR1	4n	Axl
6630AV	AX6630A-310F	LVR-IC	LDO, 3.1V±2%, 1.2A	SOT-89	20cq	VR1	4n	Axl
6630AW	AX6630A-320F	LVR-IC	LDO, 3.2V±2%, 1.2A	SOT-89	20cq	VR1	4n	Axl
6630AX	AX6630A-330F	LVR-IC	LDO, 3.3V±2%, 1.2A	SOT-89	20cq	VR1	4n	Axl
6630Ay	AX6630A-500F	LVR-IC	LDO, 5.0V±2%, 1.2A	SOT-89	20cq	VR1	4n	Axl
6630AY	AX6630A-340F	LVR-IC	LDO, 3.4V±2%, 1.2A	SOT-89	20cq	VR1	4n	Axl
6630AZ	AX6630A-350F	LVR-IC	LDO, 3.5V±2%, 1.2A	SOT-89	20cq	VR1	4n	Axl
6630b	AX6630-370F	LVR-IC	LDO, 3.7V±2%, 1.2A	SOT-89	20eu	VR1	4n	Axl
6630B	AX6630-130F	LVR-IC	LDO, 1.3V±2%, 1.2A	SOT-89	20eu	VR1	4n	Axl
6630C	AX6630-140F	LVR-IC	LDO, 1.4V±2%, 1.2A	SOT-89	20eu	VR1	4n	Axl
6630d	AX6630-380F	LVR-IC	LDO, 3.8V±2%, 1.2A	SOT-89	20eu	VR1	4n	Axl
6630D	AX6630-150F	LVR-IC	LDO, 1.5V±2%, 1.2A	SOT-89	20eu	VR1	4n	Axl
6630e	AX6630-390F	LVR-IC	LDO, 3.9V±2%, 1.2A	SOT-89	20eu	VR1	4n	Axl
6630E	AX6630-160F	LVR-IC	LDO, 1.6V±2%, 1.2A	SOT-89	20eu	VR1	4n	Axl
6630f	AX6630-400F	LVR-IC	LDO, 4.0V±2%, 1.2A	SOT-89	20eu	VR1	4n	Axl
6630F	AX6630-170F	LVR-IC	LDO, 1.7V±2%, 1.2A	SOT-89	20eu	VR1	4n	Axl
6630g	AX6630-410F	LVR-IC	LDO, 4.1V±2%, 1.2A	SOT-89	20eu	VR1	4n	Axl
6630G	AX6630-180F	LVR-IC	LDO, 1.8V±2%, 1.2A	SOT-89	20eu	VR1	4n	Axl
6630h	AX6630-420F	LVR-IC	LDO, 4.2V±2%, 1.2A	SOT-89	20eu	VR1	4n	Axl
6630H	AX6630-190F	LVR-IC	LDO, 1.9V±2%, 1.2A	SOT-89	20eu	VR1	4n	Axl
6630J	AX6630-200F	LVR-IC	LDO, 2.0V±2%, 1.2A	SOT-89	20eu	VR1	4n	Axl
6630K	AX6630-210F	LVR-IC	LDO, 2.1V±2%, 1.2A	SOT-89	20eu	VR1	4n	Axl
6630L	AX6630-220F	LVR-IC	LDO, 2.2V±2%, 1.2A	SOT-89	20eu	VR1	4n	Axl
6630m	AX6630-430F	LVR-IC	LDO, 4.3V±2%, 1.2A	SOT-89	20eu	VR1	4n	Axl
6630M	AX6630-230F	LVR-IC	LDO, 2.3V±2%, 1.2A	SOT-89	20eu	VR1	4n	Axl
6630n	AX6630-440F	LVR-IC	LDO, 4.4V±2%, 1.2A	SOT-89	20eu	VR1	4n	Axl
6630N	AX6630-240F	LVR-IC	LDO, 2.4V±2%, 1.2A	SOT-89	20eu	VR1	4n	Axl
6630o	AX6630-450F	LVR-IC	LDO, 4.5V±2%, 1.2A	SOT-89	20eu	VR1	4n	Axl
6630P	AX6630-250F	LVR-IC	LDO, 2.5V±2%, 1.2A	SOT-89	20eu	VR1	4n	Axl
6630q	AX6630-460F	LVR-IC	LDO, 4.6V±2%, 1.2A	SOT-89	20eu	VR1	4n	Axl
6630Q	AX6630-260F	LVR-IC	LDO, 2.6V±2%, 1.2A	SOT-89	20eu	VR1	4n	Axl
6630r	AX6630-470F	LVR-IC	LDO, 4.7V±2%, 1.2A	SOT-89	20eu	VR1	4n	Axl
6630R	AX6630-270F	LVR-IC	LDO, 2.7V±2%, 1.2A	SOT-89	20eu	VR1	4n	Axl
6630S	AX6630-280F	LVR-IC	LDO, 2.8V±2%, 1.2A	SOT-89	20eu	VR1	4n	Axl
6630t	AX6630-480F	LVR-IC	LDO, 4.8V±2%, 1.2A	SOT-89	20eu	VR1	4n	Axl
6630T	AX6630-290F	LVR-IC	LDO, 2.9V±2%, 1.2A	SOT-89	20eu	VR1	4n	Axl
6630u	AX6630-490F	LVR-IC	LDO, 4.9V±2%, 1.2A	SOT-89	20eu	VR1	4n	Axl
6630U	AX6630-300F	LVR-IC	LDO, 3.0V±2%, 1.2A	SOT-89	20eu	VR1	4n	Axl
6630V	AX6630-310F	LVR-IC	LDO, 3.1V±2%, 1.2A	SOT-89	20eu	VR1	4n	Axl
6630W	AX6630-320F	LVR-IC	LDO, 3.2V±2%, 1.2A	SOT-89	20eu	VR1	4n	Axl
6630X	AX6630-330F	LVR-IC	LDO, 3.3V±2%, 1.2A	SOT-89	20eu	VR1	4n	Axl
6630y	AX6630-500F	LVR-IC	LDO, 5.0V±2%, 1.2A	SOT-89	20eu	VR1	4n	Axl
6630Y	AX6630-340F	LVR-IC	LDO, 3.4V±2%, 1.2A	SOT-89	20eu	VR1	4n	Axl
6630Z	AX6630-350F	LVR-IC	LDO, 3.5V±2%, 1.2A	SOT-89	20eu	VR1	4n	Axl
6634a	AX6634-360F	LVR-IC	LDO, 3.6V±2%, 600mA	SOT-89	20vl	VR1	4n	Axl
6634A	AX6634-120F	LVR-IC	LDO, 1.2V±2%, 600mA	SOT-89	20vl	VR1	4n	Axl
6634b	AX6634-370F	LVR-IC	LDO, 3.7V±2%, 600mA	SOT-89	20vl	VR1	4n	Axl
6634B	AX6634-130F	LVR-IC	LDO, 1.3V±2%, 600mA	SOT-89	20vl	VR1	4n	Axl
6634C	AX6634-140F	LVR-IC	LDO, 1.4V±2%, 600mA	SOT-89	20vl	VR1	4n	Axl
6634d	AX6634-380F	LVR-IC	LDO, 3.8V±2%, 600mA	SOT-89	20vl	VR1	4n	Axl
6634D	AX6634-150F	LVR-IC	LDO, 1.5V±2%, 600mA	SOT-89	20vl	VR1	4n	Axl
6634e	AX6634-390F	LVR-IC	LDO, 3.9V±2%, 600mA	SOT-89	20vl	VR1	4n	Axl
6634E	AX6634-160F	LVR-IC	LDO, 1.6V±2%, 600mA	SOT-89	20vl	VR1	4n	Axl
6634f	AX6634-400F	LVR-IC	LDO, 4.0V±2%, 600mA	SOT-89	20vl	VR1	4n	Axl
6634F	AX6634-170F	LVR-IC	LDO, 1.7V±2%, 600mA	SOT-89	20vl	VR1	4n	Axl
6634g	AX6634-410F	LVR-IC	LDO, 4.1V±2%, 600mA	SOT-89	20vl	VR1	4n	Axl
6634G	AX6634-180F	LVR-IC	LDO, 1.8V±2%, 600mA	SOT-89	20vl	VR1	4n	Axl
6634h	AX6634-420F	LVR-IC	LDO, 4.2V±2%, 600mA	SOT-89	20vl	VR1	4n	Axl
6634H	AX6634-190F	LVR-IC	LDO, 1.9V±2%, 600mA	SOT-89	20vl	VR1	4n	Axl



SMD
code

Type

Function

Short description

Case Pinout Sch. St. Mnf.



6634J	AX6634-200F	LVR-IC	LDO, 2.0V±2%, 600mA	SOT-89	20vl	VR1	4n	Axl
6634K	AX6634-210F	LVR-IC	LDO, 2.1V±2%, 600mA	SOT-89	20vl	VR1	4n	Axl
6634L	AX6634-220F	LVR-IC	LDO, 2.2V±2%, 600mA	SOT-89	20vl	VR1	4n	Axl
6634m	AX6634-430F	LVR-IC	LDO, 4.3V±2%, 600mA	SOT-89	20vl	VR1	4n	Axl
6634M	AX6634-230F	LVR-IC	LDO, 2.3V±2%, 600mA	SOT-89	20vl	VR1	4n	Axl
6634n	AX6634-440F	LVR-IC	LDO, 4.4V±2%, 600mA	SOT-89	20vl	VR1	4n	Axl
6634N	AX6634-240F	LVR-IC	LDO, 2.4V±2%, 600mA	SOT-89	20vl	VR1	4n	Axl
6634o	AX6634-450F	LVR-IC	LDO, 4.5V±2%, 600mA	SOT-89	20vl	VR1	4n	Axl
6634P	AX6634-250F	LVR-IC	LDO, 2.5V±2%, 600mA	SOT-89	20vl	VR1	4n	Axl
6634q	AX6634-460F	LVR-IC	LDO, 4.6V±2%, 600mA	SOT-89	20vl	VR1	4n	Axl
6634Q	AX6634-260F	LVR-IC	LDO, 2.6V±2%, 600mA	SOT-89	20vl	VR1	4n	Axl
6634r	AX6634-470F	LVR-IC	LDO, 4.7V±2%, 600mA	SOT-89	20vl	VR1	4n	Axl
6634R	AX6634-270F	LVR-IC	LDO, 2.7V±2%, 600mA	SOT-89	20vl	VR1	4n	Axl
6634S	AX6634-280F	LVR-IC	LDO, 2.8V±2%, 600mA	SOT-89	20vl	VR1	4n	Axl
6634t	AX6634-480F	LVR-IC	LDO, 4.8V±2%, 600mA	SOT-89	20vl	VR1	4n	Axl
6634T	AX6634-290F	LVR-IC	LDO, 2.9V±2%, 600mA	SOT-89	20vl	VR1	4n	Axl
6634u	AX6634-490F	LVR-IC	LDO, 4.9V±2%, 600mA	SOT-89	20vl	VR1	4n	Axl
6634U	AX6634-300F	LVR-IC	LDO, 3.0V±2%, 600mA	SOT-89	20vl	VR1	4n	Axl
6634V	AX6634-310F	LVR-IC	LDO, 3.1V±2%, 600mA	SOT-89	20vl	VR1	4n	Axl
6634W	AX6634-320F	LVR-IC	LDO, 3.2V±2%, 600mA	SOT-89	20vl	VR1	4n	Axl
6634X	AX6634-330F	LVR-IC	LDO, 3.3V±2%, 600mA	SOT-89	20vl	VR1	4n	Axl
6634y	AX6634-500F	LVR-IC	LDO, 5.0V±2%, 600mA	SOT-89	20vl	VR1	4n	Axl
6634Y	AX6634-340F	LVR-IC	LDO, 3.4V±2%, 600mA	SOT-89	20vl	VR1	4n	Axl
6634Z	AX6634-350F	LVR-IC	LDO, 3.5V±2%, 600mA	SOT-89	20vl	VR1	4n	Axl
664	XC6206P352PR	LVR-IC	LDO, 3.5V±2%, 250mA	SOT-89	20vl	VR1	4c	Tor
664	XC9111B641PR	DC/DC-IC	PFM step-up, 100kHz, 6.4V±2.5%, 400mA	SOT-89	20br	DC5	4c	Tor
665	XC6206P362PR	LVR-IC	LDO, 3.6V±2%, 250mA	SOT-89	20vl	VR1	4c	Tor
665	XC9111B651PR	DC/DC-IC	PFM step-up, 100kHz, 6.5V±2.5%, 400mA	SOT-89	20br	DC5	4c	Tor
666	XC6206P372PR	LVR-IC	LDO, 3.7V±2%, 250mA	SOT-89	20vl	VR1	4c	Tor
666	XC9111B661PR	DC/DC-IC	PFM step-up, 100kHz, 6.6V±2.5%, 400mA	SOT-89	20br	DC5	4c	Tor
667	XC6206P382PR	LVR-IC	LDO, 3.8V±2%, 250mA	SOT-89	20vl	VR1	4c	Tor
667	XC9111B671PR	DC/DC-IC	PFM step-up, 100kHz, 6.7V±2.5%, 400mA	SOT-89	20br	DC5	4c	Tor
668	XC6206P392PR	LVR-IC	LDO, 3.9V±2%, 250mA	SOT-89	20vl	VR1	4c	Tor
668	XC9111B681PR	DC/DC-IC	PFM step-up, 100kHz, 6.8V±2.5%, 400mA	SOT-89	20br	DC5	4c	Tor
669	XC6206P402PR	LVR-IC	LDO, 4.0V±2%, 250mA	SOT-89	20vl	VR1	4c	Tor
669	XC9111B691PR	DC/DC-IC	PFM step-up, 100kHz, 6.9V±2.5%, 400mA	SOT-89	20br	DC5	4c	Tor
669AB	WTM669A-B	Si-npn	GP, 180V, 1.5A, 1W, B=60..120, 140MHz	SOT-89	20tb	-	4b	Wtr
669AC	WTM669A-C	Si-npn	GP, 180V, 1.5A, 1W, B=100..200, 140MHz	SOT-89	20tb	-	4b	Wtr
66A	XC6206P412PR	LVR-IC	LDO, 4.1V±2%, 250mA	SOT-89	20vl	VR1	4c	Tor
66B	XC6206P422PR	LVR-IC	LDO, 4.2V±2%, 250mA	SOT-89	20vl	VR1	4c	Tor
66C	XC6206P432PR	LVR-IC	LDO, 4.3V±2%, 250mA	SOT-89	20vl	VR1	4c	Tor
66D	XC6206P442PR	LVR-IC	LDO, 4.4V±2%, 250mA	SOT-89	20vl	VR1	4c	Tor
66E	XC6206P452PR	LVR-IC	LDO, 4.5V±2%, 250mA	SOT-89	20vl	VR1	4c	Tor
66G	XC6206P462PR	LVR-IC	LDO, 4.6V±2%, 250mA	SOT-89	20vl	VR1	4c	Tor
66H	XC6206P472PR	LVR-IC	LDO, 4.7V±2%, 250mA	SOT-89	20vl	VR1	4c	Tor
66K	XC6206P482PR	LVR-IC	LDO, 4.8V±2%, 250mA	SOT-89	20vl	VR1	4c	Tor
66L	XC6206P492PR	LVR-IC	LDO, 4.9V±2%, 250mA	SOT-89	20vl	VR1	4c	Tor
66LN	ELM7526CAB	Vdet-IC	2.6V±2%, +Reset PPO	SOT-89	20vda	VD7	4a	Elm
66LN	ELM7526NAB	Vdet-IC	2.6V±2%, +Reset ODO	SOT-89	20vda	VD6	4a	Elm
66M	XC6206P502PR	LVR-IC	LDO, 5.0V±2%, 250mA	SOT-89	20vl	VR1	4c	Tor
670	XC9111B701PR	DC/DC-IC	PFM step-up, 100kHz, 7.0V±2.5%, 400mA	SOT-89	20br	DC5	4c	Tor
67LN	ELM7527CAB	Vdet-IC	2.7V±2%, +Reset PPO	SOT-89	20vda	VD7	4a	Elm
67LN	ELM7527NAB	Vdet-IC	2.7V±2%, +Reset ODO	SOT-89	20vda	VD6	4a	Elm
68L	FCX688B	Si-npn	Sw, 12V, 3A, 2W, B>400, >150MHz	SOT-89	20tb	-	4b	Zx
68BA	EUP7968-25CAI	LVR-IC	LDO, 2.5V±3%, 300mA	SOT-89	20ch	VR1	4b	Eut
68BB	EUP7968-25CBI	LVR-IC	LDO, 2.5V±3%, 300mA	SOT-89	20vl	VR1	4b	Eut
68CA	EUP7968-15CAI	LVR-IC	LDO, 1.5V±3%, 300mA	SOT-89	20ch	VR1	4b	Eut
68CB	EUP7968-15CBI	LVR-IC	LDO, 1.5V±3%, 300mA	SOT-89	20vl	VR1	4b	Eut
68DA	EUP7968-18CAI	LVR-IC	LDO, 1.8V±3%, 300mA	SOT-89	20ch	VR1	4b	Eut
68DB	EUP7968-18CBI	LVR-IC	LDO, 1.8V±3%, 300mA	SOT-89	20vl	VR1	4b	Eut
68EA	EUP7968-28CAI	LVR-IC	LDO, 2.8V±3%, 300mA	SOT-89	20ch	VR1	4b	Eut
68EB	EUP7968-28CBI	LVR-IC	LDO, 2.8V±3%, 300mA	SOT-89	20vl	VR1	4b	Eut
68GA	EUP7968-30CAI	LVR-IC	LDO, 3.0V±3%, 300mA	SOT-89	20ch	VR1	4b	Eut
68GB	EUP7968-30CBI	LVR-IC	LDO, 3.0V±3%, 300mA	SOT-89	20vl	VR1	4b	Eut
68HA	EUP7968-33CAI	LVR-IC	LDO, 3.3V±3%, 300mA	SOT-89	20ch	VR1	4b	Eut
68HB	EUP7968-33CBI	LVR-IC	LDO, 3.3V±3%, 300mA	SOT-89	20vl	VR1	4b	Eut
68LN	ELM7528CAB	Vdet-IC	2.8V±2%, +Reset PPO	SOT-89	20vda	VD7	4a	Elm
68LN	ELM7528NAB	Vdet-IC	2.8V±2%, +Reset ODO	SOT-89	20vda	VD6	4a	Elm
68RA	EUP7968-35CAI	LVR-IC	LDO, 3.5V±3%, 300mA	SOT-89	20ch	VR1	4b	Eut
68RB	EUP7968-35CBI	LVR-IC	LDO, 3.5V±3%, 300mA	SOT-89	20vl	VR1	4b	Eut

SMD
code

Type

Function

Short description

Case Pinout Sch. St. Mnf.

SMD code	Type	Function	Short description	Case	Pinout	Sch.	St.	Mnf.
68Y	BZV49-C68	Z-diode	68V±5%, Izt=2mA, 1W	SOT-89	20dm	-	4b	Phi
690	FCX690B	Si-npn	Sw, 45V, 2A, 2W, B>400, >150MHz	SOT-89	20fb	-	4b	Zx
690	TK11690U	LVR-IC	LDO, 9V±1.5%, 190mA	SOT-89	20hn	VR1	4d	Tok
69LN	ELM7529CAB	Vdet-IC	2.9V±2%, +Reset PPO	SOT-89	20vda	VD7	4a	Elm
69LN	ELM7529NAB	Vdet-IC	2.9V±2%, +Reset ODO	SOT-89	20vda	VD6	4a	Elm
6A	FT531Ai	LVR-IC	LDO, 1.3V±2%, 300mA	SOT-89	20vl	VR1	4k	Fmd
6A	KIA7019AF	Vdet-IC	1.9V, -Reset OCO	SOT-89	20vdd	VD6	4a	Kec
6A0	TC55RP602EMB	LVR-IC	LDO, 6.0V±2%, 250mA	SOT-89	20vl	VR1	4h	Mcc
6A0	XC62FP6002P	LVR-IC	6.0V±2%, 250mA	SOT-89	20vl	VR1	4c	Tor
6A5	XC62KN602P	LVR-IC	LDO, -6V±2%, 100mA, 500mW	SOT-89	20ch	VR2	4c	Tor
6B	FT531Bi	LVR-IC	LDO, 1.4V±2%, 300mA	SOT-89	20vl	VR1	4k	Fmd
6B	KIA7021AF	Vdet-IC	2.1V, -Reset OCO	SOT-89	20vdd	VD6	4a	Kec
6B	RH5RL26AA	LVR-IC	2.6V±2.5%, 150mA	SOT-89	20vl	VR1	4c	Ric
6C	FT531Ci	LVR-IC	LDO, 1.5V±2%, 300mA	SOT-89	20vl	VR1	4k	Fmd
6C	KIA7023AF	Vdet-IC	2.3V, -Reset OCO	SOT-89	20vdd	VD6	4a	Kec
6C	RH5RL36AA	LVR-IC	3.6V±2.5%, 150mA	SOT-89	20vl	VR1	4c	Ric
6D	FT531Di	LVR-IC	LDO, 1.8V±2%, 300mA	SOT-89	20vl	VR1	4k	Fmd
6D	KIA7025AF	Vdet-IC	2.5V, -Reset OCO	SOT-89	20vdd	VD6	4a	Kec
6D	RH5RL46AA	LVR-IC	4.6V±2.5%, 150mA	SOT-89	20vl	VR1	4c	Ric
6E	FT531Ei	LVR-IC	LDO, 2.5V±2%, 300mA	SOT-89	20vl	VR1	4k	Fmd
6E	KIA7027AF	Vdet-IC	2.7V, -Reset OCO	SOT-89	20vdd	VD6	4a	Kec
6E	RH5RL56AA	LVR-IC	5.6V±2.5%, 150mA	SOT-89	20vl	VR1	4c	Ric
6F	FT531Fi	LVR-IC	LDO, 2.7V±2%, 300mA	SOT-89	20vl	VR1	4k	Fmd
6F	KIA7029AF	Vdet-IC	2.9V, -Reset OCO	SOT-89	20vdd	VD6	4a	Kec
6G	FT531Gi	LVR-IC	LDO, 2.8V±2%, 300mA	SOT-89	20vl	VR1	4k	Fmd
6G	KIA7031AF	Vdet-IC	3.1V, -Reset OCO	SOT-89	20vdd	VD6	4a	Kec
6H	FT531Hi	LVR-IC	LDO, 2.85V±2%, 300mA	SOT-89	20vl	VR1	4k	Fmd
6H	KIA7032AF	Vdet-IC	3.2V, -Reset OCO	SOT-89	20vdd	VD6	4a	Kec
6I	FT531Ii	LVR-IC	LDO, 3.0V±2%, 300mA	SOT-89	20vl	VR1	4k	Fmd
6J	FT531Ji	LVR-IC	LDO, 3.3V±2%, 300mA	SOT-89	20vl	VR1	4k	Fmd
6J	KIA7033AF	Vdet-IC	3.3V, -Reset OCO	SOT-89	20vdd	VD6	4a	Kec
6J	RH5RE26AA	LVR-IC	Ultra-LDO, 2.6V±2.5%, 300mA	SOT-89	20vl	VR1	4c	Ric
6K	FT531Ki	LVR-IC	LDO, 3.6V±2%, 300mA	SOT-89	20vl	VR1	4k	Fmd
6K	KIA7034AF	Vdet-IC	3.4V, -Reset OCO	SOT-89	20vdd	VD6	4a	Kec
6K	RH5RE36AA	LVR-IC	Ultra-LDO, 3.6V±2.5%, 300mA	SOT-89	20vl	VR1	4c	Ric
6L	KIA7035AF	Vdet-IC	3.5V, -Reset OCO	SOT-89	20vdd	VD6	4a	Kec
6L	RH5RE46AA	LVR-IC	Ultra-LDO, 4.6V±2.5%, 300mA	SOT-89	20vl	VR1	4c	Ric
6M	KIA7036AF	Vdet-IC	3.6V, -Reset OCO	SOT-89	20vdd	VD6	4a	Kec
6M	RH5RE56AA	LVR-IC	Ultra-LDO, 5.6V±2.5%, 300mA	SOT-89	20vl	VR1	4c	Ric
6N	KIA7039AF	Vdet-IC	3.9V, -Reset OCO	SOT-89	20vdd	VD6	4a	Kec
6P	KIA7042AF	Vdet-IC	4.2V, -Reset OCO	SOT-89	20vdd	VD6	4a	Kec
6R	KIA7045AF	Vdet-IC	4.5V, -Reset OCO	SOT-89	20vdd	VD6	4a	Kec
6Y2	BZV49-C6V2	Z-diode	6.2V±5%, Izt=5mA, 1W	SOT-89	20dm	-	4b	Phi
6Y8	BZV49-C6V8	Z-diode	6.8V±5%, Izt=5mA, 1W	SOT-89	20dm	-	4b	Phi
7024A-1	HT7024A-1	Vdet-IC	2.4V, -Reset ODO	SOT-89	20vda	VD6	4b	Htk
7027A-1	HT7027A-1	Vdet-IC	2.7V, -Reset ODO	SOT-89	20vda	VD6	4b	Htk
7033A-1	HT7033A-1	Vdet-IC	3.3V, -Reset ODO	SOT-89	20vda	VD6	4b	Htk
7039A-1	HT7039A-1	Vdet-IC	3.9V, -Reset ODO	SOT-89	20vda	VD6	4b	Htk
7044A-1	HT7044A-1	Vdet-IC	4.4V, -Reset ODO	SOT-89	20vda	VD6	4b	Htk
705	FCX705	Si-pnp-Darl	HV, 140V, 1A, 1W, B=3k, .30k, >150MHz	SOT-89	20tb	-	4b	Zx
7050A-1	HT7050A-1	Vdet-IC	5V, -Reset ODO	SOT-89	20vda	VD6	4b	Htk
70LN	ELM7530CAB	Vdet-IC	3.0V±2%, +Reset PPO	SOT-89	20vda	VD7	4a	Elm
70LN	ELM7530NAB	Vdet-IC	3.0V±2%, +Reset ODO	SOT-89	20vda	VD6	4a	Elm
7130-1	HT7130-1	LVR-IC	LDO, 3V±3%, 30mA	SOT-89	20vl	VR1	4b	Htk
7133-1	HT7133-1	LVR-IC	LDO, 3.3V±3%, 30mA	SOT-89	20vl	VR1	4b	Htk
7136-1	HT7136-1	LVR-IC	LDO, 3.6V±3%, 30mA	SOT-89	20vl	VR1	4b	Htk
7144-1	HT7144-1	LVR-IC	LDO, 4.4V±3%, 30mA	SOT-89	20vl	VR1	4b	Htk
7150-1	HT7150-1	LVR-IC	LDO, 5V±3%, 30mA	SOT-89	20vl	VR1	4b	Htk
717	2SB717PT	Si-pnp	AF, Sw, 12V, 3A, B=300, .450, 110MHz	SOT-89	20tb	-	4g	Chm
717	FCX717	Si-pnp	Sw, 12V, 3A, 2W, B=300, .450, >110MHz	SOT-89	20tb	-	4b	Zx
718	FCX718	Si-pnp	Sw, 20V, 2.5A, 2W, B=300, .450, >180MHz	SOT-89	20tb	-	4b	Zx
71LN	ELM7531CAB	Vdet-IC	3.1V±2%, +Reset PPO	SOT-89	20vda	VD7	4a	Elm
71LN	ELM7531NAB	Vdet-IC	3.1V±2%, +Reset ODO	SOT-89	20vda	VD6	4a	Elm
72LN	ELM7532CAB	Vdet-IC	3.2V±2%, +Reset PPO	SOT-89	20vda	VD7	4a	Elm
72LN	ELM7532NAB	Vdet-IC	3.2V±2%, +Reset ODO	SOT-89	20vda	VD6	4a	Elm
73L19	SJ73L19F	Vdet-IC	1.9V±5%, -Reset OCO	SOT-89	20vdd	VD6	4b	Kau
73L21	SJ73L21F	Vdet-IC	2.1V±5%, -Reset OCO	SOT-89	20vdd	VD6	4b	Kau
73L23	SJ73L23F	Vdet-IC	2.3V±5%, -Reset OCO	SOT-89	20vdd	VD6	4b	Kau
73L25	SJ73L25F	Vdet-IC	2.5V±5%, -Reset OCO	SOT-89	20vdd	VD6	4b	Kau
73L27	SJ73L27F	Vdet-IC	2.7V±5%, -Reset OCO	SOT-89	20vdd	VD6	4b	Kau

Note: ELM75xxCEB series LN- lot number L=0...9 N=A to Z(I, O, X excepted); ELM75xxNEB series LN- lot number L=A to Z(I, O, X excepted) N=0...9



SMD
code

Type

Function

Short description

Case Pinout Sch. St. Mnf.



73L29	SJ73L29F	Vdet-IC	2.9V±5%, -Reset OCO	SOT-89	20vdd	VD6	4b	Kau
73L31	SJ73L31F	Vdet-IC	3.1V±5%, -Reset OCO	SOT-89	20vdd	VD6	4b	Kau
73L32	SJ73L32F	Vdet-IC	3.2V±5%, -Reset OCO	SOT-89	20vdd	VD6	4b	Kau
73L33	SJ73L33F	Vdet-IC	3.3V±5%, -Reset OCO	SOT-89	20vdd	VD6	4b	Kau
73L34	SJ73L34F	Vdet-IC	3.4V±5%, -Reset OCO	SOT-89	20vdd	VD6	4b	Kau
73L35	SJ73L35F	Vdet-IC	3.5V±5%, -Reset OCO	SOT-89	20vdd	VD6	4b	Kau
73L36	SJ73L36F	Vdet-IC	3.6V±5%, -Reset OCO	SOT-89	20vdd	VD6	4b	Kau
73L39	SJ73L39F	Vdet-IC	3.9V±5%, -Reset OCO	SOT-89	20vdd	VD6	4b	Kau
73L42	SJ73L42F	Vdet-IC	4.2V±5%, -Reset OCO	SOT-89	20vdd	VD6	4b	Kau
73L45	SJ73L45F	Vdet-IC	4.5V±5%, -Reset OCO	SOT-89	20vdd	VD6	4b	Kau
73LN	ELM7533CAB	Vdet-IC	3.3V±2%, +Reset PPO	SOT-89	20vda	VD7	4a	Elm
73LN	ELM7533NAB	Vdet-IC	3.3V±2%, +Reset ODO	SOT-89	20vda	VD6	4a	Elm
74LN	ELM7534CAB	Vdet-IC	3.4V±2%, +Reset PPO	SOT-89	20vda	VD7	4a	Elm
74LN	ELM7534NAB	Vdet-IC	3.4V±2%, +Reset ODO	SOT-89	20vda	VD6	4a	Elm
75LN	ELM7535CAB	Vdet-IC	3.5V±2%, +Reset PPO	SOT-89	20vda	VD7	4a	Elm
75LN	ELM7535NAB	Vdet-IC	3.5V±2%, +Reset ODO	SOT-89	20vda	VD6	4a	Elm
75Y	BZV49-C75	Z-diode	75V±5%, Izt=5mA, 1W	SOT-89	20dm	-	4b	Phi
76H19	SJ76H19F	Vdet-IC	1.9V±5%, +Reset OCO	SOT-89	20vdd	VD6	4b	Kau
76H21	SJ76H21F	Vdet-IC	2.1V±5%, +Reset OCO	SOT-89	20vdd	VD6	4b	Kau
76H23	SJ76H23F	Vdet-IC	2.3V±5%, +Reset OCO	SOT-89	20vdd	VD6	4b	Kau
76H25	SJ76H25F	Vdet-IC	2.5V±5%, +Reset OCO	SOT-89	20vdd	VD6	4b	Kau
76H27	SJ76H27F	Vdet-IC	2.7V±5%, +Reset OCO	SOT-89	20vdd	VD6	4b	Kau
76H29	SJ76H29F	Vdet-IC	2.9V±5%, +Reset OCO	SOT-89	20vdd	VD6	4b	Kau
76H31	SJ76H31F	Vdet-IC	3.1V±5%, +Reset OCO	SOT-89	20vdd	VD6	4b	Kau
76H32	SJ76H32F	Vdet-IC	3.2V±5%, +Reset OCO	SOT-89	20vdd	VD6	4b	Kau
76H33	SJ76H33F	Vdet-IC	3.3V±5%, +Reset OCO	SOT-89	20vdd	VD6	4b	Kau
76H34	SJ76H34F	Vdet-IC	3.4V±5%, +Reset OCO	SOT-89	20vdd	VD6	4b	Kau
76H35	SJ76H35F	Vdet-IC	3.5V±5%, +Reset OCO	SOT-89	20vdd	VD6	4b	Kau
76H36	SJ76H36F	Vdet-IC	3.6V±5%, +Reset OCO	SOT-89	20vdd	VD6	4b	Kau
76H39	SJ76H39F	Vdet-IC	3.9V±5%, +Reset OCO	SOT-89	20vdd	VD6	4b	Kau
76H42	SJ76H42F	Vdet-IC	4.2V±5%, +Reset OCO	SOT-89	20vdd	VD6	4b	Kau
76H45	SJ76H45F	Vdet-IC	4.5V±5%, +Reset OCO	SOT-89	20vdd	VD6	4b	Kau
76LN	ELM7536CAB	Vdet-IC	3.6V±2%, +Reset PPO	SOT-89	20vda	VD7	4a	Elm
76LN	ELM7536NAB	Vdet-IC	3.6V±2%, +Reset ODO	SOT-89	20vda	VD6	4a	Elm
772	2SB772PT-P	Si-pnp	AF, Sw, 30V, 3A, B=160..320, 300MHz	SOT-89	20tb	-	4g	Chm
77LN	ELM7537CAB	Vdet-IC	3.7V±2%, +Reset PPO	SOT-89	20vda	VD7	4a	Elm
77LN	ELM7537NAB	Vdet-IC	3.7V±2%, +Reset ODO	SOT-89	20vda	VD6	4a	Elm
789	FCX789A	Si-pnp	Sw, 25V, 3A, 2W, B=300..800, >100MHz	SOT-89	20tb	-	4b	Zx
78L05	SN78L05F	LVR-IC	5.0V±10%, 150mA	SOT-89	20vl	VR1	4b	Kau
78L06	SN78L06F	LVR-IC	6.0V±10%, 150mA	SOT-89	20vl	VR1	4b	Kau
78L08	SN78L08F	LVR-IC	8.0V±10%, 150mA	SOT-89	20vl	VR1	4b	Kau
78L09	SN78L09F	LVR-IC	9.0V±10%, 150mA	SOT-89	20vl	VR1	4b	Kau
78L10	SN78L10F	LVR-IC	10V±10%, 150mA	SOT-89	20vl	VR1	4b	Kau
78L12	SN78L12F	LVR-IC	12V±10%, 150mA	SOT-89	20vl	VR1	4b	Kau
78L15	SN78L15F	LVR-IC	15V±10%, 150mA	SOT-89	20vl	VR1	4b	Kau
78L18	SN78L18F	LVR-IC	18V±10%, 150mA	SOT-89	20vl	VR1	4b	Kau
78L24	SN78L24F	LVR-IC	24V±10%, 150mA	SOT-89	20vl	VR1	4b	Kau
78LN	ELM7538CAB	Vdet-IC	3.8V±2%, +Reset PPO	SOT-89	20vda	VD7	4a	Elm
78LN	ELM7538NAB	Vdet-IC	3.8V±2%, +Reset ODO	SOT-89	20vda	VD6	4a	Elm
790	FCX790A	Si-pnp	Sw, 50V, 2A, 2W, B=300..800, >100MHz	SOT-89	20tb	-	4b	Zx
79L05	SN79L05F	LVR-IC	-5.0V±10%, 150mA	SOT-89	20vl	VR2	4b	Kau
79L06	SN79L06F	LVR-IC	-6.0V±10%, 150mA	SOT-89	20vl	VR2	4b	Kau
79L08	SN79L08F	LVR-IC	-8.0V±10%, 150mA	SOT-89	20vl	VR2	4b	Kau
79L12	SN79L12F	LVR-IC	-12V±10%, 150mA	SOT-89	20vl	VR2	4b	Kau
79L15	SN79L15F	LVR-IC	-15V±10%, 150mA	SOT-89	20vl	VR2	4b	Kau
79L18	SN79L18F	LVR-IC	-18V±10%, 150mA	SOT-89	20vl	VR2	4b	Kau
79L24	SN79L24F	LVR-IC	-24V±10%, 150mA	SOT-89	20vl	VR2	4b	Kau
79LN	ELM7539CAB	Vdet-IC	3.9V±2%, +Reset PPO	SOT-89	20vda	VD7	4a	Elm
79LN	ELM7539NAB	Vdet-IC	3.9V±2%, +Reset ODO	SOT-89	20vda	VD6	4a	Elm
7B	RH5RL27AA	LVR-IC	2.7V±2.5%, 150mA	SOT-89	20vl	VR1	4c	Ric
7C	RH5RL37AA	LVR-IC	3.7V±2.5%, 150mA	SOT-89	20vl	VR1	4c	Ric
7D	FT532Di	LVR-IC	LDO, 1.8V±2%, 700mA	SOT-89	20vl	VR1	4k	Fmd
7D	RH5RL47AA	LVR-IC	4.7V±2.5%, 150mA	SOT-89	20vl	VR1	4c	Ric
7E	FT532Ei	LVR-IC	LDO, 2.5V±2%, 700mA	SOT-89	20vl	VR1	4k	Fmd
7E	RH5RL57AA	LVR-IC	5.7V±2.5%, 150mA	SOT-89	20vl	VR1	4c	Ric
7F	FT532Fi	LVR-IC	LDO, 2.7V±2%, 700mA	SOT-89	20vl	VR1	4k	Fmd
7G	FT532Gi	LVR-IC	LDO, 2.8V±2%, 700mA	SOT-89	20vl	VR1	4k	Fmd
7H	FT532Hi	LVR-IC	LDO, 2.85V±2%, 700mA	SOT-89	20vl	VR1	4k	Fmd
7I	FT532Ii	LVR-IC	LDO, 3.0V±2%, 700mA	SOT-89	20vl	VR1	4k	Fmd
7J	FT532Ji	LVR-IC	LDO, 3.3V±2%, 700mA	SOT-89	20vl	VR1	4k	Fmd

SMD
code

Type

Function

Short description

Case Pinout Sch. St. Mnf.

SMD code	Type	Function	Short description	Case	Pinout	Sch.	St.	Mnf.
7J	RH5RE27AA	LVR-IC	Ultra-LDO, 2.7V±2.5%, 300mA	SOT-89	20vl	VR1	4c	Ric
7K	FT532Ki	LVR-IC	LDO, 3.6V±2%, 700mA	SOT-89	20vl	VR1	4k	Fmd
7K	RH5RE37AA	LVR-IC	Ultra-LDO, 3.7V±2.5%, 300mA	SOT-89	20vl	VR1	4c	Ric
7L	RH5RE47AA	LVR-IC	Ultra-LDO, 4.7V±2.5%, 300mA	SOT-89	20vl	VR1	4c	Ric
7M	RH5RE57AA	LVR-IC	Ultra-LDO, 5.7V±2.5%, 300mA	SOT-89	20vl	VR1	4c	Ric
7Y5	BZV49-C7V5	Z-diode	7.5V±5%, Izt=5mA, 1W	SOT-89	20dm	-	4b	Phi
80LN	ELM7540CAB	Vdet-IC	4.0V±2%, +Reset PPO	SOT-89	20vda	VD7	4a	Elm
80LN	ELM7540NAB	Vdet-IC	4.0V±2%, +Reset ODO	SOT-89	20vda	VD6	4a	Elm
81LN	ELM7541CAB	Vdet-IC	4.1V±2%, +Reset PPO	SOT-89	20vda	VD7	4a	Elm
81LN	ELM7541NAB	Vdet-IC	4.1V±2%, +Reset ODO	SOT-89	20vda	VD6	4a	Elm
82LN	ELM7542CAB	Vdet-IC	4.2V±2%, +Reset PPO	SOT-89	20vda	VD7	4a	Elm
82LN	ELM7542NAB	Vdet-IC	4.2V±2%, +Reset ODO	SOT-89	20vda	VD6	4a	Elm
83LN	ELM7543CAB	Vdet-IC	4.3V±2%, +Reset PPO	SOT-89	20vda	VD7	4a	Elm
83LN	ELM7543NAB	Vdet-IC	4.3V±2%, +Reset ODO	SOT-89	20vda	VD6	4a	Elm
84K	XC6701D18PR	LVR-IC	1.8V±2%, 150mA	SOT-89	20ch	VR1	4a	Tor
84L	XC6701D19PR	LVR-IC	1.9V±2%, 150mA	SOT-89	20ch	VR1	4a	Tor
84LN	ELM7544CAB	Vdet-IC	4.4V±2%, +Reset PPO	SOT-89	20vda	VD7	4a	Elm
84LN	ELM7544NAB	Vdet-IC	4.4V±2%, +Reset ODO	SOT-89	20vda	VD6	4a	Elm
84M	XC6701D20PR	LVR-IC	2.0V±2%, 150mA	SOT-89	20ch	VR1	4a	Tor
84N	XC6701D21PR	LVR-IC	2.1V±2%, 150mA	SOT-89	20ch	VR1	4a	Tor
84P	XC6701D22PR	LVR-IC	2.2V±2%, 150mA	SOT-89	20ch	VR1	4a	Tor
84R	XC6701D23PR	LVR-IC	2.3V±2%, 150mA	SOT-89	20ch	VR1	4a	Tor
84S	XC6701D24PR	LVR-IC	2.4V±2%, 150mA	SOT-89	20ch	VR1	4a	Tor
84T	XC6701D25PR	LVR-IC	2.5V±2%, 150mA	SOT-89	20ch	VR1	4a	Tor
84U	XC6701D26PR	LVR-IC	2.6V±2%, 150mA	SOT-89	20ch	VR1	4a	Tor
84V	XC6701D27PR	LVR-IC	2.7V±2%, 150mA	SOT-89	20ch	VR1	4a	Tor
84X	XC6701D28PR	LVR-IC	2.8V±2%, 150mA	SOT-89	20ch	VR1	4a	Tor
84Y	XC6701D29PR	LVR-IC	2.9V±2%, 150mA	SOT-89	20ch	VR1	4a	Tor
84Z	XC6701D30PR	LVR-IC	3.0V±2%, 150mA	SOT-89	20ch	VR1	4a	Tor
850	XC6701D31PR	LVR-IC	3.1V±2%, 150mA	SOT-89	20ch	VR1	4a	Tor
851	XC6701D32PR	LVR-IC	3.2V±2%, 150mA	SOT-89	20ch	VR1	4a	Tor
852	XC6701D33PR	LVR-IC	3.3V±2%, 150mA	SOT-89	20ch	VR1	4a	Tor
853	XC6701D34PR	LVR-IC	3.4V±2%, 150mA	SOT-89	20ch	VR1	4a	Tor
854	XC6701D35PR	LVR-IC	3.5V±2%, 150mA	SOT-89	20ch	VR1	4a	Tor
855	XC6701D36PR	LVR-IC	3.6V±2%, 150mA	SOT-89	20ch	VR1	4a	Tor
856	XC6701D37PR	LVR-IC	3.7V±2%, 150mA	SOT-89	20ch	VR1	4a	Tor
857	XC6701D38PR	LVR-IC	3.8V±2%, 150mA	SOT-89	20ch	VR1	4a	Tor
858	XC6701D39PR	LVR-IC	3.9V±2%, 150mA	SOT-89	20ch	VR1	4a	Tor
859	XC6701D40PR	LVR-IC	4.0V±2%, 150mA	SOT-89	20ch	VR1	4a	Tor
85A	XC6701D41PR	LVR-IC	4.1V±2%, 150mA	SOT-89	20ch	VR1	4a	Tor
85B	XC6701D42PR	LVR-IC	4.2V±2%, 150mA	SOT-89	20ch	VR1	4a	Tor
85C	XC6701D43PR	LVR-IC	4.3V±2%, 150mA	SOT-89	20ch	VR1	4a	Tor
85C	XC6701D58PR	LVR-IC	5.8V±2%, 150mA	SOT-89	20ch	VR1	4a	Tor
85D	XC6701D44PR	LVR-IC	4.4V±2%, 150mA	SOT-89	20ch	VR1	4a	Tor
85E	XC6701D45PR	LVR-IC	4.5V±2%, 150mA	SOT-89	20ch	VR1	4a	Tor
85F	XC6701D46PR	LVR-IC	4.6V±2%, 150mA	SOT-89	20ch	VR1	4a	Tor
85H	XC6701D47PR	LVR-IC	4.7V±2%, 150mA	SOT-89	20ch	VR1	4a	Tor
85K	XC6701D48PR	LVR-IC	4.8V±2%, 150mA	SOT-89	20ch	VR1	4a	Tor
85L	XC6701D49PR	LVR-IC	4.9V±2%, 150mA	SOT-89	20ch	VR1	4a	Tor
85LN	ELM7545CAB	Vdet-IC	4.5V±2%, +Reset PPO	SOT-89	20vda	VD7	4a	Elm
85LN	ELM7545NAB	Vdet-IC	4.5V±2%, +Reset ODO	SOT-89	20vda	VD6	4a	Elm
85M	XC6701D50PR	LVR-IC	5.0V±2%, 150mA	SOT-89	20ch	VR1	4a	Tor
85N	XC6701D51PR	LVR-IC	5.1V±2%, 150mA	SOT-89	20ch	VR1	4a	Tor
85P	XC6701D52PR	LVR-IC	5.2V±2%, 150mA	SOT-89	20ch	VR1	4a	Tor
85R	XC6701D53PR	LVR-IC	5.3V±2%, 150mA	SOT-89	20ch	VR1	4a	Tor
85S	XC6701D54PR	LVR-IC	5.4V±2%, 150mA	SOT-89	20ch	VR1	4a	Tor
85T	XC6701D55PR	LVR-IC	5.5V±2%, 150mA	SOT-89	20ch	VR1	4a	Tor
85U	XC6701D56PR	LVR-IC	5.6V±2%, 150mA	SOT-89	20ch	VR1	4a	Tor
85V	XC6701D57PR	LVR-IC	5.7V±2%, 150mA	SOT-89	20ch	VR1	4a	Tor
85Y	XC6701D59PR	LVR-IC	5.9V±2%, 150mA	SOT-89	20ch	VR1	4a	Tor
85Z	XC6701D60PR	LVR-IC	6.0V±2%, 150mA	SOT-89	20ch	VR1	4a	Tor
860	XC6701D61PR	LVR-IC	6.1V±2%, 150mA	SOT-89	20ch	VR1	4a	Tor
861	XC6701D62PR	LVR-IC	6.2V±2%, 150mA	SOT-89	20ch	VR1	4a	Tor
862	XC6701D63PR	LVR-IC	6.3V±2%, 150mA	SOT-89	20ch	VR1	4a	Tor
863	XC6701D64PR	LVR-IC	6.4V±2%, 150mA	SOT-89	20ch	VR1	4a	Tor
864	XC6701D65PR	LVR-IC	6.5V±2%, 150mA	SOT-89	20ch	VR1	4a	Tor
865	XC6701D66PR	LVR-IC	6.6V±2%, 150mA	SOT-89	20ch	VR1	4a	Tor
866	XC6701D67PR	LVR-IC	6.7V±2%, 150mA	SOT-89	20ch	VR1	4a	Tor
867	XC6701D68PR	LVR-IC	6.8V±2%, 150mA	SOT-89	20ch	VR1	4a	Tor
868	XC6701D69PR	LVR-IC	6.9V±2%, 150mA	SOT-89	20ch	VR1	4a	Tor



SMD
code

Type

Function

Short description

Case Pinout Sch. St. Mnf.



869	XC6701D70PR	LVR-IC	7.0V±2%, 150mA	SOT-89	20ch	VR1	4a	Tor
86A	XC6701D71PR	LVR-IC	7.1V±2%, 150mA	SOT-89	20ch	VR1	4a	Tor
86B	XC6701D72PR	LVR-IC	7.2V±2%, 150mA	SOT-89	20ch	VR1	4a	Tor
86C	XC6701D73PR	LVR-IC	7.3V±2%, 150mA	SOT-89	20ch	VR1	4a	Tor
86D	XC6701D74PR	LVR-IC	7.4V±2%, 150mA	SOT-89	20ch	VR1	4a	Tor
86E	XC6701D75PR	LVR-IC	7.5V±2%, 150mA	SOT-89	20ch	VR1	4a	Tor
86F	XC6701D76PR	LVR-IC	7.6V±2%, 150mA	SOT-89	20ch	VR1	4a	Tor
86H	XC6701D77PR	LVR-IC	7.7V±2%, 150mA	SOT-89	20ch	VR1	4a	Tor
86K	XC6701D78PR	LVR-IC	7.8V±2%, 150mA	SOT-89	20ch	VR1	4a	Tor
86L	XC6701D79PR	LVR-IC	7.9V±2%, 150mA	SOT-89	20ch	VR1	4a	Tor
86LN	ELM7546CAB	Vdet-IC	4.6V±2%, +Reset PPO	SOT-89	20vda	VD7	4a	Elm
86LN	ELM7546NAB	Vdet-IC	4.6V±2%, +Reset ODO	SOT-89	20vda	VD6	4a	Elm
86M	XC6701D80PR	LVR-IC	8.0V±2%, 150mA	SOT-89	20ch	VR1	4a	Tor
86N	XC6701D81PR	LVR-IC	8.1V±2%, 150mA	SOT-89	20ch	VR1	4a	Tor
86P	XC6701D82PR	LVR-IC	8.2V±2%, 150mA	SOT-89	20ch	VR1	4a	Tor
86R	XC6701D83PR	LVR-IC	8.3V±2%, 150mA	SOT-89	20ch	VR1	4a	Tor
86S	XC6701D84PR	LVR-IC	8.4V±2%, 150mA	SOT-89	20ch	VR1	4a	Tor
86T	XC6701D85PR	LVR-IC	8.5V±2%, 150mA	SOT-89	20ch	VR1	4a	Tor
86U	XC6701D86PR	LVR-IC	8.6V±2%, 150mA	SOT-89	20ch	VR1	4a	Tor
86V	XC6701D87PR	LVR-IC	8.7V±2%, 150mA	SOT-89	20ch	VR1	4a	Tor
86X	XC6701D88PR	LVR-IC	8.8V±2%, 150mA	SOT-89	20ch	VR1	4a	Tor
86Y	XC6701D89PR	LVR-IC	8.9V±2%, 150mA	SOT-89	20ch	VR1	4a	Tor
86Z	XC6701D90PR	LVR-IC	9.0V±2%, 150mA	SOT-89	20ch	VR1	4a	Tor
870	XC6701D91PR	LVR-IC	9.1V±2%, 150mA	SOT-89	20ch	VR1	4a	Tor
871	XC6701D92PR	LVR-IC	9.2V±2%, 150mA	SOT-89	20ch	VR1	4a	Tor
872	XC6701D93PR	LVR-IC	9.3V±2%, 150mA	SOT-89	20ch	VR1	4a	Tor
873	XC6701D94PR	LVR-IC	9.4V±2%, 150mA	SOT-89	20ch	VR1	4a	Tor
874	XC6701D95PR	LVR-IC	9.5V±2%, 150mA	SOT-89	20ch	VR1	4a	Tor
875	XC6701D96PR	LVR-IC	9.6V±2%, 150mA	SOT-89	20ch	VR1	4a	Tor
876	XC6701D97PR	LVR-IC	9.7V±2%, 150mA	SOT-89	20ch	VR1	4a	Tor
877	XC6701D98PR	LVR-IC	9.8V±2%, 150mA	SOT-89	20ch	VR1	4a	Tor
878	XC6701D99PR	LVR-IC	9.9V±2%, 150mA	SOT-89	20ch	VR1	4a	Tor
879	XC6701DA0PR	LVR-IC	10.0V±2%, 150mA	SOT-89	20ch	VR1	4a	Tor
87A	XC6701DA1PR	LVR-IC	10.1V±2%, 150mA	SOT-89	20ch	VR1	4a	Tor
87B	XC6701DA2PR	LVR-IC	10.2V±2%, 150mA	SOT-89	20ch	VR1	4a	Tor
87C	XC6701DA3PR	LVR-IC	10.3V±2%, 150mA	SOT-89	20ch	VR1	4a	Tor
87D	XC6701DA4PR	LVR-IC	10.4V±2%, 150mA	SOT-89	20ch	VR1	4a	Tor
87E	XC6701DA5PR	LVR-IC	10.5V±2%, 150mA	SOT-89	20ch	VR1	4a	Tor
87F	XC6701DA6PR	LVR-IC	10.6V±2%, 150mA	SOT-89	20ch	VR1	4a	Tor
87H	XC6701DA7PR	LVR-IC	10.7V±2%, 150mA	SOT-89	20ch	VR1	4a	Tor
87K	XC6701DA8PR	LVR-IC	10.8V±2%, 150mA	SOT-89	20ch	VR1	4a	Tor
87L	XC6701DA9PR	LVR-IC	10.9V±2%, 150mA	SOT-89	20ch	VR1	4a	Tor
87LN	ELM7547CAB	Vdet-IC	4.7V±2%, +Reset PPO	SOT-89	20vda	VD7	4a	Elm
87LN	ELM7547NAB	Vdet-IC	4.7V±2%, +Reset ODO	SOT-89	20vda	VD6	4a	Elm
87M	XC6701DB0PR	LVR-IC	11.0V±2%, 150mA	SOT-89	20ch	VR1	4a	Tor
87N	XC6701DB1PR	LVR-IC	11.1V±2%, 150mA	SOT-89	20ch	VR1	4a	Tor
87P	XC6701DB2PR	LVR-IC	11.2V±2%, 150mA	SOT-89	20ch	VR1	4a	Tor
87R	XC6701DB3PR	LVR-IC	11.3V±2%, 150mA	SOT-89	20ch	VR1	4a	Tor
87S	XC6701DB4PR	LVR-IC	11.4V±2%, 150mA	SOT-89	20ch	VR1	4a	Tor
87T	XC6701DB5PR	LVR-IC	11.5V±2%, 150mA	SOT-89	20ch	VR1	4a	Tor
87U	XC6701DB6PR	LVR-IC	11.6V±2%, 150mA	SOT-89	20ch	VR1	4a	Tor
87V	XC6701DB7PR	LVR-IC	11.7V±2%, 150mA	SOT-89	20ch	VR1	4a	Tor
87X	XC6701DB8PR	LVR-IC	11.8V±2%, 150mA	SOT-89	20ch	VR1	4a	Tor
87Y	XC6701DB9PR	LVR-IC	11.9V±2%, 150mA	SOT-89	20ch	VR1	4a	Tor
87Z	XC6701DC0PR	LVR-IC	12.0V±2%, 150mA	SOT-89	20ch	VR1	4a	Tor
882	2SD882PT-E	Si-npn	AF, Sw, 30V, 3A, B=250...500, 100MHz	SOT-89	20tb	-	4b	Chm
88LN	ELM7548CAB	Vdet-IC	4.8V±2%, +Reset PPO	SOT-89	20vda	VD7	4a	Elm
88LN	ELM7548NAB	Vdet-IC	4.8V±2%, +Reset ODO	SOT-89	20vda	VD6	4a	Elm
89LN	ELM7549CAB	Vdet-IC	4.9V±2%, +Reset PPO	SOT-89	20vda	VD7	4a	Elm
89LN	ELM7549NAB	Vdet-IC	4.9V±2%, +Reset ODO	SOT-89	20vda	VD6	4a	Elm
8A	HA178L02UA	LVR-IC	2.5V±5%, 150mA, 800mW	SOT-89	20ch	VR1	4e	Ren
8A	KIA78L05F	LVR-IC	5V±5%, 150mA	SOT-89	20ch	VR1	4a	Kec
8A	NJM78L02UA	LVR-IC	2.6V, 5%, 0.1A	SOT-89	20ch	VR1	4b	Njr
8B	HA178L05UA	LVR-IC	5V±5%, 150mA, 800mW	SOT-89	20ch	VR1	4e	Ren
8B	KIA78L06F	LVR-IC	6V±5%, 150mA	SOT-89	20ch	VR1	4a	Kec
8B	NJM78L03UA	LVR-IC	3V, 5%, 0.1A	SOT-89	20ch	VR1	4b	Njr
8B	RH5RL28AA	LVR-IC	2.8V±2.5%, 150mA	SOT-89	20vl	VR1	4c	Ric
8C	HA178L56UA	LVR-IC	5.6V±5%, 150mA, 800mW	SOT-89	20ch	VR1	4e	Ren
8C	NJM78L05UA	LVR-IC	5V, 5%, 0.1A	SOT-89	20ch	VR1	4b	Njr
8C	RH5RL38AA	LVR-IC	3.8V±2.5%, 150mA	SOT-89	20vl	VR1	4c	Ric

Note: ELM75xxCEB series LN- lot number L=0...9 N=A to Z(I, O, X excepted); ELM75xxNEB series LN- lot number L=A to Z(I, O, X excepted) N=0...9

SMD
code

Type

Function

Short description

Case Pinout Sch. St. Mnf.

SMD code	Type	Function	Short description	Case	Pinout	Sch.	St.	Mnf.
8C0	XC6701DC1PR	LVR-IC	12.1V±2%, 150mA	SOT-89	20ch	VR1	4a	Tor
8C1	XC6701DC2PR	LVR-IC	12.2V±2%, 150mA	SOT-89	20ch	VR1	4a	Tor
8C2	XC6701DC3PR	LVR-IC	12.3V±2%, 150mA	SOT-89	20ch	VR1	4a	Tor
8C3	XC6701DC4PR	LVR-IC	12.4V±2%, 150mA	SOT-89	20ch	VR1	4a	Tor
8C4	XC6701DC5PR	LVR-IC	12.5V±2%, 150mA	SOT-89	20ch	VR1	4a	Tor
8C5	XC6701DC6PR	LVR-IC	12.6V±2%, 150mA	SOT-89	20ch	VR1	4a	Tor
8C6	XC6701DC7PR	LVR-IC	12.7V±2%, 150mA	SOT-89	20ch	VR1	4a	Tor
8C7	XC6701DC8PR	LVR-IC	12.8V±2%, 150mA	SOT-89	20ch	VR1	4a	Tor
8C8	XC6701DC9PR	LVR-IC	12.9V±2%, 150mA	SOT-89	20ch	VR1	4a	Tor
8C9	XC6701DD0PR	LVR-IC	13.0V±2%, 150mA	SOT-89	20ch	VR1	4a	Tor
8CA	XC6701DD1PR	LVR-IC	13.1V±2%, 150mA	SOT-89	20ch	VR1	4a	Tor
8CB	XC6701DD2PR	LVR-IC	13.2V±2%, 150mA	SOT-89	20ch	VR1	4a	Tor
8CC	XC6701DD3PR	LVR-IC	13.3V±2%, 150mA	SOT-89	20ch	VR1	4a	Tor
8CD	XC6701DD4PR	LVR-IC	13.4V±2%, 150mA	SOT-89	20ch	VR1	4a	Tor
8CE	XC6701DD5PR	LVR-IC	13.5V±2%, 150mA	SOT-89	20ch	VR1	4a	Tor
8CF	XC6701DD6PR	LVR-IC	13.6V±2%, 150mA	SOT-89	20ch	VR1	4a	Tor
8CH	XC6701DD7PR	LVR-IC	13.7V±2%, 150mA	SOT-89	20ch	VR1	4a	Tor
8CK	XC6701DD8PR	LVR-IC	13.8V±2%, 150mA	SOT-89	20ch	VR1	4a	Tor
8CL	XC6701DD9PR	LVR-IC	13.9V±2%, 150mA	SOT-89	20ch	VR1	4a	Tor
8CM	XC6701DE0PR	LVR-IC	14.0V±2%, 150mA	SOT-89	20ch	VR1	4a	Tor
8CN	XC6701DE1PR	LVR-IC	14.1V±2%, 150mA	SOT-89	20ch	VR1	4a	Tor
8CP	XC6701DE2PR	LVR-IC	14.2V±2%, 150mA	SOT-89	20ch	VR1	4a	Tor
8CR	XC6701DE3PR	LVR-IC	14.3V±2%, 150mA	SOT-89	20ch	VR1	4a	Tor
8CS	XC6701DE4PR	LVR-IC	14.4V±2%, 150mA	SOT-89	20ch	VR1	4a	Tor
8CT	XC6701DE5PR	LVR-IC	14.5V±2%, 150mA	SOT-89	20ch	VR1	4a	Tor
8CU	XC6701DE6PR	LVR-IC	14.6V±2%, 150mA	SOT-89	20ch	VR1	4a	Tor
8CV	XC6701DE7PR	LVR-IC	14.7V±2%, 150mA	SOT-89	20ch	VR1	4a	Tor
8CX	XC6701DE8PR	LVR-IC	14.8V±2%, 150mA	SOT-89	20ch	VR1	4a	Tor
8CY	XC6701DE9PR	LVR-IC	14.9V±2%, 150mA	SOT-89	20ch	VR1	4a	Tor
8CZ	XC6701DF0PR	LVR-IC	15.0V±2%, 150mA	SOT-89	20ch	VR1	4a	Tor
8D	HA178L06UA	LVR-IC	6V±5%, 150mA, 800mW	SOT-89	20ch	VR1	4e	Ren
8D	KIA78L08F	LVR-IC	8V±5%, 150mA	SOT-89	20ch	VR1	4a	Kec
8D	RH5RL48AA	LVR-IC	4.8V±2.5%, 150mA	SOT-89	20vl	VR1	4c	Ric
8D0	XC6701DF1PR	LVR-IC	15.1V±2%, 150mA	SOT-89	20ch	VR1	4a	Tor
8D1	XC6701DF2PR	LVR-IC	15.2V±2%, 150mA	SOT-89	20ch	VR1	4a	Tor
8D2	XC6701DF3PR	LVR-IC	15.3V±2%, 150mA	SOT-89	20ch	VR1	4a	Tor
8D3	XC6701DF4PR	LVR-IC	15.4V±2%, 150mA	SOT-89	20ch	VR1	4a	Tor
8D4	XC6701DF5PR	LVR-IC	15.5V±2%, 150mA	SOT-89	20ch	VR1	4a	Tor
8D5	XC6701DF6PR	LVR-IC	15.6V±2%, 150mA	SOT-89	20ch	VR1	4a	Tor
8D6	XC6701DF7PR	LVR-IC	15.7V±2%, 150mA	SOT-89	20ch	VR1	4a	Tor
8D7	XC6701DF8PR	LVR-IC	15.8V±2%, 150mA	SOT-89	20ch	VR1	4a	Tor
8D8	XC6701DF9PR	LVR-IC	15.9V±2%, 150mA	SOT-89	20ch	VR1	4a	Tor
8D9	XC6701DG0PR	LVR-IC	16.0V±2%, 150mA	SOT-89	20ch	VR1	4a	Tor
8DA	XC6701DG1PR	LVR-IC	16.1V±2%, 150mA	SOT-89	20ch	VR1	4a	Tor
8DB	XC6701DG2PR	LVR-IC	16.2V±2%, 150mA	SOT-89	20ch	VR1	4a	Tor
8DC	XC6701DG3PR	LVR-IC	16.3V±2%, 150mA	SOT-89	20ch	VR1	4a	Tor
8DD	XC6701DG4PR	LVR-IC	16.4V±2%, 150mA	SOT-89	20ch	VR1	4a	Tor
8DE	XC6701DG5PR	LVR-IC	16.5V±2%, 150mA	SOT-89	20ch	VR1	4a	Tor
8DF	XC6701DG6PR	LVR-IC	16.6V±2%, 150mA	SOT-89	20ch	VR1	4a	Tor
8DH	XC6701DG7PR	LVR-IC	16.7V±2%, 150mA	SOT-89	20ch	VR1	4a	Tor
8DK	XC6701DG8PR	LVR-IC	16.8V±2%, 150mA	SOT-89	20ch	VR1	4a	Tor
8DL	XC6701DG9PR	LVR-IC	16.9V±2%, 150mA	SOT-89	20ch	VR1	4a	Tor
8DM	XC6701DH0PR	LVR-IC	17.0V±2%, 150mA	SOT-89	20ch	VR1	4a	Tor
8DN	XC6701DH1PR	LVR-IC	17.1V±2%, 150mA	SOT-89	20ch	VR1	4a	Tor
8DP	XC6701DH2PR	LVR-IC	17.2V±2%, 150mA	SOT-89	20ch	VR1	4a	Tor
8DR	XC6701DH3PR	LVR-IC	17.3V±2%, 150mA	SOT-89	20ch	VR1	4a	Tor
8DS	XC6701DH4PR	LVR-IC	17.4V±2%, 150mA	SOT-89	20ch	VR1	4a	Tor
8DT	XC6701DH5PR	LVR-IC	17.5V±2%, 150mA	SOT-89	20ch	VR1	4a	Tor
8DU	XC6701DH6PR	LVR-IC	17.6V±2%, 150mA	SOT-89	20ch	VR1	4a	Tor
8DV	XC6701DH7PR	LVR-IC	17.7V±2%, 150mA	SOT-89	20ch	VR1	4a	Tor
8DX	XC6701DH8PR	LVR-IC	17.8V±2%, 150mA	SOT-89	20ch	VR1	4a	Tor
8DY	XC6701DH9PR	LVR-IC	17.9V±2%, 150mA	SOT-89	20ch	VR1	4a	Tor
8DZ	XC6701DJ0PR	LVR-IC	18.0V±2%, 150mA	SOT-89	20ch	VR1	4a	Tor
8E	HA178L08UA	LVR-IC	8V±5%, 150mA, 800mW	SOT-89	20ch	VR1	4e	Ren
8E	KIA78L09F	LVR-IC	9V±5%, 150mA	SOT-89	20ch	VR1	4a	Kec
8E	NJM78L06UA	LVR-IC	6V, 5%, 0.1A	SOT-89	20ch	VR1	4b	Njr
8E	RH5RL58AA	LVR-IC	5.8V±2.5%, 150mA	SOT-89	20vl	VR1	4c	Ric
8F	HA178L09UA	LVR-IC	9V±5%, 150mA, 800mW	SOT-89	20ch	VR1	4e	Ren
8F	KIA78L10F	LVR-IC	10V±5%, 150mA	SOT-89	20ch	VR1	4a	Kec
8F	NJM78L07UA	LVR-IC	7V, 5%, 0.1A	SOT-89	20ch	VR1	4b	Njr



SMD
code

Type

Function

Short description

Case Pinout Sch. St. Mnf.

SMD code	Type	Function	Short description	Case	Pinout	Sch.	St.	Mnf.
8G	HA178L10UA	LVR-IC	10V±5%, 150mA, 800mW	SOT-89	20ch	VR1	4e	Ren
8G	KIA78L12F	LVR-IC	12V±5%, 150mA	SOT-89	20ch	VR1	4a	Kec
8G	NJM78L08UA	LVR-IC	8V, 5%, 0.1A	SOT-89	20ch	VR1	4b	Njr
8H	HA178L12UA	LVR-IC	12V±5%, 150mA, 800mW	SOT-89	20ch	VR1	4e	Ren
8H	NJM78L09UA	LVR-IC	9V, 5%, 0.1A	SOT-89	20ch	VR1	4b	Njr
8I	KIA78L15F	LVR-IC	15V±5%, 150mA	SOT-89	20ch	VR1	4a	Kec
8J	HA178L15UA	LVR-IC	15V±5%, 150mA, 800mW	SOT-89	20ch	VR1	4e	Ren
8J	KIA78L18F	LVR-IC	18V±5%, 150mA	SOT-89	20ch	VR1	4a	Kec
8J	NJM78L10UA	LVR-IC	10V, 5%, 0.1A	SOT-89	20ch	VR1	4b	Njr
8J	RH5RE28AA	LVR-IC	Ultra-LDO, 2.8V±2.5%, 300mA	SOT-89	20vl	VR1	4c	Ric
8K	KIA78L20F	LVR-IC	20V±5%, 150mA	SOT-89	20ch	VR1	4a	Kec
8K	NJM78L12UA	LVR-IC	12V, 5%, 0.1A	SOT-89	20ch	VR1	4b	Njr
8K	RH5RE38AA	LVR-IC	Ultra-LDO, 3.8V±2.5%, 300mA	SOT-89	20vl	VR1	4c	Ric
8L	KIA78L24F	LVR-IC	24V±5%, 150mA	SOT-89	20ch	VR1	4a	Kec
8L	NJM78L15UA	LVR-IC	15V, 5%, 0.1A	SOT-89	20ch	VR1	4b	Njr
8L	RH5RE48AA	LVR-IC	Ultra-LDO, 4.8V±2.5%, 300mA	SOT-89	20vl	VR1	4c	Ric
8M	NJM78L18UA	LVR-IC	18V, 5%, 0.1A	SOT-89	20ch	VR1	4b	Njr
8M	RH5RE58AA	LVR-IC	Ultra-LDO, 5.8V±2.5%, 300mA	SOT-89	20vl	VR1	4c	Ric
8N	NJM78L20UA	LVR-IC	20V, 5%, 0.1A	SOT-89	20ch	VR1	4b	Njr
8P	NJM78L24UA	LVR-IC	24V, 5%, 0.1A	SOT-89	20ch	VR1	4b	Njr
8Y2	BZV49-C8V2	Z-diode	8.2V±5%, Izt=5mA, 1W	SOT-89	20dm	-	4b	Phi
8Z	NJM78L62UA	LVR-IC	6.2V, 5%, 0.1A	SOT-89	20ch	VR1	4b	Njr
94LN	ELM7514CAB	Vdet-IC	1.4V±2%, +Reset PPO	SOT-89	20vda	VD7	4a	Elm
94LN	ELM7514NAB	Vdet-IC	1.4V±2%, +Reset ODO	SOT-89	20vda	VD6	4a	Elm
953	ZX5T953Z	Si-ppnp	Lo-sat, 140V, 3.5A, 1.5W, 125MHz, B=100...300	SOT-89	20tb	-	4b	Zx
95LN	ELM7515CAB	Vdet-IC	1.5V±2%, +Reset PPO	SOT-89	20vda	VD7	4a	Elm
95LN	ELM7515NAB	Vdet-IC	1.5V±2%, +Reset ODO	SOT-89	20vda	VD6	4a	Elm
96LN	ELM7516CAB	Vdet-IC	1.6V±2%, +Reset PPO	SOT-89	20vda	VD7	4a	Elm
96LN	ELM7516NAB	Vdet-IC	1.6V±2%, +Reset ODO	SOT-89	20vda	VD6	4a	Elm
97LN	ELM7517CAB	Vdet-IC	1.7V±2%, +Reset PPO	SOT-89	20vda	VD7	4a	Elm
97LN	ELM7517NAB	Vdet-IC	1.7V±2%, +Reset ODO	SOT-89	20vda	VD6	4a	Elm
98LN	ELM7518CAB	Vdet-IC	1.8V±2%, +Reset PPO	SOT-89	20vda	VD7	4a	Elm
98LN	ELM7518NAB	Vdet-IC	1.8V±2%, +Reset ODO	SOT-89	20vda	VD6	4a	Elm
99LN	ELM7519CAB	Vdet-IC	1.9V±2%, +Reset PPO	SOT-89	20vda	VD7	4a	Elm
99LN	ELM7519NAB	Vdet-IC	1.9V±2%, +Reset ODO	SOT-89	20vda	VD6	4a	Elm
9A	KIA79L05F	LVR-IC	-5V±5%, 150mA	SOT-89	20vl	VR2	4a	Kec
9B	HA179L05U	LVR-IC	-5V±5%, 150mA, 800mW	SOT-89	20ch	VR2	4e	Ren
9B	KIA79L06F	LVR-IC	-6V±5%, 150mA	SOT-89	20vl	VR2	4a	Kec
9B	NJM79L03UA	LVR-IC	-3V, 5%, 0.1A	SOT-89	20vl	VR2	4b	Njr
9B	RH5RL29AA	LVR-IC	2.9V±2.5%, 150mA	SOT-89	20vl	VR1	4c	Ric
9C	NJM79L05UA	LVR-IC	-5V, 5%, 0.1A	SOT-89	20vl	VR2	4b	Njr
9C	RH5RL39AA	LVR-IC	3.9V±2.5%, 150mA	SOT-89	20vl	VR1	4c	Ric
9D	HA179L06U	LVR-IC	-6V±5%, 150mA, 800mW	SOT-89	20ch	VR2	4e	Ren
9D	KIA79L08F	LVR-IC	-8V±5%, 150mA	SOT-89	20vl	VR2	4a	Kec
9D	RH5RL49AA	LVR-IC	4.9V±2.5%, 150mA	SOT-89	20vl	VR1	4c	Ric
9E	HA179L08U	LVR-IC	-8V±5%, 150mA, 800mW	SOT-89	20ch	VR2	4e	Ren
9E	KIA79L09F	LVR-IC	-9V±5%, 150mA	SOT-89	20vl	VR2	4a	Kec
9E	NJM79L06UA	LVR-IC	-6V, 5%, 0.1A	SOT-89	20vl	VR2	4b	Njr
9E	RH5RL59AA	LVR-IC	5.9V±2.5%, 150mA	SOT-89	20vl	VR1	4c	Ric
9F	HA179L09U	LVR-IC	-9V±5%, 150mA, 800mW	SOT-89	20ch	VR2	4e	Ren
9F	KIA79L10F	LVR-IC	-10V±5%, 150mA	SOT-89	20vl	VR2	4a	Kec
9G	HA179L10U	LVR-IC	-10V±5%, 150mA, 800mW	SOT-89	20ch	VR2	4e	Ren
9G	KIA79L12F	LVR-IC	-12V±5%, 150mA	SOT-89	20vl	VR2	4a	Kec
9G	NJM79L08UA	LVR-IC	-8V, 5%, 0.1A	SOT-89	20vl	VR2	4b	Njr
9H	HA179L12U	LVR-IC	-12V±5%, 150mA, 800mW	SOT-89	20ch	VR2	4e	Ren
9H	NJM79L09UA	LVR-IC	-9V, 5%, 0.1A	SOT-89	20vl	VR2	4b	Njr
9I	KIA79L15F	LVR-IC	-15V±5%, 150mA	SOT-89	20vl	VR2	4a	Kec
9J	HA179L15U	LVR-IC	-15V±5%, 150mA, 800mW	SOT-89	20ch	VR2	4e	Ren
9J	KIA79L18F	LVR-IC	-18V±5%, 150mA	SOT-89	20vl	VR2	4a	Kec
9J	RH5RE29AA	LVR-IC	Ultra-LDO, 2.9V±2.5%, 300mA	SOT-89	20vl	VR1	4c	Ric
9K	KIA79L20F	LVR-IC	-20V±5%, 150mA	SOT-89	20vl	VR2	4a	Kec
9K	NJM79L12UA	LVR-IC	-12V, 5%, 0.1A	SOT-89	20vl	VR2	4b	Njr
9K	RH5RE39AA	LVR-IC	Ultra-LDO, 3.9V±2.5%, 300mA	SOT-89	20vl	VR1	4c	Ric
9L	KIA79L24F	LVR-IC	-24V±5%, 150mA	SOT-89	20vl	VR2	4a	Kec
9L	NJM79L15UA	LVR-IC	-15V, 5%, 0.1A	SOT-89	20vl	VR2	4b	Njr
9L	RH5RE49AA	LVR-IC	Ultra-LDO, 4.9V±2.5%, 300mA	SOT-89	20vl	VR1	4c	Ric
9M	NJM79L18UA	LVR-IC	-18V, 5%, 0.1A	SOT-89	20vl	VR2	4b	Njr
9M	RH5RE59AA	LVR-IC	Ultra-LDO, 5.9V±2.5%, 300mA	SOT-89	20vl	VR1	4c	Ric
9P	NJM79L24UA	LVR-IC	-24V, 5%, 0.1A	SOT-89	20vl	VR2	4b	Njr
9Y1	BZV49-C9V1	Z-diode	9.1V±5%, Izt=5mA, 1W	SOT-89	20dm	-	4b	Phi

Note: ELM75xxCEB series LN- lot number L=0...9 N=A to Z(I, O, X excepted); ELM75xxNEB series LN- lot number L=A to Z(I, O, X excepted) N=0...9



SMD
code

Type

Function

Short description

Case Pinout Sch. St. Mnf.

A0	ELM9820AB	LVR-IC	2.0V±2%, 200mA	SOT-89	20vl	VR1	4a	Elm
A09	ELM9709NAB	Vdet-IC	0.9V±2.5%, +Reset ODO	SOT-89	20vda	VD6	4a	Elm
A09A	R3111H091A	Vdet-IC	0.9V±2%, -Reset PPO	SOT-89	20vda	VD7	4c	Ric
A09C	R3111H091C	Vdet-IC	0.9V±2%, -Reset ODO	SOT-89	20vda	VD6	4c	Ric
A1	D70G.05T1	Si-npn	Sw, 200/150V, 50mA	SOT-89	20tb	-	4b	Gen
A1	ELM9821AB	LVR-IC	2.1V±2%, 200mA	SOT-89	20vl	VR1	4a	Elm
A10	ELM9710NAB	Vdet-IC	1.0V±2.5%, +Reset ODO	SOT-89	20vda	VD6	4a	Elm
A1000	WJA1000	MMIC	Gain-block, 50..1200MHz, 18.5dB (900MHz, 50Ω)	SOT-89	20aa	A1	4i	Wjfc
A1001	WJA1001	MMIC	Gain-block, 50..3000MHz, 19dB (900MHz, 50Ω)	SOT-89	20aa	A1	4i	Wjfc
A1005	WJA1005	MMIC	Gain-block, 50..1200MHz, 18dB (900MHz, 50Ω)	SOT-89	20aa	A1	4i	Wjfc
A10A	R3111H101A	Vdet-IC	1V±2%, -Reset PPO	SOT-89	20vda	VD7	4c	Ric
A10C	R3111H101C	Vdet-IC	1V±2%, -Reset ODO	SOT-89	20vda	VD6	4c	Ric
A11	ELM9711NAB	Vdet-IC	1.1V±2.5%, +Reset ODO	SOT-89	20vda	VD6	4a	Elm
A11A	ML6101C113P	Vdet-IC	1.1V±3%, +Reset PPO	SOT-89	20vda	VD7	4g	Mlc
A11A	R3111H111A	Vdet-IC	1.1V±2%, -Reset PPO	SOT-89	20vda	VD7	4c	Ric
A11C	R3111H111C	Vdet-IC	1.1V±2%, -Reset ODO	SOT-89	20vda	VD6	4c	Ric
A12	ELM9712NAB	Vdet-IC	1.2V±2.5%, +Reset ODO	SOT-89	20vda	VD6	4a	Elm
A12A	ML6101C123P	Vdet-IC	1.2V±3%, +Reset PPO	SOT-89	20vda	VD7	4g	Mlc
A12A	R3111H121A	Vdet-IC	1.2V±2%, -Reset PPO	SOT-89	20vda	VD7	4c	Ric
A12C	R3111H121C	Vdet-IC	1.2V±2%, -Reset ODO	SOT-89	20vda	VD6	4c	Ric
A13	ELM9713NAB	Vdet-IC	1.3V±2.5%, +Reset ODO	SOT-89	20vda	VD6	4a	Elm
A13A	ML6101C133P	Vdet-IC	1.3V±3%, +Reset PPO	SOT-89	20vda	VD7	4g	Mlc
A13A	R3111H131A	Vdet-IC	1.3V±2%, -Reset PPO	SOT-89	20vda	VD7	4c	Ric
A13C	R3111H131C	Vdet-IC	1.3V±2%, -Reset ODO	SOT-89	20vda	VD6	4c	Ric
A14	ELM9714NAB	Vdet-IC	1.4V±2.5%, +Reset ODO	SOT-89	20vda	VD6	4a	Elm
A14A	ML6101C143P	Vdet-IC	1.4V±3%, +Reset PPO	SOT-89	20vda	VD7	4g	Mlc
A14A	R3111H141A	Vdet-IC	1.4V±2%, -Reset PPO	SOT-89	20vda	VD7	4c	Ric
A14C	R3111H141C	Vdet-IC	1.4V±2%, -Reset ODO	SOT-89	20vda	VD6	4c	Ric
A15	ELM9715NAB	Vdet-IC	1.5V±2.5%, +Reset ODO	SOT-89	20vda	VD6	4a	Elm
A15	XC31PNS0015AP	LVR-IC	Temperature Sensitive, -T*factor, 1.5V±5%, 50mA	SOT-89	20vl	VR1	4h	Tor
A15	XC31PPS0015AP	LVR-IC	Temperature Sensitive, +T*factor, 1.5V±5%, 50mA	SOT-89	20vl	VR1	4h	Tor
A1510	WJA1510	MMIC	Gain-block, 50..1000MHz, 14dB (200MHz, 50Ω)	SOT-89	20aa	A1	4i	Wjfc
A1515	WJA1515	MMIC	Gain-block, 50..1000MHz, 14dB (200MHz, 50Ω)	SOT-89	20aa	A1	4i	Wjfc
A15A	ML6101C153P	Vdet-IC	1.5V±3%, +Reset PPO	SOT-89	20vda	VD7	4g	Mlc
A15A	R3111H151A	Vdet-IC	1.5V±2%, -Reset PPO	SOT-89	20vda	VD7	4c	Ric
A15C	R3111H151C	Vdet-IC	1.5V±2%, -Reset ODO	SOT-89	20vda	VD6	4c	Ric
A16	ELM9716NAB	Vdet-IC	1.6V±2.5%, +Reset ODO	SOT-89	20vda	VD6	4a	Elm
A16	XC31PNS0016AP	LVR-IC	Temperature Sensitive, -T*factor, 1.6V±5%, 50mA	SOT-89	20vl	VR1	4h	Tor
A16	XC31PPS0016AP	LVR-IC	Temperature Sensitive, +T*factor, 1.6V±5%, 50mA	SOT-89	20vl	VR1	4h	Tor
A16A	ML6101C163P	Vdet-IC	1.6V±3%, +Reset PPO	SOT-89	20vda	VD7	4g	Mlc
A16A	R3111H161A	Vdet-IC	1.6V±2%, -Reset PPO	SOT-89	20vda	VD7	4c	Ric
A16C	R3111H161C	Vdet-IC	1.6V±2%, -Reset ODO	SOT-89	20vda	VD6	4c	Ric
A17	ELM9717NAB	Vdet-IC	1.7V±2.5%, +Reset ODO	SOT-89	20vda	VD6	4a	Elm
A17	XC31PNS0017AP	LVR-IC	Temperature Sensitive, -T*factor, 1.7V±5%, 50mA	SOT-89	20vl	VR1	4h	Tor
A17	XC31PPS0017AP	LVR-IC	Temperature Sensitive, +T*factor, 1.7V±5%, 50mA	SOT-89	20vl	VR1	4h	Tor
A17A	ML6101C173P	Vdet-IC	1.7V±3%, +Reset PPO	SOT-89	20vda	VD7	4g	Mlc
A17A	R3111H171A	Vdet-IC	1.7V±2%, -Reset PPO	SOT-89	20vda	VD7	4c	Ric
A17C	R3111H171C	Vdet-IC	1.7V±2%, -Reset ODO	SOT-89	20vda	VD6	4c	Ric
A18	ELM9718NAB	Vdet-IC	1.8V±2.5%, +Reset ODO	SOT-89	20vda	VD6	4a	Elm
A18	XC31PNS0018AP	LVR-IC	Temperature Sensitive, -T*factor, 1.8V±5%, 50mA	SOT-89	20vl	VR1	4h	Tor
A18	XC31PPS0018AP	LVR-IC	Temperature Sensitive, +T*factor, 1.8V±5%, 50mA	SOT-89	20vl	VR1	4h	Tor
A18A	ML6101C183P	Vdet-IC	1.8V±3%, +Reset PPO	SOT-89	20vda	VD7	4g	Mlc
A18A	R3111H181A	Vdet-IC	1.8V±2%, -Reset PPO	SOT-89	20vda	VD7	4c	Ric
A18C	R3111H181C	Vdet-IC	1.8V±2%, -Reset ODO	SOT-89	20vda	VD6	4c	Ric
A19	ELM9719NAB	Vdet-IC	1.9V±2.5%, +Reset ODO	SOT-89	20vda	VD6	4a	Elm
A19	XC31PNS0019AP	LVR-IC	Temperature Sensitive, -T*factor, 1.9V±5%, 50mA	SOT-89	20vl	VR1	4h	Tor
A19	XC31PPS0019AP	LVR-IC	Temperature Sensitive, +T*factor, 1.9V±5%, 50mA	SOT-89	20vl	VR1	4h	Tor
A19A	ML6101C193P	Vdet-IC	1.9V±3%, +Reset PPO	SOT-89	20vda	VD7	4g	Mlc
A19A	R3111H191A	Vdet-IC	1.9V±2%, -Reset PPO	SOT-89	20vda	VD7	4c	Ric
A19C	R3111H191C	Vdet-IC	1.9V±2%, -Reset ODO	SOT-89	20vda	VD6	4c	Ric
A10	STB1132-O	Si-pnp	AF, 40V, 1A, 500mW, B=100..200, 150MHz	SOT-89	20tb	-	4b	Auk
A1Y	STB1132-Y	Si-pnp	AF, 40V, 1A, 500mW, B=160..320, 150MHz	SOT-89	20tb	-	4b	Auk
A2	ELM9822AB	LVR-IC	2.2V±2%, 200mA	SOT-89	20vl	VR1	4a	Elm
A2	RT9161-25CX	LVR-IC	LDO, 2.5V±2%, 300mA	SOT-89	20vl	VR1	4c	Rct
A2-	RT9161-25PX	LVR-IC	LDO, 2.5V±2%, 300mA	SOT-89	20vl	VR1	4c	Rct
A20	ELM9720NAB	Vdet-IC	2.0V±2.5%, +Reset ODO	SOT-89	20vda	VD6	4a	Elm
A20	XC31PNS0020AP	LVR-IC	Temperature Sensitive, -T*factor, 2V±5%, 50mA	SOT-89	20vl	VR1	4h	Tor
A20	XC31PPS0020AP	LVR-IC	Temperature Sensitive, +T*factor, 2V±5%, 50mA	SOT-89	20vl	VR1	4h	Tor
A20	XC6371A201P	DC/DC-IC	PWM step-up, 100kHz, 2.0V±2.5%, 100mA	SOT-89	20bq	DC2	4c	Tor
A20A	ML6101C202P	Vdet-IC	2.0V±2%, +Reset PPO	SOT-89	20vda	VD7	4g	Mlc



SMD
code

Type

Function

Short description

Case Pinout Sch. St. Mnf.

SMD code	Type	Function	Short description	Case	Pinout	Sch.	St.	Mnf.
A20A	R3111H201A	Vdet-IC	2V±2%, -Reset PPO	SOT-89	20vda	VD7	4c	Ric
A20C	R3111H201C	Vdet-IC	2V±2%, -Reset ODO	SOT-89	20vda	VD6	4c	Ric
A21	ELM9721NAB	Vdet-IC	2.1V±2.5%, +Reset ODO	SOT-89	20vda	VD6	4a	Elm
A21	XC31PNS0021AP	LVR-IC	Temperature Sensitive, -T*factor, 2.1V±5%, 50mA	SOT-89	20vl	VR1	4h	Tor
A21	XC31PPS0021AP	LVR-IC	Temperature Sensitive, +T*factor, 2.1V±5%, 50mA	SOT-89	20vl	VR1	4h	Tor
A21	XC6371A211P	DC/DC-IC	PWM step-up, 100kHz, 2.1V±2.5%, 100mA	SOT-89	20bq	DC2	4c	Tor
A21A	ML6101C212P	Vdet-IC	2.1V±2%, +Reset PPO	SOT-89	20vda	VD7	4g	Mlc
A21A	R3111H211A	Vdet-IC	2.1V±2%, -Reset PPO	SOT-89	20vda	VD7	4c	Ric
A21C	R3111H211C	Vdet-IC	2.1V±2%, -Reset ODO	SOT-89	20vda	VD6	4c	Ric
A22	ELM9722NAB	Vdet-IC	2.2V±2.5%, +Reset ODO	SOT-89	20vda	VD6	4a	Elm
A22	XC31PNS0022AP	LVR-IC	Temperature Sensitive, -T*factor, 2.2V±5%, 50mA	SOT-89	20vl	VR1	4h	Tor
A22	XC31PPS0022AP	LVR-IC	Temperature Sensitive, +T*factor, 2.2V±5%, 50mA	SOT-89	20vl	VR1	4h	Tor
A22	XC6371A221P	DC/DC-IC	PWM step-up, 100kHz, 2.2V±2.5%, 100mA	SOT-89	20bq	DC2	4c	Tor
A22A	ML6101C222P	Vdet-IC	2.2V±2%, +Reset PPO	SOT-89	20vda	VD7	4g	Mlc
A22A	R3111H221A	Vdet-IC	2.2V±2%, -Reset PPO	SOT-89	20vda	VD7	4c	Ric
A22C	R3111H221C	Vdet-IC	2.2V±2%, -Reset ODO	SOT-89	20vda	VD6	4c	Ric
A23	ELM9723NAB	Vdet-IC	2.3V±2.5%, +Reset ODO	SOT-89	20vda	VD6	4a	Elm
A23	XC31PNS0023AP	LVR-IC	Temperature Sensitive, -T*factor, 2.3V±5%, 50mA	SOT-89	20vl	VR1	4h	Tor
A23	XC31PPS0023AP	LVR-IC	Temperature Sensitive, +T*factor, 2.3V±5%, 50mA	SOT-89	20vl	VR1	4h	Tor
A23	XC6371A231P	DC/DC-IC	PWM step-up, 100kHz, 2.3V±2.5%, 100mA	SOT-89	20bq	DC2	4c	Tor
A23A	ML6101C232P	Vdet-IC	2.3V±2%, +Reset PPO	SOT-89	20vda	VD7	4g	Mlc
A23A	R3111H231A	Vdet-IC	2.3V±2%, -Reset PPO	SOT-89	20vda	VD7	4c	Ric
A23C	R3111H231C	Vdet-IC	2.3V±2%, -Reset ODO	SOT-89	20vda	VD6	4c	Ric
A24	ELM9724NAB	Vdet-IC	2.4V±2.5%, +Reset ODO	SOT-89	20vda	VD6	4a	Elm
A24	XC31PNS0024AP	LVR-IC	Temperature Sensitive, -T*factor, 2.4V±5%, 50mA	SOT-89	20vl	VR1	4h	Tor
A24	XC31PPS0024AP	LVR-IC	Temperature Sensitive, +T*factor, 2.4V±5%, 50mA	SOT-89	20vl	VR1	4h	Tor
A24	XC6371A241P	DC/DC-IC	PWM step-up, 100kHz, 2.4V±2.5%, 100mA	SOT-89	20bq	DC2	4c	Tor
A24A	ML6101C242P	Vdet-IC	2.4V±2%, +Reset PPO	SOT-89	20vda	VD7	4g	Mlc
A24A	R3111H241A	Vdet-IC	2.4V±2%, -Reset PPO	SOT-89	20vda	VD7	4c	Ric
A24C	R3111H241C	Vdet-IC	2.4V±2%, -Reset ODO	SOT-89	20vda	VD6	4c	Ric
A25	ELM9725NAB	Vdet-IC	2.5V±2.5%, +Reset ODO	SOT-89	20vda	VD6	4a	Elm
A25	XC31PNS0025AP	LVR-IC	Temperature Sensitive, -T*factor, 2.5V±5%, 50mA	SOT-89	20vl	VR1	4h	Tor
A25	XC31PPS0025AP	LVR-IC	Temperature Sensitive, +T*factor, 2.5V±5%, 50mA	SOT-89	20vl	VR1	4h	Tor
A25	XC6371A251P	DC/DC-IC	PWM step-up, 100kHz, 2.5V±2.5%, 100mA	SOT-89	20bq	DC2	4c	Tor
A25A	ML6101C252P	Vdet-IC	2.5V±2%, +Reset PPO	SOT-89	20vda	VD7	4g	Mlc
A25A	R3111H251A	Vdet-IC	2.5V±2%, -Reset PPO	SOT-89	20vda	VD7	4c	Ric
A25C	R3111H251C	Vdet-IC	2.5V±2%, -Reset ODO	SOT-89	20vda	VD6	4c	Ric
A26	ELM9726NAB	Vdet-IC	2.6V±2.5%, +Reset ODO	SOT-89	20vda	VD6	4a	Elm
A26	XC31PNS0026AP	LVR-IC	Temperature Sensitive, -T*factor, 2.6V±5%, 50mA	SOT-89	20vl	VR1	4h	Tor
A26	XC31PPS0026AP	LVR-IC	Temperature Sensitive, +T*factor, 2.6V±5%, 50mA	SOT-89	20vl	VR1	4h	Tor
A26	XC6371A261P	DC/DC-IC	PWM step-up, 100kHz, 2.6V±2.5%, 100mA	SOT-89	20bq	DC2	4c	Tor
A26A	ML6101C262P	Vdet-IC	2.6V±2%, +Reset PPO	SOT-89	20vda	VD7	4g	Mlc
A26A	R3111H261A	Vdet-IC	2.6V±2%, -Reset PPO	SOT-89	20vda	VD7	4c	Ric
A26C	R3111H261C	Vdet-IC	2.6V±2%, -Reset ODO	SOT-89	20vda	VD6	4c	Ric
A27	ELM9727NAB	Vdet-IC	2.7V±2.5%, +Reset ODO	SOT-89	20vda	VD6	4a	Elm
A27	PXTA27	Si-npn-Darl	GP, 60V, 500mA, 1.2W, B>10000, >125MHz	SOT-89	20tb	-	4b	Phi
A27	XC31PNS0027AP	LVR-IC	Temperature Sensitive, -T*factor, 2.7V±5%, 50mA	SOT-89	20vl	VR1	4h	Tor
A27	XC31PPS0027AP	LVR-IC	Temperature Sensitive, +T*factor, 2.7V±5%, 50mA	SOT-89	20vl	VR1	4h	Tor
A27	XC6371A271P	DC/DC-IC	PWM step-up, 100kHz, 2.7V±2.5%, 100mA	SOT-89	20bq	DC2	4c	Tor
A27A	ML6101C272P	Vdet-IC	2.7V±2%, +Reset PPO	SOT-89	20vda	VD7	4g	Mlc
A27A	R3111H271A	Vdet-IC	2.7V±2%, -Reset PPO	SOT-89	20vda	VD7	4c	Ric
A27C	R3111H271C	Vdet-IC	2.7V±2%, -Reset ODO	SOT-89	20vda	VD6	4c	Ric
A28	ELM9728NAB	Vdet-IC	2.8V±2.5%, +Reset ODO	SOT-89	20vda	VD6	4a	Elm
A28	XC31PNS0028AP	LVR-IC	Temperature Sensitive, -T*factor, 2.8V±5%, 50mA	SOT-89	20vl	VR1	4h	Tor
A28	XC31PPS0028AP	LVR-IC	Temperature Sensitive, +T*factor, 2.8V±5%, 50mA	SOT-89	20vl	VR1	4h	Tor
A28	XC6371A281P	DC/DC-IC	PWM step-up, 100kHz, 2.8V±2.5%, 100mA	SOT-89	20bq	DC2	4c	Tor
A28A	ML6101C282P	Vdet-IC	2.8V±2%, +Reset PPO	SOT-89	20vda	VD7	4g	Mlc
A28A	R3111H281A	Vdet-IC	2.8V±2%, -Reset PPO	SOT-89	20vda	VD7	4c	Ric
A28C	R3111H281C	Vdet-IC	2.8V±2%, -Reset ODO	SOT-89	20vda	VD6	4c	Ric
A29	ELM9729NAB	Vdet-IC	2.9V±2.5%, +Reset ODO	SOT-89	20vda	VD6	4a	Elm
A29	XC31PNS0029AP	LVR-IC	Temperature Sensitive, -T*factor, 2.9V±5%, 50mA	SOT-89	20vl	VR1	4h	Tor
A29	XC31PPS0029AP	LVR-IC	Temperature Sensitive, +T*factor, 2.9V±5%, 50mA	SOT-89	20vl	VR1	4h	Tor
A29	XC6371A291P	DC/DC-IC	PWM step-up, 100kHz, 2.9V±2.5%, 100mA	SOT-89	20bq	DC2	4c	Tor
A29A	ML6101C292P	Vdet-IC	2.9V±2%, +Reset PPO	SOT-89	20vda	VD7	4g	Mlc
A29A	R3111H291A	Vdet-IC	2.9V±2%, -Reset PPO	SOT-89	20vda	VD7	4c	Ric
A29C	R3111H291C	Vdet-IC	2.9V±2%, -Reset ODO	SOT-89	20vda	VD6	4c	Ric
A2A	XC6371A202P	DC/DC-IC	PWM step-up, 180kHz, 2.0V±2.5%, 100mA	SOT-89	20bq	DC2	4c	Tor
A2B	XC6371A212P	DC/DC-IC	PWM step-up, 180kHz, 2.1V±2.5%, 100mA	SOT-89	20bq	DC2	4c	Tor
A2C	XC6371A222P	DC/DC-IC	PWM step-up, 180kHz, 2.2V±2.5%, 100mA	SOT-89	20bq	DC2	4c	Tor
A2D	XC6371A232P	DC/DC-IC	PWM step-up, 180kHz, 2.3V±2.5%, 100mA	SOT-89	20bq	DC2	4c	Tor



SMD
code

Type

Function

Short description

Case Pinout Sch. St. Mnf.



Ā2E	XC6371A242P	DC/DC-IC	PWM step-up, 180kHz, 2.4V±2.5%, 100mA	SOT-89	20bq	DC2	4c	Tor
Ā2F	XC6371A252P	DC/DC-IC	PWM step-up, 180kHz, 2.5V±2.5%, 100mA	SOT-89	20bq	DC2	4c	Tor
Ā2H	XC6371A262P	DC/DC-IC	PWM step-up, 180kHz, 2.6V±2.5%, 100mA	SOT-89	20bq	DC2	4c	Tor
Ā2K	XC6371A272P	DC/DC-IC	PWM step-up, 180kHz, 2.7V±2.5%, 100mA	SOT-89	20bq	DC2	4c	Tor
Ā2L	XC6371A282P	DC/DC-IC	PWM step-up, 180kHz, 2.8V±2.5%, 100mA	SOT-89	20bq	DC2	4c	Tor
Ā2M	XC6371A292P	DC/DC-IC	PWM step-up, 180kHz, 2.9V±2.5%, 100mA	SOT-89	20bq	DC2	4c	Tor
A3	ELM9823AB	LVR-IC	2.3V±2%, 200mA	SOT-89	20vl	VR1	4a	Elm
A3	RT9161-33CX	LVR-IC	LDO, 3.3V±2%, 300mA	SOT-89	20vl	VR1	4c	Rct
A3-	RT9161-33PX	LVR-IC	LDO, 3.3V±2%, 300mA	SOT-89	20vl	VR1	4c	Rct
A30	ELM9730NAB	Vdet-IC	3.0V±2.5%, +Reset ODO	SOT-89	20vda	VD6	4a	Elm
A30	TK11630U	LVR-IC	LDO, 3V±1.5%, 190mA	SOT-89	20hn	VR1	4d	Tok
A30	XC31PNS0030AP	LVR-IC	Temperature Sensitive, -T*factor, 3V±5%, 50mA	SOT-89	20vl	VR1	4h	Tor
A30	XC31PPS0030AP	LVR-IC	Temperature Sensitive, +T*factor, 3V±5%, 50mA	SOT-89	20vl	VR1	4h	Tor
A30	XC6371A301P	DC/DC-IC	PWM step-up, 100kHz, 3.0V±2.5%, 100mA	SOT-89	20bq	DC2	4c	Tor
A30A	ML6101C302P	Vdet-IC	3.0V±2%, +Reset PPO	SOT-89	20vda	VD7	4g	Mlc
A30A	R3111H301A	Vdet-IC	3V±2%, -Reset PPO	SOT-89	20vda	VD7	4c	Ric
A30C	R3111H301C	Vdet-IC	3V±2%, -Reset ODO	SOT-89	20vda	VD6	4c	Ric
A31	ELM9731NAB	Vdet-IC	3.1V±2.5%, +Reset ODO	SOT-89	20vda	VD6	4a	Elm
A31	XC31PNS0031AP	LVR-IC	Temperature Sensitive, -T*factor, 3.1V±5%, 50mA	SOT-89	20vl	VR1	4h	Tor
A31	XC31PPS0031AP	LVR-IC	Temperature Sensitive, +T*factor, 3.1V±5%, 50mA	SOT-89	20vl	VR1	4h	Tor
Ā31	XC6371A311P	DC/DC-IC	PWM step-up, 100kHz, 3.1V±2.5%, 100mA	SOT-89	20bq	DC2	4c	Tor
A31A	ML6101C312P	Vdet-IC	3.1V±2%, +Reset PPO	SOT-89	20vda	VD7	4g	Mlc
A31A	R3111H311A	Vdet-IC	3.1V±2%, -Reset PPO	SOT-89	20vda	VD7	4c	Ric
A31C	R3111H311C	Vdet-IC	3.1V±2%, -Reset ODO	SOT-89	20vda	VD6	4c	Ric
A32	ELM9732NAB	Vdet-IC	3.2V±2.5%, +Reset ODO	SOT-89	20vda	VD6	4a	Elm
A32	XC31PNS0032AP	LVR-IC	Temperature Sensitive, -T*factor, 3.2V±5%, 50mA	SOT-89	20vl	VR1	4h	Tor
A32	XC31PPS0032AP	LVR-IC	Temperature Sensitive, +T*factor, 3.2V±5%, 50mA	SOT-89	20vl	VR1	4h	Tor
Ā32	XC6371A321P	DC/DC-IC	PWM step-up, 100kHz, 3.2V±2.5%, 100mA	SOT-89	20bq	DC2	4c	Tor
A32A	ML6101C322P	Vdet-IC	3.2V±2%, +Reset PPO	SOT-89	20vda	VD7	4g	Mlc
A32A	R3111H321A	Vdet-IC	3.2V±2%, -Reset PPO	SOT-89	20vda	VD7	4c	Ric
A32C	R3111H321C	Vdet-IC	3.2V±2%, -Reset ODO	SOT-89	20vda	VD6	4c	Ric
A33	ELM9733NAB	Vdet-IC	3.3V±2.5%, +Reset ODO	SOT-89	20vda	VD6	4a	Elm
A33	TK11633U	LVR-IC	LDO, 3.3V±1.5%, 190mA	SOT-89	20hn	VR1	4d	Tok
A33	XC31PNS0033AP	LVR-IC	Temperature Sensitive, -T*factor, 3.3V±5%, 50mA	SOT-89	20vl	VR1	4h	Tor
A33	XC31PPS0033AP	LVR-IC	Temperature Sensitive, +T*factor, 3.3V±5%, 50mA	SOT-89	20vl	VR1	4h	Tor
Ā33	XC6371A331P	DC/DC-IC	PWM step-up, 100kHz, 3.3V±2.5%, 100mA	SOT-89	20bq	DC2	4c	Tor
A33A	ML6101C332P	Vdet-IC	3.3V±2%, +Reset PPO	SOT-89	20vda	VD7	4g	Mlc
A33A	R3111H331A	Vdet-IC	3.3V±2%, -Reset PPO	SOT-89	20vda	VD7	4c	Ric
A33C	R3111H331C	Vdet-IC	3.3V±2%, -Reset ODO	SOT-89	20vda	VD6	4c	Ric
A34	ELM9734NAB	Vdet-IC	3.4V±2.5%, +Reset ODO	SOT-89	20vda	VD6	4a	Elm
A34	XC31PNS0034AP	LVR-IC	Temperature Sensitive, -T*factor, 3.4V±5%, 50mA	SOT-89	20vl	VR1	4h	Tor
A34	XC31PPS0034AP	LVR-IC	Temperature Sensitive, +T*factor, 3.4V±5%, 50mA	SOT-89	20vl	VR1	4h	Tor
Ā34	XC6371A341P	DC/DC-IC	PWM step-up, 100kHz, 3.4V±2.5%, 100mA	SOT-89	20bq	DC2	4c	Tor
A34A	ML6101C342P	Vdet-IC	3.4V±2%, +Reset PPO	SOT-89	20vda	VD7	4g	Mlc
A34A	R3111H341A	Vdet-IC	3.4V±2%, -Reset PPO	SOT-89	20vda	VD7	4c	Ric
A34C	R3111H341C	Vdet-IC	3.4V±2%, -Reset ODO	SOT-89	20vda	VD6	4c	Ric
A35	ELM9735NAB	Vdet-IC	3.5V±2.5%, +Reset ODO	SOT-89	20vda	VD6	4a	Elm
A35	XC31PNS0035AP	LVR-IC	Temperature Sensitive, -T*factor, 3.5V±5%, 50mA	SOT-89	20vl	VR1	4h	Tor
A35	XC31PPS0035AP	LVR-IC	Temperature Sensitive, +T*factor, 3.5V±5%, 50mA	SOT-89	20vl	VR1	4h	Tor
Ā35	XC6371A351P	DC/DC-IC	PWM step-up, 100kHz, 3.5V±2.5%, 100mA	SOT-89	20bq	DC2	4c	Tor
A35A	ML6101C352P	Vdet-IC	3.5V±2%, +Reset PPO	SOT-89	20vda	VD7	4g	Mlc
A35A	R3111H351A	Vdet-IC	3.5V±2%, -Reset PPO	SOT-89	20vda	VD7	4c	Ric
A35C	R3111H351C	Vdet-IC	3.5V±2%, -Reset ODO	SOT-89	20vda	VD6	4c	Ric
A36	ELM9736NAB	Vdet-IC	3.6V±2.5%, +Reset ODO	SOT-89	20vda	VD6	4a	Elm
A36	XC31PNS0036AP	LVR-IC	Temperature Sensitive, -T*factor, 3.6V±5%, 50mA	SOT-89	20vl	VR1	4h	Tor
A36	XC31PPS0036AP	LVR-IC	Temperature Sensitive, +T*factor, 3.6V±5%, 50mA	SOT-89	20vl	VR1	4h	Tor
Ā36	XC6371A361P	DC/DC-IC	PWM step-up, 100kHz, 3.6V±2.5%, 100mA	SOT-89	20bq	DC2	4c	Tor
A36A	ML6101C362P	Vdet-IC	3.6V±2%, +Reset PPO	SOT-89	20vda	VD7	4g	Mlc
A36A	R3111H361A	Vdet-IC	3.6V±2%, -Reset PPO	SOT-89	20vda	VD7	4c	Ric
A36C	R3111H361C	Vdet-IC	3.6V±2%, -Reset ODO	SOT-89	20vda	VD6	4c	Ric
A37	ELM9737NAB	Vdet-IC	3.7V±2.5%, +Reset ODO	SOT-89	20vda	VD6	4a	Elm
A37	XC31PNS0037AP	LVR-IC	Temperature Sensitive, -T*factor, 3.7V±5%, 50mA	SOT-89	20vl	VR1	4h	Tor
A37	XC31PPS0037AP	LVR-IC	Temperature Sensitive, +T*factor, 3.7V±5%, 50mA	SOT-89	20vl	VR1	4h	Tor
Ā37	XC6371A371P	DC/DC-IC	PWM step-up, 100kHz, 3.7V±2.5%, 100mA	SOT-89	20bq	DC2	4c	Tor
A37A	ML6101C372P	Vdet-IC	3.7V±2%, +Reset PPO	SOT-89	20vda	VD7	4g	Mlc
A37A	R3111H371A	Vdet-IC	3.7V±2%, -Reset PPO	SOT-89	20vda	VD7	4c	Ric
A37C	R3111H371C	Vdet-IC	3.7V±2%, -Reset ODO	SOT-89	20vda	VD6	4c	Ric
A38	ELM9738NAB	Vdet-IC	3.8V±2.5%, +Reset ODO	SOT-89	20vda	VD6	4a	Elm
A38	XC31PNS0038AP	LVR-IC	Temperature Sensitive, -T*factor, 3.8V±5%, 50mA	SOT-89	20vl	VR1	4h	Tor
A38	XC31PPS0038AP	LVR-IC	Temperature Sensitive, +T*factor, 3.8V±5%, 50mA	SOT-89	20vl	VR1	4h	Tor

SMD
code

Type

Function

Short description

Case Pinout Sch. St. Mnf.

SMD code	Type	Function	Short description	Case	Pinout	Sch.	St.	Mnf.
Ā38	XC6371A381P	DC/DC-IC	PWM step-up, 100kHz, 3.8V±2.5%, 100mA	SOT-89	20bq	DC2	4c	Tor
A38A	ML6101C382P	Vdet-IC	3.8V±2%, +Reset PPO	SOT-89	20vda	VD7	4g	Mlc
A38A	R3111H381A	Vdet-IC	3.8V±2%, -Reset PPO	SOT-89	20vda	VD7	4c	Ric
A38C	R3111H381C	Vdet-IC	3.8V±2%, -Reset ODO	SOT-89	20vda	VD6	4c	Ric
A39	ELM9739NAB	Vdet-IC	3.9V±2.5%, +Reset ODO	SOT-89	20vda	VD6	4a	Elm
A39	XC31PNS0039AP	LVR-IC	Temperature Sensitive, -T*factor, 3.9V±5%, 50mA	SOT-89	20vl	VR1	4h	Tor
A39	XC31PPS0039AP	LVR-IC	Temperature Sensitive, +T*factor, 3.9V±5%, 50mA	SOT-89	20vl	VR1	4h	Tor
Ā39	XC6371A391P	DC/DC-IC	PWM step-up, 100kHz, 3.9V±2.5%, 100mA	SOT-89	20bq	DC2	4c	Tor
A39A	ML6101C392P	Vdet-IC	3.9V±2%, +Reset PPO	SOT-89	20vda	VD7	4g	Mlc
A39A	R3111H391A	Vdet-IC	3.9V±2%, -Reset PPO	SOT-89	20vda	VD7	4c	Ric
A39C	R3111H391C	Vdet-IC	3.9V±2%, -Reset ODO	SOT-89	20vda	VD6	4c	Ric
Ā3A	XC6371A302P	DC/DC-IC	PWM step-up, 180kHz, 3.0V±2.5%, 100mA	SOT-89	20bq	DC2	4c	Tor
Ā3B	XC6371A312P	DC/DC-IC	PWM step-up, 180kHz, 3.1V±2.5%, 100mA	SOT-89	20bq	DC2	4c	Tor
Ā3C	XC6371A322P	DC/DC-IC	PWM step-up, 180kHz, 3.2V±2.5%, 100mA	SOT-89	20bq	DC2	4c	Tor
Ā3D	XC6371A332P	DC/DC-IC	PWM step-up, 180kHz, 3.3V±2.5%, 100mA	SOT-89	20bq	DC2	4c	Tor
Ā3E	XC6371A342P	DC/DC-IC	PWM step-up, 180kHz, 3.4V±2.5%, 100mA	SOT-89	20bq	DC2	4c	Tor
Ā3F	XC6371A352P	DC/DC-IC	PWM step-up, 180kHz, 3.5V±2.5%, 100mA	SOT-89	20bq	DC2	4c	Tor
Ā3H	XC6371A362P	DC/DC-IC	PWM step-up, 180kHz, 3.6V±2.5%, 100mA	SOT-89	20bq	DC2	4c	Tor
Ā3K	XC6371A372P	DC/DC-IC	PWM step-up, 180kHz, 3.7V±2.5%, 100mA	SOT-89	20bq	DC2	4c	Tor
Ā3L	XC6371A382P	DC/DC-IC	PWM step-up, 180kHz, 3.8V±2.5%, 100mA	SOT-89	20bq	DC2	4c	Tor
Ā3M	XC6371A392P	DC/DC-IC	PWM step-up, 180kHz, 3.9V±2.5%, 100mA	SOT-89	20bq	DC2	4c	Tor
A4	AP431Y	Vref-IC	Adjustable, Precision, Shunt, 2.495V±1%	SOT-89-3L	20rb	RF1	4b	Ana
A4	ELM9824AB	LVR-IC	2.4V±2%, 200mA	SOT-89	20vl	VR1	4a	Elm
A4	RT9161-35CX	LVR-IC	LDO, 3.5V±2%, 300mA	SOT-89	20vl	VR1	4c	Rct
A40	ELM9740NAB	Vdet-IC	4.0V±2.5%, +Reset ODO	SOT-89	20vda	VD6	4a	Elm
A40	XC31PNS0040AP	LVR-IC	Temperature Sensitive, -T*factor, 4V±5%, 50mA	SOT-89	20vl	VR1	4h	Tor
A40	XC31PPS0040AP	LVR-IC	Temperature Sensitive, +T*factor, 4V±5%, 50mA	SOT-89	20vl	VR1	4h	Tor
Ā40	XC6371A401P	DC/DC-IC	PWM step-up, 100kHz, 4.0V±2.5%, 100mA	SOT-89	20bq	DC2	4c	Tor
A402G	AG402-89G	MMIC	Buff/amp, DC, 6GHz, 15dB (900MHz, 50Ω)	SOT-89	20aa	A1	4i	Wjc
A403G	AG403-89G	MMIC	Buff/amp, DC, 6GHz, 20.5dB (900MHz, 50Ω)	SOT-89	20aa	A1	4i	Wjc
A40A	ML6101C402P	Vdet-IC	4.0V±2%, +Reset PPO	SOT-89	20vda	VD7	4g	Mlc
A40A	R3111H401A	Vdet-IC	4V±2%, -Reset PPO	SOT-89	20vda	VD7	4c	Ric
A40C	R3111H401C	Vdet-IC	4V±2%, -Reset ODO	SOT-89	20vda	VD6	4c	Ric
A41	ELM9741NAB	Vdet-IC	4.1V±2.5%, +Reset ODO	SOT-89	20vda	VD6	4a	Elm
A41	XC31PNS0041AP	LVR-IC	Temperature Sensitive, -T*factor, 4.1V±5%, 50mA	SOT-89	20vl	VR1	4h	Tor
A41	XC31PPS0041AP	LVR-IC	Temperature Sensitive, +T*factor, 4.1V±5%, 50mA	SOT-89	20vl	VR1	4h	Tor
Ā41	XC6371A411P	DC/DC-IC	PWM step-up, 100kHz, 4.1V±2.5%, 100mA	SOT-89	20bq	DC2	4c	Tor
A41A	ML6101C412P	Vdet-IC	4.1V±2%, +Reset PPO	SOT-89	20vda	VD7	4g	Mlc
A41A	R3111H411A	Vdet-IC	4.1V±2%, -Reset PPO	SOT-89	20vda	VD7	4c	Ric
A41C	R3111H411C	Vdet-IC	4.1V±2%, -Reset ODO	SOT-89	20vda	VD6	4c	Ric
A42	ELM9742NAB	Vdet-IC	4.2V±2.5%, +Reset ODO	SOT-89	20vda	VD6	4a	Elm
A42	XC31PNS0042AP	LVR-IC	Temperature Sensitive, -T*factor, 4.2V±5%, 50mA	SOT-89	20vl	VR1	4h	Tor
A42	XC31PPS0042AP	LVR-IC	Temperature Sensitive, +T*factor, 4.2V±5%, 50mA	SOT-89	20vl	VR1	4h	Tor
Ā42	XC6371A421P	DC/DC-IC	PWM step-up, 100kHz, 4.2V±2.5%, 100mA	SOT-89	20bq	DC2	4c	Tor
A42A	ML6101C422P	Vdet-IC	4.2V±2%, +Reset PPO	SOT-89	20vda	VD7	4g	Mlc
A42A	MXTA42-A	Si-npn	HV-Vid, 300V, 500mA, 500mW, B=80..100, >50MHz	SOT-89	20tb	-	4b	Wtr
A42A	R3111H421A	Vdet-IC	4.2V±2%, -Reset PPO	SOT-89	20vda	VD7	4c	Ric
A42B1	MXTA42-B1	Si-npn	HV-Vid, 300V, 500mA, 500mW, B=100..150, >50MHz	SOT-89	20tb	-	4b	Wtr
A42B2	MXTA42-B2	Si-npn	HV-Vid, 300V, 500mA, 500mW, B=150..200, >50MHz	SOT-89	20tb	-	4b	Wtr
A42C	MXTA42-C	Si-npn	HV-Vid, 300V, 500mA, 500mW, B=200..250, >50MHz	SOT-89	20tb	-	4b	Wtr
A42C	R3111H421C	Vdet-IC	4.2V±2%, -Reset ODO	SOT-89	20vda	VD6	4c	Ric
A43	ELM9743NAB	Vdet-IC	4.3V±2.5%, +Reset ODO	SOT-89	20vda	VD6	4a	Elm
A43	XC31PNS0043AP	LVR-IC	Temperature Sensitive, -T*factor, 4.3V±5%, 50mA	SOT-89	20vl	VR1	4h	Tor
A43	XC31PPS0043AP	LVR-IC	Temperature Sensitive, +T*factor, 4.3V±5%, 50mA	SOT-89	20vl	VR1	4h	Tor
Ā43	XC6371A431P	DC/DC-IC	PWM step-up, 100kHz, 4.3V±2.5%, 100mA	SOT-89	20bq	DC2	4c	Tor
A43A	ML6101C432P	Vdet-IC	4.3V±2%, +Reset PPO	SOT-89	20vda	VD7	4g	Mlc
A43A	R3111H431A	Vdet-IC	4.3V±2%, -Reset PPO	SOT-89	20vda	VD7	4c	Ric
A43C	R3111H431C	Vdet-IC	4.3V±2%, -Reset ODO	SOT-89	20vda	VD6	4c	Ric
A44	ELM9744NAB	Vdet-IC	4.4V±2.5%, +Reset ODO	SOT-89	20vda	VD6	4a	Elm
A44	XC31PNS0044AP	LVR-IC	Temperature Sensitive, -T*factor, 4.4V±5%, 50mA	SOT-89	20vl	VR1	4h	Tor
A44	XC31PPS0044AP	LVR-IC	Temperature Sensitive, +T*factor, 4.4V±5%, 50mA	SOT-89	20vl	VR1	4h	Tor
Ā44	XC6371A441P	DC/DC-IC	PWM step-up, 100kHz, 4.4V±2.5%, 100mA	SOT-89	20bq	DC2	4c	Tor
A44A	ML6101C442P	Vdet-IC	4.4V±2%, +Reset PPO	SOT-89	20vda	VD7	4g	Mlc
A44A	R3111H441A	Vdet-IC	4.4V±2%, -Reset PPO	SOT-89	20vda	VD7	4c	Ric
A44C	R3111H441C	Vdet-IC	4.4V±2%, -Reset ODO	SOT-89	20vda	VD6	4c	Ric
A45	ELM9745NAB	Vdet-IC	4.5V±2.5%, +Reset ODO	SOT-89	20vda	VD6	4a	Elm
A45	XC31PNS0045AP	LVR-IC	Temperature Sensitive, -T*factor, 4.5V±5%, 50mA	SOT-89	20vl	VR1	4h	Tor
A45	XC31PPS0045AP	LVR-IC	Temperature Sensitive, +T*factor, 4.5V±5%, 50mA	SOT-89	20vl	VR1	4h	Tor
Ā45	XC6371A451P	DC/DC-IC	PWM step-up, 100kHz, 4.5V±2.5%, 100mA	SOT-89	20bq	DC2	4c	Tor
A45A	ML6101C452P	Vdet-IC	4.5V±2%, +Reset PPO	SOT-89	20vda	VD7	4g	Mlc



SMD
code

Type

Function

Short description

Case Pinout Sch. St. Mnf.

SMD code	Type	Function	Short description	Case	Pinout	Sch.	St.	Mnf.
A45A	R3111H451A	Vdet-IC	4.5V±2%, -Reset PPO	SOT-89	20vda	VD7	4c	Ric
A45C	R3111H451C	Vdet-IC	4.5V±2%, -Reset ODO	SOT-89	20vda	VD6	4c	Ric
A46	ELM9746NAB	Vdet-IC	4.6V±2.5%, +Reset ODO	SOT-89	20vda	VD6	4a	Elm
A46	XC31PNS0046AP	LVR-IC	Temperature Sensitive, -T*factor, 4.6V±5%, 50mA	SOT-89	20vl	VR1	4h	Tor
A46	XC31PPS0046AP	LVR-IC	Temperature Sensitive, +T*factor, 4.6V±5%, 50mA	SOT-89	20vl	VR1	4h	Tor
A46	XC6371A461P	DC/DC-IC	PWM step-up, 100kHz, 4.6V±2.5%, 100mA	SOT-89	20bq	DC2	4c	Tor
A46A	ML6101C462P	Vdet-IC	4.6V±2%, +Reset PPO	SOT-89	20vda	VD7	4g	Mlc
A46A	R3111H461A	Vdet-IC	4.6V±2%, -Reset PPO	SOT-89	20vda	VD7	4c	Ric
A46C	R3111H461C	Vdet-IC	4.6V±2%, -Reset ODO	SOT-89	20vda	VD6	4c	Ric
A47	ELM9747NAB	Vdet-IC	4.7V±2.5%, +Reset ODO	SOT-89	20vda	VD6	4a	Elm
A47	XC31PNS0047AP	LVR-IC	Temperature Sensitive, -T*factor, 4.7V±5%, 50mA	SOT-89	20vl	VR1	4h	Tor
A47	XC31PPS0047AP	LVR-IC	Temperature Sensitive, +T*factor, 4.7V±5%, 50mA	SOT-89	20vl	VR1	4h	Tor
A47	XC6371A471P	DC/DC-IC	PWM step-up, 100kHz, 4.7V±2.5%, 100mA	SOT-89	20bq	DC2	4c	Tor
A47A	ML6101C472P	Vdet-IC	4.7V±2%, +Reset PPO	SOT-89	20vda	VD7	4g	Mlc
A47A	R3111H471A	Vdet-IC	4.7V±2%, -Reset PPO	SOT-89	20vda	VD7	4c	Ric
A47C	R3111H471C	Vdet-IC	4.7V±2%, -Reset ODO	SOT-89	20vda	VD6	4c	Ric
A48	ELM9748NAB	Vdet-IC	4.8V±2.5%, +Reset ODO	SOT-89	20vda	VD6	4a	Elm
A48	XC31PNS0048AP	LVR-IC	Temperature Sensitive, -T*factor, 4.8V±5%, 50mA	SOT-89	20vl	VR1	4h	Tor
A48	XC31PPS0048AP	LVR-IC	Temperature Sensitive, +T*factor, 4.8V±5%, 50mA	SOT-89	20vl	VR1	4h	Tor
A48	XC6371A481P	DC/DC-IC	PWM step-up, 100kHz, 4.8V±2.5%, 100mA	SOT-89	20bq	DC2	4c	Tor
A48A	ML6101C482P	Vdet-IC	4.8V±2%, +Reset PPO	SOT-89	20vda	VD7	4g	Mlc
A48A	R3111H481A	Vdet-IC	4.8V±2%, -Reset PPO	SOT-89	20vda	VD7	4c	Ric
A48C	R3111H481C	Vdet-IC	4.8V±2%, -Reset ODO	SOT-89	20vda	VD6	4c	Ric
A49	ELM9749NAB	Vdet-IC	4.9V±2.5%, +Reset ODO	SOT-89	20vda	VD6	4a	Elm
A49	XC31PNS0049AP	LVR-IC	Temperature Sensitive, -T*factor, 4.9V±5%, 50mA	SOT-89	20vl	VR1	4h	Tor
A49	XC31PPS0049AP	LVR-IC	Temperature Sensitive, +T*factor, 4.9V±5%, 50mA	SOT-89	20vl	VR1	4h	Tor
A49	XC6371A491P	DC/DC-IC	PWM step-up, 100kHz, 4.9V±2.5%, 100mA	SOT-89	20bq	DC2	4c	Tor
A49A	ML6101C492P	Vdet-IC	4.9V±2%, +Reset PPO	SOT-89	20vda	VD7	4g	Mlc
A49A	R3111H491A	Vdet-IC	4.9V±2%, -Reset PPO	SOT-89	20vda	VD7	4c	Ric
A49C	R3111H491C	Vdet-IC	4.9V±2%, -Reset ODO	SOT-89	20vda	VD6	4c	Ric
A4A	XC6371A402P	DC/DC-IC	PWM step-up, 180kHz, 4.0V±2.5%, 100mA	SOT-89	20bq	DC2	4c	Tor
A4AB	XC6371A412P	DC/DC-IC	PWM step-up, 180kHz, 4.1V±2.5%, 100mA	SOT-89	20bq	DC2	4c	Tor
A4AC	XC6371A422P	DC/DC-IC	PWM step-up, 180kHz, 4.2V±2.5%, 100mA	SOT-89	20bq	DC2	4c	Tor
A4AD	XC6371A432P	DC/DC-IC	PWM step-up, 180kHz, 4.3V±2.5%, 100mA	SOT-89	20bq	DC2	4c	Tor
A4AE	XC6371A442P	DC/DC-IC	PWM step-up, 180kHz, 4.4V±2.5%, 100mA	SOT-89	20bq	DC2	4c	Tor
A4AF	XC6371A452P	DC/DC-IC	PWM step-up, 180kHz, 4.5V±2.5%, 100mA	SOT-89	20bq	DC2	4c	Tor
A4AH	XC6371A462P	DC/DC-IC	PWM step-up, 180kHz, 4.6V±2.5%, 100mA	SOT-89	20bq	DC2	4c	Tor
A4AK	XC6371A472P	DC/DC-IC	PWM step-up, 180kHz, 4.7V±2.5%, 100mA	SOT-89	20bq	DC2	4c	Tor
A4AL	XC6371A482P	DC/DC-IC	PWM step-up, 180kHz, 4.8V±2.5%, 100mA	SOT-89	20bq	DC2	4c	Tor
A4AM	XC6371A492P	DC/DC-IC	PWM step-up, 180kHz, 4.9V±2.5%, 100mA	SOT-89	20bq	DC2	4c	Tor
A5	AP431AY	Vref-IC	Adjustable, Precision, Shunt, 2.495V±0.5%	SOT-89-3L	20rb	RF1	4b	Ana
A5	ELM9825AB	LVR-IC	2.5V±2%, 200mA	SOT-89	20vl	VR1	4a	Elm
A5	RT9161-37CX	LVR-IC	LDO, 3.7V±2%, 300mA	SOT-89	20vl	VR1	4c	Rct
A50	ELM9750NAB	Vdet-IC	5.0V±2.5%, +Reset ODO	SOT-89	20vda	VD6	4a	Elm
A50	TK11650U	LVR-IC	LDO, 5V±1.5%, 190mA	SOT-89	20hn	VR1	4d	Tok
A50	XC31PNS0050AP	LVR-IC	Temperature Sensitive, -T*factor, 5V±5%, 50mA	SOT-89	20vl	VR1	4h	Tor
A50	XC31PPS0050AP	LVR-IC	Temperature Sensitive, +T*factor, 5V±5%, 50mA	SOT-89	20vl	VR1	4h	Tor
A50	XC6371A501P	DC/DC-IC	PWM step-up, 100kHz, 5.0V±2.5%, 100mA	SOT-89	20bq	DC2	4c	Tor
A503G	AG503-89G	MMIC	Buff/amp, DC, 4GHz, 21.5dB (900MHz, 50Ω)	SOT-89	20aa	A1	4i	Wjc
A50A	ML6101C502P	Vdet-IC	5.0V±2%, +Reset PPO	SOT-89	20vda	VD7	4g	Mlc
A50A	R3111H501A	Vdet-IC	5V±2%, -Reset PPO	SOT-89	20vda	VD7	4c	Ric
A50C	R3111H501C	Vdet-IC	5V±2%, -Reset ODO	SOT-89	20vda	VD6	4c	Ric
A51	ELM9751NAB	Vdet-IC	5.1V±2.5%, +Reset ODO	SOT-89	20vda	VD6	4a	Elm
A51	XC31PNS0051AP	LVR-IC	Temperature Sensitive, -T*factor, 5.1V±5%, 50mA	SOT-89	20vl	VR1	4h	Tor
A51	XC31PPS0051AP	LVR-IC	Temperature Sensitive, +T*factor, 5.1V±5%, 50mA	SOT-89	20vl	VR1	4h	Tor
A51	XC6371A511P	DC/DC-IC	PWM step-up, 100kHz, 5.1V±2.5%, 100mA	SOT-89	20bq	DC2	4c	Tor
A51A	ML6101C512P	Vdet-IC	5.1V±2%, +Reset PPO	SOT-89	20vda	VD7	4g	Mlc
A51A	R3111H511A	Vdet-IC	5.1V±2%, -Reset PPO	SOT-89	20vda	VD7	4c	Ric
A51C	R3111H511C	Vdet-IC	5.1V±2%, -Reset ODO	SOT-89	20vda	VD6	4c	Ric
A52	ELM9752NAB	Vdet-IC	5.2V±2.5%, +Reset ODO	SOT-89	20vda	VD6	4a	Elm
A52	XC31PNS0052AP	LVR-IC	Temperature Sensitive, -T*factor, 5.2V±5%, 50mA	SOT-89	20vl	VR1	4h	Tor
A52	XC31PPS0052AP	LVR-IC	Temperature Sensitive, +T*factor, 5.2V±5%, 50mA	SOT-89	20vl	VR1	4h	Tor
A52	XC6371A521P	DC/DC-IC	PWM step-up, 100kHz, 5.2V±2.5%, 100mA	SOT-89	20bq	DC2	4c	Tor
A52A	ML6101C522P	Vdet-IC	5.2V±2%, +Reset PPO	SOT-89	20vda	VD7	4g	Mlc
A52A	R3111H521A	Vdet-IC	5.2V±2%, -Reset PPO	SOT-89	20vda	VD7	4c	Ric
A52C	R3111H521C	Vdet-IC	5.2V±2%, -Reset ODO	SOT-89	20vda	VD6	4c	Ric
A53	ELM9753NAB	Vdet-IC	5.3V±2.5%, +Reset ODO	SOT-89	20vda	VD6	4a	Elm
A53	XC31PNS0053AP	LVR-IC	Temperature Sensitive, -T*factor, 5.3V±5%, 50mA	SOT-89	20vl	VR1	4h	Tor
A53	XC31PPS0053AP	LVR-IC	Temperature Sensitive, +T*factor, 5.3V±5%, 50mA	SOT-89	20vl	VR1	4h	Tor
A53	XC6371A531P	DC/DC-IC	PWM step-up, 100kHz, 5.3V±2.5%, 100mA	SOT-89	20bq	DC2	4c	Tor



SMD
code

Type

Function

Short description

Case Pinout Sch. St. Mnf.

A53A	ML6101C532P	Vdet-IC	5.3V±2%, +Reset PPO	SOT-89	20vda	VD7	4g	Mlc
A53A	R3111H531A	Vdet-IC	5.3V±2%, -Reset PPO	SOT-89	20vda	VD7	4c	Ric
A53C	R3111H531C	Vdet-IC	5.3V±2%, -Reset ODO	SOT-89	20vda	VD6	4c	Ric
A54	ELM9754NAB	Vdet-IC	5.4V±2.5%, +Reset ODO	SOT-89	20vda	VD6	4a	Elm
A54	XC31PNS0054AP	LVR-IC	Temperature Sensitive, -T*factor, 5.4V±5%, 50mA	SOT-89	20vl	VR1	4h	Tor
A54	XC31PPS0054AP	LVR-IC	Temperature Sensitive, +T*factor, 5.4V±5%, 50mA	SOT-89	20vl	VR1	4h	Tor
A54	XC6371A541P	DC/DC-IC	PWM step-up, 100kHz, 5.4V±2.5%, 100mA	SOT-89	20bq	DC2	4c	Tor
A54A	ML6101C542P	Vdet-IC	5.4V±2%, +Reset PPO	SOT-89	20vda	VD7	4g	Mlc
A54A	R3111H541A	Vdet-IC	5.4V±2%, -Reset PPO	SOT-89	20vda	VD7	4c	Ric
A54C	R3111H541C	Vdet-IC	5.4V±2%, -Reset ODO	SOT-89	20vda	VD6	4c	Ric
A55	ELM9755NAB	Vdet-IC	5.5V±2.5%, +Reset ODO	SOT-89	20vda	VD6	4a	Elm
A55	XC31PNS0055AP	LVR-IC	Temperature Sensitive, -T*factor, 5.5V±5%, 50mA	SOT-89	20vl	VR1	4h	Tor
A55	XC31PPS0055AP	LVR-IC	Temperature Sensitive, +T*factor, 5.5V±5%, 50mA	SOT-89	20vl	VR1	4h	Tor
A55	XC6371A551P	DC/DC-IC	PWM step-up, 100kHz, 5.5V±2.5%, 100mA	SOT-89	20bq	DC2	4c	Tor
A55A	ML6101C552P	Vdet-IC	5.5V±2%, +Reset PPO	SOT-89	20vda	VD7	4g	Mlc
A55A	R3111H551A	Vdet-IC	5.5V±2%, -Reset PPO	SOT-89	20vda	VD7	4c	Ric
A55C	R3111H551C	Vdet-IC	5.5V±2%, -Reset ODO	SOT-89	20vda	VD6	4c	Ric
A56	XC6371A561P	DC/DC-IC	PWM step-up, 100kHz, 5.6V±2.5%, 100mA	SOT-89	20bq	DC2	4c	Tor
A56A	ML6101C562P	Vdet-IC	5.6V±2%, +Reset PPO	SOT-89	20vda	VD7	4g	Mlc
A56A	R3111H561A	Vdet-IC	5.6V±2%, -Reset PPO	SOT-89	20vda	VD7	4c	Ric
A56C	R3111H561C	Vdet-IC	5.6V±2%, -Reset ODO	SOT-89	20vda	VD6	4c	Ric
A57	XC6371A571P	DC/DC-IC	PWM step-up, 100kHz, 5.7V±2.5%, 100mA	SOT-89	20bq	DC2	4c	Tor
A57A	ML6101C572P	Vdet-IC	5.7V±2%, +Reset PPO	SOT-89	20vda	VD7	4g	Mlc
A57A	R3111H571A	Vdet-IC	5.7V±2%, -Reset PPO	SOT-89	20vda	VD7	4c	Ric
A57C	R3111H571C	Vdet-IC	5.7V±2%, -Reset ODO	SOT-89	20vda	VD6	4c	Ric
A58	XC6371A581P	DC/DC-IC	PWM step-up, 100kHz, 5.8V±2.5%, 100mA	SOT-89	20bq	DC2	4c	Tor
A58A	ML6101C582P	Vdet-IC	5.8V±2%, +Reset PPO	SOT-89	20vda	VD7	4g	Mlc
A58A	R3111H581A	Vdet-IC	5.8V±2%, -Reset PPO	SOT-89	20vda	VD7	4c	Ric
A58C	R3111H581C	Vdet-IC	5.8V±2%, -Reset ODO	SOT-89	20vda	VD6	4c	Ric
A59	XC6371A591P	DC/DC-IC	PWM step-up, 100kHz, 5.9V±2.5%, 100mA	SOT-89	20bq	DC2	4c	Tor
A59A	ML6101C592P	Vdet-IC	5.9V±2%, +Reset PPO	SOT-89	20vda	VD7	4g	Mlc
A59A	R3111H591A	Vdet-IC	5.9V±2%, -Reset PPO	SOT-89	20vda	VD7	4c	Ric
A59C	R3111H591C	Vdet-IC	5.9V±2%, -Reset ODO	SOT-89	20vda	VD6	4c	Ric
A5A	XC6371A502P	DC/DC-IC	PWM step-up, 180kHz, 5.0V±2.5%, 100mA	SOT-89	20bq	DC2	4c	Tor
A5B	XC6371A512P	DC/DC-IC	PWM step-up, 180kHz, 5.1V±2.5%, 100mA	SOT-89	20bq	DC2	4c	Tor
A5C	XC6371A522P	DC/DC-IC	PWM step-up, 180kHz, 5.2V±2.5%, 100mA	SOT-89	20bq	DC2	4c	Tor
A5D	XC6371A532P	DC/DC-IC	PWM step-up, 180kHz, 5.3V±2.5%, 100mA	SOT-89	20bq	DC2	4c	Tor
A5E	XC6371A542P	DC/DC-IC	PWM step-up, 180kHz, 5.4V±2.5%, 100mA	SOT-89	20bq	DC2	4c	Tor
A5F	XC6371A552P	DC/DC-IC	PWM step-up, 180kHz, 5.5V±2.5%, 100mA	SOT-89	20bq	DC2	4c	Tor
A5H	XC6371A562P	DC/DC-IC	PWM step-up, 180kHz, 5.6V±2.5%, 100mA	SOT-89	20bq	DC2	4c	Tor
A5K	XC6371A572P	DC/DC-IC	PWM step-up, 180kHz, 5.7V±2.5%, 100mA	SOT-89	20bq	DC2	4c	Tor
A5L	XC6371A582P	DC/DC-IC	PWM step-up, 180kHz, 5.8V±2.5%, 100mA	SOT-89	20bq	DC2	4c	Tor
A5M	XC6371A592P	DC/DC-IC	PWM step-up, 180kHz, 5.9V±2.5%, 100mA	SOT-89	20bq	DC2	4c	Tor
A6	ELM9826AB	LVR-IC	2.6V±2%, 200mA	SOT-89	20vl	VR1	4a	Elm
A6	RT9161-39CX	LVR-IC	LDO, 3.9V±2%, 300mA	SOT-89	20vl	VR1	4c	Rct
A6-	RT9161-39PX	LVR-IC	LDO, 3.9V±2%, 300mA	SOT-89	20vl	VR1	4c	Rct
A60	XC6371A601P	DC/DC-IC	PWM step-up, 100kHz, 6.0V±2.5%, 100mA	SOT-89	20bq	DC2	4c	Tor
A602G	AG602-89G	MMIC	Buff/amp, DC. 3.5GHz, 14dB (900MHz, 50Ω)	SOT-89	20aa	A1	4i	Wjc
A603G	AG603-89G	MMIC	Buff/amp, DC. 3GHz, 18.5dB (900MHz, 50Ω)	SOT-89	20aa	A1	4i	Wjc
A604G	AG604-89G	MMIC	Buff/amp, DC. 2/7GHz, 21dB (900MHz, 50Ω)	SOT-89	20aa	A1	4i	Wjc
A60A	ML6101C602P	Vdet-IC	6.0V±2%, +Reset PPO	SOT-89	20vda	VD7	4g	Mlc
A60A	R3111H601A	Vdet-IC	6V±2%, -Reset PPO	SOT-89	20vda	VD7	4c	Ric
A60C	R3111H601C	Vdet-IC	6V±2%, -Reset ODO	SOT-89	20vda	VD6	4c	Ric
A61	XC6371A611P	DC/DC-IC	PWM step-up, 100kHz, 6.1V±2.5%, 100mA	SOT-89	20bq	DC2	4c	Tor
A62	XC6371A621P	DC/DC-IC	PWM step-up, 100kHz, 6.2V±2.5%, 100mA	SOT-89	20bq	DC2	4c	Tor
A63	XC6371A631P	DC/DC-IC	PWM step-up, 100kHz, 6.3V±2.5%, 100mA	SOT-89	20bq	DC2	4c	Tor
A64	XC6371A641P	DC/DC-IC	PWM step-up, 100kHz, 6.4V±2.5%, 100mA	SOT-89	20bq	DC2	4c	Tor
A65	XC6371A651P	DC/DC-IC	PWM step-up, 100kHz, 6.5V±2.5%, 100mA	SOT-89	20bq	DC2	4c	Tor
A66	XC6371A661P	DC/DC-IC	PWM step-up, 100kHz, 6.6V±2.5%, 100mA	SOT-89	20bq	DC2	4c	Tor
A67	XC6371A671P	DC/DC-IC	PWM step-up, 100kHz, 6.7V±2.5%, 100mA	SOT-89	20bq	DC2	4c	Tor
A68	XC6371A681P	DC/DC-IC	PWM step-up, 100kHz, 6.8V±2.5%, 100mA	SOT-89	20bq	DC2	4c	Tor
A69	XC6371A691P	DC/DC-IC	PWM step-up, 100kHz, 6.9V±2.5%, 100mA	SOT-89	20bq	DC2	4c	Tor
A6A	XC6371A602P	DC/DC-IC	PWM step-up, 180kHz, 6.0V±2.5%, 100mA	SOT-89	20bq	DC2	4c	Tor
A6B	XC6371A612P	DC/DC-IC	PWM step-up, 180kHz, 6.1V±2.5%, 100mA	SOT-89	20bq	DC2	4c	Tor
A6C	XC6371A622P	DC/DC-IC	PWM step-up, 180kHz, 6.2V±2.5%, 100mA	SOT-89	20bq	DC2	4c	Tor
A6D	XC6371A632P	DC/DC-IC	PWM step-up, 180kHz, 6.3V±2.5%, 100mA	SOT-89	20bq	DC2	4c	Tor
A6E	XC6371A642P	DC/DC-IC	PWM step-up, 180kHz, 6.4V±2.5%, 100mA	SOT-89	20bq	DC2	4c	Tor
A6F	XC6371A652P	DC/DC-IC	PWM step-up, 180kHz, 6.5V±2.5%, 100mA	SOT-89	20bq	DC2	4c	Tor
A6H	XC6371A662P	DC/DC-IC	PWM step-up, 180kHz, 6.6V±2.5%, 100mA	SOT-89	20bq	DC2	4c	Tor
A6K	XC6371A672P	DC/DC-IC	PWM step-up, 180kHz, 6.7V±2.5%, 100mA	SOT-89	20bq	DC2	4c	Tor



SMD
code

Type

Function

Short description

Case Pinout Sch. St. Mnf.

Ā6L	XC6371A682P	DC/DC-IC	PWM step-up, 180kHz, 6.8V±2.5%, 100mA	SOT-89	20bq	DC2	4c	Tor
Ā6M	XC6371A692P	DC/DC-IC	PWM step-up, 180kHz, 6.9V±2.5%, 100mA	SOT-89	20bq	DC2	4c	Tor
A7	ELM9827AB	LVR-IC	2.7V±2%, 200mA	SOT-89	20vl	VR1	4a	Elm
A7	RT9161-40CX	LVR-IC	LDO, 4.0V±2%, 300mA	SOT-89	20vl	VR1	4c	Rct
A7-	RT9161-40PX	LVR-IC	LDO, 4.0V±2%, 300mA	SOT-89	20vl	VR1	4c	Rct
Ā70	XC6371A701P	DC/DC-IC	PWM step-up, 100kHz, 7.0V±2.5%, 100mA	SOT-89	20bq	DC2	4c	Tor
Ā7A	XC6371A702P	DC/DC-IC	PWM step-up, 180kHz, 7.0V±2.5%, 100mA	SOT-89	20bq	DC2	4c	Tor
A8	ELM9828AB	LVR-IC	2.8V±2%, 200mA	SOT-89	20vl	VR1	4a	Elm
Ā8500BAA21	AME8500BEFTAA21	Vdet-IC	2.1V±1.5%, -Reset PPO, 1.5ms	SOT-89	20vda	VD7	4o	Ame
Ā8500BAA21	AME8500BEFTAA21Z	Vdet-IC	2.1V±1.5%, -Reset PPO, 1.5ms, lead free	SOT-89	20vda	VD7	4o	Ame
Ā8500BAA27	AME8500BEFTAA27	Vdet-IC	2.7V±1.5%, -Reset PPO, 1.5ms	SOT-89	20vda	VD7	4o	Ame
Ā8500BAA27	AME8500BEFTAA27Z	Vdet-IC	2.7V±1.5%, -Reset PPO, 1.5ms, lead free	SOT-89	20vda	VD7	4o	Ame
Ā8500BAF27	AME8500BEFTAF27	Vdet-IC	2.7V±1.5%, -Reset PPO, 210ms	SOT-89	20vda	VD7	4o	Ame
Ā8500BAF27	AME8500BEFTAF27Z	Vdet-IC	2.7V±1.5%, -Reset PPO, 210ms, lead free	SOT-89	20vda	VD7	4o	Ame
Ā8500BAF40	AME8500BEFTAF40	Vdet-IC	4V±1.5%, -Reset PPO, 210ms	SOT-89	20vda	VD7	4o	Ame
Ā8500BAF40	AME8500BEFTAF40Z	Vdet-IC	4V±1.5%, -Reset PPO, 210ms, lead free	SOT-89	20vda	VD7	4o	Ame
Ā8500BBA23	AME8500BEFTBA23	Vdet-IC	2.32V±1.5%, -Reset ODO, 1.5ms	SOT-89	20vda	VD7	4o	Ame
Ā8500BBA23	AME8500BEFTBA23Z	Vdet-IC	2.32V±1.5%, -Reset ODO, 1.5ms, lead free	SOT-89	20vda	VD7	4o	Ame
Ā8500BBA24	AME8500BEFTBA24	Vdet-IC	2.40V±1.5%, -Reset ODO, 1.5ms	SOT-89	20vda	VD7	4o	Ame
Ā8500BBA24	AME8500BEFTBA24Z	Vdet-IC	2.40V±1.5%, -Reset ODO, 1.5ms, lead free	SOT-89	20vda	VD7	4o	Ame
Ā8500CBA27	AME8500CEFTBA27	Vdet-IC	2.7V±1.5%, -Reset ODO, 1.5ms	SOT-89	20vda	VD6	4o	Ame
Ā8500CBA27	AME8500CEFTBA27Z	Vdet-IC	2.7V±1.5%, -Reset ODO, 1.5ms, lead free	SOT-89	20vda	VD6	4o	Ame
Ā8500CBA29	AME8500CEFTBA29	Vdet-IC	2.93V±1.5%, -Reset ODO, 1.5ms	SOT-89	20vda	VD6	4o	Ame
Ā8500CBA29	AME8500CEFTBA29Z	Vdet-IC	2.93V±1.5%, -Reset ODO, 1.5ms, lead free	SOT-89	20vda	VD6	4o	Ame
Ā8500CBA42	AME8500CEFTBA42	Vdet-IC	4.2V±1.5%, -Reset ODO, 1.5ms	SOT-89	20vda	VD6	4o	Ame
Ā8500CBA42	AME8500CEFTBA42Z	Vdet-IC	4.2V±1.5%, -Reset ODO, 1.5ms, lead free	SOT-89	20vda	VD6	4o	Ame
Ā8500CCD28	AME8500CEFTCD28	Vdet-IC	2.8V±1.5%, +Reset PPO, 30ms	SOT-89	20vda	VD7	4o	Ame
Ā8500CCD28	AME8500CEFTCD28Z	Vdet-IC	2.8V±1.5%, +Reset PPO, 30ms, lead free	SOT-89	20vda	VD7	4o	Ame
Ā8500CCD46	AME8500CEFTCD46	Vdet-IC	4.63V±1.5%, +Reset PPO, 30ms	SOT-89	20vda	VD7	4o	Ame
Ā8500CCD46	AME8500CEFTCD46Z	Vdet-IC	4.63V±1.5%, +Reset PPO, 30ms, lead free	SOT-89	20vda	VD7	4o	Ame
Ā8550AA220	AME8550AEFTA220L	Vdet-IC	2.2V±2%, -Reset PPO	SOT-89	20vda	VD7	4o	Ame
Ā8550AA220	AME8550AEFTA220Z	Vdet-IC	2.2V±2%, -Reset PPO	SOT-89	20vda	VD7	4o	Ame
Ā8550AA240	AME8550AEFTA240L	Vdet-IC	2.4V±2%, -Reset PPO	SOT-89	20vda	VD7	4o	Ame
Ā8550AA240	AME8550AEFTA240Z	Vdet-IC	2.4V±2%, -Reset PPO	SOT-89	20vda	VD7	4o	Ame
Ā8550AA270	AME8550AEFTA270L	Vdet-IC	2.7V±2%, -Reset PPO	SOT-89	20vda	VD7	4o	Ame
Ā8550AA270	AME8550AEFTA270Z	Vdet-IC	2.7V±2%, -Reset PPO	SOT-89	20vda	VD7	4o	Ame
Ā8550AA300	AME8550AEFTA300L	Vdet-IC	3.0V±2%, -Reset PPO	SOT-89	20vda	VD7	4o	Ame
Ā8550AA300	AME8550AEFTA300Z	Vdet-IC	3.0V±2%, -Reset PPO	SOT-89	20vda	VD7	4o	Ame
Ā8550AA500	AME8550AEFTA500L	Vdet-IC	5.0V±2%, -Reset PPO	SOT-89	20vda	VD7	4o	Ame
Ā8550AA500	AME8550AEFTA500Z	Vdet-IC	5.0V±2%, -Reset PPO	SOT-89	20vda	VD7	4o	Ame
Ā8550AB210	AME8550AEFTB210L	Vdet-IC	2.1V±2%, -Reset ODO	SOT-89	20vda	VD6	4o	Ame
Ā8550AB210	AME8550AEFTB210Z	Vdet-IC	2.1V±2%, -Reset ODO	SOT-89	20vda	VD6	4o	Ame
Ā8550AB220	AME8550AEFTB220L	Vdet-IC	2.2V±2%, -Reset ODO	SOT-89	20vda	VD6	4o	Ame
Ā8550AB220	AME8550AEFTB220Z	Vdet-IC	2.2V±2%, -Reset ODO	SOT-89	20vda	VD6	4o	Ame
Ā8550AB240	AME8550AEFTB240L	Vdet-IC	2.4V±2%, -Reset ODO	SOT-89	20vda	VD6	4o	Ame
Ā8550AB240	AME8550AEFTB240Z	Vdet-IC	2.4V±2%, -Reset ODO	SOT-89	20vda	VD6	4o	Ame
Ā8550AB250	AME8550AEFTB250L	Vdet-IC	2.5V±2%, -Reset ODO	SOT-89	20vda	VD6	4o	Ame
Ā8550AB250	AME8550AEFTB250Z	Vdet-IC	2.5V±2%, -Reset ODO	SOT-89	20vda	VD6	4o	Ame
Ā8550AB270	AME8550AEFTB270L	Vdet-IC	2.7V±2%, -Reset ODO	SOT-89	20vda	VD6	4o	Ame
Ā8550AB270	AME8550AEFTB270Z	Vdet-IC	2.7V±2%, -Reset ODO	SOT-89	20vda	VD6	4o	Ame
Ā8550AB280	AME8550AEFTB280L	Vdet-IC	2.8V±2%, -Reset ODO	SOT-89	20vda	VD6	4o	Ame
Ā8550AB280	AME8550AEFTB280Z	Vdet-IC	2.8V±2%, -Reset ODO	SOT-89	20vda	VD6	4o	Ame
Ā8550AB340	AME8550AEFTB340L	Vdet-IC	3.4V±2%, -Reset ODO	SOT-89	20vda	VD6	4o	Ame
Ā8550AB340	AME8550AEFTB340Z	Vdet-IC	3.4V±2%, -Reset ODO	SOT-89	20vda	VD6	4o	Ame
Ā8550AB440	AME8550AEFTB440L	Vdet-IC	4.4V±2%, -Reset ODO	SOT-89	20vda	VD6	4o	Ame
Ā8550AB440	AME8550AEFTB440Z	Vdet-IC	4.4V±2%, -Reset ODO	SOT-89	20vda	VD6	4o	Ame
Ā88001EF	AME88001EFT	LVR-IC	LDO, 1.3V±1.5%, 300mA	SOT-89	20vl	VR1	4q	Ame
Ā88001EF	AME88001EFTZ	LVR-IC	LDO, 1.3V±1.5%, 300mA	SOT-89	20vl	VR1	4q	Ame
Ā88002EF	AME88002EFT	LVR-IC	LDO, 2.0V±1.5%, 300mA	SOT-89	20vl	VR1	4q	Ame
Ā88002EF	AME88002EFTZ	LVR-IC	LDO, 2.0V±1.5%, 300mA	SOT-89	20vl	VR1	4q	Ame
Ā88003EF	AME88003EFT	LVR-IC	LDO, 4.2V±1.5%, 300mA	SOT-89	20vl	VR1	4q	Ame
Ā88003EF	AME88003EFTZ	LVR-IC	LDO, 4.2V±1.5%, 300mA	SOT-89	20vl	VR1	4q	Ame
Ā88004EF	AME88004EFT	LVR-IC	LDO, 4.0V±1.5%, 300mA	SOT-89	20vl	VR1	4q	Ame
Ā88004EF	AME88004EFTZ	LVR-IC	LDO, 4.0V±1.5%, 300mA	SOT-89	20vl	VR1	4q	Ame
Ā8800AEF	AME8800AEFT	LVR-IC	LDO, 3.3V±1.5%, 300mA	SOT-89	20vl	VR1	4q	Ame
Ā8800AEF	AME8800AEFTZ	LVR-IC	LDO, 3.3V±1.5%, 300mA	SOT-89	20vl	VR1	4q	Ame
Ā8800BEF	AME8800BEFT	LVR-IC	LDO, 3.0V±1.5%, 300mA	SOT-89	20vl	VR1	4q	Ame
Ā8800BEF	AME8800BEFTZ	LVR-IC	LDO, 3.0V±1.5%, 300mA	SOT-89	20vl	VR1	4q	Ame
Ā8800CEF	AME8800CEFT	LVR-IC	LDO, 2.8V±1.5%, 300mA	SOT-89	20vl	VR1	4q	Ame
Ā8800CEF	AME8800CEFTZ	LVR-IC	LDO, 2.8V±1.5%, 300mA	SOT-89	20vl	VR1	4q	Ame



SMD code	Type	Function	Short description	Case	Pinout	Sch.	St.	Mnf.
A8800DEF	AME8800DEFT	LVR-IC	LDO, 2.5V±1.5%, 300mA	SOT-89	20vl	VR1	4q	Ame
Ã8800DEF	AME8800DEFTZ	LVR-IC	LDO, 2.5V±1.5%, 300mA	SOT-89	20vl	VR1	4q	Ame
A8800EEF	AME8800EEFT	LVR-IC	LDO, 3.8V±1.5%, 300mA	SOT-89	20vl	VR1	4q	Ame
Ã8800EEF	AME8800EEFTZ	LVR-IC	LDO, 3.8V±1.5%, 300mA	SOT-89	20vl	VR1	4q	Ame
A8800FEF	AME8800FEFT	LVR-IC	LDO, 3.6V±1.5%, 300mA	SOT-89	20vl	VR1	4q	Ame
Ã8800FEF	AME8800FEFTZ	LVR-IC	LDO, 3.6V±1.5%, 300mA	SOT-89	20vl	VR1	4q	Ame
A8800GEF	AME8800GEFT	LVR-IC	LDO, 3.5V±1.5%, 300mA	SOT-89	20vl	VR1	4q	Ame
Ã8800GEF	AME8800GEFTZ	LVR-IC	LDO, 3.5V±1.5%, 300mA	SOT-89	20vl	VR1	4q	Ame
A8800HEF	AME8800HEFT	LVR-IC	LDO, 2.7V±1.5%, 300mA	SOT-89	20vl	VR1	4q	Ame
Ã8800HEF	AME8800HEFTZ	LVR-IC	LDO, 2.7V±1.5%, 300mA	SOT-89	20vl	VR1	4q	Ame
A8800IEF	AME8800IEFT	LVR-IC	LDO, 3.4V±1.5%, 300mA	SOT-89	20vl	VR1	4q	Ame
Ã8800IEF	AME8800IEFTZ	LVR-IC	LDO, 3.4V±1.5%, 300mA	SOT-89	20vl	VR1	4q	Ame
A8800JEF	AME8800JEFT	LVR-IC	LDO, 2.85V±1.5%, 300mA	SOT-89	20vl	VR1	4q	Ame
Ã8800JEF	AME8800JEFTZ	LVR-IC	LDO, 2.85V±1.5%, 300mA	SOT-89	20vl	VR1	4q	Ame
A8800KEF	AME8800KEFT	LVR-IC	LDO, 3.7V±1.5%, 300mA	SOT-89	20vl	VR1	4q	Ame
Ã8800KEF	AME8800KEFTZ	LVR-IC	LDO, 3.7V±1.5%, 300mA	SOT-89	20vl	VR1	4q	Ame
A8800LEF	AME8800LEFT	LVR-IC	LDO, 1.5V±1.5%, 300mA	SOT-89	20vl	VR1	4q	Ame
Ã8800LEF	AME8800LEFTZ	LVR-IC	LDO, 1.5V±1.5%, 300mA	SOT-89	20vl	VR1	4q	Ame
A8800MEF	AME8800MEFT	LVR-IC	LDO, 1.8V±1.5%, 300mA	SOT-89	20vl	VR1	4q	Ame
Ã8800MEF	AME8800MEFTZ	LVR-IC	LDO, 1.8V±1.5%, 300mA	SOT-89	20vl	VR1	4q	Ame
A8800NEF	AME8800NEFT	LVR-IC	LDO, 2.9V±1.5%, 300mA	SOT-89	20vl	VR1	4q	Ame
Ã8800NEF	AME8800NEFTZ	LVR-IC	LDO, 2.9V±1.5%, 300mA	SOT-89	20vl	VR1	4q	Ame
A8800OEF	AME8800OEFT	LVR-IC	LDO, 3.1V±1.5%, 300mA	SOT-89	20vl	VR1	4q	Ame
Ã8800OEF	AME8800OEFTZ	LVR-IC	LDO, 3.1V±1.5%, 300mA	SOT-89	20vl	VR1	4q	Ame
A8800SEF	AME8800SEFT	LVR-IC	LDO, 5.0V±1.5%, 300mA	SOT-89	20vl	VR1	4q	Ame
Ã8800SEF	AME8800SEFTZ	LVR-IC	LDO, 5.0V±1.5%, 300mA	SOT-89	20vl	VR1	4q	Ame
A8800WEF	AME8800WEFT	LVR-IC	LDO, 2.3V±1.5%, 300mA	SOT-89	20vl	VR1	4q	Ame
Ã8800WEF	AME8800WEFTZ	LVR-IC	LDO, 2.3V±1.5%, 300mA	SOT-89	20vl	VR1	4q	Ame
A8800ZEF	AME8800ZEFT	LVR-IC	LDO, 1.7V±1.5%, 300mA	SOT-89	20vl	VR1	4q	Ame
Ã8800ZEF	AME8800ZEFTZ	LVR-IC	LDO, 1.7V±1.5%, 300mA	SOT-89	20vl	VR1	4q	Ame
A88052EF	AME88052EFT	LVR-IC	LDO, 2.0V±1.5%, 600mA	SOT-89	20vl	VR1	4q	Ame
Ã88052EF	AME88052EFTZ	LVR-IC	LDO, 2.0V±1.5%, 600mA	SOT-89	20vl	VR1	4q	Ame
A8805AEF	AME8805AEFT	LVR-IC	LDO, 3.3V±1.5%, 600mA	SOT-89	20vl	VR1	4q	Ame
Ã8805AEF	AME8805AEFTZ	LVR-IC	LDO, 3.3V±1.5%, 600mA	SOT-89	20vl	VR1	4q	Ame
A8805BEF	AME8805BEFT	LVR-IC	LDO, 3.0V±1.5%, 600mA	SOT-89	20vl	VR1	4q	Ame
Ã8805BEF	AME8805BEFTZ	LVR-IC	LDO, 3.0V±1.5%, 600mA	SOT-89	20vl	VR1	4q	Ame
A8805CEF	AME8805CEFT	LVR-IC	LDO, 2.8V±1.5%, 600mA	SOT-89	20vl	VR1	4q	Ame
Ã8805CEF	AME8805CEFTZ	LVR-IC	LDO, 2.8V±1.5%, 600mA	SOT-89	20vl	VR1	4q	Ame
A8805DEF	AME8805DEFT	LVR-IC	LDO, 2.5V±1.5%, 600mA	SOT-89	20vl	VR1	4q	Ame
Ã8805DEF	AME8805DEFTZ	LVR-IC	LDO, 2.5V±1.5%, 600mA	SOT-89	20vl	VR1	4q	Ame
A8805EEF	AME8805EEFT	LVR-IC	LDO, 3.8V±1.5%, 600mA	SOT-89	20vl	VR1	4q	Ame
Ã8805EEF	AME8805EEFTZ	LVR-IC	LDO, 3.8V±1.5%, 600mA	SOT-89	20vl	VR1	4q	Ame
A8805FEF	AME8805FEFT	LVR-IC	LDO, 3.6V±1.5%, 600mA	SOT-89	20vl	VR1	4q	Ame
Ã8805FEF	AME8805FEFTZ	LVR-IC	LDO, 3.6V±1.5%, 600mA	SOT-89	20vl	VR1	4q	Ame
A8805GEF	AME8805GEFT	LVR-IC	LDO, 3.5V±1.5%, 600mA	SOT-89	20vl	VR1	4q	Ame
Ã8805GEF	AME8805GEFTZ	LVR-IC	LDO, 3.5V±1.5%, 600mA	SOT-89	20vl	VR1	4q	Ame
A8805HEF	AME8805HEFT	LVR-IC	LDO, 2.7V±1.5%, 600mA	SOT-89	20vl	VR1	4q	Ame
Ã8805HEF	AME8805HEFTZ	LVR-IC	LDO, 2.7V±1.5%, 600mA	SOT-89	20vl	VR1	4q	Ame
A8805IEF	AME8805IEFT	LVR-IC	LDO, 3.4V±1.5%, 600mA	SOT-89	20vl	VR1	4q	Ame
Ã8805IEF	AME8805IEFTZ	LVR-IC	LDO, 3.4V±1.5%, 600mA	SOT-89	20vl	VR1	4q	Ame
A8805JEF	AME8805JEFT	LVR-IC	LDO, 2.85V±1.5%, 600mA	SOT-89	20vl	VR1	4q	Ame
Ã8805JEF	AME8805JEFTZ	LVR-IC	LDO, 2.85V±1.5%, 600mA	SOT-89	20vl	VR1	4q	Ame
A8805KEF	AME8805KEFT	LVR-IC	LDO, 3.7V±1.5%, 600mA	SOT-89	20vl	VR1	4q	Ame
Ã8805KEF	AME8805KEFTZ	LVR-IC	LDO, 3.7V±1.5%, 600mA	SOT-89	20vl	VR1	4q	Ame
A8805LEF	AME8805LEFT	LVR-IC	LDO, 1.5V±1.5%, 600mA	SOT-89	20vl	VR1	4q	Ame
Ã8805LEF	AME8805LEFTZ	LVR-IC	LDO, 1.5V±1.5%, 600mA	SOT-89	20vl	VR1	4q	Ame
A8805MEF	AME8805MEFT	LVR-IC	LDO, 1.8V±1.5%, 600mA	SOT-89	20vl	VR1	4q	Ame
Ã8805MEF	AME8805MEFTZ	LVR-IC	LDO, 1.8V±1.5%, 600mA	SOT-89	20vl	VR1	4q	Ame
A8805NEF	AME8805NEFT	LVR-IC	LDO, 2.9V±1.5%, 600mA	SOT-89	20vl	VR1	4q	Ame
Ã8805NEF	AME8805NEFTZ	LVR-IC	LDO, 2.9V±1.5%, 600mA	SOT-89	20vl	VR1	4q	Ame
A8805OEF	AME8805OEFT	LVR-IC	LDO, 3.1V±1.5%, 600mA	SOT-89	20vl	VR1	4q	Ame
Ã8805OEF	AME8805OEFTZ	LVR-IC	LDO, 3.1V±1.5%, 600mA	SOT-89	20vl	VR1	4q	Ame
A8805SEF	AME8805SEFT	LVR-IC	LDO, 5.0V±1.5%, 600mA	SOT-89	20vl	VR1	4q	Ame
Ã8805SEF	AME8805SEFTZ	LVR-IC	LDO, 5.0V±1.5%, 600mA	SOT-89	20vl	VR1	4q	Ame
A8805YEF	AME8805YEFT	LVR-IC	LDO, 1.9V±1.5%, 600mA	SOT-89	20vl	VR1	4q	Ame
Ã8805YEF	AME8805YEFTZ	LVR-IC	LDO, 1.9V±1.5%, 600mA	SOT-89	20vl	VR1	4q	Ame
A8811AEF	AME8811AEFT	LVR-IC	LDO, 3.3V±1.5%, 300mA	SOT-89	20vl	VR1	4q	Ame
Ã8811AEF	AME8811AEFTZ	LVR-IC	LDO, 3.3V±1.5%, 300mA	SOT-89	20vl	VR1	4q	Ame
A8811BEF	AME8811BEFT	LVR-IC	LDO, 3.0V±1.5%, 300mA	SOT-89	20vl	VR1	4q	Ame
Ã8811BEF	AME8811BEFTZ	LVR-IC	LDO, 3.0V±1.5%, 300mA	SOT-89	20vl	VR1	4q	Ame
A8811CEF	AME8811CEFT	LVR-IC	LDO, 2.8V±1.5%, 300mA	SOT-89	20vl	VR1	4q	Ame



SMD code	Type	Function	Short description	Case	Pinout	Sch.	St.	Mnf.
Å8811CEF	AME8811CEFTZ	LVR-IC	LDO, 2.8V±1.5%, 300mA	SOT-89	20vl	VR1	4q	Ame
Å8811DEF	AME8811DEFTZ	LVR-IC	LDO, 2.5V±1.5%, 300mA	SOT-89	20vl	VR1	4q	Ame
Å8811DEF	AME8811DEFTZ	LVR-IC	LDO, 2.5V±1.5%, 300mA	SOT-89	20vl	VR1	4q	Ame
Å8811EEF	AME8811EEFTZ	LVR-IC	LDO, 3.8V±1.5%, 300mA	SOT-89	20vl	VR1	4q	Ame
Å8811EEF	AME8811EEFTZ	LVR-IC	LDO, 3.8V±1.5%, 300mA	SOT-89	20vl	VR1	4q	Ame
Å8811FEF	AME8811FEFTZ	LVR-IC	LDO, 3.6V±1.5%, 300mA	SOT-89	20vl	VR1	4q	Ame
Å8811FEF	AME8811FEFTZ	LVR-IC	LDO, 3.6V±1.5%, 300mA	SOT-89	20vl	VR1	4q	Ame
Å8811GFEF	AME8811GEFTZ	LVR-IC	LDO, 3.5V±1.5%, 300mA	SOT-89	20vl	VR1	4q	Ame
Å8811GFEF	AME8811GEFTZ	LVR-IC	LDO, 3.5V±1.5%, 300mA	SOT-89	20vl	VR1	4q	Ame
Å8811HEF	AME8811HEFTZ	LVR-IC	LDO, 2.7V±1.5%, 300mA	SOT-89	20vl	VR1	4q	Ame
Å8811HEF	AME8811HEFTZ	LVR-IC	LDO, 2.7V±1.5%, 300mA	SOT-89	20vl	VR1	4q	Ame
Å8811IEF	AME8811IEFTZ	LVR-IC	LDO, 3.4V±1.5%, 300mA	SOT-89	20vl	VR1	4q	Ame
Å8811IEF	AME8811IEFTZ	LVR-IC	LDO, 3.4V±1.5%, 300mA	SOT-89	20vl	VR1	4q	Ame
Å8811JEF	AME8811JEFTZ	LVR-IC	LDO, 2.85V±1.5%, 300mA	SOT-89	20vl	VR1	4q	Ame
Å8811JEF	AME8811JEFTZ	LVR-IC	LDO, 2.85V±1.5%, 300mA	SOT-89	20vl	VR1	4q	Ame
Å8811KEF	AME8811KEFTZ	LVR-IC	LDO, 3.7V±1.5%, 300mA	SOT-89	20vl	VR1	4q	Ame
Å8811KEF	AME8811KEFTZ	LVR-IC	LDO, 3.7V±1.5%, 300mA	SOT-89	20vl	VR1	4q	Ame
Å8811LEF	AME8811LEFTZ	LVR-IC	LDO, 1.5V±1.5%, 300mA	SOT-89	20vl	VR1	4q	Ame
Å8811LEF	AME8811LEFTZ	LVR-IC	LDO, 1.5V±1.5%, 300mA	SOT-89	20vl	VR1	4q	Ame
Å8811MEF	AME8811MEFTZ	LVR-IC	LDO, 1.8V±1.5%, 300mA	SOT-89	20vl	VR1	4q	Ame
Å8811MEF	AME8811MEFTZ	LVR-IC	LDO, 1.8V±1.5%, 300mA	SOT-89	20vl	VR1	4q	Ame
Å8811NEF	AME8811NEFTZ	LVR-IC	LDO, 2.9V±1.5%, 300mA	SOT-89	20vl	VR1	4q	Ame
Å8811NEF	AME8811NEFTZ	LVR-IC	LDO, 2.9V±1.5%, 300mA	SOT-89	20vl	VR1	4q	Ame
Å8811OEF	AME8811OEFTZ	LVR-IC	LDO, 3.1V±1.5%, 300mA	SOT-89	20vl	VR1	4q	Ame
Å8811OEF	AME8811OEFTZ	LVR-IC	LDO, 3.1V±1.5%, 300mA	SOT-89	20vl	VR1	4q	Ame
Å8811SEF	AME8811SEFTZ	LVR-IC	LDO, 5.0V±1.5%, 300mA	SOT-89	20vl	VR1	4q	Ame
Å8813AEF	AME8813AEFTZ	LVR-IC	LDO, 3.3V±1.5%, 600mA	SOT-89	20vl	VR1	4q	Ame
Å8813DEF	AME8813DEFTZ	LVR-IC	LDO, 2.5V±1.5%, 600mA	SOT-89	20vl	VR1	4q	Ame
Å8813SEF	AME8813SEFTZ	LVR-IC	LDO, 5.0V±1.5%, 600mA	SOT-89	20vl	VR1	4q	Ame
Å8819CB	AME8819AEFT330Z	LVR-IC	LDO, 3.3V±1.5%, 600mA	SOT-89	20vl	VR1	4q	Ame
Å8819CD	AME8819AEFT300Z	LVR-IC	LDO, 3.0V±1.5%, 600mA	SOT-89	20vl	VR1	4q	Ame
Å8819CG	AME8819AEFT250Z	LVR-IC	LDO, 2.5V±1.5%, 600mA	SOT-89	20vl	VR1	4q	Ame
Å8819CI	AME8819AEFT180Z	LVR-IC	LDO, 1.8V±1.5%, 600mA	SOT-89	20vl	VR1	4q	Ame
Å8819CJ	AME8819AEFT150Z	LVR-IC	LDO, 1.5V±1.5%, 600mA	SOT-89	20vl	VR1	4q	Ame
Å8819CK	AME8819AEFT120Z	LVR-IC	LDO, 1.2V±1.5%, 600mA	SOT-89	20vl	VR1	4q	Ame
Å8819DA	AME8819BEFT360Z	LVR-IC	LDO, 3.6V±1.5%, 600mA	SOT-89	20vl	VR1	4q	Ame
Å8819DB	AME8819BEFT330Z	LVR-IC	LDO, 3.3V±1.5%, 600mA	SOT-89	20vl	VR1	4q	Ame
Å8819DD	AME8819BEFT300Z	LVR-IC	LDO, 3.0V±1.5%, 600mA	SOT-89	20vl	VR1	4q	Ame
Å8819DG	AME8819BEFT250Z	LVR-IC	LDO, 2.5V±1.5%, 600mA	SOT-89	20vl	VR1	4q	Ame
Å8819DI	AME8819BEFT180Z	LVR-IC	LDO, 1.8V±1.5%, 600mA	SOT-89	20vl	VR1	4q	Ame
Å8819DJ	AME8819BEFT150Z	LVR-IC	LDO, 1.5V±1.5%, 600mA	SOT-89	20vl	VR1	4q	Ame
Å8819DK	AME8819BEFT120Z	LVR-IC	LDO, 1.2V±1.5%, 600mA	SOT-89	20vl	VR1	4q	Ame
Å8847A18	AME8847AEFT180Z	LVR-IC	LDO, 1.8V±1.5%, 800mA	SOT-89	20vl	VR1	4q	Ame
Å8847A25	AME8847AEFT250Z	LVR-IC	LDO, 2.5V±1.5%, 800mA	SOT-89	20vl	VR1	4q	Ame
Å8847A33	AME8847AEFT330Z	LVR-IC	LDO, 3.3V±1.5%, 800mA	SOT-89	20vl	VR1	4q	Ame
A9	ELM9709NAB	Vdet-IC	0.9V±2.5%, +Reset ODO	SOT-89	20vda	VD6	4a	Elm
A9	ELM9829AB	LVR-IC	2.9V±2%, 200mA	SOT-89	20vl	VR1	4a	Elm
A90	TK11690U	LVR-IC	LDO, 9V±1.5%, 190mA	SOT-89	20hn	VR1	4d	Tok
AA	2SD1366A	Si-npn	AF, 25V, 1A, 1W, B=85.170, 240MHz	SOT-89	20ftb	-	4b	Ren
AA	AP431IY	Vref-IC	Adjustable, Precision, Shunt, 2.495V±1%	SOT-89-3L	20rb	RF1	4b	Ana
AA	BCX51	Si-pnp	AF, 45V, 1A, 1W, B=40.250, >100MHz	SOT-89	20ftb	-	4b	Phi
AA	ELM99201B	LVR-IC	LDO, 2.0V±2%, 300mA	SOT-89	20vl	VR1	4a	Elm
AA	RT9161-28CX	LVR-IC	LDO, 2.8V±2%, 300mA	SOT-89	20vl	VR1	4c	Rct
AA-	RT9161-28PX	LVR-IC	LDO, 2.8V±2%, 300mA	SOT-89	20vl	VR1	4c	Rct
AA1	2SC4942-1	Si-npn	Sw, Hi-sp, HV, 600V, 1A, 2W, 30MHz, B=30.60	SOT-89	20ftb	-	4b	Nec
AA2	2SC4942-2	Si-npn	Sw, Hi-sp, HV, 600V, 1A, 2W, 30MHz, B=40.80	SOT-89	20ftb	-	4b	Nec
AA3	2SC4942-3	Si-npn	Sw, Hi-sp, HV, 600V, 1A, 2W, 30MHz, B=60.120	SOT-89	20ftb	-	4b	Nec
AAA21	AME8500AEFTAA21	Vdet-IC	2.1V±1.5%, -Reset PPO, 1.5ms	SOT-89	20vde	VD7	4b	Ame
ÅAA21	AME8500AEFTAA21Z	Vdet-IC	2.1V±1.5%, -Reset PPO, 1.5ms, lead free	SOT-89	20vde	VD7	4b	Ame
AAE	2SA1946-E	Si-pnp	Relay-Drv, 25V, 700mA, 500mW, B=150.300, 180MHz	SOT-89	20ftb	-	4a	Ivit
AAF	2SA1946-F	Si-pnp	Relay-Drv, 25V, 700mA, 500mW, B=250.500, 180MHz	SOT-89	20ftb	-	4a	Ivit
AAF27	AME8500AEFTAF27	Vdet-IC	2.7V±1.5%, -Reset PPO, 210ms	SOT-89	20vde	VD7	4b	Ame
AAF27	AME8500AEFTAF27Z	Vdet-IC	2.7V±1.5%, -Reset PPO, 210ms, lead free	SOT-89	20vde	VD7	4b	Ame
AAG	2SA1946-G	Si-pnp	Relay-Drv, 25V, 700mA, 500mW, B=400.800, 180MHz	SOT-89	20ftb	-	4a	Ivit
AAR	2SA1415-R	Si-pnp	Sw, 180V, 200mA, 500mW, B=100.200, >150MHz	PCP	20ftb	-	4a	San
AAS	2SA1415-S	Si-pnp	Sw, 180V, 200mA, 500mW, B=140.280, >150MHz	PCP	20ftb	-	4a	San
AAT	2SA1415-T	Si-pnp	Sw, 180V, 200mA, 500mW, B=200.400, >150MHz	PCP	20ftb	-	4a	San
AB	2SD1366A-B	Si-npn	AF, 25V, 1A, 1W, B=120.240, 240MHz	SOT-89	20ftb	-	4b	Ren
AB	AP431IAY	Vref-IC	Adjustable, Precision, Shunt, 2.495V±0.5%	SOT-89-3L	20rb	RF1	4b	Ana
AB	BCX51-06	Si-pnp	AF, 45V, 1A, 1W, B=40.100, >100MHz	SOT-89	20ftb	-	4b	Inf



SMD
code

Type

Function

Short description

Case Pinout Sch. St. Mnf.

AB	ELM99211B	LVR-IC	LDO, 2.1V±2%, 300mA	SOT-89	20vl	VR1	4a	Elm
AB	RT9161-38CX	LVR-IC	LDO, 3.8V±2%, 300mA	SOT-89	20vl	VR1	4c	Rct
AB1	2SD2425-1	Si-npn	Sw, 50V, 5A, 600/800ns, B=50..100	SOT-89	20tb	-	4b	Nec
AB2	2SD2425-2	Si-npn	Sw, 50V, 5A, 600/800ns, B=75..150	SOT-89	20tb	-	4b	Nec
AB3	2SD2425-3	Si-npn	Sw, 50V, 5A, 600/800ns, B=100..200	SOT-89	20tb	-	4b	Nec
ABC	2SA1947-C	Si-pnp	AF, 30, 1A, 500mW, B=65..110, 100MHz	SOT-89	20tb	-	4a	Mit
ABD	2SA1947-D	Si-pnp	AF, 30, 1A, 500mW, B=90..180, 100MHz	SOT-89	20tb	-	4a	Mit
ABE	2SA1947-E	Si-pnp	AF, 30, 1A, 500mW, B=150..300, 100MHz	SOT-89	20tb	-	4a	Mit
ABR	2SA1416-R	Si-pnp	HV, Sw, 120V, 1A, 500mW, B=100..200, 120MHz	PCP	20tb	-	4a	San
ABS	2SA1416-S	Si-pnp	HV, Sw, 120V, 1A, 500mW, B=140..280, 120MHz	PCP	20tb	-	4a	San
ABT	2SA1416-T	Si-pnp	HV, Sw, 120V, 1A, 500mW, B=200..400, 120MHz	PCP	20tb	-	4a	San
AC	2SA1690	Si-pnp	Sw, 400V, 100mA, 2W, B=56..270	SOT-89	20tb	-	4b	Rhm
AC	2SD1366A-C	Si-npn	AF, 30V, 1A, 1W, B=85..170, 240MHz	SOT-89	20tb	-	4b	Ren
AC	BCX51-10	Si-pnp	AF, 45V, 1A, 1W, B=63..160, >100MHz	SOT-89	20tb	-	4b	Phi
AC	ELM99221B	LVR-IC	LDO, 2.2V±2%, 300mA	SOT-89	20vl	VR1	4a	Elm
AC	RT9161-42CX	LVR-IC	LDO, 4.2V±2%, 300mA	SOT-89	20vl	VR1	4c	Rct
AC	RXT2907A	Si-pnp	GP, 60V, 600mA, 330mW, B=100..300, >200MHz	SOT-89	20tb	-	4b	Rhm
AC0	XC6371A200P	DC/DC-IC	PWM step-up, 50kHz, 2.0V±2.5%, 100mA	SOT-89	20bq	DC2	4c	Tor
AC0	XC6373A200P	DC/DC-IC	PWM step-up, 30kHz, 2.0V±2.5%, 100mA	SOT-89	20bq	DC2	4c	Tor
AC1	XC6371A210P	DC/DC-IC	PWM step-up, 50kHz, 2.1V±2.5%, 100mA	SOT-89	20bq	DC2	4c	Tor
AC1	XC6373A210P	DC/DC-IC	PWM step-up, 30kHz, 2.1V±2.5%, 100mA	SOT-89	20bq	DC2	4c	Tor
AC2	XC6371A220P	DC/DC-IC	PWM step-up, 50kHz, 2.2V±2.5%, 100mA	SOT-89	20bq	DC2	4c	Tor
AC2	XC6373A220P	DC/DC-IC	PWM step-up, 30kHz, 2.2V±2.5%, 100mA	SOT-89	20bq	DC2	4c	Tor
AC3	XC6371A230P	DC/DC-IC	PWM step-up, 50kHz, 2.3V±2.5%, 100mA	SOT-89	20bq	DC2	4c	Tor
AC3	XC6373A230P	DC/DC-IC	PWM step-up, 30kHz, 2.3V±2.5%, 100mA	SOT-89	20bq	DC2	4c	Tor
AC4	XC6371A240P	DC/DC-IC	PWM step-up, 50kHz, 2.4V±2.5%, 100mA	SOT-89	20bq	DC2	4c	Tor
AC4	XC6373A240P	DC/DC-IC	PWM step-up, 30kHz, 2.4V±2.5%, 100mA	SOT-89	20bq	DC2	4c	Tor
AC5	XC6371A250P	DC/DC-IC	PWM step-up, 50kHz, 2.5V±2.5%, 100mA	SOT-89	20bq	DC2	4c	Tor
AC5	XC6373A250P	DC/DC-IC	PWM step-up, 30kHz, 2.5V±2.5%, 100mA	SOT-89	20bq	DC2	4c	Tor
AC6	XC6371A260P	DC/DC-IC	PWM step-up, 50kHz, 2.6V±2.5%, 100mA	SOT-89	20bq	DC2	4c	Tor
AC6	XC6373A260P	DC/DC-IC	PWM step-up, 30kHz, 2.6V±2.5%, 100mA	SOT-89	20bq	DC2	4c	Tor
AC7	XC6371A270P	DC/DC-IC	PWM step-up, 50kHz, 2.7V±2.5%, 100mA	SOT-89	20bq	DC2	4c	Tor
AC7	XC6373A270P	DC/DC-IC	PWM step-up, 30kHz, 2.7V±2.5%, 100mA	SOT-89	20bq	DC2	4c	Tor
AC8	XC6371A280P	DC/DC-IC	PWM step-up, 50kHz, 2.8V±2.5%, 100mA	SOT-89	20bq	DC2	4c	Tor
AC8	XC6373A280P	DC/DC-IC	PWM step-up, 30kHz, 2.8V±2.5%, 100mA	SOT-89	20bq	DC2	4c	Tor
AC9	XC6371A290P	DC/DC-IC	PWM step-up, 50kHz, 2.9V±2.5%, 100mA	SOT-89	20bq	DC2	4c	Tor
AC9	XC6373A290P	DC/DC-IC	PWM step-up, 30kHz, 2.9V±2.5%, 100mA	SOT-89	20bq	DC2	4c	Tor
ACA21	AME8500AEFTCA21	Vdet-IC	2.1V±1.5%, +Reset PPO, 1.5ms	SOT-89	20vde	VD7	4b	Ame
ACA21	AME8500AEFTCA21Z	Vdet-IC	2.1V±1.5%, +Reset PPO, 1.5ms, lead free	SOT-89	20vde	VD7	4b	Ame
ACR	2SA1417-R	Si-pnp	HV, Sw, 120V, 2A, 500mW, B=100..200, 120MHz	PCP	20tb	-	4a	San
ACS	2SA1417-S	Si-pnp	HV, Sw, 120V, 2A, 500mW, B=140..280, 120MHz	PCP	20tb	-	4a	San
ACT	2SA1417-T	Si-pnp	HV, Sw, 120V, 2A, 500mW, B=200..400, 120MHz	PCP	20tb	-	4a	San
AD	2SD1366A-D	Si-npn	AF, 30V, 1A, 1W, B=120..240, 240MHz	SOT-89	20tb	-	4b	Ren
AD	BCX51-16	Si-pnp	AF, 45V, 1A, 1W, B=100..250, >100MHz	SOT-89	20tb	-	4b	Phi
AD	ELM99231B	LVR-IC	LDO, 2.3V±2%, 300mA	SOT-89	20vl	VR1	4a	Elm
AD	RT9161-26CX	LVR-IC	LDO, 2.6V±2%, 300mA	SOT-89	20vl	VR1	4c	Rct
AD-	RT9161-26PX	LVR-IC	LDO, 2.6V±2%, 300mA	SOT-89	20vl	VR1	4c	Rct
AD0	XC6371A300P	DC/DC-IC	PWM step-up, 50kHz, 3.0V±2.5%, 100mA	SOT-89	20bq	DC2	4c	Tor
AD0	XC6373A300P	DC/DC-IC	PWM step-up, 30kHz, 3.0V±2.5%, 100mA	SOT-89	20bq	DC2	4c	Tor
AD1	XC6371A310P	DC/DC-IC	PWM step-up, 50kHz, 3.1V±2.5%, 100mA	SOT-89	20bq	DC2	4c	Tor
AD1	XC6373A310P	DC/DC-IC	PWM step-up, 30kHz, 3.1V±2.5%, 100mA	SOT-89	20bq	DC2	4c	Tor
AD2	XC6371A320P	DC/DC-IC	PWM step-up, 50kHz, 3.2V±2.5%, 100mA	SOT-89	20bq	DC2	4c	Tor
AD2	XC6373A320P	DC/DC-IC	PWM step-up, 30kHz, 3.2V±2.5%, 100mA	SOT-89	20bq	DC2	4c	Tor
AD3	XC6371A330P	DC/DC-IC	PWM step-up, 50kHz, 3.3V±2.5%, 100mA	SOT-89	20bq	DC2	4c	Tor
AD3	XC6373A330P	DC/DC-IC	PWM step-up, 30kHz, 3.3V±2.5%, 100mA	SOT-89	20bq	DC2	4c	Tor
AD4	XC6371A340P	DC/DC-IC	PWM step-up, 50kHz, 3.4V±2.5%, 100mA	SOT-89	20bq	DC2	4c	Tor
AD4	XC6373A340P	DC/DC-IC	PWM step-up, 30kHz, 3.4V±2.5%, 100mA	SOT-89	20bq	DC2	4c	Tor
AD5	XC6371A350P	DC/DC-IC	PWM step-up, 50kHz, 3.5V±2.5%, 100mA	SOT-89	20bq	DC2	4c	Tor
AD5	XC6373A350P	DC/DC-IC	PWM step-up, 30kHz, 3.5V±2.5%, 100mA	SOT-89	20bq	DC2	4c	Tor
AD6	XC6371A360P	DC/DC-IC	PWM step-up, 50kHz, 3.6V±2.5%, 100mA	SOT-89	20bq	DC2	4c	Tor
AD6	XC6373A360P	DC/DC-IC	PWM step-up, 30kHz, 3.6V±2.5%, 100mA	SOT-89	20bq	DC2	4c	Tor
AD7	XC6371A370P	DC/DC-IC	PWM step-up, 50kHz, 3.7V±2.5%, 100mA	SOT-89	20bq	DC2	4c	Tor
AD7	XC6373A370P	DC/DC-IC	PWM step-up, 30kHz, 3.7V±2.5%, 100mA	SOT-89	20bq	DC2	4c	Tor
AD8	XC6371A380P	DC/DC-IC	PWM step-up, 50kHz, 3.8V±2.5%, 100mA	SOT-89	20bq	DC2	4c	Tor
AD8	XC6373A380P	DC/DC-IC	PWM step-up, 30kHz, 3.8V±2.5%, 100mA	SOT-89	20bq	DC2	4c	Tor
AD9	XC6371A390P	DC/DC-IC	PWM step-up, 50kHz, 3.9V±2.5%, 100mA	SOT-89	20bq	DC2	4c	Tor
AD9	XC6373A390P	DC/DC-IC	PWM step-up, 30kHz, 3.9V±2.5%, 100mA	SOT-89	20bq	DC2	4c	Tor
ADR	2SA1418-R	Si-pnp	HV, Pre-Drive, 180V, 700mA, 500mW, B=100..200, 120MHz	PCP	20tb	-	4a	San
ADS	2SA1418-S	Si-pnp	HV, Pre-Drive, 180V, 700mA, 500mW, B=140..280, 120MHz	PCP	20tb	-	4a	San
ADT	2SA1418-T	Si-pnp	HV, Pre-Drive, 180V, 700mA, 500mW, B=200..400, 120MHz	PCP	20tb	-	4a	San



SMD
code

Type

Function

Short description

Case Pinout Sch. St. Mnf.

ADW	2SC5547	Si-npn	UHF, TV-tun, 20V, 50mA, 400mW, 4.5GHz, B=30..200
AE	2SA1363-E	Si-pnp	Relay-Drv, 20V, 2A, 500mW, B=150..300, 80MHz
AE	BCX52	Si-pnp	AF, 60V, 1A, 1W, B=40..250, >100MHz
AE	ELM99241B	LVR-IC	LDO, 2.4V±2%, 300mA
AE	RT9161-30CX	LVR-IC	LDO, 3.0V±2%, 300mA
AE-	RT9161-30PX	LVR-IC	LDO, 3.0V±2%, 300mA
AE0	XC6371A400P	DC/DC-IC	PWM step-up, 50kHz, 4.0V±2.5%, 100mA
AE0	XC6373A400P	DC/DC-IC	PWM step-up, 30kHz, 4.0V±2.5%, 100mA
AE1	XC6371A410P	DC/DC-IC	PWM step-up, 50kHz, 4.1V±2.5%, 100mA
AE1	XC6373A410P	DC/DC-IC	PWM step-up, 30kHz, 4.1V±2.5%, 100mA
AE2	XC6371A420P	DC/DC-IC	PWM step-up, 50kHz, 4.2V±2.5%, 100mA
AE2	XC6373A420P	DC/DC-IC	PWM step-up, 30kHz, 4.2V±2.5%, 100mA
AE3	XC6371A430P	DC/DC-IC	PWM step-up, 50kHz, 4.3V±2.5%, 100mA
AE3	XC6373A430P	DC/DC-IC	PWM step-up, 30kHz, 4.3V±2.5%, 100mA
AE4	XC6371A440P	DC/DC-IC	PWM step-up, 50kHz, 4.4V±2.5%, 100mA
AE4	XC6373A440P	DC/DC-IC	PWM step-up, 30kHz, 4.4V±2.5%, 100mA
AE5	XC6371A450P	DC/DC-IC	PWM step-up, 50kHz, 4.5V±2.5%, 100mA
AE5	XC6373A450P	DC/DC-IC	PWM step-up, 30kHz, 4.5V±2.5%, 100mA
AE6	XC6371A460P	DC/DC-IC	PWM step-up, 50kHz, 4.6V±2.5%, 100mA
AE6	XC6373A460P	DC/DC-IC	PWM step-up, 30kHz, 4.6V±2.5%, 100mA
AE7	XC6371A470P	DC/DC-IC	PWM step-up, 50kHz, 4.7V±2.5%, 100mA
AE7	XC6373A470P	DC/DC-IC	PWM step-up, 30kHz, 4.7V±2.5%, 100mA
AE8	XC6371A480P	DC/DC-IC	PWM step-up, 50kHz, 4.8V±2.5%, 100mA
AE8	XC6373A480P	DC/DC-IC	PWM step-up, 30kHz, 4.8V±2.5%, 100mA
AE9	XC6371A490P	DC/DC-IC	PWM step-up, 50kHz, 4.9V±2.5%, 100mA
AE9	XC6373A490P	DC/DC-IC	PWM step-up, 30kHz, 4.9V±2.5%, 100mA
AEP	2SB1424-P	Si-pnp	AF, Lo-sat, 20V, 3A, 600mW, B=82..180, >240MHz
AEP	2SB1424-Q	Si-pnp	AF, Lo-sat, 20V, 3A, 600mW, B=120..270, >240MHz
AER	2SA1419-R	Si-pnp	HV, Sw, 180V, 1.5A, 500mW, B=100..200, 120MHz
AER	2SB1424-R	Si-pnp	AF, Lo-sat, 20V, 3A, 600mW, B=390..820, >240MHz
AES	2SA1419-S	Si-pnp	HV, Sw, 180V, 1.5A, 500mW, B=140..280, 120MHz
AET	2SA1419-T	Si-pnp	HV, Sw, 180V, 1.5A, 500mW, B=200..400, 120MHz
AF	2SA1363-F	Si-pnp	Relay-Drv, 20V, 2A, 500mW, B=250..500, 80MHz
AF	BCX52-06	Si-pnp	AF-Drv, 60V, 1A, 1W, B=40..100, 125MHz
AF	BCX52-6	Si-pnp	AF, 60V, 1A, 1W, B=40..100, >100MHz
AF	ELM99251B	LVR-IC	LDO, 2.5V±2%, 300mA
AF	RT9161-29CX	LVR-IC	LDO, 2.9V±2%, 300mA
AF0	XC6371A500P	DC/DC-IC	PWM step-up, 50kHz, 5.0V±2.5%, 100mA
AF0	XC6373A500P	DC/DC-IC	PWM step-up, 30kHz, 5.0V±2.5%, 100mA
AF1	XC6371A510P	DC/DC-IC	PWM step-up, 50kHz, 5.1V±2.5%, 100mA
AF1	XC6373A510P	DC/DC-IC	PWM step-up, 30kHz, 5.1V±2.5%, 100mA
AF2	XC6371A520P	DC/DC-IC	PWM step-up, 50kHz, 5.2V±2.5%, 100mA
AF2	XC6373A520P	DC/DC-IC	PWM step-up, 30kHz, 5.2V±2.5%, 100mA
AF3	XC6371A530P	DC/DC-IC	PWM step-up, 50kHz, 5.3V±2.5%, 100mA
AF3	XC6373A530P	DC/DC-IC	PWM step-up, 30kHz, 5.3V±2.5%, 100mA
AF4	XC6371A540P	DC/DC-IC	PWM step-up, 50kHz, 5.4V±2.5%, 100mA
AF4	XC6373A540P	DC/DC-IC	PWM step-up, 30kHz, 5.4V±2.5%, 100mA
AF5	XC6371A550P	DC/DC-IC	PWM step-up, 50kHz, 5.5V±2.5%, 100mA
AF5	XC6373A550P	DC/DC-IC	PWM step-up, 30kHz, 5.5V±2.5%, 100mA
AF6	XC6371A560P	DC/DC-IC	PWM step-up, 50kHz, 5.6V±2.5%, 100mA
AF6	XC6373A560P	DC/DC-IC	PWM step-up, 30kHz, 5.6V±2.5%, 100mA
AF7	XC6371A570P	DC/DC-IC	PWM step-up, 50kHz, 5.7V±2.5%, 100mA
AF7	XC6373A570P	DC/DC-IC	PWM step-up, 30kHz, 5.7V±2.5%, 100mA
AF8	XC6371A580P	DC/DC-IC	PWM step-up, 50kHz, 5.8V±2.5%, 100mA
AF8	XC6373A580P	DC/DC-IC	PWM step-up, 30kHz, 5.8V±2.5%, 100mA
AF9	XC6371A590P	DC/DC-IC	PWM step-up, 50kHz, 5.9V±2.5%, 100mA
AF9	XC6373A590P	DC/DC-IC	PWM step-up, 30kHz, 5.9V±2.5%, 100mA
AFC	2SA1575-C	Si-pnp	Vid, HF, 200V, 100mA, 500mW, B=40..80, 400MHz
AFD	2SA1575-D	Si-pnp	Vid, HF, 200V, 100mA, 500mW, B=60..120, 400MHz
AFE	2SA1575-E	Si-pnp	Vid, HF, 200V, 100mA, 500mW, B=100..200, 400MHz
AFF	2SA1575-F	Si-pnp	Vid, HF, 200V, 100mA, 500mW, B=160..320, 400MHz
AG	2SA1363-G	Si-pnp	Relay-Drv, 20V, 2A, 500mW, B=400..800, 80MHz
AG	BCX52-10	Si-pnp	AF, 60V, 1A, 1W, B=63..160, >100MHz
AG	ELM99261B	LVR-IC	LDO, 2.6V±2%, 300mA
AG	RT9161-27CX	LVR-IC	LDO, 2.7V±2%, 300mA
AG-	RT9161-27PX	LVR-IC	LDO, 2.7V±2%, 300mA
AGQ	2SA1729-Q	Si-pnp	Sw, 50V, 1.5A, 1.3W, B=70..140, 300MHz, 50/150ns
AGQ	2SA1797-P	Si-pnp	AF, Lo-sat, 50V, 2A, 500mW, B=82..180, >200MHz
AGQ	2SA1797-Q	Si-pnp	AF, Lo-sat, 50V, 2A, 500mW, B=120..270, >200MHz
AGR	2SA1729-R	Si-pnp	Sw, 50V, 1.5A, 1.3W, B=100..200, 300MHz, 50/150ns



SMD
code

Type

Function

Short description

Case Pinout Sch. St. Mnf.

AGS	2SA1729-S	Si-pnp	Sw, 50V, 1.5A, 1.3W, B=140..280, 300MHz, 50/150ns	PCP	20tb	-	4a	San
AH	2SB1000-H	Si-pnp	AF, 25V, 1A, 1W, 200MHz, B=85..120	SOT-89	20tb	-	4a	Ren
AH	BCX53	Si-pnp	AF, 80V, 1A, 1W, B=40..250, >100MHz	SOT-89	20tb	-	4b	Phi
AH	ELM99271B	LVR-IC	LDO, 2.7V±2%, 300mA	SOT-89	20vl	VR1	4a	Elm
AH	RT9161-31CX	LVR-IC	LDO, 3.1V±2%, 300mA	SOT-89	20vl	VR1	4c	Rct
AH-	RT9161-31PX	LVR-IC	LDO, 3.1V±2%, 300mA	SOT-89	20vl	VR1	4c	Rct
ÅH0	XC6371A600P	DC/DC-IC	PWM step-up, 50kHz, 6.0V±2.5%, 100mA	SOT-89	20bq	DC2	4c	Tor
ÅH0	XC6373A600P	DC/DC-IC	PWM step-up, 30kHz, 6.0V±2.5%, 100mA	SOT-89	20bq	DC2	4c	Tor
ÅH1	XC6371A610P	DC/DC-IC	PWM step-up, 50kHz, 6.1V±2.5%, 100mA	SOT-89	20bq	DC2	4c	Tor
ÅH1	XC6373A610P	DC/DC-IC	PWM step-up, 30kHz, 6.1V±2.5%, 100mA	SOT-89	20bq	DC2	4c	Tor
ÅH2	XC6371A620P	DC/DC-IC	PWM step-up, 50kHz, 6.2V±2.5%, 100mA	SOT-89	20bq	DC2	4c	Tor
ÅH2	XC6373A620P	DC/DC-IC	PWM step-up, 30kHz, 6.2V±2.5%, 100mA	SOT-89	20bq	DC2	4c	Tor
ÅH3	XC6371A630P	DC/DC-IC	PWM step-up, 50kHz, 6.3V±2.5%, 100mA	SOT-89	20bq	DC2	4c	Tor
ÅH3	XC6373A630P	DC/DC-IC	PWM step-up, 30kHz, 6.3V±2.5%, 100mA	SOT-89	20bq	DC2	4c	Tor
ÅH4	XC6371A640P	DC/DC-IC	PWM step-up, 50kHz, 6.4V±2.5%, 100mA	SOT-89	20bq	DC2	4c	Tor
ÅH4	XC6373A640P	DC/DC-IC	PWM step-up, 30kHz, 6.4V±2.5%, 100mA	SOT-89	20bq	DC2	4c	Tor
ÅH5	XC6371A650P	DC/DC-IC	PWM step-up, 50kHz, 6.5V±2.5%, 100mA	SOT-89	20bq	DC2	4c	Tor
ÅH5	XC6373A650P	DC/DC-IC	PWM step-up, 30kHz, 6.5V±2.5%, 100mA	SOT-89	20bq	DC2	4c	Tor
ÅH6	XC6371A660P	DC/DC-IC	PWM step-up, 50kHz, 6.6V±2.5%, 100mA	SOT-89	20bq	DC2	4c	Tor
ÅH6	XC6373A660P	DC/DC-IC	PWM step-up, 30kHz, 6.6V±2.5%, 100mA	SOT-89	20bq	DC2	4c	Tor
ÅH7	XC6371A670P	DC/DC-IC	PWM step-up, 50kHz, 6.7V±2.5%, 100mA	SOT-89	20bq	DC2	4c	Tor
ÅH7	XC6373A670P	DC/DC-IC	PWM step-up, 30kHz, 6.7V±2.5%, 100mA	SOT-89	20bq	DC2	4c	Tor
ÅH8	XC6371A680P	DC/DC-IC	PWM step-up, 50kHz, 6.8V±2.5%, 100mA	SOT-89	20bq	DC2	4c	Tor
ÅH8	XC6373A680P	DC/DC-IC	PWM step-up, 30kHz, 6.8V±2.5%, 100mA	SOT-89	20bq	DC2	4c	Tor
ÅH9	XC6371A690P	DC/DC-IC	PWM step-up, 50kHz, 6.9V±2.5%, 100mA	SOT-89	20bq	DC2	4c	Tor
ÅH9	XC6373A690P	DC/DC-IC	PWM step-up, 30kHz, 6.9V±2.5%, 100mA	SOT-89	20bq	DC2	4c	Tor
AHN	2SA1759-N	Si-pnp	Sw, 400/400V, 100mA, 500mW, B=82..120, 12MHz	SOT-89	20tb	-	4b	Rhm
AHP	2SA1759-P	Si-pnp	Sw, 400/400V, 100mA, 500mW, B=100..160, 12MHz	SOT-89	20tb	-	4b	Rhm
AHQ	2SA1730-Q	Si-pnp	Sw, 50V, 3A, 1.5W, B=70..140, 300MHz, 50/150ns	PCP	20tb	-	4a	San
AHQ	2SA1759-Q	Si-pnp	Sw, 400/400V, 100mA, 500mW, B=140..180, 12MHz	SOT-89	20tb	-	4b	Rhm
AHQ	2SD2098-Q	Si-npn	AF-Drv, 50V, 5A, 500mW, B=120..270, 150MHz	SOT-89	20tb	-	4b	Rhm
AHR	2SA1730-R	Si-pnp	Sw, 50V, 3A, 1.5W, B=100..200, 300MHz, 50/150ns	PCP	20tb	-	4a	San
AHR	2SD2098-R	Si-npn	AF-Drv, 50V, 5A, 500mW, B=180..390, 150MHz	SOT-89	20tb	-	4b	Rhm
AHS	2SA1730-S	Si-pnp	Sw, 50V, 3A, 1.5W, B=140..280, 300MHz, 50/150ns	PCP	20tb	-	4a	San
AIS	2SA1882-S	Si-pnp	AF-Amp, 15V, 1.5A, 1.3W, B=140..280, 300MHz	PCP	20tb	-	4a	San
AIT	2SA1882-T	Si-pnp	AF-Amp, 15V, 1.5A, 1.3W, B=200..400, 300MHz	PCP	20tb	-	4a	San
AIU	2SA1882-U	Si-pnp	AF-Amp, 15V, 1.5A, 1.3W, B=280..560, 300MHz	PCP	20tb	-	4a	San
AJ	2SA1724	Si-pnp	Vid, Hi-def, 30V, 300mA, 500mW, B=155..100, 1.5GHz	PCP	20tb	-	4a	San
AJ	2SB1000-J	Si-pnp	AF, 25V, 1A, 1W, 200MHz, B=120..240	SOT-89	20tb	-	4a	Ren
AJ	BCX53-06	Si-pnp	AF, 80V, 1A, 1W, B=40..100, >100MHz	SOT-89	20tb	-	4b	Inf
AJ	ELM99281B	LVR-IC	LDO, 2.8V±2%, 300mA	SOT-89	20vl	VR1	4a	Elm
AJ	RT9161-32CX	LVR-IC	LDO, 3.2V±2%, 300mA	SOT-89	20vl	VR1	4c	Rct
AJN	2SA1812-N	Si-pnp	Sw, 400V, 100mA, 500mW, B=56..120, >12MHz	SOT-89	20tb	-	4b	Rhm
AJP	2SA1812-P	Si-pnp	Sw, 400V, 100mA, 500mW, B=82..180, >12MHz	SOT-89	20tb	-	4b	Rhm
AJQ	2SA1812-Q	Si-pnp	Sw, 400V, 100mA, 500mW, B=120..270, >12MHz	SOT-89	20tb	-	4b	Rhm
AK	BCX53-10	Si-pnp	AF, 80V, 1A, 1W, B=63..160, >100MHz	SOT-89	20tb	-	4b	Phi
AK	ELM99291B	LVR-IC	LDO, 2.9V±2%, 300mA	SOT-89	20vl	VR1	4a	Elm
AK	RT9161-34CX	LVR-IC	LDO, 3.4V±2%, 300mA	SOT-89	20vl	VR1	4c	Rct
ÅK0	XC6371A700P	DC/DC-IC	PWM step-up, 50kHz, 7.0V±2.5%, 100mA	SOT-89	20bq	DC2	4c	Tor
ÅK0	XC6373A700P	DC/DC-IC	PWM step-up, 30kHz, 7.0V±2.5%, 100mA	SOT-89	20bq	DC2	4c	Tor
AKD	2SA1470-D	Si-pnp	HV, Drv, 400V, 200mA, 1.3W, B=60..120, 70MHz	PCP	20tb	-	4a	San
AKD	2SA1740-D	Si-pnp	Vid, HV, 400V, 200mA, 500mW, 70MHz, B=60..120	SOT-89	20tb	-	4a	San
AKE	2SA1470-E	Si-pnp	HV, Drv, 400V, 200mA, 1.3W, B=100..200, 70MHz	PCP	20tb	-	4a	San
AKE	2SA1740-E	Si-pnp	Vid, HV, 400V, 200mA, 500mW, 70MHz, B=100..200	SOT-89	20tb	-	4a	San
AKQ	2SC5807-Q	Si-npn	AF, 50V, 5A, 500mW, B=120..270, 150MHz	SOT-89	20tb	-	4a	Mit
AKR	2SC5807-R	Si-npn	AF, 50V, 5A, 500mW, B=180..390, 150MHz	SOT-89	20tb	-	4a	Mit
AL	2SA1766	Si-pnp	AF-Amp, , 30V, 300mA, 1.3W, B=500..1200, 100MHz	PCP	20tb	-	4a	San
AL	BCX53-16	Si-pnp	AF, 80V, 1A, 1W, B=100..250, >100MHz	SOT-89	20tb	-	4b	Phi
AL	RT9161-36CX	LVR-IC	LDO, 3.6V±2%, 300mA	SOT-89	20vl	VR1	4c	Rct
AL-	RT9161-36PX	LVR-IC	LDO, 3.6V±2%, 300mA	SOT-89	20vl	VR1	4c	Rct
AL15	AIC1722A-15CXAX	LVR-IC	LDO, 1.5V±1%, 300mA	SOT-89	20vl	VR1	4g	Aic
AL15G	AIC1722A-15GXAX	LVR-IC	LDO, 1.5V±1%, 300mA	SOT-89	20vl	VR1	4g	Aic
AL15P	AIC1722A-15PXAX	LVR-IC	LDO, 1.5V±1%, 300mA	SOT-89	20vl	VR1	4g	Aic
AL18	AIC1722A-18CXAX	LVR-IC	LDO, 1.8V±1%, 300mA	SOT-89	20vl	VR1	4g	Aic
AL18G	AIC1722A-18GXAX	LVR-IC	LDO, 1.8V±1%, 300mA	SOT-89	20vl	VR1	4g	Aic
AL18P	AIC1722A-18PXAX	LVR-IC	LDO, 1.8V±1%, 300mA	SOT-89	20vl	VR1	4g	Aic
AL20	AIC1722A-20CXAX	LVR-IC	LDO, 2.0V±1%, 300mA	SOT-89	20vl	VR1	4g	Aic
AL20G	AIC1722A-20GXAX	LVR-IC	LDO, 2.0V±1%, 300mA	SOT-89	20vl	VR1	4g	Aic
AL20P	AIC1722A-20PXAX	LVR-IC	LDO, 2.0V±1%, 300mA	SOT-89	20vl	VR1	4g	Aic
AL25	AIC1722A-25CXAX	LVR-IC	LDO, 2.5V±1%, 300mA	SOT-89	20vl	VR1	4g	Aic



SMD
code

Type

Function

Short description

Case Pinout Sch. St. Mnf.

SMD code	Type	Function	Short description	Case	Pinout	Sch.	St.	Mnf.
AL25G	AIC1722A-25GXA	LVR-IC	LDO, 2.5V±1%, 300mA	SOT-89	20vl	VR1	4g	Aic
AL25P	AIC1722A-25PXA	LVR-IC	LDO, 2.5V±1%, 300mA	SOT-89	20vl	VR1	4g	Aic
AL27	AIC1722A-27CXA	LVR-IC	LDO, 2.7V±1%, 300mA	SOT-89	20vl	VR1	4g	Aic
AL27G	AIC1722A-27GXA	LVR-IC	LDO, 2.7V±1%, 300mA	SOT-89	20vl	VR1	4g	Aic
AL27P	AIC1722A-27PXA	LVR-IC	LDO, 2.7V±1%, 300mA	SOT-89	20vl	VR1	4g	Aic
AL30	AIC1722A-30CXA	LVR-IC	LDO, 3.0V±1%, 300mA	SOT-89	20vl	VR1	4g	Aic
AL30G	AIC1722A-30GXA	LVR-IC	LDO, 3.0V±1%, 300mA	SOT-89	20vl	VR1	4g	Aic
AL30P	AIC1722A-30PXA	LVR-IC	LDO, 3.0V±1%, 300mA	SOT-89	20vl	VR1	4g	Aic
AL33	AIC1722A-33CXA	LVR-IC	LDO, 3.3V±1%, 300mA	SOT-89	20vl	VR1	4g	Aic
AL33G	AIC1722A-33GXA	LVR-IC	LDO, 3.3V±1%, 300mA	SOT-89	20vl	VR1	4g	Aic
AL33P	AIC1722A-33PXA	LVR-IC	LDO, 3.3V±1%, 300mA	SOT-89	20vl	VR1	4g	Aic
AL35	AIC1722A-35CXA	LVR-IC	LDO, 3.5V±1%, 300mA	SOT-89	20vl	VR1	4g	Aic
AL35G	AIC1722A-35GXA	LVR-IC	LDO, 3.5V±1%, 300mA	SOT-89	20vl	VR1	4g	Aic
AL35P	AIC1722A-35PXA	LVR-IC	LDO, 3.5V±1%, 300mA	SOT-89	20vl	VR1	4g	Aic
AL37	AIC1722A-37CXA	LVR-IC	LDO, 3.7V±1%, 300mA	SOT-89	20vl	VR1	4g	Aic
AL37G	AIC1722A-37GXA	LVR-IC	LDO, 3.7V±1%, 300mA	SOT-89	20vl	VR1	4g	Aic
AL37P	AIC1722A-37PXA	LVR-IC	LDO, 3.7V±1%, 300mA	SOT-89	20vl	VR1	4g	Aic
AL38	AIC1722A-38CXA	LVR-IC	LDO, 3.8V±1%, 300mA	SOT-89	20vl	VR1	4g	Aic
AL38G	AIC1722A-38GXA	LVR-IC	LDO, 3.8V±1%, 300mA	SOT-89	20vl	VR1	4g	Aic
AL38P	AIC1722A-38PXA	LVR-IC	LDO, 3.8V±1%, 300mA	SOT-89	20vl	VR1	4g	Aic
AL50	AIC1722A-50CXA	LVR-IC	LDO, 5.0V±1%, 300mA	SOT-89	20vl	VR1	4g	Aic
AL50G	AIC1722A-50GXA	LVR-IC	LDO, 5.0V±1%, 300mA	SOT-89	20vl	VR1	4g	Aic
AL50P	AIC1722A-50PXA	LVR-IC	LDO, 5.0V±1%, 300mA	SOT-89	20vl	VR1	4g	Aic
AL52	AIC1722A-52CXA	LVR-IC	LDO, 5.2V±1%, 300mA	SOT-89	20vl	VR1	4g	Aic
AL52G	AIC1722A-52GXA	LVR-IC	LDO, 5.2V±1%, 300mA	SOT-89	20vl	VR1	4g	Aic
AL52P	AIC1722A-52PXA	LVR-IC	LDO, 5.2V±1%, 300mA	SOT-89	20vl	VR1	4g	Aic
ALP	2SA1900-P	Si-pnp	Lo-sat, 60V, 1A, 500mW, B=82..180, >150MHz	SOT-89	20tb	-	4b	Rhm
ALQ	2SA1900-Q	Si-pnp	Lo-sat, 60V, 1A, 500mW, B=120..270, >150MHz	SOT-89	20tb	-	4b	Rhm
ALR	2SA1900-R	Si-pnp	Lo-sat, 60V, 1A, 500mW, B=180..390, >150MHz	SOT-89	20tb	-	4b	Rhm
AM	BCX52-16	Si-pnp	AF, 60V, 1A, 1W, B=100..250, >100MHz	SOT-89	20tb	-	4b	Phi
AM	RT9161-41CX	LVR-IC	LDO, 4.1V±2%, 300mA	SOT-89	20vl	VR1	4c	Rct
AMS	2SA1896-S	Si-pnp	DC/DC-Conv, 25V, 2.5A, 1.3W, B=140..280, 400MHz	PCP	20tb	-	4a	San
AMT	2SA1896-T	Si-pnp	DC/DC-Conv, 25V, 2.5A, 1.3W, B=200..400, 400MHz	PCP	20tb	-	4a	San
ANR	2SA1896-R	Si-pnp	DC/DC-Conv, 15V, 3A, 1.3W, B=100..200, 400MHz	PCP	20tb	-	4a	San
ANS	2SA1898-S	Si-pnp	DC/DC-Conv, 15V, 3A, 1.3W, B=140..280, 400MHz	PCP	20tb	-	4a	San
AO	2SC2880-O	Si-npn	HV, 150V, 50mA, 500mW, B=70..140, 120MHz	SOT-89	20tb	-	4b	Tos
AO	KTC4372-O	Si-npn	HV, Sw, 150V, 50mA, 500mW, B=70..140, 120MHz	SOT-89	20tb	-	4a	Kec
AP	RT9161-15CX	LVR-IC	LDO, 1.5V±2%, 300mA	SOT-89	20vl	VR1	4c	Rct
AP-	RT9161-15PX	LVR-IC	LDO, 1.5V±2%, 300mA	SOT-89	20vl	VR1	4c	Rct
AQ	2SA1969	Si-pnp	HF, Fast-Sw, 10/10V, 400mA, 1.3W, B=20..120, 1.7GHz	PCP	20tb	-	4a	San
AQ	2SB766-Q	Si-pnp	AF, 50V, 1A, 1W, B=85..170, 200MHz	SOT-89	20tb	-	4b	Pan
AQ	RT9161-20CX	LVR-IC	LDO, 2.0V±2%, 300mA	SOT-89	20vl	VR1	4c	Rct
AR	2SA2011	Si-pnp	Lo-sat, 15V, 6A, 1.3W, B=200..560, 380MHz, 35/1105ns	SOT-89	20tb	-	4a	San
AR	2SB766-R	Si-pnp	AF, 50V, 1A, 1W, B=120..240, 200MHz	SOT-89	20tb	-	4b	Pan
AR	2SC3338	Si-npn	UHF/VHF WB-Amp, 20V, 50mA, 400mW, 4.5GHz, B=30..200	SOT-89	20tb	-	4b	Ren
AR1	BSR40	Si-npn	AF, Sw, 70V, 1A, 1.35W, B=40..120, 100MHz	SOT-89	20tb	-	4b	Phi
AR2	BSR41	Si-npn	AF, Sw, 70V, 1A, 1W, B=100..300, 100MHz	SOT-89	20tb	-	4b	Phi
AR3	BSR42	Si-npn	AF, Sw, 90V, 1A, 1W, B=40..120, 100MHz	SOT-89	20tb	-	4b	Phi
AR4	BSR43	Si-npn	AF, Sw, 90V, 1A, 1W, B=100..300, 100MHz	SOT-89	20tb	-	4b	Phi
AS	2SA2012	Si-pnp	Lo-sat, 30V, 5A, 1.3W, B=200..560, 420MHz, 50/270ns	SOT-89	20tb	-	4a	San
AS	2SB766-S	Si-pnp	AF, 50V, 1A, 1W, B=170..340, 200MHz	SOT-89	20tb	-	4b	Pan
AS	2SC3380	Si-npn	Vid, 300V, 100mA, 1W, B=30..200, 80MHz	SOT-89	20tb	-	4b	Ren
AS	RT9161-22CX	LVR-IC	LDO, 2.2V±2%, 300mA	SOT-89	20vl	VR1	4c	Rct
AS-	RT9161-22PX	LVR-IC	LDO, 2.2V±2%, 300mA	SOT-89	20vl	VR1	4c	Rct
AS1	BST50	Si-npn-Darl+Di	AF, 60V, 500mA, 1.3W, B>2000, 350MHz	SOT-89	20tb	-	4b	Phi
AS2	BST51	Si-npn-Darl+Di	AF, 80V, 500mA, 1.3W, B>2000, 350MHz	SOT-89	20tb	-	4b	Phi
AS3	BST52	Si-npn-Darl+Di	AF, 90V, 500mA, 1.3W, B>2000, 350MHz	SOT-89	20tb	-	4b	Phi
AT	2SA2013	Si-pnp	Lo-sat, 50V, 4A, 1.3W, B=200..560, 400MHz, 30/230ns	SOT-89	20tb	-	4a	San
AT	2SD1470	Si-npn-Darl	GP, 60V, 1A, 1W, B=2000..100k	SOT-89	20te	-	4b	Ren
AT1	BST39	Si-npn	AF, Sw, Vid, 450V, 1A, >70MHz	SOT-89	20tb	-	4b	Phi
AT2	BST40	Si-npn	AF, Sw, Vid, 300V, 1A, 1W, B>40, >70MHz	SOT-89	20tb	-	4b	Phi
ATN	2SA1812T-N	Si-pnp	Sw, 400V, 500mA, 500mW, B=56..120, >12MHz	SOT-89	20tb	-	4b	Rhm
ATP	2SA1812T-P	Si-pnp	Sw, 400V, 500mA, 500mW, B=82..180, >12MHz	SOT-89	20tb	-	4b	Rhm
ATQ	2SA1812T-Q	Si-pnp	Sw, 400V, 500mA, 500mW, B=120..270, >12MHz	SOT-89	20tb	-	4b	Rhm
AU	2SA2014	Si-pnp	Relay-Drv, 15V, 9A, 1.3W, B=200..560, 220MHz	SOT-89	20tb	-	4a	San
AU	2SB804-U	Si-pnp	AF-Amp, 100V, 1A, 2W, 80MHz, B=200..400	SOT-89	20tb	-	4b	Nec
AU0	ELM9740CAB	Vdet-IC	4.0V±2.5%, +Reset PPO	SOT-89	20vda	VD7	4a	Elm
AU1	ELM9741CAB	Vdet-IC	4.1V±2.5%, +Reset PPO	SOT-89	20vda	VD7	4a	Elm
AU2	ELM9742CAB	Vdet-IC	4.2V±2.5%, +Reset PPO	SOT-89	20vda	VD7	4a	Elm
AU3	ELM9743CAB	Vdet-IC	4.3V±2.5%, +Reset PPO	SOT-89	20vda	VD7	4a	Elm



SMD
code

Type

Function

Short description

Case Pinout Sch. St. Mnf.

SMD code	Type	Function	Short description	Case	Pinout	Sch.	St.	Mnf.
AU4	ELM9744CAB	Vdet-IC	4.4V±2.5%, +Reset PPO	SOT-89	20vda	VD7	4a	Elm
AU5	ELM9745CAB	Vdet-IC	4.5V±2.5%, +Reset PPO	SOT-89	20vda	VD7	4a	Elm
AU6	ELM9746CAB	Vdet-IC	4.6V±2.5%, +Reset PPO	SOT-89	20vda	VD7	4a	Elm
AU7	ELM9747CAB	Vdet-IC	4.7V±2.5%, +Reset PPO	SOT-89	20vda	VD7	4a	Elm
AU8	ELM9748CAB	Vdet-IC	4.8V±2.5%, +Reset PPO	SOT-89	20vda	VD7	4a	Elm
AU9	ELM9749CAB	Vdet-IC	4.9V±2.5%, +Reset PPO	SOT-89	20vda	VD7	4a	Elm
AV	2SA2015	Si-pnp	Lo-sat, 30V, 8A, 1.3W, B=200..560, 320MHz, 30/190ns	SOT-89	20tb	-	4a	San
AV	2SB804-V	Si-pnp	AF-Amp, 100V, 1A, 2W, 80MHz, B=135..270	SOT-89	20tb	-	4b	Nec
AV-	RT9261-50PX	DC/DC-IC	VFM step-up, 5.0V±2%, 50mA	SOT-89	20br	DC5	4b	Rct
AV0	ELM9750CAB	Vdet-IC	5.0V±2.5%, +Reset PPO	SOT-89	20vda	VD7	4a	Elm
AV1	ELM9751CAB	Vdet-IC	5.1V±2.5%, +Reset PPO	SOT-89	20vda	VD7	4a	Elm
AV15G	AIC1723A-15GX	LVR-IC	LDO, 1.5V±1%, 500mA	SOT-89	20vl	VR1	4g	Aic
AV15P	AIC1723A-15PX	LVR-IC	LDO, 1.5V±1%, 500mA	SOT-89	20vl	VR1	4g	Aic
AV18G	AIC1723A-18GX	LVR-IC	LDO, 1.8V±1%, 500mA	SOT-89	20vl	VR1	4g	Aic
AV18P	AIC1723A-18PX	LVR-IC	LDO, 1.8V±1%, 500mA	SOT-89	20vl	VR1	4g	Aic
AV2	ELM9752CAB	Vdet-IC	5.2V±2.5%, +Reset PPO	SOT-89	20vda	VD7	4a	Elm
AV20G	AIC1723A-20GX	LVR-IC	LDO, 2.0V±1%, 500mA	SOT-89	20vl	VR1	4g	Aic
AV20P	AIC1723A-20PX	LVR-IC	LDO, 2.0V±1%, 500mA	SOT-89	20vl	VR1	4g	Aic
AV25G	AIC1723A-25GX	LVR-IC	LDO, 2.5V±1%, 500mA	SOT-89	20vl	VR1	4g	Aic
AV25P	AIC1723A-25PX	LVR-IC	LDO, 2.5V±1%, 500mA	SOT-89	20vl	VR1	4g	Aic
AV27G	AIC1723A-27GX	LVR-IC	LDO, 2.7V±1%, 500mA	SOT-89	20vl	VR1	4g	Aic
AV27P	AIC1723A-27PX	LVR-IC	LDO, 2.7V±1%, 500mA	SOT-89	20vl	VR1	4g	Aic
AV3	ELM9753CAB	Vdet-IC	5.3V±2.5%, +Reset PPO	SOT-89	20vda	VD7	4a	Elm
AV30G	AIC1723A-30GX	LVR-IC	LDO, 3.0V±1%, 500mA	SOT-89	20vl	VR1	4g	Aic
AV30P	AIC1723A-30PX	LVR-IC	LDO, 3.0V±1%, 500mA	SOT-89	20vl	VR1	4g	Aic
AV33G	AIC1723A-33GX	LVR-IC	LDO, 3.3V±1%, 500mA	SOT-89	20vl	VR1	4g	Aic
AV33P	AIC1723A-33PX	LVR-IC	LDO, 3.3V±1%, 500mA	SOT-89	20vl	VR1	4g	Aic
AV35G	AIC1723A-35GX	LVR-IC	LDO, 3.5V±1%, 500mA	SOT-89	20vl	VR1	4g	Aic
AV35P	AIC1723A-35PX	LVR-IC	LDO, 3.5V±1%, 500mA	SOT-89	20vl	VR1	4g	Aic
AV37G	AIC1723A-37GX	LVR-IC	LDO, 3.7V±1%, 500mA	SOT-89	20vl	VR1	4g	Aic
AV37P	AIC1723A-37PX	LVR-IC	LDO, 3.7V±1%, 500mA	SOT-89	20vl	VR1	4g	Aic
AV38G	AIC1723A-38GX	LVR-IC	LDO, 3.8V±1%, 500mA	SOT-89	20vl	VR1	4g	Aic
AV38P	AIC1723A-38PX	LVR-IC	LDO, 3.8V±1%, 500mA	SOT-89	20vl	VR1	4g	Aic
AV4	ELM9754CAB	Vdet-IC	5.4V±2.5%, +Reset PPO	SOT-89	20vda	VD7	4a	Elm
AV5	ELM9755CAB	Vdet-IC	5.5V±2.5%, +Reset PPO	SOT-89	20vda	VD7	4a	Elm
AV50G	AIC1723A-50GX	LVR-IC	LDO, 5.0V±1%, 500mA	SOT-89	20vl	VR1	4g	Aic
AV50P	AIC1723A-50PX	LVR-IC	LDO, 5.0V±1%, 500mA	SOT-89	20vl	VR1	4g	Aic
AV52G	AIC1723A-52GX	LVR-IC	LDO, 5.2V±1%, 500mA	SOT-89	20vl	VR1	4g	Aic
AV52P	AIC1723A-52PX	LVR-IC	LDO, 5.2V±1%, 500mA	SOT-89	20vl	VR1	4g	Aic
AW	2SA2016	Si-pnp	Lo-sat, 50V, 7A, 1.3W, B=200..560, 330MHz, 40/225ns	SOT-89	20tb	-	4a	San
AW	2SB804-W	Si-pnp	AF-Amp, 100V, 1A, 2W, 80MHz, B=90..180	SOT-89	20tb	-	4b	Nec
AW0	ELM9730CAB	Vdet-IC	3.0V±2.5%, +Reset PPO	SOT-89	20vda	VD7	4a	Elm
AW1	ELM9731CAB	Vdet-IC	3.1V±2.5%, +Reset PPO	SOT-89	20vda	VD7	4a	Elm
AW2	ELM9732CAB	Vdet-IC	3.2V±2.5%, +Reset PPO	SOT-89	20vda	VD7	4a	Elm
AW3	ELM9733CAB	Vdet-IC	3.3V±2.5%, +Reset PPO	SOT-89	20vda	VD7	4a	Elm
AW4	ELM9734CAB	Vdet-IC	3.4V±2.5%, +Reset PPO	SOT-89	20vda	VD7	4a	Elm
AW5	ELM9735CAB	Vdet-IC	3.5V±2.5%, +Reset PPO	SOT-89	20vda	VD7	4a	Elm
AW6	ELM9736CAB	Vdet-IC	3.6V±2.5%, +Reset PPO	SOT-89	20vda	VD7	4a	Elm
AW7	ELM9737CAB	Vdet-IC	3.7V±2.5%, +Reset PPO	SOT-89	20vda	VD7	4a	Elm
AW8	ELM9738CAB	Vdet-IC	3.8V±2.5%, +Reset PPO	SOT-89	20vda	VD7	4a	Elm
AW9	ELM9739CAB	Vdet-IC	3.9V±2.5%, +Reset PPO	SOT-89	20vda	VD7	4a	Elm
AX-	RT9261A-50PX	DC/DC-IC	VFM step-up, 5.0V±2%, 50mA	SOT-89	20bq	DC2	4b	Rct
AY	2SC2880-Y	Si-npn	HV, 150V, 50mA, 500mW, B=120..240, 120MHz	SOT-89	20tb	-	4b	Tos
AY	KTC4372-Y	Si-npn	HV, Sw, 150V, 50mA, 500mW, B=120..240, 120MHz	SOT-89	20tb	-	4a	Kec
AY	RT9161-17CX	LVR-IC	LDO, 1.7V±2%, 300mA	SOT-89	20vl	VR1	4c	Rct
AY0	ELM9720CAB	Vdet-IC	2.0V±2.5%, +Reset PPO	SOT-89	20vda	VD7	4a	Elm
AY1	ELM9721CAB	Vdet-IC	2.1V±2.5%, +Reset PPO	SOT-89	20vda	VD7	4a	Elm
AY2	ELM9722CAB	Vdet-IC	2.2V±2.5%, +Reset PPO	SOT-89	20vda	VD7	4a	Elm
AY3	ELM9723CAB	Vdet-IC	2.3V±2.5%, +Reset PPO	SOT-89	20vda	VD7	4a	Elm
AY4	ELM9724CAB	Vdet-IC	2.4V±2.5%, +Reset PPO	SOT-89	20vda	VD7	4a	Elm
AY5	ELM9725CAB	Vdet-IC	2.5V±2.5%, +Reset PPO	SOT-89	20vda	VD7	4a	Elm
AY6	ELM9726CAB	Vdet-IC	2.6V±2.5%, +Reset PPO	SOT-89	20vda	VD7	4a	Elm
AY7	ELM9727CAB	Vdet-IC	2.7V±2.5%, +Reset PPO	SOT-89	20vda	VD7	4a	Elm
AY8	ELM9728CAB	Vdet-IC	2.8V±2.5%, +Reset PPO	SOT-89	20vda	VD7	4a	Elm
AY9	ELM9729CAB	Vdet-IC	2.9V±2.5%, +Reset PPO	SOT-89	20vda	VD7	4a	Elm
AZ	2SJ518	p-MOSFET-e*	V-MOS, LogL, 60V, 2A, <0.63Ω(5A)	SOT-89	20fa	-	4b	Ren
AZ6	ELM9716CAB	Vdet-IC	1.6V±2.5%, +Reset PPO	SOT-89	20vda	VD7	4a	Elm
AZ7	ELM9717CAB	Vdet-IC	1.7V±2.5%, +Reset PPO	SOT-89	20vda	VD7	4a	Elm
AZ8	ELM9718CAB	Vdet-IC	1.8V±2.5%, +Reset PPO	SOT-89	20vda	VD7	4a	Elm
AZ9	ELM9719CAB	Vdet-IC	1.9V±2.5%, +Reset PPO	SOT-89	20vda	VD7	4a	Elm



SMD
code

Type

Function

Short description

Case Pinout Sch. St. Mnf.

B0	ELM9710NAB	Vdet-IC	1.0V±2.5%, +Reset ODO
B0	ELM9830AB	LVR-IC	3.0V±2%, 200mA
B1	AP432Y	Vref-IC	Adjustable, Precision, Shunt, 1.24V±1%
B1	D71G.05T1	Si-pnp	Sw, 150/150V, 50msA
B1	ELM9711NAB	Vdet-IC	1.1V±2.5%, +Reset ODO
B1	ELM9831AB	LVR-IC	3.1V±2%, 200mA
B1-	RT9169-12PX	LVR-IC	LDO, 1.2V±2%, 100mA
B11A	ML6101N113P	Vdet-IC	1.1V±3%, +Reset ODO
B12A	ML6101N123P	Vdet-IC	1.2V±3%, +Reset ODO
B13A	ML6101N133P	Vdet-IC	1.3V±3%, +Reset ODO
B14A	ML6101N143P	Vdet-IC	1.4V±3%, +Reset ODO
B15A	ML6101N153P	Vdet-IC	1.5V±3%, +Reset ODO
B16A	ML6101N163P	Vdet-IC	1.6V±3%, +Reset ODO
B17A	ML6101N173P	Vdet-IC	1.7V±3%, +Reset ODO
B18A	ML6101N183P	Vdet-IC	1.8V±3%, +Reset ODO
B19A	ML6101N193P	Vdet-IC	1.9V±3%, +Reset ODO
B2	AP432AY	Vref-IC	Adjustable, Precision, Shunt, 1.24V±0.5%
B2	ELM9712NAB	Vdet-IC	1.2V±2.5%, +Reset ODO
B2	ELM9832AB	LVR-IC	3.2V±2%, 200mA
B2	RT9169-13CX	LVR-IC	LDO, 1.3V±2%, 100mA
B20A	ML6101N202P	Vdet-IC	2.0V±2%, +Reset ODO
B21A	ML6101N212P	Vdet-IC	2.1V±2%, +Reset ODO
B22A	ML6101N222P	Vdet-IC	2.2V±2%, +Reset ODO
B23A	ML6101N232P	Vdet-IC	2.3V±2%, +Reset ODO
B24A	ML6101N242P	Vdet-IC	2.4V±2%, +Reset ODO
B25A	ML6101N252P	Vdet-IC	2.5V±2%, +Reset ODO
B26A	ML6101N262P	Vdet-IC	2.6V±2%, +Reset ODO
B27A	ML6101N272P	Vdet-IC	2.7V±2%, +Reset ODO
B28A	ML6101N282P	Vdet-IC	2.8V±2%, +Reset ODO
B29A	ML6101N292P	Vdet-IC	2.9V±2%, +Reset ODO
B3	ELM9713NAB	Vdet-IC	1.3V±2.5%, +Reset ODO
B3	ELM9833AB	LVR-IC	3.3V±2%, 200mA
B3	RT9169-14CX	LVR-IC	LDO, 1.4V±2%, 100mA
B3-	RT9169-14PX	LVR-IC	LDO, 1.4V±2%, 100mA
B30A	ML6101N302P	Vdet-IC	3.0V±2%, +Reset ODO
B31A	ML6101N312P	Vdet-IC	3.1V±2%, +Reset ODO
B32A	ML6101N322P	Vdet-IC	3.2V±2%, +Reset ODO
B33A	ML6101N332P	Vdet-IC	3.3V±2%, +Reset ODO
B34A	ML6101N342P	Vdet-IC	3.4V±2%, +Reset ODO
B35A	ML6101N352P	Vdet-IC	3.5V±2%, +Reset ODO
B36A	ML6101N362P	Vdet-IC	3.6V±2%, +Reset ODO
B37A	ML6101N372P	Vdet-IC	3.7V±2%, +Reset ODO
B38A	ML6101N382P	Vdet-IC	3.8V±2%, +Reset ODO
B39A	ML6101N392P	Vdet-IC	3.9V±2%, +Reset ODO
B4	ELM9714NAB	Vdet-IC	1.4V±2.5%, +Reset ODO
B4	ELM9834AB	LVR-IC	3.4V±2%, 200mA
B4	RT9169-15CX	LVR-IC	LDO, 1.5V±2%, 100mA
B4-	RT9169-15PX	LVR-IC	LDO, 1.5V±2%, 100mA
B40A	ML6101N402P	Vdet-IC	4.0V±2%, +Reset ODO
B41A	ML6101N412P	Vdet-IC	4.1V±2%, +Reset ODO
B42A	ML6101N422P	Vdet-IC	4.2V±2%, +Reset ODO
B43A	ML6101N432P	Vdet-IC	4.3V±2%, +Reset ODO
B44A	ML6101N442P	Vdet-IC	4.4V±2%, +Reset ODO
B45A	ML6101N452P	Vdet-IC	4.5V±2%, +Reset ODO
B46A	ML6101N462P	Vdet-IC	4.6V±2%, +Reset ODO
B47A	ML6101N472P	Vdet-IC	4.7V±2%, +Reset ODO
B48A	ML6101N482P	Vdet-IC	4.8V±2%, +Reset ODO
B49A	ML6101N492P	Vdet-IC	4.9V±2%, +Reset ODO
B5	ELM9715NAB	Vdet-IC	1.5V±2.5%, +Reset ODO
B5	ELM9835AB	LVR-IC	3.5V±2%, 200mA
B5	RT9169-16CX	LVR-IC	LDO, 1.6V±2%, 100mA
B5-	RT9169-16PX	LVR-IC	LDO, 1.6V±2%, 100mA
B50A	ML6101N502P	Vdet-IC	5.0V±2%, +Reset ODO
B51A	ML6101N512P	Vdet-IC	5.1V±2%, +Reset ODO
B52A	ML6101N522P	Vdet-IC	5.2V±2%, +Reset ODO
B53A	ML6101N532P	Vdet-IC	5.3V±2%, +Reset ODO
B54A	ML6101N542P	Vdet-IC	5.4V±2%, +Reset ODO
B55A	ML6101N552P	Vdet-IC	5.5V±2%, +Reset ODO
B56A	ML6101N562P	Vdet-IC	5.6V±2%, +Reset ODO
B57A	ML6101N572P	Vdet-IC	5.7V±2%, +Reset ODO



SMD
code

Type

Function

Short description

Case Pinout Sch. St. Mnf.

SMD code	Type	Function	Short description	Case	Pinout	Sch.	St.	Mnf.
B58A	ML6101N582P	Vdet-IC	5.8V±2%, +Reset ODO	SOT-89	20vda	VD6	4g	Mlc
B59A	ML6101N592P	Vdet-IC	5.9V±2%, +Reset ODO	SOT-89	20vda	VD6	4g	Mlc
B6	ELM9716NAB	Vdet-IC	1.6V±2.5%, +Reset ODO	SOT-89	20vda	VD6	4a	Elm
B6	ELM9836AB	LVR-IC	3.6V±2%, 200mA	SOT-89	20vl	VR1	4a	Elm
B6	XC61CC1602P	Vdet-IC	1.6V±1%, +Reset PPO	SOT-89	20vda	VD7	4b	Tor
B60A	ML6101N602P	Vdet-IC	6.0V±2%, +Reset ODO	SOT-89	20vda	VD6	4g	Mlc
B62	S-80841CLUA	Vdet-IC	4.1V, -Reset PPO	SOT-89	20vda	VD7	4b	Sii
B63	S-80842CLUA	Vdet-IC	4.2V, -Reset PPO	SOT-89	20vda	VD7	4b	Sii
B63	XE61CC1645PR	Vdet-IC	1.6V±2%, -Reset PPO	SOT-89	20cj	VD7	4j	Tor
B64	S-80843CLUA	Vdet-IC	4.3V, -Reset PPO	SOT-89	20vda	VD7	4b	Sii
B65	S-80844CLUA	Vdet-IC	4.4V, -Reset PPO	SOT-89	20vda	VD7	4b	Sii
B65	XC61FC1612P	Vdet-IC	1.6V±2%, +Reset PPO, 200ms	SOT-89	20vda	VD7	4b	Tor
B66	S-80845CLUA	Vdet-IC	4.5V, -Reset PPO	SOT-89	20vda	VD7	4b	Sii
B66	XC61FC1642P	Vdet-IC	1.6V±2%, +Reset PPO, 400ms	SOT-89	20vda	VD7	4b	Tor
B67	S-80846CLUA	Vdet-IC	4.6V, -Reset PPO	SOT-89	20vda	VD7	4b	Sii
B67	XC61FC1652P	Vdet-IC	1.6V±2%, +Reset PPO, 50ms	SOT-89	20vda	VD7	4b	Tor
B68	S-80847CLUA	Vdet-IC	4.7V, -Reset PPO	SOT-89	20vda	VD7	4b	Sii
B69	S-80848CLUA	Vdet-IC	4.8V, -Reset PPO	SOT-89	20vda	VD7	4b	Sii
B6A	S-80815CLUA	Vdet-IC	1.5V, -Reset PPO	SOT-89	20vda	VD7	4b	Sii
B6B	S-80816CLUA	Vdet-IC	1.6V, -Reset PPO	SOT-89	20vda	VD7	4b	Sii
B6C	S-80817CLUA	Vdet-IC	1.7V, -Reset PPO	SOT-89	20vda	VD7	4b	Sii
B6D	S-80818CLUA	Vdet-IC	1.8V, -Reset PPO	SOT-89	20vda	VD7	4b	Sii
B6E	S-80819CLUA	Vdet-IC	1.9V, -Reset PPO	SOT-89	20vda	VD7	4b	Sii
B6F	S-80820CLUA	Vdet-IC	2V, -Reset PPO	SOT-89	20vda	VD7	4b	Sii
B6G	S-80821CLUA	Vdet-IC	2.1V, -Reset PPO	SOT-89	20vda	VD7	4b	Sii
B6H	S-80822CLUA	Vdet-IC	2.2V, -Reset PPO	SOT-89	20vda	VD7	4b	Sii
B6I	S-80823CLUA	Vdet-IC	2.3V, -Reset PPO	SOT-89	20vda	VD7	4b	Sii
B6J	S-80824CLUA	Vdet-IC	2.4V, -Reset PPO	SOT-89	20vda	VD7	4b	Sii
B6K	S-80825CLUA	Vdet-IC	2.5V, -Reset PPO	SOT-89	20vda	VD7	4b	Sii
B6L	S-80826CLUA	Vdet-IC	2.6V, -Reset PPO	SOT-89	20vda	VD7	4b	Sii
B6M	S-80827CLUA	Vdet-IC	2.7V, -Reset PPO	SOT-89	20vda	VD7	4b	Sii
B6N	S-80828CLUA	Vdet-IC	2.8V, -Reset PPO	SOT-89	20vda	VD7	4b	Sii
B6O	S-80829CLUA	Vdet-IC	2.9V, -Reset PPO	SOT-89	20vda	VD7	4b	Sii
B6P	S-80830CLUA	Vdet-IC	3V, -Reset PPO	SOT-89	20vda	VD7	4b	Sii
B6Q	S-80831CLUA	Vdet-IC	3.1V, -Reset PPO	SOT-89	20vda	VD7	4b	Sii
B6R	S-80832CLUA	Vdet-IC	3.2V, -Reset PPO	SOT-89	20vda	VD7	4b	Sii
B6S	S-80833CLUA	Vdet-IC	3.3V, -Reset PPO	SOT-89	20vda	VD7	4b	Sii
B6T	S-80834CLUA	Vdet-IC	3.4V, -Reset PPO	SOT-89	20vda	VD7	4b	Sii
B6U	S-80835CLUA	Vdet-IC	3.5V, -Reset PPO	SOT-89	20vda	VD7	4b	Sii
B6V	S-80836CLUA	Vdet-IC	3.6V, -Reset PPO	SOT-89	20vda	VD7	4b	Sii
B6W	S-80837CLUA	Vdet-IC	3.7V, -Reset PPO	SOT-89	20vda	VD7	4b	Sii
B6X	S-80838CLUA	Vdet-IC	3.8V, -Reset PPO	SOT-89	20vda	VD7	4b	Sii
B6Y	S-80839CLUA	Vdet-IC	3.9V, -Reset PPO	SOT-89	20vda	VD7	4b	Sii
B6Z	S-80840CLUA	Vdet-IC	4V, -Reset PPO	SOT-89	20vda	VD7	4b	Sii
B7	ELM9717NAB	Vdet-IC	1.7V±2.5%, +Reset ODO	SOT-89	20vda	VD6	4a	Elm
B7	ELM9837AB	LVR-IC	3.7V±2%, 200mA	SOT-89	20vl	VR1	4a	Elm
B7	RT9169-18CX	LVR-IC	LDO, 1.8V±2%, 100mA	SOT-89	20vl	VR1	4c	Rct
B7	XC61CC1702P	Vdet-IC	1.7V±1%, +Reset PPO	SOT-89	20vda	VD7	4b	Tor
B7-	RT9169-18PX	LVR-IC	LDO, 1.8V±2%, 100mA	SOT-89	20vl	VR1	4c	Rct
B73	XE61CC1745PR	Vdet-IC	1.7V±2%, -Reset PPO	SOT-89	20cj	VD7	4j	Tor
B75	XC61FC1712P	Vdet-IC	1.7V±2%, +Reset PPO, 200ms	SOT-89	20vda	VD7	4b	Tor
B76	XC61FC1742P	Vdet-IC	1.7V±2%, +Reset PPO, 400ms	SOT-89	20vda	VD7	4b	Tor
B77	XC61FC1752P	Vdet-IC	1.7V±2%, +Reset PPO, 50ms	SOT-89	20vda	VD7	4b	Tor
B77ZGR	WTM772-GR	Si-pnp	GP, 40V, 3A, 500mW, B=200..400, 80MHz	SOT-89	20tb	-	4b	Wtr
B77ZO	WTM772-O	Si-pnp	GP, 40V, 3A, 500mW, B=100..200, 80MHz	SOT-89	20tb	-	4b	Wtr
B77ZR	WTM772-R	Si-pnp	GP, 40V, 3A, 500mW, B=60..120, 80MHz	SOT-89	20tb	-	4b	Wtr
B77ZY	WTM772-Y	Si-pnp	GP, 40V, 3A, 500mW, B=160..320, 80MHz	SOT-89	20tb	-	4b	Wtr
B7A	S-80849CLUA	Vdet-IC	4.9V, -Reset PPO	SOT-89	20vda	VD7	4b	Sii
B7B	S-80850CLUA	Vdet-IC	5.0V, -Reset PPO	SOT-89	20vda	VD7	4b	Sii
B7C	S-80851CLUA	Vdet-IC	5.1V, -Reset PPO	SOT-89	20vda	VD7	4b	Sii
B7D	S-80852CLUA	Vdet-IC	5.2V, -Reset PPO	SOT-89	20vda	VD7	4b	Sii
B7E	S-80853CLUA	Vdet-IC	5.3V, -Reset PPO	SOT-89	20vda	VD7	4b	Sii
B7F	S-80854CLUA	Vdet-IC	5.4V, -Reset PPO	SOT-89	20vda	VD7	4b	Sii
B7G	S-80855CLUA	Vdet-IC	5.5V, -Reset PPO	SOT-89	20vda	VD7	4b	Sii
B7H	S-80856CLUA	Vdet-IC	5.6V, -Reset PPO	SOT-89	20vda	VD7	4b	Sii
B7I	S-80857CLUA	Vdet-IC	5.7V, -Reset PPO	SOT-89	20vda	VD7	4b	Sii
B7J	S-80858CLUA	Vdet-IC	5.8V, -Reset PPO	SOT-89	20vda	VD7	4b	Sii
B7K	S-80859CLUA	Vdet-IC	5.9V, -Reset PPO	SOT-89	20vda	VD7	4b	Sii
B7L	S-80860CLUA	Vdet-IC	6V, -Reset PPO	SOT-89	20vda	VD7	4b	Sii
B8	ELM9718NAB	Vdet-IC	1.8V±2.5%, +Reset ODO	SOT-89	20vda	VD6	4a	Elm



SMD
code

Type

Function

Short description

Case Pinout Sch. St. Mnf.

SMD code	Type	Function	Short description	Case	Pinout	Sch.	St.	Mnf.
B8	ELM9838AB	LVR-IC	3.8V±2%, 200mA	SOT-89	20vl	VR1	4a	Elm
B8	RT9169-19CX	LVR-IC	LDO, 1.9V±2%, 100mA	SOT-89	20vl	VR1	4c	Rct
B8	XC61CC1802P	Vdet-IC	1.8V±1%, +Reset PPO	SOT-89	20vda	VD7	4b	Tor
B82	S-80841CNUA	Vdet-IC	4.1V, -Reset ODO	SOT-89	20vda	VD6	4b	Sii
B83	S-80842CNUA	Vdet-IC	4.2V, -Reset ODO	SOT-89	20vda	VD6	4b	Sii
B83	XE61CC1845PR	Vdet-IC	1.8V±2%, -Reset PPO	SOT-89	20cj	VD7	4j	Tor
B84	S-80843CNUA	Vdet-IC	4.3V, -Reset ODO	SOT-89	20vda	VD6	4b	Sii
B85	S-80844CNUA	Vdet-IC	4.4V, -Reset ODO	SOT-89	20vda	VD6	4b	Sii
B85	XC61FC1812P	Vdet-IC	1.8V±2%, +Reset PPO, 200ms	SOT-89	20vda	VD7	4b	Tor
B86	S-80845CNUA	Vdet-IC	4.5V, -Reset ODO	SOT-89	20vda	VD6	4b	Sii
B86	XC61FC1842P	Vdet-IC	1.8V±2%, +Reset PPO, 400ms	SOT-89	20vda	VD7	4b	Tor
B87	S-80846CNUA	Vdet-IC	4.6V, -Reset ODO	SOT-89	20vda	VD6	4b	Sii
B87	XC61FC1852P	Vdet-IC	1.8V±2%, +Reset PPO, 50ms	SOT-89	20vda	VD7	4b	Tor
B88	S-80847CNUA	Vdet-IC	4.7V, -Reset ODO	SOT-89	20vda	VD6	4b	Sii
B89	S-80848CNUA	Vdet-IC	4.8V, -Reset ODO	SOT-89	20vda	VD6	4b	Sii
B8A	S-80815CNUA	Vdet-IC	1.5V, -Reset ODO	SOT-89	20vda	VD6	4b	Sii
B8B	S-80816CNUA	Vdet-IC	1.6V, -Reset ODO	SOT-89	20vda	VD6	4b	Sii
B8C	S-80817CNUA	Vdet-IC	1.7V, -Reset ODO	SOT-89	20vda	VD6	4b	Sii
B8D	S-80818CNUA	Vdet-IC	1.8V, -Reset ODO	SOT-89	20vda	VD6	4b	Sii
B8E	S-80819CNUA	Vdet-IC	1.9V, -Reset ODO	SOT-89	20vda	VD6	4b	Sii
B8F	S-80820CNUA	Vdet-IC	2V, -Reset ODO	SOT-89	20vda	VD6	4b	Sii
B8G	S-80821CNUA	Vdet-IC	2.1V, -Reset ODO	SOT-89	20vda	VD6	4b	Sii
B8H	S-80822CNUA	Vdet-IC	2.2V, -Reset ODO	SOT-89	20vda	VD6	4b	Sii
B8I	S-80823CNUA	Vdet-IC	2.3V, -Reset ODO	SOT-89	20vda	VD6	4b	Sii
B8J	S-80824CNUA	Vdet-IC	2.4V, -Reset ODO	SOT-89	20vda	VD6	4b	Sii
B8K	S-80825CNUA	Vdet-IC	2.5V, -Reset ODO	SOT-89	20vda	VD6	4b	Sii
B8L	S-80826CNUA	Vdet-IC	2.6V, -Reset ODO	SOT-89	20vda	VD6	4b	Sii
B8M	S-80827CNUA	Vdet-IC	2.7V, -Reset ODO	SOT-89	20vda	VD6	4b	Sii
B8N	S-80828CNUA	Vdet-IC	2.8V, -Reset ODO	SOT-89	20vda	VD6	4b	Sii
B8O	S-80829CNUA	Vdet-IC	2.9V, -Reset ODO	SOT-89	20vda	VD6	4b	Sii
B8P	S-80830CNUA	Vdet-IC	3V, -Reset ODO	SOT-89	20vda	VD6	4b	Sii
B8Q	S-80831CNUA	Vdet-IC	3.1V, -Reset ODO	SOT-89	20vda	VD6	4b	Sii
B8R	S-80832CNUA	Vdet-IC	3.2V, -Reset ODO	SOT-89	20vda	VD6	4b	Sii
B8S	S-80833CNUA	Vdet-IC	3.3V, -Reset ODO	SOT-89	20vda	VD6	4b	Sii
B8T	S-80834CNUA	Vdet-IC	3.4V, -Reset ODO	SOT-89	20vda	VD6	4b	Sii
B8U	S-80835CNUA	Vdet-IC	3.5V, -Reset ODO	SOT-89	20vda	VD6	4b	Sii
B8V	S-80836CNUA	Vdet-IC	3.6V, -Reset ODO	SOT-89	20vda	VD6	4b	Sii
B8W	S-80837CNUA	Vdet-IC	3.7V, -Reset ODO	SOT-89	20vda	VD6	4b	Sii
B8X	S-80838CNUA	Vdet-IC	3.8V, -Reset ODO	SOT-89	20vda	VD6	4b	Sii
B8Y	S-80839CNUA	Vdet-IC	3.9V, -Reset ODO	SOT-89	20vda	VD6	4b	Sii
B8Z	S-80840CNUA	Vdet-IC	4V, -Reset ODO	SOT-89	20vda	VD6	4b	Sii
B9	ELM9719NAB	Vdet-IC	1.9V±2.5%, +Reset ODO	SOT-89	20vda	VD6	4a	Elm
B9	ELM9839AB	LVR-IC	3.9V±2%, 200mA	SOT-89	20vl	VR1	4a	Elm
B9	RT9169-20CX	LVR-IC	LDO, 2.0V±2%, 100mA	SOT-89	20vl	VR1	4c	Rct
B9	XC61CC1902P	Vdet-IC	1.9V±1%, +Reset PPO	SOT-89	20vda	VD7	4b	Tor
B93	XE61CC1945PR	Vdet-IC	1.9V±2%, -Reset PPO	SOT-89	20cj	VD7	4j	Tor
B95	XC61FC1912P	Vdet-IC	1.9V±2%, +Reset PPO, 200ms	SOT-89	20vda	VD7	4b	Tor
B96	XC61FC1942P	Vdet-IC	1.9V±2%, +Reset PPO, 400ms	SOT-89	20vda	VD7	4b	Tor
B97	XC61FC1952P	Vdet-IC	1.9V±2%, +Reset PPO, 50ms	SOT-89	20vda	VD7	4b	Tor
B9A	S-80849CNUA	Vdet-IC	4.9V, -Reset ODO	SOT-89	20vda	VD6	4b	Sii
B9B	S-80850CNUA	Vdet-IC	5V, -Reset ODO	SOT-89	20vda	VD6	4b	Sii
B9C	S-80851CNUA	Vdet-IC	5.1V, -Reset ODO	SOT-89	20vda	VD6	4b	Sii
B9D	S-80852CNUA	Vdet-IC	5.2V, -Reset ODO	SOT-89	20vda	VD6	4b	Sii
B9E	S-80853CNUA	Vdet-IC	5.3V, -Reset ODO	SOT-89	20vda	VD6	4b	Sii
B9F	S-80854CNUA	Vdet-IC	5.4V, -Reset ODO	SOT-89	20vda	VD6	4b	Sii
B9G	S-80855CNUA	Vdet-IC	5.5V, -Reset ODO	SOT-89	20vda	VD6	4b	Sii
B9H	S-80856CNUA	Vdet-IC	5.6V, -Reset ODO	SOT-89	20vda	VD6	4b	Sii
B9I	S-80857CNUA	Vdet-IC	5.7V, -Reset ODO	SOT-89	20vda	VD6	4b	Sii
B9J	S-80858CNUA	Vdet-IC	5.8V, -Reset ODO	SOT-89	20vda	VD6	4b	Sii
B9K	S-80859CNUA	Vdet-IC	5.9V, -Reset ODO	SOT-89	20vda	VD6	4b	Sii
B9L	S-80860CNUA	Vdet-IC	6V, -Reset ODO	SOT-89	20vda	VD6	4b	Sii
BA	2SD1367-A	Si-npn	AF, 20V, 2A, 1W, B=100, 200, 100MHz	SOT-89	20tb	-	4b	Ren
BA	AP432IY	Vref-IC	Adjustable, Precision, Shunt, 1.24V±1%	SOT-89-3L	20rb	RF1	4b	Ana
BA	BCX54	Si-npn	AF, 45V, 1A, 1W, B=40, 250, >100MHz	SOT-89	20tb	-	4b	Phi
BA	ELM99301B	LVR-IC	LDO, 3.0V±2%, 300mA	SOT-89	20vl	VR1	4a	Elm
BA	RT9169-21CX	LVR-IC	LDO, 2.1V±2%, 100mA	SOT-89	20vl	VR1	4c	Rct
BA15	AIC1722A-15GXT	LVR-IC	LDO, 1.5V±1%, 300mA	SOT-89	20ch	VR1	4g	Aic
BA15G	AIC1722A-15GXT	LVR-IC	LDO, 1.5V±1%, 300mA	SOT-89	20ch	VR1	4g	Aic
BA15P	AIC1722A-15PXT	LVR-IC	LDO, 1.5V±1%, 300mA	SOT-89	20ch	VR1	4g	Aic
BA18	AIC1722A-18CXT	LVR-IC	LDO, 1.8V±1%, 300mA	SOT-89	20ch	VR1	4g	Aic



SMD
code

Type

Function

Short description

Case Pinout Sch. St. Mnf.

BA18G	AIC1722A-18GXT	LVR-IC	LDO, 1.8V±1%, 300mA	SOT-89	20ch	VR1	4g	Aic
BA18P	AIC1722A-18PXT	LVR-IC	LDO, 1.8V±1%, 300mA	SOT-89	20ch	VR1	4g	Aic
BA20	AIC1722A-20CXT	LVR-IC	LDO, 2.0V±1%, 300mA	SOT-89	20ch	VR1	4g	Aic
BA20G	AIC1722A-20GXT	LVR-IC	LDO, 2.0V±1%, 300mA	SOT-89	20ch	VR1	4g	Aic
BA20P	AIC1722A-20PXT	LVR-IC	LDO, 2.0V±1%, 300mA	SOT-89	20ch	VR1	4g	Aic
BA25	AIC1722A-25CXT	LVR-IC	LDO, 2.5V±1%, 300mA	SOT-89	20ch	VR1	4g	Aic
BA25G	AIC1722A-25GXT	LVR-IC	LDO, 2.5V±1%, 300mA	SOT-89	20ch	VR1	4g	Aic
BA25P	AIC1722A-25PXT	LVR-IC	LDO, 2.5V±1%, 300mA	SOT-89	20ch	VR1	4g	Aic
BA27	AIC1722A-27CXT	LVR-IC	LDO, 2.7V±1%, 300mA	SOT-89	20ch	VR1	4g	Aic
BA27G	AIC1722A-27GXT	LVR-IC	LDO, 2.7V±1%, 300mA	SOT-89	20ch	VR1	4g	Aic
BA27P	AIC1722A-27PXT	LVR-IC	LDO, 2.7V±1%, 300mA	SOT-89	20ch	VR1	4g	Aic
BA30	AIC1722A-30CXT	LVR-IC	LDO, 3.0V±1%, 300mA	SOT-89	20ch	VR1	4g	Aic
BA30G	AIC1722A-30GXT	LVR-IC	LDO, 3.0V±1%, 300mA	SOT-89	20ch	VR1	4g	Aic
BA30P	AIC1722A-30PXT	LVR-IC	LDO, 3.0V±1%, 300mA	SOT-89	20ch	VR1	4g	Aic
BA33	AIC1722A-33CXT	LVR-IC	LDO, 3.3V±1%, 300mA	SOT-89	20ch	VR1	4g	Aic
BA33G	AIC1722A-33GXT	LVR-IC	LDO, 3.3V±1%, 300mA	SOT-89	20ch	VR1	4g	Aic
BA33P	AIC1722A-33PXT	LVR-IC	LDO, 3.3V±1%, 300mA	SOT-89	20ch	VR1	4g	Aic
BA35	AIC1722A-35CXT	LVR-IC	LDO, 3.5V±1%, 300mA	SOT-89	20ch	VR1	4g	Aic
BA35G	AIC1722A-35GXT	LVR-IC	LDO, 3.5V±1%, 300mA	SOT-89	20ch	VR1	4g	Aic
BA35P	AIC1722A-35PXT	LVR-IC	LDO, 3.5V±1%, 300mA	SOT-89	20ch	VR1	4g	Aic
BA37	AIC1722A-37CXT	LVR-IC	LDO, 3.7V±1%, 300mA	SOT-89	20ch	VR1	4g	Aic
BA37G	AIC1722A-37GXT	LVR-IC	LDO, 3.7V±1%, 300mA	SOT-89	20ch	VR1	4g	Aic
BA37P	AIC1722A-37PXT	LVR-IC	LDO, 3.7V±1%, 300mA	SOT-89	20ch	VR1	4g	Aic
BA38	AIC1722A-38CXT	LVR-IC	LDO, 3.8V±1%, 300mA	SOT-89	20ch	VR1	4g	Aic
BA38G	AIC1722A-38GXT	LVR-IC	LDO, 3.8V±1%, 300mA	SOT-89	20ch	VR1	4g	Aic
BA38P	AIC1722A-38PXT	LVR-IC	LDO, 3.8V±1%, 300mA	SOT-89	20ch	VR1	4g	Aic
BA50	AIC1722A-50CXT	LVR-IC	LDO, 5.0V±1%, 300mA	SOT-89	20ch	VR1	4g	Aic
BA50G	AIC1722A-50GXT	LVR-IC	LDO, 5.0V±1%, 300mA	SOT-89	20ch	VR1	4g	Aic
BA50P	AIC1722A-50PXT	LVR-IC	LDO, 5.0V±1%, 300mA	SOT-89	20ch	VR1	4g	Aic
BA52	AIC1722A-52CXT	LVR-IC	LDO, 5.2V±1%, 300mA	SOT-89	20ch	VR1	4g	Aic
BA52G	AIC1722A-52GXT	LVR-IC	LDO, 5.2V±1%, 300mA	SOT-89	20ch	VR1	4g	Aic
BA52P	AIC1722A-52PXT	LVR-IC	LDO, 5.2V±1%, 300mA	SOT-89	20ch	VR1	4g	Aic
BAP	2SB1132-P	Si-pnp	AF, 40V, 1A, 500mW, B=82..180, 150MHz	SOT-89	20tb	-	4b	Rhm
BAQ	2SB1132-Q	Si-pnp	AF, 40V, 1A, 500mW, B=120..270, 150MHz	SOT-89	20tb	-	4b	Rhm
BAR	2SB1132PT-R	Si-pnp	AF, Sw, 32V, 1A, B=180..390, 150MHz	SOT-89	20tb	-	4g	Chm
BAR	2SB1132-R	Si-pnp	AF, 40V, 1A, 500mW, B=180..390, 150MHz	SOT-89	20tb	-	4b	Rhm
BAS	2SB1118-S	Si-pnp	Lo-sat, 20V, 700mA, 500mW, B=140..280, 250MHz	PCP	20tb	-	4a	San
BAT	2SB1118-T	Si-pnp	Lo-sat, 20V, 700mA, 500mW, B=200..400, 250MHz	PCP	20tb	-	4a	San
BAU	2SB1118-U	Si-pnp	Lo-sat, 20V, 700mA, 500mW, B=280..560, 250MHz	PCP	20tb	-	4a	San
BB	2SD1367-B	Si-npn	AF, 20V, 2A, 1W, B=160..320, 100MHz	SOT-89	20tb	-	4b	Ren
BB	AP432IAY	Vref-IC	Adjustable, Precision, Shunt, 1.24V±0.5%	SOT-89-3L	20tb	RF1	4b	Ana
BB	BCX54-06	Si-npn	AF, 45V, 1A, 1W, B=40..100, >100MHz	SOT-89	20tb	-	4b	Inf
BB	ELM99311B	LVR-IC	LDO, 3.1V±2%, 300mA	SOT-89	20vl	VR1	4a	Elm
BB	RT9169-22CX	LVR-IC	LDO, 2.2V±2%, 100mA	SOT-89	20vl	VR1	4c	Rct
BBR	2SB1119-R	Si-pnp	AF-Amp, 25V, 1A, 500mW, B=100..200, 180MHz	PCP	20tb	-	4a	San
BBS	2SB1119-S	Si-pnp	AF-Amp, 25V, 1A, 500mW, B=140..280, 180MHz	PCP	20tb	-	4a	San
BBT	2SB1119-T	Si-pnp	AF-Amp, 25V, 1A, 500mW, B=200..400, 180MHz	PCP	20tb	-	4a	San
BBU	2SB1119-U	Si-pnp	AF-Amp, 25V, 1A, 500mW, B=280..560, 180MHz	PCP	20tb	-	4a	San
BC	2SD1367-C	Si-npn	AF, 20V, 2A, 1W, B=250..500, 100MHz	SOT-89	20tb	-	4b	Ren
BC	BCX54-10	Si-npn	AF, 45V, 1A, 1W, B=63..160, >100MHz	SOT-89	20tb	-	4b	Phi
BC	ELM99321B	LVR-IC	LDO, 3.2V±2%, 300mA	SOT-89	20vl	VR1	4a	Elm
BC	RT9169-23CX	LVR-IC	LDO, 2.3V±2%, 100mA	SOT-89	20vl	VR1	4c	Rct
BCE	2SB1120-E	Si-pnp	Relay-Drv, 20V, 2.5A, 1.3W, B=100..200, 250MHz	PCP	20tb	-	4a	San
BCF	2SB1120-F	Si-pnp	Relay-Drv, 20V, 2.5A, 1.3W, B=160..320, 250MHz	PCP	20tb	-	4a	San
BCG	2SB1120-G	Si-pnp	Relay-Drv, 20V, 2.5A, 1.3W, B=280..560, 250MHz	PCP	20tb	-	4a	San
BCp	BF0591	Si-npn	RF, 25V, 200mA, 2.25W, B=60..250, 7GHz	SOT-89	20tb	-	4g	Phi
BCP	2SB1188-P	Si-pnp	AF, 40V, 2A, 500mW, B=82..180, >100MHz	SOT-89	20tb	-	4b	Rhm
BCQ	2SB1188-Q	Si-pnp	AF, 40V, 2A, 500mW, B=120..270, >100MHz	SOT-89	20tb	-	4b	Rhm
BCR	2SB1188-R	Si-pnp	AF, 40V, 2A, 500mW, B=180..390, >100MHz	SOT-89	20tb	-	4b	Rhm
BD	BCX54-16	Si-npn	AF, 45V, 1A, 1W, B=100..250, >100MHz	SOT-89	20tb	-	4b	Phi
BD	ELM99331B	LVR-IC	LDO, 3.3V±2%, 300mA	SOT-89	20vl	VR1	4a	Elm
BD	RT9169-24CX	LVR-IC	LDO, 2.4V±2%, 100mA	SOT-89	20vl	VR1	4c	Rct
BDP	2SB1189-P	Si-pnp	AF, 80V, 800mA, 500mW, B=82..180, >100MHz	SOT-89	20tb	-	4b	Rhm
BDQ	2SB1189-Q	Si-pnp	AF, 80V, 800mA, 500mW, B=120..270, >100MHz	SOT-89	20tb	-	4b	Rhm
BDR	2SB1121-R	Si-pnp	Drv, 30V, 2A, 500mW, B=100..200, 150MHz	PCP	20tb	-	4a	San
BDR	2SB1189-R	Si-pnp	AF, 80V, 800mA, 500mW, B=180..390, >100MHz	SOT-89	20tb	-	4b	Rhm
BDS	2SB1121-S	Si-pnp	Drv, 30V, 2A, 500mW, B=140..280, 150MHz	PCP	20tb	-	4a	San
BDT	2SB1121-T	Si-pnp	Drv, 30V, 2A, 500mW, B=200..400, 150MHz	PCP	20tb	-	4a	San
BDU	2SB1121-U	Si-pnp	Drv, 30V, 2A, 500mW, B=280..560, 150MHz	PCP	20tb	-	4a	San
BE	2SC3443-E	Si-npn	Relay-Drv, 20V, 2A, 500mW, B=150..300, 80MHz	SOT-89	20tb	-	4a	Mit



SMD
code

Type

Function

Short description

Case Pinout Sch. St. Mnf.

SMD code	Type	Function	Short description	Case	Pinout	Sch.	St.	Mnf.
BE	BCX55	Si-npn	AF, 60V, 1A, 1W, B=40..250, >100MHz	SOT-89	20tb	-	4b	Phi
BE	ELM99341B	LVR-IC	LDO, 3.4V±2%, 300mA	SOT-89	20vl	VR1	4a	Elm
BE	RT9169-25CX	LVR-IC	LDO, 2.5V±2%, 100mA	SOT-89	20vl	VR1	4c	Rct
BE-	RT9169-25PX	LVR-IC	LDO, 2.5V±2%, 100mA	SOT-89	20vl	VR1	4c	Rct
BEP	2SB1260-P	Si-pnp	AF, 80V, 1A, 500mW, B=82..180, >80MHz	SOT-89	20tb	-	4b	Rhm
BEQ	2SB1260-Q	Si-pnp	AF, 80V, 1A, 500mW, B=120..270, >80MHz	SOT-89	20tb	-	4b	Rhm
BER	2SB1122-R	Si-pnp	AF-Amp, 60V, 1A, 500mW, B=100..200, 150MHz	PCP	20tb	-	4a	San
BER	2SB1260-R	Si-pnp	AF, 80V, 1A, 500mW, B=180..390, >80MHz	SOT-89	20tb	-	4b	Rhm
BES	2SB1122-S	Si-pnp	AF-Amp, 60V, 1A, 500mW, B=140..280, 150MHz	PCP	20tb	-	4a	San
BET	2SB1122-T	Si-pnp	AF-Amp, 60V, 1A, 500mW, B=200..400, 150MHz	PCP	20tb	-	4a	San
BEU	2SB1122-U	Si-pnp	AF-Amp, 60V, 1A, 500mW, B=280..560, 150MHz	PCP	20tb	-	4a	San
BF	2SC3443-F	Si-npn	Relay-Drv, 20V, 2A, 500mW, B=250..500, 80MHz	SOT-89	20tb	-	4a	Mit
BF	BCX55-06	Si-npn	AF-Drv, 60V, 1A, 1W, B=40..100, 100MHz	SOT-89	20tb	-	4b	Sie
BF	BCX55-6	Si-npn	AF, 60V, 1A, 1W, B=40..100, >100MHz	SOT-89	20tb	-	4b	Inf
BF	ELM99351B	LVR-IC	LDO, 3.5V±2%, 300mA	SOT-89	20vl	VR1	4a	Elm
BF	RT9169-26CX	LVR-IC	LDO, 2.6V±2%, 100mA	SOT-89	20vl	VR1	4c	Rct
BF	XC62RP1502P	LVR-IC	LDO, 1.5V±2%, 6mA, 500mW	SOT-89	20vl	VR1	4c	Tor
BFP	2SB1308-P	Si-pnp	Lo-sat, 30V, 3A, 0.5W, B=82..180, >120MHz	SOT-89	20tb	-	4b	Rhm
BFQ	2SB1308-Q	Si-pnp	Lo-sat, 30V, 3A, 0.5W, B=120..270, >120MHz	SOT-89	20tb	-	4b	Rhm
BFR	2SB1123-R	Si-pnp	Drv, 60V, 2A, 200mW, B=100..200, 150MHz	PCP	20tb	-	4a	San
BFR	2SB1308-R	Si-pnp	Lo-sat, 30V, 3A, 0.5W, B=180..390, >120MHz	SOT-89	20tb	-	4b	Rhm
BFS	2SB1123-S	Si-pnp	Drv, 60V, 2A, 200mW, B=140..280, 150MHz	PCP	20tb	-	4a	San
BFT	2SB1123-T	Si-pnp	Drv, 60V, 2A, 200mW, B=280..560, 150MHz	PCP	20tb	-	4a	San
BFU	2SB1123-U	Si-pnp	Drv, 60V, 2A, 200mW, B=280..560, 150MHz	PCP	20tb	-	4a	San
BG	2SC3443-G	Si-npn	Relay-Drv, 20V, 2A, 500mW, B=400..800, 80MHz	SOT-89	20tb	-	4a	Mit
BG	BCX55-10	Si-npn	AF, 60V, 1A, 1W, B=63..160, >100MHz	SOT-89	20tb	-	4b	Phi
BG	ELM99361B	LVR-IC	LDO, 3.6V±2%, 300mA	SOT-89	20vl	VR1	4a	Elm
BG	RT9169-27CX	LVR-IC	LDO, 2.7V±2%, 100mA	SOT-89	20vl	VR1	4c	Rct
BGR	2SB1124-R	Si-pnp	Drv, 60V, 3A, 500mW, B=100..200, 150MHz	PCP	20tb	-	4a	San
BGS	2SB1124-S	Si-pnp	Drv, 60V, 3A, 500mW, B=140..280, 150MHz	PCP	20tb	-	4a	San
BGT	2SB1124-T	Si-pnp	Drv, 60V, 3A, 500mW, B=280..560, 150MHz	PCP	20tb	-	4a	San
BGU	2SB1124-U	Si-pnp	Drv, 60V, 3A, 500mW, B=280..560, 150MHz	PCP	20tb	-	4a	San
BH	2SB1001-H	Si-pnp	AF, 20V, 2A, 1W, B=100..200, 150MHz	SOT-89	20tb	-	4b	Ren
BH	2SB1125	Si-pnp-Darl	Drv, 80V, 700mA, 500mW, B>5000, 200MHz	PCP	20tb	-	4a	San
BH	BCX56	Si-npn	AF, 100V, 1A, 1W, B=40..250, >100MHz	SOT-89	20tb	-	4b	Phi
BH	ELM99371B	LVR-IC	LDO, 3.7V±2%, 300mA	SOT-89	20vl	VR1	4a	Elm
BH	RT9169-28CX	LVR-IC	LDO, 2.8V±2%, 100mA	SOT-89	20vl	VR1	4c	Rct
BH	XC62RP1602P	LVR-IC	LDO, 1.6V±2%, 6mA, 500mW	SOT-89	20vl	VR1	4c	Tor
BHP	2SB1386-P	Si-pnp	AF, 30V, 5A, 500mW, B=82..180, >120MHz	SOT-89	20tb	-	4b	Rhm
BHQ	2SB1386-Q	Si-pnp	AF, 30V, 5A, 500mW, B=120..270, >120MHz	SOT-89	20tb	-	4b	Rhm
BHR	2SB1386-R	Si-pnp	AF, 30V, 5A, 500mW, B=180..390, >120MHz	SOT-89	20tb	-	4b	Rhm
BI	2SB1126	Si-pnp-Darl	Drv, 80V, 1.5A, 500mW, B>4000, 120MHz	PCP	20tb	-	4a	San
BJ	2SB1001-J	Si-pnp	AF, 20V, 2A, 1W, B=160..320, 150MHz	SOT-89	20tb	-	4b	Ren
BJ	BCX56-06	Si-npn	AF-Drv, 80V, 1A, 1W, B=40..100, 100MHz	SOT-89	20tb	-	4b	Sie
BJ	BCX56-6	Si-npn	AF, 100V, 1A, 1W, B=40..100, >100MHz	SOT-89	20tb	-	4b	Inf
BJ	ELM99381B	LVR-IC	LDO, 3.8V±2%, 300mA	SOT-89	20vl	VR1	4a	Elm
BJ	KTD1302	Si-npn	GP, 25V, 300mA, 500mW, B=200..800, 60MHz	SOT-89	20tb	-	4a	Kec
BJ	RT9169-29CX	LVR-IC	LDO, 2.9V±2%, 100mA	SOT-89	20vl	VR1	4c	Rct
BJE	2SB1427-E	Si-pnp	Hi-beta, 20V, 2A, 500mW, B=390..820, >90MHz	SOT-89	20tb	-	4b	Rhm
BJR	2SB1302-R	Si-pnp	DC/DC-Conv, 25V, 5A, 1.3W, B=100..200, 320MHz	PCP	20tb	-	4a	San
BJS	2SB1302-S	Si-pnp	DC/DC-Conv, 25V, 5A, 1.3W, B=140..280, 320MHz	PCP	20tb	-	4a	San
BJS	2SB1427-S	Si-pnp	Hi-beta, 20V, 2A, 500mW, B=270..560, >90MHz	SOT-89	20tb	-	4b	Rhm
BJT	2SB1302-T	Si-pnp	DC/DC-Conv, 25V, 5A, 1.3W, B=200..400, 320MHz	PCP	20tb	-	4a	San
BJU	2SB1427-U	Si-pnp	Hi-beta, 20V, 2A, 500mW, B=560..1200, >90MHz	SOT-89	20tb	-	4b	Rhm
BK	2SB1323	Si-pnp-Digi+Di	Motor-Drv, 40V, 3A, 1.5W, B>70, 100MHz, R1/R2=160Q/800Q	PCP	20tb	-	4a	San
BK	BCX56-10	Si-npn	AF, 100V, 1A, 1W, B=63..160, >100MHz	SOT-89	20tb	-	4b	Phi
BK	BCX56-10R	Si-npn	AF, 100V, 1A, 1.5W, B=63..160, >100MHz	SOT-89	20tb	-	4b	Ons
BK	ELM99391B	LVR-IC	LDO, 3.9V±2%, 300mA	SOT-89	20vl	VR1	4a	Elm
BK	RT9169-30CX	LVR-IC	LDO, 3.0V±2%, 100mA	SOT-89	20vl	VR1	4c	Rct
BK	XC62RP1702P	LVR-IC	LDO, 1.7V±2%, 6mA, 500mW	SOT-89	20vl	VR1	4c	Tor
BK-	RT9169-30PX	LVR-IC	LDO, 3.0V±2%, 100mA	SOT-89	20vl	VR1	4c	Rct
BL	2SB1324	Si-pnp-Digi+Di	Motor-Drv, 40V, 3A, 1.5W, B>70, 100MHz, R2=800Q	PCP	20tb	-	4a	San
BL	BCX56-16	Si-npn	AF, 100V, 1A, 1W, B=100..250, >100MHz	SOT-89	20tb	-	4b	Phi
BL	RT9169-31CX	LVR-IC	LDO, 3.1V±2%, 100mA	SOT-89	20vl	VR1	4c	Rct
BL	XC62RP1802P	LVR-IC	LDO, 1.8V±2%, 6mA, 500mW	SOT-89	20vl	VR1	4c	Tor
BLP	2SB1561-P	Si-pnp	Lo-sat, 60V, 2A, 500mW, B=82..180, >200MHz	SOT-89	20tb	-	4b	Rhm
BLQ	2SB1561-Q	Si-pnp	Lo-sat, 60V, 2A, 500mW, B=120..270, >200MHz	SOT-89	20tb	-	4b	Rhm
BM	2SB1325	Si-pnp-Digi+Di	Motor-Drv, 25V, 4A, 1.5W, B>70, 300MHz, R2=1.5kQ	PCP	20tb	-	4a	San
BM	BCX55-16	Si-npn	AF, 60V, 1A, 1W, B=100..250, >100MHz	SOT-89	20tb	-	4b	Phi
BM	RT9169-32CX	LVR-IC	LDO, 3.2V±2%, 100mA	SOT-89	20vl	VR1	4c	Rct



SMD
code

Type

Function

Short description

Case Pinout Sch. St. Mnf.

SMD code	Type	Function	Short description	Case	Pinout	Sch.	St.	Mnf.
BM	XC62RP1902P	LVR-IC	LDO, 1.9V±2%, 6mA, 500mW	SOT-89	20vl	VR1	4c	Tor
BN	2SB1394	Si-pnp-Digi+Di	Motor-Drv, 40V, 3A, 1.5W, B>70, 100kHz, R1/R2=90Q/800Q	PCP	20ftb	-	4a	San
BN	RT9169-33CX	LVR-IC	LDO, 3.3V±2%, 100mA	SOT-89	20vl	VR1	4c	Rct
BN-	RT9169-33PX	LVR-IC	LDO, 3.3V±2%, 100mA	SOT-89	20vl	VR1	4c	Rct
BO	2SA1200-O	Si-pnp	HV, 150V, 50mA, 500mW, B=70..140, 120MHz	SOT-89	20tb	-	4b	Tos
BO	KTA1660-O	Si-pnp	HV, Sw, 150V, 50mA, 500mW, B=70..140, 120MHz	SOT-89	20tb	-	4a	Kec
BOS	2SB1396-S	Si-pnp	DC/DC-Conv, 15V, 3A, 1.3W, B=140..280, 400MHz	PCP	20tb	-	4a	San
BOT	2SB1396-T	Si-pnp	DC/DC-Conv, 15V, 3A, 1.3W, B=200..400, 400MHz	PCP	20tb	-	4a	San
BOU	2SB1396-U	Si-pnp	DC/DC-Conv, 15V, 3A, 1.3W, B=280..560, 400MHz	PCP	20tb	-	4a	San
BP	2SB1397	Si-pnp-Digi+Di	Motor-Drv, 25V, 2A, 1.3W, B>70, 300MHz, R2=1.6kQ	PCP	20tb	-	4a	San
BP	RT9169-34CX	LVR-IC	LDO, 3.4V±2%, 100mA	SOT-89	20vl	VR1	4c	Rct
BQ	2SB766A-Q	Si-pnp	AF, 60V, 1A, 1W, B=85..170, 200MHz	SOT-89	20tb	-	4b	Pan
BQ	RT9169-35CX	LVR-IC	LDO, 3.5V±2%, 100mA	SOT-89	20vl	VR1	4c	Rct
BR	2SB766A-R	Si-pnp	AF, 60V, 1A, 1W, B=120..240, 200MHz	SOT-89	20tb	-	4b	Pan
BR	RT9169-36CX	LVR-IC	LDO, 3.6V±2%, 100mA	SOT-89	20vl	VR1	4c	Rct
BR1	BSR30	Si-pnp	AF, Sw, 70V, 1A, 1.35W, B=40..120, 100MHz	SOT-89	20tb	-	4b	Phi
BR2	BSR31	Si-pnp	AF, Sw, 70V, 1A, 1.35W, B=100..300, 100MHz	SOT-89	20tb	-	4b	Phi
BR3	BSR32	Si-pnp	AF, Sw, 90V, 1A, 1.35W, B=40..120, 100MHz	SOT-89	20tb	-	4b	Phi
BR4	BSR33	Si-pnp	AF, Sw, 90V, 1A, 1.35W, B=100..300, 100MHz	SOT-89	20tb	-	4b	Phi
BS	2SB766A-S	Si-pnp	AF, 60V, 1A, 1W, B=170..340, 200MHz	SOT-89	20tb	-	4b	Pan
BS	RT9169-37CX	LVR-IC	LDO, 3.7V±2%, 100mA	SOT-89	20vl	VR1	4c	Rct
BS1	BST60	Si-pnp-Darl+Di	AF, 60V, 500mA, 1.3W, B>2000, 350MHz	SOT-89	20tb	-	4b	Phi
BS2	BST61	Si-pnp-Darl+Di	AF, 80V, 500mA, 1.3W, B>2000, 350MHz	SOT-89	20tb	-	4b	Phi
BS3	BST62	Si-pnp-Darl+Di	AF, 90V, 500mA, 1.3W, B>2000, 350MHz	SOT-89	20tb	-	4b	Phi
BT	2SB1048	Si-pnp-Darl	GP, 60V, 1A, 1W, B=2000..100000	UPAK	20tb	-	4b	Ren
BT	RT9169-38CX	LVR-IC	LDO, 3.8V±2%, 100mA	SOT-89	20vl	VR1	4c	Rct
BT1	BST15	Si-pnp	AF, Sw, Vid, 200V, 1A, 1.3W, B=30..150, >15MHz	SOT-89	20tb	-	4b	Phi
BT2	BST16	Si-pnp	AF, Sw, Vid, 350V, 1A, 1.3W, B=30..120, >15MHz	SOT-89	20tb	-	4b	Phi
BU	2SD1005-U	Si-npn	AF-Amp, 100V, 1A, 2W, 160MHz, B=200..400	SOT-89	20tb	-	4a	Nec
BU	RT9169-39CX	LVR-IC	LDO, 3.9V±2%, 100mA	SOT-89	20vl	VR1	4c	Rct
BV	2SD1005-V	Si-npn	AF-Amp, 100V, 1A, 2W, 160MHz, B=135..270	SOT-89	20tb	-	4a	Nec
BV	RT9169-40CX	LVR-IC	LDO, 4.0V±2%, 100mA	SOT-89	20vl	VR1	4c	Rct
BV-	RT9169-40PX	LVR-IC	LDO, 4.0V±2%, 100mA	SOT-89	20vl	VR1	4c	Rct
BW	2SD1005-W	Si-npn	AF-Amp, 100V, 1A, 2W, 160MHz, B=90..180	SOT-89	20tb	-	4a	Nec
BW	RT9169-41CX	LVR-IC	LDO, 4.1V±2%, 100mA	SOT-89	20vl	VR1	4c	Rct
BX	RT9169-42CX	LVR-IC	LDO, 4.2V±2%, 100mA	SOT-89	20vl	VR1	4c	Rct
BY	2SA1200-Y	Si-pnp	HV, 150V, 50mA, 500mW, B=120..240, 120MHz	SOT-89	20tb	-	4b	Tos
BY	2SK1334	n-MOSFET-e*	V-MOS, 200V, 1A, <3.8Q(0.5A), 13/17ns	SOT-89	20fa	-	4b	Ren
BY	KTA1660-Y	Si-pnp	HV, Sw, 150V, 50mA, 500mW, B=120..240, 120MHz	SOT-89	20tb	-	4a	Kec
BY	RT9169-43CX	LVR-IC	LDO, 4.3V±2%, 100mA	SOT-89	20vl	VR1	4c	Rct
BZ	RT9169-44CX	LVR-IC	LDO, 4.4V±2%, 100mA	SOT-89	20vl	VR1	4c	Rct
C0	AP130-41Y	LVR-IC	LDO, 4.1V±2%, 300mA	SOT-89	20ch	VR1	4b	Ana
C0	ELM9720NAB	Vdet-IC	2.0V±2.5%, +Reset ODO	SOT-89	20vda	VD6	4a	Elm
C0	ELM9840AB	LVR-IC	4.0V±2%, 200mA	SOT-89	20vl	VR1	4a	Elm
C0	RT9169-45CX	LVR-IC	LDO, 4.5V±2%, 100mA	SOT-89	20vl	VR1	4c	Rct
C0	XC61CC2002P	Vdet-IC	2V±1%, +Reset PPO	SOT-89	20vda	VD7	4b	Tor
C03	XE61CC2045PR	Vdet-IC	2.0V±2%, -Reset PPO	SOT-89	20cj	VD7	4j	Tor
C05	XC61FC2012P	Vdet-IC	2V±2%, +Reset PPO, 200ms	SOT-89	20vda	VD7	4b	Tor
C06	XC61FC2042P	Vdet-IC	2V±2%, +Reset PPO, 400ms	SOT-89	20vda	VD7	4b	Tor
C07	XC61FC2052P	Vdet-IC	2V±2%, +Reset PPO, 50ms	SOT-89	20vda	VD7	4b	Tor
C1	AP130-42Y	LVR-IC	LDO, 4.2V±2%, 300mA	SOT-89	20ch	VR1	4b	Ana
C1	ELM9721NAB	Vdet-IC	2.1V±2.5%, +Reset ODO	SOT-89	20vda	VD6	4a	Elm
C1	ELM9841AB	LVR-IC	4.1V±2%, 200mA	SOT-89	20vl	VR1	4a	Elm
C1	RT9161-21CX	LVR-IC	LDO, 2.1V±2%, 300mA	SOT-89	20vl	VR1	4c	Rct
C1	TC54VC2102MB	Vdet-IC	2.1V±2%, -Reset PPO	SOT-89	20vda	VD6	4b	Tcs
C1	XC61CC2102P	Vdet-IC	2.1V±1%, +Reset PPO	SOT-89	20vda	VD7	4b	Tor
C1-	RT9161-21PX	LVR-IC	LDO, 2.1V±2%, 300mA	SOT-89	20vl	VR1	4c	Rct
C11B	ML61C113P	Vdet-IC	1.1V±3%, -Reset PPO	SOT-89	20vda	VD7	4g	Mlc
C12B	ML61C123P	Vdet-IC	1.2V±3%, -Reset PPO	SOT-89	20vda	VD7	4g	Mlc
C13	XE61CC2145PR	Vdet-IC	2.1V±2%, -Reset PPO	SOT-89	20cj	VD7	4j	Tor
C13B	ML61C133P	Vdet-IC	1.3V±3%, -Reset PPO	SOT-89	20vda	VD7	4g	Mlc
C14B	ML61C143P	Vdet-IC	1.4V±3%, -Reset PPO	SOT-89	20vda	VD7	4g	Mlc
C15	XC61FC2112P	Vdet-IC	2.1V±2%, +Reset PPO, 200ms	SOT-89	20vda	VD7	4b	Tor
C15B	ML61C153P	Vdet-IC	1.5V±3%, -Reset PPO	SOT-89	20vda	VD7	4g	Mlc
C16	XC61FC2142P	Vdet-IC	2.1V±2%, +Reset PPO, 400ms	SOT-89	20vda	VD7	4b	Tor
C16B	ML61C163P	Vdet-IC	1.6V±3%, -Reset PPO	SOT-89	20vda	VD7	4g	Mlc
C17	XC61FC2152P	Vdet-IC	2.1V±2%, +Reset PPO, 50ms	SOT-89	20vda	VD7	4b	Tor
C17B	ML61C173P	Vdet-IC	1.7V±3%, -Reset PPO	SOT-89	20vda	VD7	4g	Mlc
C18B	ML61C183P	Vdet-IC	1.8V±3%, -Reset PPO	SOT-89	20vda	VD7	4g	Mlc
C19B	ML61C193P	Vdet-IC	1.9V±3%, -Reset PPO	SOT-89	20vda	VD7	4g	Mlc



SMD
code

Type

Function

Short description

Case Pinout Sch. St. Mnf.

SMD code	Type	Function	Short description	Case	Pinout	Sch.	St.	Mnf.
C2	AP130-43Y	LVR-IC	LDO, 4.3V±2%, 300mA	SOT-89	20ch	VR1	4b	Ana
C2	ELM9722NAB	Vdet-IC	2.2V±2.5%, +Reset ODO	SOT-89	20vda	VD6	4a	Elm
C2	ELM9842AB	LVR-IC	4.2V±2%, 200mA	SOT-89	20vl	VR1	4a	Elm
C2	RT9169-46CX	LVR-IC	LDO, 4.6V±2%, 100mA	SOT-89	20vl	VR1	4c	Rct
C2	TC54VC2202MB	Vdet-IC	2.2V±2%, -Reset PPO	SOT-89	20vda	VD6	4b	Tcs
C2	XC61CC2202P	Vdet-IC	2.2V±1%, +Reset PPO	SOT-89	20vda	VD7	4b	Tor
C20B	ML61C202P	Vdet-IC	2.0V±2%, -Reset PPO	SOT-89	20vda	VD7	4g	Mlc
C21B	ML61C212P	Vdet-IC	2.1V±2%, -Reset PPO	SOT-89	20vda	VD7	4g	Mlc
C22B	ML61C222P	Vdet-IC	2.2V±2%, -Reset PPO	SOT-89	20vda	VD7	4g	Mlc
C23	XE61CC2245PR	Vdet-IC	2.2V±2%, -Reset PPO	SOT-89	20cj	VD7	4j	Tor
C23B	ML61C232P	Vdet-IC	2.3V±2%, -Reset PPO	SOT-89	20vda	VD7	4g	Mlc
C24B	ML61C242P	Vdet-IC	2.4V±2%, -Reset PPO	SOT-89	20vda	VD7	4g	Mlc
C25	XC61FC2212P	Vdet-IC	2.2V±2%, +Reset PPO, 200ms	SOT-89	20vda	VD7	4b	Tor
C25B	ML61C252P	Vdet-IC	2.5V±2%, -Reset PPO	SOT-89	20vda	VD7	4g	Mlc
C26	XC61FC2242P	Vdet-IC	2.2V±2%, +Reset PPO, 400ms	SOT-89	20vda	VD7	4b	Tor
C26B	ML61C262P	Vdet-IC	2.6V±2%, -Reset PPO	SOT-89	20vda	VD7	4g	Mlc
C27	XC61FC2252P	Vdet-IC	2.2V±2%, +Reset PPO, 50ms	SOT-89	20vda	VD7	4b	Tor
C27B	ML61C272P	Vdet-IC	2.7V±2%, -Reset PPO	SOT-89	20vda	VD7	4g	Mlc
C28B	ML61C282P	Vdet-IC	2.8V±2%, -Reset PPO	SOT-89	20vda	VD7	4g	Mlc
C29B	ML61C292P	Vdet-IC	2.9V±2%, -Reset PPO	SOT-89	20vda	VD7	4g	Mlc
C2A	S-812C20AUA-C2AT2G	LVR-IC	2.0V±2%, 50mA	SOT-89	20vl	VR1	4i	Sii
C2B	S-812C21AUA-C2BT2G	LVR-IC	2.1V±2%, 50mA	SOT-89	20vl	VR1	4i	Sii
C2C	S-812C22AUA-C2CT2G	LVR-IC	2.2V±2%, 50mA	SOT-89	20vl	VR1	4i	Sii
C2D	S-812C23AUA-C2DT2G	LVR-IC	2.3V±2%, 50mA	SOT-89	20vl	VR1	4i	Sii
C2E	S-812C24AUA-C2ET2G	LVR-IC	2.4V±2%, 50mA	SOT-89	20vl	VR1	4i	Sii
C2F	S-812C25AUA-C2FT2G	LVR-IC	2.5V±2%, 50mA	SOT-89	20vl	VR1	4i	Sii
C2G	S-812C26AUA-C2GT2G	LVR-IC	2.6V±2%, 50mA	SOT-89	20vl	VR1	4i	Sii
C2H	S-812C27AUA-C2HT2G	LVR-IC	2.7V±2%, 50mA	SOT-89	20vl	VR1	4i	Sii
C2I	S-812C28AUA-C2IT2G	LVR-IC	2.8V±2%, 50mA	SOT-89	20vl	VR1	4i	Sii
C2J	S-812C29AUA-C2JT2G	LVR-IC	2.9V±2%, 50mA	SOT-89	20vl	VR1	4i	Sii
C2K	S-812C30AUA-C2KT2G	LVR-IC	3.0V±2%, 50mA	SOT-89	20vl	VR1	4i	Sii
C2L	S-812C31AUA-C2LT2G	LVR-IC	3.1V±2%, 50mA	SOT-89	20vl	VR1	4i	Sii
C2M	S-812C32AUA-C2MT2G	LVR-IC	3.2V±2%, 50mA	SOT-89	20vl	VR1	4i	Sii
C2N	S-812C33AUA-C2NT2G	LVR-IC	3.3V±2%, 50mA	SOT-89	20vl	VR1	4i	Sii
C2O	S-812C34AUA-C2OT2G	LVR-IC	3.4V±2%, 50mA	SOT-89	20vl	VR1	4i	Sii
C2P	S-812C35AUA-C2PT2G	LVR-IC	3.5V±2%, 50mA	SOT-89	20vl	VR1	4i	Sii
C2Q	S-812C36AUA-C2QT2G	LVR-IC	3.6V±2%, 50mA	SOT-89	20vl	VR1	4i	Sii
C2R	S-812C37AUA-C2RT2G	LVR-IC	3.7V±2%, 50mA	SOT-89	20vl	VR1	4i	Sii
C2S	S-812C38AUA-C2ST2G	LVR-IC	3.8V±2%, 50mA	SOT-89	20vl	VR1	4i	Sii
C2T	S-812C39AUA-C2TT2G	LVR-IC	3.9V±2%, 50mA	SOT-89	20vl	VR1	4i	Sii
C2U	S-812C40AUA-C2UT2G	LVR-IC	4.0V±2%, 50mA	SOT-89	20vl	VR1	4i	Sii
C2V	S-812C41AUA-C2VT2G	LVR-IC	4.1V±2%, 50mA	SOT-89	20vl	VR1	4i	Sii
C2W	S-812C42AUA-C2WT2G	LVR-IC	4.2V±2%, 50mA	SOT-89	20vl	VR1	4i	Sii
C2X	S-812C43AUA-C2XT2G	LVR-IC	4.3V±2%, 50mA	SOT-89	20vl	VR1	4i	Sii
C2Y	S-812C44AUA-C2YT2G	LVR-IC	4.4V±2%, 50mA	SOT-89	20vl	VR1	4i	Sii
C2Z	S-812C45AUA-C2ZT2G	LVR-IC	4.5V±2%, 50mA	SOT-89	20vl	VR1	4i	Sii
C3	AP130-44Y	LVR-IC	LDO, 4.4V±2%, 300mA	SOT-89	20ch	VR1	4b	Ana
C3	ELM9723NAB	Vdet-IC	2.3V±2.5%, +Reset ODO	SOT-89	20vda	VD6	4a	Elm
C3	ELM9843AB	LVR-IC	4.3V±2%, 200mA	SOT-89	20vl	VR1	4a	Elm
C3	RT9169-47CX	LVR-IC	LDO, 4.7V±2%, 100mA	SOT-89	20vl	VR1	4c	Rct
C3	TC54VC2302MB	Vdet-IC	2.3V±2%, -Reset PPO	SOT-89	20vda	VD7	4b	Tcs
C3	XC61CC2302P	Vdet-IC	2.3V±1%, +Reset PPO	SOT-89	20vda	VD7	4b	Tor
C30B	ML61C302P	Vdet-IC	3.0V±2%, -Reset PPO	SOT-89	20vda	VD7	4g	Mlc
C31B	ML61C312P	Vdet-IC	3.1V±2%, -Reset PPO	SOT-89	20vda	VD7	4g	Mlc
C32B	ML61C322P	Vdet-IC	3.2V±2%, -Reset PPO	SOT-89	20vda	VD7	4g	Mlc
C33	XE61CC2345PR	Vdet-IC	2.3V±2%, -Reset PPO	SOT-89	20cj	VD7	4j	Tor
C33B	ML61C332P	Vdet-IC	3.3V±2%, -Reset PPO	SOT-89	20vda	VD7	4g	Mlc
C34B	ML61C342P	Vdet-IC	3.4V±2%, -Reset PPO	SOT-89	20vda	VD7	4g	Mlc
C35	XC61FC2312P	Vdet-IC	2.3V±2%, +Reset PPO, 200ms	SOT-89	20vda	VD7	4b	Tor
C35B	ML61C352P	Vdet-IC	3.5V±2%, -Reset PPO	SOT-89	20vda	VD7	4g	Mlc
C36	XC61FC2342P	Vdet-IC	2.3V±2%, +Reset PPO, 400ms	SOT-89	20vda	VD7	4b	Tor
C36B	ML61C362P	Vdet-IC	3.6V±2%, -Reset PPO	SOT-89	20vda	VD7	4g	Mlc
C37	XC61FC2352P	Vdet-IC	2.3V±2%, +Reset PPO, 50ms	SOT-89	20vda	VD7	4b	Tor
C37B	ML61C372P	Vdet-IC	3.7V±2%, -Reset PPO	SOT-89	20vda	VD7	4g	Mlc
C38B	ML61C382P	Vdet-IC	3.8V±2%, -Reset PPO	SOT-89	20vda	VD7	4g	Mlc
C39B	ML61C392P	Vdet-IC	3.9V±2%, -Reset PPO	SOT-89	20vda	VD7	4g	Mlc
C3A	S-812C46AUA-C3AT2G	LVR-IC	4.6V±2%, 50mA	SOT-89	20vl	VR1	4i	Sii
C3B	S-812C47AUA-C3BT2G	LVR-IC	4.7V±2%, 50mA	SOT-89	20vl	VR1	4i	Sii
C3C	S-812C48AUA-C3CT2G	LVR-IC	4.8V±2%, 50mA	SOT-89	20vl	VR1	4i	Sii
C3D	S-812C49AUA-C3DT2G	LVR-IC	4.9V±2%, 50mA	SOT-89	20vl	VR1	4i	Sii



SMD
code

Type

Function

Short description

Case Pinout Sch. St. Mnf.

C3E	S-812C50AUA-C3ET2G	LVR-IC	5.0V±2%, 50mA
C3F	S-812C51AUA-C3FT2G	LVR-IC	5.1V±2%, 50mA
C3G	S-812C52AUA-C3GT2G	LVR-IC	5.2V±2%, 50mA
C3H	S-812C53AUA-C3HT2G	LVR-IC	5.3V±2%, 50mA
C3I	S-812C54AUA-C3IT2G	LVR-IC	5.4V±2%, 50mA
C3J	S-812C55AUA-C3JT2G	LVR-IC	5.5V±2%, 50mA
C3K	S-812C56AUA-C3KT2G	LVR-IC	5.6V±2%, 50mA
C3L	S-812C57AUA-C3LT2G	LVR-IC	5.7V±2%, 50mA
C3M	S-812C58AUA-C3MT2G	LVR-IC	5.8V±2%, 50mA
C3N	S-812C59AUA-C3NT2G	LVR-IC	5.9V±2%, 50mA
C3O	S-812C60AUA-C3OT2G	LVR-IC	6.0V±2%, 50mA
C4	AP130-45Y	LVR-IC	LDO, 4.5V±2%, 300mA
C4	ELM9724NAB	Vdet-IC	2.4V±2.5%, +Reset ODO
C4	ELM9844AB	LVR-IC	4.4V±2%, 200mA
C4	RT9169-48CX	LVR-IC	LDO, 4.8V±2%, 100mA
C4	TC54VC2402MB	Vdet-IC	2.4V±2%, -Reset PPO
C4	XC61CC2402P	Vdet-IC	2.4V±1%, +Reset PPO
C40B	ML61C402P	Vdet-IC	4.0V±2%, -Reset PPO
C41B	ML61C412P	Vdet-IC	4.1V±2%, -Reset PPO
C42B	ML61C422P	Vdet-IC	4.2V±2%, -Reset PPO
C43	XE61CC2445PR	Vdet-IC	2.4V±2%, -Reset PPO
C43B	ML61C432P	Vdet-IC	4.3V±2%, -Reset PPO
C44B	ML61C442P	Vdet-IC	4.4V±2%, -Reset PPO
C45	XC61FC2412P	Vdet-IC	2.4V±2%, +Reset PPO, 200ms
C45B	ML61C452P	Vdet-IC	4.5V±2%, -Reset PPO
C46	XC61FC2442P	Vdet-IC	2.4V±2%, +Reset PPO, 400ms
C46B	ML61C462P	Vdet-IC	4.6V±2%, -Reset PPO
C47	XC61FC2452P	Vdet-IC	2.4V±2%, +Reset PPO, 50ms
C47B	ML61C472P	Vdet-IC	4.7V±2%, -Reset PPO
C48B	ML61C482P	Vdet-IC	4.8V±2%, -Reset PPO
C49B	ML61C492P	Vdet-IC	4.9V±2%, -Reset PPO
C5	AP130-46Y	LVR-IC	LDO, 4.6V±2%, 300mA
C5	ELM9725NAB	Vdet-IC	2.5V±2.5%, +Reset ODO
C5	ELM9845AB	LVR-IC	4.5V±2%, 200mA
C5	RT9169-49CX	LVR-IC	LDO, 4.9V±2%, 100mA
C5	TC54VC2502MB	Vdet-IC	2.5V±2%, -Reset PPO
C5	XC61CC2502P	Vdet-IC	2.5V±1%, +Reset PPO
C50B	ML61C502P	Vdet-IC	5.0V±2%, -Reset PPO
C51B	ML61C512P	Vdet-IC	5.1V±2%, -Reset PPO
C52B	ML61C522P	Vdet-IC	5.2V±2%, -Reset PPO
C53	XE61CC2545PR	Vdet-IC	2.5V±2%, -Reset PPO
C53B	ML61C532P	Vdet-IC	5.3V±2%, -Reset PPO
C54B	ML61C542P	Vdet-IC	5.4V±2%, -Reset PPO
C55	XC61FC2512P	Vdet-IC	2.5V±2%, +Reset PPO, 200ms
C55B	ML61C552P	Vdet-IC	5.5V±2%, -Reset PPO
C56	XC61FC2542P	Vdet-IC	2.5V±2%, +Reset PPO, 400ms
C56B	ML61C562P	Vdet-IC	5.6V±2%, -Reset PPO
C57	XC61FC2552P	Vdet-IC	2.5V±2%, +Reset PPO, 50ms
C57B	ML61C572P	Vdet-IC	5.7V±2%, -Reset PPO
C58B	ML61C582P	Vdet-IC	5.8V±2%, -Reset PPO
C59B	ML61C592P	Vdet-IC	5.9V±2%, -Reset PPO
C5P	S-812C33EUA-C5PT2G	LVR-IC	3.3V±2%, 50mA
C5Q	S-812C40EUA-C5QT2G	LVR-IC	4.0V±2%, 50mA
C5R	S-812C36EUA-C5RT2G	LVR-IC	3.6V±2%, 50mA
C6	AP130-47Y	LVR-IC	LDO, 4.7V±2%, 300mA
C6	ELM9726NAB	Vdet-IC	2.6V±2.5%, +Reset ODO
C6	ELM9846AB	LVR-IC	4.6V±2%, 200mA
C6	RT9169-50CX	LVR-IC	LDO, 5.0V±2%, 100mA
C6	TC54VC2602MB	Vdet-IC	2.6V±2%, -Reset PPO
C6	XC61CC2602P	Vdet-IC	2.6V±1%, +Reset PPO
C6-	RT9169-50PX	LVR-IC	LDO, 5.0V±2%, 100mA
C60B	ML61C602P	Vdet-IC	6.0V±2%, -Reset PPO
C61B	ML61C612P	Vdet-IC	6.1V±2%, -Reset PPO
C62B	ML61C622P	Vdet-IC	6.2V±2%, -Reset PPO
C63	XE61CC2645PR	Vdet-IC	2.6V±2%, -Reset PPO
C63B	ML61C632P	Vdet-IC	6.3V±2%, -Reset PPO
C64B	ML61C642P	Vdet-IC	6.4V±2%, -Reset PPO
C65	XC61FC2612P	Vdet-IC	2.6V±2%, +Reset PPO, 200ms
C65B	ML61C652P	Vdet-IC	6.5V±2%, -Reset PPO
C66	XC61FC2642P	Vdet-IC	2.6V±2%, +Reset PPO, 400ms



SMD
code

Type

Function

Short description

Case Pinout Sch. St. Mnf.

SMD code	Type	Function	Short description	Case	Pinout	Sch.	St.	Mnf.
C66B	ML61C662P	Vdet-IC	6.6V±2%, -Reset PPO	SOT-89	20vda	VD7	4g	Mlc
C67	XC61FC2652P	Vdet-IC	2.6V±2%, +Reset PPO, 50ms	SOT-89	20vda	VD7	4b	Tor
C67B	ML61C672P	Vdet-IC	6.7V±2%, -Reset PPO	SOT-89	20vda	VD7	4g	Mlc
C68B	ML61C682P	Vdet-IC	6.8V±2%, -Reset PPO	SOT-89	20vda	VD7	4g	Mlc
C69B	ML61C692P	Vdet-IC	6.9V±2%, -Reset PPO	SOT-89	20vda	VD7	4g	Mlc
C7	AP130-48Y	LVR-IC	LDO, 4.8V±2%, 300mA	SOT-89	20ch	VR1	4b	Ana
C7	ELM9727NAB	Vdet-IC	2.7V±2.5%, +Reset ODO	SOT-89	20vda	VD6	4a	Elm
C7	ELM9847AB	LVR-IC	4.7V±2%, 200mA	SOT-89	20vl	VR1	4a	Elm
C7	RT9161-45CX	LVR-IC	LDO, 4.5V±2%, 300mA	SOT-89	20vl	VR1	4c	Rct
C7	TC54VC2702MB	Vdet-IC	2.7V±2%, -Reset PPO	SOT-89	20vda	VD7	4b	Tcs
C7	XC61CC2702P	Vdet-IC	2.7V±1%, +Reset PPO	SOT-89	20vda	VD7	4b	Tor
C70B	ML61C702P	Vdet-IC	7.0V±2%, -Reset PPO	SOT-89	20vda	VD7	4g	Mlc
C73	XE61CC2745PR	Vdet-IC	2.7V±2%, -Reset PPO	SOT-89	20cj	VD7	4j	Tor
C75	XC61FC2712P	Vdet-IC	2.7V±2%, +Reset PPO, 200ms	SOT-89	20vda	VD7	4b	Tor
C76	XC61FC2742P	Vdet-IC	2.7V±2%, +Reset PPO, 400ms	SOT-89	20vda	VD7	4b	Tor
C77	XC61FC2752P	Vdet-IC	2.7V±2%, +Reset PPO, 50ms	SOT-89	20vda	VD7	4b	Tor
C8	AP130-49Y	LVR-IC	LDO, 4.9V±2%, 300mA	SOT-89	20ch	VR1	4b	Ana
C8	ELM9728NAB	Vdet-IC	2.8V±2.5%, +Reset ODO	SOT-89	20vda	VD6	4a	Elm
C8	ELM9848AB	LVR-IC	4.8V±2%, 200mA	SOT-89	20vl	VR1	4a	Elm
C8	RT9161-47CX	LVR-IC	LDO, 4.7V±2%, 300mA	SOT-89	20vl	VR1	4c	Rct
C8	TC54VC2802MB	Vdet-IC	2.8V±2%, -Reset PPO	SOT-89	20vda	VD7	4b	Tcs
C8	XC61CC2802P	Vdet-IC	2.8V±1%, +Reset PPO	SOT-89	20vda	VD7	4b	Tor
C83	XE61CC2845PR	Vdet-IC	2.8V±2%, -Reset PPO	SOT-89	20cj	VD7	4j	Tor
C85	XC61FC2812P	Vdet-IC	2.8V±2%, +Reset PPO, 200ms	SOT-89	20vda	VD7	4b	Tor
C86	XC61FC2842P	Vdet-IC	2.8V±2%, +Reset PPO, 400ms	SOT-89	20vda	VD7	4b	Tor
C87	XC61FC2852P	Vdet-IC	2.8V±2%, +Reset PPO, 50ms	SOT-89	20vda	VD7	4b	Tor
C9	AP130-50Y	LVR-IC	LDO, 5.0V±2%, 300mA	SOT-89	20ch	VR1	4b	Ana
C9	ELM9729NAB	Vdet-IC	2.9V±2.5%, +Reset ODO	SOT-89	20vda	VD6	4a	Elm
C9	ELM9849AB	LVR-IC	4.9V±2%, 200mA	SOT-89	20vl	VR1	4a	Elm
C9	RT9161-43CX	LVR-IC	LDO, 4.3V±2%, 300mA	SOT-89	20vl	VR1	4c	Rct
C9	TC54VC2902MB	Vdet-IC	2.9V±2%, -Reset PPO	SOT-89	20vda	VD7	4b	Tcs
C9	XC61CC2902P	Vdet-IC	2.9V±1%, +Reset PPO	SOT-89	20vda	VD7	4b	Tor
C93	XE61CC2945PR	Vdet-IC	2.9V±2%, -Reset PPO	SOT-89	20cj	VD7	4j	Tor
C95	XC61FC2912P	Vdet-IC	2.9V±2%, +Reset PPO, 200ms	SOT-89	20vda	VD7	4b	Tor
C96	XC61FC2942P	Vdet-IC	2.9V±2%, +Reset PPO, 400ms	SOT-89	20vda	VD7	4b	Tor
C97	XC61FC2952P	Vdet-IC	2.9V±2%, +Reset PPO, 50ms	SOT-89	20vda	VD7	4b	Tor
CA	2SD1368-A	Si-npn	AF, 100V, 1A, 1W, B=100..200, 100MHz	SOT-89	20tb	-	4b	Ren
CA	AP130-15Y	LVR-IC	LDO, 1.5V±2%, 300mA	SOT-89	20ch	VR1	4b	Ana
CA	BCX68	Si-npn	AF, 25/20V, 1A, 1W, B=85..375, >100MHz	SOT-89	20tb	-	4b	Inf
CA	ELM99401B	LVR-IC	LDO, 4.0V±2%, 300mA	SOT-89	20vl	VR1	4a	Elm
CA	XC62RP2002P	LVR-IC	LDO, 2V±2%, 6mA, 500mW	SOT-89	20vl	VR1	4c	Tor
CA18	AIC1734-18CX	LVR-IC	LDO, 1.8V±1%, 300mA	SOT-89	20vl	VR1	4g	Aic
CA18G	AIC1734-18GX	LVR-IC	LDO, 1.8V±1%, 300mA	SOT-89	20vl	VR1	4g	Aic
CA18P	AIC1734-18PX	LVR-IC	LDO, 1.8V±1%, 300mA	SOT-89	20vl	VR1	4g	Aic
CA18P	SS6734-18GX	LVR-IC	LDO, 1.8V±2%, 500mA	SOT-89	20vl	VR1	4g	Ssc
CA20	AIC1734-20CX	LVR-IC	LDO, 2.0V±1%, 300mA	SOT-89	20vl	VR1	4g	Aic
CA20G	AIC1734-20GX	LVR-IC	LDO, 2.0V±1%, 300mA	SOT-89	20vl	VR1	4g	Aic
CA20P	AIC1734-20PX	LVR-IC	LDO, 2.0V±1%, 300mA	SOT-89	20vl	VR1	4g	Aic
CA20P	SS6734-20GX	LVR-IC	LDO, 2.0V±2%, 500mA	SOT-89	20vl	VR1	4g	Ssc
CA25	AIC1734-25CX	LVR-IC	LDO, 2.5V±1%, 300mA	SOT-89	20vl	VR1	4g	Aic
CA25G	AIC1734-25GX	LVR-IC	LDO, 2.5V±1%, 300mA	SOT-89	20vl	VR1	4g	Aic
CA25P	AIC1734-25PX	LVR-IC	LDO, 2.5V±1%, 300mA	SOT-89	20vl	VR1	4g	Aic
CA25P	SS6734-25GX	LVR-IC	LDO, 2.5V±2%, 500mA	SOT-89	20vl	VR1	4g	Ssc
CA27	AIC1734-27CX	LVR-IC	LDO, 2.7V±1%, 300mA	SOT-89	20vl	VR1	4g	Aic
CA27G	AIC1734-27GX	LVR-IC	LDO, 2.7V±1%, 300mA	SOT-89	20vl	VR1	4g	Aic
CA27P	AIC1734-27PX	LVR-IC	LDO, 2.7V±1%, 300mA	SOT-89	20vl	VR1	4g	Aic
CA27P	SS6734-27GX	LVR-IC	LDO, 2.7V±2%, 500mA	SOT-89	20vl	VR1	4g	Ssc
CA30	AIC1734-30CX	LVR-IC	LDO, 3.0V±1%, 300mA	SOT-89	20vl	VR1	4g	Aic
CA30G	AIC1734-30GX	LVR-IC	LDO, 3.0V±1%, 300mA	SOT-89	20vl	VR1	4g	Aic
CA30P	AIC1734-30PX	LVR-IC	LDO, 3.0V±1%, 300mA	SOT-89	20vl	VR1	4g	Aic
CA30P	SS6734-30GX	LVR-IC	LDO, 3.0V±2%, 500mA	SOT-89	20vl	VR1	4g	Ssc
CA33	AIC1734-33CX	LVR-IC	LDO, 3.3V±1%, 300mA	SOT-89	20vl	VR1	4g	Aic
CA33G	AIC1734-33GX	LVR-IC	LDO, 3.3V±1%, 300mA	SOT-89	20vl	VR1	4g	Aic
CA33P	AIC1734-33PX	LVR-IC	LDO, 3.3V±1%, 300mA	SOT-89	20vl	VR1	4g	Aic
CA33P	SS6734-33GX	LVR-IC	LDO, 3.3V±2%, 500mA	SOT-89	20vl	VR1	4g	Ssc
CA35	AIC1734-35CX	LVR-IC	LDO, 3.5V±1%, 300mA	SOT-89	20vl	VR1	4g	Aic
CA35G	AIC1734-35GX	LVR-IC	LDO, 3.5V±1%, 300mA	SOT-89	20vl	VR1	4g	Aic
CA35P	AIC1734-35PX	LVR-IC	LDO, 3.5V±1%, 300mA	SOT-89	20vl	VR1	4g	Aic
CA35P	SS6734-35GX	LVR-IC	LDO, 3.5V±2%, 500mA	SOT-89	20vl	VR1	4g	Ssc
CA37	AIC1734-37CX	LVR-IC	LDO, 3.7V±1%, 300mA	SOT-89	20vl	VR1	4g	Aic



SMD code	Type	Function	Short description	Case	Pinout	Sch.	St.	Mnf.
CA37G	AIC1734-37GXA	LVR-IC	LDO, 3.7V±1%, 300mA	SOT-89	20vl	VR1	4g	Aic
CA37P	AIC1734-37PXA	LVR-IC	LDO, 3.7V±1%, 300mA	SOT-89	20vl	VR1	4g	Aic
CA37P	SS6734-37GXA	LVR-IC	LDO, 3.7V±2%, 500mA	SOT-89	20vl	VR1	4g	Ssc
CA38	AIC1734-38CXA	LVR-IC	LDO, 3.8V±1%, 300mA	SOT-89	20vl	VR1	4g	Aic
CA38G	AIC1734-38GXA	LVR-IC	LDO, 3.8V±1%, 300mA	SOT-89	20vl	VR1	4g	Aic
CA38P	AIC1734-38PXA	LVR-IC	LDO, 3.8V±1%, 300mA	SOT-89	20vl	VR1	4g	Aic
CA38P	SS6734-38GXA	LVR-IC	LDO, 3.8V±2%, 500mA	SOT-89	20vl	VR1	4g	Ssc
CA50	AIC1734-50CXA	LVR-IC	LDO, 5.0V±1%, 300mA	SOT-89	20vl	VR1	4g	Aic
CA50G	AIC1734-50GXA	LVR-IC	LDO, 5.0V±1%, 300mA	SOT-89	20vl	VR1	4g	Aic
CA50P	AIC1734-50PXA	LVR-IC	LDO, 5.0V±1%, 300mA	SOT-89	20vl	VR1	4g	Aic
CA50P	SS6734-50GXA	LVR-IC	LDO, 5.0V±2%, 500mA	SOT-89	20vl	VR1	4g	Ssc
CA52	AIC1734-52CXA	LVR-IC	LDO, 5.2V±1%, 300mA	SOT-89	20vl	VR1	4g	Aic
CA52G	AIC1734-52GXA	LVR-IC	LDO, 5.2V±1%, 300mA	SOT-89	20vl	VR1	4g	Aic
CA52P	AIC1734-52PXA	LVR-IC	LDO, 5.2V±1%, 300mA	SOT-89	20vl	VR1	4g	Aic
CA52P	SS6734-52GXA	LVR-IC	LDO, 5.2V±2%, 500mA	SOT-89	20vl	VR1	4g	Ssc
CAC	BC868	Si-npn	GP, 32V, 1A, 1.35W, B=50..375, >40MHz	SOT-89	20tb	-	4b	Phi
CAJR	2SC3645-R	Si-npn	HV, Sw, 180V, 200mA, 500mW, B=100..200, >150MHz	PCP	20tb	-	4a	San
CAJS	2SC3645-S	Si-npn	HV, Sw, 180V, 200mA, 500mW, B=140..280, >150MHz	PCP	20tb	-	4a	San
CAJT	2SC3645-T	Si-npn	HV, Sw, 180V, 200mA, 500mW, B=200..400, >150MHz	PCP	20tb	-	4a	San
CB	2SD1368-B	Si-npn	AF, 100V, 1A, 1W, B=160..300, 100MHz	SOT-89	20tb	-	4b	Ren
CB	AP130-16Y	LVR-IC	LDO, 1.6V±2%, 300mA	SOT-89	20ch	VR1	4b	Ana
CB	BCX68-10	Si-npn	AF, 25/20V, 1A, 1W, B=85..160, >100MHz	SOT-89	20tb	-	4b	Inf
CB	ELM99411B	LVR-IC	LDO, 4.1V±2%, 300mA	SOT-89	20vl	VR1	4a	Elm
CB	RXT2222A	Si-npn	GP, 75V, 600mA, 330mW, B=120..360, >300MHz	SOT-89	20tb	-	4b	Rhm
CB	XC62RP2102P	LVR-IC	LDO, 2.1V±2%, 6mA, 500mW	SOT-89	20vl	VR1	4c	Tor
CB18	AIC1734-18CXT	LVR-IC	LDO, 1.8V±1%, 300mA	SOT-89	20ch	VR1	4g	Aic
CB18G	AIC1734-18GXT	LVR-IC	LDO, 1.8V±1%, 300mA	SOT-89	20ch	VR1	4g	Aic
CB18P	AIC1734-18PXT	LVR-IC	LDO, 1.8V±1%, 300mA	SOT-89	20ch	VR1	4g	Aic
CB18P	SS6734-18GXT	LVR-IC	LDO, 1.8V±2%, 500mA	SOT-89	20ch	VR1	4g	Ssc
CB20	AIC1734-20CXT	LVR-IC	LDO, 2.0V±1%, 300mA	SOT-89	20ch	VR1	4g	Aic
CB20G	AIC1734-20GXT	LVR-IC	LDO, 2.0V±1%, 300mA	SOT-89	20ch	VR1	4g	Aic
CB20P	AIC1734-20PXT	LVR-IC	LDO, 2.0V±1%, 300mA	SOT-89	20ch	VR1	4g	Aic
CB20P	SS6734-20GXT	LVR-IC	LDO, 2.0V±2%, 500mA	SOT-89	20ch	VR1	4g	Ssc
CB25	AIC1734-25CXT	LVR-IC	LDO, 2.5V±1%, 300mA	SOT-89	20ch	VR1	4g	Aic
CB25G	AIC1734-25GXT	LVR-IC	LDO, 2.5V±1%, 300mA	SOT-89	20ch	VR1	4g	Aic
CB25P	AIC1734-25PXT	LVR-IC	LDO, 2.5V±1%, 300mA	SOT-89	20ch	VR1	4g	Aic
CB25P	SS6734-25GXT	LVR-IC	LDO, 2.5V±2%, 500mA	SOT-89	20ch	VR1	4g	Ssc
CB27	AIC1734-27CXT	LVR-IC	LDO, 2.7V±1%, 300mA	SOT-89	20ch	VR1	4g	Aic
CB27G	AIC1734-27GXT	LVR-IC	LDO, 2.7V±1%, 300mA	SOT-89	20ch	VR1	4g	Aic
CB27P	AIC1734-27PXT	LVR-IC	LDO, 2.7V±1%, 300mA	SOT-89	20ch	VR1	4g	Aic
CB27P	SS6734-27GXT	LVR-IC	LDO, 2.7V±2%, 500mA	SOT-89	20ch	VR1	4g	Ssc
CB30	AIC1734-30CXT	LVR-IC	LDO, 3.0V±1%, 300mA	SOT-89	20ch	VR1	4g	Aic
CB30G	AIC1734-30GXT	LVR-IC	LDO, 3.0V±1%, 300mA	SOT-89	20ch	VR1	4g	Aic
CB30P	AIC1734-30PXT	LVR-IC	LDO, 3.0V±1%, 300mA	SOT-89	20ch	VR1	4g	Aic
CB30P	SS6734-30GXT	LVR-IC	LDO, 3.0V±2%, 500mA	SOT-89	20ch	VR1	4g	Ssc
CB33	AIC1734-33CXT	LVR-IC	LDO, 3.3V±1%, 300mA	SOT-89	20ch	VR1	4g	Aic
CB33G	AIC1734-33GXT	LVR-IC	LDO, 3.3V±1%, 300mA	SOT-89	20ch	VR1	4g	Aic
CB33P	AIC1734-33PXT	LVR-IC	LDO, 3.3V±1%, 300mA	SOT-89	20ch	VR1	4g	Aic
CB33P	SS6734-33GXT	LVR-IC	LDO, 3.3V±2%, 500mA	SOT-89	20ch	VR1	4g	Ssc
CB35	AIC1734-35CXT	LVR-IC	LDO, 3.5V±1%, 300mA	SOT-89	20ch	VR1	4g	Aic
CB35G	AIC1734-35GXT	LVR-IC	LDO, 3.5V±1%, 300mA	SOT-89	20ch	VR1	4g	Aic
CB35P	AIC1734-35PXT	LVR-IC	LDO, 3.5V±1%, 300mA	SOT-89	20ch	VR1	4g	Aic
CB35P	SS6734-35GXT	LVR-IC	LDO, 3.5V±2%, 500mA	SOT-89	20ch	VR1	4g	Ssc
CB37	AIC1734-37CXT	LVR-IC	LDO, 3.7V±1%, 300mA	SOT-89	20ch	VR1	4g	Aic
CB37G	AIC1734-37GXT	LVR-IC	LDO, 3.7V±1%, 300mA	SOT-89	20ch	VR1	4g	Aic
CB37P	AIC1734-37PXT	LVR-IC	LDO, 3.7V±1%, 300mA	SOT-89	20ch	VR1	4g	Aic
CB37P	SS6734-37GXT	LVR-IC	LDO, 3.7V±2%, 500mA	SOT-89	20ch	VR1	4g	Ssc
CB38	AIC1734-38CXT	LVR-IC	LDO, 3.8V±1%, 300mA	SOT-89	20ch	VR1	4g	Aic
CB38G	AIC1734-38GXT	LVR-IC	LDO, 3.8V±1%, 300mA	SOT-89	20ch	VR1	4g	Aic
CB38P	AIC1734-38PXT	LVR-IC	LDO, 3.8V±1%, 300mA	SOT-89	20ch	VR1	4g	Aic
CB38P	SS6734-38GXT	LVR-IC	LDO, 3.8V±2%, 500mA	SOT-89	20ch	VR1	4g	Ssc
CB50	AIC1734-50CXT	LVR-IC	LDO, 5.0V±1%, 300mA	SOT-89	20ch	VR1	4g	Aic
CB50G	AIC1734-50GXT	LVR-IC	LDO, 5.0V±1%, 300mA	SOT-89	20ch	VR1	4g	Aic
CB50P	AIC1734-50PXT	LVR-IC	LDO, 5.0V±1%, 300mA	SOT-89	20ch	VR1	4g	Aic
CB50P	SS6734-50GXT	LVR-IC	LDO, 5.0V±2%, 500mA	SOT-89	20ch	VR1	4g	Ssc
CB52	AIC1734-52CXT	LVR-IC	LDO, 5.2V±1%, 300mA	SOT-89	20ch	VR1	4g	Aic
CB52G	AIC1734-52GXT	LVR-IC	LDO, 5.2V±1%, 300mA	SOT-89	20ch	VR1	4g	Aic
CB52P	AIC1734-52PXT	LVR-IC	LDO, 5.2V±1%, 300mA	SOT-89	20ch	VR1	4g	Aic
CB52P	SS6734-52GXT	LVR-IC	LDO, 5.2V±2%, 500mA	SOT-89	20ch	VR1	4g	Ssc
CBC	BC868-10	Si-npn	GP, 32V, 1A, 1.35W, B=75..150, >40MHz	SOT-89	20tb	-	4b	Phi



SMD
code

Type

Function

Short description

Case Pinout Sch. St. Mnf.

SMD code	Type	Function	Short description	Case	Pinout	Sch.	St.	Mnf.
CBP	2SC4132-P	Si-npn	Sw, 120V, 2A, 500mW, B=82..180, >80MHz	SOT-89	20tb	-	4b	Rhm
CBQ	2SC4132-Q	Si-npn	Sw, 120V, 2A, 500mW, B=120..270, >80MHz	SOT-89	20tb	-	4b	Rhm
CBR	2SC3646-R	Si-npn	HV, Sw, 120V, 1A, 500mW, B=100..200, 120MHz	PCP	20tb	-	4a	San
CBR	2SC4132-R	Si-npn	Sw, 120V, 2A, 500mW, B=180..390, >80MHz	SOT-89	20tb	-	4b	Rhm
CBS	2SC3646-S	Si-npn	HV, Sw, 120V, 1A, 500mW, B=140..280, 120MHz	PCP	20tb	-	4a	San
CBT	2SC3646-T	Si-npn	HV, Sw, 120V, 1A, 500mW, B=200..400, 120MHz	PCP	20tb	-	4a	San
CC	2SA1364-C	Si-pnp	Relay-Drv, 60V, 1A, 500mW, B=55..110, 80MHz	SOT-89	20tb	-	4b	Mit
CC	2SD1368-C	Si-npn	AF, 100V, 1A, 1W, B=250..300, 100MHz	SOT-89	20tb	-	4b	Ren
CC	AP130-17Y	LVR-IC	LDO, 1.7V±2%, 300mA	SOT-89	20ch	VR1	4b	Ana
CC	BCX68-16	Si-npn	AF, 25/20V, 1A, 1W, B=100..250, >100MHz	SOT-89	20tb	-	4b	Inf
CC	XC62RP2202P	LVR-IC	LDO, 2.2V±2%, 6mA, 500mW	SOT-89	20vl	VR1	4c	Tor
-CC	BCX68-16	Si-npn	AF, 25/20V, 1A, 1W, B=100..250, >100MHz	SOT-89	20tb	-	4b	Zx
CCC	BC868-16	Si-npn	GP, 32V, 1A, 1.35W, B=100..250, >40MHz	SOT-89	20tb	-	4b	Phi
CCR	2SC3647-R	Si-npn	HV, Sw, 120V, 2A, 500mW, B=100..200, 120MHz	PCP	20tb	-	4a	San
CCS	2SC3647-S	Si-npn	HV, Sw, 120V, 2A, 500mW, B=140..280, 120MHz	PCP	20tb	-	4a	San
CCT	2SC3647-T	Si-npn	HV, Sw, 120V, 2A, 500mW, B=200..400, 120MHz	PCP	20tb	-	4a	San
CD	2SA1364-D	Si-pnp	Relay-Drv, 60V, 1A, 500mW, B=90..180, 80MHz	SOT-89	20tb	-	4b	Mit
CD	AP130-18Y	LVR-IC	LDO, 1.8V±2%, 300mA	SOT-89	20ch	VR1	4b	Ana
CD	BCX68-25	Si-npn	AF, 25/20V, 1A, 1W, B=160..375, >100MHz	SOT-89	20tb	-	4b	Inf
CD	ELM99421B	LVR-IC	LDO, 4.2V±2%, 300mA	SOT-89	20vl	VR1	4a	Elm
CD	XC62RP2302P	LVR-IC	LDO, 2.3V±2%, 6mA, 500mW	SOT-89	20vl	VR1	4c	Tor
-CD	BCX68-25	Si-npn	AF, 25/20V, 1A, 1W, B=160..375, >100MHz	SOT-89	20tb	-	4b	Zx
CDC	2SC4673-C	Si-npn	UHF, LN, 20V, 100mA, 400mW, B=40..80, 4.5GHz	PCP	20tb	-	4a	San
CDC	BC868-25	Si-npn	GP, 32V, 1A, 1.35W, B=160..375, >40MHz	SOT-89	20tb	-	4b	Phi
CDD	2SC4673-D	Si-npn	UHF, LN, 20V, 100mA, 400mW, B=60..120, 4.5GHz	PCP	20tb	-	4a	San
CDE	2SC4673-E	Si-npn	UHF, LN, 20V, 100mA, 400mW, B=100..200, 4.5GHz	PCP	20tb	-	4a	San
CDR	2SC3648-R	Si-npn	AF-Drv, 180V, 700mA, 500mW, B=100..200, 120MHz	PCP	20tb	-	4a	San
CDS	2SC3648-S	Si-npn	AF-Drv, 180V, 700mA, 500mW, B=140..280, 120MHz	PCP	20tb	-	4a	San
CDT	2SC3648-T	Si-npn	AF-Drv, 180V, 700mA, 500mW, B=200..400, 120MHz	PCP	20tb	-	4a	San
CE	2SA1364-E	Si-pnp	Relay-Drv, 60V, 1A, 500mW, B=150..300, 80MHz	SOT-89	20tb	-	4b	Mit
CE	AP130-19Y	LVR-IC	LDO, 1.9V±2%, 300mA	SOT-89	20ch	VR1	4b	Ana
CE	BCX69	Si-pnp	AF, 25/20V, 1A, 1W, B=85..375, >100MHz	SOT-89	20tb	-	4b	Zx
CE	ELM99431B	LVR-IC	LDO, 4.3V±2%, 300mA	SOT-89	20vl	VR1	4a	Elm
CE	ELM99441B	LVR-IC	LDO, 4.4V±2%, 300mA	SOT-89	20vl	VR1	4a	Elm
CE	XC62RP2402P	LVR-IC	LDO, 2.4V±2%, 6mA, 500mW	SOT-89	20vl	VR1	4c	Tor
-CE	BCX68	Si-npn	AF, 25/20V, 1A, 1W, B=85..375, >100MHz	SOT-89	20tb	-	4b	Zx
CEC	BC869	Si-pnp	GP, 32V, 1A, 1.35W, B=50..375, >40MHz	SOT-89	20tb	-	4b	Phi
CEP	2SC4505-P	Si-npn	Sw, 400V, 100mA, 2W, 20MHz, B=82..180	MPT3	20tb	-	4b	Rhm
CEQ	2SC4505-Q	Si-npn	Sw, 400V, 100mA, 2W, 20MHz, B=120..270	MPT3	20tb	-	4b	Rhm
CER	2SC3649-R	Si-npn	HV, Sw, 180V, 1.5A, 500mW, B=100..200, 120MHz	PCP	20tb	-	4a	San
CES	2SC3649-S	Si-npn	HV, Sw, 180V, 1.5A, 500mW, B=140..280, 120MHz	PCP	20tb	-	4a	San
CET	2SC3649-T	Si-npn	HV, Sw, 180V, 1.5A, 500mW, B=200..400, 120MHz	PCP	20tb	-	4a	San
CF	2SC3650	Si-npn	AF-Amp, 30V, 1.2A, 500mW, B=800..3200, 220MHz	PCP	20tb	-	4a	San
CF	AP130-20Y	LVR-IC	LDO, 2.0V±2%, 300mA	SOT-89	20ch	VR1	4b	Ana
CF	BCX69-10	Si-pnp	AF, 25/20V, 1A, 1W, B=85..160, >100MHz	SOT-89	20tb	-	4b	Inf
CF	ELM99451B	LVR-IC	LDO, 4.5V±2%, 300mA	SOT-89	20vl	VR1	4a	Elm
CF	RT9161A-42CX	LVR-IC	LDO, 4.2V±2%, 500mA	SOT-89	20vl	VR1	4c	Rct
CF	XC62RP2502P	LVR-IC	LDO, 2.5V±2%, 6mA, 500mW	SOT-89	20vl	VR1	4c	Tor
CF-	RT9161A-42PX	LVR-IC	LDO, 4.2V±2%, 500mA	SOT-89	20vl	VR1	4c	Rct
CF15	AIC1735-15CX	LVR-IC	LDO, 1.5V±1%, 500mA	SOT-89	20vl	VR1	4g	Aic
CF15G	AIC1735-15GX	LVR-IC	LDO, 1.5V±1%, 500mA	SOT-89	20vl	VR1	4g	Aic
CF15P	AIC1735-15PX	LVR-IC	LDO, 1.5V±1%, 500mA	SOT-89	20vl	VR1	4g	Aic
CF18	AIC1735-18CX	LVR-IC	LDO, 1.8V±1%, 500mA	SOT-89	20vl	VR1	4g	Aic
CF18G	AIC1735-18GX	LVR-IC	LDO, 1.8V±1%, 500mA	SOT-89	20vl	VR1	4g	Aic
CF18P	AIC1735-18PX	LVR-IC	LDO, 1.8V±1%, 500mA	SOT-89	20vl	VR1	4g	Aic
CF18P	SS6735-18GX	LVR-IC	LDO, 1.8V±2%, 500mA	SOT-89	20vl	VR1	4g	Ssc
CF20	AIC1735-20CX	LVR-IC	LDO, 2.0V±1%, 500mA	SOT-89	20vl	VR1	4g	Aic
CF20G	AIC1735-20GX	LVR-IC	LDO, 2.0V±1%, 500mA	SOT-89	20vl	VR1	4g	Aic
CF20P	AIC1735-20PX	LVR-IC	LDO, 2.0V±1%, 500mA	SOT-89	20vl	VR1	4g	Aic
CF20P	SS6735-20GX	LVR-IC	LDO, 2.0V±2%, 500mA	SOT-89	20vl	VR1	4g	Ssc
CF25	AIC1735-25CX	LVR-IC	LDO, 2.5V±1%, 500mA	SOT-89	20vl	VR1	4g	Aic
CF25G	AIC1735-25GX	LVR-IC	LDO, 2.5V±1%, 500mA	SOT-89	20vl	VR1	4g	Aic
CF25P	AIC1735-25PX	LVR-IC	LDO, 2.5V±1%, 500mA	SOT-89	20vl	VR1	4g	Aic
CF25P	SS6735-25GX	LVR-IC	LDO, 2.5V±2%, 500mA	SOT-89	20vl	VR1	4g	Ssc
CF27	AIC1735-27CX	LVR-IC	LDO, 2.7V±1%, 500mA	SOT-89	20vl	VR1	4g	Aic
CF27G	AIC1735-27GX	LVR-IC	LDO, 2.7V±1%, 500mA	SOT-89	20vl	VR1	4g	Aic
CF27P	AIC1735-27PX	LVR-IC	LDO, 2.7V±1%, 500mA	SOT-89	20vl	VR1	4g	Aic
CF27P	SS6735-27GX	LVR-IC	LDO, 2.7V±2%, 500mA	SOT-89	20vl	VR1	4g	Ssc
CF30	AIC1735-30CX	LVR-IC	LDO, 3.0V±1%, 500mA	SOT-89	20vl	VR1	4g	Aic
CF30G	AIC1735-30GX	LVR-IC	LDO, 3.0V±1%, 500mA	SOT-89	20vl	VR1	4g	Aic



SMD
code

Type

Function

Short description

Case Pinout Sch. St. Mnf.

CF30P	AIC1735-30PX	LVR-IC	LDO, 3.0V±1%, 500mA	SOT-89	20vl	VR1	4g	Aic
CF30P	SS6735-30GX	LVR-IC	LDO, 3.0V±2%, 500mA	SOT-89	20vl	VR1	4g	Ssc
CF33	AIC1735-33CX	LVR-IC	LDO, 3.3V±1%, 500mA	SOT-89	20vl	VR1	4g	Aic
CF33G	AIC1735-33GX	LVR-IC	LDO, 3.3V±1%, 500mA	SOT-89	20vl	VR1	4g	Aic
CF33P	AIC1735-33PX	LVR-IC	LDO, 3.3V±1%, 500mA	SOT-89	20vl	VR1	4g	Aic
CF33P	SS6735-33GX	LVR-IC	LDO, 3.3V±2%, 500mA	SOT-89	20vl	VR1	4g	Ssc
CF35	AIC1735-35CX	LVR-IC	LDO, 3.5V±1%, 500mA	SOT-89	20vl	VR1	4g	Aic
CF35G	AIC1735-35GX	LVR-IC	LDO, 3.5V±1%, 500mA	SOT-89	20vl	VR1	4g	Aic
CF35P	AIC1735-35PX	LVR-IC	LDO, 3.5V±1%, 500mA	SOT-89	20vl	VR1	4g	Aic
CF35P	SS6735-35GX	LVR-IC	LDO, 3.5V±2%, 500mA	SOT-89	20vl	VR1	4g	Ssc
CF37	AIC1735-37CX	LVR-IC	LDO, 3.7V±1%, 500mA	SOT-89	20vl	VR1	4g	Aic
CF37G	AIC1735-37GX	LVR-IC	LDO, 3.7V±1%, 500mA	SOT-89	20vl	VR1	4g	Aic
CF37P	AIC1735-37PX	LVR-IC	LDO, 3.7V±1%, 500mA	SOT-89	20vl	VR1	4g	Aic
CF37P	SS6735-37GX	LVR-IC	LDO, 3.7V±2%, 500mA	SOT-89	20vl	VR1	4g	Ssc
CF38	AIC1735-38CX	LVR-IC	LDO, 3.8V±1%, 500mA	SOT-89	20vl	VR1	4g	Aic
CF38G	AIC1735-38GX	LVR-IC	LDO, 3.8V±1%, 500mA	SOT-89	20vl	VR1	4g	Aic
CF38P	AIC1735-38PX	LVR-IC	LDO, 3.8V±1%, 500mA	SOT-89	20vl	VR1	4g	Aic
CF38P	SS6735-38GX	LVR-IC	LDO, 3.8V±2%, 500mA	SOT-89	20vl	VR1	4g	Ssc
CF50	AIC1735-50CX	LVR-IC	LDO, 5.0V±1%, 500mA	SOT-89	20vl	VR1	4g	Aic
CF50G	AIC1735-50GX	LVR-IC	LDO, 5.0V±1%, 500mA	SOT-89	20vl	VR1	4g	Aic
CF50P	AIC1735-50PX	LVR-IC	LDO, 5.0V±1%, 500mA	SOT-89	20vl	VR1	4g	Aic
CF50P	SS6735-50GX	LVR-IC	LDO, 5.0V±2%, 500mA	SOT-89	20vl	VR1	4g	Ssc
CF52	AIC1735-52CX	LVR-IC	LDO, 5.2V±1%, 500mA	SOT-89	20vl	VR1	4g	Aic
CF52G	AIC1735-52GX	LVR-IC	LDO, 5.2V±1%, 500mA	SOT-89	20vl	VR1	4g	Aic
CF52P	AIC1735-52PX	LVR-IC	LDO, 5.2V±1%, 500mA	SOT-89	20vl	VR1	4g	Aic
CF52P	SS6735-52GX	LVR-IC	LDO, 5.2V±2%, 500mA	SOT-89	20vl	VR1	4g	Ssc
CFC	BC869-10	Si-pnp	AF-Drv, 25V, 1A, 1W, B>160, >40MHz	SOT-89	20tb	-	4b	Phi
CFQ	2SD2150-Q	Si-npn	AF-Drv, 40V, 3A, 500mW, B=120..270, 290MHz	SOT-89	20tb	-	4b	Rhm
CFR	2SD2150-R	Si-npn	AF-Drv, 40V, 3A, 500mW, B=180..390, 290MHz	SOT-89	20tb	-	4b	Rhm
CFS	2SD2150-S	Si-npn	AF-Drv, 40V, 3A, 500mW, B=270..560, 290MHz	SOT-89	20tb	-	4b	Rhm
CG	2SC3851	Si-npn	AF-Amp, 120V, 200mA, 500mW, B=500..2000, 150MHz	PCP	20tb	-	4a	San
CG	AP130-21Y	LVR-IC	LDO, 2.1V±2%, 300mA	SOT-89	20ch	VR1	4b	Ana
CG	BCX69-16	Si-pnp	AF, 25/20V, 1A, 1W, B=100..250, >100MHz	SOT-89	20tb	-	4b	Inf
CG	ELM99461B	LVR-IC	LDO, 4.6V±2%, 300mA	SOT-89	20vl	VR1	4a	Elm
CG	RT9161A-50CX	LVR-IC	LDO, 5.0V±2%, 500mA	SOT-89	20vl	VR1	4c	Rct
CG-	RT9161A-50PX	LVR-IC	LDO, 5.0V±2%, 500mA	SOT-89	20vl	VR1	4c	Rct
-CG	BCX69-16	Si-pnp	AF, 25/20V, 1A, 1W, B=100..250, >100MHz	SOT-89	20tb	-	4b	Zx
CGC	BC869-16	Si-pnp	GP, 32V, 1A, 1.35W, B=100..250, >40MHz	SOT-89	20tb	-	4b	Phi
CGP	2SC5053-P	Si-npn	Sw, 60V, 1A, 500mW, B=82..180, >150MHz	SOT-89	20tb	-	4b	Rhm
CGQ	2SC5053-Q	Si-npn	Sw, 60V, 1A, 500mW, B=120..270, >150MHz	SOT-89	20tb	-	4b	Rhm
CGR	2SC5053-R	Si-npn	Sw, 60V, 1A, 500mW, B=180..390, >150MHz	SOT-89	20tb	-	4b	Rhm
CH	2SB1002-H	Si-pnp	AF, 70V, 1A, 1W, B=100..200, 150MHz	SOT-89	20tb	-	4b	Ren
CH	AP130-22Y	LVR-IC	LDO, 2.2V±2%, 300mA	SOT-89	20ch	VR1	4b	Ana
CH	BCX69-25	Si-pnp	AF, 25/20V, 1A, 1W, B=160..375, >100MHz	SOT-89	20tb	-	4b	Inf
CH	ELM99471B	LVR-IC	LDO, 4.7V±2%, 300mA	SOT-89	20vl	VR1	4a	Elm
CH	XC62RP2602P	LVR-IC	LDO, 2.6V±2%, 6mA, 500mW	SOT-89	20vl	VR1	4c	Tor
-CH	BCX69-25	Si-pnp	AF, 25/20V, 1A, 1W, B=160..375, >100MHz	SOT-89	20tb	-	4b	Zx
CHC	BC869-25	Si-pnp	GP, 32V, 1A, 1.35W, B=160..375, >40MHz	SOT-89	20tb	-	4b	Phi
CHD	2SC4272-D	Si-npn	27MHz-CB, 75V, 1A, Pq=1.8W(27MHz), B=60..120, 250MHz	PCP	20tb	-	4a	San
CHE	2SC4272-E	Si-npn	27MHz-CB, 75V, 1A, Pq=1.8W(27MHz), B=100..200, 250MHz	PCP	20tb	-	4a	San
CHF	2SC4272-F	Si-npn	27MHz-CB, 75V, 1A, Pq=1.8W(27MHz), B=160..320, 250MHz	PCP	20tb	-	4a	San
CI	AP130-23Y	LVR-IC	LDO, 2.3V±2%, 300mA	SOT-89	20ch	VR1	4b	Ana
CIC	2SC4080-C	Si-npn	Vid, HF, 200V, 100mA, 500mW, B=40..80, 400MHz	SOT-89	20tb	-	4a	San
CID	2SC4080-D	Si-npn	Vid, HF, 200V, 100mA, 500mW, B=60..120, 400MHz	SOT-89	20tb	-	4a	San
CIE	2SC4080-E	Si-npn	Vid, HF, 200V, 100mA, 500mW, B=100..200, 400MHz	SOT-89	20tb	-	4a	San
CIF	2SC4080-F	Si-npn	Vid, HF, 200V, 100mA, 500mW, B=160..320, 400MHz	SOT-89	20tb	-	4a	San
CJ	2SB1002-J	Si-pnp	AF, 70V, 1A, 1W, B=160..320, 150MHz	SOT-89	20tb	-	4b	Ren
CJ	2SC4390	Si-npn	Hi-beta, AF, 20V, 2A, 500mW, B=800..3200, 260MHz	PCP	20tb	-	4a	San
CJ	AP130-24Y	LVR-IC	LDO, 2.4V±2%, 300mA	SOT-89	20ch	VR1	4b	Ana
CJ	ELM99481B	LVR-IC	LDO, 4.8V±2%, 300mA	SOT-89	20vl	VR1	4a	Elm
-CJ	BCX69	Si-pnp	AF, 25/20V, 1A, 1W, B=85..375, >100MHz	SOT-89	20tb	-	4b	Zx
CK	2SD999-K	Si-npn	AF-Drv, 30V, 1A, 2W, B=200..400, 130MHz	SOT-89	20tb	-	4b	Nec
CK	AP130-25Y	LVR-IC	LDO, 2.5V±2%, 300mA	SOT-89	20ch	VR1	4b	Ana
CK	ELM99491B	LVR-IC	LDO, 4.9V±2%, 300mA	SOT-89	20vl	VR1	4a	Elm
CK	XC62RP2702P	LVR-IC	LDO, 2.7V±2%, 6mA, 500mW	SOT-89	20vl	VR1	4c	Tor
CKR	2SC4520-R	Si-npn	Sw, Hi-Sp, 60V, 1.5A, 1.3W, B=100..200, 300MHz, 50/180ns	PCP	20tb	-	4a	San
CKS	2SC4520-S	Si-npn	Sw, Hi-Sp, 60V, 1.5A, 1.3W, B=140..280, 300MHz, 50/180ns	PCP	20tb	-	4a	San
CKT	2SC4520-T	Si-npn	Sw, Hi-Sp, 60V, 1.5A, 1.3W, B=200..400, 300MHz, 50/180ns	PCP	20tb	-	4a	San
CL	2SD999-L	Si-npn	AF-Drv, 30V, 1A, 2W, B=135..270, 130MHz	SOT-89	20tb	-	4b	Nec
CL	AP130-26Y	LVR-IC	LDO, 2.6V±2%, 300mA	SOT-89	20ch	VR1	4b	Ana



SMD
code

Type

Function

Short description

Case Pinout Sch. St. Mnf.

SMD code	Type	Function	Short description	Case	Pinout	Sch.	St.	Mnf.
CL	XC62RP2802P	LVR-IC	LDO, 2.8V±2%, 6mA, 500mW	SOT-89	20vl	VR1	4c	Tor
CLR	2SC4521-R	Si-npn	Sw, Hi-Sp, 60V, 3A, 1.5W, B=100..200, 300MHz, 50/180ns	PCP	20ftb	-	4a	San
CLS	2SC4521-S	Si-npn	Sw, Hi-Sp, 60V, 3A, 1.5W, B=140..280, 300MHz, 50/180ns	PCP	20ftb	-	4a	San
CLT	2SC4521-T	Si-npn	Sw, Hi-Sp, 60V, 3A, 1.5W, B=200..400, 300MHz, 50/180ns	PCP	20ftb	-	4a	San
CM	2SD999-M	Si-npn	AF-Drv, 30V, 1A, 2W, B=90..180, 130MHz	SOT-89	20ftb	-	4b	Nec
CM	AP130-27Y	LVR-IC	LDO, 2.7V±2%, 300mA	SOT-89	20ch	VR1	4b	Ana
CM	XC62RP2902P	LVR-IC	LDO, 2.9V±2%, 6mA, 500mW	SOT-89	20vl	VR1	4c	Tor
CMC	2SC4504-C	Si-npn	Vid-Drv, 30V, 300mA, 500mW, B=40..80, 2.2GHz	PCP	20ftb	-	4a	San
CMD	2SC4504-D	Si-npn	Vid-Drv, 30V, 300mA, 500mW, B=60..120, 2.2GHz	PCP	20ftb	-	4a	San
CME	2SC4504-E	Si-npn	Vid-Drv, 30V, 300mA, 500mW, B=100..200, 2.2GHz	PCP	20ftb	-	4a	San
CN	AP130-28Y	LVR-IC	LDO, 2.8V±2%, 300mA	SOT-89	20ch	VR1	4b	Ana
CN	RT9161-44CX	LVR-IC	LDO, 4.4V±2%, 300mA	SOT-89	20vl	VR1	4c	Rct
CND	2SC4548-D	Si-npn	HV, Drv, 400V, 200mA, 1.3W, B=60..120, 70MHz	PCP	20ftb	-	4a	San
CNE	2SC4548-E	Si-npn	HV, Drv, 400V, 200mA, 1.3W, B=100..200, 70MHz	PCP	20ftb	-	4a	San
CO	2SC2881-O	Si-npn	HV, 120V, 80mA, 500mW, B=70..140, 120MHz	SOT-89	20ftb	-	4b	Tos
CO	AP130-29Y	LVR-IC	LDO, 2.9V±2%, 300mA	SOT-89	20ch	VR1	4b	Ana
CO	KTC4373-O	Si-npn	AF-Drv, 120V, 800mA, 1W, B=80..160, 120MHz	SOT-89	20ftb	-	4a	Kec
CP	2SB767-P	Si-npn	AF, 80V, 1A, 1W, B=70..130, 120MHz	SOT-89	20ftb	-	4b	Pan
CP	2SC4705	Si-npn	AF-amp, 60V, 200mA, 1.3W, 250MHz, B=800..3200	PCP	20ftb	-	4a	San
CP	AP130-30Y	LVR-IC	LDO, 3.0V±2%, 300mA	SOT-89	20ch	VR1	4b	Ana
CQ	2SB767-Q	Si-npn	AF, 80V, 1A, 1W, B=90..155, 120MHz	SOT-89	20ftb	-	4b	Pan
CQ	AP130-31Y	LVR-IC	LDO, 3.1V±2%, 300mA	SOT-89	20ch	VR1	4b	Ana
CR	2SB767-R	Si-npn	AF, 80V, 1A, 1W, B=130..200, 120MHz	SOT-89	20ftb	-	4b	Pan
CR	2SC4422	Si-npn	UHF, 15V, 50mA, 400mW, B=50..250, >4.5GHz	SOT-89	20ftb	-	4b	Ren
CR	AP130-32Y	LVR-IC	LDO, 3.2V±2%, 300mA	SOT-89	20ch	VR1	4b	Ana
CR	RT9161-165CX	LVR-IC	LDO, 1.6V±2%, 300mA	SOT-89	20vl	VR1	4c	Rct
CS	2SB767-S	Si-npn	AF, 80V, 1A, 1W, B=90..155, 120MHz	SOT-89	20ftb	-	4b	Pan
CS	2SD1870	Si-npn	Hi-beta, 30V, 1A, B=1000..3000	SOT-89	20ftb	-	4b	Ren
CS	AP130-33Y	LVR-IC	LDO, 3.3V±2%, 300mA	SOT-89	20ch	VR1	4b	Ana
CS	RT9161-195CX	LVR-IC	LDO, 1.9V±2%, 300mA	SOT-89	20vl	VR1	4c	Rct
CT	2SD1472	Si-npn-Darl+Di	GP, 120V, 1.5A, 1W, B=2000..30k	SOT-89	20fe	-	4b	Ren
CT	AP130-34Y	LVR-IC	LDO, 3.4V±2%, 300mA	SOT-89	20ch	VR1	4b	Ana
CT	RT9161-18CX	LVR-IC	LDO, 1.8V±2%, 300mA	SOT-89	20vl	VR1	4c	Rct
CT-	RT9161-18PX	LVR-IC	LDO, 1.8V±2%, 300mA	SOT-89	20vl	VR1	4c	Rct
CTS	2SC4984-S	Si-npn	AF-Amp, 15V, 300mA, 1.3W, B=140..280, 200MHz	PCP	20ftb	-	4a	San
CTT	2SC4984-T	Si-npn	AF-Amp, 15V, 300mA, 1.3W, B=200..400, 200MHz	PCP	20ftb	-	4a	San
CTU	2SC4984-U	Si-npn	AF-Amp, 15V, 300mA, 1.3W, B=280..560, 200MHz	PCP	20ftb	-	4a	San
CU	2SC5069	Si-npn	AF-Drv, 30V, 2A, 1.5W, B=800..3200, 250MHz	PCP	20ftb	-	4a	San
CU	AP130-35Y	LVR-IC	LDO, 3.5V±2%, 300mA	SOT-89	20ch	VR1	4b	Ana
CU	RT9161-50CX	LVR-IC	LDO, 5.0V±2%, 300mA	SOT-89	20vl	VR1	4c	Rct
CU-	RT9161-50PX	LVR-IC	LDO, 5.0V±2%, 300mA	SOT-89	20vl	VR1	4c	Rct
CV	AP130-36Y	LVR-IC	LDO, 3.6V±2%, 300mA	SOT-89	20ch	VR1	4b	Ana
CW	AP130-37Y	LVR-IC	LDO, 3.7V±2%, 300mA	SOT-89	20ch	VR1	4b	Ana
CWA	S-817B11AUA-CWAT2G	LVR-IC	1.1V±2%, 50mA	SOT-89	20vl	VR1	4i	Sii
CWB	S-817B12AUA-CWBT2G	LVR-IC	1.2V±2%, 50mA	SOT-89	20vl	VR1	4i	Sii
CWC	S-817B13AUA-CWCT2G	LVR-IC	1.3V±2%, 50mA	SOT-89	20vl	VR1	4i	Sii
CWD	S-817B14AUA-CWDT2G	LVR-IC	1.4V±2%, 50mA	SOT-89	20vl	VR1	4i	Sii
CWE	S-817B15AUA-CWET2G	LVR-IC	1.5V±2%, 50mA	SOT-89	20vl	VR1	4i	Sii
CWF	S-817B16AUA-CWFT2G	LVR-IC	1.6V±2%, 50mA	SOT-89	20vl	VR1	4i	Sii
CWG	S-817B17AUA-CWGT2G	LVR-IC	1.7V±2%, 50mA	SOT-89	20vl	VR1	4i	Sii
CWH	S-817B18AUA-CWHT2G	LVR-IC	1.8V±2%, 50mA	SOT-89	20vl	VR1	4i	Sii
CWI	S-817B19AUA-CWIT2G	LVR-IC	1.9V±2%, 50mA	SOT-89	20vl	VR1	4i	Sii
CWJ	S-817B20AUA-CWJT2G	LVR-IC	2.0V±2%, 50mA	SOT-89	20vl	VR1	4i	Sii
CWK	S-817B21AUA-CWKT2G	LVR-IC	2.1V±2%, 50mA	SOT-89	20vl	VR1	4i	Sii
CWL	S-817B22AUA-CWLT2G	LVR-IC	2.2V±2%, 50mA	SOT-89	20vl	VR1	4i	Sii
CWM	S-817B23AUA-CWMT2G	LVR-IC	2.3V±2%, 50mA	SOT-89	20vl	VR1	4i	Sii
CWN	S-817B24AUA-CWNT2G	LVR-IC	2.4V±2%, 50mA	SOT-89	20vl	VR1	4i	Sii
CWO	S-817B25AUA-CWOT2G	LVR-IC	2.5V±2%, 50mA	SOT-89	20vl	VR1	4i	Sii
CWP	S-817B26AUA-CWPT2G	LVR-IC	2.6V±2%, 50mA	SOT-89	20vl	VR1	4i	Sii
CWQ	S-817B27AUA-CWQT2G	LVR-IC	2.7V±2%, 50mA	SOT-89	20vl	VR1	4i	Sii
CWR	S-817B28AUA-CWRT2G	LVR-IC	2.8V±2%, 50mA	SOT-89	20vl	VR1	4i	Sii
CWS	S-817B29AUA-CWST2G	LVR-IC	2.9V±2%, 50mA	SOT-89	20vl	VR1	4i	Sii
CWT	S-817B30AUA-CWTT2G	LVR-IC	3.0V±2%, 50mA	SOT-89	20vl	VR1	4i	Sii
CWU	S-817B31AUA-CWUT2G	LVR-IC	3.1V±2%, 50mA	SOT-89	20vl	VR1	4i	Sii
CWV	S-817B32AUA-CWVT2G	LVR-IC	3.2V±2%, 50mA	SOT-89	20vl	VR1	4i	Sii
CWW	S-817B33AUA-CWWT2G	LVR-IC	3.3V±2%, 50mA	SOT-89	20vl	VR1	4i	Sii
CWX	S-817B34AUA-CWXT2G	LVR-IC	3.4V±2%, 50mA	SOT-89	20vl	VR1	4i	Sii
CWY	S-817B35AUA-CWYT2G	LVR-IC	3.5V±2%, 50mA	SOT-89	20vl	VR1	4i	Sii
CWZ	S-817B36AUA-CWZT2G	LVR-IC	3.6V±2%, 50mA	SOT-89	20vl	VR1	4i	Sii
CX	AP130-38Y	LVR-IC	LDO, 3.8V±2%, 300mA	SOT-89	20ch	VR1	4b	Ana



SMD
code

Type

Function

Short description

Case Pinout Sch. St. Mnf.

SMD code	Type	Function	Short description	Case	Pinout	Sch.	St.	Mnf.
CX-	RT9261B-50PX	DC/DC-IC	VFM step-up, 5.0V±2%, 50mA	SOT-89	20bq	DC2	4b	Rct
CXA	S-817B37AUA-CXAT2G	LVR-IC	3.7V±2%, 50mA	SOT-89	20vl	VR1	4i	Sii
CXB	S-817B38AUA-CXBT2G	LVR-IC	3.8V±2%, 50mA	SOT-89	20vl	VR1	4i	Sii
CXC	S-817B39AUA-CXCT2G	LVR-IC	3.9V±2%, 50mA	SOT-89	20vl	VR1	4i	Sii
CXD	S-817B40AUA-CXDT2G	LVR-IC	4.0V±2%, 50mA	SOT-89	20vl	VR1	4i	Sii
CXE	S-817B41AUA-CXET2G	LVR-IC	4.1V±2%, 50mA	SOT-89	20vl	VR1	4i	Sii
CXF	S-817B42AUA-CXFT2G	LVR-IC	4.2V±2%, 50mA	SOT-89	20vl	VR1	4i	Sii
CXG	S-817B43AUA-CXGT2G	LVR-IC	4.3V±2%, 50mA	SOT-89	20vl	VR1	4i	Sii
CXH	S-817B44AUA-CXHT2G	LVR-IC	4.4V±2%, 50mA	SOT-89	20vl	VR1	4i	Sii
CXI	S-817B45AUA-CXIT2G	LVR-IC	4.5V±2%, 50mA	SOT-89	20vl	VR1	4i	Sii
CXJ	S-817B46AUA-CXJT2G	LVR-IC	4.6V±2%, 50mA	SOT-89	20vl	VR1	4i	Sii
CXK	S-817B47AUA-CXKT2G	LVR-IC	4.7V±2%, 50mA	SOT-89	20vl	VR1	4i	Sii
CXL	S-817B48AUA-CXLT2G	LVR-IC	4.8V±2%, 50mA	SOT-89	20vl	VR1	4i	Sii
CXM	S-817B49AUA-CXMT2G	LVR-IC	4.9V±2%, 50mA	SOT-89	20vl	VR1	4i	Sii
CXN	S-817B50AUA-CXNT2G	LVR-IC	5.0V±2%, 75mA	SOT-89	20vl	VR1	4i	Sii
CXO	S-817B51AUA-CXOT2G	LVR-IC	5.1V±2%, 75mA	SOT-89	20vl	VR1	4i	Sii
CXP	S-817B52AUA-CXPT2G	LVR-IC	5.2V±2%, 75mA	SOT-89	20vl	VR1	4i	Sii
CXQ	S-817B53AUA-CXQT2G	LVR-IC	5.3V±2%, 75mA	SOT-89	20vl	VR1	4i	Sii
CXR	S-817B54AUA-CXRT2G	LVR-IC	5.4V±2%, 75mA	SOT-89	20vl	VR1	4i	Sii
CXS	S-817B55AUA-CXST2G	LVR-IC	5.5V±2%, 75mA	SOT-89	20vl	VR1	4i	Sii
CXT	S-817B56AUA-CXTT2G	LVR-IC	5.6V±2%, 75mA	SOT-89	20vl	VR1	4i	Sii
CXU	S-817B57AUA-CXUT2G	LVR-IC	5.7V±2%, 75mA	SOT-89	20vl	VR1	4i	Sii
CXV	S-817B58AUA-CXVT2G	LVR-IC	5.8V±2%, 75mA	SOT-89	20vl	VR1	4i	Sii
CXW	S-817B59AUA-CXWT2G	LVR-IC	5.9V±2%, 75mA	SOT-89	20vl	VR1	4i	Sii
CXX	S-817B60AUA-CXXT2G	LVR-IC	6.0V±2%, 75mA	SOT-89	20vl	VR1	4i	Sii
CY	2SC2881-Y	Si-npn	HV, 120V, 80mA, 500mW, B=120..240, 120MHz	SOT-89	20tb	-	4b	Tos
CY	2S1886	p-MOSFET-e*	V-MOS, 200V, 500mA, <12Ω(250mA), 12/32ns	SOT-89	20fi	-	4b	Ren
CY	AP130-39Y	LVR-IC	LDO, 3.9V±2%, 300mA	SOT-89	20ch	VR1	4b	Ana
CY	KTC4373-Y	Si-npn	AF-Drv, 120V, 800mA, 1W, B=120..240, 120MHz	SOT-89	20tb	-	4a	Kec
CY	RT9161-19CX	LVR-IC	LDO, 1.9V±2%, 300mA	SOT-89	20vl	VR1	4c	Rct
CYD	2SC5229-D	Si-npn	VHF/UHF, LN, 20V, 70mA, 700mW, B=60..120, 6.5GHz	PCP	20tb	-	4g	San
CYE	2SC5229-E	Si-npn	VHF/UHF, LN, 20V, 70mA, 700mW, B=90..180, 6.5GHz	PCP	20tb	-	4g	San
CYF	2SC5229-F	Si-npn	VHF/UHF, LN, 20V, 70mA, 700mW, B=135..270, 6.5GHz	PCP	20tb	-	4g	San
CZ	AP130-40Y	LVR-IC	LDO, 4.0V±2%, 300mA	SOT-89	20ch	VR1	4b	Ana
CZD	2SC5347-D	Si-npn	UHF-Amp, 20V, 150mA, 1.3W, B=60..120, 4.7GHz	SOT-89	20tb	-	4a	San
CZE	2SC5347-E	Si-npn	UHF-Amp, 20V, 150mA, 1.3W, B=90..180, 4.7GHz	SOT-89	20tb	-	4a	San
CZF	2SC5347-F	Si-npn	UHF-Amp, 20V, 150mA, 1.3W, B=130..270, 4.7GHz	SOT-89	20tb	-	4a	San
D0	ELM9730NAB	Vdet-IC	3.0V±2.5%, +Reset ODO	SOT-89	20vda	VD6	4a	Elm
D0	ELM9850AB	LVR-IC	5.0V±2%, 200mA	SOT-89	20vl	VR1	4a	Elm
D0	TC54VC3002MB	Vdet-IC	3.0V±2%, -Reset PPO	SOT-89	20vda	VD7	4b	Tcs
D0	XC61CC3002P	Vdet-IC	3V±1%, +Reset PPO	SOT-89	20vda	VD7	4b	Tor
D03	XE61CC3045PR	Vdet-IC	3.0V±2%, -Reset PPO	SOT-89	20cj	VD7	4j	Tor
D05	XC61FC3012P	Vdet-IC	3V±2%, +Reset PPO, 200ms	SOT-89	20vda	VD7	4b	Tor
D06	XC61FC3042P	Vdet-IC	3V±2%, +Reset PPO, 400ms	SOT-89	20vda	VD7	4b	Tor
D07	XC61FC3052P	Vdet-IC	3V±2%, +Reset PPO, 50ms	SOT-89	20vda	VD7	4b	Tor
D1	ELM9731NAB	Vdet-IC	3.1V±2.5%, +Reset ODO	SOT-89	20vda	VD6	4a	Elm
D1	ELM9851AB	LVR-IC	5.1V±2%, 200mA	SOT-89	20vl	VR1	4a	Elm
D1	TC54VC3102MB	Vdet-IC	3.1V±2%, -Reset PPO	SOT-89	20vda	VD7	4b	Tcs
D1	XC61CC3102P	Vdet-IC	3.1V±1%, +Reset PPO	SOT-89	20vda	VD7	4b	Tor
D11A	ML6102C113P	Vdet-IC	1.1V±3%, -Reset PPO	SOT-89	20vda	VD7	4g	Mlc
D12A	ML6102C123P	Vdet-IC	1.2V±3%, -Reset PPO	SOT-89	20vda	VD7	4g	Mlc
D13	XE61CC3145PR	Vdet-IC	3.1V±2%, -Reset PPO	SOT-89	20cj	VD7	4j	Tor
D13A	ML6102C133P	Vdet-IC	1.3V±3%, -Reset PPO	SOT-89	20vda	VD7	4g	Mlc
D14A	ML6102C143P	Vdet-IC	1.4V±3%, -Reset PPO	SOT-89	20vda	VD7	4g	Mlc
D15	XC61FC3112P	Vdet-IC	3.1V±2%, +Reset PPO, 200ms	SOT-89	20vda	VD7	4b	Tor
D15A	ML6102C153P	Vdet-IC	1.5V±3%, -Reset PPO	SOT-89	20vda	VD7	4g	Mlc
D16	XC61FC3142P	Vdet-IC	3.1V±2%, +Reset PPO, 400ms	SOT-89	20vda	VD7	4b	Tor
D16A	ML6102C163P	Vdet-IC	1.6V±3%, -Reset PPO	SOT-89	20vda	VD7	4g	Mlc
D17	XC61FC3152P	Vdet-IC	3.1V±2%, +Reset PPO, 50ms	SOT-89	20vda	VD7	4b	Tor
D17A	ML6102C173P	Vdet-IC	1.7V±3%, -Reset PPO	SOT-89	20vda	VD7	4g	Mlc
D18A	ML6102C183P	Vdet-IC	1.8V±3%, -Reset PPO	SOT-89	20vda	VD7	4g	Mlc
D19A	ML6102C193P	Vdet-IC	1.9V±3%, -Reset PPO	SOT-89	20vda	VD7	4g	Mlc
D2	ELM9732NAB	Vdet-IC	3.2V±2.5%, +Reset ODO	SOT-89	20vda	VD6	4a	Elm
D2	ELM9852AB	LVR-IC	5.2V±2%, 200mA	SOT-89	20vl	VR1	4a	Elm
D2	TC54VC3202MB	Vdet-IC	3.2V±2%, -Reset PPO	SOT-89	20vda	VD7	4b	Tcs
D2	XC61CC3202P	Vdet-IC	3.2V±1%, +Reset PPO	SOT-89	20vda	VD7	4b	Tor
D20A	ML6102C202P	Vdet-IC	2.0V±2%, -Reset PPO	SOT-89	20vda	VD7	4g	Mlc
D21A	ML6102C212P	Vdet-IC	2.1V±2%, -Reset PPO	SOT-89	20vda	VD7	4g	Mlc
D22A	ML6102C222P	Vdet-IC	2.2V±2%, -Reset PPO	SOT-89	20vda	VD7	4g	Mlc
D23	XE61CC3245PR	Vdet-IC	3.2V±2%, -Reset PPO	SOT-89	20cj	VD7	4j	Tor



SMD
code

Type

Function

Short description

Case Pinout Sch. St. Mnf.

SMD code	Type	Function	Short description	Case	Pinout	Sch.	St.	Mnf.
D23A	ML6102C232P	Vdet-IC	2.3V±2%, -Reset PPO	SOT-89	20vda	VD7	4g	Mlc
D24A	ML6102C242P	Vdet-IC	2.4V±2%, -Reset PPO	SOT-89	20vda	VD7	4g	Mlc
D25	XC61FC3212P	Vdet-IC	3.2V±2%, +Reset PPO, 200ms	SOT-89	20vda	VD7	4b	Tor
D25A	ML6102C252P	Vdet-IC	2.5V±2%, -Reset PPO	SOT-89	20vda	VD7	4g	Mlc
D26	XC61FC3242P	Vdet-IC	3.2V±2%, +Reset PPO, 400ms	SOT-89	20vda	VD7	4b	Tor
D26A	ML6102C262P	Vdet-IC	2.6V±2%, -Reset PPO	SOT-89	20vda	VD7	4g	Mlc
D27	XC61FC3252P	Vdet-IC	3.2V±2%, +Reset PPO, 50ms	SOT-89	20vda	VD7	4b	Tor
D27A	ML6102C272P	Vdet-IC	2.7V±2%, -Reset PPO	SOT-89	20vda	VD7	4g	Mlc
D28A	ML6102C282P	Vdet-IC	2.8V±2%, -Reset PPO	SOT-89	20vda	VD7	4g	Mlc
D29A	ML6102C292P	Vdet-IC	2.9V±2%, -Reset PPO	SOT-89	20vda	VD7	4g	Mlc
D2A	S-80844KLUA	Vdet-IC	4.45V, -Reset PPO	SOT-89	20vda	VD7	4b	Sii
D2B	S-80824KNUA	Vdet-IC	2.45V, -Reset ODO	SOT-89	20vda	VD6	4a	Sii
D2C	S-80846KNUA	Vdet-IC	4.65V, -Reset ODO	SOT-89	20vda	VD6	4b	Sii
D3	ELM9733NAB	Vdet-IC	3.3V±2.5%, +Reset ODO	SOT-89	20vda	VD6	4a	Elm
D3	ELM9853AB	LVR-IC	5.3V±2%, 200mA	SOT-89	20vl	VR1	4a	Elm
D3	TC54VC3302MB	Vdet-IC	3.3V±2%, -Reset PPO	SOT-89	20vda	VD7	4b	Tcs
D3	XC61CC3302P	Vdet-IC	3.3V±1%, +Reset PPO	SOT-89	20vda	VD7	4b	Tor
D30A	ML6102C302P	Vdet-IC	3.0V±2%, -Reset PPO	SOT-89	20vda	VD7	4g	Mlc
D31A	ML6102C312P	Vdet-IC	3.1V±2%, -Reset PPO	SOT-89	20vda	VD7	4g	Mlc
D32A	ML6102C322P	Vdet-IC	3.2V±2%, -Reset PPO	SOT-89	20vda	VD7	4g	Mlc
D33	XE61CC3345PR	Vdet-IC	3.3V±2%, -Reset PPO	SOT-89	20cj	VD7	4j	Tor
D33A	ML6102C332P	Vdet-IC	3.3V±2%, -Reset PPO	SOT-89	20vda	VD7	4g	Mlc
D34A	ML6102C342P	Vdet-IC	3.4V±2%, -Reset PPO	SOT-89	20vda	VD7	4g	Mlc
D35	XC61FC3312P	Vdet-IC	3.3V±2%, +Reset PPO, 200ms	SOT-89	20vda	VD7	4b	Tor
D35A	ML6102C352P	Vdet-IC	3.5V±2%, -Reset PPO	SOT-89	20vda	VD7	4g	Mlc
D36	XC61FC3342P	Vdet-IC	3.3V±2%, +Reset PPO, 400ms	SOT-89	20vda	VD7	4b	Tor
D36A	ML6102C362P	Vdet-IC	3.6V±2%, -Reset PPO	SOT-89	20vda	VD7	4g	Mlc
D37	XC61FC3352P	Vdet-IC	3.3V±2%, +Reset PPO, 50ms	SOT-89	20vda	VD7	4b	Tor
D37A	ML6102C372P	Vdet-IC	3.7V±2%, -Reset PPO	SOT-89	20vda	VD7	4g	Mlc
D38A	ML6102C382P	Vdet-IC	3.8V±2%, -Reset PPO	SOT-89	20vda	VD7	4g	Mlc
D39A	ML6102C392P	Vdet-IC	3.9V±2%, -Reset PPO	SOT-89	20vda	VD7	4g	Mlc
D4	ELM9734NAB	Vdet-IC	3.4V±2.5%, +Reset ODO	SOT-89	20vda	VD6	4a	Elm
D4	ELM9854AB	LVR-IC	5.4V±2%, 200mA	SOT-89	20vl	VR1	4a	Elm
D4	TC54VC3402MB	Vdet-IC	3.4V±2%, -Reset PPO	SOT-89	20vda	VD7	4b	Tcs
D4	XC61CC3402P	Vdet-IC	3.4V±1%, +Reset PPO	SOT-89	20vda	VD7	4b	Tor
D40A	ML6102C402P	Vdet-IC	4.0V±2%, -Reset PPO	SOT-89	20vda	VD7	4g	Mlc
D41A	ML6102C412P	Vdet-IC	4.1V±2%, -Reset PPO	SOT-89	20vda	VD7	4g	Mlc
D42A	ML6102C422P	Vdet-IC	4.2V±2%, -Reset PPO	SOT-89	20vda	VD7	4g	Mlc
D43	XE61CC3445PR	Vdet-IC	3.4V±2%, -Reset PPO	SOT-89	20cj	VD7	4j	Tor
D43A	ML6102C432P	Vdet-IC	4.3V±2%, -Reset PPO	SOT-89	20vda	VD7	4g	Mlc
D44A	ML6102C442P	Vdet-IC	4.4V±2%, -Reset PPO	SOT-89	20vda	VD7	4g	Mlc
D45	XC61FC3412P	Vdet-IC	3.4V±2%, +Reset PPO, 200ms	SOT-89	20vda	VD7	4b	Tor
D45A	ML6102C452P	Vdet-IC	4.5V±2%, -Reset PPO	SOT-89	20vda	VD7	4g	Mlc
D46	XC61FC3442P	Vdet-IC	3.4V±2%, +Reset PPO, 400ms	SOT-89	20vda	VD7	4b	Tor
D46A	ML6102C462P	Vdet-IC	4.6V±2%, -Reset PPO	SOT-89	20vda	VD7	4g	Mlc
D47	XC61FC3452P	Vdet-IC	3.4V±2%, +Reset PPO, 50ms	SOT-89	20vda	VD7	4b	Tor
D47A	ML6102C472P	Vdet-IC	4.7V±2%, -Reset PPO	SOT-89	20vda	VD7	4g	Mlc
D48A	ML6102C482P	Vdet-IC	4.8V±2%, -Reset PPO	SOT-89	20vda	VD7	4g	Mlc
D49A	ML6102C492P	Vdet-IC	4.9V±2%, -Reset PPO	SOT-89	20vda	VD7	4g	Mlc
D5	ELM9735NAB	Vdet-IC	3.5V±2.5%, +Reset ODO	SOT-89	20vda	VD6	4a	Elm
D5	ELM9855AB	LVR-IC	5.5V±2%, 200mA	SOT-89	20vl	VR1	4a	Elm
D5	TC54VC3502MB	Vdet-IC	3.5V±2%, -Reset PPO	SOT-89	20vda	VD7	4b	Tcs
D5	XC61CC3502P	Vdet-IC	3.5V±1%, +Reset PPO	SOT-89	20vda	VD7	4b	Tor
D50A	ML6102C502P	Vdet-IC	5.0V±2%, -Reset PPO	SOT-89	20vda	VD7	4g	Mlc
D51A	ML6102C512P	Vdet-IC	5.1V±2%, -Reset PPO	SOT-89	20vda	VD7	4g	Mlc
D52A	ML6102C522P	Vdet-IC	5.2V±2%, -Reset PPO	SOT-89	20vda	VD7	4g	Mlc
D53	XE61CC3545PR	Vdet-IC	3.5V±2%, -Reset PPO	SOT-89	20cj	VD7	4j	Tor
D53A	ML6102C532P	Vdet-IC	5.3V±2%, -Reset PPO	SOT-89	20vda	VD7	4g	Mlc
D54A	ML6102C542P	Vdet-IC	5.4V±2%, -Reset PPO	SOT-89	20vda	VD7	4g	Mlc
D55	XC61FC3512P	Vdet-IC	3.5V±2%, +Reset PPO, 200ms	SOT-89	20vda	VD7	4b	Tor
D55A	ML6102C552P	Vdet-IC	5.5V±2%, -Reset PPO	SOT-89	20vda	VD7	4g	Mlc
D56	XC61FC3542P	Vdet-IC	3.5V±2%, +Reset PPO, 400ms	SOT-89	20vda	VD7	4b	Tor
D56A	ML6102C562P	Vdet-IC	5.6V±2%, -Reset PPO	SOT-89	20vda	VD7	4g	Mlc
D57	XC61FC3552P	Vdet-IC	3.5V±2%, +Reset PPO, 50ms	SOT-89	20vda	VD7	4b	Tor
D57A	ML6102C572P	Vdet-IC	5.7V±2%, -Reset PPO	SOT-89	20vda	VD7	4g	Mlc
D58A	ML6102C582P	Vdet-IC	5.8V±2%, -Reset PPO	SOT-89	20vda	VD7	4g	Mlc
D59A	ML6102C592P	Vdet-IC	5.9V±2%, -Reset PPO	SOT-89	20vda	VD7	4g	Mlc
D6	ELM9736NAB	Vdet-IC	3.6V±2.5%, +Reset ODO	SOT-89	20vda	VD6	4a	Elm
D6	ELM9856AB	LVR-IC	5.6V±2%, 200mA	SOT-89	20vl	VR1	4a	Elm
D6	TC54VC3602MB	Vdet-IC	3.6V±2%, -Reset PPO	SOT-89	20vda	VD7	4b	Tcs



SMD
code

Type

Function

Short description

Case Pinout Sch. St. Mnf.

SMD code	Type	Function	Short description	Case	Pinout	Sch.	St.	Mnf.
D6	XC61CC3602P	Vdet-IC	3.6V±1%, +Reset PPO	SOT-89	20vda	VD7	4b	Tor
D60A	ML6102C602P	Vdet-IC	6.0V±2%, -Reset PPO	SOT-89	20vda	VD7	4g	Mlc
D63	XE61CC3645PR	Vdet-IC	3.6V±2%, -Reset PPO	SOT-89	20cj	VD7	4j	Tor
D65	XC61FC3612P	Vdet-IC	3.6V±2%, +Reset PPO, 200ms	SOT-89	20vda	VD7	4b	Tor
D66	XC61FC3642P	Vdet-IC	3.6V±2%, +Reset PPO, 400ms	SOT-89	20vda	VD7	4b	Tor
D67	XC61FC3652P	Vdet-IC	3.6V±2%, +Reset PPO, 50ms	SOT-89	20vda	VD7	4b	Tor
D7	ELM9737NAB	Vdet-IC	3.7V±2.5%, +Reset ODO	SOT-89	20vda	VD6	4a	Elm
D7	ELM9857AB	LVR-IC	5.7V±2%, 200mA	SOT-89	20vl	VR1	4a	Elm
D7	TC54VC3702MB	Vdet-IC	3.7V±2%, -Reset PPO	SOT-89	20vda	VD7	4b	Tcs
D7	XC61CC3702P	Vdet-IC	3.7V±1%, +Reset PPO	SOT-89	20vda	VD7	4b	Tor
D73	XE61CC3745PR	Vdet-IC	3.7V±2%, -Reset PPO	SOT-89	20cj	VD7	4j	Tor
D75	XC61FC3712P	Vdet-IC	3.7V±2%, +Reset PPO, 200ms	SOT-89	20vda	VD7	4b	Tor
D76	XC61FC3742P	Vdet-IC	3.7V±2%, +Reset PPO, 400ms	SOT-89	20vda	VD7	4b	Tor
D77	XC61FC3752P	Vdet-IC	3.7V±2%, +Reset PPO, 50ms	SOT-89	20vda	VD7	4b	Tor
D8	ELM9738NAB	Vdet-IC	3.8V±2.5%, +Reset ODO	SOT-89	20vda	VD6	4a	Elm
D8	ELM9858AB	LVR-IC	5.8V±2%, 200mA	SOT-89	20vl	VR1	4a	Elm
D8	TC54VC3802MB	Vdet-IC	3.8V±2%, -Reset PPO	SOT-89	20vda	VD7	4b	Tcs
D8	XC61CC3802P	Vdet-IC	3.8V±1%, +Reset PPO	SOT-89	20vda	VD7	4b	Tor
D83	XE61CC3845PR	Vdet-IC	3.8V±2%, -Reset PPO	SOT-89	20cj	VD7	4j	Tor
D85	XC61FC3812P	Vdet-IC	3.8V±2%, +Reset PPO, 200ms	SOT-89	20vda	VD7	4b	Tor
D86	XC61FC3842P	Vdet-IC	3.8V±2%, +Reset PPO, 400ms	SOT-89	20vda	VD7	4b	Tor
D87	XC61FC3852P	Vdet-IC	3.8V±2%, +Reset PPO, 50ms	SOT-89	20vda	VD7	4b	Tor
D882GR	WTM882-GR	Si-npn	GP, 40V, 3A, 500mW, B=200..400, 80MHz	SOT-89	20tb	-	4b	Wtr
D882O	WTM882-O	Si-npn	GP, 40V, 3A, 500mW, B=100..200, 80MHz	SOT-89	20tb	-	4b	Wtr
D882R	WTM882-R	Si-npn	GP, 40V, 3A, 500mW, B=60..120, 80MHz	SOT-89	20tb	-	4b	Wtr
D882Y	WTM882-Y	Si-npn	GP, 40V, 3A, 500mW, B=160..320, 80MHz	SOT-89	20tb	-	4b	Wtr
D9	ELM9739NAB	Vdet-IC	3.9V±2.5%, +Reset ODO	SOT-89	20vda	VD6	4a	Elm
D9	ELM9859AB	LVR-IC	5.9V±2%, 200mA	SOT-89	20vl	VR1	4a	Elm
D9	TC54VC3902MB	Vdet-IC	3.9V±2%, -Reset PPO	SOT-89	20vda	VD7	4b	Tcs
D9	XC61CC3902P	Vdet-IC	3.9V±1%, +Reset PPO	SOT-89	20vda	VD7	4b	Tor
D93	XE61CC3945PR	Vdet-IC	3.9V±2%, -Reset PPO	SOT-89	20cj	VD7	4j	Tor
D95	XC61FC3912P	Vdet-IC	3.9V±2%, +Reset PPO, 200ms	SOT-89	20vda	VD7	4b	Tor
D96	XC61FC3942P	Vdet-IC	3.9V±2%, +Reset PPO, 400ms	SOT-89	20vda	VD7	4b	Tor
D97	XC61FC3952P	Vdet-IC	3.9V±2%, +Reset PPO, 50ms	SOT-89	20vda	VD7	4b	Tor
DA	2SD1418-A	Si-npn	AF, 120V, 1A, 1W, B=60..120, >100MHz	SOT-89	20tb	-	4b	Ren
DA	BF622	Si-npn	Vid, 250V, 50mA, 1.25W, B>50, >60MHz	SOT-89	20tb	-	4b	Phi
DA	ELM99501B	LVR-IC	LDO, 5.0V±2%, 300mA	SOT-89	20vl	VR1	4a	Elm
DA	XC62RP3002P	LVR-IC	LDO, 3V±2%, 6mA, 500mW	SOT-89	20vl	VR1	4c	Tor
DAP	2SD1664-P	Si-npn	AF-Drv, 40V, 1A, 500mW, B=82..180, >150MHz	SOT-89	20tb	-	4b	Rhm
DAP	2SD1664PT-R	Si-npn	AF, Sw, 32V, 1A, B=82..180, 150MHz	SOT-89	20tb	-	4b	Chm
DAQ	2SD1664-Q	Si-npn	AF-Drv, 40V, 1A, 500mW, B=120..270, >150MHz	SOT-89	20tb	-	4b	Rhm
DAR	2SD1664-R	Si-npn	AF-Drv, 40V, 1A, 500mW, B=180..390, >150MHz	SOT-89	20tb	-	4b	Rhm
DAS	2SD1618-S	Si-npn	Lo-sat, 20V, 700mA, 500mW, B=140..280, 250MHz	PCP	20tb	-	4a	San
DAT	2SD1618-T	Si-npn	Lo-sat, 20V, 700mA, 500mW, B=200..400, 250MHz	PCP	20tb	-	4a	San
DAU	2SD1618-U	Si-npn	Lo-sat, 20V, 700mA, 500mW, B=280..560, 250MHz	PCP	20tb	-	4a	San
DB	2SD1418-B	Si-npn	AF, 120V, 1A, 1W, B=100..200, >100MHz	SOT-89	20tb	-	4b	Ren
DB	BF623	Si-npn	Vid, 250V, 50mA, 1.25W, B>50, >60MHz	SOT-89	20tb	-	4b	Phi
DB	ELM99511B	LVR-IC	LDO, 5.1V±2%, 300mA	SOT-89	20vl	VR1	4a	Elm
DB	XC62RP3102P	LVR-IC	LDO, 3.1V±2%, 6mA, 500mW	SOT-89	20vl	VR1	4c	Tor
DBP	2SD1766B-P	Si-npn	AF-Drv, 40V, 2A, 500mW, B=82..180, >100MHz	SOT-89	20tb	-	4b	Rhm
DBQ	2SD1766B-Q	Si-npn	AF-Drv, 40V, 2A, 500mW, B=120..270, >100MHz	SOT-89	20tb	-	4b	Rhm
DBR	2SD1619-R	Si-npn	AF-Amp, 25V, 1A, 500mW, B=100..200, 180MHz	PCP	20tb	-	4a	San
DBR	2SD1766B-R	Si-npn	AF-Drv, 40V, 2A, 500mW, B=180..390, >100MHz	SOT-89	20tb	-	4b	Rhm
DBS	2SD1619-S	Si-npn	AF-Amp, 25V, 1A, 500mW, B=140..280, 180MHz	PCP	20tb	-	4a	San
DBT	2SD1619-T	Si-npn	AF-Amp, 25V, 1A, 500mW, B=200..400, 180MHz	PCP	20tb	-	4a	San
DBU	2SD1619-U	Si-npn	AF-Amp, 25V, 1A, 500mW, B=280..560, 180MHz	PCP	20tb	-	4a	San
DC	2SC3444-C	Si-npn	Relay-Drv, 60V, 1A, 500mW, B=55..110, 80MHz	SOT-89	20tb	-	4a	Mit
DC	2SD1418-C	Si-npn	AF, 120V, 1A, 1W, B=60..320, >100MHz	SOT-89	20tb	-	4b	Ren
DC	2SD1620	Si-npn	Stroke, 30V, 3A, 500mW, B=1400..210, 200MHz	PCP	20tb	-	4a	San
DC	BF620	Si-npn	Vid, 300V, 50mA, 1.25W, B>50, >60MHz	SOT-89	20tb	-	4b	Phi
DC	BFN20	Si-npn	Vid, 300V, 20..50mA, >60MHz	SOT-89	20tb	-	4b	Sie
DC	ELM99521B	LVR-IC	LDO, 5.2V±2%, 300mA	SOT-89	20vl	VR1	4a	Elm
DC	XC62RP3202P	LVR-IC	LDO, 3.2V±2%, 6mA, 500mW	SOT-89	20vl	VR1	4c	Tor
DC-	RT9261-27PX	DC/DC-IC	VFM step-up, 2.7V±2%, 50mA	SOT-89	20br	DC5	4b	Rct
DCP	2SD1767-P	Si-npn	GP, AF, 80V, 700mA, 500mW, B=82..180, >120MHz	SOT-89	20tb	-	4b	Rhm
DCQ	2SD1767-Q	Si-npn	GP, AF, 80V, 700mA, 500mW, B=120..270, >120MHz	SOT-89	20tb	-	4b	Rhm
DCR	2SD1767-R	Si-npn	GP, AF, 80V, 700mA, 500mW, B=180..390, >120MHz	SOT-89	20tb	-	4b	Rhm
DD	2SC3444-D	Si-npn	Relay-Drv, 60V, 1A, 500mW, B=90..180, 80MHz	SOT-89	20tb	-	4a	Mit
DD	2SD1419-D	Si-npn	AF, 120V, 1A, 1W, B=60..120, >100MHz	SOT-89	20tb	-	4b	Ren
DD	BFN16	Si-npn	Vid, 250V, 0.2A, >60MHz	SOT-89	20tb	-	4b	Sie,Zx



SMD
code

Type

Function

Short description

Case Pinout Sch. St. Mnf.

SMD code	Type	Function	Short description	Case	Pinout	Sch.	St.	Mnf.
DD	ELM99531B	LVR-IC	LDO, 5.3V±2%, 300mA	SOT-89	20vl	VR1	4a	Elm
DD	XC62RP3302P	LVR-IC	LDO, 3.3V±2%, 6mA, 500mW	SOT-89	20vl	VR1	4c	Tor
DDP	2SD1766D-P	Si-npn	AF-Drv, 40V, 2A, 500mW, B=82..180, >100MHz	SOT-89	20tb	-	4b	Rhm
DDQ	2SD1766D-Q	Si-npn	AF-Drv, 40V, 2A, 500mW, B=120..270, >100MHz	SOT-89	20tb	-	4b	Rhm
DDR	2SD1621-R	Si-npn	Drv, 30V, 2A, 500mW, B=100..200, 150MHz	PCP	20tb	-	4a	San
DDR	2SD1766D-R	Si-npn	AF-Drv, 40V, 2A, 500mW, B=180..390, >100MHz	SOT-89	20tb	-	4b	Rhm
DDS	2SD1621-S	Si-npn	Drv, 30V, 2A, 500mW, B=140..280, 150MHz	PCP	20tb	-	4a	San
DDT	2SD1621-T	Si-npn	Drv, 30V, 2A, 500mW, B=200..400, 150MHz	PCP	20tb	-	4a	San
DDU	2SD1621-U	Si-npn	Drv, 30V, 2A, 500mW, B=280..560, 150MHz	PCP	20tb	-	4a	San
DE	2SC3444-E	Si-npn	Relay-Drv, 60V, 1A, 500mW, B=150..300, 80MHz	SOT-89	20tb	-	4a	Mit
DE	2SD1419-E	Si-npn	AF, 120V, 1A, 1W, B=100..200, >100MHz	SOT-89	20tb	-	4b	Ren
DE	2SD1834	Si-npn-Darl	AF-Drv, 60V, 1A, 500mW, B>2000	SOT-89	20tb	-	4b	Rhm
DE	BFN18	Si-npn	Vid, 300V, 200mA, 1W, B>30, >70MHz	SOT-89	20tb	-	4b	Sie
DE	ELM99541B	LVR-IC	LDO, 5.4V±2%, 300mA	SOT-89	20vl	VR1	4a	Elm
DE	XC62RP3402P	LVR-IC	LDO, 3.4V±2%, 6mA, 500mW	SOT-89	20vl	VR1	4c	Tor
DER	2SD1622-R	Si-npn	AF-Amp, 60V, 1A, 500mW, B=100..200, 150MHz	PCP	20tb	-	4a	San
DES	2SD1622-S	Si-npn	AF-Amp, 60V, 1A, 500mW, B=140..280, 150MHz	PCP	20tb	-	4a	San
DET	2SD1622-T	Si-npn	AF-Amp, 60V, 1A, 500mW, B=200..400, 150MHz	PCP	20tb	-	4a	San
DEU	2SD1622-U	Si-npn	AF-Amp, 60V, 1A, 500mW, B=280..560, 150MHz	PCP	20tb	-	4a	San
DF	BF621	Si-npn	Vid, 300V, 50mA, 1.25W, B>50, >60MHz	SOT-89	20tb	-	4b	Phi
DF	BFN21	Si-npn	Vid, 300V, 20..50mA, >60MHz	SOT-89	20tb	-	4b	Sie
DF	ELM99551B	LVR-IC	LDO, 5.5V±2%, 300mA	SOT-89	20vl	VR1	4a	Elm
DF	XC62RP3502P	LVR-IC	LDO, 3.5V±2%, 6mA, 500mW	SOT-89	20vl	VR1	4c	Tor
DF-	RT9261-30PX	DC/DC-IC	VFM step-up, 3.0V±2%, 50mA	SOT-89	20br	DC5	4b	Rct
DF_	2SD1898	Si-npn	AF-Drv, 80V, 1A, 2W, B=82..390, >100MHz	SOT-89	20tb	-	4b	Rhm
DFF	2SD1898-P	Si-npn	GP, 100V, 1A, 500mW, 100MHz, B=82..180	SOT-89	20tb	-	4b	Rhm
DFQ	2SD1898-Q	Si-npn	GP, 100V, 1A, 500mW, 100MHz, B=120..270	SOT-89	20tb	-	4b	Rhm
DFR	2SD1623-R	Si-npn	Drv, 60V, 2A, 200mW, B=100..200, 150MHz	PCP	20tb	-	4a	San
DFR	2SD1898-R	Si-npn	GP, 100V, 1A, 500mW, 100MHz, B=180..390	SOT-89	20tb	-	4b	Rhm
DFS	2SD1623-S	Si-npn	Drv, 60V, 2A, 200mW, B=140..280, 150MHz	PCP	20tb	-	4a	San
DFT	2SD1623-T	Si-npn	Drv, 60V, 2A, 200mW, B=200..400, 150MHz	PCP	20tb	-	4a	San
DFU	2SD1623-U	Si-npn	Drv, 60V, 2A, 200mW, B=280..560, 150MHz	PCP	20tb	-	4a	San
DG	BFN17	Si-npn	Vid, 250V, 200mA, 1W, B>40, >100MHz	SOT-89	20tb	-	4b	Sie,Zx
DG	ELM99561B	LVR-IC	LDO, 5.6V±2%, 300mA	SOT-89	20vl	VR1	4a	Elm
DGQ	2SD1963-Q	Si-npn	AF-Drv, 50V, 3A, 500mW, B=120..270, >150MHz	SOT-89	20tb	-	4b	Rhm
DGR	2SD1624-R	Si-npn	Drv, 60V, 3A, 500mW, B=100..200, 150MHz	PCP	20tb	-	4a	San
DGR	2SD1963-R	Si-npn	AF-Drv, 50V, 3A, 500mW, B=180..390, >150MHz	SOT-89	20tb	-	4b	Rhm
DGS	2SD1624-S	Si-npn	Drv, 60V, 3A, 500mW, B=140..280, 150MHz	PCP	20tb	-	4a	San
DGS	2SD1963-S	Si-npn	AF-Drv, 50V, 3A, 500mW, B=270..560, >150MHz	SOT-89	20tb	-	4b	Rhm
DGT	2SD1624-T	Si-npn	Drv, 60V, 3A, 500mW, B=280..560, 150MHz	PCP	20tb	-	4a	San
DGU	2SD1624-U	Si-npn	Drv, 60V, 3A, 500mW, B=280..560, 150MHz	PCP	20tb	-	4a	San
DH	2SB1025-H	Si-npn	AF, 120V, 1A, 1W, B=60..120, >100MHz	SOT-89	20tb	-	4b	Ren
DH	2SD1625	Si-npn-Darl	Drv, 80V, 700mA, 500mW, B=5000, 200MHz	PCP	20tb	-	4a	San
DH	BFN19	Si-npn	Vid, 300V, 200mA, 1W, B>30, >100MHz	SOT-89	20tb	-	4b	Sie
DH	ELM99571B	LVR-IC	LDO, 5.7V±2%, 300mA	SOT-89	20vl	VR1	4a	Elm
DH	RXTA28	Si-npn-Darl	GP, 80V, 500mA, 500mW, B>10000, >100MHz	SOT-89	20tb	-	4b	Rhm
DI	2SD1626	Si-npn-Darl	Drv, 80V, 1.5A, 500mW, B>4000, 120MHz	PCP	20tb	-	4a	San
DJ	2SB1025-J	Si-npn	AF, 120V, 1A, 1W, B=100..200, >100MHz	SOT-89	20tb	-	4b	Ren
DJ	2SD1627	Si-npn-Darl	Drv, 30V, 2A, 500mW, B>4000, 120MHz	PCP	20tb	-	4a	San
DJ	ELM99581B	LVR-IC	LDO, 5.8V±2%, 300mA	SOT-89	20vl	VR1	4a	Elm
DJ-	RT9261-33PX	DC/DC-IC	VFM step-up, 3.3V±2%, 50mA	SOT-89	20br	DC5	4b	Rct
DK	2SB1025-K	Si-npn	AF, 120V, 1A, 1W, B=160..320, >100MHz	SOT-89	20tb	-	4b	Ren
DK	2SB798-K	Si-npn	AF-Amp, 30V, 1A, 2W, 110MHz, B=90..180	SOT-89	20tb	-	4b	Nec
DK	2SD1628-E	Si-npn	Sw, 60V, 5A, 500mA, B=120..200, 120MHz, 30/340ns	PCP	20tb	-	4a	San
DK	2SD1628-F	Si-npn	Sw, 60V, 5A, 500mA, B=160..320, 120MHz, 30/340ns	PCP	20tb	-	4a	San
DK	2SD1628-G	Si-npn	Sw, 60V, 5A, 500mA, B=280..560, 120MHz, 30/340ns	PCP	20tb	-	4a	San
DK	ELM99591B	LVR-IC	LDO, 5.9V±2%, 300mA	SOT-89	20vl	VR1	4a	Elm
DKP	2SC4672-P	Si-npn	AF-Drv, 60V, 2A, 500mW, B=82..180, >210MHz	SOT-89	20tb	-	4b	Rhm
DKQ	2SC4672-Q	Si-npn	AF-Drv, 60V, 2A, 500mW, B=120..270, >210MHz	SOT-89	20tb	-	4b	Rhm
DL	2SB1026-L	Si-npn	AF, 120V, 1A, 1W, B=60..120, >100MHz	SOT-89	20tb	-	4b	Ren
DL	2SB798-L	Si-npn	AF-Amp, 30V, 1A, 2W, 110MHz, B=135..270	SOT-89	20tb	-	4b	Nec
DL	2SD2099	Si-npn-Digi+Di	Motor-Drv, 40V, 3A, 1.5W, B>70, 100kHz, R1=90Ω, R2=800Ω	PCP	20tb	-	4a	San
DLN	2SD2167-N	Si-npn	Relay-Drv, 31V, 2A, 500mW, B=56..120, >100MHz, Z-Di (C->B)	SOT-89	20tb	-	4b	Rhm
DLP	2SD2167-P	Si-npn	Relay-Drv, 31V, 2A, 500mW, B=82..180, >100MHz, Z-Di (C->B)	SOT-89	20tb	-	4b	Rhm
DLQ	2SD2167-Q	Si-npn	Relay-Drv, 31V, 2A, 500mW, B=120..270, >100MHz, Z-Di (C->B)	SOT-89	20tb	-	4b	Rhm
DM	2SB1026-M	Si-npn	AF, 120V, 1A, 1W, B=100..200, >100MHz	SOT-89	20tb	-	4b	Ren
DM	2SB798-M	Si-npn	AF-Amp, 30V, 1A, 2W, 110MHz, B=200..400	SOT-89	20tb	-	4b	Nec
DM	2SD1998	Si-npn-Digi+Di	Motor-Drv, 40V, 3A, 1.5W, B>70, 100MHz, R2=800Ω	PCP	20tb	-	4a	San
DM	2SD2170	Si-npn-Darl	AF, 90V, 2A, 500mW, B=1000..10000, >80MHz	SOT-89	20tb	-	4b	Rhm
DN	2SD1999	Si-npn-Digi+Di	Motor-Drv, 25V, 4A, 1.5W, B>70, 200MHz, R2=1.5kΩ	PCP	20tb	-	4a	San



SMD
code

Type

Function

Short description

Case Pinout Sch. St. Mnf.

SMD code	Type	Function	Short description	Case	Pinout	Sch.	St.	Mnf.
DNV	2SD2153-U	Si-npn	Hi-beta, 30, 2A, 500mW, 110MHz, B=560..1200	MPT3	20tb	-	4b	Rhm
DNV	2SD2153-V	Si-npn	Hi-beta, 30, 2A, 500mW, 110MHz, B=820..1800	MPT3	20tb	-	4b	Rhm
DNW	2SD2153-W	Si-npn	Hi-beta, 30, 2A, 500mW, 110MHz, B=1200..2700	MPT3	20tb	-	4b	Rhm
DO	2SA1201-O	Si-pnp	HV, 120V, 80mA, 500mW, B=70..140, 120MHz	SOT-89	20tb	-	4b	Tos
DO	2SD1997	Si-npn-Digi+Di	Motor-Drv, 40V, 3A, 1.5W, B>70, 100MHz, R1=160Ω, R2=0.8k	PCP	20tb	-	4a	San
DO	KTA1661-O	Si-pnp	Drv, 120V, 800mA, 1W, B=80..160, 120MHz	SOT-89	20tb	-	4a	Kec
DP	2SB789-P	Si-pnp	AF-Drv, 100V, 1A, 1W, B=60..120, 120MHz	SOT-89	20tb	-	4b	Pan
DP	2SD2100	Si-npn-Digi+Di	Motor-Drv, 25V, 2A, 1.3W, B>70, 200MHz, R2=1.6kΩ	PCP	20tb	-	4a	San
DP	2SD2195	Si-npn-Darl+Di	GP, 100V, 2A, 2W, B=1000..10000, 80MHz	SOT-89	20tb	-	4b	Rhm
DP	HQ1L2N	Si-pnp-Digi	Sw, 20V, 2A, 2W, R1/R2=0k47/4k7	SOT-89	20tb	-	4b	Nec
DPE	XC6214P152PR	LVR-IC	LDO, 1.5V±2%, 500mA	SOT-89	20vl	VR1	4e	Tor
DPF	XC6214P162PR	LVR-IC	LDO, 1.6V±2%, 500mA	SOT-89	20vl	VR1	4e	Tor
DPH	XC6214P172PR	LVR-IC	LDO, 1.7V±2%, 500mA	SOT-89	20vl	VR1	4e	Tor
DPK	XC6214P182PR	LVR-IC	LDO, 1.8V±2%, 500mA	SOT-89	20vl	VR1	4e	Tor
DPL	XC6214P192PR	LVR-IC	LDO, 1.9V±2%, 500mA	SOT-89	20vl	VR1	4e	Tor
DPM	XC6214P202PR	LVR-IC	LDO, 2V±2%, 500mA	SOT-89	20vl	VR1	4e	Tor
DPN	XC6214P212PR	LVR-IC	LDO, 2.1V±2%, 500mA	SOT-89	20vl	VR1	4e	Tor
DPP	XC6214P222PR	LVR-IC	LDO, 2.2V±2%, 500mA	SOT-89	20vl	VR1	4e	Tor
DPR	XC6214P232PR	LVR-IC	LDO, 2.3V±2%, 500mA	SOT-89	20vl	VR1	4e	Tor
DPS	XC6214P242PR	LVR-IC	LDO, 2.4V±2%, 500mA	SOT-89	20vl	VR1	4e	Tor
DPT	XC6214P252PR	LVR-IC	LDO, 2.5V±2%, 500mA	SOT-89	20vl	VR1	4e	Tor
DPV	XC6214P262PR	LVR-IC	LDO, 2.6V±2%, 500mA	SOT-89	20vl	VR1	4e	Tor
DPV	XC6214P272PR	LVR-IC	LDO, 2.7V±2%, 500mA	SOT-89	20vl	VR1	4e	Tor
DPX	XC6214P282PR	LVR-IC	LDO, 2.8V±2%, 500mA	SOT-89	20vl	VR1	4e	Tor
DPY	XC6214P292PR	LVR-IC	LDO, 2.9V±2%, 500mA	SOT-89	20vl	VR1	4e	Tor
DPZ	XC6214P302PR	LVR-IC	LDO, 3V±2%, 500mA	SOT-89	20vl	VR1	4e	Tor
DQ	2SB789-Q	Si-pnp	AF-Drv, 100V, 1A, 1W, B=90.155, 120MHz	SOT-89	20tb	-	4b	Pan
DQ	2SD2176	Si-npn-Darl+Di	Motor-Drv, 50V, 1.2A, 1.3W, B=1000..2000, Z-Di(B > C)	PCP	20tb	-	4a	San
DQ	HQ1A3M	Si-pnp-Digi	Sw, 20V, 2A, 2W, R1/R2=1k/1k	SOT-89	20tb	-	4b	Nec
DQN	2SD2211-N	Si-npn	AF, Sw, 160V, 1.5A, 500mW, B=56..120, >80MHz	SOT-89	20tb	-	4b	Rhm
DQP	2SD2211-P	Si-npn	AF, Sw, 160V, 1.5A, 500mW, B=82..180, >80MHz	SOT-89	20tb	-	4b	Rhm
DQQ	2SD2211-Q	Si-npn	AF, Sw, 160V, 1.5A, 500mW, B=120..270, >80MHz	SOT-89	20tb	-	4b	Rhm
DR	2SB789-R	Si-pnp	AF-Drv, 100V, 1A, 1W, B=130..220, 120MHz	SOT-89	20tb	-	4b	Pan
DR	2SC4643	Si-npn	UHF, 15V, 50mA, 400mW, B=40..250, >5.5GHz	SOT-89	20tb	-	4b	Ren
DR	2SD2212	Si-npn-Darl+Di	AF, 60V, 2A, B=1k..10k, 80MHz, Z-Di(B > C)	SOT-89	20tb	-	4b	Rhm
DR	2SD2261	Si-npn-Darl+Di	Motor-Drv, 80V, 2.5A, 1.5W, B=2000..3000	PCP	20tb	-	4a	San
DR	HQ1F3M	Si-pnp-Digi	Sw, 20V, 2A, 2W, R1/R2=0k22/2k2	SOT-89	20tb	-	4b	Nec
DR-	RT9261-40PX	DC/DC-IC	VFM step-up, 4.0V±2%, 50mA	SOT-89	20br	DC5	4b	Rct
DR0	XC6214P312PR	LVR-IC	LDO, 3.1V±2%, 500mA	SOT-89	20vl	VR1	4e	Tor
DR1	XC6214P322PR	LVR-IC	LDO, 3.2V±2%, 500mA	SOT-89	20vl	VR1	4e	Tor
DR2	XC6214P332PR	LVR-IC	LDO, 3.3V±2%, 500mA	SOT-89	20vl	VR1	4e	Tor
DR3	XC6214P342PR	LVR-IC	LDO, 3.4V±2%, 500mA	SOT-89	20vl	VR1	4e	Tor
DR4	XC6214P352PR	LVR-IC	LDO, 3.5V±2%, 500mA	SOT-89	20vl	VR1	4e	Tor
DR5	XC6214P362PR	LVR-IC	LDO, 3.6V±2%, 500mA	SOT-89	20vl	VR1	4e	Tor
DR6	XC6214P372PR	LVR-IC	LDO, 3.7V±2%, 500mA	SOT-89	20vl	VR1	4e	Tor
DR7	XC6214P382PR	LVR-IC	LDO, 3.8V±2%, 500mA	SOT-89	20vl	VR1	4e	Tor
DR8	XC6214P392PR	LVR-IC	LDO, 3.9V±2%, 500mA	SOT-89	20vl	VR1	4e	Tor
DR9	XC6214P402PR	LVR-IC	LDO, 4V±2%, 500mA	SOT-89	20vl	VR1	4e	Tor
DRA	XC6214P412PR	LVR-IC	LDO, 4.1V±2%, 500mA	SOT-89	20vl	VR1	4e	Tor
DRB	XC6214P422PR	LVR-IC	LDO, 4.2V±2%, 500mA	SOT-89	20vl	VR1	4e	Tor
DRC	XC6214P432PR	LVR-IC	LDO, 4.3V±2%, 500mA	SOT-89	20vl	VR1	4e	Tor
DRD	XC6214P442PR	LVR-IC	LDO, 4.4V±2%, 500mA	SOT-89	20vl	VR1	4e	Tor
DRE	XC6214P452PR	LVR-IC	LDO, 4.5V±2%, 500mA	SOT-89	20vl	VR1	4e	Tor
DRF	XC6214P462PR	LVR-IC	LDO, 4.6V±2%, 500mA	SOT-89	20vl	VR1	4e	Tor
DRH	XC6214P472PR	LVR-IC	LDO, 4.7V±2%, 500mA	SOT-89	20vl	VR1	4e	Tor
DRK	XC6214P482PR	LVR-IC	LDO, 4.8V±2%, 500mA	SOT-89	20vl	VR1	4e	Tor
DRL	XC6214P492PR	LVR-IC	LDO, 4.9V±2%, 500mA	SOT-89	20vl	VR1	4e	Tor
DRN	XC6214P502PR	LVR-IC	LDO, 5V±2%, 500mA	SOT-89	20vl	VR1	4e	Tor
DS	2SB789-S	Si-pnp	AF-Drv, 100V, 1A, 1W, B=170..340, 120MHz	SOT-89	20tb	-	4b	Pan
DS	2SD1946	Si-npn	Hi-beta, 15V, 1A, B=800	SOT-89	20tb	-	4b	Ren
DS	HQ1F3P	Si-pnp-Digi	Sw, 20V, 2A, 2W, R1/R2=2k2/10k	SOT-89	20tb	-	4b	Nec
DT	2SD1471-D	Si-npn-Darl+Di	GP, 40V, 300mA, 1W, B=2000..100K	SOT-89	20te	-	4b	Ren
DT	HQ1L2Q	Si-pnp-Digi	Sw, 20V, 2A, 2W, R1/R2=4k7/10k	SOT-89	20tb	-	4b	Nec
DTP	2SD2391-P	Si-npn	AF, 60V, 2A, 500mW, B=82..180, >210MHz	SOT-89	20tb	-	4b	Rhm
DTQ	2SD2391-Q	Si-npn	AF, 60V, 2A, 500mW, B=120..270, >210MHz	SOT-89	20tb	-	4b	Rhm
DU	HQ1F2Q	Si-pnp-Digi	Sw, 20V, 2A, 2W, R1/R2=10k/10k	SOT-89	20tb	-	4b	Nec
DVV	2SD2537-V	Si-npn	Hi-beta, 30V, 2A, 2W, 200MHz, B=820..1800	MPT3	20tb	-	4b	Rhm
DWW	2SD2537-W	Si-npn	Hi-beta, 30V, 2A, 2W, 200MHz, B=1200..2700	MPT3	20tb	-	4b	Rhm
DX	HQ1A4A	Si-pnp-Digi	Sw, 20V, 2A, 2W, R2=10k	SOT-89	20tb	-	4b	Nec
DY	2SA1201-Y	Si-pnp	HV, 120V, 80mA, 500mW, B=120..240, 120MHz	SOT-89	20tb	-	4b	Tos



SMD
code

Type

Function

Short description

Case Pinout Sch. St. Mnf.

SMD code	Type	Function	Short description	Case	Pinout	Sch.	St.	Mnf.
DY	2SK1579	n-MOSFET-e*	V-MOS, Rgate, 12V, ±2A, 500/1500ns	SOT-89	20fa	-	4b	Ren
DY	KTG1661-Y	Si-pnp	Drv, 120V, 800mA, 1W, B=120..240, 120MHz	SOT-89	20fb	-	4a	Kec
E0	ELM9740NAB	Vdet-IC	4.0V±2.5%, +Reset ODO	SOT-89	20vda	VD6	4a	Elm
E0	ELM9860AB	LVR-IC	6.0V±2%, 200mA	SOT-89	20vl	VR1	4a	Elm
E0	TC54VC4002MB	Vdet-IC	4.0V±2%, -Reset PPO	SOT-89	20vda	VD7	4b	Tcs
E0	XC61CC4002P	Vdet-IC	4V±1%, +Reset PPO	SOT-89	20vda	VD7	4b	Tor
E001G	ECG001B-G	MMIC	Buff/amp, DC. 6GHz, 22dB (1GHz, 50Ω)	SOT-89	20aa	A1	4i	Wjc
E002G	ECG002B-G	MMIC	Buff/amp, DC. 6GHz, 20dB (1GHz, 50Ω)	SOT-89	20aa	A1	4i	Wjc
E003G	ECG003B-G	MMIC	Buff/amp, DC. 6GHz, 20dB (1GHz, 50Ω)	SOT-89	20aa	A1	4i	Wjc
E004G	ECG004B-G	MMIC	Buff/amp, DC. 6GHz, 16.2dB (1GHz, 50Ω)	SOT-89	20aa	A1	4i	Wjc
E005G	ECG005B-G	MMIC	Buff/amp, DC. 4GHz, 22.1dB (1GHz, 50Ω)	SOT-89	20aa	A1	4i	Wjc
E006G	ECG006B-G	MMIC	Buff/amp, DC. 5.5GHz, 15dB (1GHz, 50Ω)	SOT-89	20aa	A1	4i	Wjc
E008G	ECG008B-G	MMIC	Buff/amp, DC. 4GHz, 15dB (1GHz, 50Ω)	SOT-89	20aa	A1	4i	Wjc
E01	DTDG14GP	Si-npn-Digi	Sw, 60V, 1A, 500mW, B>300, 80MHz, R2=10k	SOT-89	20tb	-	4b	Rhm
E02	DTDG23YP	Si-npn-Digi	Sw, 50V, 1A, 1.5mW, 250MHz, R1/R2=4k7/4k7+Z-Diode	MPT3	20tb	-	4b	Rhm
E03	XE61CC4045PR	Vdet-IC	4.0V±2%, -Reset PPO	SOT-89	20cj	VD7	4j	Tor
E040G	ECG040B-G	MMIC	Buff/amp, DC. 4GHz, 16dB (1GHz, 50Ω)	SOT-89	20aa	A1	4i	Wjc
E05	XC61FC4012P	Vdet-IC	4V±2%, +Reset PPO, 200ms	SOT-89	20vda	VD7	4b	Tor
E055G	ECG055B-G	MMIC	Buff/amp, DC. 6GHz, 20.5B (1GHz, 50Ω)	SOT-89	20aa	A1	4i	Wjc
E06	XC61FC4042P	Vdet-IC	4V±2%, +Reset PPO, 400ms	SOT-89	20vda	VD7	4b	Tor
E07	XC61FC4052P	Vdet-IC	4V±2%, +Reset PPO, 50ms	SOT-89	20vda	VD7	4b	Tor
E1	2SA1737	Si-pnp	Vid, 85V, 100mA, 1W, 50MHz, B>60	SOT-89	20tb	-	4g	Pan
E1	ELM9741NAB	Vdet-IC	4.1V±2.5%, +Reset ODO	SOT-89	20vda	VD6	4a	Elm
E1	TC54VC4102MB	Vdet-IC	4.1V±2%, -Reset PPO	SOT-89	20vda	VD7	4b	Tcs
E1	XC61CC4102P	Vdet-IC	4.1V±1%, +Reset PPO	SOT-89	20vda	VD7	4b	Tor
E11A	ML6102N113P	Vdet-IC	1.1V±3%, -Reset ODO	SOT-89	20vda	VD6	4g	Mlc
E12A	ML6102N123P	Vdet-IC	1.2V±3%, -Reset ODO	SOT-89	20vda	VD6	4g	Mlc
E13	XE61CC4145PR	Vdet-IC	4.1V±2%, -Reset PPO	SOT-89	20cj	VD7	4j	Tor
E13A	ML6102N133P	Vdet-IC	1.3V±3%, -Reset ODO	SOT-89	20vda	VD6	4g	Mlc
E14A	ML6102N143P	Vdet-IC	1.4V±3%, -Reset ODO	SOT-89	20vda	VD6	4g	Mlc
E15	XC61FC4112P	Vdet-IC	4.1V±2%, +Reset PPO, 200ms	SOT-89	20vda	VD7	4b	Tor
E15A	ML6102N153P	Vdet-IC	1.5V±3%, -Reset ODO	SOT-89	20vda	VD6	4g	Mlc
E16	XC61FC4142P	Vdet-IC	4.1V±2%, +Reset PPO, 400ms	SOT-89	20vda	VD7	4b	Tor
E16A	ML6102N163P	Vdet-IC	1.6V±3%, -Reset ODO	SOT-89	20vda	VD6	4g	Mlc
E17	XC61FC4152P	Vdet-IC	4.1V±2%, +Reset PPO, 50ms	SOT-89	20vda	VD7	4b	Tor
E17A	ML6102N173P	Vdet-IC	1.7V±3%, -Reset ODO	SOT-89	20vda	VD6	4g	Mlc
E18A	ML6102N183P	Vdet-IC	1.8V±3%, -Reset ODO	SOT-89	20vda	VD6	4g	Mlc
E19A	ML6102N193P	Vdet-IC	1.9V±3%, -Reset ODO	SOT-89	20vda	VD6	4g	Mlc
E2	ELM9742NAB	Vdet-IC	4.2V±2.5%, +Reset ODO	SOT-89	20vda	VD6	4a	Elm
E2	TC54VC4202MB	Vdet-IC	4.2V±2%, -Reset PPO	SOT-89	20vda	VD7	4b	Tcs
E2	XC61CC4202P	Vdet-IC	4.2V±1%, +Reset PPO	SOT-89	20vda	VD7	4b	Tor
E20A	ML6102N202P	Vdet-IC	2.0V±2%, -Reset ODO	SOT-89	20vda	VD6	4g	Mlc
E21A	ML6102N212P	Vdet-IC	2.1V±2%, -Reset ODO	SOT-89	20vda	VD6	4g	Mlc
E22A	ML6102N222P	Vdet-IC	2.2V±2%, -Reset ODO	SOT-89	20vda	VD6	4g	Mlc
E23	XE61CC4245PR	Vdet-IC	4.2V±2%, -Reset PPO	SOT-89	20cj	VD7	4j	Tor
E23A	ML6102N232P	Vdet-IC	2.3V±2%, -Reset ODO	SOT-89	20vda	VD6	4g	Mlc
E24A	ML6102N242P	Vdet-IC	2.4V±2%, -Reset ODO	SOT-89	20vda	VD6	4g	Mlc
E25	XC61FC4212P	Vdet-IC	4.2V±2%, +Reset PPO, 200ms	SOT-89	20vda	VD7	4b	Tor
E25A	ML6102N252P	Vdet-IC	2.5V±2%, -Reset ODO	SOT-89	20vda	VD6	4g	Mlc
E26	XC61FC4242P	Vdet-IC	4.2V±2%, +Reset PPO, 400ms	SOT-89	20vda	VD7	4b	Tor
E26A	ML6102N262P	Vdet-IC	2.6V±2%, -Reset ODO	SOT-89	20vda	VD6	4g	Mlc
E27	XC61FC4252P	Vdet-IC	4.2V±2%, +Reset PPO, 50ms	SOT-89	20vda	VD7	4b	Tor
E27A	ML6102N272P	Vdet-IC	2.7V±2%, -Reset ODO	SOT-89	20vda	VD6	4g	Mlc
E28A	ML6102N282P	Vdet-IC	2.8V±2%, -Reset ODO	SOT-89	20vda	VD6	4g	Mlc
E29A	ML6102N292P	Vdet-IC	2.9V±2%, -Reset ODO	SOT-89	20vda	VD6	4g	Mlc
E3	ELM9743NAB	Vdet-IC	4.3V±2.5%, +Reset ODO	SOT-89	20vda	VD6	4a	Elm
E3	TC54VC4302MB	Vdet-IC	4.3V±2%, -Reset PPO	SOT-89	20vda	VD7	4b	Tcs
E3	XC61CC4302P	Vdet-IC	4.3V±1%, +Reset PPO	SOT-89	20vda	VD7	4b	Tor
E30A	ML6102N302P	Vdet-IC	3.0V±2%, -Reset ODO	SOT-89	20vda	VD6	4g	Mlc
E31A	ML6102N312P	Vdet-IC	3.1V±2%, -Reset ODO	SOT-89	20vda	VD6	4g	Mlc
E32A	ML6102N322P	Vdet-IC	3.2V±2%, -Reset ODO	SOT-89	20vda	VD6	4g	Mlc
E33	XE61CC4345PR	Vdet-IC	4.3V±2%, -Reset PPO	SOT-89	20cj	VD7	4j	Tor
E33A	ML6102N332P	Vdet-IC	3.3V±2%, -Reset ODO	SOT-89	20vda	VD6	4g	Mlc
E34A	ML6102N342P	Vdet-IC	3.4V±2%, -Reset ODO	SOT-89	20vda	VD6	4g	Mlc
E35	XC61FC4312P	Vdet-IC	4.3V±2%, +Reset PPO, 200ms	SOT-89	20vda	VD7	4b	Tor
E35A	ML6102N352P	Vdet-IC	3.5V±2%, -Reset ODO	SOT-89	20vda	VD6	4g	Mlc
E36	XC61FC4342P	Vdet-IC	4.3V±2%, +Reset PPO, 400ms	SOT-89	20vda	VD7	4b	Tor
E36A	ML6102N362P	Vdet-IC	3.6V±2%, -Reset ODO	SOT-89	20vda	VD6	4g	Mlc
E37	XC61FC4352P	Vdet-IC	4.3V±2%, +Reset PPO, 50ms	SOT-89	20vda	VD7	4b	Tor
E37A	ML6102N372P	Vdet-IC	3.7V±2%, -Reset ODO	SOT-89	20vda	VD6	4g	Mlc



SMD
code

Type

Function

Short description

Case Pinout Sch. St. Mnf.

E38A	ML6102N382P	Vdet-IC	3.8V±2%, -Reset ODO
E39A	ML6102N392P	Vdet-IC	3.9V±2%, -Reset ODO
E4	ELM9744NAB	Vdet-IC	4.4V±2.5%, +Reset ODO
E4	TC54VC4402MB	Vdet-IC	4.4V±2%, -Reset PPO
E4	XC61CC4402P	Vdet-IC	4.4V±1%, +Reset PPO
E40A	ML6102N402P	Vdet-IC	4.0V±2%, -Reset ODO
E41A	ML6102N412P	Vdet-IC	4.1V±2%, -Reset ODO
E42A	ML6102N422P	Vdet-IC	4.2V±2%, -Reset ODO
E43	XE61CC4445PR	Vdet-IC	4.4V±2%, -Reset PPO
E43A	ML6102N432P	Vdet-IC	4.3V±2%, -Reset ODO
E44A	ML6102N442P	Vdet-IC	4.4V±2%, -Reset ODO
E45	XC61FC4412P	Vdet-IC	4.4V±2%, +Reset PPO, 200ms
E45A	ML6102N452P	Vdet-IC	4.5V±2%, -Reset ODO
E46	XC61FC4442P	Vdet-IC	4.4V±2%, +Reset PPO, 400ms
E46A	ML6102N462P	Vdet-IC	4.6V±2%, -Reset ODO
E47	XC61FC4452P	Vdet-IC	4.4V±2%, +Reset PPO, 50ms
E47A	ML6102N472P	Vdet-IC	4.7V±2%, -Reset ODO
E48A	ML6102N482P	Vdet-IC	4.8V±2%, -Reset ODO
E49A	ML6102N492P	Vdet-IC	4.9V±2%, -Reset ODO
E5	ELM9745NAB	Vdet-IC	4.5V±2.5%, +Reset ODO
E5	TC54VC4502MB	Vdet-IC	4.5V±2%, -Reset PPO
E5	XC61CC4502P	Vdet-IC	4.5V±1%, +Reset PPO
E50A	ML6102N502P	Vdet-IC	5.0V±2%, -Reset ODO
E51A	ML6102N512P	Vdet-IC	5.1V±2%, -Reset ODO
E52A	ML6102N522P	Vdet-IC	5.2V±2%, -Reset ODO
E53	XE61CC4545PR	Vdet-IC	4.5V±2%, -Reset PPO
E53A	ML6102N532P	Vdet-IC	5.3V±2%, -Reset ODO
E54A	ML6102N542P	Vdet-IC	5.4V±2%, -Reset ODO
E55	XC61FC4512P	Vdet-IC	4.5V±2%, +Reset PPO, 200ms
E55A	ML6102N552P	Vdet-IC	5.5V±2%, -Reset ODO
E56	XC61FC4542P	Vdet-IC	4.5V±2%, +Reset PPO, 400ms
E56A	ML6102N562P	Vdet-IC	5.6V±2%, -Reset ODO
E57	XC61FC4552P	Vdet-IC	4.5V±2%, +Reset PPO, 50ms
E57A	ML6102N572P	Vdet-IC	5.7V±2%, -Reset ODO
E58A	ML6102N582P	Vdet-IC	5.8V±2%, -Reset ODO
E59A	ML6102N592P	Vdet-IC	5.9V±2%, -Reset ODO
E6	ELM9746NAB	Vdet-IC	4.6V±2.5%, +Reset ODO
E6	TC54VC4602MB	Vdet-IC	4.6V±2%, -Reset PPO
E6	XC61CC4602P	Vdet-IC	4.6V±1%, +Reset PPO
E60A	ML6102N602P	Vdet-IC	6.0V±2%, -Reset ODO
E63	XE61CC4645PR	Vdet-IC	4.6V±2%, -Reset PPO
E65	XC61FC4612P	Vdet-IC	4.6V±2%, +Reset PPO, 200ms
E66	XC61FC4642P	Vdet-IC	4.6V±2%, +Reset PPO, 400ms
E67	XC61FC4652P	Vdet-IC	4.6V±2%, +Reset PPO, 50ms
E7	ELM9747NAB	Vdet-IC	4.7V±2.5%, +Reset ODO
E7	TC54VC4702MB	Vdet-IC	4.7V±2%, -Reset PPO
E7	XC61CC4702P	Vdet-IC	4.7V±1%, +Reset PPO
E72	2SB772PT-E	Si-pnp	AF, Sw, 30V, 3A, B=250..500, 300MHz
E723	AZ7023RTR-E1	Vdet-IC	2.3V±1.5%, -Reset OCO
E725	AZ7025RTR-E1	Vdet-IC	2.5V±1.5%, -Reset OCO
E727	AZ7027RTR-E1	Vdet-IC	2.7V±1.5%, -Reset OCO
E729	AZ7029RTR-E1	Vdet-IC	2.9V±1.5%, -Reset OCO
E73	XE61CC4745PR	Vdet-IC	4.7V±2%, -Reset PPO
E731	AZ7031RTR-E1	Vdet-IC	3.1V±1.5%, -Reset OCO
E733	AZ7033RTR-E1	Vdet-IC	3.3V±1.5%, -Reset OCO
E742	AZ7042RTR-E1	Vdet-IC	4.2V±1.5%, -Reset OCO
E745	AZ7045RTR-E1	Vdet-IC	4.5V±1.5%, -Reset OCO
E75	XC61FC4712P	Vdet-IC	4.7V±2%, +Reset PPO, 200ms
E76	XC61FC4742P	Vdet-IC	4.7V±2%, +Reset PPO, 400ms
E77	XC61FC4752P	Vdet-IC	4.7V±2%, +Reset PPO, 50ms
E8	ELM9748NAB	Vdet-IC	4.8V±2.5%, +Reset ODO
E8	TC54VC4802MB	Vdet-IC	4.8V±2%, -Reset PPO
E8	XC61CC4802P	Vdet-IC	4.8V±1%, +Reset PPO
E83	XE61CC4845PR	Vdet-IC	4.8V±2%, -Reset PPO
E85	XC61FC4812P	Vdet-IC	4.8V±2%, +Reset PPO, 200ms
E86	XC61FC4842P	Vdet-IC	4.8V±2%, +Reset PPO, 400ms
E87	XC61FC4852P	Vdet-IC	4.8V±2%, +Reset PPO, 50ms
E9	ELM9749NAB	Vdet-IC	4.9V±2.5%, +Reset ODO
E9	TC54VC4902MB	Vdet-IC	4.9V±2%, -Reset PPO
E9	XC61CC4902P	Vdet-IC	4.9V±1%, +Reset PPO



SMD
code

Type

Function

Short description

Case Pinout Sch. St. Mnf.

SMD code	Type	Function	Short description	Case	Pinout	Sch.	St.	Mnf.
E83	XE61CC4945PR	Vdet-IC	4.9V±2%, -Reset PPO	SOT-89	20cj	VD7	4j	Tor
E85	XC61FC4912P	Vdet-IC	4.9V±2%, +Reset PPO, 200ms	SOT-89	20vda	VD7	4b	Tor
E86	XC61FC4942P	Vdet-IC	4.9V±2%, +Reset PPO, 400ms	SOT-89	20vda	VD7	4b	Tor
E87	XC61FC4952P	Vdet-IC	4.9V±2%, +Reset PPO, 50ms	SOT-89	20vda	VD7	4b	Tor
EA	2SD1420-A	Si-npn	AF, 180V, 1.5A, 1W, B=60..120	SOT-89	20tb	-	4a	Ren
EA	ELM99601B	LVR-IC	LDO, 6.0V±2%, 300mA	SOT-89	20vl	VR1	4a	Elm
EAE	2SC5415-E	Si-npn	HF, LN, 20V, 100mA, 800mW, B=90..180, 6.7GHz	PCP	20tb	-	4a	San
EAF	2SC5415-F	Si-npn	HF, LN, 20V, 100mA, 800mW, B=135..270, 6.7GHz	PCP	20tb	-	4a	San
EB	2SD1420-B	Si-npn	AF, 180V, 1.5A, 1W, B=60..120	SOT-89	20tb	-	4a	Ren
EBE	2SC5551-E	Si-npn	HF, 40V, 300mA, 1.3W, B=90..180, 3.5GHz	SOT-89	20tb	-	4a	San
EBF	2SC5551-F	Si-npn	HF, 40V, 300mA, 1.3W, B=135..270, 3.5GHz	SOT-89	20tb	-	4a	San
EC	2SA1368-C	Si-npn	AF, 100V, 500mA, 500mW, B=55..110, 130MHz	SOT-89	20tb	-	4a	Mit
EC	2SD1420-C	Si-npn	AF, 180V, 1.5A, 1W, B=160..320	SOT-89	20tb	-	4b	Ren
ED	2SA1368-D	Si-npn	AF, 100V, 500mA, 500mW, B=90..180, 130MHz	SOT-89	20tb	-	4b	Mit
ED	2SD1421-D	Si-npn	AF, 180V, 1.5A, 1W, B=60..120	SOT-89	20tb	-	4b	Ren
ED	BCV28	Si-npn-Darl	AF, 40V, 500mA, 1.3W, 220MHz, B>4000	SOT-89	20tb	-	4b	Phi
EE	2SA1368-E	Si-npn	AF, 100V, 500mA, 500mW, B=150..300, 130MHz	SOT-89	20tb	-	4b	Mit
EE	2SD1421-E	Si-npn	AF, 180V, 1.5A, 1W, B=100..200	SOT-89	20tb	-	4b	Ren
EE	BCV48	Si-npn-Darl	AF, 80V, 500mA, 1.3W, 220MHz, B>2000	SOT-89	20tb	-	4b	Phi
EF	BCV29	Si-npn-Darl	AF, 40V, 500mA, 1.3W, 220MHz, B>4000	SOT-89	20tb	-	4b	Phi
EG	BCV49	Si-npn-Darl	AF, 80V, 500mA, 1.3W, 220MHz, B>2000	SOT-89	20tb	-	4b	Phi
EH	2SB1027-H	Si-npn	AF, 180V, 1.5A, 1W, B=60..120, >100MHz	SOT-89	20tb	-	4b	Ren
EH-	RT9261A-32PX	DC/DC-IC	VFM step-up, 3.2V±2%, 50mA	SOT-89	20bq	DC2	4b	Rct
EJ	2SB1027-J	Si-npn	AF, 180V, 1.5A, 1W, B=100..200, >100MHz	SOT-89	20tb	-	4b	Ren
EJ-	RT9261A-33PX	DC/DC-IC	VFM step-up, 3.3V±2%, 50mA	SOT-89	20bq	DC2	4b	Rct
EK	2SB1027-K	Si-npn	AF, 180V, 1.5A, 1W, B=160..320, >100MHz	SOT-89	20tb	-	4b	Ren
EK	2SD1001-K	Si-npn	AF-Amp, 80V, 300mA, 2W, 140MHz, B=200..400	SOT-89	20tb	-	4a	Nec
EL	2SB1028-L	Si-npn	AF, 180V, 1.5A, 1W, B=60..120, >100MHz	SOT-89	20tb	-	4b	Ren
EL	2SD1001-L	Si-npn	AF-Amp, 80V, 300mA, 2W, 140MHz, B=135..270	SOT-89	20tb	-	4a	Nec
EM	2SB1028-M	Si-npn	AF, 180V, 1.5A, 1W, B=100..200, >100MHz	SOT-89	20tb	-	4b	Ren
EM	2SD1001-M	Si-npn	AF-Amp, 80V, 300mA, 2W, 140MHz, B=90..180	SOT-89	20tb	-	4a	Nec
EO	2SC2882-O	Si-npn	GP, 80V, 400mA, 500mW, B=70..140, 120MHz	SOT-89	20tb	-	4b	Tos
EO	KT4374-O	Si-npn	GP, AF, 80V, 400mA, 500mW, B=70..140, 120MHz	SOT-89	20tb	-	4a	Kec
EP	2SB789A-P	Si-npn	AF-Drv, 120V, 1A, 1W, B=60..120, 120MHz	SOT-89	20tb	-	4b	Pan
EQ	2SB789A-Q	Si-npn	AF-Drv, 120V, 1A, 1W, B=90..155, 120MHz	SOT-89	20tb	-	4b	Pan
ER	2SB789A-R	Si-npn	AF-Drv, 120V, 1A, 1W, B=130..220, 120MHz	SOT-89	20tb	-	4b	Pan
ER	2SC4807	Si-npn	VHF/UHF, 20V, 200mA, 80mW, 4.4GHz, B=50..250	SOT-89	20tb	-	4b	Ren
ES	2SB789A-S	Si-npn	AF-Drv, 120V, 1A, 1W, B=170..340, 120MHz	SOT-89	20tb	-	4b	Pan
ES	2SD1974	Si-npn+Di	AF, 25V, 800mA, 1W, B=250..1200	UPAK	20tb	-	4b	Ren
ET	2SD1471-E	Si-npn-Darl+Di	GP, 40V, 300mA, 1W, B=5000..100K	SOT-89	20te	-	4b	Ren
EX	2SD2402-X	Si-npn	AF, Sw, 50V, 5A, 2W, 170MHz, B=100..200	SOT-89	20tb	-	4b	Nec
EY	2SC2882-Y	Si-npn	GP, 80V, 400mA, 500mW, B=120..240, 120MHz	SOT-89	20tb	-	4b	Tos
EY	2SD2402-Y	Si-npn	AF, Sw, 50V, 5A, 2W, 170MHz, B=160..320	SOT-89	20tb	-	4b	Nec
EY	2SK1697	n-MOSFET-e*	V-MOS, LogL, 60V, 0.5A, <1.7Q(0.5A)	SOT-89	20fa	-	4b	Ren
EY	KT4374-Y	Si-npn	GP, AF, 80V, 400mA, 500mW, B=120..240, 120MHz	SOT-89	20tb	-	4a	Kec
EZ	2SD2402-Z	Si-npn	AF, Sw, 50V, 5A, 2W, 170MHz, B=200..400	SOT-89	20tb	-	4b	Nec
F0	ELM9750NAB	Vdet-IC	5.0V±2.5%, +Reset ODO	SOT-89	20vda	VD6	4a	Elm
F0	TC54VC5002MB	Vdet-IC	5.0V±2%, -Reset PPO	SOT-89	20vda	VD7	4b	Tcs
F0	XC61CC5002P	Vdet-IC	5V±1%, +Reset PPO	SOT-89	20vda	VD7	4b	Tor
F03	XE61CC5045PR	Vdet-IC	5.0V±2%, -Reset PPO	SOT-89	20cj	VD7	4j	Tor
F05	XC61FC5012P	Vdet-IC	5V±2%, +Reset PPO, 200ms	SOT-89	20vda	VD7	4b	Tor
F06	XC61FC5042P	Vdet-IC	5V±2%, +Reset PPO, 400ms	SOT-89	20vda	VD7	4b	Tor
F07	XC61FC5052P	Vdet-IC	5V±2%, +Reset PPO, 50ms	SOT-89	20vda	VD7	4b	Tor
F1	ELM9751NAB	Vdet-IC	5.1V±2.5%, +Reset ODO	SOT-89	20vda	VD6	4a	Elm
F1	TC54VC5102MB	Vdet-IC	5.1V±2%, -Reset PPO	SOT-89	20vda	VD7	4b	Tcs
F1	XC61CC5102P	Vdet-IC	5.1V±1%, +Reset PPO	SOT-89	20vda	VD7	4b	Tor
F13	XE61CC5145PR	Vdet-IC	5.1V±2%, -Reset PPO	SOT-89	20cj	VD7	4j	Tor
F15	XC61FC5112P	Vdet-IC	5.1V±2%, +Reset PPO, 200ms	SOT-89	20vda	VD7	4b	Tor
F16	XC61FC5142P	Vdet-IC	5.1V±2%, +Reset PPO, 400ms	SOT-89	20vda	VD7	4b	Tor
F17	XC61FC5152P	Vdet-IC	5.1V±2%, +Reset PPO, 50ms	SOT-89	20vda	VD7	4b	Tor
F2	ELM9752NAB	Vdet-IC	5.2V±2.5%, +Reset ODO	SOT-89	20vda	VD6	4a	Elm
F2	TC54VC5202MB	Vdet-IC	5.2V±2%, -Reset PPO	SOT-89	20vda	VD7	4b	Tcs
F2	XC61CC5202P	Vdet-IC	5.2V±1%, +Reset PPO	SOT-89	20vda	VD7	4b	Tor
F23	XE61CC5245PR	Vdet-IC	5.2V±2%, -Reset PPO	SOT-89	20cj	VD7	4j	Tor
F25	XC61FC5212P	Vdet-IC	5.2V±2%, +Reset PPO, 200ms	SOT-89	20vda	VD7	4b	Tor
F26	XC61FC5242P	Vdet-IC	5.2V±2%, +Reset PPO, 400ms	SOT-89	20vda	VD7	4b	Tor
F27	XC61FC5252P	Vdet-IC	5.2V±2%, +Reset PPO, 50ms	SOT-89	20vda	VD7	4b	Tor
F3	ELM9753NAB	Vdet-IC	5.3V±2.5%, +Reset ODO	SOT-89	20vda	VD6	4a	Elm
F3	TC54VC5302MB	Vdet-IC	5.3V±2%, -Reset PPO	SOT-89	20vda	VD7	4b	Tcs
F3	XC61CC5302P	Vdet-IC	5.3V±1%, +Reset PPO	SOT-89	20vda	VD7	4b	Tor



SMD
code

Type

Function

Short description

Case Pinout Sch. St. Mnf.

SMD code	Type	Function	Short description	Case	Pinout	Sch.	St.	Mnf.
F33	XE61CC5345PR	Vdet-IC	5.3V±2%, -Reset PPO	SOT-89	20cj	VD7	4j	Tor
F35	XC61FC5312P	Vdet-IC	5.3V±2%, +Reset PPO, 200ms	SOT-89	20vda	VD7	4b	Tor
F36	XC61FC5342P	Vdet-IC	5.3V±2%, +Reset PPO, 400ms	SOT-89	20vda	VD7	4b	Tor
F37	XC61FC5352P	Vdet-IC	5.3V±2%, +Reset PPO, 50ms	SOT-89	20vda	VD7	4b	Tor
F4	ELM9754NAB	Vdet-IC	5.4V±2.5%, +Reset ODO	SOT-89	20vda	VD6	4a	Elm
F4	TC54VC5402MB	Vdet-IC	5.4V±2%, -Reset PPO	SOT-89	20vda	VD7	4b	Tcs
F4	XC61CC5402P	Vdet-IC	5.4V±1%, +Reset PPO	SOT-89	20vda	VD7	4b	Tor
F43	XE61CC5445PR	Vdet-IC	5.4V±2%, -Reset PPO	SOT-89	20cj	VD7	4j	Tor
F45	XC61FC5412P	Vdet-IC	5.4V±2%, +Reset PPO, 200ms	SOT-89	20vda	VD7	4b	Tor
F46	XC61FC5442P	Vdet-IC	5.4V±2%, +Reset PPO, 400ms	SOT-89	20vda	VD7	4b	Tor
F47	XC61FC5452P	Vdet-IC	5.4V±2%, +Reset PPO, 50ms	SOT-89	20vda	VD7	4b	Tor
F45	ELM9755NAB	Vdet-IC	5.5V±2.5%, +Reset ODO	SOT-89	20vda	VD6	4a	Elm
F5	TC54VC5502MB	Vdet-IC	5.5V±2%, -Reset PPO	SOT-89	20vda	VD7	4b	Tcs
F5	XC61CC5502P	Vdet-IC	5.5V±1%, +Reset PPO	SOT-89	20vda	VD7	4b	Tor
F53	XE61CC5545PR	Vdet-IC	5.5V±2%, -Reset PPO	SOT-89	20cj	VD7	4j	Tor
F55	XC61FC5512P	Vdet-IC	5.5V±2%, +Reset PPO, 200ms	SOT-89	20vda	VD7	4b	Tor
F56	XC61FC5542P	Vdet-IC	5.5V±2%, +Reset PPO, 400ms	SOT-89	20vda	VD7	4b	Tor
F57	XC61FC5552P	Vdet-IC	5.5V±2%, +Reset PPO, 50ms	SOT-89	20vda	VD7	4b	Tor
F6	ELM9816AB	LVR-IC	1.6V±2%, 200mA	SOT-89	20vl	VR1	4a	Elm
F6	TC54VC5602MB	Vdet-IC	5.6V±2%, -Reset PPO	SOT-89	20vda	VD7	4b	Tcs
F6	XC61CC5602P	Vdet-IC	5.6V±1%, +Reset PPO	SOT-89	20vda	VD7	4b	Tor
F63	XE61CC5645PR	Vdet-IC	5.6V±2%, -Reset PPO	SOT-89	20cj	VD7	4j	Tor
F65	XC61FC5612P	Vdet-IC	5.6V±2%, +Reset PPO, 200ms	SOT-89	20vda	VD7	4b	Tor
F66	XC61FC5642P	Vdet-IC	5.6V±2%, +Reset PPO, 400ms	SOT-89	20vda	VD7	4b	Tor
F67	XC61FC5652P	Vdet-IC	5.6V±2%, +Reset PPO, 50ms	SOT-89	20vda	VD7	4b	Tor
F7	ELM9817AB	LVR-IC	1.7V±2%, 200mA	SOT-89	20vl	VR1	4a	Elm
F7	TC54VC5702MB	Vdet-IC	5.7V±2%, -Reset PPO	SOT-89	20vda	VD7	4b	Tcs
F7	XC61CC5702P	Vdet-IC	5.7V±1%, +Reset PPO	SOT-89	20vda	VD7	4b	Tor
F73	XE61CC5745PR	Vdet-IC	5.7V±2%, -Reset PPO	SOT-89	20cj	VD7	4j	Tor
F75	XC61FC5712P	Vdet-IC	5.7V±2%, +Reset PPO, 200ms	SOT-89	20vda	VD7	4b	Tor
F76	XC61FC5742P	Vdet-IC	5.7V±2%, +Reset PPO, 400ms	SOT-89	20vda	VD7	4b	Tor
F77	XC61FC5752P	Vdet-IC	5.7V±2%, +Reset PPO, 50ms	SOT-89	20vda	VD7	4b	Tor
F8	ELM9818AB	LVR-IC	1.8V±2%, 200mA	SOT-89	20vl	VR1	4a	Elm
F8	TC54VC5802MB	Vdet-IC	5.8V±2%, -Reset PPO	SOT-89	20vda	VD7	4b	Tcs
F8	XC61CC5802P	Vdet-IC	5.8V±1%, +Reset PPO	SOT-89	20vda	VD7	4b	Tor
F83	XE61CC5845PR	Vdet-IC	5.8V±2%, -Reset PPO	SOT-89	20cj	VD7	4j	Tor
F85	XC61FC5812P	Vdet-IC	5.8V±2%, +Reset PPO, 200ms	SOT-89	20vda	VD7	4b	Tor
F86	XC61FC5842P	Vdet-IC	5.8V±2%, +Reset PPO, 400ms	SOT-89	20vda	VD7	4b	Tor
F87	XC61FC5852P	Vdet-IC	5.8V±2%, +Reset PPO, 50ms	SOT-89	20vda	VD7	4b	Tor
F9	ELM9819AB	LVR-IC	1.9V±2%, 200mA	SOT-89	20vl	VR1	4a	Elm
F9	TC54VC5901MB	Vdet-IC	5.9V±2%, -Reset PPO	SOT-89	20vda	VD6	4b	Tcs
F9	XC61CC5902P	Vdet-IC	5.9V±1%, +Reset PPO	SOT-89	20vda	VD7	4b	Tor
F93	XE61CC5945PR	Vdet-IC	5.9V±2%, -Reset PPO	SOT-89	20cj	VD7	4j	Tor
F95	XC61FC5912P	Vdet-IC	5.9V±2%, +Reset PPO, 200ms	SOT-89	20vda	VD7	4b	Tor
F96	XC61FC5942P	Vdet-IC	5.9V±2%, +Reset PPO, 400ms	SOT-89	20vda	VD7	4b	Tor
F97	XC61FC5952P	Vdet-IC	5.9V±2%, +Reset PPO, 50ms	SOT-89	20vda	VD7	4b	Tor
FA	2SC5564	Si-npn	Lo-sat, 15V, 6A, 1.3W, B=200..560, 380MHz, 30/110ns	SOT-89	20tb	-	4a	San
FA	BFQ17	Si-npn	RF, 40V, 150mA, 1W, B=25..80, 1.5GHz	SOT-89	20tb	-	4g	Phi
FB	2SC5565	Si-npn	Lo-sat, 40V, 5A, 1.3W, B=200..560, 420MHz, 30/270ns	SOT-89	20tb	-	4a	San
FB	BFQ19	Si-npn	RF, 20V, 100mA, 1W, B=25..80, 5.5GHz	SOT-89	20tb	-	4g	Phi
FC	2SC3438-C	Si-npn	AF-Drv, 100V, 500mA, 500mW, B=55..110, 130MHz	SOT-89	20tb	-	4a	Mit
FC	2SC5566	Si-npn	Lo-sat, 80V, 4A, 1.3W, B=200..560, 400MHz, 30/230ns	SOT-89	20tb	-	4a	San
FC	BFQ64	Si-npn	UHF-A, 30V, 200mA, 3GHz	SOT-89	20tb	-	4b	Sie
FD	2SC3438-D	Si-npn	AF-Drv, 100V, 500mA, 500mW, B=90..180, 130MHz	SOT-89	20tb	-	4a	Mit
FD	2SC5567	Si-npn	Relay-Drv, 15V, 9A, 1.3W, B=200..560, 280MHz	SOT-89	20tb	-	4a	San
FD	BFQ17	Si-npn	RF, 25V, 150mA, 1W, B=25, 1.2GHz	SOT-89	20tb	-	4g	Sie
FD-	RT9261B-28PX	DC/DC-IC	VFM step-up, 2.8V±2%, 50mA	SOT-89	20bq	DC2	4b	Rct
FD=	RT9261B-28GX	DC/DC-IC	VFM step-up, 2.8V±2%, 50mA	SOT-89	20bq	DC2	4b	Rct
FE	2SC3438-E	Si-npn	AF-Drv, 100V, 500mA, 500mW, B=150..300, 130MHz	SOT-89	20tb	-	4a	Mit
FE	2SC5568	Si-npn	Lo-sat, 40V, 8A, 1.3W, B=200..560, 320MHz, 30/190ns	SOT-89	20tb	-	4a	San
FEs	BFQ19P	Si-npn	RF, 40V, 100mA, 1W, B=25..70, 5.5GHz	SOT-89	20tb	-	4g	Sie
FF	2SC5569	Si-npn	Lo-sat, 80V, 7A, 1.3W, B=200..560, 330MHz, 30/225ns	SOT-89	20tb	-	4a	San
FF	BFQ18A	Si-npn	RF, 25V, 150mA, 1W, B>25, 4GHz	SOT-89	20tb	-	4g	Phi
FF	ELM99151B	LVR-IC	LDO, 1.5V±2%, 300mA	SOT-89	20vl	VR1	4a	Elm
FF-	RT9261B-30PX	DC/DC-IC	VFM step-up, 3.0V±2%, 50mA	SOT-89	20bq	DC2	4b	Rct
FG	BFQ149	Si-npn	RF, 20V, 150mA, 1W, B=20..50, 5GHz	SOT-89	20tb	-	4g	Phi
FG	ELM99161B	LVR-IC	LDO, 1.6V±2%, 300mA	SOT-89	20vl	VR1	4a	Elm
FG11G	AIC1747-11GX3A	LVR-IC	LDO, 1.1V±2%, 300mA	SOT-89	20vl	VR1	4g	Aic
FG11P	AIC1747-11PX3A	LVR-IC	LDO, 1.1V±2%, 300mA	SOT-89	20vl	VR1	4g	Aic
FG12G	AIC1747-12GX3A	LVR-IC	LDO, 1.2V±2%, 300mA	SOT-89	20vl	VR1	4g	Aic



SMD
code

Type

Function

Short description

Case Pinout Sch. St. Mnf.

SMD code	Type	Function	Short description	Case	Pinout	Sch.	St.	Mnf.
FG12P	AIC1747-12PX3A	LVR-IC	LDO, 1.2V±2%, 300mA	SOT-89	20vl	VR1	4g	Aic
FG13G	AIC1747-13GX3A	LVR-IC	LDO, 1.3V±2%, 300mA	SOT-89	20vl	VR1	4g	Aic
FG13P	AIC1747-13PX3A	LVR-IC	LDO, 1.3V±2%, 300mA	SOT-89	20vl	VR1	4g	Aic
FG15G	AIC1747-15GX3A	LVR-IC	LDO, 1.5V±2%, 300mA	SOT-89	20vl	VR1	4g	Aic
FG15P	AIC1747-15PX3A	LVR-IC	LDO, 1.5V±2%, 300mA	SOT-89	20vl	VR1	4g	Aic
FG18G	AIC1747-18GX3A	LVR-IC	LDO, 1.8V±2%, 300mA	SOT-89	20vl	VR1	4g	Aic
FG18P	AIC1747-18PX3A	LVR-IC	LDO, 1.8V±2%, 300mA	SOT-89	20vl	VR1	4g	Aic
FG20G	AIC1747-20GX3A	LVR-IC	LDO, 2.0V±2%, 300mA	SOT-89	20vl	VR1	4g	Aic
FG20P	AIC1747-20PX3A	LVR-IC	LDO, 2.0V±2%, 300mA	SOT-89	20vl	VR1	4g	Aic
FG25G	AIC1747-25GX3A	LVR-IC	LDO, 2.5V±2%, 300mA	SOT-89	20vl	VR1	4g	Aic
FG25P	AIC1747-25PX3A	LVR-IC	LDO, 2.5V±2%, 300mA	SOT-89	20vl	VR1	4g	Aic
FG27G	AIC1747-27GX3A	LVR-IC	LDO, 2.7V±2%, 300mA	SOT-89	20vl	VR1	4g	Aic
FG27P	AIC1747-27PX3A	LVR-IC	LDO, 2.7V±2%, 300mA	SOT-89	20vl	VR1	4g	Aic
FG2JG	AIC1747-285GX3A	LVR-IC	LDO, 2.85V±2%, 300mA	SOT-89	20vl	VR1	4g	Aic
FG2JP	AIC1747-285PX3A	LVR-IC	LDO, 2.85V±2%, 300mA	SOT-89	20vl	VR1	4g	Aic
FG30G	AIC1747-30GX3A	LVR-IC	LDO, 3.0V±2%, 300mA	SOT-89	20vl	VR1	4g	Aic
FG30P	AIC1747-30PX3A	LVR-IC	LDO, 3.0V±2%, 300mA	SOT-89	20vl	VR1	4g	Aic
FG33G	AIC1747-33GX3A	LVR-IC	LDO, 3.3V±2%, 300mA	SOT-89	20vl	VR1	4g	Aic
FG33P	AIC1747-33PX3A	LVR-IC	LDO, 3.3V±2%, 300mA	SOT-89	20vl	VR1	4g	Aic
FG35G	AIC1747-35GX3A	LVR-IC	LDO, 3.5V±2%, 300mA	SOT-89	20vl	VR1	4g	Aic
FG35P	AIC1747-35PX3A	LVR-IC	LDO, 3.5V±2%, 300mA	SOT-89	20vl	VR1	4g	Aic
FG37G	AIC1747-37GX3A	LVR-IC	LDO, 3.7V±2%, 300mA	SOT-89	20vl	VR1	4g	Aic
FG37P	AIC1747-37PX3A	LVR-IC	LDO, 3.7V±2%, 300mA	SOT-89	20vl	VR1	4g	Aic
FG38G	AIC1747-38GX3A	LVR-IC	LDO, 3.8V±2%, 300mA	SOT-89	20vl	VR1	4g	Aic
FG38P	AIC1747-38PX3A	LVR-IC	LDO, 3.8V±2%, 300mA	SOT-89	20vl	VR1	4g	Aic
FGs	BFQ19S	Si-npn	RF, LN, 40V, 75mA, 1W, B=40..200, 5.5GHz	SOT-89	20tr	-	4b	Sie
FH	ELM99171B	LVR-IC	LDO, 1.7V±2%, 300mA	SOT-89	20vl	VR1	4a	Elm
FH11G	AIC1747-11GX3T	LVR-IC	LDO, 1.1V±2%, 300mA	SOT-89	20ch	VR1	4g	Aic
FH11P	AIC1747-11PX3T	LVR-IC	LDO, 1.1V±2%, 300mA	SOT-89	20ch	VR1	4g	Aic
FH12G	AIC1747-12GX3T	LVR-IC	LDO, 1.2V±2%, 300mA	SOT-89	20ch	VR1	4g	Aic
FH12P	AIC1747-12PX3T	LVR-IC	LDO, 1.2V±2%, 300mA	SOT-89	20ch	VR1	4g	Aic
FH13G	AIC1747-13GX3T	LVR-IC	LDO, 1.3V±2%, 300mA	SOT-89	20ch	VR1	4g	Aic
FH13P	AIC1747-13PX3T	LVR-IC	LDO, 1.3V±2%, 300mA	SOT-89	20ch	VR1	4g	Aic
FH15G	AIC1747-15GX3T	LVR-IC	LDO, 1.5V±2%, 300mA	SOT-89	20ch	VR1	4g	Aic
FH15P	AIC1747-15PX3T	LVR-IC	LDO, 1.5V±2%, 300mA	SOT-89	20ch	VR1	4g	Aic
FH18G	AIC1747-18GX3T	LVR-IC	LDO, 1.8V±2%, 300mA	SOT-89	20ch	VR1	4g	Aic
FH18P	AIC1747-18PX3T	LVR-IC	LDO, 1.8V±2%, 300mA	SOT-89	20ch	VR1	4g	Aic
FH20G	AIC1747-20GX3T	LVR-IC	LDO, 2.0V±2%, 300mA	SOT-89	20ch	VR1	4g	Aic
FH20P	AIC1747-20PX3T	LVR-IC	LDO, 2.0V±2%, 300mA	SOT-89	20ch	VR1	4g	Aic
FH25G	AIC1747-25GX3T	LVR-IC	LDO, 2.5V±2%, 300mA	SOT-89	20ch	VR1	4g	Aic
FH25P	AIC1747-25PX3T	LVR-IC	LDO, 2.5V±2%, 300mA	SOT-89	20ch	VR1	4g	Aic
FH27G	AIC1747-27GX3T	LVR-IC	LDO, 2.7V±2%, 300mA	SOT-89	20ch	VR1	4g	Aic
FH27P	AIC1747-27PX3T	LVR-IC	LDO, 2.7V±2%, 300mA	SOT-89	20ch	VR1	4g	Aic
FH2JG	AIC1747-285GX3T	LVR-IC	LDO, 2.85V±2%, 300mA	SOT-89	20ch	VR1	4g	Aic
FH2JP	AIC1747-285PX3T	LVR-IC	LDO, 2.85V±2%, 300mA	SOT-89	20ch	VR1	4g	Aic
FH30G	AIC1747-30GX3T	LVR-IC	LDO, 3.0V±2%, 300mA	SOT-89	20ch	VR1	4g	Aic
FH30P	AIC1747-30PX3T	LVR-IC	LDO, 3.0V±2%, 300mA	SOT-89	20ch	VR1	4g	Aic
FH33G	AIC1747-33GX3T	LVR-IC	LDO, 3.3V±2%, 300mA	SOT-89	20ch	VR1	4g	Aic
FH33P	AIC1747-33PX3T	LVR-IC	LDO, 3.3V±2%, 300mA	SOT-89	20ch	VR1	4g	Aic
FH35G	AIC1747-35GX3T	LVR-IC	LDO, 3.5V±2%, 300mA	SOT-89	20ch	VR1	4g	Aic
FH35P	AIC1747-35PX3T	LVR-IC	LDO, 3.5V±2%, 300mA	SOT-89	20ch	VR1	4g	Aic
FH37G	AIC1747-37GX3T	LVR-IC	LDO, 3.7V±2%, 300mA	SOT-89	20ch	VR1	4g	Aic
FH37P	AIC1747-37PX3T	LVR-IC	LDO, 3.7V±2%, 300mA	SOT-89	20ch	VR1	4g	Aic
FH38G	AIC1747-38GX3T	LVR-IC	LDO, 3.8V±2%, 300mA	SOT-89	20ch	VR1	4g	Aic
FH38P	AIC1747-38PX3T	LVR-IC	LDO, 3.8V±2%, 300mA	SOT-89	20ch	VR1	4g	Aic
FJ	ELM99181B	LVR-IC	LDO, 1.8V±2%, 300mA	SOT-89	20vl	VR1	4a	Elm
FJ-	RT9261B-33PX	DC/DC-IC	VFM step-up, 3.3V±2%, 50mA	SOT-89	20bq	DC2	4b	Rct
FK	2SB800-K	Si-npn	AF-Amp, 80V, 300mA, 2W, 100MHz, B=200..400	SOT-89	20tb	-	4b	Nec
FK	ELM99191B	LVR-IC	LDO, 1.9V±2%, 300mA	SOT-89	20vl	VR1	4a	Elm
FL	2SB800-L	Si-npn	AF-Amp, 80V, 300mA, 2W, 100MHz, B=135..270	SOT-89	20tb	-	4b	Nec
FM	2SB800-M	Si-npn	AF-Amp, 80V, 300mA, 2W, 100MHz, B=90..180	SOT-89	20tb	-	4b	Nec
FO	2SA1202-O	Si-npn	AF-Amp, 80V, 400mA, 500mW, B=70..140, 120MHz	SOT-89	20tb	-	4b	Tos
FO	KTA1662-O	Si-npn	GP, AF, 80V, 400mA, 500mW, B=70..140, 120MHz	SOT-89	20tb	-	4a	Kec
FP11G	AIC1746-11GX3A	LVR-IC	LDO, 1.1V±2%, 150mA	SOT-89	20vl	VR1	4g	Aic
FP11P	AIC1746-11PX3A	LVR-IC	LDO, 1.1V±2%, 150mA	SOT-89	20vl	VR1	4g	Aic
FP12G	AIC1746-12GX3A	LVR-IC	LDO, 1.2V±2%, 150mA	SOT-89	20vl	VR1	4g	Aic
FP12P	AIC1746-12PX3A	LVR-IC	LDO, 1.2V±2%, 150mA	SOT-89	20vl	VR1	4g	Aic
FP13G	AIC1746-13GX3A	LVR-IC	LDO, 1.3V±2%, 150mA	SOT-89	20vl	VR1	4g	Aic
FP13P	AIC1746-13PX3A	LVR-IC	LDO, 1.3V±2%, 150mA	SOT-89	20vl	VR1	4g	Aic
FP15G	AIC1746-15GX3A	LVR-IC	LDO, 1.5V±2%, 150mA	SOT-89	20vl	VR1	4g	Aic



SMD
code

Type

Function

Short description

Case Pinout Sch. St. Mnf.

SMD code	Type	Function	Short description	Case	Pinout	Sch.	St.	Mnf.
FP15P	AIC1746-15PX3A	LVR-IC	LDO, 1.5V±2%, 150mA	SOT-89	20vl	VR1	4g	Aic
FP18G	AIC1746-18GX3A	LVR-IC	LDO, 1.8V±2%, 150mA	SOT-89	20vl	VR1	4g	Aic
FP18P	AIC1746-18PX3A	LVR-IC	LDO, 1.8V±2%, 150mA	SOT-89	20vl	VR1	4g	Aic
FP20G	AIC1746-20GX3A	LVR-IC	LDO, 2.0V±2%, 150mA	SOT-89	20vl	VR1	4g	Aic
FP20P	AIC1746-20PX3A	LVR-IC	LDO, 2.0V±2%, 150mA	SOT-89	20vl	VR1	4g	Aic
FP25G	AIC1746-25GX3A	LVR-IC	LDO, 2.5V±2%, 150mA	SOT-89	20vl	VR1	4g	Aic
FP25P	AIC1746-25PX3A	LVR-IC	LDO, 2.5V±2%, 150mA	SOT-89	20vl	VR1	4g	Aic
FP27G	AIC1746-27GX3A	LVR-IC	LDO, 2.7V±2%, 150mA	SOT-89	20vl	VR1	4g	Aic
FP27P	AIC1746-27PX3A	LVR-IC	LDO, 2.7V±2%, 150mA	SOT-89	20vl	VR1	4g	Aic
FP2JG	AIC1746-285GX3A	LVR-IC	LDO, 2.85V±2%, 150mA	SOT-89	20vl	VR1	4g	Aic
FP2JP	AIC1746-285PX3A	LVR-IC	LDO, 2.85V±2%, 150mA	SOT-89	20vl	VR1	4g	Aic
FP30G	AIC1746-30GX3A	LVR-IC	LDO, 3.0V±2%, 150mA	SOT-89	20vl	VR1	4g	Aic
FP30P	AIC1746-30PX3A	LVR-IC	LDO, 3.0V±2%, 150mA	SOT-89	20vl	VR1	4g	Aic
FP33G	AIC1746-33GX3A	LVR-IC	LDO, 3.3V±2%, 150mA	SOT-89	20vl	VR1	4g	Aic
FP33P	AIC1746-33PX3A	LVR-IC	LDO, 3.3V±2%, 150mA	SOT-89	20vl	VR1	4g	Aic
FP35G	AIC1746-35GX3A	LVR-IC	LDO, 3.5V±2%, 150mA	SOT-89	20vl	VR1	4g	Aic
FP35P	AIC1746-35PX3A	LVR-IC	LDO, 3.5V±2%, 150mA	SOT-89	20vl	VR1	4g	Aic
FP37G	AIC1746-37GX3A	LVR-IC	LDO, 3.7V±2%, 150mA	SOT-89	20vl	VR1	4g	Aic
FP37P	AIC1746-37PX3A	LVR-IC	LDO, 3.7V±2%, 150mA	SOT-89	20vl	VR1	4g	Aic
FP38G	AIC1746-38GX3A	LVR-IC	LDO, 3.8V±2%, 150mA	SOT-89	20vl	VR1	4g	Aic
FP38P	AIC1746-38PX3A	LVR-IC	LDO, 3.8V±2%, 150mA	SOT-89	20vl	VR1	4g	Aic
FQ11G	AIC1746-11GX3T	LVR-IC	LDO, 1.1V±2%, 150mA	SOT-89	20ch	VR1	4g	Aic
FQ11P	AIC1746-11PX3T	LVR-IC	LDO, 1.1V±2%, 150mA	SOT-89	20ch	VR1	4g	Aic
FQ12G	AIC1746-12GX3T	LVR-IC	LDO, 1.2V±2%, 150mA	SOT-89	20ch	VR1	4g	Aic
FQ12P	AIC1746-12PX3T	LVR-IC	LDO, 1.2V±2%, 150mA	SOT-89	20ch	VR1	4g	Aic
FQ13G	AIC1746-13GX3T	LVR-IC	LDO, 1.3V±2%, 150mA	SOT-89	20ch	VR1	4g	Aic
FQ13P	AIC1746-13PX3T	LVR-IC	LDO, 1.3V±2%, 150mA	SOT-89	20ch	VR1	4g	Aic
FQ15G	AIC1746-15GX3T	LVR-IC	LDO, 1.5V±2%, 150mA	SOT-89	20ch	VR1	4g	Aic
FQ15P	AIC1746-15PX3T	LVR-IC	LDO, 1.5V±2%, 150mA	SOT-89	20ch	VR1	4g	Aic
FQ18G	AIC1746-18GX3T	LVR-IC	LDO, 1.8V±2%, 150mA	SOT-89	20ch	VR1	4g	Aic
FQ18P	AIC1746-18PX3T	LVR-IC	LDO, 1.8V±2%, 150mA	SOT-89	20ch	VR1	4g	Aic
FQ20G	AIC1746-20GX3T	LVR-IC	LDO, 2.0V±2%, 150mA	SOT-89	20ch	VR1	4g	Aic
FQ20P	AIC1746-20PX3T	LVR-IC	LDO, 2.0V±2%, 150mA	SOT-89	20ch	VR1	4g	Aic
FQ25G	AIC1746-25GX3T	LVR-IC	LDO, 2.5V±2%, 150mA	SOT-89	20ch	VR1	4g	Aic
FQ25P	AIC1746-25PX3T	LVR-IC	LDO, 2.5V±2%, 150mA	SOT-89	20ch	VR1	4g	Aic
FQ27G	AIC1746-27GX3T	LVR-IC	LDO, 2.7V±2%, 150mA	SOT-89	20ch	VR1	4g	Aic
FQ27P	AIC1746-27PX3T	LVR-IC	LDO, 2.7V±2%, 150mA	SOT-89	20ch	VR1	4g	Aic
FQ2JG	AIC1746-285GX3T	LVR-IC	LDO, 2.85V±2%, 150mA	SOT-89	20ch	VR1	4g	Aic
FQ2JP	AIC1746-285PX3T	LVR-IC	LDO, 2.85V±2%, 150mA	SOT-89	20ch	VR1	4g	Aic
FQ30G	AIC1746-30GX3T	LVR-IC	LDO, 3.0V±2%, 150mA	SOT-89	20ch	VR1	4g	Aic
FQ30P	AIC1746-30PX3T	LVR-IC	LDO, 3.0V±2%, 150mA	SOT-89	20ch	VR1	4g	Aic
FQ33G	AIC1746-33GX3T	LVR-IC	LDO, 3.3V±2%, 150mA	SOT-89	20ch	VR1	4g	Aic
FQ33P	AIC1746-33PX3T	LVR-IC	LDO, 3.3V±2%, 150mA	SOT-89	20ch	VR1	4g	Aic
FQ35G	AIC1746-35GX3T	LVR-IC	LDO, 3.5V±2%, 150mA	SOT-89	20ch	VR1	4g	Aic
FQ35P	AIC1746-35PX3T	LVR-IC	LDO, 3.5V±2%, 150mA	SOT-89	20ch	VR1	4g	Aic
FQ37G	AIC1746-37GX3T	LVR-IC	LDO, 3.7V±2%, 150mA	SOT-89	20ch	VR1	4g	Aic
FQ37P	AIC1746-37PX3T	LVR-IC	LDO, 3.7V±2%, 150mA	SOT-89	20ch	VR1	4g	Aic
FQ38G	AIC1746-38GX3T	LVR-IC	LDO, 3.8V±2%, 150mA	SOT-89	20ch	VR1	4g	Aic
FQ38P	AIC1746-38PX3T	LVR-IC	LDO, 3.8V±2%, 150mA	SOT-89	20ch	VR1	4g	Aic
FR	2SC4988	Si-npn	VHF/UHF, 15V, 100mA, 800mW, B=50..250, 8.5GHz	UPAK	20tb	-	4b	Ren
FS	2SB1519	Si-pnp	AF, 50V, 2A, 1W, B=40..120	SOT-89	20tb	-	4g	Ren
FT-	RT9261B-42PX	DC/DC-IC	VFM step-up, 4.2V±2%, 50mA	SOT-89	20bq	DC2	4b	Rct
FY	2SB1571-X	Si-pnp	Lo-sat, 50V, 5A, 2W, 150MHz, B=100..200	SOT-89	20tb	-	4b	Nec
FY	2SA1202-Y	Si-pnp	AF-Amp, 80V, 400mA, 500mW, B=120..240, 120MHz	SOT-89	20tb	-	4g	Tos
FY	2SB1571-Y	Si-pnp	Lo-sat, 50V, 5A, 2W, 150MHz, B=160..320	SOT-89	20tb	-	4b	Nec
FY	2SK1698	n-MOSFET-e*	V-MOS, Logl., 100V, 0.3A, <4.5Ω(0.5A)	SOT-89	20fa	-	4b	Ren
FY	KTA1662-Y	Si-pnp	GP, AF, 80V, 400mA, 500mW, B=120..240, 120MHz	SOT-89	20tb	-	4a	Kec
FZ	2SB1571-Z	Si-pnp	Lo-sat, 50V, 5A, 2W, 150MHz, B=200..400	SOT-89	20tb	-	4b	Nec
G1	D70Y1.5T1	Si-npn	AF, 30V, 1.5A	SOT-89	20tb	-	4b	Gen
G1	RT9161A-16CX	LVR-IC	LDO, 1.6V±2%, 500mA	SOT-89	20vl	VR1	4c	Rct
G1-	RT9161A-16PX	LVR-IC	LDO, 1.6V±2%, 500mA	SOT-89	20vl	VR1	4c	Rct
G3	RT9161A-18CX	LVR-IC	LDO, 1.7V±2%, 500mA	SOT-89	20vl	VR1	4c	Rct
G3-	RT9161A-18PX	LVR-IC	LDO, 1.7V±2%, 500mA	SOT-89	20vl	VR1	4c	Rct
G4	RT9808-21CX	Vdet-IC	2.1V±2%, -ODO +Reset	SOT-89	20vda	VD6	4g	Rct
G4-	RT9808-21PX	Vdet-IC	2.1V±2%, -ODO +Reset	SOT-89	20vda	VD6	4g	Rct
G5	RT9808-33CX	Vdet-IC	3.3V±2%, -ODO +Reset	SOT-89	20vda	VD6	4g	Rct
G5-	RT9808-33PX	Vdet-IC	3.3V±2%, -ODO +Reset	SOT-89	20vda	VD6	4g	Rct
G6	RT9808-23CX	Vdet-IC	2.3V±2%, -ODO +Reset	SOT-89	20vda	VD6	4g	Rct
G7	RT9808-30CX	Vdet-IC	3.0V±2%, -ODO +Reset	SOT-89	20vda	VD6	4g	Rct
G70A	AZ7023RTR-G1	Vdet-IC	2.3V±1.5%, -Reset OCO	SOT-89	20vdd	VD6	4g	Bcd



SMD
code

Type

Function

Short description

Case Pinout Sch. St. Mnf.

SMD code	Type	Function	Short description	Case	Pinout	Sch.	St.	Mnf.
G70B	AZ7027RTR-G1	Vdet-IC	2.7V±1.5%, -Reset OCO	SOT-89	20vdd	VD6	4g	Bcd
G70C	AZ7029RTR-G1	Vdet-IC	2.9V±1.5%, -Reset OCO	SOT-89	20vdd	VD6	4g	Bcd
G70D	AZ7033RTR-G1	Vdet-IC	3.3V±1.5%, -Reset OCO	SOT-89	20vdd	VD6	4g	Bcd
G70E	AZ7042RTR-G1	Vdet-IC	4.2V±1.5%, -Reset OCO	SOT-89	20vdd	VD6	4g	Bcd
G70F	AZ7045RTR-G1	Vdet-IC	4.5V±1.5%, -Reset OCO	SOT-89	20vdd	VD6	4g	Bcd
G70G	AZ7025RTR-G1	Vdet-IC	2.5V±1.5%, -Reset OCO	SOT-89	20vdd	VD6	4g	Bcd
G70H	AZ7031RTR-G1	Vdet-IC	3.1V±1.5%, -Reset OCO	SOT-89	20vdd	VD6	4g	Bcd
G8	RT9808-42CX	Vdet-IC	4.2V±2%, -ODO +Reset	SOT-89	20vda	VD6	4g	Rct
G8-	RT9808-42PX	Vdet-IC	4.2V±2%, -ODO +Reset	SOT-89	20vda	VD6	4g	Rct
G9	RT9161A-35CX	LVR-IC	LDO, 3.5V±2%, 500mA	SOT-89	20vl	VR1	4c	Rct
G9-	RT9161A-35PX	LVR-IC	LDO, 3.5V±2%, 500mA	SOT-89	20vl	VR1	4c	Rct
GA	2SD1463-A	Si-npn	GP, 120V, 50mA, 1W, B=60..120, 140MHz	SOT-89	20tb	-	4b	Ren
GA	BAW78A	Si-diode	Sw, 50V, 1A, <100ns	SOT-89	20di	-	4b	Sie
GA	RT9161A-25CX	LVR-IC	LDO, 2.5V±2%, 500mA	SOT-89	20vl	VR1	4c	Rct
GA-	RT9161A-25PX	LVR-IC	LDO, 2.5V±2%, 500mA	SOT-89	20vl	VR1	4c	Rct
GA08G	AIC1748-08GX3A	LVR-IC	LDO, 0.8V±2%, 600mA	SOT-89	20vl	VR1	4g	Aic
GA09G	AIC1748-09GX3A	LVR-IC	LDO, 0.9V±2%, 600mA	SOT-89	20vl	VR1	4g	Aic
GA1	2SA1871-1	Si-pnp	HF, HV, 600V, 1A, 2W, 30MHz, B=30..60	SOT-89	20tb	-	4b	Nec
GA10G	AIC1748-10GX3A	LVR-IC	LDO, 1.0V±2%, 600mA	SOT-89	20vl	VR1	4g	Aic
GA11G	AIC1748-11GX3A	LVR-IC	LDO, 1.1V±2%, 600mA	SOT-89	20vl	VR1	4g	Aic
GA12G	AIC1748-12GX3A	LVR-IC	LDO, 1.2V±2%, 600mA	SOT-89	20vl	VR1	4g	Aic
GA13G	AIC1748-13GX3A	LVR-IC	LDO, 1.3V±2%, 600mA	SOT-89	20vl	VR1	4g	Aic
GA14G	AIC1748-14GX3A	LVR-IC	LDO, 1.4V±2%, 600mA	SOT-89	20vl	VR1	4g	Aic
GA15G	AIC1748-15GX3A	LVR-IC	LDO, 1.5V±2%, 600mA	SOT-89	20vl	VR1	4g	Aic
GA16G	AIC1748-16GX3A	LVR-IC	LDO, 1.6V±2%, 600mA	SOT-89	20vl	VR1	4g	Aic
GA17G	AIC1748-17GX3A	LVR-IC	LDO, 1.7V±2%, 600mA	SOT-89	20vl	VR1	4g	Aic
GA18G	AIC1748-18GX3A	LVR-IC	LDO, 1.8V±2%, 600mA	SOT-89	20vl	VR1	4g	Aic
GA19G	AIC1748-19GX3A	LVR-IC	LDO, 1.9V±2%, 600mA	SOT-89	20vl	VR1	4g	Aic
GA2	2SA1871-2	Si-pnp	HF, HV, 600V, 1A, 2W, 30MHz, B=40..80	SOT-89	20tb	-	4a	Nec
GA20G	AIC1748-20GX3A	LVR-IC	LDO, 2.0V±2%, 600mA	SOT-89	20vl	VR1	4g	Aic
GA21G	AIC1748-21GX3A	LVR-IC	LDO, 2.1V±2%, 600mA	SOT-89	20vl	VR1	4g	Aic
GA22G	AIC1748-22GX3A	LVR-IC	LDO, 2.2V±2%, 600mA	SOT-89	20vl	VR1	4g	Aic
GA23G	AIC1748-23GX3A	LVR-IC	LDO, 2.3V±2%, 600mA	SOT-89	20vl	VR1	4g	Aic
GA24G	AIC1748-24GX3A	LVR-IC	LDO, 2.4V±2%, 600mA	SOT-89	20vl	VR1	4g	Aic
GA25G	AIC1748-25GX3A	LVR-IC	LDO, 2.5V±2%, 600mA	SOT-89	20vl	VR1	4g	Aic
GA26G	AIC1748-26GX3A	LVR-IC	LDO, 2.6V±2%, 600mA	SOT-89	20vl	VR1	4g	Aic
GA27G	AIC1748-27GX3A	LVR-IC	LDO, 2.7V±2%, 600mA	SOT-89	20vl	VR1	4g	Aic
GA28G	AIC1748-28GX3A	LVR-IC	LDO, 2.8V±2%, 600mA	SOT-89	20vl	VR1	4g	Aic
GA29G	AIC1748-29GX3A	LVR-IC	LDO, 2.9V±2%, 600mA	SOT-89	20vl	VR1	4g	Aic
GA2JG	AIC1748-285GX3A	LVR-IC	LDO, 2.85V±2%, 600mA	SOT-89	20vl	VR1	4g	Aic
GA3	2SA1871-3	Si-pnp	HF, HV, 600V, 1A, 2W, 30MHz, B=60..120	SOT-89	20tb	-	4a	Nec
GA30G	AIC1748-30GX3A	LVR-IC	LDO, 3.0V±2%, 600mA	SOT-89	20vl	VR1	4g	Aic
GA31G	AIC1748-32GX3A	LVR-IC	LDO, 3.1V±2%, 600mA	SOT-89	20vl	VR1	4g	Aic
GA32G	AIC1748-33GX3A	LVR-IC	LDO, 3.2V±2%, 600mA	SOT-89	20vl	VR1	4g	Aic
GA33G	AIC1748-33GX3A	LVR-IC	LDO, 3.3V±2%, 600mA	SOT-89	20vl	VR1	4g	Aic
GB	2SD1463-B	Si-npn	GP, 120V, 50mA, 1W, B=100..200, 140MHz	SOT-89	20tb	-	4b	Ren
GB	BAW78B	Si-diode	Sw, 100V, 1A, <100ns	SOT-89	20di	-	4b	Sie
GB	RT9161A-39CX	LVR-IC	LDO, 3.9V±2%, 500mA	SOT-89	20vl	VR1	4c	Rct
GB1	2SB1578-1	Si-pnp	AF-Amp, Sw, 60V, 5A, 2W, 600/600ns, B=100..200	SOT-89	20tb	-	4b	Nec
GB2	2SB1578-2	Si-pnp	AF-Amp, Sw, 60V, 5A, 2W, 600/600ns, B=160..320	SOT-89	20tb	-	4b	Nec
GB3	2SB1578-3	Si-pnp	AF-Amp, Sw, 60V, 5A, 2W, 600/600ns, B=200..400	SOT-89	20tb	-	4b	Nec
GC	BAW78C	Si-diode	Sw, 200V, 1A, <100ns	SOT-89	20di	-	4b	Sie
GD	BAW78D	Si-diode	Sw, 400V, 1A, <100ns	SOT-89	20di	-	4b	Sie
GD	RT9161A-28CX	LVR-IC	LDO, 2.8V±2%, 500mA	SOT-89	20vl	VR1	4c	Rct
GD=	RT9161A-28GX	LVR-IC	LDO, 3.0V±2%, 500mA	SOT-89	20vl	VR1	4c	Rct
GE	BAW79A	Si-diode	Dual, Sw, 2x50V, 1A, <1000ns	SOT-89	20dj	-	4b	Sie
GE	RT9161A-21CX	LVR-IC	LDO, 2.1V±2%, 500mA	SOT-89	20vl	VR1	4c	Rct
GF	BAW79B	Si-diode	Dual, Sw, 2x100V, 1A, <1000ns	SOT-89	20dj	-	4b	Sie
GF	RT9161A-15CX	LVR-IC	LDO, 1.5V±2%, 500mA	SOT-89	20vl	VR1	4c	Rct
GF-	RT9161A-15PX	LVR-IC	LDO, 1.5V±2%, 500mA	SOT-89	20vl	VR1	4c	Rct
GG	2SA1369-G	Si-pnp	AF-Drv, 30V, 1.5A, 500mW, B=400..800, 90MHz	SOT-89	20tb	-	4b	Mit
GG	BAW79C	Si-diode	Dual, Sw, 2x200V, 1A, <1000ns	SOT-89	20dj	-	4b	Sie
GG	RT9161A-45CX	LVR-IC	LDO, 4.5V±2%, 500mA	SOT-89	20vl	VR1	4c	Rct
GG-	RT9161A-45PX	LVR-IC	LDO, 4.5V±2%, 500mA	SOT-89	20vl	VR1	4c	Rct
GH	2SA1369-H	Si-pnp	AF-Drv, 30V, 1.5A, 500mW, B=600..1200, 90MHz	SOT-89	20tb	-	4b	Mit
GH	BAW79D	Si-diode	Dual, Sw, 2x400V, 1A, <1000ns	SOT-89	20dj	-	4b	Sie
GH	RT9161A-30CX	LVR-IC	LDO, 3.0V±2%, 500mA	SOT-89	20vl	VR1	4c	Rct
GH-	RT9161A-30PX	LVR-IC	LDO, 3.0V±2%, 500mA	SOT-89	20vl	VR1	4c	Rct
GJ	RT9161A-33CX	LVR-IC	LDO, 3.3V±2%, 500mA	SOT-89	20vl	VR1	4c	Rct
GJ-	RT9161A-33PX	LVR-IC	LDO, 3.3V±2%, 500mA	SOT-89	20vl	VR1	4c	Rct



SMD
code

Type

Function

Short description

Case Pinout Sch. St. Mnf.

SMD code	Type	Function	Short description	Case	Pinout	Sch.	St.	Mnf.
GK	2SD1615-K	Si-npn	AF-Amp, Sw, 60V, 1A, 2W, 160MHz, B=300..600	SOT-89	20tb	-	4b	Nec
GK	RT9808-27CX	Vdet-IC	2.7V±2%, -ODO +Reset	SOT-89	20vda	VD6	4g	Rct
GL	2SD1615-L	Si-npn	AF-Amp, Sw, 60V, 1A, 2W, 160MHz, B=200..400	SOT-89	20tb	-	4b	Nec
GL	RT9808-36CX	Vdet-IC	3.6V±2%, -ODO +Reset	SOT-89	20vda	VD6	4g	Rct
GM	2SD1615-M	Si-npn	AF-Amp, Sw, 60V, 1A, 2W, 160MHz, B=135..270	SOT-89	20tb	-	4b	Nec
GM	RT9161A-36CX	LVR-IC	LDO, 3.6V±2%, 500mA	SOT-89	20vl	VR1	4c	Rct
GN-	RT9166A-13PX	LVR-IC	LDO, 1.3V±2%, 600mA	SOT-89	20ch	VR1	4c	Rct
GO	2SC2883-O	Si-npn	GP, 30V, 1.5A, 500mW, B=70..140, 120MHz	SOT-89	20tb	-	4b	Tos
GO	AP130-15YR	LVR-IC	LDO, 1.5V±2%, 300mA	SOT-89	20vl	VR1	4b	Ana
GO	KTC4375-O	Si-npn	AF-Drv, 30V, 1.5A, 500mW, B=100..200, >120MHz	SOT-89	20tb	-	4a	Kec
GP	2SD1615A-P	Si-npn	AF-Amp, Sw, 120V, 1A, 2W, 160MHz, B=200..400	SOT-89	20tb	-	4b	Nec
GP	AP130-16YR	LVR-IC	LDO, 1.6V±2%, 300mA	SOT-89	20vl	VR1	4b	Ana
GP-	RT9161A-40PX	LVR-IC	LDO, 4.0V±2%, 500mA	SOT-89	20vl	VR1	4c	Rct
GQ	2SD1615A-Q	Si-npn	AF-Amp, Sw, 120V, 1A, 2W, 160MHz, B=135..270	SOT-89	20tb	-	4b	Nec
GQ	AP130-17YR	LVR-IC	LDO, 1.7V±2%, 300mA	SOT-89	20vl	VR1	4b	Ana
GQ-	RT9808-39PX	Vdet-IC	3.9V±2%, -ODO +Reset	SOT-89	20vda	VD6	4g	Rct
GR	AP130-18YR	LVR-IC	LDO, 1.8V±2%, 300mA	SOT-89	20vl	VR1	4b	Ana
GS	2SB1520	Si-ppn	AF, 80V, 2A, 1W, B=40..120	SOT-89	20tb	-	4g	Ren
GS	AP130-19YR	LVR-IC	LDO, 1.9V±2%, 300mA	SOT-89	20vl	VR1	4b	Ana
GT	2SD2423	Si-npn-Darl+Di	Sw, 50V, 1.5A, B>2000, Z-Di (B>C)	SOT-89	20tb	-	4b	Ren
GT	AP130-20YR	LVR-IC	LDO, 2.0V±2%, 300mA	SOT-89	20vl	VR1	4b	Ana
GU	AP130-21YR	LVR-IC	LDO, 2.1V±2%, 300mA	SOT-89	20vl	VR1	4b	Ana
GV	AP130-22YR	LVR-IC	LDO, 2.2V±2%, 300mA	SOT-89	20vl	VR1	4b	Ana
GW	AP130-23YR	LVR-IC	LDO, 2.3V±2%, 300mA	SOT-89	20vl	VR1	4b	Ana
GX	2SD2403-X	Si-npn	AF, Sw, 80V, 3A, 2W, 130MHz, B=100..200	SOT-89	20tb	-	4b	Nec
GX	AP130-24YR	LVR-IC	LDO, 2.4V±2%, 300mA	SOT-89	20vl	VR1	4b	Ana
GY	2SC2883-Y	Si-npn	GP, 30V, 1.5A, 500mW, B=120..240, 120MHz	SOT-89	20tb	-	4b	Tos
GY	2SD2403-Y	Si-npn	AF, Sw, 80V, 3A, 2W, 130MHz, B=160..320	SOT-89	20tb	-	4b	Nec
GY	AP130-25YR	LVR-IC	LDO, 2.5V±2%, 300mA	SOT-89	20vl	VR1	4b	Ana
GY	KT4375-Y	Si-npn	AF-Drv, 30V, 1.5A, 500mW, B=160..320, >120MHz	SOT-89	20tb	-	4a	Kec
GZ	2SD2403-Z	Si-npn	AF, Sw, 80V, 3A, 2W, 130MHz, B=100..200	SOT-89	20tb	-	4b	Nec
GZ	AP130-26YR	LVR-IC	LDO, 2.6V±2%, 300mA	SOT-89	20vl	VR1	4b	Ana
H0	AP130-27YR	LVR-IC	LDO, 2.7V±2%, 300mA	SOT-89	20vl	VR1	4b	Ana
H0	RT9818C-21CX	Vdet-IC	2.1V±1.5%, -ODO +Reset, Td=220ms	SOT-89	20vda	VD6	4g	Rct
H0	TC54VC6002MB	Vdet-IC	6.0V±2%, -Reset PPO	SOT-89	20vda	VD7	4b	Tcs
H0	XC61CC6002P	Vdet-IC	6V±1%, +Reset PPO	SOT-89	20vda	VD7	4b	Tor
H03	XE61CC6045PR	Vdet-IC	6.0V±2%, -Reset PPO	SOT-89	20cj	VD7	4j	Tor
H05	XC61FC6012P	Vdet-IC	6V±2%, +Reset PPO, 200ms	SOT-89	20vda	VD7	4b	Tor
H06	XC61FC6042P	Vdet-IC	6V±2%, +Reset PPO, 400ms	SOT-89	20vda	VD7	4b	Tor
H07	XC61FC6052P	Vdet-IC	6V±2%, +Reset PPO, 50ms	SOT-89	20vda	VD7	4b	Tor
H1	AP130-28YR	LVR-IC	LDO, 2.8V±2%, 300mA	SOT-89	20vl	VR1	4b	Ana
H1	D71Y1.5T1	Si-ppn	AF, 30V, 1.5A	SOT-89	20tb	-	4b	Gen
H1	RT9818C-33CX	Vdet-IC	3.3V±1.5%, -ODO +Reset, Td=220ms	SOT-89	20vda	VD6	4g	Rct
H2	AP130-29YR	LVR-IC	LDO, 2.9V±2%, 300mA	SOT-89	20vl	VR1	4b	Ana
H2	RT9818C-42CX	Vdet-IC	4.2V±1.5%, -ODO +Reset, Td=220ms	SOT-89	20vda	VD6	4g	Rct
H2-	RT9818C-42PX	Vdet-IC	4.2V±1.5%, -ODO +Reset, Td=220ms	SOT-89	20vda	VD6	4g	Rct
H3	AP130-30YR	LVR-IC	LDO, 3V±2%, 300mA	SOT-89	20vl	VR1	4b	Ana
H4	AP130-31YR	LVR-IC	LDO, 3.1V±2%, 300mA	SOT-89	20vl	VR1	4b	Ana
H5	AP130-32YR	LVR-IC	LDO, 3.2V±2%, 300mA	SOT-89	20vl	VR1	4b	Ana
H9	AP130-33YR	LVR-IC	LDO, 3.3V±2%, 300mA	SOT-89	20vl	VR1	4b	Ana
HA	2SD1464-A	Si-npn	GP, 180V, 50mA, 1W, B=60..120, 140MHz	SOT-89	20tb	-	4b	Ren
HA	AP130-34YR	LVR-IC	LDO, 3.4V±2%, 300mA	SOT-89	20vl	VR1	4b	Ana
HB	2SD1464-B	Si-npn	GP, 180V, 50mA, 1W, B=100..200, 140MHz	SOT-89	20tb	-	4b	Ren
HB	AP130-35YR	LVR-IC	LDO, 3.5V±2%, 300mA	SOT-89	20vl	VR1	4b	Ana
HC	AP130-36YR	LVR-IC	LDO, 3.6V±2%, 300mA	SOT-89	20vl	VR1	4b	Ana
HD	AP130-37YR	LVR-IC	LDO, 3.7V±2%, 300mA	SOT-89	20vl	VR1	4b	Ana
HE	AP130-38YR	LVR-IC	LDO, 3.8V±2%, 300mA	SOT-89	20vl	VR1	4b	Ana
HF	AP130-39YR	LVR-IC	LDO, 3.9V±2%, 300mA	SOT-89	20vl	VR1	4b	Ana
HG	2SC3439-G	Si-npn	Motor-Drv, 30V, 1.5A, 500mW, B=400..800, 90MHz	SOT-89	20tb	-	4a	Mit
HG	AP130-40YR	LVR-IC	LDO, 4.0V±2%, 300mA	SOT-89	20vl	VR1	4b	Ana
HH	2SB1048-H	Si-ppn	AF, 180V, 50mA, 1W, B=60..120, 140MHz	UPAK	20tb	-	4b	Ren
HH	2SC3439-H	Si-npn	Motor-Drv, 30V, 1.5A, 500mW, B=600..1200, 90MHz	SOT-89	20tb	-	4a	Mit
HH	AP130-41YR	LVR-IC	LDO, 4.1V±2%, 300mA	SOT-89	20vl	VR1	4b	Ana
HI	AP130-42YR	LVR-IC	LDO, 4.2V±2%, 300mA	SOT-89	20vl	VR1	4b	Ana
HJ	2SB1048-J	Si-ppn	AF, 180V, 50mA, 1W, B=100..200, 140MHz	UPAK	20tb	-	4b	Ren
HJ	2SC3439-J	Si-npn	Motor-Drv, 30V, 1.5A, 500mW, B=800..1600, 90MHz	SOT-89	20tb	-	4a	Mit
HJ	AP130-43YR	LVR-IC	LDO, 4.3V±2%, 300mA	SOT-89	20vl	VR1	4b	Ana
HK	2SD1006-K	Si-npn	AF-Amp, 100V, 500mA, 2W, 90MHz, B=200..400	SOT-89	20tb	-	4a	Nec
HK	AP130-44YR	LVR-IC	LDO, 4.4V±2%, 300mA	SOT-89	20vl	VR1	4b	Ana
HL	2SD1006-L	Si-npn	AF-Amp, 100V, 500mA, 2W, 90MHz, B=135..270	SOT-89	20tb	-	4a	Nec



SMD
code

Type

Function

Short description

Case Pinout Sch. St. Mnf.

HL	AP130-45YR	LVR-IC	LDO, 4.5V±2%, 300mA	SOT-89	20vl	VR1	4b	Ana
HM	2SD1006-M	Si-npn	AF-Amp, 100V, 500mA, 2W, 90MHz, B=90..180	SOT-89	20ftb	-	4a	Nec
HM	AP130-46YR	LVR-IC	LDO, 4.6V±2%, 300mA	SOT-89	20vl	VR1	4b	Ana
HN	AP130-47YR	LVR-IC	LDO, 4.7V±2%, 300mA	SOT-89	20vl	VR1	4b	Ana
HO	2SA1203-O	Si-npn	GP, 30V, 1.5A, 500mW, B=70..140, 120MHz	SOT-89	20ftb	-	4b	Tos
HO	AP130-48YR	LVR-IC	LDO, 4.8V±2%, 300mA	SOT-89	20vl	VR1	4b	Ana
HO	KTA1663-O	Si-npn	AF-Drv, 30V, 1.5A, 500mW, B=100..200, >120MHz	SOT-89	20ftb	-	4a	Kec
HP	2SD1007-P	Si-npn	AF-Amp, 120V, 500mA, 2W, 90MHz, B=200..400	SOT-89	20ftb	-	4a	Nec
HP	AP130-49YR	LVR-IC	LDO, 4.9V±2%, 300mA	SOT-89	20vl	VR1	4b	Ana
HQ	2SD1007-Q	Si-npn	AF-Amp, 120V, 500mA, 2W, 90MHz, B=135..270	SOT-89	20ftb	-	4a	Nec
HQ	AP130-50YR	LVR-IC	LDO, 5.0V±2%, 300mA	SOT-89	20vl	VR1	4b	Ana
HR	2SB956-R	Si-npn	GP, AF, 20V, 1A, 1W, B=130..210, 200MHz	SOT-89	20ftb	-	4b	Pan
HR	2SD1007-R	Si-npn	AF-Amp, 120V, 500mA, 2W, 90MHz, B=90..180	SOT-89	20ftb	-	4a	Nec
HS	2SB956-S	Si-npn	GP, AF, 20V, 1A, 1W, B=180..280, 200MHz	SOT-89	20ftb	-	4b	Pan
HS	2SD2540	Si-npn	Lo-sat, 40V, 5A, 1W, B=250..600, 190MHz	SOT-89	20ftb	-	4b	Ren
HX	2SB1572-X	Si-npn	Lo-sat, 80V, 3A, 2W, 160MHz, B=100..200	SOT-89	20ftb	-	4b	Nec
HX	2SK2922	n-MOSFET-e*	V-MOS, 10V, 0.7A, P _q >31dBm(836.5MHz)	SOT-89	20fta	-	4b	Ren
HY	2SA1203-Y	Si-npn	GP, 30V, 1.5A, 500mW, B=120..240, 120MHz	SOT-89	20ftb	-	4b	Tos
HY	2SB1572-Y	Si-npn	Lo-sat, 80V, 3A, 2W, 160MHz, B=160..320	SOT-89	20ftb	-	4b	Nec
HY	2SK1772	n-MOSFET-e*	V-MOS, LogL, 30V, 1A, <0.6C(0.5A)	SOT-89	20fta	-	4b	Ren
HY	KTA1663-Y	Si-npn	AF-Drv, 30V, 1.5A, 500mW, B=160..320, >120MHz	SOT-89	20ftb	-	4a	Kec
HZ	2SB1572-Z	Si-npn	Lo-sat, 80V, 3A, 2W, 160MHz, B=200..400	SOT-89	20ftb	-	4b	Nec
IC	UN7231	Si-npn-Digi	Sw, 20V, 700mA, 1W, 55MHz, R1/R2=1k/47k	SOT-89	20ftb	-	4b	Pan
IC	UNR7231	Si-npn-Digi	Sw, 20V, 700mA, 1W, 55MHz, R1/R2=1k/47k	SOT-89	20ftb	-	4b	Pan
IK	2SA1463-K	Si-npn	Sw, 60V, 1A, 2W, B=60..120, >300MHz	SOT-89	20ftb	-	4b	Nec
IKR	2SD2210-R	Si-npn	LV, DC-DC conv, 25V, 500mA, 1W, 200MHz, B=200..350	SOT-89	20ftb	-	4b	Pan
IKS	2SD2210-S	Si-npn	LV, DC-DC conv, 25V, 500mA, 1W, 200MHz, B=300..500	SOT-89	20ftb	-	4b	Pan
IKT	2SD2210-T	Si-npn	LV, DC-DC conv, 25V, 500mA, 1W, 200MHz, B=400..800	SOT-89	20ftb	-	4b	Pan
IL	2SA1463-L	Si-npn	Sw, 60V, 1A, 2W, B=100..200, >300MHz	SOT-89	20ftb	-	4b	Nec
IO	2SC3515-O	Si-npn	Drv, 300V, 100mA, 500mW, B=50..150, 80MHz	SOT-89	20tm	-	4f	Tos
IQ	2SB1073-Q	Si-npn	AF, Lo-sat, 30V, 4A, 1W, B=120..205, 120MHz	SOT-89	20ftb	-	4b	Pan
IR	2SB1073-R	Si-npn	AF, Lo-sat, 30V, 4A, 1W, B=180..315, 120MHz	SOT-89	20ftb	-	4b	Pan
IR	2SC3515-R	Si-npn	Drv, 300V, 100mA, 500mW, B=30..90, 80MHz	SOT-89	20tm	-	4f	Tos
IU	2SB1589	Si-npn	AF-Drv, 10V, 1.5A, 1W, B=200..700, 190MHz	SOT-89	20ftb	-	4b	Pan
J=	RT9161A-13GX	LVR-IC	LDO, 3.3V±2%, 500mA	SOT-89	20vl	VR1	4c	Rct
J0	RT9166-25CX	LVR-IC	LDO, 2.5V±2%, 300mA	SOT-89	20ch	VR1	4c	Rct
J1	RT9166-33CX	LVR-IC	LDO, 3.3V±2%, 300mA	SOT-89	20ch	VR1	4c	Rct
J1-	RT9166-33PX	LVR-IC	LDO, 3.3V±2%, 300mA	SOT-89	20ch	VR1	4c	Rct
J2	RT9166-35CX	LVR-IC	LDO, 3.5V±2%, 300mA	SOT-89	20ch	VR1	4c	Rct
J2-	RT9166-35PX	LVR-IC	LDO, 3.5V±2%, 300mA	SOT-89	20ch	VR1	4c	Rct
J3	RT9166A-25CX	LVR-IC	LDO, 2.5V±2%, 600mA	SOT-89	20ch	VR1	4c	Rct
J3-	RT9166A-25PX	LVR-IC	LDO, 2.5V±2%, 600mA	SOT-89	20ch	VR1	4c	Rct
J4	RT9166A-33CX	LVR-IC	LDO, 3.3V±2%, 600mA	SOT-89	20ch	VR1	4c	Rct
J4-	RT9166A-33PX	LVR-IC	LDO, 3.3V±2%, 600mA	SOT-89	20ch	VR1	4c	Rct
J5	RT9166A-12CX	LVR-IC	LDO, 1.2V±2%, 600mA	SOT-89	20vl	VR1	4c	Rct
J5-	RT9166A-12PX	LVR-IC	LDO, 1.2V±2%, 600mA	SOT-89	20ch	VR1	4c	Rct
J6	RT9166A-18CX	LVR-IC	LDO, 1.8V±2%, 600mA	SOT-89	20ch	VR1	4c	Rct
J6-	RT9166A-18PX	LVR-IC	LDO, 1.8V±2%, 600mA	SOT-89	20ch	VR1	4c	Rct
J7-	RT9166A-45PX	LVR-IC	LDO, 4.5V±2%, 600mA	SOT-89	20ch	VR1	4c	Rct
J8	RT9166A-35CXL	LVR-IC	LDO, 3.5V±2%, 600mA	SOT-89	20vl	VR1	4c	Rct
J8-	RT9166A-35PXL	LVR-IC	LDO, 3.5V±2%, 600mA	SOT-89	20vl	VR1	4c	Rct
J9	RT9166-33CXL	LVR-IC	LDO, 3.3V±2%, 300mA	SOT-89	20vl	VR1	4c	Rct
JA	2SJ187	p-MOSFET-e*	Sw, U-Sp, LogL, 30V, 1A, 1.5W, <0.75C(0.5A), 10/70ns	PCP	20ft	-	4a	San
JA	RT9166-12CXL	LVR-IC	LDO, 1.2V±2%, 300mA	SOT-89	20vl	VR1	4c	Rct
JA-	RT9166-12PXL	LVR-IC	LDO, 1.2V±2%, 300mA	SOT-89	20vl	VR1	4c	Rct
JB	RT9166-25CXL	LVR-IC	LDO, 2.5V±2%, 300mA	SOT-89	20vl	VR1	4c	Rct
JB-	RT9166-25PXL	LVR-IC	LDO, 2.5V±2%, 300mA	SOT-89	20vl	VR1	4c	Rct
JC	AP1115AY-28	LVR-IC	LDO, 2.8V±2%, 600mA	SOT-89	20ch	VR1	4b	Ana
JC	AP1115BY-28	LVR-IC	LDO, 2.8V±2%, 600mA	SOT-89	20vl	VR1	4b	Ana
JC	RT9166-27CXL	LVR-IC	LDO, 2.7V±2%, 300mA	SOT-89	20vl	VR1	4c	Rct
JC-	RT9166-27PXL	LVR-IC	LDO, 2.7V±2%, 300mA	SOT-89	20vl	VR1	4c	Rct
JD	2SJ287	p-MOSFET-e*	Sw, U-Sp, LogL, 30V, 500mA, 1.3W, <2.2C(0.25A), 7/35ns	PCP	20ft	-	4a	San
JD	RT9166A-25CXL	LVR-IC	LDO, 2.5V±2%, 600mA	SOT-89	20vl	VR1	4c	Rct
JD-	RT9166A-25PXL	LVR-IC	LDO, 2.5V±2%, 600mA	SOT-89	20vl	VR1	4c	Rct
JD=	RT9166A-25GXL	LVR-IC	LDO, 2.5V±2%, 600mA	SOT-89	20vl	VR1	4c	Rct
JE	2SJ288	p-MOSFET-e*	Sw, U-Sp, LogL, 60V, 500mA, 1.3W, <3C(0.25A), 7/35ns	PCP	20ft	-	4a	San
JE	AP1116Y	LVR-IC	LDO, Adjustable 1.25..13.8V, 500mA	SOT-89	20cn	VR20	4b	Ana
JE	RT9166A-33CXL	LVR-IC	LDO, 3.3V±2%, 600mA	SOT-89	20vl	VR1	4c	Rct
JE-	RT9166A-33PXL	LVR-IC	LDO, 3.3V±2%, 600mA	SOT-89	20vl	VR1	4c	Rct
JE=	RT9166A-33GXL	LVR-IC	LDO, 3.3V±2%, 600mA	SOT-89	20vl	VR1	4c	Rct



SMD
code

Type

Function

Short description

Case Pinout Sch. St. Mnf.

SMD code	Type	Function	Short description	Case	Pinout	Sch.	St.	Mnf.
JF	AP1116Y-15	LVR-IC	LDO, 1.5V±2%, 500mA	SOT-89	20cg	VR1	4b	Ana
JF	RT9166-21CXL	LVR-IC	LDO, 2.1V±2%, 300mA	SOT-89	20vl	VR1	4c	Rct
JF-	RT9166-21PXL	LVR-IC	LDO, 2.1V±2%, 300mA	SOT-89	20vl	VR1	4c	Rct
JG	2S3J16	p-MOSFET-e*	Sw, U-Sp, LogL, 12V, 1A, 1.5W, <0.42Ω(0.5A), 10/70ns	PCP	20fi	-	4a	San
JG	AP1116Y-18	LVR-IC	LDO, 1.8V±2%, 500mA	SOT-89	20cg	VR1	4b	Ana
JG	RT9166-12CX	LVR-IC	LDO, 1.2V±2%, 300mA	SOT-89	20ch	VR1	4c	Rct
JG-	RT9166-12PX	LVR-IC	LDO, 1.2V±2%, 300mA	SOT-89	20vl	VR1	4c	Rct
JH	2SB1518-D	Si-ppn	Lo-sat, 30V, 3A, 900mW, B=160..320	SOT-89	20tb	-	4g	Ren
JH	AP1116Y-25	LVR-IC	LDO, 2.5V±2%, 500mA	SOT-89	20cg	VR1	4b	Ana
JH	RT9166A-12CXL	LVR-IC	LDO, 1.2V±2%, 600mA	SOT-89	20vl	VR1	4c	Rct
JH-	RT9166A-12PXL	LVR-IC	LDO, 1.2V±2%, 600mA	SOT-89	20vl	VR1	4c	Rct
JH=	RT9166A-12GXL	LVR-IC	LDO, 1.2V±2%, 600mA	SOT-89	20ch	VR1	4c	Rct
JI	2S3J81	p-MOSFET-e*	Sw, U-Sp, LogL, 12V, 2A, 1.5W, <0.4Ω(0.5A), 20/100ns	PCP	20fi	-	4a	San
JI	AP1116Y-33	LVR-IC	LDO, 3.3V±2%, 500mA	SOT-89	20cg	VR1	4b	Ana
JJ	2SB1518-E	Si-ppn	Lo-sat, 30V, 3A, 900mW, B=250..500	SOT-89	20tb	-	4g	Ren
JJ	2S3J16	p-MOSFET-e*	Sw, U-Sp, LogL, 30V, 2A, 1.5W, 10/110ns	PCP	20fi	-	4a	San
JJ	AP1116Y-50	LVR-IC	LDO, 5V±2%, 500mA	SOT-89	20cg	VR1	4b	Ana
JJ	RT9166-15CX	LVR-IC	LDO, 1.5V±2%, 300mA	SOT-89	20ch	VR1	4c	Rct
JJ-	RT9166-15PX	LVR-IC	LDO, 1.5V±2%, 300mA	SOT-89	20ch	VR1	4c	Rct
JK	AP1115AY-35	LVR-IC	LDO, 3.5V±2%, 600mA	SOT-89	20ch	VR1	4b	Ana
JK	AP1115BY-35	LVR-IC	LDO, 3.5V±2%, 600mA	SOT-89	20vl	VR1	4b	Ana
JK	RT9166-15CXL	LVR-IC	LDO, 1.5V±2%, 300mA	SOT-89	20vl	VR1	4c	Rct
JK-	RT9166-15PXL	LVR-IC	LDO, 1.5V±2%, 300mA	SOT-89	20vl	VR1	4c	Rct
JL	2S3J60	p-MOSFET-e*	Sw, U-Sp, LogL, 20V, 1.5A, 1.3W, <1Ω(0.75A), 10/25ns	PCP	20fi	-	4a	San
JL	RT9166A-15CXL	LVR-IC	LDO, 1.5V±2%, 600mA	SOT-89	20vl	VR1	4c	Rct
JL-	RT9166A-15PXL	LVR-IC	LDO, 1.5V±2%, 600mA	SOT-89	20vl	VR1	4c	Rct
JM	2S3J61	p-MOSFET-e*	Sw, U-Sp, LogL, 30V, 1.5A, 1.3W, <0.6Ω(0.75A), 6/20ns	PCP	20fi	-	4a	San
JM	AP1115AY-30	LVR-IC	LDO, 3V±2%, 600mA	SOT-89	20ch	VR1	4b	Ana
JM	AP1115BY-30	LVR-IC	LDO, 3V±2%, 600mA	SOT-89	20vl	VR1	4b	Ana
JM	RT9166-18CX	LVR-IC	LDO, 1.8V±2%, 300mA	SOT-89	20ch	VR1	4c	Rct
JM-	RT9166-18PX	LVR-IC	LDO, 1.8V±2%, 300mA	SOT-89	20ch	VR1	4c	Rct
JN	2S3J62	p-MOSFET-e*	Sw, U-Sp, LogL, 20V, 2A, 1.5W, <0.315Ω(1A), 10/32ns	PCP	20fi	-	4a	San
JN	RT9166-18CXL	LVR-IC	LDO, 1.8V±2%, 300mA	SOT-89	20vl	VR1	4c	Rct
JN-	RT9166-18PXL	LVR-IC	LDO, 1.8V±2%, 300mA	SOT-89	20vl	VR1	4c	Rct
JO	2SA1384-O	Si-ppn	Vid, 300V, 100mA, 500mW, B=50..150, >50MHz	SOT-89	20tb	-	4b	Tos
JO	2S3J63	p-MOSFET-e*	Sw, U-Sp, LogL, 30V, 2A, 1.5W, <0.315Ω(1A), 7/23ns	PCP	20fi	-	4a	San
JO	AP1115AY	LVR-IC	LDO, Adjustable 1.25..13.8V, 600mA	SOT-89	20ck	VR20	4b	Ana
JO	AP1115BY	LVR-IC	LDO, Adjustable 1.25..13.8V, 600mA	SOT-89	20cm	VR20	4b	Ana
JO	KTA1668-O	Si-ppn	Drv, 80V, 1A, 500mW, B=60..120, 150MHz	SOT-89	20tb	-	4a	Kec
JP	2S3J78	p-MOSFET-e*	Sw, U-Sp, LogL, 60V, 1A, 1.3W, <1.3Ω(0.5A), 6/21ns	PCP	20fi	-	4a	San
JP	AP1115AY-15	LVR-IC	LDO, 1.5V±2%, 600mA	SOT-89	20ch	VR1	4b	Ana
JP	AP1115BY-15	LVR-IC	LDO, 1.5V±2%, 600mA	SOT-89	20vl	VR1	4b	Ana
JP	RT9166A-18CXL	LVR-IC	LDO, 1.8V±2%, 600mA	SOT-89	20vl	VR1	4c	Rct
JP-	RT9166A-18PXL	LVR-IC	LDO, 1.8V±2%, 600mA	SOT-89	20vl	VR1	4c	Rct
JQ	2S3J79	p-MOSFET-e*	Sw, U-Sp, LogL, 60V, 1.2A, 1.5W, <0.8Ω(0.6A), 8/22ns	PCP	20fi	-	4a	San
JQ	AP1115AY-18	LVR-IC	LDO, 1.8V±2%, 600mA	SOT-89	20ch	VR1	4b	Ana
JQ	AP1115BY-18	LVR-IC	LDO, 1.8V±2%, 600mA	SOT-89	20vl	VR1	4b	Ana
JQ	RT9166-27CX	LVR-IC	LDO, 2.7V±2%, 300mA	SOT-89	20ch	VR1	4c	Rct
JR	2SA1384-R	Si-ppn	Vid, 300V, 100mA, 500mW, B=30..90, >50MHz	SOT-89	20tb	-	4b	Tos
JR	2S3C5631	Si-ppn	UHF/VHF WB-amp, 15V, 80mA, 800mW, 11GHz, B=80..160	UPAK	20tm	-	4g	Ren
JR	2S3J80	p-MOSFET-e*	Sw, U-Sp, LogL, 60V, 1.8A, 1.5W, <0.4Ω(1A), 9/38ns	PCP	20fi	-	4a	San
JR	AP1115AY-25	LVR-IC	LDO, 2.5V±2%, 600mA	SOT-89	20ch	VR1	4b	Ana
JR	AP1115BY-25	LVR-IC	LDO, 2.5V±2%, 600mA	SOT-89	20vl	VR1	4b	Ana
JR	RT9166-28CX	LVR-IC	LDO, 2.8V±2%, 300mA	SOT-89	20ch	VR1	4c	Rct
JS	2SD2532	Si-ppn	Lo-sat, 50V, 2A, 1W, B=120..300	SOT-89	20tb	-	4b	Ren
JS	AP1115AY-33	LVR-IC	LDO, 3.3V±2%, 600mA	SOT-89	20ch	VR1	4b	Ana
JS	AP1115BY-33	LVR-IC	LDO, 3.3V±2%, 600mA	SOT-89	20vl	VR1	4b	Ana
JS	RT9166-28CXL	LVR-IC	LDO, 2.8V±2%, 300mA	SOT-89	20vl	VR1	4c	Rct
JS-	RT9166-28PXL	LVR-IC	LDO, 2.8V±2%, 300mA	SOT-89	20vl	VR1	4c	Rct
JT	AP1115AY-50	LVR-IC	LDO, 5V±2%, 600mA	SOT-89	20ch	VR1	4b	Ana
JT	AP1115BY-50	LVR-IC	LDO, 5V±2%, 600mA	SOT-89	20vl	VR1	4b	Ana
JT	RT9166-30CX	LVR-IC	LDO, 3.0V±2%, 300mA	SOT-89	20ch	VR1	4c	Rct
JT-	RT9166-30PX	LVR-IC	LDO, 3.0V±2%, 300mA	SOT-89	20ch	VR1	4c	Rct
JU	RT9166-30CXL	LVR-IC	LDO, 3.0V±2%, 300mA	SOT-89	20vl	VR1	4c	Rct
JU-	RT9166-30PXL	LVR-IC	LDO, 3.0V±2%, 300mA	SOT-89	20vl	VR1	4c	Rct
JV	RT9166A-30CXL	LVR-IC	LDO, 3.0V±2%, 600mA	SOT-89	20vl	VR1	4c	Rct
JV-	RT9166A-30PXL	LVR-IC	LDO, 3.0V±2%, 600mA	SOT-89	20vl	VR1	4c	Rct
JW	RT9166-36CX	LVR-IC	LDO, 3.6V±2%, 300mA	SOT-89	20ch	VR1	4c	Rct
JX	RT9166-36CXL	LVR-IC	LDO, 3.6V±2%, 300mA	SOT-89	20vl	VR1	4c	Rct
JX-	RT9166-36PXL	LVR-IC	LDO, 3.6V±2%, 300mA	SOT-89	20vl	VR1	4c	Rct



SMD
code

Type

Function

Short description

Case Pinout Sch. St. Mnf.

JY	2S2J44	p-MOSFET-e*	V-MOS, LogL, 12V, 2A, <0.9 Ω (0.5A), integr, Rgate	SOT-89	20fa	-	4b	Ren
JY	KTA1668-Y	Si-ppnp	Drv, 80V, 1A, 500mW, B=120..200, 150MHz	SOT-89	20fb	-	4a	Kec
JZ	RT9166-42CXL	LVR-IC	LDO, 4.2V \pm 2%, 300mA	SOT-89	20vl	VR1	4c	Rct
JZ-	RT9166-42PXL	LVR-IC	LDO, 4.2V \pm 2%, 300mA	SOT-89	20vl	VR1	4c	Rct
K	2SB1208	Si-ppnp-Digi	AF-Drv, 20V, 2A, 1W, 120MHz, B>70, R2=10k	SOT-89	20tb	-	4g	Pan
K1	2SK2741	n-MOSFET-e*	V-MOS, LogL, 60V, 5A, <0.3 Ω (1.5A)	SOT-89	20fa	-	4b	Tos
K2	2SK2742	n-MOSFET-e*	V-MOS, LogL, 100V, 3A, <0.45 Ω (5A)	SOT-89	20fa	-	4b	Tos
K2F	DXT2907A-13	Si-ppnp	GP, 60V, 600mA, 1W, B=75..300, >200MHz	SOT-89	20tb	-	4m	Di
K3	2SK2839	n-MOSFET-e*	V-MOS, LogL, 30V, 10A, <0.06 Ω (5A)	SOT-89	20fa	-	4b	Tos
K4	2SK2836	n-MOSFET-e*	V-MOS, 600V, 1A, <9 Ω (0.5A)	SOT-89	20fa	-	4b	Tos
KA	2SC4409	Si-ppnp	AF, 80V, 2A, 500mW, B=120..240, 100MHz	SOT-89	20tb	-	4b	Tos
KA	2SK2103	n-MOSFET-e	V-MOS, LogL, 30V, 2A, <0.4 Ω (5A)	SOT-89	20fa	-	4b	Rhm
KA	BSS87	n-MOSFET-e	V-MOS, LogL, 240V, 290mA, 16/55ns	SOT-89	20fa	-	4b	Phi
KB	2SC4539	Si-ppnp	Sw, Lo-sat, 40V, 1.2A, 500mW, B=120..400, 100MHz	SOT-89	20tb	-	4b	Tos
KB	2SK1311	n-MOSFET-e	V-MOS, LogL, 60V, 2A, <0.45 Ω (5A)	SOT-89	20fa	-	4b	Pan
KB	BSS192	p-MOSFET-e	V-MOS, LogL, 240V, 150mA, 1W, <3.5 Ω	SOT-89	20fi	-	4b	Sie
KC	2SC4540	Si-ppnp	Sw, Lo-sat, 60V, 1A, 500mW, B=120..400, 100MHz	SOT-89	20tb	-	4b	Tos
KC	2SK1467	n-MOSFET-e*	LogL, Sw, 30V, 2A, 3.5W, <0.3 Ω (1A), 7/35ns	SOT-89	20fi	-	4a	San
KC	2SK2463	n-MOSFET-e	V-MOS, LogL, 60V, 2A, <0.38 Ω (5A)	SOT-89	20fa	-	4b	Rhm
KD	2SC4541	Si-ppnp	Sw, Lo-sat, 60V, 3A, 500mW, B=120..400, 100MHz	SOT-89	20tb	-	4b	Tos
KD	2SK1470	n-MOSFET-e*	LogL, Sw, 60V, 2A, 3.5W, <0.45 Ω (1A), 6/60ns	SOT-89	20fa	-	4a	San
KE	2SK1473	n-MOSFET*	LogL, Sw, 100V, 2A, 3.5W, <0.95 Ω (1A), 6/60ns	SOT-89	20fa	-	4a	San
KE	2SK3065	n-MOSFET*	Sw, LogL, 30V, 2A, 500mW, 20/120ns, 0.25 Ω	SOT-89	20fi	-	4b	Rhm
KF	2SK1724	n-MOSFET*	LogL, Sw, 30V, 1A, 3.5W, <0.75 Ω (500mA), 5/30ns	SOT-89	20fa	-	4a	San
KG	2SK1726	n-MOSFET*	LogL, Sw, 60V, 1A, 3.5W, <1.2 Ω (500mA), 5/30ns	SOT-89	20fa	-	4a	San
KH	2SK1728	n-MOSFET*	LogL, Sw, 100V, 1A, 3.5W, <3.5 Ω (500mA), 5/30ns	SOT-89	20fa	-	4a	San
KI	2SK2151	n-MOSFET*	Sw, 20V, 1A, 3.5W, <0.75 Ω (500mA), 8/30ns	SOT-89	20fi	-	4a	San
KJ	2SK2152	n-MOSFET*	Sw, 20V, 2A, 3.5W, <0.25 Ω (1A), 10/50ns	SOT-89	20fi	-	4a	San
KK	2SB805-K	Si-ppnp	AF-Amp, 100V, 700mA, 2W, 75MHz, B=200..400	SOT-89	20tb	-	4b	Nec
KL	2SB805-L	Si-ppnp	AF-Amp, 100V, 700mA, 2W, 75MHz, B=135..270	SOT-89	20tb	-	4b	Nec
KM	2SB805-M	Si-ppnp	AF-Amp, 100V, 700mA, 2W, 75MHz, B=90..180	SOT-89	20tb	-	4b	Nec
KM	2SK2171	n-FET	40V, 100mA, Idss>40mA, Up<5V	SOT-89	20fa	-	4a	San
KM	BST80	n-MOSFET-e*	VMOS, 80V, 500mA, 1W, Rds=2 Ω (500mA), 10/15ns	SOT-89	20fi	-	4g	X
KM3	2SK2171-3	n-FET	40V, 100mA, 800mW, Idss=40..52mA, Up<5V	SOT-89	20fi	-	4g	San
KM4	2SK2171-4	n-FET	40V, 100mA, 800mW, Idss=48..63mA, Up<5V	SOT-89	20fi	-	4g	San
KM5	2SK2171-5	n-FET	40V, 100mA, 800mW, Idss=57..75mA, Up<5V	SOT-89	20fi	-	4g	San
KN	2SK2218	n-FET	15V, 100mA, Idss>40mA, Up<4.5V	SOT-89	20fa	-	4a	San
KN	BST84	n-MOSFET-e*	VMOS, 200V, 250mA, 1W, Rds=6 Ω (250mA), 4/15ns	SOT-89	20fi	-	4g	X
KN3	2SK2218-3	n-FET	15V, 100mA, 400mW, Idss=40..52mA, Up<4.5V	SOT-89	20fi	-	4g	San
KN4	2SK2218-4	n-FET	15V, 100mA, 400mW, Idss=48..63mA, Up<4.5V	SOT-89	20fi	-	4g	San
KN5	2SK2218-5	n-FET	15V, 100mA, 400mW, Idss=57..75mA, Up<4.5V	SOT-89	20fi	-	4g	San
KO	2SK2260	n-MOSFET-e*	V-MOS, 150V, 1.2A, <2.2 Ω (0.5A)	SOT-89	20fa	-	4a	San
KO	BST86	n-MOSFET-e*	VMOS, 180V, 300mA, 1W, Rds=7 Ω (250mA), 6/15ns	SOT-89	20fi	-	4g	X
KO	KTA1001-O	Si-ppnp	Cam. strobo-flash, 35V, 3A, 1W, B=100..200, 170MHz	SOT-89	20tb	-	4a	Kec
KP	2SB806-P	Si-ppnp	AF-Amp, 120V, 700mA, 2W, 75MHz, B=200..400	SOT-89	20tb	-	4b	Nec
KP	2SK2316	n-MOSFET*	Sw, U-sp, LogL, 20V, 2A, 1.5W, <0.2 Ω (1A), 15/50ns	PCP	20fi	-	4g	San
KQ	2SB806-Q	Si-ppnp	AF-Amp, 120V, 700mA, 2W, 75MHz, B=135..270	SOT-89	20tb	-	4b	Nec
KR	2SB806-R	Si-ppnp	AF-Amp, 120V, 700mA, 2W, 75MHz, B=90..180	SOT-89	20tb	-	4b	Nec
KS	2SD2533	Si-ppnp	Lo-sat, 80V, 2A, 1W, B=120..300, 160MHz	SOT-89	20tb	-	4b	Ren
KS	2SK3119	n-MOSFET-e*	V-MOS, LogL, 20V, 2A, <0.48 Ω (0.5A)	SOT-89	20fa	-	4a	San
KT	2SK3120	n-MOSFET-e*	V-MOS, LogL, 30V, 2A, <0.48 Ω (0.5A)	SOT-89	20fa	-	4a	San
KU	2SK3121	n-MOSFET-e*	V-MOS, LogL, 20V, 3A, <0.22 Ω (0.5A)	SOT-89	20fa	-	4a	San
KW	2SK3122	n-MOSFET-e*	V-MOS, LogL, 30V, 3A, <0.32 Ω (0.5A)	SOT-89	20fa	-	4a	San
KX	2SK3291	n-MOSFET-e*	Sw, U-Hi-Sp, 60V, 1.6A, 1.3W, 5/18ns, 0.68 Ω (0.8A)	PCP	20fi	-	4a	San
KY	2SK1764	n-MOSFET-e*	V-MOS, LogL, 60V, 2A, <0.45 Ω (5A)	SOT-89	20fa	-	4b	Ren
KY	2SK3292	n-MOSFET-e*	Sw, U-Hi-Sp, 60V, 2A, 1.5W, 7/24ns, 0.44 Ω (1A)	PCP	20fi	-	4a	San
KY	KTA1001-Y	Si-ppnp	Cam. strobo-flash, 35V, 3A, 1W, B=160..320, 170MHz	SOT-89	20tb	-	4a	Kec
KZ	2SK3293	n-MOSFET-e*	Sw, U-Hi-Sp, 60V, 3A, 1.5W, 7/30ns, 0.21 Ω (1.5A)	PCP	20fi	-	4a	San
L0	RT9166-38CXL	LVR-IC	LDO, 3.8V \pm 2%, 300mA	SOT-89	20vl	VR1	4c	Rct
L1	RT9166A-36CXL	LVR-IC	LDO, 3.6V \pm 2%, 600mA	SOT-89	20vl	VR1	4c	Rct
L1-	RT9166A-36PXL	LVR-IC	LDO, 3.6V \pm 2%, 600mA	SOT-89	20vl	VR1	4c	Rct
L2	RT9166-40CXL	LVR-IC	LDO, 4.0V \pm 2%, 300mA	SOT-89	20vl	VR1	4c	Rct
L5	RT9166A-15CX	LVR-IC	LDO, 1.5V \pm 2%, 600mA	SOT-89	20ch	VR1	4c	Rct
L5-	RT9166A-15PX	LVR-IC	LDO, 1.5V \pm 2%, 600mA	SOT-89	20ch	VR1	4c	Rct
L6	RT9166A-37CXL	LVR-IC	LDO, 3.7V \pm 2%, 600mA	SOT-89	20vl	VR1	4c	Rct
L6	XC61CN1602P	Vdet-IC	1.6V \pm 1%, +Reset ODO	SOT-89	20vda	VD6	4b	Tor
L63	XE61CN1645PR	Vdet-IC	1.6V \pm 2%, -Reset ODO	SOT-89	20cjj	VD6	4j	Tor
L65	XC61FN1612P	Vdet-IC	1.6V \pm 2%, +Reset ODO, 200ms	SOT-89	20vda	VD6	4b	Tor
L66	XC61FN1642P	Vdet-IC	1.6V \pm 2%, +Reset ODO, 400ms	SOT-89	20vda	VD6	4b	Tor
L67	XC61FN1652P	Vdet-IC	1.6V \pm 2%, +Reset ODO, 50ms	SOT-89	20vda	VD6	4b	Tor



SMD
code

Type

Function

Short description

Case Pinout Sch. St. Mnf.

SMD code	Type	Function	Short description	Case	Pinout	Sch.	St.	Mnf.
L7	XC61CN1702P	Vdet-IC	1.7V±1%, +Reset ODO	SOT-89	20vda	VD6	4b	Tor
L7-	RT9166A-28PXL	LVR-IC	LDO, 2.8V±2%, 600mA	SOT-89	20vl	VR1	4c	Rct
L73	XE61CN1745PR	Vdet-IC	1.7V±2%, -Reset ODO	SOT-89	20cj	VD6	4j	Tor
L75	XC61FN1712P	Vdet-IC	1.7V±2%, +Reset ODO, 200ms	SOT-89	20vda	VD6	4b	Tor
L76	XC61FN1742P	Vdet-IC	1.7V±2%, +Reset ODO, 400ms	SOT-89	20vda	VD6	4b	Tor
L77	XC61FN1752P	Vdet-IC	1.7V±2%, +Reset ODO, 50ms	SOT-89	20vda	VD6	4b	Tor
L8	XC61CN1802P	Vdet-IC	1.8V±1%, +Reset ODO	SOT-89	20vda	VD6	4b	Tor
L83	XE61CN1845PR	Vdet-IC	1.8V±2%, -Reset ODO	SOT-89	20cj	VD6	4j	Tor
L85	XC61FN1812P	Vdet-IC	1.8V±2%, +Reset ODO, 200ms	SOT-89	20vda	VD6	4b	Tor
L86	XC61FN1842P	Vdet-IC	1.8V±2%, +Reset ODO, 400ms	SOT-89	20vda	VD6	4b	Tor
L87	XC61FN1852P	Vdet-IC	1.8V±2%, +Reset ODO, 50ms	SOT-89	20vda	VD6	4b	Tor
L89	XC61CN1902P	Vdet-IC	1.9V±1%, +Reset ODO	SOT-89	20vda	VD6	4b	Tor
L9-	RT9166-16PX	LVR-IC	LDO, 1.6V±2%, 300mA	SOT-89	20ch	VR1	4c	Rct
L93	XE61CN1945PR	Vdet-IC	1.9V±2%, -Reset ODO	SOT-89	20cj	VD6	4j	Tor
L95	XC61FN1912P	Vdet-IC	1.9V±2%, +Reset ODO, 200ms	SOT-89	20vda	VD6	4b	Tor
L96	XC61FN1942P	Vdet-IC	1.9V±2%, +Reset ODO, 400ms	SOT-89	20vda	VD6	4b	Tor
L97	XC61FN1952P	Vdet-IC	1.9V±2%, +Reset ODO, 50ms	SOT-89	20vda	VD6	4b	Tor
LA	2SA1681	Si-ppp	AF-Amp, Sw, 60V, 2A, 500mW, B=120..400, 100MHz	SOT-89	20tb	-	4b	Tos
LA	HD2A3M	Si-npn-Digi	Sw, 60V, 1A, 2W, R1/R2=1k/1k	SOT-89	20tb	-	4b	Nec
LA	KTD1003-A	Si-npn	AF-Drv, 60V, 1A, 500mW, B=800..1600, >250MHz	SOT-89	20tb	-	4a	Kec
LA	RT9166-19CXL	LVR-IC	LDO, 1.9V±2%, 300mA	SOT-89	20vl	VR1	4c	Rct
LB	2SA1734	Si-ppp	Sw, Lo-sat, 40V, 1.2A, 500mW, B=120..400, 100MHz	SOT-89	20tb	-	4b	Tos
LB	HD2F3P	Si-npn-Digi	Sw, 80V, 1A, 2W, R1/R2=0k22/2k2	SOT-89	20tb	-	4b	Nec
LB	KTD1003-B	Si-npn	AF-Drv, 60V, 1A, 500mW, B=1200..2400, >250MHz	SOT-89	20tb	-	4a	Kec
LB	RT9166A-14CXL	LVR-IC	LDO, 1.4V±2%, 600mA	SOT-89	20vl	VR1	4c	Rct
LC	2SA1735	Si-ppp	Sw, Lo-sat, 60V, 1A, 500mW, B=120..400, 100MHz	SOT-89	20tb	-	4b	Tos
LC	2SC4357-C	Si-npn	Relay-Drv, 60V, 2A, 500mW, 80MHz, B=55..110	SOT-89	20tb	-	4a	Mit
LC	HD2L3N	Si-npn-Digi	Sw, 80V, 1A, 2W, R1/R2=4k7/10k	SOT-89	20tb	-	4b	Nec
LC	KTD1003-C	Si-npn	AF-Drv, 60V, 1A, 500mW, B=2000..3200, >250MHz	SOT-89	20tb	-	4a	Kec
LC	RT9166A-32CX	LVR-IC	LDO, 3.2V±2%, 600mA	SOT-89	20ch	VR1	4c	Rct
LC-	RT9166A-32PX	LVR-IC	LDO, 3.2V±2%, 600mA	SOT-89	20ch	VR1	4c	Rct
LD	2SA1736	Si-ppp	Sw, Lo-sat, 60V, 3A, 500mW, B=120..400, 100MHz	SOT-89	20tb	-	4b	Tos
LD	2SC4357-D	Si-npn	Relay-Drv, 60V, 2A, 500mW, 80MHz, B=90..180	SOT-89	20tb	-	4a	Mit
LD	HD2A4M	Si-npn-Digi	Sw, 60V, 1A, 2W, R2=10k	SOT-89	20tb	-	4b	Nec
LD-	RT9166A-29PXL	LVR-IC	LDO, 2.9V±2%, 600mA	SOT-89	20vl	VR1	4c	Rct
LD25	BL8534CC3TR25	DC/DC-IC	PFM step-up, 2.5±2%, 200mA	SOT-89	20bq	DC2	4b	Shb
LD26	BL8534CC3TR26	DC/DC-IC	PFM step-up, 2.6±2%, 200mA	SOT-89	20bq	DC2	4b	Shb
LD27	BL8534CC3TR27	DC/DC-IC	PFM step-up, 2.7±2%, 200mA	SOT-89	20bq	DC2	4b	Shb
LD28	BL8534CC3TR28	DC/DC-IC	PFM step-up, 2.8±2%, 200mA	SOT-89	20bq	DC2	4b	Shb
LD29	BL8534CC3TR29	DC/DC-IC	PFM step-up, 2.9±2%, 200mA	SOT-89	20bq	DC2	4b	Shb
LD30	BL8534CC3TR30	DC/DC-IC	PFM step-up, 3.0±2%, 200mA	SOT-89	20bq	DC2	4b	Shb
LD31	BL8534CC3TR31	DC/DC-IC	PFM step-up, 3.1±2%, 200mA	SOT-89	20bq	DC2	4b	Shb
LD32	BL8534CC3TR32	DC/DC-IC	PFM step-up, 3.2±2%, 200mA	SOT-89	20bq	DC2	4b	Shb
LD33	BL8534CC3TR33	DC/DC-IC	PFM step-up, 3.3±2%, 200mA	SOT-89	20bq	DC2	4b	Shb
LD34	BL8534CC3TR34	DC/DC-IC	PFM step-up, 3.4±2%, 200mA	SOT-89	20bq	DC2	4b	Shb
LD35	BL8534CC3TR35	DC/DC-IC	PFM step-up, 3.5±2%, 200mA	SOT-89	20bq	DC2	4b	Shb
LD36	BL8534CC3TR36	DC/DC-IC	PFM step-up, 3.6±2%, 200mA	SOT-89	20bq	DC2	4b	Shb
LD37	BL8534CC3TR37	DC/DC-IC	PFM step-up, 3.7±2%, 200mA	SOT-89	20bq	DC2	4b	Shb
LD38	BL8534CC3TR38	DC/DC-IC	PFM step-up, 3.8±2%, 200mA	SOT-89	20bq	DC2	4b	Shb
LD39	BL8534CC3TR39	DC/DC-IC	PFM step-up, 3.9±2%, 200mA	SOT-89	20bq	DC2	4b	Shb
LD40	BL8534CC3TR40	DC/DC-IC	PFM step-up, 4.0±2%, 200mA	SOT-89	20bq	DC2	4b	Shb
LD41	BL8534CC3TR41	DC/DC-IC	PFM step-up, 4.1±2%, 200mA	SOT-89	20bq	DC2	4b	Shb
LD42	BL8534CC3TR42	DC/DC-IC	PFM step-up, 4.2±2%, 200mA	SOT-89	20bq	DC2	4b	Shb
LD43	BL8534CC3TR43	DC/DC-IC	PFM step-up, 4.3±2%, 200mA	SOT-89	20bq	DC2	4b	Shb
LD44	BL8534CC3TR44	DC/DC-IC	PFM step-up, 4.4±2%, 200mA	SOT-89	20bq	DC2	4b	Shb
LD45	BL8534CC3TR45	DC/DC-IC	PFM step-up, 4.5±2%, 200mA	SOT-89	20bq	DC2	4b	Shb
LD46	BL8534CC3TR46	DC/DC-IC	PFM step-up, 4.6±2%, 200mA	SOT-89	20bq	DC2	4b	Shb
LD47	BL8534CC3TR47	DC/DC-IC	PFM step-up, 4.7±2%, 200mA	SOT-89	20bq	DC2	4b	Shb
LD48	BL8534CC3TR48	DC/DC-IC	PFM step-up, 4.8±2%, 200mA	SOT-89	20bq	DC2	4b	Shb
LD49	BL8534CC3TR49	DC/DC-IC	PFM step-up, 4.9±2%, 200mA	SOT-89	20bq	DC2	4b	Shb
LD50	BL8534CC3TR50	DC/DC-IC	PFM step-up, 5.0±2%, 200mA	SOT-89	20bq	DC2	4b	Shb
LD51	BL8534CC3TR51	DC/DC-IC	PFM step-up, 5.1±2%, 200mA	SOT-89	20bq	DC2	4b	Shb
LD52	BL8534CC3TR52	DC/DC-IC	PFM step-up, 5.2±2%, 200mA	SOT-89	20bq	DC2	4b	Shb
LD53	BL8534CC3TR53	DC/DC-IC	PFM step-up, 5.3±2%, 200mA	SOT-89	20bq	DC2	4b	Shb
LD54	BL8534CC3TR54	DC/DC-IC	PFM step-up, 5.4±2%, 200mA	SOT-89	20bq	DC2	4b	Shb
LD55	BL8534CC3TR55	DC/DC-IC	PFM step-up, 5.5±2%, 200mA	SOT-89	20bq	DC2	4b	Shb
LD56	BL8534CC3TR56	DC/DC-IC	PFM step-up, 5.6±2%, 200mA	SOT-89	20bq	DC2	4b	Shb
LD57	BL8534CC3TR57	DC/DC-IC	PFM step-up, 5.7±2%, 200mA	SOT-89	20bq	DC2	4b	Shb
LD58	BL8534CC3TR58	DC/DC-IC	PFM step-up, 5.8±2%, 200mA	SOT-89	20bq	DC2	4b	Shb
LD59	BL8534CC3TR59	DC/DC-IC	PFM step-up, 5.9±2%, 200mA	SOT-89	20bq	DC2	4b	Shb



SMD
code

Type

Function

Short description

Case Pinout Sch. St. Mnf.

SMD code	Type	Function	Short description	Case	Pinout	Sch.	St.	Mnf.
LD60	BL8534CC3TR60	DC/DC-IC	PFM step-up, 6.0±2%, 200mA	SOT-89	20bq	DC2	4b	Shb
LE	25C4357-E	Si-npn	Relay-Drv, 60V, 2A, 500mW, 80MHz, B=150...300	SOT-89	20fb	-	4a	Mit
LE	HD2L2Q	Si-npn-Digi	Sw, 80V, 1A, 2W, R1/R2=0k47/4k7	SOT-89	20tb	-	4b	Nec
LE-	RT9166-29PXL	LVR-IC	LDO, 2.9V±2%, 300mA	SOT-89	20vl	VR1	4c	Rct
LF	HD2F2Q	Si-npn-Digi	Sw, 80V, 1A, 2W, R1/R2=10k/10k	SOT-89	20tb	-	4b	Nec
LF-	RT9166-35PXL	LVR-IC	LDO, 3.5V±2%, 300mA	SOT-89	20vl	VR1	4c	Rct
LG	RT9166A-36CX	LVR-IC	LDO, 3.6V±2%, 600mA	SOT-89	20ch	VR1	4c	Rct
LH	RT9166-20CXL	LVR-IC	LDO, 2.0V±2%, 300mA	SOT-89	20vl	VR1	4c	Rct
LJ-	RT9166-26PXL	LVR-IC	LDO, 2.6V±2%, 300mA	SOT-89	20vl	VR1	4c	Rct
LK	2SD1000-K	Si-npn	AF-Amp, 60V, 700mA, 2W, 100MHz, B=200...400	SOT-89	20fb	-	4a	Nec
LK-	RT9166A-42PX	LVR-IC	LDO, 4.2V±2%, 600mA	SOT-89	20ch	VR1	4c	Rct
LL	2SD1000-L	Si-npn	AF-Amp, 60V, 700mA, 2W, 100MHz, B=135...270	SOT-89	20fb	-	4a	Nec
LL-	RT9166-13PX	LVR-IC	LDO, 1.3V±2%, 300mA	SOT-89	20ch	VR1	4c	Rct
LM	2SD1000-M	Si-npn	AF-Amp, 60V, 700mA, 2W, 100MHz, B=90...180	SOT-89	20fb	-	4a	Nec
LM	BST120	p-MOSFET-e*	VMOS, 60V 300mA, 1W, Rds=6Ω(250mA), 4/15ns	SOT-89	20fb	-	4g	X
LM-	RT9818B-42PX	Vdet-IC	4.2V±1.5%, -ODO +Reset, Td=55ms	SOT-89	20vda	VD6	4g	Rct
LN	BST122	p-MOSFET-e*	VMOS, 50V 250mA, 1W, Rds=7.5Ω(250mA), 5/10ns	SOT-89	20fb	-	4g	X
LN-	RT9818A-42PX	Vdet-IC	4.2V±1.5%, -ODO +Reset	SOT-89	20vda	VD6	4g	Rct
LP	HD1A3M	Si-npn-Digi	Sw, 80V, 1A, 2W, R1/R2=1k/1k	SOT-89	20tb	-	4b	Nec
LP-	RT9818E-27PX	Vdet-IC	2.7V±1.5%, +ODO +Reset	SOT-89	20vda	VD6	4g	Rct
LQ	HD1F3P	Si-npn-Digi	Sw, 80V, 1A, 2W, R1/R2=2k2/10k	SOT-89	20tb	-	4b	Nec
LQ-	RT9818E-40PX	Vdet-IC	4.0V±1.5%, +ODO +Reset	SOT-89	20vda	VD6	4g	Rct
LR	HD1L3N	Si-npn-Digi	Sw, 80V, 1A, 2W, R1/R2=4k7/10k	SOT-89	20tb	-	4b	Nec
LR-	RT9818C-27PX	Vdet-IC	2.7V±1.5%, -ODO +Reset, Td=220ms	SOT-89	20vda	VD6	4g	Rct
LS	HD1A4M	Si-npn-Digi	Sw, 80V, 1A, 2W, R1/R2=10k/10k	SOT-89	20tb	-	4b	Nec
LS-	RT9166A-31PXL	LVR-IC	LDO, 3.1V±2%, 600mA	SOT-89	20vl	VR1	4c	Rct
LT	HD1L2Q	Si-npn-Digi	Sw, 80V, 1A, 2W, R1/R2=0k47/4k7	SOT-89	20tb	-	4b	Nec
LU	HD1F2Q	Si-npn-Digi	Sw, 80V, 1A, 2W, R1/R2=0k22/2k2	SOT-89	20tb	-	4b	Nec
LX	HD1A4A	Si-npn-Digi	Sw, 80V, 1A, 2W, R2=10k	SOT-89	20tb	-	4b	Nec
M	2SK690	n-FET	GaAs, UHF, Zx 2-0i, 10V, 600mA, 1GHz	SOT-89	20fa	-	4b	Pan
M0	XC61CN2002P	Vdet-IC	2V±1%, +Reset ODO	SOT-89	20vda	VD6	4b	Tor
M03	XE61CN2045PR	Vdet-IC	2.0V±2%, -Reset ODO	SOT-89	20cj	VD6	4j	Tor
M05	XC61FN2012P	Vdet-IC	2V±2%, +Reset ODO, 200ms	SOT-89	20vda	VD6	4b	Tor
M06	XC61FN2042P	Vdet-IC	2V±2%, +Reset ODO, 400ms	SOT-89	20vda	VD6	4b	Tor
M07	XC61FN2052P	Vdet-IC	2V±2%, +Reset ODO, 50ms	SOT-89	20vda	VD6	4b	Tor
M1	D70F2T1	Si-npn	Sw, Lo-sat, 50V, 2A, 100/1100ns	SOT-89	20fb	-	4b	Gen
M1	TC54VN2102MB	Vdet-IC	2.1V±2%, -Reset ODO	SOT-89	20vda	VD6	4b	Tcs
M1	XC61CN2102P	Vdet-IC	2.1V±1%, +Reset ODO	SOT-89	20vda	VD6	4b	Tor
M13	XE61CN2145PR	Vdet-IC	2.1V±2%, -Reset ODO	SOT-89	20cj	VD6	4j	Tor
M15	XC61FN2112P	Vdet-IC	2.1V±2%, +Reset ODO, 200ms	SOT-89	20vda	VD6	4b	Tor
M16	XC61FN2142P	Vdet-IC	2.1V±2%, +Reset ODO, 400ms	SOT-89	20vda	VD6	4b	Tor
M17	XC61FN2152P	Vdet-IC	2.1V±2%, +Reset ODO, 50ms	SOT-89	20vda	VD6	4b	Tor
M2	2PD2150	Si-npn	DC/DC-Conv, 20V, 3A, 500mW, B=180...390, 220MHz	SOT-89	20tb	-	4g	Phi
M2	TC54VN2202MB	Vdet-IC	2.2V±2%, -Reset ODO	SOT-89	20vda	VD6	4b	Tcs
M2	XC61CN2202P	Vdet-IC	2.2V±1%, +Reset ODO	SOT-89	20vda	VD6	4b	Tor
M23	XE61CN2245PR	Vdet-IC	2.2V±2%, -Reset ODO	SOT-89	20cj	VD6	4j	Tor
M25	XC61FN2212P	Vdet-IC	2.2V±2%, +Reset ODO, 200ms	SOT-89	20vda	VD6	4b	Tor
M26	XC61FN2242P	Vdet-IC	2.2V±2%, +Reset ODO, 400ms	SOT-89	20vda	VD6	4b	Tor
M27	XC61FN2252P	Vdet-IC	2.2V±2%, +Reset ODO, 50ms	SOT-89	20vda	VD6	4b	Tor
M3	TC54VN2302MB	Vdet-IC	2.3V±2%, -Reset ODO	SOT-89	20vda	VD6	4b	Tcs
M3	XC61CN2302P	Vdet-IC	2.3V±1%, +Reset ODO	SOT-89	20vda	VD6	4b	Tor
M3	XC61FN2312P	Vdet-IC	2.3V±2%, +Reset ODO, 200ms	SOT-89	20vda	VD6	4b	Tor
M33	XE61CN2345PR	Vdet-IC	2.3V±2%, -Reset ODO	SOT-89	20cj	VD6	4j	Tor
M36	XC61FN2342P	Vdet-IC	2.3V±2%, +Reset ODO, 400ms	SOT-89	20vda	VD6	4b	Tor
M37	XC61FN2352P	Vdet-IC	2.3V±2%, +Reset ODO, 50ms	SOT-89	20vda	VD6	4b	Tor
M4	TC54VN2402MB	Vdet-IC	2.4V±2%, -Reset ODO	SOT-89	20vda	VD6	4b	Tcs
M4	XC61CN2402P	Vdet-IC	2.4V±1%, +Reset ODO	SOT-89	20vda	VD6	4b	Tor
M43	XE61CN2445PR	Vdet-IC	2.4V±2%, -Reset ODO	SOT-89	20cj	VD6	4j	Tor
M45	XC61FN2412P	Vdet-IC	2.4V±2%, +Reset ODO, 200ms	SOT-89	20vda	VD6	4b	Tor
M46	XC61FN2442P	Vdet-IC	2.4V±2%, +Reset ODO, 400ms	SOT-89	20vda	VD6	4b	Tor
M47	XC61FN2452P	Vdet-IC	2.4V±2%, +Reset ODO, 50ms	SOT-89	20vda	VD6	4b	Tor
M5	TC54VN2502MB	Vdet-IC	2.5V±2%, -Reset ODO	SOT-89	20vda	VD6	4b	Tcs
M5	XC61CN2502P	Vdet-IC	2.5V±1%, +Reset ODO	SOT-89	20vda	VD6	4b	Tor
M53	XE61CN2545PR	Vdet-IC	2.5V±2%, -Reset ODO	SOT-89	20cj	VD6	4j	Tor
M55	XC61FN2512P	Vdet-IC	2.5V±2%, +Reset ODO, 200ms	SOT-89	20vda	VD6	4b	Tor
M56	XC61FN2542P	Vdet-IC	2.5V±2%, +Reset ODO, 400ms	SOT-89	20vda	VD6	4b	Tor
M57	XC61FN2552P	Vdet-IC	2.5V±2%, +Reset ODO, 50ms	SOT-89	20vda	VD6	4b	Tor
M6	TC54VN2602MB	Vdet-IC	2.6V±2%, -Reset ODO	SOT-89	20vda	VD6	4b	Tcs
M6	XC61CN2602P	Vdet-IC	2.6V±1%, +Reset ODO	SOT-89	20vda	VD6	4b	Tor
M63	XE61CN2645PR	Vdet-IC	2.6V±2%, -Reset ODO	SOT-89	20cj	VD6	4j	Tor



SMD
code

Type

Function

Short description

Case Pinout Sch. St. Mnf.

M65	XC61FN2612P	Vdet-IC	2.6V±2%, +Reset ODO, 200ms	SOT-89	20vda	VD6	4b	Tor
M66	XC61FN2642P	Vdet-IC	2.6V±2%, +Reset ODO, 400ms	SOT-89	20vda	VD6	4b	Tor
M67	XC61FN2652P	Vdet-IC	2.6V±2%, +Reset ODO, 50ms	SOT-89	20vda	VD6	4b	Tor
M7	TC54VN2702MB	Vdet-IC	2.7V±2%, -Reset ODO	SOT-89	20vda	VD6	4b	Tcs
M7	XC61CN2702P	Vdet-IC	2.7V±1%, +Reset ODO	SOT-89	20vda	VD6	4b	Tor
M73	XE61CN2745PR	Vdet-IC	2.7V±2%, -Reset ODO	SOT-89	20cj	VD6	4j	Tor
M75	XC61FN2712P	Vdet-IC	2.7V±2%, +Reset ODO, 200ms	SOT-89	20vda	VD6	4b	Tor
M76	XC61FN2742P	Vdet-IC	2.7V±2%, +Reset ODO, 400ms	SOT-89	20vda	VD6	4b	Tor
M77	XC61FN2752P	Vdet-IC	2.7V±2%, +Reset ODO, 50ms	SOT-89	20vda	VD6	4b	Tor
M8	TC54VN2802MB	Vdet-IC	2.8V±2%, -Reset ODO	SOT-89	20vda	VD6	4b	Tcs
M8	XC61CN2802P	Vdet-IC	2.8V±1%, +Reset ODO	SOT-89	20vda	VD6	4b	Tor
M83	XE61CN2845PR	Vdet-IC	2.8V±2%, -Reset ODO	SOT-89	20cj	VD6	4j	Tor
M85	XC61FN2812P	Vdet-IC	2.8V±2%, +Reset ODO, 200ms	SOT-89	20vda	VD6	4b	Tor
M86	XC61FN2842P	Vdet-IC	2.8V±2%, +Reset ODO, 400ms	SOT-89	20vda	VD6	4b	Tor
M87	XC61FN2852P	Vdet-IC	2.8V±2%, +Reset ODO, 50ms	SOT-89	20vda	VD6	4b	Tor
M9	TC54VN2902MB	Vdet-IC	2.9V±2%, -Reset ODO	SOT-89	20vda	VD6	4b	Tcs
M9	XC61CN2902P	Vdet-IC	2.9V±1%, +Reset ODO	SOT-89	20vda	VD6	4b	Tor
M93	XE61CN2945PR	Vdet-IC	2.9V±2%, -Reset ODO	SOT-89	20cj	VD6	4j	Tor
M95	XC61FN2912P	Vdet-IC	2.9V±2%, +Reset ODO, 200ms	SOT-89	20vda	VD6	4b	Tor
M96	XC61FN2942P	Vdet-IC	2.9V±2%, +Reset ODO, 400ms	SOT-89	20vda	VD6	4b	Tor
M97	XC61FN2952P	Vdet-IC	2.9V±2%, +Reset ODO, 50ms	SOT-89	20vda	VD6	4b	Tor
MA	2SC3301	Si-npn	UHF, 15V, 80mA, 800mW, B=30..200, 7GHz	SOT-89	20tb	-	4b	Tos
MA	M5278L05M	LVR-IC	5V±2.5%, 100mA	SOT-89	20eu	VR1	4b	Mit
MA	M5278L56M	LVR-IC	5.6V±2.5%, 100mA	SOT-89	20eu	VR1	4b	Mit
MB	M5278L08M	LVR-IC	8V±2.5%, 100mA	SOT-89	20eu	VR1	4b	Mit
MD5-12	AMS5312	LVR-IC	LDO, 1.2V±2%, 500mA	SOT-89	20cj	VR1	4g	Ams
MD5-13	AMS5313	LVR-IC	LDO, 1.3V±2%, 500mA	SOT-89	20cj	VR1	4g	Ams
MD5-14	AMS5314	LVR-IC	LDO, 1.4V±2%, 500mA	SOT-89	20cj	VR1	4g	Ams
MD5-15	AMS5315	LVR-IC	LDO, 1.5V±2%, 500mA	SOT-89	20cj	VR1	4g	Ams
MD5-16	AMS5316	LVR-IC	LDO, 1.6V±2%, 500mA	SOT-89	20cj	VR1	4g	Ams
MD5-17	AMS5317	LVR-IC	LDO, 1.7V±2%, 500mA	SOT-89	20cj	VR1	4g	Ams
MD5-18	AMS5318	LVR-IC	LDO, 1.8V±2%, 500mA	SOT-89	20cj	VR1	4g	Ams
MD5-19	AMS5319	LVR-IC	LDO, 1.9V±2%, 500mA	SOT-89	20cj	VR1	4g	Ams
MD5-20	AMS5320	LVR-IC	LDO, 2.0V±2%, 500mA	SOT-89	20cj	VR1	4g	Ams
MD5-21	AMS5321	LVR-IC	LDO, 2.1V±2%, 500mA	SOT-89	20cj	VR1	4g	Ams
MD5-22	AMS5322	LVR-IC	LDO, 2.2V±2%, 500mA	SOT-89	20cj	VR1	4g	Ams
MD5-23	AMS5323	LVR-IC	LDO, 2.3V±2%, 500mA	SOT-89	20cj	VR1	4g	Ams
MD5-24	AMS5324	LVR-IC	LDO, 2.4V±2%, 500mA	SOT-89	20cj	VR1	4g	Ams
MD5-25	AMS5325	LVR-IC	LDO, 2.5V±2%, 500mA	SOT-89	20cj	VR1	4g	Ams
MD5-26	AMS5326	LVR-IC	LDO, 2.6V±2%, 500mA	SOT-89	20cj	VR1	4g	Ams
MD5-27	AMS5327	LVR-IC	LDO, 2.7V±2%, 500mA	SOT-89	20cj	VR1	4g	Ams
MD5-28	AMS5328	LVR-IC	LDO, 2.8V±2%, 500mA	SOT-89	20cj	VR1	4g	Ams
MD5-29	AMS5329	LVR-IC	LDO, 2.9V±2%, 500mA	SOT-89	20cj	VR1	4g	Ams
MD5-30	AMS5330	LVR-IC	LDO, 3.0V±2%, 500mA	SOT-89	20cj	VR1	4g	Ams
MD5-31	AMS5331	LVR-IC	LDO, 3.1V±2%, 500mA	SOT-89	20cj	VR1	4g	Ams
MD5-32	AMS5332	LVR-IC	LDO, 3.2V±2%, 500mA	SOT-89	20cj	VR1	4g	Ams
MD5-33	AMS5333	LVR-IC	LDO, 3.3V±2%, 500mA	SOT-89	20cj	VR1	4g	Ams
MD5-34	AMS5334	LVR-IC	LDO, 3.4V±2%, 500mA	SOT-89	20cj	VR1	4g	Ams
MD5-35	AMS5335	LVR-IC	LDO, 3.5V±2%, 500mA	SOT-89	20cj	VR1	4g	Ams
MD5-36	AMS5336	LVR-IC	LDO, 3.6V±2%, 500mA	SOT-89	20cj	VR1	4g	Ams
MD5-37	AMS5337	LVR-IC	LDO, 3.7V±2%, 500mA	SOT-89	20cj	VR1	4g	Ams
MD5-38	AMS5338	LVR-IC	LDO, 3.8V±2%, 500mA	SOT-89	20cj	VR1	4g	Ams
MD5-39	AMS5339	LVR-IC	LDO, 3.9V±2%, 500mA	SOT-89	20cj	VR1	4g	Ams
MD5-40	AMS5340	LVR-IC	LDO, 4.0V±2%, 500mA	SOT-89	20cj	VR1	4g	Ams
MD5-41	AMS5341	LVR-IC	LDO, 4.1V±2%, 500mA	SOT-89	20cj	VR1	4g	Ams
MD5-42	AMS5342	LVR-IC	LDO, 4.2V±2%, 500mA	SOT-89	20cj	VR1	4g	Ams
MD5-43	AMS5343	LVR-IC	LDO, 4.3V±2%, 500mA	SOT-89	20cj	VR1	4g	Ams
MD5-44	AMS5344	LVR-IC	LDO, 4.4V±2%, 500mA	SOT-89	20cj	VR1	4g	Ams
MD5-45	AMS5345	LVR-IC	LDO, 4.5V±2%, 500mA	SOT-89	20cj	VR1	4g	Ams
MD5-46	AMS5346	LVR-IC	LDO, 4.6V±2%, 500mA	SOT-89	20cj	VR1	4g	Ams
MD5-47	AMS5347	LVR-IC	LDO, 4.7V±2%, 500mA	SOT-89	20cj	VR1	4g	Ams
MD5-48	AMS5348	LVR-IC	LDO, 4.8V±2%, 500mA	SOT-89	20cj	VR1	4g	Ams
MD5-49	AMS5349	LVR-IC	LDO, 4.9V±2%, 500mA	SOT-89	20cj	VR1	4g	Ams
MD5-50	AMS5350	LVR-IC	LDO, 5.0V±2%, 500mA	SOT-89	20cj	VR1	4g	Ams
MD5-51	AMS5351	LVR-IC	LDO, 5.1V±2%, 500mA	SOT-89	20cj	VR1	4g	Ams
MD5-52	AMS5352	LVR-IC	LDO, 5.2V±2%, 500mA	SOT-89	20cj	VR1	4g	Ams
MD5-53	AMS5353	LVR-IC	LDO, 5.3V±2%, 500mA	SOT-89	20cj	VR1	4g	Ams
MD5-54	AMS5354	LVR-IC	LDO, 5.4V±2%, 500mA	SOT-89	20cj	VR1	4g	Ams
MD5-55	AMS5355	LVR-IC	LDO, 5.5V±2%, 500mA	SOT-89	20cj	VR1	4g	Ams
MD5-56	AMS5356	LVR-IC	LDO, 5.6V±2%, 500mA	SOT-89	20cj	VR1	4g	Ams



SMD
code

Type

Function

Short description

Case Pinout Sch. St. Mnf.

MD5-57	AMS5357	LVR-IC	LDO, 5.7V±2%, 500mA	SOT-89	20cj	VR1	4g	Ams
MD5-58	AMS5358	LVR-IC	LDO, 5.8V±2%, 500mA	SOT-89	20cj	VR1	4g	Ams
MD5-59	AMS5359	LVR-IC	LDO, 5.9V±2%, 500mA	SOT-89	20cj	VR1	4g	Ams
MD5-60	AMS5360	LVR-IC	LDO, 6.0V±2%, 500mA	SOT-89	20cj	VR1	4g	Ams
MD5-61	AMS5361	LVR-IC	LDO, 6.1V±2%, 500mA	SOT-89	20cj	VR1	4g	Ams
MD5-62	AMS5362	LVR-IC	LDO, 6.2V±2%, 500mA	SOT-89	20cj	VR1	4g	Ams
MD5-63	AMS5363	LVR-IC	LDO, 6.3V±2%, 500mA	SOT-89	20cj	VR1	4g	Ams
MD5-64	AMS5364	LVR-IC	LDO, 6.4V±2%, 500mA	SOT-89	20cj	VR1	4g	Ams
MD5-65	AMS5365	LVR-IC	LDO, 6.5V±2%, 500mA	SOT-89	20cj	VR1	4g	Ams
MD5-66	AMS5366	LVR-IC	LDO, 6.6V±2%, 500mA	SOT-89	20cj	VR1	4g	Ams
MD5-67	AMS5367	LVR-IC	LDO, 6.7V±2%, 500mA	SOT-89	20cj	VR1	4g	Ams
MD5-68	AMS5368	LVR-IC	LDO, 6.8V±2%, 500mA	SOT-89	20cj	VR1	4g	Ams
MD5-69	AMS5369	LVR-IC	LDO, 6.9V±2%, 500mA	SOT-89	20cj	VR1	4g	Ams
MD5-70	AMS5370	LVR-IC	LDO, 7.0V±2%, 500mA	SOT-89	20cj	VR1	4g	Ams
ME	2SC3268	Si-npn	VHF/UHF, 17V, 70mA, 300mW, B=25..100, 5GHz	SOT-89	20tb	-	4g	Tos
ME	M5278L09M	LVR-IC	9V±2.5%, 100mA	SOT-89	20eu	VR1	4b	Mit
MF	M5278L10M	LVR-IC	10V±2.5%, 100mA	SOT-89	20eu	VR1	4b	Mit
MG	M5278L12M	LVR-IC	12V±2.5%, 100mA	SOT-89	20eu	VR1	4b	Mit
MH	2SC3607	Si-npn	VHF/UHF, LN, 20V, 80mA, 400mW, 6.5GHz, B=30..250	SOT-89	20tb	-	4g	Tos
MH	M5278L15M	LVR-IC	15V±2.5%, 100mA	SOT-89	20eu	VR1	4b	Mit
MK	2SB799-K	Si-npn	AF-Amp, 60V, 1A, 2W, 120MHz, B=90..180	SOT-89	20tb	-	4b	Nec
ML	2SB799-L	Si-npn	AF-Amp, 60V, 1A, 2W, 120MHz, B=135..270	SOT-89	20tb	-	4b	Nec
MM	2SB799-M	Si-npn	AF-Amp, 60V, 1A, 2W, 120MHz, B=200..400	SOT-89	20tb	-	4b	Nec
MO	2SC2873-O	Si-npn	GP, 30V, 1.5A, 500mW, B=50..100, 120MHz	SOT-89	20tb	-	4b	Tos
MP	HR1A3M	Si-npn-Digi	Sw, 80V, 1A, 2W, R1/R2=1k/1k	SOT-89	20tb	-	4b	Nec
MQ	HR1F3P	Si-npn-Digi	Sw, 80V, 1A, 2W, R1/R2=2k2/10k	SOT-89	20tb	-	4b	Nec
MR	HR1L3N	Si-npn-Digi	Sw, 80V, 1A, 2W, R1/R2=4k7/10k	SOT-89	20tb	-	4b	Nec
MS	HR1A4M	Si-npn-Digi	Sw, 80V, 1A, 2W, R1/R2=10k/10k	SOT-89	20tb	-	4b	Nec
MT	HR1L2Q	Si-npn-Digi	Sw, 80V, 1A, 2W, R1/R2=0k47/4k7	SOT-89	20tb	-	4b	Nec
MU	HR1F2Q	Si-npn-Digi	Sw, 80V, 1A, 2W, R1/R2=0k22/2k2	SOT-89	20tb	-	4b	Nec
MX	HR1A4A	Si-npn-Digi	Sw, 80V, 1A, 2W, R2=10k	SOT-89	20tb	-	4b	Nec
MY	2SC2873-Y	Si-npn	GP, 30V, 1.5A, 500mW, B=90..180, 120MHz	SOT-89	20tb	-	4b	Tos
MY	2SJ278	p-MOSFET-e*	V-MOS, LogL, 60V, 1A, <0.83Ω(0.5A)	SOT-89	20fa	-	4b	Ren
N0	TC54VN3002MB	Vdet-IC	3.0V±2%, -Reset ODO	SOT-89	20vda	VD6	4b	Tcs
N0	XC61CN3002P	Vdet-IC	3V±1%, +Reset ODO	SOT-89	20vda	VD6	4b	Tor
N03	XE61CN3045PR	Vdet-IC	3.0V±2%, -Reset ODO	SOT-89	20cj	VD6	4j	Tor
N05	XC61FN3012P	Vdet-IC	3V±2%, +Reset ODO, 200ms	SOT-89	20vda	VD6	4b	Tor
N06	XC61FN3042P	Vdet-IC	3V±2%, +Reset ODO, 400ms	SOT-89	20vda	VD6	4b	Tor
N07	XC61FN3052P	Vdet-IC	3V±2%, +Reset ODO, 50ms	SOT-89	20vda	VD6	4b	Tor
N1	D71F2T1	Si-npn	Sw, Lo-sat, 50V, 2A, 100/1100ns	SOT-89	20tb	-	4b	Gen
N1	FCX491	Si-npn	GP, 80V, 1A, 1W, B=100..300, >150MHz	SOT-89	20tb	-	4b	Zx
N1	RT1N137P	Si-npn-Digi	Sw, 40V, 1A, 500mW, 150MHz, R1/R2=1k/22k	SOT-89	20tb	-	4a	Mit
N1	TC54VN3102MB	Vdet-IC	3.1V±2%, -Reset ODO	SOT-89	20vda	VD6	4b	Tcs
N1	XC61CN3102P	Vdet-IC	3.1V±1%, +Reset ODO	SOT-89	20vda	VD6	4b	Tor
N11B	ML61N113P	Vdet-IC	1.1V±3%, -Reset ODO	SOT-89	20vda	VD6	4g	Mlc
N12B	ML61N123P	Vdet-IC	1.2V±3%, -Reset ODO	SOT-89	20vda	VD6	4g	Mlc
N13	XE61CN3145PR	Vdet-IC	3.1V±2%, -Reset ODO	SOT-89	20cj	VD6	4j	Tor
N13B	ML61N133P	Vdet-IC	1.3V±3%, -Reset ODO	SOT-89	20vda	VD6	4g	Mlc
N14B	ML61N143P	Vdet-IC	1.4V±3%, -Reset ODO	SOT-89	20vda	VD6	4g	Mlc
N15	XC61FN3112P	Vdet-IC	3.1V±2%, +Reset ODO, 200ms	SOT-89	20vda	VD6	4b	Tor
N15B	ML61N153P	Vdet-IC	1.5V±3%, -Reset ODO	SOT-89	20vda	VD6	4g	Mlc
N16	XC61FN3142P	Vdet-IC	3.1V±2%, +Reset ODO, 400ms	SOT-89	20vda	VD6	4b	Tor
N16B	ML61N163P	Vdet-IC	1.6V±3%, -Reset ODO	SOT-89	20vda	VD6	4g	Mlc
N17	XC61FN3152P	Vdet-IC	3.1V±2%, +Reset ODO, 50ms	SOT-89	20vda	VD6	4b	Tor
N17B	ML61N173P	Vdet-IC	1.7V±3%, -Reset ODO	SOT-89	20vda	VD6	4g	Mlc
N18B	ML61N183P	Vdet-IC	1.8V±3%, -Reset ODO	SOT-89	20vda	VD6	4g	Mlc
N19B	ML61N193P	Vdet-IC	1.9V±3%, -Reset ODO	SOT-89	20vda	VD6	4g	Mlc
N2	FCX491A	Si-npn	GP, 40V, 1A, 1W, B=300..900, 150MHz	SOT-89	20tb	-	4g	Zx
N2	TC54VN3202MB	Vdet-IC	3.2V±2%, -Reset ODO	SOT-89	20vda	VD6	4b	Tcs
N2	XC61CN3202P	Vdet-IC	3.2V±1%, +Reset ODO	SOT-89	20vda	VD6	4b	Tor
N20B	ML61N202P	Vdet-IC	2.0V±2%, -Reset ODO	SOT-89	20vda	VD6	4g	Mlc
N21B	ML61N212P	Vdet-IC	2.1V±2%, -Reset ODO	SOT-89	20vda	VD6	4g	Mlc
N22B	ML61N222P	Vdet-IC	2.2V±2%, -Reset ODO	SOT-89	20vda	VD6	4g	Mlc
N23	XE61CN3245PR	Vdet-IC	3.2V±2%, -Reset ODO	SOT-89	20cj	VD6	4j	Tor
N23B	ML61N232P	Vdet-IC	2.3V±2%, -Reset ODO	SOT-89	20vda	VD6	4g	Mlc
N23P	2DD1766P	Si-npn	AF, Sw, 40V, 2A, 1W, B=82..180, 220MHz	SOT-89	20tb	-	4m	Di
N23Q	2DD1766Q	Si-npn	AF, Sw, 40V, 2A, 1W, B=120..270, 220MHz	SOT-89	20tb	-	4m	Di
N23R	2DD1766R	Si-npn	AF, Sw, 40V, 2A, 1W, B=180..390, 220MHz	SOT-89	20tb	-	4m	Di
N24B	ML61N242P	Vdet-IC	2.4V±2%, -Reset ODO	SOT-89	20vda	VD6	4g	Mlc
N25	XC61FN3212P	Vdet-IC	3.2V±2%, +Reset ODO, 200ms	SOT-89	20vda	VD6	4b	Tor



SMD
code

Type

Function

Short description

Case Pinout Sch. St. Mnf.

N25B	ML61N252P	Vdet-IC	2.5V±2%, -Reset ODO	SOT-89	20vda	VD6	4g	Mlc
N26	XC61FN3242P	Vdet-IC	3.2V±2%, +Reset ODO, 400ms	SOT-89	20vda	VD6	4b	Tor
N26B	ML61N262P	Vdet-IC	2.6V±2%, -Reset ODO	SOT-89	20vda	VD6	4g	Mlc
N27	XC61FN3252P	Vdet-IC	3.2V±2%, +Reset ODO, 50ms	SOT-89	20vda	VD6	4b	Tor
N27B	ML61N272P	Vdet-IC	2.7V±2%, -Reset ODO	SOT-89	20vda	VD6	4g	Mlc
N28B	ML61N282P	Vdet-IC	2.8V±2%, -Reset ODO	SOT-89	20vda	VD6	4g	Mlc
N29B	ML61N292P	Vdet-IC	2.9V±2%, -Reset ODO	SOT-89	20vda	VD6	4g	Mlc
N3	TC54VN3302MB	Vdet-IC	3.3V±2%, -Reset ODO	SOT-89	20vda	VD6	4b	Tcs
N3	XC61CN3302P	Vdet-IC	3.3V±1%, +Reset ODO	SOT-89	20vda	VD6	4b	Tor
N30B	ML61N302P	Vdet-IC	3.0V±2%, -Reset ODO	SOT-89	20vda	VD6	4g	Mlc
N31B	ML61N312P	Vdet-IC	3.1V±2%, -Reset ODO	SOT-89	20vda	VD6	4g	Mlc
N32B	ML61N322P	Vdet-IC	3.2V±2%, -Reset ODO	SOT-89	20vda	VD6	4g	Mlc
N33	XE61CN3345PR	Vdet-IC	3.3V±2%, -Reset ODO	SOT-89	20cj	VD6	4j	Tor
N33B	ML61N332P	Vdet-IC	3.3V±2%, -Reset ODO	SOT-89	20vda	VD6	4g	Mlc
N34B	ML61N342P	Vdet-IC	3.4V±2%, -Reset ODO	SOT-89	20vda	VD6	4g	Mlc
N35	XC61FN3312P	Vdet-IC	3.3V±2%, +Reset ODO, 200ms	SOT-89	20vda	VD6	4b	Tor
N35B	ML61N352P	Vdet-IC	3.5V±2%, -Reset ODO	SOT-89	20vda	VD6	4g	Mlc
N36	XC61FN3342P	Vdet-IC	3.3V±2%, +Reset ODO, 400ms	SOT-89	20vda	VD6	4b	Tor
N36B	ML61N362P	Vdet-IC	3.6V±2%, -Reset ODO	SOT-89	20vda	VD6	4g	Mlc
N37	XC61FN3352P	Vdet-IC	3.3V±2%, +Reset ODO, 50ms	SOT-89	20vda	VD6	4b	Tor
N37B	ML61N372P	Vdet-IC	3.7V±2%, -Reset ODO	SOT-89	20vda	VD6	4g	Mlc
N38B	ML61N382P	Vdet-IC	3.8V±2%, -Reset ODO	SOT-89	20vda	VD6	4g	Mlc
N39B	ML61N392P	Vdet-IC	3.9V±2%, -Reset ODO	SOT-89	20vda	VD6	4g	Mlc
N4	BFQ540	Si-npn	RF, 25V, 120mA, 1.2W, B=100..250, 9GHz	SOT-89	20tb	-	4g	Phi
N4	TC54VN3402MB	Vdet-IC	3.4V±2%, -Reset ODO	SOT-89	20vda	VD6	4b	Tcs
N4	XC61CN3402P	Vdet-IC	3.4V±1%, +Reset ODO	SOT-89	20vda	VD6	4b	Tor
N40B	ML61N402P	Vdet-IC	4.0V±2%, -Reset ODO	SOT-89	20vda	VD6	4g	Mlc
N41B	ML61N412P	Vdet-IC	4.1V±2%, -Reset ODO	SOT-89	20vda	VD6	4g	Mlc
N42B	ML61N422P	Vdet-IC	4.2V±2%, -Reset ODO	SOT-89	20vda	VD6	4g	Mlc
N43	XE61CN3445PR	Vdet-IC	3.4V±2%, -Reset ODO	SOT-89	20cj	VD6	4j	Tor
N43B	ML61N432P	Vdet-IC	4.3V±2%, -Reset ODO	SOT-89	20vda	VD6	4g	Mlc
N44B	ML61N442P	Vdet-IC	4.4V±2%, -Reset ODO	SOT-89	20vda	VD6	4g	Mlc
N45	XC61FN3412P	Vdet-IC	3.4V±2%, +Reset ODO, 200ms	SOT-89	20vda	VD6	4b	Tor
N45B	ML61N452P	Vdet-IC	4.5V±2%, -Reset ODO	SOT-89	20vda	VD6	4g	Mlc
N46	XC61FN3442P	Vdet-IC	3.4V±2%, +Reset ODO, 400ms	SOT-89	20vda	VD6	4b	Tor
N46B	ML61N462P	Vdet-IC	4.6V±2%, -Reset ODO	SOT-89	20vda	VD6	4g	Mlc
N47	XC61FN3452P	Vdet-IC	3.4V±2%, +Reset ODO, 50ms	SOT-89	20vda	VD6	4b	Tor
N47B	ML61N472P	Vdet-IC	4.7V±2%, -Reset ODO	SOT-89	20vda	VD6	4g	Mlc
N48B	ML61N482P	Vdet-IC	4.8V±2%, -Reset ODO	SOT-89	20vda	VD6	4g	Mlc
N49B	ML61N492P	Vdet-IC	4.9V±2%, -Reset ODO	SOT-89	20vda	VD6	4g	Mlc
N4A	S-1131B15UA	LVR-IC	LDO, 1.5V±1%, 300mA	SOT-89	20ch	VR1	4b	Sii
N4B	S-1131B16UA	LVR-IC	LDO, 1.6V±1%, 300mA	SOT-89	20ch	VR1	4b	Sii
N4C	S-1131B17UA	LVR-IC	LDO, 1.7V±1%, 300mA	SOT-89	20ch	VR1	4b	Sii
N4D	S-1131B18UA	LVR-IC	LDO, 1.8V±1%, 300mA	SOT-89	20ch	VR1	4b	Sii
N4E	S-1131B19UA	LVR-IC	LDO, 1.9V±1%, 300mA	SOT-89	20ch	VR1	4b	Sii
N4F	S-1131B20UA	LVR-IC	LDO, 2.0V±1%, 300mA	SOT-89	20ch	VR1	4b	Sii
N4G	S-1131B21UA	LVR-IC	LDO, 2.1V±1%, 300mA	SOT-89	20ch	VR1	4b	Sii
N4H	S-1131B22UA	LVR-IC	LDO, 2.2V±1%, 300mA	SOT-89	20ch	VR1	4b	Sii
N4I	S-1131B23UA	LVR-IC	LDO, 2.3V±1%, 300mA	SOT-89	20ch	VR1	4b	Sii
N4J	S-1131B24UA	LVR-IC	LDO, 2.4V±1%, 300mA	SOT-89	20ch	VR1	4b	Sii
N4K	S-1131B25UA	LVR-IC	LDO, 2.5V±1%, 300mA	SOT-89	20ch	VR1	4b	Sii
N4L	S-1131B26UA	LVR-IC	LDO, 2.6V±1%, 300mA	SOT-89	20ch	VR1	4b	Sii
N4M	S-1131B27UA	LVR-IC	LDO, 2.7V±1%, 300mA	SOT-89	20ch	VR1	4b	Sii
N4N	S-1131B28UA	LVR-IC	LDO, 2.8V±1%, 300mA	SOT-89	20ch	VR1	4b	Sii
N4O	S-1131B29UA	LVR-IC	LDO, 2.9V±1%, 300mA	SOT-89	20ch	VR1	4b	Sii
N4P	S-1131B30UA	LVR-IC	LDO, 3.0V±1%, 300mA	SOT-89	20ch	VR1	4b	Sii
N4Q	S-1131B31UA	LVR-IC	LDO, 3.1V±1%, 300mA	SOT-89	20ch	VR1	4b	Sii
N4R	S-1131B32UA	LVR-IC	LDO, 3.2V±1%, 300mA	SOT-89	20ch	VR1	4b	Sii
N4S	S-1131B33UA	LVR-IC	LDO, 3.3V±1%, 300mA	SOT-89	20ch	VR1	4b	Sii
N4T	S-1131B34UA	LVR-IC	LDO, 3.4V±1%, 300mA	SOT-89	20ch	VR1	4b	Sii
N4U	S-1131B35UA	LVR-IC	LDO, 3.5V±1%, 300mA	SOT-89	20ch	VR1	4b	Sii
N4V	S-1131B36UA	LVR-IC	LDO, 3.6V±1%, 300mA	SOT-89	20ch	VR1	4b	Sii
N4W	S-1131B37UA	LVR-IC	LDO, 3.7V±1%, 300mA	SOT-89	20ch	VR1	4b	Sii
N4X	S-1131B38UA	LVR-IC	LDO, 3.8V±1%, 300mA	SOT-89	20ch	VR1	4b	Sii
N4Y	S-1131B39UA	LVR-IC	LDO, 3.9V±1%, 300mA	SOT-89	20ch	VR1	4b	Sii
N4Z	S-1131B40UA	LVR-IC	LDO, 4.0V±1%, 300mA	SOT-89	20ch	VR1	4b	Sii
N5	TC54VN3502MB	Vdet-IC	3.5V±2%, -Reset ODO	SOT-89	20vda	VD6	4b	Tcs
N5	XC61CN3502P	Vdet-IC	3.5V±1%, +Reset ODO	SOT-89	20vda	VD6	4b	Tor
N50B	ML61N502P	Vdet-IC	5.0V±2%, -Reset ODO	SOT-89	20vda	VD6	4g	Mlc
N51B	ML61N512P	Vdet-IC	5.1V±2%, -Reset ODO	SOT-89	20vda	VD6	4g	Mlc



SMD
code

Type

Function

Short description

Case Pinout Sch. St. Mnf.

SMD code	Type	Function	Short description	Case	Pinout	Sch.	St.	Mnf.
N52B	ML61N522P	Vdet-IC	5.2V±2%, -Reset ODO	SOT-89	20vda	VD6	4g	Mlc
N53	XE61CN3545PR	Vdet-IC	3.5V±2%, -Reset ODO	SOT-89	20cj	VD6	4j	Tor
N53B	ML61N532P	Vdet-IC	5.3V±2%, -Reset ODO	SOT-89	20vda	VD6	4g	Mlc
N54B	ML61N542P	Vdet-IC	5.4V±2%, -Reset ODO	SOT-89	20vda	VD6	4g	Mlc
N55	XC61FN3512P	Vdet-IC	3.5V±2%, +Reset ODO, 200ms	SOT-89	20vda	VD6	4b	Tor
N55B	ML61N552P	Vdet-IC	5.5V±2%, -Reset ODO	SOT-89	20vda	VD6	4g	Mlc
N56	XC61FN3542P	Vdet-IC	3.5V±2%, +Reset ODO, 400ms	SOT-89	20vda	VD6	4b	Tor
N56B	ML61N562P	Vdet-IC	5.6V±2%, -Reset ODO	SOT-89	20vda	VD6	4g	Mlc
N57	XC61FN3552P	Vdet-IC	3.5V±2%, +Reset ODO, 50ms	SOT-89	20vda	VD6	4b	Tor
N57B	ML61N572P	Vdet-IC	5.7V±2%, -Reset ODO	SOT-89	20vda	VD6	4g	Mlc
N58	FCX458	Si-npn	Sw, 400V, 225mA, 1W, B=200...300, >50MHz	SOT-89	20tb	-	4b	Zx
N58B	ML61N582P	Vdet-IC	5.8V±2%, -Reset ODO	SOT-89	20vda	VD6	4g	Mlc
N59B	ML61N592P	Vdet-IC	5.9V±2%, -Reset ODO	SOT-89	20vda	VD6	4g	Mlc
N5A	S-1131B41UA	LVR-IC	LDO, 4.1V±1%, 300mA	SOT-89	20ch	VR1	4b	Sii
N5B	S-1131B42UA	LVR-IC	LDO, 4.2V±1%, 300mA	SOT-89	20ch	VR1	4b	Sii
N5C	S-1131B43UA	LVR-IC	LDO, 4.3V±1%, 300mA	SOT-89	20ch	VR1	4b	Sii
N5D	S-1131B44UA	LVR-IC	LDO, 4.4V±1%, 300mA	SOT-89	20ch	VR1	4b	Sii
N5E	S-1131B45UA	LVR-IC	LDO, 4.5V±1%, 300mA	SOT-89	20ch	VR1	4b	Sii
N5F	S-1131B46UA	LVR-IC	LDO, 4.6V±1%, 300mA	SOT-89	20ch	VR1	4b	Sii
N5G	S-1131B47UA	LVR-IC	LDO, 4.7V±1%, 300mA	SOT-89	20ch	VR1	4b	Sii
N5H	S-1131B48UA	LVR-IC	LDO, 4.8V±1%, 300mA	SOT-89	20ch	VR1	4b	Sii
N5I	S-1131B49UA	LVR-IC	LDO, 4.9V±1%, 300mA	SOT-89	20ch	VR1	4b	Sii
N5J	S-1131B50UA	LVR-IC	LDO, 5.0V±1%, 300mA	SOT-89	20ch	VR1	4b	Sii
N5K	S-1131B51UA	LVR-IC	LDO, 5.1V±1%, 300mA	SOT-89	20ch	VR1	4b	Sii
N5L	S-1131B52UA	LVR-IC	LDO, 5.2V±1%, 300mA	SOT-89	20ch	VR1	4b	Sii
N5M	S-1131B53UA	LVR-IC	LDO, 5.3V±1%, 300mA	SOT-89	20ch	VR1	4b	Sii
N5N	S-1131B54UA	LVR-IC	LDO, 5.4V±1%, 300mA	SOT-89	20ch	VR1	4b	Sii
N5O	S-1131B55UA	LVR-IC	LDO, 5.5V±1%, 300mA	SOT-89	20ch	VR1	4b	Sii
N6	TC54VN3602MB	Vdet-IC	3.6V±2%, -Reset ODO	SOT-89	20vda	VD6	4b	Tcs
N6	XC61CN3602P	Vdet-IC	3.6V±1%, +Reset ODO	SOT-89	20vda	VD6	4b	Tor
N60B	ML61N602P	Vdet-IC	6.0V±2%, -Reset ODO	SOT-89	20vda	VD6	4g	Mlc
N61B	ML61N612P	Vdet-IC	6.1V±2%, -Reset ODO	SOT-89	20vda	VD6	4g	Mlc
N62B	ML61N622P	Vdet-IC	6.2V±2%, -Reset ODO	SOT-89	20vda	VD6	4g	Mlc
N63	XE61CN3645PR	Vdet-IC	3.6V±2%, -Reset ODO	SOT-89	20cj	VD6	4j	Tor
N63B	ML61N632P	Vdet-IC	6.3V±2%, -Reset ODO	SOT-89	20vda	VD6	4g	Mlc
N64B	ML61N642P	Vdet-IC	6.4V±2%, -Reset ODO	SOT-89	20vda	VD6	4g	Mlc
N65	XC61FN3612P	Vdet-IC	3.6V±2%, +Reset ODO, 200ms	SOT-89	20vda	VD6	4b	Tor
N65B	ML61N652P	Vdet-IC	6.5V±2%, -Reset ODO	SOT-89	20vda	VD6	4g	Mlc
N66	XC61FN3642P	Vdet-IC	3.6V±2%, +Reset ODO, 400ms	SOT-89	20vda	VD6	4b	Tor
N66B	ML61N662P	Vdet-IC	6.6V±2%, -Reset ODO	SOT-89	20vda	VD6	4g	Mlc
N67	XC61FN3652P	Vdet-IC	3.6V±2%, +Reset ODO, 50ms	SOT-89	20vda	VD6	4b	Tor
N67B	ML61N672P	Vdet-IC	6.7V±2%, -Reset ODO	SOT-89	20vda	VD6	4g	Mlc
N68B	ML61N682P	Vdet-IC	6.8V±2%, -Reset ODO	SOT-89	20vda	VD6	4g	Mlc
N69B	ML61N692P	Vdet-IC	6.9V±2%, -Reset ODO	SOT-89	20vda	VD6	4g	Mlc
N7	TC54VN3702MB	Vdet-IC	3.7V±2%, -Reset ODO	SOT-89	20vda	VD6	4b	Tcs
N7	XC61CN3702P	Vdet-IC	3.7V±1%, +Reset ODO	SOT-89	20vda	VD6	4b	Tor
N70B	ML61N702P	Vdet-IC	7.0V±2%, -Reset ODO	SOT-89	20vda	VD6	4g	Mlc
N73	XE61CN3745PR	Vdet-IC	3.7V±2%, -Reset ODO	SOT-89	20cj	VD6	4j	Tor
N75	XC61FN3712P	Vdet-IC	3.7V±2%, +Reset ODO, 200ms	SOT-89	20vda	VD6	4b	Tor
N76	XC61FN3742P	Vdet-IC	3.7V±2%, +Reset ODO, 400ms	SOT-89	20vda	VD6	4b	Tor
N77	XC61FN3752P	Vdet-IC	3.7V±2%, +Reset ODO, 50ms	SOT-89	20vda	VD6	4b	Tor
N8	TC54VN3802MB	Vdet-IC	3.8V±2%, -Reset ODO	SOT-89	20vda	VD6	4b	Tcs
N8	XC61CN3802P	Vdet-IC	3.8V±1%, +Reset ODO	SOT-89	20vda	VD6	4b	Tor
N83	XE61CN3845PR	Vdet-IC	3.8V±2%, -Reset ODO	SOT-89	20cj	VD6	4j	Tor
N85	XC61FN3812P	Vdet-IC	3.8V±2%, +Reset ODO, 200ms	SOT-89	20vda	VD6	4b	Tor
N86	XC61FN3842P	Vdet-IC	3.8V±2%, +Reset ODO, 400ms	SOT-89	20vda	VD6	4b	Tor
N87	XC61FN3852P	Vdet-IC	3.8V±2%, +Reset ODO, 50ms	SOT-89	20vda	VD6	4b	Tor
N9	TC54VN3902MB	Vdet-IC	3.9V±2%, -Reset ODO	SOT-89	20vda	VD6	4b	Tcs
N9	XC61CN3902P	Vdet-IC	3.9V±1%, +Reset ODO	SOT-89	20vda	VD6	4b	Tor
N93	FCX493	Si-npn	Dr/Out, 120, 1A, 1W, B=100...300, >150MHz	SOT-89	20tb	-	4b	Zx
N93	XE61CN3945PR	Vdet-IC	3.9V±2%, -Reset ODO	SOT-89	20cj	VD6	4j	Tor
N95	FCX495	Si-npn	Dr/Out, 170V, 1A, 1W, B=100...300, >100MHz	SOT-89	20tb	-	4b	Zx
N95	XC61FN3912P	Vdet-IC	3.9V±2%, +Reset ODO, 200ms	SOT-89	20vda	VD6	4b	Tor
N96	XC61FN3942P	Vdet-IC	3.9V±2%, +Reset ODO, 400ms	SOT-89	20vda	VD6	4b	Tor
N97	XC61FN3952P	Vdet-IC	3.9V±2%, +Reset ODO, 50ms	SOT-89	20vda	VD6	4b	Tor
NA	2SK1273	n-MOSFET-e*	Sw, 60V, ±2A, 2W, Rds<0.31Ω(0.5A), 15/30ns	SOT-89	20fa	-	4g	X
NA1	2SK2053	n-MOSFET-e*	V-MOS, LogL, 16V, ±5A, <0.12Ω(2.5A)	SOT-89	20fa	-	4b	Nec
NA2	2SK2054	n-MOSFET-e*	V-MOS, LogL, 60V, ±3A, <0.2Ω(1.5A)	SOT-89	20fa	-	4b	Nec
NA3	2SK2055	n-MOSFET-e*	V-MOS, LogL, 100V, ±2A, <0.35Ω(5A)	SOT-89	20fa	-	4b	Nec
NA4	2SK2157	n-MOSFET-e	V-MOS, LogL, 30V, ±5A, <0.1Ω(2.5A)	SOT-89	20fa	-	4b	Nec



SMD
code

Type

Function

Short description

Case Pinout Sch. St. Mnf.

SMD code	Type	Function	Short description	Case	Pinout	Sch.	St.	Mnf.
NB	2SK1483	n-MOSFET-e*	LogL, Sw, 30V, ±2A, 2W, 0.4Ω (0.5A), 65/660ns	SOT-89	20fi	-	4g	Nec
NC	2SK1485	n-MOSFET-e*	LogL, Sw, 100V, ±1A, 2W, 0.5Ω (0.5A), 28/435ns	SOT-89	20fi	-	4g	Nec
ND	2SK1583	n-MOSFET-e*	V-MOS, LogL, 16V, ±0.5A, <1.5Ω	SOT-89	20fa	-	4b	Nec
NE	2SK1585	n-MOSFET-e*	V-MOS, LogL, 16V, ±1A <1Ω(0.5A)	SOT-89	20fa	-	4b	Nec
NE	RTGN432P	Si-pnp-Digi+Z-Di	Drv, 60V, 1A, 500mW, B>200, R1/R2=4.7k/10k	SOT-89	20tb	-	4a	Mit
NF	2SK1587	n-MOSFET-e*	V-MOS, LogL, 16V, ±2A, <0.5Ω(1A)	SOT-89	20fa	-	4b	Nec
NG	2SK1588	n-MOSFET-e*	V-MOS, LogL, 16V, ±3A, <0.3Ω(1A)	SOT-89	20fa	-	4b	Nec
NH	2SK1584	n-MOSFET-e*	V-MOS, LogL, 30V, ±0.5A, <1.5Ω	SOT-89	20fa	-	4b	Nec
NH	2SK1586	n-MOSFET-e*	V-MOS, LogL, 30V, ±1A <0.6Ω(0.5A)	SOT-89	20fa	-	4b	Nec
NK	2SC2780-K	Si-npn	AF-Amp, 140V, 50mA, 2W, 120MHz, B=200..400	SOT-89	20tb	-	4b	Nec
NL	2SC2780-L	Si-npn	AF-Amp, 140V, 50mA, 2W, 120MHz, B=135..270	SOT-89	20tb	-	4b	Nec
NM	2SC2780-M	Si-npn	AF-Amp, 140V, 50mA, 2W, 120MHz, B=90..180	SOT-89	20tb	-	4b	Nec
NO	2SA1213-O	Si-pnp	GP, 50V, 2A, 500mW, B=70..140, 100MHz	SOT-89	20tb	-	4b	Tos
NO	2SA1213PT-O	Si-pnp	AF, Sw, 50V, 2A, B=70..140, 120MHz	SOT-89	20tb	-	4g	Chm
NO	2SK1592	n-MOSFET-e*	V-MOS, LogL, 60V, ±0.5A, <2Ω(0.5A)	SOT-89	20fa	-	4b	Nec
NP	2SK1593	n-MOSFET-e*	V-MOS, LogL, 100V, ±0.5A, <5Ω(0.5A)	SOT-89	20fa	-	4b	Nec
NQ	2SK1959	n-MOSFET-e*	V-MOS, LogL, 16V, ±2A, <0.5Ω(5A)	SOT-89	20fa	-	4b	Nec
NR	2SK1960	n-MOSFET-e*	V-MOS, LogL, 16V, ±3A, <0.2Ω(1.5A)	SOT-89	20fa	-	4b	Nec
NS	2SK2109	n-MOSFET-e*	V-MOS, LogL, 60V, ±0.5A, <0.8Ω(0.5A)	SOT-89	20fa	-	4b	Nec
NT	2SK2110	n-MOSFET-e*	V-MOS, LogL, 100V, ±0.5A, <1.2Ω(0.5A)	SOT-89	20fa	-	4b	Nec
NU	2SK2111	n-MOSFET-e*	V-MOS, LogL, 60V, ±1A<0.45Ω(0.5A)	SOT-89	20fa	-	4b	Nec
NV	2SK2112	n-MOSFET-e*	V-MOS, LogL, 100V, ±1A<0.8Ω(0.5A)	SOT-89	20fa	-	4b	Nec
NW	2SK2159	n-MOSFET-e*	V-MOS, LogL, 60V, ±2A, <0.3Ω(2.5A)	SOT-89	20fa	-	4b	Nec
NX	2SK2857	n-MOSFET-e*	V-MOS, LogL, 60V, ±4A, <0.22Ω	SOT-89	20fa	-	4b	Nec
NY	2SA1213PT-Y	Si-pnp	AF, Sw, 50V, 2A, B=70..240, 120MHz	SOT-89	20tb	-	4g	Chm
NY	2SA1213-Y	Si-pnp	GP, 50V, 2A, 500mW, B=120..280, 100MHz	SOT-89	20tb	-	4b	Tos
NY	2SB1188PT-Q	Si-pnp	AF, Sw, 32V, 2A, B=120..270, 100MHz	SOT-89	20tb	-	4g	Chm
NY	2SJ317	p-MOSFET-e*	V-MOS, LogL, 12V, ±2A, <0.7Ω(0.5A), integr, Rgate	SOT-89	20fa	-	4b	Ren
O	2SK601	n-MOSFET-e	V-MOS, Sw, 80V, ±0.5A, 1W, <4Ω, 15/20ns	SOT-89	20fa	-	4b	Pan
OD	MC78LC40HT1	LVR-IC	Low Iq, 4V±2.5%, 80mA	SOT-89	20vl	VR1	4b	Ons
OE	MC78LC50HT1	LVR-IC	Low Iq, 5V±2.5%, 80mA	SOT-89	20vl	VR1	4b	Ons
OK	2SC3736-K	Si-npn	Sw, 60V, 1A, 2W, B=80..120, >300MHz	SOT-89	20tb	-	4b	Nec
OL	2SC3736-L	Si-npn	Sw, 60V, 1A, 2W, B=100..200, >300MHz	SOT-89	20tb	-	4b	Nec
P0	ELM9720CAB	Vdet-IC	2.0V±2.5%, +Reset PPO	SOT-89	20vda	VD7	4a	Elm
P0	TC54VN4002MB	Vdet-IC	4.0V±2%, -Reset ODO	SOT-89	20vda	VD6	4b	Tcs
P0	XC61CN4002P	Vdet-IC	4V±1%, +Reset ODO	SOT-89	20vda	VD6	4b	Tor
P03	XE61CN4045PR	Vdet-IC	4.0V±2%, -Reset ODO	SOT-89	20cj	VD6	4j	Tor
P05	XC61FN4012P	Vdet-IC	4V±2%, +Reset ODO, 200ms	SOT-89	20vda	VD6	4b	Tor
P06	XC61FN4042P	Vdet-IC	4V±2%, +Reset ODO, 400ms	SOT-89	20vda	VD6	4b	Tor
P07	XC61FN4052P	Vdet-IC	4V±2%, +Reset ODO, 50ms	SOT-89	20vda	VD6	4b	Tor
P1	D70Y.8T1	Si-npn	AF, 35V, 800mA, 500mW, B=70..240	SOT-89	20tb	-	4b	Gen
P1	ELM9721CAB	Vdet-IC	2.1V±2.5%, +Reset PPO	SOT-89	20vda	VD7	4a	Elm
P1	FCX591	Si-pnp	Dr/Out, 80V, 1A, 1W, B=100..300, >150MHz	SOT-89	20tb	-	4b	Zx
P1	RT1P137P	Si-pnp-Digi	Sw, 40V, 1A, 500mW, 150MHz, R1/R2=1k/22k	SOT-89	20tb	-	4a	Mit
P1	SGA-9189	MMIC	Si/Ge RF amplifier, DC..3GHz, 13.2dB (50Ω)	SOT-89	20aa	A1	4b	Sir
P1	TC54VN4102MB	Vdet-IC	4.1V±2%, -Reset ODO	SOT-89	20vda	VD6	4b	Tcs
P1	XC61CN4102P	Vdet-IC	4.1V±1%, +Reset ODO	SOT-89	20vda	VD6	4b	Tor
P1188	2SB1188PT-P	Si-pnp	AF, Sw, 32V, 2A, B=82..180, 100MHz	SOT-89	20tb	-	4g	Chm
P13	XE61CN4145PR	Vdet-IC	4.1V±2%, -Reset ODO	SOT-89	20cj	VD6	4j	Tor
P15	XC61FN4112P	Vdet-IC	4.1V±2%, +Reset ODO, 200ms	SOT-89	20vda	VD6	4b	Tor
P16	XC61FN4142P	Vdet-IC	4.1V±2%, +Reset ODO, 400ms	SOT-89	20vda	VD6	4b	Tor
P17	XC61FN4152P	Vdet-IC	4.1V±2%, +Reset ODO, 50ms	SOT-89	20vda	VD6	4b	Tor
p1A	PXT3904	Si-npn	Sw, 60V, 100mA, 1.2W, B=100..300, >300MHz	SOT-89	20tb	-	4b	Phi
p1B	PXT2222	Si-npn	GP, 60V, 600mA, 1.25W, B=100..300, >300MHz	SOT-89	20tb	-	4b	Phi
p1D	PXTA42	Si-npn	Vid, 300/300V, 200mA, 350mW, B>25, >50MHz	SOT-89	20tb	-	4b	Phi
p1E	PXTA43	Si-npn	Vid, 200/200V, 200mA, 350mW, B>25, >50MHz	SOT-89	20tb	-	4b	Phi
p1M	PXTA13	Si-npn-Darl	GP, 30V, 300mA, 300mW, B>5000, >125MHz	SOT-89	20tb	-	4b	Phi
p1N	PXTA14	Si-npn-Darl	GP, 30V, 500mA, 1.3W, B>10000, >125MHz	SOT-89	20tb	-	4b	Phi
p1P	PXT2222A	Si-npn	GP, 75V, 600mA, 1.25W, B=100..300, >300MHz	SOT-89	20tb	-	4b	Phi
P2	D70Y.8T1	Si-npn	AF, 35V, 800mA, 500mW, B=70..140	SOT-89	20tb	-	4b	Gen
P2	ELM9722CAB	Vdet-IC	2.2V±2.5%, +Reset PPO	SOT-89	20vda	VD7	4a	Elm
P2	FCX591A	Si-pnp	Dr/Out, 40V, 1A, 1W, B=300..800, >150MHz	SOT-89	20tb	-	4g	Zx
P2	TC54VN4202MB	Vdet-IC	4.2V±2%, -Reset ODO	SOT-89	20vda	VD6	4b	Tcs
P2	XC61CN4202P	Vdet-IC	4.2V±1%, +Reset ODO	SOT-89	20vda	VD6	4b	Tor
P23	XE61CN4245PR	Vdet-IC	4.2V±2%, -Reset ODO	SOT-89	20cj	VD6	4j	Tor
P25	XC61FN4212P	Vdet-IC	4.2V±2%, +Reset ODO, 200ms	SOT-89	20vda	VD6	4b	Tor
P26	XC61FN4242P	Vdet-IC	4.2V±2%, +Reset ODO, 400ms	SOT-89	20vda	VD6	4b	Tor
P27	XC61FN4252P	Vdet-IC	4.2V±2%, +Reset ODO, 50ms	SOT-89	20vda	VD6	4b	Tor
p2A	PXT3906	Si-pnp	Sw, 40V, 100mA, 1.2W, B=100..300, >250MHz	SOT-89	20tb	-	4b	Phi
p2B	PXT2907	Si-pnp	GP, 40V, 600mA, 1.3W, B=100..300, >200MHz	SOT-89	20tb	-	4b	Phi



SMD
code

Type

Function

Short description

Case Pinout Sch. St. Mnf.

SMD code	Type	Function	Short description	Case	Pinout	Sch.	St.	Mnf.
p2D	PXTA92	Si-ppnp	Vid, 300/300V, 500mA, 330mW, B=25, >50MHz	SOT-89	20tb	-	4b	Phi
p2E	PXTA93	Si-ppnp	Vid, 200/200V, 500mA, 330mW, B=25, >50MHz	SOT-89	20tb	-	4b	Phi
p2F	PXT2907A	Si-ppnp	GP, 60V, 600mA, 1.3W, B=100..300, >200MHz	SOT-89	20tb	-	4b	Phi
p2F	WTM2907A	Si-ppnp	GP, 60V, 600mA, 1.2W, B=100..300, >200MHz	SOT-89	20tb	-	4b	Wtr
p2T	PXT4403	Si-ppnp	Sw, 40V, 600mA, 1.3W, B=30..30, >200MHz	SOT-89	20tb	-	4b	Phi
p2V	PXTA64	Si-ppnp-DarI	GP, AF, 30V, 500mA, 1.5W, B>10k, >125MHz	SOT-89	20tb	-	4b	Phi
p2X	PXT4401	Si-ppnp	Sw, 60V, 600mA, 1.3W, B=20..30, >250MHz	SOT-89	20tb	-	4b	Phi
P3	D70Y.8T1	Si-ppnp	AF, 35V, 800mA, 500mW, B=120..240	SOT-89	20tb	-	4b	Gen
P3	ELM9723CAB	Vdet-IC	2.3V±2.5%, +Reset PPO	SOT-89	20vda	VD7	4a	Elm
P3	TC54VN4302MB	Vdet-IC	4.3V±2%, -Reset ODO	SOT-89	20vda	VD6	4b	Tcs
P3	XC61CN4302P	Vdet-IC	4.3V±1%, +Reset ODO	SOT-89	20vda	VD6	4b	Tor
P3101C	PAM3101CCA150	LVR-IC	LDO, 1.5V±2%, 300mA	SOT-89	20vl	VR1	4b	Pam
P3101E	PAM3101CCA180	LVR-IC	LDO, 1.8V±2%, 300mA	SOT-89	20vl	VR1	4b	Pam
P3101G	PAM3101CCA250	LVR-IC	LDO, 2.5V±2%, 300mA	SOT-89	20vl	VR1	4b	Pam
P3101H	PAM3101CCA280	LVR-IC	LDO, 2.8V±2%, 300mA	SOT-89	20vl	VR1	4b	Pam
P3101H	PAM3101HCA280	LVR-IC	LDO, 2.8V±2%, 300mA	SOT-89	20ch	VR1	4b	Pam
P3101I	PAM3101CCA285	LVR-IC	LDO, 2.85V±2%, 300mA	SOT-89	20vl	VR1	4b	Pam
P3101I	PAM3101HCA285	LVR-IC	LDO, 2.85V±2%, 300mA	SOT-89	20ch	VR1	4b	Pam
P3101J	PAM3101CCA300	LVR-IC	LDO, 3.0V±2%, 300mA	SOT-89	20vl	VR1	4b	Pam
P3101J	PAM3101HCA300	LVR-IC	LDO, 3.0V±2%, 300mA	SOT-89	20ch	VR1	4b	Pam
P3101K	PAM3101CCA330	LVR-IC	LDO, 3.3V±2%, 300mA	SOT-89	20vl	VR1	4b	Pam
P3101K	PAM3101HCA330	LVR-IC	LDO, 3.3V±2%, 300mA	SOT-89	20ch	VR1	4b	Pam
P3101M	PAM3101CCA400	LVR-IC	LDO, 4.0V±2%, 300mA	SOT-89	20vl	VR1	4b	Pam
P3101M	PAM3101HCA400	LVR-IC	LDO, 4.0V±2%, 300mA	SOT-89	20ch	VR1	4b	Pam
P3101O	PAM3101CCA380	LVR-IC	LDO, 3.8V±2%, 300mA	SOT-89	20vl	VR1	4b	Pam
P3101O	PAM3101HCA380	LVR-IC	LDO, 3.8V±2%, 300mA	SOT-89	20ch	VR1	4b	Pam
P3101P	PAM3101CCA310	LVR-IC	LDO, 3.1V±2%, 300mA	SOT-89	20vl	VR1	4b	Pam
P3101P	PAM3101HCA310	LVR-IC	LDO, 3.1V±2%, 300mA	SOT-89	20ch	VR1	4b	Pam
P3101Q	PAM3101CCA290	LVR-IC	LDO, 2.9V±2%, 300mA	SOT-89	20vl	VR1	4b	Pam
P3101Q	PAM3101HCA290	LVR-IC	LDO, 2.90V±2%, 300mA	SOT-89	20ch	VR1	4b	Pam
P3101T	PAM3101CCA475	LVR-IC	LDO, 4.75V±2%, 300mA	SOT-89	20vl	VR1	4b	Pam
P3101T	PAM3101HCA475	LVR-IC	LDO, 4.75V±2%, 300mA	SOT-89	20ch	VR1	4b	Pam
P32	2SB1132PT-P	Si-ppnp	AF, Sw, 32V, 1A, B=82..180, 150MHz	SOT-89	20tb	-	4g	Chm
P33	XE61CN4345PR	Vdet-IC	4.3V±2%, -Reset ODO	SOT-89	20cj	VD6	4j	Tor
P35	XC61FN4312P	Vdet-IC	4.3V±2%, +Reset ODO, 200ms	SOT-89	20vda	VD6	4b	Tor
P36	XC61FN4342P	Vdet-IC	4.3V±2%, +Reset ODO, 400ms	SOT-89	20vda	VD6	4b	Tor
P37	XC61FN4352P	Vdet-IC	4.3V±2%, +Reset ODO, 50ms	SOT-89	20vda	VD6	4b	Tor
P4	ELM9724CAB	Vdet-IC	2.4V±2.5%, +Reset PPO	SOT-89	20vda	VD7	4a	Elm
P4	TC54VN4402MB	Vdet-IC	4.4V±2%, -Reset ODO	SOT-89	20vda	VD6	4b	Tcs
P4	XC61CN4402P	Vdet-IC	4.4V±1%, +Reset ODO	SOT-89	20vda	VD6	4b	Tor
P43	XE61CN4445PR	Vdet-IC	4.4V±2%, -Reset ODO	SOT-89	20cj	VD6	4j	Tor
P45	XC61FN4412P	Vdet-IC	4.4V±2%, +Reset ODO, 200ms	SOT-89	20vda	VD6	4b	Tor
P46	XC61FN4442P	Vdet-IC	4.4V±2%, +Reset ODO, 400ms	SOT-89	20vda	VD6	4b	Tor
P47	XC61FN4452P	Vdet-IC	4.4V±2%, +Reset ODO, 50ms	SOT-89	20vda	VD6	4b	Tor
P5	ELM9725CAB	Vdet-IC	2.5V±2.5%, +Reset PPO	SOT-89	20vda	VD7	4a	Elm
P5	TC54VN4502MB	Vdet-IC	4.5V±2%, -Reset ODO	SOT-89	20vda	VD6	4b	Tcs
P5	XC61CN4502P	Vdet-IC	4.5V±1%, +Reset ODO	SOT-89	20vda	VD6	4b	Tor
P53	XE61CN4545PR	Vdet-IC	4.5V±2%, -Reset ODO	SOT-89	20cj	VD6	4j	Tor
P55	XC61FN4512P	Vdet-IC	4.5V±2%, +Reset ODO, 200ms	SOT-89	20vda	VD6	4b	Tor
P56	XC61FN4542P	Vdet-IC	4.5V±2%, +Reset ODO, 400ms	SOT-89	20vda	VD6	4b	Tor
P57	XC61FN4552P	Vdet-IC	4.5V±2%, +Reset ODO, 50ms	SOT-89	20vda	VD6	4b	Tor
P58	FCX558	Si-ppnp	Sw, 400V, 200mA, 1W, B=100..300, >50MHz	SOT-89	20tb	-	4b	Zx
P6	ELM9726CAB	Vdet-IC	2.6V±2.5%, +Reset PPO	SOT-89	20vda	VD7	4a	Elm
P6	TC54VN4602MB	Vdet-IC	4.6V±2%, -Reset ODO	SOT-89	20vda	VD6	4b	Tcs
P6	XC61CN4602P	Vdet-IC	4.6V±1%, +Reset ODO	SOT-89	20vda	VD6	4b	Tor
P63	XE61CN4645PR	Vdet-IC	4.6V±2%, -Reset ODO	SOT-89	20cj	VD6	4j	Tor
P64	2SD1664PT-P	Si-ppnp	AF, Sw, 32V, 1A, B=120..270, 150MHz	SOT-89	20tb	-	4b	Chm
P65	XC61FN4612P	Vdet-IC	4.6V±2%, +Reset ODO, 200ms	SOT-89	20vda	VD6	4b	Tor
P66	XC61FN4642P	Vdet-IC	4.6V±2%, +Reset ODO, 400ms	SOT-89	20vda	VD6	4b	Tor
P67	XC61FN4652P	Vdet-IC	4.6V±2%, +Reset ODO, 50ms	SOT-89	20vda	VD6	4b	Tor
P7	ELM9727CAB	Vdet-IC	2.7V±2.5%, +Reset PPO	SOT-89	20vda	VD7	4a	Elm
P7	TC54VN4702MB	Vdet-IC	4.7V±2%, -Reset ODO	SOT-89	20vda	VD6	4b	Tcs
P7	XC61CN4702P	Vdet-IC	4.7V±1%, +Reset ODO	SOT-89	20vda	VD6	4b	Tor
P73	XE61CN4745PR	Vdet-IC	4.7V±2%, -Reset ODO	SOT-89	20cj	VD6	4j	Tor
P75	XC61FN4712P	Vdet-IC	4.7V±2%, +Reset ODO, 200ms	SOT-89	20vda	VD6	4b	Tor
P76	XC61FN4742P	Vdet-IC	4.7V±2%, +Reset ODO, 400ms	SOT-89	20vda	VD6	4b	Tor
P77	XC61FN4752P	Vdet-IC	4.7V±2%, +Reset ODO, 50ms	SOT-89	20vda	VD6	4b	Tor
P8	ELM9728CAB	Vdet-IC	2.8V±2.5%, +Reset PPO	SOT-89	20vda	VD7	4a	Elm
P8	TC54VN4802MB	Vdet-IC	4.8V±2%, -Reset ODO	SOT-89	20vda	VD6	4b	Tcs
P8	XC61CN4802P	Vdet-IC	4.8V±1%, +Reset ODO	SOT-89	20vda	VD6	4b	Tor



SMD
code

Type

Function

Short description

Case Pinout Sch. St. Mnf.

SMD code	Type	Function	Short description	Case	Pinout	Sch.	St.	Mnf.
P82	2SD882PT-P	Si-npn	AF, Sw, 30V, 3A, B=160..320, 100MHz	SOT-89	20tb	-	4b	Chm
P83	XE61CN4845PR	Vdet-IC	4.8V±2%, -Reset ODO	SOT-89	20cj	VD6	4j	Tor
P85	XC61FN4812P	Vdet-IC	4.8V±2%, +Reset ODO, 200ms	SOT-89	20vda	VD6	4b	Tor
P86	2SB1386PT-P	Si-pnp	AF, Sw, 20V, 5A, B=82..180, 120MHz	SOT-89	20tb	-	4g	Chm
P86	XC61FN4842P	Vdet-IC	4.8V±2%, +Reset ODO, 400ms	SOT-89	20vda	VD6	4b	Tor
P87	XC61FN4852P	Vdet-IC	4.8V±2%, +Reset ODO, 50ms	SOT-89	20vda	VD6	4b	Tor
P89	FCX589	Si-pnp	GP, 50V, 1A, 1W, B=100..300, 100MHz	SOT-89	20tb	-	4g	Zx
P9	ELM9729CAB	Vdet-IC	2.9V±2.5%, +Reset PPO	SOT-89	20vda	VD7	4a	Elm
P9	TC54VN4902MB	Vdet-IC	4.9V±2%, -Reset ODO	SOT-89	20vda	VD6	4b	Tcs
P9	XC61CN4902P	Vdet-IC	4.9V±1%, +Reset ODO	SOT-89	20vda	VD6	4b	Tor
P93	FCX593	Si-pnp	Dr/Out, 120V, 1A, 1W, B=100..300, >50MHz	SOT-89	20tb	-	4b	Zx
P93	XE61CN4945PR	Vdet-IC	4.9V±2%, -Reset ODO	SOT-89	20cj	VD6	4j	Tor
P95	XC61FN4912P	Vdet-IC	4.9V±2%, +Reset ODO, 200ms	SOT-89	20vda	VD6	4b	Tor
P96	FCX596	Si-pnp	Dr/Out, 220V, 300mA, 1W, B=35..100, >150MHz	SOT-89	20tb	-	4b	Zx
P96	XC61FN4942P	Vdet-IC	4.9V±2%, +Reset ODO, 400ms	SOT-89	20vda	VD6	4b	Tor
P97	XC61FN4952P	Vdet-IC	4.9V±2%, +Reset ODO, 50ms	SOT-89	20vda	VD6	4b	Tor
PA	2SJ179	p-MOSFET-e*	GP, 30V, ±1.5A, 2W, <1Q(500mA), 105/580ns	SOT-89	20fa	-	4b	Nec
PB	2SJ197	p-MOSFET-e*	LogL, Sw, 60V, ±1.5A, 2W, Rds=0.9Q(500mA), 45/380ns	SOT-89	20fi	-	4g	X
PB	DCG10	Si-diode	Hi-sp rect, 200V, 1A, Vf=1V(1A), 7pF, 90ns	PCP	20dm	-	4g	San
PC	2SJ199	p-MOSFET-e*	LogL, Sw, 100V, ±1A, 2W, Rds=1.5Q(500mA), 45/360ns	SOT-89	20fi	-	4g	X
PC	DCH10	Si-diode	Hi-speed rect., 200V, 1A, Vf=1V(1A), 7pF, 90ns	PCP	20bz	-	4g	San
PD	2SJ205	p-MOSFET-e*	V-MOS, Sw, 16V, ±0.5A, <3Q(0.5A)	SOT-89	20fa	-	4b	Nec
PE	2SJ207	p-MOSFET-e*	V-MOS, Sw, 16V, ±1A <1.5Q(0.5A)	SOT-89	20fa	-	4b	Nec
PF	2SJ208	p-MOSFET-e*	V-MOS, Sw, 16V, ±2A, <1Q(5A)	SOT-89	20fa	-	4b	Nec
PH	2SJ206	p-MOSFET-e*	V-MOS, Sw, 30V, ±0.5A, <3Q(0.5A)	SOT-89	20fa	-	4b	Nec
PK	2SA1173-K	Si-pnp	AF-Amp, 140V, 50mA, 2W, B=200..400, 80MHz	SOT-89	20tb	-	4b	Nec
PL	2SA1173-L	Si-pnp	AF-Amp, 140V, 50mA, 2W, B=135..270, 80MHz	SOT-89	20tb	-	4b	Nec
PM	2SA1173-M	Si-pnp	AF-Amp, 140V, 50mA, 2W, B=90..180, 80MHz	SOT-89	20tb	-	4b	Nec
PO	2SC2884-O	Si-npn	GP, 35V, 800mA, 500mW, B=70..140, 120MHz	SOT-89	20tb	-	4b	Tos
PO	2SJ212	p-MOSFET-e*	V-MOS, Sw, 60V, ±0.5A, <3Q(0.5A)	SOT-89	20fa	-	4b	Nec
PO	KTC4376-O	Si-npn	AF-Drv, 35V, 800mA, 500mW, B=100..200, >120MHz	SOT-89	20tb	-	4a	Kec
PP	2SJ213	p-MOSFET-e*	V-MOS, Sw, 100V, ±0.5A, <4.2Q(0.5A)	SOT-89	20fa	-	4b	Nec
PQ	2SD1511-Q	Si-npn-Darl	AF, 100V, 1A, 1W, 150MHz, B=4k..10k	SOT-89	20tb	-	4b	Pan
PQ	2SJ355	p-MOSFET-e*	V-MOS, LogL, 30V, ±2A, <0.35Q(5A)	SOT-89	20fa	-	4b	Nec
PR	2SD1511-R	Si-npn-Darl	AF, 100V, 1A, 1W, 150MHz, B=8k..20k	SOT-89	20tb	-	4b	Pan
PR	2SJ356	p-MOSFET-e*	V-MOS, LogL, 60V, ±2A, <0.5Q(5A)	SOT-89	20fa	-	4b	Nec
PS	2SD1511-S	Si-npn-Darl	AF, 100V, 1A, 1W, 150MHz, B=16k..40k	SOT-89	20tb	-	4b	Pan
PY	2SC2884-Y	Si-npn	GP, 35V, 800mA, 500mW, B=120..240, 120MHz	SOT-89	20tb	-	4b	Tos
PY	2SJ363	p-MOSFET-e*	V-MOS, LogL, 30V, 2A, <0.45Q(1A), integr, Rgate	SOT-89	20fa	-	4b	Ren
Q1	KTC4376-Y	Si-npn	AF-Drv, 35V, 800mA, 500mW, B=160..320, >120MHz	SOT-89	20tb	-	4a	Kec
Q1766	2SC1766PT-Q	Si-npn	AF, Sw, 50V, 2A, B=120..270, 120MHz	SOT-89	20tb	-	4b	Chm
Q32	2SB1132PT-Q	Si-pnp	AF, Sw, 32V, 1A, B=120..270, 150MHz	SOT-89	20tb	-	4g	Chm
Q64	2SD1664PT-Q	Si-npn	AF, Sw, 32V, 1A, B=180..390, 150MHz	SOT-89	20tb	-	4b	Chm
Q72	2SB772PT-Q	Si-pnp	AF, Sw, 30V, 3A, B=100..200, 300MHz	SOT-89	20tb	-	4g	Chm
Q82	2SD882PT-Q	Si-npn	AF, Sw, 30V, 3A, B=100..200, 100MHz	SOT-89	20tb	-	4b	Chm
Q86	2SB1386PT-Q	Si-pnp	AF, Sw, 20V, 5A, B=120..270, 120MHz	SOT-89	20tb	-	4g	Chm
Q88	2SD2098PT-Q	Si-npn	AF, Sw, 20V, 5A, B=120..270, 150MHz	SOT-89	20tb	-	4b	Chm
QG	KTB1260-G	Si-pnp	GP, 80V, 1A, 500mW, B=70..140, 100MHz	SOT-89	20tb	-	4a	Kec
QK	2SC2954	Si-npn	VHF/UHF-Mix, 35V, 150mA, 2W, B=30..200, 4GHz	SOT-89	20tb	-	4b	Nec
QK	AP160-25Y	LVR-IC	LDO, 2.5V±1.5%, 600mA	SOT-89	20vl	VR1	4b	Ana
QK	KTB1260-O	Si-pnp	GP, 80V, 1A, 500mW, B=120..240, 100MHz	SOT-89	20tb	-	4a	Kec
QQ	2SC4536-Q	Si-npn	UHF/CATV, 30V, 250mA, 2W, 5.5GHz, B=40..180	SOT-89	20tb	-	4b	Nec
QQ	2SC5337-Q	Si-npn	UHF-Amp, 30V, 250mA, 2W, B=40..80, 1GHz	SOT-89	20tb	-	4b	Nec
QR	2SC4536-R	Si-npn	UHF/CATV, 30V, 250mA, 2W, 5.5GHz, B=60..120	SOT-89	20tb	-	4b	Nec
QR	2SC5337-R	Si-npn	UHF-Amp, 30V, 250mA, 2W, B=60..120, 1GHz	SOT-89	20tb	-	4b	Nec
QS	2SC4536-S	Si-npn	UHF/CATV, 30V, 250mA, 2W, 5.5GHz, B=100..200	SOT-89	20tb	-	4b	Nec
QS	2SC5337-S	Si-npn	UHF-Amp, 30V, 250mA, 2W, B=100..200, 1GHz	SOT-89	20tb	-	4b	Nec
QS	AP160-33Y	LVR-IC	LDO, 3.3V±1.5%, 600mA	SOT-89	20vl	VR1	4b	Ana
QX	NEC46134	Si-npn	µWave, 30V, 250mA, 3.75W, B=40..200, 5.5GHz	SOT-89	20tb	-	4b	Cel
QY	2SK2247	n-MOSFET-e*	V-MOS, LogL, 60V, ±2A, <0.35Q(2.5A)	SOT-89	20fa	-	4b	Ren
QY	KTB1260-Y	Si-pnp	GP, 80V, 1A, 500mW, B=200..400, 100MHz	SOT-89	20tb	-	4a	Kec
R0	ELM9730CAB	Vdet-IC	3.0V±2.5%, +Reset PPO	SOT-89	20vda	VD7	4a	Elm
R0	TC54VN5002MB	Vdet-IC	5.0V±2%, -Reset ODO	SOT-89	20vda	VD6	4b	Tcs
R0	XC61CN5002P	Vdet-IC	5V±1%, +Reset ODO	SOT-89	20vda	VD6	4b	Tor
R03	XE61CN5045PR	Vdet-IC	5.0V±2%, -Reset ODO	SOT-89	20cj	VD6	4j	Tor
R05	XC61FN5012P	Vdet-IC	5V±2%, +Reset ODO, 200ms	SOT-89	20vda	VD6	4b	Tor
R06	XC61FN5042P	Vdet-IC	5V±2%, +Reset ODO, 400ms	SOT-89	20vda	VD6	4b	Tor
R07	XC61FN5052P	Vdet-IC	5V±2%, +Reset ODO, 50ms	SOT-89	20vda	VD6	4b	Tor
R1	D71Y.8T1	Si-pnp	AF, 35V, 800mA, 500mW, B=70..240	SOT-89	20tb	-	4b	Gen
R1	ELM9731CAB	Vdet-IC	3.1V±2.5%, +Reset PPO	SOT-89	20vda	VD7	4a	Elm



SMD
code

Type

Function

Short description

Case Pinout Sch. St. Mnf.

SMD code	Type	Function	Short description	Case	Pinout	Sch.	St.	Mnf.
R1	TC54VN5102MB	Vdet-IC	5.1V±2%, -Reset ODO	SOT-89	20vda	VD6	4b	Tcs
R1	XC61CN5102P	Vdet-IC	5.1V±1%, +Reset ODO	SOT-89	20vda	VD6	4b	Tor
R113	CM7R250-11B-P	LVR-IC	LDO, 1.1V±3%, 150mA	SOT-89	20vl	VR1	4g	Can
R1188	2SB1188PT-R	Si-pnp	AF, Sw, 32V, 2A, B=180..390, 100MHz	SOT-89	20tb	-	4g	Chm
R11B	ML62113P	LVR-IC	1.1V±3%, 250mA	SOT-89	20vl	VR1	4g	Mlc
R123	CM7R250-12B-P	LVR-IC	LDO, 1.2V±3%, 150mA	SOT-89	20vl	VR1	4g	Can
R12B	ML62123P	LVR-IC	1.2V±3%, 250mA	SOT-89	20vl	VR1	4g	Mlc
R13	XE61CN5145PR	Vdet-IC	5.1V±2%, -Reset ODO	SOT-89	20cj	VD6	4j	Tor
R133	CM7R250-13B-P	LVR-IC	LDO, 1.3V±3%, 150mA	SOT-89	20vl	VR1	4g	Can
R13B	ML62133P	LVR-IC	1.3V±3%, 250mA	SOT-89	20vl	VR1	4g	Mlc
R143	CM7R250-14B-P	LVR-IC	LDO, 1.4V±3%, 150mA	SOT-89	20vl	VR1	4g	Can
R14B	ML62143P	LVR-IC	1.4V±3%, 250mA	SOT-89	20vl	VR1	4g	Mlc
R15	XC61FN5112P	Vdet-IC	5.1V±2%, +Reset ODO, 200ms	SOT-89	20vda	VD6	4b	Tor
R153	CM7R250-15B-P	LVR-IC	LDO, 1.5V±3%, 150mA	SOT-89	20vl	VR1	4g	Can
R15B	ML62153P	LVR-IC	1.5V±3%, 250mA	SOT-89	20vl	VR1	4g	Mlc
R16	XC61FN5142P	Vdet-IC	5.1V±2%, +Reset ODO, 400ms	SOT-89	20vda	VD6	4b	Tor
R163	CM7R250-16B-P	LVR-IC	LDO, 1.6V±3%, 150mA	SOT-89	20vl	VR1	4g	Can
R16B	ML62163P	LVR-IC	1.6V±3%, 250mA	SOT-89	20vl	VR1	4g	Mlc
R17	XC61FN5152P	Vdet-IC	5.1V±2%, +Reset ODO, 50ms	SOT-89	20vda	VD6	4b	Tor
R173	CM7R250-17B-P	LVR-IC	LDO, 1.7V±3%, 150mA	SOT-89	20vl	VR1	4g	Can
R17B	ML62173P	LVR-IC	1.7V±3%, 250mA	SOT-89	20vl	VR1	4g	Mlc
R183	CM7R250-18B-P	LVR-IC	LDO, 1.8V±3%, 150mA	SOT-89	20vl	VR1	4g	Can
R18B	ML62183P	LVR-IC	1.8V±3%, 250mA	SOT-89	20vl	VR1	4g	Mlc
R193	CM7R250-19B-P	LVR-IC	LDO, 1.9V±3%, 150mA	SOT-89	20vl	VR1	4g	Can
R19B	ML62193P	LVR-IC	1.9V±3%, 250mA	SOT-89	20vl	VR1	4g	Mlc
R1B3	CM7R250-11A-P	LVR-IC	LDO, 1.15V±3%, 150mA	SOT-89	20vl	VR1	4g	Can
R1C3	CM7R250-12A-P	LVR-IC	LDO, 1.25V±3%, 150mA	SOT-89	20vl	VR1	4g	Can
R1D3	CM7R250-13A-P	LVR-IC	LDO, 1.35V±3%, 150mA	SOT-89	20vl	VR1	4g	Can
R1E3	CM7R250-14A-P	LVR-IC	LDO, 1.45V±3%, 150mA	SOT-89	20vl	VR1	4g	Can
R1F3	CM7R250-15A-P	LVR-IC	LDO, 1.55V±3%, 150mA	SOT-89	20vl	VR1	4g	Can
R1G3	CM7R250-16A-P	LVR-IC	LDO, 1.65V±3%, 150mA	SOT-89	20vl	VR1	4g	Can
R1H3	CM7R250-17A-P	LVR-IC	LDO, 1.75V±3%, 150mA	SOT-89	20vl	VR1	4g	Can
R1I3	CM7R250-18A-P	LVR-IC	LDO, 1.85V±3%, 150mA	SOT-89	20vl	VR1	4g	Can
R1J3	CM7R250-19A-P	LVR-IC	LDO, 1.95V±3%, 150mA	SOT-89	20vl	VR1	4g	Can
R2	D71Y.8T1	Si-pnp	AF, 35V, 800mA, 500mW, B=70..140	SOT-89	20tb	-	4b	Gen
R2	ELM9732CAB	Vdet-IC	3.2V±2.5%, +Reset PPO	SOT-89	20vda	VD7	4a	Elm
R2	TC54VN5202MB	Vdet-IC	5.2V±2%, -Reset ODO	SOT-89	20vda	VD6	4b	Tcs
R2	XC61CN5202P	Vdet-IC	5.2V±1%, +Reset ODO	SOT-89	20vda	VD6	4b	Tor
R202	CM7R250-20B-P	LVR-IC	LDO, 2.0V±2%, 150mA	SOT-89	20vl	VR1	4g	Can
R20B	ML62202P	LVR-IC	2.0V±2%, 250mA	SOT-89	20vl	VR1	4g	Mlc
R212	CM7R250-21B-P	LVR-IC	LDO, 2.1V±2%, 150mA	SOT-89	20vl	VR1	4g	Can
R21B	ML62212P	LVR-IC	2.1V±2%, 250mA	SOT-89	20vl	VR1	4g	Mlc
R222	CM7R250-22B-P	LVR-IC	LDO, 2.2V±2%, 150mA	SOT-89	20vl	VR1	4g	Can
R22B	ML62222P	LVR-IC	2.2V±2%, 250mA	SOT-89	20vl	VR1	4g	Mlc
R23	XE61CN5245PR	Vdet-IC	5.2V±2%, -Reset ODO	SOT-89	20cj	VD6	4j	Tor
R232	CM7R250-23B-P	LVR-IC	LDO, 2.3V±2%, 150mA	SOT-89	20vl	VR1	4g	Can
R23B	ML62232P	LVR-IC	2.3V±2%, 250mA	SOT-89	20vl	VR1	4g	Mlc
R242	CM7R250-24B-P	LVR-IC	LDO, 2.4V±2%, 150mA	SOT-89	20vl	VR1	4g	Can
R24B	ML62242P	LVR-IC	2.4V±2%, 250mA	SOT-89	20vl	VR1	4g	Mlc
R25	XC61FN5212P	Vdet-IC	5.2V±2%, +Reset ODO, 200ms	SOT-89	20vda	VD6	4b	Tor
R252	CM7R250-25B-P	LVR-IC	LDO, 2.5V±2%, 150mA	SOT-89	20vl	VR1	4g	Can
R25B	ML62252P	LVR-IC	2.5V±2%, 250mA	SOT-89	20vl	VR1	4g	Mlc
R26	XC61FN5242P	Vdet-IC	5.2V±2%, +Reset ODO, 400ms	SOT-89	20vda	VD6	4b	Tor
R262	CM7R250-26B-P	LVR-IC	LDO, 2.6V±2%, 150mA	SOT-89	20vl	VR1	4g	Can
R26B	ML62262P	LVR-IC	2.6V±2%, 250mA	SOT-89	20vl	VR1	4g	Mlc
R27	XC61FN5252P	Vdet-IC	5.2V±2%, +Reset ODO, 50ms	SOT-89	20vda	VD6	4b	Tor
R272	CM7R250-27B-P	LVR-IC	LDO, 2.7V±2%, 150mA	SOT-89	20vl	VR1	4g	Can
R27B	ML62272P	LVR-IC	2.7V±2%, 250mA	SOT-89	20vl	VR1	4g	Mlc
R282	CM7R250-28B-P	LVR-IC	LDO, 2.8V±2%, 150mA	SOT-89	20vl	VR1	4g	Can
R28B	ML62282P	LVR-IC	2.8V±2%, 250mA	SOT-89	20vl	VR1	4g	Mlc
R292	CM7R250-29B-P	LVR-IC	LDO, 2.9V±2%, 150mA	SOT-89	20vl	VR1	4g	Can
R29B	ML62292P	LVR-IC	2.9V±2%, 250mA	SOT-89	20vl	VR1	4g	Mlc
R2A2	CM7R250-20A-P	LVR-IC	LDO, 2.05V±2%, 150mA	SOT-89	20vl	VR1	4g	Can
R2B2	CM7R250-21A-P	LVR-IC	LDO, 2.15V±2%, 150mA	SOT-89	20vl	VR1	4g	Can
R2C2	CM7R250-22A-P	LVR-IC	LDO, 2.25V±2%, 150mA	SOT-89	20vl	VR1	4g	Can
R2D2	CM7R250-23A-P	LVR-IC	LDO, 2.35V±2%, 150mA	SOT-89	20vl	VR1	4g	Can
R2E2	CM7R250-24A-P	LVR-IC	LDO, 2.45V±2%, 150mA	SOT-89	20vl	VR1	4g	Can
R2F2	CM7R250-25A-P	LVR-IC	LDO, 2.55V±2%, 150mA	SOT-89	20vl	VR1	4g	Can
R2G2	CM7R250-26A-P	LVR-IC	LDO, 2.65V±2%, 150mA	SOT-89	20vl	VR1	4g	Can
R2H2	CM7R250-27A-P	LVR-IC	LDO, 2.75V±2%, 150mA	SOT-89	20vl	VR1	4g	Can



SMD
code

Type

Function

Short description

Case Pinout Sch. St. Mnf.

SMD code	Type	Function	Short description	Case	Pinout	Sch.	St.	Mnf.
R2J2	CM7R250-28A-P	LVR-IC	LDO, 2.85V±2%, 150mA	SOT-89	20vl	VR1	4g	Can
R2J2	CM7R250-29A-P	LVR-IC	LDO, 2.95V±2%, 150mA	SOT-89	20vl	VR1	4g	Can
R3	D71Y.8T1	Si-pnp	AF, 35V, 800mA, 500mW, B=120...240	SOT-89	20tb	-	4b	Gen
R3	ELM9733CAB	Vdet-IC	3.3V±2.5%, +Reset PPO	SOT-89	20vda	VD7	4a	Elm
R3	TC54VN5302MB	Vdet-IC	5.3V±2%, -Reset ODO	SOT-89	20vda	VD6	4b	Tcs
R3	XC61CN5302P	Vdet-IC	5.3V±1%, +Reset ODO	SOT-89	20vda	VD6	4b	Tor
R302	CM7R250-30B-P	LVR-IC	LDO, 3.0V±2%, 150mA	SOT-89	20vl	VR1	4g	Can
R30B	ML62302P	LVR-IC	3.0V±2%, 250mA	SOT-89	20vl	VR1	4g	Mlc
R312	CM7R250-31B-P	LVR-IC	LDO, 3.1V±2%, 150mA	SOT-89	20vl	VR1	4g	Can
R31B	ML62312P	LVR-IC	3.1V±2%, 250mA	SOT-89	20vl	VR1	4g	Mlc
R322	CM7R250-32B-P	LVR-IC	LDO, 3.2V±2%, 150mA	SOT-89	20vl	VR1	4g	Can
R32B	ML62322P	LVR-IC	3.2V±2%, 250mA	SOT-89	20vl	VR1	4g	Mlc
R33	XE61CN5345PR	Vdet-IC	5.3V±2%, -Reset ODO	SOT-89	20cj	VD6	4j	Tor
R332	CM7R250-33B-P	LVR-IC	LDO, 3.3V±2%, 150mA	SOT-89	20vl	VR1	4g	Can
R33B	ML62332P	LVR-IC	3.3V±2%, 250mA	SOT-89	20vl	VR1	4g	Mlc
R342	CM7R250-34B-P	LVR-IC	LDO, 3.4V±2%, 150mA	SOT-89	20vl	VR1	4g	Can
R34B	ML62342P	LVR-IC	3.4V±2%, 250mA	SOT-89	20vl	VR1	4g	Mlc
R35	XC61FN5312P	Vdet-IC	5.3V±2%, +Reset ODO, 200ms	SOT-89	20vda	VD6	4b	Tor
R352	CM7R250-35B-P	LVR-IC	LDO, 3.5V±2%, 150mA	SOT-89	20vl	VR1	4g	Can
R35B	ML62352P	LVR-IC	3.5V±2%, 250mA	SOT-89	20vl	VR1	4g	Mlc
R36	XC61FN5342P	Vdet-IC	5.3V±2%, +Reset ODO, 400ms	SOT-89	20vda	VD6	4b	Tor
R362	CM7R250-36B-P	LVR-IC	LDO, 3.6V±2%, 150mA	SOT-89	20vl	VR1	4g	Can
R36B	ML62362P	LVR-IC	3.6V±2%, 250mA	SOT-89	20vl	VR1	4g	Mlc
R37	XC61FN5352P	Vdet-IC	5.3V±2%, +Reset ODO, 50ms	SOT-89	20vda	VD6	4b	Tor
R372	CM7R250-37B-P	LVR-IC	LDO, 3.7V±2%, 150mAV	SOT-89	20vl	VR1	4g	Can
R37B	ML62372P	LVR-IC	3.7V±2%, 250mA	SOT-89	20vl	VR1	4g	Mlc
R382	CM7R250-38B-P	LVR-IC	LDO, 3.8V±2%, 150mA	SOT-89	20vl	VR1	4g	Can
R38B	ML62382P	LVR-IC	3.8V±2%, 250mA	SOT-89	20vl	VR1	4g	Mlc
R392	CM7R250-39B-P	LVR-IC	LDO, 3.9V±2%, 150mA	SOT-89	20vl	VR1	4g	Can
R39B	ML62392P	LVR-IC	3.9V±2%, 250mA	SOT-89	20vl	VR1	4g	Mlc
R3A2	CM7R250-30A-P	LVR-IC	LDO, 3.05V±2%, 150mA	SOT-89	20vl	VR1	4g	Can
R3B2	CM7R250-31A-P	LVR-IC	LDO, 3.15V±2%, 150mA	SOT-89	20vl	VR1	4g	Can
R3C2	CM7R250-32A-P	LVR-IC	LDO, 3.25V±2%, 150mA	SOT-89	20vl	VR1	4g	Can
R3D2	CM7R250-33A-P	LVR-IC	LDO, 3.35V±2%, 150mA	SOT-89	20vl	VR1	4g	Can
R3E2	CM7R250-34A-P	LVR-IC	LDO, 3.45V±2%, 150mA	SOT-89	20vl	VR1	4g	Can
R3F2	CM7R250-35A-P	LVR-IC	LDO, 3.55V±2%, 150mA	SOT-89	20vl	VR1	4g	Can
R3G2	CM7R250-36A-P	LVR-IC	LDO, 3.65V±2%, 150mA	SOT-89	20vl	VR1	4g	Can
R3H2	CM7R250-37A-P	LVR-IC	LDO, 3.75V±2%, 150mA	SOT-89	20vl	VR1	4g	Can
R3I2	CM7R250-38A-P	LVR-IC	LDO, 3.85V±2%, 150mA	SOT-89	20vl	VR1	4g	Can
R3J2	CM7R250-39A-P	LVR-IC	LDO, 3.95V±2%, 150mA	SOT-89	20vl	VR1	4g	Can
R4	ELM9734CAB	Vdet-IC	3.4V±2.5%, +Reset PPO	SOT-89	20vda	VD7	4a	Elm
R4	TC54VN5402MB	Vdet-IC	5.4V±2%, -Reset ODO	SOT-89	20vda	VD6	4b	Tcs
R4	XC61CN5402P	Vdet-IC	5.4V±1%, +Reset ODO	SOT-89	20vda	VD6	4b	Tor
R402	CM7R250-40B-P	LVR-IC	LDO, 4.0V±2%, 150mA	SOT-89	20vl	VR1	4g	Can
R40B	ML62402P	LVR-IC	4.0V±2%, 250mA	SOT-89	20vl	VR1	4g	Mlc
R412	CM7R250-41B-P	LVR-IC	LDO, 4.1V±2%, 150mA	SOT-89	20vl	VR1	4g	Can
R41B	ML62412P	LVR-IC	4.1V±2%, 250mA	SOT-89	20vl	VR1	4g	Mlc
R422	CM7R250-42B-P	LVR-IC	LDO, 4.2V±2%, 150mA	SOT-89	20vl	VR1	4g	Can
R42B	ML62422P	LVR-IC	4.2V±2%, 250mA	SOT-89	20vl	VR1	4g	Mlc
R43	XE61CN5445PR	Vdet-IC	5.4V±2%, -Reset ODO	SOT-89	20cj	VD6	4j	Tor
R432	CM7R250-43B-P	LVR-IC	LDO, 4.3V±2%, 150mA	SOT-89	20vl	VR1	4g	Can
R43B	ML62432P	LVR-IC	4.3V±2%, 250mA	SOT-89	20vl	VR1	4g	Mlc
R442	CM7R250-44B-P	LVR-IC	LDO, 4.4V±2%, 150mA	SOT-89	20vl	VR1	4g	Can
R44B	ML62442P	LVR-IC	4.4V±2%, 250mA	SOT-89	20vl	VR1	4g	Mlc
R45	XC61FN5412P	Vdet-IC	5.4V±2%, +Reset ODO, 200ms	SOT-89	20vda	VD6	4b	Tor
R452	CM7R250-45B-P	LVR-IC	LDO, 4.5V±2%, 150mA	SOT-89	20vl	VR1	4g	Can
R45B	ML62452P	LVR-IC	4.5V±2%, 250mA	SOT-89	20vl	VR1	4g	Mlc
R46	XC61FN5442P	Vdet-IC	5.4V±2%, +Reset ODO, 400ms	SOT-89	20vda	VD6	4b	Tor
R462	CM7R250-46B-P	LVR-IC	LDO, 4.6V±2%, 150mA	SOT-89	20vl	VR1	4g	Can
R46B	ML62462P	LVR-IC	4.6V±2%, 250mA	SOT-89	20vl	VR1	4g	Mlc
R47	XC61FN5452P	Vdet-IC	5.4V±2%, +Reset ODO, 50ms	SOT-89	20vda	VD6	4b	Tor
R472	CM7R250-47B-P	LVR-IC	LDO, 4.7V±2%, 150mA	SOT-89	20vl	VR1	4g	Can
R47B	ML62472P	LVR-IC	4.7V±2%, 250mA	SOT-89	20vl	VR1	4g	Mlc
R482	CM7R250-48B-P	LVR-IC	LDO, 4.8V±2%, 150mA	SOT-89	20vl	VR1	4g	Can
R48B	ML62482P	LVR-IC	4.8V±2%, 250mA	SOT-89	20vl	VR1	4g	Mlc
R492	CM7R250-49B-P	LVR-IC	LDO, 4.9V±2%, 150mA	SOT-89	20vl	VR1	4g	Can
R49B	ML62492P	LVR-IC	4.9V±2%, 250mA	SOT-89	20vl	VR1	4g	Mlc
R4A2	CM7R250-40A-P	LVR-IC	LDO, 4.05V±2%, 150mA	SOT-89	20vl	VR1	4g	Can
R4B2	CM7R250-41A-P	LVR-IC	LDO, 4.15V±2%, 150mA	SOT-89	20vl	VR1	4g	Can
R4C2	CM7R250-42A-P	LVR-IC	LDO, 4.25V±2%, 150mA	SOT-89	20vl	VR1	4g	Can



SMD
code

Type

Function

Short description

Case Pinout Sch. St. Mnf.

SMD code	Type	Function	Short description	Case	Pinout	Sch.	St.	Mnf.
R4D2	CM7R250-43A-P	LVR-IC	LDO, 4.35V±2%, 150mA	SOT-89	20vl	VR1	4g	Can
R4E2	CM7R250-44A-P	LVR-IC	LDO, 4.45V±2%, 150mA	SOT-89	20vl	VR1	4g	Can
R4F2	CM7R250-45A-P	LVR-IC	LDO, 4.55V±2%, 150mA	SOT-89	20vl	VR1	4g	Can
R4G2	CM7R250-46A-P	LVR-IC	LDO, 4.65V±2%, 150mA	SOT-89	20vl	VR1	4g	Can
R4H2	CM7R250-47A-P	LVR-IC	LDO, 4.75V±2%, 150mA	SOT-89	20vl	VR1	4g	Can
R4I2	CM7R250-48A-P	LVR-IC	LDO, 4.85V±2%, 150mA	SOT-89	20vl	VR1	4g	Can
R4J2	CM7R250-49A-P	LVR-IC	LDO, 4.95V±2%, 150mA	SOT-89	20vl	VR1	4g	Can
R5	ELM9735CAB	Vdet-IC	3.5V±2.5%, +Reset PPO	SOT-89	20vda	VD7	4a	Elm
R5	TC54VN5502MB	Vdet-IC	5.5V±2%, -Reset ODO	SOT-89	20vda	VD6	4b	Tcs
R5	XC61CN5502P	Vdet-IC	5.5V±1%, +Reset ODO	SOT-89	20vda	VD6	4b	Tor
R502	CM7R250-50B-P	LVR-IC	LDO, 5.0V±2%, 150mA	SOT-89	20vl	VR1	4g	Can
R50B	ML62502P	LVR-IC	5.0V±2%, 250mA	SOT-89	20vl	VR1	4g	Mlc
R512	CM7R250-51B-P	LVR-IC	LDO, 5.1V±2%, 150mA	SOT-89	20vl	VR1	4g	Can
R51B	ML62512P	LVR-IC	5.1V±2%, 250mA	SOT-89	20vl	VR1	4g	Mlc
R522	CM7R250-52B-P	LVR-IC	LDO, 5.2V±2%, 150mA	SOT-89	20vl	VR1	4g	Can
R52B	ML62522P	LVR-IC	5.2V±2%, 250mA	SOT-89	20vl	VR1	4g	Mlc
R53	XE61CN5545PR	Vdet-IC	5.5V±2%, -Reset ODO	SOT-89	20cjt	VD6	4j	Tor
R532	CM7R250-53B-P	LVR-IC	LDO, 5.3V±2%, 150mA	SOT-89	20vl	VR1	4g	Can
R53B	ML62532P	LVR-IC	5.3V±2%, 250mA	SOT-89	20vl	VR1	4g	Mlc
R542	CM7R250-54B-P	LVR-IC	LDO, 5.4V±2%, 150mA	SOT-89	20vl	VR1	4g	Can
R54B	ML62542P	LVR-IC	5.4V±2%, 250mA	SOT-89	20vl	VR1	4g	Mlc
R55	XC61FN5512P	Vdet-IC	5.5V±2%, +Reset ODO, 200ms	SOT-89	20vda	VD6	4b	Tor
R552	CM7R250-55B-P	LVR-IC	LDO, 5.5V±2%, 150mA	SOT-89	20vl	VR1	4g	Can
R55B	ML62552P	LVR-IC	5.5V±2%, 250mA	SOT-89	20vl	VR1	4g	Mlc
R56	XC61FN5542P	Vdet-IC	5.5V±2%, +Reset ODO, 400ms	SOT-89	20vda	VD6	4b	Tor
R562	CM7R250-56B-P	LVR-IC	LDO, 5.6V±2%, 150mA	SOT-89	20vl	VR1	4g	Can
R56B	ML62562P	LVR-IC	5.6V±2%, 250mA	SOT-89	20vl	VR1	4g	Mlc
R57	XC61FN5552P	Vdet-IC	5.5V±2%, +Reset ODO, 50ms	SOT-89	20vda	VD6	4b	Tor
R572	CM7R250-57B-P	LVR-IC	LDO, 5.7V±2%, 150mA	SOT-89	20vl	VR1	4g	Can
R57B	ML62572P	LVR-IC	5.7V±2%, 250mA	SOT-89	20vl	VR1	4g	Mlc
R582	CM7R250-58B-P	LVR-IC	LDO, 5.8V±2%, 150mA	SOT-89	20vl	VR1	4g	Can
R58B	ML62582P	LVR-IC	5.8V±2%, 250mA	SOT-89	20vl	VR1	4g	Mlc
R592	CM7R250-59B-P	LVR-IC	LDO, 5.9V±2%, 150mA	SOT-89	20vl	VR1	4g	Can
R59B	ML62592P	LVR-IC	5.9V±2%, 250mA	SOT-89	20vl	VR1	4g	Mlc
R5A2	CM7R250-50A-P	LVR-IC	LDO, 5.05V±2%, 150mA	SOT-89	20vl	VR1	4g	Can
R5B2	CM7R250-51A-P	LVR-IC	LDO, 5.15V±2%, 150mA	SOT-89	20vl	VR1	4g	Can
R5C2	CM7R250-52A-P	LVR-IC	LDO, 5.25V±2%, 150mA	SOT-89	20vl	VR1	4g	Can
R5D2	CM7R250-53A-P	LVR-IC	LDO, 5.35V±2%, 150mA	SOT-89	20vl	VR1	4g	Can
R5E2	CM7R250-54A-P	LVR-IC	LDO, 5.45V±2%, 150mA	SOT-89	20vl	VR1	4g	Can
R5F2	CM7R250-55A-P	LVR-IC	LDO, 5.55V±2%, 150mA	SOT-89	20vl	VR1	4g	Can
R5G2	CM7R250-56A-P	LVR-IC	LDO, 5.65V±2%, 150mA	SOT-89	20vl	VR1	4g	Can
R5H2	CM7R250-57A-P	LVR-IC	LDO, 5.75V±2%, 150mA	SOT-89	20vl	VR1	4g	Can
R5I2	CM7R250-58A-P	LVR-IC	LDO, 5.85V±2%, 150mA	SOT-89	20vl	VR1	4g	Can
R5J2	CM7R250-59A-P	LVR-IC	LDO, 5.95V±2%, 150mA	SOT-89	20vl	VR1	4g	Can
R6	ELM9738CAB	Vdet-IC	3.6V±2.5%, +Reset PPO	SOT-89	20vda	VD7	4a	Elm
R6	TC54VN5602MB	Vdet-IC	5.6V±2%, -Reset ODO	SOT-89	20vda	VD6	4b	Tcs
R6	XC61CN5602P	Vdet-IC	5.6V±1%, +Reset ODO	SOT-89	20vda	VD6	4b	Tor
R602	CM7R250-60B-P	LVR-IC	LDO, 6.0V±2%, 150mA	SOT-89	20vl	VR1	4g	Can
R60B	ML62602P	LVR-IC	6.0V±2%, 250mA	SOT-89	20vl	VR1	4g	Mlc
R63	XE61CN5645PR	Vdet-IC	5.6V±2%, -Reset ODO	SOT-89	20cjt	VD6	4j	Tor
R65	XC61FN5612P	Vdet-IC	5.6V±2%, +Reset ODO, 200ms	SOT-89	20vda	VD6	4b	Tor
R66	XC61FN5642P	Vdet-IC	5.6V±2%, +Reset ODO, 400ms	SOT-89	20vda	VD6	4b	Tor
R67	XC61FN5652P	Vdet-IC	5.6V±2%, +Reset ODO, 50ms	SOT-89	20vda	VD6	4b	Tor
R7	ELM9737CAB	Vdet-IC	3.7V±2.5%, +Reset PPO	SOT-89	20vda	VD7	4a	Elm
R7	TC54VN5702MB	Vdet-IC	5.7V±2%, -Reset ODO	SOT-89	20vda	VD6	4b	Tcs
R7	XC61CN5702P	Vdet-IC	5.7V±1%, +Reset ODO	SOT-89	20vda	VD6	4b	Tor
R73	XE61CN5745PR	Vdet-IC	5.7V±2%, -Reset ODO	SOT-89	20cjt	VD6	4j	Tor
R75	XC61FN5712P	Vdet-IC	5.7V±2%, +Reset ODO, 200ms	SOT-89	20vda	VD6	4b	Tor
R76	XC61FN5742P	Vdet-IC	5.7V±2%, +Reset ODO, 400ms	SOT-89	20vda	VD6	4b	Tor
R77	XC61FN5752P	Vdet-IC	5.7V±2%, +Reset ODO, 50ms	SOT-89	20vda	VD6	4b	Tor
R8	ELM9738CAB	Vdet-IC	3.8V±2.5%, +Reset PPO	SOT-89	20vda	VD7	4a	Elm
R8	TC54VN5802MB	Vdet-IC	5.8V±2%, -Reset ODO	SOT-89	20vda	VD6	4b	Tcs
R8	XC61CN5802P	Vdet-IC	5.8V±1%, +Reset ODO	SOT-89	20vda	VD6	4b	Tor
R83	XE61CN5845PR	Vdet-IC	5.8V±2%, -Reset ODO	SOT-89	20cjt	VD6	4j	Tor
R85	XC61FN5812P	Vdet-IC	5.8V±2%, +Reset ODO, 200ms	SOT-89	20vda	VD6	4b	Tor
R86	2SB1386PT-R	Si-pnp	AF, Sw, 20V, 5A, B=180...390, 120MHz	SOT-89	20tb	-	4g	Chm
R86	XC61FN5842P	Vdet-IC	5.8V±2%, +Reset ODO, 400ms	SOT-89	20vda	VD6	4b	Tor
R87	XC61FN5852P	Vdet-IC	5.8V±2%, +Reset ODO, 50ms	SOT-89	20vda	VD6	4b	Tor
R9	ELM9739CAB	Vdet-IC	3.9V±2.5%, +Reset PPO	SOT-89	20vda	VD7	4a	Elm
R9	TC54VN5902MB	Vdet-IC	5.9V±2%, -Reset ODO	SOT-89	20vda	VD6	4b	Tcs



SMD
code

Type

Function

Short description

Case Pinout Sch. St. Mnf.

SMD code	Type	Function	Short description	Case	Pinout	Sch.	St.	Mnf.
R9	XC61CN5902P	Vdet-IC	5.9V±1%, +Reset ODO	SOT-89	20vda	VD6	4b	Tor
R93	XE61CN5945PR	Vdet-IC	5.9V±2%, -Reset ODO	SOT-89	20cj	VD6	4j	Tor
R95	XC61FN5912P	Vdet-IC	5.9V±2%, +Reset ODO, 200ms	SOT-89	20vda	VD6	4b	Tor
R96	XC61FN5942P	Vdet-IC	5.9V±2%, +Reset ODO, 400ms	SOT-89	20vda	VD6	4b	Tor
R97	XC61FN5952P	Vdet-IC	5.9V±2%, +Reset ODO, 50ms	SOT-89	20vda	VD6	4b	Tor
R98	2SD2098PT-R	Si-npn	AF, Sw, 20V, 5A, B=180..390, 150MHz	SOT-89	20tb	-	4b	Chm
RCs	BFQ193	Si-npn	UHF-A, 20V, 80mA, 600mW, B=50..500, 7.5GHz	SOT-89	20tb	-	4b	Sie
RE	2SC3357-E	Si-npn	VHF/UHF, CATV, 20V, 100mA, 1.2W, B=125..250, 6.5GHz	SOT-89	20tb	-	4b	Nec
RE	2SC5336-E	Si-npn	HF, 20V, 100mA, 1.2W, 5GHz, B=125..250	SOT-89	20tb	-	4b	Nec
RE	NE85634-E	Si-npn	VHF/UHF, CATV, 20V, 100mA, 1.2W, B=125..250, 6.5GHz	SOT-89	20tb	-	4b	Cel
RF	2SC3357-F	Si-npn	VHF/UHF, CATV, 20V, 100mA, 1.2W, B=80..160, 6.5GHz	SOT-89	20tb	-	4b	Nec
RF	2SC5336-F	Si-npn	HF, 20V, 100mA, 1.2W, 5GHz, B=80..160	SOT-89	20tb	-	4b	Nec
RF	NE85634-F	Si-npn	VHF/UHF, CATV, 20V, 100mA, 1.2W, B=80..160, 6.5GHz	SOT-89	20tb	-	4b	Cel
RH	2SC3357-H	Si-npn	VHF/UHF, CATV, 20V, 100mA, 1.2W, B=50..100, 6.5GHz	SOT-89	20tb	-	4b	Nec
RH	2SC5209-H	Si-npn	Hi-B, Rel-drv, 50V, 1A, 500mW, 130MHz, B=600..1200	SOT-89	20tb	-	4a	Ish
RH	2SC5209-J	Si-npn	Hi-B, Rel-drv, 50V, 1A, 500mW, 130MHz, B=900..1800	SOT-89	20tb	-	4a	Ish
RH	2SC5336-H	Si-npn	HF, 20V, 100mA, 1.2W, 5GHz, B=50..100	SOT-89	20tb	-	4b	Nec
RH	NE85634-H	Si-npn	VHF/UHF, CATV, 20V, 100mA, 1.2W, B=50..100, 6.5GHz	SOT-89	20tb	-	4b	Cel
RO	2SA1024-O	Si-pnp	GP, 30V, 800mA, 500mW, B=100..200, 120MHz	SOT-89	20tb	-	4b	Tos
RO	2SA1204-O	Si-pnp	GP, 35V, 800mA, 500mW, B=70..140, 120MHz	SOT-89	20tb	-	4b	Tos
RO	2SA1664-O	Si-pnp	AF, Sw, 35V, 800mA, 500mW, 120MHz, B=100..200	SOT-89	20tb	-	4b	Trs
RO	KTA1664-O	Si-pnp	AF-Drv, 35V, 800mA, 500mW, B=100..200, >120MHz	SOT-89	20tb	-	4a	Kec
RQ	2SD1280-Q	Si-npn	AF-Drv, 20V, 1A, 1W, B=90..155, 150MHz	SOT-89	20tb	-	4g	Pan
RR	2SD1280-R	Si-npn	GP, AF, 20V, 1A, 1W, B=130..210, 200MHz	SOT-89	20tb	-	4b	Pan
RS	2SD1280-S	Si-npn	GP, AF, 20V, 1A, 1W, B=180..280, 200MHz	SOT-89	20tb	-	4b	Pan
RY	2SA1024-Y	Si-pnp	GP, 30V, 800mA, 500mW, B=160..320, 120MHz	SOT-89	20tb	-	4b	Tos
RY	2SA1204-Y	Si-pnp	GP, 35V, 800mA, 500mW, B=120..240, 120MHz	SOT-89	20tb	-	4b	Tos
RY	2SA1664-Y	Si-pnp	AF, Sw, 35V, 800mA, 500mW, 120MHz, B=160..320	SOT-89	20tb	-	4b	Trs
RY	2SJ361	p-MOSFET-e*	V-MOS, LogL, 20V, 2A, <0.4Ω(1A), integr, Rgate	SOT-89	20fa	-	4b	Ren
RY	KTA1664-Y	Si-pnp	AF-Drv, 35V, 800mA, 500mW, B=160..320, >120MHz	SOT-89	20tb	-	4a	Kec
S0	ELM9740CAB	Vdet-IC	4.0V±2.5%, +Reset PPO	SOT-89	20vda	VD7	4a	Elm
S0	TC54VN6002MB	Vdet-IC	6.0V±2%, -Reset ODO	SOT-89	20vda	VD6	4b	Tcs
S0	XC61CN6002P	Vdet-IC	6V±1%, +Reset ODO	SOT-89	20vda	VD6	4b	Tor
S002G	SCG002B-G	MMIC	Buff/amp, DC..6GHz, 21dB (1GHz, 50Ω)	SOT-89	20aa	A1	4i	Wjc
S03	XE61CN6045PR	Vdet-IC	6.0V±2%, -Reset ODO	SOT-89	20cj	VD6	4j	Tor
S05	XC61FN6012P	Vdet-IC	6V±2%, +Reset ODO, 200ms	SOT-89	20vda	VD6	4b	Tor
S06	XC61FN6042P	Vdet-IC	6V±2%, +Reset ODO, 400ms	SOT-89	20vda	VD6	4b	Tor
S07	XC61FN6052P	Vdet-IC	6V±2%, +Reset ODO, 50ms	SOT-89	20vda	VD6	4b	Tor
S08	BS808	p-MOSFET-e	D-MOS, Sw, 240V, 200mA, 830mW, <7Ω(100mA), 5/20ns	SOT-89	20fi	-	4b	Itt
S1	ELM9741CAB	Vdet-IC	4.1V±2.5%, +Reset PPO	SOT-89	20vda	VD7	4a	Elm
S2	ELM9742CAB	Vdet-IC	4.2V±2.5%, +Reset PPO	SOT-89	20vda	VD7	4a	Elm
S23	BS723	p-MOSFET-e	D-MOS, Sw, 60V, 1A, 830mW, <0.7Ω(600mA), 40/100ns	SOT-89	20fi	-	4b	Itt
S3	ELM9743CAB	Vdet-IC	4.3V±2.5%, +Reset PPO	SOT-89	20vda	VD7	4a	Elm
S4	ELM9744CAB	Vdet-IC	4.4V±2.5%, +Reset PPO	SOT-89	20vda	VD7	4a	Elm
S5	ELM9745CAB	Vdet-IC	4.5V±2.5%, +Reset PPO	SOT-89	20vda	VD7	4a	Elm
S6	ELM9746CAB	Vdet-IC	4.6V±2.5%, +Reset PPO	SOT-89	20vda	VD7	4a	Elm
S7	ELM9747CAB	Vdet-IC	4.7V±2.5%, +Reset PPO	SOT-89	20vda	VD7	4a	Elm
S8	ELM9748CAB	Vdet-IC	4.8V±2.5%, +Reset PPO	SOT-89	20vda	VD7	4a	Elm
S9	ELM9749CAB	Vdet-IC	4.9V±2.5%, +Reset PPO	SOT-89	20vda	VD7	4a	Elm
SA	2SC2982-A	Si-npn	Lo-sat., 30V, 2A, 500mW, B=140..240, >140MHz	SOT-89	20tb	-	4b	Tos
SA	KTC4377-A	Si-npn	Lo-sat, 30V, 2A, 500mW, B=140..240, 150MHz	SOT-89	20tb	-	4a	Kec
SAA	S-1206B12-U3T1G	LVR-IC	LDO, 1.2V±15mV, 250mA	SOT-89	20vl	VR1	4a	Sii
SAB	S-1206B13-U3T1G	LVR-IC	LDO, 1.3V±15mV, 250mA	SOT-89	20vl	VR1	4a	Sii
SAC	S-1206B14-U3T1G	LVR-IC	LDO, 1.4V±15mV, 250mA	SOT-89	20vl	VR1	4a	Sii
SAD	S-1206B15-U3T1G	LVR-IC	LDO, 1.5V±1.0%, 250mA	SOT-89	20vl	VR1	4a	Sii
SAE	S-1206B16-U3T1G	LVR-IC	LDO, 1.6V±1.0%, 250mA	SOT-89	20vl	VR1	4a	Sii
SAF	S-1206B17-U3T1G	LVR-IC	LDO, 1.7V±1.0%, 250mA	SOT-89	20vl	VR1	4a	Sii
SAG	S-1206B18-U3T1G	LVR-IC	LDO, 1.8V±1.0%, 250mA	SOT-89	20vl	VR1	4a	Sii
SAH	S-1206B1J-U3T1G	LVR-IC	LDO, 1.85V±1.0%, 250mA	SOT-89	20vl	VR1	4a	Sii
SAI	S-1206B19-U3T1G	LVR-IC	LDO, 1.9V±1.0%, 250mA	SOT-89	20vl	VR1	4a	Sii
SAJ	S-1206B20-U3T1G	LVR-IC	LDO, 2.0V±1.0%, 250mA	SOT-89	20vl	VR1	4a	Sii
SAK	S-1206B21-U3T1G	LVR-IC	LDO, 2.1V±1.0%, 250mA	SOT-89	20vl	VR1	4a	Sii
SAL	S-1206B22-U3T1G	LVR-IC	LDO, 2.2V±1.0%, 250mA	SOT-89	20vl	VR1	4a	Sii
SAM	S-1206B23-U3T1G	LVR-IC	LDO, 2.3V±1.0%, 250mA	SOT-89	20vl	VR1	4a	Sii
SAN	S-1206B24-U3T1G	LVR-IC	LDO, 2.4V±1.0%, 250mA	SOT-89	20vl	VR1	4a	Sii
SAO	S-1206B25-U3T1G	LVR-IC	LDO, 2.5V±1.0%, 250mA	SOT-89	20vl	VR1	4a	Sii
SAP	S-1206B26-U3T1G	LVR-IC	LDO, 2.6V±1.0%, 250mA	SOT-89	20vl	VR1	4a	Sii
SAQ	S-1206B27-U3T1G	LVR-IC	LDO, 2.7V±1.0%, 250mA	SOT-89	20vl	VR1	4a	Sii
SAR	S-1206B28-U3T1G	LVR-IC	LDO, 2.8V±1.0%, 250mA	SOT-89	20vl	VR1	4a	Sii
SAS	S-1206B2JU3T1G	LVR-IC	LDO, 2.85V±1.0%, 250mA	SOT-89	20vl	VR1	4a	Sii



SMD
code

Type

Function

Short description

Case Pinout Sch. St. Mnf.

SAT	S-1206B29-U3T1G	LVR-IC	LDO, 2.9V±1.0%, 250mA
SAU	S-1206B30-U3T1G	LVR-IC	LDO, 3.0V±1.0%, 250mA
SAV	S-1206B31-U3T1G	LVR-IC	LDO, 3.1V±1.0%, 250mA
SAW	S-1206B32-U3T1G	LVR-IC	LDO, 3.2V±1.0%, 250mA
SAX	S-1206B33-U3T1G	LVR-IC	LDO, 3.3V±1.0%, 250mA
SAY	S-1206B34-U3T1G	LVR-IC	LDO, 3.4V±1.0%, 250mA
SAZ	S-1206B35-U3T1G	LVR-IC	LDO, 3.5V±1.0%, 250mA
SB	2SC2982-B	Si-npn	Lo-sat., 30V, 2A, 500mW, B=200..330, >140MHz
SB	KTC4377-B	Si-npn	Lo-sat, 30V, 2A, 500mW, B=200..330, 150MHz
SBA	S-1206B36-U3T1G	LVR-IC	LDO, 3.6V±1.0%, 250mA
SBB	S-1206B37-U3T1G	LVR-IC	LDO, 3.7V±1.0%, 250mA
SBC	S-1206B38-U3T1G	LVR-IC	LDO, 3.8V±1.0%, 250mA
SBD	S-1206B39-U3T1G	LVR-IC	LDO, 3.9V±1.0%, 250mA
SBE	S-1206B40-U3T1G	LVR-IC	LDO, 4.0V±1.0%, 250mA
SBF	S-1206B41-U3T1G	LVR-IC	LDO, 4.1V±1.0%, 250mA
SBG	S-1206B42-U3T1G	LVR-IC	LDO, 4.2V±1.0%, 250mA
SBH	S-1206B43-U3T1G	LVR-IC	LDO, 4.3V±1.0%, 250mA
SBI	S-1206B44-U3T1G	LVR-IC	LDO, 4.4V±1.0%, 250mA
SBJ	S-1206B45-U3T1G	LVR-IC	LDO, 4.5V±1.0%, 250mA
SBK	S-1206B46-U3T1G	LVR-IC	LDO, 4.6V±1.0%, 250mA
SBL	S-1206B47-U3T1G	LVR-IC	LDO, 4.7V±1.0%, 250mA
SBM	S-1206B48-U3T1G	LVR-IC	LDO, 4.8V±1.0%, 250mA
SBN	S-1206B49-U3T1G	LVR-IC	LDO, 4.9V±1.0%, 250mA
SBO	S-1206B50-U3T1G	LVR-IC	LDO, 5.0V±1.0%, 250mA
SBP	S-1206B51-U3T1G	LVR-IC	LDO, 5.1V±1.0%, 250mA
SBQ	S-1206B52-U3T1G	LVR-IC	LDO, 5.2V±1.0%, 250mA
SC	2SC2982-C	Si-npn	Lo-sat., 30V, 2A, 500mW, B=300.450, >140MHz
SC	2SC5210-C	Si-npn	TV-Vid, 300V, 100mA, 500mW, 80MHz, B=55..110
SC	KTC4377-C	Si-npn	Lo-sat, 30V, 2A, 500mW, B=300..450, 150MHz
SCO	KSC2881-O	Si-npn	AF, Sw, 120V, 800mA, 500mW, B=300..450, >120MHz
SCY	KSC2881-Y	Si-npn	AF, Sw, 120V, 800mA, 500mW, B=120..240, >120MHz
SD	2SC2982-D	Si-npn	Lo-sat., 30V, 2A, 500mW, B=420..600, >140MHz
SD	2SC5210-D	Si-npn	TV-Vid, 300V, 100mA, 500mW, 80MHz, B=90..180
SD	KTC4377-D	Si-npn	Lo-sat, 30V, 2A, 500mW, B=240..600, 150MHz
SDD	KSA1201-O	Si-pnp	AF, Sw, 120V, 800mA, 500mW, B=80..160, >120MHz
SDD	KSA1203-O	Si-pnp	AF, 30V, 1.5A, 500mW, B=100..200, 20MHz
SDY	KSA1201-Y	Si-pnp	AF, Sw, 120V, 800mA, 500mW, B=120..240, >120MHz
SDY	KSA1203-Y	Si-pnp	AF, 30V, 1.5A, 500mW, B=160..320, 20MHz
SE	2SC4703-E	Si-npn	µV, 25V, 150mA, 1.8W, 6GHz, B=125..250
SE	2SC5210-E	Si-npn	TV-Vid, 300V, 100mA, 500mW, 80MHz, B=150..300
SE	2SC5338-E	Si-npn	UHF, CATV, 25V, 150mA, 1.8W, 6GHz, B=125..250
SE	SB05W05P	Si-diode	Dual, SBR, HF, 50V, 500mA, Vf<0.55V(500mA), 25pF, 10ns
SF	2SC4703-F	Si-npn	µWave, 25V, 150mA, 1.8W, 6GHz, B=80..160
SF	2SC5338-F	Si-npn	UHF, CATV, 25V, 150mA, 1.8W, 6GHz, B=80..160
SGO	KSA1203-O	Si-pnp	AF, 30V, 1.5A, 500mW, B=100..200, 20MHz
SGY	KSA1203-Y	Si-pnp	AF, 30V, 1.5A, 500mW, B=160..320, 20MHz
SH	2SC4703-H	Si-npn	µWave, 25V, 150mA, 1.8W, 6GHz, B=50..100
SH	2SC5338-H	Si-npn	UHF, CATV, 25V, 150mA, 1.8W, 6GHz, B=50..100
SHO	KSC2883-O	Si-npn	AF-Drv, 30V, 1.5A, 500mW, B=100..200, >120MHz
SHY	KSC2883-Y	Si-npn	AF-Drv, 30V, 1.5A, 500mW, B=160..320, >120MHz
SK	2SC3554-K	Si-npn	HV, Sw, 300V, 200mA, 2W, 50MHz, B=160..250
SL	2SC3554-L	Si-npn	HV, Sw, 300V, 200mA, 2W, 50MHz, B=100..200
SLG	KSB798-G	Si-pnp	AF-Drv, 30V, 1A, 2W, B=200..400, >110MHz
SLJ	KSB798-O	Si-pnp	GP, 30V, 1A, 2W, B=90..180, >150MHz
SLO	KSB798-O	Si-pnp	AF-Drv, 30V, 1A, 2W, B=90..180, >110MHz
SLY	KSB798-Y	Si-pnp	AF-Drv, 30V, 1A, 2W, B=135..270, >110MHz
SM	2SC3554-M	Si-npn	HV, Sw, 300V, 200mA, 2W, 50MHz, B=60..120
SSA	KSC2982-A	Si-npn	AF-Drv, 30V, 2A, 500mW, B=140..240, >150MHz
SSB	KSC2982-B	Si-npn	AF-Drv, 30V, 2A, 500mW, B=200..330, >150MHz
SSC	KSC2982-C	Si-npn	AF-Drv, 30V, 2A, 500mW, B=300..450, >150MHz
SSD	KSC2982-D	Si-npn	AF-Drv, 30V, 2A, 500mW, B=420..600, >150MHz
SYR	KSD1621-R	Si-npn	AF-Drv, 30V, 2A, 500mW, B=100..200, >150MHz
SYS	KSD1621-S	Si-npn	AF-Drv, 30V, 2A, 500mW, B=140..280, >150MHz
SYT	KSD1621-T	Si-npn	AF-Drv, 30V, 2A, 500mW, B=200..400, >150MHz
SYU	KSD1621-U	Si-npn	AF-Drv, 30V, 2A, 500mW, B=280..560, >150MHz
SZR	KSB1121-R	Si-pnp	Lo-sat, 30V, 2A, 500mW, B=100..200, >150MHz
SZS	KSB1121-S	Si-pnp	Lo-sat, 30V, 2A, 500mW, B=140..280, >150MHz
SZT	KSB1121-T	Si-pnp	Lo-sat, 30V, 2A, 500mW, B=200..400, >150MHz
SZU	KSB1121-U	Si-pnp	Lo-sat, 30V, 2A, 500mW, B=280..560, >150MHz
T0	ELM9750CAB	Vdet-IC	5.0V±2.5%, +Reset PPO

SOT-89	20vl	VR1	4a	Sii
SOT-89	20vl	VR1	4a	Sii
SOT-89	20vl	VR1	4a	Sii
SOT-89	20vl	VR1	4a	Sii
SOT-89	20vl	VR1	4a	Sii
SOT-89	20vl	VR1	4a	Sii
SOT-89	20vl	VR1	4a	Sii
SOT-89	20tb	-	4b	Tos
SOT-89	20tb	-	4a	Kec
SOT-89	20vl	VR1	4a	Sii
SOT-89	20vl	VR1	4a	Sii
SOT-89	20vl	VR1	4a	Sii
SOT-89	20vl	VR1	4a	Sii
SOT-89	20vl	VR1	4a	Sii
SOT-89	20vl	VR1	4a	Sii
SOT-89	20vl	VR1	4a	Sii
SOT-89	20vl	VR1	4a	Sii
SOT-89	20vl	VR1	4a	Sii
SOT-89	20vl	VR1	4a	Sii
SOT-89	20vl	VR1	4a	Sii
SOT-89	20tb	-	4b	Tos
SOT-89	20tb	-	4a	ish
SOT-89	20tb	-	4a	Kec
SOT-89	20tb	-	4b	Sam
SOT-89	20tb	-	4b	Sam
SOT-89	20tb	-	4a	Tos
SOT-89	20tb	-	4a	ish
SOT-89	20tb	-	4a	Kec
SOT-89	20tb	-	4b	Sam
SOT-89	20tb	-	4g	Sam
SOT-89	20tb	-	4g	Sam
SOT-89	20tb	-	4g	Sam
SOT-89	20tb	-	4b	Nec
SOT-89	20tb	-	4a	ish
SOT-89	20t8	-	4b	Nec
PCP	20d1	-	4g	San
SOT-89	20tb	-	4b	Nec
SOT-89	20t8	-	4b	Nec
SOT-89	20tb	-	4g	F
SOT-89	20tb	-	4g	F
SOT-89	20tb	-	4b	Nec
SOT-89	20t8	-	4b	Nec
SOT-89	20tb	-	4b	Sam
SOT-89	20tb	-	4b	Nec
SOT-89	20tb	-	4b	Sam
SOT-89	20tb	-	4b	Sam
SOT-89	20tb	-	4b	Sam
SOT-89	20tb	-	4b	Sam
SOT-89	20tb	-	4b	Sam
SOT-89	20tb	-	4b	Sam
SOT-89	20tb	-	4b	Sam
SOT-89	20tb	-	4b	Sam
SOT-89	20tb	-	4b	Sam
SOT-89	20vda	VD7	4a	Elm



SMD
code

Type

Function

Short description

Case Pinout Sch. St. Mnf.

SMD code	Type	Function	Short description	Case	Pinout	Sch.	St.	Mnf.
T1	ELM9751CAB	Vdet-IC	5.1V±2.5%, +Reset PPO	SOT-89	20vda	VD7	4a	Elm
T2	ELM9752CAB	Vdet-IC	5.2V±2.5%, +Reset PPO	SOT-89	20vda	VD7	4a	Elm
T3	ELM9753CAB	Vdet-IC	5.3V±2.5%, +Reset PPO	SOT-89	20vda	VD7	4a	Elm
T4	ELM9754CAB	Vdet-IC	5.4V±2.5%, +Reset PPO	SOT-89	20vda	VD7	4a	Elm
T5	ELM9755CAB	Vdet-IC	5.5V±2.5%, +Reset PPO	SOT-89	20vda	VD7	4a	Elm
TA	2SA1314-A	Si-pnp	Lo-sat, 20V, 500mW, 500mW, B=140..280, 140MHz	SOT-89	20tb	-	4b	Tos
TB	2SA1314-B	Si-pnp	Lo-sat, 20V, 500mW, 500mW, B=200..400, 140MHz	SOT-89	20tb	-	4b	Tos
TC	2SA1314-C	Si-pnp	Lo-sat, 20V, 500mW, 500mW, B=300..600, 140MHz	SOT-89	20tb	-	4b	Tos
TD	2SC5211-D	Si-npn	AF-Amp-Drv, 55V, 400mA, 500mW, 150MHz, B=90..180	SOT-89	20tb	-	4a	Ish
TE	2SC5211-E	Si-npn	AF-Amp-Drv, 55V, 400mA, 500mW, 150MHz, B=150..300	SOT-89	20tb	-	4a	Ish
TE	2SD1702-E	Si-npn-Darl+Di	Drv, 60V, 800mA, 2W, B=8000..50000, 0.5/2.5µs	SOT-89	20tb	-	4g	Nec
TF	2SC5211-F	Si-npn	AF-Amp-Drv, 55V, 400mA, 500mW, 150MHz, B=250..500	SOT-89	20tb	-	4a	Ish
TF	2SD1702-F	Si-npn-Darl+Di	Drv, 60V, 800mA, 2W, B=4000..12000, 0.5/2.5µs	SOT-89	20tb	-	4g	Nec
TK	2SC3617-K	Si-npn	Hi-beta, 50V, 300mA, 500mW, 220MHz, B=2000..3200	SOT-89	20tb	-	4b	Nec
TL	2SC3617-L	Si-npn	Hi-beta, 50V, 300mA, 500mW, 220MHz, B=1200..2400	SOT-89	20tb	-	4b	Nec
TM	2SC3617-M	Si-npn	Hi-beta, 50V, 300mA, 500mW, 220MHz, B=900..1600	SOT-89	20tb	-	4b	Nec
TQ	2SD1119-Q	Si-npn	AF-Amp, 40V, 3A, 1W, 150MHz, B=230..380	SOT-89	20tb	-	4b	Pan
TQ	2SD1699-Q	Si-npn-Darl+Di	Drv, 100V, 1.6A, 2W, B=8000..50000	SOT-89	20tb	-	4b	Nec
TR	2SD1119-R	Si-npn	AF-Amp, 40V, 3A, 1W, 150MHz, B=340..600	SOT-89	20tb	-	4b	Pan
TR	2SD1699-R	Si-npn-Darl+Di	Drv, 100V, 1.6A, 2W, B=4000..12000	SOT-89	20tb	-	4b	Nec
TY	2SK2315	n-MOSFET-e*	V-MOS, LogL, 60V, ±2A, <0.45Ω(2.5A)	SOT-89	20fa	-	4b	Ren
U6	ELM9716CAB	Vdet-IC	1.6V±2.5%, +Reset PPO	SOT-89	20vda	VD7	4a	Elm
U7	ELM9717CAB	Vdet-IC	1.7V±2.5%, +Reset PPO	SOT-89	20vda	VD7	4a	Elm
U8	ELM9718CAB	Vdet-IC	1.8V±2.5%, +Reset PPO	SOT-89	20vda	VD7	4a	Elm
U9	ELM9719CAB	Vdet-IC	1.9V±2.5%, +Reset PPO	SOT-89	20vda	VD7	4a	Elm
UA1	2SJ357	p-MOSFET-e*	V-MOS, LogL, 30V, ±3A, <0.2Ω(1.5A)	SOT-89	20fa	-	4b	Nec
UA2	2SJ358	p-MOSFET-e*	V-MOS, LogL, 60V, ±3A, <0.3Ω(1.5A)	SOT-89	20fa	-	4b	Nec
UA3	2SJ462	p-MOSFET-e*	V-MOS, LogL, 12V, ±2.5A, <0.19Ω	SOT-89	20fa	-	4b	Nec
UE	2SC5212-E	Si-npn	Relay-Drv, 25V, 1A, 500mW, 180MHz, B=150..300	SOT-89	20tb	-	4a	Ish
UF	2SC5212-F	Si-npn	Relay-Drv, 25V, 1A, 500mW, 180MHz, B=250..500	SOT-89	20tb	-	4a	Ish
UG	2SC5212-G	Si-npn	Relay-Drv, 25V, 1A, 500mW, 180MHz, B=400..800	SOT-89	20tb	-	4a	Ish
UK	2SC3618-K	Si-npn	AF-Amp, Sw, 25V, 1A, 2W, 250MHz, B=2000..3200	SOT-89	20tb	-	4b	Nec
UL	2SC3618-L	Si-npn	AF-Amp, Sw, 25V, 1A, 2W, 250MHz, B=1200..2400	SOT-89	20tb	-	4b	Nec
UM	2SC3618-M	Si-npn	AF-Amp, Sw, 25V, 1A, 2W, 250MHz, B=900..1600	SOT-89	20tb	-	4b	Nec
UPQ	2SC5824-Q	Si-npn	Sw, 60V, 3A, 500mW, B=120..270, 200MHz	MPT3	20tb	-	4b	Rhm
UPR	2SC5824-R	Si-npn	Sw, 60V, 3A, 500mW, B=180..390, 200MHz	MPT3	20tb	-	4b	Rhm
UY	2SJ450	p-MOSFET-e*	V-MOS, LogL, 60V, 1A, <1.2Ω(0.5A)	SOT-89	20fa	-	4b	Ren
V113A	ML6201P113P	LVR-IC	1.1V±3%, 250mA	SOT-89	20ch	VR1	4g	Mlc
V123A	ML6201P123P	LVR-IC	1.2V±3%, 250mA	SOT-89	20ch	VR1	4g	Mlc
V133A	ML6201P133P	LVR-IC	1.3V±3%, 250mA	SOT-89	20ch	VR1	4g	Mlc
V143A	ML6201P143P	LVR-IC	1.4V±3%, 250mA	SOT-89	20ch	VR1	4g	Mlc
V153A	ML6201P153P	LVR-IC	1.5V±3%, 250mA	SOT-89	20ch	VR1	4g	Mlc
V163A	ML6201P163P	LVR-IC	1.6V±3%, 250mA	SOT-89	20ch	VR1	4g	Mlc
V173A	ML6201P173P	LVR-IC	1.7V±3%, 250mA	SOT-89	20ch	VR1	4g	Mlc
V183A	ML6201P183P	LVR-IC	1.8V±3%, 250mA	SOT-89	20ch	VR1	4g	Mlc
V193A	ML6201P193P	LVR-IC	1.9V±3%, 250mA	SOT-89	20ch	VR1	4g	Mlc
V202A	ML6201P202P	LVR-IC	2.0V±2%, 250mA	SOT-89	20ch	VR1	4g	Mlc
V212A	ML6201P212P	LVR-IC	2.1V±2%, 250mA	SOT-89	20ch	VR1	4g	Mlc
V222A	ML6201P222P	LVR-IC	2.2V±2%, 250mA	SOT-89	20ch	VR1	4g	Mlc
V232A	ML6201P232P	LVR-IC	2.3V±2%, 250mA	SOT-89	20ch	VR1	4g	Mlc
V242A	ML6201P242P	LVR-IC	2.4V±2%, 250mA	SOT-89	20ch	VR1	4g	Mlc
V252A	ML6201P252P	LVR-IC	2.5V±2%, 250mA	SOT-89	20ch	VR1	4g	Mlc
V262A	ML6201P262P	LVR-IC	2.6V±2%, 250mA	SOT-89	20ch	VR1	4g	Mlc
V272A	ML6201P272P	LVR-IC	2.7V±2%, 250mA	SOT-89	20ch	VR1	4g	Mlc
V282A	ML6201P282P	LVR-IC	2.8V±2%, 250mA	SOT-89	20ch	VR1	4g	Mlc
V292A	ML6201P292P	LVR-IC	2.9V±2%, 250mA	SOT-89	20ch	VR1	4g	Mlc
V302A	ML6201P302P	LVR-IC	3.0V±2%, 250mA	SOT-89	20ch	VR1	4g	Mlc
V312A	ML6201P312P	LVR-IC	3.1V±2%, 250mA	SOT-89	20ch	VR1	4g	Mlc
V322A	ML6201P322P	LVR-IC	3.2V±2%, 250mA	SOT-89	20ch	VR1	4g	Mlc
V332A	ML6201P332P	LVR-IC	3.3V±2%, 250mA	SOT-89	20ch	VR1	4g	Mlc
V342A	ML6201P342P	LVR-IC	3.4V±2%, 250mA	SOT-89	20ch	VR1	4g	Mlc
V352A	ML6201P352P	LVR-IC	3.5V±2%, 250mA	SOT-89	20ch	VR1	4g	Mlc
V362A	ML6201P362P	LVR-IC	3.6V±2%, 250mA	SOT-89	20ch	VR1	4g	Mlc
V372A	ML6201P372P	LVR-IC	3.7V±2%, 250mA	SOT-89	20ch	VR1	4g	Mlc
V382A	ML6201P382P	LVR-IC	3.8V±2%, 250mA	SOT-89	20ch	VR1	4g	Mlc
V392A	ML6201P392P	LVR-IC	3.9V±2%, 250mA	SOT-89	20ch	VR1	4g	Mlc
V402A	ML6201P402P	LVR-IC	4.0V±2%, 250mA	SOT-89	20ch	VR1	4g	Mlc
V412A	ML6201P412P	LVR-IC	4.1V±2%, 250mA	SOT-89	20ch	VR1	4g	Mlc
V422A	ML6201P422P	LVR-IC	4.2V±2%, 250mA	SOT-89	20ch	VR1	4g	Mlc
V432A	ML6201P432P	LVR-IC	4.3V±2%, 250mA	SOT-89	20ch	VR1	4g	Mlc



SMD
code

Type

Function

Short description

Case Pinout Sch. St. Mnf.

SMD code	Type	Function	Short description	Case	Pinout	Sch.	St.	Mnf.
V442A	ML6201P442P	LVR-IC	4.4V±2%, 250mA	SOT-89	20ch	VR1	4g	Mlc
V452A	ML6201P452P	LVR-IC	4.5V±2%, 250mA	SOT-89	20ch	VR1	4g	Mlc
V462A	ML6201P462P	LVR-IC	4.6V±2%, 250mA	SOT-89	20ch	VR1	4g	Mlc
V472A	ML6201P472P	LVR-IC	4.7V±2%, 250mA	SOT-89	20ch	VR1	4g	Mlc
V482A	ML6201P482P	LVR-IC	4.8V±2%, 250mA	SOT-89	20ch	VR1	4g	Mlc
V492A	ML6201P492P	LVR-IC	4.9V±2%, 250mA	SOT-89	20ch	VR1	4g	Mlc
V502A	ML6201P502P	LVR-IC	5.0V±2%, 250mA	SOT-89	20ch	VR1	4g	Mlc
V512A	ML6201P512P	LVR-IC	5.1V±2%, 250mA	SOT-89	20ch	VR1	4g	Mlc
V522A	ML6201P522P	LVR-IC	5.2V±2%, 250mA	SOT-89	20ch	VR1	4g	Mlc
V532A	ML6201P532P	LVR-IC	5.3V±2%, 250mA	SOT-89	20ch	VR1	4g	Mlc
V542A	ML6201P542P	LVR-IC	5.4V±2%, 250mA	SOT-89	20ch	VR1	4g	Mlc
V552A	ML6201P552P	LVR-IC	5.5V±2%, 250mA	SOT-89	20ch	VR1	4g	Mlc
V562A	ML6201P562P	LVR-IC	5.6V±2%, 250mA	SOT-89	20ch	VR1	4g	Mlc
V572A	ML6201P572P	LVR-IC	5.7V±2%, 250mA	SOT-89	20ch	VR1	4g	Mlc
V582A	ML6201P582P	LVR-IC	5.8V±2%, 250mA	SOT-89	20ch	VR1	4g	Mlc
V592A	ML6201P592P	LVR-IC	5.9V±2%, 250mA	SOT-89	20ch	VR1	4g	Mlc
V602A	ML6201P602P	LVR-IC	6.0V±2%, 250mA	SOT-89	20ch	VR1	4g	Mlc
VD	1SV268	PIN-diode	VHF/UHF, 50V, 100mA, 0.7pF, 0.5Ω(470MHz)	SOT-89	20di	-	4a	San
VK	2SD1950-K	Si-npn	GP, Hi-beta, 30V, 2A, 2W, B=2000..3200, 350MHz	SOT-89	20tb	-	4b	Nec
VL	2SD1950-L	Si-npn	GP, Hi-beta, 30V, 2A, 2W, B=1200..2400, 350MHz	SOT-89	20tb	-	4b	Nec
VM	2SD1950-M	Si-npn	GP, Hi-beta, 30V, 2A, 2W, B=800..1600, 350MHz	SOT-89	20tb	-	4b	Nec
VO	2SC3803-O	Si-npn	Sw, 60/45V, 200mA, 1W, B=70..140, 200MHz	SOT-89	20tb	-	4b	Tos
VQ	2SD968A-Q	Si-npn	AF-Drv, 120V, 1A, 1W, B=90.155, 120MHz	SOT-89	20tb	-	4b	Pan
VR	2SC3803-R	Si-npn	Sw, 60/45V, 200mA, 1W, B=40..80, 200MHz	SOT-89	20tb	-	4b	Tos
VR	2SD968A-R	Si-npn	AF-Drv, 120V, 1A, 1W, B=130..220, 120MHz	SOT-89	20tb	-	4b	Pan
VY	2SC3803-Y	Si-npn	Sw, 60/45V, 200mA, 1W, B=140..280, 200MHz	SOT-89	20tb	-	4b	Tos
VY	2SK2788	n-MOSFET-e*	V-MOS, LogL, 60V, 2A, <0.16Ω(5A)	SOT-89	20fa	-	4b	Ren
W2	BZV49-C0V8	Z-diode	0.8V±5%, lzt=5mA, 1W	SOT-89	20dm	-	4b	Sie
W3	BZV49-C2V4	Z-diode	2.4V±5%, lzt=5mA, 1W	SOT-89	20dm	-	4b	Sie
W4	BZV49-C2V7	Z-diode	2.7V±5%, lzt=5mA, 1W	SOT-89	20dm	-	4b	Sie
W5	BZV49-C3V0	Z-diode	3V±5%, lzt=5mA, 1W	SOT-89	20dm	-	4b	Sie
W6	BZV49-C3V3	Z-diode	3.3V±5%, lzt=5mA, 1W	SOT-89	20dm	-	4b	Sie
W7	BZV49-C3V6	Z-diode	3.6V±5%, lzt=5mA, 1W	SOT-89	20dm	-	4b	Sie
W8	BZV49-C3V9	Z-diode	3.9V±5%, lzt=5mA, 1W	SOT-89	20dm	-	4b	Sie,Zx
W9	BZV49-C4V3	Z-diode	4.3V±5%, lzt=5mA, 1W	SOT-89	20dm	-	4b	Sie,Zx
WC	2SC5214-C	Si-npn	AF-Amp-Drv, 30V, 1A, 500mW, 100MHz, B=55..110	SOT-89	20fb	-	4a	Ish
WD	2SC5214-D	Si-npn	AF-Amp-Drv, 30V, 1A, 500mW, 100MHz, B=90..180	SOT-89	20fb	-	4a	Ish
WE	2SC5214-E	Si-npn	AF-Amp-Drv, 30V, 1A, 500mW, 100MHz, B=150..300	SOT-89	20fb	-	4a	Ish
WO	2SA1483-O	Si-pnp	Sw, 60V, 200mA, 1W, B=70..140, >100MHz	SOT-89	20tb	-	4b	Tos
WO	KTA1666-O	Si-pnp	AF, Sw, 50V, 2A, 500mW, B=70..140, 120MHz	SOT-89	20tb	-	4a	Kec
WQ	2SD968-Q	Si-npn	AF-Drv, 100V, 1A, 1W, B=90.155, 120MHz	SOT-89	20tb	-	4b	Pan
WR	2SA1483-R	Si-pnp	Sw, 60V, 200mA, 1W, B=40..80, >100MHz	SOT-89	20tb	-	4b	Tos
WR	2SD968-R	Si-npn	AF-Drv, 100V, 1A, 1W, B=130..220, 120MHz	SOT-89	20tb	-	4b	Pan
WY	2SA1483-Y	Si-pnp	Sw, 60V, 200mA, 1W, B=120..240, >100MHz	SOT-89	20tb	-	4b	Tos
WY	2SJ484	p-MOSFET-e*	V-MOS, LogL, 30V, 2A, 1W, <0.23Ω(1A)	SOT-89	20fi	-	4a	Ren
WY	KTA1666-Y	Si-pnp	AF, Sw, 50V, 2A, 500mW, B=120..240, 120MHz	SOT-89	20tb	-	4a	Kec
X0LN	ELM7550CAB	Vdet-IC	5.0V±2%, +Reset PPO	SOT-89	20vda	VD7	4a	Elm
X0LN	ELM7550NAB	Vdet-IC	5.0V±2%, +Reset ODO	SOT-89	20vda	VD6	4a	Elm
X1	BZV49-C27	Z-diode	2.7V±5%, lzt=2mA, 1W	SOT-89	20dm	-	4b	Sie
X1	CHS04XPT	Si-diode	SBD, 40V, 1A, Vf<0.55V(1A)	SOT-89	20dm	-	4g	Chm
X16C	SS6680C-16CX	Vdet-IC	1.6V±2.5%, +Reset PPO	SOT-89	20vda	VD7	4g	Ssc
X16N	SS6680N-16CX	Vdet-IC	1.6V±2.5%, +Reset ODO	SOT-89	20vda	VD6	4g	Ssc
X16P	SS6680P-16CX	Vdet-IC	1.6V±2.5%, -Reset ODO	SOT-89	20vda	VD6	4g	Ssc
X17C	SS6680C-17CX	Vdet-IC	1.7V±2.5%, +Reset PPO	SOT-89	20vda	VD7	4g	Ssc
X17N	SS6680N-17CX	Vdet-IC	1.7V±2.5%, +Reset ODO	SOT-89	20vda	VD6	4g	Ssc
X17P	SS6680P-17CX	Vdet-IC	1.7V±2.5%, -Reset ODO	SOT-89	20vda	VD6	4g	Ssc
X18C	SS6680C-18CX	Vdet-IC	1.8V±2.5%, +Reset PPO	SOT-89	20vda	VD7	4g	Ssc
X18N	SS6680N-18CX	Vdet-IC	1.8V±2.5%, +Reset ODO	SOT-89	20vda	VD6	4g	Ssc
X18P	SS6680P-18CX	Vdet-IC	1.8V±2.5%, -Reset ODO	SOT-89	20vda	VD6	4g	Ssc
X19C	SS6680C-19CX	Vdet-IC	1.9V±2.5%, +Reset PPO	SOT-89	20vda	VD7	4g	Ssc
X19N	SS6680N-19CX	Vdet-IC	1.9V±2.5%, +Reset ODO	SOT-89	20vda	VD6	4g	Ssc
X19P	SS6680P-19CX	Vdet-IC	1.9V±2.5%, -Reset ODO	SOT-89	20vda	VD6	4g	Ssc
X1LN	ELM7551CAB	Vdet-IC	5.1V±2%, +Reset PPO	SOT-89	20vda	VD7	4a	Elm
X1LN	ELM7551NAB	Vdet-IC	5.1V±2%, +Reset ODO	SOT-89	20vda	VD6	4a	Elm
X2	BZV49-C30	Z-diode	3.0V±5%, lzt=2mA, 1W	SOT-89	20dm	-	4b	Sie,Zx
X20C	SS6680C-20CX	Vdet-IC	2.0V±2.5%, +Reset PPO	SOT-89	20vda	VD7	4g	Ssc
X20N	SS6680N-20CX	Vdet-IC	2.0V±2.5%, +Reset ODO	SOT-89	20vda	VD6	4g	Ssc
X20P	SS6680P-20CX	Vdet-IC	2.0V±2.5%, -Reset ODO	SOT-89	20vda	VD6	4g	Ssc
X21C	SS6680C-21CX	Vdet-IC	2.1V±2.5%, +Reset PPO	SOT-89	20vda	VD7	4g	Ssc
X21N	SS6680N-21CX	Vdet-IC	2.1V±2.5%, +Reset ODO	SOT-89	20vda	VD6	4g	Ssc

Note: ELM75xxCEB series LN- lot number L=0...9 N=A to Z(I, O, X excepted); ELM75xxNEB series LN- lot number L=A to Z(I, O, X excepted) N=0...9



SMD
code

Type

Function

Short description

Case Pinout Sch. St. Mnf.

SMD code	Type	Function	Short description	Case	Pinout	Sch.	St.	Mnf.
X21P	SS6680P-21CX	Vdet-IC	2.1V±2.5%, -Reset ODO	SOT-89	20vda	VD6	4g	Ssc
X22C	SS6680C-22CX	Vdet-IC	2.2V±2.5%, +Reset PPO	SOT-89	20vda	VD7	4g	Ssc
X22N	SS6680N-22CX	Vdet-IC	2.2V±2.5%, +Reset ODO	SOT-89	20vda	VD6	4g	Ssc
X22P	SS6680P-22CX	Vdet-IC	2.2V±2.5%, -Reset ODO	SOT-89	20vda	VD6	4g	Ssc
X23C	SS6680C-23CX	Vdet-IC	2.3V±2.5%, +Reset PPO	SOT-89	20vda	VD7	4g	Ssc
X23N	SS6680N-23CX	Vdet-IC	2.3V±2.5%, +Reset ODO	SOT-89	20vda	VD6	4g	Ssc
X23P	SS6680P-23CX	Vdet-IC	2.3V±2.5%, -Reset ODO	SOT-89	20vda	VD6	4g	Ssc
X24C	SS6680C-24CX	Vdet-IC	2.4V±2.5%, +Reset PPO	SOT-89	20vda	VD7	4g	Ssc
X24N	SS6680N-24CX	Vdet-IC	2.4V±2.5%, +Reset ODO	SOT-89	20vda	VD6	4g	Ssc
X24P	SS6680P-24CX	Vdet-IC	2.4V±2.5%, -Reset ODO	SOT-89	20vda	VD6	4g	Ssc
X25C	SS6680C-25CX	Vdet-IC	2.5V±2.5%, +Reset PPO	SOT-89	20vda	VD7	4g	Ssc
X25N	SS6680N-25CX	Vdet-IC	2.5V±2.5%, +Reset ODO	SOT-89	20vda	VD6	4g	Ssc
X25P	SS6680P-25CX	Vdet-IC	2.5V±2.5%, -Reset ODO	SOT-89	20vda	VD6	4g	Ssc
X26C	SS6680C-26CX	Vdet-IC	2.6V±2.5%, +Reset PPO	SOT-89	20vda	VD7	4g	Ssc
X26N	SS6680N-26CX	Vdet-IC	2.6V±2.5%, +Reset ODO	SOT-89	20vda	VD6	4g	Ssc
X26P	SS6680P-26CX	Vdet-IC	2.6V±2.5%, -Reset ODO	SOT-89	20vda	VD6	4g	Ssc
X27C	SS6680C-27CX	Vdet-IC	2.7V±2.5%, +Reset PPO	SOT-89	20vda	VD7	4g	Ssc
X27N	SS6680N-27CX	Vdet-IC	2.7V±2.5%, +Reset ODO	SOT-89	20vda	VD6	4g	Ssc
X27P	SS6680P-27CX	Vdet-IC	2.7V±2.5%, -Reset ODO	SOT-89	20vda	VD6	4g	Ssc
X28C	SS6680C-28CX	Vdet-IC	2.8V±2.5%, +Reset PPO	SOT-89	20vda	VD7	4g	Ssc
X28N	SS6680N-28CX	Vdet-IC	2.8V±2.5%, +Reset ODO	SOT-89	20vda	VD6	4g	Ssc
X28P	SS6680P-28CX	Vdet-IC	2.8V±2.5%, -Reset ODO	SOT-89	20vda	VD6	4g	Ssc
X29C	SS6680C-29CX	Vdet-IC	2.9V±2.5%, +Reset PPO	SOT-89	20vda	VD7	4g	Ssc
X29N	SS6680N-29CX	Vdet-IC	2.9V±2.5%, +Reset ODO	SOT-89	20vda	VD6	4g	Ssc
X29P	SS6680P-29CX	Vdet-IC	2.9V±2.5%, -Reset ODO	SOT-89	20vda	VD6	4g	Ssc
X2LN	ELM7552CAB	Vdet-IC	5.2V±2%, +Reset PPO	SOT-89	20vda	VD7	4a	Elm
X2LN	ELM7552NAB	Vdet-IC	5.2V±2%, +Reset ODO	SOT-89	20vda	VD6	4a	Elm
X3	BZV49-C33	Z-diode	33V±5%, Izt=2mA, 1W	SOT-89	20dm	-	4b	Sie
X30C	SS6680C-30CX	Vdet-IC	3.0V±2.5%, +Reset PPO	SOT-89	20vda	VD7	4g	Ssc
X30N	SS6680N-30CX	Vdet-IC	3.0V±2.5%, +Reset ODO	SOT-89	20vda	VD6	4g	Ssc
X30P	SS6680P-30CX	Vdet-IC	3.0V±2.5%, -Reset ODO	SOT-89	20vda	VD6	4g	Ssc
X31C	SS6680C-31CX	Vdet-IC	3.1V±2.5%, +Reset PPO	SOT-89	20vda	VD7	4g	Ssc
X31N	SS6680N-31CX	Vdet-IC	3.1V±2.5%, +Reset ODO	SOT-89	20vda	VD6	4g	Ssc
X31P	SS6680P-31CX	Vdet-IC	3.1V±2.5%, -Reset ODO	SOT-89	20vda	VD6	4g	Ssc
X32C	SS6680C-32CX	Vdet-IC	3.2V±2.5%, +Reset PPO	SOT-89	20vda	VD7	4g	Ssc
X32N	SS6680N-32CX	Vdet-IC	3.2V±2.5%, +Reset ODO	SOT-89	20vda	VD6	4g	Ssc
X32P	SS6680P-32CX	Vdet-IC	3.2V±2.5%, -Reset ODO	SOT-89	20vda	VD6	4g	Ssc
X33C	SS6680C-33CX	Vdet-IC	3.3V±2.5%, +Reset PPO	SOT-89	20vda	VD7	4g	Ssc
X33N	SS6680N-33CX	Vdet-IC	3.3V±2.5%, +Reset ODO	SOT-89	20vda	VD6	4g	Ssc
X33P	SS6680P-33CX	Vdet-IC	3.3V±2.5%, -Reset ODO	SOT-89	20vda	VD6	4g	Ssc
X34C	SS6680C-34CX	Vdet-IC	3.4V±2.5%, +Reset PPO	SOT-89	20vda	VD7	4g	Ssc
X34N	SS6680N-34CX	Vdet-IC	3.4V±2.5%, +Reset ODO	SOT-89	20vda	VD6	4g	Ssc
X34P	SS6680P-34CX	Vdet-IC	3.4V±2.5%, -Reset ODO	SOT-89	20vda	VD6	4g	Ssc
X35C	SS6680C-35CX	Vdet-IC	3.5V±2.5%, +Reset PPO	SOT-89	20vda	VD7	4g	Ssc
X35N	SS6680N-35CX	Vdet-IC	3.5V±2.5%, +Reset ODO	SOT-89	20vda	VD6	4g	Ssc
X35P	SS6680P-35CX	Vdet-IC	3.5V±2.5%, -Reset ODO	SOT-89	20vda	VD6	4g	Ssc
X36C	SS6680C-36CX	Vdet-IC	3.6V±2.5%, +Reset PPO	SOT-89	20vda	VD7	4g	Ssc
X36N	SS6680N-36CX	Vdet-IC	3.6V±2.5%, +Reset ODO	SOT-89	20vda	VD6	4g	Ssc
X36P	SS6680P-36CX	Vdet-IC	3.6V±2.5%, -Reset ODO	SOT-89	20vda	VD6	4g	Ssc
X37C	SS6680C-37CX	Vdet-IC	3.7V±2.5%, +Reset PPO	SOT-89	20vda	VD7	4g	Ssc
X37N	SS6680N-37CX	Vdet-IC	3.7V±2.5%, +Reset ODO	SOT-89	20vda	VD6	4g	Ssc
X37P	SS6680P-37CX	Vdet-IC	3.7V±2.5%, -Reset ODO	SOT-89	20vda	VD6	4g	Ssc
X38C	SS6680C-38CX	Vdet-IC	3.8V±2.5%, +Reset PPO	SOT-89	20vda	VD7	4g	Ssc
X38N	SS6680N-38CX	Vdet-IC	3.8V±2.5%, +Reset ODO	SOT-89	20vda	VD6	4g	Ssc
X38P	SS6680P-38CX	Vdet-IC	3.8V±2.5%, -Reset ODO	SOT-89	20vda	VD6	4g	Ssc
X39C	SS6680C-39CX	Vdet-IC	3.9V±2.5%, +Reset PPO	SOT-89	20vda	VD7	4g	Ssc
X39N	SS6680N-39CX	Vdet-IC	3.9V±2.5%, +Reset ODO	SOT-89	20vda	VD6	4g	Ssc
X39P	SS6680P-39CX	Vdet-IC	3.9V±2.5%, -Reset ODO	SOT-89	20vda	VD6	4g	Ssc
X3LN	ELM7553CAB	Vdet-IC	5.3V±2%, +Reset PPO	SOT-89	20vda	VD7	4a	Elm
X3LN	ELM7553NAB	Vdet-IC	5.3V±2%, +Reset ODO	SOT-89	20vda	VD6	4a	Elm
X4	BZV49-C36	Z-diode	36V±5%, Izt=2mA, 1W	SOT-89	20dm	-	4b	Sie
X40C	SS6680C-40CX	Vdet-IC	4.0V±2.5%, +Reset PPO	SOT-89	20vda	VD7	4g	Ssc
X40N	SS6680N-40CX	Vdet-IC	4.0V±2.5%, +Reset ODO	SOT-89	20vda	VD6	4g	Ssc
X40P	SS6680P-40CX	Vdet-IC	4.0V±2.5%, -Reset ODO	SOT-89	20vda	VD6	4g	Ssc
X41C	SS6680C-41CX	Vdet-IC	4.1V±2.5%, +Reset PPO	SOT-89	20vda	VD7	4g	Ssc
X41N	SS6680N-41CX	Vdet-IC	4.1V±2.5%, +Reset ODO	SOT-89	20vda	VD6	4g	Ssc
X41P	SS6680P-41CX	Vdet-IC	4.1V±2.5%, -Reset ODO	SOT-89	20vda	VD6	4g	Ssc
X42C	SS6680C-42CX	Vdet-IC	4.2V±2.5%, +Reset PPO	SOT-89	20vda	VD7	4g	Ssc
X42N	SS6680N-42CX	Vdet-IC	4.2V±2.5%, +Reset ODO	SOT-89	20vda	VD6	4g	Ssc
X42P	SS6680P-42CX	Vdet-IC	4.2V±2.5%, -Reset ODO	SOT-89	20vda	VD6	4g	Ssc

Note: ELM75xxCEB series LN- lot number L=0...9 N=A to Z(I, O, X excepted); ELM75xxNEB series LN- lot number L=A to Z(I, O, X excepted) N=0...9



SMD code	Type	Function	Short description	Case	Pinout	Sch.	St.	Mnf.
X43C	SS6680C-43CX	Vdet-IC	4.3V±2.5%, +Reset PPO	SOT-89	20vda	VD7	4g	Ssc
X43N	SS6680N-43CX	Vdet-IC	4.3V±2.5%, +Reset ODO	SOT-89	20vda	VD6	4g	Ssc
X43P	SS6680P-43CX	Vdet-IC	4.3V±2.5%, -Reset ODO	SOT-89	20vda	VD6	4g	Ssc
X44C	SS6680C-44CX	Vdet-IC	4.4V±2.5%, +Reset PPO	SOT-89	20vda	VD7	4g	Ssc
X44N	SS6680N-44CX	Vdet-IC	4.4V±2.5%, +Reset ODO	SOT-89	20vda	VD6	4g	Ssc
X44P	SS6680P-44CX	Vdet-IC	4.4V±2.5%, -Reset ODO	SOT-89	20vda	VD6	4g	Ssc
X45C	SS6680C-45CX	Vdet-IC	4.5V±2.5%, +Reset PPO	SOT-89	20vda	VD7	4g	Ssc
X45N	SS6680N-45CX	Vdet-IC	4.5V±2.5%, +Reset ODO	SOT-89	20vda	VD6	4g	Ssc
X45P	SS6680P-45CX	Vdet-IC	4.5V±2.5%, -Reset ODO	SOT-89	20vda	VD6	4g	Ssc
X46C	SS6680C-46CX	Vdet-IC	4.6V±2.5%, +Reset PPO	SOT-89	20vda	VD7	4g	Ssc
X46N	SS6680N-46CX	Vdet-IC	4.6V±2.5%, +Reset ODO	SOT-89	20vda	VD6	4g	Ssc
X46P	SS6680P-46CX	Vdet-IC	4.6V±2.5%, -Reset ODO	SOT-89	20vda	VD6	4g	Ssc
X47C	SS6680C-47CX	Vdet-IC	4.7V±2.5%, +Reset PPO	SOT-89	20vda	VD7	4g	Ssc
X47N	SS6680N-47CX	Vdet-IC	4.7V±2.5%, +Reset ODO	SOT-89	20vda	VD6	4g	Ssc
X47P	SS6680P-47CX	Vdet-IC	4.7V±2.5%, -Reset ODO	SOT-89	20vda	VD6	4g	Ssc
X48C	SS6680C-48CX	Vdet-IC	4.8V±2.5%, +Reset PPO	SOT-89	20vda	VD7	4g	Ssc
X48N	SS6680N-48CX	Vdet-IC	4.8V±2.5%, +Reset ODO	SOT-89	20vda	VD6	4g	Ssc
X48P	SS6680P-48CX	Vdet-IC	4.8V±2.5%, -Reset ODO	SOT-89	20vda	VD6	4g	Ssc
X49C	SS6680C-49CX	Vdet-IC	4.9V±2.5%, +Reset PPO	SOT-89	20vda	VD7	4g	Ssc
X49N	SS6680N-49CX	Vdet-IC	4.9V±2.5%, +Reset ODO	SOT-89	20vda	VD6	4g	Ssc
X49P	SS6680P-49CX	Vdet-IC	4.9V±2.5%, -Reset ODO	SOT-89	20vda	VD6	4g	Ssc
X4LN	ELM7554CAB	Vdet-IC	5.4V±2%, +Reset PPO	SOT-89	20vda	VD7	4a	Elm
X4LN	ELM7554NAB	Vdet-IC	5.4V±2%, +Reset ODO	SOT-89	20vda	VD6	4a	Elm
X5	BZV49-C39	Z-diode	39V±5%, Izt=2mA, 1W	SOT-89	20dm	-	4b	Sie,Zx
X50C	SS6680C-50CX	Vdet-IC	5.0V±2.5%, +Reset PPO	SOT-89	20vda	VD7	4g	Ssc
X50N	SS6680N-50CX	Vdet-IC	5.0V±2.5%, +Reset ODO	SOT-89	20vda	VD6	4g	Ssc
X50P	SS6680P-50CX	Vdet-IC	5.0V±2.5%, -Reset ODO	SOT-89	20vda	VD6	4g	Ssc
X51C	SS6680C-51CX	Vdet-IC	5.1V±2.5%, +Reset PPO	SOT-89	20vda	VD7	4g	Ssc
X51N	SS6680N-51CX	Vdet-IC	5.1V±2.5%, +Reset ODO	SOT-89	20vda	VD6	4g	Ssc
X51P	SS6680P-51CX	Vdet-IC	5.1V±2.5%, -Reset ODO	SOT-89	20vda	VD6	4g	Ssc
X52C	SS6680C-52CX	Vdet-IC	5.2V±2.5%, +Reset PPO	SOT-89	20vda	VD7	4g	Ssc
X52N	SS6680N-52CX	Vdet-IC	5.2V±2.5%, +Reset ODO	SOT-89	20vda	VD6	4g	Ssc
X52P	SS6680P-52CX	Vdet-IC	5.2V±2.5%, -Reset ODO	SOT-89	20vda	VD6	4g	Ssc
X53C	SS6680C-53CX	Vdet-IC	5.3V±2.5%, +Reset PPO	SOT-89	20vda	VD7	4g	Ssc
X53N	SS6680N-53CX	Vdet-IC	5.3V±2.5%, +Reset ODO	SOT-89	20vda	VD6	4g	Ssc
X53P	SS6680P-53CX	Vdet-IC	5.3V±2.5%, -Reset ODO	SOT-89	20vda	VD6	4g	Ssc
X54C	SS6680C-54CX	Vdet-IC	5.4V±2.5%, +Reset PPO	SOT-89	20vda	VD7	4g	Ssc
X54N	SS6680N-54CX	Vdet-IC	5.4V±2.5%, +Reset ODO	SOT-89	20vda	VD6	4g	Ssc
X54P	SS6680P-54CX	Vdet-IC	5.4V±2.5%, -Reset ODO	SOT-89	20vda	VD6	4g	Ssc
X55C	SS6680C-55CX	Vdet-IC	5.5V±2.5%, +Reset PPO	SOT-89	20vda	VD7	4g	Ssc
X55N	SS6680N-55CX	Vdet-IC	5.5V±2.5%, +Reset ODO	SOT-89	20vda	VD6	4g	Ssc
X55P	SS6680P-55CX	Vdet-IC	5.5V±2.5%, -Reset ODO	SOT-89	20vda	VD6	4g	Ssc
X56C	SS6680C-56CX	Vdet-IC	5.6V±2.5%, +Reset PPO	SOT-89	20vda	VD7	4g	Ssc
X56N	SS6680N-56CX	Vdet-IC	5.6V±2.5%, +Reset ODO	SOT-89	20vda	VD6	4g	Ssc
X56P	SS6680P-56CX	Vdet-IC	5.6V±2.5%, -Reset ODO	SOT-89	20vda	VD6	4g	Ssc
X57C	SS6680C-57CX	Vdet-IC	5.7V±2.5%, +Reset PPO	SOT-89	20vda	VD7	4g	Ssc
X57N	SS6680N-57CX	Vdet-IC	5.7V±2.5%, +Reset ODO	SOT-89	20vda	VD6	4g	Ssc
X57P	SS6680P-57CX	Vdet-IC	5.7V±2.5%, -Reset ODO	SOT-89	20vda	VD6	4g	Ssc
X58C	SS6680C-58CX	Vdet-IC	5.8V±2.5%, +Reset PPO	SOT-89	20vda	VD7	4g	Ssc
X58N	SS6680N-58CX	Vdet-IC	5.8V±2.5%, +Reset ODO	SOT-89	20vda	VD6	4g	Ssc
X58P	SS6680P-58CX	Vdet-IC	5.8V±2.5%, -Reset ODO	SOT-89	20vda	VD6	4g	Ssc
X59C	SS6680C-59CX	Vdet-IC	5.9V±2.5%, +Reset PPO	SOT-89	20vda	VD7	4g	Ssc
X59N	SS6680N-59CX	Vdet-IC	5.9V±2.5%, +Reset ODO	SOT-89	20vda	VD6	4g	Ssc
X59P	SS6680P-59CX	Vdet-IC	5.9V±2.5%, -Reset ODO	SOT-89	20vda	VD6	4g	Ssc
X5LN	ELM7555CAB	Vdet-IC	5.5V±2%, +Reset PPO	SOT-89	16vda	VD7	4a	Elm
X5LN	ELM7555NAB	Vdet-IC	5.5V±2%, +Reset ODO	SOT-89	20vda	VD6	4a	Elm
X6	BZV49-C43	Z-diode	43V±5%, Izt=2mA, 1W	SOT-89	20dm	-	4b	Sie,Zx
X60C	SS6680C-60CX	Vdet-IC	6.0V±2.5%, +Reset PPO	SOT-89	20vda	VD7	4g	Ssc
X60N	SS6680N-60CX	Vdet-IC	6.0V±2.5%, +Reset ODO	SOT-89	20vda	VD6	4g	Ssc
X60P	SS6680P-60CX	Vdet-IC	6.0V±2.5%, -Reset ODO	SOT-89	20vda	VD6	4g	Ssc
X7	BZV49-C47	Z-diode	47V±5%, Izt=2mA, 1W	SOT-89	20dm	-	4b	Sie
XA	KTB1124-A	Si-pnp	GP, 60V, 3A, 1W, B=100..200, 150MHz	SOT-89	20tb	-	4a	Kec
XAN	CHT2222XPT	Si-npn	AF, Sw, 40V, 600mA, B=100..300, 300MHz	SOT-89	20tb	-	4b	Chm
XAP	CHT2907XPT	Si-pnp	AF, Sw, 60V, 600mA, B=100..300, 200MHz	SOT-89	20tb	-	4g	Chm
XB	KTB1124-B	Si-pnp	GP, 60V, 3A, 1W, B=140..280, 150MHz	SOT-89	20tb	-	4a	Kec
XBN	CH3904XPT	Si-npn	AF, Sw, 40V, 200mA, B=100..300, 300MHz	SOT-89	20tb	-	4b	Chm
XBP	CH3906XPT	Si-pnp	AF, Sw, 40V, 200mA, B=100..300, 250MHz	SOT-89	20tb	-	4g	Chm
XC	KTB1124-C	Si-pnp	GP, 60V, 3A, 1W, B=200..400, 150MHz	SOT-89	20tb	-	4a	Kec
XCAR	YB1210ST8RR120	LVR-IC	LDO, ULN, 1.2V±2%, 300mA	SOT-89	20ch	VR1	4g	Ybn
XCAS	YB1210ST89R120	LVR-IC	LDO, ULN, 1.2V±2%, 300mA	SOT-89	20vl	VR1	4g	Ybn



SMD
code

Type

Function

Short description

Case Pinout Sch. St. Mnf.

SMD code	Type	Function	Short description	Case	Pinout	Sch.	St.	Mnf.
XCBR	YB1210ST8RR130	LVR-IC	LDO, ULN, 1.3V±2%, 300mA	SOT-89	20ch	VR1	4g	Ybn
XCBS	YB1210ST89R130	LVR-IC	LDO, ULN, 1.3V±2%, 300mA	SOT-89	20vl	VR1	4g	Ybn
XCCR	YB1210ST8RR140	LVR-IC	LDO, ULN, 1.4V±2%, 300mA	SOT-89	20ch	VR1	4g	Ybn
XCCS	YB1210ST89R140	LVR-IC	LDO, ULN, 1.4V±2%, 300mA	SOT-89	20vl	VR1	4g	Ybn
XCDR	YB1210ST8RR150	LVR-IC	LDO, ULN, 1.5V±2%, 300mA	SOT-89	20ch	VR1	4g	Ybn
XCDS	YB1210ST89R150	LVR-IC	LDO, ULN, 1.5V±2%, 300mA	SOT-89	20vl	VR1	4g	Ybn
XCER	YB1210ST8RR160	LVR-IC	LDO, ULN, 1.6V±2%, 300mA	SOT-89	20ch	VR1	4g	Ybn
XCES	YB1210ST89R160	LVR-IC	LDO, ULN, 1.6V±2%, 300mA	SOT-89	20vl	VR1	4g	Ybn
XCFR	YB1210ST8RR170	LVR-IC	LDO, ULN, 1.7V±2%, 300mA	SOT-89	20ch	VR1	4g	Ybn
XCFS	YB1210ST89R170	LVR-IC	LDO, ULN, 1.7V±2%, 300mA	SOT-89	20vl	VR1	4g	Ybn
XCGR	YB1210ST8RR180	LVR-IC	LDO, ULN, 1.8V±2%, 300mA	SOT-89	20ch	VR1	4g	Ybn
XCGS	YB1210ST89R180	LVR-IC	LDO, ULN, 1.8V±2%, 300mA	SOT-89	20vl	VR1	4g	Ybn
XCHR	YB1210ST8RR190	LVR-IC	LDO, ULN, 1.9V±2%, 300mA	SOT-89	20ch	VR1	4g	Ybn
XCHS	YB1210ST89R190	LVR-IC	LDO, ULN, 1.9V±2%, 300mA	SOT-89	20vl	VR1	4g	Ybn
XGIR	YB1210ST8RR200	LVR-IC	LDO, ULN, 2.0V±2%, 300mA	SOT-89	20ch	VR1	4g	Ybn
XGIS	YB1210ST89R200	LVR-IC	LDO, ULN, 2.0V±2%, 300mA	SOT-89	20vl	VR1	4g	Ybn
XGJR	YB1210ST8RR210	LVR-IC	LDO, ULN, 2.1V±2%, 300mA	SOT-89	20ch	VR1	4g	Ybn
XGJS	YB1210ST89R210	LVR-IC	LDO, ULN, 2.1V±2%, 300mA	SOT-89	20vl	VR1	4g	Ybn
XCKR	YB1210ST8RR220	LVR-IC	LDO, ULN, 2.2V±2%, 300mA	SOT-89	20ch	VR1	4g	Ybn
XCKS	YB1210ST89R220	LVR-IC	LDO, ULN, 2.2V±2%, 300mA	SOT-89	20vl	VR1	4g	Ybn
XCLR	YB1210ST8RR230	LVR-IC	LDO, ULN, 2.3V±2%, 300mA	SOT-89	20ch	VR1	4g	Ybn
XCLS	YB1210ST89R230	LVR-IC	LDO, ULN, 2.3V±2%, 300mA	SOT-89	20vl	VR1	4g	Ybn
XCMR	YB1210ST8RR240	LVR-IC	LDO, ULN, 2.4V±2%, 300mA	SOT-89	20ch	VR1	4g	Ybn
XCMS	YB1210ST89R240	LVR-IC	LDO, ULN, 2.4V±2%, 300mA	SOT-89	20vl	VR1	4g	Ybn
XCN	CHT3019XPT	Si-npn	AF, Sw, 80V, 1A, B=100, 300, 100MHz	SOT-89	20tb	-	4g	Chm
XCNR	YB1210ST8RR250	LVR-IC	LDO, ULN, 2.5V±2%, 300mA	SOT-89	20ch	VR1	4g	Ybn
XCNS	YB1210ST89R250	LVR-IC	LDO, ULN, 2.5V±2%, 300mA	SOT-89	20vl	VR1	4g	Ybn
XCOR	YB1210ST8RR260	LVR-IC	LDO, ULN, 2.6V±2%, 300mA	SOT-89	20ch	VR1	4g	Ybn
XCOS	YB1210ST89R260	LVR-IC	LDO, ULN, 2.6V±2%, 300mA	SOT-89	20vl	VR1	4g	Ybn
XCP	CHT4033XPT	Si-pnp	AF, Sw, 80V, 1A, B=100, 300, 100MHz	SOT-89	20tb	-	4g	Chm
XCPR	YB1210ST8RR270	LVR-IC	LDO, ULN, 2.7V±2%, 300mA	SOT-89	20ch	VR1	4g	Ybn
XCPS	YB1210ST89R270	LVR-IC	LDO, ULN, 2.7V±2%, 300mA	SOT-89	20vl	VR1	4g	Ybn
XCQR	YB1210ST8RR280	LVR-IC	LDO, ULN, 2.8V±2%, 300mA	SOT-89	20ch	VR1	4g	Ybn
XCQS	YB1210ST89R280	LVR-IC	LDO, ULN, 2.8V±2%, 300mA	SOT-89	20vl	VR1	4g	Ybn
XCRR	YB1210ST8RR290	LVR-IC	LDO, ULN, 2.9V±2%, 300mA	SOT-89	20ch	VR1	4g	Ybn
XCRS	YB1210ST89R290	LVR-IC	LDO, ULN, 2.9V±2%, 300mA	SOT-89	20vl	VR1	4g	Ybn
XCSR	YB1210ST8RR300	LVR-IC	LDO, ULN, 3.0V±2%, 300mA	SOT-89	20ch	VR1	4g	Ybn
XCSS	YB1210ST89R300	LVR-IC	LDO, ULN, 3.0V±2%, 300mA	SOT-89	20vl	VR1	4g	Ybn
XCTR	YB1210ST8RR310	LVR-IC	LDO, ULN, 3.1V±2%, 300mA	SOT-89	20ch	VR1	4g	Ybn
XCTS	YB1210ST89R310	LVR-IC	LDO, ULN, 3.1V±2%, 300mA	SOT-89	20vl	VR1	4g	Ybn
XCUR	YB1210ST8RR320	LVR-IC	LDO, ULN, 3.2V±2%, 300mA	SOT-89	20ch	VR1	4g	Ybn
XCUS	YB1210ST89R320	LVR-IC	LDO, ULN, 3.2V±2%, 300mA	SOT-89	20vl	VR1	4g	Ybn
XCVR	YB1210ST8RR330	LVR-IC	LDO, ULN, 3.3V±2%, 300mA	SOT-89	20ch	VR1	4g	Ybn
XCVS	YB1210ST89R330	LVR-IC	LDO, ULN, 3.3V±2%, 300mA	SOT-89	20vl	VR1	4g	Ybn
XCWR	YB1210ST8RR340	LVR-IC	LDO, ULN, 3.4V±2%, 300mA	SOT-89	20ch	VR1	4g	Ybn
XCWS	YB1210ST89R340	LVR-IC	LDO, ULN, 3.4V±2%, 300mA	SOT-89	20vl	VR1	4g	Ybn
XCXR	YB1210ST8RR350	LVR-IC	LDO, ULN, 3.5V±2%, 300mA	SOT-89	20ch	VR1	4g	Ybn
XXCS	YB1210ST89R350	LVR-IC	LDO, ULN, 3.5V±2%, 300mA	SOT-89	20vl	VR1	4g	Ybn
XCYS	YB1210ST8RR360	LVR-IC	LDO, ULN, 3.6V±2%, 300mA	SOT-89	20ch	VR1	4g	Ybn
XCYS	YB1210ST89R360	LVR-IC	LDO, ULN, 3.6V±2%, 300mA	SOT-89	20vl	VR1	4g	Ybn
XDN	CHT5551XPT	Si-npn	AF-Drv, 160V, 600mA, B=80..250, 100MHz	SOT-89	20tb	-	4g	Chm
XDP	CHT5401XPT	Si-pnp	AF-Drv, 150V, 500mA, B=60..240, 100MHz	SOT-89	20tb	-	4g	Chm
XEAR	YB1230ST8RX180	LVR-IC	LDO, 1.8V±2%, 600mA	SOT-89	20ch	VR1	4g	Ybn
XEAS	YB1230ST89X180	LVR-IC	LDO, 1.8V±2%, 600mA	SOT-89	20vl	VR1	4g	Ybn
XEBR	YB1230ST8RX190	LVR-IC	LDO, 1.9V±2%, 600mA	SOT-89	20ch	VR1	4g	Ybn
XEBS	YB1230ST89X190	LVR-IC	LDO, 1.9V±2%, 600mA	SOT-89	20vl	VR1	4g	Ybn
XECR	YB1230ST8RX200	LVR-IC	LDO, 2.0V±2%, 600mA	SOT-89	20ch	VR1	4g	Ybn
XECS	YB1230ST89X200	LVR-IC	LDO, 2.0V±2%, 600mA	SOT-89	20vl	VR1	4g	Ybn
XEDR	YB1230ST8RX210	LVR-IC	LDO, 2.1V±2%, 600mA	SOT-89	20ch	VR1	4g	Ybn
XEDS	YB1230ST89X210	LVR-IC	LDO, 2.1V±2%, 600mA	SOT-89	20vl	VR1	4g	Ybn
XEER	YB1230ST8RX220	LVR-IC	LDO, 2.2V±2%, 600mA	SOT-89	20ch	VR1	4g	Ybn
XEES	YB1230ST89X220	LVR-IC	LDO, 2.2V±2%, 600mA	SOT-89	20vl	VR1	4g	Ybn
XEFR	YB1230ST8RX230	LVR-IC	LDO, 2.3V±2%, 600mA	SOT-89	20ch	VR1	4g	Ybn
XEFS	YB1230ST89X230	LVR-IC	LDO, 2.3V±2%, 600mA	SOT-89	20vl	VR1	4g	Ybn
XEGR	YB1230ST8RX240	LVR-IC	LDO, 2.4V±2%, 600mA	SOT-89	20ch	VR1	4g	Ybn
XEGS	YB1230ST89X240	LVR-IC	LDO, 2.4V±2%, 600mA	SOT-89	20vl	VR1	4g	Ybn
XEHR	YB1230ST8RX250	LVR-IC	LDO, 2.5V±2%, 600mA	SOT-89	20ch	VR1	4g	Ybn
XEHS	YB1230ST89X250	LVR-IC	LDO, 2.5V±2%, 600mA	SOT-89	20vl	VR1	4g	Ybn
XEIR	YB1230ST8RX260	LVR-IC	LDO, 2.6V±2%, 600mA	SOT-89	20ch	VR1	4g	Ybn
XEIS	YB1230ST89X260	LVR-IC	LDO, 2.6V±2%, 600mA	SOT-89	20vl	VR1	4g	Ybn



SMD
code

Type

Function

Short description

Case Pinout Sch. St. Mnf.

SMD code	Type	Function	Short description	Case	Pinout	Sch.	St.	Mnf.
XEJR	YB1230ST8RX270	LVR-IC	LDO, 2.7V±2%, 600mA	SOT-89	20ch	VR1	4g	Ybn
XEJS	YB1230ST89X270	LVR-IC	LDO, 2.7V±2%, 600mA	SOT-89	20vl	VR1	4g	Ybn
XEKR	YB1230ST8RX280	LVR-IC	LDO, 2.8V±2%, 600mA	SOT-89	20ch	VR1	4g	Ybn
XEKS	YB1230ST89X280	LVR-IC	LDO, 2.8V±2%, 600mA	SOT-89	20vl	VR1	4g	Ybn
XELR	YB1230ST8RX290	LVR-IC	LDO, 2.9V±2%, 600mA	SOT-89	20ch	VR1	4g	Ybn
XELS	YB1230ST89X290	LVR-IC	LDO, 2.9V±2%, 600mA	SOT-89	20vl	VR1	4g	Ybn
XEMR	YB1230ST8RX300	LVR-IC	LDO, 3.0V±2%, 600mA	SOT-89	20ch	VR1	4g	Ybn
XEMS	YB1230ST89X300	LVR-IC	LDO, 3.0V±2%, 600mA	SOT-89	20vl	VR1	4g	Ybn
XEN	CHTA14XPT	Si-npn-Darl	AF, Sw, 30V, 500mA, B>20000, 125MHz	SOT-89	20tb	-	4b	Chm
XENR	YB1230ST8RX310	LVR-IC	LDO, 3.1V±2%, 600mA	SOT-89	20ch	VR1	4g	Ybn
XENS	YB1230ST89X310	LVR-IC	LDO, 3.1V±2%, 600mA	SOT-89	20vl	VR1	4g	Ybn
XEP	CHTA64XPT	Si-pnp-Darl	AF, Sw, 30V, 500mA, B>20000, 125MHz	SOT-89	20tb	-	4g	Chm
XFN	CHTA42XPT	Si-npn	AF-Drv, 300V, 600mA, B>40, 50MHz	SOT-89	20tb	-	4b	Chm
XG	2SA1944	Si-pnp	Relay-Drv, 50V, 1A, 500mW, B=400..800, 90MHz	SOT-89	20tb	-	4a	Mit
XGN	CHTA27XPT	Si-npn-Darl	AF, Sw, 60V, 500mA, B>10000, 125MHz	SOT-89	20tb	-	4b	Chm
XJCR	YB1231ST8RX320	LVR-IC	LDO, 3.2V±2%, 600mA	SOT-89	20ch	VR1	4g	Ybn
XJCS	YB1231ST89X320	LVR-IC	LDO, 3.2V±2%, 600mA	SOT-89	20vl	VR1	4g	Ybn
XJDR	YB1231ST8RX330	LVR-IC	LDO, 3.3V±2%, 600mA	SOT-89	20ch	VR1	4g	Ybn
XJDS	YB1231ST89X330	LVR-IC	LDO, 3.3V±2%, 600mA	SOT-89	20vl	VR1	4g	Ybn
XJER	YB1231ST8RX340	LVR-IC	LDO, 3.4V±2%, 600mA	SOT-89	20ch	VR1	4g	Ybn
XJES	YB1231ST89X340	LVR-IC	LDO, 3.4V±2%, 600mA	SOT-89	20vl	VR1	4g	Ybn
XJFR	YB1231ST8RX350	LVR-IC	LDO, 3.5V±2%, 600mA	SOT-89	20ch	VR1	4g	Ybn
XJFS	YB1231ST89X350	LVR-IC	LDO, 3.5V±2%, 600mA	SOT-89	20vl	VR1	4g	Ybn
XJGR	YB1231ST8RX360	LVR-IC	LDO, 3.6V±2%, 600mA	SOT-89	20ch	VR1	4g	Ybn
XJGS	YB1231ST89X360	LVR-IC	LDO, 3.6V±2%, 600mA	SOT-89	20vl	VR1	4g	Ybn
XJHR	YB1231ST8RX370	LVR-IC	LDO, 3.7V±2%, 600mA	SOT-89	20ch	VR1	4g	Ybn
XJHS	YB1231ST89X370	LVR-IC	LDO, 3.7V±2%, 600mA	SOT-89	20vl	VR1	4g	Ybn
XJIR	YB1231ST8RX380	LVR-IC	LDO, 3.8V±2%, 600mA	SOT-89	20ch	VR1	4g	Ybn
XJIS	YB1231ST89X380	LVR-IC	LDO, 3.8V±2%, 600mA	SOT-89	20vl	VR1	4g	Ybn
XJJR	YB1231ST8RX390	LVR-IC	LDO, 3.9V±2%, 600mA	SOT-89	20ch	VR1	4g	Ybn
XJJS	YB1231ST89X390	LVR-IC	LDO, 3.9V±2%, 600mA	SOT-89	20vl	VR1	4g	Ybn
XJKR	YB1231ST8RX400	LVR-IC	LDO, 4.0V±2%, 600mA	SOT-89	20ch	VR1	4g	Ybn
XJKS	YB1231ST89X400	LVR-IC	LDO, 4.0V±2%, 600mA	SOT-89	20vl	VR1	4g	Ybn
XJLR	YB1231ST8RX410	LVR-IC	LDO, 4.1V±2%, 600mA	SOT-89	20ch	VR1	4g	Ybn
XJLS	YB1231ST89X410	LVR-IC	LDO, 4.1V±2%, 600mA	SOT-89	20vl	VR1	4g	Ybn
XJMR	YB1231ST8RX420	LVR-IC	LDO, 4.2V±2%, 600mA	SOT-89	20ch	VR1	4g	Ybn
XJMS	YB1231ST89X420	LVR-IC	LDO, 4.2V±2%, 600mA	SOT-89	20vl	VR1	4g	Ybn
XJNR	YB1231ST8RX430	LVR-IC	LDO, 4.3V±2%, 600mA	SOT-89	20ch	VR1	4g	Ybn
XJNS	YB1231ST89X430	LVR-IC	LDO, 4.3V±2%, 600mA	SOT-89	20vl	VR1	4g	Ybn
XJOR	YB1231ST8RX440	LVR-IC	LDO, 4.4V±2%, 600mA	SOT-89	20ch	VR1	4g	Ybn
XJOS	YB1231ST89X440	LVR-IC	LDO, 4.4V±2%, 600mA	SOT-89	20vl	VR1	4g	Ybn
XJPR	YB1231ST8RX450	LVR-IC	LDO, 4.5V±2%, 600mA	SOT-89	20ch	VR1	4g	Ybn
XJPS	YB1231ST89X450	LVR-IC	LDO, 4.5V±2%, 600mA	SOT-89	20vl	VR1	4g	Ybn
XK	2SD1614-K	Si-npn	AF, Sw, 40V, 2A, 2W, B=300..600, 200MHz	SOT-89	20tb	-	4b	Nec
XL	2SD1614-L	Si-npn	AF, Sw, 40V, 2A, 2W, B=200..400, 200MHz	SOT-89	20tb	-	4b	Nec
XM	2SD1614-M	Si-npn	AF, Sw, 40V, 2A, 2W, B=135..270, 200MHz	SOT-89	20tb	-	4b	Nec
XN	2SD1784	Si-npn-Darl	Sw, 30V, 1.5A, 1W, B>4000, 0.2/0.6µs	SOT-89	20tb	-	4g	Tos
XP	2SD875-P	Si-npn	AF, 80V, 1A, 1W, B=70..135, 120MHz	SOT-89	20tb	-	4b	Pan
XQ	2SD875-Q	Si-npn	AF, 80V, 1A, 1W, B=90..155, 120MHz	SOT-89	20tb	-	4b	Pan
XR	2SD875-R	Si-npn	AF, 80V, 1A, 1W, B=130..200, 120MHz	SOT-89	20tb	-	4b	Pan
XS	2SD875-S	Si-npn	AF, 80V, 1A, 1W, B=185..330, 120MHz	SOT-89	20tb	-	4b	Pan
Y1	BZV49-C11	Z-diode	11V±5%, Izt=5mA, 1W	SOT-89	20dm	-	4b	Zx
Y153A	ML6206S153P	LVR-IC	1.5V±3%, 250mA	SOT-89	20vl	VR1	4g	Mlc
Y163A	ML6206S163P	LVR-IC	1.6V±3%, 250mA	SOT-89	20vl	VR1	4g	Mlc
Y173A	ML6206S173P	LVR-IC	1.7V±3%, 250mA	SOT-89	20vl	VR1	4g	Mlc
Y1766	2SC1766PT-Y	Si-npn	AF, Sw, 50V, 2A, B=180..90, 120MHz	SOT-89	20tb	-	4b	Chm
Y183A	ML6206S183P	LVR-IC	1.8V±3%, 250mA	SOT-89	20vl	VR1	4g	Mlc
Y193A	ML6206S193P	LVR-IC	1.9V±3%, 250mA	SOT-89	20vl	VR1	4g	Mlc
Y202A	ML6206S202P	LVR-IC	2.0V±2%, 250mA	SOT-89	20vl	VR1	4g	Mlc
Y212A	ML6206S212P	LVR-IC	2.1V±2%, 250mA	SOT-89	20vl	VR1	4g	Mlc
Y222A	ML6206S222P	LVR-IC	2.2V±2%, 250mA	SOT-89	20vl	VR1	4g	Mlc
Y232A	ML6206S232P	LVR-IC	2.3V±2%, 250mA	SOT-89	20vl	VR1	4g	Mlc
Y242A	ML6206S242P	LVR-IC	2.4V±2%, 250mA	SOT-89	20vl	VR1	4g	Mlc
Y252A	ML6206S252P	LVR-IC	2.5V±2%, 250mA	SOT-89	20vl	VR1	4g	Mlc
Y262A	ML6206S262P	LVR-IC	2.6V±2%, 250mA	SOT-89	20vl	VR1	4g	Mlc
Y272A	ML6206S272P	LVR-IC	2.7V±2%, 250mA	SOT-89	20vl	VR1	4g	Mlc
Y282A	ML6206S282P	LVR-IC	2.8V±2%, 250mA	SOT-89	20vl	VR1	4g	Mlc
Y292A	ML6206S292P	LVR-IC	2.9V±2%, 250mA	SOT-89	20vl	VR1	4g	Mlc
Y3	BZV49-C13	Z-diode	13V±5%, Izt=5mA, 1W	SOT-89	20dm	-	4b	Sie
Y302A	ML6206S302P	LVR-IC	3.0V±2%, 250mA	SOT-89	20vl	VR1	4g	Mlc



SMD
code

Type

Function

Short description

Case Pinout Sch. St. Mnf.

Y312A	ML6206S312P	LVR-IC	3.1V±2%, 250mA	SOT-89	20vl	VR1	4g	Mlc
Y322A	ML6206S322P	LVR-IC	3.2V±2%, 250mA	SOT-89	20vl	VR1	4g	Mlc
Y332A	ML6206S332P	LVR-IC	3.3V±2%, 250mA	SOT-89	20vl	VR1	4g	Mlc
Y342A	ML6206S342P	LVR-IC	3.4V±2%, 250mA	SOT-89	20vl	VR1	4g	Mlc
Y352A	ML6206S352P	LVR-IC	3.5V±2%, 250mA	SOT-89	20vl	VR1	4g	Mlc
Y362A	ML6206S362P	LVR-IC	3.6V±2%, 250mA	SOT-89	20vl	VR1	4g	Mlc
Y372A	ML6206S372P	LVR-IC	3.7V±2%, 250mA	SOT-89	20vl	VR1	4g	Mlc
Y382A	ML6206S382P	LVR-IC	3.8V±2%, 250mA	SOT-89	20vl	VR1	4g	Mlc
Y392A	ML6206S392P	LVR-IC	3.9V±2%, 250mA	SOT-89	20vl	VR1	4g	Mlc
Y4	BZV49-C15	Z-diode	15V±5%, Izt=5mA, 1W	SOT-89	20dm	-	4b	Sie,Zx
Y402A	ML6206S402P	LVR-IC	4.0V±2%, 250mA	SOT-89	20vl	VR1	4g	Mlc
Y412A	ML6206S412P	LVR-IC	4.1V±2%, 250mA	SOT-89	20vl	VR1	4g	Mlc
Y422A	ML6206S422P	LVR-IC	4.2V±2%, 250mA	SOT-89	20vl	VR1	4g	Mlc
Y432A	ML6206S432P	LVR-IC	4.3V±2%, 250mA	SOT-89	20vl	VR1	4g	Mlc
Y442A	ML6206S442P	LVR-IC	4.4V±2%, 250mA	SOT-89	20vl	VR1	4g	Mlc
Y452A	ML6206S452P	LVR-IC	4.5V±2%, 250mA	SOT-89	20vl	VR1	4g	Mlc
Y462A	ML6206S462P	LVR-IC	4.6V±2%, 250mA	SOT-89	20vl	VR1	4g	Mlc
Y472A	ML6206S472P	LVR-IC	4.7V±2%, 250mA	SOT-89	20vl	VR1	4g	Mlc
Y482A	ML6206S482P	LVR-IC	4.8V±2%, 250mA	SOT-89	20vl	VR1	4g	Mlc
Y492A	ML6206S492P	LVR-IC	4.9V±2%, 250mA	SOT-89	20vl	VR1	4g	Mlc
Y5	BZV49-C16	Z-diode	16V±5%, Izt=5mA, 1W	SOT-89	20dm	-	4b	Sie,Zx
Y502A	ML6206S502P	LVR-IC	5.0V±2%, 250mA	SOT-89	20vl	VR1	4g	Mlc
Y6	BZV49-C18	Z-diode	18V±5%, Izt=5mA, 1W	SOT-89	20dm	-	4b	Sie
Y7	BZV49-C20	Z-diode	20V±5%, Izt=5mA, 1W	SOT-89	20dm	-	4b	Sie
Y8	BZV49-C22	Z-diode	22V±5%, Izt=5mA, 1W	SOT-89	20dm	-	4b	Sie,Zx
Y9	BZV49-C24	Z-diode	24V±5%, Izt=5mA, 1W	SOT-89	20dm	-	4b	Sie,Zx
YA	RN6001	Si-pnp-Digij	Drv, 30V, 2A, 120MHz, R2=2k	SOT-89	20tb	-	4b	Tos
YDAR	YB1253ST8RX120	LVR-IC	LDO, 1.2V±2%, 300mA	SOT-89	20ch	VR1	4g	Ybn
YDAS	YB1253ST89X120	LVR-IC	LDO, 1.2V±2%, 300mA	SOT-89	20vl	VR1	4g	Ybn
YDBR	YB1253ST8RX130	LVR-IC	LDO, 1.3V±2%, 300mA	SOT-89	20ch	VR1	4g	Ybn
YDBS	YB1253ST89X130	LVR-IC	LDO, 1.3V±2%, 300mA	SOT-89	20vl	VR1	4g	Ybn
YDCR	YB1253ST8RX140	LVR-IC	LDO, 1.4V±2%, 300mA	SOT-89	20ch	VR1	4g	Ybn
YDCS	YB1253ST89X140	LVR-IC	LDO, 1.4V±2%, 300mA	SOT-89	20vl	VR1	4g	Ybn
YDDR	YB1253ST8RX150	LVR-IC	LDO, 1.5V±2%, 300mA	SOT-89	20ch	VR1	4g	Ybn
YDDS	YB1253ST89X150	LVR-IC	LDO, 1.5V±2%, 300mA	SOT-89	20vl	VR1	4g	Ybn
YDER	YB1253ST8RX160	LVR-IC	LDO, 1.6V±2%, 300mA	SOT-89	20ch	VR1	4g	Ybn
YDES	YB1253ST89X160	LVR-IC	LDO, 1.6V±2%, 300mA	SOT-89	20vl	VR1	4g	Ybn
YDFR	YB1253ST8RX170	LVR-IC	LDO, 1.7V±2%, 300mA	SOT-89	20ch	VR1	4g	Ybn
YDFS	YB1253ST89X170	LVR-IC	LDO, 1.7V±2%, 300mA	SOT-89	20vl	VR1	4g	Ybn
YDGR	YB1253ST8RX180	LVR-IC	LDO, 1.8V±2%, 300mA	SOT-89	20ch	VR1	4g	Ybn
YDGS	YB1253ST89X180	LVR-IC	LDO, 1.8V±2%, 300mA	SOT-89	20vl	VR1	4g	Ybn
YDHR	YB1253ST8RX190	LVR-IC	LDO, 1.9V±2%, 300mA	SOT-89	20ch	VR1	4g	Ybn
YDHS	YB1253ST89X190	LVR-IC	LDO, 1.9V±2%, 300mA	SOT-89	20vl	VR1	4g	Ybn
YDIR	YB1253ST8RX200	LVR-IC	LDO, 2.0V±2%, 300mA	SOT-89	20ch	VR1	4g	Ybn
YDIS	YB1253ST89X200	LVR-IC	LDO, 2.0V±2%, 300mA	SOT-89	20vl	VR1	4g	Ybn
YDJR	YB1253ST8RX210	LVR-IC	LDO, 2.1V±2%, 300mA	SOT-89	20ch	VR1	4g	Ybn
YDJS	YB1253ST89X210	LVR-IC	LDO, 2.1V±2%, 300mA	SOT-89	20vl	VR1	4g	Ybn
YDKR	YB1253ST8RX220	LVR-IC	LDO, 2.2V±2%, 300mA	SOT-89	20ch	VR1	4g	Ybn
YDKS	YB1253ST89X220	LVR-IC	LDO, 2.2V±2%, 300mA	SOT-89	20vl	VR1	4g	Ybn
YDLR	YB1253ST8RX230	LVR-IC	LDO, 2.3V±2%, 300mA	SOT-89	20ch	VR1	4g	Ybn
YDLS	YB1253ST89X230	LVR-IC	LDO, 2.3V±2%, 300mA	SOT-89	20vl	VR1	4g	Ybn
YDMR	YB1253ST8RX240	LVR-IC	LDO, 2.4V±2%, 300mA	SOT-89	20ch	VR1	4g	Ybn
YDMS	YB1253ST89X240	LVR-IC	LDO, 2.4V±2%, 300mA	SOT-89	20vl	VR1	4g	Ybn
YDNR	YB1253ST8RX250	LVR-IC	LDO, 2.5V±2%, 300mA	SOT-89	20ch	VR1	4g	Ybn
YDNS	YB1253ST89X250	LVR-IC	LDO, 2.5V±2%, 300mA	SOT-89	20vl	VR1	4g	Ybn
YDOR	YB1253ST8RX260	LVR-IC	LDO, 2.6V±2%, 300mA	SOT-89	20ch	VR1	4g	Ybn
YDOS	YB1253ST89X260	LVR-IC	LDO, 2.6V±2%, 300mA	SOT-89	20vl	VR1	4g	Ybn
YDPR	YB1253ST8RX270	LVR-IC	LDO, 2.7V±2%, 300mA	SOT-89	20ch	VR1	4g	Ybn
YDPS	YB1253ST89X270	LVR-IC	LDO, 2.7V±2%, 300mA	SOT-89	20vl	VR1	4g	Ybn
YDQR	YB1253ST8RX280	LVR-IC	LDO, 2.8V±2%, 300mA	SOT-89	20ch	VR1	4g	Ybn
YDQS	YB1253ST89X280	LVR-IC	LDO, 2.8V±2%, 300mA	SOT-89	20vl	VR1	4g	Ybn
YDRR	YB1253ST8RX290	LVR-IC	LDO, 2.9V±2%, 300mA	SOT-89	20ch	VR1	4g	Ybn
YDRS	YB1253ST89X290	LVR-IC	LDO, 2.9V±2%, 300mA	SOT-89	20vl	VR1	4g	Ybn
YDSR	YB1253ST8RX300	LVR-IC	LDO, 3.0V±2%, 300mA	SOT-89	20ch	VR1	4g	Ybn
YDSS	YB1253ST89X300	LVR-IC	LDO, 3.0V±2%, 300mA	SOT-89	20vl	VR1	4g	Ybn
YDTR	YB1253ST8RX310	LVR-IC	LDO, 3.1V±2%, 300mA	SOT-89	20ch	VR1	4g	Ybn
YDTS	YB1253ST89X310	LVR-IC	LDO, 3.1V±2%, 300mA	SOT-89	20vl	VR1	4g	Ybn
YDJR	YB1253ST8RX320	LVR-IC	LDO, 3.2V±2%, 300mA	SOT-89	20ch	VR1	4g	Ybn
YDJS	YB1253ST89X320	LVR-IC	LDO, 3.2V±2%, 300mA	SOT-89	20vl	VR1	4g	Ybn
YDVR	YB1253ST8RX330	LVR-IC	LDO, 3.3V±2%, 300mA	SOT-89	20ch	VR1	4g	Ybn



SMD
code

Type

Function

Short description

Case Pinout Sch. St. Mnf.

YDVS	YB1253ST89X330	LVR-IC	LDO, 3.3V±2%, 300mA	SOT-89	20vl	VR1	4g	Ybn
YDWR	YB1253T8RX340	LVR-IC	LDO, 3.4V±2%, 300mA	SOT-89	20ch	VR1	4g	Ybn
YDWS	YB1253ST89X340	LVR-IC	LDO, 3.4V±2%, 300mA	SOT-89	20vl	VR1	4g	Ybn
YDXR	YB1253ST8RX350	LVR-IC	LDO, 3.5V±2%, 300mA	SOT-89	20ch	VR1	4g	Ybn
YDXS	YB1253ST89X350	LVR-IC	LDO, 3.5V±2%, 300mA	SOT-89	20vl	VR1	4g	Ybn
YDYR	YB1253T8RX360	LVR-IC	LDO, 3.6V±2%, 300mA	SOT-89	20ch	VR1	4g	Ybn
YDYS	YB1253ST89X360	LVR-IC	LDO, 3.6V±2%, 300mA	SOT-89	20vl	VR1	4g	Ybn
YE	2SC3728-E	Si-npn+Diode	Drv, 20V, 2A, 500mW, 80MHz, B=150..300	SOT-89	20tb	-	4a	Mit
YF	2SC3728-F	Si-npn+Diode	Drv, 20V, 2A, 500mW, 80MHz, B=250..500	SOT-89	20tb	-	4a	Mit
YG	2SC3728-G	Si-npn+Diode	Drv, 20V, 2A, 500mW, 80MHz, B=400..800	SOT-89	20tb	-	4a	Mit
YK	2SB1115-K	Si-pnp	AF-Amp, Sw, 60V, 1A, 2W, 120MHz, B=300..600	SOT-89	20tb	-	4a	Nec
YL	2SB1115-L	Si-pnp	AF-Amp, Sw, 60V, 1A, 2W, 120MHz, B=200..400	SOT-89	20tb	-	4a	Nec
YM	2SB1115-M	Si-pnp	AF-Amp, Sw, 60V, 1A, 2W, 120MHz, B=135..270	SOT-89	20tb	-	4a	Nec
YP	2SB1115A-P	Si-pnp	AF-Amp, Sw, 80V, 1A, 2W, 120MHz, B=200..400	SOT-89	20tb	-	4a	Nec
YQ	2SB1115A-Q	Si-pnp	AF-Amp, Sw, 80V, 1A, 2W, 120MHz, B=135..270	SOT-89	20tb	-	4a	Nec
YQ	2SD874A-Q	Si-npn	GP, AF, 60V, 1A, 1W, B=85..170, 200MHz	SOT-89	20tb	-	4b	Pan
YR	2SD874A-R	Si-npn	GP, AF, 60V, 1A, 1W, B=120..240, 200MHz	SOT-89	20tb	-	4b	Pan
YS	2SD874A-S	Si-npn	GP, AF, 60V, 1A, 1W, B=170..340, 200MHz	SOT-89	20tb	-	4b	Pan
YY	2SJ517	p-MOSFET-e*	V-MOS, LogL, 20V, 2A, <0.24Ω(5A)	SOT-89	20fa	-	4b	Ren
Z1	BZV49-C10	Z-diode	10V±5%, Izt=5mA, 1W	SOT-89	20dm	-	4b	Zx
Z1	BZV49-C4V7	Z-diode	4.7V±5%, Izt=5mA, 1W	SOT-89	20dm	-	4b	Sie,Zx
Z153A	ML6206P153P	LVR-IC	1.5V±3%, 250mA	SOT-89	20vl	VR1	4g	Mlc
Z163A	ML6206P163P	LVR-IC	1.6V±3%, 250mA	SOT-89	20vl	VR1	4g	Mlc
Z173A	ML6206P173P	LVR-IC	1.7V±3%, 250mA	SOT-89	20vl	VR1	4g	Mlc
Z183A	ML6206P183P	LVR-IC	1.8V±3%, 250mA	SOT-89	20vl	VR1	4g	Mlc
Z193A	ML6206P193P	LVR-IC	1.9V±3%, 250mA	SOT-89	20vl	VR1	4g	Mlc
Z2	BZV49-C5V1	Z-diode	5.1V±5%, Izt=5mA, 1W	SOT-89	20dm	-	4b	Sie,Zx
Z202A	ML6206P202P	LVR-IC	2.0V±2%, 250mA	SOT-89	20vl	VR1	4g	Mlc
Z20C	RH5RZ20CA	LVR-IC	LDO, LN, 2V±2%, 100mA	SOT-89	20vl	VR1	4c	Ric
Z212A	ML6206P212P	LVR-IC	2.1V±2%, 250mA	SOT-89	20vl	VR1	4g	Mlc
Z21C	RH5RZ21CA	LVR-IC	LDO, LN, 2.1V±2%, 100mA	SOT-89	20vl	VR1	4c	Ric
Z222A	ML6206P222P	LVR-IC	2.2V±2%, 250mA	SOT-89	20vl	VR1	4g	Mlc
Z22C	RH5RZ22CA	LVR-IC	LDO, LN, 2.2V±2%, 100mA	SOT-89	20vl	VR1	4c	Ric
Z232A	ML6206P232P	LVR-IC	2.3V±2%, 250mA	SOT-89	20vl	VR1	4g	Mlc
Z23C	RH5RZ23CA	LVR-IC	LDO, LN, 2.3V±2%, 100mA	SOT-89	20vl	VR1	4c	Ric
Z242A	ML6206P242P	LVR-IC	2.4V±2%, 250mA	SOT-89	20vl	VR1	4g	Mlc
Z24C	RH5RZ24CA	LVR-IC	LDO, LN, 2.4V±2%, 100mA	SOT-89	20vl	VR1	4c	Ric
Z252A	ML6206P252P	LVR-IC	2.5V±2%, 250mA	SOT-89	20vl	VR1	4g	Mlc
Z25C	RH5RZ25CA	LVR-IC	LDO, LN, 2.5V±2%, 100mA	SOT-89	20vl	VR1	4c	Ric
Z262A	ML6206P262P	LVR-IC	2.6V±2%, 250mA	SOT-89	20vl	VR1	4g	Mlc
Z26C	RH5RZ26CA	LVR-IC	LDO, LN, 2.6V±2%, 100mA	SOT-89	20vl	VR1	4c	Ric
Z272A	ML6206P272P	LVR-IC	2.7V±2%, 250mA	SOT-89	20vl	VR1	4g	Mlc
Z27C	RH5RZ27CA	LVR-IC	LDO, LN, 2.7V±2%, 100mA	SOT-89	20vl	VR1	4c	Ric
Z282A	ML6206P282P	LVR-IC	2.8V±2%, 250mA	SOT-89	20vl	VR1	4g	Mlc
Z28C	RH5RZ28CA	LVR-IC	LDO, LN, 2.8V±2%, 100mA	SOT-89	20vl	VR1	4c	Ric
Z292A	ML6206P292P	LVR-IC	2.9V±2%, 250mA	SOT-89	20vl	VR1	4g	Mlc
Z29C	RH5RZ29CA	LVR-IC	LDO, LN, 2.9V±2%, 100mA	SOT-89	20vl	VR1	4c	Ric
Z3	2SK1078	n-MOSFET-e	LogL, 60V, 800mA, 900mW, <0.55Ω, 9/55ns	SOT-89	20fa	-	4g	Tos
Z3	BZV49-C5V6	Z-diode	5.6V±5%, Izt=5mA, 1W	SOT-89	20dm	-	4b	Sie,Zx
Z302A	ML6206P302P	LVR-IC	3.0V±2%, 250mA	SOT-89	20vl	VR1	4g	Mlc
Z30C	RH5RZ30CA	LVR-IC	LDO, LN, 3V±2%, 100mA	SOT-89	20vl	VR1	4c	Ric
Z312A	ML6206P312P	LVR-IC	3.1V±2%, 250mA	SOT-89	20vl	VR1	4g	Mlc
Z31C	RH5RZ31CA	LVR-IC	LDO, LN, 3.1V±2%, 100mA	SOT-89	20vl	VR1	4c	Ric
Z322A	ML6206P322P	LVR-IC	3.2V±2%, 250mA	SOT-89	20vl	VR1	4g	Mlc
Z32C	RH5RZ32CA	LVR-IC	LDO, LN, 3.2V±2%, 100mA	SOT-89	20vl	VR1	4c	Ric
Z332A	ML6206P332P	LVR-IC	3.3V±2%, 250mA	SOT-89	20vl	VR1	4g	Mlc
Z33C	RH5RZ33CA	LVR-IC	LDO, LN, 3.3V±2%, 100mA	SOT-89	20vl	VR1	4c	Ric
Z342A	ML6206P342P	LVR-IC	3.4V±2%, 250mA	SOT-89	20vl	VR1	4g	Mlc
Z34C	RH5RZ34CA	LVR-IC	LDO, LN, 3.4V±2%, 100mA	SOT-89	20vl	VR1	4c	Ric
Z352A	ML6206P352P	LVR-IC	3.5V±2%, 250mA	SOT-89	20vl	VR1	4g	Mlc
Z35C	RH5RZ35CA	LVR-IC	LDO, LN, 3.5V±2%, 100mA	SOT-89	20vl	VR1	4c	Ric
Z362A	ML6206P362P	LVR-IC	3.6V±2%, 250mA	SOT-89	20vl	VR1	4g	Mlc
Z36C	RH5RZ36CA	LVR-IC	LDO, LN, 3.6V±2%, 100mA	SOT-89	20vl	VR1	4c	Ric
Z372A	ML6206P372P	LVR-IC	3.7V±2%, 250mA	SOT-89	20vl	VR1	4g	Mlc
Z37C	RH5RZ37CA	LVR-IC	LDO, LN, 3.7V±2%, 100mA	SOT-89	20vl	VR1	4c	Ric
Z382A	ML6206P382P	LVR-IC	3.8V±2%, 250mA	SOT-89	20vl	VR1	4g	Mlc
Z38C	RH5RZ38CA	LVR-IC	LDO, LN, 3.8V±2%, 100mA	SOT-89	20vl	VR1	4c	Ric
Z392A	ML6206P392P	LVR-IC	3.9V±2%, 250mA	SOT-89	20vl	VR1	4g	Mlc
Z39C	RH5RZ39CA	LVR-IC	LDO, LN, 3.9V±2%, 100mA	SOT-89	20vl	VR1	4c	Ric
Z4	2SK1079	n-MOSFET-e	LogL, 100V, 600mA, 500mW, <0.95Ω, 9/75ns	SOT-89	20fa	-	4g	Tos



SMD
code

Type

Function

Short description

Case Pinout Sch. St. Mnf.

SMD code	Type	Function	Short description	Case	Pinout	Sch.	St.	Mnf.
Z4	BZV49-C6V2	Z-diode	6.2V±5%, Izt=5mA, 1W	SOT-89	20dm	-	4b	Sie,Zx
Z402A	ML6206P402P	LVR-IC	4.0V±2%, 250mA	SOT-89	20vl	VR1	4c	Mlc
Z40C	RH5RZ40CA	LVR-IC	LDO, LN, 4V±2%, 100mA	SOT-89	20vl	VR1	4c	Ric
Z412A	ML6206P412P2	LVR-IC	4.1V±2%, 250mA	SOT-89	20vl	VR1	4g	Mlc
Z41C	RH5RZ41CA	LVR-IC	LDO, LN, 4.1V±2%, 100mA	SOT-89	20vl	VR1	4c	Ric
Z422A	ML6206P422P	LVR-IC	4.2V±2%, 250mA	SOT-89	20vl	VR1	4g	Mlc
Z42C	RH5RZ42CA	LVR-IC	LDO, LN, 4.2V±2%, 100mA	SOT-89	20vl	VR1	4c	Ric
Z432A	ML6206P432P	LVR-IC	4.3V±2%, 250mA	SOT-89	20vl	VR1	4g	Mlc
Z43C	RH5RZ43CA	LVR-IC	LDO, LN, 4.3V±2%, 100mA	SOT-89	20vl	VR1	4c	Ric
Z442A	ML6206P442P	LVR-IC	4.4V±2%, 250mA	SOT-89	20vl	VR1	4g	Mlc
Z44C	RH5RZ44CA	LVR-IC	LDO, LN, 4.4V±2%, 100mA	SOT-89	20vl	VR1	4c	Ric
Z452A	ML6206P452P	LVR-IC	4.5V±2%, 250mA	SOT-89	20vl	VR1	4g	Mlc
Z45C	RH5RZ45CA	LVR-IC	LDO, LN, 4.5V±2%, 100mA	SOT-89	20vl	VR1	4c	Ric
Z462A	ML6206P462P	LVR-IC	4.6V±2%, 250mA	SOT-89	20vl	VR1	4g	Mlc
Z46C	RH5RZ46CA	LVR-IC	LDO, LN, 4.6V±2%, 100mA	SOT-89	20vl	VR1	4c	Ric
Z472A	ML6206P472P	LVR-IC	4.7V±2%, 250mA	SOT-89	20vl	VR1	4g	Mlc
Z47C	RH5RZ47CA	LVR-IC	LDO, LN, 4.7V±2%, 100mA	SOT-89	20vl	VR1	4c	Ric
Z482A	ML6206P482P	LVR-IC	4.8V±2%, 250mA	SOT-89	20vl	VR1	4g	Mlc
Z48C	RH5RZ48CA	LVR-IC	LDO, LN, 4.8V±2%, 100mA	SOT-89	20vl	VR1	4c	Ric
Z492A	ML6206P492P	LVR-IC	4.9V±2%, 250mA	SOT-89	20vl	VR1	4g	Mlc
Z49C	RH5RZ49CA	LVR-IC	LDO, LN, 4.9V±2%, 100mA	SOT-89	20vl	VR1	4c	Ric
Z5	2SK1717	n-MOSFET	V-MOS, LogL, 60V, 2A, 500mW, 0.37Q(10V), 60/135ns	SOT-89	20fi	-	4c	Tos
Z5	BZV49-C6V8	Z-diode	6.8V±5%, Izt=5mA, 1W	SOT-89	20dm	-	4b	Sie,Zx
Z502A	ML6206P502P	LVR-IC	5.0V±2%, 250mA	SOT-89	20vl	VR1	4g	Mlc
Z50C	RH5RZ50CA	LVR-IC	LDO, LN, 5V±2%, 100mA	SOT-89	20vl	VR1	4c	Ric
Z51C	RH5RZ51CA	LVR-IC	LDO, LN, 5.1V±2%, 100mA	SOT-89	20vl	VR1	4c	Ric
Z52C	RH5RZ52CA	LVR-IC	LDO, LN, 5.2V±2%, 100mA	SOT-89	20vl	VR1	4c	Ric
Z53C	RH5RZ53CA	LVR-IC	LDO, LN, 5.3V±2%, 100mA	SOT-89	20vl	VR1	4c	Ric
Z54C	RH5RZ54CA	LVR-IC	LDO, LN, 5.4V±2%, 100mA	SOT-89	20vl	VR1	4c	Ric
Z55C	RH5RZ55CA	LVR-IC	LDO, LN, 5.5V±2%, 100mA	SOT-89	20vl	VR1	4c	Ric
Z56C	RH5RZ56CA	LVR-IC	LDO, LN, 5.6V±2%, 100mA	SOT-89	20vl	VR1	4c	Ric
Z57C	RH5RZ57CA	LVR-IC	LDO, LN, 5.7V±2%, 100mA	SOT-89	20vl	VR1	4c	Ric
Z58C	RH5RZ58CA	LVR-IC	LDO, LN, 5.8V±2%, 100mA	SOT-89	20vl	VR1	4c	Ric
Z59C	RH5RZ59CA	LVR-IC	LDO, LN, 5.9V±2%, 100mA	SOT-89	20vl	VR1	4c	Ric
Z6	2SJ238	p-MOSFET-e*	V-MOS, LogL, 60V, 1A, <0.85Q(0.5A)	SOT-89	20fa	-	4b	Tos
Z6	BZV49-C7V5	Z-diode	7.5V±5%, Izt=5mA, 1W	SOT-89	20dm	-	4b	Sie,Zx
Z60C	RH5RZ60CA	LVR-IC	LDO, LN, 6V±2%, 100mA	SOT-89	20vl	VR1	4c	Ric
Z7	2SK2549	n-MOSFET-e*	V-MOS, LogL, 16V, 2A, <0.29Q(2.5A)	SOT-89	20fa	-	4b	Tos
Z7	BZV49-C8V2	Z-diode	8.2V±5%, Izt=5mA, 1W	SOT-89	20dm	-	4b	Sie,Zx
Z8	2SJ360	p-MOSFET-e*	V-MOS, LogL, 60V, 1A, <0.73Q(0.5A)	SOT-89	20fa	-	4b	Tos
Z8	BZV49-C9V1	Z-diode	9.1V±5%, Izt=5mA, 1W	SOT-89	20dm	-	4b	Sie,Zx
Z9	2SJ465	p-MOSFET-e*	V-MOS, LogL, 16V, 2A, <0.71Q(5A)	SOT-89	20fa	-	4b	Tos
Z9	BZV49-C10	Z-diode	10V±5%, Izt=5mA, 1W	SOT-89	20dm	-	4b	Sie
ZA	2SK2615	n-MOSFET-e*	V-MOS, LogL, 60V, 2A, <0.44Q(5A)	SOT-89	20fa	-	4b	Tos
ZC	2SK2964	n-MOSFET-e*	V-MOS, LogL, 30V, 2A, <0.25Q(5A)	SOT-89	20fa	-	4b	Tos
ZD	2SA1945-D	Si-pnp	GP, Drv, 55V, 400mA, 500mW, B=90..180, 150MHz	SOT-89	20tb	-	4a	Mit
ZD	2SK2992	n-MOSFET-e*	V-MOS, 200V, 1A, <3.5Q(0.5A), 17/45ns	SOT-89	20fa	-	4b	Tos
ZE	2SA1945-E	Si-pnp	GP, Drv, 55V, 400mA, 500mW, B=150..300, 150MHz	SOT-89	20tb	-	4a	Mit
ZF	2SA1945-F	Si-pnp	GP, Drv, 55V, 400mA, 500mW, B=250..500, 150MHz	SOT-89	20tb	-	4a	Mit
ZF	2SJ511	p-MOSFET-e*	V-MOS, 30V, 2A, <0.76Q(5A)	SOT-89	20fa	-	4b	Tos
ZFP	CHTA92XPT	Si-pnp	Vid, Drv, 300V, 500mA, B>40, 50MHz	SOT-89	20tb	-	4g	Chm
ZGR	KTD1898-GR	Si-npn	AF-Drv, 100V, 1A, 500mW, B=200..400, 100MHz	SOT-89	20tb	-	4a	Kec
ZK	2SB1114-K	Si-pnp	AF-Amp, Sw, 20V, 2A, 2W, 180MHz, B=135..270	SOT-89	20tb	-	4a	Nec
ZL	2SB1114-L	Si-pnp	AF-Amp, Sw, 20V, 2A, 2W, 180MHz, B=200..400	SOT-89	20tb	-	4a	Nec
ZLP	2SB1260-P	Si-pnp	AF, 80V, 1A, 500mW, B=82..180, >80MHz	SOT-89	20tb	-	4b	Wtr
ZLQ	2SB1260-Q	Si-pnp	AF, 80V, 1A, 500mW, B=120..270, >80MHz	SOT-89	20tb	-	4b	Wtr
ZLR	2SB1260-R	Si-pnp	AF, 80V, 1A, 500mW, B=180..390, >80MHz	SOT-89	20tb	-	4b	Wtr
ZM	2SB1114-M	Si-pnp	AF-Amp, Sw, 20V, 2A, 2W, 180MHz, B=300..600	SOT-89	20tb	-	4a	Nec
ZO	KTD1898-O	Si-npn	AF-Drv, 100V, 1A, 500mW, B=70..140, 100MHz	SOT-89	20tb	-	4a	Kec
ZP	2SB1301-P	Si-pnp	AF, Sw, 20V, 3A, 2W, B=135..200, 100MHz	SOT-89	20tb	-	4b	Nec
ZQ	2SB1301-Q	Si-pnp	AF, Sw, 20V, 3A, 2W, B=200..300, 100MHz	SOT-89	20tb	-	4b	Nec
ZQ	2SD874-Q	Si-npn	GP, AF, 30V, 1A, 1W, B=85..170, 200MHz	SOT-89	20tb	-	4b	Pan
ZR	2SB1301-R	Si-pnp	AF, Sw, 20V, 3A, 2W, B=300..600, 100MHz	SOT-89	20tb	-	4b	Nec
ZR	2SD874-R	Si-npn	GP, AF, 30V, 1A, 1W, B=120..240, 200MHz	SOT-89	20tb	-	4b	Pan
ZR	KTD1898-R	Si-npn	AF-Drv, 100V, 1A, 500mW, B=120..240, 100MHz	SOT-89	20tb	-	4a	Kec
ZS	2SD874-S	Si-npn	GP, AF, 30V, 1A, 1W, B=170..340, 200MHz	SOT-89	20tb	-	4b	Pan
ZX	2SB1628-X	Si-pnp	AF-Amp, Sw, 20V, 3A, 2W, 320MHz, B=140..280	SOT-89	20tb	-	4b	Nec
ZY	2SB1628-Y	Si-pnp	AF-Amp, Sw, 20V, 3A, 2W, 320MHz, B=200..400	SOT-89	20tb	-	4b	Nec
ZY	2SK2978	n-MOSFET-e*	V-MOS, LogL, 20V, 2.5A, <0.12Q	SOT-89	20fa	-	4b	Ren
ZZ	2SB1628-Z	Si-pnp	AF-Amp, Sw, 20V, 3A, 2W, 320MHz, B=280..560	SOT-89	20tb	-	4b	Nec



SECTION 6
4-pin CASES SMD SEMICONDUCTOR COMPONENTS

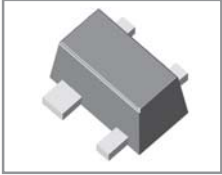
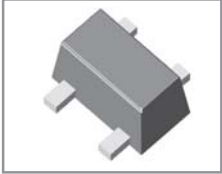

SMD code	Type	Function	Short description	Case	Pinout	Sch.	St.	Mnf.
#LN	ELM7541CCB	Vdet-IC	4.1V±2%, +Reset PPO	SC-82AB	26vdl	VD7	5c	Elm
#LN	ELM7541NCB	Vdet-IC	4.1V±2%, +Reset ODO	SC-82AB	26vdl	VD6	5c	Elm
*LN	ELM7546CCB	Vdet-IC	4.6V±2%, +Reset PPO	SC-82AB	26vdl	VD7	5c	Elm
*LN	ELM7546NCB	Vdet-IC	4.6V±2%, +Reset ODO	SC-82AB	26vdl	VD6	5c	Elm
/LN	ELM7554CCB	Vdet-IC	5.4V±2%, +Reset PPO	SC-82AB	26vdl	VD7	5c	Elm
/LN	ELM7554NCB	Vdet-IC	5.4V±2%, +Reset ODO	SC-82AB	26vdl	VD6	5c	Elm
+LN	ELM7547CCB	Vdet-IC	4.7V±2%, +Reset PPO	SC-82AB	26vdl	VD7	5c	Elm
+LN	ELM7547NCB	Vdet-IC	4.7V±2%, +Reset ODO	SC-82AB	26vdl	VD6	5c	Elm
<LN	ELM7553CCB	Vdet-IC	5.3V±2%, +Reset PPO	SC-82AB	26vdl	VD7	5c	Elm
<LN	ELM7553NCB	Vdet-IC	5.3V±2%, +Reset ODO	SC-82AB	26vdl	VD6	5c	Elm
=LN	ELM7544CCB	Vdet-IC	4.4V±2%, +Reset PPO	SC-82AB	26vdl	VD7	5c	Elm
=LN	ELM7544NCB	Vdet-IC	4.4V±2%, +Reset ODO	SC-82AB	26vdl	VD6	5c	Elm
>LN	ELM7549CCB	Vdet-IC	4.9V±2%, +Reset PPO	SC-82AB	26vdl	VD7	5c	Elm
>LN	ELM7549NCB	Vdet-IC	4.9V±2%, +Reset ODO	SC-82AB	26vdl	VD6	5c	Elm
00	XC6127N55ANR	Vdet-IC	5.5V±0.8%, -Reset ODO, -MR, Rt=50ms	SSOT-24	26er	VD4	5a	Tor
00	XC6221C081NR	LVR-IC	LDO, 0.8V±20mV, 200mA, +CE, PDR	SSOT-24	26vn	VR4	5a	Tor
01	MRF9011	Si-npn	UHF, 25V, 30mA, 300mW, B=30..200, 3.8GHz	SOT-143	24tc	-	5c	Mot
01	XC6221C091NR	LVR-IC	LDO, 0.9V±20mV, 200mA, +CE, PDR	SSOT-24	26vn	VR4	5a	Tor
02	MRF5711	Si-npn	UHF, 20V, 80mA, 580mW, B=50..300, 8GHz	SOT-143	24tc	-	5c	Mot
02	XC6221C101NR	LVR-IC	LDO, 1V±20mV, 200mA, +CE, PDR	SSOT-24	26vn	VR4	5a	Tor
03	VAM-3	MMIC	RF amplifier, DC..2GHz, 7.5dB (50Ω)	SOT-143	24aa	A1	5c	Mc
03	XC6221C111NR	LVR-IC	LDO, 1.1V±20mV, 200mA, +CE, PDR	SSOT-24	26vn	VR4	5a	Tor
04	MRF4427	Si-npn	UHF, 40V, 400mA, 220mW, B=10..200, 1.6GHz	SOT-143	24tc	-	5c	Mot
04	MRF5211	Si-npn	UHF, 20V, 70mA, 333mW, B=25..125, 4.2GHz	SOT-143	24tc	-	5c	Mot
04	XC6221C121NR	LVR-IC	LDO, 1.2V±20mV, 200mA, +CE, PDR	SSOT-24	26vn	VR4	5a	Tor
05	MRF9331	Si-npn	UHF, 15V, 2mA, 50mW, B=30..200, 5GHz	SOT-143	24tc	-	5c	Mot
05	XC6221C131NR	LVR-IC	LDO, 1.3V±20mV, 200mA, +CE, PDR	SSOT-24	26vn	VR4	5a	Tor
05F	TSDF1205R	Si-npn	UHF-VHF, LN, 9V, 12mA, 40mW, B=50..250, 12GHz	SOT-143R	26tu	-	5b	Vs
06	VAM-6	MMIC	RF amplifier, DC..2GHz, 8dB (50Ω)	SOT-143	24aa	A1	5c	Mc
06	XC6221C141NR	LVR-IC	LDO, 1.4V±20mV, 200mA, +CE, PDR	SSOT-24	26vn	VR4	5a	Tor
07	VAM-7	MMIC	RF amplifier, DC..2GHz, 7.8dB (50Ω)	SOT-143	24aa	A1	5c	Mc
07	XC6221C151NR	LVR-IC	LDO, 1.5V±20mV, 200mA, +CE, PDR	SSOT-24	26vn	VR4	5a	Tor
08	HBFP-0450	Si-npn	UHF, LN, 15V, 100mA, 450mW, B=50..150, 1.8GHz	SOT-343	2411	-	5c	Agj
08	XC6221C161NR	LVR-IC	LDO, 1.6V±20mV, 200mA, +CE, PDR	SSOT-24	26vn	VR4	5a	Tor
0808A	EC8908-08AC7	LVR-IC	LDO, 0.8V±1.5%, 300mA, +CE	SC-82-4	26vn	VR4	5e	Ecm
0808B	EC8908-08BC7	LVR-IC	LDO, 0.8V±1.5%, 500mA, +CE	SC-82-4	26vn	VR4	5e	Ecm
0808C	EC8908-08CC7	LVR-IC	LDO, 0.8V±1.5%, 300mA, -CE	SC-82-4	26vn	VR4	5e	Ecm
0808D	EC8908-08DC7	LVR-IC	LDO, 0.8V±1.5%, 500mA, -CE	SC-82-4	26vn	VR4	5e	Ecm
0809A	EC8908-09AC7	LVR-IC	LDO, 0.9V±1.5%, 300mA, +CE	SC-82-4	26vn	VR4	5e	Ecm
0809B	EC8908-09BC7	LVR-IC	LDO, 0.9V±1.5%, 500mA, +CE	SC-82-4	26vn	VR4	5e	Ecm
0809C	EC8908-09CC7	LVR-IC	LDO, 0.9V±1.5%, 300mA, -CE	SC-82-4	26vn	VR4	5e	Ecm
0809D	EC8908-09DC7	LVR-IC	LDO, 0.9V±1.5%, 500mA, -CE	SC-82-4	26vn	VR4	5e	Ecm
0810A	EC8908-10AC7	LVR-IC	LDO, 1.0V±1.5%, 300mA, +CE	SC-82-4	26vn	VR4	5e	Ecm
0810B	EC8908-10BC7	LVR-IC	LDO, 1.0V±1.5%, 500mA, +CE	SC-82-4	26vn	VR4	5e	Ecm
0810C	EC8908-10CC7	LVR-IC	LDO, 1.0V±1.5%, 300mA, -CE	SC-82-4	26vn	VR4	5e	Ecm
0810D	EC8908-10DC7	LVR-IC	LDO, 1.0V±1.5%, 500mA, -CE	SC-82-4	26vn	VR4	5e	Ecm
0811A	EC8908-11AC7	LVR-IC	LDO, 1.1V±1.5%, 300mA, +CE	SC-82-4	26vn	VR4	5e	Ecm
0811B	EC8908-11BC7	LVR-IC	LDO, 1.1V±1.5%, 500mA, +CE	SC-82-4	26vn	VR4	5e	Ecm
0811C	EC8908-11CC7	LVR-IC	LDO, 1.1V±1.5%, 300mA, -CE	SC-82-4	26vn	VR4	5e	Ecm
0811D	EC8908-11DC7	LVR-IC	LDO, 1.1V±1.5%, 500mA, -CE	SC-82-4	26vn	VR4	5e	Ecm
0812A	EC8908-12AC7	LVR-IC	LDO, 1.2V±1.5%, 300mA, +CE	SC-82-4	26vn	VR4	5e	Ecm
0812B	EC8908-12BC7	LVR-IC	LDO, 1.2V±1.5%, 500mA, +CE	SC-82-4	26vn	VR4	5e	Ecm
0812C	EC8908-12CC7	LVR-IC	LDO, 1.2V±1.5%, 300mA, -CE	SC-82-4	26vn	VR4	5e	Ecm
0812D	EC8908-12DC7	LVR-IC	LDO, 1.2V±1.5%, 500mA, -CE	SC-82-4	26vn	VR4	5e	Ecm
0813A	EC8908-13AC7	LVR-IC	LDO, 1.3V±1.5%, 300mA, +CE	SC-82-4	26vn	VR4	5e	Ecm
0813B	EC8908-13BC7	LVR-IC	LDO, 1.3V±1.5%, 500mA, +CE	SC-82-4	26vn	VR4	5e	Ecm
0813C	EC8908-13CC7	LVR-IC	LDO, 1.3V±1.5%, 300mA, -CE	SC-82-4	26vn	VR4	5e	Ecm
0813D	EC8908-13DC7	LVR-IC	LDO, 1.3V±1.5%, 500mA, -CE	SC-82-4	26vn	VR4	5e	Ecm
0814A	EC8908-14AC7	LVR-IC	LDO, 1.4V±1.5%, 300mA, +CE	SC-82-4	26vn	VR4	5e	Ecm
0814B	EC8908-14BC7	LVR-IC	LDO, 1.4V±1.5%, 500mA, +CE	SC-82-4	26vn	VR4	5e	Ecm
0814C	EC8908-14CC7	LVR-IC	LDO, 1.4V±1.5%, 300mA, -CE	SC-82-4	26vn	VR4	5e	Ecm
0814D	EC8908-14DC7	LVR-IC	LDO, 1.4V±1.5%, 500mA, -CE	SC-82-4	26vn	VR4	5e	Ecm
0815A	EC8908-15AC7	LVR-IC	LDO, 1.5V±1.5%, 300mA, +CE	SC-82-4	26vn	VR4	5e	Ecm
0815B	EC8908-15BC7	LVR-IC	LDO, 1.5V±1.5%, 500mA, +CE	SC-82-4	26vn	VR4	5e	Ecm
0815C	EC8908-15CC7	LVR-IC	LDO, 1.5V±1.5%, 300mA, -CE	SC-82-4	26vn	VR4	5e	Ecm
0815D	EC8908-15DC7	LVR-IC	LDO, 1.5V±1.5%, 500mA, -CE	SC-82-4	26vn	VR4	5e	Ecm
0816A	EC8908-16AC7	LVR-IC	LDO, 1.6V±1.5%, 300mA, +CE	SC-82-4	26vn	VR4	5e	Ecm
0816B	EC8908-16BC7	LVR-IC	LDO, 1.6V±1.5%, 500mA, +CE	SC-82-4	26vn	VR4	5e	Ecm
0816C	EC8908-16CC7	LVR-IC	LDO, 1.6V±1.5%, 300mA, -CE	SC-82-4	26vn	VR4	5e	Ecm
0816D	EC8908-16DC7	LVR-IC	LDO, 1.6V±1.5%, 500mA, -CE	SC-82-4	26vn	VR4	5e	Ecm



SMD code	Type	Function	Short description	Case	Pinout	Sch.	St.	Mnf.
0834C	EC8908-34CC7	LVR-IC	LDO, 3.4V±1.5%, 300mA, -CE	SC-82-4	26vn	VR4	5e	Ecm
0834D	EC8908-34DC7	LVR-IC	LDO, 3.4V±1.5%, 500mA, -CE	SC-82-4	26vn	VR4	5e	Ecm
0835A	EC8908-35AC7	LVR-IC	LDO, 3.5V±1.5%, 300mA, +CE	SC-82-4	26vn	VR4	5e	Ecm
0835B	EC8908-35BC7	LVR-IC	LDO, 3.5V±1.5%, 500mA, +CE	SC-82-4	26vn	VR4	5e	Ecm
0835C	EC8908-35CC7	LVR-IC	LDO, 3.5V±1.5%, 300mA, -CE	SC-82-4	26vn	VR4	5e	Ecm
0835D	EC8908-35DC7	LVR-IC	LDO, 3.5V±1.5%, 500mA, -CE	SC-82-4	26vn	VR4	5e	Ecm
0836A	EC8908-36AC7	LVR-IC	LDO, 3.6V±1.5%, 300mA, +CE	SC-82-4	26vn	VR4	5e	Ecm
0836B	EC8908-36BC7	LVR-IC	LDO, 3.6V±1.5%, 500mA, +CE	SC-82-4	26vn	VR4	5e	Ecm
0836C	EC8908-36CC7	LVR-IC	LDO, 3.6V±1.5%, 300mA, -CE	SC-82-4	26vn	VR4	5e	Ecm
0836D	EC8908-36DC7	LVR-IC	LDO, 3.6V±1.5%, 500mA, -CE	SC-82-4	26vn	VR4	5e	Ecm
0837A	EC8908-37AC7	LVR-IC	LDO, 3.7V±1.5%, 300mA, +CE	SC-82-4	26vn	VR4	5e	Ecm
0837B	EC8908-37BC7	LVR-IC	LDO, 3.7V±1.5%, 500mA, +CE	SC-82-4	26vn	VR4	5e	Ecm
0837C	EC8908-37CC7	LVR-IC	LDO, 3.7V±1.5%, 300mA, -CE	SC-82-4	26vn	VR4	5e	Ecm
0837D	EC8908-37DC7	LVR-IC	LDO, 3.7V±1.5%, 500mA, -CE	SC-82-4	26vn	VR4	5e	Ecm
0838A	EC8908-38AC7	LVR-IC	LDO, 3.8V±1.5%, 300mA, +CE	SC-82-4	26vn	VR4	5e	Ecm
0838B	EC8908-38BC7	LVR-IC	LDO, 3.8V±1.5%, 500mA, +CE	SC-82-4	26vn	VR4	5e	Ecm
0838C	EC8908-38CC7	LVR-IC	LDO, 3.8V±1.5%, 300mA, -CE	SC-82-4	26vn	VR4	5e	Ecm
0838D	EC8908-38DC7	LVR-IC	LDO, 3.8V±1.5%, 500mA, -CE	SC-82-4	26vn	VR4	5e	Ecm
0839A	EC8908-39AC7	LVR-IC	LDO, 3.9V±1.5%, 300mA, +CE	SC-82-4	26vn	VR4	5e	Ecm
0839B	EC8908-39BC7	LVR-IC	LDO, 3.9V±1.5%, 500mA, +CE	SC-82-4	26vn	VR4	5e	Ecm
0839C	EC8908-39CC7	LVR-IC	LDO, 3.9V±1.5%, 300mA, -CE	SC-82-4	26vn	VR4	5e	Ecm
0839D	EC8908-39DC7	LVR-IC	LDO, 3.9V±1.5%, 500mA, -CE	SC-82-4	26vn	VR4	5e	Ecm
0840A	EC8908-40AC7	LVR-IC	LDO, 4.0V±1.5%, 300mA, +CE	SC-82-4	26vn	VR4	5e	Ecm
0840B	EC8908-40BC7	LVR-IC	LDO, 4.0V±1.5%, 500mA, +CE	SC-82-4	26vn	VR4	5e	Ecm
0840C	EC8908-40CC7	LVR-IC	LDO, 4.0V±1.5%, 300mA, -CE	SC-82-4	26vn	VR4	5e	Ecm
0840D	EC8908-40DC7	LVR-IC	LDO, 4.0V±1.5%, 500mA, -CE	SC-82-4	26vn	VR4	5e	Ecm
0841A	EC8908-41AC7	LVR-IC	LDO, 4.1V±1.5%, 300mA, +CE	SC-82-4	26vn	VR4	5e	Ecm
0841B	EC8908-41BC7	LVR-IC	LDO, 4.1V±1.5%, 500mA, +CE	SC-82-4	26vn	VR4	5e	Ecm
0841C	EC8908-41CC7	LVR-IC	LDO, 4.1V±1.5%, 300mA, -CE	SC-82-4	26vn	VR4	5e	Ecm
0841D	EC8908-41DC7	LVR-IC	LDO, 4.1V±1.5%, 500mA, -CE	SC-82-4	26vn	VR4	5e	Ecm
0842A	EC8908-42AC7	LVR-IC	LDO, 4.2V±1.5%, 300mA, +CE	SC-82-4	26vn	VR4	5e	Ecm
0842B	EC8908-42BC7	LVR-IC	LDO, 4.2V±1.5%, 500mA, +CE	SC-82-4	26vn	VR4	5e	Ecm
0842C	EC8908-42CC7	LVR-IC	LDO, 4.2V±1.5%, 300mA, -CE	SC-82-4	26vn	VR4	5e	Ecm
0842D	EC8908-42DC7	LVR-IC	LDO, 4.2V±1.5%, 500mA, -CE	SC-82-4	26vn	VR4	5e	Ecm
0843A	EC8908-43AC7	LVR-IC	LDO, 4.3V±1.5%, 300mA, +CE	SC-82-4	26vn	VR4	5e	Ecm
0843B	EC8908-43BC7	LVR-IC	LDO, 4.3V±1.5%, 500mA, +CE	SC-82-4	26vn	VR4	5e	Ecm
0843C	EC8908-43CC7	LVR-IC	LDO, 4.3V±1.5%, 300mA, -CE	SC-82-4	26vn	VR4	5e	Ecm
0843D	EC8908-43DC7	LVR-IC	LDO, 4.3V±1.5%, 500mA, -CE	SC-82-4	26vn	VR4	5e	Ecm
0844A	EC8908-44AC7	LVR-IC	LDO, 4.4V±1.5%, 300mA, +CE	SC-82-4	26vn	VR4	5e	Ecm
0844B	EC8908-44BC7	LVR-IC	LDO, 4.4V±1.5%, 500mA, +CE	SC-82-4	26vn	VR4	5e	Ecm
0844C	EC8908-44CC7	LVR-IC	LDO, 4.4V±1.5%, 300mA, -CE	SC-82-4	26vn	VR4	5e	Ecm
0844D	EC8908-44DC7	LVR-IC	LDO, 4.4V±1.5%, 500mA, -CE	SC-82-4	26vn	VR4	5e	Ecm
0845A	EC8908-45AC7	LVR-IC	LDO, 4.5V±1.5%, 300mA, +CE	SC-82-4	26vn	VR4	5e	Ecm
0845B	EC8908-45BC7	LVR-IC	LDO, 4.5V±1.5%, 500mA, +CE	SC-82-4	26vn	VR4	5e	Ecm
0845C	EC8908-45CC7	LVR-IC	LDO, 4.5V±1.5%, 300mA, -CE	SC-82-4	26vn	VR4	5e	Ecm
0845D	EC8908-45DC7	LVR-IC	LDO, 4.5V±1.5%, 500mA, -CE	SC-82-4	26vn	VR4	5e	Ecm
0846A	EC8908-46AC7	LVR-IC	LDO, 4.6V±1.5%, 300mA, +CE	SC-82-4	26vn	VR4	5e	Ecm
0846B	EC8908-46BC7	LVR-IC	LDO, 4.6V±1.5%, 500mA, +CE	SC-82-4	26vn	VR4	5e	Ecm
0846C	EC8908-46CC7	LVR-IC	LDO, 4.6V±1.5%, 300mA, -CE	SC-82-4	26vn	VR4	5e	Ecm
0846D	EC8908-46DC7	LVR-IC	LDO, 4.6V±1.5%, 500mA, -CE	SC-82-4	26vn	VR4	5e	Ecm
0847A	EC8908-47AC7	LVR-IC	LDO, 4.7V±1.5%, 300mA, +CE	SC-82-4	26vn	VR4	5e	Ecm
0847B	EC8908-47BC7	LVR-IC	LDO, 4.7V±1.5%, 500mA, +CE	SC-82-4	26vn	VR4	5e	Ecm
0847C	EC8908-47CC7	LVR-IC	LDO, 4.7V±1.5%, 300mA, -CE	SC-82-4	26vn	VR4	5e	Ecm
0847D	EC8908-47DC7	LVR-IC	LDO, 4.7V±1.5%, 500mA, -CE	SC-82-4	26vn	VR4	5e	Ecm
0848A	EC8908-48AC7	LVR-IC	LDO, 4.8V±1.5%, 300mA, +CE	SC-82-4	26vn	VR4	5e	Ecm
0848B	EC8908-48BC7	LVR-IC	LDO, 4.8V±1.5%, 500mA, +CE	SC-82-4	26vn	VR4	5e	Ecm
0848C	EC8908-48CC7	LVR-IC	LDO, 4.8V±1.5%, 300mA, -CE	SC-82-4	26vn	VR4	5e	Ecm
084HA	EC8908-4HAC7	LVR-IC	LDO, 4.75V±1.5%, 300mA, +CE	SC-82-4	26vn	VR4	5e	Ecm
084HB	EC8908-4HBC7	LVR-IC	LDO, 4.75V±1.5%, 500mA, +CE	SC-82-4	26vn	VR4	5e	Ecm
084HC	EC8908-4HCC7	LVR-IC	LDO, 4.75V±1.5%, 300mA, -CE	SC-82-4	26vn	VR4	5e	Ecm
084HD	EC8908-4HDC7	LVR-IC	LDO, 4.75V±1.5%, 500mA, -CE	SC-82-4	26vn	VR4	5e	Ecm
09	R3111Q091B	Vdet-IC	0.9V±2%, +Reset ODO	SC-82AB	26vdl	VD6	5a	Ric
09	XC6221C171NR	LVR-IC	LDO, 1.7V±20mV, 200mA, +CE, PDR	SSOT-24	26vn	VR4	5a	Tor
0A	BU4317F	Vdet-IC	1.7V±1%, +Reset PPO	SOP-4	26vdf	VD3	5c	Rhm
0A	R3132Q10EA	Vdet-IC	1V, MR, -Reset PPO	SOT-143	24vdh	VD5	5a	Ric
0A	RQ5RW50BA	LVR-IC	LDO, 5V±2%, 150mA, +CE	SOT-143R	26vp	VR4	5c	Ric
0A	XC6127N15ANR	Vdet-IC	1.5V±0.8%, -Reset ODO, -MR, Rt=50ms	SSOT-24	26cr	VD4	5a	Tor
0A	XC6221A411NR	LVR-IC	LDO, 4.1V±1%, 200mA, +CE	SSOT-24	26vn	VR4	5a	Tor
0A	XC6221C181NR	LVR-IC	LDO, 1.8V±20mV, 200mA, +CE, PDR	SSOT-24	26vn	VR4	5a	Tor
0B	BU4318F	Vdet-IC	1.8V±1%, +Reset PPO	SOP-4	26vdf	VD3	5c	Rhm



SMD
code

Type

Function

Short description

Case

Pinout Sch.

St. Mnf.

SMD code	Type	Function	Short description	Case	Pinout Sch.	St.	Mnf.
0B	R3132Q11EA	Vdet-IC	1.1V, MR, -Reset PPO	SOT-143	24vdh	VD5	5a Ric
0B	RQ5RW51BA	LVR-IC	LDO, 5.1V±2%, 150mA, +CE	SOT-143R	26vp	VR4	5c Ric
0B	XC6127N17ANR	Vdet-IC	1.7V±0.8%, -Reset ODO, -MR, Rt=50ms	SSOT-24	26cr	VD4	5a Tor
0B	XC6221A421N1NR	LVR-IC	LDO, 4.2V±1%, 200mA, +CE	SSOT-24	26vn	VR4	5a Tor
0B	XC6221C191N1NR	LVR-IC	LDO, 1.9V±20mV, 200mA, +CE, PDR	SSOT-24	26vn	VR4	5a Tor
0C	BU4319F	Vdet-IC	1.9V±1%, +Reset PPO	SOP-4	26vdf	VD3	5c Rhm
0C	R3132Q12EA	Vdet-IC	1.2V, MR, -Reset PPO	SOT-143	24vdh	VD5	5a Ric
0C	RQ5RW52BA	LVR-IC	LDO, 5.2V±2%, 150mA, +CE	SOT-143R	26vp	VR4	5c Ric
0C	XC6127N19ANR	Vdet-IC	1.9V±0.8%, -Reset ODO, -MR, Rt=50ms	SSOT-24	26cr	VD4	5a Tor
0C	XC6221A431N1NR	LVR-IC	LDO, 4.3V±1%, 200mA, +CE	SSOT-24	26vn	VR4	5a Tor
0C	XC6221C201N1NR	LVR-IC	LDO, 2V±1%, 200mA, +CE, PDR	SSOT-24	26vn	VR4	5a Tor
0D	BU4320F	Vdet-IC	2V±1%, +Reset PPO	SOP-4	26vdf	VD3	5c Rhm
0D	R3132Q13EA	Vdet-IC	1.3V, MR, -Reset PPO	SOT-143	24vdh	VD5	5a Ric
0D	RQ5RW53BA	LVR-IC	LDO, 5.3V±2%, 150mA, +CE	SOT-143R	26vp	VR4	5c Ric
0D	XC6127N21ANR	Vdet-IC	2.1V±0.8%, -Reset ODO, -MR, Rt=50ms	SSOT-24	26cr	VD4	5a Tor
0D	XC6221A441N1NR	LVR-IC	LDO, 4.4V±1%, 200mA, +CE	SSOT-24	26vn	VR4	5a Tor
0D	XC6221C211N1NR	LVR-IC	LDO, 2.1V±1%, 200mA, +CE, PDR	SSOT-24	26vn	VR4	5a Tor
0E	BU4321F	Vdet-IC	2.1V±1%, +Reset PPO	SOP-4	26vdf	VD3	5c Rhm
0E	R3132Q14EA	Vdet-IC	1.4V, MR, -Reset PPO	SOT-143	24vdh	VD5	5a Ric
0E	RQ5RW54BA	LVR-IC	LDO, 5.4V±2%, 150mA, +CE	SOT-143R	26vp	VR4	5c Ric
0E	XC6127N23ANR	Vdet-IC	2.3V±0.8%, -Reset ODO, -MR, Rt=50ms	SSOT-24	26cr	VD4	5a Tor
0E	XC6221A451N1NR	LVR-IC	LDO, 4.5V±1%, 200mA, +CE	SSOT-24	26vn	VR4	5a Tor
0E	XC6221C221N1NR	LVR-IC	LDO, 2.2V±1%, 200mA, +CE, PDR	SSOT-24	26vn	VR4	5a Tor
0F	BU4322F	Vdet-IC	2.2V±1%, +Reset PPO	SOP-4	26vdf	VD3	5c Rhm
0F	R3132Q15EA	Vdet-IC	1.5V, MR, -Reset PPO	SOT-143	24vdh	VD5	5a Ric
0F	RQ5RW55BA	LVR-IC	LDO, 5.5V±2%, 150mA, +CE	SOT-143R	26vp	VR4	5c Ric
0F	XC6127N25ANR	Vdet-IC	2.5V±0.8%, -Reset ODO, -MR, Rt=50ms	SSOT-24	26cr	VD4	5a Tor
0F	XC6221A461N1NR	LVR-IC	LDO, 4.6V±1%, 200mA, +CE	SSOT-24	26vn	VR4	5a Tor
0F	XC6221C231N1NR	LVR-IC	LDO, 2.3V±1%, 200mA, +CE, PDR	SSOT-24	26vn	VR4	5a Tor
0G	BU4323F	Vdet-IC	2.3V±1%, +Reset PPO	SOP-4	26vdf	VD3	5c Rhm
0G	R3132Q16EA	Vdet-IC	1.6V, MR, -Reset PPO	SOT-143	24vdh	VD5	5a Ric
0G	RQ5RW56BA	LVR-IC	LDO, 5.6V±2%, 150mA, +CE	SOT-143R	26vp	VR4	5c Ric
0H	BU4324F	Vdet-IC	2.4V±1%, +Reset PPO	SOP-4	26vdf	VD3	5c Rhm
0H	R3132Q17EA	Vdet-IC	1.7V, MR, -Reset PPO	SOT-143	24vdh	VD5	5a Ric
0H	RQ5RW57BA	LVR-IC	LDO, 5.7V±2%, 150mA, +CE	SOT-143R	26vp	VR4	5c Ric
0H	XC6127N27ANR	Vdet-IC	2.7V±0.8%, -Reset ODO, -MR, Rt=50ms	SSOT-24	26cr	VD4	5a Tor
0H	XC6221A471N1NR	LVR-IC	LDO, 4.7V±1%, 200mA, +CE	SSOT-24	26vn	VR4	5a Tor
0H	XC6221C241N1NR	LVR-IC	LDO, 2.4V±1%, 200mA, +CE, PDR	SSOT-24	26vn	VR4	5a Tor
0J	BU4325F	Vdet-IC	2.5V±1%, +Reset PPO	SOP-4	26vdf	VD3	5c Rhm
0J	R3132Q18EA	Vdet-IC	1.8V, MR, -Reset PPO	SOT-143	24vdh	VD5	5a Ric
0J	RQ5RW58BA	LVR-IC	LDO, 5.8V±2%, 150mA, +CE	SOT-143R	26vp	VR4	5c Ric
0K	BU4326F	Vdet-IC	2.6V±1%, +Reset PPO	SOP-4	26vdf	VD3	5c Rhm
0K	R3132Q19EA	Vdet-IC	1.9V, MR, -Reset PPO	SOT-143	24vdh	VD5	5a Ric
0K	RQ5RW59BA	LVR-IC	LDO, 5.9V±2%, 150mA, +CE	SOT-143R	26vp	VR4	5c Ric
0K	XC6127N29ANR	Vdet-IC	2.9V±0.8%, -Reset ODO, -MR, Rt=50ms	SSOT-24	26cr	VD4	5a Tor
0K	XC6221A481N1NR	LVR-IC	LDO, 4.8V±1%, 200mA, +CE	SSOT-24	26vn	VR4	5a Tor
0K	XC6221C251N1NR	LVR-IC	LDO, 2.5V±1%, 200mA, +CE, PDR	SSOT-24	26vn	VR4	5a Tor
0L	BU4327F	Vdet-IC	2.7V±1%, +Reset PPO	SOP-4	26vdf	VD3	5c Rhm
0L	R3133Q10EA	Vdet-IC	1V, MR, +Reset PPO	SOT-143	24vdh	VD5	5a Ric
0L	XC6127N31ANR	Vdet-IC	3.1V±0.8%, -Reset ODO, -MR, Rt=50ms	SSOT-24	26cr	VD4	5a Tor
0L	XC6221A491N1NR	LVR-IC	LDO, 4.9V±1%, 200mA, +CE	SSOT-24	26vn	VR4	5a Tor
0L	XC6221C261N1NR	LVR-IC	LDO, 2.6V±1%, 200mA, +CE, PDR	SSOT-24	26vn	VR4	5a Tor
0LN	ELM7552CCB	Vdet-IC	5.2V±2%, +Reset PPO	SC-82AB	26vdl	VD7	5c Elm
0LN	ELM7552NCB	Vdet-IC	5.2V±2%, +Reset ODO	SC-82AB	26vdl	VD6	5c Elm
0M	BU4328F	Vdet-IC	2.8V±1%, +Reset PPO	SOP-4	26vdf	VD3	5c Rhm
0M	R3133Q11EA	Vdet-IC	1.1V, MR, +Reset PPO	SOT-143	24vdh	VD5	5a Ric
0M	XC6127N33ANR	Vdet-IC	3.3V±0.8%, -Reset ODO, -MR, Rt=50ms	SSOT-24	26cr	VD4	5a Tor
0M	XC6221A501N1NR	LVR-IC	LDO, 5.0V±1%, 200mA, +CE	SSOT-24	26vn	VR4	5a Tor
0M	XC6221C271N1NR	LVR-IC	LDO, 2.7V±1%, 200mA, +CE, PDR	SSOT-24	26vn	VR4	5a Tor
0N	BU4329F	Vdet-IC	2.9V±1%, +Reset PPO	SOP-4	26vdf	VD3	5c Rhm
0N	R3133Q12EA	Vdet-IC	1.2V, MR, +Reset PPO	SOT-143	24vdh	VD5	5a Ric
0N	XC6127N35ANR	Vdet-IC	3.5V±0.8%, -Reset ODO, -MR, Rt=50ms	SSOT-24	26cr	VD4	5a Tor
0N	XC6221A40BNR	LVR-IC	LDO, 4.05V±1%, 200mA, +CE	SSOT-24	26vn	VR4	5a Tor
0N	XC6221C281N1NR	LVR-IC	LDO, 2.8V±1%, 200mA, +CE, PDR	SSOT-24	26vn	VR4	5a Tor
0P	BU4330F	Vdet-IC	3V±1%, +Reset PPO	SOP-4	26vdf	VD3	5c Rhm
0P	R3133Q13EA	Vdet-IC	1.3V, MR, +Reset PPO	SOT-143	24vdh	VD5	5a Ric
0P	XC6127N37ANR	Vdet-IC	3.7V±0.8%, -Reset ODO, -MR, Rt=50ms	SSOT-24	26cr	VD4	5a Tor
0P	XC6221A41BNR	LVR-IC	LDO, 4.15V±1%, 200mA, +CE	SSOT-24	26vn	VR4	5a Tor
0P	XC6221C291N1NR	LVR-IC	LDO, 2.9V±1%, 200mA, +CE, PDR	SSOT-24	26vn	VR4	5a Tor
0Q	BU4331F	Vdet-IC	3.1V±1%, +Reset PPO	SOP-4	26vdf	VD3	5c Rhm

Note: ELM75xxCCB series LN- lot number L=0...9 N=A to Z(I, O, X excepted); ELM75xxNCB series LN- lot number L=A to Z(I, O, X excepted) N=0...9



SMD
CODE

SMD CODE	Type	Function	Short description	Case	Pinout	Sch.	St.	Mnf.
0Q	R3133Q14EA	Vdet-IC	1.4V, MR, +Reset PPO	SOT-143	24wdh	VD5	5a	Ric
0R	BU4332F	Vdet-IC	3.2V±1%, +Reset PPO	SOP-4	26vdf	VD3	5c	Rhm
0R	R3133Q15EA	Vdet-IC	1.5V, MR, +Reset PPO	SOT-143	24wdh	VD5	5a	Ric
0R	XC6127N39ANR	Vdet-IC	3.9V±0.8%, -Reset ODO, -MR, Rt=50ms	SSOT-24	26cr	VD4	5a	Tor
0R	XC6221A42BNR	LVR-IC	LDO, 4.25V±1%, 200mA, +CE	SSOT-24	26vn	VR4	5a	Tor
0R	XC6221C301NR	LVR-IC	LDO, 3V±1%, 200mA, +CE, PDR	SSOT-24	26vn	VR4	5a	Tor
0S	BU4333F	Vdet-IC	3.3V±1%, +Reset PPO	SOP-4	26vdf	VD3	5c	Rhm
0S	R3133Q16EA	Vdet-IC	1.6V, MR, +Reset PPO	SOT-143	24wdh	VD5	5a	Ric
0S	XC6127N41ANR	Vdet-IC	4.1V±0.8%, -Reset ODO, -MR, Rt=50ms	SSOT-24	26cr	VD4	5a	Tor
0S	XC6221A43BNR	LVR-IC	LDO, 4.35V±1%, 200mA, +CE	SSOT-24	26vn	VR4	5a	Tor
0S	XC6221C311NR	LVR-IC	LDO, 3.1V±1%, 200mA, +CE, PDR	SSOT-24	26vn	VR4	5a	Tor
0T	BU4334F	Vdet-IC	3.4V±1%, +Reset PPO	SOP-4	26vdf	VD3	5c	Rhm
0T	R3133Q17EA	Vdet-IC	1.7V, MR, +Reset PPO	SOT-143	24wdh	VD5	5a	Ric
0T	XC6127N43ANR	Vdet-IC	4.3V±0.8%, -Reset ODO, -MR, Rt=50ms	SSOT-24	26cr	VD4	5a	Tor
0T	XC6221A44BNR	LVR-IC	LDO, 4.45V±1%, 200mA, +CE	SSOT-24	26vn	VR4	5a	Tor
0T	XC6221C321NR	LVR-IC	LDO, 3.2V±1%, 200mA, +CE, PDR	SSOT-24	26vn	VR4	5a	Tor
0U	BU4335F	Vdet-IC	3.5V±1%, +Reset PPO	SOP-4	26vdf	VD3	5c	Rhm
0U	R3133Q18EA	Vdet-IC	1.8V, MR, +Reset PPO	SOT-143	24wdh	VD5	5a	Ric
0U	XC6127N45ANR	Vdet-IC	4.5V±0.8%, -Reset ODO, -MR, Rt=50ms	SSOT-24	26cr	VD4	5a	Tor
0U	XC6221A45BNR	LVR-IC	LDO, 4.55V±1%, 200mA, +CE	SSOT-24	26vn	VR4	5a	Tor
0U	XC6221C331NR	LVR-IC	LDO, 3.3V±1%, 200mA, +CE, PDR	SSOT-24	26vn	VR4	5a	Tor
0V	BU4336F	Vdet-IC	3.6V±1%, +Reset PPO	SOP-4	26vdf	VD3	5c	Rhm
0V	R3133Q19EA	Vdet-IC	1.9V, MR, +Reset PPO	SOT-143	24wdh	VD5	5a	Ric
0V	XC6127N47ANR	Vdet-IC	4.7V±0.8%, -Reset ODO, -MR, Rt=50ms	SSOT-24	26cr	VD4	5a	Tor
0V	XC6221A46BNR	LVR-IC	LDO, 4.65V±1%, 200mA, +CE	SSOT-24	26vn	VR4	5a	Tor
0V	XC6221C341NR	LVR-IC	LDO, 3.4V±1%, 200mA, +CE, PDR	SSOT-24	26vn	VR4	5a	Tor
0W	BU4337F	Vdet-IC	3.7V±1%, +Reset PPO	SOP-4	26vdf	VD3	5c	Rhm
0X	BU4338F	Vdet-IC	3.8V±1%, +Reset PPO	SOP-4	26vdf	VD3	5c	Rhm
0X	XC6127N49ANR	Vdet-IC	4.9V±0.8%, -Reset ODO, -MR, Rt=50ms	SSOT-24	26cr	VD4	5a	Tor
0X	XC6221A47BNR	LVR-IC	LDO, 4.75V±1%, 200mA, +CE	SSOT-24	26vn	VR4	5a	Tor
0X	XC6221C351NR	LVR-IC	LDO, 3.5V±1%, 200mA, +CE, PDR	SSOT-24	26vn	VR4	5a	Tor
0Y	BU4339F	Vdet-IC	3.9V±1%, +Reset PPO	SOP-4	26vdf	VD3	5c	Rhm
0Y	XC6127N51ANR	Vdet-IC	5.1V±0.8%, -Reset ODO, -MR, Rt=50ms	SSOT-24	26cr	VD4	5a	Tor
0Y	XC6221A48BNR	LVR-IC	LDO, 4.85V±1%, 200mA, +CE	SSOT-24	26vn	VR4	5a	Tor
0Y	XC6221C361NR	LVR-IC	LDO, 3.6V±1%, 200mA, +CE, PDR	SSOT-24	26vn	VR4	5a	Tor
0Z	BU4340F	Vdet-IC	4V±1%, +Reset PPO	SOP-4	26vdf	VD3	5c	Rhm
0Z	XC6127N53ANR	Vdet-IC	5.3V±0.8%, -Reset ODO, -MR, Rt=50ms	SSOT-24	26cr	VD4	5a	Tor
0Z	XC6221A49BNR	LVR-IC	LDO, 4.95V±1%, 200mA, +CE	SSOT-24	26vn	VR4	5a	Tor
0Z	XC6221C371NR	LVR-IC	LDO, 3.7V±1%, 200mA, +CE, PDR	SSOT-24	26vn	VR4	5a	Tor
10	R3111Q101B	Vdet-IC	1V±2%, +Reset ODO	SC-82AB	26vdl	VD6	5a	Ric
10	XC6127N55BNR	Vdet-IC	5.5V±0.8%, -Reset ODO, -MR, Rt=100ms	SSOT-24	26cr	VD4	5a	Tor
10	XC6221C381NR	LVR-IC	LDO, 3.8V±1%, 200mA, +CE, PDR	SSOT-24	26vn	VR4	5a	Tor
10W	MAZ3100W	Z-diode	Dual, 9.4..10.6V, If=100mA, Zzt=20Ω, 200mW	SOT-143	24ce	-	5b	Pan
11	MRF9511A	Si-npn	UHF, 20V, 100mA, 322mW, B=75..150, 8GHz	SOT-143	24tc	-	5c	Mot
11	R3111Q111B	Vdet-IC	1.1V±2%, +Reset ODO	SC-82AB	26vdl	VD6	5a	Ric
11	XC6221C391NR	LVR-IC	LDO, 3.9V±1%, 200mA, +CE, PDR	SSOT-24	26vn	VR4	5a	Tor
12	R3111Q121B	Vdet-IC	1.2V±2%, +Reset ODO	SC-82AB	26vdl	VD6	5a	Ric
12	XC6213B122NR	LVR-IC	LDO, 1.2V±2%, 150mA, +CE	SSOT-24	26vn	VR4	5c	Tor
12	XC6221C401NR	LVR-IC	LDO, 4V±1%, 200mA, +CE, PDR	SSOT-24	26vn	VR4	5a	Tor
13	R3111Q131B	Vdet-IC	1.3V±2%, +Reset ODO	SC-82AB	26vdl	VD6	5a	Ric
13	XC6213B132NR	LVR-IC	LDO, 1.3V±2%, 150mA, +CE	SSOT-24	26vn	VR4	5c	Tor
13	XC6221C411NR	LVR-IC	LDO, 4.1V±1%, 200mA, +CE, PDR	SSOT-24	26vn	VR4	5a	Tor
13R	S913TR	MMIC	UHF, 12V, 30mA, 200mW, Idss=50..500μA	SOT-143R	26fm	A3	5c	Vs
14	R3111Q141B	Vdet-IC	1.4V±2%, +Reset ODO	SC-82AB	26vdl	VD6	5a	Ric
14	XC6213B142NR	LVR-IC	LDO, 1.4V±2%, 150mA, +CE	SSOT-24	26vn	VR4	5c	Tor
14	XC6221C421NR	LVR-IC	LDO, 4.2V±1%, 200mA, +CE, PDR	SSOT-24	26vn	VR4	5a	Tor
15	MRF0211	Si-npn	UHF, 30V, 70mA, 580mW, B=50..300, 5.5GHz	SOT-143	24tc	-	5c	Mot
15	R3111Q151B	Vdet-IC	1.5V±2%, +Reset ODO	SC-82AB	26vdl	VD6	5a	Ric
15	XC6213B152NR	LVR-IC	LDO, 1.5V±2%, 150mA, +CE	SSOT-24	26vn	VR4	5c	Tor
15	XC6221C431NR	LVR-IC	LDO, 4.3V±1%, 200mA, +CE, PDR	SSOT-24	26vn	VR4	5a	Tor
16	R3111Q161B	Vdet-IC	1.6V±2%, +Reset ODO	SC-82AB	26vdl	VD6	5a	Ric
16	XC6213B162NR	LVR-IC	LDO, 1.6V±2%, 150mA, +CE	SSOT-24	26vn	VR4	5c	Tor
16	XC6221C441NR	LVR-IC	LDO, 4.4V±1%, 200mA, +CE, PDR	SSOT-24	26vn	VR4	5a	Tor
17	R3111Q171B	Vdet-IC	1.7V±2%, +Reset ODO	SC-82AB	26vdl	VD6	5a	Ric
17	XC6213B172NR	LVR-IC	LDO, 1.7V±2%, 150mA, +CE	SSOT-24	26vn	VR4	5c	Tor
17	XC6217C082NR	LVR-IC	LDO, 0.8V±2%, 200mA, +CE	SSOT-24	26vn	VR4	5a	Tor
17	XC6221C451NR	LVR-IC	LDO, 4.5V±1%, 200mA, +CE, PDR	SSOT-24	26vn	VR4	5a	Tor
17s	BAS125-07	Si-diode	Dual, Schottky, 25V, 100mA, Vf<0.9V(35mA), Cd<1.1pF	SOT-143	24ce	-	5h	Inf
17s	BAS125-07W	Si-diode	Dual, Schottky, 25V, 100mA, Vf<0.9V(35mA), Cd<1.1pF	SOT-343	24ce	-	5h	Inf
18	BFP181T	Si-npn	UHF, 20V, 20mA, 175mW, B=50..200, 8GHz	SOT-143	24tc	-	5b	Tfk



SMD code	Type	Function	Short description	Case	Pinout Sch.	St.	Mnf.
18	MRF9331	Si-npn	UHF, 15V, 2mA, 50mW, B=30..200, 5GHz	SOT-143	24tc -	5c	Mot
18	MRF941B	Si-npn	UHF, 20V, 50mA, 250mW, B=100..200, 8GHz	SOT-143	24tc -	5c	Mot
18	R3111Q181B	Vdet-IC	1.8V±2%, +Reset ODO	SC-82AB	26vdl VD6	5a	Ric
18	XC6213B182NLR	LVR-IC	LDO, 1.8V±2%, 150mA, +CE	SSOT-24	26vn VR4	5c	Tor
18	XC6217C092NLR	LVR-IC	LDO, 0.9V±2%, 200mA, +CE	SSOT-24	26vn VR4	5a	Tor
18	XC6221C461NLR	LVR-IC	LDO, 4.6V±1%, 200mA, +CE, PDR	SSOT-24	26vn VR4	5a	Tor
18A	AAT60018A-S15	Vdet-IC	1.8V±2%, -Reset ODO	SOT-143	26vdf VD1	5c	Aat
18B	AAT60018B-S15	Vdet-IC	1.8V±2%, -Reset PPO	SOT-143	26vdf VD3	5c	Aat
18C	AAT60018C-S15	Vdet-IC	1.8V±1%, -Reset ODO	SOT-143	26vdf VD1	5c	Aat
18D	AAT60018D-S15	Vdet-IC	1.8V±1%, -Reset PPO	SOT-143	26vdf VD3	5c	Aat
18R	S918TR	MMIC	UHF, 16V, 30mA, 200mW, Idss=50..500µA	SOT-143R	26fm A3	5c	Vs
19	R3111Q191B	Vdet-IC	1.9V±2%, +Reset ODO	SC-82AB	26vdl VD6	5a	Ric
19	XC6213B192NLR	LVR-IC	LDO, 1.9V±2%, 150mA, +CE	SSOT-24	26vn VR4	5c	Tor
19	XC6217C102NLR	LVR-IC	LDO, 1V±2%, 200mA, +CE	SSOT-24	26vn VR4	5a	Tor
19	XC6221C471NLR	LVR-IC	LDO, 4.7V±1%, 200mA, +CE, PDR	SSOT-24	26vn VR4	5a	Tor
193	BFP193T	Si-npn	UHF, 20V, 80mA, 580mW, B=50..200, 8GHz	SOT-143	24tc -	5b	Sil
19A	AAT60019A-S15	Vdet-IC	1.9V±2%, -Reset ODO	SOT-143	26vdf VD1	5c	Aat
19B	AAT60019B-S15	Vdet-IC	1.9V±2%, -Reset PPO	SOT-143	26vdf VD3	5c	Aat
19C	AAT60019C-S15	Vdet-IC	1.9V±1%, -Reset ODO	SOT-143	26vdf VD1	5c	Aat
19D	AAT60019D-S15	Vdet-IC	1.9V±1%, -Reset PPO	SOT-143	26vdf VD3	5c	Aat
1A	BU4341F	Vdet-IC	4.1V±1%, +Reset PPO	SOP-4	26vdf VD3	5c	Rhm
1A	R3132Q20EA	Vdet-IC	2V, MR, -Reset PPO	SOT-143	24vdh VD5	5a	Ric
1A	RQ5RW60BA	LVR-IC	LDO, 6V±2%, 150mA, +CE	SOT-143R	26vp VR4	5c	Ric
1A	XC6127N15BNR	Vdet-IC	1.5V±0.8%, -Reset ODO, -MR, Rt=100ms	SSOT-24	26cr VD4	5a	Tor
1A	XC6217C112NLR	LVR-IC	LDO, 1.1V±2%, 200mA, +CE	SSOT-24	26vn VR4	5a	Tor
1A	XC6221C481NLR	LVR-IC	LDO, 4.8V±1%, 200mA, +CE, PDR	SSOT-24	26vn VR4	5a	Tor
1B	BU4342F	Vdet-IC	4.2V±1%, +Reset PPO	SOP-4	26vdf VD3	5c	Rhm
1B	R3132Q21EA	Vdet-IC	2.1V, MR, -Reset PPO	SOT-143	24vdh VD5	5a	Ric
1B	RQ5RW19BA	LVR-IC	LDO, 1.9V±2%, 150mA, +CE	SOT-143R	26vp VR4	5c	Ric
1B	XC6127N17BNR	Vdet-IC	1.7V±0.8%, -Reset ODO, -MR, Rt=100ms	SSOT-24	26cr VD4	5a	Tor
1B	XC6217C122NLR	LVR-IC	LDO, 1.2V±2%, 200mA, +CE	SSOT-24	26vn VR4	5a	Tor
1B	XC6221C491NLR	LVR-IC	LDO, 4.9V±1%, 200mA, +CE, PDR	SSOT-24	26vn VR4	5a	Tor
1C	BU4343F	Vdet-IC	4.3V±1%, +Reset PPO	SOP-4	26vdf VD3	5c	Rhm
1C	R3132Q22EA	Vdet-IC	2.2V, MR, -Reset PPO	SOT-143	24vdh VD5	5a	Ric
1C	RQ5RW18BA	LVR-IC	LDO, 1.8V±2%, 150mA, +CE	SOT-143R	26vp VR4	5c	Ric
1C	XC6127N19BNR	Vdet-IC	1.9V±0.8%, -Reset ODO, -MR, Rt=100ms	SSOT-24	26cr VD4	5a	Tor
1C	XC6213B12ANR	LVR-IC	LDO, 1.25V±2%, 150mA, +CE	SSOT-24	26vn VR4	5c	Tor
1C	XC6217C132NLR	LVR-IC	LDO, 1.3V±2%, 200mA, +CE	SSOT-24	26vn VR4	5a	Tor
1C	XC6221C501NLR	LVR-IC	LDO, 5.0V±1%, 200mA, +CE, PDR	SSOT-24	26vn VR4	5a	Tor
1D	BU4344F	Vdet-IC	4.4V±1%, +Reset PPO	SOP-4	26vdf VD3	5c	Rhm
1D	R3132Q23EA	Vdet-IC	2.3V, MR, -Reset PPO	SOT-143	24vdh VD5	5a	Ric
1D	RQ5RW17BA	LVR-IC	LDO, 1.7V±2%, 150mA, +CE	SOT-143R	26vp VR4	5c	Ric
1D	XC6127N21BNR	Vdet-IC	2.1V±0.8%, -Reset ODO, -MR, Rt=100ms	SSOT-24	26cr VD4	5a	Tor
1D	XC6213B13ANR	LVR-IC	LDO, 1.35V±2%, 150mA, +CE	SSOT-24	26vn VR4	5c	Tor
1D	XC6217C142NLR	LVR-IC	LDO, 1.4V±2%, 200mA, +CE	SSOT-24	26vn VR4	5a	Tor
1D1	S-1312A33-A4T1U3	LVR-IC	LDO, 3.3V±1%, 150mA, +CE, CL, PDR	HSNT-4	78vm VR4	5b	Sii
1D2	S-1312A34-A4T1U3	LVR-IC	LDO, 3.4V±1%, 150mA, +CE, CL, PDR	HSNT-4	78vm VR4	5b	Sii
1D3	S-1312A35-A4T1U3	LVR-IC	LDO, 3.5V±1%, 150mA, +CE, CL, PDR	HSNT-4	78vm VR4	5b	Sii
1DA	S-1312A10-A4T1U3	LVR-IC	LDO, 1.0V±1%, 150mA, +CE, CL, PDR	HSNT-4	78vm VR4	5b	Sii
1DB	S-1312A11-A4T1U3	LVR-IC	LDO, 1.1V±1%, 150mA, +CE, CL, PDR	HSNT-4	78vm VR4	5b	Sii
1DC	S-1312A12-A4T1U3	LVR-IC	LDO, 1.2V±1%, 150mA, +CE, CL, PDR	HSNT-4	78vm VR4	5b	Sii
1DD	S-1312A13-A4T1U3	LVR-IC	LDO, 1.3V±1%, 150mA, +CE, CL, PDR	HSNT-4	78vm VR4	5b	Sii
1DE	S-1312A14-A4T1U3	LVR-IC	LDO, 1.4V±1%, 150mA, +CE, CL, PDR	HSNT-4	78vm VR4	5b	Sii
1DF	S-1312A15-A4T1U3	LVR-IC	LDO, 1.5V±1%, 150mA, +CE, CL, PDR	HSNT-4	78vm VR4	5b	Sii
1DG	S-1312A16-A4T1U3	LVR-IC	LDO, 1.6V±1%, 150mA, +CE, CL, PDR	HSNT-4	78vm VR4	5b	Sii
1DH	S-1312A17-A4T1U3	LVR-IC	LDO, 1.7V±1%, 150mA, +CE, CL, PDR	HSNT-4	78vm VR4	5b	Sii
1DJ	S-1312A18-A4T1U3	LVR-IC	LDO, 1.8V±1%, 150mA, +CE, CL, PDR	HSNT-4	78vm VR4	5b	Sii
1DK	S-1312A1J-A4T1U3	LVR-IC	LDO, 1.85V±1%, 150mA, +CE, CL, PDR	HSNT-4	78vm VR4	5b	Sii
1DL	S-1312A19-A4T1U3	LVR-IC	LDO, 1.9V±1%, 150mA, +CE, CL, PDR	HSNT-4	78vm VR4	5b	Sii
1DM	S-1312A20-A4T1U3	LVR-IC	LDO, 2.0V±1%, 150mA, +CE, CL, PDR	HSNT-4	78vm VR4	5b	Sii
1DN	S-1312A21-A4T1U3	LVR-IC	LDO, 2.1V±1%, 150mA, +CE, CL, PDR	HSNT-4	78vm VR4	5b	Sii
1DO	S-1312A22-A4T1U3	LVR-IC	LDO, 2.2V±1%, 150mA, +CE, CL, PDR	HSNT-4	78vm VR4	5b	Sii
1DP	S-1312A23-A4T1U3	LVR-IC	LDO, 2.3V±1%, 150mA, +CE, CL, PDR	HSNT-4	78vm VR4	5b	Sii
1DQ	S-1312A24-A4T1U3	LVR-IC	LDO, 2.4V±1%, 150mA, +CE, CL, PDR	HSNT-4	78vm VR4	5b	Sii
1DR	S-1312A25-A4T1U3	LVR-IC	LDO, 2.5V±1%, 150mA, +CE, CL, PDR	HSNT-4	78vm VR4	5b	Sii
1DS	S-1312A26-A4T1U3	LVR-IC	LDO, 2.6V±1%, 150mA, +CE, CL, PDR	HSNT-4	78vm VR4	5b	Sii
1DT	S-1312A27-A4T1U3	LVR-IC	LDO, 2.7V±1%, 150mA, +CE, CL, PDR	HSNT-4	78vm VR4	5b	Sii
1DU	S-1312A28-A4T1U3	LVR-IC	LDO, 2.8V±1%, 150mA, +CE, CL, PDR	HSNT-4	78vm VR4	5b	Sii
1DV	S-1312A2J-A4T1U3	LVR-IC	LDO, 2.85V±1%, 150mA, +CE, CL, PDR	HSNT-4	78vm VR4	5b	Sii
1DW	S-1312A29-A4T1U3	LVR-IC	LDO, 2.9V±1%, 150mA, +CE, CL, PDR	HSNT-4	78vm VR4	5b	Sii



SMD code	Type	Function	Short description	Case	Pinout	Sch.	St.	Mnf.
1DX	S-1312A30-A4T1U3	LVR-IC	LDO, 3.0V±1%, 150mA, +CE, CL, PDR	HSNT-4	78vm	VR4	5b	Sii
1DY	S-1312A31-A4T1U3	LVR-IC	LDO, 3.1V±1%, 150mA, +CE, CL, PDR	HSNT-4	78vm	VR4	5b	Sii
1DZ	S-1312A32-A4T1U3	LVR-IC	LDO, 3.2V±1%, 150mA, +CE, CL, PDR	HSNT-4	78vm	VR4	5b	Sii
1E	BU4345F	Vdet-IC	4.5V±1%, +Reset PPO	SOP-4	26vdf	VD3	5c	Rhm
1E	R3132Q24EA	Vdet-IC	2.4V, MR, -Reset PPO	SOT-143	24vdh	VD5	5a	Ric
1E	RQ5RW16BA	LVR-IC	LDO, 1.6V±2%, 150mA, +CE	SOT-143R	26vp	VR4	5c	Ric
1E	XC6127N23BNR	Vdet-IC	2.3V±0.8%, -Reset ODO, -MR, Rt=100ms	SSOT-24	26cr	VD4	5a	Tor
1E	XC6213B14ANR	LVR-IC	LDO, 1.45V±2%, 150mA, +CE	SSOT-24	26vn	VR4	5c	Tor
1E	XC6217C152NR	LVR-IC	LDO, 1.5V±2%, 200mA, +CE	SSOT-24	26vn	VR4	5a	Tor
1E1	S-1312B33-A4T1U3	LVR-IC	LDO, 3.3V±1%, 150mA, +CE, CL	HSNT-4	78vm	VR4	5b	Sii
1E2	S-1312B34-A4T1U3	LVR-IC	LDO, 3.4V±1%, 150mA, +CE, CL	HSNT-4	78vm	VR4	5b	Sii
1E3	S-1312B35-A4T1U3	LVR-IC	LDO, 3.5V±1%, 150mA, +CE, CL	HSNT-4	78vm	VR4	5b	Sii
1EA	S-1312B10-A4T1U3	LVR-IC	LDO, 1.0V±1%, 150mA, +CE, CL	HSNT-4	78vm	VR4	5b	Sii
1EB	S-1312B11-A4T1U3	LVR-IC	LDO, 1.1V±1%, 150mA, +CE, CL	HSNT-4	78vm	VR4	5b	Sii
1EC	S-1312B12-A4T1U3	LVR-IC	LDO, 1.2V±1%, 150mA, +CE, CL	HSNT-4	78vm	VR4	5b	Sii
1ED	S-1312B13-A4T1U3	LVR-IC	LDO, 1.3V±1%, 150mA, +CE, CL	HSNT-4	78vm	VR4	5b	Sii
1EE	S-1312B14-A4T1U3	LVR-IC	LDO, 1.4V±1%, 150mA, +CE, CL	HSNT-4	78vm	VR4	5b	Sii
1EF	S-1312B15-A4T1U3	LVR-IC	LDO, 1.5V±1%, 150mA, +CE, CL	HSNT-4	78vm	VR4	5b	Sii
1EG	S-1312B16-A4T1U3	LVR-IC	LDO, 1.6V±1%, 150mA, +CE, CL	HSNT-4	78vm	VR4	5b	Sii
1EH	S-1312B17-A4T1U3	LVR-IC	LDO, 1.7V±1%, 150mA, +CE, CL	HSNT-4	78vm	VR4	5b	Sii
1EJ	S-1312B18-A4T1U3	LVR-IC	LDO, 1.8V±1%, 150mA, +CE, CL	HSNT-4	78vm	VR4	5b	Sii
1EK	S-1312B1J-A4T1U3	LVR-IC	LDO, 1.85V±1%, 150mA, +CE, CL	HSNT-4	78vm	VR4	5b	Sii
1EL	S-1312B19-A4T1U3	LVR-IC	LDO, 1.9V±1%, 150mA, +CE, CL	HSNT-4	78vm	VR4	5b	Sii
1EM	S-1312B20-A4T1U3	LVR-IC	LDO, 2.0V±1%, 150mA, +CE, CL	HSNT-4	78vm	VR4	5b	Sii
1EN	S-1312B21-A4T1U3	LVR-IC	LDO, 2.1V±1%, 150mA, +CE, CL	HSNT-4	78vm	VR4	5b	Sii
1EO	S-1312B22-A4T1U3	LVR-IC	LDO, 2.2V±1%, 150mA, +CE, CL	HSNT-4	78vm	VR4	5b	Sii
1EP	S-1312B23-A4T1U3	LVR-IC	LDO, 2.3V±1%, 150mA, +CE, CL	HSNT-4	78vm	VR4	5b	Sii
1EQ	S-1312B24-A4T1U3	LVR-IC	LDO, 2.4V±1%, 150mA, +CE, CL	HSNT-4	78vm	VR4	5b	Sii
1ER	S-1312B25-A4T1U3	LVR-IC	LDO, 2.5V±1%, 150mA, +CE, CL	HSNT-4	78vm	VR4	5b	Sii
1ES	S-1312B26-A4T1U3	LVR-IC	LDO, 2.6V±1%, 150mA, +CE, CL	HSNT-4	78vm	VR4	5b	Sii
1ET	S-1312B27-A4T1U3	LVR-IC	LDO, 2.7V±1%, 150mA, +CE, CL	HSNT-4	78vm	VR4	5b	Sii
1EU	S-1312B28-A4T1U3	LVR-IC	LDO, 2.8V±1%, 150mA, +CE, CL	HSNT-4	78vm	VR4	5b	Sii
1EV	S-1312B2J-A4T1U3	LVR-IC	LDO, 2.85V±1%, 150mA, +CE, CL	HSNT-4	78vm	VR4	5b	Sii
1EW	S-1312B29-A4T1U3	LVR-IC	LDO, 2.9V±1%, 150mA, +CE, CL	HSNT-4	78vm	VR4	5b	Sii
1EX	S-1312B30-A4T1U3	LVR-IC	LDO, 3.0V±1%, 150mA, +CE, CL	HSNT-4	78vm	VR4	5b	Sii
1EY	S-1312B31-A4T1U3	LVR-IC	LDO, 3.1V±1%, 150mA, +CE, CL	HSNT-4	78vm	VR4	5b	Sii
1EZ	S-1312B32-A4T1U3	LVR-IC	LDO, 3.2V±1%, 150mA, +CE, CL	HSNT-4	78vm	VR4	5b	Sii
1F	BU4346F	Vdet-IC	4.6V±1%, +Reset PPO	SOP-4	26vdf	VD3	5c	Rhm
1F	R3132Q25EA	Vdet-IC	2.5V, MR, -Reset PPO	SOT-143	24vdh	VD5	5a	Ric
1F	RQ5RW15BA	LVR-IC	LDO, 1.5V±2%, 150mA, +CE	SOT-143R	26vp	VR4	5c	Ric
1F	XC6127N25BNR	Vdet-IC	2.5V±0.8%, -Reset ODO, -MR, Rt=100ms	SSOT-24	26cr	VD4	5a	Tor
1F	XC6213B15ANR	LVR-IC	LDO, 1.55V±2%, 150mA, +CE	SSOT-24	26vn	VR4	5c	Tor
1F	XC6217C162NR	LVR-IC	LDO, 1.6V±2%, 200mA, +CE	SSOT-24	26vn	VR4	5a	Tor
1F1	S-1312C33-A4T1U3	LVR-IC	LDO, 3.3V±1%, 150mA, +CE, PDR	HSNT-4	78vm	VR4	5b	Sii
1F2	S-1312C34-A4T1U3	LVR-IC	LDO, 3.4V±1%, 150mA, +CE, PDR	HSNT-4	78vm	VR4	5b	Sii
1F3	S-1312C35-A4T1U3	LVR-IC	LDO, 3.5V±1%, 150mA, +CE, PDR	HSNT-4	78vm	VR4	5b	Sii
1FA	S-1312C10-A4T1U3	LVR-IC	LDO, 1.0V±1%, 150mA, +CE, PDR	HSNT-4	78vm	VR4	5b	Sii
1FB	S-1312C11-A4T1U3	LVR-IC	LDO, 1.1V±1%, 150mA, +CE, PDR	HSNT-4	78vm	VR4	5b	Sii
1FC	S-1312C12-A4T1U3	LVR-IC	LDO, 1.2V±1%, 150mA, +CE, PDR	HSNT-4	78vm	VR4	5b	Sii
1FD	S-1312C13-A4T1U3	LVR-IC	LDO, 1.3V±1%, 150mA, +CE, PDR	HSNT-4	78vm	VR4	5b	Sii
1FE	S-1312C14-A4T1U3	LVR-IC	LDO, 1.4V±1%, 150mA, +CE, PDR	HSNT-4	78vm	VR4	5b	Sii
1FF	S-1312C15-A4T1U3	LVR-IC	LDO, 1.5V±1%, 150mA, +CE, PDR	HSNT-4	78vm	VR4	5b	Sii
1FG	S-1312C16-A4T1U3	LVR-IC	LDO, 1.6V±1%, 150mA, +CE, PDR	HSNT-4	78vm	VR4	5b	Sii
1FH	S-1312C17-A4T1U3	LVR-IC	LDO, 1.7V±1%, 150mA, +CE, PDR	HSNT-4	78vm	VR4	5b	Sii
1FJ	S-1312C18-A4T1U3	LVR-IC	LDO, 1.8V±1%, 150mA, +CE, PDR	HSNT-4	78vm	VR4	5b	Sii
1FK	S-1312C1J-A4T1U3	LVR-IC	LDO, 1.85V±1%, 150mA, +CE, PDR	HSNT-4	78vm	VR4	5b	Sii
1FL	S-1312C19-A4T1U3	LVR-IC	LDO, 1.9V±1%, 150mA, +CE, PDR	HSNT-4	78vm	VR4	5b	Sii
1FM	S-1312C20-A4T1U3	LVR-IC	LDO, 2.0V±1%, 150mA, +CE, PDR	HSNT-4	78vm	VR4	5b	Sii
1FN	S-1312C21-A4T1U3	LVR-IC	LDO, 2.1V±1%, 150mA, +CE, PDR	HSNT-4	78vm	VR4	5b	Sii
1FO	S-1312C22-A4T1U3	LVR-IC	LDO, 2.2V±1%, 150mA, +CE, PDR	HSNT-4	78vm	VR4	5b	Sii
1FP	S-1312C23-A4T1U3	LVR-IC	LDO, 2.3V±1%, 150mA, +CE, PDR	HSNT-4	78vm	VR4	5b	Sii
1FQ	S-1312C24-A4T1U3	LVR-IC	LDO, 2.4V±1%, 150mA, +CE, PDR	HSNT-4	78vm	VR4	5b	Sii
1FR	S-1312C25-A4T1U3	LVR-IC	LDO, 2.5V±1%, 150mA, +CE, PDR	HSNT-4	78vm	VR4	5b	Sii
1FS	S-1312C26-A4T1U3	LVR-IC	LDO, 2.6V±1%, 150mA, +CE, PDR	HSNT-4	78vm	VR4	5b	Sii
1FT	S-1312C27-A4T1U3	LVR-IC	LDO, 2.7V±1%, 150mA, +CE, PDR	HSNT-4	78vm	VR4	5b	Sii
1FU	S-1312C28-A4T1U3	LVR-IC	LDO, 2.8V±1%, 150mA, +CE, PDR	HSNT-4	78vm	VR4	5b	Sii
1FV	S-1312C2J-A4T1U3	LVR-IC	LDO, 2.85V±1%, 150mA, +CE, PDR	HSNT-4	78vm	VR4	5b	Sii
1FW	S-1312C29-A4T1U3	LVR-IC	LDO, 2.9V±1%, 150mA, +CE, PDR	HSNT-4	78vm	VR4	5b	Sii
1FX	S-1312C30-A4T1U3	LVR-IC	LDO, 3.0V±1%, 150mA, +CE, PDR	HSNT-4	78vm	VR4	5b	Sii
1FY	S-1312C31-A4T1U3	LVR-IC	LDO, 3.1V±1%, 150mA, +CE, PDR	HSNT-4	78vm	VR4	5b	Sii



SMD code	Type	Function	Short description	Case	Pinout	Sch.	St.	Mnf.
1FZ	S-1312C32-A4T1U3	LVR-IC	LDO, 3.2V±1%, 150mA, +CE, PDR	HSNT-4	78vm	VR4	5b	Sii
1G	BU4347F	Vdet-IC	4.7V±1%, +Reset PPO	SOP-4	26vdf	VD3	5c	Rhm
1G	R3132Q26EA	Vdet-IC	2.6V, MR, -Reset PPO	SOT-143	24vdh	VD5	5a	Ric
1G1	S-1312D33-A4T1U3	LVR-IC	LDO, 3.3V±1%, 150mA, +CE	HSNT-4	78vm	VR4	5b	Sii
1G2	S-1312D34-A4T1U3	LVR-IC	LDO, 3.4V±1%, 150mA, +CE	HSNT-4	78vm	VR4	5b	Sii
1G3	S-1312D35-A4T1U3	LVR-IC	LDO, 3.5V±1%, 150mA, +CE	HSNT-4	78vm	VR4	5b	Sii
1GA	S-1312D10-A4T1U3	LVR-IC	LDO, 1.0V±1%, 150mA, +CE	HSNT-4	78vm	VR4	5b	Sii
1GB	S-1312D11-A4T1U3	LVR-IC	LDO, 1.1V±1%, 150mA, +CE	HSNT-4	78vm	VR4	5b	Sii
1GC	S-1312D12-A4T1U3	LVR-IC	LDO, 1.2V±1%, 150mA, +CE	HSNT-4	78vm	VR4	5b	Sii
1GD	S-1312D13-A4T1U3	LVR-IC	LDO, 1.3V±1%, 150mA, +CE	HSNT-4	78vm	VR4	5b	Sii
1GE	S-1312D14-A4T1U3	LVR-IC	LDO, 1.4V±1%, 150mA, +CE	HSNT-4	78vm	VR4	5b	Sii
1GF	S-1312D15-A4T1U3	LVR-IC	LDO, 1.5V±1%, 150mA, +CE	HSNT-4	78vm	VR4	5b	Sii
1GG	S-1312D16-A4T1U3	LVR-IC	LDO, 1.6V±1%, 150mA, +CE	HSNT-4	78vm	VR4	5b	Sii
1GH	S-1312D17-A4T1U3	LVR-IC	LDO, 1.7V±1%, 150mA, +CE	HSNT-4	78vm	VR4	5b	Sii
1GJ	S-1312D18-A4T1U3	LVR-IC	LDO, 1.8V±1%, 150mA, +CE	HSNT-4	78vm	VR4	5b	Sii
1GK	S-1312D1J-A4T1U3	LVR-IC	LDO, 1.85V±1%, 150mA, +CE	HSNT-4	78vm	VR4	5b	Sii
1GL	S-1312D19-A4T1U3	LVR-IC	LDO, 1.9V±1%, 150mA, +CE	HSNT-4	78vm	VR4	5b	Sii
1GM	S-1312D20-A4T1U3	LVR-IC	LDO, 2.0V±1%, 150mA, +CE	HSNT-4	78vm	VR4	5b	Sii
1GN	S-1312D21-A4T1U3	LVR-IC	LDO, 2.1V±1%, 150mA, +CE	HSNT-4	78vm	VR4	5b	Sii
1GO	S-1312D22-A4T1U3	LVR-IC	LDO, 2.2V±1%, 150mA, +CE	HSNT-4	78vm	VR4	5b	Sii
1GP	S-1312D23-A4T1U3	LVR-IC	LDO, 2.3V±1%, 150mA, +CE	HSNT-4	78vm	VR4	5b	Sii
1GQ	S-1312D24-A4T1U3	LVR-IC	LDO, 2.4V±1%, 150mA, +CE	HSNT-4	78vm	VR4	5b	Sii
1GR	S-1312D25-A4T1U3	LVR-IC	LDO, 2.5V±1%, 150mA, +CE	HSNT-4	78vm	VR4	5b	Sii
1GS	S-1312D26-A4T1U3	LVR-IC	LDO, 2.6V±1%, 150mA, +CE	HSNT-4	78vm	VR4	5b	Sii
1GT	S-1312D27-A4T1U3	LVR-IC	LDO, 2.7V±1%, 150mA, +CE	HSNT-4	78vm	VR4	5b	Sii
1GU	S-1312D28-A4T1U3	LVR-IC	LDO, 2.8V±1%, 150mA, +CE	HSNT-4	78vm	VR4	5b	Sii
1GV	S-1312D2J-A4T1U3	LVR-IC	LDO, 2.85V±1%, 150mA, +CE	HSNT-4	78vm	VR4	5b	Sii
1GW	S-1312D29-A4T1U3	LVR-IC	LDO, 2.9V±1%, 150mA, +CE	HSNT-4	78vm	VR4	5b	Sii
1GX	S-1312D30-A4T1U3	LVR-IC	LDO, 3.0V±1%, 150mA, +CE	HSNT-4	78vm	VR4	5b	Sii
1GY	S-1312D31-A4T1U3	LVR-IC	LDO, 3.1V±1%, 150mA, +CE	HSNT-4	78vm	VR4	5b	Sii
1GZ	S-1312D32-A4T1U3	LVR-IC	LDO, 3.2V±1%, 150mA, +CE	HSNT-4	78vm	VR4	5b	Sii
1H	BU4348F	Vdet-IC	4.8V±1%, +Reset PPO	SOP-4	26vdf	VD3	5c	Rhm
1H	R3132Q27EA	Vdet-IC	2.7V, MR, -Reset PPO	SOT-143	24vdh	VD5	5a	Ric
1H	XC6127N27BNR	Vdet-IC	2.7V±0.8%, -Reset ODO, -MR, Rt=100ms	SSOT-24	26cr	VD4	5a	Tor
1H	XC6213B16ANR	LVR-IC	LDO, 1.65V±2%, 150mA, +CE	SSOT-24	26vn	VR4	5c	Tor
1H	XC6217C172NR	LVR-IC	LDO, 1.7V±2%, 200mA, +CE	SSOT-24	26vn	VR4	5a	Tor
1J	BCV61A	Si-npn	Dual, 30V, 100mA, 300mW, B=110..220, =250MHz	SOT-143	24t5	-	5h	Inf
1J	IMP161JCUS	Vdet-IC	4.0V±1.5%, -Reset ODO, -MR	SOT-143	24vdh	VD4	5c	Imp
1J	R3132Q28EA	Vdet-IC	2.8V, MR, -Reset PPO	SOT-143	24vdh	VD5	5a	Ric
1Jp	BCV61A	Si-npn	Dual, 30V, 100mA, 250mW, B=110..220, >100MHz	SOT-143	24t5	-	5c	Phi
1Jp	BCV61A	Si-npn	Dual, 30V, 100mA, 300mW, B=110..220, =250MHz	SOT-143	24t5	-	5b	Sie
1K	R3132Q29EA	Vdet-IC	2.9V, MR, -Reset PPO	SOT-143	24vdh	VD5	5a	Ric
1K	XC6127N29BNR	Vdet-IC	2.9V±0.8%, -Reset ODO, -MR, Rt=100ms	SSOT-24	26cr	VD4	5a	Tor
1K	XC6213B17ANR	LVR-IC	LDO, 1.75V±2%, 150mA, +CE	SSOT-24	26vn	VR4	5c	Tor
1K	XC6217C182NR	LVR-IC	LDO, 1.8V±2%, 200mA, +CE	SSOT-24	26vn	VR4	5a	Tor
1Kp	BCV61B	Si-npn	Dual, 30V, 100mA, 250mW, B=200..450, >100MHz	SOT-143	24t5	-	5c	Phi
1Ks	BCV61B	Si-npn	Dual, 30V, 100mA, 300mW, B=200..450, =250MHz	SOT-143	24t5	-	5b	Sie
1L	BCV61C	Si-npn	Dual, 30V, 100mA, 250mW, B=420..800, 100MHz	SOT-143	24t5	-	5h	Inf
1L	IMP161LCUS	Vdet-IC	4.63V±1.5%, -Reset ODO, -MR	SOT-143	24vdh	VD4	5c	Imp
1L	R3133Q20EA	Vdet-IC	2V, MR, +Reset PPO	SOT-143	24vdh	VD5	5a	Ric
1L	XC6127N31BNR	Vdet-IC	3.1V±0.8%, -Reset ODO, -MR, Rt=100ms	SSOT-24	26cr	VD4	5a	Tor
1L	XC6213B18ANR	LVR-IC	LDO, 1.85V±2%, 150mA, +CE	SSOT-24	26vn	VR4	5c	Tor
1L	XC6217C192NR	LVR-IC	LDO, 1.9V±2%, 200mA, +CE	SSOT-24	26vn	VR4	5a	Tor
1L1	S-1313A31-A4T1U3	LVR-IC	LDO, 3.1V±1%, 200mA, +CE, CL, PDR	HSNT-4	78vm	VR4	5b	Sii
1L1	S-1313A31-N4T1U3	LVR-IC	LDO, 3.1V±1%, 200mA, +CE, CL, PDR	SC-82AB	26vn	VR4	5b	Sii
1L2	S-1313A32-A4T1U3	LVR-IC	LDO, 3.2V±1%, 200mA, +CE, CL, PDR	HSNT-4	78vm	VR4	5b	Sii
1L2	S-1313A32-N4T1U3	LVR-IC	LDO, 3.2V±1%, 200mA, +CE, CL, PDR	SC-82AB	26vn	VR4	5b	Sii
1L3	S-1313A33-A4T1U3	LVR-IC	LDO, 3.3V±1%, 200mA, +CE, CL, PDR	HSNT-4	78vm	VR4	5b	Sii
1L3	S-1313A33-N4T1U3	LVR-IC	LDO, 3.3V±1%, 200mA, +CE, CL, PDR	SC-82AB	26vn	VR4	5b	Sii
1L4	S-1313A34-A4T1U3	LVR-IC	LDO, 3.4V±1%, 200mA, +CE, CL, PDR	HSNT-4	78vm	VR4	5b	Sii
1L4	S-1313A34-N4T1U3	LVR-IC	LDO, 3.4V±1%, 200mA, +CE, CL, PDR	SC-82AB	26vn	VR4	5b	Sii
1L5	S-1313A35-A4T1U3	LVR-IC	LDO, 3.5V±1%, 200mA, +CE, CL, PDR	HSNT-4	78vm	VR4	5b	Sii
1L5	S-1313A35-N4T1U3	LVR-IC	LDO, 3.5V±1%, 200mA, +CE, CL, PDR	SC-82AB	26vn	VR4	5b	Sii
1LA	S-1313A10-A4T1U3	LVR-IC	LDO, 1.0V±1%, 200mA, +CE, CL, PDR	HSNT-4	78vm	VR4	5b	Sii
1LA	S-1313A10-N4T1U3	LVR-IC	LDO, 1.0V±1%, 200mA, +CE, CL, PDR	SC-82AB	26vn	VR4	5b	Sii
1LB	S-1313A11-A4T1U3	LVR-IC	LDO, 1.1V±1%, 200mA, +CE, CL, PDR	HSNT-4	78vm	VR4	5b	Sii
1LB	S-1313A11-N4T1U3	LVR-IC	LDO, 1.1V±1%, 200mA, +CE, CL, PDR	SC-82AB	26vn	VR4	5b	Sii
1LC	S-1313A12-A4T1U3	LVR-IC	LDO, 1.2V±1%, 200mA, +CE, CL, PDR	HSNT-4	78vm	VR4	5b	Sii
1LC	S-1313A12-N4T1U3	LVR-IC	LDO, 1.2V±1%, 200mA, +CE, CL, PDR	SC-82AB	26vn	VR4	5b	Sii
1LD	S-1313A13-A4T1U3	LVR-IC	LDO, 1.3V±1%, 200mA, +CE, CL, PDR	HSNT-4	78vm	VR4	5b	Sii



SMD code	Type	Function	Short description	Case	Pinout	Sch.	St.	Mnf.
1LD	S-1313A13-N4T1U3	LVR-IC	LDO, 1.3V±1%, 200mA, +CE, CL, PDR	SC-82AB	26vn	VR4	5b	Sii
1LE	S-1313A14-A4T1U3	LVR-IC	LDO, 1.4V±1%, 200mA, +CE, CL, PDR	HSNT-4	78vm	VR4	5b	Sii
1LF	S-1313A14-N4T1U3	LVR-IC	LDO, 1.4V±1%, 200mA, +CE, CL, PDR	SC-82AB	26vn	VR4	5b	Sii
1LF	S-1313A15-N4T1U3	LVR-IC	LDO, 1.5V±1%, 200mA, +CE, CL, PDR	HSNT-4	78vm	VR4	5b	Sii
1LG	S-1313A15-A4T1U3	LVR-IC	LDO, 1.5V±1%, 200mA, +CE, CL, PDR	SC-82AB	26vn	VR4	5b	Sii
1LG	S-1313A16-N4T1U3	LVR-IC	LDO, 1.6V±1%, 200mA, +CE, CL, PDR	HSNT-4	78vm	VR4	5b	Sii
1LH	S-1313A17-A4T1U3	LVR-IC	LDO, 1.7V±1%, 200mA, +CE, CL, PDR	SC-82AB	26vn	VR4	5b	Sii
1LH	S-1313A17-N4T1U3	LVR-IC	LDO, 1.7V±1%, 200mA, +CE, CL, PDR	HSNT-4	78vm	VR4	5b	Sii
1LJ	S-1313A18-A4T1U3	LVR-IC	LDO, 1.8V±1%, 200mA, +CE, CL, PDR	SC-82AB	26vn	VR4	5b	Sii
1LJ	S-1313A18-N4T1U3	LVR-IC	LDO, 1.8V±1%, 200mA, +CE, CL, PDR	HSNT-4	78vm	VR4	5b	Sii
1LK	S-1313A1J-A4T1U3	LVR-IC	LDO, 1.85V±1%, 200mA, +CE, CL, PDR	SC-82AB	26vn	VR4	5b	Sii
1LK	S-1313A1J-N4T1U3	LVR-IC	LDO, 1.85V±1%, 200mA, +CE, CL, PDR	HSNT-4	78vm	VR4	5b	Sii
1LL	S-1313A19-A4T1U3	LVR-IC	LDO, 1.9V±1%, 200mA, +CE, CL, PDR	SC-82AB	26vn	VR4	5b	Sii
1LL	S-1313A19-N4T1U3	LVR-IC	LDO, 1.9V±1%, 200mA, +CE, CL, PDR	HSNT-4	78vm	VR4	5b	Sii
1LN	ELM7516CCB	Vdet-IC	1.6V±2%, +Reset PPO	SC-82AB	26vdl	VD7	5c	Elm
1LN	ELM7516NCB	Vdet-IC	1.6V±2%, +Reset ODO	SC-82AB	26vdl	VD6	5c	Elm
1LN	S-1313A20-A4T1U3	LVR-IC	LDO, 2.0V±1%, 200mA, +CE, CL, PDR	SC-82AB	26vn	VR4	5b	Sii
1LN	S-1313A20-N4T1U3	LVR-IC	LDO, 2.0V±1%, 200mA, +CE, CL, PDR	HSNT-4	78vm	VR4	5b	Sii
1LO	S-1313A21-A4T1U3	LVR-IC	LDO, 2.1V±1%, 200mA, +CE, CL, PDR	SC-82AB	26vn	VR4	5b	Sii
1LO	S-1313A21-N4T1U3	LVR-IC	LDO, 2.1V±1%, 200mA, +CE, CL, PDR	HSNT-4	78vm	VR4	5b	Sii
1Lp	BCV61C	Si-npn	Dual, 30V, 100mA, 250mW, B=420..800, 100MHz	SOT-143	24t5	-	5c	Phi
1LP	S-1313A22-A4T1U3	LVR-IC	LDO, 2.2V±1%, 200mA, +CE, CL, PDR	SC-82AB	26vn	VR4	5b	Sii
1LP	S-1313A22-N4T1U3	LVR-IC	LDO, 2.2V±1%, 200mA, +CE, CL, PDR	HSNT-4	78vm	VR4	5b	Sii
1LQ	S-1313A23-A4T1U3	LVR-IC	LDO, 2.3V±1%, 200mA, +CE, CL, PDR	SC-82AB	26vn	VR4	5b	Sii
1LQ	S-1313A23-N4T1U3	LVR-IC	LDO, 2.3V±1%, 200mA, +CE, CL, PDR	HSNT-4	78vm	VR4	5b	Sii
1LR	S-1313A24-A4T1U3	LVR-IC	LDO, 2.4V±1%, 200mA, +CE, CL, PDR	SC-82AB	26vn	VR4	5b	Sii
1LR	S-1313A24-N4T1U3	LVR-IC	LDO, 2.4V±1%, 200mA, +CE, CL, PDR	HSNT-4	78vm	VR4	5b	Sii
1Ls	BCV61C	Si-npn	Dual, 30V, 100mA, 300mW, B=420..800, =250MHz	SOT-143	24t5	-	5b	Sie
1LS	S-1313A25-A4T1U3	LVR-IC	LDO, 2.5V±1%, 200mA, +CE, CL, PDR	SC-82AB	26vn	VR4	5b	Sii
1LS	S-1313A25-N4T1U3	LVR-IC	LDO, 2.5V±1%, 200mA, +CE, CL, PDR	HSNT-4	78vm	VR4	5b	Sii
1LT	S-1313A26-A4T1U3	LVR-IC	LDO, 2.6V±1%, 200mA, +CE, CL, PDR	SC-82AB	26vn	VR4	5b	Sii
1LT	S-1313A26-N4T1U3	LVR-IC	LDO, 2.6V±1%, 200mA, +CE, CL, PDR	HSNT-4	78vm	VR4	5b	Sii
1LU	S-1313A28-A4T1U3	LVR-IC	LDO, 2.8V±1%, 200mA, +CE, CL, PDR	SC-82AB	26vn	VR4	5b	Sii
1LU	S-1313A28-N4T1U3	LVR-IC	LDO, 2.8V±1%, 200mA, +CE, CL, PDR	HSNT-4	78vm	VR4	5b	Sii
1LV	S-1313A27-A4T1U3	LVR-IC	LDO, 2.7V±1%, 200mA, +CE, CL, PDR	SC-82AB	26vn	VR4	5b	Sii
1LV	S-1313A27-N4T1U3	LVR-IC	LDO, 2.7V±1%, 200mA, +CE, CL, PDR	HSNT-4	78vm	VR4	5b	Sii
1LX	S-1313A2J-A4T1U3	LVR-IC	LDO, 2.85V±1%, 200mA, +CE, CL, PDR	SC-82AB	26vn	VR4	5b	Sii
1LX	S-1313A2J-N4T1U3	LVR-IC	LDO, 2.85V±1%, 200mA, +CE, CL, PDR	HSNT-4	78vm	VR4	5b	Sii
1LY	S-1313A29-A4T1U3	LVR-IC	LDO, 2.9V±1%, 200mA, +CE, CL, PDR	SC-82AB	26vn	VR4	5b	Sii
1LY	S-1313A29-N4T1U3	LVR-IC	LDO, 2.9V±1%, 200mA, +CE, CL, PDR	HSNT-4	78vm	VR4	5b	Sii
1LZ	S-1313A30-A4T1U3	LVR-IC	LDO, 3.0V±1%, 200mA, +CE, CL, PDR	SC-82AB	26vn	VR4	5b	Sii
1LZ	S-1313A30-N4T1U3	LVR-IC	LDO, 3.0V±1%, 200mA, +CE, CL, PDR	HSNT-4	78vm	VR4	5b	Sii
1M	IMP161MCUS	Vdet-IC	4.38V±1.5%, -Reset ODO, -MR	SOT-143	24vdh	VD4	5c	Imp
1M	R3133Q21EA	Vdet-IC	2.1V, MR, +Reset PPO	SOT-143	24vdh	VD5	5a	Ric
1M	XC6127N33BNR	Vdet-IC	3.3V±0.8%, -Reset ODO, -MR, Rt=100ms	SSOT-24	26cr	VD4	5a	Tor
1M	XC6213B19ANR	LVR-IC	LDO, 1.95V±2%, 150mA, +CE	SSOT-24	26vn	VR4	5c	Tor
1M	XC6217C202NR	LVR-IC	LDO, 2V±2%, 200mA, +CE	SSOT-24	26vn	VR4	5a	Tor
1Mp	BCV61	Si-npn	Dual, 30V, 100mA, 250mW, B=1100..800, >100MHz	SOT-143	24t5	-	5c	Phi
1N	R3133Q22EA	Vdet-IC	2.2V, MR, +Reset PPO	SOT-143	24vdh	VD5	5a	Ric
1N	XC6127N35BNR	Vdet-IC	3.5V±0.8%, -Reset ODO, -MR, Rt=100ms	SSOT-24	26cr	VD4	5a	Tor
1N	XC6217C212NR	LVR-IC	LDO, 2.1V±2%, 200mA, +CE	SSOT-24	26vn	VR4	5a	Tor
1N1	S-1313B31-A4T1U3	LVR-IC	LDO, 3.1V±1%, 200mA, +CE, CL	HSNT-4	78vm	VR4	5b	Sii
1N1	S-1313B31-N4T1U3	LVR-IC	LDO, 3.1V±1%, 200mA, +CE, CL	SC-82AB	26vn	VR4	5b	Sii
1N2	S-1313B32-A4T1U3	LVR-IC	LDO, 3.2V±1%, 200mA, +CE, CL	HSNT-4	78vm	VR4	5b	Sii
1N2	S-1313B32-N4T1U3	LVR-IC	LDO, 3.2V±1%, 200mA, +CE, CL	SC-82AB	26vn	VR4	5b	Sii
1N3	S-1313B33-A4T1U3	LVR-IC	LDO, 3.3V±1%, 200mA, +CE, CL	HSNT-4	78vm	VR4	5b	Sii
1N3	S-1313B33-N4T1U3	LVR-IC	LDO, 3.3V±1%, 200mA, +CE, CL	SC-82AB	26vn	VR4	5b	Sii
1N4	S-1313B34-A4T1U3	LVR-IC	LDO, 3.4V±1%, 200mA, +CE, CL	HSNT-4	78vm	VR4	5b	Sii
1N4	S-1313B34-N4T1U3	LVR-IC	LDO, 3.4V±1%, 200mA, +CE, CL	SC-82AB	26vn	VR4	5b	Sii
1N5	S-1313B35-A4T1U3	LVR-IC	LDO, 3.5V±1%, 200mA, +CE, CL	HSNT-4	78vm	VR4	5b	Sii
1N5	S-1313B35-N4T1U3	LVR-IC	LDO, 3.5V±1%, 200mA, +CE, CL	SC-82AB	26vn	VR4	5b	Sii
1NA	S-1313B10-A4T1U3	LVR-IC	LDO, 1.0V±1%, 200mA, +CE, CL	HSNT-4	78vm	VR4	5b	Sii
1NA	S-1313B10-N4T1U3	LVR-IC	LDO, 1.0V±1%, 200mA, +CE, CL	SC-82AB	26vn	VR4	5b	Sii
1NB	S-1313B11-A4T1U3	LVR-IC	LDO, 1.1V±1%, 200mA, +CE, CL	HSNT-4	78vm	VR4	5b	Sii
1NB	S-1313B11-N4T1U3	LVR-IC	LDO, 1.1V±1%, 200mA, +CE, CL	SC-82AB	26vn	VR4	5b	Sii
1NC	S-1313B12-A4T1U3	LVR-IC	LDO, 1.2V±1%, 200mA, +CE, CL	HSNT-4	78vm	VR4	5b	Sii
1NC	S-1313B12-N4T1U3	LVR-IC	LDO, 1.2V±1%, 200mA, +CE, CL	SC-82AB	26vn	VR4	5b	Sii
1ND	S-1313B13-A4T1U3	LVR-IC	LDO, 1.3V±1%, 200mA, +CE, CL	HSNT-4	78vm	VR4	5b	Sii
1ND	S-1313B13-N4T1U3	LVR-IC	LDO, 1.3V±1%, 200mA, +CE, CL	SC-82AB	26vn	VR4	5b	Sii



SMD code	Type	Function	Short description	Case	Pinout	Sch.	St.	Mnf.
1ON	S-1313C20-A4T1U3	LVR-IC	LDO, 2.0V±1%, 200mA, +CE, PDR	HSNT-4	78vm	VR4	5b	Sii
1ON	S-1313C20-N4T1U3	LVR-IC	LDO, 2.0V±1%, 200mA, +CE, PDR	SC-82AB	26vn	VR4	5b	Sii
1OO	S-1313C21-A4T1U3	LVR-IC	LDO, 2.1V±1%, 200mA, +CE, PDR	HSNT-4	78vm	VR4	5b	Sii
1OO	S-1313C21-N4T1U3	LVR-IC	LDO, 2.1V±1%, 200mA, +CE, PDR	SC-82AB	26vn	VR4	5b	Sii
1OP	S-1313C22-A4T1U3	LVR-IC	LDO, 2.2V±1%, 200mA, +CE, PDR	HSNT-4	78vm	VR4	5b	Sii
1OP	S-1313C22-N4T1U3	LVR-IC	LDO, 2.2V±1%, 200mA, +CE, PDR	SC-82AB	26vn	VR4	5b	Sii
1OQ	S-1313C23-A4T1U3	LVR-IC	LDO, 2.3V±1%, 200mA, +CE, PDR	HSNT-4	78vm	VR4	5b	Sii
1OQ	S-1313C23-N4T1U3	LVR-IC	LDO, 2.3V±1%, 200mA, +CE, PDR	SC-82AB	26vn	VR4	5b	Sii
1OR	S-1313C24-A4T1U3	LVR-IC	LDO, 2.4V±1%, 200mA, +CE, PDR	HSNT-4	78vm	VR4	5b	Sii
1OR	S-1313C24-N4T1U3	LVR-IC	LDO, 2.4V±1%, 200mA, +CE, PDR	SC-82AB	26vn	VR4	5b	Sii
1OS	S-1313C25-A4T1U3	LVR-IC	LDO, 2.5V±1%, 200mA, +CE, PDR	HSNT-4	78vm	VR4	5b	Sii
1OS	S-1313C25-N4T1U3	LVR-IC	LDO, 2.5V±1%, 200mA, +CE, PDR	SC-82AB	26vn	VR4	5b	Sii
1OT	S-1313C26-A4T1U3	LVR-IC	LDO, 2.6V±1%, 200mA, +CE, PDR	HSNT-4	78vm	VR4	5b	Sii
1OT	S-1313C26-N4T1U3	LVR-IC	LDO, 2.6V±1%, 200mA, +CE, PDR	SC-82AB	26vn	VR4	5b	Sii
1OU	S-1313C27-A4T1U3	LVR-IC	LDO, 2.7V±1%, 200mA, +CE, PDR	HSNT-4	78vm	VR4	5b	Sii
1OU	S-1313C27-N4T1U3	LVR-IC	LDO, 2.7V±1%, 200mA, +CE, PDR	SC-82AB	26vn	VR4	5b	Sii
1OV	S-1313C28-A4T1U3	LVR-IC	LDO, 2.8V±1%, 200mA, +CE, PDR	HSNT-4	78vm	VR4	5b	Sii
1OV	S-1313C28-N4T1U3	LVR-IC	LDO, 2.8V±1%, 200mA, +CE, PDR	SC-82AB	26vn	VR4	5b	Sii
1OX	S-1313C2J-A4T1U3	LVR-IC	LDO, 2.85V±1%, 200mA, +CE, PDR	HSNT-4	78vm	VR4	5b	Sii
1OX	S-1313C2J-N4T1U3	LVR-IC	LDO, 2.85V±1%, 200mA, +CE, PDR	SC-82AB	26vn	VR4	5b	Sii
1OY	S-1313C29-A4T1U3	LVR-IC	LDO, 2.9V±1%, 200mA, +CE, PDR	HSNT-4	78vm	VR4	5b	Sii
1OY	S-1313C29-N4T1U3	LVR-IC	LDO, 2.9V±1%, 200mA, +CE, PDR	SC-82AB	26vn	VR4	5b	Sii
1OZ	S-1313C30-A4T1U3	LVR-IC	LDO, 3.0V±1%, 200mA, +CE, PDR	HSNT-4	78vm	VR4	5b	Sii
1OZ	S-1313C30-N4T1U3	LVR-IC	LDO, 3.0V±1%, 200mA, +CE, PDR	SC-82AB	26vn	VR4	5b	Sii
1P	R313Q23EA	Vdet-IC	2.3V, MR, +Reset PPO	SOT-143	24vdh	VD5	5a	Ric
1P	XC6127N37BNR	Vdet-IC	3.7V±0.8%, -Reset ODO, -MR, Rt=100ms	SSOT-24	26cr	VD4	5a	Tor
1P	XC6217C222NR	LVR-IC	LDO, 2.2V±2%, 200mA, +CE	SSOT-24	26vn	VR4	5a	Tor
1P1	S-1313D31-A4T1U3	LVR-IC	LDO, 3.1V±1%, 200mA, +CE	HSNT-4	78vm	VR4	5b	Sii
1P1	S-1313D31-N4T1U3	LVR-IC	LDO, 3.1V±1%, 200mA, +CE	SC-82AB	26vn	VR4	5b	Sii
1P2	S-1313D32-A4T1U3	LVR-IC	LDO, 3.2V±1%, 200mA, +CE	HSNT-4	78vm	VR4	5b	Sii
1P2	S-1313D32-N4T1U3	LVR-IC	LDO, 3.2V±1%, 200mA, +CE	SC-82AB	26vn	VR4	5b	Sii
1P3	S-1313D33-A4T1U3	LVR-IC	LDO, 3.3V±1%, 200mA, +CE	HSNT-4	78vm	VR4	5b	Sii
1P3	S-1313D33-N4T1U3	LVR-IC	LDO, 3.3V±1%, 200mA, +CE	SC-82AB	26vn	VR4	5b	Sii
1P4	S-1313D34-A4T1U3	LVR-IC	LDO, 3.4V±1%, 200mA, +CE	HSNT-4	78vm	VR4	5b	Sii
1P4	S-1313D34-N4T1U3	LVR-IC	LDO, 3.4V±1%, 200mA, +CE	SC-82AB	26vn	VR4	5b	Sii
1P5	S-1313D35-A4T1U3	LVR-IC	LDO, 3.5V±1%, 200mA, +CE	HSNT-4	78vm	VR4	5b	Sii
1P5	S-1313D35-N4T1U3	LVR-IC	LDO, 3.5V±1%, 200mA, +CE	SC-82AB	26vn	VR4	5b	Sii
1PA	S-1313D10-A4T1U3	LVR-IC	LDO, 1.0V±1%, 200mA, +CE	HSNT-4	78vm	VR4	5b	Sii
1PA	S-1313D10-N4T1U3	LVR-IC	LDO, 1.0V±1%, 200mA, +CE	SC-82AB	26vn	VR4	5b	Sii
1PB	S-1313D11-A4T1U3	LVR-IC	LDO, 1.1V±1%, 200mA, +CE	HSNT-4	78vm	VR4	5b	Sii
1PB	S-1313D11-N4T1U3	LVR-IC	LDO, 1.1V±1%, 200mA, +CE	SC-82AB	26vn	VR4	5b	Sii
1PC	S-1313D12-A4T1U3	LVR-IC	LDO, 1.2V±1%, 200mA, +CE	HSNT-4	78vm	VR4	5b	Sii
1PC	S-1313D12-N4T1U3	LVR-IC	LDO, 1.2V±1%, 200mA, +CE	SC-82AB	26vn	VR4	5b	Sii
1PD	S-1313D13-A4T1U3	LVR-IC	LDO, 1.3V±1%, 200mA, +CE	HSNT-4	78vm	VR4	5b	Sii
1PD	S-1313D13-N4T1U3	LVR-IC	LDO, 1.3V±1%, 200mA, +CE	SC-82AB	26vn	VR4	5b	Sii
1PE	S-1313D14-A4T1U3	LVR-IC	LDO, 1.4V±1%, 200mA, +CE	HSNT-4	78vm	VR4	5b	Sii
1PE	S-1313D14-N4T1U3	LVR-IC	LDO, 1.4V±1%, 200mA, +CE	SC-82AB	26vn	VR4	5b	Sii
1PF	S-1313D15-A4T1U3	LVR-IC	LDO, 1.5V±1%, 200mA, +CE	HSNT-4	78vm	VR4	5b	Sii
1PF	S-1313D15-N4T1U3	LVR-IC	LDO, 1.5V±1%, 200mA, +CE	SC-82AB	26vn	VR4	5b	Sii
1PG	S-1313D16-A4T1U3	LVR-IC	LDO, 1.6V±1%, 200mA, +CE	HSNT-4	78vm	VR4	5b	Sii
1PG	S-1313D16-N4T1U3	LVR-IC	LDO, 1.6V±1%, 200mA, +CE	SC-82AB	26vn	VR4	5b	Sii
1PH	S-1313D17-A4T1U3	LVR-IC	LDO, 1.7V±1%, 200mA, +CE	HSNT-4	78vm	VR4	5b	Sii
1PH	S-1313D17-N4T1U3	LVR-IC	LDO, 1.7V±1%, 200mA, +CE	SC-82AB	26vn	VR4	5b	Sii
1PJ	S-1313D18-A4T1U3	LVR-IC	LDO, 1.8V±1%, 200mA, +CE	HSNT-4	78vm	VR4	5b	Sii
1PJ	S-1313D18-N4T1U3	LVR-IC	LDO, 1.8V±1%, 200mA, +CE	SC-82AB	26vn	VR4	5b	Sii
1PK	S-1313D1J-A4T1U3	LVR-IC	LDO, 1.85V±1%, 200mA, +CE	HSNT-4	78vm	VR4	5b	Sii
1PK	S-1313D1J-N4T1U3	LVR-IC	LDO, 1.85V±1%, 200mA, +CE	SC-82AB	26vn	VR4	5b	Sii
1PL	S-1313D19-A4T1U3	LVR-IC	LDO, 1.9V±1%, 200mA, +CE	HSNT-4	78vm	VR4	5b	Sii
1PL	S-1313D19-N4T1U3	LVR-IC	LDO, 1.9V±1%, 200mA, +CE	SC-82AB	26vn	VR4	5b	Sii
1PN	S-1313D20-A4T1U3	LVR-IC	LDO, 2.0V±1%, 200mA, +CE	HSNT-4	78vm	VR4	5b	Sii
1PN	S-1313D20-N4T1U3	LVR-IC	LDO, 2.0V±1%, 200mA, +CE	SC-82AB	26vn	VR4	5b	Sii
1PO	S-1313D21-A4T1U3	LVR-IC	LDO, 2.1V±1%, 200mA, +CE	HSNT-4	78vm	VR4	5b	Sii
1PO	S-1313D21-N4T1U3	LVR-IC	LDO, 2.1V±1%, 200mA, +CE	SC-82AB	26vn	VR4	5b	Sii
1PP	S-1313D22-A4T1U3	LVR-IC	LDO, 2.2V±1%, 200mA, +CE	HSNT-4	78vm	VR4	5b	Sii
1PP	S-1313D22-N4T1U3	LVR-IC	LDO, 2.2V±1%, 200mA, +CE	SC-82AB	26vn	VR4	5b	Sii
1PQ	S-1313D23-A4T1U3	LVR-IC	LDO, 2.3V±1%, 200mA, +CE	HSNT-4	78vm	VR4	5b	Sii
1PQ	S-1313D23-N4T1U3	LVR-IC	LDO, 2.3V±1%, 200mA, +CE	SC-82AB	26vn	VR4	5b	Sii
1PR	S-1313D24-A4T1U3	LVR-IC	LDO, 2.4V±1%, 200mA, +CE	HSNT-4	78vm	VR4	5b	Sii
1PR	S-1313D24-N4T1U3	LVR-IC	LDO, 2.4V±1%, 200mA, +CE	SC-82AB	26vn	VR4	5b	Sii
1PS	S-1313D25-A4T1U3	LVR-IC	LDO, 2.5V±1%, 200mA, +CE	HSNT-4	78vm	VR4	5b	Sii



SMD code	Type	Function	Short description	Case	Pinout	Sch.	St.	Mnf.
1PS	S-1313D25-N4T1U3	LVR-IC	LDO, 2.5V±1%, 200mA, +CE	SC-82AB	26vn	VR4	5b	Sii
1PT	S-1313D26-A4T1U3	LVR-IC	LDO, 2.6V±1%, 200mA, +CE	HSNT-4	78vm	VR4	5b	Sii
1PT	S-1313D26-N4T1U3	LVR-IC	LDO, 2.6V±1%, 200mA, +CE	SC-82AB	26vn	VR4	5b	Sii
1PU	S-1313D27-A4T1U3	LVR-IC	LDO, 2.7V±1%, 200mA, +CE	HSNT-4	78vm	VR4	5b	Sii
1PU	S-1313D27-N4T1U3	LVR-IC	LDO, 2.7V±1%, 200mA, +CE	SC-82AB	26vn	VR4	5b	Sii
1PV	S-1313D28-A4T1U3	LVR-IC	LDO, 2.8V±1%, 200mA, +CE	HSNT-4	78vm	VR4	5b	Sii
1PV	S-1313D28-N4T1U3	LVR-IC	LDO, 2.8V±1%, 200mA, +CE	SC-82AB	26vn	VR4	5b	Sii
1PX	S-1313D2J-A4T1U3	LVR-IC	LDO, 2.85V±1%, 200mA, +CE	HSNT-4	78vm	VR4	5b	Sii
1PX	S-1313D2J-N4T1U3	LVR-IC	LDO, 2.85V±1%, 200mA, +CE	SC-82AB	26vn	VR4	5b	Sii
1PY	S-1313D29-A4T1U3	LVR-IC	LDO, 2.9V±1%, 200mA, +CE	HSNT-4	78vm	VR4	5b	Sii
1PY	S-1313D29-N4T1U3	LVR-IC	LDO, 2.9V±1%, 200mA, +CE	SC-82AB	26vn	VR4	5b	Sii
1PZ	S-1313D30-A4T1U3	LVR-IC	LDO, 3.0V±1%, 200mA, +CE	HSNT-4	78vm	VR4	5b	Sii
1PZ	S-1313D30-N4T1U3	LVR-IC	LDO, 3.0V±1%, 200mA, +CE	SC-82AB	26vn	VR4	5b	Sii
1Q	R3133Q24EA	Vdet-IC	2.4V, MR, +Reset PPO	SOT-143	24vdh	VD5	5a	Ric
1R	IMP161RCUS	Vdet-IC	2.63V±1.5%, -Reset ODO, -MR	SOT-143	24vdh	VD4	5c	Imp
1R	R3133Q25EA	Vdet-IC	2.5V, MR, +Reset PPO	SOT-143	24vdh	VD5	5a	Ric
1R	XC6127N39BNR	Vdet-IC	3.9V±0.8%, -Reset ODO, -MR, Rt=100ms	SSOT-24	26cr	VD4	5a	Tor
1R	XC6217C232NR	LVR-IC	LDO, 2.3V±2%, 200mA, +CE	SSOT-24	26vn	VR4	5a	Tor
1S	IMP161SCUS	Vdet-IC	2.93V±1.5%, -Reset ODO, -MR	SOT-143	24vdh	VD4	5c	Imp
1S	R3133Q26EA	Vdet-IC	2.6V, MR, +Reset PPO	SOT-143	24vdh	VD5	5a	Ric
1S	XC6127N41BNR	Vdet-IC	4.1V±0.8%, -Reset ODO, -MR, Rt=100ms	SSOT-24	26cr	VD4	5a	Tor
1S	XC6217C242NR	LVR-IC	LDO, 2.4V±2%, 200mA, +CE	SSOT-24	26vn	VR4	5a	Tor
1T	IMP161TCUS	Vdet-IC	3.08V±1.5%, -Reset ODO, -MR	SOT-143	24vdh	VD4	5c	Imp
1T	R3133Q27EA	Vdet-IC	2.7V, MR, +Reset PPO	SOT-143	24vdh	VD5	5a	Ric
1T	XC6127N43BNR	Vdet-IC	4.3V±0.8%, -Reset ODO, -MR, Rt=100ms	SSOT-24	26cr	VD4	5a	Tor
1T	XC6217C252NR	LVR-IC	LDO, 2.5V±2%, 200mA, +CE	SSOT-24	26vn	VR4	5a	Tor
1U	R3133Q28EA	Vdet-IC	2.8V, MR, +Reset PPO	SOT-143	24vdh	VD5	5a	Ric
1U	XC6127N45BNR	Vdet-IC	4.5V±0.8%, -Reset ODO, -MR, Rt=100ms	SSOT-24	26cr	VD4	5a	Tor
1U	XC6217C262NR	LVR-IC	LDO, 2.6V±2%, 200mA, +CE	SSOT-24	26vn	VR4	5a	Tor
1V	R3133Q29EA	Vdet-IC	2.9V, MR, +Reset PPO	SOT-143	24vdh	VD5	5a	Ric
1V	XC6127N47BNR	Vdet-IC	4.7V±0.8%, -Reset ODO, -MR, Rt=100ms	SSOT-24	26cr	VD4	5a	Tor
1V	XC6217C272NR	LVR-IC	LDO, 2.7V±2%, 200mA, +CE	SSOT-24	26vn	VR4	5a	Tor
1X	XC6127N49BNR	Vdet-IC	4.9V±0.8%, -Reset ODO, -MR, Rt=100ms	SSOT-24	26cr	VD4	5a	Tor
1X	XC6217C282NR	LVR-IC	LDO, 2.8V±2%, 200mA, +CE	SSOT-24	26vn	VR4	5a	Tor
1Y	XC6127N51BNR	Vdet-IC	5.1V±0.8%, -Reset ODO, -MR, Rt=100ms	SSOT-24	26cr	VD4	5a	Tor
1Y	XC6217C292NR	LVR-IC	LDO, 2.9V±2%, 200mA, +CE	SSOT-24	26vn	VR4	5a	Tor
1Z	XC6127N53BNR	Vdet-IC	5.3V±0.8%, -Reset ODO, -MR, Rt=100ms	SSOT-24	26cr	VD4	5a	Tor
1Z	XC6217C302NR	LVR-IC	LDO, 3V±2%, 200mA, +CE	SSOT-24	26vn	VR4	5a	Tor
20	R3111Q201B	Vdet-IC	2V±2%, +Reset ODO	SC-82AB	26vdl	VD6	5a	Ric
20	XC6127N55CNR	Vdet-IC	5.5V±0.8%, -Reset ODO, -MR, Rt=200ms	SSOT-24	26cr	VD4	5a	Tor
20	XC6213B202NR	LVR-IC	LDO, 2V±2%, 150mA, +CE	SSOT-24	26vn	VR4	5c	Tor
20	XC6217C312NR	LVR-IC	LDO, 3.1V±2%, 200mA, +CE	SSOT-24	26vn	VR4	5a	Tor
20	XC6221C08BNR	LVR-IC	LDO, 0.85V±20mV, 200mA, +CE, PDR	SSOT-24	26vn	VR4	5a	Tor
201	SSTSD201	n-MOSFET*	VHF/UHF-Amp/Mix/Osc, 25V, 50mA, 360mW, Rds=40Ω, 1pf	SOT-143	24fx	-	5c	Cal
203	SSTSD203	n-MOSFET*	VHF/UHF-Amp/Mix/Osc, 20V, 50mA, 360mW, Rds=35Ω, 1pf	SOT-143	24fx	-	5c	Cal
20A	AAT60020A-S15	Vdet-IC	2.0V±2%, -Reset ODO	SOT-143	26vdf	VD1	5c	Aat
20B	AAT60020B-S15	Vdet-IC	2.0V±2%, -Reset PPO	SOT-143	26vdf	VD3	5c	Aat
20C	AAT60020C-S15	Vdet-IC	2.0V±1%, -Reset ODO	SOT-143	26vdf	VD1	5c	Aat
20D	AAT60020D-S15	Vdet-IC	2.0V±1%, -Reset PPO	SOT-143	26vdf	VD3	5c	Aat
20F	TSDF1220R	Si-npn	UHF-VHF, LN, 9V, 40mA, 200mW, B=50..150, 12GHz	SOT-143R	26tu	-	5b	Vs
20W	MA3200W	Z-diode	Dual, 17..22V, If=150mA, Zzt= 15Ω, 150mW	SOT-143	26ce	-	5b	Pan
20W	MAZ3200W	Z-diode	Dual, 18.8..21.2V, If=100mA, Zzt=55Ω, 200mW	SOT-143	24ce	-	5b	Pan
21	R3111Q211B	Vdet-IC	2.1V±2%, +Reset ODO	SC-82AB	26vdl	VD6	5a	Ric
21	XC6213B212NR	LVR-IC	LDO, 2.1V±2%, 150mA, +CE	SSOT-24	26vn	VR4	5c	Tor
21	XC6217C322NR	LVR-IC	LDO, 3.2V±2%, 200mA, +CE	SSOT-24	26vn	VR4	5a	Tor
21	XC6221C09BNR	LVR-IC	LDO, 0.95V±20mV, 200mA, +CE, PDR	SSOT-24	26vn	VR4	5a	Tor
211	SST211	n-MOSFET*	Sw, 30V, 50mA, 360mW, Rds=7Ω, 0.7/10ns	SOT-143	24fx	-	5b	Cal
213	SST213	n-MOSFET*	Sw, 10V, 50mA, 360mW, Rds=7Ω, 0.7/10ns	SOT-143	24fx	-	5b	Cal
215	SST215	n-MOSFET*	Sw, 20V, 50mA, 360mW, Rds=7Ω, 0.7/10ns	SOT-143	24fx	-	5b	Cal
21A	AAT60021A-S15	Vdet-IC	2.1V±2%, -Reset ODO	SOT-143	26vdf	VD1	5c	Aat
21B	AAT60021B-S15	Vdet-IC	2.1V±2%, -Reset PPO	SOT-143	26vdf	VD3	5c	Aat
21C	AAT60021C-S15	Vdet-IC	2.1V±1%, -Reset ODO	SOT-143	26vdf	VD1	5c	Aat
21D	AAT60021D-S15	Vdet-IC	2.1V±1%, -Reset PPO	SOT-143	26vdf	VD3	5c	Aat
22	R3111Q221B	Vdet-IC	2.2V±2%, +Reset ODO	SC-82AB	26vdl	VD6	5a	Ric
22	XC6213B222NR	LVR-IC	LDO, 2.2V±2%, 150mA, +CE	SSOT-24	26vn	VR4	5c	Tor
22	XC6217C332NR	LVR-IC	LDO, 3.3V±2%, 200mA, +CE	SSOT-24	26vn	VR4	5a	Tor
22	XC6221C10BNR	LVR-IC	LDO, 1.05V±20mV, 200mA, +CE, PDR	SSOT-24	26vn	VR4	5a	Tor
22A	AAT60022A-S15	Vdet-IC	2.2V±2%, -Reset ODO	SOT-143	26vdf	VD1	5c	Aat
22B	AAT60022B-S15	Vdet-IC	2.2V±2%, -Reset PPO	SOT-143	26vdf	VD3	5c	Aat
22C	AAT60022C-S15	Vdet-IC	2.2V±1%, -Reset ODO	SOT-143	26vdf	VD1	5c	Aat



SMD code	Type	Function	Short description	Case	Pinout Sch.	St.	Mnf.
22D	AAT60022D-S15	Vdet-IC	2.2V±1%, -Reset PPO	SOT-143	26vdf VD3	5c	Aat
23	R3111Q231B	Vdet-IC	2.3V±2%, +Reset ODO	SC-82AB	26vdl VD6	5a	Ric
23	XC6213B232NR	LVR-IC	LDO, 2.3V±2%, 150mA, +CE	SSOT-24	26vn VR4	5c	Tor
23	XC6217C342NR	LVR-IC	LDO, 3.4V±2%, 200mA, +CE	SSOT-24	26vn VR4	5a	Tor
23	XC6221C11BNR	LVR-IC	LDO, 1.15V±20mV, 200mA, +CE, PDR	SSOT-24	26vn VR4	5a	Tor
23A	AAT60023A-S15	Vdet-IC	2.3V±2%, -Reset ODO	SOT-143	26vdf VD1	5c	Aat
23B	AAT60023B-S15	Vdet-IC	2.3V±2%, -Reset PPO	SOT-143	26vdf VD3	5c	Aat
23C	AAT60023C-S15	Vdet-IC	2.3V±1%, -Reset ODO	SOT-143	26vdf VD1	5c	Aat
23D	AAT60023D-S15	Vdet-IC	2.3V±1%, -Reset PPO	SOT-143	26vdf VD3	5c	Aat
24	R3111Q241B	Vdet-IC	2.4V±2%, +Reset ODO	SC-82AB	26vdl VD6	5a	Ric
24	XC6213B242NR	LVR-IC	LDO, 2.4V±2%, 150mA, +CE	SSOT-24	26vn VR4	5c	Tor
24	XC6217C352NR	LVR-IC	LDO, 3.5V±2%, 200mA, +CE	SSOT-24	26vn VR4	5a	Tor
24	XC6221C12BNR	LVR-IC	LDO, 1.25V±20mV, 200mA, +CE, PDR	SSOT-24	26vn VR4	5a	Tor
24A	AAT60024A-S15	Vdet-IC	2.4V±2%, -Reset ODO	SOT-143	26vdf VD1	5c	Aat
24B	AAT60024B-S15	Vdet-IC	2.4V±2%, -Reset PPO	SOT-143	26vdf VD3	5c	Aat
24C	AAT60024C-S15	Vdet-IC	2.4V±1%, -Reset ODO	SOT-143	26vdf VD1	5c	Aat
24D	AAT60024D-S15	Vdet-IC	2.4V±1%, -Reset PPO	SOT-143	26vdf VD3	5c	Aat
25	R3111Q251B	Vdet-IC	2.5V±2%, +Reset ODO	SC-82AB	26vdl VD6	5a	Ric
25	XC6213B252NR	LVR-IC	LDO, 2.5V±2%, 150mA, +CE	SSOT-24	26vn VR4	5c	Tor
25	XC6217C362NR	LVR-IC	LDO, 3.6V±2%, 200mA, +CE	SSOT-24	26vn VR4	5a	Tor
25	XC6221C13BNR	LVR-IC	LDO, 1.35V±20mV, 200mA, +CE, PDR	SSOT-24	26vn VR4	5a	Tor
25A	AAT60025A-S15	Vdet-IC	2.5V±2%, -Reset ODO	SOT-143	26vdf VD1	5c	Aat
25B	AAT60025B-S15	Vdet-IC	2.5V±2%, -Reset PPO	SOT-143	26vdf VD3	5c	Aat
25C	AAT60025C-S15	Vdet-IC	2.5V±1%, -Reset ODO	SOT-143	26vdf VD1	5c	Aat
25D	AAT60025D-S15	Vdet-IC	2.5V±1%, -Reset PPO	SOT-143	26vdf VD3	5c	Aat
26	R3111Q261B	Vdet-IC	2.6V±2%, +Reset ODO	SC-82AB	26vdl VD6	5a	Ric
26	XC6213B262NR	LVR-IC	LDO, 2.6V±2%, 150mA, +CE	SSOT-24	26vn VR4	5c	Tor
26	XC6217C372NR	LVR-IC	LDO, 3.7V±2%, 200mA, +CE	SSOT-24	26vn VR4	5a	Tor
26	XC6221C14BNR	LVR-IC	LDO, 1.45V±20mV, 200mA, +CE, PDR	SSOT-24	26vn VR4	5a	Tor
26A	AAT60026A-S15	Vdet-IC	2.6V±2%, -Reset ODO	SOT-143	26vdf VD1	5c	Aat
26B	AAT60026B-S15	Vdet-IC	2.6V±2%, -Reset PPO	SOT-143	26vdf VD3	5c	Aat
26C	AAT60026C-S15	Vdet-IC	2.6V±1%, -Reset ODO	SOT-143	26vdf VD1	5c	Aat
26D	AAT60026D-S15	Vdet-IC	2.6V±1%, -Reset PPO	SOT-143	26vdf VD3	5c	Aat
27	R3111Q271B	Vdet-IC	2.7V±2%, +Reset ODO	SC-82AB	26vdl VD6	5a	Ric
27	XC6213B272NR	LVR-IC	LDO, 2.7V±2%, 150mA, +CE	SSOT-24	26vn VR4	5c	Tor
27	XC6217C382NR	LVR-IC	LDO, 3.8V±2%, 200mA, +CE	SSOT-24	26vn VR4	5a	Tor
27	XC6221C15BNR	LVR-IC	LDO, 1.55V±20mV, 200mA, +CE, PDR	SSOT-24	26vn VR4	5a	Tor
27A	AAT60027A-S15	Vdet-IC	2.7V±2%, -Reset ODO	SOT-143	26vdf VD1	5c	Aat
27B	AAT60027B-S15	Vdet-IC	2.7V±2%, -Reset PPO	SOT-143	26vdf VD3	5c	Aat
27C	AAT60027C-S15	Vdet-IC	2.7V±1%, -Reset ODO	SOT-143	26vdf VD1	5c	Aat
27D	AAT60027D-S15	Vdet-IC	2.7V±1%, -Reset PPO	SOT-143	26vdf VD3	5c	Aat
28	BFP280T	Si-npn	VHF/UHF, LN, 15V, 10mA, 80mW, B=50..150, 5GHz	SOT-143	24tc -	5b	Vs
28	R3111Q281B	Vdet-IC	2.8V±2%, +Reset ODO	SC-82AB	26vdl VD6	5a	Ric
28	XC6213B282NR	LVR-IC	LDO, 2.8V±2%, 150mA, +CE	SSOT-24	26vn VR4	5c	Tor
28	XC6217C392NR	LVR-IC	LDO, 3.9V±2%, 200mA, +CE	SSOT-24	26vn VR4	5a	Tor
28	XC6221C16BNR	LVR-IC	LDO, 1.65V±20mV, 200mA, +CE, PDR	SSOT-24	26vn VR4	5a	Tor
28A	AAT60028A-S15	Vdet-IC	2.8V±2%, -Reset ODO	SOT-143	26vdf VD1	5c	Aat
28B	AAT60028B-S15	Vdet-IC	2.8V±2%, -Reset PPO	SOT-143	26vdf VD3	5c	Aat
28C	AAT60028C-S15	Vdet-IC	2.8V±1%, -Reset ODO	SOT-143	26vdf VD1	5c	Aat
28D	AAT60028D-S15	Vdet-IC	2.8V±1%, -Reset PPO	SOT-143	26vdf VD3	5c	Aat
29	R3111Q291B	Vdet-IC	2.9V±2%, +Reset ODO	SC-82AB	26vdl VD6	5a	Ric
29	XC6213B292NR	LVR-IC	LDO, 2.9V±2%, 150mA, +CE	SSOT-24	26vn VR4	5c	Tor
29	XC6217C10ANR	LVR-IC	LDO, 1.05V±2%, 200mA, +CE	SSOT-24	26vn VR4	5a	Tor
29	XC6217C402NR	LVR-IC	LDO, 4V±2%, 200mA, +CE	SSOT-24	26vn VR4	5a	Tor
29	XC6221C17BNR	LVR-IC	LDO, 1.75V±20mV, 200mA, +CE, PDR	SSOT-24	26vn VR4	5a	Tor
29A	AAT60029A-S15	Vdet-IC	2.9V±2%, -Reset ODO	SOT-143	26vdf VD1	5c	Aat
29B	AAT60029B-S15	Vdet-IC	2.9V±2%, -Reset PPO	SOT-143	26vdf VD3	5c	Aat
29C	AAT60029C-S15	Vdet-IC	2.9V±1%, -Reset ODO	SOT-143	26vdf VD1	5c	Aat
29D	AAT60029D-S15	Vdet-IC	2.9V±1%, -Reset PPO	SOT-143	26vdf VD3	5c	Aat
29R	S592TR	MMIC	UHF, 8V, 20mA, 160mW, Idss=50..500µA	SOT-143R	26fm A3	5c	Vs
2A	R3132Q30EA	Vdet-IC	3V, MR, -Reset PPO	SOT-143	24vdh VD5	5a	Ric
2A	RQ5RW20AA	LVR-IC	LDO, 2V±2%, 150mA, -CE	SOT-143R	26vp VR4	5c	Ric
2A	XC6127N15CNR	Vdet-IC	1.5V±0.8%, -Reset ODO, -MR, Rt=200ms	SSOT-24	26cr VD4	5a	Tor
2A	XC6213B20ANR	LVR-IC	LDO, 2.05V±2%, 150mA, +CE	SSOT-24	26vn VR4	5c	Tor
2A	XC6221C18BNR	LVR-IC	LDO, 1.85V±20mV, 200mA, +CE, PDR	SSOT-24	26vn VR4	5a	Tor
2B	R3132Q31EA	Vdet-IC	3.1V, MR, -Reset PPO	SOT-143	24vdh VD5	5a	Ric
2B	RQ5RW21AA	LVR-IC	LDO, 2.1V±2%, 150mA, -CE	SOT-143R	26vp VR4	5c	Ric
2B	XC6127N17CNR	Vdet-IC	1.7V±0.8%, -Reset ODO, -MR, Rt=200ms	SSOT-24	26cr VD4	5a	Tor
2B	XC6213B21ANR	LVR-IC	LDO, 2.15V±2%, 150mA, +CE	SSOT-24	26vn VR4	5c	Tor
2B	XC6221C19BNR	LVR-IC	LDO, 1.95V±20mV, 200mA, +CE, PDR	SSOT-24	26vn VR4	5a	Tor



SMD code	Type	Function	Short description	Case	Pinout	Sch.	St.	Mnf.
2C	R3132Q32EA	Vdet-IC	3.2V, MR, -Reset PPO	SOT-143	24vdh	VD5	5a	Ric
2C	RQ5RW22AA	LVR-IC	LDO, 2.2V±2%, 150mA, -CE	SOT-143R	26vp	VR4	5c	Ric
2C	XC6127N19CNR	Vdet-IC	1.9V±0.8%, -Reset ODO, -MR, Rt=200ms	SSOT-24	26cr	VD4	5a	Tor
2C	XC6213B22ANR	LVR-IC	LDO, 2.25V±2%, 150mA, +CE	SSOT-24	26vn	VR4	5c	Tor
2C	XC6221C20BNR	LVR-IC	LDO, 2.05V±1%, 200mA, +CE, PDR	SSOT-24	26vn	VR4	5a	Tor
2D	R3132Q33EA	Vdet-IC	3.3V, MR, -Reset PPO	SOT-143	24vdh	VD5	5a	Ric
2D	RQ5RW23AA	LVR-IC	LDO, 2.3V±2%, 150mA, -CE	SOT-143R	26vp	VR4	5c	Ric
2D	XC6127N21CNR	Vdet-IC	2.1V±0.8%, -Reset ODO, -MR, Rt=200ms	SSOT-24	26cr	VD4	5a	Tor
2D	XC6213B23ANR	LVR-IC	LDO, 2.35V±2%, 150mA, +CE	SSOT-24	26vn	VR4	5c	Tor
2D	XC6221C21BNR	LVR-IC	LDO, 2.15V±1%, 200mA, +CE, PDR	SSOT-24	26vn	VR4	5a	Tor
2E	R3132Q34EA	Vdet-IC	3.4V, MR, -Reset PPO	SOT-143	24vdh	VD5	5a	Ric
2E	RQ5RW24AA	LVR-IC	LDO, 2.4V±2%, 150mA, -CE	SOT-143R	26vp	VR4	5c	Ric
2E	UMZ7.5K	Z-diode	Dual, 7.28..7.60V, Izt=5mA, 200mW	SOT-343	23dv	-	5f	Rhm
2E	XC6127N23CNR	Vdet-IC	2.3V±0.8%, -Reset ODO, -MR, Rt=200ms	SSOT-24	26cr	VD4	5a	Tor
2E	XC6213B24ANR	LVR-IC	LDO, 2.45V±2%, 150mA, -CE	SSOT-24	26vn	VR4	5c	Tor
2E	XC6221C22BNR	LVR-IC	LDO, 2.25V±1%, 200mA, +CE, PDR	SSOT-24	26vn	VR4	5a	Tor
2F	R3132Q35EA	Vdet-IC	3.5V, MR, -Reset PPO	SOT-143	24vdh	VD5	5a	Ric
2F	RQ5RW25AA	LVR-IC	LDO, 2.5V±2%, 150mA, -CE	SOT-143R	26vp	VR4	5c	Ric
2F	XC6127N25CNR	Vdet-IC	2.5V±0.8%, -Reset ODO, -MR, Rt=200ms	SSOT-24	26cr	VD4	5a	Tor
2F	XC6213B25ANR	LVR-IC	LDO, 2.55V±2%, 150mA, +CE	SSOT-24	26vn	VR4	5c	Tor
2F	XC6221C23BNR	LVR-IC	LDO, 2.35V±1%, 200mA, +CE, PDR	SSOT-24	26vn	VR4	5a	Tor
2G	R3132Q36EA	Vdet-IC	3.6V, MR, -Reset PPO	SOT-143	24vdh	VD5	5a	Ric
2G	RQ5RW26AA	LVR-IC	LDO, 2.6V±2%, 150mA, -CE	SOT-143R	26vp	VR4	5c	Ric
2H	R3132Q37EA	Vdet-IC	3.7V, MR, -Reset PPO	SOT-143	24vdh	VD5	5a	Ric
2H	RQ5RW27AA	LVR-IC	LDO, 2.7V±2%, 150mA, -CE	SOT-143R	26vp	VR4	5c	Ric
2H	UMZ8.2K	Z-diode	Dual, 8.02..8.36V, Izt=5mA, 200mW	SOT-343	23dv	-	5f	Rhm
2H	XC6127N27CNR	Vdet-IC	2.7V±0.8%, -Reset ODO, -MR, Rt=200ms	SSOT-24	26cr	VD4	5a	Tor
2H	XC6213B26ANR	LVR-IC	LDO, 2.65V±2%, 150mA, -CE	SSOT-24	26vn	VR4	5c	Tor
2H	XC6221C24BNR	LVR-IC	LDO, 2.45V±1%, 200mA, +CE, PDR	SSOT-24	26vn	VR4	5a	Tor
2J	IMP162JCUS	Vdet-IC	4.00V±1.5%, +Reset ODO, -MR	SOT-143	24vdh	VD4	5c	Imp
2J	R3132Q38EA	Vdet-IC	3.8V, MR, -Reset PPO	SOT-143	24vdh	VD5	5a	Ric
2J	RQ5RW28AA	LVR-IC	LDO, 2.8V±2%, 150mA, -CE	SOT-143R	26vp	VR4	5c	Ric
2K	R3132Q39EA	Vdet-IC	3.9V, MR, -Reset PPO	SOT-143	24vdh	VD5	5a	Ric
2K	RQ5RW29AA	LVR-IC	LDO, 2.9V±2%, 150mA, -CE	SOT-143R	26vp	VR4	5c	Ric
2K	UMZ11K	Z-diode	Dual, 10.76..11.22V, Izt=5mA, 200mW	SOT-343	23dv	-	5f	Rhm
2K	XC6127N29CNR	Vdet-IC	2.9V±0.8%, -Reset ODO, -MR, Rt=200ms	SSOT-24	26cr	VD4	5a	Tor
2K	XC6213B27ANR	LVR-IC	LDO, 2.75V±2%, 150mA, +CE	SSOT-24	26vn	VR4	5c	Tor
2K	XC6221C25BNR	LVR-IC	LDO, 2.55V±1%, 200mA, +CE, PDR	SSOT-24	26vn	VR4	5a	Tor
2L	IMP162LCUS	Vdet-IC	4.63V±1.5%, +Reset ODO, -MR	SOT-143	24vdh	VD4	5c	Imp
2L	R3133Q30EA	Vdet-IC	3V, MR, +Reset PPO	SOT-143	24vdh	VD5	5a	Ric
2L	RQ5RW20CA	LVR-IC	LDO, 2V±2%, 150mA	SOT-143R	26vs	VR1	5a	Ric
2L	UMZ12K	Z-diode	Dual, 11.74..12.24V, Izt=5mA, 200mW	SOT-343	23dv	-	5f	Rhm
2L	XC6127N31CNR	Vdet-IC	3.1V±0.8%, -Reset ODO, -MR, Rt=200ms	SSOT-24	26cr	VD4	5a	Tor
2L	XC6213B28ANR	LVR-IC	LDO, 2.85V±2%, 150mA, +CE	SSOT-24	26vn	VR4	5c	Tor
2L	XC6221C26BNR	LVR-IC	LDO, 2.65V±1%, 200mA, +CE, PDR	SSOT-24	26vn	VR4	5a	Tor
2LN	ELM7517CCB	Vdet-IC	1.7V±2%, +Reset PPO	SC-82AB	26vdl	VD7	5c	Elm
2LN	ELM7517NCB	Vdet-IC	1.7V±2%, +Reset ODO	SC-82AB	26vdl	VD6	5c	Elm
2M	IMP162MCUS	Vdet-IC	4.38V±1.5%, +Reset ODO, -MR	SOT-143	24vdh	VD4	5c	Imp
2M	R3133Q31EA	Vdet-IC	3.1V, MR, +Reset PPO	SOT-143	24vdh	VD5	5a	Ric
2M	RQ5RW21CA	LVR-IC	LDO, 2.1V±2%, 150mA	SOT-143R	26vs	VR1	5a	Ric
2M	UMZ15K	Z-diode	Dual, 14.34..14.98V, Izt=5mA, 200mW	SOT-343	23dv	-	5f	Rhm
2M	XC6127N33CNR	Vdet-IC	3.3V±0.8%, -Reset ODO, -MR, Rt=200ms	SSOT-24	26cr	VD4	5a	Tor
2M	XC6213B29ANR	LVR-IC	LDO, 2.95V±2%, 150mA, +CE	SSOT-24	26vn	VR4	5c	Tor
2M	XC6221C27BNR	LVR-IC	LDO, 2.75V±1%, 200mA, +CE, PDR	SSOT-24	26vn	VR4	5a	Tor
2N	R3133Q32EA	Vdet-IC	3.2V, MR, +Reset PPO	SOT-143	24vdh	VD5	5a	Ric
2N	RQ5RW22CA	LVR-IC	LDO, 2.2V±2%, 150mA	SOT-143R	26vs	VR1	5a	Ric
2N	UMZ16K	Z-diode	Dual, 15.85..16.51V, Izt=5mA, 200mW	SOT-343	23dv	-	5f	Rhm
2N	XC6127N35CNR	Vdet-IC	3.5V±0.8%, -Reset ODO, -MR, Rt=200ms	SSOT-24	26cr	VD4	5a	Tor
2N	XC6221C28BNR	LVR-IC	LDO, 2.85V±1%, 200mA, +CE, PDR	SSOT-24	26vn	VR4	5a	Tor
2P	R3133Q33EA	Vdet-IC	3.3V, MR, +Reset PPO	SOT-143	24vdh	VD5	5a	Ric
2P	RQ5RW23CA	LVR-IC	LDO, 2.3V±2%, 150mA	SOT-143R	26vs	VR1	5a	Ric
2P	UMZ18K	Z-diode	Dual, 17.56..18.35V, Izt=5mA, 200mW	SOT-343	23dv	-	5f	Rhm
2P	XC6127N37CNR	Vdet-IC	3.7V±0.8%, -Reset ODO, -MR, Rt=200ms	SSOT-24	26cr	VD4	5a	Tor
2P	XC6221C29BNR	LVR-IC	LDO, 2.95V±1%, 200mA, +CE, PDR	SSOT-24	26vn	VR4	5a	Tor
2Q	R3133Q34EA	Vdet-IC	3.4V, MR, +Reset PPO	SOT-143	24vdh	VD5	5a	Ric
2Q	UMZ20K	Z-diode	Dual, 19.52..20.39V, Izt=5mA, 200mW	SOT-343	23dv	-	5f	Rhm
2R	IMP162RCUS	Vdet-IC	2.63V±1.5%, +Reset ODO, -MR	SOT-143	24vdh	VD4	5c	Imp
2R	R3133Q35EA	Vdet-IC	3.5V, MR, +Reset PPO	SOT-143	24vdh	VD5	5a	Ric
2R	RQ5RW24CA	LVR-IC	LDO, 2.4V±2%, 150mA	SOT-143R	26vs	VR1	5a	Ric
2R	UMZ22K	Z-diode	Dual, 21.54..22.47V, Izt=5mA, 200mW	SOT-343	23dv	-	5f	Rhm



SMD code	Type	Function	Short description	Case	Pinout	Sch.	St.	Mnf.
2R	XC6127N39CNR	Vdet-IC	3.9V±0.8%, -Reset ODO, -MR, Rt=200ms	SSOT-24	26cr	VD4	5a	Tor
2R	XC6221C30BNR	LVR-IC	LDO, 3.05V±1%, 200mA, +CE, PDR	SSOT-24	26vn	VR4	5a	Tor
2S	IMP162SCUS	Vdet-IC	2.93V±1.5%, +Reset ODO, -MR	SOT-143	24vdh	VD4	5c	Imp
2S	R3133Q36EA	Vdet-IC	3.6V, MR, +Reset PPO	SOT-143	24vdh	VD5	5a	Ric
2S	RQ5RW25CA	LVR-IC	LDO, 2.5V±2%, 150mA	SOT-143R	26vs	VR1	5a	Ric
2S	UMZ24K	Z-diode	Dual, 23.72..24.78V, Izt=5mA, 200mW	SOT-343	23dv	-	5f	Rhm
2S	XC6127N41CNR	Vdet-IC	4.1V±0.8%, -Reset ODO, -MR, Rt=200ms	SSOT-24	26cr	VD4	5a	Tor
2S	XC6221C31BNR	LVR-IC	LDO, 3.15V±1%, 200mA, +CE, PDR	SSOT-24	26vn	VR4	5a	Tor
2T	IMP162TCUS	Vdet-IC	3.08V±1.5%, +Reset ODO, -MR	SOT-143	24vdh	VD4	5c	Imp
2T	R3133Q37EA	Vdet-IC	3.7V, MR, +Reset PPO	SOT-143	24vdh	VD5	5a	Ric
2T	RQ5RW26CA	LVR-IC	LDO, 2.6V±2%, 150mA	SOT-143R	26vs	VR1	5a	Ric
2T	UMZ27K	Z-diode	Dual, 26.19..27.53V, Izt=5mA, 200mW	SOT-343	23dv	-	5f	Rhm
2T	XC6127N43CNR	Vdet-IC	4.3V±0.8%, -Reset ODO, -MR, Rt=200ms	SSOT-24	26cr	VD4	5a	Tor
2T	XC6221C32BNR	LVR-IC	LDO, 3.25V±1%, 200mA, +CE, PDR	SSOT-24	26vn	VR4	5a	Tor
2U	R3133Q38EA	Vdet-IC	3.8V, MR, +Reset PPO	SOT-143	24vdh	VD5	5a	Ric
2U	RQ5RW27CA	LVR-IC	LDO, 2.7V±2%, 150mA	SOT-143R	26vs	VR1	5a	Ric
2U	UMZ30K	Z-diode	Dual, 29.19..30.69V, Izt=5mA, 200mW	SOT-343	23dv	-	5f	Rhm
2U	XC6127N45CNR	Vdet-IC	4.5V±0.8%, -Reset ODO, -MR, Rt=200ms	SSOT-24	26cr	VD4	5a	Tor
2U	XC6221C33BNR	LVR-IC	LDO, 3.35V±1%, 200mA, +CE, PDR	SSOT-24	26vn	VR4	5a	Tor
2V	R3133Q39EA	Vdet-IC	3.9V, MR, +Reset PPO	SOT-143	24vdh	VD5	5a	Ric
2V	RQ5RW28CA	LVR-IC	LDO, 2.8V±2%, 150mA	SOT-143R	26vs	VR1	5a	Ric
2V	UMZ33K	Z-diode	Dual, 32.15..33.79V, Izt=5mA, 200mW	SOT-343	23dv	-	5f	Rhm
2V	XC6127N47CNR	Vdet-IC	4.7V±0.8%, -Reset ODO, -MR, Rt=200ms	SSOT-24	26cr	VD4	5a	Tor
2V	XC6221C34BNR	LVR-IC	LDO, 3.45V±1%, 200mA, +CE, PDR	SSOT-24	26vn	VR4	5a	Tor
2W	RQ5RW29CA	LVR-IC	LDO, 2.9V±2%, 150mA	SOT-143R	26vs	VR1	5a	Ric
2W	UMZ36K	Z-diode	Dual, 35.07..36.87V, Izt=5mA, 200mW	SOT-343	23dv	-	5f	Rhm
2X	XC6127N49CNR	Vdet-IC	4.9V±0.8%, -Reset ODO, -MR, Rt=200ms	SSOT-24	26cr	VD4	5a	Tor
2X	XC6221C35BNR	LVR-IC	LDO, 3.55V±1%, 200mA, +CE, PDR	SSOT-24	26vn	VR4	5a	Tor
2Y	XC6127N51CNR	Vdet-IC	5.1V±0.8%, -Reset ODO, -MR, Rt=200ms	SSOT-24	26cr	VD4	5a	Tor
2Y	XC6221C36BNR	LVR-IC	LDO, 3.65V±1%, 200mA, +CE, PDR	SSOT-24	26vn	VR4	5a	Tor
2Z	XC6127N53CNR	Vdet-IC	5.3V±0.8%, -Reset ODO, -MR, Rt=200ms	SSOT-24	26cr	VD4	5a	Tor
2Z	XC6221C37BNR	LVR-IC	LDO, 3.75V±1%, 200mA, +CE, PDR	SSOT-24	26vn	VR4	5a	Tor
30	R3111Q301B	Vdet-IC	3V±2%, +Reset ODO	SC-82AB	26vdl	VD6	5a	Ric
30	XC6127N55DNR	Vdet-IC	5.5V±0.8%, -Reset ODO, -MR, Rt=400ms	SSOT-24	26cr	VD4	5a	Tor
30	XC6213B302NR	LVR-IC	LDO, 3V±2%, 150mA, +CE	SSOT-24	26vn	VR4	5c	Tor
30	XC6221C38BNR	LVR-IC	LDO, 3.85V±1%, 200mA, +CE, PDR	SSOT-24	26vn	VR4	5a	Tor
305	AT-30511	Si-npn	UHF, 11V, 8mA, 100mW, B=70..300, 10GHz	SOT-143	24t1	-	5c	Agj
30A	AAT60030A-S15	Vdet-IC	3.0V±2%, -Reset ODO	SOT-143	26vdf	VD1	5c	Aat
30B	AAT60030B-S15	Vdet-IC	3.0V±2%, -Reset PPO	SOT-143	26vdf	VD3	5c	Aat
30C	AAT60030C-S15	Vdet-IC	3.0V±1%, -Reset ODO	SOT-143	26vdf	VD1	5c	Aat
30D	AAT60030D-S15	Vdet-IC	3.0V±1%, -Reset PPO	SOT-143	26vdf	VD3	5c	Aat
31	R3111Q311B	Vdet-IC	3.1V±2%, +Reset ODO	SC-82AB	26vdl	VD6	5a	Ric
31	XC6213B312NR	LVR-IC	LDO, 3.1V±2%, 150mA, +CE	SSOT-24	26vn	VR4	5c	Tor
31	XC6221C39BNR	LVR-IC	LDO, 3.95V±1%, 200mA, +CE, PDR	SSOT-24	26vn	VR4	5a	Tor
310	AT-31011	Si-npn	UHF, 11V, 16mA, 150mW, B=70..300, 10GHz	SOT-143	24t1	-	5c	Agj
31A	AAT60031A-S15	Vdet-IC	3.1V±2%, -Reset ODO	SOT-143	26vdf	VD1	5c	Aat
31B	AAT60031B-S15	Vdet-IC	3.1V±2%, -Reset PPO	SOT-143	26vdf	VD3	5c	Aat
31C	AAT60031C-S15	Vdet-IC	3.1V±1%, -Reset ODO	SOT-143	26vdf	VD1	5c	Aat
31D	AAT60031D-S15	Vdet-IC	3.1V±1%, -Reset PPO	SOT-143	26vdf	VD3	5c	Aat
32	R3111Q321B	Vdet-IC	3.2V±2%, +Reset ODO	SC-82AB	26vdl	VD6	5a	Ric
32	XC6213B322NR	LVR-IC	LDO, 3.2V±2%, 150mA, +CE	SSOT-24	26vn	VR4	5c	Tor
32	XC6221C40BNR	LVR-IC	LDO, 4.05V±1%, 200mA, +CE, PDR	SSOT-24	26vn	VR4	5a	Tor
320	AT-32011	Si-npn	UHF, 11V, 32mA, 0.2W, B=70..300, 10GHz	SOT-143	24tc	-	5c	Agj
32A	AAT60032A-S15	Vdet-IC	3.2V±2%, -Reset ODO	SOT-143	26vdf	VD1	5c	Aat
32B	AAT60032B-S15	Vdet-IC	3.2V±2%, -Reset PPO	SOT-143	26vdf	VD3	5c	Aat
32C	AAT60032C-S15	Vdet-IC	3.2V±1%, -Reset ODO	SOT-143	26vdf	VD1	5c	Aat
32D	AAT60032D-S15	Vdet-IC	3.2V±1%, -Reset PPO	SOT-143	26vdf	VD3	5c	Aat
33	R3111Q331B	Vdet-IC	3.3V±2%, +Reset ODO	SC-82AB	26vdl	VD6	5a	Ric
33	XC6213B332NR	LVR-IC	LDO, 3.3V±2%, 150mA, +CE	SSOT-24	26vn	VR4	5c	Tor
33	XC6221C41BNR	LVR-IC	LDO, 4.15V±1%, 200mA, +CE, PDR	SSOT-24	26vn	VR4	5a	Tor
33A	AAT60033A-S15	Vdet-IC	3.3V±2%, -Reset ODO	SOT-143	26vdf	VD1	5c	Aat
33B	AAT60033B-S15	Vdet-IC	3.3V±2%, -Reset PPO	SOT-143	26vdf	VD3	5c	Aat
33C	AAT60033C-S15	Vdet-IC	3.3V±1%, -Reset ODO	SOT-143	26vdf	VD1	5c	Aat
33D	AAT60033D-S15	Vdet-IC	3.3V±1%, -Reset PPO	SOT-143	26vdf	VD3	5c	Aat
34	R3111Q341B	Vdet-IC	3.4V±2%, +Reset ODO	SC-82AB	26vdl	VD6	5a	Ric
34	XC6213B342NR	LVR-IC	LDO, 3.4V±2%, 150mA, +CE	SSOT-24	26vn	VR4	5c	Tor
34	XC6221C42BNR	LVR-IC	LDO, 4.25V±1%, 200mA, +CE, PDR	SSOT-24	26vn	VR4	5a	Tor
34A	AAT60034A-S15	Vdet-IC	3.4V±2%, -Reset ODO	SOT-143	26vdf	VD1	5c	Aat
34B	AAT60034B-S15	Vdet-IC	3.4V±2%, -Reset PPO	SOT-143	26vdf	VD3	5c	Aat
34C	AAT60034C-S15	Vdet-IC	3.4V±1%, -Reset ODO	SOT-143	26vdf	VD1	5c	Aat



SMD

SMD code	Type	Function	Short description	Case	Pinout Sch.	St.	Mnf.
34D	AAT60034D-S15	Vdet-IC	3.4V±1%, -Reset PPO	SOT-143	26vdf VD3	5c	Aat
35	R3111Q351B	Vdet-IC	3.5V±2%, +Reset ODO	SC-82AB	26vdl VD6	5a	Ric
35	XC6213B352NR	LVR-IC	LDO, 3.5V±2%, 150mA, +CE	SSOT-24	26vn VR4	5c	Tor
35	XC6221C43BNR	LVR-IC	LDO, 4.35V±1%, 200mA, +CE, PDR	SSOT-24	26vn VR4	5a	Tor
35A	AAT60035A-S15	Vdet-IC	3.5V±2%, -Reset ODO	SOT-143	26vdf VD1	5c	Aat
35B	AAT60035B-S15	Vdet-IC	3.5V±2%, -Reset PPO	SOT-143	26vdf VD3	5c	Aat
35C	AAT60035C-S15	Vdet-IC	3.5V±1%, -Reset ODO	SOT-143	26vdf VD1	5c	Aat
35D	AAT60035D-S15	Vdet-IC	3.5V±1%, -Reset PPO	SOT-143	26vdf VD3	5c	Aat
36	R3111Q361B	Vdet-IC	3.6V±2%, +Reset ODO	SC-82AB	26vdl VD6	5a	Ric
36	XC6213B362NR	LVR-IC	LDO, 3.6V±2%, 150mA, +CE	SSOT-24	26vn VR4	5c	Tor
36	XC6221C44BNR	LVR-IC	LDO, 4.45V±1%, 200mA, +CE, PDR	SSOT-24	26vn VR4	5a	Tor
36A	AAT60036A-S15	Vdet-IC	3.6V±2%, -Reset ODO	SOT-143	26vdf VD1	5c	Aat
36B	AAT60036B-S15	Vdet-IC	3.6V±2%, -Reset PPO	SOT-143	26vdf VD3	5c	Aat
36C	AAT60036C-S15	Vdet-IC	3.6V±1%, -Reset ODO	SOT-143	26vdf VD1	5c	Aat
36D	AAT60036D-S15	Vdet-IC	3.6V±1%, -Reset PPO	SOT-143	26vdf VD3	5c	Aat
37	R3111Q371B	Vdet-IC	3.7V±2%, +Reset ODO	SC-82AB	26vdl VD6	5a	Ric
37	XC6213B372NR	LVR-IC	LDO, 3.7V±2%, 150mA, +CE	SSOT-24	26vn VR4	5c	Tor
37	XC6217D082NR	LVR-IC	LDO, 0.8V±2%, 200mA, +CE, CL	SSOT-24	26vn VR4	5a	Tor
37	XC6221C45BNR	LVR-IC	LDO, 4.55V±1%, 200mA, +CE, PDR	SSOT-24	26vn VR4	5a	Tor
37A	AAT60037A-S15	Vdet-IC	3.7V±2%, -Reset ODO	SOT-143	26vdf VD1	5c	Aat
37B	AAT60037B-S15	Vdet-IC	3.7V±2%, -Reset PPO	SOT-143	26vdf VD3	5c	Aat
37C	AAT60037C-S15	Vdet-IC	3.7V±1%, -Reset ODO	SOT-143	26vdf VD1	5c	Aat
37D	AAT60037D-S15	Vdet-IC	3.7V±1%, -Reset PPO	SOT-143	26vdf VD3	5c	Aat
38	R3111Q381B	Vdet-IC	3.8V±2%, +Reset ODO	SC-82AB	26vdl VD6	5a	Ric
38	XC6213B382NR	LVR-IC	LDO, 3.8V±2%, 150mA, +CE	SSOT-24	26vn VR4	5c	Tor
38	XC6217D092NR	LVR-IC	LDO, 0.9V±2%, 200mA, +CE, CL	SSOT-24	26vn VR4	5a	Tor
38	XC6221C46BNR	LVR-IC	LDO, 4.65V±1%, 200mA, +CE, PDR	SSOT-24	26vn VR4	5a	Tor
38A	AAT60038A-S15	Vdet-IC	3.8V±2%, -Reset ODO	SOT-143	26vdf VD1	5c	Aat
38B	AAT60038B-S15	Vdet-IC	3.8V±2%, -Reset PPO	SOT-143	26vdf VD3	5c	Aat
38C	AAT60038C-S15	Vdet-IC	3.8V±1%, -Reset ODO	SOT-143	26vdf VD1	5c	Aat
38D	AAT60038D-S15	Vdet-IC	3.8V±1%, -Reset PPO	SOT-143	26vdf VD3	5c	Aat
39	R3111Q391B	Vdet-IC	3.9V±2%, +Reset ODO	SC-82AB	26vdl VD6	5a	Ric
39	XC6213B392NR	LVR-IC	LDO, 3.9V±2%, 150mA, +CE	SSOT-24	26vn VR4	5c	Tor
39	XC6217D102NR	LVR-IC	LDO, 1V±2%, 200mA, +CE, CL	SSOT-24	26vn VR4	5a	Tor
39	XC6221C47BNR	LVR-IC	LDO, 4.75V±1%, 200mA, +CE, PDR	SSOT-24	26vn VR4	5a	Tor
39A	AAT60039A-S15	Vdet-IC	3.9V±2%, -Reset ODO	SOT-143	26vdf VD1	5c	Aat
39B	AAT60039B-S15	Vdet-IC	3.9V±2%, -Reset PPO	SOT-143	26vdf VD3	5c	Aat
39C	AAT60039C-S15	Vdet-IC	3.9V±1%, -Reset ODO	SOT-143	26vdf VD1	5c	Aat
39D	AAT60039D-S15	Vdet-IC	3.9V±1%, -Reset PPO	SOT-143	26vdf VD3	5c	Aat
3A	2S5C473	Si-npn	HF-osc, 9V, 30mA, 150mW, B=80..200, 12GHz	SOT-343	24tu -	5b	Pan
3A	R3132Q40EA	Vdet-IC	4V, MR, -Reset PPO	SOT-143	24vdh VD5	5a	Ric
3A	RQ5RW30AA	LVR-IC	LDO, 3V±2%, 150mA, -CE	SOT-143R	26vp VR4	5c	Ric
3A	XC6127N15DNR	Vdet-IC	1.5V±0.8%, -Reset ODO, -MR, Rt=400ms	SSOT-24	26cr VD4	5a	Tor
3A	XC6213B30ANR	LVR-IC	LDO, 3.05V±2%, 150mA, +CE	SSOT-24	26vn VR4	5c	Tor
3A	XC6217D112NR	LVR-IC	LDO, 1.1V±2%, 200mA, +CE, CL	SSOT-24	26vn VR4	5a	Tor
3A	XC6221C48BNR	LVR-IC	LDO, 4.85V±1%, 200mA, +CE, PDR	SSOT-24	26vn VR4	5a	Tor
3B	R3132Q41EA	Vdet-IC	4.1V, MR, -Reset PPO	SOT-143	24vdh VD5	5a	Ric
3B	RQ5RW31AA	LVR-IC	LDO, 3.1V±2%, 150mA, -CE	SOT-143R	26vp VR4	5c	Ric
3B	XC6127N17DNR	Vdet-IC	1.7V±0.8%, -Reset ODO, -MR, Rt=400ms	SSOT-24	26cr VD4	5a	Tor
3B	XC6213B31ANR	LVR-IC	LDO, 3.15V±2%, 150mA, +CE	SSOT-24	26vn VR4	5c	Tor
3B	XC6217D122NR	LVR-IC	LDO, 1.2V±2%, 200mA, +CE, CL	SSOT-24	26vn VR4	5a	Tor
3B	XC6221C49BNR	LVR-IC	LDO, 4.95V±1%, 200mA, +CE, PDR	SSOT-24	26vn VR4	5a	Tor
3C	R3132Q42EA	Vdet-IC	4.2V, MR, -Reset PPO	SOT-143	24vdh VD5	5a	Ric
3C	RQ5RW32AA	LVR-IC	LDO, 3.2V±2%, 150mA, -CE	SOT-143R	26vp VR4	5c	Ric
3C	XC6127N19DNR	Vdet-IC	1.9V±0.8%, -Reset ODO, -MR, Rt=400ms	SSOT-24	26cr VD4	5a	Tor
3C	XC6213B32ANR	LVR-IC	LDO, 3.25V±2%, 150mA, +CE	SSOT-24	26vn VR4	5c	Tor
3C	XC6217D132NR	LVR-IC	LDO, 1.3V±2%, 200mA, +CE, CL	SSOT-24	26vn VR4	5a	Tor
3CP	3SK184-P	n-MESFET	GaAs, DG, UHF, 13V, 50mA, 200mW, Idss=8.5..17mA	SOT-143	26fm -	5b	Pan
3CQ	3SK184-Q	n-MESFET	GaAs, DG, UHF, 13V, 50mA, 200mW, Idss=15..21mA	SOT-143	26fm -	5b	Pan
3CR	3SK184-R	n-MESFET	GaAs, DG, UHF, 13V, 50mA, 200mW, Idss=19..30mA	SOT-143	26fm -	5b	Pan
3CS	3SK184-S	n-MESFET	GaAs, DG, UHF, 13V, 50mA, 200mW, Idss=25..35mA	SOT-143	26fm -	5b	Pan
3D	R3132Q43EA	Vdet-IC	4.3V, MR, -Reset PPO	SOT-143	24vdh VD5	5a	Ric
3D	RQ5RW33AA	LVR-IC	LDO, 3.3V±2%, 150mA, -CE	SOT-143R	26vp VR4	5c	Ric
3D	XC6127N21DNR	Vdet-IC	2.1V±0.8%, -Reset ODO, -MR, Rt=400ms	SSOT-24	26cr VD4	5a	Tor
3D	XC6213B33ANR	LVR-IC	LDO, 3.35V±2%, 150mA, +CE	SSOT-24	26vn VR4	5c	Tor
3D	XC6217D142NR	LVR-IC	LDO, 1.4V±2%, 200mA, +CE, CL	SSOT-24	26vn VR4	5a	Tor
3D	XC6223A301NR-G	LVR-IC	LDO, 3.0V±1%, 300mA, +CE	SSOT-24	26vn VR4	5a	Tor
3DO	3SK143-O	n-MOSFET	DG, UHF, LN, 15V, ±30mA, 200mW, Idss=0.2..1.5mA	SOT-143	26fm -	5b	Pan
3DP	3SK143-P	n-MOSFET	DG, UHF, LN, 15V, ±30mA, 200mW, Idss=0.5..4mA	SOT-143	26fm -	5b	Pan
3DQ	3SK143-Q	n-MOSFET	DG, UHF, LN, 15V, ±30mA, 200mW, Idss=3..13mA	SOT-143	26fm -	5b	Pan



SMD code	Type	Function	Short description	Case	Pinout	Sch.	St.	Mnf.
3E	R3132Q44EA	Vdet-IC	4.4V, MR, -Reset PPO	SOT-143	24vdh	VD5	5a	Ric
3E	RQ5RW34AA	LVR-IC	LDO, 3.4V±2%, 150mA, -CE	SOT-143R	26vp	VR4	5c	Ric
3E	XC6127N23DNR	Vdet-IC	2.3V±0.8%, -Reset ODO, -MR, Rt=400ms	SSOT-24	26cr	VD4	5a	Tor
3E	XC6213B34ANR	LVR-IC	LDO, 3.45V±2%, 150mA, +CE	SSOT-24	26vn	VR4	5c	Tor
3E	XC6217D152NR	LVR-IC	LDO, 1.5V±2%, 200mA, +CE, CL	SSOT-24	26vn	VR4	5a	Tor
3E	XC6223A311NR-G	LVR-IC	LDO, 3.1V±1%, 300mA, +CE	SSOT-24	26vn	VR4	5a	Tor
3EQ	3SK144-Q	n-MOSFET-d	DG, VHF, LN, 15V, ±30mA, 200mW, Idss=0.8..7mA	SOT-143	26fm	-	5b	Pan
3ER	3SK144-R	n-MOSFET-d	DG, VHF, LN, 15V, ±30mA, 150mW, Idss=4..15mA	SOT-143	26fm	-	5b	Pan
3F	R3132Q45EA	Vdet-IC	4.5V, MR, -Reset PPO	SOT-143	24vdh	VD5	5a	Ric
3F	RQ5RW35AA	LVR-IC	LDO, 3.5V±2%, 150mA, -CE	SOT-143R	26vp	VR4	5c	Ric
3F	XC6127N25DNR	Vdet-IC	2.5V±0.8%, -Reset ODO, -MR, Rt=400ms	SSOT-24	26cr	VD4	5a	Tor
3F	XC6213B35ANR	LVR-IC	LDO, 3.55V±2%, 150mA, +CE	SSOT-24	26vn	VR4	5c	Tor
3F	XC6217D162NR	LVR-IC	LDO, 1.6V±2%, 200mA, +CE, CL	SSOT-24	26vn	VR4	5a	Tor
3F	XC6223A321NR-G	LVR-IC	LDO, 3.2V±1%, 300mA, +CE	SSOT-24	26vn	VR4	5a	Tor
3G	R3132Q46EA	Vdet-IC	4.6V, MR, -Reset PPO	SOT-143	24vdh	VD5	5a	Ric
3G	RQ5RW36AA	LVR-IC	LDO, 3.6V±2%, 150mA, -CE	SOT-143R	26vp	VR4	5c	Ric
3H	R3132Q47EA	Vdet-IC	4.7V, MR, -Reset PPO	SOT-143	24vdh	VD5	5a	Ric
3H	RQ5RW37AA	LVR-IC	LDO, 3.7V±2%, 150mA, -CE	SOT-143R	26vp	VR4	5c	Ric
3H	XC6127N27DNR	Vdet-IC	2.7V±0.8%, -Reset ODO, -MR, Rt=400ms	SSOT-24	26cr	VD4	5a	Tor
3H	XC6213B36ANR	LVR-IC	LDO, 3.65V±2%, 150mA, +CE	SSOT-24	26vn	VR4	5c	Tor
3H	XC6217D172NR	LVR-IC	LDO, 1.7V±2%, 200mA, +CE, CL	SSOT-24	26vn	VR4	5a	Tor
3H	XC6223A331NR-G	LVR-IC	LDO, 3.3V±1%, 300mA, +CE	SSOT-24	26vn	VR4	5a	Tor
3J	BCV62A	Si-pnp	Dual, 30V, 100mA, 250mW, B=125..250, >100MHz	SOT-143	24t5	-	5h	Inf
3J	IMP161JEUS	Vdet-IC	4.0V±1.5%, -Reset ODO, -MR	SOT-143	24vdh	VD4	5c	Imp
3J	R3132Q48EA	Vdet-IC	4.8V, MR, -Reset PPO	SOT-143	24vdh	VD5	5a	Ric
3J	RQ5RW38AA	LVR-IC	LDO, 3.8V±2%, 150mA, -CE	SOT-143R	26vp	VR4	5c	Ric
3Jp	BCV62A	Si-pnp	Dual, 30V, 100mA, 250mW, B=125..250, >100MHz	SOT-143	24t5	-	5c	Phi
3Js	BCV62A	Si-pnp	Dual, 30V, 100mA, 300mW, B=125..220, =250MHz	SOT-143	24t5	-	5b	Sie
3K	R3132Q49EA	Vdet-IC	4.9V, MR, -Reset PPO	SOT-143	24vdh	VD5	5a	Ric
3K	RQ5RW39AA	LVR-IC	LDO, 3.9V±2%, 150mA, -CE	SOT-143R	26vp	VR4	5c	Ric
3K	XC6127N29DNR	Vdet-IC	2.9V±0.8%, -Reset ODO, -MR, Rt=400ms	SSOT-24	26cr	VD4	5a	Tor
3K	XC6213B37ANR	LVR-IC	LDO, 3.75V±2%, 150mA, +CE	SSOT-24	26vn	VR4	5c	Tor
3K	XC6217D182NR	LVR-IC	LDO, 1.8V±2%, 200mA, +CE, CL	SSOT-24	26vn	VR4	5a	Tor
3K	XC6223A341NR-G	LVR-IC	LDO, 3.4V±1%, 300mA, +CE	SSOT-24	26vn	VR4	5a	Tor
3Kp	BCV62B	Si-pnp	Dual, 30V, 100mA, 250mW, B=220..475, >100MHz	SOT-143	24t5	-	5c	Phi
3Ks	BCV62B	Si-pnp	Dual, 30V, 100mA, 300mW, B=220..475, =250MHz	SOT-143	24t5	-	5b	Sie
3L	IMP161LEUS	Vdet-IC	4.63V±1.5%, -Reset ODO, -MR	SOT-143	24vdh	VD4	5c	Imp
3L	R3133Q40EA	Vdet-IC	4V, MR, +Reset PPO	SOT-143	24vdh	VD5	5a	Ric
3L	RQ5RW30CA	LVR-IC	LDO, 3V±2%, 150mA	SOT-143R	26vs	VR1	5a	Ric
3L	XC6127N31DNR	Vdet-IC	3.1V±0.8%, -Reset ODO, -MR, Rt=400ms	SSOT-24	26cr	VD4	5a	Tor
3L	XC6213B38ANR	LVR-IC	LDO, 3.85V±2%, 150mA, +CE	SSOT-24	26vn	VR4	5c	Tor
3L	XC6217D192NR	LVR-IC	LDO, 1.9V±2%, 200mA, +CE, CL	SSOT-24	26vn	VR4	5a	Tor
3L	XC6223A351NR-G	LVR-IC	LDO, 3.5V±1%, 300mA, +CE	SSOT-24	26vn	VR4	5a	Tor
3LN	ELM7518CCB	Vdet-IC	1.8V±2%, +Reset PPO	SC-82AB	26vdl	VD7	5c	Elm
3LN	ELM7518NCB	Vdet-IC	1.8V±2%, +Reset ODO	SC-82AB	26vdl	VD6	5c	Elm
3Lp	BCV62C	Si-pnp	Dual, 30V, 100mA, 250mW, B=420..800, >100MHz	SOT-143	24t5	-	5c	Phi
3Ls	BCV62C	Si-pnp	Dual, 30V, 100mA, 300mW, B=420..800, =250MHz	SOT-143	24t5	-	5b	Sie
3M	IMP161MEUS	Vdet-IC	4.38V±1.5%, -Reset ODO, -MR	SOT-143	24vdh	VD4	5c	Imp
3M	R3133Q41EA	Vdet-IC	4.1V, MR, +Reset PPO	SOT-143	24vdh	VD5	5a	Ric
3M	RQ5RW31CA	LVR-IC	LDO, 3.1V±2%, 150mA	SOT-143R	26vs	VR1	5a	Ric
3M	XC6127N33DNR	Vdet-IC	3.3V±0.8%, -Reset ODO, -MR, Rt=400ms	SSOT-24	26cr	VD4	5a	Tor
3M	XC6213B39ANR	LVR-IC	LDO, 3.95V±2%, 150mA, +CE	SSOT-24	26vn	VR4	5c	Tor
3M	XC6217D202NR	LVR-IC	LDO, 2V±2%, 200mA, +CE, CL	SSOT-24	26vn	VR4	5a	Tor
3M	XC6223A361NR-G	LVR-IC	LDO, 3.6V±1%, 300mA, +CE	SSOT-24	26vn	VR4	5a	Tor
3Mp	BCV62	Si-pnp	Dual, 30V, 100mA, 250mW, B=100..800, >100MHz	SOT-143	24t5	-	5c	Phi
3N	R3133Q42EA	Vdet-IC	4.2V, MR, +Reset PPO	SOT-143	24vdh	VD5	5a	Ric
3N	RQ5RW32CA	LVR-IC	LDO, 3.2V±2%, 150mA	SOT-143R	26vs	VR1	5a	Ric
3N	XC6127N35DNR	Vdet-IC	3.5V±0.8%, -Reset ODO, -MR, Rt=400ms	SSOT-24	26cr	VD4	5a	Tor
3N	XC6217D212NR	LVR-IC	LDO, 2.1V±2%, 200mA, +CE, CL	SSOT-24	26vn	VR4	5a	Tor
3P	R3133Q43EA	Vdet-IC	4.3V, MR, +Reset PPO	SOT-143	24vdh	VD5	5a	Ric
3P	RQ5RW33CA	LVR-IC	LDO, 3.3V±2%, 150mA	SOT-143R	26vs	VR1	5a	Ric
3P	XC6127N37DNR	Vdet-IC	3.7V±0.8%, -Reset ODO, -MR, Rt=400ms	SSOT-24	26cr	VD4	5a	Tor
3P	XC6217D222NR	LVR-IC	LDO, 2.2V±2%, 200mA, +CE, CL	SSOT-24	26vn	VR4	5a	Tor
3P	XC6223A371NR-G	LVR-IC	LDO, 3.7V±1%, 300mA, +CE	SSOT-24	26vn	VR4	5a	Tor
3Q	R3133Q44EA	Vdet-IC	4.4V, MR, +Reset PPO	SOT-143	24vdh	VD5	5a	Ric
3R	CH481KPT	Si-diode	Dual, SBD, 30V, 200mA, Vf<0.5V(200mA)	SOT-343	26dv	-	5b	Chm
3R	IMP161REUS	Vdet-IC	2.63V±1.5%, -Reset ODO, -MR	SOT-143	24vdh	VD4	5c	Imp
3R	R3133Q45EA	Vdet-IC	4.5V, MR, +Reset PPO	SOT-143	24vdh	VD5	5a	Ric
3R	RQ5RW34CA	LVR-IC	LDO, 3.4V±2%, 150mA	SOT-143R	26vs	VR1	5a	Ric
3R	XC6127N39DNR	Vdet-IC	3.9V±0.8%, -Reset ODO, -MR, Rt=400ms	SSOT-24	26cr	VD4	5a	Tor



SMD code	Type	Function	Short description	Case	Pinout	Sch.	St.	Mnf.
3R	XC6217D232NR	LVR-IC	LDO, 2.3V±2%, 200mA, +CE, CL	SSOT-24	26vn	VR4	5a	Tor
3R	XC6223A381NR-G	LVR-IC	LDO, 3.8V±1%, 300mA, +CE	SSOT-24	26vn	VR4	5a	Tor
3S	CH480YPT	Si-diode	Dual, SBD, 30V, 100mA, Vf<0.53V(100mA)	SOT-543	59dv	-	5b	Chm
3S	IMP161SEUS	Vdet-IC	2.93V±1.5%, -Reset ODO, -MR	SOT-143	24vdh	VD4	5c	Imp
3S	R3133Q46EA	Vdet-IC	4.6V, MR, +Reset PPO	SOT-143	24vdh	VD5	5a	Ric
3S	RQ5RW35CA	LVR-IC	LDO, 3.5V±2%, 150mA	SOT-143R	26vs	VR1	5a	Ric
3S	XC6127N41DNR	Vdet-IC	4.1V±0.8%, -Reset ODO, -MR, Rt=400ms	SSOT-24	26cr	VD4	5a	Tor
3S	XC6217D242NR	LVR-IC	LDO, 2.4V±2%, 200mA, +CE, CL	SSOT-24	26vn	VR4	5a	Tor
3S	XC6223A391NR-G	LVR-IC	LDO, 3.9V±1%, 300mA, +CE	SSOT-24	26vn	VR4	5a	Tor
3T	CH480KPT	Si-diode	Dual, SBD, 45V, 100mA, Vf<0.6V(100mA)	SOT-343	26dv	-	5b	Chm
3T	IMP161TEUS	Vdet-IC	3.08V±1.5%, -Reset ODO, -MR	SOT-143	24vdh	VD4	5c	Imp
3T	R3133Q47EA	Vdet-IC	4.7V, MR, +Reset PPO	SOT-143	24vdh	VD5	5a	Ric
3T	RQ5RW36CA	LVR-IC	LDO, 3.6V±2%, 150mA	SOT-143R	26vs	VR1	5a	Ric
3T	XC6127N43DNR	Vdet-IC	4.3V±0.8%, -Reset ODO, -MR, Rt=400ms	SSOT-24	26cr	VD4	5a	Tor
3T	XC6217D252NR	LVR-IC	LDO, 2.5V±2%, 200mA, +CE, CL	SSOT-24	26vn	VR4	5a	Tor
3T	XC6223A401NR-G	LVR-IC	LDO, 4.0V±1%, 300mA, +CE	SSOT-24	26vn	VR4	5a	Tor
3U	CH481YPT	Si-diode	Dual, SBD, 30V, 100mA, Vf<0.43V(100mA)	SOT-543	59dv	-	5b	Chm
3U	R3133Q48EA	Vdet-IC	4.8V, MR, +Reset PPO	SOT-143	24vdh	VD5	5a	Ric
3U	RQ5RW37CA	LVR-IC	LDO, 3.7V±2%, 150mA	SOT-143R	26vs	VR1	5a	Ric
3U	XC6127N45DNR	Vdet-IC	4.5V±0.8%, -Reset ODO, -MR, Rt=400ms	SSOT-24	26cr	VD4	5a	Tor
3U	XC6217D262NR	LVR-IC	LDO, 2.6V±2%, 200mA, +CE, CL	SSOT-24	26vn	VR4	5a	Tor
3V	R3133Q49EA	Vdet-IC	4.9V, MR, +Reset PPO	SOT-143	24vdh	VD5	5a	Ric
3V	RQ5RW38CA	LVR-IC	LDO, 3.8V±2%, 150mA	SOT-143R	26vs	VR1	5a	Ric
3V	UMZ5.6K	Z-diode	Dual, 5.49..5.73V, Izt=5mA, 200mW	SOT-343	23dv	-	5f	Rhm
3V	XC6127N47DNR	Vdet-IC	4.7V±0.8%, -Reset ODO, -MR, Rt=400ms	SSOT-24	26cr	VD4	5a	Tor
3V	XC6217D272NR	LVR-IC	LDO, 2.7V±2%, 200mA, +CE, CL	SSOT-24	26vn	VR4	5a	Tor
3W	CH483KPT	Si-diode	Dual, SBD, 30V, 200mA, Vf<0.5V(200mA)	SOT-343	24ce	-	5b	Chm
3W	RQ5RW39CA	LVR-IC	LDO, 3.9V±2%, 150mA	SOT-143R	26vs	VR1	5a	Ric
3X	UMZ6.8K	Z-diode	Dual, 6.65..6.93V, Izt=5mA, 200mW	SOT-343	23dv	-	5f	Rhm
3X	XC6127N49DNR	Vdet-IC	4.9V±0.8%, -Reset ODO, -MR, Rt=400ms	SSOT-24	26cr	VD4	5a	Tor
3X	XC6217D282NR	LVR-IC	LDO, 2.8V±2%, 200mA, +CE, CL	SSOT-24	26vn	VR4	5a	Tor
3Y	XC6127N51DNR	Vdet-IC	5.1V±0.8%, -Reset ODO, -MR, Rt=400ms	SSOT-24	26cr	VD4	5a	Tor
3Y	XC6217D292NR	LVR-IC	LDO, 2.9V±2%, 200mA, +CE, CL	SSOT-24	26vn	VR4	5a	Tor
3Z	CH227PT	Si-diode	Dual, Sw, 80V, 100mA, Vf<1.2V(100mA), 4ns	SOT-343	26de	-	5b	Chm
3Z	UMZ10K	Z-diode	Dual, 9.77..10.21V, Izt=5mA, 200mW	SOT-343	23dv	-	5f	Rhm
3Z	XC6127N53DNR	Vdet-IC	5.3V±0.8%, -Reset ODO, -MR, Rt=400ms	SSOT-24	26cr	VD4	5a	Tor
3Z	XC6217D302NR	LVR-IC	LDO, 3V±2%, 200mA, +CE, CL	SSOT-24	26vn	VR4	5a	Tor
4.7W	MAZ3047W	Z-diode	Dual, 4.7V, If=100mA, Zzt=50Ω, 200mW	SOT-143	24ce	-	5b	Pan
40	R3111Q401B	Vdet-IC	4V±2%, +Reset ODO	SC-82AB	26vdl	VD6	5a	Ric
40	XC6127N55ENR	Vdet-IC	5.5V±0.8%, -Reset ODO, -MR, Rt=800ms	SSOT-24	26cr	VD4	5a	Tor
40	XC6213B402NR	LVR-IC	LDO, 4V±2%, 150mA, +CE	SSOT-24	26vn	VR4	5c	Tor
40	XC6217D312NR	LVR-IC	LDO, 3.1V±2%, 200mA, +CE, CL	SSOT-24	26vn	VR4	5a	Tor
40	XC6221D081NR	LVR-IC	LDO, 0.8V±20mV, 200mA, +CE, CL, PDR	SSOT-24	26vn	VR4	5a	Tor
40A	AAT60040A-S15	Vdet-IC	4.0V±2%, -Reset ODO	SOT-143	26vdf	VD1	5c	Aat
40B	AAT60040B-S15	Vdet-IC	4.0V±2%, -Reset PPO	SOT-143	26vdf	VD3	5c	Aat
40C	AAT60040C-S15	Vdet-IC	4.0V±1%, -Reset ODO	SOT-143	26vdf	VD1	5c	Aat
40D	AAT60040D-S15	Vdet-IC	4.0V±1%, -Reset PPO	SOT-143	26vdf	VD3	5c	Aat
41	R3111Q411B	Vdet-IC	4.1V±2%, +Reset ODO	SC-82AB	26vdl	VD6	5a	Ric
41	XC6213B412NR	LVR-IC	LDO, 4.1V±2%, 150mA, +CE	SSOT-24	26vn	VR4	5c	Tor
41	XC6217D322NR	LVR-IC	LDO, 3.2V±2%, 200mA, +CE, CL	SSOT-24	26vn	VR4	5a	Tor
41	XC6221D091NR	LVR-IC	LDO, 0.9V±20mV, 200mA, +CE, CL, PDR	SSOT-24	26vn	VR4	5a	Tor
414	AT-41411	Si-npn	UHF, 20V, 50mA, 225mW, B=30..270, 7GHz	SOT-143	24tc	-	5c	Agi
41A	AAT60041A-S15	Vdet-IC	4.1V±2%, -Reset ODO	SOT-143	26vdf	VD1	5c	Aat
41B	AAT60041B-S15	Vdet-IC	4.1V±2%, -Reset PPO	SOT-143	26vdf	VD3	5c	Aat
41C	AAT60041C-S15	Vdet-IC	4.1V±1%, -Reset ODO	SOT-143	26vdf	VD1	5c	Aat
41D	AAT60041D-S15	Vdet-IC	4.1V±1%, -Reset PPO	SOT-143	26vdf	VD3	5c	Aat
42	R3111Q421B	Vdet-IC	4.2V±2%, +Reset ODO	SC-82AB	26vdl	VD6	5a	Ric
42	XC6213B422NR	LVR-IC	LDO, 4.2V±2%, 150mA, +CE	SSOT-24	26vn	VR4	5c	Tor
42	XC6217D332NR	LVR-IC	LDO, 3.3V±2%, 200mA, +CE, CL	SSOT-24	26vn	VR4	5a	Tor
42	XC6221D101NR	LVR-IC	LDO, 1V±20mV, 200mA, +CE, CL, PDR	SSOT-24	26vn	VR4	5a	Tor
42A	AAT60042A-S15	Vdet-IC	4.2V±2%, -Reset ODO	SOT-143	26vdf	VD1	5c	Aat
42B	AAT60042B-S15	Vdet-IC	4.2V±2%, -Reset PPO	SOT-143	26vdf	VD3	5c	Aat
42C	AAT60042C-S15	Vdet-IC	4.2V±1%, -Reset ODO	SOT-143	26vdf	VD1	5c	Aat
42D	AAT60042D-S15	Vdet-IC	4.2V±1%, -Reset PPO	SOT-143	26vdf	VD3	5c	Aat
43	R3111Q431B	Vdet-IC	4.3V±2%, +Reset ODO	SC-82AB	26vdl	VD6	5a	Ric
43	XC6213B432NR	LVR-IC	LDO, 4.3V±2%, 150mA, +CE	SSOT-24	26vn	VR4	5c	Tor
43	XC6217D342NR	LVR-IC	LDO, 3.4V±2%, 200mA, +CE, CL	SSOT-24	26vn	VR4	5a	Tor
43	XC6221D111NR	LVR-IC	LDO, 1.1V±20mV, 200mA, +CE, CL, PDR	SSOT-24	26vn	VR4	5a	Tor
43A	AAT60043A-S15	Vdet-IC	4.3V±2%, -Reset ODO	SOT-143	26vdf	VD1	5c	Aat
43B	AAT60043B-S15	Vdet-IC	4.3V±2%, -Reset PPO	SOT-143	26vdf	VD3	5c	Aat



SMD
code

SMD code	Type	Function	Short description	Case	Pinout Sch.	St.	Mnf.
43C	AAT60043C-S15	Vdet-IC	4.3V±1%, -Reset ODO	SOT-143	26vdf VD1	5c	Aat
43D	AAT60043D-S15	Vdet-IC	4.3V±1%, -Reset PPO	SOT-143	26vdf VD3	5c	Aat
44	R3111Q441B	Vdet-IC	4.4V±2%, +Reset ODO	SC-82AB	26vdl VD6	5a	Ric
44	XC6213B442NR	LVR-IC	LDO, 4.4V±2%, 150mA, +CE	SSOT-24	26vn VR4	5c	Tor
44	XC6217D352NR	LVR-IC	LDO, 3.5V±2%, 200mA, +CE, CL	SSOT-24	26vn VR4	5a	Tor
44	XC6221D121NR	LVR-IC	LDO, 1.2V±20mV, 200mA, +CE, CL, PDR	SSOT-24	26vn VR4	5a	Tor
44A	AAT60044A-S15	Vdet-IC	4.4V±2%, -Reset ODO	SOT-143	26vdf VD1	5c	Aat
44B	AAT60044B-S15	Vdet-IC	4.4V±2%, -Reset PPO	SOT-143	26vdf VD3	5c	Aat
44C	AAT60044C-S15	Vdet-IC	4.4V±1%, -Reset ODO	SOT-143	26vdf VD1	5c	Aat
44D	AAT60044D-S15	Vdet-IC	4.4V±1%, -Reset PPO	SOT-143	26vdf VD3	5c	Aat
45	R3111Q451B	Vdet-IC	4.5V±2%, +Reset ODO	SC-82AB	26vdl VD6	5a	Ric
45	XC6213B452NR	LVR-IC	LDO, 4.5V±2%, 150mA, +CE	SSOT-24	26vn VR4	5c	Tor
45	XC6217D362NR	LVR-IC	LDO, 3.6V±2%, 200mA, +CE, CL	SSOT-24	26vn VR4	5a	Tor
45	XC6221D131NR	LVR-IC	LDO, 1.3V±20mV, 200mA, +CE, CL, PDR	SSOT-24	26vn VR4	5a	Tor
45A	AAT60045A-S15	Vdet-IC	4.5V±2%, -Reset ODO	SOT-143	26vdf VD1	5c	Aat
45B	AAT60045B-S15	Vdet-IC	4.5V±2%, -Reset PPO	SOT-143	26vdf VD3	5c	Aat
45C	AAT60045C-S15	Vdet-IC	4.5V±1%, -Reset ODO	SOT-143	26vdf VD1	5c	Aat
45D	AAT60045D-S15	Vdet-IC	4.5V±1%, -Reset PPO	SOT-143	26vdf VD3	5c	Aat
46	R3111Q461B	Vdet-IC	4.6V±2%, +Reset ODO	SC-82AB	26vdl VD6	5a	Ric
46	XC6213B462NR	LVR-IC	LDO, 4.6V±2%, 150mA, +CE	SSOT-24	26vn VR4	5c	Tor
46	XC6217D372NR	LVR-IC	LDO, 3.7V±2%, 200mA, +CE, CL	SSOT-24	26vn VR4	5a	Tor
46	XC6221D141NR	LVR-IC	LDO, 1.4V±20mV, 200mA, +CE, CL, PDR	SSOT-24	26vn VR4	5a	Tor
46A	AAT60046A-S15	Vdet-IC	4.6V±2%, -Reset ODO	SOT-143	26vdf VD1	5c	Aat
46B	AAT60046B-S15	Vdet-IC	4.6V±2%, -Reset PPO	SOT-143	26vdf VD3	5c	Aat
46C	AAT60046C-S15	Vdet-IC	4.6V±1%, -Reset ODO	SOT-143	26vdf VD1	5c	Aat
46D	AAT60046D-S15	Vdet-IC	4.6V±1%, -Reset PPO	SOT-143	26vdf VD3	5c	Aat
47	R3111Q471B	Vdet-IC	4.7V±2%, +Reset ODO	SC-82AB	26vdl VD6	5a	Ric
47	XC6213B472NR	LVR-IC	LDO, 4.7V±2%, 150mA, +CE	SSOT-24	26vn VR4	5c	Tor
47	XC6217D382NR	LVR-IC	LDO, 3.8V±2%, 200mA, +CE, CL	SSOT-24	26vn VR4	5a	Tor
47	XC6221D151NR	LVR-IC	LDO, 1.5V±20mV, 200mA, +CE, CL, PDR	SSOT-24	26vn VR4	5a	Tor
47A	AAT60047A-S15	Vdet-IC	4.7V±2%, -Reset ODO	SOT-143	26vdf VD1	5c	Aat
47B	AAT60047B-S15	Vdet-IC	4.7V±2%, -Reset PPO	SOT-143	26vdf VD3	5c	Aat
47C	AAT60047C-S15	Vdet-IC	4.7V±1%, -Reset ODO	SOT-143	26vdf VD1	5c	Aat
47D	AAT60047D-S15	Vdet-IC	4.7V±1%, -Reset PPO	SOT-143	26vdf VD3	5c	Aat
47p	BAS40-07	Si-diode	Dual, Schottky, 40V, 200mA, 200mW, Cd<5pF, <5ns	SOT-143	24ce -	5c	PHH
47s	BAS40-07	Si-diode	Dual, Schottky, 40V, 200mA, 200mW, Cd<5pF, <5ns	SOT-143	24ce -	5b	Sie
47s	BAS40-07W	Si-diode	Dual, Schottky, 40V, 200mA, 200mW, Cd<5pF, <5ns	SOT-343	24ce -	5b	Sie
47t	BAS40-07	Si-diode	Dual, Schottky, 40V, 200mA, 200mW, Cd<5pF, <5ns	SOT-143	24ce -	5c	PHM
47W	BAS40-07	Si-diode	Dual, Schottky, 40V, 200mA, 200mW, Cd<5pF, <5ns	SOT-143	24ce -	5c	PhC
48	R3111Q481B	Vdet-IC	4.8V±2%, +Reset ODO	SC-82AB	26vdl VD6	5a	Ric
48	XC6213B482NR	LVR-IC	LDO, 4.8V±2%, 150mA, +CE	SSOT-24	26vn VR4	5c	Tor
48	XC6217D392NR	LVR-IC	LDO, 3.9V±2%, 200mA, +CE, CL	SSOT-24	26vn VR4	5a	Tor
48	XC6221D161NR	LVR-IC	LDO, 1.6V±20mV, 200mA, +CE, CL, PDR	SSOT-24	26vn VR4	5a	Tor
48A	AAT60048A-S15	Vdet-IC	4.8V±2%, -Reset ODO	SOT-143	26vdf VD1	5c	Aat
48B	AAT60048B-S15	Vdet-IC	4.8V±2%, -Reset PPO	SOT-143	26vdf VD3	5c	Aat
48C	AAT60048C-S15	Vdet-IC	4.8V±1%, -Reset ODO	SOT-143	26vdf VD1	5c	Aat
48D	AAT60048D-S15	Vdet-IC	4.8V±1%, -Reset PPO	SOT-143	26vdf VD3	5c	Aat
49	R3111Q491B	Vdet-IC	4.9V±2%, +Reset ODO	SC-82AB	26vdl VD6	5a	Ric
49	XC6213B492NR	LVR-IC	LDO, 4.9V±2%, 150mA, +CE	SSOT-24	26vn VR4	5c	Tor
49	XC6217D10ANR	LVR-IC	LDO, 1.05V±2%, 200mA, +CE, CL	SSOT-24	26vn VR4	5a	Tor
49	XC6217D402NR	LVR-IC	LDO, 4V±2%, 200mA, +CE, CL	SSOT-24	26vn VR4	5a	Tor
49	XC6221D171NR	LVR-IC	LDO, 1.7V±20mV, 200mA, +CE, CL, PDR	SSOT-24	26vn VR4	5a	Tor
49A	AAT60049A-S15	Vdet-IC	4.9V±2%, -Reset ODO	SOT-143	26vdf VD1	5c	Aat
49B	AAT60049B-S15	Vdet-IC	4.9V±2%, -Reset PPO	SOT-143	26vdf VD3	5c	Aat
49C	AAT60049C-S15	Vdet-IC	4.9V±1%, -Reset ODO	SOT-143	26vdf VD1	5c	Aat
49D	AAT60049D-S15	Vdet-IC	4.9V±1%, -Reset PPO	SOT-143	26vdf VD3	5c	Aat
49D	S849TR	MMIC	UHF, 16V, 30mA, 200mW, Idss=50..500µA	SOT-143R	26fm A3	5c	Vs
4A	R3132Q50EA	Vdet-IC	5V, MR, -Reset PPO	SOT-143	24vdh VD5	5a	Ric
4A	RQ5RW40AA	LVR-IC	LDO, 4V±2%, 150mA, -CE	SOT-143R	26vp VR4	5c	Ric
4A	XC6127N15ENR	Vdet-IC	1.5V±0.8%, -Reset ODO, -MR, Rt=800ms	SSOT-24	26cr VD4	5a	Tor
4A	XC6213B40ANR	LVR-IC	LDO, 4.05V±2%, 150mA, +CE	SSOT-24	26vn VR4	5c	Tor
4A	XC6221D181NR	LVR-IC	LDO, 1.8V±20mV, 200mA, +CE, CL, PDR	SSOT-24	26vn VR4	5a	Tor
4B	RQ5RW41AA	LVR-IC	LDO, 4.1V±2%, 150mA, -CE	SOT-143R	26vp VR4	5c	Ric
4B	XC6127N17ENR	Vdet-IC	1.7V±0.8%, -Reset ODO, -MR, Rt=800ms	SSOT-24	26cr VD4	5a	Tor
4B	XC6213B41ANR	LVR-IC	LDO, 4.15V±2%, 150mA, +CE	SSOT-24	26vn VR4	5c	Tor
4B	XC6221D191NR	LVR-IC	LDO, 1.9V±20mV, 200mA, +CE, CL, PDR	SSOT-24	26vn VR4	5a	Tor
4C	3SK200	n-MOSFET-d	DG, UHF, 15V, Idss>4mA	SOT-143	26fm -	5c	Pan
4C	3SK269	n-MOSFET	DG, UHF, LN, 15V, ±30mA, 150mW, Idss=4..20mA	SOT-343	26fm -	5b	Pan
4C	RQ5RW42AA	LVR-IC	LDO, 4.2V±2%, 150mA, -CE	SOT-143R	26vp VR4	5c	Ric
4C	XC6127N19ENR	Vdet-IC	1.9V±0.8%, -Reset ODO, -MR, Rt=800ms	SSOT-24	26cr VD4	5a	Tor



SMD code	Type	Function	Short description	Case	Pinout	Sch.	St.	Mnf.
4C	XC6213B42ANR	LVR-IC	LDO, 4.25V±2%, 150mA, +CE	SSOT-24	26vn	VR4	5c	Tor
4C	XC6221D2011NR	LVR-IC	LDO, 2V±1%, 200mA, +CE, CL, PDR	SSOT-24	26vn	VR4	5a	Tor
4D	RQ5RW43AA	LVR-IC	LDO, 4.3V±2%, 150mA, -CE	SOT-143R	26vp	VR4	5c	Ric
4D	XC6127N21ENR	Vdet-IC	2.1V±0.8%, -Reset ODO, -MR, Rt=800ms	SSOT-24	26cr	VD4	5a	Tor
4D	XC6213B43ANR	LVR-IC	LDO, 4.35V±2%, 150mA, +CE	SSOT-24	26vn	VR4	5c	Tor
4D	XC6221D211NR	LVR-IC	LDO, 2.1V±1%, 200mA, +CE, CL, PDR	SSOT-24	26vn	VR4	5a	Tor
4E	RQ5RW44AA	LVR-IC	LDO, 4.4V±2%, 150mA, -CE	SOT-143R	26vp	VR4	5c	Ric
4E	XC6127N23ENR	Vdet-IC	2.3V±0.8%, -Reset ODO, -MR, Rt=800ms	SSOT-24	26cr	VD4	5a	Tor
4E	XC6213B44ANR	LVR-IC	LDO, 4.45V±2%, 150mA, +CE	SSOT-24	26vn	VR4	5c	Tor
4E	XC6221D2211NR	LVR-IC	LDO, 2.2V±1%, 200mA, +CE, CL, PDR	SSOT-24	26vn	VR4	5a	Tor
4F	RQ5RW45AA	LVR-IC	LDO, 4.5V±2%, 150mA, -CE	SOT-143R	26vp	VR4	5c	Ric
4F	XC6127N25ENR	Vdet-IC	2.5V±0.8%, -Reset ODO, -MR, Rt=800ms	SSOT-24	26cr	VD4	5a	Tor
4F	XC6213B45ANR	LVR-IC	LDO, 4.55V±2%, 150mA, +CE	SSOT-24	26vn	VR4	5c	Tor
4F	XC6221D2311NR	LVR-IC	LDO, 2.3V±1%, 200mA, +CE, CL, PDR	SSOT-24	26vn	VR4	5a	Tor
4G	RQ5RW46AA	LVR-IC	LDO, 4.6V±2%, 150mA, -CE	SOT-143R	26vp	VR4	5c	Ric
4H	RQ5RW47AA	LVR-IC	LDO, 4.7V±2%, 150mA, -CE	SOT-143R	26vp	VR4	5c	Ric
4H	XC6127N27ENR	Vdet-IC	2.7V±0.8%, -Reset ODO, -MR, Rt=800ms	SSOT-24	26cr	VD4	5a	Tor
4H	XC6213B46ANR	LVR-IC	LDO, 4.65V±2%, 150mA, +CE	SSOT-24	26vn	VR4	5c	Tor
4H	XC6221D2411NR	LVR-IC	LDO, 2.4V±1%, 200mA, +CE, CL, PDR	SSOT-24	26vn	VR4	5a	Tor
4J	IMP162JEUS	Vdet-IC	4.0V±1.5%, +Reset ODO, -MR	SOT-143	24vdh	VD4	5c	Imp
4J	RQ5RW48AA	LVR-IC	LDO, 4.8V±2%, 150mA, -CE	SOT-143R	26vp	VR4	5c	Ric
4K	RQ5RW49AA	LVR-IC	LDO, 4.9V±2%, 150mA, -CE	SOT-143R	26vp	VR4	5c	Ric
4K	XC6127N29ENR	Vdet-IC	2.9V±0.8%, -Reset ODO, -MR, Rt=800ms	SSOT-24	26cr	VD4	5a	Tor
4K	XC6213B47ANR	LVR-IC	LDO, 4.75V±2%, 150mA, +CE	SSOT-24	26vn	VR4	5c	Tor
4K	XC6221D2511NR	LVR-IC	LDO, 2.5V±1%, 200mA, +CE, CL, PDR	SSOT-24	26vn	VR4	5a	Tor
4L	IMP162LEUS	Vdet-IC	4.63V±1.5%, +Reset ODO, -MR	SOT-143	24vdh	VD4	5c	Imp
4L	R3133Q50EA	Vdet-IC	5V, MR, +Reset PPO	SOT-143	24vdh	VD5	5a	Ric
4L	RQ5RW40CA	LVR-IC	LDO, 4V±2%, 150mA	SOT-143R	26vs	VR1	5a	Ric
4L	XC6127N31ENR	Vdet-IC	3.1V±0.8%, -Reset ODO, -MR, Rt=800ms	SSOT-24	26cr	VD4	5a	Tor
4L	XC6213B48ANR	LVR-IC	LDO, 4.85V±2%, 150mA, +CE	SSOT-24	26vn	VR4	5c	Tor
4L	XC6221D2611NR	LVR-IC	LDO, 2.6V±1%, 200mA, +CE, CL, PDR	SSOT-24	26vn	VR4	5a	Tor
4LN	ELM7519CCB	Vdet-IC	1.9V±2%, +Reset PPO	SC-82AB	26vdl	VD7	5c	Elm
4LN	ELM7519NCB	Vdet-IC	1.9V±2%, +Reset ODO	SC-82AB	26vdl	VD6	5c	Elm
4M	IMP162MEUS	Vdet-IC	4.38V±1.5%, +Reset ODO, -MR	SOT-143	24vdh	VD4	5c	Imp
4M	RQ5RW41CA	LVR-IC	LDO, 4.1V±2%, 150mA	SOT-143R	26vs	VR1	5a	Ric
4M	XC6127N33ENR	Vdet-IC	3.3V±0.8%, -Reset ODO, -MR, Rt=800ms	SSOT-24	26cr	VD4	5a	Tor
4M	XC6213B49ANR	LVR-IC	LDO, 4.95V±2%, 150mA, +CE	SSOT-24	26vn	VR4	5c	Tor
4M	XC6221D2711NR	LVR-IC	LDO, 2.7V±1%, 200mA, +CE, CL, PDR	SSOT-24	26vn	VR4	5a	Tor
4N	RQ5RW42CA	LVR-IC	LDO, 4.2V±2%, 150mA	SOT-143R	26vs	VR1	5a	Ric
4N	XC6127N35ENR	Vdet-IC	3.5V±0.8%, -Reset ODO, -MR, Rt=800ms	SSOT-24	26cr	VD4	5a	Tor
4N	XC6221D2811NR	LVR-IC	LDO, 2.8V±1%, 200mA, +CE, CL, PDR	SSOT-24	26vn	VR4	5a	Tor
4P	RQ5RW43CA	LVR-IC	LDO, 4.3V±2%, 150mA	SOT-143R	26vs	VR1	5a	Ric
4P	XC6127N37ENR	Vdet-IC	3.7V±0.8%, -Reset ODO, -MR, Rt=800ms	SSOT-24	26cr	VD4	5a	Tor
4P	XC6221D2911NR	LVR-IC	LDO, 2.9V±1%, 200mA, +CE, CL, PDR	SSOT-24	26vn	VR4	5a	Tor
4R	IMP162REUS	Vdet-IC	2.63V±1.5%, +Reset ODO, -MR	SOT-143	24vdh	VD4	5c	Imp
4R	RQ5RW44CA	LVR-IC	LDO, 4.4V±2%, 150mA	SOT-143R	26vs	VR1	5a	Ric
4R	XC6127N39ENR	Vdet-IC	3.9V±0.8%, -Reset ODO, -MR, Rt=800ms	SSOT-24	26cr	VD4	5a	Tor
4R	XC6221D3011NR	LVR-IC	LDO, 3V±1%, 200mA, +CE, CL, PDR	SSOT-24	26vn	VR4	5a	Tor
4S	IMP162SEUS	Vdet-IC	2.93V±1.5%, +Reset ODO, -MR	SOT-143	24vdh	VD4	5c	Imp
4S	RQ5RW45CA	LVR-IC	LDO, 4.5V±2%, 150mA	SOT-143R	26vs	VR1	5a	Ric
4S	XC6127N41ENR	Vdet-IC	4.1V±0.8%, -Reset ODO, -MR, Rt=800ms	SSOT-24	26cr	VD4	5a	Tor
4S	XC6221D311NR	LVR-IC	LDO, 3.1V±1%, 200mA, +CE, CL, PDR	SSOT-24	26vn	VR4	5a	Tor
4T	IMP162TEUS	Vdet-IC	3.08V±1.5%, +Reset ODO, -MR	SOT-143	24vdh	VD4	5c	Imp
4T	RQ5RW46CA	LVR-IC	LDO, 4.6V±2%, 150mA	SOT-143R	26vs	VR1	5a	Ric
4T	XC6127N43ENR	Vdet-IC	4.3V±0.8%, -Reset ODO, -MR, Rt=800ms	SSOT-24	26cr	VD4	5a	Tor
4T	XC6221D3211NR	LVR-IC	LDO, 3.2V±1%, 200mA, +CE, CL, PDR	SSOT-24	26vn	VR4	5a	Tor
4U	RQ5RW47CA	LVR-IC	LDO, 4.7V±2%, 150mA	SOT-143R	26vs	VR1	5a	Ric
4U	XC6127N45ENR	Vdet-IC	4.5V±0.8%, -Reset ODO, -MR, Rt=800ms	SSOT-24	26cr	VD4	5a	Tor
4U	XC6221D3311NR	LVR-IC	LDO, 3.3V±1%, 200mA, +CE, CL, PDR	SSOT-24	26vn	VR4	5a	Tor
4V	RQ5RW48CA	LVR-IC	LDO, 4.8V±2%, 150mA	SOT-143R	26vs	VR1	5a	Ric
4V	XC6127N47ENR	Vdet-IC	4.7V±0.8%, -Reset ODO, -MR, Rt=800ms	SSOT-24	26cr	VD4	5a	Tor
4V	XC6221D3411NR	LVR-IC	LDO, 3.4V±1%, 200mA, +CE, CL, PDR	SSOT-24	26vn	VR4	5a	Tor
4W	RQ5RW49CA	LVR-IC	LDO, 4.9V±2%, 150mA	SOT-143R	26vs	VR1	5a	Ric
4X	2SC4515	Si-npn	UHF, 15V, 50mA, 200mW, 7GHz	SOT-143	26tlu	-	5c	Pan
4X	XC6127N49ENR	Vdet-IC	4.9V±0.8%, -Reset ODO, -MR, Rt=800ms	SSOT-24	26cr	VD4	5a	Tor
4X	XC6221D3511NR	LVR-IC	LDO, 3.5V±1%, 200mA, +CE, CL, PDR	SSOT-24	26vn	VR4	5a	Tor
4Y	2SC4516	Si-npn	UHF, 15V, 80mA, 200mW, 8GHz	SOT-143	26tlu	-	5c	Pan
4Y	XC6127N51ENR	Vdet-IC	5.1V±0.8%, -Reset ODO, -MR, Rt=800ms	SSOT-24	26cr	VD4	5a	Tor
4Y	XC6221D3611NR	LVR-IC	LDO, 3.6V±1%, 200mA, +CE, CL, PDR	SSOT-24	26vn	VR4	5a	Tor
4Z	XC6127N53ENR	Vdet-IC	5.3V±0.8%, -Reset ODO, -MR, Rt=800ms	SSOT-24	26cr	VD4	5a	Tor



SMD code	Type	Function	Short description	Case	Pinout	Sch.	St.	Mnf.
4Z	XC6221D371NR	LVR-IC	LDO, 3.7V±1%, 200mA, +CE, CL, PDR	SSOT-24	26vn	VR4	5a	Tor
50	R3111Q501B	Vdet-IC	5V±2%, +Reset ODO	SC-82AB	26vdl	VD6	5a	Ric
50	XC6127C55ANR	Vdet-IC	5.5V±0.8%, -Reset PPO, -MR, Rt=50ms	SSOT-24	26cr	VD5	5a	Tor
50	XC6127N55FNR	Vdet-IC	5.5V±0.8%, +Reset ODO, -MR, Rt=50ms	SSOT-24	26cr	VD4	5a	Tor
50	XC6213B502NR	LVR-IC	LDO, 5V±2%, 150mA, +CE	SSOT-24	26vn	VR4	5c	Tor
50	XC6221D381NR	LVR-IC	LDO, 3.8V±1%, 200mA, +CE, CL, PDR	SSOT-24	26vn	VR4	5a	Tor
503	S503T	MMIC	DG, UHF, 8V, 30mA, 200mW, Idss=9..18mA	SOT-143	24fd	A3	5c	Vs
504	S504T	MMIC	UHF, 8V, 30mA, 200mW, Idss=7..14mA	SOT-143	24fd	A3	5c	Vs
505	S505T	MMIC	UHF, 8V, 30mA, 200mW, Idss=8..16mA	SOT-143	24fd	A3	5c	Vs
50A	AAT60050A-S15	Vdet-IC	5.0V±2%, -Reset ODO	SOT-143	26vdf	VD1	5c	Aat
50B	AAT60050B-S15	Vdet-IC	5.0V±2%, -Reset PPO	SOT-143	26vdf	VD3	5c	Aat
50C	AAT60050C-S15	Vdet-IC	5.0V±1%, -Reset ODO	SOT-143	26vdf	VD1	5c	Aat
50D	AAT60050D-S15	Vdet-IC	5.0V±1%, -Reset PPO	SOT-143	26vdf	VD3	5c	Aat
51	R3111Q511B	Vdet-IC	5.1V±2%, +Reset ODO	SC-82AB	26vdl	VD6	5a	Ric
51	XC6221D391NR	LVR-IC	LDO, 3.9V±1%, 200mA, +CE, CL, PDR	SSOT-24	26vn	VR4	5a	Tor
51A	AAT60051A-S15	Vdet-IC	5.1V±2%, -Reset ODO	SOT-143	26vdf	VD1	5c	Aat
51B	AAT60051B-S15	Vdet-IC	5.1V±2%, -Reset PPO	SOT-143	26vdf	VD3	5c	Aat
51C	AAT60051C-S15	Vdet-IC	5.1V±1%, -Reset ODO	SOT-143	26vdf	VD1	5c	Aat
51D	AAT60051D-S15	Vdet-IC	5.1V±1%, -Reset PPO	SOT-143	26vdf	VD3	5c	Aat
52	R3111Q521B	Vdet-IC	5.2V±2%, +Reset ODO	SC-82AB	26vdl	VD6	5a	Ric
52	XC6221D401NR	LVR-IC	LDO, 4V±1%, 200mA, +CE, CL, PDR	SSOT-24	26vn	VR4	5a	Tor
52A	AAT60052A-S15	Vdet-IC	5.2V±2%, -Reset ODO	SOT-143	26vdf	VD1	5c	Aat
52B	AAT60052B-S15	Vdet-IC	5.2V±2%, -Reset PPO	SOT-143	26vdf	VD3	5c	Aat
52C	AAT60052C-S15	Vdet-IC	5.2V±1%, -Reset ODO	SOT-143	26vdf	VD1	5c	Aat
52D	AAT60052D-S15	Vdet-IC	5.2V±1%, -Reset PPO	SOT-143	26vdf	VD3	5c	Aat
53	R3111Q531B	Vdet-IC	5.3V±2%, +Reset ODO	SC-82AB	26vdl	VD6	5a	Ric
53	XC6221D411NR	LVR-IC	LDO, 4.1V±1%, 200mA, +CE, CL, PDR	SSOT-24	26vn	VR4	5a	Tor
53A	AAT60053A-S15	Vdet-IC	5.3V±2%, -Reset ODO	SOT-143	26vdf	VD1	5c	Aat
53B	AAT60053B-S15	Vdet-IC	5.3V±2%, -Reset PPO	SOT-143	26vdf	VD3	5c	Aat
53C	AAT60053C-S15	Vdet-IC	5.3V±1%, -Reset ODO	SOT-143	26vdf	VD1	5c	Aat
53D	AAT60053D-S15	Vdet-IC	5.3V±1%, -Reset PPO	SOT-143	26vdf	VD3	5c	Aat
53R	S503TR	MMIC	DG, UHF, 8V, 30mA, 200mW, Idss=9..18mA	SOT-143R	26fm	A3	5c	Vs
54	R3111Q541B	Vdet-IC	5.4V±2%, +Reset ODO	SC-82AB	26vdl	VD6	5a	Ric
54	XC6221D421NR	LVR-IC	LDO, 4.2V±1%, 200mA, +CE, CL, PDR	SSOT-24	26vn	VR4	5a	Tor
54A	AAT60054A-S15	Vdet-IC	5.4V±2%, -Reset ODO	SOT-143	26vdf	VD1	5c	Aat
54B	AAT60054B-S15	Vdet-IC	5.4V±2%, -Reset PPO	SOT-143	26vdf	VD3	5c	Aat
54C	AAT60054C-S15	Vdet-IC	5.4V±1%, -Reset ODO	SOT-143	26vdf	VD1	5c	Aat
54D	AAT60054D-S15	Vdet-IC	5.4V±1%, -Reset PPO	SOT-143	26vdf	VD3	5c	Aat
54R	S504TR	MMIC	UHF, 8V, 30mA, 200mW, Idss=7..14mA	SOT-143R	26fm	A3	5c	Vs
55	R3111Q551B	Vdet-IC	5.5V±2%, +Reset ODO	SC-82AB	26vdl	VD6	5a	Ric
55	XC6221D431NR	LVR-IC	LDO, 4.3V±1%, 200mA, +CE, CL, PDR	SSOT-24	26vn	VR4	5a	Tor
55A	AAT60055A-S15	Vdet-IC	5.5V±2%, -Reset ODO	SOT-143	26vdf	VD1	5c	Aat
55B	AAT60055B-S15	Vdet-IC	5.5V±2%, -Reset PPO	SOT-143	26vdf	VD3	5c	Aat
55C	AAT60055C-S15	Vdet-IC	5.5V±1%, -Reset ODO	SOT-143	26vdf	VD1	5c	Aat
55D	AAT60055D-S15	Vdet-IC	5.5V±1%, -Reset PPO	SOT-143	26vdf	VD3	5c	Aat
55R	S505TR	MMIC	UHF, 8V, 30mA, 200mW, Idss=8..16mA	SOT-143R	26fm	A3	5c	Vs
56	R3111Q561B	Vdet-IC	5.6V±2%, +Reset ODO	SC-82AB	26vdl	VD6	5a	Ric
56	XC6221D441NR	LVR-IC	LDO, 4.4V±1%, 200mA, +CE, CL, PDR	SSOT-24	26vn	VR4	5a	Tor
57	BAT17-07	Si-diode	Dual, Schottky, 4V, 130mA, Vf<0.6V(10mA), Cd<0.75pF	SOT-143	24ce	-	5b	Sie
57	R3111Q571B	Vdet-IC	5.7V±2%, +Reset ODO	SC-82AB	26vdl	VD6	5a	Ric
57	XC6217C08ANR	LVR-IC	LDO, 0.85V±2%, 200mA, +CE	SSOT-24	26vn	VR4	5a	Tor
57	XC6221D451NR	LVR-IC	LDO, 4.5V±1%, 200mA, +CE, CL, PDR	SSOT-24	26vn	VR4	5a	Tor
58	R3111Q581B	Vdet-IC	5.8V±2%, +Reset ODO	SC-82AB	26vdl	VD6	5a	Ric
58	XC6217C09ANR	LVR-IC	LDO, 0.95V±2%, 200mA, +CE	SSOT-24	26vn	VR4	5a	Tor
58	XC6221D461NR	LVR-IC	LDO, 4.6V±1%, 200mA, +CE, CL, PDR	SSOT-24	26vn	VR4	5a	Tor
59	R3111Q591B	Vdet-IC	5.9V±2%, +Reset ODO	SC-82AB	26vdl	VD6	5a	Ric
59	XC6221D471NR	LVR-IC	LDO, 4.7V±1%, 200mA, +CE, CL, PDR	SSOT-24	26vn	VR4	5a	Tor
592	S592T	MMIC	UHF, 8V, 20mA, 160mW, Idss=50..500µA	SOT-143	24fd	A3	5c	Vs
593	S593T	MMIC	UHF, 8V, 30mA, 200mW, Idss=50..500µA	SOT-143	24fd	A3	5c	Vs
594	S594T	MMIC	UHF, 8V, 20mA, 160mW, Idss=50..500µA	SOT-143	24fd	A3	5c	Vs
595	S595T	MMIC	UHF, 8V, 20mA, 200µA, Idss=50..500µA	SOT-143	24fd	A3	5c	Vs
59R	S595TR	MMIC	UHF, 8V, 20mA, 200µA, Idss=50..500µA	SOT-143R	26fm	A3	5c	Vs
5A	R3132Q10EC	Vdet-IC	1V, MR, -Reset ODO	SOT-143	24vdh	VD4	5a	Ric
5A	RQ5RW50AA	LVR-IC	LDO, 5V±2%, 150mA, -CE	SOT-143R	26vp	VR4	5c	Ric
5A	XC6127C15ANR	Vdet-IC	1.5V±0.8%, -Reset PPO, -MR, Rt=50ms	SSOT-24	26cr	VD5	5a	Tor
5A	XC6127N15FNR	Vdet-IC	1.5V±0.8%, +Reset ODO, -MR, Rt=50ms	SSOT-24	26cr	VD4	5a	Tor
5A	XC6217C11ANR	LVR-IC	LDO, 1.15V±2%, 200mA, +CE	SSOT-24	26vn	VR4	5a	Tor
5A	XC6221D481NR	LVR-IC	LDO, 4.8V±1%, 200mA, +CE, CL, PDR	SSOT-24	26vn	VR4	5a	Tor
5B	R3132Q11EC	Vdet-IC	1.1V, MR, -Reset ODO	SOT-143	24vdh	VD4	5a	Ric
5B	RQ5RW51AA	LVR-IC	LDO, 5.1V±2%, 150mA, -CE	SOT-143R	26vp	VR4	5c	Ric



SMD code	Type	Function	Short description	Case	Pinout	Sch.	St.	Mnf.
5B	UMZ13K	Z-diode	Dual, 12.91..13.49V, Izt=5mA, 200mW	SOT-343	23dv	-	5f	Rhm
5B	XC6127C17ANR	Vdet-IC	1.7V±0.8%, -Reset PPO, -MR, Rt=50ms	SSOT-24	26cr	VD5	5a	Tor
5B	XC6127N17FNRR	Vdet-IC	1.7V±0.8%, +Reset ODO, -MR, Rt=50ms	SSOT-24	26cr	VD4	5a	Tor
5B	XC6217C12ANR	LVR-IC	LDO, 1.25V±2%, 200mA, +CE	SSOT-24	26vn	VR4	5a	Tor
5B	XC6221D491NRR	LVR-IC	LDO, 4.9V±1%, 200mA, +CE, CL, PDR	SSOT-24	26vn	VR4	5a	Tor
5C	R3132Q12EC	Vdet-IC	1.2V, MR, -Reset ODO	SOT-143	24vdh	VD4	5a	Ric
5C	RQ5RW52AA	LVR-IC	LDO, 5.2V±2%, 150mA, -CE	SOT-143R	26vp	VR4	5c	Ric
5C	XC6127C19ANR	Vdet-IC	1.9V±0.8%, -Reset PPO, -MR, Rt=50ms	SSOT-24	26cr	VD5	5a	Tor
5C	XC6127N19FNRR	Vdet-IC	1.9V±0.8%, +Reset ODO, -MR, Rt=50ms	SSOT-24	26cr	VD4	5a	Tor
5C	XC6217C13ANR	LVR-IC	LDO, 1.35V±2%, 200mA, +CE	SSOT-24	26vn	VR4	5a	Tor
5C	XC6221D501NRR	LVR-IC	LDO, 5.0V±1%, 200mA, +CE, CLL, PDR	SSOT-24	26vn	VR4	5a	Tor
5D	R3132Q13EC	Vdet-IC	1.3V, MR, -Reset ODO	SOT-143	24vdh	VD4	5a	Ric
5D	RQ5RW53AA	LVR-IC	LDO, 5.3V±2%, 150mA, -CE	SOT-143R	26vp	VR4	5c	Ric
5D	XC6127C21ANR	Vdet-IC	2.1V±0.8%, -Reset PPO, -MR, Rt=50ms	SSOT-24	26cr	VD5	5a	Tor
5D	XC6127N21FNRR	Vdet-IC	2.1V±0.8%, +Reset ODO, -MR, Rt=50ms	SSOT-24	26cr	VD4	5a	Tor
5D	XC6217C14ANR	LVR-IC	LDO, 1.45V±2%, 200mA, -CE	SSOT-24	26vn	VR4	5a	Tor
5E	R3132Q14EC	Vdet-IC	1.4V, MR, -Reset ODO	SOT-143	24vdh	VD4	5a	Ric
5E	RQ5RW54AA	LVR-IC	LDO, 5.4V±2%, 150mA, -CE	SOT-143R	26vp	VR4	5c	Ric
5E	UMZ9.1K	Z-diode	Dual, 8.85..9.23V, Izt=5mA, 200mW	SOT-343	23dv	-	5f	Rhm
5E	XC6127C23ANR	Vdet-IC	2.3V±0.8%, -Reset PPO, -MR, Rt=50ms	SSOT-24	26cr	VD5	5a	Tor
5E	XC6127N23FNRR	Vdet-IC	2.3V±0.8%, +Reset ODO, -MR, Rt=50ms	SSOT-24	26cr	VD4	5a	Tor
5E	XC6217C15ANR	LVR-IC	LDO, 1.55V±2%, 200mA, +CE	SSOT-24	26vn	VR4	5a	Tor
5F	R3132Q15EC	Vdet-IC	1.5V, MR, -Reset ODO	SOT-143	24vdh	VD4	5a	Ric
5F	RQ5RW55AA	LVR-IC	LDO, 5.5V±2%, 150mA, -CE	SOT-143R	26vp	VR4	5c	Ric
5F	XC6127C25ANR	Vdet-IC	2.5V±0.8%, -Reset PPO, -MR, Rt=50ms	SSOT-24	26cr	VD5	5a	Tor
5F	XC6127N25FNRR	Vdet-IC	2.5V±0.8%, +Reset ODO, -MR, Rt=50ms	SSOT-24	26cr	VD4	5a	Tor
5F	XC6217C16ANR	LVR-IC	LDO, 1.65V±2%, 200mA, +CE	SSOT-24	26vn	VR4	5a	Tor
5G	R3132Q16EC	Vdet-IC	1.6V, MR, -Reset ODO	SOT-143	24vdh	VD4	5a	Ric
5G	RQ5RW56AA	LVR-IC	LDO, 5.6V±2%, 150mA, -CE	SOT-143R	26vp	VR4	5c	Ric
5H	R3132Q17EC	Vdet-IC	1.7V, MR, -Reset ODO	SOT-143	24vdh	VD4	5a	Ric
5H	RQ5RW57AA	LVR-IC	LDO, 5.7V±2%, 150mA, -CE	SOT-143R	26vp	VR4	5c	Ric
5H	XC6127C27ANR	Vdet-IC	2.7V±0.8%, -Reset PPO, -MR, Rt=50ms	SSOT-24	26cr	VD5	5a	Tor
5H	XC6127N27FNRR	Vdet-IC	2.7V±0.8%, +Reset ODO, -MR, Rt=50ms	SSOT-24	26cr	VD4	5a	Tor
5H	XC6217C17ANR	LVR-IC	LDO, 1.75V±2%, 200mA, +CE	SSOT-24	26vn	VR4	5a	Tor
5J	R3132Q18EC	Vdet-IC	1.8V, MR, -Reset ODO	SOT-143	24vdh	VD4	5a	Ric
5J	RQ5RW58AA	LVR-IC	LDO, 5.8V±2%, 150mA, -CE	SOT-143R	26vp	VR4	5c	Ric
5K	R3132Q19EC	Vdet-IC	1.9V, MR, -Reset ODO	SOT-143	24vdh	VD4	5a	Ric
5K	RQ5RW59AA	LVR-IC	LDO, 5.9V±2%, 150mA, -CE	SOT-143R	26vp	VR4	5c	Ric
5K	XC6127C29ANR	Vdet-IC	2.9V±0.8%, -Reset PPO, -MR, Rt=50ms	SSOT-24	26cr	VD5	5a	Tor
5K	XC6127N29FNRR	Vdet-IC	2.9V±0.8%, +Reset ODO, -MR, Rt=50ms	SSOT-24	26cr	VD4	5a	Tor
5K	XC6217C18ANR	LVR-IC	LDO, 1.85V±2%, 200mA, +CE	SSOT-24	26vn	VR4	5a	Tor
5L	R3133Q10EC	Vdet-IC	1V, MR, +Reset ODO	SOT-143	24vdh	VD4	5a	Ric
5L	RQ5RW50CA	LVR-IC	LDO, 5V±2%, 150mA	SOT-143R	26vs	VR1	5a	Ric
5L	XC6127C31ANR	Vdet-IC	3.1V±0.8%, -Reset PPO, -MR, Rt=50ms	SSOT-24	26cr	VD5	5a	Tor
5L	XC6127N31FNRR	Vdet-IC	3.1V±0.8%, +Reset ODO, -MR, Rt=50ms	SSOT-24	26cr	VD4	5a	Tor
5L	XC6217C19ANR	LVR-IC	LDO, 1.95V±2%, 200mA, +CE	SSOT-24	26vn	VR4	5a	Tor
5LN	ELM7542CCB	Vdet-IC	4.2V±2%, +Reset PPO	SC-82AB	26vdl	VD7	5c	Elm
5LN	ELM7542NCB	Vdet-IC	4.2V±2%, +Reset ODO	SC-82AB	26vdl	VD6	5c	Elm
5M	R3133Q11EC	Vdet-IC	1.1V, MR, +Reset ODO	SOT-143	24vdh	VD4	5a	Ric
5M	RQ5RW51CA	LVR-IC	LDO, 5.1V±2%, 150mA	SOT-143R	26vs	VR1	5a	Ric
5M	XC6127C33ANR	Vdet-IC	3.3V±0.8%, -Reset PPO, -MR, Rt=50ms	SSOT-24	26cr	VD5	5a	Tor
5M	XC6127N33FNRR	Vdet-IC	3.3V±0.8%, +Reset ODO, -MR, Rt=50ms	SSOT-24	26cr	VD4	5a	Tor
5M	XC6217C20ANR	LVR-IC	LDO, 2.05V±2%, 200mA, +CE	SSOT-24	26vn	VR4	5a	Tor
5M	XC6223B29BNR-G	LVR-IC	LDO, 2.95V±1%, 300mA, +CE, CL	SSOT-24	26vn	VR4	5a	Tor
5N	R3133Q12EC	Vdet-IC	1.2V, MR, +Reset ODO	SOT-143	24vdh	VD4	5a	Ric
5N	RQ5RW52CA	LVR-IC	LDO, 5.2V±2%, 150mA	SOT-143R	26vs	VR1	5a	Ric
5N	XC6127C35ANR	Vdet-IC	3.5V±0.8%, -Reset PPO, -MR, Rt=50ms	SSOT-24	26cr	VD5	5a	Tor
5N	XC6127N35FNRR	Vdet-IC	3.5V±0.8%, +Reset ODO, -MR, Rt=50ms	SSOT-24	26cr	VD4	5a	Tor
5N	XC6217C21ANR	LVR-IC	LDO, 2.15V±2%, 200mA, +CE	SSOT-24	26vn	VR4	5a	Tor
5N	XC6223B30BNR-G	LVR-IC	LDO, 3.05V±1%, 300mA, +CE, CL	SSOT-24	26vn	VR4	5a	Tor
5P	R3133Q13EC	Vdet-IC	1.3V, MR, +Reset ODO	SOT-143	24vdh	VD4	5a	Ric
5P	RQ5RW53CA	LVR-IC	LDO, 5.3V±2%, 150mA	SOT-143R	26vs	VR1	5a	Ric
5P	XC6127C37ANR	Vdet-IC	3.7V±0.8%, -Reset PPO, -MR, Rt=50ms	SSOT-24	26cr	VD5	5a	Tor
5P	XC6127N37FNRR	Vdet-IC	3.7V±0.8%, +Reset ODO, -MR, Rt=50ms	SSOT-24	26cr	VD4	5a	Tor
5P	XC6217C22ANR	LVR-IC	LDO, 2.25V±2%, 200mA, +CE	SSOT-24	26vn	VR4	5a	Tor
5P	XC6223B31BNR-G	LVR-IC	LDO, 3.15V±1%, 300mA, +CE, CL	SSOT-24	26vn	VR4	5a	Tor
5Q	R3133Q14EC	Vdet-IC	1.4V, MR, +Reset ODO	SOT-143	24vdh	VD4	5a	Ric
5R	R3133Q15EC	Vdet-IC	1.5V, MR, +Reset ODO	SOT-143	24vdh	VD4	5a	Ric
5R	RQ5RW54CA	LVR-IC	LDO, 5.4V±2%, 150mA	SOT-143R	26vs	VR1	5a	Ric
5R	XC6127C39ANR	Vdet-IC	3.9V±0.8%, -Reset PPO, -MR, Rt=50ms	SSOT-24	26cr	VD5	5a	Tor



SMD code	Type	Function	Short description	Case	Pinout	Sch.	St.	Mnf.
5R	XC6127N39FNR	Vdet-IC	3.9V±0.8%, +Reset ODO, -MR, Rt=50ms	SSOT-24	26cr	VD4	5a	Tor
5R	XC6217C23ANR	LVR-IC	LDO, 2.35V±2%, 200mA, +CE	SSOT-24	26vn	VR4	5a	Tor
5R	XC6223B32BNR-G	LVR-IC	LDO, 3.25V±1%, 300mA, +CE, CL	SSOT-24	26vn	VR4	5a	Tor
5S	R3133Q16EC	Vdet-IC	1.6V, MR, +Reset ODO	SOT-143	24vdh	VD4	5a	Ric
5S	RQ5RW55CA	LVR-IC	LDO, 5.5V±2%, 150mA	SOT-143R	26vs	VR1	5a	Ric
5S	XC6127C41ANR	Vdet-IC	4.1V±0.8%, -Reset PPO, -MR, Rt=50ms	SSOT-24	26cr	VD5	5a	Tor
5S	XC6127N41FNR	Vdet-IC	4.1V±0.8%, +Reset ODO, -MR, Rt=50ms	SSOT-24	26cr	VD4	5a	Tor
5S	XC6217C24ANR	LVR-IC	LDO, 2.45V±2%, 200mA, +CE	SSOT-24	26vn	VR4	5a	Tor
5S	XC6223B33BNR-G	LVR-IC	LDO, 3.35V±1%, 300mA, +CE, CL	SSOT-24	26vn	VR4	5a	Tor
5T	R3133Q17EC	Vdet-IC	1.7V, MR, +Reset ODO	SOT-143	24vdh	VD4	5a	Ric
5T	RQ5RW56CA	LVR-IC	LDO, 5.6V±2%, 150mA	SOT-143R	26vs	VR1	5a	Ric
5T	XC6127C43ANR	Vdet-IC	4.3V±0.8%, -Reset PPO, -MR, Rt=50ms	SSOT-24	26cr	VD5	5a	Tor
5T	XC6127N43FNR	Vdet-IC	4.3V±0.8%, +Reset ODO, -MR, Rt=50ms	SSOT-24	26cr	VD4	5a	Tor
5T	XC6217C25ANR	LVR-IC	LDO, 2.55V±2%, 200mA, +CE	SSOT-24	26vn	VR4	5a	Tor
5T	XC6223B34BNR-G	LVR-IC	LDO, 3.45V±1%, 300mA, +CE, CL	SSOT-24	26vn	VR4	5a	Tor
5U	R3133Q18EC	Vdet-IC	1.8V, MR, +Reset ODO	SOT-143	24vdh	VD4	5a	Ric
5U	RQ5RW57CA	LVR-IC	LDO, 5.7V±2%, 150mA	SOT-143R	26vs	VR1	5a	Ric
5U	UMZ3.6K	Z-diode	Dual, 3.60...3.845V, Izt=5mA, 200mW	SOT-343	23dv	-	5f	Rhm
5U	XC6127C45ANR	Vdet-IC	4.5V±0.8%, -Reset PPO, -MR, Rt=50ms	SSOT-24	26cr	VD5	5a	Tor
5U	XC6127N45FNR	Vdet-IC	4.5V±0.8%, +Reset ODO, -MR, Rt=50ms	SSOT-24	26cr	VD4	5a	Tor
5U	XC6217C26ANR	LVR-IC	LDO, 2.65V±2%, 200mA, +CE	SSOT-24	26vn	VR4	5a	Tor
5U	XC6223B35BNR-G	LVR-IC	LDO, 3.55V±1%, 300mA, +CE, CL	SSOT-24	26vn	VR4	5a	Tor
5V	R3133Q19EC	Vdet-IC	1.9V, MR, +Reset ODO	SOT-143	24vdh	VD4	5a	Ric
5V	RQ5RW58CA	LVR-IC	LDO, 5.8V±2%, 150mA	SOT-143R	26vs	VR1	5a	Ric
5V	UMZ3.9K	Z-diode	Dual, 3.89...4.16V, Izt=5mA, 200mW	SOT-343	23dv	-	5f	Rhm
5V	XC6127C47ANR	Vdet-IC	4.7V±0.8%, -Reset PPO, -MR, Rt=50ms	SSOT-24	26cr	VD5	5a	Tor
5V	XC6127N47FNR	Vdet-IC	4.7V±0.8%, +Reset ODO, -MR, Rt=50ms	SSOT-24	26cr	VD4	5a	Tor
5V	XC6217C27ANR	LVR-IC	LDO, 2.75V±2%, 200mA, +CE	SSOT-24	26vn	VR4	5a	Tor
5V	XC6223B36BNR-G	LVR-IC	LDO, 3.65V±1%, 300mA, +CE, CL	SSOT-24	26vn	VR4	5a	Tor
5W	RQ5RW59CA	LVR-IC	LDO, 5.9V±2%, 150mA	SOT-143R	26vs	VR1	5a	Ric
5W	UMZ4.3K	Z-diode	Dual, 4.17...4.43V, Izt=5mA, 200mW	SOT-343	23dv	-	5f	Rhm
5X	UMZ4.7K	Z-diode	Dual, 4.55...4.75V, Izt=5mA, 200mW	SOT-343	23dv	-	5f	Rhm
5X	XC6127C49ANR	Vdet-IC	4.9V±0.8%, -Reset PPO, -MR, Rt=50ms	SSOT-24	26cr	VD5	5a	Tor
5X	XC6127N49FNR	Vdet-IC	4.9V±0.8%, +Reset ODO, -MR, Rt=50ms	SSOT-24	26cr	VD4	5a	Tor
5X	XC6217C28ANR	LVR-IC	LDO, 2.85V±2%, 200mA, +CE	SSOT-24	26vn	VR4	5a	Tor
5X	XC6223B37BNR-G	LVR-IC	LDO, 3.75V±1%, 300mA, +CE, CL	SSOT-24	26vn	VR4	5a	Tor
5Y	UMZ5.1K	Z-diode	Dual, 4.98...5.20V, Izt=5mA, 200mW	SOT-343	23dv	-	5f	Rhm
5Y	XC6127C51ANR	Vdet-IC	5.1V±0.8%, -Reset PPO, -MR, Izt=50ms	SSOT-24	26cr	VD5	5a	Tor
5Y	XC6127N51FNR	Vdet-IC	5.1V±0.8%, +Reset ODO, -MR, Rt=50ms	SSOT-24	26cr	VD4	5a	Tor
5Y	XC6217C29ANR	LVR-IC	LDO, 2.95V±2%, 200mA, +CE	SSOT-24	26vn	VR4	5a	Tor
5Y	XC6223B38BNR-G	LVR-IC	LDO, 3.85V±1%, 300mA, +CE, CL	SSOT-24	26vn	VR4	5a	Tor
5Z	UMZ6.2K	Z-diode	Dual, 6.06...6.33V, Izt=5mA, 200mW	SOT-343	23dv	-	5f	Rhm
5Z	XC6127C53ANR	Vdet-IC	5.3V±0.8%, -Reset PPO, -MR, Rt=50ms	SSOT-24	26cr	VD5	5a	Tor
5Z	XC6127N53FNR	Vdet-IC	5.3V±0.8%, +Reset ODO, -MR, Rt=50ms	SSOT-24	26cr	VD4	5a	Tor
5Z	XC6217C30ANR	LVR-IC	LDO, 3.05V±2%, 200mA, +CE	SSOT-24	26vn	VR4	5a	Tor
5Z	XC6223B39BNR-G	LVR-IC	LDO, 3.95V±1%, 300mA, +CE, CL	SSOT-24	26vn	VR4	5a	Tor
6.2W	MAZ3062W	Z-diode	Dual, 6.2V, If=100mA, Zzt=20Ω, 200mW	SOT-143	24ce	-	5b	Pan
60	BAR60	PIN-diode	Triple, RF, 100V, 140mA, 250mW, Vf<1.25V (100mA), <0.5pF	SOT-143	24cd	-	5b	Sie
60	R3111Q601B	Vdet-IC	6V±2%, +Reset ODO	SC-82AB	26vdl	VD6	5a	Ric
60	XC6127C55BNR	Vdet-IC	5.5V±0.8%, -Reset PPO, -MR, Rt=100ms	SSOT-24	26cr	VD5	5a	Tor
60	XC6127N55GNR	Vdet-IC	5.5V±0.8%, +Reset ODO, -MR, Rt=100ms	SSOT-24	26cr	VD4	5a	Tor
60	XC6217C31ANR	LVR-IC	LDO, 3.15V±2%, 200mA, +CE	SSOT-24	26vn	VR4	5a	Tor
60	XC6221D08BNR	LVR-IC	LDO, 0.85V±20mV, 200mA, +CE, CL, PDR	SSOT-24	26vn	VR4	5a	Tor
61	BAR61	PIN-diode	Triple, RF, 100V, 140mA, 250mW, Vf<1.25V (100mA), <0.5pF	SOT-143	24do	-	5b	Sie
61	XC6217C32ANR	LVR-IC	LDO, 3.25V±2%, 200mA, +CE	SSOT-24	26vn	VR4	5a	Tor
61	XC6221D09BNR	LVR-IC	LDO, 0.95V±20mV, 200mA, +CE, CL, PDR	SSOT-24	26vn	VR4	5a	Tor
61s	BAR61	PIN-diode	Triple, RF, 100V, 140mA, 250mW, Vf<1.25V (100mA), <0.5pF	SOT-143	24do	-	5h	Inf
62	BAT62	Si-diode	Dual, Schottky, 40V, 20mA; Vf<1.0V, Cd<0.6pF	SOT-143	24cs	-	5h	Kex
62	XC6217C33ANR	LVR-IC	LDO, 3.35V±2%, 200mA, +CE	SSOT-24	26vn	VR4	5a	Tor
62	XC6221D10BNR	LVR-IC	LDO, 1.05V±20mV, 200mA, +CE, CL, PDR	SSOT-24	26vn	VR4	5a	Tor
62s	BAT62	Si-diode	Dual, Schottky, 40V, 20mA; Vf<1.0V, Cd<0.6pF	SOT-143	24cs	-	5h	Inf
62s	BAT62-07W	Si-diode	Dual, Schottky, 40V, 20mA; Vf<1.0V, Cd<0.6pF	SOT-343	26ce	-	5h	Inf
63	XC6217C34ANR	LVR-IC	LDO, 3.45V±2%, 200mA, +CE	SSOT-24	26vn	VR4	5a	Tor
63	XC6221D11BNR	LVR-IC	LDO, 1.15V±20mV, 200mA, +CE, CL, PDR	SSOT-24	26vn	VR4	5a	Tor
64	XC6217C35ANR	LVR-IC	LDO, 3.55V±2%, 200mA, +CE	SSOT-24	26vn	VR4	5a	Tor
64	XC6221D12BNR	LVR-IC	LDO, 1.25V±20mV, 200mA, +CE, CL, PDR	SSOT-24	26vn	VR4	5a	Tor
65	XC6217C36ANR	LVR-IC	LDO, 3.65V±2%, 200mA, +CE	SSOT-24	26vn	VR4	5a	Tor
65	XC6221D13BNR	LVR-IC	LDO, 1.35V±20mV, 200mA, +CE, CL, PDR	SSOT-24	26vn	VR4	5a	Tor
66	XC6217C37ANR	LVR-IC	LDO, 3.75V±2%, 200mA, +CE	SSOT-24	26vn	VR4	5a	Tor
66	XC6221D14BNR	LVR-IC	LDO, 1.45V±20mV, 200mA, +CE, CL, PDR	SSOT-24	26vn	VR4	5a	Tor



SMD code	Type	Function	Short description	Case	Pinout	Sch.	St.	Mnf.
67	XC6217C38ANR	LVR-IC	LDO, 3.85V±2%, 200mA, +CE	SSOT-24	26vn	VR4	5a	Tor
67	XC6221D15BNR	LVR-IC	LDO, 1.55V±20mV, 200mA, +CE, CL, PDR	SSOT-24	26vn	VR4	5a	Tor
68	XC6217C39ANR	LVR-IC	LDO, 3.95V±2%, 200mA, +CE	SSOT-24	26vn	VR4	5a	Tor
68	XC6221D16BNR	LVR-IC	LDO, 1.65V±20mV, 200mA, +CE, CL, PDR	SSOT-24	26vn	VR4	5a	Tor
69	XC6221D17BNR	LVR-IC	LDO, 1.75V±20mV, 200mA, +CE, CL, PDR	SSOT-24	26vn	VR4	5a	Tor
692Ax	SS8039L2637C	Vdet-IC	2.63V±1.5%, -Reset PPO, -MR	SOT-143	24vdh	VD5	5c	Ssc
692Bx	SS8039L2937C	Vdet-IC	2.93V±1.5%, -Reset PPO, -MR	SOT-143	24vdh	VD5	5c	Ssc
692Cx	SS8039L3087C	Vdet-IC	3.08V±1.5%, -Reset PPO, -MR	SOT-143	24vdh	VD5	5c	Ssc
692Dx	SS8039L4007C	Vdet-IC	4.0V±1.5%, -Reset PPO, -MR	SOT-143	24vdh	VD5	5c	Ssc
692Ex	SS8039L4387C	Vdet-IC	4.38V±1.5%, -Reset PPO, -MR	SOT-143	24vdh	VD5	5c	Ssc
692Fx	SS8039L4637C	Vdet-IC	4.63V±1.5%, -Reset PPO, -MR	SOT-143	24vdh	VD5	5c	Ssc
692Gx	SS8039H2637C	Vdet-IC	2.63V±1.5%, +Reset PPO, -MR	SOT-143	24vdh	VD5	5c	Ssc
692Hx	SS8039H2937C	Vdet-IC	2.93V±1.5%, +Reset PPO, -MR	SOT-143	24vdh	VD5	5c	Ssc
692Jx	SS8039H3087C	Vdet-IC	3.08V±1.5%, +Reset PPO, -MR	SOT-143	24vdh	VD5	5c	Ssc
692Lx	SS8039H4007C	Vdet-IC	4.0V±1.5%, +Reset PPO, -MR	SOT-143	24vdh	VD5	5c	Ssc
692Kx	SS8039H4387C	Vdet-IC	4.38V±1.5%, +Reset PPO, -MR	SOT-143	24vdh	VD5	5c	Ssc
692Lx	SS8039H4637C	Vdet-IC	4.63V±1.5%, +Reset PPO, -MR	SOT-143	24vdh	VD5	5c	Ssc
6A	R3132Q20EC	Vdet-IC	2V, MR, -Reset ODO	SOT-143	24vdh	VD4	5a	Ric
6A	RQ5RW60AA	LVR-IC	LDO, 6V±2%, 150mA, -CE	SOT-143R	26vp	VR4	5c	Ric
6A	XC6127C15BNR	Vdet-IC	1.5V±0.8%, -Reset PPO, -MR, Rt=100ms	SSOT-24	26cr	VD5	5a	Tor
6A	XC6127N15GNR	Vdet-IC	1.5V±0.8%, +Reset ODO, -MR, Rt=100ms	SSOT-24	26cr	VD4	5a	Tor
6A	XC6221D18BNR	LVR-IC	LDO, 1.85V±20mV, 200mA, +CE, CL, PDR	SSOT-24	26vn	VR4	5a	Tor
6B	R3132Q21EC	Vdet-IC	2.1V, MR, -Reset ODO	SOT-143	24vdh	VD4	5a	Ric
6B	RQ5RW19AA	LVR-IC	LDO, 1.9V±2%, 150mA, -CE	SOT-143R	26vp	VR4	5c	Ric
6B	XC6127C17BNR	Vdet-IC	1.7V±0.8%, -Reset PPO, -MR, Rt=100ms	SSOT-24	26cr	VD5	5a	Tor
6B	XC6127N17GNR	Vdet-IC	1.7V±0.8%, +Reset ODO, -MR, Rt=100ms	SSOT-24	26cr	VD4	5a	Tor
6B	XC6221D19BNR	LVR-IC	LDO, 1.95V±20mV, 200mA, +CE, CL, PDR	SSOT-24	26vn	VR4	5a	Tor
6C	R3132Q22EC	Vdet-IC	2.2V, MR, -Reset ODO	SOT-143	24vdh	VD4	5a	Ric
6C	RQ5RW18AA	LVR-IC	LDO, 1.8V±2%, 150mA, -CE	SOT-143R	26vp	VR4	5c	Ric
6C	XC6127C19BNR	Vdet-IC	1.9V±0.8%, -Reset PPO, -MR, Rt=100ms	SSOT-24	26cr	VD5	5a	Tor
6C	XC6127N19GNR	Vdet-IC	1.9V±0.8%, +Reset ODO, -MR, Rt=100ms	SSOT-24	26cr	VD4	5a	Tor
6C	XC6221D20BNR	LVR-IC	LDO, 2.05V±1%, 200mA, +CE, CL, PDR	SSOT-24	26vn	VR4	5a	Tor
6D	R3132Q23EC	Vdet-IC	2.3V, MR, -Reset ODO	SOT-143	24vdh	VD4	5a	Ric
6D	RQ5RW17AA	LVR-IC	LDO, 1.7V±2%, 150mA, -CE	SOT-143R	26vp	VR4	5c	Ric
6D	XC6127C21BNR	Vdet-IC	2.1V±0.8%, -Reset PPO, -MR, Rt=100ms	SSOT-24	26cr	VD5	5a	Tor
6D	XC6127N21GNR	Vdet-IC	2.1V±0.8%, +Reset ODO, -MR, Rt=100ms	SSOT-24	26cr	VD4	5a	Tor
6D	XC6221D21BNR	LVR-IC	LDO, 2.15V±1%, 200mA, +CE, CL, PDR	SSOT-24	26vn	VR4	5a	Tor
6E	R3132Q24EC	Vdet-IC	2.4V, MR, -Reset ODO	SOT-143	24vdh	VD4	5a	Ric
6E	RQ5RW16AA	LVR-IC	LDO, 1.6V±2%, 150mA, -CE	SOT-143R	26vp	VR4	5c	Ric
6E	XC6127C23BNR	Vdet-IC	2.3V±0.8%, -Reset PPO, -MR, Rt=100ms	SSOT-24	26cr	VD5	5a	Tor
6E	XC6127N23GNR	Vdet-IC	2.3V±0.8%, +Reset ODO, -MR, Rt=100ms	SSOT-24	26cr	VD4	5a	Tor
6E	XC6221D22BNR	LVR-IC	LDO, 2.25V±1%, 200mA, +CE, CL, PDR	SSOT-24	26vn	VR4	5a	Tor
6F	R3132Q25EC	Vdet-IC	2.5V, MR, -Reset ODO	SOT-143	24vdh	VD4	5a	Ric
6F	RQ5RW15AA	LVR-IC	LDO, 1.5V±2%, 150mA, -CE	SOT-143R	26vp	VR4	5c	Ric
6F	XC6127C25BNR	Vdet-IC	2.5V±0.8%, -Reset PPO, -MR, Rt=100ms	SSOT-24	26cr	VD5	5a	Tor
6F	XC6127N25GNR	Vdet-IC	2.5V±0.8%, +Reset ODO, -MR, Rt=100ms	SSOT-24	26cr	VD4	5a	Tor
6F	XC6221D23BNR	LVR-IC	LDO, 2.35V±1%, 200mA, +CE, CL, PDR	SSOT-24	26vn	VR4	5a	Tor
6G	R3132Q26EC	Vdet-IC	2.6V, MR, -Reset ODO	SOT-143	24vdh	VD4	5a	Ric
6H	R3132Q27EC	Vdet-IC	2.7V, MR, -Reset ODO	SOT-143	24vdh	VD4	5a	Ric
6H	XC6127C27BNR	Vdet-IC	2.7V±0.8%, -Reset PPO, -MR, Rt=100ms	SSOT-24	26cr	VD5	5a	Tor
6H	XC6127N27GNR	Vdet-IC	2.7V±0.8%, +Reset ODO, -MR, Rt=100ms	SSOT-24	26cr	VD4	5a	Tor
6H	XC6221D24BNR	LVR-IC	LDO, 2.45V±1%, 200mA, +CE, CL, PDR	SSOT-24	26vn	VR4	5a	Tor
6J	R3132Q28EC	Vdet-IC	2.8V, MR, -Reset ODO	SOT-143	24vdh	VD4	5a	Ric
6K	R3132Q29EC	Vdet-IC	2.9V, MR, -Reset ODO	SOT-143	24vdh	VD4	5a	Ric
6K	XC6127C29BNR	Vdet-IC	2.9V±0.8%, -Reset PPO, -MR, Rt=100ms	SSOT-24	26cr	VD5	5a	Tor
6K	XC6127N29GNR	Vdet-IC	2.9V±0.8%, +Reset ODO, -MR, Rt=100ms	SSOT-24	26cr	VD4	5a	Tor
6K	XC6221D25BNR	LVR-IC	LDO, 2.55V±1%, 200mA, +CE, CL, PDR	SSOT-24	26vn	VR4	5a	Tor
6L	R3133Q20EC	Vdet-IC	2V, MR, +Reset ODO	SOT-143	24vdh	VD4	5a	Ric
6L	RQ5RW60CA	LVR-IC	LDO, 6V±2%, 150mA	SOT-143R	26vs	VR1	5a	Ric
6L	XC6127C31BNR	Vdet-IC	3.1V±0.8%, -Reset PPO, -MR, Rt=100ms	SSOT-24	26cr	VD5	5a	Tor
6L	XC6127N31GNR	Vdet-IC	3.1V±0.8%, +Reset ODO, -MR, Rt=100ms	SSOT-24	26cr	VD4	5a	Tor
6L	XC6221D26BNR	LVR-IC	LDO, 2.65V±1%, 200mA, +CE, CL, PDR	SSOT-24	26vn	VR4	5a	Tor
6LN	ELM7543CCB	Vdet-IC	4.3V±2%, +Reset PPO	SC-82AB	26vdl	VD7	5c	Elm
6LN	ELM7543NCB	Vdet-IC	4.3V±2%, +Reset ODO	SC-82AB	26vdl	VD6	5c	Elm
6M	R3133Q21EC	Vdet-IC	2.1V, MR, +Reset ODO	SOT-143	24vdh	VD4	5a	Ric
6M	RQ5RW19CA	LVR-IC	LDO, 1.9V±2%, 150mA	SOT-143R	26vs	VR1	5a	Ric
6M	XC6127C33BNR	Vdet-IC	3.3V±0.8%, -Reset PPO, -MR, Rt=100ms	SSOT-24	26cr	VD5	5a	Tor
6M	XC6127N33GNR	Vdet-IC	3.3V±0.8%, +Reset ODO, -MR, Rt=100ms	SSOT-24	26cr	VD4	5a	Tor
6M	XC6221D27BNR	LVR-IC	LDO, 2.75V±1%, 200mA, +CE, CL, PDR	SSOT-24	26vn	VR4	5a	Tor
6N	R3133Q22EC	Vdet-IC	2.2V, MR, +Reset ODO	SOT-143	24vdh	VD4	5a	Ric



SMD code	Type	Function	Short description	Case	Pinout	Sch.	St.	Mnf.
6N	RQ5RW18CA	LVR-IC	LDO, 1.8V±2%, 150mA	SOT-143R	26vs	VR1	5a	Ric
6Ñ	XC6127C35BNR	Vdet-IC	3.5V±0.8%, -Reset PPO, -MR, Rt=100ms	SSOT-24	26cr	VD5	5a	Tor
6N	XC6127N35GNR	Vdet-IC	3.5V±0.8%, +Reset ODO, -MR, Rt=100ms	SSOT-24	26cr	VD4	5a	Tor
6Ñ	XC6221D28BNR	LVR-IC	LDO, 2.85V±1%, 200mA, +CE, CL, PDR	SSOT-24	26vn	VR4	5a	Tor
6P	R3133Q23EC	Vdet-IC	2.3V, MR, +Reset ODO	SOT-143	24vdh	VD4	5a	Ric
6P	RQ5RW17CA	LVR-IC	LDO, 1.7V±2%, 150mA	SOT-143R	26vs	VR1	5a	Ric
6P	XC6127C37BNR	Vdet-IC	3.7V±0.8%, -Reset PPO, -MR, Rt=100ms	SSOT-24	26cr	VD5	5a	Tor
6P	XC6127N37GNR	Vdet-IC	3.7V±0.8%, +Reset ODO, -MR, Rt=100ms	SSOT-24	26cr	VD4	5a	Tor
6P	XC6221D29BNR	LVR-IC	LDO, 2.95V±1%, 200mA, +CE, CL, PDR	SSOT-24	26vn	VR4	5a	Tor
6Q	R3133Q24EC	Vdet-IC	2.4V, MR, +Reset ODO	SOT-143	24vdh	VD4	5a	Ric
6R	R3133Q25EC	Vdet-IC	2.5V, MR, +Reset ODO	SOT-143	24vdh	VD4	5a	Ric
6R	XC6127C39BNR	Vdet-IC	3.9V±0.8%, -Reset PPO, -MR, Rt=100ms	SSOT-24	26cr	VD5	5a	Tor
6R	XC6127N39GNR	Vdet-IC	3.9V±0.8%, +Reset ODO, -MR, Rt=100ms	SSOT-24	26cr	VD4	5a	Tor
6R	XC6221D30BNR	LVR-IC	LDO, 3.05V±1%, 200mA, +CE, CL, PDR	SSOT-24	26vn	VR4	5a	Tor
6S	R3133Q26EC	Vdet-IC	2.6V, MR, +Reset ODO	SOT-143	24vdh	VD4	5a	Ric
6S	RQ5RW16CA	LVR-IC	LDO, 1.6V±2%, 150mA	SOT-143R	26vs	VR1	5a	Ric
6S	XC6127C41BNR	Vdet-IC	4.1V±0.8%, -Reset PPO, -MR, Rt=100ms	SSOT-24	26cr	VD5	5a	Tor
6S	XC6127N41GNR	Vdet-IC	4.1V±0.8%, +Reset ODO, -MR, Rt=100ms	SSOT-24	26cr	VD4	5a	Tor
6S	XC6221D31BNR	LVR-IC	LDO, 3.15V±1%, 200mA, +CE, CL, PDR	SSOT-24	26vn	VR4	5a	Tor
6T	R3133Q27EC	Vdet-IC	2.7V, MR, +Reset ODO	SOT-143	24vdh	VD4	5a	Ric
6T	XC6127C43BNR	Vdet-IC	4.3V±0.8%, -Reset PPO, -MR, Rt=100ms	SSOT-24	26cr	VD5	5a	Tor
6T	XC6127N43GNR	Vdet-IC	4.3V±0.8%, +Reset ODO, -MR, Rt=100ms	SSOT-24	26cr	VD4	5a	Tor
6T	XC6221D32BNR	LVR-IC	LDO, 3.25V±1%, 200mA, +CE, CL, PDR	SSOT-24	26vn	VR4	5a	Tor
6U	R3133Q28EC	Vdet-IC	2.8V, MR, +Reset ODO	SOT-143	24vdh	VD4	5a	Ric
6U	XC6127C45BNR	Vdet-IC	4.5V±0.8%, -Reset PPO, -MR, Rt=100ms	SSOT-24	26cr	VD5	5a	Tor
6U	XC6127N45GNR	Vdet-IC	4.5V±0.8%, +Reset ODO, -MR, Rt=100ms	SSOT-24	26cr	VD4	5a	Tor
6U	XC6221D33BNR	LVR-IC	LDO, 3.35V±1%, 200mA, +CE, CL, PDR	SSOT-24	26vn	VR4	5a	Tor
6V	R3133Q29EC	Vdet-IC	2.9V, MR, +Reset ODO	SOT-143	24vdh	VD4	5a	Ric
6V	XC6127C47BNR	Vdet-IC	4.7V±0.8%, -Reset PPO, -MR, Rt=100ms	SSOT-24	26cr	VD5	5a	Tor
6V	XC6127N47GNR	Vdet-IC	4.7V±0.8%, +Reset ODO, -MR, Rt=100ms	SSOT-24	26cr	VD4	5a	Tor
6V	XC6221D34BNR	LVR-IC	LDO, 3.45V±1%, 200mA, +CE, CL, PDR	SSOT-24	26vn	VR4	5a	Tor
6X	XC6127C49BNR	Vdet-IC	4.9V±0.8%, -Reset PPO, -MR, Rt=100ms	SSOT-24	26cr	VD5	5a	Tor
6X	XC6127N49GNR	Vdet-IC	4.9V±0.8%, +Reset ODO, -MR, Rt=100ms	SSOT-24	26cr	VD4	5a	Tor
6X	XC6221D35BNR	LVR-IC	LDO, 3.55V±1%, 200mA, +CE, CL, PDR	SSOT-24	26vn	VR4	5a	Tor
6Y	XC6127C51BNR	Vdet-IC	5.1V±0.8%, -Reset PPO, -MR, Rt=100ms	SSOT-24	26cr	VD5	5a	Tor
6Y	XC6127N51GNR	Vdet-IC	5.1V±0.8%, +Reset ODO, -MR, Rt=100ms	SSOT-24	26cr	VD4	5a	Tor
6Y	XC6221D36BNR	LVR-IC	LDO, 3.65V±1%, 200mA, +CE, CL, PDR	SSOT-24	26vn	VR4	5a	Tor
6Z	XC6127C53BNR	Vdet-IC	5.3V±0.8%, -Reset PPO, -MR, Rt=100ms	SSOT-24	26cr	VD5	5a	Tor
6Z	XC6127N53GNR	Vdet-IC	5.3V±0.8%, +Reset ODO, -MR, Rt=100ms	SSOT-24	26cr	VD4	5a	Tor
6Z	XC6221D37BNR	LVR-IC	LDO, 3.75V±1%, 200mA, +CE, CL, PDR	SSOT-24	26vn	VR4	5a	Tor
70	XC6127C55CNR	Vdet-IC	5.5V±0.8%, -Reset PPO, -MR, Rt=200ms	SSOT-24	26cr	VD5	5a	Tor
70	XC6127N55HNR	Vdet-IC	5.5V±0.8%, +Reset ODO, -MR, Rt=200ms	SSOT-24	26cr	VD4	5a	Tor
70	XC6221D38BNR	LVR-IC	LDO, 3.85V±1%, 200mA, +CE, CL, PDR	SSOT-24	26vn	VR4	5a	Tor
71	MGA-71543	MMIC	Ga-As, LN, RF amp, 0.1..6GHz, 15dB (50Ω), Vcc=3.3V	SOT-343	26am	A1	5c	Agi
71	XC6221D39BNR	LVR-IC	LDO, 3.95V±1%, 200mA, +CE, CL, PDR	SSOT-24	26vn	VR4	5a	Tor
72	MGA-72543	MMIC	Ga-As LN, RF amp, 0.1..6GHz, 14dB (50Ω), Vcc=3.3V	SOT-343	26am	A1	5c	Agi
72	XC6221D40BNR	LVR-IC	LDO, 4.05V±1%, 200mA, +CE, CL, PDR	SSOT-24	26vn	VR4	5a	Tor
73	XC6221D41BNR	LVR-IC	LDO, 4.15V±1%, 200mA, +CE, CL, PDR	SSOT-24	26vn	VR4	5a	Tor
73p	BAS70-07	Si-diode	Dual, Schottky, 70V, 70mA, Vf<1V(15mA), <2pF, 5ns	SOT-143	24ce	-	5c	PhH
73t	BAS70-07	Si-diode	Dual, Schottky, 70V, 70mA, Vf<1V(15mA), <2pF, 5ns	SOT-143	24ce	-	5c	PhC
73W	BAS70-07	Si-diode	Dual, Schottky, 70V, 70mA, Vf<1V(15mA), <2pF, 5ns	SOT-143	24ce	-	5c	PhC
74	XC6221D42BNR	LVR-IC	LDO, 4.25V±1%, 200mA, +CE, CL, PDR	SSOT-24	26vn	VR4	5a	Tor
75	XC6221D43BNR	LVR-IC	LDO, 4.35V±1%, 200mA, +CE, CL, PDR	SSOT-24	26vn	VR4	5a	Tor
76	XC6221D44BNR	LVR-IC	LDO, 4.45V±1%, 200mA, +CE, CL, PDR	SSOT-24	26vn	VR4	5a	Tor
77	XC6217D08ANR	LVR-IC	LDO, 0.85V±2%, 200mA, +CE, CL	SSOT-24	26vn	VR4	5a	Tor
77	XC6221D45BNR	LVR-IC	LDO, 4.55V±1%, 200mA, +CE, CL, PDR	SSOT-24	26vn	VR4	5a	Tor
77s	BAS70-07	Si-diode	Dual, Schottky, 70V, 70mA, Vf<1V(15mA), <2pF, 5ns	SOT-143	24ce	-	5h	Inf
77s	BAS70-07W	Si-diode	Dual, Schottky, 70V, 70mA, Vf<1V(15mA), <2pF, 5ns	SOT-343	24ce	-	5h	Inf
78	XC6217D09ANR	LVR-IC	LDO, 0.95V±2%, 200mA, +CE, CL	SSOT-24	26vn	VR4	5a	Tor
78	XC6221D46BNR	LVR-IC	LDO, 4.65V±1%, 200mA, +CE, CL, PDR	SSOT-24	26vn	VR4	5a	Tor
79	XC6221D47BNR	LVR-IC	LDO, 4.75V±1%, 200mA, +CE, CL, PDR	SSOT-24	26vn	VR4	5a	Tor
7A	R3133Q30EC	Vdet-IC	3V, MR, -Reset ODO	SOT-143	24vdh	VD4	5a	Ric
7A	RQ5RW20BA	LVR-IC	LDO, 2V±2%, 150mA, +CE	SOT-143R	26vp	VR4	5c	Ric
7A	XC6127C15CNR	Vdet-IC	1.5V±0.8%, -Reset PPO, -MR, Rt=200ms	SSOT-24	26cr	VD5	5a	Tor
7A	XC6127N15HNR	Vdet-IC	1.5V±0.8%, +Reset ODO, -MR, Rt=200ms	SSOT-24	26cr	VD4	5a	Tor
7A	XC6217D11ANR	LVR-IC	LDO, 1.15V±2%, 200mA, +CE, CL	SSOT-24	26vn	VR4	5a	Tor
7A	XC6221D48BNR	LVR-IC	LDO, 4.85V±1%, 200mA, +CE, CL, PDR	SSOT-24	26vn	VR4	5a	Tor
7B	R3133Q31EC	Vdet-IC	3.1V, MR, -Reset ODO	SOT-143	24vdh	VD4	5a	Ric
7B	RQ5RW21BA	LVR-IC	LDO, 2.1V±2%, 150mA, +CE	SOT-143R	26vp	VR4	5c	Ric
7B	XC6127C17CNR	Vdet-IC	1.7V±0.8%, -Reset PPO, -MR, Rt=200ms	SSOT-24	26cr	VD5	5a	Tor



SMD code	Type	Function	Short description	Case	Pinout	Sch.	St.	Mnf.
7B	XC6127N17HNR	Vdet-IC	1.7V±0.8%, +Reset ODO, -MR, Rt=200ms	SSOT-24	26cr	VD4	5a	Tor
7B	XC6217D12ANR	LVR-IC	LDO, 1.25V±2%, 200mA, +CE, CL	SSOT-24	26vn	VR4	5a	Tor
7B	XC6221D49BNR	LVR-IC	LDO, 4.95V±1%, 200mA, +CE, CL, PDR	SSOT-24	26vn	VR4	5a	Tor
7C	R3132Q32EC	Vdet-IC	3.2V, MR, -Reset ODO	SOT-143	24vdh	VD4	5a	Ric
7C	RQ5RW22BA	LVR-IC	LDO, 2.2V±2%, 150mA, +CE	SOT-143R	26vp	VR4	5c	Ric
7C	XC6127C19CNR	Vdet-IC	1.9V±0.8%, -Reset PPO, -MR, Rt=200ms	SSOT-24	26cr	VD5	5a	Tor
7C	XC6127N19HNR	Vdet-IC	1.9V±0.8%, +Reset ODO, -MR, Rt=200ms	SSOT-24	26cr	VD4	5a	Tor
7C	XC6217D13ANR	LVR-IC	LDO, 1.35V±2%, 200mA, +CE, CL	SSOT-24	26vn	VR4	5a	Tor
7D	R3132Q33EC	Vdet-IC	3.3V, MR, -Reset ODO	SOT-143	24vdh	VD4	5a	Ric
7D	RQ5RW23BA	LVR-IC	LDO, 2.3V±2%, 150mA, +CE	SOT-143R	26vp	VR4	5c	Ric
7D	XC6127C21CNR	Vdet-IC	2.1V±0.8%, -Reset PPO, -MR, Rt=200ms	SSOT-24	26cr	VD5	5a	Tor
7D	XC6127N21HNR	Vdet-IC	2.1V±0.8%, +Reset ODO, -MR, Rt=200ms	SSOT-24	26cr	VD4	5a	Tor
7D	XC6217D14ANR	LVR-IC	LDO, 1.45V±2%, 200mA, +CE, CL	SSOT-24	26vn	VR4	5a	Tor
7D	XC6223C301NR-G	LVR-IC	LDO, 3.0V±1%, 300mA, +CE, PDR	SSOT-24	26vn	VR4	5a	Tor
7E	R3132Q34EC	Vdet-IC	3.4V, MR, -Reset ODO	SOT-143	24vdh	VD4	5a	Ric
7E	RQ5RW24BA	LVR-IC	LDO, 2.4V±2%, 150mA, +CE	SOT-143R	26vp	VR4	5c	Ric
7E	XC6127C23CNR	Vdet-IC	2.3V±0.8%, -Reset PPO, -MR, Rt=200ms	SSOT-24	26cr	VD5	5a	Tor
7E	XC6127N23HNR	Vdet-IC	2.3V±0.8%, +Reset ODO, -MR, Rt=200ms	SSOT-24	26cr	VD4	5a	Tor
7E	XC6217D15ANR	LVR-IC	LDO, 1.55V±2%, 200mA, +CE, CL	SSOT-24	26vn	VR4	5a	Tor
7E	XC6223C311NR-G	LVR-IC	LDO, 3.1V±1%, 300mA, +CE, PDR	SSOT-24	26vn	VR4	5a	Tor
7F	R3132Q35EC	Vdet-IC	3.5V, MR, -Reset ODO	SOT-143	24vdh	VD4	5a	Ric
7F	RQ5RW25BA	LVR-IC	LDO, 2.5V±2%, 150mA, +CE	SOT-143R	26vp	VR4	5c	Ric
7F	XC6127C25CNR	Vdet-IC	2.5V±0.8%, -Reset PPO, -MR, Rt=200ms	SSOT-24	26cr	VD5	5a	Tor
7F	XC6127N25HNR	Vdet-IC	2.5V±0.8%, +Reset ODO, -MR, Rt=200ms	SSOT-24	26cr	VD4	5a	Tor
7F	XC6217D16ANR	LVR-IC	LDO, 1.65V±2%, 200mA, +CE, CL	SSOT-24	26vn	VR4	5a	Tor
7F	XC6223C321NR-G	LVR-IC	LDO, 3.2V±1%, 300mA, +CE, PDR	SSOT-24	26vn	VR4	5a	Tor
7G	R3132Q36EC	Vdet-IC	3.6V, MR, -Reset ODO	SOT-143	24vdh	VD4	5a	Ric
7G	RQ5RW26BA	LVR-IC	LDO, 2.6V±2%, 150mA, +CE	SOT-143R	26vp	VR4	5c	Ric
7H	R3132Q37EC	Vdet-IC	3.7V, MR, -Reset ODO	SOT-143	24vdh	VD4	5a	Ric
7H	RQ5RW27BA	LVR-IC	LDO, 2.7V±2%, 150mA, +CE	SOT-143R	26vp	VR4	5c	Ric
7H	XC6127C27CNR	Vdet-IC	2.7V±0.8%, -Reset PPO, -MR, Rt=200ms	SSOT-24	26cr	VD5	5a	Tor
7H	XC6127N27HNR	Vdet-IC	2.7V±0.8%, +Reset ODO, -MR, Rt=200ms	SSOT-24	26cr	VD4	5a	Tor
7H	XC6217D17ANR	LVR-IC	LDO, 1.75V±2%, 200mA, +CE, CL	SSOT-24	26vn	VR4	5a	Tor
7H	XC6223C331NR-G	LVR-IC	LDO, 3.3V±1%, 300mA, +CE, PDR	SSOT-24	26vn	VR4	5a	Tor
7J	R3132Q38EC	Vdet-IC	3.8V, MR, -Reset ODO	SOT-143	24vdh	VD4	5a	Ric
7J	RQ5RW28BA	LVR-IC	LDO, 2.8V±2%, 150mA, +CE	SOT-143R	26vp	VR4	5c	Ric
7K	R3132Q39EC	Vdet-IC	3.9V, MR, -Reset ODO	SOT-143	24vdh	VD4	5a	Ric
7K	RQ5RW29BA	LVR-IC	LDO, 2.9V±2%, 150mA, +CE	SOT-143R	26vp	VR4	5c	Ric
7K	XC6127C29CNR	Vdet-IC	2.9V±0.8%, -Reset PPO, -MR, Rt=200ms	SSOT-24	26cr	VD5	5a	Tor
7K	XC6127N29HNR	Vdet-IC	2.9V±0.8%, +Reset ODO, -MR, Rt=200ms	SSOT-24	26cr	VD4	5a	Tor
7K	XC6217D18ANR	LVR-IC	LDO, 1.85V±2%, 200mA, +CE, CL	SSOT-24	26vn	VR4	5a	Tor
7K	XC6223C341NR-G	LVR-IC	LDO, 3.4V±1%, 300mA, +CE, PDR	SSOT-24	26vn	VR4	5a	Tor
7L	R3133Q30EC	Vdet-IC	3V, MR, +Reset ODO	SOT-143	24vdh	VD4	5a	Ric
7L	XC6127C31CNR	Vdet-IC	3.1V±0.8%, -Reset PPO, -MR, Rt=200ms	SSOT-24	26cr	VD5	5a	Tor
7L	XC6127N31HNR	Vdet-IC	3.1V±0.8%, +Reset ODO, -MR, Rt=200ms	SSOT-24	26cr	VD4	5a	Tor
7L	XC6217D19ANR	LVR-IC	LDO, 1.95V±2%, 200mA, +CE, CL	SSOT-24	26vn	VR4	5a	Tor
7L	XC6223C351NR-G	LVR-IC	LDO, 3.5V±1%, 300mA, +CE, PDR	SSOT-24	26vn	VR4	5a	Tor
7LN	ELM7545CCB	Vdet-IC	4.5V±2%, +Reset PPO	SC-82AB	26vdl	VD7	5c	Elm
7LN	ELM7545NCB	Vdet-IC	4.5V±2%, +Reset ODO	SC-82AB	26vdl	VD6	5c	Elm
7M	R3133Q31EC	Vdet-IC	3.1V, MR, +Reset ODO	SOT-143	24vdh	VD4	5a	Ric
7M	XC6127C33CNR	Vdet-IC	3.3V±0.8%, -Reset PPO, -MR, Rt=200ms	SSOT-24	26cr	VD5	5a	Tor
7M	XC6127N33HNR	Vdet-IC	3.3V±0.8%, +Reset ODO, -MR, Rt=200ms	SSOT-24	26cr	VD4	5a	Tor
7M	XC6217D20ANR	LVR-IC	LDO, 2.05V±2%, 200mA, +CE, CL	SSOT-24	26vn	VR4	5a	Tor
7M	XC6223C361NR-G	LVR-IC	LDO, 3.6V±1%, 300mA, +CE, PDR	SSOT-24	26vn	VR4	5a	Tor
7N	R3133Q32EC	Vdet-IC	3.2V, MR, +Reset ODO	SOT-143	24vdh	VD4	5a	Ric
7N	XC6127C35CNR	Vdet-IC	3.5V±0.8%, -Reset PPO, -MR, Rt=200ms	SSOT-24	26cr	VD5	5a	Tor
7N	XC6127N35HNR	Vdet-IC	3.5V±0.8%, +Reset ODO, -MR, Rt=200ms	SSOT-24	26cr	VD4	5a	Tor
7N	XC6217D21ANR	LVR-IC	LDO, 2.15V±2%, 200mA, +CE, CL	SSOT-24	26vn	VR4	5a	Tor
7P	R3133Q33EC	Vdet-IC	3.3V, MR, ODO	SOT-143	24vdh	VD4	5a	Ric
7P	XC6127C37CNR	Vdet-IC	3.7V±0.8%, -Reset PPO, -MR, Rt=200ms	SSOT-24	26cr	VD5	5a	Tor
7P	XC6127N37HNR	Vdet-IC	3.7V±0.8%, +Reset ODO, -MR, Rt=200ms	SSOT-24	26cr	VD4	5a	Tor
7P	XC6217D22ANR	LVR-IC	LDO, 2.25V±2%, 200mA, +CE, CL	SSOT-24	26vn	VR4	5a	Tor
7P	XC6223C371NR-G	LVR-IC	LDO, 3.7V±1%, 300mA, +CE, PDR	SSOT-24	26vn	VR4	5a	Tor
7Q	R3133Q34EC	Vdet-IC	3.4V, MR, +Reset ODO	SOT-143	24vdh	VD4	5a	Ric
7R	R3133Q35EC	Vdet-IC	3.5V, MR, +Reset ODO	SOT-143	24vdh	VD4	5a	Ric
7R	XC6127C39CNR	Vdet-IC	3.9V±0.8%, -Reset PPO, -MR, Rt=200ms	SSOT-24	26cr	VD5	5a	Tor
7R	XC6127N39HNR	Vdet-IC	3.9V±0.8%, +Reset ODO, -MR, Rt=200ms	SSOT-24	26cr	VD4	5a	Tor
7R	XC6217D23ANR	LVR-IC	LDO, 2.35V±2%, 200mA, +CE, CL	SSOT-24	26vn	VR4	5a	Tor
7R	XC6223C381NR-G	LVR-IC	LDO, 3.8V±1%, 300mA, +CE, PDR	SSOT-24	26vn	VR4	5a	Tor
7S	R3133Q36EC	Vdet-IC	3.6V, MR, +Reset ODO	SOT-143	24vdh	VD4	5a	Ric



SMD code	Type	Function	Short description	Case	Pinout Sch.	St.	Mnf.
75	XC6127C41CNR	Vdet-IC	4.1V±0.8%, -Reset PPO, -MR, Rt=200ms	SSOT-24	26cr	VD5	Tor
75	XC6127N41HNR	Vdet-IC	4.1V±0.8%, +Reset ODO, -MR, Rt=200ms	SSOT-24	26cr	VD4	5a Tor
75	XC6217D24ANR	LVR-IC	LDO, 2.45V±2%, 200mA, +CE, CL	SSOT-24	26vn	VR4	5a Tor
75	XC6223C391NR-G	LVR-IC	LDO, 3.9V±1%, 300mA, +CE, PDR	SSOT-24	26vn	VR4	5a Tor
77	R3133Q37EC	Vdet-IC	3.7V, MR, +Reset ODO	SOT-143	24vdh	VD4	5a Ric
77	XC6127C43CNR	Vdet-IC	4.3V±0.8%, -Reset PPO, -MR, Rt=200ms	SSOT-24	26cr	VD5	5a Tor
77	XC6127N43HNR	Vdet-IC	4.3V±0.8%, +Reset ODO, -MR, Rt=200ms	SSOT-24	26cr	VD4	5a Tor
77	XC6217D25ANR	LVR-IC	LDO, 2.55V±2%, 200mA, +CE, CL	SSOT-24	26vn	VR4	5a Tor
77	XC6223C401NR-G	LVR-IC	LDO, 4.0V±1%, 300mA, +CE, PDR	SSOT-24	26vn	VR4	5a Tor
7U	R3133Q38EC	Vdet-IC	3.8V, MR, +Reset ODO	SOT-143	24vdh	VD4	5a Ric
7U	XC6127C45CNR	Vdet-IC	4.5V±0.8%, -Reset PPO, -MR, Rt=200ms	SSOT-24	26cr	VD5	5a Tor
7U	XC6127N45HNR	Vdet-IC	4.5V±0.8%, +Reset ODO, -MR, Rt=200ms	SSOT-24	26cr	VD4	5a Tor
7U	XC6217D26ANR	LVR-IC	LDO, 2.65V±2%, 200mA, +CE, CL	SSOT-24	26vn	VR4	5a Tor
7V	R3133Q39EC	Vdet-IC	3.9V, MR, +Reset ODO	SOT-143	24vdh	VD4	5a Ric
7V	XC6127C47CNR	Vdet-IC	4.7V±0.8%, -Reset PPO, -MR, Rt=200ms	SSOT-24	26cr	VD5	5a Tor
7V	XC6127N47HNR	Vdet-IC	4.7V±0.8%, +Reset ODO, -MR, Rt=200ms	SSOT-24	26cr	VD4	5a Tor
7V	XC6217D27ANR	LVR-IC	LDO, 2.75V±2%, 200mA, +CE, CL	SSOT-24	26vn	VR4	5a Tor
7X	XC6127C49CNR	Vdet-IC	4.9V±0.8%, -Reset PPO, -MR, Rt=200ms	SSOT-24	26cr	VD5	5a Tor
7X	XC6127N49HNR	Vdet-IC	4.9V±0.8%, +Reset ODO, -MR, Rt=200ms	SSOT-24	26cr	VD4	5a Tor
7X	XC6217D28ANR	LVR-IC	LDO, 2.85V±2%, 200mA, +CE, CL	SSOT-24	26vn	VR4	5a Tor
7Y	XC6127C51CNR	Vdet-IC	5.1V±0.8%, -Reset PPO, -MR, Rt=200ms	SSOT-24	26cr	VD5	5a Tor
7Y	XC6127N51HNR	Vdet-IC	5.1V±0.8%, +Reset ODO, -MR, Rt=200ms	SSOT-24	26cr	VD4	5a Tor
7Y	XC6217D29ANR	LVR-IC	LDO, 2.95V±2%, 200mA, +CE, CL	SSOT-24	26vn	VR4	5a Tor
7Z	XC6127C53CNR	Vdet-IC	5.3V±0.8%, -Reset PPO, -MR, Rt=200ms	SSOT-24	26cr	VD5	5a Tor
7Z	XC6127N53HNR	Vdet-IC	5.3V±0.8%, +Reset ODO, -MR, Rt=200ms	SSOT-24	26cr	VD4	5a Tor
7Z	XC6217D30ANR	LVR-IC	LDO, 3.05V±2%, 200mA, +CE, CL	SSOT-24	26vn	VR4	5a Tor
80	XC6127C55DNR	Vdet-IC	5.5V±0.8%, -Reset PPO, -MR, Rt=400ms	SSOT-24	26cr	VD5	5a Tor
80	XC6127N55JNR	Vdet-IC	5.5V±0.8%, +Reset ODO, -MR, Rt=400ms	SSOT-24	26cr	VD4	5a Tor
80	XC6217D31ANR	LVR-IC	LDO, 3.15V±2%, 200mA, +CE, CL	SSOT-24	26vn	VR4	5a Tor
81	XC6217D32ANR	LVR-IC	LDO, 3.25V±2%, 200mA, +CE, CL	SSOT-24	26vn	VR4	5a Tor
811J	SGM811-JXKA4	Vdet-IC	4.0V±1.5%, -Reset ODO, -MR	SOT-143	24vdh	VD4	5b Sgm
811L	SGM811-LXKA4	Vdet-IC	4.63V±1.5%, -Reset ODO, -MR	SOT-143	24vdh	VD4	5b Sgm
811M	SGM811-MXKA4	Vdet-IC	4.38V±1.5%, -Reset ODO, -MR	SOT-143	24vdh	VD4	5b Sgm
811R	SGM811-RXKA4	Vdet-IC	2.63V±1.5%, -Reset ODO, -MR	SOT-143	24vdh	VD4	5b Sgm
811S	SGM811-SXKA4	Vdet-IC	2.93V±1.5%, -Reset ODO, -MR	SOT-143	24vdh	VD4	5b Sgm
811T	SGM811-TXKA4	Vdet-IC	3.08V±1.5%, -Reset ODO, -MR	SOT-143	24vdh	VD4	5b Sgm
811Z	SGM811-ZXKA4	Vdet-IC	2.32V±1.5%, -Reset ODO, -MR	SOT-143	24vdh	VD4	5b Sgm
812J	SGM812-JXKA4	Vdet-IC	4.0V±1.5%, +Reset ODO, -MR	SOT-143	24vdh	VD4	5b Sgm
812L	SGM812-LXKA4	Vdet-IC	4.63V±1.5%, +Reset ODO, -MR	SOT-143	24vdh	VD4	5b Sgm
812M	SGM812-MXKA4	Vdet-IC	4.38V±1.5%, +Reset ODO, -MR	SOT-143	24vdh	VD4	5b Sgm
812R	SGM812-RXKA4	Vdet-IC	2.63V±1.5%, +Reset ODO, -MR	SOT-143	24vdh	VD4	5b Sgm
812S	SGM812-SXKA4	Vdet-IC	2.93V±1.5%, +Reset ODO, -MR	SOT-143	24vdh	VD4	5b Sgm
812T	SGM812-TXKA4	Vdet-IC	3.08V±1.5%, +Reset ODO, -MR	SOT-143	24vdh	VD4	5b Sgm
812Z	SGM812-ZXKA4	Vdet-IC	2.32V±1.5%, +Reset ODO, -MR	SOT-143	24vdh	VD4	5b Sgm
82	XC6217D33ANR	LVR-IC	LDO, 3.35V±2%, 200mA, +CE, CL	SSOT-24	26vn	VR4	5a Tor
82	XC6223A12BNR-G	LVR-IC	LDO, 1.25V±20mV, 300mA, +CE	SSOT-24	26vn	VR4	5a Tor
822	S822T	Si-npn	UHF, LN, 12V, 8mA, 30mW, B=40..150, 5.2GHz	SOT-143	24tc	-	5b Vs
82P	BFP182T	Si-npn	UHF, 20V, 35mA, 250mW, B=50..200, >8GHz	SOT-143	24tc	-	5b Tfk
82R	S886TR	MMIC	UHF, 16V, 30mA, 200mW, Idss=50..500µA	SOT-143R	26fm	A3	5c Vs
83	XC6217D34ANR	LVR-IC	LDO, 3.45V±2%, 200mA, +CE, CL	SSOT-24	26vn	VR4	5a Tor
83	XC6223A13BNR-G	LVR-IC	LDO, 1.35V±20mV, 300mA, +CE	SSOT-24	26vn	VR4	5a Tor
83P	BFP183T	Si-npn	UHF, 20V, 65mA, 450mW, B=50..200, 8GHz	SOT-143	24tc	-	5b Tfk
84	XC6217D35ANR	LVR-IC	LDO, 3.55V±2%, 200mA, +CE, CL	SSOT-24	26vn	VR4	5a Tor
84	XC6223A14BNR-G	LVR-IC	LDO, 1.45V±20mV, 300mA, +CE	SSOT-24	26vn	VR4	5a Tor
849	S849T	MMIC	UHF, 16V, 30mA, 200mW, Idss=50..500µA	SOT-143	24fd	A3	5c Vs
85	XC6217D36ANR	LVR-IC	LDO, 3.65V±2%, 200mA, +CE, CL	SSOT-24	26vn	VR4	5a Tor
85	XC6223A15BNR-G	LVR-IC	LDO, 1.55V±20mV, 300mA, +CE	SSOT-24	26vn	VR4	5a Tor
858	S858TA1	MMIC	UHF-Amplifier, 5V, Pq=5dBm(550MHz)	SOT-143	24am	A1	5b Vs
86	XC6217D37ANR	LVR-IC	LDO, 3.75V±2%, 200mA, +CE, CL	SSOT-24	26vn	VR4	5a Tor
86	XC6223A16BNR-G	LVR-IC	LDO, 1.65V±20mV, 300mA, +CE	SSOT-24	26vn	VR4	5a Tor
860	S860T	MMIC	UHF-Amplifier, 1.8V, Gp=8dB(2500MHz)	SOT-143	24am	A1	5b Vs
868	S868T	MMIC	UHF-Amplifier, 5V, Pq=13dBm(550MHz)	SOT-143	24am	A1	5b Vs
87	XC6217D38ANR	LVR-IC	LDO, 3.85V±2%, 200mA, +CE, CL	SSOT-24	26vn	VR4	5a Tor
87	XC6223A17BNR-G	LVR-IC	LDO, 1.75V±20mV, 300mA, +CE	SSOT-24	26vn	VR4	5a Tor
88	XC6217D39ANR	LVR-IC	LDO, 3.95V±2%, 200mA, +CE, CL	SSOT-24	26vn	VR4	5a Tor
88	XC6223A18BNR-G	LVR-IC	LDO, 1.85V±20mV, 300mA, +CE	SSOT-24	26vn	VR4	5a Tor
888	S888T	n-MOSFET-d	DG, UHF, 10V, 20mA, 160mW, Idss=1..12mA	SOT-143	24fd	-	5b Vs
89	XC6221B40BNR	LVR-IC	LDO, 4.05V±1%, 200mA, +CE, CL	SSOT-24	26vn	VR4	5a Tor
89	XC6223A19BNR-G	LVR-IC	LDO, 1.95V±20mV, 300mA, +CE	SSOT-24	26vn	VR4	5a Tor
897	S897T	Si-npn	UHF, 15V, 60mA, 200mW, 5GHz	SOT-143	24t1	-	5b Vs



SMD code	Type	Function	Short description	Case	Pinout	Sch.	St.	Mnf.
8A	R3132Q40EC	Vdet-IC	4V, MR, -Reset ODO	SOT-143	24vdh	VD4	5a	Ric
8A	RQ5RW30BA	LVR-IC	LDO, 3V±2%, 150mA, +CE	SOT-143R	26vp	VR4	5c	Ric
8A	XC6127C15DNR	Vdet-IC	1.5V±0.8%, -Reset PPO, -MR, Rt=400ms	SSOT-24	26cr	VD5	5a	Tor
8A	XC6127N15JNR	Vdet-IC	1.5V±0.8%, +Reset ODO, -MR, Rt=400ms	SSOT-24	26cr	VD4	5a	Tor
8A	XC6223A20BNR-G	LVR-IC	LDO, 2.05V±1%, 300mA, +CE	SSOT-24	26vn	VR4	5a	Tor
8AL	STM811L	Vdet-IC	4.63V±2%, -Reset PPO, -MR	SOT-143	24vdh	VD5	5g	Ste
8AM	STM811M	Vdet-IC	4.38V±2%, -Reset PPO, -MR	SOT-143	24vdh	VD5	5g	Ste
8AN	STM811T	Vdet-IC	3.08V±2%, -Reset PPO, -MR	SOT-143	24vdh	VD5	5g	Ste
8AP	STM811S	Vdet-IC	2.93V±2%, -Reset PPO, -MR	SOT-143	24vdh	VD5	5g	Ste
8AQ	STM811R	Vdet-IC	2.63V±2%, -Reset PPO, -MR	SOT-143	24vdh	VD5	5g	Ste
8AR	STM812L	Vdet-IC	4.63V±2%, +Reset PPO, -MR	SOT-143	24vdh	VD5	5g	Ste
8AS	STM812M	Vdet-IC	4.38V±2%, +Reset PPO, -MR	SOT-143	24vdh	VD5	5g	Ste
8AT	STM812T	Vdet-IC	3.08V±2%, +Reset PPO, -MR	SOT-143	24vdh	VD5	5g	Ste
8AU	STM812S	Vdet-IC	2.93V±2%, +Reset PPO, -MR	SOT-143	24vdh	VD5	5g	Ste
8AV	STM812R	Vdet-IC	2.63V±2%, +Reset PPO, -MR	SOT-143	24vdh	VD5	5g	Ste
8B	R3132Q41EC	Vdet-IC	4.1V, MR, -Reset ODO	SOT-143	24vdh	VD4	5a	Ric
8B	RQ5RW31BA	LVR-IC	LDO, 3.1V±2%, 150mA, +CE	SOT-143R	26vp	VR4	5c	Ric
8B	XC6127C17DNR	Vdet-IC	1.7V±0.8%, -Reset PPO, -MR, Rt=400ms	SSOT-24	26cr	VD5	5a	Tor
8B	XC6127N17JNR	Vdet-IC	1.7V±0.8%, +Reset ODO, -MR, Rt=400ms	SSOT-24	26cr	VD4	5a	Tor
8B	XC6223A21BNR-G	LVR-IC	LDO, 2.15V±1%, 300mA, +CE	SSOT-24	26vn	VR4	5a	Tor
8C	R3132Q42EC	Vdet-IC	4.2V, MR, -Reset ODO	SOT-143	24vdh	VD4	5a	Ric
8C	RQ5RW32BA	LVR-IC	LDO, 3.2V±2%, 150mA, +CE	SOT-143R	26vp	VR4	5c	Ric
8C	XC6127C19DNR	Vdet-IC	1.9V±0.8%, -Reset PPO, -MR, Rt=400ms	SSOT-24	26cr	VD5	5a	Tor
8C	XC6127N19JNR	Vdet-IC	1.9V±0.8%, +Reset ODO, -MR, Rt=400ms	SSOT-24	26cr	VD4	5a	Tor
8C	XC6223A22BNR-G	LVR-IC	LDO, 2.25V±1%, 300mA, +CE	SSOT-24	26vn	VR4	5a	Tor
8D	R3132Q43EC	Vdet-IC	4.3V, MR, -Reset ODO	SOT-143	24vdh	VD4	5a	Ric
8D	RQ5RW33BA	LVR-IC	LDO, 3.3V±2%, 150mA, +CE	SOT-143R	26vp	VR4	5c	Ric
8D	XC6127C21DNR	Vdet-IC	2.1V±0.8%, -Reset PPO, -MR, Rt=400ms	SSOT-24	26cr	VD5	5a	Tor
8D	XC6127N21JNR	Vdet-IC	2.1V±0.8%, +Reset ODO, -MR, Rt=400ms	SSOT-24	26cr	VD4	5a	Tor
8D	XC6223A23BNR-G	LVR-IC	LDO, 2.35V±1%, 300mA, +CE	SSOT-24	26vn	VR4	5a	Tor
8E	R3132Q44EC	Vdet-IC	4.4V, MR, -Reset ODO	SOT-143	24vdh	VD4	5a	Ric
8E	RQ5RW34BA	LVR-IC	LDO, 3.4V±2%, 150mA, +CE	SOT-143R	26vp	VR4	5c	Ric
8E	XC6127C23DNR	Vdet-IC	2.3V±0.8%, -Reset PPO, -MR, Rt=400ms	SSOT-24	26cr	VD5	5a	Tor
8E	XC6127N23JNR	Vdet-IC	2.3V±0.8%, +Reset ODO, -MR, Rt=400ms	SSOT-24	26cr	VD4	5a	Tor
8E	XC6223A24BNR-G	LVR-IC	LDO, 2.45V±1%, 300mA, +CE	SSOT-24	26vn	VR4	5a	Tor
8F	R3132Q45EC	Vdet-IC	4.5V, MR, -Reset ODO	SOT-143	24vdh	VD4	5a	Ric
8F	RQ5RW35BA	LVR-IC	LDO, 3.5V±2%, 150mA, +CE	SOT-143R	26vp	VR4	5c	Ric
8F	XC6127C25DNR	Vdet-IC	2.5V±0.8%, -Reset PPO, -MR, Rt=400ms	SSOT-24	26cr	VD5	5a	Tor
8F	XC6127N25JNR	Vdet-IC	2.5V±0.8%, +Reset ODO, -MR, Rt=400ms	SSOT-24	26cr	VD4	5a	Tor
8F	XC6223A25BNR-G	LVR-IC	LDO, 2.55V±1%, 300mA, +CE	SSOT-24	26vn	VR4	5a	Tor
8G	R3132Q46EC	Vdet-IC	4.6V, MR, -Reset ODO	SOT-143	24vdh	VD4	5a	Ric
8G	RQ5RW36BA	LVR-IC	LDO, 3.6V±2%, 150mA, +CE	SOT-143R	26vp	VR4	5c	Ric
8H	R3132Q47EC	Vdet-IC	4.7V, MR, -Reset ODO	SOT-143	24vdh	VD4	5a	Ric
8H	RQ5RW37BA	LVR-IC	LDO, 3.7V±2%, 150mA, +CE	SOT-143R	26vp	VR4	5c	Ric
8H	XC6127C27DNR	Vdet-IC	2.7V±0.8%, -Reset PPO, -MR, Rt=400ms	SSOT-24	26cr	VD5	5a	Tor
8H	XC6127N27JNR	Vdet-IC	2.7V±0.8%, +Reset ODO, -MR, Rt=400ms	SSOT-24	26cr	VD4	5a	Tor
8H	XC6223A26BNR-G	LVR-IC	LDO, 2.65V±1%, 300mA, +CE	SSOT-24	26vn	VR4	5a	Tor
8J	R3132Q48EC	Vdet-IC	4.8V, MR, -Reset ODO	SOT-143	24vdh	VD4	5a	Ric
8J	RQ5RW38BA	LVR-IC	LDO, 3.8V±2%, 150mA, +CE	SOT-143R	26vp	VR4	5c	Ric
8K	R3132Q49EC	Vdet-IC	4.9V, MR, -Reset ODO	SOT-143	24vdh	VD4	5a	Ric
8K	RQ5RW39BA	LVR-IC	LDO, 3.9V±2%, 150mA, +CE	SOT-143R	26vp	VR4	5c	Ric
8K	XC6127C29DNR	Vdet-IC	2.9V±0.8%, -Reset PPO, -MR, Rt=400ms	SSOT-24	26cr	VD5	5a	Tor
8K	XC6127N29JNR	Vdet-IC	2.9V±0.8%, +Reset ODO, -MR, Rt=400ms	SSOT-24	26cr	VD4	5a	Tor
8K	XC6223A27BNR-G	LVR-IC	LDO, 2.75V±1%, 300mA, +CE	SSOT-24	26vn	VR4	5a	Tor
8L	R3133Q40EC	Vdet-IC	4V, MR, +Reset ODO	SOT-143	24vdh	VD4	5a	Ric
8L	XC6127C31DNR	Vdet-IC	3.1V±0.8%, -Reset PPO, -MR, Rt=400ms	SSOT-24	26cr	VD5	5a	Tor
8L	XC6127N31JNR	Vdet-IC	3.1V±0.8%, +Reset ODO, -MR, Rt=400ms	SSOT-24	26cr	VD4	5a	Tor
8L	XC6223A28BNR-G	LVR-IC	LDO, 2.85V±1%, 300mA, +CE	SSOT-24	26vn	VR4	5a	Tor
8LN	ELM7550CCB	Vdet-IC	5.0V±2%, +Reset PPO	SC-82AB	26vdl	VD7	5c	Elm
8LN	ELM7550NCB	Vdet-IC	5.0V±2%, +Reset ODO	SC-82AB	26vdl	VD6	5c	Elm
8M	R3133Q41EC	Vdet-IC	4.1V, MR, +Reset ODO	SOT-143	24vdh	VD4	5a	Ric
8M	XC6127C33DNR	Vdet-IC	3.3V±0.8%, -Reset PPO, -MR, Rt=400ms	SSOT-24	26cr	VD5	5a	Tor
8M	XC6127N33JNR	Vdet-IC	3.3V±0.8%, +Reset ODO, -MR, Rt=400ms	SSOT-24	26cr	VD4	5a	Tor
8M	XC6223A29BNR-G	LVR-IC	LDO, 2.95V±1%, 300mA, +CE	SSOT-24	26vn	VR4	5a	Tor
8N	R3133Q42EC	Vdet-IC	4.2V, MR, +Reset ODO	SOT-143	24vdh	VD4	5a	Ric
8N	XC6127C35DNR	Vdet-IC	3.5V±0.8%, -Reset PPO, -MR, Rt=400ms	SSOT-24	26cr	VD5	5a	Tor
8N	XC6127N35JNR	Vdet-IC	3.5V±0.8%, +Reset ODO, -MR, Rt=400ms	SSOT-24	26cr	VD4	5a	Tor
8N	XC6223A30BNR-G	LVR-IC	LDO, 3.05V±1%, 300mA, +CE	SSOT-24	26vn	VR4	5a	Tor
8P	R3133Q43EC	Vdet-IC	4.3V, MR, +Reset ODO	SOT-143	24vdh	VD4	5a	Ric
8P	XC6127C37DNR	Vdet-IC	3.7V±0.8%, -Reset PPO, -MR, Rt=400ms	SSOT-24	26cr	VD5	5a	Tor



SMD
code

SMD code	Type	Function	Short description	Case	Pinout	Sch.	St.	Mnf.
8P	XC6127N37JNR	Vdet-IC	3.7V±0.8%, +Reset ODO, -MR, Rt=400ms	SSOT-24	26cr	VD4	5a	Tor
8P	XC6223A31BNR-G	LVR-IC	LDO, 3.15V±1%, 300mA, +CE	SSOT-24	26vn	VR4	5a	Tor
8Q	R3133Q44EC	Vdet-IC	4.4V, MR, +Reset ODO	SOT-143	24vdh	VD4	5a	Ric
8R	R3133Q45EC	Vdet-IC	4.5V, MR, +Reset ODO	SOT-143	24vdh	VD4	5a	Ric
8R	XC6127C39DNR	Vdet-IC	3.9V±0.8%, -Reset PPO, -MR, Rt=400ms	SSOT-24	26cr	VD5	5a	Tor
8R	XC6127N39JNR	Vdet-IC	3.9V±0.8%, +Reset ODO, -MR, Rt=400ms	SSOT-24	26cr	VD4	5a	Tor
8R	XC6223A32BNR-G	LVR-IC	LDO, 3.25V±1%, 300mA, +CE	SSOT-24	26vn	VR4	5a	Tor
8S	R3133Q46EC	Vdet-IC	4.6V, MR, +Reset ODO	SOT-143	24vdh	VD4	5a	Ric
8S	XC6127C41DNR	Vdet-IC	4.1V±0.8%, -Reset PPO, -MR, Rt=400ms	SSOT-24	26cr	VD5	5a	Tor
8S	XC6127N41JNR	Vdet-IC	4.1V±0.8%, +Reset ODO, -MR, Rt=400ms	SSOT-24	26cr	VD4	5a	Tor
8S	XC6223A33BNR-G	LVR-IC	LDO, 3.35V±1%, 300mA, +CE	SSOT-24	26vn	VR4	5a	Tor
8T	R3133Q47EC	Vdet-IC	4.7V, MR, +Reset ODO	SOT-143	24vdh	VD4	5a	Ric
8T	XC6127C43DNR	Vdet-IC	4.3V±0.8%, -Reset PPO, -MR, Rt=400ms	SSOT-24	26cr	VD5	5a	Tor
8T	XC6127N43JNR	Vdet-IC	4.3V±0.8%, +Reset ODO, -MR, Rt=400ms	SSOT-24	26cr	VD4	5a	Tor
8T	XC6223A34BNR-G	LVR-IC	LDO, 3.45V±1%, 300mA, +CE	SSOT-24	26vn	VR4	5a	Tor
8U	R3133Q48EC	Vdet-IC	4.8V, MR, +Reset ODO	SOT-143	24vdh	VD4	5a	Ric
8U	XC6127C45DNR	Vdet-IC	4.5V±0.8%, -Reset PPO, -MR, Rt=400ms	SSOT-24	26cr	VD5	5a	Tor
8U	XC6127N45JNR	Vdet-IC	4.5V±0.8%, +Reset ODO, -MR, Rt=400ms	SSOT-24	26cr	VD4	5a	Tor
8U	XC6223A35BNR-G	LVR-IC	LDO, 3.55V±1%, 300mA, +CE	SSOT-24	26vn	VR4	5a	Tor
8V	R3133Q49EC	Vdet-IC	4.9V, MR, +Reset ODO	SOT-143	24vdh	VD4	5a	Ric
8V	XC6127C47DNR	Vdet-IC	4.7V±0.8%, -Reset PPO, -MR, Rt=400ms	SSOT-24	26cr	VD5	5a	Tor
8V	XC6127N47JNR	Vdet-IC	4.7V±0.8%, +Reset ODO, -MR, Rt=400ms	SSOT-24	26cr	VD4	5a	Tor
8V	XC6223A36BNR-G	LVR-IC	LDO, 3.65V±1%, 300mA, +CE	SSOT-24	26vn	VR4	5a	Tor
8X	XC6127C49DNR	Vdet-IC	4.9V±0.8%, -Reset PPO, -MR, Rt=400ms	SSOT-24	26cr	VD5	5a	Tor
8X	XC6127N49JNR	Vdet-IC	4.9V±0.8%, +Reset ODO, -MR, Rt=400ms	SSOT-24	26cr	VD4	5a	Tor
8X	XC6221B41BNR	LVR-IC	LDO, 4.15V±1%, 200mA, +CE, CL	SSOT-24	26vn	VR4	5a	Tor
8X	XC6223A37BNR-G	LVR-IC	LDO, 3.75V±1%, 300mA, +CE	SSOT-24	26vn	VR4	5a	Tor
8Y	XC6127C51DNR	Vdet-IC	5.1V±0.8%, -Reset PPO, -MR, Rt=400ms	SSOT-24	26cr	VD5	5a	Tor
8Y	XC6127N51JNR	Vdet-IC	5.1V±0.8%, +Reset ODO, -MR, Rt=400ms	SSOT-24	26cr	VD4	5a	Tor
8Y	XC6221B42BNR	LVR-IC	LDO, 4.25V±1%, 200mA, +CE, CL	SSOT-24	26vn	VR4	5a	Tor
8Y	XC6223A38BNR-G	LVR-IC	LDO, 3.85V±1%, 300mA, +CE	SSOT-24	26vn	VR4	5a	Tor
8Z	XC6127C53DNR	Vdet-IC	5.3V±0.8%, -Reset PPO, -MR, Rt=400ms	SSOT-24	26cr	VD5	5a	Tor
8Z	XC6127N53JNR	Vdet-IC	5.3V±0.8%, +Reset ODO, -MR, Rt=400ms	SSOT-24	26cr	VD4	5a	Tor
8Z	XC6221B43BNR	LVR-IC	LDO, 4.35V±1%, 200mA, +CE, CL	SSOT-24	26vn	VR4	5a	Tor
8Z	XC6223A39BNR-G	LVR-IC	LDO, 3.95V±1%, 300mA, +CE	SSOT-24	26vn	VR4	5a	Tor
90	XC6127C55ENR	Vdet-IC	5.5V±0.8%, -Reset PPO, -MR, Rt=800ms	SSOT-24	26cr	VD5	5a	Tor
90	XC6127N55KNR	Vdet-IC	5.5V±0.8%, +Reset ODO, -MR, Rt=800ms	SSOT-24	26cr	VD4	5a	Tor
913	S913T	MMIC	UHF, 12V, 30mA, 200mW, Idss=50..500µA	SOT-143	24fd	A3	5c	Vs
918	S918T	MMIC	UHF, 16V, 30mA, 200mW, Idss=50..500µA	SOT-143	24fd	A3	5c	Vs
92	XC6223B12BNR-G	LVR-IC	LDO, 1.25V±20mV, 300mA, +CE, CL	SSOT-24	26vn	VR4	5a	Tor
93	XC6223B13BNR-G	LVR-IC	LDO, 1.35V±20mV, 300mA, +CE, CL	SSOT-24	26vn	VR4	5a	Tor
93R	S593TR	MMIC	UHF, 8V, 30mA, 200mW, Idss=50..500µA	SOT-143R	26fm	A3	5c	Vs
94	XC6223B14BNR-G	LVR-IC	LDO, 1.45V±20mV, 300mA, +CE, CL	SSOT-24	26vn	VR4	5a	Tor
949	S594T	MMIC	UHF, 12V, 30mA, 200mW, Idss=50..500µA	SOT-143	24fd	A3	5c	Vs
94R	S594TR	MMIC	UHF, 8V, 20mA, 160mW, Idss=50..500µA	SOT-143R	26fm	A3	5c	Vs
95	XC6223B15BNR-G	LVR-IC	LDO, 1.55V±20mV, 300mA, +CE, CL	SSOT-24	26vn	VR4	5a	Tor
96	XC6223B16BNR-G	LVR-IC	LDO, 1.65V±20mV, 300mA, +CE, CL	SSOT-24	26vn	VR4	5a	Tor
97	XC6221A081NR	LVR-IC	LDO, 0.8V±20mV, 200mA, +CE	SSOT-24	26vn	VR4	5a	Tor
97	XC6223B17BNR-G	LVR-IC	LDO, 1.75V±20mV, 300mA, +CE, CL	SSOT-24	26vn	VR4	5a	Tor
97p	BCV65	Si-n/p	Dual, 30V, 100mA, 250mW, B=75..800	SOT-143	24tt	-	5c	Phi
98	XC6221A091NR	LVR-IC	LDO, 0.9V±20mV, 200mA, +CE	SSOT-24	26vn	VR4	5a	Tor
98	XC6223B18BNR-G	LVR-IC	LDO, 1.85V±20mV, 300mA, +CE, CL	SSOT-24	26vn	VR4	5a	Tor
982	S886T	MMIC	UHF, 16V, 30mA, 200mW, Idss=50..500µA	SOT-143	24fd	A3	5c	Vs
98p	BCV65B	Si-n/p	Dual, 30V, 100mA, 250mW, B=75..800	SOT-143	24tt	-	5c	Phi
99	XC6221A101NR	LVR-IC	LDO, 1V±20mV, 200mA, +CE	SSOT-24	26vn	VR4	5a	Tor
99	XC6223B19BNR-G	LVR-IC	LDO, 1.95V±20mV, 300mA, +CE, CL	SSOT-24	26vn	VR4	5a	Tor
99R	S949TR	MMIC	UHF, 12V, 30mA, 200mW, Idss=50..500µA	SOT-143R	26fm	A3	5c	Vs
9A	R3132Q50EC	Vdet-IC	5V, MR, -Reset ODO	SOT-143	24vdh	VD4	5a	Ric
9A	RQ5RW40BA	LVR-IC	LDO, 4V±2%, 150mA, +CE	SOT-143R	26vp	VR4	5c	Ric
9A	XC6127C15ENR	Vdet-IC	1.5V±0.8%, -Reset PPO, -MR, Rt=800ms	SSOT-24	26cr	VD5	5a	Tor
9A	XC6127N15KNR	Vdet-IC	1.5V±0.8%, +Reset ODO, -MR, Rt=800ms	SSOT-24	26cr	VD4	5a	Tor
9A	XC6221A111NR	LVR-IC	LDO, 1.1V±20mV, 200mA, +CE	SSOT-24	26vn	VR4	5a	Tor
9A	XC6223B20BNR-G	LVR-IC	LDO, 2.05V±1%, 300mA, +CE, CL	SSOT-24	26vn	VR4	5a	Tor
9B	RQ5RW41BA	LVR-IC	LDO, 4.1V±2%, 150mA, +CE	SOT-143R	26vp	VR4	5c	Ric
9B	XC6127C17ENR	Vdet-IC	1.7V±0.8%, -Reset PPO, -MR, Rt=800ms	SSOT-24	26cr	VD5	5a	Tor
9B	XC6127N17KNR	Vdet-IC	1.7V±0.8%, +Reset ODO, -MR, Rt=800ms	SSOT-24	26cr	VD4	5a	Tor
9B	XC6221A121NR	LVR-IC	LDO, 1.2V±20mV, 200mA, +CE	SSOT-24	26vn	VR4	5a	Tor
9B	XC6223B21BNR-G	LVR-IC	LDO, 2.15V±1%, 300mA, +CE, CL	SSOT-24	26vn	VR4	5a	Tor
9C	RQ5RW42BA	LVR-IC	LDO, 4.2V±2%, 150mA, +CE	SOT-143R	26vp	VR4	5c	Ric
9C	XC6127C19ENR	Vdet-IC	1.9V±0.8%, -Reset PPO, -MR, Rt=800ms	SSOT-24	26cr	VD5	5a	Tor



SMD code	Type	Function	Short description	Case	Pinout	Sch.	St.	Mnf.
9C	XC6127N19KNR	Vdet-IC	1.9V±0.8%, +Reset ODO, -MR, Rt=800ms	SSOT-24	26cr	VD4	5a	Tor
9C	XC6221A131NR	LVR-IC	LDO, 1.3V±20mV, 200mA, +CE	SSOT-24	26vn	VR4	5a	Tor
9C	XC6223B23BNR-G	LVR-IC	LDO, 2.25V±1%, 300mA, +CE, CL	SSOT-24	26vn	VR4	5a	Tor
9D	RQ5RW43BA	LVR-IC	LDO, 4.3V±2%, 150mA, +CE	SOT-143R	26vp	VR4	5c	Ric
9D	XC6127C21ENR	Vdet-IC	2.1V±0.8%, -Reset PPO, -MR, Rt=800ms	SSOT-24	26cr	VD5	5a	Tor
9D	XC6127N21KNR	Vdet-IC	2.1V±0.8%, +Reset ODO, -MR, Rt=800ms	SSOT-24	26cr	VD4	5a	Tor
9D	XC6221A141NR	LVR-IC	LDO, 1.4V±20mV, 200mA, +CE	SSOT-24	26vn	VR4	5a	Tor
9D	XC6223B23BNR-G	LVR-IC	LDO, 2.35V±1%, 300mA, +CE, CL	SSOT-24	26vn	VR4	5a	Tor
9D	XC6223B301NR-G	LVR-IC	LDO, 3.0V±1%, 300mA, +CE, CL	SSOT-24	26vn	VR4	5a	Tor
9E	RQ5RW44BA	LVR-IC	LDO, 4.4V±2%, 150mA, +CE	SOT-143R	26vp	VR4	5c	Ric
9E	XC6127C23ENR	Vdet-IC	2.3V±0.8%, -Reset PPO, -MR, Rt=800ms	SSOT-24	26cr	VD5	5a	Tor
9E	XC6127N23KNR	Vdet-IC	2.3V±0.8%, +Reset ODO, -MR, Rt=800ms	SSOT-24	26cr	VD4	5a	Tor
9E	XC6221A151NR	LVR-IC	LDO, 1.5V±20mV, 200mA, +CE	SSOT-24	26vn	VR4	5a	Tor
9E	XC6223B24BNR-G	LVR-IC	LDO, 2.45V±1%, 300mA, +CE, CL	SSOT-24	26vn	VR4	5a	Tor
9E	XC6223B311NR-G	LVR-IC	LDO, 3.1V±1%, 300mA, +CE, CL	SSOT-24	26vn	VR4	5a	Tor
9F	RQ5RW45BA	LVR-IC	LDO, 4.5V±2%, 150mA, +CE	SOT-143R	26vp	VR4	5c	Ric
9F	XC6127C25ENR	Vdet-IC	2.5V±0.8%, -Reset PPO, -MR, Rt=800ms	SSOT-24	26cr	VD5	5a	Tor
9F	XC6127N25KNR	Vdet-IC	2.5V±0.8%, +Reset ODO, -MR, Rt=800ms	SSOT-24	26cr	VD4	5a	Tor
9F	XC6221A161NR	LVR-IC	LDO, 1.6V±20mV, 200mA, +CE	SSOT-24	26vn	VR4	5a	Tor
9F	XC6223B25BNR-G	LVR-IC	LDO, 2.55V±1%, 300mA, +CE, CL	SSOT-24	26vn	VR4	5a	Tor
9F	XC6223B321NR-G	LVR-IC	LDO, 3.2V±1%, 300mA, +CE, CL	SSOT-24	26vn	VR4	5a	Tor
9G	RQ5RW46BA	LVR-IC	LDO, 4.6V±2%, 150mA, +CE	SOT-143R	26vp	VR4	5c	Ric
9H	RQ5RW47BA	LVR-IC	LDO, 4.7V±2%, 150mA, +CE	SOT-143R	26vp	VR4	5c	Ric
9H	XC6127C27ENR	Vdet-IC	2.7V±0.8%, -Reset PPO, -MR, Rt=800ms	SSOT-24	26cr	VD5	5a	Tor
9H	XC6127N27KNR	Vdet-IC	2.7V±0.8%, +Reset ODO, -MR, Rt=800ms	SSOT-24	26cr	VD4	5a	Tor
9H	XC6221A171NR	LVR-IC	LDO, 1.7V±20mV, 200mA, +CE	SSOT-24	26vn	VR4	5a	Tor
9H	XC6223B26BNR-G	LVR-IC	LDO, 2.65V±1%, 300mA, +CE, CL	SSOT-24	26vn	VR4	5a	Tor
9H	XC6223B331NR-G	LVR-IC	LDO, 3.3V±1%, 300mA, +CE, CL	SSOT-24	26vn	VR4	5a	Tor
9J	RQ5RW48BA	LVR-IC	LDO, 4.8V±2%, 150mA, +CE	SOT-143R	26vp	VR4	5c	Ric
9K	RQ5RW49BA	LVR-IC	LDO, 4.9V±2%, 150mA, +CE	SOT-143R	26vp	VR4	5c	Ric
9K	XC6127C29ENR	Vdet-IC	2.9V±0.8%, -Reset PPO, -MR, Rt=800ms	SSOT-24	26cr	VD5	5a	Tor
9K	XC6127N29KNR	Vdet-IC	2.9V±0.8%, +Reset ODO, -MR, Rt=800ms	SSOT-24	26cr	VD4	5a	Tor
9K	XC6221A181NR	LVR-IC	LDO, 1.8V±20mV, 200mA, +CE	SSOT-24	26vn	VR4	5a	Tor
9K	XC6223B27BNR-G	LVR-IC	LDO, 2.75V±1%, 300mA, +CE, CL	SSOT-24	26vn	VR4	5a	Tor
9K	XC6223B341NR-G	LVR-IC	LDO, 3.4V±1%, 300mA, +CE, CL	SSOT-24	26vn	VR4	5a	Tor
9L	R3133Q50EC	Vdet-IC	5V, MR, +Reset ODO	SOT-143	24vdh	VD4	5a	Ric
9L	XC6127C31ENR	Vdet-IC	3.1V±0.8%, -Reset PPO, -MR, Rt=800ms	SSOT-24	26cr	VD5	5a	Tor
9L	XC6127N31KNR	Vdet-IC	3.1V±0.8%, +Reset ODO, -MR, Rt=800ms	SSOT-24	26cr	VD4	5a	Tor
9L	XC6221A191NR	LVR-IC	LDO, 1.9V±20mV, 200mA, +CE	SSOT-24	26vn	VR4	5a	Tor
9L	XC6223B28BNR-G	LVR-IC	LDO, 2.85V±1%, 300mA, +CE, CL	SSOT-24	26vn	VR4	5a	Tor
9L	XC6223B351NR-G	LVR-IC	LDO, 3.5V±1%, 300mA, +CE, CL	SSOT-24	26vn	VR4	5a	Tor
9LB	STM6315LB	Vdet-IC	4.63V±2%, 30ms, -Reset ODO	SOT-143	24vdh	VD6	5g	Ste
9LN	ELM7551CCB	Vdet-IC	5.1V±2%, +Reset PPO	SC-82AB	26vdl	VD7	5c	Elm
9LN	ELM7551NCB	Vdet-IC	5.1V±2%, +Reset ODO	SC-82AB	26vdl	VD6	5c	Elm
9M	XC6127C33ENR	Vdet-IC	3.3V±0.8%, -Reset PPO, -MR, Rt=800ms	SSOT-24	26cr	VD5	5a	Tor
9M	XC6127N33KNR	Vdet-IC	3.3V±0.8%, +Reset ODO, -MR, Rt=800ms	SSOT-24	26cr	VD4	5a	Tor
9M	XC6221A201NR	LVR-IC	LDO, 2V±1%, 200mA, +CE	SSOT-24	26vn	VR4	5a	Tor
9M	XC6223B361NR-G	LVR-IC	LDO, 3.6V±1%, 300mA, +CE, CL	SSOT-24	26vn	VR4	5a	Tor
9MD	STM6315MD	Vdet-IC	4.38V±2%, 210ms, -Reset ODO	SOT-143	24vdh	VD6	5g	Ste
9N	XC6127C35ENR	Vdet-IC	3.5V±0.8%, -Reset PPO, -MR, Rt=800ms	SSOT-24	26cr	VD5	5a	Tor
9N	XC6127N35KNR	Vdet-IC	3.5V±0.8%, +Reset ODO, -MR, Rt=800ms	SSOT-24	26cr	VD4	5a	Tor
9N	XC6221A211NR	LVR-IC	LDO, 2.1V±1%, 200mA, +CE	SSOT-24	26vn	VR4	5a	Tor
9P	XC6127C37ENR	Vdet-IC	3.7V±0.8%, -Reset PPO, -MR, Rt=800ms	SSOT-24	26cr	VD5	5a	Tor
9P	XC6127N37KNR	Vdet-IC	3.7V±0.8%, +Reset ODO, -MR, Rt=800ms	SSOT-24	26cr	VD4	5a	Tor
9P	XC6221A221NR	LVR-IC	LDO, 2.2V±1%, 200mA, +CE	SSOT-24	26vn	VR4	5a	Tor
9P	XC6223B371NR-G	LVR-IC	LDO, 3.7V±1%, 300mA, +CE, CL	SSOT-24	26vn	VR4	5a	Tor
9R	XC6127C39ENR	Vdet-IC	3.9V±0.8%, -Reset PPO, -MR, Rt=800ms	SSOT-24	26cr	VD5	5a	Tor
9R	XC6127N39KNR	Vdet-IC	3.9V±0.8%, +Reset ODO, -MR, Rt=800ms	SSOT-24	26cr	VD4	5a	Tor
9R	XC6221A231NR	LVR-IC	LDO, 2.3V±1%, 200mA, +CE	SSOT-24	26vn	VR4	5a	Tor
9R	XC6223B381NR-G	LVR-IC	LDO, 3.8V±1%, 300mA, +CE, CL	SSOT-24	26vn	VR4	5a	Tor
9RA	STM6315RA	Vdet-IC	2.63V±2%, 1.5ms, -Reset ODO	SOT-143	24vdh	VD6	5g	Ste
9RB	STM6315RB	Vdet-IC	2.63V±2%, 30ms, -Reset ODO	SOT-143	24vdh	VD6	5g	Ste
9RD	STM6315RD	Vdet-IC	2.63V±2%, 210ms, -Reset ODO	SOT-143	24vdh	VD6	5g	Ste
9RG	STM6315RG	Vdet-IC	2.63V±2%, 1680ms, -Reset ODO	SOT-143	24vdh	VD6	5g	Ste
9S	XC6127C41ENR	Vdet-IC	4.1V±0.8%, -Reset PPO, -MR, Rt=800ms	SSOT-24	26cr	VD5	5a	Tor
9S	XC6127N41KNR	Vdet-IC	4.1V±0.8%, +Reset ODO, -MR, Rt=800ms	SSOT-24	26cr	VD4	5a	Tor
9S	XC6221A241NR	LVR-IC	LDO, 2.4V±1%, 200mA, +CE	SSOT-24	26vn	VR4	5a	Tor
9S	XC6223B391NR-G	LVR-IC	LDO, 3.9V±1%, 300mA, +CE, CL	SSOT-24	26vn	VR4	5a	Tor
9SD	STM6315SD	Vdet-IC	2.93V±2%, 210ms, -Reset ODO	SOT-143	24vdh	VD6	5g	Ste
9T	XC6127C43ENR	Vdet-IC	4.3V±0.8%, -Reset PPO, -MR, Rt=800ms	SSOT-24	26cr	VD5	5a	Tor



SMD code	Type	Function	Short description	Case	Pinout Sch.	St.	Mnf.
9T	XC6127N43KNR	Vdet-IC	4.3V±0.8%, +Reset ODO, -MR, Rt=800ms	SSOT-24	26cr	VD4	5a Tor
9T	XC6221A251NR	LVR-IC	LDO, 2.5V±1%, 200mA, +CE	SSOT-24	26vn	VR4	5a Tor
9T	XC6223B401NR-G	LVR-IC	LDO, 4.0V±1%, 300mA, +CE, CL	SSOT-24	26vn	VR4	5a Tor
9U	XC6127C45ENR	Vdet-IC	4.5V±0.8%, -Reset PPO, -MR, Rt=800ms	SSOT-24	26cr	VD5	5a Tor
9U	XC6127N45KNR	Vdet-IC	4.5V±0.8%, +Reset ODO, -MR, Rt=800ms	SSOT-24	26cr	VD4	5a Tor
9U	XC6221A261NR	LVR-IC	LDO, 2.6V±1%, 200mA, +CE	SSOT-24	26vn	VR4	5a Tor
9V	XC6127C47ENR	Vdet-IC	4.7V±0.8%, -Reset PPO, -MR, Rt=800ms	SSOT-24	26cr	VD5	5a Tor
9V	XC6127N47KNR	Vdet-IC	4.7V±0.8%, +Reset ODO, -MR, Rt=800ms	SSOT-24	26cr	VD4	5a Tor
9V	XC6221A271NR	LVR-IC	LDO, 2.7V±1%, 200mA, +CE	SSOT-24	26vn	VR4	5a Tor
9X	XC6127C49ENR	Vdet-IC	4.9V±0.8%, -Reset PPO, -MR, Rt=800ms	SSOT-24	26cr	VD5	5a Tor
9X	XC6127N49KNR	Vdet-IC	4.9V±0.8%, +Reset ODO, -MR, Rt=800ms	SSOT-24	26cr	VD4	5a Tor
9X	XC6221A281NR	LVR-IC	LDO, 2.8V±1%, 200mA, +CE	SSOT-24	26vn	VR4	5a Tor
9Y	XC6127C51ENR	Vdet-IC	5.1V±0.8%, -Reset PPO, -MR, Rt=800ms	SSOT-24	26cr	VD5	5a Tor
9Y	XC6127N51KNR	Vdet-IC	5.1V±0.8%, +Reset ODO, -MR, Rt=800ms	SSOT-24	26cr	VD4	5a Tor
9Y	XC6221A291NR	LVR-IC	LDO, 2.9V±1%, 200mA, +CE	SSOT-24	26vn	VR4	5a Tor
9Z	XC6127C53ENR	Vdet-IC	5.3V±0.8%, -Reset PPO, -MR, Rt=800ms	SSOT-24	26cr	VD5	5a Tor
9Z	XC6127N53KNR	Vdet-IC	5.3V±0.8%, +Reset ODO, -MR, Rt=800ms	SSOT-24	26cr	VD4	5a Tor
9Z	XC6221A301NR	LVR-IC	LDO, 3V±1%, 200mA, +CE	SSOT-24	26vn	VR4	5a Tor
A	3SK301	n-MOSFET	DG, VHF-amp, 15V, ±30mA, 150mW, Idss=5..23mA	SOT-143	26fm	-	5b Pan
A	3SK305	n-MOSFET	DG, VHF-amp, 15V, ±30mA, 150mW, Idss=5..23mA	SOT-343	26fm	-	5b Pan
A0	R3114Q071A	Vdet-IC	0.7V±0.8%, -Reset ODO	SC-82AB	26vdl	VD9	5a Ric
A0	XC6127C55FNR	Vdet-IC	5.5V±0.8%, +Reset PPO, -MR, Rt=50ms	SSOT-24	26cr	VD5	5a Tor
A0	XC6224A081NR	LVR-IC	LDO, 0.8V±20mV, 150mA, +CE	SSOT-24	26vn	VR4	5a Tor
A0-	RT9818E-23PY	Vdet-IC	2.3V±1.5%, +Reset ODO	SOT-343	26ut	VD6	5b Rct
A1	1SS272	Si-diode	Dual, Sw, Fast, 85V, 100mA, <2pF, <4ns	SOT-143	24dv	-	5b Tos
A1	1SS382	Si-diode	Dual, Fast Sw, 85V, 100mA, 100mW, <4ns	SOT-343	26dv	-	5b Tos
A1	BGA2001	MMIC	RF amp, DC, 1.88GHz, 19.5dB (50Ω), Vcc=4.5V	SOT-143	26aa	A1	5c Phi
A1	R3114Q081A	Vdet-IC	0.8V±0.8%, -Reset ODO	SC-82AB	26vdl	VD9	5a Ric
A1	XC6224A091NR	LVR-IC	LDO, 0.9V±20mV, 150mA, +CE	SSOT-24	26vn	VR4	5a Tor
A1-	RT9198-18PY	LVR-IC	LDO, 1.8V±1%, 300mA, +CE	SOT-343	26vn	VR4	5b Rct
A2	CFY30	n-FET	GaAs, LN, UHF, 7V, 80mA, 250mW, 12GHz, 11.5dB	SOT-143	24fp	-	5b Inf
A2	DWOC010	Si-diode	Dual, Sw, Hi-sp, 200V, 100mA, Vf<1.2V(100mA), 60ns	CP4	26ce	-	5b San
A2	R1180Q121B	LVR-IC	LDO, 1.2V±2%, 150mA, +CE	SC-82AB	26vn	VR4	5a Ric
A2	R3114Q091A	Vdet-IC	0.9V±0.8%, -Reset ODO	SC-82AB	26vdl	VD9	5a Ric
A2	XC6224A101NR	LVR-IC	LDO, 1.0V±20mV, 150mA, +CE	SSOT-24	26vn	VR4	5a Tor
A2-	RT9198-25PY	LVR-IC	LDO, 2.5V±1%, 300mA, +CE	SOT-343	26vn	VR4	5b Rct
A3	1SS306	Si-diode	Dual, Sw, 250V, 100mA, <3pF, <60ns	SOT-143	24dv	-	5b Tos
A3	BGA2003	MMIC	RF amp, DC, 1.88GHz, 16dB (50Ω), Vcc=4.5V	SOT-143	26aa	A1	5c Phi
A3	R1180Q131B	LVR-IC	LDO, 1.3V±2%, 150mA, +CE	SC-82AB	26vn	VR4	5a Ric
A3	R3114Q101A	Vdet-IC	1V±0.8%, -Reset ODO	SC-82AB	26vdl	VD9	5a Ric
A3	XC6224A111NR	LVR-IC	LDO, 1.1V±20mV, 150mA, +CE	SSOT-24	26vn	VR4	5a Tor
A3-	RT9198-28PY	LVR-IC	LDO, 2.8V±1%, 300mA, +CE	SOT-343	26vn	VR4	5b Rct
A4	1SS319	Si-diode	Dual, Schottky, Sw, 45V, 100mA, Vf<0.6V(100mA)	SOT-143	24dv	-	5b Tos
A4	1SS383	Si-diode	Dual, Schottky, 45V, 100mA, 100mW, <18pF	SC-61	24dv	-	5b Tos
A4	R1180Q141B	LVR-IC	LDO, 1.4V±2%, 150mA, +CE	SC-82AB	26vn	VR4	5a Ric
A4	R3114Q111A	Vdet-IC	1.1V±0.8%, -Reset ODO	SC-82AB	26vdl	VD9	5a Ric
A4	XC6224A121NR	LVR-IC	LDO, 1.2V±20mV, 150mA, +CE	SSOT-24	26vn	VR4	5a Tor
A4-	RT9198-30PY	LVR-IC	LDO, 3.0V±1%, 300mA, +CE	SOT-343	26vn	VR4	5b Rct
A5	1SS384	Si-diode	Dual, Schottky, 15V, 100mA, 100mW, <20pF	SOT-323	24dv	-	5b Tos
A5	1SS391	Si-diode	Dual, Schottky, 15V, 100mA	SOT-143	24dv	-	5b Tos
A5	HSMS-2805	Si-diode	2x Schottky, RF, 70V, 1A, Vf<0.41V(1mA), <2pF, 35Ω(5mA)	SOT-143	24ce	-	5c Agi
A5	R1140Q151B	LVR-IC	LDO, 1.5V±2%, 120mA, +CE	SOT-143R	26vm	VR4	5a Ric
A5	R1180Q151B	LVR-IC	LDO, 1.5V±2%, 150mA, +CE	SC-82AB	26vn	VR4	5a Ric
A5	R3114Q121A	Vdet-IC	1.2V±0.8%, -Reset ODO	SC-82AB	26vdl	VD9	5a Ric
A5	XC6224A131NR	LVR-IC	LDO, 1.3V±1.5%, 150mA, +CE	SSOT-24	26vn	VR4	5a Tor
A5-	RT9198-33PY	LVR-IC	LDO, 3.3V±1%, 300mA, +CE	SOT-343	26vn	VR4	5b Rct
A6	1SS399	Si-diode	Dual, Rect, 420V, 100mA, 500ns	SOT-143	24dv	-	5b Tos
A6	R1140Q161B	LVR-IC	LDO, 1.6V±2%, 120mA, +CE	SOT-143R	26vm	VR4	5a Ric
A6	R1180Q161B	LVR-IC	LDO, 1.6V±2%, 150mA, +CE	SC-82AB	26vn	VR4	5a Ric
A6	R3114Q131A	Vdet-IC	1.3V±0.8%, -Reset ODO	SC-82AB	26vdl	VD9	5a Ric
A6	XC6224A141NR	LVR-IC	LDO, 1.4V±1.5%, 150mA, +CE	SSOT-24	26vn	VR4	5a Tor
A6-	RT9198-15PY	LVR-IC	LDO, 1.5V±1%, 300mA, +CE	SOT-343	26vn	VR4	5b Rct
A61	BAS28	Si-diode	Dual, Fast, Sw, 75V, 250mA, Vf<1.25V(150mA), <6ns	SOT-143	24ce	-	3a Cen
A7	1SS402	Si-diode	Dual, Schottky, 20V, 50mA	SOT-143	24dv	-	5b Tos
A7	BFG310WXR	Si-npn	UHF, 15V, 10mA, 60mW, B=60..200, 14GHz	SOT-343R	26tu	-	5b Phi
A7	HSMS-2807	Si-diode	4x SBD, RF, 70V, 1A, Vf<0.41V(1mA), <2pF, 35Ω(5mA)	SOT-143	24D/1	-	5c Agi
A7	R1140Q171B	LVR-IC	LDO, 1.7V±2%, 120mA, +CE	SOT-143R	26vm	VR4	5a Ric
A7	R1180Q171B	LVR-IC	LDO, 1.7V±2%, 150mA, +CE	SC-82AB	26vn	VR4	5a Ric
A7	R3114Q141A	Vdet-IC	1.4V±0.8%, -Reset ODO	SC-82AB	26vdl	VD9	5a Ric
A7	XC6221A08BNR	LVR-IC	LDO, 0.85V±20mV, 200mA, +CE	SSOT-24	26vn	VR4	5a Tor



SMD code	Type	Function	Short description	Case	Pinout	Sch.	St.	Mnf.
A7	XC6224A151NR	LVR-IC	LDO, 1.5V±1.5%, 150mA, +CE	SSOT-24	26vn	VR4	5a	Tor
A7-	RT9818A-23PY	Vdet-IC	2.3V±1.5%, +Reset ODO	SOT-343	26tu	VD6	5b	Rct
A7p	BFG310WXR	Si-npn	UHF, 15V, 10mA, 60mW, B=60..200, 14GHz	SOT-343R	26tu	-	5b	PhH
A7W	BFG310WXR	Si-npn	UHF, 15V, 10mA, 60mW, B=60..200, 14GHz	SOT-343R	26tu	-	5b	PhC
A8	HSMS-2808	Si-diode	4x SBD, RF, 70V, 1A, Vf<0.41V(1mA), <2pF, 35Q(5mA)	SOT-143	24D2	-	5c	Agi
A8	R1140Q181B	LVR-IC	LDO, 1.8V±2%, 120mA, +CE	SOT-143R	26vn	VR4	5a	Ric
A8	R1180Q181B	LVR-IC	LDO, 1.8V±2%, 150mA, +CE	SC-82AB	26vn	VR4	5a	Ric
A8	R3114Q151A	Vdet-IC	1.5V±0.8%, -Reset ODO	SC-82AB	26vdl	VD9	5a	Ric
A8	XC6221A09BNR	LVR-IC	LDO, 0.95V±20mV, 200mA, +CE	SSOT-24	26vn	VR4	5a	Tor
A8	XC6224A161NR	LVR-IC	LDO, 1.6V±1.5%, 150mA, +CE	SSOT-24	26vn	VR4	5a	Tor
A8-	RT9818E-21PY	Vdet-IC	2.1V±1.5%, +Reset ODO	SOT-343	26tu	VD6	5b	Rct
A83	SGA-8343	SiGe-npn	UHF-amp, LN, 12V, 72mA, 350mW, B=120..300, 6GHz	SOT-89	26t1	-	5b	Sir
A83Z	SGA-8343Z	SiGe-npn	UHF-amp, LN, 12V, 72mA, 350mW, B=120..300, 6GHz	SOT-143	26t1	-	5b	Sir
A9	R1140Q191B	LVR-IC	LDO, 1.9V±2%, 120mA, +CE	SOT-143R	26vn	VR4	5a	Ric
A9	R1180Q191B	LVR-IC	LDO, 1.9V±2%, 150mA, +CE	SC-82AB	26vn	VR4	5a	Ric
A9	R3114Q161A	Vdet-IC	1.6V±0.8%, -Reset ODO	SC-82AB	26vdl	VD9	5a	Ric
A9	XC6221A10BNR	LVR-IC	LDO, 1.05V±20mV, 200mA, +CE	SSOT-24	26vn	VR4	5a	Tor
A9	XC6224A171NR	LVR-IC	LDO, 1.7V±1.5%, 150mA, +CE	SSOT-24	26vn	VR4	5a	Tor
A9-	RT9818E-22PY	Vdet-IC	2.2V±1.5%, +Reset ODO	SOT-343	26tu	VD6	5b	Rct
AA	MAX6314US50D1-T	Vdet-IC	5.0V±1.8%, -MR, -Reset Bidir, PPO, 1ms	SOT-143	24vdh	VD5	5c	Max
AA	RP130Q121A	LVR-IC	LDO, LN, -CE, 1.2V±1%, 150mA	SC-82AB	26vn	VR4	5a	Ric
AA	XC6127C15FNR	Vdet-IC	1.5V±0.8%, +Reset PPO, -MR, Rt=50ms	SSOT-24	26cr	VD5	5a	Tor
AA	XC6127N16ANR	Vdet-IC	1.6V±0.8%, -Reset ODO, -MR, Rt=50ms	SSOT-24	26cr	VD4	5a	Tor
AA	XC6221A11BNR	LVR-IC	LDO, 1.15V±20mV, 200mA, +CE	SSOT-24	26vn	VR4	5a	Tor
AA	XC6224A181NR	LVR-IC	LDO, 1.8V±1.5%, 150mA, +CE	SSOT-24	26vn	VR4	5a	Tor
AA-	RT9818E-24PY	Vdet-IC	2.4V±1.5%, +Reset ODO	SOT-343	26tu	VD6	5b	Rct
AAC	PAM3101FUK150	LVR-IC	LDO, 1.5V±2%, 300mA, +CE	SC-70-4L	24vn	VR4	5d	Pam
AAE	PAM3101FUK180	LVR-IC	LDO, 1.8V±2%, 300mA, +CE	SC-70-4L	24vn	VR4	5d	Pam
AAG	PAM3101FUK250	LVR-IC	LDO, 2.5V±2%, 300mA, +CE	SC-70-4L	24vn	VR4	5d	Pam
AAH	PAM3101FUK280	LVR-IC	LDO, 2.8V±2%, 300mA, +CE	SC-70-4L	24vn	VR4	5d	Pam
AAI	PAM3101FUK285	LVR-IC	LDO, 2.85V±2%, 300mA, +CE	SC-70-4L	24vn	VR4	5d	Pam
AAJ	PAM3101FUK300	LVR-IC	LDO, 3.0V±2%, 300mA, +CE	SC-70-4L	24vn	VR4	5d	Pam
AAK	PAM3101FUK330	LVR-IC	LDO, 3.3V±2%, 300mA, +CE	SC-70-4L	24vn	VR4	5d	Pam
AAM	PAM3101FUK400	LVR-IC	LDO, 4.0V±2%, 300mA, +CE	SC-70-4L	24vn	VR4	5d	Pam
AAO	PAM3101FUK380	LVR-IC	LDO, 3.8V±2%, 300mA, +CE	SC-70-4L	24vn	VR4	5d	Pam
AAP	PAM3101FUK310	LVR-IC	LDO, 3.1V±2%, 300mA, +CE	SC-70-4L	24vn	VR4	5d	Pam
AAQ	PAM3101FUK290	LVR-IC	LDO, 2.9V±2%, 300mA, +CE	SC-70-4L	24vn	VR4	5d	Pam
AAs	BAR80	Si-diode	RF, Shunt, 35V, 100mA, Vf<1V(100mA), 0.6pF	MW-4	25cd	-	5c	Inf
AAT	PAM3101FUK475	LVR-IC	LDO, 4.75V±2%, 300mA, +CE	SC-70-4L	24vn	VR4	5d	Pam
AB	MAX6314US49D1-T	Vdet-IC	4.9V±1.8%, -MR, -Reset Bidir, PPO, 1ms	SOT-143	24vdh	VD5	5c	Max
AB	RP130Q131A	LVR-IC	LDO, LN, -CE, 1.3V±1%, 150mA	SC-82AB	26vn	VR4	5a	Ric
AB	XC6127C17FNR	Vdet-IC	1.7V±0.8%, +Reset PPO, -MR, Rt=50ms	SSOT-24	26cr	VD5	5a	Tor
AB	XC6127N18ANR	Vdet-IC	1.8V±0.8%, -Reset ODO, -MR, Rt=50ms	SSOT-24	26cr	VD4	5a	Tor
AB	XC6221A12BNR	LVR-IC	LDO, 1.25V±20mV, 200mA, +CE	SSOT-24	26vn	VR4	5a	Tor
AB	XC6224A191NR	LVR-IC	LDO, 1.9V±1.5%, 150mA, +CE	SSOT-24	26vn	VR4	5a	Tor
AB-	RT9818E-40PY	Vdet-IC	4.0V±1.5%, +Reset ODO	SOT-343	26tu	VD6	5b	Rct
AC	MAX6314US48D1-T	Vdet-IC	4.8V±1.8%, -MR, -Reset Bidir, PPO, 1ms	SOT-143	24vdh	VD5	5c	Max
AC	MT4506	Si-npn	VHF/UHF, 10V, 15mA, 10GHz	SOT-143	26tu	-	5b	Tos
AC	RP130Q141A	LVR-IC	LDO, LN, -CE, 1.4V±1%, 150mA	SC-82AB	26vn	VR4	5a	Ric
AC	XC6127C19FNR	Vdet-IC	1.9V±0.8%, +Reset PPO, -MR, Rt=50ms	SSOT-24	26cr	VD5	5a	Tor
AC	XC6127N20ANR	Vdet-IC	2.0V±0.8%, -Reset ODO, -MR, Rt=50ms	SSOT-24	26cr	VD4	5a	Tor
AC	XC6221A13BNR	LVR-IC	LDO, 1.35V±20mV, 200mA, +CE	SSOT-24	26vn	VR4	5a	Tor
AC	XC6224A201NR	LVR-IC	LDO, 2.0V±1.5%, 150mA, +CE	SSOT-24	26vn	VR4	5a	Tor
AC-	RT9198A-42PY	LVR-IC	LDO, 4.2V±1%, 300mA, -CE	SOT-343	26vn	VR4	5b	Rct
AD	MAX6314US47D1-T	Vdet-IC	4.7V±1.8%, -MR, -Reset Bidir, PPO, 1ms	SOT-143	24vdh	VD5	5c	Max
AD	RP130Q151A	LVR-IC	LDO, LN, -CE, 1.5V±1%, 150mA	SC-82AB	26vn	VR4	5a	Ric
AD	XC6127C21FNR	Vdet-IC	2.1V±0.8%, +Reset PPO, -MR, Rt=50ms	SSOT-24	26cr	VD5	5a	Tor
AD	XC6127N22ANR	Vdet-IC	2.2V±0.8%, -Reset ODO, -MR, Rt=50ms	SSOT-24	26cr	VD4	5a	Tor
AD	XC6221A14BNR	LVR-IC	LDO, 1.45V±20mV, 200mA, +CE	SSOT-24	26vn	VR4	5a	Tor
AD	XC6223D301NR-G	LVR-IC	LDO, 3.0V±1%, 300mA, +CE, PDR, CL	SSOT-24	26vn	VR4	5a	Tor
AD-	RT9818A-36PY	Vdet-IC	3.6V±1.5%, +Reset ODO	SOT-343	26tu	VD6	5b	Rct
AD=	RT9818A-36GY	Vdet-IC	3.6V±1.5%, +Reset ODO	SOT-343	26tu	VD6	5c	Rct
AE	1SS383	Si-diode	Dual, Schottky, 40V, 300mA, 100mW, <25pF	SOT-343	24dv	-	5c	Ons
AE	3SK219	n-MOSFET	DG, VHF-amp, 15V, ±30mA, 150mW, Idss=0.8mA	SOT-143	26fm	-	5b	Pan
AE	3SK268	n-MOSFET	DG, VHF-amp, 15V, ±30mA, 150mW, Idss=0.8mA	SOT-343	26fm	-	5b	Pan
AE	MAX6314US46D1-T	Vdet-IC	4.63V±1.8%, -MR, -Reset Bidir, PPO, 1ms	SOT-143	24vdh	VD5	5c	Max
AE	MT4504A	Si-npn	VHF/UHF, 10V, 40mA, 7GHz	SOT-143	26tu	-	5b	Tos
AE	RP130Q161A	LVR-IC	LDO, LN, -CE, 1.6V±1%, 150mA	SC-82AB	26vn	VR4	5a	Ric
AE	XC6127C23FNR	Vdet-IC	2.3V±0.8%, +Reset PPO, -MR, Rt=50ms	SSOT-24	26cr	VD5	5a	Tor
AE	XC6127N24ANR	Vdet-IC	2.4V±0.8%, -Reset ODO, -MR, Rt=50ms	SSOT-24	26cr	VD4	5a	Tor



SMD code	Type	Function	Short description	Case	Pinout Sch.	St.	Mnf.
AE	XC6221A15BNR	LVR-IC	LDO, 1.55V±20mV, 200mA, +CE	SSOT-24	26vn VR4	5a	Tor
AE	XC6223D311NR-G	LVR-IC	LDO, 3.1V±1%, 300mA, +CE, PDR, CL	SSOT-24	26vn VR4	5a	Tor
AE-	RT9816A-18PY	Vdet-IC	1.8V±1.5%, -Reset ODO, -MR	SC-82	26vdh VD4	5b	Rct
AF	3SK220	n-MOSFET-d	DG, VHFUFHF, 15V, 30mA	SOT-143	26fm -	5c	Pan
AF	3SK270	n-MOSFET	DG, VHFUFHF-amp, 15V, ±30mA, 150mW, Idss=12..22mA	SOT-343	26fm -	5b	Pan
AF	MAX6314US45D1-T	Vdet-IC	4.5V±0.8%, -MR, -Reset Bidir, PPO, 1ms	SOT-143	24vdh VD5	5c	Max
AF	R1141Q151B	LVR-IC	LDO, 1.5V±2%, 120mA, +CE	SOT-143R	26vm VR4	5a	Ric
AF	RP130Q171A	LVR-IC	LDO, LN, -CE, 1.7V±1%, 150mA	SC-82AB	26vn VR4	5a	Ric
AF	XC6127C25FNR	Vdet-IC	2.5V±0.8%, +Reset PPO, -MR, Rt=50ms	SSOT-24	26cr VD5	5a	Tor
AF	XC6127N26ANR	Vdet-IC	2.6V±0.8%, -Reset ODO, -MR, Rt=50ms	SSOT-24	26cr VD4	5a	Tor
AF	XC6221A16BNR	LVR-IC	LDO, 1.65V±20mV, 200mA, +CE	SSOT-24	26vn VR4	5a	Tor
AF	XC6223D321NR-G	LVR-IC	LDO, 3.2V±1%, 300mA, +CE, PDR, CL	SSOT-24	26vn VR4	5a	Tor
AF-	RT9816A-20PY	Vdet-IC	2.0V±1.5%, -Reset ODO, -MR	SC-82	26vdh VD4	5b	Rct
AF-	RT9816D-31PY	Vdet-IC	3.1V±1.5%, 450ms, -Reset ODO, -MR	SC-82	26vdh VD4	5b	Rct
AG	MAX6314US44D1-T	Vdet-IC	4.39V±1.8%, -MR, -Reset Bidir, PPO, 1ms	SOT-143	24vdh VD5	5c	Max
AG	R1141Q161B	LVR-IC	LDO, 1.6V±2%, 120mA, +CE	SOT-143R	26vm VR4	5a	Ric
AG	RP130Q181A	LVR-IC	LDO, LN, -CE, 1.8V±1%, 150mA	SC-82AB	26vn VR4	5a	Ric
AGB	MAX6468XS46D3	Vdet-IC	4.6V±1.5%, -MR, Reset PPO	SC-70-4	26vdh VD5	5c	Max
AGC	MAX6468XS29D3	Vdet-IC	2.9V±1.5%, -MR, Reset PPO	SC-70-4	26vdh VD5	5c	Max
AGL	MAX6467XS16D3	Vdet-IC	1.6V±1.5%, -MR, Reset ODO	SC-70-4	26vdh VD4	5c	Max
AGM	MAX6467XS22D3	Vdet-IC	2.2V±1.5%, -MR, Reset ODO	SC-70-4	26vdh VD4	5c	Max
AGN	MAX6467XS26D3	Vdet-IC	2.6V±1.5%, -MR, Reset ODO	SC-70-4	26vdh VD4	5c	Max
AGO	MAX6467XS29D3	Vdet-IC	2.9V±1.5%, -MR, Reset ODO	SC-70-4	26vdh VD4	5c	Max
AGP	MAX6467XS46D3	Vdet-IC	4.6V±1.5%, -MR, Reset ODO	SC-70-4	26vdh VD4	5c	Max
AGQ	MAX6468XS16D3	Vdet-IC	1.6V±1.5%, -MR, Reset PPO	SC-70-4	26vdh VD5	5c	Max
AGR	MAX6468XS22D3	Vdet-IC	2.2V±1.5%, -MR, Reset PPO	SC-70-4	26vdh VD5	5c	Max
AGS	MAX6468XS26D3	Vdet-IC	2.6V±1.5%, -MR, Reset PPO	SC-70-4	26vdh VD5	5c	Max
AH	MAX6314US43D1-T	Vdet-IC	4.3V±1.8%, -MR, -Reset Bidir, PPO, 1ms	SOT-143	24vdh VD5	5c	Max
AH	R1141Q171B	LVR-IC	LDO, 1.7V±2%, 120mA, +CE	SOT-143R	26vm VR4	5a	Ric
AH	RP130Q181A5	LVR-IC	LDO, LN, -CE, 1.85V±1%, 150mA	SC-82AB	26vn VR4	5a	Ric
AH	XC6127C27FNR	Vdet-IC	2.7V±0.8%, +Reset PPO, -MR, Rt=50ms	SSOT-24	26cr VD5	5a	Tor
AH	XC6127N28ANR	Vdet-IC	2.8V±0.8%, -Reset ODO, -MR, Rt=50ms	SSOT-24	26cr VD4	5a	Tor
AH	XC6221A17BNR	LVR-IC	LDO, 1.75V±20mV, 200mA, +CE	SSOT-24	26vn VR4	5a	Tor
AH	XC6223D331NR-G	LVR-IC	LDO, 3.3V±1%, 300mA, +CE, PDR, CL	SSOT-24	26vn VR4	5a	Tor
AJ	MAX6314US42D1-T	Vdet-IC	4.2V±1.8%, -MR, -Reset Bidir, PPO, 1ms	SOT-143	24vdh VD5	5c	Max
AJ	MAX6314US41D1-T	Vdet-IC	4.1V±1.8%, -MR, -Reset Bidir, PPO, 1ms	SOT-143	24vdh VD5	5c	Max
AJ	R1141Q181B	LVR-IC	LDO, 1.8V±2%, 120mA, +CE	SOT-143R	26vm VR4	5a	Ric
AJ	RP130Q191A	LVR-IC	LDO, LN, -CE, 1.9V±1%, 150mA	SC-82AB	26vn VR4	5a	Ric
AJ-	RT9818C-14PY	Vdet-IC	1.4V±1.5%, +Reset ODO, Td=220ms	SOT-343	26ut VD6	5b	Rct
AK	MAX6314US40D1-T	Vdet-IC	4.0V±1.8%, -MR, -Reset Bidir, PPO, 1ms	SOT-143	24vdh VD5	5c	Max
AK	R1141Q191B	LVR-IC	LDO, 1.9V±2%, 120mA, +CE	SOT-143R	26vm VR4	5a	Ric
AK	R3112Q091A	Vdet-IC	0.91V±2%, -Reset PPO	SC-82AB	26rp VD3	5a	Ric
AK	RP130Q201A	LVR-IC	LDO, LN, -CE, 2V±1%, 150mA	SC-82AB	26vn VR4	5a	Ric
AK	XC6127C29FNR	Vdet-IC	2.9V±0.8%, +Reset PPO, -MR, Rt=50ms	SSOT-24	26cr VD5	5a	Tor
AK	XC6127N30ANR	Vdet-IC	3.0V±0.8%, -Reset ODO, -MR, Rt=50ms	SSOT-24	26cr VD4	5a	Tor
AK	XC6221A18BNR	LVR-IC	LDO, 1.85V±20mV, 200mA, +CE	SSOT-24	26vn VR4	5a	Tor
AK	XC6223D341NR-G	LVR-IC	LDO, 3.4V±1%, 300mA, +CE, PDR, CL	SSOT-24	26vn VR4	5a	Tor
AK-	RT9198-31PY	LVR-IC	LDO, 3.1V±1%, 300mA, +CE	SOT-343	26vn VR4	5b	Rct
AK=	RT9198-31GY	LVR-IC	LDO, 3.1V±1%, 300mA, +CE	SOT-343	26vn VR4	5b	Rct
AL	MAX6314US39D1-T	Vdet-IC	3.9V±1.8%, -MR, -Reset Bidir, PPO, 1ms	SOT-143	24vdh VD5	5c	Max
AL	XC6127C31FNR	Vdet-IC	3.1V±0.8%, +Reset PPO, -MR, Rt=50ms	SSOT-24	26cr VD5	5a	Tor
AL	XC6127N32ANR	Vdet-IC	3.2V±0.8%, -Reset ODO, -MR, Rt=50ms	SSOT-24	26cr VD4	5a	Tor
AL	XC6221A19BNR	LVR-IC	LDO, 1.95V±20mV, 200mA, +CE	SSOT-24	26vn VR4	5a	Tor
AL	XC6223D351NR-G	LVR-IC	LDO, 3.5V±1%, 300mA, +CE, PDR, CL	SSOT-24	26vn VR4	5a	Tor
AL-	RT9198-32PY	LVR-IC	LDO, 3.2V±1%, 300mA, +CE	SOT-343	26vn VR4	5b	Rct
ALN	ELM7522CCB	Vdet-IC	2.2V±2%, +Reset PPO	SC-82AB	26vdl VD7	5c	Elm
ALN	ELM7522NCB	Vdet-IC	2.2V±2%, +Reset ODO	SC-82AB	26vdl VD6	5c	Elm
AM	IMP811LEUS-T	Vdet-IC	4.63V, MR, -Reset ODO, 140ms	SOT-143	24vdh VD4	5c	Imp
AM	MAX811LUS	Vdet-IC	4.63V±1.5%, -MR, -Reset PPO, 140ms	SOT-143	24vdh VD5	5c	Max
AM	XC6127C33FNR	Vdet-IC	3.3V±0.8%, +Reset PPO, -MR, Rt=50ms	SSOT-24	26cr VD5	5a	Tor
AM	XC6127N34ANR	Vdet-IC	3.4V±0.8%, -Reset ODO, -MR, Rt=50ms	SSOT-24	26cr VD4	5a	Tor
AM	XC6221A20BNR	LVR-IC	LDO, 2.05V±1%, 200mA, +CE	SSOT-24	26vn VR4	5a	Tor
AM	XC6223D361NR-G	LVR-IC	LDO, 3.6V±1%, 300mA, +CE, PDR, CL	SSOT-24	26vn VR4	5a	Tor
AM-	RT9198-34PY	LVR-IC	LDO, 3.4V±1%, 300mA, +CE	SOT-343	26vn VR4	5b	Rct
AN	BFP450	Si-npn	UHF, 15V, 0.1A, 24GHz	SOT-343	24t1 -	5h	Inf
AN	IMP811MEUS-T	Vdet-IC	4.38V, MR, -Reset ODO, 140ms	SOT-143	24vdh VD4	5c	Imp
AN	MAX811MUS	Vdet-IC	4.38V±1.5%, -MR, -Reset PPO, 140ms	SOT-143	24vdh VD5	5c	Max
AN	XC6127C35FNR	Vdet-IC	3.5V±0.8%, +Reset PPO, -MR, Rt=50ms	SSOT-24	26cr VD5	5a	Tor
AN	XC6127N36ANR	Vdet-IC	3.6V±0.8%, -Reset ODO, -MR, Rt=50ms	SSOT-24	26cr VD4	5a	Tor
AN	XC6221A21BNR	LVR-IC	LDO, 2.15V±1%, 200mA, +CE	SSOT-24	26vn VR4	5a	Tor



SMD

SMD code	Type	Function	Short description	Case	Pinout Sch.	St.	Mnf.
AN	XC6224A211NR	LVR-IC	LDO, 2.1V±1.5%, 150mA, +CE	SSOT-24	26vn VR4	5a	Tor
AN-	RT9198-35PY	LVR-IC	LDO, 3.5V±1%, 300mA, +CE	SOT-343	26vn VR4	5b	Rct
ANs	BFP450	Si-npn	UHF, 15V, 0.1A, 24GHz	SOT-343	24t1 -	5b	Sie
AO	IMP811JEU5-T	Vdet-IC	4V, MR, -Reset ODO, 140ms	SOT-143	24vdh VD4	5c	Imp
AO	PT7M7811LTB	Vdet-IC	4.63V±1.5%, -Reset PPO, -MR	SOT-143	24vdh VD5	5g	Pti
AO	PT7M7811LTBE	Vdet-IC	4.63V±1.5%, -Reset PPO, -MR, Lead free	SOT-143	24vdh VD5	5g	Pti
AP	IMP811TEUS-T	Vdet-IC	3.08V, MR, -Reset ODO, 140ms	SOT-143	24vdh VD4	5c	Imp
AP	MAX811TUS	Vdet-IC	3.08V±1.5%, -MR, -Reset PPO, 140ms	SOT-143	24vdh VD5	5c	Max
AP	PT7M7811MTB	Vdet-IC	4.38V±1.5%, -Reset PPO, -MR	SOT-143	24vdh VD5	5g	Pti
AP	PT7M7811MTBE	Vdet-IC	4.38V±1.5%, -Reset PPO, -MR, Lead free	SOT-143	24vdh VD5	5g	Pti
AP	XC6127C37FNR	Vdet-IC	3.7V±0.8%, +Reset PPO, -MR, Rt=50ms	SSOT-24	26cr VD5	5a	Tor
AP	XC6127N38ANR	Vdet-IC	3.8V±0.8%, -Reset ODO, -MR, Rt=50ms	SSOT-24	26cr VD4	5a	Tor
AP	XC6221A22BNR	LVR-IC	LDO, 2.25V±1%, 200mA, +CE	SSOT-24	26vn VR4	5a	Tor
AP	XC6223D371NR-G	LVR-IC	LDO, 3.7V±1%, 300mA, +CE, PDR, CL	SSOT-24	26vn VR4	5a	Tor
AP-	RT9198-44PY	LVR-IC	LDO, 4.4V±1%, 300mA, +CE	SOT-343	26vn VR4	5b	Rct
APs	BFP520	Si-npn	UHF, 12V, 40mA, 45GHz	SOT-343	24t1 -	5b	Sie
AQ	IMP811SEUS-T	Vdet-IC	2.93V, MR, -Reset ODO, 140ms	SOT-143	24vdh VD4	5c	Imp
AQ	MAX811SUS	Vdet-IC	2.93V±1.5%, -MR, -Reset PPO, 140ms	SOT-143	24vdh VD5	5c	Max
AQ	PT7M7811TTB	Vdet-IC	3.08V±1.5%, -Reset PPO, -MR	SOT-143	24vdh VD5	5g	Pti
AQ	PT7M7811TTBE	Vdet-IC	3.08V±1.5%, -Reset PPO, -MR, Lead free	SOT-143	24vdh VD5	5g	Pti
AQ-	RT9818A-27PY	Vdet-IC	2.7V±1.5%, +Reset ODO	SOT-343	26ut VD6	5b	Rct
AR	IMP811REUS-T	Vdet-IC	2.63V, MR, -Reset ODO, 140ms	SOT-143	24vdh VD4	5c	Imp
AR	MAX811RUS	Vdet-IC	2.63V±1.5%, -MR, -Reset PPO, 140ms	SOT-143	24vdh VD5	5c	Max
AR	PT7M7811STB	Vdet-IC	2.93V±1.5%, -Reset PPO, -MR	SOT-143	24vdh VD5	5g	Pti
AR	PT7M7811STBE	Vdet-IC	2.93V±1.5%, -Reset PPO, -MR, Lead free	SOT-143	24vdh VD5	5g	Pti
AR	XC6127C39FNR	Vdet-IC	3.9V±0.8%, +Reset PPO, -MR, Rt=50ms	SSOT-24	26cr VD5	5a	Tor
AR	XC6127N40ANR	Vdet-IC	4.0V±0.8%, -Reset ODO, -MR, Rt=50ms	SSOT-24	26cr VD4	5a	Tor
AR	XC6221A23BNR	LVR-IC	LDO, 2.35V±1%, 200mA, +CE	SSOT-24	26vn VR4	5a	Tor
AR	XC6223D381NR-G	LVR-IC	LDO, 3.8V±1%, 300mA, +CE, PDR, CL	SSOT-24	26vn VR4	5a	Tor
AR-	RT9818A-13PY	Vdet-IC	1.3V±1.5%, +Reset ODO	SOT-343	26ut VD6	5b	Rct
AS	IMP812LEUS-T	Vdet-IC	4.63V, MR, +Reset ODO, 140ms	SOT-143	24vdh VD4	5c	Imp
AS	MAX812LUS	Vdet-IC	4.63V±1.5%, -MR, +Reset PPO, 140ms	SOT-143	24vdh VD5	5c	Max
AS	PT7M7811RTB	Vdet-IC	2.63V±1.5%, -Reset PPO, -MR	SOT-143	24vdh VD5	5g	Pti
AS	PT7M7811RTBE	Vdet-IC	2.63V±1.5%, -Reset PPO, -MR, Lead free	SOT-143	24vdh VD5	5g	Pti
AS	XC6127C41FNR	Vdet-IC	4.1V±0.8%, +Reset PPO, -MR, Rt=50ms	SSOT-24	26cr VD5	5a	Tor
AS	XC6127N42ANR	Vdet-IC	4.2V±0.8%, -Reset ODO, -MR, Rt=50ms	SSOT-24	26cr VD4	5a	Tor
AS	XC6221A24BNR	LVR-IC	LDO, 2.45V±1%, 200mA, +CE	SSOT-24	26vn VR4	5a	Tor
AS	XC6223D391NR-G	LVR-IC	LDO, 3.9V±1%, 300mA, +CE, PDR, CL	SSOT-24	26vn VR4	5a	Tor
AS-	RT9819E-43PY	Vdet-IC	4.3V±1.5%, +PPO +Reset	SOT-343	26ut VD7	5b	Rct
AT	IMP812MEUS-T	Vdet-IC	4.38V, MR, +Reset ODO, 140ms	SOT-143	24vdh VD4	5c	Imp
AT	MAX812MUS	Vdet-IC	4.38V±1.5%, -MR, +Reset PPO, 140ms	SOT-143	24vdh VD5	5c	Max
AT	PT7M7811ZTB	Vdet-IC	2.32V±1.5%, -Reset PPO, -MR	SOT-143	24vdh VD5	5g	Pti
AT	PT7M7811ZTBE	Vdet-IC	2.32V±1.5%, -Reset PPO, -MR, Lead free	SOT-143	24vdh VD5	5g	Pti
AT	XC6127C43FNR	Vdet-IC	4.3V±0.8%, +Reset PPO, -MR, Rt=50ms	SSOT-24	26cr VD5	5a	Tor
AT	XC6127N44ANR	Vdet-IC	4.4V±0.8%, -Reset ODO, -MR, Rt=50ms	SSOT-24	26cr VD4	5a	Tor
AT	XC6221A25BNR	LVR-IC	LDO, 2.55V±1%, 200mA, +CE	SSOT-24	26vn VR4	5a	Tor
AT	XC6223D401NR-G	LVR-IC	LDO, 4.0V±1%, 300mA, +CE, PDR, CL	SSOT-24	26vn VR4	5a	Tor
AT-	RT9198A-44PY	LVR-IC	LDO, 4.4V±1%, 300mA, -CE	SOT-343	26vn VR4	5c	Rct
AT=	RT9198A-44GY	LVR-IC	LDO, 4.4V±1%, 300mA, -CE	SOT-343	26vn VR4	5c	Rct
AU	IMP812JEU5-T	Vdet-IC	4V, MR, +Reset ODO, 140ms	SOT-143	24vdh VD4	5c	Imp
AU	PT7M7811YTB	Vdet-IC	2.20V±1.5%, -Reset PPO, -MR	SOT-143	24vdh VD5	5g	Pti
AU	PT7M7811YTBE	Vdet-IC	2.20V±1.5%, -Reset PPO, -MR, Lead free	SOT-143	24vdh VD5	5g	Pti
AU	XC6127C45FNR	Vdet-IC	4.5V±0.8%, +Reset PPO, -MR, Rt=50ms	SSOT-24	26cr VD5	5a	Tor
AU	XC6127N46ANR	Vdet-IC	4.6V±0.8%, -Reset ODO, -MR, Rt=50ms	SSOT-24	26cr VD4	5a	Tor
AU	XC6221A26BNR	LVR-IC	LDO, 2.65V±1%, 200mA, +CE	SSOT-24	26vn VR4	5a	Tor
AU	XC6224A221NR	LVR-IC	LDO, 2.2V±1.5%, 150mA, +CE	SSOT-24	26vn VR4	5a	Tor
AU-	RT9818C-26PY	Vdet-IC	2.6V±1.5%, +Reset ODO, Td=220ms	SOT-343	26ut VD6	5b	Rct
AV	IMP812TEUS-T	Vdet-IC	3.08V, MR, +Reset ODO, 140ms	SOT-143	24vdh VD4	5c	Imp
AV	MAX812TUS	Vdet-IC	3.08V±1.5%, -MR, +Reset PPO, 140ms	SOT-143	24vdh VD5	5c	Max
AV	PT7M7812LTB	Vdet-IC	4.63V±1.5%, +Reset PPO, -MR	SOT-143	24vdh VD5	5g	Pti
AV	PT7M7812LTBE	Vdet-IC	4.63V±1.5%, +Reset PPO, -MR, Lead free	SOT-143	24vdh VD5	5g	Pti
AV	R3112Q091C	Vdet-IC	0.91V±2%, -Reset ODO	SC-82AB	26fp VD1	5a	Ric
AV	XC6127C47FNR	Vdet-IC	4.7V±0.8%, +Reset PPO, -MR, Rt=50ms	SSOT-24	26cr VD5	5a	Tor
AV	XC6127N48ANR	Vdet-IC	4.8V±0.8%, -Reset ODO, -MR, Rt=50ms	SSOT-24	26cr VD4	5a	Tor
AV	XC6221A27BNR	LVR-IC	LDO, 2.75V±1%, 200mA, +CE	SSOT-24	26vn VR4	5a	Tor
AV	XC6224A231NR	LVR-IC	LDO, 2.3V±1.5%, 150mA, +CE	SSOT-24	26vn VR4	5a	Tor
AW	IMP812SEUS-T	Vdet-IC	2.93V, MR, +Reset ODO, 140ms	SOT-143	24vdh VD4	5c	Imp
AW	MAX812SUS	Vdet-IC	2.93V±1.5%, -MR, +Reset PPO, 140ms	SOT-143	24vdh VD5	5c	Max
AW	PT7M7812MTB	Vdet-IC	4.38V±1.5%, +Reset PPO, -MR	SOT-143	24vdh VD5	5g	Pti
AW	PT7M7812MTBE	Vdet-IC	4.38V±1.5%, +Reset PPO, -MR, Lead free	SOT-143	24vdh VD5	5g	Pti



SMD code	Type	Function	Short description	Case	Pinout	Sch.	St.	Mnf.
AW-	RT9818E-25PY	Vdet-IC	2.5V±1.5%, +Reset ODO	SOT-343	26ut	VD6	5b	Rct
AX	IMP812REUS-T	Vdet-IC	2.63V, MR, +Reset ODO, 140ms	SOT-143	24vdh	VD4	5c	Imp
AX	MAX812RUS	Vdet-IC	2.63V±1.5%, -MR, +Reset PPO, 140ms	SOT-143	24vdh	VD5	5c	Max
AX	PT7M7812TTB	Vdet-IC	3.08V±1.5%, +Reset PPO, -MR	SOT-143	24vdh	VD5	5g	Pti
AX	PT7M7812TTBE	Vdet-IC	3.08V±1.5%, +Reset PPO, -MR, Lead free	SOT-143	24vdh	VD5	5g	Pti
AX	XC6127C49FNR	Vdet-IC	4.9V±0.8%, +Reset PPO, -MR, Rt=50ms	SSOT-24	26cr	VD5	5a	Tor
AX	XC6127N50ANR	Vdet-IC	5.0V±0.8%, -Reset ODO, -MR, Rt=50ms	SSOT-24	26cr	VD4	5a	Tor
AX	XC6221A28BNR	LVR-IC	LDO, 2.85V±1%, 200mA, +CE	SSOT-24	26vn	VR4	5a	Tor
AX	XC6224A241NR	LVR-IC	LDO, 2.4V±1.5%, 150mA, +CE	SSOT-24	26vn	VR4	5a	Tor
AX-	RT9819A-39PY	Vdet-IC	3.9V±1.5%, -PPO +Reset	SOT-343	26ut	VD7	5b	Rct
AY	PT7M7812STB	Vdet-IC	2.93V±1.5%, +Reset PPO, -MR	SOT-143	24vdh	VD5	5g	Pti
AY	PT7M7812STBE	Vdet-IC	2.93V±1.5%, +Reset PPO, -MR, Lead free	SOT-143	24vdh	VD5	5g	Pti
AY	XC6109C08AN	Vdet-IC	0.8V, +Reset PPO	SSOT-24	26rp	VD3	5c	Tor
AY	XC6119C08ANR	Vdet-IC	0.8V±30mV, -Reset PPO	SSOT-24	26gh	VD3	5a	Tor
AY	XC6127C51FNR	Vdet-IC	5.1V±0.8%, +Reset PPO, -MR, Rt=50ms	SSOT-24	26cr	VD5	5a	Tor
AY	XC6127N52ANR	Vdet-IC	5.2V±0.8%, -Reset ODO, -MR, Rt=50ms	SSOT-24	26cr	VD4	5a	Tor
AY	XC6221A29BNR	LVR-IC	LDO, 2.95V±1%, 200mA, +CE	SSOT-24	26vn	VR4	5a	Tor
AY=	RT9013A-18GY	LVR-IC	LDO, 1.8V±2%, 500mA, +CE	SOT-343	26vn	VR4	5c	Rct
AZ	MAX821LUS-T	Vdet-IC	4.63V±1.5%, -Reset PPO, Select Rt	SOT-143	26	-	5c	Max
AZ	PT7M7812RTB	Vdet-IC	2.63V±1.5%, +Reset PPO, -MR	SOT-143	24vdh	VD5	5g	Pti
AZ	PT7M7812RTBE	Vdet-IC	2.63V±1.5%, +Reset PPO, -MR, Lead free	SOT-143	24vdh	VD5	5g	Pti
AZ	XC6109C09AN	Vdet-IC	0.9V, +Reset PPO	SSOT-24	26rp	VD3	5c	Tor
AZ	XC6119C09ANR	Vdet-IC	0.9V±30mV, -Reset PPO	SSOT-24	26gh	VD3	5a	Tor
AZ	XC6127C53FNR	Vdet-IC	5.3V±0.8%, +Reset PPO, -MR, Rt=50ms	SSOT-24	26cr	VD5	5a	Tor
AZ	XC6127N54ANR	Vdet-IC	5.4V±0.8%, -Reset ODO, -MR, Rt=50ms	SSOT-24	26cr	VD4	5a	Tor
AZ	XC6221A30BNR	LVR-IC	LDO, 3.05V±1%, 200mA, +CE	SSOT-24	26vn	VR4	5a	Tor
AZ=	RT9013A-25GY	LVR-IC	LDO, 2.5V±2%, 500mA, +CE	SOT-343	26vn	VR4	5c	Rct
B	3SK302	n-MOSFET	DG, UHF-amp, 15V, ±30mA, 150mW, Idss=0..10mA	SOT-143	26fm	-	5b	Pan
B	3SK306	n-MOSFET	DG, UHF-amp, 15V, ±30mA, 150mW, Idss=0..10mA	SOT-343	26fm	-	5b	Pan
B0	R1140Q201B	LVR-IC	LDO, 2V±2%, 120mA, +CE	SOT-143R	26vm	VR4	5a	Ric
B0	R1180Q201B	LVR-IC	LDO, 2V±2%, 150mA, +CE	SC-82AB	26vn	VR4	5a	Ric
B0	R3114Q171A	Vdet-IC	1.7V±0.8%, -Reset ODO	SC-82AB	26vdl	VD9	5a	Ric
B0	XC6127C55GNR	Vdet-IC	5.5V±0.8%, +Reset PPO, -MR, Rt=100ms	SSOT-24	26cr	VD5	5a	Tor
B0=	RT9013A-28GY	LVR-IC	LDO, 2.8V±2%, 500mA, +CE	SOT-343	26vn	VR4	5c	Rct
B1	R1140Q211B	LVR-IC	LDO, 2.1V±2%, 120mA, +CE	SOT-143R	26vm	VR4	5a	Ric
B1	R1180Q211B	LVR-IC	LDO, 2.1V±2%, 150mA, +CE	SC-82AB	26vn	VR4	5a	Ric
B1	R3114Q181A	Vdet-IC	1.8V±0.8%, -Reset ODO	SC-82AB	26vdl	VD9	5a	Ric
B1=	RT9013A-33GY	LVR-IC	LDO, 3.3V±2%, 500mA, +CE	SOT-343	26vn	VR4	5c	Rct
B2	R1140Q221B	LVR-IC	LDO, 2.2V±2%, 120mA, +CE	SOT-143R	26vm	VR4	5a	Ric
B2	R1180Q221B	LVR-IC	LDO, 2.2V±2%, 150mA, +CE	SC-82AB	26vn	VR4	5a	Ric
B2	R3114Q191A	Vdet-IC	1.9V±0.8%, -Reset ODO	SC-82AB	26vdl	VD9	5a	Ric
B2	XC6223A121NR-G	LVR-IC	LDO, 1.2V±20mV, 300mA, +CE	SSOT-24	26vn	VR4	5a	Tor
B3	R1140Q231B	LVR-IC	LDO, 2.3V±2%, 120mA, +CE	SOT-143R	26vm	VR4	5a	Ric
B3	R1180Q231B	LVR-IC	LDO, 2.3V±2%, 150mA, +CE	SC-82AB	26vn	VR4	5a	Ric
B3	R3114Q201A	Vdet-IC	2V±0.8%, -Reset ODO	SC-82AB	26vdl	VD9	5a	Ric
B3	XC6223A131NR-G	LVR-IC	LDO, 1.3V±20mV, 300mA, +CE	SSOT-24	26vn	VR4	5a	Tor
B3=	RT9816D-12GY	Vdet-IC	1.2V±1.5%, 450ms, -Reset ODO, -MR	SC-82	26vdh	VD4	5b	Rct
B4	R1140Q241B	LVR-IC	LDO, 2.4V±2%, 120mA, +CE	SOT-143R	26vm	VR4	5a	Ric
B4	R1180Q241B	LVR-IC	LDO, 2.4V±2%, 150mA, +CE	SC-82AB	26vn	VR4	5a	Ric
B4	R3114Q211A	Vdet-IC	2.1V±0.8%, -Reset ODO	SC-82AB	26vdl	VD9	5a	Ric
B4	XC6223A141NR-G	LVR-IC	LDO, 1.4V±20mV, 300mA, +CE	SSOT-24	26vn	VR4	5a	Tor
B5	HSMS-2815	Si-diode	2x Schottky, RF, 20V, 1A, Vf<0.4V(1mA), <1.2pF, 15Ω(5mA)	SOT-143	24ce	-	5c	Agi
B5	R1140Q251B	LVR-IC	LDO, 2.5V±2%, 120mA, +CE	SOT-143R	26vm	VR4	5a	Ric
B5	R1180Q251B	LVR-IC	LDO, 2.5V±2%, 150mA, +CE	SC-82AB	26vn	VR4	5a	Ric
B5	R3114Q221A	Vdet-IC	2.2V±0.8%, -Reset ODO	SC-82AB	26vdl	VD9	5a	Ric
B5	XC6223A151NR-G	LVR-IC	LDO, 1.5V±20mV, 300mA, +CE	SSOT-24	26vn	VR4	5a	Tor
B5=	RT9013A-30GY	LVR-IC	LDO, 3.0V±2%, 500mA, +CE	SOT-343	26vn	VR4	5c	Rct
B6	R1140Q261B	LVR-IC	LDO, 2.6V±2%, 120mA, +CE	SOT-143R	26vm	VR4	5a	Ric
B6	R1180Q261B	LVR-IC	LDO, 2.6V±2%, 150mA, +CE	SC-82AB	26vn	VR4	5a	Ric
B6	R3114Q231A	Vdet-IC	2.3V±0.8%, -Reset ODO	SC-82AB	26vdl	VD9	5a	Ric
B6	XC61CC1602N	Vdet-IC	1.6V±1%, +Reset PPO	SOT-143R	26vdl	VD7	5c	Tor
B6	XC6223A161NR-G	LVR-IC	LDO, 1.6V±20mV, 300mA, +CE	SSOT-24	26vn	VR4	5a	Tor
B6=	RT9013A-15GY	LVR-IC	LDO, 1.5V±2%, 500mA, +CE	SOT-343	26vn	VR4	5c	Rct
B62	S-80841CLNB	Vdet-IC	4.1V, -Reset PPO	SOT-143R	26vdl	VD7	5b	Sii
B62	S-80841CLPF	Vdet-IC	4.1V, -Reset PPO	SNT-4A	42vdj	VD7	5e	Sii
B63	S-80842CLNB	Vdet-IC	4.2V, -Reset PPO	SOT-143R	26vdl	VD7	5b	Sii
B63	S-80842CLPF	Vdet-IC	4.2V, -Reset PPO	SNT-4A	42vdj	VD7	5e	Sii
B64	S-80843CLNB	Vdet-IC	4.3V, -Reset PPO	SOT-143R	26vdl	VD7	5b	Sii
B64	S-80843CLPF	Vdet-IC	4.3V, -Reset PPO	SNT-4A	42vdj	VD7	5e	Sii
B65	S-80844CLNB	Vdet-IC	4.4V, -Reset PPO	SOT-143R	26vdl	VD7	5b	Sii



SMD code	Type	Function	Short description	Case	Pinout	Sch.	St.	Mnf.
B65	S-80844CLPF	Vdet-IC	4.4V, -Reset PPO	SNT-4A	42vdj	VD7	5e	Sii
B66	S-80845CLNB	Vdet-IC	4.5V, -Reset PPO	SOT-143R	26vdl	VD7	5b	Sii
B66	S-80845CLPF	Vdet-IC	4.5V, -Reset PPO	SNT-4A	42vdj	VD7	5e	Sii
B67	S-80846CLNB	Vdet-IC	4.6V, -Reset PPO	SOT-143R	26vdl	VD7	5b	Sii
B67	S-80846CLPF	Vdet-IC	4.6V, -Reset PPO	SNT-4A	42vdj	VD7	5e	Sii
B68	S-80847CLNB	Vdet-IC	4.7V, -Reset PPO	SOT-143R	26vdl	VD7	5b	Sii
B68	S-80847CLPF	Vdet-IC	4.7V, -Reset PPO	SNT-4A	42vdj	VD7	5e	Sii
B69	S-80848CLNB	Vdet-IC	4.8V, -Reset PPO	SOT-143R	26vdl	VD7	5b	Sii
B69	S-80848CLPF	Vdet-IC	4.8V, -Reset PPO	SNT-4A	42vdj	VD7	5e	Sii
B6A	S-80815CLNB	Vdet-IC	1.5V, -Reset PPO	SOT-143R	26vdl	VD7	5b	Sii
B6A	S-80815CLPF	Vdet-IC	1.5V, -Reset PPO	SNT-4A	42vdj	VD7	5e	Sii
B6B	S-80816CLNB	Vdet-IC	1.6V, -Reset PPO	SOT-143R	26vdl	VD7	5b	Sii
B6B	S-80816CLPF	Vdet-IC	1.6V, -Reset PPO	SNT-4A	42vdj	VD7	5e	Sii
B6C	S-80817CLNB	Vdet-IC	1.7V, -Reset PPO	SOT-143R	26vdl	VD7	5b	Sii
B6C	S-80817CLPF	Vdet-IC	1.7V, -Reset PPO	SNT-4A	42vdj	VD7	5e	Sii
B6D	S-80818CLNB	Vdet-IC	1.8V, -Reset PPO	SOT-143R	26vdl	VD7	5b	Sii
B6D	S-80818CLPF	Vdet-IC	1.8V, -Reset PPO	SNT-4A	42vdj	VD7	5e	Sii
B6E	S-80819CLNB	Vdet-IC	1.9V, -Reset PPO	SOT-143R	26vdl	VD7	5b	Sii
B6E	S-80819CLPF	Vdet-IC	1.9V, -Reset PPO	SNT-4A	42vdj	VD7	5e	Sii
B6F	S-80820CLNB	Vdet-IC	2V, -Reset PPO	SOT-143R	26vdl	VD7	5b	Sii
B6F	S-80820CLPF	Vdet-IC	2V, -Reset PPO	SNT-4A	42vdj	VD7	5e	Sii
B6G	S-80821CLNB	Vdet-IC	2.1V, -Reset PPO	SOT-143R	26vdl	VD7	5b	Sii
B6G	S-80821CLPF	Vdet-IC	2.1V, -Reset PPO	SNT-4A	42vdj	VD7	5e	Sii
B6H	S-80822CLNB	Vdet-IC	2.2V, -Reset PPO	SOT-143R	26vdl	VD7	5b	Sii
B6H	S-80822CLPF	Vdet-IC	2.2V, -Reset PPO	SNT-4A	42vdj	VD7	5e	Sii
B6I	S-80823CLNB	Vdet-IC	2.3V, -Reset PPO	SOT-143R	26vdl	VD7	5b	Sii
B6I	S-80823CLPF	Vdet-IC	2.3V, -Reset PPO	SNT-4A	42vdj	VD7	5e	Sii
B6J	S-80824CLNB	Vdet-IC	2.4V, -Reset PPO	SOT-143R	26vdl	VD7	5b	Sii
B6J	S-80824CLPF	Vdet-IC	2.4V, -Reset PPO	SNT-4A	42vdj	VD7	5e	Sii
B6K	S-80825CLNB	Vdet-IC	2.5V, -Reset PPO	SOT-143R	26vdl	VD7	5b	Sii
B6K	S-80825CLPF	Vdet-IC	2.5V, -Reset PPO	SNT-4A	42vdj	VD7	5e	Sii
B6L	S-80826CLNB	Vdet-IC	2.6V, -Reset PPO	SOT-143R	26vdl	VD7	5b	Sii
B6L	S-80826CLPF	Vdet-IC	2.6V, -Reset PPO	SNT-4A	42vdj	VD7	5e	Sii
B6M	S-80827CLNB	Vdet-IC	2.7V, -Reset PPO	SOT-143R	26vdl	VD7	5b	Sii
B6M	S-80827CLPF	Vdet-IC	2.7V, -Reset PPO	SNT-4A	42vdj	VD7	5e	Sii
B6N	S-80828CLNB	Vdet-IC	2.8V, -Reset PPO	SOT-143R	26vdl	VD7	5b	Sii
B6N	S-80828CLPF	Vdet-IC	2.8V, -Reset PPO	SNT-4A	42vdj	VD7	5e	Sii
B6O	S-80829CLNB	Vdet-IC	2.9V, -Reset PPO	SOT-143R	26vdl	VD7	5b	Sii
B6O	S-80829CLPF	Vdet-IC	2.9V, -Reset PPO	SNT-4A	42vdj	VD7	5e	Sii
B6P	S-80830CLNB	Vdet-IC	3V, -Reset PPO	SOT-143R	26vdl	VD7	5b	Sii
B6P	S-80830CLPF	Vdet-IC	3V, -Reset PPO	SNT-4A	42vdj	VD7	5e	Sii
B6Q	S-80831CLNB	Vdet-IC	3.1V, -Reset PPO	SOT-143R	26vdl	VD7	5b	Sii
B6Q	S-80831CLPF	Vdet-IC	3.1V, -Reset PPO	SNT-4A	42vdj	VD7	5e	Sii
B6R	S-80832CLNB	Vdet-IC	3.2V, -Reset PPO	SOT-143R	26vdl	VD7	5b	Sii
B6R	S-80832CLPF	Vdet-IC	3.2V, -Reset PPO	SNT-4A	42vdj	VD7	5e	Sii
B6S	S-80833CLNB	Vdet-IC	3.3V, -Reset PPO	SOT-143R	26vdl	VD7	5b	Sii
B6S	S-80833CLPF	Vdet-IC	3.3V, -Reset PPO	SNT-4A	42vdj	VD7	5e	Sii
B6T	S-80834CLNB	Vdet-IC	3.4V, -Reset PPO	SOT-143R	26vdl	VD7	5b	Sii
B6T	S-80834CLPF	Vdet-IC	3.4V, -Reset PPO	SNT-4A	42vdj	VD7	5e	Sii
B6U	S-80835CLNB	Vdet-IC	3.5V, -Reset PPO	SOT-143R	26vdl	VD7	5b	Sii
B6U	S-80835CLPF	Vdet-IC	3.5V, -Reset PPO	SNT-4A	42vdj	VD7	5e	Sii
B6V	S-80836CLNB	Vdet-IC	3.6V, -Reset PPO	SOT-143R	26vdl	VD7	5b	Sii
B6V	S-80836CLPF	Vdet-IC	3.6V, -Reset PPO	SNT-4A	42vdj	VD7	5e	Sii
B6W	S-80837CLNB	Vdet-IC	3.7V, -Reset PPO	SOT-143R	26vdl	VD7	5b	Sii
B6W	S-80837CLPF	Vdet-IC	3.7V, -Reset PPO	SNT-4A	42vdj	VD7	5e	Sii
B6X	S-80838CLNB	Vdet-IC	3.8V, -Reset PPO	SOT-143R	26vdl	VD7	5b	Sii
B6X	S-80838CLPF	Vdet-IC	3.8V, -Reset PPO	SNT-4A	42vdj	VD7	5e	Sii
B6Y	S-80839CLNB	Vdet-IC	3.9V, -Reset PPO	SOT-143R	26vdl	VD7	5b	Sii
B6Y	S-80839CLPF	Vdet-IC	3.9V, -Reset PPO	SNT-4A	42vdj	VD7	5e	Sii
B6Z	S-80840CLNB	Vdet-IC	4V, -Reset PPO	SOT-143R	26vdl	VD7	5b	Sii
B6Z	S-80840CLPF	Vdet-IC	4V, -Reset PPO	SNT-4A	42vdj	VD7	5e	Sii
B7	HSMS-2817	Si-diode	4x SBD, RF, 20V, 1A, Vf<0.4V(1mA), <1.2pF, 15Ω(5mA)	SOT-143	24/D1	-	5c	Agi
B7	R1140Q271B	LVR-IC	LDO, 2.7V±2%, 120mA, +CE	SOT-143R	26vm	VR4	5a	Ric
B7	R1180Q271B	LVR-IC	LDO, 2.7V±2%, 150mA, +CE	SC-82AB	26vm	VR4	5a	Ric
B7	R3114Q241A	Vdet-IC	2.4V±0.8%, -Reset ODO	SC-82AB	26vdl	VD9	5a	Ric
B7	XC61CC1702N	Vdet-IC	1.7V±1%, +Reset PPO	SOT-143R	26vdl	VD7	5c	Tor
B7	XC6221B081NR	LVR-IC	LDO, 0.8V±20mV, 200mA, +CE, CL	SSOT-24	26vm	VR4	5a	Tor
B7	XC6223A171NR-G	LVR-IC	LDO, 1.7V±20mV, 300mA, +CE	SSOT-24	26vn	VR4	5a	Tor
B7A	S-80849CLNB	Vdet-IC	4.9V, -Reset PPO	SOT-143R	26vdl	VD7	5b	Sii
B7A	S-80849CLPF	Vdet-IC	4.9V, -Reset PPO	SNT-4A	42vdj	VD7	5e	Sii



SMD code	Type	Function	Short description	Case	Pinout	Sch.	St.	Mnf.
B7B	S-80850CLNB	Vdet-IC	5V, -Reset PPO	SOT-143R	26vdl	VD7	5b	Sii
B7B	S-80850CLPF	Vdet-IC	5V, -Reset PPO	SNT-4A	42vdj	VD7	5e	Sii
B7C	S-80851CLNB	Vdet-IC	5.1V, -Reset PPO	SOT-143R	26vdl	VD7	5b	Sii
B7C	S-80851CLPF	Vdet-IC	5.1V, -Reset PPO	SNT-4A	42vdj	VD7	5e	Sii
B7D	S-80852CLNB	Vdet-IC	5.2V, -Reset PPO	SOT-143R	26vdl	VD7	5b	Sii
B7D	S-80852CLPF	Vdet-IC	5.2V, -Reset PPO	SNT-4A	42vdj	VD7	5e	Sii
B7E	S-80853CLNB	Vdet-IC	5.3V, -Reset PPO	SOT-143R	26vdl	VD7	5b	Sii
B7E	S-80853CLPF	Vdet-IC	5.3V, -Reset PPO	SNT-4A	42vdj	VD7	5e	Sii
B7F	S-80854CLNB	Vdet-IC	5.4V, -Reset PPO	SOT-143R	26vdl	VD7	5b	Sii
B7F	S-80854CLPF	Vdet-IC	5.4V, -Reset PPO	SNT-4A	42vdj	VD7	5e	Sii
B7G	S-80855CLNB	Vdet-IC	5.5V, -Reset PPO	SOT-143R	26vdl	VD7	5b	Sii
B7G	S-80855CLPF	Vdet-IC	5.5V, -Reset PPO	SNT-4A	42vdj	VD7	5e	Sii
B7H	S-80856CLNB	Vdet-IC	5.6V, -Reset PPO	SOT-143R	26vdl	VD7	5b	Sii
B7H	S-80856CLPF	Vdet-IC	5.6V, -Reset PPO	SNT-4A	42vdj	VD7	5e	Sii
B7I	S-80857CLNB	Vdet-IC	5.7V, -Reset PPO	SOT-143R	26vdl	VD7	5b	Sii
B7I	S-80857CLPF	Vdet-IC	5.7V, -Reset PPO	SNT-4A	42vdj	VD7	5e	Sii
B7J	S-80858CLNB	Vdet-IC	5.8V, -Reset PPO	SOT-143R	26vdl	VD7	5b	Sii
B7J	S-80858CLPF	Vdet-IC	5.8V, -Reset PPO	SNT-4A	42vdj	VD7	5e	Sii
B7K	S-80859CLNB	Vdet-IC	5.9V, -Reset PPO	SOT-143R	26vdl	VD7	5b	Sii
B7K	S-80859CLPF	Vdet-IC	5.9V, -Reset PPO	SNT-4A	42vdj	VD7	5e	Sii
B7L	S-80860CLNB	Vdet-IC	6V, -Reset PPO	SOT-143R	26vdl	VD7	5b	Sii
B7L	S-80860CLPF	Vdet-IC	6V, -Reset PPO	SNT-4A	42vdj	VD7	5e	Sii
B7M	S-80808CLNB	Vdet-IC	0.8V, -Reset PPO	SOT-143R	26vdl	VD7	5b	Sii
B7M	S-80808CLPF	Vdet-IC	0.8V, -Reset PPO	SNT-4A	42vdj	VD7	5e	Sii
B7N	S-80809CLNB	Vdet-IC	0.9V, -Reset PPO	SOT-143R	26vdl	VD7	5b	Sii
B7N	S-80809CLPF	Vdet-IC	0.9V, -Reset PPO	SNT-4A	42vdj	VD7	5e	Sii
B7O	S-80810CLNB	Vdet-IC	1V, -Reset PPO	SOT-143R	26vdl	VD7	5b	Sii
B7O	S-80810CLPF	Vdet-IC	1V, -Reset PPO	SNT-4A	42vdj	VD7	5e	Sii
B7P	S-80811CLNB	Vdet-IC	1.1V, -Reset PPO	SOT-143R	26vdl	VD7	5b	Sii
B7P	S-80811CLPF	Vdet-IC	1.1V, -Reset PPO	SNT-4A	42vdj	VD7	5e	Sii
B7Q	S-80812CLNB	Vdet-IC	1.2V, -Reset PPO	SOT-143R	26vdl	VD7	5b	Sii
B7Q	S-80812CLPF	Vdet-IC	1.2V, -Reset PPO	SNT-4A	42vdj	VD7	5e	Sii
B7R	S-80813CLNB	Vdet-IC	1.3V, -Reset PPO	SOT-143R	26vdl	VD7	5b	Sii
B7R	S-80813CLPF	Vdet-IC	1.3V, -Reset PPO	SNT-4A	42vdj	VD7	5e	Sii
B7S	S-80814CLNB	Vdet-IC	1.4V, -Reset PPO	SOT-143R	26vdl	VD7	5b	Sii
B7S	S-80814CLPF	Vdet-IC	1.4V, -Reset PPO	SNT-4A	42vdj	VD7	5e	Sii
B8	HSMS-2818	Si-diode	4x SBD, RF, 20V, 1A, Vf<0.4V(1mA), <1.2pF, 15Ω(5mA)	SOT-143	24D2	-	5c	Agj
B8	R1140Q281B	LVR-IC	LDO, 2.8V±2%, 120mA, +CE	SOT-143R	26vm	VR4	5a	Ric
B8	R1180Q281B	LVR-IC	LDO, 2.8V±2%, 150mA, +CE	SC-82AB	26vn	VR4	5a	Ric
B8	R3114Q251A	Vdet-IC	2.5V±0.8%, -Reset ODO	SC-82AB	26vdl	VD9	5a	Ric
B8	XC61CC1802N	Vdet-IC	1.8V±1%, +Reset PPO	SOT-143R	26vdl	VD7	5c	Tor
B8	XC6221B091NR	LVR-IC	LDO, 0.9V±20mV, 200mA, +CE, CL	SSOT-24	26vn	VR4	5a	Tor
B8	XC6223A181NR-G	LVR-IC	LDO, 1.8V±20mV, 300mA, +CE	SSOT-24	26vn	VR4	5a	Tor
B8=	RT9818E-27GY	Vdet-IC	2.7V±1.5%, +Reset ODO	SOT-343	26ut	VD6	5b	Rct
B82	S-80841CNNB	Vdet-IC	4.1V, -Reset ODO	SOT-143R	26vdl	VD6	5b	Sii
B82	S-80841CNPF	Vdet-IC	4.1V, -Reset ODO	SNT-4A	42vdj	VD6	5e	Sii
B83	S-80842CNNB	Vdet-IC	4.2V, -Reset ODO	SOT-143R	26vdl	VD6	5b	Sii
B83	S-80842CNPF	Vdet-IC	4.2V, -Reset ODO	SNT-4A	42vdj	VD6	5e	Sii
B84	S-80843CNNB	Vdet-IC	4.3V, -Reset ODO	SOT-143R	26vdl	VD6	5b	Sii
B84	S-80843CNPF	Vdet-IC	4.3V, -Reset ODO	SNT-4A	42vdj	VD6	5e	Sii
B85	S-80844CNNB	Vdet-IC	4.4V, -Reset ODO	SOT-143R	26vdl	VD6	5b	Sii
B85	S-80844CNPF	Vdet-IC	4.4V, -Reset ODO	SNT-4A	42vdj	VD6	5e	Sii
B86	S-80845CNNB	Vdet-IC	4.5V, -Reset ODO	SOT-143R	26vdl	VD6	5b	Sii
B86	S-80845CNPF	Vdet-IC	4.5V, -Reset ODO	SNT-4A	42vdj	VD6	5e	Sii
B87	S-80846CNNB	Vdet-IC	4.6V, -Reset ODO	SOT-143R	26vdl	VD6	5b	Sii
B87	S-80846CNPF	Vdet-IC	4.6V, -Reset ODO	SNT-4A	42vdj	VD6	5e	Sii
B88	S-80847CNNB	Vdet-IC	4.7V, -Reset ODO	SOT-143R	26vdl	VD6	5b	Sii
B88	S-80847CNPF	Vdet-IC	4.7V, -Reset ODO	SNT-4A	42vdj	VD6	5e	Sii
B89	S-80848CNNB	Vdet-IC	4.8V, -Reset ODO	SOT-143R	26vdl	VD6	5b	Sii
B89	S-80848CNPF	Vdet-IC	4.8V, -Reset ODO	SNT-4A	42vdj	VD6	5e	Sii
B8A	S-80815CNNB	Vdet-IC	1.5V, -Reset ODO	SOT-143R	26vdl	VD6	5b	Sii
B8A	S-80815CNPF	Vdet-IC	1.5V, -Reset ODO	SNT-4A	42vdj	VD6	5e	Sii
B8B	S-80816CNNB	Vdet-IC	1.6V, -Reset ODO	SOT-143R	26vdl	VD6	5b	Sii
B8B	S-80816CNPF	Vdet-IC	1.6V, -Reset ODO	SNT-4A	42vdj	VD6	5e	Sii
B8C	S-80817CNNB	Vdet-IC	1.7V, -Reset ODO	SOT-143R	26vdl	VD6	5b	Sii
B8C	S-80817CNPF	Vdet-IC	1.7V, -Reset ODO	SNT-4A	42vdj	VD6	5e	Sii
B8D	S-80818CNNB	Vdet-IC	1.8V, -Reset ODO	SOT-143R	26vdl	VD6	5b	Sii
B8D	S-80818CNPF	Vdet-IC	1.8V, -Reset ODO	SNT-4A	42vdj	VD6	5e	Sii
B8E	S-80819CNNB	Vdet-IC	1.9V, -Reset ODO	SOT-143R	26vdl	VD6	5b	Sii
B8E	S-80819CNPF	Vdet-IC	1.9V, -Reset ODO	SNT-4A	42vdj	VD6	5e	Sii



SMD

SMD code	Type	Function	Short description	Case	Pinout Sch.	St.	Mnf.
B8F	S-80820CNB	Vdet-IC	2V, -Reset ODO	SOT-143R	26vdl VD6	5b	Sii
B8F	S-80820CNPF	Vdet-IC	2V, -Reset ODO	SNT-4A	42vdj VD6	5e	Sii
B8G	S-80821CNB	Vdet-IC	2.1V, -Reset ODO	SOT-143R	26vdl VD6	5b	Sii
B8G	S-80821CNPF	Vdet-IC	2.1V, -Reset ODO	SNT-4A	42vdj VD6	5e	Sii
B8H	S-80822CNB	Vdet-IC	2.2V, -Reset ODO	SOT-143R	26vdl VD6	5b	Sii
B8H	S-80822CNPF	Vdet-IC	2.2V, -Reset ODO	SNT-4A	42vdj VD6	5e	Sii
B8I	S-80823CNB	Vdet-IC	2.3V, -Reset ODO	SOT-143R	26vdl VD6	5b	Sii
B8I	S-80823CNPF	Vdet-IC	2.3V, -Reset ODO	SNT-4A	42vdj VD6	5e	Sii
B8J	S-80824CNB	Vdet-IC	2.4V, -Reset ODO	SOT-143R	26vdl VD6	5b	Sii
B8J	S-80824CNPF	Vdet-IC	2.4V, -Reset ODO	SNT-4A	42vdj VD6	5e	Sii
B8K	S-80825CNB	Vdet-IC	2.5V, -Reset ODO	SOT-143R	26vdl VD6	5b	Sii
B8K	S-80825CNPF	Vdet-IC	2.5V, -Reset ODO	SNT-4A	42vdj VD6	5e	Sii
B8L	S-80826CNB	Vdet-IC	2.6V, -Reset ODO	SOT-143R	26vdl VD6	5b	Sii
B8L	S-80826CNPF	Vdet-IC	2.6V, -Reset ODO	SNT-4A	42vdj VD6	5e	Sii
B8M	S-80827CNB	Vdet-IC	2.7V, -Reset ODO	SOT-143R	26vdl VD6	5b	Sii
B8M	S-80827CNPF	Vdet-IC	2.7V, -Reset ODO	SNT-4A	42vdj VD6	5e	Sii
B8N	S-80828CNB	Vdet-IC	2.8V, -Reset ODO	SOT-143R	26vdl VD6	5b	Sii
B8N	S-80828CNPF	Vdet-IC	2.8V, -Reset ODO	SNT-4A	42vdj VD6	5e	Sii
B8O	S-80829CNB	Vdet-IC	2.9V, -Reset ODO	SOT-143R	26vdl VD6	5b	Sii
B8O	S-80829CNPF	Vdet-IC	2.9V, -Reset ODO	SNT-4A	42vdj VD6	5e	Sii
B8P	S-80830CNB	Vdet-IC	3V, -Reset ODO	SOT-143R	26vdl VD6	5b	Sii
B8P	S-80830CNPF	Vdet-IC	3V, -Reset ODO	SNT-4A	42vdj VD6	5e	Sii
B8Q	S-80831CNB	Vdet-IC	3.1V, -Reset ODO	SOT-143R	26vdl VD6	5b	Sii
B8Q	S-80831CNPF	Vdet-IC	3.1V, -Reset ODO	SNT-4A	42vdj VD6	5e	Sii
B8R	S-80832CNB	Vdet-IC	3.2V, -Reset ODO	SOT-143R	26vdl VD6	5b	Sii
B8R	S-80832CNPF	Vdet-IC	3.2V, -Reset ODO	SNT-4A	42vdj VD6	5e	Sii
B8S	S-80833CNB	Vdet-IC	3.3V, -Reset ODO	SOT-143R	26vdl VD6	5b	Sii
B8S	S-80833CNPF	Vdet-IC	3.3V, -Reset ODO	SNT-4A	42vdj VD6	5e	Sii
B8T	S-80834CNB	Vdet-IC	3.4V, -Reset ODO	SOT-143R	26vdl VD6	5b	Sii
B8T	S-80834CNPF	Vdet-IC	3.4V, -Reset ODO	SNT-4A	42vdj VD6	5e	Sii
B8U	S-80835CNB	Vdet-IC	3.5V, -Reset ODO	SOT-143R	26vdl VD6	5b	Sii
B8U	S-80835CNPF	Vdet-IC	3.5V, -Reset ODO	SNT-4A	42vdj VD6	5e	Sii
B8V	S-80836CNB	Vdet-IC	3.6V, -Reset ODO	SOT-143R	26vdl VD6	5b	Sii
B8V	S-80836CNPF	Vdet-IC	3.6V, -Reset ODO	SNT-4A	42vdj VD6	5e	Sii
B8W	S-80837CNB	Vdet-IC	3.7V, -Reset ODO	SOT-143R	26vdl VD6	5b	Sii
B8W	S-80837CNPF	Vdet-IC	3.7V, -Reset ODO	SNT-4A	42vdj VD6	5e	Sii
B8X	S-80838CNB	Vdet-IC	3.8V, -Reset ODO	SOT-143R	26vdl VD6	5b	Sii
B8X	S-80838CNPF	Vdet-IC	3.8V, -Reset ODO	SNT-4A	42vdj VD6	5e	Sii
B8Y	S-80839CNB	Vdet-IC	3.9V, -Reset ODO	SOT-143R	26vdl VD6	5b	Sii
B8Y	S-80839CNPF	Vdet-IC	3.9V, -Reset ODO	SNT-4A	42vdj VD6	5e	Sii
B8Z	S-80840CNB	Vdet-IC	4V, -Reset ODO	SOT-143R	26vdl VD6	5b	Sii
B8Z	S-80840CNPF	Vdet-IC	4V, -Reset ODO	SNT-4A	42vdj VD6	5e	Sii
B9	R1140Q291B	LVR-IC	LDO, 2.9V±2%, 120mA, +CE	SOT-143R	26vm VR4	5a	Ric
B9	R1180Q291B	LVR-IC	LDO, 2.9V±2%, 150mA, +CE	SC-82AB	26vn VR4	5a	Ric
B9	R3114Q261A	Vdet-IC	2.6V±0.8%, -Reset ODO	SC-82AB	26vdl VD9	5a	Ric
B9	XC61CC1902N	Vdet-IC	1.9V±1%, +Reset PPO	SOT-143R	26vdl VD7	5c	Tor
B9	XC6221B101NR	LVR-IC	LDO, 1V±20mV, 200mA, +CE, CL	SSOT-24	26vn VR4	5a	Tor
B9	XC6223A191NR-G	LVR-IC	LDO, 1.9V±20mV, 300mA, +CE	SSOT-24	26vn VR4	5a	Tor
B9=	RT9818E-33GY	Vdet-IC	3.3V±1.5%, +Reset ODO	SOT-343	26ut VD6	5b	Rct
B9A	S-80849CNB	Vdet-IC	4.9V, -Reset ODO	SOT-143R	26vdl VD6	5b	Sii
B9A	S-80849CNPF	Vdet-IC	4.9V, -Reset ODO	SNT-4A	42vdj VD6	5e	Sii
B9B	S-80850CNB	Vdet-IC	5V, -Reset ODO	SOT-143R	26vdl VD6	5b	Sii
B9B	S-80850CNPF	Vdet-IC	5V, -Reset ODO	SNT-4A	42vdj VD6	5e	Sii
B9C	S-80851CNB	Vdet-IC	5.1V, -Reset ODO	SOT-143R	26vdl VD6	5b	Sii
B9C	S-80851CNPF	Vdet-IC	5.1V, -Reset ODO	SNT-4A	42vdj VD6	5e	Sii
B9D	S-80852CNB	Vdet-IC	5.2V, -Reset ODO	SOT-143R	26vdl VD6	5b	Sii
B9D	S-80852CNPF	Vdet-IC	5.2V, -Reset PPO	SNT-4A	42vdj VD7	5e	Sii
B9E	S-80853CNB	Vdet-IC	5.3V, -Reset ODO	SOT-143R	26vdl VD6	5b	Sii
B9E	S-80853CNPF	Vdet-IC	5.3V, -Reset PPO	SNT-4A	42vdj VD7	5e	Sii
B9F	S-80854CNB	Vdet-IC	5.4V, -Reset ODO	SOT-143R	26vdl VD6	5b	Sii
B9F	S-80854CNPF	Vdet-IC	5.4V, -Reset PPO	SNT-4A	42vdj VD7	5e	Sii
B9G	S-80855CNB	Vdet-IC	5.5V, -Reset ODO	SOT-143R	26vdl VD6	5b	Sii
B9G	S-80855CNPF	Vdet-IC	5.5V, -Reset PPO	SNT-4A	42vdj VD7	5e	Sii
B9H	S-80856CNB	Vdet-IC	5.6V, -Reset ODO	SOT-143R	26vdl VD6	5b	Sii
B9H	S-80856CNPF	Vdet-IC	5.6V, -Reset PPO	SNT-4A	42vdj VD7	5e	Sii
B9I	S-80857CNB	Vdet-IC	5.7V, -Reset ODO	SOT-143R	26vdl VD6	5b	Sii
B9I	S-80857CNPF	Vdet-IC	5.7V, -Reset PPO	SNT-4A	42vdj VD7	5e	Sii
B9J	S-80858CNB	Vdet-IC	5.8V, -Reset ODO	SOT-143R	26vdl VD6	5b	Sii
B9J	S-80858CNPF	Vdet-IC	5.8V, -Reset PPO	SNT-4A	42vdj VD7	5e	Sii
B9K	S-80859CNB	Vdet-IC	5.9V, -Reset ODO	SOT-143R	26vdl VD6	5b	Sii



SMD code	Type	Function	Short description	Case	Pinout	Sch.	St.	Mnf.
B9K	S-80859CNPF	Vdet-IC	5.9V, -Reset PPO	SNT-4A	42vdj	VD7	5e	Sii
B9L	S-80860CNNB	Vdet-IC	6V, -Reset ODO	SOT-143R	26vdl	VD6	5b	Sii
B9L	S-80860CNPF	Vdet-IC	6V, -Reset PPO	SNT-4A	42vdj	VD7	5e	Sii
B9M	S-80808CNNB	Vdet-IC	0.8V, -Reset ODO	SOT-143R	26vdl	VD6	5b	Sii
B9M	S-80808CNPF	Vdet-IC	0.8V, -Reset ODO	SNT-4A	42vdj	VD6	5e	Sii
B9N	S-80809CNNB	Vdet-IC	0.9V, -Reset ODO	SOT-143R	26vdl	VD6	5b	Sii
B9N	S-80809CNPF	Vdet-IC	0.9V, -Reset ODO	SNT-4A	42vdj	VD6	5e	Sii
B9O	S-80810CNNB	Vdet-IC	1V, -Reset ODO	SOT-143R	26vdl	VD6	5b	Sii
B9O	S-80810CNPF	Vdet-IC	1V, -Reset ODO	SNT-4A	42vdj	VD6	5e	Sii
B9P	S-80811CNNB	Vdet-IC	1.1V, -Reset ODO	SOT-143R	26vdl	VD6	5b	Sii
B9P	S-80811CNPF	Vdet-IC	1.1V, -Reset ODO	SNT-4A	42vdj	VD6	5e	Sii
B9Q	S-80812CNNB	Vdet-IC	1.2V, -Reset ODO	SOT-143R	26vdl	VD6	5b	Sii
B9Q	S-80812CNPF	Vdet-IC	1.2V, -Reset ODO	SNT-4A	42vdj	VD6	5e	Sii
B9R	S-80813CNNB	Vdet-IC	1.3V, -Reset ODO	SOT-143R	26vdl	VD6	5b	Sii
B9R	S-80813CNPF	Vdet-IC	1.3V, -Reset ODO	SNT-4A	42vdj	VD6	5e	Sii
B9S	S-80814CNNB	Vdet-IC	1.4V, -Reset ODO	SOT-143R	26vdl	VD6	5b	Sii
B9S	S-80814CNPF	Vdet-IC	1.4V, -Reset ODO	SNT-4A	42vdj	VD6	5e	Sii
BA	MAX821MUS-T	Vdet-IC	4.38V±1.5%, -Reset PPO, Select Rt	SOT-143	26	-	5c	Max
BA	PT7M7812ZTB	Vdet-IC	2.32V±1.5%, +Reset PPO, -MR	SOT-143	24vdh	VD5	5g	Pti
BA	PT7M7812ZTBE	Vdet-IC	2.32V±1.5%, +Reset PPO, -MR, Lead free	SOT-143	24vdh	VD5	5g	Pti
BA	R1141Q201B	LVR-IC	LDO, 2V±2%, 120mA, +CE	SOT-143R	26vm	VR4	5a	Ric
BA	R3112Q101A	Vdet-IC	1V±2%, -Reset PPO	SC-82AB	26rp	VD3	5a	Ric
BA	RP130Q211A	LVR-IC	LDO, LN, -CE, 2.1V±1%, 150mA	SC-82AB	26vn	VR4	5a	Ric
BA	XC6127C15GNR	Vdet-IC	1.5V±0.8%, +Reset PPO, -MR, Rt=100ms	SSOT-24	26cr	VD5	5a	Tor
BA	XC6127N16BNR	Vdet-IC	1.6V±0.8%, -Reset ODO, -MR, Rt=100ms	SSOT-24	26cr	VD4	5a	Tor
BA	XC6221B111NR	LVR-IC	LDO, 1.1V±20mV, 200mA, +CE, CL	SSOT-24	26vn	VR4	5a	Tor
BA	XC6223A201NR-G	LVR-IC	LDO, 2.0V±1%, 300mA, +CE	SSOT-24	26vn	VR4	5a	Tor
BA=	RT9816D-30GY	Vdet-IC	3.0V±1.5%, 450ms, -Reset ODO, -MR	SC-82	26vdh	VD4	5b	Rct
BB	1SV237	PIN-diode	Dual, VHF/UHF, 50V, 0.25pF(50V), Rs=4Ω(10mA, 100MHz)	SOT-143	24dv	-	5b	Tos
BB	MAX821TUS-T	Vdet-IC	3.08V±1.5%, -Reset PPO, Select Rt	SOT-143	26	-	5c	Max
BB	PT7M7812YTB	Vdet-IC	2.20V±1.5%, +Reset PPO, -MR	SOT-143	24vdh	VD5	5g	Pti
BB	PT7M7812YTBE	Vdet-IC	2.20V±1.5%, +Reset PPO, -MR, Lead free	SOT-143	24vdh	VD5	5g	Pti
BB	R1141Q211B	LVR-IC	LDO, 2.1V±2%, 120mA, +CE	SOT-143R	26vm	VR4	5a	Ric
BB	R3112Q111A	Vdet-IC	1.1V±2%, -Reset PPO	SC-82AB	26rp	VD3	5a	Ric
BB	RP130Q221A	LVR-IC	LDO, LN, -CE, 2.2V±1%, 150mA	SC-82AB	26vn	VR4	5a	Ric
BB	XC6127C17GNR	Vdet-IC	1.7V±0.8%, +Reset PPO, -MR, Rt=100ms	SSOT-24	26cr	VD5	5a	Tor
BB	XC6127N18BNR	Vdet-IC	1.8V±0.8%, -Reset ODO, -MR, Rt=100ms	SSOT-24	26cr	VD4	5a	Tor
BB	XC6221B121NR	LVR-IC	LDO, 1.2V±20mV, 200mA, +CE, CL	SSOT-24	26vn	VR4	5a	Tor
BB	XC6223A211NR-G	LVR-IC	LDO, 2.1V±1%, 300mA, +CE	SSOT-24	26vn	VR4	5a	Tor
BB=	RT9818A-30GY	Vdet-IC	3.0V±1.5%, +Reset ODO	SOT-343	26ut	VD6	5c	Rct
BBs	BAR81	Si-diode	RF, Shunt, 30V, 100mA, Vf<0.93V(100mA), <1.3pF	MW-4	25ed	-	5c	Inf
BC	MAX821SUS-T	Vdet-IC	2.93V±1.5%, -Reset PPO, Select Rt	SOT-143	26	-	5c	Max
BC	R1141Q221B	LVR-IC	LDO, 2.2V±2%, 120mA, +CE	SOT-143R	26vm	VR4	5a	Ric
BC	R3112Q121A	Vdet-IC	1.2V±2%, -Reset PPO	SC-82AB	26rp	VD3	5a	Ric
BC	RP130Q231A	LVR-IC	LDO, LN, -CE, 2.3V±1%, 150mA	SC-82AB	26vn	VR4	5a	Ric
BC	XC6127C19GNR	Vdet-IC	1.9V±0.8%, +Reset PPO, -MR, Rt=100ms	SSOT-24	26cr	VD5	5a	Tor
BC	XC6127N20BNR	Vdet-IC	2.0V±0.8%, -Reset ODO, -MR, Rt=100ms	SSOT-24	26cr	VD4	5a	Tor
BC	XC6221B131NR	LVR-IC	LDO, 1.3V±20mV, 200mA, +CE, CL	SSOT-24	26vn	VR4	5a	Tor
BC	XC6223A221NR-G	LVR-IC	LDO, 2.2V±1%, 300mA, +CE	SSOT-24	26vn	VR4	5a	Tor
BC=	RT9818E-20GY	Vdet-IC	2.0V±1.5%, +Reset ODO	SOT-343	26ut	VD6	5b	Rct
BD	MAX821RUS-T	Vdet-IC	2.63V±1.5%, -Reset PPO, Select Rt	SOT-143	26	-	5c	Max
BD	R1141Q231B	LVR-IC	LDO, 2.3V±2%, 120mA, +CE	SOT-143R	26vm	VR4	5a	Ric
BD	R3112Q131A	Vdet-IC	1.3V±2%, -Reset PPO	SC-82AB	26rp	VD3	5a	Ric
BD	RP130Q241A	LVR-IC	LDO, LN, -CE, 2.4V±1%, 150mA	SC-82AB	26vn	VR4	5a	Ric
BD	XC6127C21GNR	Vdet-IC	2.1V±0.8%, +Reset PPO, -MR, Rt=100ms	SSOT-24	26cr	VD5	5a	Tor
BD	XC6127N22BNR	Vdet-IC	2.2V±0.8%, -Reset ODO, -MR, Rt=100ms	SSOT-24	26cr	VD4	5a	Tor
BD	XC6221B141NR	LVR-IC	LDO, 1.4V±20mV, 200mA, +CE, CL	SSOT-24	26vn	VR4	5a	Tor
BD	XC6223A231NR-G	LVR-IC	LDO, 2.3V±1%, 300mA, +CE	SSOT-24	26vn	VR4	5a	Tor
BD=	RT9818G-20GY	Vdet-IC	2.0V±1.5%, +Reset ODO, Td=220ms	SOT-343	26ut	VD6	5b	Rct
BE	R1141Q241B	LVR-IC	LDO, 2.4V±2%, 120mA, +CE	SOT-143R	26vm	VR4	5a	Ric
BE	R3112Q141A	Vdet-IC	1.4V±2%, -Reset PPO	SC-82AB	26rp	VD3	5a	Ric
BE	RP130Q251A	LVR-IC	LDO, LN, -CE, 2.5V±1%, 150mA	SC-82AB	26vn	VR4	5a	Ric
BE	XC6127C23GNR	Vdet-IC	2.3V±0.8%, +Reset PPO, -MR, Rt=100ms	SSOT-24	26cr	VD5	5a	Tor
BE	XC6127N24BNR	Vdet-IC	2.4V±0.8%, -Reset ODO, -MR, Rt=100ms	SSOT-24	26cr	VD4	5a	Tor
BE	XC6221B151NR	LVR-IC	LDO, 1.5V±20mV, 200mA, +CE, CL	SSOT-24	26vn	VR4	5a	Tor
BE	XC6223A241NR-G	LVR-IC	LDO, 2.4V±1%, 300mA, +CE	SSOT-24	26vn	VR4	5a	Tor
BE=	RT9198-1HGY	LVR-IC	LDO, 1.85V±1%, 300mA, +CE	SOT-343	26vn	VR4	5b	Rct
BF	MAX822LUS-T	Vdet-IC	4.63V±1.5%, +Reset PPO, Select Rt	SOT-143	26	-	5c	Max
BF	R1141Q251B	LVR-IC	LDO, 2.5V±2%, 120mA, +CE	SOT-143R	26vm	VR4	5a	Ric
BF	R3112Q151A	Vdet-IC	1.5V±2%, -Reset PPO	SC-82AB	26rp	VD3	5a	Ric



SMD code	Type	Function	Short description	Case	Pinout	Sch.	St.	Mnf.
BF	RP130Q261A	LVR-IC	LDO, LN, -CE, 2.6V±1%, 150mA	SC-82AB	26vn	VR4	5a	Ric
BF	XC6127C25GNR	Vdet-IC	2.5V±0.8%, +Reset PPO, -MR, Rt=100ms	SSOT-24	26cr	VD5	5a	Tor
BF	XC6127N26BNR	Vdet-IC	2.6V±0.8%, -Reset ODO, -MR, Rt=100ms	SSOT-24	26cr	VD4	5a	Tor
BF	XC6221B161NR	LVR-IC	LDO, 1.6V±20mV, 200mA, +CE, CL	SSOT-24	26vn	VR4	5a	Tor
BF	XC6223A251NR-G	LVR-IC	LDO, 2.5V±1%, 300mA, +CE	SSOT-24	26vn	VR4	5a	Tor
BG	MAX822MUS-T	Vdet-IC	4.38V±1.5%, +Reset PPO, Select Rt	SOT-143	26	-	5c	Max
BG	R1141Q261B	LVR-IC	LDO, 2.6V±2%, 120mA, +CE	SOT-143R	26vm	VR4	5a	Ric
BG	R3112Q161A	Vdet-IC	1.6V±2%, -Reset PPO	SC-82AB	26rp	VD3	5a	Ric
BG	RP130Q271A	LVR-IC	LDO, LN, -CE, 2.7V±1%, 150mA	SC-82AB	26vn	VR4	5a	Ric
BH	MAX822TUS-T	Vdet-IC	3.08V±1.5%, +Reset PPO, Select Rt	SOT-143	26	-	5c	Max
BH	R1141Q271B	LVR-IC	LDO, 2.7V±2%, 120mA, +CE	SOT-143R	26vm	VR4	5a	Ric
BH	R3112Q171A	Vdet-IC	1.7V±2%, -Reset PPO	SC-82AB	26rp	VD3	5a	Ric
BH	RP130Q281A	LVR-IC	LDO, LN, -CE, 2.8V±1%, 150mA	SC-82AB	26vn	VR4	5a	Ric
BH	XC6127C27GNR	Vdet-IC	2.7V±0.8%, +Reset PPO, -MR, Rt=100ms	SSOT-24	26cr	VD5	5a	Tor
BH	XC6127N28BNR	Vdet-IC	2.8V±0.8%, -Reset ODO, -MR, Rt=100ms	SSOT-24	26cr	VD4	5a	Tor
BH	XC6221B171NR	LVR-IC	LDO, 1.7V±20mV, 200mA, +CE, CL	SSOT-24	26vn	VR4	5a	Tor
BH	XC6223A261NR-G	LVR-IC	LDO, 2.6V±1%, 300mA, +CE	SSOT-24	26vn	VR4	5a	Tor
BJ	MAX822SUS-T	Vdet-IC	2.93V±1.5%, +Reset PPO, Select Rt	SOT-143	26	-	5c	Max
BJ	R1141Q281B	LVR-IC	LDO, 2.8V±2%, 120mA, +CE	SOT-143R	26vm	VR4	5a	Ric
BJ	R3112Q181A	Vdet-IC	1.8V±2%, -Reset PPO	SC-82AB	26rp	VD3	5a	Ric
BJ	RP130Q281A5	LVR-IC	LDO, LN, -CE, 2.85V±1%, 150mA	SC-82AB	26vn	VR4	5a	Ric
BJQ	AME8570AEIUAF23L	Vdet-IC	2.32V±1.5%, -Reset PPO, -MR, lead free	SC-70-4	23vdh	VD5	5g	Ame
BJQ	AME8570AEIUAF23Z	Vdet-IC	2.32V±1.5%, -Reset PPO, -MR	SC-70-4	23vdh	VD5	5g	Ame
BJT	AME8570AEIUAF26L	Vdet-IC	2.63V±1.5%, -Reset PPO, -MR, lead free	SC-70-4	23vdh	VD5	5g	Ame
BJT	AME8570AEIUAF26Z	Vdet-IC	2.63V±1.5%, -Reset PPO, -MR	SC-70-4	23vdh	VD5	5g	Ame
BJW	AME8570AEIUAF29L	Vdet-IC	2.93V±1.5%, -Reset PPO, -MR, lead free	SC-70-4	23vdh	VD5	5g	Ame
BJW	AME8570AEIUAF29Z	Vdet-IC	2.93V±1.5%, -Reset PPO, -MR	SC-70-4	23vdh	VD5	5g	Ame
BJZ	AME8570AEIUAF29L	Vdet-IC	2.93V±1.5%, +Reset PPO, -MR, lead free	SC-70-4	23vdh	VD5	5g	Ame
BJZ	AME8570AEIUAF29Z	Vdet-IC	2.93V±1.5%, +Reset PPO, -MR	SC-70-4	23vdh	VD5	5g	Ame
BK	MAX822RUS-T	Vdet-IC	2.63V±1.5%, +Reset PPO, Select Rt	SOT-143	26	-	5c	Max
BK	R1141Q291B	LVR-IC	LDO, 2.9V±2%, 120mA, +CE	SOT-143R	26vm	VR4	5a	Ric
BK	R3112Q191A	Vdet-IC	1.9V±2%, -Reset PPO	SC-82AB	26rp	VD3	5a	Ric
BK	RP130Q291A	LVR-IC	LDO, LN, -CE, 2.9V±1%, 150mA	SC-82AB	26vn	VR4	5a	Ric
BK	XC6127C29GNR	Vdet-IC	2.9V±0.8%, +Reset PPO, -MR, Rt=100ms	SSOT-24	26cr	VD5	5a	Tor
BK	XC6127N30BNR	Vdet-IC	3.0V±0.8%, -Reset ODO, -MR, Rt=100ms	SSOT-24	26cr	VD4	5a	Tor
BK	XC6221B181NR	LVR-IC	LDO, 1.8V±20mV, 200mA, +CE, CL	SSOT-24	26vn	VR4	5a	Tor
BK	XC6223A271NR-G	LVR-IC	LDO, 2.7V±1%, 300mA, +CE	SSOT-24	26vn	VR4	5a	Tor
BKC	AME8570AEIUAF31L	Vdet-IC	3.08V±1.5%, -Reset PPO, -MR, lead free	SC-70-4	23vdh	VD5	5g	Ame
BKC	AME8570AEIUAF31Z	Vdet-IC	3.08V±1.5%, -Reset PPO, -MR	SC-70-4	23vdh	VD5	5g	Ame
BKF	AME8570AEIUBF31L	Vdet-IC	3.08V±1.5%, -Reset ODO, -MR, lead free	SC-70-4	23vdh	VD4	5g	Ame
BKF	AME8570AEIUBF31Z	Vdet-IC	3.08V±1.5%, -Reset ODO, -MR	SC-70-4	23vdh	VD4	5g	Ame
BKI	AME8570AEIUAF46L	Vdet-IC	4.63V±1.5%, -Reset PPO, -MR, lead free	SC-70-4	23vdh	VD5	5g	Ame
BKI	AME8570AEIUAF46Z	Vdet-IC	4.63V±1.5%, -Reset PPO, -MR	SC-70-4	23vdh	VD5	5g	Ame
BKL	AME8570AEIUCF46L	Vdet-IC	4.63V±1.5%, +Reset PPO, -MR, lead free	SC-70-4	23vdh	VD5	5g	Ame
BKL	AME8570AEIUCF46Z	Vdet-IC	4.63V±1.5%, +Reset PPO, -MR	SC-70-4	23vdh	VD5	5g	Ame
BKZ	AME8570AEIUBF29L	Vdet-IC	2.93V±1.5%, -Reset ODO, -MR, lead free	SC-70-4	23vdh	VD4	5g	Ame
BKZ	AME8570AEIUBF29Z	Vdet-IC	2.93V±1.5%, -Reset ODO, -MR	SC-70-4	23vdh	VD4	5g	Ame
BL	MAX821UUS-T	Vdet-IC	2.78V±1.5%, -Reset PPO, Select Rt	SOT-143	26	-	5c	Max
BL	R3112Q101C	Vdet-IC	1V±2%, -Reset ODO	SC-82AB	26rp	VD1	5a	Ric
BL	XC6127C31GNR	Vdet-IC	3.1V±0.8%, +Reset PPO, -MR, Rt=100ms	SSOT-24	26cr	VD5	5a	Tor
BL	XC6127N32BNR	Vdet-IC	3.2V±0.8%, -Reset ODO, -MR, Rt=100ms	SSOT-24	26cr	VD4	5a	Tor
BL	XC6221B191NR	LVR-IC	LDO, 1.9V±20mV, 200mA, +CE, CL	SSOT-24	26vn	VR4	5a	Tor
BL	XC6223A281NR-G	LVR-IC	LDO, 2.8V±1%, 300mA, +CE	SSOT-24	26vn	VR4	5a	Tor
BLM	AME8550AEIU390L	Vdet-IC	3.9V±2%, -Reset PPO	SC-70-4	23vdl	VD7	5g	Ame
BLM	AME8550AEIU390Z	Vdet-IC	3.9V±2%, -Reset PPO	SC-70-4	23vdl	VD7	5g	Ame
BLN	ELM7523CCB	Vdet-IC	2.3V±2%, +Reset PPO	SC-82AB	26vdl	VD7	5c	Elm
BLN	ELM7523NCB	Vdet-IC	2.3V±2%, +Reset ODO	SC-82AB	26vdl	VD6	5c	Elm
BLs	BGA310	MMIC	RF amp, UHF, 9dB, 0..2.4GHz	SOT-143	24aa	A1	5b	Sie
BM	MAX821PUS-T	Vdet-IC	4.0V±1.5%, -Reset PPO, Select Rt	SOT-143	26	-	5c	Max
BM	R3112Q111C	Vdet-IC	1.1V±2%, -Reset ODO	SC-82AB	26rp	VD1	5a	Ric
BM	XC6127C33GNR	Vdet-IC	3.3V±0.8%, +Reset PPO, -MR, Rt=100ms	SSOT-24	26cr	VD5	5a	Tor
BM	XC6127N34BNR	Vdet-IC	3.4V±0.8%, -Reset ODO, -MR, Rt=100ms	SSOT-24	26cr	VD4	5a	Tor
BM	XC6221B201NR	LVR-IC	LDO, 2V±1%, 200mA, +CE, CL	SSOT-24	26vn	VR4	5a	Tor
BM	XC6223A291NR-G	LVR-IC	LDO, 2.9V±1%, 300mA, +CE	SSOT-24	26vn	VR4	5a	Tor
BMG	AME8570AEIUAA16L	Vdet-IC	1.60V±1.5%, -Reset PPO, -MR, lead free	SC-70-4	23vdh	VD5	5g	Ame
BMG	AME8570AEIUAA16Z	Vdet-IC	1.60V±1.5%, -Reset PPO, -MR	SC-70-4	23vdh	VD5	5g	Ame
BML	AME8570AEIUBE20L	Vdet-IC	2.0V±1.5%, -Reset ODO, -MR, lead free	SC-70-4	23vdh	VD4	5g	Ame
BML	AME8570AEIUBE20Z	Vdet-IC	2.0V±1.5%, -Reset ODO, -MR	SC-70-4	23vdh	VD4	5g	Ame
BMQ	AME8570AEIUAE21L	Vdet-IC	2.10V±1.5%, -Reset PPO, -MR, lead free	SC-70-4	23vdh	VD5	5g	Ame
BMQ	AME8570AEIUAE21Z	Vdet-IC	2.10V±1.5%, -Reset PPO, -MR	SC-70-4	23vdh	VD5	5g	Ame



SMD code	Type	Function	Short description	Case	Pinout	Sch.	St.	Mnf.
BM s	BGA312	MMIC	RF amp, UHF, 11dB, 0.2GHz	SOT-143	24aa	A1	5b	Sie
BMW	AME8570AEIUAE26L	Vdet-IC	2.63V±1.5%, -Reset PPO, -MR, lead free	SC-70-4	23vdh	VD5	5g	Ame
BMW	AME8570AEIUAE2Z	Vdet-IC	2.63V±1.5%, -Reset PPO, -MR	SC-70-4	23vdh	VD5	5g	Ame
BN	R3112Q121C	Vdet-IC	1.2V±2%, -Reset ODO	SC-82AB	26rp	VD1	5a	Ric
BN	XC6109C10AN	Vdet-IC	1.0V, +Reset PPO	SSOT-24	26rp	VD3	5c	Tor
BN	XC6119C10ANR	Vdet-IC	1.0V±30mV, -Reset PPO	SSOT-24	26gh	VD3	5a	Tor
BN	XC6127C35GNR	Vdet-IC	3.5V±0.8%, +Reset PPO, -MR, Rt=100ms	SSOT-24	26cr	VD5	5a	Tor
BN	XC6127N36BNR	Vdet-IC	3.6V±0.8%, -Reset ODO, -MR, Rt=100ms	SSOT-24	26cr	VD4	5a	Tor
BN	XC6221B211NR	LVR-IC	LDO, 2.1V±1%, 200mA, +CE, CL	SSOT-24	26vn	VR4	5a	Tor
BNC	AME8570AEIUAA27L	Vdet-IC	2.70V±1.5%, -Reset PPO, -MR, lead free	SC-70-4	23vdh	VD5	5g	Ame
BNC	AME8570AEIUAA27Z	Vdet-IC	2.70V±1.5%, -Reset PPO, -MR	SC-70-4	23vdh	VD5	5g	Ame
BNH	AME8570AEIUAF27L	Vdet-IC	2.70V±1.5%, -Reset PPO, -MR, lead free	SC-70-4	23vdh	VD5	5g	Ame
BNH	AME8570AEIUAF27Z	Vdet-IC	2.70V±1.5%, -Reset PPO, -MR	SC-70-4	23vdh	VD5	5g	Ame
BNL	AME8570AEIUABA28L	Vdet-IC	2.80V±1.5%, -Reset ODO, -MR, lead free	SC-70-4	23vdh	VD4	5g	Ame
BNL	AME8570AEIUABA28Z	Vdet-IC	2.80V±1.5%, -Reset ODO, -MR	SC-70-4	23vdh	VD4	5g	Ame
BNQ	AME8570AEIUAE29L	Vdet-IC	2.93V±1.5%, -Reset PPO, -MR, lead free	SC-70-4	23vdh	VD5	5g	Ame
BNQ	AME8570AEIUAE29Z	Vdet-IC	2.93V±1.5%, -Reset PPO, -MR	SC-70-4	23vdh	VD5	5g	Ame
BN s	BGA318	MMIC	RF amp, UHF, 16dB, 0.1.2GHz	SOT-143	24aa	A1	5b	Sie
BO G	AME8570AEIUBE31L	Vdet-IC	3.08V±1.5%, -Reset ODO, -MR, lead free	SC-70-4	23vdh	VD4	5g	Ame
BO G	AME8570AEIUBE31Z	Vdet-IC	3.08V±1.5%, -Reset ODO, -MR	SC-70-4	23vdh	VD4	5g	Ame
BOL	AME8570AEIUFC31L	Vdet-IC	3.08V±1.5%, +Reset PPO, -MR, lead free	SC-70-4	23vdh	VD5	5g	Ame
BOL	AME8570AEIUFC31Z	Vdet-IC	3.08V±1.5%, +Reset PPO, -MR	SC-70-4	23vdh	VD5	5g	Ame
BOQ	AME8570AEIUAF40L	Vdet-IC	4.0V±1.5%, -Reset PPO, -MR, lead free	SC-70-4	23vdh	VD5	5g	Ame
BOQ	AME8570AEIUAF40Z	Vdet-IC	4.0V±1.5%, -Reset PPO, -MR	SC-70-4	23vdh	VD5	5g	Ame
BOV	AME8570AEIUAF44L	Vdet-IC	4.38V±1.5%, -Reset PPO, -MR, lead free	SC-70-4	23vdh	VD5	5g	Ame
BOV	AME8570AEIUAF44Z	Vdet-IC	4.38V±1.5%, -Reset PPO, -MR	SC-70-4	23vdh	VD5	5g	Ame
BP	R3112Q131C	Vdet-IC	1.3V±2%, -Reset ODO	SC-82AB	26rp	VD1	5a	Ric
BP	XC6109C11AN	Vdet-IC	1.1V, +Reset PPO	SSOT-24	26rp	VD3	5c	Tor
BP	XC6119C11ANR	Vdet-IC	1.1V±30mV, -Reset PPO	SSOT-24	26gh	VD3	5a	Tor
BP	XC6127C37GNR	Vdet-IC	3.7V±0.8%, +Reset PPO, -MR, Rt=100ms	SSOT-24	26cr	VD5	5a	Tor
BP	XC6127N38BNR	Vdet-IC	3.8V±0.8%, -Reset ODO, -MR, Rt=100ms	SSOT-24	26cr	VD4	5a	Tor
BP	XC6221B221NR	LVR-IC	LDO, 2.2V±1%, 200mA, +CE, CL	SSOT-24	26vn	VR4	5a	Tor
BPA	AME8570AEIUBF44L	Vdet-IC	4.38V±1.5%, -Reset ODO, -MR, lead free	SC-70-4	23vdh	VD4	5g	Ame
BPA	AME8570AEIUBF44Z	Vdet-IC	4.38V±1.5%, -Reset ODO, -MR	SC-70-4	23vdh	VD4	5g	Ame
BQ	R3112Q141C	Vdet-IC	1.4V±2%, -Reset ODO	SC-82AB	26rp	VD1	5a	Ric
BR	R3112Q151C	Vdet-IC	1.5V±2%, -Reset ODO	SC-82AB	26rp	VD1	5a	Ric
BR	XC6109C12AN	Vdet-IC	1.2V, +Reset PPO	SSOT-24	26rp	VD3	5c	Tor
BR	XC6119C12ANR	Vdet-IC	1.2V±30mV, -Reset PPO	SSOT-24	26gh	VD3	5a	Tor
BR	XC6127C39GNR	Vdet-IC	3.9V±0.8%, +Reset PPO, -MR, Rt=100ms	SSOT-24	26cr	VD5	5a	Tor
BR	XC6127N40BNR	Vdet-IC	4.0V±0.8%, -Reset ODO, -MR, Rt=100ms	SSOT-24	26cr	VD4	5a	Tor
BR	XC6221B231NR	LVR-IC	LDO, 2.3V±1%, 200mA, +CE, CL	SSOT-24	26vn	VR4	5a	Tor
BS	R3112Q161C	Vdet-IC	1.6V±2%, -Reset ODO	SC-82AB	26rp	VD1	5a	Ric
BS	XC6109C13AN	Vdet-IC	1.3V, +Reset PPO	SSOT-24	26rp	VD3	5c	Tor
BS	XC6119C13ANR	Vdet-IC	1.3V±30mV, -Reset PPO	SSOT-24	26gh	VD3	5a	Tor
BS	XC6127C41GNR	Vdet-IC	4.1V±0.8%, +Reset PPO, -MR, Rt=100ms	SSOT-24	26cr	VD5	5a	Tor
BS	XC6127N42BNR	Vdet-IC	4.2V±0.8%, -Reset ODO, -MR, Rt=100ms	SSOT-24	26cr	VD4	5a	Tor
BS	XC6221B241NR	LVR-IC	LDO, 2.4V±1%, 200mA, +CE, CL	SSOT-24	26vn	VR4	5a	Tor
BT	R3112Q171C	Vdet-IC	1.7V±2%, -Reset ODO	SC-82AB	26rp	VD1	5a	Ric
BT	XC6109C14AN	Vdet-IC	1.4V, +Reset PPO	SSOT-24	26rp	VD3	5c	Tor
BT	XC6119C14ANR	Vdet-IC	1.4V±30mV, -Reset PPO	SSOT-24	26gh	VD3	5a	Tor
BT	XC6127C43GNR	Vdet-IC	4.3V±0.8%, +Reset PPO, -MR, Rt=100ms	SSOT-24	26cr	VD5	5a	Tor
BT	XC6127N44BNR	Vdet-IC	4.4V±0.8%, -Reset ODO, -MR, Rt=100ms	SSOT-24	26cr	VD4	5a	Tor
BT	XC6221B251NR	LVR-IC	LDO, 2.5V±1%, 200mA, +CE, CL	SSOT-24	26vn	VR4	5a	Tor
BU	R3112Q181C	Vdet-IC	1.8V±2%, -Reset ODO	SC-82AB	26rp	VD1	5a	Ric
BU	XC6109C15AN	Vdet-IC	1.5V, +Reset PPO	SSOT-24	26rp	VD3	5c	Tor
BU	XC6119C15ANR	Vdet-IC	1.5V±2%, -Reset PPO	SSOT-24	26gh	VD3	5a	Tor
BU	XC6127C45GNR	Vdet-IC	4.5V±0.8%, +Reset PPO, -MR, Rt=100ms	SSOT-24	26cr	VD5	5a	Tor
BU	XC6127N46BNR	Vdet-IC	4.6V±0.8%, -Reset ODO, -MR, Rt=100ms	SSOT-24	26cr	VD4	5a	Tor
BU	XC6221B261NR	LVR-IC	LDO, 2.6V±1%, 200mA, +CE, CL	SSOT-24	26vn	VR4	5a	Tor
BV	R3112Q191C	Vdet-IC	1.9V±2%, -Reset ODO	SC-82AB	26rp	VD1	5a	Ric
BV	XC6109C16AN	Vdet-IC	1.6V, +Reset PPO	SSOT-24	26rp	VD3	5c	Tor
BV	XC6119C16ANR	Vdet-IC	1.6V±2%, -Reset PPO	SSOT-24	26gh	VD3	5a	Tor
BV	XC6127C47GNR	Vdet-IC	4.7V±0.8%, +Reset PPO, -MR, Rt=100ms	SSOT-24	26cr	VD5	5a	Tor
BV	XC6127N48BNR	Vdet-IC	4.8V±0.8%, -Reset ODO, -MR, Rt=100ms	SSOT-24	26cr	VD4	5a	Tor
BV	XC6221B271NR	LVR-IC	LDO, 2.7V±1%, 200mA, +CE, CL	SSOT-24	26vn	VR4	5a	Tor
BVM	AME8550AEIUAA270L	Vdet-IC	2.7V±2%, -Reset PPO	SC-70-4	23vdl	VD7	5g	Ame
BVM	AME8550AEIUAA270Z	Vdet-IC	2.7V±2%, -Reset PPO	SC-70-4	23vdl	VD7	5g	Ame
BVO	AME8570AEIUABA27L	Vdet-IC	2.70V±1.5%, -Reset ODO, -MR, lead free	SC-70-4	23vdh	VD4	5g	Ame
BVO	AME8570AEIUABA27Z	Vdet-IC	2.70V±1.5%, -Reset ODO, -MR	SC-70-4	23vdh	VD4	5g	Ame
BX	XC6109C17AN	Vdet-IC	1.7V, +Reset PPO	SSOT-24	26rp	VD3	5c	Tor



SMD code	Type	Function	Short description	Case	Pinout	Sch.	St.	Mnf.
BX	XC6119C17ANR	Vdet-IC	1.7V±2%, -Reset PPO	SSOT-24	26gh	VD3	5a	Tor
B \bar{X}	XC6127C49GNR	Vdet-IC	4.9V±0.8%, +Reset PPO, -MR, Rt=100ms	SSOT-24	26er	VD5	5a	Tor
B \bar{X}	XC6127N50BNR	Vdet-IC	5.0V±0.8%, -Reset ODO, -MR, Rt=100ms	SSOT-24	26cr	VD4	5a	Tor
BX	XC6221B281NLR	LVR-IC	LDO, 2.8V±1%, 200mA, +CE, CL	SSOT-24	26vn	VR4	5a	Tor
BY	XC6109C18AN	Vdet-IC	1.8V, +Reset PPO	SSOT-24	26rp	VD3	5c	Tor
BY	XC6119C18ANR	Vdet-IC	1.8V±2%, -Reset PPO	SSOT-24	26gh	VD3	5a	Tor
B \bar{Y}	XC6127C51GNR	Vdet-IC	5.1V±0.8%, +Reset PPO, -MR, Rt=100ms	SSOT-24	26er	VD5	5a	Tor
B \bar{Y}	XC6127N52BNR	Vdet-IC	5.2V±0.8%, -Reset ODO, -MR, Rt=100ms	SSOT-24	26cr	VD4	5a	Tor
BY	XC6221B291NLR	LVR-IC	LDO, 2.9V±1%, 200mA, +CE, CL	SSOT-24	26vn	VR4	5a	Tor
BZ	XC6109C19AN	Vdet-IC	1.9V, +Reset PPO	SSOT-24	26rp	VD3	5c	Tor
BZ	XC6119C19ANR	Vdet-IC	1.9V±2%, -Reset PPO	SSOT-24	26gh	VD3	5a	Tor
B \bar{Z}	XC6127C53GNR	Vdet-IC	5.3V±0.8%, +Reset PPO, -MR, Rt=100ms	SSOT-24	26cr	VD5	5a	Tor
B \bar{Z}	XC6127N54BNR	Vdet-IC	5.4V±0.8%, -Reset ODO, -MR, Rt=100ms	SSOT-24	26cr	VD4	5a	Tor
BZ	XC6221B301NLR	LVR-IC	LDO, 3V±1%, 200mA, +CE, CL	SSOT-24	26vn	VR4	5a	Tor
C	3SK303	n-MOSFET	DG, VHF-amp, 15V, ±30mA, 150mW, Idss=0..10mA	SOT-143	26fm	-	5b	Pan
C	3SK307	n-MOSFET	DG, VHF-amp, 15V, ±30mA, 150mW, Idss=0..10mA	SOT-343	26fm	-	5b	Pan
C0	R1140Q301B	LVR-IC	LDO, 3V±2%, 120mA, +CE	SOT-143R	26vm	VR4	5a	Ric
C0	R1180Q301B	LVR-IC	LDO, 3V±2%, 150mA, +CE	SC-82AB	26vn	VR4	5a	Ric
C0	R3114Q271A	Vdet-IC	2.7V±0.8%, -Reset ODO	SC-82AB	26vdl	VD9	5a	Ric
C0	XC6127C55HNR	Vdet-IC	5.5V±0.8%, +Reset PPO, -MR, Rt=200ms	SSOT-24	26cr	VD5	5a	Tor
C0	XC61CC2002N	Vdet-IC	2V±1%, +Reset PPO	SOT-143R	26vdl	VD7	5c	Tor
C1	R1140Q311B	LVR-IC	LDO, 3.1V±2%, 120mA, +CE	SOT-143R	26vm	VR4	5a	Ric
C1	R1180Q311B	LVR-IC	LDO, 3.1V±2%, 150mA, +CE	SC-82AB	26vn	VR4	5a	Ric
C1	R3114Q281A	Vdet-IC	2.8V±0.8%, -Reset ODO	SC-82AB	26vdl	VD9	5a	Ric
C1	XC61CC2102N	Vdet-IC	2.1V±1%, +Reset PPO	SOT-143R	26vdl	VD7	5c	Tor
C2	R1140Q321B	LVR-IC	LDO, 3.2V±2%, 120mA, +CE	SOT-143R	26vm	VR4	5a	Ric
C2	R1180Q321B	LVR-IC	LDO, 3.2V±2%, 150mA, +CE	SC-82AB	26vn	VR4	5a	Ric
C2	R3114Q291A	Vdet-IC	2.9V±0.8%, -Reset ODO	SC-82AB	26vdl	VD9	5a	Ric
C2	XC61CC2202N	Vdet-IC	2.2V±1%, +Reset PPO	SOT-143R	26vdl	VD7	5c	Tor
C2	XC6223B121NR-G	LVR-IC	LDO, 1.2V±20mV, 300mA, +CE, CL	SSOT-24	26vn	VR4	5a	Tor
C3	R1140Q331B	LVR-IC	LDO, 3.3V±2%, 120mA, +CE	SOT-143R	26vm	VR4	5a	Ric
C3	R1180Q331B	LVR-IC	LDO, 3.3V±2%, 150mA, +CE	SC-82AB	26vn	VR4	5a	Ric
C3	R3114Q301A	Vdet-IC	3V±0.8%, -Reset ODO	SC-82AB	26vdl	VD9	5a	Ric
C3	XC61CC2302N	Vdet-IC	2.3V±1%, +Reset PPO	SOT-143R	26vdl	VD7	5c	Tor
C3	XC6223B131NR-G	LVR-IC	LDO, 1.3V±20mV, 300mA, +CE, CL	SSOT-24	26vn	VR4	5a	Tor
C3I	CMFSH-3i	Si-diode	Dual, Sw, 30V, 100mA, 350mW, Vf<1V(100mA), 7pF	SOT-143	24ce	-	5b	Cen
C4	R1140Q341B	LVR-IC	LDO, 3.4V±2%, 120mA, +CE	SOT-143R	26vm	VR4	5a	Ric
C4	R1180Q341B	LVR-IC	LDO, 3.4V±2%, 150mA, +CE	SC-82AB	26vn	VR4	5a	Ric
C4	R3114Q311A	Vdet-IC	3.1V±0.8%, -Reset ODO	SC-82AB	26vdl	VD9	5a	Ric
C4	XC61CC2402N	Vdet-IC	2.4V±1%, +Reset PPO	SOT-143R	26vdl	VD7	5c	Tor
C4	XC6223B141NR-G	LVR-IC	LDO, 1.4V±20mV, 300mA, +CE, CL	SSOT-24	26vn	VR4	5a	Tor
C5	HSMS-2825	Si-diode	2x Schottky, RF, 15V, 1A, Vf<0.34V(1mA), <1pF, 12Q(5mA)	SOT-143	24ce	-	5c	Agj
C5	R1140Q351B	LVR-IC	LDO, 3.5V±2%, 120mA, +CE	SOT-143R	26vm	VR4	5a	Ric
C5	R1180Q351B	LVR-IC	LDO, 3.5V±2%, 150mA, +CE	SC-82AB	26vn	VR4	5a	Ric
C5	R3114Q321A	Vdet-IC	3.2V±0.8%, -Reset ODO	SC-82AB	26vdl	VD9	5a	Ric
C5	XC61CC2502N	Vdet-IC	2.5V±1%, +Reset PPO	SOT-143R	26vdl	VD7	5c	Tor
C5	XC6223B151NR-G	LVR-IC	LDO, 1.5V±20mV, 300mA, +CE, CL	SSOT-24	26vn	VR4	5a	Tor
C6	R1140Q361B	LVR-IC	LDO, 3.6V±2%, 120mA, +CE	SOT-143R	26vm	VR4	5a	Ric
C6	R1180Q361B	LVR-IC	LDO, 3.6V±2%, 150mA, +CE	SC-82AB	26vn	VR4	5a	Ric
C6	R3114Q331A	Vdet-IC	3.3V±0.8%, -Reset ODO	SC-82AB	26vdl	VD9	5a	Ric
C6	XC61CC2602N	Vdet-IC	2.6V±1%, +Reset PPO	SOT-143R	26vdl	VD7	5c	Tor
C6	XC6223B161NR-G	LVR-IC	LDO, 1.6V±20mV, 300mA, +CE, CL	SSOT-24	26vn	VR4	5a	Tor
C7	HSMS-2827	Si-diode	4x SBD, RF, 15V, 1A, Vf<0.34V(1mA), <1pF, 12Q(5mA)	SOT-143	24D1	-	5c	Agj
C7	R1140Q371B	LVR-IC	LDO, 3.7V±2%, 120mA, +CE	SOT-143R	26vm	VR4	5a	Ric
C7	R3114Q341A	Vdet-IC	3.4V±0.8%, -Reset ODO	SC-82AB	26vdl	VD9	5a	Ric
C7	XC61CC2702N	Vdet-IC	2.7V±1%, +Reset PPO	SOT-143R	26vdl	VD7	5c	Tor
C7	XC6221B08BNR	LVR-IC	LDO, 0.85V±20mV, 200mA, +CE, CL	SSOT-24	26vn	VR4	5a	Tor
C7	XC6223B171NR-G	LVR-IC	LDO, 1.7V±20mV, 300mA, +CE, CL	SSOT-24	26vn	VR4	5a	Tor
C8	HSMS-2828	Si-diode	4x SBD, RF, 15V, 1A, Vf<0.34V(1mA), <1pF, 12Q(5mA)	SOT-143	24D2	-	5c	Agj
C8	R1140Q381B	LVR-IC	LDO, 3.8V±2%, 120mA, +CE	SOT-143R	26vm	VR4	5a	Ric
C8	R3114Q351A	Vdet-IC	3.5V±0.8%, -Reset ODO	SC-82AB	26vdl	VD9	5a	Ric
C8	XC61CC2802N	Vdet-IC	2.8V±1%, +Reset PPO	SOT-143R	26vdl	VD7	5c	Tor
C8	XC6221B09BNR	LVR-IC	LDO, 0.95V±20mV, 200mA, +CE, CL	SSOT-24	26vn	VR4	5a	Tor
C8	XC6223B181NR-G	LVR-IC	LDO, 1.8V±20mV, 300mA, +CE, CL	SSOT-24	26vn	VR4	5a	Tor
C9	HSMS-2829	Si-diode	4x SBD, RF, 15V, 1A, Vf<0.34V(1mA), <1pF, 12Q(5mA)	SOT-143	24D3	-	5c	Agj
C9	R1140Q391B	LVR-IC	LDO, 3.9V±2%, 120mA, +CE	SOT-143R	26vm	VR4	5a	Ric
C9	R3114Q361A	Vdet-IC	3.6V±0.8%, -Reset ODO	SC-82AB	26vdl	VD9	5a	Ric
C9	XC61CC2902N	Vdet-IC	2.9V±1%, +Reset PPO	SOT-143R	26vdl	VD7	5c	Tor
C9	XC6221B10BNR	LVR-IC	LDO, 1.05V±20mV, 200mA, +CE, CL	SSOT-24	26vn	VR4	5a	Tor
C9	XC6223B191NR-G	LVR-IC	LDO, 1.9V±20mV, 300mA, +CE, CL	SSOT-24	26vn	VR4	5a	Tor



SMD code	Type	Function	Short description	Case	Pinout	Sch.	St.	Mnf.
C95	BCV64	Si-ppn	Dual, 30V, 100mA, 250mW, B=110..800, >100MHz	SOT-143	2445	-	5c	Phi
C96	BCV64B	Si-ppn	Dual, 30V, 100mA, 250mW, B=110..800, >100MHz	SOT-143	2445	-	5c	Phi
CA	MAX6314US38D1-T	Vdet-IC	3.8V±1.8%, -MR, -Reset Bidir, PPO, 1ms	SOT-143	24vdh	VD5	5c	Max
CA	R1141Q301B	LVR-IC	LDO, 3V±2%, 120mA, +CE	SOT-143R	26vm	VR4	5a	Ric
CA	R3112Q201A	Vdet-IC	2V±2%, -Reset PPO	SC-82AB	26rp	VD3	5a	Ric
CA	RP130Q301A	LVR-IC	LDO, LN, -CE, 3V±1%, 150mA	SC-82AB	26vn	VR4	5a	Ric
CA	XC6127C15HNR	Vdet-IC	1.5V±0.8%, +Reset PPO, -MR, Rt=200ms	SSOT-24	26cr	VD5	5a	Tor
CA	XC6127N16CNR	Vdet-IC	1.6V±0.8%, -Reset ODO, -MR, Rt=200ms	SSOT-24	26cr	VD4	5a	Tor
CA	XC6221B11BNR	LVR-IC	LDO, 1.15V±20mV, 200mA, +CE, CL	SSOT-24	26vn	VR4	5a	Tor
CA	XC6223B201NR-G	LVR-IC	LDO, 2.0V±1%, 300mA, +CE, CL	SSOT-24	26vn	VR4	5a	Tor
CB	MAX6314US37D1-T	Vdet-IC	3.7V±1.8%, -MR, -Reset Bidir, PPO, 1ms	SOT-143	24vdh	VD5	5c	Max
CB	R1141Q311B	LVR-IC	LDO, 3.1V±2%, 120mA, +CE	SOT-143R	26vm	VR4	5a	Ric
CB	R3112Q211A	Vdet-IC	2.1V±2%, -Reset PPO	SC-82AB	26rp	VD3	5a	Ric
CB	RP130Q311A	LVR-IC	LDO, LN, -CE, 3.1V±1%, 150mA	SC-82AB	26vn	VR4	5a	Ric
CB	XC6127C17HNR	Vdet-IC	1.7V±0.8%, +Reset PPO, -MR, Rt=200ms	SSOT-24	26cr	VD5	5a	Tor
CB	XC6127N18CNR	Vdet-IC	1.8V±0.8%, -Reset ODO, -MR, Rt=200ms	SSOT-24	26cr	VD4	5a	Tor
CB	XC6221B12BNR	LVR-IC	LDO, 1.25V±20mV, 200mA, +CE, CL	SSOT-24	26vn	VR4	5a	Tor
CB	XC6223B211NR-G	LVR-IC	LDO, 2.1V±1%, 300mA, +CE, CL	SSOT-24	26vn	VR4	5a	Tor
CB10	CBRHD10	BR	Rectifier, 1000V, 500mA, Vf<1V(400mA)	HD DIP	24/D5	-	5b	Cen
CBB	AME8570AE4UAF29L	Vdet-IC	2.93V±1.5%, -Reset PPO, -MR, lead free	SOT-143	24vdh	VD5	5g	Ame
CBB	AME8570AE4UAF29Z	Vdet-IC	2.93V±1.5%, -Reset PPO, -MR	SOT-143	24vdh	VD5	5g	Ame
CB2	CBRHD02	BR	Rectifier, 200V, 500mA, Vf<1V(400mA)	HD DIP	24/D5	-	5b	Cen
CB4	CBRHD04	BR	Rectifier, 400V, 500mA, Vf<1V(400mA)	HD DIP	24/D5	-	5b	Cen
CB6	CBRHD06	BR	Rectifier, 600V, 500mA, Vf<1V(400mA)	HD DIP	24/D5	-	5b	Cen
CB2	CMFBR-6F	BR	Rectifier, 60V, 140mA, Vf<1V(20mA)	SOT-143	24/D2	-	3a	Cen
CC	MAX6314US36D1-T	Vdet-IC	3.6V±1.8%, -MR, -Reset Bidir, PPO, 1ms	SOT-143	24vdh	VD5	5c	Max
CC	R1141Q321B	LVR-IC	LDO, 3.2V±2%, 120mA, +CE	SOT-143R	26vm	VR4	5a	Ric
CC	R3112Q221A	Vdet-IC	2.2V±2%, -Reset PPO	SC-82AB	26rp	VD3	5a	Ric
CC	RP130Q321A	LVR-IC	LDO, LN, -CE, 3.2V±1%, 150mA	SC-82AB	26vn	VR4	5a	Ric
CC	XC6127C19HNR	Vdet-IC	1.9V±0.8%, +Reset PPO, -MR, Rt=200ms	SSOT-24	26cr	VD5	5a	Tor
CC	XC6127N20CNR	Vdet-IC	2.0V±0.8%, -Reset ODO, -MR, Rt=200ms	SSOT-24	26cr	VD4	5a	Tor
CC	XC6221B13BNR	LVR-IC	LDO, 1.35V±20mV, 200mA, +CE, CL	SSOT-24	26vn	VR4	5a	Tor
CC	XC6223B221NR-G	LVR-IC	LDO, 2.2V±1%, 300mA, +CE, CL	SSOT-24	26vn	VR4	5a	Tor
CD	MAX6314US35D1-T	Vdet-IC	3.5V±1.8%, -MR, -Reset Bidir, PPO, 1ms	SOT-143	24vdh	VD5	5c	Max
CD	R1141Q331B	LVR-IC	LDO, 3.3V±2%, 120mA, +CE	SOT-143R	26vm	VR4	5a	Ric
CD	R3112Q231A	Vdet-IC	2.3V±2%, -Reset PPO	SC-82AB	26rp	VD3	5a	Ric
CD	RP130Q331A	LVR-IC	LDO, LN, -CE, 3.3V±1%, 150mA	SC-82AB	26vn	VR4	5a	Ric
CD	XC6127C21HNR	Vdet-IC	2.1V±0.8%, +Reset PPO, -MR, Rt=200ms	SSOT-24	26cr	VD5	5a	Tor
CD	XC6127N22CNR	Vdet-IC	2.2V±0.8%, -Reset ODO, -MR, Rt=200ms	SSOT-24	26cr	VD4	5a	Tor
CD	XC6221B14BNR	LVR-IC	LDO, 1.45V±20mV, 200mA, +CE, CL	SSOT-24	26vn	VR4	5a	Tor
CD	XC6223B231NR-G	LVR-IC	LDO, 2.3V±1%, 300mA, +CE, CL	SSOT-24	26vn	VR4	5a	Tor
CE	MAX6314US34D1-T	Vdet-IC	3.4V±1.8%, -MR, -Reset Bidir, PPO, 1ms	SOT-143	24vdh	VD5	5c	Max
CE	R1141Q341B	LVR-IC	LDO, 3.4V±2%, 120mA, +CE	SOT-143R	26vm	VR4	5a	Ric
CE	R3112Q241A	Vdet-IC	2.4V±2%, -Reset PPO	SC-82AB	26rp	VD3	5a	Ric
CE	RP130Q341A	LVR-IC	LDO, LN, -CE, 3.4V±1%, 150mA	SC-82AB	26vn	VR4	5a	Ric
CE	XC6127C23HNR	Vdet-IC	2.3V±0.8%, +Reset PPO, -MR, Rt=200ms	SSOT-24	26cr	VD5	5a	Tor
CE	XC6127N24CNR	Vdet-IC	2.4V±0.8%, -Reset ODO, -MR, Rt=200ms	SSOT-24	26cr	VD4	5a	Tor
CE	XC6221B15BNR	LVR-IC	LDO, 1.55V±20mV, 200mA, +CE, CL	SSOT-24	26vn	VR4	5a	Tor
CE	XC6223B241NR-G	LVR-IC	LDO, 2.4V±1%, 300mA, +CE, CL	SSOT-24	26vn	VR4	5a	Tor
CF	MAX6314US33D1-T	Vdet-IC	3.3V±1.8%, -MR, -Reset Bidir, PPO, 1ms	SOT-143	24vdh	VD5	5c	Max
CF	R1141Q351B	LVR-IC	LDO, 3.5V±2%, 120mA, +CE	SOT-143R	26vm	VR4	5a	Ric
CF	R3112Q251A	Vdet-IC	2.5V±2%, -Reset PPO	SC-82AB	26rp	VD3	5a	Ric
CF	RP130Q351A	LVR-IC	LDO, LN, -CE, 3.5V±1%, 150mA	SC-82AB	26vn	VR4	5a	Ric
CF	XC6127C25HNR	Vdet-IC	2.5V±0.8%, +Reset PPO, -MR, Rt=200ms	SSOT-24	26cr	VD5	5a	Tor
CF	XC6127N26CNR	Vdet-IC	2.6V±0.8%, -Reset ODO, -MR, Rt=200ms	SSOT-24	26cr	VD4	5a	Tor
CF	XC6221B16BNR	LVR-IC	LDO, 1.65V±20mV, 200mA, +CE, CL	SSOT-24	26vn	VR4	5a	Tor
CF	XC6223B251NR-G	LVR-IC	LDO, 2.5V±1%, 300mA, +CE, CL	SSOT-24	26vn	VR4	5a	Tor
CG	MAX6314US32D1-T	Vdet-IC	3.2V±1.8%, -MR, -Reset Bidir, PPO, 1ms	SOT-143	24vdh	VD5	5c	Max
CG	R1141Q361B	LVR-IC	LDO, 3.6V±2%, 120mA, +CE	SOT-143R	26vm	VR4	5a	Ric
CG	R3112Q261A	Vdet-IC	2.6V±2%, -Reset PPO	SC-82AB	26rp	VD3	5a	Ric
CG	RP130Q361A	LVR-IC	LDO, LN, -CE, 3.6V±1%, 150mA	SC-82AB	26vn	VR4	5a	Ric
CH	MAX6314US31D1-T	Vdet-IC	3.08V±1.8%, -MR, -Reset Bidir, PPO, 1ms	SOT-143	24vdh	VD5	5c	Max
CH	R1141Q371B	LVR-IC	LDO, 3.7V±2%, 120mA, +CE	SOT-143R	26vm	VR4	5a	Ric
CH	R3112Q271A	Vdet-IC	2.7V±2%, -Reset PPO	SC-82AB	26rp	VD3	5a	Ric
CH	RP130Q371A	LVR-IC	LDO, LN, -CE, 3.7V±1%, 150mA	SC-82AB	26vn	VR4	5a	Ric
CH	XC6127C27HNR	Vdet-IC	2.7V±0.8%, +Reset PPO, -MR, Rt=200ms	SSOT-24	26cr	VD5	5a	Tor
CH	XC6127N28CNR	Vdet-IC	2.8V±0.8%, -Reset ODO, -MR, Rt=200ms	SSOT-24	26cr	VD4	5a	Tor
CH	XC6221B17BNR	LVR-IC	LDO, 1.75V±20mV, 200mA, +CE, CL	SSOT-24	26vn	VR4	5a	Tor
CH	XC6223B261NR-G	LVR-IC	LDO, 2.6V±1%, 300mA, +CE, CL	SSOT-24	26vn	VR4	5a	Tor
CI	MAX6314US30D1-T	Vdet-IC	3.0V±1.8%, -MR, -Reset Bidir, PPO, 1ms	SOT-143	24vdh	VD5	5c	Max



SMD code	Type	Function	Short description	Case	Pinout	Sch.	St.	Mnf.
CJ	MAX6314US29D1-T	Vdet-IC	2.93V±1.8%, -MR, -Reset Bidir, PPO, 1ms	SOT-143	24vdh	VD5	5c	Max
CJ	R1141Q381B	LVR-IC	LDO, 3.8V±2%, 120mA, +CE	SOT-143R	26vm	VR4	5a	Ric
CJ	R3112Q281A	Vdet-IC	2.8V±2%, -Reset PPO	SC-82AB	26rp	VD3	5a	Ric
CJ	RP130Q381A	LVR-IC	LDO, LN, -CE, 3.8V±1%, 150mA	SC-82AB	26vn	VR4	5a	Ric
CJP	BAW101	Si-diode	Dual, Sw, 300V, 200mA, Vf<1.3V(100mA), 50ns	SOT-143	24ce	-	3a	Gen
CJP	CMFD2004i	Si-diode	Dual, Sw, 240V, 200mA, 350mW, Vf<1V(100mA), <5pF	SOT-143	24ce	-	5b	Gen
CJSS	BAW100	Si-diode	Dual, Sw, 75V, 250mA, Vf<1.25V (150mA), 6ns	SOT-143	24dv	-	3a	Gen
CK	MAX6314US28D1-T	Vdet-IC	2.8V±1.8%, -MR, -Reset Bidir, PPO, 1ms	SOT-143	24vdh	VD5	5c	Max
CK	R1141Q391B	LVR-IC	LDO, 3.9V±2%, 120mA, +CE	SOT-143R	26vm	VR4	5a	Ric
CK	R3112Q291A	Vdet-IC	2.9V±2%, -Reset PPO	SC-82AB	26rp	VD3	5a	Ric
CK	RP130Q391A	LVR-IC	LDO, LN, -CE, 3.9V±1%, 150mA	SC-82AB	26vn	VR4	5a	Ric
CK	XC6127C29HNR	Vdet-IC	2.9V±0.8%, +Reset PPO, -MR, Rt=200ms	SSOT-24	26cr	VD5	5a	Tor
CK	XC6127N30CNR	Vdet-IC	3.0V±0.8%, -Reset ODO, -MR, Rt=200ms	SSOT-24	26cr	VD4	5a	Tor
CK	XC6221B18BNR	LVR-IC	LDO, 1.85V±20mV, 200mA, +CE, CL	SSOT-24	26vn	VR4	5a	Tor
CK	XC6223B271NR-G	LVR-IC	LDO, 2.7V±1%, 300mA, +CE, CL	SSOT-24	26vn	VR4	5a	Tor
CL	FP6812-23CC4P	Vdet-IC	2.32V±1.5%, +Reset PPO, -MR	SC-70-4	23vdh	VD6	5b	Fit
CL	MAX6314US27D1-T	Vdet-IC	2.7V±1.8%, -MR, -Reset Bidir, PPO, 1ms	SOT-143	24vdh	VD5	5c	Max
CL	R3112Q201C	Vdet-IC	2V±2%, -Reset ODO	SC-82AB	26rp	VD1	5a	Ric
CL	XC6127C31HNR	Vdet-IC	3.1V±0.8%, +Reset PPO, -MR, Rt=200ms	SSOT-24	26cr	VD5	5a	Tor
CL	XC6127N32CNR	Vdet-IC	3.2V±0.8%, -Reset ODO, -MR, Rt=200ms	SSOT-24	26cr	VD4	5a	Tor
CL	XC6221B19BNR	LVR-IC	LDO, 1.95V±20mV, 200mA, +CE, CL	SSOT-24	26vn	VR4	5a	Tor
CL	XC6223B281NR-G	LVR-IC	LDO, 2.8V±1%, 300mA, +CE, CL	SSOT-24	26vn	VR4	5a	Tor
CLN	ELM7524CCB	Vdet-IC	2.4V±2%, +Reset PPO	SC-82AB	26vdl	VD7	5c	Elm
CLN	ELM7524NCB	Vdet-IC	2.4V±2%, +Reset ODO	SC-82AB	26vdl	VD6	5c	Elm
CM	FP6812-26CC4P	Vdet-IC	2.63V±1.5%, +Reset PPO, -MR	SC-70-4	23vdh	VD6	5b	Fit
CM	MAX6314US26D1-T	Vdet-IC	2.63V±1.8%, -MR, -Reset Bidir, PPO, 1ms	SOT-143	24vdh	VD5	5c	Max
CM	R3112Q211C	Vdet-IC	2.1V±2%, -Reset ODO	SC-82AB	26rp	VD1	5a	Ric
CM	XC6127C33HNR	Vdet-IC	3.3V±0.8%, +Reset PPO, -MR, Rt=200ms	SSOT-24	26cr	VD5	5a	Tor
CM	XC6127N34CNR	Vdet-IC	3.4V±0.8%, -Reset ODO, -MR, Rt=200ms	SSOT-24	26cr	VD4	5a	Tor
CM	XC6221B20BNR	LVR-IC	LDO, 2.05V±1%, 200mA, +CE, CL	SSOT-24	26vn	VR4	5a	Tor
CM	XC6223B291NR-G	LVR-IC	LDO, 2.9V±1%, 300mA, +CE, CL	SSOT-24	26vn	VR4	5a	Tor
CN	FP6812-29CC4P	Vdet-IC	2.93V±1.5%, +Reset PPO, -MR	SC-70-4	23vdh	VD6	5b	Fit
CN	MAX6314US25D1-T	Vdet-IC	2.5V±1.8%, -MR, -Reset Bidir, PPO, 1ms	SOT-143	24vdh	VD5	5c	Max
CN	R3112Q221C	Vdet-IC	2.2V±2%, -Reset ODO	SC-82AB	26rp	VD1	5a	Ric
CN	XC6109C20AN	Vdet-IC	2.0V, +Reset PPO	SSOT-24	26rp	VD3	5c	Tor
CN	XC6119C20ANR	Vdet-IC	2.0V±2%, -Reset PPO	SSOT-24	26gh	VD3	5a	Tor
CN	XC6127C35HNR	Vdet-IC	3.5V±0.8%, +Reset PPO, -MR, Rt=200ms	SSOT-24	26cr	VD5	5a	Tor
CN	XC6127N36CNR	Vdet-IC	3.6V±0.8%, -Reset ODO, -MR, Rt=200ms	SSOT-24	26cr	VD4	5a	Tor
CN	XC6221B21BNR	LVR-IC	LDO, 2.15V±1%, 200mA, +CE, CL	SSOT-24	26vn	VR4	5a	Tor
CN3	2SC4855-3	Si-npn	VHF/UHF, 12V, 15mA, 80mW, B=60..120, 5GHz	CP4	26tu	-	5b	San
CN4	2SC4855-4	Si-npn	VHF/UHF, 12V, 15mA, 80mW, B=901..180, 5GHz	CP4	26tu	-	5b	San
CN5	2SC4855-5	Si-npn	VHF/UHF, 12V, 15mA, 80mW, B=60..120, 5GHz	CP4	26tu	-	5b	San
CO	2SC5087-O	Si-npn	VHF/UHF, LN, 20V, 80mA, 150mW, 7GHz, B=80..160	SMQ	26tu	-	5b	Tos
CO	MAX6314US50D2-T	Vdet-IC	5.0V±1.8%, -MR, -Reset Bidir, PPO, 20ms	SOT-143	24vdh	VD5	5c	Max
CP	FP6812-31CC4P	Vdet-IC	3.08V±1.5%, +Reset PPO, -MR	SC-70-4	23vdh	VD6	5b	Fit
CP	MAX6314US49D2-T	Vdet-IC	4.9V±1.8%, -MR, -Reset Bidir, PPO, 20ms	SOT-143	24vdh	VD5	5c	Max
CP	R3112Q231C	Vdet-IC	2.3V±2%, -Reset ODO	SC-82AB	26rp	VD1	5a	Ric
CP	XC6109C21AN	Vdet-IC	2.1V, +Reset PPO	SSOT-24	26rp	VD3	5c	Tor
CP	XC6119C21ANR	Vdet-IC	2.1V±2%, -Reset PPO	SSOT-24	26gh	VD3	5a	Tor
CP	XC6127C37HNR	Vdet-IC	3.7V±0.8%, +Reset PPO, -MR, Rt=200ms	SSOT-24	26cr	VD5	5a	Tor
CP	XC6127N38CNR	Vdet-IC	3.8V±0.8%, -Reset ODO, -MR, Rt=200ms	SSOT-24	26cr	VD4	5a	Tor
CP	XC6221B22BNR	LVR-IC	LDO, 2.25V±1%, 200mA, +CE, CL	SSOT-24	26vn	VR4	5a	Tor
CQ	MAX6314US48D2-T	Vdet-IC	4.8V±1.8%, -MR, -Reset Bidir, PPO, 20ms	SOT-143	24vdh	VD5	5c	Max
CQ	R3112Q241C	Vdet-IC	2.4V±2%, -Reset ODO	SC-82AB	26rp	VD1	5a	Ric
CR	FP6812-40CC4P	Vdet-IC	4.0V±1.5%, +Reset PPO, -MR	SC-70-4	23vdh	VD6	5b	Fit
CR	MAX6314US47D2-T	Vdet-IC	4.7V±1.8%, -MR, -Reset Bidir, PPO, 20ms	SOT-143	24vdh	VD5	5c	Max
CR	R3112Q251C	Vdet-IC	2.5V±2%, -Reset ODO	SC-82AB	26rp	VD1	5a	Ric
CR	XC6109C22AN	Vdet-IC	2.2V, +Reset PPO	SSOT-24	26rp	VD3	5c	Tor
CR	XC6119C22ANR	Vdet-IC	2.2V±2%, -Reset PPO	SSOT-24	26gh	VD3	5a	Tor
CR	XC6127C39HNR	Vdet-IC	3.9V±0.8%, +Reset PPO, -MR, Rt=200ms	SSOT-24	26cr	VD5	5a	Tor
CR	XC6127N40CNR	Vdet-IC	4.0V±0.8%, -Reset ODO, -MR, Rt=200ms	SSOT-24	26cr	VD4	5a	Tor
CR	XC6221B23BNR	LVR-IC	LDO, 2.35V±1%, 200mA, +CE, CL	SSOT-24	26vn	VR4	5a	Tor
CS	FP6812-44CC4P	Vdet-IC	4.38V±1.5%, +Reset PPO, -MR	SC-70-4	23vdh	VD6	5b	Fit
CS	MAX6314US46D2-T	Vdet-IC	4.63V±1.8%, -MR, -Reset Bidir, PPO, 20ms	SOT-143	24vdh	VD5	5c	Max
CS	R3112Q261C	Vdet-IC	2.6V±2%, -Reset ODO	SC-82AB	26rp	VD1	5a	Ric
CS	XC6109C23AN	Vdet-IC	2.3V, +Reset PPO	SSOT-24	26rp	VD3	5c	Tor
CS	XC6119C23ANR	Vdet-IC	2.3V±2%, -Reset PPO	SSOT-24	26gh	VD3	5a	Tor
CS	XC6127C41HNR	Vdet-IC	4.1V±0.8%, +Reset PPO, -MR, Rt=200ms	SSOT-24	26cr	VD5	5a	Tor
CS	XC6127N42CNR	Vdet-IC	4.2V±0.8%, -Reset ODO, -MR, Rt=200ms	SSOT-24	26cr	VD4	5a	Tor
CS	XC6221B24BNR	LVR-IC	LDO, 2.45V±1%, 200mA, +CE, CL	SSOT-24	26vn	VR4	5a	Tor



SMD code	Type	Function	Short description	Case	Pinout	Sch.	St.	Mnf.
CT	FP6812-46CC4P	Vdet-IC	4.63V±1.5%, +Reset PPO, -MR	SC-70-4	23vdh	VD6	5b	Fit
CT	MAX6314US45D2-T	Vdet-IC	4.5V±1.8%, -MR, -Reset Bidir, PPO, 20ms	SOT-143	24vdh	VD5	5c	Max
CT	R3112Q271C	Vdet-IC	2.7V±2%, -Reset ODO	SC-82AB	26rp	VD1	5a	Ric
CT	XC6109C24AN	Vdet-IC	2.4V, +Reset PPO	SSOT-24	26rp	VD3	5c	Tor
CT	XC6119C24ANR	Vdet-IC	2.4V±2%, -Reset PPO	SSOT-24	26gh	VD3	5a	Tor
CT	XC6127C43HNR	Vdet-IC	4.3V±0.8%, +Reset PPO, -MR, Rt=200ms	SSOT-24	26cr	VD5	5a	Tor
CT	XC6127N44CNR	Vdet-IC	4.4V±0.8%, -Reset ODO, -MR, Rt=200ms	SSOT-24	26cr	VD4	5a	Tor
CT	XC6221B25BNR	LVR-IC	LDO, 2.55V±1%, 200mA, +CE, CL	SSOT-24	26vn	VR4	5a	Tor
CU	MAX6314US44D2-T	Vdet-IC	4.39V±1.8%, -MR, -Reset Bidir, PPO, 20ms	SOT-143	24vdh	VD5	5c	Max
CU	R3112Q281C	Vdet-IC	2.8V±2%, -Reset ODO	SC-82AB	26rp	VD1	5a	Ric
CU	XC6109C25AN	Vdet-IC	2.5V, +Reset PPO	SSOT-24	26rp	VD3	5c	Tor
CU	XC6119C25ANR	Vdet-IC	2.5V±2%, -Reset PPO	SSOT-24	26gh	VD3	5a	Tor
CU	XC6127C45HNR	Vdet-IC	4.5V±0.8%, +Reset PPO, -MR, Rt=200ms	SSOT-24	26cr	VD5	5a	Tor
CU	XC6127N46CNR	Vdet-IC	4.6V±0.8%, -Reset ODO, -MR, Rt=200ms	SSOT-24	26cr	VD4	5a	Tor
CU	XC6221B26BNR	LVR-IC	LDO, 2.65V±1%, 200mA, +CE, CL	SSOT-24	26vn	VR4	5a	Tor
CUA	S-817A11ANB-CUAT2G	LVR-IC	1.1V±2%, 50mA	SC-82AB	26vs	VR1	5e	Sii
CUA	S-817A11APF-CUATFG	LVR-IC	1.1V±2%, 50mA	SNT-4A	42rw	VR1	5e	Sii
CUB	S-817A12ANB-CUBT2G	LVR-IC	1.2V±2%, 50mA	SC-82AB	26vs	VR1	5e	Sii
CUB	S-817A12APF-CUBTFG	LVR-IC	1.2V±2%, 50mA	SNT-4A	42rw	VR1	5e	Sii
CUC	S-817A13ANB-CUCT2G	LVR-IC	1.3V±2%, 50mA	SC-82AB	26vs	VR1	5e	Sii
CUC	S-817A13APF-CUCTFG	LVR-IC	1.3V±2%, 50mA	SNT-4A	42rw	VR1	5e	Sii
CUD	S-817A14ANB-CUDT2G	LVR-IC	1.4V±2%, 50mA	SC-82AB	26vs	VR1	5e	Sii
CUD	S-817A14APF-CUDTFG	LVR-IC	1.4V±2%, 50mA	SNT-4A	42rw	VR1	5e	Sii
CUE	S-817A15ANB-CUET2G	LVR-IC	1.5V±2%, 50mA	SC-82AB	26vs	VR1	5e	Sii
CUE	S-817A15APF-CUETFG	LVR-IC	1.5V±2%, 50mA	SNT-4A	42rw	VR1	5e	Sii
CUF	S-817A16ANB-CUFT2G	LVR-IC	1.6V±2%, 50mA	SC-82AB	26vs	VR1	5e	Sii
CUF	S-817A16APF-CUFTFG	LVR-IC	1.6V±2%, 50mA	SNT-4A	42rw	VR1	5e	Sii
CUG	S-817A17ANB-CUGT2G	LVR-IC	1.7V±2%, 50mA	SC-82AB	26vs	VR1	5e	Sii
CUG	S-817A17APF-CUGTFG	LVR-IC	1.7V±2%, 50mA	SNT-4A	42rw	VR1	5e	Sii
CUH	S-817A18ANB-CUHT2G	LVR-IC	1.8V±2%, 50mA	SC-82AB	26vs	VR1	5e	Sii
CUH	S-817A18APF-CUHTFG	LVR-IC	1.8V±2%, 50mA	SNT-4A	42rw	VR1	5e	Sii
CUI	S-817A19ANB-CUIT2G	LVR-IC	1.9V±2%, 50mA	SC-82AB	26vs	VR1	5e	Sii
CUI	S-817A19APF-CUITFG	LVR-IC	1.9V±2%, 50mA	SNT-4A	42rw	VR1	5e	Sii
CUJ	S-817A20ANB-CUJT2G	LVR-IC	2.0V±2%, 50mA	SC-82AB	26vs	VR1	5e	Sii
CUJ	S-817A20APF-CUJTFG	LVR-IC	2.0V±2%, 50mA	SNT-4A	42rw	VR1	5e	Sii
CUK	S-817A21ANB-CUKT2G	LVR-IC	2.1V±2%, 50mA	SC-82AB	26vs	VR1	5e	Sii
CUK	S-817A21APF-CUKTFG	LVR-IC	2.1V±2%, 50mA	SNT-4A	42rw	VR1	5e	Sii
CUL	S-817A22ANB-CULT2G	LVR-IC	2.2V±2%, 50mA	SC-82AB	26vs	VR1	5e	Sii
CUL	S-817A22APF-CULTFG	LVR-IC	2.2V±2%, 50mA	SNT-4A	42rw	VR1	5e	Sii
CUM	S-817A23ANB-CUMT2G	LVR-IC	2.3V±2%, 50mA	SC-82AB	26vs	VR1	5e	Sii
CUM	S-817A23APF-CUMTFG	LVR-IC	2.3V±2%, 50mA	SNT-4A	42rw	VR1	5e	Sii
CUN	S-817A24ANB-CUNT2G	LVR-IC	2.4V±2%, 50mA	SC-82AB	26vs	VR1	5e	Sii
CUN	S-817A24APF-CUNTFG	LVR-IC	2.4V±2%, 50mA	SNT-4A	42rw	VR1	5e	Sii
CUO	S-817A25ANB-CUOT2G	LVR-IC	2.5V±2%, 50mA	SC-82AB	26vs	VR1	5e	Sii
CUO	S-817A25APF-CUOTFG	LVR-IC	2.5V±2%, 50mA	SNT-4A	42rw	VR1	5e	Sii
CUP	S-817A26ANB-CUPT2G	LVR-IC	2.6V±2%, 50mA	SC-82AB	26vs	VR1	5e	Sii
CUP	S-817A26APF-CUPTFG	LVR-IC	2.6V±2%, 50mA	SNT-4A	42rw	VR1	5e	Sii
CUQ	S-817A27ANB-CUQT2G	LVR-IC	2.7V±2%, 50mA	SC-82AB	26vs	VR1	5e	Sii
CUQ	S-817A27APF-CUQTFG	LVR-IC	2.7V±2%, 50mA	SNT-4A	42rw	VR1	5e	Sii
CUR	S-817A28ANB-CURT2G	LVR-IC	2.8V±2%, 50mA	SC-82AB	26vs	VR1	5e	Sii
CUR	S-817A28APF-CURTFG	LVR-IC	2.8V±2%, 50mA	SNT-4A	42rw	VR1	5e	Sii
CUS	S-817A29ANB-CUST2G	LVR-IC	2.9V±2%, 50mA	SC-82AB	26vs	VR1	5e	Sii
CUS	S-817A29APF-CUSTFG	LVR-IC	2.9V±2%, 50mA	SNT-4A	42rw	VR1	5e	Sii
CUT	S-817A30ANB-CUTT2G	LVR-IC	3.0V±2%, 50mA	SC-82AB	26vs	VR1	5e	Sii
CUT	S-817A30APF-CUTTFG	LVR-IC	3.0V±2%, 50mA	SNT-4A	42rw	VR1	5e	Sii
CUU	S-817A31ANB-CUUT2G	LVR-IC	3.1V±2%, 50mA	SC-82AB	26vs	VR1	5e	Sii
CUU	S-817A31APF-CUUTFG	LVR-IC	3.1V±2%, 50mA	SNT-4A	42rw	VR1	5e	Sii
CUV	S-817A32ANB-CUVT2G	LVR-IC	3.2V±2%, 50mA	SC-82AB	26vs	VR1	5e	Sii
CUV	S-817A32APF-CUVTFG	LVR-IC	3.2V±2%, 50mA	SNT-4A	42rw	VR1	5e	Sii
CUW	S-817A33ANB-CUWT2G	LVR-IC	3.3V±2%, 50mA	SC-82AB	26vs	VR1	5e	Sii
CUW	S-817A33APF-CUWTFG	LVR-IC	3.3V±2%, 50mA	SNT-4A	42rw	VR1	5e	Sii
CUX	S-817A34ANB-CUXT2G	LVR-IC	3.4V±2%, 50mA	SC-82AB	26vs	VR1	5e	Sii
CUX	S-817A34APF-CUXTFG	LVR-IC	3.4V±2%, 50mA	SNT-4A	42rw	VR1	5e	Sii
CUY	S-817A35ANB-CUYT2G	LVR-IC	3.5V±2%, 50mA	SC-82AB	26vs	VR1	5e	Sii
CUY	S-817A35APF-CUYTFG	LVR-IC	3.5V±2%, 50mA	SNT-4A	42rw	VR1	5e	Sii
CUZ	S-817A36ANB-CUZT2G	LVR-IC	3.6V±2%, 50mA	SC-82AB	26vs	VR1	5e	Sii
CUZ	S-817A36APF-CUZTFG	LVR-IC	3.6V±2%, 50mA	SNT-4A	42rw	VR1	5e	Sii
CV	MAX6314US43D2-T	Vdet-IC	4.3V±1.8%, -MR, -Reset Bidir, PPO, 20ms	SOT-143	24vdh	VD5	5c	Max
CV	R3112Q291C	Vdet-IC	2.9V±2%, -Reset ODO	SC-82AB	26rp	VD1	5a	Ric
CV	XC6109C26AN	Vdet-IC	2.6V, +Reset PPO	SSOT-24	26rp	VD3	5c	Tor



SMD code	Type	Function	Short description	Case	Pinout	Sch.	St.	Mnf.
CV	XC6119C26ANR	Vdet-IC	2.6V±2%, -Reset PPO	SSOT-24	26gh	VD3	5a	Tor
CV	XC6127C47HNR	Vdet-IC	4.7V±0.8%, +Reset PPO, -MR, Rt=200ms	SSOT-24	26cr	VD5	5a	Tor
CV	XC6127N48CNR	Vdet-IC	4.8V±0.8%, -Reset ODO, -MR, Rt=200ms	SSOT-24	26cr	VD4	5a	Tor
CV	XC6221B27BNR	LVR-IC	LDO, 2.75V±1%, 200mA, +CE, CL	SSOT-24	26vn	VR4	5a	Tor
CVA	S-817A37ANB-CVAT2G	LVR-IC	3.7V±2%, 50mA	SC-82AB	26vs	VR1	5e	Sii
CVA	S-817A37APF-CVATFG	LVR-IC	3.7V±2%, 50mA	SNT-4A	42rw	VR1	5e	Sii
CVB	S-817A38ANB-CVBT2G	LVR-IC	3.8V±2%, 50mA	SC-82AB	26vs	VR1	5e	Sii
CVB	S-817A38APF-CVBTFG	LVR-IC	3.8V±2%, 50mA	SNT-4A	42rw	VR1	5e	Sii
CVC	S-817A39ANB-CVCT2G	LVR-IC	3.9V±2%, 50mA	SC-82AB	26vs	VR1	5e	Sii
CVC	S-817A39APF-CVCTFG	LVR-IC	3.9V±2%, 50mA	SNT-4A	42rw	VR1	5e	Sii
CVD	S-817A40ANB-CVDT2G	LVR-IC	4.0V±2%, 50mA	SC-82AB	26vs	VR1	5e	Sii
CVD	S-817A40APF-CVDTFG	LVR-IC	4.0V±2%, 50mA	SNT-4A	42rw	VR1	5e	Sii
CVE	S-817A41ANB-CVET2G	LVR-IC	4.1V±2%, 50mA	SC-82AB	26vs	VR1	5e	Sii
CVE	S-817A41APF-CVETFG	LVR-IC	4.1V±2%, 50mA	SNT-4A	42rw	VR1	5e	Sii
CVF	S-817A42ANB-CVFT2G	LVR-IC	4.2V±2%, 50mA	SC-82AB	26vs	VR1	5e	Sii
CVF	S-817A42APF-CVFTFG	LVR-IC	4.2V±2%, 50mA	SNT-4A	42rw	VR1	5e	Sii
CVG	S-817A43ANB-CVGT2G	LVR-IC	4.3V±2%, 50mA	SC-82AB	26vs	VR1	5e	Sii
CVG	S-817A43APF-CVGTFG	LVR-IC	4.3V±2%, 50mA	SNT-4A	42rw	VR1	5e	Sii
CVH	S-817A44ANB-CVHT2G	LVR-IC	4.4V±2%, 50mA	SC-82AB	26vs	VR1	5e	Sii
CVH	S-817A44APF-CVHTFG	LVR-IC	4.4V±2%, 50mA	SNT-4A	42rw	VR1	5e	Sii
CVI	S-817A45ANB-CVIT2G	LVR-IC	4.5V±2%, 50mA	SC-82AB	26vs	VR1	5e	Sii
CVI	S-817A45APF-CVITFG	LVR-IC	4.5V±2%, 50mA	SNT-4A	42rw	VR1	5e	Sii
CVJ	S-817A46ANB-CVJT2G	LVR-IC	4.6V±2%, 50mA	SC-82AB	26vs	VR1	5e	Sii
CVJ	S-817A46APF-CVJTFG	LVR-IC	4.6V±2%, 50mA	SNT-4A	42rw	VR1	5e	Sii
CVK	S-817A47ANB-CVKT2G	LVR-IC	4.7V±2%, 50mA	SC-82AB	26vs	VR1	5e	Sii
CVK	S-817A47APF-CVKTFG	LVR-IC	4.7V±2%, 50mA	SNT-4A	42rw	VR1	5e	Sii
CVL	S-817A48ANB-CVLT2G	LVR-IC	4.8V±2%, 50mA	SC-82AB	26vs	VR1	5e	Sii
CVL	S-817A48APF-CVLTFG	LVR-IC	4.8V±2%, 50mA	SNT-4A	42rw	VR1	5e	Sii
CVM	S-817A49ANB-CVMT2G	LVR-IC	4.9V±2%, 50mA	SC-82AB	26vs	VR1	5e	Sii
CVM	S-817A49APF-CVMTFG	LVR-IC	4.9V±2%, 50mA	SNT-4A	42rw	VR1	5e	Sii
CVN	S-817A50ANB-CVNT2G	LVR-IC	5.0V±2%, 75mA	SC-82AB	26vs	VR1	5e	Sii
CVN	S-817A50APF-CVNTFG	LVR-IC	5.0V±2%, 75mA	SNT-4A	42rw	VR1	5e	Sii
CVO	S-817A51ANB-CVOT2G	LVR-IC	5.1V±2%, 75mA	SC-82AB	26vs	VR1	5e	Sii
CVO	S-817A51APF-CVOTFG	LVR-IC	5.1V±2%, 75mA	SNT-4A	42rw	VR1	5e	Sii
CVP	S-817A52ANB-CVPT2G	LVR-IC	5.2V±2%, 75mA	SC-82AB	26vs	VR1	5e	Sii
CVP	S-817A52APF-CVPTFG	LVR-IC	5.2V±2%, 75mA	SNT-4A	42rw	VR1	5e	Sii
CVQ	S-817A53ANB-CVQT2G	LVR-IC	5.3V±2%, 75mA	SC-82AB	26vs	VR1	5e	Sii
CVQ	S-817A53APF-CVQTFG	LVR-IC	5.3V±2%, 75mA	SNT-4A	42rw	VR1	5e	Sii
CVR	S-817A54ANB-CVRT2G	LVR-IC	5.4V±2%, 75mA	SC-82AB	26vs	VR1	5e	Sii
CVR	S-817A54APF-CVRTFG	LVR-IC	5.4V±2%, 75mA	SNT-4A	42rw	VR1	5e	Sii
CVS	S-817A55ANB-CVST2G	LVR-IC	5.5V±2%, 75mA	SC-82AB	26vs	VR1	5e	Sii
CVS	S-817A55APF-CVSTFG	LVR-IC	5.5V±2%, 75mA	SNT-4A	42rw	VR1	5e	Sii
CVT	S-817A56ANB-CVTT2G	LVR-IC	5.6V±2%, 75mA	SC-82AB	26vs	VR1	5e	Sii
CVT	S-817A56APF-CVTTFG	LVR-IC	5.6V±2%, 75mA	SNT-4A	42rw	VR1	5e	Sii
CVU	S-817A57ANB-CVUT2G	LVR-IC	5.7V±2%, 75mA	SC-82AB	26vs	VR1	5e	Sii
CVU	S-817A57APF-CVUTFG	LVR-IC	5.7V±2%, 75mA	SNT-4A	42rw	VR1	5e	Sii
CVV	S-817A58ANB-CVVT2G	LVR-IC	5.8V±2%, 75mA	SC-82AB	26vs	VR1	5e	Sii
CVV	S-817A58APF-CVVTFG	LVR-IC	5.8V±2%, 75mA	SNT-4A	42rw	VR1	5e	Sii
CVW	S-817A59ANB-CVWT2G	LVR-IC	5.9V±2%, 75mA	SC-82AB	26vs	VR1	5e	Sii
CVW	S-817A59APF-CVWTFG	LVR-IC	5.9V±2%, 75mA	SNT-4A	42rw	VR1	5e	Sii
CVX	S-817A60ANB-CVXT2G	LVR-IC	6.0V±2%, 75mA	SC-82AB	26vs	VR1	5e	Sii
CVX	S-817A60APF-CVXTFG	LVR-IC	6.0V±2%, 75mA	SNT-4A	42rw	VR1	5e	Sii
CW	MAX6314US42D2-T	Vdet-IC	4.2V±1.8%, -MR, -Reset Bidir, PPO, 20ms	SOT-143	24vdh	VD5	5c	Max
CX	3SX227	n-MOSFET	DG, UHF-amp, 15V, ±30mA, 200mW, Idss=6..25mA	SOT-143	26fm	-	5b	Pan
CX	3SK271	n-MOSFET	DG, UHF-amp, 15V, ±30mA, 150mW, Idss=mA	SOT-343	26fm	-	5b	Pan
CX	MAX6314US41D2-T	Vdet-IC	4.1V±1.8%, -MR, -Reset Bidir, PPO, 20ms	SOT-143	24vdh	VD5	5c	Max
CX	XC6109C27AN	Vdet-IC	2.7V, +Reset PPO	SSOT-24	26rp	VD3	5c	Tor
CX	XC6119C27ANR	Vdet-IC	2.7V±2%, -Reset PPO	SSOT-24	26gh	VD3	5a	Tor
CX	XC6127C49HNR	Vdet-IC	4.9V±0.8%, +Reset PPO, -MR, Rt=200ms	SSOT-24	26cr	VD5	5a	Tor
CX	XC6127N50CNR	Vdet-IC	5.0V±0.8%, -Reset ODO, -MR, Rt=200ms	SSOT-24	26cr	VD4	5a	Tor
CX	XC6221B28BNR	LVR-IC	LDO, 2.85V±1%, 200mA, +CE, CL	SSOT-24	26vn	VR4	5a	Tor
CY	2SC5087-Y	Si-npn	VHF/UHF, LN, 20V, 80mA, 150mW, 7GHz, B=120..240	SMQ	26tu	-	5b	Tos
CY	MAX6314US40D2-T	Vdet-IC	4.0V±1.8%, -MR, -Reset Bidir, PPO, 20ms	SOT-143	24vdh	VD5	5c	Max
CY	XC6109C28AN	Vdet-IC	2.8V, +Reset PPO	SSOT-24	26rp	VD3	5c	Tor
CY	XC6119C28ANR	Vdet-IC	2.8V±2%, -Reset PPO	SSOT-24	26gh	VD3	5a	Tor
CY	XC6127C51HNR	Vdet-IC	5.1V±0.8%, +Reset PPO, -MR, Rt=200ms	SSOT-24	26cr	VD5	5a	Tor
CY	XC6127N52CNR	Vdet-IC	5.2V±0.8%, -Reset ODO, -MR, Rt=200ms	SSOT-24	26cr	VD4	5a	Tor
CY	XC6221B29BNR	LVR-IC	LDO, 2.95V±1%, 200mA, +CE, CL	SSOT-24	26vn	VR4	5a	Tor
CZ	MAX6314US39D2-T	Vdet-IC	3.9V±1.8%, -MR, -Reset Bidir, PPO, 1ms	SOT-143	24vdh	VD5	5c	Max
CZ	XC6109C29AN	Vdet-IC	2.9V, +Reset PPO	SSOT-24	26rp	VD3	5c	Tor



SMD
code

SMD code	Type	Function	Short description	Case	Pinout	Sch.	St.	Mnf.
CZ	XC6119C29ANR	Vdet-IC	2.9V±2%, -Reset PPO	SSOT-24	26gh	VD3	5a	Tor
CZ	XC6127C53HNR	Vdet-IC	5.3V±0.8%, +Reset PPO, -MR, Rt=200ms	SSOT-24	26cr	VD5	5a	Tor
CZ	XC6127N54CNR	Vdet-IC	5.4V±0.8%, -Reset ODO, -MR, Rt=200ms	SSOT-24	26cr	VD4	5a	Tor
CZ	XC6221B30BNR	LVR-IC	LDO, 3.05V±1%, 200mA, +CE, CL	SSOT-24	26vn	VR4	5a	Tor
D	3SK304	n-MOSFET	DG, UHF-amp, 15V, ±30mA, 150mW, Idss=0..10mA	SOT-143	26fm	-	5b	Pan
D	3SK308	n-MOSFET	DG, UHF-amp, 15V, ±30mA, 150mW, Idss=0..10mA	SOT-343	26fm	-	5b	Pan
D0	R1140Q401B	LVR-IC	LDO, 4V±2%, 120mA, +CE	SOT-143R	26vm	VR4	5a	Ric
D0	R3114Q371A	Vdet-IC	3.7V±0.8%, -Reset ODO	SC-82AB	26vdl	VD9	5a	Ric
D0	XC6127C55JNR	Vdet-IC	5.5V±0.8%, +Reset PPO, -MR, Rt=400ms	SSOT-24	26cr	VD5	5a	Tor
D0	XC61CC3002N	Vdet-IC	3V±1%, +Reset PPO	SOT-143R	26vdl	VD7	5c	Tor
D0	XC6221A311NR	LVR-IC	LDO, 3.1V±1%, 200mA, +CE	SSOT-24	26vn	VR4	5a	Tor
D1	R3114Q381A	Vdet-IC	3.8V±0.8%, -Reset ODO	SC-82AB	26vdl	VD9	5a	Ric
D1	SST211	n-MOSFET*	Sw, 30V, 50mA, 360mW, Rds=7Ω, 0.7/10ns	SOT-143	24fx	-	5b	Six
D1	XC61CC3102N	Vdet-IC	3.1V±1%, +Reset PPO	SOT-143R	26vdl	VD7	5c	Tor
D1	XC6221A321NR	LVR-IC	LDO, 3.2V±1%, 200mA, +CE	SSOT-24	26vn	VR4	5a	Tor
D11	SST211	n-MOSFET*	Sw, 30V, 50mA, 360mW, Rds=7Ω, 0.7/10ns	SOT-143	24fx	-	5b	Lns
D13	SST213	n-MOSFET*	Sw, 10V, 50mA, 360mW, Rds=7Ω, 0.7/10ns	SOT-143	24fx	-	5b	Lns
D15	SST215	n-MOSFET*	Sw, 20V, 50mA, 360mW, Rds=7Ω, 0.7/10ns	SOT-143	24fx	-	5b	Lns
D2	R180Q121C	LVR-IC	LDO, 1.2V±2%, 150mA	SC-82AB	26yr	VR1	5a	Ric
D2	R3114Q391A	Vdet-IC	3.9V±0.8%, -Reset ODO	SC-82AB	26vdl	VD9	5a	Ric
D2	XC61CC3202N	Vdet-IC	3.2V±1%, +Reset PPO	SOT-143R	26vdl	VD7	5c	Tor
D2	XC6221A331NR	LVR-IC	LDO, 3.3V±1%, 200mA, +CE	SSOT-24	26vn	VR4	5a	Tor
D2	XC6223C121NR-G	LVR-IC	LDO, 1.2V±20mV, 300mA, +CE, PDR	SSOT-24	26vn	VR4	5a	Tor
D3	R180Q131C	LVR-IC	LDO, 1.3V±2%, 150mA	SC-82AB	26yr	VR1	5a	Ric
D3	R3114Q401A	Vdet-IC	4V±0.8%, -Reset ODO	SC-82AB	26vdl	VD9	5a	Ric
D3	SST213	n-MOSFET*	Sw, 10V, 50mA, 360mW, Rds=7Ω, 0.7/10ns	SOT-143	24fx	-	5b	Six
D3	XC61CC3302N	Vdet-IC	3.3V±1%, +Reset PPO	SOT-143R	26vdl	VD7	5c	Tor
D3	XC6221A341NR	LVR-IC	LDO, 3.4V±1%, 200mA, +CE	SSOT-24	26vn	VR4	5a	Tor
D3	XC6223C131NR-G	LVR-IC	LDO, 1.3V±20mV, 300mA, +CE, PDR	SSOT-24	26vn	VR4	5a	Tor
D4	R180Q141C	LVR-IC	LDO, 1.4V±2%, 150mA	SC-82AB	26yr	VR1	5a	Ric
D4	R3114Q411A	Vdet-IC	4.1V±0.8%, -Reset ODO	SC-82AB	26vdl	VD9	5a	Ric
D4	XC61CC3402N	Vdet-IC	3.4V±1%, +Reset PPO	SOT-143R	26vdl	VD7	5c	Tor
D4	XC6221A351NR	LVR-IC	LDO, 3.5V±1%, 200mA, +CE	SSOT-24	26vn	VR4	5a	Tor
D4	XC6223C141NR-G	LVR-IC	LDO, 1.4V±20mV, 300mA, +CE, PDR	SSOT-24	26vn	VR4	5a	Tor
D5	R180Q151C	LVR-IC	LDO, 1.5V±2%, 150mA	SC-82AB	26yr	VR1	5a	Ric
D5	R3114Q421A	Vdet-IC	4.2V±0.8%, -Reset ODO	SC-82AB	26vdl	VD9	5a	Ric
D5	SST215	n-MOSFET*	Sw, 20V, 50mA, 360mW, Rds=7Ω, 0.7/10ns	SOT-143	24fx	-	5b	Six
D5	XC61CC3502N	Vdet-IC	3.5V±1%, +Reset PPO	SOT-143R	26vdl	VD7	5c	Tor
D5	XC6221A361NR	LVR-IC	LDO, 3.6V±1%, 200mA, +CE	SSOT-24	26vn	VR4	5a	Tor
D5	XC6223C151NR-G	LVR-IC	LDO, 1.5V±20mV, 300mA, +CE, PDR	SSOT-24	26vn	VR4	5a	Tor
D6	R180Q161C	LVR-IC	LDO, 1.6V±2%, 150mA	SC-82AB	26yr	VR1	5a	Ric
D6	R3114Q431A	Vdet-IC	4.3V±0.8%, -Reset ODO	SC-82AB	26vdl	VD9	5a	Ric
D6	XC61CC3602N	Vdet-IC	3.6V±1%, +Reset PPO	SOT-143R	26vdl	VD7	5c	Tor
D6	XC6221A371NR	LVR-IC	LDO, 3.7V±1%, 200mA, +CE	SSOT-24	26vn	VR4	5a	Tor
D6	XC6223C161NR-G	LVR-IC	LDO, 1.6V±20mV, 300mA, +CE, PDR	SSOT-24	26vn	VR4	5a	Tor
D7	R180Q171C	LVR-IC	LDO, 1.7V±2%, 150mA	SC-82AB	26yr	VR1	5a	Ric
D7	R3114Q441A	Vdet-IC	4.4V±0.8%, -Reset ODO	SC-82AB	26vdl	VD9	5a	Ric
D7	XC61CC3702N	Vdet-IC	3.7V±1%, +Reset PPO	SOT-143R	26vdl	VD7	5c	Tor
D7	XC6221A381NR	LVR-IC	LDO, 3.8V±1%, 200mA, +CE	SSOT-24	26vn	VR4	5a	Tor
D7	XC6223C171NR-G	LVR-IC	LDO, 1.7V±20mV, 300mA, +CE, PDR	SSOT-24	26vn	VR4	5a	Tor
D8	R180Q181C	LVR-IC	LDO, 1.8V±2%, 150mA	SC-82AB	26yr	VR1	5a	Ric
D8	R3114Q451A	Vdet-IC	4.5V±0.8%, -Reset ODO	SC-82AB	26vdl	VD9	5a	Ric
D8	XC61CC3802N	Vdet-IC	3.8V±1%, +Reset PPO	SOT-143R	26vdl	VD7	5c	Tor
D8	XC6221A391NR	LVR-IC	LDO, 3.9V±1%, 200mA, +CE	SSOT-24	26vn	VR4	5a	Tor
D8	XC6223C181NR-G	LVR-IC	LDO, 1.8V±20mV, 300mA, +CE, PDR	SSOT-24	26vn	VR4	5a	Tor
D89	BAT74	Si-diode	Dual, Sw, 30V, 200mA, 250mW, Vf<0.9V(0.1A), <5ns	SOT-143B	24ce	-	5b	Ste
D9	R1180Q191C	LVR-IC	LDO, 1.9V±2%, 150mA	SC-82AB	26yr	VR1	5a	Ric
D9	R3114Q461A	Vdet-IC	4.6V±0.8%, -Reset ODO	SC-82AB	26vdl	VD9	5a	Ric
D9	XC61CC3902N	Vdet-IC	3.9V±1%, +Reset PPO	SOT-143R	26vdl	VD7	5c	Tor
D9	XC6221A401NR	LVR-IC	LDO, 4V±1%, 200mA, +CE	SSOT-24	26vn	VR4	5a	Tor
D9	XC6223C191NR-G	LVR-IC	LDO, 1.9V±20mV, 300mA, +CE, PDR	SSOT-24	26vn	VR4	5a	Tor
D95	BCV63	Si-npn	Dual, 30V, 100mA, 250mW, B=110..800, >100MHz	SOT-143	2415	-	5c	Phi
D96	BCV63B	Si-npn	Dual, 30V, 100mA, 250mW, B=200..450, >100MHz	SOT-143	2415	-	5c	Phi
DA	MAX6314US38D2-T	Vdet-IC	3.8V±1.8%, -MR, -Reset Bidir, PPO, 1ms	SOT-143	24vdh	VD5	5c	Max
DA	R1141Q401B	LVR-IC	LDO, 4V±2%, 120mA, +CE	SOT-143R	26vm	VR4	5a	Ric
DA	R3112Q301A	Vdet-IC	3V±2%, -Reset PPO	SC-82AB	26rp	VD3	5a	Ric
DA	RP130Q401A	LVR-IC	LDO, LN, -CE, 4V±1%, 150mA	SC-82AB	26vn	VR4	5a	Ric
DA	XC6127C15JNR	Vdet-IC	1.5V±0.8%, +Reset PPO, -MR, Rt=400ms	SSOT-24	26cr	VD5	5a	Tor
DA	XC6127N16DNR	Vdet-IC	1.6V±0.8%, -Reset ODO, -MR, Rt=400ms	SSOT-24	26cr	VD4	5a	Tor
DA	XC6223C201NR-G	LVR-IC	LDO, 2.0V±1%, 300mA, +CE, PDR	SSOT-24	26vn	VR4	5a	Tor



SMD code	Type	Function	Short description	Case	Pinout Sch.	St.	Mnf.
DB	MAX6314US37D2-T	Vdet-IC	3.7V±1.8%, -MR, -Reset Bidir, PPO, 1ms	SOT-143	24vdh VD5	5c	Max
DB	R3112Q311A	Vdet-IC	3.1V±2%, -Reset PPO	SC-82AB	26rp VD3	5a	Ric
DB	RP130Q411A	LVR-IC	LDO, LN, -CE, 4.1V±1%, 150mA	SC-82AB	26vn VR4	5a	Ric
DB	XC6127C17JNR	Vdet-IC	1.7V±0.8%, +Reset PPO, -MR, Rt=400ms	SSOT-24	26cr VD5	5a	Tor
DB	XC6127N18DNR	Vdet-IC	1.8V±0.8%, -Reset ODO, -MR, Rt=400ms	SSOT-24	26cr VD4	5a	Tor
DB	XC6223C211NR-G	LVR-IC	LDO, 2.1V±1%, 300mA, +CE, PDR	SSOT-24	26vn VR4	5a	Tor
DC	MAX6314US36D2-T	Vdet-IC	3.6V±1.8%, -MR, -Reset Bidir, PPO, 1ms	SOT-143	24vdh VD5	5c	Max
DC	R3112Q321A	Vdet-IC	3.2V±2%, -Reset PPO	SC-82AB	26rp VD3	5a	Ric
DC	RP130Q421A	LVR-IC	LDO, LN, -CE, 4.2V±1%, 150mA	SC-82AB	26vn VR4	5a	Ric
DC	XC6127C19JNR	Vdet-IC	1.9V±0.8%, +Reset PPO, -MR, Rt=400ms	SSOT-24	26cr VD5	5a	Tor
DC	XC6127N20DNR	Vdet-IC	2.0V±0.8%, -Reset ODO, -MR, Rt=400ms	SSOT-24	26cr VD4	5a	Tor
DC	XC6223C221NR-G	LVR-IC	LDO, 2.2V±1%, 300mA, +CE, PDR	SSOT-24	26vn VR4	5a	Tor
DD	MAX6314US35D2-T	Vdet-IC	3.5V±1.8%, -MR, -Reset Bidir, PPO, 20ms	SOT-143	24vdh VD5	5c	Max
DD	R3112Q331A	Vdet-IC	3.3V±2%, -Reset PPO	SC-82AB	26rp VD3	5a	Ric
DD	RP130Q431A	LVR-IC	LDO, LN, -CE, 4.3V±1%, 150mA	SC-82AB	26vn VR4	5a	Ric
DD	XC6127C21JNR	Vdet-IC	2.1V±0.8%, +Reset PPO, -MR, Rt=400ms	SSOT-24	26cr VD5	5a	Tor
DD	XC6127N22DNR	Vdet-IC	2.2V±0.8%, -Reset ODO, -MR, Rt=400ms	SSOT-24	26cr VD4	5a	Tor
DD	XC6223C231NR-G	LVR-IC	LDO, 2.3V±1%, 300mA, +CE, PDR	SSOT-24	26vn VR4	5a	Tor
DE	MAX6314US34D2-T	Vdet-IC	3.4V±1.8%, -MR, -Reset Bidir, PPO, 20ms	SOT-143	24vdh VD5	5c	Max
DE	R3112Q341A	Vdet-IC	3.4V±2%, -Reset PPO	SC-82AB	26rp VD3	5a	Ric
DE	RP130Q441A	LVR-IC	LDO, LN, -CE, 4.4V±1%, 150mA	SC-82AB	26vn VR4	5a	Ric
DE	XC6127C23JNR	Vdet-IC	2.3V±0.8%, +Reset PPO, -MR, Rt=400ms	SSOT-24	26cr VD5	5a	Tor
DE	XC6127N24DNR	Vdet-IC	2.4V±0.8%, -Reset ODO, -MR, Rt=400ms	SSOT-24	26cr VD4	5a	Tor
DE	XC6223C241NR-G	LVR-IC	LDO, 2.4V±1%, 300mA, +CE, PDR	SSOT-24	26vn VR4	5a	Tor
DF	R3112Q351A	Vdet-IC	3.5V±2%, -Reset PPO	SC-82AB	26rp VD3	5a	Ric
DF	RP130Q451A	LVR-IC	LDO, LN, -CE, 4.5V±1%, 150mA	SC-82AB	26vn VR4	5a	Ric
DF	XC6127C25JNR	Vdet-IC	2.5V±0.8%, +Reset PPO, -MR, Rt=400ms	SSOT-24	26cr VD5	5a	Tor
DF	XC6127N26DNR	Vdet-IC	2.6V±0.8%, -Reset ODO, -MR, Rt=400ms	SSOT-24	26cr VD4	5a	Tor
DF	XC6223C251NR-G	LVR-IC	LDO, 2.5V±1%, 300mA, +CE, PDR	SSOT-24	26vn VR4	5a	Tor
DG	R3112Q361A	Vdet-IC	3.6V±2%, -Reset PPO	SC-82AB	26rp VD3	5a	Ric
DG	RP130Q461A	LVR-IC	LDO, LN, -CE, 4.6V±1%, 150mA	SC-82AB	26vn VR4	5a	Ric
DH	R3112Q371A	Vdet-IC	3.7V±2%, -Reset PPO	SC-82AB	26rp VD3	5a	Ric
DH	RP130Q471A	LVR-IC	LDO, LN, -CE, 4.7V±1%, 150mA	SC-82AB	26vn VR4	5a	Ric
DH	XC6127C27JNR	Vdet-IC	2.7V±0.8%, +Reset PPO, -MR, Rt=400ms	SSOT-24	26cr VD5	5a	Tor
DH	XC6127N28DNR	Vdet-IC	2.8V±0.8%, -Reset ODO, -MR, Rt=400ms	SSOT-24	26cr VD4	5a	Tor
DH	XC6223C261NR-G	LVR-IC	LDO, 2.6V±1%, 300mA, +CE, PDR	SSOT-24	26vn VR4	5a	Tor
DJ	MAX6314US33D2-T	Vdet-IC	3.3V±1.8%, -MR, -Reset Bidir, PPO, 20ms	SOT-143	24vdh VD5	5c	Max
DJ	R3112Q381A	Vdet-IC	3.8V±2%, -Reset PPO	SC-82AB	26rp VD3	5a	Ric
DJ	RP130Q481A	LVR-IC	LDO, LN, -CE, 4.8V±1%, 150mA	SC-82AB	26vn VR4	5a	Ric
DJ4	3SK180-4	n-FET	DG, FMVHF, 15V, 30mA, 200mW, Idss=1.5..6mA	SOT-143	26fm -	5b	San
DJ5	3SK180-5	n-FET	DG, FMVHF, 15V, 30mA, 200mW, Idss=5..12mA	SOT-143	26fm -	5b	San
DJ6	3SK180-6	n-FET	DG, FMVHF, 15V, 30mA, 200mW, Idss=10..24mA	SOT-143	26fm -	5b	San
DK	MAX6314US32D2-T	Vdet-IC	3.2V±1.8%, -MR, -Reset Bidir, PPO, 20ms	SOT-143	24vdh VD5	5c	Max
DK	R3112Q391A	Vdet-IC	3.9V±2%, -Reset PPO	SC-82AB	26rp VD3	5a	Ric
DK	RP130Q491A	LVR-IC	LDO, LN, -CE, 4.9V±1%, 150mA	SC-82AB	26vn VR4	5a	Ric
DK	XC6127C29JNR	Vdet-IC	2.9V±0.8%, +Reset PPO, -MR, Rt=400ms	SSOT-24	26cr VD5	5a	Tor
DK	XC6127N30DNR	Vdet-IC	3.0V±0.8%, -Reset ODO, -MR, Rt=400ms	SSOT-24	26cr VD4	5a	Tor
DK	XC6223C271NR-G	LVR-IC	LDO, 2.7V±1%, 300mA, +CE, PDR	SSOT-24	26vn VR4	5a	Tor
DL	MAX6314US31D2-T	Vdet-IC	3.08V±1.8%, -MR, -Reset Bidir, PPO, 20ms	SOT-143	24vdh VD5	5c	Max
DL	R3112Q301C	Vdet-IC	3V±2%, -Reset ODO	SC-82AB	26rp VD1	5a	Ric
DL	XC6127C31JNR	Vdet-IC	3.1V±0.8%, +Reset PPO, -MR, Rt=400ms	SSOT-24	26cr VD5	5a	Tor
DL	XC6127N32DNR	Vdet-IC	3.2V±0.8%, -Reset ODO, -MR, Rt=400ms	SSOT-24	26cr VD4	5a	Tor
DL	XC6223C281NR-G	LVR-IC	LDO, 2.8V±1%, 300mA, +CE, PDR	SSOT-24	26vn VR4	5a	Tor
DLN	ELM7525CCB	Vdet-IC	2.5V±2%, +Reset PPO	SC-82AB	26vdl VD7	5c	Elm
DLN	ELM7525NCB	Vdet-IC	2.5V±2%, +Reset ODO	SC-82AB	26vdl VD6	5c	Elm
DM	MAX6314US30D2-T	Vdet-IC	3.0V±1.8%, -MR, -Reset Bidir, PPO, 20ms	SOT-143	24vdh VD5	5c	Max
DM	R3112Q311C	Vdet-IC	3.1V±2%, -Reset ODO	SC-82AB	26rp VD1	5a	Ric
DM	XC6127C33JNR	Vdet-IC	3.3V±0.8%, +Reset PPO, -MR, Rt=400ms	SSOT-24	26cr VD5	5a	Tor
DM	XC6127N34DNR	Vdet-IC	3.4V±0.8%, -Reset ODO, -MR, Rt=400ms	SSOT-24	26cr VD4	5a	Tor
DM	XC6223C291NR-G	LVR-IC	LDO, 2.9V±1%, 300mA, +CE, PDR	SSOT-24	26vn VR4	5a	Tor
DN	AAT3526ICX-2.63-200	Vdet-IC	2.63V±1.5%, -Reset PPO, -MR	SOT-143	24vdh VD5	5i	Ant
DN	MAX6314US29D2-T	Vdet-IC	2.93V±1.8%, -MR, -Reset Bidir, PPO, 20ms	SOT-143	24vdh VD5	5c	Max
DN	R3112Q321C	Vdet-IC	3.2V±2%, -Reset ODO	SC-82AB	26rp VD1	5a	Ric
DN	XC6109C30AN	Vdet-IC	3.0V, +Reset PPO	SSOT-24	26rp VD3	5c	Tor
DN	XC6119C30ANR	Vdet-IC	3.0V±2%, -Reset PPO	SSOT-24	26gh VD3	5a	Tor
DN	XC6127C35JNR	Vdet-IC	3.5V±0.8%, +Reset PPO, -MR, Rt=400ms	SSOT-24	26cr VD5	5a	Tor
DN	XC6127N36DNR	Vdet-IC	3.6V±0.8%, -Reset ODO, -MR, Rt=400ms	SSOT-24	26cr VD4	5a	Tor
DO	2SC5092-O	Si-npn	VHF/UHF, LN, 20V, 40mA, 150mW, 10GHz, B=80..160	SMQ	26tu -	5b	Tos
DO	AAT3526ICX-2.93-200	Vdet-IC	2.93V±1.5%, -Reset PPO, -MR	SOT-143	24vdh VD5	5i	Ant
DO	MAX6314US28D2-T	Vdet-IC	2.8V±1.8%, -MR, -Reset Bidir, PPO, 20ms	SOT-143	24vdh VD5	5c	Max

Note: ELM75xxCCB series LN- lot number L=0...9 N=A to Z(I, O, X excepted); ELM75xxNCB series LN- lot number L=A to Z(I, O, X excepted) N=0...9



SMD code	Type	Function	Short description	Case	Pinout	Sch.	St.	Mnf.
DP	AAT3526ICX-4.63-200	Vdet-IC	4.63V±1.5%, -Reset PPO, -MR	SOT-143	24vdh	VD5	5i	Ant
DP	MAX6314US27D2-T	Vdet-IC	2.7V±1.8%, -MR, -Reset Bidir, PPO, 20ms	SOT-143	24vdh	VD5	5c	Max
DP	R3112Q331C	Vdet-IC	3.3V±2%, -Reset ODO	SC-82AB	26rp	VD1	5a	Ric
DP	XC6109C31AN	Vdet-IC	3.1V, +Reset PPO	SSOT-24	26rp	VD3	5c	Tor
DP	XC6119C31ANR	Vdet-IC	3.1V±2%, -Reset PPO	SSOT-24	26gh	VD3	5a	Tor
DP	XC6127C37JNR	Vdet-IC	3.7V±0.8%, +Reset PPO, -MR, Rt=400ms	SSOT-24	26cr	VD5	5a	Tor
DP	XC6127N38DNR	Vdet-IC	3.8V±0.8%, -Reset ODO, -MR, Rt=400ms	SSOT-24	26cr	VD4	5a	Tor
DQ	AAT3527ICX-2.93-200	Vdet-IC	2.93V±1.5%, +Reset PPO, -MR	SOT-143	24vdh	VD5	5i	Ant
DQ	MAX6314US26D2-T	Vdet-IC	2.63V±1.8%, -MR, -Reset Bidir, PPO, 20ms	SOT-143	24vdh	VD5	5c	Max
DQ	R3112Q341C	Vdet-IC	3.4V±2%, -Reset ODO	SC-82AB	26rp	VD1	5a	Ric
DR	2SC5092-R	Si-npn	VHF/UHF, LN, 20V, 40mA, 150mW, 10GHz, B=50..100	SMQ	26tu	-	5b	Tos
DR	AAT3528ICX-2.63-200	Vdet-IC	2.63V±1.5%, -Reset ODO, -MR	SOT-143	24vdh	VD4	5i	Ant
DR	MAX6314US25D2-T	Vdet-IC	2.5V±1.8%, -MR, -Reset Bidir, PPO, 20ms	SOT-143	24vdh	VD5	5c	Max
DR	R3112Q351C	Vdet-IC	3.5V±2%, -Reset ODO	SC-82AB	26rp	VD1	5a	Ric
DR	XC6109C32AN	Vdet-IC	3.2V, +Reset PPO	SSOT-24	26rp	VD3	5c	Tor
DR	XC6119C32ANR	Vdet-IC	3.2V±2%, -Reset PPO	SSOT-24	26gh	VD3	5a	Tor
DR	XC6127C39JNR	Vdet-IC	3.9V±0.8%, +Reset PPO, -MR, Rt=400ms	SSOT-24	26cr	VD5	5a	Tor
DR	XC6127N40DNR	Vdet-IC	4.0V±0.8%, -Reset ODO, -MR, Rt=400ms	SSOT-24	26cr	VD4	5a	Tor
DS	MAX6314US50D3-T	Vdet-IC	5.0V±1.8%, -MR, -Reset Bidir, PPO, 140ms	SOT-143	24vdh	VD5	5c	Max
DS	R3112Q361C	Vdet-IC	3.6V±2%, -Reset ODO	SC-82AB	26rp	VD1	5a	Ric
DS	XC6109C33AN	Vdet-IC	3.3V, +Reset PPO	SSOT-24	26rp	VD3	5c	Tor
DS	XC6119C33ANR	Vdet-IC	3.3V±2%, -Reset PPO	SSOT-24	26gh	VD3	5a	Tor
DS	XC6127C41JNR	Vdet-IC	4.1V±0.8%, +Reset PPO, -MR, Rt=400ms	SSOT-24	26cr	VD5	5a	Tor
DS	XC6127N42DNR	Vdet-IC	4.2V±0.8%, -Reset ODO, -MR, Rt=400ms	SSOT-24	26cr	VD4	5a	Tor
DT	MAX6314US49D3-T	Vdet-IC	4.9V±1.8%, -MR, -Reset Bidir, PPO, 140ms	SOT-143	24vdh	VD5	5c	Max
DT	R3112Q371C	Vdet-IC	3.7V±2%, -Reset ODO	SC-82AB	26rp	VD1	5a	Ric
DT	XC6109C34AN	Vdet-IC	3.4V, +Reset PPO	SSOT-24	26rp	VD3	5c	Tor
DT	XC6119C34ANR	Vdet-IC	3.4V±2%, -Reset PPO	SSOT-24	26gh	VD3	5a	Tor
DT	XC6127C43JNR	Vdet-IC	4.3V±0.8%, +Reset PPO, -MR, Rt=400ms	SSOT-24	26cr	VD5	5a	Tor
DT	XC6127N44DNR	Vdet-IC	4.4V±0.8%, -Reset ODO, -MR, Rt=400ms	SSOT-24	26cr	VD4	5a	Tor
DU	3SK241	n-FET-d	GaAs, DG, VHF/UHF, 13V, 50mA, Idss=8.5..35mA, Up<3.5	SOT-143	26fm	-	5c	Pan
DU	MAX6314US48D3-T	Vdet-IC	4.8V±1.8%, -MR, -Reset Bidir, PPO, 140ms	SOT-143	24vdh	VD5	5c	Max
DU	R3112Q381C	Vdet-IC	3.8V±2%, -Reset ODO	SC-82AB	26rp	VD1	5a	Ric
DU	XC6109C35AN	Vdet-IC	3.5V, +Reset PPO	SSOT-24	26rp	VD3	5c	Tor
DU	XC6119C35ANR	Vdet-IC	3.5V±2%, -Reset PPO	SSOT-24	26gh	VD3	5a	Tor
DU	XC6127C45JNR	Vdet-IC	4.5V±0.8%, +Reset PPO, -MR, Rt=400ms	SSOT-24	26cr	VD5	5a	Tor
DU	XC6127N46DNR	Vdet-IC	4.6V±0.8%, -Reset ODO, -MR, Rt=400ms	SSOT-24	26cr	VD4	5a	Tor
DV	MAX6314US47D3-T	Vdet-IC	4.7V±1.8%, -MR, -Reset Bidir, PPO, 140ms	SOT-143	24vdh	VD5	5c	Max
DV	R3112Q391C	Vdet-IC	3.9V±2%, -Reset ODO	SC-82AB	26rp	VD1	5a	Ric
DV	XC6109C36AN	Vdet-IC	3.6V, +Reset PPO	SSOT-24	26rp	VD3	5c	Tor
DV	XC6119C36ANR	Vdet-IC	3.6V±2%, -Reset PPO	SSOT-24	26gh	VD3	5a	Tor
DV	XC6127C47JNR	Vdet-IC	4.7V±0.8%, +Reset PPO, -MR, Rt=400ms	SSOT-24	26cr	VD5	5a	Tor
DV	XC6127N48DNR	Vdet-IC	4.8V±0.8%, -Reset ODO, -MR, Rt=400ms	SSOT-24	26cr	VD4	5a	Tor
DW	MAX6314US46D3-T	Vdet-IC	4.63V±1.8%, -MR, -Reset Bidir, PPO, 140ms	SOT-143	24vdh	VD5	5c	Max
DX	MAX6314US45D3-T	Vdet-IC	4.5V±1.8%, -MR, -Reset Bidir, PPO, 140ms	SOT-143	24vdh	VD5	5c	Max
DX	XC6109C37AN	Vdet-IC	3.7V, +Reset PPO	SSOT-24	26rp	VD3	5c	Tor
DX	XC6119C37ANR	Vdet-IC	3.7V±2%, -Reset PPO	SSOT-24	26gh	VD3	5a	Tor
DX	XC6127C49JNR	Vdet-IC	4.9V±0.8%, +Reset PPO, -MR, Rt=400ms	SSOT-24	26cr	VD5	5a	Tor
DX	XC6127N50DNR	Vdet-IC	5.0V±0.8%, -Reset ODO, -MR, Rt=400ms	SSOT-24	26cr	VD4	5a	Tor
DX-	BB404M	MMVIC	DG BBFET, 5..9V, 29dB(200MHz)	MPAK-4R	24fd	-	5b	Hit
DY	MAX6314US44D3-T	Vdet-IC	4.39V±1.8%, -MR, -Reset Bidir, PPO, 140ms	SOT-143	24vdh	VD5	5c	Max
DY	XC6109C38AN	Vdet-IC	3.8V, +Reset PPO	SSOT-24	26rp	VD3	5c	Tor
DY	XC6119C38ANR	Vdet-IC	3.8V±2%, -Reset PPO	SSOT-24	26gh	VD3	5a	Tor
DY	XC6127C51JNR	Vdet-IC	5.1V±0.8%, +Reset PPO, -MR, Rt=400ms	SSOT-24	26cr	VD5	5a	Tor
DY	XC6127N52DNR	Vdet-IC	5.2V±0.8%, -Reset ODO, -MR, Rt=400ms	SSOT-24	26cr	VD4	5a	Tor
DZ	MAX6314US43D3-T	Vdet-IC	4.3V±1.8%, -MR, -Reset Bidir, PPO, 140ms	SOT-143	24vdh	VD5	5c	Max
DZ	XC6109C39AN	Vdet-IC	3.9V, +Reset PPO	SSOT-24	26rp	VD3	5c	Tor
DZ	XC6119C39ANR	Vdet-IC	3.9V±2%, -Reset PPO	SSOT-24	26gh	VD3	5a	Tor
DZ	XC6127C53JNR	Vdet-IC	5.3V±0.8%, +Reset PPO, -MR, Rt=400ms	SSOT-24	26cr	VD5	5a	Tor
DZ	XC6127N54DNR	Vdet-IC	5.4V±0.8%, -Reset ODO, -MR, Rt=400ms	SSOT-24	26cr	VD4	5a	Tor
E0	R1180Q201C	LVR-IC	LDO, 2V±2%, 150mA	SC-82AB	26yr	VR1	5a	Ric
E0	R3114Q471A	Vdet-IC	4.7V±0.8%, -Reset ODO	SC-82AB	26vdl	VD9	5a	Ric
E0	XC6127C55KNR	Vdet-IC	5.5V±0.8%, +Reset PPO, -MR, Rt=800ms	SSOT-24	26cr	VD5	5a	Tor
E0	XC61CC4002N	Vdet-IC	4V±1%, +Reset PPO	SOT-143R	26vdl	VD7	5c	Tor
E0	XC6221A31BNR	LVR-IC	LDO, 3.15V±1%, 200mA, +CE	SSOT-24	26vn	VR4	5a	Tor
E1	R1180Q211C	LVR-IC	LDO, 2.1V±2%, 150mA	SC-82AB	26yr	VR1	5a	Ric
E1	R3114Q481A	Vdet-IC	4.8V±0.8%, -Reset ODO	SC-82AB	26vdl	VD9	5a	Ric
E1	XC61CC4102N	Vdet-IC	4.1V±1%, +Reset PPO	SOT-143R	26vdl	VD7	5c	Tor
E1	XC6221A32BNR	LVR-IC	LDO, 3.25V±1%, 200mA, +CE	SSOT-24	26vn	VR4	5a	Tor
E2	R1180Q221C	LVR-IC	LDO, 2.2V±2%, 150mA	SC-82AB	26yr	VR1	5a	Ric



SMD code	Type	Function	Short description	Case	Pinout	Sch.	St.	Mnf.
E2	R3114Q491A	Vdet-IC	4.9V±0.8%, -Reset ODO	SC-82AB	26vdl	VD9	5a	Ric
E2	XC61CC4202N	Vdet-IC	4.2V±1%, +Reset PPO	SOT-143R	26vdl	VD7	5c	Tor
E2	XC6221A33BNR	LVR-IC	LDO, 3.35V±1%, 200mA, +CE	SSOT-24	26vn	VR4	5a	Tor
E2	XC6223D121NR-G	LVR-IC	LDO, 1.2V±20mV, 300mA, +CE, PDR, CL	SSOT-24	26vn	VR4	5a	Tor
E3	R1180Q231C	LVR-IC	LDO, 2.3V±2%, 150mA	SC-82AB	26yr	VR1	5a	Ric
E3	R3114Q501A	Vdet-IC	5V±0.8%, -Reset ODO	SC-82AB	26vdl	VD9	5a	Ric
E3	XC61CC4302N	Vdet-IC	4.3V±1%, +Reset PPO	SOT-143R	26vdl	VD7	5c	Tor
E3	XC6221A34BNR	LVR-IC	LDO, 3.45V±1%, 200mA, +CE	SSOT-24	26vn	VR4	5a	Tor
E3	XC6223D131NR-G	LVR-IC	LDO, 1.3V±20mV, 300mA, +CE, PDR, CL	SSOT-24	26vn	VR4	5a	Tor
E4	R1180Q241C	LVR-IC	LDO, 2.4V±2%, 150mA	SC-82AB	26yr	VR1	5a	Ric
E4	XC61CC4402N	Vdet-IC	4.4V±1%, +Reset PPO	SOT-143R	26vdl	VD7	5c	Tor
E4	XC6221A35BNR	LVR-IC	LDO, 3.55V±1%, 200mA, +CE	SSOT-24	26vn	VR4	5a	Tor
E4	XC6223D141NR-G	LVR-IC	LDO, 1.4V±20mV, 300mA, +CE, PDR, CL	SSOT-24	26vn	VR4	5a	Tor
E5	R1140Q151D	LVR-IC	LDO, 1.5V±2%, 120mA, +CE, CL	SOT-143R	26vm	VR4	5a	Ric
E5	R1180Q251C	LVR-IC	LDO, 2.5V±2%, 150mA	SC-82AB	26yr	VR1	5a	Ric
E5	XC61CC4502N	Vdet-IC	4.5V±1%, +Reset PPO	SOT-143R	26vdl	VD7	5c	Tor
E5	XC6221A36BNR	LVR-IC	LDO, 3.65V±1%, 200mA, +CE	SSOT-24	26vn	VR4	5a	Tor
E5	XC6223D151NR-G	LVR-IC	LDO, 1.5V±20mV, 300mA, +CE, PDR, CL	SSOT-24	26vn	VR4	5a	Tor
E6	BFG17A	Si-npn	VHF/UHF-Amp, 25V, 50mA, 300mW, B>20..150, 2.8GHz	SOT-143	24t6	-	5c	Phi
E6	R1140Q161D	LVR-IC	LDO, 1.6V±2%, 120mA, +CE, CL	SOT-143R	26vm	VR4	5a	Ric
E6	R1180Q261C	LVR-IC	LDO, 2.6V±2%, 150mA	SC-82AB	26yr	VR1	5a	Ric
E6	XC61CC4602N	Vdet-IC	4.6V±1%, +Reset PPO	SOT-143R	26vdl	VD7	5c	Tor
E6	XC6221A37BNR	LVR-IC	LDO, 3.75V±1%, 200mA, +CE	SSOT-24	26vn	VR4	5a	Tor
E6	XC6223D161NR-G	LVR-IC	LDO, 1.6V±20mV, 300mA, +CE, PDR, CL	SSOT-24	26vn	VR4	5a	Tor
E7	R1140Q171D	LVR-IC	LDO, 1.7V±2%, 120mA, +CE, CL	SOT-143R	26vm	VR4	5a	Ric
E7	R1180Q271C	LVR-IC	LDO, 2.7V±2%, 150mA	SC-82AB	26yr	VR1	5a	Ric
E7	XC61CC4702N	Vdet-IC	4.7V±1%, +Reset PPO	SOT-143R	26vdl	VD7	5c	Tor
E7	XC6221A38BNR	LVR-IC	LDO, 3.85V±1%, 200mA, +CE	SSOT-24	26vn	VR4	5a	Tor
E7	XC6223D171NR-G	LVR-IC	LDO, 1.7V±20mV, 300mA, +CE, PDR, CL	SSOT-24	26vn	VR4	5a	Tor
E8	R1140Q181D	LVR-IC	LDO, 1.8V±2%, 120mA, +CE, CL	SOT-143R	26vm	VR4	5a	Ric
E8	R1180Q281C	LVR-IC	LDO, 2.8V±2%, 150mA	SC-82AB	26yr	VR1	5a	Ric
E8	XC61CC4802N	Vdet-IC	4.8V±1%, +Reset PPO	SOT-143R	26vdl	VD7	5c	Tor
E8	XC6221A39BNR	LVR-IC	LDO, 3.95V±1%, 200mA, +CE	SSOT-24	26vn	VR4	5a	Tor
E8	XC6223D181NR-G	LVR-IC	LDO, 1.8V±20mV, 300mA, +CE, PDR, CL	SSOT-24	26vn	VR4	5a	Tor
E9	R1140Q191D	LVR-IC	LDO, 1.9V±2%, 120mA, +CE, CL	SOT-143R	26vm	VR4	5a	Ric
E9	R1180Q291C	LVR-IC	LDO, 2.9V±2%, 150mA	SC-82AB	26yr	VR1	5a	Ric
E9	XC61CC4902N	Vdet-IC	4.9V±1%, +Reset PPO	SOT-143R	26vdl	VD7	5c	Tor
E9	XC6223D191NR-G	LVR-IC	LDO, 1.9V±20mV, 300mA, +CE, PDR, CL	SSOT-24	26vn	VR4	5a	Tor
E99	START499ETR	Si-npn	RF, UHF-VHF, 15V, 600mA, 600mW, B=160, 42GHz	SOT-343	26t6	-	5c	Ste
EA	MAX6314US42D3-T	Vdet-IC	4.2V±1.8%, -MR, -Reset Bidir, PPO, 140ms	SOT-143	24vdp	VD5	5c	Max
EA	R3112Q401A	Vdet-IC	4V±2%, -Reset PPO	SC-82AB	26rp	VD3	5a	Ric
EA	RP130Q501A	LVR-IC	LDO, LN, -CE, 5V±1%, 150mA	SC-82AB	26vn	VR4	5a	Ric
EĀ	XC6127C15KNR	Vdet-IC	1.5V±0.8%, +Reset PPO, -MR, Rt=800ms	SSOT-24	26cr	VD5	5a	Tor
EĀ	XC6127N16ENR	Vdet-IC	1.6V±0.8%, -Reset ODO, -MR, Rt=800ms	SSOT-24	26cr	VD4	5a	Tor
EA	XC6223D201NR-G	LVR-IC	LDO, 2.0V±1%, 300mA, +CE, PDR, CL	SSOT-24	26vn	VR4	5a	Tor
EB	MAX6314US41D3-T	Vdet-IC	4.1V±1.8%, -MR, -Reset Bidir, PPO, 140ms	SOT-143	24vdh	VD5	5c	Max
EB	R3112Q411A	Vdet-IC	4.1V±2%, -Reset PPO	SC-82AB	26rp	VD3	5a	Ric
EĪ	XC6127C17KNR	Vdet-IC	1.7V±0.8%, +Reset PPO, -MR, Rt=800ms	SSOT-24	26cr	VD5	5a	Tor
EĪ	XC6127N18ENR	Vdet-IC	1.8V±0.8%, -Reset ODO, -MR, Rt=800ms	SSOT-24	26cr	VD4	5a	Tor
EB	XC6223D211NR-G	LVR-IC	LDO, 2.1V±1%, 300mA, +CE, PDR, CL	SSOT-24	26vn	VR4	5a	Tor
EC	3SK247	n-MOSFET-d	DG, VHF, 15V, Idss=0..10mA	SOT-143	26fm	-	5c	Pan
EC	MAX6314US40D3-T	Vdet-IC	4.0V±1.8%, -MR, -Reset Bidir, PPO, 140ms	SOT-143	24vdh	VD5	5c	Max
EC	R3112Q421A	Vdet-IC	4.2V±2%, -Reset PPO	SC-82AB	26rp	VD3	5a	Ric
EĊ	XC6127C19KNR	Vdet-IC	1.9V±0.8%, +Reset PPO, -MR, Rt=800ms	SSOT-24	26cr	VD5	5a	Tor
EĊ	XC6127N20ENR	Vdet-IC	2.0V±0.8%, -Reset ODO, -MR, Rt=800ms	SSOT-24	26cr	VD4	5a	Tor
EC	XC6223D221NR-G	LVR-IC	LDO, 2.2V±1%, 300mA, +CE, PDR, CL	SSOT-24	26vn	VR4	5a	Tor
ED	R3112Q431A	Vdet-IC	4.3V±2%, -Reset PPO	SC-82AB	26rp	VD3	5a	Ric
EĎ	XC6127C21KNR	Vdet-IC	2.1V±0.8%, +Reset PPO, -MR, Rt=800ms	SSOT-24	26cr	VD5	5a	Tor
EĎ	XC6127N22ENR	Vdet-IC	2.2V±0.8%, -Reset ODO, -MR, Rt=800ms	SSOT-24	26cr	VD4	5a	Tor
ED	XC6223D231NR-G	LVR-IC	LDO, 2.3V±1%, 300mA, +CE, PDR, CL	SSOT-24	26vn	VR4	5a	Tor
EE	R3112Q441A	Vdet-IC	4.4V±2%, -Reset PPO	SC-82AB	26rp	VD3	5a	Ric
EĒ	XC6127C23KNR	Vdet-IC	2.3V±0.8%, +Reset PPO, -MR, Rt=800ms	SSOT-24	26cr	VD5	5a	Tor
EĒ	XC6127N24ENR	Vdet-IC	2.4V±0.8%, -Reset ODO, -MR, Rt=800ms	SSOT-24	26cr	VD4	5a	Tor
EE	XC6223D241NR-G	LVR-IC	LDO, 2.4V±1%, 300mA, +CE, PDR, CL	SSOT-24	26vn	VR4	5a	Tor
EF	R1141Q151D	LVR-IC	LDO, 1.5V±2%, 120mA, +CE, CL	SOT-143R	26vm	VR4	5a	Ric
EF	R3112Q451A	Vdet-IC	4.5V±2%, -Reset PPO	SC-82AB	26rp	VD3	5a	Ric
EĔ	XC6127C25KNR	Vdet-IC	2.5V±0.8%, +Reset PPO, -MR, Rt=800ms	SSOT-24	26cr	VD5	5a	Tor
EĔ	XC6127N26ENR	Vdet-IC	2.6V±0.8%, -Reset ODO, -MR, Rt=800ms	SSOT-24	26cr	VD4	5a	Tor
EF	XC6223D251NR-G	LVR-IC	LDO, 2.5V±1%, 300mA, +CE, PDR, CL	SSOT-24	26vn	VR4	5a	Tor
EG	MAX6314US39D3-T	Vdet-IC	3.9V±1.8%, -MR, -Reset Bidir, PPO, 140ms	SOT-143	24vdh	VD5	5c	Max



SMD code	Type	Function	Short description	Case	Pinout	Sch.	St.	Mnf.
EG	R1141Q161D	LVR-IC	LDO, 1.6V±2%, 120mA, +CE, CL	SOT-143R	26vm	VR4	5a	Ric
EG	R3112Q461A	Vdet-IC	4.6V±2%, -Reset PPO	SC-82AB	26rp	VD3	5a	Ric
EH	MAX6314US38D3-T	Vdet-IC	3.8V±1.8%, -MR, -Reset Bidir, PPO, 140ms	SOT-143	24vdh	VD5	5c	Max
EH	R1141Q171D	LVR-IC	LDO, 1.7V±2%, 120mA, +CE, CL	SOT-143R	26vm	VR4	5a	Ric
EH	R3112Q471A	Vdet-IC	4.7V±2%, -Reset PPO	SC-82AB	26rp	VD3	5a	Ric
EĤ	XC6127C27KNR	Vdet-IC	2.7V±0.8%, +Reset PPO, -MR, Rt=800ms	SSOT-24	26cr	VD5	5a	Tor
EĤ	XC6127N28ENR	Vdet-IC	2.8V±0.8%, -Reset ODO, -MR, Rt=800ms	SSOT-24	26cr	VD4	5a	Tor
EH	XC6223D261NR-G	LVR-IC	LDO, 2.6V±1%, 300mA, +CE, PDR, CL	SSOT-24	26vn	VR4	5a	Tor
EI	MAX6314US37D3-T	Vdet-IC	3.7V±1.8%, -MR, -Reset Bidir, PPO, 140ms	SOT-143	24vdh	VD5	5c	Max
EJ	MAX6314US36D3-T	Vdet-IC	3.6V±1.8%, -MR, -Reset Bidir, PPO, 140ms	SOT-143	24vdh	VD5	5c	Max
EJ	R1141Q181D	LVR-IC	LDO, 1.8V±2%, 120mA, +CE, CL	SOT-143R	26vm	VR4	5a	Ric
EJ	R3112Q481A	Vdet-IC	4.8V±2%, -Reset PPO	SC-82AB	26rp	VD3	5a	Ric
EJ4	3SK181-4	n-FET	DG, FMVHF, 15V, 30mA, 200mW, Idss=2.5..6mA	SOT-143	26fm	-	5b	San
EJ5	3SK181-5	n-FET	DG, FMVHF, 15V, 30mA, 200mW, Idss=5..12mA	SOT-143	26fm	-	5b	San
EJ6	3SK181-6	n-FET	DG, FMVHF, 15V, 30mA, 200mW, Idss=10..24mA	SOT-143	26fm	-	5b	San
EK	MAX6314US35D3-T	Vdet-IC	3.5V±1.8%, -MR, -Reset Bidir, PPO, 140ms	SOT-143	24vdh	VD5	5c	Max
EK	R1141Q191D	LVR-IC	LDO, 1.9V±2%, 120mA, +CE, CL	SOT-143R	26vm	VR4	5a	Ric
EK	R3112Q491A	Vdet-IC	4.9V±2%, -Reset PPO	SC-82AB	26rp	VD3	5a	Ric
EĶ	XC6127C29KNR	Vdet-IC	2.9V±0.8%, +Reset PPO, -MR, Rt=800ms	SSOT-24	26cr	VD5	5a	Tor
EĶ	XC6127N30ENR	Vdet-IC	3.0V±0.8%, -Reset ODO, -MR, Rt=800ms	SSOT-24	26cr	VD4	5a	Tor
EK	XC6223D271NR-G	LVR-IC	LDO, 2.7V±1%, 300mA, +CE, PDR, CL	SSOT-24	26vn	VR4	5a	Tor
EL	MAX6314US34D3-T	Vdet-IC	3.4V±1.8%, -MR, -Reset Bidir, PPO, 140ms	SOT-143	24vdh	VD5	5c	Max
EL	R3112Q401C	Vdet-IC	4V±2%, -Reset ODO	SC-82AB	26rp	VD1	5a	Ric
EL	XC6127C31KNR	Vdet-IC	3.1V±0.8%, +Reset PPO, -MR, Rt=800ms	SSOT-24	26cr	VD5	5a	Tor
ĒL	XC6127N32ENR	Vdet-IC	3.2V±0.8%, -Reset ODO, -MR, Rt=800ms	SSOT-24	26cr	VD4	5a	Tor
EL	XC6223D281NR-G	LVR-IC	LDO, 2.8V±1%, 300mA, +CE, PDR, CL	SSOT-24	26vn	VR4	5a	Tor
ELN	ELM7526CCB	Vdet-IC	2.6V±2%, +Reset PPO	SC-82AB	26vdl	VD7	5c	Elm
ELN	ELM7526NCB	Vdet-IC	2.6V±2%, +Reset ODO	SC-82AB	26vdl	VD6	5c	Elm
EM	MAX6314US33D3-T	Vdet-IC	3.3V±1.8%, -MR, -Reset Bidir, PPO, 140ms	SOT-143	24vdh	VD5	5c	Max
EM	R3112Q411C	Vdet-IC	4.1V±2%, -Reset ODO	SC-82AB	26rp	VD1	5a	Ric
ĒM	XC6127C33KNR	Vdet-IC	3.3V±0.8%, +Reset PPO, -MR, Rt=800ms	SSOT-24	26cr	VD5	5a	Tor
ĒM	XC6127N34ENR	Vdet-IC	3.4V±0.8%, -Reset ODO, -MR, Rt=800ms	SSOT-24	26cr	VD4	5a	Tor
EM	XC6223D291NR-G	LVR-IC	LDO, 2.9V±1%, 300mA, +CE, PDR, CL	SSOT-24	26vn	VR4	5a	Tor
EN	MAX6314US32D3-T	Vdet-IC	3.2V±1.8%, -MR, -Reset Bidir, PPO, 140ms	SOT-143	24vdh	VD5	5c	Max
EN	R3112Q421C	Vdet-IC	4.2V±2%, -Reset ODO	SC-82AB	26rp	VD1	5a	Ric
EN	XC6109C40AN	Vdet-IC	4.0V, +Reset PPO	SSOT-24	26rp	VD3	5c	Tor
EN	XC6119C40ANR	Vdet-IC	4.0V±2%, -Reset PPO	SSOT-24	26gh	VD3	5a	Tor
EN	XC6127C35KNR	Vdet-IC	3.5V±0.8%, +Reset PPO, -MR, Rt=800ms	SSOT-24	26cr	VD5	5a	Tor
ĒN	XC6127N36ENR	Vdet-IC	3.6V±0.8%, -Reset ODO, -MR, Rt=800ms	SSOT-24	26cr	VD4	5a	Tor
EN3	2SC4862-3	Si-npn	UHF, Osc, 20V, 30mA, 20mW, B=60..120, 6.5GHz	SOT-143	26tu	-	5b	San
EN4	2SC4862-4	Si-npn	UHF, Osc, 20V, 30mA, 20mW, B=90..180, 6.5GHz	SOT-143	26tu	-	5b	San
EN5	2SC4862-5	Si-npn	UHF, Osc, 20V, 30mA, 20mW, B=60..120, 6.5GHz	SOT-143	26tu	-	5b	San
EO	2SC5097-O	Si-npn	VHF/UHF, LN, 20V, 15mA, 150mW, 10GHz, B=80..160	SMQ	26tu	-	5b	Tos
EO	MAX6314US31D3-T	Vdet-IC	3.08V±1.8%, -MR, -Reset Bidir, PPO, 140ms	SOT-143	24vdh	VD5	5c	Max
EP	MAX6314US30D3-T	Vdet-IC	3.0V±1.8%, -MR, -Reset Bidir, PPO, 140ms	SOT-143	24vdh	VD5	5c	Max
EP	R3112Q431C	Vdet-IC	4.3V±2%, -Reset ODO	SC-82AB	26rp	VD1	5a	Ric
EP	XC6109C41AN	Vdet-IC	4.1V, +Reset PPO	SSOT-24	26rp	VD3	5c	Tor
EP	XC6119C41ANR	Vdet-IC	4.1V±2%, -Reset PPO	SSOT-24	26gh	VD3	5a	Tor
ĒP	XC6127C37KNR	Vdet-IC	3.7V±0.8%, +Reset PPO, -MR, Rt=800ms	SSOT-24	26cr	VD5	5a	Tor
ĒP	XC6127N38ENR	Vdet-IC	3.8V±0.8%, -Reset ODO, -MR, Rt=800ms	SSOT-24	26cr	VD4	5a	Tor
EQ	AAT3526ICX-3.08-200	Vdet-IC	3.08V±1.5%, -Reset PPO, -MR	SOT-143	24vdh	VD5	5i	Ant
EQ	R3112Q441C	Vdet-IC	4.4V±2%, -Reset ODO	SC-82AB	26rp	VD1	5a	Ric
ER	2SC5097-R	Si-npn	VHF/UHF, LN, 20V, 15mA, 150mW, 10GHz, B=50..100	SMQ	26tu	-	5b	Tos
ER	R3112Q451C	Vdet-IC	4.5V±2%, -Reset ODO	SC-82AB	26rp	VD1	5a	Ric
ER	XC6109C42AN	Vdet-IC	4.2V, +Reset PPO	SSOT-24	26rp	VD3	5c	Tor
ER	XC6119C42ANR	Vdet-IC	4.2V±2%, -Reset PPO	SSOT-24	26gh	VD3	5a	Tor
ER	XC6127C39KNR	Vdet-IC	3.9V±0.8%, +Reset PPO, -MR, Rt=800ms	SSOT-24	26cr	VD5	5a	Tor
ĒR	XC6127N40ENR	Vdet-IC	4.0V±0.8%, -Reset ODO, -MR, Rt=800ms	SSOT-24	26cr	VD4	5a	Tor
ES	MAX6314US29D3-T	Vdet-IC	2.93V±1.8%, -MR, -Reset Bidir, PPO, 140ms	SOT-143	24vdh	VD5	5c	Max
ES	R3112Q461C	Vdet-IC	4.6V±2%, -Reset ODO	SC-82AB	26rp	VD1	5a	Ric
ES	XC6109C43AN	Vdet-IC	4.3V, +Reset PPO	SSOT-24	26rp	VD3	5c	Tor
ES	XC6119C43ANR	Vdet-IC	4.3V±2%, -Reset PPO	SSOT-24	26gh	VD3	5a	Tor
ĒS	XC6127C41KNR	Vdet-IC	4.1V±0.8%, +Reset PPO, -MR, Rt=800ms	SSOT-24	26cr	VD5	5a	Tor
ĒS	XC6127N42ENR	Vdet-IC	4.2V±0.8%, -Reset ODO, -MR, Rt=800ms	SSOT-24	26cr	VD4	5a	Tor
ET	MAX6314US28D3-T	Vdet-IC	2.8V±1.8%, -MR, -Reset Bidir, PPO, 140ms	SOT-143	24vdh	VD5	5c	Max
ET	R3112Q471C	Vdet-IC	4.7V±2%, -Reset ODO	SC-82AB	26rp	VD1	5a	Ric
ET	XC6109C44AN	Vdet-IC	4.4V, +Reset PPO	SSOT-24	26rp	VD3	5c	Tor
ET	XC6119C44ANR	Vdet-IC	4.4V±2%, -Reset PPO	SSOT-24	26gh	VD3	5a	Tor
ĒT	XC6127C43KNR	Vdet-IC	4.3V±0.8%, +Reset PPO, -MR, Rt=800ms	SSOT-24	26cr	VD5	5a	Tor
ĒT	XC6127N44ENR	Vdet-IC	4.4V±0.8%, -Reset ODO, -MR, Rt=800ms	SSOT-24	26cr	VD4	5a	Tor



SMD code	Type	Function	Short description	Case	Pinout	Sch.	St.	Mnf.
ETP	3SK273-P	n-MESFET	GaAs, DG, VHF/UHF, 13V, 50mA, 200mW, Idss=8.5..17mA	SOT-143	26fm	-	5b	Pan
ETQ	3SK273-Q	n-MESFET	GaAs, DG, VHF/UHF, 13V, 50mA, 200mW, Idss=15..21mA	SOT-143	26fm	-	5b	Pan
ETR	3SK273-R	n-MESFET	GaAs, DG, VHF/UHF, 13V, 50mA, 200mW, Idss=19..30mA	SOT-143	26fm	-	5b	Pan
ETS	3SK273-S	n-MESFET	GaAs, DG, VHF/UHF, 13V, 50mA, 200mW, Idss=25..35mA	SOT-143	26fm	-	5b	Pan
EU	MAX6314US27D3-T	Vdet-IC	2.7V±1.8%, -MR, -Reset Bidir, PPO, 140ms	SOT-143	24vdh	VD5	5c	Max
EU	R3112Q481C	Vdet-IC	4.8V±2%, -Reset ODO	SC-82AB	26rp	VD1	5a	Ric
EU	XC6109C45AN	Vdet-IC	4.5V, +Reset PPO	SSOT-24	26rp	VD3	5c	Tor
EU	XC6119C45ANR	Vdet-IC	4.5V±2%, -Reset PPO	SSOT-24	26gh	VD3	5a	Tor
EU	XC6127C45KNR	Vdet-IC	4.5V±0.8%, +Reset PPO, -MR, Rt=800ms	SSOT-24	26cr	VD5	5a	Tor
EU	XC6127N46ENR	Vdet-IC	4.6V±0.8%, -Reset ODO, -MR, Rt=800ms	SSOT-24	26cr	VD4	5a	Tor
EV	MAX6314US26D3-T	Vdet-IC	2.63V±1.8%, -MR, -Reset Bidir, PPO, 140ms	SOT-143	24vdh	VD5	5c	Max
EV	R3112Q491C	Vdet-IC	4.9V±2%, -Reset ODO	SC-82AB	26rp	VD1	5a	Ric
EV	XC6109C46AN	Vdet-IC	4.6V, +Reset PPO	SSOT-24	26rp	VD3	5c	Tor
EV	XC6119C46ANR	Vdet-IC	4.6V±2%, -Reset PPO	SSOT-24	26gh	VD3	5a	Tor
EV	XC6127C47KNR	Vdet-IC	4.7V±0.8%, +Reset PPO, -MR, Rt=800ms	SSOT-24	26cr	VD5	5a	Tor
EV	XC6127N48ENR	Vdet-IC	4.8V±0.8%, -Reset ODO, -MR, Rt=800ms	SSOT-24	26cr	VD4	5a	Tor
EW	MAX6314US25D3-T	Vdet-IC	2.5V±1.8%, -MR, -Reset Bidir, PPO, 140ms	SOT-143	24vdh	VD5	5c	Max
EX	MAX6314US50D4-T	Vdet-IC	5.0V±1.8%, -MR, -Reset Bidir, PPO, 1120ms	SOT-143	24vdh	VD5	5c	Max
EX	XC6109C47AN	Vdet-IC	4.7V, +Reset PPO	SSOT-24	26rp	VD3	5c	Tor
EX	XC6119C47ANR	Vdet-IC	4.7V±2%, -Reset PPO	SSOT-24	26gh	VD3	5a	Tor
EX	XC6127C49KNR	Vdet-IC	4.9V±0.8%, +Reset PPO, -MR, Rt=800ms	SSOT-24	26cr	VD5	5a	Tor
EX	XC6127N50ENR	Vdet-IC	5.0V±0.8%, -Reset ODO, -MR, Rt=800ms	SSOT-24	26cr	VD4	5a	Tor
EY	MAX6314US49D4-T	Vdet-IC	4.9V±1.8%, -MR, -Reset Bidir, PPO, 1120ms	SOT-143	24vdh	VD5	5c	Max
EY	XC6109C48AN	Vdet-IC	4.8V, +Reset PPO	SSOT-24	26rp	VD3	5c	Tor
EY	XC6119C48ANR	Vdet-IC	4.8V±2%, -Reset PPO	SSOT-24	26gh	VD3	5a	Tor
EY	XC6127C51KNR	Vdet-IC	5.1V±0.8%, +Reset PPO, -MR, Rt=800ms	SSOT-24	26cr	VD5	5a	Tor
EY	XC6127N52ENR	Vdet-IC	5.2V±0.8%, -Reset ODO, -MR, Rt=800ms	SSOT-24	26cr	VD4	5a	Tor
EZ	MAX6314US48D4-T	Vdet-IC	4.8V±1.8%, -MR, -Reset Bidir, PPO, 1120ms	SOT-143	24vdh	VD5	5c	Max
EZ	XC6109C49AN	Vdet-IC	4.9V, +Reset PPO	SSOT-24	26rp	VD3	5c	Tor
EZ	XC6119C49ANR	Vdet-IC	4.9V±2%, -Reset PPO	SSOT-24	26gh	VD3	5a	Tor
EZ	XC6127C53KNR	Vdet-IC	5.3V±0.8%, +Reset PPO, -MR, Rt=800ms	SSOT-24	26cr	VD5	5a	Tor
EZ	XC6127N54ENR	Vdet-IC	5.4V±0.8%, -Reset ODO, -MR, Rt=800ms	SSOT-24	26cr	VD4	5a	Tor
F0	R1140Q201D	LVR-IC	LDO, 2V±2%, 120mA, +CE, CL	SOT-143R	26vm	VR4	5a	Ric
F0	R1180Q301C	LVR-IC	LDO, 3V±2%, 150mA	SC-82AB	26yr	VR1	5a	Ric
F0	R3114Q071C	Vdet-IC	0.7V±0.8%, -Reset PPO	SC-82AB	26vdl	VD7	5a	Ric
F0	XC61CC5002N	Vdet-IC	5V±1%, +Reset PPO	SOT-143R	26vdl	VD7	5c	Tor
F0	XC6221B311NR	LVR-IC	LDO, 3.1V±1%, 200mA, +CE, CL	SSOT-24	26vn	VR4	5a	Tor
F0	XC6224A08BNR	LVR-IC	LDO, 0.85V±20mV, 150mA, +CE	SSOT-24	26vn	VR4	5a	Tor
F05	TSDF1205	Si-npn	UHF-VHF, LN, 9V, 12mA, 40mW, B=50..250, 12GHz	SOT-143	24tc	-	5b	Vs
F1	R1140Q211D	LVR-IC	LDO, 2.1V±2%, 120mA, +CE, CL	SOT-143R	26vm	VR4	5a	Ric
F1	R1180Q311C	LVR-IC	LDO, 3.1V±2%, 150mA	SC-82AB	26yr	VR1	5a	Ric
F1	R3114Q081C	Vdet-IC	0.8V±0.8%, -Reset PPO	SC-82AB	26vdl	VD7	5a	Ric
F1	XC61CC5102N	Vdet-IC	5.1V±1%, +Reset PPO	SOT-143R	26vdl	VD7	5c	Tor
F1	XC6221B321NR	LVR-IC	LDO, 3.2V±1%, 200mA, +CE, CL	SSOT-24	26vn	VR4	5a	Tor
F1	XC6224A09BNR	LVR-IC	LDO, 0.95V±20mV, 150mA, +CE	SSOT-24	26vn	VR4	5a	Tor
F2	R1140Q221D	LVR-IC	LDO, 2.2V±2%, 120mA, +CE, CL	SOT-143R	26vm	VR4	5a	Ric
F2	R1180Q321C	LVR-IC	LDO, 3.2V±2%, 150mA	SC-82AB	26yr	VR1	5a	Ric
F2	R3114Q091C	Vdet-IC	0.9V±0.8%, -Reset PPO	SC-82AB	26vdl	VD7	5a	Ric
F2	XC61CC5202N	Vdet-IC	5.2V±1%, +Reset PPO	SOT-143R	26vdl	VD7	5c	Tor
F2	XC6221B331NR	LVR-IC	LDO, 3.3V±1%, 200mA, +CE, CL	SSOT-24	26vn	VR4	5a	Tor
F2	XC6224A10BNR	LVR-IC	LDO, 1.05V±20mV, 150mA, +CE	SSOT-24	26vn	VR4	5a	Tor
F20	TSDF1220	Si-npn	UHF-VHF, LN, 9V, 40mA, 200mW, B=50..150, 12GHz	SOT-143	24tc	-	5b	Vs
F3	R1140Q231D	LVR-IC	LDO, 2.3V±2%, 120mA, +CE, CL	SOT-143R	26vm	VR4	5a	Ric
F3	R1180Q331C	LVR-IC	LDO, 3.3V±2%, 150mA	SC-82AB	26yr	VR1	5a	Ric
F3	R3114Q101C	Vdet-IC	1V±0.8%, -Reset PPO	SC-82AB	26vdl	VD7	5a	Ric
F3	SPF-3043	p-FET	GaAs, UHF, LN, 7V, 60mA, 420mW, 10GHz, 22dB(2GHz)	SOT-143	26fq	-	5b	Sir
F3	XC61CC5302N	Vdet-IC	5.3V±1%, +Reset PPO	SOT-143R	26vdl	VD7	5c	Tor
F3	XC6221B341NR	LVR-IC	LDO, 3.4V±1%, 200mA, +CE, CL	SSOT-24	26vn	VR4	5a	Tor
F3	XC6224A11BNR	LVR-IC	LDO, 1.15V±20mV, 150mA, +CE	SSOT-24	26vn	VR4	5a	Tor
F31Z	SPF-3143Z	p-FET	GaAs, UHF, LN, 7V, 180mA, 325mW, 3.5GHz, 21dB(2GHz)	SOT-143	26fq	-	5b	Sir
F4	R1140Q241D	LVR-IC	LDO, 2.4V±2%, 120mA, +CE, CL	SOT-143R	26vm	VR4	5a	Ric
F4	R1180Q341C	LVR-IC	LDO, 3.4V±2%, 150mA	SC-82AB	26yr	VR1	5a	Ric
F4	R3114Q111C	Vdet-IC	1.1V±0.8%, -Reset PPO	SC-82AB	26vdl	VD7	5a	Ric
F4	XC61CC5402N	Vdet-IC	5.4V±1%, +Reset PPO	SOT-143R	26vdl	VD7	5c	Tor
F4	XC6221B351NR	LVR-IC	LDO, 3.5V±1%, 200mA, +CE, CL	SSOT-24	26vn	VR4	5a	Tor
F4	XC6224A12BNR	LVR-IC	LDO, 1.25V±1.5%, 150mA, +CE	SSOT-24	26vn	VR4	5a	Tor
F5	R1140Q251D	LVR-IC	LDO, 2.5V±2%, 120mA, +CE, CL	SOT-143R	26vm	VR4	5a	Ric
F5	R1180Q351C	LVR-IC	LDO, 3.5V±2%, 150mA	SC-82AB	26yr	VR1	5a	Ric
F5	R3114Q121C	Vdet-IC	1.2V±0.8%, -Reset PPO	SC-82AB	26vdl	VD7	5a	Ric
F5	XC61CC5502N	Vdet-IC	5.5V±1%, +Reset PPO	SOT-143R	26vdl	VD7	5c	Tor



SMD

SMD code	Type	Function	Short description	Case	Pinout	Sch.	St.	Mnf.
F5	XC6221B361NR	LVR-IC	LDO, 3.6V±1%, 200mA, +CE, CL	SSOT-24	26vn	VR4	5a	Tor
F5	XC6224A13BNR	LVR-IC	LDO, 1.25V±1.5%, 150mA, +CE	SSOT-24	26vn	VR4	5a	Tor
F6	R1140Q261D	LVR-IC	LDO, 2.6V±2%, 120mA, +CE, CL	SOT-143R	26vm	VR4	5a	Ric
F6	R1180Q361C	LVR-IC	LDO, 3.6V±2%, 150mA	SC-82AB	26yr	VR1	5a	Ric
F6	R3114Q131C	Vdet-IC	1.3V±0.8%, -Reset PPO	SC-82AB	26vdl	VD7	5a	Ric
F6	XC61CC5602N	Vdet-IC	5.6V±1%, +Reset PPO	SOT-143R	26vdl	VD7	5c	Tor
F6	XC6221B371NR	LVR-IC	LDO, 3.7V±1%, 200mA, +CE, CL	SSOT-24	26vn	VR4	5a	Tor
F6	XC6224A14BNR	LVR-IC	LDO, 1.45V±1.5%, 150mA, +CE	SSOT-24	26vn	VR4	5a	Tor
F7	R1140Q271D	LVR-IC	LDO, 2.7V±2%, 120mA, +CE, CL	SOT-143R	26vm	VR4	5a	Ric
F7	R3114Q141C	Vdet-IC	1.4V±0.8%, -Reset PPO	SC-82AB	26vdl	VD7	5a	Ric
F7	XC61CC5702N	Vdet-IC	5.7V±1%, +Reset PPO	SOT-143R	26vdl	VD7	5c	Tor
F7	XC6221B381NR	LVR-IC	LDO, 3.8V±1%, 200mA, +CE, CL	SSOT-24	26vn	VR4	5a	Tor
F7	XC6224A15BNR	LVR-IC	LDO, 1.55V±1.5%, 150mA, +CE	SSOT-24	26vn	VR4	5a	Tor
F8	R1140Q281D	LVR-IC	LDO, 2.8V±2%, 120mA, +CE, CL	SOT-143R	26vm	VR4	5a	Ric
F8	R3114Q151C	Vdet-IC	1.5V±0.8%, -Reset PPO	SC-82AB	26vdl	VD7	5a	Ric
F8	XC61CC5802N	Vdet-IC	5.8V±1%, +Reset PPO	SOT-143R	26vdl	VD7	5c	Tor
F8	XC6221B391NR	LVR-IC	LDO, 3.9V±1%, 200mA, +CE, CL	SSOT-24	26vn	VR4	5a	Tor
F8	XC6224A16BNR	LVR-IC	LDO, 1.65V±1.5%, 150mA, +CE	SSOT-24	26vn	VR4	5a	Tor
F9	R1140Q291D	LVR-IC	LDO, 2.9V±2%, 120mA, +CE, CL	SOT-143R	26vm	VR4	5a	Ric
F9	R3114Q161C	Vdet-IC	1.6V±0.8%, -Reset PPO	SC-82AB	26vdl	VD7	5a	Ric
F9	XC61CC5902N	Vdet-IC	5.9V±1%, +Reset PPO	SOT-143R	26vdl	VD7	5c	Tor
F9	XC6221B401NR	LVR-IC	LDO, 4V±1%, 200mA, +CE, CL	SSOT-24	26vn	VR4	5a	Tor
F9	XC6224A17BNR	LVR-IC	LDO, 1.75V±1.5%, 150mA, +CE	SSOT-24	26vn	VR4	5a	Tor
FA	BFP81	Si-npn	VHF/UHF, 25V, 30mA, 200mW, B=50..200, >5.8GHz	SOT-143	24tc	-	5b	Vs
FA	MAX6314US47D4-T	Vdet-IC	4.7V±1.8%, -MR, -Reset Bidir, PPO, 1120ms	SOT-143	24vdh	VD5	5c	Max
FA	R1141Q201D	LVR-IC	LDO, 2V±2%, 120mA, +CE, CL	SOT-143R	26vm	VR4	5a	Ric
FA	RP130Q121B	LVR-IC	LDO, LN, +CE, 1.2V±1%, 150mA	SC-82AB	26vn	VR4	5a	Ric
FĀ	XC6127C16ANR	Vdet-IC	1.6V±0.8%, -Reset PPO, -MR, Rt=50ms	SSOT-24	26cr	VD5	5a	Tor
FĀ	XC6127N16FNr	Vdet-IC	1.6V±0.8%, +Reset ODO, -MR, Rt=50ms	SSOT-24	26cr	VD4	5a	Tor
FA	XC6224A18BNR	LVR-IC	LDO, 1.85V±1.5%, 150mA, +CE	SSOT-24	26vn	VR4	5a	Tor
FAs	BFP81	Si-npn	VHF/UHF, 25V, 30mA, 280mW, B=50..200, >5.8GHz	SOT-143	24tc	-	5b	Sie
FB	MAX6314US46D4-T	Vdet-IC	4.63V±1.8%, -MR, -Reset Bidir, PPO, 1120ms	SOT-143	24vdh	VD5	5c	Max
FB	R1141Q211D	LVR-IC	LDO, 2.1V±2%, 120mA, +CE, CL	SOT-143R	26vm	VR4	5a	Ric
FB	RP130Q131B	LVR-IC	LDO, LN, +CE, 1.3V±1%, 150mA	SC-82AB	26vn	VR4	5a	Ric
FĪ	XC6127C18ANR	Vdet-IC	1.8V±0.8%, -Reset PPO, -MR, Rt=50ms	SSOT-24	26cr	VD5	5a	Tor
FĪ	XC6127N18FNr	Vdet-IC	1.8V±0.8%, +Reset ODO, -MR, Rt=50ms	SSOT-24	26cr	VD4	5a	Tor
FB	XC6224A19BNR	LVR-IC	LDO, 1.95V±1.5%, 150mA, +CE	SSOT-24	26vn	VR4	5a	Tor
FC	MAX6314US45D4-T	Vdet-IC	4.5V±1.8%, -MR, -Reset Bidir, PPO, 1120ms	SOT-143	24vdh	VD5	5c	Max
FC	R1141Q221D	LVR-IC	LDO, 2.2V±2%, 120mA, +CE, CL	SOT-143R	26vm	VR4	5a	Ric
FC	RP130Q141B	LVR-IC	LDO, LN, +CE, 1.4V±1%, 150mA	SC-82AB	26vn	VR4	5a	Ric
FĈ	XC6127C20ANR	Vdet-IC	2.0V±0.8%, -Reset PPO, -MR, Rt=50ms	SSOT-24	26cr	VD5	5a	Tor
FĈ	XC6127N20FNr	Vdet-IC	2.0V±0.8%, +Reset ODO, -MR, Rt=50ms	SSOT-24	26cr	VD4	5a	Tor
FC	XC6224A251NR	LVR-IC	LDO, 2.5V±1.5%, 150mA, +CE	SSOT-24	26vn	VR4	5a	Tor
FD	MAX6314US44D4-T	Vdet-IC	4.39V±1.8%, -MR, -Reset Bidir, PPO, 1120ms	SOT-143	24vdh	VD5	5c	Max
FD	R1141Q231D	LVR-IC	LDO, 2.3V±2%, 120mA, +CE, CL	SOT-143R	26vm	VR4	5a	Ric
FD	RP130Q151B	LVR-IC	LDO, LN, +CE, 1.5V±1%, 150mA	SC-82AB	26vn	VR4	5a	Ric
FĎ	XC6127C22ANR	Vdet-IC	2.2V±0.8%, -Reset PPO, -MR, Rt=50ms	SSOT-24	26cr	VD5	5a	Tor
FĎ	XC6127N22FNr	Vdet-IC	2.2V±0.8%, +Reset ODO, -MR, Rt=50ms	SSOT-24	26cr	VD4	5a	Tor
FD	XC6223E301NR-G	LVR-IC	LDO, 3.0V±1%, 300mA, +CE, ICP	SSOT-24	26vn	VR4	5a	Tor
FE	BFP93A	Si-npn	VHF/UHF, 20V, 50mA, 200mW, B=50..200, >6GHz	SOT-143	24tc	-	5b	Vs
FE	MAX6314US43D4-T	Vdet-IC	4.3V±1.8%, -MR, -Reset Bidir, PPO, 1120ms	SOT-143	24vdh	VD5	5c	Max
FE	R1141Q241D	LVR-IC	LDO, 2.4V±2%, 120mA, +CE, CL	SOT-143R	26vm	VR4	5a	Ric
FE	RP130Q161B	LVR-IC	LDO, LN, +CE, 1.6V±1%, 150mA	SC-82AB	26vn	VR4	5a	Ric
FĚ	XC6127C24ANR	Vdet-IC	2.4V±0.8%, -Reset PPO, -MR, Rt=50ms	SSOT-24	26cr	VD5	5a	Tor
FĚ	XC6127N24FNr	Vdet-IC	2.4V±0.8%, +Reset ODO, -MR, Rt=50ms	SSOT-24	26cr	VD4	5a	Tor
FE	XC6223E311NR-G	LVR-IC	LDO, 3.1V±1%, 300mA, +CE, ICP	SSOT-24	26vn	VR4	5a	Tor
FEs	BFP93A	Si-npn	VHF/UHF, 20V, 50mA, 300mW, B=50..200, >6GHz	SOT-143	24tc	-	5b	Sie
FF	MAX6314US42D4-T	Vdet-IC	4.2V±1.8%, -MR, -Reset Bidir, PPO, 1120ms	SOT-143	24vdh	VD5	5c	Max
FF	R1141Q251D	LVR-IC	LDO, 2.5V±2%, 120mA, +CE, CL	SOT-143R	26vm	VR4	5a	Ric
FF	RP130Q171B	LVR-IC	LDO, LN, +CE, 1.7V±1%, 150mA	SC-82AB	26vn	VR4	5a	Ric
FĚ	XC6127C26ANR	Vdet-IC	2.6V±0.8%, -Reset PPO, -MR, Rt=50ms	SSOT-24	26cr	VD5	5a	Tor
FF	XC6127N26FNr	Vdet-IC	2.6V±0.8%, +Reset ODO, -MR, Rt=50ms	SSOT-24	26cr	VD4	5a	Tor
FF	XC6223E321NR-G	LVR-IC	LDO, 3.2V±1%, 300mA, +CE, ICP	SSOT-24	26vn	VR4	5a	Tor
FG	MAX6314US41D4-T	Vdet-IC	4.1V±1.8%, -MR, -Reset Bidir, PPO, 1120ms	SOT-143	24vdh	VD5	5c	Max
FG	R1141Q261D	LVR-IC	LDO, 2.6V±2%, 120mA, +CE, CL	SOT-143R	26vm	VR4	5a	Ric
FG	RP130Q181B	LVR-IC	LDO, LN, +CE, 1.8V±1%, 150mA	SC-82AB	26vn	VR4	5a	Ric
FH	AAT3527ICX-3.08-200	Vdet-IC	3.08V±1.5%, +Reset PPO, -MR	SOT-143	24vdh	VD5	5i	Ant
FH	MAX6314US40D4-T	Vdet-IC	4.0V±1.8%, -MR, -Reset Bidir, PPO, 1120ms	SOT-143	24vdh	VD5	5c	Max
FH	R1141Q271D	LVR-IC	LDO, 2.7V±2%, 120mA, +CE, CL	SOT-143R	26vm	VR4	5a	Ric
FH	RP130Q181B5	LVR-IC	LDO, LN, +CE, 1.85V±1%, 150mA	SC-82AB	26vn	VR4	5a	Ric



SMD

Code	Type	Function	Short description	Case	Pinout	Sch.	St.	Mnf.
FH	XC6127C28ANR	Vdet-IC	2.8V±0.8%, -Reset PPO, -MR, Rt=50ms	SSOT-24	26cr	VD5	5a	Tor
FĤ	XC6127N28FNR	Vdet-IC	2.8V±0.8%, +Reset ODO, -MR, Rt=50ms	SSOT-24	26cr	VD4	5a	Tor
FĤ	XC6223E331NR-G	LVR-IC	LDO, 3.3V±1%, 300mA, +CE, ICP	SSOT-24	26vn	VR4	5a	Tor
FI	AAT3528ICX-3.00-200	Vdet-IC	3.0V±1.5%, -Reset ODO, -MR	SOT-143	24vdh	VD4	5i	Ant
FI	MAX6314US39D4-T	Vdet-IC	3.9V±1.8%, -MR, -Reset Bidir, PPO, 1120ms	SOT-143	24vdh	VD5	5c	Max
FI-	3SK186	n-MOSFET-d	DG, UHF, 12V, Idss=0.4V	SOT-143	26fm	-	5c	Ren
FJ	AAT3528ICX-3.08-200	Vdet-IC	3.08V±1.5%, -Reset ODO, -MR	SOT-143	24vdh	VD4	5i	Ant
FJ	MAX6314US38D4-T	Vdet-IC	3.8V±1.8%, -MR, -Reset Bidir, PPO, 1120ms	SOT-143	24vdh	VD5	5c	Max
FJ	R1141Q281D	LVR-IC	LDO, 2.8V±2%, 120mA, +CE, CL	SOT-143R	26vm	VR4	5a	Ric
FJ	RP130Q191B	LVR-IC	LDO, LN, +CE, 1.9V±1%, 150mA	SC-82AB	26vn	VR4	5a	Ric
FK	MAX6314US37D4-T	Vdet-IC	3.7V±1.8%, -MR, -Reset Bidir, PPO, 1120ms	SOT-143	24vdh	VD5	5c	Max
FK	R1141Q291D	LVR-IC	LDO, 2.9V±2%, 120mA, +CE, CL	SOT-143R	26vm	VR4	5a	Ric
FK	RP130Q201B	LVR-IC	LDO, LN, +CE, 2V±1%, 150mA	SC-82AB	26vn	VR4	5a	Ric
FĤ	XC6127C30ANR	Vdet-IC	3.0V±0.8%, -Reset PPO, -MR, Rt=50ms	SSOT-24	26cr	VD5	5a	Tor
FĤ	XC6127N30FNR	Vdet-IC	3.0V±0.8%, +Reset ODO, -MR, Rt=50ms	SSOT-24	26cr	VD4	5a	Tor
FK	XC6223E341NR-G	LVR-IC	LDO, 3.4V±1%, 300mA, +CE, ICP	SSOT-24	26vn	VR4	5a	Tor
FL	MAX6314US36D4-T	Vdet-IC	3.6V±1.8%, -MR, -Reset Bidir, PPO, 1120ms	SOT-143	24vdh	VD5	5c	Max
FL	XC6127C32ANR	Vdet-IC	3.2V±0.8%, -Reset PPO, -MR, Rt=50ms	SSOT-24	26cr	VD5	5a	Tor
FL	XC6127N32FNR	Vdet-IC	3.2V±0.8%, +Reset ODO, -MR, Rt=50ms	SSOT-24	26cr	VD4	5a	Tor
FL	XC6223E351NR-G	LVR-IC	LDO, 3.5V±1%, 300mA, +CE, ICP	SSOT-24	26vn	VR4	5a	Tor
FLN	ELM7527CCB	Vdet-IC	2.7V±2%, +Reset PPO	SC-82AB	26vdl	VD7	5c	Elm
FLN	ELM7527NCB	Vdet-IC	2.7V±2%, +Reset ODO	SC-82AB	26vdl	VD6	5c	Elm
FM	MAX6314US35D4-T	Vdet-IC	3.5V±1.8%, -MR, -Reset Bidir, PPO, 1120ms	SOT-143	24vdh	VD5	5c	Max
FM	XC6127C34ANR	Vdet-IC	3.4V±0.8%, -Reset PPO, -MR, Rt=50ms	SSOT-24	26cr	VD5	5a	Tor
FM	XC6127N34FNR	Vdet-IC	3.4V±0.8%, +Reset ODO, -MR, Rt=50ms	SSOT-24	26cr	VD4	5a	Tor
FM	XC6223E361NR-G	LVR-IC	LDO, 3.6V±1%, 300mA, +CE, ICP	SSOT-24	26vn	VR4	5a	Tor
FN	MAX6314US34D4-T	Vdet-IC	3.4V±1.8%, -MR, -Reset Bidir, PPO, 1120ms	SOT-143	24vdh	VD5	5c	Max
FN	XC6109C50ANR	Vdet-IC	5.0V, +Reset PPO	SSOT-24	26ip	VD3	5c	Tor
FN	XC6119C50ANR	Vdet-IC	5.0V±2%, -Reset PPO	SSOT-24	26gh	VD3	5a	Tor
FĤ	XC6127C36ANR	Vdet-IC	3.6V±0.8%, -Reset PPO, -MR, Rt=50ms	SSOT-24	26cr	VD5	5a	Tor
FĤ	XC6127N36FNR	Vdet-IC	3.6V±0.8%, +Reset ODO, -MR, Rt=50ms	SSOT-24	26cr	VD4	5a	Tor
FN3	25C4865-3	Si-npn	VHF/UHF-Amp, 16V, 70mA, 200mW, B=60..120, 7GHz	SOT-143	26tu	-	5b	San
FN4	25C4865-4	Si-npn	VHF/UHF-Amp, 16V, 70mA, 200mW, B=90..180, 7GHz	SOT-143	26tu	-	5b	San
FN5	25C4865-5	Si-npn	VHF/UHF-Amp, 16V, 70mA, 200mW, B=130..270, 7GHz	SOT-143	26tu	-	5b	San
FO	MAX6314US33D4-T	Vdet-IC	3.3V±1.8%, -MR, -Reset Bidir, PPO, 1120ms	SOT-143	24vdh	VD5	5c	Max
FP	MAX6314US32D4-T	Vdet-IC	3.2V±1.8%, -MR, -Reset Bidir, PPO, 1120ms	SOT-143	24vdh	VD5	5c	Max
FĤ	XC6127C38ANR	Vdet-IC	3.8V±0.8%, -Reset PPO, -MR, Rt=50ms	SSOT-24	26cr	VD5	5a	Tor
FĤ	XC6127N38FNR	Vdet-IC	3.8V±0.8%, +Reset ODO, -MR, Rt=50ms	SSOT-24	26cr	VD4	5a	Tor
FP	XC6223E371NR-G	LVR-IC	LDO, 3.7V±1%, 300mA, +CE, ICP	SSOT-24	26vn	VR4	5a	Tor
FQ	AAT3528ICX-2.93-200	Vdet-IC	2.93V±1.5%, -Reset ODO, -MR	SOT-143	24vdh	VD4	5i	Ant
FQ	MAX6314US31D4-T	Vdet-IC	3.08V±1.8%, -MR, -Reset Bidir, PPO, 1120ms	SOT-143	24vdh	VD5	5c	Max
FR	MAX6314US30D4-T	Vdet-IC	3.0V±1.8%, -MR, -Reset Bidir, PPO, 1120ms	SOT-143	24vdh	VD5	5c	Max
FĤ	XC6127C40ANR	Vdet-IC	4.0V±0.8%, -Reset PPO, -MR, Rt=50ms	SSOT-24	26cr	VD5	5a	Tor
FĤ	XC6127N40FNR	Vdet-IC	4.0V±0.8%, +Reset ODO, -MR, Rt=50ms	SSOT-24	26cr	VD4	5a	Tor
FR	XC6223E381NR-G	LVR-IC	LDO, 3.8V±1%, 300mA, +CE, ICP	SSOT-24	26vn	VR4	5a	Tor
FS	MAX6314US29D4-T	Vdet-IC	2.93V±1.8%, -MR, -Reset Bidir, PPO, 1120ms	SOT-143	24vdh	VD5	5c	Max
FS	XC6127C42ANR	Vdet-IC	4.2V±0.8%, -Reset PPO, -MR, Rt=50ms	SSOT-24	26cr	VD5	5a	Tor
FĤ	XC6127N42FNR	Vdet-IC	4.2V±0.8%, +Reset ODO, -MR, Rt=50ms	SSOT-24	26cr	VD4	5a	Tor
FĤ	XC6223E391NR-G	LVR-IC	LDO, 3.9V±1%, 300mA, +CE, ICP	SSOT-24	26vn	VR4	5a	Tor
FT	MAX6314US28D4-T	Vdet-IC	2.8V±1.8%, -MR, -Reset Bidir, PPO, 1120ms	SOT-143	24vdh	VD5	5c	Max
FĤ	XC6127C44ANR	Vdet-IC	4.4V±0.8%, -Reset PPO, -MR, Rt=50ms	SSOT-24	26cr	VD5	5a	Tor
FĤ	XC6127N44FNR	Vdet-IC	4.4V±0.8%, +Reset ODO, -MR, Rt=50ms	SSOT-24	26cr	VD4	5a	Tor
FU	XC6223E401NR-G	LVR-IC	LDO, 4.0V±1%, 300mA, +CE, ICP	SSOT-24	26vn	VR4	5a	Tor
FU	MAX6314US27D4-T	Vdet-IC	2.7V±1.8%, -MR, -Reset Bidir, PPO, 1120ms	SOT-143	24vdh	VD5	5c	Max
FÜ	XC6127C46ANR	Vdet-IC	4.6V±0.8%, -Reset PPO, -MR, Rt=50ms	SSOT-24	26cr	VD5	5a	Tor
FÜ	XC6127N46FNR	Vdet-IC	4.6V±0.8%, +Reset ODO, -MR, Rt=50ms	SSOT-24	26cr	VD4	5a	Tor
FU	XC6224A261NR	LVR-IC	LDO, 2.6V±1.5%, 150mA, +CE	SSOT-24	26vn	VR4	5a	Tor
FV	MAX6314US26D4-T	Vdet-IC	2.63V±1.8%, -MR, -Reset Bidir, PPO, 1120ms	SOT-143	24vdh	VD5	5c	Max
FV	XC6127C48ANR	Vdet-IC	4.8V±0.8%, -Reset PPO, -MR, Rt=50ms	SSOT-24	26cr	VD5	5a	Tor
FV	XC6127N48FNR	Vdet-IC	4.8V±0.8%, +Reset ODO, -MR, Rt=50ms	SSOT-24	26cr	VD4	5a	Tor
FV	XC6224A271NR	LVR-IC	LDO, 2.7V±1.5%, 150mA, +CE	SSOT-24	26vn	VR4	5a	Tor
FW	MAX6314US25D4-T	Vdet-IC	2.5V±1.8%, -MR, -Reset Bidir, PPO, 1120ms	SOT-143	24vdh	VD5	5c	Max
FX	MAX6315US50D1-T	Vdet-IC	5.0V±1.8%, -MR, -Reset ODO, 1ms	SOT-143	24vdh	VD4	5c	Max
FĤ	XC6127C50ANR	Vdet-IC	5.0V±0.8%, -Reset PPO, -MR, Rt=50ms	SSOT-24	26cr	VD5	5a	Tor
FĤ	XC6127N50FNR	Vdet-IC	5.0V±0.8%, +Reset ODO, -MR, Rt=50ms	SSOT-24	26cr	VD4	5a	Tor
FX	XC6224A281NR	LVR-IC	LDO, 2.8V±1.5%, 150mA, +CE	SSOT-24	26vn	VR4	5a	Tor
FY	MAX6315US49D1-T	Vdet-IC	4.9V±1.8%, -MR, -Reset ODO, 1ms	SOT-143	24vdh	VD4	5c	Max
FY	XC6127C52ANR	Vdet-IC	5.2V±0.8%, -Reset PPO, -MR, Rt=50ms	SSOT-24	26cr	VD5	5a	Tor
FY	XC6127N52FNR	Vdet-IC	5.2V±0.8%, +Reset ODO, -MR, Rt=50ms	SSOT-24	26cr	VD4	5a	Tor
FY	XC6224A291NR	LVR-IC	LDO, 2.9V±1.5%, 150mA, +CE	SSOT-24	26vn	VR4	5a	Tor

Note: ELM75xxCCB series LN- lot number L=0...9 N=A to Z(I, O, X excepted); ELM75xxNCB series LN- lot number L=A to Z(I, O, X excepted) N=0...9



SMD code	Type	Function	Short description	Case	Pinout	Sch.	St.	Mnf.
FZ	MAX6315US48D1-T	Vdet-IC	4.8V±1.8%, -MR, -Reset ODO, 1ms	SOT-143	24wdh	VD4	5c	Max
FZ	XC6127C54ANR	Vdet-IC	5.4V±0.8%, -Reset PPO, -MR, Rt=50ms	SSOT-24	26cr	VD5	5a	Tor
FZ	XC6127N54FNR	Vdet-IC	5.4V±0.8%, +Reset ODO, -MR, Rt=50ms	SSOT-24	26cr	VD4	5a	Tor
FZ	XC6224A301NLR	LVR-IC	LDO, 3.0V±1.5%, 150mA, +CE	SSOT-24	26vn	VR4	5a	Tor
G0	R1140Q301D	LVR-IC	LDO, 3V±2%, 120mA, +CE, CL	SOT-143R	26vm	VR4	5a	Ric
G0	R3114Q171C	Vdet-IC	1.7V±0.8%, -Reset PPO	SC-82AB	26vdl	VD7	5a	Ric
G0	RP103Q121B	LVR-IC	LDO, 1.2V±1%, 150mA, +CE	SC-82AB	26vn	VR4	5a	Ric
G1	R1140Q311D	LVR-IC	LDO, 3.1V±2%, 120mA, +CE, CL	SOT-143R	26vm	VR4	5a	Ric
G1	R3114Q181C	Vdet-IC	1.8V±0.8%, -Reset PPO	SC-82AB	26vdl	VD7	5a	Ric
G1	RP103Q131B	LVR-IC	LDO, 1.3V±1%, 150mA, +CE	SC-82AB	26vn	VR4	5a	Ric
G2	CGY50	MMIC	GaAs UHF amp. 5.5..7.5V, 0.1..3GHz (30dB)	SOT-143	24aj	A1	5h	Inf
G2	R1140Q321D	LVR-IC	LDO, 3.2V±2%, 120mA, +CE, CL	SOT-143R	26vm	VR4	5a	Ric
G2	R3114Q191C	Vdet-IC	1.9V±0.8%, -Reset PPO	SC-82AB	26vdl	VD7	5a	Ric
G2	RP103Q151B	LVR-IC	LDO, 1.5V±1%, 150mA, +CE	SC-82AB	26vn	VR4	5a	Ric
G3	FP6801-24CC8P	Vdet-IC	2.4V±2%, -Reset PPO	SC-82	26vdf	VD3	5b	Fit
G3	R1140Q331D	LVR-IC	LDO, 3.3V±2%, 120mA, +CE, CL	SOT-143R	26vm	VR4	5a	Ric
G3	R3114Q201C	Vdet-IC	2V±0.8%, -Reset PPO	SC-82AB	26vdl	VD7	5a	Ric
G3	RP103Q181B	LVR-IC	LDO, 1.8V±1%, 150mA, +CE	SC-82AB	26vn	VR4	5a	Ric
G4	FP6801-27CC8P	Vdet-IC	2.7V±2%, -Reset PPO	SC-82	26vdf	VD3	5b	Fit
G4	R1140Q341D	LVR-IC	LDO, 3.4V±2%, 120mA, +CE, CL	SOT-143R	26vm	VR4	5a	Ric
G4	R3114Q211C	Vdet-IC	2.1V±0.8%, -Reset PPO	SC-82AB	26vdl	VD7	5a	Ric
G4	RP103Q181B5	LVR-IC	LDO, 1.85V±1%, 150mA, +CE	SC-82AB	26vn	VR4	5a	Ric
G5	FP6801-24NC8P	Vdet-IC	2.4V±2%, -Reset ODO	SC-82	26vdf	VD1	5b	Fit
G5	R1140Q351D	LVR-IC	LDO, 3.5V±2%, 120mA, +CE, CL	SOT-143R	26vm	VR4	5a	Ric
G5	R3114Q221C	Vdet-IC	2.2V±0.8%, -Reset PPO	SC-82AB	26vdl	VD7	5a	Ric
G5	RP103Q191B	LVR-IC	LDO, 1.9V±1%, 150mA, +CE	SC-82AB	26vn	VR4	5a	Ric
G6	FP6801-27NC8P	Vdet-IC	2.7V±2%, -Reset ODO	SC-82	26vdf	VD1	5b	Fit
G6	R1140Q361D	LVR-IC	LDO, 3.6V±2%, 120mA, +CE, CL	SOT-143R	26vm	VR4	5a	Ric
G6	R3114Q231C	Vdet-IC	2.3V±0.8%, -Reset PPO	SC-82AB	26vdl	VD7	5a	Ric
G6	RP103Q201B	LVR-IC	LDO, 2V±1%, 150mA, +CE	SC-82AB	26vn	VR4	5a	Ric
G60	S-80930CLNB	Vdet-IC	3.0V±2%, -Reset PPO	SC-82AB	26vdf	VD3	5d	Sii
G60	S-80930CLPF	Vdet-IC	3.0V±2%, -Reset ODO	SNT-4A	42hx	VD13	5e	Sii
G61	S-80931CLNB	Vdet-IC	3.1V±2%, -Reset PPO	SC-82AB	26vdf	VD3	5d	Sii
G61	S-80931CLPF	Vdet-IC	3.1V±2%, -Reset ODO	SNT-4A	42hx	VD13	5e	Sii
G62	S-80932CLNB	Vdet-IC	3.2V±2%, -Reset PPO	SC-82AB	26vdf	VD3	5d	Sii
G62	S-80932CLPF	Vdet-IC	3.2V±2%, -Reset ODO	SNT-4A	42hx	VD13	5e	Sii
G63	S-80933CLNB	Vdet-IC	3.3V±2%, -Reset PPO	SC-82AB	26vdf	VD3	5d	Sii
G63	S-80933CLPF	Vdet-IC	3.3V±2%, -Reset ODO	SNT-4A	42hx	VD13	5e	Sii
G64	S-80934CLNB	Vdet-IC	3.4V±2%, -Reset PPO	SC-82AB	26vdf	VD3	5d	Sii
G64	S-80934CLPF	Vdet-IC	3.4V±2%, -Reset ODO	SNT-4A	42hx	VD13	5e	Sii
G65	S-80935CLNB	Vdet-IC	3.5V±2%, -Reset PPO	SC-82AB	26vdf	VD3	5d	Sii
G65	S-80935CLPF	Vdet-IC	3.5V±2%, -Reset ODO	SNT-4A	42hx	VD13	5e	Sii
G66	S-80936CLNB	Vdet-IC	3.6V±2%, -Reset PPO	SC-82AB	26vdf	VD3	5d	Sii
G66	S-80936CLPF	Vdet-IC	3.6V±2%, -Reset ODO	SNT-4A	42hx	VD13	5e	Sii
G67	S-80937CLNB	Vdet-IC	3.7V±2%, -Reset PPO	SC-82AB	26vdf	VD3	5d	Sii
G67	S-80937CLPF	Vdet-IC	3.7V±2%, -Reset ODO	SNT-4A	42hx	VD13	5e	Sii
G68	S-80938CLNB	Vdet-IC	3.8V±2%, -Reset PPO	SC-82AB	26vdf	VD3	5d	Sii
G68	S-80938CLPF	Vdet-IC	3.8V±2%, -Reset ODO	SNT-4A	42hx	VD13	5e	Sii
G69	S-80939CLNB	Vdet-IC	3.9V±2%, -Reset PPO	SC-82AB	26vdf	VD3	5d	Sii
G69	S-80939CLPF	Vdet-IC	3.9V±2%, -Reset ODO	SNT-4A	42hx	VD13	5e	Sii
G6H	S-80913CLNB	Vdet-IC	1.3V±2%, -Reset PPO	SC-82AB	26vdf	VD3	5d	Sii
G6H	S-80913CLPF	Vdet-IC	1.3V±2%, -Reset ODO	SNT-4A	42hx	VD13	5e	Sii
G6J	S-80914CLNB	Vdet-IC	1.4V±2%, -Reset PPO	SC-82AB	26vdf	VD3	5d	Sii
G6J	S-80914CLPF	Vdet-IC	1.4V±2%, -Reset ODO	SNT-4A	42hx	VD13	5e	Sii
G6K	S-80915CLNB	Vdet-IC	1.5V±2%, -Reset PPO	SC-82AB	26vdf	VD3	5d	Sii
G6K	S-80915CLPF	Vdet-IC	1.5V±2%, -Reset ODO	SNT-4A	42hx	VD13	5e	Sii
G6L	S-80916CLNB	Vdet-IC	1.6V±2%, -Reset PPO	SC-82AB	26vdf	VD3	5d	Sii
G6L	S-80916CLPF	Vdet-IC	1.6V±2%, -Reset ODO	SNT-4A	42hx	VD13	5e	Sii
G6M	S-80917CLNB	Vdet-IC	1.7V±2%, -Reset PPO	SC-82AB	26vdf	VD3	5d	Sii
G6M	S-80917CLPF	Vdet-IC	1.7V±2%, -Reset ODO	SNT-4A	42hx	VD13	5e	Sii
G6N	S-80918CLNB	Vdet-IC	1.8V±2%, -Reset PPO	SC-82AB	26vdf	VD3	5d	Sii
G6N	S-80918CLPF	Vdet-IC	1.8V±2%, -Reset ODO	SNT-4A	42hx	VD13	5e	Sii
G6P	S-80919CLNB	Vdet-IC	1.9V±2%, -Reset PPO	SC-82AB	26vdf	VD3	5d	Sii
G6P	S-80919CLPF	Vdet-IC	1.9V±2%, -Reset ODO	SNT-4A	42hx	VD13	5e	Sii
G6Q	S-80920CLNB	Vdet-IC	2.0V±2%, -Reset PPO	SC-82AB	26vdf	VD3	5d	Sii
G6Q	S-80920CLPF	Vdet-IC	2.0V±2%, -Reset ODO	SNT-4A	42hx	VD13	5e	Sii
G6R	S-80921CLNB	Vdet-IC	2.1V±2%, -Reset PPO	SC-82AB	26vdf	VD3	5d	Sii
G6R	S-80921CLPF	Vdet-IC	2.1V±2%, -Reset ODO	SNT-4A	42hx	VD13	5e	Sii
G6S	S-80922CLNB	Vdet-IC	2.2V±2%, -Reset PPO	SC-82AB	26vdf	VD3	5d	Sii
G6S	S-80922CLPF	Vdet-IC	2.2V±2%, -Reset ODO	SNT-4A	42hx	VD13	5e	Sii



SMD code	Type	Function	Short description	Case	Pinout	Sch.	St.	Mnf.
G6T	S-80923CLNB	Vdet-IC	2.3V±2%, -Reset PPO	SC-82AB	26vdf	VD3	5d	Sii
G6T	S-80923CLPF	Vdet-IC	2.3V±2%, -Reset ODO	SNT-4A	42hx	VD13	5e	Sii
G6U	S-80924CLNB	Vdet-IC	2.4V±2%, -Reset PPO	SC-82AB	26vdf	VD3	5d	Sii
G6U	S-80924CLPF	Vdet-IC	2.4V±2%, -Reset ODO	SNT-4A	42hx	VD13	5e	Sii
G6V	S-80925CLNB	Vdet-IC	2.5V±2%, -Reset PPO	SC-82AB	26vdf	VD3	5d	Sii
G6V	S-80925CLPF	Vdet-IC	2.5V±2%, -Reset ODO	SNT-4A	42hx	VD13	5e	Sii
G6W	S-80926CLNB	Vdet-IC	2.6V±2%, -Reset PPO	SC-82AB	26vdf	VD3	5d	Sii
G6W	S-80926CLPF	Vdet-IC	2.6V±2%, -Reset ODO	SNT-4A	42hx	VD13	5e	Sii
G6X	S-80927CLNB	Vdet-IC	2.7V±2%, -Reset PPO	SC-82AB	26vdf	VD3	5d	Sii
G6X	S-80927CLPF	Vdet-IC	2.7V±2%, -Reset ODO	SNT-4A	42hx	VD13	5e	Sii
G6Y	S-80928CLNB	Vdet-IC	2.8V±2%, -Reset PPO	SC-82AB	26vdf	VD3	5d	Sii
G6Y	S-80928CLPF	Vdet-IC	2.8V±2%, -Reset ODO	SNT-4A	42hx	VD13	5e	Sii
G6Z	S-80929CLNB	Vdet-IC	2.9V±2%, -Reset PPO	SC-82AB	26vdf	VD3	5d	Sii
G6Z	S-80929CLPF	Vdet-IC	2.9V±2%, -Reset ODO	SNT-4A	42hx	VD13	5e	Sii
G7	R1140Q371D	LVR-IC	LDO, 3.7V±2%, 120mA, +CE, CL	SOT-143R	26vm	VR4	5a	Ric
G7	R3114Q241C	Vdet-IC	2.4V±0.8%, -Reset PPO	SC-82AB	26vdl	VD7	5a	Ric
G7	RP103Q251B	LVR-IC	LDO, 2.5V±1%, 150mA, +CE	SC-82AB	26vn	VR4	5a	Ric
G7A	S-80940CLNB	Vdet-IC	4.0V±2%, -Reset PPO	SC-82AB	26vdf	VD3	5d	Sii
G7A	S-80940CLPF	Vdet-IC	4.0V±2%, -Reset ODO	SNT-4A	42hx	VD13	5e	Sii
G7B	S-80941CLNB	Vdet-IC	4.1V±2%, -Reset PPO	SC-82AB	26vdf	VD3	5d	Sii
G7B	S-80941CLPF	Vdet-IC	4.1V±2%, -Reset ODO	SNT-4A	42hx	VD13	5e	Sii
G7C	S-80942CLNB	Vdet-IC	4.2V±2%, -Reset PPO	SC-82AB	26vdf	VD3	5d	Sii
G7C	S-80942CLPF	Vdet-IC	4.2V±2%, -Reset ODO	SNT-4A	42hx	VD13	5e	Sii
G7D	S-80943CLNB	Vdet-IC	4.3V±2%, -Reset PPO	SC-82AB	26vdf	VD3	5d	Sii
G7D	S-80943CLPF	Vdet-IC	4.3V±2%, -Reset ODO	SNT-4A	42hx	VD13	5e	Sii
G7E	S-80944CLNB	Vdet-IC	4.4V±2%, -Reset PPO	SC-82AB	26vdf	VD3	5d	Sii
G7E	S-80944CLPF	Vdet-IC	4.4V±2%, -Reset ODO	SNT-4A	42hx	VD13	5e	Sii
G7F	S-80945CLNB	Vdet-IC	4.5V±2%, -Reset PPO	SC-82AB	26vdf	VD3	5d	Sii
G7F	S-80945CLPF	Vdet-IC	4.5V±2%, -Reset ODO	SNT-4A	42hx	VD13	5e	Sii
G7G	S-80946CLNB	Vdet-IC	4.6V±2%, -Reset PPO	SC-82AB	26vdf	VD3	5d	Sii
G7G	S-80946CLPF	Vdet-IC	4.6V±2%, -Reset ODO	SNT-4A	42hx	VD13	5e	Sii
G7H	S-80947CLNB	Vdet-IC	4.7V±2%, -Reset PPO	SC-82AB	26vdf	VD3	5d	Sii
G7H	S-80947CLPF	Vdet-IC	4.7V±2%, -Reset ODO	SNT-4A	42hx	VD13	5e	Sii
G7J	S-80948CLNB	Vdet-IC	4.8V±2%, -Reset PPO	SC-82AB	26vdf	VD3	5d	Sii
G7J	S-80948CLPF	Vdet-IC	4.8V±2%, -Reset ODO	SNT-4A	42hx	VD13	5e	Sii
G7K	S-80949CLNB	Vdet-IC	4.9V±2%, -Reset PPO	SC-82AB	26vdf	VD3	5d	Sii
G7K	S-80949CLPF	Vdet-IC	4.9V±2%, -Reset ODO	SNT-4A	42hx	VD13	5e	Sii
G7L	S-80950CLNB	Vdet-IC	5.0V±2%, -Reset PPO	SC-82AB	26vdf	VD3	5d	Sii
G7L	S-80950CLPF	Vdet-IC	5.0V±2%, -Reset ODO	SNT-4A	42hx	VD13	5e	Sii
G7M	S-80951CLNB	Vdet-IC	5.1V±2%, -Reset PPO	SC-82AB	26vdf	VD3	5d	Sii
G7M	S-80951CLPF	Vdet-IC	5.1V±2%, -Reset ODO	SNT-4A	42hx	VD13	5e	Sii
G7N	S-80952CLNB	Vdet-IC	5.2V±2%, -Reset PPO	SC-82AB	26vdf	VD3	5d	Sii
G7N	S-80952CLPF	Vdet-IC	5.2V±2%, -Reset ODO	SNT-4A	42hx	VD13	5e	Sii
G7P	S-80953CLNB	Vdet-IC	5.3V±2%, -Reset PPO	SC-82AB	26vdf	VD3	5d	Sii
G7P	S-80953CLPF	Vdet-IC	5.3V±2%, -Reset ODO	SNT-4A	42hx	VD13	5e	Sii
G7Q	S-80954CLNB	Vdet-IC	5.4V±2%, -Reset PPO	SC-82AB	26vdf	VD3	5d	Sii
G7Q	S-80954CLPF	Vdet-IC	5.4V±2%, -Reset ODO	SNT-4A	42hx	VD13	5e	Sii
G7R	S-80955CLNB	Vdet-IC	5.5V±2%, -Reset PPO	SC-82AB	26vdf	VD3	5d	Sii
G7R	S-80955CLPF	Vdet-IC	5.5V±2%, -Reset ODO	SNT-4A	42hx	VD13	5e	Sii
G7S	S-80956CLNB	Vdet-IC	5.6V±2%, -Reset PPO	SC-82AB	26vdf	VD3	5d	Sii
G7S	S-80956CLPF	Vdet-IC	5.6V±2%, -Reset ODO	SNT-4A	42hx	VD13	5e	Sii
G7T	S-80957CLNB	Vdet-IC	5.7V±2%, -Reset PPO	SC-82AB	26vdf	VD3	5d	Sii
G7T	S-80957CLPF	Vdet-IC	5.7V±2%, -Reset ODO	SNT-4A	42hx	VD13	5e	Sii
G7U	S-80958CLNB	Vdet-IC	5.8V±2%, -Reset PPO	SC-82AB	26vdf	VD3	5d	Sii
G7U	S-80958CLPF	Vdet-IC	5.8V±2%, -Reset ODO	SNT-4A	42hx	VD13	5e	Sii
G7V	S-80959CLNB	Vdet-IC	5.9V±2%, -Reset PPO	SC-82AB	26vdf	VD3	5d	Sii
G7V	S-80959CLPF	Vdet-IC	5.9V±2%, -Reset ODO	SNT-4A	42hx	VD13	5e	Sii
G7W	S-80960CLNB	Vdet-IC	6.0V±2%, -Reset PPO	SC-82AB	26vdf	VD3	5d	Sii
G7W	S-80960CLPF	Vdet-IC	6.0V±2%, -Reset ODO	SNT-4A	42hx	VD13	5e	Sii
G8	R1140Q381D	LVR-IC	LDO, 3.8V±2%, 120mA, +CE, CL	SOT-143R	26vm	VR4	5a	Ric
G8	R3114Q251C	Vdet-IC	2.5V±0.8%, -Reset PPO	SC-82AB	26vdl	VD7	5a	Ric
G8	RP103Q261B	LVR-IC	LDO, 2.6V±1%, 150mA, +CE	SC-82AB	26vn	VR4	5a	Ric
G80	S-80930CNNB	Vdet-IC	3.0V±2%, -Reset ODO	SC-82AB	26vdf	VD13	5d	Sii
G80	S-80930CNPF	Vdet-IC	3.0V±2%, -Reset PPO	SNT-4A	42hx	VD3	5e	Sii
G81	S-80931CNNB	Vdet-IC	3.1V±2%, -Reset ODO	SC-82AB	26vdf	VD13	5d	Sii
G81	S-80931CNPF	Vdet-IC	3.1V±2%, -Reset PPO	SNT-4A	42hx	VD3	5e	Sii
G82	S-80932CNNB	Vdet-IC	3.2V±2%, -Reset ODO	SC-82AB	26vdf	VD13	5d	Sii
G82	S-80932CNPF	Vdet-IC	3.2V±2%, -Reset PPO	SNT-4A	42hx	VD3	5e	Sii
G83	S-80933CNNB	Vdet-IC	3.3V±2%, -Reset ODO	SC-82AB	26vdf	VD13	5d	Sii
G83	S-80933CNPF	Vdet-IC	3.3V±2%, -Reset PPO	SNT-4A	42hx	VD3	5e	Sii



SMD
code

Type

Function

Short description

Case

Pinout Sch.

St. Mnf.

SMD code	Type	Function	Short description	Case	Pinout Sch.	St.	Mnf.
G84	S-80934CNNB	Vdet-IC	3.4V±2%, -Reset ODO	SC-82AB	26vdf VD13	5d	Sii
G84	S-80934CNPF	Vdet-IC	3.4V±2%, -Reset PPO	SNT-4A	42hx VD3	5e	Sii
G85	S-80935CNNB	Vdet-IC	3.5V±2%, -Reset ODO	SC-82AB	26vdf VD13	5d	Sii
G85	S-80935CNPF	Vdet-IC	3.5V±2%, -Reset PPO	SNT-4A	42hx VD3	5e	Sii
G86	S-80936CNNB	Vdet-IC	3.6V±2%, -Reset ODO	SC-82AB	26vdf VD13	5d	Sii
G86	S-80936CNPF	Vdet-IC	3.6V±2%, -Reset PPO	SNT-4A	42hx VD3	5e	Sii
G87	S-80937CNNB	Vdet-IC	3.7V±2%, -Reset ODO	SC-82AB	26vdf VD13	5d	Sii
G87	S-80937CNPF	Vdet-IC	3.7V±2%, -Reset PPO	SNT-4A	42hx VD3	5e	Sii
G88	S-80938CNNB	Vdet-IC	3.8±V2.0%, -Reset ODO	SC-82AB	26vdf VD13	5d	Sii
G88	S-80938CNPF	Vdet-IC	3.8±V2.0%, -Reset PPO	SNT-4A	42hx VD3	5e	Sii
G89	S-80939CNNB	Vdet-IC	3.9V±2%, -Reset ODO	SC-82AB	26vdf VD13	5d	Sii
G89	S-80939CNPF	Vdet-IC	3.9V±2%, -Reset PPO	SNT-4A	42hx VD3	5e	Sii
G8H	S-80913CNNB	Vdet-IC	1.3V±2%, -Reset ODO	SC-82AB	26vdf VD13	5d	Sii
G8H	S-80913CNPF	Vdet-IC	1.3V±2%, -Reset PPO	SNT-4A	42hx VD3	5e	Sii
G8J	S-80914CNNB	Vdet-IC	1.4V±2%, -Reset ODO	SC-82AB	26vdf VD13	5d	Sii
G8J	S-80914CNPF	Vdet-IC	1.4V±2%, -Reset PPO	SNT-4A	42hx VD3	5e	Sii
G8K	S-80915CNNB	Vdet-IC	1.5V±2%, -Reset ODO	SC-82AB	26vdf VD13	5d	Sii
G8K	S-80915CNPF	Vdet-IC	1.5V±2%, -Reset PPO	SNT-4A	42hx VD3	5e	Sii
G8L	S-80916CNNB	Vdet-IC	1.6V±2%, -Reset ODO	SC-82AB	26vdf VD13	5d	Sii
G8L	S-80916CNPF	Vdet-IC	1.6V±2%, -Reset PPO	SNT-4A	42hx VD3	5e	Sii
G8M	S-80917CNNB	Vdet-IC	1.7V±2%, -Reset ODO	SC-82AB	26vdf VD13	5d	Sii
G8M	S-80917CNPF	Vdet-IC	1.7V±2%, -Reset PPO	SNT-4A	42hx VD3	5e	Sii
G8N	S-80918CNNB	Vdet-IC	1.8V±2%, -Reset ODO	SC-82AB	26vdf VD13	5d	Sii
G8N	S-80918CNPF	Vdet-IC	1.8V±2%, -Reset PPO	SNT-4A	42hx VD3	5e	Sii
G8P	S-80919CNNB	Vdet-IC	1.9V±2%, -Reset ODO	SC-82AB	26vdf VD13	5d	Sii
G8P	S-80919CNPF	Vdet-IC	1.9V±2%, -Reset PPO	SNT-4A	42hx VD3	5e	Sii
G8Q	S-80920CNNB	Vdet-IC	2.0V±2%, -Reset ODO	SC-82AB	26vdf VD13	5d	Sii
G8Q	S-80920CNPF	Vdet-IC	2.0V±2%, -Reset PPO	SNT-4A	42hx VD3	5e	Sii
G8R	S-80921CNNB	Vdet-IC	2.1V±2%, -Reset ODO	SC-82AB	26vdf VD13	5d	Sii
G8R	S-80921CNPF	Vdet-IC	2.1V±2%, -Reset PPO	SNT-4A	42hx VD3	5e	Sii
G8S	S-80922CNNB	Vdet-IC	2.2V±2%, -Reset ODO	SC-82AB	26vdf VD13	5d	Sii
G8S	S-80922CNPF	Vdet-IC	2.2V±2%, -Reset PPO	SNT-4A	42hx VD3	5e	Sii
G8T	S-80923CNNB	Vdet-IC	2.3V±2%, -Reset ODO	SC-82AB	26vdf VD13	5d	Sii
G8T	S-80923CNPF	Vdet-IC	2.3V±2%, -Reset PPO	SNT-4A	42hx VD3	5e	Sii
G8U	S-80924CNNB	Vdet-IC	2.4V±2%, -Reset ODO	SC-82AB	26vdf VD13	5d	Sii
G8U	S-80924CNPF	Vdet-IC	2.4V±2%, -Reset PPO	SNT-4A	42hx VD3	5e	Sii
G8V	S-80925CNNB	Vdet-IC	2.5V±2%, -Reset ODO	SC-82AB	26vdf VD13	5d	Sii
G8V	S-80925CNPF	Vdet-IC	2.5V±2%, -Reset PPO	SNT-4A	42hx VD3	5e	Sii
G8W	S-80926CNNB	Vdet-IC	2.6V±2%, -Reset ODO	SC-82AB	26vdf VD13	5d	Sii
G8W	S-80926CNPF	Vdet-IC	2.6V±2%, -Reset PPO	SNT-4A	42hx VD3	5e	Sii
G8X	S-80927CNNB	Vdet-IC	2.7V±2%, -Reset ODO	SC-82AB	26vdf VD13	5d	Sii
G8X	S-80927CNPF	Vdet-IC	2.7V±2%, -Reset PPO	SNT-4A	42hx VD3	5e	Sii
G8Y	S-80928CNNB	Vdet-IC	2.8V±2%, -Reset ODO	SC-82AB	26vdf VD13	5d	Sii
G8Y	S-80928CNPF	Vdet-IC	2.8V±2%, -Reset PPO	SNT-4A	42hx VD3	5e	Sii
G8Z	S-80929CNNB	Vdet-IC	2.9V±2%, -Reset ODO	SC-82AB	26vdf VD13	5d	Sii
G8Z	S-80929CNPF	Vdet-IC	2.9V±2%, -Reset PPO	SNT-4A	42hx VD3	5e	Sii
G9	R1140Q391D	LVR-IC	LDO, 3.9V±2%, 120mA, +CE, CL	SOT-143R	26vm VR4	5a	Ric
G9	R3114Q261C	LVR-IC	2.6V±0.8%, -Reset PPO	SC-82AB	26vdl VD7	5a	Ric
G9	RP103Q271B	LVR-IC	LDO, 2.7V±1%, 150mA, +CE	SC-82AB	26vm VR4	5a	Ric
G9A	S-80940CNNB	Vdet-IC	4.0V±2%, -Reset ODO	SC-82AB	26vdf VD13	5d	Sii
G9A	S-80940CNPF	Vdet-IC	4.0V±2%, -Reset PPO	SNT-4A	42hx VD3	5e	Sii
G9B	S-80941CNNB	Vdet-IC	4.1V±2%, -Reset ODO	SC-82AB	26vdf VD13	5d	Sii
G9B	S-80941CNPF	Vdet-IC	4.1V±2%, -Reset PPO	SNT-4A	42hx VD3	5e	Sii
G9C	S-80942CNNB	Vdet-IC	4.2V±2%, -Reset ODO	SC-82AB	26vdf VD13	5d	Sii
G9C	S-80942CNPF	Vdet-IC	4.2V±2%, -Reset PPO	SNT-4A	42hx VD3	5e	Sii
G9D	S-80943CNNB	Vdet-IC	4.3V±2%, -Reset ODO	SC-82AB	26vdf VD13	5d	Sii
G9D	S-80943CNPF	Vdet-IC	4.3V±2%, -Reset PPO	SNT-4A	42hx VD3	5e	Sii
G9E	S-80944CNNB	Vdet-IC	4.4V±2%, -Reset ODO	SC-82AB	26vdf VD13	5d	Sii
G9E	S-80944CNPF	Vdet-IC	4.4V±2%, -Reset PPO	SNT-4A	42hx VD3	5e	Sii
G9F	S-80945CNNB	Vdet-IC	4.5V±2%, -Reset ODO	SC-82AB	26vdf VD13	5d	Sii
G9F	S-80945CNPF	Vdet-IC	4.5V±2%, -Reset PPO	SNT-4A	42hx VD3	5e	Sii
G9G	S-80946CNNB	Vdet-IC	4.6V±2%, -Reset ODO	SC-82AB	26vdf VD13	5d	Sii
G9G	S-80946CNPF	Vdet-IC	4.6V±2%, -Reset PPO	SNT-4A	42hx VD3	5e	Sii
G9H	S-80947CNNB	Vdet-IC	4.7V±2%, -Reset ODO	SC-82AB	26vdf VD13	5d	Sii
G9H	S-80947CNPF	Vdet-IC	4.7V±2%, -Reset PPO	SNT-4A	42hx VD3	5e	Sii
G9J	S-80948CNNB	Vdet-IC	4.8V±2%, -Reset ODO	SC-82AB	26vdf VD13	5d	Sii
G9J	S-80948CNPF	Vdet-IC	4.8V±2%, -Reset PPO	SNT-4A	42hx VD3	5e	Sii
G9K	S-80949CNNB	Vdet-IC	4.9V±2%, -Reset ODO	SC-82AB	26vdf VD13	5d	Sii
G9K	S-80949CNPF	Vdet-IC	4.9V±2%, -Reset PPO	SNT-4A	42hx VD3	5e	Sii
G9L	S-80950CNNB	Vdet-IC	5.0V±2%, -Reset ODO	SC-82AB	26vdf VD13	5d	Sii



SMD code	Type	Function	Short description	Case	Pinout	Sch.	St.	Mnf.
G9L	S-80950CNPF	Vdet-IC	5.0V±2%, -Reset PPO	SNT-4A	42hx	VD3	5e	Sii
G9M	S-80951CNNB	Vdet-IC	5.1V±2%, -Reset ODO	SC-82AB	26vdf	VD13	5d	Sii
G9N	S-80951CNPF	Vdet-IC	5.1V±2%, -Reset PPO	SNT-4A	42hx	VD3	5e	Sii
G9O	S-80952CNNB	Vdet-IC	5.2V±2%, -Reset ODO	SC-82AB	26vdf	VD13	5d	Sii
G9P	S-80952CNPF	Vdet-IC	5.2V±2%, -Reset PPO	SNT-4A	42hx	VD3	5e	Sii
G9Q	S-80953CNNB	Vdet-IC	5.3V±2%, -Reset ODO	SC-82AB	26vdf	VD13	5d	Sii
G9R	S-80953CNPF	Vdet-IC	5.3V±2%, -Reset PPO	SNT-4A	42hx	VD3	5e	Sii
G9S	S-80954CNNB	Vdet-IC	5.4V±2%, -Reset ODO	SC-82AB	26vdf	VD13	5d	Sii
G9T	S-80954CNPF	Vdet-IC	5.4V±2%, -Reset PPO	SNT-4A	42hx	VD3	5e	Sii
G9U	S-80955CNNB	Vdet-IC	5.5V±2%, -Reset ODO	SC-82AB	26vdf	VD13	5d	Sii
G9V	S-80955CNPF	Vdet-IC	5.5V±2%, -Reset PPO	SNT-4A	42hx	VD3	5e	Sii
G9W	S-80956CNNB	Vdet-IC	5.6V±2%, -Reset ODO	SC-82AB	26vdf	VD13	5d	Sii
G9X	S-80956CNPF	Vdet-IC	5.6V±2%, -Reset PPO	SNT-4A	42hx	VD3	5e	Sii
G9Y	S-80957CNNB	Vdet-IC	5.7V±2%, -Reset ODO	SC-82AB	26vdf	VD13	5d	Sii
G9Z	S-80957CNPF	Vdet-IC	5.7V±2%, -Reset PPO	SNT-4A	42hx	VD3	5e	Sii
G9A	S-80958CNNB	Vdet-IC	5.8V±2%, -Reset ODO	SC-82AB	26vdf	VD13	5d	Sii
G9B	S-80958CNPF	Vdet-IC	5.8V±2%, -Reset PPO	SNT-4A	42hx	VD3	5e	Sii
G9C	S-80959CNNB	Vdet-IC	5.9V±2%, -Reset ODO	SC-82AB	26vdf	VD13	5d	Sii
G9D	S-80959CNPF	Vdet-IC	5.9V±2%, -Reset PPO	SNT-4A	42hx	VD3	5e	Sii
G9E	S-80960CNNB	Vdet-IC	6.0V±2%, -Reset ODO	SC-82AB	26vdf	VD13	5d	Sii
G9F	S-80960CNPF	Vdet-IC	6.0V±2%, -Reset PPO	SNT-4A	42hx	VD3	5e	Sii
GA	MAX6315US47D1-T	Vdet-IC	4.7V±1.8%, -MR, -Reset ODO, 1ms	SOT-143	24vdh	VD4	5c	Max
GA	R1141Q301D	LVR-IC	LDO, 3V±2%, 120mA, +CE, CL	SOT-143R	26vm	VR4	5a	Ric
GA	RP130Q211B	LVR-IC	LDO, LN, +CE, 2.1V±1%, 150mA	SC-82AB	26vn	VR4	5a	Ric
GB	MAX6315US46D1-T	Vdet-IC	4.63V±1.8%, -MR, -Reset ODO, 1ms	SOT-143	24vdh	VD4	5c	Max
GB	R1141Q311D	LVR-IC	LDO, 3.1V±2%, 120mA, +CE, CL	SOT-143R	26vm	VR4	5a	Ric
GB	RP130Q221B	LVR-IC	LDO, LN, +CE, 2.2V±1%, 150mA	SC-82AB	26vn	VR4	5a	Ric
GC	AAT3526ICX-4.38-200	Vdet-IC	4.38V±1.5%, -Reset PPO, -MR	SOT-143	24vdh	VD5	5i	Ant
GC	MAX6315US45D1-T	Vdet-IC	4.5V±1.8%, -MR, -Reset ODO, 1ms	SOT-143	24vdh	VD4	5c	Max
GC	R1141Q321D	LVR-IC	LDO, 3.2V±2%, 120mA, +CE, CL	SOT-143R	26vm	VR4	5a	Ric
GC	RP130Q231B	LVR-IC	LDO, LN, +CE, 2.3V±1%, 150mA	SC-82AB	26vn	VR4	5a	Ric
GD	FP6801-22NC8P	Vdet-IC	2.2V±2%, -Reset ODO	SC-82	26vdf	VD1	5b	Fit
GD	MAX6315US44D1-T	Vdet-IC	4.39V±1.8%, -MR, -Reset ODO, 1ms	SOT-143	24vdh	VD4	5c	Max
GD	R1141Q331D	LVR-IC	LDO, 3.3V±2%, 120mA, +CE, CL	SOT-143R	26vm	VR4	5a	Ric
GD	RP130Q241B	LVR-IC	LDO, LN, +CE, 2.4V±1%, 150mA	SC-82AB	26vn	VR4	5a	Ric
GE	FP6801-26NC8P	Vdet-IC	2.6V±2%, -Reset ODO	SC-82	26vdf	VD1	5b	Fit
GE	MAX6315US43D1-T	Vdet-IC	4.3V±1.8%, -MR, -Reset ODO, 1ms	SOT-143	24vdh	VD4	5c	Max
GE	R1141Q341D	LVR-IC	LDO, 3.4V±2%, 120mA, +CE, CL	SOT-143R	26vm	VR4	5a	Ric
GE	RP130Q251B	LVR-IC	LDO, LN, +CE, 2.5V±1%, 150mA	SC-82AB	26vn	VR4	5a	Ric
GF	FP6801-29NC8P	Vdet-IC	2.9V±2%, -Reset ODO	SC-82	26vdf	VD1	5b	Fit
GF	MAX6315US42D1-T	Vdet-IC	4.2V±1.8%, -MR, -Reset ODO, 1ms	SOT-143	24vdh	VD4	5c	Max
GF	R1141Q351D	LVR-IC	LDO, 3.5V±2%, 120mA, +CE, CL	SOT-143R	26vm	VR4	5a	Ric
GF	RP130Q261B	LVR-IC	LDO, LN, +CE, 2.6V±1%, 150mA	SC-82AB	26vn	VR4	5a	Ric
GG	FP6801-31NC8P	Vdet-IC	3.1V±2%, -Reset ODO	SC-82	26vdf	VD1	5b	Fit
GG	MAX6315US41D1-T	Vdet-IC	4.1V±1.8%, -MR, -Reset ODO, 1ms	SOT-143	24vdh	VD4	5c	Max
GG	R1141Q361D	LVR-IC	LDO, 3.6V±2%, 120mA, +CE, CL	SOT-143R	26vm	VR4	5a	Ric
GG	RP130Q271B	LVR-IC	LDO, LN, +CE, 2.7V±1%, 150mA	SC-82AB	26vn	VR4	5a	Ric
GH	MAX6315US40D1-T	Vdet-IC	4.0V±1.8%, -MR, -Reset ODO, 1ms	SOT-143	24vdh	VD4	5c	Max
GH	R1141Q371D	LVR-IC	LDO, 3.7V±2%, 120mA, +CE, CL	SOT-143R	26vm	VR4	5a	Ric
GH	RP130Q281B	LVR-IC	LDO, LN, +CE, 2.8V±1%, 150mA	SC-82AB	26vn	VR4	5a	Ric
GI	FP6801-21CC8P	Vdet-IC	2.1V±2%, -Reset PPO	SC-82	26vdf	VD3	5b	Fit
GI	MAX6315US39D1-T	Vdet-IC	3.9V±1.8%, -MR, -Reset ODO, 1ms	SOT-143	24vdh	VD4	5c	Max
GIA	2SC3957-A	Si-npn-Darl	AF, 40V, 300mA, 150mW, B=2000..10000	MPAK-4	26tq	-	5b	Ren
GIB	2SC3957-B	Si-npn-Darl	AF, 40V, 300mA, 150mW, B=5000..10000	MPAK-4	26tq	-	5b	Ren
GJ	MAX6315US38D1-T	Vdet-IC	3.8V±1.8%, -MR, -Reset ODO, 1ms	SOT-143	24vdh	VD4	5c	Max
GJ	R1141Q381D	LVR-IC	LDO, 3.8V±2%, 120mA, +CE, CL	SOT-143R	26vm	VR4	5a	Ric
GJ	RP130Q281B5	LVR-IC	LDO, LN, +CE, 2.85V±1%, 150mA	SC-82AB	26vn	VR4	5a	Ric
GK	MAX6315US37D1-T	Vdet-IC	3.7V±1.8%, -MR, -Reset ODO, 1ms	SOT-143	24vdh	VD4	5c	Max
GK	R1141Q391D	LVR-IC	LDO, 3.9V±2%, 120mA, +CE, CL	SOT-143R	26vm	VR4	5a	Ric
GK	RP130Q291B	LVR-IC	LDO, LN, +CE, 2.9V±1%, 150mA	SC-82AB	26vn	VR4	5a	Ric
GL	MAX6315US36D1-T	Vdet-IC	3.6V±1.8%, -MR, -Reset ODO, 1ms	SOT-143	24vdh	VD4	5c	Max
GLN	ELM7528CCB	Vdet-IC	2.8V±2%, +Reset PPO	SC-82AB	26vdl	VD7	5c	Elm
GLN	ELM7528NCB	Vdet-IC	2.8V±2%, +Reset ODO	SC-82AB	26vdl	VD6	5c	Elm
GM	MAX6315US35D1-T	Vdet-IC	3.5V±1.8%, -MR, -Reset ODO, 1ms	SOT-143	24vdh	VD4	5c	Max
GN	MAX6315US34D1-T	Vdet-IC	3.4V±1.8%, -MR, -Reset ODO, 1ms	SOT-143	24vdh	VD4	5c	Max
GN3	2SC4869-3	Si-npn	VHF/UHF-Amp, 16V, 50mA, 200mW, B=60..120, 9GHz	SOT-143	26tu	-	5b	San
GN4	2SC4869-4	Si-npn	VHF/UHF-Amp, 16V, 50mA, 200mW, B=90..180, 9GHz	SOT-143	26tu	-	5b	San
GN4	2SC5503-4	Si-npn	VHF/UHF, LN, 16V, 50mA, 400mW, B=90..180, 9GHz	SOT-343	26tu	-	5b	San
GN5	2SC4869-5	Si-npn	VHF/UHF-Amp, 16V, 50mA, 200mW, B=130..270, 9GHz	SOT-143	26tu	-	5b	San
GN5	2SC5503-5	Si-npn	VHF/UHF, LN, 16V, 50mA, 400mW, B=135..270, 9GHz	SOT-343	26tu	-	5b	San



SMD code	Type	Function	Short description	Case	Pinout	Sch.	St.	Mnf.
GO	MAX6315US33D1-T	Vdet-IC	3.3V±1.8%, -MR, -Reset ODO, 1ms	SOT-143	24vdh	VD4	5c	Max
Gs	FP6801-21NC8P	Vdet-IC	2.1V±2%, -Reset ODO	SC-82	26vdf	VD1	5b	Fit
GT	MAX6315US28D1-T	Vdet-IC	2.8V±1.8%, -MR, -Reset ODO, 1ms	SOT-143	24vdh	VD4	5c	Max
GU	MAX6315US27D1-T	Vdet-IC	2.7V±1.8%, -MR, -Reset ODO, 1ms	SOT-143	24vdh	VD4	5c	Max
Gv	FP6801-22CC8P	Vdet-IC	2.2V±2%, -Reset PPO	SC-82	26vdf	VD3	5b	Fit
GV	MAX6315US26D1-T	Vdet-IC	2.63V±1.8%, -MR, -Reset ODO, 1ms	SOT-143	24vdh	VD4	5c	Max
Gw	FP6801-26CC8P	Vdet-IC	2.6V±2%, -Reset PPO	SC-82	26vdf	VD3	5b	Fit
GW	MAX6315US25D1-T	Vdet-IC	2.5V±1.8%, -MR, -Reset ODO, 1ms	SOT-143	24vdh	VD4	5c	Max
GX	FP6801-29CC8P	Vdet-IC	2.9V±2%, -Reset PPO	SC-82	26vdf	VD3	5b	Fit
GX	MAX6315US50D2-T	Vdet-IC	5.0V±1.8%, -MR, -Reset ODO, 20ms	SOT-143	24vdh	VD4	5c	Max
GY	MAX6315US49D2-T	Vdet-IC	4.9V±1.8%, -MR, -Reset ODO, 20ms	SOT-143	24vdh	VD4	5c	Max
Gz	FP6801-31CC8P	Vdet-IC	3.1V±2%, -Reset PPO	SC-82	26vdf	VD3	5b	Fit
GZ	MAX6315US48D2-T	Vdet-IC	4.8V±1.8%, -MR, -Reset ODO, 20ms	SOT-143	24vdh	VD4	5c	Max
H0	R1140Q40D	LVR-IC	LDO, 4V±2%, 120mA, +CE, CL	SOT-143R	26vm	VR4	5a	Ric
H0	R3114Q271C	Vdet-IC	2.7V±0.8%, -Reset PPO	SC-82AB	26vdl	VD7	5a	Ric
H0	RP103Q281B	LVR-IC	LDO, 2.8V±1%, 150mA, +CE	SC-82AB	26vn	VR4	5a	Ric
H0	XC61CC6002N	Vdet-IC	6V±1%, +Reset PPO	SOT-143R	26vdl	VD7	5c	Tor
H0	XC6221B31BNR	LVR-IC	LDO, 3.15V±1%, 200mA, +CE, CL	SSOT-24	26vn	VR4	5a	Tor
H0	XC6224B081NR	LVR-IC	LDO, 0.8V±20mV, 150mA, +CE, PDR	SSOT-24	26vn	VR4	5a	Tor
H1	R3114Q281C	Vdet-IC	2.8V±0.8%, -Reset PPO	SC-82AB	26vdl	VD7	5a	Ric
H1	RP103Q281B5	LVR-IC	LDO, 2.85V±1%, 150mA, +CE	SC-82AB	26vn	VR4	5a	Ric
H1	XC6221B32BNR	LVR-IC	LDO, 3.25V±1%, 200mA, +CE, CL	SSOT-24	26vn	VR4	5a	Tor
H1	XC6224B091NR	LVR-IC	LDO, 0.9V±20mV, 150mA, +CE, PDR	SSOT-24	26vn	VR4	5a	Tor
H2	R3114Q291C	Vdet-IC	2.9V±0.8%, -Reset PPO	SC-82AB	26vdl	VD7	5a	Ric
H2	RP103Q291B	LVR-IC	LDO, 2.9V±1%, 150mA, +CE	SC-82AB	26vn	VR4	5a	Ric
H2	XC6221B33BNR	LVR-IC	LDO, 3.35V±1%, 200mA, +CE, CL	SSOT-24	26vn	VR4	5a	Tor
H2	XC6224B101NR	LVR-IC	LDO, 1.0V±20mV, 150mA, +CE, PDR	SSOT-24	26vn	VR4	5a	Tor
H3	R3114Q301C	Vdet-IC	3V±0.8%, -Reset PPO	SC-82AB	26vdl	VD7	5a	Ric
H3	RP103Q301B	LVR-IC	LDO, 3V±1%, 150mA, +CE	SC-82AB	26vn	VR4	5a	Ric
H3	XC6221B34BNR	LVR-IC	LDO, 3.45V±1%, 200mA, +CE, CL	SSOT-24	26vn	VR4	5a	Tor
H3	XC6224B111NR	LVR-IC	LDO, 1.1V±20mV, 150mA, +CE, PDR	SSOT-24	26vn	VR4	5a	Tor
H3s	CFH120-08	HEMT	GaAs, LN, UHF, 4V, 40mA, 180mW, 12GHz, 12.0dB	MW-4	25fp	-	5b	Inf
H4	R3114Q311C	Vdet-IC	3.1V±0.8%, -Reset PPO	SC-82AB	26vdl	VD7	5a	Ric
H4	RP103Q311B	LVR-IC	LDO, 3.1V±1%, 150mA, +CE	SC-82AB	26vn	VR4	5a	Ric
H4	RP103Q311D	LVR-IC	LDO, 3.1V±1%, 150mA, +CE, CL	SC-82AB	26vn	VR4	5a	Ric
H4	XC6221B35BNR	LVR-IC	LDO, 3.55V±1%, 200mA, +CE, CL	SSOT-24	26vn	VR4	5a	Tor
H4	XC6224B121NR	LVR-IC	LDO, 1.2V±20mV, 150mA, +CE, PDR	SSOT-24	26vn	VR4	5a	Tor
H4s	CFH120-10	HEMT	GaAs, LN, UHF, 4V, 40mA, 180mW, 12GHz, 11.0dB	MW-4	25fp	-	5b	Inf
H5	R3114Q321C	Vdet-IC	3.2V±0.8%, -Reset PPO	SC-82AB	26vdl	VD7	5a	Ric
H5	RP103Q331B	LVR-IC	LDO, 3.3V±1%, 150mA, +CE	SC-82AB	26vn	VR4	5a	Ric
H5	XC6221B36BNR	LVR-IC	LDO, 3.65V±1%, 200mA, +CE, CL	SSOT-24	26vn	VR4	5a	Tor
H5	XC6224B131NR	LVR-IC	LDO, 1.3V±1.5%, 150mA, +CE, PDR	SSOT-24	26vn	VR4	5a	Tor
H6	R3114Q331C	Vdet-IC	3.3V±0.8%, -Reset PPO	SC-82AB	26vdl	VD7	5a	Ric
H6	RP103Q231B	LVR-IC	LDO, 2.3V±1%, 150mA, +CE	SC-82AB	26vn	VR4	5a	Ric
H6	XC6221B37BNR	LVR-IC	LDO, 3.75V±1%, 200mA, +CE, CL	SSOT-24	26vn	VR4	5a	Tor
H6	XC6224B141NR	LVR-IC	LDO, 1.4V±1.5%, 150mA, +CE, PDR	SSOT-24	26vn	VR4	5a	Tor
H7	R3114Q341C	Vdet-IC	3.4V±0.8%, -Reset PPO	SC-82AB	26vdl	VD7	5a	Ric
H7	RP103Q211B	LVR-IC	LDO, 2.1V±1%, 150mA, +CE	SC-82AB	26vn	VR4	5a	Ric
H7	XC6221B38BNR	LVR-IC	LDO, 3.85V±1%, 200mA, +CE, CL	SSOT-24	26vn	VR4	5a	Tor
H7	XC6224B151NR	LVR-IC	LDO, 1.5V±1.5%, 150mA, +CE, PDR	SSOT-24	26vn	VR4	5a	Tor
H8	R3114Q351C	Vdet-IC	3.5V±0.8%, -Reset PPO	SC-82AB	26vdl	VD7	5a	Ric
H8	RP103Q321B	LVR-IC	LDO, 3.2V±1%, 150mA, +CE	SC-82AB	26vn	VR4	5a	Ric
H8	XC6221B39BNR	LVR-IC	LDO, 3.95V±1%, 200mA, +CE, CL	SSOT-24	26vn	VR4	5a	Tor
H8	XC6224B161NR	LVR-IC	LDO, 1.6V±1.5%, 150mA, +CE, PDR	SSOT-24	26vn	VR4	5a	Tor
H9	R3114Q361C	Vdet-IC	3.6V±0.8%, -Reset PPO	SC-82AB	26vdl	VD7	5a	Ric
H9	RP103Q291B5	LVR-IC	LDO, 2.9V±1%, 150mA, +CE	SC-82AB	26vn	VR4	5a	Ric
H9	XC6221B44BNR	LVR-IC	LDO, 4.45V±1%, 200mA, +CE, CL	SSOT-24	26vn	VR4	5a	Tor
H9	XC6224B171NR	LVR-IC	LDO, 1.7V±1.5%, 150mA, +CE, PDR	SSOT-24	26vn	VR4	5a	Tor
HA	BU4809F	Vdet-IC	0.9V±1%, -Reset ODO	SOP-4	26vdl	VD6	5c	Rhm
HA	MAX6315US47D2-T	Vdet-IC	4.7V±1.8%, -MR, -Reset ODO, 20ms	SOT-143	24vdh	VD4	5c	Max
HA	R1141Q401D	LVR-IC	LDO, 4V±2%, 120mA, +CE, CL	SOT-143R	26vm	VR4	5a	Ric
HA	RP130Q301B	LVR-IC	LDO, LN, +CE, 3V±1%, 150mA	SC-82AB	26vn	VR4	5a	Ric
HĀ	XC6127C16BNR	Vdet-IC	1.6V±0.8%, -Reset PPO, -MR, Rt=100ms	SSOT-24	26cr	VD5	5a	Tor
HĀ	XC6127N16GNR	Vdet-IC	1.6V±0.8%, +Reset ODO, -MR, Rt=100ms	SSOT-24	26cr	VD4	5a	Tor
HA	XC6224B181NR	LVR-IC	LDO, 1.8V±1.5%, 150mA, +CE, PDR	SSOT-24	26vn	VR4	5a	Tor
HB	BU4810F	Vdet-IC	1V±1%, -Reset ODO	SOP-4	26vdl	VD6	5c	Rhm
HB	MAX6315US46D2-T	Vdet-IC	4.63V±1.8%, -MR, -Reset ODO, 20ms	SOT-143	24vdh	VD4	5c	Max
HB	RP130Q311B	LVR-IC	LDO, LN, +CE, 3.1V±1%, 150mA	SC-82AB	26vn	VR4	5a	Ric
HĪ	XC6127C18BNR	Vdet-IC	1.8V±0.8%, -Reset PPO, -MR, Rt=100ms	SSOT-24	26cr	VD5	5a	Tor
HĪ	XC6127N18GNR	Vdet-IC	1.8V±0.8%, +Reset ODO, -MR, Rt=100ms	SSOT-24	26cr	VD4	5a	Tor



SMD code	Type	Function	Short description	Case	Pinout	Sch.	St.	Mnf.
HB	XC6224B191NR	LVR-IC	LDO, 1.9V±1.5%, 150mA, +CE, PDR	SSOT-24	26vn	VR4	5a	Tor
HC	BU4811F	Vdet-IC	1.1V±1%, -Reset ODO	SOP-4	26vdl	VD6	5c	Rhm
HC	MAX6315US45D2-T	Vdet-IC	4.5V±1.8%, -MR, -Reset ODO, 20ms	SOT-143	24vdh	VD4	5c	Max
HC	RP130Q321B	LVR-IC	LDO, LN, +CE, 3.2V±1%, 150mA	SC-82AB	26vn	VR4	5a	Ric
HC	XC6127C20BNR	Vdet-IC	2.0V±0.8%, -Reset PPO, -MR, Rt=100ms	SSOT-24	26cr	VD5	5a	Tor
HC	XC6127N20GNR	Vdet-IC	2.0V±0.8%, +Reset ODO, -MR, Rt=100ms	SSOT-24	26cr	VD4	5a	Tor
HC	XC6224B201NR	LVR-IC	LDO, 2.0V±1.5%, 150mA, +CE, PDR	SSOT-24	26vn	VR4	5a	Tor
HD	BU4812F	Vdet-IC	1.2V±1%, -Reset ODO	SOP-4	26vdl	VD6	5c	Rhm
HD	MAX6315US44D2-T	Vdet-IC	4.39V±1.8%, -MR, -Reset ODO, 20ms	SOT-143	24vdh	VD4	5c	Max
HD	RP130Q331B	LVR-IC	LDO, LN, +CE, 3.3V±1%, 150mA	SC-82AB	26vn	VR4	5a	Ric
HD	XC6127C22BNR	Vdet-IC	2.2V±0.8%, -Reset PPO, -MR, Rt=100ms	SSOT-24	26cr	VD5	5a	Tor
HD	XC6127N22GNR	Vdet-IC	2.2V±0.8%, +Reset ODO, -MR, Rt=100ms	SSOT-24	26cr	VD4	5a	Tor
HD	XC6223F301NR-G	LVR-IC	LDO, 3.0V±1%, 300mA, +CE, CL, ICP	SSOT-24	26vn	VR4	5a	Tor
HE	BU4813F	Vdet-IC	1.3V±1%, -Reset ODO	SOP-4	26vdl	VD6	5c	Rhm
HE	MAX6315US43D2-T	Vdet-IC	4.3V±1.8%, -MR, -Reset ODO, 20ms	SOT-143	24vdh	VD4	5c	Max
HE	RP130Q341B	LVR-IC	LDO, LN, +CE, 3.4V±1%, 150mA	SC-82AB	26vn	VR4	5a	Ric
HE	XC6127C24BNR	Vdet-IC	2.4V±0.8%, -Reset PPO, -MR, Rt=100ms	SSOT-24	26cr	VD5	5a	Tor
HE	XC6127N24GNR	Vdet-IC	2.4V±0.8%, +Reset ODO, -MR, Rt=100ms	SSOT-24	26cr	VD4	5a	Tor
HE	XC6223F311NR-G	LVR-IC	LDO, 3.1V±1%, 300mA, +CE, CL, ICP	SSOT-24	26vn	VR4	5a	Tor
HF	BU4814F	Vdet-IC	1.4V±1%, -Reset ODO	SOP-4	26vdl	VD6	5c	Rhm
HF	MAX6315US42D2-T	Vdet-IC	4.2V±1.8%, -MR, -Reset ODO, 20ms	SOT-143	24vdh	VD4	5c	Max
HF	RP130Q351B	LVR-IC	LDO, LN, +CE, 3.5V±1%, 150mA	SC-82AB	26vn	VR4	5a	Ric
HF	XC6127C26BNR	Vdet-IC	2.6V±0.8%, -Reset PPO, -MR, Rt=100ms	SSOT-24	26cr	VD5	5a	Tor
HF	XC6127N26GNR	Vdet-IC	2.6V±0.8%, +Reset ODO, -MR, Rt=100ms	SSOT-24	26cr	VD4	5a	Tor
HF	XC6223F321NR-G	LVR-IC	LDO, 3.2V±1%, 300mA, +CE, CL, ICP	SSOT-24	26vn	VR4	5a	Tor
HG	BU4815F	Vdet-IC	1.5V±1%, -Reset ODO	SOP-4	26vdl	VD6	5c	Rhm
HG	MAX6315US41D2-T	Vdet-IC	4.1V±1.8%, -MR, -Reset ODO, 20ms	SOT-143	24vdh	VD4	5c	Max
HG	RP130Q361B	LVR-IC	LDO, LN, +CE, 3.6V±1%, 150mA	SC-82AB	26vn	VR4	5a	Ric
HH	BU4816F	Vdet-IC	1.6V±1%, -Reset ODO	SOP-4	26vdl	VD6	5c	Rhm
HH	MAX6315US40D2-T	Vdet-IC	4.0V±1.8%, -MR, -Reset ODO, 20ms	SOT-143	24vdh	VD4	5c	Max
HH	RP130Q371B	LVR-IC	LDO, LN, +CE, 3.7V±1%, 150mA	SC-82AB	26vn	VR4	5a	Ric
HH	XC6127C28BNR	Vdet-IC	2.8V±0.8%, -Reset PPO, -MR, Rt=100ms	SSOT-24	26cr	VD5	5a	Tor
HH	XC6127N28GNR	Vdet-IC	2.8V±0.8%, +Reset ODO, -MR, Rt=100ms	SSOT-24	26cr	VD4	5a	Tor
HH	XC6223F331NR-G	LVR-IC	LDO, 3.3V±1%, 300mA, +CE, CL, ICP	SSOT-24	26vn	VR4	5a	Tor
HI	MAX6315US39D2-T	Vdet-IC	3.9V±1.8%, -MR, -Reset ODO, 20ms	SOT-143	24vdh	VD4	5c	Max
HJ	2SC3828	Si-npn	TV-UHF-Tuner, 20V, 20mA, 150mW, 1,1GHz, B=40..100	SOT-143	26t9	-	5b	Tos
HJ	BU4817F	Vdet-IC	1.7V±1%, -Reset ODO	SOP-4	26vdl	VD6	5c	Rhm
HJ	MAX6315US38D2-T	Vdet-IC	3.8V±1.8%, -MR, -Reset ODO, 20ms	SOT-143	24vdh	VD4	5c	Max
HJ	RP130Q381B	LVR-IC	LDO, LN, +CE, 3.8V±1%, 150mA	SC-82AB	26vn	VR4	5a	Ric
HK	BU4818F	Vdet-IC	1.8V±1%, -Reset ODO	SOP-4	26vdl	VD6	5c	Rhm
HK	RP130Q391B	LVR-IC	LDO, LN, +CE, 3.9V±1%, 150mA	SC-82AB	26vn	VR4	5a	Ric
HK	XC6127C30BNR	Vdet-IC	3.0V±0.8%, -Reset PPO, -MR, Rt=100ms	SSOT-24	26cr	VD5	5a	Tor
HK	XC6127N30GNR	Vdet-IC	3.0V±0.8%, +Reset ODO, -MR, Rt=100ms	SSOT-24	26cr	VD4	5a	Tor
HK	XC6223F341NR-G	LVR-IC	LDO, 3.4V±1%, 300mA, +CE, CL, ICP	SSOT-24	26vn	VR4	5a	Tor
HL	AAT3527ICX-4.38-200	Vdet-IC	4.38V±1.5%, +Reset PPO, -MR	SOT-143	24vdh	VD5	5i	Ant
HL	BU4819F	Vdet-IC	1.9V±1%, -Reset ODO	SOP-4	26vdl	VD6	5c	Rhm
HL	XC6127C32BNR	Vdet-IC	3.2V±0.8%, -Reset PPO, -MR, Rt=100ms	SSOT-24	26cr	VD5	5a	Tor
HL	XC6127N32GNR	Vdet-IC	3.2V±0.8%, +Reset ODO, -MR, Rt=100ms	SSOT-24	26cr	VD4	5a	Tor
HL	XC6223F351NR-G	LVR-IC	LDO, 3.5V±1%, 300mA, +CE, CL, ICP	SSOT-24	26vn	VR4	5a	Tor
HLN	ELM7529CCB	Vdet-IC	2.9V±2%, +Reset PPO	SC-82AB	26vdl	VD7	5c	Elm
HLN	ELM7529NCB	Vdet-IC	2.9V±2%, +Reset ODO	SC-82AB	26vdl	VD6	5c	Elm
HM	AAT3527ICX-4.63-200	Vdet-IC	4.63V±1.5%, +Reset PPO, -MR	SOT-143	24vdh	VD5	5i	Ant
HM	BU4820F	Vdet-IC	2V±1%, -Reset ODO	SOP-4	26vdl	VD6	5c	Rhm
HM	MAX6315US35D2-T	Vdet-IC	3.5V±1.8%, -MR, -Reset ODO, 20ms	SOT-143	24vdh	VD4	5c	Max
HM	XC6127C34BNR	Vdet-IC	3.4V±0.8%, -Reset PPO, -MR, Rt=100ms	SSOT-24	26cr	VD5	5a	Tor
HM	XC6127N34GNR	Vdet-IC	3.4V±0.8%, +Reset ODO, -MR, Rt=100ms	SSOT-24	26cr	VD4	5a	Tor
HM	XC6223F361NR-G	LVR-IC	LDO, 3.6V±1%, 300mA, +CE, CL, ICP	SSOT-24	26vn	VR4	5a	Tor
HN	BU4821F	Vdet-IC	2.1V±1%, -Reset ODO	SOP-4	26vdl	VD6	5c	Rhm
HN	MAX6315US34D2-T	Vdet-IC	3.4V±1.8%, -MR, -Reset ODO, 20ms	SOT-143	24vdh	VD4	5c	Max
HN	XC6127C36BNR	Vdet-IC	3.6V±0.8%, -Reset PPO, -MR, Rt=100ms	SSOT-24	26cr	VD5	5a	Tor
HN	XC6127N36GNR	Vdet-IC	3.6V±0.8%, +Reset ODO, -MR, Rt=100ms	SSOT-24	26cr	VD4	5a	Tor
HN	XC6224B211NR	LVR-IC	LDO, 2.1V±1.5%, 150mA, +CE, PDR	SSOT-24	26vn	VR4	5a	Tor
HO	MAX6315US33D2-T	Vdet-IC	3.3V±1.8%, -MR, -Reset ODO, 20ms	SOT-143	24vdh	VD4	5c	Max
HP	BU4822F	Vdet-IC	2.2V±1%, -Reset ODO	SOP-4	26vdl	VD6	5c	Rhm
HP	MAX6315US32D2-T	Vdet-IC	4.2V±1.8%, -MR, -Reset ODO, 20ms	SOT-143	24vdh	VD4	5c	Max
HP	XC6127C38BNR	Vdet-IC	3.8V±0.8%, -Reset PPO, -MR, Rt=100ms	SSOT-24	26cr	VD5	5a	Tor
HP	XC6127N38GNR	Vdet-IC	3.8V±0.8%, +Reset ODO, -MR, Rt=100ms	SSOT-24	26cr	VD4	5a	Tor
HP	XC6223F371NR-G	LVR-IC	LDO, 3.7V±1%, 300mA, +CE, CL, ICP	SSOT-24	26vn	VR4	5a	Tor
HQ	BU4823F	Vdet-IC	2.3V±1%, -Reset ODO	SOP-4	26vdl	VD6	5c	Rhm
HQ	MAX6315US31D2-T	Vdet-IC	3.08V±1.8%, -MR, -Reset ODO, 20ms	SOT-143	24vdh	VD4	5c	Max



Note: ELM75xxCCB series LN- lot number L=0...9 N=A to Z(I, O, X excepted); ELM75xxNCB series LN- lot number L=A to Z(I, O, X excepted) N=0...9

SMD

SMD code	Type	Function	Short description	Case	Pinout Sch.	St.	Mnf.
HR	BU4824F	Vdet-IC	2.4V±1%, -Reset ODO	SOP-4	26vdl VD6	5c	Rhm
HR	MAX6315US30D2-T	Vdet-IC	3.0V±1.8%, -MR, -Reset ODO, 20ms	SOT-143	24vdh VD4	5c	Max
HR	XC6127C40BNR	Vdet-IC	4.0V±0.8%, -Reset PPO, -MR, Rt=100ms	SSOT-24	26cr VD5	5a	Tor
HR	XC6127N40GNR	Vdet-IC	4.0V±0.8%, +Reset ODO, -MR, Rt=100ms	SSOT-24	26cr VD4	5a	Tor
HR	XC6223F381NR-G	LVR-IC	LDO, 3.8V±1%, 300mA, +CE, CL, ICP	SSOT-24	26vn VR4	5a	Tor
HS	BU4825F	Vdet-IC	2.5V±1%, -Reset ODO	SOP-4	26vdl VD6	5c	Rhm
HS	MAX6315US29D2-T	Vdet-IC	2.93V±1.8%, -MR, -Reset ODO, 20ms	SOT-143	24vdh VD4	5c	Max
HS	XC6127C42BNR	Vdet-IC	4.2V±0.8%, -Reset PPO, -MR, Rt=100ms	SSOT-24	26cr VD5	5a	Tor
HS	XC6127N42GNR	Vdet-IC	4.2V±0.8%, +Reset ODO, -MR, Rt=100ms	SSOT-24	26cr VD4	5a	Tor
HS	XC6223F391NR-G	LVR-IC	LDO, 3.9V±1%, 300mA, +CE, CL, ICP	SSOT-24	26vn VR4	5a	Tor
HT	BU4826F	Vdet-IC	2.6V±1%, -Reset ODO	SOP-4	26vdl VD6	5c	Rhm
HT	MAX6315US28D2-T	Vdet-IC	2.8V±1.8%, -MR, -Reset ODO, 20ms	SOT-143	24vdh VD4	5c	Max
HT	XC6127C44BNR	Vdet-IC	4.4V±0.8%, -Reset PPO, -MR, Rt=100ms	SSOT-24	26cr VD5	5a	Tor
HT	XC6127N44GNR	Vdet-IC	4.4V±0.8%, +Reset ODO, -MR, Rt=100ms	SSOT-24	26cr VD4	5a	Tor
HT	XC6223F401NR-G	LVR-IC	LDO, 4.0V±1%, 300mA, +CE, CL, ICP	SSOT-24	26vn VR4	5a	Tor
HU	BU4827F	Vdet-IC	2.7V±1%, -Reset ODO	SOP-4	26vdl VD6	5c	Rhm
HU	MAX6315US27D2-T	Vdet-IC	2.7V±1.8%, -MR, -Reset ODO, 20ms	SOT-143	24vdh VD4	5c	Max
HU	XC6127C46BNR	Vdet-IC	4.6V±0.8%, -Reset PPO, -MR, Rt=100ms	SSOT-24	26cr VD5	5a	Tor
HU	XC6127N46GNR	Vdet-IC	4.6V±0.8%, +Reset ODO, -MR, Rt=100ms	SSOT-24	26cr VD4	5a	Tor
HU	XC6224B221NR	LVR-IC	LDO, 2.2V±1.5%, 150mA, +CE, PDR	SSOT-24	26vn VR4	5a	Tor
HV	3SK285	n-MOSFET	DG, UHF, LN, 13V, ±30mA, 150mW, Idss=10..25mA	SOT-143	26fm -	5b	Pan
HV	BU4828F	Vdet-IC	2.8V±1%, -Reset ODO	SOP-4	26vdl VD6	5c	Rhm
HV	MAX6315US26D2-T	Vdet-IC	2.63V±1.8%, -MR, -Reset ODO, 20ms	SOT-143	24vdh VD4	5c	Max
HV	XC6127C48BNR	Vdet-IC	4.8V±0.8%, -Reset PPO, -MR, Rt=100ms	SSOT-24	26cr VD5	5a	Tor
HV	XC6127N48GNR	Vdet-IC	4.8V±0.8%, +Reset ODO, -MR, Rt=100ms	SSOT-24	26cr VD4	5a	Tor
HV	XC6224B231NR	LVR-IC	LDO, 2.3V±1.5%, 150mA, +CE, PDR	SSOT-24	26vn VR4	5a	Tor
HW	3SK286	n-MOSFET	DG, UHF, LN, 15V, ±30mA, 150mA, Idss=6..20mA	SOT-143	26fm -	5b	Pan
HW	BU4829F	Vdet-IC	2.9V±1%, -Reset ODO	SOP-4	26vdl VD6	5c	Rhm
HW	MAX6315US25D2-T	Vdet-IC	2.5V±1.8%, -MR, -Reset ODO, 20ms	SOT-143	24vdh VD4	5c	Max
HX	BU4830F	Vdet-IC	3V±1%, -Reset ODO	SOP-4	26vdl VD6	5c	Rhm
HX	MAX6315US50D3-T	Vdet-IC	5.0V±1.8%, -MR, -Reset ODO, 140ms	SOT-143	24vdh VD4	5c	Max
HX	XC6127C50BNR	Vdet-IC	5.0V±0.8%, -Reset PPO, -MR, Rt=100ms	SSOT-24	26cr VD5	5a	Tor
HX	XC6127N50GNR	Vdet-IC	5.0V±0.8%, +Reset ODO, -MR, Rt=100ms	SSOT-24	26cr VD4	5a	Tor
HX	XC6221B45BNR	LVR-IC	LDO, 4.55V±1%, 200mA, +CE, CL	SSOT-24	26vn VR4	5a	Tor
HX	XC6224B241NR	LVR-IC	LDO, 2.4V±1.5%, 150mA, +CE, PDR	SSOT-24	26vn VR4	5a	Tor
HY	BU4831F	Vdet-IC	3.1V±1%, -Reset ODO	SOP-4	26vdl VD6	5c	Rhm
HY	MAX6315US49D3-T	Vdet-IC	4.9V±1.8%, -MR, -Reset ODO, 140ms	SOT-143	24vdh VD4	5c	Max
HY	XC6119N08ANR	Vdet-IC	0.8V±30mV, -Reset ODO	SSOT-24	26gh VD1	5a	Tor
HY	XC6127C52BNR	Vdet-IC	5.2V±0.8%, -Reset PPO, -MR, Rt=100ms	SSOT-24	26cr VD5	5a	Tor
HY	XC6127N52GNR	Vdet-IC	5.2V±0.8%, +Reset ODO, -MR, Rt=100ms	SSOT-24	26cr VD4	5a	Tor
HY	XC6221B46BNR	LVR-IC	LDO, 4.65V±1%, 200mA, +CE, CL	SSOT-24	26vn VR4	5a	Tor
HZ	BU4832F	Vdet-IC	3.2V±1%, -Reset ODO	SOP-4	26vdl VD6	5c	Rhm
HZ	MAX6315US48D3-T	Vdet-IC	4.8V±1.8%, -MR, -Reset ODO, 140ms	SOT-143	24vdh VD4	5c	Max
HZ	XC6119N09ANR	Vdet-IC	0.9V±30mV, -Reset ODO	SSOT-24	26gh VD1	5a	Tor
HZ	XC6127C54BNR	Vdet-IC	5.4V±0.8%, -Reset PPO, -MR, Rt=100ms	SSOT-24	26cr VD5	5a	Tor
HZ	XC6127N54GNR	Vdet-IC	5.4V±0.8%, +Reset ODO, -MR, Rt=100ms	SSOT-24	26cr VD4	5a	Tor
HZ	XC6221B47BNR	LVR-IC	LDO, 4.75V±1%, 200mA, +CE, CL	SSOT-24	26vn VR4	5a	Tor
IA	MAX6315US47D3-T	Vdet-IC	4.7V±1.8%, -MR, -Reset ODO, 140ms	SOT-143	24vdh VD4	5c	Max
IB	MAX6315US46D3-T	Vdet-IC	4.63V±1.8%, -MR, -Reset ODO, 140ms	SOT-143	24vdh VD4	5c	Max
IC	MAX6315US45D3-T	Vdet-IC	4.5V±1.8%, -MR, -Reset ODO, 140ms	SOT-143	24vdh VD4	5c	Max
ID	MAX6315US44D3-T	Vdet-IC	4.39V±1.8%, -MR, -Reset ODO, 140ms	SOT-143	24vdh VD4	5c	Max
IE	MAX6315US43D3-T	Vdet-IC	4.3V±1.8%, -MR, -Reset ODO, 140ms	SOT-143	24vdh VD4	5c	Max
IF	MAX6315US42D3-T	Vdet-IC	4.2V±1.8%, -MR, -Reset ODO, 140ms	SOT-143	24vdh VD4	5c	Max
IG	MAX6315US41D3-T	Vdet-IC	4.1V±1.8%, -MR, -Reset ODO, 140ms	SOT-143	24vdh VD4	5c	Max
IH	MAX6315US40D3-T	Vdet-IC	4.0V±1.8%, -MR, -Reset ODO, 140ms	SOT-143	24vdh VD4	5c	Max
II	MAX6315US39D3-T	Vdet-IC	3.9V±1.8%, -MR, -Reset ODO, 140ms	SOT-143	24vdh VD4	5c	Max
IJ	MAX6315US38D3-T	Vdet-IC	3.8V±1.8%, -MR, -Reset ODO, 140ms	SOT-143	24vdh VD4	5c	Max
IK	MAX6315US37D3-T	Vdet-IC	3.7V±1.8%, -MR, -Reset ODO, 140ms	SOT-143	24vdh VD4	5c	Max
IL	MAX6315US36D3-T	Vdet-IC	3.6V±1.8%, -MR, -Reset ODO, 140ms	SOT-143	24vdh VD4	5c	Max
IM	MAX6315US35D3-T	Vdet-IC	3.5V±1.8%, -MR, -Reset ODO, 140ms	SOT-143	24vdh VD4	5c	Max
IN	MAX6315US34D3-T	Vdet-IC	3.4V±1.8%, -MR, -Reset ODO, 140ms	SOT-143	24vdh VD4	5c	Max
IO	MAX6315US33D3-T	Vdet-IC	3.3V±1.8%, -MR, -Reset ODO, 140ms	SOT-143	24vdh VD4	5c	Max
IP	MAX6315US32D3-T	Vdet-IC	3.2V±1.8%, -MR, -Reset ODO, 140ms	SOT-143	24vdh VD4	5c	Max
IQ	MAX6315US31D3-T	Vdet-IC	3.08V±1.8%, -MR, -Reset ODO, 140ms	SOT-143	24vdh VD4	5c	Max
IR	MAX6315US30D3-T	Vdet-IC	3.0V±1.8%, -MR, -Reset ODO, 140ms	SOT-143	24vdh VD4	5c	Max
IS	MAX6315US29D3-T	Vdet-IC	2.93V±1.8%, -MR, -Reset ODO, 140ms	SOT-143	24vdh VD4	5c	Max
IT	MAX6315US28D3-T	Vdet-IC	2.8V±1.8%, -MR, -Reset ODO, 140ms	SOT-143	24vdh VD4	5c	Max
IT-	3SK162	n-MOSFET-d	DG, VHF, 12V, Idss=0..12mA	SOT-143	26fm -	5c	Ren
IU	MAX6315US27D3-T	Vdet-IC	2.7V±1.8%, -MR, -Reset ODO, 140ms	SOT-143	24vdh VD4	5c	Max
IV	MAX6315US26D3-T	Vdet-IC	2.63V±1.8%, -MR, -Reset ODO, 140ms	SOT-143	24vdh VD4	5c	Max



SMD code	Type	Function	Short description	Case	Pinout Sch.	St.	Mnf.
IV-	3SK136	n-MOSFET-d	DG, VHF, 20V, Idss>5mA, Up<3V	SOT-143	26fm -	5c	Ren
IW	MAX6315US25D3-T	Vdet-IC	2.5V±1.8%, -MR, -Reset ODO, 140ms	SOT-143	24vdh VD4	5c	Max
IW-	3SK137	n-MOSFET-d	DG, UHF, 15V, Idss<20mA, Up<2V	SOT-143	26fm -	5c	Ren
IX	MAX6315US50D4-T	Vdet-IC	5.0V±1.8%, -MR, -Reset ODO, 1120ms	SOT-143	24vdh VD4	5c	Max
IX-	3SK138	n-MOSFET-d	DG, UHF, 15V, Idss<10mA, Up<1V	SOT-143	26fm -	5c	Ren
IY	MAX6315US49D4-T	Vdet-IC	4.9V±1.8%, -MR, -Reset ODO, 1120ms	SOT-143	24vdh VD4	5c	Max
IY-	3SK194	n-MOSFET-d	DG, VHF/UHF-Tuner, 15V, 35mA, Idss=0.10mA, Up<1.5V	SOT-143	26fm -	5c	Ren
IZ	MAX6315US48D4-T	Vdet-IC	4.8V±1.8%, -MR, -Reset ODO, 1120ms	SOT-143	24vdh VD4	5c	Max
IZ2	3SK167-2	n-FET-d	GaAs, DG, UHF, 12V, 55mA, 200mW, Idss=10.25mA	SOT-143	26fm -	5c	San
IZ3	3SK167-3	n-FET-d	GaAs, DG, UHF, 12V, 55mA, 200mW, Idss=20.35mA	SOT-143	26fm -	5c	San
IZ4	3SK167-4	n-FET-d	GaAs, DG, UHF, 12V, 55mA, 200mW, Idss=30.45mA	SOT-143	26fm -	5c	San
IZ5	3SK167-5	n-FET-d	GaAs, DG, UHF, 12V, 55mA, 200mW, Idss=40.55mA	SOT-143	26fm -	5c	San
J0	R3114Q371C	Vdet-IC	3.7V±0.8%, -Reset PPO	SC-82AB	26vdl VD7	5a	Ric
J0	RP103Q121D	LVR-IC	LDO, 1.2V±1%, 150mA, +CE, CL	SC-82AB	26vn VR4	5a	Ric
J1	R3114Q381C	Vdet-IC	3.8V±0.8%, -Reset PPO	SC-82AB	26vdl VD7	5a	Ric
J1	RP103Q131D	LVR-IC	LDO, 1.3V±1%, 150mA, +CE, CL	SC-82AB	26vn VR4	5a	Ric
J2	R3114Q391C	Vdet-IC	3.9V±0.8%, -Reset PPO	SC-82AB	26vdl VD7	5a	Ric
J2	RP103Q151D	LVR-IC	LDO, 1.5V±1%, 150mA, +CE, CL	SC-82AB	26vn VR4	5a	Ric
J3	R3114Q401C	Vdet-IC	4V±0.8%, -Reset PPO	SC-82AB	26vdl VD7	5a	Ric
J3	RP103Q181D	LVR-IC	LDO, 1.8V±1%, 150mA, +CE, CL	SC-82AB	26vn VR4	5a	Ric
J4	R3114Q411C	Vdet-IC	4.1V±0.8%, -Reset PPO	SC-82AB	26vdl VD7	5a	Ric
J4	RP103Q181D5	LVR-IC	LDO, 1.85V±1%, 150mA, +CE, CL	SC-82AB	26vn VR4	5a	Ric
J5	R3114Q421C	Vdet-IC	4.2V±0.8%, -Reset PPO	SC-82AB	26vdl VD7	5a	Ric
J5	RP103Q191D	LVR-IC	LDO, 1.9V±1%, 150mA, +CE, CL	SC-82AB	26vn VR4	5a	Ric
J6	R3114Q431C	Vdet-IC	4.3V±0.8%, -Reset PPO	SC-82AB	26vdl VD7	5a	Ric
J6	RP103Q201D	LVR-IC	LDO, 2V±1%, 150mA, +CE, CL	SC-82AB	26vn VR4	5a	Ric
J7	R3114Q441C	Vdet-IC	4.4V±0.8%, -Reset PPO	SC-82AB	26vdl VD7	5a	Ric
J7	RP103Q251D	LVR-IC	LDO, 2.5V±1%, 150mA, +CE, CL	SC-82AB	26vn VR4	5a	Ric
J8	R3114Q451C	Vdet-IC	4.5V±0.8%, -Reset PPO	SC-82AB	26vdl VD7	5a	Ric
J8	RP103Q261D	LVR-IC	LDO, 2.6V±1%, 150mA, +CE, CL	SC-82AB	26vn VR4	5a	Ric
J9	R3114Q461C	Vdet-IC	4.6V±0.8%, -Reset PPO	SC-82AB	26vdl VD7	5a	Ric
J9	RP103Q271D	LVR-IC	LDO, 2.7V±1%, 150mA, +CE, CL	SC-82AB	26vn VR4	5a	Ric
JA	BU4833F	Vdet-IC	3.3V±1%, -Reset ODO	SOP-4	26vdl VD6	5c	Rhm
JA	MAX6315US47D4-T	Vdet-IC	4.7V±1.8%, -MR, -Reset ODO, 1120ms	SOT-143	24vdh VD4	5c	Max
JA	RP130Q401B	LVR-IC	LDO, LN, +CE, 4V±1%, 150mA	SC-82AB	26vn VR4	5a	Ric
JA2	S-80141ALPF	Vdet-IC	4.1V, -Reset PPO, 50ms	SNT-4	42ye VD3	5e	Sii
JA3	S-80142ALPF	Vdet-IC	4.2V, -Reset PPO, 50ms	SNT-4	42ye VD3	5e	Sii
JA4	S-80143ALPF	Vdet-IC	4.3V, -Reset PPO, 50ms	SNT-4	42ye VD3	5e	Sii
JA5	S-80144ALPF	Vdet-IC	4.4V, -Reset PPO, 50ms	SNT-4	42ye VD3	5e	Sii
JA6	S-80145ALPF	Vdet-IC	4.5V, -Reset PPO, 50ms	SNT-4	42ye VD3	5e	Sii
JA7	S-80146ALPF	Vdet-IC	4.6V, -Reset PPO, 50ms	SNT-4	42ye VD3	5e	Sii
JA8	S-80147ALPF	Vdet-IC	4.7V, -Reset PPO, 50ms	SNT-4	42ye VD3	5e	Sii
JA9	S-80148ALPF	Vdet-IC	4.8V, -Reset PPO, 50ms	SNT-4	42ye VD3	5e	Sii
JAH	S-80122ALPF	Vdet-IC	2.2V, -Reset PPO, 50ms	SNT-4	42ye VD3	5e	Sii
JAI	S-80123ALPF	Vdet-IC	2.3V, -Reset PPO, 50ms	SNT-4	42ye VD3	5e	Sii
JAJ	S-80124ALPF	Vdet-IC	2.4V, -Reset PPO, 50ms	SNT-4	42ye VD3	5e	Sii
JAK	S-80125ALPF	Vdet-IC	2.5V, -Reset PPO, 50ms	SNT-4	42ye VD3	5e	Sii
JAL	S-80126ALPF	Vdet-IC	2.6V, -Reset PPO, 50ms	SNT-4	42ye VD3	5e	Sii
JAM	S-80127ALPF	Vdet-IC	2.7V, -Reset PPO, 50ms	SNT-4	42ye VD3	5e	Sii
JAN	S-80128ALPF	Vdet-IC	2.8V, -Reset PPO, 50ms	SNT-4	42ye VD3	5e	Sii
JAO	S-80129ALPF	Vdet-IC	2.9V, -Reset PPO, 50ms	SNT-4	42ye VD3	5e	Sii
JAP	S-80130ALPF	Vdet-IC	3V, -Reset PPO, 50ms	SNT-4	42ye VD3	5e	Sii
JAQ	S-80131ALPF	Vdet-IC	3.1V, -Reset PPO, 50ms	SNT-4	42ye VD3	5e	Sii
JAR	S-80132ALPF	Vdet-IC	3.2V, -Reset PPO, 50ms	SNT-4	42ye VD3	5e	Sii
JAS	S-80133ALPF	Vdet-IC	3.3V, -Reset PPO, 50ms	SNT-4	42ye VD3	5e	Sii
JAT	S-80134ALPF	Vdet-IC	3.4V, -Reset PPO, 50ms	SNT-4	42ye VD3	5e	Sii
JAU	S-80135ALPF	Vdet-IC	3.5V, -Reset PPO, 50ms	SNT-4	42ye VD3	5e	Sii
JAV	S-80136ALPF	Vdet-IC	3.6V, -Reset PPO, 50ms	SNT-4	42ye VD3	5e	Sii
JAW	S-80137ALPF	Vdet-IC	3.7V, -Reset PPO, 50ms	SNT-4	42ye VD3	5e	Sii
JAX	S-80138ALPF	Vdet-IC	3.8V, -Reset PPO, 50ms	SNT-4	42ye VD3	5e	Sii
JAY	S-80139ALPF	Vdet-IC	3.9V, -Reset PPO, 50ms	SNT-4	42ye VD3	5e	Sii
JAZ	S-80140ALPF	Vdet-IC	4V, -Reset PPO, 50ms	SNT-4	42ye VD3	5e	Sii
JB	BU4834F	Vdet-IC	3.4V±1%, -Reset ODO	SOP-4	26vdl VD6	5c	Rhm
JB	MAX6315US46D4-T	Vdet-IC	4.63V±1.8%, -MR, -Reset ODO, 1120ms	SOT-143	24vdh VD4	5c	Max
JB	RP130Q411B	LVR-IC	LDO, LN, +CE, 4.1V±1%, 150mA	SC-82AB	26vn VR4	5a	Ric
JBA	S-80149ALPF	Vdet-IC	4.9V, -Reset PPO, 50ms	SNT-4	42ye VD3	5e	Sii
JBB	S-80150ALPF	Vdet-IC	5V, -Reset PPO, 50ms	SNT-4	42ye VD3	5e	Sii
JBC	S-80151ALPF	Vdet-IC	5.1V, -Reset PPO, 50ms	SNT-4	42ye VD3	5e	Sii
JBD	S-80152ALPF	Vdet-IC	5.2V, -Reset PPO, 50ms	SNT-4	42ye VD3	5e	Sii
JBE	S-80153ALPF	Vdet-IC	5.3V, -Reset PPO, 50ms	SNT-4	42ye VD3	5e	Sii



SMD code	Type	Function	Short description	Case	Pinout	Sch.	St.	Mnf.
JBF	S-80154ALPF	Vdet-IC	5.4V, -Reset PPO, 50ms	SNT-4	42ye	VD3	5e	Sii
JBG	S-80155ALPF	Vdet-IC	5.5V, -Reset PPO, 50ms	SNT-4	42ye	VD3	5e	Sii
JBH	S-80156ALPF	Vdet-IC	5.6V, -Reset PPO, 50ms	SNT-4	42ye	VD3	5e	Sii
JBI	S-80157ALPF	Vdet-IC	5.7V, -Reset PPO, 50ms	SNT-4	42ye	VD3	5e	Sii
JBJ	S-80158ALPF	Vdet-IC	5.8V, -Reset PPO, 50ms	SNT-4	42ye	VD3	5e	Sii
JBK	S-80159ALPF	Vdet-IC	5.9V, -Reset PPO, 50ms	SNT-4	42ye	VD3	5e	Sii
JBL	S-80160ALPF	Vdet-IC	6V, -Reset PPO, 50ms	SNT-4	42ye	VD3	5e	Sii
JC	BU4835F	Vdet-IC	3.5V±1%, -Reset ODO	SOP-4	26vdl	VD6	5c	Rhm
JC	MAX6315US45D4-T	Vdet-IC	4.5V±1.8%, -MR, -Reset ODO, 1120ms	SOT-143	24wdh	VD4	5c	Max
JC	RP130Q421B	LVR-IC	LDO, LN, +CE, 4.2V±1%, 150mA	SC-82AB	26vn	VR4	5a	Ric
JC2	S-80141ANPF	Vdet-IC	4.1V, -Reset ODO, 50ms	SNT-4	42ye	VD1	5e	Sii
JC3	S-80142ANPF	Vdet-IC	4.2V, -Reset ODO, 50ms	SNT-4	42ye	VD1	5e	Sii
JC4	S-80143ANPF	Vdet-IC	4.3V, -Reset ODO, 50ms	SNT-4	42ye	VD1	5e	Sii
JC5	S-80144ANPF	Vdet-IC	4.4V, -Reset ODO, 50ms	SNT-4	42ye	VD1	5e	Sii
JC6	S-80145ANPF	Vdet-IC	4.5V, -Reset ODO, 50ms	SNT-4	42ye	VD1	5e	Sii
JC7	S-80146ANPF	Vdet-IC	4.6V, -Reset ODO, 50ms	SNT-4	42ye	VD1	5e	Sii
JC8	S-80147ANPF	Vdet-IC	4.7V, -Reset ODO, 50ms	SNT-4	42ye	VD1	5e	Sii
JC9	S-80148ANPF	Vdet-IC	4.8V, -Reset ODO, 50ms	SNT-4	42ye	VD1	5e	Sii
JCH	S-80122ANPF	Vdet-IC	2.2V, -Reset ODO, 50ms	SNT-4	42ye	VD1	5e	Sii
JCI	S-80123ANPF	Vdet-IC	2.3V, -Reset ODO, 50ms	SNT-4	42ye	VD1	5e	Sii
JCJ	S-80124ANPF	Vdet-IC	2.4V, -Reset ODO, 50ms	SNT-4	42ye	VD1	5e	Sii
JCK	S-80125ANPF	Vdet-IC	2.5V, -Reset ODO, 50ms	SNT-4	42ye	VD1	5e	Sii
JCL	S-80126ANPF	Vdet-IC	2.6V, -Reset ODO, 50ms	SNT-4	42ye	VD1	5e	Sii
JCM	S-80127ANPF	Vdet-IC	2.7V, -Reset ODO, 50ms	SNT-4	42ye	VD1	5e	Sii
JCN	S-80128ANPF	Vdet-IC	2.8V, -Reset ODO, 50ms	SNT-4	42ye	VD1	5e	Sii
JCO	S-80129ANPF	Vdet-IC	2.9V, -Reset ODO, 50ms	SNT-4	42ye	VD1	5e	Sii
JCP	S-80130ANPF	Vdet-IC	3V, -Reset ODO, 50ms	SNT-4	42ye	VD1	5e	Sii
JCQ	S-80131ANPF	Vdet-IC	3.1V, -Reset ODO, 50ms	SNT-4	42ye	VD1	5e	Sii
JCR	S-80132ANPF	Vdet-IC	3.2V, -Reset ODO, 50ms	SNT-4	42ye	VD1	5e	Sii
JCS	S-80133ANPF	Vdet-IC	3.3V, -Reset ODO, 50ms	SNT-4	42ye	VD1	5e	Sii
JCT	S-80134ANPF	Vdet-IC	3.4V, -Reset ODO, 50ms	SNT-4	42ye	VD1	5e	Sii
JCU	S-80135ANPF	Vdet-IC	3.5V, -Reset ODO, 50ms	SNT-4	42ye	VD1	5e	Sii
JCV	S-80136ANPF	Vdet-IC	3.6V, -Reset ODO, 50ms	SNT-4	42ye	VD1	5e	Sii
JCW	S-80137ANPF	Vdet-IC	3.7V, -Reset ODO, 50ms	SNT-4	42ye	VD1	5e	Sii
JCX	S-80138ANPF	Vdet-IC	3.8V, -Reset ODO, 50ms	SNT-4	42ye	VD1	5e	Sii
JCY	S-80139ANPF	Vdet-IC	3.9V, -Reset ODO, 50ms	SNT-4	42ye	VD1	5e	Sii
JCZ	S-80140ANPF	Vdet-IC	4V, -Reset ODO, 50ms	SNT-4	42ye	VD1	5e	Sii
JD	BU4836F	Vdet-IC	3.6V±1%, -Reset ODO	SOP-4	26vdl	VD6	5c	Rhm
JD	MAX6315US44D4-T	Vdet-IC	4.39V±1.8%, -MR, -Reset ODO, 1120ms	SOT-143	24wdh	VD4	5c	Max
JD	RP130Q431B	LVR-IC	LDO, LN, +CE, 4.3V±1%, 150mA	SC-82AB	26vn	VR4	5a	Ric
JDA	S-80149ANPF	Vdet-IC	4.9V, -Reset ODO, 50ms	SNT-4	42ye	VD1	5e	Sii
JDB	S-80150ANPF	Vdet-IC	5V, -Reset ODO, 50ms	SNT-4	42ye	VD1	5e	Sii
JDC	S-80151ANPF	Vdet-IC	5.1V, -Reset ODO, 50ms	SNT-4	42ye	VD1	5e	Sii
JDD	S-80152ANPF	Vdet-IC	5.2V, -Reset ODO, 50ms	SNT-4	42ye	VD1	5e	Sii
JDE	S-80153ANPF	Vdet-IC	5.3V, -Reset ODO, 50ms	SNT-4	42ye	VD1	5e	Sii
JDF	S-80154ANPF	Vdet-IC	5.4V, -Reset ODO, 50ms	SNT-4	42ye	VD1	5e	Sii
JDG	S-80155ANPF	Vdet-IC	5.5V, -Reset ODO, 50ms	SNT-4	42ye	VD1	5e	Sii
JDH	S-80156ANPF	Vdet-IC	5.6V, -Reset ODO, 50ms	SNT-4	42ye	VD1	5e	Sii
JDI	S-80157ANPF	Vdet-IC	5.7V, -Reset ODO, 50ms	SNT-4	42ye	VD1	5e	Sii
JDJ	S-80158ANPF	Vdet-IC	5.8V, -Reset ODO, 50ms	SNT-4	42ye	VD1	5e	Sii
JDK	S-80159ANPF	Vdet-IC	5.9V, -Reset ODO, 50ms	SNT-4	42ye	VD1	5e	Sii
JDL	S-80160ANPF	Vdet-IC	6V, -Reset ODO, 50ms	SNT-4	42ye	VD1	5e	Sii
JE	BU4837F	Vdet-IC	3.7V±1%, -Reset ODO	SOP-4	26vdl	VD6	5c	Rhm
JE	MAX6315US43D4-T	Vdet-IC	4.3V±1.8%, -MR, -Reset ODO, 1120ms	SOT-143	24wdh	VD4	5c	Max
JE	RP130Q441B	LVR-IC	LDO, LN, +CE, 4.4V±1%, 150mA	SC-82AB	26vn	VR4	5a	Ric
JE2	S-80141BLPF	Vdet-IC	4.1V, -Reset PPO, 100ms	SNT-4	42ye	VD3	5e	Sii
JE3	S-80142BLPF	Vdet-IC	4.2V, -Reset PPO, 100ms	SNT-4	42ye	VD3	5e	Sii
JE4	S-80143BLPF	Vdet-IC	4.3V, -Reset PPO, 100ms	SNT-4	42ye	VD3	5e	Sii
JE5	S-80144BLPF	Vdet-IC	4.4V, -Reset PPO, 100ms	SNT-4	42ye	VD3	5e	Sii
JE6	S-80145BLPF	Vdet-IC	4.5V, -Reset PPO, 100ms	SNT-4	42ye	VD3	5e	Sii
JE7	S-80146BLPF	Vdet-IC	4.6V, -Reset PPO, 100ms	SNT-4	42ye	VD3	5e	Sii
JE8	S-80147BLPF	Vdet-IC	4.7V, -Reset PPO, 100ms	SNT-4	42ye	VD3	5e	Sii
JE9	S-80148BLPF	Vdet-IC	4.8V, -Reset PPO, 100ms	SNT-4	42ye	VD3	5e	Sii
JEH	S-80122BLPF	Vdet-IC	2.2V, -Reset PPO, 100ms	SNT-4	42ye	VD3	5e	Sii
JEI	S-80123BLPF	Vdet-IC	2.3V, -Reset PPO, 100ms	SNT-4	42ye	VD3	5e	Sii
JEJ	S-80124BLPF	Vdet-IC	2.4V, -Reset PPO, 100ms	SNT-4	42ye	VD3	5e	Sii
JEK	S-80125BLPF	Vdet-IC	2.5V, -Reset PPO, 100ms	SNT-4	42ye	VD3	5e	Sii
JEL	S-80126BLPF	Vdet-IC	2.6V, -Reset PPO, 100ms	SNT-4	42ye	VD3	5e	Sii
JEM	S-80127BLPF	Vdet-IC	2.7V, -Reset PPO, 100ms	SNT-4	42ye	VD3	5e	Sii
JEN	S-80128BLPF	Vdet-IC	2.8V, -Reset PPO, 100ms	SNT-4	42ye	VD3	5e	Sii



SMD code	Type	Function	Short description	Case	Pinout Sch.	St.	Mnf.
JEO	S-80129BLPF	Vdet-IC	2.9V, -Reset PPO, 100ms	SNT-4	42ye VD3	5e	Sii
JEP	S-80130BLPF	Vdet-IC	3V, -Reset PPO, 100ms	SNT-4	42ye VD3	5e	Sii
JEQ	S-80131BLPF	Vdet-IC	3.1V, -Reset PPO, 100ms	SNT-4	42ye VD3	5e	Sii
JER	S-80132BLPF	Vdet-IC	3.2V, -Reset PPO, 100ms	SNT-4	42ye VD3	5e	Sii
JES	S-80133BLPF	Vdet-IC	3.3V, -Reset PPO, 100ms	SNT-4	42ye VD3	5e	Sii
JET	S-80134BLPF	Vdet-IC	3.4V, -Reset PPO, 100ms	SNT-4	42ye VD3	5e	Sii
JEU	S-80135BLPF	Vdet-IC	3.5V, -Reset PPO, 100ms	SNT-4	42ye VD3	5e	Sii
JEV	S-80136BLPF	Vdet-IC	3.6V, -Reset PPO, 100ms	SNT-4	42ye VD3	5e	Sii
JEW	S-80137BLPF	Vdet-IC	3.7V, -Reset PPO, 100ms	SNT-4	42ye VD3	5e	Sii
JEX	S-80138BLPF	Vdet-IC	3.8V, -Reset PPO, 100ms	SNT-4	42ye VD3	5e	Sii
JEY	S-80139BLPF	Vdet-IC	3.9V, -Reset PPO, 100ms	SNT-4	42ye VD3	5e	Sii
JEZ	S-80140BLPF	Vdet-IC	4V, -Reset PPO, 100ms	SNT-4	42ye VD3	5e	Sii
JF	BU4838F	Vdet-IC	3.8V±1%, -Reset ODO	SOP-4	26vdl VD6	5c	Rhm
JF	MAX6315US42D4-T	Vdet-IC	4.2V±1.8%, -MR, -Reset ODO, 1120ms	SOT-143	24vdh VD4	5c	Max
JF	R1114Q151A	LVR-IC	LDO, LN, -CE, 1.5V±2%, 150mA	SOT-143R	26vn VR4	5a	Ric
JF	RP130Q451B	LVR-IC	LDO, LN, +CE, 4.5V±1%, 150mA	SC-82AB	26vn VR4	5a	Ric
JFA	S-80149BLPF	Vdet-IC	4.9V, -Reset PPO, 100ms	SNT-4	42ye VD3	5e	Sii
JFB	S-80150BLPF	Vdet-IC	5V, -Reset PPO, 100ms	SNT-4	42ye VD3	5e	Sii
JFC	S-80151BLPF	Vdet-IC	5.1V, -Reset PPO, 100ms	SNT-4	42ye VD3	5e	Sii
JFD	S-80152BLPF	Vdet-IC	5.2V, -Reset PPO, 100ms	SNT-4	42ye VD3	5e	Sii
JFE	S-80153BLPF	Vdet-IC	5.3V, -Reset PPO, 100ms	SNT-4	42ye VD3	5e	Sii
JFF	S-80154BLPF	Vdet-IC	5.4V, -Reset PPO, 100ms	SNT-4	42ye VD3	5e	Sii
JFG	S-80155BLPF	Vdet-IC	5.5V, -Reset PPO, 100ms	SNT-4	42ye VD3	5e	Sii
JFH	S-80156BLPF	Vdet-IC	5.6V, -Reset PPO, 100ms	SNT-4	42ye VD3	5e	Sii
JFI	S-80157BLPF	Vdet-IC	5.7V, -Reset PPO, 100ms	SNT-4	42ye VD3	5e	Sii
JFJ	S-80158BLPF	Vdet-IC	5.8V, -Reset PPO, 100ms	SNT-4	42ye VD3	5e	Sii
JFK	S-80159BLPF	Vdet-IC	5.9V, -Reset PPO, 100ms	SNT-4	42ye VD3	5e	Sii
JFL	S-80160BLPF	Vdet-IC	6V, -Reset PPO, 100ms	SNT-4	42ye VD3	5e	Sii
JG	BU4839F	Vdet-IC	3.9V±1%, -Reset ODO	SOP-4	26vdl VD6	5c	Rhm
JG	MAX6315US41D4-T	Vdet-IC	4.1V±1.8%, -MR, -Reset ODO, 1120ms	SOT-143	24vdh VD4	5c	Max
JG	R1114Q161A	LVR-IC	LDO, LN, -CE, 1.6V±2%, 150mA	SOT-143R	26vn VR4	5a	Ric
JG	RP130Q461B	LVR-IC	LDO, LN, +CE, 4.6V±1%, 150mA	SC-82AB	26vn VR4	5a	Ric
JG2	S-80141BNPF	Vdet-IC	4.1V, -Reset ODO, 100ms	SNT-4	42ye VD1	5e	Sii
JG3	S-80142BNPF	Vdet-IC	4.2V, -Reset ODO, 100ms	SNT-4	42ye VD1	5e	Sii
JG4	S-80143BNPF	Vdet-IC	4.3V, -Reset ODO, 100ms	SNT-4	42ye VD1	5e	Sii
JG5	S-80144BNPF	Vdet-IC	4.4V, -Reset ODO, 100ms	SNT-4	42ye VD1	5e	Sii
JG6	S-80145BNPF	Vdet-IC	4.5V, -Reset ODO, 100ms	SNT-4	42ye VD1	5e	Sii
JG7	S-80146BNPF	Vdet-IC	4.6V, -Reset ODO, 100ms	SNT-4	42ye VD1	5e	Sii
JG8	S-80147BNPF	Vdet-IC	4.7V, -Reset ODO, 100ms	SNT-4	42ye VD1	5e	Sii
JG9	S-80148BNPF	Vdet-IC	4.8V, -Reset ODO, 100ms	SNT-4	42ye VD1	5e	Sii
JGH	S-80122BNPF	Vdet-IC	2.2V, -Reset ODO, 100ms	SNT-4	42ye VD1	5e	Sii
JGI	S-80123BNPF	Vdet-IC	2.3V, -Reset ODO, 100ms	SNT-4	42ye VD1	5e	Sii
JGJ	S-80124BNPF	Vdet-IC	2.4V, -Reset ODO, 100ms	SNT-4	42ye VD1	5e	Sii
JGK	S-80125BNPF	Vdet-IC	2.5V, -Reset ODO, 100ms	SNT-4	42ye VD1	5e	Sii
JGL	S-80126BNPF	Vdet-IC	2.6V, -Reset ODO, 100ms	SNT-4	42ye VD1	5e	Sii
JGM	S-80127BNPF	Vdet-IC	2.7V, -Reset ODO, 100ms	SNT-4	42ye VD1	5e	Sii
JGN	S-80128BNPF	Vdet-IC	2.8V, -Reset ODO, 100ms	SNT-4	42ye VD1	5e	Sii
JGO	S-80129BNPF	Vdet-IC	2.9V, -Reset ODO, 100ms	SNT-4	42ye VD1	5e	Sii
JGP	S-80130BNPF	Vdet-IC	3V, -Reset ODO, 100ms	SNT-4	42ye VD1	5e	Sii
JGQ	S-80131BNPF	Vdet-IC	3.1V, -Reset ODO, 100ms	SNT-4	42ye VD1	5e	Sii
JGR	S-80132BNPF	Vdet-IC	3.2V, -Reset ODO, 100ms	SNT-4	42ye VD1	5e	Sii
JGS	S-80133BNPF	Vdet-IC	3.3V, -Reset ODO, 100ms	SNT-4	42ye VD1	5e	Sii
JGT	S-80134BNPF	Vdet-IC	3.4V, -Reset ODO, 100ms	SNT-4	42ye VD1	5e	Sii
JGU	S-80135BNPF	Vdet-IC	3.5V, -Reset ODO, 100ms	SNT-4	42ye VD1	5e	Sii
JGV	S-80136BNPF	Vdet-IC	3.6V, -Reset ODO, 100ms	SNT-4	42ye VD1	5e	Sii
JGW	S-80137BNPF	Vdet-IC	3.7V, -Reset ODO, 100ms	SNT-4	42ye VD1	5e	Sii
JGX	S-80138BNPF	Vdet-IC	3.8V, -Reset ODO, 100ms	SNT-4	42ye VD1	5e	Sii
JGY	S-80139BNPF	Vdet-IC	3.9V, -Reset ODO, 100ms	SNT-4	42ye VD1	5e	Sii
JGZ	S-80140BNPF	Vdet-IC	4V, -Reset ODO, 100ms	SNT-4	42ye VD1	5e	Sii
JH	BU4840F	Vdet-IC	4V±1%, -Reset ODO	SOP-4	26vdl VD6	5c	Rhm
JH	MAX6315US40D4-T	Vdet-IC	4.0V±1.8%, -MR, -Reset ODO, 1120ms	SOT-143	24vdh VD4	5c	Max
JH	R1114Q171A	LVR-IC	LDO, LN, -CE, 1.7V±2%, 150mA	SOT-143R	26vn VR4	5a	Ric
JH	RP130Q471B	LVR-IC	LDO, LN, +CE, 4.7V±1%, 150mA	SC-82AB	26vn VR4	5a	Ric
JHA	S-80149BNPF	Vdet-IC	4.9V, -Reset ODO, 100ms	SNT-4	42ye VD1	5e	Sii
JHB	S-80150BNPF	Vdet-IC	5V, -Reset ODO, 100ms	SNT-4	42ye VD1	5e	Sii
JHC	S-80151BNPF	Vdet-IC	5.1V, -Reset ODO, 100ms	SNT-4	42ye VD1	5e	Sii
JHD	S-80152BNPF	Vdet-IC	5.2V, -Reset ODO, 100ms	SNT-4	42ye VD1	5e	Sii
JHE	S-80153BNPF	Vdet-IC	5.3V, -Reset ODO, 100ms	SNT-4	42ye VD1	5e	Sii
JHF	S-80154BNPF	Vdet-IC	5.4V, -Reset ODO, 100ms	SNT-4	42ye VD1	5e	Sii
JHG	S-80155BNPF	Vdet-IC	5.5V, -Reset ODO, 100ms	SNT-4	42ye VD1	5e	Sii



SMD code	Type	Function	Short description	Case	Pinout Sch.	St.	Mnf.
JHH	S-80156BNPF	Vdet-IC	5.6V, -Reset ODO, 100ms	SNT-4	42ye VD1	5e	Sii
JHI	S-80157BNPF	Vdet-IC	5.7V, -Reset ODO, 100ms	SNT-4	42ye VD1	5e	Sii
JHJ	S-80158BNPF	Vdet-IC	5.8V, -Reset ODO, 100ms	SNT-4	42ye VD1	5e	Sii
JHK	S-80159BNPF	Vdet-IC	5.9V, -Reset ODO, 100ms	SNT-4	42ye VD1	5e	Sii
JHL	S-80160BNPF	Vdet-IC	6V, -Reset ODO, 100ms	SNT-4	42ye VD1	5e	Sii
JI	MAX6315US39D4-T	Vdet-IC	3.9V±1.8%, -MR, -Reset ODO, 1120ms	SOT-143	24wdh VD4	5c	Max
JI2	S-80141CLPF	Vdet-IC	4.1V, -Reset PPO, 200ms	SNT-4	42ye VD3	5e	Sii
JI3	S-80142CLPF	Vdet-IC	4.2V, -Reset PPO, 200ms	SNT-4	42ye VD3	5e	Sii
JI4	S-80143CLPF	Vdet-IC	4.3V, -Reset PPO, 200ms	SNT-4	42ye VD3	5e	Sii
JI5	S-80144CLPF	Vdet-IC	4.4V, -Reset PPO, 200ms	SNT-4	42ye VD3	5e	Sii
JI6	S-80145CLPF	Vdet-IC	4.5V, -Reset PPO, 200ms	SNT-4	42ye VD3	5e	Sii
JI7	S-80146CLPF	Vdet-IC	4.6V, -Reset PPO, 200ms	SNT-4	42ye VD3	5e	Sii
JI8	S-80147CLPF	Vdet-IC	4.7V, -Reset PPO, 200ms	SNT-4	42ye VD3	5e	Sii
JI9	S-80148CLPF	Vdet-IC	4.8V, -Reset PPO, 200ms	SNT-4	42ye VD3	5e	Sii
JIH	S-80122CLPF	Vdet-IC	2.2V, -Reset PPO, 200ms	SNT-4	42ye VD3	5e	Sii
JII	S-80123CLPF	Vdet-IC	2.3V, -Reset PPO, 200ms	SNT-4	42ye VD3	5e	Sii
JIJ	S-80124CLPF	Vdet-IC	2.4V, -Reset PPO, 200ms	SNT-4	42ye VD3	5e	Sii
JIK	S-80125CLPF	Vdet-IC	2.5V, -Reset PPO, 200ms	SNT-4	42ye VD3	5e	Sii
JIL	S-80126CLPF	Vdet-IC	2.6V, -Reset PPO, 200ms	SNT-4	42ye VD3	5e	Sii
JIM	S-80127CLPF	Vdet-IC	2.7V, -Reset PPO, 200ms	SNT-4	42ye VD3	5e	Sii
JIN	S-80128CLPF	Vdet-IC	2.8V, -Reset PPO, 200ms	SNT-4	42ye VD3	5e	Sii
JIO	S-80129CLPF	Vdet-IC	2.9V, -Reset PPO, 200ms	SNT-4	42ye VD3	5e	Sii
JIP	S-80130CLPF	Vdet-IC	3V, -Reset PPO, 200ms	SNT-4	42ye VD3	5e	Sii
JIQ	S-80131CLPF	Vdet-IC	3.1V, -Reset PPO, 200ms	SNT-4	42ye VD3	5e	Sii
JIR	S-80132CLPF	Vdet-IC	3.2V, -Reset PPO, 200ms	SNT-4	42ye VD3	5e	Sii
JIS	S-80133CLPF	Vdet-IC	3.3V, -Reset PPO, 200ms	SNT-4	42ye VD3	5e	Sii
JIT	S-80134CLPF	Vdet-IC	3.4V, -Reset PPO, 200ms	SNT-4	42ye VD3	5e	Sii
JIU	S-80135CLPF	Vdet-IC	3.5V, -Reset PPO, 200ms	SNT-4	42ye VD3	5e	Sii
JIV	S-80136CLPF	Vdet-IC	3.6V, -Reset PPO, 200ms	SNT-4	42ye VD3	5e	Sii
JIW	S-80137CLPF	Vdet-IC	3.7V, -Reset PPO, 200ms	SNT-4	42ye VD3	5e	Sii
JIX	S-80138CLPF	Vdet-IC	3.8V, -Reset PPO, 200ms	SNT-4	42ye VD3	5e	Sii
JIY	S-80139CLPF	Vdet-IC	3.9V, -Reset PPO, 200ms	SNT-4	42ye VD3	5e	Sii
JIZ	S-80140CLPF	Vdet-IC	4V, -Reset PPO, 200ms	SNT-4	42ye VD3	5e	Sii
JJ	BU4841F	Vdet-IC	4.1V±1%, -Reset ODO	SOP-4	26vdl VD6	5c	Rhm
JJ	MAX6315US38D4-T	Vdet-IC	3.8V±1.8%, -MR, -Reset ODO, 1120ms	SOT-143	24wdh VD4	5c	Max
JJ	R1114Q181A	LVR-IC	LDO, LN, -CE, 1.8V±2%, 150mA	SOT-143R	26wn VR4	5a	Ric
JJ	RP130Q481B	LVR-IC	LDO, LN, +CE, 4.8V±1%, 150mA	SC-82AB	26wn VR4	5a	Ric
JJA	S-80149CLPF	Vdet-IC	4.9V, -Reset PPO, 200ms	SNT-4	42ye VD3	5e	Sii
JJB	S-80150CLPF	Vdet-IC	5V, -Reset PPO, 200ms	SNT-4	42ye VD3	5e	Sii
JJC	S-80151CLPF	Vdet-IC	5.1V, -Reset PPO, 200ms	SNT-4	42ye VD3	5e	Sii
JJD	S-80152CLPF	Vdet-IC	5.2V, -Reset PPO, 200ms	SNT-4	42ye VD3	5e	Sii
JJE	S-80153CLPF	Vdet-IC	5.3V, -Reset PPO, 200ms	SNT-4	42ye VD3	5e	Sii
JJF	S-80154CLPF	Vdet-IC	5.4V, -Reset PPO, 200ms	SNT-4	42ye VD3	5e	Sii
JJG	S-80155CLPF	Vdet-IC	5.5V, -Reset PPO, 200ms	SNT-4	42ye VD3	5e	Sii
JJH	S-80156CLPF	Vdet-IC	5.6V, -Reset PPO, 200ms	SNT-4	42ye VD3	5e	Sii
JJI	S-80157CLPF	Vdet-IC	5.7V, -Reset PPO, 200ms	SNT-4	42ye VD3	5e	Sii
JJJ	S-80158CLPF	Vdet-IC	5.8V, -Reset PPO, 200ms	SNT-4	42ye VD3	5e	Sii
JJK	S-80159CLPF	Vdet-IC	5.9V, -Reset PPO, 200ms	SNT-4	42ye VD3	5e	Sii
JJL	S-80160CLPF	Vdet-IC	6V, -Reset PPO, 200ms	SNT-4	42ye VD3	5e	Sii
JK	BU4842F	Vdet-IC	4.2V±1%, -Reset ODO	SOP-4	26vdl VD6	5c	Rhm
JK	MAX6315US37D4-T	Vdet-IC	3.7V±1.8%, -MR, -Reset ODO, 1120ms	SOT-143	24wdh VD4	5c	Max
JK	R1114Q191A	LVR-IC	LDO, LN, -CE, 1.9V±2%, 150mA	SOT-143R	26wn VR4	5a	Ric
JK	RP130Q491B	LVR-IC	LDO, LN, +CE, 4.9V±1%, 150mA	SC-82AB	26wn VR4	5a	Ric
JK2	S-80141CNPF	Vdet-IC	4.1V, -Reset ODO, 200ms	SNT-4	42ye VD1	5e	Sii
JK3	S-80142CNPF	Vdet-IC	4.2V, -Reset ODO, 200ms	SNT-4	42ye VD1	5e	Sii
JK4	S-80143CNPF	Vdet-IC	4.3V, -Reset ODO, 200ms	SNT-4	42ye VD1	5e	Sii
JK5	S-80144CNPF	Vdet-IC	4.4V, -Reset ODO, 200ms	SNT-4	42ye VD1	5e	Sii
JK6	S-80145CNPF	Vdet-IC	4.5V, -Reset ODO, 200ms	SNT-4	42ye VD1	5e	Sii
JK7	S-80146CNPF	Vdet-IC	4.6V, -Reset ODO, 200ms	SNT-4	42ye VD1	5e	Sii
JK8	S-80147CNPF	Vdet-IC	4.7V, -Reset ODO, 200ms	SNT-4	42ye VD1	5e	Sii
JK9	S-80148CNPF	Vdet-IC	4.8V, -Reset ODO, 200ms	SNT-4	42ye VD1	5e	Sii
JKH	S-80122CNPF	Vdet-IC	2.2V, -Reset ODO, 200ms	SNT-4	42ye VD1	5e	Sii
JKI	S-80123CNPF	Vdet-IC	2.3V, -Reset ODO, 200ms	SNT-4	42ye VD1	5e	Sii
JKJ	S-80124CNPF	Vdet-IC	2.4V, -Reset ODO, 200ms	SNT-4	42ye VD1	5e	Sii
JKK	S-80125CNPF	Vdet-IC	2.5V, -Reset ODO, 200ms	SNT-4	42ye VD1	5e	Sii
JKL	S-80126CNPF	Vdet-IC	2.6V, -Reset ODO, 200ms	SNT-4	42ye VD1	5e	Sii
JKM	S-80127CNPF	Vdet-IC	2.7V, -Reset ODO, 200ms	SNT-4	42ye VD1	5e	Sii
JKN	S-80128CNPF	Vdet-IC	2.8V, -Reset ODO, 200ms	SNT-4	42ye VD1	5e	Sii
JKO	S-80129CNPF	Vdet-IC	2.9V, -Reset ODO, 200ms	SNT-4	42ye VD1	5e	Sii
JKP	S-80130CNPF	Vdet-IC	3V, -Reset ODO, 200ms	SNT-4	42ye VD1	5e	Sii



SMD code	Type	Function	Short description	Case	Pinout	Sch.	St.	Mnf.
JKQ	S-80131CNPF	Vdet-IC	3.1V, -Reset ODO, 200ms	SNT-4	42ye	VD1	5e	Sii
JKR	S-80132CNPF	Vdet-IC	3.2V, -Reset ODO, 200ms	SNT-4	42ye	VD1	5e	Sii
JKS	S-80133CNPF	Vdet-IC	3.3V, -Reset ODO, 200ms	SNT-4	42ye	VD1	5e	Sii
JKT	S-80134CNPF	Vdet-IC	3.4V, -Reset ODO, 200ms	SNT-4	42ye	VD1	5e	Sii
JKU	S-80135CNPF	Vdet-IC	3.5V, -Reset ODO, 200ms	SNT-4	42ye	VD1	5e	Sii
JKV	S-80136CNPF	Vdet-IC	3.6V, -Reset ODO, 200ms	SNT-4	42ye	VD1	5e	Sii
JKW	S-80137CNPF	Vdet-IC	3.7V, -Reset ODO, 200ms	SNT-4	42ye	VD1	5e	Sii
JKX	S-80138CNPF	Vdet-IC	3.8V, -Reset ODO, 200ms	SNT-4	42ye	VD1	5e	Sii
JKY	S-80139CNPF	Vdet-IC	3.9V, -Reset ODO, 200ms	SNT-4	42ye	VD1	5e	Sii
JKZ	S-80140CNPF	Vdet-IC	4V, -Reset ODO, 200ms	SNT-4	42ye	VD1	5e	Sii
JL	BU4843F	Vdet-IC	4.3V±1%, -Reset ODO	SOP-4	26vdl	VD6	5c	Rhm
JLJ	MAX6315US36D4-T	Vdet-IC	3.6V±1.8%, -MR, -Reset ODO, 1120ms	SOT-143	24vdh	VD4	5c	Max
JLA	S-80149CNPF	Vdet-IC	4.9V, -Reset ODO, 200ms	SNT-4	42ye	VD3	5e	Sii
JLB	S-80150CNPF	Vdet-IC	5V, -Reset ODO, 200ms	SNT-4	42ye	VD1	5e	Sii
JLC	S-80151CNPF	Vdet-IC	5.1V, -Reset ODO, 200ms	SNT-4	42ye	VD1	5e	Sii
JLD	S-80152CNPF	Vdet-IC	5.2V, -Reset ODO, 200ms	SNT-4	42ye	VD1	5e	Sii
JLE	S-80153CNPF	Vdet-IC	5.3V, -Reset ODO, 200ms	SNT-4	42ye	VD1	5e	Sii
JLF	S-80154CNPF	Vdet-IC	5.4V, -Reset ODO, 200ms	SNT-4	42ye	VD1	5e	Sii
JLG	S-80155CNPF	Vdet-IC	5.5V, -Reset ODO, 200ms	SNT-4	42ye	VD1	5e	Sii
JLH	S-80156CNPF	Vdet-IC	5.6V, -Reset ODO, 200ms	SNT-4	42ye	VD1	5e	Sii
JLI	S-80157CNPF	Vdet-IC	5.7V, -Reset ODO, 200ms	SNT-4	42ye	VD1	5e	Sii
JLJ	S-80158CNPF	Vdet-IC	5.8V, -Reset ODO, 200ms	SNT-4	42ye	VD1	5e	Sii
JLK	S-80159CNPF	Vdet-IC	5.9V, -Reset ODO, 200ms	SNT-4	42ye	VD1	5e	Sii
JLL	S-80160CNPF	Vdet-IC	6V, -Reset ODO, 200ms	SNT-4	42ye	VD1	5e	Sii
JLN	ELM7530CCB	Vdet-IC	3.0V±2%, +Reset PPO	SC-82AB	26vdl	VD7	5c	Elm
JLN	ELM7530NCB	Vdet-IC	3.0V±2%, +Reset ODO	SC-82AB	26vdl	VD6	5c	Elm
JM	BU4844F	Vdet-IC	4.4V±1%, -Reset ODO	SOP-4	26vdl	VD6	5c	Rhm
JM	MAX6315US35D4-T	Vdet-IC	3.5V±1.8%, -MR, -Reset ODO, 1120ms	SOT-143	24vdh	VD4	5c	Max
JN	BU4845F	Vdet-IC	4.5V±1%, -Reset ODO	SOP-4	26vdl	VD6	5c	Rhm
JN	MAX6315US34D4-T	Vdet-IC	3.4V±1.8%, -MR, -Reset ODO, 1120ms	SOT-143	24vdh	VD4	5c	Max
JO	MAX6315US33D4-T	Vdet-IC	3.3V±1.8%, -MR, -Reset ODO, 1120ms	SOT-143	24vdh	VD4	5c	Max
JP	BU4846F	Vdet-IC	4.6V±1%, -Reset ODO	SOP-4	26vdl	VD6	5c	Rhm
JP	MAX6315US32D4-T	Vdet-IC	3.2V±1.8%, -MR, -Reset ODO, 1120ms	SOT-143	24vdh	VD4	5c	Max
JPs	BAW101	Si-diode	Dual, Sw, 300V, 250mA, Vf<1.3V(100mA), 1µs	SOT-143	24ce	-	5h	Inf
JQ	BU4847F	Vdet-IC	4.7V±1%, -Reset ODO	SOP-4	26vdl	VD6	5c	Rhm
JQ	MAX6315US31D4-T	Vdet-IC	3.08V±1.8%, -MR, -Reset ODO, 1120ms	SOT-143	24vdh	VD4	5c	Max
JR	BU4848F	Vdet-IC	4.8V±1%, -Reset ODO	SOP-4	26vdl	VD6	5c	Rhm
JR	MAX6315US30D4-T	Vdet-IC	3.0V±1.8%, -MR, -Reset ODO, 1120ms	SOT-143	24vdh	VD4	5c	Max
js	PT7M6218CLC4	Vdet-IC	1.8V±1.5%, -Reset PPO	SC-70-4	23vdl	VD7	5g	Pti
js	PT7M6218CLC4E	Vdet-IC	1.8V±1.5%, -Reset PPO, Lead free	SC-70-4	23vdl	VD7	5g	Pti
JS	BU4909F	Vdet-IC	0.9V±1%, +Reset PPO	SOP-4	26vdl	VD7	5c	Rhm
JS	MAX6315US29D4-T	Vdet-IC	2.93V±1.8%, -MR, -Reset ODO, 1120ms	SOT-143	24vdh	VD4	5c	Max
jt	PT7M6218CHC4	Vdet-IC	1.8V±1.5%, +Reset PPO	SC-70-4	23vdl	VD7	5g	Pti
jt	PT7M6218CHC4E	Vdet-IC	1.8V±1.5%, +Reset PPO, Lead free	SC-70-4	23vdl	VD7	5g	Pti
JT	BU4910F	Vdet-IC	1V±1%, +Reset PPO	SOP-4	26vdl	VD7	5c	Rhm
JT	MAX6315US28D4-T	Vdet-IC	2.8V±1.8%, -MR, -Reset ODO, 1120ms	SOT-143	24vdh	VD4	5c	Max
JTp	BAS28	Si-diode	Dual, Fast, Sw, 75V, 250mA, Vf<1.25V(150mA), <6ns	SOT-143	24ce	-	5c	Phi
JTs	BAS28	Si-diode	Dual, Fast, Sw, 75V, 250mA, Vf<1.25V(150mA), <6ns	SOT-143	24ce	-	5b	Sie
ju	PT7M6218NLC4	Vdet-IC	1.8V±1.5%, -Reset ODO	SC-70-4	23vdl	VD6	5g	Pti
ju	PT7M6218NLC4E	Vdet-IC	1.8V±1.5%, -Reset ODO, Lead free	SC-70-4	23vdl	VD6	5g	Pti
JU	BU4911F	Vdet-IC	1.1V±1%, +Reset PPO	SOP-4	26vdl	VD7	5c	Rhm
JU	MAX6315US27D4-T	Vdet-IC	2.7V±1.8%, -MR, -Reset ODO, 1120ms	SOT-143	24vdh	VD4	5c	Max
jv	PT7M6219CLC4	Vdet-IC	1.9V±1.5%, -Reset PPO	SC-70-4	23vdl	VD7	5g	Pti
jv	PT7M6219CLC4E	Vdet-IC	1.9V±1.5%, -Reset PPO, Lead free	SC-70-4	23vdl	VD7	5g	Pti
JV	BU4912F	Vdet-IC	1.2V±1%, +Reset PPO	SOP-4	26vdl	VD7	5c	Rhm
JV	MAX6315US26D4-T	Vdet-IC	2.63V±1.8%, -MR, -Reset ODO, 1120ms	SOT-143	24vdh	VD4	5c	Max
jw	PT7M6219CHC4	Vdet-IC	1.9V±1.5%, +Reset PPO	SC-70-4	23vdl	VD7	5g	Pti
jw	PT7M6219CHC4E	Vdet-IC	1.9V±1.5%, +Reset PPO, Lead free	SC-70-4	23vdl	VD7	5g	Pti
JW	BU4913F	Vdet-IC	1.3V±1%, +Reset PPO	SOP-4	26vdl	VD7	5c	Rhm
JW	MAX6315US25D4-T	Vdet-IC	2.5V±1.8%, -MR, -Reset ODO, 1120ms	SOT-143	24vdh	VD4	5c	Max
jx	PT7M6219NLC4	Vdet-IC	1.9V±1.5%, -Reset ODO	SC-70-4	23vdl	VD6	5g	Pti
jx	PT7M6219NLC4E	Vdet-IC	1.9V±1.5%, -Reset ODO, Lead free	SC-70-4	23vdl	VD6	5g	Pti
JX	BU4914F	Vdet-IC	1.4V±1%, +Reset PPO	SOP-4	26vdl	VD7	5c	Rhm
iy	PT7M6220CLC4	Vdet-IC	2.0V±1.5%, -Reset PPO	SC-70-4	23vdl	VD7	5g	Pti
iy	PT7M6220CLC4E	Vdet-IC	2.0V±1.5%, -Reset PPO, Lead free	SC-70-4	23vdl	VD7	5g	Pti
JY	BU4915F	Vdet-IC	1.5V±1%, +Reset PPO	SOP-4	26vdl	VD7	5c	Rhm
jz	PT7M6220CHC4	Vdet-IC	2.0V±1.5%, +Reset PPO	SC-70-4	23vdl	VD7	5g	Pti
jz	PT7M6220CHC4E	Vdet-IC	2.0V±1.5%, +Reset PPO, Lead free	SC-70-4	23vdl	VD7	5g	Pti
JZ	BU4916F	Vdet-IC	1.6V±1%, +Reset PPO	SOP-4	26vdl	VD7	5c	Rhm
K0	R3114Q471C	Vdet-IC	4.7V±0.8%, -Reset PPO	SC-82AB	26vdl	VD7	5a	Rhm



SMD code	Type	Function	Short description	Case	Pinout	Sch.	St.	Mnf.
K0	RP103Q281D	LVR-IC	LDO, 2.8V±1%, 150mA, +CE, CL	SC-82AB	26vn	VR4	5a	Ric
K1	R3114Q481C	Vdet-IC	4.8V±0.8%, -Reset PPO	SC-82AB	26vdl	VD7	5a	Ric
K1	RP103Q281D5	LVR-IC	LDO, 2.85V±1%, 150mA, +CE, CL	SC-82AB	26vn	VR4	5a	Ric
K2	R3114Q491C	Vdet-IC	4.9V±0.8%, -Reset PPO	SC-82AB	26vdl	VD7	5a	Ric
K2	RP103Q291D	LVR-IC	LDO, 2.9V±1%, 150mA, +CE, CL	SC-82AB	26vn	VR4	5a	Ric
K2	XC6223E121NR-G	LVR-IC	LDO, 1.2V±20mV, 300mA, +CE, ICP	SSOT-24	26vn	VR4	5a	Tor
K3	R3114Q501C	Vdet-IC	5V±0.8%, -Reset PPO	SC-82AB	26vdl	VD7	5a	Ric
K3	RP103Q301D	LVR-IC	LDO, 3V±1%, 150mA, +CE, CL	SC-82AB	26vn	VR4	5a	Ric
K3	XC6223E131NR-G	LVR-IC	LDO, 1.3V±20mV, 300mA, +CE, ICP	SSOT-24	26vn	VR4	5a	Tor
K4	XC6223E141NR-G	LVR-IC	LDO, 1.4V±20mV, 300mA, +CE, ICP	SSOT-24	26vn	VR4	5a	Tor
K5	RP103Q331D	LVR-IC	LDO, 3.3V±1%, 150mA, +CE, CL	SC-82AB	26vn	VR4	5a	Ric
K5	XC6223E151NR-G	LVR-IC	LDO, 1.5V±20mV, 300mA, +CE, ICP	SSOT-24	26vn	VR4	5a	Tor
K6	RP103Q231D	LVR-IC	LDO, 2.3V±1%, 150mA, +CE, CL	SC-82AB	26vn	VR4	5a	Ric
K6	XC6223E161NR-G	LVR-IC	LDO, 1.6V±20mV, 300mA, +CE, ICP	SSOT-24	26vn	VR4	5a	Tor
K7	RP103Q211D	LVR-IC	LDO, 2.1V±1%, 150mA, +CE, CL	SC-82AB	26vn	VR4	5a	Ric
K7	XC6223E171NR-G	LVR-IC	LDO, 1.7V±20mV, 300mA, +CE, ICP	SSOT-24	26vn	VR4	5a	Tor
K8	RP103Q321D	LVR-IC	LDO, 3.2V±1%, 150mA, +CE, CL	SC-82AB	26vn	VR4	5a	Ric
K8	XC6223E181NR-G	LVR-IC	LDO, 1.8V±20mV, 300mA, +CE, ICP	SSOT-24	26vn	VR4	5a	Tor
K9	R3111Q091A	Vdet-IC	0.9V±2%, -Reset PPO	SC-82AB	26vdl	VD7	5a	Ric
K9	RP103Q291D5	LVR-IC	LDO, 2.9V±1%, 150mA, +CE, CL	SC-82AB	26vn	VR4	5a	Ric
K9	XC6223E191NR-G	LVR-IC	LDO, 1.9V±20mV, 300mA, +CE, ICP	SSOT-24	26vn	VR4	5a	Tor
ka	PT7M6220NLC4	Vdet-IC	2.0V±1.5%, -Reset ODO	SC-70-4	23vdl	VD6	5g	Pti
ka	PT7M6220NLC4E	Vdet-IC	2.0V±1.5%, -Reset ODO, Lead free	SC-70-4	23vdl	VD6	5g	Pti
Ka	FP6811-23NC4P	Vdet-IC	2.32V±1.5%, -Reset ODO, -MR	SC-70-4	23vdl	VD5	5b	Fit
KA	BU4917F	Vdet-IC	1.7V±1%, +Reset PPO	SOP-4	26vdl	VD7	5c	Rhm
KA	R1114Q201A	LVR-IC	LDO, LN, -CE, 2V±2%, 150mA	SOT-143R	26vn	VR4	5a	Ric
KA	RP130Q501B	LVR-IC	LDO, LN, +CE, 5V±1%, 150mA	SC-82AB	26vn	VR4	5a	Ric
KA	XC6120C10N	Vdet-IC	1V±2%, CMOS +Reset PPO	SSOT-24	26yu	VD7	5a	Tor
Kā	XC6127C16CNR	Vdet-IC	1.6V±0.8%, -Reset PPO, -MR, Rt=200ms	SSOT-24	26cr	VD5	5a	Tor
Kā	XC6127N16HNR	Vdet-IC	1.6V±0.8%, +Reset ODO, -MR, Rt=200ms	SSOT-24	26cr	VD4	5a	Tor
KA	XC6223E201NR-G	LVR-IC	LDO, 2.0V±1%, 300mA, +CE, ICP	SSOT-24	26vn	VR4	5a	Tor
KAAP	MAX6335US16D3	Vdet-IC	1.6V±1.5%, -MR, +Reset PPO/Voltage Detector	SOT-143	24vdh	VD5	5c	Max
KAAQ	MAX6335US18D3	Vdet-IC	1.8V±1.5%, -MR, +Reset PPO	SOT-143	24vdh	VD5	5c	Max
KAAK	MAX6335US22D3	Vdet-IC	2.2V±1.5%, -MR, +Reset PPO	SOT-143	24vdh	VD5	5c	Max
KAAS	MAX6336US16D3	Vdet-IC	1.6V±1.5%, -MR, -Reset PPO	SOT-143	24vdh	VD5	5c	Max
KAAK	MAX6336US18D3	Vdet-IC	1.8V±1.5%, -MR, -Reset PPO	SOT-143	24vdh	VD5	5c	Max
KAAU	MAX6336US20D3	Vdet-IC	2.0V±1.5%, -MR, -Reset PPO	SOT-143	24vdh	VD5	5c	Max
KAAV	MAX6336US22D3	Vdet-IC	2.2V±1.5%, -MR, -Reset PPO	SOT-143	24vdh	VD5	5c	Max
KAAW	MAX6336US23D3	Vdet-IC	2.3V±1.5%, -MR, -Reset PPO	SOT-143	24vdh	VD5	5c	Max
KAAZ	MAX6337US16D3	Vdet-IC	1.6V±1.5%, -MR, -Reset ODO	SOT-143	24vdh	VD4	5c	Max
KAAZ	MAX6337US18D3	Vdet-IC	1.8V±1.5%, -MR, -Reset ODO	SOT-143	24vdh	VD4	5c	Max
KAAZ	MAX6337US22D3	Vdet-IC	2.2V±1.5%, -MR, -Reset ODO	SOT-143	24vdh	VD4	5c	Max
KABP	MAX6335US20D3	Vdet-IC	2.0V±1.5%, -MR, +Reset PPO	SOT-143	24vdh	VD5	5c	Max
KABQ	MAX6335US23D3	Vdet-IC	2.3V±1.5%, -MR, +Reset PPO	SOT-143	24vdh	VD5	5c	Max
KABR	MAX6337US20D3	Vdet-IC	2.0V±1.5%, -MR, -Reset ODO	SOT-143	24vdh	VD4	5c	Max
KABS	MAX6337US23D3	Vdet-IC	2.3V±1.5%, -MR, -Reset ODO	SOT-143	24vdh	VD4	5c	Max
KABT	MAX6806US46-T	Vdet-IC	4.6V±1.5%, -MR, -Reset PPO	SOT-143	24co	VD5	5c	Max
KABU	MAX6806US26-T	Vdet-IC	2.6V±1.5%, -MR, -Reset PPO	SOT-143	24co	VD5	5c	Max
KABV	MAX6806US23-T	Vdet-IC	2.3V±1.5%, -MR, -Reset PPO	SOT-143	24co	VD5	5c	Max
KABW	MAX6807US46-T	Vdet-IC	4.6V±1.5%, -MR, +Reset PPO	SOT-143	24co	VD5	5c	Max
KABX	MAX6807US26-T	Vdet-IC	2.6V±1.5%, -MR, +Reset PPO	SOT-143	24co	VD5	5c	Max
KABY	MAX6808US46-T	Vdet-IC	4.6V±1.5%, -MR, -Reset ODO	SOT-143	24co	VD4	5c	Max
KABZ	MAX6808US26-T	Vdet-IC	2.6V±1.5%, -MR, -Reset ODO	SOT-143	24co	VD4	5c	Max
KACC	MAX6808US32-T	Vdet-IC	3.2V±1.5%, -MR, -Reset ODO	SOT-143	24co	VD4	5c	Max
KAEW	MAX6468US29D3	Vdet-IC	2.9V±1.5%, -MR, Reset PPO	SOT-143	26vdh	VD5	5c	Max
KAFK	MAX6443US29L	Vdet-IC	2.9V±1.5%, ±MR, -Reset PPO	SOT-143	24vdh	VD5	5c	Max
KAFK	MAX6444US46L	Vdet-IC	4.6V±1.5%, ±MR, -Reset ODO	SOT-143	24vdh	VD5	5c	Max
KAFN	MAX6467US16D3	Vdet-IC	1.6V±1.5%, -MR, Reset ODO	SOT-143	26vdh	VD4	5c	Max
KAFQ	MAX6467US22D3	Vdet-IC	2.2V±1.5%, -MR, Reset ODO	SOT-143	26vdh	VD4	5c	Max
KAFQ	MAX6467US26D3	Vdet-IC	2.6V±1.5%, -MR, Reset ODO	SOT-143	26vdh	VD4	5c	Max
KAFQ	MAX6467US29D3	Vdet-IC	2.9V±1.5%, -MR, Reset ODO	SOT-143	26vdh	VD4	5c	Max
KAFR	MAX6467US46D3	Vdet-IC	4.6V±1.5%, -MR, Reset ODO	SOT-143	26vdh	VD4	5c	Max
KAFS	MAX6468US16D3	Vdet-IC	1.6V±1.5%, -MR, Reset PPO	SOT-143	26vdh	VD5	5c	Max
KAFU	MAX6468US22D3	Vdet-IC	2.2V±1.5%, -MR, Reset PPO	SOT-143	26vdh	VD5	5c	Max
KAFU	MAX6468US26D3	Vdet-IC	2.6V±1.5%, -MR, Reset PPO	SOT-143	26vdh	VD5	5c	Max
KAFV	MAX6468US46D3	Vdet-IC	4.6V±1.5%, -MR, Reset PPO	SOT-143	26vdh	VD5	5c	Max
KAFW	MAX6443US16L	Vdet-IC	1.6V±1.5%, ±MR, -Reset PPO	SOT-143	24vdh	VD5	5c	Max
KAFX	MAX6443US23L	Vdet-IC	2.3V±1.5%, ±MR, -Reset PPO	SOT-143	24vdh	VD5	5c	Max
KAFY	MAX6443US26L	Vdet-IC	2.6V±1.5%, ±MR, -Reset PPO	SOT-143	24vdh	VD5	5c	Max
KAFZ	MAX6443US46L	Vdet-IC	4.6V±1.5%, ±MR, -Reset PPO	SOT-143	24vdh	VD5	5c	Max



SMD code	Type	Function	Short description	Case	Pinout Sch.	St.	Mnf.
KAGA	MAX6444US16L	Vdet-IC	1.6V±1.5%, ±MR, -Reset ODO	SOT-143	24wdh VD5	5c	Max
KAGB	MAX6444US23L	Vdet-IC	2.3V±1.5%, ±MR, -Reset ODO	SOT-143	24wdh VD5	5c	Max
KAGC	MAX6444US26L	Vdet-IC	2.6V±1.5%, ±MR, -Reset ODO	SOT-143	24wdh VD5	5c	Max
KAGD	MAX6444US29L	Vdet-IC	2.9V±1.5%, ±MR, -Reset ODO	SOT-143	24wdh VD5	5c	Max
KAGG	MAX6394-US45D3	Vdet-IC	4.5V±1%, -MR, -Reset ODO	SOT-143	24wdh VD4	5c	Max
KAHA	MAX6394-US45D3	Vdet-IC	4.45V±1%, -MR, -Reset ODO, Rt=200ms	SOT-143	24wdh VD4	5c	Max
KAHB	MAX6394-US310D3	Vdet-IC	3.1V±1%, -MR, -Reset ODO, Rt=200ms	SOT-143	24wdh VD4	5c	Max
KAHC	MAX6394-US240D3	Vdet-IC	2.4V±1%, -MR, -Reset ODO, Rt=200ms	SOT-143	24wdh VD4	5c	Max
KAHD	MAX6394-US480D3	Vdet-IC	4.8V±1%, -MR, -Reset ODO, Rt=200ms	SOT-143	24wdh VD4	5c	Max
KAHE	MAX6394-US240D1	Vdet-IC	2.4V±1%, -MR, -Reset ODO, Rt=1.4ms	SOT-143	24wdh VD4	5c	Max
KAHF	MAX6394-US240D2	Vdet-IC	2.4V±1%, -MR, -Reset ODO, Rt=28ms	SOT-143	24wdh VD4	5c	Max
KAHG	MAX6394-US240D4	Vdet-IC	2.4V±1%, -MR, -Reset ODO, Rt=1570ms	SOT-143	24wdh VD4	5c	Max
KAHH	MAX6394-US294D1	Vdet-IC	2.9V±1%, -MR, -Reset ODO, Rt=1.4ms	SOT-143	24wdh VD4	5c	Max
KAHI	MAX6394-US294D2	Vdet-IC	2.9V±1%, -MR, -Reset ODO, Rt=28ms	SOT-143	24wdh VD4	5c	Max
KAHJ	MAX6394-US294D3	Vdet-IC	2.9V±1%, -MR, -Reset ODO, Rt=200ms	SOT-143	24wdh VD4	5c	Max
KAHK	MAX6394-US294D4	Vdet-IC	2.9V±1%, -MR, -Reset ODO, Rt=1570ms	SOT-143	24wdh VD4	5c	Max
KAHL	MAX6394-US300D1	Vdet-IC	3.0V±1%, -MR, -Reset ODO, Rt=1.4ms	SOT-143	24wdh VD4	5c	Max
KAHM	MAX6394-US300D2	Vdet-IC	3.0V±1%, -MR, -Reset ODO, Rt=28ms	SOT-143	24wdh VD4	5c	Max
KAHN	MAX6394-US300D3	Vdet-IC	3.0V±1%, -MR, -Reset ODO, Rt=200ms	SOT-143	24wdh VD4	5c	Max
KAHO	MAX6394-US300D4	Vdet-IC	3.0V±1%, -MR, -Reset ODO, Rt=1570ms	SOT-143	24wdh VD4	5c	Max
KAHP	MAX6394-US310D1	Vdet-IC	3.1V±1%, -MR, -Reset ODO, Rt=1.4ms	SOT-143	24wdh VD4	5c	Max
KAHQ	MAX6394-US310D2	Vdet-IC	3.1V±1%, -MR, -Reset ODO, Rt=28ms	SOT-143	24wdh VD4	5c	Max
KAHR	MAX6394-US310D4	Vdet-IC	3.1V±1%, -MR, -Reset ODO, Rt=1570ms	SOT-143	24wdh VD4	5c	Max
KAHS	MAX6394-US317D1	Vdet-IC	3.17V±1%, -MR, -Reset ODO, Rt=1.4ms	SOT-143	24wdh VD4	5c	Max
KAHT	MAX6394-US317D2	Vdet-IC	3.17V±1%, -MR, -Reset ODO, Rt=28ms	SOT-143	24wdh VD4	5c	Max
KAHU	MAX6394-US317D3	Vdet-IC	3.17V±1%, -MR, -Reset ODO, Rt=200ms	SOT-143	24wdh VD4	5c	Max
KAHV	MAX6394-US317D4	Vdet-IC	3.17V±1%, -MR, -Reset ODO, Rt=1570ms	SOT-143	24wdh VD4	5c	Max
KAHW	MAX6394-US445D1	Vdet-IC	4.45V±1%, -MR, -Reset ODO, Rt=1.4ms	SOT-143	24wdh VD4	5c	Max
KAHX	MAX6394-US445D2	Vdet-IC	4.45V±1%, -MR, -Reset ODO, Rt=28ms	SOT-143	24wdh VD4	5c	Max
KAHY	MAX6394-US445D3	Vdet-IC	4.45V±1%, -MR, -Reset ODO, Rt=200ms	SOT-143	24wdh VD4	5c	Max
KAHZ	MAX6394-US445D4	Vdet-IC	4.45V±1%, -MR, -Reset ODO, Rt=1570ms	SOT-143	24wdh VD4	5c	Max
KAIA	MAX6394-US455D1	Vdet-IC	4.45V±1%, -MR, -Reset ODO, Rt=1.4ms	SOT-143	24wdh VD4	5c	Max
KAIB	MAX6394-US455D2	Vdet-IC	4.45V±1%, -MR, -Reset ODO, Rt=28ms	SOT-143	24wdh VD4	5c	Max
KAIC	MAX6394-US455D4	Vdet-IC	4.45V±1%, -MR, -Reset ODO, Rt=1570ms	SOT-143	24wdh VD4	5c	Max
KAD	MAX6394-US470D1	Vdet-IC	4.7V±1%, -MR, -Reset ODO, Rt=1.4ms	SOT-143	24wdh VD4	5c	Max
KAIE	MAX6394-US470D2	Vdet-IC	4.7V±1%, -MR, -Reset ODO, Rt=28ms	SOT-143	24wdh VD4	5c	Max
KAIF	MAX6394-US470D3	Vdet-IC	4.7V±1%, -MR, -Reset ODO, Rt=200ms	SOT-143	24wdh VD4	5c	Max
KAIG	MAX6394-US470D4	Vdet-IC	4.7V±1%, -MR, -Reset ODO, Rt=1570ms	SOT-143	24wdh VD4	5c	Max
KAIH	MAX6394-US480D1	Vdet-IC	4.8V±1%, -MR, -Reset ODO, Rt=1.4ms	SOT-143	24wdh VD4	5c	Max
KAIJ	MAX6394-US480D2	Vdet-IC	4.8V±1%, -MR, -Reset ODO, Rt=28ms	SOT-143	24wdh VD4	5c	Max
KAIK	MAX6394-US480D4	Vdet-IC	4.8V±1%, -MR, -Reset ODO, Rt=1570ms	SOT-143	24wdh VD4	5c	Max
kb	PT7M6221CLC4	Vdet-IC	2.1V±1.5%, -Reset PPO	SC-70-4	23vdl VD7	5g	Pti
kB	PT7M6221CLC4E	Vdet-IC	2.1V±1.5%, -Reset PPO, Lead free	SC-70-4	23vdl VD7	5g	Pti
kB	FP6811-26NC4P	Vdet-IC	2.63V±1.5%, -Reset ODO, -MR	SC-70-4	23vdh VD5	5b	Fit
KB	BU4918F	Vdet-IC	1.8V±1%, +Reset PPO	SOP-4	26vdl VD7	5c	Rhm
KB	R1114Q211A	LVR-IC	LDO, LN, -CE, 2.1V±2%, 150mA	SOT-143R	26vn VR4	5a	Ric
KB	XC6120C11N	Vdet-IC	1.1V±2%, CMOS +Reset PPO	SSOT-24	26yu VD7	5a	Tor
kB	XC6127C18CNR	Vdet-IC	1.8V±0.8%, -Reset PPO, -MR, Rt=200ms	SSOT-24	26cr VD5	5a	Tor
kB	XC6127N18HNR	Vdet-IC	1.8V±0.8%, +Reset ODO, -MR, Rt=200ms	SSOT-24	26cr VD4	5a	Tor
KB	XC6223E211NR-G	LVR-IC	LDO, 2.1V±1%, 300mA, +CE, ICP	SSOT-24	26vn VR4	5a	Tor
kc	PT7M6221CHC4	Vdet-IC	2.1V±1.5%, +Reset PPO	SC-70-4	23vdl VD7	5g	Pti
kC	PT7M6221CHC4E	Vdet-IC	2.1V±1.5%, +Reset PPO, Lead free	SC-70-4	23vdl VD7	5g	Pti
KC	BU4919F	Vdet-IC	1.9V±1%, +Reset PPO	SOP-4	26vdl VD7	5c	Rhm
KC	R1114Q221A	LVR-IC	LDO, LN, -CE, 2.2V±2%, 150mA	SOT-143R	26vn VR4	5a	Ric
KC	XC6120C12N	Vdet-IC	1.2V±2%, CMOS +Reset PPO	SSOT-24	26yu VD7	5a	Tor
kC	XC6127C20CNR	Vdet-IC	2.0V±0.8%, -Reset PPO, -MR, Rt=200ms	SSOT-24	26cr VD5	5a	Tor
kC	XC6127N20HNR	Vdet-IC	2.0V±0.8%, +Reset ODO, -MR, Rt=200ms	SSOT-24	26cr VD4	5a	Tor
KC	XC6223E221NR-G	LVR-IC	LDO, 2.2V±1%, 300mA, +CE, ICP	SSOT-24	26vn VR4	5a	Tor
kd	PT7M6221NLC4	Vdet-IC	2.1V±1.5%, -Reset ODO	SC-70-4	23vdl VD6	5g	Pti
kD	PT7M6221NLC4E	Vdet-IC	2.1V±1.5%, -Reset ODO, Lead free	SC-70-4	23vdl VD6	5g	Pti
Kd	FP6811-29NC4P	Vdet-IC	2.93V±1.5%, -Reset ODO, -MR	SC-70-4	23vdh VD5	5b	Fit
KD	BU4920F	Vdet-IC	2V±1%, +Reset PPO	SOP-4	26vdl VD7	5c	Rhm
KD	R1114Q231A	LVR-IC	LDO, LN, -CE, 2.3V±2%, 150mA	SOT-143R	26vn VR4	5a	Ric
KD	XC6120C13N	Vdet-IC	1.3V±2%, CMOS +Reset PPO	SSOT-24	26yu VD7	5a	Tor
kD	XC6127C22CNR	Vdet-IC	2.2V±0.8%, -Reset PPO, -MR, Rt=200ms	SSOT-24	26cr VD5	5a	Tor
kD	XC6127N22HNR	Vdet-IC	2.2V±0.8%, +Reset ODO, -MR, Rt=200ms	SSOT-24	26cr VD4	5a	Tor
KD	XC6223E231NR-G	LVR-IC	LDO, 2.3V±1%, 300mA, +CE, ICP	SSOT-24	26vn VR4	5a	Tor
ke	PT7M6222CLC4	Vdet-IC	2.2V±1.5%, -Reset PPO	SC-70-4	23vdl VD7	5g	Pti
Ke	PT7M6222CLC4E	Vdet-IC	2.2V±1.5%, -Reset PPO, Lead free	SC-70-4	23vdl VD7	5g	Pti
Ke	FP6811-31NC4P	Vdet-IC	3.08V±1.5%, -Reset ODO, -MR	SC-70-4	23vdh VD5	5b	Fit



SMD code	Type	Function	Short description	Case	Pinout	Sch.	St.	Mnf.
KE	BU4921F	Vdet-IC	2.1V±1%, +Reset PPO	SOP-4	26vdl	VD7	5c	Rhm
KE	R1114Q241A	LVR-IC	LDO, LN, -CE, 2.4V±2%, 150mA	SOT-143R	26vn	VR4	5a	Ric
KE	XC6120C14N	Vdet-IC	1.4V±2%, CMOS +Reset PPO	SSOT-24	26yu	VD7	5a	Tor
KE	XC6127C24CNR	Vdet-IC	2.4V±0.8%, -Reset PPO, -MR, Rt=200ms	SSOT-24	26cr	VD5	5a	Tor
KE	XC6127N24HNR	Vdet-IC	2.4V±0.8%, +Reset ODO, -MR, Rt=200ms	SSOT-24	26cr	VD4	5a	Tor
KE	XC6223E241NR-G	LVR-IC	LDO, 2.4V±1%, 300mA, +CE, ICP	SSOT-24	26vn	VR4	5a	Tor
kf	PT7M6222CHC4	Vdet-IC	2.2V±1.5%, +Reset PPO	SC-70-4	23vdl	VD7	5g	Pti
kf	PT7M6222CHC4E	Vdet-IC	2.2V±1.5%, +Reset PPO, Lead free	SC-70-4	23vdl	VD7	5g	Pti
Kf	FP6811-40NC4P	Vdet-IC	4.0V±1.5%, -Reset ODO, -MR	SC-70-4	23vdh	VD5	5b	Fit
KF	BU4922F	Vdet-IC	2.2V±1%, +Reset PPO	SOP-4	26vdl	VD7	5c	Rhm
KF	R1114Q251A	LVR-IC	LDO, LN, -CE, 2.5V±2%, 150mA	SOT-143R	26vn	VR4	5a	Ric
KF	XC6120C15N	Vdet-IC	1.5V±2%, CMOS +Reset PPO	SSOT-24	26yu	VD7	5a	Tor
KF	XC6127C26CNR	Vdet-IC	2.6V±0.8%, -Reset PPO, -MR, Rt=200ms	SSOT-24	26cr	VD5	5a	Tor
KF	XC6127N26HNR	Vdet-IC	2.6V±0.8%, +Reset ODO, -MR, Rt=200ms	SSOT-24	26cr	VD4	5a	Tor
KF	XC6223E251NR-G	LVR-IC	LDO, 2.5V±1%, 300mA, +CE, ICP	SSOT-24	26vn	VR4	5a	Tor
kg	PT7M6222NLC4	Vdet-IC	2.2V±1.5%, -Reset ODO	SC-70-4	23vdl	VD6	5g	Pti
kg	PT7M6222NLC4E	Vdet-IC	2.2V±1.5%, -Reset ODO, Lead free	SC-70-4	23vdl	VD6	5g	Pti
KG	BU4923F	Vdet-IC	2.3V±1%, +Reset PPO	SOP-4	26vdl	VD7	5c	Rhm
KG	R1114Q261A	LVR-IC	LDO, LN, -CE, 2.6V±2%, 150mA	SOT-143R	26vn	VR4	5a	Ric
kh	PT7M6223CLC4	Vdet-IC	2.3V±1.5%, -Reset PPO	SC-70-4	23vdl	VD7	5g	Pti
kh	PT7M6223CLC4E	Vdet-IC	2.3V±1.5%, -Reset PPO, Lead free	SC-70-4	23vdl	VD7	5g	Pti
Kh	FP6811-44NC4P	Vdet-IC	4.38V±1.5%, -Reset ODO, -MR	SC-70-4	23vdh	VD5	5b	Fit
KH	BU4924F	Vdet-IC	2.4V±1%, +Reset PPO	SOP-4	26vdl	VD7	5c	Rhm
KH	R1114Q271A	LVR-IC	LDO, LN, -CE, 2.7V±2%, 150mA	SOT-143R	26vn	VR4	5a	Ric
KH	XC6120C16N	Vdet-IC	1.6V±2%, CMOS +Reset PPO	SSOT-24	26yu	VD7	5a	Tor
KH	XC6127C28CNR	Vdet-IC	2.8V±0.8%, -Reset PPO, -MR, Rt=200ms	SSOT-24	26cr	VD5	5a	Tor
KH	XC6127N28HNR	Vdet-IC	2.8V±0.8%, +Reset ODO, -MR, Rt=200ms	SSOT-24	26cr	VD4	5a	Tor
KH	XC6223E261NR-G	LVR-IC	LDO, 2.6V±1%, 300mA, +CE, ICP	SSOT-24	26vn	VR4	5a	Tor
ki	PT7M6223CHC4	Vdet-IC	2.3V±1.5%, +Reset PPO	SC-70-4	23vdl	VD7	5g	Pti
ki	PT7M6223CHC4E	Vdet-IC	2.3V±1.5%, +Reset PPO, Lead free	SC-70-4	23vdl	VD7	5g	Pti
Ki	FP6811-46NC4P	Vdet-IC	4.63V±1.5%, -Reset ODO, -MR	SC-70-4	23vdh	VD5	5b	Fit
kj	PT7M6223NLC4	Vdet-IC	2.3V±1.5%, -Reset ODO	SC-70-4	23vdl	VD6	5g	Pti
kj	PT7M6223NLC4E	Vdet-IC	2.3V±1.5%, -Reset ODO, Lead free	SC-70-4	23vdl	VD6	5g	Pti
KJ	BU4925F	Vdet-IC	2.5V±1%, +Reset PPO	SOP-4	26vdl	VD7	5c	Rhm
KJ	ETC811JU	Vdet-IC	4V, -MR, -Reset PPO	SOT-143	24vdh	VD5	5c	Etc
KJ	FM811JUX	Vdet-IC	4.0V±1.5%, -Reset PPO, -MR	SOT-143	24vdh	VD5	5c	F
KJ	MIC811JU	Vdet-IC	4V, -MR, -Reset PPO	SOT-143	24vdh	VD5	5c	Mcr
KJ	R1114Q281A	LVR-IC	LDO, LN, -CE, 2.8V±2%, 150mA	SOT-143R	26vn	VR4	5a	Ric
kk	PT7M6224CLC4	Vdet-IC	2.4V±1.5%, -Reset PPO	SC-70-4	23vdl	VD7	5g	Pti
kk	PT7M6224CLC4E	Vdet-IC	2.4V±1.5%, -Reset PPO, Lead free	SC-70-4	23vdl	VD7	5g	Pti
KK	BU4926F	Vdet-IC	2.6V±1%, +Reset PPO	SOP-4	26vdl	VD7	5c	Rhm
KK	R1114Q291A	LVR-IC	LDO, LN, -CE, 2.9V±2%, 150mA	SOT-143R	26vn	VR4	5a	Ric
KK	XC6120C17N	Vdet-IC	1.7V±2%, CMOS +Reset PPO	SSOT-24	26yu	VD7	5a	Tor
KK	XC6127C30CNR	Vdet-IC	3.0V±0.8%, -Reset PPO, -MR, Rt=200ms	SSOT-24	26cr	VD5	5a	Tor
KK	XC6127N30HNR	Vdet-IC	3.0V±0.8%, +Reset ODO, -MR, Rt=200ms	SSOT-24	26cr	VD4	5a	Tor
KK	XC6223E271NR-G	LVR-IC	LDO, 2.7V±1%, 300mA, +CE, ICP	SSOT-24	26vn	VR4	5a	Tor
kl	PT7M6224CHC4	Vdet-IC	2.4V±1.5%, +Reset PPO	SC-70-4	23vdl	VD7	5g	Pti
kl	PT7M6224CHC4E	Vdet-IC	2.4V±1.5%, +Reset PPO, Lead free	SC-70-4	23vdl	VD7	5g	Pti
KL	BU4927F	Vdet-IC	2.7V±1%, +Reset PPO	SOP-4	26vdl	VD7	5c	Rhm
KL	ETC811LU	Vdet-IC	4.63V, -MR, -Reset PPO	SOT-143	24vdh	VD5	5c	Etc
KL	FM811LUX	Vdet-IC	4.63V±1.5%, -Reset PPO, -MR	SOT-143	24vdh	VD5	5c	F
KL	MIC811LU	Vdet-IC	4.63V, -MR, -Reset PPO	SOT-143	24vdh	VD5	5c	Mcr
KL	XC6120C18N	Vdet-IC	1.8V±2%, CMOS +Reset PPO	SSOT-24	26yu	VD7	5a	Tor
KL	XC6127C32CNR	Vdet-IC	3.2V±0.8%, -Reset PPO, -MR, Rt=200ms	SSOT-24	26cr	VD5	5a	Tor
KL	XC6127N32HNR	Vdet-IC	3.2V±0.8%, +Reset ODO, -MR, Rt=200ms	SSOT-24	26cr	VD4	5a	Tor
KL	XC6223E281NR-G	LVR-IC	LDO, 2.8V±1%, 300mA, +CE, ICP	SSOT-24	26vn	VR4	5a	Tor
KLN	ELM7531CCB	Vdet-IC	3.1V±2%, +Reset PPO	SC-82AB	26vdl	VD7	5c	Elm
KLN	ELM7531NCB	Vdet-IC	3.1V±2%, +Reset ODO	SC-82AB	26vdl	VD6	5c	Elm
km	PT7M6224NLC4	Vdet-IC	2.4V±1.5%, -Reset ODO	SC-70-4	23vdl	VD6	5g	Pti
km	PT7M6224NLC4E	Vdet-IC	2.4V±1.5%, -Reset ODO, Lead free	SC-70-4	23vdl	VD6	5g	Pti
Km	FP6811-23CC4P	Vdet-IC	2.32V±1.5%, -Reset PPO, -MR	SC-70-4	23vdh	VD6	5b	Fit
KM	BU4928F	Vdet-IC	2.8V±1%, +Reset PPO	SOP-4	26vdl	VD7	5c	Rhm
KM	ETC811MU	Vdet-IC	4.38V, -MR, -Reset PPO	SOT-143	24vdh	VD5	5c	Etc
KM	FM811MUX	Vdet-IC	4.38V±1.5%, -Reset PPO, -MR	SOT-143	24vdh	VD5	5c	F
KM	MIC811MU	Vdet-IC	4.38V, -MR, -Reset PPO	SOT-143	24vdh	VD5	5c	Mcr
KM	XC6120C19N	Vdet-IC	1.9V±2%, CMOS +Reset PPO	SSOT-24	26yu	VD7	5a	Tor
KM	XC6127C34CNR	Vdet-IC	3.4V±0.8%, -Reset PPO, -MR, Rt=200ms	SSOT-24	26cr	VD5	5a	Tor
KM	XC6127N34HNR	Vdet-IC	3.4V±0.8%, +Reset ODO, -MR, Rt=200ms	SSOT-24	26cr	VD4	5a	Tor
KM	XC6223E291NR-G	LVR-IC	LDO, 2.9V±1%, 300mA, +CE, ICP	SSOT-24	26vn	VR4	5a	Tor
kn	PT7M6225CLC4	Vdet-IC	2.5V±1.5%, -Reset PPO	SC-70-4	23vdl	VD7	5g	Pti



SMD code	Type	Function	Short description	Case	Pinout	Sch.	St.	Mnf.
kn	PT7M6225CLC4E	Vdet-IC	2.5V±1.5%, -Reset PPO, Lead free	SC-70-4	23vdl	VD7	5g	Pti
<u>Kn</u>	FP6811-26CC4P	Vdet-IC	2.63V±1.5%, -Reset PPO, -MR	SC-70-4	23vdh	VD6	5b	Fit
KN	BU4929F	Vdet-IC	2.9V±1%, +Reset PPO	SOP-4	26vdl	VD7	5c	Rhm
KN	XC6119N10ANR	Vdet-IC	1.0V±30mV, -Reset ODO	SSOT-24	26gh	VD1	5a	Tor
KN	XC6120C20N	Vdet-IC	2V±2%, CMOS +Reset PPO	SSOT-24	26yu	VD7	5a	Tor
KN	XC6127C36CNR	Vdet-IC	3.6V±0.8%, -Reset PPO, -MR, Rt=200ms	SSOT-24	26cr	VD5	5a	Tor
KN	XC6127N36HNR	Vdet-IC	3.6V±0.8%, +Reset ODO, -MR, Rt=200ms	SSOT-24	26cr	VD4	5a	Tor
ko	PT7M6225CHC4	Vdet-IC	2.5V±1.5%, +Reset PPO	SC-70-4	23vdl	VD7	5g	Pti
ko	PT7M6225CHC4E	Vdet-IC	2.5V±1.5%, +Reset PPO, Lead free	SC-70-4	23vdl	VD7	5g	Pti
kp	PT7M6225NLC4	Vdet-IC	2.5V±1.5%, -Reset ODO	SC-70-4	23vdl	VD6	5g	Pti
kp	PT7M6225NLC4E	Vdet-IC	2.5V±1.5%, -Reset ODO, Lead free	SC-70-4	23vdl	VD6	5g	Pti
KP	BU4930F	Vdet-IC	3V±1%, +Reset PPO	SOP-4	26vdl	VD7	5c	Rhm
KP	XC6119N11ANR	Vdet-IC	1.1V±30mV, -Reset ODO	SSOT-24	26gh	VD1	5a	Tor
KP	XC6120C21N	Vdet-IC	2.1V±2%, CMOS +Reset PPO	SSOT-24	26yu	VD7	5a	Tor
KP	XC6127C38CNR	Vdet-IC	3.8V±0.8%, -Reset PPO, -MR, Rt=200ms	SSOT-24	26cr	VD5	5a	Tor
KP	XC6127N38HNR	Vdet-IC	3.8V±0.8%, +Reset ODO, -MR, Rt=200ms	SSOT-24	26cr	VD4	5a	Tor
kq	PT7M6226CLC4	Vdet-IC	2.6V±1.5%, -Reset PPO	SC-70-4	23vdl	VD7	5g	Pti
kq	PT7M6226CLC4E	Vdet-IC	2.6V±1.5%, -Reset PPO, Lead free	SC-70-4	23vdl	VD7	5g	Pti
KQ	BU4931F	Vdet-IC	3.1V±1%, +Reset PPO	SOP-4	26vdl	VD7	5c	Rhm
kr	PT7M6226CHC4	Vdet-IC	2.6V±1.5%, +Reset PPO	SC-70-4	23vdl	VD7	5g	Pti
kr	PT7M6226CHC4E	Vdet-IC	2.6V±1.5%, +Reset PPO, Lead free	SC-70-4	23vdl	VD7	5g	Pti
Kr	FP6811-29CC4P	Vdet-IC	2.93V±1.5%, -Reset PPO, -MR	SC-70-4	23vdh	VD6	5b	Fit
KR	BU4932F	Vdet-IC	3.2V±1%, +Reset PPO	SOP-4	26vdl	VD7	5c	Rhm
KR	ETC811RU	Vdet-IC	2.63V, -MR, -Reset PPO	SOT-143	24vdh	VD5	5c	Etc
KR	FM811RUX	Vdet-IC	2.63V±1.5%, -Reset PPO, -MR	SOT-143	24vdh	VD5	5c	F
KR	MIC811RU	Vdet-IC	2.63V, -MR, -Reset PPO	SOT-143	24vdh	VD5	5c	Mcr
KR	XC6119N12ANR	Vdet-IC	1.2V±30mV, -Reset ODO	SSOT-24	26gh	VD1	5a	Tor
KR	XC6120C22N	Vdet-IC	2.2V±2%, CMOS +Reset PPO	SSOT-24	26yu	VD7	5a	Tor
KR	XC6127C40CNR	Vdet-IC	4.0V±0.8%, -Reset PPO, -MR, Rt=200ms	SSOT-24	26cr	VD5	5a	Tor
KR	XC6127N40HNR	Vdet-IC	4.0V±0.8%, +Reset ODO, -MR, Rt=200ms	SSOT-24	26cr	VD4	5a	Tor
ks	PT7M6226NLC4	Vdet-IC	2.6V±1.5%, -Reset ODO	SC-70-4	23vdl	VD6	5g	Pti
ks	PT7M6226NLC4E	Vdet-IC	2.6V±1.5%, -Reset ODO, Lead free	SC-70-4	23vdl	VD6	5g	Pti
Ks	FP6811-31CC4P	Vdet-IC	3.08V±1.5%, -Reset PPO, -MR	SC-70-4	23vdh	VD6	5b	Fit
KS	BU4933F	Vdet-IC	3.3V±1%, +Reset PPO	SOP-4	26vdl	VD7	5c	Rhm
KS	ETC811SU	Vdet-IC	2.93V, -MR, -Reset PPO	SOT-143	24vdh	VD5	5c	Etc
KS	FM811SUX	Vdet-IC	2.93V±1.5%, -Reset PPO, -MR	SOT-143	24vdh	VD5	5c	F
KS	MIC811SU	Vdet-IC	2.93V, -MR, -Reset PPO	SOT-143	24vdh	VD5	5c	Mcr
KS	XC6119N13ANR	Vdet-IC	1.3V±30mV, -Reset ODO	SSOT-24	26gh	VD1	5a	Tor
KS	XC6120C23N	Vdet-IC	2.3V±2%, CMOS +Reset PPO	SSOT-24	26yu	VD7	5a	Tor
KS	XC6127C42CNR	Vdet-IC	4.2V±0.8%, -Reset PPO, -MR, Rt=200ms	SSOT-24	26cr	VD5	5a	Tor
KS	XC6127N42HNR	Vdet-IC	4.2V±0.8%, +Reset ODO, -MR, Rt=200ms	SSOT-24	26cr	VD4	5a	Tor
kt	PT7M6227CLC4	Vdet-IC	2.7V±1.5%, -Reset PPO	SC-70-4	23vdl	VD7	5g	Pti
kt	PT7M6227CLC4E	Vdet-IC	2.7V±1.5%, -Reset PPO, Lead free	SC-70-4	23vdl	VD7	5g	Pti
Kt	FP6811-40CC4P	Vdet-IC	4.0V±1.5%, -Reset PPO, -MR	SC-70-4	23vdh	VD6	5b	Fit
KT	BU4934F	Vdet-IC	3.4V±1%, +Reset PPO	SOP-4	26vdl	VD7	5c	Rhm
KT	ETC811TU	Vdet-IC	3.08V, -MR, -Reset PPO	SOT-143	24vdh	VD5	5c	Etc
KT	FM811TUX	Vdet-IC	3.08V±1.5%, -Reset PPO, -MR	SOT-143	24vdh	VD5	5c	F
KT	MIC811TU	Vdet-IC	3.08V, -MR, -Reset PPO	SOT-143	24vdh	VD5	5c	Mcr
KT	XC6119N14ANR	Vdet-IC	1.4V±30mV, -Reset ODO	SSOT-24	26gh	VD1	5a	Tor
KT	XC6120C24N	Vdet-IC	2.4V±2%, CMOS +Reset PPO	SSOT-24	26yu	VD7	5a	Tor
KT	XC6127C44CNR	Vdet-IC	4.4V±0.8%, -Reset PPO, -MR, Rt=200ms	SSOT-24	26cr	VD5	5a	Tor
KT	XC6127N44HNR	Vdet-IC	4.4V±0.8%, +Reset ODO, -MR, Rt=200ms	SSOT-24	26cr	VD4	5a	Tor
ku	PT7M6227CHC4	Vdet-IC	2.7V±1.5%, +Reset PPO	SC-70-4	23vdl	VD7	5g	Pti
ku	PT7M6227CHC4E	Vdet-IC	2.7V±1.5%, +Reset PPO, Lead free	SC-70-4	23vdl	VD7	5g	Pti
Ku	FP6811-44CC4P	Vdet-IC	4.38V±1.5%, -Reset PPO, -MR	SC-70-4	23vdh	VD6	5b	Fit
KU	BU4935F	Vdet-IC	3.5V±1%, +Reset PPO	SOP-4	26vdl	VD7	5c	Rhm
KU	XC6119N15ANR	Vdet-IC	1.5V±2%, -Reset ODO	SSOT-24	26gh	VD1	5a	Tor
KU	XC6120C25N	Vdet-IC	2.5V±2%, CMOS +Reset PPO	SSOT-24	26yu	VD7	5a	Tor
KU	XC6127C46CNR	Vdet-IC	4.6V±0.8%, -Reset PPO, -MR, Rt=200ms	SSOT-24	26cr	VD5	5a	Tor
KU	XC6127N46HNR	Vdet-IC	4.6V±0.8%, +Reset ODO, -MR, Rt=200ms	SSOT-24	26cr	VD4	5a	Tor
kv	PT7M6227NLC4	Vdet-IC	2.7V±1.5%, -Reset ODO	SC-70-4	23vdl	VD6	5g	Pti
kv	PT7M6227NLC4E	Vdet-IC	2.7V±1.5%, -Reset ODO, Lead free	SC-70-4	23vdl	VD6	5g	Pti
Kv	FP6811-46CC4P	Vdet-IC	4.63V±1.5%, -Reset PPO, -MR	SC-70-4	23vdh	VD6	5b	Fit
KV	BU4936F	Vdet-IC	3.6V±1%, +Reset PPO	SOP-4	26vdl	VD7	5c	Rhm
KV	XC6119N16ANR	Vdet-IC	1.6V±2%, -Reset ODO	SSOT-24	26gh	VD1	5a	Tor
KV	XC6120C26N	Vdet-IC	2.6V±2%, CMOS +Reset PPO	SSOT-24	26yu	VD7	5a	Tor
KV	XC6127C48CNR	Vdet-IC	4.8V±0.8%, -Reset PPO, -MR, Rt=200ms	SSOT-24	26cr	VD5	5a	Tor
KV	XC6127N48HNR	Vdet-IC	4.8V±0.8%, +Reset ODO, -MR, Rt=200ms	SSOT-24	26cr	VD4	5a	Tor
kw	PT7M6228CLC4	Vdet-IC	2.8V±1.5%, -Reset PPO	SC-70-4	23vdl	VD7	5g	Pti
kw	PT7M6228CLC4E	Vdet-IC	2.8V±1.5%, -Reset PPO, Lead free	SC-70-4	23vdl	VD7	5g	Pti



SMD
code

SMD code	Type	Function	Short description	Case	Pinout	Sch.	St.	Mnf.
KW	BU4937F	Vdet-IC	3.7V±1%, +Reset PPO	SOP-4	26vdl	VD7	5c	Rhm
kx	PT7M6228CHC4	Vdet-IC	2.8V±1.5%, +Reset PPO	SC-70-4	23vdl	VD7	5g	Pti
kx	PT7M6228CHC4E	Vdet-IC	2.8V±1.5%, +Reset PPO, Lead free	SC-70-4	23vdl	VD7	5g	Pti
KX	BU4938F	Vdet-IC	3.8V±1%, +Reset PPO	SOP-4	26vdl	VD7	5c	Rhm
KX	XC6119N17ANR	Vdet-IC	1.7V±2%, -Reset ODO	SSOT-24	26gh	VD1	5a	Tor
KX	XC6120C27N	Vdet-IC	2.7V±2%, CMOS +Reset PPO	SSOT-24	26yu	VD7	5a	Tor
KX	XC6127C50CNR	Vdet-IC	5.0V±0.8%, -Reset PPO, -MR, Rt=200ms	SSOT-24	26er	VD5	5a	Tor
KX	XC6127N50HNR	Vdet-IC	5.0V±0.8%, +Reset ODO, -MR, Rt=200ms	SSOT-24	26er	VD4	5a	Tor
ky	PT7M6228NLC4	Vdet-IC	2.8V±1.5%, -Reset ODO	SC-70-4	23vdl	VD6	5g	Pti
ky	PT7M6228NLC4E	Vdet-IC	2.8V±1.5%, -Reset ODO, Lead free	SC-70-4	23vdl	VD6	5g	Pti
KY	BU4939F	Vdet-IC	3.9V±1%, +Reset PPO	SOP-4	26vdl	VD7	5c	Rhm
KY	XC6109N08AN	Vdet-IC	0.8V, +Reset ODO	SSOT-24	26rp	VD1	5c	Tor
KY	XC6119N18ANR	Vdet-IC	1.8V±2%, -Reset ODO	SSOT-24	26gh	VD1	5a	Tor
KY	XC6120C28N	Vdet-IC	2.8V±2%, CMOS +Reset PPO	SSOT-24	26yu	VD7	5a	Tor
KY	XC6127C52CNR	Vdet-IC	5.2V±0.8%, -Reset PPO, -MR, Rt=200ms	SSOT-24	26er	VD5	5a	Tor
KY	XC6127N52HNR	Vdet-IC	5.2V±0.8%, +Reset ODO, -MR, Rt=200ms	SSOT-24	26er	VD4	5a	Tor
kz	PT7M6229CLC4	Vdet-IC	2.9V±1.5%, -Reset PPO	SC-70-4	23vdl	VD7	5g	Pti
kz	PT7M6229CLC4E	Vdet-IC	2.9V±1.5%, -Reset PPO, Lead free	SC-70-4	23vdl	VD7	5g	Pti
KZ	BU4940F	Vdet-IC	4V±1%, +Reset PPO	SOP-4	26vdl	VD7	5c	Rhm
KZ	XC6109N09AN	Vdet-IC	0.9V, +Reset ODO	SSOT-24	26rp	VD1	5c	Tor
KZ	XC6119N19ANR	Vdet-IC	1.9V±2%, -Reset ODO	SSOT-24	26gh	VD1	5a	Tor
KZ	XC6120C29N	Vdet-IC	2.9V±2%, CMOS +Reset PPO	SSOT-24	26yu	VD7	5a	Tor
KZ	XC6127C54CNR	Vdet-IC	5.4V±0.8%, -Reset PPO, -MR, Rt=200ms	SSOT-24	26er	VD5	5a	Tor
KZ	XC6127N54HNR	Vdet-IC	5.4V±0.8%, +Reset ODO, -MR, Rt=200ms	SSOT-24	26er	VD4	5a	Tor
L0	R3111Q101A	Vdet-IC	1V±2%, -Reset PPO	SC-82AB	26vdl	VD7	5a	Ric
L0	R3116Q071A	Vdet-IC	0.7V±0.8%, -Reset ODO	SC-82AB	26rp	VD1	5a	Ric
L0	RP104Q121B	LVR-IC	LDO, 1.2V±0.8%, 150mA, +CE	SC-82AB	26vn	VR4	5a	Ric
L0	XC6120C30N	Vdet-IC	3V±2%, CMOS +Reset PPO	SSOT-24	26yu	VD7	5a	Tor
L1	R3111Q111A	Vdet-IC	1.1V±2%, -Reset PPO	SC-82AB	26vdl	VD7	5a	Ric
L1	R3116Q081A	Vdet-IC	0.8V±0.8%, -Reset ODO	SC-82AB	26rp	VD1	5a	Ric
L1	RP104Q131B	LVR-IC	LDO, 1.3V±0.8%, 150mA, +CE	SC-82AB	26vn	VR4	5a	Ric
L1	XC6120C31N	Vdet-IC	3.1V±2%, CMOS +Reset PPO	SSOT-24	26yu	VD7	5a	Tor
L2	R3111Q121A	Vdet-IC	1.2V±2%, -Reset PPO	SC-82AB	26vdl	VD7	5a	Ric
L2	R3116Q091A	Vdet-IC	0.9V±0.8%, -Reset ODO	SC-82AB	26rp	VD1	5a	Ric
L2	RP104Q151B	LVR-IC	LDO, 1.5V±0.8%, 150mA, +CE	SC-82AB	26vn	VR4	5a	Ric
L2	XC6120C32N	Vdet-IC	3.2V±2%, CMOS +Reset PPO	SSOT-24	26yu	VD7	5a	Tor
L2	XC6223F121NR-G	LVR-IC	LDO, 1.2V±20mV, 300mA, +CE, CL, ICP	SSOT-24	26vn	VR4	5a	Tor
L3	R3111Q131A	Vdet-IC	1.3V±2%, -Reset PPO	SC-82AB	26vdl	VD7	5a	Ric
L3	R3116Q101A	Vdet-IC	1V±0.8%, -Reset ODO	SC-82AB	26rp	VD1	5a	Ric
L3	RP104Q181B	LVR-IC	LDO, 1.8V±0.8%, 150mA, +CE	SC-82AB	26vn	VR4	5a	Ric
L3	XC6120C33N	Vdet-IC	3.3V±2%, CMOS +Reset PPO	SSOT-24	26yu	VD7	5a	Tor
L3	XC6223F131NR-G	LVR-IC	LDO, 1.3V±20mV, 300mA, +CE, CL, ICP	SSOT-24	26vn	VR4	5a	Tor
L30	BAV23	Si-diode	Dual, GP, 200V, 225mA, Vs<1.25V(200mA), <50ns	SOT-143	24ce	-	5c	Phi
L4	R3111Q141A	Vdet-IC	1.4V±2%, -Reset PPO	SC-82AB	26vdl	VD7	5a	Ric
L4	R3116Q111A	Vdet-IC	1.1V±0.8%, -Reset ODO	SC-82AB	26rp	VD1	5a	Ric
L4	RP104Q181B5	LVR-IC	LDO, 1.85V±0.8%, 150mA, +CE	SC-82AB	26vn	VR4	5a	Ric
L4	XC6120C34N	Vdet-IC	3.4V±2%, CMOS +Reset PPO	SSOT-24	26yu	VD7	5a	Tor
L4	XC6223F141NR-G	LVR-IC	LDO, 1.4V±20mV, 300mA, +CE, CL, ICP	SSOT-24	26vn	VR4	5a	Tor
L41	BAT74	Si-diode	Dual, Sw, 30V, 200mA, 230mW, Vf<0.8V(0.1A), <5ns	SOT-143B	24ce	-	5c	Phi
L5	R3111Q151A	Vdet-IC	1.5V±2%, -Reset PPO	SC-82AB	26vdl	VD7	5a	Ric
L5	R3116Q121A	Vdet-IC	1.2V±0.8%, -Reset ODO	SC-82AB	26rp	VD1	5a	Ric
L5	RP104Q191B	LVR-IC	LDO, 1.9V±0.8%, 150mA, +CE	SC-82AB	26vn	VR4	5a	Ric
L5	XC6120C35N	Vdet-IC	3.5V±2%, CMOS +Reset PPO	SSOT-24	26yu	VD7	5a	Tor
L5	XC6223F151NR-G	LVR-IC	LDO, 1.5V±20mV, 300mA, +CE, CL, ICP	SSOT-24	26vn	VR4	5a	Tor
L51	BAS56	Si-diode	Dual, Sw, U-Fast, 60V, 200mA, 250mW, <6ns	SOT-143	24ce	-	5c	Phi
L6	R3111Q161A	Vdet-IC	1.6V±2%, -Reset PPO	SC-82AB	26vdl	VD7	5a	Ric
L6	R3116Q131A	Vdet-IC	1.3V±0.8%, -Reset ODO	SC-82AB	26rp	VD1	5a	Ric
L6	RP104Q201B	LVR-IC	LDO, 2.0V±0.8%, 150mA, +CE	SC-82AB	26vn	VR4	5a	Ric
L6	XC6120C36N	Vdet-IC	3.6V±2%, CMOS +Reset PPO	SSOT-24	26yu	VD7	5a	Tor
L6	XC61CN1602N	Vdet-IC	1.6V±1%, +Reset ODO	SOT-143R	26vdl	VD6	5c	Tor
L6	XC6223F161NR-G	LVR-IC	LDO, 1.6V±20mV, 300mA, +CE, CL, ICP	SSOT-24	26vn	VR4	5a	Tor
L7	R3111Q171A	Vdet-IC	1.7V±2%, -Reset PPO	SC-82AB	26vdl	VD7	5a	Ric
L7	R3116Q141A	Vdet-IC	1.4V±0.8%, -Reset ODO	SC-82AB	26rp	VD1	5a	Ric
L7	RP104Q251B	LVR-IC	LDO, 2.5V±0.8%, 150mA, +CE	SC-82AB	26vn	VR4	5a	Ric
L7	XC6120C37N	Vdet-IC	3.7V±2%, CMOS +Reset PPO	SSOT-24	26yu	VD7	5a	Tor
L7	XC61CN1702N	Vdet-IC	1.7V±1%, +Reset ODO	SOT-143R	26vdl	VD6	5c	Tor
L7	XC6223F171NR-G	LVR-IC	LDO, 1.7V±20mV, 300mA, +CE, CL, ICP	SSOT-24	26vn	VR4	5a	Tor
L8	R3111Q181A	Vdet-IC	1.8V±2%, -Reset PPO	SC-82AB	26vdl	VD7	5a	Ric
L8	R3116Q151A	Vdet-IC	1.5V±0.8%, -Reset ODO	SC-82AB	26rp	VD1	5a	Ric
L8	RP104Q261B	LVR-IC	LDO, 2.6V±0.8%, 150mA, +CE	SC-82AB	26vn	VR4	5a	Ric



SMD
code

SMD code	Type	Function	Short description	Case	Pinout	Sch.	St.	Mnf.
L8	XC6120C38N	Vdet-IC	3.8V±2%, CMOS +Reset PPO	SSOT-24	26yu	VD7	5a	Tor
L8	XC61CN1802N	Vdet-IC	1.8V±1%, +Reset ODO	SOT-143R	26vdl	VD6	5c	Tor
L8	XC6223F181NR-G	LVR-IC	LDO, 1.8V±20mV, 300mA, +CE, CL, ICP	SSOT-24	26vn	VR4	5a	Tor
L9	R3111Q191A	Vdet-IC	1.9V±2%, -Reset PPO	SC-82AB	26vdl	VD7	5a	Ric
L9	R3116Q161A	Vdet-IC	1.6V±0.8%, -Reset ODO	SC-82AB	26rp	VD1	5a	Ric
L9	RP104Q271B	LVR-IC	LDO, 2.7V±0.8%, 150mA, +CE	SC-82AB	26vn	VR4	5a	Ric
L9	XC6120C39N	Vdet-IC	3.9V±2%, CMOS +Reset PPO	SSOT-24	26yu	VD7	5a	Tor
L9	XC61CN1902N	Vdet-IC	1.9V±1%, +Reset ODO	SOT-143R	26vdl	VD6	5c	Tor
L9	XC6223F191NR-G	LVR-IC	LDO, 1.9V±20mV, 300mA, +CE, CL, ICP	SSOT-24	26vn	VR4	5a	Tor
la	PT7M6229CHC4	Vdet-IC	2.9V±1.5%, +Reset PPO	SC-70-4	23vdl	VD7	5g	Pti
lā	PT7M6229CHC4E	Vdet-IC	2.9V±1.5%, +Reset PPO, Lead free	SC-70-4	23vdl	VD7	5g	Pti
LA	BF1201WR	n-MOSFET-e*	DG, VHF, UHF, 10V, 30mA, 200mW	SOT-343R	26fd	-	5c	Phi
LA	BU4941F	Vdet-IC	4.1V±1%, +Reset PPO	SOP-4	26vdl	VD7	5c	Rhm
LA	R1114Q301A	LVR-IC	LDO, LN, -CE, 3V±2%, 150mA	SOT-143R	26vn	VR4	5a	Ric
LA	RP130Q121D	LVR-IC	LDO, LN, +CE, CL, 1.2V±1%, 150mA	SC-82AB	26vn	VR4	5a	Ric
LA	XC6120C40N	Vdet-IC	4V±2%, CMOS +Reset PPO	SSOT-24	26yu	VD7	5a	Tor
ĪA	XC6127N16JNR	Vdet-IC	1.6V±0.8%, +Reset ODO, -MR, Rt=400ms	SSOT-24	26cr	VD4	5a	Tor
LA	XC6223F201NR-G	LVR-IC	LDO, 2.0V±1%, 300mA, +CE, CL, ICP	SSOT-24	26vn	VR4	5a	Tor
LA28	MIC5203-2.8BM4	LVR-IC	LDO, 2.8V±1%, 80mA, +CE	SOT-143	24uc	VR4	5c	Mcr
LA30	MIC5203-3.0BM4	LVR-IC	LDO, 3V±1%, 80mA, +CE	SOT-143	24uc	VR4	5c	Mcr
LA33	MIC5203-3.3BM4	LVR-IC	LDO, 3.3V±1%, 80mA, +CE	SOT-143	24uc	VR4	5c	Mcr
LA36	MIC5203-3.6BM4	LVR-IC	LDO, 3.6V±1%, 80mA, +CE	SOT-143	24uc	VR4	5c	Mcr
LA38	MIC5203-3.8CM4	LVR-IC	LDO, 3.8V±1%, 80mA, +CE	SOT-143	24uc	VR4	5c	Mcr
LA40	MIC5203-4.0BM4	LVR-IC	LDO, 4V±1%, 80mA, +CE	SOT-143	24uc	VR4	5c	Mcr
LA45	MIC5203-4.5BM4	LVR-IC	LDO, 4.5V±1%, 80mA, +CE	SOT-143	24uc	VR4	5c	Mcr
LA47	MIC5203-4.7BM4	LVR-IC	LDO, 4.7V±1%, 80mA, +CE	SOT-143	24uc	VR4	5c	Mcr
LA50	MIC5203-5.0BM4	LVR-IC	LDO, 5V±1%, 80mA, +CE	SOT-143	24uc	VR4	5c	Mcr
LAp	BF1201	n-MOSFET-e*	DG, VHF, UHF, 10V, 30mA, 200mW	SOT-143	24fd	-	5c	Phi
LAW	NCP552SQ15T1	LVR-IC	Low Iq, +CE, 1.5V±2%, 80mA	SOT-143	26vp	VR4	5c	Ons
LAX	NCP552SQ18T1	LVR-IC	Low Iq, +CE, 1.8V±2%, 80mA	SOT-143	26vp	VR4	5c	Ons
LAY	NCP552SQ25T1	LVR-IC	Low Iq, +CE, 2.5V±2%, 80mA	SOT-143	26vp	VR4	5c	Ons
LAZ	NCP552SQ27T1	LVR-IC	Low Iq, +CE, 2.7V±2%, 80mA	SOT-143	26vp	VR4	5c	Ons
lb	PT7M6229NLC4	Vdet-IC	2.9V±1.5%, -Reset ODO	SC-70-4	23vdl	VD6	5g	Pti
lĪ	PT7M6229NLC4E	Vdet-IC	2.9V±1.5%, -Reset ODO, Lead free	SC-70-4	23vdl	VD6	5g	Pti
LB	BU4942F	Vdet-IC	4.2V±1%, +Reset PPO	SOP-4	26vdl	VD7	5c	Rhm
LB	R1114Q311A	LVR-IC	LDO, LN, -CE, 3.1V±2%, 150mA	SOT-143R	26vn	VR4	5a	Ric
LB	RP130Q131D	LVR-IC	LDO, LN, +CE, CL, 1.3V±1%, 150mA	SC-82AB	26vn	VR4	5a	Ric
LB	XC6120C41N	Vdet-IC	4.1V±2%, CMOS +Reset PPO	SSOT-24	26yu	VD7	5a	Tor
ĪB	XC6127N18JNR	Vdet-IC	1.8V±0.8%, +Reset ODO, -MR, Rt=400ms	SSOT-24	26cr	VD4	5a	Tor
LB	XC6223F211NR-G	LVR-IC	LDO, 2.1V±1%, 300mA, +CE, CL, ICP	SSOT-24	26vn	VR4	5a	Tor
LBA	NCP552SQ28T1	LVR-IC	Low Iq, +CE, 2.8V±2%, 80mA	SOT-143	26vp	VR4	5c	Ons
LBB	NCP552SQ30T1	LVR-IC	Low Iq, +CE, 3V±2%, 80mA	SOT-143	26vp	VR4	5c	Ons
LBC	NCP552SQ33T1	LVR-IC	Low Iq, +CE, 3.3V±2%, 80mA	SOT-143	26vp	VR4	5c	Ons
LBD	NCP552SQ50T1	LVR-IC	Low Iq, +CE, 5V±2%, 80mA	SOT-143	26vp	VR4	5c	Ons
LBE	NCP553SQ15T1	LVR-IC	Low Iq, 1.5V±2%, 80mA	SOT-143	26vs	VR1	5c	Ons
LBF	NCP553SQ18T1	LVR-IC	Low Iq, 1.8V±2%, 80mA	SOT-143	26vs	VR1	5c	Ons
LBG	NCP553SQ25T1	LVR-IC	Low Iq, 2.5V±2%, 80mA	SOT-143	26vs	VR1	5c	Ons
LBH	NCP553SQ27T1	LVR-IC	Low Iq, 2.7V±2%, 80mA	SOT-143	26vs	VR1	5c	Ons
LBI	NCP553SQ28T1	LVR-IC	Low Iq, 2.8V±2%, 80mA	SOT-143	26vs	VR1	5c	Ons
LBJ	NCP553SQ30T1	LVR-IC	Low Iq, 3V±2%, 80mA	SOT-143	26vs	VR1	5c	Ons
LBK	NCP553SQ33T1	LVR-IC	Low Iq, 3.3V±2%, 80mA	SOT-143	26vs	VR1	5c	Ons
LBL	NCP553SQ50T1	LVR-IC	Low Iq, 5V±2%, 80mA	SOT-143	26vs	VR1	5c	Ons
Lbp	BF1201R	n-MOSFET-e*	DG, VHF, UHF, 10V, 30mA, 200mW	SOT-143R	26fd	-	5c	Phi
lc	PT7M6230CLC4	Vdet-IC	3.0V±1.5%, -Reset PPO	SC-70-4	23vdl	VD7	5g	Pti
lĪ	PT7M6230CLC4E	Vdet-IC	3.0V±1.5%, -Reset PPO, Lead free	SC-70-4	23vdl	VD7	5g	Pti
LC	BU4943F	Vdet-IC	4.3V±1%, +Reset PPO	SOP-4	26vdl	VD7	5c	Rhm
LC	R1114Q321A	LVR-IC	LDO, LN, -CE, 3.2V±2%, 150mA	SOT-143R	26vn	VR4	5a	Ric
LC	RP130Q141D	LVR-IC	LDO, LN, +CE, CL, 1.4V±1%, 150mA	SC-82AB	26vn	VR4	5a	Ric
LC	XC6120C42N	Vdet-IC	4.2V±2%, CMOS +Reset PPO	SSOT-24	26yu	VD7	5a	Tor
ĪC	XC6127N20JNR	Vdet-IC	2.0V±0.8%, +Reset ODO, -MR, Rt=400ms	SSOT-24	26cr	VD4	5a	Tor
LC	XC6223F221NR-G	LVR-IC	LDO, 2.2V±1%, 300mA, +CE, CL, ICP	SSOT-24	26vn	VR4	5a	Tor
ld	PT7M6230CHC4	Vdet-IC	3.0V±1.5%, +Reset PPO	SC-70-4	23vdl	VD7	5g	Pti
lĪ	PT7M6230CHC4E	Vdet-IC	3.0V±1.5%, +Reset PPO, Lead free	SC-70-4	23vdl	VD7	5g	Pti
LD	BU4944F	Vdet-IC	4.4V±1%, +Reset PPO	SOP-4	26vdl	VD7	5c	Rhm
LD	R1114Q331A	LVR-IC	LDO, LN, -CE, 3.3V±2%, 150mA	SOT-143R	26vn	VR4	5a	Ric
LD	RP130Q151D	LVR-IC	LDO, LN, +CE, CL, 1.5V±1%, 150mA	SC-82AB	26vn	VR4	5a	Ric
LD	XC6120C43N	Vdet-IC	4.3V±2%, CMOS +Reset PPO	SSOT-24	26yu	VD7	5a	Tor
ĪD	XC6127N22JNR	Vdet-IC	2.2V±0.8%, +Reset ODO, -MR, Rt=400ms	SSOT-24	26cr	VD4	5a	Tor
LD	XC6223F231NR-G	LVR-IC	LDO, 2.3V±1%, 300mA, +CE, CL, ICP	SSOT-24	26vn	VR4	5a	Tor
LDI	NCP562SQ15T1	LVR-IC	LDO, Low Iq, +CE, 1.5V±2%, 80mA	SOT-143	26vp	VR4	5c	Ons



SMD

SMD code	Type	Function	Short description	Case	Pinout	Sch.	St.	Mnf.
LDK	NCP562SQ25T1	LVR-IC	LDO, Low Iq, +CE, 2.5V±2%, 80mA	SOT-143	26vp	VR4	5c	Ons
LDL	NCP562SQ28T1	LVR-IC	LDO, Low Iq, +CE, 2.8V±2%, 80mA	SOT-143	26vp	VR4	5c	Ons
LDM	NCP562SQ30T1	LVR-IC	LDO, Low Iq, +CE, 3V±2%, 80mA	SOT-143	26vp	VR4	5c	Ons
LDN	NCP562SQ33T1	LVR-IC	LDO, Low Iq, +CE, 3.3V±2%, 80mA	SOT-143	26vp	VR4	5c	Ons
Ldp	BF1202R	n-MOSFET-e*	DG, VHF, UHF, 10V, 30mA, 200mW, 30ms	SOT-143R	26fd	-	5c	Phi
LDP	NCP562SQ50T1	LVR-IC	LDO, Low Iq, +CE, 5V±2%, 80mA	SOT-143	26vp	VR4	5c	Ons
LDQ	NCP563SQ15T1	LVR-IC	LDO, Low Iq, 1.5V±2%, 80mA	SOT-143	26vs	VR1	5c	Ons
LDS	NCP563SQ25T1	LVR-IC	LDO, Low Iq, 2.5V±2%, 80mA	SOT-143	26vs	VR1	5c	Ons
LDT	NCP563SQ28T1	LVR-IC	LDO, Low Iq, 2.8V±2%, 80mA	SOT-143	26vs	VR1	5c	Ons
LDU	NCP563SQ30T1	LVR-IC	LDO, Low Iq, 3V±2%, 80mA	SOT-143	26vs	VR1	5c	Ons
LDV	NCP563SQ33T1	LVR-IC	LDO, Low Iq, 3.3V±2%, 80mA	SOT-143	26vs	VR1	5c	Ons
LDX	NCP563SQ50T1	LVR-IC	LDO, Low Iq, 5V±2%, 80mA	SOT-143	26vs	VR1	5c	Ons
le	PT7M6230NLC4	Vdet-IC	3.0V±1.5%, -Reset ODO	SC-70-4	23vdl	VD6	5g	Pti
le	PT7M6230NLC4E	Vdet-IC	3.0V±1.5%, -Reset ODO, Lead free	SC-70-4	23vdl	VD6	5g	Pti
LE	BF1202WE	n-MOSFET-e*	DG, VHF, UHF, 10V, 30mA, 200mW, 30ms	SOT-343R	26fd	-	5c	Phi
LE	BU4945F	Vdet-IC	4.5V±1%, +Reset PPO	SOP-4	26vdl	VD7	5c	Rhm
LE	R1114Q341A	LVR-IC	LDO, LN, -CE, 3.4V±2%, 150mA	SOT-143R	26vn	VR4	5a	Ric
LE	RP130Q161D	LVR-IC	LDO, LN, +CE, CL, 1.6V±1%, 150mA	SC-82AB	26vn	VR4	5a	Ric
LE	XC6120C44N	Vdet-IC	4.4V±2%, CMOS +Reset PPO	SSOT-24	26yu	VD7	5a	Tor
LE	XC6127N24JNR	Vdet-IC	2.4V±0.8%, +Reset ODO, -MR, Rt=400ms	SSOT-24	26cr	VD4	5a	Tor
LE	XC6223F241NR-G	LVR-IC	LDO, 2.4V±1%, 300mA, +CE, CL, ICP	SSOT-24	26vn	VR4	5a	Tor
LEp	BF1202	n-MOSFET-e*	DG, VHF, UHF, 10V, 30mA, 200mW, 30ms	SOT-143	24fd	-	5c	Phi
LEY	NCP562SQ18T1	LVR-IC	LDO, Low Iq, +CE, 1.8V±2%, 80mA	SOT-143	26vp	VR4	5c	Ons
LEZ	NCP562SQ27T1	LVR-IC	LDO, Low Iq, +CE, 2.7V±2%, 80mA	SOT-143	26vp	VR4	5c	Ons
lf	PT7M6231CLC4	Vdet-IC	3.1V±1.5%, -Reset PPO	SC-70-4	23vdl	VD7	5g	Pti
lf	PT7M6231CLC4E	Vdet-IC	3.1V±1.5%, -Reset PPO, Lead free	SC-70-4	23vdl	VD7	5g	Pti
LF	BU4946F	Vdet-IC	4.6V±1%, +Reset PPO	SOP-4	26vdl	VD7	5c	Rhm
LF	R1114Q351A	LVR-IC	LDO, LN, -CE, 3.5V±2%, 150mA	SOT-143R	26vn	VR4	5a	Ric
LF	RP130Q171D	LVR-IC	LDO, LN, +CE, CL, 1.7V±1%, 150mA	SC-82AB	26vn	VR4	5a	Ric
LF	XC6120C45N	Vdet-IC	4.5V±2%, CMOS +Reset PPO	SSOT-24	26yu	VD7	5a	Tor
LF	XC6127N26JNR	Vdet-IC	2.6V±0.8%, +Reset ODO, -MR, Rt=400ms	SSOT-24	26cr	VD4	5a	Tor
LF	XC6223F251NR-G	LVR-IC	LDO, 2.5V±1%, 300mA, +CE, CL, ICP	SSOT-24	26vn	VR4	5a	Tor
LFA	NCP563SQ18T1	LVR-IC	LDO, Low Iq, 1.8V±2%, 80mA	SOT-143	26vs	VR1	5c	Ons
LFB	NCP563SQ27T1	LVR-IC	LDO, Low Iq, 2.7V±2%, 80mA	SOT-143	26vs	VR1	5c	Ons
lg	PT7M6231CHC4	Vdet-IC	3.1V±1.5%, +Reset PPO	SC-70-4	23vdl	VD7	5g	Pti
lg	PT7M6231CHC4E	Vdet-IC	3.1V±1.5%, +Reset PPO, Lead free	SC-70-4	23vdl	VD7	5g	Pti
LG	BU4947F	Vdet-IC	4.7V±1%, +Reset PPO	SOP-4	26vdl	VD7	5c	Rhm
LG	R1114Q361A	LVR-IC	LDO, LN, -CE, 3.6V±2%, 150mA	SOT-143R	26vn	VR4	5a	Ric
LG	RP130Q181D	LVR-IC	LDO, LN, +CE, CL, 1.8V±1%, 150mA	SC-82AB	26vn	VR4	5a	Ric
lh	PT7M6231NLC4	Vdet-IC	3.1V±1.5%, -Reset ODO	SC-70-4	23vdl	VD6	5g	Pti
lh	PT7M6231NLC4E	Vdet-IC	3.1V±1.5%, -Reset ODO, Lead free	SC-70-4	23vdl	VD6	5g	Pti
LH	BU4948F	Vdet-IC	4.8V±1%, +Reset PPO	SOP-4	26vdl	VD7	5c	Rhm
LH	R1114Q371A	LVR-IC	LDO, LN, -CE, 3.7V±2%, 150mA	SOT-143R	26vn	VR4	5a	Ric
LH	RP130Q181D5	LVR-IC	LDO, LN, +CE, CL, 1.85V±1%, 150mA	SC-82AB	26vn	VR4	5a	Ric
LH	XC6120C46N	Vdet-IC	4.6V±2%, CMOS +Reset PPO	SSOT-24	26yu	VD7	5a	Tor
LH	XC6127N28JNR	Vdet-IC	2.8V±0.8%, +Reset ODO, -MR, Rt=400ms	SSOT-24	26cr	VD4	5a	Tor
LH	XC6223F261NR-G	LVR-IC	LDO, 2.6V±1%, 300mA, +CE, CL, ICP	SSOT-24	26vn	VR4	5a	Tor
li	PT7M6232CLC4	Vdet-IC	3.2V±1.5%, -Reset PPO	SC-70-4	23vdl	VD7	5g	Pti
li	PT7M6232CLC4E	Vdet-IC	3.2V±1.5%, -Reset PPO, Lead free	SC-70-4	23vdl	VD7	5g	Pti
lj	PT7M6232CHC4	Vdet-IC	3.2V±1.5%, +Reset PPO	SC-70-4	23vdl	VD7	5g	Pti
lj	PT7M6232CHC4E	Vdet-IC	3.2V±1.5%, +Reset PPO, Lead free	SC-70-4	23vdl	VD7	5g	Pti
LJ	ETC812JU	Vdet-IC	4V, -MR, +Reset PPO	SOT-143	24vdh	VD5	5c	Etc
LJ	FMB121JUX	Vdet-IC	4.0V±1.5%, +Reset PPO, -MR	SOT-143	24vdh	VD5	5c	F
LJ	MIC812JU	Vdet-IC	4V, -MR, +Reset PPO	SOT-143	24vdh	VD5	5c	Mcr
LJ	R1114Q381A	LVR-IC	LDO, LN, -CE, 3.8V±2%, 150mA	SOT-143R	26vn	VR4	5a	Ric
LJ	RP130Q191D	LVR-IC	LDO, LN, +CE, CL, 1.9V±1%, 150mA	SC-82AB	26vn	VR4	5a	Ric
lk	PT7M6232NLC4	Vdet-IC	3.2V±1.5%, -Reset ODO	SC-70-4	23vdl	VD6	5g	Pti
lk	PT7M6232NLC4E	Vdet-IC	3.2V±1.5%, -Reset ODO, Lead free	SC-70-4	23vdl	VD6	5g	Pti
LK	R1114Q391A	LVR-IC	LDO, LN, -CE, 3.9V±2%, 150mA	SOT-143R	26vn	VR4	5a	Ric
LK	RP130Q201D	LVR-IC	LDO, LN, +CE, CL, 2V±1%, 150mA	SC-82AB	26vn	VR4	5a	Ric
LK	XC6120C47N	Vdet-IC	4.7V±2%, CMOS +Reset PPO	SSOT-24	26yu	VD7	5a	Tor
LK	XC6127N30JNR	Vdet-IC	3.0V±0.8%, +Reset ODO, -MR, Rt=400ms	SSOT-24	26cr	VD4	5a	Tor
LK	XC6223F271NR-G	LVR-IC	LDO, 2.7V±1%, 300mA, +CE, CL, ICP	SSOT-24	26vn	VR4	5a	Tor
ll	PT7M6233CLC4	Vdet-IC	3.3V±1.5%, -Reset PPO	SC-70-4	23vdl	VD7	5g	Pti
ll	PT7M6233CLC4E	Vdet-IC	3.3V±1.5%, -Reset PPO, Lead free	SC-70-4	23vdl	VD7	5g	Pti
LL	ETC812LU	Vdet-IC	4.63V, -MR, +Reset PPO	SOT-143	24vdh	VD5	5c	Etc
LL	FMB121LUX	Vdet-IC	4.63V±1.5%, +Reset PPO, -MR	SOT-143	24vdh	VD5	5c	F
LL	MIC812LU	Vdet-IC	4.63V, -MR, +Reset PPO	SOT-143	24vdh	VD5	5c	Mcr
LL	XC6120C48N	Vdet-IC	4.8V±2%, CMOS +Reset PPO	SSOT-24	26yu	VD7	5a	Tor
LL	XC6127N32JNR	Vdet-IC	3.2V±0.8%, +Reset ODO, -MR, Rt=400ms	SSOT-24	26cr	VD4	5a	Tor



SMD code	Type	Function	Short description	Case	Pinout	Sch.	St.	Mnf.
LL	XC6223F281NR-G	LVR-IC	LDO, 2.8V±1%, 300mA, +CE, CL, ICP	SSOT-24	26vn	VR4	5a	Tor
LLN	ELM7532CCB	Vdet-IC	3.2V±2%, +Reset PPO	SC-82AB	26vdl	VD7	5c	Elm
LLN	ELM7532NCB	Vdet-IC	3.2V±2%, +Reset ODO	SC-82AB	26vdl	VD6	5c	Elm
lm	PT7M6233CHC4	Vdet-IC	3.3V±1.5%, +Reset PPO	SC-70-4	23vdl	VD7	5g	Pti
lm	PT7M6233CHC4E	Vdet-IC	3.3V±1.5%, +Reset PPO, Lead free	SC-70-4	23vdl	VD7	5g	Pti
LM	ETC812MU	Vdet-IC	4.38V, -MR, +Reset PPO	SOT-143	24vdh	VD5	5c	Etc
LM	FM812MUX	Vdet-IC	4.38V±1.5%, +Reset PPO, -MR	SOT-143	24vdh	VD5	5c	F
LM	MIC812MU	Vdet-IC	4.38V, -MR, +Reset PPO	SOT-143	24vdh	VD5	5c	Mcr
LM	XC6120C49N	Vdet-IC	4.9V±2%, CMOS +Reset PPO	SSOT-24	26vu	VD7	5a	Tor
LM	XC6127N34JNR	Vdet-IC	3.4V±0.8%, +Reset ODO, -MR, Rt=400ms	SSOT-24	26cr	VD4	5a	Tor
LM	XC6223F291NR-G	LVR-IC	LDO, 2.9V±1%, 300mA, +CE, CL, ICP	SSOT-24	26vn	VR4	5a	Tor
ln	PT7M6233NLC4	Vdet-IC	3.3V±1.5%, -Reset ODO	SC-70-4	23vdl	VD6	5g	Pti
ln	PT7M6233NLC4E	Vdet-IC	3.3V±1.5%, -Reset ODO, Lead free	SC-70-4	23vdl	VD6	5g	Pti
LN	XC6109N10AN	Vdet-IC	1.0V, +Reset ODO	SSOT-24	26rp	VD1	5c	Tor
LN	XC6119N20ANR	Vdet-IC	2.0V±2%, -Reset ODO	SSOT-24	26gh	VD1	5a	Tor
LN	XC6120C50N	Vdet-IC	5V±2%, CMOS +Reset PPO	SSOT-24	26yu	VD7	5a	Tor
LN	XC6127N36JNR	Vdet-IC	3.6V±0.8%, +Reset ODO, -MR, Rt=400ms	SSOT-24	26cr	VD4	5a	Tor
-LN	ELM7548CCB	Vdet-IC	4.8V±2%, +Reset PPO	SC-82AB	26vdl	VD7	5c	Elm
-LN	ELM7548NCB	Vdet-IC	4.8V±2%, +Reset ODO	SC-82AB	26vdl	VD6	5c	Elm
LN3	2SC5228-3	Si-npn	VHF/UHF, LN, 20V, 70mA, 200mW, B=60..120, 7GHz	CP4	26tu	-	5b	San
LN4	2SC5228-4	Si-npn	VHF/UHF, LN, 20V, 70mA, 200mW, B=90..180, 7GHz	CP4	26tu	-	5b	San
LN4	2SC5501-4	Si-npn	VHF/UHF LN, 20V, 70mA, 500mW, B=90..180, 7GHz	SOT-343	26tu	-	5b	San
LN5	2SC5228-5	Si-npn	VHF/UHF, LN, 20V, 70mA, 200mW, B=135..270, 7GHz	CP4	26tu	-	5b	San
LN5	2SC5501-5	Si-npn	VHF/UHF LN, 20V, 70mA, 500mW, B=135..270, 7GHz	SOT-343	26tu	-	5b	San
lo	PT7M6234CLC4	Vdet-IC	3.4V±1.5%, -Reset PPO	SC-70-4	23vdl	VD7	5g	Pti
lo	PT7M6234CLC4E	Vdet-IC	3.4V±1.5%, -Reset PPO, Lead free	SC-70-4	23vdl	VD7	5g	Pti
lp	PT7M6234CHC4	Vdet-IC	3.4V±1.5%, +Reset PPO	SC-70-4	23vdl	VD7	5g	Pti
lp	PT7M6234CHC4E	Vdet-IC	3.4V±1.5%, +Reset PPO, Lead free	SC-70-4	23vdl	VD7	5g	Pti
LP	XC6109N11AN	Vdet-IC	1.1V, +Reset ODO	SSOT-24	26rp	VD1	5c	Tor
LP	XC6119N21ANR	Vdet-IC	2.1V±2%, -Reset ODO	SSOT-24	26gh	VD1	5a	Tor
LP	XC6127N38JNR	Vdet-IC	3.8V±0.8%, +Reset ODO, -MR, Rt=400ms	SSOT-24	26cr	VD4	5a	Tor
lq	PT7M6234NLC4	Vdet-IC	3.4V±1.5%, -Reset ODO	SC-70-4	23vdl	VD6	5g	Pti
lq	PT7M6234NLC4E	Vdet-IC	3.4V±1.5%, -Reset ODO, Lead free	SC-70-4	23vdl	VD6	5g	Pti
lr	PT7M6235CLC4	Vdet-IC	3.5V±1.5%, -Reset PPO	SC-70-4	23vdl	VD7	5g	Pti
lr	PT7M6235CLC4E	Vdet-IC	3.5V±1.5%, -Reset PPO, Lead free	SC-70-4	23vdl	VD7	5g	Pti
LR	ETC812RU	Vdet-IC	2.63V, -MR, +Reset PPO	SOT-143	24vdh	VD5	5c	Etc
LR	FM812RUX	Vdet-IC	2.63V±1.5%, +Reset PPO, -MR	SOT-143	24vdh	VD5	5c	F
LR	MIC812RU	Vdet-IC	2.63V, -MR, +Reset PPO	SOT-143	24vdh	VD5	5c	Mcr
LR	XC6109N12AN	Vdet-IC	1.2V, +Reset ODO	SSOT-24	26rp	VD1	5c	Tor
LR	XC6119N22ANR	Vdet-IC	2.2V±2%, -Reset ODO	SSOT-24	26gh	VD1	5a	Tor
LR	XC6127N40JNR	Vdet-IC	4.0V±0.8%, +Reset ODO, -MR, Rt=400ms	SSOT-24	26cr	VD4	5a	Tor
ls	PT7M6235CHC4	Vdet-IC	3.5V±1.5%, +Reset PPO	SC-70-4	23vdl	VD7	5g	Pti
ls	PT7M6235CHC4E	Vdet-IC	3.5V±1.5%, +Reset PPO, Lead free	SC-70-4	23vdl	VD7	5g	Pti
LS	ETC812SU	Vdet-IC	2.93V, -MR, +Reset PPO	SOT-143	24vdh	VD5	5c	Etc
LS	FM812SUX	Vdet-IC	2.93V±1.5%, +Reset PPO, -MR	SOT-143	24vdh	VD5	5c	F
LS	MIC812SU	Vdet-IC	2.93V, -MR, +Reset PPO	SOT-143	24vdh	VD5	5c	Mcr
LS	XC6109N13AN	Vdet-IC	1.3V, +Reset ODO	SSOT-24	26rp	VD1	5c	Tor
LS	XC6119N23ANR	Vdet-IC	2.3V±2%, -Reset ODO	SSOT-24	26gh	VD1	5a	Tor
LS	XC6127N42JNR	Vdet-IC	4.2V±0.8%, +Reset ODO, -MR, Rt=400ms	SSOT-24	26cr	VD4	5a	Tor
lt	PT7M6235NLC4	Vdet-IC	3.5V±1.5%, -Reset ODO	SC-70-4	23vdl	VD6	5g	Pti
lt	PT7M6235NLC4E	Vdet-IC	3.5V±1.5%, -Reset ODO, Lead free	SC-70-4	23vdl	VD6	5g	Pti
LT	ETC812TU	Vdet-IC	3.08V, -MR, +Reset PPO	SOT-143	24vdh	VD5	5c	Etc
LT	FM812TUX	Vdet-IC	3.08V±1.5%, +Reset PPO, -MR	SOT-143	24vdh	VD5	5c	F
LT	MIC812TU	Vdet-IC	3.08V, -MR, +Reset PPO	SOT-143	24vdh	VD5	5c	Mcr
LT	XC6109N14AN	Vdet-IC	1.4V, +Reset ODO	SSOT-24	26rp	VD1	5c	Tor
LT	XC6119N24ANR	Vdet-IC	2.4V±2%, -Reset ODO	SSOT-24	26gh	VD1	5a	Tor
LT	XC6127N44JNR	Vdet-IC	4.4V±0.8%, +Reset ODO, -MR, Rt=400ms	SSOT-24	26cr	VD4	5a	Tor
lu	PT7M6236CLC4	Vdet-IC	3.6V±1.5%, -Reset PPO	SC-70-4	23vdl	VD7	5g	Pti
lu	PT7M6236CLC4E	Vdet-IC	3.6V±1.5%, -Reset PPO, Lead free	SC-70-4	23vdl	VD7	5g	Pti
LU	XC6109N15AN	Vdet-IC	1.5V, +Reset ODO	SSOT-24	26rp	VD1	5c	Tor
LU	XC6119N25ANR	Vdet-IC	2.5V±2%, -Reset ODO	SSOT-24	26gh	VD1	5a	Tor
LU	XC6127N46JNR	Vdet-IC	4.6V±0.8%, +Reset ODO, -MR, Rt=400ms	SSOT-24	26cr	VD4	5a	Tor
lv	PT7M6236CHC4	Vdet-IC	3.6V±1.5%, +Reset PPO	SC-70-4	23vdl	VD7	5g	Pti
lv	PT7M6236CHC4E	Vdet-IC	3.6V±1.5%, +Reset PPO, Lead free	SC-70-4	23vdl	VD7	5g	Pti
LV	XC6109N16AN	Vdet-IC	1.6V, +Reset ODO	SSOT-24	26rp	VD1	5c	Tor
LV	XC6119N26ANR	Vdet-IC	2.6V±2%, -Reset ODO	SSOT-24	26gh	VD1	5a	Tor
LV	XC6127N48JNR	Vdet-IC	4.8V±0.8%, +Reset ODO, -MR, Rt=400ms	SSOT-24	26cr	VD4	5a	Tor
lw	PT7M6236NLC4	Vdet-IC	3.6V±1.5%, -Reset ODO	SC-70-4	23vdl	VD6	5g	Pti
lw	PT7M6236NLC4E	Vdet-IC	3.6V±1.5%, -Reset ODO, Lead free	SC-70-4	23vdl	VD6	5g	Pti
lx	PT7M6237CLC4	Vdet-IC	3.7V±1.5%, -Reset PPO	SC-70-4	23vdl	VD7	5g	Pti



Note: ELM75xxCCB series LN- lot number L=0...9 N=A to Z(I, O, X excepted); ELM75xxNCB series LN- lot number L=A to Z(I, O, X excepted) N=0...9

SMD
code

Type

Function

Short description

Case

Pinout Sch.

St. Mnf.

LX	PT7M6237CLC4E	Vdet-IC	3.7V±1.5%, -Reset PPO, Lead free	SC-70-4	23vdl	VD7	5g	Pti
LX	XC6109N17AN	Vdet-IC	1.7V, +Reset ODO	SSOT-24	26rp	VD1	5c	Tor
LX	XC6119N27ANR	Vdet-IC	2.7V±2%, -Reset ODO	SSOT-24	26gh	VD1	5a	Tor
LX	XC6127N50JNR	Vdet-IC	5.0V±0.8%, +Reset ODO, -MR, Rt=400ms	SSOT-24	26cr	VD4	5a	Tor
ly	PT7M6237CHC4	Vdet-IC	3.7V±1.5%, +Reset PPO	SC-70-4	23vdl	VD7	5g	Pti
ly	PT7M6237CHC4E	Vdet-IC	3.7V±1.5%, +Reset PPO, Lead free	SC-70-4	23vdl	VD7	5g	Pti
LY	XC6109N18AN	Vdet-IC	1.8V, +Reset ODO	SSOT-24	26rp	VD1	5c	Tor
LY	XC6119N28ANR	Vdet-IC	2.8V±2%, -Reset ODO	SSOT-24	26gh	VD1	5a	Tor
LY	XC6127N52JNR	Vdet-IC	5.2V±0.8%, +Reset ODO, -MR, Rt=400ms	SSOT-24	26cr	VD4	5a	Tor
lz	PT7M6237NLC4	Vdet-IC	3.7V±1.5%, -Reset ODO	SC-70-4	23vdl	VD6	5g	Pti
lz	PT7M6237NLC4E	Vdet-IC	3.7V±1.5%, -Reset ODO, Lead free	SC-70-4	23vdl	VD6	5g	Pti
LZ	XC6109N19AN	Vdet-IC	1.9V, +Reset ODO	SSOT-24	26rp	VD1	5c	Tor
LZ	XC6119N29ANR	Vdet-IC	2.9V±2%, -Reset ODO	SSOT-24	26gh	VD1	5a	Tor
LZ	XC6127N54JNR	Vdet-IC	5.4V±0.8%, +Reset ODO, -MR, Rt=400ms	SSOT-24	26cr	VD4	5a	Tor
M0	R3111Q201A	Vdet-IC	2V±2%, -Reset PPO	SC-82AB	26vdl	VD7	5a	Ric
M0	R3116Q171A	Vdet-IC	1.7V±0.8%, -Reset ODO	SC-82AB	26rp	VD1	5a	Ric
M0	RP104Q281B	LVR-IC	LDO, 2.8V±0.8%, 150mA, +CE	SC-82AB	26vn	VR4	5a	Ric
M0	XC61CN2002N	Vdet-IC	2V±1%, +Reset ODO	SOT-143R	26vdl	VD6	5c	Tor
M03	BSS83	n-MOSFET-e*	Sw, 10V, 50mA, 230mW, Up<2V, <45Q, 1/5ns	SOT-143	24fl	-	5b	Ste
M04	BF904	n-MOSFET-e*	DG, VHFUJHF, 7V, 30mA, 200mW	SOT-143	24fd	-	5c	Phi
M06	BF904R	n-MOSFET-e*	DG, VHFUJHF, 7V, 30mA, 200mW	SOT-143	26fm	-	5c	Phi
M1	R3111Q211A	Vdet-IC	2.1V±2%, -Reset PPO	SC-82AB	26vdl	VD7	5a	Ric
M1	R3116Q181A	Vdet-IC	1.8V±0.8%, -Reset ODO	SC-82AB	26rp	VD1	5a	Ric
M1	RP104Q281B5	LVR-IC	LDO, 2.85V±0.8%, 150mA, +CE	SC-82AB	26vn	VR4	5a	Ric
M1	XC61CN2102N	Vdet-IC	2.1V±1%, +Reset ODO	SOT-143R	26vdl	VD6	5c	Tor
M1S	MA348	C-diode	Dual, FM-tuner AFC, 15V, <16pF	SC-61	24ce	-	5b	Pan
M1S	MA4X348	C-diode	Dual, FM-tuner AFC, 15V, <16pF	SC-61	24ce	-	5b	Pan
M2	R3111Q221A	Vdet-IC	2.2V±2%, -Reset PPO	SC-82AB	26vdl	VD7	5a	Ric
M2	R3116Q191A	Vdet-IC	1.9V±0.8%, -Reset ODO	SC-82AB	26rp	VD1	5a	Ric
M2	RP104Q291B	LVR-IC	LDO, 2.9V±0.8%, 150mA, +CE	SC-82AB	26vn	VR4	5a	Ric
M2	XC61CN2202N	Vdet-IC	2.2V±1%, +Reset ODO	SOT-143R	26vdl	VD6	5c	Tor
M2	XC6223G121NR-G	LVR-IC	LDO, 1.2V±20mV, 300mA, +CE, PDR, ICP	SSOT-24	26vn	VR4	5a	Tor
M26	BF908	n-MOSFET-d*	DG, VHFUJHF, 12V, 40mA, 200mW, 1GHz	SOT-143	24fd	-	5c	Phi
M28	BF909	n-MOSFET-e*	DG, VHFUJHF, 7V, 40mA	SOT-143	24fd	-	5c	Phi
M3	R3111Q231A	Vdet-IC	2.3V±2%, -Reset PPO	SC-82AB	26vdl	VD7	5a	Ric
M3	R3116Q201A	Vdet-IC	2V±0.8%, -Reset ODO	SC-82AB	26rp	VD1	5a	Ric
M3	RP104Q301B	LVR-IC	LDO, 3.0V±0.8%, 150mA, +CE	SC-82AB	26vn	VR4	5a	Ric
M3	XC61CN2302N	Vdet-IC	2.3V±1%, +Reset ODO	SOT-143R	26vdl	VD6	5c	Tor
M3	XC6223G131NR-G	LVR-IC	LDO, 1.3V±20mV, 300mA, +CE, PDR, ICP	SSOT-24	26vn	VR4	5a	Tor
M32	BSD22	n-MOSFET-d	Sw, Chopper, 20V, 50mA, 230mW, 25Q(1mA), 1/5ns	SOT-143	24fl	-	5c	Phi
M3K	MA999	Si-diode	Sw, 30V, 30mA, Vf<1V(30mA), 1ns	SOT-143	24ce	-	5b	Pan
M4	R3111Q241A	Vdet-IC	2.4V±2%, -Reset PPO	SC-82AB	26vdl	VD7	5a	Ric
M4	R3116Q211A	Vdet-IC	2.1V±0.8%, -Reset ODO	SC-82AB	26rp	VD1	5a	Ric
M4	RP104Q321B	LVR-IC	LDO, 3.2V±0.8%, 150mA, +CE	SC-82AB	26vn	VR4	5a	Ric
M4	XC61CN2402N	Vdet-IC	2.4V±1%, +Reset ODO	SOT-143R	26vdl	VD6	5c	Tor
M4	XC6223G141NR-G	LVR-IC	LDO, 1.4V±20mV, 300mA, +CE, PDR, ICP	SSOT-24	26vn	VR4	5a	Tor
M5	R3111Q251A	Vdet-IC	2.5V±2%, -Reset PPO	SC-82AB	26vdl	VD7	5a	Ric
M5	R3116Q221A	Vdet-IC	2.2V±0.8%, -Reset ODO	SC-82AB	26rp	VD1	5a	Ric
M5	RP104Q331B	LVR-IC	LDO, 3.3V±0.8%, 150mA, +CE	SC-82AB	26vn	VR4	5a	Ric
M5	XC61CN2502N	Vdet-IC	2.5V±1%, +Reset ODO	SOT-143R	26vdl	VD6	5c	Tor
M5	XC6223G151NR-G	LVR-IC	LDO, 1.5V±20mV, 300mA, +CE, PDR, ICP	SSOT-24	26vn	VR4	5a	Tor
M56	BF1100	n-MOSFET-e*	DG, VHF, UHF, 14V, 30mA, 200mW	SOT-143	24fd	-	5c	Phi
M57	BF1100R	n-MOSFET-e*	DG, VHF, UHF, 14V, 30mA, 200mW	SOT-143R	26fd	-	5c	Phi
M6	R3111Q261A	Vdet-IC	2.6V±2%, -Reset PPO	SC-82AB	26vdl	VD7	5a	Ric
M6	R3116Q231A	Vdet-IC	2.3V±0.8%, -Reset ODO	SC-82AB	26rp	VD1	5a	Ric
M6	RP104Q311B	LVR-IC	LDO, 3.1V±0.8%, 150mA, +CE	SC-82AB	26vn	VR4	5a	Ric
M6	XC61CN2602N	Vdet-IC	2.6V±1%, +Reset ODO	SOT-143R	26vdl	VD6	5c	Tor
M6	XC6223G161NR-G	LVR-IC	LDO, 1.6V±20mV, 300mA, +CE, PDR, ICP	SSOT-24	26vn	VR4	5a	Tor
M7	R3111Q271A	Vdet-IC	2.7V±2%, -Reset PPO	SC-82AB	26vdl	VD7	5a	Ric
M7	R3116Q241A	Vdet-IC	2.4V±0.8%, -Reset ODO	SC-82AB	26rp	VD1	5a	Ric
M7	RP104Q241B	LVR-IC	LDO, 2.4V±0.8%, 150mA, +CE	SC-82AB	26vn	VR4	5a	Ric
M7	XC61CN2702N	Vdet-IC	2.7V±1%, +Reset ODO	SOT-143R	26vdl	VD6	5c	Tor
M7	XC6223G171NR-G	LVR-IC	LDO, 1.7V±20mV, 300mA, +CE, PDR, ICP	SSOT-24	26vn	VR4	5a	Tor
M74	BSS83	n-MOSFET-e*	Sw, 10V, 50mA, 230mW, Up<2V, <45Q, 1/5ns	SOT-143	24fl	-	5c	Phi
M8	R3111Q281A	Vdet-IC	2.8V±2%, -Reset PPO	SC-82AB	26vdl	VD7	5a	Ric
M8	R3116Q251A	Vdet-IC	2.5V±0.8%, -Reset ODO	SC-82AB	26rp	VD1	5a	Ric
M8	RP104Q221B	LVR-IC	LDO, 2.2V±0.8%, 150mA, +CE	SC-82AB	26vn	VR4	5a	Ric
M8	XC61CN2802N	Vdet-IC	2.8V±1%, +Reset ODO	SOT-143R	26vdl	VD6	5c	Tor
M8	XC6223G181NR-G	LVR-IC	LDO, 1.8V±20mV, 300mA, +CE, PDR, ICP	SSOT-24	26vn	VR4	5a	Tor
M83	BF997	n-MOSFET-d*	DG, 20V, 30mA, 200mW, NF=1dB, Idss=20mA, Gf>15mQ	SOT-143	24fd	-	5c	Phi



SMD

code	Type	Function	Short description	Case	Pinout	Sch.	St.	Mnf.
M9	R3111Q291A	Vdet-IC	2.9V±2%, -Reset PPO	SC-82AB	26vdl	VD7	5a	Ric
M9	R3116Q261A	Vdet-IC	2.6V±0.8%, -Reset ODO	SC-82AB	26fp	VD1	5a	Ric
M9	RP104Q231B	LVR-IC	LDO, 2.3V±0.8%, 150mA, +CE	SC-82AB	26vn	VR4	5a	Ric
M9	XC61CN2902N	Vdet-IC	2.9V±1%, +Reset ODO	SOT-143R	26vdl	VD6	5c	Tor
M9	XC6223G191NR-G	LVR-IC	LDO, 1.9V±20mV, 300mA, +CE, PDR, ICP	SSOT-24	26vn	VR4	5a	Tor
M94	BF994	n-MOSFET-d*	DG, 20V, 30mA, 200mW, NF=1dB, Idss=20mA, Gf>15mΩ	SOT-143	24fd	-	5b	Vs
M95	BF996S	n-MOSFET-d*	DG, 20V, 50mA, 200mW, NF=1dB, Idss=20mA, Gf>15mΩ	SOT-143	24fd	-	5b	Vs
M96	BF996	n-MOSFET-d*	DG, 20V, 50mA, 200mW, NF=1dB, Idss=20mA, Gf>15mΩ	SOT-143	24fd	-	5b	Vs
ma	PT7M6238CLC4	Vdet-IC	3.8V±1.5%, -Reset PPO	SC-70-4	23vdl	VD7	5g	Pti
ma	PT7M6238CLC4E	Vdet-IC	3.8V±1.5%, -Reset PPO, Lead free	SC-70-4	23vdl	VD7	5g	Pti
MA	R1114Q401A	LVR-IC	LDO, LN, -CE, 4V±2%, 150mA	SOT-143R	26vn	VR4	5a	Ric
MA	RP130Q211D	LVR-IC	LDO, LN, +CE, CL, 2.1V±1%, 150mA	SC-82AB	26vn	VR4	5a	Ric
MA	XC6120N10N	Vdet-IC	1V±2%, N-ch, +Reset ODO	SSOT-24	26yu	VD6	5a	Tor
MA	XC6127N16KNR	Vdet-IC	1.6V±0.8%, +Reset ODO, -MR, Rt=800ms	SSOT-24	26cr	VD4	5a	Tor
MA	XC6223G201NR-G	LVR-IC	LDO, 2.0V±1%, 300mA, +CE, PDR, ICP	SSOT-24	26vn	VR4	5a	Tor
mb	PT7M6238CHC4	Vdet-IC	3.8V±1.5%, +Reset PPO	SC-70-4	23vdl	VD7	5g	Pti
mb	PT7M6238CHC4E	Vdet-IC	3.8V±1.5%, +Reset PPO, Lead free	SC-70-4	23vdl	VD7	5g	Pti
MB	BF995	n-MOSFET-d*	AF, 20V, 30mA, 200mW, NF=1.1dB, Idss=40mA, Gf>12Ω	SOT-143	24fd	-	5b	Sie
MB	BF998WR	n-MOSFET-d*	DG, 12V, 30mA, 200mW, NF=1dB, Idss=20mA, Gf>24mΩ	SOT-343	24fm	-	5c	Phi
MB	R1114Q281A5	LVR-IC	LDO, LN, -CE, 2.8V±2%, 150mA	SOT-143R	26vn	VR4	5a	Ric
MB	RP130Q221D	LVR-IC	LDO, LN, +CE, CL, 2.2V±1%, 150mA	SC-82AB	26vn	VR4	5a	Ric
MB	XC6120N11N	Vdet-IC	1.1V±2%, N-ch, +Reset ODO	SSOT-24	26yu	VD6	5a	Tor
MB	XC6127N18KNR	Vdet-IC	1.8V±0.8%, +Reset ODO, -MR, Rt=800ms	SSOT-24	26cr	VD4	5a	Tor
MB	XC6223G211NR-G	LVR-IC	LDO, 2.1V±1%, 300mA, +CE, PDR, ICP	SSOT-24	26vn	VR4	5a	Tor
MB3	ADM811-3TART	Vdet-IC	3.08V±1.5%, -Reset PPO, -MR	SOT-143	24vdh	VD5	5b	Ad
MBB	ADM811RART	Vdet-IC	2.63V±1.5%, -Reset PPO, -MR	SOT-143	24vdh	VD5	5b	Ad
MBE	ADM811SART	Vdet-IC	2.93V±1.5%, -Reset PPO, -MR	SOT-143	24vdh	VD5	5b	Ad
MBG	ADM811TART	Vdet-IC	3.08V±1.5%, -Reset PPO, -MR	SOT-143	24vdh	VD5	5b	Ad
MBT	ADM811MART	Vdet-IC	4.38V±1.5%, -Reset PPO, -MR	SOT-143	24vdh	VD5	5b	Ad
MBV	ADM811LART	Vdet-IC	4.63V±1.5%, -Reset PPO, -MR	SOT-143	24vdh	VD5	5b	Ad
MBZ	ADM811ZART	Vdet-IC	2.32V, MR, -Reset PPO	SOT-143	24vdh	VD5	5c	Ad
mc	PT7M6238NLC4	Vdet-IC	3.8V±1.5%, -Reset ODO	SC-70-4	23vdl	VD6	5g	Pti
mc	PT7M6238NLC4E	Vdet-IC	3.8V±1.5%, -Reset ODO, Lead free	SC-70-4	23vdl	VD6	5g	Pti
MC	RP130Q231D	LVR-IC	LDO, LN, +CE, CL, 2.3V±1%, 150mA	SC-82AB	26vn	VR4	5a	Ric
MC	XC6120N12N	Vdet-IC	1.2V±2%, N-ch, +Reset ODO	SSOT-24	26yu	VD6	5a	Tor
MC	XC6127N20KNR	Vdet-IC	2.0V±0.8%, +Reset ODO, -MR, Rt=800ms	SSOT-24	26cr	VD4	5a	Tor
MC	XC6223G221NR-G	LVR-IC	LDO, 2.2V±1%, 300mA, +CE, PDR, ICP	SSOT-24	26vn	VR4	5a	Tor
MCB	ADM812RART	Vdet-IC	2.63V±1.5%, +Reset PPO, -MR	SOT-143	24vdh	VD5	5b	Ad
MCE	ADM812SART	Vdet-IC	2.93V±1.5%, +Reset PPO, -MR	SOT-143	24vdh	VD5	5b	Ad
MCG	ADM812TART	Vdet-IC	3.08V±1.5%, +Reset PPO, -MR	SOT-143	24vdh	VD5	5b	Ad
MCO	2SC5088-O	Si-npn	VHF/UHF, LN, 20V, 80mA, 100mW, 7GHz, B=80..160	USQ	24tu	-	5b	Tos
MCT	ADM812MART	Vdet-IC	4.38V±1.5%, +Reset PPO, -MR	SOT-143	24vdh	VD5	5b	Ad
MCV	ADM812LART	Vdet-IC	4.63V±1.5%, +Reset PPO, -MR	SOT-143	24vdh	VD5	5b	Ad
MCY	2SC5088-Y	Si-npn	VHF/UHF, LN, 20V, 80mA, 100mW, 7GHz, B=120..240	USQ	24tu	-	5b	Tos
MCZ	ADM812ZART	Vdet-IC	2.32V, MR, +Reset PPO	SOT-143	24vdh	VD5	5c	Ad
md	PT7M6239CLC4	Vdet-IC	3.9V±1.5%, -Reset PPO	SC-70-4	23vdl	VD7	5g	Pti
md	PT7M6239CLC4E	Vdet-IC	3.9V±1.5%, -Reset PPO, Lead free	SC-70-4	23vdl	VD7	5g	Pti
MD	BF996	n-MOSFET-d*	DG, 20V, 50mA, 200mW, NF=1dB, Idss=20mA, Gf>15mΩ	SOT-143	24fd	-	5b	Sie
MD	RP130Q241D	LVR-IC	LDO, LN, +CE, CL, 2.4V±1%, 150mA	SC-82AB	26vn	VR4	5a	Ric
MD	XC6120N13N	Vdet-IC	1.3V±2%, N-ch, +Reset ODO	SSOT-24	26yu	VD6	5a	Tor
MD	XC6127N22KNR	Vdet-IC	2.2V±0.8%, +Reset ODO, -MR, Rt=800ms	SSOT-24	26cr	VD4	5a	Tor
MD	XC6223G231NR-G	LVR-IC	LDO, 2.3V±1%, 300mA, +CE, PDR, ICP	SSOT-24	26vn	VR4	5a	Tor
MDB	ADM6315-26D1ART	Vdet-IC	2.63V, MR, -Reset ODO, 1ms	SOT-143	24vdh	VD4	5c	Ad
MDC	ADM6315-29D1ART	Vdet-IC	2.93V, MR, -Reset ODO, 1ms	SOT-143	24vdh	VD4	5c	Ad
MDG	ADM6315-31D1ART	Vdet-IC	3.08V, MR, -Reset ODO, 1ms	SOT-143	24vdh	VD4	5c	Ad
MDO	2SC5093-O	Si-npn	VHF/UHF, LN, 20V, 40mA, 100mW, 10GHz, B=80..160	USQ	24tu	-	5b	Tos
MDR	2SC5093-R	Si-npn	VHF/UHF, LN, 20V, 40mA, 100mW, 10GHz, B=50..100	USQ	24tu	-	5b	Tos
MDT	ADM6315-44D1ART	Vdet-IC	4.39V, MR, -Reset ODO, 1ms	SOT-143	24vdh	VD4	5c	Ad
MDU	ADM6315-45D1ART	Vdet-IC	4.5V, MR, -Reset ODO, 1ms	SOT-143	24vdh	VD4	5c	Ad
MDV	ADM6315-46D1ART	Vdet-IC	4.63V, MR, -Reset ODO, 1ms	SOT-143	24vdh	VD4	5c	Ad
me	PT7M6239CHC4	Vdet-IC	3.9V±1.5%, +Reset PPO	SC-70-4	23vdl	VD7	5g	Pti
me	PT7M6239CHC4E	Vdet-IC	3.9V±1.5%, +Reset PPO, Lead free	SC-70-4	23vdl	VD7	5g	Pti
ME	RP130Q251D	LVR-IC	LDO, LN, +CE, CL, 2.5V±1%, 150mA	SC-82AB	26vn	VR4	5a	Ric
ME	XC6120N14N	Vdet-IC	1.4V±2%, N-ch, +Reset ODO	SSOT-24	26yu	VD6	5a	Tor
ME	XC6127N24KNR	Vdet-IC	2.4V±0.8%, +Reset ODO, -MR, Rt=800ms	SSOT-24	26cr	VD4	5a	Tor
ME	XC6223G241NR-G	LVR-IC	LDO, 2.4V±1%, 300mA, +CE, PDR, ICP	SSOT-24	26vn	VR4	5a	Tor
MEB	ADM6315-26D2ART	Vdet-IC	2.63V, MR, -Reset ODO, 20ms	SOT-143	24vdh	VD4	5c	Ad
MEC	ADM6315-29D2ART	Vdet-IC	2.93V, MR, -Reset ODO, 20ms	SOT-143	24vdh	VD4	5c	Ad
MEG	ADM6315-31D2ART	Vdet-IC	3.08V, MR, -Reset ODO, 20ms	SOT-143	24vdh	VD4	5c	Ad
MEO	2SC5098-O	Si-npn	VHF/UHF, LN, 20V, 15mA, 100mW, 10GHz, B=80..160	USQ	26tu	-	5b	Tos



SMD code	Type	Function	Short description	Case	Pinout Sch.	St.	Mnf.
MER	2SC5098-R	Si-npn	VHF/UHF, LN, 20V, 15mA, 100mW, 10GHz, B=50..100	USQ	26tu -	5b	Tos
MET	ADM6315-44D2ART	Vdet-IC	4.39V, MR, -Reset ODO, 20ms	SOT-143	24vdh VD4	5c	Ad
MEU	ADM6315-45D2ART	Vdet-IC	4.5V, MR, -Reset ODO, 20ms	SOT-143	24vdh VD4	5c	Ad
MEV	ADM6315-46D2ART	Vdet-IC	4.63V, MR, -Reset ODO, 20ms	SOT-143	24vdh VD4	5c	Ad
m _f	PT7M6239NLC4	Vdet-IC	3.9V±1.5%, -Reset ODO	SC-70-4	23vdl VD6	5g	Pti
m _f	PT7M6239NLC4E	Vdet-IC	3.9V±1.5%, -Reset ODO, Lead free	SC-70-4	23vdl VD6	5g	Pti
MF	BF1100WR	n-MOSFET-e*	DG, VHF, UHF, 14V, 30mA, 200mW	SOT-343R	26fd -	5c	Phi
MF	RP130Q261D	LVR-IC	LDO, LN, +CE, CL, 2.6V±1%, 150mA	SC-82AB	26vn VR4	5a	Ric
MF	XC6120N15N	Vdet-IC	1.5V±2%, N-ch, +Reset ODO	SSOT-24	26yu VD6	5a	Tor
M _F	XC6127N26KNR	Vdet-IC	2.6V±0.8%, +Reset ODO, -MR, Rt=800ms	SSOT-24	26cr VD4	5a	Tor
MF	XC6223G251NR-G	LVR-IC	LDO, 2.5V±1%, 300mA, +CE, PDR, ICP	SSOT-24	26vn VR4	5a	Tor
MFB	ADM6315-26D3ART	Vdet-IC	2.63V, MR, -Reset ODO, 140ms	SOT-143	24vdh VD4	5c	Ad
MFC	ADM6315-29D3ART	Vdet-IC	2.93V, MR, -Reset ODO, 140ms	SOT-143	24vdh VD4	5c	Ad
MFG	ADM6315-31D3ART	Vdet-IC	3.08V, MR, -Reset ODO, 140ms	SOT-143	24vdh VD4	5c	Ad
MFT	ADM6315-44D3ART	Vdet-IC	4.39V, MR, -Reset ODO, 140ms	SOT-143	24vdh VD4	5c	Ad
MFU	ADM6315-45D3ART	Vdet-IC	4.5V, MR, -Reset ODO, 140ms	SOT-143	24vdh VD4	5c	Ad
MFV	ADM6315-46D3ART	Vdet-IC	4.63V, MR, -Reset ODO, 140ms	SOT-143	24vdh VD4	5c	Ad
mg	PT7M6240CLC4	Vdet-IC	4.0V±1.5%, -Reset PPO	SC-70-4	23vdl VD7	5g	Pti
m _g	PT7M6240CLC4E	Vdet-IC	4.0V±1.5%, -Reset PPO, Lead free	SC-70-4	23vdl VD7	5g	Pti
MG	BF994S	n-MOSFET-d*	DG, 20V, 30mA, 200mW, Nf=1dB, Idss=20mA, Gf>15mΩ	SOT-143	24fd -	5b	Sil
MG	RP130Q271D	LVR-IC	LDO, LN, +CE, CL, 2.7V±1%, 150mA	SC-82AB	26vn VR4	5a	Ric
MGB	ADM6315-26D4ART	Vdet-IC	2.63V, MR, -Reset ODO, 1120ms	SOT-143	24vdh VD4	5c	Ad
MGC	ADM6315-29D4ART	Vdet-IC	2.93V, MR, -Reset ODO, 1120ms	SOT-143	24vdh VD4	5c	Ad
MGG	ADM6315-31D4ART	Vdet-IC	3.08V, MR, -Reset ODO, 1120ms	SOT-143	24vdh VD4	5c	Ad
M _{Gp}	BF994S	n-MOSFET-d*	DG, 20V, 30mA, 200mW, Nf=1dB, Idss=20mA, Gf>15mΩ	SOT-143	24fd -	5c	Phi
M _{Gs}	BF994S	n-MOSFET-d*	DG, 20V, 30mA, 200mW, Nf=1dB, Idss=20mA, Gf>15mΩ	SOT-143	24fd -	5b	Sie
MGT	ADM6315-44D4ART	Vdet-IC	4.39V, MR, -Reset ODO, 1120ms	SOT-143	24vdh VD4	5c	Ad
MGU	ADM6315-45D4ART	Vdet-IC	4.5V, MR, -Reset ODO, 1120ms	SOT-143	24vdh VD4	5c	Ad
MGV	ADM6315-46D4ART	Vdet-IC	4.63V, MR, -Reset ODO, 1120ms	SOT-143	24vdh VD4	5c	Ad
m _h	PT7M6240CHC4	Vdet-IC	4.0V±1.5%, +Reset PPO	SC-70-4	23vdl VD7	5g	Pti
m _h	PT7M6240CHC4E	Vdet-IC	4.0V±1.5%, +Reset PPO, Lead free	SC-70-4	23vdl VD7	5g	Pti
MH	2SC3609	Si-npn	VHF/UHF, LN, 12V, 80mA, 150mW, 7GHz, B=30..250	SOT-143	26tu -	5b	Tos
MH	BF996S	n-MOSFET-d*	DG, 20V, 50mA, 200mW, Nf=1dB, Idss=20mA, Gf>15mΩ	SOT-143	24fd -	5b	Sie
MH	RP130Q281D	LVR-IC	LDO, LN, +CE, CL, 2.8V±1%, 150mA	SC-82AB	26vn VR4	5a	Ric
MH	XC6120N16N	Vdet-IC	1.6V±2%, N-ch, +Reset ODO	SSOT-24	26yu VD6	5a	Tor
M _H	XC6127N28KNR	Vdet-IC	2.8V±0.8%, +Reset ODO, -MR, Rt=800ms	SSOT-24	26cr VD4	5a	Tor
MH	XC6223G261NR-G	LVR-IC	LDO, 2.6V±1%, 300mA, +CE, PDR, ICP	SSOT-24	26vn VR4	5a	Tor
M _{Hp}	BF996S	n-MOSFET-d*	DG, 20V, 50mA, 200mW, Nf=1dB, Idss=20mA, Gf>15mΩ	SOT-143	24fd -	5c	Phi
M _{Hs}	BF996S	n-MOSFET-d*	DG, 20V, 50mA, 200mW, Nf=1dB, Idss=20mA, Gf>15mΩ	SOT-143	24fd -	5b	Sie
m _i	PT7M6240NLC4	Vdet-IC	4.0V±1.5%, -Reset ODO	SC-70-4	23vdl VD6	5g	Pti
m _i	PT7M6240NLC4E	Vdet-IC	4.0V±1.5%, -Reset ODO, Lead free	SC-70-4	23vdl VD6	5g	Pti
M _I	2SC3745	Si-npn	UHF, 20V, 30mA, 6.5GHz	SOT-143	26tu -	5b	Tos
M _{I-}	2SC4126	Si-npn	VHF/UHF, 15V, 50mA, 150mW, B=50..250, 6GHz	SOT-143	26tu -	5c	Ren
m _j	PT7M6241CLC4	Vdet-IC	4.1V±1.5%, -Reset PPO	SC-70-4	23vdl VD7	5g	Pti
m _j	PT7M6241CLC4E	Vdet-IC	4.1V±1.5%, -Reset PPO, Lead free	SC-70-4	23vdl VD7	5g	Pti
M _J	RP130Q281D5	LVR-IC	LDO, LN, +CE, CL, 2.85V±1%, 150mA	SC-82AB	26vn VR4	5a	Ric
m _k	PT7M6241CHC4	Vdet-IC	4.1V±1.5%, +Reset PPO	SC-70-4	23vdl VD7	5g	Pti
m _k	PT7M6241CHC4E	Vdet-IC	4.1V±1.5%, +Reset PPO, Lead free	SC-70-4	23vdl VD7	5g	Pti
M _K	2SC4315	Si-npn	VHF/UHF, LN, 20V, 80mA, 150mW, B=30..250, 7GHz	SOT-143	26tu -	5b	Tos
M _K	2SC4842	Si-npn	VHF-UHF, LN, 20V, 80mA, 100mW, B=30..250, 7GHz	2-2K1A	23t8 -	5b	Tos
M _K	BF997	n-MOSFET-d*	DG, 20V, 30mA, 200mW, Nf=1dB, Idss=20mA, Gf>15mΩ	SOT-143	24fd -	5b	Sie
M _K	RP130Q291D	LVR-IC	LDO, LN, +CE, CL, 2.9V±1%, 150mA	SC-82AB	26vn VR4	5a	Ric
M _K	XC6120N17N	Vdet-IC	1.7V±2%, N-ch, +Reset ODO	SSOT-24	26yu VD6	5a	Tor
M _K	XC6127N30KNR	Vdet-IC	3.0V±0.8%, +Reset ODO, -MR, Rt=800ms	SSOT-24	26cr VD4	5a	Tor
M _K	XC6223G271NR-G	LVR-IC	LDO, 2.7V±1%, 300mA, +CE, PDR, ICP	SSOT-24	26vn VR4	5a	Tor
M _{Kp}	BF997	n-MOSFET-d*	DG, 20V, 30mA, 200mW, Nf=1dB, Idss=20mA, Gf>15mΩ	SOT-143	24fd -	5c	Phi
m _l	PT7M6241NLC4	Vdet-IC	4.1V±1.5%, -Reset ODO	SC-70-4	23vdl VD6	5g	Pti
m _l	PT7M6241NLC4E	Vdet-IC	4.1V±1.5%, -Reset ODO, Lead free	SC-70-4	23vdl VD6	5g	Pti
M _L	XC6120N18N	Vdet-IC	1.8V±2%, N-ch, +Reset ODO	SSOT-24	26yu VD6	5a	Tor
M _L	XC6127N32KNR	Vdet-IC	3.2V±0.8%, +Reset ODO, -MR, Rt=800ms	SSOT-24	26cr VD4	5a	Tor
M _L	XC6223G281NR-G	LVR-IC	LDO, 2.8V±1%, 300mA, +CE, PDR, ICP	SSOT-24	26vn VR4	5a	Tor
M _{LN}	ELM753CCB	Vdet-IC	3.3V±2%, +Reset PPO	SC-82AB	26vdl VD7	5c	Elm
M _{LN}	ELM753NCB	Vdet-IC	3.3V±2%, +Reset ODO	SC-82AB	26vdl VD6	5c	Elm
m _m	PT7M6242CLC4	Vdet-IC	4.2V±1.5%, -Reset PPO	SC-70-4	23vdl VD7	5g	Pti
m _m	PT7M6242CLC4E	Vdet-IC	4.2V±1.5%, -Reset PPO, Lead free	SC-70-4	23vdl VD7	5g	Pti
M _M	XC6120N19N	Vdet-IC	1.9V±2%, N-ch, +Reset ODO	SSOT-24	26yu VD6	5a	Tor
M _M	XC6127N34KNR	Vdet-IC	3.4V±0.8%, +Reset ODO, -MR, Rt=800ms	SSOT-24	26cr VD4	5a	Tor
M _M	XC6223G291NR-G	LVR-IC	LDO, 2.9V±1%, 300mA, +CE, PDR, ICP	SSOT-24	26vn VR4	5a	Tor
m _n	PT7M6242CHC4	Vdet-IC	4.2V±1.5%, +Reset PPO	SC-70-4	23vdl VD7	5g	Pti
m _n	PT7M6242CHC4E	Vdet-IC	4.2V±1.5%, +Reset PPO, Lead free	SC-70-4	23vdl VD7	5g	Pti



SMD code	Type	Function	Short description	Case	Pinout	Sch.	St.	Mnf.
MN	2SC4843	Si-npn	VHF-UHF, LN, 20V, 40mA, 100mW, B=50..250, 10GHz	2-2K1A	23t8	-	5b	Tos
MN	XC6109N20AN	Vdet-IC	2.0V, +Reset ODO	SSOT-24	26tp	VD1	5c	Tor
MN	XC6119N30ANR	Vdet-IC	3.0V±2%, -Reset ODO	SSOT-24	26gh	VD1	5a	Tor
MN	XC6120N20N	Vdet-IC	2V±2%, N-ch, +Reset ODO	SSOT-24	26yu	VD6	5a	Tor
MN	XC6127N36KNR	Vdet-IC	3.6V±0.8%, +Reset ODO, -MR, Rt=800ms	SSOT-24	26cr	VD4	5a	Tor
MN3	2SC5276-3	Si-npn	UHF-S-band, 20V, 30mA, 200mW, B=60..120, 11GHz	CP4	26tu	-	5b	San
MN4	2SC5276-4	Si-npn	UHF-S-band, 20V, 30mA, 200mW, B=90..180, 11GHz	CP4	26tu	-	5b	San
MN4	2SC5504-4	Si-npn	UHF-S-Band, LN, 20V, 30mA, 300mW, B=90..180, 11GHz	SOT-343	26tu	-	5b	San
MN5	2SC5276-5	Si-npn	UHF-S-band, 20V, 30mA, 200mW, B=135..270, 11GHz	CP4	26tu	-	5b	San
MN5	2SC5504-5	Si-npn	UHF-S-Band, LN, 20V, 30mA, 300mW, B=135..270, 11GHz	SOT-343	26tu	-	5b	San
mo	PT7M6242NLC4	Vdet-IC	4.2V±1.5%, -Reset ODO	SC-70-4	23vdl	VD6	5g	Pti
mō	PT7M6242NLC4E	Vdet-IC	4.2V±1.5%, -Reset ODO, Lead free	SC-70-4	23vdl	VD6	5g	Pti
MO	2SC4844	Si-npn	VHF-UHF, LN, 20V, 15mA, 100mW, B=50..250, 10GHz	2-2K1A	23t8	-	5b	Tos
MO	BF998	n-MOSFET-d*	DG, 12V, 30mA, 200mW, Nf=1dB, Idss=20mA, Gf>24mΩ	SOT-143	24fd	-	5b	Sie
MO1	BF901	n-MOSFET-e*	DG, VHF/UHF, 12V, 30mA	SOT-143	24fd	-	5c	Phi
MOp	BF998R	n-MOSFET-d*	DG, 12V, 30mA, 200mW, Nf=1dB, Idss=20mA, Gf>24mΩ	SOT-143R	24fm	-	5c	Phi
MOR	BF998R	n-MOSFET-d*	DG, 12V, 30mA, 200mW, Nf=1dB, Idss=20mA, Gf>24mΩ	SOT-143R	24fm	-	5b	Sil
MOS	BF998	n-MOSFET-d*	DG, 12V, 30mA, 200mW, Nf=1dB, Idss=20mA, Gf>24mΩ	SOT-143	24fd	-	5b	Sie
mp	PT7M6243CLC4	Vdet-IC	4.3V±1.5%, -Reset PPO	SC-70-4	23vdl	VD7	5g	Pti
mḡ	PT7M6243CLC4E	Vdet-IC	4.3V±1.5%, -Reset PPO, Lead free	SC-70-4	23vdl	VD7	5g	Pti
MP	XC6109N21AN	Vdet-IC	2.1V, +Reset ODO	SSOT-24	26rp	VD1	5c	Tor
MP	XC6119N31ANR	Vdet-IC	3.1V±2%, -Reset ODO	SSOT-24	26gh	VD1	5a	Tor
MP	XC6120N21N	Vdet-IC	2.1V±2%, N-ch, +Reset ODO	SSOT-24	26yu	VD6	5a	Tor
Mḡ	XC6127N38KNR	Vdet-IC	3.8V±0.8%, +Reset ODO, -MR, Rt=800ms	SSOT-24	26cr	VD4	5a	Tor
mḡ	PT7M6243CHC4	Vdet-IC	4.3V±1.5%, +Reset PPO	SC-70-4	23vdl	VD7	5g	Pti
mḡ	PT7M6243CHC4E	Vdet-IC	4.3V±1.5%, +Reset PPO, Lead free	SC-70-4	23vdl	VD7	5g	Pti
mr	PT7M6243NLC4	Vdet-IC	4.3V±1.5%, -Reset ODO	SC-70-4	23vdl	VD6	5g	Pti
mḡ	PT7M6243NLC4E	Vdet-IC	4.3V±1.5%, -Reset ODO, Lead free	SC-70-4	23vdl	VD6	5g	Pti
MR	BF998W	n-MOSFET-d*	DG, 12V, 30mA, 200mW, Nf=1dB, Idss=20mA, Gf>24mΩ	SOT-143R	24fm	-	5b	Sie
MR	MT4S03A	Si-npn	VHF/UHF, 10V, 40mA, 10GHz	SOT-143	26tu	-	5b	Tos
MR	XC6109N22AN	Vdet-IC	2.2V, +Reset ODO	SSOT-24	26rp	VD1	5c	Tor
MR	XC6119N32ANR	Vdet-IC	3.2V±2%, -Reset ODO	SSOT-24	26gh	VD1	5a	Tor
MR	XC6120N22N	Vdet-IC	2.2V±2%, N-ch, +Reset ODO	SSOT-24	26yu	VD6	5a	Tor
Mḡ	XC6127N40KNR	Vdet-IC	4.0V±0.8%, +Reset ODO, -MR, Rt=800ms	SSOT-24	26cr	VD4	5a	Tor
ms	PT7M6244CLC4	Vdet-IC	4.4V±1.5%, -Reset PPO	SC-70-4	23vdl	VD7	5g	Pti
mḡ	PT7M6244CLC4E	Vdet-IC	4.4V±1.5%, -Reset PPO, Lead free	SC-70-4	23vdl	VD7	5g	Pti
Ms	BAR65-07	PIN-diode	Dual, TV-Tuner, 30V, 100mA, Vf<1V(50mA), <0.9pF	SOT-143	24ce	-	5h	Inf
MS	XC6109N23AN	Vdet-IC	2.3V, +Reset ODO	SSOT-24	26rp	VD1	5c	Tor
MS	XC6119N33ANR	Vdet-IC	3.3V±2%, -Reset ODO	SSOT-24	26gh	VD1	5a	Tor
MS	XC6120N23N	Vdet-IC	2.3V±2%, N-ch, +Reset ODO	SSOT-24	26yu	VD6	5a	Tor
Mḡ	XC6127N42KNR	Vdet-IC	4.2V±0.8%, +Reset ODO, -MR, Rt=800ms	SSOT-24	26cr	VD4	5a	Tor
MSs	CF739	n-MESFET-d	GaAs, DG, UHF, 10V, 80mA, 240mW, Idss=6..60mA, Gfs=25ms	SOT-143	24fd	-	5h	Inf
mt	PT7M6244CHC4	Vdet-IC	4.4V±1.5%, +Reset PPO	SC-70-4	23vdl	VD7	5g	Pti
mḡ	PT7M6244CHC4E	Vdet-IC	4.4V±1.5%, +Reset PPO, Lead free	SC-70-4	23vdl	VD7	5g	Pti
MT	XC6109N24AN	Vdet-IC	2.4V, +Reset ODO	SSOT-24	26rp	VD1	5c	Tor
MT	XC6119N34ANR	Vdet-IC	3.4V±2%, -Reset ODO	SSOT-24	26gh	VD1	5a	Tor
MT	XC6120N24N	Vdet-IC	2.4V±2%, N-ch, +Reset ODO	SSOT-24	26yu	VD6	5a	Tor
Mḡ	XC6127N44KNR	Vdet-IC	4.4V±0.8%, +Reset ODO, -MR, Rt=800ms	SSOT-24	26cr	VD4	5a	Tor
mu	PT7M6244NLC4	Vdet-IC	4.4V±1.5%, -Reset ODO	SC-70-4	23vdl	VD6	5g	Pti
mū	PT7M6244NLC4E	Vdet-IC	4.4V±1.5%, -Reset ODO, Lead free	SC-70-4	23vdl	VD6	5g	Pti
MU	XC6109N25AN	Vdet-IC	2.5V, +Reset ODO	SSOT-24	26rp	VD1	5c	Tor
MU	XC6119N35ANR	Vdet-IC	3.5V±2%, -Reset ODO	SSOT-24	26gh	VD1	5a	Tor
MU	XC6120N25N	Vdet-IC	2.5V±2%, N-ch, +Reset ODO	SSOT-24	26yu	VD6	5a	Tor
Mū	XC6127N46KNR	Vdet-IC	4.6V±0.8%, +Reset ODO, -MR, Rt=800ms	SSOT-24	26cr	VD4	5a	Tor
mv	PT7M6245CLC4	Vdet-IC	4.5V±1.5%, -Reset PPO	SC-70-4	23vdl	VD7	5g	Pti
mḡ	PT7M6245CLC4E	Vdet-IC	4.5V±1.5%, -Reset PPO, Lead free	SC-70-4	23vdl	VD7	5g	Pti
MV	XC6109N26AN	Vdet-IC	2.6V, +Reset ODO	SSOT-24	26rp	VD1	5c	Tor
MV	XC6119N36ANR	Vdet-IC	3.6V±2%, -Reset ODO	SSOT-24	26gh	VD1	5a	Tor
MV	XC6120N26N	Vdet-IC	2.6V±2%, N-ch, +Reset ODO	SSOT-24	26yu	VD6	5a	Tor
Mḡ	XC6127N48KNR	Vdet-IC	4.8V±0.8%, +Reset ODO, -MR, Rt=800ms	SSOT-24	26cr	VD4	5a	Tor
mḡ	PT7M6245CHC4	Vdet-IC	4.5V±1.5%, +Reset PPO	SC-70-4	23vdl	VD7	5g	Pti
mḡ	PT7M6245CHC4E	Vdet-IC	4.5V±1.5%, +Reset PPO, Lead free	SC-70-4	23vdl	VD7	5g	Pti
MW	BF996S	n-MOSFET-d*	DG, 20V, 50mA, 200mW, Nf=1dB, Idss=20mA, Gf>15mΩ	SOT-143	24fd	-	5c	Phi
mx	PT7M6245NLC4	Vdet-IC	4.5V±1.5%, -Reset ODO	SC-70-4	23vdl	VD6	5g	Pti
mḡ	PT7M6245NLC4E	Vdet-IC	4.5V±1.5%, -Reset ODO, Lead free	SC-70-4	23vdl	VD6	5g	Pti
MX	CF750	MMIC	GaAs UHF-mix, amp, 8V, 80mA, 300mW, Gfs=25ms	SOT-143	24ai	A2	5h	Inf
MX	XC6109N27AN	Vdet-IC	2.7V, +Reset ODO	SSOT-24	26rp	VD1	5c	Tor
MX	XC6119N37ANR	Vdet-IC	3.7V±2%, -Reset ODO	SSOT-24	26gh	VD1	5a	Tor
MX	XC6120N27N	Vdet-IC	2.7V±2%, N-ch, +Reset ODO	SSOT-24	26yu	VD6	5a	Tor
Mḡ	XC6127N50KNR	Vdet-IC	5.0V±0.8%, +Reset ODO, -MR, Rt=800ms	SSOT-24	26cr	VD4	5a	Tor



SMD code	Type	Function	Short description	Case	Pinout	Sch.	St.	Mnf.
my	PT7M6246CLC4	Vdet-IC	4.6V±1.5%, -Reset PPO	SC-70-4	23vdl	VD7	5g	Pti
my	PT7M6246CLC4E	Vdet-IC	4.6V±1.5%, -Reset PPO, Lead free	SC-70-4	23vdl	VD7	5g	Pti
MY	BF1012	n-MOSFET-d	DG, 16V, Id=25mA, 200mW, Nf=1.4dB, Gf=26mΩ	SOT-143	24fd	-	5b	Sie
MY	BF1012S	n-MOSFET-d	DG, 16V, 25mA, 200mW, Nf=1.4dB, Gf=26mΩ	SOT-143	24fd	-	5h	Inf
MY	XC6109N28AN	Vdet-IC	2.8V, +Reset ODO	SSOT-24	26rp	VD1	5c	Tor
MY	XC6119N38ANR	Vdet-IC	3.8V±2%, -Reset ODO	SSOT-24	26gh	VD1	5a	Tor
MY	XC6120N28N	Vdet-IC	2.8V±2%, N-ch, +Reset ODO	SSOT-24	26yu	VD6	5a	Tor
MY	XC6127N52KNR	Vdet-IC	5.2V±0.8%, +Reset ODO, -MR, Rt=800ms	SSOT-24	26cr	VD4	5a	Tor
MYs	BF1012	n-MOSFET-d	DG, 16V, Id=25mA, 200mW, Nf=1.4dB, Gf=26mΩ	SOT-143	24fd	-	5b	Sie
mz	PT7M6246CHC4	Vdet-IC	4.6V±1.5%, +Reset PPO	SC-70-4	23vdl	VD7	5g	Pti
mz	PT7M6246CHC4E	Vdet-IC	4.6V±1.5%, +Reset PPO, Lead free	SC-70-4	23vdl	VD7	5g	Pti
MZ	BF1005W	MMIC	UHF, 8V, 25mA, 200mW, Idss=50..500µA	SOT-343R	26fm	A3	5h	Inf
MZ	XC6109N29AN	Vdet-IC	2.9V, +Reset ODO	SSOT-24	26rp	VD1	5c	Tor
MZ	XC6119N39ANR	Vdet-IC	3.9V±2%, -Reset ODO	SSOT-24	26gh	VD1	5a	Tor
MZ	XC6120N29N	Vdet-IC	2.9V±2%, N-ch, +Reset ODO	SSOT-24	26yu	VD6	5a	Tor
MZ	XC6127N54KNR	Vdet-IC	5.4V±0.8%, +Reset ODO, -MR, Rt=800ms	SSOT-24	26cr	VD4	5a	Tor
MZs	BF1005	MMIC	UHF, 8V, 25mA, 200mW, Idss=50..500µA	SOT-143	24fd	A3	5h	Inf
MZs	BF1005R	MMIC	UHF, 8V, 25mA, 200mW, Idss=50..500µA	SOT-143R	26fm	A3	5h	Inf
N0	BFG505W	Si-npn	UHF, 20V, 18mA, 150mW, B=120..250, 9GHz	SOT-343	24t6	-	5b	Phi
N0	R3111Q301A	Vdet-IC	3V±2%, -Reset PPO	SC-82AB	26vdl	VD7	5a	Ric
N0	R3116Q271A	Vdet-IC	2.7V±0.8%, -Reset ODO	SC-82AB	26rp	VD1	5a	Ric
N0	RP104Q121C	LVR-IC	LDO, 1.2V±0.8%, 150mA	SC-82AB	26yr	VR1	5a	Ric
N0	XC6120N30N	Vdet-IC	3V±2%, N-ch, +Reset ODO	SSOT-24	26yu	VD6	5a	Tor
N0	XC61CN3002N	Vdet-IC	3V±1%, +Reset ODO	SOT-143R	26vdl	VD6	5c	Tor
N1	BFG505W/X	Si-npn	UHF, 20V, 18mA, 150mW, B=120..250, 9GHz	SOT-343	26tc	-	5b	Phi
N1	R3111Q311A	Vdet-IC	3.1V±2%, -Reset PPO	SC-82AB	26vdl	VD7	5a	Ric
N1	R3116Q281A	Vdet-IC	2.8V±0.8%, -Reset ODO	SC-82AB	26rp	VD1	5a	Ric
N1	RP104Q131C	LVR-IC	LDO, 1.3V±0.8%, 150mA	SC-82AB	26yr	VR1	5a	Ric
N1	XC6120N31N	Vdet-IC	3.1V±2%, N-ch, +Reset ODO	SSOT-24	26yu	VD6	5a	Tor
N1	XC61CN3102N	Vdet-IC	3.1V±1%, +Reset ODO	SOT-143R	26vdl	VD6	5c	Tor
N2	R3111Q321A	Vdet-IC	3.2V±2%, -Reset PPO	SC-82AB	26vdl	VD7	5a	Ric
N2	R3116Q291A	Vdet-IC	2.9V±0.8%, -Reset ODO	SC-82AB	26rp	VD1	5a	Ric
N2	RP104Q151C	LVR-IC	LDO, 1.5V±0.8%, 150mA	SC-82AB	26yr	VR1	5a	Ric
N2	XC6120N32N	Vdet-IC	3.2V±2%, N-ch, +Reset ODO	SSOT-24	26yu	VD6	5a	Tor
N2	XC61CN3202N	Vdet-IC	3.2V±1%, +Reset ODO	SOT-143R	26vdl	VD6	5c	Tor
N2	XC6223H121NR-G	LVR-IC	LDO, 1.2V±20mV, 300mA, +CE, PDR, CL, ICP	SSOT-24	26vn	VR4	5a	Tor
N20	DA227	Si-diode	Dual, Sw, 80V, 300mA, 150mW, Vf<1.2V(100mA), <1.5ns	SOT-343	23ce	-	5f	Rhm
N3	BFG520W	Si-npn	UHF, 20V, 70mA, 300mW, B=60..250, 9GHz	SOT-343	24t6	-	5b	Phi
N3	R3111Q331A	Vdet-IC	3.3V±2%, -Reset PPO	SC-82AB	26vdl	VD7	5a	Ric
N3	R3116Q301A	Vdet-IC	3V±0.8%, -Reset ODO	SC-82AB	26rp	VD1	5a	Ric
N3	RP104Q181C	LVR-IC	LDO, 1.8V±0.8%, 150mA	SC-82AB	26yr	VR1	5a	Ric
N3	XC6120N33N	Vdet-IC	3.3V±2%, N-ch, +Reset ODO	SSOT-24	26yu	VD6	5a	Tor
N3	XC61CN3302N	Vdet-IC	3.3V±1%, +Reset ODO	SOT-143R	26vdl	VD6	5c	Tor
N3	XC6223H131NR-G	LVR-IC	LDO, 1.3V±20mV, 300mA, +CE, PDR, CL, ICP	SSOT-24	26vn	VR4	5a	Tor
N33	BFG505	Si-npn	UHF, 20V, 18mA, 150mW, B=120..250, 9GHz	SOT-143	24t6	-	5b	Phi
N36	BFG520	Si-npn	UHF, 20V, 70mA, 300mW, B=60..250, 9GHz	SOT-143	24t6	-	5b	Phi
N37	BFG540	Si-npn	UHF, 20V, 120mA, 400mW, B=60..250, 9GHz	SOT-143	24t6	-	5b	Phi
N38	BFG590	Si-npn	UHF, 20V, 200mA, 400mW, B=60..250, 5GHz	SOT-143	24t6	-	5b	Phi
N39	BFG505/X	Si-npn	UHF, 20V, 18mA, 150mW, B=120..250, 9GHz	SOT-143	26tc	-	5b	Phi
N4	BFG520W/X	Si-npn	UHF, 20V, 70mA, 300mW, B=60..250, 9GHz	SOT-343	26tc	-	5b	Phi
N4	R3111Q341A	Vdet-IC	3.4V±2%, -Reset PPO	SC-82AB	26vdl	VD7	5a	Ric
N4	R3116Q311A	Vdet-IC	3.1V±0.8%, -Reset ODO	SC-82AB	26rp	VD1	5a	Ric
N4	RP104Q181C5	LVR-IC	LDO, 1.85V±0.8%, 150mA	SC-82AB	26yr	VR1	5a	Ric
N4	XC6120N34N	Vdet-IC	3.4V±2%, N-ch, +Reset ODO	SSOT-24	26yu	VD6	5a	Tor
N4	XC61CN3402N	Vdet-IC	3.4V±1%, +Reset ODO	SOT-143R	26vdl	VD6	5c	Tor
N4	XC6223H141NR-G	LVR-IC	LDO, 1.4V±20mV, 300mA, +CE, PDR, CL, ICP	SSOT-24	26vn	VR4	5a	Tor
N42	BFG520/X	Si-npn	UHF, 20V, 70mA, 300mW, B=60..250, 9GHz	SOT-143	26tc	-	5b	Phi
N43	BFG540/X	Si-npn	UHF, 20V, 120mA, 400mW, B=60..250, 9GHz	SOT-143	26tc	-	5b	Phi
N43	BFG540X	Si-npn	UHF, 20V, 120mA, 400mW, B=60..250, 9GHz	SOT-143	26tc	-	5b	Phi
N44	BFG590/X	Si-npn	UHF, 20V, 200mA, 400mW, B=60..250, 5GHz	SOT-143	26tc	-	5b	Phi
N45	BFG505/XR	Si-npn	UHF, 20V, 18mA, 150mW, B=120..250, 9GHz	SOT-143R	26tu	-	5b	Phi
N48	BFG520/XR	Si-npn	UHF, 20V, 70mA, 300mW, B=60..250, 9GHz	SOT-143R	26tu	-	5b	Phi
N49	BFG540/XR	Si-npn	UHF, 20V, 120mA, 400mW, B=60..250, 9GHz	SOT-143R	26tu	-	5b	Phi
N49	BFG540XR	Si-npn	UHF, 20V, 120mA, 400mW, B=60..250, 9GHz	SOT-143R	26tu	-	5b	Phi
N4s	CFH400	PHEMT	GaAs, LN, UHF, 6.5V, 80mA, 150mW, 1.8GHz, 15.7dB	SOT-343	26fq	-	5h	Inf
N4s	CFH400T	PHEMT	GaAs, LN, UHF, 6.5V, 80mA, 150mW, 1.8GHz, 15.7dB	TSFP-4	42fq	-	5b	Inf
N5	BFG520W/XR	Si-npn	UHF, 20V, 70mA, 300mW, B=60..250, 9GHz	SOT-343R	26tu	-	5b	Phi
N5	R3111Q351A	Vdet-IC	3.5V±2%, -Reset PPO	SC-82AB	26vdl	VD7	5a	Ric
N5	R3116Q321A	Vdet-IC	3.2V±0.8%, -Reset ODO	SC-82AB	26rp	VD1	5a	Ric
N5	RP104Q191C	LVR-IC	LDO, 1.9V±0.8%, 150mA	SC-82AB	26yr	VR1	5a	Ric



SMD

SMD code	Type	Function	Short description	Case	Pinout	Sch.	St.	Mnf.
N5	XC6120N35N	Vdet-IC	3.5V±2%, N-ch, +Reset ODO	SSOT-24	26yu	VD6	5a	Tor
N5	XC61CN3502N	Vdet-IC	3.5V±1%, +Reset ODO	SOT-143R	26vdl	VD6	5c	Tor
N5	XC6223H151NR-G	LVR-IC	LDO, 1.5V±20mV, 300mA, +CE, PDR, CL, ICP	SSOT-24	26vn	VR4	5a	Tor
N50	BFG590/XR	Si-npn	UHF, 20V, 200mA, 400mW, B=60..250, 5GHz	SOT-143R	26tu	-	5b	Phi
N6	BFG25AW	Si-npn	VHF/UHF-Amp, 8V, 6.5mA, 200mW, B>50..200, 5GHz	SOT-343	24te	-	5b	Phi
N6	R3111Q361A	Vdet-IC	3.6V±2%, -Reset PPO	SC-82AB	26vdl	VD7	5a	Ric
N6	R3116Q331A	Vdet-IC	3.3V±0.8%, -Reset ODO	SC-82AB	26rp	VD1	5a	Ric
N6	RP104Q201C	LVR-IC	LDO, 2.0V±0.8%, 150mA	SC-82AB	26yr	VR1	5a	Ric
N6	XC6120N36N	Vdet-IC	3.6V±2%, N-ch, +Reset ODO	SSOT-24	26yu	VD6	5a	Tor
N6	XC61CN3602N	Vdet-IC	3.6V±1%, +Reset ODO	SOT-143R	26vdl	VD6	5c	Tor
N6	XC6223H161NR-G	LVR-IC	LDO, 1.6V±20mV, 300mA, +CE, PDR, CL, ICP	SSOT-24	26vn	VR4	5a	Tor
N7	BFG540W/X	Si-npn	UHF, 20V, 120mA, 400mW, B=60..250, 9GHz	SOT-343	26tc	-	5b	Phi
N7	R3111Q371A	Vdet-IC	3.7V±2%, -Reset PPO	SC-82AB	26vdl	VD7	5a	Ric
N7	R3116Q341A	Vdet-IC	3.4V±0.8%, -Reset ODO	SC-82AB	26rp	VD1	5a	Ric
N7	RP104Q251C	LVR-IC	LDO, 2.5V±0.8%, 150mA	SC-82AB	26yr	VR1	5a	Ric
N7	XC6120N37N	Vdet-IC	3.7V±2%, N-ch, +Reset ODO	SSOT-24	26yu	VD6	5a	Tor
N7	XC61CN3702N	Vdet-IC	3.7V±1%, +Reset ODO	SOT-143R	26vdl	VD6	5c	Tor
N7	XC6223H171NR-G	LVR-IC	LDO, 1.7V±20mV, 300mA, +CE, PDR, CL, ICP	SSOT-24	26vn	VR4	5a	Tor
N70	BFG10	Si-npn	VHF/UHF-Amp, 20V, 250mA, 400mW, B>25, 1.9GHz	SOT-143	24te	-	5c	Phi
N71	BFG10/X	Si-npn	VHF/UHF-Amp, 20V, 250mA, 400mW, B>25, 1.9GHz	SOT-143	24tc	-	5c	Phi
N72	BFG11	Si-npn	VHF/UHF-Amp, 20V, 500mA, 400mW, B>25, 1.9GHz	SOT-143	24te	-	5c	Phi
N72	BFG11W/X	Si-npn	VHF/UHF-Amp, 20V, 500mA, 400mW, B>25, 1.9GHz	SOT-343	24tc	-	5c	Phi
N73	BFG11/X	Si-npn	VHF/UHF-Amp, 20V, 500mA, 400mW, B>25, 1.9GHz	SOT-143	24tc	-	5b	Phi
N8	BFG540W/XR	Si-npn	UHF, 20V, 120mA, 400mW, B=60..250, 9GHz	SOT-343R	26tu	-	5b	Phi
N8	R3111Q381A	Vdet-IC	3.8V±2%, -Reset PPO	SC-82AB	26vdl	VD7	5a	Ric
N8	R3116Q351A	Vdet-IC	3.5V±0.8%, -Reset ODO	SC-82AB	26rp	VD1	5a	Ric
N8	RP104Q261C	LVR-IC	LDO, 2.6V±0.8%, 150mA	SC-82AB	26yr	VR1	5a	Ric
N8	XC6120N38N	Vdet-IC	3.8V±2%, N-ch, +Reset ODO	SSOT-24	26yu	VD6	5a	Tor
N8	XC61CN3802N	Vdet-IC	3.8V±1%, +Reset ODO	SOT-143R	26vdl	VD6	5c	Tor
N8	XC6223H181NR-G	LVR-IC	LDO, 1.8V±20mV, 300mA, +CE, PDR, CL, ICP	SSOT-24	26vn	VR4	5a	Tor
N8A	S-1323B15NB	LVR-IC	LDO, 1.5V±1.0%, 150mA, +CE	SC-82AB	26vm	VR4	5c	Sii
N8A	S-1323B15PF	LVR-IC	LDO, 1.5V±1.0%, 150mA, +CE	SNT-4A	42ee	VR4	5e	Sii
N8B	S-1323B16NB	LVR-IC	LDO, 1.6V±1.0%, 150mA, +CE	SC-82AB	26vm	VR4	5c	Sii
N8B	S-1323B16PF	LVR-IC	LDO, 1.6V±1.0%, 150mA, +CE	SNT-4A	42ee	VR4	5e	Sii
N8C	S-1323B17NB	LVR-IC	LDO, 1.7V±1.0%, 150mA, +CE	SC-82AB	26vm	VR4	5c	Sii
N8C	S-1323B17PF	LVR-IC	LDO, 1.7V±1.0%, 150mA, +CE	SNT-4A	42ee	VR4	5e	Sii
N8D	S-1323B18NB	LVR-IC	LDO, 1.8V±1.0%, 150mA, +CE	SC-82AB	26vm	VR4	5c	Sii
N8D	S-1323B18PF	LVR-IC	LDO, 1.8V±1.0%, 150mA, +CE	SNT-4A	42ee	VR4	5e	Sii
N8E	S-1323B19NB	LVR-IC	LDO, 1.9V±1.0%, 150mA, +CE	SC-82AB	26vm	VR4	5c	Sii
N8E	S-1323B19PF	LVR-IC	LDO, 1.9V±1.0%, 150mA, +CE	SNT-4A	42ee	VR4	5e	Sii
N8F	S-1323B20NB	LVR-IC	LDO, 2.0V±1.0%, 150mA, +CE	SC-82AB	26vm	VR4	5c	Sii
N8F	S-1323B20PF	LVR-IC	LDO, 2.0V±1.0%, 150mA, +CE	SNT-4A	42ee	VR4	5e	Sii
N8G	S-1323B21NB	LVR-IC	LDO, 2.1V±1.0%, 150mA, +CE	SC-82AB	26vm	VR4	5c	Sii
N8G	S-1323B21PF	LVR-IC	LDO, 2.1V±1.0%, 150mA, +CE	SNT-4A	42ee	VR4	5e	Sii
N8H	S-1323B22NB	LVR-IC	LDO, 2.2V±1.0%, 150mA, +CE	SC-82AB	26vm	VR4	5c	Sii
N8H	S-1323B22PF	LVR-IC	LDO, 2.2V±1.0%, 150mA, +CE	SNT-4A	42ee	VR4	5e	Sii
N8I	S-1323B23NB	LVR-IC	LDO, 2.3V±1.0%, 150mA, +CE	SC-82AB	26vm	VR4	5c	Sii
N8I	S-1323B23PF	LVR-IC	LDO, 2.3V±1.0%, 150mA, +CE	SNT-4A	42ee	VR4	5e	Sii
N8J	S-1323B24NB	LVR-IC	LDO, 2.4V±1.0%, 150mA, +CE	SC-82AB	26vm	VR4	5c	Sii
N8J	S-1323B24PF	LVR-IC	LDO, 2.4V±1.0%, 150mA, +CE	SNT-4A	42ee	VR4	5e	Sii
N8K	S-1323B25NB	LVR-IC	LDO, 2.5V±1.0%, 150mA, +CE	SC-82AB	26vm	VR4	5c	Sii
N8K	S-1323B25PF	LVR-IC	LDO, 2.5V±1.0%, 150mA, +CE	SNT-4A	42ee	VR4	5e	Sii
N8L	S-1323B26NB	LVR-IC	LDO, 2.6V±1.0%, 150mA, +CE	SC-82AB	26vm	VR4	5c	Sii
N8L	S-1323B26PF	LVR-IC	LDO, 2.6V±1.0%, 150mA, +CE	SNT-4A	42ee	VR4	5e	Sii
N8M	S-1323B27NB	LVR-IC	LDO, 2.7V±1.0%, 150mA, +CE	SC-82AB	26vm	VR4	5c	Sii
N8M	S-1323B27PF	LVR-IC	LDO, 2.7V±1.0%, 150mA, +CE	SNT-4A	42ee	VR4	5e	Sii
N8N	S-1323B28NB	LVR-IC	LDO, 2.8V±1.0%, 150mA, +CE	SC-82AB	26vm	VR4	5c	Sii
N8N	S-1323B28PF	LVR-IC	LDO, 2.8V±1.0%, 150mA, +CE	SNT-4A	42ee	VR4	5e	Sii
N8O	S-1323B29NB	LVR-IC	LDO, 2.9V±1.0%, 150mA, +CE	SC-82AB	26vm	VR4	5c	Sii
N8O	S-1323B29PF	LVR-IC	LDO, 2.9V±1.0%, 150mA, +CE	SNT-4A	42ee	VR4	5e	Sii
N8P	S-1323B30NB	LVR-IC	LDO, 3.0V±1.0%, 150mA, +CE	SC-82AB	26vm	VR4	5c	Sii
N8P	S-1323B30PF	LVR-IC	LDO, 3.0V±1.0%, 150mA, +CE	SNT-4A	42ee	VR4	5e	Sii
N8Q	S-1323B31NB	LVR-IC	LDO, 3.1V±1.0%, 150mA, +CE	SC-82AB	26vm	VR4	5c	Sii
N8Q	S-1323B31PF	LVR-IC	LDO, 3.1V±1.0%, 150mA, +CE	SNT-4A	42ee	VR4	5e	Sii
N8R	S-1323B32NB	LVR-IC	LDO, 3.2V±1.0%, 150mA, +CE	SC-82AB	26vm	VR4	5c	Sii
N8R	S-1323B32PF	LVR-IC	LDO, 3.2V±1.0%, 150mA, +CE	SNT-4A	42ee	VR4	5e	Sii
N8s	CFH800	PHEMT	GaAs, LN, UHF, 6.5V, 160mA, 350mW, 4GHz, 15.2dB	SOT-343	26fq	-	5h	Inf
N8s	CFH800T	PHEMT	GaAs, LN, UHF, 6.5V, 160mA, 350mW, 4GHz, 15.2dB	TSFP-4	42fq	-	5b	Inf
N8S	S-1323B33NB	LVR-IC	LDO, 3.3V±1.0%, 150mA, +CE	SC-82AB	26vm	VR4	5c	Sii
N8S	S-1323B33PF	LVR-IC	LDO, 3.3V±1.0%, 150mA, +CE	SNT-4A	42ee	VR4	5e	Sii



SMD code	Type	Function	Short description	Case	Pinout	Sch.	St.	Mnf.
N8T	S-1323B34NB	LVR-IC	LDO, 3.4V±1.0%, 150mA, +CE	SC-82AB	26vm	VR4	5c	Sii
N8T	S-1323B34PF	LVR-IC	LDO, 3.4V±1.0%, 150mA, +CE	SNT-4A	42ee	VR4	5e	Sii
N8U	S-1323B35NB	LVR-IC	LDO, 3.5V±1.0%, 150mA, +CE	SC-82AB	26vm	VR4	5c	Sii
N8U	S-1323B35PF	LVR-IC	LDO, 3.5V±1.0%, 150mA, +CE	SNT-4A	42ee	VR4	5e	Sii
N8V	S-1323B36NB	LVR-IC	LDO, 3.6V±1.0%, 150mA, +CE	SC-82AB	26vm	VR4	5c	Sii
N8V	S-1323B36PF	LVR-IC	LDO, 3.6V±1.0%, 150mA, +CE	SNT-4A	42ee	VR4	5e	Sii
N8W	S-1323B37NB	LVR-IC	LDO, 3.7V±1.0%, 150mA, +CE	SC-82AB	26vm	VR4	5c	Sii
N8W	S-1323B37PF	LVR-IC	LDO, 3.7V±1.0%, 150mA, +CE	SNT-4A	42ee	VR4	5e	Sii
N8X	S-1323B38NB	LVR-IC	LDO, 3.8V±1.0%, 150mA, +CE	SC-82AB	26vm	VR4	5c	Sii
N8X	S-1323B38PF	LVR-IC	LDO, 3.8V±1.0%, 150mA, +CE	SNT-4A	42ee	VR4	5e	Sii
N8Y	S-1323B39NB	LVR-IC	LDO, 3.9V±1.0%, 150mA, +CE	SC-82AB	26vm	VR4	5c	Sii
N8Y	S-1323B39PF	LVR-IC	LDO, 3.9V±1.0%, 150mA, +CE	SNT-4A	42ee	VR4	5e	Sii
N8Z	S-1323B40NB	LVR-IC	LDO, 4.0V±1.0%, 150mA, +CE	SC-82AB	26vm	VR4	5c	Sii
N8Z	S-1323B40PF	LVR-IC	LDO, 4.0V±1.0%, 150mA, +CE	SNT-4A	42ee	VR4	5e	Sii
N9	BF6540W	Si-npn	UHF, 20V, 120mA, 400mW, B=60..250, 9GHz	SOT-343	246i	-	5b	Phi
N9	R3111Q391A	Vdet-IC	3.9V±2%, -Reset PPO	SC-82AB	26vdl	VD7	5a	Ric
N9	R3116Q361A	Vdet-IC	3.6V±0.8%, -Reset ODO	SC-82AB	26rp	VD1	5a	Ric
N9	RP104Q271C	LVR-IC	LDO, 2.7V±0.8%, 150mA	SC-82AB	26yr	VR1	5a	Ric
N9	XC6120N39N	Vdet-IC	3.9V±2%, N-ch, +Reset ODO	SSOT-24	26yu	VD6	5a	Tor
N9	XC61CN3902N	Vdet-IC	3.9V±1%, +Reset ODO	SOT-143R	26vdl	VD6	5c	Tor
N9	XC6223H191NR-G	LVR-IC	LDO, 1.9V±20mV, 300mA, +CE, PDR, CL, ICP	SSOT-24	26vn	VR4	5a	Tor
N9A	S-1323B41NB	LVR-IC	LDO, 4.1V±1.0%, 150mA, +CE	SC-82AB	26vm	VR4	5c	Sii
N9A	S-1323B41PF	LVR-IC	LDO, 4.1V±1.0%, 150mA, +CE	SNT-4A	42ee	VR4	5e	Sii
N9B	S-1323B42NB	LVR-IC	LDO, 4.2V±1.0%, 150mA, +CE	SC-82AB	26vm	VR4	5c	Sii
N9B	S-1323B42PF	LVR-IC	LDO, 4.2V±1.0%, 150mA, +CE	SNT-4A	42ee	VR4	5e	Sii
N9C	S-1323B43NB	LVR-IC	LDO, 4.3V±1.0%, 150mA, +CE	SC-82AB	26vm	VR4	5c	Sii
N9C	S-1323B43PF	LVR-IC	LDO, 4.3V±1.0%, 150mA, +CE	SNT-4A	42ee	VR4	5e	Sii
N9D	S-1323B44NB	LVR-IC	LDO, 4.4V±1.0%, 150mA, +CE	SC-82AB	26vm	VR4	5c	Sii
N9D	S-1323B44PF	LVR-IC	LDO, 4.4V±1.0%, 150mA, +CE	SNT-4A	42ee	VR4	5e	Sii
N9E	S-1323B45NB	LVR-IC	LDO, 4.5V±1.0%, 150mA, +CE	SC-82AB	26vm	VR4	5c	Sii
N9E	S-1323B45PF	LVR-IC	LDO, 4.5V±1.0%, 150mA, +CE	SNT-4A	42ee	VR4	5e	Sii
N9F	S-1323B46NB	LVR-IC	LDO, 4.6V±1.0%, 150mA, +CE	SC-82AB	26vm	VR4	5c	Sii
N9F	S-1323B46PF	LVR-IC	LDO, 4.6V±1.0%, 150mA, +CE	SNT-4A	42ee	VR4	5e	Sii
N9G	S-1323B47NB	LVR-IC	LDO, 4.7V±1.0%, 150mA, +CE	SC-82AB	26vm	VR4	5c	Sii
N9G	S-1323B47PF	LVR-IC	LDO, 4.7V±1.0%, 150mA, +CE	SNT-4A	42ee	VR4	5e	Sii
N9H	S-1323B48NB	LVR-IC	LDO, 4.8V±1.0%, 150mA, +CE	SC-82AB	26vm	VR4	5c	Sii
N9H	S-1323B48PF	LVR-IC	LDO, 4.8V±1.0%, 150mA, +CE	SNT-4A	42ee	VR4	5e	Sii
N9I	S-1323B49NB	LVR-IC	LDO, 4.9V±1.0%, 150mA, +CE	SC-82AB	26vm	VR4	5c	Sii
N9I	S-1323B49PF	LVR-IC	LDO, 4.9V±1.0%, 150mA, +CE	SNT-4A	42ee	VR4	5e	Sii
N9J	S-1323B50NB	LVR-IC	LDO, 5.0V±1.0%, 150mA, +CE	SC-82AB	26vm	VR4	5c	Sii
N9J	S-1323B50PF	LVR-IC	LDO, 5.0V±1.0%, 150mA, +CE	SNT-4A	42ee	VR4	5e	Sii
N9K	S-1323B51NB	LVR-IC	LDO, 5.1V±1.0%, 150mA, +CE	SC-82AB	26vm	VR4	5c	Sii
N9K	S-1323B51PF	LVR-IC	LDO, 5.1V±1.0%, 150mA, +CE	SNT-4A	42ee	VR4	5e	Sii
N9L	S-1323B52NB	LVR-IC	LDO, 5.2V±1.0%, 150mA, +CE	SC-82AB	26vm	VR4	5c	Sii
N9L	S-1323B52PF	LVR-IC	LDO, 5.2V±1.0%, 150mA, +CE	SNT-4A	42ee	VR4	5e	Sii
N9M	S-1323B53NB	LVR-IC	LDO, 5.3V±1.0%, 150mA, +CE	SC-82AB	26vm	VR4	5c	Sii
N9M	S-1323B53PF	LVR-IC	LDO, 5.3V±1.0%, 150mA, +CE	SNT-4A	42ee	VR4	5e	Sii
N9N	S-1323B54NB	LVR-IC	LDO, 5.4V±1.0%, 150mA, +CE	SC-82AB	26vm	VR4	5c	Sii
N9N	S-1323B54PF	LVR-IC	LDO, 5.4V±1.0%, 150mA, +CE	SNT-4A	42ee	VR4	5e	Sii
N9O	S-1323B55NB	LVR-IC	LDO, 5.5V±1.0%, 150mA, +CE	SC-82AB	26vm	VR4	5c	Sii
N9O	S-1323B55PF	LVR-IC	LDO, 5.5V±1.0%, 150mA, +CE	SNT-4A	42ee	VR4	5e	Sii
N9P	S-1323B1JPF	LVR-IC	LDO, 1.85V±1.0%, 150mA, +CE	SNT-4A	42ee	VR4	5e	Sii
N9Q	S-1323B2JPF	LVR-IC	LDO, 2.85V±1.0%, 150mA, +CE	SNT-4A	42ee	VR4	5e	Sii
na	PT7M6246NLC4	Vdet-IC	4.6V±1.5%, -Reset ODO	SC-70-4	23vdl	VD6	5g	Pti
nā	PT7M6246NLC4E	Vdet-IC	4.6V±1.5%, -Reset ODO, Lead free	SC-70-4	23vdl	VD6	5g	Pti
NA	BF1105WR	n-MOSFET-e*	DG, VHF, UHF, 7V, 30mA, 200mW	SOT-343R	26fd	-	5c	Phi
NA	CFY35-20	n-FET	GaAs, LN, UHF, 6V, 60mA, 250mW, 12GHz, 1.9dB	MW-4	25fp	-	5b	Inf
NA	RP130Q301D	LVR-IC	LDO, LN, +CE, CL, 3V±1%, 150mA	SC-82AB	26vn	VR4	5a	Ric
NA	XC6120N40N	Vdet-IC	4V±2%, N-ch, +Reset ODO	SSOT-24	26yu	VD6	5a	Tor
NĀ	XC6127C16DNR	Vdet-IC	1.6V±0.8%, -Reset PPO, -MR, Rt=400ms	SSOT-24	26cr	VD5	5a	Tor
NA	XC6223H201NR-G	LVR-IC	LDO, 2.0V±1%, 300mA, +CE, PDR, CL, ICP	SSOT-24	26vn	VR4	5a	Tor
NĀp	BF1105R	n-MOSFET-e*	DG, VHF, UHF, 7V, 30mA, 200mW	SOT-143R	26fd	-	5c	Phi
nb	PT7M6247CLC4	Vdet-IC	4.7V±1.5%, -Reset PPO	SC-70-4	23vdl	VD7	5g	Pti
nĀ	PT7M6247CLC4E	Vdet-IC	4.7V±1.5%, -Reset PPO, Lead free	SC-70-4	23vdl	VD7	5g	Pti
NB	BF1109WR	n-MOSFET-e*	DG, VHF, UHF, 11V, 30mA, 200mW	SOT-343R	26fd	-	5c	Phi
NB	CFY35-23	n-FET	GaAs, LN, UHF, 6V, 60mA, 250mW, 12GHz, 2.2dB	MW-4	25fp	-	5b	Inf
NB	RP130Q311D	LVR-IC	LDO, LN, +CE, CL, 3.1V±1%, 150mA	SC-82AB	26vn	VR4	5a	Ric
NB	XC6120N41N	Vdet-IC	4.1V±2%, N-ch, +Reset ODO	SSOT-24	26yu	VD6	5a	Tor
NĀ	XC6127C18DNR	Vdet-IC	1.8V±0.8%, -Reset PPO, -MR, Rt=400ms	SSOT-24	26cr	VD5	5a	Tor
NB	XC6223H211NR-G	LVR-IC	LDO, 2.1V±1%, 300mA, +CE, PDR, CL, ICP	SSOT-24	26vn	VR4	5a	Tor



SMD code	Type	Function	Short description	Case	Pinout	Sch.	St.	Mnf.
NBp	BF1109R	n-MOSFET-e*	DG, VHF, UHF, 11V, 30mA, 200mW	SOT-143R	26fd	-	5c	Phi
nc	PT7M6247CHC4	Vdet-IC	4.7V±1.5%, +Reset PPO	SC-70-4	23vdl	VD7	5g	Pti
nc̄	PT7M6247CHC4E	Vdet-IC	4.7V±1.5%, +Reset PPO, Lead free	SC-70-4	23vdl	VD7	5g	Pti
NC	RP130Q321D	LVR-IC	LDO, LN, +CE, CL, 3.2V±1%, 150mA	SC-82AB	26vn	VR4	5a	Ric
NC	XC6120N42N	Vdet-IC	4.2V±2%, N-ch, +Reset ODO	SSOT-24	26yu	VD6	5a	Tor
NC̄	XC6127C20DNR	Vdet-IC	2.0V±0.8%, -Reset PPO, -MR, Rt=400ms	SSOT-24	26cr	VD5	5a	Tor
NC	XC6223H221NR-G	LVR-IC	LDO, 2.2V±1%, 300mA, +CE, PDR, CL, ICP	SSOT-24	26vn	VR4	5a	Tor
NCs	BF2040	n-MOSFET-d	DG, UHF, 14V, 40mA	SOT-143	24fd	-	5b	Sie
nd	PT7M6247NLC4	Vdet-IC	4.7V±1.5%, -Reset ODO	SC-70-4	23vdl	VD6	5g	Pti
nd̄	PT7M6247NLC4E	Vdet-IC	4.7V±1.5%, -Reset ODO, Lead free	SC-70-4	23vdl	VD6	5g	Pti
ND	RP130Q331D	LVR-IC	LDO, LN, +CE, CL, 3.3V±1%, 150mA	SC-82AB	26vn	VR4	5a	Ric
ND	XC6120N43N	Vdet-IC	4.3V±2%, N-ch, +Reset ODO	SSOT-24	26yu	VD6	5a	Tor
ND̄	XC6127C22DNR	Vdet-IC	2.2V±0.8%, -Reset PPO, -MR, Rt=400ms	SSOT-24	26cr	VD5	5a	Tor
ND	XC6223H231NR-G	LVR-IC	LDO, 2.3V±1%, 300mA, +CE, PDR, CL, ICP	SSOT-24	26vn	VR4	5a	Tor
NDs	BF2000	n-MOSFET-e	DG, UHF, 12V, 30mA, 200mW, 1GHz	SOT-143	24fd	-	5b	Sie
NDs	BF2000W	n-MOSFET-e	DG, UHF, 12V, 30mA, 200mW, 1GHz	SOT-343	25fm	-	5b	Sie
ne	PT7M6248CLC4	Vdet-IC	4.8V±1.5%, -Reset PPO	SC-70-4	23vdl	VD7	5g	Pti
nē	PT7M6248CLC4E	Vdet-IC	4.8V±1.5%, -Reset PPO, Lead free	SC-70-4	23vdl	VD7	5g	Pti
NE	RP130Q341D	LVR-IC	LDO, LN, +CE, CL, 3.4V±1%, 150mA	SC-82AB	26vn	VR4	5a	Ric
NE	XC6120N44N	Vdet-IC	4.4V±2%, N-ch, +Reset ODO	SSOT-24	26yu	VD6	5a	Tor
NĒ	XC6127C24DNR	Vdet-IC	2.4V±0.8%, -Reset PPO, -MR, Rt=400ms	SSOT-24	26cr	VD5	5a	Tor
NE	XC6223H241NR-G	LVR-IC	LDO, 2.4V±1%, 300mA, +CE, PDR, CL, ICP	SSOT-24	26vn	VR4	5a	Tor
NEp	BF1105	n-MOSFET-e*	DG, VHF, UHF, 7V, 30mA, 200mW	SOT-143	24fd	-	5c	Phi
NEs	BF2030	n-MOSFET-d	DG, UHF, 14V, 40mA	SOT-143	24fd	-	5b	Sie
nf	PT7M6248CHC4	Vdet-IC	4.8V±1.5%, +Reset PPO	SC-70-4	23vdl	VD7	5g	Pti
nf̄	PT7M6248CHC4E	Vdet-IC	4.8V±1.5%, +Reset PPO, Lead free	SC-70-4	23vdl	VD7	5g	Pti
NF	R1114Q151B	LVR-IC	LDO, LN, +CE, 1.5V±2%, 150mA	SOT-143R	26vn	VR4	5a	Ric
NF	RP130Q351D	LVR-IC	LDO, LN, +CE, CL, 3.5V±1%, 150mA	SC-82AB	26vn	VR4	5a	Ric
NF	XC6120N45N	Vdet-IC	4.5V±2%, N-ch, +Reset ODO	SSOT-24	26yu	VD6	5a	Tor
NF̄	XC6127C26DNR	Vdet-IC	2.6V±0.8%, -Reset PPO, -MR, Rt=400ms	SSOT-24	26cr	VD5	5a	Tor
NF	XC6223H251NR-G	LVR-IC	LDO, 2.5V±1%, 300mA, +CE, PDR, CL, ICP	SSOT-24	26vn	VR4	5a	Tor
NFp	BF1109	n-MOSFET-e*	DG, VHF, UHF, 11V, 30mA, 200mW	SOT-143	24fd	-	5c	Phi
ng	PT7M6248NLC4	Vdet-IC	4.8V±1.5%, -Reset ODO	SC-70-4	23vdl	VD6	5g	Pti
nḡ	PT7M6248NLC4E	Vdet-IC	4.8V±1.5%, -Reset ODO, Lead free	SC-70-4	23vdl	VD6	5g	Pti
NG	R1114Q161B	LVR-IC	LDO, LN, +CE, 1.6V±2%, 150mA	SOT-143R	26vn	VR4	5a	Ric
NG	RP130Q361D	LVR-IC	LDO, LN, +CE, CL, 3.6V±1%, 150mA	SC-82AB	26vn	VR4	5a	Ric
nh	PT7M6249CLC4	Vdet-IC	4.9V±1.5%, -Reset PPO	SC-70-4	23vdl	VD7	5g	Pti
nh̄	PT7M6249CLC4E	Vdet-IC	4.9V±1.5%, -Reset PPO, Lead free	SC-70-4	23vdl	VD7	5g	Pti
NH	R1114Q171B	LVR-IC	LDO, LN, +CE, 1.7V±2%, 150mA	SOT-143R	26vn	VR4	5a	Ric
NH	RP130Q371D	LVR-IC	LDO, LN, +CE, CL, 3.7V±1%, 150mA	SC-82AB	26vn	VR4	5a	Ric
NH	XC6120N46N	Vdet-IC	4.6V±2%, N-ch, +Reset ODO	SSOT-24	26yu	VD6	5a	Tor
NH̄	XC6127C28DNR	Vdet-IC	2.8V±0.8%, -Reset PPO, -MR, Rt=400ms	SSOT-24	26cr	VD5	5a	Tor
NH	XC6223H261NR-G	LVR-IC	LDO, 2.6V±1%, 300mA, +CE, PDR, CL, ICP	SSOT-24	26vn	VR4	5a	Tor
ni	PT7M6249CHC4	Vdet-IC	4.9V±1.5%, +Reset PPO	SC-70-4	23vdl	VD7	5g	Pti
nī	PT7M6249CHC4E	Vdet-IC	4.9V±1.5%, +Reset PPO, Lead free	SC-70-4	23vdl	VD7	5g	Pti
NI-	3SK191	n-MOSFET-d	GaAs, DG, UHF, 12V, Idss>10mA	SOT-143	26fm	-	5c	Ren
nj	PT7M6249NLC4	Vdet-IC	4.9V±1.5%, -Reset ODO	SC-70-4	23vdl	VD6	5g	Pti
nj̄	PT7M6249NLC4E	Vdet-IC	4.9V±1.5%, -Reset ODO, Lead free	SC-70-4	23vdl	VD6	5g	Pti
NJ	3SK248	n-MOSFET-e	DG, 10V, 100mA, Up<1.5V	SOT-143	26fm	-	5b	San
NJ	R1114Q181B	LVR-IC	LDO, LN, +CE, 1.8V±2%, 150mA	SOT-143R	26vn	VR4	5a	Ric
NJ	RP130Q381D	LVR-IC	LDO, LN, +CE, CL, 3.8V±1%, 150mA	SC-82AB	26vn	VR4	5a	Ric
nk	PT7M6250CLC4	Vdet-IC	5.0V±1.5%, -Reset PPO	SC-70-4	23vdl	VD7	5g	Pti
nk̄	PT7M6250CLC4E	Vdet-IC	5.0V±1.5%, -Reset PPO, Lead free	SC-70-4	23vdl	VD7	5g	Pti
NK	R1114Q191B	LVR-IC	LDO, LN, +CE, 1.9V±2%, 150mA	SOT-143R	26vn	VR4	5a	Ric
NK	RP130Q391D	LVR-IC	LDO, LN, +CE, CL, 3.9V±1%, 150mA	SC-82AB	26vn	VR4	5a	Ric
NK	XC6120N47N	Vdet-IC	4.7V±2%, N-ch, +Reset ODO	SSOT-24	26yu	VD6	5a	Tor
NK̄	XC6127C30DNR	Vdet-IC	3.0V±0.8%, -Reset PPO, -MR, Rt=400ms	SSOT-24	26cr	VD5	5a	Tor
NK	XC6223H271NR-G	LVR-IC	LDO, 2.7V±1%, 300mA, +CE, PDR, CL, ICP	SSOT-24	26vn	VR4	5a	Tor
nl	PT7M6250CHC4	Vdet-IC	5.0V±1.5%, +Reset PPO	SC-70-4	23vdl	VD7	5g	Pti
nl̄	PT7M6250CHC4E	Vdet-IC	5.0V±1.5%, +Reset PPO, Lead free	SC-70-4	23vdl	VD7	5g	Pti
NL	XC6120N48N	Vdet-IC	4.8V±2%, N-ch, +Reset ODO	SSOT-24	26yu	VD6	5a	Tor
NL̄	XC6127C32DNR	Vdet-IC	3.2V±0.8%, -Reset PPO, -MR, Rt=400ms	SSOT-24	26cr	VD5	5a	Tor
NL	XC6223H281NR-G	LVR-IC	LDO, 2.8V±1%, 300mA, +CE, PDR, CL, ICP	SSOT-24	26vn	VR4	5a	Tor
NLN	ELM7534CCB	Vdet-IC	3.4V±2%, +Reset PPO	SC-82AB	26vdl	VD7	5c	Elm
NLN	ELM7534NCB	Vdet-IC	3.4V±2%, +Reset ODO	SC-82AB	26vdl	VD6	5c	Elm
nm	PT7M6250NLC4	Vdet-IC	5.0V±1.5%, -Reset ODO	SC-70-4	23vdl	VD6	5g	Pti
nm̄	PT7M6250NLC4E	Vdet-IC	5.0V±1.5%, -Reset ODO, Lead free	SC-70-4	23vdl	VD6	5g	Pti
NM	ASM811LEUSF	Vdet-IC	4.63V±1.5%, -Reset PPO, -MR	SOT-143	24vdh	VD5	5c	Ali
NM	XC6120N49N	Vdet-IC	4.9V±2%, N-ch, +Reset ODO	SSOT-24	26yu	VD6	5a	Tor
NM̄	XC6127C34DNR	Vdet-IC	3.4V±0.8%, -Reset PPO, -MR, Rt=400ms	SSOT-24	26cr	VD5	5a	Tor



SMD

SMD code	Type	Function	Short description	Case	Pinout	Sch.	St.	Mnf.
MM	XC6223H291NR-G	LVR-IC	LDO, 2.9V±1%, 300mA, +CE, PDR, CL, ICP	SSOT-24	26vn	VR4	5a	Tor
NN	ASM811MEUSF	Vdet-IC	4.38V±1.5%, -Reset PPO, -MR	SOT-143	24vdh	VD5	5c	Ali
NN	XC6109N30AN	Vdet-IC	3.0V, +Reset ODO	SSOT-24	26rp	VD1	5c	Tor
NN	XC6119N40ANR	Vdet-IC	4.0V±2%, -Reset ODO	SSOT-24	26gh	VD1	5a	Tor
NN	XC6120N50N	Vdet-IC	5V±2%, N-ch, +Reset ODO	SSOT-24	26yu	VD6	5a	Tor
NN	XC6127C36DNR	Vdet-IC	3.6V±0.8%, -Reset PPO, -MR, Rt=400ms	SSOT-24	26cr	VD5	5a	Tor
NO	AAT3526ICX-2.32-200	Vdet-IC	2.32V±1.5%, -Reset PPO, -MR	SOT-143	24vdh	VD5	5i	Ant
NO	ASM811JEUFS	Vdet-IC	4.0V±1.5%, -Reset PPO, -MR	SOT-143	24vdh	VD5	5c	Ali
NP	ASM811TEUSF	Vdet-IC	3.08V±1.5%, -Reset PPO, -MR	SOT-143	24vdh	VD5	5c	Ali
NP	XC6109N31AN	Vdet-IC	3.1V, +Reset ODO	SSOT-24	26rp	VD1	5c	Tor
NP	XC6119N41ANR	Vdet-IC	4.1V±2%, -Reset ODO	SSOT-24	26gh	VD1	5a	Tor
NP	XC6127C38DNR	Vdet-IC	3.8V±0.8%, -Reset PPO, -MR, Rt=400ms	SSOT-24	26cr	VD5	5a	Tor
NQ	ASM811SEUSF	Vdet-IC	2.93V±1.5%, -Reset PPO, -MR	SOT-143	24vdh	VD5	5c	Ali
NR	ASM811REUSF	Vdet-IC	2.63V±1.5%, -Reset PPO, -MR	SOT-143	24vdh	VD5	5c	Ali
NR	XC6109N32AN	Vdet-IC	3.2V, +Reset ODO	SSOT-24	26rp	VD1	5c	Tor
NR	XC6119N42ANR	Vdet-IC	4.2V±2%, -Reset ODO	SSOT-24	26gh	VD1	5a	Tor
NR	XC6127C40DNR	Vdet-IC	4.0V±0.8%, -Reset PPO, -MR, Rt=400ms	SSOT-24	26cr	VD5	5a	Tor
NS	ASM812LEUSF	Vdet-IC	4.63V±1.5%, +Reset PPO, -MR	SOT-143	24vdh	VD5	5c	Ali
NS	XC6109N33AN	Vdet-IC	3.3V, +Reset ODO	SSOT-24	26rp	VD1	5c	Tor
NS	XC6119N43ANR	Vdet-IC	4.3V±2%, -Reset ODO	SSOT-24	26gh	VD1	5a	Tor
NS	XC6127C42DNR	Vdet-IC	4.2V±0.8%, -Reset PPO, -MR, Rt=400ms	SSOT-24	26cr	VD5	5a	Tor
NT	ASM812MEUSF	Vdet-IC	4.38V±1.5%, +Reset PPO, -MR	SOT-143	24vdh	VD5	5c	Ali
NT	XC6109N34AN	Vdet-IC	3.4V, +Reset ODO	SSOT-24	26rp	VD1	5c	Tor
NT	XC6119N44ANR	Vdet-IC	4.4V±2%, -Reset ODO	SSOT-24	26gh	VD1	5a	Tor
NT	XC6127C44DNR	Vdet-IC	4.4V±0.8%, -Reset PPO, -MR, Rt=400ms	SSOT-24	26cr	VD5	5a	Tor
NU	ASM812JEUFS	Vdet-IC	4.0V±1.5%, +Reset PPO, -MR	SOT-143	24vdh	VD5	5c	Ali
NU	XC6109N35AN	Vdet-IC	3.5V, +Reset ODO	SSOT-24	26rp	VD1	5c	Tor
NU	XC6119N45ANR	Vdet-IC	4.5V±2%, -Reset ODO	SSOT-24	26gh	VD1	5a	Tor
NU	XC6127C46DNR	Vdet-IC	4.6V±0.8%, -Reset PPO, -MR, Rt=400ms	SSOT-24	26cr	VD5	5a	Tor
NV	ASM812TEUSF	Vdet-IC	3.08V±1.5%, +Reset PPO, -MR	SOT-143	24vdh	VD5	5c	Ali
NV	XC6109N36AN	Vdet-IC	3.6V, +Reset ODO	SSOT-24	26rp	VD1	5c	Tor
NV	XC6119N46ANR	Vdet-IC	4.6V±2%, -Reset ODO	SSOT-24	26gh	VD1	5a	Tor
NV	XC6127C48DNR	Vdet-IC	4.8V±0.8%, -Reset PPO, -MR, Rt=400ms	SSOT-24	26cr	VD5	5a	Tor
NW	ASM812SEUSF	Vdet-IC	2.93V±1.5%, +Reset PPO, -MR	SOT-143	24vdh	VD5	5c	Ali
NX	ASM812REUS	Vdet-IC	2.63V±1.5%, +Reset PPO, -MR	SOT-143	24vdh	VD5	5c	Ali
NX	XC6109N37AN	Vdet-IC	3.7V, +Reset ODO	SSOT-24	26rp	VD1	5c	Tor
NX	XC6119N47ANR	Vdet-IC	4.7V±2%, -Reset ODO	SSOT-24	26gh	VD1	5a	Tor
NX	XC6127C50DNR	Vdet-IC	5.0V±0.8%, -Reset PPO, -MR, Rt=400ms	SSOT-24	26cr	VD5	5a	Tor
NY	BF1012S	n-MOSFET-d	DG, 16V, 25mA, 200 mW, Nf=1.4dB, Gf=26mΩ	SOT-143	24fd	-	5b	Sie
NY	XC6109N38AN	Vdet-IC	3.8V, +Reset ODO	SSOT-24	26rp	VD1	5c	Tor
NY	XC6119N48ANR	Vdet-IC	4.8V±2%, -Reset ODO	SSOT-24	26gh	VD1	5a	Tor
NY	XC6127C52DNR	Vdet-IC	5.2V±0.8%, -Reset PPO, -MR, Rt=400ms	SSOT-24	26cr	VD5	5a	Tor
NYs	BF1012S	n-MOSFET-d	DG, 16V, 25mA, 200mW, Nf=1.4dB, Gf=26mΩ	SOT-143	24fd	-	5b	Sie
NZ	BF1005SW	MMIC	UHF, 8V, 25mA, 200mW, Idss=50..500µA	SOT-343	24fd	A3	5h	Inf
NZ	XC6109N39AN	Vdet-IC	3.9V, +Reset ODO	SSOT-24	26rp	VD1	5c	Tor
NZ	XC6119N49ANR	Vdet-IC	4.9V±2%, -Reset ODO	SSOT-24	26gh	VD1	5a	Tor
NZ	XC6127C54DNR	Vdet-IC	5.4V±0.8%, -Reset PPO, -MR, Rt=400ms	SSOT-24	26cr	VD5	5a	Tor
NZs	BF1005S	MMIC	UHF, 8V, 25mA, 200mW, Idss=50..500µA	SOT-143	24fd	A3	5h	Inf
NZs	BF1005SR	MMIC	UHF, 8V, 25mA, 200mW, Idss=50..500µA	SOT-143	24fd	A3	5h	Inf
P0	BFG505WXR	Si-npn	UHF, 20V, 18mA, 150mW, B=120..250, 9GHZ	SOT-343R	26tu	-	5b	Phi
P0	R3111Q401A	Vdet-IC	4V±2%, -Reset PPO	SC-82AB	26vdl	VD7	5a	Ric
P0	R3116Q371A	Vdet-IC	3.7V±0.8%, -Reset ODO	SC-82AB	26rp	VD1	5a	Ric
P0	RP104Q281C	LVR-IC	LDO, 2.8V±0.8%, 150mA	SC-82AB	26yr	VR1	5a	Ric
P0	XC61CN4002N	Vdet-IC	4V±1%, +Reset ODO	SOT-143R	26vdl	VD6	5c	Tor
P0	XC6221B411NR	LVR-IC	LDO, 4.1V±1%, 200mA, +CE, CL	SSOT-24	26vn	VR4	5a	Tor
P0	XC6224B08BNR	LVR-IC	LDO, 0.85V±20mV, 150mA, +CE, PDR	SSOT-24	26vn	VR4	5a	Tor
P1	BFG121W	Si-npn	VHF/UHF-Amp, 15V, 500mA, 600mW, B=40..100, 1.9GHZ	SOT-343R	26tu	-	5c	Phi
P1	BFG21W	Si-npn	VHF/UHF-Amp, 15V, 500mA, 600mW, B=40..100, 18GHZ	SOT-343R	26tm	-	5b	Phi
P1	R3111Q411A	Vdet-IC	4.1V±2%, -Reset PPO	SC-82AB	26vdl	VD7	5a	Ric
P1	R3116Q381A	Vdet-IC	3.8V±0.8%, -Reset ODO	SC-82AB	26rp	VD1	5a	Ric
P1	RP104Q281C5	LVR-IC	LDO, 2.85V±0.8%, 150mA	SC-82AB	26yr	VR1	5a	Ric
P1	XC61CN4102N	Vdet-IC	4.1V±1%, +Reset ODO	SOT-143R	26vdl	VD6	5c	Tor
P1	XC6221B421NR	LVR-IC	LDO, 4.2V±1%, 200mA, +CE, CL	SSOT-24	26vn	VR4	5a	Tor
P1	XC6224B09BNR	LVR-IC	LDO, 0.95V±20mV, 150mA, +CE, PDR	SSOT-24	26vn	VR4	5a	Tor
P2	R3111Q421A	Vdet-IC	4.2V±2%, -Reset PPO	SC-82AB	26vdl	VD7	5a	Ric
P2	R3116Q391A	Vdet-IC	3.9V±0.8%, -Reset ODO	SC-82AB	26rp	VD1	5a	Ric
P2	RP104Q291C	LVR-IC	LDO, 2.9V±0.8%, 150mA	SC-82AB	26yr	VR1	5a	Ric
P2	XC61CN4202N	Vdet-IC	4.2V±1%, +Reset ODO	SOT-143R	26vdl	VD6	5c	Tor
P2	XC6221B431NR	LVR-IC	LDO, 4.3V±1%, 200mA, +CE, CL	SSOT-24	26vn	VR4	5a	Tor
P2	XC6224B10BNR	LVR-IC	LDO, 1.05V±20mV, 150mA, +CE, PDR	SSOT-24	26vn	VR4	5a	Tor



SMD code	Type	Function	Short description	Case	Pinout	Sch.	St.	Mnf.
P3	R3111Q431A	Vdet-IC	4.3V±2%, -Reset PPO	SC-82AB	26vdl	VD7	5a	Ric
P3	R3116Q401A	Vdet-IC	4V±0.8%, -Reset ODO	SC-82AB	26fp	VD1	5a	Ric
P3	RP104Q301C	LVR-IC	LDO, 3.0V±0.8%, 150mA	SC-82AB	26yr	VR1	5a	Ric
P3	XC61CN4302N	Vdet-IC	4.3V±1%, +Reset ODO	SOT-143R	26vdl	VD6	5c	Tor
P3	XC6221B441NR	LVR-IC	LDO, 4.4V±1%, 200mA, +CE, CL	SSOT-24	26vn	VR4	5a	Tor
P3	XC6224B11BNR	LVR-IC	LDO, 1.15V±20mV, 150mA, +CE, PDR	SSOT-24	26vn	VR4	5a	Tor
P4	R3111Q441A	Vdet-IC	4.4V±2%, -Reset PPO	SC-82AB	26vdl	VD7	5a	Ric
P4	R3116Q411A	Vdet-IC	4.1V±0.8%, -Reset ODO	SC-82AB	26rp	VD1	5a	Ric
P4	RP104Q321C	LVR-IC	LDO, 3.2V±0.8%, 150mA	SC-82AB	26yr	VR1	5a	Ric
P4	XC61CN4402N	Vdet-IC	4.4V±1%, +Reset ODO	SOT-143R	26vdl	VD6	5c	Tor
P4	XC6221B451NR	LVR-IC	LDO, 4.5V±1%, 200mA, +CE, CL	SSOT-24	26vn	VR4	5a	Tor
P4	XC6224B12BNR	LVR-IC	LDO, 1.25V±1.5%, 150mA, +CE, PDR	SSOT-24	26vn	VR4	5a	Tor
P5	R3111Q451A	Vdet-IC	4.5V±2%, -Reset PPO	SC-82AB	26vdl	VD7	5a	Ric
P5	R3116Q421A	Vdet-IC	4.2V±0.8%, -Reset ODO	SC-82AB	26rp	VD1	5a	Ric
P5	RP104Q331C	LVR-IC	LDO, 3.3V±0.8%, 150mA	SC-82AB	26yr	VR1	5a	Ric
P5	XC61CN4502N	Vdet-IC	4.5V±1%, +Reset ODO	SOT-143R	26vdl	VD6	5c	Tor
P5	XC6221B461NR	LVR-IC	LDO, 4.6V±1%, 200mA, +CE, CL	SSOT-24	26vn	VR4	5a	Tor
P5	XC6224B13BNR	LVR-IC	LDO, 1.25V±1.5%, 150mA, +CE, PDR	SSOT-24	26vn	VR4	5a	Tor
P6	R3111Q461A	Vdet-IC	4.6V±2%, -Reset PPO	SC-82AB	26vdl	VD7	5a	Ric
P6	R3116Q431A	Vdet-IC	4.3V±0.8%, -Reset ODO	SC-82AB	26fp	VD1	5a	Ric
P6	RP104Q311C	LVR-IC	LDO, 3.1V±0.8%, 150mA	SC-82AB	26yr	VR1	5a	Ric
P6	XC61CN4602N	Vdet-IC	4.6V±1%, +Reset ODO	SOT-143R	26vdl	VD6	5c	Tor
P6	XC6221B471NR	LVR-IC	LDO, 4.7V±1%, 200mA, +CE, CL	SSOT-24	26vn	VR4	5a	Tor
P6	XC6224B14BNR	LVR-IC	LDO, 1.45V±1.5%, 150mA, +CE, PDR	SSOT-24	26vn	VR4	5a	Tor
P7	R3111Q471A	Vdet-IC	4.7V±2%, -Reset PPO	SC-82AB	26vdl	VD7	5a	Ric
P7	R3116Q441A	Vdet-IC	4.4V±0.8%, -Reset ODO	SC-82AB	26rp	VD1	5a	Ric
P7	RP104Q241C	LVR-IC	LDO, 2.4V±0.8%, 150mA	SC-82AB	26yr	VR1	5a	Ric
P7	XC61CN4702N	Vdet-IC	4.7V±1%, +Reset ODO	SOT-143R	26vdl	VD6	5c	Tor
P7	XC6221B481NR	LVR-IC	LDO, 4.8V±1%, 200mA, +CE, CL	SSOT-24	26vn	VR4	5a	Tor
P7	XC6224B15BNR	LVR-IC	LDO, 1.55V±1.5%, 150mA, +CE, PDR	SSOT-24	26vn	VR4	5a	Tor
P8	BFG92A	Si-npn	VHF/UHF-Amp, 20V, 30mA, 200mW, B=50..150, 6GHz	SOT-143	24t6	-	5c	Phi
P8	R3111Q481A	Vdet-IC	4.8V±2%, -Reset PPO	SC-82AB	26vdl	VD7	5a	Ric
P8	R3116Q451A	Vdet-IC	4.5V±0.8%, -Reset ODO	SC-82AB	26rp	VD1	5a	Ric
P8	RP104Q221C	LVR-IC	LDO, 2.2V±0.8%, 150mA	SC-82AB	26yr	VR1	5a	Ric
P8	XC61CN4802N	Vdet-IC	4.8V±1%, +Reset ODO	SOT-143R	26vdl	VD6	5c	Tor
P8	XC6218P09N	LVR-IC	LDO, 0.9V±2%, 200mA	SSOT-24	26yr	VR1	5a	Tor
P8	XC6224B16BNR	LVR-IC	LDO, 1.65V±1.5%, 150mA, +CE, PDR	SSOT-24	26vn	VR4	5a	Tor
P9	R3111Q491A	Vdet-IC	4.9V±2%, -Reset PPO	SC-82AB	26vdl	VD7	5a	Ric
P9	R3116Q461A	Vdet-IC	4.6V±0.8%, -Reset ODO	SC-82AB	26rp	VD1	5a	Ric
P9	RP104Q231C	LVR-IC	LDO, 2.3V±0.8%, 150mA	SC-82AB	26yr	VR1	5a	Ric
P9	XC61CN4902N	Vdet-IC	4.9V±1%, +Reset ODO	SOT-143R	26vdl	VD6	5c	Tor
P9	XC6218P10N	LVR-IC	LDO, 1V±2%, 200mA	SSOT-24	26yr	VR1	5a	Tor
P9	XC6224B17BNR	LVR-IC	LDO, 1.75V±1.5%, 150mA, +CE, PDR	SSOT-24	26vn	VR4	5a	Tor
PA	R1114Q201B	LVR-IC	LDO, LN, +CE, 2V±2%, 150mA	SOT-143R	26vn	VR4	5a	Ric
PA	RP130Q401D	LVR-IC	LDO, LN, +CE, CL, 4V±1%, 150mA	SC-82AB	26vn	VR4	5a	Ric
PA	XC6127C16ENR	Vdet-IC	1.6V±0.8%, -Reset PPO, -MR, Rt=800ms	SSOT-24	26cr	VD5	5a	Tor
PA	XC6218P11N	LVR-IC	LDO, 1.1V±2%, 200mA	SSOT-24	26yr	VR1	5a	Tor
PA	XC6224B18BNR	LVR-IC	LDO, 1.85V±1.5%, 150mA, +CE, PDR	SSOT-24	26vn	VR4	5a	Tor
PAAs	BFP136W	Si-npn	UHF, DECT, 20V, 0.15A, 5.5GHz	SOT-343	26tu	-	5b	Sie
PB	R1114Q211B	LVR-IC	LDO, LN, +CE, 2.1V±2%, 150mA	SOT-143R	26vn	VR4	5a	Ric
PB	RP130Q411D	LVR-IC	LDO, LN, +CE, CL, 4.1V±1%, 150mA	SC-82AB	26vn	VR4	5a	Ric
PB	XC6127C18ENR	Vdet-IC	1.8V±0.8%, -Reset PPO, -MR, Rt=800ms	SSOT-24	26cr	VD5	5a	Tor
PB	XC6218P12N	LVR-IC	LDO, 1.2V±2%, 200mA	SSOT-24	26yr	VR1	5a	Tor
PB	XC6224B19BNR	LVR-IC	LDO, 1.95V±1.5%, 150mA, +CE, PDR	SSOT-24	26vn	VR4	5a	Tor
PC	R1114Q221B	LVR-IC	LDO, LN, +CE, 2.2V±2%, 150mA	SOT-143R	26vn	VR4	5a	Ric
PC	RP130Q421D	LVR-IC	LDO, LN, +CE, CL, 4.2V±1%, 150mA	SC-82AB	26vn	VR4	5a	Ric
PC	XC6127C20ENR	Vdet-IC	2.0V±0.8%, -Reset PPO, -MR, Rt=800ms	SSOT-24	26cr	VD5	5a	Tor
PC	XC6218P13N	LVR-IC	LDO, 1.3V±2%, 200mA	SSOT-24	26yr	VR1	5a	Tor
PC	XC6224B251NR	LVR-IC	LDO, 2.5V±1.5%, 150mA, +CE, PDR	SSOT-24	26vn	VR4	5a	Tor
PD	R1114Q231B	LVR-IC	LDO, LN, +CE, 2.3V±2%, 150mA	SOT-143R	26vn	VR4	5a	Ric
PD	RP130Q431D	LVR-IC	LDO, LN, +CE, CL, 4.3V±1%, 150mA	SC-82AB	26vn	VR4	5a	Ric
PD	XC6127C22ENR	Vdet-IC	2.2V±0.8%, -Reset PPO, -MR, Rt=800ms	SSOT-24	26cr	VD5	5a	Tor
PD	XC6218P14N	LVR-IC	LDO, 1.4V±2%, 200mA	SSOT-24	26yr	VR1	5a	Tor
PD	XC6223G301NR-G	LVR-IC	LDO, 3.0V±1%, 300mA, +CE, PDR, ICP	SSOT-24	26vn	VR4	5a	Tor
PE	R1114Q241B	LVR-IC	LDO, LN, +CE, 2.4V±2%, 150mA	SOT-143R	26vn	VR4	5a	Ric
PE	RP130Q441D	LVR-IC	LDO, LN, +CE, CL, 4.4V±1%, 150mA	SC-82AB	26vn	VR4	5a	Ric
PE	XC6127C24ENR	Vdet-IC	2.4V±0.8%, -Reset PPO, -MR, Rt=800ms	SSOT-24	26cr	VD5	5a	Tor
PE	XC6218P15N	LVR-IC	LDO, 1.5V±2%, 200mA	SSOT-24	26yr	VR1	5a	Tor
PE	XC6223G311NR-G	LVR-IC	LDO, 3.1V±1%, 300mA, +CE, PDR, ICP	SSOT-24	26vn	VR4	5a	Tor
PF	R1114Q251B	LVR-IC	LDO, LN, +CE, 2.5V±2%, 150mA	SOT-143R	26vn	VR4	5a	Ric



SMD code	Type	Function	Short description	Case	Pinout	Sch.	St.	Mnf.
PF	RP130Q451D	LVR-IC	LDO, LN, +CE, CL, 4.5V±1%, 150mA	SC-82AB	26vn	VR4	5a	Ric
PF	XC6127C26ENR	Vdet-IC	2.6V±0.8%, -Reset PPO, -MR, Rt=800ms	SSOT-24	26cr	VD5	5a	Tor
PF	XC6218P16N	LVR-IC	LDO, 1.6V±2%, 200mA	SSOT-24	26yr	VR1	5a	Tor
PF	XC6223G321NR-G	LVR-IC	LDO, 3.2V±1%, 300mA, +CE, PDR, ICP	SSOT-24	26vn	VR4	5a	Tor
PG	R1114Q261B	LVR-IC	LDO, LN, +CE, 2.6V±2%, 150mA	SOT-143R	26vn	VR4	5a	Ric
PG	RP130Q461D	LVR-IC	LDO, LN, +CE, CL, 4.6V±1%, 150mA	SC-82AB	26vn	VR4	5a	Ric
PH	R1114Q271B	LVR-IC	LDO, LN, +CE, 2.7V±2%, 150mA	SOT-143R	26vn	VR4	5a	Ric
PH	RP130Q471D	LVR-IC	LDO, LN, +CE, CL, 4.7V±1%, 150mA	SC-82AB	26vn	VR4	5a	Ric
PH	XC6127C28ENR	Vdet-IC	2.8V±0.8%, -Reset PPO, -MR, Rt=800ms	SSOT-24	26cr	VD5	5a	Tor
PH	XC6218P17N	LVR-IC	LDO, 1.7V±2%, 200mA	SSOT-24	26yr	VR1	5a	Tor
PH	XC6223G331NR-G	LVR-IC	LDO, 3.3V±1%, 300mA, +CE, PDR, ICP	SSOT-24	26vn	VR4	5a	Tor
PJ	R1114Q281B	LVR-IC	LDO, LN, +CE, 2.8V±2%, 150mA	SOT-143R	26vn	VR4	5a	Ric
PJ	RP130Q481D	LVR-IC	LDO, LN, +CE, CL, 4.8V±1%, 150mA	SC-82AB	26vn	VR4	5a	Ric
PK	R1114Q291B	LVR-IC	LDO, LN, +CE, 2.9V±2%, 150mA	SOT-143R	26vn	VR4	5a	Ric
PK	RP130Q491D	LVR-IC	LDO, LN, +CE, CL, 4.9V±1%, 150mA	SC-82AB	26vn	VR4	5a	Ric
PK	XC6127C30ENR	Vdet-IC	3.0V±0.8%, -Reset PPO, -MR, Rt=800ms	SSOT-24	26cr	VD5	5a	Tor
PK	XC6218P18N	LVR-IC	LDO, 1.8V±2%, 200mA	SSOT-24	26yr	VR1	5a	Tor
PK	XC6223G341NR-G	LVR-IC	LDO, 3.4V±1%, 300mA, +CE, PDR, ICP	SSOT-24	26vn	VR4	5a	Tor
PK2	S-1000C41-I4T1G	Vdet-IC	4.1V, -Reset PPO	SNT-4A	42vdj	VD7	5e	Sii
PK2	S-1000C41-N4T1	Vdet-IC	4.1V, -Reset PPO	SC-82AB	26vdl	VD7	5b	Sii
PK3	S-1000C42-I4T1G	Vdet-IC	4.2V, -Reset PPO	SNT-4A	42vdj	VD7	5e	Sii
PK3	S-1000C42-N4T1	Vdet-IC	4.2V, -Reset PPO	SC-82AB	26vdl	VD7	5b	Sii
PK4	S-1000C43-I4T1G	Vdet-IC	4.3V, -Reset PPO	SNT-4A	42vdj	VD7	5e	Sii
PK4	S-1000C43-N4T1	Vdet-IC	4.3V, -Reset PPO	SC-82AB	26vdl	VD7	5b	Sii
PK5	S-1000C44-I4T1G	Vdet-IC	4.4V, -Reset PPO	SNT-4A	42vdj	VD7	5e	Sii
PK5	S-1000C44-N4T1	Vdet-IC	4.4V, -Reset PPO	SC-82AB	26vdl	VD7	5b	Sii
PK6	S-1000C45-I4T1G	Vdet-IC	4.5V, -Reset PPO	SNT-4A	42vdj	VD7	5e	Sii
PK6	S-1000C45-N4T1	Vdet-IC	4.5V, -Reset PPO	SC-82AB	26vdl	VD7	5b	Sii
PK7	S-1000C46-I4T1G	Vdet-IC	4.6V, -Reset PPO	SNT-4A	42vdj	VD7	5e	Sii
PK7	S-1000C46-N4T1	Vdet-IC	4.6V, -Reset PPO	SC-82AB	26vdl	VD7	5b	Sii
PKA	S-1000C15-I4T1G	Vdet-IC	1.5V, -Reset PPO	SNT-4A	42vdj	VD7	5e	Sii
PKA	S-1000C15-N4T1	Vdet-IC	1.5V, -Reset PPO	SC-82AB	26vdl	VD7	5b	Sii
PKB	S-1000C16-I4T1G	Vdet-IC	1.6V, -Reset PPO	SNT-4A	42vdj	VD7	5e	Sii
PKB	S-1000C16-N4T1	Vdet-IC	1.6V, -Reset PPO	SC-82AB	26vdl	VD7	5b	Sii
PKC	S-1000C17-I4T1G	Vdet-IC	1.7V, -Reset PPO	SNT-4A	42vdj	VD7	5e	Sii
PKC	S-1000C17-N4T1	Vdet-IC	1.7V, -Reset PPO	SC-82AB	26vdl	VD7	5b	Sii
PKD	S-1000C18-I4T1G	Vdet-IC	1.8V, -Reset PPO	SNT-4A	42vdj	VD7	5e	Sii
PKD	S-1000C18-N4T1	Vdet-IC	1.8V, -Reset PPO	SC-82AB	26vdl	VD7	5b	Sii
PKE	S-1000C19-I4T1G	Vdet-IC	1.9V, -Reset PPO	SNT-4A	42vdj	VD7	5e	Sii
PKE	S-1000C19-N4T1	Vdet-IC	1.9V, -Reset PPO	SC-82AB	26vdl	VD7	5b	Sii
PKF	S-1000C20-I4T1G	Vdet-IC	2.0V, -Reset PPO	SNT-4A	42vdj	VD7	5e	Sii
PKF	S-1000C20-N4T1	Vdet-IC	2.0V, -Reset PPO	SC-82AB	26vdl	VD7	5b	Sii
PKG	S-1000C21-I4T1G	Vdet-IC	2.1V, -Reset PPO	SNT-4A	42vdj	VD7	5e	Sii
PKG	S-1000C21-N4T1	Vdet-IC	2.1V, -Reset PPO	SC-82AB	26vdl	VD7	5b	Sii
PKH	S-1000C22-I4T1G	Vdet-IC	2.2V, -Reset PPO	SNT-4A	42vdj	VD7	5e	Sii
PKH	S-1000C22-N4T1	Vdet-IC	2.2V, -Reset PPO	SC-82AB	26vdl	VD7	5b	Sii
PKI	S-1000C23-I4T1G	Vdet-IC	2.3V, -Reset PPO	SNT-4A	42vdj	VD7	5e	Sii
PKI	S-1000C23-N4T1	Vdet-IC	2.3V, -Reset PPO	SC-82AB	26vdl	VD7	5b	Sii
PKJ	S-1000C24-I4T1G	Vdet-IC	2.4V, -Reset PPO	SNT-4A	42vdj	VD7	5e	Sii
PKJ	S-1000C24-N4T1	Vdet-IC	2.4V, -Reset PPO	SC-82AB	26vdl	VD7	5b	Sii
PKK	S-1000C25-I4T1G	Vdet-IC	2.5V, -Reset PPO	SNT-4A	42vdj	VD7	5e	Sii
PKK	S-1000C25-N4T1	Vdet-IC	2.5V, -Reset PPO	SC-82AB	26vdl	VD7	5b	Sii
PKL	S-1000C26-I4T1G	Vdet-IC	2.6V, -Reset PPO	SNT-4A	42vdj	VD7	5e	Sii
PKL	S-1000C26-N4T1	Vdet-IC	2.6V, -Reset PPO	SC-82AB	26vdl	VD7	5b	Sii
PKM	S-1000C27-I4T1G	Vdet-IC	2.7V, -Reset PPO	SNT-4A	42vdj	VD7	5e	Sii
PKM	S-1000C27-N4T1	Vdet-IC	2.7V, -Reset PPO	SC-82AB	26vdl	VD7	5b	Sii
PKN	S-1000C28-I4T1G	Vdet-IC	2.8V, -Reset PPO	SNT-4A	42vdj	VD7	5e	Sii
PKN	S-1000C28-N4T1	Vdet-IC	2.8V, -Reset PPO	SC-82AB	26vdl	VD7	5b	Sii
PKO	S-1000C29-I4T1G	Vdet-IC	2.9V, -Reset PPO	SNT-4A	42vdj	VD7	5e	Sii
PKO	S-1000C29-N4T1	Vdet-IC	2.9V, -Reset PPO	SC-82AB	26vdl	VD7	5b	Sii
PKP	S-1000C30-I4T1G	Vdet-IC	3.0V, -Reset PPO	SNT-4A	42vdj	VD7	5e	Sii
PKP	S-1000C30-N4T1	Vdet-IC	3.0V, -Reset PPO	SC-82AB	26vdl	VD7	5b	Sii
PKQ	S-1000C31-I4T1G	Vdet-IC	3.1V, -Reset PPO	SNT-4A	42vdj	VD7	5e	Sii
PKQ	S-1000C31-N4T1	Vdet-IC	3.1V, -Reset PPO	SC-82AB	26vdl	VD7	5b	Sii
PKR	S-1000C32-I4T1G	Vdet-IC	3.2V, -Reset PPO	SNT-4A	42vdj	VD7	5e	Sii
PKR	S-1000C32-N4T1	Vdet-IC	3.2V, -Reset PPO	SC-82AB	26vdl	VD7	5b	Sii
PKS	S-1000C33-I4T1G	Vdet-IC	3.3V, -Reset PPO	SNT-4A	42vdj	VD7	5e	Sii
PKS	S-1000C33-N4T1	Vdet-IC	3.3V, -Reset PPO	SC-82AB	26vdl	VD7	5b	Sii
PKT	S-1000C34-I4T1G	Vdet-IC	3.4V, -Reset PPO	SNT-4A	42vdj	VD7	5e	Sii
PKT	S-1000C34-N4T1	Vdet-IC	3.4V, -Reset PPO	SC-82AB	26vdl	VD7	5b	Sii



SMD code	Type	Function	Short description	Case	Pinout	Sch.	St.	Mnf.
PKU	S-1000C35-I4T1G	Vdet-IC	3.5V, -Reset PPO	SNT-4A	42vdj	VD7	5e	Sii
PKU	S-1000C35-N4T1	Vdet-IC	3.5V, -Reset PPO	SC-82AB	26vdl	VD7	5b	Sii
PKV	S-1000C36-I4T1G	Vdet-IC	3.6V, -Reset PPO	SNT-4A	42vdj	VD7	5e	Sii
PKV	S-1000C36-N4T1	Vdet-IC	3.6V, -Reset PPO	SC-82AB	26vdl	VD7	5b	Sii
PKW	S-1000C37-I4T1G	Vdet-IC	3.7V, -Reset PPO	SNT-4A	42vdj	VD7	5e	Sii
PKW	S-1000C37-N4T1	Vdet-IC	3.7V, -Reset PPO	SC-82AB	26vdl	VD7	5b	Sii
PKX	S-1000C38-I4T1G	Vdet-IC	3.8V, -Reset PPO	SNT-4A	42vdj	VD7	5e	Sii
PKX	S-1000C38-N4T1	Vdet-IC	3.8V, -Reset PPO	SC-82AB	26vdl	VD7	5b	Sii
PKY	S-1000C39-I4T1G	Vdet-IC	3.9V, -Reset PPO	SNT-4A	42vdj	VD7	5e	Sii
PKY	S-1000C39-N4T1	Vdet-IC	3.9V, -Reset PPO	SC-82AB	26vdl	VD7	5b	Sii
PKZ	S-1000C40-I4T1G	Vdet-IC	4.0V, -Reset PPO	SNT-4A	42vdj	VD7	5e	Sii
PKZ	S-1000C40-N4T1	Vdet-IC	4.0V, -Reset PPO	SC-82AB	26vdl	VD7	5b	Sii
PL	XC6127C32ENR	Vdet-IC	3.2V±0.8%, -Reset PPO, -MR, Rt=800ms	SSOT-24	26cr	VD5	5a	Tor
PL	XC6218P19N	LVR-IC	LDO, 1.9V±2%, 200mA	SSOT-24	26yr	VR1	5a	Tor
PL	XC6223G351NR-G	LVR-IC	LDO, 3.5V±1%, 300mA, +CE, PDR, ICP	SSOT-24	26wn	VR4	5a	Tor
PL2	S-1000N41-I4T1G	Vdet-IC	4.1V, -Reset ODO	SNT-4A	42vdj	VD6	5e	Sii
PL2	S-1000N41-N4T1	Vdet-IC	4.1V, -Reset ODO	SC-82AB	26vdl	VD6	5b	Sii
PL3	S-1000N42-I4T1G	Vdet-IC	4.2V, -Reset ODO	SNT-4A	42vdj	VD6	5e	Sii
PL3	S-1000N42-N4T1	Vdet-IC	4.2V, -Reset ODO	SC-82AB	26vdl	VD6	5b	Sii
PL4	S-1000N43-I4T1G	Vdet-IC	4.3V, -Reset ODO	SNT-4A	42vdj	VD6	5e	Sii
PL4	S-1000N43-N4T1	Vdet-IC	4.3V, -Reset ODO	SC-82AB	26vdl	VD6	5b	Sii
PL5	S-1000N44-I4T1G	Vdet-IC	4.4V, -Reset ODO	SNT-4A	42vdj	VD6	5e	Sii
PL5	S-1000N44-N4T1	Vdet-IC	4.4V, -Reset ODO	SC-82AB	26vdl	VD6	5b	Sii
PL6	S-1000N45-I4T1G	Vdet-IC	4.5V, -Reset ODO	SNT-4A	42vdj	VD6	5e	Sii
PL6	S-1000N45-N4T1	Vdet-IC	4.5V, -Reset ODO	SC-82AB	26vdl	VD6	5b	Sii
PL7	S-1000N46-I4T1G	Vdet-IC	4.6V, -Reset ODO	SNT-4A	42vdj	VD6	5e	Sii
PL7	S-1000N46-N4T1	Vdet-IC	4.6V, -Reset ODO	SC-82AB	26vdl	VD6	5b	Sii
PLA	S-1000N15-I4T1G	Vdet-IC	1.5V, -Reset ODO	SNT-4A	42vdj	VD6	5e	Sii
PLA	S-1000N15-N4T1	Vdet-IC	1.5V, -Reset ODO	SC-82AB	26vdl	VD6	5b	Sii
PLB	S-1000N16-I4T1G	Vdet-IC	1.6V, -Reset ODO	SNT-4A	42vdj	VD6	5e	Sii
PLB	S-1000N16-N4T1	Vdet-IC	1.6V, -Reset ODO	SC-82AB	26vdl	VD6	5b	Sii
PLC	S-1000N17-I4T1G	Vdet-IC	1.7V, -Reset ODO	SNT-4A	42vdj	VD6	5e	Sii
PLC	S-1000N17-N4T1	Vdet-IC	1.7V, -Reset ODO	SC-82AB	26vdl	VD6	5b	Sii
PLD	S-1000N18-I4T1G	Vdet-IC	1.8V, -Reset ODO	SNT-4A	42vdj	VD6	5e	Sii
PLD	S-1000N18-N4T1	Vdet-IC	1.8V, -Reset ODO	SC-82AB	26vdl	VD6	5b	Sii
PLE	S-1000N19-I4T1G	Vdet-IC	1.9V, -Reset ODO	SNT-4A	42vdj	VD6	5e	Sii
PLE	S-1000N19-N4T1	Vdet-IC	1.9V, -Reset ODO	SC-82AB	26vdl	VD6	5b	Sii
PLF	S-1000N20-I4T1G	Vdet-IC	2.0V, -Reset ODO	SNT-4A	42vdj	VD6	5e	Sii
PLF	S-1000N20-N4T1	Vdet-IC	2.0V, -Reset ODO	SC-82AB	26vdl	VD6	5b	Sii
PLG	S-1000N21-I4T1G	Vdet-IC	2.1V, -Reset ODO	SNT-4A	42vdj	VD6	5e	Sii
PLG	S-1000N21-N4T1	Vdet-IC	2.1V, -Reset ODO	SC-82AB	26vdl	VD6	5b	Sii
PLH	S-1000N22-I4T1G	Vdet-IC	2.2V, -Reset ODO	SNT-4A	42vdj	VD6	5e	Sii
PLH	S-1000N22-N4T1	Vdet-IC	2.2V, -Reset ODO	SC-82AB	26vdl	VD6	5b	Sii
PLI	S-1000N23-I4T1G	Vdet-IC	2.3V, -Reset ODO	SNT-4A	42vdj	VD6	5e	Sii
PLI	S-1000N23-N4T1	Vdet-IC	2.3V, -Reset ODO	SC-82AB	26vdl	VD6	5b	Sii
PLJ	S-1000N24-I4T1G	Vdet-IC	2.4V, -Reset ODO	SNT-4A	42vdj	VD6	5e	Sii
PLJ	S-1000N24-N4T1	Vdet-IC	2.4V, -Reset ODO	SC-82AB	26vdl	VD6	5b	Sii
PLK	S-1000N25-I4T1G	Vdet-IC	2.5V, -Reset ODO	SNT-4A	42vdj	VD6	5e	Sii
PLK	S-1000N25-N4T1	Vdet-IC	2.5V, -Reset ODO	SC-82AB	26vdl	VD6	5b	Sii
PLL	S-1000N26-I4T1G	Vdet-IC	2.6V, -Reset ODO	SNT-4A	42vdj	VD6	5e	Sii
PLL	S-1000N26-N4T1	Vdet-IC	2.6V, -Reset ODO	SC-82AB	26vdl	VD6	5b	Sii
PLM	S-1000N27-I4T1G	Vdet-IC	2.7V, -Reset ODO	SNT-4A	42vdj	VD6	5e	Sii
PLM	S-1000N27-N4T1	Vdet-IC	2.7V, -Reset ODO	SC-82AB	26vdl	VD6	5b	Sii
PLN	ELM7535CCB	Vdet-IC	3.5V±2%, +Reset PPO	SC-82AB	26vdl	VD7	5c	Elm
PLN	ELM7535NCB	Vdet-IC	3.5V±2%, +Reset ODO	SC-82AB	26vdl	VD6	5c	Elm
PLN	S-1000N28-I4T1G	Vdet-IC	2.8V, -Reset ODO	SNT-4A	42vdj	VD6	5e	Sii
PLN	S-1000N28-N4T1	Vdet-IC	2.8V, -Reset ODO	SC-82AB	26vdl	VD6	5b	Sii
PLO	S-1000N29-I4T1G	Vdet-IC	2.9V, -Reset ODO	SNT-4A	42vdj	VD6	5e	Sii
PLO	S-1000N29-N4T1	Vdet-IC	2.9V, -Reset ODO	SC-82AB	26vdl	VD6	5b	Sii
PLP	S-1000N30-I4T1G	Vdet-IC	3.0V, -Reset ODO	SNT-4A	42vdj	VD6	5e	Sii
PLP	S-1000N30-N4T1	Vdet-IC	3.0V, -Reset ODO	SC-82AB	26vdl	VD6	5b	Sii
PLQ	S-1000N31-I4T1G	Vdet-IC	3.1V, -Reset ODO	SNT-4A	42vdj	VD6	5e	Sii
PLQ	S-1000N31-N4T1	Vdet-IC	3.1V, -Reset ODO	SC-82AB	26vdl	VD6	5b	Sii
PLR	S-1000N32-I4T1G	Vdet-IC	3.2V, -Reset ODO	SNT-4A	42vdj	VD6	5e	Sii
PLR	S-1000N32-N4T1	Vdet-IC	3.2V, -Reset ODO	SC-82AB	26vdl	VD6	5b	Sii
PLS	S-1000N33-I4T1G	Vdet-IC	3.3V, -Reset ODO	SNT-4A	42vdj	VD6	5e	Sii
PLS	S-1000N33-N4T1	Vdet-IC	3.3V, -Reset ODO	SC-82AB	26vdl	VD6	5b	Sii
PLT	S-1000N34-I4T1G	Vdet-IC	3.4V, -Reset ODO	SNT-4A	42vdj	VD6	5e	Sii
PLT	S-1000N34-N4T1	Vdet-IC	3.4V, -Reset ODO	SC-82AB	26vdl	VD6	5b	Sii
PLU	S-1000N35-I4T1G	Vdet-IC	3.5V, -Reset ODO	SNT-4A	42vdj	VD6	5e	Sii



SMD code	Type	Function	Short description	Case	Pinout	Sch.	St.	Mnf.
PLU	S-1000N35-N4T1	Vdet-IC	3.5V, -Reset ODO	SC-82AB	26vdl	VD6	5b	Sii
PLV	S-1000N36-I4T1G	Vdet-IC	3.6V, -Reset ODO	SNT-4A	42vdj	VD6	5e	Sii
PLW	S-1000N36-N4T1	Vdet-IC	3.6V, -Reset ODO	SC-82AB	26vdl	VD6	5b	Sii
PLW	S-1000N37-I4T1G	Vdet-IC	3.7V, -Reset ODO	SNT-4A	42vdj	VD6	5e	Sii
PLW	S-1000N37-N4T1	Vdet-IC	3.7V, -Reset ODO	SC-82AB	26vdl	VD6	5b	Sii
PLX	S-1000N38-I4T1G	Vdet-IC	3.8V, -Reset ODO	SNT-4A	42vdj	VD6	5e	Sii
PLX	S-1000N38-N4T1	Vdet-IC	3.8V, -Reset ODO	SC-82AB	26vdl	VD6	5b	Sii
PLY	S-1000N39-I4T1G	Vdet-IC	3.9V, -Reset ODO	SNT-4A	42vdj	VD6	5e	Sii
PLY	S-1000N39-N4T1	Vdet-IC	3.9V, -Reset ODO	SC-82AB	26vdl	VD6	5b	Sii
PLZ	S-1000N40-I4T1G	Vdet-IC	4.0V, -Reset ODO	SNT-4A	42vdj	VD6	5e	Sii
PLZ	S-1000N40-N4T1	Vdet-IC	4.0V, -Reset ODO	SC-82AB	26vdl	VD6	5b	Sii
PM	XC6127C34ENR	Vdet-IC	3.4V±0.8%, -Reset PPO, -MR, Rt=800ms	SSOT-24	26cr	VD5	5a	Tor
PM	XC6218P20N	LVR-IC	LDO, 2V±2%, 200mA	SSOT-24	26yr	VR1	5a	Tor
PM	XC6223G361NR-G	LVR-IC	LDO, 3.6V±1%, 300mA, +CE, PDR, ICP	SSOT-24	26vn	VR4	5a	Tor
PN	XC6109N40AN	Vdet-IC	4.0V, +Reset ODO	SSOT-24	26rp	VD1	5c	Tor
PN	XC6119N50ANR	Vdet-IC	5.0V±2%, -Reset ODO	SSOT-24	26gh	VD1	5a	Tor
PÑ	XC6127C36ENR	Vdet-IC	3.6V±0.8%, -Reset PPO, -MR, Rt=800ms	SSOT-24	26cr	VD5	5a	Tor
PN	XC6218P21N	LVR-IC	LDO, 2.1V±2%, 200mA	SSOT-24	26yr	VR1	5a	Tor
PP	XC6109N41AN	Vdet-IC	4.1V, +Reset ODO	SSOT-24	26rp	VD1	5c	Tor
PḠ	XC6127C38ENR	Vdet-IC	3.8V±0.8%, -Reset PPO, -MR, Rt=800ms	SSOT-24	26cr	VD5	5a	Tor
PP	XC6218P22N	LVR-IC	LDO, 2.2V±2%, 200mA	SSOT-24	26yr	VR1	5a	Tor
PP	XC6223G371NR-G	LVR-IC	LDO, 3.7V±1%, 300mA, +CE, PDR, ICP	SSOT-24	26vn	VR4	5a	Tor
PR	XC6109N42AN	Vdet-IC	4.2V, +Reset ODO	SSOT-24	26rp	VD1	5c	Tor
PR	XC6127C40ENR	Vdet-IC	4.0V±0.8%, -Reset PPO, -MR, Rt=800ms	SSOT-24	26cr	VD5	5a	Tor
PR	XC6218P23N	LVR-IC	LDO, 2.3V±2%, 200mA	SSOT-24	26yr	VR1	5a	Tor
PR	XC6223G381NR-G	LVR-IC	LDO, 3.8V±1%, 300mA, +CE, PDR, ICP	SSOT-24	26vn	VR4	5a	Tor
PS	XC6109N43AN	Vdet-IC	4.3V, +Reset ODO	SSOT-24	26rp	VD1	5c	Tor
PŠ	XC6127C42ENR	Vdet-IC	4.2V±0.8%, -Reset PPO, -MR, Rt=800ms	SSOT-24	26cr	VD5	5a	Tor
PS	XC6218P24N	LVR-IC	LDO, 2.4V±2%, 200mA	SSOT-24	26yr	VR1	5a	Tor
PS	XC6223G391NR-G	LVR-IC	LDO, 3.9V±1%, 300mA, +CE, PDR, ICP	SSOT-24	26vn	VR4	5a	Tor
PT	XC6109N44AN	Vdet-IC	4.4V, +Reset ODO	SSOT-24	26rp	VD1	5c	Tor
PṪ	XC6127C44ENR	Vdet-IC	4.4V±0.8%, -Reset PPO, -MR, Rt=800ms	SSOT-24	26cr	VD5	5a	Tor
PT	XC6218P25N	LVR-IC	LDO, 2.5V±2%, 200mA	SSOT-24	26yr	VR1	5a	Tor
PT	XC6223G401NR-G	LVR-IC	LDO, 4.0V±1%, 300mA, +CE, PDR, ICP	SSOT-24	26vn	VR4	5a	Tor
PTs	BAR64-07	PIN-diode	Dual, Sw, RF-Att, 150V, 100mA, Vf<1.1V(50mA), < 0.35pF	SOT-143	24ce	-	5h	Inf
PU	XC6109N45AN	Vdet-IC	4.5V, +Reset ODO	SSOT-24	26rp	VD1	5c	Tor
PŪ	XC6127C46ENR	Vdet-IC	4.6V±0.8%, -Reset PPO, -MR, Rt=800ms	SSOT-24	26cr	VD5	5a	Tor
PU	XC6218P26N	LVR-IC	LDO, 2.6V±2%, 200mA	SSOT-24	26yr	VR1	5a	Tor
PU	XC6224B261NR	LVR-IC	LDO, 2.6V±1.5%, 150mA, +CE, PDR	SSOT-24	26vn	VR4	5a	Tor
PV	XC6109N46AN	Vdet-IC	4.6V, +Reset ODO	SSOT-24	26rp	VD1	5c	Tor
PṼ	XC6127C48ENR	Vdet-IC	4.8V±0.8%, -Reset PPO, -MR, Rt=800ms	SSOT-24	26cr	VD5	5a	Tor
PV	XC6218P27N	LVR-IC	LDO, 2.7V±2%, 200mA	SSOT-24	26yr	VR1	5a	Tor
PV	XC6224B271NR	LVR-IC	LDO, 2.7V±1.5%, 150mA, +CE, PDR	SSOT-24	26vn	VR4	5a	Tor
PX	XC6109N47AN	Vdet-IC	4.7V, +Reset ODO	SSOT-24	26rp	VD1	5c	Tor
PḪ	XC6127C50ENR	Vdet-IC	5.0V±0.8%, -Reset PPO, -MR, Rt=800ms	SSOT-24	26cr	VD5	5a	Tor
PX	XC6218P28N	LVR-IC	LDO, 2.8V±2%, 200mA	SSOT-24	26yr	VR1	5a	Tor
PX	XC6224B281NR	LVR-IC	LDO, 2.8V±1.5%, 150mA, +CE, PDR	SSOT-24	26vn	VR4	5a	Tor
PY	XC6109N48AN	Vdet-IC	4.8V, +Reset ODO	SSOT-24	26rp	VD1	5c	Tor
PŸ	XC6127C52ENR	Vdet-IC	5.2V±0.8%, -Reset PPO, -MR, Rt=800ms	SSOT-24	26cr	VD5	5a	Tor
PY	XC6218P29N	LVR-IC	LDO, 2.9V±2%, 200mA	SSOT-24	26yr	VR1	5a	Tor
PY	XC6224B291NR	LVR-IC	LDO, 2.9V±1.5%, 150mA, +CE, PDR	SSOT-24	26vn	VR4	5a	Tor
PZ	XC6109N49AN	Vdet-IC	4.9V, +Reset ODO	SSOT-24	26rp	VD1	5c	Tor
PŽ	XC6127C54ENR	Vdet-IC	5.4V±0.8%, -Reset PPO, -MR, Rt=800ms	SSOT-24	26cr	VD5	5a	Tor
PZ	XC6218P30N	LVR-IC	LDO, 3V±2%, 200mA	SSOT-24	26yr	VR1	5a	Tor
PZ	XC6224B301NR	LVR-IC	LDO, 3.0V±1.5%, 150mA, +CE, PDR	SSOT-24	26vn	VR4	5a	Tor
Q0	R3116Q471A	Vdet-IC	4.7V±0.8%, -Reset ODO	SC-82AB	26rp	VD1	5a	Ric
Q1	R3116Q481A	Vdet-IC	4.8V±0.8%, -Reset ODO	SC-82AB	26rp	VD1	5a	Ric
Q2	R3116Q491A	Vdet-IC	4.9V±0.8%, -Reset ODO	SC-82AB	26rp	VD1	5a	Ric
Q3	R3116Q501A	Vdet-IC	5V±0.8%, -Reset ODO	SC-82AB	26rp	VD1	5a	Ric
QA	R1114Q301B	LVR-IC	LDO, LN, +CE, 3V±2%, 150mA	SOT-143R	26vn	VR4	5a	Ric
QA	RP130Q501D	LVR-IC	LDO, LN, +CE, CL, 5V±1%, 150mA	SC-82AB	26vn	VR4	5a	Ric
QB	R1114Q311B	LVR-IC	LDO, LN, +CE, 3.1V±2%, 150mA	SOT-143R	26vn	VR4	5a	Ric
QC	R1114Q321B	LVR-IC	LDO, LN, +CE, 3.2V±2%, 150mA	SOT-143R	26vn	VR4	5a	Ric
QD	R1114Q331B	LVR-IC	LDO, LN, +CE, 3.3V±2%, 150mA	SOT-143R	26vn	VR4	5a	Ric
QE	R1114Q341B	LVR-IC	LDO, LN, +CE, 3.4V±2%, 150mA	SOT-143R	26vn	VR4	5a	Ric
QF	R1114Q351B	LVR-IC	LDO, LN, +CE, 3.5V±2%, 150mA	SOT-143R	26vn	VR4	5a	Ric
QG	R1114Q361B	LVR-IC	LDO, LN, +CE, 3.6V±2%, 150mA	SOT-143R	26vn	VR4	5a	Ric
QH	R1114Q371B	LVR-IC	LDO, LN, +CE, 3.7V±2%, 150mA	SOT-143R	26vn	VR4	5a	Ric
QJ	R1114Q381B	LVR-IC	LDO, LN, +CE, 3.8V±2%, 150mA	SOT-143R	26vn	VR4	5a	Ric
QK	R1114Q391B	LVR-IC	LDO, LN, +CE, 3.9V±2%, 150mA	SOT-143R	26vn	VR4	5a	Ric



SMD code

SMD code	Type	Function	Short description	Case	Pinout	Sch.	St.	Mnf.
QLN	ELM7536CCB	Vdet-IC	3.6V±2%, +Reset PPO	SC-82AB	26vdl	VD7	5c	Elm
QLN	ELM7536NCB	Vdet-IC	3.6V±2%, +Reset ODO	SC-82AB	26vdl	VD6	5c	Elm
QV	1SV298	PIN-diode	Triple, VHF/UHF Atten., 50V, 0.05A, 0.23pF, 7Ω(100MHz)	SOT-143	26do	-	5b	San
R0	R3111Q501A	Vdet-IC	5V±2%, -Reset PPO	SC-82AB	26vdl	VD7	5a	Ric
R0	R3116Q071C	Vdet-IC	0.7V±0.8%, -Reset PPO	SC-82AB	26rp	VD3	5a	Ric
R0	RP104Q121D	LVR-IC	LDO, 1.2V±0.8%, 150mA, +CE, CL	SC-82AB	26vn	VR4	5a	Ric
R0	XC61CN5002N	Vdet-IC	5V±1%, +Reset ODO	SOT-143R	26vdl	VD6	5c	Tor
R0	XC6218P31N	LVR-IC	LDO, 3.1V±2%, 200mA	SSOT-24	26yr	VR1	5a	Tor
R1	R3111Q511A	Vdet-IC	5.1V±2%, -Reset PPO	SC-82AB	26vdl	VD7	5a	Ric
R1	R3116Q081C	Vdet-IC	0.8V±0.8%, -Reset PPO	SC-82AB	26rp	VD3	5a	Ric
R1	RP104Q131D	LVR-IC	LDO, 1.3V±0.8%, 150mA, +CE, CL	SC-82AB	26vn	VR4	5a	Ric
R1	XC61CN5102N	Vdet-IC	5.1V±1%, +Reset ODO	SOT-143R	26vdl	VD6	5c	Tor
R1	XC6218P32N	LVR-IC	LDO, 3.2V±2%, 200mA	SSOT-24	26yr	VR1	5a	Tor
R2	R3111Q521A	Vdet-IC	5.2V±2%, -Reset PPO	SC-82AB	26vdl	VD7	5a	Ric
R2	R3116Q091C	Vdet-IC	0.9V±0.8%, -Reset PPO	SC-82AB	26rp	VD3	5a	Ric
R2	RP104Q151D	LVR-IC	LDO, 1.5V±0.8%, 150mA, +CE, CL	SC-82AB	26vn	VR4	5a	Ric
R2	XC61CN5202N	Vdet-IC	5.2V±1%, +Reset ODO	SOT-143R	26vdl	VD6	5c	Tor
R2	XC6218P33N	LVR-IC	LDO, 3.3V±2%, 200mA	SSOT-24	26yr	VR1	5a	Tor
R26	2SC4093-26	Si-npn	VHF/UHF, CATV, 20V, 100mA, 200mW, B=50..100, 7GHz	SOT-143	26tu	-	5c	Nec
R26	2SC4093RB-F	Si-npn	VHF/UHF, CATV, 20V, 100mA, 200mW, B=50..100, 7GHz	SOT-143	26tu	-	5c	Nec
R26	2SC5011-EB	Si-npn	UHF, LN, 20V, 100mA, 150mW, B=50..100, 6.5Hz	SOT-143	25tu	-	5b	Nec
R26	NE85618-EB	Si-npn	UHF, LN, 20V, 100mA, 150mW, B=50..100, 6.5Hz	SOT-143	25tu	-	5c	Cel
R26	NE85639-26	Si-npn	VHF/UHF, CATV, 20V, 100mA, 200mW, B=50..100, 7GHz	SOT-143	24tu	-	5c	Cel
R26	NE85639R-F	Si-npn	VHF/UHF, CATV, 20V, 100mA, 200mW, B=50..100, 7GHz	SOT-143	26tu	-	5c	Cel
R27	2SC4093-27	Si-npn	VHF/UHF, CATV, 20V, 100mA, 200mW, B=80..160, 7GHz	SOT-143	26tu	-	5c	Nec
R27	2SC4093RB-G	Si-npn	VHF/UHF, CATV, 20V, 100mA, 200mW, B=80..160, 7GHz	SOT-143	26tu	-	5c	Nec
R27	2SC5011-FB	Si-npn	UHF, LN, 20V, 100mA, 150mW, B=80..160, 6.5Hz	SOT-143	25tu	-	5b	Nec
R27	NE85618-FB	Si-npn	UHF, LN, 20V, 100mA, 150mW, B=80..160, 6.5Hz	SOT-143	25tu	-	5c	Cel
R27	NE85639-27	Si-npn	VHF/UHF, CATV, 20V, 100mA, 200mW, B=80..160, 7GHz	SOT-143	24tu	-	5c	Cel
R27	NE85639R-G	Si-npn	VHF/UHF, CATV, 20V, 100mA, 200mW, B=80..160, 7GHz	SOT-143	26tu	-	5c	Cel
R28	2SC4093-28	Si-npn	VHF/UHF, CATV, 20V, 100mA, 200mW, B=125..250, 7GHz	SOT-143	26tu	-	5c	Nec
R28	2SC4093RB-H	Si-npn	VHF/UHF, CATV, 20V, 100mA, 200mW, B=125..250, 7GHz	SOT-143	26tu	-	5c	Nec
R28	2SC5011-GB	Si-npn	UHF, LN, 20V, 100mA, 150mW, B=125..250, 6.5Hz	SOT-143	25tu	-	5b	Nec
R28	NE85618-GB	Si-npn	UHF, LN, 20V, 100mA, 150mW, B=125..250, 6.5Hz	SOT-143	25tu	-	5c	Cel
R28	NE85639-28	Si-npn	VHF/UHF, CATV, 20V, 100mA, 200mW, B=125..250, 7GHz	SOT-143	24tu	-	5c	Cel
R28	NE85639R-H	Si-npn	VHF/UHF, CATV, 20V, 100mA, 200mW, B=125..250, 7GHz	SOT-143	24tu	-	5c	Nec
R3	R3111Q531A	Vdet-IC	5.3V±2%, -Reset PPO	SC-82AB	26vdl	VD7	5a	Ric
R3	R3116Q101C	Vdet-IC	1V±0.8%, -Reset PPO	SC-82AB	26rp	VD3	5a	Ric
R3	RP104Q181D	LVR-IC	LDO, 1.8V±0.8%, 150mA, +CE, CL	SC-82AB	26vn	VR4	5a	Ric
R3	XC61CN5302N	Vdet-IC	5.3V±1%, +Reset ODO	SOT-143R	26vdl	VD6	5c	Tor
R3	XC6218P34N	LVR-IC	LDO, 3.4V±2%, 200mA	SSOT-24	26yr	VR1	5a	Tor
R36	2SC4094-36	Si-npn	VHF/UHF, 20V, 35mA, 200mW, B=50..100, 9GHz	SOT-143	26tu	-	5c	Nec
R36	2SC4094RC-F	Si-npn	VHF/UHF, 20V, 35mA, 200mW, B=50..100, 9GHz	SOT-143	26tu	-	5c	Nec
R36	2SC5012-EB	Si-npn	HF, WB, LN, 20V, 65mA, 150mW, B=50..100, 9GHz	SOT-343	25tu	-	5b	Nec
R36	NE68118-EB	Si-npn	HF, WB, LN, 20V, 65mA, 150mW, B=50..100, 9GHz	SOT-343	25tu	-	5c	Cel
R36	NE68139-36	Si-npn	VHF/UHF, 20V, 35mA, 200mW, B=50..100, 9GHz	SOT-143	26tu	-	5c	Cel
R36	NE68139R-F	Si-npn	VHF/UHF, 20V, 35mA, 200mW, B=50..100, 9GHz	SOT-143	26tu	-	5c	Cel
R37	2SC4094-37	Si-npn	VHF/UHF, 20V, 35mA, 200mW, B=80..160, 9GHz	SOT-143	26tu	-	5c	Nec
R37	2SC4094RC-G	Si-npn	VHF/UHF, 20V, 35mA, 200mW, B=80..160, 9GHz	SOT-143	26tu	-	5c	Nec
R37	2SC5012-FB	Si-npn	HF, WB, LN, 20V, 65mA, 150mW, B=80..160, 9GHz	SOT-343	25tu	-	5b	Nec
R37	NE68118-FB	Si-npn	HF, WB, LN, 20V, 65mA, 150mW, B=80..160, 9GHz	SOT-343	25tu	-	5c	Cel
R37	NE68139-37	Si-npn	VHF/UHF, 20V, 35mA, 200mW, B=80..160, 9GHz	SOT-143	26tu	-	5c	Cel
R37	NE68139R-G	Si-npn	VHF/UHF, 20V, 35mA, 200mW, B=80..160, 9GHz	SOT-143	26tu	-	5c	Cel
R38	2SC4094-38	Si-npn	VHF/UHF, 20V, 35mA, 200mW, B=125..250, 9GHz	SOT-143	26tu	-	5c	Nec
R38	2SC4094RC-H	Si-npn	VHF/UHF, 20V, 35mA, 200mW, B=125..250, 9GHz	SOT-143	26tu	-	5c	Nec
R38	2SC5012-GB	Si-npn	HF, WB, LN, 20V, 65mA, 150mW, B=125..250, 9GHz	SOT-343	25tu	-	5b	Nec
R38	NE68139-38	Si-npn	VHF/UHF, 20V, 35mA, 200mW, B=125..250, 9GHz	SOT-143	26tu	-	5c	Cel
R38	NE68139R-H	Si-npn	VHF/UHF, 20V, 35mA, 200mW, B=125..250, 9GHz	SOT-143	26tu	-	5c	Cel
R4	2SC4092-4	Si-npn	UHF, LN, 25V, 70mA, 200mW, B=40..120, 6GHz	SOT-143	26tu	-	5c	Nec
R4	2SC4092-D	Si-npn	UHF, LN, 25V, 70mA, 200mW, B=40..120, 6GHz	SOT-143	26tu	-	5c	Nec
R4	NE02139-4	Si-npn	UHF, LN, 25V, 70mA, 200mW, B=40..120, 4.5Hz	SOT-143	26tu	-	5c	Cel
R4	NE02139-D	Si-npn	UHF, LN, 25V, 70mA, 200mW, B=40..120, 4.5Hz	SOT-143	26tu	-	5c	Cel
R4	R3111Q541A	Vdet-IC	5.4V±2%, -Reset PPO	SC-82AB	26vdl	VD7	5a	Ric
R4	R3116Q111C	Vdet-IC	1.1V±0.8%, -Reset PPO	SC-82AB	26rp	VD3	5a	Ric
R4	RP104Q181D5	LVR-IC	LDO, 1.85V±0.8%, 150mA, +CE, CL	SC-82AB	26vn	VR4	5a	Ric
R4	XC61CN5402N	Vdet-IC	5.4V±1%, +Reset ODO	SOT-143R	26vdl	VD6	5c	Tor
R4	XC6218P35N	LVR-IC	LDO, 3.5V±2%, 200mA	SSOT-24	26yr	VR1	5a	Tor
R46	2SC4095-46	Si-npn	VHF/UHF, 20V, 35mA, 200mW, B=50..100, 10GHz	SOT-143	26tu	-	5c	Nec
R46	2SC4095RD-F	Si-npn	VHF/UHF, 20V, 35mA, 200mW, B=80..160, 10GHz	SOT-143	26tu	-	5c	Nec
R46	2SC5013-EB	Si-npn	HF, WB, LN, 20V, 35mA, 150mW, B=50..100, 10GHz	SOT-143	26t8	-	5b	Nec

Note: ELM75xxCCB series LN- lot number L=0...9 N=A to Z(I, O, X excepted); ELM75xxNCB series LN- lot number L=A to Z(I, O, X excepted) N=0...9



SMD
code

SMD code	Type	Function	Short description	Case	Pinout	Sch.	St.	Mnf.
R47	2SC4095-47	Si-npn	VHF/UHF, 20V, 35mA, 200mW, B=80...160, 10GHz	SOT-143	26tu	-	5c	Nec
R47	2SC4095RD-G	Si-npn	VHF/UHF, 20V, 35mA, 200mW, B=80...160, 10GHz	SOT-143	26tu	-	5c	Nec
R47	2SC5013-FB	Si-npn	HF, WB, LN, 20V, 35mA, 150mW, B=80...160, 10GHz	SOT-143	26t8	-	5b	Nec
R48	2SC4095-48	Si-npn	VHF/UHF, 20V, 35mA, 200mW, B=80...160, 10GHz	SOT-143	26tu	-	5c	Nec
R48	2SC4095RF-H	Si-npn	VHF/UHF, 20V, 35mA, 200mW, B=80...160, 10GHz	SOT-143	26tu	-	5c	Nec
R48	2SC5013-GB	Si-npn	HF, WB, LN, 20V, 35mA, 150mW, B=125...250, 10GHz	SOT-143	26t8	-	5b	Nec
R5	2SC4092-5	Si-npn	UHF, LN, 25V, 70mA, 200mW, B=100...200, 6GHz	SOT-143	26tu	-	5c	Nec
R5	2SC4092-E	Si-npn	UHF, LN, 25V, 70mA, 200mW, B=100...200, 6GHz	SOT-143	26tu	-	5c	Nec
R5	NE02139-5	Si-npn	UHF, LN, 25V, 70mA, 200mW, B=100...200, 4.5Hz	SOT-143	26tu	-	5c	Cel
R5	NE02139-E	Si-npn	UHF, LN, 25V, 70mA, 200mW, B=100...200, 4.5Hz	SOT-143	26tu	-	5c	Cel
R5	R3111Q551A	Vdet-IC	5.5V±2%, -Reset PPO	SC-82AB	26vdl	VD7	5a	Ric
R5	R3116Q121C	Vdet-IC	1.2V±0.8%, -Reset PPO	SC-82AB	26rp	VD3	5a	Ric
R5	RP104Q191D	LVR-IC	LDO, 1.9V±0.8%, 150mA, +CE, CL	SC-82AB	26vn	VR4	5a	Ric
R5	XC61CN5502N	Vdet-IC	5.5V±1%, +Reset ODO	SOT-143R	26vdl	VD6	5c	Tor
R5	XC6218P36N	LVR-IC	LDO, 3.6V±2%, 200mA	SSOT-24	26yr	VR1	5a	Tor
R6	R3111Q561A	Vdet-IC	5.6V±2%, -Reset PPO	SC-82AB	26vdl	VD7	5a	Ric
R6	R3116Q131C	Vdet-IC	1.3V±0.8%, -Reset PPO	SC-82AB	26rp	VD3	5a	Ric
R6	RP104Q201D	LVR-IC	LDO, 2.0V±0.8%, 150mA, +CE, CL	SC-82AB	26vn	VR4	5a	Ric
R6	XC61CN5602N	Vdet-IC	5.6V±1%, +Reset ODO	SOT-143R	26vdl	VD6	5c	Tor
R6	XC6218P37N	LVR-IC	LDO, 3.7V±2%, 200mA	SSOT-24	26yr	VR1	5a	Tor
R66	2SC4091-Q	Si-npn	UHF, 15V, 5mA, 50mW, B=50...100, 4GHz	SOT-143	26tc	-	5b	Nec
R67	2SC4091-R	Si-npn	UHF, 15V, 5mA, 50mW, B=80...160, 4GHz	SOT-143	26tc	-	5b	Nec
R68	2SC4091-S	Si-npn	UHF, 15V, 5mA, 50mW, B=15...250, 4GHz	SOT-143	26tc	-	5b	Nec
R7	R3111Q571A	Vdet-IC	5.7V±2%, -Reset PPO	SC-82AB	26vdl	VD7	5a	Ric
R7	R3116Q141C	Vdet-IC	1.4V±0.8%, -Reset PPO	SC-82AB	26rp	VD3	5a	Ric
R7	RP104Q251D	LVR-IC	LDO, 2.5V±0.8%, 150mA, +CE, CL	SC-82AB	26vn	VR4	5a	Ric
R7	XC61CN5702N	Vdet-IC	5.7V±1%, +Reset ODO	SOT-143R	26vdl	VD6	5c	Tor
R7	XC6218P38N	LVR-IC	LDO, 3.8V±2%, 200mA	SSOT-24	26yr	VR1	5a	Tor
R8	BFG93A	Si-npn	VHF/UHF-Amp, 20V, 35mA, 300mW, B=90, 6GHz	SOT-143	24t6	-	5c	Phi
R8	R3111Q581A	Vdet-IC	5.8V±2%, -Reset PPO	SC-82AB	26vdl	VD7	5a	Ric
R8	R3116Q151C	Vdet-IC	1.5V±0.8%, -Reset PPO	SC-82AB	26rp	VD3	5a	Ric
R8	RP104Q261D	LVR-IC	LDO, 2.6V±0.8%, 150mA, +CE, CL	SC-82AB	26vn	VR4	5a	Ric
R8	XC61CN5802N	Vdet-IC	5.8V±1%, +Reset ODO	SOT-143R	26vdl	VD6	5c	Tor
R8	XC6218P39N	LVR-IC	LDO, 3.9V±2%, 200mA	SSOT-24	26yr	VR1	5a	Tor
R9	R3111Q591A	Vdet-IC	5.9V±2%, -Reset PPO	SC-82AB	26vdl	VD7	5a	Ric
R9	R3116Q161C	Vdet-IC	1.6V±0.8%, -Reset PPO	SC-82AB	26rp	VD3	5a	Ric
R9	RP104Q271D	LVR-IC	LDO, 2.7V±0.8%, 150mA, +CE, CL	SC-82AB	26vn	VR4	5a	Ric
R9	XC61CN5902N	Vdet-IC	5.9V±1%, +Reset ODO	SOT-143R	26vdl	VD6	5c	Tor
R9	XC6218P40N	LVR-IC	LDO, 4V±2%, 200mA	SSOT-24	26yr	VR1	5a	Tor
RA	R1114Q401B	LVR-IC	LDO, LN, +CE, 4V±2%, 150mA	SOT-143R	26vn	VR4	5a	Ric
RA	XC6127C16FNR	Vdet-IC	1.6V±0.8%, +Reset PPO, -MR, Rt=50ms	SSOT-24	26cr	VD5	5a	Tor
RB	R1114Q281B5	LVR-IC	LDO, LN, +CE, 2.8V±2%, 150mA	SOT-143R	26vn	VR4	5a	Ric
RB	XC6127C18FNR	Vdet-IC	1.8V±0.8%, +Reset PPO, -MR, Rt=50ms	SSOT-24	26cr	VD5	5a	Tor
RC	BFP193W	Si-npn	UHF, 20V, 80mA, 580mW, B=50...200, 8GHz	SOT-343	24tc	-	5h	Inf
RC	XC6127C20FNR	Vdet-IC	2.0V±0.8%, +Reset PPO, -MR, Rt=50ms	SSOT-24	26cr	VD5	5a	Tor
RCs	BFP193	Si-npn	UHF, 20V, 80mA, 580mW, B=50...200, 8GHz	SOT-143	24tc	-	5b	Sie
RCs	BFP193W	Si-npn	UHF, 20V, 80mA, 580mW, B=50...200, 8GHz	SOT-343	24tc	-	5b	Sie
RD	BFP180W	Si-npn	UHF, 10V, 4mA, 30mW, B=30...200, 6.2GHz	SOT-343	24tc	-	5h	Inf
RD	XC6127C22FNR	Vdet-IC	2.2V±0.8%, +Reset PPO, -MR, Rt=50ms	SSOT-24	26cr	VD5	5a	Tor
RDs	BFP180	Si-npn	UHF, 10V, 4mA, 30mW, B=30...200, 6.2GHz	SOT-143	24tc	-	5b	Sie
RDs	BFP180W	Si-npn	UHF, 10V, 4mA, 30mW, B=30...200, 6.2GHz	SOT-343	24tc	-	5b	Sie
RDs	BFP193	Si-npn	UHF, 20V, 80mA, 580mW, B=50...200, 8GHz	SOT-143	24tc	-	5b	Sie
RE	BFP280W	Si-npn	UHF, 10V, 10mA, 80mW, B=30...200, 7GHz	SOT-343	24tc	-	5h	Inf
RE	XC6127C24FNR	Vdet-IC	2.4V±0.8%, +Reset PPO, -MR, Rt=50ms	SSOT-24	26cr	VD5	5a	Tor
REs	BFP280	Si-npn	UHF, 10V, 10mA, 80mW, B=30...200, 7GHz	SOT-143	24tc	-	5b	Sie
REs	BFP280W	Si-npn	UHF, 10V, 10mA, 80mW, B=30...200, 7GHz	SOT-343	24tc	-	5b	Sie
RF	BFP181W	Si-npn	UHF, 20V, 20mA, 175mW, B=50...200, 8GHz	SOT-343	24tc	-	5h	Inf
RF	XC6127C26FNR	Vdet-IC	2.6V±0.8%, +Reset PPO, -MR, Rt=50ms	SSOT-24	26cr	VD5	5a	Tor
RFs	BFP181	Si-npn	UHF, 20V, 20mA, 175mW, B=50...200, 8GHz	SOT-143	24tc	-	5b	Sie
RFs	BFP181R	Si-npn	UHF, 20V, 20mA, 175mW, B=50...200, 8GHz	SOT-143	24tc	-	5b	Sie
RFs	BFP181W	Si-npn	UHF, 20V, 20mA, 175mW, B=50...200, 8GHz	SOT-343	24tc	-	5b	Sie
RG	BFP182W	Si-npn	UHF, 20V, 35mA, 250mW, B=50...200, >8GHz	SOT-343	24tc	-	5h	Inf
RGs	BFP182	Si-npn	UHF, 20V, 35mA, 250mW, B=50...200, >8GHz	SOT-143	24tc	-	5b	Sie
RGs	BFP182R	Si-npn	UHF, 20V, 35mA, 250mW, B=50...200, >8GHz	SOT-143	26tu	-	5b	Sie
RGs	BFP182W	Si-npn	UHF, 20V, 35mA, 250mW, B=50...200, >8GHz	SOT-343	24tc	-	5b	Sie
RH	BFP183W	Si-npn	UHF, 20V, 65mA, 450mW, B=50...200, 8GHz	SOT-343	24tc	-	5h	Inf
RH	XC6127C28FNR	Vdet-IC	2.8V±0.8%, +Reset PPO, -MR, Rt=50ms	SSOT-24	26cr	VD5	5a	Tor
RHs	BFP183	Si-npn	UHF, 20V, 65mA, 450mW, B=50...200, 8GHz	SOT-143	24tc	-	5b	Sie
RHs	BFP183R	Si-npn	UHF, 20V, 65mA, 450mW, B=50...200, 8GHz	SOT-143	26tu	-	5b	Sie
RHs	BFP183W	Si-npn	UHF, 20V, 65mA, 450mW, B=50...200, 8GHz	SOT-343	24tc	-	5b	Sie



SMD code	Type	Function	Short description	Case	Pinout	Sch.	St.	Mnf.
RJ4	3SK263-4	n-MOSFET-d	VHF FM-Tuner, DG, 15V, 30mA, 200mW, I _{dsx} =2.5..6mA	CP4	26fm	-	5b	San
RJ5	3SK263-5	n-MOSFET-d	VHF FM-Tuner, DG, 15V, 30mA, 200mW, I _{dsx} =5..12mA	CP4	26fm	-	5b	San
RJ6	3SK263-6	n-MOSFET-d	VHF FM-Tuner, DG, 15V, 30mA, 200mW, I _{dsx} =10..24mA	CP4	26fm	-	5b	San
RK	XC6127C30FNR	Vdet-IC	3.0V±0.8%, +Reset PPO, -MR, Rt=50ms	SSOT-24	26cr	VD5	5a	Tor
RKs	BFP194	Si-npn	UHF, 20V, 100mA, 700mW, B=20..150, 5GHz	SOT-143	24tc	-	5b	Sie
RL	XC6127C32FNR	Vdet-IC	3.2V±0.8%, +Reset PPO, -MR, Rt=50ms	SSOT-24	26cr	VD5	5a	Tor
RLN	ELM7537CCB	Vdet-IC	3.7V±2%, +Reset PPO	SC-82AB	26vdl	VD7	5c	Elm
RLN	ELM7537NCB	Vdet-IC	3.7V±2%, +Reset ODO	SC-82AB	26vdl	VD6	5c	Elm
RLs	BFP196	Si-npn	UHF-A, 20V, 100mA, 700mW, B=50..200, 7.5GHz	SOT-143	24tl	-	5b	Sie
RLm	XC6127C34FNR	Vdet-IC	3.4V±0.8%, +Reset PPO, -MR, Rt=50ms	SSOT-24	26cr	VD5	5a	Tor
RN	XC6109N50AN	Vdet-IC	5.0V, +Reset ODO	SSOT-24	26rp	VD1	5c	Tor
RN	XC6127C36FNR	Vdet-IC	3.6V±0.8%, +Reset PPO, -MR, Rt=50ms	SSOT-24	26cr	VD5	5a	Tor
RN	XC6224B20BNR	LVR-IC	LDO, 2.05V±1.5%, 150mA, +CE, PDR	SSOT-24	26vn	VR4	5a	Tor
RP	XC6127C38FNR	Vdet-IC	3.8V±0.8%, +Reset PPO, -MR, Rt=50ms	SSOT-24	26cr	VD5	5a	Tor
RP	XC6224B21BNR	LVR-IC	LDO, 2.15V±1.5%, 150mA, +CE, PDR	SSOT-24	26vn	VR4	5a	Tor
RR	XC6127C40FNR	Vdet-IC	4.0V±0.8%, +Reset PPO, -MR, Rt=50ms	SSOT-24	26cr	VD5	5a	Tor
RR	XC6224B22BNR	LVR-IC	LDO, 2.25V±1.5%, 150mA, +CE, PDR	SSOT-24	26vn	VR4	5a	Tor
RS	XC6127C42FNR	Vdet-IC	4.2V±0.8%, +Reset PPO, -MR, Rt=50ms	SSOT-24	26cr	VD5	5a	Tor
RS	XC6224B23BNR	LVR-IC	LDO, 2.25V±1.5%, 150mA, +CE, PDR	SSOT-24	26vn	VR4	5a	Tor
RT	XC6127C44FNR	Vdet-IC	4.4V±0.8%, +Reset PPO, -MR, Rt=50ms	SSOT-24	26cr	VD5	5a	Tor
RT	XC6224B24BNR	LVR-IC	LDO, 2.45V±1.5%, 150mA, +CE, PDR	SSOT-24	26vn	VR4	5a	Tor
RÜ	XC6127C46FNR	Vdet-IC	4.6V±0.8%, +Reset PPO, -MR, Rt=50ms	SSOT-24	26cr	VD5	5a	Tor
RU	XC6224B25BNR	LVR-IC	LDO, 2.55V±1.5%, 150mA, +CE, PDR	SSOT-24	26vn	VR4	5a	Tor
RÜ	XC6127C48FNR	Vdet-IC	4.8V±0.8%, +Reset PPO, -MR, Rt=50ms	SSOT-24	26cr	VD5	5a	Tor
RV	XC6224B26BNR	LVR-IC	LDO, 2.65V±1.5%, 150mA, +CE, PDR	SSOT-24	26vn	VR4	5a	Tor
RX	XC6127C50FNR	Vdet-IC	5.0V±0.8%, +Reset PPO, -MR, Rt=50ms	SSOT-24	26cr	VD5	5a	Tor
RX	XC6224B27BNR	LVR-IC	LDO, 2.75V±1.5%, 150mA, +CE, PDR	SSOT-24	26vn	VR4	5a	Tor
RY	2SC5534	Si-npn	UHF-S-Band, LN, 9V, 30mA, 150mW, B=90..200, 13GHz	SOT-343	26tu	-	5b	San
RY	XC6127C52FNR	Vdet-IC	5.2V±0.8%, +Reset PPO, -MR, Rt=50ms	SSOT-24	26cr	VD5	5a	Tor
RY	XC6224B28BNR	LVR-IC	LDO, 2.85V±1.5%, 150mA, +CE, PDR	SSOT-24	26vn	VR4	5a	Tor
RZ	XC6127C54FNR	Vdet-IC	5.4V±0.8%, +Reset PPO, -MR, Rt=50ms	SSOT-24	26cr	VD5	5a	Tor
RZ	XC6224B29BNR	LVR-IC	LDO, 2.95V±1.5%, 150mA, +CE, PDR	SSOT-24	26vn	VR4	5a	Tor
S0	R3111Q601A	Vdet-IC	6V±2%, -Reset PPO	SC-82AB	26vdl	VD7	5a	Ric
S0	R3116Q171C	Vdet-IC	1.7V±0.8%, -Reset PPO	SC-82AB	26rp	VD3	5a	Ric
S0	RP104Q281D	LVR-IC	LDO, 2.8V±0.8%, 150mA, +CE, CL	SC-82AB	26vn	VR4	5a	Ric
S0	XC61CN6002N	Vdet-IC	6V±1%, +Reset ODO	SOT-143R	26vdl	VD6	5c	Tor
S1	BFG310/XR	Si-npn	UHF, 15V, 10mA, 60mW, B=60..200, 14GHz	SOT-143R	26tu	-	5b	Phi
S1	R3116Q181C	Vdet-IC	1.8V±0.8%, -Reset PPO	SC-82AB	26rp	VD3	5a	Ric
S1	RP104Q281D5	LVR-IC	LDO, 2.85V±0.8%, 150mA, +CE, CL	SC-82AB	26vn	VR4	5a	Ric
S1p	BFG310/XR	Si-npn	UHF, 15V, 10mA, 60mW, B=60..200, 14GHz	SOT-143R	26tu	-	5b	PHH
S1W	BFG310/XR	Si-npn	UHF, 15V, 10mA, 60mW, B=60..200, 14GHz	SOT-143R	26tu	-	5b	PhiC
S2	R3116Q191C	Vdet-IC	1.9V±0.8%, -Reset PPO	SC-82AB	26rp	VD3	5a	Ric
S2	RP104Q291D	LVR-IC	LDO, 2.9V±0.8%, 150mA, +CE, CL	SC-82AB	26vn	VR4	5a	Ric
S2	XC6223C12BNR-G	LVR-IC	LDO, 1.25V±20mV, 300mA, +CE, PDR	SSOT-24	26vn	VR4	5a	Tor
S3	R3116Q201C	Vdet-IC	2V±0.8%, -Reset PPO	SC-82AB	26rp	VD3	5a	Ric
S3	RP104Q301D	LVR-IC	LDO, 3.0V±0.8%, 150mA, +CE, CL	SC-82AB	26vn	VR4	5a	Ric
S3	XC6223C13BNR-G	LVR-IC	LDO, 1.35V±20mV, 300mA, +CE, PDR	SSOT-24	26vn	VR4	5a	Tor
S4	BBY62	C-diode	Dual, UHF-Tuning, 30V, 20mA, 1.6..16.5pF(28/1V)	SOT-143	24ce	-	5c	Phi
S4	R3116Q211C	Vdet-IC	2.1V±0.8%, -Reset PPO	SC-82AB	26rp	VD3	5a	Ric
S4	RP104Q321D	LVR-IC	LDO, 3.2V±0.8%, 150mA, +CE, CL	SC-82AB	26vn	VR4	5a	Ric
S4	XC6223C14BNR-G	LVR-IC	LDO, 1.45V±20mV, 300mA, +CE, PDR	SSOT-24	26vn	VR4	5a	Tor
S5	R3116Q221C	Vdet-IC	2.2V±0.8%, -Reset PPO	SC-82AB	26rp	VD3	5a	Ric
S5	RP104Q331D	LVR-IC	LDO, 3.3V±0.8%, 150mA, +CE, CL	SC-82AB	26vn	VR4	5a	Ric
S5	XC6223C15BNR-G	LVR-IC	LDO, 1.55V±20mV, 300mA, +CE, PDR	SSOT-24	26vn	VR4	5a	Tor
S5s	BAT15-099	Si-diode	Dual, Schottky, DBS-mix, 4V, 100mA, <12GHz, <0.35pF	SOT-143	24ef	-	5h	Inf
S6	R3116Q231C	Vdet-IC	2.3V±0.8%, -Reset PPO	SC-82AB	26rp	VD3	5a	Ric
S6	RP104Q311D	LVR-IC	LDO, 3.1V±0.8%, 150mA, +CE, CL	SC-82AB	26vn	VR4	5a	Ric
S6	XC6223C16BNR-G	LVR-IC	LDO, 1.65V±20mV, 300mA, +CE, PDR	SSOT-24	26vn	VR4	5a	Tor
S6s	BAT15-099R	Si-diode	Quad, Schottky, DBS-mix, 4V, 100mA, <12GHz, <0.35pF	SOT-143	24D3	-	5h	Inf
S7	R3116Q241C	Vdet-IC	2.4V±0.8%, -Reset PPO	SC-82AB	26rp	VD3	5a	Ric
S7	RP104Q241D	LVR-IC	LDO, 2.4V±0.8%, 150mA, +CE, CL	SC-82AB	26vn	VR4	5a	Ric
S7	XC6223C17BNR-G	LVR-IC	LDO, 1.75V±20mV, 300mA, +CE, PDR	SSOT-24	26vn	VR4	5a	Tor
S8	R3116Q251C	Vdet-IC	2.5V±0.8%, -Reset PPO	SC-82AB	26rp	VD3	5a	Ric
S8	RP104Q221D	LVR-IC	LDO, 2.2V±0.8%, 150mA, +CE, CL	SC-82AB	26vn	VR4	5a	Ric
S8	XC6223C18BNR-G	LVR-IC	LDO, 1.85V±20mV, 300mA, +CE, PDR	SSOT-24	26vn	VR4	5a	Tor
S8s	BAT14-099R	Si-diode	Quad, Schottky, UHF-mix, 4V, 90mA, Vf<0.66V(10mA), <0.35pF	SOT-143	24D3	-	5b	Sie
S9	BAT14-099	Si-diode	Dual, Schottky, UHF-mix, 4V, 90mA, Vf<0.66V(10mA), <0.35pF	SOT-143	24D3	-	5b	Sie
S9	R3116Q261C	Vdet-IC	2.6V±0.8%, -Reset PPO	SC-82AB	26rp	VD3	5a	Ric
S9	RP104Q231D	LVR-IC	LDO, 2.3V±0.8%, 150mA, +CE, CL	SC-82AB	26vn	VR4	5a	Ric
S9	XC6223C19BNR-G	LVR-IC	LDO, 1.95V±20mV, 300mA, +CE, PDR	SSOT-24	26vn	VR4	5a	Tor



SMD code	Type	Function	Short description	Case	Pinout	Sch.	St.	Mnf.
SĀ	XC6127C16GNR	Vdet-IC	1.6V±0.8%, +Reset PPO, -MR, Rt=100ms	SSOT-24	26cr	VD5	5a	Tor
SA	XC6223C20BNR-G	LVR-IC	LDO, 2.05V±1%, 300mA, +CE, PDR	SSOT-24	26vn	VR4	5a	Tor
SĀ	XC6127C18GNR	Vdet-IC	1.8V±0.8%, +Reset PPO, -MR, Rt=100ms	SSOT-24	26cr	VD5	5a	Tor
SB	XC6223C21BNR-G	LVR-IC	LDO, 2.15V±1%, 300mA, +CE, PDR	SSOT-24	26vn	VR4	5a	Tor
SĀ	XC6127C20GNR	Vdet-IC	2.0V±0.8%, +Reset PPO, -MR, Rt=100ms	SSOT-24	26cr	VD5	5a	Tor
SC	XC6223C22BNR-G	LVR-IC	LDO, 2.25V±1%, 300mA, +CE, PDR	SSOT-24	26vn	VR4	5a	Tor
SĀ	XC6127C22GNR	Vdet-IC	2.2V±0.8%, +Reset PPO, -MR, Rt=100ms	SSOT-24	26cr	VD5	5a	Tor
SD	XC6223C23BNR-G	LVR-IC	LDO, 2.35V±1%, 300mA, +CE, PDR	SSOT-24	26vn	VR4	5a	Tor
SĒ	XC6127C24GNR	Vdet-IC	2.4V±0.8%, +Reset PPO, -MR, Rt=100ms	SSOT-24	26cr	VD5	5a	Tor
SE	XC6223C24BNR-G	LVR-IC	LDO, 2.45V±1%, 300mA, +CE, PDR	SSOT-24	26vn	VR4	5a	Tor
sf	PT7M7811JTB	Vdet-IC	4.0V±1.5%, -Reset PPO, -MR	SOT-143	24vdh	VD5	5g	Pti
sf	PT7M7811JTBE	Vdet-IC	4.0V±1.5%, -Reset PPO, -MR, Lead free	SOT-143	24vdh	VD5	5g	Pti
SF	R1114Q151D	LVR-IC	LDO, LN, +CE, CL, 1.5V±2%, 150mA	SOT-143R	26vn	VR4	5a	Ric
SF	XC6127C26GNR	Vdet-IC	2.6V±0.8%, +Reset PPO, -MR, Rt=100ms	SSOT-24	26cr	VD5	5a	Tor
SF	XC6223C25BNR-G	LVR-IC	LDO, 2.55V±1%, 300mA, +CE, PDR	SSOT-24	26vn	VR4	5a	Tor
SFQ	NCP304LSQ47T1	Vdet-IC	4.7V±1.5%, -Reset PPO	SC-82AB	26vdl	VD7	5g	Ons
SFR	NCP304LSQ46T1	Vdet-IC	4.6V±1.5%, -Reset PPO	SC-82AB	26vdl	VD7	5g	Ons
SFS	NCP304LSQ45T1	Vdet-IC	4.5V±1.5%, -Reset PPO	SC-82AB	26vdl	VD7	5g	Ons
SFU	NCP304LSQ42T1	Vdet-IC	4.2V±1.5%, -Reset PPO	SC-82AB	26vdl	VD7	5g	Ons
SFV	NCP304LSQ43T1	Vdet-IC	4.3V±1.5%, -Reset PPO	SC-82AB	26vdl	VD7	5g	Ons
SFY	NCP304LSQ40T1	Vdet-IC	4.0V±1.5%, -Reset PPO	SC-82AB	26vdl	VD7	5g	Ons
sg	PT7M7812JTB	Vdet-IC	4.0V±1.5%, +Reset PPO, -MR	SOT-143	24vdh	VD5	5g	Pti
sg	PT7M7812JTBE	Vdet-IC	4.0V±1.5%, +Reset PPO, -MR, Lead free	SOT-143	24vdh	VD5	5g	Pti
SG	R1114Q161D	LVR-IC	LDO, LN, +CE, CL, 1.6V±2%, 150mA	SOT-143R	26vn	VR4	5a	Ric
SGA	NCP304LSQ38T1	Vdet-IC	3.8V±1.5%, -Reset PPO	SC-82AB	26vdl	VD7	5g	Ons
SGB	NCP304LSQ37T1	Vdet-IC	3.7V±1.5%, -Reset PPO	SC-82AB	26vdl	VD7	5g	Ons
SGG	NCP304LSQ33T1	Vdet-IC	3.3V±1.5%, -Reset PPO	SC-82AB	26vdl	VD7	5g	Ons
SGJ	NCP304LSQ30T1	Vdet-IC	3.0V±1.5%, -Reset PPO	SC-82AB	26vdl	VD7	5g	Ons
SGK	NCP304LSQ29T1	Vdet-IC	2.9V±1.5%, -Reset PPO	SC-82AB	26vdl	VD7	5g	Ons
SGN	NCP304LSQ27T1	Vdet-IC	2.7V±1.5%, -Reset PPO	SC-82AB	26vdl	VD7	5g	Ons
SGP	NCP304LSQ25T1	Vdet-IC	2.5V±1.5%, -Reset PPO	SC-82AB	26vdl	VD7	5g	Ons
SGR	NCP304LSQ23T1	Vdet-IC	2.3V±1.5%, -Reset PPO	SC-82AB	26vdl	VD7	5g	Ons
SGV	NCP304LSQ20T1	Vdet-IC	2.0V±1.5%, -Reset PPO	SC-82AB	26vdl	VD7	5g	Ons
SGX	NCP304LSQ18T1	Vdet-IC	1.8V±1.5%, -Reset PPO	SC-82AB	26vdl	VD7	5g	Ons
SH	R1114Q171D	LVR-IC	LDO, LN, +CE, CL, 1.7V±2%, 150mA	SOT-143R	26vn	VR4	5a	Ric
SĤ	XC6127C28GNR	Vdet-IC	2.8V±0.8%, +Reset PPO, -MR, Rt=100ms	SSOT-24	26cr	VD5	5a	Tor
SH	XC6223C26BNR-G	LVR-IC	LDO, 2.65V±1%, 300mA, +CE, PDR	SSOT-24	26vn	VR4	5a	Tor
SHG	NCP304LSQ09T1	Vdet-IC	0.9V±1.5%, -Reset PPO	SC-82AB	26vdl	VD7	5g	Ons
SHH	NCP305LSQ49T1	Vdet-IC	4.9V±1.5%, -Reset ODO	SC-82AB	26vdl	VD6	5g	Ons
SHJ	NCP305LSQ47T1	Vdet-IC	4.7V±1.5%, -Reset ODO	SC-82AB	26vdl	VD6	5g	Ons
SHL	NCP305LSQ45T1	Vdet-IC	4.5V±1.5%, -Reset ODO	SC-82AB	26vdl	VD6	5g	Ons
SHN	NCP305LSQ44T1	Vdet-IC	4.4V±1.5%, -Reset ODO	SC-82AB	26vdl	VD6	5g	Ons
SHR	NCP305LSQ40T1	Vdet-IC	4.0V±1.5%, -Reset ODO	SC-82AB	26vdl	VD6	5g	Ons
SHU	NCP305LSQ36T1	Vdet-IC	3.6V±1.5%, -Reset ODO	SC-82AB	26vdl	VD6	5g	Ons
SHV	NCP305LSQ37T1	Vdet-IC	3.7V±1.5%, -Reset ODO	SC-82AB	26vdl	VD6	5g	Ons
SHX	NCP305LSQ35T1	Vdet-IC	3.5V±1.5%, -Reset ODO	SC-82AB	26vdl	VD6	5g	Ons
SHY	NCP305LSQ34T1	Vdet-IC	3.4V±1.5%, -Reset ODO	SC-82AB	26vdl	VD6	5g	Ons
SHZ	NCP305LSQ33T1	Vdet-IC	3.3V±1.5%, -Reset ODO	SC-82AB	26vdl	VD6	5g	Ons
SIA	NCP305LSQ32T1	Vdet-IC	3.2V±1.5%, -Reset ODO	SC-82AB	26vdl	VD6	5g	Ons
SIB	NCP305LSQ31T1	Vdet-IC	3.1V±1.5%, -Reset ODO	SC-82AB	26vdl	VD6	5g	Ons
SIC	NCP305LSQ30T1	Vdet-IC	3.0V±1.5%, -Reset ODO	SC-82AB	26vdl	VD6	5g	Ons
SID	NCP305LSQ29T1	Vdet-IC	2.9V±1.5%, -Reset ODO	SC-82AB	26vdl	VD6	5g	Ons
SIE	NCP305LSQ28T1	Vdet-IC	2.8V±1.5%, -Reset ODO	SC-82AB	26vdl	VD6	5g	Ons
SIF	NCP305LSQ27T1	Vdet-IC	2.7V±1.5%, -Reset ODO	SC-82AB	26vdl	VD6	5g	Ons
SIH	NCP305LSQ25T1	Vdet-IC	2.5V±1.5%, -Reset ODO	SC-82AB	26vdl	VD6	5g	Ons
SII	NCP305LSQ24T1	Vdet-IC	2.4V±1.5%, -Reset ODO	SC-82AB	26vdl	VD6	5g	Ons
SIJ	NCP305LSQ23T1	Vdet-IC	2.3V±1.5%, -Reset ODO	SC-82AB	26vdl	VD6	5g	Ons
SIK	NCP305LSQ22T1	Vdet-IC	2.2V±1.5%, -Reset ODO	SC-82AB	26vdl	VD6	5g	Ons
SIN	NCP305LSQ20T1	Vdet-IC	2.0V±1.5%, -Reset ODO	SC-82AB	26vdl	VD6	5g	Ons
SIP	NCP305LSQ18T1	Vdet-IC	1.8V±1.5%, -Reset ODO	SC-82AB	26vdl	VD6	5g	Ons
SIQ	NCP305LSQ17T1	Vdet-IC	1.7V±1.5%, -Reset ODO	SC-82AB	26vdl	VD6	5g	Ons
SIR	NCP305LSQ16T1	Vdet-IC	1.6V±1.5%, -Reset ODO	SC-82AB	26vdl	VD6	5g	Ons
SIS	NCP305LSQ15T1	Vdet-IC	1.5V±1.5%, -Reset ODO	SC-82AB	26vdl	VD6	5g	Ons
SIX	NCP305LSQ11T1	Vdet-IC	1.1V±1.5%, -Reset ODO	SC-82AB	26vdl	VD6	5g	Ons
SIZ	NCP305LSQ09T1	Vdet-IC	0.9V±1.5%, -Reset PPO	SC-82AB	26vdl	VD6	5g	Ons
SJ	R1114Q181D	LVR-IC	LDO, LN, +CE, CL, 1.8V±2%, 150mA	SOT-143R	26vn	VR4	5a	Ric
SJ5	3SK264-5	n-MOSFET-d	VHF-Tuner, DG, 15V, 30mA, 200mW, Idsx=5..12mA	CP4	26fm	-	5b	San
SJ6	3SK264-6	n-MOSFET-d	VHF-Tuner, DG, 15V, 30mA, 200mW, Idsx=10..24mA	CP4	26fm	-	5b	San
SK	R1114Q191D	LVR-IC	LDO, LN, +CE, CL, 1.9V±2%, 150mA	SOT-143R	26vn	VR4	5a	Ric
SĶ	XC6127C30GNR	Vdet-IC	3.0V±0.8%, +Reset PPO, -MR, Rt=100ms	SSOT-24	26cr	VD5	5a	Tor



SMD code	Type	Function	Short description	Case	Pinout	Sch.	St.	Mnf.
SK	XC6223C27BNR-G	LVR-IC	LDO, 2.75V±1%, 300mA, +CE, PDR	SSOT-24	26vn	VR4	5a	Tor
SL	XC6127C32GNR	Vdet-IC	3.2V±0.8%, +Reset PPO, -MR, Rt=100ms	SSOT-24	26cr	VD5	5a	Tor
SL	XC6223C28BNR-G	LVR-IC	LDO, 2.85V±1%, 300mA, +CE, PDR	SSOT-24	26vn	VR4	5a	Tor
SLN	ELM7538CCB	Vdet-IC	3.8V±2%, +Reset PPO	SC-82AB	26vdl	VD7	5c	Elm
SLN	ELM7538NCB	Vdet-IC	3.8V±2%, +Reset ODO	SC-82AB	26vdl	VD6	5c	Elm
SM	ASM811LEUS	Vdet-IC	4.63V±1.5%, +Reset PPO, -MR	SOT-143	24vdh	VD5	5c	Ali
SM	XC6127C34GNR	Vdet-IC	3.4V±0.8%, +Reset PPO, -MR, Rt=100ms	SSOT-24	26cr	VD5	5a	Tor
SM	XC6223C29BNR-G	LVR-IC	LDO, 2.95V±1%, 300mA, +CE, PDR	SSOT-24	26vn	VR4	5a	Tor
SN	ASM811MEUS	Vdet-IC	4.38V±1.5%, +Reset PPO, -MR	SOT-143	24vdh	VD5	5c	Ali
SN	XC6127C36GNR	Vdet-IC	3.6V±0.8%, +Reset PPO, -MR, Rt=100ms	SSOT-24	26cr	VD5	5a	Tor
SN	XC6223C30BNR-G	LVR-IC	LDO, 3.05V±1%, 300mA, +CE, PDR	SSOT-24	26vn	VR4	5a	Tor
SNQ	NCP304HSQ09T1	Vdet-IC	0.9V±1.5%, +Reset PPO	SC-82AB	26vdl	VD7	5g	Ons
SNZ	NCP304HSQ18T1	Vdet-IC	1.8V±1.5%, +Reset PPO	SC-82AB	26vdl	VD7	5g	Ons
SO	ASM811JEUUS	Vdet-IC	4.0V±1.5%, -Reset PPO, -MR	SOT-143	24vdh	VD5	5c	Ali
SOB	NCP304HSQ20T1	Vdet-IC	2.0V±1.5%, +Reset PPO	SC-82AB	26vdl	VD7	5g	Ons
SOD	NCP304HSQ22T1	Vdet-IC	2.2V±1.5%, +Reset PPO	SC-82AB	26vdl	VD7	5g	Ons
SOI	NCP304HSQ27T1	Vdet-IC	2.7V±1.5%, +Reset PPO	SC-82AB	26vdl	VD7	5g	Ons
SOK	NCP304HSQ29T1	Vdet-IC	2.9V±1.5%, +Reset PPO	SC-82AB	26vdl	VD7	5g	Ons
SOL	NCP304HSQ30T1	Vdet-IC	3.0V±1.5%, +Reset PPO	SC-82AB	26vdl	VD7	5g	Ons
SP	ASM811TEUS	Vdet-IC	3.08V±1.5%, -Reset PPO, -MR	SOT-143	24vdh	VD5	5c	Ali
SP	XC6127C38GNR	Vdet-IC	3.8V±0.8%, +Reset PPO, -MR, Rt=100ms	SSOT-24	26cr	VD5	5a	Tor
SP	XC6223C31BNR-G	LVR-IC	LDO, 3.15V±1%, 300mA, +CE, PDR	SSOT-24	26vn	VR4	5a	Tor
SPA	NCP304HSQ45T1	Vdet-IC	4.5V±1.5%, +Reset PPO	SC-82AB	26vdl	VD7	5g	Ons
SPC	NCP304HSQ47T1	Vdet-IC	4.7V±1.5%, +Reset PPO	SC-82AB	26vdl	VD7	5g	Ons
SQ	ASM811SEUS	Vdet-IC	2.93V±1.5%, +Reset PPO, -MR	SOT-143	24vdh	VD5	5c	Ali
SR	ASM811REUS	Vdet-IC	2.63V±1.5%, -Reset PPO, -MR	SOT-143	24vdh	VD5	5c	Ali
SR	XC6127C40GNR	Vdet-IC	4.0V±0.8%, +Reset PPO, -MR, Rt=100ms	SSOT-24	26cr	VD5	5a	Tor
SRR	XC6223C32BNR-G	LVR-IC	LDO, 3.25V±1%, 300mA, +CE, PDR	SSOT-24	26vn	VR4	5a	Tor
SS	ASM812LEUS	Vdet-IC	4.63V±1.5%, +Reset PPO, -MR	SOT-143	24vdh	VD5	5c	Ali
SS	XC6127C42GNR	Vdet-IC	4.2V±0.8%, +Reset PPO, -MR, Rt=100ms	SSOT-24	26cr	VD5	5a	Tor
SS	XC6223C33BNR-G	LVR-IC	LDO, 3.35V±1%, 300mA, +CE, PDR	SSOT-24	26vn	VR4	5a	Tor
ST	ASM812MEUS	Vdet-IC	4.38V±1.5%, +Reset PPO, -MR	SOT-143	24vdh	VD5	5c	Ali
ST	XC6127C44GNR	Vdet-IC	4.4V±0.8%, +Reset PPO, -MR, Rt=100ms	SSOT-24	26cr	VD5	5a	Tor
ST	XC6223C34BNR-G	LVR-IC	LDO, 3.45V±1%, 300mA, +CE, PDR	SSOT-24	26vn	VR4	5a	Tor
SU	ASM812JEUUS	Vdet-IC	4.0V±1.5%, +Reset PPO, -MR	SOT-143	24vdh	VD5	5c	Ali
SU	XC6127C46GNR	Vdet-IC	4.6V±0.8%, +Reset PPO, -MR, Rt=100ms	SSOT-24	26cr	VD5	5a	Tor
SU	XC6223C35BNR-G	LVR-IC	LDO, 3.55V±1%, 300mA, +CE, PDR	SSOT-24	26vn	VR4	5a	Tor
SV	ASM812TEUS	Vdet-IC	3.08V±1.5%, +Reset PPO, -MR	SOT-143	24vdh	VD5	5c	Ali
SV	XC6127C48GNR	Vdet-IC	4.8V±0.8%, +Reset PPO, -MR, Rt=100ms	SSOT-24	26cr	VD5	5a	Tor
SV	XC6223C36BNR-G	LVR-IC	LDO, 3.65V±1%, 300mA, +CE, PDR	SSOT-24	26vn	VR4	5a	Tor
SW	ASM812SEUS	Vdet-IC	2.93V±1.5%, +Reset PPO, -MR	SOT-143	24vdh	VD5	5c	Ali
SX	ASM812REUS	Vdet-IC	2.63V±1.5%, +Reset PPO, -MR	SOT-143	24vdh	VD5	5c	Ali
SX	XC6127C50GNR	Vdet-IC	5.0V±0.8%, +Reset PPO, -MR, Rt=100ms	SSOT-24	26cr	VD5	5a	Tor
SX	XC6223C37BNR-G	LVR-IC	LDO, 3.75V±1%, 300mA, +CE, PDR	SSOT-24	26vn	VR4	5a	Tor
SY	PT7M6314US25D3	Vdet-IC	2.5V±1.5%, 200ms, -Reset PPO, -MR	SOT-143	24vdh	VD5	5g	Pti
SY	XC6127C52GNR	Vdet-IC	5.2V±0.8%, +Reset PPO, -MR, Rt=100ms	SSOT-24	26cr	VD5	5a	Tor
SY	XC6223C38BNR-G	LVR-IC	LDO, 3.85V±1%, 300mA, +CE, PDR	SSOT-24	26vn	VR4	5a	Tor
SZ	PT7M6314US25D4	Vdet-IC	2.5V±1.5%, 1570ms, -Reset PPO, -MR	SOT-143	24vdh	VD5	5g	Pti
SZ	XC6127C54GNR	Vdet-IC	5.4V±0.8%, +Reset PPO, -MR, Rt=100ms	SSOT-24	26cr	VD5	5a	Tor
SZ	XC6223C39BNR-G	LVR-IC	LDO, 3.95V±1%, 300mA, +CE, PDR	SSOT-24	26vn	VR4	5a	Tor
T0	R3116Q271C	Vdet-IC	2.7V±0.8%, -Reset PPO	SC-82AB	26rp	VD3	5a	Ric
T0	RP104Q271B5	LVR-IC	LDO, 2.75V±0.8%, 150mA, +CE	SC-82AB	26vn	VR4	5a	Ric
T1	BFG590W	Si-npn	UHF, 20V, 200mA, 400mW, B=60..250, 5GHz	SOT-343	24tc	-	5b	Phi
T1	R3116Q281C	Vdet-IC	2.8V±0.8%, -Reset PPO	SC-82AB	26rp	VD3	5a	Ric
T1	RP104Q211B	LVR-IC	LDO, 2.1V±0.8%, 150mA, +CE	SC-82AB	26vn	VR4	5a	Ric
T2	BFG590WX	Si-npn	UHF, 20V, 200mA, 400mW, B=60..250, 5GHz	SOT-343	26tc	-	5b	Phi
T2	R3116Q291C	Vdet-IC	2.9V±0.8%, -Reset PPO	SC-82AB	26rp	VD3	5a	Ric
T2	XC6223D12BNR-G	LVR-IC	LDO, 1.25V±20mV, 300mA, +CE, PDR, CL	SSOT-24	26vn	VR4	5a	Tor
T3	BFG590WXR	Si-npn	UHF, 20V, 200mA, 400mW, B=60..250, 5GHz	SOT-343R	26tu	-	5b	Phi
T3	R3116Q301C	Vdet-IC	3V±0.8%, -Reset PPO	SC-82AB	26rp	VD3	5a	Ric
T3	XC6223D13BNR-G	LVR-IC	LDO, 1.35V±20mV, 300mA, +CE, PDR, CL	SSOT-24	26vn	VR4	5a	Tor
T4	R3116Q311C	Vdet-IC	3.1V±0.8%, -Reset PPO	SC-82AB	26rp	VD3	5a	Ric
T4	XC6223D14BNR-G	LVR-IC	LDO, 1.45V±20mV, 300mA, +CE, PDR, CL	SSOT-24	26vn	VR4	5a	Tor
T5	BFG10WX	Si-npn	VHF/UHF-Amp, 20V, 250mA, 400mW, B>25, 1.9GHz	SOT-343	24tc	-	5c	Phi
T5	R3116Q321C	Vdet-IC	3.2V±0.8%, -Reset PPO	SC-82AB	26rp	VD3	5a	Ric
T5	XC6223D15BNR-G	LVR-IC	LDO, 1.55V±20mV, 300mA, +CE, PDR, CL	SSOT-24	26vn	VR4	5a	Tor
T6	R3116Q331C	Vdet-IC	3.3V±0.8%, -Reset PPO	SC-82AB	26rp	VD3	5a	Ric
T6	XC6223D16BNR-G	LVR-IC	LDO, 1.65V±20mV, 300mA, +CE, PDR, CL	SSOT-24	26vn	VR4	5a	Tor
T6A	S-1009C08I-N4T1U	Vdet-IC	0.8V±12mV, -Reset PPO	SC-82AB	26vdf	VD1	5c	Sii
T6B	S-1009C09I-N4T1U	Vdet-IC	0.9V±12mV, -Reset PPO	SC-82AB	26vdf	VD3	5c	Sii



SMD code	Type	Function	Short description	Case	Pinout Sch.	St.	Mnf.
T6C	S-1009C10I-N4T1U	Vdet-IC	1.0V±12mV, -Reset PPO	SC-82AB	26vdf VD3	5c	Sii
T6D	S-1009C11I-N4T1U	Vdet-IC	1.1V±12mV, -Reset PPO	SC-82AB	26vdf VD3	5c	Sii
T6E	S-1009C12I-N4T1U	Vdet-IC	1.2V±12mV, -Reset PPO	SC-82AB	26vdf VD3	5c	Sii
T6F	S-1009C13I-N4T1U	Vdet-IC	1.3V±12mV, -Reset PPO	SC-82AB	26vdf VD3	5c	Sii
T6G	S-1009C14I-N4T1U	Vdet-IC	1.4V±12mV, -Reset PPO	SC-82AB	26vdf VD3	5c	Sii
T6H	S-1009C15I-N4T1U	Vdet-IC	1.5V±12mV, -Reset PPO	SC-82AB	26vdf VD3	5c	Sii
T6I	S-1009C16I-N4T1U	Vdet-IC	1.6V±12mV, -Reset PPO	SC-82AB	26vdf VD3	5c	Sii
T6J	S-1009C17I-N4T1U	Vdet-IC	1.7V±12mV, -Reset PPO	SC-82AB	26vdf VD3	5c	Sii
T6K	S-1009C18I-N4T1U	Vdet-IC	1.8V±12mV, -Reset PPO	SC-82AB	26vdf VD3	5c	Sii
T6L	S-1009C19I-N4T1U	Vdet-IC	1.9V±12mV, -Reset PPO	SC-82AB	26vdf VD3	5c	Sii
T6M	S-1009C20I-N4T1U	Vdet-IC	2.0V±12mV, -Reset PPO	SC-82AB	26vdf VD3	5c	Sii
T6N	S-1009C21I-N4T1U	Vdet-IC	2.1V±12mV, -Reset PPO	SC-82AB	26vdf VD3	5c	Sii
T6O	S-1009C22I-N4T1U	Vdet-IC	2.2V±12mV, -Reset PPO	SC-82AB	26vdf VD3	5c	Sii
T6P	S-1009C23I-N4T1U	Vdet-IC	2.3V±12mV, -Reset PPO	SC-82AB	26vdf VD3	5c	Sii
T6Q	S-1009C24I-N4T1U	Vdet-IC	2.4V±0.5%, -Reset PPO	SC-82AB	26vdf VD3	5c	Sii
T6R	S-1009C25I-N4T1U	Vdet-IC	2.5V±0.5%, -Reset PPO	SC-82AB	26vdf VD3	5c	Sii
T6S	S-1009C26I-N4T1U	Vdet-IC	2.6V±0.5%, -Reset PPO	SC-82AB	26vdf VD3	5c	Sii
T6T	S-1009C27I-N4T1U	Vdet-IC	2.7V±0.5%, -Reset PPO	SC-82AB	26vdf VD3	5c	Sii
T6U	S-1009C28I-N4T1U	Vdet-IC	2.8V±0.5%, -Reset PPO	SC-82AB	26vdf VD3	5c	Sii
T6V	S-1009C29I-N4T1U	Vdet-IC	2.9V±0.5%, -Reset PPO	SC-82AB	26vdf VD3	5c	Sii
T6W	S-1009C30I-N4T1U	Vdet-IC	3.0V±0.5%, -Reset PPO	SC-82AB	26vdf VD3	5c	Sii
T6X	S-1009C31I-N4T1U	Vdet-IC	3.1V±0.5%, -Reset PPO	SC-82AB	26vdf VD3	5c	Sii
T6Y	S-1009C32I-N4T1U	Vdet-IC	3.2V±0.5%, -Reset PPO	SC-82AB	26vdf VD3	5c	Sii
T6Z	S-1009C33I-N4T1U	Vdet-IC	3.3V±0.5%, -Reset PPO	SC-82AB	26vdf VD3	5c	Sii
T7	R3116Q341C	Vdet-IC	3.4V±0.8%, -Reset PPO	SC-82AB	26rp VD3	5a	Ric
T7	XC6223D17BNR-G	LVR-IC	LDO, 1.75V±20mV, 300mA, +CE, PDR, CL	SSOT-24	26vn VR4	5a	Tor
T78	2SC5507-FB	Si-npn	RF, L, N, 15V, 12mA, 39mW, B=50..100, 25GHz	SOT-343	24tc -	5c	Nec
T79	2SC5508-FB	Si-npn	RF, L, N, 15V, 35mA, 115mW, B=50..100, 25GHz	SOT-343	24tc -	5c	Nec
T7A	S-1009C34I-N4T1U	Vdet-IC	3.4V±0.5%, -Reset PPO	SC-82AB	26vdf VD3	5c	Sii
T7B	S-1009C35I-N4T1U	Vdet-IC	3.5V±0.5%, -Reset PPO	SC-82AB	26vdf VD3	5c	Sii
T7C	S-1009C36I-N4T1U	Vdet-IC	3.6V±0.5%, -Reset PPO	SC-82AB	26vdf VD3	5c	Sii
T7D	S-1009C37I-N4T1U	Vdet-IC	3.7V±0.5%, -Reset PPO	SC-82AB	26vdf VD3	5c	Sii
T7E	S-1009C38I-N4T1U	Vdet-IC	3.8V±0.5%, -Reset PPO	SC-82AB	26vdf VD3	5c	Sii
T7F	S-1009C39I-N4T1U	Vdet-IC	3.9V±0.5%, -Reset PPO	SC-82AB	26vdf VD3	5c	Sii
T7G	S-1009C40I-N4T1U	Vdet-IC	4.0V±0.5%, -Reset PPO	SC-82AB	26vdf VD3	5c	Sii
T7H	S-1009C41I-N4T1U	Vdet-IC	4.1V±0.5%, -Reset PPO	SC-82AB	26vdf VD3	5c	Sii
T7I	S-1009C42I-N4T1U	Vdet-IC	4.2V±0.5%, -Reset PPO	SC-82AB	26vdf VD3	5c	Sii
T7J	S-1009C43I-N4T1U	Vdet-IC	4.3V±0.5%, -Reset PPO	SC-82AB	26vdf VD3	5c	Sii
T7K	S-1009C44I-N4T1U	Vdet-IC	4.4V±0.5%, -Reset PPO	SC-82AB	26vdf VD3	5c	Sii
T7L	S-1009C45I-N4T1U	Vdet-IC	4.5V±0.5%, -Reset PPO	SC-82AB	26vdf VD3	5c	Sii
T7M	S-1009C46I-N4T1U	Vdet-IC	4.6V±0.5%, -Reset PPO	SC-82AB	26vdf VD3	5c	Sii
T8	1SV306	C-diode	Dual, VCO, VHF-Band, 15V, 5.5/6.5pF(2/10V), Rs<0.4Ω	SOT-343	24dv -	5b	Tos
T8	R3116Q351C	Vdet-IC	3.5V±0.8%, -Reset PPO	SC-82AB	26rp VD3	5a	Ric
T8	XC6215B092NR	LVR-IC	LDO, 0.9V±2%, 200mA, +CE	SSOT-24	26vn VR4	5b	Tor
T8	XC6223D18BNR-G	LVR-IC	LDO, 1.85V±20mV, 300mA, +CE, PDR, CL	SSOT-24	26vn VR4	5a	Tor
T80	2SC5509-FB	Si-npn	RF, L, N, 15V, 100mA, 190mW, B=50..100, 15GHz	SOT-343	24tc -	5c	Nec
T82	2SC4956	Si-npn	LN, HF, 9V, 10mA, 60mW, B=75..150, 12GHz	SOT-143	26tu -	5c	Nec
T82	2SC5014-KB	Si-npn	HF, L, N, 9V, 10mA, 60mW, B=75..150, 12GHz	SOT-143	26tu -	5b	Nec
T83	2SC5015-KB	Si-npn	HF, L, N, 9V, 30mA, 150mW, B=75..150, 12GHz	SOT-143	26tu -	5b	Nec
T84	2SC5178	Si-npn	UHF, L, N, 5V, 10mA, 30mW, B=70..140, 13.5GHz	SOT-143	26tu -	5b	Nec
T84	2SC5178-FB	Si-npn	μWave, LN, 5V, 10mA, 30mW, B=70..140, 13.5GHz	SC-61	26tu -	5b	Nec
T84	2SC5180-FB	Si-npn	μWave, LN, 5V, 10mA, 30mW, B=70..140, 15GHz	SOT-143	26tu -	5b	Nec
T86	2SC5183-FB	Si-npn	μWave, LN, 5V, 30mA, 90mW, B=70..140, 12.5GHz	SC-61	26tu -	5b	Nec
T86	2SC5185-FB	Si-npn	μWave, LN, 5V, 30mA, 90mW, B=70..140, 13GHz	SOT-143	26tu -	5b	Nec
T88	2SC5192-FB	Si-npn	μWave, LN, 9V, 100mA, 200mW, B=80..160, 4.5GHz	SOT-143	26tu -	5b	Nec
T88	2SC5194-FB	Si-npn	μWave, LN, 9V, 100mA, 150mW, 5GHz, B=80..160	SOT-143	26tu -	5b	Nec
T89	2SC5288	Si-npn	UHF, DECT, 9V, 150mA, 200mW, 1.9GHz, B>60	SOT-143	26tc -	5b	Nec
T8A	S-1009N08I-N4T1U	Vdet-IC	0.8V±12mV, -Reset ODO	SC-82AB	26vdf VD1	5c	Sii
T8B	S-1009N09I-N4T1U	Vdet-IC	0.9V±12mV, -Reset ODO	SC-82AB	26vdf VD1	5c	Sii
T8C	S-1009N10I-N4T1U	Vdet-IC	1.0V±12mV, -Reset ODO	SC-82AB	26vdf VD1	5c	Sii
T8D	S-1009N11I-N4T1U	Vdet-IC	1.1V±12mV, -Reset ODO	SC-82AB	26vdf VD1	5c	Sii
T8E	S-1009N12I-N4T1U	Vdet-IC	1.2V±12mV, -Reset ODO	SC-82AB	26vdf VD1	5c	Sii
T8F	S-1009N13I-N4T1U	Vdet-IC	1.3V±12mV, -Reset ODO	SC-82AB	26vdf VD1	5c	Sii
T8G	S-1009N14I-N4T1U	Vdet-IC	1.4V±12mV, -Reset ODO	SC-82AB	26vdf VD1	5c	Sii
T8H	S-1009N15I-N4T1U	Vdet-IC	1.5V±12mV, -Reset ODO	SC-82AB	26vdf VD1	5c	Sii
T8I	S-1009N16I-N4T1U	Vdet-IC	1.6V±12mV, -Reset ODO	SC-82AB	26vdf VD1	5c	Sii
T8J	S-1009N17I-N4T1U	Vdet-IC	1.7V±12mV, -Reset ODO	SC-82AB	26vdf VD1	5c	Sii
T8K	S-1009N18I-N4T1U	Vdet-IC	1.8V±12mV, -Reset ODO	SC-82AB	26vdf VD1	5c	Sii
T8L	S-1009N19I-N4T1U	Vdet-IC	1.9V±12mV, -Reset ODO	SC-82AB	26vdf VD1	5c	Sii
T8M	S-1009N20I-N4T1U	Vdet-IC	2.0V±12mV, -Reset ODO	SC-82AB	26vdf VD1	5c	Sii



SMD code	Type	Function	Short description	Case	Pinout Sch.	St.	Mnf.
T8N	S-1009N21I-N4T1U	Vdet-IC	2.1V±12mV, -Reset ODO	SC-82AB	26vdf VD1	5c	Sii
T8O	S-1009N22I-N4T1U	Vdet-IC	2.2V±12mV, -Reset ODO	SC-82AB	26vdf VD1	5c	Sii
T8P	S-1009N23I-N4T1U	Vdet-IC	2.3V±12mV, -Reset ODO	SC-82AB	26vdf VD1	5c	Sii
T8Q	S-1009N24I-N4T1U	Vdet-IC	2.4V±0.5%, -Reset ODO	SC-82AB	26vdf VD1	5c	Sii
T8R	S-1009N25I-N4T1U	Vdet-IC	2.5V±0.5%, -Reset ODO	SC-82AB	26vdf VD1	5c	Sii
T8S	S-1009N26I-N4T1U	Vdet-IC	2.6V±0.5%, -Reset ODO	SC-82AB	26vdf VD1	5c	Sii
T8T	S-1009N27I-N4T1U	Vdet-IC	2.7V±0.5%, -Reset ODO	SC-82AB	26vdf VD1	5c	Sii
T8U	S-1009N28I-N4T1U	Vdet-IC	2.8V±0.5%, -Reset ODO	SC-82AB	26vdf VD1	5c	Sii
T8V	S-1009N29I-N4T1U	Vdet-IC	2.9V±0.5%, -Reset ODO	SC-82AB	26vdf VD1	5c	Sii
T8W	S-1009N30I-N4T1U	Vdet-IC	3.0V±0.5%, -Reset ODO	SC-82AB	26vdf VD1	5c	Sii
T8X	S-1009N31I-N4T1U	Vdet-IC	3.1V±0.5%, -Reset ODO	SC-82AB	26vdf VD1	5c	Sii
T8Y	S-1009N32I-N4T1U	Vdet-IC	3.2V±0.5%, -Reset ODO	SC-82AB	26vdf VD1	5c	Sii
T8Z	S-1009N33I-N4T1U	Vdet-IC	3.3V±0.5%, -Reset ODO	SC-82AB	26vdf VD1	5c	Sii
T9	R3111Q09IC	Vdet-IC	0.9V±2%, -Reset ODO	SC-82AB	26vdl VD6	5a	Ric
T9	R3116Q36IC	Vdet-IC	3.6V±0.8%, -Reset PPO	SC-82AB	26np VD3	5a	Ric
T9	XC6215B102NR	LVR-IC	LDO, 1V±2%, 200mA, +CE	SSOT-24	26vn VR4	5b	Tor
T9	XC6223D19BNR-G	LVR-IC	LDO, 1.95V±20mV, 300mA, +CE, PDR, CL	SSOT-24	26vn VR4	5a	Tor
T90	2SC5289	Si-npn	UHF, DECT, 9V, 300mA, 1.9GHz	SOT-143	26tc -	5b	Nec
T9A	S-1009N34I-N4T1U	Vdet-IC	3.4V±0.5%, -Reset ODO	SC-82AB	26vdf VD1	5c	Sii
T9B	S-1009N35I-N4T1U	Vdet-IC	3.5V±0.5%, -Reset ODO	SC-82AB	26vdf VD1	5c	Sii
T9C	S-1009N36I-N4T1U	Vdet-IC	3.6V±0.5%, -Reset ODO	SC-82AB	26vdf VD1	5c	Sii
T9D	S-1009N37I-N4T1U	Vdet-IC	3.7V±0.5%, -Reset ODO	SC-82AB	26vdf VD1	5c	Sii
T9E	S-1009N38I-N4T1U	Vdet-IC	3.8V±0.5%, -Reset ODO	SC-82AB	26vdf VD1	5c	Sii
T9F	S-1009N39I-N4T1U	Vdet-IC	3.9V±0.5%, -Reset ODO	SC-82AB	26vdf VD1	5c	Sii
T9G	S-1009N40I-N4T1U	Vdet-IC	4.0V±0.5%, -Reset ODO	SC-82AB	26vdf VD1	5c	Sii
T9H	S-1009N41I-N4T1U	Vdet-IC	4.1V±0.5%, -Reset ODO	SC-82AB	26vdf VD1	5c	Sii
T9I	S-1009N42I-N4T1U	Vdet-IC	4.2V±0.5%, -Reset ODO	SC-82AB	26vdf VD1	5c	Sii
T9J	S-1009N43I-N4T1U	Vdet-IC	4.3V±0.5%, -Reset ODO	SC-82AB	26vdf VD1	5c	Sii
T9K	S-1009N44I-N4T1U	Vdet-IC	4.4V±0.5%, -Reset ODO	SC-82AB	26vdf VD1	5c	Sii
T9L	S-1009N45I-N4T1U	Vdet-IC	4.5V±0.5%, -Reset ODO	SC-82AB	26vdf VD1	5c	Sii
T9M	S-1009N46I-N4T1U	Vdet-IC	4.6V±0.5%, -Reset ODO	SC-82AB	26vdf VD1	5c	Sii
TA	ASM161LCUS	Vdet-IC	4.63V, -MR, -Reset ODO	SOT-143	24vhd VD4	5c	Ali
TĀ	R1114Q201D	LVR-IC	LDO, LN, +CE, CL, 2V±2%, 150mA	SOT-143R	26vn VR4	5a	Ric
TA	XC6127C16HNR	Vdet-IC	1.6V±0.8%, +Reset PPO, -MR, Rt=200ms	SSOT-24	26cr VD5	5a	Tor
TA	XC6215B112NR	LVR-IC	LDO, 1.1V±2%, 200mA, +CE	SSOT-24	26vn VR4	5b	Tor
TA	XC6223D20BNR-G	LVR-IC	LDO, 2.05V±1%, 300mA, +CE, PDR, CL	SSOT-24	26vn VR4	5a	Tor
TA3	S858TA3	MMIC	UHF-Amplifier, 3.6V, Pq=10dBm(500MHz)	SOT-143	24am A1	5b	Vs
TB	ASM161MCUS	Vdet-IC	4.38V, -MR, -Reset ODO	SOT-143	24vhd VD4	5c	Ali
TĪ	R1114Q211D	LVR-IC	LDO, LN, +CE, CL, 2.1V±2%, 150mA	SOT-143R	26vn VR4	5a	Ric
TB	XC6127C18HNR	Vdet-IC	1.8V±0.8%, +Reset PPO, -MR, Rt=200ms	SSOT-24	26cr VD5	5a	Tor
TB	XC6215B122NR	LVR-IC	LDO, 1.2V±2%, 200mA, +CE	SSOT-24	26vn VR4	5b	Tor
TB	XC6223D21BNR-G	LVR-IC	LDO, 2.15V±1%, 300mA, +CE, PDR, CL	SSOT-24	26vn VR4	5a	Tor
TC	ASM161JCUS	Vdet-IC	4V, -MR, -Reset ODO	SOT-143	24vhd VD4	5c	Ali
TC	PT7M6314US26D3	Vdet-IC	2.6V±1.5%, 200ms, -Restet PPO, -MR	SOT-143	24vhd VD5	5g	Pti
TC	R1114Q221D	LVR-IC	LDO, LN, +CE, CL, 2.2V±2%, 150mA	SOT-143R	26vn VR4	5a	Ric
TĈ	XC6127C20HNR	Vdet-IC	2.0V±0.8%, +Reset PPO, -MR, Rt=200ms	SSOT-24	26cr VD5	5a	Tor
TC	XC6215B132NR	LVR-IC	LDO, 1.3V±2%, 200mA, +CE	SSOT-24	26vn VR4	5b	Tor
TC	XC6223D22BNR-G	LVR-IC	LDO, 2.25V±1%, 300mA, +CE, PDR, CL	SSOT-24	26vn VR4	5a	Tor
TD	ASM161TCUS	Vdet-IC	3.08V, -MR, -Reset ODO	SOT-143	24vhd VD4	5c	Ali
TD	PT7M6314US26D4	Vdet-IC	2.6V±1.5%, 1570ms, -Restet PPO, -MR	SOT-143	24vhd VD5	5g	Pti
TD	R1114Q231D	LVR-IC	LDO, LN, +CE, CL, 2.3V±2%, 150mA	SOT-143R	26vn VR4	5a	Ric
TĎ	XC6127C22HNR	Vdet-IC	2.2V±0.8%, +Reset PPO, -MR, Rt=200ms	SSOT-24	26cr VD5	5a	Tor
TD	XC6215B142NR	LVR-IC	LDO, 1.4V±2%, 200mA, +CE	SSOT-24	26vn VR4	5b	Tor
TD	XC6223D23BNR-G	LVR-IC	LDO, 2.35V±1%, 300mA, +CE, PDR, CL	SSOT-24	26vn VR4	5a	Tor
TE	ASM161SCUS	Vdet-IC	2.93V, -MR, -Reset ODO	SOT-143	24vhd VD4	5c	Ali
TE	R1114Q241D	LVR-IC	LDO, LN, +CE, CL, 2.4V±2%, 150mA	SOT-143R	26vn VR4	5a	Ric
TĚ	XC6127C24HNR	Vdet-IC	2.4V±0.8%, +Reset PPO, -MR, Rt=200ms	SSOT-24	26cr VD5	5a	Tor
TE	XC6215B152NR	LVR-IC	LDO, 1.5V±2%, 200mA, +CE	SSOT-24	26vn VR4	5b	Tor
TE	XC6223D24BNR-G	LVR-IC	LDO, 2.45V±1%, 300mA, +CE, PDR, CL	SSOT-24	26vn VR4	5a	Tor
TF	ASM161RCUS	Vdet-IC	2.63V, -MR, -Reset ODO	SOT-143	24vhd VD4	5c	Ali
TF	R1114Q251D	LVR-IC	LDO, LN, +CE, CL, 2.5V±2%, 150mA	SOT-143R	26vn VR4	5a	Ric
TĚ	XC6127C26HNR	Vdet-IC	2.6V±0.8%, +Reset PPO, -MR, Rt=200ms	SSOT-24	26cr VD5	5a	Tor
TF	XC6215B162NR	LVR-IC	LDO, 1.6V±2%, 200mA, +CE	SSOT-24	26vn VR4	5b	Tor
TF	XC6223D25BNR-G	LVR-IC	LDO, 2.55V±1%, 300mA, +CE, PDR, CL	SSOT-24	26vn VR4	5a	Tor
TG	ASM162LCUS	Vdet-IC	4.63V, -MR, +Reset ODO	SOT-143	24vhd VD4	5c	Ali
TG	PT7M6314US27D3	Vdet-IC	2.7V±1.5%, 200ms, -Restet PPO, -MR	SOT-143	24vhd VD5	5g	Pti
TG	R1114Q261D	LVR-IC	LDO, LN, +CE, CL, 2.6V±2%, 150mA	SOT-143R	26vn VR4	5a	Ric
TH	ASM162MCUS	Vdet-IC	4.38V, -MR, +Reset ODO	SOT-143	24vhd VD4	5c	Ali
TH	PT7M6314US27D4	Vdet-IC	2.7V±1.5%, 1570ms, -Restet PPO, -MR	SOT-143	24vhd VD5	5g	Pti
TH	R1114Q271D	LVR-IC	LDO, LN, +CE, CL, 2.7V±2%, 150mA	SOT-143R	26vn VR4	5a	Ric



SMD code	Type	Function	Short description	Case	Pinout	Sch.	St.	Mnf.
TH	XC6127C28HNR	Vdet-IC	2.8V±0.8%, +Reset PPO, -MR, Rt=200ms	SSOT-24	26cr	VD5	5a	Tor
TH	XC6215B172NR	LVR-IC	LDO, 1.7V±2%, 200mA, +CE	SSOT-24	26vn	VR4	5b	Tor
TH	XC6223D26BNR-G	LVR-IC	LDO, 2.65V±1%, 300mA, +CE, PDR, CL	SSOT-24	26vn	VR4	5a	Tor
TI	ASM162JCUS	Vdet-IC	4V, -MR, +Reset ODO	SOT-143	24vdh	VD4	5c	Ali
TJ	ASM162TCUS	Vdet-IC	3.08V, -MR, +Reset ODO	SOT-143	24vdh	VD4	5c	Ali
TJ	R1114Q281D	LVR-IC	LDO, LN, +CE, CL, 2.8V±2%, 150mA	SOT-143R	26vn	VR4	5a	Ric
TJ5	3SK265-5	n-MOSFET-d	VHF Catv-Tuner, DG, 15V, 30mA, 200mW, ldsx=5..12mA	CP4	26fm	-	5b	San
TJ6	3SK265-6	n-MOSFET-d	VHF Catv-Tuner, DG, 15V, 30mA, 200mW, ldsx=10..24mA	CP4	26fm	-	5b	San
TK	ASM162SCUS	Vdet-IC	2.93V, -MR, +Reset ODO	SOT-143	24vdh	VD4	5c	Ali
TK	PT7M6314US28D3	Vdet-IC	2.8V±1.5%, 200ms, -Reset PPO, -MR	SOT-143	24vdh	VD5	5g	Pti
TK	R1114Q291D	LVR-IC	LDO, LN, +CE, CL, 2.9V±2%, 150mA	SOT-143R	26vn	VR4	5a	Ric
TK	XC6127C30HNR	Vdet-IC	3.0V±0.8%, +Reset PPO, -MR, Rt=200ms	SSOT-24	26cr	VD5	5a	Tor
TK	XC6215B182NR	LVR-IC	LDO, 1.8V±2%, 200mA, +CE	SSOT-24	26vn	VR4	5b	Tor
TK	XC6223D27BNR-G	LVR-IC	LDO, 2.75V±1%, 300mA, +CE, PDR, CL	SSOT-24	26vn	VR4	5a	Tor
TL	ASM162RCUS	Vdet-IC	2.63V, -MR, +Reset ODO	SOT-143	24vdh	VD4	5c	Ali
TL	PT7M6314US28D4	Vdet-IC	2.8V±1.5%, 1570ms, -Reset PPO, -MR	SOT-143	24vdh	VD5	5g	Pti
TL	XC6127C32HNR	Vdet-IC	3.2V±0.8%, +Reset PPO, -MR, Rt=200ms	SSOT-24	26cr	VD5	5a	Tor
TL	XC6215B192NR	LVR-IC	LDO, 1.9V±2%, 200mA, +CE	SSOT-24	26vn	VR4	5b	Tor
TL	XC6223D28BNR-G	LVR-IC	LDO, 2.85V±1%, 300mA, +CE, PDR, CL	SSOT-24	26vn	VR4	5a	Tor
TLN	ELM7539CCB	Vdet-IC	3.9V±2%, +Reset PPO	SC-82AB	26vdl	VD7	5c	Elm
TLN	ELM7539NCB	Vdet-IC	3.9V±2%, +Reset ODO	SC-82AB	26vdl	VD6	5c	Elm
TM	ASM161LEUS	Vdet-IC	4.63V, -MR, -Reset ODO	SOT-143	24vdh	VD4	5c	Ali
TM	XC6127C34HNR	Vdet-IC	3.4V±0.8%, +Reset PPO, -MR, Rt=200ms	SSOT-24	26cr	VD5	5a	Tor
TM	XC6215B202NR	LVR-IC	LDO, 2V±2%, 200mA, +CE	SSOT-24	26vn	VR4	5b	Tor
TM	XC6223D29BNR-G	LVR-IC	LDO, 2.95V±1%, 300mA, +CE, PDR, CL	SSOT-24	26vn	VR4	5a	Tor
TN	ASM161MEUS	Vdet-IC	4.38V, -MR, -Reset ODO	SOT-143	24vdh	VD4	5c	Ali
TN	XC6127C36HNR	Vdet-IC	3.6V±0.8%, +Reset PPO, -MR, Rt=200ms	SSOT-24	26cr	VD5	5a	Tor
TN	XC6215B212NR	LVR-IC	LDO, 2.1V±2%, 200mA, +CE	SSOT-24	26vn	VR4	5b	Tor
TN	XC6223D30BNR-G	LVR-IC	LDO, 3.05V±1%, 300mA, +CE, PDR, CL	SSOT-24	26vn	VR4	5a	Tor
TO	ASM161JEUS	Vdet-IC	4V, -MR, -Reset ODO	SOT-143	24vdh	VD4	5c	Ali
TO	PT7M6314US29D3	Vdet-IC	2.9V±1.5%, 200ms, -Reset PPO, -MR	SOT-143	24vdh	VD5	5g	Pti
TP	ASM161TEUS	Vdet-IC	3.08V, -MR, -Reset ODO	SOT-143	24vdh	VD4	5c	Ali
TP	PT7M6314US29D4	Vdet-IC	2.9V±1.5%, 1570ms, -Reset PPO, -MR	SOT-143	24vdh	VD5	5g	Pti
TP	XC6127C38HNR	Vdet-IC	3.8V±0.8%, +Reset PPO, -MR, Rt=200ms	SSOT-24	26cr	VD5	5a	Tor
TP	XC6215B222NR	LVR-IC	LDO, 2.2V±2%, 200mA, +CE	SSOT-24	26vn	VR4	5b	Tor
TP	XC6223D31BNR-G	LVR-IC	LDO, 3.15V±1%, 300mA, +CE, PDR, CL	SSOT-24	26vn	VR4	5a	Tor
TQ	ASM161SEUS	Vdet-IC	2.93V, -MR, -Reset ODO	SOT-143	24vdh	VD4	5c	Ali
TR	ASM161REUS	Vdet-IC	2.63V, -MR, -Reset ODO	SOT-143	24vdh	VD4	5c	Ali
TR	XC6127C40HNR	Vdet-IC	4.0V±0.8%, +Reset PPO, -MR, Rt=200ms	SSOT-24	26cr	VD5	5a	Tor
TR	XC6215B232NR	LVR-IC	LDO, 2.3V±2%, 200mA, +CE	SSOT-24	26vn	VR4	5b	Tor
TR	XC6223D32BNR-G	LVR-IC	LDO, 3.25V±1%, 300mA, +CE, PDR, CL	SSOT-24	26vn	VR4	5a	Tor
TS	ASM162LEUS	Vdet-IC	4.63V, -MR, +Reset ODO	SOT-143	24vdh	VD4	5c	Ali
TS	PT7M6314US30D3	Vdet-IC	3.0V±1.5%, 200ms, -Reset PPO, -MR	SOT-143	24vdh	VD5	5g	Pti
TS	XC6127C42HNR	Vdet-IC	4.2V±0.8%, +Reset PPO, -MR, Rt=200ms	SSOT-24	26cr	VD5	5a	Tor
TS	XC6215B242NR	LVR-IC	LDO, 2.4V±2%, 200mA, +CE	SSOT-24	26vn	VR4	5b	Tor
TS	XC6223D33BNR-G	LVR-IC	LDO, 3.35V±1%, 300mA, +CE, PDR, CL	SSOT-24	26vn	VR4	5a	Tor
TT	ASM162MEUS	Vdet-IC	4.38V, -MR, +Reset ODO	SOT-143	24vdh	VD4	5c	Ali
TT	PT7M6314US30D4	Vdet-IC	3.0V±1.5%, 1570ms, -Reset PPO, -MR	SOT-143	24vdh	VD5	5g	Pti
TT	XC6127C44HNR	Vdet-IC	4.4V±0.8%, +Reset PPO, -MR, Rt=200ms	SSOT-24	26cr	VD5	5a	Tor
TT	XC6215B252NR	LVR-IC	LDO, 2.5V±2%, 200mA, +CE	SSOT-24	26vn	VR4	5b	Tor
TT	XC6223D34BNR-G	LVR-IC	LDO, 3.45V±1%, 300mA, +CE, PDR, CL	SSOT-24	26vn	VR4	5a	Tor
TU	ASM162JEUS	Vdet-IC	4V, -MR, +Reset ODO	SOT-143	24vdh	VD4	5c	Ali
TU	XC6127C46HNR	Vdet-IC	4.6V±0.8%, +Reset PPO, -MR, Rt=200ms	SSOT-24	26cr	VD5	5a	Tor
TU	XC6215B262NR	LVR-IC	LDO, 2.6V±2%, 200mA, +CE	SSOT-24	26vn	VR4	5b	Tor
TU	XC6223D35BNR-G	LVR-IC	LDO, 3.55V±1%, 300mA, +CE, PDR, CL	SSOT-24	26vn	VR4	5a	Tor
TV	ASM162TEUS	Vdet-IC	3.08V, -MR, +Reset ODO	SOT-143	24vdh	VD4	5c	Ali
TV	XC6127C48HNR	Vdet-IC	4.8V±0.8%, +Reset PPO, -MR, Rt=200ms	SSOT-24	26cr	VD5	5a	Tor
TV	XC6215B272NR	LVR-IC	LDO, 2.7V±2%, 200mA, +CE	SSOT-24	26vn	VR4	5b	Tor
TV	XC6223D36BNR-G	LVR-IC	LDO, 3.65V±1%, 300mA, +CE, PDR, CL	SSOT-24	26vn	VR4	5a	Tor
TW	ASM162SEUS	Vdet-IC	2.93V, -MR, +Reset ODO	SOT-143	24vdh	VD4	5c	Ali
TW	PT7M6314US31D3	Vdet-IC	3.1V±1.5%, 200ms, -Reset PPO, -MR	SOT-143	24vdh	VD5	5g	Pti
TX	ASM162REUS	Vdet-IC	2.63V, -MR, +Reset ODO	SOT-143	24vdh	VD4	5c	Ali
TX	PT7M6314US31D4	Vdet-IC	3.1V±1.5%, 1570ms, -Reset PPO, -MR	SOT-143	24vdh	VD5	5g	Pti
TX	XC6127C50HNR	Vdet-IC	5.0V±0.8%, +Reset PPO, -MR, Rt=200ms	SSOT-24	26cr	VD5	5a	Tor
TX	XC6215B282NR	LVR-IC	LDO, 2.8V±2%, 200mA, +CE	SSOT-24	26vn	VR4	5b	Tor
TX	XC6223D37BNR-G	LVR-IC	LDO, 3.75V±1%, 300mA, +CE, PDR, CL	SSOT-24	26vn	VR4	5a	Tor
TY	XC6127C52HNR	Vdet-IC	5.2V±0.8%, +Reset PPO, -MR, Rt=200ms	SSOT-24	26cr	VD5	5a	Tor
TY	XC6215B292NR	LVR-IC	LDO, 2.9V±2%, 200mA, +CE	SSOT-24	26vn	VR4	5b	Tor
TY	XC6223D38BNR-G	LVR-IC	LDO, 3.85V±1%, 300mA, +CE, PDR, CL	SSOT-24	26vn	VR4	5a	Tor
TY4	25C5502-4	Si-npn	VHF/UHF LN, 20V, 100mA, 500mW, B=90..180, 8GHz	SOT-343	26tu	-	5b	San



SMD code	Type	Function	Short description	Case	Pinout	Sch.	St.	Mnf.
TY5	2SC5502-5	Si-npn	VHF/UHF LN, 20V, 100mA, 500mW, B=135..270, 8GHz	SOT-343	26tu	-	5b	San
TZ	XC6127C54HNR	Vdet-IC	5.4V±0.8%, +Reset PPO, -MR, Rt=200ms	SSOT-24	26cr	VD5	5a	Tor
TZ	XC6215B302NR	LVR-IC	LDO, 3V±2%, 200mA, +CE	SSOT-24	26vn	VR4	5b	Tor
TZ	XC6223D39BNR-G	LVR-IC	LDO, 3.95V±1%, 300mA, +CE, PDR, CL	SSOT-24	26vn	VR4	5a	Tor
U0	R3111Q101C	Vdet-IC	1V±2%, -Reset ODO	SC-82AB	26vdl	VD6	5a	Ric
U0	R3116Q371C	Vdet-IC	3.7V±0.8%, -Reset PPO	SC-82AB	26rp	VD3	5a	Ric
U0	RP104Q271C5	LVR-IC	LDO, 2.75V±0.8%, 150mA	SC-82AB	26yr	VR1	5a	Ric
U0	XC6215B312NR	LVR-IC	LDO, 3.1V±2%, 200mA, +CE	SSOT-24	26vn	VR4	5b	Tor
U1	3SK283	n-FET-d	GaAs, DG, UHF-TV-Tuner, 6V, Idss=4..16mA, Up=0.5..1.5V	SOT-143	26fm	-	5b	Tos
U1	R3111Q111C	Vdet-IC	1.1V±2%, -Reset ODO	SC-82AB	26vdl	VD6	5a	Ric
U1	R3116Q381C	Vdet-IC	3.8V±0.8%, -Reset PPO	SC-82AB	26rp	VD3	5a	Ric
U1	RP104Q211C	LVR-IC	LDO, 2.1V±0.8%, 150mA	SC-82AB	26yr	VR1	5a	Ric
U1	XC6215B322NR	LVR-IC	LDO, 3.2V±2%, 200mA, +CE	SSOT-24	26vn	VR4	5b	Tor
U2	R3111Q121C	Vdet-IC	1.2V±2%, -Reset ODO	SC-82AB	26vdl	VD6	5a	Ric
U2	R3116Q391C	Vdet-IC	3.9V±0.8%, -Reset PPO	SC-82AB	26rp	VD3	5a	Ric
U2	XC6215B332NR	LVR-IC	LDO, 3.3V±2%, 200mA, +CE	SSOT-24	26vn	VR4	5b	Tor
U2	XC6223E12BNR-G	LVR-IC	LDO, 1.25V±20mV, 300mA, +CE, ICP	SSOT-24	26vn	VR4	5a	Tor
U3	R3111Q131C	Vdet-IC	1.3V±2%, -Reset ODO	SC-82AB	26vdl	VD6	5a	Ric
U3	R3116Q401C	Vdet-IC	4V±0.8%, -Reset PPO	SC-82AB	26rp	VD3	5a	Ric
U3	XC6215B342NR	LVR-IC	LDO, 3.4V±2%, 200mA, +CE	SSOT-24	26vn	VR4	5b	Tor
U3	XC6223E13BNR-G	LVR-IC	LDO, 1.35V±20mV, 300mA, +CE, ICP	SSOT-24	26vn	VR4	5a	Tor
U32	3SK132-32	n-MOSFET-d	DG, VHF-Tuner, 20V, 25mA, 200mW, Idss=0.5..5mA	SOT-143	26fm	-	5c	Nec
U33	3SK132-33	n-MOSFET-d	DG, VHF-Tuner, 20V, 25mA, 200mW, Idss=3..8mA	SOT-143	26fm	-	5c	Nec
U4	R3111Q141C	Vdet-IC	1.4V±2%, -Reset ODO	SC-82AB	26vdl	VD6	5a	Ric
U4	R3116Q411C	Vdet-IC	4.1V±0.8%, -Reset PPO	SC-82AB	26rp	VD3	5a	Ric
U4	XC6215B352NR	LVR-IC	LDO, 3.5V±2%, 200mA, +CE	SSOT-24	26vn	VR4	5b	Tor
U4	XC6223E14BNR-G	LVR-IC	LDO, 1.45V±20mV, 300mA, +CE, ICP	SSOT-24	26vn	VR4	5a	Tor
U42	3SK133-42	n-MOSFET-d	DG, VHF-Tuner, 20V, 25mA, 200mW, Idss=0.01..2mA	SOT-143	26fm	-	5c	Nec
U43	3SK133-43	n-MOSFET-d	DG, VHF-Tuner, 20V, 25mA, 200mW, Idss=1..6mA	SOT-143	26fm	-	5c	Nec
U5	R3111Q151C	Vdet-IC	1.5V±2%, -Reset ODO	SC-82AB	26vdl	VD6	5a	Ric
U5	R3116Q421C	Vdet-IC	4.2V±0.8%, -Reset PPO	SC-82AB	26rp	VD3	5a	Ric
U5	XC6215B362NR	LVR-IC	LDO, 3.6V±2%, 200mA, +CE	SSOT-24	26vn	VR4	5b	Tor
U5	XC6223E15BNR-G	LVR-IC	LDO, 1.55V±20mV, 300mA, +CE, ICP	SSOT-24	26vn	VR4	5a	Tor
U56	3SK245	n-MOSFET-d	DG, UHF-Tuner, 18V, 25mA	SOT-343	26fm	-	5c	Nec
U6	R3111Q161C	Vdet-IC	1.6V±2%, -Reset ODO	SC-82AB	26vdl	VD6	5a	Ric
U6	R3116Q431C	Vdet-IC	4.3V±0.8%, -Reset PPO	SC-82AB	26rp	VD3	5a	Ric
U6	XC6215B372NR	LVR-IC	LDO, 3.7V±2%, 200mA, +CE	SSOT-24	26vn	VR4	5b	Tor
U6	XC6223E16BNR-G	LVR-IC	LDO, 1.65V±20mV, 300mA, +CE, ICP	SSOT-24	26vn	VR4	5a	Tor
U7	3SK320	n-MESFET	GaAs, DG, UHF, 6V, 18mA, 100mW, 20.5dB	2-2K1B	23fd	-	5b	Tos
U7	R3111Q171C	Vdet-IC	1.7V±2%, -Reset ODO	SC-82AB	26vdl	VD6	5a	Ric
U7	R3116Q441C	Vdet-IC	4.4V±0.8%, -Reset PPO	SC-82AB	26rp	VD3	5a	Ric
U7	XC6215B382NR	LVR-IC	LDO, 3.8V±2%, 200mA, +CE	SSOT-24	26vn	VR4	5b	Tor
U7	XC6223E17BNR-G	LVR-IC	LDO, 1.75V±20mV, 300mA, +CE, ICP	SSOT-24	26vn	VR4	5a	Tor
U71	3SK177-71	n-MESFET	GaAs, DG, UHF, 13V, 40mA, 200mW, Idss=5..15mA	SOT-143	23fm	-	5b	Nec
U71	3SK299-71	n-MOSFET	GaAs, DG, UHF, 13V, Idss=5..15mA	SOT-343	26fm	-	5c	Nec
U72	3SK177-72	n-MESFET	GaAs, DG, UHF, 13V, 40mA, 200mW, Idss=10..25mA	SOT-143	23fm	-	5b	Nec
U72	3SK299-72	n-MOSFET	GaAs, DG, UHF, 13V, Idss=10..25mA	SOT-343	26fm	-	5c	Nec
U73	3SK177-73	n-MOSFET	GaAs, DG, UHF, 13V, 40mA, 200mW, Idss=20..35mA	SOT-143	23fm	-	5b	Nec
U73	3SK299-73	n-MOSFET	GaAs, DG, UHF, 13V, Idss=20..35mA	SOT-343	26fm	-	5c	Nec
U74	3SK177-74	n-MESFET	GaAs, DG, UHF, 13V, 40mA, 200mW, Idss=30..40mA	SOT-143	23fm	-	5b	Nec
U74	3SK299-74	n-MOSFET	GaAs, DG, UHF, 13V, Idss=30..40mA	SOT-343	26fm	-	5c	Nec
U76	3SK206-76	n-MESFET	GaAs, DG, UHF, 10V, 80mA, 200mW, Idss=10..25mA	SOT-143	23fm	-	5b	Nec
U77	3SK206-77	n-MESFET	GaAs, DG, UHF, 10V, 80mA, 200mW, Idss=20..35mA	SOT-143	23fm	-	5b	Nec
U78	3SK206-78	n-MESFET	GaAs, DG, UHF, 10V, 80mA, 200mW, Idss=30..50mA	SOT-143	23fm	-	5b	Nec
U79	3SK206-79	n-MESFET	GaAs, DG, UHF, 10V, 80mA, 200mW, Idss=45..80mA	SOT-143	23fm	-	5b	Nec
U8	R3111Q181C	Vdet-IC	1.8V±2%, -Reset ODO	SC-82AB	26vdl	VD6	5a	Ric
U8	R3116Q451C	Vdet-IC	4.5V±0.8%, -Reset PPO	SC-82AB	26rp	VD3	5a	Ric
U8	XC6215B392NR	LVR-IC	LDO, 3.9V±2%, 200mA, +CE	SSOT-24	26vn	VR4	5b	Tor
U8	XC6223E18BNR-G	LVR-IC	LDO, 1.85V±20mV, 300mA, +CE, ICP	SSOT-24	26vn	VR4	5a	Tor
U9	R3111Q191C	Vdet-IC	1.9V±2%, -Reset ODO	SC-82AB	26vdl	VD6	5a	Ric
U9	R3116Q461C	Vdet-IC	4.6V±0.8%, -Reset PPO	SC-82AB	26rp	VD3	5a	Ric
U9	XC6215B402NR	LVR-IC	LDO, 4V±2%, 200mA, +CE	SSOT-24	26vn	VR4	5b	Tor
U9	XC6223E19BNR-G	LVR-IC	LDO, 1.95V±20mV, 300mA, +CE, ICP	SSOT-24	26vn	VR4	5a	Tor
U91	3SK243	n-MOSFET-d	DG, CATV-Tuner, 18V, 25mA	SOT-143	26fm	-	5c	Nec
UA	PT7M6314US32D3	Vdet-IC	3.2V±1.5%, 200ms, -Reset PPO, -MR	SOT-143	24vdh	VD5	5g	Pti
UA	R1114Q301D	LVR-IC	LDO, LN, +CE, CL, 3V±2%, 150mA	SOT-143R	26vn	VR4	5a	Ric
UA	XC6127C16JNR	Vdet-IC	1.6V±0.8%, +Reset PPO, -MR, Rt=400ms	SSOT-24	26cr	VD5	5a	Tor
UA	XC6215B412NR	LVR-IC	LDO, 4.1V±2%, 200mA, +CE	SSOT-24	26vn	VR4	5b	Tor
UA	XC6223E20BNR-G	LVR-IC	LDO, 2.05V±1%, 300mA, +CE, ICP	SSOT-24	26vn	VR4	5a	Tor
UAG	UIC8111G-A-AD4-R	Vdet-IC	2.63V, -MR, -Reset PPO	SOT-143	24vdh	VD5	5b	Utc



SMD code	Type	Function	Short description	Case	Pinout	Sch.	St.	Mnf.
UB	2SK1771	n-MOSFET-e	V-MOS, FMVHF, 12.5V, 30mA, 150mW, Gps=23dB	SOT-143R	26fm	-	5b	Tos
UB	PT7M6314US32D4	Vdet-IC	3.2V±1.5%, 1570ms, -Reset PPO, -MR	SOT-143	24vdh	VD5	5g	Pti
UB	R1114Q311D	LVR-IC	LDO, LN, +CE, CL, 3.1V±2%, 150mA	SOT-143R	26vn	VR4	5a	Ric
UB	XC6127C18JNR	Vdet-IC	1.8V±0.8%, +Reset PPO, -MR, Rt=400ms	SSOT-24	26cr	VD5	5a	Tor
UB	XC6215B422NR	LVR-IC	LDO, 4.2V±2%, 200mA, +CE	SSOT-24	26vn	VR4	5b	Tor
UB	XC6223E21BNR-G	LVR-IC	LDO, 2.15V±1%, 300mA, +CE, ICP	SSOT-24	26vn	VR4	5a	Tor
UBG	UIC8111G-B-AD4-R	Vdet-IC	2.93V, -MR, -Reset PPO	SOT-143	24vdh	VD5	5b	Utc
UC	3SK126	n-MOSFET-d	DG, VHF, 15V, Idss>0mA, Up<1V	SOT-143	26fm	-	5b	Tos
UC	R1114Q321D	LVR-IC	LDO, LN, +CE, CL, 3.2V±2%, 150mA	SOT-143R	26vn	VR4	5a	Ric
UC	XC6127C20JNR	Vdet-IC	2.0V±0.8%, +Reset PPO, -MR, Rt=400ms	SSOT-24	26cr	VD5	5a	Tor
UC	XC6215B432NR	LVR-IC	LDO, 4.3V±2%, 200mA, +CE	SSOT-24	26vn	VR4	5b	Tor
UC	XC6223E22BNR-G	LVR-IC	LDO, 2.25V±1%, 300mA, +CE, ICP	SSOT-24	26vn	VR4	5a	Tor
UCG	UIC8111G-C-AD4-R	Vdet-IC	3.08V, -MR, -Reset PPO	SOT-143	24vdh	VD5	5b	Utc
UD	3SK127	n-MOSFET-d	DG, UHF, 15V, Idss>0mA, Up<1V	SOT-143	26fm	-	5b	Tos
UD	R1114Q331D	LVR-IC	LDO, LN, +CE, CL, 3.3V±2%, 150mA	SOT-143R	26vn	VR4	5a	Ric
UD	XC6127C22JNR	Vdet-IC	2.2V±0.8%, +Reset PPO, -MR, Rt=400ms	SSOT-24	26cr	VD5	5a	Tor
UD	XC6215B442NR	LVR-IC	LDO, 4.4V±2%, 200mA, +CE	SSOT-24	26vn	VR4	5b	Tor
UD	XC6223E23BNR-G	LVR-IC	LDO, 2.35V±1%, 300mA, +CE, ICP	SSOT-24	26vn	VR4	5a	Tor
UDG	UIC8111G-D-AD4-R	Vdet-IC	4.0V, -MR, -Reset PPO	SOT-143	24vdh	VD5	5b	Utc
UE	PT7M6314US33D3	Vdet-IC	3.3V±1.5%, 200ms, -Reset PPO, -MR	SOT-143	24vdh	VD5	5g	Pti
UE	R1114Q341D	LVR-IC	LDO, LN, +CE, CL, 3.4V±2%, 150mA	SOT-143R	26vn	VR4	5a	Ric
UE	XC6127C24JNR	Vdet-IC	2.4V±0.8%, +Reset PPO, -MR, Rt=400ms	SSOT-24	26cr	VD5	5a	Tor
UE	XC6215B452NR	LVR-IC	LDO, 4.5V±2%, 200mA, +CE	SSOT-24	26vn	VR4	5b	Tor
UE	XC6223E24BNR-G	LVR-IC	LDO, 2.45V±1%, 300mA, +CE, ICP	SSOT-24	26vn	VR4	5a	Tor
UEG	UIC8111G-E-AD4-R	Vdet-IC	4.38V, -MR, -Reset PPO	SOT-143	24vdh	VD5	5b	Utc
UF	PT7M6314US33D4	Vdet-IC	3.3V±1.5%, 1570ms, -Reset PPO, -MR	SOT-143	24vdh	VD5	5g	Pti
UF	R1114Q351D	LVR-IC	LDO, LN, +CE, CL, 3.5V±2%, 150mA	SOT-143R	26vn	VR4	5a	Ric
UF	XC6127C26JNR	Vdet-IC	2.6V±0.8%, +Reset PPO, -MR, Rt=400ms	SSOT-24	26cr	VD5	5a	Tor
UF	XC6215B462NR	LVR-IC	LDO, 4.6V±2%, 200mA, +CE	SSOT-24	26vn	VR4	5b	Tor
UF	XC6223E25BNR-G	LVR-IC	LDO, 2.55V±1%, 300mA, +CE, ICP	SSOT-24	26vn	VR4	5a	Tor
UG	3SK140	n-MOSFET-d	GaAs, DG, UHF-TV-Tuner	SOT-143	26fm	-	5b	Tos
UG	R1114Q361D	LVR-IC	LDO, LN, +CE, CL, 3.6V±2%, 150mA	SOT-143R	26vn	VR4	5a	Ric
UH	R1114Q371D	LVR-IC	LDO, LN, +CE, CL, 3.7V±2%, 150mA	SOT-143R	26vn	VR4	5a	Ric
UH	XC6127C28JNR	Vdet-IC	2.8V±0.8%, +Reset PPO, -MR, Rt=400ms	SSOT-24	26cr	VD5	5a	Tor
UH	XC6215B472NR	LVR-IC	LDO, 4.7V±2%, 200mA, +CE	SSOT-24	26vn	VR4	5b	Tor
UH	XC6223E26BNR-G	LVR-IC	LDO, 2.65V±1%, 300mA, +CE, ICP	SSOT-24	26vn	VR4	5a	Tor
UI	PT7M6314US34D3	Vdet-IC	3.4V±1.5%, 200ms, -Reset PPO, -MR	SOT-143	24vdh	VD5	5g	Pti
UJ	3SK195	n-MOSFET-d	DG, VHF, 13.5V, Idss>0mA	SOT-143	26fm	-	5b	Tos
UJ	PT7M6314US34D4	Vdet-IC	3.4V±1.5%, 1570ms, -Reset PPO, -MR	SOT-143	24vdh	VD5	5g	Pti
UJ	R1114Q381D	LVR-IC	LDO, LN, +CE, CL, 3.8V±2%, 150mA	SOT-143R	26vn	VR4	5a	Ric
UK	R1114Q391D	LVR-IC	LDO, LN, +CE, CL, 3.9V±2%, 150mA	SOT-143R	26vn	VR4	5a	Ric
UK	XC6127C30JNR	Vdet-IC	3.0V±0.8%, +Reset PPO, -MR, Rt=400ms	SSOT-24	26cr	VD5	5a	Tor
UK	XC6215B482NR	LVR-IC	LDO, 4.8V±2%, 200mA, +CE	SSOT-24	26vn	VR4	5b	Tor
UK	XC6223E27BNR-G	LVR-IC	LDO, 2.75V±1%, 300mA, +CE, ICP	SSOT-24	26vn	VR4	5a	Tor
UL	XC6127C32JNR	Vdet-IC	3.2V±0.8%, +Reset PPO, -MR, Rt=400ms	SSOT-24	26cr	VD5	5a	Tor
UL	XC6215B492NR	LVR-IC	LDO, 4.9V±2%, 200mA, +CE	SSOT-24	26vn	VR4	5b	Tor
UL	XC6223E28BNR-G	LVR-IC	LDO, 2.85V±1%, 300mA, +CE, ICP	SSOT-24	26vn	VR4	5a	Tor
ULN	ELM7540CCB	Vdet-IC	4.0V±2%, +Reset PPO	SC-82AB	26vdl	VD7	5c	Elm
ULN	ELM7540NCB	Vdet-IC	4.0V±2%, +Reset ODO	SC-82AB	26vdl	VD6	5c	Elm
UM	PT7M6314US35D3	Vdet-IC	3.5V±1.5%, 200ms, -Reset PPO, -MR	SOT-143	24vdh	VD5	5g	Pti
UM	XC6127C34JNR	Vdet-IC	3.4V±0.8%, +Reset PPO, -MR, Rt=400ms	SSOT-24	26cr	VD5	5a	Tor
UM	XC6215B502NR	LVR-IC	LDO, 5V±2%, 200mA, +CE	SSOT-24	26vn	VR4	5b	Tor
UM	XC6223E29BNR-G	LVR-IC	LDO, 2.95V±1%, 300mA, +CE, ICP	SSOT-24	26vn	VR4	5a	Tor
UN	3SK240	n-FET-d	GaAs, DG, UHF, 9V, Idss=6..20mA	SOT-143	26fm	-	5b	Tos
UN	3SK274	n-FET	GaAs, DG, UHF, RF-Amp, 9V, Idss=6..20mA, 100mW, 19ms	SOT-143	24f1	-	5b	Tos
UN	PT7M6314US35D4	Vdet-IC	3.5V±1.5%, 1570ms, -Reset PPO, -MR	SOT-143	24vdh	VD5	5g	Pti
UN	XC6127C36JNR	Vdet-IC	3.6V±0.8%, +Reset PPO, -MR, Rt=400ms	SSOT-24	26cr	VD5	5a	Tor
UN	XC6223E30BNR-G	LVR-IC	LDO, 3.05V±1%, 300mA, +CE, ICP	SSOT-24	26vn	VR4	5a	Tor
UO	3SK232	n-MOSFET-d	DG, UHF, 12.5V, Idss<0.1mA	SOT-143	26fm	-	5b	Tos
UF	XC6127C38JNR	Vdet-IC	3.8V±0.8%, +Reset PPO, -MR, Rt=400ms	SSOT-24	26cr	VD5	5a	Tor
UP	XC6223E31BNR-G	LVR-IC	LDO, 3.15V±1%, 300mA, +CE, ICP	SSOT-24	26vn	VR4	5a	Tor
UQ	PT7M6314US36D3	Vdet-IC	3.6V±1.5%, 200ms, -Reset PPO, -MR	SOT-143	24vdh	VD5	5g	Pti
UR	3SK207	n-MOSFET-d	DG, UHF, 13.5V, Idss>0V	SOT-143	26fm	-	5b	Tos
UR	PT7M6314US36D4	Vdet-IC	3.6V±1.5%, 1570ms, -Reset PPO, -MR	SOT-143	24vdh	VD5	5g	Pti
UR	XC6127C40JNR	Vdet-IC	4.0V±0.8%, +Reset PPO, -MR, Rt=400ms	SSOT-24	26cr	VD5	5a	Tor
UR	XC6223E32BNR-G	LVR-IC	LDO, 3.25V±1%, 300mA, +CE, ICP	SSOT-24	26vn	VR4	5a	Tor
US	XC6127C42JNR	Vdet-IC	4.2V±0.8%, +Reset PPO, -MR, Rt=400ms	SSOT-24	26cr	VD5	5a	Tor
US	XC6223E33BNR-G	LVR-IC	LDO, 3.35V±1%, 300mA, +CE, ICP	SSOT-24	26vn	VR4	5a	Tor
UT	3SK225	n-MOSFET-d	DG, FM, UHF, 13.5V, Idss>0V	SOT-143	26fm	-	5b	Tos
UT	XC6127C44JNR	Vdet-IC	4.4V±0.8%, +Reset PPO, -MR, Rt=400ms	SSOT-24	26cr	VD5	5a	Tor



SMD code	Type	Function	Short description	Case	Pinout Sch.	St.	Mnf.
UT	XC6223E34BNR-G	LVR-IC	LDO, 3.45V±1%, 300mA, +CE, ICP	SSOT-24	26vn	VR4	5a Tor
UU	3SK226	n-MOSFET-d	DG, FMVHF, 13.5V, Idss>0V	SOT-143	26fm	-	5b Tos
UU	PT7M6314US37D3	Vdet-IC	3.7V±1.5%, 200ms, -Reset PPO, -MR	SOT-143	24vdh	VD5	5g Pti
UU	XC6127C46JNR	Vdet-IC	4.6V±0.8%, +Reset PPO, -MR, Rt=400ms	SSOT-24	26cr	VD5	5a Tor
UU	XC6223E35BNR-G	LVR-IC	LDO, 3.55V±1%, 300mA, +CE, ICP	SSOT-24	26vn	VR4	5a Tor
UV	PT7M6314US37D4	Vdet-IC	3.7V±1.5%, 1570ms, -Reset PPO, -MR	SOT-143	24vdh	VD5	5g Pti
UV	XC6127C48JNR	Vdet-IC	4.8V±0.8%, +Reset PPO, -MR, Rt=400ms	SSOT-24	26cr	VD5	5a Tor
UV	XC6223E36BNR-G	LVR-IC	LDO, 3.65V±1%, 300mA, +CE, ICP	SSOT-24	26vn	VR4	5a Tor
UX	XC6127C50JNR	Vdet-IC	5.0V±0.8%, +Reset PPO, -MR, Rt=400ms	SSOT-24	26cr	VD5	5a Tor
UX	XC6221B491NR	LVR-IC	LDO, 4.9V±1%, 200mA, +CE, CL	SSOT-24	26vn	VR4	5a Tor
UX	XC6223E37BNR-G	LVR-IC	LDO, 3.75V±1%, 300mA, +CE, ICP	SSOT-24	26vn	VR4	5a Tor
UY	PT7M6314US38D3	Vdet-IC	3.8V±1.5%, 200ms, -Reset PPO, -MR	SOT-143	24vdh	VD5	5g Pti
UY	XC6127C52JNR	Vdet-IC	5.2V±0.8%, +Reset PPO, -MR, Rt=400ms	SSOT-24	26cr	VD5	5a Tor
UY	XC6221B501NR	LVR-IC	LDO, 5.0V±1%, 200mA, +CE, CL	SSOT-24	26vn	VR4	5a Tor
UY	XC6223E38BNR-G	LVR-IC	LDO, 3.85V±1%, 300mA, +CE, ICP	SSOT-24	26vn	VR4	5a Tor
UZ	PT7M6314US38D4	Vdet-IC	3.8V±1.5%, 1570ms, -Reset PPO, -MR	SOT-143	24vdh	VD5	5g Pti
UZ	XC6127C54JNR	Vdet-IC	5.4V±0.8%, +Reset PPO, -MR, Rt=400ms	SSOT-24	26cr	VD5	5a Tor
UZ	XC6223E39BNR-G	LVR-IC	LDO, 3.95V±1%, 300mA, +CE, ICP	SSOT-24	26vn	VR4	5a Tor
V0	R3111Q201C	Vdet-IC	2V±2%, -Reset ODO	SC-82AB	26vdl	VD6	5a Ric
V0	R3116Q471C	Vdet-IC	4.7V±0.8%, -Reset PPO	SC-82AB	26rp	VD3	5a Ric
V0	RP104Q271D5	LVR-IC	LDO, 2.75V±0.8%, 150mA, +CE, CL	SC-82AB	26vn	VR4	5a Ric
V01	3SK179-M	n-MOSFET	DG, VHF TV-Tun/Mix, 20V, 20mA, 200mW, Idsx=7..13mA	SOT-143	26fm	-	5b Pan
V02	3SK179-L	n-MOSFET	DG, VHF TV-Tun/Mix, 20V, 20mA, 200mW, Idsx=11..19mA	SOT-143	26fm	-	5b Pan
V03	3SK179-K	n-MOSFET	DG, VHF TV-Tun/Mix, 20V, 20mA, 200mW, Idsx=17..25mA	SOT-143	26fm	-	5b Pan
V1	BFG25AWX	Si-npn	VHF/UHF-Amp, 8V, 6.5mA, 200mW, B>50..200, 5GHz	SOT-343	24tc	-	5b Phi
V1	R3111Q211C	Vdet-IC	2.1V±2%, -Reset ODO	SC-82AB	26vdl	VD6	5a Ric
V1	R3116Q481C	Vdet-IC	4.8V±0.8%, -Reset PPO	SC-82AB	26rp	VD3	5a Ric
V1	RP104Q211D	LVR-IC	LDO, 2.1V±0.8%, 150mA, +CE, CL	SC-82AB	26vn	VR4	5a Ric
V10	3SK131-10	n-MOSFET-d	DG, VHF-Tuner, 20V, 25mA, 200mW, Idss=7..13mA	SOT-143	26fm	-	5c Nec
V11	3SK131-11	n-MOSFET-d	DG, VHF-Tuner, 20V, 25mA, 200mW, Idss=11..19mA	SOT-143	26fm	-	5c Nec
V11	3SK242	n-MOSFET-d	DG, VHF-Tuner, 20V, 25mA	SOT-343	26fm	-	5c Nec
V11	BFG25A/X	Si-npn	VHF/UHF-Amp, 8V, 6.5mA, 32mW, B>50..200, 5GHz	SOT-143B	24tc	-	5c Phi
V12	3SK131-12	n-MOSFET-d	DG, VHF-Tuner, 20V, 25mA, 200mW, Idss=17..25mA	SOT-143	26fm	-	5c Nec
V12	BFG67/X	Si-npn	VHF/UHF-Amp, 20V, 50mA, 200mW, B=65..150, 7.5GHz	SOT-143	24tc	-	5c Phi
V13	3SK131-13	n-MOSFET-d	DG, VHF-Tuner, 20V, 25mA, 200mW, Idss=20..30mA	SOT-143	26fm	-	5c Nec
V13	BFG197/X	Si-npn	VHF/UHF, 20V, 100mA, 350mW, B=110, 7.5GHz	SOT-143	24tc	-	5c Phi
V14	BFG93A/X	Si-npn	VHF/UHF-Amp, 20V, 35mA, 300mW, B=90, 6GHz	SOT-143	24tc	-	5c Phi
V16	BFG33/X	Si-npn	UHF, 9V, 20mA, 140mW, B=50..90, 12GHz	SOT-143	24tc	-	5b Phi
V2	BFG67W	Si-npn	VHF/UHF-Amp, 20V, 50mA, 200mW, B=65..150, 7.5GHz	SOT-343	24tc	-	5c Phi
V2	R3111Q221C	Vdet-IC	2.2V±2%, -Reset ODO	SC-82AB	26vdl	VD6	5a Ric
V2	R3116Q491C	Vdet-IC	4.9V±0.8%, -Reset PPO	SC-82AB	26rp	VD3	5a Ric
V2	XC6223F12BNR-G	LVR-IC	LDO, 1.25V±20mV, 300mA, +CE, CL, ICP	SSOT-24	26vn	VR4	5a Tor
V21	3SK222	n-MOSFET-d	DG, VHF, 18V, 25mA	SOT-143	26fm	-	5c Nec
V21	3SK246	n-MOSFET-d	DG, FMVHF, 18V, 25mA	SOT-343	26fm	-	5c Nec
V22	3SK223	n-MOSFET-d	DG, CATV, 18V, 25mA	SOT-143	26fm	-	5c Nec
V26	BFG67/XR	Si-npn	VHF/UHF-Amp, 20V, 50mA, 200mW, B=65..150, 7.5GHz	SOT-143R	26tc	-	5c Phi
V3	BFG25AW/XR	Si-npn	VHF/UHF-Amp, 8V, 6.5mA, 200mW, B>50..200, 5GHz	SOT-343R	26tc	-	5b Phi
V3	BFG67	Si-npn	VHF/UHF-Amp, 20V, 50mA, 200mW, B=65..150, 7.5GHz	SOT-143	24tc	-	5c Phi
V3	R3111Q231C	Vdet-IC	2.3V±2%, -Reset ODO	SC-82AB	26vdl	VD6	5a Ric
V3	R3116Q501C	Vdet-IC	5V±0.8%, -Reset PPO	SC-82AB	26rp	VD3	5a Ric
V3	XC6223F13BNR-G	LVR-IC	LDO, 1.35V±20mV, 300mA, +CE, CL, ICP	SSOT-24	26vn	VR4	5a Tor
V32	BF750	Si-npn	UHF, 15V, 35mA, 7000MHz	SOT-143	26tu	-	5c Phi
V34	BF749	Si-npn	UHF, 20V, 25mA, 5000MHz	SOT-143	26tu	-	5c Phi
V35	BFG197/XR	Si-npn	VHF/UHF, 20V, 100mA, 350mW, B=110, 7.5GHz	SOT-143R	26tc	-	5c Phi
V38	BF752	Si-npn	UHF, 15V, 35mA, 7GHz	SOT-143	24t1	-	5c Phi
V4	R3111Q241C	Vdet-IC	2.4V±2%, -Reset ODO	SC-82AB	26vdl	VD6	5a Ric
V4	XC6223F14BNR-G	LVR-IC	LDO, 1.45V±20mV, 300mA, +CE, CL, ICP	SSOT-24	26vn	VR4	5a Tor
V5	BFG197	Si-npn	VHF/UHF, 20V, 100mA, 350mW, B=110, 7.5GHz	SOT-143	24tc	-	5c Phi
V5	R3111Q251C	Vdet-IC	2.5V±2%, -Reset ODO	SC-82AB	26vdl	VD6	5a Ric
V5	XC6223F15BNR-G	LVR-IC	LDO, 1.55V±20mV, 300mA, +CE, CL, ICP	SSOT-24	26vn	VR4	5a Tor
V6	BFG33	Si-npn	UHF, 9V, 20mA, 140mW, B=50..90, 12GHz	SOT-143	24tc	-	5b Phi
V6	BFG67W/X	Si-npn	VHF/UHF-Amp, 20V, 50mA, 200mW, B=65..150, 7.5GHz	SOT-343	24tc	-	5c Phi
V6	R3111Q261C	Vdet-IC	2.6V±2%, -Reset ODO	SC-82AB	26vdl	VD6	5a Ric
V6	XC6223F16BNR-G	LVR-IC	LDO, 1.65V±20mV, 300mA, +CE, CL, ICP	SSOT-24	26vn	VR4	5a Tor
V7	BFG67W/XR	Si-npn	VHF/UHF-Amp, 20V, 50mA, 200mW, B=65..150, 7.5GHz	SOT-343R	26tc	-	5c Phi
V7	R3111Q271C	Vdet-IC	2.7V±2%, -Reset ODO	SC-82AB	26vdl	VD6	5a Ric
V7	XC6223F17BNR-G	LVR-IC	LDO, 1.75V±20mV, 300mA, +CE, CL, ICP	SSOT-24	26vn	VR4	5a Tor
V8	R3111Q281C	Vdet-IC	2.8V±2%, -Reset ODO	SC-82AB	26vdl	VD6	5a Ric
V8	XC6223F18BNR-G	LVR-IC	LDO, 1.85V±20mV, 300mA, +CE, CL, ICP	SSOT-24	26vn	VR4	5a Tor
V9	R3111Q291C	Vdet-IC	2.9V±2%, -Reset ODO	SC-82AB	26vdl	VD6	5a Ric



SMD
code

Type

Function

Short description

Case

Pinout Sch.

St. Mnf.

SMD code	Type	Function	Short description	Case	Pinout Sch.	St.	Mnf.
V9	XC6223F19BNR-G	LVR-IC	LDO, 1.95V±20mV, 300mA, +CE, CL, ICP	SSOT-24	26vn VR4	5a	Tor
VA	R1114Q401D	LVR-IC	LDO, LN, +CE, CL, 4V±2%, 150mA	SOT-143R	26vn VR4	5a	Ric
VĀ	XC6127C16KNR	Vdet-IC	1.6V±0.8%, +Reset PPO, -MR, Rt=800ms	SSOT-24	26cr VD5	5a	Tor
VA	XC6223F20BNR-G	LVR-IC	LDO, 2.05V±1%, 300mA, +CE, CL, ICP	SSOT-24	26vn VR4	5a	Tor
VB	R1114Q281D5	LVR-IC	LDO, LN, +CE, CL, 2.8V±2%, 150mA	SOT-143R	26vn VR4	5a	Ric
VĪ	XC6127C18KNR	Vdet-IC	1.8V±0.8%, +Reset PPO, -MR, Rt=800ms	SSOT-24	26cr VD5	5a	Tor
VB	XC6223F21BNR-G	LVR-IC	LDO, 2.15V±1%, 300mA, +CE, CL, ICP	SSOT-24	26vn VR4	5a	Tor
VC	PT7M6314US39D3	Vdet-IC	3.9V±1.5%, 200ms, -Reset PPO, -MR	SOT-143	24vdh VD5	5g	Pti
VĈ	XC6127C20KNR	Vdet-IC	2.0V±0.8%, +Reset PPO, -MR, Rt=800ms	SSOT-24	26cr VD5	5a	Tor
VC	XC6223F22BNR-G	LVR-IC	LDO, 2.25V±1%, 300mA, +CE, CL, ICP	SSOT-24	26vn VR4	5a	Tor
VD	PT7M6314US39D4	Vdet-IC	3.9V±1.5%, 1570ms, -Reset PPO, -MR	SOT-143	24vdh VD5	5g	Pti
VĎ	XC6127C22KNR	Vdet-IC	2.2V±0.8%, +Reset PPO, -MR, Rt=800ms	SSOT-24	26cr VD5	5a	Tor
VD	XC6223F23BNR-G	LVR-IC	LDO, 2.35V±1%, 300mA, +CE, CL, ICP	SSOT-24	26vn VR4	5a	Tor
VE	XC6127C24KNR	Vdet-IC	2.4V±0.8%, +Reset PPO, -MR, Rt=800ms	SSOT-24	26cr VD5	5a	Tor
VE	XC6223F24BNR-G	LVR-IC	LDO, 2.45V±1%, 300mA, +CE, CL, ICP	SSOT-24	26vn VR4	5a	Tor
VĚ	XC6127C26KNR	Vdet-IC	2.6V±0.8%, +Reset PPO, -MR, Rt=800ms	SSOT-24	26cr VD5	5a	Tor
VF	XC6223F25BNR-G	LVR-IC	LDO, 2.55V±1%, 300mA, +CE, CL, ICP	SSOT-24	26vn VR4	5a	Tor
VG	PT7M6314US40D3	Vdet-IC	4.0V±1.5%, 200ms, -Reset PPO, -MR	SOT-143	24vdh VD5	5g	Pti
VH	PT7M6314US40D4	Vdet-IC	4.0V±1.5%, 1570ms, -Reset PPO, -MR	SOT-143	24vdh VD5	5g	Pti
VĪ	XC6127C28KNR	Vdet-IC	2.8V±0.8%, +Reset PPO, -MR, Rt=800ms	SSOT-24	26cr VD5	5a	Tor
VH	XC6223F26BNR-G	LVR-IC	LDO, 2.65V±1%, 300mA, +CE, CL, ICP	SSOT-24	26vn VR4	5a	Tor
VK	PT7M6314US41D3	Vdet-IC	4.1V±1.5%, 200ms, -Reset PPO, -MR	SOT-143	24vdh VD5	5g	Pti
VĚ	XC6127C30KNR	Vdet-IC	3.0V±0.8%, +Reset PPO, -MR, Rt=800ms	SSOT-24	26cr VD5	5a	Tor
VK	XC6223F27BNR-G	LVR-IC	LDO, 2.75V±1%, 300mA, +CE, CL, ICP	SSOT-24	26vn VR4	5a	Tor
VL	PT7M6314US41D4	Vdet-IC	4.1V±1.5%, 1570ms, -Reset PPO, -MR	SOT-143	24vdh VD5	5g	Pti
VĽ	XC6127C32KNR	Vdet-IC	3.2V±0.8%, +Reset PPO, -MR, Rt=800ms	SSOT-24	26cr VD5	5a	Tor
VL	XC6223F28BNR-G	LVR-IC	LDO, 2.85V±1%, 300mA, +CE, CL, ICP	SSOT-24	26vn VR4	5a	Tor
VLN	ELM7520CCB	Vdet-IC	2.0V±2%, +Reset PPO	SC-82AB	26vdl VD7	5c	Elm
VLN	ELM7520NCB	Vdet-IC	2.0V±2%, +Reset ODO	SC-82AB	26vdl VD6	5c	Elm
VĹ	XC6127C34KNR	Vdet-IC	3.4V±0.8%, +Reset PPO, -MR, Rt=800ms	SSOT-24	26cr VD5	5a	Tor
VM	XC6223F29BNR-G	LVR-IC	LDO, 2.95V±1%, 300mA, +CE, CL, ICP	SSOT-24	26vn VR4	5a	Tor
VŃ	XC6127C36KNR	Vdet-IC	3.6V±0.8%, +Reset PPO, -MR, Rt=800ms	SSOT-24	26cr VD5	5a	Tor
VN	XC6223F30BNR-G	LVR-IC	LDO, 3.05V±1%, 300mA, +CE, CL, ICP	SSOT-24	26vn VR4	5a	Tor
VO	PT7M6314US42D3	Vdet-IC	4.2V±1.5%, 200ms, -Reset PPO, -MR	SOT-143	24vdh VD5	5g	Pti
VP	PT7M6314US42D4	Vdet-IC	4.2V±1.5%, 1570ms, -Reset PPO, -MR	SOT-143	24vdh VD5	5g	Pti
VĚ	XC6127C38KNR	Vdet-IC	3.8V±0.8%, +Reset PPO, -MR, Rt=800ms	SSOT-24	26cr VD5	5a	Tor
VP	XC6223F31BNR-G	LVR-IC	LDO, 3.15V±1%, 300mA, +CE, CL, ICP	SSOT-24	26vn VR4	5a	Tor
VŘ	XC6127C40KNR	Vdet-IC	4.0V±0.8%, +Reset PPO, -MR, Rt=800ms	SSOT-24	26cr VD5	5a	Tor
VR	XC6223F32BNR-G	LVR-IC	LDO, 3.25V±1%, 300mA, +CE, CL, ICP	SSOT-24	26vn VR4	5a	Tor
VS	PT7M6314US43D3	Vdet-IC	4.3V±1.5%, 200ms, -Reset PPO, -MR	SOT-143	24vdh VD5	5g	Pti
VŠ	XC6127C42KNR	Vdet-IC	4.2V±0.8%, +Reset PPO, -MR, Rt=800ms	SSOT-24	26cr VD5	5a	Tor
VS	XC6223F33BNR-G	LVR-IC	LDO, 3.35V±1%, 300mA, +CE, CL, ICP	SSOT-24	26vn VR4	5a	Tor
VT	PT7M6314US43D4	Vdet-IC	4.3V±1.5%, 1570ms, -Reset PPO, -MR	SOT-143	24vdh VD5	5g	Pti
VĚ	XC6127C44KNR	Vdet-IC	4.4V±0.8%, +Reset PPO, -MR, Rt=800ms	SSOT-24	26cr VD5	5a	Tor
VT	XC6223F34BNR-G	LVR-IC	LDO, 3.45V±1%, 300mA, +CE, CL, ICP	SSOT-24	26vn VR4	5a	Tor
VŮ	XC6127C46KNR	Vdet-IC	4.6V±0.8%, +Reset PPO, -MR, Rt=800ms	SSOT-24	26cr VD5	5a	Tor
VU	XC6223F35BNR-G	LVR-IC	LDO, 3.55V±1%, 300mA, +CE, CL, ICP	SSOT-24	26vn VR4	5a	Tor
VŃ	XC6127C48KNR	Vdet-IC	4.8V±0.8%, +Reset PPO, -MR, Rt=800ms	SSOT-24	26cr VD5	5a	Tor
VV	XC6223F36BNR-G	LVR-IC	LDO, 3.65V±1%, 300mA, +CE, CL, ICP	SSOT-24	26vn VR4	5a	Tor
VW	PT7M6314US44D3	Vdet-IC	4.4V±1.5%, 200ms, -Reset PPO, -MR	SOT-143	24vdh VD5	5g	Pti
VX	PT7M6314US44D4	Vdet-IC	4.4V±1.5%, 1570ms, -Reset PPO, -MR	SOT-143	24vdh VD5	5g	Pti
VX	XC6127C50KNR	Vdet-IC	5.0V±0.8%, +Reset PPO, -MR, Rt=800ms	SSOT-24	26cr VD5	5a	Tor
VX	XC6223F37BNR-G	LVR-IC	LDO, 3.75V±1%, 300mA, +CE, CL, ICP	SSOT-24	26vn VR4	5a	Tor
VX3	S593TRW	MMIC	UHF, 8V, 30mA, 200mW, Idss=50..500µA	SOT-343R	26fm A3	5c	Vs
VY	XC6127C52KNR	Vdet-IC	5.2V±0.8%, +Reset PPO, -MR, Rt=800ms	SSOT-24	26cr VD5	5a	Tor
VY	XC6223F38BNR-G	LVR-IC	LDO, 3.85V±1%, 300mA, +CE, CL, ICP	SSOT-24	26vn VR4	5a	Tor
VZ	XC6127C54KNR	Vdet-IC	5.4V±0.8%, +Reset PPO, -MR, Rt=800ms	SSOT-24	26cr VD5	5a	Tor
VZ	XC6223F39BNR-G	LVR-IC	LDO, 3.95V±1%, 300mA, +CE, CL, ICP	SSOT-24	26vn VR4	5a	Tor
W0	R3111Q301C	Vdet-IC	3V±2%, -Reset ODO	SC-82AB	26vdl VD6	5a	Ric
W0	RP103Q221B	LVR-IC	LDO, 2.2V±1%, 150mA, +CE	SC-82AB	26vn VR4	5a	Ric
W03	S503TRW	MMIC	DG, UHF, 8V, 30mA, 200mW, Idss=9..18mA	SOT-343R	26fm A3	5c	Vs
W04	S504TRW	MMIC	UHF, 8V, 30mA, 200mW, Idss=7..14mA	SOT-343R	26fm A3	5c	Vs
W05	S505TRW	MMIC	UHF, 8V, 30mA, 200mW, Idss=8..16mA	SOT-343R	26fm A3	5c	Vs
W0F	TSDF1205RW	Si-npn	UHF-VHF, LN, 9V, 12mA, 40mW, B=50..250, 12GHz	SOT-343R	26tu -	5b	Vs
W1	R3111Q311C	Vdet-IC	3.1V±2%, -Reset ODO	SC-82AB	26vdl VD6	5a	Ric
W1	RP103Q161B	LVR-IC	LDO, 1.6V±1%, 150mA, +CE	SC-82AB	26vn VR4	5a	Ric
W13	S913TRW	MMIC	UHF, 12V, 30mA, 200mW, Idss=50..500µA	SOT-343R	26fm A3	5c	Vs
W18	BFP181TRW	Si-npn	UHF, 20V, 20mA, 175mW, B=50..200, 8GHz	SOT-343R	26tu -	5b	Vs
W18	BFP181TW	Si-npn	UHF, 20V, 20mA, 175mW, B=50..200, 8GHz	SOT-343	24tc -	5b	Sil
W19	BFP193TRW	Si-npn	UHF, 20V, 80mA, 580mW, B=50..200, 8GHz	SOT-343	26tu -	5b	Sil



SMD code	Type	Function	Short description	Case	Pinout	Sch.	St.	Mnf.
W2	R3111Q321C	Vdet-IC	3.2V±2%, -Reset ODO	SC-82AB	26vdl	VD6	5a	Ric
W2	RP103Q141B	LVR-IC	LDO, 1.4V±1%, 150mA, +CE	SC-82AB	26vn	VR4	5a	Ric
W2	TSDF1220RW	Si-npn	UHF-VHF, LN, 9V, 40mA, 200mW, B=50..150, 12GHz	SOT-343R	26tu	-	5b	Vs
W22	S822TRW	Si-npn	UHF, LN, 12V, 8mA, 30mW, B=40..150, 5.2GHz	SOT-343R	26tu	-	5b	Vs
W28	BFP280TRW	Si-npn	UHF, 10V, 10mA, 80mW, B=30..200, 7GHz	SOT-343	26tu	-	5b	Vs
W28	BFP280TW	Si-npn	VHF/UHF, LN, 15V, 10mA, 80mW, B=50..150, 5GHz	SOT-343	24tc	-	5b	Vs
W3	R3111Q331C	Vdet-IC	3.3V±2%, -Reset ODO	SC-82AB	26vdl	VD6	5a	Ric
W3	RP103Q171B	LVR-IC	LDO, 1.7V±1%, 150mA, +CE	SC-82AB	26vn	VR4	5a	Ric
W4	R3111Q341C	Vdet-IC	3.4V±2%, -Reset ODO	SC-82AB	26vdl	VD6	5a	Ric
W4	RP103Q241B	LVR-IC	LDO, 2.4V±1%, 150mA, +CE	SC-82AB	26vn	VR4	5a	Ric
W5	R3111Q351C	Vdet-IC	3.5V±2%, -Reset ODO	SC-82AB	26vdl	VD6	5a	Ric
W59	S595TRW	MMIC	UHF, 8V, 20mA, 200µA, Idss=50..500µA	SOT-343R	26fm	A3	5c	Vs
W5L	S592TRW	MMIC	UHF, 8V, 20mA, 160mW, Idss=50..500µA	SOT-343R	26fm	A3	5c	Vs
W6	R3111Q361C	Vdet-IC	3.6V±2%, -Reset ODO	SC-82AB	26vdl	VD6	5a	Ric
W7	R3111Q371C	Vdet-IC	3.7V±2%, -Reset ODO	SC-82AB	26vdl	VD6	5a	Ric
W8	DWA010	Si-diode	Dual, Sw, U-sp, 85V, 100mA, Vf<1.2V(100mA), 4ns	CP4	26dv	-	5b	San
W8	R3111Q381C	Vdet-IC	3.8V±2%, -Reset ODO	SC-82AB	26vdl	VD6	5a	Ric
W82	BFP182TRW	Si-npn	UHF, 20V, 35mA, 250mW, B=50..200, >8GHz	SOT-343	26tu	-	5b	Vs
W82	BFP182TW	Si-npn	UHF, 20V, 35mA, 250mW, B=50..200, >8GHz	SOT-343	24tc	-	5b	Sil
W83	BFP183T	Si-npn	UHF, 20V, 65mA, 450mW, B=50..200, 8GHz	SOT-143	24tc	-	5b	Vs
W83	BFP183TRW	Si-npn	UHF, 20V, 65mA, 450mW, B=50..200, 8GHz	SOT-343	26tu	-	5b	Vs
W83	BFP183TW	Si-npn	UHF, 20V, 65mA, 450mW, B=50..200, 8GHz	SOT-343	24tc	-	5b	Sil
W9	R3111Q391C	Vdet-IC	3.9V±2%, -Reset ODO	SC-82AB	26vdl	VD6	5a	Ric
W91	BFP193TW	Si-npn	UHF, 20V, 80mA, 580mW, B=50..200, 8GHz	SOT-343	24tc	-	5b	Sil
W93	S593TRW	MMIC	UHF, 8V, 30mA, 200mW, Idss=50..500µA	SOT-343R	26fm	A3	5c	Vs
W94	S594TRW	MMIC	UHF, 8V, 20mA, 160mW, Idss=50..500µA	SOT-343R	26fm	A3	5c	Vs
W99	S949TRW	MMIC	UHF, 12V, 30mA, 200mW, Idss=50..500µA	SOT-343R	26fm	A3	5c	Vs
WA	PT7M6314US45D3	Vdet-IC	4.5V±1.5%, 200ms, -Reset PPO, -MR	SOT-143	24vdh	VD5	5g	Pti
WA	R3112Q501A	Vdet-IC	5V±2%, -Reset PPO	SC-82AB	26rp	VD3	5a	Ric
WA	R3132Q23EA2	Vdet-IC	2.32V, MR, -Reset PPO	SOT-143	24vdh	VD5	5a	Ric
WB	PT7M6314US45D4	Vdet-IC	4.5V±1.5%, 1570ms, -Reset PPO, -MR	SOT-143	24vdh	VD5	5g	Pti
WB	R3132Q26EA3	Vdet-IC	2.63V, MR, -Reset PPO	SOT-143	24vdh	VD5	5a	Ric
WC	R3132Q29EA3	Vdet-IC	2.93V, MR, -Reset PPO	SOT-143	24vdh	VD5	5a	Ric
WD	R3132Q30EA8	Vdet-IC	3.06V, MR, -Reset PPO	SOT-143	24vdh	VD5	5a	Ric
WE	PT7M6314US46D3	Vdet-IC	4.6V±1.5%, 200ms, -Reset PPO, -MR	SOT-143	24vdh	VD5	5g	Pti
WE	R3132Q43EA8	Vdet-IC	4.38V, MR, -Reset PPO	SOT-143	24vdh	VD5	5a	Ric
WF	PT7M6314US46D4	Vdet-IC	4.6V±1.5%, 1570ms, -Reset PPO, -MR	SOT-143	24vdh	VD5	5g	Pti
WF	R3132Q46EA3	Vdet-IC	4.63V, MR, -Reset PPO	SOT-143	24vdh	VD5	5a	Ric
WF0	TSDF1205W	Si-npn	UHF-VHF, LN, 9V, 12mA, 40mW, B=50..250, 12GHz	SOT-343	24tc	-	5b	Vs
WF2	TSDF1220W	Si-npn	UHF-VHF, LN, 9V, 40mA, 200mW, B=50..150, 12GHz	SOT-343	24tc	-	5b	Vs
WFE	BFP93AW	Si-npn	VHF/UHF, 20V, 50mA, 200mW, B=50..200, >6GHz	SOT-343	24tc	-	5b	Vs
WI	PT7M6314US47D3	Vdet-IC	4.7V±1.5%, 200ms, -Reset PPO, -MR	SOT-143	24vdh	VD5	5g	Pti
WI-	3SK197	n-MOSFET-d	DG, VHF-TV-Tun, 12V, 35mA, Idss=10mA, Up<1V	SOT-143	26fm	-	5c	Ren
WJ	PT7M6314US47D4	Vdet-IC	4.7V±1.5%, 1570ms, -Reset PPO, -MR	SOT-143	24vdh	VD5	5g	Pti
WL	R3112Q501C	Vdet-IC	5V±2%, -Reset ODO	SC-82AB	26rp	VD1	5a	Ric
WL	R3132Q23EA2	Vdet-IC	2.32V, MR, +Reset PPO	SOT-143	24vdh	VD5	5a	Ric
WLN	ELM7521CCB	Vdet-IC	2.1V±2%, +Reset PPO	SC-82AB	26vdl	VD7	5c	Elm
WLN	ELM7521NCB	Vdet-IC	2.1V±2%, +Reset ODO	SC-82AB	26vdl	VD6	5c	Elm
WM	PT7M6314US48D3	Vdet-IC	4.8V±1.5%, 200ms, -Reset PPO, -MR	SOT-143	24vdh	VD5	5g	Pti
WM	R3133Q26EA3	Vdet-IC	2.63V, MR, +Reset PPO	SOT-143	24vdh	VD5	5a	Ric
WMO	BF998RW	n-MOSFET-d*	DG, 12V, 30mA, 200mW, Nf=1dB, Idss=20mA, Gf>24mΩ	SOT-343R	24fm	-	5b	Sil
WN	PT7M6314US48D4	Vdet-IC	4.8V±1.5%, 1570ms, -Reset PPO, -MR	SOT-143	24vdh	VD5	5g	Pti
WN	R3133Q29EA3	Vdet-IC	2.93V, MR, +Reset PPO	SOT-143	24vdh	VD5	5a	Ric
WQ	PT7M6314US49D3	Vdet-IC	4.9V±1.5%, 200ms, -Reset PPO, -MR	SOT-143	24vdh	VD5	5g	Pti
WQ	R3133Q43EA8	Vdet-IC	4.38V, MR, +Reset PPO	SOT-143	24vdh	VD5	5a	Ric
WR	PT7M6314US49D4	Vdet-IC	4.9V±1.5%, 1570ms, -Reset PPO, -MR	SOT-143	24vdh	VD5	5g	Pti
WR	R3133Q46EA3	Vdet-IC	4.63V, MR, +Reset PPO	SOT-143	24vdh	VD5	5a	Ric
WS2	S822TRW	Si-npn	UHF, LN, 12V, 8mA, 30mW, B=40..150, 5.2GHz	SOT-343	24tc	-	5b	Vs
WSE	BFP280TRW	Si-npn	VHF/UHF, LN, 15V, 10mA, 80mW, B=50..150, 5GHz	SOT-343	26tu	-	5b	Vs
WU	PT7M6314US50D3	Vdet-IC	5.0V±1.5%, 200ms, -Reset PPO, -MR	SOT-143	24vdh	VD5	5g	Pti
WV	PT7M6314US50D4	Vdet-IC	5.0V±1.5%, 1570ms, -Reset PPO, -MR	SOT-143	24vdh	VD5	5g	Pti
WX4	S594TRW	MMIC	UHF, 8V, 20mA, 160mW, Idss=50..500µA	SOT-343R	26fm	A3	5c	Vs
WX5	S595TRW	MMIC	UHF, 8V, 20mA, 200µA, Idss=50..500µA	SOT-343R	26fm	A3	5c	Vs
WX6	S504TXRW	MMIC	UHF, 8V, 30mA, 200mW, Idss=7..14mA	SOT-343R	26fm	A3	5c	Vs
WX7	S505TXRW	MMIC	UHF, 8V, 30mA, 200mW, Idss=8..16mA	SOT-343R	26fm	A3	5c	Vs
WX8	S503TXRW	MMIC	DG, UHF, 8V, 30mA, 200mW, Idss=9..18mA	SOT-343R	26fm	A3	5c	Vs
WY-	2SC5820	Si-npn	HF, LN, 12V, 35mA, 100mW, 20GHz, B=70..150	OMPAK-4	26tl	-	5b	Ren
X0	R3111Q401C	Vdet-IC	4V±2%, -Reset ODO	SC-82AB	26vdl	VD6	5a	Ric
X0	RP103Q221D	LVR-IC	LDO, 2.2V±1%, 150mA, +CE, CL	SC-82AB	26vn	VR4	5a	Ric
X03	S503TX	MMIC	DG, UHF, 8V, 30mA, 200mW, Idss=9..18mA	SOT-143	24fd	A3	5c	Vs



SMD code	Type	Function	Short description	Case	Pinout	Sch.	St.	Mnf.
X04	S504TX	MMIC	UHF, 8V, 30mA, 200mW, Idss=7..14mA	SOT-143	24fd	A3	5c	Vs
X05	S505TX	MMIC	UHF, 8V, 30mA, 200mW, Idss=8..16mA	SOT-143	24fd	A3	5c	Vs
X1	R3111Q441C	Vdet-IC	4.1V±2%, -Reset ODO	SC-82AB	26vdl	VD6	5a	Ric
X1	RP103Q161D	LVR-IC	LDO, 1.6V±1%, 150mA, +CE, CL	SC-82AB	26vn	VR4	5a	Ric
X2	R3111Q421C	Vdet-IC	4.2V±2%, -Reset ODO	SC-82AB	26vdl	VD6	5a	Ric
X2	RP103Q141D	LVR-IC	LDO, 1.4V±1%, 150mA, +CE, CL	SC-82AB	26vn	VR4	5a	Ric
X2	XC6223G12BNR-G	LVR-IC	LDO, 1.25V±20mV, 300mA, +CE, PDR, ICP	SSOT-24	26vn	VR4	5a	Tor
X3	R3111Q431C	Vdet-IC	4.3V±2%, -Reset ODO	SC-82AB	26vdl	VD6	5a	Ric
X3	RP103Q171D	LVR-IC	LDO, 1.7V±1%, 150mA, +CE, CL	SC-82AB	26vn	VR4	5a	Ric
X3	XC6223G13BNR-G	LVR-IC	LDO, 1.35V±20mV, 300mA, +CE, PDR, ICP	SSOT-24	26vn	VR4	5a	Tor
X3R	S593TXR	MMIC	UHF, 8V, 30mA, 200mW, Idss=50..500µA	SOT-143R	26fm	A3	5c	Vs
X4	R3111Q441C	Vdet-IC	4.4V±2%, -Reset ODO	SC-82AB	26vdl	VD6	5a	Ric
X4	RP103Q241D	LVR-IC	LDO, 2.4V±1%, 150mA, +CE, CL	SC-82AB	26vn	VR4	5a	Ric
X4	XC6223G14BNR-G	LVR-IC	LDO, 1.45V±20mV, 300mA, +CE, PDR, ICP	SSOT-24	26vn	VR4	5a	Tor
X4R	S594TR	MMIC	UHF, 8V, 20mA, 160mW, Idss=50..500µA	SOT-143R	26fm	A3	5c	Vs
X5	R3111Q451C	Vdet-IC	4.5V±2%, -Reset ODO	SC-82AB	26vdl	VD6	5a	Ric
X5	XC6223G15BNR-G	LVR-IC	LDO, 1.55V±20mV, 300mA, +CE, PDR, ICP	SSOT-24	26vn	VR4	5a	Tor
X5R	S595TR	MMIC	UHF, 8V, 20mA, 200µA, Idss=50..500µA	SOT-143R	26fm	A3	5c	Vs
X6	R3111Q461C	Vdet-IC	4.6V±2%, -Reset ODO	SC-82AB	26vdl	VD6	5a	Ric
X6	XC6223G16BNR-G	LVR-IC	LDO, 1.65V±20mV, 300mA, +CE, PDR, ICP	SSOT-24	26vn	VR4	5a	Tor
X6R	S504TXR	MMIC	UHF, 8V, 30mA, 200mW, Idss=7..14mA	SOT-143R	26fm	A3	5c	Vs
X7	R3111Q471C	Vdet-IC	4.7V±2%, -Reset ODO	SC-82AB	26vdl	VD6	5a	Ric
X7	XC6223G17BNR-G	LVR-IC	LDO, 1.75V±20mV, 300mA, +CE, PDR, ICP	SSOT-24	26vn	VR4	5a	Tor
X7R	S505TXR	MMIC	UHF, 8V, 30mA, 200mW, Idss=8..16mA	SOT-143R	26fm	A3	5c	Vs
X8	R3111Q481C	Vdet-IC	4.8V±2%, -Reset ODO	SC-82AB	26vdl	VD6	5a	Ric
X8	XC6223G18BNR-G	LVR-IC	LDO, 1.85V±20mV, 300mA, +CE, PDR, ICP	SSOT-24	26vn	VR4	5a	Tor
X8R	S503TXR	MMIC	DG, UHF, 8V, 30mA, 200mW, Idss=9..18mA	SOT-143R	26fm	A3	5c	Vs
X9	R3111Q491C	Vdet-IC	4.9V±2%, -Reset ODO	SC-82AB	26vdl	VD6	5a	Ric
X9	XC6223G19BNR-G	LVR-IC	LDO, 1.95V±20mV, 300mA, +CE, PDR, ICP	SSOT-24	26vn	VR4	5a	Tor
X93	S593TX	MMIC	UHF, 8V, 30mA, 200mW, Idss=50..500µA	SOT-143	24fd	A3	5c	Vs
X94	S594T	MMIC	UHF, 8V, 20mA, 160mW, Idss=50..500µA	SOT-143	24fd	A3	5c	Vs
X95	S595T	MMIC	UHF, 8V, 20mA, 200µA, Idss=50..500µA	SOT-143	24fd	A3	5c	Vs
XA	R3132Q23EC2	Vdet-IC	2.32V, MR, -Reset ODO	SOT-143	24vdh	VD4	5a	Ric
XA	XC6223G20BNR-G	LVR-IC	LDO, 2.05V±1%, 300mA, +CE, PDR, ICP	SSOT-24	26vn	VR4	5a	Tor
XB	R3132Q26EC3	Vdet-IC	2.63V, MR, -Reset ODO	SOT-143	24vdh	VD4	5a	Ric
XB	XC6223G21BNR-G	LVR-IC	LDO, 2.15V±1%, 300mA, +CE, PDR, ICP	SSOT-24	26vn	VR4	5a	Tor
XC	R3132Q29EC3	Vdet-IC	2.93V, MR, -Reset ODO	SOT-143	24vdh	VD4	5a	Ric
XC	XC6223G22BNR-G	LVR-IC	LDO, 2.25V±1%, 300mA, +CE, PDR, ICP	SSOT-24	26vn	VR4	5a	Tor
XD	R3132Q30EC8	Vdet-IC	3.08V, MR, -Reset ODO	SOT-143	24vdh	VD4	5a	Ric
XD	XC6223G23BNR-G	LVR-IC	LDO, 2.35V±1%, 300mA, +CE, PDR, ICP	SSOT-24	26vn	VR4	5a	Tor
XE	R3132Q43EC8	Vdet-IC	4.38V, MR, -Reset ODO	SOT-143	24vdh	VD4	5a	Ric
XE	XC6223G24BNR-G	LVR-IC	LDO, 2.45V±1%, 300mA, +CE, PDR, ICP	SSOT-24	26vn	VR4	5a	Tor
XF	R3132Q46EC3	Vdet-IC	4.63V, MR, -Reset ODO	SOT-143	24vdh	VD4	5a	Ric
XF	XC6223G25BNR-G	LVR-IC	LDO, 2.55V±1%, 300mA, +CE, PDR, ICP	SSOT-24	26vn	VR4	5a	Tor
XH	XC6223G26BNR-G	LVR-IC	LDO, 2.65V±1%, 300mA, +CE, PDR, ICP	SSOT-24	26vn	VR4	5a	Tor
XI-	3SK196	n-MOSFET-d	DG, VHF/UHF-Tuner, 12V, 35mA, Idss=1mA, Up<1.5V	SOT-143	26fm	-	5c	Ren
XK	XC6223G27BNR-G	LVR-IC	LDO, 2.75V±1%, 300mA, +CE, PDR, ICP	SSOT-24	26vn	VR4	5a	Tor
XL	R3133Q23EC2	Vdet-IC	2.32V, MR, +Reset ODO	SOT-143	24vdh	VD4	5a	Ric
XL	XC6223G28BNR-G	LVR-IC	LDO, 2.85V±1%, 300mA, +CE, PDR, ICP	SSOT-24	26vn	VR4	5a	Tor
XLN	ELM7555CCB	Vdet-IC	5.5V±2%, +Reset PPO	SC-82AB	26vdl	VD7	5c	Elm
XLN	ELM7555NCB	Vdet-IC	5.5V±2%, +Reset ODO	SC-82AB	26vdl	VD6	5c	Elm
XM	R3133Q26EC3	Vdet-IC	2.63V, MR, +Reset ODO	SOT-143	24vdh	VD4	5a	Ric
XM	XC6223G29BNR-G	LVR-IC	LDO, 2.95V±1%, 300mA, +CE, PDR, ICP	SSOT-24	26vn	VR4	5a	Tor
XN	R3133Q29EC3	Vdet-IC	2.93V, MR, +Reset ODO	SOT-143	24vdh	VD4	5a	Ric
XN	XC6223G30BNR-G	LVR-IC	LDO, 3.05V±1%, 300mA, +CE, PDR, ICP	SSOT-24	26vn	VR4	5a	Tor
XN-	2SC4592	Si-npn	UHF/VHF WB-amp, 15V, 50mA, 150mW, 9.5GHz, B=40..250	SOT-143	26tu	-	5b	Ren
XP	R3133Q30EC8	Vdet-IC	3.08V, MR, +Reset ODO	SOT-143	24vdh	VD4	5a	Ric
XP	XC6223G31BNR-G	LVR-IC	LDO, 3.15V±1%, 300mA, +CE, PDR, ICP	SSOT-24	26vn	VR4	5a	Tor
XP-	2SC5594	Si-npn	HF, LN, 12V, 35mA, 100mW, 24GHz, B=60..140	COMPAK-4	26t1	-	5b	Ren
XQ	R3133Q43EC8	Vdet-IC	4.38V, MR, +Reset ODO	SOT-143	24vdh	VD4	5a	Ric
XR	R3133Q46EC3	Vdet-IC	4.63V, MR, +Reset ODO	SOT-143	24vdh	VD4	5a	Ric
XR	XC6223G32BNR-G	LVR-IC	LDO, 3.25V±1%, 300mA, +CE, PDR, ICP	SSOT-24	26vn	VR4	5a	Tor
XS	XC6223G33BNR-G	LVR-IC	LDO, 3.35V±1%, 300mA, +CE, PDR, ICP	SSOT-24	26vn	VR4	5a	Tor
XS-	3SK229	n-FET-d	GaAs, DG, UHF-TV-Tuner, 12V, 80mA, Idss=15..40mA, Up<3.5V	SOT-143	26fm	-	5c	Ren
XT	XC6223G34BNR-G	LVR-IC	LDO, 3.45V±1%, 300mA, +CE, PDR, ICP	SSOT-24	26vn	VR4	5a	Tor
XU	XC6223G35BNR-G	LVR-IC	LDO, 3.55V±1%, 300mA, +CE, PDR, ICP	SSOT-24	26vn	VR4	5a	Tor
XV	XC6223G36BNR-G	LVR-IC	LDO, 3.65V±1%, 300mA, +CE, PDR, ICP	SSOT-24	26vn	VR4	5a	Tor
XV-	3SK309	n-FET-d	GaAs, DG, UHF, 6V, 18mA, Idss=25..60mA, Up=0.2..1.5V	SOT-143	26fm	-	5c	Ren
XW-	3SK233	n-MOSFET-d	DG, UHF-TV-Tuner, 12V, 35mA, Idss=0..2mA, Up<0.8V	SOT-143	26fm	-	5c	Ren
XX	XC6223G37BNR-G	LVR-IC	LDO, 3.75V±1%, 300mA, +CE, PDR, ICP	SSOT-24	26vn	VR4	5a	Tor



Note: ELM75xxCCB series LN- lot number L=0...9 N=A to Z(I, O, X excepted); ELM75xxNCB series LN- lot number L=A to Z(I, O, X excepted) N=0...9

SMD code	Type	Function	Short description	Case	Pinout Sch.	St.	Mnf.
XX-	3SK234	n-MOSFET-d	DG, VHF-TV-Tuner, 12V, 35mA, Idss=0.1mA, U=0.1V	SOT-143	26fm -	5c	Ren
XY	XC6223G38BNR-G	LVR-IC	LDO, 3.85V±1%, 300mA, +CE, PDR, ICP	SSOT-24	26vn VR4	5a	Tor
XZ	XC6223G39BNR-G	LVR-IC	LDO, 3.95V±1%, 300mA, +CE, PDR, ICP	SSOT-24	26vn VR4	5a	Tor
Y0	R3111Q501C	Vdet-IC	5V±2%, -Reset ODO	SC-82AB	26vdl VD6	5a	Ric
Y1	R3111Q511C	Vdet-IC	5.1V±2%, -Reset ODO	SC-82AB	26vdl VD6	5a	Ric
Y2	R3111Q521C	Vdet-IC	5.2V±2%, -Reset ODO	SC-82AB	26vdl VD6	5a	Ric
Y2	XC6223H12BNR-G	LVR-IC	LDO, 1.25V±20mV, 300mA, +CE, PDR, CL, ICP	SSOT-24	26vn VR4	5a	Tor
Y3	R3111Q531C	Vdet-IC	5.3V±2%, -Reset ODO	SC-82AB	26vdl VD6	5a	Ric
Y3	XC6223H13BNR-G	LVR-IC	LDO, 1.35V±20mV, 300mA, +CE, PDR, CL, ICP	SSOT-24	26vn VR4	5a	Tor
Y4	R3111Q541C	Vdet-IC	5.4V±2%, -Reset ODO	SC-82AB	26vdl VD6	5a	Ric
Y4	XC6223H14BNR-G	LVR-IC	LDO, 1.45V±20mV, 300mA, +CE, PDR, CL, ICP	SSOT-24	26vn VR4	5a	Tor
Y5	R3111Q551C	Vdet-IC	5.5V±2%, -Reset ODO	SC-82AB	26vdl VD6	5a	Ric
Y5	XC6223H15BNR-G	LVR-IC	LDO, 1.55V±20mV, 300mA, +CE, PDR, CL, ICP	SSOT-24	26vn VR4	5a	Tor
Y6	R3111Q561C	Vdet-IC	5.6V±2%, -Reset ODO	SC-82AB	26vdl VD6	5a	Ric
Y6	XC6223H16BNR-G	LVR-IC	LDO, 1.65V±20mV, 300mA, +CE, PDR, CL, ICP	SSOT-24	26vn VR4	5a	Tor
Y7	R3111Q571C	Vdet-IC	5.7V±2%, -Reset ODO	SC-82AB	26vdl VD6	5a	Ric
Y7	XC6223H17BNR-G	LVR-IC	LDO, 1.75V±20mV, 300mA, +CE, PDR, CL, ICP	SSOT-24	26vn VR4	5a	Tor
Y8	R3111Q581C	Vdet-IC	5.8V±2%, -Reset ODO	SC-82AB	26vdl VD6	5a	Ric
Y8	XC6223H18BNR-G	LVR-IC	LDO, 1.85V±20mV, 300mA, +CE, PDR, CL, ICP	SSOT-24	26vn VR4	5a	Tor
Y9	R3111Q591C	Vdet-IC	5.9V±2%, -Reset ODO	SC-82AB	26vdl VD6	5a	Ric
Y9	XC6223H19BNR-G	LVR-IC	LDO, 1.95V±20mV, 300mA, +CE, PDR, CL, ICP	SSOT-24	26vn VR4	5a	Tor
YA	BU4209F	Vdet-IC	0.9V±1%, +Reset ODO	SOP-4	26vdf VD1	5c	Rhm
YA	XC6223H20BNR-G	LVR-IC	LDO, 2.05V±1%, 300mA, +CE, PDR, CL, ICP	SSOT-24	26vn VR4	5a	Tor
YA-	2SC4791	Si-npn	VHF/UHF, 15V, 20mA, 150mW, B=50.250, 10GHz	MPAK-4	26tu -	5b	Ren
YB	BU4210F	Vdet-IC	1V±1%, +Reset ODO	SOP-4	26vdf VD1	5c	Rhm
YB	XC6223H21BNR-G	LVR-IC	LDO, 2.15V±1%, 300mA, +CE, PDR, CL, ICP	SSOT-24	26vn VR4	5a	Tor
YC	BU4211F	Vdet-IC	1.1V±1%, +Reset ODO	SOP-4	26vdf VD1	5c	Rhm
YC	XC6223H22BNR-G	LVR-IC	LDO, 2.25V±1%, 300mA, +CE, PDR, CL, ICP	SSOT-24	26vn VR4	5a	Tor
YD	BU4212F	Vdet-IC	1.2V±1%, +Reset ODO	SOP-4	26vdf VD1	5c	Rhm
YD	XC6223H23BNR-G	LVR-IC	LDO, 2.35V±1%, 300mA, +CE, PDR, CL, ICP	SSOT-24	26vn VR4	5a	Tor
YD-	2SC4926	Si-npn	VHF/UHF, 15V, 50mA, 11GHz	SOT-143	26tu -	5c	Ren
YD-	2SC4995	Si-npn	VHF/UHF, 15V, 50mA, 100mW, B=50.250, 11GHz	CMPAK-4	26tu -	5b	Ren
YE	BU4213F	Vdet-IC	1.3V±1%, +Reset ODO	SOP-4	26vdf VD1	5c	Rhm
YE	XC6223H24BNR-G	LVR-IC	LDO, 2.45V±1%, 300mA, +CE, PDR, CL, ICP	SSOT-24	26vn VR4	5a	Tor
YF	BU4214F	Vdet-IC	1.4V±1%, +Reset ODO	SOP-4	26vdf VD1	5c	Rhm
YF	XC6223H25BNR-G	LVR-IC	LDO, 2.55V±1%, 300mA, +CE, PDR, CL, ICP	SSOT-24	26vn VR4	5a	Tor
YG	BU4215F	Vdet-IC	1.5V±1%, +Reset ODO	SOP-4	26vdf VD1	5c	Rhm
YH	BU4216F	Vdet-IC	1.6V±1%, +Reset ODO	SOP-4	26vdf VD1	5c	Rhm
YH	XC6223H26BNR-G	LVR-IC	LDO, 2.65V±1%, 300mA, +CE, PDR, CL, ICP	SSOT-24	26vn VR4	5a	Tor
YJ	BU4217F	Vdet-IC	1.7V±1%, +Reset ODO	SOP-4	26vdf VD1	5c	Rhm
YJ-	2SC4900	Si-npn	VHF/UHF, 15V, 20mA, 100mW, 9GHz, B=50.250	SOT-143	26tu -	5c	Ren
YK	BU4218F	Vdet-IC	1.8V±1%, +Reset ODO	SOP-4	26vdf VD1	5c	Rhm
YK	XC6223H27BNR-G	LVR-IC	LDO, 2.75V±1%, 300mA, +CE, PDR, CL, ICP	SSOT-24	26vn VR4	5a	Tor
YL	BU4219F	Vdet-IC	1.9V±1%, +Reset ODO	SOP-4	26vdf VD1	5c	Rhm
YL	XC6223H28BNR-G	LVR-IC	LDO, 2.85V±1%, 300mA, +CE, PDR, CL, ICP	SSOT-24	26vn VR4	5a	Tor
YLN	ELM7514CCB	Vdet-IC	1.4V±2%, +Reset PPO	SC-82AB	26vdl VD7	5c	Elm
YLN	ELM7514NCB	Vdet-IC	1.4V±2%, +Reset ODO	SC-82AB	26vdl VD6	5c	Elm
YM	BU4220F	Vdet-IC	2V±1%, +Reset ODO	SOP-4	26vdf VD1	5c	Rhm
YM	XC6223H29BNR-G	LVR-IC	LDO, 2.95V±1%, 300mA, +CE, PDR, CL, ICP	SSOT-24	26vn VR4	5a	Tor
YN	BU4221F	Vdet-IC	2.1V±1%, +Reset ODO	SOP-4	26vdf VD1	5c	Rhm
YN	XC6223H30BNR-G	LVR-IC	LDO, 3.05V±1%, 300mA, +CE, PDR, CL, ICP	SSOT-24	26vn VR4	5a	Tor
YP	BU4222F	Vdet-IC	2.2V±1%, +Reset ODO	SOP-4	26vdf VD1	5c	Rhm
YP	R3133Q30EA8	Vdet-IC	3.08V, MR, +Reset PPO	SOT-143	24vhd VD5	5a	Ric
YP	XC6223H31BNR-G	LVR-IC	LDO, 3.15V±1%, 300mA, +CE, PDR, CL, ICP	SSOT-24	26vn VR4	5a	Tor
YQ	BU4223F	Vdet-IC	2.3V±1%, +Reset ODO	SOP-4	26vdf VD1	5c	Rhm
YR	BU4224F	Vdet-IC	2.4V±1%, +Reset ODO	SOP-4	26vdf VD1	5c	Rhm
YR	XC6223H32BNR-G	LVR-IC	LDO, 3.25V±1%, 300mA, +CE, PDR, CL, ICP	SSOT-24	26vn VR4	5a	Tor
YR-	2SC4991	Si-npn	VHF/UHF, 15V, 50mA, 9.5GHz	SOT-143	26tu -	5c	Ren
YS	BU4225F	Vdet-IC	2.5V±1%, +Reset ODO	SOP-4	26vdf VD1	5c	Rhm
YS	XC6223H33BNR-G	LVR-IC	LDO, 3.35V±1%, 300mA, +CE, PDR, CL, ICP	SSOT-24	26vn VR4	5a	Tor
YS-	2SC4993	Si-npn	VHF/UHF, 15V, 20mA, 150mW, B=50.250, 10.5GHz	MPAK-4	26tu -	5b	Ren
YS-	2SC4994	Si-npn	VHF/UHF, 15V, 20mA, 100mW, B=50.250, 10.5GHz	CMPAK-4	26tu -	5b	Ren
YT	BU4226F	Vdet-IC	2.6V±1%, +Reset ODO	SOP-4	26vdf VD1	5c	Rhm
YT	XC6223H34BNR-G	LVR-IC	LDO, 3.45V±1%, 300mA, +CE, PDR, CL, ICP	SSOT-24	26vn VR4	5a	Tor
YU	BU4227F	Vdet-IC	2.7V±1%, +Reset ODO	SOP-4	26vdf VD1	5c	Rhm
YU	XC6223H35BNR-G	LVR-IC	LDO, 3.55V±1%, 300mA, +CE, PDR, CL, ICP	SSOT-24	26vn VR4	5a	Tor
YV	BU4228F	Vdet-IC	2.8V±1%, +Reset ODO	SOP-4	26vdf VD1	5c	Rhm
YV	XC6223H36BNR-G	LVR-IC	LDO, 3.65V±1%, 300mA, +CE, PDR, CL, ICP	SSOT-24	26vn VR4	5a	Tor
YW	BU4229F	Vdet-IC	2.9V±1%, +Reset ODO	SOP-4	26vdf VD1	5c	Rhm
YX	BU4230F	Vdet-IC	3V±1%, +Reset ODO	SOP-4	26vdf VD1	5c	Rhm



SMD code	Type	Function	Short description	Case	Pinout	Sch.	St.	Mnf.
YX	XC6223H37BNR-G	LVR-IC	LDO, 3.75V±1%, 300mA, +CE, PDR, CL, ICP	SSOT-24	26vn	VR4	5a	Tor
YY	BU4231F	Vdet-IC	3.1V±1%, +Reset ODO	SOP-4	26vdf	VD1	5c	Rhm
YY	XC6223H38BNR-G	LVR-IC	LDO, 3.85V±1%, 300mA, +CE, PDR, CL, ICP	SSOT-24	26vn	VR4	5a	Tor
YZ	BU4232F	Vdet-IC	3.2V±1%, +Reset ODO	SOP-4	26vdf	VD1	5c	Rhm
YZ	XC6223H39BNR-G	LVR-IC	LDO, 3.95V±1%, 300mA, +CE, PDR, CL, ICP	SSOT-24	26vn	VR4	5a	Tor
Z0	R3111Q601C	Vdet-IC	6V±2%, -Reset ODO	SC-82AB	26vdl	VD6	5a	Ric
Z0	XC6224A20BNR	LVR-IC	LDO, 2.05V±1.5%, 150mA, +CE	SSOT-24	26vn	VR4	5a	Tor
Z1	XC6224A21BNR	LVR-IC	LDO, 2.15V±1.5%, 150mA, +CE	SSOT-24	26vn	VR4	5a	Tor
Z2	XC6224A22BNR	LVR-IC	LDO, 2.25V±1.5%, 150mA, +CE	SSOT-24	26vn	VR4	5a	Tor
Z3	XC6224A23BNR	LVR-IC	LDO, 2.25V±1.5%, 150mA, +CE	SSOT-24	26vn	VR4	5a	Tor
Z4	XC6224A24BNR	LVR-IC	LDO, 2.45V±1.5%, 150mA, +CE	SSOT-24	26vn	VR4	5a	Tor
Z5	XC6224A25BNR	LVR-IC	LDO, 2.55V±1.5%, 150mA, +CE	SSOT-24	26vn	VR4	5a	Tor
Z6	XC6224A26BNR	LVR-IC	LDO, 2.65V±1.5%, 150mA, +CE	SSOT-24	26vn	VR4	5a	Tor
Z7	XC6224A27BNR	LVR-IC	LDO, 2.75V±1.5%, 150mA, +CE	SSOT-24	26vn	VR4	5a	Tor
Z8	XC6224A28BNR	LVR-IC	LDO, 2.85V±1.5%, 150mA, +CE	SSOT-24	26vn	VR4	5a	Tor
Z9	XC6224A29BNR	LVR-IC	LDO, 2.95V±1.5%, 150mA, +CE	SSOT-24	26vn	VR4	5a	Tor
ZA	BU4233F	Vdet-IC	3.3V±1%, +Reset ODO	SOP-4	26vdf	VD1	5c	Rhm
ZB	BU4234F	Vdet-IC	3.4V±1%, +Reset ODO	SOP-4	26vdf	VD1	5c	Rhm
ZC	BU4235F	Vdet-IC	3.5V±1%, +Reset ODO	SOP-4	26vdf	VD1	5c	Rhm
ZC-	2SC5078	Si-npn	VHF/UHF, LN, 15V, 20mA, 150mW, B=50..160, 12GHz	MPAK-4	26tu	-	5b	Ren
ZC-	2SC5079	Si-npn	VHF/UHF, LN, 15V, 20mA, 100mW, B=50..160, 12GHz	COMPAK-4	26tu	-	5b	Ren
ZD	BU4236F	Vdet-IC	3.6V±1%, +Reset ODO	SOP-4	26vdf	VD1	5c	Rhm
ZD	XC6223H301NR-G	LVR-IC	LDO, 3.0V±1%, 300mA, +CE, PDR, CL, ICP	SSOT-24	26vn	VR4	5a	Tor
ZD-	2SC5080	Si-npn	VHF/UHF, LN, 15V, 50mA, 150mW, B=50..160, 13.5GHz	MPAK-4	26tu	-	5b	Ren
ZD-	2SC5081	Si-npn	VHF/UHF, LN, 15V, 50mA, 100mW, B=50..160, 13.5GHz	COMPAK-4	26tu	-	5b	Ren
ZE	BU4237F	Vdet-IC	3.7V±1%, +Reset ODO	SOP-4	26vdf	VD1	5c	Rhm
ZE	XC6223H311NR-G	LVR-IC	LDO, 3.1V±1%, 300mA, +CE, PDR, CL, ICP	SSOT-24	26vn	VR4	5a	Tor
ZF	BU4238F	Vdet-IC	3.8V±1%, +Reset ODO	SOP-4	26vdf	VD1	5c	Rhm
ZF	XC6223H321NR-G	LVR-IC	LDO, 3.2V±1%, 300mA, +CE, PDR, CL, ICP	SSOT-24	26vn	VR4	5a	Tor
ZG	BU4239F	Vdet-IC	3.9V±1%, +Reset ODO	SOP-4	26vdf	VD1	5c	Rhm
ZG-	3SK276	n-MOSFET-d	DG, VHF/UHF, 12V, 25mA, Idss=0.5..10mA, Up<0.8V	SOT-143	26fm	-	5c	Ren
ZH	BU4240F	Vdet-IC	4V±1%, +Reset ODO	SOP-4	26vdf	VD1	5c	Rhm
ZH	XC6223H331NR-G	LVR-IC	LDO, 3.3V±1%, 300mA, +CE, PDR, CL, ICP	SSOT-24	26vn	VR4	5a	Tor
ZH-	3SK288	n-MOSFET-d	DG, VHF, 12V, 25mA, Idss=1..10mA, Up<1V	SOT-143	26fm	-	5c	Ren
ZJ	BU4241F	Vdet-IC	4.1V±1%, +Reset ODO	SOP-4	26vdf	VD1	5c	Rhm
ZJ-	3SK290	n-MOSFET-d	DG, UHF, 12V, 25mA, Idss=0.5..10mA, Up<1V	SOT-343	26fm	-	5c	Ren
ZK	BU4242F	Vdet-IC	4.2V±1%, +Reset ODO	SOP-4	26vdf	VD1	5c	Rhm
ZK	XC6223H341NR-G	LVR-IC	LDO, 3.4V±1%, 300mA, +CE, PDR, CL, ICP	SSOT-24	26vn	VR4	5a	Tor
ZL	BU4243F	Vdet-IC	4.3V±1%, +Reset ODO	SOP-4	26vdf	VD1	5c	Rhm
ZL	XC6223H351NR-G	LVR-IC	LDO, 3.5V±1%, 300mA, +CE, PDR, CL, ICP	SSOT-24	26vn	VR4	5a	Tor
ZLN	ELM7515CCB	Vdet-IC	1.5V±2%, +Reset ODO	SC-82AB	26vdl	VD7	5c	Elm
ZLN	ELM7515NCB	Vdet-IC	1.5V±2%, +Reset ODO	SC-82AB	26vdl	VD6	5c	Elm
ZM	BU4244F	Vdet-IC	4.4V±1%, +Reset ODO	SOP-4	26vdf	VD1	5c	Rhm
ZM	XC6223H361NR-G	LVR-IC	LDO, 3.6V±1%, 300mA, +CE, PDR, CL, ICP	SSOT-24	26vn	VR4	5a	Tor
ZN	BU4245F	Vdet-IC	4.5V±1%, +Reset ODO	SOP-4	26vdf	VD1	5c	Rhm
ZP	BU4246F	Vdet-IC	4.6V±1%, +Reset ODO	SOP-4	26vdf	VD1	5c	Rhm
ZP	XC6223H371NR-G	LVR-IC	LDO, 3.7V±1%, 300mA, +CE, PDR, CL, ICP	SSOT-24	26vn	VR4	5a	Tor
ZQ	BU4247F	Vdet-IC	4.7V±1%, +Reset ODO	SOP-4	26vdf	VD1	5c	Rhm
ZQ-	3SK295	n-MOSFET	DG, UHF, 12V, 25mA, Up<1V	SOT-143	26fm	-	5c	Ren
ZR	BU4248F	Vdet-IC	4.8V±1%, +Reset ODO	SOP-4	26vdf	VD1	5c	Rhm
ZR	XC6223H381NR-G	LVR-IC	LDO, 3.8V±1%, 300mA, +CE, PDR, CL, ICP	SSOT-24	26vn	VR4	5a	Tor
ZR-	3SK300	n-MOSFET-d	DG, VHF/UHF, 14V, 25mA, Up<1V, F<4dB(900MHz)	SOT-143	26fm	-	5c	Ren
ZS	BU4309F	Vdet-IC	0.9V±1%, +Reset PPO	SOP-4	26vdf	VD3	5c	Rhm
ZS	XC6223H391NR-G	LVR-IC	LDO, 3.9V±1%, 300mA, +CE, PDR, CL, ICP	SSOT-24	26vn	VR4	5a	Tor
ZT	BU4310F	Vdet-IC	1V±1%, +Reset PPO	SOP-4	26vdf	VD3	5c	Rhm
ZT	XC6223H401NR-G	LVR-IC	LDO, 4.0V±1%, 300mA, +CE, PDR, CL, ICP	SSOT-24	26vn	VR4	5a	Tor
ZU	BU4311F	Vdet-IC	1.1V±1%, +Reset PPO	SOP-4	26vdf	VD3	5c	Rhm
ZV	BU4312F	Vdet-IC	1.2V±1%, +Reset PPO	SOP-4	26vdf	VD3	5c	Rhm
ZW	BU4313F	Vdet-IC	1.3V±1%, +Reset PPO	SOP-4	26vdf	VD3	5c	Rhm
ZX	BU4314F	Vdet-IC	1.4V±1%, +Reset PPO	SOP-4	26vdf	VD3	5c	Rhm
ZX	XC6221B48BNR	LVR-IC	LDO, 4.85V±1%, 200mA, +CE, CL	SSOT-24	26vn	VR4	5a	Tor
ZY	BU4315F	Vdet-IC	1.5V±1%, +Reset PPO	SOP-4	26vdf	VD3	5c	Rhm
ZY	XC6221B49BNR	LVR-IC	LDO, 4.95V±1%, 200mA, +CE, CL	SSOT-24	26vn	VR4	5a	Tor
ZZ	BU4316F	Vdet-IC	1.6V±1%, +Reset PPO	SOP-4	26vdf	VD3	5c	Rhm



SECTION 7
5-pin CASES SMD SEMICONDUCTOR COMPONENTS

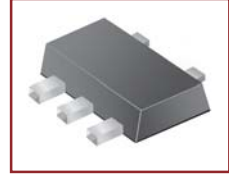
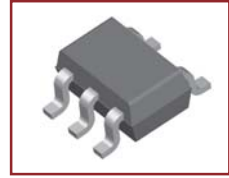

SMD

SMD code	Type	Function	Short description	Case	Pinout	Sch.	St.	Mnf.
00	R1223N252A	DC/DC-IC	PWM/FM step-down, +CE, 2.5V, 300kHz, L-Pr.	SOT-23-5	28ud	DC7	6g	Ric
00	RN5RF50BA	LVR-IC	LRIp, +CE, 5V±2%, 1A*	SOT-23-5	28vw	VR6	6g	Ric
00	RN5RZ50BA	LVR-IC	LDO, LN, +CE, 5V±2%, 100mA	SOT-23-5	28vrt	VR4	6g	Ric
000	XC6101A131MR	Vdet-IC	3.1V±2%, Hst, -MR, -Reset PPO, Wt=6.25ms, Rt=3.13ms	SOT-25	28cp	VD17	6g	Tor
001	XC6101A132MR	Vdet-IC	3.2V±2%, Hst, -MR, -Reset PPO, Wt=6.25ms, Rt=3.13ms	SOT-25	28cp	VD17	6g	Tor
002	XC6101A133MR	Vdet-IC	3.3V±2%, Hst, -MR, -Reset PPO, Wt=6.25ms, Rt=3.13ms	SOT-25	28cp	VD17	6g	Tor
003	XC6101A134MR	Vdet-IC	3.4V±2%, Hst, -MR, -Reset PPO, Wt=6.25ms, Rt=3.13ms	SOT-25	28cp	VD17	6g	Tor
004	XC6101A135MR	Vdet-IC	3.5V±2%, Hst, -MR, -Reset PPO, Wt=6.25ms, Rt=3.13ms	SOT-25	28cp	VD17	6g	Tor
005	XC6101A136MR	Vdet-IC	3.6V±2%, Hst, -MR, -Reset PPO, Wt=6.25ms, Rt=3.13ms	SOT-25	28cp	VD17	6g	Tor
006	XC6101A137MR	Vdet-IC	3.7V±2%, Hst, -MR, -Reset PPO, Wt=6.25ms, Rt=3.13ms	SOT-25	28cp	VD17	6g	Tor
007	XC6101A138MR	Vdet-IC	3.8V±2%, Hst, -MR, -Reset PPO, Wt=6.25ms, Rt=3.13ms	SOT-25	28cp	VD17	6g	Tor
008	R1160N081A	LVR-IC	LDO, 0.8V±2%, 200mA, -CE, AE(Mode)	SOT-23-5	28x9	VR10	6g	Ric
008	XC6101A139MR	Vdet-IC	3.9V±2%, Hst, -MR, -Reset PPO, Wt=6.25ms, Rt=3.13ms	SOT-25	28cp	VD17	6g	Tor
009	R1160N091A	LVR-IC	LDO, 0.9V±2%, 200mA, -CE, AE(Mode)	SOT-23-5	28x9	VR10	6g	Ric
009	XC6101A140MR	Vdet-IC	4.0V±2%, Hst, -MR, -Reset PPO, Wt=6.25ms, Rt=3.13ms	SOT-25	28cp	VD17	6g	Tor
00A	XC6101A141MR	Vdet-IC	4.1V±2%, Hst, -MR, -Reset PPO, Wt=6.25ms, Rt=3.13ms	SOT-25	28cp	VD17	6g	Tor
00B	XC6101A142MR	Vdet-IC	4.2V±2%, Hst, -MR, -Reset PPO, Wt=6.25ms, Rt=3.13ms	SOT-25	28cp	VD17	6g	Tor
00C	XC6101A143MR	Vdet-IC	4.3V±2%, Hst, -MR, -Reset PPO, Wt=6.25ms, Rt=3.13ms	SOT-25	28cp	VD17	6g	Tor
00D	XC6101A144MR	Vdet-IC	4.4V±2%, Hst, -MR, -Reset PPO, Wt=6.25ms, Rt=3.13ms	SOT-25	28cp	VD17	6g	Tor
00E	XC6505A151MR	LVR-IC	LDO, 1.5V±20mV, 200mA, +CE	SOT-25	28cx	VR4	6a	Tor
00E	XC6101A145MR	Vdet-IC	4.5V±2%, Hst, -MR, -Reset PPO, Wt=6.25ms, Rt=3.13ms	SOT-25	28cp	VD17	6g	Tor
00F	XC6505A161MR	LVR-IC	LDO, 1.6V±20mV, 200mA, +CE	SOT-25	28cx	VR4	6a	Tor
00F	XC6101A116MR	Vdet-IC	1.6V±2%, Hst, -MR, -Reset PPO, Wt=6.25ms, Rt=3.13ms	SOT-25	28cp	VD17	6g	Tor
00F	XC6101A146MR	Vdet-IC	4.6V±2%, Hst, -MR, -Reset PPO, Wt=6.25ms, Rt=3.13ms	SOT-25	28cp	VD17	6g	Tor
00H	XC6505A171MR	LVR-IC	LDO, 1.7V±20mV, 200mA, +CE	SOT-25	28cx	VR4	6a	Tor
00H	XC6101A117MR	Vdet-IC	1.7V±2%, Hst, -MR, -Reset PPO, Wt=6.25ms, Rt=3.13ms	SOT-25	28cp	VD17	6g	Tor
00H	XC6101A147MR	Vdet-IC	4.7V±2%, Hst, -MR, -Reset PPO, Wt=6.25ms, Rt=3.13ms	SOT-25	28cp	VD17	6g	Tor
00K	XC6505A181MR	LVR-IC	LDO, 1.8V±20mV, 200mA, +CE	SOT-25	28cx	VR4	6a	Tor
00K	XC6101A118MR	Vdet-IC	1.8V±2%, Hst, -MR, -Reset PPO, Wt=6.25ms, Rt=3.13ms	SOT-25	28cp	VD17	6g	Tor
00K	XC6101A148MR	Vdet-IC	4.8V±2%, Hst, -MR, -Reset PPO, Wt=6.25ms, Rt=3.13ms	SOT-25	28cp	VD17	6g	Tor
00L	XC6505A191MR	LVR-IC	LDO, 1.9V±20mV, 200mA, +CE	SOT-25	28cx	VR4	6a	Tor
00L	XC6101A119MR	Vdet-IC	1.9V±2%, Hst, -MR, -Reset PPO, Wt=6.25ms, Rt=3.13ms	SOT-25	28cp	VD17	6g	Tor
00L	XC6101A149MR	Vdet-IC	4.9V±2%, Hst, -MR, -Reset PPO, Wt=6.25ms, Rt=3.13ms	SOT-25	28cp	VD17	6g	Tor
00M	XC6505A201MR	LVR-IC	LDO, 2.0V±1%, 200mA, +CE	SOT-25	28cx	VR4	6a	Tor
00M	XC6101A120MR	Vdet-IC	2.0V±2%, Hst, -MR, -Reset PPO, Wt=6.25ms, Rt=3.13ms	SOT-25	28cp	VD17	6g	Tor
00M	XC6101A150MR	Vdet-IC	5.0V±2%, Hst, -MR, -Reset PPO, Wt=6.25ms, Rt=3.13ms	SOT-25	28cp	VD17	6g	Tor
00N	XC6505A211MR	LVR-IC	LDO, 2.1V±1%, 200mA, +CE	SOT-25	28cx	VR4	6a	Tor
00N	XC6101A121MR	Vdet-IC	2.1V±2%, Hst, -MR, -Reset PPO, Wt=6.25ms, Rt=3.13ms	SOT-25	28cp	VD17	6g	Tor
00P	XC6505A221MR	LVR-IC	LDO, 2.2V±1%, 200mA, +CE	SOT-25	28cx	VR4	6a	Tor
00P	XC6101A122MR	Vdet-IC	2.2V±2%, Hst, -MR, -Reset PPO, Wt=6.25ms, Rt=3.13ms	SOT-25	28cp	VD17	6g	Tor
00R	XC6505A231MR	LVR-IC	LDO, 2.3V±1%, 200mA, +CE	SOT-25	28cx	VR4	6a	Tor
00R	XC6101A123MR	Vdet-IC	2.3V±2%, Hst, -MR, -Reset PPO, Wt=6.25ms, Rt=3.13ms	SOT-25	28cp	VD17	6g	Tor
00S	XC6505A241MR	LVR-IC	LDO, 2.4V±1%, 200mA, +CE	SOT-25	28cx	VR4	6a	Tor
00S	XC6101A124MR	Vdet-IC	2.4V±2%, Hst, -MR, -Reset PPO, Wt=6.25ms, Rt=3.13ms	SOT-25	28cp	VD17	6g	Tor
00T	XC6505A251MR	LVR-IC	LDO, 2.5V±1%, 200mA, +CE	SOT-25	28cx	VR4	6a	Tor
00T	XC6101A125MR	Vdet-IC	2.5V±2%, Hst, -MR, -Reset PPO, Wt=6.25ms, Rt=3.13ms	SOT-25	28cp	VD17	6g	Tor
00U	XC6505A261MR	LVR-IC	LDO, 2.6V±1%, 200mA, +CE	SOT-25	28cx	VR4	6a	Tor
00U	XC6101A126MR	Vdet-IC	2.6V±2%, Hst, -MR, -Reset PPO, Wt=6.25ms, Rt=3.13ms	SOT-25	28cp	VD17	6g	Tor
00V	XC6505A271MR	LVR-IC	LDO, 2.7V±1%, 200mA, +CE	SOT-25	28cx	VR4	6a	Tor
00V	XC6101A127MR	Vdet-IC	2.7V±2%, Hst, -MR, -Reset PPO, Wt=6.25ms, Rt=3.13ms	SOT-25	28cp	VD17	6g	Tor
00X	XC6505A281MR	LVR-IC	LDO, 2.8V±1%, 200mA, +CE	SOT-25	28cx	VR4	6a	Tor
00X	XC6101A128MR	Vdet-IC	2.8V±2%, Hst, -MR, -Reset PPO, Wt=6.25ms, Rt=3.13ms	SOT-25	28cp	VD17	6g	Tor
00Y	XC6505A291MR	LVR-IC	LDO, 2.9V±1%, 200mA, +CE	SOT-25	28cx	VR4	6a	Tor
00Y	XC6101A129MR	Vdet-IC	2.9V±2%, Hst, -MR, -Reset PPO, Wt=6.25ms, Rt=3.13ms	SOT-25	28cp	VD17	6g	Tor
00Z	XC6505A301MR	LVR-IC	LDO, 3.0V±1%, 200mA, +CE	SOT-25	28cx	VR4	6a	Tor
00Z	XC6101A130MR	Vdet-IC	3.0V±2%, Hst, -MR, -Reset PPO, Wt=6.25ms, Rt=3.13ms	SOT-25	28cp	VD17	6g	Tor
01	R1223N152C	DC/DC-IC	PWM step-down, +CE, 1.5V, 300kHz, Latch-Pr.	SOT-23-5	28ud	DC7	6g	Ric
01	RN5RF51BA	LVR-IC	LRIp, +CE, 5.1V±2%, 1A*	SOT-23-5	28vw	VR6	6g	Ric
01	RN5RZ51BA	LVR-IC	LDO, LN, +CE, 5.1V±2%, 100mA	SOT-23-5	28vrt	VR4	6g	Ric
010	R1160N101A	LVR-IC	LDO, 1V±2%, 200mA, -CE, AE(Mode)	SOT-23-5	28x9	VR10	6g	Ric
010	XC6505A311MR	LVR-IC	LDO, 3.1V±1%, 200mA, +CE	SOT-25	28cx	VR4	6a	Tor
010	XC6101A231MR	Vdet-IC	3.1V±2%, Hst, -MR, -Reset PPO, Wt=50ms, Rt=3.13ms	SOT-25	28cp	VD17	6g	Tor
011	R1160N111A	LVR-IC	LDO, 1.1V±2%, 200mA, -CE, AE(Mode)	SOT-23-5	28x9	VR10	6g	Ric
011	XC6505A321MR	LVR-IC	LDO, 3.2V±1%, 200mA, +CE	SOT-25	28cx	VR4	6a	Tor
011	XC6101A232MR	Vdet-IC	3.2V±2%, Hst, -MR, -Reset PPO, Wt=50ms, Rt=3.13ms	SOT-25	28cp	VD17	6g	Tor
012	R1160N121A	LVR-IC	LDO, 1.2V±2%, 200mA, -CE, AE(Mode)	SOT-23-5	28x9	VR10	6g	Ric
012	XC6505A331MR	LVR-IC	LDO, 3.3V±1%, 200mA, +CE	SOT-25	28cx	VR4	6a	Tor
012	XC6101A233MR	Vdet-IC	3.3V±2%, Hst, -MR, -Reset PPO, Wt=50ms, Rt=3.13ms	SOT-25	28cp	VD17	6g	Tor
013	R1160N131A	LVR-IC	LDO, 1.3V±2%, 200mA, -CE, AE(Mode)	SOT-23-5	28x9	VR10	6g	Ric
013	XC6505A341MR	LVR-IC	LDO, 3.4V±1%, 200mA, +CE	SOT-25	28cx	VR4	6a	Tor



SMD code	Type	Function	Short description	Case	Pinout	Sch.	St.Mnf.
013	XC6101A234MR	Vdet-IC	3.4V±2%, Hst, -MR, -Reset PPO, Wt=50ms, Rt=3.13ms	SOT-25	28cp	VD17	6g Tor
014	R1160N141A	LVR-IC	LDO, 1.4V±2%, 200mA, -CE, AE(Mode)	SOT-23-5	28x9	VR10	6g Ric
014	XC6505A351MR	LVR-IC	LDO, 3.5V±1%, 200mA, +CE	SOT-25	28cx	VR4	6a Tor
014	XC6101A235MR	Vdet-IC	3.5V±2%, Hst, -MR, -Reset PPO, Wt=50ms, Rt=3.13ms	SOT-25	28cp	VD17	6g Tor
015	R1116N151B	LVR-IC	LDO, LN, +CE, 1.5V±1.5%, 150mA	SOT-23-5	28cx	VR4	6g Ric
015	R1160N151A	LVR-IC	LDO, 1.5V±2%, 200mA, -CE, AE(Mode)	SOT-23-5	28x9	VR10	6g Ric
015	XC6505A361MR	LVR-IC	LDO, 3.6V±1%, 200mA, +CE	SOT-25	28cx	VR4	6a Tor
015	XC6101A236MR	Vdet-IC	3.6V±2%, Hst, -MR, -Reset PPO, Wt=50ms, Rt=3.13ms	SOT-25	28cp	VD17	6g Tor
016	R1116N161B	LVR-IC	LDO, LN, +CE, 1.6V±1.5%, 150mA	SOT-23-5	28cx	VR4	6g Ric
016	R1160N161A	LVR-IC	LDO, 1.6V±2%, 200mA, -CE, AE(Mode)	SOT-23-5	28x9	VR10	6g Ric
016	XC6505A371MR	LVR-IC	LDO, 3.7V±1%, 200mA, +CE	SOT-25	28cx	VR4	6a Tor
016	XC6101A237MR	Vdet-IC	3.7V±2%, Hst, -MR, -Reset PPO, Wt=50ms, Rt=3.13ms	SOT-25	28cp	VD17	6g Tor
017	R1116N171B	LVR-IC	LDO, LN, +CE, 1.7V±1.5%, 150mA	SOT-23-5	28cx	VR4	6g Ric
017	R1160N171A	LVR-IC	LDO, 1.7V±2%, 200mA, -CE, AE(Mode)	SOT-23-5	28x9	VR10	6g Ric
017	XC6505A381MR	LVR-IC	LDO, 3.8V±1%, 200mA, +CE	SOT-25	28cx	VR4	6a Tor
017	XC6101A238MR	Vdet-IC	3.8V±2%, Hst, -MR, -Reset PPO, Wt=50ms, Rt=3.13ms	SOT-25	28cp	VD17	6g Tor
018	R1116N181B	LVR-IC	LDO, LN, +CE, 1.8V±1.5%, 150mA	SOT-23-5	28cx	VR4	6g Ric
018	R1160N181A	LVR-IC	LDO, 1.8V±2%, 200mA, -CE, AE(Mode)	SOT-23-5	28x9	VR10	6g Ric
018	XC6505A391MR	LVR-IC	LDO, 3.9V±1%, 200mA, +CE	SOT-25	28cx	VR4	6a Tor
018	XC6101A239MR	Vdet-IC	3.9V±2%, Hst, -MR, -Reset PPO, Wt=50ms, Rt=3.13ms	SOT-25	28cp	VD17	6g Tor
019	R1116N191B	LVR-IC	LDO, LN, +CE, 1.9V±1.5%, 150mA	SOT-23-5	28cx	VR4	6g Ric
019	R1160N191A	LVR-IC	LDO, 1.9V±2%, 200mA, -CE, AE(Mode)	SOT-23-5	28x9	VR10	6g Ric
019	XC6505A401MR	LVR-IC	LDO, 4.0V±1%, 200mA, +CE	SOT-25	28cx	VR4	6a Tor
019	XC6101A240MR	Vdet-IC	4.0V±2%, Hst, -MR, -Reset PPO, Wt=50ms, Rt=3.13ms	SOT-25	28cp	VD17	6g Tor
01A	APR3001-15B	Vdet-IC	1.5V, -Reset PPO	SOT-23-5	28vdm	VD7	6k Anp
01A	XC6505A411MR	LVR-IC	LDO, 4.1V±1%, 200mA, +CE	SOT-25	28cx	VR4	6a Tor
01A	XC6101A241MR	Vdet-IC	4.1V±2%, Hst, -MR, -Reset PPO, Wt=50ms, Rt=3.13ms	SOT-25	28cp	VD17	6g Tor
01B	APR3001-17B	Vdet-IC	1.75V, -Reset PPO	SOT-23-5	28vdm	VD7	6k Anp
01B	XC6505A421MR	LVR-IC	LDO, 4.2V±1%, 200mA, +CE	SOT-25	28cx	VR4	6a Tor
01B	XC6101A242MR	Vdet-IC	4.2V±2%, Hst, -MR, -Reset PPO, Wt=50ms, Rt=3.13ms	SOT-25	28cp	VD17	6g Tor
01C	APR3001-23B	Vdet-IC	2.32V, -Reset PPO	SOT-23-5	28vdm	VD7	6k Anp
01C	R1182N121B	LVR-IC	LDO, 1.2V±2%, 150mA, +CE	SOT-23-5	28vrt	VR4	6g Ric
01C	XC6505A431MR	LVR-IC	LDO, 4.3V±1%, 200mA, +CE	SOT-25	28cx	VR4	6a Tor
01C	XC6101A243MR	Vdet-IC	4.3V±2%, Hst, -MR, -Reset PPO, Wt=50ms, Rt=3.13ms	SOT-25	28cp	VD17	6g Tor
01D	APR3001-26B	Vdet-IC	2.63V, -Reset PPO	SOT-23-5	28vdm	VD7	6k Anp
01D	R1182N131B	LVR-IC	LDO, 1.3V±2%, 150mA, +CE	SOT-23-5	28vrt	VR4	6g Ric
01D	XC6505A441MR	LVR-IC	LDO, 4.4V±1%, 200mA, +CE	SOT-25	28cx	VR4	6a Tor
01D	XC6101A244MR	Vdet-IC	4.4V±2%, Hst, -MR, -Reset PPO, Wt=50ms, Rt=3.13ms	SOT-25	28cp	VD17	6g Tor
01E	APR3001-29B	Vdet-IC	2.93V, -Reset PPO	SOT-23-5	28vdm	VD7	6k Anp
01E	R1182N141B	LVR-IC	LDO, 1.4V±2%, 150mA, +CE	SOT-23-5	28vrt	VR4	6g Ric
01E	XC6505A451MR	LVR-IC	LDO, 4.5V±1%, 200mA, +CE	SOT-25	28cx	VR4	6a Tor
01E	XC6101A245MR	Vdet-IC	4.5V±2%, Hst, -MR, -Reset PPO, Wt=50ms, Rt=3.13ms	SOT-25	28cp	VD17	6g Tor
01F	APR3001-30B	Vdet-IC	3.08V, -Reset PPO	SOT-23-5	28vdm	VD7	6k Anp
01F	R1182N151B	LVR-IC	LDO, 1.5V±2%, 150mA, +CE	SOT-23-5	28vrt	VR4	6g Ric
01F	XC6505A461MR	LVR-IC	LDO, 4.6V±1%, 200mA, +CE	SOT-25	28cx	VR4	6a Tor
01F	XC6101A216MR	Vdet-IC	1.6V±2%, Hst, -MR, -Reset PPO, Wt=50ms, Rt=3.13ms	SOT-25	28cp	VD17	6g Tor
01F	XC6101A246MR	Vdet-IC	4.6V±2%, Hst, -MR, -Reset PPO, Wt=50ms, Rt=3.13ms	SOT-25	28cp	VD17	6g Tor
01G	APR3001-39B	Vdet-IC	3.9V, -Reset PPO	SOT-23-5	28vdm	VD7	6k Anp
01G	R1182N161B	LVR-IC	LDO, 1.6V±2%, 150mA, +CE	SOT-23-5	28vrt	VR4	6g Ric
01H	APR3001-43B	Vdet-IC	4.38V, -Reset PPO	SOT-23-5	28vdm	VD7	6k Anp
01H	R1182N171B	LVR-IC	LDO, 1.7V±2%, 150mA, +CE	SOT-23-5	28vrt	VR4	6g Ric
01H	XC6505A471MR	LVR-IC	LDO, 4.7V±1%, 200mA, +CE	SOT-25	28cx	VR4	6a Tor
01H	XC6101A217MR	Vdet-IC	1.7V±2%, Hst, -MR, -Reset PPO, Wt=50ms, Rt=3.13ms	SOT-25	28cp	VD17	6g Tor
01H	XC6101A247MR	Vdet-IC	4.7V±2%, Hst, -MR, -Reset PPO, Wt=50ms, Rt=3.13ms	SOT-25	28cp	VD17	6g Tor
01J	APR3001-46B	Vdet-IC	4.63V, -Reset PPO	SOT-23-5	28vdm	VD7	6k Anp
01J	R1182N181B	LVR-IC	LDO, 1.8V±2%, 150mA, +CE	SOT-23-5	28vrt	VR4	6g Ric
01J	R1182N191B	LVR-IC	LDO, 1.9V±2%, 150mA, +CE	SOT-23-5	28vrt	VR4	6g Ric
01K	XC6505A481MR	LVR-IC	LDO, 4.8V±1%, 200mA, +CE	SOT-25	28cx	VR4	6a Tor
01K	XC6101A218MR	Vdet-IC	1.8V±2%, Hst, -MR, -Reset PPO, Wt=50ms, Rt=3.13ms	SOT-25	28cp	VD17	6g Tor
01K	XC6101A248MR	Vdet-IC	4.8V±2%, Hst, -MR, -Reset PPO, Wt=50ms, Rt=3.13ms	SOT-25	28cp	VD17	6g Tor
01L	XC6505A491MR	LVR-IC	LDO, 4.9V±1%, 200mA, +CE	SOT-25	28cx	VR4	6a Tor
01L	XC6101A219MR	Vdet-IC	1.9V±2%, Hst, -MR, -Reset PPO, Wt=50ms, Rt=3.13ms	SOT-25	28cp	VD17	6g Tor
01L	XC6101A249MR	Vdet-IC	4.9V±2%, Hst, -MR, -Reset PPO, Wt=50ms, Rt=3.13ms	SOT-25	28cp	VD17	6g Tor
01M	XC6505A501MR	LVR-IC	LDO, 5.0V±1%, 200mA, +CE	SOT-25	28cx	VR4	6a Tor
01M	XC6101A220MR	Vdet-IC	2.0V±2%, Hst, -MR, -Reset PPO, Wt=50ms, Rt=3.13ms	SOT-25	28cp	VD17	6g Tor
01M	XC6101A250MR	Vdet-IC	5.0V±2%, Hst, -MR, -Reset PPO, Wt=50ms, Rt=3.13ms	SOT-25	28cp	VD17	6g Tor
01N	XC6101A221MR	Vdet-IC	2.1V±2%, Hst, -MR, -Reset PPO, Wt=50ms, Rt=3.13ms	SOT-25	28cp	VD17	6g Tor
01P	XC6101A222MR	Vdet-IC	2.2V±2%, Hst, -MR, -Reset PPO, Wt=50ms, Rt=3.13ms	SOT-25	28cp	VD17	6g Tor
01R	XC6101A223MR	Vdet-IC	2.3V±2%, Hst, -MR, -Reset PPO, Wt=50ms, Rt=3.13ms	SOT-25	28cp	VD17	6g Tor
01S	XC6101A224MR	Vdet-IC	2.4V±2%, Hst, -MR, -Reset PPO, Wt=50ms, Rt=3.13ms	SOT-25	28cp	VD17	6g Tor



SMD code	Type	Function	Short description	Case	Pinout	Sch.	St.	Mnf.
<u>01T</u>	XC6101A225MR	Vdet-IC	2.5V±2%, Hst, -MR, -Reset PPO, Wt=50ms, Rt=3.13ms	SOT-25	28cp	VD17	6g	Tor
<u>01U</u>	XC6101A226MR	Vdet-IC	2.6V±2%, Hst, -MR, -Reset PPO, Wt=50ms, Rt=3.13ms	SOT-25	28cp	VD17	6g	Tor
<u>01V</u>	XC6101A227MR	Vdet-IC	2.7V±2%, Hst, -MR, -Reset PPO, Wt=50ms, Rt=3.13ms	SOT-25	28cp	VD17	6g	Tor
<u>01X</u>	XC6101A228MR	Vdet-IC	2.8V±2%, Hst, -MR, -Reset PPO, Wt=50ms, Rt=3.13ms	SOT-25	28cp	VD17	6g	Tor
<u>01Y</u>	XC6101A229MR	Vdet-IC	2.9V±2%, Hst, -MR, -Reset PPO, Wt=50ms, Rt=3.13ms	SOT-25	28cp	VD17	6g	Tor
<u>01Z</u>	XC6101A230MR	Vdet-IC	3.0V±2%, Hst, -MR, -Reset PPO, Wt=50ms, Rt=3.13ms	SOT-25	28cp	VD17	6g	Tor
<u>02</u>	R1223N182C	DC/DC-IC	PWM step-down, +CE, 1.8V, 300kHz, Latch-Pr.	SOT-23-5	28ud	DC7	6g	Ric
<u>02</u>	RN5RF52BA	LVR-IC	LRip, +CE, 5.2V±2%, 1A*	SOT-23-5	28vw	VR6	6g	Ric
<u>02</u>	RN5RZ52BA	LVR-IC	LDO, LN, +CE, 5.2V±2%, 100mA	SOT-23-5	28wrt	VR4	6g	Ric
<u>020</u>	R1116N201B	LVR-IC	LDO, LN, +CE, 2V±1.5%, 150mA	SOT-23-5	28cx	VR4	6g	Ric
<u>020</u>	R1160N201A	LVR-IC	LDO, 2V±2%, 200mA, -CE, AE(Mode)	SOT-23-5	28x9	VR10	6g	Ric
<u>020</u>	XC6505A611MR	LVR-IC	LDO, 6.1V±1%, 200mA, +CE	SOT-25	28cx	VR4	6a	Tor
<u>020</u>	XC6101A331MR	Vdet-IC	3.1V±2%, Hst, -MR, -Reset PPO, Wt=100ms, Rt=3.13ms	SOT-25	28cp	VD17	6g	Tor
<u>021</u>	R1116N211B	LVR-IC	LDO, LN, +CE, 2.1V±1.5%, 150mA	SOT-23-5	28cx	VR4	6g	Ric
<u>021</u>	R1160N211A	LVR-IC	LDO, 2.1V±2%, 200mA, -CE, AE(Mode)	SOT-23-5	28x9	VR10	6g	Ric
<u>021</u>	XC6505A621MR	LVR-IC	LDO, 6.2V±1%, 200mA, +CE	SOT-25	28cx	VR4	6a	Tor
<u>021</u>	XC6101A332MR	Vdet-IC	3.2V±2%, Hst, -MR, -Reset PPO, Wt=100ms, Rt=3.13ms	SOT-25	28cp	VD17	6g	Tor
<u>022</u>	R1116N221B	LVR-IC	LDO, LN, +CE, 2.2V±1.5%, 150mA	SOT-23-5	28cx	VR4	6g	Ric
<u>022</u>	R1160N221A	LVR-IC	LDO, 2.2V±2%, 200mA, -CE, AE(Mode)	SOT-23-5	28x9	VR10	6g	Ric
<u>022</u>	XC6505A631MR	LVR-IC	LDO, 6.3V±1%, 200mA, +CE	SOT-25	28cx	VR4	6a	Tor
<u>022</u>	XC6101A333MR	Vdet-IC	3.3V±2%, Hst, -MR, -Reset PPO, Wt=100ms, Rt=3.13ms	SOT-25	28cp	VD17	6g	Tor
<u>023</u>	R1116N231B	LVR-IC	LDO, LN, +CE, 2.3V±1.5%, 150mA	SOT-23-5	28cx	VR4	6g	Ric
<u>023</u>	R1160N231A	LVR-IC	LDO, 2.3V±2%, 200mA, -CE, AE(Mode)	SOT-23-5	28x9	VR10	6g	Ric
<u>023</u>	XC6505A641MR	LVR-IC	LDO, 6.4V±1%, 200mA, +CE	SOT-25	28cx	VR4	6a	Tor
<u>023</u>	XC6101A334MR	Vdet-IC	3.4V±2%, Hst, -MR, -Reset PPO, Wt=100ms, Rt=3.13ms	SOT-25	28cp	VD17	6g	Tor
<u>024</u>	R1116N241B	LVR-IC	LDO, LN, +CE, 2.4V±1.5%, 150mA	SOT-23-5	28cx	VR4	6g	Ric
<u>024</u>	R1160N241A	LVR-IC	LDO, 2.4V±2%, 200mA, -CE, AE(Mode)	SOT-23-5	28x9	VR10	6g	Ric
<u>024</u>	XC6505A651MR	LVR-IC	LDO, 6.5V±1%, 200mA, +CE	SOT-25	28cx	VR4	6a	Tor
<u>024</u>	XC6101A335MR	Vdet-IC	3.5V±2%, Hst, -MR, -Reset PPO, Wt=100ms, Rt=3.13ms	SOT-25	28cp	VD17	6g	Tor
<u>024A</u>	HT7024A-1	Vdet-IC	2.4V, -Reset ODO	SOT-23-5	28vdm	VD6	6a	Htk
<u>025</u>	R1116N251B	LVR-IC	LDO, LN, +CE, 2.5V±1.5%, 150mA	SOT-23-5	28cx	VR4	6g	Ric
<u>025</u>	R1160N251A	LVR-IC	LDO, 2.5V±2%, 200mA, -CE, AE(Mode)	SOT-23-5	28x9	VR10	6g	Ric
<u>025</u>	XC6505A661MR	LVR-IC	LDO, 6.6V±1%, 200mA, +CE	SOT-25	28cx	VR4	6a	Tor
<u>025</u>	XC6101A336MR	Vdet-IC	3.6V±2%, Hst, -MR, -Reset PPO, Wt=100ms, Rt=3.13ms	SOT-25	28cp	VD17	6g	Tor
<u>026</u>	R1116N261B	LVR-IC	LDO, LN, +CE, 2.6V±1.5%, 150mA	SOT-23-5	28cx	VR4	6g	Ric
<u>026</u>	R1160N261A	LVR-IC	LDO, 2.6V±2%, 200mA, -CE, AE(Mode)	SOT-23-5	28x9	VR10	6g	Ric
<u>026</u>	XC6505A671MR	LVR-IC	LDO, 6.7V±1%, 200mA, +CE	SOT-25	28cx	VR4	6a	Tor
<u>026</u>	XC6101A337MR	Vdet-IC	3.7V±2%, Hst, -MR, -Reset PPO, Wt=100ms, Rt=3.13ms	SOT-25	28cp	VD17	6g	Tor
<u>027</u>	R1116N271B	LVR-IC	LDO, LN, +CE, 2.7V±1.5%, 150mA	SOT-23-5	28cx	VR4	6g	Ric
<u>027</u>	R1160N271A	LVR-IC	LDO, 2.7V±2%, 200mA, -CE, AE(Mode)	SOT-23-5	28x9	VR10	6g	Ric
<u>027</u>	XC6505A681MR	LVR-IC	LDO, 6.8V±1%, 200mA, +CE	SOT-25	28cx	VR4	6a	Tor
<u>027</u>	XC6101A338MR	Vdet-IC	3.8V±2%, Hst, -MR, -Reset PPO, Wt=100ms, Rt=3.13ms	SOT-25	28cp	VD17	6g	Tor
<u>027A</u>	HT7027A-1	Vdet-IC	2.7V, -Reset ODO	SOT-23-5	28vdm	VD6	6a	Htk
<u>028</u>	R1116N281B	LVR-IC	LDO, LN, +CE, 2.8V±1.5%, 150mA	SOT-23-5	28cx	VR4	6g	Ric
<u>028</u>	R1160N281A	LVR-IC	LDO, 2.8V±2%, 200mA, -CE, AE(Mode)	SOT-23-5	28x9	VR10	6g	Ric
<u>028</u>	XC6505A691MR	LVR-IC	LDO, 6.9V±1%, 200mA, +CE	SOT-25	28cx	VR4	6a	Tor
<u>028</u>	XC6101A339MR	Vdet-IC	3.9V±2%, Hst, -MR, -Reset PPO, Wt=100ms, Rt=3.13ms	SOT-25	28cp	VD17	6g	Tor
<u>029</u>	R1116N291B	LVR-IC	LDO, LN, +CE, 2.9V±1.5%, 150mA	SOT-23-5	28cx	VR4	6g	Ric
<u>029</u>	R1160N291A	LVR-IC	LDO, 2.9V±2%, 200mA, -CE, AE(Mode)	SOT-23-5	28x9	VR10	6g	Ric
<u>029</u>	XC6505A701MR	LVR-IC	LDO, 7.0V±1%, 200mA, +CE	SOT-25	28cx	VR4	6a	Tor
<u>029</u>	XC6101A340MR	Vdet-IC	4.0V±2%, Hst, -MR, -Reset PPO, Wt=100ms, Rt=3.13ms	SOT-25	28cp	VD17	6g	Tor
<u>02A</u>	APR3002-15B	Vdet-IC	1.5V, +Reset PPO	SOT-23-5	28vdm	VD7	6k	Anp
<u>02A</u>	R1182N201B	LVR-IC	LDO, 2V±2%, 150mA, +CE	SOT-23-5	28vrt	VR4	6g	Ric
<u>02A</u>	XC6101A341MR	Vdet-IC	4.1V±2%, Hst, -MR, -Reset PPO, Wt=100ms, Rt=3.13ms	SOT-25	28cp	VD17	6g	Tor
<u>02B</u>	APR3002-17B	Vdet-IC	1.75V, +Reset PPO	SOT-23-5	28vdm	VD7	6k	Anp
<u>02B</u>	R1182N211B	LVR-IC	LDO, 2.1V±2%, 150mA, +CE	SOT-23-5	28vrt	VR4	6g	Ric
<u>02B</u>	XC6101A342MR	Vdet-IC	4.2V±2%, Hst, -MR, -Reset PPO, Wt=100ms, Rt=3.13ms	SOT-25	28cp	VD17	6g	Tor
<u>02C</u>	APR3002-23B	Vdet-IC	2.32V, +Reset PPO	SOT-23-5	28vdm	VD7	6k	Anp
<u>02C</u>	R1182N221B	LVR-IC	LDO, 2.2V±2%, 150mA, +CE	SOT-23-5	28vrt	VR4	6g	Ric
<u>02C</u>	XC6101A343MR	Vdet-IC	4.3V±2%, Hst, -MR, -Reset PPO, Wt=100ms, Rt=3.13ms	SOT-25	28cp	VD17	6g	Tor
<u>02D</u>	APR3002-26B	Vdet-IC	2.63V, +Reset PPO	SOT-23-5	28vdm	VD7	6k	Anp
<u>02D</u>	R1182N231B	LVR-IC	LDO, 2.3V±2%, 150mA, +CE	SOT-23-5	28vrt	VR4	6g	Ric
<u>02D</u>	XC6101A344MR	Vdet-IC	4.4V±2%, Hst, -MR, -Reset PPO, Wt=100ms, Rt=3.13ms	SOT-25	28cp	VD17	6g	Tor
<u>02E</u>	APR3002-29B	Vdet-IC	2.93V, +Reset PPO	SOT-23-5	28vdm	VD7	6k	Anp
<u>02E</u>	R1182N241B	LVR-IC	LDO, 2.4V±2%, 150mA, +CE	SOT-23-5	28vrt	VR4	6g	Ric
<u>02E</u>	XC6101A345MR	Vdet-IC	4.5V±2%, Hst, -MR, -Reset PPO, Wt=100ms, Rt=3.13ms	SOT-25	28cp	VD17	6g	Tor
<u>02F</u>	APR3002-30B	Vdet-IC	3.08V, +Reset PPO	SOT-23-5	28vdm	VD7	6k	Anp
<u>02F</u>	R1182N251B	LVR-IC	LDO, 2.5V±2%, 150mA, +CE	SOT-23-5	28vrt	VR4	6g	Ric
<u>02F</u>	XC6101A316MR	Vdet-IC	1.6V±2%, Hst, -MR, -Reset PPO, Wt=100ms, Rt=3.13ms	SOT-25	28cp	VD17	6g	Tor
<u>02F</u>	XC6101A346MR	Vdet-IC	4.6V±2%, Hst, -MR, -Reset PPO, Wt=100ms, Rt=3.13ms	SOT-25	28cp	VD17	6g	Tor



SMD code	Type	Function	Short description	Case	Pinout	Sch.	St.	Mnf.
02G	APR3002-39B	Vdet-IC	3.9V, +Reset PPO	SOT-23-5	28vdm	VD7	6k	Anp
02G	R1182N261B	LVR-IC	LDO, 2.6V±2%, 150mA, +CE	SOT-23-5	28vrt	VR4	6g	Ric
02H	APR3002-43B	Vdet-IC	4.38V, +Reset PPO	SOT-23-5	28vdm	VD7	6k	Anp
02H	R1182N271B	LVR-IC	LDO, 2.7V±2%, 150mA, +CE	SOT-23-5	28vrt	VR4	6g	Ric
02H	XC6101A317MR	Vdet-IC	1.7V±2%, Hst, -MR, -Reset PPO, Wt=100ms, Rt=3.13ms	SOT-25	28cp	VD17	6g	Tor
02H	XC6101A347MR	Vdet-IC	4.7V±2%, Hst, -MR, -Reset PPO, Wt=100ms, Rt=3.13ms	SOT-25	28cp	VD17	6g	Tor
02J	APR3002-46B	Vdet-IC	4.63V, +Reset PPO	SOT-23-5	28vdm	VD7	6k	Anp
02J	R1182N281B	LVR-IC	LDO, 2.8V±2%, 150mA, +CE	SOT-23-5	28vrt	VR4	6g	Ric
02K	R1182N291B	LVR-IC	LDO, 2.9V±2%, 150mA, +CE	SOT-23-5	28vrt	VR4	6g	Ric
02K	XC6101A318MR	Vdet-IC	1.8V±2%, Hst, -MR, -Reset PPO, Wt=100ms, Rt=3.13ms	SOT-25	28cp	VD17	6g	Tor
02K	XC6101A348MR	Vdet-IC	4.8V±2%, Hst, -MR, -Reset PPO, Wt=100ms, Rt=3.13ms	SOT-25	28cp	VD17	6g	Tor
02L	XC6101A319MR	Vdet-IC	1.9V±2%, Hst, -MR, -Reset PPO, Wt=100ms, Rt=3.13ms	SOT-25	28cp	VD17	6g	Tor
02L	XC6101A349MR	Vdet-IC	4.9V±2%, Hst, -MR, -Reset PPO, Wt=100ms, Rt=3.13ms	SOT-25	28cp	VD17	6g	Tor
02M	XC6101A320MR	Vdet-IC	2.0V±2%, Hst, -MR, -Reset PPO, Wt=100ms, Rt=3.13ms	SOT-25	28cp	VD17	6g	Tor
02M	XC6101A350MR	Vdet-IC	5.0V±2%, Hst, -MR, -Reset PPO, Wt=100ms, Rt=3.13ms	SOT-25	28cp	VD17	6g	Tor
02N	XC6505A511MR	LVR-IC	LDO, 5.1V±1%, 200mA, +CE	SOT-25	28cx	VR4	6a	Tor
02N	XC6101A321MR	Vdet-IC	2.1V±2%, Hst, -MR, -Reset PPO, Wt=100ms, Rt=3.13ms	SOT-25	28cp	VD17	6g	Tor
02P	XC6505A521MR	LVR-IC	LDO, 5.2V±1%, 200mA, +CE	SOT-25	28cx	VR4	6a	Tor
02P	XC6101A322MR	Vdet-IC	2.2V±2%, Hst, -MR, -Reset PPO, Wt=100ms, Rt=3.13ms	SOT-25	28cp	VD17	6g	Tor
02R	XC6505A531MR	LVR-IC	LDO, 5.3V±1%, 200mA, +CE	SOT-25	28cx	VR4	6a	Tor
02R	XC6101A323MR	Vdet-IC	2.3V±2%, Hst, -MR, -Reset PPO, Wt=100ms, Rt=3.13ms	SOT-25	28cp	VD17	6g	Tor
02S	XC6505A541MR	LVR-IC	LDO, 5.4V±1%, 200mA, +CE	SOT-25	28cx	VR4	6a	Tor
02S	XC6101A324MR	Vdet-IC	2.4V±2%, Hst, -MR, -Reset PPO, Wt=100ms, Rt=3.13ms	SOT-25	28cp	VD17	6g	Tor
02T	XC6505A551MR	LVR-IC	LDO, 5.5V±1%, 200mA, +CE	SOT-25	28cx	VR4	6a	Tor
02T	XC6101A325MR	Vdet-IC	2.5V±2%, Hst, -MR, -Reset PPO, Wt=100ms, Rt=3.13ms	SOT-25	28cp	VD17	6g	Tor
02U	XC6505A561MR	LVR-IC	LDO, 5.6V±1%, 200mA, +CE	SOT-25	28cx	VR4	6a	Tor
02U	XC6101A326MR	Vdet-IC	2.6V±2%, Hst, -MR, -Reset PPO, Wt=100ms, Rt=3.13ms	SOT-25	28cp	VD17	6g	Tor
02V	XC6505A571MR	LVR-IC	LDO, 5.7V±1%, 200mA, +CE	SOT-25	28cx	VR4	6a	Tor
02V	XC6101A327MR	Vdet-IC	2.7V±2%, Hst, -MR, -Reset PPO, Wt=100ms, Rt=3.13ms	SOT-25	28cp	VD17	6g	Tor
02X	XC6505A581MR	LVR-IC	LDO, 5.8V±1%, 200mA, +CE	SOT-25	28cx	VR4	6a	Tor
02X	XC6101A328MR	Vdet-IC	2.8V±2%, Hst, -MR, -Reset PPO, Wt=100ms, Rt=3.13ms	SOT-25	28cp	VD17	6g	Tor
02Y	XC6505A591MR	LVR-IC	LDO, 5.9V±1%, 200mA, +CE	SOT-25	28cx	VR4	6a	Tor
02Y	XC6101A329MR	Vdet-IC	2.9V±2%, Hst, -MR, -Reset PPO, Wt=100ms, Rt=3.13ms	SOT-25	28cp	VD17	6g	Tor
02Z	XC6505A601MR	LVR-IC	LDO, 6.0V±1%, 200mA, +CE	SOT-25	28cx	VR4	6a	Tor
02Z	XC6101A330MR	Vdet-IC	3.0V±2%, Hst, -MR, -Reset PPO, Wt=100ms, Rt=3.13ms	SOT-25	28cp	VD17	6g	Tor
03	R1223N252C	DC/DC-IC	PWM step-down, +CE, 2.5V, 300kHz, Latch-Pr.	SOT-23-5	28ud	DC7	6g	Ric
03	RN5RF53BA	LVR-IC	LRip, +CE, 5.3V±2%, 1A*	SOT-23-5	28vw	VR6	6g	Ric
03	RN5RZ53BA	LVR-IC	LDO, LN, +CE, 5.3V±2%, 100mA	SOT-23-5	28vrt	VR4	6g	Ric
030	R1116N301B	LVR-IC	LDO, LN, +CE, 3V±1.5%, 150mA	SOT-23-5	28cx	VR4	6g	Ric
030	R1160N301A	LVR-IC	LDO, 3V±2%, 200mA, -CE, AE(Mode)	SOT-23-5	28x9	VR10	6g	Ric
030	XC6101A431MR	Vdet-IC	3.1V±2%, Hst, -MR, -Reset PPO, Wt=200ms, Rt=3.13ms	SOT-25	28cp	VD17	6g	Tor
031	R1116N311B	LVR-IC	LDO, LN, +CE, 3.1V±2%, 150mA	SOT-23-5	28cx	VR4	6g	Ric
031	R1160N311A	LVR-IC	LDO, 3.1V±2%, 200mA, -CE, AE(Mode)	SOT-23-5	28x9	VR10	6g	Ric
031	XC6101A432MR	Vdet-IC	3.2V±2%, Hst, -MR, -Reset PPO, Wt=200ms, Rt=3.13ms	SOT-25	28cp	VD17	6g	Tor
032	R1116N321B	LVR-IC	LDO, LN, +CE, 3.2V±2%, 150mA	SOT-23-5	28cx	VR4	6g	Ric
032	R1160N321A	LVR-IC	LDO, 3.2V±2%, 200mA, -CE, AE(Mode)	SOT-23-5	28x9	VR10	6g	Ric
032	XC6101A433MR	Vdet-IC	3.3V±2%, Hst, -MR, -Reset PPO, Wt=200ms, Rt=3.13ms	SOT-25	28cp	VD17	6g	Tor
033	R1116N331B	LVR-IC	LDO, LN, +CE, 3.3V±2%, 150mA	SOT-23-5	28cx	VR4	6g	Ric
033	R1160N331A	LVR-IC	LDO, 3.3V±2%, 200mA, -CE, AE(Mode)	SOT-23-5	28x9	VR10	6g	Ric
033	XC6101A434MR	Vdet-IC	3.4V±2%, Hst, -MR, -Reset PPO, Wt=200ms, Rt=3.13ms	SOT-25	28cp	VD17	6g	Tor
033A	HT7033A-1	Vdet-IC	3.3V, -Reset ODO	SOT-23-5	28vdm	VD6	6a	Htk
034	R1116N341B	LVR-IC	LDO, LN, +CE, 3.4V±2%, 150mA	SOT-23-5	28cx	VR4	6g	Ric
034	XC6101A435MR	Vdet-IC	3.5V±2%, Hst, -MR, -Reset PPO, Wt=200ms, Rt=3.13ms	SOT-25	28cp	VD17	6g	Tor
035	R1116N351B	LVR-IC	LDO, LN, +CE, 3.5V±2%, 150mA	SOT-23-5	28cx	VR4	6g	Ric
035	XC6101A436MR	Vdet-IC	3.6V±2%, Hst, -MR, -Reset PPO, Wt=200ms, Rt=3.13ms	SOT-25	28cp	VD17	6g	Tor
036	R1116N361B	LVR-IC	LDO, LN, +CE, 3.6V±2%, 150mA	SOT-23-5	28cx	VR4	6g	Ric
036	XC6101A437MR	Vdet-IC	3.7V±2%, Hst, -MR, -Reset PPO, Wt=200ms, Rt=3.13ms	SOT-25	28cp	VD17	6g	Tor
037	R1116N371B	LVR-IC	LDO, LN, +CE, 3.7V±2%, 150mA	SOT-23-5	28cx	VR4	6g	Ric
037	XC6101A438MR	Vdet-IC	3.8V±2%, Hst, -MR, -Reset PPO, Wt=200ms, Rt=3.13ms	SOT-25	28cp	VD17	6g	Tor
038	R1116N381B	LVR-IC	LDO, LN, +CE, 3.8V±2%, 150mA	SOT-23-5	28cx	VR4	6g	Ric
038	XC6101A439MR	Vdet-IC	3.9V±2%, Hst, -MR, -Reset PPO, Wt=200ms, Rt=3.13ms	SOT-25	28cp	VD17	6g	Tor
039	R1116N391B	LVR-IC	LDO, LN, +CE, 3.9V±2%, 150mA	SOT-23-5	28cx	VR4	6g	Ric
039	XC6101A440MR	Vdet-IC	4.0V±2%, Hst, -MR, -Reset PPO, Wt=200ms, Rt=3.13ms	SOT-25	28cp	VD17	6g	Tor
039A	HT7039A-1	Vdet-IC	3.9V, -Reset ODO	SOT-23-5	28vdm	VD6	6a	Htk
03A	APR3003-15B	Vdet-IC	1.5V, -Reset ODO	SOT-23-5	28vdm	VD6	6k	Anp
03A	R1182N301B	LVR-IC	LDO, 3V±2%, 150mA, +CE	SOT-23-5	28vrt	VR4	6g	Ric
03A	XC6505A711MR	LVR-IC	LDO, 7.1V±1%, 200mA, +CE	SOT-25	28cx	VR4	6a	Tor
03A	XC6101A441MR	Vdet-IC	4.1V±2%, Hst, -MR, -Reset PPO, Wt=200ms, Rt=3.13ms	SOT-25	28cp	VD17	6g	Tor
03B	APR3003-17B	Vdet-IC	1.75V, -Reset ODO	SOT-23-5	28vdm	VD6	6k	Anp
03B	R1182N311B	LVR-IC	LDO, 3.1V±2%, 150mA, +CE	SOT-23-5	28vrt	VR4	6g	Ric



SMD code	Type	Function	Short description	Case	Pinout	Sch.	St.	Mnf.
<u>03B</u>	XC6505A721MR	LVR-IC	LDO, 7.2V±1%, 200mA, +CE	SOT-25	28cx	VR4	6a	Tor
<u>03B</u>	XC6101A442MR	Vdet-IC	4.2V±2%, Hst, -MR, -Reset PPO, Wt=200ms, Rt=3.13ms	SOT-25	28cp	VD17	6g	Tor
<u>03C</u>	APR3003-23B	Vdet-IC	2.32V, -Reset ODO	SOT-23-5	28vdm	VD6	6k	Ang
<u>03C</u>	R1182N321B	LVR-IC	LDO, 3.2V±2%, 150mA, +CE	SOT-23-5	28vrt	VR4	6g	Ric
<u>03C</u>	XC6505A731MR	LVR-IC	LDO, 7.3V±1%, 200mA, +CE	SOT-25	28cx	VR4	6a	Tor
<u>03C</u>	XC6101A443MR	Vdet-IC	4.3V±2%, Hst, -MR, -Reset PPO, Wt=200ms, Rt=3.13ms	SOT-25	28cp	VD17	6g	Tor
<u>03D</u>	APR3003-26B	Vdet-IC	2.63V, -Reset ODO	SOT-23-5	28vdm	VD6	6k	Ang
<u>03D</u>	R1182N331B	LVR-IC	LDO, 3.3V±2%, 150mA, +CE	SOT-23-5	28vrt	VR4	6g	Ric
<u>03D</u>	XC6505A741MR	LVR-IC	LDO, 7.4V±1%, 200mA, +CE	SOT-25	28cx	VR4	6a	Tor
<u>03D</u>	XC6101A444MR	Vdet-IC	4.4V±2%, Hst, -MR, -Reset PPO, Wt=200ms, Rt=3.13ms	SOT-25	28cp	VD17	6g	Tor
<u>03E</u>	APR3003-29B	Vdet-IC	2.93V, -Reset ODO	SOT-23-5	28vdm	VD6	6k	Ang
<u>03E</u>	R1182N341B	LVR-IC	LDO, 3.4V±2%, 150mA, +CE	SOT-23-5	28vrt	VR4	6g	Ric
<u>03E</u>	XC6505A751MR	LVR-IC	LDO, 7.5V±1%, 200mA, +CE	SOT-25	28cx	VR4	6a	Tor
<u>03E</u>	XC6101A445MR	Vdet-IC	4.5V±2%, Hst, -MR, -Reset PPO, Wt=200ms, Rt=3.13ms	SOT-25	28cp	VD17	6g	Tor
<u>03F</u>	APR3003-30B	Vdet-IC	3.08V, -Reset ODO	SOT-23-5	28vdm	VD6	6k	Ang
<u>03F</u>	R1182N351B	LVR-IC	LDO, 3.5V±2%, 150mA, +CE	SOT-23-5	28vrt	VR4	6g	Ric
<u>03F</u>	XC6505A761MR	LVR-IC	LDO, 7.6V±1%, 200mA, +CE	SOT-25	28cx	VR4	6a	Tor
<u>03F</u>	XC6101A416MR	Vdet-IC	1.6V±2%, Hst, -MR, -Reset PPO, Wt=200ms, Rt=3.13ms	SOT-25	28cp	VD17	6g	Tor
<u>03F</u>	XC6101A446MR	Vdet-IC	4.6V±2%, Hst, -MR, -Reset PPO, Wt=200ms, Rt=3.13ms	SOT-25	28cp	VD17	6g	Tor
<u>03G</u>	APR3003-39B	Vdet-IC	3.9V, -Reset ODO	SOT-23-5	28vdm	VD6	6k	Ang
<u>03G</u>	R1182N361B	LVR-IC	LDO, 3.6V±2%, 150mA, +CE	SOT-23-5	28vrt	VR4	6g	Ric
<u>03H</u>	APR3003-43B	Vdet-IC	4.38V, -Reset ODO	SOT-23-5	28vdm	VD6	6k	Ang
<u>03H</u>	R1182N371B	LVR-IC	LDO, 3.7V±2%, 150mA, +CE	SOT-23-5	28vrt	VR4	6g	Ric
<u>03H</u>	XC6505A771MR	LVR-IC	LDO, 7.7V±1%, 200mA, +CE	SOT-25	28cx	VR4	6a	Tor
<u>03H</u>	XC6101A417MR	Vdet-IC	1.7V±2%, Hst, -MR, -Reset PPO, Wt=200ms, Rt=3.13ms	SOT-25	28cp	VD17	6g	Tor
<u>03H</u>	XC6101A447MR	Vdet-IC	4.7V±2%, Hst, -MR, -Reset PPO, Wt=200ms, Rt=3.13ms	SOT-25	28cp	VD17	6g	Tor
<u>03J</u>	APR3003-46B	Vdet-IC	4.63V, -Reset ODO	SOT-23-5	28vdm	VD6	6k	Ang
<u>03J</u>	R1182N381B	LVR-IC	LDO, 3.8V±2%, 150mA, +CE	SOT-23-5	28vrt	VR4	6g	Ric
<u>03K</u>	R1182N391B	LVR-IC	LDO, 3.9V±2%, 150mA, +CE	SOT-23-5	28vrt	VR4	6g	Ric
<u>03K</u>	XC6505A781MR	LVR-IC	LDO, 7.8V±1%, 200mA, +CE	SOT-25	28cx	VR4	6a	Tor
<u>03K</u>	XC6101A418MR	Vdet-IC	1.8V±2%, Hst, -MR, -Reset PPO, Wt=200ms, Rt=3.13ms	SOT-25	28cp	VD17	6g	Tor
<u>03K</u>	XC6101A448MR	Vdet-IC	4.8V±2%, Hst, -MR, -Reset PPO, Wt=200ms, Rt=3.13ms	SOT-25	28cp	VD17	6g	Tor
<u>03L</u>	R1182N401B	LVR-IC	LDO, 4V±2%, 150mA, +CE	SOT-23-5	28vrt	VR4	6g	Ric
<u>03L</u>	XC6505A791MR	LVR-IC	LDO, 7.9V±1%, 200mA, +CE	SOT-25	28cx	VR4	6a	Tor
<u>03L</u>	XC6101A419MR	Vdet-IC	1.9V±2%, Hst, -MR, -Reset PPO, Wt=200ms, Rt=3.13ms	SOT-25	28cp	VD17	6g	Tor
<u>03L</u>	XC6101A449MR	Vdet-IC	4.9V±2%, Hst, -MR, -Reset PPO, Wt=200ms, Rt=3.13ms	SOT-25	28cp	VD17	6g	Tor
<u>03M</u>	R1182N121B5	LVR-IC	LDO, 1.25V±2%, 150mA, +CE	SOT-23-5	28vrt	VR4	6g	Ric
<u>03M</u>	XC6505A801MR	LVR-IC	LDO, 8.0V±1%, 200mA, +CE	SOT-25	28cx	VR4	6a	Tor
<u>03M</u>	XC6101A420MR	Vdet-IC	2.0V±2%, Hst, -MR, -Reset PPO, Wt=200ms, Rt=3.13ms	SOT-25	28cp	VD17	6g	Tor
<u>03M</u>	XC6101A450MR	Vdet-IC	5.0V±2%, Hst, -MR, -Reset PPO, Wt=200ms, Rt=3.13ms	SOT-25	28cp	VD17	6g	Tor
<u>03N</u>	R1182N181B5	LVR-IC	LDO, 1.85V±2%, 150mA, +CE	SOT-23-5	28vrt	VR4	6g	Ric
<u>03N</u>	XC6101A421MR	Vdet-IC	2.1V±2%, Hst, -MR, -Reset PPO, Wt=200ms, Rt=3.13ms	SOT-25	28cp	VD17	6g	Tor
<u>03P</u>	R1182N291B5	LVR-IC	LDO, 2.95V±2%, 150mA, +CE	SOT-23-5	28vrt	VR4	6g	Ric
<u>03P</u>	XC6101A422MR	Vdet-IC	2.2V±2%, Hst, -MR, -Reset PPO, Wt=200ms, Rt=3.13ms	SOT-25	28cp	VD17	6g	Tor
<u>03R</u>	XC6101A423MR	Vdet-IC	2.3V±2%, Hst, -MR, -Reset PPO, Wt=200ms, Rt=3.13ms	SOT-25	28cp	VD17	6g	Tor
<u>03S</u>	XC6101A424MR	Vdet-IC	2.4V±2%, Hst, -MR, -Reset PPO, Wt=200ms, Rt=3.13ms	SOT-25	28cp	VD17	6g	Tor
<u>03T</u>	XC6101A425MR	Vdet-IC	2.5V±2%, Hst, -MR, -Reset PPO, Wt=200ms, Rt=3.13ms	SOT-25	28cp	VD17	6g	Tor
<u>03U</u>	XC6101A426MR	Vdet-IC	2.6V±2%, Hst, -MR, -Reset PPO, Wt=200ms, Rt=3.13ms	SOT-25	28cp	VD17	6g	Tor
<u>03V</u>	XC6101A427MR	Vdet-IC	2.7V±2%, Hst, -MR, -Reset PPO, Wt=200ms, Rt=3.13ms	SOT-25	28cp	VD17	6g	Tor
<u>03X</u>	XC6101A428MR	Vdet-IC	2.8V±2%, Hst, -MR, -Reset PPO, Wt=200ms, Rt=3.13ms	SOT-25	28cp	VD17	6g	Tor
<u>03Y</u>	XC6101A429MR	Vdet-IC	2.9V±2%, Hst, -MR, -Reset PPO, Wt=200ms, Rt=3.13ms	SOT-25	28cp	VD17	6g	Tor
<u>03Z</u>	XC6101A430MR	Vdet-IC	3.0V±2%, Hst, -MR, -Reset PPO, Wt=200ms, Rt=3.13ms	SOT-25	28cp	VD17	6g	Tor
<u>04</u>	R1223N302C	DC/DC-IC	PWM step-down, +CE, 3V, 300kHz, Latch-Pr	SOT-23-5	28ud	DC7	6g	Ric
<u>04</u>	RN5RF54BA	LVR-IC	LDO, +CE, 5.4V±2%, 1A*	SOT-23-5	28vww	VR6	6g	Ric
<u>04</u>	RN5RZ54BA	LVR-IC	LDO, LN, +CE, 5.4V±2%, 100mA	SOT-23-5	28vrt	VR4	6g	Ric
<u>040</u>	R1116N401B	LVR-IC	LDO, LN, +CE, 4V±2%, 150mA	SOT-23-5	28cx	VR4	6g	Ric
<u>040</u>	XC6101A531MR	Vdet-IC	3.1V±2%, Hst, -MR, -Reset PPO, Wt=400ms, Rt=3.13ms	SOT-25	28cp	VD17	6g	Tor
<u>041</u>	R1116N181B5	LVR-IC	LDO, LN, +CE, 1.85V±1.5%, 150mA	SOT-23-5	28cx	VR4	6g	Ric
<u>041</u>	XC6101A532MR	Vdet-IC	3.2V±2%, Hst, -MR, -Reset PPO, Wt=400ms, Rt=3.13ms	SOT-25	28cp	VD17	6g	Tor
<u>042</u>	R1116N281B5	LVR-IC	LDO, LN, +CE, 2.85V±1.5%, 150mA	SOT-23-5	28cx	VR4	6g	Ric
<u>042</u>	XC6101A533MR	Vdet-IC	3.3V±2%, Hst, -MR, -Reset PPO, Wt=400ms, Rt=3.13ms	SOT-25	28cp	VD17	6g	Tor
<u>043</u>	XC6101A534MR	Vdet-IC	3.4V±2%, Hst, -MR, -Reset PPO, Wt=400ms, Rt=3.13ms	SOT-25	28cp	VD17	6g	Tor
<u>044</u>	XC6101A535MR	Vdet-IC	3.5V±2%, Hst, -MR, -Reset PPO, Wt=400ms, Rt=3.13ms	SOT-25	28cp	VD17	6g	Tor
<u>044A</u>	HT7044A-1	Vdet-IC	4.4V, -Reset ODO	SOT-23-5	28vdm	VD6	6a	Htk
<u>045</u>	XC6101A536MR	Vdet-IC	3.6V±2%, Hst, -MR, -Reset PPO, Wt=400ms, Rt=3.13ms	SOT-25	28cp	VD17	6g	Tor
<u>046</u>	XC6101A537MR	Vdet-IC	3.7V±2%, Hst, -MR, -Reset PPO, Wt=400ms, Rt=3.13ms	SOT-25	28cp	VD17	6g	Tor
<u>047</u>	XC6101A538MR	Vdet-IC	3.8V±2%, Hst, -MR, -Reset PPO, Wt=400ms, Rt=3.13ms	SOT-25	28cp	VD17	6g	Tor
<u>048</u>	XC6101A539MR	Vdet-IC	3.9V±2%, Hst, -MR, -Reset PPO, Wt=400ms, Rt=3.13ms	SOT-25	28cp	VD17	6g	Tor
<u>049</u>	XC6101A540MR	Vdet-IC	4.0V±2%, Hst, -MR, -Reset PPO, Wt=400ms, Rt=3.13ms	SOT-25	28cp	VD17	6g	Tor
<u>04A</u>	XC6101A541MR	Vdet-IC	4.1V±2%, Hst, -MR, -Reset PPO, Wt=400ms, Rt=3.13ms	SOT-25	28cp	VD17	6g	Tor



SMD code	Type	Function	Short description	Case	Pinout	Sch.	St.	Mnf.
<u>04B</u>	XC6101A542MR	Vdet-IC	4.2V±2%, Hst, -MR, -Reset PPO, Wt=400ms, Rt=3.13ms	SOT-25	28cp	VD17	6g	Tor
<u>04C</u>	XC6101A543MR	Vdet-IC	4.3V±2%, Hst, -MR, -Reset PPO, Wt=400ms, Rt=3.13ms	SOT-25	28cp	VD17	6g	Tor
<u>04D</u>	XC6101A544MR	Vdet-IC	4.4V±2%, Hst, -MR, -Reset PPO, Wt=400ms, Rt=3.13ms	SOT-25	28cp	VD17	6g	Tor
<u>04E</u>	XC6505C151MR	LVR-IC	LDO, 1.5V±20mV, 200mA, +CE, CL	SOT-25	28cx	VR4	6a	Tor
<u>04F</u>	XC6101A545MR	Vdet-IC	4.5V±2%, Hst, -MR, -Reset PPO, Wt=400ms, Rt=3.13ms	SOT-25	28cp	VD17	6g	Tor
<u>04G</u>	XC6505C161MR	LVR-IC	LDO, 1.6V±20mV, 200mA, +CE, CL	SOT-25	28cx	VR4	6a	Tor
<u>04H</u>	XC6101A516MR	Vdet-IC	1.6V±2%, Hst, -MR, -Reset PPO, Wt=400ms, Rt=3.13ms	SOT-25	28cp	VD17	6g	Tor
<u>04I</u>	XC6101A546MR	Vdet-IC	4.6V±2%, Hst, -MR, -Reset PPO, Wt=400ms, Rt=3.13ms	SOT-25	28cp	VD17	6g	Tor
<u>04J</u>	XC6505C171MR	LVR-IC	LDO, 1.7V±20mV, 200mA, +CE, CL	SOT-25	28cx	VR4	6a	Tor
<u>04K</u>	XC6101A517MR	Vdet-IC	1.7V±2%, Hst, -MR, -Reset PPO, Wt=400ms, Rt=3.13ms	SOT-25	28cp	VD17	6g	Tor
<u>04L</u>	XC6101A547MR	Vdet-IC	4.7V±2%, Hst, -MR, -Reset PPO, Wt=400ms, Rt=3.13ms	SOT-25	28cp	VD17	6g	Tor
<u>04M</u>	XC6505C181MR	LVR-IC	LDO, 1.8V±20mV, 200mA, +CE, CL	SOT-25	28cx	VR4	6a	Tor
<u>04N</u>	XC6101A518MR	Vdet-IC	1.8V±2%, Hst, -MR, -Reset PPO, Wt=400ms, Rt=3.13ms	SOT-25	28cp	VD17	6g	Tor
<u>04O</u>	XC6101A548MR	Vdet-IC	4.8V±2%, Hst, -MR, -Reset PPO, Wt=400ms, Rt=3.13ms	SOT-25	28cp	VD17	6g	Tor
<u>04P</u>	XC6505C191MR	LVR-IC	LDO, 1.9V±20mV, 200mA, +CE, CL	SOT-25	28cx	VR4	6a	Tor
<u>04Q</u>	XC6101A519MR	Vdet-IC	1.9V±2%, Hst, -MR, -Reset PPO, Wt=400ms, Rt=3.13ms	SOT-25	28cp	VD17	6g	Tor
<u>04R</u>	XC6101A549MR	Vdet-IC	4.9V±2%, Hst, -MR, -Reset PPO, Wt=400ms, Rt=3.13ms	SOT-25	28cp	VD17	6g	Tor
<u>04S</u>	XC6505C201MR	LVR-IC	LDO, 2.0V±1%, 200mA, +CE, CL	SOT-25	28cx	VR4	6a	Tor
<u>04T</u>	XC6101A520MR	Vdet-IC	2.0V±2%, Hst, -MR, -Reset PPO, Wt=400ms, Rt=3.13ms	SOT-25	28cp	VD17	6g	Tor
<u>04U</u>	XC6101A550MR	Vdet-IC	5.0V±2%, Hst, -MR, -Reset PPO, Wt=400ms, Rt=3.13ms	SOT-25	28cp	VD17	6g	Tor
<u>04V</u>	XC6505C211MR	LVR-IC	LDO, 2.1V±1%, 200mA, +CE, CL	SOT-25	28cx	VR4	6a	Tor
<u>04W</u>	XC6101A521MR	Vdet-IC	2.1V±2%, Hst, -MR, -Reset PPO, Wt=400ms, Rt=3.13ms	SOT-25	28cp	VD17	6g	Tor
<u>04X</u>	XC6505C221MR	LVR-IC	LDO, 2.2V±1%, 200mA, +CE, CL	SOT-25	28cx	VR4	6a	Tor
<u>04Y</u>	XC6101A522MR	Vdet-IC	2.2V±2%, Hst, -MR, -Reset PPO, Wt=400ms, Rt=3.13ms	SOT-25	28cp	VD17	6g	Tor
<u>04Z</u>	XC6505C231MR	LVR-IC	LDO, 2.3V±1%, 200mA, +CE, CL	SOT-25	28cx	VR4	6a	Tor
<u>050</u>	XC6101A523MR	Vdet-IC	2.3V±2%, Hst, -MR, -Reset PPO, Wt=400ms, Rt=3.13ms	SOT-25	28cp	VD17	6g	Tor
<u>051</u>	XC6505C241MR	LVR-IC	LDO, 2.4V±1%, 200mA, +CE, CL	SOT-25	28cx	VR4	6a	Tor
<u>052</u>	XC6101A524MR	Vdet-IC	2.4V±2%, Hst, -MR, -Reset PPO, Wt=400ms, Rt=3.13ms	SOT-25	28cp	VD17	6g	Tor
<u>053</u>	XC6505C251MR	LVR-IC	LDO, 2.5V±1%, 200mA, +CE, CL	SOT-25	28cx	VR4	6a	Tor
<u>054</u>	XC6101A525MR	Vdet-IC	2.5V±2%, Hst, -MR, -Reset PPO, Wt=400ms, Rt=3.13ms	SOT-25	28cp	VD17	6g	Tor
<u>055</u>	XC6505C261MR	LVR-IC	LDO, 2.6V±1%, 200mA, +CE, CL	SOT-25	28cx	VR4	6a	Tor
<u>056</u>	XC6101A526MR	Vdet-IC	2.6V±2%, Hst, -MR, -Reset PPO, Wt=400ms, Rt=3.13ms	SOT-25	28cp	VD17	6g	Tor
<u>057</u>	XC6505C271MR	LVR-IC	LDO, 2.7V±1%, 200mA, +CE, CL	SOT-25	28cx	VR4	6a	Tor
<u>058</u>	XC6101A527MR	Vdet-IC	2.7V±2%, Hst, -MR, -Reset PPO, Wt=400ms, Rt=3.13ms	SOT-25	28cp	VD17	6g	Tor
<u>059</u>	XC6505C281MR	LVR-IC	LDO, 2.8V±1%, 200mA, +CE, CL	SOT-25	28cx	VR4	6a	Tor
<u>05A</u>	XC6101A528MR	Vdet-IC	2.8V±2%, Hst, -MR, -Reset PPO, Wt=400ms, Rt=3.13ms	SOT-25	28cp	VD17	6g	Tor
<u>05B</u>	XC6505C291MR	LVR-IC	LDO, 2.9V±1%, 200mA, +CE, CL	SOT-25	28cx	VR4	6a	Tor
<u>05C</u>	XC6101A529MR	Vdet-IC	2.9V±2%, Hst, -MR, -Reset PPO, Wt=400ms, Rt=3.13ms	SOT-25	28cp	VD17	6g	Tor
<u>05D</u>	XC6505C301MR	LVR-IC	LDO, 3.0V±1%, 200mA, +CE, CL	SOT-25	28cx	VR4	6a	Tor
<u>05E</u>	XC6101A530MR	Vdet-IC	3.0V±2%, Hst, -MR, -Reset PPO, Wt=400ms, Rt=3.13ms	SOT-25	28cp	VD17	6g	Tor
<u>05F</u>	R1223N332C	DC/DC-IC	PWM step-down, +CE, 3.3V, 300kHz, Latch-Pr.	SOT-23-5	28ud	DC7	6g	Ric
<u>05G</u>	RN5RF55BA	LVR-IC	LRip, +CE, 5.5V±2%, 1A*	SOT-23-5	28vw	VR6	6g	Ric
<u>05H</u>	RN5RZ55BA	LVR-IC	LDO, LN, +CE, 5.5V±2%, 100mA	SOT-23-5	28vt	VR4	6g	Ric
<u>05I</u>	XC6505C311MR	LVR-IC	LDO, 3.1V±1%, 200mA, +CE, CL	SOT-25	28cx	VR4	6a	Tor
<u>05J</u>	XC6101A631MR	Vdet-IC	3.1V±2%, Hst, -MR, -Reset PPO, Wt=1.6s, Rt=3.13ms	SOT-25	28cp	VD17	6g	Tor
<u>05K</u>	HT7050A-1	Vdet-IC	5V, -Reset ODO	SOT-23-5	28vdm	VD6	6a	Hkk
<u>05L</u>	XC6505C321MR	LVR-IC	LDO, 3.2V±1%, 200mA, +CE, CL	SOT-25	28cx	VR4	6a	Tor
<u>05M</u>	XC6101A632MR	Vdet-IC	3.2V±2%, Hst, -MR, -Reset PPO, Wt=1.6s, Rt=3.13ms	SOT-25	28cp	VD17	6g	Tor
<u>05N</u>	XC6505C331MR	LVR-IC	LDO, 3.3V±1%, 200mA, +CE, CL	SOT-25	28cx	VR4	6a	Tor
<u>05O</u>	XC6101A633MR	Vdet-IC	3.3V±2%, Hst, -MR, -Reset PPO, Wt=1.6s, Rt=3.13ms	SOT-25	28cp	VD17	6g	Tor
<u>05P</u>	XC6505C341MR	LVR-IC	LDO, 3.4V±1%, 200mA, +CE, CL	SOT-25	28cx	VR4	6a	Tor
<u>05Q</u>	XC6101A634MR	Vdet-IC	3.4V±2%, Hst, -MR, -Reset PPO, Wt=1.6s, Rt=3.13ms	SOT-25	28cp	VD17	6g	Tor
<u>05R</u>	XC6505C351MR	LVR-IC	LDO, 3.5V±1%, 200mA, +CE, CL	SOT-25	28cx	VR4	6a	Tor
<u>05S</u>	XC6101A635MR	Vdet-IC	3.5V±2%, Hst, -MR, -Reset PPO, Wt=1.6s, Rt=3.13ms	SOT-25	28cp	VD17	6g	Tor
<u>05T</u>	XC6505C361MR	LVR-IC	LDO, 3.6V±1%, 200mA, +CE, CL	SOT-25	28cx	VR4	6a	Tor
<u>05U</u>	XC6101A636MR	Vdet-IC	3.6V±2%, Hst, -MR, -Reset PPO, Wt=1.6s, Rt=3.13ms	SOT-25	28cp	VD17	6g	Tor
<u>05V</u>	XC6505C371MR	LVR-IC	LDO, 3.7V±1%, 200mA, +CE, CL	SOT-25	28cx	VR4	6a	Tor
<u>05W</u>	XC6101A637MR	Vdet-IC	3.7V±2%, Hst, -MR, -Reset PPO, Wt=1.6s, Rt=3.13ms	SOT-25	28cp	VD17	6g	Tor
<u>05X</u>	XC6505C381MR	LVR-IC	LDO, 3.8V±1%, 200mA, +CE, CL	SOT-25	28cx	VR4	6a	Tor
<u>05Y</u>	XC6101A638MR	Vdet-IC	3.8V±2%, Hst, -MR, -Reset PPO, Wt=1.6s, Rt=3.13ms	SOT-25	28cp	VD17	6g	Tor
<u>05Z</u>	XC6505C391MR	LVR-IC	LDO, 3.9V±1%, 200mA, +CE, CL	SOT-25	28cx	VR4	6a	Tor
<u>060</u>	XC6101A639MR	Vdet-IC	3.9V±2%, Hst, -MR, -Reset PPO, Wt=1.6s, Rt=3.13ms	SOT-25	28cp	VD17	6g	Tor
<u>061</u>	XC6505C401MR	LVR-IC	LDO, 4.0V±1%, 200mA, +CE, CL	SOT-25	28cx	VR4	6a	Tor
<u>062</u>	XC6101A640MR	Vdet-IC	4.0V±2%, Hst, -MR, -Reset PPO, Wt=1.6s, Rt=3.13ms	SOT-25	28cp	VD17	6g	Tor
<u>063</u>	XC6505C411MR	LVR-IC	LDO, 4.1V±1%, 200mA, +CE, CL	SOT-25	28cx	VR4	6a	Tor
<u>064</u>	XC6101A641MR	Vdet-IC	4.1V±2%, Hst, -MR, -Reset PPO, Wt=1.6s, Rt=3.13ms	SOT-25	28cp	VD17	6g	Tor
<u>065</u>	XC6505C421MR	LVR-IC	LDO, 4.2V±1%, 200mA, +CE, CL	SOT-25	28cx	VR4	6a	Tor
<u>066</u>	XC6101A642MR	Vdet-IC	4.2V±2%, Hst, -MR, -Reset PPO, Wt=1.6s, Rt=3.13ms	SOT-25	28cp	VD17	6g	Tor
<u>067</u>	XC6505C431MR	LVR-IC	LDO, 4.3V±1%, 200mA, +CE, CL	SOT-25	28cx	VR4	6a	Tor
<u>068</u>	XC6101A643MR	Vdet-IC	4.3V±2%, Hst, -MR, -Reset PPO, Wt=1.6s, Rt=3.13ms	SOT-25	28cp	VD17	6g	Tor



SMD code	Type	Function	Short description	Case	Pinout	Sch.	St.	Mnf.
<u>05D</u>	XC6505C441MR	LVR-IC	LDO, 4.4V±1%, 200mA, +CE, CL	SOT-25	28cx	VR4	6a	Tor
<u>05D</u>	XC6101A644MR	Vdet-IC	4.4V±2%, Hst, -MR, -Reset PPO, Wt=1.6s, Rt=3.13ms	SOT-25	28cp	VD17	6g	Tor
<u>05E</u>	XC6505C451MR	LVR-IC	LDO, 4.5V±1%, 200mA, +CE, CL	SOT-25	28cx	VR4	6a	Tor
<u>05E</u>	XC6101A645MR	Vdet-IC	4.5V±2%, Hst, -MR, -Reset PPO, Wt=1.6s, Rt=3.13ms	SOT-25	28cp	VD17	6g	Tor
<u>05F</u>	XC6505C461MR	LVR-IC	LDO, 4.6V±1%, 200mA, +CE, CL	SOT-25	28cx	VR4	6a	Tor
<u>05F</u>	XC6101A616MR	Vdet-IC	1.6V±2%, Hst, -MR, -Reset PPO, Wt=1.6s, Rt=3.13ms	SOT-25	28cp	VD17	6g	Tor
<u>05E</u>	XC6101A646MR	Vdet-IC	4.6V±2%, Hst, -MR, -Reset PPO, Wt=1.6s, Rt=3.13ms	SOT-25	28cp	VD17	6g	Tor
<u>05H</u>	XC6505C471MR	LVR-IC	LDO, 4.7V±1%, 200mA, +CE, CL	SOT-25	28cx	VR4	6a	Tor
<u>05H</u>	XC6101A617MR	Vdet-IC	1.7V±2%, Hst, -MR, -Reset PPO, Wt=1.6s, Rt=3.13ms	SOT-25	28cp	VD17	6g	Tor
<u>05H</u>	XC6101A647MR	Vdet-IC	4.7V±2%, Hst, -MR, -Reset PPO, Wt=1.6s, Rt=3.13ms	SOT-25	28cp	VD17	6g	Tor
<u>05K</u>	XC6505C481MR	LVR-IC	LDO, 4.8V±1%, 200mA, +CE, CL	SOT-25	28cx	VR4	6a	Tor
<u>05K</u>	XC6101A618MR	Vdet-IC	1.8V±2%, Hst, -MR, -Reset PPO, Wt=1.6s, Rt=3.13ms	SOT-25	28cp	VD17	6g	Tor
<u>05K</u>	XC6101A648MR	Vdet-IC	4.8V±2%, Hst, -MR, -Reset PPO, Wt=1.6s, Rt=3.13ms	SOT-25	28cp	VD17	6g	Tor
<u>05L</u>	XC6505C491MR	LVR-IC	LDO, 4.9V±1%, 200mA, +CE, CL	SOT-25	28cx	VR4	6a	Tor
<u>05L</u>	XC6101A619MR	Vdet-IC	1.9V±2%, Hst, -MR, -Reset PPO, Wt=1.6s, Rt=3.13ms	SOT-25	28cp	VD17	6g	Tor
<u>05L</u>	XC6101A649MR	Vdet-IC	4.9V±2%, Hst, -MR, -Reset PPO, Wt=1.6s, Rt=3.13ms	SOT-25	28cp	VD17	6g	Tor
<u>05M</u>	XC6505C501MR	LVR-IC	LDO, 5.0V±1%, 200mA, +CE, CL	SOT-25	28cx	VR4	6a	Tor
<u>05M</u>	XC6101A620MR	Vdet-IC	2.0V±2%, Hst, -MR, -Reset PPO, Wt=1.6s, Rt=3.13ms	SOT-25	28cp	VD17	6g	Tor
<u>05M</u>	XC6101A650MR	Vdet-IC	5.0V±2%, Hst, -MR, -Reset PPO, Wt=1.6s, Rt=3.13ms	SOT-25	28cp	VD17	6g	Tor
<u>05N</u>	XC6101A621MR	Vdet-IC	2.1V±2%, Hst, -MR, -Reset PPO, Wt=1.6s, Rt=3.13ms	SOT-25	28cp	VD17	6g	Tor
<u>05P</u>	XC6101A622MR	Vdet-IC	2.2V±2%, Hst, -MR, -Reset PPO, Wt=1.6s, Rt=3.13ms	SOT-25	28cp	VD17	6g	Tor
<u>05R</u>	XC6101A623MR	Vdet-IC	2.3V±2%, Hst, -MR, -Reset PPO, Wt=1.6s, Rt=3.13ms	SOT-25	28cp	VD17	6g	Tor
<u>05S</u>	XC6101A624MR	Vdet-IC	2.4V±2%, Hst, -MR, -Reset PPO, Wt=1.6s, Rt=3.13ms	SOT-25	28cp	VD17	6g	Tor
<u>05T</u>	XC6101A625MR	Vdet-IC	2.5V±2%, Hst, -MR, -Reset PPO, Wt=1.6s, Rt=3.13ms	SOT-25	28cp	VD17	6g	Tor
<u>05U</u>	XC6101A626MR	Vdet-IC	2.6V±2%, Hst, -MR, -Reset PPO, Wt=1.6s, Rt=3.13ms	SOT-25	28cp	VD17	6g	Tor
<u>05V</u>	XC6101A627MR	Vdet-IC	2.7V±2%, Hst, -MR, -Reset PPO, Wt=1.6s, Rt=3.13ms	SOT-25	28cp	VD17	6g	Tor
<u>05X</u>	XC6101A628MR	Vdet-IC	2.8V±2%, Hst, -MR, -Reset PPO, Wt=1.6s, Rt=3.13ms	SOT-25	28cp	VD17	6g	Tor
<u>05Y</u>	XC6101A629MR	Vdet-IC	2.9V±2%, Hst, -MR, -Reset PPO, Wt=1.6s, Rt=3.13ms	SOT-25	28cp	VD17	6g	Tor
<u>05Z</u>	XC6101A630MR	Vdet-IC	3.0V±2%, Hst, -MR, -Reset PPO, Wt=1.6s, Rt=3.13ms	SOT-25	28cp	VD17	6g	Tor
<u>06</u>	R1223N502C	DC/DC-IC	PWM step-down, +CE, 5V, 300kHz, Latch-Pr.	SOT-23-5	28du	DC7	6g	Ric
<u>06</u>	RN5RF56BA	LVR-IC	LRp, +CE, 5.6V±2%, 1A*	SOT-23-5	28vw	VR6	6g	Ric
<u>06</u>	RN5RZ56BA	LVR-IC	LDO, LN, +CE, 5.6V±2%, 100mA	SOT-23-5	28vrt	VR4	6g	Ric
<u>060</u>	XC6505C611MR	LVR-IC	LDO, 6.1V±1%, 200mA, +CE, CL	SOT-25	28cx	VR4	6a	Tor
<u>060</u>	XC6101B231MR	Vdet-IC	3.1V±2%, Hst, -MR, -Reset PPO, Wt=50ms, Rt=25ms	SOT-25	28cp	VD17	6g	Tor
<u>061</u>	XC6505C621MR	LVR-IC	LDO, 6.2V±1%, 200mA, +CE, CL	SOT-25	28cx	VR4	6a	Tor
<u>061</u>	XC6101B232MR	Vdet-IC	3.2V±2%, Hst, -MR, -Reset PPO, Wt=50ms, Rt=25ms	SOT-25	28cp	VD17	6g	Tor
<u>062</u>	XC6505C631MR	LVR-IC	LDO, 6.3V±1%, 200mA, +CE, CL	SOT-25	28cx	VR4	6a	Tor
<u>062</u>	XC6101B233MR	Vdet-IC	3.3V±2%, Hst, -MR, -Reset PPO, Wt=50ms, Rt=25ms	SOT-25	28cp	VD17	6g	Tor
<u>063</u>	XC6505C641MR	LVR-IC	LDO, 6.4V±1%, 200mA, +CE, CL	SOT-25	28cx	VR4	6a	Tor
<u>063</u>	XC6101B234MR	Vdet-IC	3.4V±2%, Hst, -MR, -Reset PPO, Wt=50ms, Rt=25ms	SOT-25	28cp	VD17	6g	Tor
<u>064</u>	XC6505C651MR	LVR-IC	LDO, 6.5V±1%, 200mA, +CE, CL	SOT-25	28cx	VR4	6a	Tor
<u>064</u>	XC6101B235MR	Vdet-IC	3.5V±2%, Hst, -MR, -Reset PPO, Wt=50ms, Rt=25ms	SOT-25	28cp	VD17	6g	Tor
<u>065</u>	XC6505C661MR	LVR-IC	LDO, 6.6V±1%, 200mA, +CE, CL	SOT-25	28cx	VR4	6a	Tor
<u>065</u>	XC6101B236MR	Vdet-IC	3.6V±2%, Hst, -MR, -Reset PPO, Wt=50ms, Rt=25ms	SOT-25	28cp	VD17	6g	Tor
<u>066</u>	XC6505C671MR	LVR-IC	LDO, 6.7V±1%, 200mA, +CE, CL	SOT-25	28cx	VR4	6a	Tor
<u>066</u>	XC6101B237MR	Vdet-IC	3.7V±2%, Hst, -MR, -Reset PPO, Wt=50ms, Rt=25ms	SOT-25	28cp	VD17	6g	Tor
<u>067</u>	XC6505C681MR	LVR-IC	LDO, 6.8V±1%, 200mA, +CE, CL	SOT-25	28cx	VR4	6a	Tor
<u>067</u>	XC6101B238MR	Vdet-IC	3.8V±2%, Hst, -MR, -Reset PPO, Wt=50ms, Rt=25ms	SOT-25	28cp	VD17	6g	Tor
<u>068</u>	XC6505C691MR	LVR-IC	LDO, 6.9V±1%, 200mA, +CE, CL	SOT-25	28cx	VR4	6a	Tor
<u>068</u>	XC6101B239MR	Vdet-IC	3.9V±2%, Hst, -MR, -Reset PPO, Wt=50ms, Rt=25ms	SOT-25	28cp	VD17	6g	Tor
<u>069</u>	XC6505C701MR	LVR-IC	LDO, 7.0V±1%, 200mA, +CE, CL	SOT-25	28cx	VR4	6a	Tor
<u>069</u>	XC6101B240MR	Vdet-IC	4.0V±2%, Hst, -MR, -Reset PPO, Wt=50ms, Rt=25ms	SOT-25	28cp	VD17	6g	Tor
<u>06A</u>	XC6101B241MR	Vdet-IC	4.1V±2%, Hst, -MR, -Reset PPO, Wt=50ms, Rt=25ms	SOT-25	28cp	VD17	6g	Tor
<u>06A</u>	XC6101B242MR	Vdet-IC	4.2V±2%, Hst, -MR, -Reset PPO, Wt=50ms, Rt=25ms	SOT-25	28cp	VD17	6g	Tor
<u>06C</u>	XC6101B243MR	Vdet-IC	4.3V±2%, Hst, -MR, -Reset PPO, Wt=50ms, Rt=25ms	SOT-25	28cp	VD17	6g	Tor
<u>06D</u>	XC6101B244MR	Vdet-IC	4.4V±2%, Hst, -MR, -Reset PPO, Wt=50ms, Rt=25ms	SOT-25	28cp	VD17	6g	Tor
<u>06E</u>	XC6101B245MR	Vdet-IC	4.5V±2%, Hst, -MR, -Reset PPO, Wt=50ms, Rt=25ms	SOT-25	28cp	VD17	6g	Tor
<u>06F</u>	XC6101B216MR	Vdet-IC	1.6V±2%, Hst, -MR, -Reset PPO, Wt=50ms, Rt=25ms	SOT-25	28cp	VD17	6g	Tor
<u>06E</u>	XC6101B246MR	Vdet-IC	4.6V±2%, Hst, -MR, -Reset PPO, Wt=50ms, Rt=25ms	SOT-25	28cp	VD17	6g	Tor
<u>06H</u>	XC6101B217MR	Vdet-IC	1.7V±2%, Hst, -MR, -Reset PPO, Wt=50ms, Rt=25ms	SOT-25	28cp	VD17	6g	Tor
<u>06H</u>	XC6101B247MR	Vdet-IC	4.7V±2%, Hst, -MR, -Reset PPO, Wt=50ms, Rt=25ms	SOT-25	28cp	VD17	6g	Tor
<u>06K</u>	XC6101B218MR	Vdet-IC	1.8V±2%, Hst, -MR, -Reset PPO, Wt=50ms, Rt=25ms	SOT-25	28cp	VD17	6g	Tor
<u>06K</u>	XC6101B248MR	Vdet-IC	4.8V±2%, Hst, -MR, -Reset PPO, Wt=50ms, Rt=25ms	SOT-25	28cp	VD17	6g	Tor
<u>06L</u>	XC6101B219MR	Vdet-IC	1.9V±2%, Hst, -MR, -Reset PPO, Wt=50ms, Rt=25ms	SOT-25	28cp	VD17	6g	Tor
<u>06L</u>	XC6101B249MR	Vdet-IC	4.9V±2%, Hst, -MR, -Reset PPO, Wt=50ms, Rt=25ms	SOT-25	28cp	VD17	6g	Tor
<u>06M</u>	XC6101B220MR	Vdet-IC	2.0V±2%, Hst, -MR, -Reset PPO, Wt=50ms, Rt=25ms	SOT-25	28cp	VD17	6g	Tor
<u>06M</u>	XC6101B250MR	Vdet-IC	5.0V±2%, Hst, -MR, -Reset PPO, Wt=50ms, Rt=25ms	SOT-25	28cp	VD17	6g	Tor
<u>06N</u>	XC6505C511MR	LVR-IC	LDO, 5.1V±1%, 200mA, +CE, CL	SOT-25	28cx	VR4	6a	Tor
<u>06N</u>	XC6101B221MR	Vdet-IC	2.1V±2%, Hst, -MR, -Reset PPO, Wt=50ms, Rt=25ms	SOT-25	28cp	VD17	6g	Tor
<u>06P</u>	XC6505C521MR	LVR-IC	LDO, 5.2V±1%, 200mA, +CE, CL	SOT-25	28cx	VR4	6a	Tor



SMD code	Type	Function	Short description	Case	Pinout	Sch.	St.	Mnf.
06P	XC6101B222MR	Vdet-IC	2.2V±2%, Hst, -MR, -Reset PPO, Wt=50ms, Rt=25ms	SOT-25	28cp	VD17	6g	Tor
06R	XC6505C531MR	LVR-IC	LDO, 5.3V±1%, 200mA, +CE, CL	SOT-25	28cx	VR4	6a	Tor
06R	XC6101B223MR	Vdet-IC	2.3V±2%, Hst, -MR, -Reset PPO, Wt=50ms, Rt=25ms	SOT-25	28cp	VD17	6g	Tor
06S	XC6505C541MR	LVR-IC	LDO, 5.4V±1%, 200mA, +CE, CL	SOT-25	28cx	VR4	6a	Tor
06S	XC6101B224MR	Vdet-IC	2.4V±2%, Hst, -MR, -Reset PPO, Wt=50ms, Rt=25ms	SOT-25	28cp	VD17	6g	Tor
06T	XC6505C551MR	LVR-IC	LDO, 5.5V±1%, 200mA, +CE, CL	SOT-25	28cx	VR4	6a	Tor
06T	XC6101B225MR	Vdet-IC	2.5V±2%, Hst, -MR, -Reset PPO, Wt=50ms, Rt=25ms	SOT-25	28cp	VD17	6g	Tor
06U	XC6505C561MR	LVR-IC	LDO, 5.6V±1%, 200mA, +CE, CL	SOT-25	28cx	VR4	6a	Tor
06U	XC6101B226MR	Vdet-IC	2.6V±2%, Hst, -MR, -Reset PPO, Wt=50ms, Rt=25ms	SOT-25	28cp	VD17	6g	Tor
06V	XC6505C571MR	LVR-IC	LDO, 5.7V±1%, 200mA, +CE, CL	SOT-25	28cx	VR4	6a	Tor
06V	XC6101B227MR	Vdet-IC	2.7V±2%, Hst, -MR, -Reset PPO, Wt=50ms, Rt=25ms	SOT-25	28cp	VD17	6g	Tor
06X	XC6505C581MR	LVR-IC	LDO, 5.8V±1%, 200mA, +CE, CL	SOT-25	28cx	VR4	6a	Tor
06X	XC6101B228MR	Vdet-IC	2.8V±2%, Hst, -MR, -Reset PPO, Wt=50ms, Rt=25ms	SOT-25	28cp	VD17	6g	Tor
06Y	XC6505C591MR	LVR-IC	LDO, 5.9V±1%, 200mA, +CE, CL	SOT-25	28cx	VR4	6a	Tor
06Y	XC6101B229MR	Vdet-IC	2.9V±2%, Hst, -MR, -Reset PPO, Wt=50ms, Rt=25ms	SOT-25	28cp	VD17	6g	Tor
06Z	XC6505C601MR	LVR-IC	LDO, 6.0V±1%, 200mA, +CE, CL	SOT-25	28cx	VR4	6a	Tor
06Z	XC6101B230MR	Vdet-IC	3.0V±2%, Hst, -MR, -Reset PPO, Wt=50ms, Rt=25ms	SOT-25	28cp	VD17	6g	Tor
07	R1223N252D	DC/DC-IC	PWM step-down, +CE, 2.5V, 500kHz, Latch-Pr.	SOT-23-5	28du	DC7	6g	Ric
07	RN5RF57BA	LVR-IC	L.Rip, +CE, 5.7V±2%, 1A*	SOT-23-5	28vw	VR6	6g	Ric
07	RN5RZ57BA	LVR-IC	LDO, LN, +CE, 5.7V±2%, 100mA	SOT-23-5	28vrt	VR4	6g	Ric
070	XC6101B331MR	Vdet-IC	3.1V±2%, Hst, -MR, -Reset PPO, Wt=100ms, Rt=25ms	SOT-25	28cp	VD17	6g	Tor
071	XC6101B332MR	Vdet-IC	3.2V±2%, Hst, -MR, -Reset PPO, Wt=100ms, Rt=25ms	SOT-25	28cp	VD17	6g	Tor
072	XC6101B333MR	Vdet-IC	3.3V±2%, Hst, -MR, -Reset PPO, Wt=100ms, Rt=25ms	SOT-25	28cp	VD17	6g	Tor
073	XC6101B334MR	Vdet-IC	3.4V±2%, Hst, -MR, -Reset PPO, Wt=100ms, Rt=25ms	SOT-25	28cp	VD17	6g	Tor
074	XC6101B335MR	Vdet-IC	3.5V±2%, Hst, -MR, -Reset PPO, Wt=100ms, Rt=25ms	SOT-25	28cp	VD17	6g	Tor
075	XC6101B336MR	Vdet-IC	3.6V±2%, Hst, -MR, -Reset PPO, Wt=100ms, Rt=25ms	SOT-25	28cp	VD17	6g	Tor
076	XC6101B337MR	Vdet-IC	3.7V±2%, Hst, -MR, -Reset PPO, Wt=100ms, Rt=25ms	SOT-25	28cp	VD17	6g	Tor
077	XC6101B338MR	Vdet-IC	3.8V±2%, Hst, -MR, -Reset PPO, Wt=100ms, Rt=25ms	SOT-25	28cp	VD17	6g	Tor
078	XC6101B339MR	Vdet-IC	3.9V±2%, Hst, -MR, -Reset PPO, Wt=100ms, Rt=25ms	SOT-25	28cp	VD17	6g	Tor
079	XC6101B340MR	Vdet-IC	4.0V±2%, Hst, -MR, -Reset PPO, Wt=100ms, Rt=25ms	SOT-25	28cp	VD17	6g	Tor
07A	XC6505C711MR	LVR-IC	LDO, 7.1V±1%, 200mA, +CE, CL	SOT-25	28cx	VR4	6a	Tor
07A	XC6101B341MR	Vdet-IC	4.1V±2%, Hst, -MR, -Reset PPO, Wt=100ms, Rt=25ms	SOT-25	28cp	VD17	6g	Tor
07B	XC6505C721MR	LVR-IC	LDO, 7.2V±1%, 200mA, +CE, CL	SOT-25	28cx	VR4	6a	Tor
07B	XC6101B342MR	Vdet-IC	4.2V±2%, Hst, -MR, -Reset PPO, Wt=100ms, Rt=25ms	SOT-25	28cp	VD17	6g	Tor
07C	XC6505C731MR	LVR-IC	LDO, 7.3V±1%, 200mA, +CE, CL	SOT-25	28cx	VR4	6a	Tor
07C	XC6101B343MR	Vdet-IC	4.3V±2%, Hst, -MR, -Reset PPO, Wt=100ms, Rt=25ms	SOT-25	28cp	VD17	6g	Tor
07D	XC6505C741MR	LVR-IC	LDO, 7.4V±1%, 200mA, +CE, CL	SOT-25	28cx	VR4	6a	Tor
07D	XC6101B344MR	Vdet-IC	4.4V±2%, Hst, -MR, -Reset PPO, Wt=100ms, Rt=25ms	SOT-25	28cp	VD17	6g	Tor
07E	XC6505C751MR	LVR-IC	LDO, 7.5V±1%, 200mA, +CE, CL	SOT-25	28cx	VR4	6a	Tor
07E	XC6101B345MR	Vdet-IC	4.5V±2%, Hst, -MR, -Reset PPO, Wt=100ms, Rt=25ms	SOT-25	28cp	VD17	6g	Tor
07F	XC6505C761MR	LVR-IC	LDO, 7.6V±1%, 200mA, +CE, CL	SOT-25	28cx	VR4	6a	Tor
07F	XC6101B316MR	Vdet-IC	1.6V±2%, Hst, -MR, -Reset PPO, Wt=100ms, Rt=25ms	SOT-25	28cp	VD17	6g	Tor
07F	XC6101B346MR	Vdet-IC	4.6V±2%, Hst, -MR, -Reset PPO, Wt=100ms, Rt=25ms	SOT-25	28cp	VD17	6g	Tor
07H	XC6505C771MR	LVR-IC	LDO, 7.7V±1%, 200mA, +CE, CL	SOT-25	28cx	VR4	6a	Tor
07H	XC6101B317MR	Vdet-IC	1.7V±2%, Hst, -MR, -Reset PPO, Wt=100ms, Rt=25ms	SOT-25	28cp	VD17	6g	Tor
07H	XC6101B347MR	Vdet-IC	4.7V±2%, Hst, -MR, -Reset PPO, Wt=100ms, Rt=25ms	SOT-25	28cp	VD17	6g	Tor
07K	XC6505C781MR	LVR-IC	LDO, 7.8V±1%, 200mA, +CE, CL	SOT-25	28cx	VR4	6a	Tor
07K	XC6101B318MR	Vdet-IC	1.8V±2%, Hst, -MR, -Reset PPO, Wt=100ms, Rt=25ms	SOT-25	28cp	VD17	6g	Tor
07K	XC6101B348MR	Vdet-IC	4.8V±2%, Hst, -MR, -Reset PPO, Wt=100ms, Rt=25ms	SOT-25	28cp	VD17	6g	Tor
07L	XC6505C791MR	LVR-IC	LDO, 7.9V±1%, 200mA, +CE, CL	SOT-25	28cx	VR4	6a	Tor
07L	XC6101B319MR	Vdet-IC	1.9V±2%, Hst, -MR, -Reset PPO, Wt=100ms, Rt=25ms	SOT-25	28cp	VD17	6g	Tor
07L	XC6101B349MR	Vdet-IC	4.9V±2%, Hst, -MR, -Reset PPO, Wt=100ms, Rt=25ms	SOT-25	28cp	VD17	6g	Tor
07M	XC6505C801MR	LVR-IC	LDO, 8.0V±1%, 200mA, +CE, CL	SOT-25	28cx	VR4	6a	Tor
07M	XC6101B320MR	Vdet-IC	2.0V±2%, Hst, -MR, -Reset PPO, Wt=100ms, Rt=25ms	SOT-25	28cp	VD17	6g	Tor
07M	XC6101B350MR	Vdet-IC	5.0V±2%, Hst, -MR, -Reset PPO, Wt=100ms, Rt=25ms	SOT-25	28cp	VD17	6g	Tor
07N	XC6101B321MR	Vdet-IC	2.1V±2%, Hst, -MR, -Reset PPO, Wt=100ms, Rt=25ms	SOT-25	28cp	VD17	6g	Tor
07P	XC6101B322MR	Vdet-IC	2.2V±2%, Hst, -MR, -Reset PPO, Wt=100ms, Rt=25ms	SOT-25	28cp	VD17	6g	Tor
07R	XC6101B323MR	Vdet-IC	2.3V±2%, Hst, -MR, -Reset PPO, Wt=100ms, Rt=25ms	SOT-25	28cp	VD17	6g	Tor
07S	XC6101B324MR	Vdet-IC	2.4V±2%, Hst, -MR, -Reset PPO, Wt=100ms, Rt=25ms	SOT-25	28cp	VD17	6g	Tor
07T	XC6101B325MR	Vdet-IC	2.5V±2%, Hst, -MR, -Reset PPO, Wt=100ms, Rt=25ms	SOT-25	28cp	VD17	6g	Tor
07U	XC6101B326MR	Vdet-IC	2.6V±2%, Hst, -MR, -Reset PPO, Wt=100ms, Rt=25ms	SOT-25	28cp	VD17	6g	Tor
07V	XC6101B327MR	Vdet-IC	2.7V±2%, Hst, -MR, -Reset PPO, Wt=100ms, Rt=25ms	SOT-25	28cp	VD17	6g	Tor
07X	XC6101B328MR	Vdet-IC	2.8V±2%, Hst, -MR, -Reset PPO, Wt=100ms, Rt=25ms	SOT-25	28cp	VD17	6g	Tor
07Y	XC6101B329MR	Vdet-IC	2.9V±2%, Hst, -MR, -Reset PPO, Wt=100ms, Rt=25ms	SOT-25	28cp	VD17	6g	Tor
07Z	XC6101B330MR	Vdet-IC	3.0V±2%, Hst, -MR, -Reset PPO, Wt=100ms, Rt=25ms	SOT-25	28cp	VD17	6g	Tor
08	R1223N152D	DC/DC-IC	PWM step-down, +CE, 1.5V, 500kHz, Latch-Pr.	SOT-23-5	28du	DC7	6g	Ric
08	RN5RF58BA	LVR-IC	L.Rip, +CE, 5.8V±2%, 1A*	SOT-23-5	28vw	VR6	6g	Ric
08	RN5RZ58BA	LVR-IC	LDO, LN, +CE, 5.8V±2%, 100mA	SOT-23-5	28vrt	VR4	6g	Ric
080	XC6101B431MR	Vdet-IC	3.1V±2%, Hst, -MR, -Reset PPO, Wt=200ms, Rt=25ms	SOT-25	28cp	VD17	6g	Tor
0808A	EC8908-08AB2	LVR-IC	LDO, 0.8V±1.5%, 300mA, +CE	SOT-23-5	28cx	VR4	6r	Ecm



SMD code	Type	Function	Short description	Case	Pinout	Sch.	St.	Mnf.
0808A	EC8908-08AC5	LVR-IC	LDO, 0.8V±1.5%, 300mA, +CE	SC-70-5	28cx	VR4	6r	Ecm
0808B	EC8908-08BB2	LVR-IC	LDO, 0.8V±1.5%, 500mA, +CE	SOT-23-5	28cx	VR4	6r	Ecm
0808B	EC8908-08BC5	LVR-IC	LDO, 0.8V±1.5%, 500mA, +CE	SC-70-5	28cx	VR4	6r	Ecm
0808C	EC8908-08CB2	LVR-IC	LDO, 0.8V±1.5%, 300mA, -CE	SOT-23-5	28cx	VR4	6r	Ecm
0808C	EC8908-08CC5	LVR-IC	LDO, 0.8V±1.5%, 300mA, -CE	SC-70-5	28cx	VR4	6r	Ecm
0808D	EC8908-08DB2	LVR-IC	LDO, 0.8V±1.5%, 500mA, -CE	SOT-23-5	28cx	VR4	6r	Ecm
0808D	EC8908-08DC5	LVR-IC	LDO, 0.8V±1.5%, 500mA, -CE	SC-70-5	28cx	VR4	6r	Ecm
0809A	EC8908-09AB2	LVR-IC	LDO, 0.9V±1.5%, 300mA, +CE	SOT-23-5	28cx	VR4	6r	Ecm
0809A	EC8908-09AC5	LVR-IC	LDO, 0.9V±1.5%, 300mA, +CE	SC-70-5	28cx	VR4	6r	Ecm
0809B	EC8908-09BB2	LVR-IC	LDO, 0.9V±1.5%, 500mA, +CE	SOT-23-5	28cx	VR4	6r	Ecm
0809B	EC8908-09BC5	LVR-IC	LDO, 0.9V±1.5%, 500mA, +CE	SC-70-5	28cx	VR4	6r	Ecm
0809C	EC8908-09CB2	LVR-IC	LDO, 0.9V±1.5%, 300mA, -CE	SOT-23-5	28cx	VR4	6r	Ecm
0809C	EC8908-09CC5	LVR-IC	LDO, 0.9V±1.5%, 300mA, -CE	SC-70-5	28cx	VR4	6r	Ecm
0809D	EC8908-09DB2	LVR-IC	LDO, 0.9V±1.5%, 500mA, -CE	SOT-23-5	28cx	VR4	6r	Ecm
0809D	EC8908-09DC5	LVR-IC	LDO, 0.9V±1.5%, 500mA, -CE	SC-70-5	28cx	VR4	6r	Ecm
081	XC6101B432MR	Vdet-IC	3.2V±2%, Hst, -MR, -Reset PPO, Wt=200ms, Rt=25ms	SOT-25	28cp	VD17	6g	Tor
0810A	EC8908-10AB2	LVR-IC	LDO, 1.0V±1.5%, 300mA, +CE	SOT-23-5	28cx	VR4	6r	Ecm
0810A	EC8908-10AC5	LVR-IC	LDO, 1.0V±1.5%, 300mA, +CE	SC-70-5	28cx	VR4	6r	Ecm
0810B	EC8908-10BB2	LVR-IC	LDO, 1.0V±1.5%, 500mA, +CE	SOT-23-5	28cx	VR4	6r	Ecm
0810B	EC8908-10BC5	LVR-IC	LDO, 1.0V±1.5%, 500mA, +CE	SC-70-5	28cx	VR4	6r	Ecm
0810C	EC8908-10CB2	LVR-IC	LDO, 1.0V±1.5%, 300mA, -CE	SOT-23-5	28cx	VR4	6r	Ecm
0810C	EC8908-10CC5	LVR-IC	LDO, 1.0V±1.5%, 300mA, -CE	SC-70-5	28cx	VR4	6r	Ecm
0810D	EC8908-10DB2	LVR-IC	LDO, 1.0V±1.5%, 500mA, -CE	SOT-23-5	28cx	VR4	6r	Ecm
0810D	EC8908-10DC5	LVR-IC	LDO, 1.0V±1.5%, 500mA, -CE	SC-70-5	28cx	VR4	6r	Ecm
0811A	EC8908-11AB2	LVR-IC	LDO, 1.1V±1.5%, 300mA, +CE	SOT-23-5	28cx	VR4	6r	Ecm
0811A	EC8908-11AC5	LVR-IC	LDO, 1.1V±1.5%, 300mA, +CE	SC-70-5	28cx	VR4	6r	Ecm
0811B	EC8908-11BB2	LVR-IC	LDO, 1.1V±1.5%, 500mA, +CE	SOT-23-5	28cx	VR4	6r	Ecm
0811B	EC8908-11BC5	LVR-IC	LDO, 1.1V±1.5%, 500mA, +CE	SC-70-5	28cx	VR4	6r	Ecm
0811C	EC8908-11CB2	LVR-IC	LDO, 1.1V±1.5%, 300mA, -CE	SOT-23-5	28cx	VR4	6r	Ecm
0811C	EC8908-11CC5	LVR-IC	LDO, 1.1V±1.5%, 300mA, -CE	SC-70-5	28cx	VR4	6r	Ecm
0811D	EC8908-11DB2	LVR-IC	LDO, 1.1V±1.5%, 500mA, -CE	SOT-23-5	28cx	VR4	6r	Ecm
0811D	EC8908-11DC5	LVR-IC	LDO, 1.1V±1.5%, 500mA, -CE	SC-70-5	28cx	VR4	6r	Ecm
0812A	EC8908-12AB2	LVR-IC	LDO, 1.2V±1.5%, 300mA, +CE	SOT-23-5	28cx	VR4	6r	Ecm
0812A	EC8908-12AC5	LVR-IC	LDO, 1.2V±1.5%, 300mA, +CE	SC-70-5	28cx	VR4	6r	Ecm
0812B	EC8908-12BB2	LVR-IC	LDO, 1.2V±1.5%, 500mA, +CE	SOT-23-5	28cx	VR4	6r	Ecm
0812B	EC8908-12BC5	LVR-IC	LDO, 1.2V±1.5%, 500mA, +CE	SC-70-5	28cx	VR4	6r	Ecm
0812C	EC8908-12CB2	LVR-IC	LDO, 1.2V±1.5%, 300mA, -CE	SOT-23-5	28cx	VR4	6r	Ecm
0812C	EC8908-12CC5	LVR-IC	LDO, 1.2V±1.5%, 300mA, -CE	SC-70-5	28cx	VR4	6r	Ecm
0812D	EC8908-12DB2	LVR-IC	LDO, 1.2V±1.5%, 500mA, -CE	SOT-23-5	28cx	VR4	6r	Ecm
0812D	EC8908-12DC5	LVR-IC	LDO, 1.2V±1.5%, 500mA, -CE	SC-70-5	28cx	VR4	6r	Ecm
0813A	EC8908-13AB2	LVR-IC	LDO, 1.3V±1.5%, 300mA, +CE	SOT-23-5	28cx	VR4	6r	Ecm
0813A	EC8908-13AC5	LVR-IC	LDO, 1.3V±1.5%, 300mA, +CE	SC-70-5	28cx	VR4	6r	Ecm
0813B	EC8908-13BB2	LVR-IC	LDO, 1.3V±1.5%, 500mA, +CE	SOT-23-5	28cx	VR4	6r	Ecm
0813B	EC8908-13BC5	LVR-IC	LDO, 1.3V±1.5%, 500mA, +CE	SC-70-5	28cx	VR4	6r	Ecm
0813C	EC8908-13CB2	LVR-IC	LDO, 1.3V±1.5%, 300mA, -CE	SOT-23-5	28cx	VR4	6r	Ecm
0813C	EC8908-13CC5	LVR-IC	LDO, 1.3V±1.5%, 300mA, -CE	SC-70-5	28cx	VR4	6r	Ecm
0813D	EC8908-13DB2	LVR-IC	LDO, 1.3V±1.5%, 500mA, -CE	SOT-23-5	28cx	VR4	6r	Ecm
0813D	EC8908-13DC5	LVR-IC	LDO, 1.3V±1.5%, 500mA, -CE	SC-70-5	28cx	VR4	6r	Ecm
0814A	EC8908-14AB2	LVR-IC	LDO, 1.4V±1.5%, 300mA, +CE	SOT-23-5	28cx	VR4	6r	Ecm
0814A	EC8908-14AC5	LVR-IC	LDO, 1.4V±1.5%, 300mA, +CE	SC-70-5	28cx	VR4	6r	Ecm
0814B	EC8908-14BB2	LVR-IC	LDO, 1.4V±1.5%, 500mA, +CE	SOT-23-5	28cx	VR4	6r	Ecm
0814B	EC8908-14BC5	LVR-IC	LDO, 1.4V±1.5%, 500mA, +CE	SC-70-5	28cx	VR4	6r	Ecm
0814C	EC8908-14CB2	LVR-IC	LDO, 1.4V±1.5%, 300mA, -CE	SOT-23-5	28cx	VR4	6r	Ecm
0814C	EC8908-14CC5	LVR-IC	LDO, 1.4V±1.5%, 300mA, -CE	SC-70-5	28cx	VR4	6r	Ecm
0814D	EC8908-14DB2	LVR-IC	LDO, 1.4V±1.5%, 500mA, -CE	SOT-23-5	28cx	VR4	6r	Ecm
0814D	EC8908-14DC5	LVR-IC	LDO, 1.4V±1.5%, 500mA, -CE	SC-70-5	28cx	VR4	6r	Ecm
0815A	EC8908-15AB2	LVR-IC	LDO, 1.5V±1.5%, 300mA, +CE	SOT-23-5	28cx	VR4	6r	Ecm
0815A	EC8908-15AC5	LVR-IC	LDO, 1.5V±1.5%, 300mA, +CE	SC-70-5	28cx	VR4	6r	Ecm
0815B	EC8908-15BB2	LVR-IC	LDO, 1.5V±1.5%, 500mA, +CE	SOT-23-5	28cx	VR4	6r	Ecm
0815B	EC8908-15BC5	LVR-IC	LDO, 1.5V±1.5%, 500mA, +CE	SC-70-5	28cx	VR4	6r	Ecm
0815C	EC8908-15CB2	LVR-IC	LDO, 1.5V±1.5%, 300mA, -CE	SOT-23-5	28cx	VR4	6r	Ecm
0815C	EC8908-15CC5	LVR-IC	LDO, 1.5V±1.5%, 300mA, -CE	SC-70-5	28cx	VR4	6r	Ecm
0815D	EC8908-15DB2	LVR-IC	LDO, 1.5V±1.5%, 500mA, -CE	SOT-23-5	28cx	VR4	6r	Ecm
0815D	EC8908-15DC5	LVR-IC	LDO, 1.5V±1.5%, 500mA, -CE	SC-70-5	28cx	VR4	6r	Ecm
0816A	EC8908-16AB2	LVR-IC	LDO, 1.6V±1.5%, 300mA, +CE	SOT-23-5	28cx	VR4	6r	Ecm
0816A	EC8908-16AC5	LVR-IC	LDO, 1.6V±1.5%, 300mA, +CE	SC-70-5	28cx	VR4	6r	Ecm
0816B	EC8908-16BB2	LVR-IC	LDO, 1.6V±1.5%, 500mA, +CE	SOT-23-5	28cx	VR4	6r	Ecm
0816B	EC8908-16BC5	LVR-IC	LDO, 1.6V±1.5%, 500mA, +CE	SC-70-5	28cx	VR4	6r	Ecm
0816C	EC8908-16CB2	LVR-IC	LDO, 1.6V±1.5%, 300mA, -CE	SOT-23-5	28cx	VR4	6r	Ecm
0816C	EC8908-16CC5	LVR-IC	LDO, 1.6V±1.5%, 300mA, -CE	SC-70-5	28cx	VR4	6r	Ecm



SMD code	Type	Function	Short description	Case	Pinout	Sch.	St.	Mnf.
0816D	EC8908-16DB2	LVR-IC	LDO, 1.6V±1.5%, 500mA, -CE	SOT-23-5	28cx	VR4	6r	Ecm
0816D	EC8908-16DC5	LVR-IC	LDO, 1.6V±1.5%, 500mA, -CE	SC-70-5	28cx	VR4	6r	Ecm
0817A	EC8908-17AB2	LVR-IC	LDO, 1.7V±1.5%, 300mA, +CE	SOT-23-5	28cx	VR4	6r	Ecm
0817A	EC8908-17AC5	LVR-IC	LDO, 1.7V±1.5%, 300mA, +CE	SC-70-5	28cx	VR4	6r	Ecm
0817B	EC8908-17BB2	LVR-IC	LDO, 1.7V±1.5%, 500mA, +CE	SOT-23-5	28cx	VR4	6r	Ecm
0817B	EC8908-17BC5	LVR-IC	LDO, 1.7V±1.5%, 500mA, +CE	SC-70-5	28cx	VR4	6r	Ecm
0817C	EC8908-17CB2	LVR-IC	LDO, 1.7V±1.5%, 300mA, -CE	SOT-23-5	28cx	VR4	6r	Ecm
0817C	EC8908-17CC5	LVR-IC	LDO, 1.7V±1.5%, 300mA, -CE	SC-70-5	28cx	VR4	6r	Ecm
0817D	EC8908-17DB2	LVR-IC	LDO, 1.7V±1.5%, 500mA, -CE	SOT-23-5	28cx	VR4	6r	Ecm
0817D	EC8908-17DC5	LVR-IC	LDO, 1.7V±1.5%, 500mA, -CE	SC-70-5	28cx	VR4	6r	Ecm
0818A	EC8908-18AB2	LVR-IC	LDO, 1.8V±1.5%, 300mA, +CE	SOT-23-5	28cx	VR4	6r	Ecm
0818A	EC8908-18AC5	LVR-IC	LDO, 1.8V±1.5%, 300mA, +CE	SC-70-5	28cx	VR4	6r	Ecm
0818B	EC8908-18BB2	LVR-IC	LDO, 1.8V±1.5%, 500mA, +CE	SOT-23-5	28cx	VR4	6r	Ecm
0818B	EC8908-18BC5	LVR-IC	LDO, 1.8V±1.5%, 500mA, +CE	SC-70-5	28cx	VR4	6r	Ecm
0818C	EC8908-18CB2	LVR-IC	LDO, 1.8V±1.5%, 300mA, -CE	SOT-23-5	28cx	VR4	6r	Ecm
0818C	EC8908-18CC5	LVR-IC	LDO, 1.8V±1.5%, 300mA, -CE	SC-70-5	28cx	VR4	6r	Ecm
0818D	EC8908-18DB2	LVR-IC	LDO, 1.8V±1.5%, 500mA, -CE	SOT-23-5	28cx	VR4	6r	Ecm
0818D	EC8908-18DC5	LVR-IC	LDO, 1.8V±1.5%, 500mA, -CE	SC-70-5	28cx	VR4	6r	Ecm
0819A	EC8908-19AB2	LVR-IC	LDO, 1.9V±1.5%, 300mA, +CE	SOT-23-5	28cx	VR4	6r	Ecm
0819A	EC8908-19AC5	LVR-IC	LDO, 1.9V±1.5%, 300mA, +CE	SC-70-5	28cx	VR4	6r	Ecm
0819B	EC8908-19BB2	LVR-IC	LDO, 1.9V±1.5%, 500mA, +CE	SOT-23-5	28cx	VR4	6r	Ecm
0819B	EC8908-19BC5	LVR-IC	LDO, 1.9V±1.5%, 500mA, +CE	SC-70-5	28cx	VR4	6r	Ecm
0819C	EC8908-19CB2	LVR-IC	LDO, 1.9V±1.5%, 300mA, -CE	SOT-23-5	28cx	VR4	6r	Ecm
0819C	EC8908-19CC5	LVR-IC	LDO, 1.9V±1.5%, 300mA, -CE	SC-70-5	28cx	VR4	6r	Ecm
0819D	EC8908-19DB2	LVR-IC	LDO, 1.9V±1.5%, 500mA, -CE	SOT-23-5	28cx	VR4	6r	Ecm
0819D	EC8908-19DC5	LVR-IC	LDO, 1.9V±1.5%, 500mA, -CE	SC-70-5	28cx	VR4	6r	Ecm
082	XC6101B433MR	Vdet-IC	3.3V±2%, Hst., -MR, -Reset PPO, Wt=200ms, Rt=25ms	SOT-25	28cp	VD17	6g	Tor
0820A	EC8908-20AB2	LVR-IC	LDO, 2.0V±1.5%, 300mA, +CE	SOT-23-5	28cx	VR4	6r	Ecm
0820A	EC8908-20AC5	LVR-IC	LDO, 2.0V±1.5%, 300mA, +CE	SC-70-5	28cx	VR4	6r	Ecm
0820B	EC8908-20BB2	LVR-IC	LDO, 2.0V±1.5%, 500mA, +CE	SOT-23-5	28cx	VR4	6r	Ecm
0820B	EC8908-20BC5	LVR-IC	LDO, 2.0V±1.5%, 500mA, +CE	SC-70-5	28cx	VR4	6r	Ecm
0820C	EC8908-20CB2	LVR-IC	LDO, 2.0V±1.5%, 300mA, -CE	SOT-23-5	28cx	VR4	6r	Ecm
0820C	EC8908-20CC5	LVR-IC	LDO, 2.0V±1.5%, 300mA, -CE	SC-70-5	28cx	VR4	6r	Ecm
0820D	EC8908-20DB2	LVR-IC	LDO, 2.0V±1.5%, 500mA, -CE	SOT-23-5	28cx	VR4	6r	Ecm
0820D	EC8908-20DC5	LVR-IC	LDO, 2.0V±1.5%, 500mA, -CE	SC-70-5	28cx	VR4	6r	Ecm
0821A	EC8908-21AB2	LVR-IC	LDO, 2.1V±1.5%, 300mA, +CE	SOT-23-5	28cx	VR4	6r	Ecm
0821A	EC8908-21AC5	LVR-IC	LDO, 2.1V±1.5%, 300mA, +CE	SC-70-5	28cx	VR4	6r	Ecm
0821B	EC8908-21BB2	LVR-IC	LDO, 2.1V±1.5%, 500mA, +CE	SOT-23-5	28cx	VR4	6r	Ecm
0821B	EC8908-21BC5	LVR-IC	LDO, 2.1V±1.5%, 500mA, +CE	SC-70-5	28cx	VR4	6r	Ecm
0821C	EC8908-21CB2	LVR-IC	LDO, 2.1V±1.5%, 300mA, -CE	SOT-23-5	28cx	VR4	6r	Ecm
0821C	EC8908-21CC5	LVR-IC	LDO, 2.1V±1.5%, 300mA, -CE	SC-70-5	28cx	VR4	6r	Ecm
0821D	EC8908-21DB2	LVR-IC	LDO, 2.1V±1.5%, 500mA, -CE	SOT-23-5	28cx	VR4	6r	Ecm
0821D	EC8908-21DC5	LVR-IC	LDO, 2.1V±1.5%, 500mA, -CE	SC-70-5	28cx	VR4	6r	Ecm
0822A	EC8908-22AB2	LVR-IC	LDO, 2.2V±1.5%, 300mA, +CE	SOT-23-5	28cx	VR4	6r	Ecm
0822A	EC8908-22AC5	LVR-IC	LDO, 2.2V±1.5%, 300mA, +CE	SC-70-5	28cx	VR4	6r	Ecm
0822B	EC8908-22BB2	LVR-IC	LDO, 2.2V±1.5%, 500mA, +CE	SOT-23-5	28cx	VR4	6r	Ecm
0822B	EC8908-22BC5	LVR-IC	LDO, 2.2V±1.5%, 500mA, +CE	SC-70-5	28cx	VR4	6r	Ecm
0822C	EC8908-22CB2	LVR-IC	LDO, 2.2V±1.5%, 300mA, -CE	SOT-23-5	28cx	VR4	6r	Ecm
0822C	EC8908-22CC5	LVR-IC	LDO, 2.2V±1.5%, 300mA, -CE	SC-70-5	28cx	VR4	6r	Ecm
0822D	EC8908-22DB2	LVR-IC	LDO, 2.2V±1.5%, 500mA, -CE	SOT-23-5	28cx	VR4	6r	Ecm
0822D	EC8908-22DC5	LVR-IC	LDO, 2.2V±1.5%, 500mA, -CE	SC-70-5	28cx	VR4	6r	Ecm
0823A	EC8908-23AB2	LVR-IC	LDO, 2.3V±1.5%, 300mA, +CE	SOT-23-5	28cx	VR4	6r	Ecm
0823A	EC8908-23AC5	LVR-IC	LDO, 2.3V±1.5%, 300mA, +CE	SC-70-5	28cx	VR4	6r	Ecm
0823B	EC8908-23BB2	LVR-IC	LDO, 2.3V±1.5%, 500mA, +CE	SOT-23-5	28cx	VR4	6r	Ecm
0823B	EC8908-23BC5	LVR-IC	LDO, 2.3V±1.5%, 500mA, +CE	SC-70-5	28cx	VR4	6r	Ecm
0823C	EC8908-23CB2	LVR-IC	LDO, 2.3V±1.5%, 300mA, -CE	SOT-23-5	28cx	VR4	6r	Ecm
0823C	EC8908-23CC5	LVR-IC	LDO, 2.3V±1.5%, 300mA, -CE	SC-70-5	28cx	VR4	6r	Ecm
0823D	EC8908-23DB2	LVR-IC	LDO, 2.3V±1.5%, 500mA, -CE	SOT-23-5	28cx	VR4	6r	Ecm
0823D	EC8908-23DC5	LVR-IC	LDO, 2.3V±1.5%, 500mA, -CE	SC-70-5	28cx	VR4	6r	Ecm
0824A	EC8908-24AB2	LVR-IC	LDO, 2.4V±1.5%, 300mA, +CE	SOT-23-5	28cx	VR4	6r	Ecm
0824A	EC8908-24AC5	LVR-IC	LDO, 2.4V±1.5%, 300mA, +CE	SC-70-5	28cx	VR4	6r	Ecm
0824B	EC8908-24BB2	LVR-IC	LDO, 2.4V±1.5%, 500mA, +CE	SOT-23-5	28cx	VR4	6r	Ecm
0824B	EC8908-24BC5	LVR-IC	LDO, 2.4V±1.5%, 500mA, +CE	SC-70-5	28cx	VR4	6r	Ecm
0824C	EC8908-24CB2	LVR-IC	LDO, 2.4V±1.5%, 300mA, -CE	SOT-23-5	28cx	VR4	6r	Ecm
0824C	EC8908-24CC5	LVR-IC	LDO, 2.4V±1.5%, 300mA, -CE	SC-70-5	28cx	VR4	6r	Ecm
0824D	EC8908-24DB2	LVR-IC	LDO, 2.4V±1.5%, 500mA, -CE	SOT-23-5	28cx	VR4	6r	Ecm
0824D	EC8908-24DC5	LVR-IC	LDO, 2.4V±1.5%, 500mA, -CE	SC-70-5	28cx	VR4	6r	Ecm
0825A	EC8908-25AB2	LVR-IC	LDO, 2.5V±1.5%, 300mA, +CE	SOT-23-5	28cx	VR4	6r	Ecm
0825A	EC8908-25AC5	LVR-IC	LDO, 2.5V±1.5%, 300mA, +CE	SC-70-5	28cx	VR4	6r	Ecm
0825B	EC8908-25BB2	LVR-IC	LDO, 2.5V±1.5%, 500mA, +CE	SOT-23-5	28cx	VR4	6r	Ecm



SMD code	Type	Function	Short description	Case	Pinout	Sch.	St.	Mnf.
0825B	EC8908-25BC5	LVR-IC	LDO, 2.5V±1.5%, 500mA, +CE	SC-70-5	28cx	VR4	6r	Ecm
0825C	EC8908-25CB2	LVR-IC	LDO, 2.5V±1.5%, 300mA, -CE	SOT-23-5	28cx	VR4	6r	Ecm
0825C	EC8908-25CC5	LVR-IC	LDO, 2.5V±1.5%, 300mA, -CE	SC-70-5	28cx	VR4	6r	Ecm
0825D	EC8908-25DB2	LVR-IC	LDO, 2.5V±1.5%, 500mA, -CE	SOT-23-5	28cx	VR4	6r	Ecm
0825D	EC8908-25DC5	LVR-IC	LDO, 2.5V±1.5%, 500mA, -CE	SC-70-5	28cx	VR4	6r	Ecm
0826A	EC8908-26AB2	LVR-IC	LDO, 2.6V±1.5%, 300mA, +CE	SOT-23-5	28cx	VR4	6r	Ecm
0826A	EC8908-26AC5	LVR-IC	LDO, 2.6V±1.5%, 300mA, +CE	SC-70-5	28cx	VR4	6r	Ecm
0826B	EC8908-26BB2	LVR-IC	LDO, 2.6V±1.5%, 500mA, +CE	SOT-23-5	28cx	VR4	6r	Ecm
0826B	EC8908-26BC5	LVR-IC	LDO, 2.6V±1.5%, 500mA, +CE	SC-70-5	28cx	VR4	6r	Ecm
0826C	EC8908-26CB2	LVR-IC	LDO, 2.6V±1.5%, 300mA, -CE	SOT-23-5	28cx	VR4	6r	Ecm
0826C	EC8908-26CC5	LVR-IC	LDO, 2.6V±1.5%, 300mA, -CE	SC-70-5	28cx	VR4	6r	Ecm
0826D	EC8908-26DB2	LVR-IC	LDO, 2.6V±1.5%, 500mA, -CE	SOT-23-5	28cx	VR4	6r	Ecm
0826D	EC8908-26DC5	LVR-IC	LDO, 2.6V±1.5%, 500mA, -CE	SC-70-5	28cx	VR4	6r	Ecm
0827A	EC8908-27AB2	LVR-IC	LDO, 2.7V±1.5%, 300mA, +CE	SOT-23-5	28cx	VR4	6r	Ecm
0827A	EC8908-27AC5	LVR-IC	LDO, 2.7V±1.5%, 300mA, +CE	SC-70-5	28cx	VR4	6r	Ecm
0827B	EC8908-27BB2	LVR-IC	LDO, 2.7V±1.5%, 500mA, +CE	SOT-23-5	28cx	VR4	6r	Ecm
0827B	EC8908-27BC5	LVR-IC	LDO, 2.7V±1.5%, 500mA, +CE	SC-70-5	28cx	VR4	6r	Ecm
0827C	EC8908-27CB2	LVR-IC	LDO, 2.7V±1.5%, 300mA, -CE	SOT-23-5	28cx	VR4	6r	Ecm
0827C	EC8908-27CC5	LVR-IC	LDO, 2.7V±1.5%, 300mA, -CE	SC-70-5	28cx	VR4	6r	Ecm
0827D	EC8908-27DB2	LVR-IC	LDO, 2.7V±1.5%, 500mA, -CE	SOT-23-5	28cx	VR4	6r	Ecm
0827D	EC8908-27DC5	LVR-IC	LDO, 2.7V±1.5%, 500mA, -CE	SC-70-5	28cx	VR4	6r	Ecm
0828A	EC8908-28AB2	LVR-IC	LDO, 2.8V±1.5%, 300mA, +CE	SOT-23-5	28cx	VR4	6r	Ecm
0828A	EC8908-28AC5	LVR-IC	LDO, 2.8V±1.5%, 300mA, +CE	SC-70-5	28cx	VR4	6r	Ecm
0828B	EC8908-28BB2	LVR-IC	LDO, 2.8V±1.5%, 500mA, +CE	SOT-23-5	28cx	VR4	6r	Ecm
0828B	EC8908-28BC5	LVR-IC	LDO, 2.8V±1.5%, 500mA, +CE	SC-70-5	28cx	VR4	6r	Ecm
0828C	EC8908-28CB2	LVR-IC	LDO, 2.8V±1.5%, 300mA, -CE	SOT-23-5	28cx	VR4	6r	Ecm
0828C	EC8908-28CC5	LVR-IC	LDO, 2.8V±1.5%, 300mA, -CE	SC-70-5	28cx	VR4	6r	Ecm
0828D	EC8908-28DB2	LVR-IC	LDO, 2.8V±1.5%, 500mA, -CE	SOT-23-5	28cx	VR4	6r	Ecm
0828D	EC8908-28DC5	LVR-IC	LDO, 2.8V±1.5%, 500mA, -CE	SC-70-5	28cx	VR4	6r	Ecm
0829A	EC8908-29AB2	LVR-IC	LDO, 2.9V±1.5%, 300mA, +CE	SOT-23-5	28cx	VR4	6r	Ecm
0829A	EC8908-29AC5	LVR-IC	LDO, 2.9V±1.5%, 300mA, +CE	SC-70-5	28cx	VR4	6r	Ecm
0829B	EC8908-29BB2	LVR-IC	LDO, 2.9V±1.5%, 500mA, +CE	SOT-23-5	28cx	VR4	6r	Ecm
0829B	EC8908-29BC5	LVR-IC	LDO, 2.9V±1.5%, 500mA, +CE	SC-70-5	28cx	VR4	6r	Ecm
0829C	EC8908-29CB2	LVR-IC	LDO, 2.9V±1.5%, 300mA, -CE	SOT-23-5	28cx	VR4	6r	Ecm
0829C	EC8908-29CC5	LVR-IC	LDO, 2.9V±1.5%, 300mA, -CE	SC-70-5	28cx	VR4	6r	Ecm
0829D	EC8908-29DB2	LVR-IC	LDO, 2.9V±1.5%, 500mA, -CE	SOT-23-5	28cx	VR4	6r	Ecm
0829D	EC8908-29DC5	LVR-IC	LDO, 2.9V±1.5%, 500mA, -CE	SC-70-5	28cx	VR4	6r	Ecm
083	XC6101B434MR	Vdet-IC	3.4V±2%, Hst, -MR, -Reset PPO, Wt=200ms, Rt=25ms	SOT-25	28cp	VD17	6g	Tor
0830A	EC8908-30AB2	LVR-IC	LDO, 3.0V±1.5%, 300mA, +CE	SOT-23-5	28cx	VR4	6r	Ecm
0830A	EC8908-30AC5	LVR-IC	LDO, 3.0V±1.5%, 300mA, +CE	SC-70-5	28cx	VR4	6r	Ecm
0830B	EC8908-30BB2	LVR-IC	LDO, 3.0V±1.5%, 500mA, +CE	SOT-23-5	28cx	VR4	6r	Ecm
0830B	EC8908-30BC5	LVR-IC	LDO, 3.0V±1.5%, 500mA, +CE	SC-70-5	28cx	VR4	6r	Ecm
0830C	EC8908-30CB2	LVR-IC	LDO, 3.0V±1.5%, 300mA, -CE	SOT-23-5	28cx	VR4	6r	Ecm
0830C	EC8908-30CC5	LVR-IC	LDO, 3.0V±1.5%, 300mA, -CE	SC-70-5	28cx	VR4	6r	Ecm
0830D	EC8908-30DB2	LVR-IC	LDO, 3.0V±1.5%, 500mA, -CE	SOT-23-5	28cx	VR4	6r	Ecm
0830D	EC8908-30DC5	LVR-IC	LDO, 3.0V±1.5%, 500mA, -CE	SC-70-5	28cx	VR4	6r	Ecm
0831A	EC8908-31AB2	LVR-IC	LDO, 3.1V±1.5%, 300mA, +CE	SOT-23-5	28cx	VR4	6r	Ecm
0831A	EC8908-31AC5	LVR-IC	LDO, 3.1V±1.5%, 300mA, +CE	SC-70-5	28cx	VR4	6r	Ecm
0831B	EC8908-31BB2	LVR-IC	LDO, 3.1V±1.5%, 500mA, +CE	SOT-23-5	28cx	VR4	6r	Ecm
0831B	EC8908-31BC5	LVR-IC	LDO, 3.1V±1.5%, 500mA, +CE	SC-70-5	28cx	VR4	6r	Ecm
0831C	EC8908-31CB2	LVR-IC	LDO, 3.1V±1.5%, 300mA, -CE	SOT-23-5	28cx	VR4	6r	Ecm
0831C	EC8908-31CC5	LVR-IC	LDO, 3.1V±1.5%, 300mA, -CE	SC-70-5	28cx	VR4	6r	Ecm
0831D	EC8908-31DB2	LVR-IC	LDO, 3.1V±1.5%, 500mA, -CE	SOT-23-5	28cx	VR4	6r	Ecm
0831D	EC8908-31DC5	LVR-IC	LDO, 3.1V±1.5%, 500mA, -CE	SC-70-5	28cx	VR4	6r	Ecm
0832A	EC8908-32AB2	LVR-IC	LDO, 3.2V±1.5%, 300mA, +CE	SOT-23-5	28cx	VR4	6r	Ecm
0832A	EC8908-32AC5	LVR-IC	LDO, 3.2V±1.5%, 300mA, +CE	SC-70-5	28cx	VR4	6r	Ecm
0832B	EC8908-32BB2	LVR-IC	LDO, 3.2V±1.5%, 500mA, +CE	SOT-23-5	28cx	VR4	6r	Ecm
0832B	EC8908-32BC5	LVR-IC	LDO, 3.2V±1.5%, 500mA, +CE	SC-70-5	28cx	VR4	6r	Ecm
0832C	EC8908-32CB2	LVR-IC	LDO, 3.2V±1.5%, 300mA, -CE	SOT-23-5	28cx	VR4	6r	Ecm
0832C	EC8908-32CC5	LVR-IC	LDO, 3.2V±1.5%, 300mA, -CE	SC-70-5	28cx	VR4	6r	Ecm
0832D	EC8908-32DB2	LVR-IC	LDO, 3.2V±1.5%, 500mA, -CE	SOT-23-5	28cx	VR4	6r	Ecm
0832D	EC8908-32DC5	LVR-IC	LDO, 3.2V±1.5%, 500mA, -CE	SC-70-5	28cx	VR4	6r	Ecm
0833A	EC8908-33AB2	LVR-IC	LDO, 3.3V±1.5%, 300mA, +CE	SOT-23-5	28cx	VR4	6r	Ecm
0833A	EC8908-33AC5	LVR-IC	LDO, 3.3V±1.5%, 300mA, +CE	SC-70-5	28cx	VR4	6r	Ecm
0833B	EC8908-33BB2	LVR-IC	LDO, 3.3V±1.5%, 500mA, +CE	SOT-23-5	28cx	VR4	6r	Ecm
0833B	EC8908-33BC5	LVR-IC	LDO, 3.3V±1.5%, 500mA, +CE	SC-70-5	28cx	VR4	6r	Ecm
0833C	EC8908-33CB2	LVR-IC	LDO, 3.3V±1.5%, 300mA, -CE	SOT-23-5	28cx	VR4	6r	Ecm
0833C	EC8908-33CC5	LVR-IC	LDO, 3.3V±1.5%, 300mA, -CE	SC-70-5	28cx	VR4	6r	Ecm
0833D	EC8908-33DB2	LVR-IC	LDO, 3.3V±1.5%, 500mA, -CE	SOT-23-5	28cx	VR4	6r	Ecm
0833D	EC8908-33DC5	LVR-IC	LDO, 3.3V±1.5%, 500mA, -CE	SC-70-5	28cx	VR4	6r	Ecm



SMD code	Type	Function	Short description	Case	Pinout	Sch.	St.	Mnf.
0834A	EC8908-34AB2	LVR-IC	LDO, 3.4V±1.5%, 300mA, +CE	SOT-23-5	28cx	VR4	6r	Ecm
0834A	EC8908-34AC5	LVR-IC	LDO, 3.4V±1.5%, 300mA, +CE	SC-70-5	28cx	VR4	6r	Ecm
0834B	EC8908-34BB2	LVR-IC	LDO, 3.4V±1.5%, 500mA, +CE	SOT-23-5	28cx	VR4	6r	Ecm
0834B	EC8908-34BC5	LVR-IC	LDO, 3.4V±1.5%, 500mA, +CE	SC-70-5	28cx	VR4	6r	Ecm
0834C	EC8908-34CB2	LVR-IC	LDO, 3.4V±1.5%, 300mA, -CE	SOT-23-5	28cx	VR4	6r	Ecm
0834C	EC8908-34CC5	LVR-IC	LDO, 3.4V±1.5%, 300mA, -CE	SC-70-5	28cx	VR4	6r	Ecm
0834D	EC8908-34DB2	LVR-IC	LDO, 3.4V±1.5%, 500mA, -CE	SOT-23-5	28cx	VR4	6r	Ecm
0834D	EC8908-34DC5	LVR-IC	LDO, 3.4V±1.5%, 500mA, -CE	SC-70-5	28cx	VR4	6r	Ecm
0835A	EC8908-35AB2	LVR-IC	LDO, 3.5V±1.5%, 300mA, +CE	SOT-23-5	28cx	VR4	6r	Ecm
0835A	EC8908-35AC5	LVR-IC	LDO, 3.5V±1.5%, 300mA, +CE	SC-70-5	28cx	VR4	6r	Ecm
0835B	EC8908-35BB2	LVR-IC	LDO, 3.5V±1.5%, 500mA, +CE	SOT-23-5	28cx	VR4	6r	Ecm
0835B	EC8908-35BC5	LVR-IC	LDO, 3.5V±1.5%, 500mA, +CE	SC-70-5	28cx	VR4	6r	Ecm
0835C	EC8908-35CB2	LVR-IC	LDO, 3.5V±1.5%, 300mA, -CE	SOT-23-5	28cx	VR4	6r	Ecm
0835C	EC8908-35CC5	LVR-IC	LDO, 3.5V±1.5%, 300mA, -CE	SC-70-5	28cx	VR4	6r	Ecm
0835D	EC8908-35DB2	LVR-IC	LDO, 3.5V±1.5%, 500mA, -CE	SOT-23-5	28cx	VR4	6r	Ecm
0835D	EC8908-35DC5	LVR-IC	LDO, 3.5V±1.5%, 500mA, -CE	SC-70-5	28cx	VR4	6r	Ecm
0836A	EC8908-36AB2	LVR-IC	LDO, 3.6V±1.5%, 300mA, +CE	SOT-23-5	28cx	VR4	6r	Ecm
0836A	EC8908-36AC5	LVR-IC	LDO, 3.6V±1.5%, 300mA, +CE	SC-70-5	28cx	VR4	6r	Ecm
0836B	EC8908-36BB2	LVR-IC	LDO, 3.6V±1.5%, 500mA, +CE	SOT-23-5	28cx	VR4	6r	Ecm
0836B	EC8908-36BC5	LVR-IC	LDO, 3.6V±1.5%, 500mA, +CE	SC-70-5	28cx	VR4	6r	Ecm
0836C	EC8908-36CB2	LVR-IC	LDO, 3.6V±1.5%, 300mA, -CE	SOT-23-5	28cx	VR4	6r	Ecm
0836C	EC8908-36CC5	LVR-IC	LDO, 3.6V±1.5%, 300mA, -CE	SC-70-5	28cx	VR4	6r	Ecm
0836D	EC8908-36DB2	LVR-IC	LDO, 3.6V±1.5%, 500mA, -CE	SOT-23-5	28cx	VR4	6r	Ecm
0836D	EC8908-36DC5	LVR-IC	LDO, 3.6V±1.5%, 500mA, -CE	SC-70-5	28cx	VR4	6r	Ecm
0837A	EC8908-37AB2	LVR-IC	LDO, 3.7V±1.5%, 300mA, +CE	SOT-23-5	28cx	VR4	6r	Ecm
0837A	EC8908-37AC5	LVR-IC	LDO, 3.7V±1.5%, 300mA, +CE	SC-70-5	28cx	VR4	6r	Ecm
0837B	EC8908-37BB2	LVR-IC	LDO, 3.7V±1.5%, 500mA, +CE	SOT-23-5	28cx	VR4	6r	Ecm
0837B	EC8908-37BC5	LVR-IC	LDO, 3.7V±1.5%, 500mA, +CE	SC-70-5	28cx	VR4	6r	Ecm
0837C	EC8908-37CB2	LVR-IC	LDO, 3.7V±1.5%, 300mA, -CE	SOT-23-5	28cx	VR4	6r	Ecm
0837C	EC8908-37CC5	LVR-IC	LDO, 3.7V±1.5%, 300mA, -CE	SC-70-5	28cx	VR4	6r	Ecm
0837D	EC8908-37DB2	LVR-IC	LDO, 3.7V±1.5%, 500mA, -CE	SOT-23-5	28cx	VR4	6r	Ecm
0837D	EC8908-37DC5	LVR-IC	LDO, 3.7V±1.5%, 500mA, -CE	SC-70-5	28cx	VR4	6r	Ecm
0838A	EC8908-38AB2	LVR-IC	LDO, 3.8V±1.5%, 300mA, +CE	SOT-23-5	28cx	VR4	6r	Ecm
0838A	EC8908-38AC5	LVR-IC	LDO, 3.8V±1.5%, 300mA, +CE	SC-70-5	28cx	VR4	6r	Ecm
0838B	EC8908-38BB2	LVR-IC	LDO, 3.8V±1.5%, 500mA, +CE	SOT-23-5	28cx	VR4	6r	Ecm
0838B	EC8908-38BC5	LVR-IC	LDO, 3.8V±1.5%, 500mA, +CE	SC-70-5	28cx	VR4	6r	Ecm
0838C	EC8908-38CB2	LVR-IC	LDO, 3.8V±1.5%, 300mA, -CE	SOT-23-5	28cx	VR4	6r	Ecm
0838C	EC8908-38CC5	LVR-IC	LDO, 3.8V±1.5%, 300mA, -CE	SC-70-5	28cx	VR4	6r	Ecm
0838D	EC8908-38DB2	LVR-IC	LDO, 3.8V±1.5%, 500mA, -CE	SOT-23-5	28cx	VR4	6r	Ecm
0838D	EC8908-38DC5	LVR-IC	LDO, 3.8V±1.5%, 500mA, -CE	SC-70-5	28cx	VR4	6r	Ecm
0839A	EC8908-39AB2	LVR-IC	LDO, 3.9V±1.5%, 300mA, +CE	SOT-23-5	28cx	VR4	6r	Ecm
0839A	EC8908-39AC5	LVR-IC	LDO, 3.9V±1.5%, 300mA, +CE	SC-70-5	28cx	VR4	6r	Ecm
0839B	EC8908-39BB2	LVR-IC	LDO, 3.9V±1.5%, 500mA, +CE	SOT-23-5	28cx	VR4	6r	Ecm
0839B	EC8908-39BC5	LVR-IC	LDO, 3.9V±1.5%, 500mA, +CE	SC-70-5	28cx	VR4	6r	Ecm
0839C	EC8908-39CB2	LVR-IC	LDO, 3.9V±1.5%, 300mA, -CE	SOT-23-5	28cx	VR4	6r	Ecm
0839C	EC8908-39CC5	LVR-IC	LDO, 3.9V±1.5%, 300mA, -CE	SC-70-5	28cx	VR4	6r	Ecm
0839D	EC8908-39DB2	LVR-IC	LDO, 3.9V±1.5%, 500mA, -CE	SOT-23-5	28cx	VR4	6r	Ecm
0839D	EC8908-39DC5	LVR-IC	LDO, 3.9V±1.5%, 500mA, -CE	SC-70-5	28cx	VR4	6r	Ecm
084	XG6101B435MR	Vdet-IC	3.5V±2%, Hst, -MR, -Reset PPO, Wt=200ms, Rt=25ms	SOT-25	28cp	VD17	6g	Tor
0840A	EC8908-40AB2	LVR-IC	LDO, 4.0V±1.5%, 300mA, +CE	SOT-23-5	28cx	VR4	6r	Ecm
0840A	EC8908-40AC5	LVR-IC	LDO, 4.0V±1.5%, 300mA, +CE	SC-70-5	28cx	VR4	6r	Ecm
0840B	EC8908-40BB2	LVR-IC	LDO, 4.0V±1.5%, 500mA, +CE	SOT-23-5	28cx	VR4	6r	Ecm
0840B	EC8908-40BC5	LVR-IC	LDO, 4.0V±1.5%, 500mA, +CE	SC-70-5	28cx	VR4	6r	Ecm
0840C	EC8908-40CB2	LVR-IC	LDO, 4.0V±1.5%, 300mA, -CE	SOT-23-5	28cx	VR4	6r	Ecm
0840C	EC8908-40CC5	LVR-IC	LDO, 4.0V±1.5%, 300mA, -CE	SC-70-5	28cx	VR4	6r	Ecm
0840D	EC8908-40DB2	LVR-IC	LDO, 4.0V±1.5%, 500mA, -CE	SOT-23-5	28cx	VR4	6r	Ecm
0840D	EC8908-40DC5	LVR-IC	LDO, 4.0V±1.5%, 500mA, -CE	SC-70-5	28cx	VR4	6r	Ecm
0841A	EC8908-41AB2	LVR-IC	LDO, 4.1V±1.5%, 300mA, +CE	SOT-23-5	28cx	VR4	6r	Ecm
0841A	EC8908-41AC5	LVR-IC	LDO, 4.1V±1.5%, 300mA, +CE	SC-70-5	28cx	VR4	6r	Ecm
0841B	EC8908-41BB2	LVR-IC	LDO, 4.1V±1.5%, 500mA, +CE	SOT-23-5	28cx	VR4	6r	Ecm
0841B	EC8908-41BC5	LVR-IC	LDO, 4.1V±1.5%, 500mA, +CE	SC-70-5	28cx	VR4	6r	Ecm
0841C	EC8908-41CB2	LVR-IC	LDO, 4.1V±1.5%, 300mA, -CE	SOT-23-5	28cx	VR4	6r	Ecm
0841C	EC8908-41CC5	LVR-IC	LDO, 4.1V±1.5%, 300mA, -CE	SC-70-5	28cx	VR4	6r	Ecm
0841D	EC8908-41DB2	LVR-IC	LDO, 4.1V±1.5%, 500mA, -CE	SOT-23-5	28cx	VR4	6r	Ecm
0841D	EC8908-41DC5	LVR-IC	LDO, 4.1V±1.5%, 500mA, -CE	SC-70-5	28cx	VR4	6r	Ecm
0842A	EC8908-42AB2	LVR-IC	LDO, 4.2V±1.5%, 300mA, +CE	SOT-23-5	28cx	VR4	6r	Ecm
0842A	EC8908-42AC5	LVR-IC	LDO, 4.2V±1.5%, 300mA, +CE	SC-70-5	28cx	VR4	6r	Ecm
0842B	EC8908-42BB2	LVR-IC	LDO, 4.2V±1.5%, 500mA, +CE	SOT-23-5	28cx	VR4	6r	Ecm
0842B	EC8908-42BC5	LVR-IC	LDO, 4.2V±1.5%, 500mA, +CE	SC-70-5	28cx	VR4	6r	Ecm
0842C	EC8908-42CB2	LVR-IC	LDO, 4.2V±1.5%, 300mA, -CE	SOT-23-5	28cx	VR4	6r	Ecm



SMD code	Type	Function	Short description	Case	Pinout	Sch.	St.	Mnf.
0842C	EC8908-42CC5	LVR-IC	LDO, 4.2V±1.5%, 300mA, -CE	SC-70-5	28cx	VR4	6r	Ecm
0842D	EC8908-42DB2	LVR-IC	LDO, 4.2V±1.5%, 500mA, -CE	SOT-23-5	28cx	VR4	6r	Ecm
0842D	EC8908-42DC5	LVR-IC	LDO, 4.2V±1.5%, 500mA, -CE	SC-70-5	28cx	VR4	6r	Ecm
0843A	EC8908-43AB2	LVR-IC	LDO, 4.3V±1.5%, 300mA, +CE	SOT-23-5	28cx	VR4	6r	Ecm
0843A	EC8908-43AC5	LVR-IC	LDO, 4.3V±1.5%, 300mA, +CE	SC-70-5	28cx	VR4	6r	Ecm
0843B	EC8908-43BB2	LVR-IC	LDO, 4.3V±1.5%, 500mA, +CE	SOT-23-5	28cx	VR4	6r	Ecm
0843B	EC8908-43BC5	LVR-IC	LDO, 4.3V±1.5%, 500mA, +CE	SC-70-5	28cx	VR4	6r	Ecm
0843C	EC8908-43CB2	LVR-IC	LDO, 4.3V±1.5%, 300mA, -CE	SOT-23-5	28cx	VR4	6r	Ecm
0843C	EC8908-43CC5	LVR-IC	LDO, 4.3V±1.5%, 300mA, -CE	SC-70-5	28cx	VR4	6r	Ecm
0843D	EC8908-43DB2	LVR-IC	LDO, 4.3V±1.5%, 500mA, -CE	SOT-23-5	28cx	VR4	6r	Ecm
0843D	EC8908-43DC5	LVR-IC	LDO, 4.3V±1.5%, 500mA, -CE	SC-70-5	28cx	VR4	6r	Ecm
0844A	EC8908-44AB2	LVR-IC	LDO, 4.4V±1.5%, 300mA, +CE	SOT-23-5	28cx	VR4	6r	Ecm
0844A	EC8908-44AC5	LVR-IC	LDO, 4.4V±1.5%, 300mA, +CE	SC-70-5	28cx	VR4	6r	Ecm
0844B	EC8908-44BB2	LVR-IC	LDO, 4.4V±1.5%, 500mA, +CE	SOT-23-5	28cx	VR4	6r	Ecm
0844B	EC8908-44BC5	LVR-IC	LDO, 4.4V±1.5%, 500mA, +CE	SC-70-5	28cx	VR4	6r	Ecm
0844C	EC8908-44CB2	LVR-IC	LDO, 4.4V±1.5%, 300mA, -CE	SOT-23-5	28cx	VR4	6r	Ecm
0844C	EC8908-44CC5	LVR-IC	LDO, 4.4V±1.5%, 300mA, -CE	SC-70-5	28cx	VR4	6r	Ecm
0844D	EC8908-44DB2	LVR-IC	LDO, 4.4V±1.5%, 500mA, -CE	SOT-23-5	28cx	VR4	6r	Ecm
0844D	EC8908-44DC5	LVR-IC	LDO, 4.4V±1.5%, 500mA, -CE	SC-70-5	28cx	VR4	6r	Ecm
0845A	EC8908-45AB2	LVR-IC	LDO, 4.5V±1.5%, 300mA, +CE	SOT-23-5	28cx	VR4	6r	Ecm
0845A	EC8908-45AC5	LVR-IC	LDO, 4.5V±1.5%, 300mA, +CE	SC-70-5	28cx	VR4	6r	Ecm
0845B	EC8908-45BB2	LVR-IC	LDO, 4.5V±1.5%, 500mA, +CE	SOT-23-5	28cx	VR4	6r	Ecm
0845B	EC8908-45BC5	LVR-IC	LDO, 4.5V±1.5%, 500mA, +CE	SC-70-5	28cx	VR4	6r	Ecm
0845C	EC8908-45CB2	LVR-IC	LDO, 4.5V±1.5%, 300mA, -CE	SOT-23-5	28cx	VR4	6r	Ecm
0845C	EC8908-45CC5	LVR-IC	LDO, 4.5V±1.5%, 300mA, -CE	SC-70-5	28cx	VR4	6r	Ecm
0845D	EC8908-45DB2	LVR-IC	LDO, 4.5V±1.5%, 500mA, -CE	SOT-23-5	28cx	VR4	6r	Ecm
0845D	EC8908-45DC5	LVR-IC	LDO, 4.5V±1.5%, 500mA, -CE	SC-70-5	28cx	VR4	6r	Ecm
0846A	EC8908-46AB2	LVR-IC	LDO, 4.6V±1.5%, 300mA, +CE	SOT-23-5	28cx	VR4	6r	Ecm
0846A	EC8908-46AC5	LVR-IC	LDO, 4.6V±1.5%, 300mA, +CE	SC-70-5	28cx	VR4	6r	Ecm
0846B	EC8908-46BB2	LVR-IC	LDO, 4.6V±1.5%, 500mA, +CE	SOT-23-5	28cx	VR4	6r	Ecm
0846B	EC8908-46BC5	LVR-IC	LDO, 4.6V±1.5%, 500mA, +CE	SC-70-5	28cx	VR4	6r	Ecm
0846C	EC8908-46CB2	LVR-IC	LDO, 4.6V±1.5%, 300mA, -CE	SOT-23-5	28cx	VR4	6r	Ecm
0846C	EC8908-46CC5	LVR-IC	LDO, 4.6V±1.5%, 300mA, -CE	SC-70-5	28cx	VR4	6r	Ecm
0846D	EC8908-46DB2	LVR-IC	LDO, 4.6V±1.5%, 500mA, -CE	SOT-23-5	28cx	VR4	6r	Ecm
0846D	EC8908-46DC5	LVR-IC	LDO, 4.6V±1.5%, 500mA, -CE	SC-70-5	28cx	VR4	6r	Ecm
0847A	EC8908-47AB2	LVR-IC	LDO, 4.7V±1.5%, 300mA, +CE	SOT-23-5	28cx	VR4	6r	Ecm
0847A	EC8908-47AC5	LVR-IC	LDO, 4.7V±1.5%, 300mA, +CE	SC-70-5	28cx	VR4	6r	Ecm
0847B	EC8908-47BB2	LVR-IC	LDO, 4.7V±1.5%, 500mA, +CE	SOT-23-5	28cx	VR4	6r	Ecm
0847B	EC8908-47BC5	LVR-IC	LDO, 4.7V±1.5%, 500mA, +CE	SC-70-5	28cx	VR4	6r	Ecm
0847C	EC8908-47CB2	LVR-IC	LDO, 4.7V±1.5%, 300mA, -CE	SOT-23-5	28cx	VR4	6r	Ecm
0847C	EC8908-47CC5	LVR-IC	LDO, 4.7V±1.5%, 300mA, -CE	SC-70-5	28cx	VR4	6r	Ecm
0847D	EC8908-47DB2	LVR-IC	LDO, 4.7V±1.5%, 500mA, -CE	SOT-23-5	28cx	VR4	6r	Ecm
0847D	EC8908-47DC5	LVR-IC	LDO, 4.7V±1.5%, 500mA, -CE	SC-70-5	28cx	VR4	6r	Ecm
0848A	EC8908-48AB2	LVR-IC	LDO, 4.8V±1.5%, 300mA, +CE	SOT-23-5	28cx	VR4	6r	Ecm
0848A	EC8908-48AC5	LVR-IC	LDO, 4.8V±1.5%, 300mA, +CE	SC-70-5	28cx	VR4	6r	Ecm
0848B	EC8908-48BB2	LVR-IC	LDO, 4.8V±1.5%, 500mA, +CE	SOT-23-5	28cx	VR4	6r	Ecm
0848B	EC8908-48BC5	LVR-IC	LDO, 4.8V±1.5%, 500mA, +CE	SC-70-5	28cx	VR4	6r	Ecm
0848C	EC8908-48CB2	LVR-IC	LDO, 4.8V±1.5%, 300mA, -CE	SOT-23-5	28cx	VR4	6r	Ecm
0848C	EC8908-48CC5	LVR-IC	LDO, 4.8V±1.5%, 300mA, -CE	SC-70-5	28cx	VR4	6r	Ecm
0848D	EC8908-48DB2	LVR-IC	LDO, 4.8V±1.5%, 500mA, -CE	SOT-23-5	28cx	VR4	6r	Ecm
0848D	EC8908-48DC5	LVR-IC	LDO, 4.8V±1.5%, 500mA, -CE	SC-70-5	28cx	VR4	6r	Ecm
085	XC6101B436MR	Vdet-IC	3.6V±2%, Hst, -MR, -Reset PPO, Wt=200ms, Rt=25ms	SOT-25	28cp	VD17	6g	Tor
086	XC6101B437MR	Vdet-IC	3.7V±2%, Hst, -MR, -Reset PPO, Wt=200ms, Rt=25ms	SOT-25	28cp	VD17	6g	Tor
087	XC6101B438MR	Vdet-IC	3.8V±2%, Hst, -MR, -Reset PPO, Wt=200ms, Rt=25ms	SOT-25	28cp	VD17	6g	Tor
088	XC6101B439MR	Vdet-IC	3.9V±2%, Hst, -MR, -Reset PPO, Wt=200ms, Rt=25ms	SOT-25	28cp	VD17	6g	Tor
089	XC6101B440MR	Vdet-IC	4.0V±2%, Hst, -MR, -Reset PPO, Wt=200ms, Rt=25ms	SOT-25	28cp	VD17	6g	Tor
08A	XC6101B441MR	Vdet-IC	4.1V±2%, Hst, -MR, -Reset PPO, Wt=200ms, Rt=25ms	SOT-25	28cp	VD17	6g	Tor
08B	XC6101B442MR	Vdet-IC	4.2V±2%, Hst, -MR, -Reset PPO, Wt=200ms, Rt=25ms	SOT-25	28cp	VD17	6g	Tor
08C	XC6101B443MR	Vdet-IC	4.3V±2%, Hst, -MR, -Reset PPO, Wt=200ms, Rt=25ms	SOT-25	28cp	VD17	6g	Tor
08D	XC6101B444MR	Vdet-IC	4.4V±2%, Hst, -MR, -Reset PPO, Wt=200ms, Rt=25ms	SOT-25	28cp	VD17	6g	Tor
08E	XC6101B445MR	Vdet-IC	4.5V±2%, Hst, -MR, -Reset PPO, Wt=200ms, Rt=25ms	SOT-25	28cp	VD17	6g	Tor
08F	XC6101B446MR	Vdet-IC	1.6V±2%, Hst, -MR, -Reset PPO, Wt=200ms, Rt=25ms	SOT-25	28cp	VD17	6g	Tor
08E	XC6101B446MR	Vdet-IC	4.6V±2%, Hst, -MR, -Reset PPO, Wt=200ms, Rt=25ms	SOT-25	28cp	VD17	6g	Tor
08H	XC6101B447MR	Vdet-IC	1.7V±2%, Hst, -MR, -Reset PPO, Wt=200ms, Rt=25ms	SOT-25	28cp	VD17	6g	Tor



SMD code	Type	Function	Short description	Case	Pinout	Sch.	St.	Mnf.
08H	XC6101B447MR	Vdet-IC	4.7V±2%, Hst, -MR, -Reset PPO, Wt=200ms, Rt=25ms	SOT-25	28cp	VD17	6g	Tor
08K	XC6101B418MR	Vdet-IC	1.8V±2%, Hst, -MR, -Reset PPO, Wt=200ms, Rt=25ms	SOT-25	28cp	VD17	6g	Tor
08K	XC6101B448MR	Vdet-IC	4.8V±2%, Hst, -MR, -Reset PPO, Wt=200ms, Rt=25ms	SOT-25	28cp	VD17	6g	Tor
08L	XC6101B419MR	Vdet-IC	1.9V±2%, Hst, -MR, -Reset PPO, Wt=200ms, Rt=25ms	SOT-25	28cp	VD17	6g	Tor
08L	XC6101B449MR	Vdet-IC	4.9V±2%, Hst, -MR, -Reset PPO, Wt=200ms, Rt=25ms	SOT-25	28cp	VD17	6g	Tor
08M	XC6101B420MR	Vdet-IC	2.0V±2%, Hst, -MR, -Reset PPO, Wt=200ms, Rt=25ms	SOT-25	28cp	VD17	6g	Tor
08M	XC6101B450MR	Vdet-IC	5.0V±2%, Hst, -MR, -Reset PPO, Wt=200ms, Rt=25ms	SOT-25	28cp	VD17	6g	Tor
08N	XC6101B421MR	Vdet-IC	2.1V±2%, Hst, -MR, -Reset PPO, Wt=200ms, Rt=25ms	SOT-25	28cp	VD17	6g	Tor
08P	XC6101B422MR	Vdet-IC	2.2V±2%, Hst, -MR, -Reset PPO, Wt=200ms, Rt=25ms	SOT-25	28cp	VD17	6g	Tor
08R	XC6101B423MR	Vdet-IC	2.3V±2%, Hst, -MR, -Reset PPO, Wt=200ms, Rt=25ms	SOT-25	28cp	VD17	6g	Tor
08S	XC6101B424MR	Vdet-IC	2.4V±2%, Hst, -MR, -Reset PPO, Wt=200ms, Rt=25ms	SOT-25	28cp	VD17	6g	Tor
08T	XC6101B425MR	Vdet-IC	2.5V±2%, Hst, -MR, -Reset PPO, Wt=200ms, Rt=25ms	SOT-25	28cp	VD17	6g	Tor
08U	XC6101B426MR	Vdet-IC	2.6V±2%, Hst, -MR, -Reset PPO, Wt=200ms, Rt=25ms	SOT-25	28cp	VD17	6g	Tor
08V	XC6101B427MR	Vdet-IC	2.7V±2%, Hst, -MR, -Reset PPO, Wt=200ms, Rt=25ms	SOT-25	28cp	VD17	6g	Tor
08X	XC6101B428MR	Vdet-IC	2.8V±2%, Hst, -MR, -Reset PPO, Wt=200ms, Rt=25ms	SOT-25	28cp	VD17	6g	Tor
08Y	XC6101B429MR	Vdet-IC	2.9V±2%, Hst, -MR, -Reset PPO, Wt=200ms, Rt=25ms	SOT-25	28cp	VD17	6g	Tor
08Z	XC6101B430MR	Vdet-IC	3.0V±2%, Hst, -MR, -Reset PPO, Wt=200ms, Rt=25ms	SOT-25	28cp	VD17	6g	Tor
09	R1223N182D	DC/DC-IC	PWM step-down, +CE, 1.8V, 500kHz, Latch-Pr.	SOT-23-5	28ud	DC7	6g	Ric
09	RN5RF59BA	LVR-IC	L.Rip, +CE, 5.9V±2%, 1A*	SOT-23-5	28vw	VR6	6g	Ric
09	RN5RZ59BA	LVR-IC	LDO, LN, +CE, 5.9V±2%, 100mA	SOT-23-5	28wrt	VR4	6g	Ric
090	XC6101B531MR	Vdet-IC	3.1V±2%, Hst, -MR, -Reset PPO, Wt=400ms, Rt=25ms	SOT-25	28cp	VD17	6g	Tor
091	XC6101B532MR	Vdet-IC	3.2V±2%, Hst, -MR, -Reset PPO, Wt=400ms, Rt=25ms	SOT-25	28cp	VD17	6g	Tor
092	XC6101B533MR	Vdet-IC	3.3V±2%, Hst, -MR, -Reset PPO, Wt=400ms, Rt=25ms	SOT-25	28cp	VD17	6g	Tor
093	XC6101B534MR	Vdet-IC	3.4V±2%, Hst, -MR, -Reset PPO, Wt=400ms, Rt=25ms	SOT-25	28cp	VD17	6g	Tor
094	XC6101B535MR	Vdet-IC	3.5V±2%, Hst, -MR, -Reset PPO, Wt=400ms, Rt=25ms	SOT-25	28cp	VD17	6g	Tor
095	XC6101B536MR	Vdet-IC	3.6V±2%, Hst, -MR, -Reset PPO, Wt=400ms, Rt=25ms	SOT-25	28cp	VD17	6g	Tor
096	XC6101B537MR	Vdet-IC	3.7V±2%, Hst, -MR, -Reset PPO, Wt=400ms, Rt=25ms	SOT-25	28cp	VD17	6g	Tor
097	XC6101B538MR	Vdet-IC	3.8V±2%, Hst, -MR, -Reset PPO, Wt=400ms, Rt=25ms	SOT-25	28cp	VD17	6g	Tor
098	XC6101B539MR	Vdet-IC	3.9V±2%, Hst, -MR, -Reset PPO, Wt=400ms, Rt=25ms	SOT-25	28cp	VD17	6g	Tor
099	XC6101B540MR	Vdet-IC	4.0V±2%, Hst, -MR, -Reset PPO, Wt=400ms, Rt=25ms	SOT-25	28cp	VD17	6g	Tor
09A	XC6101B541MR	Vdet-IC	4.1V±2%, Hst, -MR, -Reset PPO, Wt=400ms, Rt=25ms	SOT-25	28cp	VD17	6g	Tor
09B	XC6101B542MR	Vdet-IC	4.2V±2%, Hst, -MR, -Reset PPO, Wt=400ms, Rt=25ms	SOT-25	28cp	VD17	6g	Tor
09C	XC6101B543MR	Vdet-IC	4.3V±2%, Hst, -MR, -Reset PPO, Wt=400ms, Rt=25ms	SOT-25	28cp	VD17	6g	Tor
09D	XC6101B544MR	Vdet-IC	4.4V±2%, Hst, -MR, -Reset PPO, Wt=400ms, Rt=25ms	SOT-25	28cp	VD17	6g	Tor
09E	XC6101B545MR	Vdet-IC	4.5V±2%, Hst, -MR, -Reset PPO, Wt=400ms, Rt=25ms	SOT-25	28cp	VD17	6g	Tor
09F	XC6101B516MR	Vdet-IC	1.6V±2%, Hst, -MR, -Reset PPO, Wt=400ms, Rt=25ms	SOT-25	28cp	VD17	6g	Tor
09F	XC6101B546MR	Vdet-IC	4.6V±2%, Hst, -MR, -Reset PPO, Wt=400ms, Rt=25ms	SOT-25	28cp	VD17	6g	Tor
09H	XC6101B517MR	Vdet-IC	1.7V±2%, Hst, -MR, -Reset PPO, Wt=400ms, Rt=25ms	SOT-25	28cp	VD17	6g	Tor
09H	XC6101B547MR	Vdet-IC	4.7V±2%, Hst, -MR, -Reset PPO, Wt=400ms, Rt=25ms	SOT-25	28cp	VD17	6g	Tor
09K	XC6101B518MR	Vdet-IC	1.8V±2%, Hst, -MR, -Reset PPO, Wt=400ms, Rt=25ms	SOT-25	28cp	VD17	6g	Tor
09K	XC6101B548MR	Vdet-IC	4.8V±2%, Hst, -MR, -Reset PPO, Wt=400ms, Rt=25ms	SOT-25	28cp	VD17	6g	Tor
09L	XC6101B519MR	Vdet-IC	1.9V±2%, Hst, -MR, -Reset PPO, Wt=400ms, Rt=25ms	SOT-25	28cp	VD17	6g	Tor
09L	XC6101B549MR	Vdet-IC	4.9V±2%, Hst, -MR, -Reset PPO, Wt=400ms, Rt=25ms	SOT-25	28cp	VD17	6g	Tor
09M	XC6101B520MR	Vdet-IC	2.0V±2%, Hst, -MR, -Reset PPO, Wt=400ms, Rt=25ms	SOT-25	28cp	VD17	6g	Tor
09M	XC6101B550MR	Vdet-IC	5.0V±2%, Hst, -MR, -Reset PPO, Wt=400ms, Rt=25ms	SOT-25	28cp	VD17	6g	Tor
09N	XC6101B521MR	Vdet-IC	2.1V±2%, Hst, -MR, -Reset PPO, Wt=400ms, Rt=25ms	SOT-25	28cp	VD17	6g	Tor
09P	XC6101B522MR	Vdet-IC	2.2V±2%, Hst, -MR, -Reset PPO, Wt=400ms, Rt=25ms	SOT-25	28cp	VD17	6g	Tor
09R	XC6101B523MR	Vdet-IC	2.3V±2%, Hst, -MR, -Reset PPO, Wt=400ms, Rt=25ms	SOT-25	28cp	VD17	6g	Tor
09S	XC6101B524MR	Vdet-IC	2.4V±2%, Hst, -MR, -Reset PPO, Wt=400ms, Rt=25ms	SOT-25	28cp	VD17	6g	Tor
09T	XC6101B525MR	Vdet-IC	2.5V±2%, Hst, -MR, -Reset PPO, Wt=400ms, Rt=25ms	SOT-25	28cp	VD17	6g	Tor
09U	XC6101B526MR	Vdet-IC	2.6V±2%, Hst, -MR, -Reset PPO, Wt=400ms, Rt=25ms	SOT-25	28cp	VD17	6g	Tor
09V	XC6101B527MR	Vdet-IC	2.7V±2%, Hst, -MR, -Reset PPO, Wt=400ms, Rt=25ms	SOT-25	28cp	VD17	6g	Tor
09X	XC6101B528MR	Vdet-IC	2.8V±2%, Hst, -MR, -Reset PPO, Wt=400ms, Rt=25ms	SOT-25	28cp	VD17	6g	Tor
09Y	XC6101B529MR	Vdet-IC	2.9V±2%, Hst, -MR, -Reset PPO, Wt=400ms, Rt=25ms	SOT-25	28cp	VD17	6g	Tor
09Z	XC6101B530MR	Vdet-IC	3.0V±2%, Hst, -MR, -Reset PPO, Wt=400ms, Rt=25ms	SOT-25	28cp	VD17	6g	Tor
0A	BU4317FWE	Vdet-IC	1.7V, +Reset PPO	VSOFF-5	30vka	VD3	6c	Rhm
0A	BU4317G	Vdet-IC	1.7V, +Reset PPO	SSOP-5	28vdo	VD3	6c	Rhm
0A0	XC6210A312MR	LVR-IC	LDO, 3.1V±2%, 700mA, +CE, PDR	SOT-25	28cx	VR4	6g	Tor
0A0	XC6221C311MR	LVR-IC	LDO, 3.1V±1%, 200mA, +CE, PDR	SOT-25	28cx	VR4	6g	Tor
0A0	XC6101B631MR	Vdet-IC	3.1V±2%, Hst, -MR, -Reset PPO, Wt=1.6s, Rt=25ms	SOT-25	28cp	VD17	6g	Tor
0A1	XC6210A322MR	LVR-IC	LDO, 3.2V±2%, 700mA, +CE, PDR	SOT-25	28cx	VR4	6g	Tor
0A1	XC6221C321MR	LVR-IC	LDO, 3.2V±1%, 200mA, +CE, PDR	SOT-25	28cx	VR4	6g	Tor
0A1	XC6101B632MR	Vdet-IC	3.2V±2%, Hst, -MR, -Reset PPO, Wt=1.6s, Rt=25ms	SOT-25	28cp	VD17	6g	Tor
0A2	XC6210A332MR	LVR-IC	LDO, 3.3V±2%, 700mA, +CE, PDR	SOT-25	28cx	VR4	6g	Tor
0A2	XC6221C331MR	LVR-IC	LDO, 3.3V±1%, 200mA, +CE, PDR	SOT-25	28cx	VR4	6g	Tor
0A2	XC6101B633MR	Vdet-IC	3.3V±2%, Hst, -MR, -Reset PPO, Wt=1.6s, Rt=25ms	SOT-25	28cp	VD17	6g	Tor
0A3	XC6210A342MR	LVR-IC	LDO, 3.4V±2%, 700mA, +CE, PDR	SOT-25	28cx	VR4	6g	Tor
0A3	XC6221C341MR	LVR-IC	LDO, 3.4V±1%, 200mA, +CE, PDR	SOT-25	28cx	VR4	6g	Tor
0A3	XC6101B634MR	Vdet-IC	3.4V±2%, Hst, -MR, -Reset PPO, Wt=1.6s, Rt=25ms	SOT-25	28cp	VD17	6g	Tor
0A4	XC6210A352MR	LVR-IC	LDO, 3.5V±2%, 700mA, +CE, PDR	SOT-25	28cx	VR4	6g	Tor



SMD code	Type	Function	Short description	Case	Pinout	Sch.	St.	Mnf.
0A4	XC6221C351MR	LVR-IC	LDO, 3.5V±1%, 200mA, +CE, PDR	SOT-25	28cx	VR4	6g	Tor
0A4	XC6101B635MR	Vdet-IC	3.5V±2%, Hst, -MR, -Reset PPO, Wt=1.6s, Rt=25ms	SOT-25	28cp	VD17	6g	Tor
0A5	XC6210A362MR	LVR-IC	LDO, 3.6V±2%, 700mA, +CE, PDR	SOT-25	28cx	VR4	6g	Tor
0A5	XC6221C361MR	LVR-IC	LDO, 3.6V±1%, 200mA, +CE, PDR	SOT-25	28cx	VR4	6g	Tor
0A5	XC6101B636MR	Vdet-IC	3.6V±2%, Hst, -MR, -Reset PPO, Wt=1.6s, Rt=25ms	SOT-25	28cp	VD17	6g	Tor
0A6	XC6210A372MR	LVR-IC	LDO, 3.7V±2%, 700mA, +CE, PDR	SOT-25	28cx	VR4	6g	Tor
0A6	XC6221C371MR	LVR-IC	LDO, 3.7V±1%, 200mA, +CE, PDR	SOT-25	28cx	VR4	6g	Tor
0A6	XC6101B637MR	Vdet-IC	3.7V±2%, Hst, -MR, -Reset PPO, Wt=1.6s, Rt=25ms	SOT-25	28cp	VD17	6g	Tor
0A7	XC6210A382MR	LVR-IC	LDO, 3.8V±2%, 700mA, +CE, PDR	SOT-25	28cx	VR4	6g	Tor
0A7	XC6221C381MR	LVR-IC	LDO, 3.8V±1%, 200mA, +CE, PDR	SOT-25	28cx	VR4	6g	Tor
0A7	XC6101B638MR	Vdet-IC	3.8V±2%, Hst, -MR, -Reset PPO, Wt=1.6s, Rt=25ms	SOT-25	28cp	VD17	6g	Tor
0A8	XC6210A392MR	LVR-IC	LDO, 3.9V±2%, 700mA, +CE, PDR	SOT-25	28cx	VR4	6g	Tor
0A8	XC6221C391MR	LVR-IC	LDO, 3.9V±1%, 200mA, +CE, PDR	SOT-25	28cx	VR4	6g	Tor
0A8	XC6101B639MR	Vdet-IC	3.9V±2%, Hst, -MR, -Reset PPO, Wt=1.6s, Rt=25ms	SOT-25	28cp	VD17	6g	Tor
0A9	XC6210A402MR	LVR-IC	LDO, 4V±2%, 700mA, +CE, PDR	SOT-25	28cx	VR4	6g	Tor
0A9	XC6221C401MR	LVR-IC	LDO, 4V±1%, 200mA, +CE, PDR	SOT-25	28cx	VR4	6g	Tor
0A9	XC6101B640MR	Vdet-IC	4.0V±2%, Hst, -MR, -Reset PPO, Wt=1.6s, Rt=25ms	SOT-25	28cp	VD17	6g	Tor
0AA	XC6210A412MR	LVR-IC	LDO, 4.1V±2%, 700mA, +CE, PDR	SOT-25	28cx	VR4	6g	Tor
0AA	XC6221C411MR	LVR-IC	LDO, 4.1±1%, 200mA, +CE, PDR	SOT-25	28cx	VR4	6g	Tor
0AA	XC6101B641MR	Vdet-IC	4.1V±2%, Hst, -MR, -Reset PPO, Wt=1.6s, Rt=25ms	SOT-25	28cp	VD17	6g	Tor
0AB	XC6210A422MR	LVR-IC	LDO, 4.2V±2%, 700mA, +CE, PDR	SOT-25	28cx	VR4	6g	Tor
0AB	XC6221C421MR	LVR-IC	LDO, 4.2±1%, 200mA, +CE, PDR	SOT-25	28cx	VR4	6g	Tor
0AB	XC6101B642MR	Vdet-IC	4.2V±2%, Hst, -MR, -Reset PPO, Wt=1.6s, Rt=25ms	SOT-25	28cp	VD17	6g	Tor
0AC	XC6210A432MR	LVR-IC	LDO, 4.3V±2%, 700mA, +CE, PDR	SOT-25	28cx	VR4	6g	Tor
0AC	XC6221C431MR	LVR-IC	LDO, 4.3±1%, 200mA, +CE, PDR	SOT-25	28cx	VR4	6g	Tor
0AC	XC6101B643MR	Vdet-IC	4.3V±2%, Hst, -MR, -Reset PPO, Wt=1.6s, Rt=25ms	SOT-25	28cp	VD17	6g	Tor
0AD	XC6210A442MR	LVR-IC	LDO, 4.4V±2%, 700mA, +CE, PDR	SOT-25	28cx	VR4	6g	Tor
0AD	XC6221C441MR	LVR-IC	LDO, 4.4±1%, 200mA, +CE, PDR	SOT-25	28cx	VR4	6g	Tor
0AD	XC6101B644MR	Vdet-IC	4.4V±2%, Hst, -MR, -Reset PPO, Wt=1.6s, Rt=25ms	SOT-25	28cp	VD17	6g	Tor
0AE	XC6210A452MR	LVR-IC	LDO, 4.5V±2%, 700mA, +CE, PDR	SOT-25	28cx	VR4	6g	Tor
0AE	XC6221C451MR	LVR-IC	LDO, 4.5±1%, 200mA, +CE, PDR	SOT-25	28cx	VR4	6g	Tor
0AE	XC6101B645MR	Vdet-IC	4.5V±2%, Hst, -MR, -Reset PPO, Wt=1.6s, Rt=25ms	SOT-25	28cp	VD17	6g	Tor
0AF	XC6210A462MR	LVR-IC	LDO, 4.6V±2%, 700mA, +CE, PDR	SOT-25	28cx	VR4	6g	Tor
0AF	XC6221C461MR	LVR-IC	LDO, 4.6±1%, 200mA, +CE, PDR	SOT-25	28cx	VR4	6g	Tor
0AF	XC6101B616MR	Vdet-IC	1.6V±2%, Hst, -MR, -Reset PPO, Wt=1.6s, Rt=25ms	SOT-25	28cp	VD17	6g	Tor
0AF	XC6101B646MR	Vdet-IC	4.6V±2%, Hst, -MR, -Reset PPO, Wt=1.6s, Rt=25ms	SOT-25	28cp	VD17	6g	Tor
0AH	XC6210A472MR	LVR-IC	LDO, 4.7V±2%, 700mA, +CE, PDR	SOT-25	28cx	VR4	6g	Tor
0AH	XC6221C471MR	LVR-IC	LDO, 4.7±1%, 200mA, +CE, PDR	SOT-25	28cx	VR4	6g	Tor
0AH	XC6101B617MR	Vdet-IC	1.7V±2%, Hst, -MR, -Reset PPO, Wt=1.6s, Rt=25ms	SOT-25	28cp	VD17	6g	Tor
0AH	XC6101B647MR	Vdet-IC	4.7V±2%, Hst, -MR, -Reset PPO, Wt=1.6s, Rt=25ms	SOT-25	28cp	VD17	6g	Tor
0AK	XC6210A482MR	LVR-IC	LDO, 4.8V±2%, 700mA, +CE, PDR	SOT-25	28cx	VR4	6g	Tor
0AK	XC6221C481MR	LVR-IC	LDO, 4.8±1%, 200mA, +CE, PDR	SOT-25	28cx	VR4	6g	Tor
0AK	XC6101B618MR	Vdet-IC	1.8V±2%, Hst, -MR, -Reset PPO, Wt=1.6s, Rt=25ms	SOT-25	28cp	VD17	6g	Tor
0AK	XC6101B648MR	Vdet-IC	4.8V±2%, Hst, -MR, -Reset PPO, Wt=1.6s, Rt=25ms	SOT-25	28cp	VD17	6g	Tor
0AL	XC6210A492MR	LVR-IC	LDO, 4.9V±2%, 700mA, +CE, PDR	SOT-25	28cx	VR4	6g	Tor
0AL	XC6221C491MR	LVR-IC	LDO, 4.9±1%, 200mA, +CE, PDR	SOT-25	28cx	VR4	6g	Tor
0AL	XC6101B619MR	Vdet-IC	1.9V±2%, Hst, -MR, -Reset PPO, Wt=1.6s, Rt=25ms	SOT-25	28cp	VD17	6g	Tor
0AL	XC6101B649MR	Vdet-IC	4.9V±2%, Hst, -MR, -Reset PPO, Wt=1.6s, Rt=25ms	SOT-25	28cp	VD17	6g	Tor
0AM	XC6210A502MR	LVR-IC	LDO, 5V±2%, 700mA, +CE, PDR	SOT-25	28cx	VR4	6g	Tor
0AM	XC6221C501MR	LVR-IC	LDO, 5.0±1%, 200mA, +CE, PDR	SOT-25	28cx	VR4	6g	Tor
0AM	XC6101B620MR	Vdet-IC	2.0V±2%, Hst, -MR, -Reset PPO, Wt=1.6s, Rt=25ms	SOT-25	28cp	VD17	6g	Tor
0AM	XC6101B650MR	Vdet-IC	5.0V±2%, Hst, -MR, -Reset PPO, Wt=1.6s, Rt=25ms	SOT-25	28cp	VD17	6g	Tor
0AN	XC6101B621MR	Vdet-IC	2.1V±2%, Hst, -MR, -Reset PPO, Wt=1.6s, Rt=25ms	SOT-25	28cp	VD17	6g	Tor
0AN	XC6101B622MR	Vdet-IC	2.2V±2%, Hst, -MR, -Reset PPO, Wt=1.6s, Rt=25ms	SOT-25	28cp	VD17	6g	Tor
0AN	XC6101B623MR	Vdet-IC	2.3V±2%, Hst, -MR, -Reset PPO, Wt=1.6s, Rt=25ms	SOT-25	28cp	VD17	6g	Tor
0AS	XC6101B624MR	Vdet-IC	2.4V±2%, Hst, -MR, -Reset PPO, Wt=1.6s, Rt=25ms	SOT-25	28cp	VD17	6g	Tor
0AT	XC6101B625MR	Vdet-IC	2.5V±2%, Hst, -MR, -Reset PPO, Wt=1.6s, Rt=25ms	SOT-25	28cp	VD17	6g	Tor
0AU	XC6101B626MR	Vdet-IC	2.6V±2%, Hst, -MR, -Reset PPO, Wt=1.6s, Rt=25ms	SOT-25	28cp	VD17	6g	Tor
0AV	XC6101B627MR	Vdet-IC	2.7V±2%, Hst, -MR, -Reset PPO, Wt=1.6s, Rt=25ms	SOT-25	28cp	VD17	6g	Tor
0AV	XC6101B628MR	Vdet-IC	2.8V±2%, Hst, -MR, -Reset PPO, Wt=1.6s, Rt=25ms	SOT-25	28cp	VD17	6g	Tor
0AY	XC6101B629MR	Vdet-IC	2.9V±2%, Hst, -MR, -Reset PPO, Wt=1.6s, Rt=25ms	SOT-25	28cp	VD17	6g	Tor
0AZ	XC6101B630MR	Vdet-IC	3.0V±2%, Hst, -MR, -Reset PPO, Wt=1.6s, Rt=25ms	SOT-25	28cp	VD17	6g	Tor
0B	BU4318FWE	Vdet-IC	1.8V, +Reset PPO	VSOF-5	30vka	VD3	6c	Rhm
0B	BU4318G	Vdet-IC	1.8V, +Reset PPO	SSOP-5	28vdo	VD3	6c	Rhm
0B	R3111N101A	Vdet-IC	1.0V±2%, -Reset PPO	SOT-23-5	28vdm	VD7	6g	Ric
0B	RN5RL20AA	LVR-IC	2.0V±2.5%, 150mA	SOT-23-5	28vru	VR1	6g	Ric
0B	RN5VD10CA	Vdet-IC	1.0V±2.5%, -Reset ODO	SOT-23-5	28vdo	VD1	6g	Ric
0B0	XC6210B312MR	LVR-IC	LDO, 3.1V±2%, 700mA, +CE	SOT-25	28cx	VR4	6g	Tor
0B0	XC6101C231MR	Vdet-IC	3.1V±2%, Hst, -MR, -Reset PPO, Wt=50ms, Rt=50ms	SOT-25	28cp	VD17	6g	Tor
0B1	XC6210B322MR	LVR-IC	LDO, 3.2V±2%, 700mA, +CE	SOT-25	28cx	VR4	6g	Tor



SMD code	Type	Function	Short description	Case	Pinout	Sch.	St.	Mnf.
0B1	XC6221D321MR	LVR-IC	LDO, 3.2V±1%, 200mA, +CE, CL, PDR	SOT-25	28cx	VR4	6g	Tor
0B1	XC6101C232MR	Vdet-IC	3.2V±2%, Hst, -MR, -Reset PPO, Wt=50ms, Rt=50ms	SOT-25	28cp	VD17	6g	Tor
0B2	XC6210B332MR	LVR-IC	LDO, 3.3V±2%, 700mA, +CE	SOT-25	28cx	VR4	6g	Tor
0B2	XC6221D331MR	LVR-IC	LDO, 3.3V±1%, 200mA, +CE, CL, PDR	SOT-25	28cx	VR4	6g	Tor
0B2	XC6101C233MR	Vdet-IC	3.3V±2%, Hst, -MR, -Reset PPO, Wt=50ms, Rt=50ms	SOT-25	28cp	VD17	6g	Tor
0B3	XC6210B342MR	LVR-IC	LDO, 3.4V±2%, 700mA, +CE	SOT-25	28cx	VR4	6g	Tor
0B3	XC6221D341MR	LVR-IC	LDO, 3.4V±1%, 200mA, +CE, CL, PDR	SOT-25	28cx	VR4	6g	Tor
0B3	XC6101C234MR	Vdet-IC	3.4V±2%, Hst, -MR, -Reset PPO, Wt=50ms, Rt=50ms	SOT-25	28cp	VD17	6g	Tor
0B4	XC6210B352MR	LVR-IC	LDO, 3.5V±2%, 700mA, +CE	SOT-25	28cx	VR4	6g	Tor
0B4	XC6221D351MR	LVR-IC	LDO, 3.5V±1%, 200mA, +CE, CL, PDR	SOT-25	28cx	VR4	6g	Tor
0B4	XC6101C235MR	Vdet-IC	3.5V±2%, Hst, -MR, -Reset PPO, Wt=50ms, Rt=50ms	SOT-25	28cp	VD17	6g	Tor
0B5	XC6210B362MR	LVR-IC	LDO, 3.6V±2%, 700mA, +CE	SOT-25	28cx	VR4	6g	Tor
0B5	XC6221D361MR	LVR-IC	LDO, 3.6V±1%, 200mA, +CE, CL, PDR	SOT-25	28cx	VR4	6g	Tor
0B5	XC6101C236MR	Vdet-IC	3.6V±2%, Hst, -MR, -Reset PPO, Wt=50ms, Rt=50ms	SOT-25	28cp	VD17	6g	Tor
0B6	XC6210B372MR	LVR-IC	LDO, 3.7V±2%, 700mA, +CE	SOT-25	28cx	VR4	6g	Tor
0B6	XC6221D371MR	LVR-IC	LDO, 3.7V±1%, 200mA, +CE, CL, PDR	SOT-25	28cx	VR4	6g	Tor
0B6	XC6101C237MR	Vdet-IC	3.7V±2%, Hst, -MR, -Reset PPO, Wt=50ms, Rt=50ms	SOT-25	28cp	VD17	6g	Tor
0B7	XC6210B382MR	LVR-IC	LDO, 3.8V±2%, 700mA, +CE	SOT-25	28cx	VR4	6g	Tor
0B7	XC6221D381MR	LVR-IC	LDO, 3.8V±1%, 200mA, +CE, CL, PDR	SOT-25	28cx	VR4	6g	Tor
0B7	XC6101C238MR	Vdet-IC	3.8V±2%, Hst, -MR, -Reset PPO, Wt=50ms, Rt=50ms	SOT-25	28cp	VD17	6g	Tor
0B8	XC6210B392MR	LVR-IC	LDO, 3.9V±2%, 700mA, +CE	SOT-25	28cx	VR4	6g	Tor
0B8	XC6221D391MR	LVR-IC	LDO, 3.9V±1%, 200mA, +CE, CL, PDR	SOT-25	28cx	VR4	6g	Tor
0B8	XC6101C239MR	Vdet-IC	3.9V±2%, Hst, -MR, -Reset PPO, Wt=50ms, Rt=50ms	SOT-25	28cp	VD17	6g	Tor
0B9	XC6210B402MR	LVR-IC	LDO, 4V±2%, 700mA, +CE	SOT-25	28cx	VR4	6g	Tor
0B9	XC6221D401MR	LVR-IC	LDO, 4V±1%, 200mA, +CE, CL, PDR	SOT-25	28cx	VR4	6g	Tor
0B9	XC6101C240MR	Vdet-IC	4.0V±2%, Hst, -MR, -Reset PPO, Wt=50ms, Rt=50ms	SOT-25	28cp	VD17	6g	Tor
0BA	XC6210B412MR	LVR-IC	LDO, 4.1V±2%, 700mA, +CE	SOT-25	28cx	VR4	6g	Tor
0BA	XC6221D411MR	LVR-IC	LDO, 4.1V±1%, 200mA, +CE, CL, PDR	SOT-25	28cx	VR4	6g	Tor
0BA	XC6101C241MR	Vdet-IC	4.1V±2%, Hst, -MR, -Reset PPO, Wt=50ms, Rt=50ms	SOT-25	28cp	VD17	6g	Tor
0BB	XC6210B422MR	LVR-IC	LDO, 4.2V±2%, 700mA, +CE	SOT-25	28cx	VR4	6g	Tor
0BB	XC6221D421MR	LVR-IC	LDO, 4.2V±1%, 200mA, +CE, CL, PDR	SOT-25	28cx	VR4	6g	Tor
0BB	XC6101C242MR	Vdet-IC	4.2V±2%, Hst, -MR, -Reset PPO, Wt=50ms, Rt=50ms	SOT-25	28cp	VD17	6g	Tor
0BC	XC6210B432MR	LVR-IC	LDO, 4.3V±2%, 700mA, +CE	SOT-25	28cx	VR4	6g	Tor
0BC	XC6221D431MR	LVR-IC	LDO, 4.3V±1%, 200mA, +CE, CL, PDR	SOT-25	28cx	VR4	6g	Tor
0BC	XC6101C243MR	Vdet-IC	4.3V±2%, Hst, -MR, -Reset PPO, Wt=50ms, Rt=50ms	SOT-25	28cp	VD17	6g	Tor
0BD	XC6210B442MR	LVR-IC	LDO, 4.4V±2%, 700mA, +CE	SOT-25	28cx	VR4	6g	Tor
0BD	XC6221D441MR	LVR-IC	LDO, 4.4V±1%, 200mA, +CE, CL, PDR	SOT-25	28cx	VR4	6g	Tor
0BD	XC6101C244MR	Vdet-IC	4.4V±2%, Hst, -MR, -Reset PPO, Wt=50ms, Rt=50ms	SOT-25	28cp	VD17	6g	Tor
0BE	XC6210B452MR	LVR-IC	LDO, 4.5V±2%, 700mA, +CE	SOT-25	28cx	VR4	6g	Tor
0BE	XC6221D451MR	LVR-IC	LDO, 4.5V±1%, 200mA, +CE, CL, PDR	SOT-25	28cx	VR4	6g	Tor
0BE	XC6101C245MR	Vdet-IC	4.5V±2%, Hst, -MR, -Reset PPO, Wt=50ms, Rt=50ms	SOT-25	28cp	VD17	6g	Tor
0BF	XC6210B462MR	LVR-IC	LDO, 4.6V±2%, 700mA, +CE	SOT-25	28cx	VR4	6g	Tor
0BF	XC6221D461MR	LVR-IC	LDO, 4.6V±1%, 200mA, +CE, CL, PDR	SOT-25	28cx	VR4	6g	Tor
0BF	XC6101C216MR	Vdet-IC	1.6V±2%, Hst, -MR, -Reset PPO, Wt=50ms, Rt=50ms	SOT-25	28cp	VD17	6g	Tor
0BF	XC6101C246MR	Vdet-IC	4.6V±2%, Hst, -MR, -Reset PPO, Wt=50ms, Rt=50ms	SOT-25	28cp	VD17	6g	Tor
0BH	XC6210B472MR	LVR-IC	LDO, 4.7V±2%, 700mA, +CE	SOT-25	28cx	VR4	6g	Tor
0BH	XC6221D471MR	LVR-IC	LDO, 4.7V±1%, 200mA, +CE, CL, PDR	SOT-25	28cx	VR4	6g	Tor
0BH	XC6101C217MR	Vdet-IC	1.7V±2%, Hst, -MR, -Reset PPO, Wt=50ms, Rt=50ms	SOT-25	28cp	VD17	6g	Tor
0BH	XC6101C247MR	Vdet-IC	4.7V±2%, Hst, -MR, -Reset PPO, Wt=50ms, Rt=50ms	SOT-25	28cp	VD17	6g	Tor
0BK	XC6210B482MR	LVR-IC	LDO, 4.8V±2%, 700mA, +CE	SOT-25	28cx	VR4	6g	Tor
0BK	XC6221D481MR	LVR-IC	LDO, 4.8V±1%, 200mA, +CE, CL, PDR	SOT-25	28cx	VR4	6g	Tor
0BK	XC6101C218MR	Vdet-IC	1.8V±2%, Hst, -MR, -Reset PPO, Wt=50ms, Rt=50ms	SOT-25	28cp	VD17	6g	Tor
0BK	XC6101C248MR	Vdet-IC	4.8V±2%, Hst, -MR, -Reset PPO, Wt=50ms, Rt=50ms	SOT-25	28cp	VD17	6g	Tor
0BL	XC6210B492MR	LVR-IC	LDO, 4.9V±2%, 700mA, +CE	SOT-25	28cx	VR4	6g	Tor
0BL	XC6221D491MR	LVR-IC	LDO, 4.9V±1%, 200mA, +CE, CL, PDR	SOT-25	28cx	VR4	6g	Tor
0BL	XC6101C219MR	Vdet-IC	1.9V±2%, Hst, -MR, -Reset PPO, Wt=50ms, Rt=50ms	SOT-25	28cp	VD17	6g	Tor
0BL	XC6101C249MR	Vdet-IC	4.9V±2%, Hst, -MR, -Reset PPO, Wt=50ms, Rt=50ms	SOT-25	28cp	VD17	6g	Tor
0BM	XC6210B502MR	LVR-IC	LDO, 5V±2%, 700mA, +CE	SOT-25	28cx	VR4	6g	Tor
0BM	XC6221D501MR	LVR-IC	LDO, 5.0V±1%, 200mA, +CE, CL, PDR	SOT-25	28cx	VR4	6g	Tor
0BM	XC6101C220MR	Vdet-IC	2.0V±2%, Hst, -MR, -Reset PPO, Wt=50ms, Rt=50ms	SOT-25	28cp	VD17	6g	Tor
0BM	XC6101C250MR	Vdet-IC	5.0V±2%, Hst, -MR, -Reset PPO, Wt=50ms, Rt=50ms	SOT-25	28cp	VD17	6g	Tor
0BN	XC6101C221MR	Vdet-IC	2.1V±2%, Hst, -MR, -Reset PPO, Wt=50ms, Rt=50ms	SOT-25	28cp	VD17	6g	Tor
0BP	XC6101C222MR	Vdet-IC	2.2V±2%, Hst, -MR, -Reset PPO, Wt=50ms, Rt=50ms	SOT-25	28cp	VD17	6g	Tor
0BP	XC6101C223MR	Vdet-IC	2.3V±2%, Hst, -MR, -Reset PPO, Wt=50ms, Rt=50ms	SOT-25	28cp	VD17	6g	Tor
0BS	XC6101C224MR	Vdet-IC	2.4V±2%, Hst, -MR, -Reset PPO, Wt=50ms, Rt=50ms	SOT-25	28cp	VD17	6g	Tor
0BT	XC6101C225MR	Vdet-IC	2.5V±2%, Hst, -MR, -Reset PPO, Wt=50ms, Rt=50ms	SOT-25	28cp	VD17	6g	Tor
0BU	XC6101C226MR	Vdet-IC	2.6V±2%, Hst, -MR, -Reset PPO, Wt=50ms, Rt=50ms	SOT-25	28cp	VD17	6g	Tor
0BV	XC6101C227MR	Vdet-IC	2.7V±2%, Hst, -MR, -Reset PPO, Wt=50ms, Rt=50ms	SOT-25	28cp	VD17	6g	Tor
0BX	XC6101C228MR	Vdet-IC	2.8V±2%, Hst, -MR, -Reset PPO, Wt=50ms, Rt=50ms	SOT-25	28cp	VD17	6g	Tor
0BY	XC6101C229MR	Vdet-IC	2.9V±2%, Hst, -MR, -Reset PPO, Wt=50ms, Rt=50ms	SOT-25	28cp	VD17	6g	Tor



SMD code	Type	Function	Short description	Case	Pinout	Sch.	St.	Mnf.
0BZ	XC6101C230MR	Vdet-IC	3.0V±2%, Hst, -MR, -Reset PPO, Wt=50ms, Rt=50ms	SOT-25	28cp	VD17	6g	Tor
0C	BU4319FWE	Vdet-IC	1.9V, +Reset PPO	VSOFF-5	30vka	VD3	6c	Rhm
0C	BU4319G	Vdet-IC	1.9V, +Reset PPO	SSOP-5	28vdo	VD3	6c	Rhm
0C	MC78LC30NTR	LVR-IC	Low Iq, 3V±2.5%, 80mA	SOT-23-5	28vu	VR1	6b	Ons
0C	R3111N201A	Vdet-IC	2.0V±2%, -Reset PPO	SOT-23-5	28vdm	VD7	6g	Ric
0C	RN5RL30AA	LVR-IC	3V±2.5%, 150mA	SOT-23-5	28vu	VR1	6g	Ric
0C	RN5VD20CA	Vdet-IC	2.0V±2.5%, -Reset ODO	SOT-23-5	28vdo	VD1	6g	Ric
0C0	XC6210C312MR	LVR-IC	LDO, 3.1V±2%, 700mA, -CE, PDR	SOT-25	28cx	VR4	6g	Tor
0C0	XC6101C331MR	Vdet-IC	3.1V±2%, Hst, -MR, -Reset PPO, Wt=100ms, Rt=50ms	SOT-25	28cp	VD17	6g	Tor
0C1	XC6210C322MR	LVR-IC	LDO, 3.2V±2%, 700mA, -CE, PDR	SOT-25	28cx	VR4	6g	Tor
0C1	XC6101C332MR	Vdet-IC	3.2V±2%, Hst, -MR, -Reset PPO, Wt=100ms, Rt=50ms	SOT-25	28cp	VD17	6g	Tor
0C2	XC6210C332MR	LVR-IC	LDO, 3.3V±2%, 700mA, -CE, PDR	SOT-25	28cx	VR4	6g	Tor
0C2	XC6101C333MR	Vdet-IC	3.3V±2%, Hst, -MR, -Reset PPO, Wt=100ms, Rt=50ms	SOT-25	28cp	VD17	6g	Tor
0C3	XC6210C342MR	LVR-IC	LDO, 3.4V±2%, 700mA, -CE, PDR	SOT-25	28cx	VR4	6g	Tor
0C3	XC6101C334MR	Vdet-IC	3.4V±2%, Hst, -MR, -Reset PPO, Wt=100ms, Rt=50ms	SOT-25	28cp	VD17	6g	Tor
0C4	XC6210C352MR	LVR-IC	LDO, 3.5V±2%, 700mA, -CE, PDR	SOT-25	28cx	VR4	6g	Tor
0C4	XC6101C335MR	Vdet-IC	3.5V±2%, Hst, -MR, -Reset PPO, Wt=100ms, Rt=50ms	SOT-25	28cp	VD17	6g	Tor
0C5	XC6210C362MR	LVR-IC	LDO, 3.6V±2%, 700mA, -CE, PDR	SOT-25	28cx	VR4	6g	Tor
0C5	XC6101C336MR	Vdet-IC	3.6V±2%, Hst, -MR, -Reset PPO, Wt=100ms, Rt=50ms	SOT-25	28cp	VD17	6g	Tor
0C6	XC6210C372MR	LVR-IC	LDO, 3.7V±2%, 700mA, -CE, PDR	SOT-25	28cx	VR4	6g	Tor
0C6	XC6101C337MR	Vdet-IC	3.7V±2%, Hst, -MR, -Reset PPO, Wt=100ms, Rt=50ms	SOT-25	28cp	VD17	6g	Tor
0C7	XC6210C382MR	LVR-IC	LDO, 3.8V±2%, 700mA, -CE, PDR	SOT-25	28cx	VR4	6g	Tor
0C7	XC6101C338MR	Vdet-IC	3.8V±2%, Hst, -MR, -Reset PPO, Wt=100ms, Rt=50ms	SOT-25	28cp	VD17	6g	Tor
0C8	XC6210C392MR	LVR-IC	LDO, 3.9V±2%, 700mA, -CE, PDR	SOT-25	28cx	VR4	6g	Tor
0C8	XC6101C339MR	Vdet-IC	3.9V±2%, Hst, -MR, -Reset PPO, Wt=100ms, Rt=50ms	SOT-25	28cp	VD17	6g	Tor
0C9	XC6210C402MR	LVR-IC	LDO, 4V±2%, 700mA, -CE, PDR	SOT-25	28cx	VR4	6g	Tor
0C9	XC6101C340MR	Vdet-IC	4.0V±2%, Hst, -MR, -Reset PPO, Wt=100ms, Rt=50ms	SOT-25	28cp	VD17	6g	Tor
0CA	XC6210C412MR	LVR-IC	LDO, 4.1V±2%, 700mA, -CE, PDR	SOT-25	28cx	VR4	6g	Tor
0CA	XC6101C341MR	Vdet-IC	4.1V±2%, Hst, -MR, -Reset PPO, Wt=100ms, Rt=50ms	SOT-25	28cp	VD17	6g	Tor
0CB	XC6210C422MR	LVR-IC	LDO, 4.2V±2%, 700mA, -CE, PDR	SOT-25	28cx	VR4	6g	Tor
0CB	XC6101C342MR	Vdet-IC	4.2V±2%, Hst, -MR, -Reset PPO, Wt=100ms, Rt=50ms	SOT-25	28cp	VD17	6g	Tor
0CC	XC6210C432MR	LVR-IC	LDO, 4.3V±2%, 700mA, -CE, PDR	SOT-25	28cx	VR4	6g	Tor
0CC	XC6101C343MR	Vdet-IC	4.3V±2%, Hst, -MR, -Reset PPO, Wt=100ms, Rt=50ms	SOT-25	28cp	VD17	6g	Tor
0CD	XC6210C442MR	LVR-IC	LDO, 4.4V±2%, 700mA, -CE, PDR	SOT-25	28cx	VR4	6g	Tor
0CD	XC6101C344MR	Vdet-IC	4.4V±2%, Hst, -MR, -Reset PPO, Wt=100ms, Rt=50ms	SOT-25	28cp	VD17	6g	Tor
0CE	XC6210C452MR	LVR-IC	LDO, 4.5V±2%, 700mA, -CE, PDR	SOT-25	28cx	VR4	6g	Tor
0CE	XC6101C345MR	Vdet-IC	4.5V±2%, Hst, -MR, -Reset PPO, Wt=100ms, Rt=50ms	SOT-25	28cp	VD17	6g	Tor
0CF	XC6210C462MR	LVR-IC	LDO, 4.6V±2%, 700mA, -CE, PDR	SOT-25	28cx	VR4	6g	Tor
0CF	XC6101C316MR	Vdet-IC	1.6V±2%, Hst, -MR, -Reset PPO, Wt=100ms, Rt=50ms	SOT-25	28cp	VD17	6g	Tor
0CF	XC6101C346MR	Vdet-IC	4.6V±2%, Hst, -MR, -Reset PPO, Wt=100ms, Rt=50ms	SOT-25	28cp	VD17	6g	Tor
0CH	XC6210C472MR	LVR-IC	LDO, 4.7V±2%, 700mA, -CE, PDR	SOT-25	28cx	VR4	6g	Tor
0CH	XC6101C317MR	Vdet-IC	1.7V±2%, Hst, -MR, -Reset PPO, Wt=100ms, Rt=50ms	SOT-25	28cp	VD17	6g	Tor
0CH	XC6101C347MR	Vdet-IC	4.7V±2%, Hst, -MR, -Reset PPO, Wt=100ms, Rt=50ms	SOT-25	28cp	VD17	6g	Tor
0CK	XC6210C482MR	LVR-IC	LDO, 4.8V±2%, 700mA, -CE, PDR	SOT-25	28cx	VR4	6g	Tor
0CK	XC6101C318MR	Vdet-IC	1.8V±2%, Hst, -MR, -Reset PPO, Wt=100ms, Rt=50ms	SOT-25	28cp	VD17	6g	Tor
0CK	XC6101C348MR	Vdet-IC	4.8V±2%, Hst, -MR, -Reset PPO, Wt=100ms, Rt=50ms	SOT-25	28cp	VD17	6g	Tor
0CL	XC6210C492MR	LVR-IC	LDO, 4.9V±2%, 700mA, -CE, PDR	SOT-25	28cx	VR4	6g	Tor
0CL	XC6101C319MR	Vdet-IC	1.9V±2%, Hst, -MR, -Reset PPO, Wt=100ms, Rt=50ms	SOT-25	28cp	VD17	6g	Tor
0CL	XC6101C349MR	Vdet-IC	4.9V±2%, Hst, -MR, -Reset PPO, Wt=100ms, Rt=50ms	SOT-25	28cp	VD17	6g	Tor
0CM	XC6210C502MR	LVR-IC	LDO, 5V±2%, 700mA, -CE, PDR	SOT-25	28cx	VR4	6g	Tor
0CM	XC6101C320MR	Vdet-IC	2.0V±2%, Hst, -MR, -Reset PPO, Wt=100ms, Rt=50ms	SOT-25	28cp	VD17	6g	Tor
0CM	XC6101C350MR	Vdet-IC	5.0V±2%, Hst, -MR, -Reset PPO, Wt=100ms, Rt=50ms	SOT-25	28cp	VD17	6g	Tor
0CN	XC6101C321MR	Vdet-IC	2.1V±2%, Hst, -MR, -Reset PPO, Wt=100ms, Rt=50ms	SOT-25	28cp	VD17	6g	Tor
0CN	XC6101C322MR	Vdet-IC	2.2V±2%, Hst, -MR, -Reset PPO, Wt=100ms, Rt=50ms	SOT-25	28cp	VD17	6g	Tor
0CR	XC6101C323MR	Vdet-IC	2.3V±2%, Hst, -MR, -Reset PPO, Wt=100ms, Rt=50ms	SOT-25	28cp	VD17	6g	Tor
0CS	XC6101C324MR	Vdet-IC	2.4V±2%, Hst, -MR, -Reset PPO, Wt=100ms, Rt=50ms	SOT-25	28cp	VD17	6g	Tor
0CS	XC6101C325MR	Vdet-IC	2.5V±2%, Hst, -MR, -Reset PPO, Wt=100ms, Rt=50ms	SOT-25	28cp	VD17	6g	Tor
0CU	XC6101C326MR	Vdet-IC	2.6V±2%, Hst, -MR, -Reset PPO, Wt=100ms, Rt=50ms	SOT-25	28cp	VD17	6g	Tor
0CV	XC6101C327MR	Vdet-IC	2.7V±2%, Hst, -MR, -Reset PPO, Wt=100ms, Rt=50ms	SOT-25	28cp	VD17	6g	Tor
0CV	XC6101C328MR	Vdet-IC	2.8V±2%, Hst, -MR, -Reset PPO, Wt=100ms, Rt=50ms	SOT-25	28cp	VD17	6g	Tor
0CY	XC6101C329MR	Vdet-IC	2.9V±2%, Hst, -MR, -Reset PPO, Wt=100ms, Rt=50ms	SOT-25	28cp	VD17	6g	Tor
0CZ	XC6101C330MR	Vdet-IC	3.0V±2%, Hst, -MR, -Reset PPO, Wt=100ms, Rt=50ms	SOT-25	28cp	VD17	6g	Tor
0D	BU4320FWE	Vdet-IC	2.0V, +Reset PPO	VSOFF-5	30vka	VD3	6c	Rhm
0D	BU4320G	Vdet-IC	2.0V, +Reset PPO	SSOP-5	28vdo	VD3	6c	Rhm
0D	R3111N301A	Vdet-IC	3.0V±2%, -Reset PPO	SOT-23-5	28vdm	VD7	6g	Ric
0D	RN5RL40AA	LVR-IC	4V±2.5%, 150mA	SOT-23-5	28vu	VR1	6g	Ric
0D	RN5VD30CA	Vdet-IC	3V±2.5%, -Reset ODO	SOT-23-5	28vdo	VD1	6g	Ric
0D0	XC6210D312MR	LVR-IC	LDO, 3.1V±2%, 700mA, -CE	SOT-25	28cx	VR4	6g	Tor
0D0	XC6101C431MR	Vdet-IC	3.1V±2%, Hst, -MR, -Reset PPO, Wt=200ms, Rt=50ms	SOT-25	28cp	VD17	6g	Tor
0D1	XC6210D322MR	LVR-IC	LDO, 3.2V±2%, 700mA, -CE	SOT-25	28cx	VR4	6g	Tor



SMD code	Type	Function	Short description	Case	Pinout	Sch.	St.	Mnf.
<u>0D1</u>	XC6101C432MR	Vdet-IC	3.2V±2%, Hst, -MR, -Reset PPO, Wt=200ms, Rt=50ms	SOT-25	28cp	VD17	6g	Tor
<u>0D2</u>	XC6210D332MR	LVR-IC	LDO, 3.3V±2%, 700mA, -CE	SOT-25	28cx	VR4	6g	Tor
<u>0D2</u>	XC6101C433MR	Vdet-IC	3.3V±2%, Hst, -MR, -Reset PPO, Wt=200ms, Rt=50ms	SOT-25	28cp	VD17	6g	Tor
<u>0D3</u>	XC6210D342MR	LVR-IC	LDO, 3.4V±2%, 700mA, -CE	SOT-25	28cx	VR4	6g	Tor
<u>0D3</u>	XC6101C434MR	Vdet-IC	3.4V±2%, Hst, -MR, -Reset PPO, Wt=200ms, Rt=50ms	SOT-25	28cp	VD17	6g	Tor
<u>0D4</u>	XC6210D352MR	LVR-IC	LDO, 3.5V±2%, 700mA, -CE	SOT-25	28cx	VR4	6g	Tor
<u>0D4</u>	XC6101C435MR	Vdet-IC	3.5V±2%, Hst, -MR, -Reset PPO, Wt=200ms, Rt=50ms	SOT-25	28cp	VD17	6g	Tor
<u>0D5</u>	XC6210D362MR	LVR-IC	LDO, 3.6V±2%, 700mA, -CE	SOT-25	28cx	VR4	6g	Tor
<u>0D5</u>	XC6101C436MR	Vdet-IC	3.6V±2%, Hst, -MR, -Reset PPO, Wt=200ms, Rt=50ms	SOT-25	28cp	VD17	6g	Tor
<u>0D6</u>	XC6210D372MR	LVR-IC	LDO, 3.7V±2%, 700mA, -CE	SOT-25	28cx	VR4	6g	Tor
<u>0D6</u>	XC6101C437MR	Vdet-IC	3.7V±2%, Hst, -MR, -Reset PPO, Wt=200ms, Rt=50ms	SOT-25	28cp	VD17	6g	Tor
<u>0D7</u>	XC6210D382MR	LVR-IC	LDO, 3.8V±2%, 700mA, -CE	SOT-25	28cx	VR4	6g	Tor
<u>0D7</u>	XC6101C438MR	Vdet-IC	3.8V±2%, Hst, -MR, -Reset PPO, Wt=200ms, Rt=50ms	SOT-25	28cp	VD17	6g	Tor
<u>0D8</u>	XC6210D392MR	LVR-IC	LDO, 3.9V±2%, 700mA, -CE	SOT-25	28cx	VR4	6g	Tor
<u>0D8</u>	XC6101C439MR	Vdet-IC	3.9V±2%, Hst, -MR, -Reset PPO, Wt=200ms, Rt=50ms	SOT-25	28cp	VD17	6g	Tor
<u>0D9</u>	XC6210D402MR	LVR-IC	LDO, 4.0V±2%, 700mA, -CE	SOT-25	28cx	VR4	6g	Tor
<u>0D9</u>	XC6101C440MR	Vdet-IC	4.0V±2%, Hst, -MR, -Reset PPO, Wt=200ms, Rt=50ms	SOT-25	28cp	VD17	6g	Tor
<u>0DA</u>	XC6210D412MR	LVR-IC	LDO, 4.1V±2%, 700mA, -CE	SOT-25	28cx	VR4	6g	Tor
<u>0DA</u>	XC6101C441MR	Vdet-IC	4.1V±2%, Hst, -MR, -Reset PPO, Wt=200ms, Rt=50ms	SOT-25	28cp	VD17	6g	Tor
<u>0DB</u>	XC6210D422MR	LVR-IC	LDO, 4.2V±2%, 700mA, -CE	SOT-25	28cx	VR4	6g	Tor
<u>0DB</u>	XC6101C442MR	Vdet-IC	4.2V±2%, Hst, -MR, -Reset PPO, Wt=200ms, Rt=50ms	SOT-25	28cp	VD17	6g	Tor
<u>0DC</u>	XC6210D432MR	LVR-IC	LDO, 4.3V±2%, 700mA, -CE	SOT-25	28cx	VR4	6g	Tor
<u>0DC</u>	XC6101C443MR	Vdet-IC	4.3V±2%, Hst, -MR, -Reset PPO, Wt=200ms, Rt=50ms	SOT-25	28cp	VD17	6g	Tor
<u>0DD</u>	XC6210D442MR	LVR-IC	LDO, 4.4V±2%, 700mA, -CE	SOT-25	28cx	VR4	6g	Tor
<u>0DD</u>	XC6101C444MR	Vdet-IC	4.4V±2%, Hst, -MR, -Reset PPO, Wt=200ms, Rt=50ms	SOT-25	28cp	VD17	6g	Tor
<u>0DE</u>	XC6210D452MR	LVR-IC	LDO, 4.5V±2%, 700mA, -CE	SOT-25	28cx	VR4	6g	Tor
<u>0DE</u>	XC6101C445MR	Vdet-IC	4.5V±2%, Hst, -MR, -Reset PPO, Wt=200ms, Rt=50ms	SOT-25	28cp	VD17	6g	Tor
<u>0DF</u>	XC6210D462MR	LVR-IC	LDO, 4.6V±2%, 700mA, -CE	SOT-25	28cx	VR4	6g	Tor
<u>0DF</u>	XC6101C416MR	Vdet-IC	1.6V±2%, Hst, -MR, -Reset PPO, Wt=200ms, Rt=50ms	SOT-25	28cp	VD17	6g	Tor
<u>0DF</u>	XC6101C446MR	Vdet-IC	4.6V±2%, Hst, -MR, -Reset PPO, Wt=200ms, Rt=50ms	SOT-25	28cp	VD17	6g	Tor
<u>0DH</u>	XC6210D472MR	LVR-IC	LDO, 4.7V±2%, 700mA, -CE	SOT-25	28cx	VR4	6g	Tor
<u>0DH</u>	XC6101C417MR	Vdet-IC	1.7V±2%, Hst, -MR, -Reset PPO, Wt=200ms, Rt=50ms	SOT-25	28cp	VD17	6g	Tor
<u>0DH</u>	XC6101C447MR	Vdet-IC	4.7V±2%, Hst, -MR, -Reset PPO, Wt=200ms, Rt=50ms	SOT-25	28cp	VD17	6g	Tor
<u>0DK</u>	XC6210D482MR	LVR-IC	LDO, 4.8V±2%, 700mA, -CE	SOT-25	28cx	VR4	6g	Tor
<u>0DK</u>	XC6101C418MR	Vdet-IC	1.8V±2%, Hst, -MR, -Reset PPO, Wt=200ms, Rt=50ms	SOT-25	28cp	VD17	6g	Tor
<u>0DK</u>	XC6101C448MR	Vdet-IC	4.8V±2%, Hst, -MR, -Reset PPO, Wt=200ms, Rt=50ms	SOT-25	28cp	VD17	6g	Tor
<u>0DL</u>	XC6210D492MR	LVR-IC	LDO, 4.9V±2%, 700mA, -CE	SOT-25	28cx	VR4	6g	Tor
<u>0DL</u>	XC6101C419MR	Vdet-IC	1.9V±2%, Hst, -MR, -Reset PPO, Wt=200ms, Rt=50ms	SOT-25	28cp	VD17	6g	Tor
<u>0DL</u>	XC6101C449MR	Vdet-IC	4.9V±2%, Hst, -MR, -Reset PPO, Wt=200ms, Rt=50ms	SOT-25	28cp	VD17	6g	Tor
<u>0DM</u>	XC6210D502MR	LVR-IC	LDO, 5.0V±2%, 700mA, -CE	SOT-25	28cx	VR4	6g	Tor
<u>0DM</u>	XC6101C420MR	Vdet-IC	2.0V±2%, Hst, -MR, -Reset PPO, Wt=200ms, Rt=50ms	SOT-25	28cp	VD17	6g	Tor
<u>0DM</u>	XC6101C450MR	Vdet-IC	5.0V±2%, Hst, -MR, -Reset PPO, Wt=200ms, Rt=50ms	SOT-25	28cp	VD17	6g	Tor
<u>0DN</u>	XC6101C421MR	Vdet-IC	2.1V±2%, Hst, -MR, -Reset PPO, Wt=200ms, Rt=50ms	SOT-25	28cp	VD17	6g	Tor
<u>0DN</u>	XC6101C422MR	Vdet-IC	2.2V±2%, Hst, -MR, -Reset PPO, Wt=200ms, Rt=50ms	SOT-25	28cp	VD17	6g	Tor
<u>0DP</u>	XC6101C423MR	Vdet-IC	2.3V±2%, Hst, -MR, -Reset PPO, Wt=200ms, Rt=50ms	SOT-25	28cp	VD17	6g	Tor
<u>0DR</u>	XC6101C424MR	Vdet-IC	2.4V±2%, Hst, -MR, -Reset PPO, Wt=200ms, Rt=50ms	SOT-25	28cp	VD17	6g	Tor
<u>0DS</u>	XC6101C425MR	Vdet-IC	2.5V±2%, Hst, -MR, -Reset PPO, Wt=200ms, Rt=50ms	SOT-25	28cp	VD17	6g	Tor
<u>0DT</u>	XC6101C426MR	Vdet-IC	2.6V±2%, Hst, -MR, -Reset PPO, Wt=200ms, Rt=50ms	SOT-25	28cp	VD17	6g	Tor
<u>0DV</u>	XC6101C427MR	Vdet-IC	2.7V±2%, Hst, -MR, -Reset PPO, Wt=200ms, Rt=50ms	SOT-25	28cp	VD17	6g	Tor
<u>0DX</u>	XC6101C428MR	Vdet-IC	2.8V±2%, Hst, -MR, -Reset PPO, Wt=200ms, Rt=50ms	SOT-25	28cp	VD17	6g	Tor
<u>0DY</u>	XC6101C429MR	Vdet-IC	2.9V±2%, Hst, -MR, -Reset PPO, Wt=200ms, Rt=50ms	SOT-25	28cp	VD17	6g	Tor
<u>0DZ</u>	XC6101C430MR	Vdet-IC	3.0V±2%, Hst, -MR, -Reset PPO, Wt=200ms, Rt=50ms	SOT-25	28cp	VD17	6g	Tor
<u>0E</u>	BU4321FWE	Vdet-IC	2.1V, +Reset PPO	VSOF-5	30vka	VD3	6c	Rhm
<u>0E</u>	BU4321G	Vdet-IC	2.1V, +Reset PPO	SSOP-5	28vdo	VD3	6c	Rhm
<u>0E</u>	R3111N401A	Vdet-IC	4.0V±2%, -Reset PPO	SOT-23-5	28vdm	VD7	6g	Ric
<u>0E</u>	RN5RL50AA	LVR-IC	5V±2.5%, 150mA	SOT-23-5	28vu	VR1	6g	Ric
<u>0E</u>	RN5VD40CA	Vdet-IC	4V±2.5%, -Reset ODO	SOT-23-5	28vdo	VD1	6g	Ric
<u>0E0</u>	XC6101C531MR	Vdet-IC	3.1V±2%, Hst, -MR, -Reset PPO, Wt=400ms, Rt=50ms	SOT-25	28cp	VD17	6g	Tor
<u>0E1</u>	XC6101C532MR	Vdet-IC	3.2V±2%, Hst, -MR, -Reset PPO, Wt=400ms, Rt=50ms	SOT-25	28cp	VD17	6g	Tor
<u>0E2</u>	XC6101C533MR	Vdet-IC	3.3V±2%, Hst, -MR, -Reset PPO, Wt=400ms, Rt=50ms	SOT-25	28cp	VD17	6g	Tor
<u>0E3</u>	XC6101C534MR	Vdet-IC	3.4V±2%, Hst, -MR, -Reset PPO, Wt=400ms, Rt=50ms	SOT-25	28cp	VD17	6g	Tor
<u>0E4</u>	XC6101C535MR	Vdet-IC	3.5V±2%, Hst, -MR, -Reset PPO, Wt=400ms, Rt=50ms	SOT-25	28cp	VD17	6g	Tor
<u>0E5</u>	XC6101C536MR	Vdet-IC	3.6V±2%, Hst, -MR, -Reset PPO, Wt=400ms, Rt=50ms	SOT-25	28cp	VD17	6g	Tor
<u>0E6</u>	XC6101C537MR	Vdet-IC	3.7V±2%, Hst, -MR, -Reset PPO, Wt=400ms, Rt=50ms	SOT-25	28cp	VD17	6g	Tor
<u>0E7</u>	XC6221C08BMR	LVR-IC	LDO, 0.85V±20mV, 200mA, +CE, PDR	SOT-25	28cx	VR4	6g	Tor
<u>0E7</u>	XC6101C538MR	Vdet-IC	3.8V±2%, Hst, -MR, -Reset PPO, Wt=400ms, Rt=50ms	SOT-25	28cp	VD17	6g	Tor
<u>0E8</u>	XC6210A08AMR	LVR-IC	LDO, 0.85V±2%, 700mA, +CE, PDR	SOT-25	28cx	VR4	6g	Tor
<u>0E8</u>	XC6221C09BMR	LVR-IC	LDO, 0.95V±20mV, 200mA, +CE, PDR	SOT-25	28cx	VR4	6g	Tor
<u>0E8</u>	XC6101C539MR	Vdet-IC	3.9V±2%, Hst, -MR, -Reset PPO, Wt=400ms, Rt=50ms	SOT-25	28cp	VD17	6g	Tor
<u>0E9</u>	XC6210A09AMR	LVR-IC	LDO, 0.95V±2%, 700mA, +CE, PDR	SOT-25	28cx	VR4	6g	Tor



SMD code	Type	Function	Short description	Case	Pinout	Sch.	St.	Mnf.
0E9	XC6221C10BMR	LVR-IC	LDO, 1.05V±20mV, 200mA, +CE, PDR	SOT-25	28cx	VR4	6g	Tor
0EA	XC6101C540MR	Vdet-IC	4.0V±2%, Hst, -MR, -Reset PPO, Wt=400ms, Rt=50ms	SOT-25	28cp	VD17	6g	Tor
0EA	XC6210A11AMR	LVR-IC	LDO, 1.15V±2%, 700mA, +CE, PDR	SOT-25	28cx	VR4	6g	Tor
0EA	XC6221C11BMR	LVR-IC	LDO, 1.15V±20mV, 200mA, +CE, PDR	SOT-25	28cx	VR4	6g	Tor
0EA	XC6101C541MR	Vdet-IC	4.1V±2%, Hst, -MR, -Reset PPO, Wt=400ms, Rt=50ms	SOT-25	28cp	VD17	6g	Tor
0EB	XC6210A12AMR	LVR-IC	LDO, 1.25V±2%, 700mA, +CE, PDR	SOT-25	28cx	VR4	6g	Tor
0EB	XC6221C12BMR	LVR-IC	LDO, 1.25V±20mV, 200mA, +CE, PDR	SOT-25	28cx	VR4	6g	Tor
0EB	XC6101C542MR	Vdet-IC	4.2V±2%, Hst, -MR, -Reset PPO, Wt=400ms, Rt=50ms	SOT-25	28cp	VD17	6g	Tor
0EC	XC6210A13AMR	LVR-IC	LDO, 1.35V±2%, 700mA, +CE, PDR	SOT-25	28cx	VR4	6g	Tor
0EC	XC6221C13BMR	LVR-IC	LDO, 1.35V±20mV, 200mA, +CE, PDR	SOT-25	28cx	VR4	6g	Tor
0EC	XC6101C543MR	Vdet-IC	4.3V±2%, Hst, -MR, -Reset PPO, Wt=400ms, Rt=50ms	SOT-25	28cp	VD17	6g	Tor
0ED	XC6210A14AMR	LVR-IC	LDO, 1.45V±2%, 700mA, +CE, PDR	SOT-25	28cx	VR4	6g	Tor
0ED	XC6221C14BMR	LVR-IC	LDO, 1.45V±20mV, 200mA, +CE, PDR	SOT-25	28cx	VR4	6g	Tor
0ED	XC6101C544MR	Vdet-IC	4.4V±2%, Hst, -MR, -Reset PPO, Wt=400ms, Rt=50ms	SOT-25	28cp	VD17	6g	Tor
0EE	XC6210A15AMR	LVR-IC	LDO, 1.55V±2%, 700mA, +CE, PDR	SOT-25	28cx	VR4	6g	Tor
0EE	XC6221C15BMR	LVR-IC	LDO, 1.55V±20mV, 200mA, +CE, PDR	SOT-25	28cx	VR4	6g	Tor
0EE	XC6101C545MR	Vdet-IC	4.5V±2%, Hst, -MR, -Reset PPO, Wt=400ms, Rt=50ms	SOT-25	28cp	VD17	6g	Tor
0EF	XC6210A16AMR	LVR-IC	LDO, 1.65V±2%, 700mA, +CE, PDR	SOT-25	28cx	VR4	6g	Tor
0EF	XC6221C16BMR	LVR-IC	LDO, 1.65V±20mV, 200mA, +CE, PDR	SOT-25	28cx	VR4	6g	Tor
0EF	XC6101C516MR	Vdet-IC	1.6V±2%, Hst, -MR, -Reset PPO, Wt=400ms, Rt=50ms	SOT-25	28cp	VD17	6g	Tor
0EE	XC6101C546MR	Vdet-IC	4.6V±2%, Hst, -MR, -Reset PPO, Wt=400ms, Rt=50ms	SOT-25	28cp	VD17	6g	Tor
0EH	XC6210A17AMR	LVR-IC	LDO, 1.75V±2%, 700mA, +CE, PDR	SOT-25	28cx	VR4	6g	Tor
0EH	XC6221C17BMR	LVR-IC	LDO, 1.75V±20mV, 200mA, +CE, PDR	SOT-25	28cx	VR4	6g	Tor
0EH	XC6101C517MR	Vdet-IC	1.7V±2%, Hst, -MR, -Reset PPO, Wt=400ms, Rt=50ms	SOT-25	28cp	VD17	6g	Tor
0EH	XC6101C547MR	Vdet-IC	4.7V±2%, Hst, -MR, -Reset PPO, Wt=400ms, Rt=50ms	SOT-25	28cp	VD17	6g	Tor
0EK	XC6210A18AMR	LVR-IC	LDO, 1.85V±2%, 700mA, +CE, PDR	SOT-25	28cx	VR4	6g	Tor
0EK	XC6221C18BMR	LVR-IC	LDO, 1.85V±20mV, 200mA, +CE, PDR	SOT-25	28cx	VR4	6g	Tor
0EK	XC6101C518MR	Vdet-IC	1.8V±2%, Hst, -MR, -Reset PPO, Wt=400ms, Rt=50ms	SOT-25	28cp	VD17	6g	Tor
0EK	XC6101C548MR	Vdet-IC	4.8V±2%, Hst, -MR, -Reset PPO, Wt=400ms, Rt=50ms	SOT-25	28cp	VD17	6g	Tor
0EL	XC6210A19AMR	LVR-IC	LDO, 1.95V±2%, 700mA, +CE, PDR	SOT-25	28cx	VR4	6g	Tor
0EL	XC6221C19BMR	LVR-IC	LDO, 1.95V±20mV, 200mA, +CE, PDR	SOT-25	28cx	VR4	6g	Tor
0EL	XC6101C519MR	Vdet-IC	1.9V±2%, Hst, -MR, -Reset PPO, Wt=400ms, Rt=50ms	SOT-25	28cp	VD17	6g	Tor
0EL	XC6101C549MR	Vdet-IC	4.9V±2%, Hst, -MR, -Reset PPO, Wt=400ms, Rt=50ms	SOT-25	28cp	VD17	6g	Tor
0EM	XC6210A20AMR	LVR-IC	LDO, 2.05V±2%, 700mA, +CE, PDR	SOT-25	28cx	VR4	6g	Tor
0EM	XC6221C20BMR	LVR-IC	LDO, 2.05V±1%, 200mA, +CE, PDR	SOT-25	28cx	VR4	6g	Tor
0EM	XC6101C520MR	Vdet-IC	2.0V±2%, Hst, -MR, -Reset PPO, Wt=400ms, Rt=50ms	SOT-25	28cp	VD17	6g	Tor
0EM	XC6101C550MR	Vdet-IC	5.0V±2%, Hst, -MR, -Reset PPO, Wt=400ms, Rt=50ms	SOT-25	28cp	VD17	6g	Tor
0EN	XC6210A21AMR	LVR-IC	LDO, 2.15V±2%, 700mA, +CE, PDR	SOT-25	28cx	VR4	6g	Tor
0EN	XC6221C21BMR	LVR-IC	LDO, 2.15V±1%, 200mA, +CE, PDR	SOT-25	28cx	VR4	6g	Tor
0EN	XC6101C521MR	Vdet-IC	2.1V±2%, Hst, -MR, -Reset PPO, Wt=400ms, Rt=50ms	SOT-25	28cp	VD17	6g	Tor
0EP	XC6210A22AMR	LVR-IC	LDO, 2.25V±2%, 700mA, +CE, PDR	SOT-25	28cx	VR4	6g	Tor
0EP	XC6221C22BMR	LVR-IC	LDO, 2.25V±1%, 200mA, +CE, PDR	SOT-25	28cx	VR4	6g	Tor
0EP	XC6101C522MR	Vdet-IC	2.2V±2%, Hst, -MR, -Reset PPO, Wt=400ms, Rt=50ms	SOT-25	28cp	VD17	6g	Tor
0ER	XC6210A23AMR	LVR-IC	LDO, 2.35V±2%, 700mA, +CE, PDR	SOT-25	28cx	VR4	6g	Tor
0ER	XC6221C23BMR	LVR-IC	LDO, 2.35V±1%, 200mA, +CE, PDR	SOT-25	28cx	VR4	6g	Tor
0ER	XC6101C523MR	Vdet-IC	2.3V±2%, Hst, -MR, -Reset PPO, Wt=400ms, Rt=50ms	SOT-25	28cp	VD17	6g	Tor
0ES	XC6210A24AMR	LVR-IC	LDO, 2.45V±2%, 700mA, +CE, PDR	SOT-25	28cx	VR4	6g	Tor
0ES	XC6221C24BMR	LVR-IC	LDO, 2.45V±1%, 200mA, +CE, PDR	SOT-25	28cx	VR4	6g	Tor
0ES	XC6101C524MR	Vdet-IC	2.4V±2%, Hst, -MR, -Reset PPO, Wt=400ms, Rt=50ms	SOT-25	28cp	VD17	6g	Tor
0ET	XC6210A25AMR	LVR-IC	LDO, 2.55V±2%, 700mA, +CE, PDR	SOT-25	28cx	VR4	6g	Tor
0ET	XC6221C25BMR	LVR-IC	LDO, 2.55V±1%, 200mA, +CE, PDR	SOT-25	28cx	VR4	6g	Tor
0ET	XC6101C525MR	Vdet-IC	2.5V±2%, Hst, -MR, -Reset PPO, Wt=400ms, Rt=50ms	SOT-25	28cp	VD17	6g	Tor
0EU	XC6210A26AMR	LVR-IC	LDO, 2.65V±2%, 700mA, +CE, PDR	SOT-25	28cx	VR4	6g	Tor
0EU	XC6221C26BMR	LVR-IC	LDO, 2.65V±1%, 200mA, +CE, PDR	SOT-25	28cx	VR4	6g	Tor
0EU	XC6101C526MR	Vdet-IC	2.6V±2%, Hst, -MR, -Reset PPO, Wt=400ms, Rt=50ms	SOT-25	28cp	VD17	6g	Tor
0EV	XC6210A27AMR	LVR-IC	LDO, 2.75V±2%, 700mA, +CE, PDR	SOT-25	28cx	VR4	6g	Tor
0EV	XC6221C27BMR	LVR-IC	LDO, 2.75V±1%, 200mA, +CE, PDR	SOT-25	28cx	VR4	6g	Tor
0EV	XC6101C527MR	Vdet-IC	2.7V±2%, Hst, -MR, -Reset PPO, Wt=400ms, Rt=50ms	SOT-25	28cp	VD17	6g	Tor
0EX	XC6210A28AMR	LVR-IC	LDO, 2.85V±2%, 700mA, +CE, PDR	SOT-25	28cx	VR4	6g	Tor
0EX	XC6221C28BMR	LVR-IC	LDO, 2.85V±1%, 200mA, +CE, PDR	SOT-25	28cx	VR4	6g	Tor
0EX	XC6101C528MR	Vdet-IC	2.8V±2%, Hst, -MR, -Reset PPO, Wt=400ms, Rt=50ms	SOT-25	28cp	VD17	6g	Tor
0EY	XC6210A29AMR	LVR-IC	LDO, 2.95V±2%, 700mA, +CE, PDR	SOT-25	28cx	VR4	6g	Tor
0EY	XC6221C29BMR	LVR-IC	LDO, 2.95V±1%, 200mA, +CE, PDR	SOT-25	28cx	VR4	6g	Tor
0EY	XC6101C529MR	Vdet-IC	2.9V±2%, Hst, -MR, -Reset PPO, Wt=400ms, Rt=50ms	SOT-25	28cp	VD17	6g	Tor
0EZ	XC6210A30AMR	LVR-IC	LDO, 3.05V±2%, 700mA, +CE, PDR	SOT-25	28cx	VR4	6g	Tor
0EZ	XC6221C30BMR	LVR-IC	LDO, 3.05V±1%, 200mA, +CE, PDR	SOT-25	28cx	VR4	6g	Tor
0EZ	XC6101C530MR	Vdet-IC	3.0V±2%, Hst, -MR, -Reset PPO, Wt=400ms, Rt=50ms	SOT-25	28cp	VD17	6g	Tor
0F	BU4322FWE	Vdet-IC	2.2V, +Reset PPO	VSOFF-5	30wka	VD3	6c	Rhm
0F	BU4322G	Vdet-IC	2.2V, +Reset PPO	SSOP-5	28vdo	VD3	6c	Rhm
0F	R3111N501A	Vdet-IC	5.0V±2%, -Reset PPO	SOT-23-5	28vdm	VD7	6g	Ric



SMD code	Type	Function	Short description	Case	Pinout	Sch.	St.	Mnf.
0F	RN5RL60AA	LVR-IC	6V±2.5%, 150mA	SOT-23-5	28vu	VR1	6g	Ric
0F	RN5VD50CA	Vdet-IC	5V±2.5%, -Reset ODO	SOT-23-5	28vdo	VD1	6g	Ric
0F0	XC6101C631MR	Vdet-IC	3.1V±2%, Hst, -MR, -Reset PPO, Wt=1.6s, Rt=50ms	SOT-25	28cp	VD17	6g	Tor
0F1	XC6101C632MR	Vdet-IC	3.2V±2%, Hst, -MR, -Reset PPO, Wt=1.6s, Rt=50ms	SOT-25	28cp	VD17	6g	Tor
0F2	XC6101C633MR	Vdet-IC	3.3V±2%, Hst, -MR, -Reset PPO, Wt=1.6s, Rt=50ms	SOT-25	28cp	VD17	6g	Tor
0F3	XC6101C634MR	Vdet-IC	3.4V±2%, Hst, -MR, -Reset PPO, Wt=1.6s, Rt=50ms	SOT-25	28cp	VD17	6g	Tor
0F4	XC6101C635MR	Vdet-IC	3.5V±2%, Hst, -MR, -Reset PPO, Wt=1.6s, Rt=50ms	SOT-25	28cp	VD17	6g	Tor
0F5	XC6101C636MR	Vdet-IC	3.6V±2%, Hst, -MR, -Reset PPO, Wt=1.6s, Rt=50ms	SOT-25	28cp	VD17	6g	Tor
0F6	U74HCT1G66-AF5	CMOS-Logic	Bilateral analogic switch	SOT-25	28/Log16	-	6a	Utc
0F6	XC6101C637MR	Vdet-IC	3.7V±2%, Hst, -MR, -Reset PPO, Wt=1.6s, Rt=50ms	SOT-25	28cp	VD17	6g	Tor
0F6L	U74HCT1G66L-AF5	CMOS-Logic	Bilateral analogic switch	SOT-25	28/Log16	-	6a	Utc
0F6L	U74HCT1G66G-AF5	CMOS-Logic	Bilateral analogic switch	SOT-25	28/Log16	-	6a	Utc
0F7	XC6221D08BMR	LVR-IC	LDO, 0.85V±20mV, 200mA, +CE, CL, PDR	SOT-25	28cx	VR4	6g	Tor
0F7	XC6101C638MR	Vdet-IC	3.8V±2%, Hst, -MR, -Reset PPO, Wt=1.6s, Rt=50ms	SOT-25	28cp	VD17	6g	Tor
0F8	XC6210B08AMR	LVR-IC	LDO, 0.85V±2%, 700mA, +CE	SOT-25	28cx	VR4	6g	Tor
0F8	XC6221D09BMR	LVR-IC	LDO, 0.95V±20mV, 200mA, +CE, CL, PDR	SOT-25	28cx	VR4	6g	Tor
0F8	XC6101C639MR	Vdet-IC	3.9V±2%, Hst, -MR, -Reset PPO, Wt=1.6s, Rt=50ms	SOT-25	28cp	VD17	6g	Tor
0F9	XC6210B09AMR	LVR-IC	LDO, 0.95V±2%, 700mA, +CE	SOT-25	28cx	VR4	6g	Tor
0F9	XC6221D10BMR	LVR-IC	LDO, 1.05V±20mV, 200mA, +CE, CL, PDR	SOT-25	28cx	VR4	6g	Tor
0F9	XC6101C640MR	Vdet-IC	4.0V±2%, Hst, -MR, -Reset PPO, Wt=1.6s, Rt=50ms	SOT-25	28cp	VD17	6g	Tor
0FA	XC6210B11AMR	LVR-IC	LDO, 1.15V±2%, 700mA, +CE	SOT-25	28cx	VR4	6g	Tor
0FA	XC6221D11BMR	LVR-IC	LDO, 1.15V±20mV, 200mA, +CE, CL, PDR	SOT-25	28cx	VR4	6g	Tor
0FA	XC6101C641MR	Vdet-IC	4.1V±2%, Hst, -MR, -Reset PPO, Wt=1.6s, Rt=50ms	SOT-25	28cp	VD17	6g	Tor
0FB	XC6210B12AMR	LVR-IC	LDO, 1.25V±2%, 700mA, +CE	SOT-25	28cx	VR4	6g	Tor
0FB	XC6221D12BMR	LVR-IC	LDO, 1.25V±20mV, 200mA, +CE, CL, PDR	SOT-25	28cx	VR4	6g	Tor
0FB	XC6101C642MR	Vdet-IC	4.2V±2%, Hst, -MR, -Reset PPO, Wt=1.6s, Rt=50ms	SOT-25	28cp	VD17	6g	Tor
0FC	XC6210B13AMR	LVR-IC	LDO, 1.35V±2%, 700mA, +CE	SOT-25	28cx	VR4	6g	Tor
0FC	XC6221D13BMR	LVR-IC	LDO, 1.35V±20mV, 200mA, +CE, CL, PDR	SOT-25	28cx	VR4	6g	Tor
0FC	XC6101C643MR	Vdet-IC	4.3V±2%, Hst, -MR, -Reset PPO, Wt=1.6s, Rt=50ms	SOT-25	28cp	VD17	6g	Tor
0FD	XC6210B14AMR	LVR-IC	LDO, 1.45V±2%, 700mA, +CE	SOT-25	28cx	VR4	6g	Tor
0FD	XC6221D14BMR	LVR-IC	LDO, 1.45V±20mV, 200mA, +CE, CL, PDR	SOT-25	28cx	VR4	6g	Tor
0FD	XC6101C644MR	Vdet-IC	4.4V±2%, Hst, -MR, -Reset PPO, Wt=1.6s, Rt=50ms	SOT-25	28cp	VD17	6g	Tor
0FE	XC6210B15AMR	LVR-IC	LDO, 1.55V±2%, 700mA, +CE	SOT-25	28cx	VR4	6g	Tor
0FE	XC6221D15BMR	LVR-IC	LDO, 1.55V±20mV, 200mA, +CE, CL, PDR	SOT-25	28cx	VR4	6g	Tor
0FE	XC6101C645MR	Vdet-IC	4.5V±2%, Hst, -MR, -Reset PPO, Wt=1.6s, Rt=50ms	SOT-25	28cp	VD17	6g	Tor
0FF	XC6210B16AMR	LVR-IC	LDO, 1.65V±2%, 700mA, +CE	SOT-25	28cx	VR4	6g	Tor
0FF	XC6221D16BMR	LVR-IC	LDO, 1.65V±20mV, 200mA, +CE, CL, PDR	SOT-25	28cx	VR4	6g	Tor
0FF	XC6101C616MR	Vdet-IC	1.6V±2%, Hst, -MR, -Reset PPO, Wt=1.6s, Rt=50ms	SOT-25	28cp	VD17	6g	Tor
0FE	XC6101C646MR	Vdet-IC	4.6V±2%, Hst, -MR, -Reset PPO, Wt=1.6s, Rt=50ms	SOT-25	28cp	VD17	6g	Tor
0FH	XC6210B17AMR	LVR-IC	LDO, 1.75V±2%, 700mA, +CE	SOT-25	28cx	VR4	6g	Tor
0FH	XC6221D17BMR	LVR-IC	LDO, 1.75V±20mV, 200mA, +CE, CL, PDR	SOT-25	28cx	VR4	6g	Tor
0FH	XC6101C617MR	Vdet-IC	1.7V±2%, Hst, -MR, -Reset PPO, Wt=1.6s, Rt=50ms	SOT-25	28cp	VD17	6g	Tor
0FH	XC6101C647MR	Vdet-IC	4.7V±2%, Hst, -MR, -Reset PPO, Wt=1.6s, Rt=50ms	SOT-25	28cp	VD17	6g	Tor
0FK	XC6210B18AMR	LVR-IC	LDO, 1.85V±2%, 700mA, +CE	SOT-25	28cx	VR4	6g	Tor
0FK	XC6221D18BMR	LVR-IC	LDO, 1.85V±20mV, 200mA, +CE, CL, PDR	SOT-25	28cx	VR4	6g	Tor
0FK	XC6101C618MR	Vdet-IC	1.8V±2%, Hst, -MR, -Reset PPO, Wt=1.6s, Rt=50ms	SOT-25	28cp	VD17	6g	Tor
0FK	XC6101C648MR	Vdet-IC	4.8V±2%, Hst, -MR, -Reset PPO, Wt=1.6s, Rt=50ms	SOT-25	28cp	VD17	6g	Tor
0FL	XC6210B19AMR	LVR-IC	LDO, 1.95V±2%, 700mA, +CE	SOT-25	28cx	VR4	6g	Tor
0FL	XC6221D19BMR	LVR-IC	LDO, 1.95V±20mV, 200mA, +CE, CL, PDR	SOT-25	28cx	VR4	6g	Tor
0FL	XC6101C619MR	Vdet-IC	1.9V±2%, Hst, -MR, -Reset PPO, Wt=1.6s, Rt=50ms	SOT-25	28cp	VD17	6g	Tor
0FL	XC6101C649MR	Vdet-IC	4.9V±2%, Hst, -MR, -Reset PPO, Wt=1.6s, Rt=50ms	SOT-25	28cp	VD17	6g	Tor
0FM	XC6210B20AMR	LVR-IC	LDO, 2.05V±2%, 700mA, +CE	SOT-25	28cx	VR4	6g	Tor
0FM	XC6221D20BMR	LVR-IC	LDO, 2.05V±1%, 200mA, +CE, CL, PDR	SOT-25	28cx	VR4	6g	Tor
0FM	XC6101C620MR	Vdet-IC	2.0V±2%, Hst, -MR, -Reset PPO, Wt=1.6s, Rt=50ms	SOT-25	28cp	VD17	6g	Tor
0FM	XC6101C650MR	Vdet-IC	5.0V±2%, Hst, -MR, -Reset PPO, Wt=1.6s, Rt=50ms	SOT-25	28cp	VD17	6g	Tor
0FN	XC6210B21AMR	LVR-IC	LDO, 2.15V±2%, 700mA, +CE	SOT-25	28cx	VR4	6g	Tor
0FN	XC6221D21BMR	LVR-IC	LDO, 2.15V±1%, 200mA, +CE, CL, PDR	SOT-25	28cx	VR4	6g	Tor
0FN	XC6101C621MR	Vdet-IC	2.1V±2%, Hst, -MR, -Reset PPO, Wt=1.6s, Rt=50ms	SOT-25	28cp	VD17	6g	Tor
0FP	XC6210B22AMR	LVR-IC	LDO, 2.25V±2%, 700mA, +CE	SOT-25	28cx	VR4	6g	Tor
0FP	XC6221D22BMR	LVR-IC	LDO, 2.25V±1%, 200mA, +CE, CL, PDR	SOT-25	28cx	VR4	6g	Tor
0FP	XC6101C622MR	Vdet-IC	2.2V±2%, Hst, -MR, -Reset PPO, Wt=1.6s, Rt=50ms	SOT-25	28cp	VD17	6g	Tor
0FR	XC6210B23AMR	LVR-IC	LDO, 2.35V±2%, 700mA, +CE	SOT-25	28cx	VR4	6g	Tor
0FR	XC6221D23BMR	LVR-IC	LDO, 2.35V±1%, 200mA, +CE, CL, PDR	SOT-25	28cx	VR4	6g	Tor
0FR	XC6101C623MR	Vdet-IC	2.3V±2%, Hst, -MR, -Reset PPO, Wt=1.6s, Rt=50ms	SOT-25	28cp	VD17	6g	Tor
0FS	XC6210B24AMR	LVR-IC	LDO, 2.45V±2%, 700mA, +CE	SOT-25	28cx	VR4	6g	Tor
0FS	XC6221D24BMR	LVR-IC	LDO, 2.45V±1%, 200mA, +CE, CL, PDR	SOT-25	28cx	VR4	6g	Tor
0FS	XC6101C624MR	Vdet-IC	2.4V±2%, Hst, -MR, -Reset PPO, Wt=1.6s, Rt=50ms	SOT-25	28cp	VD17	6g	Tor
0FT	XC6210B25AMR	LVR-IC	LDO, 2.55V±2%, 700mA, +CE	SOT-25	28cx	VR4	6g	Tor
0FT	XC6221D25BMR	LVR-IC	LDO, 2.55V±1%, 200mA, +CE, CL, PDR	SOT-25	28cx	VR4	6g	Tor
0FT	XC6101C625MR	Vdet-IC	2.5V±2%, Hst, -MR, -Reset PPO, Wt=1.6s, Rt=50ms	SOT-25	28cp	VD17	6g	Tor



SMD code	Type	Function	Short description	Case	Pinout	Sch.	St.	Mnf.
0FU	XC6210B26AMR	LVR-IC	LDO, 2.65V±2%, 700mA, +CE	SOT-25	28cx	VR4	6g	Tor
0FU	XC6221D26BMR	LVR-IC	LDO, 2.65V±1%, 200mA, +CE, CL, PDR	SOT-25	28cx	VR4	6g	Tor
0FU	XC6101C626MR	Vdet-IC	2.6V±2%, Hst, -MR, -Reset PPO, Wt=1.6s, Rt=50ms	SOT-25	28cp	VD17	6g	Tor
0FV	XC6210B27AMR	LVR-IC	LDO, 2.75V±2%, 700mA, +CE	SOT-25	28cx	VR4	6g	Tor
0FV	XC6221D27BMR	LVR-IC	LDO, 2.75V±1%, 200mA, +CE, CL, PDR	SOT-25	28cx	VR4	6g	Tor
0FV	XC6101C627MR	Vdet-IC	2.7V±2%, Hst, -MR, -Reset PPO, Wt=1.6s, Rt=50ms	SOT-25	28cp	VD17	6g	Tor
0FX	XC6210B28AMR	LVR-IC	LDO, 2.85V±2%, 700mA, +CE	SOT-25	28cx	VR4	6g	Tor
0FX	XC6221D28BMR	LVR-IC	LDO, 2.85V±1%, 200mA, +CE, CL, PDR	SOT-25	28cx	VR4	6g	Tor
0FX	XC6101C628MR	Vdet-IC	2.8V±2%, Hst, -MR, -Reset PPO, Wt=1.6s, Rt=50ms	SOT-25	28cp	VD17	6g	Tor
0FY	XC6210B29AMR	LVR-IC	LDO, 2.95V±2%, 700mA, +CE	SOT-25	28cx	VR4	6g	Tor
0FY	XC6221D29BMR	LVR-IC	LDO, 2.95V±1%, 200mA, +CE, CL, PDR	SOT-25	28cx	VR4	6g	Tor
0FY	XC6101C629MR	Vdet-IC	2.9V±2%, Hst, -MR, -Reset PPO, Wt=1.6s, Rt=50ms	SOT-25	28cp	VD17	6g	Tor
0FZ	XC6210B30AMR	LVR-IC	LDO, 3.05V±2%, 700mA, +CE	SOT-25	28cx	VR4	6g	Tor
0FZ	XC6221D30BMR	LVR-IC	LDO, 3.05V±1%, 200mA, +CE, CL, PDR	SOT-25	28cx	VR4	6g	Tor
0FZ	XC6101C630MR	Vdet-IC	3.0V±2%, Hst, -MR, -Reset PPO, Wt=1.6s, Rt=50ms	SOT-25	28cp	VD17	6g	Tor
0G	BU4323FWE	Vdet-IC	2.3V, +Reset PPO	VSOFF-5	30vka	VD3	6c	Rhm
0G	BU4323G	Vdet-IC	2.3V, +Reset PPO	SSOP-5	28vdo	VD3	6c	Rhm
0G	R3111N601A	Vdet-IC	6.0V±2%, -Reset PPO	SOT-23-5	28vdm	VD7	6g	Ric
0G	RN5VD60CA	Vdet-IC	6V±2.5%, -Reset ODO	SOT-23-5	28vdo	VD1	6g	Ric
0G=	RT9193-39GB	LVR-IC	LDO, 3.9V±1%, 300mA, +CE	SOT-23-5	28vrx	VR7	6g	Rct
0H	BU4324FWE	Vdet-IC	2.4V, +Reset PPO	VSOFF-5	30vka	VD3	6c	Rhm
0H	BU4324G	Vdet-IC	2.4V, +Reset PPO	SSOP-5	28vdo	VD3	6c	Rhm
0H=	RT9198-4GGBR	LVR-IC	LDO, 4.75V±1%, 300mA, +CE	SOT-23-5	28cx	VR4	6a	Rct
0H0	XC6101D331MR	Vdet-IC	3.1V±2%, Hst, -MR, -Reset PPO, Wt=100ms, Rt=100ms	SOT-25	28cp	VD17	6g	Tor
0H1	XC6101D332MR	Vdet-IC	3.2V±2%, Hst, -MR, -Reset PPO, Wt=100ms, Rt=100ms	SOT-25	28cp	VD17	6g	Tor
0H2	XC6101D333MR	Vdet-IC	3.3V±2%, Hst, -MR, -Reset PPO, Wt=100ms, Rt=100ms	SOT-25	28cp	VD17	6g	Tor
0H3	XC6101D334MR	Vdet-IC	3.4V±2%, Hst, -MR, -Reset PPO, Wt=100ms, Rt=100ms	SOT-25	28cp	VD17	6g	Tor
0H4	XC6101D335MR	Vdet-IC	3.5V±2%, Hst, -MR, -Reset PPO, Wt=100ms, Rt=100ms	SOT-25	28cp	VD17	6g	Tor
0H5	XC6101D336MR	Vdet-IC	3.6V±2%, Hst, -MR, -Reset PPO, Wt=100ms, Rt=100ms	SOT-25	28cp	VD17	6g	Tor
0H6	XC6101D337MR	Vdet-IC	3.7V±2%, Hst, -MR, -Reset PPO, Wt=100ms, Rt=100ms	SOT-25	28cp	VD17	6g	Tor
0H7	XC6101D338MR	Vdet-IC	3.8V±2%, Hst, -MR, -Reset PPO, Wt=100ms, Rt=100ms	SOT-25	28cp	VD17	6g	Tor
0H8	XC6210C08AMR	LVR-IC	LDO, 0.85V±2%, 700mA, -CE, PDR	SOT-25	28cx	VR4	6g	Tor
0H8	XC6101D339MR	Vdet-IC	3.9V±2%, Hst, -MR, -Reset PPO, Wt=100ms, Rt=100ms	SOT-25	28cp	VD17	6g	Tor
0H9	XC6210C09AMR	LVR-IC	LDO, 0.95V±2%, 700mA, -CE, PDR	SOT-25	28cx	VR4	6g	Tor
0H9	XC6101D340MR	Vdet-IC	4.0V±2%, Hst, -MR, -Reset PPO, Wt=100ms, Rt=100ms	SOT-25	28cp	VD17	6g	Tor
0HA	XC6210C11AMR	LVR-IC	LDO, 1.15V±2%, 700mA, -CE, PDR	SOT-25	28cx	VR4	6g	Tor
0HA	XC6101D341MR	Vdet-IC	4.1V±2%, Hst, -MR, -Reset PPO, Wt=100ms, Rt=100ms	SOT-25	28cp	VD17	6g	Tor
0HB	XC6210C12AMR	LVR-IC	LDO, 1.25V±2%, 700mA, -CE, PDR	SOT-25	28cx	VR4	6g	Tor
0HB	XC6101D342MR	Vdet-IC	4.2V±2%, Hst, -MR, -Reset PPO, Wt=100ms, Rt=100ms	SOT-25	28cp	VD17	6g	Tor
0HC	XC6210C13AMR	LVR-IC	LDO, 1.35V±2%, 700mA, -CE, PDR	SOT-25	28cx	VR4	6g	Tor
0HC	XC6101D343MR	Vdet-IC	4.3V±2%, Hst, -MR, -Reset PPO, Wt=100ms, Rt=100ms	SOT-25	28cp	VD17	6g	Tor
0HD	XC6210C14AMR	LVR-IC	LDO, 1.45V±2%, 700mA, -CE, PDR	SOT-25	28cx	VR4	6g	Tor
0HD	XC6101D344MR	Vdet-IC	4.4V±2%, Hst, -MR, -Reset PPO, Wt=100ms, Rt=100ms	SOT-25	28cp	VD17	6g	Tor
0HE	XC6210C15AMR	LVR-IC	LDO, 1.55V±2%, 700mA, -CE, PDR	SOT-25	28cx	VR4	6g	Tor
0HE	XC6101D345MR	Vdet-IC	4.5V±2%, Hst, -MR, -Reset PPO, Wt=100ms, Rt=100ms	SOT-25	28cp	VD17	6g	Tor
0HF	XC6210C16AMR	LVR-IC	LDO, 1.65V±2%, 700mA, -CE, PDR	SOT-25	28cx	VR4	6g	Tor
0HF	XC6101D346MR	Vdet-IC	1.6V±2%, Hst, -MR, -Reset PPO, Wt=100ms, Rt=100ms	SOT-25	28cp	VD17	6g	Tor
0HF	XC6101D346MR	Vdet-IC	4.6V±2%, Hst, -MR, -Reset PPO, Wt=100ms, Rt=100ms	SOT-25	28cp	VD17	6g	Tor
0HH	XC6210C17AMR	LVR-IC	LDO, 1.75V±2%, 700mA, -CE, PDR	SOT-25	28cx	VR4	6g	Tor
0HH	XC6101D347MR	Vdet-IC	1.7V±2%, Hst, -MR, -Reset PPO, Wt=100ms, Rt=100ms	SOT-25	28cp	VD17	6g	Tor
0HH	XC6101D347MR	Vdet-IC	4.7V±2%, Hst, -MR, -Reset PPO, Wt=100ms, Rt=100ms	SOT-25	28cp	VD17	6g	Tor
0HK	XC6210C18AMR	LVR-IC	LDO, 1.85V±2%, 700mA, -CE, PDR	SOT-25	28cx	VR4	6g	Tor
0HK	XC6101D348MR	Vdet-IC	1.8V±2%, Hst, -MR, -Reset PPO, Wt=100ms, Rt=100ms	SOT-25	28cp	VD17	6g	Tor
0HK	XC6101D348MR	Vdet-IC	4.8V±2%, Hst, -MR, -Reset PPO, Wt=100ms, Rt=100ms	SOT-25	28cp	VD17	6g	Tor
0HL	XC6210C19AMR	LVR-IC	LDO, 1.95V±2%, 700mA, -CE, PDR	SOT-25	28cx	VR4	6g	Tor
0HL	XC6101D349MR	Vdet-IC	1.9V±2%, Hst, -MR, -Reset PPO, Wt=100ms, Rt=100ms	SOT-25	28cp	VD17	6g	Tor
0HL	XC6101D349MR	Vdet-IC	4.9V±2%, Hst, -MR, -Reset PPO, Wt=100ms, Rt=100ms	SOT-25	28cp	VD17	6g	Tor
0HM	XC6210C20AMR	LVR-IC	LDO, 2.05V±2%, 700mA, -CE, PDR	SOT-25	28cx	VR4	6g	Tor
0HM	XC6101D350MR	Vdet-IC	2.0V±2%, Hst, -MR, -Reset PPO, Wt=100ms, Rt=100ms	SOT-25	28cp	VD17	6g	Tor
0HM	XC6101D350MR	Vdet-IC	5.0V±2%, Hst, -MR, -Reset PPO, Wt=100ms, Rt=100ms	SOT-25	28cp	VD17	6g	Tor
0HN	XC6210C21AMR	LVR-IC	LDO, 2.15V±2%, 700mA, -CE, PDR	SOT-25	28cx	VR4	6g	Tor
0HN	XC6101D351MR	Vdet-IC	2.1V±2%, Hst, -MR, -Reset PPO, Wt=100ms, Rt=100ms	SOT-25	28cp	VD17	6g	Tor
0HP	XC6210C22AMR	LVR-IC	LDO, 2.25V±2%, 700mA, -CE, PDR	SOT-25	28cx	VR4	6g	Tor
0HP	XC6101D352MR	Vdet-IC	2.2V±2%, Hst, -MR, -Reset PPO, Wt=100ms, Rt=100ms	SOT-25	28cp	VD17	6g	Tor
0HR	XC6210C23AMR	LVR-IC	LDO, 2.35V±2%, 700mA, -CE, PDR	SOT-25	28cx	VR4	6g	Tor
0HR	XC6101D353MR	Vdet-IC	2.3V±2%, Hst, -MR, -Reset PPO, Wt=100ms, Rt=100ms	SOT-25	28cp	VD17	6g	Tor
0HS	XC6210C24AMR	LVR-IC	LDO, 2.45V±2%, 700mA, -CE, PDR	SOT-25	28cx	VR4	6g	Tor
0HS	XC6101D354MR	Vdet-IC	2.4V±2%, Hst, -MR, -Reset PPO, Wt=100ms, Rt=100ms	SOT-25	28cp	VD17	6g	Tor
0HT	XC6210C25AMR	LVR-IC	LDO, 2.55V±2%, 700mA, -CE, PDR	SOT-25	28cx	VR4	6g	Tor
0HT	XC6101D355MR	Vdet-IC	2.5V±2%, Hst, -MR, -Reset PPO, Wt=100ms, Rt=100ms	SOT-25	28cp	VD17	6g	Tor



SMD code	Type	Function	Short description	Case	Pinout	Sch.	St.	Mnf.
0HU	XC6210C26AMR	LVR-IC	LDO, 2.65V±2%, 700mA, -CE, PDR	SOT-25	28cx	VR4	6g	Tor
0HU	XC6101D326MR	Vdet-IC	2.6V±2%, Hst, -MR, -Reset PPO, Wt=100ms, Rt=100ms	SOT-25	28cp	VD17	6g	Tor
0HV	XC6210C27AMR	LVR-IC	LDO, 2.75V±2%, 700mA, -CE, PDR	SOT-25	28cx	VR4	6g	Tor
0HV	XC6101D327MR	Vdet-IC	2.7V±2%, Hst, -MR, -Reset PPO, Wt=100ms, Rt=100ms	SOT-25	28cp	VD17	6g	Tor
0HX	XC6210C28AMR	LVR-IC	LDO, 2.85V±2%, 700mA, -CE, PDR	SOT-25	28cx	VR4	6g	Tor
0HX	XC6101D328MR	Vdet-IC	2.8V±2%, Hst, -MR, -Reset PPO, Wt=100ms, Rt=100ms	SOT-25	28cp	VD17	6g	Tor
0HY	XC6210C29AMR	LVR-IC	LDO, 2.95V±2%, 700mA, -CE, PDR	SOT-25	28cx	VR4	6g	Tor
0HY	XC6101D329MR	Vdet-IC	2.9V±2%, Hst, -MR, -Reset PPO, Wt=100ms, Rt=100ms	SOT-25	28cp	VD17	6g	Tor
0HZ	XC6210C30AMR	LVR-IC	LDO, 3.05V±2%, 700mA, -CE, PDR	SOT-25	28cx	VR4	6g	Tor
0HZ	XC6101D330MR	Vdet-IC	3.0V±2%, Hst, -MR, -Reset PPO, Wt=100ms, Rt=100ms	SOT-25	28cp	VD17	6g	Tor
0J	BU4325FWE	Vdet-IC	2.5V, +Reset PPO	VSOFF-5	30vka	VD3	6c	Rhm
0J	BU4325G	Vdet-IC	2.5V, +Reset PPO	SSOP-5	28vdo	VD3	6c	Rhm
0J	R3111N101C	Vdet-IC	1.0V±2%, -Reset ODO	SOT-23-5	28vdm	VD6	6g	Ric
0K	BU4326FWE	Vdet-IC	2.6V, +Reset PPO	VSOFF-5	30vka	VD3	6c	Rhm
0K	BU4326G	Vdet-IC	2.6V, +Reset PPO	SSOP-5	28vdo	VD3	6c	Rhm
0K	R3111N201C	Vdet-IC	2.0V±2%, -Reset ODO	SOT-23-5	28vdm	VD6	6g	Ric
0K0	XC6101D431MR	Vdet-IC	3.1V±2%, Hst, -MR, -Reset PPO, Wt=200ms, Rt=100ms	SOT-25	28cp	VD17	6g	Tor
0K1	XC6101D432MR	Vdet-IC	3.2V±2%, Hst, -MR, -Reset PPO, Wt=200ms, Rt=100ms	SOT-25	28cp	VD17	6g	Tor
0K2	XC6101D433MR	Vdet-IC	3.3V±2%, Hst, -MR, -Reset PPO, Wt=200ms, Rt=100ms	SOT-25	28cp	VD17	6g	Tor
0K3	XC6101D434MR	Vdet-IC	3.4V±2%, Hst, -MR, -Reset PPO, Wt=200ms, Rt=100ms	SOT-25	28cp	VD17	6g	Tor
0K4	XC6101D435MR	Vdet-IC	3.5V±2%, Hst, -MR, -Reset PPO, Wt=200ms, Rt=100ms	SOT-25	28cp	VD17	6g	Tor
0K5	XC6101D436MR	Vdet-IC	3.6V±2%, Hst, -MR, -Reset PPO, Wt=200ms, Rt=100ms	SOT-25	28cp	VD17	6g	Tor
0K6	XC6101D437MR	Vdet-IC	3.7V±2%, Hst, -MR, -Reset PPO, Wt=200ms, Rt=100ms	SOT-25	28cp	VD17	6g	Tor
0K7	XC6101D438MR	Vdet-IC	3.8V±2%, Hst, -MR, -Reset PPO, Wt=200ms, Rt=100ms	SOT-25	28cp	VD17	6g	Tor
0K8	XC6210D08AMR	LVR-IC	LDO, 0.85V±2%, 700mA, -CE	SOT-25	28cx	VR4	6g	Tor
0K8	XC6101D439MR	Vdet-IC	3.9V±2%, Hst, -MR, -Reset PPO, Wt=200ms, Rt=100ms	SOT-25	28cp	VD17	6g	Tor
0K9	XC6210D09AMR	LVR-IC	LDO, 0.95V±2%, 700mA, -CE	SOT-25	28cx	VR4	6g	Tor
0K9	XC6101D440MR	Vdet-IC	4.0V±2%, Hst, -MR, -Reset PPO, Wt=200ms, Rt=100ms	SOT-25	28cp	VD17	6g	Tor
0KA	XC6210D11AMR	LVR-IC	LDO, 1.15V±2%, 700mA, -CE	SOT-25	28cx	VR4	6g	Tor
0KA	XC6101D441MR	Vdet-IC	4.1V±2%, Hst, -MR, -Reset PPO, Wt=200ms, Rt=100ms	SOT-25	28cp	VD17	6g	Tor
0KB	XC6210D12AMR	LVR-IC	LDO, 1.25V±2%, 700mA, -CE	SOT-25	28cx	VR4	6g	Tor
0KB	XC6101D442MR	Vdet-IC	4.2V±2%, Hst, -MR, -Reset PPO, Wt=200ms, Rt=100ms	SOT-25	28cp	VD17	6g	Tor
0KC	XC6210D13AMR	LVR-IC	LDO, 1.35V±2%, 700mA, -CE	SOT-25	28cx	VR4	6g	Tor
0KC	XC6101D443MR	Vdet-IC	4.3V±2%, Hst, -MR, -Reset PPO, Wt=200ms, Rt=100ms	SOT-25	28cp	VD17	6g	Tor
0KD	XC6210D14AMR	LVR-IC	LDO, 1.45V±2%, 700mA, -CE	SOT-25	28cx	VR4	6g	Tor
0KD	XC6101D444MR	Vdet-IC	4.4V±2%, Hst, -MR, -Reset PPO, Wt=200ms, Rt=100ms	SOT-25	28cp	VD17	6g	Tor
0KE	XC6210D15AMR	LVR-IC	LDO, 1.55V±2%, 700mA, -CE	SOT-25	28cx	VR4	6g	Tor
0KE	XC6101D445MR	Vdet-IC	4.5V±2%, Hst, -MR, -Reset PPO, Wt=200ms, Rt=100ms	SOT-25	28cp	VD17	6g	Tor
0KF	XC6210D16AMR	LVR-IC	LDO, 1.65V±2%, 700mA, -CE	SOT-25	28cx	VR4	6g	Tor
0KF	XC6101D416MR	Vdet-IC	1.6V±2%, Hst, -MR, -Reset PPO, Wt=200ms, Rt=100ms	SOT-25	28cp	VD17	6g	Tor
0KF	XC6101D446MR	Vdet-IC	4.6V±2%, Hst, -MR, -Reset PPO, Wt=200ms, Rt=100ms	SOT-25	28cp	VD17	6g	Tor
0KH	XC6210D17AMR	LVR-IC	LDO, 1.75V±2%, 700mA, -CE	SOT-25	28cx	VR4	6g	Tor
0KH	XC6101D417MR	Vdet-IC	1.7V±2%, Hst, -MR, -Reset PPO, Wt=200ms, Rt=100ms	SOT-25	28cp	VD17	6g	Tor
0KH	XC6101D447MR	Vdet-IC	4.7V±2%, Hst, -MR, -Reset PPO, Wt=200ms, Rt=100ms	SOT-25	28cp	VD17	6g	Tor
0KK	XC6210D18AMR	LVR-IC	LDO, 1.85V±2%, 700mA, -CE	SOT-25	28cx	VR4	6g	Tor
0KK	XC6101D418MR	Vdet-IC	1.8V±2%, Hst, -MR, -Reset PPO, Wt=200ms, Rt=100ms	SOT-25	28cp	VD17	6g	Tor
0KK	XC6101D448MR	Vdet-IC	4.8V±2%, Hst, -MR, -Reset PPO, Wt=200ms, Rt=100ms	SOT-25	28cp	VD17	6g	Tor
0KL	XC6210D19AMR	LVR-IC	LDO, 1.95V±2%, 700mA, -CE	SOT-25	28cx	VR4	6g	Tor
0KL	XC6101D419MR	Vdet-IC	1.9V±2%, Hst, -MR, -Reset PPO, Wt=200ms, Rt=100ms	SOT-25	28cp	VD17	6g	Tor
0KL	XC6101D449MR	Vdet-IC	4.9V±2%, Hst, -MR, -Reset PPO, Wt=200ms, Rt=100ms	SOT-25	28cp	VD17	6g	Tor
0KM	XC6210D20AMR	LVR-IC	LDO, 2.05V±2%, 700mA, -CE	SOT-25	28cx	VR4	6g	Tor
0KM	XC6101D420MR	Vdet-IC	2.0V±2%, Hst, -MR, -Reset PPO, Wt=200ms, Rt=100ms	SOT-25	28cp	VD17	6g	Tor
0KM	XC6101D450MR	Vdet-IC	5.0V±2%, Hst, -MR, -Reset PPO, Wt=200ms, Rt=100ms	SOT-25	28cp	VD17	6g	Tor
0KN	XC6210D21AMR	LVR-IC	LDO, 2.15V±2%, 700mA, -CE	SOT-25	28cx	VR4	6g	Tor
0KN	XC6101D421MR	Vdet-IC	2.1V±2%, Hst, -MR, -Reset PPO, Wt=200ms, Rt=100ms	SOT-25	28cp	VD17	6g	Tor
0KP	XC6210D22AMR	LVR-IC	LDO, 2.25V±2%, 700mA, -CE	SOT-25	28cx	VR4	6g	Tor
0KP	XC6101D422MR	Vdet-IC	2.2V±2%, Hst, -MR, -Reset PPO, Wt=200ms, Rt=100ms	SOT-25	28cp	VD17	6g	Tor
0KR	XC6210D23AMR	LVR-IC	LDO, 2.35V±2%, 700mA, -CE	SOT-25	28cx	VR4	6g	Tor
0KR	XC6101D423MR	Vdet-IC	2.3V±2%, Hst, -MR, -Reset PPO, Wt=200ms, Rt=100ms	SOT-25	28cp	VD17	6g	Tor
0KS	XC6210D24AMR	LVR-IC	LDO, 2.45V±2%, 700mA, -CE	SOT-25	28cx	VR4	6g	Tor
0KS	XC6101D424MR	Vdet-IC	2.4V±2%, Hst, -MR, -Reset PPO, Wt=200ms, Rt=100ms	SOT-25	28cp	VD17	6g	Tor
0KT	XC6210D25AMR	LVR-IC	LDO, 2.55V±2%, 700mA, -CE	SOT-25	28cx	VR4	6g	Tor
0KT	XC6101D425MR	Vdet-IC	2.5V±2%, Hst, -MR, -Reset PPO, Wt=200ms, Rt=100ms	SOT-25	28cp	VD17	6g	Tor
0KU	XC6210D26AMR	LVR-IC	LDO, 2.65V±2%, 700mA, -CE	SOT-25	28cx	VR4	6g	Tor
0KU	XC6101D426MR	Vdet-IC	2.6V±2%, Hst, -MR, -Reset PPO, Wt=200ms, Rt=100ms	SOT-25	28cp	VD17	6g	Tor
0KV	XC6210D27AMR	LVR-IC	LDO, 2.75V±2%, 700mA, -CE	SOT-25	28cx	VR4	6g	Tor
0KV	XC6101D427MR	Vdet-IC	2.7V±2%, Hst, -MR, -Reset PPO, Wt=200ms, Rt=100ms	SOT-25	28cp	VD17	6g	Tor
0KX	XC6210D28AMR	LVR-IC	LDO, 2.85V±2%, 700mA, -CE	SOT-25	28cx	VR4	6g	Tor
0KX	XC6101D428MR	Vdet-IC	2.8V±2%, Hst, -MR, -Reset PPO, Wt=200ms, Rt=100ms	SOT-25	28cp	VD17	6g	Tor
0KY	XC6210D29AMR	LVR-IC	LDO, 2.95V±2%, 700mA, -CE	SOT-25	28cx	VR4	6g	Tor



SMD code	Type	Function	Short description	Case	Pinout	Sch.	St.	Mnf.
<u>0KY</u>	XC6101D429MR	Vdet-IC	2.9V±2%, Hst, -MR, -Reset PPO, Wt=200ms, Rt=100ms	SOT-25	28cp	VD17	6g	Tor
<u>0KZ</u>	XC6210D30AMR	LVR-IC	LDO, 3.05V±2%, 700mA, -CE	SOT-25	28cx	VR4	6g	Tor
<u>0KZ</u>	XC6101D430MR	Vdet-IC	3.0V±2%, Hst, -MR, -Reset PPO, Wt=200ms, Rt=100ms	SOT-25	28cp	VD17	6g	Tor
<u>0L</u>	BU4327FWE	Vdet-IC	2.7V, +Reset PPO	VSOFF-5	30vka	VD3	6c	Rhm
<u>0L</u>	BU4327G	Vdet-IC	2.7V, +Reset PPO	SSOP-5	28vdo	VD3	6c	Rhm
<u>0L</u>	R3111N301C	Vdet-IC	3.0V±2%, -Reset ODO	SOT-23-5	28vdm	VD6	6g	Ric
<u>0L=</u>	RT9818A-40GB	Vdet-IC	4.0V±1.5%, -ODO +Reset	SOT-23-5	28vdm	VD6	6a	Rct
<u>0L0</u>	XC6210A31AMR	LVR-IC	LDO, 3.15V±2%, 700mA, +CE, PDR	SOT-25	28cx	VR4	6g	Tor
<u>0L0</u>	XC6221C31BMR	LVR-IC	LDO, 3.15V±1%, 200mA, +CE, PDR	SOT-25	28cx	VR4	6g	Tor
<u>0L0</u>	XC6101D531MR	Vdet-IC	3.1V±2%, Hst, -MR, -Reset PPO, Wt=400ms, Rt=100ms	SOT-25	28cp	VD17	6g	Tor
<u>0L1</u>	XC6210A32AMR	LVR-IC	LDO, 3.25V±2%, 700mA, +CE, PDR	SOT-25	28cx	VR4	6g	Tor
<u>0L1</u>	XC6221C32BMR	LVR-IC	LDO, 3.25V±1%, 200mA, +CE, PDR	SOT-25	28cx	VR4	6g	Tor
<u>0L1</u>	XC6101D532MR	Vdet-IC	3.2V±2%, Hst, -MR, -Reset PPO, Wt=400ms, Rt=100ms	SOT-25	28cp	VD17	6g	Tor
<u>0L2</u>	XC6210A33AMR	LVR-IC	LDO, 3.35V±2%, 700mA, +CE, PDR	SOT-25	28cx	VR4	6g	Tor
<u>0L2</u>	XC6221C33BMR	LVR-IC	LDO, 3.35V±1%, 200mA, +CE, PDR	SOT-25	28cx	VR4	6g	Tor
<u>0L2</u>	XC6101D533MR	Vdet-IC	3.3V±2%, Hst, -MR, -Reset PPO, Wt=400ms, Rt=100ms	SOT-25	28cp	VD17	6g	Tor
<u>0L3</u>	XC6210A34AMR	LVR-IC	LDO, 3.45V±2%, 700mA, +CE, PDR	SOT-25	28cx	VR4	6g	Tor
<u>0L3</u>	XC6221C34BMR	LVR-IC	LDO, 3.45V±1%, 200mA, +CE, PDR	SOT-25	28cx	VR4	6g	Tor
<u>0L3</u>	XC6101D534MR	Vdet-IC	3.4V±2%, Hst, -MR, -Reset PPO, Wt=400ms, Rt=100ms	SOT-25	28cp	VD17	6g	Tor
<u>0L4</u>	XC6210A35AMR	LVR-IC	LDO, 3.55V±2%, 700mA, +CE, PDR	SOT-25	28cx	VR4	6g	Tor
<u>0L4</u>	XC6221C35BMR	LVR-IC	LDO, 3.55V±1%, 200mA, +CE, PDR	SOT-25	28cx	VR4	6g	Tor
<u>0L4</u>	XC6101D535MR	Vdet-IC	3.5V±2%, Hst, -MR, -Reset PPO, Wt=400ms, Rt=100ms	SOT-25	28cp	VD17	6g	Tor
<u>0L5</u>	XC6210A36AMR	LVR-IC	LDO, 3.65V±2%, 700mA, +CE, PDR	SOT-25	28cx	VR4	6g	Tor
<u>0L5</u>	XC6221C36BMR	LVR-IC	LDO, 3.65V±1%, 200mA, +CE, PDR	SOT-25	28cx	VR4	6g	Tor
<u>0L5</u>	XC6101D536MR	Vdet-IC	3.6V±2%, Hst, -MR, -Reset PPO, Wt=400ms, Rt=100ms	SOT-25	28cp	VD17	6g	Tor
<u>0L6</u>	XC6210A37AMR	LVR-IC	LDO, 3.75V±2%, 700mA, +CE, PDR	SOT-25	28cx	VR4	6g	Tor
<u>0L6</u>	XC6221C37BMR	LVR-IC	LDO, 3.75V±1%, 200mA, +CE, PDR	SOT-25	28cx	VR4	6g	Tor
<u>0L6</u>	XC6101D537MR	Vdet-IC	3.7V±2%, Hst, -MR, -Reset PPO, Wt=400ms, Rt=100ms	SOT-25	28cp	VD17	6g	Tor
<u>0L7</u>	XC6210A38AMR	LVR-IC	LDO, 3.85V±2%, 700mA, +CE, PDR	SOT-25	28cx	VR4	6g	Tor
<u>0L7</u>	XC6221C38BMR	LVR-IC	LDO, 3.85V±1%, 200mA, +CE, PDR	SOT-25	28cx	VR4	6g	Tor
<u>0L7</u>	XC6101D538MR	Vdet-IC	3.8V±2%, Hst, -MR, -Reset PPO, Wt=400ms, Rt=100ms	SOT-25	28cp	VD17	6g	Tor
<u>0L8</u>	XC6210A39AMR	LVR-IC	LDO, 3.95V±2%, 700mA, +CE, PDR	SOT-25	28cx	VR4	6g	Tor
<u>0L8</u>	XC6221C39BMR	LVR-IC	LDO, 3.95V±1%, 200mA, +CE, PDR	SOT-25	28cx	VR4	6g	Tor
<u>0L8</u>	XC6101D539MR	Vdet-IC	3.9V±2%, Hst, -MR, -Reset PPO, Wt=400ms, Rt=100ms	SOT-25	28cp	VD17	6g	Tor
<u>0L9</u>	XC6210A40AMR	LVR-IC	LDO, 4.05V±2%, 700mA, +CE, PDR	SOT-25	28cx	VR4	6g	Tor
<u>0L9</u>	XC6221C40BMR	LVR-IC	LDO, 4.05±1%, 200mA, +CE, PDR	SOT-25	28cx	VR4	6g	Tor
<u>0L9</u>	XC6101D540MR	Vdet-IC	4.0V±2%, Hst, -MR, -Reset PPO, Wt=400ms, Rt=100ms	SOT-25	28cp	VD17	6g	Tor
<u>0LA</u>	XC6210A41AMR	LVR-IC	LDO, 4.15V±2%, 700mA, +CE, PDR	SOT-25	28cx	VR4	6g	Tor
<u>0LA</u>	XC6221C41BMR	LVR-IC	LDO, 4.15±1%, 200mA, +CE, PDR	SOT-25	28cx	VR4	6g	Tor
<u>0LA</u>	XC6101D541MR	Vdet-IC	4.1V±2%, Hst, -MR, -Reset PPO, Wt=400ms, Rt=100ms	SOT-25	28cp	VD17	6g	Tor
<u>0LB</u>	XC6210A42AMR	LVR-IC	LDO, 4.25V±2%, 700mA, +CE, PDR	SOT-25	28cx	VR4	6g	Tor
<u>0LB</u>	XC6221C42BMR	LVR-IC	LDO, 4.25±1%, 200mA, +CE, PDR	SOT-25	28cx	VR4	6g	Tor
<u>0LB</u>	XC6101D542MR	Vdet-IC	4.2V±2%, Hst, -MR, -Reset PPO, Wt=400ms, Rt=100ms	SOT-25	28cp	VD17	6g	Tor
<u>0LC</u>	XC6210A43AMR	LVR-IC	LDO, 4.35V±2%, 700mA, +CE, PDR	SOT-25	28cx	VR4	6g	Tor
<u>0LC</u>	XC6221C43BMR	LVR-IC	LDO, 4.35±1%, 200mA, +CE, PDR	SOT-25	28cx	VR4	6g	Tor
<u>0LC</u>	XC6101D543MR	Vdet-IC	4.3V±2%, Hst, -MR, -Reset PPO, Wt=400ms, Rt=100ms	SOT-25	28cp	VD17	6g	Tor
<u>0LD</u>	XC6210A44AMR	LVR-IC	LDO, 4.45V±2%, 700mA, +CE, PDR	SOT-25	28cx	VR4	6g	Tor
<u>0LD</u>	XC6221C44BMR	LVR-IC	LDO, 4.45±1%, 200mA, +CE, PDR	SOT-25	28cx	VR4	6g	Tor
<u>0LD</u>	XC6101D544MR	Vdet-IC	4.4V±2%, Hst, -MR, -Reset PPO, Wt=400ms, Rt=100ms	SOT-25	28cp	VD17	6g	Tor
<u>0LE</u>	XC6210A45AMR	LVR-IC	LDO, 4.55V±2%, 700mA, +CE, PDR	SOT-25	28cx	VR4	6g	Tor
<u>0LE</u>	XC6221C45BMR	LVR-IC	LDO, 4.55±1%, 200mA, +CE, PDR	SOT-25	28cx	VR4	6g	Tor
<u>0LE</u>	XC6101D545MR	Vdet-IC	4.5V±2%, Hst, -MR, -Reset PPO, Wt=400ms, Rt=100ms	SOT-25	28cp	VD17	6g	Tor
<u>0LF</u>	XC6210A46AMR	LVR-IC	LDO, 4.65V±2%, 700mA, +CE, PDR	SOT-25	28cx	VR4	6g	Tor
<u>0LF</u>	XC6221C46BMR	LVR-IC	LDO, 4.65±1%, 200mA, +CE, PDR	SOT-25	28cx	VR4	6g	Tor
<u>0LF</u>	XC6101D516MR	Vdet-IC	1.6V±2%, Hst, -MR, -Reset PPO, Wt=400ms, Rt=100ms	SOT-25	28cp	VD17	6g	Tor
<u>0LF</u>	XC6101D546MR	Vdet-IC	4.6V±2%, Hst, -MR, -Reset PPO, Wt=400ms, Rt=100ms	SOT-25	28cp	VD17	6g	Tor
<u>0LH</u>	XC6210A47AMR	LVR-IC	LDO, 4.75V±2%, 700mA, +CE, PDR	SOT-25	28cx	VR4	6g	Tor
<u>0LH</u>	XC6221C47BMR	LVR-IC	LDO, 4.75±1%, 200mA, +CE, PDR	SOT-25	28cx	VR4	6g	Tor
<u>0LH</u>	XC6101D517MR	Vdet-IC	1.7V±2%, Hst, -MR, -Reset PPO, Wt=400ms, Rt=100ms	SOT-25	28cp	VD17	6g	Tor
<u>0LH</u>	XC6101D547MR	Vdet-IC	4.7V±2%, Hst, -MR, -Reset PPO, Wt=400ms, Rt=100ms	SOT-25	28cp	VD17	6g	Tor
<u>0LK</u>	XC6210A48AMR	LVR-IC	LDO, 4.85V±2%, 700mA, +CE, PDR	SOT-25	28cx	VR4	6g	Tor
<u>0LK</u>	XC6221C48BMR	LVR-IC	LDO, 4.85±1%, 200mA, +CE, PDR	SOT-25	28cx	VR4	6g	Tor
<u>0LK</u>	XC6101D518MR	Vdet-IC	1.8V±2%, Hst, -MR, -Reset PPO, Wt=400ms, Rt=100ms	SOT-25	28cp	VD17	6g	Tor
<u>0LK</u>	XC6101D548MR	Vdet-IC	4.8V±2%, Hst, -MR, -Reset PPO, Wt=400ms, Rt=100ms	SOT-25	28cp	VD17	6g	Tor
<u>0LL</u>	XC6210A49AMR	LVR-IC	LDO, 4.95V±2%, 700mA, +CE, PDR	SOT-25	28cx	VR4	6g	Tor
<u>0LL</u>	XC6221C49BMR	LVR-IC	LDO, 4.95±1%, 200mA, +CE, PDR	SOT-25	28cx	VR4	6g	Tor
<u>0LL</u>	XC6101D519MR	Vdet-IC	1.9V±2%, Hst, -MR, -Reset PPO, Wt=400ms, Rt=100ms	SOT-25	28cp	VD17	6g	Tor
<u>0LL</u>	XC6101D549MR	Vdet-IC	4.9V±2%, Hst, -MR, -Reset PPO, Wt=400ms, Rt=100ms	SOT-25	28cp	VD17	6g	Tor
<u>0LM</u>	XC6101D520MR	Vdet-IC	2.0V±2%, Hst, -MR, -Reset PPO, Wt=400ms, Rt=100ms	SOT-25	28cp	VD17	6g	Tor
<u>0LM</u>	XC6101D550MR	Vdet-IC	5.0V±2%, Hst, -MR, -Reset PPO, Wt=400ms, Rt=100ms	SOT-25	28cp	VD17	6g	Tor



SMD code	Type	Function	Short description	Case	Pinout	Sch.	St.	Mnf.
<u>OLN</u>	XC6101D521MR	Vdet-IC	2.1V±2%, Hst, -MR, -Reset PPO, Wt=400ms, Rt=100ms	SOT-25	28cp	VD17	6g	Tor
<u>OLP</u>	XC6101D522MR	Vdet-IC	2.2V±2%, Hst, -MR, -Reset PPO, Wt=400ms, Rt=100ms	SOT-25	28cp	VD17	6g	Tor
<u>OLR</u>	XC6101D523MR	Vdet-IC	2.3V±2%, Hst, -MR, -Reset PPO, Wt=400ms, Rt=100ms	SOT-25	28cp	VD17	6g	Tor
<u>OLS</u>	XC6101D524MR	Vdet-IC	2.4V±2%, Hst, -MR, -Reset PPO, Wt=400ms, Rt=100ms	SOT-25	28cp	VD17	6g	Tor
<u>OLT</u>	XC6101D525MR	Vdet-IC	2.5V±2%, Hst, -MR, -Reset PPO, Wt=400ms, Rt=100ms	SOT-25	28cp	VD17	6g	Tor
<u>OLU</u>	XC6101D526MR	Vdet-IC	2.6V±2%, Hst, -MR, -Reset PPO, Wt=400ms, Rt=100ms	SOT-25	28cp	VD17	6g	Tor
<u>OLV</u>	XC6101D527MR	Vdet-IC	2.7V±2%, Hst, -MR, -Reset PPO, Wt=400ms, Rt=100ms	SOT-25	28cp	VD17	6g	Tor
<u>OLX</u>	XC6101D528MR	Vdet-IC	2.8V±2%, Hst, -MR, -Reset PPO, Wt=400ms, Rt=100ms	SOT-25	28cp	VD17	6g	Tor
<u>OLY</u>	XC6101D529MR	Vdet-IC	2.9V±2%, Hst, -MR, -Reset PPO, Wt=400ms, Rt=100ms	SOT-25	28cp	VD17	6g	Tor
<u>OLZ</u>	XC6101D530MR	Vdet-IC	3.0V±2%, Hst, -MR, -Reset PPO, Wt=400ms, Rt=100ms	SOT-25	28cp	VD17	6g	Tor
<u>OM</u>	BU4328FWE	Vdet-IC	2.8V, +Reset PPO	VSOF-5	30vka	VD3	6c	Rhm
<u>OM</u>	BU4328G	Vdet-IC	2.8V, +Reset PPO	SSOP-5	28vdo	VD3	6c	Rhm
<u>OM</u>	R3111N401C	Vdet-IC	4.0V±2%, -Reset ODO	SOT-23-5	28vdm	VD6	6g	Ric
<u>OM0</u>	XC6210B31AMR	LVR-IC	LDO, 3.15V±2%, 700mA, +CE	SOT-25	28cx	VR4	6g	Tor
<u>OM0</u>	XC6221D31BMR	LVR-IC	LDO, 3.15V±1%, 200mA, +CE, CL, PDR	SOT-25	28cx	VR4	6g	Tor
<u>OM0</u>	XC6101D631MR	Vdet-IC	3.1V±2%, Hst, -MR, -Reset PPO, Wt=1.6s, Rt=100ms	SOT-25	28cp	VD17	6g	Tor
<u>OM1</u>	XC6210B32AMR	LVR-IC	LDO, 3.25V±2%, 700mA, +CE	SOT-25	28cx	VR4	6g	Tor
<u>OM1</u>	XC6221D32BMR	LVR-IC	LDO, 3.25V±1%, 200mA, +CE, CL, PDR	SOT-25	28cx	VR4	6g	Tor
<u>OM1</u>	XC6101D632MR	Vdet-IC	3.2V±2%, Hst, -MR, -Reset PPO, Wt=1.6s, Rt=100ms	SOT-25	28cp	VD17	6g	Tor
<u>OM2</u>	XC6210B33AMR	LVR-IC	LDO, 3.35V±2%, 700mA, +CE	SOT-25	28cx	VR4	6g	Tor
<u>OM2</u>	XC6221D33BMR	LVR-IC	LDO, 3.35V±1%, 200mA, +CE, CL, PDR	SOT-25	28cx	VR4	6g	Tor
<u>OM2</u>	XC6101D633MR	Vdet-IC	3.3V±2%, Hst, -MR, -Reset PPO, Wt=1.6s, Rt=100ms	SOT-25	28cp	VD17	6g	Tor
<u>OM3</u>	XC6210B34AMR	LVR-IC	LDO, 3.45V±2%, 700mA, +CE	SOT-25	28cx	VR4	6g	Tor
<u>OM3</u>	XC6221D34BMR	LVR-IC	LDO, 3.45V±1%, 200mA, +CE, CL, PDR	SOT-25	28cx	VR4	6g	Tor
<u>OM3</u>	XC6101D634MR	Vdet-IC	3.4V±2%, Hst, -MR, -Reset PPO, Wt=1.6s, Rt=100ms	SOT-25	28cp	VD17	6g	Tor
<u>OM4</u>	XC6210B35AMR	LVR-IC	LDO, 3.55V±2%, 700mA, +CE	SOT-25	28cx	VR4	6g	Tor
<u>OM4</u>	XC6221D35BMR	LVR-IC	LDO, 3.55V±1%, 200mA, +CE, CL, PDR	SOT-25	28cx	VR4	6g	Tor
<u>OM4</u>	XC6101D635MR	Vdet-IC	3.5V±2%, Hst, -MR, -Reset PPO, Wt=1.6s, Rt=100ms	SOT-25	28cp	VD17	6g	Tor
<u>OM5</u>	XC6210B36AMR	LVR-IC	LDO, 3.65V±2%, 700mA, +CE	SOT-25	28cx	VR4	6g	Tor
<u>OM5</u>	XC6221D36BMR	LVR-IC	LDO, 3.65V±1%, 200mA, +CE, CL, PDR	SOT-25	28cx	VR4	6g	Tor
<u>OM5</u>	XC6101D636MR	Vdet-IC	3.6V±2%, Hst, -MR, -Reset PPO, Wt=1.6s, Rt=100ms	SOT-25	28cp	VD17	6g	Tor
<u>OM6</u>	XC6210B37AMR	LVR-IC	LDO, 3.75V±2%, 700mA, +CE	SOT-25	28cx	VR4	6g	Tor
<u>OM6</u>	XC6221D37BMR	LVR-IC	LDO, 3.75V±1%, 200mA, +CE, CL, PDR	SOT-25	28cx	VR4	6g	Tor
<u>OM6</u>	XC6101D637MR	Vdet-IC	3.7V±2%, Hst, -MR, -Reset PPO, Wt=1.6s, Rt=100ms	SOT-25	28cp	VD17	6g	Tor
<u>OM7</u>	XC6210B38AMR	LVR-IC	LDO, 3.85V±2%, 700mA, +CE	SOT-25	28cx	VR4	6g	Tor
<u>OM7</u>	XC6221D38BMR	LVR-IC	LDO, 3.85V±1%, 200mA, +CE, CL, PDR	SOT-25	28cx	VR4	6g	Tor
<u>OM7</u>	XC6101D638MR	Vdet-IC	3.8V±2%, Hst, -MR, -Reset PPO, Wt=1.6s, Rt=100ms	SOT-25	28cp	VD17	6g	Tor
<u>OM8</u>	XC6210B39AMR	LVR-IC	LDO, 3.95V±2%, 700mA, +CE	SOT-25	28cx	VR4	6g	Tor
<u>OM8</u>	XC6221D39BMR	LVR-IC	LDO, 3.95V±1%, 200mA, +CE, CL, PDR	SOT-25	28cx	VR4	6g	Tor
<u>OM8</u>	XC6101D639MR	Vdet-IC	3.9V±2%, Hst, -MR, -Reset PPO, Wt=1.6s, Rt=100ms	SOT-25	28cp	VD17	6g	Tor
<u>OM9</u>	XC6210B40AMR	LVR-IC	LDO, 4.05V±2%, 700mA, +CE	SOT-25	28cx	VR4	6g	Tor
<u>OM9</u>	XC6221D40BMR	LVR-IC	LDO, 4.05V±1%, 200mA, +CE, CL, PDR	SOT-25	28cx	VR4	6g	Tor
<u>OM9</u>	XC6101D640MR	Vdet-IC	4.0V±2%, Hst, -MR, -Reset PPO, Wt=1.6s, Rt=100ms	SOT-25	28cp	VD17	6g	Tor
<u>OMA</u>	XC6210B41AMR	LVR-IC	LDO, 4.15V±2%, 700mA, +CE	SOT-25	28cx	VR4	6g	Tor
<u>OMA</u>	XC6221D41BMR	LVR-IC	LDO, 4.15V±1%, 200mA, +CE, CL, PDR	SOT-25	28cx	VR4	6g	Tor
<u>OMA</u>	XC6101D641MR	Vdet-IC	4.1V±2%, Hst, -MR, -Reset PPO, Wt=1.6s, Rt=100ms	SOT-25	28cp	VD17	6g	Tor
<u>OMB</u>	XC6210B42AMR	LVR-IC	LDO, 4.25V±2%, 700mA, +CE	SOT-25	28cx	VR4	6g	Tor
<u>OMB</u>	XC6221D42BMR	LVR-IC	LDO, 4.25V±1%, 200mA, +CE, CL, PDR	SOT-25	28cx	VR4	6g	Tor
<u>OMB</u>	XC6101D642MR	Vdet-IC	4.2V±2%, Hst, -MR, -Reset PPO, Wt=1.6s, Rt=100ms	SOT-25	28cp	VD17	6g	Tor
<u>OMC</u>	XC6210B43AMR	LVR-IC	LDO, 4.35V±2%, 700mA, +CE	SOT-25	28cx	VR4	6g	Tor
<u>OMC</u>	XC6221D43BMR	LVR-IC	LDO, 4.35V±1%, 200mA, +CE, CL, PDR	SOT-25	28cx	VR4	6g	Tor
<u>OMC</u>	XC6101D643MR	Vdet-IC	4.3V±2%, Hst, -MR, -Reset PPO, Wt=1.6s, Rt=100ms	SOT-25	28cp	VD17	6g	Tor
<u>OMD</u>	XC6210B44AMR	LVR-IC	LDO, 4.45V±2%, 700mA, +CE	SOT-25	28cx	VR4	6g	Tor
<u>OMD</u>	XC6221D44BMR	LVR-IC	LDO, 4.45V±1%, 200mA, +CE, CL, PDR	SOT-25	28cx	VR4	6g	Tor
<u>OMD</u>	XC6101D644MR	Vdet-IC	4.4V±2%, Hst, -MR, -Reset PPO, Wt=1.6s, Rt=100ms	SOT-25	28cp	VD17	6g	Tor
<u>OME</u>	XC6210B45AMR	LVR-IC	LDO, 4.55V±2%, 700mA, +CE	SOT-25	28cx	VR4	6g	Tor
<u>OME</u>	XC6221D45BMR	LVR-IC	LDO, 4.55V±1%, 200mA, +CE, CL, PDR	SOT-25	28cx	VR4	6g	Tor
<u>OME</u>	XC6101D645MR	Vdet-IC	4.5V±2%, Hst, -MR, -Reset PPO, Wt=1.6s, Rt=100ms	SOT-25	28cp	VD17	6g	Tor
<u>OMF</u>	XC6210B46AMR	LVR-IC	LDO, 4.65V±2%, 700mA, +CE	SOT-25	28cx	VR4	6g	Tor
<u>OMF</u>	XC6221D46BMR	LVR-IC	LDO, 4.65V±1%, 200mA, +CE, CL, PDR	SOT-25	28cx	VR4	6g	Tor
<u>OMF</u>	XC6101D616MR	Vdet-IC	1.6V±2%, Hst, -MR, -Reset PPO, Wt=1.6s, Rt=100ms	SOT-25	28cp	VD17	6g	Tor
<u>OMF</u>	XC6101D646MR	Vdet-IC	4.6V±2%, Hst, -MR, -Reset PPO, Wt=1.6s, Rt=100ms	SOT-25	28cp	VD17	6g	Tor
<u>OMH</u>	XC6210B47AMR	LVR-IC	LDO, 4.75V±2%, 700mA, +CE	SOT-25	28cx	VR4	6g	Tor
<u>OMH</u>	XC6221D47BMR	LVR-IC	LDO, 4.75V±1%, 200mA, +CE, CL, PDR	SOT-25	28cx	VR4	6g	Tor
<u>OMH</u>	XC6101D617MR	Vdet-IC	1.7V±2%, Hst, -MR, -Reset PPO, Wt=1.6s, Rt=100ms	SOT-25	28cp	VD17	6g	Tor
<u>OMH</u>	XC6101D647MR	Vdet-IC	4.7V±2%, Hst, -MR, -Reset PPO, Wt=1.6s, Rt=100ms	SOT-25	28cp	VD17	6g	Tor
<u>OMK</u>	XC6210B48AMR	LVR-IC	LDO, 4.85V±2%, 700mA, +CE	SOT-25	28cx	VR4	6g	Tor
<u>OMK</u>	XC6221D48BMR	LVR-IC	LDO, 4.85V±1%, 200mA, +CE, CL, PDR	SOT-25	28cx	VR4	6g	Tor
<u>OMK</u>	XC6101D618MR	Vdet-IC	1.8V±2%, Hst, -MR, -Reset PPO, Wt=1.6s, Rt=100ms	SOT-25	28cp	VD17	6g	Tor
<u>OMK</u>	XC6101D648MR	Vdet-IC	4.8V±2%, Hst, -MR, -Reset PPO, Wt=1.6s, Rt=100ms	SOT-25	28cp	VD17	6g	Tor



SMD code	Type	Function	Short description	Case	Pinout	Sch.	St.	Mnf.
OML	XC6210B49AMR	LVR-IC	LDO, 4.95V±2%, 700mA, +CE	SOT-25	28cx	VR4	6g	Tor
OML	XC6221D49BMR	LVR-IC	LDO, 4.95V±1%, 200mA, +CE, CL, PDR	SOT-25	28cx	VR4	6g	Tor
OML	XC6101D619MR	Vdet-IC	1.9V±2%, Hst, -MR, -Reset PPO, Wt=1.6s, Rt=100ms	SOT-25	28cp	VD17	6g	Tor
OML	XC6101D649MR	Vdet-IC	4.9V±2%, Hst, -MR, -Reset PPO, Wt=1.6s, Rt=100ms	SOT-25	28cp	VD17	6g	Tor
OMM	XC6101D620MR	Vdet-IC	2.0V±2%, Hst, -MR, -Reset PPO, Wt=1.6s, Rt=100ms	SOT-25	28cp	VD17	6g	Tor
OMM	XC6101D650MR	Vdet-IC	5.0V±2%, Hst, -MR, -Reset PPO, Wt=1.6s, Rt=100ms	SOT-25	28cp	VD17	6g	Tor
OMN	XC6101D621MR	Vdet-IC	2.1V±2%, Hst, -MR, -Reset PPO, Wt=1.6s, Rt=100ms	SOT-25	28cp	VD17	6g	Tor
OMP	XC6101D622MR	Vdet-IC	2.2V±2%, Hst, -MR, -Reset PPO, Wt=1.6s, Rt=100ms	SOT-25	28cp	VD17	6g	Tor
OMR	XC6101D623MR	Vdet-IC	2.3V±2%, Hst, -MR, -Reset PPO, Wt=1.6s, Rt=100ms	SOT-25	28cp	VD17	6g	Tor
OMS	XC6101D624MR	Vdet-IC	2.4V±2%, Hst, -MR, -Reset PPO, Wt=1.6s, Rt=100ms	SOT-25	28cp	VD17	6g	Tor
OMT	XC6101D625MR	Vdet-IC	2.5V±2%, Hst, -MR, -Reset PPO, Wt=1.6s, Rt=100ms	SOT-25	28cp	VD17	6g	Tor
OMU	XC6101D626MR	Vdet-IC	2.6V±2%, Hst, -MR, -Reset PPO, Wt=1.6s, Rt=100ms	SOT-25	28cp	VD17	6g	Tor
OMV	XC6101D627MR	Vdet-IC	2.7V±2%, Hst, -MR, -Reset PPO, Wt=1.6s, Rt=100ms	SOT-25	28cp	VD17	6g	Tor
OMX	XC6101D628MR	Vdet-IC	2.8V±2%, Hst, -MR, -Reset PPO, Wt=1.6s, Rt=100ms	SOT-25	28cp	VD17	6g	Tor
OMY	XC6101D629MR	Vdet-IC	2.9V±2%, Hst, -MR, -Reset PPO, Wt=1.6s, Rt=100ms	SOT-25	28cp	VD17	6g	Tor
OMZ	XC6101D630MR	Vdet-IC	3.0V±2%, Hst, -MR, -Reset PPO, Wt=1.6s, Rt=100ms	SOT-25	28cp	VD17	6g	Tor
ON	BU4329FWE	Vdet-IC	2.9V, +Reset PPO	VSOFF-5	30vka	VD3	6c	Rhm
ON	BU4329G	Vdet-IC	2.9V, +Reset PPO	SSOP-5	28vdo	VD3	6c	Rhm
ON	R3111N501C	Vdet-IC	5.0V±2%, -Reset ODO	SOT-23-5	28vdm	VD6	6g	Ric
ON0	XC6210C31AMR	LVR-IC	LDO, 3.15V±2%, 700mA, -CE, PDR	SOT-25	28cx	VR4	6g	Tor
ON1	XC6210C32AMR	LVR-IC	LDO, 3.25V±2%, 700mA, -CE, PDR	SOT-25	28cx	VR4	6g	Tor
ON2	XC6210C33AMR	LVR-IC	LDO, 3.35V±2%, 700mA, -CE, PDR	SOT-25	28cx	VR4	6g	Tor
ON3	XC6210C34AMR	LVR-IC	LDO, 3.45V±2%, 700mA, -CE, PDR	SOT-25	28cx	VR4	6g	Tor
ON4	XC6210C35AMR	LVR-IC	LDO, 3.55V±2%, 700mA, -CE, PDR	SOT-25	28cx	VR4	6g	Tor
ON5	XC6210C36AMR	LVR-IC	LDO, 3.65V±2%, 700mA, -CE, PDR	SOT-25	28cx	VR4	6g	Tor
ON6	XC6210C37AMR	LVR-IC	LDO, 3.75V±2%, 700mA, -CE, PDR	SOT-25	28cx	VR4	6g	Tor
ON7	XC6210C38AMR	LVR-IC	LDO, 3.85V±2%, 700mA, -CE, PDR	SOT-25	28cx	VR4	6g	Tor
ON8	XC6210C39AMR	LVR-IC	LDO, 3.95V±2%, 700mA, -CE, PDR	SOT-25	28cx	VR4	6g	Tor
ON9	XC6210C40AMR	LVR-IC	LDO, 4.05V±2%, 700mA, -CE, PDR	SOT-25	28cx	VR4	6g	Tor
ONA	XC6210C41AMR	LVR-IC	LDO, 4.15V±2%, 700mA, -CE, PDR	SOT-25	28cx	VR4	6g	Tor
ONB	XC6210C42AMR	LVR-IC	LDO, 4.25V±2%, 700mA, -CE, PDR	SOT-25	28cx	VR4	6g	Tor
ONC	XC6210C43AMR	LVR-IC	LDO, 4.35V±2%, 700mA, -CE, PDR	SOT-25	28cx	VR4	6g	Tor
OND	XC6210C44AMR	LVR-IC	LDO, 4.45V±2%, 700mA, -CE, PDR	SOT-25	28cx	VR4	6g	Tor
ONE	XC6210C45AMR	LVR-IC	LDO, 4.55V±2%, 700mA, -CE, PDR	SOT-25	28cx	VR4	6g	Tor
ONF	XC6210C46AMR	LVR-IC	LDO, 4.65V±2%, 700mA, -CE, PDR	SOT-25	28cx	VR4	6g	Tor
ONH	XC6210C47AMR	LVR-IC	LDO, 4.75V±2%, 700mA, -CE, PDR	SOT-25	28cx	VR4	6g	Tor
ONK	XC6210C48AMR	LVR-IC	LDO, 4.85V±2%, 700mA, -CE, PDR	SOT-25	28cx	VR4	6g	Tor
ONL	XC6210C49AMR	LVR-IC	LDO, 4.95V±2%, 700mA, -CE, PDR	SOT-25	28cx	VR4	6g	Tor
OP	BU4330FWE	Vdet-IC	3V, +Reset PPO	VSOFF-5	30vka	VD3	6c	Rhm
OP	BU4330G	Vdet-IC	3V, +Reset PPO	SSOP-5	28vdo	VD3	6c	Rhm
OP	R3111N601C	Vdet-IC	6.0V±2%, -Reset ODO	SOT-23-5	28vdm	VD6	6g	Ric
OP0	XC6210D31AMR	LVR-IC	LDO, 3.15V±2%, 700mA, -CE	SOT-25	28cx	VR4	6g	Tor
OP0	XC6101E431MR	Vdet-IC	3.1V±2%, Hst, -MR, -Reset PPO, Wt=200ms, Rt=200ms	SOT-25	28cp	VD17	6g	Tor
OP1	XC6210D32AMR	LVR-IC	LDO, 3.25V±2%, 700mA, -CE	SOT-25	28cx	VR4	6g	Tor
OP1	XC6101E432MR	Vdet-IC	3.2V±2%, Hst, -MR, -Reset PPO, Wt=200ms, Rt=200ms	SOT-25	28cp	VD17	6g	Tor
OP2	XC6210D33AMR	LVR-IC	LDO, 3.35V±2%, 700mA, -CE	SOT-25	28cx	VR4	6g	Tor
OP2	XC6101E433MR	Vdet-IC	3.3V±2%, Hst, -MR, -Reset PPO, Wt=200ms, Rt=200ms	SOT-25	28cp	VD17	6g	Tor
OP3	XC6210D34AMR	LVR-IC	LDO, 3.45V±2%, 700mA, -CE	SOT-25	28cx	VR4	6g	Tor
OP3	XC6101E434MR	Vdet-IC	3.4V±2%, Hst, -MR, -Reset PPO, Wt=200ms, Rt=200ms	SOT-25	28cp	VD17	6g	Tor
OP4	XC6210D35AMR	LVR-IC	LDO, 3.55V±2%, 700mA, -CE	SOT-25	28cx	VR4	6g	Tor
OP4	XC6101E435MR	Vdet-IC	3.5V±2%, Hst, -MR, -Reset PPO, Wt=200ms, Rt=200ms	SOT-25	28cp	VD17	6g	Tor
OP5	XC6210D36AMR	LVR-IC	LDO, 3.65V±2%, 700mA, -CE	SOT-25	28cx	VR4	6g	Tor
OP5	XC6101E436MR	Vdet-IC	3.6V±2%, Hst, -MR, -Reset PPO, Wt=200ms, Rt=200ms	SOT-25	28cp	VD17	6g	Tor
OP6	XC6210D37AMR	LVR-IC	LDO, 3.75V±2%, 700mA, -CE	SOT-25	28cx	VR4	6g	Tor
OP6	XC6101E437MR	Vdet-IC	3.7V±2%, Hst, -MR, -Reset PPO, Wt=200ms, Rt=200ms	SOT-25	28cp	VD17	6g	Tor
OP7	XC6210D38AMR	LVR-IC	LDO, 3.85V±2%, 700mA, -CE	SOT-25	28cx	VR4	6g	Tor
OP7	XC6101E438MR	Vdet-IC	3.8V±2%, Hst, -MR, -Reset PPO, Wt=200ms, Rt=200ms	SOT-25	28cp	VD17	6g	Tor
OP8	XC6210D39AMR	LVR-IC	LDO, 3.95V±2%, 700mA, -CE	SOT-25	28cx	VR4	6g	Tor
OP8	XC6101E439MR	Vdet-IC	3.9V±2%, Hst, -MR, -Reset PPO, Wt=200ms, Rt=200ms	SOT-25	28cp	VD17	6g	Tor
OP9	XC6210D40AMR	LVR-IC	LDO, 4.05V±2%, 700mA, -CE	SOT-25	28cx	VR4	6g	Tor
OP9	XC6101E440MR	Vdet-IC	4.0V±2%, Hst, -MR, -Reset PPO, Wt=200ms, Rt=200ms	SOT-25	28cp	VD17	6g	Tor
OPA	XC6210D41AMR	LVR-IC	LDO, 4.15V±2%, 700mA, -CE	SOT-25	28cx	VR4	6g	Tor
OPA	XC6101E441MR	Vdet-IC	4.1V±2%, Hst, -MR, -Reset PPO, Wt=200ms, Rt=200ms	SOT-25	28cp	VD17	6g	Tor
OPB	XC6210D42AMR	LVR-IC	LDO, 4.25V±2%, 700mA, -CE	SOT-25	28cx	VR4	6g	Tor
OPB	XC6101E442MR	Vdet-IC	4.2V±2%, Hst, -MR, -Reset PPO, Wt=200ms, Rt=200ms	SOT-25	28cp	VD17	6g	Tor
OPC	XC6210D43AMR	LVR-IC	LDO, 4.35V±2%, 700mA, -CE	SOT-25	28cx	VR4	6g	Tor
OPC	XC6101E443MR	Vdet-IC	4.3V±2%, Hst, -MR, -Reset PPO, Wt=200ms, Rt=200ms	SOT-25	28cp	VD17	6g	Tor
OPD	XC6210D44AMR	LVR-IC	LDO, 4.45V±2%, 700mA, -CE	SOT-25	28cx	VR4	6g	Tor
OPD	XC6101E444MR	Vdet-IC	4.4V±2%, Hst, -MR, -Reset PPO, Wt=200ms, Rt=200ms	SOT-25	28cp	VD17	6g	Tor
OPE	XC6210D45AMR	LVR-IC	LDO, 4.55V±2%, 700mA, -CE	SOT-25	28cx	VR4	6g	Tor



SMD code	Type	Function	Short description	Case	Pinout	Sch.	St.	Mnf.
<u>0PE</u>	XC6101E445MR	Vdet-IC	4.5V±2%, Hst, -MR, -Reset PPO, Wt=200ms, Rt=200ms	SOT-25	28cp	VD17	6g	Tor
<u>0PF</u>	XC6210D46AMR	LVR-IC	LDO, 4.65V±2%, 700mA, -CE	SOT-25	28cx	VR4	6g	Tor
<u>0PF</u>	XC6101E416MR	Vdet-IC	1.6V±2%, Hst, -MR, -Reset PPO, Wt=200ms, Rt=200ms	SOT-25	28cp	VD17	6g	Tor
<u>0PE</u>	XC6101E446MR	Vdet-IC	4.6V±2%, Hst, -MR, -Reset PPO, Wt=200ms, Rt=200ms	SOT-25	28cp	VD17	6g	Tor
<u>0PH</u>	XC6210D47AMR	LVR-IC	LDO, 4.75V±2%, 700mA, -CE	SOT-25	28cx	VR4	6g	Tor
<u>0PH</u>	XC6101E417MR	Vdet-IC	1.7V±2%, Hst, -MR, -Reset PPO, Wt=200ms, Rt=200ms	SOT-25	28cp	VD17	6g	Tor
<u>0PH</u>	XC6101E447MR	Vdet-IC	4.7V±2%, Hst, -MR, -Reset PPO, Wt=200ms, Rt=200ms	SOT-25	28cp	VD17	6g	Tor
<u>0PK</u>	XC6210D48AMR	LVR-IC	LDO, 4.85V±2%, 700mA, -CE	SOT-25	28cx	VR4	6g	Tor
<u>0PK</u>	XC6101E418MR	Vdet-IC	1.8V±2%, Hst, -MR, -Reset PPO, Wt=200ms, Rt=200ms	SOT-25	28cp	VD17	6g	Tor
<u>0PK</u>	XC6101E448MR	Vdet-IC	4.8V±2%, Hst, -MR, -Reset PPO, Wt=200ms, Rt=200ms	SOT-25	28cp	VD17	6g	Tor
<u>0PL</u>	XC6210D49AMR	LVR-IC	LDO, 4.95V±2%, 700mA, -CE	SOT-25	28cx	VR4	6g	Tor
<u>0PL</u>	XC6101E419MR	Vdet-IC	1.9V±2%, Hst, -MR, -Reset PPO, Wt=200ms, Rt=200ms	SOT-25	28cp	VD17	6g	Tor
<u>0PL</u>	XC6101E449MR	Vdet-IC	4.9V±2%, Hst, -MR, -Reset PPO, Wt=200ms, Rt=200ms	SOT-25	28cp	VD17	6g	Tor
<u>0PM</u>	XC6101E420MR	Vdet-IC	2.0V±2%, Hst, -MR, -Reset PPO, Wt=200ms, Rt=200ms	SOT-25	28cp	VD17	6g	Tor
<u>0PM</u>	XC6101E450MR	Vdet-IC	5.0V±2%, Hst, -MR, -Reset PPO, Wt=200ms, Rt=200ms	SOT-25	28cp	VD17	6g	Tor
<u>0PN</u>	XC6101E421MR	Vdet-IC	2.1V±2%, Hst, -MR, -Reset PPO, Wt=200ms, Rt=200ms	SOT-25	28cp	VD17	6g	Tor
<u>0PP</u>	XC6101E422MR	Vdet-IC	2.2V±2%, Hst, -MR, -Reset PPO, Wt=200ms, Rt=200ms	SOT-25	28cp	VD17	6g	Tor
<u>0PP</u>	XC6101E423MR	Vdet-IC	2.3V±2%, Hst, -MR, -Reset PPO, Wt=200ms, Rt=200ms	SOT-25	28cp	VD17	6g	Tor
<u>0PS</u>	XC6101E424MR	Vdet-IC	2.4V±2%, Hst, -MR, -Reset PPO, Wt=200ms, Rt=200ms	SOT-25	28cp	VD17	6g	Tor
<u>0PT</u>	XC6101E425MR	Vdet-IC	2.5V±2%, Hst, -MR, -Reset PPO, Wt=200ms, Rt=200ms	SOT-25	28cp	VD17	6g	Tor
<u>0PU</u>	XC6101E426MR	Vdet-IC	2.6V±2%, Hst, -MR, -Reset PPO, Wt=200ms, Rt=200ms	SOT-25	28cp	VD17	6g	Tor
<u>0PV</u>	XC6101E427MR	Vdet-IC	2.7V±2%, Hst, -MR, -Reset PPO, Wt=200ms, Rt=200ms	SOT-25	28cp	VD17	6g	Tor
<u>0PX</u>	XC6101E428MR	Vdet-IC	2.8V±2%, Hst, -MR, -Reset PPO, Wt=200ms, Rt=200ms	SOT-25	28cp	VD17	6g	Tor
<u>0PY</u>	XC6101E429MR	Vdet-IC	2.9V±2%, Hst, -MR, -Reset PPO, Wt=200ms, Rt=200ms	SOT-25	28cp	VD17	6g	Tor
<u>0PZ</u>	XC6101E430MR	Vdet-IC	3.0V±2%, Hst, -MR, -Reset PPO, Wt=200ms, Rt=200ms	SOT-25	28cp	VD17	6g	Tor
<u>0Q</u>	BU4331FWE	Vdet-IC	3.1V, +Reset PPO	VSOFF-5	30wka	VD3	6c	Rhm
<u>0Q</u>	BU4331G	Vdet-IC	3.1V, +Reset PPO	SSOP-5	28vdo	VD3	6c	Rhm
<u>0R</u>	BU4332FWE	Vdet-IC	3.2V, +Reset PPO	VSOFF-5	30wka	VD3	6c	Rhm
<u>0R</u>	BU4332G	Vdet-IC	3.2V, +Reset PPO	SSOP-5	28vdo	VD3	6c	Rhm
<u>0R</u>	R1210N301A	DC/DC-IC	PWM step-up, 3V, 35..100kHz	SOT-23-5	28sc	DC3	6g	Ric
<u>0R=</u>	RT9818C-29GB	Vdet-IC	2.9V±1.5%, -ODO +Reset, Td=220ms	SOT-23-5	28vdm	VD6	6a	Rct
<u>0R0</u>	XC6101E531MR	Vdet-IC	3.1V±2%, Hst, -MR, -Reset PPO, Wt=400ms, Rt=200ms	SOT-25	28cp	VD17	6g	Tor
<u>0R1</u>	XC6101E532MR	Vdet-IC	3.2V±2%, Hst, -MR, -Reset PPO, Wt=400ms, Rt=200ms	SOT-25	28cp	VD17	6g	Tor
<u>0R2</u>	XC6101E533MR	Vdet-IC	3.3V±2%, Hst, -MR, -Reset PPO, Wt=400ms, Rt=200ms	SOT-25	28cp	VD17	6g	Tor
<u>0R3</u>	XC6101E534MR	Vdet-IC	3.4V±2%, Hst, -MR, -Reset PPO, Wt=400ms, Rt=200ms	SOT-25	28cp	VD17	6g	Tor
<u>0R4</u>	XC6101E535MR	Vdet-IC	3.5V±2%, Hst, -MR, -Reset PPO, Wt=400ms, Rt=200ms	SOT-25	28cp	VD17	6g	Tor
<u>0R5</u>	XC6101E536MR	Vdet-IC	3.6V±2%, Hst, -MR, -Reset PPO, Wt=400ms, Rt=200ms	SOT-25	28cp	VD17	6g	Tor
<u>0R6</u>	XC6101E537MR	Vdet-IC	3.7V±2%, Hst, -MR, -Reset PPO, Wt=400ms, Rt=200ms	SOT-25	28cp	VD17	6g	Tor
<u>0R7</u>	XC6101E538MR	Vdet-IC	3.8V±2%, Hst, -MR, -Reset PPO, Wt=400ms, Rt=200ms	SOT-25	28cp	VD17	6g	Tor
<u>0R8</u>	XC6101E539MR	Vdet-IC	3.9V±2%, Hst, -MR, -Reset PPO, Wt=400ms, Rt=200ms	SOT-25	28cp	VD17	6g	Tor
<u>0R9</u>	XC6101E540MR	Vdet-IC	4.0V±2%, Hst, -MR, -Reset PPO, Wt=400ms, Rt=200ms	SOT-25	28cp	VD17	6g	Tor
<u>0RA</u>	XC6101E541MR	Vdet-IC	4.1V±2%, Hst, -MR, -Reset PPO, Wt=400ms, Rt=200ms	SOT-25	28cp	VD17	6g	Tor
<u>0RB</u>	XC6101E542MR	Vdet-IC	4.2V±2%, Hst, -MR, -Reset PPO, Wt=400ms, Rt=200ms	SOT-25	28cp	VD17	6g	Tor
<u>0RC</u>	XC6101E543MR	Vdet-IC	4.3V±2%, Hst, -MR, -Reset PPO, Wt=400ms, Rt=200ms	SOT-25	28cp	VD17	6g	Tor
<u>0RD</u>	XC6101E544MR	Vdet-IC	4.4V±2%, Hst, -MR, -Reset PPO, Wt=400ms, Rt=200ms	SOT-25	28cp	VD17	6g	Tor
<u>0RE</u>	XC6101E545MR	Vdet-IC	4.5V±2%, Hst, -MR, -Reset PPO, Wt=400ms, Rt=200ms	SOT-25	28cp	VD17	6g	Tor
<u>0RF</u>	XC6101E516MR	Vdet-IC	1.6V±2%, Hst, -MR, -Reset PPO, Wt=400ms, Rt=200ms	SOT-25	28cp	VD17	6g	Tor
<u>0RF</u>	XC6101E546MR	Vdet-IC	4.6V±2%, Hst, -MR, -Reset PPO, Wt=400ms, Rt=200ms	SOT-25	28cp	VD17	6g	Tor
<u>0RH</u>	XC6101E517MR	Vdet-IC	1.7V±2%, Hst, -MR, -Reset PPO, Wt=400ms, Rt=200ms	SOT-25	28cp	VD17	6g	Tor
<u>0RH</u>	XC6101E547MR	Vdet-IC	4.7V±2%, Hst, -MR, -Reset PPO, Wt=400ms, Rt=200ms	SOT-25	28cp	VD17	6g	Tor
<u>0RK</u>	XC6101E518MR	Vdet-IC	1.8V±2%, Hst, -MR, -Reset PPO, Wt=400ms, Rt=200ms	SOT-25	28cp	VD17	6g	Tor
<u>0RK</u>	XC6101E548MR	Vdet-IC	4.8V±2%, Hst, -MR, -Reset PPO, Wt=400ms, Rt=200ms	SOT-25	28cp	VD17	6g	Tor
<u>0RL</u>	XC6101E519MR	Vdet-IC	1.9V±2%, Hst, -MR, -Reset PPO, Wt=400ms, Rt=200ms	SOT-25	28cp	VD17	6g	Tor
<u>0RL</u>	XC6101E549MR	Vdet-IC	4.9V±2%, Hst, -MR, -Reset PPO, Wt=400ms, Rt=200ms	SOT-25	28cp	VD17	6g	Tor
<u>0RM</u>	XC6101E520MR	Vdet-IC	2.0V±2%, Hst, -MR, -Reset PPO, Wt=400ms, Rt=200ms	SOT-25	28cp	VD17	6g	Tor
<u>0RM</u>	XC6101E550MR	Vdet-IC	5.0V±2%, Hst, -MR, -Reset PPO, Wt=400ms, Rt=200ms	SOT-25	28cp	VD17	6g	Tor
<u>0RN</u>	XC6101E521MR	Vdet-IC	2.1V±2%, Hst, -MR, -Reset PPO, Wt=400ms, Rt=200ms	SOT-25	28cp	VD17	6g	Tor
<u>0RP</u>	XC6101E522MR	Vdet-IC	2.2V±2%, Hst, -MR, -Reset PPO, Wt=400ms, Rt=200ms	SOT-25	28cp	VD17	6g	Tor
<u>0RR</u>	XC6101E523MR	Vdet-IC	2.3V±2%, Hst, -MR, -Reset PPO, Wt=400ms, Rt=200ms	SOT-25	28cp	VD17	6g	Tor
<u>0RS</u>	XC6101E524MR	Vdet-IC	2.4V±2%, Hst, -MR, -Reset PPO, Wt=400ms, Rt=200ms	SOT-25	28cp	VD17	6g	Tor
<u>0RT</u>	XC6101E525MR	Vdet-IC	2.5V±2%, Hst, -MR, -Reset PPO, Wt=400ms, Rt=200ms	SOT-25	28cp	VD17	6g	Tor
<u>0RU</u>	XC6101E526MR	Vdet-IC	2.6V±2%, Hst, -MR, -Reset PPO, Wt=400ms, Rt=200ms	SOT-25	28cp	VD17	6g	Tor
<u>0RV</u>	XC6101E527MR	Vdet-IC	2.7V±2%, Hst, -MR, -Reset PPO, Wt=400ms, Rt=200ms	SOT-25	28cp	VD17	6g	Tor
<u>0RX</u>	XC6101E528MR	Vdet-IC	2.8V±2%, Hst, -MR, -Reset PPO, Wt=400ms, Rt=200ms	SOT-25	28cp	VD17	6g	Tor
<u>0RY</u>	XC6101E529MR	Vdet-IC	2.9V±2%, Hst, -MR, -Reset PPO, Wt=400ms, Rt=200ms	SOT-25	28cp	VD17	6g	Tor
<u>0RZ</u>	XC6101E530MR	Vdet-IC	3.0V±2%, Hst, -MR, -Reset PPO, Wt=400ms, Rt=200ms	SOT-25	28cp	VD17	6g	Tor
<u>0S</u>	BU4333FWE	Vdet-IC	3.3V, +Reset PPO	VSOFF-5	30wka	VD3	6c	Rhm
<u>0S</u>	BU4333G	Vdet-IC	3.3V, +Reset PPO	SSOP-5	28vdo	VD3	6c	Rhm
<u>0S0</u>	XC6101E631MR	Vdet-IC	3.1V±2%, Hst, -MR, -Reset PPO, Wt=1.6s, Rt=200ms	SOT-25	28cp	VD17	6g	Tor
<u>0S1</u>	XC6101E632MR	Vdet-IC	3.2V±2%, Hst, -MR, -Reset PPO, Wt=1.6s, Rt=200ms	SOT-25	28cp	VD17	6g	Tor



SMD code	Type	Function	Short description	Case	Pinout	Sch.	St.	Mnf.
0U	BU4335FWE	Vdet-IC	3.5V, +Reset PPO	VSOFF-5	30vka	VD3	6c	Rhm
0U	BU4335G	Vdet-IC	3.5V, +Reset PPO	SSOP-5	28vdo	VD3	6c	Rhm
0U0	XC6101F631MR	Vdet-IC	3.1V±2%, Hst, -MR, -Reset PPO, Wt=1.6s, Rt=400ms	SOT-25	28cp	VD17	6g	Tor
0U1	XC6101F632MR	Vdet-IC	3.2V±2%, Hst, -MR, -Reset PPO, Wt=1.6s, Rt=400ms	SOT-25	28cp	VD17	6g	Tor
0U2	XC6101F633MR	Vdet-IC	3.3V±2%, Hst, -MR, -Reset PPO, Wt=1.6s, Rt=400ms	SOT-25	28cp	VD17	6g	Tor
0U3	XC6101F634MR	Vdet-IC	3.4V±2%, Hst, -MR, -Reset PPO, Wt=1.6s, Rt=400ms	SOT-25	28cp	VD17	6g	Tor
0U4	XC6101F635MR	Vdet-IC	3.5V±2%, Hst, -MR, -Reset PPO, Wt=1.6s, Rt=400ms	SOT-25	28cp	VD17	6g	Tor
0U5	XC6101F636MR	Vdet-IC	3.6V±2%, Hst, -MR, -Reset PPO, Wt=1.6s, Rt=400ms	SOT-25	28cp	VD17	6g	Tor
0U6	XC6101F637MR	Vdet-IC	3.7V±2%, Hst, -MR, -Reset PPO, Wt=1.6s, Rt=400ms	SOT-25	28cp	VD17	6g	Tor
0U7	XC6101F638MR	Vdet-IC	3.8V±2%, Hst, -MR, -Reset PPO, Wt=1.6s, Rt=400ms	SOT-25	28cp	VD17	6g	Tor
0U8	XC6101F639MR	Vdet-IC	3.9V±2%, Hst, -MR, -Reset PPO, Wt=1.6s, Rt=400ms	SOT-25	28cp	VD17	6g	Tor
0U9	XC6101F640MR	Vdet-IC	4.0V±2%, Hst, -MR, -Reset PPO, Wt=1.6s, Rt=400ms	SOT-25	28cp	VD17	6g	Tor
0UA	XC6101F641MR	Vdet-IC	4.1V±2%, Hst, -MR, -Reset PPO, Wt=1.6s, Rt=400ms	SOT-25	28cp	VD17	6g	Tor
0UB	XC6101F642MR	Vdet-IC	4.2V±2%, Hst, -MR, -Reset PPO, Wt=1.6s, Rt=400ms	SOT-25	28cp	VD17	6g	Tor
0UC	XC6101F643MR	Vdet-IC	4.3V±2%, Hst, -MR, -Reset PPO, Wt=1.6s, Rt=400ms	SOT-25	28cp	VD17	6g	Tor
0UD	XC6101F644MR	Vdet-IC	4.4V±2%, Hst, -MR, -Reset PPO, Wt=1.6s, Rt=400ms	SOT-25	28cp	VD17	6g	Tor
0UE	XC6101F645MR	Vdet-IC	4.5V±2%, Hst, -MR, -Reset PPO, Wt=1.6s, Rt=400ms	SOT-25	28cp	VD17	6g	Tor
0UF	XC6101F616MR	Vdet-IC	1.6V±2%, Hst, -MR, -Reset PPO, Wt=1.6s, Rt=400ms	SOT-25	28cp	VD17	6g	Tor
0UF	XC6101F646MR	Vdet-IC	4.6V±2%, Hst, -MR, -Reset PPO, Wt=1.6s, Rt=400ms	SOT-25	28cp	VD17	6g	Tor
0UH	XC6101F617MR	Vdet-IC	1.7V±2%, Hst, -MR, -Reset PPO, Wt=1.6s, Rt=400ms	SOT-25	28cp	VD17	6g	Tor
0UH	XC6101F647MR	Vdet-IC	4.7V±2%, Hst, -MR, -Reset PPO, Wt=1.6s, Rt=400ms	SOT-25	28cp	VD17	6g	Tor
0UK	XC6101F618MR	Vdet-IC	1.8V±2%, Hst, -MR, -Reset PPO, Wt=1.6s, Rt=400ms	SOT-25	28cp	VD17	6g	Tor
0UK	XC6101F648MR	Vdet-IC	4.8V±2%, Hst, -MR, -Reset PPO, Wt=1.6s, Rt=400ms	SOT-25	28cp	VD17	6g	Tor
0UL	XC6101F619MR	Vdet-IC	1.9V±2%, Hst, -MR, -Reset PPO, Wt=1.6s, Rt=400ms	SOT-25	28cp	VD17	6g	Tor
0UL	XC6101F649MR	Vdet-IC	4.9V±2%, Hst, -MR, -Reset PPO, Wt=1.6s, Rt=400ms	SOT-25	28cp	VD17	6g	Tor
0UM	XC6101F620MR	Vdet-IC	2.0V±2%, Hst, -MR, -Reset PPO, Wt=1.6s, Rt=400ms	SOT-25	28cp	VD17	6g	Tor
0UM	XC6101F650MR	Vdet-IC	5.0V±2%, Hst, -MR, -Reset PPO, Wt=1.6s, Rt=400ms	SOT-25	28cp	VD17	6g	Tor
0UN	XC6101F621MR	Vdet-IC	2.1V±2%, Hst, -MR, -Reset PPO, Wt=1.6s, Rt=400ms	SOT-25	28cp	VD17	6g	Tor
0UP	XC6101F622MR	Vdet-IC	2.2V±2%, Hst, -MR, -Reset PPO, Wt=1.6s, Rt=400ms	SOT-25	28cp	VD17	6g	Tor
0UR	XC6101F623MR	Vdet-IC	2.3V±2%, Hst, -MR, -Reset PPO, Wt=1.6s, Rt=400ms	SOT-25	28cp	VD17	6g	Tor
0US	XC6101F624MR	Vdet-IC	2.4V±2%, Hst, -MR, -Reset PPO, Wt=1.6s, Rt=400ms	SOT-25	28cp	VD17	6g	Tor
0UT	XC6101F625MR	Vdet-IC	2.5V±2%, Hst, -MR, -Reset PPO, Wt=1.6s, Rt=400ms	SOT-25	28cp	VD17	6g	Tor
0UU	XC6101F626MR	Vdet-IC	2.6V±2%, Hst, -MR, -Reset PPO, Wt=1.6s, Rt=400ms	SOT-25	28cp	VD17	6g	Tor
0UV	XC6101F627MR	Vdet-IC	2.7V±2%, Hst, -MR, -Reset PPO, Wt=1.6s, Rt=400ms	SOT-25	28cp	VD17	6g	Tor
0UX	XC6101F628MR	Vdet-IC	2.8V±2%, Hst, -MR, -Reset PPO, Wt=1.6s, Rt=400ms	SOT-25	28cp	VD17	6g	Tor
0UY	XC6101F629MR	Vdet-IC	2.9V±2%, Hst, -MR, -Reset PPO, Wt=1.6s, Rt=400ms	SOT-25	28cp	VD17	6g	Tor
0UZ	XC6101F630MR	Vdet-IC	3.0V±2%, Hst, -MR, -Reset PPO, Wt=1.6s, Rt=400ms	SOT-25	28cp	VD17	6g	Tor
0V	BU4336FWE	Vdet-IC	3.6V, +Reset PPO	VSOFF-5	30vka	VD3	6c	Rhm
0V	BU4336G	Vdet-IC	3.6V, +Reset PPO	SSOP-5	28vdo	VD3	6c	Rhm
0V0	XC6101H631MR	Vdet-IC	3.1V±2%, Hst, -MR, -Reset PPO, Wt=1.6s, Rt=1.6s	SOT-25	28cp	VD17	6g	Tor
0V1	XC6101H632MR	Vdet-IC	3.2V±2%, Hst, -MR, -Reset PPO, Wt=1.6s, Rt=1.6s	SOT-25	28cp	VD17	6g	Tor
0V2	XC6101H633MR	Vdet-IC	3.3V±2%, Hst, -MR, -Reset PPO, Wt=1.6s, Rt=1.6s	SOT-25	28cp	VD17	6g	Tor
0V3	XC6101H634MR	Vdet-IC	3.4V±2%, Hst, -MR, -Reset PPO, Wt=1.6s, Rt=1.6s	SOT-25	28cp	VD17	6g	Tor
0V4	XC6101H635MR	Vdet-IC	3.5V±2%, Hst, -MR, -Reset PPO, Wt=1.6s, Rt=1.6s	SOT-25	28cp	VD17	6g	Tor
0V5	XC6101H636MR	Vdet-IC	3.6V±2%, Hst, -MR, -Reset PPO, Wt=1.6s, Rt=1.6s	SOT-25	28cp	VD17	6g	Tor
0V6	XC6101H637MR	Vdet-IC	3.7V±2%, Hst, -MR, -Reset PPO, Wt=1.6s, Rt=1.6s	SOT-25	28cp	VD17	6g	Tor
0V7	XC6210A082MR	LVR-IC	LDO, 0.8V±2%, 700mA, +CE, PDR	SOT-25	28cx	VR4	6g	Tor
0V7	XC6221C081MR	LVR-IC	LDO, 0.8V±20mV, 200mA, +CE, PDR	SOT-25	28cx	VR4	6g	Tor
0V7	XC6101H638MR	Vdet-IC	3.8V±2%, Hst, -MR, -Reset PPO, Wt=1.6s, Rt=1.6s	SOT-25	28cp	VD17	6g	Tor
0V8	XC6210A092MR	LVR-IC	LDO, 0.9V±2%, 700mA, +CE, PDR	SOT-25	28cx	VR4	6g	Tor
0V8	XC6221C091MR	LVR-IC	LDO, 0.9V±20mV, 200mA, +CE, PDR	SOT-25	28cx	VR4	6g	Tor
0V8	XC6101H639MR	Vdet-IC	3.9V±2%, Hst, -MR, -Reset PPO, Wt=1.6s, Rt=1.6s	SOT-25	28cp	VD17	6g	Tor
0V9	XC6210A102MR	LVR-IC	LDO, 1V±2%, 700mA, +CE, PDR	SOT-25	28cx	VR4	6g	Tor
0V9	XC6221C101MR	LVR-IC	LDO, 1V±20mV, 200mA, +CE, PDR	SOT-25	28cx	VR4	6g	Tor
0V9	XC6101H640MR	Vdet-IC	4.0V±2%, Hst, -MR, -Reset PPO, Wt=1.6s, Rt=1.6s	SOT-25	28cp	VD17	6g	Tor
0VA	XC6210A112MR	LVR-IC	LDO, 1.1V±2%, 700mA, +CE, PDR	SOT-25	28cx	VR4	6g	Tor
0VA	XC6221C111MR	LVR-IC	LDO, 1.1V±20mV, 200mA, +CE, PDR	SOT-25	28cx	VR4	6g	Tor
0VA	XC6101H641MR	Vdet-IC	4.1V±2%, Hst, -MR, -Reset PPO, Wt=1.6s, Rt=1.6s	SOT-25	28cp	VD17	6g	Tor
0VB	XC6210A122MR	LVR-IC	LDO, 1.2V±2%, 700mA, +CE, PDR	SOT-25	28cx	VR4	6g	Tor
0VB	XC6221C121MR	LVR-IC	LDO, 1.2V±20mV, 200mA, +CE, PDR	SOT-25	28cx	VR4	6g	Tor
0VB	XC6101H642MR	Vdet-IC	4.2V±2%, Hst, -MR, -Reset PPO, Wt=1.6s, Rt=1.6s	SOT-25	28cp	VD17	6g	Tor
0VC	XC6210A132MR	LVR-IC	LDO, 1.3V±2%, 700mA, +CE, PDR	SOT-25	28cx	VR4	6g	Tor
0VC	XC6221C131MR	LVR-IC	LDO, 1.3V±20mV, 200mA, +CE, PDR	SOT-25	28cx	VR4	6g	Tor
0VC	XC6101H643MR	Vdet-IC	4.3V±2%, Hst, -MR, -Reset PPO, Wt=1.6s, Rt=1.6s	SOT-25	28cp	VD17	6g	Tor
0VD	XC6210A142MR	LVR-IC	LDO, 1.4V±2%, 700mA, +CE, PDR	SOT-25	28cx	VR4	6g	Tor
0VD	XC6221C141MR	LVR-IC	LDO, 1.4V±20mV, 200mA, +CE, PDR	SOT-25	28cx	VR4	6g	Tor
0VD	XC6101H644MR	Vdet-IC	4.4V±2%, Hst, -MR, -Reset PPO, Wt=1.6s, Rt=1.6s	SOT-25	28cp	VD17	6g	Tor
0VE	XC6210A152MR	LVR-IC	LDO, 1.5V±2%, 700mA, +CE, PDR	SOT-25	28cx	VR4	6g	Tor
0VE	XC6221C151MR	LVR-IC	LDO, 1.5V±20mV, 200mA, +CE, PDR	SOT-25	28cx	VR4	6g	Tor
0VE	XC6101H645MR	Vdet-IC	4.5V±2%, Hst, -MR, -Reset PPO, Wt=1.6s, Rt=1.6s	SOT-25	28cp	VD17	6g	Tor



SMD code	Type	Function	Short description	Case	Pinout	Sch.	St.	Mnf.
0VF	XC6210A162MR	LVR-IC	LDO, 1.6V±2%, 700mA, +CE, PDR	SOT-25	28cx	VR4	6g	Tor
0VF	XC6221C161MR	LVR-IC	LDO, 1.6V±20mV, 200mA, +CE, PDR	SOT-25	28cx	VR4	6g	Tor
0VF	XC6101H616MR	Vdet-IC	1.6V±2%, Hst, -MR, -Reset PPO, Wt=1.6s, Rt=1.6s	SOT-25	28cp	VD17	6g	Tor
0VE	XC6101H646MR	Vdet-IC	4.6V±2%, Hst, -MR, -Reset PPO, Wt=1.6s, Rt=1.6s	SOT-25	28cp	VD17	6g	Tor
0VH	XC6210A172MR	LVR-IC	LDO, 1.7V±2%, 700mA, +CE, PDR	SOT-25	28cx	VR4	6g	Tor
0VH	XC6221C171MR	LVR-IC	LDO, 1.7V±20mV, 200mA, +CE, PDR	SOT-25	28cx	VR4	6g	Tor
0VH	XC6101H617MR	Vdet-IC	1.7V±2%, Hst, -MR, -Reset PPO, Wt=1.6s, Rt=1.6s	SOT-25	28cp	VD17	6g	Tor
0VH	XC6101H647MR	Vdet-IC	4.7V±2%, Hst, -MR, -Reset PPO, Wt=1.6s, Rt=1.6s	SOT-25	28cp	VD17	6g	Tor
0VK	XC6210A182MR	LVR-IC	LDO, 1.8V±2%, 700mA, +CE, PDR	SOT-25	28cx	VR4	6g	Tor
0VK	XC6221C181MR	LVR-IC	LDO, 1.8V±20mV, 200mA, +CE, PDR	SOT-25	28cx	VR4	6g	Tor
0VK	XC6101H618MR	Vdet-IC	1.8V±2%, Hst, -MR, -Reset PPO, Wt=1.6s, Rt=1.6s	SOT-25	28cp	VD17	6g	Tor
0VK	XC6101H648MR	Vdet-IC	4.8V±2%, Hst, -MR, -Reset PPO, Wt=1.6s, Rt=1.6s	SOT-25	28cp	VD17	6g	Tor
0VL	XC6210A192MR	LVR-IC	LDO, 1.9V±2%, 700mA, +CE, PDR	SOT-25	28cx	VR4	6g	Tor
0VL	XC6221C191MR	LVR-IC	LDO, 1.9V±20mV, 200mA, +CE, PDR	SOT-25	28cx	VR4	6g	Tor
0VL	XC6101H619MR	Vdet-IC	1.9V±2%, Hst, -MR, -Reset PPO, Wt=1.6s, Rt=1.6s	SOT-25	28cp	VD17	6g	Tor
0VL	XC6101H649MR	Vdet-IC	4.9V±2%, Hst, -MR, -Reset PPO, Wt=1.6s, Rt=1.6s	SOT-25	28cp	VD17	6g	Tor
0VM	XC6210A202MR	LVR-IC	LDO, 2.0V±2%, 700mA, +CE, PDR	SOT-25	28cx	VR4	6g	Tor
0VM	XC6221C201MR	LVR-IC	LDO, 2.0V±1%, 200mA, +CE, PDR	SOT-25	28cx	VR4	6g	Tor
0VM	XC6101H620MR	Vdet-IC	2.0V±2%, Hst, -MR, -Reset PPO, Wt=1.6s, Rt=1.6s	SOT-25	28cp	VD17	6g	Tor
0VM	XC6101H650MR	Vdet-IC	5.0V±2%, Hst, -MR, -Reset PPO, Wt=1.6s, Rt=1.6s	SOT-25	28cp	VD17	6g	Tor
0VN	XC6210A212MR	LVR-IC	LDO, 2.1V±2%, 700mA, +CE, PDR	SOT-25	28cx	VR4	6g	Tor
0VN	XC6221C211MR	LVR-IC	LDO, 2.1V±1%, 200mA, +CE, PDR	SOT-25	28cx	VR4	6g	Tor
0VN	XC6101H621MR	Vdet-IC	2.1V±2%, Hst, -MR, -Reset PPO, Wt=1.6s, Rt=1.6s	SOT-25	28cp	VD17	6g	Tor
0VP	XC6210A222MR	LVR-IC	LDO, 2.2V±2%, 700mA, +CE, PDR	SOT-25	28cx	VR4	6g	Tor
0VP	XC6221C221MR	LVR-IC	LDO, 2.2V±1%, 200mA, +CE, PDR	SOT-25	28cx	VR4	6g	Tor
0VP	XC6101H622MR	Vdet-IC	2.2V±2%, Hst, -MR, -Reset PPO, Wt=1.6s, Rt=1.6s	SOT-25	28cp	VD17	6g	Tor
0VR	XC6210A232MR	LVR-IC	LDO, 2.3V±2%, 700mA, +CE, PDR	SOT-25	28cx	VR4	6g	Tor
0VR	XC6221C231MR	LVR-IC	LDO, 2.3V±1%, 200mA, +CE, PDR	SOT-25	28cx	VR4	6g	Tor
0VR	XC6101H623MR	Vdet-IC	2.3V±2%, Hst, -MR, -Reset PPO, Wt=1.6s, Rt=1.6s	SOT-25	28cp	VD17	6g	Tor
0VS	XC6210A242MR	LVR-IC	LDO, 2.4V±2%, 700mA, +CE, PDR	SOT-25	28cx	VR4	6g	Tor
0VS	XC6221C241MR	LVR-IC	LDO, 2.4V±1%, 200mA, +CE, PDR	SOT-25	28cx	VR4	6g	Tor
0VS	XC6101H624MR	Vdet-IC	2.4V±2%, Hst, -MR, -Reset PPO, Wt=1.6s, Rt=1.6s	SOT-25	28cp	VD17	6g	Tor
0VT	XC6210A252MR	LVR-IC	LDO, 2.5V±2%, 700mA, +CE, PDR	SOT-25	28cx	VR4	6g	Tor
0VT	XC6221C251MR	LVR-IC	LDO, 2.5V±1%, 200mA, +CE, PDR	SOT-25	28cx	VR4	6g	Tor
0VT	XC6101H625MR	Vdet-IC	2.5V±2%, Hst, -MR, -Reset PPO, Wt=1.6s, Rt=1.6s	SOT-25	28cp	VD17	6g	Tor
0VU	XC6210A262MR	LVR-IC	LDO, 2.6V±2%, 700mA, +CE, PDR	SOT-25	28cx	VR4	6g	Tor
0VU	XC6221C261MR	LVR-IC	LDO, 2.6V±1%, 200mA, +CE, PDR	SOT-25	28cx	VR4	6g	Tor
0VU	XC6101H626MR	Vdet-IC	2.6V±2%, Hst, -MR, -Reset PPO, Wt=1.6s, Rt=1.6s	SOT-25	28cp	VD17	6g	Tor
0VV	XC6210A272MR	LVR-IC	LDO, 2.7V±2%, 700mA, +CE, PDR	SOT-25	28cx	VR4	6g	Tor
0VV	XC6221C271MR	LVR-IC	LDO, 2.7V±1%, 200mA, +CE, PDR	SOT-25	28cx	VR4	6g	Tor
0VV	XC6101H627MR	Vdet-IC	2.7V±2%, Hst, -MR, -Reset PPO, Wt=1.6s, Rt=1.6s	SOT-25	28cp	VD17	6g	Tor
0VX	XC6210A282MR	LVR-IC	LDO, 2.8V±2%, 700mA, +CE, PDR	SOT-25	28cx	VR4	6g	Tor
0VX	XC6221C281MR	LVR-IC	LDO, 2.8V±1%, 200mA, +CE, PDR	SOT-25	28cx	VR4	6g	Tor
0VX	XC6101H628MR	Vdet-IC	2.8V±2%, Hst, -MR, -Reset PPO, Wt=1.6s, Rt=1.6s	SOT-25	28cp	VD17	6g	Tor
0VY	XC6210A292MR	LVR-IC	LDO, 2.9V±2%, 700mA, +CE, PDR	SOT-25	28cx	VR4	6g	Tor
0VY	XC6221C291MR	LVR-IC	LDO, 2.9V±1%, 200mA, +CE, PDR	SOT-25	28cx	VR4	6g	Tor
0VY	XC6101H629MR	Vdet-IC	2.9V±2%, Hst, -MR, -Reset PPO, Wt=1.6s, Rt=1.6s	SOT-25	28cp	VD17	6g	Tor
0VZ	XC6210A302MR	LVR-IC	LDO, 3.0V±2%, 700mA, +CE, PDR	SOT-25	28cx	VR4	6g	Tor
0VZ	XC6221C301MR	LVR-IC	LDO, 3.0V±1%, 200mA, +CE, PDR	SOT-25	28cx	VR4	6g	Tor
0VZ	XC6101H630MR	Vdet-IC	3.0V±2%, Hst, -MR, -Reset PPO, Wt=1.6s, Rt=1.6s	SOT-25	28cp	VD17	6g	Tor
0W	BU4337FE	Vdet-IC	3.7V, +Reset PPO	VSOFF-5	30wka	VD3	6c	Rhm
0W	BU4337G	Vdet-IC	3.7V, +Reset PPO	SSOP-5	28vdo	VD3	6c	Rhm
0W	R1210N301C	DC/DC-IC	PWM step-up, 3V, 100kHz	SOT-23-5	28sc	DC3	6g	Ric
0X	BU4338FE	Vdet-IC	3.8V, +Reset PPO	VSOFF-5	30wka	VD3	6c	Rhm
0X	BU4338G	Vdet-IC	3.8V, +Reset PPO	SSOP-5	28vdo	VD3	6c	Rhm
0X	R1210N401C	DC/DC-IC	PWM step-up, 4V, 100kHz	SOT-23-5	28sc	DC3	6g	Ric
0X=	RT9193-36GB	LVR-IC	LDO, 3.6V±1%, 300mA, +CE	SOT-23-5	28wrx	VR7	6g	Rct
0X0	XC6221D311MR	LVR-IC	LDO, 3.1V±1%, 200mA, +CE, CL, PDR	SOT-25	28cx	VR4	6g	Tor
0X7	XC6210B082MR	LVR-IC	LDO, 0.8V±2%, 700mA, +CE	SOT-25	28cx	VR4	6g	Tor
0X7	XC6221D081MR	LVR-IC	LDO, 0.8V±20mV, 200mA, +CE, CL, PDR	SOT-25	28cx	VR4	6g	Tor
0X8	XC6210B092MR	LVR-IC	LDO, 0.9V±2%, 700mA, +CE	SOT-25	28cx	VR4	6g	Tor
0X8	XC6221D091MR	LVR-IC	LDO, 0.9V±20mV, 200mA, +CE, CL, PDR	SOT-25	28cx	VR4	6g	Tor
0X9	XC6210B102MR	LVR-IC	LDO, 1.0V±2%, 700mA, +CE	SOT-25	28cx	VR4	6g	Tor
0X9	XC6221D101MR	LVR-IC	LDO, 1.0V±20mV, 200mA, +CE, CL, PDR	SOT-25	28cx	VR4	6g	Tor
0XA	XC6210B112MR	LVR-IC	LDO, 1.1V±2%, 700mA, +CE	SOT-25	28cx	VR4	6g	Tor
0XA	XC6221D111MR	LVR-IC	LDO, 1.1V±20mV, 200mA, +CE, CL, PDR	SOT-25	28cx	VR4	6g	Tor
0XB	XC6210B122MR	LVR-IC	LDO, 1.2V±2%, 700mA, +CE	SOT-25	28cx	VR4	6g	Tor
0XB	XC6221D121MR	LVR-IC	LDO, 1.2V±20mV, 200mA, +CE, CL, PDR	SOT-25	28cx	VR4	6g	Tor
0XC	XC6210B132MR	LVR-IC	LDO, 1.3V±2%, 700mA, +CE	SOT-25	28cx	VR4	6g	Tor
0XC	XC6221D131MR	LVR-IC	LDO, 1.3V±20mV, 200mA, +CE, CL, PDR	SOT-25	28cx	VR4	6g	Tor



SMD code	Type	Function	Short description	Case	Pinout	Sch.	St.	Mnf.
0XD	XC6210B142MR	LVR-IC	LDO, 1.4V±2%, 700mA, +CE	SOT-25	28cx	VR4	6g	Tor
0XD	XC6221D141MR	LVR-IC	LDO, 1.4V±20mV, 200mA, +CE, CL, PDR	SOT-25	28cx	VR4	6g	Tor
0XE	XC6210B152MR	LVR-IC	LDO, 1.5V±2%, 700mA, +CE	SOT-25	28cx	VR4	6g	Tor
0XE	XC6221D151MR	LVR-IC	LDO, 1.5V±20mV, 200mA, +CE, CL, PDR	SOT-25	28cx	VR4	6g	Tor
0XF	XC6210B162MR	LVR-IC	LDO, 1.6V±2%, 700mA, +CE	SOT-25	28cx	VR4	6g	Tor
0XF	XC6221D161MR	LVR-IC	LDO, 1.6V±20mV, 200mA, +CE, CL, PDR	SOT-25	28cx	VR4	6g	Tor
0XH	XC6210B172MR	LVR-IC	LDO, 1.7V±2%, 700mA, +CE	SOT-25	28cx	VR4	6g	Tor
0XH	XC6221D171MR	LVR-IC	LDO, 1.7V±20mV, 200mA, +CE, CL, PDR	SOT-25	28cx	VR4	6g	Tor
0XK	XC6210B182MR	LVR-IC	LDO, 1.8V±2%, 700mA, +CE	SOT-25	28cx	VR4	6g	Tor
0XK	XC6221D181MR	LVR-IC	LDO, 1.8V±20mV, 200mA, +CE, CL, PDR	SOT-25	28cx	VR4	6g	Tor
0XL	XC6210B192MR	LVR-IC	LDO, 1.9V±2%, 700mA, +CE	SOT-25	28cx	VR4	6g	Tor
0XL	XC6221D191MR	LVR-IC	LDO, 1.9V±20mV, 200mA, +CE, CL, PDR	SOT-25	28cx	VR4	6g	Tor
0XM	XC6210B202MR	LVR-IC	LDO, 2V±2%, 700mA, +CE	SOT-25	28cx	VR4	6g	Tor
0XM	XC6221D201MR	LVR-IC	LDO, 2V±1%, 200mA, +CE, CL, PDR	SOT-25	28cx	VR4	6g	Tor
0XN	XC6210B212MR	LVR-IC	LDO, 2.1V±2%, 700mA, +CE	SOT-25	28cx	VR4	6g	Tor
0XN	XC6221D211MR	LVR-IC	LDO, 2.1V±1%, 200mA, +CE, CL, PDR	SOT-25	28cx	VR4	6g	Tor
0XP	XC6210B222MR	LVR-IC	LDO, 2.2V±2%, 700mA, +CE	SOT-25	28cx	VR4	6g	Tor
0XP	XC6221D221MR	LVR-IC	LDO, 2.2V±1%, 200mA, +CE, CL, PDR	SOT-25	28cx	VR4	6g	Tor
0XR	XC6210B232MR	LVR-IC	LDO, 2.3V±2%, 700mA, +CE	SOT-25	28cx	VR4	6g	Tor
0XR	XC6221D231MR	LVR-IC	LDO, 2.3V±1%, 200mA, +CE, CL, PDR	SOT-25	28cx	VR4	6g	Tor
0XS	XC6210B242MR	LVR-IC	LDO, 2.4V±2%, 700mA, +CE	SOT-25	28cx	VR4	6g	Tor
0XS	XC6221D241MR	LVR-IC	LDO, 2.4V±1%, 200mA, +CE, CL, PDR	SOT-25	28cx	VR4	6g	Tor
0XT	XC6210B252MR	LVR-IC	LDO, 2.5V±2%, 700mA, +CE	SOT-25	28cx	VR4	6g	Tor
0XT	XC6221D251MR	LVR-IC	LDO, 2.5V±1%, 200mA, +CE, CL, PDR	SOT-25	28cx	VR4	6g	Tor
0XU	XC6210B262MR	LVR-IC	LDO, 2.6V±2%, 700mA, +CE	SOT-25	28cx	VR4	6g	Tor
0XU	XC6221D261MR	LVR-IC	LDO, 2.6V±1%, 200mA, +CE, CL, PDR	SOT-25	28cx	VR4	6g	Tor
0XV	XC6210B272MR	LVR-IC	LDO, 2.7V±2%, 700mA, +CE	SOT-25	28cx	VR4	6g	Tor
0XV	XC6221D271MR	LVR-IC	LDO, 2.7V±1%, 200mA, +CE, CL, PDR	SOT-25	28cx	VR4	6g	Tor
0XX	XC6210B282MR	LVR-IC	LDO, 2.8V±2%, 700mA, +CE	SOT-25	28cx	VR4	6g	Tor
0XX	XC6221D281MR	LVR-IC	LDO, 2.8V±1%, 200mA, +CE, CL, PDR	SOT-25	28cx	VR4	6g	Tor
0XY	XC6210B292MR	LVR-IC	LDO, 2.9V±2%, 700mA, +CE	SOT-25	28cx	VR4	6g	Tor
0XY	XC6221D291MR	LVR-IC	LDO, 2.9V±1%, 200mA, +CE, CL, PDR	SOT-25	28cx	VR4	6g	Tor
0XZ	XC6210B302MR	LVR-IC	LDO, 3V±2%, 700mA, +CE	SOT-25	28cx	VR4	6g	Tor
0XZ	XC6221D301MR	LVR-IC	LDO, 3V±1%, 200mA, +CE, CL, PDR	SOT-25	28cx	VR4	6g	Tor
0Y	BU4339FWE	Vdet-IC	3.9V, +Reset PPO	VSOF-5	30vka	VD3	6c	Rhm
0Y	BU4339G	Vdet-IC	3.9V, +Reset PPO	SSOP-5	28vdo	VD3	6c	Rhm
0Y	R12N1501C	DC/DC-IC	PWM step-up, 5V, 100kHz	SOT-23-5	28sc	DC3	6g	Ric
0Y7	XC6210C082MR	LVR-IC	LDO, 0.8V±2%, 700mA, -CE, PDR	SOT-25	28cx	VR4	6g	Tor
0Y8	XC6210C092MR	LVR-IC	LDO, 0.9V±2%, 700mA, -CE, PDR	SOT-25	28cx	VR4	6g	Tor
0Y9	XC6210C102MR	LVR-IC	LDO, 1V±2%, 700mA, -CE, PDR	SOT-25	28cx	VR4	6g	Tor
0YA	XC6210C112MR	LVR-IC	LDO, 1.1V±2%, 700mA, -CE, PDR	SOT-25	28cx	VR4	6g	Tor
0YB	XC6210C122MR	LVR-IC	LDO, 1.2V±2%, 700mA, -CE, PDR	SOT-25	28cx	VR4	6g	Tor
0YC	XC6210C132MR	LVR-IC	LDO, 1.3V±2%, 700mA, -CE, PDR	SOT-25	28cx	VR4	6g	Tor
0YD	XC6210C142MR	LVR-IC	LDO, 1.4V±2%, 700mA, -CE, PDR	SOT-25	28cx	VR4	6g	Tor
0YE	XC6210C152MR	LVR-IC	LDO, 1.5V±2%, 700mA, -CE, PDR	SOT-25	28cx	VR4	6g	Tor
0YF	XC6210C162MR	LVR-IC	LDO, 1.6V±2%, 700mA, -CE, PDR	SOT-25	28cx	VR4	6g	Tor
0YH	XC6210C172MR	LVR-IC	LDO, 1.7V±2%, 700mA, -CE, PDR	SOT-25	28cx	VR4	6g	Tor
0YK	XC6210C182MR	LVR-IC	LDO, 1.8V±2%, 700mA, -CE, PDR	SOT-25	28cx	VR4	6g	Tor
0YL	XC6210C192MR	LVR-IC	LDO, 1.9V±2%, 700mA, -CE, PDR	SOT-25	28cx	VR4	6g	Tor
0YM	XC6210C202MR	LVR-IC	LDO, 2V±2%, 700mA, -CE, PDR	SOT-25	28cx	VR4	6g	Tor
0YN	XC6210C212MR	LVR-IC	LDO, 2.1V±2%, 700mA, -CE, PDR	SOT-25	28cx	VR4	6g	Tor
0YP	XC6210C222MR	LVR-IC	LDO, 2.2V±2%, 700mA, -CE, PDR	SOT-25	28cx	VR4	6g	Tor
0YR	XC6210C232MR	LVR-IC	LDO, 2.3V±2%, 700mA, -CE, PDR	SOT-25	28cx	VR4	6g	Tor
0YS	XC6210C242MR	LVR-IC	LDO, 2.4V±2%, 700mA, -CE, PDR	SOT-25	28cx	VR4	6g	Tor
0YT	XC6210C252MR	LVR-IC	LDO, 2.5V±2%, 700mA, -CE, PDR	SOT-25	28cx	VR4	6g	Tor
0YU	XC6210C262MR	LVR-IC	LDO, 2.6V±2%, 700mA, -CE, PDR	SOT-25	28cx	VR4	6g	Tor
0YV	XC6210C272MR	LVR-IC	LDO, 2.7V±2%, 700mA, -CE, PDR	SOT-25	28cx	VR4	6g	Tor
0YX	XC6210C282MR	LVR-IC	LDO, 2.8V±2%, 700mA, -CE, PDR	SOT-25	28cx	VR4	6g	Tor
0YY	XC6210C292MR	LVR-IC	LDO, 2.9V±2%, 700mA, -CE, PDR	SOT-25	28cx	VR4	6g	Tor
0YZ	XC6210C302MR	LVR-IC	LDO, 3V±2%, 700mA, -CE, PDR	SOT-25	28cx	VR4	6g	Tor
0Z	BU4340FWE	Vdet-IC	4V, +Reset PPO	VSOF-5	30vka	VD3	6c	Rhm
0Z	BU4340G	Vdet-IC	4V, +Reset PPO	SSOP-5	28vdo	VD3	6c	Rhm
0Z0	XC6210D102MR	LVR-IC	LDO, 1V±2%, 700mA, -CE	SOT-25	28cx	VR4	6g	Tor
0Z7	XC6210D082MR	LVR-IC	LDO, 0.8V±2%, 700mA, -CE	SOT-25	28cx	VR4	6g	Tor
0Z8	XC6210D092MR	LVR-IC	LDO, 0.9V±2%, 700mA, -CE	SOT-25	28cx	VR4	6g	Tor
0ZA	XC6210D112MR	LVR-IC	LDO, 1.1V±2%, 700mA, -CE	SOT-25	28cx	VR4	6g	Tor
0ZB	XC6210D122MR	LVR-IC	LDO, 1.2V±2%, 700mA, -CE	SOT-25	28cx	VR4	6g	Tor
0ZC	XC6210D132MR	LVR-IC	LDO, 1.3V±2%, 700mA, -CE	SOT-25	28cx	VR4	6g	Tor
0ZD	XC6210D142MR	LVR-IC	LDO, 1.4V±2%, 700mA, -CE	SOT-25	28cx	VR4	6g	Tor
0ZE	XC6210D152MR	LVR-IC	LDO, 1.5V±2%, 700mA, -CE	SOT-25	28cx	VR4	6g	Tor



SMD code	Type	Function	Short description	Case	Pinout	Sch.	St.	Mnf.
02F	XC6210D162MR	LVR-IC	LDO, 1.6V±2%, 700mA, -CE	SOT-25	28cx	VR4	6g	Tor
02H	XC6210D172MR	LVR-IC	LDO, 1.7V±2%, 700mA, -CE	SOT-25	28cx	VR4	6g	Tor
02K	XC6210D182MR	LVR-IC	LDO, 1.8V±2%, 700mA, -CE	SOT-25	28cx	VR4	6g	Tor
02L	XC6210D192MR	LVR-IC	LDO, 1.9V±2%, 700mA, -CE	SOT-25	28cx	VR4	6g	Tor
02M	XC6210D202MR	LVR-IC	LDO, 2.0V±2%, 700mA, -CE	SOT-25	28cx	VR4	6g	Tor
02N	XC6210D212MR	LVR-IC	LDO, 2.1V±2%, 700mA, -CE	SOT-25	28cx	VR4	6g	Tor
02P	XC6210D222MR	LVR-IC	LDO, 2.2V±2%, 700mA, -CE	SOT-25	28cx	VR4	6g	Tor
02R	XC6210D232MR	LVR-IC	LDO, 2.3V±2%, 700mA, -CE	SOT-25	28cx	VR4	6g	Tor
02S	XC6210D242MR	LVR-IC	LDO, 2.4V±2%, 700mA, -CE	SOT-25	28cx	VR4	6g	Tor
02T	XC6210D252MR	LVR-IC	LDO, 2.5V±2%, 700mA, -CE	SOT-25	28cx	VR4	6g	Tor
02U	XC6210D262MR	LVR-IC	LDO, 2.6V±2%, 700mA, -CE	SOT-25	28cx	VR4	6g	Tor
02V	XC6210D272MR	LVR-IC	LDO, 2.7V±2%, 700mA, -CE	SOT-25	28cx	VR4	6g	Tor
02X	XC6210D282MR	LVR-IC	LDO, 2.8V±2%, 700mA, -CE	SOT-25	28cx	VR4	6g	Tor
02Y	XC6210D292MR	LVR-IC	LDO, 2.9V±2%, 700mA, -CE	SOT-25	28cx	VR4	6g	Tor
02Z	XC6210D302MR	LVR-IC	LDO, 3.0V±2%, 700mA, -CE	SOT-25	28cx	VR4	6g	Tor
10	R1223N302D	DC/DC-IC	PWM step-down, +CE, 3V, 500kHz, Latch-Pr.	SOT-23-5	28ud	DC7	6g	Ric
10	RN5RF60BA	LVR-IC	LRIp, +CE, 6V±2%, 1A*	SOT-23-5	28vw	VR6	6g	Ric
10	RN5RZ60BA	LVR-IC	LDO, LN, +CE, 6V±2%, 100mA	SOT-23-5	28vrt	VR4	6g	Ric
100	XC6102A131MR	Vdet-IC	3.1V±2%, Hst, -MR, -Reset ODO, Wt=6.25ms, Rt=3.13ms	SOT-25	28cp	VD16	6g	Tor
101	XC6102A132MR	Vdet-IC	3.2V±2%, Hst, -MR, -Reset ODO, Wt=6.25ms, Rt=3.13ms	SOT-25	28cp	VD16	6g	Tor
102	XC6102A133MR	Vdet-IC	3.3V±2%, Hst, -MR, -Reset ODO, Wt=6.25ms, Rt=3.13ms	SOT-25	28cp	VD16	6g	Tor
103	XC6102A134MR	Vdet-IC	3.4V±2%, Hst, -MR, -Reset ODO, Wt=6.25ms, Rt=3.13ms	SOT-25	28cp	VD16	6g	Tor
104	XC6102A135MR	Vdet-IC	3.5V±2%, Hst, -MR, -Reset ODO, Wt=6.25ms, Rt=3.13ms	SOT-25	28cp	VD16	6g	Tor
105	XC6102A136MR	Vdet-IC	3.6V±2%, Hst, -MR, -Reset ODO, Wt=6.25ms, Rt=3.13ms	SOT-25	28cp	VD16	6g	Tor
106	XC6102A137MR	Vdet-IC	3.7V±2%, Hst, -MR, -Reset ODO, Wt=6.25ms, Rt=3.13ms	SOT-25	28cp	VD16	6g	Tor
107	XC6102A138MR	Vdet-IC	3.8V±2%, Hst, -MR, -Reset ODO, Wt=6.25ms, Rt=3.13ms	SOT-25	28cp	VD16	6g	Tor
108	R1160N081B	LVR-IC	LDO, 0.8V±2%, 200mA, +CE, AE(Mode)	SOT-23-5	28x9	VR10	6g	Ric
108	XC6102A139MR	Vdet-IC	3.9V±2%, Hst, -MR, -Reset ODO, Wt=6.25ms, Rt=3.13ms	SOT-25	28cp	VD16	6g	Tor
109	R1160N091B	LVR-IC	LDO, 0.9V±2%, 200mA, +CE, AE(Mode)	SOT-23-5	28x9	VR10	6g	Ric
109	XC6102A140MR	Vdet-IC	4.0V±2%, Hst, -MR, -Reset ODO, Wt=6.25ms, Rt=3.13ms	SOT-25	28cp	VD16	6g	Tor
10A	XC6102A141MR	Vdet-IC	4.1V±2%, Hst, -MR, -Reset ODO, Wt=6.25ms, Rt=3.13ms	SOT-25	28cp	VD16	6g	Tor
10B	XC6102A142MR	Vdet-IC	4.2V±2%, Hst, -MR, -Reset ODO, Wt=6.25ms, Rt=3.13ms	SOT-25	28cp	VD16	6g	Tor
10C	XC6102A143MR	Vdet-IC	4.3V±2%, Hst, -MR, -Reset ODO, Wt=6.25ms, Rt=3.13ms	SOT-25	28cp	VD16	6g	Tor
10D	XC6102A144MR	Vdet-IC	4.4V±2%, Hst, -MR, -Reset ODO, Wt=6.25ms, Rt=3.13ms	SOT-25	28cp	VD16	6g	Tor
10E	XC6102A145MR	Vdet-IC	4.5V±2%, Hst, -MR, -Reset ODO, Wt=6.25ms, Rt=3.13ms	SOT-25	28cp	VD16	6g	Tor
10F	XC6102A116MR	Vdet-IC	1.6V±2%, Hst, -MR, -Reset ODO, Wt=6.25ms, Rt=3.13ms	SOT-25	28cp	VD16	6g	Tor
10E	XC6102A146MR	Vdet-IC	4.6V±2%, Hst, -MR, -Reset ODO, Wt=6.25ms, Rt=3.13ms	SOT-25	28cp	VD16	6g	Tor
10H	XC6102A117MR	Vdet-IC	1.7V±2%, Hst, -MR, -Reset ODO, Wt=6.25ms, Rt=3.13ms	SOT-25	28cp	VD16	6g	Tor
10H	XC6102A147MR	Vdet-IC	4.7V±2%, Hst, -MR, -Reset ODO, Wt=6.25ms, Rt=3.13ms	SOT-25	28cp	VD16	6g	Tor
10K	XC6102A118MR	Vdet-IC	1.8V±2%, Hst, -MR, -Reset ODO, Wt=6.25ms, Rt=3.13ms	SOT-25	28cp	VD16	6g	Tor
10K	XC6102A148MR	Vdet-IC	4.8V±2%, Hst, -MR, -Reset ODO, Wt=6.25ms, Rt=3.13ms	SOT-25	28cp	VD16	6g	Tor
10L	XC6102A119MR	Vdet-IC	1.9V±2%, Hst, -MR, -Reset ODO, Wt=6.25ms, Rt=3.13ms	SOT-25	28cp	VD16	6g	Tor
10L	XC6102A149MR	Vdet-IC	4.9V±2%, Hst, -MR, -Reset ODO, Wt=6.25ms, Rt=3.13ms	SOT-25	28cp	VD16	6g	Tor
10M	XC6102A120MR	Vdet-IC	2.0V±2%, Hst, -MR, -Reset ODO, Wt=6.25ms, Rt=3.13ms	SOT-25	28cp	VD16	6g	Tor
10M	XC6102A150MR	Vdet-IC	5.0V±2%, Hst, -MR, -Reset ODO, Wt=6.25ms, Rt=3.13ms	SOT-25	28cp	VD16	6g	Tor
10N	XC6102A121MR	Vdet-IC	2.1V±2%, Hst, -MR, -Reset ODO, Wt=6.25ms, Rt=3.13ms	SOT-25	28cp	VD16	6g	Tor
10P	XC6102A122MR	Vdet-IC	2.2V±2%, Hst, -MR, -Reset ODO, Wt=6.25ms, Rt=3.13ms	SOT-25	28cp	VD16	6g	Tor
10R	XC6102A123MR	Vdet-IC	2.3V±2%, Hst, -MR, -Reset ODO, Wt=6.25ms, Rt=3.13ms	SOT-25	28cp	VD16	6g	Tor
10S	XC6102A124MR	Vdet-IC	2.4V±2%, Hst, -MR, -Reset ODO, Wt=6.25ms, Rt=3.13ms	SOT-25	28cp	VD16	6g	Tor
10T	XC6102A125MR	Vdet-IC	2.5V±2%, Hst, -MR, -Reset ODO, Wt=6.25ms, Rt=3.13ms	SOT-25	28cp	VD16	6g	Tor
10U	XC6102A126MR	Vdet-IC	2.6V±2%, Hst, -MR, -Reset ODO, Wt=6.25ms, Rt=3.13ms	SOT-25	28cp	VD16	6g	Tor
10V	XC6102A127MR	Vdet-IC	2.7V±2%, Hst, -MR, -Reset ODO, Wt=6.25ms, Rt=3.13ms	SOT-25	28cp	VD16	6g	Tor
10X	XC6102A128MR	Vdet-IC	2.8V±2%, Hst, -MR, -Reset ODO, Wt=6.25ms, Rt=3.13ms	SOT-25	28cp	VD16	6g	Tor
10Y	XC6102A129MR	Vdet-IC	2.9V±2%, Hst, -MR, -Reset ODO, Wt=6.25ms, Rt=3.13ms	SOT-25	28cp	VD16	6g	Tor
10Z	MAZL100H	SA-Z-diode	Quad, 10V, 5mA, 200mW	SC-74A	28bc	-	6a	Pan
10Z	MAZM100H	SA-Z-diode	Quad, 10V, 5mA, 150mW	SSMini5	30bc	-	6a	Pan
10Z	MAZZ100H	SA-Z-diode	Quad, 10V, 5mA, 200mW	SIMini5	30bc	-	6a	Pan
10Z	XC6102A130MR	Vdet-IC	3.0V±2%, Hst, -MR, -Reset ODO, Wt=6.25ms, Rt=3.13ms	SOT-25	28cp	VD16	6g	Tor
11	BU4S11G2	CMOS-Logic	2-input NAND gate	SSOP-5	28/Log1	-	6c	Rhm
11	R1223N332D	DC/DC-IC	PWM step-down, +CE, 3.3V, 500kHz, Latch-Pr.	SOT-23-5	28ud	DC7	6g	Ric
110	R1160N101B	LVR-IC	LDO, 1V±2%, 200mA, +CE, AE(Mode)	SOT-23-5	28x9	VR10	6g	Ric
110	XC6102A231MR	Vdet-IC	3.1V±2%, Hst, -MR, -Reset ODO, Wt=50ms, Rt=3.13ms	SOT-25	28cp	VD16	6g	Tor
111	R1160N111B	LVR-IC	LDO, 1.1V±2%, 200mA, +CE, AE(Mode)	SOT-23-5	28x9	VR10	6g	Ric
111	XC6102A232MR	Vdet-IC	3.2V±2%, Hst, -MR, -Reset ODO, Wt=50ms, Rt=3.13ms	SOT-25	28cp	VD16	6g	Tor
112	R1160N121B	LVR-IC	LDO, 1.2V±2%, 200mA, +CE, AE(Mode)	SOT-23-5	28x9	VR10	6g	Ric
112	XC6102A233MR	Vdet-IC	3.3V±2%, Hst, -MR, -Reset ODO, Wt=50ms, Rt=3.13ms	SOT-25	28cp	VD16	6g	Tor
113	R1160N131B	LVR-IC	LDO, 1.3V±2%, 200mA, +CE, AE(Mode)	SOT-23-5	28x9	VR10	6g	Ric
113	XC6102A234MR	Vdet-IC	3.4V±2%, Hst, -MR, -Reset ODO, Wt=50ms, Rt=3.13ms	SOT-25	28cp	VD16	6g	Tor
114	R1160N141B	LVR-IC	LDO, 1.4V±2%, 200mA, +CE, AE(Mode)	SOT-23-5	28x9	VR10	6g	Ric
114	XC6102A235MR	Vdet-IC	3.5V±2%, Hst, -MR, -Reset ODO, Wt=50ms, Rt=3.13ms	SOT-25	28cp	VD16	6g	Tor



SMD code	Type	Function	Short description	Case	Pinout	Sch.	St.	Mnf.
115	R1116N151D	LVR-IC	LDO, LN, +CE, CL, 1.5V±1.5%, 150mA	SOT-23-5	28cx	VR4	6g	Ric
115	R1160N151B	LVR-IC	LDO, 1.5V±2%, 200mA, +CE, AE(Mode)	SOT-23-5	28x9	VR10	6g	Ric
115	XC6102A236MR	Vdet-IC	3.6V±2%, Hst, -MR, -Reset ODO, Wt=50ms, Rt=3.13ms	SOT-25	28cp	VD16	6g	Tor
116	R1116N161D	LVR-IC	LDO, LN, +CE, CL, 1.6V±1.5%, 150mA	SOT-23-5	28cx	VR4	6g	Ric
116	R1160N161B	LVR-IC	LDO, 1.6V±2%, 200mA, +CE, AE(Mode)	SOT-23-5	28x9	VR10	6g	Ric
116	XC6102A237MR	Vdet-IC	3.7V±2%, Hst, -MR, -Reset ODO, Wt=50ms, Rt=3.13ms	SOT-25	28cp	VD16	6g	Tor
117	R1116N171D	LVR-IC	LDO, LN, +CE, CL, 1.7V±1.5%, 150mA	SOT-23-5	28cx	VR4	6g	Ric
117	R1160N171B	LVR-IC	LDO, 1.7V±2%, 200mA, +CE, AE(Mode)	SOT-23-5	28x9	VR10	6g	Ric
117	XC6102A238MR	Vdet-IC	3.8V±2%, Hst, -MR, -Reset ODO, Wt=50ms, Rt=3.13ms	SOT-25	28cp	VD16	6g	Tor
118	R1116N181D	LVR-IC	LDO, LN, +CE, CL, 1.8V±1.5%, 150mA	SOT-23-5	28cx	VR4	6g	Ric
118	R1160N181B	LVR-IC	LDO, 1.8V±2%, 200mA, +CE, AE(Mode)	SOT-23-5	28x9	VR10	6g	Ric
118	XC6102A239MR	Vdet-IC	3.9V±2%, Hst, -MR, -Reset ODO, Wt=50ms, Rt=3.13ms	SOT-25	28cp	VD16	6g	Tor
118A	AAT60118A-S5	Vdet-IC	1.8V±2%, +Reset ODO	SOT-23-5	28vda	VD6	6g	Aat
118B	AAT60118B-S5	Vdet-IC	1.8V±2%, +Reset PPO	SOT-23-5	28vda	VD7	6g	Aat
118C	AAT60118C-S5	Vdet-IC	1.8V±2%, -Reset ODO	SOT-23-5	28vda	VD6	6g	Aat
118D	AAT60118D-S5	Vdet-IC	1.8V±2%, -Reset PPO	SOT-23-5	28vda	VD7	6g	Aat
119	R1116N191D	LVR-IC	LDO, LN, +CE, CL, 1.9V±1.5%, 150mA	SOT-23-5	28cx	VR4	6g	Ric
119	R1160N191B	LVR-IC	LDO, 1.9V±2%, 200mA, +CE, AE(Mode)	SOT-23-5	28x9	VR10	6g	Ric
119	XC6102A240MR	Vdet-IC	4.0V±2%, Hst, -MR, -Reset ODO, Wt=50ms, Rt=3.13ms	SOT-25	28cp	VD16	6g	Tor
119A	AAT60119A-S5	Vdet-IC	1.9V±2%, +Reset ODO	SOT-23-5	28vda	VD6	6g	Aat
119B	AAT60119B-S5	Vdet-IC	1.9V±2%, +Reset PPO	SOT-23-5	28vda	VD7	6g	Aat
119C	AAT60119C-S5	Vdet-IC	1.9V±2%, -Reset ODO	SOT-23-5	28vda	VD6	6g	Aat
119D	AAT60119D-S5	Vdet-IC	1.9V±2%, -Reset PPO	SOT-23-5	28vda	VD6	6g	Aat
11A	APR3011-15B	Vdet-IC	1.5V, -Reset PPO	SOT-23-5	28vdg	VD7	6k	Anp
11A	XC6102A241MR	Vdet-IC	4.1V±2%, Hst, -MR, -Reset ODO, Wt=50ms, Rt=3.13ms	SOT-25	28cp	VD16	6g	Tor
11B	APR3011-17B	Vdet-IC	1.75V, -Reset PPO	SOT-23-5	28vdg	VD7	6k	Anp
11B	XC6102A242MR	Vdet-IC	4.2V±2%, Hst, -MR, -Reset ODO, Wt=50ms, Rt=3.13ms	SOT-25	28cp	VD16	6g	Tor
11C	APR3011-23B	Vdet-IC	2.32V, -Reset PPO	SOT-23-5	28vdg	VD7	6k	Anp
11C	R1182N121D	LVR-IC	LDO, 1.2V±2%, 150mA, +CE, CL	SOT-23-5	28vrt	VR4	6g	Ric
11C	XC6102A243MR	Vdet-IC	4.3V±2%, Hst, -MR, -Reset ODO, Wt=50ms, Rt=3.13ms	SOT-25	28cp	VD16	6g	Tor
11D	APR3011-26B	Vdet-IC	2.63V, -Reset PPO	SOT-23-5	28vdg	VD7	6k	Anp
11D	R1182N131D	LVR-IC	LDO, 1.3V±2%, 150mA, +CE, CL	SOT-23-5	28vrt	VR4	6g	Ric
11D	XC6102A244MR	Vdet-IC	4.4V±2%, Hst, -MR, -Reset ODO, Wt=50ms, Rt=3.13ms	SOT-25	28cp	VD16	6g	Tor
11E	APR3011-29B	Vdet-IC	2.93V, -Reset PPO	SOT-23-5	28vdg	VD7	6k	Anp
11E	R1182N141D	LVR-IC	LDO, 1.4V±2%, 150mA, +CE, CL	SOT-23-5	28vrt	VR4	6g	Ric
11E	XC6102A245MR	Vdet-IC	4.5V±2%, Hst, -MR, -Reset ODO, Wt=50ms, Rt=3.13ms	SOT-25	28cp	VD16	6g	Tor
11F	APR3011-30B	Vdet-IC	3.08V, -Reset PPO	SOT-23-5	28vdg	VD7	6k	Anp
11F	R1182N151D	LVR-IC	LDO, 1.5V±2%, 150mA, +CE, CL	SOT-23-5	28vrt	VR4	6g	Ric
11F	XC6102A216MR	Vdet-IC	1.6V±2%, Hst, -MR, -Reset ODO, Wt=50ms, Rt=3.13ms	SOT-25	28cp	VD16	6g	Tor
11F	XC6102A246MR	Vdet-IC	4.6V±2%, Hst, -MR, -Reset ODO, Wt=50ms, Rt=3.13ms	SOT-25	28cp	VD16	6g	Tor
11G	APR3011-39B	Vdet-IC	3.9V, -Reset PPO	SOT-23-5	28vdg	VD7	6k	Anp
11G	R1182N161D	LVR-IC	LDO, 1.6V±2%, 150mA, +CE, CL	SOT-23-5	28vrt	VR4	6g	Ric
11H	APR3011-43B	Vdet-IC	4.38V, -Reset PPO	SOT-23-5	28vdg	VD7	6k	Anp
11H	R1182N171D	LVR-IC	LDO, 1.7V±2%, 150mA, +CE, CL	SOT-23-5	28vrt	VR4	6g	Ric
11H	XC6102A217MR	Vdet-IC	1.7V±2%, Hst, -MR, -Reset ODO, Wt=50ms, Rt=3.13ms	SOT-25	28cp	VD16	6g	Tor
11H	XC6102A247MR	Vdet-IC	4.7V±2%, Hst, -MR, -Reset ODO, Wt=50ms, Rt=3.13ms	SOT-25	28cp	VD16	6g	Tor
11J	APR3011-46B	Vdet-IC	4.63V, -Reset PPO	SOT-23-5	28vdg	VD7	6k	Anp
11J	R1182N181D	LVR-IC	LDO, 1.8V±2%, 150mA, +CE, CL	SOT-23-5	28vrt	VR4	6g	Ric
11K	R1182N191D	LVR-IC	LDO, 1.9V±2%, 150mA, +CE, CL	SOT-23-5	28vrt	VR4	6g	Ric
11K	XC6102A218MR	Vdet-IC	1.8V±2%, Hst, -MR, -Reset ODO, Wt=50ms, Rt=3.13ms	SOT-25	28cp	VD16	6g	Tor
11K	XC6102A248MR	Vdet-IC	4.8V±2%, Hst, -MR, -Reset ODO, Wt=50ms, Rt=3.13ms	SOT-25	28cp	VD16	6g	Tor
11L	XC6102A219MR	Vdet-IC	1.9V±2%, Hst, -MR, -Reset ODO, Wt=50ms, Rt=3.13ms	SOT-25	28cp	VD16	6g	Tor
11L	XC6102A249MR	Vdet-IC	4.9V±2%, Hst, -MR, -Reset ODO, Wt=50ms, Rt=3.13ms	SOT-25	28cp	VD16	6g	Tor
11M	XC6102A220MR	Vdet-IC	2.0V±2%, Hst, -MR, -Reset ODO, Wt=50ms, Rt=3.13ms	SOT-25	28cp	VD16	6g	Tor
11M	XC6102A250MR	Vdet-IC	5.0V±2%, Hst, -MR, -Reset ODO, Wt=50ms, Rt=3.13ms	SOT-25	28cp	VD16	6g	Tor
11N	XC6102A221MR	Vdet-IC	2.1V±2%, Hst, -MR, -Reset ODO, Wt=50ms, Rt=3.13ms	SOT-25	28cp	VD16	6g	Tor
11P	XC6102A222MR	Vdet-IC	2.2V±2%, Hst, -MR, -Reset ODO, Wt=50ms, Rt=3.13ms	SOT-25	28cp	VD16	6g	Tor
11R	XC6102A223MR	Vdet-IC	2.3V±2%, Hst, -MR, -Reset ODO, Wt=50ms, Rt=3.13ms	SOT-25	28cp	VD16	6g	Tor
11S	XC6102A224MR	Vdet-IC	2.4V±2%, Hst, -MR, -Reset ODO, Wt=50ms, Rt=3.13ms	SOT-25	28cp	VD16	6g	Tor
11T	XC6102A225MR	Vdet-IC	2.5V±2%, Hst, -MR, -Reset ODO, Wt=50ms, Rt=3.13ms	SOT-25	28cp	VD16	6g	Tor
11U	XC6102A226MR	Vdet-IC	2.6V±2%, Hst, -MR, -Reset ODO, Wt=50ms, Rt=3.13ms	SOT-25	28cp	VD16	6g	Tor
11V	XC6102A227MR	Vdet-IC	2.7V±2%, Hst, -MR, -Reset ODO, Wt=50ms, Rt=3.13ms	SOT-25	28cp	VD16	6g	Tor
11X	XC6102A228MR	Vdet-IC	2.8V±2%, Hst, -MR, -Reset ODO, Wt=50ms, Rt=3.13ms	SOT-25	28cp	VD16	6g	Tor
11Y	XC6102A229MR	Vdet-IC	2.9V±2%, Hst, -MR, -Reset ODO, Wt=50ms, Rt=3.13ms	SOT-25	28cp	VD16	6g	Tor
11Z	XC6102A230MR	Vdet-IC	3.0V±2%, Hst, -MR, -Reset ODO, Wt=50ms, Rt=3.13ms	SOT-25	28cp	VD16	6g	Tor
12	BU4S01G2	CMOS-Logic	2-input NOR gate	SSOP-5	28Log2	-	6c	Rhm
12	BU4S81G2	CMOS-Logic	2-input AND gate	SSOP-5	28Log3	-	6c	Rhm
12	R1223N502D	DC/DC-IC	PWM step-down, +CE, 5V, 500kHz, Latch-Pr.	SOT-23-5	28ud	DC7	6g	Ric
120	R1116N201D	LVR-IC	LDO, LN, +CE, CL, 2V±1.5%, 150mA	SOT-23-5	28cx	VR4	6g	Ric
120	R1160N201B	LVR-IC	LDO, 2V±2%, 200mA, +CE, AE(Mode)	SOT-23-5	28x9	VR10	6g	Ric



SMD code	Type	Function	Short description	Case	Pinout	Sch.	St.	Mnf.
120	XC6102A331MR	Vdet-IC	3.1V±2%, Hst, -MR, -Reset ODO, Wt=100ms, Rt=3.13ms	SOT-25	28cp	VD16	6g	Tor
120A	AAT60120A-S5	Vdet-IC	2.0V±2%, +Reset ODO	SOT-23-5	28vda	VD7	6g	Aat
120B	AAT60120B-S5	Vdet-IC	2.0V±2%, +Reset PPO	SOT-23-5	28vda	VD6	6g	Aat
120C	AAT60120C-S5	Vdet-IC	2.0V±2%, -Reset ODO	SOT-23-5	28vda	VD6	6g	Aat
120D	AAT60120D-S5	Vdet-IC	2.0V±2%, -Reset PPO	SOT-23-5	28vda	VD7	6g	Aat
121	R1116N211D	LVR-IC	LDO, LN, +CE, CL, 2.1V±1.5%, 150mA	SOT-23-5	28cx	VR4	6g	Ric
121	R1160N211B	LVR-IC	LDO, 2.1V±2%, 200mA, +CE, AE(Mode)	SOT-23-5	28x9	VR10	6g	Ric
121	XC6102A332MR	Vdet-IC	3.2V±2%, Hst, -MR, -Reset ODO, Wt=100ms, Rt=3.13ms	SOT-25	28cp	VD16	6g	Tor
121A	AAT60121A-S5	Vdet-IC	2.1V±2%, +Reset ODO	SOT-23-5	28vda	VD6	6g	Aat
121B	AAT60121B-S5	Vdet-IC	2.1V±2%, +Reset PPO	SOT-23-5	28vda	VD7	6g	Aat
121C	AAT60121C-S5	Vdet-IC	2.1V±2%, -Reset ODO	SOT-23-5	28vda	VD6	6g	Aat
121D	AAT60121D-S5	Vdet-IC	2.1V±2%, -Reset PPO	SOT-23-5	28vda	VD7	6g	Aat
122	R1116N221D	LVR-IC	LDO, LN, +CE, CL, 2.2V±1.5%, 150mA	SOT-23-5	28cx	VR4	6g	Ric
122	R1160N221B	LVR-IC	LDO, 2.2V±2%, 200mA, +CE, AE(Mode)	SOT-23-5	28x9	VR10	6g	Ric
122	XC6102A333MR	Vdet-IC	3.3V±2%, Hst, -MR, -Reset ODO, Wt=100ms, Rt=3.13ms	SOT-25	28cp	VD16	6g	Tor
122A	AAT60122A-S5	Vdet-IC	2.2V±2%, +Reset ODO	SOT-23-5	28vda	VD6	6g	Aat
122B	AAT60122B-S5	Vdet-IC	2.2V±2%, +Reset PPO	SOT-23-5	28vda	VD7	6g	Aat
122C	AAT60122C-S5	Vdet-IC	2.2V±2%, -Reset ODO	SOT-23-5	28vda	VD6	6g	Aat
122D	AAT60122D-S5	Vdet-IC	2.2V±2%, -Reset PPO	SOT-23-5	28vda	VD7	6g	Aat
123	R1116N231D	LVR-IC	LDO, LN, +CE, CL, 2.3V±1.5%, 150mA	SOT-23-5	28cx	VR4	6g	Ric
123	R1160N231B	LVR-IC	LDO, 2.3V±2%, 200mA, +CE, AE(Mode)	SOT-23-5	28x9	VR10	6g	Ric
123	XC6102A334MR	Vdet-IC	3.4V±2%, Hst, -MR, -Reset ODO, Wt=100ms, Rt=3.13ms	SOT-25	28cp	VD16	6g	Tor
123A	AAT60123A-S5	Vdet-IC	2.3V±2%, +Reset ODO	SOT-23-5	28vda	VD6	6g	Aat
123B	AAT60123B-S5	Vdet-IC	2.3V±2%, +Reset PPO	SOT-23-5	28vda	VD7	6g	Aat
123C	AAT60123C-S5	Vdet-IC	2.3V±2%, -Reset ODO	SOT-23-5	28vda	VD6	6g	Aat
123D	AAT60123D-S5	Vdet-IC	2.3V±2%, -Reset PPO	SOT-23-5	28vda	VD7	6g	Aat
124	R1116N241D	LVR-IC	LDO, LN, +CE, CL, 2.4V±1.5%, 150mA	SOT-23-5	28cx	VR4	6g	Ric
124	R1160N241B	LVR-IC	LDO, 2.4V±2%, 200mA, +CE, AE(Mode)	SOT-23-5	28x9	VR10	6g	Ric
124	XC6102A335MR	Vdet-IC	3.5V±2%, Hst, -MR, -Reset ODO, Wt=100ms, Rt=3.13ms	SOT-25	28cp	VD16	6g	Tor
124A	AAT60124A-S5	Vdet-IC	2.4V±2%, +Reset ODO	SOT-23-5	28vda	VD6	6g	Aat
124B	AAT60124B-S5	Vdet-IC	2.4V±2%, +Reset PPO	SOT-23-5	28vda	VD7	6g	Aat
124C	AAT60124C-S5	Vdet-IC	2.4V±2%, -Reset ODO	SOT-23-5	28vda	VD6	6g	Aat
124D	AAT60124D-S5	Vdet-IC	2.4V±2%, -Reset PPO	SOT-23-5	28vda	VD7	6g	Aat
125	R1116N251D	LVR-IC	LDO, LN, +CE, CL, 2.5V±1.5%, 150mA	SOT-23-5	28cx	VR4	6g	Ric
125	R1160N251B	LVR-IC	LDO, 2.5V±2%, 200mA, +CE, AE(Mode)	SOT-23-5	28x9	VR10	6g	Ric
125	XC6102A336MR	Vdet-IC	3.6V±2%, Hst, -MR, -Reset ODO, Wt=100ms, Rt=3.13ms	SOT-25	28cp	VD16	6g	Tor
125A	AAT60125A-S5	Vdet-IC	2.5V±2%, +Reset ODO	SOT-23-5	28vda	VD6	6g	Aat
125B	AAT60125B-S5	Vdet-IC	2.5V±2%, +Reset PPO	SOT-23-5	28vda	VD7	6g	Aat
125C	AAT60125C-S5	Vdet-IC	2.5V±2%, -Reset ODO	SOT-23-5	28vda	VD6	6g	Aat
125D	AAT60125D-S5	Vdet-IC	2.5V±2%, -Reset PPO	SOT-23-5	28vda	VD7	6g	Aat
126	R1116N261D	LVR-IC	LDO, LN, +CE, CL, 2.6V±1.5%, 150mA	SOT-23-5	28cx	VR4	6g	Ric
126	R1160N261B	LVR-IC	LDO, 2.6V±2%, 200mA, +CE, AE(Mode)	SOT-23-5	28x9	VR10	6g	Ric
126	XC6102A337MR	Vdet-IC	3.7V±2%, Hst, -MR, -Reset ODO, Wt=100ms, Rt=3.13ms	SOT-25	28cp	VD16	6g	Tor
126A	AAT60126A-S5	Vdet-IC	2.6V±2%, +Reset ODO	SOT-23-5	28vda	VD6	6g	Aat
126B	AAT60126B-S5	Vdet-IC	2.6V±2%, +Reset PPO	SOT-23-5	28vda	VD7	6g	Aat
126C	AAT60126C-S5	Vdet-IC	2.6V±2%, -Reset ODO	SOT-23-5	28vda	VD6	6g	Aat
126D	AAT60126D-S5	Vdet-IC	2.6V±2%, -Reset PPO	SOT-23-5	28vda	VD7	6g	Aat
127	R1116N271D	LVR-IC	LDO, LN, +CE, CL, 2.7V±1.5%, 150mA	SOT-23-5	28cx	VR4	6g	Ric
127	R1160N271B	LVR-IC	LDO, 2.7V±2%, 200mA, +CE, AE(Mode)	SOT-23-5	28x9	VR10	6g	Ric
127	XC6102A338MR	Vdet-IC	3.8V±2%, Hst, -MR, -Reset ODO, Wt=100ms, Rt=3.13ms	SOT-25	28cp	VD16	6g	Tor
127A	AAT60127A-S5	Vdet-IC	2.7V±2%, +Reset ODO	SOT-23-5	28vda	VD6	6g	Aat
127B	AAT60127B-S5	Vdet-IC	2.7V±2%, +Reset PPO	SOT-23-5	28vda	VD7	6g	Aat
127C	AAT60127C-S5	Vdet-IC	2.7V±2%, -Reset ODO	SOT-23-5	28vda	VD6	6g	Aat
127D	AAT60127D-S5	Vdet-IC	2.7V±2%, -Reset PPO	SOT-23-5	28vda	VD7	6g	Aat
128	R1116N281D	LVR-IC	LDO, LN, +CE, CL, 2.8V±1.5%, 150mA	SOT-23-5	28cx	VR4	6g	Ric
128	R1160N281B	LVR-IC	LDO, 2.8V±2%, 200mA, +CE, AE(Mode)	SOT-23-5	28x9	VR10	6g	Ric
128	XC6102A339MR	Vdet-IC	3.9V±2%, Hst, -MR, -Reset ODO, Wt=100ms, Rt=3.13ms	SOT-25	28cp	VD16	6g	Tor
128A	AAT60128A-S5	Vdet-IC	2.8V±2%, +Reset ODO	SOT-23-5	28vda	VD6	6g	Aat
128B	AAT60128B-S5	Vdet-IC	2.8V±2%, +Reset PPO	SOT-23-5	28vda	VD7	6g	Aat
128C	AAT60128C-S5	Vdet-IC	2.8V±2%, -Reset ODO	SOT-23-5	28vda	VD6	6g	Aat
128D	AAT60128D-S5	Vdet-IC	2.8V±2%, -Reset PPO	SOT-23-5	28vda	VD7	6g	Aat
129	R1116N291D	LVR-IC	LDO, LN, +CE, CL, 2.9V±1.5%, 150mA	SOT-23-5	28cx	VR4	6g	Ric
129	R1160N291B	LVR-IC	LDO, 2.9V±2%, 200mA, +CE, AE(Mode)	SOT-23-5	28x9	VR10	6g	Ric
129	XC6102A340MR	Vdet-IC	4.0V±2%, Hst, -MR, -Reset ODO, Wt=100ms, Rt=3.13ms	SOT-25	28cp	VD16	6g	Tor
129A	AAT60129A-S5	Vdet-IC	2.9V±2%, +Reset ODO	SOT-23-5	28vda	VD6	6g	Aat
129B	AAT60129B-S5	Vdet-IC	2.9V±2%, +Reset PPO	SOT-23-5	28vda	VD7	6g	Aat
129C	AAT60129C-S5	Vdet-IC	2.9V±2%, -Reset ODO	SOT-23-5	28vda	VD6	6g	Aat
129D	AAT60129D-S5	Vdet-IC	2.9V±2%, -Reset PPO	SOT-23-5	28vda	VD7	6g	Aat
12A	APR3012-15B	Vdet-IC	1.5V, +Reset PPO	SOT-23-5	28vdg	VD7	6k	Anp
12A	MAZK120D	Z-diode	Quad, 12V, Zzt=10Ω(5mA), 200mW	SOT-23-5	28bc	-	6a	Pan



SMD

SMD code	Type	Function	Short description	Case	Pinout	Sch.	St.	Mnf.
12A	R1182N201D	LVR-IC	LDO, 2V±2%, 150mA, +CE, CL	SOT-23-5	28vrt	VR4	6g	Ric
12A	XC6102A341MR	Vdet-IC	4.1V±2%, Hst, -MR, -Reset ODO, Wt=100ms, Rt=3.13ms	SOT-25	28cp	VD16	6g	Tor
12B	APR3012-17B	Vdet-IC	1.75V, +Reset PPO	SOT-23-5	28vdg	VD7	6k	Ans
12B	R1182N211D	LVR-IC	LDO, 2.1V±2%, 150mA, +CE, CL	SOT-23-5	28vrt	VR4	6g	Ric
12B	XC6102A342MR	Vdet-IC	4.2V±2%, Hst, -MR, -Reset ODO, Wt=100ms, Rt=3.13ms	SOT-25	28cp	VD16	6g	Tor
12C	APR3012-23B	Vdet-IC	2.32V, +Reset PPO	SOT-23-5	28vdg	VD7	6k	Ans
12C	R1182N221D	LVR-IC	LDO, 2.2V±2%, 150mA, +CE, CL	SOT-23-5	28vrt	VR4	6g	Ric
12C	XC6102A343MR	Vdet-IC	4.3V±2%, Hst, -MR, -Reset ODO, Wt=100ms, Rt=3.13ms	SOT-25	28cp	VD16	6g	Tor
12D	APR3012-26B	Vdet-IC	2.63V, +Reset PPO	SOT-23-5	28vdg	VD7	6k	Ans
12D	MAZL120D	Z-diode	Quad, 12V, Zzt=30Ω(5mA), 200mW	SOT-23-5	28bc	-	6a	Pan
12D	R1182N231D	LVR-IC	LDO, 2.3V±2%, 150mA, +CE, CL	SOT-23-5	28vrt	VR4	6g	Ric
12D	XC6102A344MR	Vdet-IC	4.4V±2%, Hst, -MR, -Reset ODO, Wt=100ms, Rt=3.13ms	SOT-25	28cp	VD16	6g	Tor
12E	APR3012-29B	Vdet-IC	2.93V, +Reset PPO	SOT-23-5	28vdg	VD7	6k	Ans
12E	R1182N241D	LVR-IC	LDO, 2.4V±2%, 150mA, +CE, CL	SOT-23-5	28vrt	VR4	6g	Ric
12E	XC6102A345MR	Vdet-IC	4.5V±2%, Hst, -MR, -Reset ODO, Wt=100ms, Rt=3.13ms	SOT-25	28cp	VD16	6g	Tor
12F	APR3012-30B	Vdet-IC	3.08V, +Reset PPO	SOT-23-5	28vdg	VD7	6k	Ans
12F	R1182N251D	LVR-IC	LDO, 2.5V±2%, 150mA, +CE, CL	SOT-23-5	28vrt	VR4	6g	Ric
12F	XC6102A316MR	Vdet-IC	1.6V±2%, Hst, -MR, -Reset ODO, Wt=100ms, Rt=3.13ms	SOT-25	28cp	VD16	6g	Tor
12F	XC6102A346MR	Vdet-IC	4.6V±2%, Hst, -MR, -Reset ODO, Wt=100ms, Rt=3.13ms	SOT-25	28cp	VD16	6g	Tor
12G	APR3012-39B	Vdet-IC	3.9V, +Reset PPO	SOT-23-5	28vdg	VD7	6k	Ans
12G	R1182N261D	LVR-IC	LDO, 2.6V±2%, 150mA, +CE, CL	SOT-23-5	28vrt	VR4	6g	Ric
12H	APR3012-43B	Vdet-IC	4.38V, +Reset PPO	SOT-23-5	28vdg	VD7	6k	Ans
12H	R1182N271D	LVR-IC	LDO, 2.7V±2%, 150mA, +CE, CL	SOT-23-5	28vrt	VR4	6g	Ric
12H	XC6102A317MR	Vdet-IC	1.7V±2%, Hst, -MR, -Reset ODO, Wt=100ms, Rt=3.13ms	SOT-25	28cp	VD16	6g	Tor
12H	XC6102A347MR	Vdet-IC	4.7V±2%, Hst, -MR, -Reset ODO, Wt=100ms, Rt=3.13ms	SOT-25	28cp	VD16	6g	Tor
12J	APR3012-46B	Vdet-IC	4.63V, +Reset PPO	SOT-23-5	28vdg	VD7	6k	Ans
12J	R1182N281D	LVR-IC	LDO, 2.8V±2%, 150mA, +CE, CL	SOT-23-5	28vrt	VR4	6g	Ric
12K	R1182N291D	LVR-IC	LDO, 2.9V±2%, 150mA, +CE, CL	SOT-23-5	28vrt	VR4	6g	Ric
12K	XC6102A318MR	Vdet-IC	1.8V±2%, Hst, -MR, -Reset ODO, Wt=100ms, Rt=3.13ms	SOT-25	28cp	VD16	6g	Tor
12K	XC6102A348MR	Vdet-IC	4.8V±2%, Hst, -MR, -Reset ODO, Wt=100ms, Rt=3.13ms	SOT-25	28cp	VD16	6g	Tor
12L	XC6102A319MR	Vdet-IC	1.9V±2%, Hst, -MR, -Reset ODO, Wt=100ms, Rt=3.13ms	SOT-25	28cp	VD16	6g	Tor
12L	XC6102A349MR	Vdet-IC	4.9V±2%, Hst, -MR, -Reset ODO, Wt=100ms, Rt=3.13ms	SOT-25	28cp	VD16	6g	Tor
12M	XC6102A320MR	Vdet-IC	2.0V±2%, Hst, -MR, -Reset ODO, Wt=100ms, Rt=3.13ms	SOT-25	28cp	VD16	6g	Tor
12M	XC6102A350MR	Vdet-IC	5.0V±2%, Hst, -MR, -Reset ODO, Wt=100ms, Rt=3.13ms	SOT-25	28cp	VD16	6g	Tor
12N	XC6102A321MR	Vdet-IC	2.1V±2%, Hst, -MR, -Reset ODO, Wt=100ms, Rt=3.13ms	SOT-25	28cp	VD16	6g	Tor
12P	XC6102A322MR	Vdet-IC	2.2V±2%, Hst, -MR, -Reset ODO, Wt=100ms, Rt=3.13ms	SOT-25	28cp	VD16	6g	Tor
12R	XC6102A323MR	Vdet-IC	2.3V±2%, Hst, -MR, -Reset ODO, Wt=100ms, Rt=3.13ms	SOT-25	28cp	VD16	6g	Tor
12S	XC6102A324MR	Vdet-IC	2.4V±2%, Hst, -MR, -Reset ODO, Wt=100ms, Rt=3.13ms	SOT-25	28cp	VD16	6g	Tor
12T	XC6102A325MR	Vdet-IC	2.5V±2%, Hst, -MR, -Reset ODO, Wt=100ms, Rt=3.13ms	SOT-25	28cp	VD16	6g	Tor
12U	XC6102A326MR	Vdet-IC	2.6V±2%, Hst, -MR, -Reset ODO, Wt=100ms, Rt=3.13ms	SOT-25	28cp	VD16	6g	Tor
12V	XC6102A327MR	Vdet-IC	2.7V±2%, Hst, -MR, -Reset ODO, Wt=100ms, Rt=3.13ms	SOT-25	28cp	VD16	6g	Tor
12X	XC6102A328MR	Vdet-IC	2.8V±2%, Hst, -MR, -Reset ODO, Wt=100ms, Rt=3.13ms	SOT-25	28cp	VD16	6g	Tor
12Y	XC6102A329MR	Vdet-IC	2.9V±2%, Hst, -MR, -Reset ODO, Wt=100ms, Rt=3.13ms	SOT-25	28cp	VD16	6g	Tor
12Z	MAZL120H	SA-Z-diode	Quad, 12V, Zzt=30Ω(5mA), 200mW	SC-74A	28bc	-	6a	Pan
12Z	MAZM120H	SA-Z-diode	Quad, 12V, 5mA, 150mW	SSMini5	30bc	-	6a	Pan
12Z	MAZZ120H	SA-Z-diode	Quad, 12V, 5mA, 200mW	SMini5	30bc	-	6a	Pan
12Z	XC6102A330MR	Vdet-IC	3.0V±2%, Hst, -MR, -Reset ODO, Wt=100ms, Rt=3.13ms	SOT-25	28cp	VD16	6g	Tor
13	R1223N152A	DC/DC-IC	PWM/FM step-down, +CE, 1.5V, 300kHz, L-Pr.	SOT-23-5	28ud	DC7	6g	Ric
13	RN5RF13BA	LVR-IC	LRip, +CE, 1.3V±2%, 1A*	SOT-23-5	28vw	VR6	6g	Ric
130	R1116N301D	LVR-IC	LDO, LN, +CE, CL, 3V±1.5%, 150mA	SOT-23-5	28cx	VR4	6g	Ric
130	R1160N301B	LVR-IC	LDO, 3V±2%, 200mA, +CE, AE(Mode)	SOT-23-5	28x9	VR10	6g	Ric
130	XC6102A431MR	Vdet-IC	3.1V±2%, Hst, -MR, -Reset ODO, Wt=200ms, Rt=3.13ms	SOT-25	28cp	VD16	6g	Tor
1301	HT7130-1	LVR-IC	LDO, 3V±3%, 30mA	SOT-23-5	28vu	VR1	6a	Htk
130A	AAT60130A-S5	Vdet-IC	3.0V±2%, +Reset ODO	SOT-23-5	28vda	VD6	6g	Aat
130B	AAT60130B-S5	Vdet-IC	3.0V±2%, +Reset PPO	SOT-23-5	28vda	VD7	6g	Aat
130C	AAT60130C-S5	Vdet-IC	3.0V±2%, -Reset ODO	SOT-23-5	28vda	VD6	6g	Aat
130D	AAT60130D-S5	Vdet-IC	3.0V±2%, -Reset PPO	SOT-23-5	28vda	VD7	6g	Aat
131	R1116N311D	LVR-IC	LDO, LN, +CE, CL, 3.1V±2%, 150mA	SOT-23-5	28cx	VR4	6g	Ric
131	R1160N311B	LVR-IC	LDO, 3.1V±2%, 200mA, +CE, AE(Mode)	SOT-23-5	28x9	VR10	6g	Ric
131	XC6102A432MR	Vdet-IC	3.2V±2%, Hst, -MR, -Reset ODO, Wt=200ms, Rt=3.13ms	SOT-25	28cp	VD16	6g	Tor
131A	AAT60131A-S5	Vdet-IC	3.1V±2%, +Reset ODO	SOT-23-5	28vda	VD6	6g	Aat
131B	AAT60131B-S5	Vdet-IC	3.1V±2%, +Reset PPO	SOT-23-5	28vda	VD7	6g	Aat
131C	AAT60131C-S5	Vdet-IC	3.1V±2%, -Reset ODO	SOT-23-5	28vda	VD6	6g	Aat
131D	AAT60131D-S5	Vdet-IC	3.1V±2%, -Reset PPO	SOT-23-5	28vda	VD7	6g	Aat
132	R1116N321D	LVR-IC	LDO, LN, +CE, CL, 3.2V±2%, 150mA	SOT-23-5	28cx	VR4	6g	Ric
132	R1160N321B	LVR-IC	LDO, 3.2V±2%, 200mA, +CE, AE(Mode)	SOT-23-5	28x9	VR10	6g	Ric
132	XC6102A433MR	Vdet-IC	3.3V±2%, Hst, -MR, -Reset ODO, Wt=200ms, Rt=3.13ms	SOT-25	28cp	VD16	6g	Tor
132A	AAT60132A-S5	Vdet-IC	3.2V±2%, +Reset ODO	SOT-23-5	28vda	VD6	6g	Aat
132B	AAT60132B-S5	Vdet-IC	3.2V±2%, +Reset PPO	SOT-23-5	28vda	VD7	6g	Aat
132C	AAT60132C-S5	Vdet-IC	3.2V±2%, -Reset ODO	SOT-23-5	28vda	VD6	6g	Aat



SMD

SMD code	Type	Function	Short description	Case	Pinout	Sch.	St.	Mnf.
132D	AAT60132D-S5	Vdet-IC	3.2V±2%, -Reset PPO	SOT-23-5	28vda	VD7	6g	Aat
133	R1116N331D	LVR-IC	LDO, LN, +CE, CL, 3.3V±2%, 150mA	SOT-23-5	28cx	VR4	6g	Ric
133	R1160N331B	LVR-IC	LDO, 3.3V±2%, 200mA, +CE, AE(Mode)	SOT-23-5	28x9	VR10	6g	Ric
133	XC6102A434MR	Vdet-IC	3.4V±2%, Hst, -MR, -Reset ODO, Wt=200ms, Rt=3.13ms	SOT-25	28cp	VD16	6g	Tor
1331	HT7133-1	LVR-IC	LDO, 3.3V±3%, 30mA	SOT-23-5	28vu	VR1	6a	Htk
133A	AAT60133A-S5	Vdet-IC	3.3V±2%, +Reset ODO	SOT-23-5	28vda	VD6	6g	Aat
133B	AAT60133B-S5	Vdet-IC	3.3V±2%, +Reset PPO	SOT-23-5	28vda	VD7	6g	Aat
133C	AAT60133C-S5	Vdet-IC	3.3V±2%, -Reset ODO	SOT-23-5	28vda	VD6	6g	Aat
133D	AAT60133D-S5	Vdet-IC	3.3V±2%, -Reset PPO	SOT-23-5	28vda	VD7	6g	Aat
134	R1116N341D	LVR-IC	LDO, LN, +CE, CL, 3.4V±2%, 150mA	SOT-23-5	28cx	VR4	6g	Ric
134	XC6102A435MR	Vdet-IC	3.5V±2%, Hst, -MR, -Reset ODO, Wt=200ms, Rt=3.13ms	SOT-25	28cp	VD16	6g	Tor
134A	AAT60134A-S5	Vdet-IC	3.4V±2%, +Reset ODO	SOT-23-5	28vda	VD6	6g	Aat
134B	AAT60134B-S5	Vdet-IC	3.4V±2%, +Reset PPO	SOT-23-5	28vda	VD7	6g	Aat
134C	AAT60134C-S5	Vdet-IC	3.4V±2%, -Reset ODO	SOT-23-5	28vda	VD6	6g	Aat
134D	AAT60134D-S5	Vdet-IC	3.4V±2%, -Reset PPO	SOT-23-5	28vda	VD7	6g	Aat
135	R1116N351D	LVR-IC	LDO, LN, +CE, CL, 3.5V±2%, 150mA	SOT-23-5	28cx	VR4	6g	Ric
135	XC6102A436MR	Vdet-IC	3.6V±2%, Hst, -MR, -Reset ODO, Wt=200ms, Rt=3.13ms	SOT-25	28cp	VD16	6g	Tor
135A	AAT60135A-S5	Vdet-IC	3.5V±2%, +Reset ODO	SOT-23-5	28vda	VD6	6g	Aat
135B	AAT60135B-S5	Vdet-IC	3.5V±2%, +Reset PPO	SOT-23-5	28vda	VD7	6g	Aat
135C	AAT60135C-S5	Vdet-IC	3.5V±2%, -Reset ODO	SOT-23-5	28vda	VD6	6g	Aat
135D	AAT60135D-S5	Vdet-IC	3.5V±2%, -Reset PPO	SOT-23-5	28vda	VD7	6g	Aat
136	R1116N361D	LVR-IC	LDO, LN, +CE, CL, 3.6V±2%, 150mA	SOT-23-5	28cx	VR4	6g	Ric
136	XC6102A437MR	Vdet-IC	3.7V±2%, Hst, -MR, -Reset ODO, Wt=200ms, Rt=3.13ms	SOT-25	28cp	VD16	6g	Tor
1361	HT7136-1	LVR-IC	LDO, 3.6V±3%, 30mA	SOT-23-5	28vu	VR1	6a	Htk
136A	AAT60136A-S5	Vdet-IC	3.6V±2%, +Reset ODO	SOT-23-5	28vda	VD6	6g	Aat
136B	AAT60136B-S5	Vdet-IC	3.6V±2%, +Reset PPO	SOT-23-5	28vda	VD7	6g	Aat
136C	AAT60136C-S5	Vdet-IC	3.6V±2%, -Reset ODO	SOT-23-5	28vda	VD6	6g	Aat
136D	AAT60136D-S5	Vdet-IC	3.6V±2%, -Reset PPO	SOT-23-5	28vda	VD7	6g	Aat
137	R1116N371D	LVR-IC	LDO, LN, +CE, CL, 3.7V±2%, 150mA	SOT-23-5	28cx	VR4	6g	Ric
137	XC6102A438MR	Vdet-IC	3.8V±2%, Hst, -MR, -Reset ODO, Wt=200ms, Rt=3.13ms	SOT-25	28cp	VD16	6g	Tor
137A	AAT60137A-S5	Vdet-IC	3.7V±2%, +Reset ODO	SOT-23-5	28vda	VD6	6g	Aat
137B	AAT60137B-S5	Vdet-IC	3.7V±2%, +Reset PPO	SOT-23-5	28vda	VD7	6g	Aat
137C	AAT60137C-S5	Vdet-IC	3.7V±2%, -Reset ODO	SOT-23-5	28vda	VD6	6g	Aat
137D	AAT60137D-S5	Vdet-IC	3.7V±2%, -Reset PPO	SOT-23-5	28vda	VD7	6g	Aat
138	R1116N381D	LVR-IC	LDO, LN, +CE, CL, 3.8V±2%, 150mA	SOT-23-5	28cx	VR4	6g	Ric
138	XC6102A439MR	Vdet-IC	3.9V±2%, Hst, -MR, -Reset ODO, Wt=200ms, Rt=3.13ms	SOT-25	28cp	VD16	6g	Tor
138A	AAT60138A-S5	Vdet-IC	3.8V±2%, +Reset ODO	SOT-23-5	28vda	VD6	6g	Aat
138B	AAT60138B-S5	Vdet-IC	3.8V±2%, +Reset PPO	SOT-23-5	28vda	VD7	6g	Aat
138C	AAT60138C-S5	Vdet-IC	3.8V±2%, -Reset ODO	SOT-23-5	28vda	VD6	6g	Aat
138D	AAT60138D-S5	Vdet-IC	3.8V±2%, -Reset PPO	SOT-23-5	28vda	VD7	6g	Aat
139	R1116N391D	LVR-IC	LDO, LN, +CE, CL, 3.9V±2%, 150mA	SOT-23-5	28cx	VR4	6g	Ric
139	XC6102A440MR	Vdet-IC	4.0V±2%, Hst, -MR, -Reset ODO, Wt=200ms, Rt=3.13ms	SOT-25	28cp	VD16	6g	Tor
139A	AAT60139A-S5	Vdet-IC	3.9V±2%, +Reset ODO	SOT-23-5	28vda	VD6	6g	Aat
139B	AAT60139B-S5	Vdet-IC	3.9V±2%, +Reset PPO	SOT-23-5	28vda	VD7	6g	Aat
139C	AAT60139C-S5	Vdet-IC	3.9V±2%, -Reset ODO	SOT-23-5	28vda	VD6	6g	Aat
139D	AAT60139D-S5	Vdet-IC	3.9V±2%, -Reset PPO	SOT-23-5	28vda	VD7	6g	Aat
13A	APR3013-15B	Vdet-IC	1.5V, -Reset ODO	SOT-23-5	28vdtg	VD6	6k	App
13A	R1182N301D	LVR-IC	LDO, 3V±2%, 150mA, +CE, CL	SOT-23-5	28vrt	VR4	6g	Ric
13A	XC6102A441MR	Vdet-IC	4.1V±2%, Hst, -MR, -Reset ODO, Wt=200ms, Rt=3.13ms	SOT-25	28cp	VD16	6g	Tor
13B	APR3013-17B	Vdet-IC	1.75V, -Reset ODO	SOT-23-5	28vdtg	VD6	6k	App
13B	R1182N311D	LVR-IC	LDO, 3.1V±2%, 150mA, +CE, CL	SOT-23-5	28vrt	VR4	6g	Ric
13B	XC6102A442MR	Vdet-IC	4.2V±2%, Hst, -MR, -Reset ODO, Wt=200ms, Rt=3.13ms	SOT-25	28cp	VD16	6g	Tor
13C	APR3013-23B	Vdet-IC	2.32V, -Reset ODO	SOT-23-5	28vdtg	VD6	6k	App
13C	R1182N321D	LVR-IC	LDO, 3.2V±2%, 150mA, +CE, CL	SOT-23-5	28vrt	VR4	6g	Ric
13C	XC6102A443MR	Vdet-IC	4.3V±2%, Hst, -MR, -Reset ODO, Wt=200ms, Rt=3.13ms	SOT-25	28cp	VD16	6g	Tor
13D	APR3013-26B	Vdet-IC	2.63V, -Reset ODO	SOT-23-5	28vdtg	VD6	6k	App
13D	R1182N331D	LVR-IC	LDO, 3.3V±2%, 150mA, +CE, CL	SOT-23-5	28vrt	VR4	6g	Ric
13D	XC6102A444MR	Vdet-IC	4.4V±2%, Hst, -MR, -Reset ODO, Wt=200ms, Rt=3.13ms	SOT-25	28cp	VD16	6g	Tor
13E	APR3013-29B	Vdet-IC	2.93V, -Reset ODO	SOT-23-5	28vdtg	VD6	6k	App
13E	R1182N341D	LVR-IC	LDO, 3.4V±2%, 150mA, +CE, CL	SOT-23-5	28vrt	VR4	6g	Ric
13E	XC6102A445MR	Vdet-IC	4.5V±2%, Hst, -MR, -Reset ODO, Wt=200ms, Rt=3.13ms	SOT-25	28cp	VD16	6g	Tor
13F	APR3013-30B	Vdet-IC	3.08V, -Reset ODO	SOT-23-5	28vdtg	VD6	6k	App
13F	R1182N351D	LVR-IC	LDO, 3.5V±2%, 150mA, +CE, CL	SOT-23-5	28vrt	VR4	6g	Ric
13F	XC6102A416MR	Vdet-IC	1.6V±2%, Hst, -MR, -Reset ODO, Wt=200ms, Rt=3.13ms	SOT-25	28cp	VD16	6g	Tor
13F	XC6102A446MR	Vdet-IC	4.6V±2%, Hst, -MR, -Reset ODO, Wt=200ms, Rt=3.13ms	SOT-25	28cp	VD16	6g	Tor
13G	APR3013-39B	Vdet-IC	3.9V, -Reset ODO	SOT-23-5	28vdtg	VD6	6k	App
13G	R1182N361D	LVR-IC	LDO, 3.6V±2%, 150mA, +CE, CL	SOT-23-5	28vrt	VR4	6g	Ric
13H	APR3013-43B	Vdet-IC	4.38V, -Reset ODO	SOT-23-5	28vdtg	VD6	6k	App
13H	R1182N371D	LVR-IC	LDO, 3.7V±2%, 150mA, +CE, CL	SOT-23-5	28vrt	VR4	6g	Ric
13H	XC6102A417MR	Vdet-IC	1.7V±2%, Hst, -MR, -Reset ODO, Wt=200ms, Rt=3.13ms	SOT-25	28cp	VD16	6g	Tor



SMD code	Type	Function	Short description	Case	Pinout	Sch.	St.	Mnf.
13H	XC6102A447MR	Vdet-IC	4.7V±2%, Hst, -MR, -Reset ODO, Wt=200ms, Rt=3.13ms	SOT-25	28cp	VD16	6g	Tor
13J	APR3013-46B	Vdet-IC	4.63V, -Reset ODO	SOT-23-5	28vdg	VD6	6k	Anp
13J	R1182N381D	LVR-IC	LDO, 3.8V±2%, 150mA, +CE, CL	SOT-23-5	28vrt	VR4	6g	Ric
13K	R1182N391D	LVR-IC	LDO, 3.9V±2%, 150mA, +CE, CL	SOT-23-5	28vrt	VR4	6g	Ric
13K	XC6102A418MR	Vdet-IC	1.8V±2%, Hst, -MR, -Reset ODO, Wt=200ms, Rt=3.13ms	SOT-25	28cp	VD16	6g	Tor
13K	XC6102A448MR	Vdet-IC	4.8V±2%, Hst, -MR, -Reset ODO, Wt=200ms, Rt=3.13ms	SOT-25	28cp	VD16	6g	Tor
13L	R1182N401D	LVR-IC	LDO, 4V±2%, 150mA, +CE, CL	SOT-23-5	28vrt	VR4	6g	Ric
13L	TK71613ASCL	LVR-IC	LDO, 1.3V±2%, 150mA, +CE, -30...+80°C	SOT-23-5	28vrx	VR7	6k	Tok
13L	XC6102A419MR	Vdet-IC	1.9V±2%, Hst, -MR, -Reset ODO, Wt=200ms, Rt=3.13ms	SOT-25	28cp	VD16	6g	Tor
13L	XC6102A449MR	Vdet-IC	4.9V±2%, Hst, -MR, -Reset ODO, Wt=200ms, Rt=3.13ms	SOT-25	28cp	VD16	6g	Tor
13M	R1182N121D5	LVR-IC	LDO, 1.25V±2%, 150mA, +CE, CL	SOT-23-5	28vrt	VR4	6g	Ric
13M	XC6102A420MR	Vdet-IC	2.0V±2%, Hst, -MR, -Reset ODO, Wt=200ms, Rt=3.13ms	SOT-25	28cp	VD16	6g	Tor
13M	XC6102A450MR	Vdet-IC	5.0V±2%, Hst, -MR, -Reset ODO, Wt=200ms, Rt=3.13ms	SOT-25	28cp	VD16	6g	Tor
13N	R1182N181D5	LVR-IC	LDO, 1.85V±2%, 150mA, +CE, CL	SOT-23-5	28vrt	VR4	6g	Ric
13N	XC6102A421MR	Vdet-IC	2.1V±2%, Hst, -MR, -Reset ODO, Wt=200ms, Rt=3.13ms	SOT-25	28cp	VD16	6g	Tor
13P	R1182N291D5	LVR-IC	LDO, 2.95V±2%, 150mA, +CE, CL	SOT-23-5	28vrt	VR4	6g	Ric
13P	XC6102A422MR	Vdet-IC	2.2V±2%, Hst, -MR, -Reset ODO, Wt=200ms, Rt=3.13ms	SOT-25	28cp	VD16	6g	Tor
13R	XC6102A423MR	Vdet-IC	2.3V±2%, Hst, -MR, -Reset ODO, Wt=200ms, Rt=3.13ms	SOT-25	28cp	VD16	6g	Tor
13S	XC6102A424MR	Vdet-IC	2.4V±2%, Hst, -MR, -Reset ODO, Wt=200ms, Rt=3.13ms	SOT-25	28cp	VD16	6g	Tor
13T	XC6102A425MR	Vdet-IC	2.5V±2%, Hst, -MR, -Reset ODO, Wt=200ms, Rt=3.13ms	SOT-25	28cp	VD16	6g	Tor
13U	XC6102A426MR	Vdet-IC	2.6V±2%, Hst, -MR, -Reset ODO, Wt=200ms, Rt=3.13ms	SOT-25	28cp	VD16	6g	Tor
13V	XC6102A427MR	Vdet-IC	2.7V±2%, Hst, -MR, -Reset ODO, Wt=200ms, Rt=3.13ms	SOT-25	28cp	VD16	6g	Tor
13X	XC6102A428MR	Vdet-IC	2.8V±2%, Hst, -MR, -Reset ODO, Wt=200ms, Rt=3.13ms	SOT-25	28cp	VD16	6g	Tor
13Y	XC6102A429MR	Vdet-IC	2.9V±2%, Hst, -MR, -Reset ODO, Wt=200ms, Rt=3.13ms	SOT-25	28cp	VD16	6g	Tor
13Z	XC6102A430MR	Vdet-IC	3.0V±2%, Hst, -MR, -Reset ODO, Wt=200ms, Rt=3.13ms	SOT-25	28cp	VD16	6g	Tor
14	BU4S71G2	CMOS-Logic	2-input OR gate	SSOP-5	28/Log4	-	6c	Rhm
14	R1223N182A	DC/DC-IC	PWM/VFM step-down, +CE, 1.8V, 300kHz, L-Pr.	SOT-23-5	28ud	DC7	6g	Ric
140	R1116N401D	LVR-IC	LDO, LN, +CE, CL, 4V±2%, 150mA	SOT-23-5	28cx	VR4	6g	Ric
140	XC6102A531MR	Vdet-IC	3.1V±2%, Hst, -MR, -Reset ODO, Wt=400ms, Rt=3.13ms	SOT-25	28cp	VD16	6g	Tor
140A	AAT60140A-S5	Vdet-IC	4.0V±2%, +Reset ODO	SOT-23-5	28vda	VD6	6g	Aat
140B	AAT60140B-S5	Vdet-IC	4.0V±2%, +Reset PPO	SOT-23-5	28vda	VD7	6g	Aat
140C	AAT60140C-S5	Vdet-IC	4.0V±2%, -Reset ODO	SOT-23-5	28vda	VD6	6g	Aat
140D	AAT60140D-S5	Vdet-IC	4.0V±2%, -Reset PPO	SOT-23-5	28vda	VD7	6g	Aat
141	R1116N181D5	LVR-IC	LDO, LN, +CE, CL, 1.85V±1.5%, 150mA	SOT-23-5	28cx	VR4	6g	Ric
141	XC6102A532MR	Vdet-IC	3.2V±2%, Hst, -MR, -Reset ODO, Wt=400ms, Rt=3.13ms	SOT-25	28cp	VD16	6g	Tor
141A	AAT60141A-S5	Vdet-IC	4.1V±2%, +Reset ODO	SOT-23-5	28vda	VD6	6g	Aat
141B	AAT60141B-S5	Vdet-IC	4.1V±2%, +Reset PPO	SOT-23-5	28vda	VD7	6g	Aat
141C	AAT60141C-S5	Vdet-IC	4.1V±2%, -Reset ODO	SOT-23-5	28vda	VD6	6g	Aat
141D	AAT60141D-S5	Vdet-IC	4.1V±2%, -Reset PPO	SOT-23-5	28vda	VD7	6g	Aat
142	R1116N281D5	LVR-IC	LDO, LN, +CE, CL, 2.85V±1.5%, 150mA	SOT-23-5	28cx	VR4	6g	Ric
142	XC6102A533MR	Vdet-IC	3.3V±2%, Hst, -MR, -Reset ODO, Wt=400ms, Rt=3.13ms	SOT-25	28cp	VD16	6g	Tor
142A	AAT60142A-S5	Vdet-IC	4.2V±2%, +Reset ODO	SOT-23-5	28vda	VD6	6g	Aat
142B	AAT60142B-S5	Vdet-IC	4.2V±2%, +Reset PPO	SOT-23-5	28vda	VD7	6g	Aat
142C	AAT60142C-S5	Vdet-IC	4.2V±2%, -Reset ODO	SOT-23-5	28vda	VD6	6g	Aat
142D	AAT60142D-S5	Vdet-IC	4.2V±2%, -Reset PPO	SOT-23-5	28vda	VD7	6g	Aat
143	XC6102A534MR	Vdet-IC	3.4V±2%, Hst, -MR, -Reset ODO, Wt=400ms, Rt=3.13ms	SOT-25	28cp	VD16	6g	Tor
143A	AAT60143A-S5	Vdet-IC	4.3V±2%, +Reset ODO	SOT-23-5	28vda	VD6	6g	Aat
143B	AAT60143B-S5	Vdet-IC	4.3V±2%, +Reset PPO	SOT-23-5	28vda	VD7	6g	Aat
143C	AAT60143C-S5	Vdet-IC	4.3V±2%, -Reset ODO	SOT-23-5	28vda	VD6	6g	Aat
143D	AAT60143D-S5	Vdet-IC	4.3V±2%, -Reset PPO	SOT-23-5	28vda	VD7	6g	Aat
144	XC6102A535MR	Vdet-IC	3.5V±2%, Hst, -MR, -Reset ODO, Wt=400ms, Rt=3.13ms	SOT-25	28cp	VD16	6g	Tor
1441	HT7144-1	LVR-IC	LDO, 4.4V±3%, 30mA	SOT-23-5	28vu	VR1	6a	Htk
144A	AAT60144A-S5	Vdet-IC	4.4V±2%, +Reset ODO	SOT-23-5	28vda	VD6	6g	Aat
144B	AAT60144B-S5	Vdet-IC	4.4V±2%, +Reset PPO	SOT-23-5	28vda	VD7	6g	Aat
144C	AAT60144C-S5	Vdet-IC	4.4V±2%, -Reset ODO	SOT-23-5	28vda	VD6	6g	Aat
144D	AAT60144D-S5	Vdet-IC	4.4V±2%, -Reset PPO	SOT-23-5	28vda	VD7	6g	Aat
145	XC6102A536MR	Vdet-IC	3.6V±2%, Hst, -MR, -Reset ODO, Wt=400ms, Rt=3.13ms	SOT-25	28cp	VD16	6g	Tor
145A	AAT60145A-S5	Vdet-IC	4.5V±2%, +Reset ODO	SOT-23-5	28vda	VD6	6g	Aat
145B	AAT60145B-S5	Vdet-IC	4.5V±2%, +Reset PPO	SOT-23-5	28vda	VD7	6g	Aat
145C	AAT60145C-S5	Vdet-IC	4.5V±2%, -Reset ODO	SOT-23-5	28vda	VD6	6g	Aat
145D	AAT60145D-S5	Vdet-IC	4.5V±2%, -Reset PPO	SOT-23-5	28vda	VD7	6g	Aat
146	XC6102A537MR	Vdet-IC	3.7V±2%, Hst, -MR, -Reset ODO, Wt=400ms, Rt=3.13ms	SOT-25	28cp	VD16	6g	Tor
146A	AAT60146A-S5	Vdet-IC	4.6V±2%, +Reset ODO	SOT-23-5	28vda	VD6	6g	Aat
146B	AAT60146B-S5	Vdet-IC	4.6V±2%, +Reset PPO	SOT-23-5	28vda	VD7	6g	Aat
146C	AAT60146C-S5	Vdet-IC	4.6V±2%, -Reset ODO	SOT-23-5	28vda	VD6	6g	Aat
146D	AAT60146D-S5	Vdet-IC	4.6V±2%, -Reset PPO	SOT-23-5	28vda	VD7	6g	Aat
147	XC6102A538MR	Vdet-IC	3.8V±2%, Hst, -MR, -Reset ODO, Wt=400ms, Rt=3.13ms	SOT-25	28cp	VD16	6g	Tor
147A	AAT60147A-S5	Vdet-IC	4.7V±2%, +Reset ODO	SOT-23-5	28vda	VD6	6g	Aat
147B	AAT60147B-S5	Vdet-IC	4.7V±2%, +Reset PPO	SOT-23-5	28vda	VD7	6g	Aat
147C	AAT60147C-S5	Vdet-IC	4.7V±2%, -Reset ODO	SOT-23-5	28vda	VD6	6g	Aat



SMD code	Type	Function	Short description	Case	Pinout	Sch.	St.	Mnf.
147D	AAT60147D-S5	Vdet-IC	4.7V±2%, -Reset PPO	SOT-23-5	28vda	VD6	6g	Aat
148	XC6102A539MR	Vdet-IC	3.9V±2%, Hst, -MR, -Reset ODO, Wt=400ms, Rt=3.13ms	SOT-25	28cp	VD16	6g	Tor
148A	AAT60148A-S5	Vdet-IC	4.8V±2%, +Reset ODO	SOT-23-5	28vda	VD6	6g	Aat
148B	AAT60148B-S5	Vdet-IC	4.8V±2%, +Reset PPO	SOT-23-5	28vda	VD7	6g	Aat
148C	AAT60148C-S5	Vdet-IC	4.8V±2%, -Reset ODO	SOT-23-5	28vda	VD6	6g	Aat
148D	AAT60148D-S5	Vdet-IC	4.8V±2%, -Reset PPO	SOT-23-5	28vda	VD7	6g	Aat
149	XC6102A540MR	Vdet-IC	4.0V±2%, Hst, -MR, -Reset ODO, Wt=400ms, Rt=3.13ms	SOT-25	28cp	VD16	6g	Tor
149A	AAT60149A-S5	Vdet-IC	4.9V±2%, +Reset ODO	SOT-23-5	28vda	VD6	6g	Aat
149B	AAT60149B-S5	Vdet-IC	4.9V±2%, +Reset PPO	SOT-23-5	28vda	VD7	6g	Aat
149C	AAT60149C-S5	Vdet-IC	4.9V±2%, -Reset ODO	SOT-23-5	28vda	VD6	6g	Aat
149D	AAT60149D-S5	Vdet-IC	4.9V±2%, -Reset PPO	SOT-23-5	28vda	VD7	6g	Aat
14A	XC6102A541MR	Vdet-IC	4.1V±2%, Hst, -MR, -Reset ODO, Wt=400ms, Rt=3.13ms	SOT-25	28cp	VD16	6g	Tor
14AA	DS1814A	Vdet-IC	5V±5%, MR and Strobe, -Reset Output	SOT-23-5	28cp	-	6a	Dal
14AB	DS1814A	Vdet-IC	5V±10%, MR, Strobe, -Reset Output	SOT-23-5	28cp	-	6a	Dal
14AC	DS1814A	Vdet-IC	5V±20%, MR and Strobe, -Reset Output	SOT-23-5	28cp	-	6a	Dal
14B	XC6102A542MR	Vdet-IC	4.2V±2%, Hst, -MR, -Reset ODO, Wt=400ms, Rt=3.13ms	SOT-25	28cp	VD16	6g	Tor
14BA	DS1814B	Vdet-IC	5V±5%, Strobe, ±Reset Output	SOT-23-5	28xq	-	6a	Dal
14BB	DS1814B	Vdet-IC	5V±10%, Strobe, ±Reset Output	SOT-23-5	28xq	-	6a	Dal
14BC	DS1814B	Vdet-IC	5V±20%, Strobe, ±Reset Output	SOT-23-5	28xq	-	6a	Dal
14C	XC6102A543MR	Vdet-IC	4.3V±2%, Hst, -MR, -Reset ODO, Wt=400ms, Rt=3.13ms	SOT-25	28cp	VD16	6g	Tor
14CA	DS1814C	Vdet-IC	5V±5%, ±Reset PPO, MR	SOT-23-5	28xf	VD21	6a	Dal
14CB	DS1814C	Vdet-IC	5V±10%, ±Reset PPO, MR	SOT-23-5	28xf	VD21	6a	Dal
14CC	DS1814C	Vdet-IC	5V±20%, ±Reset PPO, MR	SOT-23-5	28xf	VD21	6a	Dal
14D	XC6102A544MR	Vdet-IC	4.4V±2%, Hst, -MR, -Reset ODO, Wt=400ms, Rt=3.13ms	SOT-25	28cp	VD16	6g	Tor
14E	XC6102A545MR	Vdet-IC	4.5V±2%, Hst, -MR, -Reset ODO, Wt=400ms, Rt=3.13ms	SOT-25	28cp	VD16	6g	Tor
14F	XC6102A516MR	Vdet-IC	1.6V±2%, Hst, -MR, -Reset ODO, Wt=400ms, Rt=3.13ms	SOT-25	28cp	VD16	6g	Tor
14F	XC6102A546MR	Vdet-IC	4.6V±2%, Hst, -MR, -Reset ODO, Wt=400ms, Rt=3.13ms	SOT-25	28cp	VD16	6g	Tor
14H	XC6102A517MR	Vdet-IC	1.7V±2%, Hst, -MR, -Reset ODO, Wt=400ms, Rt=3.13ms	SOT-25	28cp	VD16	6g	Tor
14H	XC6102A547MR	Vdet-IC	4.7V±2%, Hst, -MR, -Reset ODO, Wt=400ms, Rt=3.13ms	SOT-25	28cp	VD16	6g	Tor
14K	XC6102A518MR	Vdet-IC	1.8V±2%, Hst, -MR, -Reset ODO, Wt=400ms, Rt=3.13ms	SOT-25	28cp	VD16	6g	Tor
14K	XC6102A548MR	Vdet-IC	4.8V±2%, Hst, -MR, -Reset ODO, Wt=400ms, Rt=3.13ms	SOT-25	28cp	VD16	6g	Tor
14L	TK71614ASCL	LVR-IC	LDO, 1.4V±2%, 150mA, +CE, -30, +80°C	SOT-23-5	28vrx	VR7	6k	Tok
14L	XC6102A519MR	Vdet-IC	1.9V±2%, Hst, -MR, -Reset ODO, Wt=400ms, Rt=3.13ms	SOT-25	28cp	VD16	6g	Tor
14L	XC6102A549MR	Vdet-IC	4.9V±2%, Hst, -MR, -Reset ODO, Wt=400ms, Rt=3.13ms	SOT-25	28cp	VD16	6g	Tor
14M	XC6102A520MR	Vdet-IC	2.0V±2%, Hst, -MR, -Reset ODO, Wt=400ms, Rt=3.13ms	SOT-25	28cp	VD16	6g	Tor
14M	XC6102A550MR	Vdet-IC	5.0V±2%, Hst, -MR, -Reset ODO, Wt=400ms, Rt=3.13ms	SOT-25	28cp	VD16	6g	Tor
14N	XC6102A521MR	Vdet-IC	2.1V±2%, Hst, -MR, -Reset ODO, Wt=400ms, Rt=3.13ms	SOT-25	28cp	VD16	6g	Tor
14P	XC6102A522MR	Vdet-IC	2.2V±2%, Hst, -MR, -Reset ODO, Wt=400ms, Rt=3.13ms	SOT-25	28cp	VD16	6g	Tor
14R	XC6102A523MR	Vdet-IC	2.3V±2%, Hst, -MR, -Reset ODO, Wt=400ms, Rt=3.13ms	SOT-25	28cp	VD16	6g	Tor
14S	XC6102A524MR	Vdet-IC	2.4V±2%, Hst, -MR, -Reset ODO, Wt=400ms, Rt=3.13ms	SOT-25	28cp	VD16	6g	Tor
14T	XC6102A525MR	Vdet-IC	2.5V±2%, Hst, -MR, -Reset ODO, Wt=400ms, Rt=3.13ms	SOT-25	28cp	VD16	6g	Tor
14U	XC6102A526MR	Vdet-IC	2.6V±2%, Hst, -MR, -Reset ODO, Wt=400ms, Rt=3.13ms	SOT-25	28cp	VD16	6g	Tor
14V	XC6102A527MR	Vdet-IC	2.7V±2%, Hst, -MR, -Reset ODO, Wt=400ms, Rt=3.13ms	SOT-25	28cp	VD16	6g	Tor
14X	XC6102A528MR	Vdet-IC	2.8V±2%, Hst, -MR, -Reset ODO, Wt=400ms, Rt=3.13ms	SOT-25	28cp	VD16	6g	Tor
14Y	XC6102A529MR	Vdet-IC	2.9V±2%, Hst, -MR, -Reset ODO, Wt=400ms, Rt=3.13ms	SOT-25	28cp	VD16	6g	Tor
14Z	XC6102A530MR	Vdet-IC	3.0V±2%, Hst, -MR, -Reset ODO, Wt=400ms, Rt=3.13ms	SOT-25	28cp	VD16	6g	Tor
15	BU4SU69G2	CMOS-Logic	Inverter	SSOP-5	28/Log6	-	6c	Rhm
15	R1223N302A	DC/DC-IC	PWM/FM step-down, +CE, 3V, 300kHz, L-P.	SOT-23-5	28ud	DC7	6g	Ric
15	RN5RF15AA	LVR-IC	LRip, -CE, 1.5V±2%, 1A*	SOT-23-5	28vw	VR6	6g	Ric
150	XC6102A631MR	Vdet-IC	3.1V±2%, Hst, -MR, -Reset ODO, Wt=1.6s, Rt=3.13ms	SOT-25	28cp	VD16	6g	Tor
1501	HT7150-1	LVR-IC	LDO, 5V±3%, 30mA	SOT-23-5	28vu	VR1	6a	Htk
150A	AAT60150A-S5	Vdet-IC	5.0V±2%, +Reset ODO	SOT-23-5	28vda	VD6	6g	Aat
150B	AAT60150B-S5	Vdet-IC	5.0V±2%, +Reset PPO	SOT-23-5	28vda	VD7	6g	Aat
150C	AAT60150C-S5	Vdet-IC	5.0V±2%, -Reset ODO	SOT-23-5	28vda	VD6	6g	Aat
150D	AAT60150D-S5	Vdet-IC	5.0V±2%, -Reset PPO	SOT-23-5	28vda	VD7	6g	Aat
151	XC6102A632MR	Vdet-IC	3.2V±2%, Hst, -MR, -Reset ODO, Wt=1.6s, Rt=3.13ms	SOT-25	28cp	VD16	6g	Tor
1512	APL5151-285	LVR-IC	LDO, LN, +CE, 2.85V, 150mA	SOT-23-5	28vrx	VR7	6k	Anp
1517	APL5151-13	LVR-IC	LDO, LN, +CE, 1.3V, 150mA	SOT-23-5	28vrx	VR7	6k	Anp
1518	APL5151-14	LVR-IC	LDO, LN, +CE, 1.4V, 150mA	SOT-23-5	28vrx	VR7	6k	Anp
1519	APL5151-15	LVR-IC	LDO, LN, +CE, 1.5V, 150mA	SOT-23-5	28vrx	VR7	6k	Anp
151A	AAT60151A-S5	Vdet-IC	5.1V±2%, +Reset ODO	SOT-23-5	28vda	VD6	6g	Aat
151A	APL5151-16	LVR-IC	LDO, LN, +CE, 1.6V, 150mA	SOT-23-5	28vrx	VR7	6k	Anp
151B	AAT60151B-S5	Vdet-IC	5.1V±2%, +Reset PPO	SOT-23-5	28vda	VD7	6g	Aat
151B	APL5151-17	LVR-IC	LDO, LN, +CE, 1.7V, 150mA	SOT-23-5	28vrx	VR7	6k	Anp
151C	AAT60151C-S5	Vdet-IC	5.1V±2%, -Reset ODO	SOT-23-5	28vda	VD6	6g	Aat
151C	APL5151-18	LVR-IC	LDO, LN, +CE, 1.8V, 150mA	SOT-23-5	28vrx	VR7	6k	Anp
151D	AAT60151D-S5	Vdet-IC	5.1V±2%, -Reset PPO	SOT-23-5	28vda	VD7	6g	Aat
151D	APL5151-19	LVR-IC	LDO, LN, +CE, 1.9V, 150mA	SOT-23-5	28vrx	VR7	6k	Anp
151E	APL5151-20	LVR-IC	LDO, LN, +CE, 2V, 150mA	SOT-23-5	28vrx	VR7	6k	Anp
151F	APL5151-21	LVR-IC	LDO, LN, +CE, 2.1V, 150mA	SOT-23-5	28vrx	VR7	6k	Anp



SMD code	Type	Function	Short description	Case	Pinout	Sch.	St.	Mnf.
151G	APL5151-22	LVR-IC	LDO, LN, +CE, 2.2V, 150mA	SOT-23-5	28vrx	VR7	6k	Anp
151H	APL5151-23	LVR-IC	LDO, LN, +CE, 2.3V, 150mA	SOT-23-5	28vrx	VR7	6k	Anp
151I	APL5151-24	LVR-IC	LDO, LN, +CE, 2.4V, 150mA	SOT-23-5	28vrx	VR7	6k	Anp
151J	APL5151-25	LVR-IC	LDO, LN, +CE, 2.5V, 150mA	SOT-23-5	28vrx	VR7	6k	Anp
151K	APL5151-26	LVR-IC	LDO, LN, +CE, 2.6V, 150mA	SOT-23-5	28vrx	VR7	6k	Anp
151L	APL5151-27	LVR-IC	LDO, LN, +CE, 2.7V, 150mA	SOT-23-5	28vrx	VR7	6k	Anp
151M	APL5151-28	LVR-IC	LDO, LN, +CE, 2.8V, 150mA	SOT-23-5	28vrx	VR7	6k	Anp
151N	APL5151-29	LVR-IC	LDO, LN, +CE, 2.9V, 150mA	SOT-23-5	28vrx	VR7	6k	Anp
151O	APL5151-30	LVR-IC	LDO, LN, +CE, 3V, 150mA	SOT-23-5	28vrx	VR7	6k	Anp
151P	APL5151-31	LVR-IC	LDO, LN, +CE, 3.1V, 150mA	SOT-23-5	28vrx	VR7	6k	Anp
151Q	APL5151-32	LVR-IC	LDO, LN, +CE, 3.2V, 150mA	SOT-23-5	28vrx	VR7	6k	Anp
151R	APL5151-33	LVR-IC	LDO, LN, +CE, 3.3V, 150mA	SOT-23-5	28vrx	VR7	6k	Anp
151S	APL5151-34	LVR-IC	LDO, LN, +CE, 3.4V, 150mA	SOT-23-5	28vrx	VR7	6k	Anp
151T	APL5151-35	LVR-IC	LDO, LN, +CE, 3.5V, 150mA	SOT-23-5	28vrx	VR7	6k	Anp
151X	APL5151-48	LVR-IC	LDO, LN, +CE, 4.8V, 150mA	SOT-23-5	28vrx	VR7	6k	Anp
151Y	APL5151-49	LVR-IC	LDO, LN, +CE, 4.9V, 150mA	SOT-23-5	28vrx	VR7	6k	Anp
151Z	APL5151-50	LVR-IC	LDO, LN, +CE, 5V, 150mA	SOT-23-5	28vrx	VR7	6k	Anp
152	XC6102A633MR	Vdet-IC	3.3V±2%, Hst, -MR, -Reset ODO, Wt=1.6s, Rt=3.13ms	SOT-25	28cp	VD16	6g	Tor
1522	APL5152-285	LVR-IC	LDO, LN, +CE, 2.85V, 150mA	SOT-23-5	28sp	VR7	6k	Anp
1527	APL5152-13	LVR-IC	LDO, LN, +CE, 1.3V, 150mA	SOT-23-5	28sp	VR7	6k	Anp
1528	APL5152-14	LVR-IC	LDO, LN, +CE, 1.4V, 150mA	SOT-23-5	28sp	VR7	6k	Anp
1529	APL5152-15	LVR-IC	LDO, LN, +CE, 1.5V, 150mA	SOT-23-5	28sp	VR7	6k	Anp
152A	AAT60152A-S5	Vdet-IC	5.2V±2%, +Reset ODO	SOT-23-5	28vda	VD6	6g	Aat
152A	APL5152-16	LVR-IC	LDO, LN, +CE, 1.6V, 150mA	SOT-23-5	28sp	VR7	6k	Anp
152B	AAT60152B-S5	Vdet-IC	5.2V±2%, +Reset PPO	SOT-23-5	28vda	VD7	6g	Aat
152B	APL5152-17	LVR-IC	LDO, LN, +CE, 1.7V, 150mA	SOT-23-5	28sp	VR7	6k	Anp
152C	AAT60152C-S5	Vdet-IC	5.2V±2%, -Reset ODO	SOT-23-5	28vda	VD6	6g	Aat
152C	APL5152-18	LVR-IC	LDO, LN, +CE, 1.7V, 150mA	SOT-23-5	28sp	VR7	6k	Anp
152D	AAT60152D-S5	Vdet-IC	5.2V±2%, -Reset PPO	SOT-23-5	28vda	VD7	6g	Aat
152D	APL5152-19	LVR-IC	LDO, LN, +CE, 1.9V, 150mA	SOT-23-5	28sp	VR7	6k	Anp
152E	APL5152-20	LVR-IC	LDO, LN, +CE, 2V, 150mA	SOT-23-5	28sp	VR7	6k	Anp
152F	APL5152-21	LVR-IC	LDO, LN, +CE, 2.1V, 150mA	SOT-23-5	28sp	VR7	6k	Anp
152G	APL5152-22	LVR-IC	LDO, LN, +CE, 2.2V, 150mA	SOT-23-5	28sp	VR7	6k	Anp
152H	APL5152-23	LVR-IC	LDO, LN, +CE, 2.3V, 150mA	SOT-23-5	28sp	VR7	6k	Anp
152I	APL5152-24	LVR-IC	LDO, LN, +CE, 2.4V, 150mA	SOT-23-5	28sp	VR7	6k	Anp
152J	APL5152-25	LVR-IC	LDO, LN, +CE, 2.5V, 150mA	SOT-23-5	28sp	VR7	6k	Anp
152K	APL5152-26	LVR-IC	LDO, LN, +CE, 2.6V, 150mA	SOT-23-5	28sp	VR7	6k	Anp
152L	APL5152-27	LVR-IC	LDO, LN, +CE, 2.7V, 150mA	SOT-23-5	28sp	VR7	6k	Anp
152M	APL5152-28	LVR-IC	LDO, LN, +CE, 2.8V, 150mA	SOT-23-5	28sp	VR7	6k	Anp
152N	APL5152-29	LVR-IC	LDO, LN, +CE, 2.9V, 150mA	SOT-23-5	28sp	VR7	6k	Anp
152O	APL5152-30	LVR-IC	LDO, LN, +CE, 3V, 150mA	SOT-23-5	28sp	VR7	6k	Anp
152P	APL5152-31	LVR-IC	LDO, LN, +CE, 3.1V, 150mA	SOT-23-5	28sp	VR7	6k	Anp
152Q	APL5152-32	LVR-IC	LDO, LN, +CE, 3.2V, 150mA	SOT-23-5	28sp	VR7	6k	Anp
152R	APL5152-33	LVR-IC	LDO, LN, +CE, 3.3V, 150mA	SOT-23-5	28sp	VR7	6k	Anp
152S	APL5152-34	LVR-IC	LDO, LN, +CE, 3.4V, 150mA	SOT-23-5	28sp	VR7	6k	Anp
152T	APL5152-35	LVR-IC	LDO, LN, +CE, 3.5V, 150mA	SOT-23-5	28sp	VR7	6k	Anp
152X	APL5152-48	LVR-IC	LDO, LN, +CE, 4.8V, 150mA	SOT-23-5	28sp	VR7	6k	Anp
152Y	APL5152-49	LVR-IC	LDO, LN, +CE, 4.9V, 150mA	SOT-23-5	28sp	VR7	6k	Anp
152Z	APL5152-50	LVR-IC	LDO, LN, +CE, 5V, 150mA	SOT-23-5	28sp	VR7	6k	Anp
153	XC6102A634MR	Vdet-IC	3.4V±2%, Hst, -MR, -Reset ODO, Wt=1.6s, Rt=3.13ms	SOT-25	28cp	VD16	6g	Tor
1532	APL5153-285	LVR-IC	LDO, LN, +CE, 2.85V, 150mA	SOT-23-5	28vr1	VR7	6k	Anp
1537	APL5153-13	LVR-IC	LDO, LN, +CE, 1.3V, 150mA	SOT-23-5	28vr1	VR7	6k	Anp
1538	APL5153-14	LVR-IC	LDO, LN, +CE, 1.4V, 150mA	SOT-23-5	28vr1	VR7	6k	Anp
1539	APL5153-15	LVR-IC	LDO, LN, +CE, 1.5V, 150mA	SOT-23-5	28vr1	VR7	6k	Anp
153A	AAT60153A-S5	Vdet-IC	5.3V±2%, +Reset ODO	SOT-23-5	28vda	VD6	6g	Aat
153A	APL5153-16	LVR-IC	LDO, LN, +CE, 1.6V, 150mA	SOT-23-5	28vr1	VR7	6k	Anp
153B	AAT60153B-S5	Vdet-IC	5.3V±2%, +Reset PPO	SOT-23-5	28vda	VD7	6g	Aat
153B	APL5153-17	LVR-IC	LDO, LN, +CE, 1.7V, 150mA	SOT-23-5	28vr1	VR7	6k	Anp
153C	AAT60153C-S5	Vdet-IC	5.3V±2%, -Reset ODO	SOT-23-5	28vda	VD6	6g	Aat
153C	APL5153-18	LVR-IC	LDO, LN, +CE, 1.8V, 150mA	SOT-23-5	28vr1	VR7	6k	Anp
153D	AAT60153D-S5	Vdet-IC	5.3V±2%, -Reset PPO	SOT-23-5	28vda	VD7	6g	Aat
153D	APL5153-19	LVR-IC	LDO, LN, +CE, 1.9V, 150mA	SOT-23-5	28vr1	VR7	6k	Anp
153E	APL5153-20	LVR-IC	LDO, LN, +CE, 2V, 150mA	SOT-23-5	28vr1	VR7	6k	Anp
153F	APL5153-21	LVR-IC	LDO, LN, +CE, 2.1V, 150mA	SOT-23-5	28vr1	VR7	6k	Anp
153G	APL5153-22	LVR-IC	LDO, LN, +CE, 2.2V, 150mA	SOT-23-5	28vr1	VR7	6k	Anp
153H	APL5153-23	LVR-IC	LDO, LN, +CE, 2.3V, 150mA	SOT-23-5	28vr1	VR7	6k	Anp
153I	APL5153-24	LVR-IC	LDO, LN, +CE, 2.4V, 150mA	SOT-23-5	28vr1	VR7	6k	Anp
153J	APL5153-25	LVR-IC	LDO, LN, +CE, 2.5V, 150mA	SOT-23-5	28vr1	VR7	6k	Anp
153K	APL5153-26	LVR-IC	LDO, LN, +CE, 2.6V, 150mA	SOT-23-5	28vr1	VR7	6k	Anp
153L	APL5153-27	LVR-IC	LDO, LN, +CE, 2.7V, 150mA	SOT-23-5	28vr1	VR7	6k	Anp



SMD code	Type	Function	Short description	Case	Pinout	Sch.	St.	Mnf.
153M	APL5153-28	LVR-IC	LDO, LN, +CE, 2.8V, 150mA	SOT-23-5	28vr1	VR7	6k	Anp
153N	APL5153-29	LVR-IC	LDO, LN, +CE, 2.9V, 150mA	SOT-23-5	28vr1	VR7	6k	Anp
153O	APL5153-30	LVR-IC	LDO, LN, +CE, 3V, 150mA	SOT-23-5	28vr1	VR7	6k	Anp
153P	APL5153-31	LVR-IC	LDO, LN, +CE, 3.1V, 150mA	SOT-23-5	28vr1	VR7	6k	Anp
153Q	APL5153-32	LVR-IC	LDO, LN, +CE, 3.2V, 150mA	SOT-23-5	28vr1	VR7	6k	Anp
153R	APL5153-33	LVR-IC	LDO, LN, +CE, 3.3V, 150mA	SOT-23-5	28vr1	VR7	6k	Anp
153S	APL5153-34	LVR-IC	LDO, LN, +CE, 3.4V, 150mA	SOT-23-5	28vr1	VR7	6k	Anp
153T	APL5153-35	LVR-IC	LDO, LN, +CE, 3.5V, 150mA	SOT-23-5	28vr1	VR7	6k	Anp
153X	APL5153-48	LVR-IC	LDO, LN, +CE, 4.8V, 150mA	SOT-23-5	28vr1	VR7	6k	Anp
153Y	APL5153-49	LVR-IC	LDO, LN, +CE, 4.9V, 150mA	SOT-23-5	28vr1	VR7	6k	Anp
153Z	APL5153-50	LVR-IC	LDO, LN, +CE, 5V, 150mA	SOT-23-5	28vr1	VR7	6k	Anp
154	XC6102A635MR	Vdet-IC	3.5V±2%, Hst, -MR, -Reset ODO, Wt=1.6s, Rt=3.13ms	SOT-25	28cp	VD16	6g	Tor
1542	APL5154-285	LVR-IC	LDO, LN, +CE, 2.85V, 150mA	SOT-23-5	28un	VR7	6k	Anp
1547	APL5154-13	LVR-IC	LDO, LN, +CE, 1.3V, 150mA	SOT-23-5	28un	VR7	6k	Anp
1548	APL5154-14	LVR-IC	LDO, LN, +CE, 1.4V, 150mA	SOT-23-5	28un	VR7	6k	Anp
1549	APL5154-15	LVR-IC	LDO, LN, +CE, 1.5V, 150mA	SOT-23-5	28un	VR7	6k	Anp
154A	AAT60154A-S5	Vdet-IC	5.4V±2%, +Reset ODO	SOT-23-5	28vda	VD6	6g	Aat
154A	APL5154-16	LVR-IC	LDO, LN, +CE, 1.6V, 150mA	SOT-23-5	28un	VR7	6k	Anp
154B	AAT60154B-S5	Vdet-IC	5.4V±2%, +Reset PPO	SOT-23-5	28vda	VD7	6g	Aat
154B	APL5154-17	LVR-IC	LDO, LN, +CE, 1.7V, 150mA	SOT-23-5	28un	VR7	6k	Anp
154C	AAT60154C-S5	Vdet-IC	5.4V±2%, -Reset ODO	SOT-23-5	28vda	VD6	6g	Aat
154C	APL5154-18	LVR-IC	LDO, LN, +CE, 1.8V, 150mA	SOT-23-5	28un	VR7	6k	Anp
154D	AAT60154D-S5	Vdet-IC	5.4V±2%, -Reset PPO	SOT-23-5	28vda	VD7	6g	Aat
154D	APL5154-19	LVR-IC	LDO, LN, +CE, 1.9V, 150mA	SOT-23-5	28un	VR7	6k	Anp
154E	APL5154-20	LVR-IC	LDO, LN, +CE, 2V, 150mA	SOT-23-5	28un	VR7	6k	Anp
154F	APL5154-21	LVR-IC	LDO, LN, +CE, 2.1V, 150mA	SOT-23-5	28un	VR7	6k	Anp
154G	APL5154-22	LVR-IC	LDO, LN, +CE, 2.2V, 150mA	SOT-23-5	28un	VR7	6k	Anp
154H	APL5154-23	LVR-IC	LDO, LN, +CE, 2.3V, 150mA	SOT-23-5	28un	VR7	6k	Anp
154I	APL5154-24	LVR-IC	LDO, LN, +CE, 2.4V, 150mA	SOT-23-5	28un	VR7	6k	Anp
154J	APL5154-25	LVR-IC	LDO, LN, +CE, 2.5V, 150mA	SOT-23-5	28un	VR7	6k	Anp
154K	APL5154-26	LVR-IC	LDO, LN, +CE, 2.6V, 150mA	SOT-23-5	28un	VR7	6k	Anp
154L	APL5154-27	LVR-IC	LDO, LN, +CE, 2.7V, 150mA	SOT-23-5	28un	VR7	6k	Anp
154M	APL5154-28	LVR-IC	LDO, LN, +CE, 2.8V, 150mA	SOT-23-5	28un	VR7	6k	Anp
154N	APL5154-29	LVR-IC	LDO, LN, +CE, 2.9V, 150mA	SOT-23-5	28un	VR7	6k	Anp
154O	APL5154-30	LVR-IC	LDO, LN, +CE, 3V, 150mA	SOT-23-5	28un	VR7	6k	Anp
154P	APL5154-31	LVR-IC	LDO, LN, +CE, 3.1V, 150mA	SOT-23-5	28un	VR7	6k	Anp
154Q	APL5154-32	LVR-IC	LDO, LN, +CE, 3.2V, 150mA	SOT-23-5	28un	VR7	6k	Anp
154R	APL5154-33	LVR-IC	LDO, LN, +CE, 3.3V, 150mA	SOT-23-5	28un	VR7	6k	Anp
154S	APL5154-34	LVR-IC	LDO, LN, +CE, 3.4V, 150mA	SOT-23-5	28un	VR7	6k	Anp
154T	APL5154-35	LVR-IC	LDO, LN, +CE, 3.5V, 150mA	SOT-23-5	28un	VR7	6k	Anp
154X	APL5154-48	LVR-IC	LDO, LN, +CE, 4.8V, 150mA	SOT-23-5	28un	VR7	6k	Anp
154Y	APL5154-49	LVR-IC	LDO, LN, +CE, 4.9V, 150mA	SOT-23-5	28un	VR7	6k	Anp
154Z	APL5154-50	LVR-IC	LDO, LN, +CE, 5V, 150mA	SOT-23-5	28un	VR7	6k	Anp
155	XC6102A636MR	Vdet-IC	3.6V±2%, Hst, -MR, -Reset ODO, Wt=1.6s, Rt=3.13ms	SOT-25	28cp	VD16	6g	Tor
155A	AAT60155A-S5	Vdet-IC	5.5V±2%, +Reset ODO	SOT-23-5	28vda	VD6	6g	Aat
155B	AAT60155B-S5	Vdet-IC	5.5V±2%, +Reset PPO	SOT-23-5	28vda	VD7	6g	Aat
155C	AAT60155C-S5	Vdet-IC	5.5V±2%, -Reset ODO	SOT-23-5	28vda	VD6	6g	Aat
155D	AAT60155D-S5	Vdet-IC	5.5V±2%, -Reset PPO	SOT-23-5	28vda	VD7	6g	Aat
155	XC6102A637MR	Vdet-IC	3.7V±2%, Hst, -MR, -Reset ODO, Wt=1.6s, Rt=3.13ms	SOT-25	28cp	VD16	6g	Tor
157	XC6102A638MR	Vdet-IC	3.8V±2%, Hst, -MR, -Reset ODO, Wt=1.6s, Rt=3.13ms	SOT-25	28cp	VD16	6g	Tor
158	XC6102A639MR	Vdet-IC	3.9V±2%, Hst, -MR, -Reset ODO, Wt=1.6s, Rt=3.13ms	SOT-25	28cp	VD16	6g	Tor
159	XC6102A640MR	Vdet-IC	4.0V±2%, Hst, -MR, -Reset ODO, Wt=1.6s, Rt=3.13ms	SOT-25	28cp	VD16	6g	Tor
15A	XC6102A641MR	Vdet-IC	4.1V±2%, Hst, -MR, -Reset ODO, Wt=1.6s, Rt=3.13ms	SOT-25	28cp	VD16	6g	Tor
15B	XC6102A642MR	Vdet-IC	4.2V±2%, Hst, -MR, -Reset ODO, Wt=1.6s, Rt=3.13ms	SOT-25	28cp	VD16	6g	Tor
15C	XC6201132MR	LVR-IC	1.3V±2%, 250mA	SOT-25	28ym	VR1	6g	Tor
15C	XC6102A643MR	Vdet-IC	4.3V±2%, Hst, -MR, -Reset ODO, Wt=1.6s, Rt=3.13ms	SOT-25	28cp	VD16	6g	Tor
15D	XC6201142MR	LVR-IC	1.4V±2%, 250mA	SOT-25	28ym	VR1	6g	Tor
15D	XC6102A644MR	Vdet-IC	4.4V±2%, Hst, -MR, -Reset ODO, Wt=1.6s, Rt=3.13ms	SOT-25	28cp	VD16	6g	Tor
15E	XC6201152MR	LVR-IC	1.5V±2%, 250mA	SOT-25	28ym	VR1	6g	Tor
15E	XC6102A645MR	Vdet-IC	4.5V±2%, Hst, -MR, -Reset ODO, Wt=1.6s, Rt=3.13ms	SOT-25	28cp	VD16	6g	Tor
15F	XC6201162MR	LVR-IC	1.6V±2%, 250mA	SOT-25	28ym	VR1	6g	Tor
15F	XC6102A616MR	Vdet-IC	1.6V±2%, Hst, -MR, -Reset ODO, Wt=1.6s, Rt=3.13ms	SOT-25	28cp	VD16	6g	Tor
15E	XC6102A646MR	Vdet-IC	4.6V±2%, Hst, -MR, -Reset ODO, Wt=1.6s, Rt=3.13ms	SOT-25	28cp	VD16	6g	Tor
15H	XC6201172MR	LVR-IC	1.7V±2%, 250mA	SOT-25	28ym	VR1	6g	Tor
15H	XC6102A617MR	Vdet-IC	1.7V±2%, Hst, -MR, -Reset ODO, Wt=1.6s, Rt=3.13ms	SOT-25	28cp	VD16	6g	Tor
15H	XC6102A647MR	Vdet-IC	4.7V±2%, Hst, -MR, -Reset ODO, Wt=1.6s, Rt=3.13ms	SOT-25	28cp	VD16	6g	Tor
15K	TK71715S	LVR-IC	LDO, 1.5V±1.5%, 300mA, +CE	SOT-23-5	28vrx	VR7	6k	Tok
15K	XC6201182MR	LVR-IC	1.8V±2%, 250mA	SOT-25	28ym	VR1	6g	Tor
15K	XC6102A618MR	Vdet-IC	1.8V±2%, Hst, -MR, -Reset ODO, Wt=1.6s, Rt=3.13ms	SOT-25	28cp	VD16	6g	Tor
15K	XC6102A648MR	Vdet-IC	4.8V±2%, Hst, -MR, -Reset ODO, Wt=1.6s, Rt=3.13ms	SOT-25	28cp	VD16	6g	Tor



SMD code	Type	Function	Short description	Case	Pinout	Sch.	St.	Mnf.
15L	TK71615ASCL	LVR-IC	LDO, 1.5V±2%, 150mA, +CE, -30...+80°C	SOT-23-5	28vrx	VR7	6k	Tok
15L	XC6201192MR	LVR-IC	1.9V±2%, 250mA	SOT-25	28ym	VR1	6g	Tor
15L	XC6102A619MR	Vdet-IC	1.9V±2%, Hst, -MR, -Reset ODO, Wt=1.6s, Rt=3.13ms	SOT-25	28cp	VD16	6g	Tor
15L	XC6102A649MR	Vdet-IC	4.9V±2%, Hst, -MR, -Reset ODO, Wt=1.6s, Rt=3.13ms	SOT-25	28cp	VD16	6g	Tor
15M	XC6201202MR	LVR-IC	2.0V±2%, 250mA	SOT-25	28ym	VR1	6g	Tor
15M	XC6102A620MR	Vdet-IC	2.0V±2%, Hst, -MR, -Reset ODO, Wt=1.6s, Rt=3.13ms	SOT-25	28cp	VD16	6g	Tor
15M	XC6102A650MR	Vdet-IC	5.0V±2%, Hst, -MR, -Reset ODO, Wt=1.6s, Rt=3.13ms	SOT-25	28cp	VD16	6g	Tor
15N	XC6201212MR	LVR-IC	2.1V±2%, 250mA	SOT-25	28ym	VR1	6g	Tor
15N	XC6102A621MR	Vdet-IC	2.1V±2%, Hst, -MR, -Reset ODO, Wt=1.6s, Rt=3.13ms	SOT-25	28cp	VD16	6g	Tor
15P	XC6201222MR	LVR-IC	2.2V±2%, 250mA	SOT-25	28ym	VR1	6g	Tor
15P	XC6102A622MR	Vdet-IC	2.2V±2%, Hst, -MR, -Reset ODO, Wt=1.6s, Rt=3.13ms	SOT-25	28cp	VD16	6g	Tor
15R	XC6201232MR	LVR-IC	2.3V±2%, 250mA	SOT-25	28ym	VR1	6g	Tor
15R	XC6102A623MR	Vdet-IC	2.3V±2%, Hst, -MR, -Reset ODO, Wt=1.6s, Rt=3.13ms	SOT-25	28cp	VD16	6g	Tor
15S	XC6201242MR	LVR-IC	2.4V±2%, 250mA	SOT-25	28ym	VR1	6g	Tor
15S	XC6102A624MR	Vdet-IC	2.4V±2%, Hst, -MR, -Reset ODO, Wt=1.6s, Rt=3.13ms	SOT-25	28cp	VD16	6g	Tor
15T	TK71415S	LVR-IC	LDO, 1.5V±2%, 100mA, +CE, Ext. transistor	SOT-23-5	28zh	VR6	6a	Tok
15T	XC6201252MR	LVR-IC	2.5V±2%, 250mA	SOT-25	28ym	VR1	6g	Tor
15T	XC6102A625MR	Vdet-IC	2.5V±2%, Hst, -MR, -Reset ODO, Wt=1.6s, Rt=3.13ms	SOT-25	28cp	VD16	6g	Tor
15U	XC6201262MR	LVR-IC	2.6V±2%, 250mA	SOT-25	28ym	VR1	6g	Tor
15U	XC6102A626MR	Vdet-IC	2.6V±2%, Hst, -MR, -Reset ODO, Wt=1.6s, Rt=3.13ms	SOT-25	28cp	VD16	6g	Tor
15V	XC6201272MR	LVR-IC	2.7V±2%, 250mA	SOT-25	28ym	VR1	6g	Tor
15V	XC6102A627MR	Vdet-IC	2.7V±2%, Hst, -MR, -Reset ODO, Wt=1.6s, Rt=3.13ms	SOT-25	28cp	VD16	6g	Tor
15X	XC6201282MR	LVR-IC	2.8V±2%, 250mA	SOT-25	28ym	VR1	6g	Tor
15X	XC6102A628MR	Vdet-IC	2.8V±2%, Hst, -MR, -Reset ODO, Wt=1.6s, Rt=3.13ms	SOT-25	28cp	VD16	6g	Tor
15Y	XC6201292MR	LVR-IC	2.9V±2%, 250mA	SOT-25	28ym	VR1	6g	Tor
15Y	XC6102A629MR	Vdet-IC	2.9V±2%, Hst, -MR, -Reset ODO, Wt=1.6s, Rt=3.13ms	SOT-25	28cp	VD16	6g	Tor
15Z	XC6201302MR	LVR-IC	3V±2%, 250mA	SOT-25	28ym	VR1	6g	Tor
15Z	XC6102A630MR	Vdet-IC	3.0V±2%, Hst, -MR, -Reset ODO, Wt=1.6s, Rt=3.13ms	SOT-25	28cp	VD16	6g	Tor
16	BU4S584G2	CMOS-Logic	Inverting Schmitt-trigger	SSOP-5	28/Log7	-	6c	Rhm
16	R1223N332A	DC/DC-IC	PWM/FM step-down, +CE, 3.3V, 300kHz, L-Pr.	SOT-23-5	28ud	DC7	6g	Ric
160	XC6201312MR	LVR-IC	3.1V±2%, 250mA	SOT-25	28ym	VR1	6g	Tor
160	XC6102B231MR	Vdet-IC	3.1V±2%, Hst, -MR, -Reset ODO, Wt=50ms, Rt=25ms	SOT-25	28cp	VD16	6g	Tor
161	XC6201322MR	LVR-IC	3.2V±2%, 250mA	SOT-25	28ym	VR1	6g	Tor
161	XC6102B232MR	Vdet-IC	3.2V±2%, Hst, -MR, -Reset ODO, Wt=50ms, Rt=25ms	SOT-25	28cp	VD16	6g	Tor
162	XC6201332MR	LVR-IC	3.3V±2%, 250mA	SOT-25	28ym	VR1	6g	Tor
162	XC6102B233MR	Vdet-IC	3.3V±2%, Hst, -MR, -Reset ODO, Wt=50ms, Rt=25ms	SOT-25	28cp	VD16	6g	Tor
163	XC6201342MR	LVR-IC	3.4V±2%, 250mA	SOT-25	28ym	VR1	6g	Tor
163	XC6102B234MR	Vdet-IC	3.4V±2%, Hst, -MR, -Reset ODO, Wt=50ms, Rt=25ms	SOT-25	28cp	VD16	6g	Tor
164	XC6201352MR	LVR-IC	3.5V±2%, 250mA	SOT-25	28ym	VR1	6g	Tor
164	XC6102B235MR	Vdet-IC	3.5V±2%, Hst, -MR, -Reset ODO, Wt=50ms, Rt=25ms	SOT-25	28cp	VD16	6g	Tor
1647	AIC1647CV	LDR-IC	1.2 MHz PWM White LED driver, OVP 4.2V	SOT-23-5	28sq	LD3	6a	Aic
1647P	AIC1647PV	LDR-IC	1.2 MHz PWM White LED driver, OVP 4.2V	SOT-23-5	28sq	LD3	6a	Aic
165	XC6201362MR	LVR-IC	3.6V±2%, 250mA	SOT-25	28ym	VR1	6g	Tor
165	XC6102B236MR	Vdet-IC	3.6V±2%, Hst, -MR, -Reset ODO, Wt=50ms, Rt=25ms	SOT-25	28cp	VD16	6g	Tor
166	XC6201372MR	LVR-IC	3.7V±2%, 250mA	SOT-25	28ym	VR1	6g	Tor
166	XC6102B237MR	Vdet-IC	3.7V±2%, Hst, -MR, -Reset ODO, Wt=50ms, Rt=25ms	SOT-25	28cp	VD16	6g	Tor
167	XC6201382MR	LVR-IC	3.8V±2%, 250mA	SOT-25	28ym	VR1	6g	Tor
167	XC6102B238MR	Vdet-IC	3.8V±2%, Hst, -MR, -Reset ODO, Wt=50ms, Rt=25ms	SOT-25	28cp	VD16	6g	Tor
168	XC6201392MR	LVR-IC	3.9V±2%, 250mA	SOT-25	28ym	VR1	6g	Tor
168	XC6102B239MR	Vdet-IC	3.9V±2%, Hst, -MR, -Reset ODO, Wt=50ms, Rt=25ms	SOT-25	28cp	VD16	6g	Tor
169	XC6201402MR	LVR-IC	4V±2%, 250mA	SOT-25	28ym	VR1	6g	Tor
169	XC6102B240MR	Vdet-IC	4.0V±2%, Hst, -MR, -Reset ODO, Wt=50ms, Rt=25ms	SOT-25	28cp	VD16	6g	Tor
16A	XC6201412MR	LVR-IC	4.1V±2%, 250mA	SOT-25	28ym	VR1	6g	Tor
16A	XC6102B241MR	Vdet-IC	4.1V±2%, Hst, -MR, -Reset ODO, Wt=50ms, Rt=25ms	SOT-25	28cp	VD16	6g	Tor
16B	XC6201422MR	LVR-IC	4.2V±2%, 250mA	SOT-25	28ym	VR1	6g	Tor
16B	XC6102B242MR	Vdet-IC	4.2V±2%, Hst, -MR, -Reset ODO, Wt=50ms, Rt=25ms	SOT-25	28cp	VD16	6g	Tor
16C	XC6201432MR	LVR-IC	4.3V±2%, 250mA	SOT-25	28ym	VR1	6g	Tor
16C	XC6102B243MR	Vdet-IC	4.3V±2%, Hst, -MR, -Reset ODO, Wt=50ms, Rt=25ms	SOT-25	28cp	VD16	6g	Tor
16D	XC6201442MR	LVR-IC	4.4V±2%, 250mA	SOT-25	28ym	VR1	6g	Tor
16D	XC6102B244MR	Vdet-IC	4.4V±2%, Hst, -MR, -Reset ODO, Wt=50ms, Rt=25ms	SOT-25	28cp	VD16	6g	Tor
16E	XC6201452MR	LVR-IC	4.5V±2%, 250mA	SOT-25	28ym	VR1	6g	Tor
16E	XC6102B245MR	Vdet-IC	4.5V±2%, Hst, -MR, -Reset ODO, Wt=50ms, Rt=25ms	SOT-25	28cp	VD16	6g	Tor
16F	XC6201462MR	LVR-IC	4.6V±2%, 250mA	SOT-25	28ym	VR1	6g	Tor
16F	XC6102B216MR	Vdet-IC	1.6V±2%, Hst, -MR, -Reset ODO, Wt=50ms, Rt=25ms	SOT-25	28cp	VD16	6g	Tor
16F	XC6102B246MR	Vdet-IC	4.6V±2%, Hst, -MR, -Reset ODO, Wt=50ms, Rt=25ms	SOT-25	28cp	VD16	6g	Tor
16H	XC6201472MR	LVR-IC	4.7V±2%, 250mA	SOT-25	28ym	VR1	6g	Tor
16H	XC6102B217MR	Vdet-IC	1.7V±2%, Hst, -MR, -Reset ODO, Wt=50ms, Rt=25ms	SOT-25	28cp	VD16	6g	Tor
16H	XC6102B247MR	Vdet-IC	4.7V±2%, Hst, -MR, -Reset ODO, Wt=50ms, Rt=25ms	SOT-25	28cp	VD16	6g	Tor
16K	TK71716S	LVR-IC	LDO, 1.6V±1.5%, 300mA, +CE	SOT-23-5	28vrx	VR7	6k	Tok
16K	XC6201482MR	LVR-IC	4.8V±2%, 250mA	SOT-25	28ym	VR1	6g	Tor



SMD code	Type	Function	Short description	Case	Pinout	Sch.	St.	Mnf.
16K	XC6102B218MR	Vdet-IC	1.8V±2%, Hst, -MR, -Reset ODO, Wt=50ms, Rt=25ms	SOT-25	28cp	VD16	6g	Tor
16K	XC6102B248MR	Vdet-IC	4.8V±2%, Hst, -MR, -Reset ODO, Wt=50ms, Rt=25ms	SOT-25	28cp	VD16	6g	Tor
16L	TK71616ASCL	LVR-IC	LDO, 1.6V±2%, 150mA, +CE, -30, +80°C	SOT-23-5	28vrx	VR7	6k	Tok
16L	XC6201492MR	LVR-IC	4.9V±2%, 250mA	SOT-25	28ym	VR1	6g	Tor
16L	XC6102B219MR	Vdet-IC	1.9V±2%, Hst, -MR, -Reset ODO, Wt=50ms, Rt=25ms	SOT-25	28cp	VD16	6g	Tor
16L	XC6102B249MR	Vdet-IC	4.9V±2%, Hst, -MR, -Reset ODO, Wt=50ms, Rt=25ms	SOT-25	28cp	VD16	6g	Tor
16M	XC6201502MR	LVR-IC	5V±2%, 250mA	SOT-25	28ym	VR1	6g	Tor
16M	XC6102B220MR	Vdet-IC	2.0V±2%, Hst, -MR, -Reset ODO, Wt=50ms, Rt=25ms	SOT-25	28cp	VD16	6g	Tor
16M	XC6102B250MR	Vdet-IC	5.0V±2%, Hst, -MR, -Reset ODO, Wt=50ms, Rt=25ms	SOT-25	28cp	VD16	6g	Tor
16N	XC6201512MR	LVR-IC	5.1V±2%, 250mA	SOT-25	28ym	VR1	6g	Tor
16N	XC6102B221MR	Vdet-IC	2.1V±2%, Hst, -MR, -Reset ODO, Wt=50ms, Rt=25ms	SOT-25	28cp	VD16	6g	Tor
16P	XC6201522MR	LVR-IC	5.2V±2%, 250mA	SOT-25	28ym	VR1	6g	Tor
16P	XC6102B222MR	Vdet-IC	2.2V±2%, Hst, -MR, -Reset ODO, Wt=50ms, Rt=25ms	SOT-25	28cp	VD16	6g	Tor
16R	XC6201532MR	LVR-IC	5.3V±2%, 250mA	SOT-25	28ym	VR1	6g	Tor
16R	XC6102B223MR	Vdet-IC	2.3V±2%, Hst, -MR, -Reset ODO, Wt=50ms, Rt=25ms	SOT-25	28cp	VD16	6g	Tor
16S	XC6201542MR	LVR-IC	5.4V±2%, 250mA	SOT-25	28ym	VR1	6g	Tor
16S	XC6102B224MR	Vdet-IC	2.4V±2%, Hst, -MR, -Reset ODO, Wt=50ms, Rt=25ms	SOT-25	28cp	VD16	6g	Tor
16T	TK71416S	LVR-IC	LDO, 1.6V±2%, 100mA, +CE, Ext. transistor	SOT-23-5	28zh	VR6	6a	Tok
16T	XC6201552MR	LVR-IC	5.5V±2%, 250mA	SOT-25	28ym	VR1	6g	Tor
16T	XC6102B225MR	Vdet-IC	2.5V±2%, Hst, -MR, -Reset ODO, Wt=50ms, Rt=25ms	SOT-25	28cp	VD16	6g	Tor
16U	XC6201562MR	LVR-IC	5.6V±2%, 250mA	SOT-25	28ym	VR1	6g	Tor
16U	XC6102B226MR	Vdet-IC	2.6V±2%, Hst, -MR, -Reset ODO, Wt=50ms, Rt=25ms	SOT-25	28cp	VD16	6g	Tor
16V	XC6201572MR	LVR-IC	5.7V±2%, 250mA	SOT-25	28ym	VR1	6g	Tor
16V	XC6102B227MR	Vdet-IC	2.7V±2%, Hst, -MR, -Reset ODO, Wt=50ms, Rt=25ms	SOT-25	28cp	VD16	6g	Tor
16X	XC6201582MR	LVR-IC	5.8V±2%, 250mA	SOT-25	28ym	VR1	6g	Tor
16X	XC6102B228MR	Vdet-IC	2.8V±2%, Hst, -MR, -Reset ODO, Wt=50ms, Rt=25ms	SOT-25	28cp	VD16	6g	Tor
16Y	XC6201592MR	LVR-IC	5.9V±2%, 250mA	SOT-25	28ym	VR1	6g	Tor
16Y	XC6102B229MR	Vdet-IC	2.9V±2%, Hst, -MR, -Reset ODO, Wt=50ms, Rt=25ms	SOT-25	28cp	VD16	6g	Tor
16Z	XC6201602MR	LVR-IC	6V±2%, 250mA	SOT-25	28ym	VR1	6g	Tor
16Z	XC6102B230MR	Vdet-IC	3.0V±2%, Hst, -MR, -Reset ODO, Wt=50ms, Rt=25ms	SOT-25	28cp	VD16	6g	Tor
17	BU4S66G2	CMOS-Logic	Bilateral analog switch	SSOP-5	28Log16	-	6c	Rhm
17	R1223N502A	DC/DC-IC	PWM/FM step-down, +CE, 5V, 300kHz, L-Pr.	SOT-23-5	28ud	DC7	6g	Ric
170	XC6102B331MR	Vdet-IC	3.1V±2%, Hst, -MR, -Reset ODO, Wt=100ms, Rt=25ms	SOT-25	28cp	VD16	6g	Tor
171	XC6102B332MR	Vdet-IC	3.2V±2%, Hst, -MR, -Reset ODO, Wt=100ms, Rt=25ms	SOT-25	28cp	VD16	6g	Tor
172	XC6102B333MR	Vdet-IC	3.3V±2%, Hst, -MR, -Reset ODO, Wt=100ms, Rt=25ms	SOT-25	28cp	VD16	6g	Tor
173	XC6102B334MR	Vdet-IC	3.4V±2%, Hst, -MR, -Reset ODO, Wt=100ms, Rt=25ms	SOT-25	28cp	VD16	6g	Tor
174	XC6102B335MR	Vdet-IC	3.5V±2%, Hst, -MR, -Reset ODO, Wt=100ms, Rt=25ms	SOT-25	28cp	VD16	6g	Tor
175	XC6102B336MR	Vdet-IC	3.6V±2%, Hst, -MR, -Reset ODO, Wt=100ms, Rt=25ms	SOT-25	28cp	VD16	6g	Tor
176	XC6102B337MR	Vdet-IC	3.7V±2%, Hst, -MR, -Reset ODO, Wt=100ms, Rt=25ms	SOT-25	28cp	VD16	6g	Tor
177	XC6102B338MR	Vdet-IC	3.8V±2%, Hst, -MR, -Reset ODO, Wt=100ms, Rt=25ms	SOT-25	28cp	VD16	6g	Tor
178	XC6102B339MR	Vdet-IC	3.9V±2%, Hst, -MR, -Reset ODO, Wt=100ms, Rt=25ms	SOT-25	28cp	VD16	6g	Tor
179	XC6102B340MR	Vdet-IC	4.0V±2%, Hst, -MR, -Reset ODO, Wt=100ms, Rt=25ms	SOT-25	28cp	VD16	6g	Tor
17A	XC6102B341MR	Vdet-IC	4.1V±2%, Hst, -MR, -Reset ODO, Wt=100ms, Rt=25ms	SOT-25	28cp	VD16	6g	Tor
17B	XC6102B342MR	Vdet-IC	4.2V±2%, Hst, -MR, -Reset ODO, Wt=100ms, Rt=25ms	SOT-25	28cp	VD16	6g	Tor
17C	XC6102B343MR	Vdet-IC	4.3V±2%, Hst, -MR, -Reset ODO, Wt=100ms, Rt=25ms	SOT-25	28cp	VD16	6g	Tor
17D	XC6102B344MR	Vdet-IC	4.4V±2%, Hst, -MR, -Reset ODO, Wt=100ms, Rt=25ms	SOT-25	28cp	VD16	6g	Tor
17E	XC6102B345MR	Vdet-IC	4.5V±2%, Hst, -MR, -Reset ODO, Wt=100ms, Rt=25ms	SOT-25	28cp	VD16	6g	Tor
17F	XC6102B316MR	Vdet-IC	1.6V±2%, Hst, -MR, -Reset ODO, Wt=100ms, Rt=25ms	SOT-25	28cp	VD16	6g	Tor
17F	XC6102B346MR	Vdet-IC	4.6V±2%, Hst, -MR, -Reset ODO, Wt=100ms, Rt=25ms	SOT-25	28cp	VD16	6g	Tor
17H	XC6102B317MR	Vdet-IC	1.7V±2%, Hst, -MR, -Reset ODO, Wt=100ms, Rt=25ms	SOT-25	28cp	VD16	6g	Tor
17H	XC6102B347MR	Vdet-IC	4.7V±2%, Hst, -MR, -Reset ODO, Wt=100ms, Rt=25ms	SOT-25	28cp	VD16	6g	Tor
17K	TK71717S	LVR-IC	LDO, 1.7V±1.5%, 300mA, +CE	SOT-23-5	28vrx	VR7	6k	Tok
17K	XC6102B318MR	Vdet-IC	1.8V±2%, Hst, -MR, -Reset ODO, Wt=100ms, Rt=25ms	SOT-25	28cp	VD16	6g	Tor
17K	XC6102B348MR	Vdet-IC	4.8V±2%, Hst, -MR, -Reset ODO, Wt=100ms, Rt=25ms	SOT-25	28cp	VD16	6g	Tor
17L	TK71617ASCL	LVR-IC	LDO, 1.7V±2%, 150mA, +CE, -30, +80°C	SOT-23-5	28vrx	VR7	6k	Tok
17L	XC6102B319MR	Vdet-IC	1.9V±2%, Hst, -MR, -Reset ODO, Wt=100ms, Rt=25ms	SOT-25	28cp	VD16	6g	Tor
17L	XC6102B349MR	Vdet-IC	4.9V±2%, Hst, -MR, -Reset ODO, Wt=100ms, Rt=25ms	SOT-25	28cp	VD16	6g	Tor
17M	XC6102B320MR	Vdet-IC	2.0V±2%, Hst, -MR, -Reset ODO, Wt=100ms, Rt=25ms	SOT-25	28cp	VD16	6g	Tor
17M	XC6102B350MR	Vdet-IC	5.0V±2%, Hst, -MR, -Reset ODO, Wt=100ms, Rt=25ms	SOT-25	28cp	VD16	6g	Tor
17N	XC6102B321MR	Vdet-IC	2.1V±2%, Hst, -MR, -Reset ODO, Wt=100ms, Rt=25ms	SOT-25	28cp	VD16	6g	Tor
17P	XC6102B322MR	Vdet-IC	2.2V±2%, Hst, -MR, -Reset ODO, Wt=100ms, Rt=25ms	SOT-25	28cp	VD16	6g	Tor
17R	XC6102B323MR	Vdet-IC	2.3V±2%, Hst, -MR, -Reset ODO, Wt=100ms, Rt=25ms	SOT-25	28cp	VD16	6g	Tor
17S	XC6102B324MR	Vdet-IC	2.4V±2%, Hst, -MR, -Reset ODO, Wt=100ms, Rt=25ms	SOT-25	28cp	VD16	6g	Tor
17T	TK71417S	LVR-IC	LDO, 1.7V±2%, 100mA, +CE, Ext. transistor	SOT-23-5	28zh	VR6	6a	Tok
17T	XC6102B325MR	Vdet-IC	2.5V±2%, Hst, -MR, -Reset ODO, Wt=100ms, Rt=25ms	SOT-25	28cp	VD16	6g	Tor
17U	XC6102B326MR	Vdet-IC	2.6V±2%, Hst, -MR, -Reset ODO, Wt=100ms, Rt=25ms	SOT-25	28cp	VD16	6g	Tor
17V	XC6102B327MR	Vdet-IC	2.7V±2%, Hst, -MR, -Reset ODO, Wt=100ms, Rt=25ms	SOT-25	28cp	VD16	6g	Tor
17X	XC6102B328MR	Vdet-IC	2.8V±2%, Hst, -MR, -Reset ODO, Wt=100ms, Rt=25ms	SOT-25	28cp	VD16	6g	Tor
17Y	XC6102B329MR	Vdet-IC	2.9V±2%, Hst, -MR, -Reset ODO, Wt=100ms, Rt=25ms	SOT-25	28cp	VD16	6g	Tor
17Z	XC6102B330MR	Vdet-IC	3.0V±2%, Hst, -MR, -Reset ODO, Wt=100ms, Rt=25ms	SOT-25	28cp	VD16	6g	Tor



SMD code	Type	Function	Short description	Case	Pinout	Sch.	St.	Mnf.
18	R1223N152B	DC/DC-IC	PWMVFM step-down, +CE, 1.5V, 500kHz, L-Pr.	SOT-23-5	28ud	DC7	6g	Ric
180	XC6102B431MR	Vdet-IC	3.1V±2%, Hst, -MR, -Reset ODO, Wt=200ms, Rt=25ms	SOT-25	28cp	VD16	6g	Tor
181	XC6102B432MR	Vdet-IC	3.2V±2%, Hst, -MR, -Reset ODO, Wt=200ms, Rt=25ms	SOT-25	28cp	VD16	6g	Tor
182	XC6102B433MR	Vdet-IC	3.3V±2%, Hst, -MR, -Reset ODO, Wt=200ms, Rt=25ms	SOT-25	28cp	VD16	6g	Tor
183	XC6102B434MR	Vdet-IC	3.4V±2%, Hst, -MR, -Reset ODO, Wt=200ms, Rt=25ms	SOT-25	28cp	VD16	6g	Tor
184	XC6102B435MR	Vdet-IC	3.5V±2%, Hst, -MR, -Reset ODO, Wt=200ms, Rt=25ms	SOT-25	28cp	VD16	6g	Tor
185	XC6102B436MR	Vdet-IC	3.6V±2%, Hst, -MR, -Reset ODO, Wt=200ms, Rt=25ms	SOT-25	28cp	VD16	6g	Tor
186	XC6102B437MR	Vdet-IC	3.7V±2%, Hst, -MR, -Reset ODO, Wt=200ms, Rt=25ms	SOT-25	28cp	VD16	6g	Tor
187	XC6102B438MR	Vdet-IC	3.8V±2%, Hst, -MR, -Reset ODO, Wt=200ms, Rt=25ms	SOT-25	28cp	VD16	6g	Tor
188	XC6102B439MR	Vdet-IC	3.9V±2%, Hst, -MR, -Reset ODO, Wt=200ms, Rt=25ms	SOT-25	28cp	VD16	6g	Tor
189	XC6102B440MR	Vdet-IC	4.0V±2%, Hst, -MR, -Reset ODO, Wt=200ms, Rt=25ms	SOT-25	28cp	VD16	6g	Tor
18A	AAT60018A-S5	Vdet-IC	1.8V±2%, -Reset ODO	SOT-23-5	28vdo	VD1	6g	Aat
18A	XC6102B441MR	Vdet-IC	4.1V±2%, Hst, -MR, -Reset ODO, Wt=200ms, Rt=25ms	SOT-25	28cp	VD16	6g	Tor
18-A	UTC8118-A	Vdet-IC	1.8V, -Reset OCO	SOT-23-5	28vzd	VD6	6k	Utc
18AA	DS1819A	Vdet-IC	3.3V±5%, MR and Strobe, -Reset Output	SOT-23-5	28cp	-	6a	Dal
18AB	DS1819A	Vdet-IC	3.3V±10%, MR, Strobe, -Reset Output	SOT-23-5	28cp	-	6a	Dal
18AC	DS1819A	Vdet-IC	3.3V±20%, MR, Strobe, -Reset Output	SOT-23-5	28cp	-	6a	Dal
18B	AAT60018B-S5	Vdet-IC	1.8V±2%, -Reset PPO	SOT-23-5	28vdo	VD3	6g	Aat
18B	XC6102B442MR	Vdet-IC	4.2V±2%, Hst, -MR, -Reset ODO, Wt=200ms, Rt=25ms	SOT-25	28cp	VD16	6g	Tor
18-B	UTC8118-B	Vdet-IC	1.8V, -Reset OCO	SOT-23-5	28vdm	VD6	6k	Utc
18BA	DS1819B	Vdet-IC	3.3V±5%, Strobe, ±Reset Output	SOT-23-5	28xq	-	6a	Dal
18BB	DS1819B	Vdet-IC	3.3V±10%, Strobe, ±Reset Output	SOT-23-5	28xq	-	6a	Dal
18BC	DS1819B	Vdet-IC	3.3V±20%, Strobe, ±Reset Output	SOT-23-5	28xq	-	6a	Dal
18C	AAT60018C-S5	Vdet-IC	1.8V±1%, -Reset ODO	SOT-23-5	28vdo	VD1	6g	Aat
18C	XC6102B443MR	Vdet-IC	4.3V±2%, Hst, -MR, -Reset ODO, Wt=200ms, Rt=25ms	SOT-25	28cp	VD16	6g	Tor
18CA	DS1819C	Vdet-IC	3.3V±5%, MR, ±Reset PPO	SOT-23-5	28xf	VD21	6a	Dal
18CB	DS1819C	Vdet-IC	3.3V±10%, MR, ±Reset PPO	SOT-23-5	28xf	VD21	6a	Dal
18CC	DS1819C	Vdet-IC	3.3V±20%, MR, ±Reset PPO	SOT-23-5	28xf	VD21	6a	Dal
18D	AAT60018D-S5	Vdet-IC	1.8V±1%, -Reset PPO	SOT-23-5	28vdo	VD3	6g	Aat
18D	XC6102B444MR	Vdet-IC	4.4V±2%, Hst, -MR, -Reset ODO, Wt=200ms, Rt=25ms	SOT-25	28cp	VD16	6g	Tor
18E	XC6102B445MR	Vdet-IC	4.5V±2%, Hst, -MR, -Reset ODO, Wt=200ms, Rt=25ms	SOT-25	28cp	VD16	6g	Tor
18F	XC6102B446MR	Vdet-IC	4.6V±2%, Hst, -MR, -Reset ODO, Wt=200ms, Rt=25ms	SOT-25	28cp	VD16	6g	Tor
18E	XC6102B446MR	Vdet-IC	4.6V±2%, Hst, -MR, -Reset ODO, Wt=200ms, Rt=25ms	SOT-25	28cp	VD16	6g	Tor
18H	XC6102B447MR	Vdet-IC	4.7V±2%, Hst, -MR, -Reset ODO, Wt=200ms, Rt=25ms	SOT-25	28cp	VD16	6g	Tor
18H	XC6102B447MR	Vdet-IC	4.7V±2%, Hst, -MR, -Reset ODO, Wt=200ms, Rt=25ms	SOT-25	28cp	VD16	6g	Tor
18K	TK71718S	LVR-IC	LDO, 1.8V±1.5%, 300mA, +CE	SOT-23-5	28vrx	VR7	6k	Tok
18K	XC6102B448MR	Vdet-IC	4.8V±2%, Hst, -MR, -Reset ODO, Wt=200ms, Rt=25ms	SOT-25	28cp	VD16	6g	Tor
18K	XC6102B448MR	Vdet-IC	4.8V±2%, Hst, -MR, -Reset ODO, Wt=200ms, Rt=25ms	SOT-25	28cp	VD16	6g	Tor
18L	TK71618ASCL	LVR-IC	LDO, 1.8V±2%, 150mA, +CE, -30...+80°C	SOT-23-5	28vrx	VR7	6k	Tok
18L	XC6102B449MR	Vdet-IC	4.9V±2%, Hst, -MR, -Reset ODO, Wt=200ms, Rt=25ms	SOT-25	28cp	VD16	6g	Tor
18L	XC6102B449MR	Vdet-IC	4.9V±2%, Hst, -MR, -Reset ODO, Wt=200ms, Rt=25ms	SOT-25	28cp	VD16	6g	Tor
18M	XC6102B420MR	Vdet-IC	2.0V±2%, Hst, -MR, -Reset ODO, Wt=200ms, Rt=25ms	SOT-25	28cp	VD16	6g	Tor
18M	XC6102B450MR	Vdet-IC	5.0V±2%, Hst, -MR, -Reset ODO, Wt=200ms, Rt=25ms	SOT-25	28cp	VD16	6g	Tor
18N	XC6102B421MR	Vdet-IC	2.1V±2%, Hst, -MR, -Reset ODO, Wt=200ms, Rt=25ms	SOT-25	28cp	VD16	6g	Tor
18P	XC6102B422MR	Vdet-IC	2.2V±2%, Hst, -MR, -Reset ODO, Wt=200ms, Rt=25ms	SOT-25	28cp	VD16	6g	Tor
18R	XC6102B423MR	Vdet-IC	2.3V±2%, Hst, -MR, -Reset ODO, Wt=200ms, Rt=25ms	SOT-25	28cp	VD16	6g	Tor
18S	XC6102B424MR	Vdet-IC	2.4V±2%, Hst, -MR, -Reset ODO, Wt=200ms, Rt=25ms	SOT-25	28cp	VD16	6g	Tor
18T	TK71418S	LVR-IC	LDO, 1.8V±2%, 100mA, +CE, Ext. transistor	SOT-23-5	28zhz	VR6	6a	Tok
18T	XC6102B425MR	Vdet-IC	2.5V±2%, Hst, -MR, -Reset ODO, Wt=200ms, Rt=25ms	SOT-25	28cp	VD16	6g	Tor
18U	XC6102B426MR	Vdet-IC	2.6V±2%, Hst, -MR, -Reset ODO, Wt=200ms, Rt=25ms	SOT-25	28cp	VD16	6g	Tor
18V	XC6102B427MR	Vdet-IC	2.7V±2%, Hst, -MR, -Reset ODO, Wt=200ms, Rt=25ms	SOT-25	28cp	VD16	6g	Tor
18X	XC6102B428MR	Vdet-IC	2.8V±2%, Hst, -MR, -Reset ODO, Wt=200ms, Rt=25ms	SOT-25	28cp	VD16	6g	Tor
18Y	XC6102B429MR	Vdet-IC	2.9V±2%, Hst, -MR, -Reset ODO, Wt=200ms, Rt=25ms	SOT-25	28cp	VD16	6g	Tor
18Z	XC6102B430MR	Vdet-IC	3.0V±2%, Hst, -MR, -Reset ODO, Wt=200ms, Rt=25ms	SOT-25	28cp	VD16	6g	Tor
19	R1223N182B	DC/DC-IC	PWMVFM step-down, +CE, 1.8V, 500kHz, L-Pr.	SOT-23-5	28ud	DC7	6g	Ric
190	XC6102B531MR	Vdet-IC	3.1V±2%, Hst, -MR, -Reset ODO, Wt=400ms, Rt=25ms	SOT-25	28cp	VD16	6g	Tor
191	XC6102B532MR	Vdet-IC	3.2V±2%, Hst, -MR, -Reset ODO, Wt=400ms, Rt=25ms	SOT-25	28cp	VD16	6g	Tor
192	XC6102B533MR	Vdet-IC	3.3V±2%, Hst, -MR, -Reset ODO, Wt=400ms, Rt=25ms	SOT-25	28cp	VD16	6g	Tor
193	XC6102B534MR	Vdet-IC	3.4V±2%, Hst, -MR, -Reset ODO, Wt=400ms, Rt=25ms	SOT-25	28cp	VD16	6g	Tor
194	XC6102B535MR	Vdet-IC	3.5V±2%, Hst, -MR, -Reset ODO, Wt=400ms, Rt=25ms	SOT-25	28cp	VD16	6g	Tor
195	XC6102B536MR	Vdet-IC	3.6V±2%, Hst, -MR, -Reset ODO, Wt=400ms, Rt=25ms	SOT-25	28cp	VD16	6g	Tor
196	XC6102B537MR	Vdet-IC	3.7V±2%, Hst, -MR, -Reset ODO, Wt=400ms, Rt=25ms	SOT-25	28cp	VD16	6g	Tor
197	XC6102B538MR	Vdet-IC	3.8V±2%, Hst, -MR, -Reset ODO, Wt=400ms, Rt=25ms	SOT-25	28cp	VD16	6g	Tor
198	XC6102B539MR	Vdet-IC	3.9V±2%, Hst, -MR, -Reset ODO, Wt=400ms, Rt=25ms	SOT-25	28cp	VD16	6g	Tor
199	XC6102B540MR	Vdet-IC	4.0V±2%, Hst, -MR, -Reset ODO, Wt=400ms, Rt=25ms	SOT-25	28cp	VD16	6g	Tor
19A	AAT60019A-S5	Vdet-IC	1.9V±2%, -Reset ODO	SOT-23-5	28vdo	VD1	6g	Aat
19A	XC6102B541MR	Vdet-IC	4.1V±2%, Hst, -MR, -Reset ODO, Wt=400ms, Rt=25ms	SOT-25	28cp	VD16	6g	Tor
19-A	UTC8119-A	Vdet-IC	1.9V, -Reset OCO	SOT-23-5	28vdz	VD6	6k	Utc
19B	AAT60019B-S5	Vdet-IC	1.9V±2%, -Reset PPO	SOT-23-5	28vdo	VD3	6g	Aat
19B	XC6102B542MR	Vdet-IC	4.2V±2%, Hst, -MR, -Reset ODO, Wt=400ms, Rt=25ms	SOT-25	28cp	VD16	6g	Tor



SMD code	Type	Function	Short description	Case	Pinout	Sch.	St.	Mnf.
19-B	UTC8119-B	Vdet-IC	1.9V, -Reset OCO	SOT-23-5	28vdm	VD6	6k	Utc
19C	AAT60019C-S5	Vdet-IC	1.9V±1%, -Reset ODO	SOT-23-5	28vdo	VD1	6g	Aat
19C	XC6102B543MR	Vdet-IC	4.3V±2%, Hst, -MR, -Reset ODO, Wt=400ms, Rt=25ms	SOT-25	28cp	VD16	6g	Tor
19D	AAT60019D-S5	Vdet-IC	1.9V±1%, -Reset PPO	SOT-23-5	28vdo	VD3	6g	Aat
19D	XC6102B544MR	Vdet-IC	4.4V±2%, Hst, -MR, -Reset ODO, Wt=400ms, Rt=25ms	SOT-25	28cp	VD16	6g	Tor
19E	XC6102B545MR	Vdet-IC	4.5V±2%, Hst, -MR, -Reset ODO, Wt=400ms, Rt=25ms	SOT-25	28cp	VD16	6g	Tor
19F	XC6102B516MR	Vdet-IC	1.6V±2%, Hst, -MR, -Reset ODO, Wt=400ms, Rt=25ms	SOT-25	28cp	VD16	6g	Tor
19F	XC6102B546MR	Vdet-IC	4.6V±2%, Hst, -MR, -Reset ODO, Wt=400ms, Rt=25ms	SOT-25	28cp	VD16	6g	Tor
19H	XC6102B517MR	Vdet-IC	1.7V±2%, Hst, -MR, -Reset ODO, Wt=400ms, Rt=25ms	SOT-25	28cp	VD16	6g	Tor
19H	XC6102B547MR	Vdet-IC	4.7V±2%, Hst, -MR, -Reset ODO, Wt=400ms, Rt=25ms	SOT-25	28cp	VD16	6g	Tor
19K	TK71719S	LVR-IC	LDO, 1.9V±1.5%, 300mA, +CE	SOT-23-5	28vrx	VR7	6k	Tok
19K	XC6102B518MR	Vdet-IC	1.8V±2%, Hst, -MR, -Reset ODO, Wt=400ms, Rt=25ms	SOT-25	28cp	VD16	6g	Tor
19K	XC6102B548MR	Vdet-IC	4.8V±2%, Hst, -MR, -Reset ODO, Wt=400ms, Rt=25ms	SOT-25	28cp	VD16	6g	Tor
19L	TK71619ASCL	LVR-IC	LDO, 1.9V±2%, 150mA, +CE, -30...+80°C	SOT-23-5	28vrx	VR7	6k	Tok
19L	XC6102B519MR	Vdet-IC	1.9V±2%, Hst, -MR, -Reset ODO, Wt=400ms, Rt=25ms	SOT-25	28cp	VD16	6g	Tor
19L	XC6102B549MR	Vdet-IC	4.9V±2%, Hst, -MR, -Reset ODO, Wt=400ms, Rt=25ms	SOT-25	28cp	VD16	6g	Tor
19M	XC6102B520MR	Vdet-IC	2.0V±2%, Hst, -MR, -Reset ODO, Wt=400ms, Rt=25ms	SOT-25	28cp	VD16	6g	Tor
19M	XC6102B550MR	Vdet-IC	5.0V±2%, Hst, -MR, -Reset ODO, Wt=400ms, Rt=25ms	SOT-25	28cp	VD16	6g	Tor
19N	XC6102B521MR	Vdet-IC	2.1V±2%, Hst, -MR, -Reset ODO, Wt=400ms, Rt=25ms	SOT-25	28cp	VD16	6g	Tor
19P	XC6102B522MR	Vdet-IC	2.2V±2%, Hst, -MR, -Reset ODO, Wt=400ms, Rt=25ms	SOT-25	28cp	VD16	6g	Tor
19R	XC6102B523MR	Vdet-IC	2.3V±2%, Hst, -MR, -Reset ODO, Wt=400ms, Rt=25ms	SOT-25	28cp	VD16	6g	Tor
19S	XC6102B524MR	Vdet-IC	2.4V±2%, Hst, -MR, -Reset ODO, Wt=400ms, Rt=25ms	SOT-25	28cp	VD16	6g	Tor
19T	TK71419S	LVR-IC	LDO, 1.9V±2%, 100mA, +CE, Ext. transistor	SOT-23-5	28zh	VR6	6a	Tok
19T	XC6102B525MR	Vdet-IC	2.5V±2%, Hst, -MR, -Reset ODO, Wt=400ms, Rt=25ms	SOT-25	28cp	VD16	6g	Tor
19U	XC6102B526MR	Vdet-IC	2.6V±2%, Hst, -MR, -Reset ODO, Wt=400ms, Rt=25ms	SOT-25	28cp	VD16	6g	Tor
19V	XC6102B527MR	Vdet-IC	2.7V±2%, Hst, -MR, -Reset ODO, Wt=400ms, Rt=25ms	SOT-25	28cp	VD16	6g	Tor
19X	XC6102B528MR	Vdet-IC	2.8V±2%, Hst, -MR, -Reset ODO, Wt=400ms, Rt=25ms	SOT-25	28cp	VD16	6g	Tor
19Y	XC6102B529MR	Vdet-IC	2.9V±2%, Hst, -MR, -Reset ODO, Wt=400ms, Rt=25ms	SOT-25	28cp	VD16	6g	Tor
19Z	XC6102B530MR	Vdet-IC	3.0V±2%, Hst, -MR, -Reset ODO, Wt=400ms, Rt=25ms	SOT-25	28cp	VD16	6g	Tor
1A	BU4341FWE	Vdet-IC	4.1V, +Reset PPO	VSOFF-5	30vka	VD3	6c	Rhm
1A	BU4341G	Vdet-IC	4.1V, +Reset PPO	SSOP-5	28vdo	VD3	6c	Rhm
1A0	XC2211A1100M	Op-IC	µPower, ±0.6..±5V, Icc0=15µA, 550kHz, 0.5V/µs	SOT-25	28obp	OP1	6g	Tor
1A0	XC6102B631MR	Vdet-IC	3.1V±2%, Hst, -MR, -Reset ODO, Wt=1.6s, Rt=25ms	SOT-25	28cp	VD16	6g	Tor
1A1	XC6102B632MR	Vdet-IC	3.2V±2%, Hst, -MR, -Reset ODO, Wt=1.6s, Rt=25ms	SOT-25	28cp	VD16	6g	Tor
1A2	XC6102B633MR	Vdet-IC	3.3V±2%, Hst, -MR, -Reset ODO, Wt=1.6s, Rt=25ms	SOT-25	28cp	VD16	6g	Tor
1A3	XC6102B634MR	Vdet-IC	3.4V±2%, Hst, -MR, -Reset ODO, Wt=1.6s, Rt=25ms	SOT-25	28cp	VD16	6g	Tor
1A4	XC6102B635MR	Vdet-IC	3.5V±2%, Hst, -MR, -Reset ODO, Wt=1.6s, Rt=25ms	SOT-25	28cp	VD16	6g	Tor
1A5	XC6102B636MR	Vdet-IC	3.6V±2%, Hst, -MR, -Reset ODO, Wt=1.6s, Rt=25ms	SOT-25	28cp	VD16	6g	Tor
1A6	XC6102B637MR	Vdet-IC	3.7V±2%, Hst, -MR, -Reset ODO, Wt=1.6s, Rt=25ms	SOT-25	28cp	VD16	6g	Tor
1A7	XC6217A08AMR	LVR-IC	LDO, 0.85V±2%, 200mA, +CE, Shutdown	SOT-25	28cu	VR4a	6g	Tor
1A7	XC6102B638MR	Vdet-IC	3.8V±2%, Hst, -MR, -Reset ODO, Wt=1.6s, Rt=25ms	SOT-25	28cp	VD16	6g	Tor
1A8	XC6217A09AMR	LVR-IC	LDO, 0.95V±2%, 200mA, +CE, Shutdown	SOT-25	28cu	VR4a	6g	Tor
1A8	XC6102B639MR	Vdet-IC	3.9V±2%, Hst, -MR, -Reset ODO, Wt=1.6s, Rt=25ms	SOT-25	28cp	VD16	6g	Tor
1A9	XC6217A402MR	LVR-IC	LDO, 4V±2%, 200mA, +CE, Shutdown	SOT-25	28cu	VR4a	6g	Tor
1A9	XC6102B640MR	Vdet-IC	4.0V±2%, Hst, -MR, -Reset ODO, Wt=1.6s, Rt=25ms	SOT-25	28cp	VD16	6g	Tor
1AA	XC6217A11AMR	LVR-IC	LDO, 1.15V±2%, 200mA, +CE, Shutdown	SOT-25	28cu	VR4a	6g	Tor
1AA	XC6102B641MR	Vdet-IC	4.1V±2%, Hst, -MR, -Reset ODO, Wt=1.6s, Rt=25ms	SOT-25	28cp	VD16	6g	Tor
1AB	XC6217A12AMR	LVR-IC	LDO, 1.25V±2%, 200mA, +CE, Shutdown	SOT-25	28cu	VR4a	6g	Tor
1AB	XC6102B642MR	Vdet-IC	4.2V±2%, Hst, -MR, -Reset ODO, Wt=1.6s, Rt=25ms	SOT-25	28cp	VD16	6g	Tor
1AC	XC6217A13AMR	LVR-IC	LDO, 1.35V±2%, 200mA, +CE, Shutdown	SOT-25	28cu	VR4a	6g	Tor
1AC	XC6102B643MR	Vdet-IC	4.3V±2%, Hst, -MR, -Reset ODO, Wt=1.6s, Rt=25ms	SOT-25	28cp	VD16	6g	Tor
1AD	XC6217A14AMR	LVR-IC	LDO, 1.45V±2%, 200mA, +CE, Shutdown	SOT-25	28cu	VR4a	6g	Tor
1AD	XC6102B644MR	Vdet-IC	4.4V±2%, Hst, -MR, -Reset ODO, Wt=1.6s, Rt=25ms	SOT-25	28cp	VD16	6g	Tor
1AE	XC6217A15AMR	LVR-IC	LDO, 1.55V±2%, 200mA, +CE, Shutdown	SOT-25	28cu	VR4a	6g	Tor
1AE	XC6102B645MR	Vdet-IC	4.5V±2%, Hst, -MR, -Reset ODO, Wt=1.6s, Rt=25ms	SOT-25	28cp	VD16	6g	Tor
1AF	XC6217A16AMR	LVR-IC	LDO, 1.65V±2%, 200mA, +CE, Shutdown	SOT-25	28cu	VR4a	6g	Tor
1AF	XC6102B616MR	Vdet-IC	1.6V±2%, Hst, -MR, -Reset ODO, Wt=1.6s, Rt=25ms	SOT-25	28cp	VD16	6g	Tor
1AF	XC6102B646MR	Vdet-IC	4.6V±2%, Hst, -MR, -Reset ODO, Wt=1.6s, Rt=25ms	SOT-25	28cp	VD16	6g	Tor
1AH	XC6217A17AMR	LVR-IC	LDO, 1.75V±2%, 200mA, +CE, Shutdown	SOT-25	28cu	VR4a	6g	Tor
1AH	XC6102B617MR	Vdet-IC	1.7V±2%, Hst, -MR, -Reset ODO, Wt=1.6s, Rt=25ms	SOT-25	28cp	VD16	6g	Tor
1AH	XC6102B647MR	Vdet-IC	4.7V±2%, Hst, -MR, -Reset ODO, Wt=1.6s, Rt=25ms	SOT-25	28cp	VD16	6g	Tor
1AK	XC6217A18AMR	LVR-IC	LDO, 1.85V±2%, 200mA, +CE, Shutdown	SOT-25	28cu	VR4a	6g	Tor
1AK	XC6102B618MR	Vdet-IC	1.8V±2%, Hst, -MR, -Reset ODO, Wt=1.6s, Rt=25ms	SOT-25	28cp	VD16	6g	Tor
1AK	XC6102B648MR	Vdet-IC	4.8V±2%, Hst, -MR, -Reset ODO, Wt=1.6s, Rt=25ms	SOT-25	28cp	VD16	6g	Tor
1AL	XC6217A19AMR	LVR-IC	LDO, 1.95V±2%, 200mA, +CE, Shutdown	SOT-25	28cu	VR4a	6g	Tor
1AL	XC6102B619MR	Vdet-IC	1.9V±2%, Hst, -MR, -Reset ODO, Wt=1.6s, Rt=25ms	SOT-25	28cp	VD16	6g	Tor
1AL	XC6102B649MR	Vdet-IC	4.9V±2%, Hst, -MR, -Reset ODO, Wt=1.6s, Rt=25ms	SOT-25	28cp	VD16	6g	Tor
1AM	XC6217A20AMR	LVR-IC	LDO, 2.05V±2%, 200mA, +CE, Shutdown	SOT-25	28cu	VR4a	6g	Tor
1AM	XC6102B620MR	Vdet-IC	2.0V±2%, Hst, -MR, -Reset ODO, Wt=1.6s, Rt=25ms	SOT-25	28cp	VD16	6g	Tor
1AM	XC6102B650MR	Vdet-IC	5.0V±2%, Hst, -MR, -Reset ODO, Wt=1.6s, Rt=25ms	SOT-25	28cp	VD16	6g	Tor



SMD code	Type	Function	Short description	Case	Pinout	Sch.	St.	Mnf.
1AN	XC6217A21AMR	LVR-IC	LDO, 2.15V±2%, 200mA, +CE, Shutdown	SOT-25	28cu	VR4a	6g	Tor
1AN	XC6102B621MR	Vdet-IC	LDO, 2.1V±2%, Hst, -MR, -Reset ODO, Wt=1.6s, Rt=25ms	SOT-25	28cp	VD16	6g	Tor
1AP	XC6217A22AMR	LVR-IC	LDO, 2.25V±2%, 200mA, +CE, Shutdown	SOT-25	28cu	VR4a	6g	Tor
1AP	XC6102B622MR	Vdet-IC	LDO, 2.2V±2%, Hst, -MR, -Reset ODO, Wt=1.6s, Rt=25ms	SOT-25	28cp	VD16	6g	Tor
1AR	XC6217A23AMR	LVR-IC	LDO, 2.35V±2%, 200mA, +CE, Shutdown	SOT-25	28cu	VR4a	6g	Tor
1AR	XC6102B623MR	Vdet-IC	LDO, 2.3V±2%, Hst, -MR, -Reset ODO, Wt=1.6s, Rt=25ms	SOT-25	28cp	VD16	6g	Tor
1AS	XC6217A24AMR	LVR-IC	LDO, 2.45V±2%, 200mA, +CE, Shutdown	SOT-25	28cu	VR4a	6g	Tor
1AS	XC6102B624MR	Vdet-IC	LDO, 2.4V±2%, Hst, -MR, -Reset ODO, Wt=1.6s, Rt=25ms	SOT-25	28cp	VD16	6g	Tor
1AT	XC6217A25AMR	LVR-IC	LDO, 2.55V±2%, 200mA, +CE, Shutdown	SOT-25	28cu	VR4a	6g	Tor
1AT	XC6102B625MR	Vdet-IC	LDO, 2.5V±2%, Hst, -MR, -Reset ODO, Wt=1.6s, Rt=25ms	SOT-25	28cp	VD16	6g	Tor
1AU	XC6217A26AMR	LVR-IC	LDO, 2.65V±2%, 200mA, +CE, Shutdown	SOT-25	28cu	VR4a	6g	Tor
1AU	XC6102B626MR	Vdet-IC	LDO, 2.6V±2%, Hst, -MR, -Reset ODO, Wt=1.6s, Rt=25ms	SOT-25	28cp	VD16	6g	Tor
1AV	XC6217A27AMR	LVR-IC	LDO, 2.75V±2%, 200mA, +CE, Shutdown	SOT-25	28cu	VR4a	6g	Tor
1AV	XC6102B627MR	Vdet-IC	LDO, 2.7V±2%, Hst, -MR, -Reset ODO, Wt=1.6s, Rt=25ms	SOT-25	28cp	VD16	6g	Tor
1AX	XC6217A28AMR	LVR-IC	LDO, 2.85V±2%, 200mA, +CE, Shutdown	SOT-25	28cu	VR4a	6g	Tor
1AX	XC6102B628MR	Vdet-IC	LDO, 2.8V±2%, Hst, -MR, -Reset ODO, Wt=1.6s, Rt=25ms	SOT-25	28cp	VD16	6g	Tor
1AY	XC6217A29AMR	LVR-IC	LDO, 2.95V±2%, 200mA, +CE, Shutdown	SOT-25	28cu	VR4a	6g	Tor
1AY	XC6102B629MR	Vdet-IC	LDO, 2.9V±2%, Hst, -MR, -Reset ODO, Wt=1.6s, Rt=25ms	SOT-25	28cp	VD16	6g	Tor
1AZ	XC6217A30AMR	LVR-IC	LDO, 3.05V±2%, 200mA, +CE, Shutdown	SOT-25	28cu	VR4a	6g	Tor
1AZ	XC6102B630MR	Vdet-IC	LDO, 3.0V±2%, Hst, -MR, -Reset ODO, Wt=1.6s, Rt=25ms	SOT-25	28cp	VD16	6g	Tor
1B	BU4342FWE	Vdet-IC	4.2V, +Reset PPO	VSOF-5	30vka	VD3	6c	Rhm
1B	BU4342G	Vdet-IC	4.2V, +Reset PPO	SSOP-5	28vdo	VD3	6c	Rhm
1B	R3111N111A	Vdet-IC	1.1V±2%, -Reset PPO	SOT-23-5	28vdm	VD7	6g	Ric
1B	RN5RL21AA	LVR-IC	LDO, 2.1V±2.5%, 150mA	SOT-23-5	28vru	VR1	6g	Ric
1B	RN5VD11CA	Vdet-IC	1.1V±2.5%, -Reset ODO	SOT-23-5	28vdo	VD1	6g	Ric
1B0	XC6217B312MR	LVR-IC	LDO, 3.1V±2%, 200mA, +CE, CL, Shutdown	SOT-25	28cu	VR4a	6g	Tor
1B0	XC6102C231MR	Vdet-IC	LDO, 3.1V±2%, Hst, -MR, -Reset ODO, Wt=50ms, Rt=50ms	SOT-25	28cp	VD16	6g	Tor
1B1	XC6217B322MR	LVR-IC	LDO, 3.2V±2%, 200mA, +CE, CL, Shutdown	SOT-25	28cu	VR4a	6g	Tor
1B1	XC6102C232MR	Vdet-IC	LDO, 3.2V±2%, Hst, -MR, -Reset ODO, Wt=50ms, Rt=50ms	SOT-25	28cp	VD16	6g	Tor
1B2	XC6217B332MR	LVR-IC	LDO, 3.3V±2%, 200mA, +CE, CL, Shutdown	SOT-25	28cu	VR4a	6g	Tor
1B2	XC6102C233MR	Vdet-IC	LDO, 3.3V±2%, Hst, -MR, -Reset ODO, Wt=50ms, Rt=50ms	SOT-25	28cp	VD16	6g	Tor
1B3	XC6217B342MR	LVR-IC	LDO, 3.4V±2%, 200mA, +CE, CL, Shutdown	SOT-25	28cu	VR4a	6g	Tor
1B3	XC6102C234MR	Vdet-IC	LDO, 3.4V±2%, Hst, -MR, -Reset ODO, Wt=50ms, Rt=50ms	SOT-25	28cp	VD16	6g	Tor
1B4	XC6217B352MR	LVR-IC	LDO, 3.5V±2%, 200mA, +CE, CL, Shutdown	SOT-25	28cu	VR4a	6g	Tor
1B4	XC6102C235MR	Vdet-IC	LDO, 3.5V±2%, Hst, -MR, -Reset ODO, Wt=50ms, Rt=50ms	SOT-25	28cp	VD16	6g	Tor
1B5	TAR5SB15	LVR-IC	LDO, 1.5V±1%, 200mA, +CE	SSOP-5	28vrx	VR7	6a	Tos
1B5	XC6217B362MR	LVR-IC	LDO, 3.6V±2%, 200mA, +CE, CL, Shutdown	SOT-25	28cu	VR4a	6g	Tor
1B5	XC6102C236MR	Vdet-IC	LDO, 3.6V±2%, Hst, -MR, -Reset ODO, Wt=50ms, Rt=50ms	SOT-25	28cp	VD16	6g	Tor
1B6	TAR5SB16	LVR-IC	LDO, 1.6V±1%, 200mA, +CE	SSOP-5	28vrx	VR7	6a	Tos
1B6	XC6217B372MR	LVR-IC	LDO, 3.7V±2%, 200mA, +CE, CL, Shutdown	SOT-25	28cu	VR4a	6g	Tor
1B6	XC6102C237MR	Vdet-IC	LDO, 3.7V±2%, Hst, -MR, -Reset ODO, Wt=50ms, Rt=50ms	SOT-25	28cp	VD16	6g	Tor
1B7	TAR5SB17	LVR-IC	LDO, 1.7V±1%, 200mA, +CE	SSOP-5	28vrx	VR7	6a	Tos
1B7	XC6217B382MR	LVR-IC	LDO, 3.8V±2%, 200mA, +CE, CL, Shutdown	SOT-25	28cu	VR4a	6g	Tor
1B7	XC6102C238MR	Vdet-IC	LDO, 3.8V±2%, Hst, -MR, -Reset ODO, Wt=50ms, Rt=50ms	SOT-25	28cp	VD16	6g	Tor
1B8	TAR5SB18	LVR-IC	LDO, 1.8V±1%, 200mA, +CE	SSOP-5	28vrx	VR7	6a	Tos
1B8	XC6217B392MR	LVR-IC	LDO, 3.9V±2%, 200mA, +CE, CL, Shutdown	SOT-25	28cu	VR4a	6g	Tor
1B8	XC6102C239MR	Vdet-IC	LDO, 3.9V±2%, Hst, -MR, -Reset ODO, Wt=50ms, Rt=50ms	SOT-25	28cp	VD16	6g	Tor
1B9	TAR5SB19	LVR-IC	LDO, 1.9V±1%, 200mA, +CE	SSOP-5	28vrx	VR7	6a	Tos
1B9	XC6217B402MR	LVR-IC	LDO, 4V±2%, 200mA, +CE, CL, Shutdown	SOT-25	28cu	VR4a	6g	Tor
1B9	XC6102C240MR	Vdet-IC	LDO, 4.0V±2%, Hst, -MR, -Reset ODO, Wt=50ms, Rt=50ms	SOT-25	28cp	VD16	6g	Tor
1BA	XC6102C241MR	Vdet-IC	LDO, 4.1V±2%, Hst, -MR, -Reset ODO, Wt=50ms, Rt=50ms	SOT-25	28cp	VD16	6g	Tor
1BB	XC6102C242MR	Vdet-IC	LDO, 4.2V±2%, Hst, -MR, -Reset ODO, Wt=50ms, Rt=50ms	SOT-25	28cp	VD16	6g	Tor
1BC	XC6102C243MR	Vdet-IC	LDO, 4.3V±2%, Hst, -MR, -Reset ODO, Wt=50ms, Rt=50ms	SOT-25	28cp	VD16	6g	Tor
1BD	XC6102C244MR	Vdet-IC	LDO, 4.4V±2%, Hst, -MR, -Reset ODO, Wt=50ms, Rt=50ms	SOT-25	28cp	VD16	6g	Tor
1BE	XC6102C245MR	Vdet-IC	LDO, 4.5V±2%, Hst, -MR, -Reset ODO, Wt=50ms, Rt=50ms	SOT-25	28cp	VD16	6g	Tor
1BF	XC6102C216MR	Vdet-IC	LDO, 1.6V±2%, Hst, -MR, -Reset ODO, Wt=50ms, Rt=50ms	SOT-25	28cp	VD16	6g	Tor
1BF	XC6102C246MR	Vdet-IC	LDO, 4.6V±2%, Hst, -MR, -Reset ODO, Wt=50ms, Rt=50ms	SOT-25	28cp	VD16	6g	Tor
1BH	XC6102C217MR	Vdet-IC	LDO, 1.7V±2%, Hst, -MR, -Reset ODO, Wt=50ms, Rt=50ms	SOT-25	28cp	VD16	6g	Tor
1BH	XC6102C247MR	Vdet-IC	LDO, 4.7V±2%, Hst, -MR, -Reset ODO, Wt=50ms, Rt=50ms	SOT-25	28cp	VD16	6g	Tor
1BK	XC6102C218MR	Vdet-IC	LDO, 1.8V±2%, Hst, -MR, -Reset ODO, Wt=50ms, Rt=50ms	SOT-25	28cp	VD16	6g	Tor
1BK	XC6102C248MR	Vdet-IC	LDO, 4.8V±2%, Hst, -MR, -Reset ODO, Wt=50ms, Rt=50ms	SOT-25	28cp	VD16	6g	Tor
1BL	XC6102C219MR	Vdet-IC	LDO, 1.9V±2%, Hst, -MR, -Reset ODO, Wt=50ms, Rt=50ms	SOT-25	28cp	VD16	6g	Tor
1BL	XC6102C249MR	Vdet-IC	LDO, 4.9V±2%, Hst, -MR, -Reset ODO, Wt=50ms, Rt=50ms	SOT-25	28cp	VD16	6g	Tor
1BM	XC6102C220MR	Vdet-IC	LDO, 2.0V±2%, Hst, -MR, -Reset ODO, Wt=50ms, Rt=50ms	SOT-25	28cp	VD16	6g	Tor
1BM	XC6102C250MR	Vdet-IC	LDO, 5.0V±2%, Hst, -MR, -Reset ODO, Wt=50ms, Rt=50ms	SOT-25	28cp	VD16	6g	Tor
1BN	XC6102C221MR	Vdet-IC	LDO, 2.1V±2%, Hst, -MR, -Reset ODO, Wt=50ms, Rt=50ms	SOT-25	28cp	VD16	6g	Tor
1BP	XC6102C222MR	Vdet-IC	LDO, 2.2V±2%, Hst, -MR, -Reset ODO, Wt=50ms, Rt=50ms	SOT-25	28cp	VD16	6g	Tor
1BR	XC6102C223MR	Vdet-IC	LDO, 2.3V±2%, Hst, -MR, -Reset ODO, Wt=50ms, Rt=50ms	SOT-25	28cp	VD16	6g	Tor
1BS	XC6102C224MR	Vdet-IC	LDO, 2.4V±2%, Hst, -MR, -Reset ODO, Wt=50ms, Rt=50ms	SOT-25	28cp	VD16	6g	Tor
1BT	XC6102C225MR	Vdet-IC	LDO, 2.5V±2%, Hst, -MR, -Reset ODO, Wt=50ms, Rt=50ms	SOT-25	28cp	VD16	6g	Tor



SMD code	Type	Function	Short description	Case	Pinout	Sch.	St.	Mnf.
1BU	XC6102C226MR	Vdet-IC	2.6V±2%, Hst, -MR, -Reset ODO, Wt=50ms, Rt=50ms	SOT-25	28cp	VD16	6g	Tor
1BV	XC6102C227MR	Vdet-IC	2.7V±2%, Hst, -MR, -Reset ODO, Wt=50ms, Rt=50ms	SOT-25	28cp	VD16	6g	Tor
1BX	XC6102C228MR	Vdet-IC	2.8V±2%, Hst, -MR, -Reset ODO, Wt=50ms, Rt=50ms	SOT-25	28cp	VD16	6g	Tor
1BY	XC6102C229MR	Vdet-IC	2.9V±2%, Hst, -MR, -Reset ODO, Wt=50ms, Rt=50ms	SOT-25	28cp	VD16	6g	Tor
1BZ	XC6102C230MR	Vdet-IC	3.0V±2%, Hst, -MR, -Reset ODO, Wt=50ms, Rt=50ms	SOT-25	28cp	VD16	6g	Tor
1C	BU4343FWE	Vdet-IC	4.3V, +Reset PPO	VSOFF-5	30wka	VD3	6c	Rhm
1C	BU4343G	Vdet-IC	4.3V, +Reset PPO	SSOP-5	28vdo	VD3	6c	Rhm
1C	R3111N211A	Vdet-IC	2.1V±2%, -Reset PPO	SOT-23-5	28vdm	VD7	6g	Ric
1C	RN5RL31AA	LVR-IC	3.1V±2.5%, 150mA	SOT-23-5	28vu	VR1	6g	Ric
1C	RN5VD21CA	Vdet-IC	2.1V±2.5%, -Reset ODO	SOT-23-5	28vdo	VD1	6g	Ric
1C0	XC6224A081MR	LVR-IC	LDO, 0.8V±20mV, 150mA, +CE	SOT-25	28cx	VR4	6g	Tor
1C0	XC6503D121MR-G	LVR-IC	LDO, 1.2V±20mV, 500mA, +CE	SOT-25	28cx	VR4	6g	Tor
1C0	XC6102C331MR	Vdet-IC	3.1V±2%, Hst, -MR, -Reset ODO, Wt=100ms, Rt=50ms	SOT-25	28cp	VD16	6g	Tor
1C1	XC6224A091MR	LVR-IC	LDO, 0.9V±20mV, 150mA, +CE	SOT-25	28cx	VR4	6g	Tor
1C1	XC6503D131MR-G	LVR-IC	LDO, 1.3V±20mV, 500mA, +CE	SOT-25	28cx	VR4	6g	Tor
1C1	XC6102C332MR	Vdet-IC	3.2V±2%, Hst, -MR, -Reset ODO, Wt=100ms, Rt=50ms	SOT-25	28cp	VD16	6g	Tor
1C2	XC6224A101MR	LVR-IC	LDO, 1.0V±20mV, 150mA, +CE	SOT-25	28cx	VR4	6g	Tor
1C2	XC6503D141MR-G	LVR-IC	LDO, 1.4V±20mV, 500mA, +CE	SOT-25	28cx	VR4	6g	Tor
1C2	XC6102C333MR	Vdet-IC	3.3V±2%, Hst, -MR, -Reset ODO, Wt=100ms, Rt=50ms	SOT-25	28cp	VD16	6g	Tor
1C3	XC6224A111MR	LVR-IC	LDO, 1.1V±20mV, 150mA, +CE	SOT-25	28cx	VR4	6g	Tor
1C3	XC6503D151MR-G	LVR-IC	LDO, 1.5V±20mV, 500mA, +CE	SOT-25	28cx	VR4	6g	Tor
1C3	XC6102C334MR	Vdet-IC	3.4V±2%, Hst, -MR, -Reset ODO, Wt=100ms, Rt=50ms	SOT-25	28cp	VD16	6g	Tor
1C4	XC6224A121MR	LVR-IC	LDO, 1.2V±20mV, 150mA, +CE	SOT-25	28cx	VR4	6g	Tor
1C4	XC6503D161MR-G	LVR-IC	LDO, 1.6V±20mV, 500mA, +CE	SOT-25	28cx	VR4	6g	Tor
1C4	XC6102C335MR	Vdet-IC	3.5V±2%, Hst, -MR, -Reset ODO, Wt=100ms, Rt=50ms	SOT-25	28cp	VD16	6g	Tor
1C5	XC6224A131MR	LVR-IC	LDO, 1.3V±1.5%, 150mA, +CE	SOT-25	28cx	VR4	6g	Tor
1C5	XC6503D171MR-G	LVR-IC	LDO, 1.7V±20mV, 500mA, +CE	SOT-25	28cx	VR4	6g	Tor
1C5	XC6102C336MR	Vdet-IC	3.6V±2%, Hst, -MR, -Reset ODO, Wt=100ms, Rt=50ms	SOT-25	28cp	VD16	6g	Tor
1C6	XC6224A141MR	LVR-IC	LDO, 1.4V±1.5%, 150mA, +CE	SOT-25	28cx	VR4	6g	Tor
1C6	XC6503D181MR-G	LVR-IC	LDO, 1.8V±20mV, 500mA, +CE	SOT-25	28cx	VR4	6g	Tor
1C6	XC6102C337MR	Vdet-IC	3.7V±2%, Hst, -MR, -Reset ODO, Wt=100ms, Rt=50ms	SOT-25	28cp	VD16	6g	Tor
1C7	XC6224A151MR	LVR-IC	LDO, 1.5V±1.5%, 150mA, +CE	SOT-25	28cx	VR4	6g	Tor
1C7	XC6503D191MR-G	LVR-IC	LDO, 1.9V±20mV, 500mA, +CE	SOT-25	28cx	VR4	6g	Tor
1C7	XC6102C338MR	Vdet-IC	3.8V±2%, Hst, -MR, -Reset ODO, Wt=100ms, Rt=50ms	SOT-25	28cp	VD16	6g	Tor
1C8	XC6224A161MR	LVR-IC	LDO, 1.6V±1.5%, 150mA, +CE	SOT-25	28cx	VR4	6g	Tor
1C8	XC6503D201MR-G	LVR-IC	LDO, 2.0V±1%, 500mA, +CE	SOT-25	28cx	VR4	6g	Tor
1C8	XC6102C339MR	Vdet-IC	3.9V±2%, Hst, -MR, -Reset ODO, Wt=100ms, Rt=50ms	SOT-25	28cp	VD16	6g	Tor
1C9	XC6224A171MR	LVR-IC	LDO, 1.7V±1.5%, 150mA, +CE	SOT-25	28cx	VR4	6g	Tor
1C9	XC6503D211MR-G	LVR-IC	LDO, 2.1V±1%, 500mA, +CE	SOT-25	28cx	VR4	6g	Tor
1C9	XC6102C340MR	Vdet-IC	4.0V±2%, Hst, -MR, -Reset ODO, Wt=100ms, Rt=50ms	SOT-25	28cp	VD16	6g	Tor
1CA	XC6224A181MR	LVR-IC	LDO, 1.8V±1.5%, 150mA, +CE	SOT-25	28cx	VR4	6g	Tor
1CA	XC6503D221MR-G	LVR-IC	LDO, 2.2V±1%, 500mA, +CE	SOT-25	28cx	VR4	6g	Tor
1CA	XC6102C341MR	Vdet-IC	4.1V±2%, Hst, -MR, -Reset ODO, Wt=100ms, Rt=50ms	SOT-25	28cp	VD16	6g	Tor
1CB	XC6224A191MR	LVR-IC	LDO, 1.9V±1.5%, 150mA, +CE	SOT-25	28cx	VR4	6g	Tor
1CB	XC6503D231MR-G	LVR-IC	LDO, 2.3V±1%, 500mA, +CE	SOT-25	28cx	VR4	6g	Tor
1CB	XC6102C342MR	Vdet-IC	4.2V±2%, Hst, -MR, -Reset ODO, Wt=100ms, Rt=50ms	SOT-25	28cp	VD16	6g	Tor
1CC	XC6224A201MR	LVR-IC	LDO, 2.0V±1.5%, 150mA, +CE	SOT-25	28cx	VR4	6g	Tor
1CC	XC6503D241MR-G	LVR-IC	LDO, 2.4V±1%, 500mA, +CE	SOT-25	28cx	VR4	6g	Tor
1CC	XC6102C343MR	Vdet-IC	4.3V±2%, Hst, -MR, -Reset ODO, Wt=100ms, Rt=50ms	SOT-25	28cp	VD16	6g	Tor
1CD	XC6224A211MR	LVR-IC	LDO, 2.1V±1.5%, 150mA, +CE	SOT-25	28cx	VR4	6g	Tor
1CD	XC6503D251MR-G	LVR-IC	LDO, 2.5V±1%, 500mA, +CE	SOT-25	28cx	VR4	6g	Tor
1CD	XC6102C344MR	Vdet-IC	4.4V±2%, Hst, -MR, -Reset ODO, Wt=100ms, Rt=50ms	SOT-25	28cp	VD16	6g	Tor
1CE	XC6224A221MR	LVR-IC	LDO, 2.2V±1.5%, 150mA, +CE	SOT-25	28cx	VR4	6g	Tor
1CE	XC6503D261MR-G	LVR-IC	LDO, 2.6V±1%, 500mA, +CE	SOT-25	28cx	VR4	6g	Tor
1CE	XC6102C345MR	Vdet-IC	4.5V±2%, Hst, -MR, -Reset ODO, Wt=100ms, Rt=50ms	SOT-25	28cp	VD16	6g	Tor
1CF	XC6224A231MR	LVR-IC	LDO, 2.3V±1.5%, 150mA, +CE	SOT-25	28cx	VR4	6g	Tor
1CF	XC6503D271MR-G	LVR-IC	LDO, 2.7V±1%, 500mA, +CE	SOT-25	28cx	VR4	6g	Tor
1CF	XC6102C316MR	Vdet-IC	1.6V±2%, Hst, -MR, -Reset ODO, Wt=100ms, Rt=50ms	SOT-25	28cp	VD16	6g	Tor
1CF	XC6102C346MR	Vdet-IC	4.6V±2%, Hst, -MR, -Reset ODO, Wt=100ms, Rt=50ms	SOT-25	28cp	VD16	6g	Tor
1CH	XC6224A241MR	LVR-IC	LDO, 2.4V±1.5%, 150mA, +CE	SOT-25	28cx	VR4	6g	Tor
1CH	XC6503D281MR-G	LVR-IC	LDO, 2.8V±1%, 500mA, +CE	SOT-25	28cx	VR4	6g	Tor
1CH	XC6102C317MR	Vdet-IC	1.7V±2%, Hst, -MR, -Reset ODO, Wt=100ms, Rt=50ms	SOT-25	28cp	VD16	6g	Tor
1CH	XC6102C347MR	Vdet-IC	4.7V±2%, Hst, -MR, -Reset ODO, Wt=100ms, Rt=50ms	SOT-25	28cp	VD16	6g	Tor
1CK	XC6224A251MR	LVR-IC	LDO, 2.5V±1.5%, 150mA, +CE	SOT-25	28cx	VR4	6g	Tor
1CK	XC6503D291MR-G	LVR-IC	LDO, 2.9V±1%, 500mA, +CE	SOT-25	28cx	VR4	6g	Tor
1CK	XC6102C318MR	Vdet-IC	1.8V±2%, Hst, -MR, -Reset ODO, Wt=100ms, Rt=50ms	SOT-25	28cp	VD16	6g	Tor
1CK	XC6102C348MR	Vdet-IC	4.8V±2%, Hst, -MR, -Reset ODO, Wt=100ms, Rt=50ms	SOT-25	28cp	VD16	6g	Tor
1CL	XC6224A261MR	LVR-IC	LDO, 2.6V±1.5%, 150mA, +CE	SOT-25	28cx	VR4	6g	Tor
1CL	XC6503D301MR-G	LVR-IC	LDO, 3.0V±1%, 500mA, +CE	SOT-25	28cx	VR4	6g	Tor
1CL	XC6102C319MR	Vdet-IC	1.9V±2%, Hst, -MR, -Reset ODO, Wt=100ms, Rt=50ms	SOT-25	28cp	VD16	6g	Tor



SMD code	Type	Function	Short description	Case	Pinout	Sch.	St.	Mnf.
1CL	XC6102C349MR	Vdet-IC	4.9V±2%, Hst, -MR, -Reset ODO, Wt=100ms, Rt=50ms	SOT-25	28cp	VD16	6g	Tor
1CM	XC6224A271MR	LVR-IC	LDO, 2.7V±1.5%, 150mA, +CE	SOT-25	28cx	VR4	6g	Tor
1CM	XC6503D311MR-G	LVR-IC	LDO, 3.1V±1%, 500mA, +CE	SOT-25	28cx	VR4	6g	Tor
1CM	XC6102C320MR	Vdet-IC	2.0V±2%, Hst, -MR, -Reset ODO, Wt=100ms, Rt=50ms	SOT-25	28cp	VD16	6g	Tor
1CM	XC6102C350MR	Vdet-IC	5.0V±2%, Hst, -MR, -Reset ODO, Wt=100ms, Rt=50ms	SOT-25	28cp	VD16	6g	Tor
1CN	XC6224A281MR	LVR-IC	LDO, 2.8V±1.5%, 150mA, +CE	SOT-25	28cx	VR4	6g	Tor
1CN	XC6503D321MR-G	LVR-IC	LDO, 3.2V±1%, 500mA, +CE	SOT-25	28cx	VR4	6g	Tor
1CN	XC6102C321MR	Vdet-IC	2.1V±2%, Hst, -MR, -Reset ODO, Wt=100ms, Rt=50ms	SOT-25	28cp	VD16	6g	Tor
1CP	XC6224A291MR	LVR-IC	LDO, 2.9V±1.5%, 150mA, +CE	SOT-25	28cx	VR4	6g	Tor
1CP	XC6503D331MR-G	LVR-IC	LDO, 3.3V±1%, 500mA, +CE	SOT-25	28cx	VR4	6g	Tor
1CP	XC6102C322MR	Vdet-IC	2.2V±2%, Hst, -MR, -Reset ODO, Wt=100ms, Rt=50ms	SOT-25	28cp	VD16	6g	Tor
1CR	XC6224A301MR	LVR-IC	LDO, 3.0V±1.5%, 150mA, +CE	SOT-25	28cx	VR4	6g	Tor
1CR	XC6503D341MR-G	LVR-IC	LDO, 3.4V±1%, 500mA, +CE	SOT-25	28cx	VR4	6g	Tor
1CR	XC6102C323MR	Vdet-IC	2.3V±2%, Hst, -MR, -Reset ODO, Wt=100ms, Rt=50ms	SOT-25	28cp	VD16	6g	Tor
1CS	XC6503D351MR-G	LVR-IC	LDO, 3.5V±1%, 500mA, +CE	SOT-25	28cx	VR4	6g	Tor
1CS	XC6102C324MR	Vdet-IC	2.4V±2%, Hst, -MR, -Reset ODO, Wt=100ms, Rt=50ms	SOT-25	28cp	VD16	6g	Tor
1CT	XC6503D361MR-G	LVR-IC	LDO, 3.6V±1%, 500mA, +CE	SOT-25	28cx	VR4	6g	Tor
1CT	XC6102C325MR	Vdet-IC	2.5V±2%, Hst, -MR, -Reset ODO, Wt=100ms, Rt=50ms	SOT-25	28cp	VD16	6g	Tor
1CU	XC6503D371MR-G	LVR-IC	LDO, 3.7V±1%, 500mA, +CE	SOT-25	28cx	VR4	6g	Tor
1CU	XC6102C326MR	Vdet-IC	2.6V±2%, Hst, -MR, -Reset ODO, Wt=100ms, Rt=50ms	SOT-25	28cp	VD16	6g	Tor
1CV	XC6503D381MR-G	LVR-IC	LDO, 3.8V±1%, 500mA, +CE	SOT-25	28cx	VR4	6g	Tor
1CV	XC6102C327MR	Vdet-IC	2.7V±2%, Hst, -MR, -Reset ODO, Wt=100ms, Rt=50ms	SOT-25	28cp	VD16	6g	Tor
1CX	XC6503D391MR-G	LVR-IC	LDO, 3.9V±1%, 500mA, +CE	SOT-25	28cx	VR4	6g	Tor
1CX	XC6102C328MR	Vdet-IC	2.8V±2%, Hst, -MR, -Reset ODO, Wt=100ms, Rt=50ms	SOT-25	28cp	VD16	6g	Tor
1CY	XC6503D401MR-G	LVR-IC	LDO, 4.0V±1%, 500mA, +CE	SOT-25	28cx	VR4	6g	Tor
1CY	XC6102C329MR	Vdet-IC	2.9V±2%, Hst, -MR, -Reset ODO, Wt=100ms, Rt=50ms	SOT-25	28cp	VD16	6g	Tor
1CZ	XC6503D411MR-G	LVR-IC	LDO, 4.1V±1%, 500mA, +CE	SOT-25	28cx	VR4	6g	Tor
1CZ	XC6102C330MR	Vdet-IC	3.0V±2%, Hst, -MR, -Reset ODO, Wt=100ms, Rt=50ms	SOT-25	28cp	VD16	6g	Tor
1D	BU4344FWE	Vdet-IC	4.4V, +Reset PPO	VSOFF-5	30vka	VD3	6c	Rhm
1D	BU4344G	Vdet-IC	4.4V, +Reset PPO	SSOP-5	28vdo	VD3	6c	Rhm
1D	R3111N311A	Vdet-IC	3.1V±2%, -Reset PPO	SOT-23-5	28vdm	VD7	6g	Ric
1D	RN5RL41AA	LVR-IC	4.1V±2.5%, 150mA	SOT-23-5	28vur	VR1	6g	Ric
1D	RN5VD31CA	Vdet-IC	3.1V±2.5%, -Reset ODO	SOT-23-5	28vdo	VD1	6g	Ric
1D=	RT9818B-30GB	Vdet-IC	3.0V±1.5%, -ODO +Reset, Td=55ms	SOT-23-5	28vdm	VD6	6a	Rct
1D0	XC6224B081MR	LVR-IC	LDO, 0.8V±20mV, 150mA, +CE, PDR	SOT-25	28cx	VR4	6g	Tor
1D0	XC6503D421MR-G	LVR-IC	LDO, 4.2V±1%, 500mA, +CE	SOT-25	28cx	VR4	6g	Tor
1D0	XC6102C431MR	Vdet-IC	3.1V±2%, Hst, -MR, -Reset ODO, Wt=200ms, Rt=50ms	SOT-25	28cp	VD16	6g	Tor
1D1	S-1312A33-M5T1U3	LVR-IC	LDO, 3.3V±1%, 150mA, +CE, CL, PDR	SOT-23-5	28cx	VR4	6g	Sii
1D1	XC6224B091MR	LVR-IC	LDO, 0.9V±20mV, 150mA, +CE, PDR	SOT-25	28cx	VR4	6g	Tor
1D1	XC6503D431MR-G	LVR-IC	LDO, 4.3V±1%, 500mA, +CE	SOT-25	28cx	VR4	6g	Tor
1D1	XC6102C432MR	Vdet-IC	3.2V±2%, Hst, -MR, -Reset ODO, Wt=200ms, Rt=50ms	SOT-25	28cp	VD16	6g	Tor
1D2	S-1312A34-M5T1U3	LVR-IC	LDO, 3.4V±1%, 150mA, +CE, CL, PDR	SOT-23-5	28cx	VR4	6g	Sii
1D2	XC6224B101MR	LVR-IC	LDO, 1.0V±20mV, 150mA, +CE, PDR	SOT-25	28cx	VR4	6g	Tor
1D2	XC6503D441MR-G	LVR-IC	LDO, 4.4V±1%, 500mA, +CE	SOT-25	28cx	VR4	6g	Tor
1D2	XC6102C433MR	Vdet-IC	3.3V±2%, Hst, -MR, -Reset ODO, Wt=200ms, Rt=50ms	SOT-25	28cp	VD16	6g	Tor
1D3	S-1312A35-M5T1U3	LVR-IC	LDO, 3.5V±1%, 150mA, +CE, CL, PDR	SOT-23-5	28cx	VR4	6g	Sii
1D3	XC6224B111MR	LVR-IC	LDO, 1.1V±20mV, 150mA, +CE, PDR	SOT-25	28cx	VR4	6g	Tor
1D3	XC6503D451MR-G	LVR-IC	LDO, 4.5V±1%, 500mA, +CE	SOT-25	28cx	VR4	6g	Tor
1D3	XC6102C434MR	Vdet-IC	3.4V±2%, Hst, -MR, -Reset ODO, Wt=200ms, Rt=50ms	SOT-25	28cp	VD16	6g	Tor
1D4	XC6224B121MR	LVR-IC	LDO, 1.2V±20mV, 150mA, +CE, PDR	SOT-25	28cx	VR4	6g	Tor
1D4	XC6503D461MR-G	LVR-IC	LDO, 4.6V±1%, 500mA, +CE	SOT-25	28cx	VR4	6g	Tor
1D4	XC6102C435MR	Vdet-IC	3.5V±2%, Hst, -MR, -Reset ODO, Wt=200ms, Rt=50ms	SOT-25	28cp	VD16	6g	Tor
1D5	XC6224B131MR	LVR-IC	LDO, 1.3V±1.5%, 150mA, +CE, PDR	SOT-25	28cx	VR4	6g	Tor
1D5	XC6503D471MR-G	LVR-IC	LDO, 4.7V±1%, 500mA, +CE	SOT-25	28cx	VR4	6g	Tor
1D5	XC6102C436MR	Vdet-IC	3.6V±2%, Hst, -MR, -Reset ODO, Wt=200ms, Rt=50ms	SOT-25	28cp	VD16	6g	Tor
1D6	XC6224B141MR	LVR-IC	LDO, 1.4V±1.5%, 150mA, +CE, PDR	SOT-25	28cx	VR4	6g	Tor
1D6	XC6503D481MR-G	LVR-IC	LDO, 4.8V±1%, 500mA, +CE	SOT-25	28cx	VR4	6g	Tor
1D6	XC6102C437MR	Vdet-IC	3.7V±2%, Hst, -MR, -Reset ODO, Wt=200ms, Rt=50ms	SOT-25	28cp	VD16	6g	Tor
1D7	XC6224B151MR	LVR-IC	LDO, 1.5V±1.5%, 150mA, +CE, PDR	SOT-25	28cx	VR4	6g	Tor
1D7	XC6503D491MR-G	LVR-IC	LDO, 4.9V±1%, 500mA, +CE	SOT-25	28cx	VR4	6g	Tor
1D7	XC6102C438MR	Vdet-IC	3.8V±2%, Hst, -MR, -Reset ODO, Wt=200ms, Rt=50ms	SOT-25	28cp	VD16	6g	Tor
1D8	XC6224B161MR	LVR-IC	LDO, 1.6V±1.5%, 150mA, +CE, PDR	SOT-25	28cx	VR4	6g	Tor
1D8	XC6503D501MR-G	LVR-IC	LDO, 5.0V±1%, 500mA, +CE	SOT-25	28cx	VR4	6g	Tor
1D8	XC6102C439MR	Vdet-IC	3.9V±2%, Hst, -MR, -Reset ODO, Wt=200ms, Rt=50ms	SOT-25	28cp	VD16	6g	Tor
1D9	XC6224B171MR	LVR-IC	LDO, 1.7V±1.5%, 150mA, +CE, PDR	SOT-25	28cx	VR4	6g	Tor
1D9	XC6102C440MR	Vdet-IC	4.0V±2%, Hst, -MR, -Reset ODO, Wt=200ms, Rt=50ms	SOT-25	28cp	VD16	6g	Tor
1DA	S-1312A10-M5T1U3	LVR-IC	LDO, 1.0V±1%, 150mA, +CE, CL, PDR	SOT-23-5	28cx	VR4	6g	Sii
1DA	XC6224B181MR	LVR-IC	LDO, 1.8V±1.5%, 150mA, +CE, PDR	SOT-25	28cx	VR4	6g	Tor
1DA	XC6102C441MR	Vdet-IC	4.1V±2%, Hst, -MR, -Reset ODO, Wt=200ms, Rt=50ms	SOT-25	28cp	VD16	6g	Tor
1DB	S-1312A11-M5T1U3	LVR-IC	LDO, 1.1V±1%, 150mA, +CE, CL, PDR	SOT-23-5	28cx	VR4	6g	Sii



SMD code	Type	Function	Short description	Case	Pinout	Sch.	St.	Mnf.
1DB	XC6224B191MR	LVR-IC	LDO, 1.9V±1.5%, 150mA, +CE, PDR	SOT-25	28cx	VR4	6g	Tor
1DB	XC6102C442MR	Vdet-IC	4.2V±2%, Hst, -MR, -Reset ODO, Wt=200ms, Rt=50ms	SOT-25	28cp	VD16	6g	Tor
1DC	S-1312A12-M5T1U3	LVR-IC	LDO, 1.2V±1%, 150mA, +CE, CL, PDR	SOT-23-5	28cx	VR4	6g	Sii
1DC	XC6224B201MR	LVR-IC	LDO, 2.0V±1.5%, 150mA, +CE, PDR	SOT-25	28cx	VR4	6g	Tor
1DC	XC6102C443MR	Vdet-IC	4.3V±2%, Hst, -MR, -Reset ODO, Wt=200ms, Rt=50ms	SOT-25	28cp	VD16	6g	Tor
1DD	S-1312A13-M5T1U3	LVR-IC	LDO, 1.3V±1%, 150mA, +CE, CL, PDR	SOT-23-5	28cx	VR4	6g	Sii
1DD	XC6224B211MR	LVR-IC	LDO, 2.1V±1.5%, 150mA, +CE, PDR	SOT-25	28cx	VR4	6g	Tor
1DD	XC6102C444MR	Vdet-IC	4.4V±2%, Hst, -MR, -Reset ODO, Wt=200ms, Rt=50ms	SOT-25	28cp	VD16	6g	Tor
1DE	S-1312A14-M5T1U3	LVR-IC	LDO, 1.4V±1%, 150mA, +CE, CL, PDR	SOT-23-5	28cx	VR4	6g	Sii
1DE	XC6224B221MR	LVR-IC	LDO, 2.2V±1.5%, 150mA, +CE, PDR	SOT-25	28cx	VR4	6g	Tor
1DE	XC6102C445MR	Vdet-IC	4.5V±2%, Hst, -MR, -Reset ODO, Wt=200ms, Rt=50ms	SOT-25	28cp	VD16	6g	Tor
1DF	S-1312A15-M5T1U3	LVR-IC	LDO, 1.5V±1%, 150mA, +CE, CL, PDR	SOT-23-5	28cx	VR4	6g	Sii
1DF	XC6224B231MR	LVR-IC	LDO, 2.3V±1.5%, 150mA, +CE, PDR	SOT-25	28cx	VR4	6g	Tor
1DF	XC6102C416MR	Vdet-IC	1.6V±2%, Hst, -MR, -Reset ODO, Wt=200ms, Rt=50ms	SOT-25	28cp	VD16	6g	Tor
1DF	XC6102C446MR	Vdet-IC	4.6V±2%, Hst, -MR, -Reset ODO, Wt=200ms, Rt=50ms	SOT-25	28cp	VD16	6g	Tor
1DG	S-1312A16-M5T1U3	LVR-IC	LDO, 1.6V±1%, 150mA, +CE, CL, PDR	SOT-23-5	28cx	VR4	6g	Sii
1DH	S-1312A17-M5T1U3	LVR-IC	LDO, 1.7V±1%, 150mA, +CE, CL, PDR	SOT-23-5	28cx	VR4	6g	Sii
1DH	XC6224B241MR	LVR-IC	LDO, 2.4V±1.5%, 150mA, +CE, PDR	SOT-25	28cx	VR4	6g	Tor
1DH	XC6102C417MR	Vdet-IC	1.7V±2%, Hst, -MR, -Reset ODO, Wt=200ms, Rt=50ms	SOT-25	28cp	VD16	6g	Tor
1DH	XC6102C447MR	Vdet-IC	4.7V±2%, Hst, -MR, -Reset ODO, Wt=200ms, Rt=50ms	SOT-25	28cp	VD16	6g	Tor
1DJ	S-1312A18-M5T1U3	LVR-IC	LDO, 1.8V±1%, 150mA, +CE, CL, PDR	SOT-23-5	28cx	VR4	6g	Sii
1DK	S-1312A1J-M5T1U3	LVR-IC	LDO, 1.85V±1%, 150mA, +CE, CL, PDR	SOT-23-5	28cx	VR4	6g	Sii
1DK	XC6224B251MR	LVR-IC	LDO, 2.5V±1.5%, 150mA, +CE, PDR	SOT-25	28cx	VR4	6g	Tor
1DK	XC6102C418MR	Vdet-IC	1.8V±2%, Hst, -MR, -Reset ODO, Wt=200ms, Rt=50ms	SOT-25	28cp	VD16	6g	Tor
1DK	XC6102C448MR	Vdet-IC	4.8V±2%, Hst, -MR, -Reset ODO, Wt=200ms, Rt=50ms	SOT-25	28cp	VD16	6g	Tor
1DL	S-1312A19-M5T1U3	LVR-IC	LDO, 1.9V±1%, 150mA, +CE, CL, PDR	SOT-23-5	28cx	VR4	6g	Sii
1DL	XC6224B261MR	LVR-IC	LDO, 2.6V±1.5%, 150mA, +CE, PDR	SOT-25	28cx	VR4	6g	Tor
1DL	XC6102C419MR	Vdet-IC	1.9V±2%, Hst, -MR, -Reset ODO, Wt=200ms, Rt=50ms	SOT-25	28cp	VD16	6g	Tor
1DL	XC6102C449MR	Vdet-IC	4.9V±2%, Hst, -MR, -Reset ODO, Wt=200ms, Rt=50ms	SOT-25	28cp	VD16	6g	Tor
1DM	S-1312A20-M5T1U3	LVR-IC	LDO, 2.0V±1%, 150mA, +CE, CL, PDR	SOT-23-5	28cx	VR4	6g	Sii
1DM	XC6224B271MR	LVR-IC	LDO, 2.7V±1.5%, 150mA, +CE, PDR	SOT-25	28cx	VR4	6g	Tor
1DM	XC6102C420MR	Vdet-IC	2.0V±2%, Hst, -MR, -Reset ODO, Wt=200ms, Rt=50ms	SOT-25	28cp	VD16	6g	Tor
1DM	XC6102C450MR	Vdet-IC	5.0V±2%, Hst, -MR, -Reset ODO, Wt=200ms, Rt=50ms	SOT-25	28cp	VD16	6g	Tor
1DN	S-1312A21-M5T1U3	LVR-IC	LDO, 2.1V±1%, 150mA, +CE, CL, PDR	SOT-23-5	28cx	VR4	6g	Sii
1DN	XC6224B281MR	LVR-IC	LDO, 2.8V±1.5%, 150mA, +CE, PDR	SOT-25	28cx	VR4	6g	Tor
1DN	XC6102C421MR	Vdet-IC	2.1V±2%, Hst, -MR, -Reset ODO, Wt=200ms, Rt=50ms	SOT-25	28cp	VD16	6g	Tor
1DO	S-1312A22-M5T1U3	LVR-IC	LDO, 2.2V±1%, 150mA, +CE, CL, PDR	SOT-23-5	28cx	VR4	6g	Sii
1DP	S-1312A23-M5T1U3	LVR-IC	LDO, 2.3V±1%, 150mA, +CE, CL, PDR	SOT-23-5	28cx	VR4	6g	Sii
1DP	XC6224B291MR	LVR-IC	LDO, 2.9V±1.5%, 150mA, +CE, PDR	SOT-25	28cx	VR4	6g	Tor
1DP	XC6102C422MR	Vdet-IC	2.2V±2%, Hst, -MR, -Reset ODO, Wt=200ms, Rt=50ms	SOT-25	28cp	VD16	6g	Tor
1DQ	S-1312A24-M5T1U3	LVR-IC	LDO, 2.4V±1%, 150mA, +CE, CL, PDR	SOT-23-5	28cx	VR4	6g	Sii
1DR	S-1312A25-M5T1U3	LVR-IC	LDO, 2.5V±1%, 150mA, +CE, CL, PDR	SOT-23-5	28cx	VR4	6g	Sii
1DR	XC6224B301MR	LVR-IC	LDO, 3.0V±1.5%, 150mA, +CE, PDR	SOT-25	28cx	VR4	6g	Tor
1DR	XC6102C423MR	Vdet-IC	2.3V±2%, Hst, -MR, -Reset ODO, Wt=200ms, Rt=50ms	SOT-25	28cp	VD16	6g	Tor
1DS	S-1312A26-M5T1U3	LVR-IC	LDO, 2.6V±1%, 150mA, +CE, CL, PDR	SOT-23-5	28cx	VR4	6g	Sii
1DS	XC6102C424MR	Vdet-IC	2.4V±2%, Hst, -MR, -Reset ODO, Wt=200ms, Rt=50ms	SOT-25	28cp	VD16	6g	Tor
1DT	S-1312A27-M5T1U3	LVR-IC	LDO, 2.7V±1%, 150mA, +CE, CL, PDR	SOT-23-5	28cx	VR4	6g	Sii
1DT	XC6102C425MR	Vdet-IC	2.5V±2%, Hst, -MR, -Reset ODO, Wt=200ms, Rt=50ms	SOT-25	28cp	VD16	6g	Tor
1DU	S-1312A28-M5T1U3	LVR-IC	LDO, 2.8V±1%, 150mA, +CE, CL, PDR	SOT-23-5	28cx	VR4	6g	Sii
1DU	XC6102C426MR	Vdet-IC	2.6V±2%, Hst, -MR, -Reset ODO, Wt=200ms, Rt=50ms	SOT-25	28cp	VD16	6g	Tor
1DV	S-1312A2J-M5T1U3	LVR-IC	LDO, 2.85V±1%, 150mA, +CE, CL, PDR	SOT-23-5	28cx	VR4	6g	Sii
1DV	XC6102C427MR	Vdet-IC	2.7V±2%, Hst, -MR, -Reset ODO, Wt=200ms, Rt=50ms	SOT-25	28cp	VD16	6g	Tor
1DW	S-1312A29-M5T1U3	LVR-IC	LDO, 2.9V±1%, 150mA, +CE, CL, PDR	SOT-23-5	28cx	VR4	6g	Sii
1DX	S-1312A30-M5T1U3	LVR-IC	LDO, 3.0V±1%, 150mA, +CE, CL, PDR	SOT-23-5	28cx	VR4	6g	Sii
1DX	XC6102C428MR	Vdet-IC	2.8V±2%, Hst, -MR, -Reset ODO, Wt=200ms, Rt=50ms	SOT-25	28cp	VD16	6g	Tor
1DY	S-1312A31-M5T1U3	LVR-IC	LDO, 3.1V±1%, 150mA, +CE, CL, PDR	SOT-23-5	28cx	VR4	6g	Sii
1DY	XC6102C429MR	Vdet-IC	2.9V±2%, Hst, -MR, -Reset ODO, Wt=200ms, Rt=50ms	SOT-25	28cp	VD16	6g	Tor
1DZ	S-1312A32-M5T1U3	LVR-IC	LDO, 3.2V±1%, 150mA, +CE, CL, PDR	SOT-23-5	28cx	VR4	6g	Sii
1DZ	XC6102C430MR	Vdet-IC	3.0V±2%, Hst, -MR, -Reset ODO, Wt=200ms, Rt=50ms	SOT-25	28cp	VD16	6g	Tor
1E	BU4345FWE	Vdet-IC	4.5V, +Reset PPO	SOP-5	30wka	VD3	6c	Rhm
1E	BU4345G	Vdet-IC	4.5V, +Reset PPO	SSOF-5	28vdo	VD3	6c	Rhm
1E	R3111N411A	Vdet-IC	4.1V±2%, -Reset PPO	SOT-23-5	28vdm	VD7	6g	Ric
1E	RN5RL51AA	LVR-IC	5.1V±2.5%, 150mA	SOT-23-5	28vu	VR1	6g	Ric
1E	RN5VD41CA	Vdet-IC	4.1V±2.5%, -Reset ODO	SOT-23-5	28vdo	VD1	6g	Ric
1E=	RT9198-15GBG	LVR-IC	LDO, 1.5V±1%, 300mA, +CE	SOT-23-5	28cx	VR4	6a	Rct
1E0	XC6217A312MR	LVR-IC	LDO, 3.1V±2%, 200mA, +CE, Shutdown	SOT-25	28cu	VR4a	6g	Tor
1E0	XC6503D12AMR-G	LVR-IC	LDO, 1.25V±20mV, 500mA, +CE	SOT-25	28cx	VR4	6g	Tor
1E0	XC6102C531MR	Vdet-IC	3.1V±2%, Hst, -MR, -Reset ODO, Wt=400ms, Rt=50ms	SOT-25	28cp	VD16	6g	Tor
1E1	S-1312B33-M5T1U3	LVR-IC	LDO, 3.3V±1%, 150mA, +CE, CL	SOT-23-5	28cx	VR4	6g	Sii
1E1	XC6217A322MR	LVR-IC	LDO, 3.2V±2%, 200mA, +CE, Shutdown	SOT-25	28cu	VR4a	6g	Tor



SMD code	Type	Function	Short description	Case	Pinout	Sch.	St.	Mnf.
1E1	XC6503D13AMR-G	LVR-IC	LDO, 1.35V±20mV, 500mA, +CE	SOT-25	28cx	VR4	6g	Tor
1E1	XC6102C532MR	Vdet-IC	3.2V±2%, Hst, -MR, -Reset ODO, Wt=400ms, Rt=50ms	SOT-25	28cp	VD16	6g	Tor
1E2	S-1312B34-M5T1U3	LVR-IC	LDO, 3.4V±1%, 150mA, +CE, CL	SOT-23-5	28cx	VR4	6g	Sii
1E2	XC6217A332MR	LVR-IC	LDO, 3.3V±2%, 200mA, +CE, Shutdown	SOT-25	28cu	VR4a	6g	Tor
1E2	XC6503D14AMR-G	LVR-IC	LDO, 1.45V±20mV, 500mA, +CE	SOT-25	28cx	VR4	6g	Tor
1E2	XC6102C533MR	Vdet-IC	3.3V±2%, Hst, -MR, -Reset ODO, Wt=400ms, Rt=50ms	SOT-25	28cp	VD16	6g	Tor
1E3	S-1312B35-M5T1U3	LVR-IC	LDO, 3.5V±1%, 150mA, +CE, CL	SOT-23-5	28cx	VR4	6g	Sii
1E3	XC6217A342MR	LVR-IC	LDO, 3.4V±2%, 200mA, +CE, Shutdown	SOT-25	28cu	VR4a	6g	Tor
1E3	XC6503D15AMR-G	LVR-IC	LDO, 1.55V±20mV, 500mA, +CE	SOT-25	28cx	VR4	6g	Tor
1E3	XC6102C534MR	Vdet-IC	3.4V±2%, Hst, -MR, -Reset ODO, Wt=400ms, Rt=50ms	SOT-25	28cp	VD16	6g	Tor
1E4	XC6217A352MR	LVR-IC	LDO, 3.5V±2%, 200mA, +CE, Shutdown	SOT-25	28cu	VR4a	6g	Tor
1E4	XC6503D16AMR-G	LVR-IC	LDO, 1.65V±20mV, 500mA, +CE	SOT-25	28cx	VR4	6g	Tor
1E4	XC6102C535MR	Vdet-IC	3.5V±2%, Hst, -MR, -Reset ODO, Wt=400ms, Rt=50ms	SOT-25	28cp	VD16	6g	Tor
1E5	XC6217A362MR	LVR-IC	LDO, 3.6V±2%, 200mA, +CE, Shutdown	SOT-25	28cu	VR4a	6g	Tor
1E5	XC6503D17AMR-G	LVR-IC	LDO, 1.75V±20mV, 500mA, +CE	SOT-25	28cx	VR4	6g	Tor
1E5	XC6102C536MR	Vdet-IC	3.6V±2%, Hst, -MR, -Reset ODO, Wt=400ms, Rt=50ms	SOT-25	28cp	VD16	6g	Tor
1E6	XC6217A372MR	LVR-IC	LDO, 3.7V±2%, 200mA, +CE, Shutdown	SOT-25	28cu	VR4a	6g	Tor
1E6	XC6503D18AMR-G	LVR-IC	LDO, 1.85V±20mV, 500mA, +CE	SOT-25	28cx	VR4	6g	Tor
1E6	XC6102C537MR	Vdet-IC	3.7V±2%, Hst, -MR, -Reset ODO, Wt=400ms, Rt=50ms	SOT-25	28cp	VD16	6g	Tor
1E7	XC6217A382MR	LVR-IC	LDO, 3.8V±2%, 200mA, +CE, Shutdown	SOT-25	28cu	VR4a	6g	Tor
1E7	XC6503D19AMR-G	LVR-IC	LDO, 1.95V±20mV, 500mA, +CE	SOT-25	28cx	VR4	6g	Tor
1E7	XC6102C538MR	Vdet-IC	3.8V±2%, Hst, -MR, -Reset ODO, Wt=400ms, Rt=50ms	SOT-25	28cp	VD16	6g	Tor
1E8	XC6217A392MR	LVR-IC	LDO, 3.9V±2%, 200mA, +CE, Shutdown	SOT-25	28cu	VR4a	6g	Tor
1E8	XC6503D20AMR-G	LVR-IC	LDO, 2.05V±1%, 500mA, +CE	SOT-25	28cx	VR4	6g	Tor
1E8	XC6102C539MR	Vdet-IC	3.9V±2%, Hst, -MR, -Reset ODO, Wt=400ms, Rt=50ms	SOT-25	28cp	VD16	6g	Tor
1E9	XC6217A10AMR	LVR-IC	LDO, 1.05V±2%, 200mA, +CE, Shutdown	SOT-25	28cu	VR4a	6g	Tor
1E9	XC6503D21AMR-G	LVR-IC	LDO, 2.15V±1%, 500mA, +CE	SOT-25	28cx	VR4	6g	Tor
1E9	XC6102C540MR	Vdet-IC	4.0V±2%, Hst, -MR, -Reset ODO, Wt=400ms, Rt=50ms	SOT-25	28cp	VD16	6g	Tor
1EA	S-1312B10-M5T1U3	LVR-IC	LDO, 1.0V±1%, 150mA, +CE, CL	SOT-23-5	28cx	VR4	6g	Sii
1EA	XC6503D22AMR-G	LVR-IC	LDO, 2.25V±1%, 500mA, +CE	SOT-25	28cx	VR4	6g	Tor
1EA	XC6102C541MR	Vdet-IC	4.1V±2%, Hst, -MR, -Reset ODO, Wt=400ms, Rt=50ms	SOT-25	28cp	VD16	6g	Tor
1EB	S-1312B11-M5T1U3	LVR-IC	LDO, 1.1V±1%, 150mA, +CE, CL	SOT-23-5	28cx	VR4	6g	Sii
1EB	XC6503D23AMR-G	LVR-IC	LDO, 2.35V±1%, 500mA, +CE	SOT-25	28cx	VR4	6g	Tor
1EB	XC6102C542MR	Vdet-IC	4.2V±2%, Hst, -MR, -Reset ODO, Wt=400ms, Rt=50ms	SOT-25	28cp	VD16	6g	Tor
1EC	S-1312B12-M5T1U3	LVR-IC	LDO, 1.2V±1%, 150mA, +CE, CL	SOT-23-5	28cx	VR4	6g	Sii
1EC	XC6503D24AMR-G	LVR-IC	LDO, 2.45V±1%, 500mA, +CE	SOT-25	28cx	VR4	6g	Tor
1EC	XC6102C543MR	Vdet-IC	4.3V±2%, Hst, -MR, -Reset ODO, Wt=400ms, Rt=50ms	SOT-25	28cp	VD16	6g	Tor
1ED	S-1312B13-M5T1U3	LVR-IC	LDO, 1.3V±1%, 150mA, +CE, CL	SOT-23-5	28cx	VR4	6g	Sii
1ED	XC6503D25AMR-G	LVR-IC	LDO, 2.55V±1%, 500mA, +CE	SOT-25	28cx	VR4	6g	Tor
1ED	XC6102C544MR	Vdet-IC	4.4V±2%, Hst, -MR, -Reset ODO, Wt=400ms, Rt=50ms	SOT-25	28cp	VD16	6g	Tor
1EE	S-1312B14-M5T1U3	LVR-IC	LDO, 1.4V±1%, 150mA, +CE, CL	SOT-23-5	28cx	VR4	6g	Sii
1EE	XC6503D26AMR-G	LVR-IC	LDO, 2.65V±1%, 500mA, +CE	SOT-25	28cx	VR4	6g	Tor
1EE	XC6102C545MR	Vdet-IC	4.5V±2%, Hst, -MR, -Reset ODO, Wt=400ms, Rt=50ms	SOT-25	28cp	VD16	6g	Tor
1EF	S-1312B15-M5T1U3	LVR-IC	LDO, 1.5V±1%, 150mA, +CE, CL	SOT-23-5	28cx	VR4	6g	Sii
1EF	XC6503D27AMR-G	LVR-IC	LDO, 2.75V±1%, 500mA, +CE	SOT-25	28cx	VR4	6g	Tor
1EF	XC6102C516MR	Vdet-IC	1.6V±2%, Hst, -MR, -Reset ODO, Wt=400ms, Rt=50ms	SOT-25	28cp	VD16	6g	Tor
1EF	XC6102C546MR	Vdet-IC	4.6V±2%, Hst, -MR, -Reset ODO, Wt=400ms, Rt=50ms	SOT-25	28cp	VD16	6g	Tor
1EG	S-1312B16-M5T1U3	LVR-IC	LDO, 1.6V±1%, 150mA, +CE, CL	SOT-23-5	28cx	VR4	6g	Sii
1EH	S-1312B17-M5T1U3	LVR-IC	LDO, 1.7V±1%, 150mA, +CE, CL	SOT-23-5	28cx	VR4	6g	Sii
1EH	XC6503D28AMR-G	LVR-IC	LDO, 2.85V±1%, 500mA, +CE	SOT-25	28cx	VR4	6g	Tor
1EH	XC6102C517MR	Vdet-IC	1.7V±2%, Hst, -MR, -Reset ODO, Wt=400ms, Rt=50ms	SOT-25	28cp	VD16	6g	Tor
1EH	XC6102C547MR	Vdet-IC	4.7V±2%, Hst, -MR, -Reset ODO, Wt=400ms, Rt=50ms	SOT-25	28cp	VD16	6g	Tor
1EJ	S-1312B18-M5T1U3	LVR-IC	LDO, 1.8V±1%, 150mA, +CE, CL	SOT-23-5	28cx	VR4	6g	Sii
1EK	S-1312B1J-M5T1U3	LVR-IC	LDO, 1.85V±1%, 150mA, +CE, CL	SOT-23-5	28cx	VR4	6g	Sii
1EK	XC6503D29AMR-G	LVR-IC	LDO, 2.95V±1%, 500mA, +CE	SOT-25	28cx	VR4	6g	Tor
1EK	XC6102C518MR	Vdet-IC	1.8V±2%, Hst, -MR, -Reset ODO, Wt=400ms, Rt=50ms	SOT-25	28cp	VD16	6g	Tor
1EK	XC6102C548MR	Vdet-IC	4.8V±2%, Hst, -MR, -Reset ODO, Wt=400ms, Rt=50ms	SOT-25	28cp	VD16	6g	Tor
1EL	S-1312B19-M5T1U3	LVR-IC	LDO, 1.9V±1%, 150mA, +CE, CL	SOT-23-5	28cx	VR4	6g	Sii
1EL	XC6503D30AMR-G	LVR-IC	LDO, 3.05V±1%, 500mA, +CE	SOT-25	28cx	VR4	6g	Tor
1EL	XC6102C519MR	Vdet-IC	1.9V±2%, Hst, -MR, -Reset ODO, Wt=400ms, Rt=50ms	SOT-25	28cp	VD16	6g	Tor
1EL	XC6102C549MR	Vdet-IC	4.9V±2%, Hst, -MR, -Reset ODO, Wt=400ms, Rt=50ms	SOT-25	28cp	VD16	6g	Tor
1EM	S-1312B20-M5T1U3	LVR-IC	LDO, 2.0V±1%, 150mA, +CE, CL	SOT-23-5	28cx	VR4	6g	Sii
1EM	XC6503D31AMR-G	LVR-IC	LDO, 3.15V±1%, 500mA, +CE	SOT-25	28cx	VR4	6g	Tor
1EM	XC6102C520MR	Vdet-IC	2.0V±2%, Hst, -MR, -Reset ODO, Wt=400ms, Rt=50ms	SOT-25	28cp	VD16	6g	Tor
1EM	XC6102C550MR	Vdet-IC	5.0V±2%, Hst, -MR, -Reset ODO, Wt=400ms, Rt=50ms	SOT-25	28cp	VD16	6g	Tor
1EN	S-1312B21-M5T1U3	LVR-IC	LDO, 2.1V±1%, 150mA, +CE, CL	SOT-23-5	28cx	VR4	6g	Sii
1EN	XC6503D32AMR-G	LVR-IC	LDO, 3.25V±1%, 500mA, +CE	SOT-25	28cx	VR4	6g	Tor
1EN	XC6102C521MR	Vdet-IC	2.1V±2%, Hst, -MR, -Reset ODO, Wt=400ms, Rt=50ms	SOT-25	28cp	VD16	6g	Tor
1EO	S-1312B22-M5T1U3	LVR-IC	LDO, 2.2V±1%, 150mA, +CE, CL	SOT-23-5	28cx	VR4	6g	Sii
1EP	S-1312B23-M5T1U3	LVR-IC	LDO, 2.3V±1%, 150mA, +CE, CL	SOT-23-5	28cx	VR4	6g	Sii



SMD code	Type	Function	Short description	Case	Pinout	Sch.	St.	Mnf.
1EP	XC6503D33AMR-G	LVR-IC	LDO, 3.35V±1%, 500mA, +CE	SOT-25	28cx	VR4	6g	Tor
1EP	XC6102C522MR	Vdet-IC	2.2V±2%, Hst, -MR, -Reset ODO, Wt=400ms, Rt=50ms	SOT-25	28cp	VD16	6g	Tor
1EQ	S-1312B24-M5T1U3	LVR-IC	LDO, 2.4V±1%, 150mA, +CE, CL	SOT-23-5	28cx	VR4	6g	Sii
1ER	S-1312B25-M5T1U3	LVR-IC	LDO, 2.5V±1%, 150mA, +CE, CL	SOT-23-5	28cx	VR4	6g	Sii
1ER	XC6503D34AMR-G	LVR-IC	LDO, 3.45V±1%, 500mA, +CE	SOT-25	28cx	VR4	6g	Tor
1ER	XC6102C523MR	Vdet-IC	2.3V±2%, Hst, -MR, -Reset ODO, Wt=400ms, Rt=50ms	SOT-25	28cp	VD16	6g	Tor
1ES	S-1312B26-M5T1U3	LVR-IC	LDO, 2.6V±1%, 150mA, +CE, CL	SOT-23-5	28cx	VR4	6g	Sii
1ES	XC6503D35AMR-G	LVR-IC	LDO, 3.55V±1%, 500mA, +CE	SOT-25	28cx	VR4	6g	Tor
1ES	XC6102C524MR	Vdet-IC	2.4V±2%, Hst, -MR, -Reset ODO, Wt=400ms, Rt=50ms	SOT-25	28cp	VD16	6g	Tor
1ET	S-1312B27-M5T1U3	LVR-IC	LDO, 2.7V±1%, 150mA, +CE, CL	SOT-23-5	28cx	VR4	6g	Sii
1ET	XC6503D36AMR-G	LVR-IC	LDO, 3.65V±1%, 500mA, +CE	SOT-25	28cx	VR4	6g	Tor
1ET	XC6102C525MR	Vdet-IC	2.5V±2%, Hst, -MR, -Reset ODO, Wt=400ms, Rt=50ms	SOT-25	28cp	VD16	6g	Tor
1EU	S-1312B28-M5T1U3	LVR-IC	LDO, 2.8V±1%, 150mA, +CE, CL	SOT-23-5	28cx	VR4	6g	Sii
1EU	XC6503D37AMR-G	LVR-IC	LDO, 3.75V±1%, 500mA, +CE	SOT-25	28cx	VR4	6g	Tor
1EU	XC6102C526MR	Vdet-IC	2.6V±2%, Hst, -MR, -Reset ODO, Wt=400ms, Rt=50ms	SOT-25	28cp	VD16	6g	Tor
1EV	S-1312B2J-M5T1U3	LVR-IC	LDO, 2.85V±1%, 150mA, +CE, CL	SOT-23-5	28cx	VR4	6g	Sii
1EV	XC6503D38AMR-G	LVR-IC	LDO, 3.85V±1%, 500mA, +CE	SOT-25	28cx	VR4	6g	Tor
1EV	XC6102C527MR	Vdet-IC	2.7V±2%, Hst, -MR, -Reset ODO, Wt=400ms, Rt=50ms	SOT-25	28cp	VD16	6g	Tor
1EW	S-1312B29-M5T1U3	LVR-IC	LDO, 2.9V±1%, 150mA, +CE, CL	SOT-23-5	28cx	VR4	6g	Sii
1EX	S-1312B30-M5T1U3	LVR-IC	LDO, 3.0V±1%, 150mA, +CE, CL	SOT-23-5	28cx	VR4	6g	Sii
1EX	XC6503D39AMR-G	LVR-IC	LDO, 3.95V±1%, 500mA, +CE	SOT-25	28cx	VR4	6g	Tor
1EX	XC6102C528MR	Vdet-IC	2.8V±2%, Hst, -MR, -Reset ODO, Wt=400ms, Rt=50ms	SOT-25	28cp	VD16	6g	Tor
1EY	S-1312B31-M5T1U3	LVR-IC	LDO, 3.1V±1%, 150mA, +CE, CL	SOT-23-5	28cx	VR4	6g	Sii
1EY	XC6503D40AMR-G	LVR-IC	LDO, 4.05V±1%, 500mA, +CE	SOT-25	28cx	VR4	6g	Tor
1EY	XC6102C529MR	Vdet-IC	2.9V±2%, Hst, -MR, -Reset ODO, Wt=400ms, Rt=50ms	SOT-25	28cp	VD16	6g	Tor
1EZ	S-1312B32-M5T1U3	LVR-IC	LDO, 3.2V±1%, 150mA, +CE, CL	SOT-23-5	28cx	VR4	6g	Sii
1EZ	XC6503D41AMR-G	LVR-IC	LDO, 4.15V±1%, 500mA, +CE	SOT-25	28cx	VR4	6g	Tor
1EZ	XC6102C530MR	Vdet-IC	3.0V±2%, Hst, -MR, -Reset ODO, Wt=400ms, Rt=50ms	SOT-25	28cp	VD16	6g	Tor
1F	BU4346FWE	Vdet-IC	4.6V, +Reset PPO	VSOFF-5	30vka	VD3	6c	Rhm
1F	BU4346G	Vdet-IC	4.6V, +Reset PPO	SSOP-5	28vdo	VD3	6c	Rhm
1F	R3111N511A	Vdet-IC	5.1V±2%, -Reset PPO	SOT-23-5	28vdm	VD7	6g	Ric
1F	RN5VD51CA	Vdet-IC	5.1V±2.5%, -Reset ODO	SOT-23-5	28vdo	VD1	6g	Ric
1F0	XC6503D42AMR-G	LVR-IC	LDO, 4.25V±1%, 500mA, +CE	SOT-25	28cx	VR4	6g	Tor
1F0	XC6102C631MR	Vdet-IC	3.1V±2%, Hst, -MR, -Reset ODO, Wt=1.6s, Rt=50ms	SOT-25	28cp	VD16	6g	Tor
1F1	S-1312C33-M5T1U3	LVR-IC	LDO, 3.3V±1%, 150mA, +CE, PDR	SOT-23-5	28cx	VR4	6g	Sii
1F1	XC6503D43AMR-G	LVR-IC	LDO, 4.35V±1%, 500mA, +CE	SOT-25	28cx	VR4	6g	Tor
1F1	XC6102C632MR	Vdet-IC	3.2V±2%, Hst, -MR, -Reset ODO, Wt=1.6s, Rt=50ms	SOT-25	28cp	VD16	6g	Tor
1F2	S-1312C34-M5T1U3	LVR-IC	LDO, 3.4V±1%, 150mA, +CE, PDR	SOT-23-5	28cx	VR4	6g	Sii
1F2	XC6503D44AMR-G	LVR-IC	LDO, 4.45V±1%, 500mA, +CE	SOT-25	28cx	VR4	6g	Tor
1F2	XC6102C633MR	Vdet-IC	3.3V±2%, Hst, -MR, -Reset ODO, Wt=1.6s, Rt=50ms	SOT-25	28cp	VD16	6g	Tor
1F3	S-1312C35-M5T1U3	LVR-IC	LDO, 3.5V±1%, 150mA, +CE, PDR	SOT-23-5	28cx	VR4	6g	Sii
1F3	XC6503D45AMR-G	LVR-IC	LDO, 4.55V±1%, 500mA, +CE	SOT-25	28cx	VR4	6g	Tor
1F3	XC6102C634MR	Vdet-IC	3.4V±2%, Hst, -MR, -Reset ODO, Wt=1.6s, Rt=50ms	SOT-25	28cp	VD16	6g	Tor
1F4	XC6503D46AMR-G	LVR-IC	LDO, 4.65V±1%, 500mA, +CE	SOT-25	28cx	VR4	6g	Tor
1F4	XC6102C635MR	Vdet-IC	3.5V±2%, Hst, -MR, -Reset ODO, Wt=1.6s, Rt=50ms	SOT-25	28cp	VD16	6g	Tor
1F5	XC6503D47AMR-G	LVR-IC	LDO, 4.75V±1%, 500mA, +CE	SOT-25	28cx	VR4	6g	Tor
1F5	XC6102C636MR	Vdet-IC	3.6V±2%, Hst, -MR, -Reset ODO, Wt=1.6s, Rt=50ms	SOT-25	28cp	VD16	6g	Tor
1F6	XC6503D48AMR-G	LVR-IC	LDO, 4.85V±1%, 500mA, +CE	SOT-25	28cx	VR4	6g	Tor
1F6	XC6102C637MR	Vdet-IC	3.7V±2%, Hst, -MR, -Reset ODO, Wt=1.6s, Rt=50ms	SOT-25	28cp	VD16	6g	Tor
1F7	XC6217B08AMR	LVR-IC	LDO, 0.85V±2%, 200mA, +CE, CL, Shutdown	SOT-25	28cu	VR4a	6g	Tor
1F7	XC6503D49AMR-G	LVR-IC	LDO, 4.95V±1%, 500mA, +CE	SOT-25	28cx	VR4	6g	Tor
1F7	XC6102C638MR	Vdet-IC	3.8V±2%, Hst, -MR, -Reset ODO, Wt=1.6s, Rt=50ms	SOT-25	28cp	VD16	6g	Tor
1F8	XC6217B09AMR	LVR-IC	LDO, 0.95V±2%, 200mA, +CE, CL, Shutdown	SOT-25	28cu	VR4a	6g	Tor
1F8	XC6102C639MR	Vdet-IC	3.9V±2%, Hst, -MR, -Reset ODO, Wt=1.6s, Rt=50ms	SOT-25	28cp	VD16	6g	Tor
1F9	XC6217B10AMR	LVR-IC	LDO, 1.05V±2%, 200mA, +CE, CL, Shutdown	SOT-25	28cu	VR4a	6g	Tor
1F9	XC6102C640MR	Vdet-IC	4.0V±2%, Hst, -MR, -Reset ODO, Wt=1.6s, Rt=50ms	SOT-25	28cp	VD16	6g	Tor
1FA	S-1312C10-M5T1U3	LVR-IC	LDO, 1.0V±1%, 150mA, +CE, PDR	SOT-23-5	28cx	VR4	6g	Sii
1FA	XC6217B11AMR	LVR-IC	LDO, 1.15V±2%, 200mA, +CE, CL, Shutdown	SOT-25	28cu	VR4a	6g	Tor
1FA	XC6102C641MR	Vdet-IC	4.1V±2%, Hst, -MR, -Reset ODO, Wt=1.6s, Rt=50ms	SOT-25	28cp	VD16	6g	Tor
1FB	S-1312C11-M5T1U3	LVR-IC	LDO, 1.1V±1%, 150mA, +CE, PDR	SOT-23-5	28cx	VR4	6g	Sii
1FB	XC6217B12AMR	LVR-IC	LDO, 1.25V±2%, 200mA, +CE, CL, Shutdown	SOT-25	28cu	VR4a	6g	Tor
1FB	XC6102C642MR	Vdet-IC	4.2V±2%, Hst, -MR, -Reset ODO, Wt=1.6s, Rt=50ms	SOT-25	28cp	VD16	6g	Tor
1FC	S-1312C12-M5T1U3	LVR-IC	LDO, 1.2V±1%, 150mA, +CE, PDR	SOT-23-5	28cx	VR4	6g	Sii
1FC	XC6217B13AMR	LVR-IC	LDO, 1.35V±2%, 200mA, +CE, CL, Shutdown	SOT-25	28cu	VR4a	6g	Tor
1FC	XC6102C643MR	Vdet-IC	4.3V±2%, Hst, -MR, -Reset ODO, Wt=1.6s, Rt=50ms	SOT-25	28cp	VD16	6g	Tor
1FD	S-1312C13-M5T1U3	LVR-IC	LDO, 1.3V±1%, 150mA, +CE, PDR	SOT-23-5	28cx	VR4	6g	Sii
1FD	XC6217B14AMR	LVR-IC	LDO, 1.45V±2%, 200mA, +CE, CL, Shutdown	SOT-25	28cu	VR4a	6g	Tor
1FD	XC6102C644MR	Vdet-IC	4.4V±2%, Hst, -MR, -Reset ODO, Wt=1.6s, Rt=50ms	SOT-25	28cp	VD16	6g	Tor
1FE	S-1312C14-M5T1U3	LVR-IC	LDO, 1.4V±1%, 150mA, +CE, PDR	SOT-23-5	28cx	VR4	6g	Sii
1FE	XC6217B15AMR	LVR-IC	LDO, 1.55V±2%, 200mA, +CE, CL, Shutdown	SOT-25	28cu	VR4a	6g	Tor



SMD code	Type	Function	Short description	Case	Pinout	Sch.	St.	Mnf.
1FE	XC6102C645MR	Vdet-IC	4.5V±2%, Hst, -MR, -Reset ODO, Wt=1.6s, Rt=50ms	SOT-25	28cp	VD16	6g	Tor
1FF	S-1312C15-M5T1U3	LVR-IC	LDO, 1.5V±1%, 150mA, +CE, PDR	SOT-23-5	28cx	VR4	6g	Sii
1FF	XC6217B16AMR	LVR-IC	LDO, 1.65V±2%, 200mA, +CE, CL, Shutdown	SOT-25	28cu	VR4a	6g	Tor
1FH	XC6102C616MR	Vdet-IC	1.6V±2%, Hst, -MR, -Reset ODO, Wt=1.6s, Rt=50ms	SOT-25	28cp	VD16	6g	Tor
1FE	XC6102C646MR	Vdet-IC	4.6V±2%, Hst, -MR, -Reset ODO, Wt=1.6s, Rt=50ms	SOT-25	28cp	VD16	6g	Tor
1FG	S-1312C16-M5T1U3	LVR-IC	LDO, 1.6V±1%, 150mA, +CE, PDR	SOT-23-5	28cx	VR4	6g	Sii
1FH	S-1312C17-M5T1U3	LVR-IC	LDO, 1.7V±1%, 150mA, +CE, PDR	SOT-23-5	28cx	VR4	6g	Sii
1FH	XC6217B17AMR	LVR-IC	LDO, 1.75V±2%, 200mA, +CE, CL, Shutdown	SOT-25	28cu	VR4a	6g	Tor
1FH	XC6102C617MR	Vdet-IC	1.7V±2%, Hst, -MR, -Reset ODO, Wt=1.6s, Rt=50ms	SOT-25	28cp	VD16	6g	Tor
1FH	XC6102C647MR	Vdet-IC	4.7V±2%, Hst, -MR, -Reset ODO, Wt=1.6s, Rt=50ms	SOT-25	28cp	VD16	6g	Tor
1FJ	S-1312C18-M5T1U3	LVR-IC	LDO, 1.8V±1%, 150mA, +CE, PDR	SOT-23-5	28cx	VR4	6g	Sii
1FK	S-1312C19-M5T1U3	LVR-IC	LDO, 1.85V±1%, 150mA, +CE, PDR	SOT-23-5	28cx	VR4	6g	Sii
1FK	XC6217B18AMR	LVR-IC	LDO, 1.85V±2%, 200mA, +CE, CL, Shutdown	SOT-25	28cu	VR4a	6g	Tor
1FK	XC6102C618MR	Vdet-IC	1.8V±2%, Hst, -MR, -Reset ODO, Wt=1.6s, Rt=50ms	SOT-25	28cp	VD16	6g	Tor
1FK	XC6102C648MR	Vdet-IC	4.8V±2%, Hst, -MR, -Reset ODO, Wt=1.6s, Rt=50ms	SOT-25	28cp	VD16	6g	Tor
1FL	S-1312C19-M5T1U3	LVR-IC	LDO, 1.9V±1%, 150mA, +CE, PDR	SOT-23-5	28cx	VR4	6g	Sii
1FL	XC6217B19AMR	LVR-IC	LDO, 1.95V±2%, 200mA, +CE, CL, Shutdown	SOT-25	28cu	VR4a	6g	Tor
1FL	XC6102C619MR	Vdet-IC	1.9V±2%, Hst, -MR, -Reset ODO, Wt=1.6s, Rt=50ms	SOT-25	28cp	VD16	6g	Tor
1FL	XC6102C649MR	Vdet-IC	4.9V±2%, Hst, -MR, -Reset ODO, Wt=1.6s, Rt=50ms	SOT-25	28cp	VD16	6g	Tor
1FM	S-1312C20-M5T1U3	LVR-IC	LDO, 2.0V±1%, 150mA, +CE, PDR	SOT-23-5	28cx	VR4	6g	Sii
1FM	XC6217B20AMR	LVR-IC	LDO, 2.05V±2%, 200mA, +CE, CL, Shutdown	SOT-25	28cu	VR4a	6g	Tor
1FM	XC6102C620MR	Vdet-IC	2.0V±2%, Hst, -MR, -Reset ODO, Wt=1.6s, Rt=50ms	SOT-25	28cp	VD16	6g	Tor
1FM	XC6102C650MR	Vdet-IC	5.0V±2%, Hst, -MR, -Reset ODO, Wt=1.6s, Rt=50ms	SOT-25	28cp	VD16	6g	Tor
1FN	S-1312C21-M5T1U3	LVR-IC	LDO, 2.1V±1%, 150mA, +CE, PDR	SOT-23-5	28cx	VR4	6g	Sii
1FN	XC6217B21AMR	LVR-IC	LDO, 2.15V±2%, 200mA, +CE, CL, Shutdown	SOT-25	28cu	VR4a	6g	Tor
1FN	XC6102C621MR	Vdet-IC	2.1V±2%, Hst, -MR, -Reset ODO, Wt=1.6s, Rt=50ms	SOT-25	28cp	VD16	6g	Tor
1FO	S-1312C22-M5T1U3	LVR-IC	LDO, 2.2V±1%, 150mA, +CE, PDR	SOT-23-5	28cx	VR4	6g	Sii
1FP	S-1312C23-M5T1U3	LVR-IC	LDO, 2.3V±1%, 150mA, +CE, PDR	SOT-23-5	28cx	VR4	6g	Sii
1FP	XC6217B22AMR	LVR-IC	LDO, 2.25V±2%, 200mA, +CE, CL, Shutdown	SOT-25	28cu	VR4a	6g	Tor
1FP	XC6102C622MR	Vdet-IC	2.2V±2%, Hst, -MR, -Reset ODO, Wt=1.6s, Rt=50ms	SOT-25	28cp	VD16	6g	Tor
1FQ	S-1312C24-M5T1U3	LVR-IC	LDO, 2.4V±1%, 150mA, +CE, PDR	SOT-23-5	28cx	VR4	6g	Sii
1FR	S-1312C25-M5T1U3	LVR-IC	LDO, 2.5V±1%, 150mA, +CE, PDR	SOT-23-5	28cx	VR4	6g	Sii
1FR	XC6217B23AMR	LVR-IC	LDO, 2.35V±2%, 200mA, +CE, CL, Shutdown	SOT-25	28cu	VR4a	6g	Tor
1FR	XC6102C623MR	Vdet-IC	2.3V±2%, Hst, -MR, -Reset ODO, Wt=1.6s, Rt=50ms	SOT-25	28cp	VD16	6g	Tor
1FS	S-1312C26-M5T1U3	LVR-IC	LDO, 2.6V±1%, 150mA, +CE, PDR	SOT-23-5	28cx	VR4	6g	Sii
1FS	XC6217B24AMR	LVR-IC	LDO, 2.45V±2%, 200mA, +CE, CL, Shutdown	SOT-25	28cu	VR4a	6g	Tor
1FS	XC6102C624MR	Vdet-IC	2.4V±2%, Hst, -MR, -Reset ODO, Wt=1.6s, Rt=50ms	SOT-25	28cp	VD16	6g	Tor
1FT	S-1312C27-M5T1U3	LVR-IC	LDO, 2.7V±1%, 150mA, +CE, PDR	SOT-23-5	28cx	VR4	6g	Sii
1FT	XC6217B25AMR	LVR-IC	LDO, 2.55V±2%, 200mA, +CE, CL, Shutdown	SOT-25	28cu	VR4a	6g	Tor
1FT	XC6102C625MR	Vdet-IC	2.5V±2%, Hst, -MR, -Reset ODO, Wt=1.6s, Rt=50ms	SOT-25	28cp	VD16	6g	Tor
1FU	S-1312C28-M5T1U3	LVR-IC	LDO, 2.8V±1%, 150mA, +CE, PDR	SOT-23-5	28cx	VR4	6g	Sii
1FU	XC6217B26AMR	LVR-IC	LDO, 2.65V±2%, 200mA, +CE, CL, Shutdown	SOT-25	28cu	VR4a	6g	Tor
1FU	XC6102C626MR	Vdet-IC	2.6V±2%, Hst, -MR, -Reset ODO, Wt=1.6s, Rt=50ms	SOT-25	28cp	VD16	6g	Tor
1FV	S-1312C29-M5T1U3	LVR-IC	LDO, 2.85V±1%, 150mA, +CE, PDR	SOT-23-5	28cx	VR4	6g	Sii
1FV	XC6217B27AMR	LVR-IC	LDO, 2.75V±2%, 200mA, +CE, CL, Shutdown	SOT-25	28cu	VR4a	6g	Tor
1FV	XC6102C627MR	Vdet-IC	2.7V±2%, Hst, -MR, -Reset ODO, Wt=1.6s, Rt=50ms	SOT-25	28cp	VD16	6g	Tor
1FW	S-1312C29-M5T1U3	LVR-IC	LDO, 2.9V±1%, 150mA, +CE, PDR	SOT-23-5	28cx	VR4	6g	Sii
1FX	S-1312C30-M5T1U3	LVR-IC	LDO, 3.0V±1%, 150mA, +CE, PDR	SOT-23-5	28cx	VR4	6g	Sii
1FX	XC6217B28AMR	LVR-IC	LDO, 2.85V±2%, 200mA, +CE, CL, Shutdown	SOT-25	28cu	VR4a	6g	Tor
1FX	XC6102C628MR	Vdet-IC	2.8V±2%, Hst, -MR, -Reset ODO, Wt=1.6s, Rt=50ms	SOT-25	28cp	VD16	6g	Tor
1FY	S-1312C31-M5T1U3	LVR-IC	LDO, 3.1V±1%, 150mA, +CE, PDR	SOT-23-5	28cx	VR4	6g	Sii
1FY	XC6217B29AMR	LVR-IC	LDO, 2.95V±2%, 200mA, +CE, CL, Shutdown	SOT-25	28cu	VR4a	6g	Tor
1FY	XC6102C629MR	Vdet-IC	2.9V±2%, Hst, -MR, -Reset ODO, Wt=1.6s, Rt=50ms	SOT-25	28cp	VD16	6g	Tor
1FZ	S-1312C32-M5T1U3	LVR-IC	LDO, 3.2V±1%, 150mA, +CE, PDR	SOT-23-5	28cx	VR4	6g	Sii
1FZ	XC6217B30AMR	LVR-IC	LDO, 3.05V±2%, 200mA, +CE, CL, Shutdown	SOT-25	28cu	VR4a	6g	Tor
1FZ	XC6102C630MR	Vdet-IC	3.0V±2%, Hst, -MR, -Reset ODO, Wt=1.6s, Rt=50ms	SOT-25	28cp	VD16	6g	Tor
1G	BU4347FWE	Vdet-IC	4.7V, +Reset PPO	V50F-5	30wka	VD3	6c	Rhm
1G	BU4347G	Vdet-IC	4.7V, +Reset PPO	SSOP-5	28vdo	VD3	6c	Rhm
1G1	S-1312D33-M5T1U3	LVR-IC	LDO, 3.3V±1%, 150mA, +CE	SOT-23-5	28cx	VR4	6g	Sii
1G2	S-1312D34-M5T1U3	LVR-IC	LDO, 3.4V±1%, 150mA, +CE	SOT-23-5	28cx	VR4	6g	Sii
1G3	S-1312D35-M5T1U3	LVR-IC	LDO, 3.5V±1%, 150mA, +CE	SOT-23-5	28cx	VR4	6g	Sii
1GA	S-1312D10-M5T1U3	LVR-IC	LDO, 1.0V±1%, 150mA, +CE	SOT-23-5	28cx	VR4	6g	Sii
1GB	S-1312D11-M5T1U3	LVR-IC	LDO, 1.1V±1%, 150mA, +CE	SOT-23-5	28cx	VR4	6g	Sii
1GC	S-1312D12-M5T1U3	LVR-IC	LDO, 1.2V±1%, 150mA, +CE	SOT-23-5	28cx	VR4	6g	Sii
1GD	S-1312D13-M5T1U3	LVR-IC	LDO, 1.3V±1%, 150mA, +CE	SOT-23-5	28cx	VR4	6g	Sii
1GE	S-1312D14-M5T1U3	LVR-IC	LDO, 1.4V±1%, 150mA, +CE	SOT-23-5	28cx	VR4	6g	Sii
1GF	S-1312D15-M5T1U3	LVR-IC	LDO, 1.5V±1%, 150mA, +CE	SOT-23-5	28cx	VR4	6g	Sii
1GG	S-1312D16-M5T1U3	LVR-IC	LDO, 1.6V±1%, 150mA, +CE	SOT-23-5	28cx	VR4	6g	Sii
1GH	S-1312D17-M5T1U3	LVR-IC	LDO, 1.7V±1%, 150mA, +CE	SOT-23-5	28cx	VR4	6g	Sii
1GJ	S-1312D18-M5T1U3	LVR-IC	LDO, 1.8V±1%, 150mA, +CE	SOT-23-5	28cx	VR4	6g	Sii



SMD code	Type	Function	Short description	Case	Pinout	Sch.	St.Mnf.
1GK	S-1312D1J-M5T1U3	LVR-IC	LDO, 1.85V±1%, 150mA, +CE	SOT-23-5	28cx	VR4	6g Sii
1GL	S-1312D19-M5T1U3	LVR-IC	LDO, 1.9V±1%, 150mA, +CE	SOT-23-5	28cx	VR4	6g Sii
1GM	S-1312D20-M5T1U3	LVR-IC	LDO, 2.0V±1%, 150mA, +CE	SOT-23-5	28cx	VR4	6g Sii
1GN	S-1312D21-M5T1U3	LVR-IC	LDO, 2.1V±1%, 150mA, +CE	SOT-23-5	28cx	VR4	6g Sii
1GO	S-1312D22-M5T1U3	LVR-IC	LDO, 2.2V±1%, 150mA, +CE	SOT-23-5	28cx	VR4	6g Sii
1GP	S-1312D23-M5T1U3	LVR-IC	LDO, 2.3V±1%, 150mA, +CE	SOT-23-5	28cx	VR4	6g Sii
1GQ	S-1312D24-M5T1U3	LVR-IC	LDO, 2.4V±1%, 150mA, +CE	SOT-23-5	28cx	VR4	6g Sii
1GR	S-1312D25-M5T1U3	LVR-IC	LDO, 2.5V±1%, 150mA, +CE	SOT-23-5	28cx	VR4	6g Sii
1GS	S-1312D26-M5T1U3	LVR-IC	LDO, 2.6V±1%, 150mA, +CE	SOT-23-5	28cx	VR4	6g Sii
1GT	S-1312D27-M5T1U3	LVR-IC	LDO, 2.7V±1%, 150mA, +CE	SOT-23-5	28cx	VR4	6g Sii
1GU	S-1312D28-M5T1U3	LVR-IC	LDO, 2.8V±1%, 150mA, +CE	SOT-23-5	28cx	VR4	6g Sii
1GV	S-1312D2J-M5T1U3	LVR-IC	LDO, 2.85V±1%, 150mA, +CE	SOT-23-5	28cx	VR4	6g Sii
1GW	S-1312D29-M5T1U3	LVR-IC	LDO, 2.9V±1%, 150mA, +CE	SOT-23-5	28cx	VR4	6g Sii
1GX	S-1312D30-M5T1U3	LVR-IC	LDO, 3.0V±1%, 150mA, +CE	SOT-23-5	28cx	VR4	6g Sii
1GY	S-1312D31-M5T1U3	LVR-IC	LDO, 3.1V±1%, 150mA, +CE	SOT-23-5	28cx	VR4	6g Sii
1GZ	S-1312D32-M5T1U3	LVR-IC	LDO, 3.2V±1%, 150mA, +CE	SOT-23-5	28cx	VR4	6g Sii
1H	BU4348FWE	Vdet-IC	4.8V, +Reset PPO	VSOFF-5	30wka	VD3	6c Rhm
1H	BU4348G	Vdet-IC	4.8V, +Reset PPO	SSOP-5	28vdo	VD3	6c Rhm
1H0	XC6224A08BMR	LVR-IC	LDO, 0.85V±20mV, 150mA, +CE	SOT-25	28cx	VR4	6g Tor
1H0	XC6102D331MR	Vdet-IC	3.1V±2%, Hst, -MR, -Reset ODO, Wt=100ms, Rt=100ms	SOT-25	28cp	VD16	6g Tor
1H1	XC6224A09BMR	LVR-IC	LDO, 0.95V±20mV, 150mA, +CE	SOT-25	28cx	VR4	6g Tor
1H1	XC6102D332BMR	Vdet-IC	3.2V±2%, Hst, -MR, -Reset ODO, Wt=100ms, Rt=100ms	SOT-25	28cp	VD16	6g Tor
1H2	XC6224A10BMR	LVR-IC	LDO, 1.05V±20mV, 150mA, +CE	SOT-25	28cx	VR4	6g Tor
1H2	XC6102D333MR	Vdet-IC	3.3V±2%, Hst, -MR, -Reset ODO, Wt=100ms, Rt=100ms	SOT-25	28cp	VD16	6g Tor
1H3	XC6224A11BMR	LVR-IC	LDO, 1.15V±20mV, 150mA, +CE	SOT-25	28cx	VR4	6g Tor
1H3	XC6102D334MR	Vdet-IC	3.4V±2%, Hst, -MR, -Reset ODO, Wt=100ms, Rt=100ms	SOT-25	28cp	VD16	6g Tor
1H4	XC6224A12BMR	LVR-IC	LDO, 1.25V±1.5%, 150mA, +CE	SOT-25	28cx	VR4	6g Tor
1H4	XC6102D335MR	Vdet-IC	3.5V±2%, Hst, -MR, -Reset ODO, Wt=100ms, Rt=100ms	SOT-25	28cp	VD16	6g Tor
1H5	XC6224A13BMR	LVR-IC	LDO, 1.25V±1.5%, 150mA, +CE	SOT-25	28cx	VR4	6g Tor
1H5	XC6102D336MR	Vdet-IC	3.6V±2%, Hst, -MR, -Reset ODO, Wt=100ms, Rt=100ms	SOT-25	28cp	VD16	6g Tor
1H6	XC6224A14BMR	LVR-IC	LDO, 1.45V±1.5%, 150mA, +CE	SOT-25	28cx	VR4	6g Tor
1H6	XC6102D337MR	Vdet-IC	3.7V±2%, Hst, -MR, -Reset ODO, Wt=100ms, Rt=100ms	SOT-25	28cp	VD16	6g Tor
1H7	XC6224A15BMR	LVR-IC	LDO, 1.55V±1.5%, 150mA, +CE	SOT-25	28cx	VR4	6g Tor
1H7	XC6102D338MR	Vdet-IC	3.8V±2%, Hst, -MR, -Reset ODO, Wt=100ms, Rt=100ms	SOT-25	28cp	VD16	6g Tor
1H8	XC6224A16BMR	LVR-IC	LDO, 1.65V±1.5%, 150mA, +CE	SOT-25	28cx	VR4	6g Tor
1H8	XC6102D339MR	Vdet-IC	3.9V±2%, Hst, -MR, -Reset ODO, Wt=100ms, Rt=100ms	SOT-25	28cp	VD16	6g Tor
1H9	XC6224A17BMR	LVR-IC	LDO, 1.75V±1.5%, 150mA, +CE	SOT-25	28cx	VR4	6g Tor
1H9	XC6102D340MR	Vdet-IC	4.0V±2%, Hst, -MR, -Reset ODO, Wt=100ms, Rt=100ms	SOT-25	28cp	VD16	6g Tor
1HA	XC6224A18BMR	LVR-IC	LDO, 1.85V±1.5%, 150mA, +CE	SOT-25	28cx	VR4	6g Tor
1HA	XC6102D341MR	Vdet-IC	4.1V±2%, Hst, -MR, -Reset ODO, Wt=100ms, Rt=100ms	SOT-25	28cp	VD16	6g Tor
1HB	XC6224A19BMR	LVR-IC	LDO, 1.95V±1.5%, 150mA, +CE	SOT-25	28cx	VR4	6g Tor
1HB	XC6102D342MR	Vdet-IC	4.2V±2%, Hst, -MR, -Reset ODO, Wt=100ms, Rt=100ms	SOT-25	28cp	VD16	6g Tor
1HC	XC6224A20BMR	LVR-IC	LDO, 2.05V±1.5%, 150mA, +CE	SOT-25	28cx	VR4	6g Tor
1HC	XC6102D343MR	Vdet-IC	4.3V±2%, Hst, -MR, -Reset ODO, Wt=100ms, Rt=100ms	SOT-25	28cp	VD16	6g Tor
1HD	XC6224A21BMR	LVR-IC	LDO, 2.15V±1.5%, 150mA, +CE	SOT-25	28cx	VR4	6g Tor
1HD	XC6102D344MR	Vdet-IC	4.4V±2%, Hst, -MR, -Reset ODO, Wt=100ms, Rt=100ms	SOT-25	28cp	VD16	6g Tor
1HE	XC6224A22BMR	LVR-IC	LDO, 2.25V±1.5%, 150mA, +CE	SOT-25	28cx	VR4	6g Tor
1HE	XC6102D345MR	Vdet-IC	4.5V±2%, Hst, -MR, -Reset ODO, Wt=100ms, Rt=100ms	SOT-25	28cp	VD16	6g Tor
1HF	XC6224A23BMR	LVR-IC	LDO, 2.25V±1.5%, 150mA, +CE	SOT-25	28cx	VR4	6g Tor
1HF	XC6102D316MR	Vdet-IC	1.6V±2%, Hst, -MR, -Reset ODO, Wt=100ms, Rt=100ms	SOT-25	28cp	VD16	6g Tor
1HF	XC6102D346MR	Vdet-IC	4.6V±2%, Hst, -MR, -Reset ODO, Wt=100ms, Rt=100ms	SOT-25	28cp	VD16	6g Tor
1HH	XC6224A24BMR	LVR-IC	LDO, 2.45V±1.5%, 150mA, +CE	SOT-25	28cx	VR4	6g Tor
1HH	XC6102D317MR	Vdet-IC	1.7V±2%, Hst, -MR, -Reset ODO, Wt=100ms, Rt=100ms	SOT-25	28cp	VD16	6g Tor
1HH	XC6102D347MR	Vdet-IC	4.7V±2%, Hst, -MR, -Reset ODO, Wt=100ms, Rt=100ms	SOT-25	28cp	VD16	6g Tor
1HK	XC6224A25BMR	LVR-IC	LDO, 2.55V±1.5%, 150mA, +CE	SOT-25	28cx	VR4	6g Tor
1HK	XC6102D318MR	Vdet-IC	1.8V±2%, Hst, -MR, -Reset ODO, Wt=100ms, Rt=100ms	SOT-25	28cp	VD16	6g Tor
1HK	XC6102D348MR	Vdet-IC	4.8V±2%, Hst, -MR, -Reset ODO, Wt=100ms, Rt=100ms	SOT-25	28cp	VD16	6g Tor
1HL	XC6224A26BMR	LVR-IC	LDO, 2.65V±1.5%, 150mA, +CE	SOT-25	28cx	VR4	6g Tor
1HL	XC6102D319MR	Vdet-IC	1.9V±2%, Hst, -MR, -Reset ODO, Wt=100ms, Rt=100ms	SOT-25	28cp	VD16	6g Tor
1HL	XC6102D349MR	Vdet-IC	4.9V±2%, Hst, -MR, -Reset ODO, Wt=100ms, Rt=100ms	SOT-25	28cp	VD16	6g Tor
1HM	XC6224A27BMR	LVR-IC	LDO, 2.75V±1.5%, 150mA, +CE	SOT-25	28cx	VR4	6g Tor
1HM	XC6102D320MR	Vdet-IC	2.0V±2%, Hst, -MR, -Reset ODO, Wt=100ms, Rt=100ms	SOT-25	28cp	VD16	6g Tor
1HM	XC6102D350MR	Vdet-IC	5.0V±2%, Hst, -MR, -Reset ODO, Wt=100ms, Rt=100ms	SOT-25	28cp	VD16	6g Tor
1HN	XC6224A28BMR	LVR-IC	LDO, 2.85V±1.5%, 150mA, +CE	SOT-25	28cx	VR4	6g Tor
1HN	XC6102D321MR	Vdet-IC	2.1V±2%, Hst, -MR, -Reset ODO, Wt=100ms, Rt=100ms	SOT-25	28cp	VD16	6g Tor
1HP	XC6224A29BMR	LVR-IC	LDO, 2.95V±1.5%, 150mA, +CE	SOT-25	28cx	VR4	6g Tor
1HP	XC6102D322MR	Vdet-IC	2.2V±2%, Hst, -MR, -Reset ODO, Wt=100ms, Rt=100ms	SOT-25	28cp	VD16	6g Tor
1HR	XC6102D323MR	Vdet-IC	2.3V±2%, Hst, -MR, -Reset ODO, Wt=100ms, Rt=100ms	SOT-25	28cp	VD16	6g Tor
1HS	XC6102D324MR	Vdet-IC	2.4V±2%, Hst, -MR, -Reset ODO, Wt=100ms, Rt=100ms	SOT-25	28cp	VD16	6g Tor
1HT	XC6102D325MR	Vdet-IC	2.5V±2%, Hst, -MR, -Reset ODO, Wt=100ms, Rt=100ms	SOT-25	28cp	VD16	6g Tor



SMD code	Type	Function	Short description	Case	Pinout	Sch.	St.	Mnf.
<u>1</u> HU	XC6102D326MR	Vdet-IC	2.6V±2%, Hst, -MR, -Reset ODO, Wt=100ms, Rt=100ms	SOT-25	28cp	VD16	6g	Tor
<u>1</u> HV	XC6102D327MR	Vdet-IC	2.7V±2%, Hst, -MR, -Reset ODO, Wt=100ms, Rt=100ms	SOT-25	28cp	VD16	6g	Tor
<u>1</u> HX	XC6102D328MR	Vdet-IC	2.8V±2%, Hst, -MR, -Reset ODO, Wt=100ms, Rt=100ms	SOT-25	28cp	VD16	6g	Tor
<u>1</u> HY	XC6102D329MR	Vdet-IC	2.9V±2%, Hst, -MR, -Reset ODO, Wt=100ms, Rt=100ms	SOT-25	28cp	VD16	6g	Tor
<u>1</u> HZ	XC6102D330MR	Vdet-IC	3.0V±2%, Hst, -MR, -Reset ODO, Wt=100ms, Rt=100ms	SOT-25	28cp	VD16	6g	Tor
<u>1</u> J	R3111N111C	Vdet-IC	1.1V±2%, -Reset ODO	SOT-23-5	28vdm	VD6	6g	Ric
<u>1</u> K	R3111N211C	Vdet-IC	2.1V±2%, -Reset ODO	SOT-23-5	28vdm	VD6	6g	Ric
<u>1</u> K0	XC6224B08BMR	LVR-IC	LDO, 0.85V±20mV, 150mA, +CE, PDR	SOT-25	28cx	VR4	6g	Tor
<u>1</u> K0	XC6102D431MR	Vdet-IC	3.1V±2%, Hst, -MR, -Reset ODO, Wt=200ms, Rt=100ms	SOT-25	28cp	VD16	6g	Tor
<u>1</u> K1	XC6224B09BMR	LVR-IC	LDO, 0.95V±20mV, 150mA, +CE, PDR	SOT-25	28cx	VR4	6g	Tor
<u>1</u> K1	XC6102D432MR	Vdet-IC	3.2V±2%, Hst, -MR, -Reset ODO, Wt=200ms, Rt=100ms	SOT-25	28cp	VD16	6g	Tor
<u>1</u> K2	XC6224B10BMR	LVR-IC	LDO, 1.05V±20mV, 150mA, +CE, PDR	SOT-25	28cx	VR4	6g	Tor
<u>1</u> K2	XC6102D433MR	Vdet-IC	3.3V±2%, Hst, -MR, -Reset ODO, Wt=200ms, Rt=100ms	SOT-25	28cp	VD16	6g	Tor
<u>1</u> K3	XC6224B11BMR	LVR-IC	LDO, 1.15V±20mV, 150mA, +CE, PDR	SOT-25	28cx	VR4	6g	Tor
<u>1</u> K3	XC6102D434MR	Vdet-IC	3.4V±2%, Hst, -MR, -Reset ODO, Wt=200ms, Rt=100ms	SOT-25	28cp	VD16	6g	Tor
<u>1</u> K4	XC6224B12BMR	LVR-IC	LDO, 1.25V±1.5%, 150mA, +CE, PDR	SOT-25	28cx	VR4	6g	Tor
<u>1</u> K4	XC6102D435MR	Vdet-IC	3.5V±2%, Hst, -MR, -Reset ODO, Wt=200ms, Rt=100ms	SOT-25	28cp	VD16	6g	Tor
<u>1</u> K5	XC6224B13BMR	LVR-IC	LDO, 1.25V±1.5%, 150mA, +CE, PDR	SOT-25	28cx	VR4	6g	Tor
<u>1</u> K5	XC6102D436MR	Vdet-IC	3.6V±2%, Hst, -MR, -Reset ODO, Wt=200ms, Rt=100ms	SOT-25	28cp	VD16	6g	Tor
<u>1</u> K6	XC6224B14BMR	LVR-IC	LDO, 1.45V±1.5%, 150mA, +CE, PDR	SOT-25	28cx	VR4	6g	Tor
<u>1</u> K6	XC6102D437MR	Vdet-IC	3.7V±2%, Hst, -MR, -Reset ODO, Wt=200ms, Rt=100ms	SOT-25	28cp	VD16	6g	Tor
<u>1</u> K7	XC6224B15BMR	LVR-IC	LDO, 1.55V±1.5%, 150mA, +CE, PDR	SOT-25	28cx	VR4	6g	Tor
<u>1</u> K7	XC6102D438MR	Vdet-IC	3.8V±2%, Hst, -MR, -Reset ODO, Wt=200ms, Rt=100ms	SOT-25	28cp	VD16	6g	Tor
<u>1</u> K8	XC6224B16BMR	LVR-IC	LDO, 1.65V±1.5%, 150mA, +CE, PDR	SOT-25	28cx	VR4	6g	Tor
<u>1</u> K8	XC6102D439MR	Vdet-IC	3.9V±2%, Hst, -MR, -Reset ODO, Wt=200ms, Rt=100ms	SOT-25	28cp	VD16	6g	Tor
<u>1</u> K9	XC6224B17BMR	LVR-IC	LDO, 1.75V±1.5%, 150mA, +CE, PDR	SOT-25	28cx	VR4	6g	Tor
<u>1</u> K9	XC6102D440MR	Vdet-IC	4.0V±2%, Hst, -MR, -Reset ODO, Wt=200ms, Rt=100ms	SOT-25	28cp	VD16	6g	Tor
<u>1</u> KA	XC6224B18BMR	LVR-IC	LDO, 1.85V±1.5%, 150mA, +CE, PDR	SOT-25	28cx	VR4	6g	Tor
<u>1</u> KA	XC6102D441MR	Vdet-IC	4.1V±2%, Hst, -MR, -Reset ODO, Wt=200ms, Rt=100ms	SOT-25	28cp	VD16	6g	Tor
<u>1</u> KB	XC6224B19BMR	LVR-IC	LDO, 1.95V±1.5%, 150mA, +CE, PDR	SOT-25	28cx	VR4	6g	Tor
<u>1</u> KB	XC6102D442MR	Vdet-IC	4.2V±2%, Hst, -MR, -Reset ODO, Wt=200ms, Rt=100ms	SOT-25	28cp	VD16	6g	Tor
<u>1</u> KC	XC6224B20BMR	LVR-IC	LDO, 2.05V±1.5%, 150mA, +CE, PDR	SOT-25	28cx	VR4	6g	Tor
<u>1</u> KC	XC6102D443MR	Vdet-IC	4.3V±2%, Hst, -MR, -Reset ODO, Wt=200ms, Rt=100ms	SOT-25	28cp	VD16	6g	Tor
<u>1</u> KD	XC6224B21BMR	LVR-IC	LDO, 2.15V±1.5%, 150mA, +CE, PDR	SOT-25	28cx	VR4	6g	Tor
<u>1</u> KD	XC6102D444MR	Vdet-IC	4.4V±2%, Hst, -MR, -Reset ODO, Wt=200ms, Rt=100ms	SOT-25	28cp	VD16	6g	Tor
<u>1</u> KE	XC6224B22BMR	LVR-IC	LDO, 2.25V±1.5%, 150mA, +CE, PDR	SOT-25	28cx	VR4	6g	Tor
<u>1</u> KE	XC6102D445MR	Vdet-IC	4.5V±2%, Hst, -MR, -Reset ODO, Wt=200ms, Rt=100ms	SOT-25	28cp	VD16	6g	Tor
<u>1</u> KF	XC6224B23BMR	LVR-IC	LDO, 2.25V±1.5%, 150mA, +CE, PDR	SOT-25	28cx	VR4	6g	Tor
<u>1</u> KF	XC6102D416MR	Vdet-IC	1.6V±2%, Hst, -MR, -Reset ODO, Wt=200ms, Rt=100ms	SOT-25	28cp	VD16	6g	Tor
<u>1</u> KF	XC6102D446MR	Vdet-IC	4.6V±2%, Hst, -MR, -Reset ODO, Wt=200ms, Rt=100ms	SOT-25	28cp	VD16	6g	Tor
<u>1</u> KH	XC6224B24BMR	LVR-IC	LDO, 2.45V±1.5%, 150mA, +CE, PDR	SOT-25	28cx	VR4	6g	Tor
<u>1</u> KH	XC6102D417MR	Vdet-IC	1.7V±2%, Hst, -MR, -Reset ODO, Wt=200ms, Rt=100ms	SOT-25	28cp	VD16	6g	Tor
<u>1</u> KH	XC6102D447MR	Vdet-IC	4.7V±2%, Hst, -MR, -Reset ODO, Wt=200ms, Rt=100ms	SOT-25	28cp	VD16	6g	Tor
<u>1</u> KK	XC6224B25BMR	LVR-IC	LDO, 2.55V±1.5%, 150mA, +CE, PDR	SOT-25	28cx	VR4	6g	Tor
<u>1</u> KK	XC6102D418MR	Vdet-IC	1.8V±2%, Hst, -MR, -Reset ODO, Wt=200ms, Rt=100ms	SOT-25	28cp	VD16	6g	Tor
<u>1</u> KK	XC6102D448MR	Vdet-IC	4.8V±2%, Hst, -MR, -Reset ODO, Wt=200ms, Rt=100ms	SOT-25	28cp	VD16	6g	Tor
<u>1</u> KL	XC6224B26BMR	LVR-IC	LDO, 2.65V±1.5%, 150mA, +CE, PDR	SOT-25	28cx	VR4	6g	Tor
<u>1</u> KL	XC6102D419MR	Vdet-IC	1.9V±2%, Hst, -MR, -Reset ODO, Wt=200ms, Rt=100ms	SOT-25	28cp	VD16	6g	Tor
<u>1</u> KL	XC6102D449MR	Vdet-IC	4.9V±2%, Hst, -MR, -Reset ODO, Wt=200ms, Rt=100ms	SOT-25	28cp	VD16	6g	Tor
<u>1</u> KM	XC6224B27BMR	LVR-IC	LDO, 2.75V±1.5%, 150mA, +CE, PDR	SOT-25	28cx	VR4	6g	Tor
<u>1</u> KM	XC6102D420MR	Vdet-IC	2.0V±2%, Hst, -MR, -Reset ODO, Wt=200ms, Rt=100ms	SOT-25	28cp	VD16	6g	Tor
<u>1</u> KM	XC6102D450MR	Vdet-IC	5.0V±2%, Hst, -MR, -Reset ODO, Wt=200ms, Rt=100ms	SOT-25	28cp	VD16	6g	Tor
<u>1</u> KN	XC6224B28BMR	LVR-IC	LDO, 2.85V±1.5%, 150mA, +CE, PDR	SOT-25	28cx	VR4	6g	Tor
<u>1</u> KN	XC6102D421MR	Vdet-IC	2.1V±2%, Hst, -MR, -Reset ODO, Wt=200ms, Rt=100ms	SOT-25	28cp	VD16	6g	Tor
<u>1</u> KP	XC6224B29BMR	LVR-IC	LDO, 2.95V±1.5%, 150mA, +CE, PDR	SOT-25	28cx	VR4	6g	Tor
<u>1</u> KP	XC6102D422MR	Vdet-IC	2.2V±2%, Hst, -MR, -Reset ODO, Wt=200ms, Rt=100ms	SOT-25	28cp	VD16	6g	Tor
<u>1</u> KR	XC6102D423MR	Vdet-IC	2.3V±2%, Hst, -MR, -Reset ODO, Wt=200ms, Rt=100ms	SOT-25	28cp	VD16	6g	Tor
<u>1</u> KS	XC6102D424MR	Vdet-IC	2.4V±2%, Hst, -MR, -Reset ODO, Wt=200ms, Rt=100ms	SOT-25	28cp	VD16	6g	Tor
<u>1</u> KT	XC6102D425MR	Vdet-IC	2.5V±2%, Hst, -MR, -Reset ODO, Wt=200ms, Rt=100ms	SOT-25	28cp	VD16	6g	Tor
<u>1</u> KU	XC6102D426MR	Vdet-IC	2.6V±2%, Hst, -MR, -Reset ODO, Wt=200ms, Rt=100ms	SOT-25	28cp	VD16	6g	Tor
<u>1</u> KV	XC6102D427MR	Vdet-IC	2.7V±2%, Hst, -MR, -Reset ODO, Wt=200ms, Rt=100ms	SOT-25	28cp	VD16	6g	Tor
<u>1</u> KX	XC6102D428MR	Vdet-IC	2.8V±2%, Hst, -MR, -Reset ODO, Wt=200ms, Rt=100ms	SOT-25	28cp	VD16	6g	Tor
<u>1</u> KY	XC6102D429MR	Vdet-IC	2.9V±2%, Hst, -MR, -Reset ODO, Wt=200ms, Rt=100ms	SOT-25	28cp	VD16	6g	Tor
<u>1</u> KZ	XC6102D430MR	Vdet-IC	3.0V±2%, Hst, -MR, -Reset ODO, Wt=200ms, Rt=100ms	SOT-25	28cp	VD16	6g	Tor
<u>1</u> L	R3111N311C	Vdet-IC	3.1V±2%, -Reset ODO	SOT-23-5	28vdm	VD6	6g	Ric
<u>1</u> L0	XC6217A31AMR	LVR-IC	LDO, 3.15V±2%, 200mA, +CE, Shutdown	SOT-25	28cu	VR4a	6g	Tor
<u>1</u> L0	XC6102D531MR	Vdet-IC	3.1V±2%, Hst, -MR, -Reset ODO, Wt=400ms, Rt=100ms	SOT-25	28cp	VD16	6g	Tor
<u>1</u> L1	S-1313A31-M5T1U3	LVR-IC	LDO, 3.1V±1%, 200mA, +CE, CL, PDR	SOT-23-5	28cx	VR4	6g	Sii
<u>1</u> L1	XC6217A32AMR	LVR-IC	LDO, 3.25V±2%, 200mA, +CE, Shutdown	SOT-25	28cu	VR4a	6g	Tor
<u>1</u> L1	XC6102D532MR	Vdet-IC	3.2V±2%, Hst, -MR, -Reset ODO, Wt=400ms, Rt=100ms	SOT-25	28cp	VD16	6g	Tor



SMD code	Type	Function	Short description	Case	Pinout	Sch.	St.	Mnf.
1L2	S-1313A32-M5T1U3	LVR-IC	LDO, 3.2V±1%, 200mA, +CE, CL, PDR	SOT-23-5	28cx	VR4	6g	Sii
1L2	XC6217A33AMR	LVR-IC	LDO, 3.35V±2%, 200mA, +CE, Shutdown	SOT-25	28cu	VR4a	6g	Tor
1L2	XC6102D533MR	Vdet-IC	3.3V±2%, Hst, -MR, -Reset ODO, Wt=400ms, Rt=100ms	SOT-25	28cp	VD16	6g	Tor
1L3	S-1313A33-M5T1U3	LVR-IC	LDO, 3.3V±1%, 200mA, +CE, CL, PDR	SOT-23-5	28cx	VR4	6g	Sii
1L3	XC6217A34AMR	LVR-IC	LDO, 3.45V±2%, 200mA, +CE, Shutdown	SOT-25	28cu	VR4a	6g	Tor
1L3	XC6102D534MR	Vdet-IC	3.4V±2%, Hst, -MR, -Reset ODO, Wt=400ms, Rt=100ms	SOT-25	28cp	VD16	6g	Tor
1L4	S-1313A34-M5T1U3	LVR-IC	LDO, 3.4V±1%, 200mA, +CE, CL, PDR	SOT-23-5	28cx	VR4	6g	Sii
1L4	XC6217A35AMR	LVR-IC	LDO, 3.55V±2%, 200mA, +CE, Shutdown	SOT-25	28cu	VR4a	6g	Tor
1L4	XC6102D535MR	Vdet-IC	3.5V±2%, Hst, -MR, -Reset ODO, Wt=400ms, Rt=100ms	SOT-25	28cp	VD16	6g	Tor
1L5	S-1313A35-M5T1U3	LVR-IC	LDO, 3.5V±1%, 200mA, +CE, CL, PDR	SOT-23-5	28cx	VR4	6g	Sii
1L5	XC6217A36AMR	LVR-IC	LDO, 3.65V±2%, 200mA, +CE, Shutdown	SOT-25	28cu	VR4a	6g	Tor
1L5	XC6102D536MR	Vdet-IC	3.6V±2%, Hst, -MR, -Reset ODO, Wt=400ms, Rt=100ms	SOT-25	28cp	VD16	6g	Tor
1L6	XC6217A37AMR	LVR-IC	LDO, 3.75V±2%, 200mA, +CE, Shutdown	SOT-25	28cu	VR4a	6g	Tor
1L6	XC6102D537MR	Vdet-IC	3.7V±2%, Hst, -MR, -Reset ODO, Wt=400ms, Rt=100ms	SOT-25	28cp	VD16	6g	Tor
1L7	XC6217A38AMR	LVR-IC	LDO, 3.85V±2%, 200mA, +CE, Shutdown	SOT-25	28cu	VR4a	6g	Tor
1L7	XC6102D538MR	Vdet-IC	3.8V±2%, Hst, -MR, -Reset ODO, Wt=400ms, Rt=100ms	SOT-25	28cp	VD16	6g	Tor
1L8	XC6217A39AMR	LVR-IC	LDO, 3.95V±2%, 200mA, +CE, Shutdown	SOT-25	28cu	VR4a	6g	Tor
1L8	XC6102D539MR	Vdet-IC	3.9V±2%, Hst, -MR, -Reset ODO, Wt=400ms, Rt=100ms	SOT-25	28cp	VD16	6g	Tor
1L9	XC6102D540MR	Vdet-IC	4.0V±2%, Hst, -MR, -Reset ODO, Wt=400ms, Rt=100ms	SOT-25	28cp	VD16	6g	Tor
1LA	S-1313A10-M5T1U3	LVR-IC	LDO, 1.0V±1%, 200mA, +CE, CL, PDR	SOT-23-5	28cx	VR4	6g	Sii
1LA	XC6102D541MR	Vdet-IC	4.1V±2%, Hst, -MR, -Reset ODO, Wt=400ms, Rt=100ms	SOT-25	28cp	VD16	6g	Tor
1LB	S-1313A11-M5T1U3	LVR-IC	LDO, 1.1V±1%, 200mA, +CE, CL, PDR	SOT-23-5	28cx	VR4	6g	Sii
1LB	XC6102D542MR	Vdet-IC	4.2V±2%, Hst, -MR, -Reset ODO, Wt=400ms, Rt=100ms	SOT-25	28cp	VD16	6g	Tor
1LC	S-1313A12-M5T1U3	LVR-IC	LDO, 1.2V±1%, 200mA, +CE, CL, PDR	SOT-23-5	28cx	VR4	6g	Sii
1LC	XC6102D543MR	Vdet-IC	4.3V±2%, Hst, -MR, -Reset ODO, Wt=400ms, Rt=100ms	SOT-25	28cp	VD16	6g	Tor
1LD	S-1313A13-M5T1U3	LVR-IC	LDO, 1.3V±1%, 200mA, +CE, CL, PDR	SOT-23-5	28cx	VR4	6g	Sii
1LD	XC6102D544MR	Vdet-IC	4.4V±2%, Hst, -MR, -Reset ODO, Wt=400ms, Rt=100ms	SOT-25	28cp	VD16	6g	Tor
1LE	S-1313A14-M5T1U3	LVR-IC	LDO, 1.4V±1%, 200mA, +CE, CL, PDR	SOT-23-5	28cx	VR4	6g	Sii
1LE	XC6102D545MR	Vdet-IC	4.5V±2%, Hst, -MR, -Reset ODO, Wt=400ms, Rt=100ms	SOT-25	28cp	VD16	6g	Tor
1LF	S-1313A15-M5T1U3	LVR-IC	LDO, 1.5V±1%, 200mA, +CE, CL, PDR	SOT-23-5	28cx	VR4	6g	Sii
1LF	XC6102D516MR	Vdet-IC	1.6V±2%, Hst, -MR, -Reset ODO, Wt=400ms, Rt=100ms	SOT-25	28cp	VD16	6g	Tor
1LF	XC6102D546MR	Vdet-IC	4.6V±2%, Hst, -MR, -Reset ODO, Wt=400ms, Rt=100ms	SOT-25	28cp	VD16	6g	Tor
1LG	S-1313A16-M5T1U3	LVR-IC	LDO, 1.6V±1%, 200mA, +CE, CL, PDR	SOT-23-5	28cx	VR4	6g	Sii
1LH	S-1313A17-M5T1U3	LVR-IC	LDO, 1.7V±1%, 200mA, +CE, CL, PDR	SOT-23-5	28cx	VR4	6g	Sii
1LH	XC6102D517MR	Vdet-IC	1.7V±2%, Hst, -MR, -Reset ODO, Wt=400ms, Rt=100ms	SOT-25	28cp	VD16	6g	Tor
1LH	XC6102D547MR	Vdet-IC	4.7V±2%, Hst, -MR, -Reset ODO, Wt=400ms, Rt=100ms	SOT-25	28cp	VD16	6g	Tor
1LJ	S-1313A18-M5T1U3	LVR-IC	LDO, 1.8V±1%, 200mA, +CE, CL, PDR	SOT-23-5	28cx	VR4	6g	Sii
1LK	S-1313A1J-M5T1U3	LVR-IC	LDO, 1.85V±1%, 200mA, +CE, CL, PDR	SOT-23-5	28cx	VR4	6g	Sii
1LK	XC6102D518MR	Vdet-IC	1.8V±2%, Hst, -MR, -Reset ODO, Wt=400ms, Rt=100ms	SOT-25	28cp	VD16	6g	Tor
1LK	XC6102D548MR	Vdet-IC	4.8V±2%, Hst, -MR, -Reset ODO, Wt=400ms, Rt=100ms	SOT-25	28cp	VD16	6g	Tor
1LL	S-1313A19-M5T1U3	LVR-IC	LDO, 1.9V±1%, 200mA, +CE, CL, PDR	SOT-23-5	28cx	VR4	6g	Sii
1LL	XC6102D519MR	Vdet-IC	1.9V±2%, Hst, -MR, -Reset ODO, Wt=400ms, Rt=100ms	SOT-25	28cp	VD16	6g	Tor
1LL	XC6102D549MR	Vdet-IC	4.9V±2%, Hst, -MR, -Reset ODO, Wt=400ms, Rt=100ms	SOT-25	28cp	VD16	6g	Tor
1LM	XC6102D520MR	Vdet-IC	2.0V±2%, Hst, -MR, -Reset ODO, Wt=400ms, Rt=100ms	SOT-25	28cp	VD16	6g	Tor
1LM	XC6102D550MR	Vdet-IC	5.0V±2%, Hst, -MR, -Reset ODO, Wt=400ms, Rt=100ms	SOT-25	28cp	VD16	6g	Tor
1LN	S-1313A20-M5T1U3	LVR-IC	LDO, 2.0V±1%, 200mA, +CE, CL, PDR	SOT-23-5	28cx	VR4	6g	Sii
1LN	XC6102D521MR	Vdet-IC	2.1V±2%, Hst, -MR, -Reset ODO, Wt=400ms, Rt=100ms	SOT-25	28cp	VD16	6g	Tor
1LO	S-1313A21-M5T1U3	LVR-IC	LDO, 2.1V±1%, 200mA, +CE, CL, PDR	SOT-23-5	28cx	VR4	6g	Sii
1LP	S-1313A22-M5T1U3	LVR-IC	LDO, 2.2V±1%, 200mA, +CE, CL, PDR	SOT-23-5	28cx	VR4	6g	Sii
1LP	XC6102D522MR	Vdet-IC	2.2V±2%, Hst, -MR, -Reset ODO, Wt=400ms, Rt=100ms	SOT-25	28cp	VD16	6g	Tor
1LQ	S-1313A23-M5T1U3	LVR-IC	LDO, 2.3V±1%, 200mA, +CE, CL, PDR	SOT-23-5	28cx	VR4	6g	Sii
1LR	S-1313A24-M5T1U3	LVR-IC	LDO, 2.4V±1%, 200mA, +CE, CL, PDR	SOT-23-5	28cx	VR4	6g	Sii
1LR	XC6102D523MR	Vdet-IC	2.3V±2%, Hst, -MR, -Reset ODO, Wt=400ms, Rt=100ms	SOT-25	28cp	VD16	6g	Tor
1LS	S-1313A25-M5T1U3	LVR-IC	LDO, 2.5V±1%, 200mA, +CE, CL, PDR	SOT-23-5	28cx	VR4	6g	Sii
1LS	XC6102D524MR	Vdet-IC	2.4V±2%, Hst, -MR, -Reset ODO, Wt=400ms, Rt=100ms	SOT-25	28cp	VD16	6g	Tor
1LT	S-1313A26-M5T1U3	LVR-IC	LDO, 2.6V±1%, 200mA, +CE, CL, PDR	SOT-23-5	28cx	VR4	6g	Sii
1LT	XC6102D525MR	Vdet-IC	2.5V±2%, Hst, -MR, -Reset ODO, Wt=400ms, Rt=100ms	SOT-25	28cp	VD16	6g	Tor
1LU	S-1313A28-M5T1U3	LVR-IC	LDO, 2.8V±1%, 200mA, +CE, CL, PDR	SOT-23-5	28cx	VR4	6g	Sii
1LU	XC6102D526MR	Vdet-IC	2.6V±2%, Hst, -MR, -Reset ODO, Wt=400ms, Rt=100ms	SOT-25	28cp	VD16	6g	Tor
1LV	S-1313A27-M5T1U3	LVR-IC	LDO, 2.7V±1%, 200mA, +CE, CL, PDR	SOT-23-5	28cx	VR4	6g	Sii
1LV	XC6102D527MR	Vdet-IC	2.7V±2%, Hst, -MR, -Reset ODO, Wt=400ms, Rt=100ms	SOT-25	28cp	VD16	6g	Tor
1LX	S-1313A2J-M5T1U3	LVR-IC	LDO, 2.85V±1%, 200mA, +CE, CL, PDR	SOT-23-5	28cx	VR4	6g	Sii
1LX	XC6102D528MR	Vdet-IC	2.8V±2%, Hst, -MR, -Reset ODO, Wt=400ms, Rt=100ms	SOT-25	28cp	VD16	6g	Tor
1LY	S-1313A29-M5T1U3	LVR-IC	LDO, 2.9V±1%, 200mA, +CE, CL, PDR	SOT-23-5	28cx	VR4	6g	Sii
1LY	XC6102D529MR	Vdet-IC	2.9V±2%, Hst, -MR, -Reset ODO, Wt=400ms, Rt=100ms	SOT-25	28cp	VD16	6g	Tor
1LZ	S-1313A30-M5T1U3	LVR-IC	LDO, 3.0V±1%, 200mA, +CE, CL, PDR	SOT-23-5	28cx	VR4	6g	Sii
1LZ	XC6102D530MR	Vdet-IC	3.0V±2%, Hst, -MR, -Reset ODO, Wt=400ms, Rt=100ms	SOT-25	28cp	VD16	6g	Tor
1M	R3111N411C	Vdet-IC	4.1V±2%, -Reset ODO	SOT-23-5	28vdm	VD6	6g	Ric
1MO	XC6217B31AMR	LVR-IC	LDO, 3.15V±2%, 200mA, +CE, CL, Shutdown	SOT-25	28cu	VR4a	6g	Tor
1MO	XC6102D631MR	Vdet-IC	3.1V±2%, Hst, -MR, -Reset ODO, Wt=1.6s, Rt=100ms	SOT-25	28cp	VD16	6g	Tor



SMD code	Type	Function	Short description	Case	Pinout	Sch.	St.	Mnf.
1M1	XC6217B32AMR	LVR-IC	LDO, 3.25V±2%, 200mA, +CE, CL, Shutdown	SOT-25	28cu	VR4a	6g	Tor
1M1	XC6102D632MR	Vdet-IC	3.2V±2%, Hst, -MR, -Reset ODO, Wt=1.6s, Rt=100ms	SOT-25	28cp	VD16	6g	Tor
1M2	XC6217B33AMR	LVR-IC	LDO, 3.35V±2%, 200mA, +CE, CL, Shutdown	SOT-25	28cu	VR4a	6g	Tor
1M2	XC6102D633MR	Vdet-IC	3.3V±2%, Hst, -MR, -Reset ODO, Wt=1.6s, Rt=100ms	SOT-25	28cp	VD16	6g	Tor
1M3	XC6217B34AMR	LVR-IC	LDO, 3.45V±2%, 200mA, +CE, CL, Shutdown	SOT-25	28cu	VR4a	6g	Tor
1M3	XC6102D634MR	Vdet-IC	3.4V±2%, Hst, -MR, -Reset ODO, Wt=1.6s, Rt=100ms	SOT-25	28cp	VD16	6g	Tor
1M4	XC6217B35AMR	LVR-IC	LDO, 3.55V±2%, 200mA, +CE, CL, Shutdown	SOT-25	28cu	VR4a	6g	Tor
1M4	XC6102D635MR	Vdet-IC	3.5V±2%, Hst, -MR, -Reset ODO, Wt=1.6s, Rt=100ms	SOT-25	28cp	VD16	6g	Tor
1M5	XC6217B36AMR	LVR-IC	LDO, 3.65V±2%, 200mA, +CE, CL, Shutdown	SOT-25	28cu	VR4a	6g	Tor
1M5	XC6102D636MR	Vdet-IC	3.6V±2%, Hst, -MR, -Reset ODO, Wt=1.6s, Rt=100ms	SOT-25	28cp	VD16	6g	Tor
1M6	XC6217B37AMR	LVR-IC	LDO, 3.75V±2%, 200mA, +CE, CL, Shutdown	SOT-25	28cu	VR4a	6g	Tor
1M6	XC6102D637MR	Vdet-IC	3.7V±2%, Hst, -MR, -Reset ODO, Wt=1.6s, Rt=100ms	SOT-25	28cp	VD16	6g	Tor
1M7	XC6217B38AMR	LVR-IC	LDO, 3.85V±2%, 200mA, +CE, CL, Shutdown	SOT-25	28cu	VR4a	6g	Tor
1M7	XC6102D638MR	Vdet-IC	3.8V±2%, Hst, -MR, -Reset ODO, Wt=1.6s, Rt=100ms	SOT-25	28cp	VD16	6g	Tor
1M8	XC6217B39AMR	LVR-IC	LDO, 3.95V±2%, 200mA, +CE, CL, Shutdown	SOT-25	28cu	VR4a	6g	Tor
1M8	XC6102D639MR	Vdet-IC	3.9V±2%, Hst, -MR, -Reset ODO, Wt=1.6s, Rt=100ms	SOT-25	28cp	VD16	6g	Tor
1M9	XC6102D640MR	Vdet-IC	4.0V±2%, Hst, -MR, -Reset ODO, Wt=1.6s, Rt=100ms	SOT-25	28cp	VD16	6g	Tor
1MA	XC6102D641MR	Vdet-IC	4.1V±2%, Hst, -MR, -Reset ODO, Wt=1.6s, Rt=100ms	SOT-25	28cp	VD16	6g	Tor
1MB	XC6102D642MR	Vdet-IC	4.2V±2%, Hst, -MR, -Reset ODO, Wt=1.6s, Rt=100ms	SOT-25	28cp	VD16	6g	Tor
1MC	XC6102D643MR	Vdet-IC	4.3V±2%, Hst, -MR, -Reset ODO, Wt=1.6s, Rt=100ms	SOT-25	28cp	VD16	6g	Tor
1MD	XC6102D644MR	Vdet-IC	4.4V±2%, Hst, -MR, -Reset ODO, Wt=1.6s, Rt=100ms	SOT-25	28cp	VD16	6g	Tor
1ME	XC6102D645MR	Vdet-IC	4.5V±2%, Hst, -MR, -Reset ODO, Wt=1.6s, Rt=100ms	SOT-25	28cp	VD16	6g	Tor
1MF	XC6102D616MR	Vdet-IC	1.6V±2%, Hst, -MR, -Reset ODO, Wt=1.6s, Rt=100ms	SOT-25	28cp	VD16	6g	Tor
1MF	XC6102D646MR	Vdet-IC	4.6V±2%, Hst, -MR, -Reset ODO, Wt=1.6s, Rt=100ms	SOT-25	28cp	VD16	6g	Tor
1MH	XC6102D617MR	Vdet-IC	1.7V±2%, Hst, -MR, -Reset ODO, Wt=1.6s, Rt=100ms	SOT-25	28cp	VD16	6g	Tor
1MH	XC6102D647MR	Vdet-IC	4.7V±2%, Hst, -MR, -Reset ODO, Wt=1.6s, Rt=100ms	SOT-25	28cp	VD16	6g	Tor
1MK	XC6102D618MR	Vdet-IC	1.8V±2%, Hst, -MR, -Reset ODO, Wt=1.6s, Rt=100ms	SOT-25	28cp	VD16	6g	Tor
1MK	XC6102D648MR	Vdet-IC	4.8V±2%, Hst, -MR, -Reset ODO, Wt=1.6s, Rt=100ms	SOT-25	28cp	VD16	6g	Tor
1ML	XC6102D619MR	Vdet-IC	1.9V±2%, Hst, -MR, -Reset ODO, Wt=1.6s, Rt=100ms	SOT-25	28cp	VD16	6g	Tor
1ML	XC6102D649MR	Vdet-IC	4.9V±2%, Hst, -MR, -Reset ODO, Wt=1.6s, Rt=100ms	SOT-25	28cp	VD16	6g	Tor
1MM	XC6102D620MR	Vdet-IC	2.0V±2%, Hst, -MR, -Reset ODO, Wt=1.6s, Rt=100ms	SOT-25	28cp	VD16	6g	Tor
1MM	XC6102D650MR	Vdet-IC	5.0V±2%, Hst, -MR, -Reset ODO, Wt=1.6s, Rt=100ms	SOT-25	28cp	VD16	6g	Tor
1MN	XC6102D621MR	Vdet-IC	2.1V±2%, Hst, -MR, -Reset ODO, Wt=1.6s, Rt=100ms	SOT-25	28cp	VD16	6g	Tor
1MP	XC6102D622MR	Vdet-IC	2.2V±2%, Hst, -MR, -Reset ODO, Wt=1.6s, Rt=100ms	SOT-25	28cp	VD16	6g	Tor
1MP	XC6102D623MR	Vdet-IC	2.3V±2%, Hst, -MR, -Reset ODO, Wt=1.6s, Rt=100ms	SOT-25	28cp	VD16	6g	Tor
1MS	XC6102D624MR	Vdet-IC	2.4V±2%, Hst, -MR, -Reset ODO, Wt=1.6s, Rt=100ms	SOT-25	28cp	VD16	6g	Tor
1MT	XC6102D625MR	Vdet-IC	2.5V±2%, Hst, -MR, -Reset ODO, Wt=1.6s, Rt=100ms	SOT-25	28cp	VD16	6g	Tor
1MU	XC6102D626MR	Vdet-IC	2.6V±2%, Hst, -MR, -Reset ODO, Wt=1.6s, Rt=100ms	SOT-25	28cp	VD16	6g	Tor
1MV	XC6102D627MR	Vdet-IC	2.7V±2%, Hst, -MR, -Reset ODO, Wt=1.6s, Rt=100ms	SOT-25	28cp	VD16	6g	Tor
1MX	XC6102D628MR	Vdet-IC	2.8V±2%, Hst, -MR, -Reset ODO, Wt=1.6s, Rt=100ms	SOT-25	28cp	VD16	6g	Tor
1MY	XC6102D629MR	Vdet-IC	2.9V±2%, Hst, -MR, -Reset ODO, Wt=1.6s, Rt=100ms	SOT-25	28cp	VD16	6g	Tor
1MZ	XC6102D630MR	Vdet-IC	3.0V±2%, Hst, -MR, -Reset ODO, Wt=1.6s, Rt=100ms	SOT-25	28cp	VD16	6g	Tor
1N	R3111N511C	Vdet-IC	5.1V±2%, -Reset ODO	SOT-23-5	28vdm	VD6	6g	Ric
1N1	S-1313B31-M5T1U3	LVR-IC	LDO, 3.1V±1%, 200mA, +CE, CL	SOT-23-5	28cx	VR4	6g	Sii
1N2	S-1313B32-M5T1U3	LVR-IC	LDO, 3.2V±1%, 200mA, +CE, CL	SOT-23-5	28cx	VR4	6g	Sii
1N3	S-1313B33-M5T1U3	LVR-IC	LDO, 3.3V±1%, 200mA, +CE, CL	SOT-23-5	28cx	VR4	6g	Sii
1N4	S-1313B34-M5T1U3	LVR-IC	LDO, 3.4V±1%, 200mA, +CE, CL	SOT-23-5	28cx	VR4	6g	Sii
1N5	S-1313B35-M5T1U3	LVR-IC	LDO, 3.5V±1%, 200mA, +CE, CL	SOT-23-5	28cx	VR4	6g	Sii
1NA	S-1313B10-M5T1U3	LVR-IC	LDO, 1.0V±1%, 200mA, +CE, CL	SOT-23-5	28cx	VR4	6g	Sii
1NB	S-1313B11-M5T1U3	LVR-IC	LDO, 1.1V±1%, 200mA, +CE, CL	SOT-23-5	28cx	VR4	6g	Sii
1NC	S-1313B12-M5T1U3	LVR-IC	LDO, 1.2V±1%, 200mA, +CE, CL	SOT-23-5	28cx	VR4	6g	Sii
1ND	S-1313B13-M5T1U3	LVR-IC	LDO, 1.3V±1%, 200mA, +CE, CL	SOT-23-5	28cx	VR4	6g	Sii
1NE	S-1313B14-M5T1U3	LVR-IC	LDO, 1.4V±1%, 200mA, +CE, CL	SOT-23-5	28cx	VR4	6g	Sii
1NF	S-1313B15-M5T1U3	LVR-IC	LDO, 1.5V±1%, 200mA, +CE, CL	SOT-23-5	28cx	VR4	6g	Sii
1NG	S-1313B16-M5T1U3	LVR-IC	LDO, 1.6V±1%, 200mA, +CE, CL	SOT-23-5	28cx	VR4	6g	Sii
1NH	S-1313B17-M5T1U3	LVR-IC	LDO, 1.7V±1%, 200mA, +CE, CL	SOT-23-5	28cx	VR4	6g	Sii
1NJ	S-1313B18-M5T1U3	LVR-IC	LDO, 1.8V±1%, 200mA, +CE, CL	SOT-23-5	28cx	VR4	6g	Sii
1NK	S-1313B1J-M5T1U3	LVR-IC	LDO, 1.85V±1%, 200mA, +CE, CL	SOT-23-5	28cx	VR4	6g	Sii
1NL	S-1313B19-M5T1U3	LVR-IC	LDO, 1.9V±1%, 200mA, +CE, CL	SOT-23-5	28cx	VR4	6g	Sii
1NN	S-1313B20-M5T1U3	LVR-IC	LDO, 2.0V±1%, 200mA, +CE, CL	SOT-23-5	28cx	VR4	6g	Sii
1NO	S-1313B21-M5T1U3	LVR-IC	LDO, 2.1V±1%, 200mA, +CE, CL	SOT-23-5	28cx	VR4	6g	Sii
1NP	S-1313B22-M5T1U3	LVR-IC	LDO, 2.2V±1%, 200mA, +CE, CL	SOT-23-5	28cx	VR4	6g	Sii
1NQ	S-1313B23-M5T1U3	LVR-IC	LDO, 2.3V±1%, 200mA, +CE, CL	SOT-23-5	28cx	VR4	6g	Sii
1NR	S-1313B24-M5T1U3	LVR-IC	LDO, 2.4V±1%, 200mA, +CE, CL	SOT-23-5	28cx	VR4	6g	Sii
1NS	S-1313B25-M5T1U3	LVR-IC	LDO, 2.5V±1%, 200mA, +CE, CL	SOT-23-5	28cx	VR4	6g	Sii
1NT	S-1313B26-M5T1U3	LVR-IC	LDO, 2.6V±1%, 200mA, +CE, CL	SOT-23-5	28cx	VR4	6g	Sii
1NU	S-1313B27-M5T1U3	LVR-IC	LDO, 2.7V±1%, 200mA, +CE, CL	SOT-23-5	28cx	VR4	6g	Sii
1NV	S-1313B28-M5T1U3	LVR-IC	LDO, 2.8V±1%, 200mA, +CE, CL	SOT-23-5	28cx	VR4	6g	Sii
1NX	S-1313B2J-M5T1U3	LVR-IC	LDO, 2.85V±1%, 200mA, +CE, CL	SOT-23-5	28cx	VR4	6g	Sii
1NY	S-1313B29-M5T1U3	LVR-IC	LDO, 2.9V±1%, 200mA, +CE, CL	SOT-23-5	28cx	VR4	6g	Sii



SMD code	Type	Function	Short description	Case	Pinout	Sch.	St.	Mnf.
1NZ	S-1313B30-M5T1U3	LVR-IC	LDO, 3.0V±1%, 200mA, +CE, CL	SOT-23-5	28cx	VR4	6g	Sii
1O1	S-1313C31-M5T1U3	LVR-IC	LDO, 3.1V±1%, 200mA, +CE, PDR	SOT-23-5	28cx	VR4	6g	Sii
1O2	S-1313C32-M5T1U3	LVR-IC	LDO, 3.2V±1%, 200mA, +CE, PDR	SOT-23-5	28cx	VR4	6g	Sii
1O3	S-1313C33-M5T1U3	LVR-IC	LDO, 3.3V±1%, 200mA, +CE, PDR	SOT-23-5	28cx	VR4	6g	Sii
1O4	S-1313C34-M5T1U3	LVR-IC	LDO, 3.4V±1%, 200mA, +CE, PDR	SOT-23-5	28cx	VR4	6g	Sii
1O5	S-1313C35-M5T1U3	LVR-IC	LDO, 3.5V±1%, 200mA, +CE, PDR	SOT-23-5	28cx	VR4	6g	Sii
1OA	S-1313C10-M5T1U3	LVR-IC	LDO, 1.0V±1%, 200mA, +CE, PDR	SOT-23-5	28cx	VR4	6g	Sii
1OB	S-1313C11-M5T1U3	LVR-IC	LDO, 1.1V±1%, 200mA, +CE, PDR	SOT-23-5	28cx	VR4	6g	Sii
1OC	S-1313C12-M5T1U3	LVR-IC	LDO, 1.2V±1%, 200mA, +CE, PDR	SOT-23-5	28cx	VR4	6g	Sii
1OD	S-1313C13-M5T1U3	LVR-IC	LDO, 1.3V±1%, 200mA, +CE, PDR	SOT-23-5	28cx	VR4	6g	Sii
1OE	S-1313C14-M5T1U3	LVR-IC	LDO, 1.4V±1%, 200mA, +CE, PDR	SOT-23-5	28cx	VR4	6g	Sii
1OF	S-1313C15-M5T1U3	LVR-IC	LDO, 1.5V±1%, 200mA, +CE, PDR	SOT-23-5	28cx	VR4	6g	Sii
1OG	S-1313C16-M5T1U3	LVR-IC	LDO, 1.6V±1%, 200mA, +CE, PDR	SOT-23-5	28cx	VR4	6g	Sii
1OH	S-1313C17-M5T1U3	LVR-IC	LDO, 1.7V±1%, 200mA, +CE, PDR	SOT-23-5	28cx	VR4	6g	Sii
1OJ	S-1313C18-M5T1U3	LVR-IC	LDO, 1.8V±1%, 200mA, +CE, PDR	SOT-23-5	28cx	VR4	6g	Sii
1OK	S-1313C1J-M5T1U3	LVR-IC	LDO, 1.85V±1%, 200mA, +CE, PDR	SOT-23-5	28cx	VR4	6g	Sii
1OL	S-1313C19-M5T1U3	LVR-IC	LDO, 1.9V±1%, 200mA, +CE, PDR	SOT-23-5	28cx	VR4	6g	Sii
1ON	S-1313C20-M5T1U3	LVR-IC	LDO, 2.0V±1%, 200mA, +CE, PDR	SOT-23-5	28cx	VR4	6g	Sii
1OO	S-1313C21-M5T1U3	LVR-IC	LDO, 2.1V±1%, 200mA, +CE, PDR	SOT-23-5	28cx	VR4	6g	Sii
1OP	S-1313C22-M5T1U3	LVR-IC	LDO, 2.2V±1%, 200mA, +CE, PDR	SOT-23-5	28cx	VR4	6g	Sii
1OQ	S-1313C23-M5T1U3	LVR-IC	LDO, 2.3V±1%, 200mA, +CE, PDR	SOT-23-5	28cx	VR4	6g	Sii
1OR	S-1313C24-M5T1U3	LVR-IC	LDO, 2.4V±1%, 200mA, +CE, PDR	SOT-23-5	28cx	VR4	6g	Sii
1OS	S-1313C25-M5T1U3	LVR-IC	LDO, 2.5V±1%, 200mA, +CE, PDR	SOT-23-5	28cx	VR4	6g	Sii
1OT	S-1313C26-M5T1U3	LVR-IC	LDO, 2.6V±1%, 200mA, +CE, PDR	SOT-23-5	28cx	VR4	6g	Sii
1OU	S-1313C27-M5T1U3	LVR-IC	LDO, 2.7V±1%, 200mA, +CE, PDR	SOT-23-5	28cx	VR4	6g	Sii
1OV	S-1313C28-M5T1U3	LVR-IC	LDO, 2.8V±1%, 200mA, +CE, PDR	SOT-23-5	28cx	VR4	6g	Sii
1OX	S-1313C2J-M5T1U3	LVR-IC	LDO, 2.85V±1%, 200mA, +CE, PDR	SOT-23-5	28cx	VR4	6g	Sii
1OY	S-1313C29-M5T1U3	LVR-IC	LDO, 2.9V±1%, 200mA, +CE, PDR	SOT-23-5	28cx	VR4	6g	Sii
1OZ	S-1313C30-M5T1U3	LVR-IC	LDO, 3.0V±1%, 200mA, +CE, PDR	SOT-23-5	28cx	VR4	6g	Sii
1P0	XC6102E431MR	Vdet-IC	3.1V±2%, Hst, -MR, -Reset ODO, Wt=200ms, Rt=200ms	SOT-25	28cp	VD16	6g	Tor
1P1	S-1313D31-M5T1U3	LVR-IC	LDO, 3.1V±1%, 200mA, +CE	SOT-23-5	28cx	VR4	6g	Sii
1P1	XC6102E432MR	Vdet-IC	3.2V±2%, Hst, -MR, -Reset ODO, Wt=200ms, Rt=200ms	SOT-25	28cp	VD16	6g	Tor
1P2	S-1313D32-M5T1U3	LVR-IC	LDO, 3.2V±1%, 200mA, +CE	SOT-23-5	28cx	VR4	6g	Sii
1P2	XC6102E433MR	Vdet-IC	3.3V±2%, Hst, -MR, -Reset ODO, Wt=200ms, Rt=200ms	SOT-25	28cp	VD16	6g	Tor
1P3	S-1313D33-M5T1U3	LVR-IC	LDO, 3.3V±1%, 200mA, +CE	SOT-23-5	28cx	VR4	6g	Sii
1P3	XC6102E434MR	Vdet-IC	3.4V±2%, Hst, -MR, -Reset ODO, Wt=200ms, Rt=200ms	SOT-25	28cp	VD16	6g	Tor
1P4	S-1313D34-M5T1U3	LVR-IC	LDO, 3.4V±1%, 200mA, +CE	SOT-23-5	28cx	VR4	6g	Sii
1P4	XC6102E435MR	Vdet-IC	3.5V±2%, Hst, -MR, -Reset ODO, Wt=200ms, Rt=200ms	SOT-25	28cp	VD16	6g	Tor
1P5	S-1313D35-M5T1U3	LVR-IC	LDO, 3.5V±1%, 200mA, +CE	SOT-23-5	28cx	VR4	6g	Sii
1P5	XC6102E436MR	Vdet-IC	3.6V±2%, Hst, -MR, -Reset ODO, Wt=200ms, Rt=200ms	SOT-25	28cp	VD16	6g	Tor
1P6	XC6102E437MR	Vdet-IC	3.7V±2%, Hst, -MR, -Reset ODO, Wt=200ms, Rt=200ms	SOT-25	28cp	VD16	6g	Tor
1P7	XC6102E438MR	Vdet-IC	3.8V±2%, Hst, -MR, -Reset ODO, Wt=200ms, Rt=200ms	SOT-25	28cp	VD16	6g	Tor
1P8	XC6102E439MR	Vdet-IC	3.9V±2%, Hst, -MR, -Reset ODO, Wt=200ms, Rt=200ms	SOT-25	28cp	VD16	6g	Tor
1P9	XC6102E440MR	Vdet-IC	4.0V±2%, Hst, -MR, -Reset ODO, Wt=200ms, Rt=200ms	SOT-25	28cp	VD16	6g	Tor
1PA	S-1313D10-M5T1U3	LVR-IC	LDO, 1.0V±1%, 200mA, +CE	SOT-23-5	28cx	VR4	6g	Sii
1PA	XC6102E441MR	Vdet-IC	4.1V±2%, Hst, -MR, -Reset ODO, Wt=200ms, Rt=200ms	SOT-25	28cp	VD16	6g	Tor
1PB	S-1313D11-M5T1U3	LVR-IC	LDO, 1.1V±1%, 200mA, +CE	SOT-23-5	28cx	VR4	6g	Sii
1PB	XC6102E442MR	Vdet-IC	4.2V±2%, Hst, -MR, -Reset ODO, Wt=200ms, Rt=200ms	SOT-25	28cp	VD16	6g	Tor
1PC	S-1313D12-M5T1U3	LVR-IC	LDO, 1.2V±1%, 200mA, +CE	SOT-23-5	28cx	VR4	6g	Sii
1PC	XC6102E443MR	Vdet-IC	4.3V±2%, Hst, -MR, -Reset ODO, Wt=200ms, Rt=200ms	SOT-25	28cp	VD16	6g	Tor
1PD	S-1313D13-M5T1U3	LVR-IC	LDO, 1.3V±1%, 200mA, +CE	SOT-23-5	28cx	VR4	6g	Sii
1PD	XC6102E444MR	Vdet-IC	4.4V±2%, Hst, -MR, -Reset ODO, Wt=200ms, Rt=200ms	SOT-25	28cp	VD16	6g	Tor
1PE	S-1313D14-M5T1U3	LVR-IC	LDO, 1.4V±1%, 200mA, +CE	SOT-23-5	28cx	VR4	6g	Sii
1PE	XC6102E445MR	Vdet-IC	4.5V±2%, Hst, -MR, -Reset ODO, Wt=200ms, Rt=200ms	SOT-25	28cp	VD16	6g	Tor
1PF	S-1313D15-M5T1U3	LVR-IC	LDO, 1.5V±1%, 200mA, +CE	SOT-23-5	28cx	VR4	6g	Sii
1PF	XC6102E446MR	Vdet-IC	1.6V±2%, Hst, -MR, -Reset ODO, Wt=200ms, Rt=200ms	SOT-25	28cp	VD16	6g	Tor
1PF	XC6102E446MR	Vdet-IC	4.6V±2%, Hst, -MR, -Reset ODO, Wt=200ms, Rt=200ms	SOT-25	28cp	VD16	6g	Tor
1PG	S-1313D16-M5T1U3	LVR-IC	LDO, 1.6V±1%, 200mA, +CE	SOT-23-5	28cx	VR4	6g	Sii
1PH	S-1313D17-M5T1U3	LVR-IC	LDO, 1.7V±1%, 200mA, +CE	SOT-23-5	28cx	VR4	6g	Sii
1PH	XC6102E447MR	Vdet-IC	1.7V±2%, Hst, -MR, -Reset ODO, Wt=200ms, Rt=200ms	SOT-25	28cp	VD16	6g	Tor
1PH	XC6102E447MR	Vdet-IC	4.7V±2%, Hst, -MR, -Reset ODO, Wt=200ms, Rt=200ms	SOT-25	28cp	VD16	6g	Tor
1PJ	S-1313D18-M5T1U3	LVR-IC	LDO, 1.8V±1%, 200mA, +CE	SOT-23-5	28cx	VR4	6g	Sii
1PK	S-1313D1J-M5T1U3	LVR-IC	LDO, 1.85V±1%, 200mA, +CE	SOT-23-5	28cx	VR4	6g	Sii
1PK	XC6102E448MR	Vdet-IC	1.8V±2%, Hst, -MR, -Reset ODO, Wt=200ms, Rt=200ms	SOT-25	28cp	VD16	6g	Tor
1PK	XC6102E448MR	Vdet-IC	4.8V±2%, Hst, -MR, -Reset ODO, Wt=200ms, Rt=200ms	SOT-25	28cp	VD16	6g	Tor
1PL	S-1313D19-M5T1U3	LVR-IC	LDO, 1.9V±1%, 200mA, +CE	SOT-23-5	28cx	VR4	6g	Sii
1PL	XC6102E449MR	Vdet-IC	1.9V±2%, Hst, -MR, -Reset ODO, Wt=200ms, Rt=200ms	SOT-25	28cp	VD16	6g	Tor
1PL	XC6102E449MR	Vdet-IC	4.9V±2%, Hst, -MR, -Reset ODO, Wt=200ms, Rt=200ms	SOT-25	28cp	VD16	6g	Tor
1PM	XC6102E420MR	Vdet-IC	2.0V±2%, Hst, -MR, -Reset ODO, Wt=200ms, Rt=200ms	SOT-25	28cp	VD16	6g	Tor
1PM	XC6102E450MR	Vdet-IC	5.0V±2%, Hst, -MR, -Reset ODO, Wt=200ms, Rt=200ms	SOT-25	28cp	VD16	6g	Tor



SMD code	Type	Function	Short description	Case	Pinout	Sch.	St.	Mnf.
<u>1PN</u>	S-1313D20-M5T1U3	LVR-IC	LDO, 2.0V±1%, 200mA, +CE	SOT-23-5	28cx	VR4	6g	Sii
<u>1PN</u>	X06102E421MR	Vdet-IC	2.1V±2%, Hst, -MR, -Reset ODO, Wt=200ms, Rt=200ms	SOT-25	28cp	VD16	6g	Tor
<u>1PO</u>	S-1313D21-M5T1U3	LVR-IC	LDO, 2.1V±1%, 200mA, +CE	SOT-23-5	28cx	VR4	6g	Sii
<u>1PP</u>	S-1313D22-M5T1U3	LVR-IC	LDO, 2.2V±1%, 200mA, +CE	SOT-23-5	28cx	VR4	6g	Sii
<u>1PP</u>	X06102E422MR	Vdet-IC	2.2V±2%, Hst, -MR, -Reset ODO, Wt=200ms, Rt=200ms	SOT-25	28cp	VD16	6g	Tor
<u>1PQ</u>	S-1313D23-M5T1U3	LVR-IC	LDO, 2.5V±1%, 200mA, +CE	SOT-23-5	28cx	VR4	6g	Sii
<u>1PR</u>	S-1313D24-M5T1U3	LVR-IC	LDO, 2.4V±1%, 200mA, +CE	SOT-23-5	28cx	VR4	6g	Sii
<u>1PR</u>	X06102E423MR	Vdet-IC	2.3V±2%, Hst, -MR, -Reset ODO, Wt=200ms, Rt=200ms	SOT-25	28cp	VD16	6g	Tor
<u>1PS</u>	S-1313D25-M5T1U3	LVR-IC	LDO, 2.5V±1%, 200mA, +CE	SOT-23-5	28cx	VR4	6g	Sii
<u>1PS</u>	X06102E424MR	Vdet-IC	2.4V±2%, Hst, -MR, -Reset ODO, Wt=200ms, Rt=200ms	SOT-25	28cp	VD16	6g	Tor
<u>1PT</u>	S-1313D26-M5T1U3	LVR-IC	LDO, 2.6V±1%, 200mA, +CE	SOT-23-5	28cx	VR4	6g	Sii
<u>1PT</u>	X06102E425MR	Vdet-IC	2.5V±2%, Hst, -MR, -Reset ODO, Wt=200ms, Rt=200ms	SOT-25	28cp	VD16	6g	Tor
<u>1PU</u>	S-1313D27-M5T1U3	LVR-IC	LDO, 2.7V±1%, 200mA, +CE	SOT-23-5	28cx	VR4	6g	Sii
<u>1PU</u>	X06102E426MR	Vdet-IC	2.6V±2%, Hst, -MR, -Reset ODO, Wt=200ms, Rt=200ms	SOT-25	28cp	VD16	6g	Tor
<u>1PV</u>	S-1313D28-M5T1U3	LVR-IC	LDO, 2.8V±1%, 200mA, +CE	SOT-23-5	28cx	VR4	6g	Sii
<u>1PV</u>	X06102E427MR	Vdet-IC	2.7V±2%, Hst, -MR, -Reset ODO, Wt=200ms, Rt=200ms	SOT-25	28cp	VD16	6g	Tor
<u>1PX</u>	S-1313D2J-M5T1U3	LVR-IC	LDO, 2.85V±1%, 200mA, +CE	SOT-23-5	28cx	VR4	6g	Sii
<u>1PX</u>	X06102E428MR	Vdet-IC	2.8V±2%, Hst, -MR, -Reset ODO, Wt=200ms, Rt=200ms	SOT-25	28cp	VD16	6g	Tor
<u>1PY</u>	S-1313D29-M5T1U3	LVR-IC	LDO, 2.9V±1%, 200mA, +CE	SOT-23-5	28cx	VR4	6g	Sii
<u>1PY</u>	X06102E429MR	Vdet-IC	2.9V±2%, Hst, -MR, -Reset ODO, Wt=200ms, Rt=200ms	SOT-25	28cp	VD16	6g	Tor
<u>1PZ</u>	S-1313D30-M5T1U3	LVR-IC	LDO, 3.0V±1%, 200mA, +CE	SOT-23-5	28cx	VR4	6g	Sii
<u>1PZ</u>	X06102E430MR	Vdet-IC	3.0V±2%, Hst, -MR, -Reset ODO, Wt=200ms, Rt=200ms	SOT-25	28cp	VD16	6g	Tor
<u>1R</u>	R1210N311A	DC/DC-IC	PWM step-up, 3.1V, 35..100kHz	SOT-23-5	28sc	DC3	6g	Ric
<u>1R0</u>	X06102E531MR	Vdet-IC	3.1V±2%, Hst, -MR, -Reset ODO, Wt=400ms, Rt=200ms	SOT-25	28cp	VD16	6g	Tor
<u>1R1</u>	X06102E532MR	Vdet-IC	3.2V±2%, Hst, -MR, -Reset ODO, Wt=400ms, Rt=200ms	SOT-25	28cp	VD16	6g	Tor
<u>1R2</u>	X06102E533MR	Vdet-IC	3.3V±2%, Hst, -MR, -Reset ODO, Wt=400ms, Rt=200ms	SOT-25	28cp	VD16	6g	Tor
<u>1R3</u>	X06102E534MR	Vdet-IC	3.4V±2%, Hst, -MR, -Reset ODO, Wt=400ms, Rt=200ms	SOT-25	28cp	VD16	6g	Tor
<u>1R4</u>	X06102E535MR	Vdet-IC	3.5V±2%, Hst, -MR, -Reset ODO, Wt=400ms, Rt=200ms	SOT-25	28cp	VD16	6g	Tor
<u>1R5</u>	X06102E536MR	Vdet-IC	3.6V±2%, Hst, -MR, -Reset ODO, Wt=400ms, Rt=200ms	SOT-25	28cp	VD16	6g	Tor
<u>1R6</u>	X06102E537MR	Vdet-IC	3.7V±2%, Hst, -MR, -Reset ODO, Wt=400ms, Rt=200ms	SOT-25	28cp	VD16	6g	Tor
<u>1R7</u>	X06102E538MR	Vdet-IC	3.8V±2%, Hst, -MR, -Reset ODO, Wt=400ms, Rt=200ms	SOT-25	28cp	VD16	6g	Tor
<u>1R8</u>	X06102E539MR	Vdet-IC	3.9V±2%, Hst, -MR, -Reset ODO, Wt=400ms, Rt=200ms	SOT-25	28cp	VD16	6g	Tor
<u>1R9</u>	X06102E540MR	Vdet-IC	4.0V±2%, Hst, -MR, -Reset ODO, Wt=400ms, Rt=200ms	SOT-25	28cp	VD16	6g	Tor
<u>1RA</u>	X06102E541MR	Vdet-IC	4.1V±2%, Hst, -MR, -Reset ODO, Wt=400ms, Rt=200ms	SOT-25	28cp	VD16	6g	Tor
<u>1RB</u>	X06102E542MR	Vdet-IC	4.2V±2%, Hst, -MR, -Reset ODO, Wt=400ms, Rt=200ms	SOT-25	28cp	VD16	6g	Tor
<u>1RC</u>	X06102E543MR	Vdet-IC	4.3V±2%, Hst, -MR, -Reset ODO, Wt=400ms, Rt=200ms	SOT-25	28cp	VD16	6g	Tor
<u>1RD</u>	X06102E544MR	Vdet-IC	4.4V±2%, Hst, -MR, -Reset ODO, Wt=400ms, Rt=200ms	SOT-25	28cp	VD16	6g	Tor
<u>1RE</u>	X06102E545MR	Vdet-IC	4.5V±2%, Hst, -MR, -Reset ODO, Wt=400ms, Rt=200ms	SOT-25	28cp	VD16	6g	Tor
<u>1RF</u>	X06102E516MR	Vdet-IC	1.6V±2%, Hst, -MR, -Reset ODO, Wt=400ms, Rt=200ms	SOT-25	28cp	VD16	6g	Tor
<u>1RE</u>	X06102E546MR	Vdet-IC	4.6V±2%, Hst, -MR, -Reset ODO, Wt=400ms, Rt=200ms	SOT-25	28cp	VD16	6g	Tor
<u>1RH</u>	X06102E517MR	Vdet-IC	1.7V±2%, Hst, -MR, -Reset ODO, Wt=400ms, Rt=200ms	SOT-25	28cp	VD16	6g	Tor
<u>1RH</u>	X06102E547MR	Vdet-IC	4.7V±2%, Hst, -MR, -Reset ODO, Wt=400ms, Rt=200ms	SOT-25	28cp	VD16	6g	Tor
<u>1RK</u>	X06102E518MR	Vdet-IC	1.8V±2%, Hst, -MR, -Reset ODO, Wt=400ms, Rt=200ms	SOT-25	28cp	VD16	6g	Tor
<u>1RK</u>	X06102E548MR	Vdet-IC	4.8V±2%, Hst, -MR, -Reset ODO, Wt=400ms, Rt=200ms	SOT-25	28cp	VD16	6g	Tor
<u>1RL</u>	X06102E519MR	Vdet-IC	1.9V±2%, Hst, -MR, -Reset ODO, Wt=400ms, Rt=200ms	SOT-25	28cp	VD16	6g	Tor
<u>1RL</u>	X06102E549MR	Vdet-IC	4.9V±2%, Hst, -MR, -Reset ODO, Wt=400ms, Rt=200ms	SOT-25	28cp	VD16	6g	Tor
<u>1RM</u>	X06102E520MR	Vdet-IC	2.0V±2%, Hst, -MR, -Reset ODO, Wt=400ms, Rt=200ms	SOT-25	28cp	VD16	6g	Tor
<u>1RM</u>	X06102E550MR	Vdet-IC	5.0V±2%, Hst, -MR, -Reset ODO, Wt=400ms, Rt=200ms	SOT-25	28cp	VD16	6g	Tor
<u>1RN</u>	X06102E521MR	Vdet-IC	2.1V±2%, Hst, -MR, -Reset ODO, Wt=400ms, Rt=200ms	SOT-25	28cp	VD16	6g	Tor
<u>1RP</u>	X06102E522MR	Vdet-IC	2.2V±2%, Hst, -MR, -Reset ODO, Wt=400ms, Rt=200ms	SOT-25	28cp	VD16	6g	Tor
<u>1RR</u>	X06102E523MR	Vdet-IC	2.3V±2%, Hst, -MR, -Reset ODO, Wt=400ms, Rt=200ms	SOT-25	28cp	VD16	6g	Tor
<u>1RS</u>	X06102E524MR	Vdet-IC	2.4V±2%, Hst, -MR, -Reset ODO, Wt=400ms, Rt=200ms	SOT-25	28cp	VD16	6g	Tor
<u>1RT</u>	X06102E525MR	Vdet-IC	2.5V±2%, Hst, -MR, -Reset ODO, Wt=400ms, Rt=200ms	SOT-25	28cp	VD16	6g	Tor
<u>1RU</u>	X06102E526MR	Vdet-IC	2.6V±2%, Hst, -MR, -Reset ODO, Wt=400ms, Rt=200ms	SOT-25	28cp	VD16	6g	Tor
<u>1RV</u>	X06102E527MR	Vdet-IC	2.7V±2%, Hst, -MR, -Reset ODO, Wt=400ms, Rt=200ms	SOT-25	28cp	VD16	6g	Tor
<u>1RX</u>	X06102E528MR	Vdet-IC	2.8V±2%, Hst, -MR, -Reset ODO, Wt=400ms, Rt=200ms	SOT-25	28cp	VD16	6g	Tor
<u>1RY</u>	X06102E529MR	Vdet-IC	2.9V±2%, Hst, -MR, -Reset ODO, Wt=400ms, Rt=200ms	SOT-25	28cp	VD16	6g	Tor
<u>1RZ</u>	X06102E530MR	Vdet-IC	3.0V±2%, Hst, -MR, -Reset ODO, Wt=400ms, Rt=200ms	SOT-25	28cp	VD16	6g	Tor
<u>1S0</u>	X06102E631MR	Vdet-IC	3.1V±2%, Hst, -MR, -Reset ODO, Wt=1.6s, Rt=200ms	SOT-25	28cp	VD16	6g	Tor
<u>1S1</u>	X06102E632MR	Vdet-IC	3.2V±2%, Hst, -MR, -Reset ODO, Wt=1.6s, Rt=200ms	SOT-25	28cp	VD16	6g	Tor
<u>1S2</u>	X06102E633MR	Vdet-IC	3.3V±2%, Hst, -MR, -Reset ODO, Wt=1.6s, Rt=200ms	SOT-25	28cp	VD16	6g	Tor
<u>1S3</u>	X06102E634MR	Vdet-IC	3.4V±2%, Hst, -MR, -Reset ODO, Wt=1.6s, Rt=200ms	SOT-25	28cp	VD16	6g	Tor
<u>1S4</u>	X06102E635MR	Vdet-IC	3.5V±2%, Hst, -MR, -Reset ODO, Wt=1.6s, Rt=200ms	SOT-25	28cp	VD16	6g	Tor
<u>1S5</u>	X06102E636MR	Vdet-IC	3.6V±2%, Hst, -MR, -Reset ODO, Wt=1.6s, Rt=200ms	SOT-25	28cp	VD16	6g	Tor
<u>1S6</u>	X06102E637MR	Vdet-IC	3.7V±2%, Hst, -MR, -Reset ODO, Wt=1.6s, Rt=200ms	SOT-25	28cp	VD16	6g	Tor
<u>1S7</u>	X06102E638MR	Vdet-IC	3.8V±2%, Hst, -MR, -Reset ODO, Wt=1.6s, Rt=200ms	SOT-25	28cp	VD16	6g	Tor
<u>1S8</u>	X06102E639MR	Vdet-IC	3.9V±2%, Hst, -MR, -Reset ODO, Wt=1.6s, Rt=200ms	SOT-25	28cp	VD16	6g	Tor
<u>1S9</u>	X06102E640MR	Vdet-IC	4.0V±2%, Hst, -MR, -Reset ODO, Wt=1.6s, Rt=200ms	SOT-25	28cp	VD16	6g	Tor
<u>1SA</u>	X06102E641MR	Vdet-IC	4.1V±2%, Hst, -MR, -Reset ODO, Wt=1.6s, Rt=200ms	SOT-25	28cp	VD16	6g	Tor
<u>1SB</u>	X06102E642MR	Vdet-IC	4.2V±2%, Hst, -MR, -Reset ODO, Wt=1.6s, Rt=200ms	SOT-25	28cp	VD16	6g	Tor



SMD code	Type	Function	Short description	Case	Pinout	Sch.	St.	Mnf.
<u>1UJ</u>	XC6102F643MR	Vdet-IC	4.3V±2%, Hst, -MR, -Reset ODO, Wt=1.6s, Rt=400ms	SOT-25	28cp	VD16	6g	Tor
<u>1UD</u>	XC6102F644MR	Vdet-IC	4.4V±2%, Hst, -MR, -Reset ODO, Wt=1.6s, Rt=400ms	SOT-25	28cp	VD16	6g	Tor
<u>1UE</u>	XC6102F645MR	Vdet-IC	4.5V±2%, Hst, -MR, -Reset ODO, Wt=1.6s, Rt=400ms	SOT-25	28cp	VD16	6g	Tor
<u>1UF</u>	XC6102F616MR	Vdet-IC	1.6V±2%, Hst, -MR, -Reset ODO, Wt=1.6s, Rt=400ms	SOT-25	28cp	VD16	6g	Tor
<u>1UF</u>	XC6102F646MR	Vdet-IC	4.6V±2%, Hst, -MR, -Reset ODO, Wt=1.6s, Rt=400ms	SOT-25	28cp	VD16	6g	Tor
<u>1UH</u>	XC6102F617MR	Vdet-IC	1.7V±2%, Hst, -MR, -Reset ODO, Wt=1.6s, Rt=400ms	SOT-25	28cp	VD16	6g	Tor
<u>1UH</u>	XC6102F647MR	Vdet-IC	4.7V±2%, Hst, -MR, -Reset ODO, Wt=1.6s, Rt=400ms	SOT-25	28cp	VD16	6g	Tor
<u>1UK</u>	XC6102F618MR	Vdet-IC	1.8V±2%, Hst, -MR, -Reset ODO, Wt=1.6s, Rt=400ms	SOT-25	28cp	VD16	6g	Tor
<u>1UK</u>	XC6102F648MR	Vdet-IC	4.8V±2%, Hst, -MR, -Reset ODO, Wt=1.6s, Rt=400ms	SOT-25	28cp	VD16	6g	Tor
<u>1UL</u>	XC6102F619MR	Vdet-IC	1.9V±2%, Hst, -MR, -Reset ODO, Wt=1.6s, Rt=400ms	SOT-25	28cp	VD16	6g	Tor
<u>1UL</u>	XC6102F649MR	Vdet-IC	4.9V±2%, Hst, -MR, -Reset ODO, Wt=1.6s, Rt=400ms	SOT-25	28cp	VD16	6g	Tor
<u>1UM</u>	XC6102F620MR	Vdet-IC	2.0V±2%, Hst, -MR, -Reset ODO, Wt=1.6s, Rt=400ms	SOT-25	28cp	VD16	6g	Tor
<u>1UM</u>	XC6102F650MR	Vdet-IC	5.0V±2%, Hst, -MR, -Reset ODO, Wt=1.6s, Rt=400ms	SOT-25	28cp	VD16	6g	Tor
<u>1UN</u>	XC6102F621MR	Vdet-IC	2.1V±2%, Hst, -MR, -Reset ODO, Wt=1.6s, Rt=400ms	SOT-25	28cp	VD16	6g	Tor
<u>1UP</u>	XC6102F622MR	Vdet-IC	2.2V±2%, Hst, -MR, -Reset ODO, Wt=1.6s, Rt=400ms	SOT-25	28cp	VD16	6g	Tor
<u>1UR</u>	XC6102F623MR	Vdet-IC	2.3V±2%, Hst, -MR, -Reset ODO, Wt=1.6s, Rt=400ms	SOT-25	28cp	VD16	6g	Tor
<u>1US</u>	XC6102F624MR	Vdet-IC	2.4V±2%, Hst, -MR, -Reset ODO, Wt=1.6s, Rt=400ms	SOT-25	28cp	VD16	6g	Tor
<u>1UT</u>	XC6102F625MR	Vdet-IC	2.5V±2%, Hst, -MR, -Reset ODO, Wt=1.6s, Rt=400ms	SOT-25	28cp	VD16	6g	Tor
<u>1UU</u>	XC6102F626MR	Vdet-IC	2.6V±2%, Hst, -MR, -Reset ODO, Wt=1.6s, Rt=400ms	SOT-25	28cp	VD16	6g	Tor
<u>1UV</u>	XC6102F627MR	Vdet-IC	2.7V±2%, Hst, -MR, -Reset ODO, Wt=1.6s, Rt=400ms	SOT-25	28cp	VD16	6g	Tor
<u>1UX</u>	XC6102F628MR	Vdet-IC	2.8V±2%, Hst, -MR, -Reset ODO, Wt=1.6s, Rt=400ms	SOT-25	28cp	VD16	6g	Tor
<u>1UY</u>	XC6102F629MR	Vdet-IC	2.9V±2%, Hst, -MR, -Reset ODO, Wt=1.6s, Rt=400ms	SOT-25	28cp	VD16	6g	Tor
<u>1UZ</u>	XC6102F630MR	Vdet-IC	3.0V±2%, Hst, -MR, -Reset ODO, Wt=1.6s, Rt=400ms	SOT-25	28cp	VD16	6g	Tor
<u>1V0</u>	XC6102H631MR	Vdet-IC	3.1V±2%, Hst, -MR, -Reset ODO, Wt=1.6s, Rt=1.6s	SOT-25	28cp	VD16	6g	Tor
<u>1V1</u>	XC6102H632MR	Vdet-IC	3.2V±2%, Hst, -MR, -Reset ODO, Wt=1.6s, Rt=1.6s	SOT-25	28cp	VD16	6g	Tor
<u>1V2</u>	XC6102H633MR	Vdet-IC	3.3V±2%, Hst, -MR, -Reset ODO, Wt=1.6s, Rt=1.6s	SOT-25	28cp	VD16	6g	Tor
<u>1V3</u>	XC6102H634MR	Vdet-IC	3.4V±2%, Hst, -MR, -Reset ODO, Wt=1.6s, Rt=1.6s	SOT-25	28cp	VD16	6g	Tor
<u>1V4</u>	XC6102H635MR	Vdet-IC	3.5V±2%, Hst, -MR, -Reset ODO, Wt=1.6s, Rt=1.6s	SOT-25	28cp	VD16	6g	Tor
<u>1V5</u>	TAR5S15	LVR-IC	LDO, 1.5V±1%, 200mA, +CE	SSOP-5	28un	VR7	6a	Tos
<u>1V5</u>	TAR5S15U	LVR-IC	LDO, 1.5V±1%, 200mA, +CE	SSOP-5-P	30un	VR7	6a	Tos
<u>1V5</u>	XC6102H636MR	Vdet-IC	3.6V±2%, Hst, -MR, -Reset ODO, Wt=1.6s, Rt=1.6s	SOT-25	28cp	VD16	6g	Tor
<u>1V6</u>	TAR5S16	LVR-IC	LDO, 1.6V±1%, 200mA, +CE	SSOP-5	28un	VR7	6a	Tos
<u>1V6</u>	TAR5S16U	LVR-IC	LDO, 1.6V±1%, 200mA, +CE	SSOP-5-P	30un	VR7	6a	Tos
<u>1V6</u>	XC6102H637MR	Vdet-IC	3.7V±2%, Hst, -MR, -Reset ODO, Wt=1.6s, Rt=1.6s	SOT-25	28cp	VD16	6g	Tor
<u>1V7</u>	TAR5S17	LVR-IC	LDO, 1.7V±1%, 200mA, +CE	SSOP-5	28un	VR7	6a	Tos
<u>1V7</u>	TAR5S17U	LVR-IC	LDO, 1.7V±1%, 200mA, +CE	SSOP-5-P	30un	VR7	6a	Tos
<u>1V7</u>	XC6217A082MR	LVR-IC	LDO, 0.8V±2%, 200mA, +CE, Shutdown	SOT-25	28cu	VR4a	6g	Tor
<u>1V7</u>	XC6102H638MR	Vdet-IC	3.8V±2%, Hst, -MR, -Reset ODO, Wt=1.6s, Rt=1.6s	SOT-25	28cp	VD16	6g	Tor
<u>1V8</u>	TAR5S18	LVR-IC	LDO, 1.8V±1%, 200mA, +CE	SSOP-5	28un	VR7	6a	Tos
<u>1V8</u>	TAR5S18U	LVR-IC	LDO, 1.8V±1%, 200mA, +CE	SSOP-5-P	30un	VR7	6a	Tos
<u>1V8</u>	XC6217A092MR	LVR-IC	LDO, 0.9V±2%, 200mA, +CE, Shutdown	SOT-25	28cu	VR4a	6g	Tor
<u>1V8</u>	XC6102H639MR	Vdet-IC	3.9V±2%, Hst, -MR, -Reset ODO, Wt=1.6s, Rt=1.6s	SOT-25	28cp	VD16	6g	Tor
<u>1V9</u>	TAR5S19	LVR-IC	LDO, 1.9V±1%, 200mA, +CE	SSOP-5	28un	VR7	6a	Tos
<u>1V9</u>	TAR5S19U	LVR-IC	LDO, 1.9V±1%, 200mA, +CE	SSOP-5-P	30un	VR7	6a	Tos
<u>1V9</u>	XC6217A102MR	LVR-IC	LDO, 1V±2%, 200mA, +CE, Shutdown	SOT-25	28cu	VR4a	6g	Tor
<u>1V9</u>	XC6102H640MR	Vdet-IC	4.0V±2%, Hst, -MR, -Reset ODO, Wt=1.6s, Rt=1.6s	SOT-25	28cp	VD16	6g	Tor
<u>1VA</u>	XC6217A112MR	LVR-IC	LDO, 1.1V±2%, 200mA, +CE, Shutdown	SOT-25	28cu	VR4a	6g	Tor
<u>1VA</u>	XC6102H641MR	Vdet-IC	4.1V±2%, Hst, -MR, -Reset ODO, Wt=1.6s, Rt=1.6s	SOT-25	28cp	VD16	6g	Tor
<u>1VB</u>	XC6217A122MR	LVR-IC	LDO, 1.2V±2%, 200mA, +CE, Shutdown	SOT-25	28cu	VR4a	6g	Tor
<u>1VB</u>	XC6102H642MR	Vdet-IC	4.2V±2%, Hst, -MR, -Reset ODO, Wt=1.6s, Rt=1.6s	SOT-25	28cp	VD16	6g	Tor
<u>1VC</u>	XC6217A132MR	LVR-IC	LDO, 1.3V±2%, 200mA, +CE, Shutdown	SOT-25	28cu	VR4a	6g	Tor
<u>1VC</u>	XC6102H643MR	Vdet-IC	4.3V±2%, Hst, -MR, -Reset ODO, Wt=1.6s, Rt=1.6s	SOT-25	28cp	VD16	6g	Tor
<u>1VD</u>	XC6217A142MR	LVR-IC	LDO, 1.4V±2%, 200mA, +CE, Shutdown	SOT-25	28cu	VR4a	6g	Tor
<u>1VD</u>	XC6102H644MR	Vdet-IC	4.4V±2%, Hst, -MR, -Reset ODO, Wt=1.6s, Rt=1.6s	SOT-25	28cp	VD16	6g	Tor
<u>1VE</u>	XC6217A152MR	LVR-IC	LDO, 1.5V±2%, 200mA, +CE, Shutdown	SOT-25	28cu	VR4a	6g	Tor
<u>1VE</u>	XC6102H645MR	Vdet-IC	4.5V±2%, Hst, -MR, -Reset ODO, Wt=1.6s, Rt=1.6s	SOT-25	28cp	VD16	6g	Tor
<u>1VF</u>	XC6217A162MR	LVR-IC	LDO, 1.6V±2%, 200mA, +CE, Shutdown	SOT-25	28cu	VR4a	6g	Tor
<u>1VF</u>	XC6102H616MR	Vdet-IC	1.6V±2%, Hst, -MR, -Reset ODO, Wt=1.6s, Rt=1.6s	SOT-25	28cp	VD16	6g	Tor
<u>1VE</u>	XC6102H646MR	Vdet-IC	4.6V±2%, Hst, -MR, -Reset ODO, Wt=1.6s, Rt=1.6s	SOT-25	28cp	VD16	6g	Tor
<u>1VH</u>	XC6217A172MR	LVR-IC	LDO, 1.7V±2%, 200mA, +CE, Shutdown	SOT-25	28cu	VR4a	6g	Tor
<u>1VH</u>	XC6102H617MR	Vdet-IC	1.7V±2%, Hst, -MR, -Reset ODO, Wt=1.6s, Rt=1.6s	SOT-25	28cp	VD16	6g	Tor
<u>1VH</u>	XC6102H647MR	Vdet-IC	4.7V±2%, Hst, -MR, -Reset ODO, Wt=1.6s, Rt=1.6s	SOT-25	28cp	VD16	6g	Tor
<u>1VK</u>	XC6217A182MR	LVR-IC	LDO, 1.8V±2%, 200mA, +CE, Shutdown	SOT-25	28cu	VR4a	6g	Tor
<u>1VK</u>	XC6102H618MR	Vdet-IC	1.8V±2%, Hst, -MR, -Reset ODO, Wt=1.6s, Rt=1.6s	SOT-25	28cp	VD16	6g	Tor
<u>1VK</u>	XC6102H648MR	Vdet-IC	4.8V±2%, Hst, -MR, -Reset ODO, Wt=1.6s, Rt=1.6s	SOT-25	28cp	VD16	6g	Tor
<u>1VL</u>	XC6217A192MR	LVR-IC	LDO, 1.9V±2%, 200mA, +CE, Shutdown	SOT-25	28cu	VR4a	6g	Tor
<u>1VL</u>	XC6102H619MR	Vdet-IC	1.9V±2%, Hst, -MR, -Reset ODO, Wt=1.6s, Rt=1.6s	SOT-25	28cp	VD16	6g	Tor
<u>1VL</u>	XC6102H649MR	Vdet-IC	4.9V±2%, Hst, -MR, -Reset ODO, Wt=1.6s, Rt=1.6s	SOT-25	28cp	VD16	6g	Tor
<u>1VM</u>	XC6217A202MR	LVR-IC	LDO, 2V±2%, 200mA, +CE, Shutdown	SOT-25	28cu	VR4a	6g	Tor
<u>1VM</u>	XC6102H620MR	Vdet-IC	2.0V±2%, Hst, -MR, -Reset ODO, Wt=1.6s, Rt=1.6s	SOT-25	28cp	VD16	6g	Tor



SMD code	Type	Function	Short description	Case	Pinout	Sch.	St.	Mnf.
<u>1VM</u>	XC6102H650MR	Vdet-IC	5.0V±2%, Hst, -MR, -Reset ODO, Wt=1.6s, Rt=1.6s	SOT-25	28cp	VD16	6g	Tor
<u>1VN</u>	XC6217A212MR	LVR-IC	LDO, 2.1V±2%, 200mA, +CE, Shutdown	SOT-25	28cu	VR4a	6g	Tor
<u>1VO</u>	XC6102H621MR	Vdet-IC	2.1V±2%, Hst, -MR, -Reset ODO, Wt=1.6s, Rt=1.6s	SOT-25	28cp	VD16	6g	Tor
<u>1VP</u>	XC6217A222MR	LVR-IC	LDO, 2.2V±2%, 200mA, +CE, Shutdown	SOT-25	28cu	VR4a	6g	Tor
<u>1VP</u>	XC6102H622MR	Vdet-IC	2.2V±2%, Hst, -MR, -Reset ODO, Wt=1.6s, Rt=1.6s	SOT-25	28cp	VD16	6g	Tor
<u>1VR</u>	XC6217A232MR	LVR-IC	LDO, 2.3V±2%, 200mA, +CE, Shutdown	SOT-25	28cu	VR4a	6g	Tor
<u>1VR</u>	XC6102H623MR	Vdet-IC	2.3V±2%, Hst, -MR, -Reset ODO, Wt=1.6s, Rt=1.6s	SOT-25	28cp	VD16	6g	Tor
<u>1VS</u>	XC6217A242MR	LVR-IC	LDO, 2.4V±2%, 200mA, +CE, Shutdown	SOT-25	28cu	VR4a	6g	Tor
<u>1VS</u>	XC6102H624MR	Vdet-IC	2.4V±2%, Hst, -MR, -Reset ODO, Wt=1.6s, Rt=1.6s	SOT-25	28cp	VD16	6g	Tor
<u>1VT</u>	XC6217A252MR	LVR-IC	LDO, 2.5V±2%, 200mA, +CE, Shutdown	SOT-25	28cu	VR4a	6g	Tor
<u>1VT</u>	XC6102H625MR	Vdet-IC	2.5V±2%, Hst, -MR, -Reset ODO, Wt=1.6s, Rt=1.6s	SOT-25	28cp	VD16	6g	Tor
<u>1VU</u>	XC6217A262MR	LVR-IC	LDO, 2.6V±2%, 200mA, +CE, Shutdown	SOT-25	28cu	VR4a	6g	Tor
<u>1VU</u>	XC6102H626MR	Vdet-IC	2.6V±2%, Hst, -MR, -Reset ODO, Wt=1.6s, Rt=1.6s	SOT-25	28cp	VD16	6g	Tor
<u>1VV</u>	XC6217A272MR	LVR-IC	LDO, 2.7V±2%, 200mA, +CE, Shutdown	SOT-25	28cu	VR4a	6g	Tor
<u>1VV</u>	XC6102H627MR	Vdet-IC	2.7V±2%, Hst, -MR, -Reset ODO, Wt=1.6s, Rt=1.6s	SOT-25	28cp	VD16	6g	Tor
<u>1VX</u>	XC6217A282MR	LVR-IC	LDO, 2.8V±2%, 200mA, +CE, Shutdown	SOT-25	28cu	VR4a	6g	Tor
<u>1VX</u>	XC6102H628MR	Vdet-IC	2.8V±2%, Hst, -MR, -Reset ODO, Wt=1.6s, Rt=1.6s	SOT-25	28cp	VD16	6g	Tor
<u>1VY</u>	XC6217A292MR	LVR-IC	LDO, 2.9V±2%, 200mA, +CE, Shutdown	SOT-25	28cu	VR4a	6g	Tor
<u>1VY</u>	XC6102H629MR	Vdet-IC	2.9V±2%, Hst, -MR, -Reset ODO, Wt=1.6s, Rt=1.6s	SOT-25	28cp	VD16	6g	Tor
<u>1VZ</u>	XC6217A302MR	LVR-IC	LDO, 3V±2%, 200mA, +CE, Shutdown	SOT-25	28cu	VR4a	6g	Tor
<u>1VZ</u>	XC6102H630MR	Vdet-IC	3.0V±2%, Hst, -MR, -Reset ODO, Wt=1.6s, Rt=1.6s	SOT-25	28cp	VD16	6g	Tor
<u>1W</u>	R1210N311C	DC/DC-IC	PWM step-up, 3.1V, 100kHz	SOT-23-5	28sc	DC3	6g	Ric
<u>1X</u>	R1210N411C	DC/DC-IC	PWM step-up, 4.1V, 100kHz	SOT-23-5	28sc	DC3	6g	Ric
<u>1X7</u>	XC6217B082MR	LVR-IC	LDO, 0.8V±2%, 200mA, +CE, CL, Shutdown	SOT-25	28cu	VR4a	6g	Tor
<u>1X8</u>	XC6217B092MR	LVR-IC	LDO, 0.9V±2%, 200mA, +CE, CL, Shutdown	SOT-25	28cu	VR4a	6g	Tor
<u>1X9</u>	XC6217B102MR	LVR-IC	LDO, 1V±2%, 200mA, +CE, CL, Shutdown	SOT-25	28cu	VR4a	6g	Tor
<u>1XA</u>	XC6217B112MR	LVR-IC	LDO, 1.1V±2%, 200mA, +CE, CL, Shutdown	SOT-25	28cu	VR4a	6g	Tor
<u>1XB</u>	XC6217B122MR	LVR-IC	LDO, 1.2V±2%, 200mA, +CE, CL, Shutdown	SOT-25	28cu	VR4a	6g	Tor
<u>1XC</u>	XC6217B132MR	LVR-IC	LDO, 1.3V±2%, 200mA, +CE, CL, Shutdown	SOT-25	28cu	VR4a	6g	Tor
<u>1XD</u>	XC6217B142MR	LVR-IC	LDO, 1.4V±2%, 200mA, +CE, CL, Shutdown	SOT-25	28cu	VR4a	6g	Tor
<u>1XE</u>	XC6217B152MR	LVR-IC	LDO, 1.5V±2%, 200mA, +CE, CL, Shutdown	SOT-25	28cu	VR4a	6g	Tor
<u>1XF</u>	XC6217B162MR	LVR-IC	LDO, 1.6V±2%, 200mA, +CE, CL, Shutdown	SOT-25	28cu	VR4a	6g	Tor
<u>1XH</u>	XC6217B172MR	LVR-IC	LDO, 1.7V±2%, 200mA, +CE, CL, Shutdown	SOT-25	28cu	VR4a	6g	Tor
<u>1XK</u>	XC6217B182MR	LVR-IC	LDO, 1.8V±2%, 200mA, +CE, CL, Shutdown	SOT-25	28cu	VR4a	6g	Tor
<u>1XL</u>	XC6217B192MR	LVR-IC	LDO, 1.9V±2%, 200mA, +CE, CL, Shutdown	SOT-25	28cu	VR4a	6g	Tor
<u>1XM</u>	XC6217B202MR	LVR-IC	LDO, 2V±2%, 200mA, +CE, CL, Shutdown	SOT-25	28cu	VR4a	6g	Tor
<u>1XN</u>	XC6217B212MR	LVR-IC	LDO, 2.1V±2%, 200mA, +CE, CL, Shutdown	SOT-25	28cu	VR4a	6g	Tor
<u>1XP</u>	XC6217B222MR	LVR-IC	LDO, 2.2V±2%, 200mA, +CE, CL, Shutdown	SOT-25	28cu	VR4a	6g	Tor
<u>1XR</u>	XC6217B232MR	LVR-IC	LDO, 2.3V±2%, 200mA, +CE, CL, Shutdown	SOT-25	28cu	VR4a	6g	Tor
<u>1XS</u>	XC6217B242MR	LVR-IC	LDO, 2.4V±2%, 200mA, +CE, CL, Shutdown	SOT-25	28cu	VR4a	6g	Tor
<u>1XT</u>	XC6217B252MR	LVR-IC	LDO, 2.5V±2%, 200mA, +CE, CL, Shutdown	SOT-25	28cu	VR4a	6g	Tor
<u>1XU</u>	XC6217B262MR	LVR-IC	LDO, 2.6V±2%, 200mA, +CE, CL, Shutdown	SOT-25	28cu	VR4a	6g	Tor
<u>1XV</u>	XC6217B272MR	LVR-IC	LDO, 2.7V±2%, 200mA, +CE, CL, Shutdown	SOT-25	28cu	VR4a	6g	Tor
<u>1XX</u>	XC6217B282MR	LVR-IC	LDO, 2.8V±2%, 200mA, +CE, CL, Shutdown	SOT-25	28cu	VR4a	6g	Tor
<u>1XY</u>	XC6217B292MR	LVR-IC	LDO, 2.9V±2%, 200mA, +CE, CL, Shutdown	SOT-25	28cu	VR4a	6g	Tor
<u>1XZ</u>	XC6217B302MR	LVR-IC	LDO, 3V±2%, 200mA, +CE, CL, Shutdown	SOT-25	28cu	VR4a	6g	Tor
<u>1Y</u>	R1210N511C	DC/DC-IC	PWM step-up, 5.1V, 100kHz	SOT-23-5	28sc	DC3	6g	Ric
<u>20</u>	R1223N252B	DC/DC-IC	PWM/FM step-down, +CE, 2.5V, 500kHz, L-Pr.	SOT-23-5	28ud	DC7	6g	Ric
<u>20</u>	RN5RF20AA	LVR-IC	LRip, -CE, 2V±2%, 1A*	SOT-23-5	28vw	VR6	6g	Ric
<u>20</u>	RN5RZ20AA	LVR-IC	LDO, LN, -CE, 2V±2%, 100mA	SOT-23-5	28vrt	VR4	6g	Ric
<u>200</u>	XC6103A131MR	Vdet-IC	3.1V±2%, Hst, -MR, +Reset PPO, Wt=6.25ms, Rt=3.13ms	SOT-25	28cp	VD17	6g	Tor
<u>201</u>	XC6103A132MR	Vdet-IC	3.2V±2%, Hst, -MR, +Reset PPO, Wt=6.25ms, Rt=3.13ms	SOT-25	28cp	VD17	6g	Tor
<u>202</u>	XC6103A133MR	Vdet-IC	3.3V±2%, Hst, -MR, +Reset PPO, Wt=6.25ms, Rt=3.13ms	SOT-25	28cp	VD17	6g	Tor
<u>203</u>	XC6103A134MR	Vdet-IC	3.4V±2%, Hst, -MR, +Reset PPO, Wt=6.25ms, Rt=3.13ms	SOT-25	28cp	VD17	6g	Tor
<u>204</u>	XC6103A135MR	Vdet-IC	3.5V±2%, Hst, -MR, +Reset PPO, Wt=6.25ms, Rt=3.13ms	SOT-25	28cp	VD17	6g	Tor
<u>205</u>	XC6103A136MR	Vdet-IC	3.6V±2%, Hst, -MR, +Reset PPO, Wt=6.25ms, Rt=3.13ms	SOT-25	28cp	VD17	6g	Tor
<u>206</u>	XC6103A137MR	Vdet-IC	3.7V±2%, Hst, -MR, +Reset PPO, Wt=6.25ms, Rt=3.13ms	SOT-25	28cp	VD17	6g	Tor
<u>207</u>	XC6103A138MR	Vdet-IC	3.8V±2%, Hst, -MR, +Reset PPO, Wt=6.25ms, Rt=3.13ms	SOT-25	28cp	VD17	6g	Tor
<u>208</u>	XC6103A139MR	Vdet-IC	3.9V±2%, Hst, -MR, +Reset PPO, Wt=6.25ms, Rt=3.13ms	SOT-25	28cp	VD17	6g	Tor
<u>209</u>	R3112N091A	Vdet-IC	0.91V±2%, -Reset PPO	SOT-23-5	28vdo	VD3	6g	Ric
<u>209</u>	XC6103A140MR	Vdet-IC	4.0V±2%, Hst, -MR, +Reset PPO, Wt=6.25ms, Rt=3.13ms	SOT-25	28cp	VD17	6g	Tor
<u>20A</u>	AAT60020A-S5	Vdet-IC	2.0V±2%, -Reset ODO	SOT-23-5	28vdo	VD1	6g	Aat
<u>20A</u>	XC6103A141MR	Vdet-IC	4.1V±2%, Hst, -MR, +Reset PPO, Wt=6.25ms, Rt=3.13ms	SOT-25	28cp	VD17	6g	Tor
<u>20-A</u>	UTC8120-A	Vdet-IC	2.0V, -Reset OCO	SOT-23-5	28vdz	VD6	6k	Utc
<u>20B</u>	AAT60020B-S5	Vdet-IC	2.0V±2%, -Reset PPO	SOT-23-5	28vdo	VD3	6g	Aat
<u>20B</u>	XC6103A142MR	Vdet-IC	4.2V±2%, Hst, -MR, +Reset PPO, Wt=6.25ms, Rt=3.13ms	SOT-25	28cp	VD17	6g	Tor
<u>20-B</u>	UTC8120-B	Vdet-IC	2.0V, -Reset OCO	SOT-23-5	28vdm	VD6	6k	Utc
<u>20C</u>	AAT60020C-S5	Vdet-IC	2.0V±1%, -Reset ODO	SOT-23-5	28vdo	VD1	6g	Aat
<u>20C</u>	XC6103A143MR	Vdet-IC	4.3V±2%, Hst, -MR, +Reset PPO, Wt=6.25ms, Rt=3.13ms	SOT-25	28cp	VD17	6g	Tor
<u>20D</u>	AAT60020D-S5	Vdet-IC	2.0V±1%, -Reset PPO	SOT-23-5	28vdo	VD3	6g	Aat



SMD code	Type	Function	Short description	Case	Pinout	Sch.	St.	Mnf.
<u>20D</u>	XC6103A144MR	Vdet-IC	4.4V±2%, Hst, -MR, +Reset PPO, Wt=6.25ms, Rt=3.13ms	SOT-25	28cp	VD17	6g	Tor
<u>20E</u>	XC6103A145MR	Vdet-IC	4.5V±2%, Hst, -MR, +Reset PPO, Wt=6.25ms, Rt=3.13ms	SOT-25	28cp	VD17	6g	Tor
<u>20F</u>	XC6103A116MR	Vdet-IC	1.6V±2%, Hst, -MR, +Reset PPO, Wt=6.25ms, Rt=3.13ms	SOT-25	28cp	VD17	6g	Tor
<u>20E</u>	XC6103A146MR	Vdet-IC	4.6V±2%, Hst, -MR, +Reset PPO, Wt=6.25ms, Rt=3.13ms	SOT-25	28cp	VD17	6g	Tor
<u>20H</u>	XC6103A117MR	Vdet-IC	1.7V±2%, Hst, -MR, +Reset PPO, Wt=6.25ms, Rt=3.13ms	SOT-25	28cp	VD17	6g	Tor
<u>20H</u>	XC6103A147MR	Vdet-IC	4.7V±2%, Hst, -MR, +Reset PPO, Wt=6.25ms, Rt=3.13ms	SOT-25	28cp	VD17	6g	Tor
<u>20K</u>	TK71720S	LVR-IC	LDO, 2V±1.5%, 300mA, +CE	SOT-23-5	28vrx	VR7	6k	Tok
<u>20K</u>	XC6103A118MR	Vdet-IC	1.8V±2%, Hst, -MR, +Reset PPO, Wt=6.25ms, Rt=3.13ms	SOT-25	28cp	VD17	6g	Tor
<u>20K</u>	XC6103A148MR	Vdet-IC	4.8V±2%, Hst, -MR, +Reset PPO, Wt=6.25ms, Rt=3.13ms	SOT-25	28cp	VD17	6g	Tor
<u>20L</u>	TK71620ASCL	LVR-IC	LDO, 2V±2%, 150mA, +CE, -30...+80°C	SOT-23-5	28vrx	VR7	6k	Tok
<u>20L</u>	XC6103A119MR	Vdet-IC	1.9V±2%, Hst, -MR, +Reset PPO, Wt=6.25ms, Rt=3.13ms	SOT-25	28cp	VD17	6g	Tor
<u>20L</u>	XC6103A149MR	Vdet-IC	4.9V±2%, Hst, -MR, +Reset PPO, Wt=6.25ms, Rt=3.13ms	SOT-25	28cp	VD17	6g	Tor
<u>20M</u>	XC6216B202MR	LVR-IC	2.0V±2%, 150mA, +CE	SOT-25	28hw	VR4	6g	Tor
<u>20M</u>	XC6103A120MR	Vdet-IC	2.0V±2%, Hst, -MR, +Reset PPO, Wt=6.25ms, Rt=3.13ms	SOT-25	28cp	VD17	6g	Tor
<u>20M</u>	XC6103A150MR	Vdet-IC	5.0V±2%, Hst, -MR, +Reset PPO, Wt=6.25ms, Rt=3.13ms	SOT-25	28cp	VD17	6g	Tor
<u>20N</u>	XC6216B212MR	LVR-IC	2.1V±2%, 150mA, +CE	SOT-25	28hw	VR4	6g	Tor
<u>20N</u>	XC6103A121MR	Vdet-IC	2.1V±2%, Hst, -MR, +Reset PPO, Wt=6.25ms, Rt=3.13ms	SOT-25	28cp	VD17	6g	Tor
<u>20P</u>	XC6216B222MR	LVR-IC	2.2V±2%, 150mA, +CE	SOT-25	28hw	VR4	6g	Tor
<u>20P</u>	XC6103A122MR	Vdet-IC	2.2V±2%, Hst, -MR, +Reset PPO, Wt=6.25ms, Rt=3.13ms	SOT-25	28cp	VD17	6g	Tor
<u>20R</u>	XC6216B232MR	LVR-IC	2.3V±2%, 150mA, +CE	SOT-25	28hw	VR4	6g	Tor
<u>20R</u>	XC6103A123MR	Vdet-IC	2.3V±2%, Hst, -MR, +Reset PPO, Wt=6.25ms, Rt=3.13ms	SOT-25	28cp	VD17	6g	Tor
<u>20S</u>	XC6216B242MR	LVR-IC	2.4V±2%, 150mA, +CE	SOT-25	28hw	VR4	6g	Tor
<u>20S</u>	XC6103A124MR	Vdet-IC	2.4V±2%, Hst, -MR, +Reset PPO, Wt=6.25ms, Rt=3.13ms	SOT-25	28cp	VD17	6g	Tor
<u>20T</u>	TK71420S	LVR-IC	LDO, 2.0V±2%, 100mA, +CE, Ext. transistor	SOT-23-5	28zh	VR6	6a	Tok
<u>20T</u>	XC6216B252MR	LVR-IC	2.5V±2%, 150mA, +CE	SOT-25	28hw	VR4	6g	Tor
<u>20T</u>	XC6103A125MR	Vdet-IC	2.5V±2%, Hst, -MR, +Reset PPO, Wt=6.25ms, Rt=3.13ms	SOT-25	28cp	VD17	6g	Tor
<u>20U</u>	XC6216B262MR	LVR-IC	2.6V±2%, 150mA, +CE	SOT-25	28hw	VR4	6g	Tor
<u>20U</u>	XC6103A126MR	Vdet-IC	2.6V±2%, Hst, -MR, +Reset PPO, Wt=6.25ms, Rt=3.13ms	SOT-25	28cp	VD17	6g	Tor
<u>20V</u>	XC6216B272MR	LVR-IC	2.7V±2%, 150mA, +CE	SOT-25	28hw	VR4	6g	Tor
<u>20V</u>	XC6103A127MR	Vdet-IC	2.7V±2%, Hst, -MR, +Reset PPO, Wt=6.25ms, Rt=3.13ms	SOT-25	28cp	VD17	6g	Tor
<u>20X</u>	XC6216B282MR	LVR-IC	2.8V±2%, 150mA, +CE	SOT-25	28hw	VR4	6g	Tor
<u>20X</u>	XC6103A128MR	Vdet-IC	2.8V±2%, Hst, -MR, +Reset PPO, Wt=6.25ms, Rt=3.13ms	SOT-25	28cp	VD17	6g	Tor
<u>20Y</u>	XC6216B292MR	LVR-IC	2.9V±2%, 150mA, +CE	SOT-25	28hw	VR4	6g	Tor
<u>20Y</u>	XC6103A129MR	Vdet-IC	2.9V±2%, Hst, -MR, +Reset PPO, Wt=6.25ms, Rt=3.13ms	SOT-25	28cp	VD17	6g	Tor
<u>20Z</u>	XC6216B302MR	LVR-IC	3.0V±2%, 150mA, +CE	SOT-25	28hw	VR4	6g	Tor
<u>20Z</u>	XC6103A130MR	Vdet-IC	3.0V±2%, Hst, -MR, +Reset PPO, Wt=6.25ms, Rt=3.13ms	SOT-25	28cp	VD17	6g	Tor
<u>21</u>	R1223N302B	DC/DC-IC	PWM/VFM step-down, +CE, 3V, 500kHz, L.Pr.	SOT-23-5	28ud	DC7	6g	Ric
<u>21</u>	RN5RF21AA	LVR-IC	L.Rip, -CE, 2.1V±2%, 1A*	SOT-23-5	28vw	VR6	6g	Ric
<u>21</u>	RN5RZ21AA	LVR-IC	LDO, LN, -CE, 2.1V±2%, 100mA	SOT-23-5	28vrt	VR4	6g	Ric
<u>210</u>	R3112N101A	Vdet-IC	1.0V±2%, -Reset PPO	SOT-23-5	28vdo	VD3	6g	Ric
<u>210</u>	XC6216B312MR	LVR-IC	3.1V±2%, 150mA, +CE	SOT-25	28hw	VR4	6g	Tor
<u>210</u>	XC6103A231MR	Vdet-IC	3.1V±2%, Hst, -MR, +Reset PPO, Wt=50ms, Rt=3.13ms	SOT-25	28cp	VD17	6g	Tor
<u>211</u>	R3112N111A	Vdet-IC	1.1V±2%, -Reset PPO	SOT-23-5	28vdo	VD3	6g	Ric
<u>211</u>	XC6216B322MR	LVR-IC	3.2V±2%, 150mA, +CE	SOT-25	28hw	VR4	6g	Tor
<u>211</u>	XC6103A232MR	Vdet-IC	3.2V±2%, Hst, -MR, +Reset PPO, Wt=50ms, Rt=3.13ms	SOT-25	28cp	VD17	6g	Tor
<u>212</u>	R3112N121A	Vdet-IC	1.2V±2%, -Reset PPO	SOT-23-5	28vdo	VD3	6g	Ric
<u>212</u>	XC6216B332MR	LVR-IC	3.3V±2%, 150mA, +CE	SOT-25	28hw	VR4	6g	Tor
<u>212</u>	XC6103A233MR	Vdet-IC	3.3V±2%, Hst, -MR, +Reset PPO, Wt=50ms, Rt=3.13ms	SOT-25	28cp	VD17	6g	Tor
<u>213</u>	R3112N131A	Vdet-IC	1.3V±2%, -Reset PPO	SOT-23-5	28vdo	VD3	6g	Ric
<u>213</u>	XC6216B342MR	LVR-IC	3.4V±2%, 150mA, +CE	SOT-25	28hw	VR4	6g	Tor
<u>213</u>	XC6103A234MR	Vdet-IC	3.4V±2%, Hst, -MR, +Reset PPO, Wt=50ms, Rt=3.13ms	SOT-25	28cp	VD17	6g	Tor
<u>214</u>	R3112N141A	Vdet-IC	1.4V±2%, -Reset PPO	SOT-23-5	28vdo	VD3	6g	Ric
<u>214</u>	XC6216B352MR	LVR-IC	3.5V±2%, 150mA, +CE	SOT-25	28hw	VR4	6g	Tor
<u>214</u>	XC6103A235MR	Vdet-IC	3.5V±2%, Hst, -MR, +Reset PPO, Wt=50ms, Rt=3.13ms	SOT-25	28cp	VD17	6g	Tor
<u>215</u>	R1126N151B	LVR-IC	LDO, LN, +CE, 1.5V±2%, 150mA	SOT-23-5	28vc	VR4	6g	Ric
<u>215</u>	R3112N151A	Vdet-IC	1.5V±2%, -Reset PPO	SOT-23-5	28vdo	VD3	6g	Ric
<u>215</u>	XC6216B362MR	LVR-IC	3.6V±2%, 150mA, +CE	SOT-25	28hw	VR4	6g	Tor
<u>215</u>	XC6103A236MR	Vdet-IC	3.6V±2%, Hst, -MR, +Reset PPO, Wt=50ms, Rt=3.13ms	SOT-25	28cp	VD17	6g	Tor
<u>216</u>	R1126N161B	LVR-IC	LDO, LN, +CE, 1.6V±2%, 150mA	SOT-23-5	28vc	VR4	6g	Ric
<u>216</u>	R3112N161A	Vdet-IC	1.6V±2%, -Reset PPO	SOT-23-5	28vdo	VD3	6g	Ric
<u>216</u>	XC6216B372MR	LVR-IC	3.7V±2%, 150mA, +CE	SOT-25	28hw	VR4	6g	Tor
<u>216</u>	XC6103A237MR	Vdet-IC	3.7V±2%, Hst, -MR, +Reset PPO, Wt=50ms, Rt=3.13ms	SOT-25	28cp	VD17	6g	Tor
<u>217</u>	R1126N171B	LVR-IC	LDO, LN, +CE, 1.7V±2%, 150mA	SOT-23-5	28vc	VR4	6g	Ric
<u>217</u>	R3112N171A	Vdet-IC	1.7V±2%, -Reset PPO	SOT-23-5	28vdo	VD3	6g	Ric
<u>217</u>	XC6216B382MR	LVR-IC	3.8V±2%, 150mA, +CE	SOT-25	28hw	VR4	6g	Tor
<u>217</u>	XC6103A238MR	Vdet-IC	3.8V±2%, Hst, -MR, +Reset PPO, Wt=50ms, Rt=3.13ms	SOT-25	28cp	VD17	6g	Tor
<u>218</u>	R1126N181B	LVR-IC	LDO, LN, +CE, 1.8V±2%, 150mA	SOT-23-5	28vc	VR4	6g	Ric
<u>218</u>	R3112N181A	Vdet-IC	1.8V±2%, -Reset PPO	SOT-23-5	28vdo	VD3	6g	Ric
<u>218</u>	XC6216B392MR	LVR-IC	3.9V±2%, 150mA, +CE	SOT-25	28hw	VR4	6g	Tor
<u>218</u>	XC6103A239MR	Vdet-IC	3.9V±2%, Hst, -MR, +Reset PPO, Wt=50ms, Rt=3.13ms	SOT-25	28cp	VD17	6g	Tor



SMD code	Type	Function	Short description	Case	Pinout	Sch.	St.	Mnf.
219	R1126N191B	LVR-IC	LDO, LN, +CE, 1.9V±2%, 150mA	SOT-23-5	28vc	VR4	6g	Ric
219	R3112N191A	Vdet-IC	1.9V±2%, -Reset PPO	SOT-23-5	28vdo	VD3	6g	Ric
219	XC6216B402MR	LVR-IC	4.0V±2%, 150mA, +CE	SOT-25	28hw	VR4	6g	Tor
219	XC6103A240MR	Vdet-IC	4.0V±2%, Hst, -MR, +Reset PPO, Wt=50ms, Rt=3.13ms	SOT-25	28cp	VD17	6g	Tor
21A	AAT60021A-S5	Vdet-IC	2.1V±2%, -Reset ODO	SOT-23-5	28vdo	VD1	6g	Aat
21A	APR3021-15B	Vdet-IC	1.5V, -Reset PPO	SOT-23-5	28vd1	VD7	6k	App
21A	XC6216B412MR	LVR-IC	4.1V±2%, 150mA, +CE	SOT-25	28hw	VR4	6g	Tor
21A	XC6103A241MR	Vdet-IC	4.1V±2%, Hst, -MR, +Reset PPO, Wt=50ms, Rt=3.13ms	SOT-25	28cp	VD17	6g	Tor
21-A	UTC8121-A	Vdet-IC	2.1V, -Reset OCO	SOT-23-5	28vdz	VD6	6k	Utc
21B	AAT60021B-S5	Vdet-IC	2.1V±2%, -Reset PPO	SOT-23-5	28vdo	VD3	6g	Aat
21B	APR3021-17B	Vdet-IC	1.75V, -Reset PPO	SOT-23-5	28vd1	VD7	6k	App
21B	XC6216B422MR	LVR-IC	4.2V±2%, 150mA, +CE	SOT-25	28hw	VR4	6g	Tor
21B	XC6103A242MR	Vdet-IC	4.2V±2%, Hst, -MR, +Reset PPO, Wt=50ms, Rt=3.13ms	SOT-25	28cp	VD17	6g	Tor
21-B	UTC8121-B	Vdet-IC	2.1V, -Reset OCO	SOT-23-5	28vdm	VD6	6k	Utc
21C	AAT60021C-S5	Vdet-IC	2.1V±1%, -Reset ODO	SOT-23-5	28vdo	VD1	6g	Aat
21C	APR3021-23B	Vdet-IC	2.32V, -Reset PPO	SOT-23-5	28vd1	VD7	6k	App
21C	XC6216B432MR	LVR-IC	4.3V±2%, 150mA, +CE	SOT-25	28hw	VR4	6g	Tor
21C	XC6103A243MR	Vdet-IC	4.3V±2%, Hst, -MR, +Reset PPO, Wt=50ms, Rt=3.13ms	SOT-25	28cp	VD17	6g	Tor
21D	AAT60021D-S5	Vdet-IC	2.1V±1%, -Reset PPO	SOT-23-5	28vdo	VD3	6g	Aat
21D	APR3021-26B	Vdet-IC	2.63V, -Reset PPO	SOT-23-5	28vd1	VD7	6k	App
21D	XC6216B442MR	LVR-IC	4.4V±2%, 150mA, +CE	SOT-25	28hw	VR4	6g	Tor
21D	XC6103A244MR	Vdet-IC	4.4V±2%, Hst, -MR, +Reset PPO, Wt=50ms, Rt=3.13ms	SOT-25	28cp	VD17	6g	Tor
21E	APR3021-29B	Vdet-IC	2.93V, -Reset PPO	SOT-23-5	28vd1	VD7	6k	App
21E	XC6216B452MR	LVR-IC	4.5V±2%, 150mA, +CE	SOT-25	28hw	VR4	6g	Tor
21E	XC6103A245MR	Vdet-IC	4.5V±2%, Hst, -MR, +Reset PPO, Wt=50ms, Rt=3.13ms	SOT-25	28cp	VD17	6g	Tor
21F	APR3021-30B	Vdet-IC	3.08V, -Reset PPO	SOT-23-5	28vd1	VD7	6k	App
21F	XC6216B462MR	LVR-IC	4.6V±2%, 150mA, +CE	SOT-25	28hw	VR4	6g	Tor
21F	XC6103A216MR	Vdet-IC	1.6V±2%, Hst, -MR, +Reset PPO, Wt=50ms, Rt=3.13ms	SOT-25	28cp	VD17	6g	Tor
21F	XC6103A246MR	Vdet-IC	4.6V±2%, Hst, -MR, +Reset PPO, Wt=50ms, Rt=3.13ms	SOT-25	28cp	VD17	6g	Tor
21G	APR3021-39B	Vdet-IC	3.9V, -Reset PPO	SOT-23-5	28vd1	VD7	6k	App
21H	APR3021-43B	Vdet-IC	4.38V, -Reset PPO	SOT-23-5	28vd1	VD7	6k	App
21H	XC6216B472MR	LVR-IC	4.7V±2%, 150mA, +CE	SOT-25	28hw	VR4	6g	Tor
21H	XC6103A217MR	Vdet-IC	1.7V±2%, Hst, -MR, +Reset PPO, Wt=50ms, Rt=3.13ms	SOT-25	28cp	VD17	6g	Tor
21H	XC6103A247MR	Vdet-IC	4.7V±2%, Hst, -MR, +Reset PPO, Wt=50ms, Rt=3.13ms	SOT-25	28cp	VD17	6g	Tor
21J	APR3021-46B	Vdet-IC	4.63V, -Reset PPO	SOT-23-5	28vd1	VD7	6k	App
21K	TK71721S	LVR-IC	LDO, 2.1V±1.5%, 300mA, +CE	SOT-23-5	28vrx	VR7	6k	Tok
21K	XC6216B482MR	LVR-IC	4.8V±2%, 150mA, +CE	SOT-25	28hw	VR4	6g	Tor
21K	XC6103A218MR	Vdet-IC	1.8V±2%, Hst, -MR, +Reset PPO, Wt=50ms, Rt=3.13ms	SOT-25	28cp	VD17	6g	Tor
21K	XC6103A248MR	Vdet-IC	4.8V±2%, Hst, -MR, +Reset PPO, Wt=50ms, Rt=3.13ms	SOT-25	28cp	VD17	6g	Tor
21L	TK71621ASCL	LVR-IC	LDO, 2.1V±2%, 150mA, +CE, -30...+80°C	SOT-23-5	28vrx	VR7	6k	Tok
21L	XC6216B492MR	LVR-IC	4.9V±2%, 150mA, +CE	SOT-25	28hw	VR4	6g	Tor
21L	XC6103A219MR	Vdet-IC	1.9V±2%, Hst, -MR, +Reset PPO, Wt=50ms, Rt=3.13ms	SOT-25	28cp	VD17	6g	Tor
21L	XC6103A249MR	Vdet-IC	4.9V±2%, Hst, -MR, +Reset PPO, Wt=50ms, Rt=3.13ms	SOT-25	28cp	VD17	6g	Tor
21M	XC6216B502MR	LVR-IC	5.0V±2%, 150mA, +CE	SOT-25	28hw	VR4	6g	Tor
21M	XC6103A220MR	Vdet-IC	2.0V±2%, Hst, -MR, +Reset PPO, Wt=50ms, Rt=3.13ms	SOT-25	28cp	VD17	6g	Tor
21M	XC6103A250MR	Vdet-IC	5.0V±2%, Hst, -MR, +Reset PPO, Wt=50ms, Rt=3.13ms	SOT-25	28cp	VD17	6g	Tor
21N	XC6216B512MR	LVR-IC	5.1V±2%, 150mA, +CE	SOT-25	28hw	VR4	6g	Tor
21N	XC6103A221MR	Vdet-IC	2.1V±2%, Hst, -MR, +Reset PPO, Wt=50ms, Rt=3.13ms	SOT-25	28cp	VD17	6g	Tor
21P	XC6216B522MR	LVR-IC	5.2V±2%, 150mA, +CE	SOT-25	28hw	VR4	6g	Tor
21P	XC6103A222MR	Vdet-IC	2.2V±2%, Hst, -MR, +Reset PPO, Wt=50ms, Rt=3.13ms	SOT-25	28cp	VD17	6g	Tor
21R	XC6216B532MR	LVR-IC	5.3V±2%, 150mA, +CE	SOT-25	28hw	VR4	6g	Tor
21R	XC6103A223MR	Vdet-IC	2.3V±2%, Hst, -MR, +Reset PPO, Wt=50ms, Rt=3.13ms	SOT-25	28cp	VD17	6g	Tor
21S	XC6216B542MR	LVR-IC	5.4V±2%, 150mA, +CE	SOT-25	28hw	VR4	6g	Tor
21S	XC6103A224MR	Vdet-IC	2.4V±2%, Hst, -MR, +Reset PPO, Wt=50ms, Rt=3.13ms	SOT-25	28cp	VD17	6g	Tor
21T	TK71421S	LVR-IC	LDO, 2.1V±2%, 100mA, +CE, Ext. transistor	SOT-23-5	28zh	VR6	6a	Tok
21T	XC6216B552MR	LVR-IC	5.5V±2%, 150mA, +CE	SOT-25	28hw	VR4	6g	Tor
21T	XC6103A225MR	Vdet-IC	2.5V±2%, Hst, -MR, +Reset PPO, Wt=50ms, Rt=3.13ms	SOT-25	28cp	VD17	6g	Tor
21U	XC6216B562MR	LVR-IC	5.6V±2%, 150mA, +CE	SOT-25	28hw	VR4	6g	Tor
21U	XC6103A226MR	Vdet-IC	2.6V±2%, Hst, -MR, +Reset PPO, Wt=50ms, Rt=3.13ms	SOT-25	28cp	VD17	6g	Tor
21V	XC6216B572MR	LVR-IC	5.7V±2%, 150mA, +CE	SOT-25	28hw	VR4	6g	Tor
21V	XC6103A227MR	Vdet-IC	2.7V±2%, Hst, -MR, +Reset PPO, Wt=50ms, Rt=3.13ms	SOT-25	28cp	VD17	6g	Tor
21X	XC6216B582MR	LVR-IC	5.8V±2%, 150mA, +CE	SOT-25	28hw	VR4	6g	Tor
21X	XC6103A228MR	Vdet-IC	2.8V±2%, Hst, -MR, +Reset PPO, Wt=50ms, Rt=3.13ms	SOT-25	28cp	VD17	6g	Tor
21Y	XC6216B592MR	LVR-IC	5.9V±2%, 150mA, +CE	SOT-25	28hw	VR4	6g	Tor
21Y	XC6103A229MR	Vdet-IC	2.9V±2%, Hst, -MR, +Reset PPO, Wt=50ms, Rt=3.13ms	SOT-25	28cp	VD17	6g	Tor
21Z	XC6216B602MR	LVR-IC	6.0V±2%, 150mA, +CE	SOT-25	28hw	VR4	6g	Tor
21Z	XC6103A230MR	Vdet-IC	3.0V±2%, Hst, -MR, +Reset PPO, Wt=50ms, Rt=3.13ms	SOT-25	28cp	VD17	6g	Tor
22	R1223N332B	DC/DC-IC	PWM/VFM step-down, +CE, 3.3V, 500kHz, L-Pr.	SOT-23-5	28ud	DC7	6g	Ric
22	RN5RF22AA	LVR-IC	LRip, -CE, 2.2V±2%, 1A*	SOT-23-5	28vw	VR6	6g	Ric
22	RN5RZ22AA	LVR-IC	LDO, LN, -CE, 2.2V±2%, 100mA	SOT-23-5	28vrt	VR4	6g	Ric



SMD

SMD code	Type	Function	Short description	Case	Pinout	Sch.	St.	Mnf.
220	R1126N201B	LVR-IC	LDO, LN, +CE, 2V±2%, 150mA	SOT-23-5	28vc	VR4	6g	Ric
220	R3112N201A	Vdet-IC	2.0V±2%, -Reset PPO	SOT-23-5	28vdo	VD3	6g	Ric
220	XC6216B612MR	LVR-IC	6.1V±2%, 150mA, +CE	SOT-25	28hw	VR4	6g	Tor
220	XC6103A331MR	Vdet-IC	3.1V±2%, Hst, -MR, +Reset PPO, Wt=100ms, Rt=3.13ms	SOT-25	28cp	VD17	6g	Tor
221	R1126N211B	LVR-IC	LDO, LN, +CE, 2.1V±2%, 150mA	SOT-23-5	28vc	VR4	6g	Ric
221	R3112N211A	Vdet-IC	2.1V±2%, -Reset PPO	SOT-23-5	28vdo	VD3	6g	Ric
221	XC6216B622MR	LVR-IC	6.2V±2%, 150mA, +CE	SOT-25	28hw	VR4	6g	Tor
221	XC6103A332MR	Vdet-IC	3.2V±2%, Hst, -MR, +Reset PPO, Wt=100ms, Rt=3.13ms	SOT-25	28cp	VD17	6g	Tor
222	R1126N221B	LVR-IC	LDO, LN, +CE, 2.2V±2%, 150mA	SOT-23-5	28vc	VR4	6g	Ric
222	R3112N221A	Vdet-IC	2.2V±2%, -Reset PPO	SOT-23-5	28vdo	VD3	6g	Ric
222	XC6216B632MR	LVR-IC	6.3V±2%, 150mA, +CE	SOT-25	28hw	VR4	6g	Tor
222	XC6103A333MR	Vdet-IC	3.3V±2%, Hst, -MR, +Reset PPO, Wt=100ms, Rt=3.13ms	SOT-25	28cp	VD17	6g	Tor
223	R1126N231B	LVR-IC	LDO, LN, +CE, 2.3V±2%, 150mA	SOT-23-5	28vc	VR4	6g	Ric
223	R3112N231A	Vdet-IC	2.3V±2%, -Reset PPO	SOT-23-5	28vdo	VD3	6g	Ric
223	XC6216B642MR	LVR-IC	6.4V±2%, 150mA, +CE	SOT-25	28hw	VR4	6g	Tor
223	XC6103A334MR	Vdet-IC	3.4V±2%, Hst, -MR, +Reset PPO, Wt=100ms, Rt=3.13ms	SOT-25	28cp	VD17	6g	Tor
224	R1126N241B	LVR-IC	LDO, LN, +CE, 2.4V±2%, 150mA	SOT-23-5	28vc	VR4	6g	Ric
224	R3112N241A	Vdet-IC	2.4V±2%, -Reset PPO	SOT-23-5	28vdo	VD3	6g	Ric
224	XC6216B652MR	LVR-IC	6.5V±2%, 150mA, +CE	SOT-25	28hw	VR4	6g	Tor
224	XC6103A335MR	Vdet-IC	3.5V±2%, Hst, -MR, +Reset PPO, Wt=100ms, Rt=3.13ms	SOT-25	28cp	VD17	6g	Tor
225	R1126N251B	LVR-IC	LDO, LN, +CE, 2.5V±2%, 150mA	SOT-23-5	28vc	VR4	6g	Ric
225	R3112N251A	Vdet-IC	2.5V±2%, -Reset PPO	SOT-23-5	28vdo	VD3	6g	Ric
225	XC6216B662MR	LVR-IC	6.6V±2%, 150mA, +CE	SOT-25	28hw	VR4	6g	Tor
225	XC6103A336MR	Vdet-IC	3.6V±2%, Hst, -MR, +Reset PPO, Wt=100ms, Rt=3.13ms	SOT-25	28cp	VD17	6g	Tor
226	R1126N261B	LVR-IC	LDO, LN, +CE, 2.6V±2%, 150mA	SOT-23-5	28vc	VR4	6g	Ric
226	R3112N261A	Vdet-IC	2.6V±2%, -Reset PPO	SOT-23-5	28vdo	VD3	6g	Ric
226	XC6216B672MR	LVR-IC	6.7V±2%, 150mA, +CE	SOT-25	28hw	VR4	6g	Tor
226	XC6103A337MR	Vdet-IC	3.7V±2%, Hst, -MR, +Reset PPO, Wt=100ms, Rt=3.13ms	SOT-25	28cp	VD17	6g	Tor
227	R1126N271B	LVR-IC	LDO, LN, +CE, 2.7V±2%, 150mA	SOT-23-5	28vc	VR4	6g	Ric
227	R3112N271A	Vdet-IC	2.7V±2%, -Reset PPO	SOT-23-5	28vdo	VD3	6g	Ric
227	XC6216B682MR	LVR-IC	6.8V±2%, 150mA, +CE	SOT-25	28hw	VR4	6g	Tor
227	XC6103A338MR	Vdet-IC	3.8V±2%, Hst, -MR, +Reset PPO, Wt=100ms, Rt=3.13ms	SOT-25	28cp	VD17	6g	Tor
228	R1126N281B	LVR-IC	LDO, LN, +CE, 2.8V±2%, 150mA	SOT-23-5	28vc	VR4	6g	Ric
228	R3112N281A	Vdet-IC	2.8V±2%, -Reset PPO	SOT-23-5	28vdo	VD3	6g	Ric
228	XC6216B692MR	LVR-IC	6.9V±2%, 150mA, +CE	SOT-25	28hw	VR4	6g	Tor
228	XC6103A339MR	Vdet-IC	3.9V±2%, Hst, -MR, +Reset PPO, Wt=100ms, Rt=3.13ms	SOT-25	28cp	VD17	6g	Tor
229	R1126N291B	LVR-IC	LDO, LN, +CE, 2.9V±2%, 150mA	SOT-23-5	28vc	VR4	6g	Ric
229	R3112N291A	Vdet-IC	2.9V±2%, -Reset PPO	SOT-23-5	28vdo	VD3	6g	Ric
229	XC6216B702MR	LVR-IC	7.0V±2%, 150mA, +CE	SOT-25	28hw	VR4	6g	Tor
229	XC6103A340MR	Vdet-IC	4.0V±2%, Hst, -MR, +Reset PPO, Wt=100ms, Rt=3.13ms	SOT-25	28cp	VD17	6g	Tor
22A	AAT60022A-S5	Vdet-IC	2.2V±2%, -Reset ODO	SOT-23-5	28vdo	VD1	6g	Aat
22A	APR3022-15B	Vdet-IC	1.5V, +Reset PPO	SOT-23-5	28vd1	VD7	6k	Anp
22A	XC6216B712MR	LVR-IC	7.1V±2%, 150mA, +CE	SOT-25	28hw	VR4	6g	Tor
22A	XC6103A341MR	Vdet-IC	4.1V±2%, Hst, -MR, +Reset PPO, Wt=100ms, Rt=3.13ms	SOT-25	28cp	VD17	6g	Tor
22-A	UTC8122-A	Vdet-IC	2.2V, -Reset OCO	SOT-23-5	28vdz	VD6	6k	Utc
22B	AAT60022B-S5	Vdet-IC	2.2V±2%, -Reset PPO	SOT-23-5	28vdo	VD3	6g	Aat
22B	APR3022-17B	Vdet-IC	1.75V, +Reset PPO	SOT-23-5	28vd1	VD7	6k	Anp
22B	XC6216B722MR	LVR-IC	7.2V±2%, 150mA, +CE	SOT-25	28hw	VR4	6g	Tor
22B	XC6103A342MR	Vdet-IC	4.2V±2%, Hst, -MR, +Reset PPO, Wt=100ms, Rt=3.13ms	SOT-25	28cp	VD17	6g	Tor
22-B	UTC8122-B	Vdet-IC	2.2V, -Reset OCO	SOT-23-5	28vdm	VD6	6k	Utc
22C	AAT60022C-S5	Vdet-IC	2.2V±1%, -Reset ODO	SOT-23-5	28vdo	VD1	6g	Aat
22C	APR3022-23B	Vdet-IC	2.32V, +Reset PPO	SOT-23-5	28vd1	VD7	6k	Anp
22C	XC6216B732MR	LVR-IC	7.3V±2%, 150mA, +CE	SOT-25	28hw	VR4	6g	Tor
22C	XC6103A343MR	Vdet-IC	4.3V±2%, Hst, -MR, +Reset PPO, Wt=100ms, Rt=3.13ms	SOT-25	28cp	VD17	6g	Tor
22D	AAT60022D-S5	Vdet-IC	2.2V±1%, -Reset PPO	SOT-23-5	28vdo	VD3	6g	Aat
22D	APR3022-26B	Vdet-IC	2.63V, +Reset PPO	SOT-23-5	28vd1	VD7	6k	Anp
22D	XC6216B742MR	LVR-IC	7.4V±2%, 150mA, +CE	SOT-25	28hw	VR4	6g	Tor
22D	XC6103A344MR	Vdet-IC	4.4V±2%, Hst, -MR, +Reset PPO, Wt=100ms, Rt=3.13ms	SOT-25	28cp	VD17	6g	Tor
22E	APR3022-29B	Vdet-IC	2.93V, +Reset PPO	SOT-23-5	28vd1	VD7	6k	Anp
22E	XC6216B752MR	LVR-IC	7.5V±2%, 150mA, +CE	SOT-25	28hw	VR4	6g	Tor
22E	XC6103A345MR	Vdet-IC	4.5V±2%, Hst, -MR, +Reset PPO, Wt=100ms, Rt=3.13ms	SOT-25	28cp	VD17	6g	Tor
22F	APR3022-30B	Vdet-IC	3.08V, +Reset PPO	SOT-23-5	28vd1	VD7	6k	Anp
22F	XC6216B762MR	LVR-IC	7.6V±2%, 150mA, +CE	SOT-25	28hw	VR4	6g	Tor
22F	XC6103A316MR	Vdet-IC	1.6V±2%, Hst, -MR, +Reset PPO, Wt=100ms, Rt=3.13ms	SOT-25	28cp	VD17	6g	Tor
22F	XC6103A346MR	Vdet-IC	4.6V±2%, Hst, -MR, +Reset PPO, Wt=100ms, Rt=3.13ms	SOT-25	28cp	VD17	6g	Tor
22G	APR3022-39B	Vdet-IC	3.9V, +Reset PPO	SOT-23-5	28vd1	VD7	6k	Anp
22H	APR3022-43B	Vdet-IC	4.38V, +Reset PPO	SOT-23-5	28vd1	VD7	6k	Anp
22H	XC6216B772MR	LVR-IC	7.7V±2%, 150mA, +CE	SOT-25	28hw	VR4	6g	Tor
22H	XC6103A317MR	Vdet-IC	1.7V±2%, Hst, -MR, +Reset PPO, Wt=100ms, Rt=3.13ms	SOT-25	28cp	VD17	6g	Tor
22H	XC6103A347MR	Vdet-IC	4.7V±2%, Hst, -MR, +Reset PPO, Wt=100ms, Rt=3.13ms	SOT-25	28cp	VD17	6g	Tor



SMD code	Type	Function	Short description	Case	Pinout	Sch.	St.	Mnf.
22J	APR3022-46B	Vdet-IC	4.63V, +Reset PPO	SOT-23-5	28vd1	VD7	6k	Anp
22K	TK17122S	LVR-IC	LDO, 2.2V±1.5%, 300mA, +CE	SOT-23-5	28vrx	VR7	6k	Tok
22K	XC6216B782MR	LVR-IC	7.8V±2%, 150mA, +CE	SOT-25	28hw	VR4	6g	Tor
22K	XC6103A318MR	Vdet-IC	1.8V±2%, Hst, -MR, +Reset PPO, Wt=100ms, Rt=3.13ms	SOT-25	28cp	VD17	6g	Tor
22K	XC6103A348MR	Vdet-IC	4.8V±2%, Hst, -MR, +Reset PPO, Wt=100ms, Rt=3.13ms	SOT-25	28cp	VD17	6g	Tor
22L	TK1622ASCL	LVR-IC	LDO, 2.2V±2%, 150mA, +CE, -30, +80°C	SOT-23-5	28vrx	VR7	6k	Tok
22L	XC6216B792MR	LVR-IC	7.9V±2%, 150mA, +CE	SOT-25	28hw	VR4	6g	Tor
22L	XC6103A319MR	Vdet-IC	1.9V±2%, Hst, -MR, +Reset PPO, Wt=100ms, Rt=3.13ms	SOT-25	28cp	VD17	6g	Tor
22L	XC6103A349MR	Vdet-IC	4.9V±2%, Hst, -MR, +Reset PPO, Wt=100ms, Rt=3.13ms	SOT-25	28cp	VD17	6g	Tor
22M	XC6216B802MR	LVR-IC	8.0V±2%, 150mA, +CE	SOT-25	28hw	VR4	6g	Tor
22M	XC6103A320MR	Vdet-IC	2.0V±2%, Hst, -MR, +Reset PPO, Wt=100ms, Rt=3.13ms	SOT-25	28cp	VD17	6g	Tor
22M	XC6103A350MR	Vdet-IC	5.0V±2%, Hst, -MR, +Reset PPO, Wt=100ms, Rt=3.13ms	SOT-25	28cp	VD17	6g	Tor
22N	XC6216B812MR	LVR-IC	8.1V±2%, 150mA, +CE	SOT-25	28hw	VR4	6g	Tor
22N	XC6103A321MR	Vdet-IC	2.1V±2%, Hst, -MR, +Reset PPO, Wt=100ms, Rt=3.13ms	SOT-25	28cp	VD17	6g	Tor
22P	XC6216B822MR	LVR-IC	8.2V±2%, 150mA, +CE	SOT-25	28hw	VR4	6g	Tor
22P	XC6103A322MR	Vdet-IC	2.2V±2%, Hst, -MR, +Reset PPO, Wt=100ms, Rt=3.13ms	SOT-25	28cp	VD17	6g	Tor
22R	XC6216B832MR	LVR-IC	8.3V±2%, 150mA, +CE	SOT-25	28hw	VR4	6g	Tor
22R	XC6103A323MR	Vdet-IC	2.3V±2%, Hst, -MR, +Reset PPO, Wt=100ms, Rt=3.13ms	SOT-25	28cp	VD17	6g	Tor
22S	XC6216B842MR	LVR-IC	8.4V±2%, 150mA, +CE	SOT-25	28hw	VR4	6g	Tor
22S	XC6103A324MR	Vdet-IC	2.4V±2%, Hst, -MR, +Reset PPO, Wt=100ms, Rt=3.13ms	SOT-25	28cp	VD17	6g	Tor
22T	TK17422S	LVR-IC	LDO, 2.2V±2%, 100mA, +CE, Ext. transistor	SOT-23-5	28zh	VR6	6a	Tok
22T	XC6216B852MR	LVR-IC	8.5V±2%, 150mA, +CE	SOT-25	28hw	VR4	6g	Tor
22T	XC6103A325MR	Vdet-IC	2.5V±2%, Hst, -MR, +Reset PPO, Wt=100ms, Rt=3.13ms	SOT-25	28cp	VD17	6g	Tor
22U	XC6216B862MR	LVR-IC	8.6V±2%, 150mA, +CE	SOT-25	28hw	VR4	6g	Tor
22U	XC6103A326MR	Vdet-IC	2.6V±2%, Hst, -MR, +Reset PPO, Wt=100ms, Rt=3.13ms	SOT-25	28cp	VD17	6g	Tor
22V	XC6216B872MR	LVR-IC	8.7V±2%, 150mA, +CE	SOT-25	28hw	VR4	6g	Tor
22V	XC6103A327MR	Vdet-IC	2.7V±2%, Hst, -MR, +Reset PPO, Wt=100ms, Rt=3.13ms	SOT-25	28cp	VD17	6g	Tor
22X	XC6216B882MR	LVR-IC	8.8V±2%, 150mA, +CE	SOT-25	28hw	VR4	6g	Tor
22X	XC6103A328MR	Vdet-IC	2.8V±2%, Hst, -MR, +Reset PPO, Wt=100ms, Rt=3.13ms	SOT-25	28cp	VD17	6g	Tor
22Y	XC6216B892MR	LVR-IC	8.9V±2%, 150mA, +CE	SOT-25	28hw	VR4	6g	Tor
22Y	XC6103A329MR	Vdet-IC	2.9V±2%, Hst, -MR, +Reset PPO, Wt=100ms, Rt=3.13ms	SOT-25	28cp	VD17	6g	Tor
22Z	XC6216B902MR	LVR-IC	9.0V±2%, 150mA, +CE	SOT-25	28hw	VR4	6g	Tor
22Z	XC6103A330MR	Vdet-IC	3.0V±2%, Hst, -MR, +Reset PPO, Wt=100ms, Rt=3.13ms	SOT-25	28cp	VD17	6g	Tor
23	R1223N502B	DC/DC-IC	PWM/VFM step-down, +CE, 5V, 500kHz, L-Pr.	SOT-23-5	28ud	DC7	6g	Ric
23	RN5RF23AA	LVR-IC	L.Rip, -CE, 2.3V±2%, 1A*	SOT-23-5	28vw	VR6	6g	Ric
23	RN5RZ23AA	LVR-IC	LDO, LN, -CE, 2.3V±2%, 100mA	SOT-23-5	28vrt	VR4	6g	Ric
230	R1126N301B	LVR-IC	LDO, LN, +CE, 3V±2%, 150mA	SOT-23-5	28vc	VR4	6g	Ric
230	R3112N301A	Vdet-IC	3V±2%, -Reset PPO	SOT-23-5	28vdo	VD3	6g	Ric
230	XC6216B912MR	LVR-IC	9.1V±2%, 150mA, +CE	SOT-25	28hw	VR4	6g	Tor
230	XC6103A431MR	Vdet-IC	3.1V±2%, Hst, -MR, +Reset PPO, Wt=200ms, Rt=3.13ms	SOT-25	28cp	VD17	6g	Tor
231	R1126N311B	LVR-IC	LDO, LN, +CE, 3.1V±2%, 150mA	SOT-23-5	28vc	VR4	6g	Ric
231	R3112N311A	Vdet-IC	3.1V±2%, -Reset PPO	SOT-23-5	28vdo	VD3	6g	Ric
231	XC6216B922MR	LVR-IC	9.2V±2%, 150mA, +CE	SOT-25	28hw	VR4	6g	Tor
231	XC6103A432MR	Vdet-IC	3.2V±2%, Hst, -MR, +Reset PPO, Wt=200ms, Rt=3.13ms	SOT-25	28cp	VD17	6g	Tor
232	R1126N321B	LVR-IC	LDO, LN, +CE, 3.2V±2%, 150mA	SOT-23-5	28vc	VR4	6g	Ric
232	R3112N321A	Vdet-IC	3.2V±2%, -Reset PPO	SOT-23-5	28vdo	VD3	6g	Ric
232	XC6216B932MR	LVR-IC	9.3V±2%, 150mA, +CE	SOT-25	28hw	VR4	6g	Tor
232	XC6103A433MR	Vdet-IC	3.3V±2%, Hst, -MR, +Reset PPO, Wt=200ms, Rt=3.13ms	SOT-25	28cp	VD17	6g	Tor
233	R1126N331B	LVR-IC	LDO, LN, +CE, 3.3V±2%, 150mA	SOT-23-5	28vc	VR4	6g	Ric
233	R3112N331A	Vdet-IC	3.3V±2%, -Reset PPO	SOT-23-5	28vdo	VD3	6g	Ric
233	XC6216B942MR	LVR-IC	9.4V±2%, 150mA, +CE	SOT-25	28hw	VR4	6g	Tor
233	XC6103A434MR	Vdet-IC	3.4V±2%, Hst, -MR, +Reset PPO, Wt=200ms, Rt=3.13ms	SOT-25	28cp	VD17	6g	Tor
234	R1126N341B	LVR-IC	LDO, LN, +CE, 3.4V±2%, 150mA	SOT-23-5	28vc	VR4	6g	Ric
234	R3112N341A	Vdet-IC	3.4V±2%, -Reset PPO	SOT-23-5	28vdo	VD3	6g	Ric
234	XC6216B952MR	LVR-IC	9.5V±2%, 150mA, +CE	SOT-25	28hw	VR4	6g	Tor
234	XC6103A435MR	Vdet-IC	3.5V±2%, Hst, -MR, +Reset PPO, Wt=200ms, Rt=3.13ms	SOT-25	28cp	VD17	6g	Tor
235	R1126N351B	LVR-IC	LDO, LN, +CE, 3.5V±2%, 150mA	SOT-23-5	28vc	VR4	6g	Ric
235	R3112N351A	Vdet-IC	3.5V±2%, -Reset PPO	SOT-23-5	28vdo	VD3	6g	Ric
235	XC6216B962MR	LVR-IC	9.6V±2%, 150mA, +CE	SOT-25	28hw	VR4	6g	Tor
235	XC6103A436MR	Vdet-IC	3.6V±2%, Hst, -MR, +Reset PPO, Wt=200ms, Rt=3.13ms	SOT-25	28cp	VD17	6g	Tor
236	R1126N361B	LVR-IC	LDO, LN, +CE, 3.6V±2%, 150mA	SOT-23-5	28vc	VR4	6g	Ric
236	R3112N361A	Vdet-IC	3.6V±2%, -Reset PPO	SOT-23-5	28vdo	VD3	6g	Ric
236	XC6216B972MR	LVR-IC	9.7V±2%, 150mA, +CE	SOT-25	28hw	VR4	6g	Tor
236	XC6103A437MR	Vdet-IC	3.7V±2%, Hst, -MR, +Reset PPO, Wt=200ms, Rt=3.13ms	SOT-25	28cp	VD17	6g	Tor
237	R1126N371B	LVR-IC	LDO, LN, +CE, 3.7V±2%, 150mA	SOT-23-5	28vc	VR4	6g	Ric
237	R3112N371A	Vdet-IC	3.7V±2%, -Reset PPO	SOT-23-5	28vdo	VD3	6g	Ric
237	XC6216B982MR	LVR-IC	9.8V±2%, 150mA, +CE	SOT-25	28hw	VR4	6g	Tor
237	XC6103A438MR	Vdet-IC	3.8V±2%, Hst, -MR, +Reset PPO, Wt=200ms, Rt=3.13ms	SOT-25	28cp	VD17	6g	Tor
238	R1126N381B	LVR-IC	LDO, LN, +CE, 3.8V±2%, 150mA	SOT-23-5	28vc	VR4	6g	Ric
238	R3112N381A	Vdet-IC	3.8V±2%, -Reset PPO	SOT-23-5	28vdo	VD3	6g	Ric



SMD code	Type	Function	Short description	Case	Pinout	Sch.	St.	Mnf.
238	XC6216B992MR	LVR-IC	9.9V±2%, 150mA, +CE	SOT-25	28hw	VR4	6g	Tor
238	XC6103A439MR	Vdet-IC	3.9V±2%, Hst, -MR, +Reset PPO, Wt=200ms, Rt=3.13ms	SOT-25	28cp	VD17	6g	Tor
239	R1126N391B	LVR-IC	LDO, LN, +CE, 3.9V±2%, 150mA	SOT-23-5	28vc	VR4	6g	Ric
239	R3112N391A	Vdet-IC	3.9V±2%, -Reset PPO	SOT-23-5	28vdo	VD3	6g	Ric
239	XC6216BA02MR	LVR-IC	10.0V±2%, 150mA, +CE	SOT-25	28hw	VR4	6g	Tor
239	XC6103A440MR	Vdet-IC	4.0V±2%, Hst, -MR, +Reset PPO, Wt=200ms, Rt=3.13ms	SOT-25	28cp	VD17	6g	Tor
23A	AAT60023A-S5	Vdet-IC	2.3V±2%, -Reset ODO	SOT-23-5	28vdo	VD1	6g	Aat
23A	APR3023-15B	Vdet-IC	1.5V, -Reset ODO	SOT-23-5	28vd1	VD6	6k	Anp
23A	XC6216BA12MR	LVR-IC	10.1V±2%, 150mA, +CE	SOT-25	28hw	VR4	6g	Tor
23A	XC6103A441MR	Vdet-IC	4.1V±2%, Hst, -MR, +Reset PPO, Wt=200ms, Rt=3.13ms	SOT-25	28cp	VD17	6g	Tor
23-A	UTC8123-A	Vdet-IC	2.3V, -Reset OCO	SOT-23-5	28vdo	VD6	6k	Utc
23B	AAT60023B-S5	Vdet-IC	2.3V±2%, -Reset PPO	SOT-23-5	28vdo	VD3	6g	Aat
23B	APR3023-17B	Vdet-IC	1.75V, -Reset ODO	SOT-23-5	28vd1	VD6	6k	Anp
23B	XC6216BA22MR	LVR-IC	10.2V±2%, 150mA, +CE	SOT-25	28hw	VR4	6g	Tor
23B	XC6103A442MR	Vdet-IC	4.2V±2%, Hst, -MR, +Reset PPO, Wt=200ms, Rt=3.13ms	SOT-25	28cp	VD17	6g	Tor
23-B	UTC8123-B	Vdet-IC	2.3V, -Reset OCO	SOT-23-5	28vdm	VD6	6k	Utc
23C	AAT60023C-S5	Vdet-IC	2.3V±1%, -Reset ODO	SOT-23-5	28vdo	VD1	6g	Aat
23C	APR3023-23B	Vdet-IC	2.32V, -Reset ODO	SOT-23-5	28vd1	VD6	6k	Anp
23C	XC6216BA32MR	LVR-IC	10.3V±2%, 150mA, +CE	SOT-25	28hw	VR4	6g	Tor
23C	XC6103A443MR	Vdet-IC	4.3V±2%, Hst, -MR, +Reset PPO, Wt=200ms, Rt=3.13ms	SOT-25	28cp	VD17	6g	Tor
23D	AAT60023D-S5	Vdet-IC	2.3V±1%, -Reset PPO	SOT-23-5	28vdo	VD3	6g	Aat
23D	APR3023-26B	Vdet-IC	2.63V, -Reset ODO	SOT-23-5	28vd1	VD6	6k	Anp
23D	XC6216BA42MR	LVR-IC	10.4V±2%, 150mA, +CE	SOT-25	28hw	VR4	6g	Tor
23D	XC6103A444MR	Vdet-IC	4.4V±2%, Hst, -MR, +Reset PPO, Wt=200ms, Rt=3.13ms	SOT-25	28cp	VD17	6g	Tor
23E	APR3023-29B	Vdet-IC	2.93V, -Reset ODO	SOT-23-5	28vd1	VD6	6k	Anp
23E	XC6216BA52MR	LVR-IC	10.5V±2%, 150mA, +CE	SOT-25	28hw	VR4	6g	Tor
23E	XC6103A445MR	Vdet-IC	4.5V±2%, Hst, -MR, +Reset PPO, Wt=200ms, Rt=3.13ms	SOT-25	28cp	VD17	6g	Tor
23F	APR3023-30B	Vdet-IC	3.08V, -Reset ODO	SOT-23-5	28vd1	VD6	6k	Anp
23F	XC6216BA62MR	LVR-IC	10.6V±2%, 150mA, +CE	SOT-25	28hw	VR4	6g	Tor
23F	XC6103A416MR	Vdet-IC	1.6V±2%, Hst, -MR, +Reset PPO, Wt=200ms, Rt=3.13ms	SOT-25	28cp	VD17	6g	Tor
23F	XC6103A446MR	Vdet-IC	4.6V±2%, Hst, -MR, +Reset PPO, Wt=200ms, Rt=3.13ms	SOT-25	28cp	VD17	6g	Tor
23G	APR3023-39B	Vdet-IC	3.9V, -Reset ODO	SOT-23-5	28vd1	VD6	6k	Anp
23H	APR3023-43B	Vdet-IC	4.38V, -Reset ODO	SOT-23-5	28vd1	VD6	6k	Anp
23H	XC6216BA72MR	LVR-IC	10.7V±2%, 150mA, +CE	SOT-25	28hw	VR4	6g	Tor
23H	XC6103A417MR	Vdet-IC	1.7V±2%, Hst, -MR, +Reset PPO, Wt=200ms, Rt=3.13ms	SOT-25	28cp	VD17	6g	Tor
23H	XC6103A447MR	Vdet-IC	4.7V±2%, Hst, -MR, +Reset PPO, Wt=200ms, Rt=3.13ms	SOT-25	28cp	VD17	6g	Tor
23J	APR3023-46B	Vdet-IC	4.63V, -Reset ODO	SOT-23-5	28vd1	VD6	6k	Anp
23K	TK71723S	LVR-IC	LDO, 2.3V±1.5%, 300mA, +CE	SOT-23-5	28vrx	VR7	6k	Tok
23K	XC6216BA82MR	LVR-IC	10.8V±2%, 150mA, +CE	SOT-25	28hw	VR4	6g	Tor
23K	XC6103A418MR	Vdet-IC	1.8V±2%, Hst, -MR, +Reset PPO, Wt=200ms, Rt=3.13ms	SOT-25	28cp	VD17	6g	Tor
23K	XC6103A448MR	Vdet-IC	4.8V±2%, Hst, -MR, +Reset PPO, Wt=200ms, Rt=3.13ms	SOT-25	28cp	VD17	6g	Tor
23L	TK71623ASCL	LVR-IC	LDO, 2.3V±2%, 150mA, +CE, -30...+80°C	SOT-23-5	28vrx	VR7	6k	Tok
23L	XC6216BA92MR	LVR-IC	10.9V±2%, 150mA, +CE	SOT-25	28hw	VR4	6g	Tor
23L	XC6103A419MR	Vdet-IC	1.9V±2%, Hst, -MR, +Reset PPO, Wt=200ms, Rt=3.13ms	SOT-25	28cp	VD17	6g	Tor
23L	XC6103A449MR	Vdet-IC	4.9V±2%, Hst, -MR, +Reset PPO, Wt=200ms, Rt=3.13ms	SOT-25	28cp	VD17	6g	Tor
23M	XC6216BB02MR	LVR-IC	11.0V±2%, 150mA, +CE	SOT-25	28hw	VR4	6g	Tor
23M	XC6103A420MR	Vdet-IC	2.0V±2%, Hst, -MR, +Reset PPO, Wt=200ms, Rt=3.13ms	SOT-25	28cp	VD17	6g	Tor
23M	XC6103A450MR	Vdet-IC	5.0V±2%, Hst, -MR, +Reset PPO, Wt=200ms, Rt=3.13ms	SOT-25	28cp	VD17	6g	Tor
23N	XC6216BB12MR	LVR-IC	11.1V±2%, 150mA, +CE	SOT-25	28hw	VR4	6g	Tor
23N	XC6103A421MR	Vdet-IC	2.1V±2%, Hst, -MR, +Reset PPO, Wt=200ms, Rt=3.13ms	SOT-25	28cp	VD17	6g	Tor
23P	XC6216BB22MR	LVR-IC	11.2V±2%, 150mA, +CE	SOT-25	28hw	VR4	6g	Tor
23P	XC6103A422MR	Vdet-IC	2.2V±2%, Hst, -MR, +Reset PPO, Wt=200ms, Rt=3.13ms	SOT-25	28cp	VD17	6g	Tor
23R	XC6216BB32MR	LVR-IC	11.3V±2%, 150mA, +CE	SOT-25	28hw	VR4	6g	Tor
23R	XC6103A423MR	Vdet-IC	2.3V±2%, Hst, -MR, +Reset PPO, Wt=200ms, Rt=3.13ms	SOT-25	28cp	VD17	6g	Tor
23S	XC6216BB42MR	LVR-IC	11.4V±2%, 150mA, +CE	SOT-25	28hw	VR4	6g	Tor
23S	XC6103A424MR	Vdet-IC	2.4V±2%, Hst, -MR, +Reset PPO, Wt=200ms, Rt=3.13ms	SOT-25	28cp	VD17	6g	Tor
23T	TK71423S	LVR-IC	LDO, 2.3V±2%, 100mA, +CE, Ext. transistor	SOT-23-5	28zh	VR6	6a	Tok
23T	XC6216BB52MR	LVR-IC	11.5V±2%, 150mA, +CE	SOT-25	28hw	VR4	6g	Tor
23T	XC6103A425MR	Vdet-IC	2.5V±2%, Hst, -MR, +Reset PPO, Wt=200ms, Rt=3.13ms	SOT-25	28cp	VD17	6g	Tor
23U	TK61023S	Vdet-IC	2.3V±2%, -Reset PPO	SOT-23-5	28vdm	VD7	6a	Tok
23U	XC6216BB62MR	LVR-IC	11.6V±2%, 150mA, +CE	SOT-25	28hw	VR4	6g	Tor
23U	XC6103A426MR	Vdet-IC	2.6V±2%, Hst, -MR, +Reset PPO, Wt=200ms, Rt=3.13ms	SOT-25	28cp	VD17	6g	Tor
23V	XC6216BB72MR	LVR-IC	11.7V±2%, 150mA, +CE	SOT-25	28hw	VR4	6g	Tor
23V	XC6103A427MR	Vdet-IC	2.7V±2%, Hst, -MR, +Reset PPO, Wt=200ms, Rt=3.13ms	SOT-25	28cp	VD17	6g	Tor
23X	XC6216BB82MR	LVR-IC	11.8V±2%, 150mA, +CE	SOT-25	28hw	VR4	6g	Tor
23X	XC6103A428MR	Vdet-IC	2.8V±2%, Hst, -MR, +Reset PPO, Wt=200ms, Rt=3.13ms	SOT-25	28cp	VD17	6g	Tor
23Y	XC6216BB92MR	LVR-IC	11.9V±2%, 150mA, +CE	SOT-25	28hw	VR4	6g	Tor
23Y	XC6103A429MR	Vdet-IC	2.9V±2%, Hst, -MR, +Reset PPO, Wt=200ms, Rt=3.13ms	SOT-25	28cp	VD17	6g	Tor
23Z	XC6216BC02MR	LVR-IC	12.0V±2%, 150mA, +CE	SOT-25	28hw	VR4	6g	Tor
23Z	XC6103A430MR	Vdet-IC	3.0V±2%, Hst, -MR, +Reset PPO, Wt=200ms, Rt=3.13ms	SOT-25	28cp	VD17	6g	Tor



SMD code	Type	Function	Short description	Case	Pinout	Sch.	St.	Mnf.
24	R1223N152E	DC/DC-IC	PWMVFM step-down, +CE, 1.5V, 300kHz, R-Pr.	SOT-23-5	28ud	DC7	6g	Ric
24	RN5RF24AA	LVR-IC	LVRip, -CE, 2.4V±2%, 1A*	SOT-23-5	28vww	VR6	6g	Ric
24	RN5RZ24AA	LVR-IC	LDO, LN, -CE, 2.4V±2%, 100mA	SOT-23-5	28vrt	VR4	6g	Ric
240	R1126N401B	LVR-IC	LDO, LN, +CE, 4V±2%, 150mA	SOT-23-5	28vc	VR4	6g	Ric
240	R3112N401A	Vdet-IC	4V±2%, -Reset PPO	SOT-23-5	28vdo	VD3	6g	Ric
240	XC6103A531MR	Vdet-IC	3.1V±2%, Hst, -MR, +Reset PPO, Wt=400ms, Rt=3.13ms	SOT-25	28cp	VD17	6g	Tor
241	R1126N181B5	LVR-IC	LDO, LN, +CE, 1.85V±2%, 150mA	SOT-23-5	28vc	VR4	6g	Ric
241	R3112N411A	Vdet-IC	4.1V±2%, -Reset PPO	SOT-23-5	28vdo	VD3	6g	Ric
241	XC6103A532MR	Vdet-IC	3.2V±2%, Hst, -MR, +Reset PPO, Wt=400ms, Rt=3.13ms	SOT-25	28cp	VD17	6g	Tor
242	R1126N281B5	LVR-IC	LDO, LN, +CE, 2.85V±2%, 150mA	SOT-23-5	28vc	VR4	6g	Ric
242	R3112N421A	Vdet-IC	4.2V±2%, -Reset PPO	SOT-23-5	28vdo	VD3	6g	Ric
242	XC6103A533MR	Vdet-IC	3.3V±2%, Hst, -MR, +Reset PPO, Wt=400ms, Rt=3.13ms	SOT-25	28cp	VD17	6g	Tor
243	R3112N431A	Vdet-IC	4.3V±2%, -Reset PPO	SOT-23-5	28vdo	VD3	6g	Ric
243	XC6103A534MR	Vdet-IC	3.4V±2%, Hst, -MR, +Reset PPO, Wt=400ms, Rt=3.13ms	SOT-25	28cp	VD17	6g	Tor
244	R3112N441A	Vdet-IC	4.4V±2%, -Reset PPO	SOT-23-5	28vdo	VD3	6g	Ric
244	XC6103A535MR	Vdet-IC	3.5V±2%, Hst, -MR, +Reset PPO, Wt=400ms, Rt=3.13ms	SOT-25	28cp	VD17	6g	Tor
245	R3112N451A	Vdet-IC	4.5V±2%, -Reset PPO	SOT-23-5	28vdo	VD3	6g	Ric
245	XC6103A536MR	Vdet-IC	3.6V±2%, Hst, -MR, +Reset PPO, Wt=400ms, Rt=3.13ms	SOT-25	28cp	VD17	6g	Tor
246	R3112N461A	Vdet-IC	4.6V±2%, -Reset PPO	SOT-23-5	28vdo	VD3	6g	Ric
246	XC6103A537MR	Vdet-IC	3.7V±2%, Hst, -MR, +Reset PPO, Wt=400ms, Rt=3.13ms	SOT-25	28cp	VD17	6g	Tor
247	R3112N471A	Vdet-IC	4.7V±2%, -Reset PPO	SOT-23-5	28vdo	VD3	6g	Ric
247	XC6103A538MR	Vdet-IC	3.8V±2%, Hst, -MR, +Reset PPO, Wt=400ms, Rt=3.13ms	SOT-25	28cp	VD17	6g	Tor
248	R3112N481A	Vdet-IC	4.8V±2%, -Reset PPO	SOT-23-5	28vdo	VD3	6g	Ric
248	XC6103A539MR	Vdet-IC	3.9V±2%, Hst, -MR, +Reset PPO, Wt=400ms, Rt=3.13ms	SOT-25	28cp	VD17	6g	Tor
249	R3112N491A	Vdet-IC	4.9V±2%, -Reset PPO	SOT-23-5	28vdo	VD3	6g	Ric
249	XC6103A540MR	Vdet-IC	4.0V±2%, Hst, -MR, +Reset PPO, Wt=400ms, Rt=3.13ms	SOT-25	28cp	VD17	6g	Tor
24A	AAT60024A-S5	Vdet-IC	2.4V±2%, -Reset ODO	SOT-23-5	28vdo	VD1	6g	Aat
24A	XC6103A541MR	Vdet-IC	4.1V±2%, Hst, -MR, +Reset PPO, Wt=400ms, Rt=3.13ms	SOT-25	28cp	VD17	6g	Tor
24-A	UTC8124-A	Vdet-IC	2.4V, -Reset OCO	SOT-23-5	28vdz	VD6	6k	Utc
24A1	MAS9124AST1-T	LVR-IC	LDO, 3.3V, 150mA, +CE	SOT-23-5	28vrx	VR7	6a	Mas
24A2	MAS9124AST2-T	LVR-IC	LDO, 2.8V, 150mA, +CE	SOT-23-5	28vrx	VR7	6a	Mas
24A3	MAS9124AST3-T	LVR-IC	LDO, 2.5V, 150mA, +CE	SOT-23-5	28vrx	VR7	6a	Mas
24A4	MAS9124AST4-T	LVR-IC	LDO, 1.8V, 150mA, +CE	SOT-23-5	28vrx	VR7	6a	Mas
24A5	MAS9124AST5-T	LVR-IC	LDO, 1.5V, 150mA, +CE	SOT-23-5	28vrx	VR7	6a	Mas
24A6	MAS9124AST6-T	LVR-IC	LDO, 3V, 150mA, +CE	SOT-23-5	28vrx	VR7	6a	Mas
24A7	MAS9124AST7-T	LVR-IC	LDO, 2.9V, 150mA, +CE	SOT-23-5	28vrx	VR7	6a	Mas
24A8	MAS9124AST8-T	LVR-IC	LDO, 2.86V, 150mA, +CE	SOT-23-5	28vrx	VR7	6a	Mas
24A9	MAS9124AST9-T	LVR-IC	LDO, 2.7V, 150mA, +CE	SOT-23-5	28vrx	VR7	6a	Mas
24AA	MAS9124ASTA-T	LVR-IC	LDO, 2.3V, 150mA, +CE	SOT-23-5	28vrx	VR7	6a	Mas
24AB	MAS9124ASTB-T	LVR-IC	LDO, 2.4V, 150mA, +CE	SOT-23-5	28vrx	VR7	6a	Mas
24AC	MAS9124ASTC-T	LVR-IC	LDO, 2.6V, 150mA, +CE	SOT-23-5	28vrx	VR7	6a	Mas
24AD	MAS9124ASTD-T	LVR-IC	LDO, 3.1V, 150mA, +CE	SOT-23-5	28vrx	VR7	6a	Mas
24AF	MAS9124ASTF-T	LVR-IC	LDO, 4V, 150mA, +CE	SOT-23-5	28vrx	VR7	6a	Mas
24AG	MAS9124ASTF-T	LVR-IC	LDO, 5V, 150mA, +CE	SOT-23-5	28vrx	VR7	6a	Mas
24B	AAT60024B-S5	Vdet-IC	2.4V±2%, -Reset PPO	SOT-23-5	28vdo	VD3	6g	Aat
24B	XC6103A542MR	Vdet-IC	4.2V±2%, Hst, -MR, +Reset PPO, Wt=400ms, Rt=3.13ms	SOT-25	28cp	VD17	6g	Tor
24-B	UTC8124-B	Vdet-IC	2.4V, -Reset OCO	SOT-23-5	28vdm	VD6	6k	Utc
24C	AAT60024C-S5	Vdet-IC	2.4V±1%, -Reset ODO	SOT-23-5	28vdo	VD1	6g	Aat
24C	XC6103A543MR	Vdet-IC	4.3V±2%, Hst, -MR, +Reset PPO, Wt=400ms, Rt=3.13ms	SOT-25	28cp	VD17	6g	Tor
24D	AAT60024D-S5	Vdet-IC	2.4V±1%, -Reset PPO	SOT-23-5	28vdo	VD3	6g	Aat
24D	XC6103A544MR	Vdet-IC	4.4V±2%, Hst, -MR, +Reset PPO, Wt=400ms, Rt=3.13ms	SOT-25	28cp	VD17	6g	Tor
24E	XC6103A545MR	Vdet-IC	4.5V±2%, Hst, -MR, +Reset PPO, Wt=400ms, Rt=3.13ms	SOT-25	28cp	VD17	6g	Tor
24F	XC6103A516MR	Vdet-IC	1.6V±2%, Hst, -MR, +Reset PPO, Wt=400ms, Rt=3.13ms	SOT-25	28cp	VD17	6g	Tor
24F	XC6103A546MR	Vdet-IC	4.6V±2%, Hst, -MR, +Reset PPO, Wt=400ms, Rt=3.13ms	SOT-25	28cp	VD17	6g	Tor
24H	XC6103A517MR	Vdet-IC	1.7V±2%, Hst, -MR, +Reset PPO, Wt=400ms, Rt=3.13ms	SOT-25	28cp	VD17	6g	Tor
24H	XC6103A547MR	Vdet-IC	4.7V±2%, Hst, -MR, +Reset PPO, Wt=400ms, Rt=3.13ms	SOT-25	28cp	VD17	6g	Tor
24K	TK71724S	LVR-IC	LDO, 2.4V±1.5%, 300mA, +CE	SOT-23-5	28vrx	VR7	6k	Tok
24K	XC6103A518MR	Vdet-IC	1.8V±2%, Hst, -MR, +Reset PPO, Wt=400ms, Rt=3.13ms	SOT-25	28cp	VD17	6g	Tor
24K	XC6103A548MR	Vdet-IC	4.8V±2%, Hst, -MR, +Reset PPO, Wt=400ms, Rt=3.13ms	SOT-25	28cp	VD17	6g	Tor
24L	TK71624ASCL	LVR-IC	LDO, 2.4V±2%, 150mA, +CE, -30...+80°C	SOT-23-5	28vrx	VR7	6k	Tok
24L	XC6103A519MR	Vdet-IC	1.9V±2%, Hst, -MR, +Reset PPO, Wt=400ms, Rt=3.13ms	SOT-25	28cp	VD17	6g	Tor
24L	XC6103A549MR	Vdet-IC	4.9V±2%, Hst, -MR, +Reset PPO, Wt=400ms, Rt=3.13ms	SOT-25	28cp	VD17	6g	Tor
24M	XC6103A520MR	Vdet-IC	2.0V±2%, Hst, -MR, +Reset PPO, Wt=400ms, Rt=3.13ms	SOT-25	28cp	VD17	6g	Tor
24M	XC6103A550MR	Vdet-IC	5.0V±2%, Hst, -MR, +Reset PPO, Wt=400ms, Rt=3.13ms	SOT-25	28cp	VD17	6g	Tor
24N	XC6103A521MR	Vdet-IC	2.1V±2%, Hst, -MR, +Reset PPO, Wt=400ms, Rt=3.13ms	SOT-25	28cp	VD17	6g	Tor
24P	XC6103A522MR	Vdet-IC	2.2V±2%, Hst, -MR, +Reset PPO, Wt=400ms, Rt=3.13ms	SOT-25	28cp	VD17	6g	Tor
24R	XC6103A523MR	Vdet-IC	2.3V±2%, Hst, -MR, +Reset PPO, Wt=400ms, Rt=3.13ms	SOT-25	28cp	VD17	6g	Tor
24S	XC6103A524MR	Vdet-IC	2.4V±2%, Hst, -MR, +Reset PPO, Wt=400ms, Rt=3.13ms	SOT-25	28cp	VD17	6g	Tor
24T	TK71424S	LVR-IC	LDO, 2.4V±2%, 100mA, +CE, Ext. transistor	SOT-23-5	28zh	VR6	6a	Tok
24T	XC6103A525MR	Vdet-IC	2.5V±2%, Hst, -MR, +Reset PPO, Wt=400ms, Rt=3.13ms	SOT-25	28cp	VD17	6g	Tor



SMD code	Type	Function	Short description	Case	Pinout	Sch.	St.	Mnf.
24U	XC6103A526MR	Vdet-IC	2.6V±2%, Hst, -MR, +Reset PPO, Wt=400ms, Rt=3.13ms	SOT-25	28cp	VD17	6g	Tor
24V	XC6103A527MR	Vdet-IC	2.7V±2%, Hst, -MR, +Reset PPO, Wt=400ms, Rt=3.13ms	SOT-25	28cp	VD17	6g	Tor
24X	XC6103A528MR	Vdet-IC	2.8V±2%, Hst, -MR, +Reset PPO, Wt=400ms, Rt=3.13ms	SOT-25	28cp	VD17	6g	Tor
24Y	XC6103A529MR	Vdet-IC	2.9V±2%, Hst, -MR, +Reset PPO, Wt=400ms, Rt=3.13ms	SOT-25	28cp	VD17	6g	Tor
24Z	XC6103A530MR	Vdet-IC	3.0V±2%, Hst, -MR, +Reset PPO, Wt=400ms, Rt=3.13ms	SOT-25	28cp	VD17	6g	Tor
25	R1223N182E	DC/DC-IC	PWMVFM step-down, +CE, 1.8V, 300kHz, R-Pr.	SOT-23-5	28ud	DC7	6g	Ric
25	RN5RF25AA	LVR-IC	LRip, -CE, 2.5V±2%, 1A*	SOT-23-5	28wv	VR6	6g	Ric
25	RN5RZ25AA	LVR-IC	LDO, LN, -CE, 2.5V±2%, 100mA	SOT-23-5	28vrt	VR4	6g	Ric
250	R3112N501A	Vdet-IC	5V±2%, -Reset PPO	SOT-23-5	28vdo	VD3	6g	Ric
250	XC6103A631MR	Vdet-IC	3.1V±2%, Hst, -MR, +Reset PPO, Wt=1.6s, Rt=3.13ms	SOT-25	28cp	VD17	6g	Tor
251	XC6103A632MR	Vdet-IC	3.2V±2%, Hst, -MR, +Reset PPO, Wt=1.6s, Rt=3.13ms	SOT-25	28cp	VD17	6g	Tor
252	XC6103A633MR	Vdet-IC	3.3V±2%, Hst, -MR, +Reset PPO, Wt=1.6s, Rt=3.13ms	SOT-25	28cp	VD17	6g	Tor
253	XC6103A634MR	Vdet-IC	3.4V±2%, Hst, -MR, +Reset PPO, Wt=1.6s, Rt=3.13ms	SOT-25	28cp	VD17	6g	Tor
254	XC6103A635MR	Vdet-IC	3.5V±2%, Hst, -MR, +Reset PPO, Wt=1.6s, Rt=3.13ms	SOT-25	28cp	VD17	6g	Tor
255	XC6103A636MR	Vdet-IC	3.6V±2%, Hst, -MR, +Reset PPO, Wt=1.6s, Rt=3.13ms	SOT-25	28cp	VD17	6g	Tor
256	XC6103A637MR	Vdet-IC	3.7V±2%, Hst, -MR, +Reset PPO, Wt=1.6s, Rt=3.13ms	SOT-25	28cp	VD17	6g	Tor
257	XC6103A638MR	Vdet-IC	3.8V±2%, Hst, -MR, +Reset PPO, Wt=1.6s, Rt=3.13ms	SOT-25	28cp	VD17	6g	Tor
258	XC6103A639MR	Vdet-IC	3.9V±2%, Hst, -MR, +Reset PPO, Wt=1.6s, Rt=3.13ms	SOT-25	28cp	VD17	6g	Tor
259	XC6103A640MR	Vdet-IC	4.0V±2%, Hst, -MR, +Reset PPO, Wt=1.6s, Rt=3.13ms	SOT-25	28cp	VD17	6g	Tor
25A	AAT60025A-S5	Vdet-IC	2.5V±2%, -Reset ODO	SOT-23-5	28vdo	VD1	6g	Aat
25A	XC6103A641MR	Vdet-IC	4.1V±2%, Hst, -MR, +Reset PPO, Wt=1.6s, Rt=3.13ms	SOT-25	28cp	VD17	6g	Tor
25-A	UTC8125-A	Vdet-IC	2.5V, -Reset OCO	SOT-23-5	28vdz	VD6	6k	Utc
25B	AAT60025B-S5	Vdet-IC	2.5V±2%, -Reset PPO	SOT-23-5	28vdo	VD3	6g	Aat
25B	XC6103A642MR	Vdet-IC	4.2V±2%, Hst, -MR, +Reset PPO, Wt=1.6s, Rt=3.13ms	SOT-25	28cp	VD17	6g	Tor
25-B	UTC8125-B	Vdet-IC	2.5V, -Reset OCO	SOT-23-5	28vdm	VD6	6k	Utc
25C	AAT60025C-S5	Vdet-IC	2.5V±1%, -Reset ODO	SOT-23-5	28vdo	VD1	6g	Aat
25C	XC6103A643MR	Vdet-IC	4.3V±2%, Hst, -MR, +Reset PPO, Wt=1.6s, Rt=3.13ms	SOT-25	28cp	VD17	6g	Tor
25D	AAT60025D-S5	Vdet-IC	2.5V±1%, -Reset PPO	SOT-23-5	28vdo	VD3	6g	Aat
25D	XC6103A644MR	Vdet-IC	4.4V±2%, Hst, -MR, +Reset PPO, Wt=1.6s, Rt=3.13ms	SOT-25	28cp	VD17	6g	Tor
25E	XC6103A645MR	Vdet-IC	4.5V±2%, Hst, -MR, +Reset PPO, Wt=1.6s, Rt=3.13ms	SOT-25	28cp	VD17	6g	Tor
25F	XC6103A616MR	Vdet-IC	1.6V±2%, Hst, -MR, +Reset PPO, Wt=1.6s, Rt=3.13ms	SOT-25	28cp	VD17	6g	Tor
25F	XC6103A646MR	Vdet-IC	4.6V±2%, Hst, -MR, +Reset PPO, Wt=1.6s, Rt=3.13ms	SOT-25	28cp	VD17	6g	Tor
25H	XC6103A617MR	Vdet-IC	1.7V±2%, Hst, -MR, +Reset PPO, Wt=1.6s, Rt=3.13ms	SOT-25	28cp	VD17	6g	Tor
25H	XC6103A647MR	Vdet-IC	4.7V±2%, Hst, -MR, +Reset PPO, Wt=1.6s, Rt=3.13ms	SOT-25	28cp	VD17	6g	Tor
25K	TK71725S	LVR-IC	LDO, 2.5V±1.5%, 300mA, +CE	SOT-23-5	28vrx	VR7	6k	Tok
25K	XC6103A618MR	Vdet-IC	1.8V±2%, Hst, -MR, +Reset PPO, Wt=1.6s, Rt=3.13ms	SOT-25	28cp	VD17	6g	Tor
25K	XC6103A648MR	Vdet-IC	4.8V±2%, Hst, -MR, +Reset PPO, Wt=1.6s, Rt=3.13ms	SOT-25	28cp	VD17	6g	Tor
25L	TK71625ASCL	LVR-IC	LDO, 2.5V±2%, 150mA, +CE, -30, +80°C	SOT-23-5	28vrx	VR7	6k	Tok
25L	XC6103A619MR	Vdet-IC	1.9V±2%, Hst, -MR, +Reset PPO, Wt=1.6s, Rt=3.13ms	SOT-25	28cp	VD17	6g	Tor
25L	XC6103A649MR	Vdet-IC	4.9V±2%, Hst, -MR, +Reset PPO, Wt=1.6s, Rt=3.13ms	SOT-25	28cp	VD17	6g	Tor
25M	XC6103A620MR	Vdet-IC	2.0V±2%, Hst, -MR, +Reset PPO, Wt=1.6s, Rt=3.13ms	SOT-25	28cp	VD17	6g	Tor
25M	XC6103A650MR	Vdet-IC	5.0V±2%, Hst, -MR, +Reset PPO, Wt=1.6s, Rt=3.13ms	SOT-25	28cp	VD17	6g	Tor
25N	XC6103A621MR	Vdet-IC	2.1V±2%, Hst, -MR, +Reset PPO, Wt=1.6s, Rt=3.13ms	SOT-25	28cp	VD17	6g	Tor
25P	XC6103A622MR	Vdet-IC	2.2V±2%, Hst, -MR, +Reset PPO, Wt=1.6s, Rt=3.13ms	SOT-25	28cp	VD17	6g	Tor
25R	XC6103A623MR	Vdet-IC	2.3V±2%, Hst, -MR, +Reset PPO, Wt=1.6s, Rt=3.13ms	SOT-25	28cp	VD17	6g	Tor
25S	XC6103A624MR	Vdet-IC	2.4V±2%, Hst, -MR, +Reset PPO, Wt=1.6s, Rt=3.13ms	SOT-25	28cp	VD17	6g	Tor
25T	TK71425S	LVR-IC	LDO, 2.5V±2%, 100mA, +CE, Ext. transistor	SOT-23-5	28zh	VR6	6a	Tok
25T	XC6103A625MR	Vdet-IC	2.5V±2%, Hst, -MR, +Reset PPO, Wt=1.6s, Rt=3.13ms	SOT-25	28cp	VD17	6g	Tor
25U	TK61025S	Vdet-IC	2.5V±2%, -Reset PPO	SOT-23-5	28vdm	VD7	6a	Tok
25U	XC6103A626MR	Vdet-IC	2.6V±2%, Hst, -MR, +Reset PPO, Wt=1.6s, Rt=3.13ms	SOT-25	28cp	VD17	6g	Tor
25V	XC6103A627MR	Vdet-IC	2.7V±2%, Hst, -MR, +Reset PPO, Wt=1.6s, Rt=3.13ms	SOT-25	28cp	VD17	6g	Tor
25X	XC6103A628MR	Vdet-IC	2.8V±2%, Hst, -MR, +Reset PPO, Wt=1.6s, Rt=3.13ms	SOT-25	28cp	VD17	6g	Tor
25Y	XC6103A629MR	Vdet-IC	2.9V±2%, Hst, -MR, +Reset PPO, Wt=1.6s, Rt=3.13ms	SOT-25	28cp	VD17	6g	Tor
25Z	XC6103A630MR	Vdet-IC	3.0V±2%, Hst, -MR, +Reset PPO, Wt=1.6s, Rt=3.13ms	SOT-25	28cp	VD17	6g	Tor
26	R1223N252E	DC/DC-IC	PWMVFM step-down, +CE, 2.5V, 300kHz, R-Pr.	SOT-23-5	28ud	DC7	6g	Ric
26	RN5RF26AA	LVR-IC	LRip, -CE, 2.6V±2%, 1A*	SOT-23-5	28wv	VR6	6g	Ric
26	RN5RZ26AA	LVR-IC	LDO, LN, -CE, 2.6V±2%, 100mA	SOT-23-5	28vrt	VR4	6g	Ric
260	XC6103B231MR	Vdet-IC	3.1V±2%, Hst, -MR, +Reset PPO, Wt=50ms, Rt=25ms	SOT-25	28cp	VD17	6g	Tor
261	XC6103B232MR	Vdet-IC	3.2V±2%, Hst, -MR, +Reset PPO, Wt=50ms, Rt=25ms	SOT-25	28cp	VD17	6g	Tor
262	XC6103B233MR	Vdet-IC	3.3V±2%, Hst, -MR, +Reset PPO, Wt=50ms, Rt=25ms	SOT-25	28cp	VD17	6g	Tor
263	XC6103B234MR	Vdet-IC	3.4V±2%, Hst, -MR, +Reset PPO, Wt=50ms, Rt=25ms	SOT-25	28cp	VD17	6g	Tor
264	XC6103B235MR	Vdet-IC	3.5V±2%, Hst, -MR, +Reset PPO, Wt=50ms, Rt=25ms	SOT-25	28cp	VD17	6g	Tor
265	XC6103B236MR	Vdet-IC	3.6V±2%, Hst, -MR, +Reset PPO, Wt=50ms, Rt=25ms	SOT-25	28cp	VD17	6g	Tor
266	XC6103B237MR	Vdet-IC	3.7V±2%, Hst, -MR, +Reset PPO, Wt=50ms, Rt=25ms	SOT-25	28cp	VD17	6g	Tor
267	XC6103B238MR	Vdet-IC	3.8V±2%, Hst, -MR, +Reset PPO, Wt=50ms, Rt=25ms	SOT-25	28cp	VD17	6g	Tor
268	XC6103B239MR	Vdet-IC	3.9V±2%, Hst, -MR, +Reset PPO, Wt=50ms, Rt=25ms	SOT-25	28cp	VD17	6g	Tor
269	XC6103B240MR	Vdet-IC	4.0V±2%, Hst, -MR, +Reset PPO, Wt=50ms, Rt=25ms	SOT-25	28cp	VD17	6g	Tor
26A	AAT60026A-S5	Vdet-IC	2.6V±2%, -Reset ODO	SOT-23-5	28vdo	VD1	6g	Aat
26A	XC6103B241MR	Vdet-IC	4.1V±2%, Hst, -MR, +Reset PPO, Wt=50ms, Rt=25ms	SOT-25	28cp	VD17	6g	Tor
26-A	UTC8126-A	Vdet-IC	2.6V, -Reset OCO	SOT-23-5	28vdz	VD6	6k	Utc



SMD code	Type	Function	Short description	Case	Pinout	Sch.	St.	Mnf.
26B	AAT60026B-S5	Vdet-IC	2.6V±2%, -Reset PPO	SOT-23-5	28vdo	VD3	6g	Aat
26B	XC6103B242MR	Vdet-IC	4.2V±2%, Hst, -MR, +Reset PPO, Wt=50ms, Rt=25ms	SOT-25	28cp	VD17	6g	Tor
26-B	UTC8126-B	Vdet-IC	2.6V, -Reset OCO	SOT-23-5	28vdm	VD6	6k	Utc
26C	AAT60026C-S5	Vdet-IC	2.6V±1%, -Reset ODO	SOT-23-5	28vdo	VD1	6g	Aat
26C	XC6103B243MR	Vdet-IC	4.3V±2%, Hst, -MR, +Reset PPO, Wt=50ms, Rt=25ms	SOT-25	28cp	VD17	6g	Tor
26D	AAT60026D-S5	Vdet-IC	2.6V±1%, -Reset PPO	SOT-23-5	28vdo	VD3	6g	Aat
26D	XC6103B244MR	Vdet-IC	4.4V±2%, Hst, -MR, +Reset PPO, Wt=50ms, Rt=25ms	SOT-25	28cp	VD17	6g	Tor
26E	XC6103B245MR	Vdet-IC	4.5V±2%, Hst, -MR, +Reset PPO, Wt=50ms, Rt=25ms	SOT-25	28cp	VD17	6g	Tor
26F	XC6103B216MR	Vdet-IC	1.6V±2%, Hst, -MR, +Reset PPO, Wt=50ms, Rt=25ms	SOT-25	28cp	VD17	6g	Tor
26F	XC6103B246MR	Vdet-IC	4.6V±2%, Hst, -MR, +Reset PPO, Wt=50ms, Rt=25ms	SOT-25	28cp	VD17	6g	Tor
26H	XC6103B217MR	Vdet-IC	1.7V±2%, Hst, -MR, +Reset PPO, Wt=50ms, Rt=25ms	SOT-25	28cp	VD17	6g	Tor
26H	XC6103B247MR	Vdet-IC	4.7V±2%, Hst, -MR, +Reset PPO, Wt=50ms, Rt=25ms	SOT-25	28cp	VD17	6g	Tor
26K	TK71726S	LVR-IC	LDO, 2.6V±1.5%, 300mA, +CE	SOT-23-5	28vrx	VR7	6k	Tok
26K	XC6103B218MR	Vdet-IC	1.8V±2%, Hst, -MR, +Reset PPO, Wt=50ms, Rt=25ms	SOT-25	28cp	VD17	6g	Tor
26K	XC6103B248MR	Vdet-IC	4.8V±2%, Hst, -MR, +Reset PPO, Wt=50ms, Rt=25ms	SOT-25	28cp	VD17	6g	Tor
26L	TK71626ASCL	LVR-IC	LDO, 2.6V±2%, 150mA, +CE, -30...+80°C	SOT-23-5	28vrx	VR7	6k	Tok
26L	XC6103B219MR	Vdet-IC	1.9V±2%, Hst, -MR, +Reset PPO, Wt=50ms, Rt=25ms	SOT-25	28cp	VD17	6g	Tor
26L	XC6103B249MR	Vdet-IC	4.9V±2%, Hst, -MR, +Reset PPO, Wt=50ms, Rt=25ms	SOT-25	28cp	VD17	6g	Tor
26M	XC6103B220MR	Vdet-IC	2.0V±2%, Hst, -MR, +Reset PPO, Wt=50ms, Rt=25ms	SOT-25	28cp	VD17	6g	Tor
26M	XC6103B250MR	Vdet-IC	5.0V±2%, Hst, -MR, +Reset PPO, Wt=50ms, Rt=25ms	SOT-25	28cp	VD17	6g	Tor
26N	XC6103B221MR	Vdet-IC	2.1V±2%, Hst, -MR, +Reset PPO, Wt=50ms, Rt=25ms	SOT-25	28cp	VD17	6g	Tor
26P	XC6103B222MR	Vdet-IC	2.2V±2%, Hst, -MR, +Reset PPO, Wt=50ms, Rt=25ms	SOT-25	28cp	VD17	6g	Tor
26R	XC6103B223MR	Vdet-IC	2.3V±2%, Hst, -MR, +Reset PPO, Wt=50ms, Rt=25ms	SOT-25	28cp	VD17	6g	Tor
26S	XC6103B224MR	Vdet-IC	2.4V±2%, Hst, -MR, +Reset PPO, Wt=50ms, Rt=25ms	SOT-25	28cp	VD17	6g	Tor
26T	TK71426S	LVR-IC	LDO, 2.6V±2%, 100mA, +CE, Ext. transistor	SOT-23-5	28zh	VR6	6a	Tok
26T	XC6103B225MR	Vdet-IC	2.5V±2%, Hst, -MR, +Reset PPO, Wt=50ms, Rt=25ms	SOT-25	28cp	VD17	6g	Tor
26U	XC6103B226MR	Vdet-IC	2.6V±2%, Hst, -MR, +Reset PPO, Wt=50ms, Rt=25ms	SOT-25	28cp	VD17	6g	Tor
26V	XC6103B227MR	Vdet-IC	2.7V±2%, Hst, -MR, +Reset PPO, Wt=50ms, Rt=25ms	SOT-25	28cp	VD17	6g	Tor
26X	XC6103B228MR	Vdet-IC	2.8V±2%, Hst, -MR, +Reset PPO, Wt=50ms, Rt=25ms	SOT-25	28cp	VD17	6g	Tor
26Y	XC6103B229MR	Vdet-IC	2.9V±2%, Hst, -MR, +Reset PPO, Wt=50ms, Rt=25ms	SOT-25	28cp	VD17	6g	Tor
26Z	XC6103B230MR	Vdet-IC	3.0V±2%, Hst, -MR, +Reset PPO, Wt=50ms, Rt=25ms	SOT-25	28cp	VD17	6g	Tor
27	R1223N302E	DC/DC-IC	PWM/FM step-down, +CE, 3V, 300kHz, R-Pr.	SOT-23-5	28ud	DC7	6g	Ric
27	RN5RF27AA	LVR-IC	LRip, -CE, 2.7V±2%, 1A*	SOT-23-5	28vw	VR6	6g	Ric
27	RN5RZ27AA	LVR-IC	LDO, LN, -CE, 2.7V±2%, 100mA	SOT-23-5	28vr	VR4	6g	Ric
270	XC6103B331MR	Vdet-IC	3.1V±2%, Hst, -MR, +Reset PPO, Wt=100ms, Rt=25ms	SOT-25	28cp	VD17	6g	Tor
271	XC6103B332MR	Vdet-IC	3.2V±2%, Hst, -MR, +Reset PPO, Wt=100ms, Rt=25ms	SOT-25	28cp	VD17	6g	Tor
272	XC6103B333MR	Vdet-IC	3.3V±2%, Hst, -MR, +Reset PPO, Wt=100ms, Rt=25ms	SOT-25	28cp	VD17	6g	Tor
273	XC6103B334MR	Vdet-IC	3.4V±2%, Hst, -MR, +Reset PPO, Wt=100ms, Rt=25ms	SOT-25	28cp	VD17	6g	Tor
274	XC6103B335MR	Vdet-IC	3.5V±2%, Hst, -MR, +Reset PPO, Wt=100ms, Rt=25ms	SOT-25	28cp	VD17	6g	Tor
275	XC6103B336MR	Vdet-IC	3.6V±2%, Hst, -MR, +Reset PPO, Wt=100ms, Rt=25ms	SOT-25	28cp	VD17	6g	Tor
276	XC6103B337MR	Vdet-IC	3.7V±2%, Hst, -MR, +Reset PPO, Wt=100ms, Rt=25ms	SOT-25	28cp	VD17	6g	Tor
277	XC6103B338MR	Vdet-IC	3.8V±2%, Hst, -MR, +Reset PPO, Wt=100ms, Rt=25ms	SOT-25	28cp	VD17	6g	Tor
278	XC6103B339MR	Vdet-IC	3.9V±2%, Hst, -MR, +Reset PPO, Wt=100ms, Rt=25ms	SOT-25	28cp	VD17	6g	Tor
279	XC6103B340MR	Vdet-IC	4.0V±2%, Hst, -MR, +Reset PPO, Wt=100ms, Rt=25ms	SOT-25	28cp	VD17	6g	Tor
27A	AAT60027A-S5	Vdet-IC	2.7V±2%, -Reset ODO	SOT-23-5	28vdo	VD1	6g	Aat
27A	MAZK270D	Z-diode	Quad, 27V, Zzt=25Q(2mA), 200mW	SOT-23-5	28bc	-	6a	Pan
27A	XC6103B341MR	Vdet-IC	4.1V±2%, Hst, -MR, +Reset PPO, Wt=100ms, Rt=25ms	SOT-25	28cp	VD17	6g	Tor
27-A	UTC8127-A	Vdet-IC	2.7V, -Reset OCO	SOT-23-5	28vzd	VD6	6k	Utc
27B	AAT60027B-S5	Vdet-IC	2.7V±2%, -Reset PPO	SOT-23-5	28vdo	VD3	6g	Aat
27B	XC6103B342MR	Vdet-IC	4.2V±2%, Hst, -MR, +Reset PPO, Wt=100ms, Rt=25ms	SOT-25	28cp	VD17	6g	Tor
27-B	UTC8127-B	Vdet-IC	2.7V, -Reset OCO	SOT-23-5	28vdm	VD6	6k	Utc
27C	AAT60027C-S5	Vdet-IC	2.7V±1%, -Reset ODO	SOT-23-5	28vdo	VD1	6g	Aat
27C	XC6103B343MR	Vdet-IC	4.3V±2%, Hst, -MR, +Reset PPO, Wt=100ms, Rt=25ms	SOT-25	28cp	VD17	6g	Tor
27D	AAT60027D-S5	Vdet-IC	2.7V±1%, -Reset PPO	SOT-23-5	28vdo	VD3	6g	Aat
27D	XC6103B344MR	Vdet-IC	4.4V±2%, Hst, -MR, +Reset PPO, Wt=100ms, Rt=25ms	SOT-25	28cp	VD17	6g	Tor
27E	XC6103B345MR	Vdet-IC	4.5V±2%, Hst, -MR, +Reset PPO, Wt=100ms, Rt=25ms	SOT-25	28cp	VD17	6g	Tor
27F	XC6103B316MR	Vdet-IC	1.6V±2%, Hst, -MR, +Reset PPO, Wt=100ms, Rt=25ms	SOT-25	28cp	VD17	6g	Tor
27E	XC6103B346MR	Vdet-IC	4.6V±2%, Hst, -MR, +Reset PPO, Wt=100ms, Rt=25ms	SOT-25	28cp	VD17	6g	Tor
27H	XC6103B317MR	Vdet-IC	1.7V±2%, Hst, -MR, +Reset PPO, Wt=100ms, Rt=25ms	SOT-25	28cp	VD17	6g	Tor
27H	XC6103B347MR	Vdet-IC	4.7V±2%, Hst, -MR, +Reset PPO, Wt=100ms, Rt=25ms	SOT-25	28cp	VD17	6g	Tor
27K	TK71727S	LVR-IC	LDO, 2.7V±1.5%, 300mA, +CE	SOT-23-5	28vrx	VR7	6k	Tok
27K	XC6103B318MR	Vdet-IC	1.8V±2%, Hst, -MR, +Reset PPO, Wt=100ms, Rt=25ms	SOT-25	28cp	VD17	6g	Tor
27K	XC6103B348MR	Vdet-IC	4.8V±2%, Hst, -MR, +Reset PPO, Wt=100ms, Rt=25ms	SOT-25	28cp	VD17	6g	Tor
27L	TK71627ASCL	LVR-IC	LDO, 2.7V±2%, 150mA, +CE, -30...+80°C	SOT-23-5	28vrx	VR7	6k	Tok
27L	XC6103B319MR	Vdet-IC	1.9V±2%, Hst, -MR, +Reset PPO, Wt=100ms, Rt=25ms	SOT-25	28cp	VD17	6g	Tor
27L	XC6103B349MR	Vdet-IC	4.9V±2%, Hst, -MR, +Reset PPO, Wt=100ms, Rt=25ms	SOT-25	28cp	VD17	6g	Tor
27M	XC6103B320MR	Vdet-IC	2.0V±2%, Hst, -MR, +Reset PPO, Wt=100ms, Rt=25ms	SOT-25	28cp	VD17	6g	Tor
27M	XC6103B350MR	Vdet-IC	5.0V±2%, Hst, -MR, +Reset PPO, Wt=100ms, Rt=25ms	SOT-25	28cp	VD17	6g	Tor
27N	XC6103B321MR	Vdet-IC	2.1V±2%, Hst, -MR, +Reset PPO, Wt=100ms, Rt=25ms	SOT-25	28cp	VD17	6g	Tor
27P	XC6103B322MR	Vdet-IC	2.2V±2%, Hst, -MR, +Reset PPO, Wt=100ms, Rt=25ms	SOT-25	28cp	VD17	6g	Tor



SMD code	Type	Function	Short description	Case	Pinout	Sch.	St.	Mnf.
27R	XC6103B323MR	Vdet-IC	2.3V±2%, Hst, -MR, +Reset PPO, Wt=100ms, Rt=25ms	SOT-25	28cp	VD17	6g	Tor
27S	XC6103B324MR	Vdet-IC	2.4V±2%, Hst, -MR, +Reset PPO, Wt=100ms, Rt=25ms	SOT-25	28cp	VD17	6g	Tor
27T	TK71427S	LVR-IC	LDO, 2.7V±2%, 100mA, +CE, Ext. transistor	SOT-23-5	28zh	VR6	6a	Tok
27T	XC6103B325MR	Vdet-IC	2.5V±2%, Hst, -MR, +Reset PPO, Wt=100ms, Rt=25ms	SOT-25	28cp	VD17	6g	Tor
27U	TK61027S	Vdet-IC	2.7V±2%, -Reset PPO	SOT-23-5	28vdm	VD7	6a	Tok
27U	XC6103B326MR	Vdet-IC	2.6V±2%, Hst, -MR, +Reset PPO, Wt=100ms, Rt=25ms	SOT-25	28cp	VD17	6g	Tor
27V	XC6103B327MR	Vdet-IC	2.7V±2%, Hst, -MR, +Reset PPO, Wt=100ms, Rt=25ms	SOT-25	28cp	VD17	6g	Tor
27X	XC6103B328MR	Vdet-IC	2.8V±2%, Hst, -MR, +Reset PPO, Wt=100ms, Rt=25ms	SOT-25	28cp	VD17	6g	Tor
27Y	XC6103B329MR	Vdet-IC	2.9V±2%, Hst, -MR, +Reset PPO, Wt=100ms, Rt=25ms	SOT-25	28cp	VD17	6g	Tor
27Z	XC6103B330MR	Vdet-IC	3.0V±2%, Hst, -MR, +Reset PPO, Wt=100ms, Rt=25ms	SOT-25	28cp	VD17	6g	Tor
28	R1223N332E	DC/DC-IC	PWM/VFM step-down, +CE, 3.3V, 500kHz, R-Pr.	SOT-23-5	28ud	DC7	6g	Ric
28	RN5RF28AA	LVR-IC	LRip, -CE, 2.8V±2%, 1A*	SOT-23-5	28vw	VR6	6g	Ric
28	RN5RZ28AA	LVR-IC	LDO, LN, -CE, 2.8V±2%, 100mA	SOT-23-5	28vrt	VR4	6g	Ric
280	XC6103B431MR	Vdet-IC	3.1V±2%, Hst, -MR, +Reset PPO, Wt=200ms, Rt=25ms	SOT-25	28cp	VD17	6g	Tor
281	XC6103B432MR	Vdet-IC	3.2V±2%, Hst, -MR, +Reset PPO, Wt=200ms, Rt=25ms	SOT-25	28cp	VD17	6g	Tor
282	XC6103B433MR	Vdet-IC	3.3V±2%, Hst, -MR, +Reset PPO, Wt=200ms, Rt=25ms	SOT-25	28cp	VD17	6g	Tor
283	XC6103B434MR	Vdet-IC	3.4V±2%, Hst, -MR, +Reset PPO, Wt=200ms, Rt=25ms	SOT-25	28cp	VD17	6g	Tor
284	XC6103B435MR	Vdet-IC	3.5V±2%, Hst, -MR, +Reset PPO, Wt=200ms, Rt=25ms	SOT-25	28cp	VD17	6g	Tor
285	XC6103B436MR	Vdet-IC	3.6V±2%, Hst, -MR, +Reset PPO, Wt=200ms, Rt=25ms	SOT-25	28cp	VD17	6g	Tor
286	XC6103B437MR	Vdet-IC	3.7V±2%, Hst, -MR, +Reset PPO, Wt=200ms, Rt=25ms	SOT-25	28cp	VD17	6g	Tor
287	XC6103B438MR	Vdet-IC	3.8V±2%, Hst, -MR, +Reset PPO, Wt=200ms, Rt=25ms	SOT-25	28cp	VD17	6g	Tor
288	XC6103B439MR	Vdet-IC	3.9V±2%, Hst, -MR, +Reset PPO, Wt=200ms, Rt=25ms	SOT-25	28cp	VD17	6g	Tor
289	XC6103B440MR	Vdet-IC	4.0V±2%, Hst, -MR, +Reset PPO, Wt=200ms, Rt=25ms	SOT-25	28cp	VD17	6g	Tor
28A	AAT60028A-S5	Vdet-IC	2.8V±2%, -Reset ODO	SOT-23-5	28vdo	VD1	6g	Aat
28A	XC6103B441MR	Vdet-IC	4.1V±2%, Hst, -MR, +Reset PPO, Wt=200ms, Rt=25ms	SOT-25	28cp	VD17	6g	Tor
28-A	UTC8128-A	Vdet-IC	2.8V, -Reset OCO	SOT-23-5	28vdz	VD6	6k	Utc
28B	AAT60028B-S5	Vdet-IC	2.8V±2%, -Reset PPO	SOT-23-5	28vdo	VD3	6g	Aat
28B	XC6103B442MR	Vdet-IC	4.2V±2%, Hst, -MR, +Reset PPO, Wt=200ms, Rt=25ms	SOT-25	28cp	VD17	6g	Tor
28-B	UTC8128-B	Vdet-IC	2.8V, -Reset OCO	SOT-23-5	28vdm	VD6	6k	Utc
28C	AAT60028C-S5	Vdet-IC	2.8V±1%, -Reset ODO	SOT-23-5	28vdo	VD1	6g	Aat
28C	XC6103B443MR	Vdet-IC	4.3V±2%, Hst, -MR, +Reset PPO, Wt=200ms, Rt=25ms	SOT-25	28cp	VD17	6g	Tor
28D	AAT60028D-S5	Vdet-IC	2.8V±1%, -Reset PPO	SOT-23-5	28vdo	VD3	6g	Aat
28D	XC6103B444MR	Vdet-IC	4.4V±2%, Hst, -MR, +Reset PPO, Wt=200ms, Rt=25ms	SOT-25	28cp	VD17	6g	Tor
28E	XC6103B445MR	Vdet-IC	4.5V±2%, Hst, -MR, +Reset PPO, Wt=200ms, Rt=25ms	SOT-25	28cp	VD17	6g	Tor
28F	XC6103B446MR	Vdet-IC	1.6V±2%, Hst, -MR, +Reset PPO, Wt=200ms, Rt=25ms	SOT-25	28cp	VD17	6g	Tor
28F	XC6103B446MR	Vdet-IC	4.6V±2%, Hst, -MR, +Reset PPO, Wt=200ms, Rt=25ms	SOT-25	28cp	VD17	6g	Tor
28H	XC6103B447MR	Vdet-IC	1.7V±2%, Hst, -MR, +Reset PPO, Wt=200ms, Rt=25ms	SOT-25	28cp	VD17	6g	Tor
28H	XC6103B447MR	Vdet-IC	4.7V±2%, Hst, -MR, +Reset PPO, Wt=200ms, Rt=25ms	SOT-25	28cp	VD17	6g	Tor
28K	TK71728S	LVR-IC	LDO, 2.8V±1.5%, 300mA, +CE	SOT-23-5	28vrx	VR7	6k	Tok
28K	XC6103B418MR	Vdet-IC	1.8V±2%, Hst, -MR, +Reset PPO, Wt=200ms, Rt=25ms	SOT-25	28cp	VD17	6g	Tor
28K	XC6103B448MR	Vdet-IC	4.8V±2%, Hst, -MR, +Reset PPO, Wt=200ms, Rt=25ms	SOT-25	28cp	VD17	6g	Tor
28L	TK71628ASCL	LVR-IC	LDO, 2.8V±2%, 150mA, +CE, -30...+80°C	SOT-23-5	28vrx	VR7	6k	Tok
28L	XC6103B419MR	Vdet-IC	1.9V±2%, Hst, -MR, +Reset PPO, Wt=200ms, Rt=25ms	SOT-25	28cp	VD17	6g	Tor
28L	XC6103B449MR	Vdet-IC	4.9V±2%, Hst, -MR, +Reset PPO, Wt=200ms, Rt=25ms	SOT-25	28cp	VD17	6g	Tor
28M	XC6103B420MR	Vdet-IC	2.0V±2%, Hst, -MR, +Reset PPO, Wt=200ms, Rt=25ms	SOT-25	28cp	VD17	6g	Tor
28M	XC6103B450MR	Vdet-IC	5.0V±2%, Hst, -MR, +Reset PPO, Wt=200ms, Rt=25ms	SOT-25	28cp	VD17	6g	Tor
28N	XC6103B421MR	Vdet-IC	2.1V±2%, Hst, -MR, +Reset PPO, Wt=200ms, Rt=25ms	SOT-25	28cp	VD17	6g	Tor
28P	XC6103B422MR	Vdet-IC	2.2V±2%, Hst, -MR, +Reset PPO, Wt=200ms, Rt=25ms	SOT-25	28cp	VD17	6g	Tor
28R	XC6103B423MR	Vdet-IC	2.3V±2%, Hst, -MR, +Reset PPO, Wt=200ms, Rt=25ms	SOT-25	28cp	VD17	6g	Tor
28S	XC6103B424MR	Vdet-IC	2.4V±2%, Hst, -MR, +Reset PPO, Wt=200ms, Rt=25ms	SOT-25	28cp	VD17	6g	Tor
28T	TK71428S	LVR-IC	LDO, 2.8V±2%, 100mA, +CE, Ext. transistor	SOT-23-5	28zh	VR6	6a	Tok
28T	XC6103B425MR	Vdet-IC	2.5V±2%, Hst, -MR, +Reset PPO, Wt=200ms, Rt=25ms	SOT-25	28cp	VD17	6g	Tor
28U	XC6103B426MR	Vdet-IC	2.6V±2%, Hst, -MR, +Reset PPO, Wt=200ms, Rt=25ms	SOT-25	28cp	VD17	6g	Tor
28V	XC6103B427MR	Vdet-IC	2.7V±2%, Hst, -MR, +Reset PPO, Wt=200ms, Rt=25ms	SOT-25	28cp	VD17	6g	Tor
28X	XC6103B428MR	Vdet-IC	2.8V±2%, Hst, -MR, +Reset PPO, Wt=200ms, Rt=25ms	SOT-25	28cp	VD17	6g	Tor
28Y	XC6103B429MR	Vdet-IC	2.9V±2%, Hst, -MR, +Reset PPO, Wt=200ms, Rt=25ms	SOT-25	28cp	VD17	6g	Tor
28Z	XC6103B430MR	Vdet-IC	3.0V±2%, Hst, -MR, +Reset PPO, Wt=200ms, Rt=25ms	SOT-25	28cp	VD17	6g	Tor
29	R1223N502E	DC/DC-IC	PWM/VFM step-down, +CE, 5V, 300kHz, R-Pr.	SOT-23-5	28ud	DC7	6g	Ric
29	RN5RF29AA	LVR-IC	LRip, -CE, 2.9V±2%, 1A*	SOT-23-5	28vw	VR6	6g	Ric
29	RN5RZ29AA	LVR-IC	LDO, LN, -CE, 2.9V±2%, 100mA	SOT-23-5	28vrt	VR4	6g	Ric
290	XC6103B531MR	Vdet-IC	3.1V±2%, Hst, -MR, +Reset PPO, Wt=400ms, Rt=25ms	SOT-25	28cp	VD17	6g	Tor
291	XC6103B532MR	Vdet-IC	3.2V±2%, Hst, -MR, +Reset PPO, Wt=400ms, Rt=25ms	SOT-25	28cp	VD17	6g	Tor
292	XC6103B533MR	Vdet-IC	3.3V±2%, Hst, -MR, +Reset PPO, Wt=400ms, Rt=25ms	SOT-25	28cp	VD17	6g	Tor
293	XC6103B534MR	Vdet-IC	3.4V±2%, Hst, -MR, +Reset PPO, Wt=400ms, Rt=25ms	SOT-25	28cp	VD17	6g	Tor
294	XC6103B535MR	Vdet-IC	3.5V±2%, Hst, -MR, +Reset PPO, Wt=400ms, Rt=25ms	SOT-25	28cp	VD17	6g	Tor
295	XC6103B536MR	Vdet-IC	3.6V±2%, Hst, -MR, +Reset PPO, Wt=400ms, Rt=25ms	SOT-25	28cp	VD17	6g	Tor
296	XC6103B537MR	Vdet-IC	3.7V±2%, Hst, -MR, +Reset PPO, Wt=400ms, Rt=25ms	SOT-25	28cp	VD17	6g	Tor
297	XC6103B538MR	Vdet-IC	3.8V±2%, Hst, -MR, +Reset PPO, Wt=400ms, Rt=25ms	SOT-25	28cp	VD17	6g	Tor
298	XC6103B539MR	Vdet-IC	3.9V±2%, Hst, -MR, +Reset PPO, Wt=400ms, Rt=25ms	SOT-25	28cp	VD17	6g	Tor
299	XC6103B540MR	Vdet-IC	4.0V±2%, Hst, -MR, +Reset PPO, Wt=400ms, Rt=25ms	SOT-25	28cp	VD17	6g	Tor



SMD code	Type	Function	Short description	Case	Pinout	Sch.	St.	Mnf.
<u>29A</u>	AAT60029A-S5	Vdet-IC	2.9V±2%, -Reset ODO	SOT-23-5	28vdo	VD1	6g	Aat
<u>29A</u>	XC6103B541MR	Vdet-IC	4.1V±2%, Hst, -MR, +Reset PPO, Wt=400ms, Rt=25ms	SOT-25	28cp	VD17	6g	Tor
<u>29-A</u>	UTC8129-A	Vdet-IC	3.9V, -Reset OCO	SOT-23-5	28vdz	VD6	6k	Utc
<u>29B</u>	AAT60029B-S5	Vdet-IC	2.9V±2%, -Reset PPO	SOT-23-5	28vdo	VD3	6g	Aat
<u>29B</u>	XC6103B542MR	Vdet-IC	4.2V±2%, Hst, -MR, +Reset PPO, Wt=400ms, Rt=25ms	SOT-25	28cp	VD17	6g	Tor
<u>29-B</u>	UTC8129-B	Vdet-IC	3.9V, -Reset OCO	SOT-23-5	28vdm	VD6	6k	Utc
<u>29C</u>	AAT60029C-S5	Vdet-IC	2.9V±1%, -Reset ODO	SOT-23-5	28vdo	VD1	6g	Aat
<u>29C</u>	XC6103B543MR	Vdet-IC	4.3V±2%, Hst, -MR, +Reset PPO, Wt=400ms, Rt=25ms	SOT-25	28cp	VD17	6g	Tor
<u>29D</u>	AAT60029D-S5	Vdet-IC	2.9V±1%, -Reset PPO	SOT-23-5	28vdo	VD3	6g	Aat
<u>29D</u>	XC6103B544MR	Vdet-IC	4.4V±2%, Hst, -MR, +Reset PPO, Wt=400ms, Rt=25ms	SOT-25	28cp	VD17	6g	Tor
<u>29E</u>	XC6103B545MR	Vdet-IC	4.5V±2%, Hst, -MR, +Reset PPO, Wt=400ms, Rt=25ms	SOT-25	28cp	VD17	6g	Tor
<u>29F</u>	XC6103B516MR	Vdet-IC	1.6V±2%, Hst, -MR, +Reset PPO, Wt=400ms, Rt=25ms	SOT-25	28cp	VD17	6g	Tor
<u>29F</u>	XC6103B546MR	Vdet-IC	4.6V±2%, Hst, -MR, +Reset PPO, Wt=400ms, Rt=25ms	SOT-25	28cp	VD17	6g	Tor
<u>29H</u>	XC6103B517MR	Vdet-IC	1.7V±2%, Hst, -MR, +Reset PPO, Wt=400ms, Rt=25ms	SOT-25	28cp	VD17	6g	Tor
<u>29H</u>	XC6103B547MR	Vdet-IC	4.7V±2%, Hst, -MR, +Reset PPO, Wt=400ms, Rt=25ms	SOT-25	28cp	VD17	6g	Tor
<u>29K</u>	TK71729S	LVR-IC	LDO, 2.9V±1.5%, 300mA, +CE	SOT-23-5	28vrx	VR7	6k	Tok
<u>29K</u>	XC6103B518MR	Vdet-IC	1.8V±2%, Hst, -MR, +Reset PPO, Wt=400ms, Rt=25ms	SOT-25	28cp	VD17	6g	Tor
<u>29K</u>	XC6103B548MR	Vdet-IC	4.8V±2%, Hst, -MR, +Reset PPO, Wt=400ms, Rt=25ms	SOT-25	28cp	VD17	6g	Tor
<u>29L</u>	TK71629ASCL	LVR-IC	LDO, 2.9V±2%, 150mA, +CE, -30, +80°C	SOT-23-5	28vrx	VR7	6k	Tok
<u>29L</u>	XC6103B519MR	Vdet-IC	1.9V±2%, Hst, -MR, +Reset PPO, Wt=400ms, Rt=25ms	SOT-25	28cp	VD17	6g	Tor
<u>29L</u>	XC6103B549MR	Vdet-IC	4.9V±2%, Hst, -MR, +Reset PPO, Wt=400ms, Rt=25ms	SOT-25	28cp	VD17	6g	Tor
<u>29M</u>	XC6103B520MR	Vdet-IC	2.0V±2%, Hst, -MR, +Reset PPO, Wt=400ms, Rt=25ms	SOT-25	28cp	VD17	6g	Tor
<u>29M</u>	XC6103B550MR	Vdet-IC	5.0V±2%, Hst, -MR, +Reset PPO, Wt=400ms, Rt=25ms	SOT-25	28cp	VD17	6g	Tor
<u>29N</u>	XC6103B521MR	Vdet-IC	2.1V±2%, Hst, -MR, +Reset PPO, Wt=400ms, Rt=25ms	SOT-25	28cp	VD17	6g	Tor
<u>29P</u>	XC6103B522MR	Vdet-IC	2.2V±2%, Hst, -MR, +Reset PPO, Wt=400ms, Rt=25ms	SOT-25	28cp	VD17	6g	Tor
<u>29R</u>	XC6103B523MR	Vdet-IC	2.3V±2%, Hst, -MR, +Reset PPO, Wt=400ms, Rt=25ms	SOT-25	28cp	VD17	6g	Tor
<u>29S</u>	XC6103B524MR	Vdet-IC	2.4V±2%, Hst, -MR, +Reset PPO, Wt=400ms, Rt=25ms	SOT-25	28cp	VD17	6g	Tor
<u>29T</u>	TK71429S	LVR-IC	LDO, 2.9V±2%, 100mA, +CE, Ext. transistor	SOT-23-5	28zh	VR6	6a	Tok
<u>29T</u>	XC6103B525MR	Vdet-IC	2.5V±2%, Hst, -MR, +Reset PPO, Wt=400ms, Rt=25ms	SOT-25	28cp	VD17	6g	Tor
<u>29U</u>	XC6103B526MR	Vdet-IC	2.6V±2%, Hst, -MR, +Reset PPO, Wt=400ms, Rt=25ms	SOT-25	28cp	VD17	6g	Tor
<u>29U</u>	XC6103B527MR	Vdet-IC	2.7V±2%, Hst, -MR, +Reset PPO, Wt=400ms, Rt=25ms	SOT-25	28cp	VD17	6g	Tor
<u>29X</u>	XC6103B528MR	Vdet-IC	2.8V±2%, Hst, -MR, +Reset PPO, Wt=400ms, Rt=25ms	SOT-25	28cp	VD17	6g	Tor
<u>29Y</u>	XC6103B529MR	Vdet-IC	2.9V±2%, Hst, -MR, +Reset PPO, Wt=400ms, Rt=25ms	SOT-25	28cp	VD17	6g	Tor
<u>29Z</u>	XC6103B530MR	Vdet-IC	3.0V±2%, Hst, -MR, +Reset PPO, Wt=400ms, Rt=25ms	SOT-25	28cp	VD17	6g	Tor
<u>2A0</u>	XC2211A1200M	Op-IC	µPower, ±0.6.±5V, Icco=100µA, 550kHz, 0.5V/µs	SOT-25	28obp	OP1	6g	Tor
<u>2A0</u>	XC6103B631MR	Vdet-IC	3.1V±2%, Hst, -MR, +Reset PPO, Wt=1.6s, Rt=25ms	SOT-25	28cp	VD17	6g	Tor
<u>2A1</u>	XC6103B632MR	Vdet-IC	3.2V±2%, Hst, -MR, +Reset PPO, Wt=1.6s, Rt=25ms	SOT-25	28cp	VD17	6g	Tor
<u>2A2</u>	XC6103B633MR	Vdet-IC	3.3V±2%, Hst, -MR, +Reset PPO, Wt=1.6s, Rt=25ms	SOT-25	28cp	VD17	6g	Tor
<u>2A3</u>	XC6103B634MR	Vdet-IC	3.4V±2%, Hst, -MR, +Reset PPO, Wt=1.6s, Rt=25ms	SOT-25	28cp	VD17	6g	Tor
<u>2A4</u>	XC6103B635MR	Vdet-IC	3.5V±2%, Hst, -MR, +Reset PPO, Wt=1.6s, Rt=25ms	SOT-25	28cp	VD17	6g	Tor
<u>2A5</u>	XC6103B636MR	Vdet-IC	3.6V±2%, Hst, -MR, +Reset PPO, Wt=1.6s, Rt=25ms	SOT-25	28cp	VD17	6g	Tor
<u>2A6</u>	XC6103B637MR	Vdet-IC	3.7V±2%, Hst, -MR, +Reset PPO, Wt=1.6s, Rt=25ms	SOT-25	28cp	VD17	6g	Tor
<u>2A7</u>	XC6103B638MR	Vdet-IC	3.8V±2%, Hst, -MR, +Reset PPO, Wt=1.6s, Rt=25ms	SOT-25	28cp	VD17	6g	Tor
<u>2A8</u>	XC6103B639MR	Vdet-IC	3.9V±2%, Hst, -MR, +Reset PPO, Wt=1.6s, Rt=25ms	SOT-25	28cp	VD17	6g	Tor
<u>2A9</u>	XC6103B640MR	Vdet-IC	4.0V±2%, Hst, -MR, +Reset PPO, Wt=1.6s, Rt=25ms	SOT-25	28cp	VD17	6g	Tor
<u>2AA</u>	XC6103B641MR	Vdet-IC	4.1V±2%, Hst, -MR, +Reset PPO, Wt=1.6s, Rt=25ms	SOT-25	28cp	VD17	6g	Tor
<u>2AB</u>	XC6103B642MR	Vdet-IC	4.2V±2%, Hst, -MR, +Reset PPO, Wt=1.6s, Rt=25ms	SOT-25	28cp	VD17	6g	Tor
<u>2AC</u>	XC6103B643MR	Vdet-IC	4.3V±2%, Hst, -MR, +Reset PPO, Wt=1.6s, Rt=25ms	SOT-25	28cp	VD17	6g	Tor
<u>2AD</u>	XC6103B644MR	Vdet-IC	4.4V±2%, Hst, -MR, +Reset PPO, Wt=1.6s, Rt=25ms	SOT-25	28cp	VD17	6g	Tor
<u>2AE</u>	XC6103B645MR	Vdet-IC	4.5V±2%, Hst, -MR, +Reset PPO, Wt=1.6s, Rt=25ms	SOT-25	28cp	VD17	6g	Tor
<u>2AF</u>	XC6103B616MR	Vdet-IC	1.6V±2%, Hst, -MR, +Reset PPO, Wt=1.6s, Rt=25ms	SOT-25	28cp	VD17	6g	Tor
<u>2AF</u>	XC6103B646MR	Vdet-IC	4.6V±2%, Hst, -MR, +Reset PPO, Wt=1.6s, Rt=25ms	SOT-25	28cp	VD17	6g	Tor
<u>2AH</u>	XC6103B617MR	Vdet-IC	1.7V±2%, Hst, -MR, +Reset PPO, Wt=1.6s, Rt=25ms	SOT-25	28cp	VD17	6g	Tor
<u>2AH</u>	XC6103B647MR	Vdet-IC	4.7V±2%, Hst, -MR, +Reset PPO, Wt=1.6s, Rt=25ms	SOT-25	28cp	VD17	6g	Tor
<u>2AK</u>	XC6103B618MR	Vdet-IC	1.8V±2%, Hst, -MR, +Reset PPO, Wt=1.6s, Rt=25ms	SOT-25	28cp	VD17	6g	Tor
<u>2AK</u>	XC6103B648MR	Vdet-IC	4.8V±2%, Hst, -MR, +Reset PPO, Wt=1.6s, Rt=25ms	SOT-25	28cp	VD17	6g	Tor
<u>2AL</u>	XC6103B619MR	Vdet-IC	1.9V±2%, Hst, -MR, +Reset PPO, Wt=1.6s, Rt=25ms	SOT-25	28cp	VD17	6g	Tor
<u>2AL</u>	XC6103B649MR	Vdet-IC	4.9V±2%, Hst, -MR, +Reset PPO, Wt=1.6s, Rt=25ms	SOT-25	28cp	VD17	6g	Tor
<u>2AM</u>	XC6103B620MR	Vdet-IC	2.0V±2%, Hst, -MR, +Reset PPO, Wt=1.6s, Rt=25ms	SOT-25	28cp	VD17	6g	Tor
<u>2AM</u>	XC6103B650MR	Vdet-IC	5.0V±2%, Hst, -MR, +Reset PPO, Wt=1.6s, Rt=25ms	SOT-25	28cp	VD17	6g	Tor
<u>2AN</u>	XC6103B621MR	Vdet-IC	2.1V±2%, Hst, -MR, +Reset PPO, Wt=1.6s, Rt=25ms	SOT-25	28cp	VD17	6g	Tor
<u>2AP</u>	XC6103B622MR	Vdet-IC	2.2V±2%, Hst, -MR, +Reset PPO, Wt=1.6s, Rt=25ms	SOT-25	28cp	VD17	6g	Tor
<u>2AR</u>	XC6103B623MR	Vdet-IC	2.3V±2%, Hst, -MR, +Reset PPO, Wt=1.6s, Rt=25ms	SOT-25	28cp	VD17	6g	Tor
<u>2AS</u>	XC6103B624MR	Vdet-IC	2.4V±2%, Hst, -MR, +Reset PPO, Wt=1.6s, Rt=25ms	SOT-25	28cp	VD17	6g	Tor
<u>2AT</u>	XC6103B625MR	Vdet-IC	2.5V±2%, Hst, -MR, +Reset PPO, Wt=1.6s, Rt=25ms	SOT-25	28cp	VD17	6g	Tor
<u>2AU</u>	XC6103B626MR	Vdet-IC	2.6V±2%, Hst, -MR, +Reset PPO, Wt=1.6s, Rt=25ms	SOT-25	28cp	VD17	6g	Tor
<u>2AV</u>	XC6103B627MR	Vdet-IC	2.7V±2%, Hst, -MR, +Reset PPO, Wt=1.6s, Rt=25ms	SOT-25	28cp	VD17	6g	Tor
<u>2AX</u>	XC6103B628MR	Vdet-IC	2.8V±2%, Hst, -MR, +Reset PPO, Wt=1.6s, Rt=25ms	SOT-25	28cp	VD17	6g	Tor
<u>2AY</u>	XC6103B629MR	Vdet-IC	2.9V±2%, Hst, -MR, +Reset PPO, Wt=1.6s, Rt=25ms	SOT-25	28cp	VD17	6g	Tor
<u>2AZ</u>	XC6103B630MR	Vdet-IC	3.0V±2%, Hst, -MR, +Reset PPO, Wt=1.6s, Rt=25ms	SOT-25	28cp	VD17	6g	Tor



SMD code	Type	Function	Short description	Case	Pinout	Sch.	St.	Mnf.
2B	R3111N121A	Vdet-IC	1.2V±2%, -Reset PPO	SOT-23-5	28vdm	VD7	6g	Ric
2B	RN5RL22AA	LVR-IC	2.2V±2.5%, 150mA	SOT-23-5	28vu	VR1	6g	Ric
2B	RN5VD12CA	Vdet-IC	1.2V±2.5%, -Reset ODO	SOT-23-5	28vdo	VD1	6g	Ric
2B0	TAR5SB20	LVR-IC	LDO, 2V±1%, 200mA, +CE	SSOP-5	28vrx	VR7	6a	Tos
2B0	XC6103C231MR	Vdet-IC	3.1V±2%, Hst, -MR, +Reset PPO, Wt=50ms, Rt=50ms	SOT-25	28cp	VD17	6g	Tor
2B1	TAR5SB21	LVR-IC	LDO, 2.1V±1%, 200mA, +CE	SSOP-5	28vrx	VR7	6a	Tos
2B1	XC6103C232MR	Vdet-IC	3.2V±2%, Hst, -MR, +Reset PPO, Wt=50ms, Rt=50ms	SOT-25	28cp	VD17	6g	Tor
2B2	TAR5SB22	LVR-IC	LDO, 2.2V±1%, 200mA, +CE	SSOP-5	28vrx	VR7	6a	Tos
2B2	XC6103C233MR	Vdet-IC	3.3V±2%, Hst, -MR, +Reset PPO, Wt=50ms, Rt=50ms	SOT-25	28cp	VD17	6g	Tor
2B3	TAR5SB23	LVR-IC	LDO, 2.3V±1%, 200mA, +CE	SSOP-5	28vrx	VR7	6a	Tos
2B3	XC6103C234MR	Vdet-IC	3.4V±2%, Hst, -MR, +Reset PPO, Wt=50ms, Rt=50ms	SOT-25	28cp	VD17	6g	Tor
2B4	TAR5SB24	LVR-IC	LDO, 2.3V±1%, 200mA, +CE	SSOP-5	28vrx	VR7	6a	Tos
2B4	XC6103C235MR	Vdet-IC	3.5V±2%, Hst, -MR, +Reset PPO, Wt=50ms, Rt=50ms	SOT-25	28cp	VD17	6g	Tor
2B5	TAR5SB25	LVR-IC	LDO, 2.5V±1%, 200mA, +CE	SSOP-5	28vrx	VR7	6a	Tos
2B5	XC6103C236MR	Vdet-IC	3.6V±2%, Hst, -MR, +Reset PPO, Wt=50ms, Rt=50ms	SOT-25	28cp	VD17	6g	Tor
2B6	TAR5SB26	LVR-IC	LDO, 2.6V±1%, 200mA, +CE	SSOP-5	28vrx	VR7	6a	Tos
2B6	XC6103C237MR	Vdet-IC	3.7V±2%, Hst, -MR, +Reset PPO, Wt=50ms, Rt=50ms	SOT-25	28cp	VD17	6g	Tor
2B7	TAR5SB27	LVR-IC	LDO, 2.7V±1%, 200mA, +CE	SSOP-5	28vrx	VR7	6a	Tos
2B7	XC6103C238MR	Vdet-IC	3.8V±2%, Hst, -MR, +Reset PPO, Wt=50ms, Rt=50ms	SOT-25	28cp	VD17	6g	Tor
2B8	TAR5SB28	LVR-IC	LDO, 2.8V±1%, 200mA, +CE	SSOP-5	28vrx	VR7	6a	Tos
2B8	XC6103C239MR	Vdet-IC	3.9V±2%, Hst, -MR, +Reset PPO, Wt=50ms, Rt=50ms	SOT-25	28cp	VD17	6g	Tor
2B9	TAR5SB29	LVR-IC	LDO, 2.9V±1%, 200mA, +CE	SSOP-5	28vrx	VR7	6a	Tos
2B9	XC6103C240MR	Vdet-IC	4.0V±2%, Hst, -MR, +Reset PPO, Wt=50ms, Rt=50ms	SOT-25	28cp	VD17	6g	Tor
2BA	XC6103C241MR	Vdet-IC	4.1V±2%, Hst, -MR, +Reset PPO, Wt=50ms, Rt=50ms	SOT-25	28cp	VD17	6g	Tor
2BA	XC6103C242MR	Vdet-IC	4.2V±2%, Hst, -MR, +Reset PPO, Wt=50ms, Rt=50ms	SOT-25	28cp	VD17	6g	Tor
2BC	XC6103C243MR	Vdet-IC	4.3V±2%, Hst, -MR, +Reset PPO, Wt=50ms, Rt=50ms	SOT-25	28cp	VD17	6g	Tor
2BD	XC6103C244MR	Vdet-IC	4.4V±2%, Hst, -MR, +Reset PPO, Wt=50ms, Rt=50ms	SOT-25	28cp	VD17	6g	Tor
2BE	XC6103C245MR	Vdet-IC	4.5V±2%, Hst, -MR, +Reset PPO, Wt=50ms, Rt=50ms	SOT-25	28cp	VD17	6g	Tor
2BF	XC6103C216MR	Vdet-IC	1.6V±2%, Hst, -MR, +Reset PPO, Wt=50ms, Rt=50ms	SOT-25	28cp	VD17	6g	Tor
2BF	XC6103C246MR	Vdet-IC	4.6V±2%, Hst, -MR, +Reset PPO, Wt=50ms, Rt=50ms	SOT-25	28cp	VD17	6g	Tor
2BH	XC6103C217MR	Vdet-IC	1.7V±2%, Hst, -MR, +Reset PPO, Wt=50ms, Rt=50ms	SOT-25	28cp	VD17	6g	Tor
2BH	XC6103C247MR	Vdet-IC	4.7V±2%, Hst, -MR, +Reset PPO, Wt=50ms, Rt=50ms	SOT-25	28cp	VD17	6g	Tor
2BK	XC6103C218MR	Vdet-IC	1.8V±2%, Hst, -MR, +Reset PPO, Wt=50ms, Rt=50ms	SOT-25	28cp	VD17	6g	Tor
2BK	XC6103C248MR	Vdet-IC	4.8V±2%, Hst, -MR, +Reset PPO, Wt=50ms, Rt=50ms	SOT-25	28cp	VD17	6g	Tor
2BL	XC6103C219MR	Vdet-IC	1.9V±2%, Hst, -MR, +Reset PPO, Wt=50ms, Rt=50ms	SOT-25	28cp	VD17	6g	Tor
2BL	XC6103C249MR	Vdet-IC	4.9V±2%, Hst, -MR, +Reset PPO, Wt=50ms, Rt=50ms	SOT-25	28cp	VD17	6g	Tor
2BM	XC6103C220MR	Vdet-IC	2.0V±2%, Hst, -MR, +Reset PPO, Wt=50ms, Rt=50ms	SOT-25	28cp	VD17	6g	Tor
2BM	XC6103C250MR	Vdet-IC	5.0V±2%, Hst, -MR, +Reset PPO, Wt=50ms, Rt=50ms	SOT-25	28cp	VD17	6g	Tor
2BN	XC6103C221MR	Vdet-IC	2.1V±2%, Hst, -MR, +Reset PPO, Wt=50ms, Rt=50ms	SOT-25	28cp	VD17	6g	Tor
2BP	XC6103C222MR	Vdet-IC	2.2V±2%, Hst, -MR, +Reset PPO, Wt=50ms, Rt=50ms	SOT-25	28cp	VD17	6g	Tor
2BR	XC6103C223MR	Vdet-IC	2.3V±2%, Hst, -MR, +Reset PPO, Wt=50ms, Rt=50ms	SOT-25	28cp	VD17	6g	Tor
2BS	XC6103C224MR	Vdet-IC	2.4V±2%, Hst, -MR, +Reset PPO, Wt=50ms, Rt=50ms	SOT-25	28cp	VD17	6g	Tor
2BT	XC6103C225MR	Vdet-IC	2.5V±2%, Hst, -MR, +Reset PPO, Wt=50ms, Rt=50ms	SOT-25	28cp	VD17	6g	Tor
2BU	XC6103C226MR	Vdet-IC	2.6V±2%, Hst, -MR, +Reset PPO, Wt=50ms, Rt=50ms	SOT-25	28cp	VD17	6g	Tor
2BV	XC6103C227MR	Vdet-IC	2.7V±2%, Hst, -MR, +Reset PPO, Wt=50ms, Rt=50ms	SOT-25	28cp	VD17	6g	Tor
2BX	XC6103C228MR	Vdet-IC	2.8V±2%, Hst, -MR, +Reset PPO, Wt=50ms, Rt=50ms	SOT-25	28cp	VD17	6g	Tor
2BY	XC6103C229MR	Vdet-IC	2.9V±2%, Hst, -MR, +Reset PPO, Wt=50ms, Rt=50ms	SOT-25	28cp	VD17	6g	Tor
2BZ	XC6103C230MR	Vdet-IC	3.0V±2%, Hst, -MR, +Reset PPO, Wt=50ms, Rt=50ms	SOT-25	28cp	VD17	6g	Tor
2C	R3111N221A	Vdet-IC	2.2V±2%, -Reset PPO	SOT-23-5	28vdm	VD7	6g	Ric
2C	RN5RL32AA	LVR-IC	3.2V±2.5%, 150mA	SOT-23-5	28vu	VR1	6g	Ric
2C	RN5VD22CA	Vdet-IC	2.2V±2.5%, -Reset ODO	SOT-23-5	28vdo	VD1	6g	Ric
2C0	XC6103C331MR	Vdet-IC	3.1V±2%, Hst, -MR, +Reset PPO, Wt=100ms, Rt=50ms	SOT-25	28cp	VD17	6g	Tor
2C1	XC6103C332MR	Vdet-IC	3.2V±2%, Hst, -MR, +Reset PPO, Wt=100ms, Rt=50ms	SOT-25	28cp	VD17	6g	Tor
2C2	XC6103C333MR	Vdet-IC	3.3V±2%, Hst, -MR, +Reset PPO, Wt=100ms, Rt=50ms	SOT-25	28cp	VD17	6g	Tor
2C3	XC6103C334MR	Vdet-IC	3.4V±2%, Hst, -MR, +Reset PPO, Wt=100ms, Rt=50ms	SOT-25	28cp	VD17	6g	Tor
2C4	XC6103C335MR	Vdet-IC	3.5V±2%, Hst, -MR, +Reset PPO, Wt=100ms, Rt=50ms	SOT-25	28cp	VD17	6g	Tor
2C5	XC6103C336MR	Vdet-IC	3.6V±2%, Hst, -MR, +Reset PPO, Wt=100ms, Rt=50ms	SOT-25	28cp	VD17	6g	Tor
2C6	XC6103C337MR	Vdet-IC	3.7V±2%, Hst, -MR, +Reset PPO, Wt=100ms, Rt=50ms	SOT-25	28cp	VD17	6g	Tor
2C7	XC6103C338MR	Vdet-IC	3.8V±2%, Hst, -MR, +Reset PPO, Wt=100ms, Rt=50ms	SOT-25	28cp	VD17	6g	Tor
2C8	XC6103C339MR	Vdet-IC	3.9V±2%, Hst, -MR, +Reset PPO, Wt=100ms, Rt=50ms	SOT-25	28cp	VD17	6g	Tor
2C9	XC6103C340MR	Vdet-IC	4.0V±2%, Hst, -MR, +Reset PPO, Wt=100ms, Rt=50ms	SOT-25	28cp	VD17	6g	Tor
2CA	XC6103C341MR	Vdet-IC	4.1V±2%, Hst, -MR, +Reset PPO, Wt=100ms, Rt=50ms	SOT-25	28cp	VD17	6g	Tor
2CB	XC6103C342MR	Vdet-IC	4.2V±2%, Hst, -MR, +Reset PPO, Wt=100ms, Rt=50ms	SOT-25	28cp	VD17	6g	Tor
2CC	XC6103C343MR	Vdet-IC	4.3V±2%, Hst, -MR, +Reset PPO, Wt=100ms, Rt=50ms	SOT-25	28cp	VD17	6g	Tor
2CD	XC6103C344MR	Vdet-IC	4.4V±2%, Hst, -MR, +Reset PPO, Wt=100ms, Rt=50ms	SOT-25	28cp	VD17	6g	Tor
2CE	XC6103C345MR	Vdet-IC	4.5V±2%, Hst, -MR, +Reset PPO, Wt=100ms, Rt=50ms	SOT-25	28cp	VD17	6g	Tor
2CF	XC6103C316MR	Vdet-IC	1.6V±2%, Hst, -MR, +Reset PPO, Wt=100ms, Rt=50ms	SOT-25	28cp	VD17	6g	Tor
2CF	XC6103C346MR	Vdet-IC	4.6V±2%, Hst, -MR, +Reset PPO, Wt=100ms, Rt=50ms	SOT-25	28cp	VD17	6g	Tor
2CH	XC6103C317MR	Vdet-IC	1.7V±2%, Hst, -MR, +Reset PPO, Wt=100ms, Rt=50ms	SOT-25	28cp	VD17	6g	Tor
2CH	XC6103C347MR	Vdet-IC	4.7V±2%, Hst, -MR, +Reset PPO, Wt=100ms, Rt=50ms	SOT-25	28cp	VD17	6g	Tor



SMD code	Type	Function	Short description	Case	Pinout	Sch.	St.	Mnf.
<u>2U0</u>	XC6103F631MR	Vdet-IC	3.1V±2%, Hst, -MR, +Reset PPO, Wt=1.6s, Rt=400ms	SOT-25	28cp	VD17	6g	Tor
<u>2U1</u>	XC6103F632MR	Vdet-IC	3.2V±2%, Hst, -MR, +Reset PPO, Wt=1.6s, Rt=400ms	SOT-25	28cp	VD17	6g	Tor
<u>2U2</u>	XC6103F633MR	Vdet-IC	3.3V±2%, Hst, -MR, +Reset PPO, Wt=1.6s, Rt=400ms	SOT-25	28cp	VD17	6g	Tor
<u>2U3</u>	XC6103F634MR	Vdet-IC	3.4V±2%, Hst, -MR, +Reset PPO, Wt=1.6s, Rt=400ms	SOT-25	28cp	VD17	6g	Tor
<u>2U4</u>	XC6103F635MR	Vdet-IC	3.5V±2%, Hst, -MR, +Reset PPO, Wt=1.6s, Rt=400ms	SOT-25	28cp	VD17	6g	Tor
<u>2U5</u>	XC6103F636MR	Vdet-IC	3.6V±2%, Hst, -MR, +Reset PPO, Wt=1.6s, Rt=400ms	SOT-25	28cp	VD17	6g	Tor
<u>2U6</u>	XC6103F637MR	Vdet-IC	3.7V±2%, Hst, -MR, +Reset PPO, Wt=1.6s, Rt=400ms	SOT-25	28cp	VD17	6g	Tor
<u>2U7</u>	XC6103F638MR	Vdet-IC	3.8V±2%, Hst, -MR, +Reset PPO, Wt=1.6s, Rt=400ms	SOT-25	28cp	VD17	6g	Tor
<u>2U8</u>	XC6103F639MR	Vdet-IC	3.9V±2%, Hst, -MR, +Reset PPO, Wt=1.6s, Rt=400ms	SOT-25	28cp	VD17	6g	Tor
<u>2U9</u>	XC6103F640MR	Vdet-IC	4.0V±2%, Hst, -MR, +Reset PPO, Wt=1.6s, Rt=400ms	SOT-25	28cp	VD17	6g	Tor
<u>2UA</u>	XC6103F641MR	Vdet-IC	4.1V±2%, Hst, -MR, +Reset PPO, Wt=1.6s, Rt=400ms	SOT-25	28cp	VD17	6g	Tor
<u>2UB</u>	XC6103F642MR	Vdet-IC	4.2V±2%, Hst, -MR, +Reset PPO, Wt=1.6s, Rt=400ms	SOT-25	28cp	VD17	6g	Tor
<u>2UC</u>	XC6103F643MR	Vdet-IC	4.3V±2%, Hst, -MR, +Reset PPO, Wt=1.6s, Rt=400ms	SOT-25	28cp	VD17	6g	Tor
<u>2UD</u>	XC6103F644MR	Vdet-IC	4.4V±2%, Hst, -MR, +Reset PPO, Wt=1.6s, Rt=400ms	SOT-25	28cp	VD17	6g	Tor
<u>2UE</u>	XC6103F645MR	Vdet-IC	4.5V±2%, Hst, -MR, +Reset PPO, Wt=1.6s, Rt=400ms	SOT-25	28cp	VD17	6g	Tor
<u>2UF</u>	XC6103F616MR	Vdet-IC	1.6V±2%, Hst, -MR, +Reset PPO, Wt=1.6s, Rt=400ms	SOT-25	28cp	VD17	6g	Tor
<u>2UF</u>	XC6103F646MR	Vdet-IC	4.6V±2%, Hst, -MR, +Reset PPO, Wt=1.6s, Rt=400ms	SOT-25	28cp	VD17	6g	Tor
<u>2UH</u>	XC6103F617MR	Vdet-IC	1.7V±2%, Hst, -MR, +Reset PPO, Wt=1.6s, Rt=400ms	SOT-25	28cp	VD17	6g	Tor
<u>2UH</u>	XC6103F647MR	Vdet-IC	4.7V±2%, Hst, -MR, +Reset PPO, Wt=1.6s, Rt=400ms	SOT-25	28cp	VD17	6g	Tor
<u>2UK</u>	XC6103F618MR	Vdet-IC	1.8V±2%, Hst, -MR, +Reset PPO, Wt=1.6s, Rt=400ms	SOT-25	28cp	VD17	6g	Tor
<u>2UK</u>	XC6103F648MR	Vdet-IC	4.8V±2%, Hst, -MR, +Reset PPO, Wt=1.6s, Rt=400ms	SOT-25	28cp	VD17	6g	Tor
<u>2UL</u>	XC6103F619MR	Vdet-IC	1.9V±2%, Hst, -MR, +Reset PPO, Wt=1.6s, Rt=400ms	SOT-25	28cp	VD17	6g	Tor
<u>2UL</u>	XC6103F649MR	Vdet-IC	4.9V±2%, Hst, -MR, +Reset PPO, Wt=1.6s, Rt=400ms	SOT-25	28cp	VD17	6g	Tor
<u>2UM</u>	XC6103F620MR	Vdet-IC	2.0V±2%, Hst, -MR, +Reset PPO, Wt=1.6s, Rt=400ms	SOT-25	28cp	VD17	6g	Tor
<u>2UM</u>	XC6103F650MR	Vdet-IC	5.0V±2%, Hst, -MR, +Reset PPO, Wt=1.6s, Rt=400ms	SOT-25	28cp	VD17	6g	Tor
<u>2UN</u>	XC6103F621MR	Vdet-IC	2.1V±2%, Hst, -MR, +Reset PPO, Wt=1.6s, Rt=400ms	SOT-25	28cp	VD17	6g	Tor
<u>2UR</u>	XC6103F622MR	Vdet-IC	2.2V±2%, Hst, -MR, +Reset PPO, Wt=1.6s, Rt=400ms	SOT-25	28cp	VD17	6g	Tor
<u>2UR</u>	XC6103F623MR	Vdet-IC	2.3V±2%, Hst, -MR, +Reset PPO, Wt=1.6s, Rt=400ms	SOT-25	28cp	VD17	6g	Tor
<u>2US</u>	XC6103F624MR	Vdet-IC	2.4V±2%, Hst, -MR, +Reset PPO, Wt=1.6s, Rt=400ms	SOT-25	28cp	VD17	6g	Tor
<u>2UT</u>	XC6103F625MR	Vdet-IC	2.5V±2%, Hst, -MR, +Reset PPO, Wt=1.6s, Rt=400ms	SOT-25	28cp	VD17	6g	Tor
<u>2UU</u>	XC6103F626MR	Vdet-IC	2.6V±2%, Hst, -MR, +Reset PPO, Wt=1.6s, Rt=400ms	SOT-25	28cp	VD17	6g	Tor
<u>2UV</u>	XC6103F627MR	Vdet-IC	2.7V±2%, Hst, -MR, +Reset PPO, Wt=1.6s, Rt=400ms	SOT-25	28cp	VD17	6g	Tor
<u>2UX</u>	XC6103F628MR	Vdet-IC	2.8V±2%, Hst, -MR, +Reset PPO, Wt=1.6s, Rt=400ms	SOT-25	28cp	VD17	6g	Tor
<u>2UY</u>	XC6103F629MR	Vdet-IC	2.9V±2%, Hst, -MR, +Reset PPO, Wt=1.6s, Rt=400ms	SOT-25	28cp	VD17	6g	Tor
<u>2UZ</u>	XC6103F630MR	Vdet-IC	3.0V±2%, Hst, -MR, +Reset PPO, Wt=1.6s, Rt=400ms	SOT-25	28cp	VD17	6g	Tor
<u>2V0</u>	TAR5S20	LVR-IC	LDO, 2V±1%, 200mA, +CE	SSOP-5	28un	VR7	6a	Tos
<u>2V0</u>	TAR5S20U	LVR-IC	LDO, 2V±1%, 200mA, +CE	SSOP-5-P	30un	VR7	6a	Tos
<u>2V0</u>	XC6103H631MR	Vdet-IC	3.1V±2%, Hst, -MR, +Reset PPO, Wt=1.6s, Rt=1.6s	SOT-25	28cp	VD17	6g	Tor
<u>2V1</u>	TAR5S21	LVR-IC	LDO, 2.1V±1%, 200mA, +CE	SSOP-5	28un	VR7	6a	Tos
<u>2V1</u>	TAR5S21U	LVR-IC	LDO, 2.1V±1%, 200mA, +CE	SSOP-5-P	30un	VR7	6a	Tos
<u>2V1</u>	XC6103H632MR	Vdet-IC	3.2V±2%, Hst, -MR, +Reset PPO, Wt=1.6s, Rt=1.6s	SOT-25	28cp	VD17	6g	Tor
<u>2V2</u>	TAR5S22	LVR-IC	LDO, 2.2V±1%, 200mA, +CE	SSOP-5	28un	VR7	6a	Tos
<u>2V2</u>	TAR5S22U	LVR-IC	LDO, 2.2V±1%, 200mA, +CE	SSOP-5-P	30un	VR7	6a	Tos
<u>2V2</u>	XC6103H633MR	Vdet-IC	3.3V±2%, Hst, -MR, +Reset PPO, Wt=1.6s, Rt=1.6s	SOT-25	28cp	VD17	6g	Tor
<u>2V3</u>	TAR5S23	LVR-IC	LDO, 2.3V±1%, 200mA, +CE	SSOP-5	28un	VR7	6a	Tos
<u>2V3</u>	TAR5S23U	LVR-IC	LDO, 2.3V±1%, 200mA, +CE	SSOP-5-P	30un	VR7	6a	Tos
<u>2V3</u>	XC6103H634MR	Vdet-IC	3.4V±2%, Hst, -MR, +Reset PPO, Wt=1.6s, Rt=1.6s	SOT-25	28cp	VD17	6g	Tor
<u>2V4</u>	TAR5S24	LVR-IC	LDO, 2.3V±1%, 200mA, +CE	SSOP-5	28un	VR7	6a	Tos
<u>2V4</u>	TAR5S24U	LVR-IC	LDO, 2.3V±1%, 200mA, +CE	SSOP-5-P	30un	VR7	6a	Tos
<u>2V4</u>	XC6103H635MR	Vdet-IC	3.5V±2%, Hst, -MR, +Reset PPO, Wt=1.6s, Rt=1.6s	SOT-25	28cp	VD17	6g	Tor
<u>2V5</u>	TAR5S25	LVR-IC	LDO, 2.5V±1%, 200mA, +CE	SSOP-5	28un	VR7	6a	Tos
<u>2V5</u>	TAR5S25U	LVR-IC	LDO, 2.5V±1%, 200mA, +CE	SSOP-5-P	30un	VR7	6a	Tos
<u>2V5</u>	XC6103H636MR	Vdet-IC	3.6V±2%, Hst, -MR, +Reset PPO, Wt=1.6s, Rt=1.6s	SOT-25	28cp	VD17	6g	Tor
<u>2V6</u>	TAR5S26	LVR-IC	LDO, 2.6V±1%, 200mA, +CE	SSOP-5	28un	VR7	6a	Tos
<u>2V6</u>	TAR5S26U	LVR-IC	LDO, 2.6V±1%, 200mA, +CE	SSOP-5-P	30un	VR7	6a	Tos
<u>2V6</u>	XC6103H637MR	Vdet-IC	3.7V±2%, Hst, -MR, +Reset PPO, Wt=1.6s, Rt=1.6s	SOT-25	28cp	VD17	6g	Tor
<u>2V7</u>	TAR5S27	LVR-IC	LDO, 2.7V±1%, 200mA, +CE	SSOP-5	28un	VR7	6a	Tos
<u>2V7</u>	TAR5S27U	LVR-IC	LDO, 2.7V±1%, 200mA, +CE	SSOP-5-P	30un	VR7	6a	Tos
<u>2V7</u>	XC6103H638MR	Vdet-IC	3.8V±2%, Hst, -MR, +Reset PPO, Wt=1.6s, Rt=1.6s	SOT-25	28cp	VD17	6g	Tor
<u>2V8</u>	TAR5S28	LVR-IC	LDO, 2.8V±1%, 200mA, +CE	SSOP-5	28un	VR7	6a	Tos
<u>2V8</u>	TAR5S28U	LVR-IC	LDO, 2.8V±1%, 200mA, +CE	SSOP-5-P	30un	VR7	6a	Tos
<u>2V8</u>	XC6103H639MR	Vdet-IC	3.9V±2%, Hst, -MR, +Reset PPO, Wt=1.6s, Rt=1.6s	SOT-25	28cp	VD17	6g	Tor
<u>2V9</u>	TAR5S29	LVR-IC	LDO, 2.9V±1%, 200mA, +CE	SSOP-5	28un	VR7	6a	Tos
<u>2V9</u>	TAR5S29U	LVR-IC	LDO, 2.9V±1%, 200mA, +CE	SSOP-5-P	30un	VR7	6a	Tos
<u>2V9</u>	XC6103H640MR	Vdet-IC	4.0V±2%, Hst, -MR, +Reset PPO, Wt=1.6s, Rt=1.6s	SOT-25	28cp	VD17	6g	Tor
<u>2VA</u>	XC6103H641MR	Vdet-IC	4.1V±2%, Hst, -MR, +Reset PPO, Wt=1.6s, Rt=1.6s	SOT-25	28cp	VD17	6g	Tor
<u>2VB</u>	XC6103H642MR	Vdet-IC	4.2V±2%, Hst, -MR, +Reset PPO, Wt=1.6s, Rt=1.6s	SOT-25	28cp	VD17	6g	Tor
<u>2VC</u>	XC6103H643MR	Vdet-IC	4.3V±2%, Hst, -MR, +Reset PPO, Wt=1.6s, Rt=1.6s	SOT-25	28cp	VD17	6g	Tor
<u>2VD</u>	XC6103H644MR	Vdet-IC	4.4V±2%, Hst, -MR, +Reset PPO, Wt=1.6s, Rt=1.6s	SOT-25	28cp	VD17	6g	Tor
<u>2VE</u>	XC6103H645MR	Vdet-IC	4.5V±2%, Hst, -MR, +Reset PPO, Wt=1.6s, Rt=1.6s	SOT-25	28cp	VD17	6g	Tor



SMD code	Type	Function	Short description	Case	Pinout	Sch.	St.	Mnf.
<u>2V</u> F	XC6103H616MR	Vdet-IC	1.6V±2%, Hst, -MR, +Reset PPO, Wt=1.6s, Rt=1.6s	SOT-25	28cp	VD17	6g	Tor
<u>2V</u> F	XC6103H646MR	Vdet-IC	4.6V±2%, Hst, -MR, +Reset PPO, Wt=1.6s, Rt=1.6s	SOT-25	28cp	VD17	6g	Tor
<u>2V</u> H	XC6103H617MR	Vdet-IC	1.7V±2%, Hst, -MR, +Reset PPO, Wt=1.6s, Rt=1.6s	SOT-25	28cp	VD17	6g	Tor
<u>2V</u> H	XC6103H647MR	Vdet-IC	4.7V±2%, Hst, -MR, +Reset PPO, Wt=1.6s, Rt=1.6s	SOT-25	28cp	VD17	6g	Tor
<u>2V</u> K	XC6103H618MR	Vdet-IC	1.8V±2%, Hst, -MR, +Reset PPO, Wt=1.6s, Rt=1.6s	SOT-25	28cp	VD17	6g	Tor
<u>2V</u> K	XC6103H648MR	Vdet-IC	4.8V±2%, Hst, -MR, +Reset PPO, Wt=1.6s, Rt=1.6s	SOT-25	28cp	VD17	6g	Tor
<u>2V</u> L	XC6103H619MR	Vdet-IC	1.9V±2%, Hst, -MR, +Reset PPO, Wt=1.6s, Rt=1.6s	SOT-25	28cp	VD17	6g	Tor
<u>2V</u> L	XC6103H649MR	Vdet-IC	4.9V±2%, Hst, -MR, +Reset PPO, Wt=1.6s, Rt=1.6s	SOT-25	28cp	VD17	6g	Tor
<u>2V</u> M	XC6103H620MR	Vdet-IC	2.0V±2%, Hst, -MR, +Reset PPO, Wt=1.6s, Rt=1.6s	SOT-25	28cp	VD17	6g	Tor
<u>2V</u> M	XC6103H650MR	Vdet-IC	5.0V±2%, Hst, -MR, +Reset PPO, Wt=1.6s, Rt=1.6s	SOT-25	28cp	VD17	6g	Tor
<u>2V</u> N	XC6103H621MR	Vdet-IC	2.1V±2%, Hst, -MR, +Reset PPO, Wt=1.6s, Rt=1.6s	SOT-25	28cp	VD17	6g	Tor
<u>2V</u> P	XC6103H622MR	Vdet-IC	2.2V±2%, Hst, -MR, +Reset PPO, Wt=1.6s, Rt=1.6s	SOT-25	28cp	VD17	6g	Tor
<u>2V</u> R	XC6103H623MR	Vdet-IC	2.3V±2%, Hst, -MR, +Reset PPO, Wt=1.6s, Rt=1.6s	SOT-25	28cp	VD17	6g	Tor
<u>2V</u> S	XC6103H624MR	Vdet-IC	2.4V±2%, Hst, -MR, +Reset PPO, Wt=1.6s, Rt=1.6s	SOT-25	28cp	VD17	6g	Tor
<u>2V</u> T	XC6103H625MR	Vdet-IC	2.5V±2%, Hst, -MR, +Reset PPO, Wt=1.6s, Rt=1.6s	SOT-25	28cp	VD17	6g	Tor
<u>2V</u> U	XC6103H626MR	Vdet-IC	2.6V±2%, Hst, -MR, +Reset PPO, Wt=1.6s, Rt=1.6s	SOT-25	28cp	VD17	6g	Tor
<u>2V</u> V	XC6103H627MR	Vdet-IC	2.7V±2%, Hst, -MR, +Reset PPO, Wt=1.6s, Rt=1.6s	SOT-25	28cp	VD17	6g	Tor
<u>2V</u> W	XC6103H628MR	Vdet-IC	2.8V±2%, Hst, -MR, +Reset PPO, Wt=1.6s, Rt=1.6s	SOT-25	28cp	VD17	6g	Tor
<u>2V</u> Y	XC6103H629MR	Vdet-IC	2.9V±2%, Hst, -MR, +Reset PPO, Wt=1.6s, Rt=1.6s	SOT-25	28cp	VD17	6g	Tor
<u>2V</u> Z	XC6103H630MR	Vdet-IC	3.0V±2%, Hst, -MR, +Reset PPO, Wt=1.6s, Rt=1.6s	SOT-25	28cp	VD17	6g	Tor
<u>2W</u>	R1210N321C	DC/DC-IC	PWM step-up, 3.2V, 100kHz	SOT-23-5	28sc	DC3	6g	Ric
<u>2X</u>	R1210N421C	DC/DC-IC	PWM step-up, 4.1V, 100kHz	SOT-23-5	28sc	DC3	6g	Ric
<u>2Y</u>	R1210N521C	DC/DC-IC	PWM step-up, 5.2V, 100kHz	SOT-23-5	28sc	DC3	6g	Ric
<u>2Z</u>	R1210N221D	DC/DC-IC	PWM step-up, 2.1V, 180kHz	SOT-23-5	28sc	DC3	6g	Ric
<u>30</u>	R1223N152F	DC/DC-IC	PWM/FM step-down, +CE, 1.5V, 500kHz, R-Pr.	SOT-23-5	28ud	DC7	6g	Ric
<u>30</u>	RN5RF30AA	LVR-IC	LRip, -CE, 3V±2%, 1A*	SOT-23-5	28vw	VR6	6g	Ric
<u>30</u>	RN5RZ30AA	LVR-IC	LDO, LN, -CE, 3V±2%, 100mA	SOT-23-5	28vrt	VR4	6g	Ric
<u>300</u>	XC6104A131MR	Vdet-IC	3.1V±2%, Hst, ±Reset PPO, Wt=6.25ms, Rt=3.13ms	SOT-25	28xg	VD19	6g	Tor
<u>301</u>	XC6104A132MR	Vdet-IC	3.2V±2%, Hst, ±Reset PPO, Wt=6.25ms, Rt=3.13ms	SOT-25	28xg	VD19	6g	Tor
<u>302</u>	XC6104A133MR	Vdet-IC	3.3V±2%, Hst, ±Reset PPO, Wt=6.25ms, Rt=3.13ms	SOT-25	28xg	VD19	6g	Tor
<u>303</u>	XC6104A134MR	Vdet-IC	3.4V±2%, Hst, ±Reset PPO, Wt=6.25ms, Rt=3.13ms	SOT-25	28xg	VD19	6g	Tor
<u>304</u>	XC6104A135MR	Vdet-IC	3.5V±2%, Hst, ±Reset PPO, Wt=6.25ms, Rt=3.13ms	SOT-25	28xg	VD19	6g	Tor
<u>305</u>	XC6104A136MR	Vdet-IC	3.6V±2%, Hst, ±Reset PPO, Wt=6.25ms, Rt=3.13ms	SOT-25	28xg	VD19	6g	Tor
<u>306</u>	XC6104A137MR	Vdet-IC	3.7V±2%, Hst, ±Reset PPO, Wt=6.25ms, Rt=3.13ms	SOT-25	28xg	VD19	6g	Tor
<u>307</u>	XC6104A138MR	Vdet-IC	3.8V±2%, Hst, ±Reset PPO, Wt=6.25ms, Rt=3.13ms	SOT-25	28xg	VD19	6g	Tor
<u>308</u>	XC6104A139MR	Vdet-IC	3.9V±2%, Hst, ±Reset PPO, Wt=6.25ms, Rt=3.13ms	SOT-25	28xg	VD19	6g	Tor
<u>309</u>	R3112N091C	Vdet-IC	0.91V±2%, -Reset ODO	SOT-23-5	28vdo	VD1	6g	Ric
<u>309</u>	XC6104A140MR	Vdet-IC	4.0V±2%, Hst, ±Reset PPO, Wt=6.25ms, Rt=3.13ms	SOT-25	28xg	VD19	6g	Tor
<u>30A</u>	AAT60030A-S5	Vdet-IC	3.0V±2%, -Reset ODO	SOT-23-5	28vdo	VD1	6g	Aat
<u>30A</u>	XC6104A141MR	Vdet-IC	4.1V±2%, Hst, ±Reset PPO, Wt=6.25ms, Rt=3.13ms	SOT-25	28xg	VD19	6g	Tor
<u>30-A</u>	UTC8130-A	Vdet-IC	3V, -Reset OCO	SOT-23-5	28vdz	VD6	6k	Utc
<u>30B</u>	AAT60030B-S5	Vdet-IC	3.0V±2%, -Reset PPO	SOT-23-5	28vdo	VD3	6g	Aat
<u>30B</u>	XC6104A142MR	Vdet-IC	4.2V±2%, Hst, ±Reset PPO, Wt=6.25ms, Rt=3.13ms	SOT-25	28xg	VD19	6g	Tor
<u>30-B</u>	UTC8130-B	Vdet-IC	3V, -Reset OCO	SOT-23-5	28vdm	VD6	6k	Utc
<u>30C</u>	AAT60030C-S5	Vdet-IC	3.0V±1%, -Reset ODO	SOT-23-5	28vdo	VD1	6g	Aat
<u>30C</u>	XC6104A143MR	Vdet-IC	4.3V±2%, Hst, ±Reset PPO, Wt=6.25ms, Rt=3.13ms	SOT-25	28xg	VD19	6g	Tor
<u>30D</u>	AAT60030D-S5	Vdet-IC	3.0V±1%, -Reset PPO	SOT-23-5	28vdo	VD3	6g	Aat
<u>30D</u>	XC6104A144MR	Vdet-IC	4.4V±2%, Hst, ±Reset PPO, Wt=6.25ms, Rt=3.13ms	SOT-25	28xg	VD19	6g	Tor
<u>30E</u>	XC6104A145MR	Vdet-IC	4.5V±2%, Hst, ±Reset PPO, Wt=6.25ms, Rt=3.13ms	SOT-25	28xg	VD19	6g	Tor
<u>30F</u>	XC6104A116MR	Vdet-IC	1.6V±2%, Hst, ±Reset PPO, Wt=6.25ms, Rt=3.13ms	SOT-25	28xg	VD19	6g	Tor
<u>30F</u>	XC6104A146MR	Vdet-IC	4.6V±2%, Hst, ±Reset PPO, Wt=6.25ms, Rt=3.13ms	SOT-25	28xg	VD19	6g	Tor
<u>30H</u>	XC6104A117MR	Vdet-IC	1.7V±2%, Hst, ±Reset PPO, Wt=6.25ms, Rt=3.13ms	SOT-25	28xg	VD19	6g	Tor
<u>30H</u>	XC6104A147MR	Vdet-IC	4.7V±2%, Hst, ±Reset PPO, Wt=6.25ms, Rt=3.13ms	SOT-25	28xg	VD19	6g	Tor
<u>30K</u>	TK71730S	LVR-IC	LDO, 3V±1.5%, 300mA, +CE	SOT-23-5	28vrx	VR7	6k	Tok
<u>30K</u>	XC6104A118MR	Vdet-IC	1.8V±2%, Hst, ±Reset PPO, Wt=6.25ms, Rt=3.13ms	SOT-25	28xg	VD19	6g	Tor
<u>30K</u>	XC6104A148MR	Vdet-IC	4.8V±2%, Hst, ±Reset PPO, Wt=6.25ms, Rt=3.13ms	SOT-25	28xg	VD19	6g	Tor
<u>30L</u>	TK71630ASCL	LVR-IC	LDO, 3V±2%, 150mA, +CE, -30, -80°C	SOT-23-5	28vrx	VR7	6k	Tok
<u>30L</u>	XC6104A119MR	Vdet-IC	1.9V±2%, Hst, ±Reset PPO, Wt=6.25ms, Rt=3.13ms	SOT-25	28xg	VD19	6g	Tor
<u>30L</u>	XC6104A149MR	Vdet-IC	4.9V±2%, Hst, ±Reset PPO, Wt=6.25ms, Rt=3.13ms	SOT-25	28xg	VD19	6g	Tor
<u>30M</u>	XC6104A120MR	Vdet-IC	2.0V±2%, Hst, ±Reset PPO, Wt=6.25ms, Rt=3.13ms	SOT-25	28xg	VD19	6g	Tor
<u>30M</u>	XC6104A150MR	Vdet-IC	5.0V±2%, Hst, ±Reset PPO, Wt=6.25ms, Rt=3.13ms	SOT-25	28xg	VD19	6g	Tor
<u>30N</u>	XC6104A121MR	Vdet-IC	2.1V±2%, Hst, ±Reset PPO, Wt=6.25ms, Rt=3.13ms	SOT-25	28xg	VD19	6g	Tor
<u>30P</u>	XC6104A122MR	Vdet-IC	2.2V±2%, Hst, ±Reset PPO, Wt=6.25ms, Rt=3.13ms	SOT-25	28xg	VD19	6g	Tor
<u>30R</u>	XC6104A123MR	Vdet-IC	2.3V±2%, Hst, ±Reset PPO, Wt=6.25ms, Rt=3.13ms	SOT-25	28xg	VD19	6g	Tor
<u>30S</u>	XC6104A124MR	Vdet-IC	2.4V±2%, Hst, ±Reset PPO, Wt=6.25ms, Rt=3.13ms	SOT-25	28xg	VD19	6g	Tor
<u>30T</u>	TK71430S	LVR-IC	LDO, 3.0V±2%, 100mA, +CE, Ext. transistor	SOT-23-5	28zh	VR6	6a	Tok
<u>30T</u>	XC6104A125MR	Vdet-IC	2.5V±2%, Hst, ±Reset PPO, Wt=6.25ms, Rt=3.13ms	SOT-25	28xg	VD19	6g	Tor
<u>30U</u>	TK61030S	Vdet-IC	3.0V±2%, -Reset PPO	SOT-23-5	28vdm	VD7	6a	Tok
<u>30U</u>	XC6104A126MR	Vdet-IC	2.6V±2%, Hst, ±Reset PPO, Wt=6.25ms, Rt=3.13ms	SOT-25	28xg	VD19	6g	Tor
<u>30V</u>	XC6104A127MR	Vdet-IC	2.7V±2%, Hst, ±Reset PPO, Wt=6.25ms, Rt=3.13ms	SOT-25	28xg	VD19	6g	Tor



SMD code	Type	Function	Short description	Case	Pinout	Sch.	St.	Mnf.
30X	XC6104A128MR	Vdet-IC	2.8V±2%, Hst, ±Reset PPO, Wt=6.25ms, Rt=3.13ms	SOT-25	28xg	VD19	6g	Tor
30Y	XC6104A129MR	Vdet-IC	2.9V±2%, Hst, ±Reset PPO, Wt=6.25ms, Rt=3.13ms	SOT-25	28xg	VD19	6g	Tor
30Z	XC6104A130MR	Vdet-IC	3.0V±2%, Hst, ±Reset PPO, Wt=6.25ms, Rt=3.13ms	SOT-25	28xg	VD19	6g	Tor
31	R1223N182F	DC/DC-IC	PWM/FM step-down, +CE, 1.8V, 500kHz, R-Pr.	SOT-23-5	28ud	DC7	6g	Ric
31	RN5RF31AA	LVR-IC	LRip, -CE, 3.1V±2%, 1A*	SOT-23-5	28vw	VR6	6g	Ric
31	RN5RZ31AA	LVR-IC	LDO, LN, -CE, 3.1V±2%, 100mA	SOT-23-5	28vrt	VR4	6g	Ric
310	R3112N101C	Vdet-IC	1.0V±2%, -Reset ODO	SOT-23-5	28vdo	VD1	6g	Ric
310	XC6104A231MR	Vdet-IC	3.1V±2%, Hst, ±Reset PPO, Wt=50ms, Rt=3.13ms	SOT-25	28xg	VD19	6g	Tor
311	R3112N111C	Vdet-IC	1.1V±2%, -Reset ODO	SOT-23-5	28vdo	VD1	6g	Ric
311	XC6104A232MR	Vdet-IC	3.2V±2%, Hst, ±Reset PPO, Wt=50ms, Rt=3.13ms	SOT-25	28xg	VD19	6g	Tor
312	R3112N121C	Vdet-IC	1.2V±2%, -Reset ODO	SOT-23-5	28vdo	VD1	6g	Ric
312	XC6104A233MR	Vdet-IC	3.3V±2%, Hst, ±Reset PPO, Wt=50ms, Rt=3.13ms	SOT-25	28xg	VD19	6g	Tor
313	R3112N131C	Vdet-IC	1.3V±2%, -Reset ODO	SOT-23-5	28vdo	VD1	6g	Ric
313	XC6104A234MR	Vdet-IC	3.4V±2%, Hst, ±Reset PPO, Wt=50ms, Rt=3.13ms	SOT-25	28xg	VD19	6g	Tor
314	R3112N141C	Vdet-IC	1.4V±2%, -Reset ODO	SOT-23-5	28vdo	VD1	6g	Ric
314	XC6104A235MR	Vdet-IC	3.5V±2%, Hst, ±Reset PPO, Wt=50ms, Rt=3.13ms	SOT-25	28xg	VD19	6g	Tor
315	R3112N151C	Vdet-IC	1.5V±2%, -Reset ODO	SOT-23-5	28vdo	VD1	6g	Ric
315	XC6104A236MR	Vdet-IC	3.6V±2%, Hst, ±Reset PPO, Wt=50ms, Rt=3.13ms	SOT-25	28xg	VD19	6g	Tor
316	R3112N161C	Vdet-IC	1.6V±2%, -Reset ODO	SOT-23-5	28vdo	VD1	6g	Ric
316	XC6104A237MR	Vdet-IC	3.7V±2%, Hst, ±Reset PPO, Wt=50ms, Rt=3.13ms	SOT-25	28xg	VD19	6g	Tor
317	R3112N171C	Vdet-IC	1.7V±2%, -Reset ODO	SOT-23-5	28vdo	VD1	6g	Ric
317	XC6104A238MR	Vdet-IC	3.8V±2%, Hst, ±Reset PPO, Wt=50ms, Rt=3.13ms	SOT-25	28xg	VD19	6g	Tor
318	R3112N181C	Vdet-IC	1.8V±2%, -Reset ODO	SOT-23-5	28vdo	VD1	6g	Ric
318	XC6104A239MR	Vdet-IC	3.9V±2%, Hst, ±Reset PPO, Wt=50ms, Rt=3.13ms	SOT-25	28xg	VD19	6g	Tor
319	R3112N191C	Vdet-IC	1.9V±2%, -Reset ODO	SOT-23-5	28vdo	VD1	6g	Ric
319	XC6104A240MR	Vdet-IC	4.0V±2%, Hst, ±Reset PPO, Wt=50ms, Rt=3.13ms	SOT-25	28xg	VD19	6g	Tor
31A	AAT60031A-S5	Vdet-IC	3.1V±2%, -Reset ODO	SOT-23-5	28vdo	VD1	6g	Aat
31A	XC6104A241MR	Vdet-IC	4.1V±2%, Hst, ±Reset PPO, Wt=50ms, Rt=3.13ms	SOT-25	28xg	VD19	6g	Tor
31-A	UTC8131-A	Vdet-IC	3.1V, -Reset OCO	SOT-23-5	28vdz	VD6	6k	Utc
31B	AAT60031B-S5	Vdet-IC	3.1V±2%, -Reset PPO	SOT-23-5	28vdo	VD3	6g	Aat
31B	XC6104A242MR	Vdet-IC	4.2V±2%, Hst, ±Reset PPO, Wt=50ms, Rt=3.13ms	SOT-25	28xg	VD19	6g	Tor
31-B	UTC8131-B	Vdet-IC	3.1V, -Reset OCO	SOT-23-5	28vdm	VD6	6k	Utc
31C	AAT60031C-S5	Vdet-IC	3.1V±1%, -Reset ODO	SOT-23-5	28vdo	VD1	6g	Aat
31C	TK11031M	Tdet-IC	Sensor (-30 to +105°C), 10mV/°C, 4.5...10V	SOT-23-5	28		6a	X
31C	XC6104A243MR	Vdet-IC	4.3V±2%, Hst, ±Reset PPO, Wt=50ms, Rt=3.13ms	SOT-25	28xg	VD19	6g	Tor
31D	AAT60031D-S5	Vdet-IC	3.1V±1%, -Reset PPO	SOT-23-5	28vdo	VD3	6g	Aat
31D	XC6104A244MR	Vdet-IC	4.4V±2%, Hst, ±Reset PPO, Wt=50ms, Rt=3.13ms	SOT-25	28xg	VD19	6g	Tor
31E	XC6104A245MR	Vdet-IC	4.5V±2%, Hst, ±Reset PPO, Wt=50ms, Rt=3.13ms	SOT-25	28xg	VD19	6g	Tor
31F	R1163N151E	LVR-IC	LDO, 1.5V±1.5%, 150mA, +CE, AE(Mode)	SOT-23-5	28x9	VR10	6g	Ric
31F	XC6104A216MR	Vdet-IC	1.6V±2%, Hst, ±Reset PPO, Wt=50ms, Rt=3.13ms	SOT-25	28xg	VD19	6g	Tor
31E	XC6104A246MR	Vdet-IC	4.6V±2%, Hst, ±Reset PPO, Wt=50ms, Rt=3.13ms	SOT-25	28xg	VD19	6g	Tor
31G	R1163N161E	LVR-IC	LDO, 1.6V±1.5%, 150mA, +CE, AE(Mode)	SOT-23-5	28x9	VR10	6g	Ric
31H	R1163N171E	LVR-IC	LDO, 1.7V±1.5%, 150mA, +CE, AE(Mode)	SOT-23-5	28x9	VR10	6g	Ric
31H	XC6104A217MR	Vdet-IC	1.7V±2%, Hst, ±Reset PPO, Wt=50ms, Rt=3.13ms	SOT-25	28xg	VD19	6g	Tor
31H	XC6104A247MR	Vdet-IC	4.7V±2%, Hst, ±Reset PPO, Wt=50ms, Rt=3.13ms	SOT-25	28xg	VD19	6g	Tor
31J	R1163N181E5	LVR-IC	LDO, 1.85V±1.5%, 150mA, +CE, AE(Mode)	SOT-23-5	28x9	VR10	6g	Ric
31K	R1163N191E	LVR-IC	LDO, 1.9V±1.5%, 150mA, +CE, AE(Mode)	SOT-23-5	28x9	VR10	6g	Ric
31K	TK71731S	LVR-IC	LDO, 3.1V±1.5%, 300mA, +CE	SOT-23-5	28vrx	VR7	6k	Tok
31K	XC6104A218MR	Vdet-IC	1.8V±2%, Hst, ±Reset PPO, Wt=50ms, Rt=3.13ms	SOT-25	28xg	VD19	6g	Tor
31K	XC6104A248MR	Vdet-IC	4.8V±2%, Hst, ±Reset PPO, Wt=50ms, Rt=3.13ms	SOT-25	28xg	VD19	6g	Tor
31L	TK71631ASCL	LVR-IC	LDO, 3.1V±2%, 150mA, +CE, -30...+80°C	SOT-23-5	28vrx	VR7	6k	Tok
31L	XC6104A219MR	Vdet-IC	1.9V±2%, Hst, ±Reset PPO, Wt=50ms, Rt=3.13ms	SOT-25	28xg	VD19	6g	Tor
31L	XC6104A249MR	Vdet-IC	4.9V±2%, Hst, ±Reset PPO, Wt=50ms, Rt=3.13ms	SOT-25	28xg	VD19	6g	Tor
31M	XC6104A220MR	Vdet-IC	2.0V±2%, Hst, ±Reset PPO, Wt=50ms, Rt=3.13ms	SOT-25	28xg	VD19	6g	Tor
31M	XC6104A250MR	Vdet-IC	5.0V±2%, Hst, ±Reset PPO, Wt=50ms, Rt=3.13ms	SOT-25	28xg	VD19	6g	Tor
31N	XC6104A221MR	Vdet-IC	2.1V±2%, Hst, ±Reset PPO, Wt=50ms, Rt=3.13ms	SOT-25	28xg	VD19	6g	Tor
31P	XC6104A222MR	Vdet-IC	2.2V±2%, Hst, ±Reset PPO, Wt=50ms, Rt=3.13ms	SOT-25	28xg	VD19	6g	Tor
31R	XC6104A223MR	Vdet-IC	2.3V±2%, Hst, ±Reset PPO, Wt=50ms, Rt=3.13ms	SOT-25	28xg	VD19	6g	Tor
31S	XC6104A224MR	Vdet-IC	2.4V±2%, Hst, ±Reset PPO, Wt=50ms, Rt=3.13ms	SOT-25	28xg	VD19	6g	Tor
31T	TK71431S	LVR-IC	LDO, 3.1V±2%, 100mA, +CE, Ext. transistor	SOT-23-5	28zh	VR6	6a	Tok
31T	XC6104A225MR	Vdet-IC	2.5V±2%, Hst, ±Reset PPO, Wt=50ms, Rt=3.13ms	SOT-25	28xg	VD19	6g	Tor
31U	XC6104A226MR	Vdet-IC	2.6V±2%, Hst, ±Reset PPO, Wt=50ms, Rt=3.13ms	SOT-25	28xg	VD19	6g	Tor
31V	XC6104A227MR	Vdet-IC	2.7V±2%, Hst, ±Reset PPO, Wt=50ms, Rt=3.13ms	SOT-25	28xg	VD19	6g	Tor
31X	XC6104A228MR	Vdet-IC	2.8V±2%, Hst, ±Reset PPO, Wt=50ms, Rt=3.13ms	SOT-25	28xg	VD19	6g	Tor
31Y	XC6104A229MR	Vdet-IC	2.9V±2%, Hst, ±Reset PPO, Wt=50ms, Rt=3.13ms	SOT-25	28xg	VD19	6g	Tor
31Z	XC6104A230MR	Vdet-IC	3.0V±2%, Hst, ±Reset PPO, Wt=50ms, Rt=3.13ms	SOT-25	28xg	VD19	6g	Tor
32	R1223N252F	DC/DC-IC	PWM/FM step-down, +CE, 2.5V, 500kHz, R-Pr.	SOT-23-5	28ud	DC7	6g	Ric
32	RN5RF32AA	LVR-IC	LRip, -CE, 3.2V±2%, 1A*	SOT-23-5	28vw	VR6	6g	Ric
32	RN5RZ32AA	LVR-IC	LDO, LN, -CE, 3.2V±2%, 100mA	SOT-23-5	28vrt	VR4	6g	Ric
320	R3112N201C	Vdet-IC	2.0V±2%, -Reset ODO	SOT-23-5	28vdo	VD1	6g	Ric



SMD code	Type	Function	Short description	Case	Pinout	Sch.	St.	Mnf.
320	XC6104A331MR	Vdet-IC	3.1V±2%, Hst, ±Reset PPO, Wt=100ms, Rt=3.13ms	SOT-25	28xg	VD19	6g	Tor
321	R3112N211C	Vdet-IC	2.1V±2%, -Reset ODO	SOT-23-5	28vdo	VD1	6g	Ric
321	XC6104A332MR	Vdet-IC	3.2V±2%, Hst, ±Reset PPO, Wt=100ms, Rt=3.13ms	SOT-25	28xg	VD19	6g	Tor
322	R3112N221C	Vdet-IC	2.2V±2%, -Reset ODO	SOT-23-5	28vdo	VD1	6g	Ric
322	XC6104A333MR	Vdet-IC	3.3V±2%, Hst, ±Reset PPO, Wt=100ms, Rt=3.13ms	SOT-25	28xg	VD19	6g	Tor
323	R3112N231C	Vdet-IC	2.3V±2%, -Reset ODO	SOT-23-5	28vdo	VD1	6g	Ric
323	XC6104A334MR	Vdet-IC	3.4V±2%, Hst, ±Reset PPO, Wt=100ms, Rt=3.13ms	SOT-25	28xg	VD19	6g	Tor
324	R3112N241C	Vdet-IC	2.0V±2%, -Reset ODO	SOT-23-5	28vdo	VD1	6g	Ric
324	XC6104A335MR	Vdet-IC	3.5V±2%, Hst, ±Reset PPO, Wt=100ms, Rt=3.13ms	SOT-25	28xg	VD19	6g	Tor
325	R3112N251C	Vdet-IC	2.5V±2%, -Reset ODO	SOT-23-5	28vdo	VD1	6g	Ric
325	XC6104A336MR	Vdet-IC	3.6V±2%, Hst, ±Reset PPO, Wt=100ms, Rt=3.13ms	SOT-25	28xg	VD19	6g	Tor
326	R3112N261C	Vdet-IC	2.6V±2%, -Reset ODO	SOT-23-5	28vdo	VD1	6g	Ric
326	XC6104A337MR	Vdet-IC	3.7V±2%, Hst, ±Reset PPO, Wt=100ms, Rt=3.13ms	SOT-25	28xg	VD19	6g	Tor
327	R3112N271C	Vdet-IC	2.7V±2%, -Reset ODO	SOT-23-5	28vdo	VD1	6g	Ric
327	XC6104A338MR	Vdet-IC	3.8V±2%, Hst, ±Reset PPO, Wt=100ms, Rt=3.13ms	SOT-25	28xg	VD19	6g	Tor
328	R3112N281C	Vdet-IC	2.8V±2%, -Reset ODO	SOT-23-5	28vdo	VD1	6g	Ric
328	XC6104A339MR	Vdet-IC	3.9V±2%, Hst, ±Reset PPO, Wt=100ms, Rt=3.13ms	SOT-25	28xg	VD19	6g	Tor
329	R3112N291C	Vdet-IC	2.9V±2%, -Reset ODO	SOT-23-5	28vdo	VD1	6g	Ric
329	XC6104A340MR	Vdet-IC	4.0V±2%, Hst, ±Reset PPO, Wt=100ms, Rt=3.13ms	SOT-25	28xg	VD19	6g	Tor
32A	AAT60032A-S5	Vdet-IC	3.2V±2%, -Reset ODO	SOT-23-5	28vdo	VD1	6g	Aat
32A	R1163N201E	LVR-IC	LDO, 2V±1.5%, 150mA, +CE, AE(Mode)	SOT-23-5	28x9	VR10	6g	Ric
32A	SP432AS25RG	Vref-IC	Precision, Shunt, adjustable 1.24...20V, 0.5%	SOT-23-5L	28re	RF1	6k	Syn
32A	SP432AS35RG	Vref-IC	Precision, Shunt, adjustable 1.24...20V, 0.5%	SOT-353	30gh	RF1	6k	Syn
32A	XC6104A341MR	Vdet-IC	4.1V±2%, Hst, ±Reset PPO, Wt=100ms, Rt=3.13ms	SOT-25	28xg	VD19	6g	Tor
32-A	UTC8132-A	Vdet-IC	3.2V, -Reset OCO	SOT-23-5	28vzd	VD6	6k	Utc
32B	AAT60032B-S5	Vdet-IC	3.2V±2%, -Reset PPO	SOT-23-5	28vdo	VD3	6g	Aat
32B	R1163N211E	LVR-IC	LDO, 2.1V±1.5%, 150mA, +CE, AE(Mode)	SOT-23-5	28x9	VR10	6g	Ric
32B	SP432BS25RG	Vref-IC	Precision, Shunt, adjustable 1.24...20V, 1.0%	SOT-23-5L	28re	RF1	6k	Syn
32B	SP432BS35RG	Vref-IC	Precision, Shunt, adjustable 1.24...20V, 1.0%	SOT-353	30re	RF1	6k	Syn
32B	XC6104A342MR	Vdet-IC	4.2V±2%, Hst, ±Reset PPO, Wt=100ms, Rt=3.13ms	SOT-25	28xg	VD19	6g	Tor
32-B	UTC8132-B	Vdet-IC	3.2V, -Reset OCO	SOT-23-5	28vdm	VD6	6k	Utc
32C	AAT60032C-S5	Vdet-IC	3.2V±1%, -Reset ODO	SOT-23-5	28vdo	VD1	6g	Aat
32C	R1163N221E	LVR-IC	LDO, 2.2V±1.5%, 150mA, +CE, AE(Mode)	SOT-23-5	28x9	VR10	6g	Ric
32C	TK11032M	Tdet-IC	Sensor (-30 to +105°C), 6mV/°C, 2.7...10V	SOT-23-5	28	6a	X	
32C	XC6104A343MR	Vdet-IC	4.3V±2%, Hst, ±Reset PPO, Wt=100ms, Rt=3.13ms	SOT-25	28xg	VD19	6g	Tor
32D	AAT60032D-S5	Vdet-IC	3.2V±1%, -Reset PPO	SOT-23-5	28vdo	VD3	6g	Aat
32D	R1163N231E	LVR-IC	LDO, 2.3V±1.5%, 150mA, +CE, AE(Mode)	SOT-23-5	28x9	VR10	6g	Ric
32D	XC6104A344MR	Vdet-IC	4.4V±2%, Hst, ±Reset PPO, Wt=100ms, Rt=3.13ms	SOT-25	28xg	VD19	6g	Tor
32E	R1163N241E	LVR-IC	LDO, 2.4V±1.5%, 150mA, +CE, AE(Mode)	SOT-23-5	28x9	VR10	6g	Ric
32E	XC6104A345MR	Vdet-IC	4.5V±2%, Hst, ±Reset PPO, Wt=100ms, Rt=3.13ms	SOT-25	28xg	VD19	6g	Tor
32F	R1163N251E	LVR-IC	LDO, 2.5V±1.5%, 150mA, +CE, AE(Mode)	SOT-23-5	28x9	VR10	6g	Ric
32F	XC6104A316MR	Vdet-IC	1.6V±2%, Hst, ±Reset PPO, Wt=100ms, Rt=3.13ms	SOT-25	28xg	VD19	6g	Tor
32F	XC6104A346MR	Vdet-IC	4.6V±2%, Hst, ±Reset PPO, Wt=100ms, Rt=3.13ms	SOT-25	28xg	VD19	6g	Tor
32G	R1163N261E	LVR-IC	LDO, 2.6V±1.5%, 150mA, +CE, AE(Mode)	SOT-23-5	28x9	VR10	6g	Ric
32H	R1163N271E	LVR-IC	LDO, 2.7V±1.5%, 150mA, +CE, AE(Mode)	SOT-23-5	28x9	VR10	6g	Ric
32H	XC6104A317MR	Vdet-IC	1.7V±2%, Hst, ±Reset PPO, Wt=100ms, Rt=3.13ms	SOT-25	28xg	VD19	6g	Tor
32H	XC6104A347MR	Vdet-IC	4.7V±2%, Hst, ±Reset PPO, Wt=100ms, Rt=3.13ms	SOT-25	28xg	VD19	6g	Tor
32J	R1163N281E5	LVR-IC	LDO, 2.85V±1.5%, 150mA, +CE, AE(Mode)	SOT-23-5	28x9	VR10	6g	Ric
32K	R1163N291E	LVR-IC	LDO, 2.9V±1.5%, 150mA, +CE, AE(Mode)	SOT-23-5	28x9	VR10	6g	Ric
32K	TK71732S	LVR-IC	LDO, 3.2V±1.5%, 300mA, +CE	SOT-23-5	28vrx	VR7	6k	Tok
32K	XC6104A318MR	Vdet-IC	1.8V±2%, Hst, ±Reset PPO, Wt=100ms, Rt=3.13ms	SOT-25	28xg	VD19	6g	Tor
32K	XC6104A348MR	Vdet-IC	4.8V±2%, Hst, ±Reset PPO, Wt=100ms, Rt=3.13ms	SOT-25	28xg	VD19	6g	Tor
32L	TK11632ASCL	LVR-IC	LDO, 3.2V±2%, 150mA, +CE, -30...+80°C	SOT-23-5	28vrx	VR7	6k	Tok
32L	XC6104A319MR	Vdet-IC	1.9V±2%, Hst, ±Reset PPO, Wt=100ms, Rt=3.13ms	SOT-25	28xg	VD19	6g	Tor
32L	XC6104A349MR	Vdet-IC	4.9V±2%, Hst, ±Reset PPO, Wt=100ms, Rt=3.13ms	SOT-25	28xg	VD19	6g	Tor
32M	XC6104A320MR	Vdet-IC	2.0V±2%, Hst, ±Reset PPO, Wt=100ms, Rt=3.13ms	SOT-25	28xg	VD19	6g	Tor
32M	XC6104A350MR	Vdet-IC	5.0V±2%, Hst, ±Reset PPO, Wt=100ms, Rt=3.13ms	SOT-25	28xg	VD19	6g	Tor
32N	XC6104A321MR	Vdet-IC	2.1V±2%, Hst, ±Reset PPO, Wt=100ms, Rt=3.13ms	SOT-25	28xg	VD19	6g	Tor
32P	XC6104A322MR	Vdet-IC	2.2V±2%, Hst, ±Reset PPO, Wt=100ms, Rt=3.13ms	SOT-25	28xg	VD19	6g	Tor
32R	XC6104A323MR	Vdet-IC	2.3V±2%, Hst, ±Reset PPO, Wt=100ms, Rt=3.13ms	SOT-25	28xg	VD19	6g	Tor
32S	XC6104A324MR	Vdet-IC	2.4V±2%, Hst, ±Reset PPO, Wt=100ms, Rt=3.13ms	SOT-25	28xg	VD19	6g	Tor
32T	TK71432S	LVR-IC	LDO, 3.2V±2%, 100mA, +CE, Ext. transistor	SOT-23-5	28zh	VR6	6a	Tok
32T	XC6104A325MR	Vdet-IC	2.5V±2%, Hst, ±Reset PPO, Wt=100ms, Rt=3.13ms	SOT-25	28xg	VD19	6g	Tor
32U	XC6104A326MR	Vdet-IC	2.6V±2%, Hst, ±Reset PPO, Wt=100ms, Rt=3.13ms	SOT-25	28xg	VD19	6g	Tor
32V	XC6104A327MR	Vdet-IC	2.7V±2%, Hst, ±Reset PPO, Wt=100ms, Rt=3.13ms	SOT-25	28xg	VD19	6g	Tor
32X	XC6104A328MR	Vdet-IC	2.8V±2%, Hst, ±Reset PPO, Wt=100ms, Rt=3.13ms	SOT-25	28xg	VD19	6g	Tor
32Y	XC6104A329MR	Vdet-IC	2.9V±2%, Hst, ±Reset PPO, Wt=100ms, Rt=3.13ms	SOT-25	28xg	VD19	6g	Tor
32Z	XC6104A330MR	Vdet-IC	3.0V±2%, Hst, ±Reset PPO, Wt=100ms, Rt=3.13ms	SOT-25	28xg	VD19	6g	Tor
33	R1223N302F	DC/DC-IC	PWM/VFM step-down, +CE, 3V, 500kHz, R-Pr.	SOT-23-5	28ud	DC7	6g	Ric
33	RN5RF33AA	LVR-IC	LRip, -CE, 3.3V±2%, 1A*	SOT-23-5	28vw	VR6	6g	Ric



SMD code	Type	Function	Short description	Case	Pinout	Sch.	St.	Mnf.
330	RN5RZ33AA	LVR-IC	LDO, LN, -CE, 3.3V±2%, 100mA	SOT-23-5	28vrt	VR4	6g	Ric
330	R3112N301C	Vdet-IC	3V±2%, -Reset ODO	SOT-23-5	28vdo	VD1	6g	Ric
330	XC6104A431MR	Vdet-IC	3.1V±2%, Hst, ±Reset PPO, Wt=200ms, Rt=3.13ms	SOT-25	28xg	VD19	6g	Tor
331	R3112N311C	Vdet-IC	3.1V±2%, -Reset ODO	SOT-23-5	28vdo	VD1	6g	Ric
331	XC6104A432MR	Vdet-IC	3.2V±2%, Hst, ±Reset PPO, Wt=200ms, Rt=3.13ms	SOT-25	28xg	VD19	6g	Tor
332	R3112N321C	Vdet-IC	3.2V±2%, -Reset ODO	SOT-23-5	28vdo	VD1	6g	Ric
332	XC6104A433MR	Vdet-IC	3.3V±2%, Hst, ±Reset PPO, Wt=200ms, Rt=3.13ms	SOT-25	28xg	VD19	6g	Tor
333	R3112N331C	Vdet-IC	3.3V±2%, -Reset ODO	SOT-23-5	28vdo	VD1	6g	Ric
333	XC6104A434MR	Vdet-IC	3.4V±2%, Hst, ±Reset PPO, Wt=200ms, Rt=3.13ms	SOT-25	28xg	VD19	6g	Tor
334	R1126N341D	LVR-IC	LDO, LN, +CE, CL, 3.4V±2%, 150mA	SOT-23-5	28vc	VR4	6g	Ric
334	R3112N341C	Vdet-IC	3.4V±2%, -Reset ODO	SOT-23-5	28vdo	VD1	6g	Ric
334	XC6104A435MR	Vdet-IC	3.5V±2%, Hst, ±Reset PPO, Wt=200ms, Rt=3.13ms	SOT-25	28xg	VD19	6g	Tor
335	R1126N351D	LVR-IC	LDO, LN, +CE, CL, 3.5V±2%, 150mA	SOT-23-5	28vc	VR4	6g	Ric
335	R3112N351C	Vdet-IC	3.5V±2%, -Reset ODO	SOT-23-5	28vdo	VD1	6g	Ric
335	XC6104A436MR	Vdet-IC	3.6V±2%, Hst, ±Reset PPO, Wt=200ms, Rt=3.13ms	SOT-25	28xg	VD19	6g	Tor
336	R1126N361D	LVR-IC	LDO, LN, +CE, CL, 3.6V±2%, 150mA	SOT-23-5	28vc	VR4	6g	Ric
336	R3112N361C	Vdet-IC	3.6V±2%, -Reset ODO	SOT-23-5	28vdo	VD1	6g	Ric
336	XC6104A437MR	Vdet-IC	3.7V±2%, Hst, ±Reset PPO, Wt=200ms, Rt=3.13ms	SOT-25	28xg	VD19	6g	Tor
337	R1126N371D	LVR-IC	LDO, LN, +CE, CL, 3.7V±2%, 150mA	SOT-23-5	28vc	VR4	6g	Ric
337	R3112N371C	Vdet-IC	3.7V±2%, -Reset ODO	SOT-23-5	28vdo	VD1	6g	Ric
337	XC6104A438MR	Vdet-IC	3.8V±2%, Hst, ±Reset PPO, Wt=200ms, Rt=3.13ms	SOT-25	28xg	VD19	6g	Tor
338	R1126N381D	LVR-IC	LDO, LN, +CE, CL, 3.8V±2%, 150mA	SOT-23-5	28vc	VR4	6g	Ric
338	R3112N381C	Vdet-IC	3.8V±2%, -Reset ODO	SOT-23-5	28vdo	VD1	6g	Ric
338	XC6104A439MR	Vdet-IC	3.9V±2%, Hst, ±Reset PPO, Wt=200ms, Rt=3.13ms	SOT-25	28xg	VD19	6g	Tor
339	R1126N391D	LVR-IC	LDO, LN, +CE, CL, 3.9V±2%, 150mA	SOT-23-5	28vc	VR4	6g	Ric
339	R3112N391C	Vdet-IC	3.9V±2%, -Reset ODO	SOT-23-5	28vdo	VD1	6g	Ric
339	XC6104A440MR	Vdet-IC	4.0V±2%, Hst, ±Reset PPO, Wt=200ms, Rt=3.13ms	SOT-25	28xg	VD19	6g	Tor
339A	AAT60033A-S5	Vdet-IC	3.3V±2%, -Reset ODO	SOT-23-5	28vdo	VD1	6g	Aat
33A	R1163N301E	LVR-IC	LDO, 3V±1.5%, 150mA, +CE, AE(Mode)	SOT-23-5	28x9	VR10	6g	Ric
33A	XC6104A441MR	Vdet-IC	4.1V±2%, Hst, ±Reset PPO, Wt=200ms, Rt=3.13ms	SOT-25	28xg	VD19	6g	Tor
33-A	UTC8133-A	Vdet-IC	3.3V, -Reset OCO	SOT-23-5	28vdz	VD6	6k	Utc
33B	AAT60033B-S5	Vdet-IC	3.3V±2%, -Reset PPO	SOT-23-5	28vdo	VD3	6g	Aat
33B	R1163N311E	LVR-IC	LDO, 3.1V±1.5%, 150mA, +CE, AE(Mode)	SOT-23-5	28x9	VR10	6g	Ric
33B	XC6104A442MR	Vdet-IC	4.2V±2%, Hst, ±Reset PPO, Wt=200ms, Rt=3.13ms	SOT-25	28xg	VD19	6g	Tor
33-B	UTC8133-B	Vdet-IC	3.3V, -Reset OCO	SOT-23-5	28vdm	VD6	6k	Utc
33C	AAT60033C-S5	Vdet-IC	3.3V±1%, -Reset ODO	SOT-23-5	28vdo	VD1	6g	Aat
33C	R1163N321E	LVR-IC	LDO, 3.2V±1.5%, 150mA, +CE, AE(Mode)	SOT-23-5	28x9	VR10	6g	Ric
33C	TK11033M	Tdet-IC	Sensor (-30 to +105°C), 5mV/°C, 2.4...10V	SOT-23-5	28x		6a	X
33C	XC6104A443MR	Vdet-IC	4.3V±2%, Hst, ±Reset PPO, Wt=200ms, Rt=3.13ms	SOT-25	28xg	VD19	6g	Tor
33D	AAT60033D-S5	Vdet-IC	3.3V±1%, -Reset PPO	SOT-23-5	28vdo	VD3	6g	Aat
33D	R1163N331E	LVR-IC	LDO, 3.3V±1.5%, 150mA, +CE, AE(Mode)	SOT-23-5	28x9	VR10	6g	Ric
33D	XC6104A444MR	Vdet-IC	4.4V±2%, Hst, ±Reset PPO, Wt=200ms, Rt=3.13ms	SOT-25	28xg	VD19	6g	Tor
33E	R1163N341E	LVR-IC	LDO, 3.4V±1.5%, 150mA, +CE, AE(Mode)	SOT-23-5	28x9	VR10	6g	Ric
33E	XC6104A445MR	Vdet-IC	4.5V±2%, Hst, ±Reset PPO, Wt=200ms, Rt=3.13ms	SOT-25	28xg	VD19	6g	Tor
33F	R1163N351E	LVR-IC	LDO, 3.5V±1.5%, 150mA, +CE, AE(Mode)	SOT-23-5	28x9	VR10	6g	Ric
33F	XC6104A416MR	Vdet-IC	1.6V±2%, Hst, ±Reset PPO, Wt=200ms, Rt=3.13ms	SOT-25	28xg	VD19	6g	Tor
33F	XC6104A446MR	Vdet-IC	4.6V±2%, Hst, ±Reset PPO, Wt=200ms, Rt=3.13ms	SOT-25	28xg	VD19	6g	Tor
33G	R1163N361E	LVR-IC	LDO, 3.6V±1.5%, 150mA, +CE, AE(Mode)	SOT-23-5	28x9	VR10	6g	Ric
33H	R1163N371E	LVR-IC	LDO, 3.7V±1.5%, 150mA, +CE, AE(Mode)	SOT-23-5	28x9	VR10	6g	Ric
33H	XC6104A417MR	Vdet-IC	1.7V±2%, Hst, ±Reset PPO, Wt=200ms, Rt=3.13ms	SOT-25	28xg	VD19	6g	Tor
33H	XC6104A447MR	Vdet-IC	4.7V±2%, Hst, ±Reset PPO, Wt=200ms, Rt=3.13ms	SOT-25	28xg	VD19	6g	Tor
33J	R1163N381E	LVR-IC	LDO, 3.8V±1.5%, 150mA, +CE, AE(Mode)	SOT-23-5	28x9	VR10	6g	Ric
33K	R1163N391E	LVR-IC	LDO, 3.9V±1.5%, 150mA, +CE, AE(Mode)	SOT-23-5	28x9	VR10	6g	Ric
33K	TK71733S	LVR-IC	LDO, 3.3V±1.5%, 300mA, +CE	SOT-23-5	28vrx	VR7	6k	Tok
33K	XC6104A418MR	Vdet-IC	1.8V±2%, Hst, ±Reset PPO, Wt=200ms, Rt=3.13ms	SOT-25	28xg	VD19	6g	Tor
33K	XC6104A448MR	Vdet-IC	4.8V±2%, Hst, ±Reset PPO, Wt=200ms, Rt=3.13ms	SOT-25	28xg	VD19	6g	Tor
33L	TK71633ASCL	LVR-IC	LDO, 3.3V±2%, 150mA, +CE, -30...+80°C	SOT-23-5	28vrx	VR7	6k	Tok
33L	XC6104A419MR	Vdet-IC	1.9V±2%, Hst, ±Reset PPO, Wt=200ms, Rt=3.13ms	SOT-25	28xg	VD19	6g	Tor
33L	XC6104A449MR	Vdet-IC	4.9V±2%, Hst, ±Reset PPO, Wt=200ms, Rt=3.13ms	SOT-25	28xg	VD19	6g	Tor
33M	XC6104A420MR	Vdet-IC	2.0V±2%, Hst, ±Reset PPO, Wt=200ms, Rt=3.13ms	SOT-25	28xg	VD19	6g	Tor
33M	XC6104A450MR	Vdet-IC	5.0V±2%, Hst, ±Reset PPO, Wt=200ms, Rt=3.13ms	SOT-25	28xg	VD19	6g	Tor
33N	XC6104A421MR	Vdet-IC	2.1V±2%, Hst, ±Reset PPO, Wt=200ms, Rt=3.13ms	SOT-25	28xg	VD19	6g	Tor
33P	XC6104A422MR	Vdet-IC	2.2V±2%, Hst, ±Reset PPO, Wt=200ms, Rt=3.13ms	SOT-25	28xg	VD19	6g	Tor
33P	XC6104A423MR	Vdet-IC	2.3V±2%, Hst, ±Reset PPO, Wt=200ms, Rt=3.13ms	SOT-25	28xg	VD19	6g	Tor
33S	XC6104A424MR	Vdet-IC	2.4V±2%, Hst, ±Reset PPO, Wt=200ms, Rt=3.13ms	SOT-25	28xg	VD19	6g	Tor
33T	TK71433S	LVR-IC	LDO, 3.3V±2%, 100mA, +CE, Ext. transistor	SOT-23-5	28zh	VR6	6a	Tok
33T	XC6104A425MR	Vdet-IC	2.5V±2%, Hst, ±Reset PPO, Wt=200ms, Rt=3.13ms	SOT-25	28xg	VD19	6g	Tor
33U	TK61033S	Vdet-IC	3.3V±2%, -Reset PPO	SOT-23-5	28vdm	VD7	6a	Tok
33U	XC6104A426MR	Vdet-IC	2.6V±2%, Hst, ±Reset PPO, Wt=200ms, Rt=3.13ms	SOT-25	28xg	VD19	6g	Tor
33V	XC6104A427MR	Vdet-IC	2.7V±2%, Hst, ±Reset PPO, Wt=200ms, Rt=3.13ms	SOT-25	28xg	VD19	6g	Tor



SMD code	Type	Function	Short description	Case	Pinout	Sch.	St.	Mnf.
33X	XC6104A428MR	Vdet-IC	2.8V±2%, Hst, ±Reset PPO, Wt=200ms, Rt=3.13ms	SOT-25	28xg	VD19	6g	Tor
33Y	XC6104A429MR	Vdet-IC	2.9V±2%, Hst, ±Reset PPO, Wt=200ms, Rt=3.13ms	SOT-25	28xg	VD19	6g	Tor
33Z	XC6104A430MR	Vdet-IC	3.0V±2%, Hst, ±Reset PPO, Wt=200ms, Rt=3.13ms	SOT-25	28xg	VD19	6g	Tor
34	R1223N332F	DC/DC-IC	PWM/FM step-down, +CE, 3.3V, 500kHz, R-Pr.	SOT-23-5	28ud	DC7	6g	Ric
34	RN5RF34AA	LVR-IC	LRip, -CE, 3.4V±2%, 1A*	SOT-23-5	28vw	VR6	6g	Ric
34	RN5RZ34AA	LVR-IC	LDO, LN, -CE, 3.4V±2%, 100mA	SOT-23-5	28vrt	VR4	6g	Ric
340	R1126N401D	LVR-IC	LDO, LN, +CE, CL, 4V±2%, 150mA	SOT-23-5	28vc	VR4	6g	Ric
340	R3112N401C	Vdet-IC	4V±2%, -Reset ODO	SOT-23-5	28vdo	VD1	6g	Ric
340	XC6104A531MR	Vdet-IC	3.1V±2%, Hst, ±Reset PPO, Wt=400ms, Rt=3.13ms	SOT-25	28xg	VD19	6g	Tor
341	R1126N181D5	LVR-IC	LDO, LN, +CE, CL, 1.85V±2%, 150mA	SOT-23-5	28vc	VR4	6g	Ric
341	R3112N411C	Vdet-IC	4.1V±2%, -Reset ODO	SOT-23-5	28vdo	VD1	6g	Ric
341	XC6104A532MR	Vdet-IC	3.2V±2%, Hst, ±Reset PPO, Wt=400ms, Rt=3.13ms	SOT-25	28xg	VD19	6g	Tor
342	R1126N281D5	LVR-IC	LDO, LN, +CE, CL, 2.85V±2%, 150mA	SOT-23-5	28vc	VR4	6g	Ric
342	R3112N421C	Vdet-IC	4.2V±2%, -Reset ODO	SOT-23-5	28vdo	VD1	6g	Ric
342	XC6104A533MR	Vdet-IC	3.3V±2%, Hst, ±Reset PPO, Wt=400ms, Rt=3.13ms	SOT-25	28xg	VD19	6g	Tor
343	R3112N431C	Vdet-IC	4.3V±2%, -Reset ODO	SOT-23-5	28vdo	VD1	6g	Ric
343	XC6104A534MR	Vdet-IC	3.4V±2%, Hst, ±Reset PPO, Wt=400ms, Rt=3.13ms	SOT-25	28xg	VD19	6g	Tor
344	R3112N441C	Vdet-IC	4.4V±2%, -Reset ODO	SOT-23-5	28vdo	VD1	6g	Ric
344	XC6104A535MR	Vdet-IC	3.5V±2%, Hst, ±Reset PPO, Wt=400ms, Rt=3.13ms	SOT-25	28xg	VD19	6g	Tor
345	R3112N451C	Vdet-IC	4.5V±2%, -Reset ODO	SOT-23-5	28vdo	VD1	6g	Ric
345	XC6104A536MR	Vdet-IC	3.6V±2%, Hst, ±Reset PPO, Wt=400ms, Rt=3.13ms	SOT-25	28xg	VD19	6g	Tor
346	R3112N461C	Vdet-IC	4.6V±2%, -Reset ODO	SOT-23-5	28vdo	VD1	6g	Ric
346	XC6104A537MR	Vdet-IC	3.7V±2%, Hst, ±Reset PPO, Wt=400ms, Rt=3.13ms	SOT-25	28xg	VD19	6g	Tor
347	R3112N471C	Vdet-IC	4.7V±2%, -Reset ODO	SOT-23-5	28vdo	VD1	6g	Ric
347	XC6104A538MR	Vdet-IC	3.8V±2%, Hst, ±Reset PPO, Wt=400ms, Rt=3.13ms	SOT-25	28xg	VD19	6g	Tor
348	R3112N481C	Vdet-IC	4.8V±2%, -Reset ODO	SOT-23-5	28vdo	VD1	6g	Ric
348	XC6104A539MR	Vdet-IC	3.9V±2%, Hst, ±Reset PPO, Wt=400ms, Rt=3.13ms	SOT-25	28xg	VD19	6g	Tor
349	R3112N491C	Vdet-IC	4.9V±2%, -Reset ODO	SOT-23-5	28vdo	VD1	6g	Ric
349	XC6104A540MR	Vdet-IC	4.0V±2%, Hst, ±Reset PPO, Wt=400ms, Rt=3.13ms	SOT-25	28xg	VD19	6g	Tor
34A	AAT60034A-S5	Vdet-IC	3.4V±2%, -Reset ODO	SOT-23-5	28vdo	VD1	6g	Aat
34A	R1163N401E	LVR-IC	LDO, 4V±1.5%, 150mA, +CE, AE(Mode)	SOT-23-5	28x9	VR10	6g	Ric
34A	XC6104A541MR	Vdet-IC	4.1V±2%, Hst, ±Reset PPO, Wt=400ms, Rt=3.13ms	SOT-25	28xg	VD19	6g	Tor
34-A	UTC8134-A	Vdet-IC	3.4V, -Reset OCO	SOT-23-5	28vdz	VD6	6k	Utc
34B	AAT60034B-S5	Vdet-IC	3.4V±2%, -Reset PPO	SOT-23-5	28vdo	VD3	6g	Aat
34B	R1163N181E	LVR-IC	LDO, 1.8V±1.5%, 150mA, +CE, AE(Mode)	SOT-23-5	28x9	VR10	6g	Ric
34B	XC6104A542MR	Vdet-IC	4.2V±2%, Hst, ±Reset PPO, Wt=400ms, Rt=3.13ms	SOT-25	28xg	VD19	6g	Tor
34-B	UTC8134-B	Vdet-IC	3.4V, -Reset OCO	SOT-23-5	28vdm	VD6	6k	Utc
34C	AAT60034C-S5	Vdet-IC	3.4V±1%, -Reset ODO	SOT-23-5	28vdo	VD1	6g	Aat
34C	R1163N281E	LVR-IC	LDO, 2.8V±1.5%, 150mA, +CE, AE(Mode)	SOT-23-5	28x9	VR10	6g	Ric
34C	XC6104A543MR	Vdet-IC	4.3V±2%, Hst, ±Reset PPO, Wt=400ms, Rt=3.13ms	SOT-25	28xg	VD19	6g	Tor
34D	AAT60034D-S5	Vdet-IC	3.4V±1%, -Reset PPO	SOT-23-5	28vdo	VD3	6g	Aat
34D	XC6104A544MR	Vdet-IC	4.4V±2%, Hst, ±Reset PPO, Wt=400ms, Rt=3.13ms	SOT-25	28xg	VD19	6g	Tor
34E	XC6104A545MR	Vdet-IC	4.5V±2%, Hst, ±Reset PPO, Wt=400ms, Rt=3.13ms	SOT-25	28xg	VD19	6g	Tor
34E	XC6104A516MR	Vdet-IC	1.6V±2%, Hst, ±Reset PPO, Wt=400ms, Rt=3.13ms	SOT-25	28xg	VD19	6g	Tor
34E	XC6104A546MR	Vdet-IC	4.6V±2%, Hst, ±Reset PPO, Wt=400ms, Rt=3.13ms	SOT-25	28xg	VD19	6g	Tor
34H	XC6104A517MR	Vdet-IC	1.7V±2%, Hst, ±Reset PPO, Wt=400ms, Rt=3.13ms	SOT-25	28xg	VD19	6g	Tor
34H	XC6104A547MR	Vdet-IC	4.7V±2%, Hst, ±Reset PPO, Wt=400ms, Rt=3.13ms	SOT-25	28xg	VD19	6g	Tor
34K	TK71734S	LVR-IC	LDO, 3.4V±1.5%, 300mA, +CE	SOT-23-5	28vrx	VR7	6k	Tok
34K	XC6104A518MR	Vdet-IC	1.8V±2%, Hst, ±Reset PPO, Wt=400ms, Rt=3.13ms	SOT-25	28xg	VD19	6g	Tor
34K	XC6104A548MR	Vdet-IC	4.8V±2%, Hst, ±Reset PPO, Wt=400ms, Rt=3.13ms	SOT-25	28xg	VD19	6g	Tor
34L	TK71634ASCL	LVR-IC	LDO, 3.4V±2%, 150mA, +CE, -30...+80°C	SOT-23-5	28vrx	VR7	6k	Tok
34L	XC6104A519MR	Vdet-IC	1.9V±2%, Hst, ±Reset PPO, Wt=400ms, Rt=3.13ms	SOT-25	28xg	VD19	6g	Tor
34L	XC6104A549MR	Vdet-IC	4.9V±2%, Hst, ±Reset PPO, Wt=400ms, Rt=3.13ms	SOT-25	28xg	VD19	6g	Tor
34M	XC6104A520MR	Vdet-IC	2.0V±2%, Hst, ±Reset PPO, Wt=400ms, Rt=3.13ms	SOT-25	28xg	VD19	6g	Tor
34M	XC6104A550MR	Vdet-IC	5.0V±2%, Hst, ±Reset PPO, Wt=400ms, Rt=3.13ms	SOT-25	28xg	VD19	6g	Tor
34N	XC6104A521MR	Vdet-IC	2.1V±2%, Hst, ±Reset PPO, Wt=400ms, Rt=3.13ms	SOT-25	28xg	VD19	6g	Tor
34P	XC6104A522MR	Vdet-IC	2.2V±2%, Hst, ±Reset PPO, Wt=400ms, Rt=3.13ms	SOT-25	28xg	VD19	6g	Tor
34R	XC6104A523MR	Vdet-IC	2.3V±2%, Hst, ±Reset PPO, Wt=400ms, Rt=3.13ms	SOT-25	28xg	VD19	6g	Tor
34S	XC6104A524MR	Vdet-IC	2.4V±2%, Hst, ±Reset PPO, Wt=400ms, Rt=3.13ms	SOT-25	28xg	VD19	6g	Tor
34T	TK71434S	LVR-IC	LDO, 3.4V±2%, 100mA, +CE, Ext. transistor	SOT-23-5	28zh	VR6	6a	Tok
34T	XC6104A525MR	Vdet-IC	2.5V±2%, Hst, ±Reset PPO, Wt=400ms, Rt=3.13ms	SOT-25	28xg	VD19	6g	Tor
34U	XC6104A526MR	Vdet-IC	2.6V±2%, Hst, ±Reset PPO, Wt=400ms, Rt=3.13ms	SOT-25	28xg	VD19	6g	Tor
34V	XC6104A527MR	Vdet-IC	2.7V±2%, Hst, ±Reset PPO, Wt=400ms, Rt=3.13ms	SOT-25	28xg	VD19	6g	Tor
34X	XC6104A528MR	Vdet-IC	2.8V±2%, Hst, ±Reset PPO, Wt=400ms, Rt=3.13ms	SOT-25	28xg	VD19	6g	Tor
34Y	XC6104A529MR	Vdet-IC	2.9V±2%, Hst, ±Reset PPO, Wt=400ms, Rt=3.13ms	SOT-25	28xg	VD19	6g	Tor
34Z	XC6104A530MR	Vdet-IC	3.0V±2%, Hst, ±Reset PPO, Wt=400ms, Rt=3.13ms	SOT-25	28xg	VD19	6g	Tor
35	R1223N502F	DC/DC-IC	PWM/FM step-down, +CE, 5V, 500kHz, R-Pr.	SOT-23-5	28ud	DC7	6g	Ric
35	RN5RF35AA	LVR-IC	LRip, -CE, 3.5V±2%, 1A*	SOT-23-5	28vw	VR6	6g	Ric
35	RN5RZ35AA	LVR-IC	LDO, LN, -CE, 3.5V±2%, 100mA	SOT-23-5	28vrt	VR4	6g	Ric
350	R3112N501C	Vdet-IC	5V±2%, -Reset ODO	SOT-23-5	28vdo	VD1	6g	Ric



SMD code	Type	Function	Short description	Case	Pinout	Sch.	St.	Mnf.
350	XC6104A631MR	Vdet-IC	3.1V±2%, Hst, ±Reset PPO, Wt=1.6s, Rt=3.13ms	SOT-25	28xg	VD19	6g	Tor
351	XC6104A632MR	Vdet-IC	3.2V±2%, Hst, ±Reset PPO, Wt=1.6s, Rt=3.13ms	SOT-25	28xg	VD19	6g	Tor
352	XC6104A633MR	Vdet-IC	3.3V±2%, Hst, ±Reset PPO, Wt=1.6s, Rt=3.13ms	SOT-25	28xg	VD19	6g	Tor
353	XC6104A634MR	Vdet-IC	3.4V±2%, Hst, ±Reset PPO, Wt=1.6s, Rt=3.13ms	SOT-25	28xg	VD19	6g	Tor
354	XC6104A635MR	Vdet-IC	3.5V±2%, Hst, ±Reset PPO, Wt=1.6s, Rt=3.13ms	SOT-25	28xg	VD19	6g	Tor
355	XC6104A636MR	Vdet-IC	3.6V±2%, Hst, ±Reset PPO, Wt=1.6s, Rt=3.13ms	SOT-25	28xg	VD19	6g	Tor
356	XC6104A637MR	Vdet-IC	3.7V±2%, Hst, ±Reset PPO, Wt=1.6s, Rt=3.13ms	SOT-25	28xg	VD19	6g	Tor
357	XC6104A638MR	Vdet-IC	3.8V±2%, Hst, ±Reset PPO, Wt=1.6s, Rt=3.13ms	SOT-25	28xg	VD19	6g	Tor
358	XC6104A639MR	Vdet-IC	3.9V±2%, Hst, ±Reset PPO, Wt=1.6s, Rt=3.13ms	SOT-25	28xg	VD19	6g	Tor
359	XC6104A640MR	Vdet-IC	4.0V±2%, Hst, ±Reset PPO, Wt=1.6s, Rt=3.13ms	SOT-25	28xg	VD19	6g	Tor
35A	AAT60035A-S5	Vdet-IC	3.5V±2%, -Reset ODO	SOT-23-5	28vdo	VD1	6g	Aat
35A	XC6104A641MR	Vdet-IC	4.1V±2%, Hst, ±Reset PPO, Wt=1.6s, Rt=3.13ms	SOT-25	28xg	VD19	6g	Tor
35-A	UTC8135-A	Vdet-IC	3.5V, -Reset OCO	SOT-23-5	28vdz	VD6	6k	Utc
35B	AAT60035B-S5	Vdet-IC	3.5V±2%, -Reset PPO	SOT-23-5	28vdo	VD3	6g	Aat
35B	XC6104A642MR	Vdet-IC	4.2V±2%, Hst, ±Reset PPO, Wt=1.6s, Rt=3.13ms	SOT-25	28xg	VD19	6g	Tor
35-B	UTC8135-B	Vdet-IC	3.5V, -Reset OCO	SOT-23-5	28vdm	VD6	6k	Utc
35C	AAT60035C-S5	Vdet-IC	3.5V±1%, -Reset ODO	SOT-23-5	28vdo	VD1	6g	Aat
35C	XC6104A643MR	Vdet-IC	4.3V±2%, Hst, ±Reset PPO, Wt=1.6s, Rt=3.13ms	SOT-25	28xg	VD19	6g	Tor
35D	AAT60035D-S5	Vdet-IC	3.5V±1%, -Reset PPO	SOT-23-5	28vdo	VD3	6g	Aat
35D	XC6104A644MR	Vdet-IC	4.4V±2%, Hst, ±Reset PPO, Wt=1.6s, Rt=3.13ms	SOT-25	28xg	VD19	6g	Tor
35E	XC6104A645MR	Vdet-IC	4.5V±2%, Hst, ±Reset PPO, Wt=1.6s, Rt=3.13ms	SOT-25	28xg	VD19	6g	Tor
35F	XC6104A616MR	Vdet-IC	1.6V±2%, Hst, ±Reset PPO, Wt=1.6s, Rt=3.13ms	SOT-25	28xg	VD19	6g	Tor
35F	XC6104A646MR	Vdet-IC	4.6V±2%, Hst, ±Reset PPO, Wt=1.6s, Rt=3.13ms	SOT-25	28xg	VD19	6g	Tor
35H	XC6104A617MR	Vdet-IC	1.7V±2%, Hst, ±Reset PPO, Wt=1.6s, Rt=3.13ms	SOT-25	28xg	VD19	6g	Tor
35H	XC6104A647MR	Vdet-IC	4.7V±2%, Hst, ±Reset PPO, Wt=1.6s, Rt=3.13ms	SOT-25	28xg	VD19	6g	Tor
35K	TK71735S	LVR-IC	LDO, 3.5V±1.5%, 300mA, +CE	SOT-23-5	28vrx	VR7	6k	Tok
35K	XC6104A618MR	Vdet-IC	1.8V±2%, Hst, ±Reset PPO, Wt=1.6s, Rt=3.13ms	SOT-25	28xg	VD19	6g	Tor
35K	XC6104A648MR	Vdet-IC	4.8V±2%, Hst, ±Reset PPO, Wt=1.6s, Rt=3.13ms	SOT-25	28xg	VD19	6g	Tor
35L	TK71635ASCL	LVR-IC	LDO, 3.5V±2%, 150mA, +CE, -30...+80°C	SOT-23-5	28vrx	VR7	6k	Tok
35L	XC6104A619MR	Vdet-IC	1.9V±2%, Hst, ±Reset PPO, Wt=1.6s, Rt=3.13ms	SOT-25	28xg	VD19	6g	Tor
35L	XC6104A649MR	Vdet-IC	4.9V±2%, Hst, ±Reset PPO, Wt=1.6s, Rt=3.13ms	SOT-25	28xg	VD19	6g	Tor
35M	XC6104A620MR	Vdet-IC	2.0V±2%, Hst, ±Reset PPO, Wt=1.6s, Rt=3.13ms	SOT-25	28xg	VD19	6g	Tor
35M	XC6104A650MR	Vdet-IC	5.0V±2%, Hst, ±Reset PPO, Wt=1.6s, Rt=3.13ms	SOT-25	28xg	VD19	6g	Tor
35N	XC6104A621MR	Vdet-IC	2.1V±2%, Hst, ±Reset PPO, Wt=1.6s, Rt=3.13ms	SOT-25	28xg	VD19	6g	Tor
35P	XC6104A622MR	Vdet-IC	2.2V±2%, Hst, ±Reset PPO, Wt=1.6s, Rt=3.13ms	SOT-25	28xg	VD19	6g	Tor
35R	XC6104A623MR	Vdet-IC	2.3V±2%, Hst, ±Reset PPO, Wt=1.6s, Rt=3.13ms	SOT-25	28xg	VD19	6g	Tor
35S	XC6104A624MR	Vdet-IC	2.4V±2%, Hst, ±Reset PPO, Wt=1.6s, Rt=3.13ms	SOT-25	28xg	VD19	6g	Tor
35T	TK71435S	LVR-IC	LDO, 3.5V±2%, 100mA, +CE, Ext. transistor	SOT-23-5	28zh	VR6	6a	Tok
35T	XC6104A625MR	Vdet-IC	2.5V±2%, Hst, ±Reset PPO, Wt=1.6s, Rt=3.13ms	SOT-25	28xg	VD19	6g	Tor
35U	XC6104A626MR	Vdet-IC	2.6V±2%, Hst, ±Reset PPO, Wt=1.6s, Rt=3.13ms	SOT-25	28xg	VD19	6g	Tor
35V	XC6104A627MR	Vdet-IC	2.7V±2%, Hst, ±Reset PPO, Wt=1.6s, Rt=3.13ms	SOT-25	28xg	VD19	6g	Tor
35X	XC6104A628MR	Vdet-IC	2.8V±2%, Hst, ±Reset PPO, Wt=1.6s, Rt=3.13ms	SOT-25	28xg	VD19	6g	Tor
35Y	XC6104A629MR	Vdet-IC	2.9V±2%, Hst, ±Reset PPO, Wt=1.6s, Rt=3.13ms	SOT-25	28xg	VD19	6g	Tor
35Z	XC6104A630MR	Vdet-IC	3.0V±2%, Hst, ±Reset PPO, Wt=1.6s, Rt=3.13ms	SOT-25	28xg	VD19	6g	Tor
36	R1223N152G	DC/DC-IC	PWM step-down, +CE, 1.5V, 300kHz, +Reset-Pr.	SOT-23-5	28ud	DC7	6g	Ric
36	RN5RF36AA	LVR-IC	LRip, -CE, 3.6V±2%, 1A*	SOT-23-5	28vw	VR6	6g	Ric
36	RN5RZ36AA	LVR-IC	LDO, LN, -CE, 3.6V±2%, 100mA	SOT-23-5	28vrt	VR4	6g	Ric
360	XC6104B231MR	Vdet-IC	3.1V±2%, Hst, ±Reset PPO, Wt=50ms, Rt=25ms	SOT-25	28xg	VD19	6g	Tor
361	XC6104B232MR	Vdet-IC	3.2V±2%, Hst, ±Reset PPO, Wt=50ms, Rt=25ms	SOT-25	28xg	VD19	6g	Tor
362	XC6104B233MR	Vdet-IC	3.3V±2%, Hst, ±Reset PPO, Wt=50ms, Rt=25ms	SOT-25	28xg	VD19	6g	Tor
363	XC6104B234MR	Vdet-IC	3.4V±2%, Hst, ±Reset PPO, Wt=50ms, Rt=25ms	SOT-25	28xg	VD19	6g	Tor
364	XC6104B235MR	Vdet-IC	3.5V±2%, Hst, ±Reset PPO, Wt=50ms, Rt=25ms	SOT-25	28xg	VD19	6g	Tor
365	XC6104B236MR	Vdet-IC	3.6V±2%, Hst, ±Reset PPO, Wt=50ms, Rt=25ms	SOT-25	28xg	VD19	6g	Tor
366	XC6104B237MR	Vdet-IC	3.7V±2%, Hst, ±Reset PPO, Wt=50ms, Rt=25ms	SOT-25	28xg	VD19	6g	Tor
367	XC6104B238MR	Vdet-IC	3.8V±2%, Hst, ±Reset PPO, Wt=50ms, Rt=25ms	SOT-25	28xg	VD19	6g	Tor
368	XC6104B239MR	Vdet-IC	3.9V±2%, Hst, ±Reset PPO, Wt=50ms, Rt=25ms	SOT-25	28xg	VD19	6g	Tor
369	XC6104B240MR	Vdet-IC	4.0V±2%, Hst, ±Reset PPO, Wt=50ms, Rt=25ms	SOT-25	28xg	VD19	6g	Tor
36A	AAT60036A-S5	Vdet-IC	3.6V±2%, -Reset ODO	SOT-23-5	28vdo	VD1	6g	Aat
36A	XC6104B241MR	Vdet-IC	4.1V±2%, Hst, ±Reset PPO, Wt=50ms, Rt=25ms	SOT-25	28xg	VD19	6g	Tor
36-A	UTC8136-A	Vdet-IC	3.6V, -Reset OCO	SOT-23-5	28vdz	VD6	6k	Utc
36B	AAT60036B-S5	Vdet-IC	3.6V±2%, -Reset PPO	SOT-23-5	28vdo	VD3	6g	Aat
36B	XC6104B242MR	Vdet-IC	4.2V±2%, Hst, ±Reset PPO, Wt=50ms, Rt=25ms	SOT-25	28xg	VD19	6g	Tor
36-B	UTC8136-B	Vdet-IC	3.6V, -Reset OCO	SOT-23-5	28vdm	VD6	6k	Utc
36C	AAT60036C-S5	Vdet-IC	3.6V±1%, -Reset ODO	SOT-23-5	28vdo	VD1	6g	Aat
36C	XC6104B243MR	Vdet-IC	4.3V±2%, Hst, ±Reset PPO, Wt=50ms, Rt=25ms	SOT-25	28xg	VD19	6g	Tor
36D	AAT60036D-S5	Vdet-IC	3.6V±1%, -Reset PPO	SOT-23-5	28vdo	VD3	6g	Aat
36D	XC6104B244MR	Vdet-IC	4.4V±2%, Hst, ±Reset PPO, Wt=50ms, Rt=25ms	SOT-25	28xg	VD19	6g	Tor
36E	XC6104B245MR	Vdet-IC	4.5V±2%, Hst, ±Reset PPO, Wt=50ms, Rt=25ms	SOT-25	28xg	VD19	6g	Tor
36F	XC6104B216MR	Vdet-IC	1.6V±2%, Hst, ±Reset PPO, Wt=50ms, Rt=25ms	SOT-25	28xg	VD19	6g	Tor
36F	XC6104B246MR	Vdet-IC	4.6V±2%, Hst, ±Reset PPO, Wt=50ms, Rt=25ms	SOT-25	28xg	VD19	6g	Tor



SMD code	Type	Function	Short description	Case	Pinout	Sch.	St.	Mnf.
36H	XC6104B217MR	Vdet-IC	1.7V±2%, Hst, ±Reset PPO, Wt=50ms, Rt=25ms	SOT-25	28xg	VD19	6g	Tor
36H	XC6104B247MR	Vdet-IC	4.7V±2%, Hst, ±Reset PPO, Wt=50ms, Rt=25ms	SOT-25	28xg	VD19	6g	Tor
36K	TK71736S	LVR-IC	LDO, 3.6V±1.5%, 300mA, +CE	SOT-23-5	28vrx	VR7	6k	Tok
36K	XC6104B218MR	Vdet-IC	1.8V±2%, Hst, ±Reset PPO, Wt=50ms, Rt=25ms	SOT-25	28xg	VD19	6g	Tor
36K	XC6104B248MR	Vdet-IC	4.8V±2%, Hst, ±Reset PPO, Wt=50ms, Rt=25ms	SOT-25	28xg	VD19	6g	Tor
36L	TK71636ASCL	LVR-IC	LDO, 3.6V±2%, 150mA, +CE, -30, +80°C	SOT-23-5	28vrx	VR7	6k	Tok
36L	XC6104B219MR	Vdet-IC	1.9V±2%, Hst, ±Reset PPO, Wt=50ms, Rt=25ms	SOT-25	28xg	VD19	6g	Tor
36L	XC6104B249MR	Vdet-IC	4.9V±2%, Hst, ±Reset PPO, Wt=50ms, Rt=25ms	SOT-25	28xg	VD19	6g	Tor
36M	XC6104B220MR	Vdet-IC	2.0V±2%, Hst, ±Reset PPO, Wt=50ms, Rt=25ms	SOT-25	28xg	VD19	6g	Tor
36M	XC6104B250MR	Vdet-IC	5.0V±2%, Hst, ±Reset PPO, Wt=50ms, Rt=25ms	SOT-25	28xg	VD19	6g	Tor
36N	XC6104B221MR	Vdet-IC	2.1V±2%, Hst, ±Reset PPO, Wt=50ms, Rt=25ms	SOT-25	28xg	VD19	6g	Tor
36P	XC6104B222MR	Vdet-IC	2.2V±2%, Hst, ±Reset PPO, Wt=50ms, Rt=25ms	SOT-25	28xg	VD19	6g	Tor
36R	XC6104B223MR	Vdet-IC	2.3V±2%, Hst, ±Reset PPO, Wt=50ms, Rt=25ms	SOT-25	28xg	VD19	6g	Tor
36S	XC6104B224MR	Vdet-IC	2.4V±2%, Hst, ±Reset PPO, Wt=50ms, Rt=25ms	SOT-25	28xg	VD19	6g	Tor
36T	TK71436S	LVR-IC	LDO, 3.6V±2%, 100mA, +CE, Ext. transistor	SOT-23-5	28zh	VR6	6a	Tok
36T	XC6104B225MR	Vdet-IC	2.5V±2%, Hst, ±Reset PPO, Wt=50ms, Rt=25ms	SOT-25	28xg	VD19	6g	Tor
36U	TK61036S	Vdet-IC	3.6V±2%, -Reset PPO	SOT-23-5	28vdm	VD7	6a	Tok
36U	XC6104B226MR	Vdet-IC	2.6V±2%, Hst, ±Reset PPO, Wt=50ms, Rt=25ms	SOT-25	28xg	VD19	6g	Tor
36V	XC6104B227MR	Vdet-IC	2.7V±2%, Hst, ±Reset PPO, Wt=50ms, Rt=25ms	SOT-25	28xg	VD19	6g	Tor
36X	XC6104B228MR	Vdet-IC	2.8V±2%, Hst, ±Reset PPO, Wt=50ms, Rt=25ms	SOT-25	28xg	VD19	6g	Tor
36Y	XC6104B229MR	Vdet-IC	2.9V±2%, Hst, ±Reset PPO, Wt=50ms, Rt=25ms	SOT-25	28xg	VD19	6g	Tor
36Z	XC6104B230MR	Vdet-IC	3.0V±2%, Hst, ±Reset PPO, Wt=50ms, Rt=25ms	SOT-25	28xg	VD19	6g	Tor
37	R1223N182G	DC/DC-IC	PWM step-down, +CE, 1.8V, 300kHz, +Reset-Pr.	SOT-23-5	28ud	DC7	6g	Ric
37	RN5RF37AA	LVR-IC	LRip, -CE, 3.7V±2%, 1A*	SOT-23-5	28vw	VR6	6g	Ric
37	RN5RZ37AA	LVR-IC	LDO, LN, -CE, 3.7V±2%, 100mA	SOT-23-5	28wrt	VR6	6g	Ric
370	XC6104B331MR	Vdet-IC	3.1V±2%, Hst, ±Reset PPO, Wt=100ms, Rt=25ms	SOT-25	28xg	VD19	6g	Tor
371	XC6104B332MR	Vdet-IC	3.2V±2%, Hst, ±Reset PPO, Wt=100ms, Rt=25ms	SOT-25	28xg	VD19	6g	Tor
372	XC6104B333MR	Vdet-IC	3.3V±2%, Hst, ±Reset PPO, Wt=100ms, Rt=25ms	SOT-25	28xg	VD19	6g	Tor
373	XC6104B334MR	Vdet-IC	3.4V±2%, Hst, ±Reset PPO, Wt=100ms, Rt=25ms	SOT-25	28xg	VD19	6g	Tor
374	XC6104B335MR	Vdet-IC	3.5V±2%, Hst, ±Reset PPO, Wt=100ms, Rt=25ms	SOT-25	28xg	VD19	6g	Tor
375	XC6104B336MR	Vdet-IC	3.6V±2%, Hst, ±Reset PPO, Wt=100ms, Rt=25ms	SOT-25	28xg	VD19	6g	Tor
376	XC6104B337MR	Vdet-IC	3.7V±2%, Hst, ±Reset PPO, Wt=100ms, Rt=25ms	SOT-25	28xg	VD19	6g	Tor
377	XC6104B338MR	Vdet-IC	3.8V±2%, Hst, ±Reset PPO, Wt=100ms, Rt=25ms	SOT-25	28xg	VD19	6g	Tor
378	XC6104B339MR	Vdet-IC	3.9V±2%, Hst, ±Reset PPO, Wt=100ms, Rt=25ms	SOT-25	28xg	VD19	6g	Tor
379	XC6104B340MR	Vdet-IC	4.0V±2%, Hst, ±Reset PPO, Wt=100ms, Rt=25ms	SOT-25	28xg	VD19	6g	Tor
37A	AAT60037A-S5	Vdet-IC	3.7V±2%, -Reset ODO	SOT-23-5	28vdo	VD1	6g	Aat
37A	XC6104B341MR	Vdet-IC	4.1V±2%, Hst, ±Reset PPO, Wt=100ms, Rt=25ms	SOT-25	28xg	VD19	6g	Tor
37-A	UTC8137-A	Vdet-IC	3.7V, -Reset OCO	SOT-23-5	28vdz	VD6	6k	Utc
37B	AAT60037B-S5	Vdet-IC	3.7V±2%, -Reset PPO	SOT-23-5	28vdo	VD3	6g	Aat
37B	XC6104B342MR	Vdet-IC	4.2V±2%, Hst, ±Reset PPO, Wt=100ms, Rt=25ms	SOT-25	28xg	VD19	6g	Tor
37-B	UTC8137-B	Vdet-IC	3.7V, -Reset OCO	SOT-23-5	28vdm	VD6	6k	Utc
37C	AAT60037C-S5	Vdet-IC	3.7V±1%, -Reset ODO	SOT-23-5	28vdo	VD1	6g	Aat
37C	XC6104B343MR	Vdet-IC	4.3V±2%, Hst, ±Reset PPO, Wt=100ms, Rt=25ms	SOT-25	28xg	VD19	6g	Tor
37D	AAT60037D-S5	Vdet-IC	3.7V±1%, -Reset PPO	SOT-23-5	28vdo	VD3	6g	Aat
37D	XC6104B344MR	Vdet-IC	4.4V±2%, Hst, ±Reset PPO, Wt=100ms, Rt=25ms	SOT-25	28xg	VD19	6g	Tor
37E	XC6104B345MR	Vdet-IC	4.5V±2%, Hst, ±Reset PPO, Wt=100ms, Rt=25ms	SOT-25	28xg	VD19	6g	Tor
37F	XC6104B316MR	Vdet-IC	1.6V±2%, Hst, ±Reset PPO, Wt=100ms, Rt=25ms	SOT-25	28xg	VD19	6g	Tor
37F	XC6104B346MR	Vdet-IC	4.6V±2%, Hst, ±Reset PPO, Wt=100ms, Rt=25ms	SOT-25	28xg	VD19	6g	Tor
37H	XC6104B317MR	Vdet-IC	1.7V±2%, Hst, ±Reset PPO, Wt=100ms, Rt=25ms	SOT-25	28xg	VD19	6g	Tor
37H	XC6104B347MR	Vdet-IC	4.7V±2%, Hst, ±Reset PPO, Wt=100ms, Rt=25ms	SOT-25	28xg	VD19	6g	Tor
37K	TK71737S	LVR-IC	LDO, 3.7V±1.5%, 300mA, +CE	SOT-23-5	28vrx	VR7	6k	Tok
37K	XC6104B318MR	Vdet-IC	1.8V±2%, Hst, ±Reset PPO, Wt=100ms, Rt=25ms	SOT-25	28xg	VD19	6g	Tor
37K	XC6104B348MR	Vdet-IC	4.8V±2%, Hst, ±Reset PPO, Wt=100ms, Rt=25ms	SOT-25	28xg	VD19	6g	Tor
37L	TK71637ASCL	LVR-IC	LDO, 3.7V±2%, 150mA, +CE, -30, +80°C	SOT-23-5	28vrx	VR7	6k	Tok
37L	XC6104B319MR	Vdet-IC	1.9V±2%, Hst, ±Reset PPO, Wt=100ms, Rt=25ms	SOT-25	28xg	VD19	6g	Tor
37L	XC6104B349MR	Vdet-IC	4.9V±2%, Hst, ±Reset PPO, Wt=100ms, Rt=25ms	SOT-25	28xg	VD19	6g	Tor
37M	XC6104B320MR	Vdet-IC	2.0V±2%, Hst, ±Reset PPO, Wt=100ms, Rt=25ms	SOT-25	28xg	VD19	6g	Tor
37M	XC6104B350MR	Vdet-IC	5.0V±2%, Hst, ±Reset PPO, Wt=100ms, Rt=25ms	SOT-25	28xg	VD19	6g	Tor
37N	XC6104B321MR	Vdet-IC	2.1V±2%, Hst, ±Reset PPO, Wt=100ms, Rt=25ms	SOT-25	28xg	VD19	6g	Tor
37P	XC6104B322MR	Vdet-IC	2.2V±2%, Hst, ±Reset PPO, Wt=100ms, Rt=25ms	SOT-25	28xg	VD19	6g	Tor
37R	XC6104B323MR	Vdet-IC	2.3V±2%, Hst, ±Reset PPO, Wt=100ms, Rt=25ms	SOT-25	28xg	VD19	6g	Tor
37S	XC6104B324MR	Vdet-IC	2.4V±2%, Hst, ±Reset PPO, Wt=100ms, Rt=25ms	SOT-25	28xg	VD19	6g	Tor
37T	TK71437S	LVR-IC	LDO, 3.7V±2%, 100mA, +CE, Ext. transistor	SOT-23-5	28zh	VR6	6a	Tok
37T	XC6104B325MR	Vdet-IC	2.5V±2%, Hst, ±Reset PPO, Wt=100ms, Rt=25ms	SOT-25	28xg	VD19	6g	Tor
37U	XC6104B326MR	Vdet-IC	2.6V±2%, Hst, ±Reset PPO, Wt=100ms, Rt=25ms	SOT-25	28xg	VD19	6g	Tor
37V	XC6104B327MR	Vdet-IC	2.7V±2%, Hst, ±Reset PPO, Wt=100ms, Rt=25ms	SOT-25	28xg	VD19	6g	Tor
37X	XC6104B328MR	Vdet-IC	2.8V±2%, Hst, ±Reset PPO, Wt=100ms, Rt=25ms	SOT-25	28xg	VD19	6g	Tor
37Y	XC6104B329MR	Vdet-IC	2.9V±2%, Hst, ±Reset PPO, Wt=100ms, Rt=25ms	SOT-25	28xg	VD19	6g	Tor
37Z	XC6104B330MR	Vdet-IC	3.0V±2%, Hst, ±Reset PPO, Wt=100ms, Rt=25ms	SOT-25	28xg	VD19	6g	Tor
38	R1223N252G	DC/DC-IC	PWM step-down, +CE, 2.5V, 300kHz, +Reset-Pr.	SOT-23-5	28ud	DC7	6g	Ric



SMD code	Type	Function	Short description	Case	Pinout	Sch.	St.	Mnf.
38	RN5RF38AA	LVR-IC	LRip, -CE, 3.8V±2%, 1A*	SOT-23-5	28vw	VR6	6g	Ric
38	RN5RZ38AA	LVR-IC	LDO, LN, -CE, 3.8V±2%, 100mA	SOT-23-5	28wrt	VR4	6g	Ric
380	XC6104B431MR	Vdet-IC	3.1V±2%, Hst, ±Reset PPO, Wt=200ms, Rt=25ms	SOT-25	28xg	VD19	6g	Tor
381	XC6104B432MR	Vdet-IC	3.2V±2%, Hst, ±Reset PPO, Wt=200ms, Rt=25ms	SOT-25	28xg	VD19	6g	Tor
382	XC6104B433MR	Vdet-IC	3.3V±2%, Hst, ±Reset PPO, Wt=200ms, Rt=25ms	SOT-25	28xg	VD19	6g	Tor
383	XC6104B434MR	Vdet-IC	3.4V±2%, Hst, ±Reset PPO, Wt=200ms, Rt=25ms	SOT-25	28xg	VD19	6g	Tor
384	XC6104B435MR	Vdet-IC	3.5V±2%, Hst, ±Reset PPO, Wt=200ms, Rt=25ms	SOT-25	28xg	VD19	6g	Tor
385	XC6104B436MR	Vdet-IC	3.6V±2%, Hst, ±Reset PPO, Wt=200ms, Rt=25ms	SOT-25	28xg	VD19	6g	Tor
386	XC6104B437MR	Vdet-IC	3.7V±2%, Hst, ±Reset PPO, Wt=200ms, Rt=25ms	SOT-25	28xg	VD19	6g	Tor
387	XC6104B438MR	Vdet-IC	3.8V±2%, Hst, ±Reset PPO, Wt=200ms, Rt=25ms	SOT-25	28xg	VD19	6g	Tor
388	XC6104B439MR	Vdet-IC	3.9V±2%, Hst, ±Reset PPO, Wt=200ms, Rt=25ms	SOT-25	28xg	VD19	6g	Tor
389	XC6104B440MR	Vdet-IC	4.0V±2%, Hst, ±Reset PPO, Wt=200ms, Rt=25ms	SOT-25	28xg	VD19	6g	Tor
38A	AAT60038A-S5	Vdet-IC	3.8V±2%, -Reset ODO	SOT-23-5	28vdo	VD1	6g	Aat
38-A	XC6104B441MR	Vdet-IC	4.1V±2%, Hst, ±Reset PPO, Wt=200ms, Rt=25ms	SOT-25	28xg	VD19	6g	Tor
38A	UTC8138-A	Vdet-IC	3.8V, -Reset OCO	SOT-23-5	28vdz	VD6	6k	Utc
38B	AAT60038B-S5	Vdet-IC	3.8V±2%, -Reset PPO	SOT-23-5	28vdo	VD3	6g	Aat
38B	XC6104B442MR	Vdet-IC	4.2V±2%, Hst, ±Reset PPO, Wt=200ms, Rt=25ms	SOT-25	28xg	VD19	6g	Tor
38-B	UTC8138-B	Vdet-IC	3.8V, -Reset OCO	SOT-23-5	28vdm	VD6	6k	Utc
38C	AAT60038C-S5	Vdet-IC	3.8V±1%, -Reset ODO	SOT-23-5	28vdo	VD1	6g	Aat
38C	XC6104B443MR	Vdet-IC	4.3V±2%, Hst, ±Reset PPO, Wt=200ms, Rt=25ms	SOT-25	28xg	VD19	6g	Tor
38D	AAT60038D-S5	Vdet-IC	3.8V±1%, -Reset PPO	SOT-23-5	28vdo	VD3	6g	Aat
38D	XC6104B444MR	Vdet-IC	4.4V±2%, Hst, ±Reset PPO, Wt=200ms, Rt=25ms	SOT-25	28xg	VD19	6g	Tor
38E	XC6104B445MR	Vdet-IC	4.5V±2%, Hst, ±Reset PPO, Wt=200ms, Rt=25ms	SOT-25	28xg	VD19	6g	Tor
38F	XC6104B446MR	Vdet-IC	1.6V±2%, Hst, ±Reset PPO, Wt=200ms, Rt=25ms	SOT-25	28xg	VD19	6g	Tor
38E	XC6104B446MR	Vdet-IC	4.6V±2%, Hst, ±Reset PPO, Wt=200ms, Rt=25ms	SOT-25	28xg	VD19	6g	Tor
38H	XC6104B417MR	Vdet-IC	1.7V±2%, Hst, ±Reset PPO, Wt=200ms, Rt=25ms	SOT-25	28xg	VD19	6g	Tor
38H	XC6104B447MR	Vdet-IC	4.7V±2%, Hst, ±Reset PPO, Wt=200ms, Rt=25ms	SOT-25	28xg	VD19	6g	Tor
38K	TK71738S	LVR-IC	LDO, 3.8V±1.5%, 300mA, +CE	SOT-23-5	28vrx	VR7	6k	Tok
38K	XC6104B418MR	Vdet-IC	1.8V±2%, Hst, ±Reset PPO, Wt=200ms, Rt=25ms	SOT-25	28xg	VD19	6g	Tor
38K	XC6104B448MR	Vdet-IC	4.8V±2%, Hst, ±Reset PPO, Wt=200ms, Rt=25ms	SOT-25	28xg	VD19	6g	Tor
38L	TK71638ASCL	LVR-IC	LDO, 3.8V±2%, 150mA, +CE, -30...+80°C	SOT-23-5	28vrx	VR7	6k	Tok
38L	XC6104B419MR	Vdet-IC	1.9V±2%, Hst, ±Reset PPO, Wt=200ms, Rt=25ms	SOT-25	28xg	VD19	6g	Tor
38L	XC6104B449MR	Vdet-IC	4.9V±2%, Hst, ±Reset PPO, Wt=200ms, Rt=25ms	SOT-25	28xg	VD19	6g	Tor
38M	XC6104B420MR	Vdet-IC	2.0V±2%, Hst, ±Reset PPO, Wt=200ms, Rt=25ms	SOT-25	28xg	VD19	6g	Tor
38M	XC6104B450MR	Vdet-IC	5.0V±2%, Hst, ±Reset PPO, Wt=200ms, Rt=25ms	SOT-25	28xg	VD19	6g	Tor
38N	XC6104B421MR	Vdet-IC	2.1V±2%, Hst, ±Reset PPO, Wt=200ms, Rt=25ms	SOT-25	28xg	VD19	6g	Tor
38P	XC6104B422MR	Vdet-IC	2.2V±2%, Hst, ±Reset PPO, Wt=200ms, Rt=25ms	SOT-25	28xg	VD19	6g	Tor
38R	XC6104B423MR	Vdet-IC	2.3V±2%, Hst, ±Reset PPO, Wt=200ms, Rt=25ms	SOT-25	28xg	VD19	6g	Tor
38S	XC6104B424MR	Vdet-IC	2.4V±2%, Hst, ±Reset PPO, Wt=200ms, Rt=25ms	SOT-25	28xg	VD19	6g	Tor
38T	TK71438S	LVR-IC	LDO, 3.8V±2%, 100mA, +CE, Ext. transistor	SOT-23-5	28zh	VR6	6a	Tok
38T	XC6104B425MR	Vdet-IC	2.5V±2%, Hst, ±Reset PPO, Wt=200ms, Rt=25ms	SOT-25	28xg	VD19	6g	Tor
38U	XC6104B426MR	Vdet-IC	2.6V±2%, Hst, ±Reset PPO, Wt=200ms, Rt=25ms	SOT-25	28xg	VD19	6g	Tor
38V	XC6104B427MR	Vdet-IC	2.7V±2%, Hst, ±Reset PPO, Wt=200ms, Rt=25ms	SOT-25	28xg	VD19	6g	Tor
38X	XC6104B428MR	Vdet-IC	2.8V±2%, Hst, ±Reset PPO, Wt=200ms, Rt=25ms	SOT-25	28xg	VD19	6g	Tor
38Y	XC6104B429MR	Vdet-IC	2.9V±2%, Hst, ±Reset PPO, Wt=200ms, Rt=25ms	SOT-25	28xg	VD19	6g	Tor
38Z	XC6104B430MR	Vdet-IC	3.0V±2%, Hst, ±Reset PPO, Wt=200ms, Rt=25ms	SOT-25	28xg	VD19	6g	Tor
39	R1223N302G	DC/DC-IC	PWM step-down, +CE, 3V, 300kHz, +Reset-Pr.	SOT-23-5	28ud	DC7	6g	Ric
39	RN5RF39AA	LVR-IC	LRip, -CE, 3.9V±2%, 1A*	SOT-23-5	28vw	VR6	6g	Ric
39	RN5RZ39AA	LVR-IC	LDO, LN, -CE, 3.9V±2%, 100mA	SOT-23-5	28wrt	VR4	6g	Ric
390	XC6104B531MR	Vdet-IC	3.1V±2%, Hst, ±Reset PPO, Wt=400ms, Rt=25ms	SOT-25	28xg	VD19	6g	Tor
391	XC6104B532MR	Vdet-IC	3.2V±2%, Hst, ±Reset PPO, Wt=400ms, Rt=25ms	SOT-25	28xg	VD19	6g	Tor
392	XC6104B533MR	Vdet-IC	3.3V±2%, Hst, ±Reset PPO, Wt=400ms, Rt=25ms	SOT-25	28xg	VD19	6g	Tor
393	XC6104B534MR	Vdet-IC	3.4V±2%, Hst, ±Reset PPO, Wt=400ms, Rt=25ms	SOT-25	28xg	VD19	6g	Tor
394	XC6104B535MR	Vdet-IC	3.5V±2%, Hst, ±Reset PPO, Wt=400ms, Rt=25ms	SOT-25	28xg	VD19	6g	Tor
395	XC6104B536MR	Vdet-IC	3.6V±2%, Hst, ±Reset PPO, Wt=400ms, Rt=25ms	SOT-25	28xg	VD19	6g	Tor
396	XC6104B537MR	Vdet-IC	3.7V±2%, Hst, ±Reset PPO, Wt=400ms, Rt=25ms	SOT-25	28xg	VD19	6g	Tor
397	XC6104B538MR	Vdet-IC	3.8V±2%, Hst, ±Reset PPO, Wt=400ms, Rt=25ms	SOT-25	28xg	VD19	6g	Tor
398	XC6104B539MR	Vdet-IC	3.9V±2%, Hst, ±Reset PPO, Wt=400ms, Rt=25ms	SOT-25	28xg	VD19	6g	Tor
399	XC6104B540MR	Vdet-IC	4.0V±2%, Hst, ±Reset PPO, Wt=400ms, Rt=25ms	SOT-25	28xg	VD19	6g	Tor
39A	AAT60039A-S5	Vdet-IC	3.9V±2%, -Reset ODO	SOT-23-5	28vdo	VD1	6g	Aat
39A	XC6104B541MR	Vdet-IC	4.1V±2%, Hst, ±Reset PPO, Wt=400ms, Rt=25ms	SOT-25	28xg	VD19	6g	Tor
39-A	UTC8139-A	Vdet-IC	3.9V, -Reset OCO	SOT-23-5	28vdz	VD6	6k	Utc
39B	AAT60039B-S5	Vdet-IC	3.9V±2%, -Reset PPO	SOT-23-5	28vdo	VD3	6g	Aat
39B	XC6104B542MR	Vdet-IC	4.2V±2%, Hst, ±Reset PPO, Wt=400ms, Rt=25ms	SOT-25	28xg	VD19	6g	Tor
39-B	UTC8139-B	Vdet-IC	3.9V, -Reset OCO	SOT-23-5	28vdm	VD6	6k	Utc
39C	AAT60039C-S5	Vdet-IC	3.9V±1%, -Reset ODO	SOT-23-5	28vdo	VD1	6g	Aat
39C	XC6104B543MR	Vdet-IC	4.3V±2%, Hst, ±Reset PPO, Wt=400ms, Rt=25ms	SOT-25	28xg	VD19	6g	Tor
39D	AAT60039D-S5	Vdet-IC	3.9V±1%, -Reset PPO	SOT-23-5	28vdo	VD3	6g	Aat
39D	XC6104B544MR	Vdet-IC	4.4V±2%, Hst, ±Reset PPO, Wt=400ms, Rt=25ms	SOT-25	28xg	VD19	6g	Tor
39E	XC6104B545MR	Vdet-IC	4.5V±2%, Hst, ±Reset PPO, Wt=400ms, Rt=25ms	SOT-25	28xg	VD19	6g	Tor



SMD code	Type	Function	Short description	Case	Pinout	Sch.	St.	Mnf.
39F	XC6104B516MR	Vdet-IC	1.6V±2%, Hst, ±Reset PPO, Wt=400ms, Rt=25ms	SOT-25	28xg	VD19	6g	Tor
39F	XC6104B546MR	Vdet-IC	4.6V±2%, Hst, ±Reset PPO, Wt=400ms, Rt=25ms	SOT-25	28xg	VD19	6g	Tor
39H	XC6104B517MR	Vdet-IC	1.7V±2%, Hst, ±Reset PPO, Wt=400ms, Rt=25ms	SOT-25	28xg	VD19	6g	Tor
39H	XC6104B547MR	Vdet-IC	4.7V±2%, Hst, ±Reset PPO, Wt=400ms, Rt=25ms	SOT-25	28xg	VD19	6g	Tor
39K	TK71739S	LVR-IC	LDO, 3.9V±1.5%, 300mA, +CE	SOT-23-5	28vrx	VR7	6k	Tok
39K	XC6104B518MR	Vdet-IC	1.8V±2%, Hst, ±Reset PPO, Wt=400ms, Rt=25ms	SOT-25	28xg	VD19	6g	Tor
39K	XC6104B548MR	Vdet-IC	4.8V±2%, Hst, ±Reset PPO, Wt=400ms, Rt=25ms	SOT-25	28xg	VD19	6g	Tor
39L	TK71639ASCL	LVR-IC	LDO, 3.9V±2%, 150mA, +CE, -30...+80°C	SOT-23-5	28vrx	VR7	6k	Tok
39L	XC6104B519MR	Vdet-IC	1.9V±2%, Hst, ±Reset PPO, Wt=400ms, Rt=25ms	SOT-25	28xg	VD19	6g	Tor
39L	XC6104B549MR	Vdet-IC	4.9V±2%, Hst, ±Reset PPO, Wt=400ms, Rt=25ms	SOT-25	28xg	VD19	6g	Tor
39M	XC6104B520MR	Vdet-IC	2.0V±2%, Hst, ±Reset PPO, Wt=400ms, Rt=25ms	SOT-25	28xg	VD19	6g	Tor
39M	XC6104B550MR	Vdet-IC	5.0V±2%, Hst, ±Reset PPO, Wt=400ms, Rt=25ms	SOT-25	28xg	VD19	6g	Tor
39N	XC6104B521MR	Vdet-IC	2.1V±2%, Hst, ±Reset PPO, Wt=400ms, Rt=25ms	SOT-25	28xg	VD19	6g	Tor
39P	XC6104B522MR	Vdet-IC	2.2V±2%, Hst, ±Reset PPO, Wt=400ms, Rt=25ms	SOT-25	28xg	VD19	6g	Tor
39P	XC6104B523MR	Vdet-IC	2.3V±2%, Hst, ±Reset PPO, Wt=400ms, Rt=25ms	SOT-25	28xg	VD19	6g	Tor
39S	XC6104B524MR	Vdet-IC	2.4V±2%, Hst, ±Reset PPO, Wt=400ms, Rt=25ms	SOT-25	28xg	VD19	6g	Tor
39T	TK71439S	LVR-IC	LDO, 3.9V±2%, 100mA, +CE, Ext. transistor	SOT-23-5	28zh	VR6	6a	Tok
39T	XC6104B525MR	Vdet-IC	2.5V±2%, Hst, ±Reset PPO, Wt=400ms, Rt=25ms	SOT-25	28xg	VD19	6g	Tor
39U	XC6104B526MR	Vdet-IC	2.6V±2%, Hst, ±Reset PPO, Wt=400ms, Rt=25ms	SOT-25	28xg	VD19	6g	Tor
39V	XC6104B527MR	Vdet-IC	2.7V±2%, Hst, ±Reset PPO, Wt=400ms, Rt=25ms	SOT-25	28xg	VD19	6g	Tor
39X	XC6104B528MR	Vdet-IC	2.8V±2%, Hst, ±Reset PPO, Wt=400ms, Rt=25ms	SOT-25	28xg	VD19	6g	Tor
39Y	XC6104B529MR	Vdet-IC	2.9V±2%, Hst, ±Reset PPO, Wt=400ms, Rt=25ms	SOT-25	28xg	VD19	6g	Tor
39Z	XC6104B530MR	Vdet-IC	3.0V±2%, Hst, ±Reset PPO, Wt=400ms, Rt=25ms	SOT-25	28xg	VD19	6g	Tor
3A0	XC6221A311MR	LVR-IC	LDO, 3.1V±1%, 200mA, +CE	SOT-25	28cx	VR4	6g	Tor
3A0	XC6104B631MR	Vdet-IC	3.1V±2%, Hst, ±Reset PPO, Wt=1.6s, Rt=25ms	SOT-25	28xg	VD19	6g	Tor
3A1	XC6221A321MR	LVR-IC	LDO, 3.2V±1%, 200mA, +CE	SOT-25	28cx	VR4	6g	Tor
3A1	XC6104B632MR	Vdet-IC	3.2V±2%, Hst, ±Reset PPO, Wt=1.6s, Rt=25ms	SOT-25	28xg	VD19	6g	Tor
3A2	XC6221A331MR	LVR-IC	LDO, 3.3V±1%, 200mA, +CE	SOT-25	28cx	VR4	6g	Tor
3A2	XC6104B633MR	Vdet-IC	3.3V±2%, Hst, ±Reset PPO, Wt=1.6s, Rt=25ms	SOT-25	28xg	VD19	6g	Tor
3A3	XC6221A341MR	LVR-IC	LDO, 3.4V±1%, 200mA, +CE	SOT-25	28cx	VR4	6g	Tor
3A3	XC6104B634MR	Vdet-IC	3.4V±2%, Hst, ±Reset PPO, Wt=1.6s, Rt=25ms	SOT-25	28xg	VD19	6g	Tor
3A4	U74LVC1G14-AF5	CMOS-Logic	Inverting Schmitt-trigger	SOT-23-5	28Log7	-	6a	Utc
3A4	U74LVC1G14-AL5	CMOS-Logic	Inverting Schmitt-trigger	SOT-353	28Log7	-	6a	Utc
3A4	XC6221A351MR	LVR-IC	LDO, 3.5V±1%, 200mA, +CE	SOT-25	28cx	VR4	6g	Tor
3A4	XC6104B635MR	Vdet-IC	3.5V±2%, Hst, ±Reset PPO, Wt=1.6s, Rt=25ms	SOT-25	28xg	VD19	6g	Tor
3A4L	U74LVC1G14L-AF5	CMOS-Logic	Inverting Schmitt-trigger	SOT-23-5	28Log7	-	6a	Utc
3A4L	U74LVC1G14L-AL5	CMOS-Logic	Inverting Schmitt-trigger	SOT-353	28Log7	-	6a	Utc
3A5	XC6221A361MR	LVR-IC	LDO, 3.6V±1%, 200mA, +CE	SOT-25	28cx	VR4	6g	Tor
3A5	XC6104B636MR	Vdet-IC	3.6V±2%, Hst, ±Reset PPO, Wt=1.6s, Rt=25ms	SOT-25	28xg	VD19	6g	Tor
3A6	XC6221A371MR	LVR-IC	LDO, 3.7V±1%, 200mA, +CE	SOT-25	28cx	VR4	6g	Tor
3A6	XC6104B637MR	Vdet-IC	3.7V±2%, Hst, ±Reset PPO, Wt=1.6s, Rt=25ms	SOT-25	28xg	VD19	6g	Tor
3A7	U74LVC1G17-AF5	CMOS-Logic	Schmitt-trigger	SOT-23-5	28Log11	-	6a	Utc
3A7	U74LVC1G17-AL5	CMOS-Logic	Schmitt-trigger	SOT-353	28Log11	-	6a	Utc
3A7	XC6221A381MR	LVR-IC	LDO, 3.8V±1%, 200mA, +CE	SOT-25	28cx	VR4	6g	Tor
3A7	XC6104B638MR	Vdet-IC	3.8V±2%, Hst, ±Reset PPO, Wt=1.6s, Rt=25ms	SOT-25	28xg	VD19	6g	Tor
3A7L	U74LVC1G17L-AF5	CMOS-Logic	Schmitt-trigger	SOT-23-5	28Log11	-	6a	Utc
3A7L	U74LVC1G17L-AL5	CMOS-Logic	Schmitt-trigger	SOT-353	28Log11	-	6a	Utc
3A7L	U74LVC1G17G-AF5	CMOS-Logic	Schmitt-trigger	SOT-23-5	28Log11	-	6a	Utc
3A7L	U74LVC1G17G-AL5	CMOS-Logic	Schmitt-trigger	SOT-353	28Log11	-	6a	Utc
3A8	XC6221A391MR	LVR-IC	LDO, 3.9V±1%, 200mA, +CE	SOT-25	28cx	VR4	6g	Tor
3A8	XC6221A081MR	LVR-IC	LDO, 0.8V±20mV, 700mA, +CE	SOT-25	28cx	VR4	6a	Tor
3A8	XC6104B639MR	Vdet-IC	3.9V±2%, Hst, ±Reset PPO, Wt=1.6s, Rt=25ms	SOT-25	28xg	VD19	6g	Tor
3A9	XC6221A401MR	LVR-IC	LDO, 4V±1%, 200mA, +CE	SOT-25	28cx	VR4	6g	Tor
3A9	XC6221A091MR	LVR-IC	LDO, 0.9V±20mV, 700mA, +CE	SOT-25	28cx	VR4	6a	Tor
3A9	XC6104B640MR	Vdet-IC	4.0V±2%, Hst, ±Reset PPO, Wt=1.6s, Rt=25ms	SOT-25	28xg	VD19	6g	Tor
3AA	XC6221A411MR	LVR-IC	LDO, 4.1±1%, 200mA, +CE	SOT-25	28cx	VR4	6g	Tor
3AA	XC6221A101MR	LVR-IC	LDO, 1.0V±20mV, 700mA, +CE	SOT-25	28cx	VR4	6a	Tor
3AA	XC6104B641MR	Vdet-IC	4.1V±2%, Hst, ±Reset PPO, Wt=1.6s, Rt=25ms	SOT-25	28xg	VD19	6g	Tor
3AB	XC6221A421MR	LVR-IC	LDO, 4.2±1%, 200mA, +CE	SOT-25	28cx	VR4	6g	Tor
3AB	XC6221A111MR	LVR-IC	LDO, 1.1V±20mV, 700mA, +CE	SOT-25	28cx	VR4	6a	Tor
3AB	XC6104B642MR	Vdet-IC	4.2V±2%, Hst, ±Reset PPO, Wt=1.6s, Rt=25ms	SOT-25	28xg	VD19	6g	Tor
3AC	XC6221A431MR	LVR-IC	LDO, 4.3±1%, 200mA, +CE	SOT-25	28cx	VR4	6g	Tor
3AC	XC6221A121MR	LVR-IC	LDO, 1.2V±20mV, 700mA, +CE	SOT-25	28cx	VR4	6a	Tor
3AC	XC6104B643MR	Vdet-IC	4.3V±2%, Hst, ±Reset PPO, Wt=1.6s, Rt=25ms	SOT-25	28xg	VD19	6g	Tor
3AD	XC6221A441MR	LVR-IC	LDO, 4.4±1%, 200mA, +CE	SOT-25	28cx	VR4	6g	Tor
3AD	XC6221A131MR	LVR-IC	LDO, 1.3V±20mV, 700mA, +CE	SOT-25	28cx	VR4	6a	Tor
3AD	XC6104B644MR	Vdet-IC	4.4V±2%, Hst, ±Reset PPO, Wt=1.6s, Rt=25ms	SOT-25	28xg	VD19	6g	Tor
3AE	XC6221A451MR	LVR-IC	LDO, 4.5±1%, 200mA, +CE	SOT-25	28cx	VR4	6g	Tor
3AE	XC6221A141MR	LVR-IC	LDO, 1.4V±20mV, 700mA, +CE	SOT-25	28cx	VR4	6a	Tor
3AE	XC6104B645MR	Vdet-IC	4.5V±2%, Hst, ±Reset PPO, Wt=1.6s, Rt=25ms	SOT-25	28xg	VD19	6g	Tor



SMD Code	Type	Function	Short description	Case	Pinout	Sch.	St.	Mnf.
3AF	XC6221A461MR	LVR-IC	LDO, 4.6±1%, 200mA, +CE	SOT-25	28cx	VR4	6g	Tor
3AF	XC6227A151MR	LVR-IC	LDO, 1.5V±20mV, 700mA, +CE	SOT-25	28cx	VR4	6a	Tor
3AF	XC6104B616MR	Vdet-IC	1.6V±2%, Hst, ±Reset PPO, Wt=1.6s, Rt=25ms	SOT-25	28xg	VD19	6g	Tor
3AE	XC6104B646MR	Vdet-IC	4.6V±2%, Hst, ±Reset PPO, Wt=1.6s, Rt=25ms	SOT-25	28xg	VD19	6g	Tor
3AH	XC6221A471MR	LVR-IC	LDO, 4.7±1%, 200mA, +CE	SOT-25	28cx	VR4	6g	Tor
3AH	XC6227A161MR	LVR-IC	LDO, 1.6V±20mV, 700mA, +CE	SOT-25	28cx	VR4	6a	Tor
3AH	XC6104B617MR	Vdet-IC	1.7V±2%, Hst, ±Reset PPO, Wt=1.6s, Rt=25ms	SOT-25	28xg	VD19	6g	Tor
3AH	XC6104B647MR	Vdet-IC	4.7V±2%, Hst, ±Reset PPO, Wt=1.6s, Rt=25ms	SOT-25	28xg	VD19	6g	Tor
3AK	XC6221A481MR	LVR-IC	LDO, 4.8±1%, 200mA, +CE	SOT-25	28cx	VR4	6g	Tor
3AK	XC6227A171MR	LVR-IC	LDO, 1.7V±20mV, 700mA, +CE	SOT-25	28cx	VR4	6a	Tor
3AK	XC6104B618MR	Vdet-IC	1.8V±2%, Hst, ±Reset PPO, Wt=1.6s, Rt=25ms	SOT-25	28xg	VD19	6g	Tor
3AK	XC6104B648MR	Vdet-IC	4.8V±2%, Hst, ±Reset PPO, Wt=1.6s, Rt=25ms	SOT-25	28xg	VD19	6g	Tor
3AL	XC6221A491MR	LVR-IC	LDO, 4.9±1%, 200mA, +CE	SOT-25	28cx	VR4	6g	Tor
3AL	XC6227A181MR	LVR-IC	LDO, 1.8V±20mV, 700mA, +CE	SOT-25	28cx	VR4	6a	Tor
3AL	XC6104B619MR	Vdet-IC	1.9V±2%, Hst, ±Reset PPO, Wt=1.6s, Rt=25ms	SOT-25	28xg	VD19	6g	Tor
3AL	XC6104B649MR	Vdet-IC	4.9V±2%, Hst, ±Reset PPO, Wt=1.6s, Rt=25ms	SOT-25	28xg	VD19	6g	Tor
3AM	XC6221A501MR	LVR-IC	LDO, 5.0±1%, 200mA, +CE	SOT-25	28cx	VR4	6g	Tor
3AM	XC6227A191MR	LVR-IC	LDO, 1.9V±20mV, 700mA, +CE	SOT-25	28cx	VR4	6a	Tor
3AM	XC6104B620MR	Vdet-IC	2.0V±2%, Hst, ±Reset PPO, Wt=1.6s, Rt=25ms	SOT-25	28xg	VD19	6g	Tor
3AM	XC6104B650MR	Vdet-IC	5.0V±2%, Hst, ±Reset PPO, Wt=1.6s, Rt=25ms	SOT-25	28xg	VD19	6g	Tor
3AN	XC6227A201MR	LVR-IC	LDO, 2.0V±20mV, 700mA, +CE	SOT-25	28cx	VR4	6a	Tor
3AN	XC6104B621MR	Vdet-IC	2.1V±2%, Hst, ±Reset PPO, Wt=1.6s, Rt=25ms	SOT-25	28xg	VD19	6g	Tor
3AP	XC6227A211MR	LVR-IC	LDO, 2.1V±1%, 700mA, +CE	SOT-25	28cx	VR4	6a	Tor
3AP	XC6104B622MR	Vdet-IC	2.2V±2%, Hst, ±Reset PPO, Wt=1.6s, Rt=25ms	SOT-25	28xg	VD19	6g	Tor
3AR	XC6227A221MR	LVR-IC	LDO, 2.2V±1%, 700mA, +CE	SOT-25	28cx	VR4	6a	Tor
3AR	XC6104B623MR	Vdet-IC	2.3V±2%, Hst, ±Reset PPO, Wt=1.6s, Rt=25ms	SOT-25	28xg	VD19	6g	Tor
3AS	XC6227A231MR	LVR-IC	LDO, 2.3V±1%, 700mA, +CE	SOT-25	28cx	VR4	6a	Tor
3AS	XC6104B624MR	Vdet-IC	2.4V±2%, Hst, ±Reset PPO, Wt=1.6s, Rt=25ms	SOT-25	28xg	VD19	6g	Tor
3AT	XC6227A241MR	LVR-IC	LDO, 2.4V±1%, 700mA, +CE	SOT-25	28cx	VR4	6a	Tor
3AT	XC6104B625MR	Vdet-IC	2.5V±2%, Hst, ±Reset PPO, Wt=1.6s, Rt=25ms	SOT-25	28xg	VD19	6g	Tor
3AU	XC6227A251MR	LVR-IC	LDO, 2.5V±1%, 700mA, +CE	SOT-25	28cx	VR4	6a	Tor
3AU	XC6104B626MR	Vdet-IC	2.6V±2%, Hst, ±Reset PPO, Wt=1.6s, Rt=25ms	SOT-25	28xg	VD19	6g	Tor
3AV	XC6227A261MR	LVR-IC	LDO, 2.6V±1%, 700mA, +CE	SOT-25	28cx	VR4	6a	Tor
3AV	XC6104B627MR	Vdet-IC	2.7V±2%, Hst, ±Reset PPO, Wt=1.6s, Rt=25ms	SOT-25	28xg	VD19	6g	Tor
3AX	XC6227A271MR	LVR-IC	LDO, 2.7V±1%, 700mA, +CE	SOT-25	28cx	VR4	6a	Tor
3AX	XC6104B628MR	Vdet-IC	2.8V±2%, Hst, ±Reset PPO, Wt=1.6s, Rt=25ms	SOT-25	28xg	VD19	6g	Tor
3AY	XC6227A281MR	LVR-IC	LDO, 2.8V±1%, 700mA, +CE	SOT-25	28cx	VR4	6a	Tor
3AY	XC6104B629MR	Vdet-IC	2.9V±2%, Hst, ±Reset PPO, Wt=1.6s, Rt=25ms	SOT-25	28xg	VD19	6g	Tor
3AZ	XC6227A291MR	LVR-IC	LDO, 2.9V±1%, 700mA, +CE	SOT-25	28cx	VR4	6a	Tor
3AZ	XC6104B630MR	Vdet-IC	3.0V±2%, Hst, ±Reset PPO, Wt=1.6s, Rt=25ms	SOT-25	28xg	VD19	6g	Tor
3B	R311N131A	Vdet-IC	1.3V±2%, -Reset PPO	SOT-23-5	28vdm	VD7	6g	Ric
3B	RN5RL23AA	LVR-IC	2.3V±2.5%, 150mA	SOT-23-5	28vu	VR1	6g	Ric
3B	RN5VD13CA	Vdet-IC	1.3V±2.5%, -Reset ODO	SOT-23-5	28vdo	VD1	6g	Ric
3B0	TAR5SB30	LVR-IC	LDO, 3V±1%, 200mA, +CE	SSOP-5	28vrx	VR7	6a	Tos
3B0	XC6104C231MR	Vdet-IC	3.1V±2%, Hst, ±Reset PPO, Wt=50ms, Rt=50ms	SOT-25	28xg	VD19	6g	Tor
3B1	TAR5SB31	LVR-IC	LDO, 3.1V±1%, 200mA, +CE	SSOP-5	28vrx	VR7	6a	Tos
3B1	XC6221B321MR	LVR-IC	LDO, 3.2V±1%, 200mA, +CE, CL	SOT-25	28cx	VR4	6g	Tor
3B1	XC6104C232MR	Vdet-IC	3.2V±2%, Hst, ±Reset PPO, Wt=50ms, Rt=50ms	SOT-25	28xg	VD19	6g	Tor
3B2	TAR5SB32	LVR-IC	LDO, 3.2V±1%, 200mA, +CE	SSOP-5	28vrx	VR7	6a	Tos
3B2	XC6221B331MR	LVR-IC	LDO, 3.3V±1%, 200mA, +CE, CL	SOT-25	28cx	VR4	6g	Tor
3B2	XC6104C233MR	Vdet-IC	3.3V±2%, Hst, ±Reset PPO, Wt=50ms, Rt=50ms	SOT-25	28xg	VD19	6g	Tor
3B3	TAR5SB33	LVR-IC	LDO, 3.3V±1%, 200mA, +CE	SSOP-5	28vrx	VR7	6a	Tos
3B3	XC6221B341MR	LVR-IC	LDO, 3.4V±1%, 200mA, +CE, CL	SOT-25	28cx	VR4	6g	Tor
3B3	XC6104C234MR	Vdet-IC	3.4V±2%, Hst, ±Reset PPO, Wt=50ms, Rt=50ms	SOT-25	28xg	VD19	6g	Tor
3B4	TAR5SB34	LVR-IC	LDO, 3.4V±1%, 200mA, +CE	SSOP-5	28vrx	VR7	6a	Tos
3B4	XC6221B351MR	LVR-IC	LDO, 3.5V±1%, 200mA, +CE, CL	SOT-25	28cx	VR4	6g	Tor
3B4	XC6104C235MR	Vdet-IC	3.5V±2%, Hst, ±Reset PPO, Wt=50ms, Rt=50ms	SOT-25	28xg	VD19	6g	Tor
3B5	TAR5SB35	LVR-IC	LDO, 3.5V±1%, 200mA, +CE	SSOP-5	28vrx	VR7	6a	Tos
3B5	XC6221B361MR	LVR-IC	LDO, 3.6V±1%, 200mA, +CE, CL	SOT-25	28cx	VR4	6g	Tor
3B5	XC6104C236MR	Vdet-IC	3.6V±2%, Hst, ±Reset PPO, Wt=50ms, Rt=50ms	SOT-25	28xg	VD19	6g	Tor
3B6	TAR5SB36	LVR-IC	LDO, 3.6V±1%, 200mA, +CE	SSOP-5	28vrx	VR7	6a	Tos
3B6	XC6221B371MR	LVR-IC	LDO, 3.7V±1%, 200mA, +CE, CL	SOT-25	28cx	VR4	6g	Tor
3B6	XC6104C237MR	Vdet-IC	3.7V±2%, Hst, ±Reset PPO, Wt=50ms, Rt=50ms	SOT-25	28xg	VD19	6g	Tor
3B7	TAR5SB37	LVR-IC	LDO, 3.7V±1%, 200mA, +CE	SSOP-5	28vrx	VR7	6a	Tos
3B7	XC6221B381MR	LVR-IC	LDO, 3.8V±1%, 200mA, +CE, CL	SOT-25	28cx	VR4	6g	Tor
3B7	XC6104C238MR	Vdet-IC	3.8V±2%, Hst, ±Reset PPO, Wt=50ms, Rt=50ms	SOT-25	28xg	VD19	6g	Tor
3B8	TAR5SB38	LVR-IC	LDO, 3.8V±1%, 200mA, +CE	SSOP-5	28vrx	VR7	6a	Tos
3B8	XC6221B391MR	LVR-IC	LDO, 3.9V±1%, 200mA, +CE, CL	SOT-25	28cx	VR4	6g	Tor
3B8	XC6227A08BMR	LVR-IC	LDO, 0.85V±20mV, 700mA, +CE	SOT-25	28cx	VR4	6a	Tor
3B8	XC6104C239MR	Vdet-IC	3.9V±2%, Hst, ±Reset PPO, Wt=50ms, Rt=50ms	SOT-25	28xg	VD19	6g	Tor



SMD code	Type	Function	Short description	Case	Pinout	Sch.	St.	Mnf.
3B9	TAR5SB39	LVR-IC	LDO, 3.9V±1%, 200mA, +CE	SSOP-5	28vrx	VR7	6a	Tos
3B9	XC6221B401MR	LVR-IC	LDO, 4V±1%, 200mA, +CE, CL	SOT-25	28cxc	VR4	6g	Tor
3B9	XC6227A09BMR	LVR-IC	LDO, 1.95V±20mV, 700mA, +CE	SOT-25	28cxc	VR4	6a	Tor
3B9	XC6104C240MR	Vdet-IC	4.0V±2%, Hst, ±Reset PPO, Wt=50ms, Rt=50ms	SOT-25	28xg	VD19	6g	Tor
3BA	XC6221B411MR	LVR-IC	LDO, 4.1V±1%, 200mA, +CE, CL	SOT-25	28cxc	VR4	6g	Tor
3BA	XC6227A10BMR	LVR-IC	LDO, 1.05V±20mV, 700mA, +CE	SOT-25	28cxc	VR4	6a	Tor
3BA	XC6104C241MR	Vdet-IC	4.1V±2%, Hst, ±Reset PPO, Wt=50ms, Rt=50ms	SOT-25	28xg	VD19	6g	Tor
3BB	XC6221B421MR	LVR-IC	LDO, 4.2V±1%, 200mA, +CE, CL	SOT-25	28cxc	VR4	6g	Tor
3BB	XC6227A11BMR	LVR-IC	LDO, 1.15V±20mV, 700mA, +CE	SOT-25	28cxc	VR4	6a	Tor
3BB	XC6104C242MR	Vdet-IC	4.2V±2%, Hst, ±Reset PPO, Wt=50ms, Rt=50ms	SOT-25	28xg	VD19	6g	Tor
3BC	XC6221B431MR	LVR-IC	LDO, 4.3V±1%, 200mA, +CE, CL	SOT-25	28cxc	VR4	6g	Tor
3BC	XC6227A12BMR	LVR-IC	LDO, 1.25V±20mV, 700mA, +CE	SOT-25	28cxc	VR4	6a	Tor
3BC	XC6104C243MR	Vdet-IC	4.3V±2%, Hst, ±Reset PPO, Wt=50ms, Rt=50ms	SOT-25	28xg	VD19	6g	Tor
3BD	XC6221B441MR	LVR-IC	LDO, 4.4V±1%, 200mA, +CE, CL	SOT-25	28cxc	VR4	6g	Tor
3BD	XC6227A13BMR	LVR-IC	LDO, 1.35V±20mV, 700mA, +CE	SOT-25	28cxc	VR4	6a	Tor
3BD	XC6104C244MR	Vdet-IC	4.4V±2%, Hst, ±Reset PPO, Wt=50ms, Rt=50ms	SOT-25	28xg	VD19	6g	Tor
3BE	XC6221B451MR	LVR-IC	LDO, 4.5V±1%, 200mA, +CE, CL	SOT-25	28cxc	VR4	6g	Tor
3BE	XC6227A14BMR	LVR-IC	LDO, 1.45V±20mV, 700mA, +CE	SOT-25	28cxc	VR4	6a	Tor
3BE	XC6104C245MR	Vdet-IC	4.5V±2%, Hst, ±Reset PPO, Wt=50ms, Rt=50ms	SOT-25	28xg	VD19	6g	Tor
3BF	XC6221B461MR	LVR-IC	LDO, 4.6V±1%, 200mA, +CE, CL	SOT-25	28cxc	VR4	6g	Tor
3BF	XC6227A15BMR	LVR-IC	LDO, 1.55V±20mV, 700mA, +CE	SOT-25	28cxc	VR4	6a	Tor
3BF	XC6104C216MR	Vdet-IC	1.6V±2%, Hst, ±Reset PPO, Wt=50ms, Rt=50ms	SOT-25	28xg	VD19	6g	Tor
3BF	XC6104C246MR	Vdet-IC	4.6V±2%, Hst, ±Reset PPO, Wt=50ms, Rt=50ms	SOT-25	28xg	VD19	6g	Tor
3BH	XC6221B471MR	LVR-IC	LDO, 4.7V±1%, 200mA, +CE, CL	SOT-25	28cxc	VR4	6g	Tor
3BH	XC6227A16BMR	LVR-IC	LDO, 1.65V±20mV, 700mA, +CE	SOT-25	28cxc	VR4	6a	Tor
3BH	XC6104C217MR	Vdet-IC	1.7V±2%, Hst, ±Reset PPO, Wt=50ms, Rt=50ms	SOT-25	28xg	VD19	6g	Tor
3BH	XC6104C247MR	Vdet-IC	4.7V±2%, Hst, ±Reset PPO, Wt=50ms, Rt=50ms	SOT-25	28xg	VD19	6g	Tor
3BK	XC6221B481MR	LVR-IC	LDO, 4.8V±1%, 200mA, +CE, CL	SOT-25	28cxc	VR4	6g	Tor
3BK	XC6227A17BMR	LVR-IC	LDO, 1.75V±20mV, 700mA, +CE	SOT-25	28cxc	VR4	6a	Tor
3BK	XC6104C218MR	Vdet-IC	1.8V±2%, Hst, ±Reset PPO, Wt=50ms, Rt=50ms	SOT-25	28xg	VD19	6g	Tor
3BK	XC6104C248MR	Vdet-IC	4.8V±2%, Hst, ±Reset PPO, Wt=50ms, Rt=50ms	SOT-25	28xg	VD19	6g	Tor
3BL	XC6221B491MR	LVR-IC	LDO, 4.9V±1%, 200mA, +CE, CL	SOT-25	28cxc	VR4	6g	Tor
3BL	XC6227A18BMR	LVR-IC	LDO, 1.85V±20mV, 700mA, +CE	SOT-25	28cxc	VR4	6a	Tor
3BL	XC6104C219MR	Vdet-IC	1.9V±2%, Hst, ±Reset PPO, Wt=50ms, Rt=50ms	SOT-25	28xg	VD19	6g	Tor
3BL	XC6104C249MR	Vdet-IC	4.9V±2%, Hst, ±Reset PPO, Wt=50ms, Rt=50ms	SOT-25	28xg	VD19	6g	Tor
3BM	XC6221B501MR	LVR-IC	LDO, 5.0V±1%, 200mA, +CE, CL	SOT-25	28cxc	VR4	6g	Tor
3BM	XC6227A19BMR	LVR-IC	LDO, 1.95V±20mV, 700mA, +CE	SOT-25	28cxc	VR4	6a	Tor
3BM	XC6104C220MR	Vdet-IC	2.0V±2%, Hst, ±Reset PPO, Wt=50ms, Rt=50ms	SOT-25	28xg	VD19	6g	Tor
3BM	XC6104C250MR	Vdet-IC	5.0V±2%, Hst, ±Reset PPO, Wt=50ms, Rt=50ms	SOT-25	28xg	VD19	6g	Tor
3BN	XC6227A20BMR	LVR-IC	LDO, 2.05V±1%, 700mA, +CE	SOT-25	28cxc	VR4	6a	Tor
3BN	XC6104C221MR	Vdet-IC	2.1V±2%, Hst, ±Reset PPO, Wt=50ms, Rt=50ms	SOT-25	28xg	VD19	6g	Tor
3BP	XC6227A21BMR	LVR-IC	LDO, 2.15V±1%, 700mA, +CE	SOT-25	28cxc	VR4	6a	Tor
3BP	XC6104C222MR	Vdet-IC	2.2V±2%, Hst, ±Reset PPO, Wt=50ms, Rt=50ms	SOT-25	28xg	VD19	6g	Tor
3BR	XC6227A22BMR	LVR-IC	LDO, 2.25V±1%, 700mA, +CE	SOT-25	28cxc	VR4	6a	Tor
3BR	XC6104C223MR	Vdet-IC	2.3V±2%, Hst, ±Reset PPO, Wt=50ms, Rt=50ms	SOT-25	28xg	VD19	6g	Tor
3BS	XC6227A23BMR	LVR-IC	LDO, 2.35V±1%, 700mA, +CE	SOT-25	28cxc	VR4	6a	Tor
3BS	XC6104C224MR	Vdet-IC	2.4V±2%, Hst, ±Reset PPO, Wt=50ms, Rt=50ms	SOT-25	28xg	VD19	6g	Tor
3BT	XC6227A24BMR	LVR-IC	LDO, 2.45V±1%, 700mA, +CE	SOT-25	28cxc	VR4	6a	Tor
3BT	XC6104C225MR	Vdet-IC	2.5V±2%, Hst, ±Reset PPO, Wt=50ms, Rt=50ms	SOT-25	28xg	VD19	6g	Tor
3BU	XC6227A25BMR	LVR-IC	LDO, 2.55V±1%, 700mA, +CE	SOT-25	28cxc	VR4	6a	Tor
3BU	XC6104C226MR	Vdet-IC	2.6V±2%, Hst, ±Reset PPO, Wt=50ms, Rt=50ms	SOT-25	28xg	VD19	6g	Tor
3BV	XC6227A26BMR	LVR-IC	LDO, 2.65V±1%, 700mA, +CE	SOT-25	28cxc	VR4	6a	Tor
3BV	XC6104C227MR	Vdet-IC	2.7V±2%, Hst, ±Reset PPO, Wt=50ms, Rt=50ms	SOT-25	28xg	VD19	6g	Tor
3BX	XC6227A27BMR	LVR-IC	LDO, 2.75V±1%, 700mA, +CE	SOT-25	28cxc	VR4	6a	Tor
3BX	XC6104C228MR	Vdet-IC	2.8V±2%, Hst, ±Reset PPO, Wt=50ms, Rt=50ms	SOT-25	28xg	VD19	6g	Tor
3BY	XC6227A28BMR	LVR-IC	LDO, 2.85V±1%, 700mA, +CE	SOT-25	28cxc	VR4	6a	Tor
3BY	XC6104C229MR	Vdet-IC	2.9V±2%, Hst, ±Reset PPO, Wt=50ms, Rt=50ms	SOT-25	28xg	VD19	6g	Tor
3BZ	XC6227A29BMR	LVR-IC	LDO, 2.95V±1%, 700mA, +CE	SOT-25	28cxc	VR4	6a	Tor
3BZ	XC6104C230MR	Vdet-IC	3.0V±2%, Hst, ±Reset PPO, Wt=50ms, Rt=50ms	SOT-25	28xg	VD19	6g	Tor
3C	R3111N231A	Vdet-IC	2.3V±2%, -Reset PPO	SOT-23-5	28vdm	VD7	6g	Ric
3C	RN5RL33AA	LVR-IC	3.3V±2.5%, 150mA	SOT-23-5	28vur	VR1	6g	Ric
3C	RN5VD23CA	Vdet-IC	2.3V±2.5%, -Reset ODO	SOT-23-5	28vdo	VD1	6g	Ric
3C0	XC6227A301MR	LVR-IC	LDO, 3.0V±1%, 700mA, +CE	SOT-25	28cxc	VR4	6a	Tor
3C0	XC6104C331MR	Vdet-IC	3.1V±2%, Hst, ±Reset PPO, Wt=100ms, Rt=50ms	SOT-25	28xg	VD19	6g	Tor
3C1	XC6227A311MR	LVR-IC	LDO, 3.1V±1%, 700mA, +CE	SOT-25	28cxc	VR4	6a	Tor
3C1	XC6104C332MR	Vdet-IC	3.2V±2%, Hst, ±Reset PPO, Wt=100ms, Rt=50ms	SOT-25	28xg	VD19	6g	Tor
3C2	XC6227A321MR	LVR-IC	LDO, 3.2V±1%, 700mA, +CE	SOT-25	28cxc	VR4	6a	Tor
3C2	XC6104C333MR	Vdet-IC	3.3V±2%, Hst, ±Reset PPO, Wt=100ms, Rt=50ms	SOT-25	28xg	VD19	6g	Tor
3C3	XC6227A331MR	LVR-IC	LDO, 3.3V±1%, 700mA, +CE	SOT-25	28cxc	VR4	6a	Tor
3C3	XC6104C334MR	Vdet-IC	3.4V±2%, Hst, ±Reset PPO, Wt=100ms, Rt=50ms	SOT-25	28xg	VD19	6g	Tor



SMD code	Type	Function	Short description	Case	Pinout	Sch.	St.	Mnf.
3C4	U74LVC1G34-AF5	CMOS-Logic	Noninverting buffer	SOT-23-5	28/Log10	-	6a	Utc
3C4	U74LVC1G34-AL5	CMOS-Logic	Noninverting buffer	SOT-353	28/Log10	-	6a	Utc
3C4	XC6227A341MR	LVR-IC	LDO, 3.4V±1%, 700mA, +CE	SOT-25	28cx	VR4	6a	Tor
3C4	XC6104C335MR	Vdet-IC	3.5V±2%, Hst, ±Reset PPO, Wt=100ms, Rt=50ms	SOT-25	28xg	VD19	6g	Tor
3C4L	U74LVC1G34L-AF5	CMOS-Logic	Noninverting buffer	SOT-23-5	28/Log10	-	6a	Utc
3C4L	U74LVC1G34L-AL5	CMOS-Logic	Noninverting buffer	SOT-353	28/Log10	-	6a	Utc
3C5	XC6227A351MR	LVR-IC	LDO, 3.5V±1%, 700mA, +CE	SOT-25	28cx	VR4	6a	Tor
3C5	XC6104C336MR	Vdet-IC	3.6V±2%, Hst, ±Reset PPO, Wt=100ms, Rt=50ms	SOT-25	28xg	VD19	6g	Tor
3C6	XC6227A361MR	LVR-IC	LDO, 3.6V±1%, 700mA, +CE	SOT-25	28cx	VR4	6a	Tor
3C6	XC6104C337MR	Vdet-IC	3.7V±2%, Hst, ±Reset PPO, Wt=100ms, Rt=50ms	SOT-25	28xg	VD19	6g	Tor
3C7	XC6227A371MR	LVR-IC	LDO, 3.7V±1%, 700mA, +CE	SOT-25	28cx	VR4	6a	Tor
3C7	XC6104C338MR	Vdet-IC	3.8V±2%, Hst, ±Reset PPO, Wt=100ms, Rt=50ms	SOT-25	28xg	VD19	6g	Tor
3C8	XC6227A381MR	LVR-IC	LDO, 3.8V±1%, 700mA, +CE	SOT-25	28cx	VR4	6a	Tor
3C8	XC6104C339MR	Vdet-IC	3.9V±2%, Hst, ±Reset PPO, Wt=100ms, Rt=50ms	SOT-25	28xg	VD19	6g	Tor
3C9	XC6227A391MR	LVR-IC	LDO, 3.9V±1%, 700mA, +CE	SOT-25	28cx	VR4	6a	Tor
3C9	XC6104C340MR	Vdet-IC	4.0V±2%, Hst, ±Reset PPO, Wt=100ms, Rt=50ms	SOT-25	28xg	VD19	6g	Tor
3CA	XC6227A401MR	LVR-IC	LDO, 4.0V±1%, 700mA, +CE	SOT-25	28cx	VR4	6a	Tor
3CA	XC6104C341MR	Vdet-IC	4.1V±2%, Hst, ±Reset PPO, Wt=100ms, Rt=50ms	SOT-25	28xg	VD19	6g	Tor
3CB	XC6227A411MR	LVR-IC	LDO, 4.1V±1%, 700mA, +CE	SOT-25	28cx	VR4	6a	Tor
3CB	XC6104C342MR	Vdet-IC	4.2V±2%, Hst, ±Reset PPO, Wt=100ms, Rt=50ms	SOT-25	28xg	VD19	6g	Tor
3CC	XC6227A421MR	LVR-IC	LDO, 4.2V±1%, 700mA, +CE	SOT-25	28cx	VR4	6a	Tor
3CC	XC6104C343MR	Vdet-IC	4.3V±2%, Hst, ±Reset PPO, Wt=100ms, Rt=50ms	SOT-25	28xg	VD19	6g	Tor
3CD	XC6227A431MR	LVR-IC	LDO, 4.3V±1%, 700mA, +CE	SOT-25	28cx	VR4	6a	Tor
3CD	XC6104C344MR	Vdet-IC	4.4V±2%, Hst, ±Reset PPO, Wt=100ms, Rt=50ms	SOT-25	28xg	VD19	6g	Tor
3CE	XC6227A441MR	LVR-IC	LDO, 4.4V±1%, 700mA, +CE	SOT-25	28cx	VR4	6a	Tor
3CE	XC6104C345MR	Vdet-IC	4.5V±2%, Hst, ±Reset PPO, Wt=100ms, Rt=50ms	SOT-25	28xg	VD19	6g	Tor
3CF	XC6227A451MR	LVR-IC	LDO, 4.5V±1%, 700mA, +CE	SOT-25	28cx	VR4	6a	Tor
3CF	XC6104C316MR	Vdet-IC	1.6V±2%, Hst, ±Reset PPO, Wt=100ms, Rt=50ms	SOT-25	28xg	VD19	6g	Tor
3CF	XC6104C346MR	Vdet-IC	4.6V±2%, Hst, ±Reset PPO, Wt=100ms, Rt=50ms	SOT-25	28xg	VD19	6g	Tor
3CH	XC6227A461MR	LVR-IC	LDO, 4.6V±1%, 700mA, +CE	SOT-25	28cx	VR4	6a	Tor
3CH	XC6104C317MR	Vdet-IC	1.7V±2%, Hst, ±Reset PPO, Wt=100ms, Rt=50ms	SOT-25	28xg	VD19	6g	Tor
3CH	XC6104C347MR	Vdet-IC	4.7V±2%, Hst, ±Reset PPO, Wt=100ms, Rt=50ms	SOT-25	28xg	VD19	6g	Tor
3CK	XC6227A471MR	LVR-IC	LDO, 4.7V±1%, 700mA, +CE	SOT-25	28cx	VR4	6a	Tor
3CK	XC6104C318MR	Vdet-IC	1.8V±2%, Hst, ±Reset PPO, Wt=100ms, Rt=50ms	SOT-25	28xg	VD19	6g	Tor
3CK	XC6104C348MR	Vdet-IC	4.8V±2%, Hst, ±Reset PPO, Wt=100ms, Rt=50ms	SOT-25	28xg	VD19	6g	Tor
3CL	XC6227A481MR	LVR-IC	LDO, 4.8V±1%, 700mA, +CE	SOT-25	28cx	VR4	6a	Tor
3CL	XC6104C319MR	Vdet-IC	1.9V±2%, Hst, ±Reset PPO, Wt=100ms, Rt=50ms	SOT-25	28xg	VD19	6g	Tor
3CL	XC6104C349MR	Vdet-IC	4.9V±2%, Hst, ±Reset PPO, Wt=100ms, Rt=50ms	SOT-25	28xg	VD19	6g	Tor
3CM	XC6227A491MR	LVR-IC	LDO, 4.9V±1%, 700mA, +CE	SOT-25	28cx	VR4	6a	Tor
3CM	XC6104C320MR	Vdet-IC	2.0V±2%, Hst, ±Reset PPO, Wt=100ms, Rt=50ms	SOT-25	28xg	VD19	6g	Tor
3CM	XC6104C350MR	Vdet-IC	5.0V±2%, Hst, ±Reset PPO, Wt=100ms, Rt=50ms	SOT-25	28xg	VD19	6g	Tor
3CN	XC6227A501MR	LVR-IC	LDO, 5.0V±1%, 700mA, +CE	SOT-25	28cx	VR4	6a	Tor
3CN	XC6104C321MR	Vdet-IC	2.1V±2%, Hst, ±Reset PPO, Wt=100ms, Rt=50ms	SOT-25	28xg	VD19	6g	Tor
3CP	XC6104C322MR	Vdet-IC	2.2V±2%, Hst, ±Reset PPO, Wt=100ms, Rt=50ms	SOT-25	28xg	VD19	6g	Tor
3CR	XC6104C323MR	Vdet-IC	2.3V±2%, Hst, ±Reset PPO, Wt=100ms, Rt=50ms	SOT-25	28xg	VD19	6g	Tor
3CS	XC6104C324MR	Vdet-IC	2.4V±2%, Hst, ±Reset PPO, Wt=100ms, Rt=50ms	SOT-25	28xg	VD19	6g	Tor
3CT	XC6104C325MR	Vdet-IC	2.5V±2%, Hst, ±Reset PPO, Wt=100ms, Rt=50ms	SOT-25	28xg	VD19	6g	Tor
3CU	XC6104C326MR	Vdet-IC	2.6V±2%, Hst, ±Reset PPO, Wt=100ms, Rt=50ms	SOT-25	28xg	VD19	6g	Tor
3CV	XC6104C327MR	Vdet-IC	2.7V±2%, Hst, ±Reset PPO, Wt=100ms, Rt=50ms	SOT-25	28xg	VD19	6g	Tor
3CX	XC6104C328MR	Vdet-IC	2.8V±2%, Hst, ±Reset PPO, Wt=100ms, Rt=50ms	SOT-25	28xg	VD19	6g	Tor
3CY	XC6104C329MR	Vdet-IC	2.9V±2%, Hst, ±Reset PPO, Wt=100ms, Rt=50ms	SOT-25	28xg	VD19	6g	Tor
3CZ	XC6104C330MR	Vdet-IC	3.0V±2%, Hst, ±Reset PPO, Wt=100ms, Rt=50ms	SOT-25	28xg	VD19	6g	Tor
3D	R3111N331A	Vdet-IC	3.3V±2%, -Reset PPO	SOT-23-5	28vdm	VD7	6g	Ric
3D	RN5RL43AA	LVR-IC	4.3V±2.5%, 150mA	SOT-23-5	28vu	VR1	6g	Ric
3D	RN5VD33CA	Vdet-IC	3.3V±2.5%, -Reset ODO	SOT-23-5	28vdo	VD1	6g	Ric
3D0	XC6227A30BMR	LVR-IC	LDO, 3.05V±1%, 700mA, +CE	SOT-25	28cx	VR4	6a	Tor
3D0	XC6104C431MR	Vdet-IC	3.1V±2%, Hst, ±Reset PPO, Wt=200ms, Rt=50ms	SOT-25	28xg	VD19	6g	Tor
3D1	XC6227A31BMR	LVR-IC	LDO, 3.15V±1%, 700mA, +CE	SOT-25	28cx	VR4	6a	Tor
3D1	XC6104C432MR	Vdet-IC	3.2V±2%, Hst, ±Reset PPO, Wt=200ms, Rt=50ms	SOT-25	28xg	VD19	6g	Tor
3D2	XC6227A32BMR	LVR-IC	LDO, 3.25V±1%, 700mA, +CE	SOT-25	28cx	VR4	6a	Tor
3D2	XC6104C433MR	Vdet-IC	3.3V±2%, Hst, ±Reset PPO, Wt=200ms, Rt=50ms	SOT-25	28xg	VD19	6g	Tor
3D3	XC6227A33BMR	LVR-IC	LDO, 3.35V±1%, 700mA, +CE	SOT-25	28cx	VR4	6a	Tor
3D3	XC6104C434MR	Vdet-IC	3.4V±2%, Hst, ±Reset PPO, Wt=200ms, Rt=50ms	SOT-25	28xg	VD19	6g	Tor
3D4	XC6227A34BMR	LVR-IC	LDO, 3.45V±1%, 700mA, +CE	SOT-25	28cx	VR4	6a	Tor
3D4	XC6104C435MR	Vdet-IC	3.5V±2%, Hst, ±Reset PPO, Wt=200ms, Rt=50ms	SOT-25	28xg	VD19	6g	Tor
3D5	XC6227A35BMR	LVR-IC	LDO, 3.55V±1%, 700mA, +CE	SOT-25	28cx	VR4	6a	Tor
3D5	XC6104C436MR	Vdet-IC	3.6V±2%, Hst, ±Reset PPO, Wt=200ms, Rt=50ms	SOT-25	28xg	VD19	6g	Tor
3D6	XC6227A36BMR	LVR-IC	LDO, 3.65V±1%, 700mA, +CE	SOT-25	28cx	VR4	6a	Tor
3D6	XC6104C437MR	Vdet-IC	3.7V±2%, Hst, ±Reset PPO, Wt=200ms, Rt=50ms	SOT-25	28xg	VD19	6g	Tor
3D7	XC6227A37BMR	LVR-IC	LDO, 3.75V±1%, 700mA, +CE	SOT-25	28cx	VR4	6a	Tor



SMD code	Type	Function	Short description	Case	Pinout	Sch.	St.	Mnf.
<u>3D7</u>	XC6104C438MR	Vdet-IC	3.8V±2%, Hst, ±Reset PPO, Wt=200ms, Rt=50ms	SOT-25	28xg	VD19	6g	Tor
<u>3D8</u>	XC6227A38BMR	LVR-IC	LDO, 3.85V±1%, 700mA, +CE	SOT-25	28cx	VR4	6a	Tor
<u>3D8</u>	XC6104C439MR	Vdet-IC	3.9V±2%, Hst, ±Reset PPO, Wt=200ms, Rt=50ms	SOT-25	28xg	VD19	6g	Tor
<u>3D9</u>	XC6227A39BMR	LVR-IC	LDO, 3.95V±1%, 700mA, +CE	SOT-25	28cx	VR4	6a	Tor
<u>3D9</u>	XC6104C440MR	Vdet-IC	4.0V±2%, Hst, ±Reset PPO, Wt=200ms, Rt=50ms	SOT-25	28xg	VD19	6g	Tor
<u>3DA</u>	XC6227A40BMR	LVR-IC	LDO, 4.05V±1%, 700mA, +CE	SOT-25	28cx	VR4	6a	Tor
<u>3DA</u>	XC6104C441MR	Vdet-IC	4.1V±2%, Hst, ±Reset PPO, Wt=200ms, Rt=50ms	SOT-25	28xg	VD19	6g	Tor
<u>3DB</u>	XC6227A41BMR	LVR-IC	LDO, 4.15V±1%, 700mA, +CE	SOT-25	28cx	VR4	6a	Tor
<u>3DB</u>	XC6104C442MR	Vdet-IC	4.2V±2%, Hst, ±Reset PPO, Wt=200ms, Rt=50ms	SOT-25	28xg	VD19	6g	Tor
<u>3DC</u>	XC6227A42BMR	LVR-IC	LDO, 4.25V±1%, 700mA, +CE	SOT-25	28cx	VR4	6a	Tor
<u>3DC</u>	XC6104C443MR	Vdet-IC	4.3V±2%, Hst, ±Reset PPO, Wt=200ms, Rt=50ms	SOT-25	28xg	VD19	6g	Tor
<u>3DD</u>	XC6227A43BMR	LVR-IC	LDO, 4.35V±1%, 700mA, +CE	SOT-25	28cx	VR4	6a	Tor
<u>3DD</u>	XC6104C444MR	Vdet-IC	4.4V±2%, Hst, ±Reset PPO, Wt=200ms, Rt=50ms	SOT-25	28xg	VD19	6g	Tor
<u>3DE</u>	XC6227A44BMR	LVR-IC	LDO, 4.45V±1%, 700mA, +CE	SOT-25	28cx	VR4	6a	Tor
<u>3DE</u>	XC6104C445MR	Vdet-IC	4.5V±2%, Hst, ±Reset PPO, Wt=200ms, Rt=50ms	SOT-25	28xg	VD19	6g	Tor
<u>3DF</u>	XC6227A45BMR	LVR-IC	LDO, 4.55V±1%, 700mA, +CE	SOT-25	28cx	VR4	6a	Tor
<u>3DF</u>	XC6104C416MR	Vdet-IC	1.6V±2%, Hst, ±Reset PPO, Wt=200ms, Rt=50ms	SOT-25	28xg	VD19	6g	Tor
<u>3DF</u>	XC6104C446MR	Vdet-IC	4.6V±2%, Hst, ±Reset PPO, Wt=200ms, Rt=50ms	SOT-25	28xg	VD19	6g	Tor
<u>3DH</u>	XC6227A46BMR	LVR-IC	LDO, 4.65V±1%, 700mA, +CE	SOT-25	28cx	VR4	6a	Tor
<u>3DH</u>	XC6104C417MR	Vdet-IC	1.7V±2%, Hst, ±Reset PPO, Wt=200ms, Rt=50ms	SOT-25	28xg	VD19	6g	Tor
<u>3DH</u>	XC6104C447MR	Vdet-IC	4.7V±2%, Hst, ±Reset PPO, Wt=200ms, Rt=50ms	SOT-25	28xg	VD19	6g	Tor
<u>3DK</u>	XC6227A47BMR	LVR-IC	LDO, 4.75V±1%, 700mA, +CE	SOT-25	28cx	VR4	6a	Tor
<u>3DK</u>	XC6104C418MR	Vdet-IC	1.8V±2%, Hst, ±Reset PPO, Wt=200ms, Rt=50ms	SOT-25	28xg	VD19	6g	Tor
<u>3DK</u>	XC6104C448MR	Vdet-IC	4.8V±2%, Hst, ±Reset PPO, Wt=200ms, Rt=50ms	SOT-25	28xg	VD19	6g	Tor
<u>3DL</u>	XC6227A48BMR	LVR-IC	LDO, 4.85V±1%, 700mA, +CE	SOT-25	28cx	VR4	6a	Tor
<u>3DL</u>	XC6104C419MR	Vdet-IC	1.9V±2%, Hst, ±Reset PPO, Wt=200ms, Rt=50ms	SOT-25	28xg	VD19	6g	Tor
<u>3DL</u>	XC6104C449MR	Vdet-IC	4.9V±2%, Hst, ±Reset PPO, Wt=200ms, Rt=50ms	SOT-25	28xg	VD19	6g	Tor
<u>3DM</u>	XC6227A49BMR	LVR-IC	LDO, 4.95V±1%, 700mA, +CE	SOT-25	28cx	VR4	6a	Tor
<u>3DM</u>	XC6104C420MR	Vdet-IC	2.0V±2%, Hst, ±Reset PPO, Wt=200ms, Rt=50ms	SOT-25	28xg	VD19	6g	Tor
<u>3DM</u>	XC6104C450MR	Vdet-IC	5.0V±2%, Hst, ±Reset PPO, Wt=200ms, Rt=50ms	SOT-25	28xg	VD19	6g	Tor
<u>3DN</u>	XC6104C421MR	Vdet-IC	2.1V±2%, Hst, ±Reset PPO, Wt=200ms, Rt=50ms	SOT-25	28xg	VD19	6g	Tor
<u>3DP</u>	XC6104C422MR	Vdet-IC	2.2V±2%, Hst, ±Reset PPO, Wt=200ms, Rt=50ms	SOT-25	28xg	VD19	6g	Tor
<u>3DR</u>	XC6104C423MR	Vdet-IC	2.3V±2%, Hst, ±Reset PPO, Wt=200ms, Rt=50ms	SOT-25	28xg	VD19	6g	Tor
<u>3DS</u>	XC6104C424MR	Vdet-IC	2.4V±2%, Hst, ±Reset PPO, Wt=200ms, Rt=50ms	SOT-25	28xg	VD19	6g	Tor
<u>3DT</u>	XC6104C425MR	Vdet-IC	2.5V±2%, Hst, ±Reset PPO, Wt=200ms, Rt=50ms	SOT-25	28xg	VD19	6g	Tor
<u>3DU</u>	XC6104C426MR	Vdet-IC	2.6V±2%, Hst, ±Reset PPO, Wt=200ms, Rt=50ms	SOT-25	28xg	VD19	6g	Tor
<u>3DV</u>	XC6104C427MR	Vdet-IC	2.7V±2%, Hst, ±Reset PPO, Wt=200ms, Rt=50ms	SOT-25	28xg	VD19	6g	Tor
<u>3DX</u>	XC6104C428MR	Vdet-IC	2.8V±2%, Hst, ±Reset PPO, Wt=200ms, Rt=50ms	SOT-25	28xg	VD19	6g	Tor
<u>3DY</u>	XC6104C429MR	Vdet-IC	2.9V±2%, Hst, ±Reset PPO, Wt=200ms, Rt=50ms	SOT-25	28xg	VD19	6g	Tor
<u>3DZ</u>	XC6104C430MR	Vdet-IC	3.0V±2%, Hst, ±Reset PPO, Wt=200ms, Rt=50ms	SOT-25	28xg	VD19	6g	Tor
<u>3E</u>	R3111N431A	Vdet-IC	4.3V±2%, -Reset PPO	SOT-23-5	28vdm	VD7	6g	Ric
<u>3E</u>	RN5RL53AA	LVR-IC	5.3V±2.5%, 150mA	SOT-23-5	28vu	VR1	6g	Ric
<u>3E</u>	RN5VD43CA	Vdet-IC	4.3V±2.5%, -Reset ODO	SOT-23-5	28vdo	VD1	6g	Ric
<u>3E0</u>	XC6104C531MR	Vdet-IC	3.1V±2%, Hst, ±Reset PPO, Wt=400ms, Rt=50ms	SOT-25	28xg	VD19	6g	Tor
<u>3E1</u>	XC6104C532MR	Vdet-IC	3.2V±2%, Hst, ±Reset PPO, Wt=400ms, Rt=50ms	SOT-25	28xg	VD19	6g	Tor
<u>3E2</u>	XC6104C533MR	Vdet-IC	3.3V±2%, Hst, ±Reset PPO, Wt=400ms, Rt=50ms	SOT-25	28xg	VD19	6g	Tor
<u>3E3</u>	XC6104C534MR	Vdet-IC	3.4V±2%, Hst, ±Reset PPO, Wt=400ms, Rt=50ms	SOT-25	28xg	VD19	6g	Tor
<u>3E4</u>	XC6104C535MR	Vdet-IC	3.5V±2%, Hst, ±Reset PPO, Wt=400ms, Rt=50ms	SOT-25	28xg	VD19	6g	Tor
<u>3E5</u>	XC6104C536MR	Vdet-IC	3.6V±2%, Hst, ±Reset PPO, Wt=400ms, Rt=50ms	SOT-25	28xg	VD19	6g	Tor
<u>3E6</u>	XC6104C537MR	Vdet-IC	3.7V±2%, Hst, ±Reset PPO, Wt=400ms, Rt=50ms	SOT-25	28xg	VD19	6g	Tor
<u>3E7</u>	XC6221A08BMR	LVR-IC	LDO, 0.85V±20mV, 200mA, +CE	SOT-25	28cx	VR4	6g	Tor
<u>3E7</u>	XC6104C538MR	Vdet-IC	3.8V±2%, Hst, ±Reset PPO, Wt=400ms, Rt=50ms	SOT-25	28xg	VD19	6g	Tor
<u>3E8</u>	XC6221A09BMR	LVR-IC	LDO, 0.95V±20mV, 200mA, +CE	SOT-25	28cx	VR4	6g	Tor
<u>3E8</u>	XC6227C081MR	LVR-IC	LDO, 0.8V±20mV, 700mA, +CE, PDR	SOT-25	28cx	VR4	6a	Tor
<u>3E8</u>	XC6104C539MR	Vdet-IC	3.9V±2%, Hst, ±Reset PPO, Wt=400ms, Rt=50ms	SOT-25	28xg	VD19	6g	Tor
<u>3E9</u>	XC6221A10BMR	LVR-IC	LDO, 1.05V±20mV, 200mA, +CE	SOT-25	28cx	VR4	6g	Tor
<u>3E9</u>	XC6227C091MR	LVR-IC	LDO, 0.9V±20mV, 700mA, +CE, PDR	SOT-25	28cx	VR4	6a	Tor
<u>3E9</u>	XC6104C540MR	Vdet-IC	4.0V±2%, Hst, ±Reset PPO, Wt=400ms, Rt=50ms	SOT-25	28xg	VD19	6g	Tor
<u>3EA</u>	XC6221A11BMR	LVR-IC	LDO, 1.15V±20mV, 200mA, +CE	SOT-25	28cx	VR4	6g	Tor
<u>3EA</u>	XC6227C101MR	LVR-IC	LDO, 1.0V±20mV, 700mA, +CE, PDR	SOT-25	28cx	VR4	6a	Tor
<u>3EA</u>	XC6104C541MR	Vdet-IC	4.1V±2%, Hst, ±Reset PPO, Wt=400ms, Rt=50ms	SOT-25	28xg	VD19	6g	Tor
<u>3EB</u>	XC6221A12BMR	LVR-IC	LDO, 1.25V±20mV, 200mA, +CE	SOT-25	28cx	VR4	6g	Tor
<u>3EB</u>	XC6227C111MR	LVR-IC	LDO, 1.1V±20mV, 700mA, +CE, PDR	SOT-25	28cx	VR4	6a	Tor
<u>3EB</u>	XC6104C542MR	Vdet-IC	4.2V±2%, Hst, ±Reset PPO, Wt=400ms, Rt=50ms	SOT-25	28xg	VD19	6g	Tor
<u>3EC</u>	XC6221A13BMR	LVR-IC	LDO, 1.35V±20mV, 200mA, +CE	SOT-25	28cx	VR4	6g	Tor
<u>3EC</u>	XC6227C121MR	LVR-IC	LDO, 1.2V±20mV, 700mA, +CE, PDR	SOT-25	28cx	VR4	6a	Tor
<u>3EC</u>	XC6104C543MR	Vdet-IC	4.3V±2%, Hst, ±Reset PPO, Wt=400ms, Rt=50ms	SOT-25	28xg	VD19	6g	Tor
<u>3ED</u>	XC6221A14BMR	LVR-IC	LDO, 1.45V±20mV, 200mA, +CE	SOT-25	28cx	VR4	6g	Tor
<u>3ED</u>	XC6227C131MR	LVR-IC	LDO, 1.3V±20mV, 700mA, +CE, PDR	SOT-25	28cx	VR4	6a	Tor
<u>3ED</u>	XC6104C544MR	Vdet-IC	4.4V±2%, Hst, ±Reset PPO, Wt=400ms, Rt=50ms	SOT-25	28xg	VD19	6g	Tor



SMD code	Type	Function	Short description	Case	Pinout	Sch.	St.	Mnf.
3EE	XC6221A15BMR	LVR-IC	LDO, 1.55V±20mV, 200mA, +CE	SOT-25	28cx	VR4	6g	Tor
3EE	XC6227C141MR	LVR-IC	LDO, 1.4V±20mV, 700mA, +CE, PDR	SOT-25	28cx	VR4	6a	Tor
3EE	XC6104C545MR	Vdet-IC	4.5V±2%, Hst, ±Reset PPO, Wt=400ms, Rt=50ms	SOT-25	28xg	VD19	6g	Tor
3EF	XC6221A16BMR	LVR-IC	LDO, 1.65V±20mV, 200mA, +CE	SOT-25	28cx	VR4	6g	Tor
3EF	XC6227C151MR	LVR-IC	LDO, 1.5V±20mV, 700mA, +CE, PDR	SOT-25	28cx	VR4	6a	Tor
3EF	XC6104C516MR	Vdet-IC	1.6V±2%, Hst, ±Reset PPO, Wt=400ms, Rt=50ms	SOT-25	28xg	VD19	6g	Tor
3EF	XC6104C546MR	Vdet-IC	4.6V±2%, Hst, ±Reset PPO, Wt=400ms, Rt=50ms	SOT-25	28xg	VD19	6g	Tor
3EH	XC6221A17BMR	LVR-IC	LDO, 1.75V±20mV, 200mA, +CE	SOT-25	28cx	VR4	6g	Tor
3EH	XC6227C161MR	LVR-IC	LDO, 1.6V±20mV, 700mA, +CE, PDR	SOT-25	28cx	VR4	6a	Tor
3EH	XC6104C517MR	Vdet-IC	1.7V±2%, Hst, ±Reset PPO, Wt=400ms, Rt=50ms	SOT-25	28xg	VD19	6g	Tor
3EH	XC6104C547MR	Vdet-IC	4.7V±2%, Hst, ±Reset PPO, Wt=400ms, Rt=50ms	SOT-25	28xg	VD19	6g	Tor
3EK	XC6221A18BMR	LVR-IC	LDO, 1.85V±20mV, 200mA, +CE	SOT-25	28cx	VR4	6g	Tor
3EK	XC6227C171MR	LVR-IC	LDO, 1.7V±20mV, 700mA, +CE, PDR	SOT-25	28cx	VR4	6a	Tor
3EK	XC6104C518MR	Vdet-IC	1.8V±2%, Hst, ±Reset PPO, Wt=400ms, Rt=50ms	SOT-25	28xg	VD19	6g	Tor
3EK	XC6104C548MR	Vdet-IC	4.8V±2%, Hst, ±Reset PPO, Wt=400ms, Rt=50ms	SOT-25	28xg	VD19	6g	Tor
3EL	XC6221A19BMR	LVR-IC	LDO, 1.95V±20mV, 200mA, +CE	SOT-25	28cx	VR4	6g	Tor
3EL	XC6227C181MR	LVR-IC	LDO, 1.8V±20mV, 700mA, +CE, PDR	SOT-25	28cx	VR4	6a	Tor
3EL	XC6104C519MR	Vdet-IC	1.9V±2%, Hst, ±Reset PPO, Wt=400ms, Rt=50ms	SOT-25	28xg	VD19	6g	Tor
3EL	XC6104C549MR	Vdet-IC	4.9V±2%, Hst, ±Reset PPO, Wt=400ms, Rt=50ms	SOT-25	28xg	VD19	6g	Tor
3EM	XC6221A20BMR	LVR-IC	LDO, 2.05V±1%, 200mA, +CE	SOT-25	28cx	VR4	6g	Tor
3EM	XC6227C191MR	LVR-IC	LDO, 1.9V±20mV, 700mA, +CE, PDR	SOT-25	28cx	VR4	6a	Tor
3EM	XC6104C520MR	Vdet-IC	2.0V±2%, Hst, ±Reset PPO, Wt=400ms, Rt=50ms	SOT-25	28xg	VD19	6g	Tor
3EM	XC6104C550MR	Vdet-IC	5.0V±2%, Hst, ±Reset PPO, Wt=400ms, Rt=50ms	SOT-25	28xg	VD19	6g	Tor
3EN	XC6221A21BMR	LVR-IC	LDO, 2.15V±1%, 200mA, +CE	SOT-25	28cx	VR4	6g	Tor
3EN	XC6227C201MR	LVR-IC	LDO, 2.0V±20mV, 700mA, +CE, PDR	SOT-25	28cx	VR4	6a	Tor
3EN	XC6104C521MR	Vdet-IC	2.1V±2%, Hst, ±Reset PPO, Wt=400ms, Rt=50ms	SOT-25	28xg	VD19	6g	Tor
3EP	XC6221A22BMR	LVR-IC	LDO, 2.25V±1%, 200mA, +CE	SOT-25	28cx	VR4	6g	Tor
3EP	XC6227C211MR	LVR-IC	LDO, 2.1V±1%, 700mA, +CE, PDR	SOT-25	28cx	VR4	6a	Tor
3EP	XC6104C522MR	Vdet-IC	2.2V±2%, Hst, ±Reset PPO, Wt=400ms, Rt=50ms	SOT-25	28xg	VD19	6g	Tor
3ER	XC6221A23BMR	LVR-IC	LDO, 2.35V±1%, 200mA, +CE	SOT-25	28cx	VR4	6g	Tor
3ER	XC6227C221MR	LVR-IC	LDO, 2.2V±1%, 700mA, +CE, PDR	SOT-25	28cx	VR4	6a	Tor
3ER	XC6104C523MR	Vdet-IC	2.3V±2%, Hst, ±Reset PPO, Wt=400ms, Rt=50ms	SOT-25	28xg	VD19	6g	Tor
3ES	XC6221A24BMR	LVR-IC	LDO, 2.45V±1%, 200mA, +CE	SOT-25	28cx	VR4	6g	Tor
3ES	XC6227C231MR	LVR-IC	LDO, 2.3V±1%, 700mA, +CE, PDR	SOT-25	28cx	VR4	6a	Tor
3ES	XC6104C524MR	Vdet-IC	2.4V±2%, Hst, ±Reset PPO, Wt=400ms, Rt=50ms	SOT-25	28xg	VD19	6g	Tor
3ET	XC6221A25BMR	LVR-IC	LDO, 2.55V±1%, 200mA, +CE	SOT-25	28cx	VR4	6g	Tor
3ET	XC6227C241MR	LVR-IC	LDO, 2.4V±1%, 700mA, +CE, PDR	SOT-25	28cx	VR4	6a	Tor
3ET	XC6104C525MR	Vdet-IC	2.5V±2%, Hst, ±Reset PPO, Wt=400ms, Rt=50ms	SOT-25	28xg	VD19	6g	Tor
3EU	XC6221A26BMR	LVR-IC	LDO, 2.65V±1%, 200mA, +CE	SOT-25	28cx	VR4	6g	Tor
3EU	XC6227C251MR	LVR-IC	LDO, 2.5V±1%, 700mA, +CE, PDR	SOT-25	28cx	VR4	6a	Tor
3EU	XC6104C526MR	Vdet-IC	2.6V±2%, Hst, ±Reset PPO, Wt=400ms, Rt=50ms	SOT-25	28xg	VD19	6g	Tor
3EV	XC6221A27BMR	LVR-IC	LDO, 2.75V±1%, 200mA, +CE	SOT-25	28cx	VR4	6g	Tor
3EV	XC6227C261MR	LVR-IC	LDO, 2.6V±1%, 700mA, +CE, PDR	SOT-25	28cx	VR4	6a	Tor
3EV	XC6104C527MR	Vdet-IC	2.7V±2%, Hst, ±Reset PPO, Wt=400ms, Rt=50ms	SOT-25	28xg	VD19	6g	Tor
3EX	XC6221A28BMR	LVR-IC	LDO, 2.85V±1%, 200mA, +CE	SOT-25	28cx	VR4	6g	Tor
3EX	XC6227C271MR	LVR-IC	LDO, 2.7V±1%, 700mA, +CE, PDR	SOT-25	28cx	VR4	6a	Tor
3EX	XC6104C528MR	Vdet-IC	2.8V±2%, Hst, ±Reset PPO, Wt=400ms, Rt=50ms	SOT-25	28xg	VD19	6g	Tor
3EY	XC6221A29BMR	LVR-IC	LDO, 2.95V±1%, 200mA, +CE	SOT-25	28cx	VR4	6g	Tor
3EY	XC6227C281MR	LVR-IC	LDO, 2.8V±1%, 700mA, +CE, PDR	SOT-25	28cx	VR4	6a	Tor
3EY	XC6104C529MR	Vdet-IC	2.9V±2%, Hst, ±Reset PPO, Wt=400ms, Rt=50ms	SOT-25	28xg	VD19	6g	Tor
3EZ	XC6221A30BMR	LVR-IC	LDO, 3.05V±1%, 200mA, +CE	SOT-25	28cx	VR4	6g	Tor
3EZ	XC6227C291MR	LVR-IC	LDO, 2.9V±1%, 700mA, +CE, PDR	SOT-25	28cx	VR4	6a	Tor
3EZ	XC6104C530MR	Vdet-IC	3.0V±2%, Hst, ±Reset PPO, Wt=400ms, Rt=50ms	SOT-25	28xg	VD19	6g	Tor
3F	R3111N531A	Vdet-IC	5.3V±2%, -Reset PPO	SOT-23-5	28vdm	VD7	6g	Ric
3F	RN5VD53CA	Vdet-IC	5.3V±2.5%, -Reset ODO	SOT-23-5	28vdo	VD1	6g	Ric
3F0	XC6104C631MR	Vdet-IC	3.1V±2%, Hst, ±Reset PPO, Wt=1.6s, Rt=50ms	SOT-25	28xg	VD19	6g	Tor
3F1	XC6104C632MR	Vdet-IC	3.2V±2%, Hst, ±Reset PPO, Wt=1.6s, Rt=50ms	SOT-25	28xg	VD19	6g	Tor
3F2	XC6104C633MR	Vdet-IC	3.3V±2%, Hst, ±Reset PPO, Wt=1.6s, Rt=50ms	SOT-25	28xg	VD19	6g	Tor
3F3	XC6104C634MR	Vdet-IC	3.4V±2%, Hst, ±Reset PPO, Wt=1.6s, Rt=50ms	SOT-25	28xg	VD19	6g	Tor
3F4	XC6104C635MR	Vdet-IC	3.5V±2%, Hst, ±Reset PPO, Wt=1.6s, Rt=50ms	SOT-25	28xg	VD19	6g	Tor
3F5	XC6104C636MR	Vdet-IC	3.6V±2%, Hst, ±Reset PPO, Wt=1.6s, Rt=50ms	SOT-25	28xg	VD19	6g	Tor
3F6	XC6104C637MR	Vdet-IC	3.7V±2%, Hst, ±Reset PPO, Wt=1.6s, Rt=50ms	SOT-25	28xg	VD19	6g	Tor
3F7	XC6221B08BMR	LVR-IC	LDO, 0.85V±20mV, 200mA, +CE, CL	SOT-25	28cx	VR4	6g	Tor
3F7	XC6104C638MR	Vdet-IC	3.8V±2%, Hst, ±Reset PPO, Wt=1.6s, Rt=50ms	SOT-25	28xg	VD19	6g	Tor
3F8	XC6221B09BMR	LVR-IC	LDO, 0.95V±20mV, 200mA, +CE, CL	SOT-25	28cx	VR4	6g	Tor
3F8	XC6227C08BMR	LVR-IC	LDO, 0.85V±20mV, 700mA, +CE, PDR	SOT-25	28cx	VR4	6a	Tor
3F8	XC6104C639MR	Vdet-IC	3.9V±2%, Hst, ±Reset PPO, Wt=1.6s, Rt=50ms	SOT-25	28xg	VD19	6g	Tor
3F9	XC6221B10BMR	LVR-IC	LDO, 1.05V±20mV, 200mA, +CE, CL	SOT-25	28cx	VR4	6g	Tor
3F9	XC6227C09BMR	LVR-IC	LDO, 1.95V±20mV, 700mA, +CE, PDR	SOT-25	28cx	VR4	6a	Tor
3F9	XC6104C640MR	Vdet-IC	4.0V±2%, Hst, ±Reset PPO, Wt=1.6s, Rt=50ms	SOT-25	28xg	VD19	6g	Tor



SMD code	Type	Function	Short description	Case	Pinout	Sch.	St.	Mnf.
3FA	XC6221B11BMR	LVR-IC	LDO, 1.15V±20mV, 200mA, +CE, CL	SOT-25	28cx	VR4	6g	Tor
3FA	XC6227C10BMR	LVR-IC	LDO, 1.05V±20mV, 700mA, +CE, PDR	SOT-25	28cx	VR4	6a	Tor
3FA	XC6104C641MR	Vdet-IC	4.1V±2%, Hst, ±Reset PPO, Wt=1.6s, Rt=50ms	SOT-25	28xg	VD19	6g	Tor
3FB	XC6221B12BMR	LVR-IC	LDO, 1.25V±20mV, 200mA, +CE, CL	SOT-25	28cx	VR4	6g	Tor
3FB	XC6227C11BMR	LVR-IC	LDO, 1.15V±20mV, 700mA, +CE, PDR	SOT-25	28cx	VR4	6a	Tor
3FB	XC6104C642MR	Vdet-IC	4.2V±2%, Hst, ±Reset PPO, Wt=1.6s, Rt=50ms	SOT-25	28xg	VD19	6g	Tor
3FC	XC6221B13BMR	LVR-IC	LDO, 1.35V±20mV, 200mA, +CE, CL	SOT-25	28cx	VR4	6g	Tor
3FC	XC6227C12BMR	LVR-IC	LDO, 1.25V±20mV, 700mA, +CE, PDR	SOT-25	28cx	VR4	6a	Tor
3FC	XC6104C643MR	Vdet-IC	4.3V±2%, Hst, ±Reset PPO, Wt=1.6s, Rt=50ms	SOT-25	28xg	VD19	6g	Tor
3FD	XC6221B14BMR	LVR-IC	LDO, 1.45V±20mV, 200mA, +CE, CL	SOT-25	28cx	VR4	6g	Tor
3FD	XC6227C13BMR	LVR-IC	LDO, 1.35V±20mV, 700mA, +CE, PDR	SOT-25	28cx	VR4	6a	Tor
3FD	XC6104C644MR	Vdet-IC	4.4V±2%, Hst, ±Reset PPO, Wt=1.6s, Rt=50ms	SOT-25	28xg	VD19	6g	Tor
3FE	XC6221B15BMR	LVR-IC	LDO, 1.55V±20mV, 200mA, +CE, CL	SOT-25	28cx	VR4	6g	Tor
3FE	XC6227C14BMR	LVR-IC	LDO, 1.45V±20mV, 700mA, +CE, PDR	SOT-25	28cx	VR4	6a	Tor
3FE	XC6104C645MR	Vdet-IC	4.5V±2%, Hst, ±Reset PPO, Wt=1.6s, Rt=50ms	SOT-25	28xg	VD19	6g	Tor
3FF	XC6221B16BMR	LVR-IC	LDO, 1.65V±20mV, 200mA, +CE, CL	SOT-25	28cx	VR4	6g	Tor
3FF	XC6227C15BMR	LVR-IC	LDO, 1.55V±20mV, 700mA, +CE, PDR	SOT-25	28cx	VR4	6a	Tor
3FF	XC6104C616MR	Vdet-IC	1.6V±2%, Hst, ±Reset PPO, Wt=1.6s, Rt=50ms	SOT-25	28xg	VD19	6g	Tor
3FF	XC6104C646MR	Vdet-IC	4.6V±2%, Hst, ±Reset PPO, Wt=1.6s, Rt=50ms	SOT-25	28xg	VD19	6g	Tor
3FH	XC6221B17BMR	LVR-IC	LDO, 1.75V±20mV, 200mA, +CE, CL	SOT-25	28cx	VR4	6g	Tor
3FH	XC6227C16BMR	LVR-IC	LDO, 1.65V±20mV, 700mA, +CE, PDR	SOT-25	28cx	VR4	6a	Tor
3FH	XC6104C617MR	Vdet-IC	1.7V±2%, Hst, ±Reset PPO, Wt=1.6s, Rt=50ms	SOT-25	28xg	VD19	6g	Tor
3FH	XC6104C647MR	Vdet-IC	4.7V±2%, Hst, ±Reset PPO, Wt=1.6s, Rt=50ms	SOT-25	28xg	VD19	6g	Tor
3FK	XC6221B18BMR	LVR-IC	LDO, 1.85V±20mV, 200mA, +CE, CL	SOT-25	28cx	VR4	6g	Tor
3FK	XC6227C17BMR	LVR-IC	LDO, 1.75V±20mV, 700mA, +CE, PDR	SOT-25	28cx	VR4	6a	Tor
3FK	XC6104C618MR	Vdet-IC	1.8V±2%, Hst, ±Reset PPO, Wt=1.6s, Rt=50ms	SOT-25	28xg	VD19	6g	Tor
3FK	XC6104C648MR	Vdet-IC	4.8V±2%, Hst, ±Reset PPO, Wt=1.6s, Rt=50ms	SOT-25	28xg	VD19	6g	Tor
3FL	XC6221B19BMR	LVR-IC	LDO, 1.95V±20mV, 200mA, +CE, CL	SOT-25	28cx	VR4	6g	Tor
3FL	XC6227C18BMR	LVR-IC	LDO, 1.85V±20mV, 700mA, +CE, PDR	SOT-25	28cx	VR4	6a	Tor
3FL	XC6104C619MR	Vdet-IC	1.9V±2%, Hst, ±Reset PPO, Wt=1.6s, Rt=50ms	SOT-25	28xg	VD19	6g	Tor
3FL	XC6104C649MR	Vdet-IC	4.9V±2%, Hst, ±Reset PPO, Wt=1.6s, Rt=50ms	SOT-25	28xg	VD19	6g	Tor
3FM	XC6221B20BMR	LVR-IC	LDO, 2.05V±1%, 200mA, +CE, CL	SOT-25	28cx	VR4	6g	Tor
3FM	XC6227C19BMR	LVR-IC	LDO, 1.95V±20mV, 700mA, +CE, PDR	SOT-25	28cx	VR4	6a	Tor
3FM	XC6104C620MR	Vdet-IC	2.0V±2%, Hst, ±Reset PPO, Wt=1.6s, Rt=50ms	SOT-25	28xg	VD19	6g	Tor
3FM	XC6104C650MR	Vdet-IC	5.0V±2%, Hst, ±Reset PPO, Wt=1.6s, Rt=50ms	SOT-25	28xg	VD19	6g	Tor
3FN	XC6221B21BMR	LVR-IC	LDO, 2.15V±1%, 200mA, +CE, CL	SOT-25	28cx	VR4	6g	Tor
3FN	XC6227C20BMR	LVR-IC	LDO, 2.05V±1%, 700mA, +CE, PDR	SOT-25	28cx	VR4	6a	Tor
3FN	XC6104C621MR	Vdet-IC	2.1V±2%, Hst, ±Reset PPO, Wt=1.6s, Rt=50ms	SOT-25	28xg	VD19	6g	Tor
3FP	XC6221B22BMR	LVR-IC	LDO, 2.25V±1%, 200mA, +CE, CL	SOT-25	28cx	VR4	6g	Tor
3FP	XC6227C21BMR	LVR-IC	LDO, 2.15V±1%, 700mA, +CE, PDR	SOT-25	28cx	VR4	6a	Tor
3FP	XC6104C622MR	Vdet-IC	2.2V±2%, Hst, ±Reset PPO, Wt=1.6s, Rt=50ms	SOT-25	28xg	VD19	6g	Tor
3FR	XC6221B23BMR	LVR-IC	LDO, 2.35V±1%, 200mA, +CE, CL	SOT-25	28cx	VR4	6g	Tor
3FR	XC6227C22BMR	LVR-IC	LDO, 2.25V±1%, 700mA, +CE, PDR	SOT-25	28cx	VR4	6a	Tor
3FR	XC6104C623MR	Vdet-IC	2.3V±2%, Hst, ±Reset PPO, Wt=1.6s, Rt=50ms	SOT-25	28xg	VD19	6g	Tor
3FS	XC6221B24BMR	LVR-IC	LDO, 2.45V±1%, 200mA, +CE, CL	SOT-25	28cx	VR4	6g	Tor
3FS	XC6227C23BMR	LVR-IC	LDO, 2.35V±1%, 700mA, +CE, PDR	SOT-25	28cx	VR4	6a	Tor
3FS	XC6104C624MR	Vdet-IC	2.4V±2%, Hst, ±Reset PPO, Wt=1.6s, Rt=50ms	SOT-25	28xg	VD19	6g	Tor
3FT	XC6221B25BMR	LVR-IC	LDO, 2.55V±1%, 200mA, +CE, CL	SOT-25	28cx	VR4	6g	Tor
3FT	XC6227C24BMR	LVR-IC	LDO, 2.45V±1%, 700mA, +CE, PDR	SOT-25	28cx	VR4	6a	Tor
3FT	XC6104C625MR	Vdet-IC	2.5V±2%, Hst, ±Reset PPO, Wt=1.6s, Rt=50ms	SOT-25	28xg	VD19	6g	Tor
3FU	XC6221B26BMR	LVR-IC	LDO, 2.65V±1%, 200mA, +CE, CL	SOT-25	28cx	VR4	6g	Tor
3FU	XC6227C25BMR	LVR-IC	LDO, 2.55V±1%, 700mA, +CE, PDR	SOT-25	28cx	VR4	6a	Tor
3FU	XC6104C626MR	Vdet-IC	2.6V±2%, Hst, ±Reset PPO, Wt=1.6s, Rt=50ms	SOT-25	28xg	VD19	6g	Tor
3FV	XC6221B27BMR	LVR-IC	LDO, 2.75V±1%, 200mA, +CE, CL	SOT-25	28cx	VR4	6g	Tor
3FV	XC6227C26BMR	LVR-IC	LDO, 2.65V±1%, 700mA, +CE, PDR	SOT-25	28cx	VR4	6a	Tor
3FV	XC6104C627MR	Vdet-IC	2.7V±2%, Hst, ±Reset PPO, Wt=1.6s, Rt=50ms	SOT-25	28xg	VD19	6g	Tor
3FX	XC6221B28BMR	LVR-IC	LDO, 2.85V±1%, 200mA, +CE, CL	SOT-25	28cx	VR4	6g	Tor
3FX	XC6227C27BMR	LVR-IC	LDO, 2.75V±1%, 700mA, +CE, PDR	SOT-25	28cx	VR4	6a	Tor
3FX	XC6104C628MR	Vdet-IC	2.8V±2%, Hst, ±Reset PPO, Wt=1.6s, Rt=50ms	SOT-25	28xg	VD19	6g	Tor
3FY	XC6221B29BMR	LVR-IC	LDO, 2.95V±1%, 200mA, +CE, CL	SOT-25	28cx	VR4	6g	Tor
3FY	XC6227C28BMR	LVR-IC	LDO, 2.85V±1%, 700mA, +CE, PDR	SOT-25	28cx	VR4	6a	Tor
3FY	XC6104C629MR	Vdet-IC	2.9V±2%, Hst, ±Reset PPO, Wt=1.6s, Rt=50ms	SOT-25	28xg	VD19	6g	Tor
3FZ	XC6221B30BMR	LVR-IC	LDO, 3.05V±1%, 200mA, +CE, CL	SOT-25	28cx	VR4	6g	Tor
3FZ	XC6227C29BMR	LVR-IC	LDO, 2.95V±1%, 700mA, +CE, PDR	SOT-25	28cx	VR4	6a	Tor
3FZ	XC6104C630MR	Vdet-IC	3.0V±2%, Hst, ±Reset PPO, Wt=1.6s, Rt=50ms	SOT-25	28xg	VD19	6g	Tor
3H0	XC6227C301MR	LVR-IC	LDO, 3.0V±1%, 700mA, +CE, PDR	SOT-25	28cx	VR4	6a	Tor
3H0	XC6104D331MR	Vdet-IC	3.1V±2%, Hst, ±Reset PPO, Wt=100ms, Rt=100ms	SOT-25	28xg	VD19	6g	Tor
3H1	XC6227C311MR	LVR-IC	LDO, 3.1V±1%, 700mA, +CE, PDR	SOT-25	28cx	VR4	6a	Tor
3H1	XC6104D332MR	Vdet-IC	3.2V±2%, Hst, ±Reset PPO, Wt=100ms, Rt=100ms	SOT-25	28xg	VD19	6g	Tor
3H2	XC6227C321MR	LVR-IC	LDO, 3.2V±1%, 700mA, +CE, PDR	SOT-25	28cx	VR4	6a	Tor



SMD code	Type	Function	Short description	Case	Pinout	Sch.	St.	Mnf.
3H2	XC6104D333MR	Vdet-IC	3.3V±2%, Hst, ±Reset PPO, Wt=100ms, Rt=100ms	SOT-25	28xg	VD19	6g	Tor
3H3	XC6227C331MR	LVR-IC	LDO, 3.3V±1%, 700mA, +CE, PDR	SOT-25	28cx	VR4	6a	Tor
3H3	XC6104D334MR	Vdet-IC	3.4V±2%, Hst, ±Reset PPO, Wt=100ms, Rt=100ms	SOT-25	28xg	VD19	6g	Tor
3H4	XC6227C341MR	LVR-IC	LDO, 3.4V±1%, 700mA, +CE, PDR	SOT-25	28cx	VR4	6a	Tor
3H4	XC6104D335MR	Vdet-IC	3.5V±2%, Hst, ±Reset PPO, Wt=100ms, Rt=100ms	SOT-25	28xg	VD19	6g	Tor
3H5	XC6227C351MR	LVR-IC	LDO, 3.5V±1%, 700mA, +CE, PDR	SOT-25	28cx	VR4	6a	Tor
3H5	XC6104D336MR	Vdet-IC	3.6V±2%, Hst, ±Reset PPO, Wt=100ms, Rt=100ms	SOT-25	28xg	VD19	6g	Tor
3H6	XC6227C361MR	LVR-IC	LDO, 3.6V±1%, 700mA, +CE, PDR	SOT-25	28cx	VR4	6a	Tor
3H6	XC6104D337MR	Vdet-IC	3.7V±2%, Hst, ±Reset PPO, Wt=100ms, Rt=100ms	SOT-25	28xg	VD19	6g	Tor
3H7	XC6227C371MR	LVR-IC	LDO, 3.7V±1%, 700mA, +CE, PDR	SOT-25	28cx	VR4	6a	Tor
3H7	XC6104D338MR	Vdet-IC	3.8V±2%, Hst, ±Reset PPO, Wt=100ms, Rt=100ms	SOT-25	28xg	VD19	6g	Tor
3H8	XC6227C381MR	LVR-IC	LDO, 3.8V±1%, 700mA, +CE, PDR	SOT-25	28cx	VR4	6a	Tor
3H8	XC6104D339MR	Vdet-IC	3.9V±2%, Hst, ±Reset PPO, Wt=100ms, Rt=100ms	SOT-25	28xg	VD19	6g	Tor
3H9	XC6227C391MR	LVR-IC	LDO, 3.9V±1%, 700mA, +CE, PDR	SOT-25	28cx	VR4	6a	Tor
3H9	XC6104D340MR	Vdet-IC	4.0V±2%, Hst, ±Reset PPO, Wt=100ms, Rt=100ms	SOT-25	28xg	VD19	6g	Tor
3HA	XC6227C401MR	LVR-IC	LDO, 4.0V±1%, 700mA, +CE, PDR	SOT-25	28cx	VR4	6a	Tor
3HA	XC6104D341MR	Vdet-IC	4.1V±2%, Hst, ±Reset PPO, Wt=100ms, Rt=100ms	SOT-25	28xg	VD19	6g	Tor
3HB	XC6227C411MR	LVR-IC	LDO, 4.1V±1%, 700mA, +CE, PDR	SOT-25	28cx	VR4	6a	Tor
3HB	XC6104D342MR	Vdet-IC	4.2V±2%, Hst, ±Reset PPO, Wt=100ms, Rt=100ms	SOT-25	28xg	VD19	6g	Tor
3HC	XC6227C421MR	LVR-IC	LDO, 4.2V±1%, 700mA, +CE, PDR	SOT-25	28cx	VR4	6a	Tor
3HC	XC6104D343MR	Vdet-IC	4.3V±2%, Hst, ±Reset PPO, Wt=100ms, Rt=100ms	SOT-25	28xg	VD19	6g	Tor
3HD	XC6227C431MR	LVR-IC	LDO, 4.3V±1%, 700mA, +CE, PDR	SOT-25	28cx	VR4	6a	Tor
3HD	XC6104D344MR	Vdet-IC	4.4V±2%, Hst, ±Reset PPO, Wt=100ms, Rt=100ms	SOT-25	28xg	VD19	6g	Tor
3HE	XC6227C441MR	LVR-IC	LDO, 4.4V±1%, 700mA, +CE, PDR	SOT-25	28cx	VR4	6a	Tor
3HE	XC6104D345MR	Vdet-IC	4.5V±2%, Hst, ±Reset PPO, Wt=100ms, Rt=100ms	SOT-25	28xg	VD19	6g	Tor
3HF	XC6227C451MR	LVR-IC	LDO, 4.5V±1%, 700mA, +CE, PDR	SOT-25	28cx	VR4	6a	Tor
3HF	XC6104D316MR	Vdet-IC	1.6V±2%, Hst, ±Reset PPO, Wt=100ms, Rt=100ms	SOT-25	28xg	VD19	6g	Tor
3HF	XC6104D346MR	Vdet-IC	4.6V±2%, Hst, ±Reset PPO, Wt=100ms, Rt=100ms	SOT-25	28xg	VD19	6g	Tor
3HH	XC6227C461MR	LVR-IC	LDO, 4.6V±1%, 700mA, +CE, PDR	SOT-25	28cx	VR4	6a	Tor
3HH	XC6104D317MR	Vdet-IC	1.7V±2%, Hst, ±Reset PPO, Wt=100ms, Rt=100ms	SOT-25	28xg	VD19	6g	Tor
3HH	XC6104D347MR	Vdet-IC	4.7V±2%, Hst, ±Reset PPO, Wt=100ms, Rt=100ms	SOT-25	28xg	VD19	6g	Tor
3HK	XC6227C471MR	LVR-IC	LDO, 4.7V±1%, 700mA, +CE, PDR	SOT-25	28cx	VR4	6a	Tor
3HK	XC6104D318MR	Vdet-IC	1.8V±2%, Hst, ±Reset PPO, Wt=100ms, Rt=100ms	SOT-25	28xg	VD19	6g	Tor
3HK	XC6104D348MR	Vdet-IC	4.8V±2%, Hst, ±Reset PPO, Wt=100ms, Rt=100ms	SOT-25	28xg	VD19	6g	Tor
3HL	XC6227C481MR	LVR-IC	LDO, 4.8V±1%, 700mA, +CE, PDR	SOT-25	28cx	VR4	6a	Tor
3HL	XC6104D319MR	Vdet-IC	1.9V±2%, Hst, ±Reset PPO, Wt=100ms, Rt=100ms	SOT-25	28xg	VD19	6g	Tor
3HL	XC6104D349MR	Vdet-IC	4.9V±2%, Hst, ±Reset PPO, Wt=100ms, Rt=100ms	SOT-25	28xg	VD19	6g	Tor
3HM	XC6227C491MR	LVR-IC	LDO, 4.9V±1%, 700mA, +CE, PDR	SOT-25	28cx	VR4	6a	Tor
3HM	XC6104D320MR	Vdet-IC	2.0V±2%, Hst, ±Reset PPO, Wt=100ms, Rt=100ms	SOT-25	28xg	VD19	6g	Tor
3HM	XC6104D350MR	Vdet-IC	5.0V±2%, Hst, ±Reset PPO, Wt=100ms, Rt=100ms	SOT-25	28xg	VD19	6g	Tor
3HN	XC6227C501MR	LVR-IC	LDO, 5.0V±1%, 700mA, +CE, PDR	SOT-25	28cx	VR4	6a	Tor
3HN	XC6104D321MR	Vdet-IC	2.1V±2%, Hst, ±Reset PPO, Wt=100ms, Rt=100ms	SOT-25	28xg	VD19	6g	Tor
3HP	XC6104D322MR	Vdet-IC	2.2V±2%, Hst, ±Reset PPO, Wt=100ms, Rt=100ms	SOT-25	28xg	VD19	6g	Tor
3HP	XC6104D323MR	Vdet-IC	2.3V±2%, Hst, ±Reset PPO, Wt=100ms, Rt=100ms	SOT-25	28xg	VD19	6g	Tor
3HS	XC6104D324MR	Vdet-IC	2.4V±2%, Hst, ±Reset PPO, Wt=100ms, Rt=100ms	SOT-25	28xg	VD19	6g	Tor
3HT	XC6104D325MR	Vdet-IC	2.5V±2%, Hst, ±Reset PPO, Wt=100ms, Rt=100ms	SOT-25	28xg	VD19	6g	Tor
3HU	XC6104D326MR	Vdet-IC	2.6V±2%, Hst, ±Reset PPO, Wt=100ms, Rt=100ms	SOT-25	28xg	VD19	6g	Tor
3HV	XC6104D327MR	Vdet-IC	2.7V±2%, Hst, ±Reset PPO, Wt=100ms, Rt=100ms	SOT-25	28xg	VD19	6g	Tor
3HX	XC6104D328MR	Vdet-IC	2.8V±2%, Hst, ±Reset PPO, Wt=100ms, Rt=100ms	SOT-25	28xg	VD19	6g	Tor
3HY	XC6104D329MR	Vdet-IC	2.9V±2%, Hst, ±Reset PPO, Wt=100ms, Rt=100ms	SOT-25	28xg	VD19	6g	Tor
3HZ	XC6104D330MR	Vdet-IC	3.0V±2%, Hst, ±Reset PPO, Wt=100ms, Rt=100ms	SOT-25	28xg	VD19	6g	Tor
3J	R3111N131C	Vdet-IC	1.3V±2%, -Reset ODO	SOT-23-5	28vdm	VD6	6g	Ric
3K	R3111N231C	Vdet-IC	2.3V±2%, -Reset ODO	SOT-23-5	28vdm	VD6	6g	Ric
3K0	XC6227C30BMR	LVR-IC	LDO, 3.05V±1%, 700mA, +CE, PDR	SOT-25	28cx	VR4	6a	Tor
3K0	XC6104D431MR	Vdet-IC	3.1V±2%, Hst, ±Reset PPO, Wt=200ms, Rt=100ms	SOT-25	28xg	VD19	6g	Tor
3K1	XC6227C31BMR	LVR-IC	LDO, 3.15V±1%, 700mA, +CE, PDR	SOT-25	28cx	VR4	6a	Tor
3K1	XC6104D432MR	Vdet-IC	3.2V±2%, Hst, ±Reset PPO, Wt=200ms, Rt=100ms	SOT-25	28xg	VD19	6g	Tor
3K2	XC6227C32BMR	LVR-IC	LDO, 3.25V±1%, 700mA, +CE, PDR	SOT-25	28cx	VR4	6a	Tor
3K2	XC6104D433MR	Vdet-IC	3.3V±2%, Hst, ±Reset PPO, Wt=200ms, Rt=100ms	SOT-25	28xg	VD19	6g	Tor
3K3	XC6227C33BMR	LVR-IC	LDO, 3.35V±1%, 700mA, +CE, PDR	SOT-25	28cx	VR4	6a	Tor
3K3	XC6104D434MR	Vdet-IC	3.4V±2%, Hst, ±Reset PPO, Wt=200ms, Rt=100ms	SOT-25	28xg	VD19	6g	Tor
3K4	XC6227C34BMR	LVR-IC	LDO, 3.45V±1%, 700mA, +CE, PDR	SOT-25	28cx	VR4	6a	Tor
3K4	XC6104D435MR	Vdet-IC	3.5V±2%, Hst, ±Reset PPO, Wt=200ms, Rt=100ms	SOT-25	28xg	VD19	6g	Tor
3K5	XC6227C35BMR	LVR-IC	LDO, 3.55V±1%, 700mA, +CE, PDR	SOT-25	28cx	VR4	6a	Tor
3K5	XC6104D436MR	Vdet-IC	3.6V±2%, Hst, ±Reset PPO, Wt=200ms, Rt=100ms	SOT-25	28xg	VD19	6g	Tor
3K6	XC6227C36BMR	LVR-IC	LDO, 3.65V±1%, 700mA, +CE, PDR	SOT-25	28cx	VR4	6a	Tor
3K6	XC6104D437MR	Vdet-IC	3.7V±2%, Hst, ±Reset PPO, Wt=200ms, Rt=100ms	SOT-25	28xg	VD19	6g	Tor
3K7	XC6227C37BMR	LVR-IC	LDO, 3.75V±1%, 700mA, +CE, PDR	SOT-25	28cx	VR4	6a	Tor
3K7	XC6104D438MR	Vdet-IC	3.8V±2%, Hst, ±Reset PPO, Wt=200ms, Rt=100ms	SOT-25	28xg	VD19	6g	Tor
3K8	XC6227C38BMR	LVR-IC	LDO, 3.85V±1%, 700mA, +CE, PDR	SOT-25	28cx	VR4	6a	Tor



SMD code	Type	Function	Short description	Case	Pinout	Sch.	St.	Mnf.
3K8	XC6104D439MR	Vdet-IC	3.9V±2%, Hst, ±Reset PPO, Wt=200ms, Rt=100ms	SOT-25	28xg	VD19	6g	Tor
3K9	XC6227C39BMR	LVR-IC	LDO, 3.95V±1%, 700mA, +CE, PDR	SOT-25	28cx	VR4	6a	Tor
3K9	XC6104D440MR	Vdet-IC	4.0V±2%, Hst, ±Reset PPO, Wt=200ms, Rt=100ms	SOT-25	28xg	VD19	6g	Tor
3KA	XC6227C40BMR	LVR-IC	LDO, 4.05V±1%, 700mA, +CE, PDR	SOT-25	28cx	VR4	6a	Tor
3KA	XC6104D441MR	Vdet-IC	4.1V±2%, Hst, ±Reset PPO, Wt=200ms, Rt=100ms	SOT-25	28xg	VD19	6g	Tor
3KB	XC6227C41BMR	LVR-IC	LDO, 4.15V±1%, 700mA, +CE, PDR	SOT-25	28cx	VR4	6a	Tor
3KB	XC6104D442MR	Vdet-IC	4.2V±2%, Hst, ±Reset PPO, Wt=200ms, Rt=100ms	SOT-25	28xg	VD19	6g	Tor
3KC	XC6227C42BMR	LVR-IC	LDO, 4.25V±1%, 700mA, +CE, PDR	SOT-25	28cx	VR4	6a	Tor
3KC	XC6104D443MR	Vdet-IC	4.3V±2%, Hst, ±Reset PPO, Wt=200ms, Rt=100ms	SOT-25	28xg	VD19	6g	Tor
3KD	XC6227C43BMR	LVR-IC	LDO, 4.35V±1%, 700mA, +CE, PDR	SOT-25	28cx	VR4	6a	Tor
3KD	XC6104D444MR	Vdet-IC	4.4V±2%, Hst, ±Reset PPO, Wt=200ms, Rt=100ms	SOT-25	28xg	VD19	6g	Tor
3KE	XC6227C44BMR	LVR-IC	LDO, 4.45V±1%, 700mA, +CE, PDR	SOT-25	28cx	VR4	6a	Tor
3KE	XC6104D445MR	Vdet-IC	4.5V±2%, Hst, ±Reset PPO, Wt=200ms, Rt=100ms	SOT-25	28xg	VD19	6g	Tor
3KF	XC6227C45BMR	LVR-IC	LDO, 4.55V±1%, 700mA, +CE, PDR	SOT-25	28cx	VR4	6a	Tor
3KF	XC6104D416MR	Vdet-IC	1.6V±2%, Hst, ±Reset PPO, Wt=200ms, Rt=100ms	SOT-25	28xg	VD19	6g	Tor
3KF	XC6104D446MR	Vdet-IC	4.6V±2%, Hst, ±Reset PPO, Wt=200ms, Rt=100ms	SOT-25	28xg	VD19	6g	Tor
3KH	XC6227C46BMR	LVR-IC	LDO, 4.65V±1%, 700mA, +CE, PDR	SOT-25	28cx	VR4	6a	Tor
3KH	XC6104D417MR	Vdet-IC	1.7V±2%, Hst, ±Reset PPO, Wt=200ms, Rt=100ms	SOT-25	28xg	VD19	6g	Tor
3KH	XC6104D447MR	Vdet-IC	4.7V±2%, Hst, ±Reset PPO, Wt=200ms, Rt=100ms	SOT-25	28xg	VD19	6g	Tor
3KK	XC6227C47BMR	LVR-IC	LDO, 4.75V±1%, 700mA, +CE, PDR	SOT-25	28cx	VR4	6a	Tor
3KK	XC6104D418MR	Vdet-IC	1.8V±2%, Hst, ±Reset PPO, Wt=200ms, Rt=100ms	SOT-25	28xg	VD19	6g	Tor
3KK	XC6104D448MR	Vdet-IC	4.8V±2%, Hst, ±Reset PPO, Wt=200ms, Rt=100ms	SOT-25	28xg	VD19	6g	Tor
3KL	XC6227C48BMR	LVR-IC	LDO, 4.85V±1%, 700mA, +CE, PDR	SOT-25	28cx	VR4	6a	Tor
3KL	XC6104D419MR	Vdet-IC	1.9V±2%, Hst, ±Reset PPO, Wt=200ms, Rt=100ms	SOT-25	28xg	VD19	6g	Tor
3KL	XC6104D449MR	Vdet-IC	4.9V±2%, Hst, ±Reset PPO, Wt=200ms, Rt=100ms	SOT-25	28xg	VD19	6g	Tor
3KM	XC6227C49BMR	LVR-IC	LDO, 4.95V±1%, 700mA, +CE, PDR	SOT-25	28cx	VR4	6a	Tor
3KM	XC6104D420MR	Vdet-IC	2.0V±2%, Hst, ±Reset PPO, Wt=200ms, Rt=100ms	SOT-25	28xg	VD19	6g	Tor
3KM	XC6104D450MR	Vdet-IC	5.0V±2%, Hst, ±Reset PPO, Wt=200ms, Rt=100ms	SOT-25	28xg	VD19	6g	Tor
3KN	XC6104D421MR	Vdet-IC	2.1V±2%, Hst, ±Reset PPO, Wt=200ms, Rt=100ms	SOT-25	28xg	VD19	6g	Tor
3KP	XC6104D422MR	Vdet-IC	2.2V±2%, Hst, ±Reset PPO, Wt=200ms, Rt=100ms	SOT-25	28xg	VD19	6g	Tor
3KR	XC6104D423MR	Vdet-IC	2.3V±2%, Hst, ±Reset PPO, Wt=200ms, Rt=100ms	SOT-25	28xg	VD19	6g	Tor
3KS	XC6104D424MR	Vdet-IC	2.4V±2%, Hst, ±Reset PPO, Wt=200ms, Rt=100ms	SOT-25	28xg	VD19	6g	Tor
3KT	XC6104D425MR	Vdet-IC	2.5V±2%, Hst, ±Reset PPO, Wt=200ms, Rt=100ms	SOT-25	28xg	VD19	6g	Tor
3KU	XC6104D426MR	Vdet-IC	2.6V±2%, Hst, ±Reset PPO, Wt=200ms, Rt=100ms	SOT-25	28xg	VD19	6g	Tor
3KV	XC6104D427MR	Vdet-IC	2.7V±2%, Hst, ±Reset PPO, Wt=200ms, Rt=100ms	SOT-25	28xg	VD19	6g	Tor
3KX	XC6104D428MR	Vdet-IC	2.8V±2%, Hst, ±Reset PPO, Wt=200ms, Rt=100ms	SOT-25	28xg	VD19	6g	Tor
3KY	XC6104D429MR	Vdet-IC	2.9V±2%, Hst, ±Reset PPO, Wt=200ms, Rt=100ms	SOT-25	28xg	VD19	6g	Tor
3KZ	XC6104D430MR	Vdet-IC	3.0V±2%, Hst, ±Reset PPO, Wt=200ms, Rt=100ms	SOT-25	28xg	VD19	6g	Tor
3L	R3111N331C	Vdet-IC	3.3V±2%, -Reset ODO	SOT-23-5	28vdm	VD6	6g	Ric
3L0	XC6221A31BMR	LVR-IC	LDO, 3.15V±1%, 200mA, +CE	SOT-25	28cx	VR4	6g	Tor
3L0	XC6104D531MR	Vdet-IC	3.1V±2%, Hst, ±Reset PPO, Wt=400ms, Rt=100ms	SOT-25	28xg	VD19	6g	Tor
3L1	XC6221A32BMR	LVR-IC	LDO, 3.25V±1%, 200mA, +CE	SOT-25	28cx	VR4	6g	Tor
3L1	XC6104D532MR	Vdet-IC	3.2V±2%, Hst, ±Reset PPO, Wt=400ms, Rt=100ms	SOT-25	28xg	VD19	6g	Tor
3L2	XC6221A33BMR	LVR-IC	LDO, 3.35V±1%, 200mA, +CE	SOT-25	28cx	VR4	6g	Tor
3L2	XC6104D533MR	Vdet-IC	3.3V±2%, Hst, ±Reset PPO, Wt=400ms, Rt=100ms	SOT-25	28xg	VD19	6g	Tor
3L3	XC6221A34BMR	LVR-IC	LDO, 3.45V±1%, 200mA, +CE	SOT-25	28cx	VR4	6g	Tor
3L3	XC6104D534MR	Vdet-IC	3.4V±2%, Hst, ±Reset PPO, Wt=400ms, Rt=100ms	SOT-25	28xg	VD19	6g	Tor
3L4	XC6221A35BMR	LVR-IC	LDO, 3.55V±1%, 200mA, +CE	SOT-25	28cx	VR4	6g	Tor
3L4	XC6104D535MR	Vdet-IC	3.5V±2%, Hst, ±Reset PPO, Wt=400ms, Rt=100ms	SOT-25	28xg	VD19	6g	Tor
3L5	XC6221A36BMR	LVR-IC	LDO, 3.65V±1%, 200mA, +CE	SOT-25	28cx	VR4	6g	Tor
3L5	XC6104D536MR	Vdet-IC	3.6V±2%, Hst, ±Reset PPO, Wt=400ms, Rt=100ms	SOT-25	28xg	VD19	6g	Tor
3L6	XC6221A37BMR	LVR-IC	LDO, 3.75V±1%, 200mA, +CE	SOT-25	28cx	VR4	6g	Tor
3L6	XC6104D537MR	Vdet-IC	3.7V±2%, Hst, ±Reset PPO, Wt=400ms, Rt=100ms	SOT-25	28xg	VD19	6g	Tor
3L7	XC6221A38BMR	LVR-IC	LDO, 3.85V±1%, 200mA, +CE	SOT-25	28cx	VR4	6g	Tor
3L7	XC6104D538MR	Vdet-IC	3.8V±2%, Hst, ±Reset PPO, Wt=400ms, Rt=100ms	SOT-25	28xg	VD19	6g	Tor
3L8	XC6221A39BMR	LVR-IC	LDO, 3.95V±1%, 200mA, +CE	SOT-25	28cx	VR4	6g	Tor
3L8	XC6104D539MR	Vdet-IC	3.9V±2%, Hst, ±Reset PPO, Wt=400ms, Rt=100ms	SOT-25	28xg	VD19	6g	Tor
3L9	XC6221A40BMR	LVR-IC	LDO, 4.05±1%, 200mA, +CE	SOT-25	28cx	VR4	6g	Tor
3L9	XC6104D540MR	Vdet-IC	4.0V±2%, Hst, ±Reset PPO, Wt=400ms, Rt=100ms	SOT-25	28xg	VD19	6g	Tor
3LA	XC6221A41BMR	LVR-IC	LDO, 4.15±1%, 200mA, +CE	SOT-25	28cx	VR4	6g	Tor
3LA	XC6104D541MR	Vdet-IC	4.1V±2%, Hst, ±Reset PPO, Wt=400ms, Rt=100ms	SOT-25	28xg	VD19	6g	Tor
3LB	XC6221A42BMR	LVR-IC	LDO, 4.25±1%, 200mA, +CE	SOT-25	28cx	VR4	6g	Tor
3LB	XC6104D542MR	Vdet-IC	4.2V±2%, Hst, ±Reset PPO, Wt=400ms, Rt=100ms	SOT-25	28xg	VD19	6g	Tor
3LC	XC6221A43BMR	LVR-IC	LDO, 4.35±1%, 200mA, +CE	SOT-25	28cx	VR4	6g	Tor
3LC	XC6104D543MR	Vdet-IC	4.3V±2%, Hst, ±Reset PPO, Wt=400ms, Rt=100ms	SOT-25	28xg	VD19	6g	Tor
3LD	XC6221A44BMR	LVR-IC	LDO, 4.45±1%, 200mA, +CE	SOT-25	28cx	VR4	6g	Tor
3LD	XC6104D544MR	Vdet-IC	4.4V±2%, Hst, ±Reset PPO, Wt=400ms, Rt=100ms	SOT-25	28xg	VD19	6g	Tor
3LE	XC6221A45BMR	LVR-IC	LDO, 4.55±1%, 200mA, +CE	SOT-25	28cx	VR4	6g	Tor
3LE	XC6104D545MR	Vdet-IC	4.5V±2%, Hst, ±Reset PPO, Wt=400ms, Rt=100ms	SOT-25	28xg	VD19	6g	Tor
3LF	XC6221A46BMR	LVR-IC	LDO, 4.65±1%, 200mA, +CE	SOT-25	28cx	VR4	6g	Tor



SMD Code	Type	Function	Short description	Case	Pinout	Sch.	St.	Mnf.
3LF	XC6104D516MR	Vdet-IC	1.6V±2%, Hst, ±Reset PPO, Wt=400ms, Rt=100ms	SOT-25	28xg	VD19	6g	Tor
3LF	XC6104D546MR	Vdet-IC	4.6V±2%, Hst, ±Reset PPO, Wt=400ms, Rt=100ms	SOT-25	28xg	VD19	6g	Tor
3LH	XC6221A47BMR	LVR-IC	LDO, 4.75±1%, 200mA, +CE	SOT-25	28xcx	VR4	6g	Tor
3LH	XC6104D517MR	Vdet-IC	1.7V±2%, Hst, ±Reset PPO, Wt=400ms, Rt=100ms	SOT-25	28xg	VD19	6g	Tor
3LH	XC6104D547MR	Vdet-IC	4.7V±2%, Hst, ±Reset PPO, Wt=400ms, Rt=100ms	SOT-25	28xg	VD19	6g	Tor
3LK	XC6221A48BMR	LVR-IC	LDO, 4.85±1%, 200mA, +CE	SOT-25	28xcx	VR4	6g	Tor
3LK	XC6104D518MR	Vdet-IC	1.8V±2%, Hst, ±Reset PPO, Wt=400ms, Rt=100ms	SOT-25	28xg	VD19	6g	Tor
3LK	XC6104D548MR	Vdet-IC	4.8V±2%, Hst, ±Reset PPO, Wt=400ms, Rt=100ms	SOT-25	28xg	VD19	6g	Tor
3LL	XC6221A49BMR	LVR-IC	LDO, 4.95±1%, 200mA, +CE	SOT-25	28xcx	VR4	6g	Tor
3LL	XC6104D519MR	Vdet-IC	1.9V±2%, Hst, ±Reset PPO, Wt=400ms, Rt=100ms	SOT-25	28xg	VD19	6g	Tor
3LL	XC6104D549MR	Vdet-IC	4.9V±2%, Hst, ±Reset PPO, Wt=400ms, Rt=100ms	SOT-25	28xg	VD19	6g	Tor
3LM	XC6104D520MR	Vdet-IC	2.0V±2%, Hst, ±Reset PPO, Wt=400ms, Rt=100ms	SOT-25	28xg	VD19	6g	Tor
3LM	XC6104D550MR	Vdet-IC	5.0V±2%, Hst, ±Reset PPO, Wt=400ms, Rt=100ms	SOT-25	28xg	VD19	6g	Tor
3LN	XC6104D521MR	Vdet-IC	2.1V±2%, Hst, ±Reset PPO, Wt=400ms, Rt=100ms	SOT-25	28xg	VD19	6g	Tor
3LP	XC6104D522MR	Vdet-IC	2.2V±2%, Hst, ±Reset PPO, Wt=400ms, Rt=100ms	SOT-25	28xg	VD19	6g	Tor
3LR	XC6104D523MR	Vdet-IC	2.3V±2%, Hst, ±Reset PPO, Wt=400ms, Rt=100ms	SOT-25	28xg	VD19	6g	Tor
3LS	XC6104D524MR	Vdet-IC	2.4V±2%, Hst, ±Reset PPO, Wt=400ms, Rt=100ms	SOT-25	28xg	VD19	6g	Tor
3LT	XC6104D525MR	Vdet-IC	2.5V±2%, Hst, ±Reset PPO, Wt=400ms, Rt=100ms	SOT-25	28xg	VD19	6g	Tor
3LU	XC6104D526MR	Vdet-IC	2.6V±2%, Hst, ±Reset PPO, Wt=400ms, Rt=100ms	SOT-25	28xg	VD19	6g	Tor
3LV	XC6104D527MR	Vdet-IC	2.7V±2%, Hst, ±Reset PPO, Wt=400ms, Rt=100ms	SOT-25	28xg	VD19	6g	Tor
3LX	XC6104D528MR	Vdet-IC	2.8V±2%, Hst, ±Reset PPO, Wt=400ms, Rt=100ms	SOT-25	28xg	VD19	6g	Tor
3LY	XC6104D529MR	Vdet-IC	2.9V±2%, Hst, ±Reset PPO, Wt=400ms, Rt=100ms	SOT-25	28xg	VD19	6g	Tor
3LZ	XC6104D530MR	Vdet-IC	3.0V±2%, Hst, ±Reset PPO, Wt=400ms, Rt=100ms	SOT-25	28xg	VD19	6g	Tor
3M	R3111N431C	Vdet-IC	4.3V±2%, -Reset ODO	SOT-23-5	28xvdm	VD6	6g	Ric
3M0	XC6221B31BMR	LVR-IC	LDO, 3.15V±1%, 200mA, +CE, CL	SOT-25	28xcx	VR4	6g	Tor
3M0	XC6104D631MR	Vdet-IC	3.1V±2%, Hst, ±Reset PPO, Wt=1.6s, Rt=100ms	SOT-25	28xg	VD19	6g	Tor
3M1	XC6221B32BMR	LVR-IC	LDO, 3.25V±1%, 200mA, +CE, CL	SOT-25	28xcx	VR4	6g	Tor
3M1	XC6104D632MR	Vdet-IC	3.2V±2%, Hst, ±Reset PPO, Wt=1.6s, Rt=100ms	SOT-25	28xg	VD19	6g	Tor
3M2	XC6221B33BMR	LVR-IC	LDO, 3.35V±1%, 200mA, +CE, CL	SOT-25	28xcx	VR4	6g	Tor
3M2	XC6104D633MR	Vdet-IC	3.3V±2%, Hst, ±Reset PPO, Wt=1.6s, Rt=100ms	SOT-25	28xg	VD19	6g	Tor
3M3	XC6221B34BMR	LVR-IC	LDO, 3.45V±1%, 200mA, +CE, CL	SOT-25	28xcx	VR4	6g	Tor
3M3	XC6104D634MR	Vdet-IC	3.4V±2%, Hst, ±Reset PPO, Wt=1.6s, Rt=100ms	SOT-25	28xg	VD19	6g	Tor
3M4	XC6221B35BMR	LVR-IC	LDO, 3.55V±1%, 200mA, +CE, CL	SOT-25	28xcx	VR4	6g	Tor
3M4	XC6104D635MR	Vdet-IC	3.5V±2%, Hst, ±Reset PPO, Wt=1.6s, Rt=100ms	SOT-25	28xg	VD19	6g	Tor
3M5	XC6221B36BMR	LVR-IC	LDO, 3.65V±1%, 200mA, +CE, CL	SOT-25	28xcx	VR4	6g	Tor
3M5	XC6104D636MR	Vdet-IC	3.6V±2%, Hst, ±Reset PPO, Wt=1.6s, Rt=100ms	SOT-25	28xg	VD19	6g	Tor
3M6	XC6221B37BMR	LVR-IC	LDO, 3.75V±1%, 200mA, +CE, CL	SOT-25	28xcx	VR4	6g	Tor
3M6	XC6104D637MR	Vdet-IC	3.7V±2%, Hst, ±Reset PPO, Wt=1.6s, Rt=100ms	SOT-25	28xg	VD19	6g	Tor
3M7	XC6221B38BMR	LVR-IC	LDO, 3.85V±1%, 200mA, +CE, CL	SOT-25	28xcx	VR4	6g	Tor
3M7	XC6104D638MR	Vdet-IC	3.8V±2%, Hst, ±Reset PPO, Wt=1.6s, Rt=100ms	SOT-25	28xg	VD19	6g	Tor
3M8	XC6221B39BMR	LVR-IC	LDO, 3.95V±1%, 200mA, +CE, CL	SOT-25	28xcx	VR4	6g	Tor
3M8	XC6104D639MR	Vdet-IC	3.9V±2%, Hst, ±Reset PPO, Wt=1.6s, Rt=100ms	SOT-25	28xg	VD19	6g	Tor
3M9	XC6221B40BMR	LVR-IC	LDO, 4.05V±1%, 200mA, +CE, CL	SOT-25	28xcx	VR4	6g	Tor
3M9	XC6104D640MR	Vdet-IC	4.0V±2%, Hst, ±Reset PPO, Wt=1.6s, Rt=100ms	SOT-25	28xg	VD19	6g	Tor
3MA	XC6221B41BMR	LVR-IC	LDO, 4.15V±1%, 200mA, +CE, CL	SOT-25	28xcx	VR4	6g	Tor
3MA	XC6104D641MR	Vdet-IC	4.1V±2%, Hst, ±Reset PPO, Wt=1.6s, Rt=100ms	SOT-25	28xg	VD19	6g	Tor
3MB	XC6221B42BMR	LVR-IC	LDO, 4.25V±1%, 200mA, +CE, CL	SOT-25	28xcx	VR4	6g	Tor
3MB	XC6104D642MR	Vdet-IC	4.2V±2%, Hst, ±Reset PPO, Wt=1.6s, Rt=100ms	SOT-25	28xg	VD19	6g	Tor
3MC	XC6221B43BMR	LVR-IC	LDO, 4.35V±1%, 200mA, +CE, CL	SOT-25	28xcx	VR4	6g	Tor
3MC	XC6104D643MR	Vdet-IC	4.3V±2%, Hst, ±Reset PPO, Wt=1.6s, Rt=100ms	SOT-25	28xg	VD19	6g	Tor
3MD	XC6221B44BMR	LVR-IC	LDO, 4.45V±1%, 200mA, +CE, CL	SOT-25	28xcx	VR4	6g	Tor
3MD	XC6104D644MR	Vdet-IC	4.4V±2%, Hst, ±Reset PPO, Wt=1.6s, Rt=100ms	SOT-25	28xg	VD19	6g	Tor
3ME	XC6221B45BMR	LVR-IC	LDO, 4.55V±1%, 200mA, +CE, CL	SOT-25	28xcx	VR4	6g	Tor
3ME	XC6104D645MR	Vdet-IC	4.5V±2%, Hst, ±Reset PPO, Wt=1.6s, Rt=100ms	SOT-25	28xg	VD19	6g	Tor
3MF	XC6221B46BMR	LVR-IC	LDO, 4.65V±1%, 200mA, +CE, CL	SOT-25	28xcx	VR4	6g	Tor
3MF	XC6104D616MR	Vdet-IC	1.6V±2%, Hst, ±Reset PPO, Wt=1.6s, Rt=100ms	SOT-25	28xg	VD19	6g	Tor
3MF	XC6104D646MR	Vdet-IC	4.6V±2%, Hst, ±Reset PPO, Wt=1.6s, Rt=100ms	SOT-25	28xg	VD19	6g	Tor
3MH	XC6221B47BMR	LVR-IC	LDO, 4.75V±1%, 200mA, +CE, CL	SOT-25	28xcx	VR4	6g	Tor
3MH	XC6104D617MR	Vdet-IC	1.7V±2%, Hst, ±Reset PPO, Wt=1.6s, Rt=100ms	SOT-25	28xg	VD19	6g	Tor
3MH	XC6104D647MR	Vdet-IC	4.7V±2%, Hst, ±Reset PPO, Wt=1.6s, Rt=100ms	SOT-25	28xg	VD19	6g	Tor
3MK	XC6221B48BMR	LVR-IC	LDO, 4.85V±1%, 200mA, +CE, CL	SOT-25	28xcx	VR4	6g	Tor
3MK	XC6104D618MR	Vdet-IC	1.8V±2%, Hst, ±Reset PPO, Wt=1.6s, Rt=100ms	SOT-25	28xg	VD19	6g	Tor
3MK	XC6104D648MR	Vdet-IC	4.8V±2%, Hst, ±Reset PPO, Wt=1.6s, Rt=100ms	SOT-25	28xg	VD19	6g	Tor
3ML	XC6221B49BMR	LVR-IC	LDO, 4.95V±1%, 200mA, +CE, CL	SOT-25	28xcx	VR4	6g	Tor
3ML	XC6104D619MR	Vdet-IC	1.9V±2%, Hst, ±Reset PPO, Wt=1.6s, Rt=100ms	SOT-25	28xg	VD19	6g	Tor
3ML	XC6104D649MR	Vdet-IC	4.9V±2%, Hst, ±Reset PPO, Wt=1.6s, Rt=100ms	SOT-25	28xg	VD19	6g	Tor
3MM	XC6104D620MR	Vdet-IC	2.0V±2%, Hst, ±Reset PPO, Wt=1.6s, Rt=100ms	SOT-25	28xg	VD19	6g	Tor
3MM	XC6104D650MR	Vdet-IC	5.0V±2%, Hst, ±Reset PPO, Wt=1.6s, Rt=100ms	SOT-25	28xg	VD19	6g	Tor
3MN	XC6104D621MR	Vdet-IC	2.1V±2%, Hst, ±Reset PPO, Wt=1.6s, Rt=100ms	SOT-25	28xg	VD19	6g	Tor
3MP	XC6104D622MR	Vdet-IC	2.2V±2%, Hst, ±Reset PPO, Wt=1.6s, Rt=100ms	SOT-25	28xg	VD19	6g	Tor



SMD code	Type	Function	Short description	Case	Pinout	Sch.	St.	Mnf.
<u>3</u> TM	XC6104F520MR	Vdet-IC	2.0V±2%, Hst, ±Reset PPO, Wt=400ms, Rt=400ms	SOT-25	28xg	VD19	6g	Tor
<u>3</u> TM	XC6104F550MR	Vdet-IC	5.0V±2%, Hst, ±Reset PPO, Wt=400ms, Rt=400ms	SOT-25	28xg	VD19	6g	Tor
<u>3</u> TN	XC6104F521MR	Vdet-IC	2.1V±2%, Hst, ±Reset PPO, Wt=400ms, Rt=400ms	SOT-25	28xg	VD19	6g	Tor
<u>3</u> TP	XC6104F522MR	Vdet-IC	2.2V±2%, Hst, ±Reset PPO, Wt=400ms, Rt=400ms	SOT-25	28xg	VD19	6g	Tor
<u>3</u> TR	XC6104F523MR	Vdet-IC	2.3V±2%, Hst, ±Reset PPO, Wt=400ms, Rt=400ms	SOT-25	28xg	VD19	6g	Tor
<u>3</u> TS	XC6104F524MR	Vdet-IC	2.4V±2%, Hst, ±Reset PPO, Wt=400ms, Rt=400ms	SOT-25	28xg	VD19	6g	Tor
<u>3</u> TT	XC6104F525MR	Vdet-IC	2.5V±2%, Hst, ±Reset PPO, Wt=400ms, Rt=400ms	SOT-25	28xg	VD19	6g	Tor
<u>3</u> TU	XC6104F526MR	Vdet-IC	2.6V±2%, Hst, ±Reset PPO, Wt=400ms, Rt=400ms	SOT-25	28xg	VD19	6g	Tor
<u>3</u> TV	XC6104F527MR	Vdet-IC	2.7V±2%, Hst, ±Reset PPO, Wt=400ms, Rt=400ms	SOT-25	28xg	VD19	6g	Tor
<u>3</u> TX	XC6104F528MR	Vdet-IC	2.8V±2%, Hst, ±Reset PPO, Wt=400ms, Rt=400ms	SOT-25	28xg	VD19	6g	Tor
<u>3</u> TY	XC6104F529MR	Vdet-IC	2.9V±2%, Hst, ±Reset PPO, Wt=400ms, Rt=400ms	SOT-25	28xg	VD19	6g	Tor
<u>3</u> TZ	XC6104F530MR	Vdet-IC	3.0V±2%, Hst, ±Reset PPO, Wt=400ms, Rt=400ms	SOT-25	28xg	VD19	6g	Tor
<u>3</u> U	R1210N231C	DC/DC-IC	PWM step-up, 2.3V, 100kHz	SOT-23-5	28sc	DC3	6g	Ric
<u>3</u> U0	XC6104F631MR	Vdet-IC	3.1V±2%, Hst, ±Reset PPO, Wt=1.6s, Rt=400ms	SOT-25	28xg	VD19	6g	Tor
<u>3</u> U1	XC6104F632MR	Vdet-IC	3.2V±2%, Hst, ±Reset PPO, Wt=1.6s, Rt=400ms	SOT-25	28xg	VD19	6g	Tor
<u>3</u> U2	XC6104F633MR	Vdet-IC	3.3V±2%, Hst, ±Reset PPO, Wt=1.6s, Rt=400ms	SOT-25	28xg	VD19	6g	Tor
<u>3</u> U3	XC6104F634MR	Vdet-IC	3.4V±2%, Hst, ±Reset PPO, Wt=1.6s, Rt=400ms	SOT-25	28xg	VD19	6g	Tor
<u>3</u> U4	XC6104F635MR	Vdet-IC	3.5V±2%, Hst, ±Reset PPO, Wt=1.6s, Rt=400ms	SOT-25	28xg	VD19	6g	Tor
<u>3</u> U5	XC6104F636MR	Vdet-IC	3.6V±2%, Hst, ±Reset PPO, Wt=1.6s, Rt=400ms	SOT-25	28xg	VD19	6g	Tor
<u>3</u> U6	XC6104F637MR	Vdet-IC	3.7V±2%, Hst, ±Reset PPO, Wt=1.6s, Rt=400ms	SOT-25	28xg	VD19	6g	Tor
<u>3</u> U7	XC6104F638MR	Vdet-IC	3.8V±2%, Hst, ±Reset PPO, Wt=1.6s, Rt=400ms	SOT-25	28xg	VD19	6g	Tor
<u>3</u> U8	XC6104F639MR	Vdet-IC	3.9V±2%, Hst, ±Reset PPO, Wt=1.6s, Rt=400ms	SOT-25	28xg	VD19	6g	Tor
<u>3</u> U9	XC6104F640MR	Vdet-IC	4.0V±2%, Hst, ±Reset PPO, Wt=1.6s, Rt=400ms	SOT-25	28xg	VD19	6g	Tor
<u>3</u> UA	XC6104F641MR	Vdet-IC	4.1V±2%, Hst, ±Reset PPO, Wt=1.6s, Rt=400ms	SOT-25	28xg	VD19	6g	Tor
<u>3</u> UB	XC6104F642MR	Vdet-IC	4.2V±2%, Hst, ±Reset PPO, Wt=1.6s, Rt=400ms	SOT-25	28xg	VD19	6g	Tor
<u>3</u> UC	XC6104F643MR	Vdet-IC	4.3V±2%, Hst, ±Reset PPO, Wt=1.6s, Rt=400ms	SOT-25	28xg	VD19	6g	Tor
<u>3</u> UD	XC6104F644MR	Vdet-IC	4.4V±2%, Hst, ±Reset PPO, Wt=1.6s, Rt=400ms	SOT-25	28xg	VD19	6g	Tor
<u>3</u> UE	XC6104F645MR	Vdet-IC	4.5V±2%, Hst, ±Reset PPO, Wt=1.6s, Rt=400ms	SOT-25	28xg	VD19	6g	Tor
<u>3</u> UF	XC6104F616MR	Vdet-IC	1.6V±2%, Hst, ±Reset PPO, Wt=1.6s, Rt=400ms	SOT-25	28xg	VD19	6g	Tor
<u>3</u> UF	XC6104F646MR	Vdet-IC	4.6V±2%, Hst, ±Reset PPO, Wt=1.6s, Rt=400ms	SOT-25	28xg	VD19	6g	Tor
<u>3</u> UH	XC6104F617MR	Vdet-IC	1.7V±2%, Hst, ±Reset PPO, Wt=1.6s, Rt=400ms	SOT-25	28xg	VD19	6g	Tor
<u>3</u> UH	XC6104F647MR	Vdet-IC	4.7V±2%, Hst, ±Reset PPO, Wt=1.6s, Rt=400ms	SOT-25	28xg	VD19	6g	Tor
<u>3</u> UK	XC6104F618MR	Vdet-IC	1.8V±2%, Hst, ±Reset PPO, Wt=1.6s, Rt=400ms	SOT-25	28xg	VD19	6g	Tor
<u>3</u> UK	XC6104F648MR	Vdet-IC	4.8V±2%, Hst, ±Reset PPO, Wt=1.6s, Rt=400ms	SOT-25	28xg	VD19	6g	Tor
<u>3</u> UL	XC6104F619MR	Vdet-IC	1.9V±2%, Hst, ±Reset PPO, Wt=1.6s, Rt=400ms	SOT-25	28xg	VD19	6g	Tor
<u>3</u> UL	XC6104F649MR	Vdet-IC	4.9V±2%, Hst, ±Reset PPO, Wt=1.6s, Rt=400ms	SOT-25	28xg	VD19	6g	Tor
<u>3</u> UM	XC6104F620MR	Vdet-IC	2.0V±2%, Hst, ±Reset PPO, Wt=1.6s, Rt=400ms	SOT-25	28xg	VD19	6g	Tor
<u>3</u> UM	XC6104F650MR	Vdet-IC	5.0V±2%, Hst, ±Reset PPO, Wt=1.6s, Rt=400ms	SOT-25	28xg	VD19	6g	Tor
<u>3</u> UN	XC6104F621MR	Vdet-IC	2.1V±2%, Hst, ±Reset PPO, Wt=1.6s, Rt=400ms	SOT-25	28xg	VD19	6g	Tor
<u>3</u> UP	XC6104F622MR	Vdet-IC	2.2V±2%, Hst, ±Reset PPO, Wt=1.6s, Rt=400ms	SOT-25	28xg	VD19	6g	Tor
<u>3</u> UR	XC6104F623MR	Vdet-IC	2.3V±2%, Hst, ±Reset PPO, Wt=1.6s, Rt=400ms	SOT-25	28xg	VD19	6g	Tor
<u>3</u> US	XC6104F624MR	Vdet-IC	2.4V±2%, Hst, ±Reset PPO, Wt=1.6s, Rt=400ms	SOT-25	28xg	VD19	6g	Tor
<u>3</u> UT	XC6104F625MR	Vdet-IC	2.5V±2%, Hst, ±Reset PPO, Wt=1.6s, Rt=400ms	SOT-25	28xg	VD19	6g	Tor
<u>3</u> UT	XC6104F626MR	Vdet-IC	2.6V±2%, Hst, ±Reset PPO, Wt=1.6s, Rt=400ms	SOT-25	28xg	VD19	6g	Tor
<u>3</u> UV	XC6104F627MR	Vdet-IC	2.7V±2%, Hst, ±Reset PPO, Wt=1.6s, Rt=400ms	SOT-25	28xg	VD19	6g	Tor
<u>3</u> UX	XC6104F628MR	Vdet-IC	2.8V±2%, Hst, ±Reset PPO, Wt=1.6s, Rt=400ms	SOT-25	28xg	VD19	6g	Tor
<u>3</u> UY	XC6104F629MR	Vdet-IC	2.9V±2%, Hst, ±Reset PPO, Wt=1.6s, Rt=400ms	SOT-25	28xg	VD19	6g	Tor
<u>3</u> UZ	XC6104F630MR	Vdet-IC	3.0V±2%, Hst, ±Reset PPO, Wt=1.6s, Rt=400ms	SOT-25	28xg	VD19	6g	Tor
<u>3</u> V0	TAR5S30	LVR-IC	LDO, 3V±1%, 200mA, +CE	SSOP-5	28un	VR7	6a	Tos
<u>3</u> V0	TAR5S30U	LVR-IC	LDO, 3V±1%, 200mA, +CE	SSOP-5-P	30un	VR7	6a	Tos
<u>3</u> V0	XC6104H631MR	Vdet-IC	3.1V±2%, Hst, ±Reset PPO, Wt=1.6s, Rt=1.6s	SOT-25	28xg	VD19	6g	Tor
<u>3</u> V1	TAR5S31	LVR-IC	LDO, 3.1V±1%, 200mA, +CE	SSOP-5	28un	VR7	6a	Tos
<u>3</u> V1	TAR5S31U	LVR-IC	LDO, 3.1V±1%, 200mA, +CE	SSOP-5-P	30un	VR7	6a	Tos
<u>3</u> V1	XC6104H632MR	Vdet-IC	3.2V±2%, Hst, ±Reset PPO, Wt=1.6s, Rt=1.6s	SOT-25	28xg	VD19	6g	Tor
<u>3</u> V2	TAR5S32	LVR-IC	LDO, 3.2V±1%, 200mA, +CE	SSOP-5	28un	VR7	6a	Tos
<u>3</u> V2	TAR5S32U	LVR-IC	LDO, 3.2V±1%, 200mA, +CE	SSOP-5-P	30un	VR7	6a	Tos
<u>3</u> V2	XC6104H633MR	Vdet-IC	3.3V±2%, Hst, ±Reset PPO, Wt=1.6s, Rt=1.6s	SOT-25	28xg	VD19	6g	Tor
<u>3</u> V3	TAR5S33	LVR-IC	LDO, 3.3V±1%, 200mA, +CE	SSOP-5	28un	VR7	6a	Tos
<u>3</u> V3	TAR5S33U	LVR-IC	LDO, 3.3V±1%, 200mA, +CE	SSOP-5-P	30un	VR7	6a	Tos
<u>3</u> V3	XC6104H634MR	Vdet-IC	3.4V±2%, Hst, ±Reset PPO, Wt=1.6s, Rt=1.6s	SOT-25	28xg	VD19	6g	Tor
<u>3</u> V4	TAR5S34	LVR-IC	LDO, 3.4V±1%, 200mA, +CE	SSOP-5	28un	VR7	6a	Tos
<u>3</u> V4	TAR5S34U	LVR-IC	LDO, 3.4V±1%, 200mA, +CE	SSOP-5-P	30un	VR7	6a	Tos
<u>3</u> V4	XC6104H635MR	Vdet-IC	3.5V±2%, Hst, ±Reset PPO, Wt=1.6s, Rt=1.6s	SOT-25	28xg	VD19	6g	Tor
<u>3</u> V5	TAR5S35	LVR-IC	LDO, 3.5V±1%, 200mA, +CE	SSOP-5	28un	VR7	6a	Tos
<u>3</u> V5	TAR5S35U	LVR-IC	LDO, 3.5V±1%, 200mA, +CE	SSOP-5-P	30un	VR7	6a	Tos
<u>3</u> V5	XC6104H636MR	Vdet-IC	3.6V±2%, Hst, ±Reset PPO, Wt=1.6s, Rt=1.6s	SOT-25	28xg	VD19	6g	Tor
<u>3</u> V6	TAR5S36	LVR-IC	LDO, 3.6V±1%, 200mA, +CE	SSOP-5	28un	VR7	6a	Tos
<u>3</u> V6	TAR5S36U	LVR-IC	LDO, 3.6V±1%, 200mA, +CE	SSOP-5-P	30un	VR7	6a	Tos
<u>3</u> V6	XC6104H637MR	Vdet-IC	3.7V±2%, Hst, ±Reset PPO, Wt=1.6s, Rt=1.6s	SOT-25	28xg	VD19	6g	Tor
<u>3</u> V7	TAR5S37	LVR-IC	LDO, 3.7V±1%, 200mA, +CE	SSOP-5	28un	VR7	6a	Tos



SMD code	Type	Function	Short description	Case	Pinout	Sch.	St.	Mnf.
3V7	TAR5S37U	LVR-IC	LDO, 3.7V±1%, 200mA, +CE	SSOP-5-P	30un	VR7	6a	Tos
3V7	XC6221A081MR	LVR-IC	LDO, 0.8V±20mV, 200mA, +CE	SOT-25	28cx	VR4	6g	Tor
3V7	XC6104H638MR	Vdet-IC	3.8V±2%, Hst, ±Reset PPO, Wt=1.6s, Rt=1.6s	SOT-25	28xg	VD19	6g	Tor
3V8	TAR5S38	LVR-IC	LDO, 3.8V±1%, 200mA, +CE	SSOP-5	28un	VR7	6a	Tos
3V8	TAR5S38U	LVR-IC	LDO, 3.8V±1%, 200mA, +CE	SSOP-5-P	30un	VR7	6a	Tos
3V8	XC6221A091MR	LVR-IC	LDO, 0.9V±20mV, 200mA, +CE	SOT-25	28cx	VR4	6g	Tor
3V8	XC6104H639MR	Vdet-IC	3.9V±2%, Hst, ±Reset PPO, Wt=1.6s, Rt=1.6s	SOT-25	28xg	VD19	6g	Tor
3V9	TAR5S39	LVR-IC	LDO, 3.9V±1%, 200mA, +CE	SSOP-5	28un	VR7	6a	Tos
3V9	TAR5S39U	LVR-IC	LDO, 3.9V±1%, 200mA, +CE	SSOP-5-P	30un	VR7	6a	Tos
3V9	XC6221A101MR	LVR-IC	LDO, 1V±20mV, 200mA, +CE	SOT-25	28cx	VR4	6g	Tor
3V9	XC6104H640MR	Vdet-IC	4.0V±2%, Hst, ±Reset PPO, Wt=1.6s, Rt=1.6s	SOT-25	28xg	VD19	6g	Tor
3VA	XC6221A111MR	LVR-IC	LDO, 1.1V±20mV, 200mA, +CE	SOT-25	28cx	VR4	6g	Tor
3VA	XC6104H641MR	Vdet-IC	4.1V±2%, Hst, ±Reset PPO, Wt=1.6s, Rt=1.6s	SOT-25	28xg	VD19	6g	Tor
3VB	XC6221A121MR	LVR-IC	LDO, 1.2V±20mV, 200mA, +CE	SOT-25	28cx	VR4	6g	Tor
3VB	XC6104H642MR	Vdet-IC	4.2V±2%, Hst, ±Reset PPO, Wt=1.6s, Rt=1.6s	SOT-25	28xg	VD19	6g	Tor
3VC	XC6221A131MR	LVR-IC	LDO, 1.3V±20mV, 200mA, +CE	SOT-25	28cx	VR4	6g	Tor
3VC	XC6104H643MR	Vdet-IC	4.3V±2%, Hst, ±Reset PPO, Wt=1.6s, Rt=1.6s	SOT-25	28xg	VD19	6g	Tor
3VD	XC6221A141MR	LVR-IC	LDO, 1.4V±20mV, 200mA, +CE	SOT-25	28cx	VR4	6g	Tor
3VD	XC6104H644MR	Vdet-IC	4.4V±2%, Hst, ±Reset PPO, Wt=1.6s, Rt=1.6s	SOT-25	28xg	VD19	6g	Tor
3VE	XC6221A151MR	LVR-IC	LDO, 1.5V±20mV, 200mA, +CE	SOT-25	28cx	VR4	6g	Tor
3VE	XC6104H645MR	Vdet-IC	4.5V±2%, Hst, ±Reset PPO, Wt=1.6s, Rt=1.6s	SOT-25	28xg	VD19	6g	Tor
3VF	XC6221A161MR	LVR-IC	LDO, 1.6V±20mV, 200mA, +CE	SOT-25	28cx	VR4	6g	Tor
3VF	XC6104H646MR	Vdet-IC	4.6V±2%, Hst, ±Reset PPO, Wt=1.6s, Rt=1.6s	SOT-25	28xg	VD19	6g	Tor
3VF	XC6104H646MR	Vdet-IC	4.6V±2%, Hst, ±Reset PPO, Wt=1.6s, Rt=1.6s	SOT-25	28xg	VD19	6g	Tor
3VH	XC6221A171MR	LVR-IC	LDO, 1.7V±20mV, 200mA, +CE	SOT-25	28cx	VR4	6g	Tor
3VH	XC6104H617MR	Vdet-IC	1.7V±2%, Hst, ±Reset PPO, Wt=1.6s, Rt=1.6s	SOT-25	28xg	VD19	6g	Tor
3VH	XC6104H647MR	Vdet-IC	4.7V±2%, Hst, ±Reset PPO, Wt=1.6s, Rt=1.6s	SOT-25	28xg	VD19	6g	Tor
3VK	XC6221A181MR	LVR-IC	LDO, 1.8V±20mV, 200mA, +CE	SOT-25	28cx	VR4	6g	Tor
3VK	XC6104H618MR	Vdet-IC	1.8V±2%, Hst, ±Reset PPO, Wt=1.6s, Rt=1.6s	SOT-25	28xg	VD19	6g	Tor
3VK	XC6104H648MR	Vdet-IC	4.8V±2%, Hst, ±Reset PPO, Wt=1.6s, Rt=1.6s	SOT-25	28xg	VD19	6g	Tor
3VL	XC6221A191MR	LVR-IC	LDO, 1.9V±20mV, 200mA, +CE	SOT-25	28cx	VR4	6g	Tor
3VL	XC6104H619MR	Vdet-IC	1.9V±2%, Hst, ±Reset PPO, Wt=1.6s, Rt=1.6s	SOT-25	28xg	VD19	6g	Tor
3VL	XC6104H649MR	Vdet-IC	4.9V±2%, Hst, ±Reset PPO, Wt=1.6s, Rt=1.6s	SOT-25	28xg	VD19	6g	Tor
3VM	XC6221A201MR	LVR-IC	LDO, 2V±1%, 200mA, +CE	SOT-25	28cx	VR4	6g	Tor
3VM	XC6104H620MR	Vdet-IC	2.0V±2%, Hst, ±Reset PPO, Wt=1.6s, Rt=1.6s	SOT-25	28xg	VD19	6g	Tor
3VM	XC6104H650MR	Vdet-IC	5.0V±2%, Hst, ±Reset PPO, Wt=1.6s, Rt=1.6s	SOT-25	28xg	VD19	6g	Tor
3VN	XC6221A211MR	LVR-IC	LDO, 2.1V±1%, 200mA, +CE	SOT-25	28cx	VR4	6g	Tor
3VN	XC6104H621MR	Vdet-IC	2.1V±2%, Hst, ±Reset PPO, Wt=1.6s, Rt=1.6s	SOT-25	28xg	VD19	6g	Tor
3VP	XC6221A221MR	LVR-IC	LDO, 2.2V±1%, 200mA, +CE	SOT-25	28cx	VR4	6g	Tor
3VP	XC6104H622MR	Vdet-IC	2.2V±2%, Hst, ±Reset PPO, Wt=1.6s, Rt=1.6s	SOT-25	28xg	VD19	6g	Tor
3VR	XC6221A231MR	LVR-IC	LDO, 2.3V±1%, 200mA, +CE	SOT-25	28cx	VR4	6g	Tor
3VR	XC6104H623MR	Vdet-IC	2.3V±2%, Hst, ±Reset PPO, Wt=1.6s, Rt=1.6s	SOT-25	28xg	VD19	6g	Tor
3VS	XC6221A241MR	LVR-IC	LDO, 2.4V±1%, 200mA, +CE	SOT-25	28cx	VR4	6g	Tor
3VS	XC6104H624MR	Vdet-IC	2.4V±2%, Hst, ±Reset PPO, Wt=1.6s, Rt=1.6s	SOT-25	28xg	VD19	6g	Tor
3VT	XC6221A251MR	LVR-IC	LDO, 2.5V±1%, 200mA, +CE	SOT-25	28cx	VR4	6g	Tor
3VT	XC6104H625MR	Vdet-IC	2.5V±2%, Hst, ±Reset PPO, Wt=1.6s, Rt=1.6s	SOT-25	28xg	VD19	6g	Tor
3VU	XC6221A261MR	LVR-IC	LDO, 2.6V±1%, 200mA, +CE	SOT-25	28cx	VR4	6g	Tor
3VU	XC6104H626MR	Vdet-IC	2.6V±2%, Hst, ±Reset PPO, Wt=1.6s, Rt=1.6s	SOT-25	28xg	VD19	6g	Tor
3VV	XC6221A271MR	LVR-IC	LDO, 2.7V±1%, 200mA, +CE	SOT-25	28cx	VR4	6g	Tor
3VV	XC6104H627MR	Vdet-IC	2.7V±2%, Hst, ±Reset PPO, Wt=1.6s, Rt=1.6s	SOT-25	28xg	VD19	6g	Tor
3VX	XC6221A281MR	LVR-IC	LDO, 2.8V±1%, 200mA, +CE	SOT-25	28cx	VR4	6g	Tor
3VX	XC6104H628MR	Vdet-IC	2.8V±2%, Hst, ±Reset PPO, Wt=1.6s, Rt=1.6s	SOT-25	28xg	VD19	6g	Tor
3VY	XC6221A291MR	LVR-IC	LDO, 2.9V±1%, 200mA, +CE	SOT-25	28cx	VR4	6g	Tor
3VY	XC6104H629MR	Vdet-IC	2.9V±2%, Hst, ±Reset PPO, Wt=1.6s, Rt=1.6s	SOT-25	28xg	VD19	6g	Tor
3VZ	XC6221A301MR	LVR-IC	LDO, 3V±1%, 200mA, +CE	SOT-25	28cx	VR4	6g	Tor
3VZ	XC6104H630MR	Vdet-IC	3.0V±2%, Hst, ±Reset PPO, Wt=1.6s, Rt=1.6s	SOT-25	28xg	VD19	6g	Tor
3W	R1210N331C	DC/DC-IC	PWM step-up, 3.3V, 100kHz	SOT-23-5	28sc	DC3	6g	Ric
3X	R1210N431C	DC/DC-IC	PWM step-up, 4.2V, 100kHz	SOT-23-5	28sc	DC3	6g	Ric
3X0	XC6221B311MR	LVR-IC	LDO, 3.1V±1%, 200mA, +CE, CL	SOT-25	28cx	VR4	6g	Tor
3X7	XC6221B081MR	LVR-IC	LDO, 0.8V±20mV, 200mA, +CE, CL	SOT-25	28cx	VR4	6g	Tor
3X8	XC6221B091MR	LVR-IC	LDO, 0.9V±20mV, 200mA, +CE, CL	SOT-25	28cx	VR4	6g	Tor
3X9	XC6221B101MR	LVR-IC	LDO, 1V±20mV, 200mA, +CE, CL	SOT-25	28cx	VR4	6g	Tor
3XA	XC6221B111MR	LVR-IC	LDO, 1.1V±20mV, 200mA, +CE, CL	SOT-25	28cx	VR4	6g	Tor
3XB	XC6221B121MR	LVR-IC	LDO, 1.2V±20mV, 200mA, +CE, CL	SOT-25	28cx	VR4	6g	Tor
3XC	XC6221B131MR	LVR-IC	LDO, 1.3V±20mV, 200mA, +CE, CL	SOT-25	28cx	VR4	6g	Tor
3XD	XC6221B141MR	LVR-IC	LDO, 1.4V±20mV, 200mA, +CE, CL	SOT-25	28cx	VR4	6g	Tor
3XE	XC6221B151MR	LVR-IC	LDO, 1.5V±20mV, 200mA, +CE, CL	SOT-25	28cx	VR4	6g	Tor
3XF	XC6221B161MR	LVR-IC	LDO, 1.6V±20mV, 200mA, +CE, CL	SOT-25	28cx	VR4	6g	Tor
3XH	XC6221B171MR	LVR-IC	LDO, 1.7V±20mV, 200mA, +CE, CL	SOT-25	28cx	VR4	6g	Tor
3XK	XC6221B181MR	LVR-IC	LDO, 1.8V±20mV, 200mA, +CE, CL	SOT-25	28cx	VR4	6g	Tor



SMD code	Type	Function	Short description	Case	Pinout	Sch.	St.	Mnf.
3XL	XC6221B191MR	LVR-IC	LDO, 1.9V±20mV, 200mA, +CE, CL	SOT-25	28cx	VR4	6g	Tor
3XM	XC6221B201MR	LVR-IC	LDO, 2V±1%, 200mA, +CE, CL	SOT-25	28cx	VR4	6g	Tor
3XN	XC6221B211MR	LVR-IC	LDO, 2.1V±1%, 200mA, +CE, CL	SOT-25	28cx	VR4	6g	Tor
3XP	XC6221B221MR	LVR-IC	LDO, 2.2V±1%, 200mA, +CE, CL	SOT-25	28cx	VR4	6g	Tor
3XR	XC6221B231MR	LVR-IC	LDO, 2.3V±1%, 200mA, +CE, CL	SOT-25	28cx	VR4	6g	Tor
3XS	XC6221B241MR	LVR-IC	LDO, 2.4V±1%, 200mA, +CE, CL	SOT-25	28cx	VR4	6g	Tor
3XT	XC6221B251MR	LVR-IC	LDO, 2.5V±1%, 200mA, +CE, CL	SOT-25	28cx	VR4	6g	Tor
3XU	XC6221B261MR	LVR-IC	LDO, 2.6V±1%, 200mA, +CE, CL	SOT-25	28cx	VR4	6g	Tor
3XV	XC6221B271MR	LVR-IC	LDO, 2.7V±1%, 200mA, +CE, CL	SOT-25	28cx	VR4	6g	Tor
3XX	XC6221B281MR	LVR-IC	LDO, 2.8V±1%, 200mA, +CE, CL	SOT-25	28cx	VR4	6g	Tor
3XY	XC6221B291MR	LVR-IC	LDO, 2.9V±1%, 200mA, +CE, CL	SOT-25	28cx	VR4	6g	Tor
3XZ	XC6221B301MR	LVR-IC	LDO, 3V±1%, 200mA, +CE, CL	SOT-25	28cx	VR4	6g	Tor
3Y	R1210N531C	DC/DC-IC	PWM step-up, 5.3V, 100kHz	SOT-23-5	28sc	DC3	6g	Ric
3Y0	U74LVC1G00-AF5	CMOS-Logic	2-input NAND gate	SOT-23-5	28Log1	-	6a	Utc
3Y0	U74LVC1G00-AL5	CMOS-Logic	2-input NAND gate	SOT-353	28Log1	-	6a	Utc
3Y0L	U74LVC1G00L-AF5	CMOS-Logic	2-input NAND gate	SOT-23-5	28Log1	-	6a	Utc
3Y0L	U74LVC1G00L-AL5	CMOS-Logic	2-input NAND gate	SOT-353	28Log1	-	6a	Utc
3Y4	U74LVC1G04-AF5	CMOS-Logic	Inverter	SOT-23-5	28Log6	-	6a	Utc
3Y4	U74LVC1G04-AL5	CMOS-Logic	Inverter	SOT-353	28Log6	-	6a	Utc
3Y4L	U74LVC1G04L-AF5	CMOS-Logic	Inverter	SOT-23-5	28Log6	-	6a	Utc
3Y4L	U74LVC1G04L-AL5	CMOS-Logic	Inverter	SOT-353	28Log6	-	6a	Utc
3Y6	U74LVC1G06-AF5	CMOS-Logic	Inverter (ODO)	SOT-23-5	28Log19	-	6a	Utc
3Y6	U74LVC1G06-AL5	CMOS-Logic	Inverter (ODO)	SOT-353	28Log19	-	6a	Utc
3Y6L	U74LVC1G06L-AF5	CMOS-Logic	Inverter (ODO)	SOT-23-5	28Log19	-	6a	Utc
3Y6L	U74LVC1G06L-AL5	CMOS-Logic	Inverter (ODO)	SOT-353	28Log19	-	6a	Utc
3Y7	U74LVC1G07-AF5	CMOS-Logic	Noninverting buffer/driver (ODO)	SOT-23-5	28Log8	-	6a	Utc
3Y7	U74LVC1G07-AL5	CMOS-Logic	Noninverting buffer/driver (ODO)	SOT-353	28Log8	-	6a	Utc
3Y7L	U74LVC1G07L-AF5	CMOS-Logic	Noninverting buffer/driver (ODO)	SOT-23-5	28Log8	-	6a	Utc
3Y7L	U74LVC1G07L-AL5	CMOS-Logic	Noninverting buffer/driver (ODO)	SOT-353	28Log8	-	6a	Utc
3Y8	U74LVC1G08-AF5	CMOS-Logic	2-input AND gate	SOT-23-5	28Log3	-	6a	Utc
3Y8	U74LVC1G08-AL5	CMOS-Logic	2-input AND gate	SOT-353	28Log3	-	6a	Utc
3Y8L	U74LVC1G08L-AF5	CMOS-Logic	2-input AND gate	SOT-23-5	28Log3	-	6a	Utc
3Y8L	U74LVC1G08L-AL5	CMOS-Logic	2-input AND gate	SOT-353	28Log3	-	6a	Utc
3Z	R1210N231D	DC/DC-IC	PWM step-up, 2.3V, 180kHz	SOT-23-5	28sc	DC3	6g	Ric
40	R1223N332G	DC/DC-IC	PWM step-down, +CE, 3.3V, 300kHz, +Reset.Pr.	SOT-23-5	28sd	DC7	6g	Ric
40	RN5RF40AA	LVR-IC	LRip, -CE, 4V±2%, 1A*	SOT-23-5	28vw	VR6	6g	Ric
40	RN5RZ40AA	LVR-IC	LDO, LN, -CE, 4V±2%, 100mA	SOT-23-5	28vrt	VR4	6g	Ric
400	XC6105A131MR	Vdet-IC	3.1V±2%, Hst, +Rst PPO, -Rst ODO, Wt=6.25ms, Rt=3.13ms	SOT-25	28xg	VD20	6g	Tor
401	XC6105A132MR	Vdet-IC	3.2V±2%, Hst, +Rst PPO, -Rst ODO, Wt=6.25ms, Rt=3.13ms	SOT-25	28xg	VD20	6g	Tor
402	XC6105A133MR	Vdet-IC	3.3V±2%, Hst, +Rst PPO, -Rst ODO, Wt=6.25ms, Rt=3.13ms	SOT-25	28xg	VD20	6g	Tor
403	XC6105A134MR	Vdet-IC	3.4V±2%, Hst, +Rst PPO, -Rst ODO, Wt=6.25ms, Rt=3.13ms	SOT-25	28xg	VD20	6g	Tor
404	XC6105A135MR	Vdet-IC	3.5V±2%, Hst, +Rst PPO, -Rst ODO, Wt=6.25ms, Rt=3.13ms	SOT-25	28xg	VD20	6g	Tor
405	XC6105A136MR	Vdet-IC	3.6V±2%, Hst, +Rst PPO, -Rst ODO, Wt=6.25ms, Rt=3.13ms	SOT-25	28xg	VD20	6g	Tor
406	XC6105A137MR	Vdet-IC	3.7V±2%, Hst, +Rst PPO, -Rst ODO, Wt=6.25ms, Rt=3.13ms	SOT-25	28xg	VD20	6g	Tor
407	XC6105A138MR	Vdet-IC	3.8V±2%, Hst, +Rst PPO, -Rst ODO, Wt=6.25ms, Rt=3.13ms	SOT-25	28xg	VD20	6g	Tor
408	XC6105A139MR	Vdet-IC	3.9V±2%, Hst, +Rst PPO, -Rst ODO, Wt=6.25ms, Rt=3.13ms	SOT-25	28xg	VD20	6g	Tor
409	XC6105A140MR	Vdet-IC	4.0V±2%, Hst, +Rst PPO, -Rst ODO, Wt=6.25ms, Rt=3.13ms	SOT-25	28xg	VD20	6g	Tor
40A	AAT60040A-S5	Vdet-IC	4.0V±2%, -Reset ODO	SOT-23-5	28vdo	VD1	6g	Aat
40A	XC6105A141MR	Vdet-IC	4.1V±2%, Hst, +Rst PPO, -Rst ODO, Wt=6.25ms, Rt=3.13ms	SOT-25	28xg	VD20	6g	Tor
40-A	UTC8140-A	Vdet-IC	4V, -Reset OCO	SOT-23-5	28vdz	VD6	6k	Utc
40B	AAT60040B-S5	Vdet-IC	4.0V±2%, -Reset PPO	SOT-23-5	28vdo	VD3	6g	Aat
40B	XC6105A142MR	Vdet-IC	4.2V±2%, Hst, +Rst PPO, -Rst ODO, Wt=6.25ms, Rt=3.13ms	SOT-25	28xg	VD20	6g	Tor
40-B	UTC8140-B	Vdet-IC	4V, -Reset OCO	SOT-23-5	28vdm	VD6	6k	Utc
40C	AAT60040C-S5	Vdet-IC	4.0V±1%, -Reset ODO	SOT-23-5	28vdo	VD1	6g	Aat
40C	XC6105A143MR	Vdet-IC	4.3V±2%, Hst, +Rst PPO, -Rst ODO, Wt=6.25ms, Rt=3.13ms	SOT-25	28xg	VD20	6g	Tor
40D	AAT60040D-S5	Vdet-IC	4.0V±1%, -Reset PPO	SOT-23-5	28vdo	VD3	6g	Aat
40D	XC6105A144MR	Vdet-IC	4.4V±2%, Hst, +Rst PPO, -Rst ODO, Wt=6.25ms, Rt=3.13ms	SOT-25	28xg	VD20	6g	Tor
40E	XC6105A145MR	Vdet-IC	4.5V±2%, Hst, +Rst PPO, -Rst ODO, Wt=6.25ms, Rt=3.13ms	SOT-25	28xg	VD20	6g	Tor
40F	XC6105A116MR	Vdet-IC	1.6V±2%, Hst, +Rst PPO, -Rst ODO, Wt=6.25ms, Rt=3.13ms	SOT-25	28xg	VD20	6g	Tor
40F	XC6105A146MR	Vdet-IC	4.6V±2%, Hst, +Rst PPO, -Rst ODO, Wt=6.25ms, Rt=3.13ms	SOT-25	28xg	VD20	6g	Tor
40H	XC6105A117MR	Vdet-IC	1.7V±2%, Hst, +Rst PPO, -Rst ODO, Wt=6.25ms, Rt=3.13ms	SOT-25	28xg	VD20	6g	Tor
40H	XC6105A147MR	Vdet-IC	4.7V±2%, Hst, +Rst PPO, -Rst ODO, Wt=6.25ms, Rt=3.13ms	SOT-25	28xg	VD20	6g	Tor
40K	TK71740S	LVR-IC	LDO, 4V±1.5%, 300mA, +CE	SOT-23-5	28vrx	VR7	6k	Tok
40K	XC6105A118MR	Vdet-IC	1.8V±2%, Hst, +Rst PPO, -Rst ODO, Wt=6.25ms, Rt=3.13ms	SOT-25	28xg	VD20	6g	Tor
40K	XC6105A148MR	Vdet-IC	4.8V±2%, Hst, +Rst PPO, -Rst ODO, Wt=6.25ms, Rt=3.13ms	SOT-25	28xg	VD20	6g	Tor
40L	TK71640ASCL	LVR-IC	LDO, 4V±2%, 150mA, +CE, -30...+80°C	SOT-23-5	28vrx	VR7	6k	Tok
40L	XC6105A119MR	Vdet-IC	1.9V±2%, Hst, +Rst PPO, -Rst ODO, Wt=6.25ms, Rt=3.13ms	SOT-25	28xg	VD20	6g	Tor
40L	XC6105A149MR	Vdet-IC	4.9V±2%, Hst, +Rst PPO, -Rst ODO, Wt=6.25ms, Rt=3.13ms	SOT-25	28xg	VD20	6g	Tor
40M	XC6105A120MR	Vdet-IC	2.0V±2%, Hst, +Rst PPO, -Rst ODO, Wt=6.25ms, Rt=3.13ms	SOT-25	28xg	VD20	6g	Tor
40M	XC6105A150MR	Vdet-IC	5.0V±2%, Hst, +Rst PPO, -Rst ODO, Wt=6.25ms, Rt=3.13ms	SOT-25	28xg	VD20	6g	Tor



SMD code	Type	Function	Short description	Case	Pinout	Sch.	St.	Mnf.
40N	XC6105A121MR	Vdet-IC	2.1V±2%, Hst, +Rst PPO, -Rst ODO, Wt=6.25ms, Rt=3.13ms	SOT-25	28xg	VD20	6g	Tor
40P	XC6105A122MR	Vdet-IC	2.2V±2%, Hst, +Rst PPO, -Rst ODO, Wt=6.25ms, Rt=3.13ms	SOT-25	28xg	VD20	6g	Tor
40R	XC6105A123MR	Vdet-IC	2.3V±2%, Hst, +Rst PPO, -Rst ODO, Wt=6.25ms, Rt=3.13ms	SOT-25	28xg	VD20	6g	Tor
40S	XC6105A124MR	Vdet-IC	2.4V±2%, Hst, +Rst PPO, -Rst ODO, Wt=6.25ms, Rt=3.13ms	SOT-25	28xg	VD20	6g	Tor
40T	TK71440S	LVR-IC	LDO, 4.0V±2%, 100mA, +CE, Ext. transistor	SOT-23-5	28zh	VR6	6a	Tok
40T	XC6105A125MR	Vdet-IC	2.5V±2%, Hst, +Rst PPO, -Rst ODO, Wt=6.25ms, Rt=3.13ms	SOT-25	28xg	VD20	6g	Tor
40U	TK61040S	Vdet-IC	4.0V±2%, -Reset PPO	SOT-23-5	28vdm	VD7	6a	Tok
40U	XC6105A126MR	Vdet-IC	2.6V±2%, Hst, +Rst PPO, -Rst ODO, Wt=6.25ms, Rt=3.13ms	SOT-25	28xg	VD20	6g	Tor
40V	XC6105A127MR	Vdet-IC	2.7V±2%, Hst, +Rst PPO, -Rst ODO, Wt=6.25ms, Rt=3.13ms	SOT-25	28xg	VD20	6g	Tor
40X	XC6105A128MR	Vdet-IC	2.8V±2%, Hst, +Rst PPO, -Rst ODO, Wt=6.25ms, Rt=3.13ms	SOT-25	28xg	VD20	6g	Tor
40Y	XC6105A129MR	Vdet-IC	2.9V±2%, Hst, +Rst PPO, -Rst ODO, Wt=6.25ms, Rt=3.13ms	SOT-25	28xg	VD20	6g	Tor
40Z	XC6105A130MR	Vdet-IC	3.0V±2%, Hst, +Rst PPO, -Rst ODO, Wt=6.25ms, Rt=3.13ms	SOT-25	28xg	VD20	6g	Tor
41	R1223N502G	DC/DC-IC	PWM step-down, +CE, 5V, 300kHz, +Reset-Pr.	SOT-23-5	28ud	DC7	6g	Ric
41	RN5RF41AA	LVR-IC	LRip, -CE, 4.1V±2%, 1A*	SOT-23-5	28vw	VR6	6g	Ric
41	RN5RZ41AA	LVR-IC	LDO, LN, -CE, 4.1V±2%, 100mA	SOT-23-5	28wrt	VR4	6g	Ric
410	XC6105A231MR	Vdet-IC	3.1V±2%, Hst, +Rst PPO, -Rst ODO, Wt=50ms, Rt=3.13ms	SOT-25	28xg	VD20	6g	Tor
411	XC6105A232MR	Vdet-IC	3.2V±2%, Hst, +Rst PPO, -Rst ODO, Wt=50ms, Rt=3.13ms	SOT-25	28xg	VD20	6g	Tor
412	XC6105A233MR	Vdet-IC	3.3V±2%, Hst, +Rst PPO, -Rst ODO, Wt=50ms, Rt=3.13ms	SOT-25	28xg	VD20	6g	Tor
413	XC6105A234MR	Vdet-IC	3.4V±2%, Hst, +Rst PPO, -Rst ODO, Wt=50ms, Rt=3.13ms	SOT-25	28xg	VD20	6g	Tor
414	XC6105A235MR	Vdet-IC	3.5V±2%, Hst, +Rst PPO, -Rst ODO, Wt=50ms, Rt=3.13ms	SOT-25	28xg	VD20	6g	Tor
415	R1114N151A	LVR-IC	LDO, LN, -CE, 1.5V±2%, 150mA	SOT-23-5	28cx	VR4	6g	Ric
415	XC6105A236MR	Vdet-IC	3.6V±2%, Hst, +Rst PPO, -Rst ODO, Wt=50ms, Rt=3.13ms	SOT-25	28xg	VD20	6g	Tor
416	R1114N161A	LVR-IC	LDO, LN, -CE, 1.6V±2%, 150mA	SOT-23-5	28cx	VR4	6g	Ric
416	XC6105A237MR	Vdet-IC	3.7V±2%, Hst, +Rst PPO, -Rst ODO, Wt=50ms, Rt=3.13ms	SOT-25	28xg	VD20	6g	Tor
417	R1114N171A	LVR-IC	LDO, LN, -CE, 1.7V±2%, 150mA	SOT-23-5	28cx	VR4	6g	Ric
417	XC6105A238MR	Vdet-IC	3.8V±2%, Hst, +Rst PPO, -Rst ODO, Wt=50ms, Rt=3.13ms	SOT-25	28xg	VD20	6g	Tor
418	R1114N181A	LVR-IC	LDO, LN, -CE, 1.8V±2%, 150mA	SOT-23-5	28cx	VR4	6g	Ric
418	XC6105A239MR	Vdet-IC	3.9V±2%, Hst, +Rst PPO, -Rst ODO, Wt=50ms, Rt=3.13ms	SOT-25	28xg	VD20	6g	Tor
419	R1114N191A	LVR-IC	LDO, LN, -CE, 1.9V±2%, 150mA	SOT-23-5	28cx	VR4	6g	Ric
419	XC6105A240MR	Vdet-IC	4.0V±2%, Hst, +Rst PPO, -Rst ODO, Wt=50ms, Rt=3.13ms	SOT-25	28xg	VD20	6g	Tor
41A	AAT60041A-S5	Vdet-IC	4.1V±2%, -Reset ODO	SOT-23-5	28vdo	VD1	6g	Aat
41A	XC6105A241MR	Vdet-IC	4.1V±2%, Hst, +Rst PPO, -Rst ODO, Wt=50ms, Rt=3.13ms	SOT-25	28xg	VD20	6g	Tor
41-A	UTC8141-A	Vdet-IC	4.1V, -Reset OCO	SOT-23-5	28vdz	VD6	6k	Utc
41B	AAT60041B-S5	Vdet-IC	4.1V±2%, -Reset PPO	SOT-23-5	28vdo	VD3	6g	Aat
41B	XC6105A242MR	Vdet-IC	4.2V±2%, Hst, +Rst PPO, -Rst ODO, Wt=50ms, Rt=3.13ms	SOT-25	28xg	VD20	6g	Tor
41-B	UTC8141-B	Vdet-IC	4.1V, -Reset OCO	SOT-23-5	28vdm	VD6	6k	Utc
41C	AAT60041C-S5	Vdet-IC	4.1V±1%, -Reset ODO	SOT-23-5	28vdo	VD1	6g	Aat
41C	TK11041M-1	Tdet-IC	Sensor (-30 to +105°C), 10mV/°C, 4.5...10V	SOT-23-5	28		6a	X
41C	XC6105A243MR	Vdet-IC	4.3V±2%, Hst, +Rst PPO, -Rst ODO, Wt=50ms, Rt=3.13ms	SOT-25	28xg	VD20	6g	Tor
41D	AAT60041D-S5	Vdet-IC	4.1V±1%, -Reset PPO	SOT-23-5	28vdo	VD3	6g	Aat
41D	XC6105A244MR	Vdet-IC	4.4V±2%, Hst, +Rst PPO, -Rst ODO, Wt=50ms, Rt=3.13ms	SOT-25	28xg	VD20	6g	Tor
41E	XC6105A245MR	Vdet-IC	4.5V±2%, Hst, +Rst PPO, -Rst ODO, Wt=50ms, Rt=3.13ms	SOT-25	28xg	VD20	6g	Tor
41F	XC6105A216MR	Vdet-IC	1.6V±2%, Hst, +Rst PPO, -Rst ODO, Wt=50ms, Rt=3.13ms	SOT-25	28xg	VD20	6g	Tor
41F	XC6105A246MR	Vdet-IC	4.6V±2%, Hst, +Rst PPO, -Rst ODO, Wt=50ms, Rt=3.13ms	SOT-25	28xg	VD20	6g	Tor
41H	XC6105A217MR	Vdet-IC	1.7V±2%, Hst, +Rst PPO, -Rst ODO, Wt=50ms, Rt=3.13ms	SOT-25	28xg	VD20	6g	Tor
41H	XC6105A247MR	Vdet-IC	4.7V±2%, Hst, +Rst PPO, -Rst ODO, Wt=50ms, Rt=3.13ms	SOT-25	28xg	VD20	6g	Tor
41K	TK71741S	LVR-IC	LDO, 4.1V±1.5%, 300mA, +CE	SOT-23-5	28vrx	VR7	6k	Tok
41K	XC6105A218MR	Vdet-IC	1.8V±2%, Hst, +Rst PPO, -Rst ODO, Wt=50ms, Rt=3.13ms	SOT-25	28xg	VD20	6g	Tor
41K	XC6105A248MR	Vdet-IC	4.8V±2%, Hst, +Rst PPO, -Rst ODO, Wt=50ms, Rt=3.13ms	SOT-25	28xg	VD20	6g	Tor
41L	TK71641ASCL	LVR-IC	LDO, 4.1V±2%, 150mA, +CE, -30...+80°C	SOT-23-5	28vrx	VR7	6k	Tok
41L	XC6105A219MR	Vdet-IC	1.9V±2%, Hst, +Rst PPO, -Rst ODO, Wt=50ms, Rt=3.13ms	SOT-25	28xg	VD20	6g	Tor
41L	XC6105A249MR	Vdet-IC	4.9V±2%, Hst, +Rst PPO, -Rst ODO, Wt=50ms, Rt=3.13ms	SOT-25	28xg	VD20	6g	Tor
41M	XC6105A220MR	Vdet-IC	2.0V±2%, Hst, +Rst PPO, -Rst ODO, Wt=50ms, Rt=3.13ms	SOT-25	28xg	VD20	6g	Tor
41M	XC6105A250MR	Vdet-IC	5.0V±2%, Hst, +Rst PPO, -Rst ODO, Wt=50ms, Rt=3.13ms	SOT-25	28xg	VD20	6g	Tor
41N	XC6105A221MR	Vdet-IC	2.1V±2%, Hst, +Rst PPO, -Rst ODO, Wt=50ms, Rt=3.13ms	SOT-25	28xg	VD20	6g	Tor
41P	XC6105A222MR	Vdet-IC	2.2V±2%, Hst, +Rst PPO, -Rst ODO, Wt=50ms, Rt=3.13ms	SOT-25	28xg	VD20	6g	Tor
41R	XC6105A223MR	Vdet-IC	2.3V±2%, Hst, +Rst PPO, -Rst ODO, Wt=50ms, Rt=3.13ms	SOT-25	28xg	VD20	6g	Tor
41S	XC6105A224MR	Vdet-IC	2.4V±2%, Hst, +Rst PPO, -Rst ODO, Wt=50ms, Rt=3.13ms	SOT-25	28xg	VD20	6g	Tor
41T	TK71441S	LVR-IC	LDO, 4.1V±2%, 100mA, +CE, Ext. transistor	SOT-23-5	28zh	VR6	6a	Tok
41T	XC6105A225MR	Vdet-IC	2.5V±2%, Hst, +Rst PPO, -Rst ODO, Wt=50ms, Rt=3.13ms	SOT-25	28xg	VD20	6g	Tor
41U	TK61041S	Vdet-IC	5.1V±2%, -Reset PPO	SOT-23-5	28vdm	VD7	6a	Tok
41U	XC6105A226MR	Vdet-IC	2.6V±2%, Hst, +Rst PPO, -Rst ODO, Wt=50ms, Rt=3.13ms	SOT-25	28xg	VD20	6g	Tor
41V	XC6105A227MR	Vdet-IC	2.7V±2%, Hst, +Rst PPO, -Rst ODO, Wt=50ms, Rt=3.13ms	SOT-25	28xg	VD20	6g	Tor
41X	XC6105A228MR	Vdet-IC	2.8V±2%, Hst, +Rst PPO, -Rst ODO, Wt=50ms, Rt=3.13ms	SOT-25	28xg	VD20	6g	Tor
41Y	XC6105A229MR	Vdet-IC	2.9V±2%, Hst, +Rst PPO, -Rst ODO, Wt=50ms, Rt=3.13ms	SOT-25	28xg	VD20	6g	Tor
41Z	XC6105A230MR	Vdet-IC	3.0V±2%, Hst, +Rst PPO, -Rst ODO, Wt=50ms, Rt=3.13ms	SOT-25	28xg	VD20	6g	Tor
42	R1223N152H	DC/DC-IC	PWM step-down, +CE, 1.5V, 500kHz, +Reset-Pr.	SOT-23-5	28ud	DC7	6g	Ric
42	RN5RF42AA	LVR-IC	LRip, -CE, 4.2V±2%, 1A*	SOT-23-5	28vw	VR6	6g	Ric
42	RN5RZ42AA	LVR-IC	LDO, LN, -CE, 4.2V±2%, 100mA	SOT-23-5	28wrt	VR4	6g	Ric
420	R1114N201A	LVR-IC	LDO, LN, -CE, 2V±2%, 150mA	SOT-23-5	28cx	VR4	6g	Ric



SMD code	Type	Function	Short description	Case	Pinout	Sch.	St.	Mnf.
420	XC6105A331MR	Vdet-IC	3.1V±2%, Hst, +Rst PPO, -Rst ODO, Wt=100ms, Rt=3.13ms	SOT-25	28xg	VD20	6g	Tor
421	R1114N211A	LVR-IC	LDO, LN, -CE, 2.1V±2%, 150mA	SOT-23-5	28cx	VR4	6g	Ric
421	XC6105A332MR	Vdet-IC	3.2V±2%, Hst, +Rst PPO, -Rst ODO, Wt=100ms, Rt=3.13ms	SOT-25	28xg	VD20	6g	Tor
422	R1114N221A	LVR-IC	LDO, LN, -CE, 2.2V±2%, 150mA	SOT-23-5	28cx	VR4	6g	Ric
422	XC6105A333MR	Vdet-IC	3.3V±2%, Hst, +Rst PPO, -Rst ODO, Wt=100ms, Rt=3.13ms	SOT-25	28xg	VD20	6g	Tor
423	R1114N231A	LVR-IC	LDO, LN, -CE, 2.3V±2%, 150mA	SOT-23-5	28cx	VR4	6g	Ric
423	XC6105A334MR	Vdet-IC	3.4V±2%, Hst, +Rst PPO, -Rst ODO, Wt=100ms, Rt=3.13ms	SOT-25	28xg	VD20	6g	Tor
424	R1114N241A	LVR-IC	LDO, LN, -CE, 2.4V±2%, 150mA	SOT-23-5	28cx	VR4	6g	Ric
424	XC6105A335MR	Vdet-IC	3.5V±2%, Hst, +Rst PPO, -Rst ODO, Wt=100ms, Rt=3.13ms	SOT-25	28xg	VD20	6g	Tor
425	R1114N251A	LVR-IC	LDO, LN, -CE, 2.5V±2%, 150mA	SOT-23-5	28cx	VR4	6g	Ric
425	XC6105A336MR	Vdet-IC	3.6V±2%, Hst, +Rst PPO, -Rst ODO, Wt=100ms, Rt=3.13ms	SOT-25	28xg	VD20	6g	Tor
426	R1114N261A	LVR-IC	LDO, LN, -CE, 2.6V±2%, 150mA	SOT-23-5	28cx	VR4	6g	Ric
426	XC6105A337MR	Vdet-IC	3.7V±2%, Hst, +Rst PPO, -Rst ODO, Wt=100ms, Rt=3.13ms	SOT-25	28xg	VD20	6g	Tor
427	R1114N271A	LVR-IC	LDO, LN, -CE, 2.7V±2%, 150mA	SOT-23-5	28cx	VR4	6g	Ric
427	XC6105A338MR	Vdet-IC	3.8V±2%, Hst, +Rst PPO, -Rst ODO, Wt=100ms, Rt=3.13ms	SOT-25	28xg	VD20	6g	Tor
428	R1114N281A	LVR-IC	LDO, LN, -CE, 2.8V±2%, 150mA	SOT-23-5	28cx	VR4	6g	Ric
428	XC6105A339MR	Vdet-IC	3.9V±2%, Hst, +Rst PPO, -Rst ODO, Wt=100ms, Rt=3.13ms	SOT-25	28xg	VD20	6g	Tor
429	R1114N291A	LVR-IC	LDO, LN, -CE, 2.9V±2%, 150mA	SOT-23-5	28cx	VR4	6g	Ric
429	XC6105A340MR	Vdet-IC	4.0V±2%, Hst, +Rst PPO, -Rst ODO, Wt=100ms, Rt=3.13ms	SOT-25	28xg	VD20	6g	Tor
42A	AAT60042A-S5	Vdet-IC	4.2V±2%, -Reset ODO	SOT-23-5	28vdo	VD1	6g	Aat
42A	XC6105A341MR	Vdet-IC	4.1V±2%, Hst, +Rst PPO, -Rst ODO, Wt=100ms, Rt=3.13ms	SOT-25	28xg	VD20	6g	Tor
42-A	UTC8142-A	Vdet-IC	4.2V, -Reset OCO	SOT-23-5	28vzd	VD6	6k	Utc
42B	AAT60042B-S5	Vdet-IC	4.2V±2%, -Reset PPO	SOT-23-5	28vdo	VD3	6g	Aat
42B	XC6105A342MR	Vdet-IC	4.2V±2%, Hst, +Rst PPO, -Rst ODO, Wt=100ms, Rt=3.13ms	SOT-25	28xg	VD20	6g	Tor
42-B	UTC8142-B	Vdet-IC	4.2V, -Reset OCO	SOT-23-5	28vdm	VD6	6k	Utc
42C	AAT60042C-S5	Vdet-IC	4.2V±1%, -Reset ODO	SOT-23-5	28vdo	VD1	6g	Aat
42C	TK11042M-1	Tdet-IC	Sensor (-30 to +105°C), 6mV/°C, 2.7...10V	SOT-23-5	28	6a	6a	X
42C	XC6105A343MR	Vdet-IC	4.3V±2%, Hst, +Rst PPO, -Rst ODO, Wt=100ms, Rt=3.13ms	SOT-25	28xg	VD20	6g	Tor
42D	AAT60042D-S5	Vdet-IC	4.2V±1%, -Reset PPO	SOT-23-5	28vdo	VD3	6g	Aat
42D	XC6105A344MR	Vdet-IC	4.4V±2%, Hst, +Rst PPO, -Rst ODO, Wt=100ms, Rt=3.13ms	SOT-25	28xg	VD20	6g	Tor
42E	XC6105A345MR	Vdet-IC	4.5V±2%, Hst, +Rst PPO, -Rst ODO, Wt=100ms, Rt=3.13ms	SOT-25	28xg	VD20	6g	Tor
42F	XC6105A316MR	Vdet-IC	1.6V±2%, Hst, +Rst PPO, -Rst ODO, Wt=100ms, Rt=3.13ms	SOT-25	28xg	VD20	6g	Tor
42E	XC6105A346MR	Vdet-IC	4.6V±2%, Hst, +Rst PPO, -Rst ODO, Wt=100ms, Rt=3.13ms	SOT-25	28xg	VD20	6g	Tor
42H	XC6105A317MR	Vdet-IC	1.7V±2%, Hst, +Rst PPO, -Rst ODO, Wt=100ms, Rt=3.13ms	SOT-25	28xg	VD20	6g	Tor
42H	XC6105A347MR	Vdet-IC	4.7V±2%, Hst, +Rst PPO, -Rst ODO, Wt=100ms, Rt=3.13ms	SOT-25	28xg	VD20	6g	Tor
42K	TK71742S	LVR-IC	LDO, 4.2V±1.5%, 300mA, +CE	SOT-23-5	28vrx	VR7	6k	Tok
42K	XC6105A318MR	Vdet-IC	1.8V±2%, Hst, +Rst PPO, -Rst ODO, Wt=100ms, Rt=3.13ms	SOT-25	28xg	VD20	6g	Tor
42K	XC6105A348MR	Vdet-IC	4.8V±2%, Hst, +Rst PPO, -Rst ODO, Wt=100ms, Rt=3.13ms	SOT-25	28xg	VD20	6g	Tor
42L	TK71642ASCL	LVR-IC	LDO, 4.2V±2%, 150mA, +CE, -30...+80°C	SOT-23-5	28vrx	VR7	6k	Tok
42L	XC6105A319MR	Vdet-IC	1.9V±2%, Hst, +Rst PPO, -Rst ODO, Wt=100ms, Rt=3.13ms	SOT-25	28xg	VD20	6g	Tor
42L	XC6105A349MR	Vdet-IC	4.9V±2%, Hst, +Rst PPO, -Rst ODO, Wt=100ms, Rt=3.13ms	SOT-25	28xg	VD20	6g	Tor
42M	XC6105A320MR	Vdet-IC	2.0V±2%, Hst, +Rst PPO, -Rst ODO, Wt=100ms, Rt=3.13ms	SOT-25	28xg	VD20	6g	Tor
42M	XC6105A350MR	Vdet-IC	5.0V±2%, Hst, +Rst PPO, -Rst ODO, Wt=100ms, Rt=3.13ms	SOT-25	28xg	VD20	6g	Tor
42N	XC6105A321MR	Vdet-IC	2.1V±2%, Hst, +Rst PPO, -Rst ODO, Wt=100ms, Rt=3.13ms	SOT-25	28xg	VD20	6g	Tor
42P	XC6105A322MR	Vdet-IC	2.2V±2%, Hst, +Rst PPO, -Rst ODO, Wt=100ms, Rt=3.13ms	SOT-25	28xg	VD20	6g	Tor
42R	XC6105A323MR	Vdet-IC	2.3V±2%, Hst, +Rst PPO, -Rst ODO, Wt=100ms, Rt=3.13ms	SOT-25	28xg	VD20	6g	Tor
42S	XC6105A324MR	Vdet-IC	2.4V±2%, Hst, +Rst PPO, -Rst ODO, Wt=100ms, Rt=3.13ms	SOT-25	28xg	VD20	6g	Tor
42T	TK71442S	LVR-IC	LDO, 4.2V±2%, 100mA, +CE, Ext. transistor	SOT-23-5	28zh	VR6	6a	Tok
42T	XC6105A325MR	Vdet-IC	2.5V±2%, Hst, +Rst PPO, -Rst ODO, Wt=100ms, Rt=3.13ms	SOT-25	28xg	VD20	6g	Tor
42U	TK61042S	Vdet-IC	4.2V±2%, -Reset PPO	SOT-23-5	28vdm	VD7	6a	Tok
42U	XC6105A326MR	Vdet-IC	2.6V±2%, Hst, +Rst PPO, -Rst ODO, Wt=100ms, Rt=3.13ms	SOT-25	28xg	VD20	6g	Tor
42V	XC6105A327MR	Vdet-IC	2.7V±2%, Hst, +Rst PPO, -Rst ODO, Wt=100ms, Rt=3.13ms	SOT-25	28xg	VD20	6g	Tor
42X	XC6105A328MR	Vdet-IC	2.8V±2%, Hst, +Rst PPO, -Rst ODO, Wt=100ms, Rt=3.13ms	SOT-25	28xg	VD20	6g	Tor
42Y	XC6105A329MR	Vdet-IC	2.9V±2%, Hst, +Rst PPO, -Rst ODO, Wt=100ms, Rt=3.13ms	SOT-25	28xg	VD20	6g	Tor
42Z	XC6105A330MR	Vdet-IC	3.0V±2%, Hst, +Rst PPO, -Rst ODO, Wt=100ms, Rt=3.13ms	SOT-25	28xg	VD20	6g	Tor
43	R1223N182H	DC/DC-IC	PWM step-down, +CE, 1.8V, 500kHz, +Reset-Pr.	SOT-23-5	28ud	DC7	6g	Ric
43	RN5RF43AA	LVR-IC	LRip, -CE, 4.3V±2%, 1A*	SOT-23-5	28vw	VR6	6g	Ric
43	RN5RZ43AA	LVR-IC	LDO, LN, -CE, 4.3V±2%, 100mA	SOT-23-5	28vrt	VR4	6g	Ric
430	R1114N301A	LVR-IC	LDO, LN, -CE, 3V±2%, 150mA	SOT-23-5	28cx	VR4	6g	Ric
430	XC6105A431MR	Vdet-IC	3.1V±2%, Hst, +Rst PPO, -Rst ODO, Wt=200ms, Rt=3.13ms	SOT-25	28xg	VD20	6g	Tor
431	R1114N311A	LVR-IC	LDO, LN, -CE, 3.1V±2%, 150mA	SOT-23-5	28cx	VR4	6g	Ric
431	XC6105A432MR	Vdet-IC	3.2V±2%, Hst, +Rst PPO, -Rst ODO, Wt=200ms, Rt=3.13ms	SOT-25	28xg	VD20	6g	Tor
432	R1114N321A	LVR-IC	LDO, LN, -CE, 3.2V±2%, 150mA	SOT-23-5	28cx	VR4	6g	Ric
432	XC6105A433MR	Vdet-IC	3.3V±2%, Hst, +Rst PPO, -Rst ODO, Wt=200ms, Rt=3.13ms	SOT-25	28xg	VD20	6g	Tor
433	R1114N331A	LVR-IC	LDO, LN, -CE, 3.3V±2%, 150mA	SOT-23-5	28cx	VR4	6g	Ric
433	XC6105A434MR	Vdet-IC	3.4V±2%, Hst, +Rst PPO, -Rst ODO, Wt=200ms, Rt=3.13ms	SOT-25	28xg	VD20	6g	Tor
434	R1114N341A	LVR-IC	LDO, LN, -CE, 3.4V±2%, 150mA	SOT-23-5	28cx	VR4	6g	Ric
434	XC6105A435MR	Vdet-IC	3.5V±2%, Hst, +Rst PPO, -Rst ODO, Wt=200ms, Rt=3.13ms	SOT-25	28xg	VD20	6g	Tor
435	R1114N351A	LVR-IC	LDO, LN, -CE, 3.5V±2%, 150mA	SOT-23-5	28cx	VR4	6g	Ric
435	XC6105A436MR	Vdet-IC	3.6V±2%, Hst, +Rst PPO, -Rst ODO, Wt=200ms, Rt=3.13ms	SOT-25	28xg	VD20	6g	Tor



SMD code	Type	Function	Short description	Case	Pinout	Sch.	St.	Mnf.
436	R1114N361A	LVR-IC	LDO, LN, -CE, 3.6V±2%, 150mA	SOT-23-5	28cx	VR4	6g	Ric
436	XC6105A437MR	Vdet-IC	3.7V±2%, Hst, +Rst PPO, -Rst ODO, Wt=200ms, Rt=3.13ms	SOT-25	28xg	VD20	6g	Tor
437	R1114N371A	LVR-IC	LDO, LN, -CE, 3.7V±2%, 150mA	SOT-23-5	28cx	VR4	6g	Ric
437	XC6105A438MR	Vdet-IC	3.8V±2%, Hst, +Rst PPO, -Rst ODO, Wt=200ms, Rt=3.13ms	SOT-25	28xg	VD20	6g	Tor
438	R1114N381A	LVR-IC	LDO, LN, -CE, 3.8V±2%, 150mA	SOT-23-5	28cx	VR4	6g	Ric
438	XC6105A439MR	Vdet-IC	3.9V±2%, Hst, +Rst PPO, -Rst ODO, Wt=200ms, Rt=3.13ms	SOT-25	28xg	VD20	6g	Tor
439	R1114N391A	LVR-IC	LDO, LN, -CE, 3.9V±2%, 150mA	SOT-23-5	28cx	VR4	6g	Ric
439	XC6105A440MR	Vdet-IC	4.0V±2%, Hst, +Rst PPO, -Rst ODO, Wt=200ms, Rt=3.13ms	SOT-25	28xg	VD20	6g	Tor
43A	AAT60043A-S5	Vdet-IC	4.3V±2%, -Reset ODO	SOT-23-5	28vdo	VD1	6g	Aat
43A	XC6105A441MR	Vdet-IC	4.1V±2%, Hst, +Rst PPO, -Rst ODO, Wt=200ms, Rt=3.13ms	SOT-25	28xg	VD20	6g	Tor
43-A	UTC8143-A	Vdet-IC	4.3V, -Reset OCO	SOT-23-5	28vzd	VD6	6k	Utc
43B	AAT60043B-S5	Vdet-IC	4.3V±2%, -Reset PPO	SOT-23-5	28vdo	VD3	6g	Aat
43B	XC6105A442MR	Vdet-IC	4.2V±2%, Hst, +Rst PPO, -Rst ODO, Wt=200ms, Rt=3.13ms	SOT-25	28xg	VD20	6g	Tor
43-B	UTC8143-B	Vdet-IC	4.3V, -Reset OCO	SOT-23-5	28vdm	VD6	6k	Utc
43C	AAT60043C-S5	Vdet-IC	4.3V±1%, -Reset ODO	SOT-23-5	28vdo	VD1	6g	Aat
43C	TK11043M-1	Tdet-IC	Sensor (-30 to +105°C), 5mV/°C, 2.4...10V	SOT-23-5	28	6a	X	
43C	XC6105A443MR	Vdet-IC	4.3V±2%, Hst, +Rst PPO, -Rst ODO, Wt=200ms, Rt=3.13ms	SOT-25	28xg	VD20	6g	Tor
43D	AAT60043D-S5	Vdet-IC	4.3V±1%, -Reset PPO	SOT-23-5	28vdo	VD3	6g	Aat
43D	XC6105A444MR	Vdet-IC	4.4V±2%, Hst, +Rst PPO, -Rst ODO, Wt=200ms, Rt=3.13ms	SOT-25	28xg	VD20	6g	Tor
43E	XC6105A446MR	Vdet-IC	4.5V±2%, Hst, +Rst PPO, -Rst ODO, Wt=200ms, Rt=3.13ms	SOT-25	28xg	VD20	6g	Tor
43F	XC6105A416MR	Vdet-IC	1.6V±2%, Hst, +Rst PPO, -Rst ODO, Wt=200ms, Rt=3.13ms	SOT-25	28xg	VD20	6g	Tor
43F	XC6105A446MR	Vdet-IC	4.6V±2%, Hst, +Rst PPO, -Rst ODO, Wt=200ms, Rt=3.13ms	SOT-25	28xg	VD20	6g	Tor
43H	XC6105A417MR	Vdet-IC	1.7V±2%, Hst, +Rst PPO, -Rst ODO, Wt=200ms, Rt=3.13ms	SOT-25	28xg	VD20	6g	Tor
43H	XC6105A447MR	Vdet-IC	4.7V±2%, Hst, +Rst PPO, -Rst ODO, Wt=200ms, Rt=3.13ms	SOT-25	28xg	VD20	6g	Tor
43K	TK71743S	LVR-IC	LDO, 4.3V±1.5%, 300mA, +CE	SOT-23-5	28vrx	VR7	6k	Tok
43K	XC6105A418MR	Vdet-IC	1.8V±2%, Hst, +Rst PPO, -Rst ODO, Wt=200ms, Rt=3.13ms	SOT-25	28xg	VD20	6g	Tor
43K	XC6105A448MR	Vdet-IC	4.8V±2%, Hst, +Rst PPO, -Rst ODO, Wt=200ms, Rt=3.13ms	SOT-25	28xg	VD20	6g	Tor
43L	TK71643ASCL	LVR-IC	LDO, 4.3V±2%, 150mA, +CE, -30...+80°C	SOT-23-5	28vrx	VR7	6k	Tok
43L	XC6105A419MR	Vdet-IC	1.9V±2%, Hst, +Rst PPO, -Rst ODO, Wt=200ms, Rt=3.13ms	SOT-25	28xg	VD20	6g	Tor
43L	XC6105A449MR	Vdet-IC	4.9V±2%, Hst, +Rst PPO, -Rst ODO, Wt=200ms, Rt=3.13ms	SOT-25	28xg	VD20	6g	Tor
43M	XC6105A420MR	Vdet-IC	2.0V±2%, Hst, +Rst PPO, -Rst ODO, Wt=200ms, Rt=3.13ms	SOT-25	28xg	VD20	6g	Tor
43M	XC6105A450MR	Vdet-IC	5.0V±2%, Hst, +Rst PPO, -Rst ODO, Wt=200ms, Rt=3.13ms	SOT-25	28xg	VD20	6g	Tor
43N	XC6105A421MR	Vdet-IC	2.1V±2%, Hst, +Rst PPO, -Rst ODO, Wt=200ms, Rt=3.13ms	SOT-25	28xg	VD20	6g	Tor
43P	XC6105A422MR	Vdet-IC	2.2V±2%, Hst, +Rst PPO, -Rst ODO, Wt=200ms, Rt=3.13ms	SOT-25	28xg	VD20	6g	Tor
43R	XC6105A423MR	Vdet-IC	2.3V±2%, Hst, +Rst PPO, -Rst ODO, Wt=200ms, Rt=3.13ms	SOT-25	28xg	VD20	6g	Tor
43S	XC6105A424MR	Vdet-IC	2.4V±2%, Hst, +Rst PPO, -Rst ODO, Wt=200ms, Rt=3.13ms	SOT-25	28xg	VD20	6g	Tor
43T	TK71443S	LVR-IC	LDO, 4.3V±2%, 100mA, +CE, Ext. transistor	SOT-23-5	28zh	VR6	6a	Tok
43T	XC6105A425MR	Vdet-IC	2.5V±2%, Hst, +Rst PPO, -Rst ODO, Wt=200ms, Rt=3.13ms	SOT-25	28xg	VD20	6g	Tor
43U	XC6105A426MR	Vdet-IC	2.6V±2%, Hst, +Rst PPO, -Rst ODO, Wt=200ms, Rt=3.13ms	SOT-25	28xg	VD20	6g	Tor
43V	XC6105A427MR	Vdet-IC	2.7V±2%, Hst, +Rst PPO, -Rst ODO, Wt=200ms, Rt=3.13ms	SOT-25	28xg	VD20	6g	Tor
43X	XC6105A428MR	Vdet-IC	2.8V±2%, Hst, +Rst PPO, -Rst ODO, Wt=200ms, Rt=3.13ms	SOT-25	28xg	VD20	6g	Tor
43Y	XC6105A429MR	Vdet-IC	2.9V±2%, Hst, +Rst PPO, -Rst ODO, Wt=200ms, Rt=3.13ms	SOT-25	28xg	VD20	6g	Tor
43Z	XC6105A430MR	Vdet-IC	3.0V±2%, Hst, +Rst PPO, -Rst ODO, Wt=200ms, Rt=3.13ms	SOT-25	28xg	VD20	6g	Tor
44	R1223N252H	DC/DC-IC	PWM step-down, +CE, 2.5V, 500kHz, +Reset-Pr.	SOT-23-5	28ud	DC7	6g	Ric
44	RN5RF44AA	LVR-IC	L/Rip, -CE, 4.4V±2%, 1A*	SOT-23-5	28wv	VR6	6g	Ric
44	RN5RZ44AA	LVR-IC	LDO, LN, -CE, 4.4V±2%, 100mA	SOT-23-5	28vrt	VR4	6g	Ric
440	R1114N401A	LVR-IC	LDO, LN, -CE, 4V±2%, 150mA	SOT-23-5	28cx	VR4	6g	Ric
440	XC6105A531MR	Vdet-IC	3.1V±2%, Hst, +Rst PPO, -Rst ODO, Wt=400ms, Rt=3.13ms	SOT-25	28xg	VD20	6g	Tor
441	R1114N281A5	LVR-IC	LDO, LN, -CE, 2.8V±2%, 150mA	SOT-23-5	28cx	VR4	6g	Ric
441	XC6105A532MR	Vdet-IC	3.2V±2%, Hst, +Rst PPO, -Rst ODO, Wt=400ms, Rt=3.13ms	SOT-25	28xg	VD20	6g	Tor
442	XC6105A533MR	Vdet-IC	3.3V±2%, Hst, +Rst PPO, -Rst ODO, Wt=400ms, Rt=3.13ms	SOT-25	28xg	VD20	6g	Tor
443	XC6105A534MR	Vdet-IC	3.4V±2%, Hst, +Rst PPO, -Rst ODO, Wt=400ms, Rt=3.13ms	SOT-25	28xg	VD20	6g	Tor
444	XC6105A535MR	Vdet-IC	3.5V±2%, Hst, +Rst PPO, -Rst ODO, Wt=400ms, Rt=3.13ms	SOT-25	28xg	VD20	6g	Tor
445	XC6105A536MR	Vdet-IC	3.6V±2%, Hst, +Rst PPO, -Rst ODO, Wt=400ms, Rt=3.13ms	SOT-25	28xg	VD20	6g	Tor
446	XC6105A537MR	Vdet-IC	3.7V±2%, Hst, +Rst PPO, -Rst ODO, Wt=400ms, Rt=3.13ms	SOT-25	28xg	VD20	6g	Tor
447	XC6105A538MR	Vdet-IC	3.8V±2%, Hst, +Rst PPO, -Rst ODO, Wt=400ms, Rt=3.13ms	SOT-25	28xg	VD20	6g	Tor
448	XC6105A539MR	Vdet-IC	3.9V±2%, Hst, +Rst PPO, -Rst ODO, Wt=400ms, Rt=3.13ms	SOT-25	28xg	VD20	6g	Tor
449	XC6105A540MR	Vdet-IC	4.0V±2%, Hst, +Rst PPO, -Rst ODO, Wt=400ms, Rt=3.13ms	SOT-25	28xg	VD20	6g	Tor
44A	AAT60044A-S5	Vdet-IC	4.4V±2%, -Reset ODO	SOT-23-5	28vdo	VD1	6g	Aat
44A	XC6105A541MR	Vdet-IC	4.1V±2%, Hst, +Rst PPO, -Rst ODO, Wt=400ms, Rt=3.13ms	SOT-25	28xg	VD20	6g	Tor
44-A	UTC8144-A	Vdet-IC	4.4V, -Reset OCO	SOT-23-5	28vzd	VD6	6k	Utc
44B	AAT60044B-S5	Vdet-IC	4.4V±2%, -Reset PPO	SOT-23-5	28vdo	VD3	6g	Aat
44B	XC6105A542MR	Vdet-IC	4.2V±2%, Hst, +Rst PPO, -Rst ODO, Wt=400ms, Rt=3.13ms	SOT-25	28xg	VD20	6g	Tor
44-B	UTC8144-B	Vdet-IC	4.4V, -Reset OCO	SOT-23-5	28vdm	VD6	6k	Utc
44C	AAT60044C-S5	Vdet-IC	4.4V±1%, -Reset ODO	SOT-23-5	28vdo	VD1	6g	Aat
44C	XC6105A543MR	Vdet-IC	4.3V±2%, Hst, +Rst PPO, -Rst ODO, Wt=400ms, Rt=3.13ms	SOT-25	28xg	VD20	6g	Tor
44D	AAT60044D-S5	Vdet-IC	4.4V±1%, -Reset PPO	SOT-23-5	28vdo	VD3	6g	Aat
44D	XC6105A544MR	Vdet-IC	4.4V±2%, Hst, +Rst PPO, -Rst ODO, Wt=400ms, Rt=3.13ms	SOT-25	28xg	VD20	6g	Tor
44E	XC6105A545MR	Vdet-IC	4.5V±2%, Hst, +Rst PPO, -Rst ODO, Wt=400ms, Rt=3.13ms	SOT-25	28xg	VD20	6g	Tor
44F	XC6105A516MR	Vdet-IC	1.6V±2%, Hst, +Rst PPO, -Rst ODO, Wt=400ms, Rt=3.13ms	SOT-25	28xg	VD20	6g	Tor



SMD code	Type	Function	Short description	Case	Pinout	Sch.	St.	Mnf.
44E	XC6105A546MR	Vdet-IC	4.6V±2%, Hst, +Rst PPO, -Rst ODO, Wt=400ms, Rt=3.13ms	SOT-25	28xg	VD20	6g	Tor
44H	XC6105A517MR	Vdet-IC	1.7V±2%, Hst, +Rst PPO, -Rst ODO, Wt=400ms, Rt=3.13ms	SOT-25	28xg	VD20	6g	Tor
44H	XC6105A547MR	Vdet-IC	4.7V±2%, Hst, +Rst PPO, -Rst ODO, Wt=400ms, Rt=3.13ms	SOT-25	28xg	VD20	6g	Tor
44K	TK71744S	LVR-IC	LDO, 4.4V±1.5%, 300mA, +CE	SOT-23-5	28vrx	VR7	6k	Tok
44K	XC6105A518MR	Vdet-IC	1.8V±2%, Hst, +Rst PPO, -Rst ODO, Wt=400ms, Rt=3.13ms	SOT-25	28xg	VD20	6g	Tor
44K	XC6105A548MR	Vdet-IC	4.8V±2%, Hst, +Rst PPO, -Rst ODO, Wt=400ms, Rt=3.13ms	SOT-25	28xg	VD20	6g	Tor
44L	TK71644ASCL	LVR-IC	LDO, 4.4V±2%, 150mA, +CE, -30, +80°C	SOT-23-5	28vrx	VR7	6k	Tok
44L	XC6105A519MR	Vdet-IC	1.9V±2%, Hst, +Rst PPO, -Rst ODO, Wt=400ms, Rt=3.13ms	SOT-25	28xg	VD20	6g	Tor
44L	XC6105A549MR	Vdet-IC	4.9V±2%, Hst, +Rst PPO, -Rst ODO, Wt=400ms, Rt=3.13ms	SOT-25	28xg	VD20	6g	Tor
44M	XC6105A520MR	Vdet-IC	2.0V±2%, Hst, +Rst PPO, -Rst ODO, Wt=400ms, Rt=3.13ms	SOT-25	28xg	VD20	6g	Tor
44M	XC6105A550MR	Vdet-IC	5.0V±2%, Hst, +Rst PPO, -Rst ODO, Wt=400ms, Rt=3.13ms	SOT-25	28xg	VD20	6g	Tor
44N	XC6105A521MR	Vdet-IC	2.1V±2%, Hst, +Rst PPO, -Rst ODO, Wt=400ms, Rt=3.13ms	SOT-25	28xg	VD20	6g	Tor
44P	XC6105A522MR	Vdet-IC	2.2V±2%, Hst, +Rst PPO, -Rst ODO, Wt=400ms, Rt=3.13ms	SOT-25	28xg	VD20	6g	Tor
44R	XC6105A523MR	Vdet-IC	2.3V±2%, Hst, +Rst PPO, -Rst ODO, Wt=400ms, Rt=3.13ms	SOT-25	28xg	VD20	6g	Tor
44S	XC6105A524MR	Vdet-IC	2.4V±2%, Hst, +Rst PPO, -Rst ODO, Wt=400ms, Rt=3.13ms	SOT-25	28xg	VD20	6g	Tor
44T	TK71444S	LVR-IC	LDO, 4.4V±2%, 100mA, +CE, Ext. transistor	SOT-23-5	28zh	VR6	6a	Tok
44T	XC6105A525MR	Vdet-IC	2.5V±2%, Hst, +Rst PPO, -Rst ODO, Wt=400ms, Rt=3.13ms	SOT-25	28xg	VD20	6g	Tor
44U	XC6105A526MR	Vdet-IC	2.6V±2%, Hst, +Rst PPO, -Rst ODO, Wt=400ms, Rt=3.13ms	SOT-25	28xg	VD20	6g	Tor
44V	XC6105A527MR	Vdet-IC	2.7V±2%, Hst, +Rst PPO, -Rst ODO, Wt=400ms, Rt=3.13ms	SOT-25	28xg	VD20	6g	Tor
44X	XC6105A528MR	Vdet-IC	2.8V±2%, Hst, +Rst PPO, -Rst ODO, Wt=400ms, Rt=3.13ms	SOT-25	28xg	VD20	6g	Tor
44Y	XC6105A529MR	Vdet-IC	2.9V±2%, Hst, +Rst PPO, -Rst ODO, Wt=400ms, Rt=3.13ms	SOT-25	28xg	VD20	6g	Tor
44Z	XC6105A530MR	Vdet-IC	3.0V±2%, Hst, +Rst PPO, -Rst ODO, Wt=400ms, Rt=3.13ms	SOT-25	28xg	VD20	6g	Tor
45	R1223N302H	DC/DC-IC	PWM step-down, +CE, 3V, 500kHz, +Reset-Pr.	SOT-23-5	28ud	DC7	6g	Ric
45	RN5RF45AA	LVR-IC	LRip, -CE, 4.5V±2%, 1A*	SOT-23-5	28vw	VR6	6g	Ric
45	RN5RZ45AA	LVR-IC	LDO, LN, -CE, 4.5V±2%, 100mA	SOT-23-5	28wrt	VR4	6g	Ric
450	XC6105A631MR	Vdet-IC	3.1V±2%, Hst, +Rst PPO, -Rst ODO, Wt=1.6s, Rt=3.13ms	SOT-25	28xg	VD20	6g	Tor
451	XC6105A632MR	Vdet-IC	3.2V±2%, Hst, +Rst PPO, -Rst ODO, Wt=1.6s, Rt=3.13ms	SOT-25	28xg	VD20	6g	Tor
452	XC6105A633MR	Vdet-IC	3.3V±2%, Hst, +Rst PPO, -Rst ODO, Wt=1.6s, Rt=3.13ms	SOT-25	28xg	VD20	6g	Tor
453	XC6105A634MR	Vdet-IC	3.4V±2%, Hst, +Rst PPO, -Rst ODO, Wt=1.6s, Rt=3.13ms	SOT-25	28xg	VD20	6g	Tor
454	XC6105A635MR	Vdet-IC	3.5V±2%, Hst, +Rst PPO, -Rst ODO, Wt=1.6s, Rt=3.13ms	SOT-25	28xg	VD20	6g	Tor
455	XC6105A636MR	Vdet-IC	3.6V±2%, Hst, +Rst PPO, -Rst ODO, Wt=1.6s, Rt=3.13ms	SOT-25	28xg	VD20	6g	Tor
456	XC6105A637MR	Vdet-IC	3.7V±2%, Hst, +Rst PPO, -Rst ODO, Wt=1.6s, Rt=3.13ms	SOT-25	28xg	VD20	6g	Tor
457	XC6105A638MR	Vdet-IC	3.8V±2%, Hst, +Rst PPO, -Rst ODO, Wt=1.6s, Rt=3.13ms	SOT-25	28xg	VD20	6g	Tor
458	XC6105A639MR	Vdet-IC	3.9V±2%, Hst, +Rst PPO, -Rst ODO, Wt=1.6s, Rt=3.13ms	SOT-25	28xg	VD20	6g	Tor
459	XC6105A640MR	Vdet-IC	4.0V±2%, Hst, +Rst PPO, -Rst ODO, Wt=1.6s, Rt=3.13ms	SOT-25	28xg	VD20	6g	Tor
45A	AAT60045A-S5	Vdet-IC	4.5V±2%, -Reset ODO	SOT-23-5	28vdo	VD1	6g	Aat
45A	XC6105A641MR	Vdet-IC	4.1V±2%, Hst, +Rst PPO, -Rst ODO, Wt=1.6s, Rt=3.13ms	SOT-25	28xg	VD20	6g	Tor
45-A	UTC8145-A	Vdet-IC	4.5V, -Reset OCO	SOT-23-5	28vdz	VD6	6k	Utc
45B	AAT60045B-S5	Vdet-IC	4.5V±2%, -Reset PPO	SOT-23-5	28vdo	VD3	6g	Aat
45B	XC6105A642MR	Vdet-IC	4.2V±2%, Hst, +Rst PPO, -Rst ODO, Wt=1.6s, Rt=3.13ms	SOT-25	28xg	VD20	6g	Tor
45-B	UTC8145-B	Vdet-IC	4.5V, -Reset OCO	SOT-23-5	28vdm	VD6	6k	Utc
45C	AAT60045C-S5	Vdet-IC	4.5V±1%, -Reset ODO	SOT-23-5	28vdo	VD1	6g	Aat
45C	XC6105A643MR	Vdet-IC	4.3V±2%, Hst, +Rst PPO, -Rst ODO, Wt=1.6s, Rt=3.13ms	SOT-25	28xg	VD20	6g	Tor
45D	AAT60045D-S5	Vdet-IC	4.5V±1%, -Reset PPO	SOT-23-5	28vdo	VD3	6g	Aat
45D	XC6105A644MR	Vdet-IC	4.4V±2%, Hst, +Rst PPO, -Rst ODO, Wt=1.6s, Rt=3.13ms	SOT-25	28xg	VD20	6g	Tor
45E	XC6105A645MR	Vdet-IC	4.5V±2%, Hst, +Rst PPO, -Rst ODO, Wt=1.6s, Rt=3.13ms	SOT-25	28xg	VD20	6g	Tor
45F	XC6105A616MR	Vdet-IC	1.6V±2%, Hst, +Rst PPO, -Rst ODO, Wt=1.6s, Rt=3.13ms	SOT-25	28xg	VD20	6g	Tor
45F	XC6105A646MR	Vdet-IC	4.6V±2%, Hst, +Rst PPO, -Rst ODO, Wt=1.6s, Rt=3.13ms	SOT-25	28xg	VD20	6g	Tor
45H	XC6105A617MR	Vdet-IC	1.7V±2%, Hst, +Rst PPO, -Rst ODO, Wt=1.6s, Rt=3.13ms	SOT-25	28xg	VD20	6g	Tor
45H	XC6105A647MR	Vdet-IC	4.7V±2%, Hst, +Rst PPO, -Rst ODO, Wt=1.6s, Rt=3.13ms	SOT-25	28xg	VD20	6g	Tor
45K	TK71745S	LVR-IC	LDO, 4.5V±1.5%, 300mA, +CE	SOT-23-5	28vrx	VR7	6k	Tok
45K	XC6105A618MR	Vdet-IC	1.8V±2%, Hst, +Rst PPO, -Rst ODO, Wt=1.6s, Rt=3.13ms	SOT-25	28xg	VD20	6g	Tor
45K	XC6105A648MR	Vdet-IC	4.8V±2%, Hst, +Rst PPO, -Rst ODO, Wt=1.6s, Rt=3.13ms	SOT-25	28xg	VD20	6g	Tor
45L	TK71645ASCL	LVR-IC	LDO, 4.5V±2%, 150mA, +CE, -30, +80°C	SOT-23-5	28vrx	VR7	6k	Tok
45L	XC6105A619MR	Vdet-IC	1.9V±2%, Hst, +Rst PPO, -Rst ODO, Wt=1.6s, Rt=3.13ms	SOT-25	28xg	VD20	6g	Tor
45L	XC6105A649MR	Vdet-IC	4.9V±2%, Hst, +Rst PPO, -Rst ODO, Wt=1.6s, Rt=3.13ms	SOT-25	28xg	VD20	6g	Tor
45M	XC6105A620MR	Vdet-IC	2.0V±2%, Hst, +Rst PPO, -Rst ODO, Wt=1.6s, Rt=3.13ms	SOT-25	28xg	VD20	6g	Tor
45M	XC6105A650MR	Vdet-IC	5.0V±2%, Hst, +Rst PPO, -Rst ODO, Wt=1.6s, Rt=3.13ms	SOT-25	28xg	VD20	6g	Tor
45N	XC6105A621MR	Vdet-IC	2.1V±2%, Hst, +Rst PPO, -Rst ODO, Wt=1.6s, Rt=3.13ms	SOT-25	28xg	VD20	6g	Tor
45P	XC6105A622MR	Vdet-IC	2.2V±2%, Hst, +Rst PPO, -Rst ODO, Wt=1.6s, Rt=3.13ms	SOT-25	28xg	VD20	6g	Tor
45R	XC6105A623MR	Vdet-IC	2.3V±2%, Hst, +Rst PPO, -Rst ODO, Wt=1.6s, Rt=3.13ms	SOT-25	28xg	VD20	6g	Tor
45S	XC6105A624MR	Vdet-IC	2.4V±2%, Hst, +Rst PPO, -Rst ODO, Wt=1.6s, Rt=3.13ms	SOT-25	28xg	VD20	6g	Tor
45T	TK71445S	LVR-IC	LDO, 4.5V±2%, 100mA, +CE, Ext. transistor	SOT-23-5	28zh	VR6	6a	Tok
45T	XC6105A625MR	Vdet-IC	2.5V±2%, Hst, +Rst PPO, -Rst ODO, Wt=1.6s, Rt=3.13ms	SOT-25	28xg	VD20	6g	Tor
45U	TK61045S	Vdet-IC	4.5V±2%, -Reset PPO	SOT-23-5	28vdm	VD7	6a	Tok
45U	XC6105A626MR	Vdet-IC	2.6V±2%, Hst, +Rst PPO, -Rst ODO, Wt=1.6s, Rt=3.13ms	SOT-25	28xg	VD20	6g	Tor
45V	XC6105A627MR	Vdet-IC	2.7V±2%, Hst, +Rst PPO, -Rst ODO, Wt=1.6s, Rt=3.13ms	SOT-25	28xg	VD20	6g	Tor
45X	XC6105A628MR	Vdet-IC	2.8V±2%, Hst, +Rst PPO, -Rst ODO, Wt=1.6s, Rt=3.13ms	SOT-25	28xg	VD20	6g	Tor
45Y	XC6105A629MR	Vdet-IC	2.9V±2%, Hst, +Rst PPO, -Rst ODO, Wt=1.6s, Rt=3.13ms	SOT-25	28xg	VD20	6g	Tor
45Z	XC6105A630MR	Vdet-IC	3.0V±2%, Hst, +Rst PPO, -Rst ODO, Wt=1.6s, Rt=3.13ms	SOT-25	28xg	VD20	6g	Tor



SMD code	Type	Function	Short description	Case	Pinout	Sch.	St.	Mnf.
46	R1223N332H	DC/DC-IC	PWM step-down, +CE, 3.3V, 500kHz, +Reset-Pr.	SOT-23-5	28ud	DC7	6g	Ric
46	RN5RF46AA	LVR-IC	LRip, -CE, 4.6V±2%, 1A*	SOT-23-5	28ww	VR6	6g	Ric
46	RN5RZ46AA	LVR-IC	LDO, LN, -CE, 4.6V±2%, 100mA	SOT-23-5	28vrt	VR4	6g	Ric
460	XC6105B231MR	Vdet-IC	3.1V±2%, Hst, +Rst PPO, -Rst ODO, Wt=50ms, Rt=25ms	SOT-25	28xg	VD20	6g	Tor
461	XC6105B232MR	Vdet-IC	3.2V±2%, Hst, +Rst PPO, -Rst ODO, Wt=50ms, Rt=25ms	SOT-25	28xg	VD20	6g	Tor
462	XC6105B233MR	Vdet-IC	3.3V±2%, Hst, +Rst PPO, -Rst ODO, Wt=50ms, Rt=25ms	SOT-25	28xg	VD20	6g	Tor
463	XC6105B234MR	Vdet-IC	3.4V±2%, Hst, +Rst PPO, -Rst ODO, Wt=50ms, Rt=25ms	SOT-25	28xg	VD20	6g	Tor
464	XC6105B235MR	Vdet-IC	3.5V±2%, Hst, +Rst PPO, -Rst ODO, Wt=50ms, Rt=25ms	SOT-25	28xg	VD20	6g	Tor
465	XC6105B236MR	Vdet-IC	3.6V±2%, Hst, +Rst PPO, -Rst ODO, Wt=50ms, Rt=25ms	SOT-25	28xg	VD20	6g	Tor
466	XC6105B237MR	Vdet-IC	3.7V±2%, Hst, +Rst PPO, -Rst ODO, Wt=50ms, Rt=25ms	SOT-25	28xg	VD20	6g	Tor
467	XC6105B238MR	Vdet-IC	3.8V±2%, Hst, +Rst PPO, -Rst ODO, Wt=50ms, Rt=25ms	SOT-25	28xg	VD20	6g	Tor
468	XC6105B239MR	Vdet-IC	3.9V±2%, Hst, +Rst PPO, -Rst ODO, Wt=50ms, Rt=25ms	SOT-25	28xg	VD20	6g	Tor
469	XC6105B240MR	Vdet-IC	4.0V±2%, Hst, +Rst PPO, -Rst ODO, Wt=50ms, Rt=25ms	SOT-25	28xg	VD20	6g	Tor
46A	AAT60046A-S5	Vdet-IC	4.6V±2%, -Reset ODO	SOT-23-5	28vdo	VD1	6g	Aat
46A	XC6105B241MR	Vdet-IC	4.1V±2%, Hst, +Rst PPO, -Rst ODO, Wt=50ms, Rt=25ms	SOT-25	28xg	VD20	6g	Tor
46-A	UTC8146-A	Vdet-IC	4.6V, -Reset OCO	SOT-23-5	28vdz	VD6	6k	Utc
46B	AAT60046B-S5	Vdet-IC	4.6V±2%, -Reset PPO	SOT-23-5	28vdo	VD3	6g	Aat
46B	XC6105B242MR	Vdet-IC	4.2V±2%, Hst, +Rst PPO, -Rst ODO, Wt=50ms, Rt=25ms	SOT-25	28xg	VD20	6g	Tor
46-B	UTC8146-B	Vdet-IC	4.6V, -Reset OCO	SOT-23-5	28vdm	VD6	6k	Utc
46C	AAT60046C-S5	Vdet-IC	4.6V±1%, -Reset ODO	SOT-23-5	28vdo	VD1	6g	Aat
46C	XC6105B243MR	Vdet-IC	4.3V±2%, Hst, +Rst PPO, -Rst ODO, Wt=50ms, Rt=25ms	SOT-25	28xg	VD20	6g	Tor
46D	AAT60046D-S5	Vdet-IC	4.6V±1%, -Reset PPO	SOT-23-5	28vdo	VD3	6g	Aat
46D	XC6105B244MR	Vdet-IC	4.4V±2%, Hst, +Rst PPO, -Rst ODO, Wt=50ms, Rt=25ms	SOT-25	28xg	VD20	6g	Tor
46E	XC6105B245MR	Vdet-IC	4.5V±2%, Hst, +Rst PPO, -Rst ODO, Wt=50ms, Rt=25ms	SOT-25	28xg	VD20	6g	Tor
46F	XC6105B216MR	Vdet-IC	1.6V±2%, Hst, +Rst PPO, -Rst ODO, Wt=50ms, Rt=25ms	SOT-25	28xg	VD20	6g	Tor
46F	XC6105B246MR	Vdet-IC	4.6V±2%, Hst, +Rst PPO, -Rst ODO, Wt=50ms, Rt=25ms	SOT-25	28xg	VD20	6g	Tor
46H	XC6105B217MR	Vdet-IC	1.7V±2%, Hst, +Rst PPO, -Rst ODO, Wt=50ms, Rt=25ms	SOT-25	28xg	VD20	6g	Tor
46H	XC6105B247MR	Vdet-IC	4.7V±2%, Hst, +Rst PPO, -Rst ODO, Wt=50ms, Rt=25ms	SOT-25	28xg	VD20	6g	Tor
46K	TK71746S	LVR-IC	LDO, 4.6V±1.5%, 300mA, +CE	SOT-23-5	28vrx	VR7	6k	Tok
46K	XC6105B218MR	Vdet-IC	1.8V±2%, Hst, +Rst PPO, -Rst ODO, Wt=50ms, Rt=25ms	SOT-25	28xg	VD20	6g	Tor
46K	XC6105B248MR	Vdet-IC	4.8V±2%, Hst, +Rst PPO, -Rst ODO, Wt=50ms, Rt=25ms	SOT-25	28xg	VD20	6g	Tor
46L	TK71646ASCL	LVR-IC	LDO, 4.6V±2%, 150mA, +CE, -30, +80°C	SOT-23-5	28vrx	VR7	6k	Tok
46L	XC6105B219MR	Vdet-IC	1.9V±2%, Hst, +Rst PPO, -Rst ODO, Wt=50ms, Rt=25ms	SOT-25	28xg	VD20	6g	Tor
46L	XC6105B249MR	Vdet-IC	4.9V±2%, Hst, +Rst PPO, -Rst ODO, Wt=50ms, Rt=25ms	SOT-25	28xg	VD20	6g	Tor
46M	XC6105B220MR	Vdet-IC	2.0V±2%, Hst, +Rst PPO, -Rst ODO, Wt=50ms, Rt=25ms	SOT-25	28xg	VD20	6g	Tor
46M	XC6105B250MR	Vdet-IC	5.0V±2%, Hst, +Rst PPO, -Rst ODO, Wt=50ms, Rt=25ms	SOT-25	28xg	VD20	6g	Tor
46N	XC6105B221MR	Vdet-IC	2.1V±2%, Hst, +Rst PPO, -Rst ODO, Wt=50ms, Rt=25ms	SOT-25	28xg	VD20	6g	Tor
46P	XC6105B222MR	Vdet-IC	2.2V±2%, Hst, +Rst PPO, -Rst ODO, Wt=50ms, Rt=25ms	SOT-25	28xg	VD20	6g	Tor
46R	XC6105B223MR	Vdet-IC	2.3V±2%, Hst, +Rst PPO, -Rst ODO, Wt=50ms, Rt=25ms	SOT-25	28xg	VD20	6g	Tor
46S	XC6105B224MR	Vdet-IC	2.4V±2%, Hst, +Rst PPO, -Rst ODO, Wt=50ms, Rt=25ms	SOT-25	28xg	VD20	6g	Tor
46T	TK71446S	LVR-IC	LDO, 4.6V±2%, 100mA, +CE, Ext. transistor	SOT-23-5	28zh	VR6	6a	Tok
46T	XC6105B225MR	Vdet-IC	2.5V±2%, Hst, +Rst PPO, -Rst ODO, Wt=50ms, Rt=25ms	SOT-25	28xg	VD20	6g	Tor
46U	XC6105B226MR	Vdet-IC	2.6V±2%, Hst, +Rst PPO, -Rst ODO, Wt=50ms, Rt=25ms	SOT-25	28xg	VD20	6g	Tor
46V	XC6105B227MR	Vdet-IC	2.7V±2%, Hst, +Rst PPO, -Rst ODO, Wt=50ms, Rt=25ms	SOT-25	28xg	VD20	6g	Tor
46X	XC6105B228MR	Vdet-IC	2.8V±2%, Hst, +Rst PPO, -Rst ODO, Wt=50ms, Rt=25ms	SOT-25	28xg	VD20	6g	Tor
46Y	XC6105B229MR	Vdet-IC	2.9V±2%, Hst, +Rst PPO, -Rst ODO, Wt=50ms, Rt=25ms	SOT-25	28xg	VD20	6g	Tor
46Z	XC6105B230MR	Vdet-IC	3.0V±2%, Hst, +Rst PPO, -Rst ODO, Wt=50ms, Rt=25ms	SOT-25	28xg	VD20	6g	Tor
47	R1223N502H	DC/DC-IC	PWM step-down, +CE, 5V, 500kHz, +Reset-Pr.	SOT-23-5	28ud	DC7	6g	Ric
47	RN5RF47AA	LVR-IC	LRip, -CE, 4.7V±2%, 1A*	SOT-23-5	28ww	VR6	6g	Ric
47	RN5RZ47AA	LVR-IC	LDO, LN, -CE, 4.7V±2%, 100mA	SOT-23-5	28vrt	VR4	6g	Ric
470	XC6105B331MR	Vdet-IC	3.1V±2%, Hst, +Rst PPO, -Rst ODO, Wt=100ms, Rt=25ms	SOT-25	28xg	VD20	6g	Tor
471	XC6105B332MR	Vdet-IC	3.2V±2%, Hst, +Rst PPO, -Rst ODO, Wt=100ms, Rt=25ms	SOT-25	28xg	VD20	6g	Tor
472	XC6105B333MR	Vdet-IC	3.3V±2%, Hst, +Rst PPO, -Rst ODO, Wt=100ms, Rt=25ms	SOT-25	28xg	VD20	6g	Tor
473	XC6105B334MR	Vdet-IC	3.4V±2%, Hst, +Rst PPO, -Rst ODO, Wt=100ms, Rt=25ms	SOT-25	28xg	VD20	6g	Tor
474	XC6105B335MR	Vdet-IC	3.5V±2%, Hst, +Rst PPO, -Rst ODO, Wt=100ms, Rt=25ms	SOT-25	28xg	VD20	6g	Tor
475	XC6105B336MR	Vdet-IC	3.6V±2%, Hst, +Rst PPO, -Rst ODO, Wt=100ms, Rt=25ms	SOT-25	28xg	VD20	6g	Tor
476	XC6105B337MR	Vdet-IC	3.7V±2%, Hst, +Rst PPO, -Rst ODO, Wt=100ms, Rt=25ms	SOT-25	28xg	VD20	6g	Tor
477	XC6105B338MR	Vdet-IC	3.8V±2%, Hst, +Rst PPO, -Rst ODO, Wt=100ms, Rt=25ms	SOT-25	28xg	VD20	6g	Tor
478	XC6105B339MR	Vdet-IC	3.9V±2%, Hst, +Rst PPO, -Rst ODO, Wt=100ms, Rt=25ms	SOT-25	28xg	VD20	6g	Tor
479	XC6105B340MR	Vdet-IC	4.0V±2%, Hst, +Rst PPO, -Rst ODO, Wt=100ms, Rt=25ms	SOT-25	28xg	VD20	6g	Tor
47A	AAT60047A-S5	Vdet-IC	4.7V±2%, -Reset ODO	SOT-23-5	28vdo	VD1	6g	Aat
47A	XC6105B341MR	Vdet-IC	4.1V±2%, Hst, +Rst PPO, -Rst ODO, Wt=100ms, Rt=25ms	SOT-25	28xg	VD20	6g	Tor
47B	AAT60047B-S5	Vdet-IC	4.7V±2%, -Reset PPO	SOT-23-5	28vdo	VD3	6g	Aat
47B	XC6105B342MR	Vdet-IC	4.2V±2%, Hst, +Rst PPO, -Rst ODO, Wt=100ms, Rt=25ms	SOT-25	28xg	VD20	6g	Tor
47C	AAT60047C-S5	Vdet-IC	4.7V±1%, -Reset ODO	SOT-23-5	28vdo	VD1	6g	Aat
47C	XC6105B343MR	Vdet-IC	4.3V±2%, Hst, +Rst PPO, -Rst ODO, Wt=100ms, Rt=25ms	SOT-25	28xg	VD20	6g	Tor
47D	AAT60047D-S5	Vdet-IC	4.7V±1%, -Reset PPO	SOT-23-5	28vdo	VD3	6g	Aat
47D	XC6105B344MR	Vdet-IC	4.4V±2%, Hst, +Rst PPO, -Rst ODO, Wt=100ms, Rt=25ms	SOT-25	28xg	VD20	6g	Tor
47E	XC6105B345MR	Vdet-IC	4.5V±2%, Hst, +Rst PPO, -Rst ODO, Wt=100ms, Rt=25ms	SOT-25	28xg	VD20	6g	Tor
47F	XC6105B316MR	Vdet-IC	1.6V±2%, Hst, +Rst PPO, -Rst ODO, Wt=100ms, Rt=25ms	SOT-25	28xg	VD20	6g	Tor



SMD code	Type	Function	Short description	Case	Pinout	Sch.	St.	Mnf.
47E	XC6105B346MR	Vdet-IC	4.6V±2%, Hst, +Rst PPO, -Rst ODO, Wt=100ms, Rt=25ms	SOT-25	28xg	VD20	6g	Tor
47H	XC6105B317MR	Vdet-IC	1.7V±2%, Hst, +Rst PPO, -Rst ODO, Wt=100ms, Rt=25ms	SOT-25	28xg	VD20	6g	Tor
47H	XC6105B347MR	Vdet-IC	4.7V±2%, Hst, +Rst PPO, -Rst ODO, Wt=100ms, Rt=25ms	SOT-25	28xg	VD20	6g	Tor
47K	TK71747S	LVR-IC	LDO, 4.7V±1.5%, 300mA, +CE	SOT-23-5	28vrx	VR7	6k	Tok
47K	XC6105B318MR	Vdet-IC	1.8V±2%, Hst, +Rst PPO, -Rst ODO, Wt=100ms, Rt=25ms	SOT-25	28xg	VD20	6g	Tor
47K	XC6105B348MR	Vdet-IC	4.8V±2%, Hst, +Rst PPO, -Rst ODO, Wt=100ms, Rt=25ms	SOT-25	28xg	VD20	6g	Tor
47L	TK71647ASCL	LVR-IC	LDO, 4.7V±2%, 150mA, +CE, -30, +80°C	SOT-23-5	28vrx	VR7	6k	Tok
47L	XC6105B319MR	Vdet-IC	1.9V±2%, Hst, +Rst PPO, -Rst ODO, Wt=100ms, Rt=25ms	SOT-25	28xg	VD20	6g	Tor
47L	XC6105B349MR	Vdet-IC	4.9V±2%, Hst, +Rst PPO, -Rst ODO, Wt=100ms, Rt=25ms	SOT-25	28xg	VD20	6g	Tor
47M	XC6105B320MR	Vdet-IC	2.0V±2%, Hst, +Rst PPO, -Rst ODO, Wt=100ms, Rt=25ms	SOT-25	28xg	VD20	6g	Tor
47M	XC6105B350MR	Vdet-IC	5.0V±2%, Hst, +Rst PPO, -Rst ODO, Wt=100ms, Rt=25ms	SOT-25	28xg	VD20	6g	Tor
47N	XC6105B321MR	Vdet-IC	2.1V±2%, Hst, +Rst PPO, -Rst ODO, Wt=100ms, Rt=25ms	SOT-25	28xg	VD20	6g	Tor
47P	XC6105B322MR	Vdet-IC	2.2V±2%, Hst, +Rst PPO, -Rst ODO, Wt=100ms, Rt=25ms	SOT-25	28xg	VD20	6g	Tor
47R	XC6105B323MR	Vdet-IC	2.3V±2%, Hst, +Rst PPO, -Rst ODO, Wt=100ms, Rt=25ms	SOT-25	28xg	VD20	6g	Tor
47S	XC6105B324MR	Vdet-IC	2.4V±2%, Hst, +Rst PPO, -Rst ODO, Wt=100ms, Rt=25ms	SOT-25	28xg	VD20	6g	Tor
47T	TK71447S	LVR-IC	LDO, 4.7V±2%, 100mA, +CE, Ext. transistor	SOT-23-5	28zh	VR6	6a	Tok
47T	XC6105B325MR	Vdet-IC	2.5V±2%, Hst, +Rst PPO, -Rst ODO, Wt=100ms, Rt=25ms	SOT-25	28xg	VD20	6g	Tor
47U	XC6105B326MR	Vdet-IC	2.6V±2%, Hst, +Rst PPO, -Rst ODO, Wt=100ms, Rt=25ms	SOT-25	28xg	VD20	6g	Tor
47V	XC6105B327MR	Vdet-IC	2.7V±2%, Hst, +Rst PPO, -Rst ODO, Wt=100ms, Rt=25ms	SOT-25	28xg	VD20	6g	Tor
47X	XC6105B328MR	Vdet-IC	2.8V±2%, Hst, +Rst PPO, -Rst ODO, Wt=100ms, Rt=25ms	SOT-25	28xg	VD20	6g	Tor
47Y	XC6105B329MR	Vdet-IC	2.9V±2%, Hst, +Rst PPO, -Rst ODO, Wt=100ms, Rt=25ms	SOT-25	28xg	VD20	6g	Tor
47Z	XC6105B330MR	Vdet-IC	3.0V±2%, Hst, +Rst PPO, -Rst ODO, Wt=100ms, Rt=25ms	SOT-25	28xg	VD20	6g	Tor
48	R1223N162F	DC/DC-IC	PWM/VFM step-down, +CE, 1.6V, 500kHz, R-Pr.	SOT-23-5	28ud	DC7	6g	Ric
48	RN5RF48AA	LVR-IC	LRip, -CE, 4.8V±2%, 1A*	SOT-23-5	28vw	VR6	6g	Ric
48	RN5RZ48AA	LVR-IC	LDO, LN, -CE, 4.8V±2%, 100mA	SOT-23-5	28vrt	VR4	6g	Ric
480	XC6105B431MR	Vdet-IC	3.1V±2%, Hst, +Rst PPO, -Rst ODO, Wt=200ms, Rt=25ms	SOT-25	28xg	VD20	6g	Tor
481	XC6105B432MR	Vdet-IC	3.2V±2%, Hst, +Rst PPO, -Rst ODO, Wt=200ms, Rt=25ms	SOT-25	28xg	VD20	6g	Tor
482	XC6105B433MR	Vdet-IC	3.3V±2%, Hst, +Rst PPO, -Rst ODO, Wt=200ms, Rt=25ms	SOT-25	28xg	VD20	6g	Tor
483	XC6105B434MR	Vdet-IC	3.4V±2%, Hst, +Rst PPO, -Rst ODO, Wt=200ms, Rt=25ms	SOT-25	28xg	VD20	6g	Tor
484	XC6105B435MR	Vdet-IC	3.5V±2%, Hst, +Rst PPO, -Rst ODO, Wt=200ms, Rt=25ms	SOT-25	28xg	VD20	6g	Tor
485	XC6105B436MR	Vdet-IC	3.6V±2%, Hst, +Rst PPO, -Rst ODO, Wt=200ms, Rt=25ms	SOT-25	28xg	VD20	6g	Tor
486	XC6105B437MR	Vdet-IC	3.7V±2%, Hst, +Rst PPO, -Rst ODO, Wt=200ms, Rt=25ms	SOT-25	28xg	VD20	6g	Tor
487	XC6105B438MR	Vdet-IC	3.8V±2%, Hst, +Rst PPO, -Rst ODO, Wt=200ms, Rt=25ms	SOT-25	28xg	VD20	6g	Tor
488	XC6105B439MR	Vdet-IC	3.9V±2%, Hst, +Rst PPO, -Rst ODO, Wt=200ms, Rt=25ms	SOT-25	28xg	VD20	6g	Tor
489	XC6105B440MR	Vdet-IC	4.0V±2%, Hst, +Rst PPO, -Rst ODO, Wt=200ms, Rt=25ms	SOT-25	28xg	VD20	6g	Tor
48A	AAT60048A-S5	Vdet-IC	4.8V±2%, -Reset ODO	SOT-23-5	28vdo	VD1	6g	Aat
48A	XC6105B441MR	Vdet-IC	4.1V±2%, Hst, +Rst PPO, -Rst ODO, Wt=200ms, Rt=25ms	SOT-25	28xg	VD20	6g	Tor
48B	AAT60048B-S5	Vdet-IC	4.8V±2%, -Reset PPO	SOT-23-5	28vdo	VD3	6g	Aat
48B	XC6105B442MR	Vdet-IC	4.2V±2%, Hst, +Rst PPO, -Rst ODO, Wt=200ms, Rt=25ms	SOT-25	28xg	VD20	6g	Tor
48C	AAT60048C-S5	Vdet-IC	4.8V±1%, -Reset ODO	SOT-23-5	28vdo	VD1	6g	Aat
48C	XC6105B443MR	Vdet-IC	4.3V±2%, Hst, +Rst PPO, -Rst ODO, Wt=200ms, Rt=25ms	SOT-25	28xg	VD20	6g	Tor
48D	AAT60048D-S5	Vdet-IC	4.8V±1%, -Reset PPO	SOT-23-5	28vdo	VD3	6g	Aat
48D	XC6105B444MR	Vdet-IC	4.4V±2%, Hst, +Rst PPO, -Rst ODO, Wt=200ms, Rt=25ms	SOT-25	28xg	VD20	6g	Tor
48E	XC6105B445MR	Vdet-IC	4.5V±2%, Hst, +Rst PPO, -Rst ODO, Wt=200ms, Rt=25ms	SOT-25	28xg	VD20	6g	Tor
48F	XC6105B416MR	Vdet-IC	1.6V±2%, Hst, +Rst PPO, -Rst ODO, Wt=200ms, Rt=25ms	SOT-25	28xg	VD20	6g	Tor
48E	XC6105B446MR	Vdet-IC	4.6V±2%, Hst, +Rst PPO, -Rst ODO, Wt=200ms, Rt=25ms	SOT-25	28xg	VD20	6g	Tor
48H	XC6105B417MR	Vdet-IC	1.7V±2%, Hst, +Rst PPO, -Rst ODO, Wt=200ms, Rt=25ms	SOT-25	28xg	VD20	6g	Tor
48H	XC6105B447MR	Vdet-IC	4.7V±2%, Hst, +Rst PPO, -Rst ODO, Wt=200ms, Rt=25ms	SOT-25	28xg	VD20	6g	Tor
48K	TK71748S	LVR-IC	LDO, 4.8V±1.5%, 300mA, +CE	SOT-23-5	28vrx	VR7	6k	Tok
48K	XC6105B418MR	Vdet-IC	1.8V±2%, Hst, +Rst PPO, -Rst ODO, Wt=200ms, Rt=25ms	SOT-25	28xg	VD20	6g	Tor
48K	XC6105B448MR	Vdet-IC	4.8V±2%, Hst, +Rst PPO, -Rst ODO, Wt=200ms, Rt=25ms	SOT-25	28xg	VD20	6g	Tor
48L	TK71648ASCL	LVR-IC	LDO, 4.8V±2%, 150mA, +CE, -30, +80°C	SOT-23-5	28vrx	VR7	6k	Tok
48L	XC6105B419MR	Vdet-IC	1.9V±2%, Hst, +Rst PPO, -Rst ODO, Wt=200ms, Rt=25ms	SOT-25	28xg	VD20	6g	Tor
48L	XC6105B449MR	Vdet-IC	4.9V±2%, Hst, +Rst PPO, -Rst ODO, Wt=200ms, Rt=25ms	SOT-25	28xg	VD20	6g	Tor
48M	XC6105B420MR	Vdet-IC	2.0V±2%, Hst, +Rst PPO, -Rst ODO, Wt=200ms, Rt=25ms	SOT-25	28xg	VD20	6g	Tor
48M	XC6105B450MR	Vdet-IC	5.0V±2%, Hst, +Rst PPO, -Rst ODO, Wt=200ms, Rt=25ms	SOT-25	28xg	VD20	6g	Tor
48N	XC6105B421MR	Vdet-IC	2.1V±2%, Hst, +Rst PPO, -Rst ODO, Wt=200ms, Rt=25ms	SOT-25	28xg	VD20	6g	Tor
48P	XC6105B422MR	Vdet-IC	2.2V±2%, Hst, +Rst PPO, -Rst ODO, Wt=200ms, Rt=25ms	SOT-25	28xg	VD20	6g	Tor
48R	XC6105B423MR	Vdet-IC	2.3V±2%, Hst, +Rst PPO, -Rst ODO, Wt=200ms, Rt=25ms	SOT-25	28xg	VD20	6g	Tor
48S	XC6105B424MR	Vdet-IC	2.4V±2%, Hst, +Rst PPO, -Rst ODO, Wt=200ms, Rt=25ms	SOT-25	28xg	VD20	6g	Tor
48T	TK71448S	LVR-IC	LDO, 4.8V±2%, 100mA, +CE, Ext. transistor	SOT-23-5	28zh	VR6	6a	Tok
48T	XC6105B425MR	Vdet-IC	2.5V±2%, Hst, +Rst PPO, -Rst ODO, Wt=200ms, Rt=25ms	SOT-25	28xg	VD20	6g	Tor
48U	XC6105B426MR	Vdet-IC	2.6V±2%, Hst, +Rst PPO, -Rst ODO, Wt=200ms, Rt=25ms	SOT-25	28xg	VD20	6g	Tor
48V	XC6105B427MR	Vdet-IC	2.7V±2%, Hst, +Rst PPO, -Rst ODO, Wt=200ms, Rt=25ms	SOT-25	28xg	VD20	6g	Tor
48X	XC6105B428MR	Vdet-IC	2.8V±2%, Hst, +Rst PPO, -Rst ODO, Wt=200ms, Rt=25ms	SOT-25	28xg	VD20	6g	Tor
48Y	XC6105B429MR	Vdet-IC	2.9V±2%, Hst, +Rst PPO, -Rst ODO, Wt=200ms, Rt=25ms	SOT-25	28xg	VD20	6g	Tor
48Z	XC6105B430MR	Vdet-IC	3.0V±2%, Hst, +Rst PPO, -Rst ODO, Wt=200ms, Rt=25ms	SOT-25	28xg	VD20	6g	Tor
49	R1223N382C	DC/DC-IC	PWM step-down, +CE, 3.8V, 300kHz, Latch-Pr.	SOT-23-5	28ud	DC7	6g	Ric
49	RN5RF49AA	LVR-IC	LRip, -CE, 4.9V±2%, 1A*	SOT-23-5	28vw	VR6	6g	Ric
49	RN5RZ49AA	LVR-IC	LDO, LN, -CE, 4.9V±2%, 100mA	SOT-23-5	28vrt	VR4	6g	Ric



SMD code	Type	Function	Short description	Case	Pinout	Sch.	St.	Mnf.
490	XC6105B531MR	Vdet-IC	3.1V±2%, Hst, +Rst PPO, -Rst ODO, Wt=400ms, Rt=25ms	SOT-25	28xg	VD20	6g	Tor
491	XC6105B532MR	Vdet-IC	3.2V±2%, Hst, +Rst PPO, -Rst ODO, Wt=400ms, Rt=25ms	SOT-25	28xg	VD20	6g	Tor
492	XC6105B533MR	Vdet-IC	3.3V±2%, Hst, +Rst PPO, -Rst ODO, Wt=400ms, Rt=25ms	SOT-25	28xg	VD20	6g	Tor
493	XC6105B534MR	Vdet-IC	3.4V±2%, Hst, +Rst PPO, -Rst ODO, Wt=400ms, Rt=25ms	SOT-25	28xg	VD20	6g	Tor
494	XC6105B535MR	Vdet-IC	3.5V±2%, Hst, +Rst PPO, -Rst ODO, Wt=400ms, Rt=25ms	SOT-25	28xg	VD20	6g	Tor
495	XC6105B536MR	Vdet-IC	3.6V±2%, Hst, +Rst PPO, -Rst ODO, Wt=400ms, Rt=25ms	SOT-25	28xg	VD20	6g	Tor
496	XC6105B537MR	Vdet-IC	3.7V±2%, Hst, +Rst PPO, -Rst ODO, Wt=400ms, Rt=25ms	SOT-25	28xg	VD20	6g	Tor
497	XC6105B538MR	Vdet-IC	3.8V±2%, Hst, +Rst PPO, -Rst ODO, Wt=400ms, Rt=25ms	SOT-25	28xg	VD20	6g	Tor
498	XC6105B539MR	Vdet-IC	3.9V±2%, Hst, +Rst PPO, -Rst ODO, Wt=400ms, Rt=25ms	SOT-25	28xg	VD20	6g	Tor
499	XC6105B540MR	Vdet-IC	4.0V±2%, Hst, +Rst PPO, -Rst ODO, Wt=400ms, Rt=25ms	SOT-25	28xg	VD20	6g	Tor
49A	AAT60049A-S5	Vdet-IC	4.9V±2%, -Reset ODO	SOT-23-5	28vdo	VD1	6g	Aat
49A	XC6105B541MR	Vdet-IC	4.1V±2%, Hst, +Rst PPO, -Rst ODO, Wt=400ms, Rt=25ms	SOT-25	28xg	VD20	6g	Tor
49B	AAT60049B-S5	Vdet-IC	4.9V±2%, -Reset PPO	SOT-23-5	28vdo	VD3	6g	Aat
49B	XC6105B542MR	Vdet-IC	4.2V±2%, Hst, +Rst PPO, -Rst ODO, Wt=400ms, Rt=25ms	SOT-25	28xg	VD20	6g	Tor
49C	AAT60049C-S5	Vdet-IC	4.9V±1%, -Reset ODO	SOT-23-5	28vdo	VD1	6g	Aat
49C	XC6105B543MR	Vdet-IC	4.3V±2%, Hst, +Rst PPO, -Rst ODO, Wt=400ms, Rt=25ms	SOT-25	28xg	VD20	6g	Tor
49D	AAT60049D-S5	Vdet-IC	4.9V±1%, -Reset PPO	SOT-23-5	28vdo	VD3	6g	Aat
49D	XC6105B544MR	Vdet-IC	4.4V±2%, Hst, +Rst PPO, -Rst ODO, Wt=400ms, Rt=25ms	SOT-25	28xg	VD20	6g	Tor
49E	XC6105B545MR	Vdet-IC	4.5V±2%, Hst, +Rst PPO, -Rst ODO, Wt=400ms, Rt=25ms	SOT-25	28xg	VD20	6g	Tor
49F	XC6105B516MR	Vdet-IC	1.6V±2%, Hst, +Rst PPO, -Rst ODO, Wt=400ms, Rt=25ms	SOT-25	28xg	VD20	6g	Tor
49E	XC6105B546MR	Vdet-IC	4.6V±2%, Hst, +Rst PPO, -Rst ODO, Wt=400ms, Rt=25ms	SOT-25	28xg	VD20	6g	Tor
49H	XC6105B517MR	Vdet-IC	1.7V±2%, Hst, +Rst PPO, -Rst ODO, Wt=400ms, Rt=25ms	SOT-25	28xg	VD20	6g	Tor
49H	XC6105B547MR	Vdet-IC	4.7V±2%, Hst, +Rst PPO, -Rst ODO, Wt=400ms, Rt=25ms	SOT-25	28xg	VD20	6g	Tor
49K	TK71749S	LVR-IC	LDO, 4.9V±1.5%, 300mA, +CE	SOT-23-5	28vrx	VR7	6k	Tok
49K	XC6105B518MR	Vdet-IC	1.8V±2%, Hst, +Rst PPO, -Rst ODO, Wt=400ms, Rt=25ms	SOT-25	28xg	VD20	6g	Tor
49K	XC6105B548MR	Vdet-IC	4.8V±2%, Hst, +Rst PPO, -Rst ODO, Wt=400ms, Rt=25ms	SOT-25	28xg	VD20	6g	Tor
49L	TK71649ASCL	LVR-IC	LDO, 4.9V±2%, 150mA, +CE, -30, +80°C	SOT-23-5	28vrx	VR7	6k	Tok
49L	XC6105B519MR	Vdet-IC	1.9V±2%, Hst, +Rst PPO, -Rst ODO, Wt=400ms, Rt=25ms	SOT-25	28xg	VD20	6g	Tor
49L	XC6105B549MR	Vdet-IC	4.9V±2%, Hst, +Rst PPO, -Rst ODO, Wt=400ms, Rt=25ms	SOT-25	28xg	VD20	6g	Tor
49M	XC6105B520MR	Vdet-IC	2.0V±2%, Hst, +Rst PPO, -Rst ODO, Wt=400ms, Rt=25ms	SOT-25	28xg	VD20	6g	Tor
49M	XC6105B550MR	Vdet-IC	5.0V±2%, Hst, +Rst PPO, -Rst ODO, Wt=400ms, Rt=25ms	SOT-25	28xg	VD20	6g	Tor
49N	XC6105B521MR	Vdet-IC	2.1V±2%, Hst, +Rst PPO, -Rst ODO, Wt=400ms, Rt=25ms	SOT-25	28xg	VD20	6g	Tor
49P	XC6105B522MR	Vdet-IC	2.2V±2%, Hst, +Rst PPO, -Rst ODO, Wt=400ms, Rt=25ms	SOT-25	28xg	VD20	6g	Tor
49R	XC6105B523MR	Vdet-IC	2.3V±2%, Hst, +Rst PPO, -Rst ODO, Wt=400ms, Rt=25ms	SOT-25	28xg	VD20	6g	Tor
49S	XC6105B524MR	Vdet-IC	2.4V±2%, Hst, +Rst PPO, -Rst ODO, Wt=400ms, Rt=25ms	SOT-25	28xg	VD20	6g	Tor
49T	TK71449S	LVR-IC	LDO, 4.9V±2%, 100mA, +CE, Ext. transistor	SOT-23-5	28zh	VR6	6a	Tok
49T	XC6105B525MR	Vdet-IC	2.5V±2%, Hst, +Rst PPO, -Rst ODO, Wt=400ms, Rt=25ms	SOT-25	28xg	VD20	6g	Tor
49U	XC6105B526MR	Vdet-IC	2.6V±2%, Hst, +Rst PPO, -Rst ODO, Wt=400ms, Rt=25ms	SOT-25	28xg	VD20	6g	Tor
49V	XC6105B527MR	Vdet-IC	2.7V±2%, Hst, +Rst PPO, -Rst ODO, Wt=400ms, Rt=25ms	SOT-25	28xg	VD20	6g	Tor
49X	XC6105B528MR	Vdet-IC	2.8V±2%, Hst, +Rst PPO, -Rst ODO, Wt=400ms, Rt=25ms	SOT-25	28xg	VD20	6g	Tor
49Y	XC6105B529MR	Vdet-IC	2.9V±2%, Hst, +Rst PPO, -Rst ODO, Wt=400ms, Rt=25ms	SOT-25	28xg	VD20	6g	Tor
49Z	XC6105B530MR	Vdet-IC	3.0V±2%, Hst, +Rst PPO, -Rst ODO, Wt=400ms, Rt=25ms	SOT-25	28xg	VD20	6g	Tor
4A0	XC6204A312MR	LVR-IC	LDO, 3.1V±2%, 150mA, +CE, PDR	SOT-25	28cx	VR4	6g	Tor
4A0	XC6105B631MR	Vdet-IC	3.1V±2%, Hst, +Rst PPO, -Rst ODO, Wt=1.6s, Rt=25ms	SOT-25	28xg	VD20	6g	Tor
4A0	XC6204E312MR	LVR-IC	LDO, 3.1V±2%, 300mA, +CE, PDR	SOT-25	28cx	VR4	6g	Tor
4A1	XC6204A322MR	LVR-IC	LDO, 3.2V±2%, 150mA, +CE, PDR	SOT-25	28cx	VR4	6g	Tor
4A1	XC6105B632MR	Vdet-IC	3.2V±2%, Hst, +Rst PPO, -Rst ODO, Wt=1.6s, Rt=25ms	SOT-25	28xg	VD20	6g	Tor
4A1	XC6204E322MR	LVR-IC	LDO, 3.2V±2%, 300mA, +CE, PDR	SOT-25	28cx	VR4	6g	Tor
4A2	XC6204A332MR	LVR-IC	LDO, 3.3V±2%, 150mA, +CE, PDR	SOT-25	28cx	VR4	6g	Tor
4A2	XC6105B633MR	Vdet-IC	3.3V±2%, Hst, +Rst PPO, -Rst ODO, Wt=1.6s, Rt=25ms	SOT-25	28xg	VD20	6g	Tor
4A2	XC6204E332MR	LVR-IC	LDO, 3.3V±2%, 300mA, +CE, PDR	SOT-25	28cx	VR4	6g	Tor
4A3	XC6204A342MR	LVR-IC	LDO, 3.4V±2%, 150mA, +CE, PDR	SOT-25	28cx	VR4	6g	Tor
4A3	XC6105B634MR	Vdet-IC	3.4V±2%, Hst, +Rst PPO, -Rst ODO, Wt=1.6s, Rt=25ms	SOT-25	28xg	VD20	6g	Tor
4A3	XC6204E342MR	LVR-IC	LDO, 3.4V±2%, 300mA, +CE, PDR	SOT-25	28cx	VR4	6g	Tor
4A4	XC6204A352MR	LVR-IC	LDO, 3.5V±2%, 150mA, +CE, PDR	SOT-25	28cx	VR4	6g	Tor
4A4	XC6105B635MR	Vdet-IC	3.5V±2%, Hst, +Rst PPO, -Rst ODO, Wt=1.6s, Rt=25ms	SOT-25	28xg	VD20	6g	Tor
4A4	XC6204E352MR	LVR-IC	LDO, 3.5V±2%, 300mA, +CE, PDR	SOT-25	28cx	VR4	6g	Tor
4A5	XC6204A362MR	LVR-IC	LDO, 3.6V±2%, 150mA, +CE, PDR	SOT-25	28cx	VR4	6g	Tor
4A5	XC6105B636MR	Vdet-IC	3.6V±2%, Hst, +Rst PPO, -Rst ODO, Wt=1.6s, Rt=25ms	SOT-25	28xg	VD20	6g	Tor
4A5	XC6204E362MR	LVR-IC	LDO, 3.6V±2%, 300mA, +CE, PDR	SOT-25	28cx	VR4	6g	Tor
4A6	XC6204A372MR	LVR-IC	LDO, 3.7V±2%, 150mA, +CE, PDR	SOT-25	28cx	VR4	6g	Tor
4A6	XC6105B637MR	Vdet-IC	3.7V±2%, Hst, +Rst PPO, -Rst ODO, Wt=1.6s, Rt=25ms	SOT-25	28xg	VD20	6g	Tor
4A6	XC6204E372MR	LVR-IC	LDO, 3.7V±2%, 300mA, +CE, PDR	SOT-25	28cx	VR4	6g	Tor
4A7	XC6204A382MR	LVR-IC	LDO, 3.8V±2%, 150mA, +CE, PDR	SOT-25	28cx	VR4	6g	Tor
4A7	XC6105B638MR	Vdet-IC	3.8V±2%, Hst, +Rst PPO, -Rst ODO, Wt=1.6s, Rt=25ms	SOT-25	28xg	VD20	6g	Tor
4A7	XC6204E382MR	LVR-IC	LDO, 3.8V±2%, 300mA, +CE, PDR	SOT-25	28cx	VR4	6g	Tor
4A8	XC6204A392MR	LVR-IC	LDO, 3.9V±2%, 150mA, +CE, PDR	SOT-25	28cx	VR4	6g	Tor
4A8	XC9235A08CMR	DC-DC-IC	PWM, st-dwn, 0.8V±2%, 600mA, 1.2MHz, Vin>2V, LSSST	SOT-25	28dc4	DC1	6g	Tor
4A8	XC6105B639MR	Vdet-IC	3.9V±2%, Hst, +Rst PPO, -Rst ODO, Wt=1.6s, Rt=25ms	SOT-25	28xg	VD20	6g	Tor
4A8	XC6204E392MR	LVR-IC	LDO, 3.9V±2%, 300mA, +CE, PDR	SOT-25	28cx	VR4	6g	Tor



SMD code	Type	Function	Short description	Case	Pinout	Sch.	St.Mnf.
4A9	XC6204A402MR	LVR-IC	LDO, 4V±2%, 150mA, +CE, PDR	SOT-25	28cx	VR4	6g Tor
4A9	XC9235A09CMR	DC-DC-IC	PWM, st-dwn, 0.9V±2%, 600mA, 1.2MHz, Vin>2V, LSST	SOT-25	28dc4	DC1	6g Tor
4A9	XC6105B640MR	Vdet-IC	4.0V±2%, Hst, +Rst PPO, -Rst ODO, Wt=1.6s, Rt=25ms	SOT-25	28xg	VD20	6g Tor
4A9	XC6204E402MR	LVR-IC	LDO, 4V±2%, 300mA, +CE, PDR	SOT-25	28cx	VR4	6g Tor
4AA	XC6204A412MR	LVR-IC	LDO, 4.1V±2%, 150mA, +CE, PDR	SOT-25	28cx	VR4	6g Tor
4AA	XC6105B641MR	Vdet-IC	4.1V±2%, Hst, +Rst PPO, -Rst ODO, Wt=1.6s, Rt=25ms	SOT-25	28xg	VD20	6g Tor
4AB	XC6204E412MR	LVR-IC	LDO, 4.1V±2%, 300mA, +CE, PDR	SOT-25	28cx	VR4	6g Tor
4AB	XC6204A422MR	LVR-IC	LDO, 4.2V±2%, 150mA, +CE, PDR	SOT-25	28cx	VR4	6g Tor
4AB	XC6105B642MR	Vdet-IC	4.2V±2%, Hst, +Rst PPO, -Rst ODO, Wt=1.6s, Rt=25ms	SOT-25	28xg	VD20	6g Tor
4AB	XC6204E422MR	LVR-IC	LDO, 4.2V±2%, 300mA, +CE, PDR	SOT-25	28cx	VR4	6g Tor
4AC	XC6204A432MR	LVR-IC	LDO, 4.3V±2%, 150mA, +CE, PDR	SOT-25	28cx	VR4	6g Tor
4AC	XC6105B643MR	Vdet-IC	4.3V±2%, Hst, +Rst PPO, -Rst ODO, Wt=1.6s, Rt=25ms	SOT-25	28xg	VD20	6g Tor
4AC	XC6204E432MR	LVR-IC	LDO, 4.3V±2%, 300mA, +CE, PDR	SOT-25	28cx	VR4	6g Tor
4AD	XC6204A442MR	LVR-IC	LDO, 4.4V±2%, 150mA, +CE, PDR	SOT-25	28cx	VR4	6g Tor
4AD	XC6105B644MR	Vdet-IC	4.4V±2%, Hst, +Rst PPO, -Rst ODO, Wt=1.6s, Rt=25ms	SOT-25	28xg	VD20	6g Tor
4AD	XC6204E442MR	LVR-IC	LDO, 4.4V±2%, 300mA, +CE, PDR	SOT-25	28cx	VR4	6g Tor
4AE	XC6204A452MR	LVR-IC	LDO, 4.5V±2%, 150mA, +CE, PDR	SOT-25	28cx	VR4	6g Tor
4AE	XC6105B645MR	Vdet-IC	4.5V±2%, Hst, +Rst PPO, -Rst ODO, Wt=1.6s, Rt=25ms	SOT-25	28xg	VD20	6g Tor
4AE	XC6204E452MR	LVR-IC	LDO, 4.5V±2%, 300mA, +CE, PDR	SOT-25	28cx	VR4	6g Tor
4AF	XC6204A462MR	LVR-IC	LDO, 4.6V±2%, 150mA, +CE, PDR	SOT-25	28cx	VR4	6g Tor
4AF	XC6105B616MR	Vdet-IC	1.6V±2%, Hst, +Rst PPO, -Rst ODO, Wt=1.6s, Rt=25ms	SOT-25	28xg	VD20	6g Tor
4AF	XC6105B646MR	Vdet-IC	4.6V±2%, Hst, +Rst PPO, -Rst ODO, Wt=1.6s, Rt=25ms	SOT-25	28xg	VD20	6g Tor
4AF	XC6204E462MR	LVR-IC	LDO, 4.6V±2%, 300mA, +CE, PDR	SOT-25	28cx	VR4	6g Tor
4AH	XC6204A472MR	LVR-IC	LDO, 4.7V±2%, 150mA, +CE, PDR	SOT-25	28cx	VR4	6g Tor
4AH	XC6105B617MR	Vdet-IC	1.7V±2%, Hst, +Rst PPO, -Rst ODO, Wt=1.6s, Rt=25ms	SOT-25	28xg	VD20	6g Tor
4AH	XC6105B647MR	Vdet-IC	4.7V±2%, Hst, +Rst PPO, -Rst ODO, Wt=1.6s, Rt=25ms	SOT-25	28xg	VD20	6g Tor
4AH	XC6204E472MR	LVR-IC	LDO, 4.7V±2%, 300mA, +CE, PDR	SOT-25	28cx	VR4	6g Tor
4AK	XC6204A482MR	LVR-IC	LDO, 4.8V±2%, 150mA, +CE, PDR	SOT-25	28cx	VR4	6g Tor
4AK	XC6105B618MR	Vdet-IC	1.8V±2%, Hst, +Rst PPO, -Rst ODO, Wt=1.6s, Rt=25ms	SOT-25	28xg	VD20	6g Tor
4AK	XC6105B648MR	Vdet-IC	4.8V±2%, Hst, +Rst PPO, -Rst ODO, Wt=1.6s, Rt=25ms	SOT-25	28xg	VD20	6g Tor
4AK	XC6204E482MR	LVR-IC	LDO, 4.8V±2%, 300mA, +CE, PDR	SOT-25	28cx	VR4	6g Tor
4AL	XC6204A492MR	LVR-IC	LDO, 4.9V±2%, 150mA, +CE, PDR	SOT-25	28cx	VR4	6g Tor
4AL	XC9235A0LCMR	DC-DC-IC	PWM, st-dwn, 0.85V±2%, 600mA, 1.2MHz, Vin>2V, LSST	SOT-25	28dc4	DC1	6g Tor
4AL	XC6105B619MR	Vdet-IC	1.9V±2%, Hst, +Rst PPO, -Rst ODO, Wt=1.6s, Rt=25ms	SOT-25	28xg	VD20	6g Tor
4AL	XC6105B649MR	Vdet-IC	4.9V±2%, Hst, +Rst PPO, -Rst ODO, Wt=1.6s, Rt=25ms	SOT-25	28xg	VD20	6g Tor
4AL	XC6204E492MR	LVR-IC	LDO, 4.9V±2%, 300mA, +CE, PDR	SOT-25	28cx	VR4	6g Tor
4AM	XC6204A502MR	LVR-IC	LDO, 5.0V±2%, 150mA, +CE, PDR	SOT-25	28cx	VR4	6g Tor
4AM	XC9235A0MCMR	DC-DC-IC	PWM, st-dwn, 0.95V±2%, 600mA, 1.2MHz, Vin>2V, LSST	SOT-25	28dc4	DC1	6g Tor
4AM	XC6105B620MR	Vdet-IC	2.0V±2%, Hst, +Rst PPO, -Rst ODO, Wt=1.6s, Rt=25ms	SOT-25	28xg	VD20	6g Tor
4AM	XC6105B650MR	Vdet-IC	5.0V±2%, Hst, +Rst PPO, -Rst ODO, Wt=1.6s, Rt=25ms	SOT-25	28xg	VD20	6g Tor
4AM	XC6204E502MR	LVR-IC	LDO, 5V±2%, 300mA, +CE, PDR	SOT-25	28cx	VR4	6g Tor
4AN	XC6204A512MR	LVR-IC	LDO, 5.1V±2%, 150mA, +CE, PDR	SOT-25	28cx	VR4	6g Tor
4AN	XC6105B621MR	Vdet-IC	2.1V±2%, Hst, +Rst PPO, -Rst ODO, Wt=1.6s, Rt=25ms	SOT-25	28xg	VD20	6g Tor
4AN	XC6204E512MR	LVR-IC	LDO, 5.1V±2%, 300mA, +CE, PDR	SOT-25	28cx	VR4	6g Tor
4AP	XC6204A522MR	LVR-IC	LDO, 5.2V±2%, 150mA, +CE, PDR	SOT-25	28cx	VR4	6g Tor
4AP	XC6105B622MR	Vdet-IC	2.2V±2%, Hst, +Rst PPO, -Rst ODO, Wt=1.6s, Rt=25ms	SOT-25	28xg	VD20	6g Tor
4AP	XC6204E522MR	LVR-IC	LDO, 5.2V±2%, 300mA, +CE, PDR	SOT-25	28cx	VR4	6g Tor
4AR	XC6204A532MR	LVR-IC	LDO, 5.3V±2%, 150mA, +CE, PDR	SOT-25	28cx	VR4	6g Tor
4AR	XC6105B623MR	Vdet-IC	2.3V±2%, Hst, +Rst PPO, -Rst ODO, Wt=1.6s, Rt=25ms	SOT-25	28xg	VD20	6g Tor
4AR	XC6204E532MR	LVR-IC	LDO, 5.3V±2%, 300mA, +CE, PDR	SOT-25	28cx	VR4	6g Tor
4AS	XC6204A542MR	LVR-IC	LDO, 5.4V±2%, 150mA, +CE, PDR	SOT-25	28cx	VR4	6g Tor
4AS	XC6105B624MR	Vdet-IC	2.4V±2%, Hst, +Rst PPO, -Rst ODO, Wt=1.6s, Rt=25ms	SOT-25	28xg	VD20	6g Tor
4AS	XC6204E542MR	LVR-IC	LDO, 5.4V±2%, 300mA, +CE, PDR	SOT-25	28cx	VR4	6g Tor
4AT	XC6204A552MR	LVR-IC	LDO, 5.5V±2%, 150mA, +CE, PDR	SOT-25	28cx	VR4	6g Tor
4AT	XC6105B625MR	Vdet-IC	2.5V±2%, Hst, +Rst PPO, -Rst ODO, Wt=1.6s, Rt=25ms	SOT-25	28xg	VD20	6g Tor
4AT	XC6204E552MR	LVR-IC	LDO, 5.5V±2%, 300mA, +CE, PDR	SOT-25	28cx	VR4	6g Tor
4AU	XC6204A562MR	LVR-IC	LDO, 5.6V±2%, 150mA, +CE, PDR	SOT-25	28cx	VR4	6g Tor
4AU	XC6105B626MR	Vdet-IC	2.6V±2%, Hst, +Rst PPO, -Rst ODO, Wt=1.6s, Rt=25ms	SOT-25	28xg	VD20	6g Tor
4AV	XC6204E562MR	LVR-IC	LDO, 5.6V±2%, 300mA, +CE, PDR	SOT-25	28cx	VR4	6g Tor
4AV	XC6204A572MR	LVR-IC	LDO, 5.7V±2%, 150mA, +CE, PDR	SOT-25	28cx	VR4	6g Tor
4AV	XC6105B627MR	Vdet-IC	2.7V±2%, Hst, +Rst PPO, -Rst ODO, Wt=1.6s, Rt=25ms	SOT-25	28xg	VD20	6g Tor
4AV	XC6204E572MR	LVR-IC	LDO, 5.7V±2%, 300mA, +CE, PDR	SOT-25	28cx	VR4	6g Tor
4AX	XC6204A582MR	LVR-IC	LDO, 5.8V±2%, 150mA, +CE, PDR	SOT-25	28cx	VR4	6g Tor
4AX	XC6105B628MR	Vdet-IC	2.8V±2%, Hst, +Rst PPO, -Rst ODO, Wt=1.6s, Rt=25ms	SOT-25	28xg	VD20	6g Tor
4AX	XC6204E582MR	LVR-IC	LDO, 5.8V±2%, 300mA, +CE, PDR	SOT-25	28cx	VR4	6g Tor
4AY	XC6204A592MR	LVR-IC	LDO, 5.9V±2%, 150mA, +CE, PDR	SOT-25	28cx	VR4	6g Tor
4AY	XC6105B629MR	Vdet-IC	2.9V±2%, Hst, +Rst PPO, -Rst ODO, Wt=1.6s, Rt=25ms	SOT-25	28xg	VD20	6g Tor
4AY	XC6204E592MR	LVR-IC	LDO, 5.9V±2%, 300mA, +CE, PDR	SOT-25	28cx	VR4	6g Tor
4AZ	XC6204A602MR	LVR-IC	LDO, 6V±2%, 150mA, +CE, PDR	SOT-25	28cx	VR4	6g Tor
4AZ	XC6105B630MR	Vdet-IC	3.0V±2%, Hst, +Rst PPO, -Rst ODO, Wt=1.6s, Rt=25ms	SOT-25	28xg	VD20	6g Tor



SMD code	Type	Function	Short description	Case	Pinout	Sch.	St.	Mnf.
4AZ	XC6204E602MR	LVR-IC	LDO, 6V±2%, 300mA, +CE, PDR	SOT-25	28cx	VR4	6g	Tor
4B	R3111N141A	Vdet-IC	1.4V±2%, -Reset PPO	SOT-23-5	28vdm	VD7	6g	Ric
4B	RN5RL24AA	LVR-IC	2.4V±2.5%, 150mA	SOT-23-5	28vru	VR1	6g	Ric
4B	RN5VD14CA	Vdet-IC	1.4V±2.5%, -Reset ODO	SOT-23-5	28vdo	VD1	6g	Ric
4B0	TAR5SB40	LVR-IC	LDO, 4V±1%, 200mA, +CE	SSOP-5	28vrx	VR7	6a	Tos
4B0	XC6204B312MR	LVR-IC	LDO, 3.1V±2%, 150mA, +CE	SOT-25	28cx	VR4	6g	Tor
4B0	XC9235A10CMR	DC-DC-IC	PWM, st-dwn, 1.0V±2%, 600mA, 1.2MHz, Vin>2V, LSST	SOT-25	28dc4	DC1	6g	Tor
4B0	XC6105C231MR	Vdet-IC	3.1V±2%, Hst, +Rst PPO, -Rst ODO, Wt=50ms, Rt=50ms	SOT-25	28gx	VD20	6g	Tor
4B0	XC6204F312MR	LVR-IC	LDO, 3.1V±2%, 300mA, +CE	SOT-25	28cx	VR4	6g	Tor
4B1	TAR5SB41	LVR-IC	LDO, 4.1V±1%, 200mA, +CE	SSOP-5	28vrx	VR7	6a	Tos
4B1	XC6204B322MR	LVR-IC	LDO, 3.2V±2%, 150mA, +CE	SOT-25	28cx	VR4	6g	Tor
4B1	XC9235A11CMR	DC-DC-IC	PWM, st-dwn, 1.1V±2%, 600mA, 1.2MHz, Vin>2V, LSST	SOT-25	28dc4	DC1	6g	Tor
4B1	XC6105C232MR	Vdet-IC	3.2V±2%, Hst, +Rst PPO, -Rst ODO, Wt=50ms, Rt=50ms	SOT-25	28gx	VD20	6g	Tor
4B1	XC6204F322MR	LVR-IC	LDO, 3.2V±2%, 300mA, +CE	SOT-25	28cx	VR4	6g	Tor
4B2	TAR5SB42	LVR-IC	LDO, 4.2V±1%, 200mA, +CE	SSOP-5	28vrx	VR7	6a	Tos
4B2	XC6204B332MR	LVR-IC	LDO, 3.3V±2%, 150mA, +CE	SOT-25	28cx	VR4	6g	Tor
4B2	XC9235A12CMR	DC-DC-IC	PWM, st-dwn, 1.2V±2%, 600mA, 1.2MHz, Vin>2V, LSST	SOT-25	28dc4	DC1	6g	Tor
4B2	XC6105C233MR	Vdet-IC	3.3V±2%, Hst, +Rst PPO, -Rst ODO, Wt=50ms, Rt=50ms	SOT-25	28gx	VD20	6g	Tor
4B2	XC6204F332MR	LVR-IC	LDO, 3.3V±2%, 300mA, +CE	SOT-25	28cx	VR4	6g	Tor
4B3	TAR5SB43	LVR-IC	LDO, 4.3V±1%, 200mA, +CE	SSOP-5	28vrx	VR7	6a	Tos
4B3	XC6204B342MR	LVR-IC	LDO, 3.4V±2%, 150mA, +CE	SOT-25	28cx	VR4	6g	Tor
4B3	XC9235A13CMR	DC-DC-IC	PWM, st-dwn, 1.3V±2%, 600mA, 1.2MHz, Vin>2V, LSST	SOT-25	28dc4	DC1	6g	Tor
4B3	XC6105C234MR	Vdet-IC	3.4V±2%, Hst, +Rst PPO, -Rst ODO, Wt=50ms, Rt=50ms	SOT-25	28gx	VD20	6g	Tor
4B3	XC6204F342MR	LVR-IC	LDO, 3.4V±2%, 300mA, +CE	SOT-25	28cx	VR4	6g	Tor
4B4	TAR5SB44	LVR-IC	LDO, 4.4V±1%, 200mA, +CE	SSOP-5	28vrx	VR7	6a	Tos
4B4	XC6204B352MR	LVR-IC	LDO, 3.5V±2%, 150mA, +CE	SOT-25	28cx	VR4	6g	Tor
4B4	XC9235A14CMR	DC-DC-IC	PWM, st-dwn, 1.4V±2%, 600mA, 1.2MHz, Vin>2V, LSST	SOT-25	28dc4	DC1	6g	Tor
4B4	XC6105C235MR	Vdet-IC	3.5V±2%, Hst, +Rst PPO, -Rst ODO, Wt=50ms, Rt=50ms	SOT-25	28gx	VD20	6g	Tor
4B4	XC6204F352MR	LVR-IC	LDO, 3.5V±2%, 300mA, +CE	SOT-25	28cx	VR4	6g	Tor
4B5	TAR5SB45	LVR-IC	LDO, 4.5V±1%, 200mA, +CE	SSOP-5	28vrx	VR7	6a	Tos
4B5	XC6204B362MR	LVR-IC	LDO, 3.6V±2%, 150mA, +CE	SOT-25	28cx	VR4	6g	Tor
4B5	XC9235A15CMR	DC-DC-IC	PWM, st-dwn, 1.5V±2%, 600mA, 1.2MHz, Vin>2V, LSST	SOT-25	28dc4	DC1	6g	Tor
4B5	XC6105C236MR	Vdet-IC	3.6V±2%, Hst, +Rst PPO, -Rst ODO, Wt=50ms, Rt=50ms	SOT-25	28gx	VD20	6g	Tor
4B5	XC6204F362MR	LVR-IC	LDO, 3.6V±2%, 300mA, +CE	SOT-25	28cx	VR4	6g	Tor
4B6	TAR5SB46	LVR-IC	LDO, 4.6V±1%, 200mA, +CE	SSOP-5	28vrx	VR7	6a	Tos
4B6	XC6204B372MR	LVR-IC	LDO, 3.7V±2%, 150mA, +CE	SOT-25	28cx	VR4	6g	Tor
4B6	XC9235A16CMR	DC-DC-IC	PWM, st-dwn, 1.6V±2%, 600mA, 1.2MHz, Vin>2V, LSST	SOT-25	28dc4	DC1	6g	Tor
4B6	XC6105C237MR	Vdet-IC	3.7V±2%, Hst, +Rst PPO, -Rst ODO, Wt=50ms, Rt=50ms	SOT-25	28gx	VD20	6g	Tor
4B6	XC6204F372MR	LVR-IC	LDO, 3.7V±2%, 300mA, +CE	SOT-25	28cx	VR4	6g	Tor
4B7	TAR5SB47	LVR-IC	LDO, 4.7V±1%, 200mA, +CE	SSOP-5	28vrx	VR7	6a	Tos
4B7	XC6204B382MR	LVR-IC	LDO, 3.8V±2%, 150mA, +CE	SOT-25	28cx	VR4	6g	Tor
4B7	XC9235A17CMR	DC-DC-IC	PWM, st-dwn, 1.7V±2%, 600mA, 1.2MHz, Vin>2V, LSST	SOT-25	28dc4	DC1	6g	Tor
4B7	XC6105C238MR	Vdet-IC	3.8V±2%, Hst, +Rst PPO, -Rst ODO, Wt=50ms, Rt=50ms	SOT-25	28gx	VD20	6g	Tor
4B7	XC6204F382MR	LVR-IC	LDO, 3.8V±2%, 300mA, +CE	SOT-25	28cx	VR4	6g	Tor
4B8	TAR5SB48	LVR-IC	LDO, 4.8V±1%, 200mA, +CE	SSOP-5	28vrx	VR7	6a	Tos
4B8	XC6204B392MR	LVR-IC	LDO, 3.9V±2%, 150mA, +CE	SOT-25	28cx	VR4	6g	Tor
4B8	XC9235A18CMR	DC-DC-IC	PWM, st-dwn, 1.8V±2%, 600mA, 1.2MHz, Vin>2V, LSST	SOT-25	28dc4	DC1	6g	Tor
4B8	XC6105C239MR	Vdet-IC	3.9V±2%, Hst, +Rst PPO, -Rst ODO, Wt=50ms, Rt=50ms	SOT-25	28gx	VD20	6g	Tor
4B8	XC6204F392MR	LVR-IC	LDO, 3.9V±2%, 300mA, +CE	SOT-25	28cx	VR4	6g	Tor
4B9	TAR5SB49	LVR-IC	LDO, 4.9V±1%, 200mA, +CE	SSOP-5	28vrx	VR7	6a	Tos
4B9	XC6204B402MR	LVR-IC	LDO, 4V±2%, 150mA, +CE	SOT-25	28cx	VR4	6g	Tor
4B9	XC9235A19CMR	DC-DC-IC	PWM, st-dwn, 1.9V±2%, 600mA, 1.2MHz, Vin>2V, LSST	SOT-25	28dc4	DC1	6g	Tor
4B9	XC6105C240MR	Vdet-IC	4.0V±2%, Hst, +Rst PPO, -Rst ODO, Wt=50ms, Rt=50ms	SOT-25	28gx	VD20	6g	Tor
4B9	XC6204F402MR	LVR-IC	LDO, 4V±2%, 300mA, +CE	SOT-25	28cx	VR4	6g	Tor
4BA	XC6204B412MR	LVR-IC	LDO, 4.1V±2%, 150mA, +CE	SOT-25	28cx	VR4	6g	Tor
4BA	XC9235A1ACMR	DC-DC-IC	PWM, st-dwn, 1.05V±2%, 600mA, 1.2MHz, Vin>2V, LSST	SOT-25	28dc4	DC1	6g	Tor
4BA	XC6105C241MR	Vdet-IC	4.1V±2%, Hst, +Rst PPO, -Rst ODO, Wt=50ms, Rt=50ms	SOT-25	28gx	VD20	6g	Tor
4BA	XC6204F412MR	LVR-IC	LDO, 4.1V±2%, 300mA, +CE	SOT-25	28cx	VR4	6g	Tor
4BB	XC6204B422MR	LVR-IC	LDO, 4.2V±2%, 150mA, +CE	SOT-25	28cx	VR4	6g	Tor
4BB	XC9235A1BCMR	DC-DC-IC	PWM, st-dwn, 1.15V±2%, 600mA, 1.2MHz, Vin>2V, LSST	SOT-25	28dc4	DC1	6g	Tor
4BB	XC6105C242MR	Vdet-IC	4.2V±2%, Hst, +Rst PPO, -Rst ODO, Wt=50ms, Rt=50ms	SOT-25	28gx	VD20	6g	Tor
4BB	XC6204F422MR	LVR-IC	LDO, 4.2V±2%, 300mA, +CE	SOT-25	28cx	VR4	6g	Tor
4BC	XC6204B432MR	LVR-IC	LDO, 4.3V±2%, 150mA, +CE	SOT-25	28cx	VR4	6g	Tor
4BC	XC9235A1CCMR	DC-DC-IC	PWM, st-dwn, 1.25V±2%, 600mA, 1.2MHz, Vin>2V, LSST	SOT-25	28dc4	DC1	6g	Tor
4BC	XC6105C243MR	Vdet-IC	4.3V±2%, Hst, +Rst PPO, -Rst ODO, Wt=50ms, Rt=50ms	SOT-25	28gx	VD20	6g	Tor
4BC	XC6204F432MR	LVR-IC	LDO, 4.3V±2%, 300mA, +CE	SOT-25	28cx	VR4	6g	Tor
4BD	XC6204B442MR	LVR-IC	LDO, 4.4V±2%, 150mA, +CE	SOT-25	28cx	VR4	6g	Tor
4BD	XC9235A1DCMR	DC-DC-IC	PWM, st-dwn, 1.35V±2%, 600mA, 1.2MHz, Vin>2V, LSST	SOT-25	28dc4	DC1	6g	Tor
4BD	XC6105C244MR	Vdet-IC	4.4V±2%, Hst, +Rst PPO, -Rst ODO, Wt=50ms, Rt=50ms	SOT-25	28gx	VD20	6g	Tor
4BD	XC6204F442MR	LVR-IC	LDO, 4.4V±2%, 300mA, +CE	SOT-25	28cx	VR4	6g	Tor



SMD code	Type	Function	Short description	Case	Pinout	Sch.	St.	Mnf.
4BE	XC6204B452MR	LVR-IC	LDO, 4.5V±2%, 150mA, +CE	SOT-25	28cx	VR4	6g	Tor
4BE	XC9235A1ECMR	DC-DC-IC	PWM, st-dwn, 1.45V±2%, 600mA, 1.2MHz, Vin>2V, LSST	SOT-25	28dc4	DC1	6g	Tor
4BE	XC6105C217MR	Vdet-IC	4.5V±2%, Hst, +Rst PPO, -Rst ODO, Wt=50ms, Rt=50ms	SOT-25	28xg	VD20	6g	Tor
4BE	XC6204F452MR	LVR-IC	LDO, 4.5V±2%, 300mA, +CE	SOT-25	28cx	VR4	6g	Tor
4BF	XC6204B462MR	LVR-IC	LDO, 4.6V±2%, 150mA, +CE	SOT-25	28cx	VR4	6g	Tor
4BF	XC9235A1FCMR	DC-DC-IC	PWM, st-dwn, 1.55V±2%, 600mA, 1.2MHz, Vin>2V, LSST	SOT-25	28dc4	DC1	6g	Tor
4BF	XC6105C216MR	Vdet-IC	1.6V±2%, Hst, +Rst PPO, -Rst ODO, Wt=50ms, Rt=50ms	SOT-25	28xg	VD20	6g	Tor
4BF	XC6105C246MR	Vdet-IC	4.6V±2%, Hst, +Rst PPO, -Rst ODO, Wt=50ms, Rt=50ms	SOT-25	28xg	VD20	6g	Tor
4BF	XC6204F462MR	LVR-IC	LDO, 4.6V±2%, 300mA, +CE	SOT-25	28cx	VR4	6g	Tor
4BH	XC6204B472MR	LVR-IC	LDO, 4.7V±2%, 150mA, +CE	SOT-25	28cx	VR4	6g	Tor
4BH	XC9235A1HCMR	DC-DC-IC	PWM, st-dwn, 1.65V±2%, 600mA, 1.2MHz, Vin>2V, LSST	SOT-25	28dc4	DC1	6g	Tor
4BH	XC6105C217MR	Vdet-IC	1.7V±2%, Hst, +Rst PPO, -Rst ODO, Wt=50ms, Rt=50ms	SOT-25	28xg	VD20	6g	Tor
4BH	XC6105C247MR	Vdet-IC	4.7V±2%, Hst, +Rst PPO, -Rst ODO, Wt=50ms, Rt=50ms	SOT-25	28xg	VD20	6g	Tor
4BH	XC6204F472MR	LVR-IC	LDO, 4.7V±2%, 300mA, +CE	SOT-25	28cx	VR4	6g	Tor
4BK	XC6204B482MR	LVR-IC	LDO, 4.8V±2%, 150mA, +CE	SOT-25	28cx	VR4	6g	Tor
4BK	XC9235A1KCMR	DC-DC-IC	PWM, st-dwn, 1.75V±2%, 600mA, 1.2MHz, Vin>2V, LSST	SOT-25	28dc4	DC1	6g	Tor
4BK	XC6105C218MR	Vdet-IC	1.8V±2%, Hst, +Rst PPO, -Rst ODO, Wt=50ms, Rt=50ms	SOT-25	28xg	VD20	6g	Tor
4BK	XC6105C248MR	Vdet-IC	4.8V±2%, Hst, +Rst PPO, -Rst ODO, Wt=50ms, Rt=50ms	SOT-25	28xg	VD20	6g	Tor
4BK	XC6204F482MR	LVR-IC	LDO, 4.8V±2%, 300mA, +CE	SOT-25	28cx	VR4	6g	Tor
4BL	XC6204B492MR	LVR-IC	LDO, 4.9V±2%, 150mA, +CE	SOT-25	28cx	VR4	6g	Tor
4BL	XC9235A1LCMR	DC-DC-IC	PWM, st-dwn, 1.85V±2%, 600mA, 1.2MHz, Vin>2V, LSST	SOT-25	28dc4	DC1	6g	Tor
4BL	XC6105C219MR	Vdet-IC	1.9V±2%, Hst, +Rst PPO, -Rst ODO, Wt=50ms, Rt=50ms	SOT-25	28xg	VD20	6g	Tor
4BL	XC6105C249MR	Vdet-IC	4.9V±2%, Hst, +Rst PPO, -Rst ODO, Wt=50ms, Rt=50ms	SOT-25	28xg	VD20	6g	Tor
4BL	XC6204F492MR	LVR-IC	LDO, 4.9V±2%, 300mA, +CE	SOT-25	28cx	VR4	6g	Tor
4BM	XC6204B502MR	LVR-IC	LDO, 5V±2%, 150mA, +CE	SOT-25	28cx	VR4	6g	Tor
4BM	XC9235A1MCMR	DC-DC-IC	PWM, st-dwn, 1.95V±2%, 600mA, 1.2MHz, Vin>2V, LSST	SOT-25	28dc4	DC1	6g	Tor
4BM	XC6105C220MR	Vdet-IC	2.0V±2%, Hst, +Rst PPO, -Rst ODO, Wt=50ms, Rt=50ms	SOT-25	28xg	VD20	6g	Tor
4BM	XC6105C250MR	Vdet-IC	5.0V±2%, Hst, +Rst PPO, -Rst ODO, Wt=50ms, Rt=50ms	SOT-25	28xg	VD20	6g	Tor
4BM	XC6204F502MR	LVR-IC	LDO, 5V±2%, 300mA, +CE	SOT-25	28cx	VR4	6g	Tor
4BN	XC6204B512MR	LVR-IC	LDO, 5.1V±2%, 150mA, +CE	SOT-25	28cx	VR4	6g	Tor
4BN	XC6105C221MR	Vdet-IC	2.1V±2%, Hst, +Rst PPO, -Rst ODO, Wt=50ms, Rt=50ms	SOT-25	28xg	VD20	6g	Tor
4BN	XC6204F512MR	LVR-IC	LDO, 5.1V±2%, 300mA, +CE	SOT-25	28cx	VR4	6g	Tor
4BP	XC6204B522MR	LVR-IC	LDO, 5.2V±2%, 150mA, +CE	SOT-25	28cx	VR4	6g	Tor
4BP	XC6105C222MR	Vdet-IC	2.2V±2%, Hst, +Rst PPO, -Rst ODO, Wt=50ms, Rt=50ms	SOT-25	28xg	VD20	6g	Tor
4BP	XC6204F522MR	LVR-IC	LDO, 5.2V±2%, 300mA, +CE	SOT-25	28cx	VR4	6g	Tor
4BR	XC6204B532MR	LVR-IC	LDO, 5.3V±2%, 150mA, +CE	SOT-25	28cx	VR4	6g	Tor
4BR	XC6105C223MR	Vdet-IC	2.3V±2%, Hst, +Rst PPO, -Rst ODO, Wt=50ms, Rt=50ms	SOT-25	28xg	VD20	6g	Tor
4BR	XC6204F532MR	LVR-IC	LDO, 5.3V±2%, 300mA, +CE	SOT-25	28cx	VR4	6g	Tor
4BS	XC6204B542MR	LVR-IC	LDO, 5.4V±2%, 150mA, +CE	SOT-25	28cx	VR4	6g	Tor
4BS	XC6105C224MR	Vdet-IC	2.4V±2%, Hst, +Rst PPO, -Rst ODO, Wt=50ms, Rt=50ms	SOT-25	28xg	VD20	6g	Tor
4BS	XC6204F542MR	LVR-IC	LDO, 5.4V±2%, 300mA, +CE	SOT-25	28cx	VR4	6g	Tor
4BT	XC6204B552MR	LVR-IC	LDO, 5.5V±2%, 150mA, +CE	SOT-25	28cx	VR4	6g	Tor
4BT	XC6105C225MR	Vdet-IC	2.5V±2%, Hst, +Rst PPO, -Rst ODO, Wt=50ms, Rt=50ms	SOT-25	28xg	VD20	6g	Tor
4BT	XC6204F552MR	LVR-IC	LDO, 5.5V±2%, 300mA, +CE	SOT-25	28cx	VR4	6g	Tor
4BU	XC6204B562MR	LVR-IC	LDO, 5.6V±2%, 150mA, +CE	SOT-25	28cx	VR4	6g	Tor
4BU	XC6105C226MR	Vdet-IC	2.6V±2%, Hst, +Rst PPO, -Rst ODO, Wt=50ms, Rt=50ms	SOT-25	28xg	VD20	6g	Tor
4BU	XC6204F562MR	LVR-IC	LDO, 5.6V±2%, 300mA, +CE	SOT-25	28cx	VR4	6g	Tor
4BV	XC6204B572MR	LVR-IC	LDO, 5.7V±2%, 150mA, +CE	SOT-25	28cx	VR4	6g	Tor
4BV	XC6105C227MR	Vdet-IC	2.7V±2%, Hst, +Rst PPO, -Rst ODO, Wt=50ms, Rt=50ms	SOT-25	28xg	VD20	6g	Tor
4BV	XC6204F572MR	LVR-IC	LDO, 5.7V±2%, 300mA, +CE	SOT-25	28cx	VR4	6g	Tor
4BX	XC6204B582MR	LVR-IC	LDO, 5.8V±2%, 150mA, +CE	SOT-25	28cx	VR4	6g	Tor
4BX	XC6105C228MR	Vdet-IC	2.8V±2%, Hst, +Rst PPO, -Rst ODO, Wt=50ms, Rt=50ms	SOT-25	28xg	VD20	6g	Tor
4BX	XC6204F582MR	LVR-IC	LDO, 5.8V±2%, 300mA, +CE	SOT-25	28cx	VR4	6g	Tor
4BY	XC6204B592MR	LVR-IC	LDO, 5.9V±2%, 150mA, +CE	SOT-25	28cx	VR4	6g	Tor
4BY	XC6105C229MR	Vdet-IC	2.9V±2%, Hst, +Rst PPO, -Rst ODO, Wt=50ms, Rt=50ms	SOT-25	28xg	VD20	6g	Tor
4BY	XC6204F592MR	LVR-IC	LDO, 5.9V±2%, 300mA, +CE	SOT-25	28cx	VR4	6g	Tor
4BZ	XC6204B602MR	LVR-IC	LDO, 6V±2%, 150mA, +CE	SOT-25	28cx	VR4	6g	Tor
4BZ	XC6105C230MR	Vdet-IC	3.0V±2%, Hst, +Rst PPO, -Rst ODO, Wt=50ms, Rt=50ms	SOT-25	28xg	VD20	6g	Tor
4BZ	XC6204F602MR	LVR-IC	LDO, 6V±2%, 300mA, +CE	SOT-25	28cx	VR4	6g	Tor
4C	R3111N241A	Vdet-IC	2.4V±2%, -Reset PPO	SOT-23-5	28vdm	VD7	6g	Ric
4C	RN5RL34AA	LVR-IC	3.4V±2.5%, 150mA	SOT-23-5	28vri	VR1	6g	Ric
4C	RN5VD24CA	Vdet-IC	2.4V±2.5%, -Reset ODO	SOT-23-5	28vdo	VD1	6g	Ric
4C0	XC6204C312MR	LVR-IC	LDO, 3.1V±2%, 150mA, -CE, PDR	SOT-25	28cx	VR4	6g	Tor
4C0	XC9235A20CMR	DC-DC-IC	PWM, st-dwn, 2.0V±2%, 600mA, 1.2MHz, Vin>2V, LSST	SOT-25	28dc4	DC1	6g	Tor
4C0	XC6105C331MR	Vdet-IC	3.1V±2%, Hst, +Rst PPO, -Rst ODO, Wt=100ms, Rt=50ms	SOT-25	28xg	VD20	6g	Tor
4C0	XC6204G312MR	LVR-IC	LDO, 3.1V±2%, 300mA, -CE, PDR	SOT-25	28cx	VR4	6g	Tor
4C1	XC6204C322MR	LVR-IC	LDO, 3.2V±2%, 150mA, -CE, PDR	SOT-25	28cx	VR4	6g	Tor
4C1	XC9235A21CMR	DC-DC-IC	PWM, st-dwn, 2.1V±2%, 600mA, 1.2MHz, Vin>2V, LSST	SOT-25	28dc4	DC1	6g	Tor
4C1	XC6105C332MR	Vdet-IC	3.2V±2%, Hst, +Rst PPO, -Rst ODO, Wt=100ms, Rt=50ms	SOT-25	28xg	VD20	6g	Tor
4C1	XC6204G322MR	LVR-IC	LDO, 3.2V±2%, 300mA, -CE, PDR	SOT-25	28cx	VR4	6g	Tor



SMD code	Type	Function	Short description	Case	Pinout	Sch.	St.	Mnf.
4C2	XC6204C332MR	LVR-IC	LDO, 3.3V±2%, 150mA, -CE, PDR	SOT-25	28cx	VR4	6g	Tor
4C2	XC9235A22CMR	DC-DC-IC	PWM, st-dwn, 2.2V±2%, 600mA, 1.2MHz, Vin>2V, LSST	SOT-25	28dc4	DC1	6g	Tor
4C2	XC6105C333MR	Vdet-IC	3.3V±2%, Hst, +Rst PPO, -Rst ODO, Wt=100ms, Rt=50ms	SOT-25	28xg	VD20	6g	Tor
4G2	XC6204G332MR	LVR-IC	LDO, 3.3V±2%, 300mA, -CE, PDR	SOT-25	28cx	VR4	6g	Tor
4C3	XC6204C342MR	LVR-IC	LDO, 3.4V±2%, 150mA, -CE, PDR	SOT-25	28cx	VR4	6g	Tor
4C3	XC9235A23CMR	DC-DC-IC	PWM, st-dwn, 2.3V±2%, 600mA, 1.2MHz, Vin>2V, LSST	SOT-25	28dc4	DC1	6g	Tor
4C3	XC6105C334MR	Vdet-IC	3.4V±2%, Hst, +Rst PPO, -Rst ODO, Wt=100ms, Rt=50ms	SOT-25	28xg	VD20	6g	Tor
4C3	XC6204G342MR	LVR-IC	LDO, 3.4V±2%, 300mA, -CE, PDR	SOT-25	28cx	VR4	6g	Tor
4C4	XC6204C352MR	LVR-IC	LDO, 3.5V±2%, 150mA, -CE, PDR	SOT-25	28cx	VR4	6g	Tor
4C4	XC9235A24CMR	DC-DC-IC	PWM, st-dwn, 2.4V±2%, 600mA, 1.2MHz, Vin>2V, LSST	SOT-25	28dc4	DC1	6g	Tor
4C4	XC6105C335MR	Vdet-IC	3.5V±2%, Hst, +Rst PPO, -Rst ODO, Wt=100ms, Rt=50ms	SOT-25	28xg	VD20	6g	Tor
4C4	XC6204G352MR	LVR-IC	LDO, 3.5V±2%, 300mA, -CE, PDR	SOT-25	28cx	VR4	6g	Tor
4C5	XC6204C362MR	LVR-IC	LDO, 3.6V±2%, 150mA, -CE, PDR	SOT-25	28cx	VR4	6g	Tor
4C5	XC9235A25CMR	DC-DC-IC	PWM, st-dwn, 2.5V±2%, 600mA, 1.2MHz, Vin>2V, LSST	SOT-25	28dc4	DC1	6g	Tor
4C5	XC6105C336MR	Vdet-IC	3.6V±2%, Hst, +Rst PPO, -Rst ODO, Wt=100ms, Rt=50ms	SOT-25	28xg	VD20	6g	Tor
4C5	XC6204G362MR	LVR-IC	LDO, 3.6V±2%, 300mA, -CE, PDR	SOT-25	28cx	VR4	6g	Tor
4C6	XC6204C372MR	LVR-IC	LDO, 3.7V±2%, 150mA, -CE, PDR	SOT-25	28cx	VR4	6g	Tor
4C6	XC9235A26CMR	DC-DC-IC	PWM, st-dwn, 2.6V±2%, 600mA, 1.2MHz, Vin>2V, LSST	SOT-25	28dc4	DC1	6g	Tor
4C6	XC6105C337MR	Vdet-IC	3.7V±2%, Hst, +Rst PPO, -Rst ODO, Wt=100ms, Rt=50ms	SOT-25	28xg	VD20	6g	Tor
4C6	XC6204G372MR	LVR-IC	LDO, 3.7V±2%, 300mA, -CE, PDR	SOT-25	28cx	VR4	6g	Tor
4C7	XC6204C382MR	LVR-IC	LDO, 3.8V±2%, 150mA, -CE, PDR	SOT-25	28cx	VR4	6g	Tor
4C7	XC9235A27CMR	DC-DC-IC	PWM, st-dwn, 2.7V±2%, 600mA, 1.2MHz, Vin>2V, LSST	SOT-25	28dc4	DC1	6g	Tor
4C7	XC6105C338MR	Vdet-IC	3.8V±2%, Hst, +Rst PPO, -Rst ODO, Wt=100ms, Rt=50ms	SOT-25	28xg	VD20	6g	Tor
4G7	XC6204G382MR	LVR-IC	LDO, 3.8V±2%, 300mA, -CE, PDR	SOT-25	28cx	VR4	6g	Tor
4C8	XC6204C392MR	LVR-IC	LDO, 3.9V±2%, 150mA, -CE, PDR	SOT-25	28cx	VR4	6g	Tor
4C8	XC9235A28CMR	DC-DC-IC	PWM, st-dwn, 2.8V±2%, 600mA, 1.2MHz, Vin>2V, LSST	SOT-25	28dc4	DC1	6g	Tor
4C8	XC6105C339MR	Vdet-IC	3.9V±2%, Hst, +Rst PPO, -Rst ODO, Wt=100ms, Rt=50ms	SOT-25	28xg	VD20	6g	Tor
4C8	XC6204G392MR	LVR-IC	LDO, 3.9V±2%, 300mA, -CE, PDR	SOT-25	28cx	VR4	6g	Tor
4C9	XC6204C402MR	LVR-IC	LDO, 4V±2%, 150mA, -CE, PDR	SOT-25	28cx	VR4	6g	Tor
4C9	XC9235A29CMR	DC-DC-IC	PWM, st-dwn, 2.9V±2%, 600mA, 1.2MHz, Vin>2V, LSST	SOT-25	28dc4	DC1	6g	Tor
4C9	XC6105C340MR	Vdet-IC	4.0V±2%, Hst, +Rst PPO, -Rst ODO, Wt=100ms, Rt=50ms	SOT-25	28xg	VD20	6g	Tor
4C9	XC6204G402MR	LVR-IC	LDO, 4V±2%, 300mA, -CE, PDR	SOT-25	28cx	VR4	6g	Tor
4CA	XC6204C412MR	LVR-IC	LDO, 4.1V±2%, 150mA, -CE, PDR	SOT-25	28cx	VR4	6g	Tor
4CA	XC9235A2ACMR	DC-DC-IC	PWM, st-dwn, 2.05V±2%, 600mA, 1.2MHz, Vin>2V, LSST	SOT-25	28dc4	DC1	6g	Tor
4CA	XC6105C341MR	Vdet-IC	4.1V±2%, Hst, +Rst PPO, -Rst ODO, Wt=100ms, Rt=50ms	SOT-25	28xg	VD20	6g	Tor
4CA	XC6204G412MR	LVR-IC	LDO, 4.1V±2%, 300mA, -CE, PDR	SOT-25	28cx	VR4	6g	Tor
4CB	XC6204C422MR	LVR-IC	LDO, 4.2V±2%, 150mA, -CE, PDR	SOT-25	28cx	VR4	6g	Tor
4CB	XC9235A2BCMR	DC-DC-IC	PWM, st-dwn, 2.15V±2%, 600mA, 1.2MHz, Vin>2V, LSST	SOT-25	28dc4	DC1	6g	Tor
4CB	XC6105C342MR	Vdet-IC	4.2V±2%, Hst, +Rst PPO, -Rst ODO, Wt=100ms, Rt=50ms	SOT-25	28xg	VD20	6g	Tor
4CB	XC6204G422MR	LVR-IC	LDO, 4.2V±2%, 300mA, -CE, PDR	SOT-25	28cx	VR4	6g	Tor
4CC	XC6204C432MR	LVR-IC	LDO, 4.3V±2%, 150mA, -CE, PDR	SOT-25	28cx	VR4	6g	Tor
4CC	XC9235A2CCMR	DC-DC-IC	PWM, st-dwn, 2.25V±2%, 600mA, 1.2MHz, Vin>2V, LSST	SOT-25	28dc4	DC1	6g	Tor
4CC	XC6105C343MR	Vdet-IC	4.3V±2%, Hst, +Rst PPO, -Rst ODO, Wt=100ms, Rt=50ms	SOT-25	28xg	VD20	6g	Tor
4CC	XC6204G432MR	LVR-IC	LDO, 4.3V±2%, 300mA, -CE, PDR	SOT-25	28cx	VR4	6g	Tor
4CD	XC6204C442MR	LVR-IC	LDO, 4.4V±2%, 150mA, -CE, PDR	SOT-25	28cx	VR4	6g	Tor
4CD	XC9235A2DCMR	DC-DC-IC	PWM, st-dwn, 2.35V±2%, 600mA, 1.2MHz, Vin>2V, LSST	SOT-25	28dc4	DC1	6g	Tor
4CD	XC6105C344MR	Vdet-IC	4.4V±2%, Hst, +Rst PPO, -Rst ODO, Wt=100ms, Rt=50ms	SOT-25	28xg	VD20	6g	Tor
4CD	XC6204G442MR	LVR-IC	LDO, 4.4V±2%, 300mA, -CE, PDR	SOT-25	28cx	VR4	6g	Tor
4CE	XC6204C452MR	LVR-IC	LDO, 4.5V±2%, 150mA, -CE, PDR	SOT-25	28cx	VR4	6g	Tor
4CE	XC9235A2ECMR	DC-DC-IC	PWM, st-dwn, 2.45V±2%, 600mA, 1.2MHz, Vin>2V, LSST	SOT-25	28dc4	DC1	6g	Tor
4CE	XC6105C345MR	Vdet-IC	4.5V±2%, Hst, +Rst PPO, -Rst ODO, Wt=100ms, Rt=50ms	SOT-25	28xg	VD20	6g	Tor
4CE	XC6204G452MR	LVR-IC	LDO, 4.5V±2%, 300mA, -CE, PDR	SOT-25	28cx	VR4	6g	Tor
4CF	XC6204C462MR	LVR-IC	LDO, 4.6V±2%, 150mA, -CE, PDR	SOT-25	28cx	VR4	6g	Tor
4CF	XC9235A2FCMR	DC-DC-IC	PWM, st-dwn, 2.55V±2%, 600mA, 1.2MHz, Vin>2V, LSST	SOT-25	28dc4	DC1	6g	Tor
4CF	XC6105C316MR	Vdet-IC	1.6V±2%, Hst, +Rst PPO, -Rst ODO, Wt=100ms, Rt=50ms	SOT-25	28xg	VD20	6g	Tor
4CF	XC6105C346MR	Vdet-IC	4.6V±2%, Hst, +Rst PPO, -Rst ODO, Wt=100ms, Rt=50ms	SOT-25	28xg	VD20	6g	Tor
4CF	XC6204G462MR	LVR-IC	LDO, 4.6V±2%, 300mA, -CE, PDR	SOT-25	28cx	VR4	6g	Tor
4CH	XC6204C472MR	LVR-IC	LDO, 4.7V±2%, 150mA, -CE, PDR	SOT-25	28cx	VR4	6g	Tor
4CH	XC9235A2HCMR	DC-DC-IC	PWM, st-dwn, 2.65V±2%, 600mA, 1.2MHz, Vin>2V, LSST	SOT-25	28dc4	DC1	6g	Tor
4CH	XC6105C317MR	Vdet-IC	1.7V±2%, Hst, +Rst PPO, -Rst ODO, Wt=100ms, Rt=50ms	SOT-25	28xg	VD20	6g	Tor
4CH	XC6105C347MR	Vdet-IC	4.7V±2%, Hst, +Rst PPO, -Rst ODO, Wt=100ms, Rt=50ms	SOT-25	28xg	VD20	6g	Tor
4CH	XC6204G472MR	LVR-IC	LDO, 4.7V±2%, 300mA, -CE, PDR	SOT-25	28cx	VR4	6g	Tor
4CK	XC6204C482MR	LVR-IC	LDO, 4.8V±2%, 150mA, -CE, PDR	SOT-25	28cx	VR4	6g	Tor
4CK	XC9235A2KCMR	DC-DC-IC	PWM, st-dwn, 2.75V±2%, 600mA, 1.2MHz, Vin>2V, LSST	SOT-25	28dc4	DC1	6g	Tor
4CK	XC6105C318MR	Vdet-IC	1.8V±2%, Hst, +Rst PPO, -Rst ODO, Wt=100ms, Rt=50ms	SOT-25	28xg	VD20	6g	Tor
4CK	XC6105C348MR	Vdet-IC	4.8V±2%, Hst, +Rst PPO, -Rst ODO, Wt=100ms, Rt=50ms	SOT-25	28xg	VD20	6g	Tor
4CK	XC6204G482MR	LVR-IC	LDO, 4.8V±2%, 300mA, -CE, PDR	SOT-25	28cx	VR4	6g	Tor
4CL	XC6204C492MR	LVR-IC	LDO, 4.9V±2%, 150mA, -CE, PDR	SOT-25	28cx	VR4	6g	Tor
4CL	XC9235A2LCMR	DC-DC-IC	PWM, st-dwn, 2.85V±2%, 600mA, 1.2MHz, Vin>2V, LSST	SOT-25	28dc4	DC1	6g	Tor
4CL	XC6105C319MR	Vdet-IC	1.9V±2%, Hst, +Rst PPO, -Rst ODO, Wt=100ms, Rt=50ms	SOT-25	28xg	VD20	6g	Tor



SMD code	Type	Function	Short description	Case	Pinout	Sch.	St.	Mnf.
4CL	XC6105C349MR	Vdet-IC	4.9V±2%, Hst, +Rst PPO, -Rst ODO, Wt=100ms, Rt=50ms	SOT-25	28xg	VD20	6g	Tor
4CL	XC6204G492MR	LVR-IC	LDO, 4.9V±2%, 300mA, -CE, PDR	SOT-25	28cx	VR4	6g	Tor
4CM	XC6204C502MR	LVR-IC	LDO, 5V±2%, 150mA, -CE, PDR	SOT-25	28cx	VR4	6g	Tor
4CM	XC9235A21CMCMR	DC-DC-IC	PWM, st-dwn, 2.95V±2%, 600mA, 1.2MHz, Vin>2V, LSST	SOT-25	28dc4	DC1	6g	Tor
4CM	XC6105C320MR	Vdet-IC	2.0V±2%, Hst, +Rst PPO, -Rst ODO, Wt=100ms, Rt=50ms	SOT-25	28xg	VD20	6g	Tor
4CM	XC6105C350MR	Vdet-IC	5.0V±2%, Hst, +Rst PPO, -Rst ODO, Wt=100ms, Rt=50ms	SOT-25	28xg	VD20	6g	Tor
4CM	XC6204C502MR	LVR-IC	LDO, 5V±2%, 300mA, -CE, PDR	SOT-25	28cx	VR4	6g	Tor
4CN	XC6204C512MR	LVR-IC	LDO, 5.1V±2%, 150mA, -CE, PDR	SOT-25	28cx	VR4	6g	Tor
4CN	XC6105C321MR	Vdet-IC	2.1V±2%, Hst, +Rst PPO, -Rst ODO, Wt=100ms, Rt=50ms	SOT-25	28xg	VD20	6g	Tor
4CN	XC6204G512MR	LVR-IC	LDO, 5.1V±2%, 300mA, -CE, PDR	SOT-25	28cx	VR4	6g	Tor
4CP	XC6204C522MR	LVR-IC	LDO, 5.2V±2%, 150mA, -CE, PDR	SOT-25	28cx	VR4	6g	Tor
4CP	XC6105C322MR	Vdet-IC	2.2V±2%, Hst, +Rst PPO, -Rst ODO, Wt=100ms, Rt=50ms	SOT-25	28xg	VD20	6g	Tor
4CP	XC6204G522MR	LVR-IC	LDO, 5.2V±2%, 300mA, -CE, PDR	SOT-25	28cx	VR4	6g	Tor
4CR	XC6204C532MR	LVR-IC	LDO, 5.3V±2%, 150mA, -CE, PDR	SOT-25	28cx	VR4	6g	Tor
4CR	XC6105C323MR	Vdet-IC	2.3V±2%, Hst, +Rst PPO, -Rst ODO, Wt=100ms, Rt=50ms	SOT-25	28xg	VD20	6g	Tor
4CR	XC6204G532MR	LVR-IC	LDO, 5.3V±2%, 300mA, -CE, PDR	SOT-25	28cx	VR4	6g	Tor
4CS	XC6204C542MR	LVR-IC	LDO, 5.4V±2%, 150mA, -CE, PDR	SOT-25	28cx	VR4	6g	Tor
4CS	XC6105C324MR	Vdet-IC	2.4V±2%, Hst, +Rst PPO, -Rst ODO, Wt=100ms, Rt=50ms	SOT-25	28xg	VD20	6g	Tor
4CS	XC6204G542MR	LVR-IC	LDO, 5.4V±2%, 300mA, -CE, PDR	SOT-25	28cx	VR4	6g	Tor
4CT	XC6204C552MR	LVR-IC	LDO, 5.5V±2%, 150mA, -CE, PDR	SOT-25	28cx	VR4	6g	Tor
4CT	XC6105C325MR	Vdet-IC	2.5V±2%, Hst, +Rst PPO, -Rst ODO, Wt=100ms, Rt=50ms	SOT-25	28xg	VD20	6g	Tor
4CT	XC6204G552MR	LVR-IC	LDO, 5.5V±2%, 300mA, -CE, PDR	SOT-25	28cx	VR4	6g	Tor
4CU	XC6204C562MR	LVR-IC	LDO, 5.6V±2%, 150mA, -CE, PDR	SOT-25	28cx	VR4	6g	Tor
4CU	XC6105C326MR	Vdet-IC	2.6V±2%, Hst, +Rst PPO, -Rst ODO, Wt=100ms, Rt=50ms	SOT-25	28xg	VD20	6g	Tor
4CU	XC6204G562MR	LVR-IC	LDO, 5.6V±2%, 300mA, -CE, PDR	SOT-25	28cx	VR4	6g	Tor
4CV	XC6204C572MR	LVR-IC	LDO, 5.7V±2%, 150mA, -CE, PDR	SOT-25	28cx	VR4	6g	Tor
4CV	XC6105C327MR	Vdet-IC	2.7V±2%, Hst, +Rst PPO, -Rst ODO, Wt=100ms, Rt=50ms	SOT-25	28xg	VD20	6g	Tor
4CV	XC6204G572MR	LVR-IC	LDO, 5.7V±2%, 300mA, -CE, PDR	SOT-25	28cx	VR4	6g	Tor
4CX	XC6204C582MR	LVR-IC	LDO, 5.8V±2%, 150mA, -CE, PDR	SOT-25	28cx	VR4	6g	Tor
4CX	XC6105C328MR	Vdet-IC	2.8V±2%, Hst, +Rst PPO, -Rst ODO, Wt=100ms, Rt=50ms	SOT-25	28xg	VD20	6g	Tor
4CX	XC6204G582MR	LVR-IC	LDO, 5.8V±2%, 300mA, -CE, PDR	SOT-25	28cx	VR4	6g	Tor
4CY	XC6204C592MR	LVR-IC	LDO, 5.9V±2%, 150mA, -CE, PDR	SOT-25	28cx	VR4	6g	Tor
4CY	XC6105C329MR	Vdet-IC	2.9V±2%, Hst, +Rst PPO, -Rst ODO, Wt=100ms, Rt=50ms	SOT-25	28xg	VD20	6g	Tor
4CY	XC6204G592MR	LVR-IC	LDO, 5.9V±2%, 300mA, -CE, PDR	SOT-25	28cx	VR4	6g	Tor
4CZ	XC6204C602MR	LVR-IC	LDO, 6V±2%, 150mA, -CE, PDR	SOT-25	28cx	VR4	6g	Tor
4CZ	XC6105C330MR	Vdet-IC	3.0V±2%, Hst, +Rst PPO, -Rst ODO, Wt=100ms, Rt=50ms	SOT-25	28xg	VD20	6g	Tor
4CZ	XC6204G602MR	LVR-IC	LDO, 6V±2%, 300mA, -CE, PDR	SOT-25	28cx	VR4	6g	Tor
4D	R3111N341A	Vdet-IC	3.4V±2%, -Reset PPO	SOT-23-5	28vdm	VD7	6g	Ric
4D	RN5RL44AA	LVR-IC	4.4V±2.5%, 150mA	SOT-23-5	28vu	VR1	6g	Ric
4D	RN5VD34CA	Vdet-IC	3.4V±2.5%, -Reset ODO	SOT-23-5	28vdo	VD1	6g	Ric
4D0	XC6204D312MR	LVR-IC	LDO, 3.1V±2%, 150mA, -CE	SOT-25	28cx	VR4	6g	Tor
4D0	XC9235A30CMR	DC-DC-IC	PWM, st-dwn, 3.0V±2%, 600mA, 1.2MHz, Vin>2V, LSST	SOT-25	28dc4	DC1	6g	Tor
4D0	XC6105C431MR	Vdet-IC	3.1V±2%, Hst, +Rst PPO, -Rst ODO, Wt=200ms, Rt=50ms	SOT-25	28xg	VD20	6g	Tor
4D0	XC6204H312MR	LVR-IC	LDO, 3.1V±2%, 300mA, -CE	SOT-25	28cx	VR4	6g	Tor
4D1	XC6204D322MR	LVR-IC	LDO, 3.2V±2%, 150mA, -CE	SOT-25	28cx	VR4	6g	Tor
4D1	XC9235A31CMR	DC-DC-IC	PWM, st-dwn, 3.1V±2%, 600mA, 1.2MHz, Vin>2V, LSST	SOT-25	28dc4	DC1	6g	Tor
4D1	XC6105C432MR	Vdet-IC	3.2V±2%, Hst, +Rst PPO, -Rst ODO, Wt=200ms, Rt=50ms	SOT-25	28xg	VD20	6g	Tor
4D1	XC6204H322MR	LVR-IC	LDO, 3.2V±2%, 300mA, -CE	SOT-25	28cx	VR4	6g	Tor
4D2	XC6204D332MR	LVR-IC	LDO, 3.3V±2%, 150mA, -CE	SOT-25	28cx	VR4	6g	Tor
4D2	XC9235A32CMR	DC-DC-IC	PWM, st-dwn, 3.2V±2%, 600mA, 1.2MHz, Vin>2V, LSST	SOT-25	28dc4	DC1	6g	Tor
4D2	XC6105C433MR	Vdet-IC	3.3V±2%, Hst, +Rst PPO, -Rst ODO, Wt=200ms, Rt=50ms	SOT-25	28xg	VD20	6g	Tor
4D2	XC6204H332MR	LVR-IC	LDO, 3.3V±2%, 300mA, -CE	SOT-25	28cx	VR4	6g	Tor
4D3	XC6204D342MR	LVR-IC	LDO, 3.4V±2%, 150mA, -CE	SOT-25	28cx	VR4	6g	Tor
4D3	XC9235A33CMR	DC-DC-IC	PWM, st-dwn, 3.3V±2%, 600mA, 1.2MHz, Vin>2V, LSST	SOT-25	28dc4	DC1	6g	Tor
4D3	XC6105C434MR	Vdet-IC	3.4V±2%, Hst, +Rst PPO, -Rst ODO, Wt=200ms, Rt=50ms	SOT-25	28xg	VD20	6g	Tor
4D3	XC6204H342MR	LVR-IC	LDO, 3.4V±2%, 300mA, -CE	SOT-25	28cx	VR4	6g	Tor
4D4	XC6204D352MR	LVR-IC	LDO, 3.5V±2%, 150mA, -CE	SOT-25	28cx	VR4	6g	Tor
4D4	XC9235A34CMR	DC-DC-IC	PWM, st-dwn, 3.4V±2%, 600mA, 1.2MHz, Vin>2V, LSST	SOT-25	28dc4	DC1	6g	Tor
4D4	XC6105C435MR	Vdet-IC	3.5V±2%, Hst, +Rst PPO, -Rst ODO, Wt=200ms, Rt=50ms	SOT-25	28xg	VD20	6g	Tor
4D4	XC6204H352MR	LVR-IC	LDO, 3.5V±2%, 300mA, -CE	SOT-25	28cx	VR4	6g	Tor
4D5	XC6204D362MR	LVR-IC	LDO, 3.6V±2%, 150mA, -CE	SOT-25	28cx	VR4	6g	Tor
4D5	XC9235A35CMR	DC-DC-IC	PWM, st-dwn, 3.5V±2%, 600mA, 1.2MHz, Vin>2V, LSST	SOT-25	28dc4	DC1	6g	Tor
4D5	XC6105C436MR	Vdet-IC	3.6V±2%, Hst, +Rst PPO, -Rst ODO, Wt=200ms, Rt=50ms	SOT-25	28xg	VD20	6g	Tor
4D5	XC6204H362MR	LVR-IC	LDO, 3.6V±2%, 300mA, -CE	SOT-25	28cx	VR4	6g	Tor
4D6	XC6204D372MR	LVR-IC	LDO, 3.7V±2%, 150mA, -CE	SOT-25	28cx	VR4	6g	Tor
4D6	XC9235A36CMR	DC-DC-IC	PWM, st-dwn, 3.6V±2%, 600mA, 1.2MHz, Vin>2V, LSST	SOT-25	28dc4	DC1	6g	Tor
4D6	XC6105C437MR	Vdet-IC	3.7V±2%, Hst, +Rst PPO, -Rst ODO, Wt=200ms, Rt=50ms	SOT-25	28xg	VD20	6g	Tor
4D6	XC6204H372MR	LVR-IC	LDO, 3.7V±2%, 300mA, -CE	SOT-25	28cx	VR4	6g	Tor
4D7	XC6204D382MR	LVR-IC	LDO, 3.8V±2%, 150mA, -CE	SOT-25	28cx	VR4	6g	Tor
4D7	XC9235A37CMR	DC-DC-IC	PWM, st-dwn, 3.7V±2%, 600mA, 1.2MHz, Vin>2V, LSST	SOT-25	28dc4	DC1	6g	Tor



SMD code	Type	Function	Short description	Case	Pinout	Sch.	St.	Mnf.
4D7	XC6105C438MR	Vdet-IC	3.8V±2%, Hst, +Rst PPO, -Rst ODO, Wt=200ms, Rt=50ms	SOT-25	28xc	VD20	6g	Tor
4D7	XC6204H382MR	LVR-IC	LDO, 3.8V±2%, 300mA, -CE	SOT-25	28xc	VR4	6g	Tor
4D8	XC6204D392MR	LVR-IC	LDO, 3.9V±2%, 150mA, -CE	SOT-25	28xc	VR4	6g	Tor
4D8	XC9235A383CMR	DC-DC-IC	PWM, st-dwn, 3.8V±2%, 600mA, 1.2MHz, Vin>2V, LSST	SOT-25	28dc4	DC1	6g	Tor
4D8	XC6105C439MR	Vdet-IC	3.9V±2%, Hst, +Rst PPO, -Rst ODO, Wt=200ms, Rt=50ms	SOT-25	28xc	VD20	6g	Tor
4D8	XC6204H392MR	LVR-IC	LDO, 3.9V±2%, 300mA, -CE	SOT-25	28xc	VR4	6g	Tor
4D9	XC6204D402MR	LVR-IC	LDO, 4V±2%, 150mA, -CE	SOT-25	28xc	VR4	6g	Tor
4D9	XC9235A393CMR	DC-DC-IC	PWM, st-dwn, 3.9V±2%, 600mA, 1.2MHz, Vin>2V, LSST	SOT-25	28dc4	DC1	6g	Tor
4D9	XC6105C440MR	Vdet-IC	4.0V±2%, Hst, +Rst PPO, -Rst ODO, Wt=200ms, Rt=50ms	SOT-25	28xc	VD20	6g	Tor
4D9	XC6204H402MR	LVR-IC	LDO, 4V±2%, 300mA, -CE	SOT-25	28xc	VR4	6g	Tor
4DA	XC6204D412MR	LVR-IC	LDO, 4.1V±2%, 150mA, -CE	SOT-25	28xc	VR4	6g	Tor
4DA	XC9235A3ACMR	DC-DC-IC	PWM, st-dwn, 3.05V±2%, 600mA, 1.2MHz, Vin>2V, LSST	SOT-25	28dc4	DC1	6g	Tor
4DA	XC6105C441MR	Vdet-IC	4.1V±2%, Hst, +Rst PPO, -Rst ODO, Wt=200ms, Rt=50ms	SOT-25	28xc	VD20	6g	Tor
4DA	XC6204H412MR	LVR-IC	LDO, 4.1V±2%, 300mA, -CE	SOT-25	28xc	VR4	6g	Tor
4DB	XC6204D422MR	LVR-IC	LDO, 4.2V±2%, 150mA, -CE	SOT-25	28xc	VR4	6g	Tor
4DB	XC9235A3BCMR	DC-DC-IC	PWM, st-dwn, 3.15V±2%, 600mA, 1.2MHz, Vin>2V, LSST	SOT-25	28dc4	DC1	6g	Tor
4DB	XC6105C442MR	Vdet-IC	4.2V±2%, Hst, +Rst PPO, -Rst ODO, Wt=200ms, Rt=50ms	SOT-25	28xc	VD20	6g	Tor
4DB	XC6204H422MR	LVR-IC	LDO, 4.2V±2%, 300mA, -CE	SOT-25	28xc	VR4	6g	Tor
4DC	XC6204D432MR	LVR-IC	LDO, 4.3V±2%, 150mA, -CE	SOT-25	28xc	VR4	6g	Tor
4DC	XC9235A3CCMR	DC-DC-IC	PWM, st-dwn, 3.25V±2%, 600mA, 1.2MHz, Vin>2V, LSST	SOT-25	28dc4	DC1	6g	Tor
4DC	XC6105C443MR	Vdet-IC	4.3V±2%, Hst, +Rst PPO, -Rst ODO, Wt=200ms, Rt=50ms	SOT-25	28xc	VD20	6g	Tor
4DC	XC6204H432MR	LVR-IC	LDO, 4.3V±2%, 300mA, -CE	SOT-25	28xc	VR4	6g	Tor
4DD	XC6204D442MR	LVR-IC	LDO, 4.4V±2%, 150mA, -CE	SOT-25	28xc	VR4	6g	Tor
4DD	XC9235A3DCMR	DC-DC-IC	PWM, st-dwn, 3.35V±2%, 600mA, 1.2MHz, Vin>2V, LSST	SOT-25	28dc4	DC1	6g	Tor
4DD	XC6105C444MR	Vdet-IC	4.4V±2%, Hst, +Rst PPO, -Rst ODO, Wt=200ms, Rt=50ms	SOT-25	28xc	VD20	6g	Tor
4DD	XC6204H442MR	LVR-IC	LDO, 4.4V±2%, 300mA, -CE	SOT-25	28xc	VR4	6g	Tor
4DE	XC6204D452MR	LVR-IC	LDO, 4.5V±2%, 150mA, -CE	SOT-25	28xc	VR4	6g	Tor
4DE	XC9235A3ECMR	DC-DC-IC	PWM, st-dwn, 3.45V±2%, 600mA, 1.2MHz, Vin>2V, LSST	SOT-25	28dc4	DC1	6g	Tor
4DE	XC6105C445MR	Vdet-IC	4.5V±2%, Hst, +Rst PPO, -Rst ODO, Wt=200ms, Rt=50ms	SOT-25	28xc	VD20	6g	Tor
4DE	XC6204H452MR	LVR-IC	LDO, 4.5V±2%, 300mA, -CE	SOT-25	28xc	VR4	6g	Tor
4DF	XC6204D462MR	LVR-IC	LDO, 4.6V±2%, 150mA, -CE	SOT-25	28xc	VR4	6g	Tor
4DF	XC9235A3FCMR	DC-DC-IC	PWM, st-dwn, 3.55V±2%, 600mA, 1.2MHz, Vin>2V, LSST	SOT-25	28dc4	DC1	6g	Tor
4DF	XC6105C416MR	Vdet-IC	1.6V±2%, Hst, +Rst PPO, -Rst ODO, Wt=200ms, Rt=50ms	SOT-25	28xc	VD20	6g	Tor
4DE	XC6105C446MR	Vdet-IC	4.6V±2%, Hst, +Rst PPO, -Rst ODO, Wt=200ms, Rt=50ms	SOT-25	28xc	VD20	6g	Tor
4DF	XC6204H462MR	LVR-IC	LDO, 4.6V±2%, 300mA, -CE	SOT-25	28xc	VR4	6g	Tor
4DH	XC6204D472MR	LVR-IC	LDO, 4.7V±2%, 150mA, -CE	SOT-25	28xc	VR4	6g	Tor
4DH	XC9235A3HCMR	DC-DC-IC	PWM, st-dwn, 3.65V±2%, 600mA, 1.2MHz, Vin>2V, LSST	SOT-25	28dc4	DC1	6g	Tor
4DH	XC6105C417MR	Vdet-IC	1.7V±2%, Hst, +Rst PPO, -Rst ODO, Wt=200ms, Rt=50ms	SOT-25	28xc	VD20	6g	Tor
4DH	XC6105C447MR	Vdet-IC	4.7V±2%, Hst, +Rst PPO, -Rst ODO, Wt=200ms, Rt=50ms	SOT-25	28xc	VD20	6g	Tor
4DH	XC6204H472MR	LVR-IC	LDO, 4.7V±2%, 300mA, -CE	SOT-25	28xc	VR4	6g	Tor
4DK	XC6204D482MR	LVR-IC	LDO, 4.8V±2%, 150mA, -CE	SOT-25	28xc	VR4	6g	Tor
4DK	XC9235A3KCMR	DC-DC-IC	PWM, st-dwn, 3.75V±2%, 600mA, 1.2MHz, Vin>2V, LSST	SOT-25	28dc4	DC1	6g	Tor
4DK	XC6105C418MR	Vdet-IC	1.8V±2%, Hst, +Rst PPO, -Rst ODO, Wt=200ms, Rt=50ms	SOT-25	28xc	VD20	6g	Tor
4DK	XC6105C448MR	Vdet-IC	4.8V±2%, Hst, +Rst PPO, -Rst ODO, Wt=200ms, Rt=50ms	SOT-25	28xc	VD20	6g	Tor
4DK	XC6204H482MR	LVR-IC	LDO, 4.8V±2%, 300mA, -CE	SOT-25	28xc	VR4	6g	Tor
4DL	XC6204D492MR	LVR-IC	LDO, 4.9V±2%, 150mA, -CE	SOT-25	28xc	VR4	6g	Tor
4DL	XC9235A3LCMR	DC-DC-IC	PWM, st-dwn, 3.85V±2%, 600mA, 1.2MHz, Vin>2V, LSST	SOT-25	28dc4	DC1	6g	Tor
4DL	XC6105C419MR	Vdet-IC	1.9V±2%, Hst, +Rst PPO, -Rst ODO, Wt=200ms, Rt=50ms	SOT-25	28xc	VD20	6g	Tor
4DL	XC6105C449MR	Vdet-IC	4.9V±2%, Hst, +Rst PPO, -Rst ODO, Wt=200ms, Rt=50ms	SOT-25	28xc	VD20	6g	Tor
4DL	XC6204H492MR	LVR-IC	LDO, 4.9V±2%, 300mA, -CE	SOT-25	28xc	VR4	6g	Tor
4DM	XC6204D502MR	LVR-IC	LDO, 5V±2%, 150mA, -CE	SOT-25	28xc	VR4	6g	Tor
4DM	XC9235A3MCMR	DC-DC-IC	PWM, st-dwn, 3.95V±2%, 600mA, 1.2MHz, Vin>2V, LSST	SOT-25	28dc4	DC1	6g	Tor
4DM	XC6105C420MR	Vdet-IC	2.0V±2%, Hst, +Rst PPO, -Rst ODO, Wt=200ms, Rt=50ms	SOT-25	28xc	VD20	6g	Tor
4DM	XC6105C450MR	Vdet-IC	5.0V±2%, Hst, +Rst PPO, -Rst ODO, Wt=200ms, Rt=50ms	SOT-25	28xc	VD20	6g	Tor
4DM	XC6204H502MR	LVR-IC	LDO, 5V±2%, 300mA, -CE	SOT-25	28xc	VR4	6g	Tor
4DN	XC6204D512MR	LVR-IC	LDO, 5.1V±2%, 150mA, -CE	SOT-25	28xc	VR4	6g	Tor
4DN	XC6105C421MR	Vdet-IC	2.1V±2%, Hst, +Rst PPO, -Rst ODO, Wt=200ms, Rt=50ms	SOT-25	28xc	VD20	6g	Tor
4DN	XC6204H512MR	LVR-IC	LDO, 5.1V±2%, 300mA, -CE	SOT-25	28xc	VR4	6g	Tor
4DP	XC6204D522MR	LVR-IC	LDO, 5.2V±2%, 150mA, -CE	SOT-25	28xc	VR4	6g	Tor
4DP	XC6105C422MR	Vdet-IC	2.2V±2%, Hst, +Rst PPO, -Rst ODO, Wt=200ms, Rt=50ms	SOT-25	28xc	VD20	6g	Tor
4DP	XC6204H522MR	LVR-IC	LDO, 5.2V±2%, 300mA, -CE	SOT-25	28xc	VR4	6g	Tor
4DR	XC6204D532MR	LVR-IC	LDO, 5.3V±2%, 150mA, -CE	SOT-25	28xc	VR4	6g	Tor
4DR	XC6105C423MR	Vdet-IC	2.3V±2%, Hst, +Rst PPO, -Rst ODO, Wt=200ms, Rt=50ms	SOT-25	28xc	VD20	6g	Tor
4DR	XC6204H532MR	LVR-IC	LDO, 5.3V±2%, 300mA, -CE	SOT-25	28xc	VR4	6g	Tor
4DS	XC6204D542MR	LVR-IC	LDO, 5.4V±2%, 150mA, -CE	SOT-25	28xc	VR4	6g	Tor
4DS	XC6105C424MR	Vdet-IC	2.4V±2%, Hst, +Rst PPO, -Rst ODO, Wt=200ms, Rt=50ms	SOT-25	28xc	VD20	6g	Tor
4DS	XC6204H542MR	LVR-IC	LDO, 5.4V±2%, 300mA, -CE	SOT-25	28xc	VR4	6g	Tor
4DT	XC6204D552MR	LVR-IC	LDO, 5.5V±2%, 150mA, -CE	SOT-25	28xc	VR4	6g	Tor
4DT	XC6105C425MR	Vdet-IC	2.5V±2%, Hst, +Rst PPO, -Rst ODO, Wt=200ms, Rt=50ms	SOT-25	28xc	VD20	6g	Tor
4DT	XC6204H552MR	LVR-IC	LDO, 5.5V±2%, 300mA, -CE	SOT-25	28xc	VR4	6g	Tor



SMD code	Type	Function	Short description	Case	Pinout	Sch.	St.	Mnf.
4DU	XC6204D562MR	LVR-IC	LDO, 5.6V±2%, 150mA, -CE	SOT-25	28cx	VR4	6g	Tor
4DU	XG6105C426MR	Vdet-IC	2.6V±2%, Hst, +Rst PPO, -Rst ODO, Wt=200ms, Rt=50ms	SOT-25	28cx	VD20	6g	Tor
4DU	XC6204H562MR	LVR-IC	LDO, 5.6V±2%, 300mA, -CE	SOT-25	28cx	VR4	6g	Tor
4DV	XC6204D572MR	LVR-IC	LDO, 5.7V±2%, 150mA, -CE	SOT-25	28cx	VR4	6g	Tor
4DV	XC6105C427MR	Vdet-IC	2.7V±2%, Hst, +Rst PPO, -Rst ODO, Wt=200ms, Rt=50ms	SOT-25	28cx	VD20	6g	Tor
4DV	XC6204H572MR	LVR-IC	LDO, 5.7V±2%, 300mA, -CE	SOT-25	28cx	VR4	6g	Tor
4DX	XC6204D582MR	LVR-IC	LDO, 5.8V±2%, 150mA, -CE	SOT-25	28cx	VR4	6g	Tor
4DX	XC6105C428MR	Vdet-IC	2.8V±2%, Hst, +Rst PPO, -Rst ODO, Wt=200ms, Rt=50ms	SOT-25	28cx	VD20	6g	Tor
4DX	XC6204H582MR	LVR-IC	LDO, 5.8V±2%, 300mA, -CE	SOT-25	28cx	VR4	6g	Tor
4DY	XC6204D592MR	LVR-IC	LDO, 5.9V±2%, 150mA, -CE	SOT-25	28cx	VR4	6g	Tor
4DY	XC6105C429MR	Vdet-IC	2.9V±2%, Hst, +Rst PPO, -Rst ODO, Wt=200ms, Rt=50ms	SOT-25	28cx	VD20	6g	Tor
4DY	XC6204H592MR	LVR-IC	LDO, 5.9V±2%, 300mA, -CE	SOT-25	28cx	VR4	6g	Tor
4DZ	XC6204D602MR	LVR-IC	LDO, 6V±2%, 150mA, -CE	SOT-25	28cx	VR4	6g	Tor
4DZ	XC6105C430MR	Vdet-IC	3.0V±2%, Hst, +Rst PPO, -Rst ODO, Wt=200ms, Rt=50ms	SOT-25	28cx	VD20	6g	Tor
4DZ	XC6204H602MR	LVR-IC	LDO, 6V±2%, 300mA, -CE	SOT-25	28cx	VR4	6g	Tor
4E	R3111N441A	Vdet-IC	4.4V±2%, -Reset PPO	SOT-23-5	28vdm	VD7	6g	Ric
4E	RN5RL54AA	LVR-IC	5.4V±2.5%, 150mA	SOT-23-5	28vu	VR1	6g	Ric
4E	RN5VD44CA	Vdet-IC	4.4V±2.5%, -Reset ODO	SOT-23-5	28vdo	VD1	6g	Ric
4E0	XC9235A40CMR	DC-DC-IC	PWM, st-dwn, 4.0V±2%, 600mA, 1.2MHz, Vin>2V, LSSST	SOT-25	28dc4	DC1	6g	Tor
4E1	XC6105C531MR	Vdet-IC	3.1V±2%, Hst, +Rst PPO, -Rst ODO, Wt=400ms, Rt=50ms	SOT-25	28cx	VD20	6g	Tor
4E1	XC6105C532MR	Vdet-IC	3.2V±2%, Hst, +Rst PPO, -Rst ODO, Wt=400ms, Rt=50ms	SOT-25	28cx	VD20	6g	Tor
4E2	XC6105C533MR	Vdet-IC	3.3V±2%, Hst, +Rst PPO, -Rst ODO, Wt=400ms, Rt=50ms	SOT-25	28cx	VD20	6g	Tor
4E3	XC6105C534MR	Vdet-IC	3.4V±2%, Hst, +Rst PPO, -Rst ODO, Wt=400ms, Rt=50ms	SOT-25	28cx	VD20	6g	Tor
4E4	XC6105C535MR	Vdet-IC	3.5V±2%, Hst, +Rst PPO, -Rst ODO, Wt=400ms, Rt=50ms	SOT-25	28cx	VD20	6g	Tor
4E5	XC6105C536MR	Vdet-IC	3.6V±2%, Hst, +Rst PPO, -Rst ODO, Wt=400ms, Rt=50ms	SOT-25	28cx	VD20	6g	Tor
4E6	XC6105C537MR	Vdet-IC	3.7V±2%, Hst, +Rst PPO, -Rst ODO, Wt=400ms, Rt=50ms	SOT-25	28cx	VD20	6g	Tor
4E7	XC6105C538MR	Vdet-IC	3.8V±2%, Hst, +Rst PPO, -Rst ODO, Wt=400ms, Rt=50ms	SOT-25	28cx	VD20	6g	Tor
4E8	XC6105C539MR	Vdet-IC	3.9V±2%, Hst, +Rst PPO, -Rst ODO, Wt=400ms, Rt=50ms	SOT-25	28cx	VD20	6g	Tor
4E9	XC6105C540MR	Vdet-IC	4.0V±2%, Hst, +Rst PPO, -Rst ODO, Wt=400ms, Rt=50ms	SOT-25	28cx	VD20	6g	Tor
4EA	XC6105C541MR	Vdet-IC	4.1V±2%, Hst, +Rst PPO, -Rst ODO, Wt=400ms, Rt=50ms	SOT-25	28cx	VD20	6g	Tor
4EB	XC6105C542MR	Vdet-IC	4.2V±2%, Hst, +Rst PPO, -Rst ODO, Wt=400ms, Rt=50ms	SOT-25	28cx	VD20	6g	Tor
4EC	XC6105C543MR	Vdet-IC	4.3V±2%, Hst, +Rst PPO, -Rst ODO, Wt=400ms, Rt=50ms	SOT-25	28cx	VD20	6g	Tor
4ED	XC6105C544MR	Vdet-IC	4.4V±2%, Hst, +Rst PPO, -Rst ODO, Wt=400ms, Rt=50ms	SOT-25	28cx	VD20	6g	Tor
4EE	XC6105C545MR	Vdet-IC	4.5V±2%, Hst, +Rst PPO, -Rst ODO, Wt=400ms, Rt=50ms	SOT-25	28cx	VD20	6g	Tor
4EF	XC6105C546MR	Vdet-IC	4.6V±2%, Hst, +Rst PPO, -Rst ODO, Wt=400ms, Rt=50ms	SOT-25	28cx	VD20	6g	Tor
4EF	XC6105C546MR	Vdet-IC	4.6V±2%, Hst, +Rst PPO, -Rst ODO, Wt=400ms, Rt=50ms	SOT-25	28cx	VD20	6g	Tor
4EH	XC6105C547MR	Vdet-IC	4.7V±2%, Hst, +Rst PPO, -Rst ODO, Wt=400ms, Rt=50ms	SOT-25	28cx	VD20	6g	Tor
4EH	XC6105C547MR	Vdet-IC	4.7V±2%, Hst, +Rst PPO, -Rst ODO, Wt=400ms, Rt=50ms	SOT-25	28cx	VD20	6g	Tor
4EH	XC6105C547MR	Vdet-IC	4.7V±2%, Hst, +Rst PPO, -Rst ODO, Wt=400ms, Rt=50ms	SOT-25	28cx	VD20	6g	Tor
4EK	XC6204A18AMR	LVR-IC	LDO, 1.85V±2%, 150mA, +CE, PDR	SOT-25	28cx	VR4	6g	Tor
4EK	XC6105C518MR	Vdet-IC	1.8V±2%, Hst, +Rst PPO, -Rst ODO, Wt=400ms, Rt=50ms	SOT-25	28cx	VD20	6g	Tor
4EK	XC6105C548MR	Vdet-IC	4.8V±2%, Hst, +Rst PPO, -Rst ODO, Wt=400ms, Rt=50ms	SOT-25	28cx	VD20	6g	Tor
4EK	XC6204E18AMR	LVR-IC	LDO, 1.85V±2%, 300mA, +CE, PDR	SOT-25	28cx	VR4	6g	Tor
4EL	XC6204A19AMR	LVR-IC	LDO, 1.95V±2%, 150mA, +CE, PDR	SOT-25	28cx	VR4	6g	Tor
4EL	XC6105C519MR	Vdet-IC	1.9V±2%, Hst, +Rst PPO, -Rst ODO, Wt=400ms, Rt=50ms	SOT-25	28cx	VD20	6g	Tor
4EL	XC6105C549MR	Vdet-IC	4.9V±2%, Hst, +Rst PPO, -Rst ODO, Wt=400ms, Rt=50ms	SOT-25	28cx	VD20	6g	Tor
4EL	XC6204E19AMR	LVR-IC	LDO, 1.95V±2%, 300mA, +CE, PDR	SOT-25	28cx	VR4	6g	Tor
4EM	XC6204A20AMR	LVR-IC	LDO, 2.05V±2%, 150mA, +CE, PDR	SOT-25	28cx	VR4	6g	Tor
4EM	XC6105C520MR	Vdet-IC	2.0V±2%, Hst, +Rst PPO, -Rst ODO, Wt=400ms, Rt=50ms	SOT-25	28cx	VD20	6g	Tor
4EM	XC6105C550MR	Vdet-IC	5.0V±2%, Hst, +Rst PPO, -Rst ODO, Wt=400ms, Rt=50ms	SOT-25	28cx	VD20	6g	Tor
4EM	XC6204E20AMR	LVR-IC	LDO, 2.05V±2%, 300mA, +CE, PDR	SOT-25	28cx	VR4	6g	Tor
4EN	XC6204A21AMR	LVR-IC	LDO, 2.15V±2%, 150mA, +CE, PDR	SOT-25	28cx	VR4	6g	Tor
4EN	XC6105C521MR	Vdet-IC	2.1V±2%, Hst, +Rst PPO, -Rst ODO, Wt=400ms, Rt=50ms	SOT-25	28cx	VD20	6g	Tor
4EN	XC6204E21AMR	LVR-IC	LDO, 2.15V±2%, 300mA, +CE, PDR	SOT-25	28cx	VR4	6g	Tor
4EP	XC6204A22AMR	LVR-IC	LDO, 2.25V±2%, 150mA, +CE, PDR	SOT-25	28cx	VR4	6g	Tor
4EP	XC6105C522MR	Vdet-IC	2.2V±2%, Hst, +Rst PPO, -Rst ODO, Wt=400ms, Rt=50ms	SOT-25	28cx	VD20	6g	Tor
4EP	XC6204E22AMR	LVR-IC	LDO, 2.25V±2%, 300mA, +CE, PDR	SOT-25	28cx	VR4	6g	Tor
4EP	XC6204A23AMR	LVR-IC	LDO, 2.35V±2%, 150mA, +CE, PDR	SOT-25	28cx	VR4	6g	Tor
4ER	XC6105C523MR	Vdet-IC	2.3V±2%, Hst, +Rst PPO, -Rst ODO, Wt=400ms, Rt=50ms	SOT-25	28cx	VD20	6g	Tor
4ER	XC6204E23AMR	LVR-IC	LDO, 2.35V±2%, 300mA, +CE, PDR	SOT-25	28cx	VR4	6g	Tor
4ES	XC6204A24AMR	LVR-IC	LDO, 2.45V±2%, 150mA, +CE, PDR	SOT-25	28cx	VR4	6g	Tor
4ES	XC6105C524MR	Vdet-IC	2.4V±2%, Hst, +Rst PPO, -Rst ODO, Wt=400ms, Rt=50ms	SOT-25	28cx	VD20	6g	Tor
4ES	XC6204E24AMR	LVR-IC	LDO, 2.45V±2%, 300mA, +CE, PDR	SOT-25	28cx	VR4	6g	Tor
4ET	XC6204A25AMR	LVR-IC	LDO, 2.55V±2%, 150mA, +CE, PDR	SOT-25	28cx	VR4	6g	Tor
4ET	XC6105C525MR	Vdet-IC	2.5V±2%, Hst, +Rst PPO, -Rst ODO, Wt=400ms, Rt=50ms	SOT-25	28cx	VD20	6g	Tor
4ET	XC6204E25AMR	LVR-IC	LDO, 2.55V±2%, 300mA, +CE, PDR	SOT-25	28cx	VR4	6g	Tor
4EU	XC6204A26AMR	LVR-IC	LDO, 2.65V±2%, 150mA, +CE, PDR	SOT-25	28cx	VR4	6g	Tor
4EU	XC6105C526MR	Vdet-IC	2.6V±2%, Hst, +Rst PPO, -Rst ODO, Wt=400ms, Rt=50ms	SOT-25	28cx	VD20	6g	Tor
4EU	XC6204E26AMR	LVR-IC	LDO, 2.65V±2%, 300mA, +CE, PDR	SOT-25	28cx	VR4	6g	Tor
4EV	XC6204A27AMR	LVR-IC	LDO, 2.75V±2%, 150mA, +CE, PDR	SOT-25	28cx	VR4	6g	Tor
4EV	XC6105C527MR	Vdet-IC	2.7V±2%, Hst, +Rst PPO, -Rst ODO, Wt=400ms, Rt=50ms	SOT-25	28cx	VD20	6g	Tor



SMD code	Type	Function	Short description	Case	Pinout	Sch.	St.	Mnf.
4EV	XC6204E27AMR	LVR-IC	LDO, 2.75V±2%, 300mA, +CE, PDR	SOT-25	28cx	VR4	6g	Tor
4EX	XC6204A28AMR	LVR-IC	LDO, 2.85V±2%, 150mA, +CE, PDR	SOT-25	28cx	VR4	6g	Tor
4EX	XC6105C528MR	Vdet-IC	2.8V±2%, Hst, +Rst PPO, -Rst ODO, Wt=400ms, Rt=50ms	SOT-25	28xg	VD20	6g	Tor
4EX	XC6204E28AMR	LVR-IC	LDO, 2.85V±2%, 300mA, +CE, PDR	SOT-25	28cx	VR4	6g	Tor
4EY	XC6204A29AMR	LVR-IC	LDO, 2.95V±2%, 150mA, +CE, PDR	SOT-25	28cx	VR4	6g	Tor
4EY	XC6105C529MR	Vdet-IC	2.9V±2%, Hst, +Rst PPO, -Rst ODO, Wt=400ms, Rt=50ms	SOT-25	28xg	VD20	6g	Tor
4EY	XC6204E29AMR	LVR-IC	LDO, 2.95V±2%, 300mA, +CE, PDR	SOT-25	28cx	VR4	6g	Tor
4EZ	XC6204A30AMR	LVR-IC	LDO, 3.05V±2%, 150mA, +CE, PDR	SOT-25	28cx	VR4	6g	Tor
4EZ	XC6105C530MR	Vdet-IC	3.0V±2%, Hst, +Rst PPO, -Rst ODO, Wt=400ms, Rt=50ms	SOT-25	28xg	VD20	6g	Tor
4EZ	XC6204E30AMR	LVR-IC	LDO, 3.05V±2%, 300mA, +CE, PDR	SOT-25	28cx	VR4	6g	Tor
4F	R3111N541A	Vdet-IC	5.4V±2%, -Reset PPO	SOT-23-5	28vdm	VD7	6g	Ric
4F	RN5VD54CA	Vdet-IC	5.4V±2.5%, -Reset ODO	SOT-23-5	28vdo	VD1	6g	Ric
4F0	XC6105C631MR	Vdet-IC	3.1V±2%, Hst, +Rst PPO, -Rst ODO, Wt=1.6s, Rt=50ms	SOT-25	28xg	VD20	6g	Tor
4F1	XC6105C632MR	Vdet-IC	3.2V±2%, Hst, +Rst PPO, -Rst ODO, Wt=1.6s, Rt=50ms	SOT-25	28xg	VD20	6g	Tor
4F2	XC6105C633MR	Vdet-IC	3.3V±2%, Hst, +Rst PPO, -Rst ODO, Wt=1.6s, Rt=50ms	SOT-25	28xg	VD20	6g	Tor
4F3	XC6105C634MR	Vdet-IC	3.4V±2%, Hst, +Rst PPO, -Rst ODO, Wt=1.6s, Rt=50ms	SOT-25	28xg	VD20	6g	Tor
4F4	XC6105C635MR	Vdet-IC	3.5V±2%, Hst, +Rst PPO, -Rst ODO, Wt=1.6s, Rt=50ms	SOT-25	28xg	VD20	6g	Tor
4F5	XC6105C636MR	Vdet-IC	3.6V±2%, Hst, +Rst PPO, -Rst ODO, Wt=1.6s, Rt=50ms	SOT-25	28xg	VD20	6g	Tor
4F6	XC6105C637MR	Vdet-IC	3.7V±2%, Hst, +Rst PPO, -Rst ODO, Wt=1.6s, Rt=50ms	SOT-25	28xg	VD20	6g	Tor
4F7	XC6105C638MR	Vdet-IC	3.8V±2%, Hst, +Rst PPO, -Rst ODO, Wt=1.6s, Rt=50ms	SOT-25	28xg	VD20	6g	Tor
4F8	XC9235A08DMR	DC-DC-IC	PWM, st-dwn, 0.8V±2%, 600mA, 3MHz, Vin>2V, LSST	SOT-25	28dc4	DC1	6g	Tor
4F8	XC6105C639MR	Vdet-IC	3.9V±2%, Hst, +Rst PPO, -Rst ODO, Wt=1.6s, Rt=50ms	SOT-25	28xg	VD20	6g	Tor
4F9	XC9235A09DMR	DC-DC-IC	PWM, st-dwn, 0.9V±2%, 600mA, 3MHz, Vin>2V, LSST	SOT-25	28dc4	DC1	6g	Tor
4F9	XC6105C640MR	Vdet-IC	4.0V±2%, Hst, +Rst PPO, -Rst ODO, Wt=1.6s, Rt=50ms	SOT-25	28xg	VD20	6g	Tor
4FA	XC6105C641MR	Vdet-IC	4.1V±2%, Hst, +Rst PPO, -Rst ODO, Wt=1.6s, Rt=50ms	SOT-25	28xg	VD20	6g	Tor
4FB	XC6105C642MR	Vdet-IC	4.2V±2%, Hst, +Rst PPO, -Rst ODO, Wt=1.6s, Rt=50ms	SOT-25	28xg	VD20	6g	Tor
4FC	XC6105C643MR	Vdet-IC	4.3V±2%, Hst, +Rst PPO, -Rst ODO, Wt=1.6s, Rt=50ms	SOT-25	28xg	VD20	6g	Tor
4FD	XC6105C644MR	Vdet-IC	4.4V±2%, Hst, +Rst PPO, -Rst ODO, Wt=1.6s, Rt=50ms	SOT-25	28xg	VD20	6g	Tor
4FE	XC6105C645MR	Vdet-IC	4.5V±2%, Hst, +Rst PPO, -Rst ODO, Wt=1.6s, Rt=50ms	SOT-25	28xg	VD20	6g	Tor
4FF	XC6105C616MR	Vdet-IC	1.6V±2%, Hst, +Rst PPO, -Rst ODO, Wt=1.6s, Rt=50ms	SOT-25	28xg	VD20	6g	Tor
4FE	XC6105C646MR	Vdet-IC	4.6V±2%, Hst, +Rst PPO, -Rst ODO, Wt=1.6s, Rt=50ms	SOT-25	28xg	VD20	6g	Tor
4FH	XC6105C617MR	Vdet-IC	1.7V±2%, Hst, +Rst PPO, -Rst ODO, Wt=1.6s, Rt=50ms	SOT-25	28xg	VD20	6g	Tor
4FH	XC6105C647MR	Vdet-IC	4.7V±2%, Hst, +Rst PPO, -Rst ODO, Wt=1.6s, Rt=50ms	SOT-25	28xg	VD20	6g	Tor
4FK	XC6204B18AMR	LVR-IC	LDO, 1.85V±2%, 150mA, +CE	SOT-25	28cx	VR4	6g	Tor
4FK	XC6105C618MR	Vdet-IC	1.8V±2%, Hst, +Rst PPO, -Rst ODO, Wt=1.6s, Rt=50ms	SOT-25	28xg	VD20	6g	Tor
4FK	XC6105C648MR	Vdet-IC	4.8V±2%, Hst, +Rst PPO, -Rst ODO, Wt=1.6s, Rt=50ms	SOT-25	28xg	VD20	6g	Tor
4EK	XC6204F18AMR	LVR-IC	LDO, 1.85V±2%, 300mA, +CE	SOT-25	28cx	VR4	6g	Tor
4FL	XC6204B19AMR	LVR-IC	LDO, 1.95V±2%, 150mA, +CE	SOT-25	28cx	VR4	6g	Tor
4FL	XC9235A0LDMR	DC-DC-IC	PWM, st-dwn, 0.85V±2%, 600mA, 3MHz, Vin>2V, LSST	SOT-25	28dc4	DC1	6g	Tor
4FL	XC6105C619MR	Vdet-IC	1.9V±2%, Hst, +Rst PPO, -Rst ODO, Wt=1.6s, Rt=50ms	SOT-25	28xg	VD20	6g	Tor
4FL	XC6105C649MR	Vdet-IC	4.9V±2%, Hst, +Rst PPO, -Rst ODO, Wt=1.6s, Rt=50ms	SOT-25	28xg	VD20	6g	Tor
4FL	XC6204F19AMR	LVR-IC	LDO, 1.95V±2%, 300mA, +CE	SOT-25	28cx	VR4	6g	Tor
4FM	XC6204B20AMR	LVR-IC	LDO, 2.05V±2%, 150mA, +CE	SOT-25	28cx	VR4	6g	Tor
4FM	XC9235A0MDMR	DC-DC-IC	PWM, st-dwn, 0.95V±2%, 600mA, 3MHz, Vin>2V, LSST	SOT-25	28dc4	DC1	6g	Tor
4FM	XC6105C620MR	Vdet-IC	2.0V±2%, Hst, +Rst PPO, -Rst ODO, Wt=1.6s, Rt=50ms	SOT-25	28xg	VD20	6g	Tor
4FM	XC6105C650MR	Vdet-IC	5.0V±2%, Hst, +Rst PPO, -Rst ODO, Wt=1.6s, Rt=50ms	SOT-25	28xg	VD20	6g	Tor
4FM	XC6204F20AMR	LVR-IC	LDO, 2.05V±2%, 300mA, +CE	SOT-25	28cx	VR4	6g	Tor
4FN	XC6204B21AMR	LVR-IC	LDO, 2.15V±2%, 150mA, +CE	SOT-25	28cx	VR4	6g	Tor
4FN	XC6105C621MR	Vdet-IC	2.1V±2%, Hst, +Rst PPO, -Rst ODO, Wt=1.6s, Rt=50ms	SOT-25	28xg	VD20	6g	Tor
4FN	XC6204F21AMR	LVR-IC	LDO, 2.15V±2%, 300mA, +CE	SOT-25	28cx	VR4	6g	Tor
4FP	XC6204B22AMR	LVR-IC	LDO, 2.25V±2%, 150mA, +CE	SOT-25	28cx	VR4	6g	Tor
4FP	XC6105C622MR	Vdet-IC	2.2V±2%, Hst, +Rst PPO, -Rst ODO, Wt=1.6s, Rt=50ms	SOT-25	28xg	VD20	6g	Tor
4EP	XC6204F22AMR	LVR-IC	LDO, 2.25V±2%, 300mA, +CE	SOT-25	28cx	VR4	6g	Tor
4FR	XC6204B23AMR	LVR-IC	LDO, 2.35V±2%, 150mA, +CE	SOT-25	28cx	VR4	6g	Tor
4FR	XC6105C623MR	Vdet-IC	2.3V±2%, Hst, +Rst PPO, -Rst ODO, Wt=1.6s, Rt=50ms	SOT-25	28xg	VD20	6g	Tor
4FR	XC6204F23AMR	LVR-IC	LDO, 2.35V±2%, 300mA, +CE	SOT-25	28cx	VR4	6g	Tor
4FS	XC6204B24AMR	LVR-IC	LDO, 2.45V±2%, 150mA, +CE	SOT-25	28cx	VR4	6g	Tor
4FS	XC6105C624MR	Vdet-IC	2.4V±2%, Hst, +Rst PPO, -Rst ODO, Wt=1.6s, Rt=50ms	SOT-25	28xg	VD20	6g	Tor
4FT	XC6204F24AMR	LVR-IC	LDO, 2.45V±2%, 300mA, +CE	SOT-25	28cx	VR4	6g	Tor
4FT	XC6204B25AMR	LVR-IC	LDO, 2.55V±2%, 150mA, +CE	SOT-25	28cx	VR4	6g	Tor
4FT	XC6105C625MR	Vdet-IC	2.5V±2%, Hst, +Rst PPO, -Rst ODO, Wt=1.6s, Rt=50ms	SOT-25	28xg	VD20	6g	Tor
4ET	XC6204F25AMR	LVR-IC	LDO, 2.55V±2%, 300mA, +CE	SOT-25	28cx	VR4	6g	Tor
4FU	XC6204B26AMR	LVR-IC	LDO, 2.65V±2%, 150mA, +CE	SOT-25	28cx	VR4	6g	Tor
4FU	XC6105C626MR	Vdet-IC	2.6V±2%, Hst, +Rst PPO, -Rst ODO, Wt=1.6s, Rt=50ms	SOT-25	28xg	VD20	6g	Tor
4EU	XC6204F26AMR	LVR-IC	LDO, 2.65V±2%, 300mA, +CE	SOT-25	28cx	VR4	6g	Tor
4FV	XC6204B27AMR	LVR-IC	LDO, 2.75V±2%, 150mA, +CE	SOT-25	28cx	VR4	6g	Tor
4FV	XC6105C627MR	Vdet-IC	2.7V±2%, Hst, +Rst PPO, -Rst ODO, Wt=1.6s, Rt=50ms	SOT-25	28xg	VD20	6g	Tor
4FV	XC6204F27AMR	LVR-IC	LDO, 2.75V±2%, 300mA, +CE	SOT-25	28cx	VR4	6g	Tor
4FX	XC6204B28AMR	LVR-IC	LDO, 2.85V±2%, 150mA, +CE	SOT-25	28cx	VR4	6g	Tor
4FX	XC6105C628MR	Vdet-IC	2.8V±2%, Hst, +Rst PPO, -Rst ODO, Wt=1.6s, Rt=50ms	SOT-25	28xg	VD20	6g	Tor



SMD code	Type	Function	Short description	Case	Pinout	Sch.	St.	Mnf.
4FX	XC6204F28AMR	LVR-IC	LDO, 2.85V±2%, 300mA, +CE	SOT-25	28cx	VR4	6g	Tor
4FY	XC6204B29AMR	LVR-IC	LDO, 2.95V±2%, 150mA, +CE	SOT-25	28cx	VR4	6g	Tor
4FY	XC6105C629MR	Vdet-IC	2.9V±2%, Hst, +Rst PPO, -Rst ODO, Wt=1.6s, Rt=50ms	SOT-25	28xg	VD20	6g	Tor
4EY	XC6204F29AMR	LVR-IC	LDO, 2.95V±2%, 300mA, +CE	SOT-25	28cx	VR4	6g	Tor
4FZ	XC6204B30AMR	LVR-IC	LDO, 3.05V±2%, 150mA, +CE	SOT-25	28cx	VR4	6g	Tor
4FZ	XC6105C630MR	Vdet-IC	3.0V±2%, Hst, +Rst PPO, -Rst ODO, Wt=1.6s, Rt=50ms	SOT-25	28xg	VD20	6g	Tor
4FZ	XC6204F30AMR	LVR-IC	LDO, 3.05V±2%, 300mA, +CE	SOT-25	28cx	VR4	6g	Tor
4H0	XC9235A10DMR	DC-DC-IC	PWM, st-dwn, 1.0V±2%, 600mA, 3MHz, Vin>2V, LSST	SOT-25	28dc4	DC1	6g	Tor
4H0	XC6105D331MR	Vdet-IC	3.1V±2%, Hst, +Rst PPO, -Rst ODO, Wt=100ms, Rt=100ms	SOT-25	28xg	VD20	6g	Tor
4H1	XC9235A11DMR	DC-DC-IC	PWM, st-dwn, 1.1V±2%, 600mA, 3MHz, Vin>2V, LSST	SOT-25	28dc4	DC1	6g	Tor
4H1	XC6105D332MR	Vdet-IC	3.2V±2%, Hst, +Rst PPO, -Rst ODO, Wt=100ms, Rt=100ms	SOT-25	28xg	VD20	6g	Tor
4H2	XC9235A12DMR	DC-DC-IC	PWM, st-dwn, 1.2V±2%, 600mA, 3MHz, Vin>2V, LSST	SOT-25	28dc4	DC1	6g	Tor
4H2	XC6105D333MR	Vdet-IC	3.3V±2%, Hst, +Rst PPO, -Rst ODO, Wt=100ms, Rt=100ms	SOT-25	28xg	VD20	6g	Tor
4H3	XC9235A13DMR	DC-DC-IC	PWM, st-dwn, 1.3V±2%, 600mA, 3MHz, Vin>2V, LSST	SOT-25	28dc4	DC1	6g	Tor
4H3	XC6105D334MR	Vdet-IC	3.4V±2%, Hst, +Rst PPO, -Rst ODO, Wt=100ms, Rt=100ms	SOT-25	28xg	VD20	6g	Tor
4H4	XC9235A14DMR	DC-DC-IC	PWM, st-dwn, 1.4V±2%, 600mA, 3MHz, Vin>2V, LSST	SOT-25	28dc4	DC1	6g	Tor
4H4	XC6105D335MR	Vdet-IC	3.5V±2%, Hst, +Rst PPO, -Rst ODO, Wt=100ms, Rt=100ms	SOT-25	28xg	VD20	6g	Tor
4H5	XC9235A15DMR	DC-DC-IC	PWM, st-dwn, 1.5V±2%, 600mA, 3MHz, Vin>2V, LSST	SOT-25	28dc4	DC1	6g	Tor
4H5	XC6105D336MR	Vdet-IC	3.6V±2%, Hst, +Rst PPO, -Rst ODO, Wt=100ms, Rt=100ms	SOT-25	28xg	VD20	6g	Tor
4H6	XC9235A16DMR	DC-DC-IC	PWM, st-dwn, 1.6V±2%, 600mA, 3MHz, Vin>2V, LSST	SOT-25	28dc4	DC1	6g	Tor
4H6	XC6105D337MR	Vdet-IC	3.7V±2%, Hst, +Rst PPO, -Rst ODO, Wt=100ms, Rt=100ms	SOT-25	28xg	VD20	6g	Tor
4H7	XC9235A17DMR	DC-DC-IC	PWM, st-dwn, 1.7V±2%, 600mA, 3MHz, Vin>2V, LSST	SOT-25	28dc4	DC1	6g	Tor
4H7	XC6105D338MR	Vdet-IC	3.8V±2%, Hst, +Rst PPO, -Rst ODO, Wt=100ms, Rt=100ms	SOT-25	28xg	VD20	6g	Tor
4H8	XC9235A18DMR	DC-DC-IC	PWM, st-dwn, 1.8V±2%, 600mA, 3MHz, Vin>2V, LSST	SOT-25	28dc4	DC1	6g	Tor
4H8	XC6105D339MR	Vdet-IC	3.9V±2%, Hst, +Rst PPO, -Rst ODO, Wt=100ms, Rt=100ms	SOT-25	28xg	VD20	6g	Tor
4H9	XC9235A19DMR	DC-DC-IC	PWM, st-dwn, 1.9V±2%, 600mA, 3MHz, Vin>2V, LSST	SOT-25	28dc4	DC1	6g	Tor
4H9	XC6105D340MR	Vdet-IC	4.0V±2%, Hst, +Rst PPO, -Rst ODO, Wt=100ms, Rt=100ms	SOT-25	28xg	VD20	6g	Tor
4HA	XC9235A1ADMR	DC-DC-IC	PWM, st-dwn, 1.05V±2%, 600mA, 3MHz, Vin>2V, LSST	SOT-25	28dc4	DC1	6g	Tor
4HA	XC6105D341MR	Vdet-IC	4.1V±2%, Hst, +Rst PPO, -Rst ODO, Wt=100ms, Rt=100ms	SOT-25	28xg	VD20	6g	Tor
4HB	XC9235A1BDMR	DC-DC-IC	PWM, st-dwn, 1.15V±2%, 600mA, 3MHz, Vin>2V, LSST	SOT-25	28dc4	DC1	6g	Tor
4HB	XC6105D342MR	Vdet-IC	4.2V±2%, Hst, +Rst PPO, -Rst ODO, Wt=100ms, Rt=100ms	SOT-25	28xg	VD20	6g	Tor
4HC	XC6105D343MR	Vdet-IC	4.3V±2%, Hst, +Rst PPO, -Rst ODO, Wt=100ms, Rt=100ms	SOT-25	28xg	VD20	6g	Tor
4HC	XC9235A1CDMR	DC-DC-IC	PWM, st-dwn, 1.25V±2%, 600mA, 3MHz, Vin>2V, LSST	SOT-25	28dc4	DC1	6g	Tor
4HC	XC6105D343MR	Vdet-IC	4.3V±2%, Hst, +Rst PPO, -Rst ODO, Wt=100ms, Rt=100ms	SOT-25	28xg	VD20	6g	Tor
4HD	XC9235A1DDMR	DC-DC-IC	PWM, st-dwn, 1.35V±2%, 600mA, 3MHz, Vin>2V, LSST	SOT-25	28dc4	DC1	6g	Tor
4HD	XC6105D344MR	Vdet-IC	4.4V±2%, Hst, +Rst PPO, -Rst ODO, Wt=100ms, Rt=100ms	SOT-25	28xg	VD20	6g	Tor
4HE	XC9235A1EDMR	DC-DC-IC	PWM, st-dwn, 1.45V±2%, 600mA, 3MHz, Vin>2V, LSST	SOT-25	28dc4	DC1	6g	Tor
4HE	XC6105D345MR	Vdet-IC	4.5V±2%, Hst, +Rst PPO, -Rst ODO, Wt=100ms, Rt=100ms	SOT-25	28xg	VD20	6g	Tor
4HF	XC9235A1FDMR	DC-DC-IC	PWM, st-dwn, 1.55V±2%, 600mA, 3MHz, Vin>2V, LSST	SOT-25	28dc4	DC1	6g	Tor
4HF	XC6105D316MR	Vdet-IC	1.6V±2%, Hst, +Rst PPO, -Rst ODO, Wt=100ms, Rt=100ms	SOT-25	28xg	VD20	6g	Tor
4HF	XC6105D346MR	Vdet-IC	4.6V±2%, Hst, +Rst PPO, -Rst ODO, Wt=100ms, Rt=100ms	SOT-25	28xg	VD20	6g	Tor
4HH	XC9235A1HDMR	DC-DC-IC	PWM, st-dwn, 1.65V±2%, 600mA, 3MHz, Vin>2V, LSST	SOT-25	28dc4	DC1	6g	Tor
4HH	XC6105D317MR	Vdet-IC	1.7V±2%, Hst, +Rst PPO, -Rst ODO, Wt=100ms, Rt=100ms	SOT-25	28xg	VD20	6g	Tor
4HH	XC6105D347MR	Vdet-IC	4.7V±2%, Hst, +Rst PPO, -Rst ODO, Wt=100ms, Rt=100ms	SOT-25	28xg	VD20	6g	Tor
4HK	XC6204C18AMR	LVR-IC	LDO, 1.85V±2%, 150mA, -CE, PDR	SOT-25	28cx	VR4	6g	Tor
4HK	XC9235A1KDMR	DC-DC-IC	PWM, st-dwn, 1.75V±2%, 600mA, 3MHz, Vin>2V, LSST	SOT-25	28dc4	DC1	6g	Tor
4HK	XC6105D318MR	Vdet-IC	1.8V±2%, Hst, +Rst PPO, -Rst ODO, Wt=100ms, Rt=100ms	SOT-25	28xg	VD20	6g	Tor
4HK	XC6105D348MR	Vdet-IC	4.8V±2%, Hst, +Rst PPO, -Rst ODO, Wt=100ms, Rt=100ms	SOT-25	28xg	VD20	6g	Tor
4HL	XC6204G18AMR	LVR-IC	LDO, 1.85V±2%, 300mA, -CE, PDR	SOT-25	28cx	VR4	6g	Tor
4HL	XC6204C19AMR	LVR-IC	LDO, 1.95V±2%, 150mA, -CE, PDR	SOT-25	28cx	VR4	6g	Tor
4HL	XC9235A1LDMR	DC-DC-IC	PWM, st-dwn, 1.85V±2%, 600mA, 3MHz, Vin>2V, LSST	SOT-25	28dc4	DC1	6g	Tor
4HL	XC6105D319MR	Vdet-IC	1.9V±2%, Hst, +Rst PPO, -Rst ODO, Wt=100ms, Rt=100ms	SOT-25	28xg	VD20	6g	Tor
4HL	XC6105D349MR	Vdet-IC	4.9V±2%, Hst, +Rst PPO, -Rst ODO, Wt=100ms, Rt=100ms	SOT-25	28xg	VD20	6g	Tor
4HL	XC6204G19AMR	LVR-IC	LDO, 1.95V±2%, 300mA, -CE, PDR	SOT-25	28cx	VR4	6g	Tor
4HM	XC6204C20AMR	LVR-IC	LDO, 2.05V±2%, 150mA, -CE, PDR	SOT-25	28cx	VR4	6g	Tor
4HM	XC9235A1MDMR	DC-DC-IC	PWM, st-dwn, 1.95V±2%, 600mA, 3MHz, Vin>2V, LSST	SOT-25	28dc4	DC1	6g	Tor
4HM	XC6105D320MR	Vdet-IC	2.0V±2%, Hst, +Rst PPO, -Rst ODO, Wt=100ms, Rt=100ms	SOT-25	28xg	VD20	6g	Tor
4HM	XC6105D350MR	Vdet-IC	5.0V±2%, Hst, +Rst PPO, -Rst ODO, Wt=100ms, Rt=100ms	SOT-25	28xg	VD20	6g	Tor
4HM	XC6204G20AMR	LVR-IC	LDO, 2.05V±2%, 300mA, -CE, PDR	SOT-25	28cx	VR4	6g	Tor
4HN	XC6204C21AMR	LVR-IC	LDO, 2.15V±2%, 150mA, -CE, PDR	SOT-25	28cx	VR4	6g	Tor
4HN	XC6105D321MR	Vdet-IC	2.1V±2%, Hst, +Rst PPO, -Rst ODO, Wt=100ms, Rt=100ms	SOT-25	28xg	VD20	6g	Tor
4HN	XC6204G21AMR	LVR-IC	LDO, 2.15V±2%, 300mA, -CE, PDR	SOT-25	28cx	VR4	6g	Tor
4HP	XC6204C22AMR	LVR-IC	LDO, 2.25V±2%, 150mA, -CE, PDR	SOT-25	28cx	VR4	6g	Tor
4HP	XC6105D322MR	Vdet-IC	2.2V±2%, Hst, +Rst PPO, -Rst ODO, Wt=100ms, Rt=100ms	SOT-25	28xg	VD20	6g	Tor
4HP	XC6204G22AMR	LVR-IC	LDO, 2.25V±2%, 300mA, -CE, PDR	SOT-25	28cx	VR4	6g	Tor
4HR	XC6204C23AMR	LVR-IC	LDO, 2.35V±2%, 150mA, -CE, PDR	SOT-25	28cx	VR4	6g	Tor
4HR	XC6105D323MR	Vdet-IC	2.3V±2%, Hst, +Rst PPO, -Rst ODO, Wt=100ms, Rt=100ms	SOT-25	28xg	VD20	6g	Tor
4HR	XC6204G23AMR	LVR-IC	LDO, 2.35V±2%, 300mA, -CE, PDR	SOT-25	28cx	VR4	6g	Tor
4HS	XC6204C24AMR	LVR-IC	LDO, 2.45V±2%, 150mA, -CE, PDR	SOT-25	28cx	VR4	6g	Tor
4HS	XC6105D324MR	Vdet-IC	2.4V±2%, Hst, +Rst PPO, -Rst ODO, Wt=100ms, Rt=100ms	SOT-25	28xg	VD20	6g	Tor
4HS	XC6204G24AMR	LVR-IC	LDO, 2.45V±2%, 300mA, -CE, PDR	SOT-25	28cx	VR4	6g	Tor



SMD code	Type	Function	Short description	Case	Pinout	Sch.	St.	Mnf.
4HT	XC6204C25AMR	LVR-IC	LDO, 2.55V±2%, 150mA, -CE, PDR	SOT-25	28cx	VR4	6g	Tor
4HT	XC6105D325MR	Vdet-IC	2.5V±2%, Hst, +Rst PPO, -Rst ODO, Wt=100ms, Rt=100ms	SOT-25	28cx	VD20	6g	Tor
4HT	XC6204G25AMR	LVR-IC	LDO, 2.55V±2%, 300mA, -CE, PDR	SOT-25	28cx	VR4	6g	Tor
4HU	XC6204C26AMR	LVR-IC	LDO, 2.65V±2%, 150mA, -CE, PDR	SOT-25	28cx	VR4	6g	Tor
4HU	XC6105D326MR	Vdet-IC	2.6V±2%, Hst, +Rst PPO, -Rst ODO, Wt=100ms, Rt=100ms	SOT-25	28cx	VD20	6g	Tor
4HU	XC6204G26AMR	LVR-IC	LDO, 2.65V±2%, 300mA, -CE, PDR	SOT-25	28cx	VR4	6g	Tor
4HV	XC6204C27AMR	LVR-IC	LDO, 2.75V±2%, 150mA, -CE, PDR	SOT-25	28cx	VR4	6g	Tor
4HV	XC6105D327MR	Vdet-IC	2.7V±2%, Hst, +Rst PPO, -Rst ODO, Wt=100ms, Rt=100ms	SOT-25	28cx	VD20	6g	Tor
4HV	XC6204G27AMR	LVR-IC	LDO, 2.75V±2%, 300mA, -CE, PDR	SOT-25	28cx	VR4	6g	Tor
4HX	XC6204C28AMR	LVR-IC	LDO, 2.85V±2%, 150mA, -CE, PDR	SOT-25	28cx	VR4	6g	Tor
4HX	XC6105D328MR	Vdet-IC	2.8V±2%, Hst, +Rst PPO, -Rst ODO, Wt=100ms, Rt=100ms	SOT-25	28cx	VD20	6g	Tor
4HX	XC6204G28AMR	LVR-IC	LDO, 2.85V±2%, 300mA, -CE, PDR	SOT-25	28cx	VR4	6g	Tor
4HY	XC6204C29AMR	LVR-IC	LDO, 2.95V±2%, 150mA, -CE, PDR	SOT-25	28cx	VR4	6g	Tor
4HY	XC6105D329MR	Vdet-IC	2.9V±2%, Hst, +Rst PPO, -Rst ODO, Wt=100ms, Rt=100ms	SOT-25	28cx	VD20	6g	Tor
4HY	XC6204G29AMR	LVR-IC	LDO, 2.95V±2%, 300mA, -CE, PDR	SOT-25	28cx	VR4	6g	Tor
4HZ	XC6204C30AMR	LVR-IC	LDO, 3.05V±2%, 150mA, -CE, PDR	SOT-25	28cx	VR4	6g	Tor
4HZ	XC6105D330MR	Vdet-IC	3.0V±2%, Hst, +Rst PPO, -Rst ODO, Wt=100ms, Rt=100ms	SOT-25	28cx	VD20	6g	Tor
4HZ	XC6204G30AMR	LVR-IC	LDO, 3.05V±2%, 300mA, -CE, PDR	SOT-25	28cx	VR4	6g	Tor
4J	R3111N141C	Vdet-IC	1.4V±2%, -Reset ODO	SOT-23-5	28vdm	VD6	6g	Ric
4K	R3111N241C	Vdet-IC	2.4V±2%, -Reset ODO	SOT-23-5	28vdm	VD6	6g	Ric
4K0	XC9235A20DMR	DC-DC-IC	PWM, st-dwn, 2.0V±2%, 600mA, 3MHz, Vin>2V, LSST	SOT-25	28dc4	DC1	6g	Tor
4K0	XC6105D431MR	Vdet-IC	3.1V±2%, Hst, +Rst PPO, -Rst ODO, Wt=200ms, Rt=100ms	SOT-25	28cx	VD20	6g	Tor
4K1	XC9235A21DMR	DC-DC-IC	PWM, st-dwn, 2.1V±2%, 600mA, 3MHz, Vin>2V, LSST	SOT-25	28dc4	DC1	6g	Tor
4K1	XC6105D432MR	Vdet-IC	3.2V±2%, Hst, +Rst PPO, -Rst ODO, Wt=200ms, Rt=100ms	SOT-25	28cx	VD20	6g	Tor
4K2	XC9235A22DMR	DC-DC-IC	PWM, st-dwn, 2.2V±2%, 600mA, 3MHz, Vin>2V, LSST	SOT-25	28dc4	DC1	6g	Tor
4K2	XC6105D433MR	Vdet-IC	3.3V±2%, Hst, +Rst PPO, -Rst ODO, Wt=200ms, Rt=100ms	SOT-25	28cx	VD20	6g	Tor
4K3	XC9235A23DMR	DC-DC-IC	PWM, st-dwn, 2.3V±2%, 600mA, 3MHz, Vin>2V, LSST	SOT-25	28dc4	DC1	6g	Tor
4K3	XC6105D434MR	Vdet-IC	3.4V±2%, Hst, +Rst PPO, -Rst ODO, Wt=200ms, Rt=100ms	SOT-25	28cx	VD20	6g	Tor
4K4	XC9235A24DMR	DC-DC-IC	PWM, st-dwn, 2.4V±2%, 600mA, 3MHz, Vin>2V, LSST	SOT-25	28dc4	DC1	6g	Tor
4K4	XC6105D435MR	Vdet-IC	3.5V±2%, Hst, +Rst PPO, -Rst ODO, Wt=200ms, Rt=100ms	SOT-25	28cx	VD20	6g	Tor
4K5	XC9235A25DMR	DC-DC-IC	PWM, st-dwn, 2.5V±2%, 600mA, 3MHz, Vin>2V, LSST	SOT-25	28dc4	DC1	6g	Tor
4K5	XC6105D436MR	Vdet-IC	3.6V±2%, Hst, +Rst PPO, -Rst ODO, Wt=200ms, Rt=100ms	SOT-25	28cx	VD20	6g	Tor
4K6	XC9235A26DMR	DC-DC-IC	PWM, st-dwn, 2.6V±2%, 600mA, 3MHz, Vin>2V, LSST	SOT-25	28dc4	DC1	6g	Tor
4K6	XC6105D437MR	Vdet-IC	3.7V±2%, Hst, +Rst PPO, -Rst ODO, Wt=200ms, Rt=100ms	SOT-25	28cx	VD20	6g	Tor
4K7	XC9235A27DMR	DC-DC-IC	PWM, st-dwn, 2.7V±2%, 600mA, 3MHz, Vin>2V, LSST	SOT-25	28dc4	DC1	6g	Tor
4K7	XC6105D438MR	Vdet-IC	3.8V±2%, Hst, +Rst PPO, -Rst ODO, Wt=200ms, Rt=100ms	SOT-25	28cx	VD20	6g	Tor
4K8	XC9235A28DMR	DC-DC-IC	PWM, st-dwn, 2.8V±2%, 600mA, 3MHz, Vin>2V, LSST	SOT-25	28dc4	DC1	6g	Tor
4K8	XC6105D439MR	Vdet-IC	3.9V±2%, Hst, +Rst PPO, -Rst ODO, Wt=200ms, Rt=100ms	SOT-25	28cx	VD20	6g	Tor
4K9	XC9235A29DMR	DC-DC-IC	PWM, st-dwn, 2.9V±2%, 600mA, 3MHz, Vin>2V, LSST	SOT-25	28dc4	DC1	6g	Tor
4K9	XC6105D440MR	Vdet-IC	4.0V±2%, Hst, +Rst PPO, -Rst ODO, Wt=200ms, Rt=100ms	SOT-25	28cx	VD20	6g	Tor
4KA	XC9235A2ADM	DC-DC-IC	PWM, st-dwn, 2.05V±2%, 600mA, 3MHz, Vin>2V, LSST	SOT-25	28dc4	DC1	6g	Tor
4KA	XC6105D441MR	Vdet-IC	4.1V±2%, Hst, +Rst PPO, -Rst ODO, Wt=200ms, Rt=100ms	SOT-25	28cx	VD20	6g	Tor
4KB	XC9235A2BDMR	DC-DC-IC	PWM, st-dwn, 2.15V±2%, 600mA, 3MHz, Vin>2V, LSST	SOT-25	28dc4	DC1	6g	Tor
4KB	XC6105D442MR	Vdet-IC	4.2V±2%, Hst, +Rst PPO, -Rst ODO, Wt=200ms, Rt=100ms	SOT-25	28cx	VD20	6g	Tor
4KC	XC9235A2CDMR	DC-DC-IC	PWM, st-dwn, 2.25V±2%, 600mA, 3MHz, Vin>2V, LSST	SOT-25	28dc4	DC1	6g	Tor
4KC	XC6105D443MR	Vdet-IC	4.3V±2%, Hst, +Rst PPO, -Rst ODO, Wt=200ms, Rt=100ms	SOT-25	28cx	VD20	6g	Tor
4KD	XC9235A2DDMR	DC-DC-IC	PWM, st-dwn, 2.35V±2%, 600mA, 3MHz, Vin>2V, LSST	SOT-25	28dc4	DC1	6g	Tor
4KD	XC6105D444MR	Vdet-IC	4.4V±2%, Hst, +Rst PPO, -Rst ODO, Wt=200ms, Rt=100ms	SOT-25	28cx	VD20	6g	Tor
4KE	XC9235A2EDMR	DC-DC-IC	PWM, st-dwn, 2.45V±2%, 600mA, 3MHz, Vin>2V, LSST	SOT-25	28dc4	DC1	6g	Tor
4KE	XC6105D445MR	Vdet-IC	4.5V±2%, Hst, +Rst PPO, -Rst ODO, Wt=200ms, Rt=100ms	SOT-25	28cx	VD20	6g	Tor
4KF	XC9235A2FDMR	DC-DC-IC	PWM, st-dwn, 2.55V±2%, 600mA, 3MHz, Vin>2V, LSST	SOT-25	28dc4	DC1	6g	Tor
4KF	XC6105D446MR	Vdet-IC	1.6V±2%, Hst, +Rst PPO, -Rst ODO, Wt=200ms, Rt=100ms	SOT-25	28cx	VD20	6g	Tor
4KE	XC6105D446MR	Vdet-IC	4.6V±2%, Hst, +Rst PPO, -Rst ODO, Wt=200ms, Rt=100ms	SOT-25	28cx	VD20	6g	Tor
4KH	XC9235A2HDMR	DC-DC-IC	PWM, st-dwn, 2.65V±2%, 600mA, 3MHz, Vin>2V, LSST	SOT-25	28dc4	DC1	6g	Tor
4KH	XC6105D417MR	Vdet-IC	1.7V±2%, Hst, +Rst PPO, -Rst ODO, Wt=200ms, Rt=100ms	SOT-25	28cx	VD20	6g	Tor
4KH	XC6105D447MR	Vdet-IC	4.7V±2%, Hst, +Rst PPO, -Rst ODO, Wt=200ms, Rt=100ms	SOT-25	28cx	VD20	6g	Tor
4KK	XC6204D18AMR	LVR-IC	LDO, 1.85V±2%, 150mA, -CE	SOT-25	28cx	VR4	6g	Tor
4KK	XC9235A2KDMR	DC-DC-IC	PWM, st-dwn, 2.75V±2%, 600mA, 3MHz, Vin>2V, LSST	SOT-25	28dc4	DC1	6g	Tor
4KK	XC6105D418MR	Vdet-IC	1.8V±2%, Hst, +Rst PPO, -Rst ODO, Wt=200ms, Rt=100ms	SOT-25	28cx	VD20	6g	Tor
4KK	XC6105D448MR	Vdet-IC	4.8V±2%, Hst, +Rst PPO, -Rst ODO, Wt=200ms, Rt=100ms	SOT-25	28cx	VD20	6g	Tor
4KK	XC6204H18AMR	LVR-IC	LDO, 1.85V±2%, 300mA, -CE	SOT-25	28cx	VR4	6g	Tor
4KL	XC6204D19AMR	LVR-IC	LDO, 1.95V±2%, 150mA, -CE	SOT-25	28cx	VR4	6g	Tor
4KL	XC9235A2LDMR	DC-DC-IC	PWM, st-dwn, 2.85V±2%, 600mA, 3MHz, Vin>2V, LSST	SOT-25	28dc4	DC1	6g	Tor
4KL	XC6105D419MR	Vdet-IC	1.9V±2%, Hst, +Rst PPO, -Rst ODO, Wt=200ms, Rt=100ms	SOT-25	28cx	VD20	6g	Tor
4KL	XC6105D449MR	Vdet-IC	4.9V±2%, Hst, +Rst PPO, -Rst ODO, Wt=200ms, Rt=100ms	SOT-25	28cx	VD20	6g	Tor
4KL	XC6204H19AMR	LVR-IC	LDO, 1.95V±2%, 300mA, -CE	SOT-25	28cx	VR4	6g	Tor
4KM	XC6204D20AMR	LVR-IC	LDO, 2.05V±2%, 150mA, -CE	SOT-25	28cx	VR4	6g	Tor
4KM	XC9235A2MDMR	DC-DC-IC	PWM, st-dwn, 2.95V±2%, 600mA, 3MHz, Vin>2V, LSST	SOT-25	28dc4	DC1	6g	Tor
4KM	XC6105D420MR	Vdet-IC	2.0V±2%, Hst, +Rst PPO, -Rst ODO, Wt=200ms, Rt=100ms	SOT-25	28cx	VD20	6g	Tor
4KM	XC6105D450MR	Vdet-IC	5.0V±2%, Hst, +Rst PPO, -Rst ODO, Wt=200ms, Rt=100ms	SOT-25	28cx	VD20	6g	Tor



SMD Code	Type	Function	Short description	Case	Pinout	Sch.	St.	Mnf.
4KM	XC6204H20AMR	LVR-IC	LDO, 2.05V±2%, 300mA, -CE	SOT-25	28cx	VR4	6g	Tor
4KN	XC6204D21AMR	LVR-IC	LDO, 2.15V±2%, 150mA, -CE	SOT-25	28cx	VR4	6g	Tor
4KN	XC6105D421MR	Vdet-IC	2.1V±2%, Hst, +Rst PPO, -Rst ODO, Wt=200ms, Rt=100ms	SOT-25	28xg	VD20	6g	Tor
4KN	XC6204H21AMR	LVR-IC	LDO, 2.15V±2%, 300mA, -CE	SOT-25	28cx	VR4	6g	Tor
4KP	XC6204D22AMR	LVR-IC	LDO, 2.25V±2%, 150mA, -CE	SOT-25	28cx	VR4	6g	Tor
4KP	XC6105D422MR	Vdet-IC	2.2V±2%, Hst, +Rst PPO, -Rst ODO, Wt=200ms, Rt=100ms	SOT-25	28xg	VD20	6g	Tor
4KR	XC6204H22AMR	LVR-IC	LDO, 2.25V±2%, 300mA, -CE	SOT-25	28cx	VR4	6g	Tor
4KR	XC6204D23AMR	LVR-IC	LDO, 2.35V±2%, 150mA, -CE	SOT-25	28cx	VR4	6g	Tor
4KR	XC6105D423MR	Vdet-IC	2.3V±2%, Hst, +Rst PPO, -Rst ODO, Wt=200ms, Rt=100ms	SOT-25	28xg	VD20	6g	Tor
4KR	XC6204H23AMR	LVR-IC	LDO, 2.35V±2%, 300mA, -CE	SOT-25	28cx	VR4	6g	Tor
4KS	XC6204D24AMR	LVR-IC	LDO, 2.45V±2%, 150mA, -CE	SOT-25	28cx	VR4	6g	Tor
4KS	XC6105D424MR	Vdet-IC	2.4V±2%, Hst, +Rst PPO, -Rst ODO, Wt=200ms, Rt=100ms	SOT-25	28xg	VD20	6g	Tor
4KS	XC6204H24AMR	LVR-IC	LDO, 2.45V±2%, 300mA, -CE	SOT-25	28cx	VR4	6g	Tor
4KT	XC6204D25AMR	LVR-IC	LDO, 2.55V±2%, 150mA, -CE	SOT-25	28cx	VR4	6g	Tor
4KT	XC6105D425MR	Vdet-IC	2.5V±2%, Hst, +Rst PPO, -Rst ODO, Wt=200ms, Rt=100ms	SOT-25	28xg	VD20	6g	Tor
4KT	XC6204H25AMR	LVR-IC	LDO, 2.55V±2%, 300mA, -CE	SOT-25	28cx	VR4	6g	Tor
4KU	XC6204D26AMR	LVR-IC	LDO, 2.65V±2%, 150mA, -CE	SOT-25	28cx	VR4	6g	Tor
4KU	XC6105D426MR	Vdet-IC	2.6V±2%, Hst, +Rst PPO, -Rst ODO, Wt=200ms, Rt=100ms	SOT-25	28xg	VD20	6g	Tor
4KU	XC6204H26AMR	LVR-IC	LDO, 2.65V±2%, 300mA, -CE	SOT-25	28cx	VR4	6g	Tor
4KV	XC6204D27AMR	LVR-IC	LDO, 2.75V±2%, 150mA, -CE	SOT-25	28cx	VR4	6g	Tor
4KV	XC6105D427MR	Vdet-IC	2.7V±2%, Hst, +Rst PPO, -Rst ODO, Wt=200ms, Rt=100ms	SOT-25	28xg	VD20	6g	Tor
4KV	XC6204H27AMR	LVR-IC	LDO, 2.75V±2%, 300mA, -CE	SOT-25	28cx	VR4	6g	Tor
4KX	XC6204D28AMR	LVR-IC	LDO, 2.85V±2%, 150mA, -CE	SOT-25	28cx	VR4	6g	Tor
4KX	XC6105D428MR	Vdet-IC	2.8V±2%, Hst, +Rst PPO, -Rst ODO, Wt=200ms, Rt=100ms	SOT-25	28xg	VD20	6g	Tor
4KX	XC6204H28AMR	LVR-IC	LDO, 2.85V±2%, 300mA, -CE	SOT-25	28cx	VR4	6g	Tor
4KY	XC6204D29AMR	LVR-IC	LDO, 2.95V±2%, 150mA, -CE	SOT-25	28cx	VR4	6g	Tor
4KY	XC6105D429MR	Vdet-IC	2.9V±2%, Hst, +Rst PPO, -Rst ODO, Wt=200ms, Rt=100ms	SOT-25	28xg	VD20	6g	Tor
4KY	XC6204H29AMR	LVR-IC	LDO, 2.95V±2%, 300mA, -CE	SOT-25	28cx	VR4	6g	Tor
4KZ	XC6204D30AMR	LVR-IC	LDO, 3.05V±2%, 150mA, -CE	SOT-25	28cx	VR4	6g	Tor
4KZ	XC6105D430MR	Vdet-IC	3.0V±2%, Hst, +Rst PPO, -Rst ODO, Wt=200ms, Rt=100ms	SOT-25	28xg	VD20	6g	Tor
4KZ	XC6204H30AMR	LVR-IC	LDO, 3.05V±2%, 300mA, -CE	SOT-25	28cx	VR4	6g	Tor
4L	R3111N341C	Vdet-IC	3.4V±2%, -Reset ODO	SOT-23-5	28vdm	VD6	6g	Ric
4L0	XC6204A31AMR	LVR-IC	LDO, 3.15V±2%, 150mA, +CE, PDR	SOT-25	28cx	VR4	6g	Tor
4L0	XC9235A30DMR	DC-DC-IC	PWM, st-dwn, 3.0V±2%, 600mA, 3MHz, Vin>2V, LSST	SOT-25	28dc4	DC1	6g	Tor
4L0	XC6105D531MR	Vdet-IC	3.1V±2%, Hst, +Rst PPO, -Rst ODO, Wt=400ms, Rt=100ms	SOT-25	28xg	VD20	6g	Tor
4L0	XC6204E31AMR	LVR-IC	LDO, 3.15V±2%, 300mA, +CE, PDR	SOT-25	28cx	VR4	6g	Tor
4L1	XC6204A32AMR	LVR-IC	LDO, 3.25V±2%, 150mA, +CE, PDR	SOT-25	28cx	VR4	6g	Tor
4L1	XC9235A31DMR	DC-DC-IC	PWM, st-dwn, 3.1V±2%, 600mA, 3MHz, Vin>2V, LSST	SOT-25	28dc4	DC1	6g	Tor
4L1	XC6105D532MR	Vdet-IC	3.2V±2%, Hst, +Rst PPO, -Rst ODO, Wt=400ms, Rt=100ms	SOT-25	28xg	VD20	6g	Tor
4L1	XC6204E32AMR	LVR-IC	LDO, 3.25V±2%, 300mA, +CE, PDR	SOT-25	28cx	VR4	6g	Tor
4L2	XC6204A33AMR	LVR-IC	LDO, 3.35V±2%, 150mA, +CE, PDR	SOT-25	28cx	VR4	6g	Tor
4L2	XC9235A32DMR	DC-DC-IC	PWM, st-dwn, 3.2V±2%, 600mA, 3MHz, Vin>2V, LSST	SOT-25	28dc4	DC1	6g	Tor
4L2	XC6105D533MR	Vdet-IC	3.3V±2%, Hst, +Rst PPO, -Rst ODO, Wt=400ms, Rt=100ms	SOT-25	28xg	VD20	6g	Tor
4L2	XC6204E33AMR	LVR-IC	LDO, 3.35V±2%, 300mA, +CE, PDR	SOT-25	28cx	VR4	6g	Tor
4L3	XC6204A34AMR	LVR-IC	LDO, 3.45V±2%, 150mA, +CE, PDR	SOT-25	28cx	VR4	6g	Tor
4L3	XC9235A33DMR	DC-DC-IC	PWM, st-dwn, 3.3V±2%, 600mA, 3MHz, Vin>2V, LSST	SOT-25	28dc4	DC1	6g	Tor
4L3	XC6105D534MR	Vdet-IC	3.4V±2%, Hst, +Rst PPO, -Rst ODO, Wt=400ms, Rt=100ms	SOT-25	28xg	VD20	6g	Tor
4L3	XC6204E34AMR	LVR-IC	LDO, 3.45V±2%, 300mA, +CE, PDR	SOT-25	28cx	VR4	6g	Tor
4L4	XC6204A35AMR	LVR-IC	LDO, 3.55V±2%, 150mA, +CE, PDR	SOT-25	28cx	VR4	6g	Tor
4L4	XC9235A34DMR	DC-DC-IC	PWM, st-dwn, 3.4V±2%, 600mA, 3MHz, Vin>2V, LSST	SOT-25	28dc4	DC1	6g	Tor
4L4	XC6105D535MR	Vdet-IC	3.5V±2%, Hst, +Rst PPO, -Rst ODO, Wt=400ms, Rt=100ms	SOT-25	28xg	VD20	6g	Tor
4L4	XC6204E35AMR	LVR-IC	LDO, 3.55V±2%, 300mA, +CE, PDR	SOT-25	28cx	VR4	6g	Tor
4L5	XC6204A36AMR	LVR-IC	LDO, 3.65V±2%, 150mA, +CE, PDR	SOT-25	28cx	VR4	6g	Tor
4L5	XC9235A35DMR	DC-DC-IC	PWM, st-dwn, 3.5V±2%, 600mA, 3MHz, Vin>2V, LSST	SOT-25	28dc4	DC1	6g	Tor
4L5	XC6105D536MR	Vdet-IC	3.6V±2%, Hst, +Rst PPO, -Rst ODO, Wt=400ms, Rt=100ms	SOT-25	28xg	VD20	6g	Tor
4L5	XC6204E36AMR	LVR-IC	LDO, 3.65V±2%, 300mA, +CE, PDR	SOT-25	28cx	VR4	6g	Tor
4L6	XC6204A37AMR	LVR-IC	LDO, 3.75V±2%, 150mA, +CE, PDR	SOT-25	28cx	VR4	6g	Tor
4L6	XC9235A36DMR	DC-DC-IC	PWM, st-dwn, 3.6V±2%, 600mA, 3MHz, Vin>2V, LSST	SOT-25	28dc4	DC1	6g	Tor
4L6	XC6105D537MR	Vdet-IC	3.7V±2%, Hst, +Rst PPO, -Rst ODO, Wt=400ms, Rt=100ms	SOT-25	28xg	VD20	6g	Tor
4L6	XC6204E37AMR	LVR-IC	LDO, 3.75V±2%, 300mA, +CE, PDR	SOT-25	28cx	VR4	6g	Tor
4L7	XC6204A38AMR	LVR-IC	LDO, 3.85V±2%, 150mA, +CE, PDR	SOT-25	28cx	VR4	6g	Tor
4L7	XC9235A37DMR	DC-DC-IC	PWM, st-dwn, 3.7V±2%, 600mA, 3MHz, Vin>2V, LSST	SOT-25	28dc4	DC1	6g	Tor
4L7	XC6105D538MR	Vdet-IC	3.8V±2%, Hst, +Rst PPO, -Rst ODO, Wt=400ms, Rt=100ms	SOT-25	28xg	VD20	6g	Tor
4L7	XC6204E38AMR	LVR-IC	LDO, 3.85V±2%, 300mA, +CE, PDR	SOT-25	28cx	VR4	6g	Tor
4L8	XC6204A39AMR	LVR-IC	LDO, 3.95V±2%, 150mA, +CE, PDR	SOT-25	28cx	VR4	6g	Tor
4L8	XC9235A38DMR	DC-DC-IC	PWM, st-dwn, 3.8V±2%, 600mA, 3MHz, Vin>2V, LSST	SOT-25	28dc4	DC1	6g	Tor
4L8	XC6105D539MR	Vdet-IC	3.9V±2%, Hst, +Rst PPO, -Rst ODO, Wt=400ms, Rt=100ms	SOT-25	28xg	VD20	6g	Tor
4L8	XC6204E39AMR	LVR-IC	LDO, 3.95V±2%, 300mA, +CE, PDR	SOT-25	28cx	VR4	6g	Tor
4L9	XC6204A40AMR	LVR-IC	LDO, 4.05V±2%, 150mA, +CE, PDR	SOT-25	28cx	VR4	6g	Tor
4L9	XC9235A39DMR	DC-DC-IC	PWM, st-dwn, 3.9V±2%, 600mA, 3MHz, Vin>2V, LSST	SOT-25	28dc4	DC1	6g	Tor



SMD code	Type	Function	Short description	Case	Pinout	Sch.	St.	Mnf.
4L9	XC6105D540MR	Vdet-IC	4.0V±2%, Hst, +Rst PPO, -Rst ODO, Wt=400ms, Rt=100ms	SOT-25	28xg	VD20	6g	Tor
4L9	XC6204E40AMR	LVR-IC	LDO, 4.05V±2%, 300mA, +CE, PDR	SOT-25	28cx	VR4	6g	Tor
4LA	XC6204A41AMR	LVR-IC	LDO, 4.15V±2%, 150mA, +CE, PDR	SOT-25	28cx	VR4	6g	Tor
4LA	XC9235A3ADMR	DC-DC-IC	PWM, st-dwn, 3.05V±2%, 600mA, 3MHz, Vin>2V, LSST	SOT-25	28dc4	DC1	6g	Tor
4LA	XC6105D541MR	Vdet-IC	4.1V±2%, Hst, +Rst PPO, -Rst ODO, Wt=400ms, Rt=100ms	SOT-25	28xg	VD20	6g	Tor
4LA	XC6204E41AMR	LVR-IC	LDO, 4.15V±2%, 300mA, +CE, PDR	SOT-25	28cx	VR4	6g	Tor
4LB	XC6204A42AMR	LVR-IC	LDO, 4.25V±2%, 150mA, +CE, PDR	SOT-25	28cx	VR4	6g	Tor
4LB	XC9235A3BDMR	DC-DC-IC	PWM, st-dwn, 3.15V±2%, 600mA, 3MHz, Vin>2V, LSST	SOT-25	28dc4	DC1	6g	Tor
4LB	XC6105D542MR	Vdet-IC	4.2V±2%, Hst, +Rst PPO, -Rst ODO, Wt=400ms, Rt=100ms	SOT-25	28xg	VD20	6g	Tor
4LB	XC6204E42AMR	LVR-IC	LDO, 4.25V±2%, 300mA, +CE, PDR	SOT-25	28cx	VR4	6g	Tor
4LC	XC6204A43AMR	LVR-IC	LDO, 4.35V±2%, 150mA, +CE, PDR	SOT-25	28cx	VR4	6g	Tor
4LC	XC9235A3CDMR	DC-DC-IC	PWM, st-dwn, 3.25V±2%, 600mA, 3MHz, Vin>2V, LSST	SOT-25	28dc4	DC1	6g	Tor
4LC	XC6105D543MR	Vdet-IC	4.3V±2%, Hst, +Rst PPO, -Rst ODO, Wt=400ms, Rt=100ms	SOT-25	28xg	VD20	6g	Tor
4LC	XC6204E43AMR	LVR-IC	LDO, 4.35V±2%, 300mA, +CE, PDR	SOT-25	28cx	VR4	6g	Tor
4LD	XC6204A44AMR	LVR-IC	LDO, 4.45V±2%, 150mA, +CE, PDR	SOT-25	28cx	VR4	6g	Tor
4LD	XC9235A3DDMR	DC-DC-IC	PWM, st-dwn, 3.35V±2%, 600mA, 3MHz, Vin>2V, LSST	SOT-25	28dc4	DC1	6g	Tor
4LD	XC6105D544MR	Vdet-IC	4.4V±2%, Hst, +Rst PPO, -Rst ODO, Wt=400ms, Rt=100ms	SOT-25	28xg	VD20	6g	Tor
4LD	XC6204E44AMR	LVR-IC	LDO, 4.45V±2%, 300mA, +CE, PDR	SOT-25	28cx	VR4	6g	Tor
4LE	XC6204A45AMR	LVR-IC	LDO, 4.55V±2%, 150mA, +CE, PDR	SOT-25	28cx	VR4	6g	Tor
4LE	XC9235A3EDMR	DC-DC-IC	PWM, st-dwn, 3.45V±2%, 600mA, 3MHz, Vin>2V, LSST	SOT-25	28dc4	DC1	6g	Tor
4LE	XC6105D545MR	Vdet-IC	4.5V±2%, Hst, +Rst PPO, -Rst ODO, Wt=400ms, Rt=100ms	SOT-25	28xg	VD20	6g	Tor
4LE	XC6204E45AMR	LVR-IC	LDO, 4.55V±2%, 300mA, +CE, PDR	SOT-25	28cx	VR4	6g	Tor
4LF	XC6204A46AMR	LVR-IC	LDO, 4.65V±2%, 150mA, +CE, PDR	SOT-25	28cx	VR4	6g	Tor
4LF	XC9235A3FDMR	DC-DC-IC	PWM, st-dwn, 3.55V±2%, 600mA, 3MHz, Vin>2V, LSST	SOT-25	28dc4	DC1	6g	Tor
4LF	XC6105D516MR	Vdet-IC	1.6V±2%, Hst, +Rst PPO, -Rst ODO, Wt=400ms, Rt=100ms	SOT-25	28xg	VD20	6g	Tor
4LE	XC6105D546MR	Vdet-IC	4.6V±2%, Hst, +Rst PPO, -Rst ODO, Wt=400ms, Rt=100ms	SOT-25	28xg	VD20	6g	Tor
4LF	XC6204E46AMR	LVR-IC	LDO, 4.65V±2%, 300mA, +CE, PDR	SOT-25	28cx	VR4	6g	Tor
4LH	XC6204A47AMR	LVR-IC	LDO, 4.75V±2%, 150mA, +CE, PDR	SOT-25	28cx	VR4	6g	Tor
4LH	XC9235A3HDMR	DC-DC-IC	PWM, st-dwn, 3.65V±2%, 600mA, 3MHz, Vin>2V, LSST	SOT-25	28dc4	DC1	6g	Tor
4LH	XC6105D517MR	Vdet-IC	1.7V±2%, Hst, +Rst PPO, -Rst ODO, Wt=400ms, Rt=100ms	SOT-25	28xg	VD20	6g	Tor
4LH	XC6105D547MR	Vdet-IC	4.7V±2%, Hst, +Rst PPO, -Rst ODO, Wt=400ms, Rt=100ms	SOT-25	28xg	VD20	6g	Tor
4LH	XC6204E47AMR	LVR-IC	LDO, 4.75V±2%, 300mA, +CE, PDR	SOT-25	28cx	VR4	6g	Tor
4LK	XC6204A48AMR	LVR-IC	LDO, 4.85V±2%, 150mA, +CE, PDR	SOT-25	28cx	VR4	6g	Tor
4LK	XC9235A3KDMR	DC-DC-IC	PWM, st-dwn, 3.75V±2%, 600mA, 3MHz, Vin>2V, LSST	SOT-25	28dc4	DC1	6g	Tor
4LK	XC6105D518MR	Vdet-IC	1.8V±2%, Hst, +Rst PPO, -Rst ODO, Wt=400ms, Rt=100ms	SOT-25	28xg	VD20	6g	Tor
4LK	XC6105D548MR	Vdet-IC	4.8V±2%, Hst, +Rst PPO, -Rst ODO, Wt=400ms, Rt=100ms	SOT-25	28xg	VD20	6g	Tor
4LK	XC6204E48AMR	LVR-IC	LDO, 4.85V±2%, 300mA, +CE, PDR	SOT-25	28cx	VR4	6g	Tor
4LL	XC6204A49AMR	LVR-IC	LDO, 4.95V±2%, 150mA, +CE, PDR	SOT-25	28cx	VR4	6g	Tor
4LL	XC9235A3LDMR	DC-DC-IC	PWM, st-dwn, 3.85V±2%, 600mA, 3MHz, Vin>2V, LSST	SOT-25	28dc4	DC1	6g	Tor
4LL	XC6105D519MR	Vdet-IC	1.9V±2%, Hst, +Rst PPO, -Rst ODO, Wt=400ms, Rt=100ms	SOT-25	28xg	VD20	6g	Tor
4LL	XC6105D549MR	Vdet-IC	4.9V±2%, Hst, +Rst PPO, -Rst ODO, Wt=400ms, Rt=100ms	SOT-25	28xg	VD20	6g	Tor
4LL	XC6204E49AMR	LVR-IC	LDO, 4.95V±2%, 300mA, +CE, PDR	SOT-25	28cx	VR4	6g	Tor
4LM	XC6204A50AMR	LVR-IC	LDO, 5.05V±2%, 150mA, +CE, PDR	SOT-25	28cx	VR4	6g	Tor
4LM	XC9235A3MDMR	DC-DC-IC	PWM, st-dwn, 3.95V±2%, 600mA, 3MHz, Vin>2V, LSST	SOT-25	28dc4	DC1	6g	Tor
4LM	XC6105D520MR	Vdet-IC	2.0V±2%, Hst, +Rst PPO, -Rst ODO, Wt=400ms, Rt=100ms	SOT-25	28xg	VD20	6g	Tor
4LM	XC6105D550MR	Vdet-IC	5.0V±2%, Hst, +Rst PPO, -Rst ODO, Wt=400ms, Rt=100ms	SOT-25	28xg	VD20	6g	Tor
4LM	XC6204E50AMR	LVR-IC	LDO, 5.05V±2%, 300mA, +CE, PDR	SOT-25	28cx	VR4	6g	Tor
4LN	XC6204A51AMR	LVR-IC	LDO, 5.15V±2%, 150mA, +CE, PDR	SOT-25	28cx	VR4	6g	Tor
4LN	XC6105D521MR	Vdet-IC	2.1V±2%, Hst, +Rst PPO, -Rst ODO, Wt=400ms, Rt=100ms	SOT-25	28xg	VD20	6g	Tor
4LN	XC6204E51AMR	LVR-IC	LDO, 5.15V±2%, 300mA, +CE, PDR	SOT-25	28cx	VR4	6g	Tor
4LP	XC6204A52AMR	LVR-IC	LDO, 5.25V±2%, 150mA, +CE, PDR	SOT-25	28cx	VR4	6g	Tor
4LP	XC6105D522MR	Vdet-IC	2.2V±2%, Hst, +Rst PPO, -Rst ODO, Wt=400ms, Rt=100ms	SOT-25	28xg	VD20	6g	Tor
4LP	XC6204E52AMR	LVR-IC	LDO, 5.25V±2%, 300mA, +CE, PDR	SOT-25	28cx	VR4	6g	Tor
4LR	XC6204A53AMR	LVR-IC	LDO, 5.35V±2%, 150mA, +CE, PDR	SOT-25	28cx	VR4	6g	Tor
4LR	XC6105D523MR	Vdet-IC	2.3V±2%, Hst, +Rst PPO, -Rst ODO, Wt=400ms, Rt=100ms	SOT-25	28xg	VD20	6g	Tor
4LR	XC6204E53AMR	LVR-IC	LDO, 5.35V±2%, 300mA, +CE, PDR	SOT-25	28cx	VR4	6g	Tor
4LS	XC6204A54AMR	LVR-IC	LDO, 5.45V±2%, 150mA, +CE, PDR	SOT-25	28cx	VR4	6g	Tor
4LS	XC6105D524MR	Vdet-IC	2.4V±2%, Hst, +Rst PPO, -Rst ODO, Wt=400ms, Rt=100ms	SOT-25	28xg	VD20	6g	Tor
4LS	XC6204E54AMR	LVR-IC	LDO, 5.45V±2%, 300mA, +CE, PDR	SOT-25	28cx	VR4	6g	Tor
4LT	XC6204A55AMR	LVR-IC	LDO, 5.55V±2%, 150mA, +CE, PDR	SOT-25	28cx	VR4	6g	Tor
4LT	XC6105D525MR	Vdet-IC	2.5V±2%, Hst, +Rst PPO, -Rst ODO, Wt=400ms, Rt=100ms	SOT-25	28xg	VD20	6g	Tor
4LT	XC6204E55AMR	LVR-IC	LDO, 5.55V±2%, 300mA, +CE, PDR	SOT-25	28cx	VR4	6g	Tor
4LU	XC6204A56AMR	LVR-IC	LDO, 5.65V±2%, 150mA, +CE, PDR	SOT-25	28cx	VR4	6g	Tor
4LU	XC6105D526MR	Vdet-IC	2.6V±2%, Hst, +Rst PPO, -Rst ODO, Wt=400ms, Rt=100ms	SOT-25	28xg	VD20	6g	Tor
4LU	XC6204E56AMR	LVR-IC	LDO, 5.65V±2%, 300mA, +CE, PDR	SOT-25	28cx	VR4	6g	Tor
4LV	XC6204A57AMR	LVR-IC	LDO, 5.75V±2%, 150mA, +CE, PDR	SOT-25	28cx	VR4	6g	Tor
4LV	XC6105D527MR	Vdet-IC	2.7V±2%, Hst, +Rst PPO, -Rst ODO, Wt=400ms, Rt=100ms	SOT-25	28xg	VD20	6g	Tor
4LV	XC6204E57AMR	LVR-IC	LDO, 5.75V±2%, 300mA, +CE, PDR	SOT-25	28cx	VR4	6g	Tor
4LX	XC6204A58AMR	LVR-IC	LDO, 5.85V±2%, 150mA, +CE, PDR	SOT-25	28cx	VR4	6g	Tor
4LX	XC6105D528MR	Vdet-IC	2.8V±2%, Hst, +Rst PPO, -Rst ODO, Wt=400ms, Rt=100ms	SOT-25	28xg	VD20	6g	Tor



SMD code	Type	Function	Short description	Case	Pinout	Sch.	St.	Mnf.
4LX	XC6204E58AMR	LVR-IC	LDO, 5.85V±2%, 300mA, +CE, PDR	SOT-25	28cx	VR4	6g	Tor
4LY	XC6204A59AMR	LVR-IC	LDO, 5.95V±2%, 150mA, +CE, PDR	SOT-25	28cx	VR4	6g	Tor
4LY	XC6105D529MR	Vdet-IC	2.9V±2%, Hst, +Rst PPO, -Rst ODO, Wt=400ms, Rt=100ms	SOT-25	28xg	VD20	6g	Tor
4LY	XC6204E59AMR	LVR-IC	LDO, 5.95V±2%, 300mA, +CE, PDR	SOT-25	28cx	VR4	6g	Tor
4LZ	XC6105D530MR	Vdet-IC	3.0V±2%, Hst, +Rst PPO, -Rst ODO, Wt=400ms, Rt=100ms	SOT-25	28xg	VD20	6g	Tor
4M	R3111N441C	Vdet-IC	4.4V±2%, -Reset ODO	SOT-23-5	28vdm	VD6	6g	Ric
4M0	XC6204B31AMR	LVR-IC	LDO, 3.15V±2%, 150mA, +CE	SOT-25	28cx	VR4	6g	Tor
4M0	XC9235A40DIMR	DC-DC-IC	PWM, st-dwn, 4.0V±2%, 600mA, 3MHz, Vin>2V, LSST	SOT-25	28dc4	DC1	6g	Tor
4M0	XC6105D631MR	Vdet-IC	3.1V±2%, Hst, +Rst PPO, -Rst ODO, Wt=1.6s, Rt=100ms	SOT-25	28xg	VD20	6g	Tor
4M0	XC6204F31AMR	LVR-IC	LDO, 3.15V±2%, 300mA, +CE	SOT-25	28cx	VR4	6g	Tor
4M1	XC6204B32AMR	LVR-IC	LDO, 3.25V±2%, 150mA, +CE	SOT-25	28cx	VR4	6g	Tor
4M1	XC6105D632MR	Vdet-IC	3.2V±2%, Hst, +Rst PPO, -Rst ODO, Wt=1.6s, Rt=100ms	SOT-25	28xg	VD20	6g	Tor
4M1	XC6204F32AMR	LVR-IC	LDO, 3.25V±2%, 300mA, +CE	SOT-25	28cx	VR4	6g	Tor
4M2	XC6204B33AMR	LVR-IC	LDO, 3.35V±2%, 150mA, +CE	SOT-25	28cx	VR4	6g	Tor
4M2	XC6105D633MR	Vdet-IC	3.3V±2%, Hst, +Rst PPO, -Rst ODO, Wt=1.6s, Rt=100ms	SOT-25	28xg	VD20	6g	Tor
4M2	XC6204F33AMR	LVR-IC	LDO, 3.35V±2%, 300mA, +CE	SOT-25	28cx	VR4	6g	Tor
4M3	XC6204B34AMR	LVR-IC	LDO, 3.45V±2%, 150mA, +CE	SOT-25	28cx	VR4	6g	Tor
4M3	XC6105D634MR	Vdet-IC	3.4V±2%, Hst, +Rst PPO, -Rst ODO, Wt=1.6s, Rt=100ms	SOT-25	28xg	VD20	6g	Tor
4M3	XC6204F34AMR	LVR-IC	LDO, 3.45V±2%, 300mA, +CE	SOT-25	28cx	VR4	6g	Tor
4M4	XC6204B35AMR	LVR-IC	LDO, 3.55V±2%, 150mA, +CE	SOT-25	28cx	VR4	6g	Tor
4M4	XC6105D635MR	Vdet-IC	3.5V±2%, Hst, +Rst PPO, -Rst ODO, Wt=1.6s, Rt=100ms	SOT-25	28xg	VD20	6g	Tor
4M4	XC6204F35AMR	LVR-IC	LDO, 3.55V±2%, 300mA, +CE	SOT-25	28cx	VR4	6g	Tor
4M5	XC6204B36AMR	LVR-IC	LDO, 3.65V±2%, 150mA, +CE	SOT-25	28cx	VR4	6g	Tor
4M5	XC6105D636MR	Vdet-IC	3.6V±2%, Hst, +Rst PPO, -Rst ODO, Wt=1.6s, Rt=100ms	SOT-25	28xg	VD20	6g	Tor
4M5	XC6204F36AMR	LVR-IC	LDO, 3.65V±2%, 300mA, +CE	SOT-25	28cx	VR4	6g	Tor
4M6	XC6204B37AMR	LVR-IC	LDO, 3.75V±2%, 150mA, +CE	SOT-25	28cx	VR4	6g	Tor
4M6	XC6105D637MR	Vdet-IC	3.7V±2%, Hst, +Rst PPO, -Rst ODO, Wt=1.6s, Rt=100ms	SOT-25	28xg	VD20	6g	Tor
4M6	XC6204F37AMR	LVR-IC	LDO, 3.75V±2%, 300mA, +CE	SOT-25	28cx	VR4	6g	Tor
4M7	XC6204B38AMR	LVR-IC	LDO, 3.85V±2%, 150mA, +CE	SOT-25	28cx	VR4	6g	Tor
4M7	XC6105D638MR	Vdet-IC	3.8V±2%, Hst, +Rst PPO, -Rst ODO, Wt=1.6s, Rt=100ms	SOT-25	28xg	VD20	6g	Tor
4M7	XC6204F38AMR	LVR-IC	LDO, 3.85V±2%, 300mA, +CE	SOT-25	28cx	VR4	6g	Tor
4M8	XC6204B39AMR	LVR-IC	LDO, 3.95V±2%, 150mA, +CE	SOT-25	28cx	VR4	6g	Tor
4M8	XC6105D639MR	Vdet-IC	3.9V±2%, Hst, +Rst PPO, -Rst ODO, Wt=1.6s, Rt=100ms	SOT-25	28xg	VD20	6g	Tor
4M8	XC6204F39AMR	LVR-IC	LDO, 3.95V±2%, 300mA, +CE	SOT-25	28cx	VR4	6g	Tor
4M9	XC6204B40AMR	LVR-IC	LDO, 4.05V±2%, 150mA, +CE	SOT-25	28cx	VR4	6g	Tor
4M9	XC6105D640MR	Vdet-IC	4.0V±2%, Hst, +Rst PPO, -Rst ODO, Wt=1.6s, Rt=100ms	SOT-25	28xg	VD20	6g	Tor
4M9	XC6204F40AMR	LVR-IC	LDO, 4.05V±2%, 300mA, +CE	SOT-25	28cx	VR4	6g	Tor
4MA	XC6204B41AMR	LVR-IC	LDO, 4.15V±2%, 150mA, +CE	SOT-25	28cx	VR4	6g	Tor
4MA	XC6105D641MR	Vdet-IC	4.1V±2%, Hst, +Rst PPO, -Rst ODO, Wt=1.6s, Rt=100ms	SOT-25	28xg	VD20	6g	Tor
4MA	XC6204F41AMR	LVR-IC	LDO, 4.15V±2%, 300mA, +CE	SOT-25	28cx	VR4	6g	Tor
4MB	XC6204B42AMR	LVR-IC	LDO, 4.25V±2%, 150mA, +CE	SOT-25	28cx	VR4	6g	Tor
4MB	XC6105D642MR	Vdet-IC	4.2V±2%, Hst, +Rst PPO, -Rst ODO, Wt=1.6s, Rt=100ms	SOT-25	28xg	VD20	6g	Tor
4MB	XC6204F42AMR	LVR-IC	LDO, 4.25V±2%, 300mA, +CE	SOT-25	28cx	VR4	6g	Tor
4MC	XC6204B43AMR	LVR-IC	LDO, 4.35V±2%, 150mA, +CE	SOT-25	28cx	VR4	6g	Tor
4MC	XC6105D643MR	Vdet-IC	4.3V±2%, Hst, +Rst PPO, -Rst ODO, Wt=1.6s, Rt=100ms	SOT-25	28xg	VD20	6g	Tor
4MC	XC6204F43AMR	LVR-IC	LDO, 4.35V±2%, 300mA, +CE	SOT-25	28cx	VR4	6g	Tor
4MD	XC6204B44AMR	LVR-IC	LDO, 4.45V±2%, 150mA, +CE	SOT-25	28cx	VR4	6g	Tor
4MD	XC6105D644MR	Vdet-IC	4.4V±2%, Hst, +Rst PPO, -Rst ODO, Wt=1.6s, Rt=100ms	SOT-25	28xg	VD20	6g	Tor
4MD	XC6204F44AMR	LVR-IC	LDO, 4.45V±2%, 300mA, +CE	SOT-25	28cx	VR4	6g	Tor
4ME	XC6204B45AMR	LVR-IC	LDO, 4.55V±2%, 150mA, +CE	SOT-25	28cx	VR4	6g	Tor
4ME	XC6105D645MR	Vdet-IC	4.5V±2%, Hst, +Rst PPO, -Rst ODO, Wt=1.6s, Rt=100ms	SOT-25	28xg	VD20	6g	Tor
4ME	XC6204F45AMR	LVR-IC	LDO, 4.55V±2%, 300mA, +CE	SOT-25	28cx	VR4	6g	Tor
4MF	XC6204B46AMR	LVR-IC	LDO, 4.65V±2%, 150mA, +CE	SOT-25	28cx	VR4	6g	Tor
4MF	XC6105D616MR	Vdet-IC	1.6V±2%, Hst, +Rst PPO, -Rst ODO, Wt=1.6s, Rt=100ms	SOT-25	28xg	VD20	6g	Tor
4MF	XC6105D646MR	Vdet-IC	4.6V±2%, Hst, +Rst PPO, -Rst ODO, Wt=1.6s, Rt=100ms	SOT-25	28xg	VD20	6g	Tor
4MF	XC6204F46AMR	LVR-IC	LDO, 4.65V±2%, 300mA, +CE	SOT-25	28cx	VR4	6g	Tor
4MH	XC6204B47AMR	LVR-IC	LDO, 4.75V±2%, 150mA, +CE	SOT-25	28cx	VR4	6g	Tor
4MH	XC6105D617MR	Vdet-IC	1.7V±2%, Hst, +Rst PPO, -Rst ODO, Wt=1.6s, Rt=100ms	SOT-25	28xg	VD20	6g	Tor
4MH	XC6105D647MR	Vdet-IC	4.7V±2%, Hst, +Rst PPO, -Rst ODO, Wt=1.6s, Rt=100ms	SOT-25	28xg	VD20	6g	Tor
4MH	XC6204F47AMR	LVR-IC	LDO, 4.75V±2%, 300mA, +CE	SOT-25	28cx	VR4	6g	Tor
4MK	XC6204B48AMR	LVR-IC	LDO, 4.85V±2%, 150mA, +CE	SOT-25	28cx	VR4	6g	Tor
4MK	XC6105D618MR	Vdet-IC	1.8V±2%, Hst, +Rst PPO, -Rst ODO, Wt=1.6s, Rt=100ms	SOT-25	28xg	VD20	6g	Tor
4MK	XC6105D648MR	Vdet-IC	4.8V±2%, Hst, +Rst PPO, -Rst ODO, Wt=1.6s, Rt=100ms	SOT-25	28xg	VD20	6g	Tor
4MK	XC6204F48AMR	LVR-IC	LDO, 4.85V±2%, 300mA, +CE	SOT-25	28cx	VR4	6g	Tor
4ML	XC6204B49AMR	LVR-IC	LDO, 4.95V±2%, 150mA, +CE	SOT-25	28cx	VR4	6g	Tor
4ML	XC6105D619MR	Vdet-IC	1.9V±2%, Hst, +Rst PPO, -Rst ODO, Wt=1.6s, Rt=100ms	SOT-25	28xg	VD20	6g	Tor
4ML	XC6105D649MR	Vdet-IC	4.9V±2%, Hst, +Rst PPO, -Rst ODO, Wt=1.6s, Rt=100ms	SOT-25	28xg	VD20	6g	Tor
4ML	XC6204F49AMR	LVR-IC	LDO, 4.95V±2%, 300mA, +CE	SOT-25	28cx	VR4	6g	Tor
4MM	XC6204B50AMR	LVR-IC	LDO, 5.05V±2%, 150mA, +CE	SOT-25	28cx	VR4	6g	Tor
4MM	XC6105D620MR	Vdet-IC	2.0V±2%, Hst, +Rst PPO, -Rst ODO, Wt=1.6s, Rt=100ms	SOT-25	28xg	VD20	6g	Tor



SMD code	Type	Function	Short description	Case	Pinout	Sch.	St.	Mnf.
4MM	XC6105D650MR	Vdet-IC	5.0V±2%, Hst, +Rst PPO, -Rst ODO, Wt=1.6s, Rt=100ms	SOT-25	28xg	VD20	6g	Tor
4MN	XC6204F50AMR	LVR-IC	LDO, 5.05V±2%, 300mA, +CE	SOT-25	28xc	VR4	6g	Tor
4MN	XC6204B51AMR	LVR-IC	LDO, 5.15V±2%, 150mA, +CE	SOT-25	28xc	VR4	6g	Tor
4MN	XC6105D621MR	Vdet-IC	2.1V±2%, Hst, +Rst PPO, -Rst ODO, Wt=1.6s, Rt=100ms	SOT-25	28xg	VD20	6g	Tor
4MN	XC6204F51AMR	LVR-IC	LDO, 5.15V±2%, 300mA, +CE	SOT-25	28xc	VR4	6g	Tor
4MP	XC6204B52AMR	LVR-IC	LDO, 5.25V±2%, 150mA, +CE	SOT-25	28xc	VR4	6g	Tor
4MP	XC6105D622MR	Vdet-IC	2.2V±2%, Hst, +Rst PPO, -Rst ODO, Wt=1.6s, Rt=100ms	SOT-25	28xg	VD20	6g	Tor
4MP	XC6204F52AMR	LVR-IC	LDO, 5.25V±2%, 300mA, +CE	SOT-25	28xc	VR4	6g	Tor
4MR	XC6204B53AMR	LVR-IC	LDO, 5.35V±2%, 150mA, +CE	SOT-25	28xc	VR4	6g	Tor
4MR	XC6105D623MR	Vdet-IC	2.3V±2%, Hst, +Rst PPO, -Rst ODO, Wt=1.6s, Rt=100ms	SOT-25	28xg	VD20	6g	Tor
4MR	XC6204F53AMR	LVR-IC	LDO, 5.35V±2%, 300mA, +CE	SOT-25	28xc	VR4	6g	Tor
4MS	XC6204B54AMR	LVR-IC	LDO, 5.45V±2%, 150mA, +CE	SOT-25	28xc	VR4	6g	Tor
4MS	XC6105D624MR	Vdet-IC	2.4V±2%, Hst, +Rst PPO, -Rst ODO, Wt=1.6s, Rt=100ms	SOT-25	28xg	VD20	6g	Tor
4MS	XC6204F54AMR	LVR-IC	LDO, 5.45V±2%, 300mA, +CE	SOT-25	28xc	VR4	6g	Tor
4MT	XC6204B55AMR	LVR-IC	LDO, 5.55V±2%, 150mA, +CE	SOT-25	28xc	VR4	6g	Tor
4MT	XC6105D625MR	Vdet-IC	2.5V±2%, Hst, +Rst PPO, -Rst ODO, Wt=1.6s, Rt=100ms	SOT-25	28xg	VD20	6g	Tor
4MT	XC6204F55AMR	LVR-IC	LDO, 5.55V±2%, 300mA, +CE	SOT-25	28xc	VR4	6g	Tor
4MU	XC6204B56AMR	LVR-IC	LDO, 5.65V±2%, 150mA, +CE	SOT-25	28xc	VR4	6g	Tor
4MU	XC6105D626MR	Vdet-IC	2.6V±2%, Hst, +Rst PPO, -Rst ODO, Wt=1.6s, Rt=100ms	SOT-25	28xg	VD20	6g	Tor
4MU	XC6204F56AMR	LVR-IC	LDO, 5.65V±2%, 300mA, +CE	SOT-25	28xc	VR4	6g	Tor
4MV	XC6204B57AMR	LVR-IC	LDO, 5.75V±2%, 150mA, +CE	SOT-25	28xc	VR4	6g	Tor
4MV	XC6105D627MR	Vdet-IC	2.7V±2%, Hst, +Rst PPO, -Rst ODO, Wt=1.6s, Rt=100ms	SOT-25	28xg	VD20	6g	Tor
4MV	XC6204F57AMR	LVR-IC	LDO, 5.75V±2%, 300mA, +CE	SOT-25	28xc	VR4	6g	Tor
4MX	XC6204B58AMR	LVR-IC	LDO, 5.85V±2%, 150mA, +CE	SOT-25	28xc	VR4	6g	Tor
4MX	XC6105D628MR	Vdet-IC	2.8V±2%, Hst, +Rst PPO, -Rst ODO, Wt=1.6s, Rt=100ms	SOT-25	28xg	VD20	6g	Tor
4MX	XC6204F58AMR	LVR-IC	LDO, 5.85V±2%, 300mA, +CE	SOT-25	28xc	VR4	6g	Tor
4MY	XC6204B59AMR	LVR-IC	LDO, 5.95V±2%, 150mA, +CE	SOT-25	28xc	VR4	6g	Tor
4MY	XC6105D629MR	Vdet-IC	2.9V±2%, Hst, +Rst PPO, -Rst ODO, Wt=1.6s, Rt=100ms	SOT-25	28xg	VD20	6g	Tor
4MY	XC6204F59AMR	LVR-IC	LDO, 5.95V±2%, 300mA, +CE	SOT-25	28xc	VR4	6g	Tor
4MZ	XC6105D630MR	Vdet-IC	3.0V±2%, Hst, +Rst PPO, -Rst ODO, Wt=1.6s, Rt=100ms	SOT-25	28xg	VD20	6g	Tor
4N	R3111N541C	Vdet-IC	5.4V±2%, -Reset ODO	SOT-23-5	28vdm	VD6	6g	Ric
4N0	XC6204C31AMR	LVR-IC	LDO, 3.15V±2%, 150mA, -CE, PDR	SOT-25	28xc	VR4	6g	Tor
4N0	XC6204G31AMR	LVR-IC	LDO, 3.15V±2%, 300mA, -CE, PDR	SOT-25	28xc	VR4	6g	Tor
4N1	XC6204C32AMR	LVR-IC	LDO, 3.25V±2%, 150mA, -CE, PDR	SOT-25	28xc	VR4	6g	Tor
4N1	XC6204G32AMR	LVR-IC	LDO, 3.25V±2%, 300mA, -CE, PDR	SOT-25	28xc	VR4	6g	Tor
4N2	XC6204C33AMR	LVR-IC	LDO, 3.35V±2%, 150mA, -CE, PDR	SOT-25	28xc	VR4	6g	Tor
4N2	XC6204G33AMR	LVR-IC	LDO, 3.35V±2%, 300mA, -CE, PDR	SOT-25	28xc	VR4	6g	Tor
4N3	XC6204C34AMR	LVR-IC	LDO, 3.45V±2%, 150mA, -CE, PDR	SOT-25	28xc	VR4	6g	Tor
4N3	XC6204G34AMR	LVR-IC	LDO, 3.45V±2%, 300mA, -CE, PDR	SOT-25	28xc	VR4	6g	Tor
4N4	XC6204C35AMR	LVR-IC	LDO, 3.55V±2%, 150mA, -CE, PDR	SOT-25	28xc	VR4	6g	Tor
4N4	XC6204G35AMR	LVR-IC	LDO, 3.55V±2%, 300mA, -CE, PDR	SOT-25	28xc	VR4	6g	Tor
4N5	XC6204C36AMR	LVR-IC	LDO, 3.65V±2%, 150mA, -CE, PDR	SOT-25	28xc	VR4	6g	Tor
4N5	XC6204G36AMR	LVR-IC	LDO, 3.65V±2%, 300mA, -CE, PDR	SOT-25	28xc	VR4	6g	Tor
4N6	XC6204C37AMR	LVR-IC	LDO, 3.75V±2%, 150mA, -CE, PDR	SOT-25	28xc	VR4	6g	Tor
4N6	XC6204G37AMR	LVR-IC	LDO, 3.75V±2%, 300mA, -CE, PDR	SOT-25	28xc	VR4	6g	Tor
4N7	XC6204C38AMR	LVR-IC	LDO, 3.85V±2%, 150mA, -CE, PDR	SOT-25	28xc	VR4	6g	Tor
4N7	XC6204G38AMR	LVR-IC	LDO, 3.85V±2%, 300mA, -CE, PDR	SOT-25	28xc	VR4	6g	Tor
4N8	XC6204C39AMR	LVR-IC	LDO, 3.95V±2%, 150mA, -CE, PDR	SOT-25	28xc	VR4	6g	Tor
4N8	XC6204G39AMR	LVR-IC	LDO, 3.95V±2%, 300mA, -CE, PDR	SOT-25	28xc	VR4	6g	Tor
4N9	XC6204C40AMR	LVR-IC	LDO, 4.05V±2%, 150mA, -CE, PDR	SOT-25	28xc	VR4	6g	Tor
4N9	XC6204G40AMR	LVR-IC	LDO, 4.05V±2%, 300mA, -CE, PDR	SOT-25	28xc	VR4	6g	Tor
4NA	XC6204C41AMR	LVR-IC	LDO, 4.15V±2%, 150mA, -CE, PDR	SOT-25	28xc	VR4	6g	Tor
4NA	XC6204G41AMR	LVR-IC	LDO, 4.15V±2%, 300mA, -CE, PDR	SOT-25	28xc	VR4	6g	Tor
4NB	XC6204C42AMR	LVR-IC	LDO, 4.25V±2%, 150mA, -CE, PDR	SOT-25	28xc	VR4	6g	Tor
4NB	XC6204G42AMR	LVR-IC	LDO, 4.25V±2%, 300mA, -CE, PDR	SOT-25	28xc	VR4	6g	Tor
4NC	XC6204C43AMR	LVR-IC	LDO, 4.35V±2%, 150mA, -CE, PDR	SOT-25	28xc	VR4	6g	Tor
4NC	XC6204G43AMR	LVR-IC	LDO, 4.35V±2%, 300mA, -CE, PDR	SOT-25	28xc	VR4	6g	Tor
4ND	XC6204C44AMR	LVR-IC	LDO, 4.45V±2%, 150mA, -CE, PDR	SOT-25	28xc	VR4	6g	Tor
4ND	XC6204G44AMR	LVR-IC	LDO, 4.45V±2%, 300mA, -CE, PDR	SOT-25	28xc	VR4	6g	Tor
4NE	XC6204C45AMR	LVR-IC	LDO, 4.55V±2%, 150mA, -CE, PDR	SOT-25	28xc	VR4	6g	Tor
4NE	XC6204G45AMR	LVR-IC	LDO, 4.55V±2%, 300mA, -CE, PDR	SOT-25	28xc	VR4	6g	Tor
4NF	XC6204C46AMR	LVR-IC	LDO, 4.65V±2%, 150mA, -CE, PDR	SOT-25	28xc	VR4	6g	Tor
4NF	XC6204G46AMR	LVR-IC	LDO, 4.65V±2%, 300mA, -CE, PDR	SOT-25	28xc	VR4	6g	Tor
4NH	XC6204C47AMR	LVR-IC	LDO, 4.75V±2%, 150mA, -CE, PDR	SOT-25	28xc	VR4	6g	Tor
4NH	XC6204G47AMR	LVR-IC	LDO, 4.75V±2%, 300mA, -CE, PDR	SOT-25	28xc	VR4	6g	Tor
4NK	XC6204C48AMR	LVR-IC	LDO, 4.85V±2%, 150mA, -CE, PDR	SOT-25	28xc	VR4	6g	Tor
4NK	XC6204G48AMR	LVR-IC	LDO, 4.85V±2%, 300mA, -CE, PDR	SOT-25	28xc	VR4	6g	Tor
4NL	XC6204C49AMR	LVR-IC	LDO, 4.95V±2%, 150mA, -CE, PDR	SOT-25	28xc	VR4	6g	Tor
4NL	XC6204G49AMR	LVR-IC	LDO, 4.95V±2%, 300mA, -CE, PDR	SOT-25	28xc	VR4	6g	Tor
4NM	XC6204C50AMR	LVR-IC	LDO, 5.05V±2%, 150mA, -CE, PDR	SOT-25	28xc	VR4	6g	Tor



SMD code	Type	Function	Short description	Case	Pinout	Sch.	St.	Mnf.
4NM	XC6204G50AMR	LVR-IC	LDO, 5.05V±2%, 300mA, -CE, PDR	SOT-25	28cx	VR4	6g	Tor
4NN	XC6204C51AMR	LVR-IC	LDO, 5.15V±2%, 150mA, -CE, PDR	SOT-25	28cx	VR4	6g	Tor
4NN	XC6204G51AMR	LVR-IC	LDO, 5.15V±2%, 300mA, -CE, PDR	SOT-25	28cx	VR4	6g	Tor
4NP	XC6204C52AMR	LVR-IC	LDO, 5.25V±2%, 150mA, -CE, PDR	SOT-25	28cx	VR4	6g	Tor
4NP	XC6204G52AMR	LVR-IC	LDO, 5.25V±2%, 300mA, -CE, PDR	SOT-25	28cx	VR4	6g	Tor
4NR	XC6204C53AMR	LVR-IC	LDO, 5.35V±2%, 150mA, -CE, PDR	SOT-25	28cx	VR4	6g	Tor
4NR	XC6204G53AMR	LVR-IC	LDO, 5.35V±2%, 300mA, -CE, PDR	SOT-25	28cx	VR4	6g	Tor
4NS	XC6204C54AMR	LVR-IC	LDO, 5.45V±2%, 150mA, -CE, PDR	SOT-25	28cx	VR4	6g	Tor
4NS	XC6204G54AMR	LVR-IC	LDO, 5.45V±2%, 300mA, -CE, PDR	SOT-25	28cx	VR4	6g	Tor
4NT	XC6204C55AMR	LVR-IC	LDO, 5.55V±2%, 150mA, -CE, PDR	SOT-25	28cx	VR4	6g	Tor
4NT	XC6204G55AMR	LVR-IC	LDO, 5.55V±2%, 300mA, -CE, PDR	SOT-25	28cx	VR4	6g	Tor
4NU	XC6204C56AMR	LVR-IC	LDO, 5.65V±2%, 150mA, -CE, PDR	SOT-25	28cx	VR4	6g	Tor
4NU	XC6204G56AMR	LVR-IC	LDO, 5.65V±2%, 300mA, -CE, PDR	SOT-25	28cx	VR4	6g	Tor
4NV	XC6204C57AMR	LVR-IC	LDO, 5.75V±2%, 150mA, -CE, PDR	SOT-25	28cx	VR4	6g	Tor
4NV	XC6204G57AMR	LVR-IC	LDO, 5.75V±2%, 300mA, -CE, PDR	SOT-25	28cx	VR4	6g	Tor
4NX	XC6204C58AMR	LVR-IC	LDO, 5.85V±2%, 150mA, -CE, PDR	SOT-25	28cx	VR4	6g	Tor
4NX	XC6204G58AMR	LVR-IC	LDO, 5.85V±2%, 300mA, -CE, PDR	SOT-25	28cx	VR4	6g	Tor
4NY	XC6204C59AMR	LVR-IC	LDO, 5.95V±2%, 150mA, -CE, PDR	SOT-25	28cx	VR4	6g	Tor
4NY	XC6204G59AMR	LVR-IC	LDO, 5.95V±2%, 300mA, -CE, PDR	SOT-25	28cx	VR4	6g	Tor
4O	XP01507	Si-npn	Dual, LN, 150V, 50mA, 150mW, >150MHz	SC-88A	28/T11	-	6a	Pan
4O	XP1507	Si-npn	Dual, LN, 150V, 50mA, 150mW, >150MHz	SC-88A	28/T11	-	6a	Pan
4P	XN1A312	Si-n/p-Digi	Dual, 50V, 100mA, 300mW, 150MHz, R1/R2=22k/22k	SOT-23-5	28/TD1	-	6a	Pan
4P0	XC6204D31AMR	LVR-IC	LDO, 3.15V±2%, 150mA, -CE	SOT-25	28cx	VR4	6g	Tor
4P0	XC6105E431MR	Vdet-IC	3.1V±2%, Hst, +Rst PPO, -Rst ODO, Wt=200ms, Rt=200ms	SOT-25	28gx	VD20	6g	Tor
4P0	XC6204H31AMR	LVR-IC	LDO, 3.15V±2%, 300mA, -CE	SOT-25	28cx	VR4	6g	Tor
4P1	XC6204D32AMR	LVR-IC	LDO, 3.25V±2%, 150mA, -CE	SOT-25	28cx	VR4	6g	Tor
4P1	XC6105E432MR	Vdet-IC	3.2V±2%, Hst, +Rst PPO, -Rst ODO, Wt=200ms, Rt=200ms	SOT-25	28gx	VD20	6g	Tor
4P1	XC6204H32AMR	LVR-IC	LDO, 3.25V±2%, 300mA, -CE	SOT-25	28cx	VR4	6g	Tor
4P2	XC6204D33AMR	LVR-IC	LDO, 3.35V±2%, 150mA, -CE	SOT-25	28cx	VR4	6g	Tor
4P2	XC6105E433MR	Vdet-IC	3.3V±2%, Hst, +Rst PPO, -Rst ODO, Wt=200ms, Rt=200ms	SOT-25	28gx	VD20	6g	Tor
4P2	XC6204H33AMR	LVR-IC	LDO, 3.35V±2%, 300mA, -CE	SOT-25	28cx	VR4	6g	Tor
4P3	XC6204D34AMR	LVR-IC	LDO, 3.45V±2%, 150mA, -CE	SOT-25	28cx	VR4	6g	Tor
4P3	XC6105E434MR	Vdet-IC	3.4V±2%, Hst, +Rst PPO, -Rst ODO, Wt=200ms, Rt=200ms	SOT-25	28gx	VD20	6g	Tor
4P3	XC6204H34AMR	LVR-IC	LDO, 3.45V±2%, 300mA, -CE	SOT-25	28cx	VR4	6g	Tor
4P4	XC6204D35AMR	LVR-IC	LDO, 3.55V±2%, 150mA, -CE	SOT-25	28cx	VR4	6g	Tor
4P4	XC6105E435MR	Vdet-IC	3.5V±2%, Hst, +Rst PPO, -Rst ODO, Wt=200ms, Rt=200ms	SOT-25	28gx	VD20	6g	Tor
4P4	XC6204H35AMR	LVR-IC	LDO, 3.55V±2%, 300mA, -CE	SOT-25	28cx	VR4	6g	Tor
4P5	XC6204D36AMR	LVR-IC	LDO, 3.65V±2%, 150mA, -CE	SOT-25	28cx	VR4	6g	Tor
4P5	XC6105E436MR	Vdet-IC	3.6V±2%, Hst, +Rst PPO, -Rst ODO, Wt=200ms, Rt=200ms	SOT-25	28gx	VD20	6g	Tor
4P5	XC6204H36AMR	LVR-IC	LDO, 3.65V±2%, 300mA, -CE	SOT-25	28cx	VR4	6g	Tor
4P6	XC6204D37AMR	LVR-IC	LDO, 3.75V±2%, 150mA, -CE	SOT-25	28cx	VR4	6g	Tor
4P6	XC6105E437MR	Vdet-IC	3.7V±2%, Hst, +Rst PPO, -Rst ODO, Wt=200ms, Rt=200ms	SOT-25	28gx	VD20	6g	Tor
4P6	XC6204H37AMR	LVR-IC	LDO, 3.75V±2%, 300mA, -CE	SOT-25	28cx	VR4	6g	Tor
4P7	XC6204D38AMR	LVR-IC	LDO, 3.85V±2%, 150mA, -CE	SOT-25	28cx	VR4	6g	Tor
4P7	XC6105E438MR	Vdet-IC	3.8V±2%, Hst, +Rst PPO, -Rst ODO, Wt=200ms, Rt=200ms	SOT-25	28gx	VD20	6g	Tor
4P7	XC6204H38AMR	LVR-IC	LDO, 3.85V±2%, 300mA, -CE	SOT-25	28cx	VR4	6g	Tor
4P8	XC6204D39AMR	LVR-IC	LDO, 3.95V±2%, 150mA, -CE	SOT-25	28cx	VR4	6g	Tor
4P8	XC6105E439MR	Vdet-IC	3.9V±2%, Hst, +Rst PPO, -Rst ODO, Wt=200ms, Rt=200ms	SOT-25	28gx	VD20	6g	Tor
4P8	XC6204H39AMR	LVR-IC	LDO, 3.95V±2%, 300mA, -CE	SOT-25	28cx	VR4	6g	Tor
4P9	XC6204D40AMR	LVR-IC	LDO, 4.05V±2%, 150mA, -CE	SOT-25	28cx	VR4	6g	Tor
4P9	XC6105E440MR	Vdet-IC	4.0V±2%, Hst, +Rst PPO, -Rst ODO, Wt=200ms, Rt=200ms	SOT-25	28gx	VD20	6g	Tor
4P9	XC6204H40AMR	LVR-IC	LDO, 4.05V±2%, 300mA, -CE	SOT-25	28cx	VR4	6g	Tor
4PA	XC6204D41AMR	LVR-IC	LDO, 4.15V±2%, 150mA, -CE	SOT-25	28cx	VR4	6g	Tor
4PA	XC6105E441MR	Vdet-IC	4.1V±2%, Hst, +Rst PPO, -Rst ODO, Wt=200ms, Rt=200ms	SOT-25	28gx	VD20	6g	Tor
4PA	XC6204H41AMR	LVR-IC	LDO, 4.15V±2%, 300mA, -CE	SOT-25	28cx	VR4	6g	Tor
4PB	XC6204D42AMR	LVR-IC	LDO, 4.25V±2%, 150mA, -CE	SOT-25	28cx	VR4	6g	Tor
4PB	XC6105E442MR	Vdet-IC	4.2V±2%, Hst, +Rst PPO, -Rst ODO, Wt=200ms, Rt=200ms	SOT-25	28gx	VD20	6g	Tor
4PB	XC6204H42AMR	LVR-IC	LDO, 4.25V±2%, 300mA, -CE	SOT-25	28cx	VR4	6g	Tor
4PC	XC6204D43AMR	LVR-IC	LDO, 4.35V±2%, 150mA, -CE	SOT-25	28cx	VR4	6g	Tor
4PC	XC6105E443MR	Vdet-IC	4.3V±2%, Hst, +Rst PPO, -Rst ODO, Wt=200ms, Rt=200ms	SOT-25	28gx	VD20	6g	Tor
4PC	XC6204H43AMR	LVR-IC	LDO, 4.35V±2%, 300mA, -CE	SOT-25	28cx	VR4	6g	Tor
4PD	XC6204D44AMR	LVR-IC	LDO, 4.45V±2%, 150mA, -CE	SOT-25	28cx	VR4	6g	Tor
4PD	XC6105E444MR	Vdet-IC	4.4V±2%, Hst, +Rst PPO, -Rst ODO, Wt=200ms, Rt=200ms	SOT-25	28gx	VD20	6g	Tor
4PD	XC6204H44AMR	LVR-IC	LDO, 4.45V±2%, 300mA, -CE	SOT-25	28cx	VR4	6g	Tor
4PE	XC6204D45AMR	LVR-IC	LDO, 4.55V±2%, 150mA, -CE	SOT-25	28cx	VR4	6g	Tor
4PE	XC6105E445MR	Vdet-IC	4.5V±2%, Hst, +Rst PPO, -Rst ODO, Wt=200ms, Rt=200ms	SOT-25	28gx	VD20	6g	Tor
4PE	XC6204H45AMR	LVR-IC	LDO, 4.55V±2%, 300mA, -CE	SOT-25	28cx	VR4	6g	Tor
4PF	XC6204D46AMR	LVR-IC	LDO, 4.65V±2%, 150mA, -CE	SOT-25	28cx	VR4	6g	Tor
4PF	XC6105E446MR	Vdet-IC	4.6V±2%, Hst, +Rst PPO, -Rst ODO, Wt=200ms, Rt=200ms	SOT-25	28gx	VD20	6g	Tor
4PF	XC6204H46AMR	LVR-IC	LDO, 4.65V±2%, 300mA, -CE	SOT-25	28cx	VR4	6g	Tor



SMD code	Type	Function	Short description	Case	Pinout	Sch.	St.	Mnf.
<u>4PF</u>	XC6204H46AMR	LVR-IC	LDO, 4.65V±2%, 300mA, -CE	SOT-25	28cx	VR4	6g	Tor
<u>4PH</u>	XC6204D47AMR	LVR-IC	LDO, 4.75V±2%, 150mA, -CE	SOT-25	28cx	VR4	6g	Tor
<u>4PH</u>	XC6105E417MR	Vdet-IC	1.7V±2%, Hst, +Rst PPO, -Rst ODO, Wt=200ms, Rt=200ms	SOT-25	28xg	VD20	6g	Tor
<u>4PH</u>	XC6105E447MR	Vdet-IC	4.7V±2%, Hst, +Rst PPO, -Rst ODO, Wt=200ms, Rt=200ms	SOT-25	28xg	VD20	6g	Tor
<u>4PH</u>	XC6204H47AMR	LVR-IC	LDO, 4.75V±2%, 300mA, -CE	SOT-25	28cx	VR4	6g	Tor
<u>4PK</u>	XC6204D48AMR	LVR-IC	LDO, 4.85V±2%, 150mA, -CE	SOT-25	28cx	VR4	6g	Tor
<u>4PK</u>	XC6105E418MR	Vdet-IC	1.8V±2%, Hst, +Rst PPO, -Rst ODO, Wt=200ms, Rt=200ms	SOT-25	28xg	VD20	6g	Tor
<u>4PK</u>	XC6105E448MR	Vdet-IC	4.8V±2%, Hst, +Rst PPO, -Rst ODO, Wt=200ms, Rt=200ms	SOT-25	28xg	VD20	6g	Tor
<u>4PK</u>	XC6204H48AMR	LVR-IC	LDO, 4.85V±2%, 300mA, -CE	SOT-25	28cx	VR4	6g	Tor
<u>4PL</u>	XC6204D49AMR	LVR-IC	LDO, 4.95V±2%, 150mA, -CE	SOT-25	28cx	VR4	6g	Tor
<u>4PL</u>	XC6105E419MR	Vdet-IC	1.9V±2%, Hst, +Rst PPO, -Rst ODO, Wt=200ms, Rt=200ms	SOT-25	28xg	VD20	6g	Tor
<u>4PL</u>	XC6105E449MR	Vdet-IC	4.9V±2%, Hst, +Rst PPO, -Rst ODO, Wt=200ms, Rt=200ms	SOT-25	28xg	VD20	6g	Tor
<u>4PL</u>	XC6204H49AMR	LVR-IC	LDO, 4.95V±2%, 300mA, -CE	SOT-25	28cx	VR4	6g	Tor
<u>4PM</u>	XC6204D50AMR	LVR-IC	LDO, 5.05V±2%, 150mA, -CE	SOT-25	28cx	VR4	6g	Tor
<u>4PM</u>	XC6105E420MR	Vdet-IC	2.0V±2%, Hst, +Rst PPO, -Rst ODO, Wt=200ms, Rt=200ms	SOT-25	28xg	VD20	6g	Tor
<u>4PM</u>	XC6105E450MR	Vdet-IC	5.0V±2%, Hst, +Rst PPO, -Rst ODO, Wt=200ms, Rt=200ms	SOT-25	28xg	VD20	6g	Tor
<u>4PM</u>	XC6204H50AMR	LVR-IC	LDO, 5.05V±2%, 300mA, -CE	SOT-25	28cx	VR4	6g	Tor
<u>4PN</u>	XC6204D51AMR	LVR-IC	LDO, 5.15V±2%, 150mA, -CE	SOT-25	28cx	VR4	6g	Tor
<u>4PN</u>	XC6105E421MR	Vdet-IC	2.1V±2%, Hst, +Rst PPO, -Rst ODO, Wt=200ms, Rt=200ms	SOT-25	28xg	VD20	6g	Tor
<u>4PN</u>	XC6204H51AMR	LVR-IC	LDO, 5.15V±2%, 300mA, -CE	SOT-25	28cx	VR4	6g	Tor
<u>4PP</u>	XC6204D52AMR	LVR-IC	LDO, 5.25V±2%, 150mA, -CE	SOT-25	28cx	VR4	6g	Tor
<u>4PP</u>	XC6105E422MR	Vdet-IC	2.2V±2%, Hst, +Rst PPO, -Rst ODO, Wt=200ms, Rt=200ms	SOT-25	28xg	VD20	6g	Tor
<u>4PP</u>	XC6204H52AMR	LVR-IC	LDO, 5.25V±2%, 300mA, -CE	SOT-25	28cx	VR4	6g	Tor
<u>4PR</u>	XC6204D53AMR	LVR-IC	LDO, 5.35V±2%, 150mA, -CE	SOT-25	28cx	VR4	6g	Tor
<u>4PR</u>	XC6105E423MR	Vdet-IC	2.3V±2%, Hst, +Rst PPO, -Rst ODO, Wt=200ms, Rt=200ms	SOT-25	28xg	VD20	6g	Tor
<u>4PR</u>	XC6204H53AMR	LVR-IC	LDO, 5.35V±2%, 300mA, -CE	SOT-25	28cx	VR4	6g	Tor
<u>4PS</u>	XC6204D54AMR	LVR-IC	LDO, 5.45V±2%, 150mA, -CE	SOT-25	28cx	VR4	6g	Tor
<u>4PS</u>	XC6105E424MR	Vdet-IC	2.4V±2%, Hst, +Rst PPO, -Rst ODO, Wt=200ms, Rt=200ms	SOT-25	28xg	VD20	6g	Tor
<u>4PS</u>	XC6204H54AMR	LVR-IC	LDO, 5.45V±2%, 300mA, -CE	SOT-25	28cx	VR4	6g	Tor
<u>4PT</u>	XC6204D55AMR	LVR-IC	LDO, 5.55V±2%, 150mA, -CE	SOT-25	28cx	VR4	6g	Tor
<u>4PT</u>	XC6105E425MR	Vdet-IC	2.5V±2%, Hst, +Rst PPO, -Rst ODO, Wt=200ms, Rt=200ms	SOT-25	28xg	VD20	6g	Tor
<u>4PT</u>	XC6204H55AMR	LVR-IC	LDO, 5.55V±2%, 300mA, -CE	SOT-25	28cx	VR4	6g	Tor
<u>4PU</u>	XC6204D56AMR	LVR-IC	LDO, 5.65V±2%, 150mA, -CE	SOT-25	28cx	VR4	6g	Tor
<u>4PU</u>	XC6105E426MR	Vdet-IC	2.6V±2%, Hst, +Rst PPO, -Rst ODO, Wt=200ms, Rt=200ms	SOT-25	28xg	VD20	6g	Tor
<u>4PU</u>	XC6204H56AMR	LVR-IC	LDO, 5.65V±2%, 300mA, -CE	SOT-25	28cx	VR4	6g	Tor
<u>4PV</u>	XC6204D57AMR	LVR-IC	LDO, 5.75V±2%, 150mA, -CE	SOT-25	28cx	VR4	6g	Tor
<u>4PV</u>	XC6105E427MR	Vdet-IC	2.7V±2%, Hst, +Rst PPO, -Rst ODO, Wt=200ms, Rt=200ms	SOT-25	28xg	VD20	6g	Tor
<u>4PV</u>	XC6204H57AMR	LVR-IC	LDO, 5.75V±2%, 300mA, -CE	SOT-25	28cx	VR4	6g	Tor
<u>4PX</u>	XC6204D58AMR	LVR-IC	LDO, 5.85V±2%, 150mA, -CE	SOT-25	28cx	VR4	6g	Tor
<u>4PX</u>	XC6105E428MR	Vdet-IC	2.8V±2%, Hst, +Rst PPO, -Rst ODO, Wt=200ms, Rt=200ms	SOT-25	28xg	VD20	6g	Tor
<u>4PX</u>	XC6204H58AMR	LVR-IC	LDO, 5.85V±2%, 300mA, -CE	SOT-25	28cx	VR4	6g	Tor
<u>4PY</u>	XC6204D59AMR	LVR-IC	LDO, 5.95V±2%, 150mA, -CE	SOT-25	28cx	VR4	6g	Tor
<u>4PY</u>	XC6105E429MR	Vdet-IC	2.9V±2%, Hst, +Rst PPO, -Rst ODO, Wt=200ms, Rt=200ms	SOT-25	28xg	VD20	6g	Tor
<u>4PY</u>	XC6204H59AMR	LVR-IC	LDO, 5.95V±2%, 300mA, -CE	SOT-25	28cx	VR4	6g	Tor
<u>4PZ</u>	XC6105E430MR	Vdet-IC	3.0V±2%, Hst, +Rst PPO, -Rst ODO, Wt=200ms, Rt=200ms	SOT-25	28xg	VD20	6g	Tor
<u>4Q</u>	R1210N241A	DC/DC-IC	PWM step-up, 2.4V, 35..100kHz	SOT-23-5	28sc	DC3	6g	Ric
<u>4R</u>	R1210N341A	DC/DC-IC	PWM step-up, 3.4V, 35..100kHz	SOT-23-5	28sc	DC3	6g	Ric
<u>4R0</u>	XC6105E531MR	Vdet-IC	3.1V±2%, Hst, +Rst PPO, -Rst ODO, Wt=400ms, Rt=200ms	SOT-25	28xg	VD20	6g	Tor
<u>4R1</u>	XC6105E532MR	Vdet-IC	3.2V±2%, Hst, +Rst PPO, -Rst ODO, Wt=400ms, Rt=200ms	SOT-25	28xg	VD20	6g	Tor
<u>4R2</u>	XC6105E533MR	Vdet-IC	3.3V±2%, Hst, +Rst PPO, -Rst ODO, Wt=400ms, Rt=200ms	SOT-25	28xg	VD20	6g	Tor
<u>4R3</u>	XC6105E534MR	Vdet-IC	3.4V±2%, Hst, +Rst PPO, -Rst ODO, Wt=400ms, Rt=200ms	SOT-25	28xg	VD20	6g	Tor
<u>4R4</u>	XC6105E535MR	Vdet-IC	3.5V±2%, Hst, +Rst PPO, -Rst ODO, Wt=400ms, Rt=200ms	SOT-25	28xg	VD20	6g	Tor
<u>4R5</u>	XC6105E536MR	Vdet-IC	3.6V±2%, Hst, +Rst PPO, -Rst ODO, Wt=400ms, Rt=200ms	SOT-25	28xg	VD20	6g	Tor
<u>4R6</u>	XC6105E537MR	Vdet-IC	3.7V±2%, Hst, +Rst PPO, -Rst ODO, Wt=400ms, Rt=200ms	SOT-25	28xg	VD20	6g	Tor
<u>4R7</u>	XC6105E538MR	Vdet-IC	3.8V±2%, Hst, +Rst PPO, -Rst ODO, Wt=400ms, Rt=200ms	SOT-25	28xg	VD20	6g	Tor
<u>4R8</u>	XC6105E539MR	Vdet-IC	3.9V±2%, Hst, +Rst PPO, -Rst ODO, Wt=400ms, Rt=200ms	SOT-25	28xg	VD20	6g	Tor
<u>4R9</u>	XC6105E540MR	Vdet-IC	4.0V±2%, Hst, +Rst PPO, -Rst ODO, Wt=400ms, Rt=200ms	SOT-25	28xg	VD20	6g	Tor
<u>4RA</u>	XC6105E541MR	Vdet-IC	4.1V±2%, Hst, +Rst PPO, -Rst ODO, Wt=400ms, Rt=200ms	SOT-25	28xg	VD20	6g	Tor
<u>4RB</u>	XC6105E542MR	Vdet-IC	4.2V±2%, Hst, +Rst PPO, -Rst ODO, Wt=400ms, Rt=200ms	SOT-25	28xg	VD20	6g	Tor
<u>4RC</u>	XC6105E543MR	Vdet-IC	4.3V±2%, Hst, +Rst PPO, -Rst ODO, Wt=400ms, Rt=200ms	SOT-25	28xg	VD20	6g	Tor
<u>4RD</u>	XC6105E544MR	Vdet-IC	4.4V±2%, Hst, +Rst PPO, -Rst ODO, Wt=400ms, Rt=200ms	SOT-25	28xg	VD20	6g	Tor
<u>4RE</u>	XC6105E545MR	Vdet-IC	4.5V±2%, Hst, +Rst PPO, -Rst ODO, Wt=400ms, Rt=200ms	SOT-25	28xg	VD20	6g	Tor
<u>4RF</u>	XC6105E516MR	Vdet-IC	1.6V±2%, Hst, +Rst PPO, -Rst ODO, Wt=400ms, Rt=200ms	SOT-25	28xg	VD20	6g	Tor
<u>4RF</u>	XC6105E546MR	Vdet-IC	4.6V±2%, Hst, +Rst PPO, -Rst ODO, Wt=400ms, Rt=200ms	SOT-25	28xg	VD20	6g	Tor
<u>4RH</u>	XC6105E517MR	Vdet-IC	1.7V±2%, Hst, +Rst PPO, -Rst ODO, Wt=400ms, Rt=200ms	SOT-25	28xg	VD20	6g	Tor
<u>4RH</u>	XC6105E547MR	Vdet-IC	4.7V±2%, Hst, +Rst PPO, -Rst ODO, Wt=400ms, Rt=200ms	SOT-25	28xg	VD20	6g	Tor
<u>4RK</u>	XC6105E518MR	Vdet-IC	1.8V±2%, Hst, +Rst PPO, -Rst ODO, Wt=400ms, Rt=200ms	SOT-25	28xg	VD20	6g	Tor
<u>4RK</u>	XC6105E548MR	Vdet-IC	4.8V±2%, Hst, +Rst PPO, -Rst ODO, Wt=400ms, Rt=200ms	SOT-25	28xg	VD20	6g	Tor
<u>4RL</u>	XC6105E519MR	Vdet-IC	1.9V±2%, Hst, +Rst PPO, -Rst ODO, Wt=400ms, Rt=200ms	SOT-25	28xg	VD20	6g	Tor
<u>4RL</u>	XC6105E549MR	Vdet-IC	4.9V±2%, Hst, +Rst PPO, -Rst ODO, Wt=400ms, Rt=200ms	SOT-25	28xg	VD20	6g	Tor



SMD code	Type	Function	Short description	Case	Pinout	Sch.	St.	Mnf.
<u>4TL</u>	XC6105F519MR	Vdet-IC	1.9V±2%, Hst, +Rst PPO, -Rst ODO, Wt=400ms, Rt=400ms	SOT-25	28xg	VD20	6g	Tor
<u>4TL</u>	XC6105F549MR	Vdet-IC	4.9V±2%, Hst, +Rst PPO, -Rst ODO, Wt=400ms, Rt=400ms	SOT-25	28xg	VD20	6g	Tor
<u>4TM</u>	XC6105F520MR	Vdet-IC	2.0V±2%, Hst, +Rst PPO, -Rst ODO, Wt=400ms, Rt=400ms	SOT-25	28xg	VD20	6g	Tor
<u>4TM</u>	XC6105F550MR	Vdet-IC	5.0V±2%, Hst, +Rst PPO, -Rst ODO, Wt=400ms, Rt=400ms	SOT-25	28xg	VD20	6g	Tor
<u>4TN</u>	XC6105F521MR	Vdet-IC	2.1V±2%, Hst, +Rst PPO, -Rst ODO, Wt=400ms, Rt=400ms	SOT-25	28xg	VD20	6g	Tor
<u>4TP</u>	XC6105F522MR	Vdet-IC	2.2V±2%, Hst, +Rst PPO, -Rst ODO, Wt=400ms, Rt=400ms	SOT-25	28xg	VD20	6g	Tor
<u>4TR</u>	XC6105F523MR	Vdet-IC	2.3V±2%, Hst, +Rst PPO, -Rst ODO, Wt=400ms, Rt=400ms	SOT-25	28xg	VD20	6g	Tor
<u>4TS</u>	XC6105F524MR	Vdet-IC	2.4V±2%, Hst, +Rst PPO, -Rst ODO, Wt=400ms, Rt=400ms	SOT-25	28xg	VD20	6g	Tor
<u>4TT</u>	XC6105F525MR	Vdet-IC	2.5V±2%, Hst, +Rst PPO, -Rst ODO, Wt=400ms, Rt=400ms	SOT-25	28xg	VD20	6g	Tor
<u>4TU</u>	XC6105F526MR	Vdet-IC	2.6V±2%, Hst, +Rst PPO, -Rst ODO, Wt=400ms, Rt=400ms	SOT-25	28xg	VD20	6g	Tor
<u>4TV</u>	XC6105F527MR	Vdet-IC	2.7V±2%, Hst, +Rst PPO, -Rst ODO, Wt=400ms, Rt=400ms	SOT-25	28xg	VD20	6g	Tor
<u>4TX</u>	XC6105F528MR	Vdet-IC	2.8V±2%, Hst, +Rst PPO, -Rst ODO, Wt=400ms, Rt=400ms	SOT-25	28xg	VD20	6g	Tor
<u>4TY</u>	XC6105F529MR	Vdet-IC	2.9V±2%, Hst, +Rst PPO, -Rst ODO, Wt=400ms, Rt=400ms	SOT-25	28xg	VD20	6g	Tor
<u>4TZ</u>	XC6105F530MR	Vdet-IC	3.0V±2%, Hst, +Rst PPO, -Rst ODO, Wt=400ms, Rt=400ms	SOT-25	28xg	VD20	6g	Tor
<u>4U</u>	R1210N241C	DC/DC-IC	PWM step-up, 2.4V, 100kHz	SOT-23-5	28sc	DC3	6g	Ric
<u>4U0</u>	XC6105F631MR	Vdet-IC	3.1V±2%, Hst, +Rst PPO, -Rst ODO, Wt=1.6s, Rt=400ms	SOT-25	28xg	VD20	6g	Tor
<u>4U1</u>	XC6105F632MR	Vdet-IC	3.2V±2%, Hst, +Rst PPO, -Rst ODO, Wt=1.6s, Rt=400ms	SOT-25	28xg	VD20	6g	Tor
<u>4U2</u>	XC6105F633MR	Vdet-IC	3.3V±2%, Hst, +Rst PPO, -Rst ODO, Wt=1.6s, Rt=400ms	SOT-25	28xg	VD20	6g	Tor
<u>4U3</u>	XC6105F634MR	Vdet-IC	3.4V±2%, Hst, +Rst PPO, -Rst ODO, Wt=1.6s, Rt=400ms	SOT-25	28xg	VD20	6g	Tor
<u>4U4</u>	XC6105F635MR	Vdet-IC	3.5V±2%, Hst, +Rst PPO, -Rst ODO, Wt=1.6s, Rt=400ms	SOT-25	28xg	VD20	6g	Tor
<u>4U5</u>	XC6105F636MR	Vdet-IC	3.6V±2%, Hst, +Rst PPO, -Rst ODO, Wt=1.6s, Rt=400ms	SOT-25	28xg	VD20	6g	Tor
<u>4U6</u>	XC6105F637MR	Vdet-IC	3.7V±2%, Hst, +Rst PPO, -Rst ODO, Wt=1.6s, Rt=400ms	SOT-25	28xg	VD20	6g	Tor
<u>4U7</u>	XC6105F638MR	Vdet-IC	3.8V±2%, Hst, +Rst PPO, -Rst ODO, Wt=1.6s, Rt=400ms	SOT-25	28xg	VD20	6g	Tor
<u>4U8</u>	XC6105F639MR	Vdet-IC	3.9V±2%, Hst, +Rst PPO, -Rst ODO, Wt=1.6s, Rt=400ms	SOT-25	28xg	VD20	6g	Tor
<u>4U9</u>	XC6105F640MR	Vdet-IC	4.0V±2%, Hst, +Rst PPO, -Rst ODO, Wt=1.6s, Rt=400ms	SOT-25	28xg	VD20	6g	Tor
<u>4UA</u>	XC6105F641MR	Vdet-IC	4.1V±2%, Hst, +Rst PPO, -Rst ODO, Wt=1.6s, Rt=400ms	SOT-25	28xg	VD20	6g	Tor
<u>4UB</u>	XC6105F642MR	Vdet-IC	4.2V±2%, Hst, +Rst PPO, -Rst ODO, Wt=1.6s, Rt=400ms	SOT-25	28xg	VD20	6g	Tor
<u>4UC</u>	XC6105F643MR	Vdet-IC	4.3V±2%, Hst, +Rst PPO, -Rst ODO, Wt=1.6s, Rt=400ms	SOT-25	28xg	VD20	6g	Tor
<u>4UD</u>	XC6105F644MR	Vdet-IC	4.4V±2%, Hst, +Rst PPO, -Rst ODO, Wt=1.6s, Rt=400ms	SOT-25	28xg	VD20	6g	Tor
<u>4UE</u>	XC6105F645MR	Vdet-IC	4.5V±2%, Hst, +Rst PPO, -Rst ODO, Wt=1.6s, Rt=400ms	SOT-25	28xg	VD20	6g	Tor
<u>4UF</u>	XC6105F616MR	Vdet-IC	1.6V±2%, Hst, +Rst PPO, -Rst ODO, Wt=1.6s, Rt=400ms	SOT-25	28xg	VD20	6g	Tor
<u>4UF</u>	XC6105F646MR	Vdet-IC	4.6V±2%, Hst, +Rst PPO, -Rst ODO, Wt=1.6s, Rt=400ms	SOT-25	28xg	VD20	6g	Tor
<u>4UH</u>	XC6105F617MR	Vdet-IC	1.7V±2%, Hst, +Rst PPO, -Rst ODO, Wt=1.6s, Rt=400ms	SOT-25	28xg	VD20	6g	Tor
<u>4UH</u>	XC6105F647MR	Vdet-IC	4.7V±2%, Hst, +Rst PPO, -Rst ODO, Wt=1.6s, Rt=400ms	SOT-25	28xg	VD20	6g	Tor
<u>4UK</u>	XC6105F618MR	Vdet-IC	1.8V±2%, Hst, +Rst PPO, -Rst ODO, Wt=1.6s, Rt=400ms	SOT-25	28xg	VD20	6g	Tor
<u>4UK</u>	XC6105F648MR	Vdet-IC	4.8V±2%, Hst, +Rst PPO, -Rst ODO, Wt=1.6s, Rt=400ms	SOT-25	28xg	VD20	6g	Tor
<u>4UL</u>	XC6105F619MR	Vdet-IC	1.9V±2%, Hst, +Rst PPO, -Rst ODO, Wt=1.6s, Rt=400ms	SOT-25	28xg	VD20	6g	Tor
<u>4UL</u>	XC6105F649MR	Vdet-IC	4.9V±2%, Hst, +Rst PPO, -Rst ODO, Wt=1.6s, Rt=400ms	SOT-25	28xg	VD20	6g	Tor
<u>4UM</u>	XC6105F620MR	Vdet-IC	2.0V±2%, Hst, +Rst PPO, -Rst ODO, Wt=1.6s, Rt=400ms	SOT-25	28xg	VD20	6g	Tor
<u>4UM</u>	XC6105F650MR	Vdet-IC	5.0V±2%, Hst, +Rst PPO, -Rst ODO, Wt=1.6s, Rt=400ms	SOT-25	28xg	VD20	6g	Tor
<u>4UN</u>	XC6105F621MR	Vdet-IC	2.1V±2%, Hst, +Rst PPO, -Rst ODO, Wt=1.6s, Rt=400ms	SOT-25	28xg	VD20	6g	Tor
<u>4UP</u>	XC6105F622MR	Vdet-IC	2.2V±2%, Hst, +Rst PPO, -Rst ODO, Wt=1.6s, Rt=400ms	SOT-25	28xg	VD20	6g	Tor
<u>4UR</u>	XC6105F623MR	Vdet-IC	2.3V±2%, Hst, +Rst PPO, -Rst ODO, Wt=1.6s, Rt=400ms	SOT-25	28xg	VD20	6g	Tor
<u>4US</u>	XC6105F624MR	Vdet-IC	2.4V±2%, Hst, +Rst PPO, -Rst ODO, Wt=1.6s, Rt=400ms	SOT-25	28xg	VD20	6g	Tor
<u>4UT</u>	XC6105F625MR	Vdet-IC	2.5V±2%, Hst, +Rst PPO, -Rst ODO, Wt=1.6s, Rt=400ms	SOT-25	28xg	VD20	6g	Tor
<u>4UU</u>	XC6105F626MR	Vdet-IC	2.6V±2%, Hst, +Rst PPO, -Rst ODO, Wt=1.6s, Rt=400ms	SOT-25	28xg	VD20	6g	Tor
<u>4UV</u>	XC6105F627MR	Vdet-IC	2.7V±2%, Hst, +Rst PPO, -Rst ODO, Wt=1.6s, Rt=400ms	SOT-25	28xg	VD20	6g	Tor
<u>4UX</u>	XC6105F628MR	Vdet-IC	2.8V±2%, Hst, +Rst PPO, -Rst ODO, Wt=1.6s, Rt=400ms	SOT-25	28xg	VD20	6g	Tor
<u>4UY</u>	XC6105F629MR	Vdet-IC	2.9V±2%, Hst, +Rst PPO, -Rst ODO, Wt=1.6s, Rt=400ms	SOT-25	28xg	VD20	6g	Tor
<u>4UZ</u>	XC6105F630MR	Vdet-IC	3.0V±2%, Hst, +Rst PPO, -Rst ODO, Wt=1.6s, Rt=400ms	SOT-25	28xg	VD20	6g	Tor
<u>4V</u>	R1210N501D	DC/DC-IC	PWM step-up, 5V, 180kHz	SOT-23-5	28sc	DC3	6g	Ric
<u>4V0</u>	TAR5S40	LVR-IC	LDO, 4V±1%, 200mA, +CE	SSOP-5	28un	VR7	6a	Tos
<u>4V0</u>	TAR5S40A	LVR-IC	LDO, 4V±1%, 200mA, +CE	SSOP-5-P	30un	VR7	6a	Tos
<u>4V0</u>	XC6105H631MR	Vdet-IC	3.1V±2%, Hst, +Rst PPO, -Rst ODO, Wt=1.6s, Rt=1.6s	SOT-25	28xg	VD20	6g	Tor
<u>4V1</u>	TAR5S41	LVR-IC	LDO, 4.1V±1%, 200mA, +CE	SSOP-5	28un	VR7	6a	Tos
<u>4V1</u>	TAR5S41U	LVR-IC	LDO, 4.1V±1%, 200mA, +CE	SSOP-5-P	30un	VR7	6a	Tos
<u>4V1</u>	XC6105H632MR	Vdet-IC	3.2V±2%, Hst, +Rst PPO, -Rst ODO, Wt=1.6s, Rt=1.6s	SOT-25	28xg	VD20	6g	Tor
<u>4V2</u>	TAR5S42	LVR-IC	LDO, 4.2V±1%, 200mA, +CE	SSOP-5	28un	VR7	6a	Tos
<u>4V2</u>	TAR5S42U	LVR-IC	LDO, 4.2V±1%, 200mA, +CE	SSOP-5-P	30un	VR7	6a	Tos
<u>4V2</u>	XC6105H633MR	Vdet-IC	3.3V±2%, Hst, +Rst PPO, -Rst ODO, Wt=1.6s, Rt=1.6s	SOT-25	28xg	VD20	6g	Tor
<u>4V3</u>	TAR5S43	LVR-IC	LDO, 4.3V±1%, 200mA, +CE	SSOP-5	28un	VR7	6a	Tos
<u>4V3</u>	TAR5S43U	LVR-IC	LDO, 4.3V±1%, 200mA, +CE	SSOP-5-P	30un	VR7	6a	Tos
<u>4V3</u>	XC6105H634MR	Vdet-IC	3.4V±2%, Hst, +Rst PPO, -Rst ODO, Wt=1.6s, Rt=1.6s	SOT-25	28xg	VD20	6g	Tor
<u>4V4</u>	TAR5S44	LVR-IC	LDO, 4.4V±1%, 200mA, +CE	SSOP-5	28un	VR7	6a	Tos
<u>4V4</u>	TAR5S44U	LVR-IC	LDO, 4.4V±1%, 200mA, +CE	SSOP-5-P	30un	VR7	6a	Tos
<u>4V4</u>	XC6105H635MR	Vdet-IC	3.5V±2%, Hst, +Rst PPO, -Rst ODO, Wt=1.6s, Rt=1.6s	SOT-25	28xg	VD20	6g	Tor
<u>4V5</u>	TAR5S45	LVR-IC	LDO, 4.5V±1%, 200mA, +CE	SSOP-5	28un	VR7	6a	Tos
<u>4V5</u>	TAR5S45U	LVR-IC	LDO, 4.5V±1%, 200mA, +CE	SSOP-5-P	30un	VR7	6a	Tos
<u>4V5</u>	XC6105H636MR	Vdet-IC	3.6V±2%, Hst, +Rst PPO, -Rst ODO, Wt=1.6s, Rt=1.6s	SOT-25	28xg	VD20	6g	Tor
<u>4V6</u>	TAR5S46	LVR-IC	LDO, 4.6V±1%, 200mA, +CE	SSOP-5	28un	VR7	6a	Tos



SMD code	Type	Function	Short description	Case	Pinout	Sch.	St.	Mnf.
4V6	TAR5S46U	LVR-IC	LDO, 4.6V±1%, 200mA, +CE	SSOP-5-P	30un	VR7	6a	Tos
4V6	XC6105H637MR	Vdet-IC	3.7V±2%, Hst, +Rst PPO, -Rst ODO, Wt=1.6s, Rt=1.6s	SOT-25	28xg	VD20	6g	Tor
4V7	TAR5S47	LVR-IC	LDO, 4.7V±1%, 200mA, +CE	SSOP-5	28un	VR7	6a	Tos
4V7	TAR5S47U	LVR-IC	LDO, 4.7V±1%, 200mA, +CE	SSOP-5-P	30un	VR7	6a	Tos
4V7	XC6105H638MR	Vdet-IC	3.8V±2%, Hst, +Rst PPO, -Rst ODO, Wt=1.6s, Rt=1.6s	SOT-25	28xg	VD20	6g	Tor
4V8	TAR5S48	LVR-IC	LDO, 4.8V±1%, 200mA, +CE	SSOP-5	28un	VR7	6a	Tos
4V8	TAR5S48U	LVR-IC	LDO, 4.8V±1%, 200mA, +CE	SSOP-5-P	30un	VR7	6a	Tos
4V8	XC6105H639MR	Vdet-IC	3.9V±2%, Hst, +Rst PPO, -Rst ODO, Wt=1.6s, Rt=1.6s	SOT-25	28xg	VD20	6g	Tor
4V9	TAR5S49	LVR-IC	LDO, 4.9V±1%, 200mA, +CE	SSOP-5	28un	VR7	6a	Tos
4V9	TAR5S49U	LVR-IC	LDO, 4.9V±1%, 200mA, +CE	SSOP-5-P	30un	VR7	6a	Tos
4V9	XC6105H640MR	Vdet-IC	4.0V±2%, Hst, +Rst PPO, -Rst ODO, Wt=1.6s, Rt=1.6s	SOT-25	28xg	VD20	6g	Tor
4VA	XC6105H641MR	Vdet-IC	4.1V±2%, Hst, +Rst PPO, -Rst ODO, Wt=1.6s, Rt=1.6s	SOT-25	28xg	VD20	6g	Tor
4VB	XC6105H642MR	Vdet-IC	4.2V±2%, Hst, +Rst PPO, -Rst ODO, Wt=1.6s, Rt=1.6s	SOT-25	28xg	VD20	6g	Tor
4VC	XC6105H643MR	Vdet-IC	4.3V±2%, Hst, +Rst PPO, -Rst ODO, Wt=1.6s, Rt=1.6s	SOT-25	28xg	VD20	6g	Tor
4VD	XC6105H644MR	Vdet-IC	4.4V±2%, Hst, +Rst PPO, -Rst ODO, Wt=1.6s, Rt=1.6s	SOT-25	28xg	VD20	6g	Tor
4VE	XC6105H645MR	Vdet-IC	4.5V±2%, Hst, +Rst PPO, -Rst ODO, Wt=1.6s, Rt=1.6s	SOT-25	28xg	VD20	6g	Tor
4VF	XC6105H646MR	Vdet-IC	4.6V±2%, Hst, +Rst PPO, -Rst ODO, Wt=1.6s, Rt=1.6s	SOT-25	28xg	VD20	6g	Tor
4VH	XC6105H647MR	Vdet-IC	4.7V±2%, Hst, +Rst PPO, -Rst ODO, Wt=1.6s, Rt=1.6s	SOT-25	28xg	VD20	6g	Tor
4VH	XC6105H647MR	Vdet-IC	4.7V±2%, Hst, +Rst PPO, -Rst ODO, Wt=1.6s, Rt=1.6s	SOT-25	28xg	VD20	6g	Tor
4VK	XC6204A182MR	LVR-IC	LDO, 1.8V±2%, 150mA, +CE, PDR	SOT-25	28cx	VR4	6g	Tor
4VK	XC6105H618MR	Vdet-IC	1.8V±2%, Hst, +Rst PPO, -Rst ODO, Wt=1.6s, Rt=1.6s	SOT-25	28xg	VD20	6g	Tor
4VK	XC6105H648MR	Vdet-IC	4.8V±2%, Hst, +Rst PPO, -Rst ODO, Wt=1.6s, Rt=1.6s	SOT-25	28xg	VD20	6g	Tor
4VK	XC6204E182MR	LVR-IC	LDO, 1.8V±2%, 300mA, +CE, PDR	SOT-25	28cx	VR4	6g	Tor
4VL	XC6204A192MR	LVR-IC	LDO, 1.9V±2%, 150mA, +CE, PDR	SOT-25	28cx	VR4	6g	Tor
4VL	XC6105H619MR	Vdet-IC	1.9V±2%, Hst, +Rst PPO, -Rst ODO, Wt=1.6s, Rt=1.6s	SOT-25	28xg	VD20	6g	Tor
4VL	XC6105H649MR	Vdet-IC	4.9V±2%, Hst, +Rst PPO, -Rst ODO, Wt=1.6s, Rt=1.6s	SOT-25	28xg	VD20	6g	Tor
4VL	XC6204E192MR	LVR-IC	LDO, 1.9V±2%, 300mA, +CE, PDR	SOT-25	28cx	VR4	6g	Tor
4VM	XC6204A202MR	LVR-IC	LDO, 2.0V±2%, 150mA, +CE, PDR	SOT-25	28cx	VR4	6g	Tor
4VM	XC6105H620MR	Vdet-IC	2.0V±2%, Hst, +Rst PPO, -Rst ODO, Wt=1.6s, Rt=1.6s	SOT-25	28xg	VD20	6g	Tor
4VM	XC6105H650MR	Vdet-IC	5.0V±2%, Hst, +Rst PPO, -Rst ODO, Wt=1.6s, Rt=1.6s	SOT-25	28xg	VD20	6g	Tor
4VM	XC6204E202MR	LVR-IC	LDO, 2.0V±2%, 300mA, +CE, PDR	SOT-25	28cx	VR4	6g	Tor
4VN	XC6204A212MR	LVR-IC	LDO, 2.1V±2%, 150mA, +CE, PDR	SOT-25	28cx	VR4	6g	Tor
4VN	XC6105H621MR	Vdet-IC	2.1V±2%, Hst, +Rst PPO, -Rst ODO, Wt=1.6s, Rt=1.6s	SOT-25	28xg	VD20	6g	Tor
4VN	XC6204E212MR	LVR-IC	LDO, 2.1V±2%, 300mA, +CE, PDR	SOT-25	28cx	VR4	6g	Tor
4VP	XC6204A222MR	LVR-IC	LDO, 2.2V±2%, 150mA, +CE, PDR	SOT-25	28cx	VR4	6g	Tor
4VP	XC6105H622MR	Vdet-IC	2.2V±2%, Hst, +Rst PPO, -Rst ODO, Wt=1.6s, Rt=1.6s	SOT-25	28xg	VD20	6g	Tor
4VP	XC6204E222MR	LVR-IC	LDO, 2.2V±2%, 300mA, +CE, PDR	SOT-25	28cx	VR4	6g	Tor
4VR	XC6204A232MR	LVR-IC	LDO, 2.3V±2%, 150mA, +CE, PDR	SOT-25	28cx	VR4	6g	Tor
4VR	XC6105H623MR	Vdet-IC	2.3V±2%, Hst, +Rst PPO, -Rst ODO, Wt=1.6s, Rt=1.6s	SOT-25	28xg	VD20	6g	Tor
4VR	XC6204E232MR	LVR-IC	LDO, 2.3V±2%, 300mA, +CE, PDR	SOT-25	28cx	VR4	6g	Tor
4VS	XC6204A242MR	LVR-IC	LDO, 2.4V±2%, 150mA, +CE, PDR	SOT-25	28cx	VR4	6g	Tor
4VS	XC6105H624MR	Vdet-IC	2.4V±2%, Hst, +Rst PPO, -Rst ODO, Wt=1.6s, Rt=1.6s	SOT-25	28xg	VD20	6g	Tor
4VS	XC6204E242MR	LVR-IC	LDO, 2.4V±2%, 300mA, +CE, PDR	SOT-25	28cx	VR4	6g	Tor
4VT	XC6204A252MR	LVR-IC	LDO, 2.5V±2%, 150mA, +CE, PDR	SOT-25	28cx	VR4	6g	Tor
4VT	XC6105H625MR	Vdet-IC	2.5V±2%, Hst, +Rst PPO, -Rst ODO, Wt=1.6s, Rt=1.6s	SOT-25	28xg	VD20	6g	Tor
4VT	XC6204E252MR	LVR-IC	LDO, 2.5V±2%, 300mA, +CE, PDR	SOT-25	28cx	VR4	6g	Tor
4VU	XC6204A262MR	LVR-IC	LDO, 2.6V±2%, 150mA, +CE, PDR	SOT-25	28cx	VR4	6g	Tor
4VU	XC6105H626MR	Vdet-IC	2.6V±2%, Hst, +Rst PPO, -Rst ODO, Wt=1.6s, Rt=1.6s	SOT-25	28xg	VD20	6g	Tor
4VU	XC6204E262MR	LVR-IC	LDO, 2.6V±2%, 300mA, +CE, PDR	SOT-25	28cx	VR4	6g	Tor
4VV	XC6204A272MR	LVR-IC	LDO, 2.7V±2%, 150mA, +CE, PDR	SOT-25	28cx	VR4	6g	Tor
4VV	XC6105H627MR	Vdet-IC	2.7V±2%, Hst, +Rst PPO, -Rst ODO, Wt=1.6s, Rt=1.6s	SOT-25	28xg	VD20	6g	Tor
4VY	XC6204E272MR	LVR-IC	LDO, 2.7V±2%, 300mA, +CE, PDR	SOT-25	28cx	VR4	6g	Tor
4VX	XC6204A282MR	LVR-IC	LDO, 2.8V±2%, 150mA, +CE, PDR	SOT-25	28cx	VR4	6g	Tor
4VX	XC6105H628MR	Vdet-IC	2.8V±2%, Hst, +Rst PPO, -Rst ODO, Wt=1.6s, Rt=1.6s	SOT-25	28xg	VD20	6g	Tor
4VX	XC6204E282MR	LVR-IC	LDO, 2.8V±2%, 300mA, +CE, PDR	SOT-25	28cx	VR4	6g	Tor
4VY	XC6204A292MR	LVR-IC	LDO, 2.9V±2%, 150mA, +CE, PDR	SOT-25	28cx	VR4	6g	Tor
4VY	XC6105H629MR	Vdet-IC	2.9V±2%, Hst, +Rst PPO, -Rst ODO, Wt=1.6s, Rt=1.6s	SOT-25	28xg	VD20	6g	Tor
4VY	XC6204E292MR	LVR-IC	LDO, 2.9V±2%, 300mA, +CE, PDR	SOT-25	28cx	VR4	6g	Tor
4VZ	XC6204A302MR	LVR-IC	LDO, 3.0V±2%, 150mA, +CE, PDR	SOT-25	28cx	VR4	6g	Tor
4VZ	XC6105H630MR	Vdet-IC	3.0V±2%, Hst, +Rst PPO, -Rst ODO, Wt=1.6s, Rt=1.6s	SOT-25	28xg	VD20	6g	Tor
4VZ	XC6204E302MR	LVR-IC	LDO, 3.0V±2%, 300mA, +CE, PDR	SOT-25	28cx	VR4	6g	Tor
4W	R1210N341C	DC/DC-IC	PWM step-up, 3.4V, 100kHz	SOT-23-5	28sc	DC3	6g	Ric
4X	R1210N441C	DC/DC-IC	PWM step-up, 4.3V, 100kHz	SOT-23-5	28sc	DC3	6g	Ric
4XK	XC6204B182MR	LVR-IC	LDO, 1.8V±2%, 150mA, +CE	SOT-25	28cx	VR4	6g	Tor
4XK	XC6204F182MR	LVR-IC	LDO, 1.8V±2%, 300mA, +CE	SOT-25	28cx	VR4	6g	Tor
4XL	XC6204B192MR	LVR-IC	LDO, 1.9V±2%, 150mA, +CE	SOT-25	28cx	VR4	6g	Tor
4XL	XC6204F192MR	LVR-IC	LDO, 1.9V±2%, 300mA, +CE	SOT-25	28cx	VR4	6g	Tor
4XM	XC6204B202MR	LVR-IC	LDO, 2.0V±2%, 150mA, +CE	SOT-25	28cx	VR4	6g	Tor
4XM	XC6204F202MR	LVR-IC	LDO, 2.0V±2%, 300mA, +CE	SOT-25	28cx	VR4	6g	Tor



SMD code	Type	Function	Short description	Case	Pinout	Sch.	St.	Mnf.
4XN	XC6204B212MR	LVR-IC	LDO, 2.1V±2%, 150mA, +CE	SOT-25	28cx	VR4	6g	Tor
4XN	XC6204F212MR	LVR-IC	LDO, 2.1V±2%, 300mA, +CE	SOT-25	28cx	VR4	6g	Tor
4XP	XC6204B222MR	LVR-IC	LDO, 2.2V±2%, 150mA, +CE	SOT-25	28cx	VR4	6g	Tor
4XP	XC6204F222MR	LVR-IC	LDO, 2.2V±2%, 300mA, +CE	SOT-25	28cx	VR4	6g	Tor
4XR	XC6204B232MR	LVR-IC	LDO, 2.3V±2%, 150mA, +CE	SOT-25	28cx	VR4	6g	Tor
4XR	XC6204F232MR	LVR-IC	LDO, 2.3V±2%, 300mA, +CE	SOT-25	28cx	VR4	6g	Tor
4XS	XC6204B242MR	LVR-IC	LDO, 2.4V±2%, 150mA, +CE	SOT-25	28cx	VR4	6g	Tor
4XS	XC6204F242MR	LVR-IC	LDO, 2.4V±2%, 300mA, +CE	SOT-25	28cx	VR4	6g	Tor
4XT	XC6204B252MR	LVR-IC	LDO, 2.5V±2%, 150mA, +CE	SOT-25	28cx	VR4	6g	Tor
4XT	XC6204F252MR	LVR-IC	LDO, 2.5V±2%, 300mA, +CE	SOT-25	28cx	VR4	6g	Tor
4XU	XC6204B262MR	LVR-IC	LDO, 2.6V±2%, 150mA, +CE	SOT-25	28cx	VR4	6g	Tor
4XU	XC6204F262MR	LVR-IC	LDO, 2.6V±2%, 300mA, +CE	SOT-25	28cx	VR4	6g	Tor
4XV	XC6204B272MR	LVR-IC	LDO, 2.7V±2%, 150mA, +CE	SOT-25	28cx	VR4	6g	Tor
4XV	XC6204F272MR	LVR-IC	LDO, 2.7V±2%, 300mA, +CE	SOT-25	28cx	VR4	6g	Tor
4XX	XC6204B282MR	LVR-IC	LDO, 2.8V±2%, 150mA, +CE	SOT-25	28cx	VR4	6g	Tor
4XX	XC6204F282MR	LVR-IC	LDO, 2.8V±2%, 300mA, +CE	SOT-25	28cx	VR4	6g	Tor
4XY	XC6204B292MR	LVR-IC	LDO, 2.9V±2%, 150mA, +CE	SOT-25	28cx	VR4	6g	Tor
4XY	XC6204F292MR	LVR-IC	LDO, 2.9V±2%, 300mA, +CE	SOT-25	28cx	VR4	6g	Tor
4XZ	XC6204B302MR	LVR-IC	LDO, 3V±2%, 150mA, +CE	SOT-25	28cx	VR4	6g	Tor
4XZ	XC6204F302MR	LVR-IC	LDO, 3V±2%, 300mA, +CE	SOT-25	28cx	VR4	6g	Tor
4Y	R1210N541C	DC/DC-IC	PWM step-up, 5.4V, 100kHz	SOT-23-5	28sc	DC3	6g	Ric
4YK	XC6204C182MR	LVR-IC	LDO, 1.8V±2%, 150mA, -CE, PDR	SOT-25	28cx	VR4	6g	Tor
4YK	XC6204G182MR	LVR-IC	LDO, 1.8V±2%, 300mA, -CE, PDR	SOT-25	28cx	VR4	6g	Tor
4YL	XC6204C192MR	LVR-IC	LDO, 1.9V±2%, 150mA, -CE, PDR	SOT-25	28cx	VR4	6g	Tor
4YL	XC6204G192MR	LVR-IC	LDO, 1.9V±2%, 300mA, -CE, PDR	SOT-25	28cx	VR4	6g	Tor
4YM	XC6204C202MR	LVR-IC	LDO, 2V±2%, 150mA, -CE, PDR	SOT-25	28cx	VR4	6g	Tor
4YM	XC6204G202MR	LVR-IC	LDO, 2V±2%, 300mA, -CE, PDR	SOT-25	28cx	VR4	6g	Tor
4YN	XC6204C212MR	LVR-IC	LDO, 2.1V±2%, 150mA, -CE, PDR	SOT-25	28cx	VR4	6g	Tor
4YN	XC6204G212MR	LVR-IC	LDO, 2.1V±2%, 300mA, -CE, PDR	SOT-25	28cx	VR4	6g	Tor
4YP	XC6204C222MR	LVR-IC	LDO, 2.2V±2%, 150mA, -CE, PDR	SOT-25	28cx	VR4	6g	Tor
4YP	XC6204G222MR	LVR-IC	LDO, 2.2V±2%, 300mA, -CE, PDR	SOT-25	28cx	VR4	6g	Tor
4YR	XC6204C232MR	LVR-IC	LDO, 2.3V±2%, 150mA, -CE, PDR	SOT-25	28cx	VR4	6g	Tor
4YR	XC6204G232MR	LVR-IC	LDO, 2.3V±2%, 300mA, -CE, PDR	SOT-25	28cx	VR4	6g	Tor
4YS	XC6204C242MR	LVR-IC	LDO, 2.4V±2%, 150mA, -CE, PDR	SOT-25	28cx	VR4	6g	Tor
4YS	XC6204G242MR	LVR-IC	LDO, 2.4V±2%, 300mA, -CE, PDR	SOT-25	28cx	VR4	6g	Tor
4YT	XC6204C252MR	LVR-IC	LDO, 2.5V±2%, 150mA, -CE, PDR	SOT-25	28cx	VR4	6g	Tor
4YT	XC6204G252MR	LVR-IC	LDO, 2.5V±2%, 300mA, -CE, PDR	SOT-25	28cx	VR4	6g	Tor
4YU	XC6204C262MR	LVR-IC	LDO, 2.6V±2%, 150mA, -CE, PDR	SOT-25	28cx	VR4	6g	Tor
4YU	XC6204G262MR	LVR-IC	LDO, 2.6V±2%, 300mA, -CE, PDR	SOT-25	28cx	VR4	6g	Tor
4YV	XC6204C272MR	LVR-IC	LDO, 2.7V±2%, 150mA, -CE, PDR	SOT-25	28cx	VR4	6g	Tor
4YV	XC6204G272MR	LVR-IC	LDO, 2.7V±2%, 300mA, -CE, PDR	SOT-25	28cx	VR4	6g	Tor
4YX	XC6204C282MR	LVR-IC	LDO, 2.8V±2%, 150mA, -CE, PDR	SOT-25	28cx	VR4	6g	Tor
4YX	XC6204G282MR	LVR-IC	LDO, 2.8V±2%, 300mA, -CE, PDR	SOT-25	28cx	VR4	6g	Tor
4YY	XC6204C292MR	LVR-IC	LDO, 2.9V±2%, 150mA, -CE, PDR	SOT-25	28cx	VR4	6g	Tor
4YY	XC6204G292MR	LVR-IC	LDO, 2.9V±2%, 300mA, -CE, PDR	SOT-25	28cx	VR4	6g	Tor
4YZ	XC6204C302MR	LVR-IC	LDO, 3V±2%, 150mA, -CE, PDR	SOT-25	28cx	VR4	6g	Tor
4YZ	XC6204G302MR	LVR-IC	LDO, 3V±2%, 300mA, -CE, PDR	SOT-25	28cx	VR4	6g	Tor
4Z	R1210N241D	DC/DC-IC	PWM step-up, 2.4V, 180kHz	SOT-23-5	28sc	DC3	6g	Ric
4ZK	XC6204D182MR	LVR-IC	LDO, 1.8V±2%, 150mA, -CE	SOT-25	28cx	VR4	6g	Tor
4ZK	XC6204H182MR	LVR-IC	LDO, 1.8V±2%, 300mA, -CE	SOT-25	28cx	VR4	6g	Tor
4ZL	XC6204D192MR	LVR-IC	LDO, 1.9V±2%, 150mA, -CE	SOT-25	28cx	VR4	6g	Tor
4ZL	XC6204H192MR	LVR-IC	LDO, 1.9V±2%, 300mA, -CE	SOT-25	28cx	VR4	6g	Tor
4ZM	XC6204D202MR	LVR-IC	LDO, 2V±2%, 150mA, -CE	SOT-25	28cx	VR4	6g	Tor
4ZM	XC6204H202MR	LVR-IC	LDO, 2V±2%, 300mA, -CE	SOT-25	28cx	VR4	6g	Tor
4ZN	XC6204D212MR	LVR-IC	LDO, 2.1V±2%, 150mA, -CE	SOT-25	28cx	VR4	6g	Tor
4ZN	XC6204H212MR	LVR-IC	LDO, 2.1V±2%, 300mA, -CE	SOT-25	28cx	VR4	6g	Tor
4ZP	XC6204D222MR	LVR-IC	LDO, 2.2V±2%, 150mA, -CE	SOT-25	28cx	VR4	6g	Tor
4ZP	XC6204H222MR	LVR-IC	LDO, 2.2V±2%, 300mA, -CE	SOT-25	28cx	VR4	6g	Tor
4ZR	XC6204D232MR	LVR-IC	LDO, 2.3V±2%, 150mA, -CE	SOT-25	28cx	VR4	6g	Tor
4ZR	XC6204H232MR	LVR-IC	LDO, 2.3V±2%, 300mA, -CE	SOT-25	28cx	VR4	6g	Tor
4ZS	XC6204D242MR	LVR-IC	LDO, 2.4V±2%, 150mA, -CE	SOT-25	28cx	VR4	6g	Tor
4ZS	XC6204H242MR	LVR-IC	LDO, 2.4V±2%, 300mA, -CE	SOT-25	28cx	VR4	6g	Tor
4ZT	XC6204D252MR	LVR-IC	LDO, 2.5V±2%, 150mA, -CE	SOT-25	28cx	VR4	6g	Tor
4ZT	XC6204H252MR	LVR-IC	LDO, 2.5V±2%, 300mA, -CE	SOT-25	28cx	VR4	6g	Tor
4ZU	XC6204D262MR	LVR-IC	LDO, 2.6V±2%, 150mA, -CE	SOT-25	28cx	VR4	6g	Tor
4ZU	XC6204H262MR	LVR-IC	LDO, 2.6V±2%, 300mA, -CE	SOT-25	28cx	VR4	6g	Tor
4ZV	XC6204D272MR	LVR-IC	LDO, 2.7V±2%, 150mA, -CE	SOT-25	28cx	VR4	6g	Tor
4ZV	XC6204H272MR	LVR-IC	LDO, 2.7V±2%, 300mA, -CE	SOT-25	28cx	VR4	6g	Tor
4ZX	XC6204D282MR	LVR-IC	LDO, 2.8V±2%, 150mA, -CE	SOT-25	28cx	VR4	6g	Tor
4ZX	XC6204H282MR	LVR-IC	LDO, 2.8V±2%, 300mA, -CE	SOT-25	28cx	VR4	6g	Tor



SMD code	Type	Function	Short description	Case	Pinout	Sch.	St.	Mnf.
4ZY	XC6204D292MR	LVR-IC	LDO, 2.9V±2%, 150mA, -CE	SOT-25	28cx	VR4	6g	Tor
4ZY	XC6204H292MR	LVR-IC	LDO, 2.9V±2%, 300mA, -CE	SOT-25	28cx	VR4	6g	Tor
4ZZ	XC6204D302MR	LVR-IC	LDO, 3V±2%, 150mA, -CE	SOT-25	28cx	VR4	6g	Tor
4ZZ	XC6204H302MR	LVR-IC	LDO, 3V±2%, 300mA, -CE	SOT-25	28cx	VR4	6g	Tor
5.6Z	MAZZ056H	SA-Z-diode	Quad, 5.6V, 5mA, 200mW	SIMini5	30bc	-	6a	Pan
50	R1223N472F	DC/DC-IC	PWM/VFM step-down, +CE, 4.7V, 500kHz, R-Pr.	SOT-23-5	28ud	DC7	6g	Ric
50	RN5RF50AA	LVR-IC	LRip, -CE, 5V±2%, 1A*	SOT-23-5	28vw	VR6	6g	Ric
50	RN5RZ50AA	LVR-IC	LDO, LN, -CE, 5V±2%, 100mA	SOT-23-5	28vrt	VR4	6g	Ric
50A	AAT60050A-S5	Vdet-IC	5.0V±2%, -Reset ODO	SOT-23-5	28vdo	VD1	6g	Aat
50A	RP100N121B	LVR-IC	LDO, LN, +CE, 1.2V±0.8%, 200mA	SOT-23-5	28cx	VR4	6g	Ric
50A	XC6127C55AMR	Vdet-IC	5.5V±0.8%, -Reset PPO, -MR, Rt=50ms	SOT-25	28yx	VD5	6g	Tor
50-A	UTC8150-A	Vdet-IC	5V, -Reset OCO	SOT-23-5	28vzd	VD6	6k	Utc
50B	AAT60050B-S5	Vdet-IC	5.0V±2%, -Reset PPO	SOT-23-5	28vdo	VD3	6g	Aat
50B	RP100N131B	LVR-IC	LDO, LN, +CE, 1.3V±0.8%, 200mA	SOT-23-5	28cx	VR4	6g	Ric
50B	XC6127C55BMR	Vdet-IC	5.5V±0.8%, -Reset PPO, -MR, Rt=100ms	SOT-25	28yx	VD5	6g	Tor
50-B	UTC8150-B	Vdet-IC	5V, -Reset OCO	SOT-23-5	28vdm	VD6	6k	Utc
50C	AAT60050C-S5	Vdet-IC	5.0V±1%, -Reset ODO	SOT-23-5	28vdo	VD1	6g	Aat
50C	RP100N151B	LVR-IC	LDO, LN, +CE, 1.5V±0.8%, 200mA	SOT-23-5	28cx	VR4	6g	Ric
50C	XC6127C55CMR	Vdet-IC	5.5V±0.8%, -Reset PPO, -MR, Rt=200ms	SOT-25	28yx	VD5	6g	Tor
50D	AAT60050D-S5	Vdet-IC	5.0V±1%, -Reset PPO	SOT-23-5	28vdo	VD3	6g	Aat
50D	RP100N181B	LVR-IC	LDO, LN, +CE, 1.8V±0.8%, 200mA	SOT-23-5	28cx	VR4	6g	Ric
50D	XC6127C55DMR	Vdet-IC	5.5V±0.8%, -Reset PPO, -MR, Rt=400ms	SOT-25	28yx	VD5	6g	Tor
50E	RP100N181B5	LVR-IC	LDO, LN, +CE, 1.85V±0.8%, 200mA	SOT-23-5	28cx	VR4	6g	Ric
50E	XC6127C55EMR	Vdet-IC	5.5V±0.8%, -Reset PPO, -MR, Rt=800ms	SOT-25	28yx	VD5	6g	Tor
50F	RP100N191B	LVR-IC	LDO, LN, +CE, 1.9V±0.8%, 200mA	SOT-23-5	28cx	VR4	6g	Ric
50F	XC6127C55FMR	Vdet-IC	5.5V±0.8%, +Reset PPO, -MR, Rt=50ms	SOT-25	28yx	VD5	6g	Tor
50G	RP100N201B	LVR-IC	LDO, LN, +CE, 2V±0.8%, 200mA	SOT-23-5	28cx	VR4	6g	Ric
50H	RP100N251B	LVR-IC	LDO, LN, +CE, 2.5V±0.8%, 200mA	SOT-23-5	28cx	VR4	6g	Ric
50H	XC6127C55GMR	Vdet-IC	5.5V±0.8%, +Reset PPO, -MR, Rt=100ms	SOT-25	28yx	VD5	6g	Tor
50J	RP100N261B	LVR-IC	LDO, LN, +CE, 2.6V±0.8%, 200mA	SOT-23-5	28cx	VR4	6g	Ric
50K	RP100N271B	LVR-IC	LDO, LN, +CE, 2.7V±0.8%, 200mA	SOT-23-5	28cx	VR4	6g	Ric
50K	TK71750S	LVR-IC	LDO, 5V±1.5%, 300mA, +CE	SOT-23-5	28vrx	VR7	6k	Tok
50K	XC6127C55HMR	Vdet-IC	5.5V±0.8%, +Reset PPO, -MR, Rt=200ms	SOT-25	28yx	VD5	6g	Tor
50L	RP100N281B	LVR-IC	LDO, LN, +CE, 2.8V±0.8%, 200mA	SOT-23-5	28cx	VR4	6g	Ric
50L	TK71650ASCL	LVR-IC	LDO, 5V±2%, 150mA, +CE, -30...+80°C	SOT-23-5	28vrx	VR7	6k	Tok
50L	XC6127C55JMR	Vdet-IC	5.5V±0.8%, +Reset PPO, -MR, Rt=400ms	SOT-25	28yx	VD5	6g	Tor
50M	RP100N281B5	LVR-IC	LDO, LN, +CE, 2.85V±0.8%, 200mA	SOT-23-5	28cx	VR4	6g	Ric
50M	XC6127C55KMR	Vdet-IC	5.5V±0.8%, +Reset PPO, -MR, Rt=800ms	SOT-25	28yx	VD5	6g	Tor
50N	RP100N291B	LVR-IC	LDO, LN, +CE, 2.9V±0.8%, 200mA	SOT-23-5	28cx	VR4	6g	Ric
50P	RP100N301B	LVR-IC	LDO, LN, +CE, 3V±0.8%, 200mA	SOT-23-5	28cx	VR4	6g	Ric
50Q	RP100N311B	LVR-IC	LDO, LN, +CE, 3.1V±0.8%, 200mA	SOT-23-5	28cx	VR4	6g	Ric
50R	RP100N331B	LVR-IC	LDO, LN, +CE, 3.3V±0.8%, 200mA	SOT-23-5	28cx	VR4	6g	Ric
50T	TK17450S	LVR-IC	LDO, 5.0V±2%, 100mA, +CE, Ext. transistor	SOT-23-5	28zh	VR6	6a	Tok
51	R1223N322F	DC/DC-IC	PWM/VFM step-down, +CE, 3.2V, 500kHz, R-Pr.	SOT-23-5	28ud	DC7	6g	Ric
51	RN5RF51AA	LVR-IC	LRip, -CE, 5.1V±2%, 1A*	SOT-23-5	28vw	VR6	6g	Ric
51	RN5RZ51AA	LVR-IC	LDO, LN, -CE, 5.4V±2%, 100mA	SOT-23-5	28vrt	VR4	6g	Ric
515	R1114N151B	LVR-IC	LDO, LN, +CE, 1.5V±2%, 150mA	SOT-23-5	28cx	VR4	6g	Ric
515	XC9111C151MR	DC/DC-IC	PFM step-up, 100kHz, 1.5V±2.5%, 400mA, +CE	SOT-25	28sc	DC3	6g	Tor
516	R1114N161B	LVR-IC	LDO, LN, +CE, 1.6V±2%, 150mA	SOT-23-5	28cx	VR4	6g	Ric
516	XC9111C161MR	DC/DC-IC	PFM step-up, 100kHz, 1.6V±2.5%, 400mA, +CE	SOT-25	28sc	DC3	6g	Tor
517	R1114N171B	LVR-IC	LDO, LN, -CE, 1.7V±2%, 150mA	SOT-23-5	28cx	VR4	6g	Ric
517	XC9111C171MR	DC/DC-IC	PFM step-up, 100kHz, 1.7V±2.5%, 400mA, +CE	SOT-25	28sc	DC3	6g	Tor
518	R1114N181B	LVR-IC	LDO, LN, +CE, 1.8V±2%, 150mA	SOT-23-5	28cx	VR4	6g	Ric
518	XC9111C181MR	DC/DC-IC	PFM step-up, 100kHz, 1.8V±2.5%, 400mA, +CE	SOT-25	28sc	DC3	6g	Tor
519	R1114N191B	LVR-IC	LDO, LN, +CE, 1.9V±2%, 150mA	SOT-23-5	28cx	VR4	6g	Ric
519	XC9111C191MR	DC/DC-IC	PFM step-up, 100kHz, 1.9V±2.5%, 400mA, +CE	SOT-25	28sc	DC3	6g	Tor
51A	AAT60051A-S5	Vdet-IC	5.1V±2%, -Reset ODO	SOT-23-5	28vdo	VD1	6g	Aat
51A	RP100N121D	LVR-IC	LDO, LN, +CE, CL, 1.2V±0.8%, 200mA	SOT-23-5	28cx	VR4	6g	Ric
51B	AAT60051B-S5	Vdet-IC	5.1V±2%, -Reset PPO	SOT-23-5	28vdo	VD3	6g	Aat
51B	RP100N131D	LVR-IC	LDO, LN, +CE, CL, 1.3V±0.8%, 200mA	SOT-23-5	28cx	VR4	6g	Ric
51C	AAT60051C-S5	Vdet-IC	5.1V±1%, -Reset ODO	SOT-23-5	28vdo	VD1	6g	Aat
51C	RP100N151D	LVR-IC	LDO, LN, +CE, CL, 1.5V±0.8%, 200mA	SOT-23-5	28cx	VR4	6g	Ric
51D	AAT60051D-S5	Vdet-IC	5.1V±1%, -Reset PPO	SOT-23-5	28vdo	VD3	6g	Aat
51D	RP100N181D	LVR-IC	LDO, LN, +CE, CL, 1.8V±0.8%, 200mA	SOT-23-5	28cx	VR4	6g	Ric
51E	RP100N181D5	LVR-IC	LDO, LN, +CE, CL, 1.85V±0.8%, 200mA	SOT-23-5	28cx	VR4	6g	Ric
51F	RP100N191D	LVR-IC	LDO, LN, +CE, CL, 1.9V±0.8%, 200mA	SOT-23-5	28cx	VR4	6g	Ric
51G	RP100N201D	LVR-IC	LDO, LN, +CE, CL, 2V±0.8%, 200mA	SOT-23-5	28cx	VR4	6g	Ric
51H	RP100N251D	LVR-IC	LDO, LN, +CE, CL, 2.5V±0.8%, 200mA	SOT-23-5	28cx	VR4	6g	Ric
51J	RP100N261D	LVR-IC	LDO, LN, +CE, CL, 2.6V±0.8%, 200mA	SOT-23-5	28cx	VR4	6g	Ric
51K	RP100N271D	LVR-IC	LDO, LN, +CE, CL, 2.7V±0.8%, 200mA	SOT-23-5	28cx	VR4	6g	Ric



SMD code	Type	Function	Short description	Case	Pinout	Sch.	St.	Mnf.
51L	RP100N281D	LVR-IC	LDO, LN, +CE, CL, 2.8V±0.8%, 200mA	SOT-23-5	28cx	VR4	6g	Ric
51L	TK71651ASCL	LVR-IC	LDO, 5.1V±2%, 150mA, +CE, -30...+80°C	SOT-23-5	28vrx	VR7	6k	Tok
51M	RP100N281D5	LVR-IC	LDO, LN, +CE, CL, 2.85V±0.8%, 200mA	SOT-23-5	28cx	VR4	6g	Ric
51N	RP100N291D	LVR-IC	LDO, LN, +CE, CL, 2.9V±0.8%, 200mA	SOT-23-5	28cx	VR4	6g	Ric
51P	RP100N301D	LVR-IC	LDO, LN, +CE, CL, 3.0V±0.8%, 200mA	SOT-23-5	28cx	VR4	6g	Ric
51Q	RP100N311D	LVR-IC	LDO, LN, +CE, CL, 3.1V±0.8%, 200mA	SOT-23-5	28cx	VR4	6g	Ric
51R	RP100N331D	LVR-IC	LDO, LN, +CE, CL, 3.3V±0.8%, 200mA	SOT-23-5	28cx	VR4	6g	Ric
52	R1223N482F	DC/DC-IC	PWM/VFM step-down, +CE, 4.8V, 500kHz, R-Pr.	SOT-23-5	28ud	DC7	6g	Ric
52	RN5RF52AA	LVR-IC	LRip, -CE, 5.2V±2%, 1A*	SOT-23-5	28vw	VR6	6g	Ric
52	RN5RZ52AA	LVR-IC	LDO, LN, -CE, 5.2V±2%, 100mA	SOT-23-5	28vrt	VR4	6g	Ric
520	R1114N201B	LVR-IC	LDO, LN, +CE, 2V±2%, 150mA	SOT-23-5	28cx	VR4	6g	Ric
520	XC9111C201MR	DC/DC-IC	PFM step-up, 100kHz, 2.0V±2.5%, 400mA, +CE	SOT-25	28sc	DC3	6g	Tor
521	R1114N211B	LVR-IC	LDO, LN, +CE, 2.1V±2%, 150mA	SOT-23-5	28cx	VR4	6g	Ric
521	XC9111C211MR	DC/DC-IC	PFM step-up, 100kHz, 2.1V±2.5%, 400mA, +CE	SOT-25	28sc	DC3	6g	Tor
522	R1114N221B	LVR-IC	LDO, LN, +CE, 2.2V±2%, 150mA	SOT-23-5	28cx	VR4	6g	Ric
522	XC9111C221MR	DC/DC-IC	PFM step-up, 100kHz, 2.2V±2.5%, 400mA, +CE	SOT-25	28sc	DC3	6g	Tor
523	R1114N231B	LVR-IC	LDO, LN, +CE, 2.3V±2%, 150mA	SOT-23-5	28cx	VR4	6g	Ric
523	XC9111C231MR	DC/DC-IC	PFM step-up, 100kHz, 2.3V±2.5%, 400mA, +CE	SOT-25	28sc	DC3	6g	Tor
524	R1114N241B	LVR-IC	LDO, LN, +CE, 2.4V±2%, 150mA	SOT-23-5	28cx	VR4	6g	Ric
524	XC9111C241MR	DC/DC-IC	PFM step-up, 100kHz, 2.4V±2.5%, 400mA, +CE	SOT-25	28sc	DC3	6g	Tor
525	R1114N251B	LVR-IC	LDO, LN, +CE, 2.5V±2%, 150mA	SOT-23-5	28cx	VR4	6g	Ric
525	XC9111C251MR	DC/DC-IC	PFM step-up, 100kHz, 2.5V±2.5%, 400mA, +CE	SOT-25	28sc	DC3	6g	Tor
526	R1114N261B	LVR-IC	LDO, LN, +CE, 2.6V±2%, 150mA	SOT-23-5	28cx	VR4	6g	Ric
526	XC9111C261MR	DC/DC-IC	PFM step-up, 100kHz, 2.6V±2.5%, 400mA, +CE	SOT-25	28sc	DC3	6g	Tor
527	R1114N271B	LVR-IC	LDO, LN, +CE, 2.7V±2%, 150mA	SOT-23-5	28cx	VR4	6g	Ric
527	XC9111C271MR	DC/DC-IC	PFM step-up, 100kHz, 2.7V±2.5%, 400mA, +CE	SOT-25	28sc	DC3	6g	Tor
528	R1114N281B	LVR-IC	LDO, LN, +CE, 2.8V±2%, 150mA	SOT-23-5	28cx	VR4	6g	Ric
528	XC9111C281MR	DC/DC-IC	PFM step-up, 100kHz, 2.8V±2.5%, 400mA, +CE	SOT-25	28sc	DC3	6g	Tor
529	R1114N291B	LVR-IC	LDO, LN, +CE, 2.9V±2%, 150mA	SOT-23-5	28cx	VR4	6g	Ric
529	XC9111C291MR	DC/DC-IC	PFM step-up, 100kHz, 2.9V±2.5%, 400mA, +CE	SOT-25	28sc	DC3	6g	Tor
52A	AAT60052A-S5	Vdet-IC	5.2V±2%, -Reset ODO	SOT-23-5	28vdo	VD1	6g	Aat
52B	AAT60052B-S5	Vdet-IC	5.2V±2%, -Reset PPO	SOT-23-5	28vdo	VD3	6g	Aat
52C	AAT60052C-S5	Vdet-IC	5.2V±1%, -Reset ODO	SOT-23-5	28vdo	VD1	6g	Aat
52D	AAT60052D-S5	Vdet-IC	5.2V±1%, -Reset PPO	SOT-23-5	28vdo	VD3	6g	Aat
52L	TK71652ASCL	LVR-IC	LDO, 5.2V±2%, 150mA, +CE, -30...+80°C	SOT-23-5	28vrx	VR7	6k	Tok
53	R1223N322H	DC/DC-IC	PWM step-down, +CE, 3.2V, 500kHz, +Reset-Pr.	SOT-23-5	28ud	DC7	6g	Ric
53	RN5RF53AA	LVR-IC	LRip, -CE, 5.3V±2%, 1A*	SOT-23-5	28vw	VR6	6g	Ric
53	RN5RZ53AA	LVR-IC	LDO, LN, -CE, 5.3V±2%, 100mA	SOT-23-5	28vrt	VR4	6g	Ric
530	R1114N301B	LVR-IC	LDO, LN, +CE, 3V±2%, 150mA	SOT-23-5	28cx	VR4	6g	Ric
530	XC9111C301MR	DC/DC-IC	PFM step-up, 100kHz, 3.0V±2.5%, 400mA, +CE	SOT-25	28sc	DC3	6g	Tor
531	R1114N311B	LVR-IC	LDO, LN, +CE, 3.1V±2%, 150mA	SOT-23-5	28cx	VR4	6g	Ric
531	XC9111C311MR	DC/DC-IC	PFM step-up, 100kHz, 3.1V±2.5%, 400mA, +CE	SOT-25	28sc	DC3	6g	Tor
532	R1114N321B	LVR-IC	LDO, LN, +CE, 3.2V±2%, 150mA	SOT-23-5	28cx	VR4	6g	Ric
532	XC9111C321MR	DC/DC-IC	PFM step-up, 100kHz, 3.2V±2.5%, 400mA, +CE	SOT-25	28sc	DC3	6g	Tor
533	R1114N331B	LVR-IC	LDO, LN, +CE, 3.3V±2%, 150mA	SOT-23-5	28cx	VR4	6g	Ric
533	XC9111C331MR	DC/DC-IC	PFM step-up, 100kHz, 3.3V±2.5%, 400mA, +CE	SOT-25	28sc	DC3	6g	Tor
534	R1114N341B	LVR-IC	LDO, LN, +CE, 3.4V±2%, 150mA	SOT-23-5	28cx	VR4	6g	Ric
534	XC9111C341MR	DC/DC-IC	PFM step-up, 100kHz, 3.4V±2.5%, 400mA, +CE	SOT-25	28sc	DC3	6g	Tor
535	R1114N351B	LVR-IC	LDO, LN, +CE, 3.5V±2%, 150mA	SOT-23-5	28cx	VR4	6g	Ric
535	XC9111C351MR	DC/DC-IC	PFM step-up, 100kHz, 3.5V±2.5%, 400mA, +CE	SOT-25	28sc	DC3	6g	Tor
536	R1114N361B	LVR-IC	LDO, LN, +CE, 3.6V±2%, 150mA	SOT-23-5	28cx	VR4	6g	Ric
536	XC9111C361MR	DC/DC-IC	PFM step-up, 100kHz, 3.6V±2.5%, 400mA, +CE	SOT-25	28sc	DC3	6g	Tor
537	R1114N371B	LVR-IC	LDO, LN, +CE, 3.7V±2%, 150mA	SOT-23-5	28cx	VR4	6g	Ric
537	XC9111C371MR	DC/DC-IC	PFM step-up, 100kHz, 3.7V±2.5%, 400mA, +CE	SOT-25	28sc	DC3	6g	Tor
538	R1114N381B	LVR-IC	LDO, LN, +CE, 3.8V±2%, 150mA	SOT-23-5	28cx	VR4	6g	Ric
538	XC9111C381MR	DC/DC-IC	PFM step-up, 100kHz, 3.8V±2.5%, 400mA, +CE	SOT-25	28sc	DC3	6g	Tor
539	R1114N391B	LVR-IC	LDO, LN, +CE, 3.9V±2%, 150mA	SOT-23-5	28cx	VR4	6g	Ric
539	XC9111C391MR	DC/DC-IC	PFM step-up, 100kHz, 3.9V±2.5%, 400mA, +CE	SOT-25	28sc	DC3	6g	Tor
53A	AAT60053A-S5	Vdet-IC	5.3V±2%, -Reset ODO	SOT-23-5	28vdo	VD1	6g	Aat
53B	AAT60053B-S5	Vdet-IC	5.3V±2%, -Reset PPO	SOT-23-5	28vdo	VD3	6g	Aat
53C	AAT60053C-S5	Vdet-IC	5.3V±1%, -Reset ODO	SOT-23-5	28vdo	VD1	6g	Aat
53D	AAT60053D-S5	Vdet-IC	5.3V±1%, -Reset PPO	SOT-23-5	28vdo	VD3	6g	Aat
53L	TK71653ASCL	LVR-IC	LDO, 5.3V±2%, 150mA, +CE, -30...+80°C	SOT-23-5	28vrx	VR7	6k	Tok
54	MIC5365-1.2YMT	LVR-IC	LDO, 1.2V±2%, 150mA, +CE	SC-70-5	28gf	VR4	6g	Mcr
54	RN5RF54AA	LVR-IC	LRip, -CE, 5.4V±2%, 1A*	SOT-23-5	28vw	VR6	6g	Ric
54	RN5RZ54AA	LVR-IC	LDO, LN, -CE, 5.4V±2%, 100mA	SOT-23-5	28vrt	VR4	6g	Ric
540	R1114N401B	LVR-IC	LDO, LN, +CE, 4V±2%, 150mA	SOT-23-5	28cx	VR4	6g	Ric
540	XC9111C401MR	DC/DC-IC	PFM step-up, 100kHz, 4.0V±2.5%, 400mA, +CE	SOT-25	28sc	DC3	6g	Tor
541	R1114N281B5	LVR-IC	LDO, LN, +CE, 2.8V±2%, 150mA	SOT-23-5	28cx	VR4	6g	Ric
541	XC9111C411MR	DC/DC-IC	PFM step-up, 100kHz, 4.1V±2.5%, 400mA, +CE	SOT-25	28sc	DC3	6g	Tor



SMD code	Type	Function	Short description	Case	Pinout	Sch.	St.	Mnf.
542	XC9111C421MR	DC/DC-IC	PFM step-up, 100kHz, 4.2V±2.5%, 400mA, +CE	SOT-25	28sc	DC3	6g	Tor
543	XC9111C431MR	DC/DC-IC	PFM step-up, 100kHz, 4.3V±2.5%, 400mA, +CE	SOT-25	28sc	DC3	6g	Tor
544	XC9111C441MR	DC/DC-IC	PFM step-up, 100kHz, 4.4V±2.5%, 400mA, +CE	SOT-25	28sc	DC3	6g	Tor
545	XC9111C451MR	DC/DC-IC	PFM step-up, 100kHz, 4.5V±2.5%, 400mA, +CE	SOT-25	28sc	DC3	6g	Tor
546	XC9111C461MR	DC/DC-IC	PFM step-up, 100kHz, 4.6V±2.5%, 400mA, +CE	SOT-25	28sc	DC3	6g	Tor
547	XC9111C471MR	DC/DC-IC	PFM step-up, 100kHz, 4.7V±2.5%, 400mA, +CE	SOT-25	28sc	DC3	6g	Tor
548	XC9111C481MR	DC/DC-IC	PFM step-up, 100kHz, 4.8V±2.5%, 400mA, +CE	SOT-25	28sc	DC3	6g	Tor
549	XC9111C491MR	DC/DC-IC	PFM step-up, 100kHz, 4.9V±2.5%, 400mA, +CE	SOT-25	28sc	DC3	6g	Tor
54A	AAT60054A-S5	Vdet-IC	5.4V±2%, -Reset ODO	SOT-23-5	28vdo	VD1	6g	Aat
54B	AAT60054B-S5	Vdet-IC	5.4V±2%, -Reset PPO	SOT-23-5	28vdo	VD3	6g	Aat
54C	AAT60054C-S5	Vdet-IC	5.4V±1%, -Reset ODO	SOT-23-5	28vdo	VD1	6g	Aat
54D	AAT60054D-S5	Vdet-IC	5.4V±1%, -Reset PPO	SOT-23-5	28vdo	VD3	6g	Aat
54L	TK71654ASCL	LVR-IC	LDO, 5.4V±2%, 150mA, +CE, -30...+80°C	SOT-23-5	28vrx	VR7	6k	Tok
55	MIC5365-1.3YMT	LVR-IC	LDO, 1.3V±2%, 150mA, +CE	SC-70-5	28gf	VR4	6g	Mcr
55	RN5RF55AA	LVR-IC	LRip, -CE, 5.5V±2%, 1A*	SOT-23-5	28vww	VR6	6g	Ric
55	RN5RZ55AA	LVR-IC	LDO, LN, -CE, 5.5V±2%, 100mA	SOT-23-5	28vrt	VR4	6g	Ric
550	XC9111C501MR	DC/DC-IC	PFM step-up, 100kHz, 5.0V±2.5%, 400mA, +CE	SOT-25	28sc	DC3	6g	Tor
551	XC9111C511MR	DC/DC-IC	PFM step-up, 100kHz, 5.1V±2.5%, 400mA, +CE	SOT-25	28sc	DC3	6g	Tor
552	XC9111C521MR	DC/DC-IC	PFM step-up, 100kHz, 5.2V±2.5%, 400mA, +CE	SOT-25	28sc	DC3	6g	Tor
553	XC9111C531MR	DC/DC-IC	PFM step-up, 100kHz, 5.3V±2.5%, 400mA, +CE	SOT-25	28sc	DC3	6g	Tor
554	XC9111C541MR	DC/DC-IC	PFM step-up, 100kHz, 5.4V±2.5%, 400mA, +CE	SOT-25	28sc	DC3	6g	Tor
555	XC9111C551MR	DC/DC-IC	PFM step-up, 100kHz, 5.5V±2.5%, 400mA, +CE	SOT-25	28sc	DC3	6g	Tor
556	XC9111C561MR	DC/DC-IC	PFM step-up, 100kHz, 5.6V±2.5%, 400mA, +CE	SOT-25	28sc	DC3	6g	Tor
557	XC9111C571MR	DC/DC-IC	PFM step-up, 100kHz, 5.7V±2.5%, 400mA, +CE	SOT-25	28sc	DC3	6g	Tor
558	XC9111C581MR	DC/DC-IC	PFM step-up, 100kHz, 5.8V±2.5%, 400mA, +CE	SOT-25	28sc	DC3	6g	Tor
559	XC9111C591MR	DC/DC-IC	PFM step-up, 100kHz, 5.9V±2.5%, 400mA, +CE	SOT-25	28sc	DC3	6g	Tor
55A	AAT60055A-S5	Vdet-IC	5.5V±2%, -Reset ODO	SOT-23-5	28vdo	VD1	6g	Aat
55B	AAT60055B-S5	Vdet-IC	5.5V±2%, -Reset PPO	SOT-23-5	28vdo	VD3	6g	Aat
55C	AAT60055C-S5	Vdet-IC	5.5V±1%, -Reset ODO	SOT-23-5	28vdo	VD1	6g	Aat
55D	AAT60055D-S5	Vdet-IC	5.5V±1%, -Reset PPO	SOT-23-5	28vdo	VD3	6g	Aat
56	RN5RF56AA	LVR-IC	LRip, -CE, 5.6V±2%, 1A*	SOT-23-5	28vww	VR6	6g	Ric
56	RN5RZ56AA	LVR-IC	LDO, LN, -CE, 5.6V±2%, 100mA	SOT-23-5	28vrt	VR4	6g	Ric
560	XC9111C601MR	DC/DC-IC	PFM step-up, 100kHz, 6.0V±2.5%, 400mA, +CE	SOT-25	28sc	DC3	6g	Tor
561	XC9111C611MR	DC/DC-IC	PFM step-up, 100kHz, 6.1V±2.5%, 400mA, +CE	SOT-25	28sc	DC3	6g	Tor
562	XC9111C621MR	DC/DC-IC	PFM step-up, 100kHz, 6.2V±2.5%, 400mA, +CE	SOT-25	28sc	DC3	6g	Tor
563	XC9111C631MR	DC/DC-IC	PFM step-up, 100kHz, 6.3V±2.5%, 400mA, +CE	SOT-25	28sc	DC3	6g	Tor
564	XC9111C641MR	DC/DC-IC	PFM step-up, 100kHz, 6.4V±2.5%, 400mA, +CE	SOT-25	28sc	DC3	6g	Tor
565	XC9111C651MR	DC/DC-IC	PFM step-up, 100kHz, 6.5V±2.5%, 400mA, +CE	SOT-25	28sc	DC3	6g	Tor
566	XC9111C661MR	DC/DC-IC	PFM step-up, 100kHz, 6.6V±2.5%, 400mA, +CE	SOT-25	28sc	DC3	6g	Tor
567	XC9111C671MR	DC/DC-IC	PFM step-up, 100kHz, 6.7V±2.5%, 400mA, +CE	SOT-25	28sc	DC3	6g	Tor
568	XC9111C681MR	DC/DC-IC	PFM step-up, 100kHz, 6.8V±2.5%, 400mA, +CE	SOT-25	28sc	DC3	6g	Tor
569	XC9111C691MR	DC/DC-IC	PFM step-up, 100kHz, 6.9V±2.5%, 400mA, +CE	SOT-25	28sc	DC3	6g	Tor
57	RN5RF57AA	LVR-IC	LRip, -CE, 5.7V±2%, 1A*	SOT-23-5	28vww	VR6	6g	Ric
57	RN5RZ57AA	LVR-IC	LDO, LN, -CE, 5.7V±2%, 100mA	SOT-23-5	28vrt	VR4	6g	Ric
570	XC9111C701MR	DC/DC-IC	PFM step-up, 100kHz, 7.0V±2.5%, 400mA, +CE	SOT-25	28sc	DC3	6g	Tor
58	RN5RF58AA	LVR-IC	LRip, -CE, 5.8V±2%, 1A*	SOT-23-5	28vww	VR6	6g	Ric
58	RN5RZ58AA	LVR-IC	LDO, LN, -CE, 5.8V±2%, 100mA	SOT-23-5	28vrt	VR4	6g	Ric
59	74AUP1T97GW	CMOS-Logic	Configurable gate with voltage-level translator	SOT-353-1	28fLog81	-	6a	Phi
59	RN5RF59AA	LVR-IC	LRip, -CE, 5.9V±2%, 1A*	SOT-23-5	28vww	VR6	6g	Ric
59	RN5RZ59AA	LVR-IC	LDO, LN, -CE, 5.9V±2%, 100mA	SOT-23-5	28vrt	VR4	6g	Ric
5A0	XC6106A031MR	Vdet-IC	3.1V±2%, Hst, -MR, ±Reset PPO, Rt=3.13ms	SOT-25	28xf	VD21	6g	Tor
5A1	XC6106A032MR	Vdet-IC	3.2V±2%, Hst, -MR, ±Reset PPO, Rt=3.13ms	SOT-25	28xf	VD21	6g	Tor
5A2	XC6106A033MR	Vdet-IC	3.3V±2%, Hst, -MR, ±Reset PPO, Rt=3.13ms	SOT-25	28xf	VD21	6g	Tor
5A3	XC6106A034MR	Vdet-IC	3.4V±2%, Hst, -MR, ±Reset PPO, Rt=3.13ms	SOT-25	28xf	VD21	6g	Tor
5A4	XC6106A035MR	Vdet-IC	3.5V±2%, Hst, -MR, ±Reset PPO, Rt=3.13ms	SOT-25	28xf	VD21	6g	Tor
5A5	XC6106A036MR	Vdet-IC	3.6V±2%, Hst, -MR, ±Reset PPO, Rt=3.13ms	SOT-25	28xf	VD21	6g	Tor
5A6	XC6106A037MR	Vdet-IC	3.7V±2%, Hst, -MR, ±Reset PPO, Rt=3.13ms	SOT-25	28xf	VD21	6g	Tor
5A7	XC6106A038MR	Vdet-IC	3.8V±2%, Hst, -MR, ±Reset PPO, Rt=3.13ms	SOT-25	28xf	VD21	6g	Tor
5A8	XC9236A08C1MR	DC-DC-IC	PWM/PFM, st-dwn, 0.8V±2%, 600mA, 1.2MHz, Vin>2V, LSST	SOT-25	28dc4	DC1	6g	Tor
5A8	XC6106A039MR	Vdet-IC	3.9V±2%, Hst, -MR, ±Reset PPO, Rt=3.13ms	SOT-25	28xf	VD21	6g	Tor
5A9	XC9236A09C1MR	DC-DC-IC	PWM/PFM, st-dwn, 0.9V±2%, 600mA, 1.2MHz, Vin>2V, LSST	SOT-25	28dc4	DC1	6g	Tor
5A9	XC6106A040MR	Vdet-IC	4.0V±2%, Hst, -MR, ±Reset PPO, Rt=3.13ms	SOT-25	28xf	VD21	6g	Tor
5AA	XC6127C15AMR	Vdet-IC	1.5V±0.8%, -Reset PPO, -MR, Rt=50ms	SOT-25	28yx	VD5	6g	Tor
5AA	XC6106A041MR	Vdet-IC	4.1V±2%, Hst, -MR, ±Reset PPO, Rt=3.13ms	SOT-25	28xf	VD21	6g	Tor
5AB	XC6127C15BMR	Vdet-IC	1.5V±0.8%, -Reset PPO, -MR, Rt=100ms	SOT-25	28yx	VD5	6g	Tor
5AB	XC6106A042MR	Vdet-IC	4.2V±2%, Hst, -MR, ±Reset PPO, Rt=3.13ms	SOT-25	28xf	VD21	6g	Tor
5AC	XC6127C15C1MR	Vdet-IC	1.5V±0.8%, -Reset PPO, -MR, Rt=200ms	SOT-25	28yx	VD5	6g	Tor
5AC	XC6106A043MR	Vdet-IC	4.3V±2%, Hst, -MR, ±Reset PPO, Rt=3.13ms	SOT-25	28xf	VD21	6g	Tor
5AD	XC6127C15DMR	Vdet-IC	1.5V±0.8%, -Reset PPO, -MR, Rt=400ms	SOT-25	28yx	VD5	6g	Tor
5AD	XC6106A044MR	Vdet-IC	4.4V±2%, Hst, -MR, ±Reset PPO, Rt=3.13ms	SOT-25	28xf	VD21	6g	Tor



SMD code	Type	Function	Short description	Case	Pinout	Sch.	St.	Mnf.
5AE	XC6127C15EMR	Vdet-IC	1.5V±0.8%, -Reset PPO, -MR, Rt=800ms	SOT-25	28yx	VD5	6g	Tor
5AE	XC6106A045MR	Vdet-IC	4.5V±2%, Hst, -MR, ±Reset PPO, Rt=3.13ms	SOT-25	28xf	VD21	6g	Tor
5AF	XC6127C15FMR	Vdet-IC	1.5V±0.8%, +Reset PPO, -MR, Rt=50ms	SOT-25	28yx	VD5	6g	Tor
5AF	XC6106A016MR	Vdet-IC	1.6V±2%, Hst, -MR, ±Reset PPO, Rt=3.13ms	SOT-25	28xf	VD21	6g	Tor
5AF	XC6106A046MR	Vdet-IC	4.6V±2%, Hst, -MR, ±Reset PPO, Rt=3.13ms	SOT-25	28xf	VD21	6g	Tor
5AH	XC6127C15GMR	Vdet-IC	1.5V±0.8%, +Reset PPO, -MR, Rt=100ms	SOT-25	28yx	VD5	6g	Tor
5AH	XC6106A017MR	Vdet-IC	1.7V±2%, Hst, -MR, ±Reset PPO, Rt=3.13ms	SOT-25	28xf	VD21	6g	Tor
5AH	XC6106A047MR	Vdet-IC	4.7V±2%, Hst, -MR, ±Reset PPO, Rt=3.13ms	SOT-25	28xf	VD21	6g	Tor
5AK	XC6127C15HMR	Vdet-IC	1.5V±0.8%, +Reset PPO, -MR, Rt=200ms	SOT-25	28yx	VD5	6g	Tor
5AK	XC6106A018MR	Vdet-IC	1.8V±2%, Hst, -MR, ±Reset PPO, Rt=3.13ms	SOT-25	28xf	VD21	6g	Tor
5AK	XC6106A048MR	Vdet-IC	4.8V±2%, Hst, -MR, ±Reset PPO, Rt=3.13ms	SOT-25	28xf	VD21	6g	Tor
5AL	XC6127C15JMR	Vdet-IC	1.5V±0.8%, +Reset PPO, -MR, Rt=400ms	SOT-25	28yx	VD5	6g	Tor
5AL	XC9236A0LCMR	DC-DC-IC	PWM/PFM, st-dwn, 0.85V±2%, 600mA, 1.2MHz, Vin>2V, LSST	SOT-25	28dc4	DC1	6g	Tor
5AL	XC6106A019MR	Vdet-IC	1.9V±2%, Hst, -MR, ±Reset PPO, Rt=3.13ms	SOT-25	28xf	VD21	6g	Tor
5AL	XC6106A049MR	Vdet-IC	4.9V±2%, Hst, -MR, ±Reset PPO, Rt=3.13ms	SOT-25	28xf	VD21	6g	Tor
5AM	XC6127C15KMR	Vdet-IC	1.5V±0.8%, +Reset PPO, -MR, Rt=800ms	SOT-25	28yx	VD5	6g	Tor
5AM	XC9236A0MCMR	DC-DC-IC	PWM/PFM, st-dwn, 0.95V±2%, 600mA, 1.2MHz, Vin>2V, LSST	SOT-25	28dc4	DC1	6g	Tor
5AM	XC6106A020MR	Vdet-IC	2.0V±2%, Hst, -MR, ±Reset PPO, Rt=3.13ms	SOT-25	28xf	VD21	6g	Tor
5AM	XC6106A050MR	Vdet-IC	5.0V±2%, Hst, -MR, ±Reset PPO, Rt=3.13ms	SOT-25	28xf	VD21	6g	Tor
5AN	XC6127C16AMR	Vdet-IC	1.6V±0.8%, -Reset PPO, -MR, Rt=50ms	SOT-25	28yx	VD5	6g	Tor
5AN	XC6106A021MR	Vdet-IC	2.1V±2%, Hst, -MR, ±Reset PPO, Rt=3.13ms	SOT-25	28xf	VD21	6g	Tor
5AP	XC6127C16BMR	Vdet-IC	1.6V±0.8%, -Reset PPO, -MR, Rt=100ms	SOT-25	28yx	VD5	6g	Tor
5AP	XC6106A022MR	Vdet-IC	2.2V±2%, Hst, -MR, ±Reset PPO, Rt=3.13ms	SOT-25	28xf	VD21	6g	Tor
5AR	XC6127C16CMR	Vdet-IC	1.6V±0.8%, -Reset PPO, -MR, Rt=200ms	SOT-25	28yx	VD5	6g	Tor
5AR	XC6106A023MR	Vdet-IC	2.3V±2%, Hst, -MR, ±Reset PPO, Rt=3.13ms	SOT-25	28xf	VD21	6g	Tor
5AS	XC6127C16DMR	Vdet-IC	1.6V±0.8%, -Reset PPO, -MR, Rt=400ms	SOT-25	28yx	VD5	6g	Tor
5AS	XC6106A024MR	Vdet-IC	2.4V±2%, Hst, -MR, ±Reset PPO, Rt=3.13ms	SOT-25	28xf	VD21	6g	Tor
5AT	XC6127C16EMR	Vdet-IC	1.6V±0.8%, -Reset PPO, -MR, Rt=800ms	SOT-25	28yx	VD5	6g	Tor
5AT	XC6106A025MR	Vdet-IC	2.5V±2%, Hst, -MR, ±Reset PPO, Rt=3.13ms	SOT-25	28xf	VD21	6g	Tor
5AU	XC6127C16FMR	Vdet-IC	1.6V±0.8%, +Reset PPO, -MR, Rt=50ms	SOT-25	28yx	VD5	6g	Tor
5AU	XC6106A026MR	Vdet-IC	2.6V±2%, Hst, -MR, ±Reset PPO, Rt=3.13ms	SOT-25	28xf	VD21	6g	Tor
5AV	XC6127C16GMR	Vdet-IC	1.6V±0.8%, +Reset PPO, -MR, Rt=100ms	SOT-25	28yx	VD5	6g	Tor
5AV	XC6106A027MR	Vdet-IC	2.7V±2%, Hst, -MR, ±Reset PPO, Rt=3.13ms	SOT-25	28xf	VD21	6g	Tor
5AX	XC6127C16HMR	Vdet-IC	1.6V±0.8%, +Reset PPO, -MR, Rt=200ms	SOT-25	28yx	VD5	6g	Tor
5AX	XC6106A028MR	Vdet-IC	2.8V±2%, Hst, -MR, ±Reset PPO, Rt=3.13ms	SOT-25	28xf	VD21	6g	Tor
5AY	XC6127C16JMR	Vdet-IC	1.6V±0.8%, +Reset PPO, -MR, Rt=400ms	SOT-25	28yx	VD5	6g	Tor
5AY	XC6106A029MR	Vdet-IC	2.9V±2%, Hst, -MR, ±Reset PPO, Rt=3.13ms	SOT-25	28xf	VD21	6g	Tor
5AZ	XC6127C16KMR	Vdet-IC	1.6V±0.8%, +Reset PPO, -MR, Rt=800ms	SOT-25	28yx	VD5	6g	Tor
5AZ	XC6106A030MR	Vdet-IC	3.0V±2%, Hst, -MR, ±Reset PPO, Rt=3.13ms	SOT-25	28xf	VD21	6g	Tor
5B	R311N151A	Vdet-IC	1.5V±2%, -Reset PPO	SOT-23-5	28vdm	VD7	6g	Ric
5B	RN5RL25AA	LVR-IC	2.5V±2.5%, 150mA	SOT-23-5	28vur	VR1	6g	Ric
5B	RN5VD15CA	Vdet-IC	1.5V±2.5%, -Reset ODO	SOT-23-5	28vdo	VD1	6g	Ric
5B0	TAR5SB50	LVR-IC	LDO, 5V±1%, 200mA, +CE	SSOP-5	28vrx	VR7	6a	Tos
5B0	XC9236A10CMR	DC-DC-IC	PWM/PFM, st-dwn, 1.0V±2%, 600mA, 1.2MHz, Vin>2V, LSST	SOT-25	28dc4	DC1	6g	Tor
5B0	XC6106B031MR	Vdet-IC	3.1V±2%, Hst, -MR, ±Reset PPO, Rt=25ms	SOT-25	28xf	VD21	6g	Tor
5B1	XC9236A11CMR	DC-DC-IC	PWM/PFM, st-dwn, 1.1V±2%, 600mA, 1.2MHz, Vin>2V, LSST	SOT-25	28dc4	DC1	6g	Tor
5B1	XC6106B032MR	Vdet-IC	3.2V±2%, Hst, -MR, ±Reset PPO, Rt=25ms	SOT-25	28xf	VD21	6g	Tor
5B2	XC9236A12CMR	DC-DC-IC	PWM/PFM, st-dwn, 1.2V±2%, 600mA, 1.2MHz, Vin>2V, LSST	SOT-25	28dc4	DC1	6g	Tor
5B2	XC6106B033MR	Vdet-IC	3.3V±2%, Hst, -MR, ±Reset PPO, Rt=25ms	SOT-25	28xf	VD21	6g	Tor
5B3	XC9236A13CMR	DC-DC-IC	PWM/PFM, st-dwn, 1.3V±2%, 600mA, 1.2MHz, Vin>2V, LSST	SOT-25	28dc4	DC1	6g	Tor
5B3	XC6106B034MR	Vdet-IC	3.4V±2%, Hst, -MR, ±Reset PPO, Rt=25ms	SOT-25	28xf	VD21	6g	Tor
5B4	XC9236A14CMR	DC-DC-IC	PWM/PFM, st-dwn, 1.4V±2%, 600mA, 1.2MHz, Vin>2V, LSST	SOT-25	28dc4	DC1	6g	Tor
5B4	XC6106B035MR	Vdet-IC	3.5V±2%, Hst, -MR, ±Reset PPO, Rt=25ms	SOT-25	28xf	VD21	6g	Tor
5B5	XC9236A15CMR	DC-DC-IC	PWM/PFM, st-dwn, 1.5V±2%, 600mA, 1.2MHz, Vin>2V, LSST	SOT-25	28dc4	DC1	6g	Tor
5B5	XC6106B036MR	Vdet-IC	3.6V±2%, Hst, -MR, ±Reset PPO, Rt=25ms	SOT-25	28xf	VD21	6g	Tor
5B6	XC9236A16CMR	DC-DC-IC	PWM/PFM, st-dwn, 1.6V±2%, 600mA, 1.2MHz, Vin>2V, LSST	SOT-25	28dc4	DC1	6g	Tor
5B6	XC6106B037MR	Vdet-IC	3.7V±2%, Hst, -MR, ±Reset PPO, Rt=25ms	SOT-25	28xf	VD21	6g	Tor
5B7	XC9236A17CMR	DC-DC-IC	PWM/PFM, st-dwn, 1.7V±2%, 600mA, 1.2MHz, Vin>2V, LSST	SOT-25	28dc4	DC1	6g	Tor
5B7	XC6106B038MR	Vdet-IC	3.8V±2%, Hst, -MR, ±Reset PPO, Rt=25ms	SOT-25	28xf	VD21	6g	Tor
5B8	XC9236A18CMR	DC-DC-IC	PWM/PFM, st-dwn, 1.8V±2%, 600mA, 1.2MHz, Vin>2V, LSST	SOT-25	28dc4	DC1	6g	Tor
5B8	XC6106B039MR	Vdet-IC	3.9V±2%, Hst, -MR, ±Reset PPO, Rt=25ms	SOT-25	28xf	VD21	6g	Tor
5B9	XC9236A19CMR	DC-DC-IC	PWM/PFM, st-dwn, 1.9V±2%, 600mA, 1.2MHz, Vin>2V, LSST	SOT-25	28dc4	DC1	6g	Tor
5B9	XC6106B040MR	Vdet-IC	4.0V±2%, Hst, -MR, ±Reset PPO, Rt=25ms	SOT-25	28xf	VD21	6g	Tor
5BA	XC6127C17AMR	Vdet-IC	1.7V±0.8%, -Reset PPO, -MR, Rt=50ms	SOT-25	28yx	VD5	6g	Tor
5BA	XC9236A1ACMR	DC-DC-IC	PWM/PFM, st-dwn, 1.05V±2%, 600mA, 1.2MHz, Vin>2V, LSST	SOT-25	28dc4	DC1	6g	Tor
5BA	XC6106B041MR	Vdet-IC	4.1V±2%, Hst, -MR, ±Reset PPO, Rt=25ms	SOT-25	28xf	VD21	6g	Tor
5BB	XC6127C17BMR	Vdet-IC	1.7V±0.8%, -Reset PPO, -MR, Rt=100ms	SOT-25	28yx	VD5	6g	Tor
5BB	XC9236A1BCMR	DC-DC-IC	PWM/PFM, st-dwn, 1.15V±2%, 600mA, 1.2MHz, Vin>2V, LSST	SOT-25	28dc4	DC1	6g	Tor
5BB	XC6106B042MR	Vdet-IC	4.2V±2%, Hst, -MR, ±Reset PPO, Rt=25ms	SOT-25	28xf	VD21	6g	Tor
5BC	XC6127C17CMR	Vdet-IC	1.7V±0.8%, -Reset PPO, -MR, Rt=200ms	SOT-25	28yx	VD5	6g	Tor



SMD code	Type	Function	Short description	Case	Pinout	Sch.	St.	Mnf.
5BC	XC9236A1CCMR	DC-DC-IC	PWM/PFM, st-dwn, 1.25V±2%, 600mA, 1.2MHz, Vin>2V, LSST	SOT-25	28dc4	DC1	6g	Tor
5BD	XC6106B043MR	Vdet-IC	4.3V±2%, Hst, -MR, ±Reset PPO, Rt=25ms	SOT-25	28xf	VD21	6g	Tor
5BD	XC6127C17DMR	Vdet-IC	1.7V±0.8%, -Reset PPO, -MR, Rt=400ms	SOT-25	28yx	VD5	6g	Tor
5BD	XC9236A1DCMR	DC-DC-IC	PWM/PFM, st-dwn, 1.35V±2%, 600mA, 1.2MHz, Vin>2V, LSST	SOT-25	28dc4	DC1	6g	Tor
5BD	XC6106B044MR	Vdet-IC	4.4V±2%, Hst, -MR, ±Reset PPO, Rt=25ms	SOT-25	28xf	VD21	6g	Tor
5BE	XC6127C17EMR	Vdet-IC	1.7V±0.8%, -Reset PPO, -MR, Rt=800ms	SOT-25	28yx	VD5	6g	Tor
5BE	XC9236A1ECMR	DC-DC-IC	PWM/PFM, st-dwn, 1.45V±2%, 600mA, 1.2MHz, Vin>2V, LSST	SOT-25	28dc4	DC1	6g	Tor
5BE	XC6106B045MR	Vdet-IC	4.5V±2%, Hst, -MR, ±Reset PPO, Rt=25ms	SOT-25	28xf	VD21	6g	Tor
5BF	XC6127C17FMR	Vdet-IC	1.7V±0.8%, +Reset PPO, -MR, Rt=50ms	SOT-25	28yx	VD5	6g	Tor
5BF	XC9236A1FCMR	DC-DC-IC	PWM/PFM, st-dwn, 1.55V±2%, 600mA, 1.2MHz, Vin>2V, LSST	SOT-25	28dc4	DC1	6g	Tor
5BF	XC6106B016MR	Vdet-IC	1.6V±2%, Hst, -MR, ±Reset PPO, Rt=25ms	SOT-25	28xf	VD21	6g	Tor
5BF	XC6106B046MR	Vdet-IC	4.6V±2%, Hst, -MR, ±Reset PPO, Rt=25ms	SOT-25	28xf	VD21	6g	Tor
5BH	XC6127C17GMR	Vdet-IC	1.7V±0.8%, +Reset PPO, -MR, Rt=100ms	SOT-25	28yx	VD5	6g	Tor
5BH	XC9236A1HCMR	DC-DC-IC	PWM/PFM, st-dwn, 1.65V±2%, 600mA, 1.2MHz, Vin>2V, LSST	SOT-25	28dc4	DC1	6g	Tor
5BH	XC6106B017MR	Vdet-IC	1.7V±2%, Hst, -MR, ±Reset PPO, Rt=25ms	SOT-25	28xf	VD21	6g	Tor
5BH	XC6106B047MR	Vdet-IC	4.7V±2%, Hst, -MR, ±Reset PPO, Rt=25ms	SOT-25	28xf	VD21	6g	Tor
5BK	XC6127C17HMR	Vdet-IC	1.7V±0.8%, +Reset PPO, -MR, Rt=200ms	SOT-25	28yx	VD5	6g	Tor
5BK	XC9236A1KCMR	DC-DC-IC	PWM/PFM, st-dwn, 1.75V±2%, 600mA, 1.2MHz, Vin>2V, LSST	SOT-25	28dc4	DC1	6g	Tor
5BK	XC6106B018MR	Vdet-IC	1.8V±2%, Hst, -MR, ±Reset PPO, Rt=25ms	SOT-25	28xf	VD21	6g	Tor
5BK	XC6106B048MR	Vdet-IC	4.8V±2%, Hst, -MR, ±Reset PPO, Rt=25ms	SOT-25	28xf	VD21	6g	Tor
5BL	XC6127C17JMR	Vdet-IC	1.7V±0.8%, +Reset PPO, -MR, Rt=400ms	SOT-25	28yx	VD5	6g	Tor
5BL	XC9236A1LCMR	DC-DC-IC	PWM/PFM, st-dwn, 1.85V±2%, 600mA, 1.2MHz, Vin>2V, LSST	SOT-25	28dc4	DC1	6g	Tor
5BL	XC6106B019MR	Vdet-IC	1.9V±2%, Hst, -MR, ±Reset PPO, Rt=25ms	SOT-25	28xf	VD21	6g	Tor
5BL	XC6106B049MR	Vdet-IC	4.9V±2%, Hst, -MR, ±Reset PPO, Rt=25ms	SOT-25	28xf	VD21	6g	Tor
5BL	XC6127C17KMR	Vdet-IC	1.7V±0.8%, +Reset PPO, -MR, Rt=800ms	SOT-25	28yx	VD5	6g	Tor
5BM	XC9236A1MCMR	DC-DC-IC	PWM/PFM, st-dwn, 1.95V±2%, 600mA, 1.2MHz, Vin>2V, LSST	SOT-25	28dc4	DC1	6g	Tor
5BM	XC6106B020MR	Vdet-IC	2.0V±2%, Hst, -MR, ±Reset PPO, Rt=25ms	SOT-25	28xf	VD21	6g	Tor
5BM	XC6106B050MR	Vdet-IC	5.0V±2%, Hst, -MR, ±Reset PPO, Rt=25ms	SOT-25	28xf	VD21	6g	Tor
5BN	XC6127C18AMR	Vdet-IC	1.8V±0.8%, -Reset PPO, -MR, Rt=50ms	SOT-25	28yx	VD5	6g	Tor
5BN	XC6106B021MR	Vdet-IC	2.1V±2%, Hst, -MR, ±Reset PPO, Rt=25ms	SOT-25	28xf	VD21	6g	Tor
5BP	XC6127C18BMR	Vdet-IC	1.8V±0.8%, -Reset PPO, -MR, Rt=100ms	SOT-25	28yx	VD5	6g	Tor
5BP	XC6106B022MR	Vdet-IC	2.2V±2%, Hst, -MR, ±Reset PPO, Rt=25ms	SOT-25	28xf	VD21	6g	Tor
5BR	XC6127C18CMR	Vdet-IC	1.8V±0.8%, -Reset PPO, -MR, Rt=200ms	SOT-25	28yx	VD5	6g	Tor
5BR	XC6106B023MR	Vdet-IC	2.3V±2%, Hst, -MR, ±Reset PPO, Rt=25ms	SOT-25	28xf	VD21	6g	Tor
5BS	XC6127C18DMR	Vdet-IC	1.8V±0.8%, -Reset PPO, -MR, Rt=400ms	SOT-25	28yx	VD5	6g	Tor
5BS	XC6106B024MR	Vdet-IC	2.4V±2%, Hst, -MR, ±Reset PPO, Rt=25ms	SOT-25	28xf	VD21	6g	Tor
5BT	XC6127C18EMR	Vdet-IC	1.8V±0.8%, -Reset PPO, -MR, Rt=800ms	SOT-25	28yx	VD5	6g	Tor
5BT	XC6106B025MR	Vdet-IC	2.5V±2%, Hst, -MR, ±Reset PPO, Rt=25ms	SOT-25	28xf	VD21	6g	Tor
5BU	XC6127C18FMR	Vdet-IC	1.8V±0.8%, +Reset PPO, -MR, Rt=50ms	SOT-25	28yx	VD5	6g	Tor
5BU	XC6106B026MR	Vdet-IC	2.6V±2%, Hst, -MR, ±Reset PPO, Rt=25ms	SOT-25	28xf	VD21	6g	Tor
5BV	XC6127C18GMR	Vdet-IC	1.8V±0.8%, +Reset PPO, -MR, Rt=100ms	SOT-25	28yx	VD5	6g	Tor
5BV	XC6106B027MR	Vdet-IC	2.7V±2%, Hst, -MR, ±Reset PPO, Rt=25ms	SOT-25	28xf	VD21	6g	Tor
5BX	XC6127C18HMR	Vdet-IC	1.8V±0.8%, +Reset PPO, -MR, Rt=200ms	SOT-25	28yx	VD5	6g	Tor
5BX	XC6106B028MR	Vdet-IC	2.8V±2%, Hst, -MR, ±Reset PPO, Rt=25ms	SOT-25	28xf	VD21	6g	Tor
5BY	XC6127C18JMR	Vdet-IC	1.8V±0.8%, +Reset PPO, -MR, Rt=400ms	SOT-25	28yx	VD5	6g	Tor
5BY	XC6106B029MR	Vdet-IC	2.9V±2%, Hst, -MR, ±Reset PPO, Rt=25ms	SOT-25	28xf	VD21	6g	Tor
5BZ	XC6127C18KMR	Vdet-IC	1.8V±0.8%, +Reset PPO, -MR, Rt=800ms	SOT-25	28yx	VD5	6g	Tor
5BZ	XC6106B030MR	Vdet-IC	3.0V±2%, Hst, -MR, ±Reset PPO, Rt=25ms	SOT-25	28xf	VD21	6g	Tor
5C	MIC5365-1.0VMT	LVR-IC	LDO, 1.0V±2%, 150mA, +CE	SC-70-5	28gf	VR4	6g	Mcr
5C	R3111N251A	Vdet-IC	2.5V±2%, -Reset PPO	SOT-23-5	28vdm	VD7	6g	Ric
5C	RN5RL35AA	LVR-IC	3.5V±2.5%, 150mA	SOT-23-5	28vu	VR1	6g	Ric
5C	RN5VD25CA	Vdet-IC	2.5V±2.5%, -Reset ODO	SOT-23-5	28vdo	VD1	6g	Ric
5C0	XC9236A20CMR	DC-DC-IC	PWM/PFM, st-dwn, 2.0V±2%, 600mA, 1.2MHz, Vin>2V, LSST	SOT-25	28dc4	DC1	6g	Tor
5C0	XC6106C031MR	Vdet-IC	3.1V±2%, Hst, -MR, ±Reset PPO, Rt=50ms	SOT-25	28xf	VD21	6g	Tor
5C1	XC9236A21CMR	DC-DC-IC	PWM/PFM, st-dwn, 2.1V±2%, 600mA, 1.2MHz, Vin>2V, LSST	SOT-25	28dc4	DC1	6g	Tor
5C1	XC6106C032MR	Vdet-IC	3.2V±2%, Hst, -MR, ±Reset PPO, Rt=50ms	SOT-25	28xf	VD21	6g	Tor
5C2	XC9236A22CMR	DC-DC-IC	PWM/PFM, st-dwn, 2.2V±2%, 600mA, 1.2MHz, Vin>2V, LSST	SOT-25	28dc4	DC1	6g	Tor
5C2	XC6106C033MR	Vdet-IC	3.3V±2%, Hst, -MR, ±Reset PPO, Rt=50ms	SOT-25	28xf	VD21	6g	Tor
5C3	XC9236A23CMR	DC-DC-IC	PWM/PFM, st-dwn, 2.3V±2%, 600mA, 1.2MHz, Vin>2V, LSST	SOT-25	28dc4	DC1	6g	Tor
5C3	XC6106C034MR	Vdet-IC	3.4V±2%, Hst, -MR, ±Reset PPO, Rt=50ms	SOT-25	28xf	VD21	6g	Tor
5C4	XC9236A24CMR	DC-DC-IC	PWM/PFM, st-dwn, 2.4V±2%, 600mA, 1.2MHz, Vin>2V, LSST	SOT-25	28dc4	DC1	6g	Tor
5C4	XC6106C035MR	Vdet-IC	3.5V±2%, Hst, -MR, ±Reset PPO, Rt=50ms	SOT-25	28xf	VD21	6g	Tor
5C5	XC9236A25CMR	DC-DC-IC	PWM/PFM, st-dwn, 2.5V±2%, 600mA, 1.2MHz, Vin>2V, LSST	SOT-25	28dc4	DC1	6g	Tor
5C5	XC6106C036MR	Vdet-IC	3.6V±2%, Hst, -MR, ±Reset PPO, Rt=50ms	SOT-25	28xf	VD21	6g	Tor
5C6	XC9236A26CMR	DC-DC-IC	PWM/PFM, st-dwn, 2.6V±2%, 600mA, 1.2MHz, Vin>2V, LSST	SOT-25	28dc4	DC1	6g	Tor
5C6	XC6106C037MR	Vdet-IC	3.7V±2%, Hst, -MR, ±Reset PPO, Rt=50ms	SOT-25	28xf	VD21	6g	Tor
5C7	XC9236A27CMR	DC-DC-IC	PWM/PFM, st-dwn, 2.7V±2%, 600mA, 1.2MHz, Vin>2V, LSST	SOT-25	28dc4	DC1	6g	Tor
5C7	XC6106C038MR	Vdet-IC	3.8V±2%, Hst, -MR, ±Reset PPO, Rt=50ms	SOT-25	28xf	VD21	6g	Tor
5C8	XC9236A28CMR	DC-DC-IC	PWM/PFM, st-dwn, 2.8V±2%, 600mA, 1.2MHz, Vin>2V, LSST	SOT-25	28dc4	DC1	6g	Tor
5C8	XC6106C039MR	Vdet-IC	3.9V±2%, Hst, -MR, ±Reset PPO, Rt=50ms	SOT-25	28xf	VD21	6g	Tor



SMD code	Type	Function	Short description	Case	Pinout	Sch.	St.	Mnf.
5C9	XC9236A29CMR	DC-DC-IC	PWM/PFM, st-dwn, 2.9V±2%, 600mA, 1.2MHz, Vin>2V, LSST	SOT-25	28dc4	DC1	6g	Tor
5C9	XC6106C040MR	Vdet-IC	4.0V±2%, Hst, -MR, ±Reset PPO, Rt=50ms	SOT-25	28xf	VD21	6g	Tor
5CA	XC6127C19AMR	Vdet-IC	1.9V±0.8%, -Reset PPO, -MR, Rt=50ms	SOT-25	28yx	VD5	6g	Tor
5CA	XC9236A2ACMR	DC-DC-IC	PWM/PFM, st-dwn, 2.05V±2%, 600mA, 1.2MHz, Vin>2V, LSST	SOT-25	28dc4	DC1	6g	Tor
5CA	XC6106C041MR	Vdet-IC	4.1V±2%, Hst, -MR, ±Reset PPO, Rt=50ms	SOT-25	28xf	VD21	6g	Tor
5CB	XC6127C19BMR	Vdet-IC	1.9V±0.8%, -Reset PPO, -MR, Rt=100ms	SOT-25	28yx	VD5	6g	Tor
5CB	XC9236A2BCMR	DC-DC-IC	PWM/PFM, st-dwn, 2.15V±2%, 600mA, 1.2MHz, Vin>2V, LSST	SOT-25	28dc4	DC1	6g	Tor
5CB	XC6106C042MR	Vdet-IC	4.2V±2%, Hst, -MR, ±Reset PPO, Rt=50ms	SOT-25	28xf	VD21	6g	Tor
5CC	XC6127C19CMR	Vdet-IC	1.9V±0.8%, -Reset PPO, -MR, Rt=50ms	SOT-25	28yx	VD5	6g	Tor
5CC	XC9236A2CCMR	DC-DC-IC	PWM/PFM, st-dwn, 2.25V±2%, 600mA, 1.2MHz, Vin>2V, LSST	SOT-25	28dc4	DC1	6g	Tor
5CC	XC6106C043MR	Vdet-IC	4.3V±2%, Hst, -MR, ±Reset PPO, Rt=50ms	SOT-25	28xf	VD21	6g	Tor
5CD	XC6127C19DMR	Vdet-IC	1.9V±0.8%, -Reset PPO, -MR, Rt=400ms	SOT-25	28yx	VD5	6g	Tor
5CD	XC9236A2DCMR	DC-DC-IC	PWM/PFM, st-dwn, 2.35V±2%, 600mA, 1.2MHz, Vin>2V, LSST	SOT-25	28dc4	DC1	6g	Tor
5CD	XC6106C044MR	Vdet-IC	4.4V±2%, Hst, -MR, ±Reset PPO, Rt=50ms	SOT-25	28xf	VD21	6g	Tor
5CE	XC6127C19EMR	Vdet-IC	1.9V±0.8%, -Reset PPO, -MR, Rt=800ms	SOT-25	28yx	VD5	6g	Tor
5CE	XC9236A2ECMR	DC-DC-IC	PWM/PFM, st-dwn, 2.45V±2%, 600mA, 1.2MHz, Vin>2V, LSST	SOT-25	28dc4	DC1	6g	Tor
5CE	XC6106C045MR	Vdet-IC	4.5V±2%, Hst, -MR, ±Reset PPO, Rt=50ms	SOT-25	28xf	VD21	6g	Tor
5CF	XC6127C19FMR	Vdet-IC	1.9V±0.8%, +Reset PPO, -MR, Rt=50ms	SOT-25	28yx	VD5	6g	Tor
5CF	XC9236A2FCMR	DC-DC-IC	PWM/PFM, st-dwn, 2.55V±2%, 600mA, 1.2MHz, Vin>2V, LSST	SOT-25	28dc4	DC1	6g	Tor
5CF	XC6106C016MR	Vdet-IC	1.6V±2%, Hst, -MR, ±Reset PPO, Rt=50ms	SOT-25	28xf	VD21	6g	Tor
5CF	XC6106C046MR	Vdet-IC	4.6V±2%, Hst, -MR, ±Reset PPO, Rt=50ms	SOT-25	28xf	VD21	6g	Tor
5CH	XC6127C19GMR	Vdet-IC	1.9V±0.8%, +Reset PPO, -MR, Rt=100ms	SOT-25	28yx	VD5	6g	Tor
5CH	XC9236A2HCMR	DC-DC-IC	PWM/PFM, st-dwn, 2.65V±2%, 600mA, 1.2MHz, Vin>2V, LSST	SOT-25	28dc4	DC1	6g	Tor
5CH	XC6106C017MR	Vdet-IC	1.7V±2%, Hst, -MR, ±Reset PPO, Rt=50ms	SOT-25	28xf	VD21	6g	Tor
5CH	XC6106C047MR	Vdet-IC	4.7V±2%, Hst, -MR, ±Reset PPO, Rt=50ms	SOT-25	28xf	VD21	6g	Tor
5CK	XC6127C19HMR	Vdet-IC	1.9V±0.8%, +Reset PPO, -MR, Rt=200ms	SOT-25	28yx	VD5	6g	Tor
5CK	XC9236A2KCMR	DC-DC-IC	PWM/PFM, st-dwn, 2.75V±2%, 600mA, 1.2MHz, Vin>2V, LSST	SOT-25	28dc4	DC1	6g	Tor
5CK	XC6106C018MR	Vdet-IC	1.8V±2%, Hst, -MR, ±Reset PPO, -MR, Rt=50ms	SOT-25	28xf	VD21	6g	Tor
5CK	XC6106C048MR	Vdet-IC	4.8V±2%, Hst, -MR, ±Reset PPO, Rt=50ms	SOT-25	28xf	VD21	6g	Tor
5CL	XC6127C19JMR	Vdet-IC	1.9V±0.8%, +Reset PPO, -MR, Rt=400ms	SOT-25	28yx	VD5	6g	Tor
5CL	XC9236A2LCMR	DC-DC-IC	PWM/PFM, st-dwn, 2.85V±2%, 600mA, 1.2MHz, Vin>2V, LSST	SOT-25	28dc4	DC1	6g	Tor
5CL	XC6106C019MR	Vdet-IC	1.9V±2%, Hst, -MR, ±Reset PPO, Rt=50ms	SOT-25	28xf	VD21	6g	Tor
5CL	XC6106C049MR	Vdet-IC	4.9V±2%, Hst, -MR, ±Reset PPO, Rt=50ms	SOT-25	28xf	VD21	6g	Tor
5CM	XC6127C19KMR	Vdet-IC	1.9V±0.8%, +Reset PPO, -MR, Rt=800ms	SOT-25	28yx	VD5	6g	Tor
5CM	XC9236A2MCMR	DC-DC-IC	PWM/PFM, st-dwn, 2.95V±2%, 600mA, 1.2MHz, Vin>2V, LSST	SOT-25	28dc4	DC1	6g	Tor
5CM	XC6106C020MR	Vdet-IC	2.0V±2%, Hst, -MR, ±Reset PPO, Rt=50ms	SOT-25	28xf	VD21	6g	Tor
5CM	XC6106C050MR	Vdet-IC	5.0V±2%, Hst, -MR, ±Reset PPO, Rt=50ms	SOT-25	28xf	VD21	6g	Tor
5CN	XC6127C20AMR	Vdet-IC	2.0V±0.8%, -Reset PPO, -MR, Rt=50ms	SOT-25	28yx	VD5	6g	Tor
5CN	XC6106C021MR	Vdet-IC	2.1V±2%, Hst, -MR, ±Reset PPO, Rt=50ms	SOT-25	28xf	VD21	6g	Tor
5CP	XC6127C20BMR	Vdet-IC	2.0V±0.8%, -Reset PPO, -MR, Rt=100ms	SOT-25	28yx	VD5	6g	Tor
5CP	XC6106C022MR	Vdet-IC	2.2V±2%, Hst, -MR, ±Reset PPO, Rt=50ms	SOT-25	28xf	VD21	6g	Tor
5CR	XC6127C20CMR	Vdet-IC	2.0V±0.8%, -Reset PPO, -MR, Rt=200ms	SOT-25	28yx	VD5	6g	Tor
5CR	XC6106C023MR	Vdet-IC	2.3V±2%, Hst, -MR, ±Reset PPO, Rt=50ms	SOT-25	28xf	VD21	6g	Tor
5CS	XC6127C20DMR	Vdet-IC	2.0V±0.8%, -Reset PPO, -MR, Rt=400ms	SOT-25	28yx	VD5	6g	Tor
5CS	XC6106C024MR	Vdet-IC	2.4V±2%, Hst, -MR, ±Reset PPO, Rt=50ms	SOT-25	28xf	VD21	6g	Tor
5CT	XC6127C20EMR	Vdet-IC	2.0V±0.8%, -Reset PPO, -MR, Rt=800ms	SOT-25	28yx	VD5	6g	Tor
5CT	XC6106C025MR	Vdet-IC	2.5V±2%, Hst, -MR, ±Reset PPO, Rt=50ms	SOT-25	28xf	VD21	6g	Tor
5CU	XC6127C20FMR	Vdet-IC	2.0V±0.8%, +Reset PPO, -MR, Rt=50ms	SOT-25	28yx	VD5	6g	Tor
5CU	XC6106C026MR	Vdet-IC	2.6V±2%, Hst, -MR, ±Reset PPO, Rt=50ms	SOT-25	28xf	VD21	6g	Tor
5CV	XC6127C20GMR	Vdet-IC	2.0V±0.8%, +Reset PPO, -MR, Rt=100ms	SOT-25	28yx	VD5	6g	Tor
5CV	XC6106C027MR	Vdet-IC	2.7V±2%, Hst, -MR, ±Reset PPO, Rt=50ms	SOT-25	28xf	VD21	6g	Tor
5CX	XC6127C20HMR	Vdet-IC	2.0V±0.8%, +Reset PPO, -MR, Rt=200ms	SOT-25	28yx	VD5	6g	Tor
5CX	XC6106C028MR	Vdet-IC	2.8V±2%, Hst, -MR, ±Reset PPO, Rt=50ms	SOT-25	28xf	VD21	6g	Tor
5CY	XC6127C20JMR	Vdet-IC	2.0V±0.8%, +Reset PPO, -MR, Rt=400ms	SOT-25	28yx	VD5	6g	Tor
5CY	XC6106C029MR	Vdet-IC	2.9V±2%, Hst, -MR, ±Reset PPO, Rt=50ms	SOT-25	28xf	VD21	6g	Tor
5CZ	XC6127C20KMR	Vdet-IC	2.0V±0.8%, +Reset PPO, -MR, Rt=800ms	SOT-25	28yx	VD5	6g	Tor
5CZ	XC6106C030MR	Vdet-IC	3.0V±2%, Hst, -MR, ±Reset PPO, Rt=50ms	SOT-25	28xf	VD21	6g	Tor
5D	R3111N351A	Vdet-IC	3.5V±2%, -Reset PPO	SOT-23-5	28vdm	VD7	6g	Ric
5D	RN5RL45AA	LVR-IC	4.5V±2.5%, 150mA	SOT-23-5	28vu	VR1	6g	Ric
5D	RN5VD35CA	Vdet-IC	3.5V±2.5%, -Reset ODO	SOT-23-5	28vdo	VD1	6g	Ric
5D0	XC9236A30CMR	DC-DC-IC	PWM/PFM, st-dwn, 3.0V±2%, 600mA, 1.2MHz, Vin>2V, LSST	SOT-25	28dc4	DC1	6g	Tor
5D0	XC6106D031MR	Vdet-IC	3.1V±2%, Hst, -MR, ±Reset PPO, Rt=100ms	SOT-25	28xf	VD21	6g	Tor
5D1	XC9236A31CMR	DC-DC-IC	PWM/PFM, st-dwn, 3.1V±2%, 600mA, 1.2MHz, Vin>2V, LSST	SOT-25	28dc4	DC1	6g	Tor
5D1	XC6106D032MR	Vdet-IC	3.2V±2%, Hst, -MR, ±Reset PPO, Rt=100ms	SOT-25	28xf	VD21	6g	Tor
5D2	XC9236A32CMR	DC-DC-IC	PWM/PFM, st-dwn, 3.2V±2%, 600mA, 1.2MHz, Vin>2V, LSST	SOT-25	28dc4	DC1	6g	Tor
5D2	XC6106D033MR	Vdet-IC	3.3V±2%, Hst, -MR, ±Reset PPO, Rt=100ms	SOT-25	28xf	VD21	6g	Tor
5D3	XC9236A33CMR	DC-DC-IC	PWM/PFM, st-dwn, 3.3V±2%, 600mA, 1.2MHz, Vin>2V, LSST	SOT-25	28dc4	DC1	6g	Tor
5D3	XC6106D034MR	Vdet-IC	3.4V±2%, Hst, -MR, ±Reset PPO, Rt=100ms	SOT-25	28xf	VD21	6g	Tor
5D4	XC9236A34CMR	DC-DC-IC	PWM/PFM, st-dwn, 3.4V±2%, 600mA, 1.2MHz, Vin>2V, LSST	SOT-25	28dc4	DC1	6g	Tor
5D4	XC6106D035MR	Vdet-IC	3.5V±2%, Hst, -MR, ±Reset PPO, Rt=100ms	SOT-25	28xf	VD21	6g	Tor



SMD code	Type	Function	Short description	Case	Pinout	Sch.	St.	Mnf.
5D5	XC9236A35CMR	DC-DC-IC	PWM/PFM, st-dwn, 3.5V±2%, 600mA, 1.2MHz, Vin>2V, LSST	SOT-25	28dc4	DC1	6g	Tor
5D5	XC6106D036MR	Vdet-IC	3.6V±2%, Hst, -MR, ±Reset PPO, Rt=100ms	SOT-25	28xf	VD21	6g	Tor
5D6	XC9236A36CMR	DC-DC-IC	PWM/PFM, st-dwn, 3.6V±2%, 600mA, 1.2MHz, Vin>2V, LSST	SOT-25	28dc4	DC1	6g	Tor
5D6	XC6106D037MR	Vdet-IC	3.7V±2%, Hst, -MR, ±Reset PPO, Rt=100ms	SOT-25	28xf	VD21	6g	Tor
5D7	XC9236A37CMR	DC-DC-IC	PWM/PFM, st-dwn, 3.7V±2%, 600mA, 1.2MHz, Vin>2V, LSST	SOT-25	28dc4	DC1	6g	Tor
5D7	XC6106D038MR	Vdet-IC	3.8V±2%, Hst, -MR, ±Reset PPO, Rt=100ms	SOT-25	28xf	VD21	6g	Tor
5D8	XC9236A38CMR	DC-DC-IC	PWM/PFM, st-dwn, 3.8V±2%, 600mA, 1.2MHz, Vin>2V, LSST	SOT-25	28dc4	DC1	6g	Tor
5D8	XC6106D039MR	Vdet-IC	3.9V±2%, Hst, -MR, ±Reset PPO, Rt=100ms	SOT-25	28xf	VD21	6g	Tor
5D9	XC9236A39CMR	DC-DC-IC	PWM/PFM, st-dwn, 3.9V±2%, 600mA, 1.2MHz, Vin>2V, LSST	SOT-25	28dc4	DC1	6g	Tor
5D9	XC6106D040MR	Vdet-IC	4.0V±2%, Hst, -MR, ±Reset PPO, Rt=100ms	SOT-25	28xf	VD21	6g	Tor
5Da	FT533Da	LVR-IC	LDO, 1.8V±2%, 700mA, +CE	SOT-23-5	28cx	VR4	6g	Fmd
5Da	XC6127C21AMR	Vdet-IC	2.1V±0.8%, -Reset PPO, -MR, Rt=50ms	SOT-25	28yx	VD5	6g	Tor
5Da	XC9236A3ACMR	DC-DC-IC	PWM/PFM, st-dwn, 3.05V±2%, 600mA, 1.2MHz, Vin>2V, LSST	SOT-25	28dc4	DC1	6g	Tor
5Da	XC6106D041MR	Vdet-IC	4.1V±2%, Hst, -MR, ±Reset PPO, Rt=100ms	SOT-25	28xf	VD21	6g	Tor
5Db	FT533Db	LVR-IC	LDO, 1.8V±2%, 700mA, +CE	SOT-23-5	28wc	VR4	6g	Fmd
5Db	XC6127C21BMR	Vdet-IC	2.1V±0.8%, -Reset PPO, -MR, Rt=100ms	SOT-25	28yx	VD5	6g	Tor
5Db	XC9236A3BCMR	DC-DC-IC	PWM/PFM, st-dwn, 3.15V±2%, 600mA, 1.2MHz, Vin>2V, LSST	SOT-25	28dc4	DC1	6g	Tor
5Db	XC6106D042MR	Vdet-IC	4.2V±2%, Hst, -MR, ±Reset PPO, Rt=100ms	SOT-25	28xf	VD21	6g	Tor
5Dc	FT533Dc	LVR-IC	LDO, 1.8V±2%, 700mA, +CE	SOT-23-5	28xm	VR4	6g	Fmd
5Dc	XC6127C21CMR	Vdet-IC	2.1V±0.8%, -Reset PPO, -MR, Rt=200ms	SOT-25	28yx	VD5	6g	Tor
5Dc	XC9236A3CCMR	DC-DC-IC	PWM/PFM, st-dwn, 3.25V±2%, 600mA, 1.2MHz, Vin>2V, LSST	SOT-25	28dc4	DC1	6g	Tor
5Dc	XC6106D043MR	Vdet-IC	4.3V±2%, Hst, -MR, ±Reset PPO, Rt=100ms	SOT-25	28xf	VD21	6g	Tor
5Dd	FT533Dd	LVR-IC	LDO, 1.8V±2%, 700mA, +CE	SC-70-5	28cx	VR4	6g	Fmd
5Dd	XC6127C21DMR	Vdet-IC	2.1V±0.8%, -Reset PPO, -MR, Rt=400ms	SOT-25	28yx	VD5	6g	Tor
5Dd	XC9236A3DCMR	DC-DC-IC	PWM/PFM, st-dwn, 3.35V±2%, 600mA, 1.2MHz, Vin>2V, LSST	SOT-25	28dc4	DC1	6g	Tor
5Dd	XC6106D044MR	Vdet-IC	4.4V±2%, Hst, -MR, ±Reset PPO, Rt=100ms	SOT-25	28xf	VD21	6g	Tor
5De	FT533De	LVR-IC	LDO, 1.8V±2%, 700mA, +CE	SC-70-5	28vc	VR4	6g	Fmd
5De	XC6127C21EMR	Vdet-IC	2.1V±0.8%, -Reset PPO, -MR, Rt=800ms	SOT-25	28yx	VD5	6g	Tor
5De	XC9236A3ECMR	DC-DC-IC	PWM/PFM, st-dwn, 3.45V±2%, 600mA, 1.2MHz, Vin>2V, LSST	SOT-25	28dc4	DC1	6g	Tor
5De	XC6106D045MR	Vdet-IC	4.5V±2%, Hst, -MR, ±Reset PPO, Rt=100ms	SOT-25	28xf	VD21	6g	Tor
5Df	FT533Df	LVR-IC	LDO, 1.8V±2%, 700mA, +CE	SC-70-5	28xm	VR4	6g	Fmd
5Df	XC6127C21FMR	Vdet-IC	2.1V±0.8%, +Reset PPO, -MR, Rt=50ms	SOT-25	28yx	VD5	6g	Tor
5Df	XC9236A3FCMR	DC-DC-IC	PWM/PFM, st-dwn, 3.55V±2%, 600mA, 1.2MHz, Vin>2V, LSST	SOT-25	28dc4	DC1	6g	Tor
5Df	XC6106D016MR	Vdet-IC	1.6V±2%, Hst, -MR, ±Reset PPO, Rt=100ms	SOT-25	28xf	VD21	6g	Tor
5Df	XC6106D046MR	Vdet-IC	4.6V±2%, Hst, -MR, ±Reset PPO, Rt=100ms	SOT-25	28xf	VD21	6g	Tor
5Dh	XC6127C21GMR	Vdet-IC	2.1V±0.8%, +Reset PPO, -MR, Rt=100ms	SOT-25	28yx	VD5	6g	Tor
5Dh	XC9236A3HCMR	DC-DC-IC	PWM/PFM, st-dwn, 3.65V±2%, 600mA, 1.2MHz, Vin>2V, LSST	SOT-25	28dc4	DC1	6g	Tor
5Dh	XC6106D017MR	Vdet-IC	1.7V±2%, Hst, -MR, ±Reset PPO, Rt=100ms	SOT-25	28xf	VD21	6g	Tor
5Dh	XC6106D047MR	Vdet-IC	4.7V±2%, Hst, -MR, ±Reset PPO, Rt=100ms	SOT-25	28xf	VD21	6g	Tor
5Dk	XC6127C21HMR	Vdet-IC	2.1V±0.8%, +Reset PPO, -MR, Rt=200ms	SOT-25	28yx	VD5	6g	Tor
5Dk	XC9236A3KCMR	DC-DC-IC	PWM/PFM, st-dwn, 3.75V±2%, 600mA, 1.2MHz, Vin>2V, LSST	SOT-25	28dc4	DC1	6g	Tor
5Dk	XC6106D018MR	Vdet-IC	1.8V±2%, Hst, -MR, ±Reset PPO, Rt=100ms	SOT-25	28xf	VD21	6g	Tor
5Dk	XC6106D048MR	Vdet-IC	4.8V±2%, Hst, -MR, ±Reset PPO, Rt=100ms	SOT-25	28xf	VD21	6g	Tor
5Dl	XC6127C21JMR	Vdet-IC	2.1V±0.8%, +Reset PPO, -MR, Rt=400ms	SOT-25	28yx	VD5	6g	Tor
5Dl	XC9236A3LCMR	DC-DC-IC	PWM/PFM, st-dwn, 3.85V±2%, 600mA, 1.2MHz, Vin>2V, LSST	SOT-25	28dc4	DC1	6g	Tor
5Dl	XC6106D019MR	Vdet-IC	1.9V±2%, Hst, -MR, ±Reset PPO, Rt=100ms	SOT-25	28xf	VD21	6g	Tor
5Dl	XC6106D049MR	Vdet-IC	4.9V±2%, Hst, -MR, ±Reset PPO, Rt=100ms	SOT-25	28xf	VD21	6g	Tor
5Dm	XC6127C21KMR	Vdet-IC	2.1V±0.8%, +Reset PPO, -MR, Rt=800ms	SOT-25	28yx	VD5	6g	Tor
5Dm	XC9236A3MCMR	DC-DC-IC	PWM/PFM, st-dwn, 3.95V±2%, 600mA, 1.2MHz, Vin>2V, LSST	SOT-25	28dc4	DC1	6g	Tor
5Dm	XC6106D020MR	Vdet-IC	2.0V±2%, Hst, -MR, ±Reset PPO, Rt=100ms	SOT-25	28xf	VD21	6g	Tor
5Dm	XC6106D050MR	Vdet-IC	5.0V±2%, Hst, -MR, ±Reset PPO, Rt=100ms	SOT-25	28xf	VD21	6g	Tor
5Dn	XC6127C22AMR	Vdet-IC	2.2V±0.8%, -Reset PPO, -MR, Rt=50ms	SOT-25	28yx	VD5	6g	Tor
5Dn	XC6106D021MR	Vdet-IC	2.1V±2%, Hst, -MR, ±Reset PPO, Rt=100ms	SOT-25	28xf	VD21	6g	Tor
5Dp	XC6127C22BMR	Vdet-IC	2.2V±0.8%, -Reset PPO, -MR, Rt=100ms	SOT-25	28yx	VD5	6g	Tor
5Dp	XC6106D022MR	Vdet-IC	2.2V±2%, Hst, -MR, ±Reset PPO, Rt=100ms	SOT-25	28xf	VD21	6g	Tor
5Dr	XC6127C22CMR	Vdet-IC	2.2V±0.8%, -Reset PPO, -MR, Rt=200ms	SOT-25	28yx	VD5	6g	Tor
5Dr	XC6106D023MR	Vdet-IC	2.3V±2%, Hst, -MR, ±Reset PPO, Rt=100ms	SOT-25	28xf	VD21	6g	Tor
5Ds	XC6127C22DMR	Vdet-IC	2.2V±0.8%, -Reset PPO, -MR, Rt=400ms	SOT-25	28yx	VD5	6g	Tor
5Ds	XC6106D024MR	Vdet-IC	2.4V±2%, Hst, -MR, ±Reset PPO, Rt=100ms	SOT-25	28xf	VD21	6g	Tor
5Dt	XC6127C22EMR	Vdet-IC	2.2V±0.8%, -Reset PPO, -MR, Rt=800ms	SOT-25	28yx	VD5	6g	Tor
5Dt	XC6106D025MR	Vdet-IC	2.5V±2%, Hst, -MR, ±Reset PPO, Rt=100ms	SOT-25	28xf	VD21	6g	Tor
5Du	XC6127C22FMR	Vdet-IC	2.2V±0.8%, +Reset PPO, -MR, Rt=50ms	SOT-25	28yx	VD5	6g	Tor
5Du	XC6106D026MR	Vdet-IC	2.6V±2%, Hst, -MR, ±Reset PPO, Rt=100ms	SOT-25	28xf	VD21	6g	Tor
5Dv	XC6127C22GMR	Vdet-IC	2.2V±0.8%, +Reset PPO, -MR, Rt=100ms	SOT-25	28yx	VD5	6g	Tor
5Dv	XC6106D027MR	Vdet-IC	2.7V±2%, Hst, -MR, ±Reset PPO, Rt=100ms	SOT-25	28xf	VD21	6g	Tor
5Dx	XC6127C22HMR	Vdet-IC	2.2V±0.8%, +Reset PPO, -MR, Rt=200ms	SOT-25	28yx	VD5	6g	Tor
5Dx	XC6106D028MR	Vdet-IC	2.8V±2%, Hst, -MR, ±Reset PPO, Rt=100ms	SOT-25	28xf	VD21	6g	Tor
5Dy	XC6127C22JMR	Vdet-IC	2.2V±0.8%, +Reset PPO, -MR, Rt=400ms	SOT-25	28yx	VD5	6g	Tor
5Dy	XC6106D029MR	Vdet-IC	2.9V±2%, Hst, -MR, ±Reset PPO, Rt=100ms	SOT-25	28xf	VD21	6g	Tor
5Dz	XC6127C22KMR	Vdet-IC	2.2V±0.8%, +Reset PPO, -MR, Rt=800ms	SOT-25	28yx	VD5	6g	Tor



SMD CODE	Type	Function	Short description	Case	Pinout	Sch.	St.	Mnf.
5DZ	XC6106D030MR	Vdet-IC	3.0V±2%, Hst, -MR, ±Reset PPO, Rt=100ms	SOT-25	28xf	VD21	6g	Tor
5E	R3111N451A	Vdet-IC	4.5V±2%, -Reset PPO	SOT-23-5	28vdm	VD7	6g	Ric
5E	RN5RL55AA	LVR-IC	5.5V±2.5%, 150mA	SOT-23-5	28vu	VR1	6g	Ric
5E	RN5VD45CA	Vdet-IC	4.5V±2.5%, -Reset ODO	SOT-23-5	28vdo	VD1	6g	Ric
5E0	XC9236A40CMR	DC-DC-IC	PWM/PPM, st-dwn, 4.0V±2%, 600mA, 1.2MHz, Vin>2V, LSST	SOT-25	28dc4	DC1	6g	Tor
5E0	XC6106E031MR	Vdet-IC	3.1V±2%, Hst, -MR, ±Reset PPO, Rt=200ms	SOT-25	28xf	VD21	6g	Tor
5E1	XC6106E032MR	Vdet-IC	3.2V±2%, Hst, -MR, ±Reset PPO, Rt=200ms	SOT-25	28xf	VD21	6g	Tor
5E2	XC6106E033MR	Vdet-IC	3.3V±2%, Hst, -MR, ±Reset PPO, Rt=200ms	SOT-25	28xf	VD21	6g	Tor
5E3	XC6106E034MR	Vdet-IC	3.4V±2%, Hst, -MR, ±Reset PPO, Rt=200ms	SOT-25	28xf	VD21	6g	Tor
5E4	XC6106E035MR	Vdet-IC	3.5V±2%, Hst, -MR, ±Reset PPO, Rt=200ms	SOT-25	28xf	VD21	6g	Tor
5E5	XC6106E036MR	Vdet-IC	3.6V±2%, Hst, -MR, ±Reset PPO, Rt=200ms	SOT-25	28xf	VD21	6g	Tor
5E6	XC6106E037MR	Vdet-IC	3.7V±2%, Hst, -MR, ±Reset PPO, Rt=200ms	SOT-25	28xf	VD21	6g	Tor
5E7	XC6106E038MR	Vdet-IC	3.8V±2%, Hst, -MR, ±Reset PPO, Rt=200ms	SOT-25	28xf	VD21	6g	Tor
5E8	XC6205A09AMR	LVR-IC	LDO, 0.95V±2%, 150mA, +CE, PDR	SOT-25	28cx	VR4	6g	Tor
5E8	XC6106E039MR	Vdet-IC	3.9V±2%, Hst, -MR, ±Reset PPO, Rt=200ms	SOT-25	28xf	VD21	6g	Tor
5E9	XC6205A10AMR	LVR-IC	LDO, 1.05V±2%, 150mA, +CE, PDR	SOT-25	28cx	VR4	6g	Tor
5E9	XC6106E040MR	Vdet-IC	4.0V±2%, Hst, -MR, ±Reset PPO, Rt=200ms	SOT-25	28xf	VD21	6g	Tor
5EA	FT533Ea	LVR-IC	LDO, 2.5V±2%, 700mA, +CE	SOT-23-5	28cx	VR4	6g	Fmd
5EA	XC6127C23AMR	Vdet-IC	2.3V±0.8%, -Reset PPO, -MR, Rt=50ms	SOT-25	28yx	VD5	6g	Tor
5EA	XC6205A11AMR	LVR-IC	LDO, 1.15V±2%, 150mA, +CE, PDR	SOT-25	28cx	VR4	6g	Tor
5EA	XC6106E041MR	Vdet-IC	4.1V±2%, Hst, -MR, ±Reset PPO, Rt=200ms	SOT-25	28xf	VD21	6g	Tor
5Eb	FT533Eb	LVR-IC	LDO, 2.5V±2%, 700mA, +CE	SOT-23-5	28vc	VR4	6g	Fmd
5EB	XC6127C23BMR	Vdet-IC	2.3V±0.8%, -Reset PPO, -MR, Rt=100ms	SOT-25	28yx	VD5	6g	Tor
5EB	XC6205A12AMR	LVR-IC	LDO, 1.25V±2%, 150mA, +CE, PDR	SOT-25	28cx	VR4	6g	Tor
5EB	XC6106E042MR	Vdet-IC	4.2V±2%, Hst, -MR, ±Reset PPO, Rt=200ms	SOT-25	28xf	VD21	6g	Tor
5Ec	FT533Ec	LVR-IC	LDO, 2.5V±2%, 700mA, +CE	SOT-23-5	28xm	VR4	6g	Fmd
5EC	XC6127C23CMR	Vdet-IC	2.3V±0.8%, -Reset PPO, -MR, Rt=200ms	SOT-25	28yx	VD5	6g	Tor
5EC	XC6205A13AMR	LVR-IC	LDO, 1.35V±2%, 150mA, +CE, PDR	SOT-25	28cx	VR4	6g	Tor
5EC	XC6106E043MR	Vdet-IC	4.3V±2%, Hst, -MR, ±Reset PPO, Rt=200ms	SOT-25	28xf	VD21	6g	Tor
5Ed	FT533Ed	LVR-IC	LDO, 2.5V±2%, 700mA, +CE	SC-70-5	28cx	VR4	6g	Fmd
5ED	XC6127C23DMR	Vdet-IC	2.3V±0.8%, -Reset PPO, -MR, Rt=400ms	SOT-25	28yx	VD5	6g	Tor
5ED	XC6205A14AMR	LVR-IC	LDO, 1.45V±2%, 150mA, +CE, PDR	SOT-25	28cx	VR4	6g	Tor
5ED	XC6106E044MR	Vdet-IC	4.4V±2%, Hst, -MR, ±Reset PPO, Rt=200ms	SOT-25	28xf	VD21	6g	Tor
5Ee	FT533Ee	LVR-IC	LDO, 2.5V±2%, 700mA, +CE	SC-70-5	28vc	VR4	6g	Fmd
5EE	XC6127C23EMR	Vdet-IC	2.3V±0.8%, -Reset PPO, -MR, Rt=800ms	SOT-25	28yx	VD5	6g	Tor
5EE	XC6205A15AMR	LVR-IC	LDO, 1.55V±2%, 150mA, +CE, PDR	SOT-25	28cx	VR4	6g	Tor
5EE	XC6106E045MR	Vdet-IC	4.5V±2%, Hst, -MR, ±Reset PPO, Rt=200ms	SOT-25	28xf	VD21	6g	Tor
5Ef	FT533Ef	LVR-IC	LDO, 2.5V±2%, 700mA, +CE	SC-70-5	28xm	VR4	6g	Fmd
5EF	XC6127C23FMR	Vdet-IC	2.3V±0.8%, +Reset PPO, -MR, Rt=50ms	SOT-25	28yx	VD5	6g	Tor
5EF	XC6205A16AMR	LVR-IC	LDO, 1.65V±2%, 150mA, +CE, PDR	SOT-25	28cx	VR4	6g	Tor
5EF	XC6106E016MR	Vdet-IC	1.6V±2%, Hst, -MR, ±Reset PPO, Rt=200ms	SOT-25	28xf	VD21	6g	Tor
5EF	XC6106E046MR	Vdet-IC	4.6V±2%, Hst, -MR, ±Reset PPO, Rt=200ms	SOT-25	28xf	VD21	6g	Tor
5EH	XC6127C23GMR	Vdet-IC	2.3V±0.8%, +Reset PPO, -MR, Rt=100ms	SOT-25	28yx	VD5	6g	Tor
5EH	XC6205A17AMR	LVR-IC	LDO, 1.75V±2%, 150mA, +CE, PDR	SOT-25	28cx	VR4	6g	Tor
5EH	XC6106E017MR	Vdet-IC	1.7V±2%, Hst, -MR, ±Reset PPO, Rt=200ms	SOT-25	28xf	VD21	6g	Tor
5EH	XC6106E047MR	Vdet-IC	4.7V±2%, Hst, -MR, ±Reset PPO, Rt=200ms	SOT-25	28xf	VD21	6g	Tor
5EK	XC6127C23HMR	Vdet-IC	2.3V±0.8%, +Reset PPO, -MR, Rt=200ms	SOT-25	28yx	VD5	6g	Tor
5EK	XC6106E018MR	Vdet-IC	1.8V±2%, Hst, -MR, ±Reset PPO, Rt=200ms	SOT-25	28xf	VD21	6g	Tor
5EK	XC6106E048MR	Vdet-IC	4.8V±2%, Hst, -MR, ±Reset PPO, Rt=200ms	SOT-25	28xf	VD21	6g	Tor
5EL	XC6127C23JMR	Vdet-IC	2.3V±0.8%, +Reset PPO, -MR, Rt=400ms	SOT-25	28yx	VD5	6g	Tor
5EL	XC6106E019MR	Vdet-IC	1.9V±2%, Hst, -MR, ±Reset PPO, Rt=200ms	SOT-25	28xf	VD21	6g	Tor
5EL	XC6106E049MR	Vdet-IC	4.9V±2%, Hst, -MR, ±Reset PPO, Rt=200ms	SOT-25	28xf	VD21	6g	Tor
5EM	XC6127C23KMR	Vdet-IC	2.3V±0.8%, +Reset PPO, -MR, Rt=800ms	SOT-25	28yx	VD5	6g	Tor
5EM	XC6106E020MR	Vdet-IC	2.0V±2%, Hst, -MR, ±Reset PPO, Rt=200ms	SOT-25	28xf	VD21	6g	Tor
5EM	XC6106E050MR	Vdet-IC	5.0V±2%, Hst, -MR, ±Reset PPO, Rt=200ms	SOT-25	28xf	VD21	6g	Tor
5EN	XC6127C24AMR	Vdet-IC	2.4V±0.8%, -Reset PPO, -MR, Rt=50ms	SOT-25	28yx	VD5	6g	Tor
5EN	XC6106E021MR	Vdet-IC	2.1V±2%, Hst, -MR, ±Reset PPO, Rt=200ms	SOT-25	28xf	VD21	6g	Tor
5EP	XC6127C24BMR	Vdet-IC	2.4V±0.8%, -Reset PPO, -MR, Rt=100ms	SOT-25	28yx	VD5	6g	Tor
5EP	XC6106E022MR	Vdet-IC	2.2V±2%, Hst, -MR, ±Reset PPO, Rt=200ms	SOT-25	28xf	VD21	6g	Tor
5ER	XC6127C24CMR	Vdet-IC	2.4V±0.8%, -Reset PPO, -MR, Rt=200ms	SOT-25	28yx	VD5	6g	Tor
5ER	XC6106E023MR	Vdet-IC	2.3V±2%, Hst, -MR, ±Reset PPO, Rt=200ms	SOT-25	28xf	VD21	6g	Tor
5ES	XC6127C24DMR	Vdet-IC	2.4V±0.8%, -Reset PPO, -MR, Rt=400ms	SOT-25	28yx	VD5	6g	Tor
5ES	XC6106E024MR	Vdet-IC	2.4V±2%, Hst, -MR, ±Reset PPO, Rt=200ms	SOT-25	28xf	VD21	6g	Tor
5ET	XC6127C24EMR	Vdet-IC	2.4V±0.8%, -Reset PPO, -MR, Rt=800ms	SOT-25	28yx	VD5	6g	Tor
5ET	XC6106E025MR	Vdet-IC	2.5V±2%, Hst, -MR, ±Reset PPO, Rt=200ms	SOT-25	28xf	VD21	6g	Tor
5EU	XC6127C24FMR	Vdet-IC	2.4V±0.8%, +Reset PPO, -MR, Rt=50ms	SOT-25	28yx	VD5	6g	Tor
5EU	XC6106E026MR	Vdet-IC	2.6V±2%, Hst, -MR, ±Reset PPO, Rt=200ms	SOT-25	28xf	VD21	6g	Tor
5EV	XC6127C24GMR	Vdet-IC	2.4V±0.8%, +Reset PPO, -MR, Rt=100ms	SOT-25	28yx	VD5	6g	Tor
5EV	XC6106E027MR	Vdet-IC	2.7V±2%, Hst, -MR, ±Reset PPO, Rt=200ms	SOT-25	28xf	VD21	6g	Tor
5EX	XC6127C24HMR	Vdet-IC	2.4V±0.8%, +Reset PPO, -MR, Rt=200ms	SOT-25	28yx	VD5	6g	Tor



SMD code	Type	Function	Short description	Case	Pinout	Sch.	St.	Mnf.
5EX	XC6106E028MR	Vdet-IC	2.8V±2%, Hst, -MR, ±Reset PPO, Rt=200ms	SOT-25	28xf	VD21	6g	Tor
5EY	XC6127C24JMR	Vdet-IC	2.4V±0.8%, +Reset PPO, -MR, Rt=400ms	SOT-25	28yx	VD5	6g	Tor
5EY	XC6106E029MR	Vdet-IC	2.9V±2%, Hst, -MR, ±Reset PPO, Rt=200ms	SOT-25	28xf	VD21	6g	Tor
5EZ	XC6127C24KMR	Vdet-IC	2.4V±0.8%, +Reset PPO, -MR, Rt=800ms	SOT-25	28yx	VD5	6g	Tor
5EZ	XC6106E030MR	Vdet-IC	3.0V±2%, Hst, -MR, ±Reset PPO, Rt=200ms	SOT-25	28xf	VD21	6g	Tor
5F	MIC5365-1.5YMT	LVR-IC	LDO, 1.5V±2%, 150mA, +CE	SC-70-5	28gf	VR4	6g	Mcr
5F	R3111N551A	Vdet-IC	5.5V±2%, -Reset PPO	SOT-23-5	28vdm	VD7	6g	Ric
5F	RN5VD55CA	Vdet-IC	5.5V±2.5%, -Reset ODO	SOT-23-5	28vdo	VD1	6g	Ric
5F0	XC6106F031MR	Vdet-IC	3.1V±2%, Hst, -MR, ±Reset PPO, Rt=400ms	SOT-25	28xf	VD21	6g	Tor
5F1	XC6106F032MR	Vdet-IC	3.2V±2%, Hst, -MR, ±Reset PPO, Rt=400ms	SOT-25	28xf	VD21	6g	Tor
5F2	XC6106F033MR	Vdet-IC	3.3V±2%, Hst, -MR, ±Reset PPO, Rt=400ms	SOT-25	28xf	VD21	6g	Tor
5F3	XC6106F034MR	Vdet-IC	3.4V±2%, Hst, -MR, ±Reset PPO, Rt=400ms	SOT-25	28xf	VD21	6g	Tor
5F4	XC6106F035MR	Vdet-IC	3.5V±2%, Hst, -MR, ±Reset PPO, Rt=400ms	SOT-25	28xf	VD21	6g	Tor
5F5	XC6106F036MR	Vdet-IC	3.6V±2%, Hst, -MR, ±Reset PPO, Rt=400ms	SOT-25	28xf	VD21	6g	Tor
5F6	XC6106F037MR	Vdet-IC	3.7V±2%, Hst, -MR, ±Reset PPO, Rt=400ms	SOT-25	28xf	VD21	6g	Tor
5F7	XC6106F038MR	Vdet-IC	3.8V±2%, Hst, -MR, ±Reset PPO, Rt=400ms	SOT-25	28xf	VD21	6g	Tor
5F8	XC6205B09AMR	LVR-IC	LDO, 0.95V±2%, 150mA, +CE	SOT-25	28cx	VR4	6g	Tor
5F8	XC9236A08DMR	DC-DC-IC	PWM/PFM, st-dwn, 0.8V±2%, 600mA, 3MHz, Vin>2V, LSST	SOT-25	28dc4	DC1	6g	Tor
5F8	XC6106F039MR	Vdet-IC	3.9V±2%, Hst, -MR, ±Reset PPO, Rt=400ms	SOT-25	28xf	VD21	6g	Tor
5F9	XC6205B10AMR	LVR-IC	LDO, 1.05V±2%, 150mA, +CE	SOT-25	28cx	VR4	6g	Tor
5F9	XC9236A09DMR	DC-DC-IC	PWM/PFM, st-dwn, 0.9V±2%, 600mA, 3MHz, Vin>2V, LSST	SOT-25	28dc4	DC1	6g	Tor
5F9	XC6106F040MR	Vdet-IC	4.0V±2%, Hst, -MR, ±Reset PPO, Rt=400ms	SOT-25	28xf	VD21	6g	Tor
5Fa	FT533Fa	LVR-IC	LDO, 2.7V±2%, 700mA, +CE	SOT-23-5	28cx	VR4	6g	Fmd
5FA	XC6127C25AMR	Vdet-IC	2.5V±0.8%, -Reset PPO, -MR, Rt=50ms	SOT-25	28yx	VD5	6g	Tor
5FA	XC6205B11AMR	LVR-IC	LDO, 1.15V±2%, 150mA, +CE	SOT-25	28cx	VR4	6g	Tor
5FA	XC6106F041MR	Vdet-IC	4.1V±2%, Hst, -MR, ±Reset PPO, Rt=400ms	SOT-25	28xf	VD21	6g	Tor
5Fb	FT533Fb	LVR-IC	LDO, 2.7V±2%, 700mA, +CE	SOT-23-5	28vc	VR4	6g	Fmd
5Fb	XC6127C25BMR	Vdet-IC	2.5V±0.8%, -Reset PPO, -MR, Rt=100ms	SOT-25	28yx	VD5	6g	Tor
5Fb	XC6205B12AMR	LVR-IC	LDO, 1.25V±2%, 150mA, +CE	SOT-25	28cx	VR4	6g	Tor
5Fb	XC6106F042MR	Vdet-IC	4.2V±2%, Hst, -MR, ±Reset PPO, Rt=400ms	SOT-25	28xf	VD21	6g	Tor
5Fc	FT533Fc	LVR-IC	LDO, 2.7V±2%, 700mA, +CE	SOT-23-5	28xm	VR4	6g	Fmd
5FC	XC6127C25CMR	Vdet-IC	2.5V±0.8%, -Reset PPO, -MR, Rt=200ms	SOT-25	28yx	VD5	6g	Tor
5FC	XC6205B13AMR	LVR-IC	LDO, 1.35V±2%, 150mA, +CE	SOT-25	28cx	VR4	6g	Tor
5FC	XC6106F043MR	Vdet-IC	4.3V±2%, Hst, -MR, ±Reset PPO, Rt=400ms	SOT-25	28xf	VD21	6g	Tor
5Fd	FT533Fd	LVR-IC	LDO, 2.7V±2%, 700mA, +CE	SC-70-5	28xf	VR4	6g	Fmd
5FD	XC6127C25DMR	Vdet-IC	2.5V±0.8%, -Reset PPO, -MR, Rt=400ms	SOT-25	28yx	VD5	6g	Tor
5FD	XC6205B14AMR	LVR-IC	LDO, 1.45V±2%, 150mA, +CE	SOT-25	28cx	VR4	6g	Tor
5FD	XC6106F044MR	Vdet-IC	4.4V±2%, Hst, -MR, ±Reset PPO, Rt=400ms	SOT-25	28xf	VD21	6g	Tor
5Fe	FT533Fe	LVR-IC	LDO, 2.7V±2%, 700mA, +CE	SC-70-5	28vc	VR4	6g	Fmd
5FE	XC6127C25EMR	Vdet-IC	2.5V±0.8%, -Reset PPO, -MR, Rt=800ms	SOT-25	28yx	VD5	6g	Tor
5FE	XC6205B15AMR	LVR-IC	LDO, 1.55V±2%, 150mA, +CE	SOT-25	28cx	VR4	6g	Tor
5FE	XC6106F045MR	Vdet-IC	4.5V±2%, Hst, -MR, ±Reset PPO, Rt=400ms	SOT-25	28xf	VD21	6g	Tor
5Ff	FT533Ff	LVR-IC	LDO, 2.7V±2%, 700mA, +CE	SC-70-5	28xm	VR4	6g	Fmd
5FF	XC6127C25FMR	Vdet-IC	2.5V±0.8%, +Reset PPO, -MR, Rt=50ms	SOT-25	28yx	VD5	6g	Tor
5FF	XC6205B16AMR	LVR-IC	LDO, 1.65V±2%, 150mA, +CE	SOT-25	28cx	VR4	6g	Tor
5FF	XC6106F016MR	Vdet-IC	1.6V±2%, Hst, -MR, ±Reset PPO, Rt=400ms	SOT-25	28xf	VD21	6g	Tor
5FE	XC6106F046MR	Vdet-IC	4.6V±2%, Hst, -MR, ±Reset PPO, Rt=400ms	SOT-25	28xf	VD21	6g	Tor
5FH	XC6127C25GMR	Vdet-IC	2.5V±0.8%, +Reset PPO, -MR, Rt=100ms	SOT-25	28yx	VD5	6g	Tor
5FH	XC6205B17AMR	LVR-IC	LDO, 1.75V±2%, 150mA, +CE	SOT-25	28cx	VR4	6g	Tor
5FH	XC6106F017MR	Vdet-IC	1.7V±2%, Hst, -MR, ±Reset PPO, Rt=400ms	SOT-25	28xf	VD21	6g	Tor
5FH	XC6106F047MR	Vdet-IC	4.7V±2%, Hst, -MR, ±Reset PPO, Rt=400ms	SOT-25	28xf	VD21	6g	Tor
5FK	XC6127C25HMR	Vdet-IC	2.5V±0.8%, +Reset PPO, -MR, Rt=200ms	SOT-25	28yx	VD5	6g	Tor
5FK	XC6106F018MR	Vdet-IC	1.8V±2%, Hst, -MR, ±Reset PPO, Rt=400ms	SOT-25	28xf	VD21	6g	Tor
5FK	XC6106F048MR	Vdet-IC	4.8V±2%, Hst, -MR, ±Reset PPO, Rt=400ms	SOT-25	28xf	VD21	6g	Tor
5FL	XC6127C25JMR	Vdet-IC	2.5V±0.8%, +Reset PPO, -MR, Rt=400ms	SOT-25	28yx	VD5	6g	Tor
5FL	XC9236A0LDMR	DC-DC-IC	PWM/PFM, st-dwn, 0.85V±2%, 600mA, 3MHz, Vin>2V, LSST	SOT-25	28dc4	DC1	6g	Tor
5FL	XC6106F019MR	Vdet-IC	1.9V±2%, Hst, -MR, ±Reset PPO, Rt=400ms	SOT-25	28xf	VD21	6g	Tor
5FL	XC6106F049MR	Vdet-IC	4.9V±2%, Hst, -MR, ±Reset PPO, Rt=400ms	SOT-25	28xf	VD21	6g	Tor
5FM	XC6127C25KMR	Vdet-IC	2.5V±0.8%, +Reset PPO, -MR, Rt=800ms	SOT-25	28yx	VD5	6g	Tor
5FM	XC9236A0MDMR	DC-DC-IC	PWM/PFM, st-dwn, 0.95V±2%, 600mA, 3MHz, Vin>2V, LSST	SOT-25	28dc4	DC1	6g	Tor
5FM	XC6106F020MR	Vdet-IC	2.0V±2%, Hst, -MR, ±Reset PPO, Rt=400ms	SOT-25	28xf	VD21	6g	Tor
5FM	XC6106F050MR	Vdet-IC	5.0V±2%, Hst, -MR, ±Reset PPO, Rt=400ms	SOT-25	28xf	VD21	6g	Tor
5FN	XC6127C26AMR	Vdet-IC	2.6V±0.8%, -Reset PPO, -MR, Rt=50ms	SOT-25	28yx	VD5	6g	Tor
5FN	XC6106F021MR	Vdet-IC	2.1V±2%, Hst, -MR, ±Reset PPO, Rt=400ms	SOT-25	28xf	VD21	6g	Tor
5FP	XC6127C26BMR	Vdet-IC	2.6V±0.8%, -Reset PPO, -MR, Rt=100ms	SOT-25	28yx	VD5	6g	Tor
5FP	XC6106F022MR	Vdet-IC	2.2V±2%, Hst, -MR, ±Reset PPO, Rt=400ms	SOT-25	28xf	VD21	6g	Tor
5FR	XC6127C26CMR	Vdet-IC	2.6V±0.8%, -Reset PPO, -MR, Rt=200ms	SOT-25	28yx	VD5	6g	Tor
5FR	XC6106F023MR	Vdet-IC	2.3V±2%, Hst, -MR, ±Reset PPO, Rt=400ms	SOT-25	28xf	VD21	6g	Tor
5FS	XC6127C26DMR	Vdet-IC	2.6V±0.8%, -Reset PPO, -MR, Rt=400ms	SOT-25	28yx	VD5	6g	Tor
5FS	XC6106F024MR	Vdet-IC	2.4V±2%, Hst, -MR, ±Reset PPO, Rt=400ms	SOT-25	28xf	VD21	6g	Tor



SMD code	Type	Function	Short description	Case	Pinout	Sch.	St.	Mnf.
5FT	XC6127C26EMR	Vdet-IC	2.6V±0.8%, -Reset PPO, -MR, Rt=800ms	SOT-25	28yx	VD5	6g	Tor
5FT	XC6106F025MR	Vdet-IC	2.5V±2%, Hst, -MR, ±Reset PPO, Rt=400ms	SOT-25	28xf	VD21	6g	Tor
5FU	XC6127C26FMR	Vdet-IC	2.6V±0.8%, +Reset PPO, -MR, Rt=50ms	SOT-25	28yx	VD5	6g	Tor
5FU	XC6106F026MR	Vdet-IC	2.6V±2%, Hst, -MR, ±Reset PPO, Rt=400ms	SOT-25	28xf	VD21	6g	Tor
5FV	XC6127C26GMR	Vdet-IC	2.6V±0.8%, +Reset PPO, -MR, Rt=100ms	SOT-25	28yx	VD5	6g	Tor
5FV	XC6106F027MR	Vdet-IC	2.7V±2%, Hst, -MR, ±Reset PPO, Rt=400ms	SOT-25	28xf	VD21	6g	Tor
5FX	XC6127C26HMR	Vdet-IC	2.6V±0.8%, +Reset PPO, -MR, Rt=200ms	SOT-25	28yx	VD5	6g	Tor
5FX	XC6106F028MR	Vdet-IC	2.8V±2%, Hst, -MR, ±Reset PPO, Rt=400ms	SOT-25	28xf	VD21	6g	Tor
5FY	XC6127C26JMR	Vdet-IC	2.6V±0.8%, +Reset PPO, -MR, Rt=400ms	SOT-25	28yx	VD5	6g	Tor
5FY	XC6106F029MR	Vdet-IC	2.9V±2%, Hst, -MR, ±Reset PPO, Rt=400ms	SOT-25	28xf	VD21	6g	Tor
5FZ	XC6127C26KMR	Vdet-IC	2.6V±0.8%, +Reset PPO, -MR, Rt=800ms	SOT-25	28yx	VD5	6g	Tor
5FZ	XC6106F030MR	Vdet-IC	3.0V±2%, Hst, -MR, ±Reset PPO, Rt=400ms	SOT-25	28xf	VD21	6g	Tor
5G	MIC5365-1.8YMT	LVR-IC	LDO, 1.8V±2%, 150mA, +CE	SC-70-5	28gf	VR4	6g	Mcr
5Ga	FT533Ga	LVR-IC	LDO, 2.8V±2%, 700mA, +CE	SOT-23-5	28cx	VR4	6g	Fmd
5Gb	FT533Gb	LVR-IC	LDO, 2.8V±2%, 700mA, +CE	SOT-23-5	28wc	VR4	6g	Fmd
5Gc	FT533Gc	LVR-IC	LDO, 2.8V±2%, 700mA, +CE	SOT-23-5	28xm	VR4	6g	Fmd
5Gd	FT533Gd	LVR-IC	LDO, 2.8V±2%, 700mA, +CE	SC-70-5	28cx	VR4	6g	Fmd
5Ge	FT533Ge	LVR-IC	LDO, 2.8V±2%, 700mA, +CE	SC-70-5	28vc	VR4	6g	Fmd
5Gf	FT533Gf	LVR-IC	LDO, 2.8V±2%, 700mA, +CE	SC-70-5	28xm	VR4	6g	Fmd
5H	MIC5365-2.0YMT	LVR-IC	LDO, 2.0V±2%, 150mA, +CE	SC-70-5	28gf	VR4	6g	Mcr
5H0	XC9236A10DMR	DC-DC-IC	PWM/PFM, st-dwn, 1.0V±2%, 600mA, 3MHz, Vin>2V, LSST	SOT-25	28dc4	DC1	6g	Tor
5H0	XC6106H031MR	Vdet-IC	3.1V±2%, Hst, -MR, ±Reset PPO, Rt=1.6s	SOT-25	28xf	VD21	6g	Tor
5H1	XC9236A11DMR	DC-DC-IC	PWM/PFM, st-dwn, 1.1V±2%, 600mA, 3MHz, Vin>2V, LSST	SOT-25	28dc4	DC1	6g	Tor
5H1	XC6106H032MR	Vdet-IC	3.2V±2%, Hst, -MR, ±Reset PPO, Rt=1.6s	SOT-25	28xf	VD21	6g	Tor
5H2	XC9236A12DMR	DC-DC-IC	PWM/PFM, st-dwn, 1.2V±2%, 600mA, 3MHz, Vin>2V, LSST	SOT-25	28dc4	DC1	6g	Tor
5H2	XC6106H033MR	Vdet-IC	3.3V±2%, Hst, -MR, ±Reset PPO, Rt=1.6s	SOT-25	28xf	VD21	6g	Tor
5H3	XC9236A13DMR	DC-DC-IC	PWM/PFM, st-dwn, 1.3V±2%, 600mA, 3MHz, Vin>2V, LSST	SOT-25	28dc4	DC1	6g	Tor
5H3	XC6106H034MR	Vdet-IC	3.4V±2%, Hst, -MR, ±Reset PPO, Rt=1.6s	SOT-25	28xf	VD21	6g	Tor
5H4	XC9236A14DMR	DC-DC-IC	PWM/PFM, st-dwn, 1.4V±2%, 600mA, 3MHz, Vin>2V, LSST	SOT-25	28dc4	DC1	6g	Tor
5H4	XC6106H035MR	Vdet-IC	3.5V±2%, Hst, -MR, ±Reset PPO, Rt=1.6s	SOT-25	28xf	VD21	6g	Tor
5H5	XC9236A15DMR	DC-DC-IC	PWM/PFM, st-dwn, 1.5V±2%, 600mA, 3MHz, Vin>2V, LSST	SOT-25	28dc4	DC1	6g	Tor
5H5	XC6106H036MR	Vdet-IC	3.6V±2%, Hst, -MR, ±Reset PPO, Rt=1.6s	SOT-25	28xf	VD21	6g	Tor
5H6	XC9236A16DMR	DC-DC-IC	PWM/PFM, st-dwn, 1.6V±2%, 600mA, 3MHz, Vin>2V, LSST	SOT-25	28dc4	DC1	6g	Tor
5H6	XC6106H037MR	Vdet-IC	3.7V±2%, Hst, -MR, ±Reset PPO, Rt=1.6s	SOT-25	28xf	VD21	6g	Tor
5H7	XC9236A17DMR	DC-DC-IC	PWM/PFM, st-dwn, 1.7V±2%, 600mA, 3MHz, Vin>2V, LSST	SOT-25	28dc4	DC1	6g	Tor
5H7	XC6106H038MR	Vdet-IC	3.8V±2%, Hst, -MR, ±Reset PPO, Rt=1.6s	SOT-25	28xf	VD21	6g	Tor
5H8	XC6205C09AMR	LVR-IC	LDO, 0.95V±2%, 150mA, -CE, PDR	SOT-25	28cx	VR4	6g	Tor
5H8	XC9236A18DMR	DC-DC-IC	PWM/PFM, st-dwn, 1.8V±2%, 600mA, 3MHz, Vin>2V, LSST	SOT-25	28dc4	DC1	6g	Tor
5H8	XC6106H039MR	Vdet-IC	3.9V±2%, Hst, -MR, ±Reset PPO, Rt=1.6s	SOT-25	28xf	VD21	6g	Tor
5H9	XC6205C10AMR	LVR-IC	LDO, 1.05V±2%, 150mA, -CE, PDR	SOT-25	28cx	VR4	6g	Tor
5H9	XC9236A19DMR	DC-DC-IC	PWM/PFM, st-dwn, 1.9V±2%, 600mA, 3MHz, Vin>2V, LSST	SOT-25	28dc4	DC1	6g	Tor
5H9	XC6106H040MR	Vdet-IC	4.0V±2%, Hst, -MR, ±Reset PPO, Rt=1.6s	SOT-25	28xf	VD21	6g	Tor
5Ha	FT533Ha	LVR-IC	LDO, 2.85V±2%, 700mA, +CE	SOT-23-5	28cx	VR4	6g	Fmd
5HA	XC6127C27AMR	Vdet-IC	2.7V±0.8%, -Reset PPO, -MR, Rt=50ms	SOT-25	28yx	VD5	6g	Tor
5HA	XC6205C11AMR	LVR-IC	LDO, 1.15V±2%, 150mA, -CE, PDR	SOT-25	28cx	VR4	6g	Tor
5HA	XC9236A1ADMR	DC-DC-IC	PWM/PFM, st-dwn, 1.05V±2%, 600mA, 3MHz, Vin>2V, LSST	SOT-25	28dc4	DC1	6g	Tor
5HA	XC6106H041MR	Vdet-IC	4.1V±2%, Hst, -MR, ±Reset PPO, Rt=1.6s	SOT-25	28xf	VD21	6g	Tor
5Hb	FT533Hb	LVR-IC	LDO, 2.85V±2%, 700mA, +CE	SOT-23-5	28vc	VR4	6g	Fmd
5HB	XC6127C27BMR	Vdet-IC	2.7V±0.8%, -Reset PPO, -MR, Rt=100ms	SOT-25	28yx	VD5	6g	Tor
5HB	XC6205C12AMR	LVR-IC	LDO, 1.25V±2%, 150mA, -CE, PDR	SOT-25	28cx	VR4	6g	Tor
5HB	XC9236A1BDMR	DC-DC-IC	PWM/PFM, st-dwn, 1.15V±2%, 600mA, 3MHz, Vin>2V, LSST	SOT-25	28dc4	DC1	6g	Tor
5HB	XC6106H042MR	Vdet-IC	4.2V±2%, Hst, -MR, ±Reset PPO, Rt=1.6s	SOT-25	28xf	VD21	6g	Tor
5Hc	FT533Hc	LVR-IC	LDO, 2.85V±2%, 700mA, +CE	SOT-23-5	28xm	VR4	6g	Fmd
5HC	XC6127C27CMR	Vdet-IC	2.7V±0.8%, -Reset PPO, -MR, Rt=200ms	SOT-25	28yx	VD5	6g	Tor
5HC	XC6205C13AMR	LVR-IC	LDO, 1.35V±2%, 150mA, -CE, PDR	SOT-25	28cx	VR4	6g	Tor
5HC	XC9236A1CDMR	DC-DC-IC	PWM/PFM, st-dwn, 1.25V±2%, 600mA, 3MHz, Vin>2V, LSST	SOT-25	28dc4	DC1	6g	Tor
5HC	XC6106H043MR	Vdet-IC	4.3V±2%, Hst, -MR, ±Reset PPO, Rt=1.6s	SOT-25	28xf	VD21	6g	Tor
5Hd	FT533Hd	LVR-IC	LDO, 2.85V±2%, 700mA, +CE	SC-70-5	28cx	VR4	6g	Fmd
5HD	XC6127C27DMR	Vdet-IC	2.7V±0.8%, -Reset PPO, -MR, Rt=400ms	SOT-25	28yx	VD5	6g	Tor
5HD	XC6205C14AMR	LVR-IC	LDO, 1.45V±2%, 150mA, -CE, PDR	SOT-25	28cx	VR4	6g	Tor
5HD	XC9236A1DDMR	DC-DC-IC	PWM/PFM, st-dwn, 1.35V±2%, 600mA, 3MHz, Vin>2V, LSST	SOT-25	28dc4	DC1	6g	Tor
5HD	XC6106H044MR	Vdet-IC	4.4V±2%, Hst, -MR, ±Reset PPO, Rt=1.6s	SOT-25	28xf	VD21	6g	Tor
5He	FT533He	LVR-IC	LDO, 2.85V±2%, 700mA, +CE	SC-70-5	28vc	VR4	6g	Fmd
5HE	XC6127C27EMR	Vdet-IC	2.7V±0.8%, -Reset PPO, -MR, Rt=800ms	SOT-25	28yx	VD5	6g	Tor
5HE	XC6205C15AMR	LVR-IC	LDO, 1.55V±2%, 150mA, -CE, PDR	SOT-25	28cx	VR4	6g	Tor
5HE	XC9236A1EDMR	DC-DC-IC	PWM/PFM, st-dwn, 1.45V±2%, 600mA, 3MHz, Vin>2V, LSST	SOT-25	28dc4	DC1	6g	Tor
5HE	XC6106H045MR	Vdet-IC	4.5V±2%, Hst, -MR, ±Reset PPO, Rt=1.6s	SOT-25	28xf	VD21	6g	Tor
5Hf	FT533Hf	LVR-IC	LDO, 2.85V±2%, 700mA, +CE	SC-70-5	28xm	VR4	6g	Fmd
5HF	XC6127C27FMR	Vdet-IC	2.7V±0.8%, +Reset PPO, -MR, Rt=50ms	SOT-25	28yx	VD5	6g	Tor
5HF	XC6205C16AMR	LVR-IC	LDO, 1.65V±2%, 150mA, -CE, PDR	SOT-25	28cx	VR4	6g	Tor



SMD code	Type	Function	Short description	Case	Pinout	Sch.	St.	Mnf.
5HF	XC9236A1FDMR	DC-DC-IC	PWM/PFM, st-dwn, 1.55V±2%, 600mA, 3MHz, Vin>2V, LSST	SOT-25	28dc4	DC1	6g	Tor
5HF	XC6106H016MR	Vdet-IC	1.6V±2%, Hst, -MR, ±Reset PPO, Rt=1.6s	SOT-25	28xf	VD21	6g	Tor
5HE	XC6106H046MR	Vdet-IC	4.6V±2%, Hst, -MR, ±Reset PPO, Rt=1.6s	SOT-25	28xf	VD21	6g	Tor
5HH	XC6127C27GMR	Vdet-IC	2.7V±0.8%, +Reset PPO, -MR, Rt=100ms	SOT-25	28yx	VD5	6g	Tor
5HH	XC6205C17AMR	LVR-IC	LDO, 1.75V±2%, 150mA, -CE, PDR	SOT-25	28cx	VR4	6g	Tor
5HH	XC9236A1HDMR	DC-DC-IC	PWM/PFM, st-dwn, 1.65V±2%, 600mA, 3MHz, Vin>2V, LSST	SOT-25	28dc4	DC1	6g	Tor
5HH	XC6106H017MR	Vdet-IC	1.7V±2%, Hst, -MR, ±Reset PPO, Rt=1.6s	SOT-25	28xf	VD21	6g	Tor
5HH	XC6106H047MR	Vdet-IC	4.7V±2%, Hst, -MR, ±Reset PPO, Rt=1.6s	SOT-25	28xf	VD21	6g	Tor
5HK	XC6127C27HMR	Vdet-IC	2.7V±0.8%, +Reset PPO, -MR, Rt=200ms	SOT-25	28yx	VD5	6g	Tor
5HK	XC9236A1KDMR	DC-DC-IC	PWM/PFM, st-dwn, 1.75V±2%, 600mA, 3MHz, Vin>2V, LSST	SOT-25	28dc4	DC1	6g	Tor
5HK	XC6106H018MR	Vdet-IC	1.8V±2%, Hst, -MR, ±Reset PPO, Rt=1.6s	SOT-25	28xf	VD21	6g	Tor
5HK	XC6106H048MR	Vdet-IC	4.8V±2%, Hst, -MR, ±Reset PPO, Rt=1.6s	SOT-25	28xf	VD21	6g	Tor
5HL	XC6127C27JMR	Vdet-IC	2.7V±0.8%, +Reset PPO, -MR, Rt=400ms	SOT-25	28yx	VD5	6g	Tor
5HL	XC9236A1LDMR	DC-DC-IC	PWM/PFM, st-dwn, 1.85V±2%, 600mA, 3MHz, Vin>2V, LSST	SOT-25	28dc4	DC1	6g	Tor
5HL	XC6106H019MR	Vdet-IC	1.9V±2%, Hst, -MR, ±Reset PPO, Rt=1.6s	SOT-25	28xf	VD21	6g	Tor
5HL	XC6106H049MR	Vdet-IC	4.9V±2%, Hst, -MR, ±Reset PPO, Rt=1.6s	SOT-25	28xf	VD21	6g	Tor
5HM	XC6127C27KMR	Vdet-IC	2.7V±0.8%, +Reset PPO, -MR, Rt=800ms	SOT-25	28yx	VD5	6g	Tor
5HM	XC9236A1MDMR	DC-DC-IC	PWM/PFM, st-dwn, 1.95V±2%, 600mA, 3MHz, Vin>2V, LSST	SOT-25	28dc4	DC1	6g	Tor
5HM	XC6106H020MR	Vdet-IC	2.0V±2%, Hst, -MR, ±Reset PPO, Rt=1.6s	SOT-25	28xf	VD21	6g	Tor
5HM	XC6106H050MR	Vdet-IC	5.0V±2%, Hst, -MR, ±Reset PPO, Rt=1.6s	SOT-25	28xf	VD21	6g	Tor
5HN	XC6127C28AMR	Vdet-IC	2.8V±0.8%, -Reset PPO, -MR, Rt=50ms	SOT-25	28yx	VD5	6g	Tor
5HN	XC6106H021MR	Vdet-IC	2.1V±2%, Hst, -MR, ±Reset PPO, Rt=1.6s	SOT-25	28xf	VD21	6g	Tor
5HP	XC6127C28BMR	Vdet-IC	2.8V±0.8%, -Reset PPO, -MR, Rt=100ms	SOT-25	28yx	VD5	6g	Tor
5HP	XC6106H022MR	Vdet-IC	2.2V±2%, Hst, -MR, ±Reset PPO, Rt=1.6s	SOT-25	28xf	VD21	6g	Tor
5HR	XC6127C28CMR	Vdet-IC	2.8V±0.8%, -Reset PPO, -MR, Rt=200ms	SOT-25	28yx	VD5	6g	Tor
5HR	XC6106H023MR	Vdet-IC	2.3V±2%, Hst, -MR, ±Reset PPO, Rt=1.6s	SOT-25	28xf	VD21	6g	Tor
5HS	XC6127C28DMR	Vdet-IC	2.8V±0.8%, -Reset PPO, -MR, Rt=400ms	SOT-25	28yx	VD5	6g	Tor
5HS	XC6106H024MR	Vdet-IC	2.4V±2%, Hst, -MR, ±Reset PPO, Rt=1.6s	SOT-25	28xf	VD21	6g	Tor
5HT	XC6127C28EMR	Vdet-IC	2.8V±0.8%, -Reset PPO, -MR, Rt=800ms	SOT-25	28yx	VD5	6g	Tor
5HT	XC6106H025MR	Vdet-IC	2.5V±2%, Hst, -MR, ±Reset PPO, Rt=1.6s	SOT-25	28xf	VD21	6g	Tor
5HU	XC6127C28FMR	Vdet-IC	2.8V±0.8%, +Reset PPO, -MR, Rt=50ms	SOT-25	28yx	VD5	6g	Tor
5HU	XC6106H026MR	Vdet-IC	2.6V±2%, Hst, -MR, ±Reset PPO, Rt=1.6s	SOT-25	28xf	VD21	6g	Tor
5HV	XC6127C28GMR	Vdet-IC	2.8V±0.8%, +Reset PPO, -MR, Rt=100ms	SOT-25	28yx	VD5	6g	Tor
5HV	XC6106H027MR	Vdet-IC	2.7V±2%, Hst, -MR, ±Reset PPO, Rt=1.6s	SOT-25	28xf	VD21	6g	Tor
5HX	XC6127C28HMR	Vdet-IC	2.8V±0.8%, +Reset PPO, -MR, Rt=200ms	SOT-25	28yx	VD5	6g	Tor
5HX	XC6106H028MR	Vdet-IC	2.8V±2%, Hst, -MR, ±Reset PPO, Rt=1.6s	SOT-25	28xf	VD21	6g	Tor
5HY	XC6127C28JMR	Vdet-IC	2.8V±0.8%, +Reset PPO, -MR, Rt=400ms	SOT-25	28yx	VD5	6g	Tor
5HY	XC6106H029MR	Vdet-IC	2.9V±2%, Hst, -MR, ±Reset PPO, Rt=1.6s	SOT-25	28xf	VD21	6g	Tor
5HZ	XC6127C28KMR	Vdet-IC	2.8V±0.8%, +Reset PPO, -MR, Rt=800ms	SOT-25	28yx	VD5	6g	Tor
5HZ	XC6106H030MR	Vdet-IC	3.0V±2%, Hst, -MR, ±Reset PPO, Rt=1.6s	SOT-25	28xf	VD21	6g	Tor
5ia	FT5331a	LVR-IC	LDO, 3.0V±2%, 700mA, +CE	SOT-23-5	28cx	VR4	6g	Fmd
5ib	FT5331b	LVR-IC	LDO, 3.0V±2%, 700mA, +CE	SOT-23-5	28vc	VR4	6g	Fmd
5ic	FT5331c	LVR-IC	LDO, 3.0V±2%, 700mA, +CE	SOT-23-5	28xm	VR4	6g	Fmd
5id	FT5331d	LVR-IC	LDO, 3.0V±2%, 700mA, +CE	SC-70-5	28cx	VR4	6g	Fmd
5ie	FT5331e	LVR-IC	LDO, 3.0V±2%, 700mA, +CE	SC-70-5	28vc	VR4	6g	Fmd
5if	FT5331f	LVR-IC	LDO, 3.0V±2%, 700mA, +CE	SC-70-5	28xm	VR4	6g	Fmd
5J	MIC5365-2.5YMT	LVR-IC	LDO, 2.5V±2%, 150mA, +CE	SC-70-5	28gf	VR4	6g	Mcr
5J	R3111N151C	Vdet-IC	1.5V±2%, -Reset ODO	SOT-23-5	28vdm	VD6	6g	Ric
5Ja	FT5331Ja	LVR-IC	LDO, 3.3V±2%, 700mA, +CE	SOT-23-5	28cx	VR4	6g	Fmd
5Jb	FT5331Jb	LVR-IC	LDO, 3.3V±2%, 700mA, +CE	SOT-23-5	28vc	VR4	6g	Fmd
5Jc	FT5331Jc	LVR-IC	LDO, 3.3V±2%, 700mA, +CE	SOT-23-5	28xm	VR4	6g	Fmd
5Jd	FT5331Jd	LVR-IC	LDO, 3.3V±2%, 700mA, +CE	SC-70-5	28cx	VR4	6g	Fmd
5Je	FT5331Je	LVR-IC	LDO, 3.3V±2%, 700mA, +CE	SC-70-5	28vc	VR4	6g	Fmd
5Jf	FT5331Jf	LVR-IC	LDO, 3.3V±2%, 700mA, +CE	SC-70-5	28xm	VR4	6g	Fmd
5K	MIC5365-2.6YMT	LVR-IC	LDO, 2.6V±2%, 150mA, +CE	SC-70-5	28gf	VR4	6g	Mcr
5K	R3111N251C	Vdet-IC	2.5V±2%, -Reset ODO	SOT-23-5	28vdm	VD6	6g	Ric
5K0	XC9236A20DMR	DC-DC-IC	PWM/PFM, st-dwn, 2.0V±2%, 600mA, 3MHz, Vin>2V, LSST	SOT-25	28dc4	DC1	6g	Tor
5K1	XC9236A21DMR	DC-DC-IC	PWM/PFM, st-dwn, 2.1V±2%, 600mA, 3MHz, Vin>2V, LSST	SOT-25	28dc4	DC1	6g	Tor
5K2	XC9236A22DMR	DC-DC-IC	PWM/PFM, st-dwn, 2.2V±2%, 600mA, 3MHz, Vin>2V, LSST	SOT-25	28dc4	DC1	6g	Tor
5K3	XC9236A23DMR	DC-DC-IC	PWM/PFM, st-dwn, 2.3V±2%, 600mA, 3MHz, Vin>2V, LSST	SOT-25	28dc4	DC1	6g	Tor
5K4	XC9236A24DMR	DC-DC-IC	PWM/PFM, st-dwn, 2.4V±2%, 600mA, 3MHz, Vin>2V, LSST	SOT-25	28dc4	DC1	6g	Tor
5K5	XC9236A25DMR	DC-DC-IC	PWM/PFM, st-dwn, 2.5V±2%, 600mA, 3MHz, Vin>2V, LSST	SOT-25	28dc4	DC1	6g	Tor
5K6	XC9236A26DMR	DC-DC-IC	PWM/PFM, st-dwn, 2.6V±2%, 600mA, 3MHz, Vin>2V, LSST	SOT-25	28dc4	DC1	6g	Tor
5K7	XC9236A27DMR	DC-DC-IC	PWM/PFM, st-dwn, 2.7V±2%, 600mA, 3MHz, Vin>2V, LSST	SOT-25	28dc4	DC1	6g	Tor
5K8	XC6205D09AMR	LVR-IC	LDO, 0.95V±2%, 150mA, -CE	SOT-25	28cx	VR4	6g	Tor
5K8	XC9236A28DMR	DC-DC-IC	PWM/PFM, st-dwn, 2.8V±2%, 600mA, 3MHz, Vin>2V, LSST	SOT-25	28dc4	DC1	6g	Tor
5K9	XC6205D10AMR	LVR-IC	LDO, 1.05V±2%, 150mA, -CE	SOT-25	28cx	VR4	6g	Tor
5K9	XC9236A29DMR	DC-DC-IC	PWM/PFM, st-dwn, 2.9V±2%, 600mA, 3MHz, Vin>2V, LSST	SOT-25	28dc4	DC1	6g	Tor
5Ka	FT5331Ka	LVR-IC	LDO, 3.6V±2%, 700mA, +CE	SOT-23-5	28cx	VR4	6g	Fmd
5KA	XC6127C29AMR	Vdet-IC	2.9V±0.8%, -Reset PPO, -MR, Rt=50ms	SOT-25	28yx	VD5	6g	Tor



SMD code	Type	Function	Short description	Case	Pinout	Sch.	St.	Mnf.
5KA	XC6205D11AMR	LVR-IC	LDO, 1.15V±2%, 150mA, -CE	SOT-25	28cx	VR4	6g	Tor
5KA	XC9236A2ADMR	DC-DC-IC	PWM/PPM, st-dwn, 2.05V±2%, 600mA, 3MHz, Vin>2V, LSST	SOT-25	28dc4	DC1	6g	Tor
5Kb	FT533Kb	LVR-IC	LDO, 3.6V±2%, 700mA, +CE	SOT-23-5	28vc	VR4	6g	Fmd
5KB	XC6127C29BMR	Vdet-IC	2.9V±0.8%, -Reset PPO, -MR, Rt=100ms	SOT-25	28yx	VD5	6g	Tor
5KB	XC6205D12AMR	LVR-IC	LDO, 1.25V±2%, 150mA, -CE	SOT-25	28cx	VR4	6g	Tor
5KB	XC9236A2BDMR	DC-DC-IC	PWM/PPM, st-dwn, 2.15V±2%, 600mA, 3MHz, Vin>2V, LSST	SOT-25	28dc4	DC1	6g	Tor
5Kc	FT533Kc	LVR-IC	LDO, 3.6V±2%, 700mA, +CE	SOT-23-5	28mx	VR4	6g	Fmd
5KC	XC6127C29CMR	Vdet-IC	2.9V±0.8%, -Reset PPO, -MR, Rt=200ms	SOT-25	28yx	VD5	6g	Tor
5KC	XC6205D13AMR	LVR-IC	LDO, 1.35V±2%, 150mA, -CE	SOT-25	28cx	VR4	6g	Tor
5KC	XC9236A2CDMR	DC-DC-IC	PWM/PPM, st-dwn, 2.25V±2%, 600mA, 3MHz, Vin>2V, LSST	SOT-25	28dc4	DC1	6g	Tor
5Kd	FT533Kd	LVR-IC	LDO, 3.6V±2%, 700mA, +CE	SC-70-5	28cx	VR4	6g	Fmd
5KD	XC6127C29DMR	Vdet-IC	2.9V±0.8%, -Reset PPO, -MR, Rt=400ms	SOT-25	28yx	VD5	6g	Tor
5KD	XC6205D14AMR	LVR-IC	LDO, 1.45V±2%, 150mA, -CE	SOT-25	28cx	VR4	6g	Tor
5KD	XC9236A2DDMR	DC-DC-IC	PWM/PPM, st-dwn, 2.35V±2%, 600mA, 3MHz, Vin>2V, LSST	SOT-25	28dc4	DC1	6g	Tor
5Ke	FT533Ke	LVR-IC	LDO, 3.6V±2%, 700mA, +CE	SC-70-5	28vc	VR4	6g	Fmd
5KE	XC6127C29EMR	Vdet-IC	2.9V±0.8%, -Reset PPO, -MR, Rt=800ms	SOT-25	28yx	VD5	6g	Tor
5KE	XC6205D15AMR	LVR-IC	LDO, 1.55V±2%, 150mA, -CE	SOT-25	28cx	VR4	6g	Tor
5KE	XC9236A2EDMR	DC-DC-IC	PWM/PPM, st-dwn, 2.45V±2%, 600mA, 3MHz, Vin>2V, LSST	SOT-25	28dc4	DC1	6g	Tor
5Kf	FT533Kf	LVR-IC	LDO, 3.6V±2%, 700mA, +CE	SC-70-5	28mx	VR4	6g	Fmd
5KF	XC6127C29FMR	Vdet-IC	2.9V±0.8%, +Reset PPO, -MR, Rt=50ms	SOT-25	28yx	VD5	6g	Tor
5KF	XC6205D16AMR	LVR-IC	LDO, 1.65V±2%, 150mA, -CE	SOT-25	28cx	VR4	6g	Tor
5KF	XC9236A2FDMR	DC-DC-IC	PWM/PPM, st-dwn, 2.55V±2%, 600mA, 3MHz, Vin>2V, LSST	SOT-25	28dc4	DC1	6g	Tor
5KH	XC6127C29GMR	Vdet-IC	2.9V±0.8%, +Reset PPO, -MR, Rt=100ms	SOT-25	28yx	VD5	6g	Tor
5KH	XC6205D17AMR	LVR-IC	LDO, 1.75V±2%, 150mA, -CE	SOT-25	28cx	VR4	6g	Tor
5KH	XC9236A2HDMR	DC-DC-IC	PWM/PPM, st-dwn, 2.65V±2%, 600mA, 3MHz, Vin>2V, LSST	SOT-25	28dc4	DC1	6g	Tor
5KK	XC6127C29HMR	Vdet-IC	2.9V±0.8%, +Reset PPO, -MR, Rt=200ms	SOT-25	28yx	VD5	6g	Tor
5KK	XC9236A2IDMR	DC-DC-IC	PWM/PPM, st-dwn, 2.75V±2%, 600mA, 3MHz, Vin>2V, LSST	SOT-25	28dc4	DC1	6g	Tor
5KL	XC6127C29JMR	Vdet-IC	2.9V±0.8%, +Reset PPO, -MR, Rt=400ms	SOT-25	28yx	VD5	6g	Tor
5KL	XC9236A2LDMR	DC-DC-IC	PWM/PPM, st-dwn, 2.85V±2%, 600mA, 3MHz, Vin>2V, LSST	SOT-25	28dc4	DC1	6g	Tor
5KM	XC6127C29KMR	Vdet-IC	2.9V±0.8%, +Reset PPO, -MR, Rt=800ms	SOT-25	28yx	VD5	6g	Tor
5KM	XC9236A2MDMR	DC-DC-IC	PWM/PPM, st-dwn, 2.95V±2%, 600mA, 3MHz, Vin>2V, LSST	SOT-25	28dc4	DC1	6g	Tor
5KN	XC6127C30AMR	Vdet-IC	3.0V±0.8%, -Reset PPO, -MR, Rt=50ms	SOT-25	28yx	VD5	6g	Tor
5KP	XC6127C30BMR	Vdet-IC	3.0V±0.8%, -Reset PPO, -MR, Rt=100ms	SOT-25	28yx	VD5	6g	Tor
5KR	XC6127C30CMR	Vdet-IC	3.0V±0.8%, -Reset PPO, -MR, Rt=200ms	SOT-25	28yx	VD5	6g	Tor
5KS	XC6127C30DMR	Vdet-IC	3.0V±0.8%, -Reset PPO, -MR, Rt=400ms	SOT-25	28yx	VD5	6g	Tor
5KT	XC6127C30EMR	Vdet-IC	3.0V±0.8%, -Reset PPO, -MR, Rt=800ms	SOT-25	28yx	VD5	6g	Tor
5KU	XC6127C30FMR	Vdet-IC	3.0V±0.8%, +Reset PPO, -MR, Rt=50ms	SOT-25	28yx	VD5	6g	Tor
5KV	XC6127C30GMR	Vdet-IC	3.0V±0.8%, +Reset PPO, -MR, Rt=100ms	SOT-25	28yx	VD5	6g	Tor
5KX	XC6127C30HMR	Vdet-IC	3.0V±0.8%, +Reset PPO, -MR, Rt=200ms	SOT-25	28yx	VD5	6g	Tor
5KY	XC6127C30JMR	Vdet-IC	3.0V±0.8%, +Reset PPO, -MR, Rt=400ms	SOT-25	28yx	VD5	6g	Tor
5KZ	XC6127C30KMR	Vdet-IC	3.0V±0.8%, +Reset PPO, -MR, Rt=800ms	SOT-25	28yx	VD5	6g	Tor
5L	MIC5365-2.7YMT	LVR-IC	LDO, 2.7V±2%, 150mA, +CE	SC-70-5	28gf	VR4	6g	Mcr
5L	R3111N351C	Vdet-IC	3.5V±2%, -Reset ODO	SOT-23-5	28vdm	VD6	6g	Ric
5L0	XC9236A30DMR	DC-DC-IC	PWM/PPM, st-dwn, 3.0V±2%, 600mA, 3MHz, Vin>2V, LSST	SOT-25	28dc4	DC1	6g	Tor
5L1	S-75L00ANC	CMOS-Logic	2-input NAND gate	SC-88A	28fLog1	-	6a	Sii
5L1	XC9236A31DMR	DC-DC-IC	PWM/PPM, st-dwn, 3.1V±2%, 600mA, 3MHz, Vin>2V, LSST	SOT-25	28dc4	DC1	6g	Tor
5L2	S-75L08ANC	CMOS-Logic	2-input AND gate	SC-88A	28fLog3	-	6a	Sii
5L2	XC9236A32DMR	DC-DC-IC	PWM/PPM, st-dwn, 3.2V±2%, 600mA, 3MHz, Vin>2V, LSST	SOT-25	28dc4	DC1	6g	Tor
5L3	S-75L02ANC	CMOS-Logic	2-input NOR gate	SC-88A	28fLog2	-	6a	Sii
5L3	XC9236A33DMR	DC-DC-IC	PWM/PPM, st-dwn, 3.3V±2%, 600mA, 3MHz, Vin>2V, LSST	SOT-25	28dc4	DC1	6g	Tor
5L4	S-75L32ANC	CMOS-Logic	2-input OR gate	SC-88A	28fLog4	-	6a	Sii
5L4	XC9236A34DMR	DC-DC-IC	PWM/PPM, st-dwn, 3.4V±2%, 600mA, 3MHz, Vin>2V, LSST	SOT-25	28dc4	DC1	6g	Tor
5L5	S-75L04ANC	CMOS-Logic	Inverter	SC-88A	28fLog6	-	6a	Sii
5L5	XC9236A35DMR	DC-DC-IC	PWM/PPM, st-dwn, 3.5V±2%, 600mA, 3MHz, Vin>2V, LSST	SOT-25	28dc4	DC1	6g	Tor
5L6	S-75LU04ANC	CMOS-Logic	Inverter	SC-88A	28fLog6	-	6a	Sii
5L6	XC9236A36DMR	DC-DC-IC	PWM/PPM, st-dwn, 3.6V±2%, 600mA, 3MHz, Vin>2V, LSST	SOT-25	28dc4	DC1	6g	Tor
5L7	XC9236A37DMR	DC-DC-IC	PWM/PPM, st-dwn, 3.7V±2%, 600mA, 3MHz, Vin>2V, LSST	SOT-25	28dc4	DC1	6g	Tor
5L8	S-75L86ANC	CMOS-Logic	2-input EXCLUSIVE-OR gate	SC-88A	28fLog5	-	6a	Sii
5L8	XC9236A38DMR	DC-DC-IC	PWM/PPM, st-dwn, 3.8V±2%, 600mA, 3MHz, Vin>2V, LSST	SOT-25	28dc4	DC1	6g	Tor
5L9	XC9236A39DMR	DC-DC-IC	PWM/PPM, st-dwn, 3.9V±2%, 600mA, 3MHz, Vin>2V, LSST	SOT-25	28dc4	DC1	6g	Tor
5LA	S-75L14ANC	CMOS-Logic	Inverting Schmitt-trigger	SC-88A	28fLog7	-	6a	Sii
5LA	XC6127C31AMR	Vdet-IC	3.1V±0.8%, -Reset PPO, -MR, Rt=50ms	SOT-25	28yx	VD5	6g	Tor
5LA	XC9236A3ADMR	DC-DC-IC	PWM/PPM, st-dwn, 3.05V±2%, 600mA, 3MHz, Vin>2V, LSST	SOT-25	28dc4	DC1	6g	Tor
5LB	XC6127C31BMR	Vdet-IC	3.1V±0.8%, -Reset PPO, -MR, Rt=100ms	SOT-25	28yx	VD5	6g	Tor
5LB	XC9236A3BDMR	DC-DC-IC	PWM/PPM, st-dwn, 3.15V±2%, 600mA, 3MHz, Vin>2V, LSST	SOT-25	28dc4	DC1	6g	Tor
5LC	XC6127C31CMR	Vdet-IC	3.1V±0.8%, -Reset PPO, -MR, Rt=200ms	SOT-25	28yx	VD5	6g	Tor
5LC	XC9236A3CDMR	DC-DC-IC	PWM/PPM, st-dwn, 3.25V±2%, 600mA, 3MHz, Vin>2V, LSST	SOT-25	28dc4	DC1	6g	Tor
5LD	XC6127C31DMR	Vdet-IC	3.1V±0.8%, -Reset PPO, -MR, Rt=400ms	SOT-25	28yx	VD5	6g	Tor
5LD	XC9236A3DDMR	DC-DC-IC	PWM/PPM, st-dwn, 3.35V±2%, 600mA, 3MHz, Vin>2V, LSST	SOT-25	28dc4	DC1	6g	Tor
5LE	XC6127C31EMR	Vdet-IC	3.1V±0.8%, -Reset PPO, -MR, Rt=800ms	SOT-25	28yx	VD5	6g	Tor



SMD code	Type	Function	Short description	Case	Pinout	Sch.	St.	Mnf.
5LE	XC9236A3EDMR	DC-DC-IC	PWM/PFM, st-dwn, 3.45V±2%, 600mA, 3MHz, Vin>2V, LSST	SOT-25	28dc4	DC1	6g	Tor
5LF	XO6127C31FMR	Vdet-IC	3.1V±0.8%, +Reset PPO, -MR, Rt=50ms	SOT-25	28yx	VD5	6g	Tor
5LF	XC9236A3FDMR	DC-DC-IC	PWM/PFM, st-dwn, 3.55V±2%, 600mA, 3MHz, Vin>2V, LSST	SOT-25	28dc4	DC1	6g	Tor
5LH	XO6127C31GMR	Vdet-IC	3.1V±0.8%, +Reset PPO, -MR, Rt=100ms	SOT-25	28yx	VD5	6g	Tor
5LH	XC9236A3HDMR	DC-DC-IC	PWM/PFM, st-dwn, 3.65V±2%, 600mA, 3MHz, Vin>2V, LSST	SOT-25	28dc4	DC1	6g	Tor
5LK	XO6127C31HMR	Vdet-IC	3.1V±0.8%, +Reset PPO, -MR, Rt=200ms	SOT-25	28yx	VD5	6g	Tor
5LK	XC9236A3KDMR	DC-DC-IC	PWM/PFM, st-dwn, 3.75V±2%, 600mA, 3MHz, Vin>2V, LSST	SOT-25	28dc4	DC1	6g	Tor
5LL	XO6127C31JMR	Vdet-IC	3.1V±0.8%, +Reset PPO, -MR, Rt=400ms	SOT-25	28yx	VD5	6g	Tor
5LL	XC9236A3LDMR	DC-DC-IC	PWM/PFM, st-dwn, 3.85V±2%, 600mA, 3MHz, Vin>2V, LSST	SOT-25	28dc4	DC1	6g	Tor
5LM	XO6127C31KMR	Vdet-IC	3.1V±0.8%, +Reset PPO, -MR, Rt=800ms	SOT-25	28yx	VD5	6g	Tor
5LM	XC9236A3MDMR	DC-DC-IC	PWM/PFM, st-dwn, 3.95V±2%, 600mA, 3MHz, Vin>2V, LSST	SOT-25	28dc4	DC1	6g	Tor
5LN	XO6127C32AMR	Vdet-IC	3.2V±0.8%, -Reset PPO, -MR, Rt=50ms	SOT-25	28yx	VD5	6g	Tor
5LP	XO6127C32BMR	Vdet-IC	3.2V±0.8%, -Reset PPO, -MR, Rt=100ms	SOT-25	28yx	VD5	6g	Tor
5LR	XO6127C32CMR	Vdet-IC	3.2V±0.8%, -Reset PPO, -MR, Rt=200ms	SOT-25	28yx	VD5	6g	Tor
5LS	XO6127C32DMR	Vdet-IC	3.2V±0.8%, -Reset PPO, -MR, Rt=400ms	SOT-25	28yx	VD5	6g	Tor
5LT	XO6127C32EMR	Vdet-IC	3.2V±0.8%, -Reset PPO, -MR, Rt=800ms	SOT-25	28yx	VD5	6g	Tor
5LU	XO6127C32FMR	Vdet-IC	3.2V±0.8%, +Reset PPO, -MR, Rt=50ms	SOT-25	28yx	VD5	6g	Tor
5LV	XO6127C32GMR	Vdet-IC	3.2V±0.8%, +Reset PPO, -MR, Rt=100ms	SOT-25	28yx	VD5	6g	Tor
5LX	XO6127C32HMR	Vdet-IC	3.2V±0.8%, +Reset PPO, -MR, Rt=200ms	SOT-25	28yx	VD5	6g	Tor
5LY	XO6127C32JMR	Vdet-IC	3.2V±0.8%, +Reset PPO, -MR, Rt=400ms	SOT-25	28yx	VD5	6g	Tor
5LZ	XO6127C32KMR	Vdet-IC	3.2V±0.8%, +Reset PPO, -MR, Rt=800ms	SOT-25	28yx	VD5	6g	Tor
5M	MIC5365-2.8YMT	LVR-IC	LDO, 2.8V±2%, 150mA, +CE	SC-70-5	28gf	VR4	6g	Mcr
5M	R3111N451C	Vdet-IC	4.5V±2%, -Reset ODO	SOT-23-5	28vdm	VD6	6g	Ric
5MO	XC9236A40DMR	DC-DC-IC	PWM/PFM, st-dwn, 4.0V±2%, 600mA, 3MHz, Vin>2V, LSST	SOT-25	28dc4	DC1	6g	Tor
5MA	XO6127C33AMR	Vdet-IC	3.3V±0.8%, -Reset PPO, -MR, Rt=50ms	SOT-25	28yx	VD5	6g	Tor
5MB	XO6127C33BMR	Vdet-IC	3.3V±0.8%, -Reset PPO, -MR, Rt=100ms	SOT-25	28yx	VD5	6g	Tor
5MC	XO6127C33CMR	Vdet-IC	3.3V±0.8%, -Reset PPO, -MR, Rt=200ms	SOT-25	28yx	VD5	6g	Tor
5MD	XO6127C33DMR	Vdet-IC	3.3V±0.8%, -Reset PPO, -MR, Rt=400ms	SOT-25	28yx	VD5	6g	Tor
5ME	XO6127C33EMR	Vdet-IC	3.3V±0.8%, -Reset PPO, -MR, Rt=800ms	SOT-25	28yx	VD5	6g	Tor
5MF	XO6127C33FMR	Vdet-IC	3.3V±0.8%, +Reset PPO, -MR, Rt=50ms	SOT-25	28yx	VD5	6g	Tor
5MH	XO6127C33GMR	Vdet-IC	3.3V±0.8%, +Reset PPO, -MR, Rt=100ms	SOT-25	28yx	VD5	6g	Tor
5MK	XO6127C33HMR	Vdet-IC	3.3V±0.8%, +Reset PPO, -MR, Rt=200ms	SOT-25	28yx	VD5	6g	Tor
5ML	XO6127C33JMR	Vdet-IC	3.3V±0.8%, +Reset PPO, -MR, Rt=400ms	SOT-25	28yx	VD5	6g	Tor
5MM	XO6127C33KMR	Vdet-IC	3.3V±0.8%, +Reset PPO, -MR, Rt=800ms	SOT-25	28yx	VD5	6g	Tor
5MN	XO6127C34AMR	Vdet-IC	3.4V±0.8%, -Reset PPO, -MR, Rt=50ms	SOT-25	28yx	VD5	6g	Tor
5MP	XO6127C34BMR	Vdet-IC	3.4V±0.8%, -Reset PPO, -MR, Rt=100ms	SOT-25	28yx	VD5	6g	Tor
5MR	XO6127C34CMR	Vdet-IC	3.4V±0.8%, -Reset PPO, -MR, Rt=200ms	SOT-25	28yx	VD5	6g	Tor
5MS	XO6127C34DMR	Vdet-IC	3.4V±0.8%, -Reset PPO, -MR, Rt=400ms	SOT-25	28yx	VD5	6g	Tor
5MT	XO6127C34EMR	Vdet-IC	3.4V±0.8%, -Reset PPO, -MR, Rt=800ms	SOT-25	28yx	VD5	6g	Tor
5MU	XO6127C34FMR	Vdet-IC	3.4V±0.8%, +Reset PPO, -MR, Rt=50ms	SOT-25	28yx	VD5	6g	Tor
5MV	XO6127C34GMR	Vdet-IC	3.4V±0.8%, +Reset PPO, -MR, Rt=100ms	SOT-25	28yx	VD5	6g	Tor
5MX	XO6127C34HMR	Vdet-IC	3.4V±0.8%, +Reset PPO, -MR, Rt=200ms	SOT-25	28yx	VD5	6g	Tor
5MY	XO6127C34JMR	Vdet-IC	3.4V±0.8%, +Reset PPO, -MR, Rt=400ms	SOT-25	28yx	VD5	6g	Tor
5MZ	XO6127C34KMR	Vdet-IC	3.4V±0.8%, +Reset PPO, -MR, Rt=800ms	SOT-25	28yx	VD5	6g	Tor
5N	MIC5365-2.85YMT	LVR-IC	LDO, 2.85V±2%, 150mA, +CE	SC-70-5	28gf	VR4	6g	Mcr
5N	R3111N551C	Vdet-IC	5.5V±2%, -Reset ODO	SOT-23-5	28vdm	VD6	6g	Ric
5NA	XO6127C35AMR	Vdet-IC	3.5V±0.8%, -Reset PPO, -MR, Rt=50ms	SOT-25	28yx	VD5	6g	Tor
5NB	XO6127C35BMR	Vdet-IC	3.5V±0.8%, -Reset PPO, -MR, Rt=100ms	SOT-25	28yx	VD5	6g	Tor
5NC	XO6127C35CMR	Vdet-IC	3.5V±0.8%, -Reset PPO, -MR, Rt=200ms	SOT-25	28yx	VD5	6g	Tor
5ND	XO6127C35DMR	Vdet-IC	3.5V±0.8%, -Reset PPO, -MR, Rt=400ms	SOT-25	28yx	VD5	6g	Tor
5NE	XO6127C35EMR	Vdet-IC	3.5V±0.8%, -Reset PPO, -MR, Rt=800ms	SOT-25	28yx	VD5	6g	Tor
5NF	XO6127C35FMR	Vdet-IC	3.5V±0.8%, +Reset PPO, -MR, Rt=50ms	SOT-25	28yx	VD5	6g	Tor
5NH	XO6127C35GMR	Vdet-IC	3.5V±0.8%, +Reset PPO, -MR, Rt=100ms	SOT-25	28yx	VD5	6g	Tor
5NK	XO6127C35HMR	Vdet-IC	3.5V±0.8%, +Reset PPO, -MR, Rt=200ms	SOT-25	28yx	VD5	6g	Tor
5NL	XO6127C35JMR	Vdet-IC	3.5V±0.8%, +Reset PPO, -MR, Rt=400ms	SOT-25	28yx	VD5	6g	Tor
5NM	XO6127C35KMR	Vdet-IC	3.5V±0.8%, +Reset PPO, -MR, Rt=800ms	SOT-25	28yx	VD5	6g	Tor
5NN	XO6127C36AMR	Vdet-IC	3.6V±0.8%, -Reset PPO, -MR, Rt=50ms	SOT-25	28yx	VD5	6g	Tor
5NP	XO6127C36BMR	Vdet-IC	3.6V±0.8%, -Reset PPO, -MR, Rt=100ms	SOT-25	28yx	VD5	6g	Tor
5NR	XO6127C36CMR	Vdet-IC	3.6V±0.8%, -Reset PPO, -MR, Rt=200ms	SOT-25	28yx	VD5	6g	Tor
5NS	XO6127C36DMR	Vdet-IC	3.6V±0.8%, -Reset PPO, -MR, Rt=400ms	SOT-25	28yx	VD5	6g	Tor
5NT	XO6127C36EMR	Vdet-IC	3.6V±0.8%, -Reset PPO, -MR, Rt=800ms	SOT-25	28yx	VD5	6g	Tor
5NU	XO6127C36FMR	Vdet-IC	3.6V±0.8%, +Reset PPO, -MR, Rt=50ms	SOT-25	28yx	VD5	6g	Tor
5NV	XO6127C36GMR	Vdet-IC	3.6V±0.8%, +Reset PPO, -MR, Rt=100ms	SOT-25	28yx	VD5	6g	Tor
5NX	XO6127C36HMR	Vdet-IC	3.6V±0.8%, +Reset PPO, -MR, Rt=200ms	SOT-25	28yx	VD5	6g	Tor
5NY	XO6127C36JMR	Vdet-IC	3.6V±0.8%, +Reset PPO, -MR, Rt=400ms	SOT-25	28yx	VD5	6g	Tor
5NZ	XO6127C36KMR	Vdet-IC	3.6V±0.8%, +Reset PPO, -MR, Rt=800ms	SOT-25	28yx	VD5	6g	Tor
5O	MIC5365-2.9YMT	LVR-IC	LDO, 2.9V±2%, 150mA, +CE	SC-70-5	28gf	VR4	6g	Mcr
5P	MIC5365-3.0YMT	LVR-IC	LDO, 3.0V±2%, 150mA, +CE	SC-70-5	28gf	VR4	6g	Mcr
5PA	XO6127C37AMR	Vdet-IC	3.7V±0.8%, -Reset PPO, -MR, Rt=50ms	SOT-25	28yx	VD5	6g	Tor
5PB	XO6127C37BMR	Vdet-IC	3.7V±0.8%, -Reset PPO, -MR, Rt=100ms	SOT-25	28yx	VD5	6g	Tor



SMD code	Type	Function	Short description	Case	Pinout	Sch.	St.	Mnf.
5PC	XC6127C37CMR	Vdet-IC	3.7V±0.8%, -Reset PPO, -MR, Rt=200ms	SOT-25	28yx	VD5	6g	Tor
5PD	XC6127C37DMR	Vdet-IC	3.7V±0.8%, -Reset PPO, -MR, Rt=400ms	SOT-25	28yx	VD5	6g	Tor
5PE	XC6127C37EMR	Vdet-IC	3.7V±0.8%, -Reset PPO, -MR, Rt=800ms	SOT-25	28yx	VD5	6g	Tor
5PF	XC6127C37FMR	Vdet-IC	3.7V±0.8%, +Reset PPO, -MR, Rt=50ms	SOT-25	28yx	VD5	6g	Tor
5PH	XC6127C37GMR	Vdet-IC	3.7V±0.8%, +Reset PPO, -MR, Rt=100ms	SOT-25	28yx	VD5	6g	Tor
5PK	XC6127C37HMR	Vdet-IC	3.7V±0.8%, +Reset PPO, -MR, Rt=200ms	SOT-25	28yx	VD5	6g	Tor
5PL	XC6127C37JMR	Vdet-IC	3.7V±0.8%, +Reset PPO, -MR, Rt=400ms	SOT-25	28yx	VD5	6g	Tor
5PM	XC6127C37KMR	Vdet-IC	3.7V±0.8%, +Reset PPO, -MR, Rt=800ms	SOT-25	28yx	VD5	6g	Tor
5PN	XC6127C38AMR	Vdet-IC	3.8V±0.8%, -Reset PPO, -MR, Rt=50ms	SOT-25	28yx	VD5	6g	Tor
5PP	XC6127C38BMR	Vdet-IC	3.8V±0.8%, -Reset PPO, -MR, Rt=100ms	SOT-25	28yx	VD5	6g	Tor
5PR	XC6127C38CMR	Vdet-IC	3.8V±0.8%, -Reset PPO, -MR, Rt=200ms	SOT-25	28yx	VD5	6g	Tor
5PS	XC6127C38DMR	Vdet-IC	3.8V±0.8%, -Reset PPO, -MR, Rt=400ms	SOT-25	28yx	VD5	6g	Tor
5PT	XC6127C38EMR	Vdet-IC	3.8V±0.8%, -Reset PPO, -MR, Rt=800ms	SOT-25	28yx	VD5	6g	Tor
5PU	XC6127C38FMR	Vdet-IC	3.8V±0.8%, +Reset PPO, -MR, Rt=50ms	SOT-25	28yx	VD5	6g	Tor
5PV	XC6127C38GMR	Vdet-IC	3.8V±0.8%, +Reset PPO, -MR, Rt=100ms	SOT-25	28yx	VD5	6g	Tor
5PX	XC6127C38HMR	Vdet-IC	3.8V±0.8%, +Reset PPO, -MR, Rt=200ms	SOT-25	28yx	VD5	6g	Tor
5PY	XC6127C38JMR	Vdet-IC	3.8V±0.8%, +Reset PPO, -MR, Rt=400ms	SOT-25	28yx	VD5	6g	Tor
5PZ	XC6127C38KMR	Vdet-IC	3.8V±0.8%, +Reset PPO, -MR, Rt=800ms	SOT-25	28yx	VD5	6g	Tor
5Q	MIC5365-3.1YMT	LVR-IC	LDO, 3.1V±2%, 150mA, +CE	SC-70-5	28gf	VR4	6g	Mcr
5Q	R1210N251A	DC/DC-IC	PWM step-up, 2.5V, 35..100kHz	SOT-23-5	28sc	DC3	6g	Ric
5R	R1210N351A	DC/DC-IC	PWM step-up, 3.5V, 35..100kHz	SOT-23-5	28sc	DC3	6g	Ric
5RA	XC6127C39AMR	Vdet-IC	3.9V±0.8%, -Reset PPO, -MR, Rt=50ms	SOT-25	28yx	VD5	6g	Tor
5RB	XC6127C39BMR	Vdet-IC	3.9V±0.8%, -Reset PPO, -MR, Rt=100ms	SOT-25	28yx	VD5	6g	Tor
5RC	XC6127C39CMR	Vdet-IC	3.9V±0.8%, -Reset PPO, -MR, Rt=200ms	SOT-25	28yx	VD5	6g	Tor
5RD	XC6127C39DMR	Vdet-IC	3.9V±0.8%, -Reset PPO, -MR, Rt=400ms	SOT-25	28yx	VD5	6g	Tor
5RE	XC6127C39EMR	Vdet-IC	3.9V±0.8%, -Reset PPO, -MR, Rt=800ms	SOT-25	28yx	VD5	6g	Tor
5RF	XC6127C39FMR	Vdet-IC	3.9V±0.8%, +Reset PPO, -MR, Rt=50ms	SOT-25	28yx	VD5	6g	Tor
5RH	XC6127C39GMR	Vdet-IC	3.9V±0.8%, +Reset PPO, -MR, Rt=100ms	SOT-25	28yx	VD5	6g	Tor
5RK	XC6127C39HMR	Vdet-IC	3.9V±0.8%, +Reset PPO, -MR, Rt=200ms	SOT-25	28yx	VD5	6g	Tor
5RL	XC6127C39JMR	Vdet-IC	3.9V±0.8%, +Reset PPO, -MR, Rt=400ms	SOT-25	28yx	VD5	6g	Tor
5RM	XC6127C39KMR	Vdet-IC	3.9V±0.8%, +Reset PPO, -MR, Rt=800ms	SOT-25	28yx	VD5	6g	Tor
5RN	XC6127C40AMR	Vdet-IC	4.0V±0.8%, -Reset PPO, -MR, Rt=50ms	SOT-25	28yx	VD5	6g	Tor
5RP	XC6127C40BMR	Vdet-IC	4.0V±0.8%, -Reset PPO, -MR, Rt=100ms	SOT-25	28yx	VD5	6g	Tor
5RR	XC6127C40CMR	Vdet-IC	4.0V±0.8%, -Reset PPO, -MR, Rt=200ms	SOT-25	28yx	VD5	6g	Tor
5RS	XC6127C40DMR	Vdet-IC	4.0V±0.8%, -Reset PPO, -MR, Rt=400ms	SOT-25	28yx	VD5	6g	Tor
5RT	XC6127C40EMR	Vdet-IC	4.0V±0.8%, -Reset PPO, -MR, Rt=800ms	SOT-25	28yx	VD5	6g	Tor
5RU	XC6127C40FMR	Vdet-IC	4.0V±0.8%, +Reset PPO, -MR, Rt=50ms	SOT-25	28yx	VD5	6g	Tor
5RV	XC6127C40GMR	Vdet-IC	4.0V±0.8%, +Reset PPO, -MR, Rt=100ms	SOT-25	28yx	VD5	6g	Tor
5RX	XC6127C40HMR	Vdet-IC	4.0V±0.8%, +Reset PPO, -MR, Rt=200ms	SOT-25	28yx	VD5	6g	Tor
5RY	XC6127C40JMR	Vdet-IC	4.0V±0.8%, +Reset PPO, -MR, Rt=400ms	SOT-25	28yx	VD5	6g	Tor
5RZ	XC6127C40KMR	Vdet-IC	4.0V±0.8%, +Reset PPO, -MR, Rt=800ms	SOT-25	28yx	VD5	6g	Tor
5S	MIC5365-3.3YMT	LVR-IC	LDO, 3.3V±2%, 150mA, +CE	SC-70-5	28gf	VR4	6g	Mcr
5SA	XC6127C41AMR	Vdet-IC	4.1V±0.8%, -Reset PPO, -MR, Rt=50ms	SOT-25	28yx	VD5	6g	Tor
5SB	XC6127C41BMR	Vdet-IC	4.1V±0.8%, -Reset PPO, -MR, Rt=100ms	SOT-25	28yx	VD5	6g	Tor
5SC	XC6127C41CMR	Vdet-IC	4.1V±0.8%, -Reset PPO, -MR, Rt=200ms	SOT-25	28yx	VD5	6g	Tor
5SD	XC6127C41DMR	Vdet-IC	4.1V±0.8%, -Reset PPO, -MR, Rt=400ms	SOT-25	28yx	VD5	6g	Tor
5SE	XC6127C41EMR	Vdet-IC	4.1V±0.8%, -Reset PPO, -MR, Rt=800ms	SOT-25	28yx	VD5	6g	Tor
5SF	XC6127C41FMR	Vdet-IC	4.1V±0.8%, +Reset PPO, -MR, Rt=50ms	SOT-25	28yx	VD5	6g	Tor
5SH	XC6127C41GMR	Vdet-IC	4.1V±0.8%, +Reset PPO, -MR, Rt=100ms	SOT-25	28yx	VD5	6g	Tor
5SK	XC6127C41HMR	Vdet-IC	4.1V±0.8%, +Reset PPO, -MR, Rt=200ms	SOT-25	28yx	VD5	6g	Tor
5SL	XC6127C41JMR	Vdet-IC	4.1V±0.8%, +Reset PPO, -MR, Rt=400ms	SOT-25	28yx	VD5	6g	Tor
5SM	XC6127C41KMR	Vdet-IC	4.1V±0.8%, +Reset PPO, -MR, Rt=800ms	SOT-25	28yx	VD5	6g	Tor
5SN	XC6127C42AMR	Vdet-IC	4.2V±0.8%, -Reset PPO, -MR, Rt=50ms	SOT-25	28yx	VD5	6g	Tor
5SP	XC6127C42BMR	Vdet-IC	4.2V±0.8%, -Reset PPO, -MR, Rt=100ms	SOT-25	28yx	VD5	6g	Tor
5SR	XC6127C42CMR	Vdet-IC	4.2V±0.8%, -Reset PPO, -MR, Rt=200ms	SOT-25	28yx	VD5	6g	Tor
5SS	XC6127C42DMR	Vdet-IC	4.2V±0.8%, -Reset PPO, -MR, Rt=400ms	SOT-25	28yx	VD5	6g	Tor
5ST	XC6127C42EMR	Vdet-IC	4.2V±0.8%, -Reset PPO, -MR, Rt=800ms	SOT-25	28yx	VD5	6g	Tor
5SU	XC6127C42FMR	Vdet-IC	4.2V±0.8%, +Reset PPO, -MR, Rt=50ms	SOT-25	28yx	VD5	6g	Tor
5SV	XC6127C42GMR	Vdet-IC	4.2V±0.8%, +Reset PPO, -MR, Rt=100ms	SOT-25	28yx	VD5	6g	Tor
5SX	XC6127C42HMR	Vdet-IC	4.2V±0.8%, +Reset PPO, -MR, Rt=200ms	SOT-25	28yx	VD5	6g	Tor
5SY	XC6127C42JMR	Vdet-IC	4.2V±0.8%, +Reset PPO, -MR, Rt=400ms	SOT-25	28yx	VD5	6g	Tor
5SZ	XC6127C42KMR	Vdet-IC	4.2V±0.8%, +Reset PPO, -MR, Rt=800ms	SOT-25	28yx	VD5	6g	Tor
5T	RN5RF15BA	LVR-IC	LRip, +CE, 1.5V±2%, 1A*	SOT-23-5	28vw	VR6	6g	Ric
5TA	XC6127C43AMR	Vdet-IC	4.3V±0.8%, -Reset PPO, -MR, Rt=50ms	SOT-25	28yx	VD5	6g	Tor
5TB	XC6127C43BMR	Vdet-IC	4.3V±0.8%, -Reset PPO, -MR, Rt=100ms	SOT-25	28yx	VD5	6g	Tor
5TC	XC6127C43CMR	Vdet-IC	4.3V±0.8%, -Reset PPO, -MR, Rt=200ms	SOT-25	28yx	VD5	6g	Tor
5TD	XC6127C43DMR	Vdet-IC	4.3V±0.8%, -Reset PPO, -MR, Rt=400ms	SOT-25	28yx	VD5	6g	Tor
5TE	XC6127C43EMR	Vdet-IC	4.3V±0.8%, -Reset PPO, -MR, Rt=800ms	SOT-25	28yx	VD5	6g	Tor
5TF	XC6127C43FMR	Vdet-IC	4.3V±0.8%, +Reset PPO, -MR, Rt=50ms	SOT-25	28yx	VD5	6g	Tor
5TH	XC6127C43GMR	Vdet-IC	4.3V±0.8%, +Reset PPO, -MR, Rt=100ms	SOT-25	28yx	VD5	6g	Tor



SMD code	Type	Function	Short description	Case	Pinout	Sch.	St.	Mnf.
5TK	XC6127C43HMR	Vdet-IC	4.3V±0.8%, +Reset PPO, -MR, Rt=200ms	SOT-25	28yx	VD5	6g	Tor
5TL	XC6127C43JMR	Vdet-IC	4.3V±0.8%, +Reset PPO, -MR, Rt=400ms	SOT-25	28yx	VD5	6g	Tor
5TM	XC6127C43KMR	Vdet-IC	4.3V±0.8%, +Reset PPO, -MR, Rt=800ms	SOT-25	28yx	VD5	6g	Tor
5TN	XC6127C44AMR	Vdet-IC	4.4V±0.8%, -Reset PPO, -MR, Rt=50ms	SOT-25	28yx	VD5	6g	Tor
5TP	XC6127C44BMR	Vdet-IC	4.4V±0.8%, -Reset PPO, -MR, Rt=100ms	SOT-25	28yx	VD5	6g	Tor
5TR	XC6127C44CMR	Vdet-IC	4.4V±0.8%, -Reset PPO, -MR, Rt=200ms	SOT-25	28yx	VD5	6g	Tor
5TS	XC6127C44DMR	Vdet-IC	4.4V±0.8%, -Reset PPO, -MR, Rt=400ms	SOT-25	28yx	VD5	6g	Tor
5TT	XC6127C44EMR	Vdet-IC	4.4V±0.8%, -Reset PPO, -MR, Rt=800ms	SOT-25	28yx	VD5	6g	Tor
5TU	XC6127C44FMR	Vdet-IC	4.4V±0.8%, +Reset PPO, -MR, Rt=50ms	SOT-25	28yx	VD5	6g	Tor
5TV	XC6127C44GMR	Vdet-IC	4.4V±0.8%, +Reset PPO, -MR, Rt=100ms	SOT-25	28yx	VD5	6g	Tor
5TX	XC6127C44HMR	Vdet-IC	4.4V±0.8%, +Reset PPO, -MR, Rt=200ms	SOT-25	28yx	VD5	6g	Tor
5TY	XC6127C44JMR	Vdet-IC	4.4V±0.8%, +Reset PPO, -MR, Rt=400ms	SOT-25	28yx	VD5	6g	Tor
5TZ	XC6127C44KMR	Vdet-IC	4.4V±0.8%, +Reset PPO, -MR, Rt=800ms	SOT-25	28yx	VD5	6g	Tor
5U	R1210N251C	DC/DC-IC	PWM step-up, 2.5V, 100kHz	SOT-23-5	28sc	DC3	6g	Ric
5UA	XC6127C45AMR	Vdet-IC	4.5V±0.8%, -Reset PPO, -MR, Rt=50ms	SOT-25	28yx	VD5	6g	Tor
5UB	XC6127C45BMR	Vdet-IC	4.5V±0.8%, -Reset PPO, -MR, Rt=100ms	SOT-25	28yx	VD5	6g	Tor
5UC	XC6127C45CMR	Vdet-IC	4.5V±0.8%, -Reset PPO, -MR, Rt=200ms	SOT-25	28yx	VD5	6g	Tor
5UD	XC6127C45DMR	Vdet-IC	4.5V±0.8%, -Reset PPO, -MR, Rt=400ms	SOT-25	28yx	VD5	6g	Tor
5UE	XC6127C45EMR	Vdet-IC	4.5V±0.8%, -Reset PPO, -MR, Rt=800ms	SOT-25	28yx	VD5	6g	Tor
5UF	XC6127C45FMR	Vdet-IC	4.5V±0.8%, +Reset PPO, -MR, Rt=50ms	SOT-25	28yx	VD5	6g	Tor
5UH	XC6127C45GMR	Vdet-IC	4.5V±0.8%, +Reset PPO, -MR, Rt=100ms	SOT-25	28yx	VD5	6g	Tor
5UK	XC6127C45HMR	Vdet-IC	4.5V±0.8%, +Reset PPO, -MR, Rt=200ms	SOT-25	28yx	VD5	6g	Tor
5UL	XC6127C45JMR	Vdet-IC	4.5V±0.8%, +Reset PPO, -MR, Rt=400ms	SOT-25	28yx	VD5	6g	Tor
5UM	XC6127C45KMR	Vdet-IC	4.5V±0.8%, +Reset PPO, -MR, Rt=800ms	SOT-25	28yx	VD5	6g	Tor
5UN	XC6127C46AMR	Vdet-IC	4.6V±0.8%, -Reset PPO, -MR, Rt=50ms	SOT-25	28yx	VD5	6g	Tor
5UP	XC6127C46BMR	Vdet-IC	4.6V±0.8%, -Reset PPO, -MR, Rt=100ms	SOT-25	28yx	VD5	6g	Tor
5UR	XC6127C46CMR	Vdet-IC	4.6V±0.8%, -Reset PPO, -MR, Rt=200ms	SOT-25	28yx	VD5	6g	Tor
5US	XC6127C46DMR	Vdet-IC	4.6V±0.8%, -Reset PPO, -MR, Rt=400ms	SOT-25	28yx	VD5	6g	Tor
5UT	XC6127C46EMR	Vdet-IC	4.6V±0.8%, -Reset PPO, -MR, Rt=800ms	SOT-25	28yx	VD5	6g	Tor
5UU	XC6127C46FMR	Vdet-IC	4.6V±0.8%, +Reset PPO, -MR, Rt=50ms	SOT-25	28yx	VD5	6g	Tor
5UV	XC6127C46GMR	Vdet-IC	4.6V±0.8%, +Reset PPO, -MR, Rt=100ms	SOT-25	28yx	VD5	6g	Tor
5UX	XC6127C46HMR	Vdet-IC	4.6V±0.8%, +Reset PPO, -MR, Rt=200ms	SOT-25	28yx	VD5	6g	Tor
5UY	XC6127C46JMR	Vdet-IC	4.6V±0.8%, +Reset PPO, -MR, Rt=400ms	SOT-25	28yx	VD5	6g	Tor
5UZ	XC6127C46KMR	Vdet-IC	4.6V±0.8%, +Reset PPO, -MR, Rt=800ms	SOT-25	28yx	VD5	6g	Tor
5V0	TAR5S50	LVR-IC	LDO, 5V±1%, 200mA, +CE	SSOP-5	28un	VR7	6a	Tos
5V0	TAR5S50U	LVR-IC	LDO, 5V±1%, 200mA, +CE	SSOP-5-P	30un	VR7	6a	Tos
5V1	S-75V00ANC	CMOS-Logic	2-input NAND gate	SC-88A	28/Log1	-	6a	Sii
5V2	S-75V08ANC	CMOS-Logic	2-input AND gate	SC-88A	28/Log3	-	6a	Sii
5V3	S-75V02ANC	CMOS-Logic	2-input NOR gate	SC-88A	28/Log2	-	6a	Sii
5V4	S-75V32ANC	CMOS-Logic	2-input OR gate	SC-88A	28/Log4	-	6a	Sii
5V5	S-75V04ANC	CMOS-Logic	Inverter	SC-88A	28/Log6	-	6a	Sii
5V6	S-75VU04ANC	CMOS-Logic	Inverter	SC-88A	28/Log6	-	6a	Sii
5V8	S-75V86ANC	CMOS-Logic	2-input EXCLUSIVE-OR gate	SC-88A	28/Log5	-	6a	Sii
5V8	XC6205A092MR	LVR-IC	LDO, 0.9V±2%, 150mA, +CE, PDR	SOT-25	28cx	VR4	6g	Tor
5V9	XC6205A102MR	LVR-IC	LDO, 1V±2%, 150mA, +CE, PDR	SOT-25	28cx	VR4	6g	Tor
5VA	S-75V14ANC	CMOS-Logic	Inverting Schmitt-trigger	SC-88A	28/Log7	-	6a	Sii
5VA	XC6127C47AMR	Vdet-IC	4.7V±0.8%, -Reset PPO, -MR, Rt=50ms	SOT-25	28yx	VD5	6g	Tor
5VA	XC6205A112MR	LVR-IC	LDO, 1.1V±2%, 150mA, +CE, PDR	SOT-25	28cx	VR4	6g	Tor
5VB	XC6127C47BMR	Vdet-IC	4.7V±0.8%, -Reset PPO, -MR, Rt=100ms	SOT-25	28yx	VD5	6g	Tor
5VB	XC6205A122MR	LVR-IC	LDO, 1.2V±2%, 150mA, +CE, PDR	SOT-25	28cx	VR4	6g	Tor
5VC	XC6127C47CMR	Vdet-IC	4.7V±0.8%, -Reset PPO, -MR, Rt=200ms	SOT-25	28yx	VD5	6g	Tor
5VC	XC6205A132MR	LVR-IC	LDO, 1.3V±2%, 150mA, +CE, PDR	SOT-25	28cx	VR4	6g	Tor
5VD	XC6127C47DMR	Vdet-IC	4.7V±0.8%, -Reset PPO, -MR, Rt=400ms	SOT-25	28yx	VD5	6g	Tor
5VD	XC6205A142MR	LVR-IC	LDO, 1.4V±2%, 150mA, +CE, PDR	SOT-25	28cx	VR4	6g	Tor
5VE	XC6127C47EMR	Vdet-IC	4.7V±0.8%, -Reset PPO, -MR, Rt=800ms	SOT-25	28yx	VD5	6g	Tor
5VE	XC6205A152MR	LVR-IC	LDO, 1.5V±2%, 150mA, +CE, PDR	SOT-25	28cx	VR4	6g	Tor
5VF	XC6127C47FMR	Vdet-IC	4.7V±0.8%, +Reset PPO, -MR, Rt=50ms	SOT-25	28yx	VD5	6g	Tor
5VF	XC6205A162MR	LVR-IC	LDO, 1.6V±2%, 150mA, +CE, PDR	SOT-25	28cx	VR4	6g	Tor
5VH	XC6127C47GMR	Vdet-IC	4.7V±0.8%, +Reset PPO, -MR, Rt=100ms	SOT-25	28yx	VD5	6g	Tor
5VH	XC6205A172MR	LVR-IC	LDO, 1.7V±2%, 150mA, +CE, PDR	SOT-25	28cx	VR4	6g	Tor
5VK	XC6127C47HMR	Vdet-IC	4.7V±0.8%, +Reset PPO, -MR, Rt=200ms	SOT-25	28yx	VD5	6g	Tor
5VL	XC6127C47JMR	Vdet-IC	4.7V±0.8%, +Reset PPO, -MR, Rt=400ms	SOT-25	28yx	VD5	6g	Tor
5VM	XC6127C47KMR	Vdet-IC	4.7V±0.8%, +Reset PPO, -MR, Rt=800ms	SOT-25	28yx	VD5	6g	Tor
5VN	XC6127C48AMR	Vdet-IC	4.8V±0.8%, -Reset PPO, -MR, Rt=50ms	SOT-25	28yx	VD5	6g	Tor
5VP	XC6127C48BMR	Vdet-IC	4.8V±0.8%, -Reset PPO, -MR, Rt=100ms	SOT-25	28yx	VD5	6g	Tor
5VR	XC6127C48CMR	Vdet-IC	4.8V±0.8%, -Reset PPO, -MR, Rt=200ms	SOT-25	28yx	VD5	6g	Tor
5VS	XC6127C48DMR	Vdet-IC	4.8V±0.8%, -Reset PPO, -MR, Rt=400ms	SOT-25	28yx	VD5	6g	Tor
5VT	XC6127C48EMR	Vdet-IC	4.8V±0.8%, -Reset PPO, -MR, Rt=800ms	SOT-25	28yx	VD5	6g	Tor
5VU	XC6127C48FMR	Vdet-IC	4.8V±0.8%, +Reset PPO, -MR, Rt=50ms	SOT-25	28yx	VD5	6g	Tor
5VV	XC6127C48GMR	Vdet-IC	4.8V±0.8%, +Reset PPO, -MR, Rt=100ms	SOT-25	28yx	VD5	6g	Tor



SMD code	Type	Function	Short description	Case	Pinout	Sch.	St.	Mnf.
5VX	XC6127C48HMR	Vdet-IC	4.8V±0.8%, +Reset PPO, -MR, Rt=200ms	SOT-25	28yx	VD5	6g	Tor
5VY	XC6127C48JMR	Vdet-IC	4.8V±0.8%, +Reset PPO, -MR, Rt=400ms	SOT-25	28yx	VD5	6g	Tor
5VZ	XC6127C48KMR	Vdet-IC	4.8V±0.8%, +Reset PPO, -MR, Rt=800ms	SOT-25	28yx	VD5	6g	Tor
5W	R1210N351C	DC/DC-IC	PWM step-up, 3.5V, 100kHz	SOT-23-5	28sc	DC3	6g	Ric
5X	R1210N451C	DC/DC-IC	PWM step-up, 4.4V, 100kHz	SOT-23-5	28sc	DC3	6g	Ric
5X8	XC6205B092MR	LVR-IC	LDO, 0.9V±2%, 150mA, +CE	SOT-25	28cx	VR4	6g	Tor
5X9	XC6205B102MR	LVR-IC	LDO, 1V±2%, 150mA, +CE	SOT-25	28cx	VR4	6g	Tor
5XA	XC6127C49AMR	Vdet-IC	4.9V±0.8%, -Reset PPO, -MR, Rt=50ms	SOT-25	28yx	VD5	6g	Tor
5XA	XC6205B112MR	LVR-IC	LDO, 1.1V±2%, 150mA, +CE	SOT-25	28cx	VR4	6g	Tor
5XB	XC6127C49BMR	Vdet-IC	4.9V±0.8%, -Reset PPO, -MR, Rt=100ms	SOT-25	28yx	VD5	6g	Tor
5XB	XC6205B122MR	LVR-IC	LDO, 1.2V±2%, 150mA, +CE	SOT-25	28cx	VR4	6g	Tor
5XC	XC6127C49CMR	Vdet-IC	4.9V±0.8%, -Reset PPO, -MR, Rt=200ms	SOT-25	28yx	VD5	6g	Tor
5XC	XC6205B132MR	LVR-IC	LDO, 1.3V±2%, 150mA, +CE	SOT-25	28cx	VR4	6g	Tor
5XD	XC6127C49DMR	Vdet-IC	4.9V±0.8%, -Reset PPO, -MR, Rt=400ms	SOT-25	28yx	VD5	6g	Tor
5XD	XC6205B142MR	LVR-IC	LDO, 1.4V±2%, 150mA, +CE	SOT-25	28cx	VR4	6g	Tor
5XE	XC6127C49EMR	Vdet-IC	4.9V±0.8%, -Reset PPO, -MR, Rt=800ms	SOT-25	28yx	VD5	6g	Tor
5XE	XC6205B152MR	LVR-IC	LDO, 1.5V±2%, 150mA, +CE	SOT-25	28cx	VR4	6g	Tor
5XF	XC6127C49FMR	Vdet-IC	4.9V±0.8%, +Reset PPO, -MR, Rt=50ms	SOT-25	28yx	VD5	6g	Tor
5XF	XC6205B162MR	LVR-IC	LDO, 1.6V±2%, 150mA, +CE	SOT-25	28cx	VR4	6g	Tor
5XH	XC6127C49GMR	Vdet-IC	4.9V±0.8%, +Reset PPO, -MR, Rt=100ms	SOT-25	28yx	VD5	6g	Tor
5XH	XC6205B172MR	LVR-IC	LDO, 1.7V±2%, 150mA, +CE	SOT-25	28cx	VR4	6g	Tor
5XK	XC6127C49HMR	Vdet-IC	4.9V±0.8%, +Reset PPO, -MR, Rt=200ms	SOT-25	28yx	VD5	6g	Tor
5XL	XC6127C49JMR	Vdet-IC	4.9V±0.8%, +Reset PPO, -MR, Rt=400ms	SOT-25	28yx	VD5	6g	Tor
5XM	XC6127C49KMR	Vdet-IC	4.9V±0.8%, +Reset PPO, -MR, Rt=800ms	SOT-25	28yx	VD5	6g	Tor
5XN	XC6127C50AMR	Vdet-IC	5.0V±0.8%, -Reset PPO, -MR, Rt=50ms	SOT-25	28yx	VD5	6g	Tor
5XP	XC6127C50BMR	Vdet-IC	5.0V±0.8%, -Reset PPO, -MR, Rt=100ms	SOT-25	28yx	VD5	6g	Tor
5XR	XC6127C50CMR	Vdet-IC	5.0V±0.8%, -Reset PPO, -MR, Rt=200ms	SOT-25	28yx	VD5	6g	Tor
5XS	XC6127C50DMR	Vdet-IC	5.0V±0.8%, -Reset PPO, -MR, Rt=400ms	SOT-25	28yx	VD5	6g	Tor
5XT	XC6127C50EMR	Vdet-IC	5.0V±0.8%, -Reset PPO, -MR, Rt=800ms	SOT-25	28yx	VD5	6g	Tor
5XU	XC6127C50FMR	Vdet-IC	5.0V±0.8%, +Reset PPO, -MR, Rt=50ms	SOT-25	28yx	VD5	6g	Tor
5XV	XC6127C50GMR	Vdet-IC	5.0V±0.8%, +Reset PPO, -MR, Rt=100ms	SOT-25	28yx	VD5	6g	Tor
5XX	XC6127C50HMR	Vdet-IC	5.0V±0.8%, +Reset PPO, -MR, Rt=200ms	SOT-25	28yx	VD5	6g	Tor
5XY	XC6127C50JMR	Vdet-IC	5.0V±0.8%, +Reset PPO, -MR, Rt=400ms	SOT-25	28yx	VD5	6g	Tor
5XZ	XC6127C50KMR	Vdet-IC	5.0V±0.8%, +Reset PPO, -MR, Rt=800ms	SOT-25	28yx	VD5	6g	Tor
5Y	R1210N551C	DC/DC-IC	PWM step-up, 5.5V, 100kHz	SOT-23-5	28sc	DC3	6g	Ric
5Y8	XC6205C092MR	LVR-IC	LDO, 0.9V±2%, 150mA, -CE, PDR	SOT-25	28cx	VR4	6g	Tor
5Y9	XC6205C102MR	LVR-IC	LDO, 1V±2%, 150mA, -CE, PDR	SOT-25	28cx	VR4	6g	Tor
5YA	XC6127C51AMR	Vdet-IC	5.1V±0.8%, -Reset PPO, -MR, Rt=50ms	SOT-25	28yx	VD5	6g	Tor
5YA	XC6205C112MR	LVR-IC	LDO, 1.1V±2%, 150mA, -CE, PDR	SOT-25	28cx	VR4	6g	Tor
5YB	XC6127C51BMR	Vdet-IC	5.1V±0.8%, -Reset PPO, -MR, Rt=100ms	SOT-25	28yx	VD5	6g	Tor
5YB	XC6205C122MR	LVR-IC	LDO, 1.2V±2%, 150mA, -CE, PDR	SOT-25	28cx	VR4	6g	Tor
5YC	XC6127C51CMR	Vdet-IC	5.1V±0.8%, -Reset PPO, -MR, Rt=200ms	SOT-25	28yx	VD5	6g	Tor
5YC	XC6205C132MR	LVR-IC	LDO, 1.3V±2%, 150mA, -CE, PDR	SOT-25	28cx	VR4	6g	Tor
5YD	XC6127C51DMR	Vdet-IC	5.1V±0.8%, -Reset PPO, -MR, Rt=400ms	SOT-25	28yx	VD5	6g	Tor
5YD	XC6205C142MR	LVR-IC	LDO, 1.4V±2%, 150mA, -CE, PDR	SOT-25	28cx	VR4	6g	Tor
5YE	XC6127C51EMR	Vdet-IC	5.1V±0.8%, -Reset PPO, -MR, Rt=800ms	SOT-25	28yx	VD5	6g	Tor
5YE	XC6205C152MR	LVR-IC	LDO, 1.5V±2%, 150mA, -CE, PDR	SOT-25	28cx	VR4	6g	Tor
5YF	XC6127C51FMR	Vdet-IC	5.1V±0.8%, +Reset PPO, -MR, Rt=50ms	SOT-25	28yx	VD5	6g	Tor
5YF	XC6205C162MR	LVR-IC	LDO, 1.6V±2%, 150mA, -CE, PDR	SOT-25	28cx	VR4	6g	Tor
5YH	XC6127C51GMR	Vdet-IC	5.1V±0.8%, +Reset PPO, -MR, Rt=100ms	SOT-25	28yx	VD5	6g	Tor
5YH	XC6205C172MR	LVR-IC	LDO, 1.7V±2%, 150mA, -CE, PDR	SOT-25	28cx	VR4	6g	Tor
5YK	XC6127C51HMR	Vdet-IC	5.1V±0.8%, +Reset PPO, -MR, Rt=200ms	SOT-25	28yx	VD5	6g	Tor
5YL	XC6127C51JMR	Vdet-IC	5.1V±0.8%, +Reset PPO, -MR, Rt=400ms	SOT-25	28yx	VD5	6g	Tor
5YM	XC6127C51KMR	Vdet-IC	5.1V±0.8%, +Reset PPO, -MR, Rt=800ms	SOT-25	28yx	VD5	6g	Tor
5YN	XC6127C52AMR	Vdet-IC	5.2V±0.8%, -Reset PPO, -MR, Rt=50ms	SOT-25	28yx	VD5	6g	Tor
5YP	XC6127C52BMR	Vdet-IC	5.2V±0.8%, -Reset PPO, -MR, Rt=100ms	SOT-25	28yx	VD5	6g	Tor
5YR	XC6127C52CMR	Vdet-IC	5.2V±0.8%, -Reset PPO, -MR, Rt=200ms	SOT-25	28yx	VD5	6g	Tor
5YS	XC6127C52DMR	Vdet-IC	5.2V±0.8%, -Reset PPO, -MR, Rt=400ms	SOT-25	28yx	VD5	6g	Tor
5YT	XC6127C52EMR	Vdet-IC	5.2V±0.8%, -Reset PPO, -MR, Rt=800ms	SOT-25	28yx	VD5	6g	Tor
5YU	XC6127C52FMR	Vdet-IC	5.2V±0.8%, +Reset PPO, -MR, Rt=50ms	SOT-25	28yx	VD5	6g	Tor
5YV	XC6127C52GMR	Vdet-IC	5.2V±0.8%, +Reset PPO, -MR, Rt=100ms	SOT-25	28yx	VD5	6g	Tor
5YX	XC6127C52HMR	Vdet-IC	5.2V±0.8%, +Reset PPO, -MR, Rt=200ms	SOT-25	28yx	VD5	6g	Tor
5YY	XC6127C52JMR	Vdet-IC	5.2V±0.8%, +Reset PPO, -MR, Rt=400ms	SOT-25	28yx	VD5	6g	Tor
5YZ	XC6127C52KMR	Vdet-IC	5.2V±0.8%, +Reset PPO, -MR, Rt=800ms	SOT-25	28yx	VD5	6g	Tor
5Z	R1210N251D	DC/DC-IC	PWM step-up, 2.5V, 180kHz	SOT-23-5	28sc	DC3	6g	Ric
5Z8	XC6205D092MR	LVR-IC	LDO, 0.9V±2%, 150mA, -CE	SOT-25	28cx	VR4	6g	Tor
5Z9	XC6205D102MR	LVR-IC	LDO, 1V±2%, 150mA, -CE	SOT-25	28cx	VR4	6g	Tor
5ZA	XC6127C53AMR	Vdet-IC	5.3V±0.8%, -Reset PPO, -MR, Rt=50ms	SOT-25	28yx	VD5	6g	Tor
5ZA	XC6205D112MR	LVR-IC	LDO, 1.1V±2%, 150mA, -CE	SOT-25	28cx	VR4	6g	Tor
5ZB	XC6127C53BMR	Vdet-IC	5.3V±0.8%, -Reset PPO, -MR, Rt=100ms	SOT-25	28yx	VD5	6g	Tor



SMD code	Type	Function	Short description	Case	Pinout	Sch.	St.	Mnf.
52B	XC6205D122MR	LVR-IC	LDO, 1.2V±2%, 150mA, -CE	SOT-25	28cx	VR4	6g	Tor
52C	XO6127C53CMR	Vdet-IC	5.3V±0.8%, Vreset PPO, -MR, Rt=200ms	SOT-25	28yx	VD5	6g	Tor
52C	XC6205D132MR	LVR-IC	LDO, 1.3V±2%, 150mA, -CE	SOT-25	28cx	VR4	6g	Tor
52D	XO6127C53DMR	Vdet-IC	5.3V±0.8%, -Reset PPO, -MR, Rt=400ms	SOT-25	28yx	VD5	6g	Tor
52D	XC6205D142MR	LVR-IC	LDO, 1.4V±2%, 150mA, -CE	SOT-25	28cx	VR4	6g	Tor
52E	XO6127C53EMR	Vdet-IC	5.3V±0.8%, -Reset PPO, -MR, Rt=800ms	SOT-25	28yx	VD5	6g	Tor
52E	XC6205D152MR	LVR-IC	LDO, 1.5V±2%, 150mA, -CE	SOT-25	28cx	VR4	6g	Tor
52F	XO6127C53FMR	Vdet-IC	5.3V±0.8%, +Reset PPO, -MR, Rt=50ms	SOT-25	28yx	VD5	6g	Tor
52F	XC6205D162MR	LVR-IC	LDO, 1.6V±2%, 150mA, -CE	SOT-25	28cx	VR4	6g	Tor
52H	XO6127C53GMR	Vdet-IC	5.3V±0.8%, +Reset PPO, -MR, Rt=100ms	SOT-25	28yx	VD5	6g	Tor
52H	XC6205D172MR	LVR-IC	LDO, 1.7V±2%, 150mA, -CE	SOT-25	28cx	VR4	6g	Tor
52K	XO6127C53HMR	Vdet-IC	5.3V±0.8%, +Reset PPO, -MR, Rt=200ms	SOT-25	28yx	VD5	6g	Tor
52L	XO6127C53JMR	Vdet-IC	5.3V±0.8%, +Reset PPO, -MR, Rt=400ms	SOT-25	28yx	VD5	6g	Tor
52M	XO6127C53KMR	Vdet-IC	5.3V±0.8%, +Reset PPO, -MR, Rt=800ms	SOT-25	28yx	VD5	6g	Tor
52N	XO6127C54AMR	Vdet-IC	5.4V±0.8%, -Reset PPO, -MR, Rt=50ms	SOT-25	28yx	VD5	6g	Tor
52P	XO6127C54BMR	Vdet-IC	5.4V±0.8%, -Reset PPO, -MR, Rt=100ms	SOT-25	28yx	VD5	6g	Tor
52R	XO6127C54CMR	Vdet-IC	5.4V±0.8%, -Reset PPO, -MR, Rt=200ms	SOT-25	28yx	VD5	6g	Tor
52S	XO6127C54DMR	Vdet-IC	5.4V±0.8%, -Reset PPO, -MR, Rt=400ms	SOT-25	28yx	VD5	6g	Tor
52T	XO6127C54EMR	Vdet-IC	5.4V±0.8%, -Reset PPO, -MR, Rt=800ms	SOT-25	28yx	VD5	6g	Tor
52U	XO6127C54FMR	Vdet-IC	5.4V±0.8%, +Reset PPO, -MR, Rt=50ms	SOT-25	28yx	VD5	6g	Tor
52V	XO6127C54GMR	Vdet-IC	5.4V±0.8%, +Reset PPO, -MR, Rt=100ms	SOT-25	28yx	VD5	6g	Tor
52X	XO6127C54HMR	Vdet-IC	5.4V±0.8%, +Reset PPO, -MR, Rt=200ms	SOT-25	28yx	VD5	6g	Tor
52Y	XO6127C54JMR	Vdet-IC	5.4V±0.8%, +Reset PPO, -MR, Rt=400ms	SOT-25	28yx	VD5	6g	Tor
52Z	XO6127C54KMR	Vdet-IC	5.4V±0.8%, +Reset PPO, -MR, Rt=800ms	SOT-25	28yx	VD5	6g	Tor
6.2D	MAZL062D	SA-Z-diode	Quad, 6.2V±5%, Zzt=30Ω(5mA), 100mA, 200mW	SOT-23-5	28bc	-	6a	Pan
6.2Z	MAZL062H	SA-Z-diode	Quad, 6.2V±5%, Zzt=30Ω(5mA), 200mW	SC-74A	28bc	-	6a	Pan
6.2Z	MAZM062H	SA-Z-diode	Quad, 6.2V, 5mA, 150mW	SSMini5	30bc	-	6a	Pan
6.2Z	MAZZ062H	SA-Z-diode	Quad, 6.2V, 5mA, 200mW	SMini5	30bc	-	6a	Pan
6.8A	MAZK068D	SA-Z-diode	Quad, 6.8V±5%, Zzt=60Ω(5mA), 100mA, 200mW	SOT-23-5	28bc	-	6a	Pan
6.8D	MAZL068D	SA-Z-diode	Quad, 6.8V±5%, Zzt=20Ω(5mA), 100mA, 200mW	SOT-23-5	28bc	-	6a	Pan
6.8Z	MAZL068H	SA-Z-diode	Quad, 6.8V, 5mA, 200mW	SC-74A	28bc	-	6a	Pan
6.8Z	MAZM068H	SA-Z-diode	Quad, 6.8V, 5mA, 150mW	SSMini5	30bc	-	6a	Pan
6.8Z	MAZZ068H	SA-Z-diode	Quad, 6.8V, 5mA, 200mW	SMini5	30bc	-	6a	Pan
60	RN5RF60AA	LVR-IC	LRip, -CE, 6V±2%, 1A*	SOT-23-5	28vw	VR6	6g	Ric
60	RN5RZ60AA	LVR-IC	LDO, LN, -CE, 6V±2%, 100mA	SOT-23-5	28wrt	VR4	6g	Ric
609	XC9206A093M	DC/DC-IC	PWM st-down, 300kHz, 0.9V±2%, 600mA, +CE	SOT-25	28zq	DC1	6g	Tor
60A	RP102N121B	LVR-IC	LDO, LN, +CE, 1.2V±1%, 300mA	SOT-23-5	28cx	VR4	6g	Ric
60A	XO6127N55AMR	Vdet-IC	5.5V±0.8%, -Reset ODO, -MR, Rt=50ms	SOT-25	28yx	VD4	6g	Tor
60B	RP102N131B	LVR-IC	LDO, LN, +CE, 1.3V±1%, 300mA	SOT-23-5	28cx	VR4	6g	Ric
60B	XO6127N55BMR	Vdet-IC	5.5V±0.8%, -Reset ODO, -MR, Rt=100ms	SOT-25	28yx	VD4	6g	Tor
60C	RP102N151B	LVR-IC	LDO, LN, +CE, 1.5V±1%, 300mA	SOT-23-5	28cx	VR4	6g	Ric
60C	XO6127N55CMR	Vdet-IC	5.5V±0.8%, -Reset ODO, -MR, Rt=200ms	SOT-25	28yx	VD4	6g	Tor
60D	RP102N181B	LVR-IC	LDO, LN, +CE, 1.8V±1%, 300mA	SOT-23-5	28cx	VR4	6g	Ric
60D	XO6127N55DMR	Vdet-IC	5.5V±0.8%, -Reset ODO, -MR, Rt=400ms	SOT-25	28yx	VD4	6g	Tor
60E	RP102N251B	LVR-IC	LDO, LN, +CE, 2.5V±1%, 300mA	SOT-23-5	28cx	VR4	6g	Ric
60E	XO6127N55EMR	Vdet-IC	5.5V±0.8%, -Reset ODO, -MR, Rt=800ms	SOT-25	28yx	VD4	6g	Tor
60F	RP102N261B	LVR-IC	LDO, LN, +CE, 2.6V±1%, 300mA	SOT-23-5	28cx	VR4	6g	Ric
60F	XO6127N55FMR	Vdet-IC	5.5V±0.8%, +Reset ODO, -MR, Rt=50ms	SOT-25	28yx	VD4	6g	Tor
60G	RP102N281B	LVR-IC	LDO, LN, +CE, 2.8V±1%, 300mA	SOT-23-5	28cx	VR4	6g	Ric
60H	RP102N281B5	LVR-IC	LDO, LN, +CE, 2.85V±1%, 300mA	SOT-23-5	28cx	VR4	6g	Ric
60H	XO6127N55GMR	Vdet-IC	5.5V±0.8%, +Reset ODO, -MR, Rt=100ms	SOT-25	28yx	VD4	6g	Tor
60J	RP102N291B	LVR-IC	LDO, LN, +CE, 2.9V±1%, 300mA	SOT-23-5	28cx	VR4	6g	Ric
60K	RP102N301B	LVR-IC	LDO, LN, +CE, 3V±1%, 300mA	SOT-23-5	28cx	VR4	6g	Ric
60K	XO6127N55HMR	Vdet-IC	5.5V±0.8%, +Reset ODO, -MR, Rt=200ms	SOT-25	28yx	VD4	6g	Tor
60L	RP102N331B	LVR-IC	LDO, LN, +CE, 3.3V±1%, 300mA	SOT-23-5	28cx	VR4	6g	Ric
60L	XO6127N55JMR	Vdet-IC	5.5V±0.8%, +Reset ODO, -MR, Rt=400ms	SOT-25	28yx	VD4	6g	Tor
60M	XO6127N55KMR	Vdet-IC	5.5V±0.8%, +Reset ODO, -MR, Rt=800ms	SOT-25	28yx	VD4	6g	Tor
60M	XC9206A096M	DC/DC-IC	PWM st-down, 600kHz, 0.9V±2%, 600mA, +CE	SOT-25	28zq	DC1	6g	Tor
610	XC9206A103M	DC/DC-IC	PWM st-down, 300kHz, 1.0V±2%, 600mA, +CE	SOT-25	28zq	DC1	6g	Tor
611	XC9206A113M	DC/DC-IC	PWM st-down, 300kHz, 1.1V±2%, 600mA, +CE	SOT-25	28zq	DC1	6g	Tor
612	XC9206A123M	DC/DC-IC	PWM st-down, 300kHz, 1.2V±2%, 600mA, +CE	SOT-25	28zq	DC1	6g	Tor
613	XC9206A133M	DC/DC-IC	PWM st-down, 300kHz, 1.3V±2%, 600mA, +CE	SOT-25	28zq	DC1	6g	Tor
614	XC9206A143M	DC/DC-IC	PWM st-down, 300kHz, 1.4V±2%, 600mA, +CE	SOT-25	28zq	DC1	6g	Tor
615	R114N151D	LVR-IC	LDO, LN, +CE, CL, 1.5V±2%, 150mA	SOT-23-5	28cx	VR4	6g	Ric
615	XC9111D151MR	DC/DC-IC	PFM step-up, 100kHz, 1.5V±2.5%, 400mA, +CE	SOT-25	28sd	DC6	6g	Tor
615	XC9206A153M	DC/DC-IC	PWM st-down, 300kHz, 1.5V±2%, 600mA, +CE	SOT-25	28zq	DC1	6g	Tor
616	R114N161D	LVR-IC	LDO, LN, +CE, CL, 1.6V±2%, 150mA	SOT-23-5	28cx	VR4	6g	Ric
616	XC9111D161MR	DC/DC-IC	PFM step-up, 100kHz, 1.6V±2.5%, 400mA, +CE	SOT-25	28sd	DC6	6g	Tor
616	XC9206A163M	DC/DC-IC	PWM st-down, 300kHz, 1.6V±2%, 600mA, +CE	SOT-25	28zq	DC1	6g	Tor
617	R114N171D	LVR-IC	LDO, LN, +CE, CL, 1.7V±2%, 150mA	SOT-23-5	28cx	VR4	6g	Ric



SMD code	Type	Function	Short description	Case	Pinout	Sch.	St.	Mnf.
617	XC9111D171MR	DC/DC-IC	PFM step-up, 100kHz, 1.7V±2.5%, 400mA, +CE	SOT-25	28sd	DC6	6g	Tor
617	XC9206A173M	DC/DC-IC	PWM st-down, 300kHz, 1.7V±2%, 600mA, +CE	SOT-25	28zq	DC1	6g	Tor
618	R1114N181D	LVR-IC	LDO, LN, +CE, CL, 1.8V±2%, 150mA	SOT-23-5	28cx	VR4	6g	Ric
618	XC9111D181MR	DC/DC-IC	PFM step-up, 100kHz, 1.8V±2.5%, 400mA, +CE	SOT-25	28sd	DC6	6g	Tor
618	XC9206A183M	DC/DC-IC	PWM st-down, 300kHz, 1.8V±2%, 600mA, +CE	SOT-25	28zq	DC1	6g	Tor
619	R1114N191D	LVR-IC	LDO, LN, +CE, CL, 1.9V±2%, 150mA	SOT-23-5	28cx	VR4	6g	Ric
619	XC9111D191MR	DC/DC-IC	PFM step-up, 100kHz, 1.9V±2.5%, 400mA, +CE	SOT-25	28sd	DC6	6g	Tor
619	XC9206A193M	DC/DC-IC	PWM st-down, 300kHz, 1.9V±2%, 600mA, +CE	SOT-25	28zq	DC1	6g	Tor
61A	RP102N121D	LVR-IC	LDO, LN, +CE, CL, 1.2V±1%, 300mA	SOT-23-5	28cx	VR4	6g	Ric
61A	XC9206A106M	DC/DC-IC	PWM st-down, 600kHz, 1.0V±2%, 600mA, +CE	SOT-25	28zq	DC1	6g	Tor
61B	RP102N131D	LVR-IC	LDO, LN, +CE, CL, 1.3V±1%, 300mA	SOT-23-5	28cx	VR4	6g	Ric
61B	XC9206A116M	DC/DC-IC	PWM st-down, 600kHz, 1.1V±2%, 600mA, +CE	SOT-25	28zq	DC1	6g	Tor
61C	RP102N151D	LVR-IC	LDO, LN, +CE, CL, 1.5V±1%, 300mA	SOT-23-5	28cx	VR4	6g	Ric
61C	XC9206A126M	DC/DC-IC	PWM st-down, 600kHz, 1.2V±2%, 600mA, +CE	SOT-25	28zq	DC1	6g	Tor
61D	RP102N181D	LVR-IC	LDO, LN, +CE, CL, 1.8V±1%, 300mA	SOT-23-5	28cx	VR4	6g	Ric
61D	XC9206A136M	DC/DC-IC	PWM st-down, 600kHz, 1.3V±2%, 600mA, +CE	SOT-25	28zq	DC1	6g	Tor
61E	RP102N251D	LVR-IC	LDO, LN, +CE, CL, 2.5V±1%, 300mA	SOT-23-5	28cx	VR4	6g	Ric
61E	XC9206A146M	DC/DC-IC	PWM st-down, 600kHz, 1.4V±2%, 600mA, +CE	SOT-25	28zq	DC1	6g	Tor
61F	RP102N261D	LVR-IC	LDO, LN, +CE, CL, 2.6V±1%, 300mA	SOT-23-5	28cx	VR4	6g	Ric
61F	XC9206A156M	DC/DC-IC	PWM st-down, 600kHz, 1.5V±2%, 600mA, +CE	SOT-25	28zq	DC1	6g	Tor
61G	RP102N281D	LVR-IC	LDO, LN, +CE, CL, 2.8V±1%, 300mA	SOT-23-5	28cx	VR4	6g	Ric
61H	RP102N281D5	LVR-IC	LDO, LN, +CE, CL, 2.85V±1%, 300mA	SOT-23-5	28cx	VR4	6g	Ric
61H	XC9206A166M	DC/DC-IC	PWM st-down, 600kHz, 1.6V±2%, 600mA, +CE	SOT-25	28zq	DC1	6g	Tor
61J	RP102N291D	LVR-IC	LDO, LN, +CE, CL, 2.9V±1%, 300mA	SOT-23-5	28cx	VR4	6g	Ric
61K	RP102N301D	LVR-IC	LDO, LN, +CE, CL, 3V±1%, 300mA	SOT-23-5	28cx	VR4	6g	Ric
61K	XC9206A176M	DC/DC-IC	PWM st-down, 600kHz, 1.7V±2%, 600mA, +CE	SOT-25	28zq	DC1	6g	Tor
61L	RP102N331D	LVR-IC	LDO, LN, +CE, CL, 3.3V±1%, 300mA	SOT-23-5	28cx	VR4	6g	Ric
61L	XC9206A186M	DC/DC-IC	PWM st-down, 600kHz, 1.8V±2%, 600mA, +CE	SOT-25	28zq	DC1	6g	Tor
61M	XC9206A196M	DC/DC-IC	PWM st-down, 600kHz, 1.9V±2%, 600mA, +CE	SOT-25	28zq	DC1	6g	Tor
61Y	XC9206A1L6M	DC/DC-IC	PWM st-down, 600kHz, 1.85V±2%, 600mA, +CE	SOT-25	28zq	DC1	6g	Tor
61Z	XC9206A1L3M	DC/DC-IC	PWM st-down, 300kHz, 1.85V±2%, 600mA, +CE	SOT-25	28zq	DC1	6g	Tor
620	R1114N201D	LVR-IC	LDO, LN, +CE, CL, 2V±2%, 150mA	SOT-23-5	28cx	VR4	6g	Ric
620	XC9111D201MR	DC/DC-IC	PFM step-up, 100kHz, 2.0V±2.5%, 400mA, +CE	SOT-25	28sd	DC6	6g	Tor
620	XC9206A203M	DC/DC-IC	PWM st-down, 300kHz, 2.0V±2%, 600mA, +CE	SOT-25	28zq	DC1	6g	Tor
621	R1114N211D	LVR-IC	LDO, LN, +CE, CL, 2.1V±2%, 150mA	SOT-23-5	28cx	VR4	6g	Ric
621	XC9111D211MR	DC/DC-IC	PFM step-up, 100kHz, 2.1V±2.5%, 400mA, +CE	SOT-25	28sd	DC6	6g	Tor
621	XC9206A213M	DC/DC-IC	PWM st-down, 300kHz, 2.1V±2%, 600mA, +CE	SOT-25	28zq	DC1	6g	Tor
622	R1114N221D	LVR-IC	LDO, LN, +CE, CL, 2.2V±2%, 150mA	SOT-23-5	28cx	VR4	6g	Ric
622	XC9111D221MR	DC/DC-IC	PFM step-up, 100kHz, 2.2V±2.5%, 400mA, +CE	SOT-25	28sd	DC6	6g	Tor
622	XC9206A223M	DC/DC-IC	PWM st-down, 300kHz, 2.2V±2%, 600mA, +CE	SOT-25	28zq	DC1	6g	Tor
623	R1114N231D	LVR-IC	LDO, LN, +CE, CL, 2.3V±2%, 150mA	SOT-23-5	28cx	VR4	6g	Ric
623	XC9111D231MR	DC/DC-IC	PFM step-up, 100kHz, 2.3V±2.5%, 400mA, +CE	SOT-25	28sd	DC6	6g	Tor
623	XC9206A233M	DC/DC-IC	PWM st-down, 300kHz, 2.3V±2%, 600mA, +CE	SOT-25	28zq	DC1	6g	Tor
624	R1114N241D	LVR-IC	LDO, LN, +CE, CL, 2.4V±2%, 150mA	SOT-23-5	28cx	VR4	6g	Ric
624	XC9111D241MR	DC/DC-IC	PFM step-up, 100kHz, 2.4V±2.5%, 400mA, +CE	SOT-25	28sd	DC6	6g	Tor
624	XC9206A243M	DC/DC-IC	PWM st-down, 300kHz, 2.4V±2%, 600mA, +CE	SOT-25	28zq	DC1	6g	Tor
625	R1114N251D	LVR-IC	LDO, LN, +CE, CL, 2.5V±2%, 150mA	SOT-23-5	28cx	VR4	6g	Ric
625	XC9111D251MR	DC/DC-IC	PFM step-up, 100kHz, 2.5V±2.5%, 400mA, +CE	SOT-25	28sd	DC6	6g	Tor
625	XC9206A253M	DC/DC-IC	PWM st-down, 300kHz, 2.5V±2%, 600mA, +CE	SOT-25	28zq	DC1	6g	Tor
626	R1114N261D	LVR-IC	LDO, LN, +CE, CL, 2.6V±2%, 150mA	SOT-23-5	28cx	VR4	6g	Ric
626	XC9111D261MR	DC/DC-IC	PFM step-up, 100kHz, 2.6V±2.5%, 400mA, +CE	SOT-25	28sd	DC6	6g	Tor
626	XC9206A263M	DC/DC-IC	PWM st-down, 300kHz, 2.6V±2%, 600mA, +CE	SOT-25	28zq	DC1	6g	Tor
627	R1114N271D	LVR-IC	LDO, LN, +CE, CL, 2.7V±2%, 150mA	SOT-23-5	28cx	VR4	6g	Ric
627	XC9111D271MR	DC/DC-IC	PFM step-up, 100kHz, 2.7V±2.5%, 400mA, +CE	SOT-25	28sd	DC6	6g	Tor
627	XC9206A273M	DC/DC-IC	PWM st-down, 300kHz, 2.7V±2%, 600mA, +CE	SOT-25	28zq	DC1	6g	Tor
628	R1114N281D	LVR-IC	LDO, LN, +CE, CL, 2.8V±2%, 150mA	SOT-23-5	28cx	VR4	6g	Ric
628	XC9111D281MR	DC/DC-IC	PFM step-up, 100kHz, 2.8V±2.5%, 400mA, +CE	SOT-25	28sd	DC6	6g	Tor
628	XC9206A283M	DC/DC-IC	PWM st-down, 300kHz, 2.8V±2%, 600mA, +CE	SOT-25	28zq	DC1	6g	Tor
629	R1114N291D	LVR-IC	LDO, LN, +CE, CL, 2.9V±2%, 150mA	SOT-23-5	28cx	VR4	6g	Ric
629	XC9111D291MR	DC/DC-IC	PFM step-up, 100kHz, 2.9V±2.5%, 400mA, +CE	SOT-25	28sd	DC6	6g	Tor
629	XC9206A293M	DC/DC-IC	PWM st-down, 300kHz, 2.9V±2%, 600mA, +CE	SOT-25	28zq	DC1	6g	Tor
62A	XC9206A206M	DC/DC-IC	PWM st-down, 600kHz, 2.0V±2%, 600mA, +CE	SOT-25	28zq	DC1	6g	Tor
62B	XC9206A216M	DC/DC-IC	PWM st-down, 600kHz, 2.1V±2%, 600mA, +CE	SOT-25	28zq	DC1	6g	Tor
62C	XC9206A226M	DC/DC-IC	PWM st-down, 600kHz, 2.2V±2%, 600mA, +CE	SOT-25	28zq	DC1	6g	Tor
62D	XC9206A236M	DC/DC-IC	PWM st-down, 600kHz, 2.3V±2%, 600mA, +CE	SOT-25	28zq	DC1	6g	Tor
62E	XC9206A246M	DC/DC-IC	PWM st-down, 600kHz, 2.4V±2%, 600mA, +CE	SOT-25	28zq	DC1	6g	Tor
62F	XC9206A256M	DC/DC-IC	PWM st-down, 600kHz, 2.5V±2%, 600mA, +CE	SOT-25	28zq	DC1	6g	Tor
62H	XC9206A266M	DC/DC-IC	PWM st-down, 600kHz, 2.6V±2%, 600mA, +CE	SOT-25	28zq	DC1	6g	Tor
62K	XC9206A276M	DC/DC-IC	PWM st-down, 600kHz, 2.7V±2%, 600mA, +CE	SOT-25	28zq	DC1	6g	Tor
62L	XC9206A286M	DC/DC-IC	PWM st-down, 600kHz, 2.8V±2%, 600mA, +CE	SOT-25	28zq	DC1	6g	Tor



SMD code	Type	Function	Short description	Case	Pinout	Sch.	St.	Mnf.
62M	XC9206A296M	DC/DC-IC	PWM st-down, 600kHz, 2.9V±2%, 600mA, +CE	SOT-25	28zq	DC1	6g	Tor
62N	HZL6 22MFA	TVS	Quad, 6.2V, 200mW	SOT-23-5	28bc	-	6a	Ren
62Y	XC9206A2L6M	DC/DC-IC	PWM st-down, 600kHz, 2.85V±2%, 600mA, +CE	SOT-25	28zq	DC1	6g	Tor
62Z	XC9206A2L3M	DC/DC-IC	PWM st-down, 300kHz, 2.85V±2%, 600mA, +CE	SOT-25	28zq	DC1	6g	Tor
630	R1114N301D	LVR-IC	LDO, LN, +CE, CL, 3V±2%, 150mA	SOT-23-5	28cx	VR4	6g	Ric
630	XC9111D301MR	DC/DC-IC	PFM step-up, 100kHz, 3.0V±2.5%, 400mA, +CE	SOT-25	28sd	DC6	6g	Tor
630	XC9206A303M	DC/DC-IC	PWM st-down, 300kHz, 3.0V±2%, 600mA, +CE	SOT-25	28zq	DC1	6g	Tor
631	R1114N311D	LVR-IC	LDO, LN, +CE, CL, 3.1V±2%, 150mA	SOT-23-5	28cx	VR4	6g	Ric
631	XC9111D311MR	DC/DC-IC	PFM step-up, 100kHz, 3.1V±2.5%, 400mA, +CE	SOT-25	28sd	DC6	6g	Tor
631	XC9206A313M	DC/DC-IC	PWM st-down, 300kHz, 3.1V±2%, 600mA, +CE	SOT-25	28zq	DC1	6g	Tor
632	R1114N321D	LVR-IC	LDO, LN, +CE, CL, 3.2V±2%, 150mA	SOT-23-5	28cx	VR4	6g	Ric
632	XC9111D321MR	DC/DC-IC	PFM step-up, 100kHz, 3.2V±2.5%, 400mA, +CE	SOT-25	28sd	DC6	6g	Tor
632	XC9206A323M	DC/DC-IC	PWM st-down, 300kHz, 3.2V±2%, 600mA, +CE	SOT-25	28zq	DC1	6g	Tor
633	R1114N331D	LVR-IC	LDO, LN, +CE, CL, 3.3V±2%, 150mA	SOT-23-5	28cx	VR4	6g	Ric
633	XC9111D331MR	DC/DC-IC	PFM step-up, 100kHz, 3.3V±2.5%, 400mA, +CE	SOT-25	28sd	DC6	6g	Tor
633	XC9206A333M	DC/DC-IC	PWM st-down, 300kHz, 3.3V±2%, 600mA, +CE	SOT-25	28zq	DC1	6g	Tor
634	R1114N341D	LVR-IC	LDO, LN, +CE, CL, 3.4V±2%, 150mA	SOT-23-5	28cx	VR4	6g	Ric
634	XC9111D341MR	DC/DC-IC	PFM step-up, 100kHz, 3.4V±2.5%, 400mA, +CE	SOT-25	28sd	DC6	6g	Tor
634	XC9206A343M	DC/DC-IC	PWM st-down, 300kHz, 3.4V±2%, 600mA, +CE	SOT-25	28zq	DC1	6g	Tor
635	R1114N351D	LVR-IC	LDO, LN, +CE, CL, 3.5V±2%, 150mA	SOT-23-5	28cx	VR4	6g	Ric
635	XC9111D351MR	DC/DC-IC	PFM step-up, 100kHz, 3.5V±2.5%, 400mA, +CE	SOT-25	28sd	DC6	6g	Tor
635	XC9206A353M	DC/DC-IC	PWM st-down, 300kHz, 3.5V±2%, 600mA, +CE	SOT-25	28zq	DC1	6g	Tor
636	R1114N361D	LVR-IC	LDO, LN, +CE, CL, 3.6V±2%, 150mA	SOT-23-5	28cx	VR4	6g	Ric
636	XC9111D361MR	DC/DC-IC	PFM step-up, 100kHz, 3.6V±2.5%, 400mA, +CE	SOT-25	28sd	DC6	6g	Tor
636	XC9206A363M	DC/DC-IC	PWM st-down, 300kHz, 3.6V±2%, 600mA, +CE	SOT-25	28zq	DC1	6g	Tor
637	R1114N371D	LVR-IC	LDO, LN, +CE, CL, 3.7V±2%, 150mA	SOT-23-5	28cx	VR4	6g	Ric
637	XC9111D371MR	DC/DC-IC	PFM step-up, 100kHz, 3.7V±2.5%, 400mA, +CE	SOT-25	28sd	DC6	6g	Tor
637	XC9206A373M	DC/DC-IC	PWM st-down, 300kHz, 3.7V±2%, 600mA, +CE	SOT-25	28zq	DC1	6g	Tor
638	R1114N381D	LVR-IC	LDO, LN, +CE, CL, 3.8V±2%, 150mA	SOT-23-5	28cx	VR4	6g	Ric
638	XC9111D381MR	DC/DC-IC	PFM step-up, 100kHz, 3.8V±2.5%, 400mA, +CE	SOT-25	28sd	DC6	6g	Tor
638	XC9206A383M	DC/DC-IC	PWM st-down, 300kHz, 3.8V±2%, 600mA, +CE	SOT-25	28zq	DC1	6g	Tor
639	R1114N391D	LVR-IC	LDO, LN, +CE, CL, 3.9V±2%, 150mA	SOT-23-5	28cx	VR4	6g	Ric
639	XC9111D391MR	DC/DC-IC	PFM step-up, 100kHz, 3.9V±2.5%, 400mA, +CE	SOT-25	28sd	DC6	6g	Tor
639	XC9206A393M	DC/DC-IC	PWM st-down, 300kHz, 3.9V±2%, 600mA, +CE	SOT-25	28zq	DC1	6g	Tor
63A	XC9206A306M	DC/DC-IC	PWM st-down, 600kHz, 3.0V±2%, 600mA, +CE	SOT-25	28zq	DC1	6g	Tor
63B	XC9206A316M	DC/DC-IC	PWM st-down, 600kHz, 3.1V±2%, 600mA, +CE	SOT-25	28zq	DC1	6g	Tor
63C	XC9206A326M	DC/DC-IC	PWM st-down, 600kHz, 3.2V±2%, 600mA, +CE	SOT-25	28zq	DC1	6g	Tor
63D	XC9206A336M	DC/DC-IC	PWM st-down, 600kHz, 3.3V±2%, 600mA, +CE	SOT-25	28zq	DC1	6g	Tor
63E	XC9206A346M	DC/DC-IC	PWM st-down, 600kHz, 3.4V±2%, 600mA, +CE	SOT-25	28zq	DC1	6g	Tor
63F	XC9206A356M	DC/DC-IC	PWM st-down, 600kHz, 3.5V±2%, 600mA, +CE	SOT-25	28zq	DC1	6g	Tor
63H	XC9206A366M	DC/DC-IC	PWM st-down, 600kHz, 3.6V±2%, 600mA, +CE	SOT-25	28zq	DC1	6g	Tor
63K	XC9206A376M	DC/DC-IC	PWM st-down, 600kHz, 3.7V±2%, 600mA, +CE	SOT-25	28zq	DC1	6g	Tor
63L	XC9206A386M	DC/DC-IC	PWM st-down, 600kHz, 3.8V±2%, 600mA, +CE	SOT-25	28zq	DC1	6g	Tor
63M	XC9206A396M	DC/DC-IC	PWM st-down, 600kHz, 3.9V±2%, 600mA, +CE	SOT-25	28zq	DC1	6g	Tor
64	MIC5366-1.2YMT	LVR-IC	LDO, 1.2V±2%, 150mA, +CE, CL	SC-70-5	28gf	VR4	6g	Mcr
640	R1114N401D	LVR-IC	LDO, LN, +CE, CL, 4V±2%, 150mA	SOT-23-5	28cx	VR4	6g	Ric
640	XC9111D401MR	DC/DC-IC	PFM step-up, 100kHz, 4.0V±2.5%, 400mA, +CE	SOT-25	28sd	DC6	6g	Tor
640	XC9206A403M	DC/DC-IC	PWM st-down, 300kHz, 4.0V±2%, 600mA, +CE	SOT-25	28zq	DC1	6g	Tor
641	R1114N281D5	LVR-IC	LDO, LN, +CE, CL, 2.8V±2%, 150mA	SOT-23-5	28cx	VR4	6g	Ric
641	XC9111D411MR	DC/DC-IC	PFM step-up, 100kHz, 4.1V±2.5%, 400mA, +CE	SOT-25	28sd	DC6	6g	Tor
642	XC9111D421MR	DC/DC-IC	PFM step-up, 100kHz, 4.2V±2.5%, 400mA, +CE	SOT-25	28sd	DC6	6g	Tor
643	XC9111D431MR	DC/DC-IC	PFM step-up, 100kHz, 4.3V±2.5%, 400mA, +CE	SOT-25	28sd	DC6	6g	Tor
644	XC9111D441MR	DC/DC-IC	PFM step-up, 100kHz, 4.4V±2.5%, 400mA, +CE	SOT-25	28sd	DC6	6g	Tor
645	XC9111D451MR	DC/DC-IC	PFM step-up, 100kHz, 4.5V±2.5%, 400mA, +CE	SOT-25	28sd	DC6	6g	Tor
646	XC9111D461MR	DC/DC-IC	PFM step-up, 100kHz, 4.6V±2.5%, 400mA, +CE	SOT-25	28sd	DC6	6g	Tor
647	XC9111D471MR	DC/DC-IC	PFM step-up, 100kHz, 4.7V±2.5%, 400mA, +CE	SOT-25	28sd	DC6	6g	Tor
648	XC9111D481MR	DC/DC-IC	PFM step-up, 100kHz, 4.8V±2.5%, 400mA, +CE	SOT-25	28sd	DC6	6g	Tor
649	XC9111D491MR	DC/DC-IC	PFM step-up, 100kHz, 4.9V±2.5%, 400mA, +CE	SOT-25	28sd	DC6	6g	Tor
64A	XC9206A406M	DC/DC-IC	PWM st-down, 600kHz, 4.0V±2%, 600mA, +CE	SOT-25	28zq	DC1	6g	Tor
65	MIC5366-1.3YMT	LVR-IC	LDO, 1.3V±2%, 150mA, +CE, CL	SC-70-5	28gf	VR4	6g	Mcr
650	XC9111D501MR	DC/DC-IC	PFM step-up, 100kHz, 5.0V±2.5%, 400mA, +CE	SOT-25	28sd	DC6	6g	Tor
651	XC9111D511MR	DC/DC-IC	PFM step-up, 100kHz, 5.1V±2.5%, 400mA, +CE	SOT-25	28sd	DC6	6g	Tor
652	XC9111D521MR	DC/DC-IC	PFM step-up, 100kHz, 5.2V±2.5%, 400mA, +CE	SOT-25	28sd	DC6	6g	Tor
653	XC9111D531MR	DC/DC-IC	PFM step-up, 100kHz, 5.3V±2.5%, 400mA, +CE	SOT-25	28sd	DC6	6g	Tor
654	XC9111D541MR	DC/DC-IC	PFM step-up, 100kHz, 5.4V±2.5%, 400mA, +CE	SOT-25	28sd	DC6	6g	Tor
655	XC9111D551MR	DC/DC-IC	PFM step-up, 100kHz, 5.5V±2.5%, 400mA, +CE	SOT-25	28sd	DC6	6g	Tor
656	XC9111D561MR	DC/DC-IC	PFM step-up, 100kHz, 5.6V±2.5%, 400mA, +CE	SOT-25	28sd	DC6	6g	Tor
657	XC9111D571MR	DC/DC-IC	PFM step-up, 100kHz, 5.7V±2.5%, 400mA, +CE	SOT-25	28sd	DC6	6g	Tor
658	XC9111D581MR	DC/DC-IC	PFM step-up, 100kHz, 5.8V±2.5%, 400mA, +CE	SOT-25	28sd	DC6	6g	Tor
659	XC9111D591MR	DC/DC-IC	PFM step-up, 100kHz, 5.9V±2.5%, 400mA, +CE	SOT-25	28sd	DC6	6g	Tor



SMD code	Type	Function	Short description	Case	Pinout	Sch.	St.	Mnf.
660	XC9111D601MR	DC/DC-IC	PFM step-up, 100kHz, 6.0V±2.5%, 400mA, +CE	SOT-25	28sd	DC6	6g	Tor
661	XC9111D611MR	DC/DC-IC	PFM step-up, 100kHz, 6.1V±2.5%, 400mA, +CE	SOT-25	28sd	DC6	6g	Tor
662	XC9111D621MR	DC/DC-IC	PFM step-up, 100kHz, 6.2V±2.5%, 400mA, +CE	SOT-25	28sd	DC6	6g	Tor
663	XC9111D631MR	DC/DC-IC	PFM step-up, 100kHz, 6.3V±2.5%, 400mA, +CE	SOT-25	28sd	DC6	6g	Tor
664	XC9111D641MR	DC/DC-IC	PFM step-up, 100kHz, 6.4V±2.5%, 400mA, +CE	SOT-25	28sd	DC6	6g	Tor
665	XC9111D651MR	DC/DC-IC	PFM step-up, 100kHz, 6.5V±2.5%, 400mA, +CE	SOT-25	28sd	DC6	6g	Tor
666	XC9111D661MR	DC/DC-IC	PFM step-up, 100kHz, 6.6V±2.5%, 400mA, +CE	SOT-25	28sd	DC6	6g	Tor
667	XC9111D671MR	DC/DC-IC	PFM step-up, 100kHz, 6.7V±2.5%, 400mA, +CE	SOT-25	28sd	DC6	6g	Tor
668	XC9111D681MR	DC/DC-IC	PFM step-up, 100kHz, 6.8V±2.5%, 400mA, +CE	SOT-25	28sd	DC6	6g	Tor
669	XC9111D691MR	DC/DC-IC	PFM step-up, 100kHz, 6.9V±2.5%, 400mA, +CE	SOT-25	28sd	DC6	6g	Tor
670	XC9111D701MR	DC/DC-IC	PFM step-up, 100kHz, 7.0V±2.5%, 400mA, +CE	SOT-25	28sd	DC6	6g	Tor
6A0	XC6107A031MR	Vdet-IC	3.1V±2%, Hst, -MR, +Rst PPO, -Rst ODO, Rt=3.13ms	SOT-25	28xf	VD22	6g	Tor
6A1	XC6107A032MR	Vdet-IC	3.2V±2%, Hst, -MR, +Rst PPO, -Rst ODO, Rt=3.13ms	SOT-25	28xf	VD22	6g	Tor
6A2	XC6107A033MR	Vdet-IC	3.3V±2%, Hst, -MR, +Rst PPO, -Rst ODO, Rt=3.13ms	SOT-25	28xf	VD22	6g	Tor
6A3	XC6107A034MR	Vdet-IC	3.4V±2%, Hst, -MR, +Rst PPO, -Rst ODO, Rt=3.13ms	SOT-25	28xf	VD22	6g	Tor
6A4	XC6107A035MR	Vdet-IC	3.5V±2%, Hst, -MR, +Rst PPO, -Rst ODO, Rt=3.13ms	SOT-25	28xf	VD22	6g	Tor
6A5	XC6107A036MR	Vdet-IC	3.6V±2%, Hst, -MR, +Rst PPO, -Rst ODO, Rt=3.13ms	SOT-25	28xf	VD22	6g	Tor
6A6	XC6107A037MR	Vdet-IC	3.7V±2%, Hst, -MR, +Rst PPO, -Rst ODO, Rt=3.13ms	SOT-25	28xf	VD22	6g	Tor
6A7	XC6107A038MR	Vdet-IC	3.8V±2%, Hst, -MR, +Rst PPO, -Rst ODO, Rt=3.13ms	SOT-25	28xf	VD22	6g	Tor
6A8	XC9237A08CMR	DC-DC-IC	PWM-PWM/PFM, st-dwn, 0.8V±2%, 600mA, 1.2MHz, Vin>2V, LSST	SOT-25	28dc4	DC1	6g	Tor
6A8	XC6107A039MR	Vdet-IC	3.9V±2%, Hst, -MR, +Rst PPO, -Rst ODO, Rt=3.13ms	SOT-25	28xf	VD22	6g	Tor
6A9	XC9237A09CMR	DC-DC-IC	PWM-PWM/PFM, st-dwn, 0.9V±2%, 600mA, 1.2MHz, Vin>2V, LSST	SOT-25	28dc4	DC1	6g	Tor
6A9	XC6107A040MR	Vdet-IC	4.0V±2%, Hst, -MR, +Rst PPO, -Rst ODO, Rt=3.13ms	SOT-25	28xf	VD22	6g	Tor
6Aa	FT531Aa	LVR-IC	LDO, 1.3V±2%, 300mA, +CE	SOT-23-5	28cx	VR4	6g	Fmd
6AA	XC6127N15AMR	Vdet-IC	1.5V±0.8%, -Reset ODO, -MR, Rt=50ms	SOT-25	28yx	VD4	6g	Tor
6AA	XC6107A041MR	Vdet-IC	4.1V±2%, Hst, -MR, +Rst PPO, -Rst ODO, Rt=3.13ms	SOT-25	28xf	VD22	6g	Tor
6Ab	FT531Ab	LVR-IC	LDO, 1.3V±2%, 300mA, +CE	SOT-23-5	28vc	VR4	6g	Fmd
6Ab	XC6127N15BMR	Vdet-IC	1.5V±0.8%, -Reset ODO, -MR, Rt=100ms	SOT-25	28yx	VD4	6g	Tor
6AB	XC6107A042MR	Vdet-IC	4.2V±2%, Hst, -MR, +Rst PPO, -Rst ODO, Rt=3.13ms	SOT-25	28xf	VD22	6g	Tor
6Ac	FT531Ac	LVR-IC	LDO, 1.3V±2%, 300mA, +CE	SOT-23-5	28xm	VR4	6g	Fmd
6AC	XC6127N15CMR	Vdet-IC	1.5V±0.8%, -Reset ODO, -MR, Rt=200ms	SOT-25	28yx	VD4	6g	Tor
6AC	XC6107A043MR	Vdet-IC	4.3V±2%, Hst, -MR, +Rst PPO, -Rst ODO, Rt=3.13ms	SOT-25	28xf	VD22	6g	Tor
6Ad	FT531Ad	LVR-IC	LDO, 1.3V±2%, 300mA, +CE	SC-70-5	28cx	VR4	6g	Fmd
6AD	XC6127N15DMR	Vdet-IC	1.5V±0.8%, -Reset ODO, -MR, Rt=400ms	SOT-25	28yx	VD4	6g	Tor
6AD	XC6107A044MR	Vdet-IC	4.4V±2%, Hst, -MR, +Rst PPO, -Rst ODO, Rt=3.13ms	SOT-25	28xf	VD22	6g	Tor
6Ae	FT531Ae	LVR-IC	LDO, 1.3V±2%, 300mA, +CE	SC-70-5	28vc	VR4	6g	Fmd
6AE	XC6127N15EMR	Vdet-IC	1.5V±0.8%, -Reset ODO, -MR, Rt=800ms	SOT-25	28yx	VD4	6g	Tor
6AE	XC6107A045MR	Vdet-IC	4.5V±2%, Hst, -MR, +Rst PPO, -Rst ODO, Rt=3.13ms	SOT-25	28xf	VD22	6g	Tor
6Af	FT531Af	LVR-IC	LDO, 1.3V±2%, 300mA, +CE	SC-70-5	28xm	VR4	6g	Fmd
6AF	XC6127N15FMR	Vdet-IC	1.5V±0.8%, +Reset ODO, -MR, Rt=50ms	SOT-25	28yx	VD4	6g	Tor
6AF	XC6107A016MR	Vdet-IC	1.6V±2%, Hst, -MR, +Rst PPO, -Rst ODO, Rt=3.13ms	SOT-25	28xf	VD22	6g	Tor
6AF	XC6107A046MR	Vdet-IC	4.6V±2%, Hst, -MR, +Rst PPO, -Rst ODO, Rt=3.13ms	SOT-25	28xf	VD22	6g	Tor
6AH	XC6127N15GMR	Vdet-IC	1.5V±0.8%, +Reset ODO, -MR, Rt=100ms	SOT-25	28yx	VD4	6g	Tor
6AH	XC6107A017MR	Vdet-IC	1.7V±2%, Hst, -MR, +Rst PPO, -Rst ODO, Rt=3.13ms	SOT-25	28xf	VD22	6g	Tor
6AH	XC6107A047MR	Vdet-IC	4.7V±2%, Hst, -MR, +Rst PPO, -Rst ODO, Rt=3.13ms	SOT-25	28xf	VD22	6g	Tor
6AK	XC6127N15HMR	Vdet-IC	1.5V±0.8%, +Reset ODO, -MR, Rt=200ms	SOT-25	28yx	VD4	6g	Tor
6AK	XC6107A018MR	Vdet-IC	1.8V±2%, Hst, -MR, +Rst PPO, -Rst ODO, Rt=3.13ms	SOT-25	28xf	VD22	6g	Tor
6AK	XC6107A048MR	Vdet-IC	4.8V±2%, Hst, -MR, +Rst PPO, -Rst ODO, Rt=3.13ms	SOT-25	28xf	VD22	6g	Tor
6AL	XC6127N15JMR	Vdet-IC	1.5V±0.8%, +Reset ODO, -MR, Rt=400ms	SOT-25	28yx	VD4	6g	Tor
6AL	XC9237A0LCMR	DC-DC-IC	PWM-PWM/PFM, st-dwn, 0.85V±2%, 600mA, 1.2MHz, Vin>2V, LSST	SOT-25	28dc4	DC1	6g	Tor
6AL	XC6107A019MR	Vdet-IC	1.9V±2%, Hst, -MR, +Rst PPO, -Rst ODO, Rt=3.13ms	SOT-25	28xf	VD22	6g	Tor
6AL	XC6107A049MR	Vdet-IC	4.9V±2%, Hst, -MR, +Rst PPO, -Rst ODO, Rt=3.13ms	SOT-25	28xf	VD22	6g	Tor
6AM	XC6127N15KMR	Vdet-IC	1.5V±0.8%, +Reset ODO, -MR, Rt=800ms	SOT-25	28yx	VD4	6g	Tor
6AM	XC9237A0MCMR	DC-DC-IC	PWM-PWM/PFM, st-dwn, 0.95V±2%, 600mA, 1.2MHz, Vin>2V, LSST	SOT-25	28dc4	DC1	6g	Tor
6AM	XC6107A020MR	Vdet-IC	2.0V±2%, Hst, -MR, +Rst PPO, -Rst ODO, Rt=3.13ms	SOT-25	28xf	VD22	6g	Tor
6AM	XC6107A050MR	Vdet-IC	5.0V±2%, Hst, -MR, +Rst PPO, -Rst ODO, Rt=3.13ms	SOT-25	28xf	VD22	6g	Tor
6AM	XC9206A09CM	DC/DC-IC	PWM st-dwn, 1.2MHz, 0.9V±2%, 600mA, +CE	SOT-25	28zq	DC1	6g	Tor
6AN	XC6127N16AMR	Vdet-IC	1.6V±0.8%, -Reset ODO, -MR, Rt=50ms	SOT-25	28yx	VD4	6g	Tor
6AN	XC6107A021MR	Vdet-IC	2.1V±2%, Hst, -MR, +Rst PPO, -Rst ODO, Rt=3.13ms	SOT-25	28xf	VD22	6g	Tor
6AP	XC6127N16BMR	Vdet-IC	1.6V±0.8%, -Reset ODO, -MR, Rt=100ms	SOT-25	28yx	VD4	6g	Tor
6AP	XC6107A022MR	Vdet-IC	2.2V±2%, Hst, -MR, +Rst PPO, -Rst ODO, Rt=3.13ms	SOT-25	28xf	VD22	6g	Tor
6AR	XC6127N16CMR	Vdet-IC	1.6V±0.8%, -Reset ODO, -MR, Rt=200ms	SOT-25	28yx	VD4	6g	Tor
6AR	XC6107A023MR	Vdet-IC	2.3V±2%, Hst, -MR, +Rst PPO, -Rst ODO, Rt=3.13ms	SOT-25	28xf	VD22	6g	Tor
6AS	XC6127N16DMR	Vdet-IC	1.6V±0.8%, -Reset ODO, -MR, Rt=400ms	SOT-25	28yx	VD4	6g	Tor
6AS	XC6107A024MR	Vdet-IC	2.4V±2%, Hst, -MR, +Rst PPO, -Rst ODO, Rt=3.13ms	SOT-25	28xf	VD22	6g	Tor
6AT	XC6127N16EMR	Vdet-IC	1.6V±0.8%, -Reset ODO, -MR, Rt=800ms	SOT-25	28yx	VD4	6g	Tor
6AT	XC6107A025MR	Vdet-IC	2.5V±2%, Hst, -MR, +Rst PPO, -Rst ODO, Rt=3.13ms	SOT-25	28xf	VD22	6g	Tor
6AU	XC6127N16FMR	Vdet-IC	1.6V±0.8%, +Reset ODO, -MR, Rt=50ms	SOT-25	28yx	VD4	6g	Tor
6AU	XC6107A026MR	Vdet-IC	2.6V±2%, Hst, -MR, +Rst PPO, -Rst ODO, Rt=3.13ms	SOT-25	28xf	VD22	6g	Tor
6AV	XC6127N16GMR	Vdet-IC	1.6V±0.8%, +Reset ODO, -MR, Rt=100ms	SOT-25	28yx	VD4	6g	Tor



SMD code	Type	Function	Short description	Case	Pinout	Sch.	St.	Mnf.
6AV	XC6107A027MR	Vdet-IC	2.7V±2%, Hst, -MR, +Rst PPO, -Rst ODO, Rt=3.13ms	SOT-25	28xf	VD22	6g	Tor
6AX	XC6127N16HMR	Vdet-IC	1.6V±0.8%, +Reset ODO, -MR, Rt=200ms	SOT-25	28yx	VD4	6g	Tor
6AX	XC6107A028MR	Vdet-IC	2.8V±2%, Hst, -MR, +Rst PPO, -Rst ODO, Rt=3.13ms	SOT-25	28xf	VD22	6g	Tor
6AY	XC6127N16JMR	Vdet-IC	1.6V±0.8%, +Reset ODO, -MR, Rt=400ms	SOT-25	28yx	VD4	6g	Tor
6AY	XC6107A029MR	Vdet-IC	2.9V±2%, Hst, -MR, +Rst PPO, -Rst ODO, Rt=3.13ms	SOT-25	28xf	VD22	6g	Tor
6AZ	XC6127N16KMR	Vdet-IC	1.6V±0.8%, +Reset ODO, -MR, Rt=800ms	SOT-25	28yx	VD4	6g	Tor
6AZ	XC6107A030MR	Vdet-IC	3.0V±2%, Hst, -MR, +Rst PPO, -Rst ODO, Rt=3.13ms	SOT-25	28xf	VD22	6g	Tor
6B	R3111N161A	Vdet-IC	1.6V±2%, -Reset PPO	SOT-23-5	28vdm	VD7	6g	Ric
6B	RN5RL26AA	LVR-IC	2.6V±2.5%, 150mA	SOT-23-5	28wu	VR1	6g	Ric
6B	RN5VD16CA	Vdet-IC	1.6V±2.5V, -Reset ODO	SOT-23-5	28vdo	VD1	6g	Ric
6B0	XC9237A10CMR	DC-DC-IC	PWM-PWM/PFM, st-dwn, 1.0V±2%, 600mA, 1.2MHz, Vin>2V, LSST	SOT-25	28dc4	DC1	6g	Tor
6B0	XC6107B031MR	Vdet-IC	3.1V±2%, Hst, -MR, +Rst PPO, -Rst ODO, Rt=25ms	SOT-25	28xf	VD22	6g	Tor
6B1	XC9237A11CMR	DC-DC-IC	PWM-PWM/PFM, st-dwn, 1.1V±2%, 600mA, 1.2MHz, Vin>2V, LSST	SOT-25	28dc4	DC1	6g	Tor
6B1	XC6107B032MR	Vdet-IC	3.2V±2%, Hst, -MR, +Rst PPO, -Rst ODO, Rt=25ms	SOT-25	28xf	VD22	6g	Tor
6B2	XC9237A12CMR	DC-DC-IC	PWM-PWM/PFM, st-dwn, 1.2V±2%, 600mA, 1.2MHz, Vin>2V, LSST	SOT-25	28dc4	DC1	6g	Tor
6B2	XC6107B033MR	Vdet-IC	3.3V±2%, Hst, -MR, +Rst PPO, -Rst ODO, Rt=25ms	SOT-25	28xf	VD22	6g	Tor
6B3	XC9237A13CMR	DC-DC-IC	PWM-PWM/PFM, st-dwn, 1.3V±2%, 600mA, 1.2MHz, Vin>2V, LSST	SOT-25	28dc4	DC1	6g	Tor
6B3	XC6107B034MR	Vdet-IC	3.4V±2%, Hst, -MR, +Rst PPO, -Rst ODO, Rt=25ms	SOT-25	28xf	VD22	6g	Tor
6B4	XC9237A14CMR	DC-DC-IC	PWM-PWM/PFM, st-dwn, 1.4V±2%, 600mA, 1.2MHz, Vin>2V, LSST	SOT-25	28dc4	DC1	6g	Tor
6B4	XC6107B035MR	Vdet-IC	3.5V±2%, Hst, -MR, +Rst PPO, -Rst ODO, Rt=25ms	SOT-25	28xf	VD22	6g	Tor
6B5	XC9237A15CMR	DC-DC-IC	PWM-PWM/PFM, st-dwn, 1.5V±2%, 600mA, 1.2MHz, Vin>2V, LSST	SOT-25	28dc4	DC1	6g	Tor
6B5	XC6107B036MR	Vdet-IC	3.6V±2%, Hst, -MR, +Rst PPO, -Rst ODO, Rt=25ms	SOT-25	28xf	VD22	6g	Tor
6B6	XC9237A16CMR	DC-DC-IC	PWM-PWM/PFM, st-dwn, 1.6V±2%, 600mA, 1.2MHz, Vin>2V, LSST	SOT-25	28dc4	DC1	6g	Tor
6B6	XC6107B037MR	Vdet-IC	3.7V±2%, Hst, -MR, +Rst PPO, -Rst ODO, Rt=25ms	SOT-25	28xf	VD22	6g	Tor
6B7	XC9237A17CMR	DC-DC-IC	PWM-PWM/PFM, st-dwn, 1.7V±2%, 600mA, 1.2MHz, Vin>2V, LSST	SOT-25	28dc4	DC1	6g	Tor
6B7	XC6107B038MR	Vdet-IC	3.8V±2%, Hst, -MR, +Rst PPO, -Rst ODO, Rt=25ms	SOT-25	28xf	VD22	6g	Tor
6B8	XC9237A18CMR	DC-DC-IC	PWM-PWM/PFM, st-dwn, 1.8V±2%, 600mA, 1.2MHz, Vin>2V, LSST	SOT-25	28dc4	DC1	6g	Tor
6B8	XC6107B039MR	Vdet-IC	3.9V±2%, Hst, -MR, +Rst PPO, -Rst ODO, Rt=25ms	SOT-25	28xf	VD22	6g	Tor
6B9	XC9237A19CMR	DC-DC-IC	PWM-PWM/PFM, st-dwn, 1.9V±2%, 600mA, 1.2MHz, Vin>2V, LSST	SOT-25	28dc4	DC1	6g	Tor
6B9	XC6107B040MR	Vdet-IC	4.0V±2%, Hst, -MR, +Rst PPO, -Rst ODO, Rt=25ms	SOT-25	28xf	VD22	6g	Tor
6Ba	FT531Ba	LVR-IC	LDO, 1.4V±2%, 300mA, +CE	SOT-23-5	28cx	VR4	6g	Fmd
6BA	XC6127N17AMR	Vdet-IC	1.7V±0.8%, -Reset ODO, -MR, Rt=50ms	SOT-25	28yx	VD4	6g	Tor
6BA	XC9237A1ACMR	DC-DC-IC	PWM-PWM/PFM, st-dwn, 1.05V±2%, 600mA, 1.2MHz, Vin>2V, LSST	SOT-25	28dc4	DC1	6g	Tor
6BA	XC6107B041MR	Vdet-IC	4.1V±2%, Hst, -MR, +Rst PPO, -Rst ODO, Rt=25ms	SOT-25	28xf	VD22	6g	Tor
6Bb	XC9206A10CM	DC/DC-IC	PWM st-dwn, 1.2MHz, 1.0V±2%, 600mA, +CE	SOT-25	28zq	DC1	6g	Tor
6Bb	FT531Bb	LVR-IC	LDO, 1.4V±2%, 300mA, +CE	SOT-23-5	28vc	VR4	6g	Fmd
6Bb	XC6127N17BMR	Vdet-IC	1.7V±0.8%, -Reset ODO, -MR, Rt=100ms	SOT-25	28yx	VD4	6g	Tor
6Bb	XC9237A1BCMR	DC-DC-IC	PWM-PWM/PFM, st-dwn, 1.15V±2%, 600mA, 1.2MHz, Vin>2V, LSST	SOT-25	28dc4	DC1	6g	Tor
6Bb	XC6107B042MR	Vdet-IC	4.2V±2%, Hst, -MR, +Rst PPO, -Rst ODO, Rt=25ms	SOT-25	28xf	VD22	6g	Tor
6Bc	XC9206A11CM	DC/DC-IC	PWM st-dwn, 1.2MHz, 1.1V±2%, 600mA, +CE	SOT-25	28zq	DC1	6g	Tor
6Bc	FT531Bc	LVR-IC	LDO, 1.4V±2%, 300mA, +CE	SOT-23-5	28xm	VR4	6g	Fmd
6Bc	XC6127N17CMR	Vdet-IC	1.7V±0.8%, -Reset ODO, -MR, Rt=200ms	SOT-25	28yx	VD4	6g	Tor
6Bc	XC9237A1CCMR	DC-DC-IC	PWM-PWM/PFM, st-dwn, 1.25V±2%, 600mA, 1.2MHz, Vin>2V, LSST	SOT-25	28dc4	DC1	6g	Tor
6Bc	XC6107B043MR	Vdet-IC	4.3V±2%, Hst, -MR, +Rst PPO, -Rst ODO, Rt=25ms	SOT-25	28xf	VD22	6g	Tor
6Bc	XC9206A12CM	DC/DC-IC	PWM st-dwn, 1.2MHz, 1.2V±2%, 600mA, +CE	SOT-25	28zq	DC1	6g	Tor
6Bd	FT531Bd	LVR-IC	LDO, 1.4V±2%, 300mA, +CE	SC-70-5	28cx	VR4	6g	Fmd
6Bd	XC6127N17DMR	Vdet-IC	1.7V±0.8%, -Reset ODO, -MR, Rt=400ms	SOT-25	28yx	VD4	6g	Tor
6Bd	XC9237A1DCMR	DC-DC-IC	PWM-PWM/PFM, st-dwn, 1.35V±2%, 600mA, 1.2MHz, Vin>2V, LSST	SOT-25	28dc4	DC1	6g	Tor
6Bd	XC6107B044MR	Vdet-IC	4.4V±2%, Hst, -MR, +Rst PPO, -Rst ODO, Rt=25ms	SOT-25	28xf	VD22	6g	Tor
6Bd	XC9206A13CM	DC/DC-IC	PWM st-dwn, 1.2MHz, 1.3V±2%, 600mA, +CE	SOT-25	28zq	DC1	6g	Tor
6Be	FT531Be	LVR-IC	LDO, 1.4V±2%, 300mA, +CE	SC-70-5	28vc	VR4	6g	Fmd
6BE	XC6127N17EMR	Vdet-IC	1.7V±0.8%, -Reset ODO, -MR, Rt=800ms	SOT-25	28yx	VD4	6g	Tor
6BE	XC9237A1ECMR	DC-DC-IC	PWM-PWM/PFM, st-dwn, 1.45V±2%, 600mA, 1.2MHz, Vin>2V, LSST	SOT-25	28dc4	DC1	6g	Tor
6BE	XC6107B045MR	Vdet-IC	4.5V±2%, Hst, -MR, +Rst PPO, -Rst ODO, Rt=25ms	SOT-25	28xf	VD22	6g	Tor
6BE	XC9206A14CM	DC/DC-IC	PWM st-dwn, 1.2MHz, 1.4V±2%, 600mA, +CE	SOT-25	28zq	DC1	6g	Tor
6Bf	FT531Bf	LVR-IC	LDO, 1.4V±2%, 300mA, +CE	SC-70-5	28xm	VR4	6g	Fmd
6BF	XC6127N17FMR	Vdet-IC	1.7V±0.8%, +Reset ODO, -MR, Rt=50ms	SOT-25	28yx	VD4	6g	Tor
6BF	XC9237A1FCMR	DC-DC-IC	PWM-PWM/PFM, st-dwn, 1.55V±2%, 600mA, 1.2MHz, Vin>2V, LSST	SOT-25	28dc4	DC1	6g	Tor
6BF	XC6107B016MR	Vdet-IC	1.6V±2%, Hst, -MR, +Rst PPO, -Rst ODO, Rt=25ms	SOT-25	28xf	VD22	6g	Tor
6BF	XC6107B046MR	Vdet-IC	4.6V±2%, Hst, -MR, +Rst PPO, -Rst ODO, Rt=25ms	SOT-25	28xf	VD22	6g	Tor
6BF	XC9206A15CM	DC/DC-IC	PWM st-dwn, 1.2MHz, 1.5V±2%, 600mA, +CE	SOT-25	28zq	DC1	6g	Tor
6BH	XC6127N17GMR	Vdet-IC	1.7V±0.8%, +Reset ODO, -MR, Rt=100ms	SOT-25	28yx	VD4	6g	Tor
6BH	XC9237A1HCMR	DC-DC-IC	PWM-PWM/PFM, st-dwn, 1.65V±2%, 600mA, 1.2MHz, Vin>2V, LSST	SOT-25	28dc4	DC1	6g	Tor
6BH	XC6107B017MR	Vdet-IC	1.7V±2%, Hst, -MR, +Rst PPO, -Rst ODO, Rt=25ms	SOT-25	28xf	VD22	6g	Tor
6BH	XC6107B047MR	Vdet-IC	4.7V±2%, Hst, -MR, +Rst PPO, -Rst ODO, Rt=25ms	SOT-25	28xf	VD22	6g	Tor
6BH	XC9206A16CM	DC/DC-IC	PWM st-dwn, 1.2MHz, 1.6V±2%, 600mA, +CE	SOT-25	28zq	DC1	6g	Tor
6BK	XC6127N17HMR	Vdet-IC	1.7V±0.8%, +Reset ODO, -MR, Rt=200ms	SOT-25	28yx	VD4	6g	Tor
6BK	XC9237A1KCMR	DC-DC-IC	PWM-PWM/PFM, st-dwn, 1.75V±2%, 600mA, 1.2MHz, Vin>2V, LSST	SOT-25	28dc4	DC1	6g	Tor
6BK	XC6107B018MR	Vdet-IC	1.8V±2%, Hst, -MR, +Rst PPO, -Rst ODO, Rt=25ms	SOT-25	28xf	VD22	6g	Tor
6BK	XC6107B048MR	Vdet-IC	4.8V±2%, Hst, -MR, +Rst PPO, -Rst ODO, Rt=25ms	SOT-25	28xf	VD22	6g	Tor



SMD code	Type	Function	Short description	Case	Pinout	Sch.	St.	Mnf.
6BK	XC9206A17CM	DC/DC-IC	PWM st-down, 1.2MHz, 1.7V±2%, 600mA, +CE	SOT-25	28zq	DC1	6g	Tor
6BL	XC6127N17JMR	Vdet-IC	1.7V±0.8%, +Reset ODO, -MR, Rt=400ms	SOT-25	28yx	VD4	6g	Tor
6BL	XC9237A1LCMR	DC-DC-IC	PWM-PWM/PFM, st-dwn, 1.85V±2%, 600mA, 1.2MHz, Vin>2V, LSST	SOT-25	28dc4	DC1	6g	Tor
6BL	XC6107B019MR	Vdet-IC	1.9V±2%, Hst, -MR, +Rst PPO, -Rst ODO, Rt=25ms	SOT-25	28xf	VD22	6g	Tor
6BL	XC6107B049MR	Vdet-IC	4.9V±2%, Hst, -MR, +Rst PPO, -Rst ODO, Rt=25ms	SOT-25	28xf	VD22	6g	Tor
6BL	XC9206A18CM	DC/DC-IC	PWM st-down, 1.2MHz, 1.8V±2%, 600mA, +CE	SOT-25	28zq	DC1	6g	Tor
6BM	XC6127N17KMR	Vdet-IC	1.7V±0.8%, +Reset ODO, -MR, Rt=800ms	SOT-25	28yx	VD4	6g	Tor
6BM	XC9237A1MCMR	DC-DC-IC	PWM-PWM/PFM, st-dwn, 1.95V±2%, 600mA, 1.2MHz, Vin>2V, LSST	SOT-25	28dc4	DC1	6g	Tor
6BM	XC6107B020MR	Vdet-IC	2.0V±2%, Hst, -MR, +Rst PPO, -Rst ODO, Rt=25ms	SOT-25	28xf	VD22	6g	Tor
6BM	XC6107B050MR	Vdet-IC	5.0V±2%, Hst, -MR, +Rst PPO, -Rst ODO, Rt=25ms	SOT-25	28xf	VD22	6g	Tor
6BM	XC9206A19CM	DC/DC-IC	PWM st-down, 1.2MHz, 1.9V±2%, 600mA, +CE	SOT-25	28zq	DC1	6g	Tor
6BN	XC6127N18AMR	Vdet-IC	1.8V±0.8%, -Reset ODO, -MR, Rt=50ms	SOT-25	28yx	VD4	6g	Tor
6BN	XC6107B021MR	Vdet-IC	2.1V±2%, Hst, -MR, +Rst PPO, -Rst ODO, Rt=25ms	SOT-25	28xf	VD22	6g	Tor
6BP	XC6127N18BMR	Vdet-IC	1.8V±0.8%, -Reset ODO, -MR, Rt=100ms	SOT-25	28yx	VD4	6g	Tor
6BP	XC6107B022MR	Vdet-IC	2.2V±2%, Hst, -MR, +Rst PPO, -Rst ODO, Rt=25ms	SOT-25	28xf	VD22	6g	Tor
6BR	XC6127N18CMR	Vdet-IC	1.8V±0.8%, -Reset ODO, -MR, Rt=200ms	SOT-25	28yx	VD4	6g	Tor
6BR	XC6107B023MR	Vdet-IC	2.3V±2%, Hst, -MR, +Rst PPO, -Rst ODO, Rt=25ms	SOT-25	28xf	VD22	6g	Tor
6BS	XC6127N18DMR	Vdet-IC	1.8V±0.8%, -Reset ODO, -MR, Rt=400ms	SOT-25	28yx	VD4	6g	Tor
6BS	XC6107B024MR	Vdet-IC	2.4V±2%, Hst, -MR, +Rst PPO, -Rst ODO, Rt=25ms	SOT-25	28xf	VD22	6g	Tor
6BT	XC6127N18EMR	Vdet-IC	1.8V±0.8%, -Reset ODO, -MR, Rt=800ms	SOT-25	28yx	VD4	6g	Tor
6BT	XC6107B025MR	Vdet-IC	2.5V±2%, Hst, -MR, +Rst PPO, -Rst ODO, Rt=25ms	SOT-25	28xf	VD22	6g	Tor
6BU	XC6127N18FMR	Vdet-IC	1.8V±0.8%, +Reset ODO, -MR, Rt=50ms	SOT-25	28yx	VD4	6g	Tor
6BU	XC6107B026MR	Vdet-IC	2.6V±2%, Hst, -MR, +Rst PPO, -Rst ODO, Rt=25ms	SOT-25	28xf	VD22	6g	Tor
6BV	XC6127N18GMR	Vdet-IC	1.8V±0.8%, +Reset ODO, -MR, Rt=100ms	SOT-25	28yx	VD4	6g	Tor
6BV	XC6107B027MR	Vdet-IC	2.7V±2%, Hst, -MR, +Rst PPO, -Rst ODO, Rt=25ms	SOT-25	28xf	VD22	6g	Tor
6BX	XC6127N18HMR	Vdet-IC	1.8V±0.8%, +Reset ODO, -MR, Rt=200ms	SOT-25	28yx	VD4	6g	Tor
6BX	XC6107B028MR	Vdet-IC	2.8V±2%, Hst, -MR, +Rst PPO, -Rst ODO, Rt=25ms	SOT-25	28xf	VD22	6g	Tor
6BY	XC6127N18JMR	Vdet-IC	1.8V±0.8%, +Reset ODO, -MR, Rt=400ms	SOT-25	28yx	VD4	6g	Tor
6BY	XC6107B029MR	Vdet-IC	2.9V±2%, Hst, -MR, +Rst PPO, -Rst ODO, Rt=25ms	SOT-25	28xf	VD22	6g	Tor
6BY	XC9206A1LCM	DC/DC-IC	PWM st-down, 1.2MHz, 1.85V±2%, 600mA, +CE	SOT-25	28zq	DC1	6g	Tor
6BZ	XC6127N18KMR	Vdet-IC	1.8V±0.8%, +Reset ODO, -MR, Rt=800ms	SOT-25	28yx	VD4	6g	Tor
6BZ	XC6107B030MR	Vdet-IC	3.0V±2%, Hst, -MR, +Rst PPO, -Rst ODO, Rt=25ms	SOT-25	28xf	VD22	6g	Tor
6C	MIC5366-1.0YMT	LVR-IC	LDO, 1.0V±2%, 150mA, +CE, CL	SC-70-5	28gf	VR4	6g	Mcr
6C	R3111N261A	Vdet-IC	2.6V±2%, -Reset PPO	SOT-23-5	28vdm	VD7	6g	Ric
6C	RN5RL36AA	LVR-IC	3.6V±2.5%, 150mA	SOT-23-5	28vu	VR1	6g	Ric
6C	RN5VD26CA	Vdet-IC	2.6V±2.5%, -Reset ODO	SOT-23-5	28vdo	VD1	6g	Ric
6C0	XC9237A20CMR	DC-DC-IC	PWM-PWM/PFM, st-dwn, 2.0V±2%, 600mA, 1.2MHz, Vin>2V, LSST	SOT-25	28dc4	DC1	6g	Tor
6C0	XC6107C031MR	Vdet-IC	3.1V±2%, Hst, -MR, +Rst PPO, -Rst ODO, Rt=50ms	SOT-25	28xf	VD22	6g	Tor
6C1	XC9237A21CMR	DC-DC-IC	PWM-PWM/PFM, st-dwn, 2.1V±2%, 600mA, 1.2MHz, Vin>2V, LSST	SOT-25	28dc4	DC1	6g	Tor
6C1	XC6107C032MR	Vdet-IC	3.2V±2%, Hst, -MR, +Rst PPO, -Rst ODO, Rt=50ms	SOT-25	28xf	VD22	6g	Tor
6C2	XC9237A22CMR	DC-DC-IC	PWM-PWM/PFM, st-dwn, 2.2V±2%, 600mA, 1.2MHz, Vin>2V, LSST	SOT-25	28dc4	DC1	6g	Tor
6C2	XC6107C033MR	Vdet-IC	3.3V±2%, Hst, -MR, +Rst PPO, -Rst ODO, Rt=50ms	SOT-25	28xf	VD22	6g	Tor
6C3	XC9237A23CMR	DC-DC-IC	PWM-PWM/PFM, st-dwn, 2.3V±2%, 600mA, 1.2MHz, Vin>2V, LSST	SOT-25	28dc4	DC1	6g	Tor
6C3	XC6107C034MR	Vdet-IC	3.4V±2%, Hst, -MR, +Rst PPO, -Rst ODO, Rt=50ms	SOT-25	28xf	VD22	6g	Tor
6C4	XC9237A24CMR	DC-DC-IC	PWM-PWM/PFM, st-dwn, 2.4V±2%, 600mA, 1.2MHz, Vin>2V, LSST	SOT-25	28dc4	DC1	6g	Tor
6C4	XC6107C035MR	Vdet-IC	3.5V±2%, Hst, -MR, +Rst PPO, -Rst ODO, Rt=50ms	SOT-25	28xf	VD22	6g	Tor
6C5	XC9237A25CMR	DC-DC-IC	PWM-PWM/PFM, st-dwn, 2.5V±2%, 600mA, 1.2MHz, Vin>2V, LSST	SOT-25	28dc4	DC1	6g	Tor
6C5	XC6107C036MR	Vdet-IC	3.6V±2%, Hst, -MR, +Rst PPO, -Rst ODO, Rt=50ms	SOT-25	28xf	VD22	6g	Tor
6C6	XC9237A26CMR	DC-DC-IC	PWM-PWM/PFM, st-dwn, 2.6V±2%, 600mA, 1.2MHz, Vin>2V, LSST	SOT-25	28dc4	DC1	6g	Tor
6C6	XC6107C037MR	Vdet-IC	3.7V±2%, Hst, -MR, +Rst PPO, -Rst ODO, Rt=50ms	SOT-25	28xf	VD22	6g	Tor
6C7	XC9237A27CMR	DC-DC-IC	PWM-PWM/PFM, st-dwn, 2.7V±2%, 600mA, 1.2MHz, Vin>2V, LSST	SOT-25	28dc4	DC1	6g	Tor
6C7	XC6107C038MR	Vdet-IC	3.8V±2%, Hst, -MR, +Rst PPO, -Rst ODO, Rt=50ms	SOT-25	28xf	VD22	6g	Tor
6C8	XC9237A28CMR	DC-DC-IC	PWM-PWM/PFM, st-dwn, 2.8V±2%, 600mA, 1.2MHz, Vin>2V, LSST	SOT-25	28dc4	DC1	6g	Tor
6C8	XC6107C039MR	Vdet-IC	3.9V±2%, Hst, -MR, +Rst PPO, -Rst ODO, Rt=50ms	SOT-25	28xf	VD22	6g	Tor
6C9	XC9237A29CMR	DC-DC-IC	PWM-PWM/PFM, st-dwn, 2.9V±2%, 600mA, 1.2MHz, Vin>2V, LSST	SOT-25	28dc4	DC1	6g	Tor
6C9	XC6107C040MR	Vdet-IC	4.0V±2%, Hst, -MR, +Rst PPO, -Rst ODO, Rt=50ms	SOT-25	28xf	VD22	6g	Tor
6Ca	FT531Ca	LVR-IC	LDO, 1.5V±2%, 300mA, +CE	SOT-23-5	28cx	VR4	6g	Fmd
6CA	XC6127N19AMR	Vdet-IC	1.9V±0.8%, -Reset ODO, -MR, Rt=50ms	SOT-25	28yx	VD4	6g	Tor
6CA	XC9237A2A2CMR	DC-DC-IC	PWM-PWM/PFM, st-dwn, 2.05V±2%, 600mA, 1.2MHz, Vin>2V, LSST	SOT-25	28dc4	DC1	6g	Tor
6CA	XC6107C041MR	Vdet-IC	4.1V±2%, Hst, -MR, +Rst PPO, -Rst ODO, Rt=50ms	SOT-25	28xf	VD22	6g	Tor
6CA	XC9206A20CM	DC/DC-IC	PWM st-down, 1.2MHz, 2.0V±2%, 600mA, +CE	SOT-25	28zq	DC1	6g	Tor
6Cb	FT531Cb	LVR-IC	LDO, 1.5V±2%, 300mA, +CE	SOT-23-5	28vc	VR4	6g	Fmd
6CB	XC6127N19BMR	Vdet-IC	1.9V±0.8%, -Reset ODO, -MR, Rt=100ms	SOT-25	28yx	VD4	6g	Tor
6CB	XC9237A2B2CMR	DC-DC-IC	PWM-PWM/PFM, st-dwn, 2.15V±2%, 600mA, 1.2MHz, Vin>2V, LSST	SOT-25	28dc4	DC1	6g	Tor
6CB	XC6107C042MR	Vdet-IC	4.2V±2%, Hst, -MR, +Rst PPO, -Rst ODO, Rt=50ms	SOT-25	28xf	VD22	6g	Tor
6Cb	XC9206A21CM	DC/DC-IC	PWM st-down, 1.2MHz, 2.1V±2%, 600mA, +CE	SOT-25	28zq	DC1	6g	Tor
6Cc	FT531Cc	LVR-IC	LDO, 1.5V±2%, 300mA, +CE	SOT-23-5	28xm	VR4	6g	Fmd
6CC	XC6127N19CMR	Vdet-IC	1.9V±0.8%, -Reset ODO, -MR, Rt=200ms	SOT-25	28yx	VD4	6g	Tor
6CC	XC9237A2C2CMR	DC-DC-IC	PWM-PWM/PFM, st-dwn, 2.25V±2%, 600mA, 1.2MHz, Vin>2V, LSST	SOT-25	28dc4	DC1	6g	Tor
6CC	XC6107C043MR	Vdet-IC	4.3V±2%, Hst, -MR, +Rst PPO, -Rst ODO, Rt=50ms	SOT-25	28xf	VD22	6g	Tor



SMD code	Type	Function	Short description	Case	Pinout	Sch.	St.	Mnf.
6CC	XC9206A22CM	DC/DC-IC	PWM st-down, 1.2MHz, 2.2V±2%, 600mA, +CE	SOT-25	28zq	DC1	6g	Tor
6Cd	FT531Cd	LVR-IC	LDO, 1.5V±2%, 300mA, +CE	SC-70-5	28cx	VR4	6g	Fmd
6CD	XC6127N19D1MR	Vdet-IC	1.9V±0.8%, -Reset ODO, -MR, Rt=400ms	SOT-25	28yx	VD4	6g	Tor
6CD	XC9237A2DCMR	DC-DC-IC	PWM-PWM/PFM, st-dwn, 2.35V±2%, 600mA, 1.2MHz, Vin>2V, LSST	SOT-25	28dc4	DC1	6g	Tor
6CD	XC6107C044MR	Vdet-IC	4.4V±2%, Hst, -MR, +Rst PPO, -Rst ODO, Rt=50ms	SOT-25	28xf	VD22	6g	Tor
6CD	XC9206A23CM	DC/DC-IC	PWM st-down, 1.2MHz, 2.3V±2%, 600mA, +CE	SOT-25	28zq	DC1	6g	Tor
6Ce	FT531Ce	LVR-IC	LDO, 1.5V±2%, 300mA, +CE	SC-70-5	28vc	VR4	6g	Fmd
6CE	XC6127N19EMR	Vdet-IC	1.9V±0.8%, -Reset ODO, -MR, Rt=800ms	SOT-25	28yx	VD4	6g	Tor
6CE	XC9237A2ECMR	DC-DC-IC	PWM-PWM/PFM, st-dwn, 2.45V±2%, 600mA, 1.2MHz, Vin>2V, LSST	SOT-25	28dc4	DC1	6g	Tor
6CE	XC6107C045MR	Vdet-IC	4.5V±2%, Hst, -MR, +Rst PPO, -Rst ODO, Rt=50ms	SOT-25	28xf	VD22	6g	Tor
6CE	XC9206A24CM	DC/DC-IC	PWM st-down, 1.2MHz, 2.4V±2%, 600mA, +CE	SOT-25	28zq	DC1	6g	Tor
6Cf	FT531Cf	LVR-IC	LDO, 1.5V±2%, 300mA, +CE	SC-70-5	28xm	VR4	6g	Fmd
6CF	XC6127N19FMR	Vdet-IC	1.9V±0.8%, +Reset ODO, -MR, Rt=50ms	SOT-25	28yx	VD4	6g	Tor
6CF	XC9237A2FCMR	DC-DC-IC	PWM-PWM/PFM, st-dwn, 2.55V±2%, 600mA, 1.2MHz, Vin>2V, LSST	SOT-25	28dc4	DC1	6g	Tor
6CF	XC6107C016MR	Vdet-IC	1.6V±2%, Hst, -MR, +Rst PPO, -Rst ODO, Rt=50ms	SOT-25	28xf	VD22	6g	Tor
6CF	XC6107C046MR	Vdet-IC	4.6V±2%, Hst, -MR, +Rst PPO, -Rst ODO, Rt=50ms	SOT-25	28xf	VD22	6g	Tor
6CF	XC9206A25CM	DC/DC-IC	PWM st-down, 1.2MHz, 2.5V±2%, 600mA, +CE	SOT-25	28zq	DC1	6g	Tor
6CH	XC6127N19GMR	Vdet-IC	1.9V±0.8%, +Reset ODO, -MR, Rt=100ms	SOT-25	28yx	VD4	6g	Tor
6CH	XC9237A2HCMR	DC-DC-IC	PWM-PWM/PFM, st-dwn, 2.65V±2%, 600mA, 1.2MHz, Vin>2V, LSST	SOT-25	28dc4	DC1	6g	Tor
6CH	XC6107C017MR	Vdet-IC	1.7V±2%, Hst, -MR, +Rst PPO, -Rst ODO, Rt=50ms	SOT-25	28xf	VD22	6g	Tor
6CH	XC6107C047MR	Vdet-IC	4.7V±2%, Hst, -MR, +Rst PPO, -Rst ODO, Rt=50ms	SOT-25	28xf	VD22	6g	Tor
6CH	XC9206A26CM	DC/DC-IC	PWM st-down, 1.2MHz, 2.6V±2%, 600mA, +CE	SOT-25	28zq	DC1	6g	Tor
6CK	XC6127N19HMR	Vdet-IC	1.9V±0.8%, +Reset ODO, -MR, Rt=200ms	SOT-25	28yx	VD4	6g	Tor
6CK	XC9237A2KCMR	DC-DC-IC	PWM-PWM/PFM, st-dwn, 2.75V±2%, 600mA, 1.2MHz, Vin>2V, LSST	SOT-25	28dc4	DC1	6g	Tor
6CK	XC6107C018MR	Vdet-IC	1.8V±2%, Hst, -MR, +Rst PPO, -Rst ODO, Rt=50ms	SOT-25	28xf	VD22	6g	Tor
6CK	XC6107C048MR	Vdet-IC	4.8V±2%, Hst, -MR, +Rst PPO, -Rst ODO, Rt=50ms	SOT-25	28xf	VD22	6g	Tor
6CK	XC9206A27CM	DC/DC-IC	PWM st-down, 1.2MHz, 2.7V±2%, 600mA, +CE	SOT-25	28zq	DC1	6g	Tor
6CL	XC6127N19JMR	Vdet-IC	1.9V±0.8%, +Reset ODO, -MR, Rt=400ms	SOT-25	28yx	VD4	6g	Tor
6CL	XC9237A2LCMR	DC-DC-IC	PWM-PWM/PFM, st-dwn, 2.85V±2%, 600mA, 1.2MHz, Vin>2V, LSST	SOT-25	28dc4	DC1	6g	Tor
6CL	XC6107C019MR	Vdet-IC	1.9V±2%, Hst, -MR, +Rst PPO, -Rst ODO, Rt=50ms	SOT-25	28xf	VD22	6g	Tor
6CL	XC6107C049MR	Vdet-IC	4.9V±2%, Hst, -MR, +Rst PPO, -Rst ODO, Rt=50ms	SOT-25	28xf	VD22	6g	Tor
6CL	XC9206A28CM	DC/DC-IC	PWM st-down, 1.2MHz, 2.8V±2%, 600mA, +CE	SOT-25	28zq	DC1	6g	Tor
6CM	XC6127N19KMR	Vdet-IC	1.9V±0.8%, +Reset ODO, -MR, Rt=800ms	SOT-25	28yx	VD4	6g	Tor
6CM	XC9237A2MCMR	DC-DC-IC	PWM-PWM/PFM, st-dwn, 2.95V±2%, 600mA, 1.2MHz, Vin>2V, LSST	SOT-25	28dc4	DC1	6g	Tor
6CM	XC6107C020MR	Vdet-IC	2.0V±2%, Hst, -MR, +Rst PPO, -Rst ODO, Rt=50ms	SOT-25	28xf	VD22	6g	Tor
6CM	XC6107C050MR	Vdet-IC	5.0V±2%, Hst, -MR, +Rst PPO, -Rst ODO, Rt=50ms	SOT-25	28xf	VD22	6g	Tor
6CM	XC9206A29CM	DC/DC-IC	PWM st-down, 1.2MHz, 2.9V±2%, 600mA, +CE	SOT-25	28zq	DC1	6g	Tor
6CN	XC6127N20AMR	Vdet-IC	2.0V±0.8%, -Reset ODO, -MR, Rt=50ms	SOT-25	28yx	VD4	6g	Tor
6CN	XC6107C021MR	Vdet-IC	2.1V±2%, Hst, -MR, +Rst PPO, -Rst ODO, Rt=50ms	SOT-25	28xf	VD22	6g	Tor
6CP	XC6127N20BMR	Vdet-IC	2.0V±0.8%, -Reset ODO, -MR, Rt=100ms	SOT-25	28yx	VD4	6g	Tor
6CP	XC6107C022MR	Vdet-IC	2.2V±2%, Hst, -MR, +Rst PPO, -Rst ODO, Rt=50ms	SOT-25	28xf	VD22	6g	Tor
6CR	XC6127N20CMR	Vdet-IC	2.0V±0.8%, -Reset ODO, -MR, Rt=200ms	SOT-25	28yx	VD4	6g	Tor
6CR	XC6107C023MR	Vdet-IC	2.3V±2%, Hst, -MR, +Rst PPO, -Rst ODO, Rt=50ms	SOT-25	28xf	VD22	6g	Tor
6CS	XC6127N20DMR	Vdet-IC	2.0V±0.8%, -Reset ODO, -MR, Rt=400ms	SOT-25	28yx	VD4	6g	Tor
6CS	XC6107C024MR	Vdet-IC	2.4V±2%, Hst, -MR, +Rst PPO, -Rst ODO, Rt=50ms	SOT-25	28xf	VD22	6g	Tor
6CT	XC6127N20EMR	Vdet-IC	2.0V±0.8%, -Reset ODO, -MR, Rt=800ms	SOT-25	28yx	VD4	6g	Tor
6CT	XC6107C025MR	Vdet-IC	2.5V±2%, Hst, -MR, +Rst PPO, -Rst ODO, Rt=50ms	SOT-25	28xf	VD22	6g	Tor
6CU	XC6127N20FMR	Vdet-IC	2.0V±0.8%, +Reset ODO, -MR, Rt=50ms	SOT-25	28yx	VD4	6g	Tor
6CU	XC6107C026MR	Vdet-IC	2.6V±2%, Hst, -MR, +Rst PPO, -Rst ODO, Rt=50ms	SOT-25	28xf	VD22	6g	Tor
6CV	XC6127N20GMR	Vdet-IC	2.0V±0.8%, +Reset ODO, -MR, Rt=100ms	SOT-25	28yx	VD4	6g	Tor
6CV	XC6107C027MR	Vdet-IC	2.7V±2%, Hst, -MR, +Rst PPO, -Rst ODO, Rt=50ms	SOT-25	28xf	VD22	6g	Tor
6CX	XC6127N20HMR	Vdet-IC	2.0V±0.8%, +Reset ODO, -MR, Rt=200ms	SOT-25	28yx	VD4	6g	Tor
6CX	XC6107C028MR	Vdet-IC	2.8V±2%, Hst, -MR, +Rst PPO, -Rst ODO, Rt=50ms	SOT-25	28xf	VD22	6g	Tor
6CY	XC6127N20JMR	Vdet-IC	2.0V±0.8%, +Reset ODO, -MR, Rt=400ms	SOT-25	28yx	VD4	6g	Tor
6CY	XC6107C029MR	Vdet-IC	2.9V±2%, Hst, -MR, +Rst PPO, -Rst ODO, Rt=50ms	SOT-25	28xf	VD22	6g	Tor
6CZ	XC9206A2LCM	DC/DC-IC	PWM st-down, 1.2MHz, 2.85V±2%, 600mA, +CE	SOT-25	28zq	DC1	6g	Tor
6CZ	XC6127N20KMR	Vdet-IC	2.0V±0.8%, +Reset ODO, -MR, Rt=800ms	SOT-25	28yx	VD4	6g	Tor
6CZ	XC6107C030MR	Vdet-IC	3.0V±2%, Hst, -MR, +Rst PPO, -Rst ODO, Rt=50ms	SOT-25	28xf	VD22	6g	Tor
6D	R3111N361A	Vdet-IC	3.6V±2%, -Reset PPO	SOT-23-5	28vdm	VD7	6g	Ric
6D	RN5RL46AA	LVR-IC	4.6V±2.5%, 150mA	SOT-23-5	28vu	VR1	6g	Ric
6D	RN5VD36CA	Vdet-IC	3.6V±2.5%, -Reset ODO	SOT-23-5	28vdo	VD1	6g	Ric
6D0	XC9237A30CMR	DC-DC-IC	PWM-PWM/PFM, st-dwn, 3.0V±2%, 600mA, 1.2MHz, Vin>2V, LSST	SOT-25	28dc4	DC1	6g	Tor
6D0	XC6107D031MR	Vdet-IC	3.1V±2%, Hst, -MR, +Rst PPO, -Rst ODO, Rt=100ms	SOT-25	28xf	VD22	6g	Tor
6D1	XC9237A31CMR	DC-DC-IC	PWM-PWM/PFM, st-dwn, 3.1V±2%, 600mA, 1.2MHz, Vin>2V, LSST	SOT-25	28dc4	DC1	6g	Tor
6D1	XC6107D032MR	Vdet-IC	3.2V±2%, Hst, -MR, +Rst PPO, -Rst ODO, Rt=100ms	SOT-25	28xf	VD22	6g	Tor
6D2	XC9237A32CMR	DC-DC-IC	PWM-PWM/PFM, st-dwn, 3.2V±2%, 600mA, 1.2MHz, Vin>2V, LSST	SOT-25	28dc4	DC1	6g	Tor
6D2	XC6107D033MR	Vdet-IC	3.3V±2%, Hst, -MR, +Rst PPO, -Rst ODO, Rt=100ms	SOT-25	28xf	VD22	6g	Tor
6D3	XC9237A33CMR	DC-DC-IC	PWM-PWM/PFM, st-dwn, 3.3V±2%, 600mA, 1.2MHz, Vin>2V, LSST	SOT-25	28dc4	DC1	6g	Tor
6D3	XC6107D034MR	Vdet-IC	3.4V±2%, Hst, -MR, +Rst PPO, -Rst ODO, Rt=100ms	SOT-25	28xf	VD22	6g	Tor
6D4	XC9237A34CMR	DC-DC-IC	PWM-PWM/PFM, st-dwn, 3.4V±2%, 600mA, 1.2MHz, Vin>2V, LSST	SOT-25	28dc4	DC1	6g	Tor



SMD code	Type	Function	Short description	Case	Pinout	Sch.	St.	Mnf.
6D4	XC6107D035MR	Vdet-IC	3.5V±2%, Hst, -MR, +Rst PPO, -Rst ODO, Rt=100ms	SOT-25	28xf	VD22	6g	Tor
6D5	XC9237A35CMR	DC-DC-IC	PWM-PWM/PFM, st-dwn, 3.5V±2%, 600mA, 1.2MHz, Vin>2V, LSST	SOT-25	28dc4	DC1	6g	Tor
6D5	XC6107D036MR	Vdet-IC	3.6V±2%, Hst, -MR, +Rst PPO, -Rst ODO, Rt=100ms	SOT-25	28xf	VD22	6g	Tor
6D6	XC9237A36CMR	DC-DC-IC	PWM-PWM/PFM, st-dwn, 3.6V±2%, 600mA, 1.2MHz, Vin>2V, LSST	SOT-25	28dc4	DC1	6g	Tor
6D6	XC6107D037MR	Vdet-IC	3.7V±2%, Hst, -MR, +Rst PPO, -Rst ODO, Rt=100ms	SOT-25	28xf	VD22	6g	Tor
6D7	XC9237A37CMR	DC-DC-IC	PWM-PWM/PFM, st-dwn, 3.7V±2%, 600mA, 1.2MHz, Vin>2V, LSST	SOT-25	28dc4	DC1	6g	Tor
6D7	XC6107D038MR	Vdet-IC	3.8V±2%, Hst, -MR, +Rst PPO, -Rst ODO, Rt=100ms	SOT-25	28xf	VD22	6g	Tor
6D8	XC9237A38CMR	DC-DC-IC	PWM-PWM/PFM, st-dwn, 3.8V±2%, 600mA, 1.2MHz, Vin>2V, LSST	SOT-25	28dc4	DC1	6g	Tor
6D8	XC6107D039MR	Vdet-IC	3.9V±2%, Hst, -MR, +Rst PPO, -Rst ODO, Rt=100ms	SOT-25	28xf	VD22	6g	Tor
6D9	XC9237A39CMR	DC-DC-IC	PWM-PWM/PFM, st-dwn, 3.9V±2%, 600mA, 1.2MHz, Vin>2V, LSST	SOT-25	28dc4	DC1	6g	Tor
6D9	XC6107D040MR	Vdet-IC	4.0V±2%, Hst, -MR, +Rst PPO, -Rst ODO, Rt=100ms	SOT-25	28xf	VD22	6g	Tor
6Da	FT531Da	LVR-IC	LDO, 1.8V±2%, 300mA, +CE	SOT-23-5	28cx	VR4	6g	Fmd
6DA	XC6127N21AMR	Vdet-IC	2.1V±0.8%, -Reset ODO, -MR, Rt=50ms	SOT-25	28yx	VD4	6g	Tor
6DA	XC9237A3ACMR	DC-DC-IC	PWM-PWM/PFM, st-dwn, 3.05V±2%, 600mA, 1.2MHz, Vin>2V, LSST	SOT-25	28dc4	DC1	6g	Tor
6DA	XC6107D041MR	Vdet-IC	4.1V±2%, Hst, -MR, +Rst PPO, -Rst ODO, Rt=100ms	SOT-25	28xf	VD22	6g	Tor
6DA	XC9206A30CM	DC/DC-IC	PWM st-down, 1.2MHz, 3.0V±2%, 600mA, +CE	SOT-25	28zq	DC1	6g	Tor
6Db	FT531Db	LVR-IC	LDO, 1.8V±2%, 300mA, +CE	SOT-23-5	28vc	VR4	6g	Fmd
6DB	XC6127N21BMR	Vdet-IC	2.1V±0.8%, -Reset ODO, -MR, Rt=100ms	SOT-25	28yx	VD4	6g	Tor
6DB	XC9237A3BCMR	DC-DC-IC	PWM-PWM/PFM, st-dwn, 3.15V±2%, 600mA, 1.2MHz, Vin>2V, LSST	SOT-25	28dc4	DC1	6g	Tor
6DB	XC6107D042MR	Vdet-IC	4.2V±2%, Hst, -MR, +Rst PPO, -Rst ODO, Rt=100ms	SOT-25	28xf	VD22	6g	Tor
6DB	XC9206A31CM	DC/DC-IC	PWM st-down, 1.2MHz, 3.1V±2%, 600mA, +CE	SOT-25	28zq	DC1	6g	Tor
6Dc	FT531Dc	LVR-IC	LDO, 1.8V±2%, 300mA, +CE	SOT-23-5	28xm	VR4	6g	Fmd
6DC	XC6127N21CMR	Vdet-IC	2.1V±0.8%, -Reset ODO, -MR, Rt=200ms	SOT-25	28yx	VD4	6g	Tor
6DC	XC9237A3CCMR	DC-DC-IC	PWM-PWM/PFM, st-dwn, 3.25V±2%, 600mA, 1.2MHz, Vin>2V, LSST	SOT-25	28dc4	DC1	6g	Tor
6DC	XC6107D043MR	Vdet-IC	4.3V±2%, Hst, -MR, +Rst PPO, -Rst ODO, Rt=100ms	SOT-25	28xf	VD22	6g	Tor
6DC	XC9206A32CM	DC/DC-IC	PWM st-down, 1.2MHz, 3.2V±2%, 600mA, +CE	SOT-25	28zq	DC1	6g	Tor
6Dd	FT531Dd	LVR-IC	LDO, 1.8V±2%, 300mA, +CE	SC-70-5	28cx	VR4	6g	Fmd
6DD	XC6127N21DMR	Vdet-IC	2.1V±0.8%, -Reset ODO, -MR, Rt=400ms	SOT-25	28yx	VD4	6g	Tor
6DD	XC9237A3DCMR	DC-DC-IC	PWM-PWM/PFM, st-dwn, 3.35V±2%, 600mA, 1.2MHz, Vin>2V, LSST	SOT-25	28dc4	DC1	6g	Tor
6DD	XC6107D044MR	Vdet-IC	4.4V±2%, Hst, -MR, +Rst PPO, -Rst ODO, Rt=100ms	SOT-25	28xf	VD22	6g	Tor
6DD	XC9206A33CM	DC/DC-IC	PWM st-down, 1.2MHz, 3.3V±2%, 600mA, +CE	SOT-25	28zq	DC1	6g	Tor
6De	FT531De	LVR-IC	LDO, 1.8V±2%, 300mA, +CE	SC-70-5	28vc	VR4	6g	Fmd
6DE	XC6127N21EMR	Vdet-IC	2.1V±0.8%, -Reset ODO, -MR, Rt=800ms	SOT-25	28yx	VD4	6g	Tor
6DE	XC9237A3ECMR	DC-DC-IC	PWM-PWM/PFM, st-dwn, 3.45V±2%, 600mA, 1.2MHz, Vin>2V, LSST	SOT-25	28dc4	DC1	6g	Tor
6DE	XC6107D045MR	Vdet-IC	4.5V±2%, Hst, -MR, +Rst PPO, -Rst ODO, Rt=100ms	SOT-25	28xf	VD22	6g	Tor
6DE	XC9206A34CM	DC/DC-IC	PWM st-down, 1.2MHz, 3.4V±2%, 600mA, +CE	SOT-25	28zq	DC1	6g	Tor
6Df	FT531Df	LVR-IC	LDO, 1.8V±2%, 300mA, +CE	SC-70-5	28xm	VR4	6g	Fmd
6DF	XC6127N21FMR	Vdet-IC	2.1V±0.8%, +Reset ODO, -MR, Rt=50ms	SOT-25	28yx	VD4	6g	Tor
6DF	XC9237A3FCMR	DC-DC-IC	PWM-PWM/PFM, st-dwn, 3.55V±2%, 600mA, 1.2MHz, Vin>2V, LSST	SOT-25	28dc4	DC1	6g	Tor
6DF	XC6107D016MR	Vdet-IC	1.6V±2%, Hst, -MR, +Rst PPO, -Rst ODO, Rt=100ms	SOT-25	28xf	VD22	6g	Tor
6DF	XC6107D046MR	Vdet-IC	4.6V±2%, Hst, -MR, +Rst PPO, -Rst ODO, Rt=100ms	SOT-25	28xf	VD22	6g	Tor
6DF	XC9206A35CM	DC/DC-IC	PWM st-down, 1.2MHz, 3.5V±2%, 600mA, +CE	SOT-25	28zq	DC1	6g	Tor
6DH	XC6127N21GMR	Vdet-IC	2.1V±0.8%, +Reset ODO, -MR, Rt=100ms	SOT-25	28yx	VD4	6g	Tor
6DH	XC9237A3HCMR	DC-DC-IC	PWM-PWM/PFM, st-dwn, 3.65V±2%, 600mA, 1.2MHz, Vin>2V, LSST	SOT-25	28dc4	DC1	6g	Tor
6DH	XC6107D017MR	Vdet-IC	1.7V±2%, Hst, -MR, +Rst PPO, -Rst ODO, Rt=100ms	SOT-25	28xf	VD22	6g	Tor
6DH	XC6107D047MR	Vdet-IC	4.7V±2%, Hst, -MR, +Rst PPO, -Rst ODO, Rt=100ms	SOT-25	28xf	VD22	6g	Tor
6DH	XC9206A36CM	DC/DC-IC	PWM st-down, 1.2MHz, 3.6V±2%, 600mA, +CE	SOT-25	28zq	DC1	6g	Tor
6DK	XC6127N21HMR	Vdet-IC	2.1V±0.8%, +Reset ODO, -MR, Rt=200ms	SOT-25	28yx	VD4	6g	Tor
6DK	XC9237A3KCMR	DC-DC-IC	PWM-PWM/PFM, st-dwn, 3.75V±2%, 600mA, 1.2MHz, Vin>2V, LSST	SOT-25	28dc4	DC1	6g	Tor
6DK	XC6107D018MR	Vdet-IC	1.8V±2%, Hst, -MR, +Rst PPO, -Rst ODO, Rt=100ms	SOT-25	28xf	VD22	6g	Tor
6DK	XC6107D048MR	Vdet-IC	4.8V±2%, Hst, -MR, +Rst PPO, -Rst ODO, Rt=100ms	SOT-25	28xf	VD22	6g	Tor
6DK	XC9206A37CM	DC/DC-IC	PWM st-down, 1.2MHz, 3.7V±2%, 600mA, +CE	SOT-25	28zq	DC1	6g	Tor
6DL	XC6127N21JMR	Vdet-IC	2.1V±0.8%, +Reset ODO, -MR, Rt=400ms	SOT-25	28yx	VD4	6g	Tor
6DL	XC9237A3LCMR	DC-DC-IC	PWM-PWM/PFM, st-dwn, 3.85V±2%, 600mA, 1.2MHz, Vin>2V, LSST	SOT-25	28dc4	DC1	6g	Tor
6DL	XC6107D019MR	Vdet-IC	1.9V±2%, Hst, -MR, +Rst PPO, -Rst ODO, Rt=100ms	SOT-25	28xf	VD22	6g	Tor
6DL	XC6107D049MR	Vdet-IC	4.9V±2%, Hst, -MR, +Rst PPO, -Rst ODO, Rt=100ms	SOT-25	28xf	VD22	6g	Tor
6DL	XC9206A38CM	DC/DC-IC	PWM st-down, 1.2MHz, 3.8V±2%, 600mA, +CE	SOT-25	28zq	DC1	6g	Tor
6DM	XC6127N21KMR	Vdet-IC	2.1V±0.8%, +Reset ODO, -MR, Rt=800ms	SOT-25	28yx	VD4	6g	Tor
6DM	XC9237A3MCMR	DC-DC-IC	PWM-PWM/PFM, st-dwn, 3.95V±2%, 600mA, 1.2MHz, Vin>2V, LSST	SOT-25	28dc4	DC1	6g	Tor
6DM	XC6107D020MR	Vdet-IC	2.0V±2%, Hst, -MR, +Rst PPO, -Rst ODO, Rt=100ms	SOT-25	28xf	VD22	6g	Tor
6DM	XC6107D050MR	Vdet-IC	5.0V±2%, Hst, -MR, +Rst PPO, -Rst ODO, Rt=100ms	SOT-25	28xf	VD22	6g	Tor
6DM	XC9206A39CM	DC/DC-IC	PWM st-down, 1.2MHz, 3.9V±2%, 600mA, +CE	SOT-25	28zq	DC1	6g	Tor
6DN	XC6127N22AMR	Vdet-IC	2.2V±0.8%, -Reset ODO, -MR, Rt=50ms	SOT-25	28yx	VD4	6g	Tor
6DN	XC6107D021MR	Vdet-IC	2.1V±2%, Hst, -MR, +Rst PPO, -Rst ODO, Rt=100ms	SOT-25	28xf	VD22	6g	Tor
6DP	XC6127N22BMR	Vdet-IC	2.2V±0.8%, -Reset ODO, -MR, Rt=100ms	SOT-25	28yx	VD4	6g	Tor
6DP	XC6107D022MR	Vdet-IC	2.2V±2%, Hst, -MR, +Rst PPO, -Rst ODO, Rt=100ms	SOT-25	28xf	VD22	6g	Tor
6DR	XC6127N22CMR	Vdet-IC	2.2V±0.8%, -Reset ODO, -MR, Rt=200ms	SOT-25	28yx	VD4	6g	Tor
6DR	XC6107D023MR	Vdet-IC	2.3V±2%, Hst, -MR, +Rst PPO, -Rst ODO, Rt=100ms	SOT-25	28xf	VD22	6g	Tor
6DS	XC6127N22DMR	Vdet-IC	2.2V±0.8%, -Reset ODO, -MR, Rt=400ms	SOT-25	28yx	VD4	6g	Tor
6DS	XC6107D024MR	Vdet-IC	2.4V±2%, Hst, -MR, +Rst PPO, -Rst ODO, Rt=100ms	SOT-25	28xf	VD22	6g	Tor



SMD Code	Type	Function	Short description	Case	Pinout	Sch.	St.	Mnf.
6DT	XC6127N22EMR	Vdet-IC	2.2V±0.8%, -Reset ODO, -MR, Rt=800ms	SOT-25	28yx	VD4	6g	Tor
6DT	XC6107D025MR	Vdet-IC	2.5V±2%, Hst, -MR, +Rst PPO, -Rst ODO, Rt=100ms	SOT-25	28xf	VD22	6g	Tor
6DU	XC6127N22FMR	Vdet-IC	2.2V±0.8%, +Reset ODO, -MR, Rt=50ms	SOT-25	28yx	VD4	6g	Tor
6DU	XC6107D026MR	Vdet-IC	2.6V±2%, Hst, -MR, +Rst PPO, -Rst ODO, Rt=100ms	SOT-25	28xf	VD22	6g	Tor
6DV	XC6127N22GMR	Vdet-IC	2.2V±0.8%, +Reset ODO, -MR, Rt=100ms	SOT-25	28yx	VD4	6g	Tor
6DV	XC6107D027MR	Vdet-IC	2.7V±2%, Hst, -MR, +Rst PPO, -Rst ODO, Rt=100ms	SOT-25	28xf	VD22	6g	Tor
6DX	XC6127N22HMR	Vdet-IC	2.2V±0.8%, +Reset ODO, -MR, Rt=200ms	SOT-25	28yx	VD4	6g	Tor
6DX	XC6107D028MR	Vdet-IC	2.8V±2%, Hst, -MR, +Rst PPO, -Rst ODO, Rt=100ms	SOT-25	28xf	VD22	6g	Tor
6DY	XC6127N22JMR	Vdet-IC	2.2V±0.8%, +Reset ODO, -MR, Rt=400ms	SOT-25	28yx	VD4	6g	Tor
6DY	XC6107D029MR	Vdet-IC	2.9V±2%, Hst, -MR, +Rst PPO, -Rst ODO, Rt=100ms	SOT-25	28xf	VD22	6g	Tor
6DZ	XC6127N22KMR	Vdet-IC	2.2V±0.8%, +Reset ODO, -MR, Rt=800ms	SOT-25	28yx	VD4	6g	Tor
6DZ	XC6107D030MR	Vdet-IC	3.0V±2%, Hst, -MR, +Rst PPO, -Rst ODO, Rt=100ms	SOT-25	28xf	VD22	6g	Tor
6E	R3111N461A	Vdet-IC	4.6V±2%, -Reset PPO	SOT-23-5	28vdm	VD7	6g	Ric
6E	RN5RL56AA	LVR-IC	5.6V±2.5%, 150mA	SOT-23-5	28vu	VR1	6g	Ric
6E	RN5VD46CA	Vdet-IC	4.6V±2.5%, -Reset ODO	SOT-23-5	28vdo	VD1	6g	Ric
6E0	XC9237A40CMR	DC-DC-IC	PWM-PWM/PFM, st-dwn, 4.0V±2%, 600mA, 1.2MHz, Vin>2V, LSST	SOT-25	28dc4	DC1	6g	Tor
6E0	XC6107E031MR	Vdet-IC	3.1V±2%, Hst, -MR, +Rst PPO, -Rst ODO, Rt=200ms	SOT-25	28xf	VD22	6g	Tor
6E1	XC6107E032MR	Vdet-IC	3.2V±2%, Hst, -MR, +Rst PPO, -Rst ODO, Rt=200ms	SOT-25	28xf	VD22	6g	Tor
6E2	XC6107E033MR	Vdet-IC	3.3V±2%, Hst, -MR, +Rst PPO, -Rst ODO, Rt=200ms	SOT-25	28xf	VD22	6g	Tor
6E3	XC6107E034MR	Vdet-IC	3.4V±2%, Hst, -MR, +Rst PPO, -Rst ODO, Rt=200ms	SOT-25	28xf	VD22	6g	Tor
6E4	XC6107E035MR	Vdet-IC	3.5V±2%, Hst, -MR, +Rst PPO, -Rst ODO, Rt=200ms	SOT-25	28xf	VD22	6g	Tor
6E5	XC6107E036MR	Vdet-IC	3.6V±2%, Hst, -MR, +Rst PPO, -Rst ODO, Rt=200ms	SOT-25	28xf	VD22	6g	Tor
6E6	XC6107E037MR	Vdet-IC	3.7V±2%, Hst, -MR, +Rst PPO, -Rst ODO, Rt=200ms	SOT-25	28xf	VD22	6g	Tor
6E7	XC6107E038MR	Vdet-IC	3.8V±2%, Hst, -MR, +Rst PPO, -Rst ODO, Rt=200ms	SOT-25	28xf	VD22	6g	Tor
6E8	XC6107E039MR	Vdet-IC	3.9V±2%, Hst, -MR, +Rst PPO, -Rst ODO, Rt=200ms	SOT-25	28xf	VD22	6g	Tor
6E9	XC6107E040MR	Vdet-IC	4.0V±2%, Hst, -MR, +Rst PPO, -Rst ODO, Rt=200ms	SOT-25	28xf	VD22	6g	Tor
6Ea	FT531Ea	LVR-IC	LDO, 2.5V±2%, 300mA, +CE	SOT-23-5	28cx	VR4	6g	Fmd
6EA	XC6127N23AMR	Vdet-IC	2.3V±0.8%, -Reset ODO, -MR, Rt=50ms	SOT-25	28yx	VD4	6g	Tor
6EA	XC6107E041MR	Vdet-IC	4.1V±2%, Hst, -MR, +Rst PPO, -Rst ODO, Rt=200ms	SOT-25	28xf	VD22	6g	Tor
6EA	XC9206A40CM	DC/DC-IC	PWM st-down, 1.2MHz, 4.0V±2%, 600mA, +CE	SOT-25	28zq	DC1	6g	Tor
6Eb	FT531Eb	LVR-IC	LDO, 2.5V±2%, 300mA, +CE	SOT-23-5	28vc	VR4	6g	Fmd
6EB	XC6127N23BMR	Vdet-IC	2.3V±0.8%, -Reset ODO, -MR, Rt=100ms	SOT-25	28yx	VD4	6g	Tor
6EB	XC6107E042MR	Vdet-IC	4.2V±2%, Hst, -MR, +Rst PPO, -Rst ODO, Rt=200ms	SOT-25	28xf	VD22	6g	Tor
6Ec	FT531Ec	LVR-IC	LDO, 2.5V±2%, 300mA, +CE	SOT-23-5	28xm	VR4	6g	Fmd
6EC	XC6127N23CMR	Vdet-IC	2.3V±0.8%, -Reset ODO, -MR, Rt=200ms	SOT-25	28yx	VD4	6g	Tor
6EC	XC6107E043MR	Vdet-IC	4.3V±2%, Hst, -MR, +Rst PPO, -Rst ODO, Rt=200ms	SOT-25	28xf	VD22	6g	Tor
6Ed	FT531Ed	LVR-IC	LDO, 2.5V±2%, 300mA, +CE	SC-70-5	28cx	VR4	6g	Fmd
6ED	XC6127N23DMR	Vdet-IC	2.3V±0.8%, -Reset ODO, -MR, Rt=400ms	SOT-25	28yx	VD4	6g	Tor
6ED	XC6107E044MR	Vdet-IC	4.4V±2%, Hst, -MR, +Rst PPO, -Rst ODO, Rt=200ms	SOT-25	28xf	VD22	6g	Tor
6Ee	FT531Ee	LVR-IC	LDO, 2.5V±2%, 300mA, +CE	SC-70-5	28vc	VR4	6g	Fmd
6EE	XC6127N23EMR	Vdet-IC	2.3V±0.8%, -Reset ODO, -MR, Rt=800ms	SOT-25	28yx	VD4	6g	Tor
6EE	XC6107E045MR	Vdet-IC	4.5V±2%, Hst, -MR, +Rst PPO, -Rst ODO, Rt=200ms	SOT-25	28xf	VD22	6g	Tor
6Ef	FT531Ef	LVR-IC	LDO, 2.5V±2%, 300mA, +CE	SC-70-5	28xm	VR4	6g	Fmd
6EF	XC6127N23FMR	Vdet-IC	2.3V±0.8%, +Reset ODO, -MR, Rt=50ms	SOT-25	28yx	VD4	6g	Tor
6EF	XC6107E016MR	Vdet-IC	1.6V±2%, Hst, -MR, +Rst PPO, -Rst ODO, Rt=200ms	SOT-25	28xf	VD22	6g	Tor
6EF	XC6107E046MR	Vdet-IC	4.6V±2%, Hst, -MR, +Rst PPO, -Rst ODO, Rt=200ms	SOT-25	28xf	VD22	6g	Tor
6EH	XC6127N23GMR	Vdet-IC	2.3V±0.8%, +Reset ODO, -MR, Rt=100ms	SOT-25	28yx	VD4	6g	Tor
6EH	XC6107E017MR	Vdet-IC	1.7V±2%, Hst, -MR, +Rst PPO, -Rst ODO, Rt=200ms	SOT-25	28xf	VD22	6g	Tor
6EH	XC6107E047MR	Vdet-IC	4.7V±2%, Hst, -MR, +Rst PPO, -Rst ODO, Rt=200ms	SOT-25	28xf	VD22	6g	Tor
6EK	XC6127N23HMR	Vdet-IC	2.3V±0.8%, +Reset ODO, -MR, Rt=200ms	SOT-25	28yx	VD4	6g	Tor
6EK	XC6107E018MR	Vdet-IC	1.8V±2%, Hst, -MR, +Rst PPO, -Rst ODO, Rt=200ms	SOT-25	28xf	VD22	6g	Tor
6EK	XC6107E048MR	Vdet-IC	4.8V±2%, Hst, -MR, +Rst PPO, -Rst ODO, Rt=200ms	SOT-25	28xf	VD22	6g	Tor
6EL	XC6127N23JMR	Vdet-IC	2.3V±0.8%, +Reset ODO, -MR, Rt=400ms	SOT-25	28yx	VD4	6g	Tor
6EL	XC6107E019MR	Vdet-IC	1.9V±2%, Hst, -MR, +Rst PPO, -Rst ODO, Rt=200ms	SOT-25	28xf	VD22	6g	Tor
6EL	XC6107E049MR	Vdet-IC	4.9V±2%, Hst, -MR, +Rst PPO, -Rst ODO, Rt=200ms	SOT-25	28xf	VD22	6g	Tor
6EM	XC6127N23KMR	Vdet-IC	2.3V±0.8%, +Reset ODO, -MR, Rt=800ms	SOT-25	28yx	VD4	6g	Tor
6EM	XC6107E020MR	Vdet-IC	2.0V±2%, Hst, -MR, +Rst PPO, -Rst ODO, Rt=200ms	SOT-25	28xf	VD22	6g	Tor
6EM	XC6107E050MR	Vdet-IC	5.0V±2%, Hst, -MR, +Rst PPO, -Rst ODO, Rt=200ms	SOT-25	28xf	VD22	6g	Tor
6EN	XC6127N24AMR	Vdet-IC	2.4V±0.8%, -Reset ODO, -MR, Rt=50ms	SOT-25	28yx	VD4	6g	Tor
6EN	XC6107E021MR	Vdet-IC	2.1V±2%, Hst, -MR, +Rst PPO, -Rst ODO, Rt=200ms	SOT-25	28xf	VD22	6g	Tor
6EP	XC6127N24BMR	Vdet-IC	2.4V±0.8%, -Reset ODO, -MR, Rt=100ms	SOT-25	28yx	VD4	6g	Tor
6EP	XC6107E022MR	Vdet-IC	2.2V±2%, Hst, -MR, +Rst PPO, -Rst ODO, Rt=200ms	SOT-25	28xf	VD22	6g	Tor
6ER	XC6127N24CMR	Vdet-IC	2.4V±0.8%, -Reset ODO, -MR, Rt=200ms	SOT-25	28yx	VD4	6g	Tor
6ER	XC6107E023MR	Vdet-IC	2.3V±2%, Hst, -MR, +Rst PPO, -Rst ODO, Rt=200ms	SOT-25	28xf	VD22	6g	Tor
6ES	XC6127N24DMR	Vdet-IC	2.4V±0.8%, -Reset ODO, -MR, Rt=400ms	SOT-25	28yx	VD4	6g	Tor
6ES	XC6107E024MR	Vdet-IC	2.4V±2%, Hst, -MR, +Rst PPO, -Rst ODO, Rt=200ms	SOT-25	28xf	VD22	6g	Tor
6ET	XC6127N24EMR	Vdet-IC	2.4V±0.8%, -Reset ODO, -MR, Rt=800ms	SOT-25	28yx	VD4	6g	Tor
6ET	XC6107E025MR	Vdet-IC	2.5V±2%, Hst, -MR, +Rst PPO, -Rst ODO, Rt=200ms	SOT-25	28xf	VD22	6g	Tor
6EU	XC6127N24FMR	Vdet-IC	2.4V±0.8%, +Reset ODO, -MR, Rt=50ms	SOT-25	28yx	VD4	6g	Tor
6EU	XC6107E026MR	Vdet-IC	2.6V±2%, Hst, -MR, +Rst PPO, -Rst ODO, Rt=200ms	SOT-25	28xf	VD22	6g	Tor



SMD code	Type	Function	Short description	Case	Pinout	Sch.	St.	Mnf.
6EV	XC6127N24GMR	Vdet-IC	2.4V±0.8%, +Reset ODO, -MR, Rt=100ms	SOT-25	28yx	VD4	6g	Tor
6EV	XC6107E027MR	Vdet-IC	2.7V±2%, Hst, -MR, +Rst PPO, -Rst ODO, Rt=200ms	SOT-25	28xf	VD22	6g	Tor
6EX	XC6127N24HMR	Vdet-IC	2.4V±0.8%, +Reset ODO, -MR, Rt=200ms	SOT-25	28yx	VD4	6g	Tor
6EX	XC6107E028MR	Vdet-IC	2.8V±2%, Hst, -MR, +Rst PPO, -Rst ODO, Rt=200ms	SOT-25	28xf	VD22	6g	Tor
6EY	XC6127N24JMR	Vdet-IC	2.4V±0.8%, +Reset ODO, -MR, Rt=400ms	SOT-25	28yx	VD4	6g	Tor
6EY	XC6107E029MR	Vdet-IC	2.9V±2%, Hst, -MR, +Rst PPO, -Rst ODO, Rt=200ms	SOT-25	28xf	VD22	6g	Tor
6EZ	XC6127N24KMR	Vdet-IC	2.4V±0.8%, +Reset ODO, -MR, Rt=800ms	SOT-25	28yx	VD4	6g	Tor
6EZ	XC6107E030MR	Vdet-IC	3.0V±2%, Hst, -MR, +Rst PPO, -Rst ODO, Rt=200ms	SOT-25	28xf	VD22	6g	Tor
6F	MC5366-1.5YMT	LVR-IC	LDO, 1.5V±2%, 150mA, +CE, CL	SC-70-5	28gf	VR4	6g	Mor
6F	R3111N561A	Vdet-IC	5.6V±2%, -Reset PPO	SOT-23-5	28vdm	VD7	6g	Ric
6F	RN5VD56CA	Vdet-IC	5.6V±2.5%, -Reset ODO	SOT-23-5	28vdo	VD1	6g	Ric
6F0	XC6107F031MR	Vdet-IC	3.1V±2%, Hst, -MR, +Rst PPO, -Rst ODO, Rt=400ms	SOT-25	28xf	VD22	6g	Tor
6F1	XC6107F032MR	Vdet-IC	3.2V±2%, Hst, -MR, +Rst PPO, -Rst ODO, Rt=400ms	SOT-25	28xf	VD22	6g	Tor
6F2	XC6107F033MR	Vdet-IC	3.3V±2%, Hst, -MR, +Rst PPO, -Rst ODO, Rt=400ms	SOT-25	28xf	VD22	6g	Tor
6F3	XC6107F034MR	Vdet-IC	3.4V±2%, Hst, -MR, +Rst PPO, -Rst ODO, Rt=400ms	SOT-25	28xf	VD22	6g	Tor
6F4	XC6107F035MR	Vdet-IC	3.5V±2%, Hst, -MR, +Rst PPO, -Rst ODO, Rt=400ms	SOT-25	28xf	VD22	6g	Tor
6F5	XC6107F036MR	Vdet-IC	3.6V±2%, Hst, -MR, +Rst PPO, -Rst ODO, Rt=400ms	SOT-25	28xf	VD22	6g	Tor
6F6	XC6107F037MR	Vdet-IC	3.7V±2%, Hst, -MR, +Rst PPO, -Rst ODO, Rt=400ms	SOT-25	28xf	VD22	6g	Tor
6F7	XC6107F038MR	Vdet-IC	3.8V±2%, Hst, -MR, +Rst PPO, -Rst ODO, Rt=400ms	SOT-25	28xf	VD22	6g	Tor
6F8	XC9237A08DMR	DC-DC-IC	PWM-PWM/PPM, st-dwn, 0.8V±2%, 600mA, 3MHz, Vin>2V, LSST	SOT-25	28dc4	DC1	6g	Tor
6F8	XC6107F039MR	Vdet-IC	3.9V±2%, Hst, -MR, +Rst PPO, -Rst ODO, Rt=400ms	SOT-25	28xf	VD22	6g	Tor
6F9	XC9237A09DMR	DC-DC-IC	PWM-PWM/PPM, st-dwn, 0.9V±2%, 600mA, 3MHz, Vin>2V, LSST	SOT-25	28dc4	DC1	6g	Tor
6F9	XC6107F040MR	Vdet-IC	4.0V±2%, Hst, -MR, +Rst PPO, -Rst ODO, Rt=400ms	SOT-25	28xf	VD22	6g	Tor
6FA	FT531Fa	LVR-IC	LDO, 2.7V±2%, 300mA, +CE	SOT-23-5	28cx	VR4	6g	Fmd
6Fa	XC6127N25AMR	Vdet-IC	2.5V±0.8%, -Reset ODO, -MR, Rt=50ms	SOT-25	28yx	VD4	6g	Tor
6FA	XC6107F041MR	Vdet-IC	4.1V±2%, Hst, -MR, +Rst PPO, -Rst ODO, Rt=400ms	SOT-25	28xf	VD22	6g	Tor
6Fb	FT531Fb	LVR-IC	LDO, 2.7V±2%, 300mA, +CE	SOT-23-5	28vc	VR4	6g	Fmd
6Fb	XC6127N25BMR	Vdet-IC	2.5V±0.8%, -Reset ODO, -MR, Rt=100ms	SOT-25	28yx	VD4	6g	Tor
6FB	XC6107F042MR	Vdet-IC	4.2V±2%, Hst, -MR, +Rst PPO, -Rst ODO, Rt=400ms	SOT-25	28xf	VD22	6g	Tor
6Fc	FT531Fc	LVR-IC	LDO, 2.7V±2%, 300mA, +CE	SOT-23-5	28xm	VR4	6g	Fmd
6FC	XC6127N25CMR	Vdet-IC	2.5V±0.8%, -Reset ODO, -MR, Rt=200ms	SOT-25	28yx	VD4	6g	Tor
6FC	XC6107F043MR	Vdet-IC	4.3V±2%, Hst, -MR, +Rst PPO, -Rst ODO, Rt=400ms	SOT-25	28xf	VD22	6g	Tor
6Fd	FT531Fd	LVR-IC	LDO, 2.7V±2%, 300mA, +CE	SC-70-5	28cx	VR4	6g	Fmd
6FD	XC6127N25DMR	Vdet-IC	2.5V±0.8%, -Reset ODO, -MR, Rt=400ms	SOT-25	28yx	VD4	6g	Tor
6FD	XC6107F044MR	Vdet-IC	4.4V±2%, Hst, -MR, +Rst PPO, -Rst ODO, Rt=400ms	SOT-25	28xf	VD22	6g	Tor
6Fe	FT531Fe	LVR-IC	LDO, 2.7V±2%, 300mA, +CE	SC-70-5	28vc	VR4	6g	Fmd
6FE	XC6127N25EMR	Vdet-IC	2.5V±0.8%, -Reset ODO, -MR, Rt=800ms	SOT-25	28yx	VD4	6g	Tor
6FE	XC6107F045MR	Vdet-IC	4.5V±2%, Hst, -MR, +Rst PPO, -Rst ODO, Rt=400ms	SOT-25	28xf	VD22	6g	Tor
6Fi	FT531Fi	LVR-IC	LDO, 2.7V±2%, 300mA, +CE	SC-70-5	28xm	VR4	6g	Fmd
6FF	XC6127N25FMR	Vdet-IC	2.5V±0.8%, +Reset ODO, -MR, Rt=50ms	SOT-25	28yx	VD4	6g	Tor
6FF	XC6107F016MR	Vdet-IC	1.6V±2%, Hst, -MR, +Rst PPO, -Rst ODO, Rt=400ms	SOT-25	28xf	VD22	6g	Tor
6FF	XC6107F046MR	Vdet-IC	4.6V±2%, Hst, -MR, +Rst PPO, -Rst ODO, Rt=400ms	SOT-25	28xf	VD22	6g	Tor
6FH	XC6127N25GMR	Vdet-IC	2.5V±0.8%, +Reset ODO, -MR, Rt=100ms	SOT-25	28yx	VD4	6g	Tor
6FH	XC6107F017MR	Vdet-IC	1.7V±2%, Hst, -MR, +Rst PPO, -Rst ODO, Rt=400ms	SOT-25	28xf	VD22	6g	Tor
6FH	XC6107F047MR	Vdet-IC	4.7V±2%, Hst, -MR, +Rst PPO, -Rst ODO, Rt=400ms	SOT-25	28xf	VD22	6g	Tor
6FK	XC6127N25HMR	Vdet-IC	2.5V±0.8%, +Reset ODO, -MR, Rt=200ms	SOT-25	28yx	VD4	6g	Tor
6FK	XC6107F018MR	Vdet-IC	1.8V±2%, Hst, -MR, +Rst PPO, -Rst ODO, Rt=400ms	SOT-25	28xf	VD22	6g	Tor
6FK	XC6107F048MR	Vdet-IC	4.8V±2%, Hst, -MR, +Rst PPO, -Rst ODO, Rt=400ms	SOT-25	28xf	VD22	6g	Tor
6FL	XC6127N25JMR	Vdet-IC	2.5V±0.8%, +Reset ODO, -MR, Rt=400ms	SOT-25	28yx	VD4	6g	Tor
6FL	XC9237A0LDMR	DC-DC-IC	PWM-PWM/PPM, st-dwn, 0.85V±2%, 600mA, 3MHz, Vin>2V, LSST	SOT-25	28dc4	DC1	6g	Tor
6FL	XC6107F019MR	Vdet-IC	1.9V±2%, Hst, -MR, +Rst PPO, -Rst ODO, Rt=400ms	SOT-25	28xf	VD22	6g	Tor
6FL	XC6107F049MR	Vdet-IC	4.9V±2%, Hst, -MR, +Rst PPO, -Rst ODO, Rt=400ms	SOT-25	28xf	VD22	6g	Tor
6FM	XC6127N25KMR	Vdet-IC	2.5V±0.8%, +Reset ODO, -MR, Rt=800ms	SOT-25	28yx	VD4	6g	Tor
6FM	XC9237A0MDMR	DC-DC-IC	PWM-PWM/PPM, st-dwn, 0.95V±2%, 600mA, 3MHz, Vin>2V, LSST	SOT-25	28dc4	DC1	6g	Tor
6FM	XC6107F020MR	Vdet-IC	2.0V±2%, Hst, -MR, +Rst PPO, -Rst ODO, Rt=400ms	SOT-25	28xf	VD22	6g	Tor
6FM	XC6107F050MR	Vdet-IC	5.0V±2%, Hst, -MR, +Rst PPO, -Rst ODO, Rt=400ms	SOT-25	28xf	VD22	6g	Tor
6FN	XC6127N26AMR	Vdet-IC	2.6V±0.8%, -Reset ODO, -MR, Rt=50ms	SOT-25	28yx	VD4	6g	Tor
6FN	XC6107F021MR	Vdet-IC	2.1V±2%, Hst, -MR, +Rst PPO, -Rst ODO, Rt=400ms	SOT-25	28xf	VD22	6g	Tor
6FP	XC6127N26BMR	Vdet-IC	2.6V±0.8%, -Reset ODO, -MR, Rt=100ms	SOT-25	28yx	VD4	6g	Tor
6FP	XC6107F022MR	Vdet-IC	2.2V±2%, Hst, -MR, +Rst PPO, -Rst ODO, Rt=400ms	SOT-25	28xf	VD22	6g	Tor
6FR	XC6127N26CMR	Vdet-IC	2.6V±0.8%, -Reset ODO, -MR, Rt=200ms	SOT-25	28yx	VD4	6g	Tor
6FR	XC6107F023MR	Vdet-IC	2.3V±2%, Hst, -MR, +Rst PPO, -Rst ODO, Rt=400ms	SOT-25	28xf	VD22	6g	Tor
6FS	XC6127N26DMR	Vdet-IC	2.6V±0.8%, -Reset ODO, -MR, Rt=400ms	SOT-25	28yx	VD4	6g	Tor
6FS	XC6107F024MR	Vdet-IC	2.4V±2%, Hst, -MR, +Rst PPO, -Rst ODO, Rt=400ms	SOT-25	28xf	VD22	6g	Tor
6FT	XC6127N26EMR	Vdet-IC	2.6V±0.8%, -Reset ODO, -MR, Rt=800ms	SOT-25	28yx	VD4	6g	Tor
6FT	XC6107F025MR	Vdet-IC	2.5V±2%, Hst, -MR, +Rst PPO, -Rst ODO, Rt=400ms	SOT-25	28xf	VD22	6g	Tor
6FU	XC6127N26FMR	Vdet-IC	2.6V±0.8%, +Reset ODO, -MR, Rt=50ms	SOT-25	28yx	VD4	6g	Tor
6FU	XC6107F026MR	Vdet-IC	2.6V±2%, Hst, -MR, +Rst PPO, -Rst ODO, Rt=400ms	SOT-25	28xf	VD22	6g	Tor
6FV	XC6127N26GMR	Vdet-IC	2.6V±0.8%, +Reset ODO, -MR, Rt=100ms	SOT-25	28yx	VD4	6g	Tor
6FV	XC6107F027MR	Vdet-IC	2.7V±2%, Hst, -MR, +Rst PPO, -Rst ODO, Rt=400ms	SOT-25	28xf	VD22	6g	Tor



SMD code	Type	Function	Short description	Case	Pinout	Sch.	St.	Mnf.
6FX	XC6127N26HMR	Vdet-IC	2.6V±0.8%, +Reset ODO, -MR, Rt=200ms	SOT-25	28yx	VD4	6g	Tor
6FX	XC6107F028MR	Vdet-IC	2.8V±2%, Hst, -MR, +Rst PPO, -Rst ODO, Rt=400ms	SOT-25	28xf	VD22	6g	Tor
6FY	XC6127N26JMR	Vdet-IC	2.6V±0.8%, +Reset ODO, -MR, Rt=400ms	SOT-25	28yx	VD4	6g	Tor
6FY	XC6107F029MR	Vdet-IC	2.9V±2%, Hst, -MR, +Rst PPO, -Rst ODO, Rt=400ms	SOT-25	28xf	VD22	6g	Tor
6FZ	XC6127N26KMR	Vdet-IC	2.6V±0.8%, +Reset ODO, -MR, Rt=800ms	SOT-25	28yx	VD4	6g	Tor
6FZ	XC6107F030MR	Vdet-IC	3.0V±2%, Hst, -MR, +Rst PPO, -Rst ODO, Rt=400ms	SOT-25	28xf	VD22	6g	Tor
6G	MIC5366-1.8YMT	LVR-IC	LDO, 1.8V±2%, 150mA, +CE, CL	SC-70-5	28gf	VR4	6g	Mcr
6Ga	FT531Ga	LVR-IC	LDO, 2.8V±2%, 300mA, +CE	SOT-23-5	28cx	VR4	6g	Fmd
6Gb	FT531Gb	LVR-IC	LDO, 2.8V±2%, 300mA, +CE	SOT-23-5	28vc	VR4	6g	Fmd
6Gc	FT531Gc	LVR-IC	LDO, 2.8V±2%, 300mA, +CE	SOT-23-5	28xm	VR4	6g	Fmd
6Gd	FT531Gd	LVR-IC	LDO, 2.8V±2%, 300mA, +CE	SC-70-5	28cx	VR4	6g	Fmd
6Ge	FT531Ge	LVR-IC	LDO, 2.8V±2%, 300mA, +CE	SC-70-5	28vc	VR4	6g	Fmd
6Gf	FT531Gf	LVR-IC	LDO, 2.8V±2%, 300mA, +CE	SC-70-5	28xm	VR4	6g	Fmd
6H	MIC5366-2.0YMT	LVR-IC	LDO, 2.0V±2%, 150mA, +CE, CL	SC-70-5	28gf	VR4	6g	Mcr
6H_	SN74AUP1T86DCK	CMOS-Logic	2-input EXCLUSIVE OR gate	SC-70-5	28LQg5	-	6a	Ti
6H0	XC9237A10DMR	DC-DC-IC	PWM-PWM/PFM, st-dwn, 1.0V±2%, 600mA, 3MHz, Vin>2V, LSST	SOT-25	28dc4	DC1	6g	Tor
6H0	XC6107H031MR	Vdet-IC	3.1V±2%, Hst, -MR, +Rst PPO, -Rst ODO, Rt=1.6s	SOT-25	28xf	VD22	6g	Tor
6H1	XC9237A11DMR	DC-DC-IC	PWM-PWM/PFM, st-dwn, 1.1V±2%, 600mA, 3MHz, Vin>2V, LSST	SOT-25	28dc4	DC1	6g	Tor
6H1	XC6107H032MR	Vdet-IC	3.2V±2%, Hst, -MR, +Rst PPO, -Rst ODO, Rt=1.6s	SOT-25	28xf	VD22	6g	Tor
6H2	XC9237A12DMR	DC-DC-IC	PWM-PWM/PFM, st-dwn, 1.2V±2%, 600mA, 3MHz, Vin>2V, LSST	SOT-25	28dc4	DC1	6g	Tor
6H2	XC6107H033MR	Vdet-IC	3.3V±2%, Hst, -MR, +Rst PPO, -Rst ODO, Rt=1.6s	SOT-25	28xf	VD22	6g	Tor
6H3	XC9237A13DMR	DC-DC-IC	PWM-PWM/PFM, st-dwn, 1.3V±2%, 600mA, 3MHz, Vin>2V, LSST	SOT-25	28dc4	DC1	6g	Tor
6H3	XC6107H034MR	Vdet-IC	3.4V±2%, Hst, -MR, +Rst PPO, -Rst ODO, Rt=1.6s	SOT-25	28xf	VD22	6g	Tor
6H4	XC9237A14DMR	DC-DC-IC	PWM-PWM/PFM, st-dwn, 1.4V±2%, 600mA, 3MHz, Vin>2V, LSST	SOT-25	28dc4	DC1	6g	Tor
6H4	XC6107H035MR	Vdet-IC	3.5V±2%, Hst, -MR, +Rst PPO, -Rst ODO, Rt=1.6s	SOT-25	28xf	VD22	6g	Tor
6H5	XC9237A15DMR	DC-DC-IC	PWM-PWM/PFM, st-dwn, 1.5V±2%, 600mA, 3MHz, Vin>2V, LSST	SOT-25	28dc4	DC1	6g	Tor
6H5	XC6107H036MR	Vdet-IC	3.6V±2%, Hst, -MR, +Rst PPO, -Rst ODO, Rt=1.6s	SOT-25	28xf	VD22	6g	Tor
6H6	XC9237A16DMR	DC-DC-IC	PWM-PWM/PFM, st-dwn, 1.6V±2%, 600mA, 3MHz, Vin>2V, LSST	SOT-25	28dc4	DC1	6g	Tor
6H6	XC6107H037MR	Vdet-IC	3.7V±2%, Hst, -MR, +Rst PPO, -Rst ODO, Rt=1.6s	SOT-25	28xf	VD22	6g	Tor
6H7	XC9237A17DMR	DC-DC-IC	PWM-PWM/PFM, st-dwn, 1.7V±2%, 600mA, 3MHz, Vin>2V, LSST	SOT-25	28dc4	DC1	6g	Tor
6H7	XC6107H038MR	Vdet-IC	3.8V±2%, Hst, -MR, +Rst PPO, -Rst ODO, Rt=1.6s	SOT-25	28xf	VD22	6g	Tor
6H8	XC9237A18DMR	DC-DC-IC	PWM-PWM/PFM, st-dwn, 1.8V±2%, 600mA, 3MHz, Vin>2V, LSST	SOT-25	28dc4	DC1	6g	Tor
6H8	XC6107H039MR	Vdet-IC	3.9V±2%, Hst, -MR, +Rst PPO, -Rst ODO, Rt=1.6s	SOT-25	28xf	VD22	6g	Tor
6H9	XC9237A19DMR	DC-DC-IC	PWM-PWM/PFM, st-dwn, 1.9V±2%, 600mA, 3MHz, Vin>2V, LSST	SOT-25	28dc4	DC1	6g	Tor
6H9	XC6107H040MR	Vdet-IC	4.0V±2%, Hst, -MR, +Rst PPO, -Rst ODO, Rt=1.6s	SOT-25	28xf	VD22	6g	Tor
6Ha	FT531Ha	LVR-IC	LDO, 2.85V±2%, 300mA, +CE	SOT-23-5	28cx	VR4	6g	Fmd
6HA	XC6127N27AMR	Vdet-IC	2.7V±0.8%, -Reset ODO, -MR, Rt=50ms	SOT-25	28yx	VD4	6g	Tor
6HA	XC9237A1ADMR	DC-DC-IC	PWM-PWM/PFM, st-dwn, 1.05V±2%, 600mA, 3MHz, Vin>2V, LSST	SOT-25	28dc4	DC1	6g	Tor
6HA	XC6107H041MR	Vdet-IC	4.1V±2%, Hst, -MR, +Rst PPO, -Rst ODO, Rt=1.6s	SOT-25	28xf	VD22	6g	Tor
6Hb	FT531Hb	LVR-IC	LDO, 2.85V±2%, 300mA, +CE	SOT-23-5	28vc	VR4	6g	Fmd
6HB	XC6127N27BMR	Vdet-IC	2.7V±0.8%, -Reset ODO, -MR, Rt=100ms	SOT-25	28yx	VD4	6g	Tor
6HB	XC9237A1BDMR	DC-DC-IC	PWM-PWM/PFM, st-dwn, 1.15V±2%, 600mA, 3MHz, Vin>2V, LSST	SOT-25	28dc4	DC1	6g	Tor
6HB	XC6107H042MR	Vdet-IC	4.2V±2%, Hst, -MR, +Rst PPO, -Rst ODO, Rt=1.6s	SOT-25	28xf	VD22	6g	Tor
6Hc	FT531Hc	LVR-IC	LDO, 2.85V±2%, 300mA, +CE	SOT-23-5	28xm	VR4	6g	Fmd
6HC	XC6127N27CMR	Vdet-IC	2.7V±0.8%, -Reset ODO, -MR, Rt=200ms	SOT-25	28yx	VD4	6g	Tor
6HC	XC9237A1CDMR	DC-DC-IC	PWM-PWM/PFM, st-dwn, 1.25V±2%, 600mA, 3MHz, Vin>2V, LSST	SOT-25	28dc4	DC1	6g	Tor
6HC	XC6107H043MR	Vdet-IC	4.3V±2%, Hst, -MR, +Rst PPO, -Rst ODO, Rt=1.6s	SOT-25	28xf	VD22	6g	Tor
6Hd	FT531Hd	LVR-IC	LDO, 2.85V±2%, 300mA, +CE	SC-70-5	28cx	VR4	6g	Fmd
6HD	XC6127N27DMR	Vdet-IC	2.7V±0.8%, -Reset ODO, -MR, Rt=400ms	SOT-25	28yx	VD4	6g	Tor
6HD	XC9237A1DDMR	DC-DC-IC	PWM-PWM/PFM, st-dwn, 1.35V±2%, 600mA, 3MHz, Vin>2V, LSST	SOT-25	28dc4	DC1	6g	Tor
6HD	XC6107H044MR	Vdet-IC	4.4V±2%, Hst, -MR, +Rst PPO, -Rst ODO, Rt=1.6s	SOT-25	28xf	VD22	6g	Tor
6He	FT531He	LVR-IC	LDO, 2.85V±2%, 300mA, +CE	SC-70-5	28vc	VR4	6g	Fmd
6HE	XC6127N27EMR	Vdet-IC	2.7V±0.8%, -Reset ODO, -MR, Rt=800ms	SOT-25	28yx	VD4	6g	Tor
6HE	XC9237A1EDMR	DC-DC-IC	PWM-PWM/PFM, st-dwn, 1.45V±2%, 600mA, 3MHz, Vin>2V, LSST	SOT-25	28dc4	DC1	6g	Tor
6HE	XC6107H045MR	Vdet-IC	4.5V±2%, Hst, -MR, +Rst PPO, -Rst ODO, Rt=1.6s	SOT-25	28xf	VD22	6g	Tor
6Hf	FT531Hf	LVR-IC	LDO, 2.85V±2%, 300mA, +CE	SC-70-5	28xm	VR4	6g	Fmd
6HF	XC6127N27FMR	Vdet-IC	2.7V±0.8%, +Reset ODO, -MR, Rt=50ms	SOT-25	28yx	VD4	6g	Tor
6HF	XC9237A1FDMR	DC-DC-IC	PWM-PWM/PFM, st-dwn, 1.55V±2%, 600mA, 3MHz, Vin>2V, LSST	SOT-25	28dc4	DC1	6g	Tor
6HF	XC6107H016MR	Vdet-IC	1.6V±2%, Hst, -MR, +Rst PPO, -Rst ODO, Rt=1.6s	SOT-25	28xf	VD22	6g	Tor
6HF	XC6107H046MR	Vdet-IC	4.6V±2%, Hst, -MR, +Rst PPO, -Rst ODO, Rt=1.6s	SOT-25	28xf	VD22	6g	Tor
6HH	XC6127N27GMR	Vdet-IC	2.7V±0.8%, +Reset ODO, -MR, Rt=100ms	SOT-25	28yx	VD4	6g	Tor
6HH	XC9237A1HDMR	DC-DC-IC	PWM-PWM/PFM, st-dwn, 1.65V±2%, 600mA, 3MHz, Vin>2V, LSST	SOT-25	28dc4	DC1	6g	Tor
6HH	XC6107H017MR	Vdet-IC	1.7V±2%, Hst, -MR, +Rst PPO, -Rst ODO, Rt=1.6s	SOT-25	28xf	VD22	6g	Tor
6HH	XC6107H047MR	Vdet-IC	4.7V±2%, Hst, -MR, +Rst PPO, -Rst ODO, Rt=1.6s	SOT-25	28xf	VD22	6g	Tor
6HK	XC6127N27HMR	Vdet-IC	2.7V±0.8%, +Reset ODO, -MR, Rt=200ms	SOT-25	28yx	VD4	6g	Tor
6HK	XC9237A1KDMR	DC-DC-IC	PWM-PWM/PFM, st-dwn, 1.75V±2%, 600mA, 3MHz, Vin>2V, LSST	SOT-25	28dc4	DC1	6g	Tor
6HK	XC6107H018MR	Vdet-IC	1.8V±2%, Hst, -MR, +Rst PPO, -Rst ODO, Rt=1.6s	SOT-25	28xf	VD22	6g	Tor
6HK	XC6107H048MR	Vdet-IC	4.8V±2%, Hst, -MR, +Rst PPO, -Rst ODO, Rt=1.6s	SOT-25	28xf	VD22	6g	Tor
6HL	XC6127N27JMR	Vdet-IC	2.7V±0.8%, +Reset ODO, -MR, Rt=400ms	SOT-25	28yx	VD4	6g	Tor
6HL	XC9237A1LDMR	DC-DC-IC	PWM-PWM/PFM, st-dwn, 1.85V±2%, 600mA, 3MHz, Vin>2V, LSST	SOT-25	28dc4	DC1	6g	Tor



SMD code	Type	Function	Short description	Case	Pinout	Sch.	St.	Mnf.
6HL	XC6107H019MR	Vdet-IC	1.9V±2%, Hst, -MR, +Rst PPO, -Rst ODO, Rt=1.6s	SOT-25	28xf	VD22	6g	Tor
6HL	XC6107H049MR	Vdet-IC	4.9V±2%, Hst, -MR, +Rst PPO, -Rst ODO, Rt=1.6s	SOT-25	28xf	VD22	6g	Tor
6HM	XC6127N27KMR	Vdet-IC	2.7V±0.8%, +Reset ODO, -MR, Rt=800ms	SOT-25	28yx	VD4	6g	Tor
6HM	XC9237A1MDMR	DC-DC-IC	PWM-PWM/PFM, st-dwn, 1.95V±2%, 600mA, 3MHz, Vin>2V, LSST	SOT-25	28dc4	DC1	6g	Tor
6HM	XC6107H020MR	Vdet-IC	2.0V±2%, Hst, -MR, +Rst PPO, -Rst ODO, Rt=1.6s	SOT-25	28xf	VD22	6g	Tor
6HM	XC6107H050MR	Vdet-IC	5.0V±2%, Hst, -MR, +Rst PPO, -Rst ODO, Rt=1.6s	SOT-25	28xf	VD22	6g	Tor
6HN	XC6127N28AMR	Vdet-IC	2.8V±0.8%, -Reset ODO, -MR, Rt=50ms	SOT-25	28yx	VD4	6g	Tor
6HN	XC6107H021MR	Vdet-IC	2.1V±2%, Hst, -MR, +Rst PPO, -Rst ODO, Rt=1.6s	SOT-25	28xf	VD22	6g	Tor
6HP	XC6127N28BMR	Vdet-IC	2.8V±0.8%, -Reset ODO, -MR, Rt=100ms	SOT-25	28yx	VD4	6g	Tor
6HP	XC6107H022MR	Vdet-IC	2.2V±2%, Hst, -MR, +Rst PPO, -Rst ODO, Rt=1.6s	SOT-25	28xf	VD22	6g	Tor
6HR	XC6127N28CMR	Vdet-IC	2.8V±0.8%, -Reset ODO, -MR, Rt=200ms	SOT-25	28yx	VD4	6g	Tor
6HR	XC6107H023MR	Vdet-IC	2.3V±2%, Hst, -MR, +Rst PPO, -Rst ODO, Rt=1.6s	SOT-25	28xf	VD22	6g	Tor
6HS	XC6127N28DMR	Vdet-IC	2.8V±0.8%, -Reset ODO, -MR, Rt=400ms	SOT-25	28yx	VD4	6g	Tor
6HS	XC6107H024MR	Vdet-IC	2.4V±2%, Hst, -MR, +Rst PPO, -Rst ODO, Rt=1.6s	SOT-25	28xf	VD22	6g	Tor
6HT	XC6127N28EMR	Vdet-IC	2.8V±0.8%, -Reset ODO, -MR, Rt=800ms	SOT-25	28yx	VD4	6g	Tor
6HT	XC6107H025MR	Vdet-IC	2.5V±2%, Hst, -MR, +Rst PPO, -Rst ODO, Rt=1.6s	SOT-25	28xf	VD22	6g	Tor
6HU	XC6127N28FMR	Vdet-IC	2.8V±0.8%, +Reset ODO, -MR, Rt=50ms	SOT-25	28yx	VD4	6g	Tor
6HU	XC6107H026MR	Vdet-IC	2.6V±2%, Hst, -MR, +Rst PPO, -Rst ODO, Rt=1.6s	SOT-25	28xf	VD22	6g	Tor
6HV	XC6127N28GMR	Vdet-IC	2.8V±0.8%, +Reset ODO, -MR, Rt=100ms	SOT-25	28yx	VD4	6g	Tor
6HV	XC6107H027MR	Vdet-IC	2.7V±2%, Hst, -MR, +Rst PPO, -Rst ODO, Rt=1.6s	SOT-25	28xf	VD22	6g	Tor
6HX	XC6127N28HMR	Vdet-IC	2.8V±0.8%, +Reset ODO, -MR, Rt=200ms	SOT-25	28yx	VD4	6g	Tor
6HX	XC6107H028MR	Vdet-IC	2.8V±2%, Hst, -MR, +Rst PPO, -Rst ODO, Rt=1.6s	SOT-25	28xf	VD22	6g	Tor
6HY	XC6127N28JMR	Vdet-IC	2.8V±0.8%, +Reset ODO, -MR, Rt=400ms	SOT-25	28yx	VD4	6g	Tor
6HY	XC6107H029MR	Vdet-IC	2.9V±2%, Hst, -MR, +Rst PPO, -Rst ODO, Rt=1.6s	SOT-25	28xf	VD22	6g	Tor
6HZ	XC6127N28KMR	Vdet-IC	2.8V±0.8%, +Reset ODO, -MR, Rt=800ms	SOT-25	28yx	VD4	6g	Tor
6HZ	XC6107H030MR	Vdet-IC	3.0V±2%, Hst, -MR, +Rst PPO, -Rst ODO, Rt=1.6s	SOT-25	28xf	VD22	6g	Tor
6ia	FT5311a	LVR-IC	LDO, 3.0V±2%, 300mA, +CE	SOT-23-5	28cx	VR4	6g	Fmd
6ib	FT5311b	LVR-IC	LDO, 3.0V±2%, 300mA, +CE	SOT-23-5	28bc	VR4	6g	Fmd
6ic	FT5311c	LVR-IC	LDO, 3.0V±2%, 300mA, +CE	SOT-23-5	28xm	VR4	6g	Fmd
6id	FT5311d	LVR-IC	LDO, 3.0V±2%, 300mA, +CE	SC-70-5	28cx	VR4	6g	Fmd
6ie	FT5311e	LVR-IC	LDO, 3.0V±2%, 300mA, +CE	SC-70-5	28vc	VR4	6g	Fmd
6if	FT5311f	LVR-IC	LDO, 3.0V±2%, 300mA, +CE	SC-70-5	28xm	VR4	6g	Fmd
6J	MIC5366-2.5YMT	LVR-IC	LDO, 2.5V±2%, 150mA, +CE, CL	SC-70-5	28gf	VR4	6g	Mcr
6J	R3111N161C	Vdet-IC	1.6V±2%, -Reset ODO	SOT-23-5	28vdm	VD6	6g	Ric
6J_	SN74AUP1T87DCK	CMOS-Logic	2-input EXCLUSIVE NOR gate	SC-70-5	28vLog87	-	6a	Ti
6Ja	FT5311Ja	LVR-IC	LDO, 3.3V±2%, 300mA, +CE	SOT-23-5	28cx	VR4	6g	Fmd
6Jb	FT5311Jb	LVR-IC	LDO, 3.3V±2%, 300mA, +CE	SOT-23-5	28vc	VR4	6g	Fmd
6Jc	FT5311Jc	LVR-IC	LDO, 3.3V±2%, 300mA, +CE	SOT-23-5	28xm	VR4	6g	Fmd
6Jd	FT5311Jd	LVR-IC	LDO, 3.3V±2%, 300mA, +CE	SC-70-5	28cx	VR4	6g	Fmd
6Je	FT5311Je	LVR-IC	LDO, 3.3V±2%, 300mA, +CE	SC-70-5	28vc	VR4	6g	Fmd
6Jf	FT5311Jf	LVR-IC	LDO, 3.3V±2%, 300mA, +CE	SC-70-5	28xm	VR4	6g	Fmd
6K	MIC5366-2.6YMT	LVR-IC	LDO, 2.6V±2%, 150mA, +CE, CL	SC-70-5	28gf	VR4	6g	Mcr
6K	R3111N261C	Vdet-IC	2.6V±2%, -Reset ODO	SOT-23-5	28vdm	VD6	6g	Ric
6K0	XC9237A20DMR	DC-DC-IC	PWM-PWM/PFM, st-dwn, 2.0V±2%, 600mA, 3MHz, Vin>2V, LSST	SOT-25	28dc4	DC1	6g	Tor
6K1	XC9237A21DMR	DC-DC-IC	PWM-PWM/PFM, st-dwn, 2.1V±2%, 600mA, 3MHz, Vin>2V, LSST	SOT-25	28dc4	DC1	6g	Tor
6K2	XC9237A22DMR	DC-DC-IC	PWM-PWM/PFM, st-dwn, 2.2V±2%, 600mA, 3MHz, Vin>2V, LSST	SOT-25	28dc4	DC1	6g	Tor
6K3	XC9237A23DMR	DC-DC-IC	PWM-PWM/PFM, st-dwn, 2.3V±2%, 600mA, 3MHz, Vin>2V, LSST	SOT-25	28dc4	DC1	6g	Tor
6K4	XC9237A24DMR	DC-DC-IC	PWM-PWM/PFM, st-dwn, 2.4V±2%, 600mA, 3MHz, Vin>2V, LSST	SOT-25	28dc4	DC1	6g	Tor
6K5	XC9237A25DMR	DC-DC-IC	PWM-PWM/PFM, st-dwn, 2.5V±2%, 600mA, 3MHz, Vin>2V, LSST	SOT-25	28dc4	DC1	6g	Tor
6K6	XC9237A26DMR	DC-DC-IC	PWM-PWM/PFM, st-dwn, 2.6V±2%, 600mA, 3MHz, Vin>2V, LSST	SOT-25	28dc4	DC1	6g	Tor
6K7	XC9237A27DMR	DC-DC-IC	PWM-PWM/PFM, st-dwn, 2.7V±2%, 600mA, 3MHz, Vin>2V, LSST	SOT-25	28dc4	DC1	6g	Tor
6K8	XC9237A28DMR	DC-DC-IC	PWM-PWM/PFM, st-dwn, 2.8V±2%, 600mA, 3MHz, Vin>2V, LSST	SOT-25	28dc4	DC1	6g	Tor
6K9	XC9237A29DMR	DC-DC-IC	PWM-PWM/PFM, st-dwn, 2.9V±2%, 600mA, 3MHz, Vin>2V, LSST	SOT-25	28dc4	DC1	6g	Tor
6Ka	FT5311Ka	LVR-IC	LDO, 3.6V±2%, 300mA, +CE	SOT-23-5	28cx	VR4	6g	Fmd
6KA	XC6127N29AMR	Vdet-IC	2.9V±0.8%, -Reset ODO, -MR, Rt=50ms	SOT-25	28yx	VD4	6g	Tor
6KA	XC9237A2ADMR	DC-DC-IC	PWM-PWM/PFM, st-dwn, 2.05V±2%, 600mA, 3MHz, Vin>2V, LSST	SOT-25	28dc4	DC1	6g	Tor
6Kb	FT5311Kb	LVR-IC	LDO, 3.6V±2%, 300mA, +CE	SOT-23-5	28vc	VR4	6g	Fmd
6KB	XC6127N29BMR	Vdet-IC	2.9V±0.8%, -Reset ODO, -MR, Rt=100ms	SOT-25	28yx	VD4	6g	Tor
6KB	XC9237A2BDMR	DC-DC-IC	PWM-PWM/PFM, st-dwn, 2.15V±2%, 600mA, 3MHz, Vin>2V, LSST	SOT-25	28dc4	DC1	6g	Tor
6Kc	FT5311Kc	LVR-IC	LDO, 3.6V±2%, 300mA, +CE	SOT-23-5	28xm	VR4	6g	Fmd
6KC	XC6127N29CMR	Vdet-IC	2.9V±0.8%, -Reset ODO, -MR, Rt=200ms	SOT-25	28yx	VD4	6g	Tor
6KC	XC9237A2CDMR	DC-DC-IC	PWM-PWM/PFM, st-dwn, 2.25V±2%, 600mA, 3MHz, Vin>2V, LSST	SOT-25	28dc4	DC1	6g	Tor
6Kd	FT5311Kd	LVR-IC	LDO, 3.6V±2%, 300mA, +CE	SC-70-5	28cx	VR4	6g	Fmd
6KD	XC6127N29DMR	Vdet-IC	2.9V±0.8%, -Reset ODO, -MR, Rt=400ms	SOT-25	28yx	VD4	6g	Tor
6KD	XC9237A2DDMR	DC-DC-IC	PWM-PWM/PFM, st-dwn, 2.35V±2%, 600mA, 3MHz, Vin>2V, LSST	SOT-25	28dc4	DC1	6g	Tor
6Ke	FT5311Ke	LVR-IC	LDO, 3.6V±2%, 300mA, +CE	SC-70-5	28vc	VR4	6g	Fmd
6KE	XC6127N29EMR	Vdet-IC	2.9V±0.8%, -Reset ODO, -MR, Rt=800ms	SOT-25	28yx	VD4	6g	Tor
6KE	XC9237A2EDMR	DC-DC-IC	PWM-PWM/PFM, st-dwn, 2.45V±2%, 600mA, 3MHz, Vin>2V, LSST	SOT-25	28dc4	DC1	6g	Tor
6Kf	FT5311Kf	LVR-IC	LDO, 3.6V±2%, 300mA, +CE	SC-70-5	28xm	VR4	6g	Fmd
6KF	XC6127N29FMR	Vdet-IC	2.9V±0.8%, +Reset ODO, -MR, Rt=50ms	SOT-25	28yx	VD4	6g	Tor



SMD code	Type	Function	Short description	Case	Pinout	Sch.	St.	Mnf.
6KF	XC9237A2FDMR	DC-DC-IC	PWM-PWM/PFM, st-dwn, 2.55V±2%, 600mA, 3MHz, Vin>2V, LSST	SOT-25	28dc4	DC1	6g	Tor
6KH	XC6127N29GMR	Vdet-IC	2.9V±0.8%, +Reset ODO, -MR, Rt=100ms	SOT-25	28yx	VD4	6g	Tor
6KH	XC9237A2HDMR	DC-DC-IC	PWM-PWM/PFM, st-dwn, 2.65V±2%, 600mA, 3MHz, Vin>2V, LSST	SOT-25	28dc4	DC1	6g	Tor
6KK	XC6127N29HMR	Vdet-IC	2.9V±0.8%, +Reset ODO, -MR, Rt=200ms	SOT-25	28yx	VD4	6g	Tor
6KK	XC9237A2KDMR	DC-DC-IC	PWM-PWM/PFM, st-dwn, 2.75V±2%, 600mA, 3MHz, Vin>2V, LSST	SOT-25	28dc4	DC1	6g	Tor
6KL	XC6127N29JMR	Vdet-IC	2.9V±0.8%, +Reset ODO, -MR, Rt=400ms	SOT-25	28yx	VD4	6g	Tor
6KL	XC9237A2LDMR	DC-DC-IC	PWM-PWM/PFM, st-dwn, 2.85V±2%, 600mA, 3MHz, Vin>2V, LSST	SOT-25	28dc4	DC1	6g	Tor
6KM	XC6127N29KMR	Vdet-IC	2.9V±0.8%, +Reset ODO, -MR, Rt=800ms	SOT-25	28yx	VD4	6g	Tor
6KM	XC9237A2MDMR	DC-DC-IC	PWM-PWM/PFM, st-dwn, 2.95V±2%, 600mA, 3MHz, Vin>2V, LSST	SOT-25	28dc4	DC1	6g	Tor
6KN	XC6127N30AMR	Vdet-IC	3.0V±0.8%, -Reset ODO, -MR, Rt=50ms	SOT-25	28yx	VD4	6g	Tor
6KP	XC6127N30BMR	Vdet-IC	3.0V±0.8%, -Reset ODO, -MR, Rt=100ms	SOT-25	28yx	VD4	6g	Tor
6KR	XC6127N30CMR	Vdet-IC	3.0V±0.8%, -Reset ODO, -MR, Rt=200ms	SOT-25	28yx	VD4	6g	Tor
6KS	XC6127N30DMR	Vdet-IC	3.0V±0.8%, -Reset ODO, -MR, Rt=400ms	SOT-25	28yx	VD4	6g	Tor
6KT	XC6127N30EMR	Vdet-IC	3.0V±0.8%, -Reset ODO, -MR, Rt=800ms	SOT-25	28yx	VD4	6g	Tor
6KU	XC6127N30FMR	Vdet-IC	3.0V±0.8%, +Reset ODO, -MR, Rt=50ms	SOT-25	28yx	VD4	6g	Tor
6KV	XC6127N30GMR	Vdet-IC	3.0V±0.8%, +Reset ODO, -MR, Rt=100ms	SOT-25	28yx	VD4	6g	Tor
6KX	XC6127N30HMR	Vdet-IC	3.0V±0.8%, +Reset ODO, -MR, Rt=200ms	SOT-25	28yx	VD4	6g	Tor
6KY	XC6127N30JMR	Vdet-IC	3.0V±0.8%, +Reset ODO, -MR, Rt=400ms	SOT-25	28yx	VD4	6g	Tor
6KZ	XC6127N30KMR	Vdet-IC	3.0V±0.8%, +Reset ODO, -MR, Rt=800ms	SOT-25	28yx	VD4	6g	Tor
6L	MIC5366-2.7YMT	LVR-IC	LDO, 2.7V±2%, 150mA, +CE, CL	SC-70-5	28gf	VR4	6g	Mcr
6L	R3111N361C	Vdet-IC	3.6V±2%, -Reset ODO	SOT-23-5	28vdm	VD6	6g	Ric
6L0	XC9237A30DMR	DC-DC-IC	PWM-PWM/PFM, st-dwn, 3.0V±2%, 600mA, 3MHz, Vin>2V, LSST	SOT-25	28dc4	DC1	6g	Tor
6L1	XC9237A31DMR	DC-DC-IC	PWM-PWM/PFM, st-dwn, 3.1V±2%, 600mA, 3MHz, Vin>2V, LSST	SOT-25	28dc4	DC1	6g	Tor
6L2	XC9237A32DMR	DC-DC-IC	PWM-PWM/PFM, st-dwn, 3.2V±2%, 600mA, 3MHz, Vin>2V, LSST	SOT-25	28dc4	DC1	6g	Tor
6L3	XC9237A33DMR	DC-DC-IC	PWM-PWM/PFM, st-dwn, 3.3V±2%, 600mA, 3MHz, Vin>2V, LSST	SOT-25	28dc4	DC1	6g	Tor
6L4	XC9237A34DMR	DC-DC-IC	PWM-PWM/PFM, st-dwn, 3.4V±2%, 600mA, 3MHz, Vin>2V, LSST	SOT-25	28dc4	DC1	6g	Tor
6L5	XC9237A35DMR	DC-DC-IC	PWM-PWM/PFM, st-dwn, 3.5V±2%, 600mA, 3MHz, Vin>2V, LSST	SOT-25	28dc4	DC1	6g	Tor
6L6	XC9237A36DMR	DC-DC-IC	PWM-PWM/PFM, st-dwn, 3.6V±2%, 600mA, 3MHz, Vin>2V, LSST	SOT-25	28dc4	DC1	6g	Tor
6L7	XC9237A37DMR	DC-DC-IC	PWM-PWM/PFM, st-dwn, 3.7V±2%, 600mA, 3MHz, Vin>2V, LSST	SOT-25	28dc4	DC1	6g	Tor
6L8	XC9237A38DMR	DC-DC-IC	PWM-PWM/PFM, st-dwn, 3.8V±2%, 600mA, 3MHz, Vin>2V, LSST	SOT-25	28dc4	DC1	6g	Tor
6L9	XC9237A39DMR	DC-DC-IC	PWM-PWM/PFM, st-dwn, 3.9V±2%, 600mA, 3MHz, Vin>2V, LSST	SOT-25	28dc4	DC1	6g	Tor
6LA	XC6127N31AMR	Vdet-IC	3.1V±0.8%, -Reset ODO, -MR, Rt=50ms	SOT-25	28yx	VD4	6g	Tor
6LA	XC9237A3ADM	DC-DC-IC	PWM-PWM/PFM, st-dwn, 3.05V±2%, 600mA, 3MHz, Vin>2V, LSST	SOT-25	28dc4	DC1	6g	Tor
6LB	XC6127N31BMR	Vdet-IC	3.1V±0.8%, -Reset ODO, -MR, Rt=100ms	SOT-25	28yx	VD4	6g	Tor
6LB	XC9237A3BDMR	DC-DC-IC	PWM-PWM/PFM, st-dwn, 3.15V±2%, 600mA, 3MHz, Vin>2V, LSST	SOT-25	28dc4	DC1	6g	Tor
6LC	XC6127N31CMR	Vdet-IC	3.1V±0.8%, -Reset ODO, -MR, Rt=200ms	SOT-25	28yx	VD4	6g	Tor
6LC	XC9237A3CDMR	DC-DC-IC	PWM-PWM/PFM, st-dwn, 3.25V±2%, 600mA, 3MHz, Vin>2V, LSST	SOT-25	28dc4	DC1	6g	Tor
6LD	XC6127N31DMR	Vdet-IC	3.1V±0.8%, -Reset ODO, -MR, Rt=400ms	SOT-25	28yx	VD4	6g	Tor
6LD	XC9237A3DDMR	DC-DC-IC	PWM-PWM/PFM, st-dwn, 3.35V±2%, 600mA, 3MHz, Vin>2V, LSST	SOT-25	28dc4	DC1	6g	Tor
6LE	XC6127N31EMR	Vdet-IC	3.1V±0.8%, -Reset ODO, -MR, Rt=800ms	SOT-25	28yx	VD4	6g	Tor
6LE	XC9237A3EDMR	DC-DC-IC	PWM-PWM/PFM, st-dwn, 3.45V±2%, 600mA, 3MHz, Vin>2V, LSST	SOT-25	28dc4	DC1	6g	Tor
6LF	XC6127N31FMR	Vdet-IC	3.1V±0.8%, +Reset ODO, -MR, Rt=50ms	SOT-25	28yx	VD4	6g	Tor
6LF	XC9237A3FDMR	DC-DC-IC	PWM-PWM/PFM, st-dwn, 3.55V±2%, 600mA, 3MHz, Vin>2V, LSST	SOT-25	28dc4	DC1	6g	Tor
6LH	XC6127N31GMR	Vdet-IC	3.1V±0.8%, +Reset ODO, -MR, Rt=100ms	SOT-25	28yx	VD4	6g	Tor
6LH	XC9237A3HDMR	DC-DC-IC	PWM-PWM/PFM, st-dwn, 3.65V±2%, 600mA, 3MHz, Vin>2V, LSST	SOT-25	28dc4	DC1	6g	Tor
6LK	XC6127N31HMR	Vdet-IC	3.1V±0.8%, +Reset ODO, -MR, Rt=200ms	SOT-25	28yx	VD4	6g	Tor
6LK	XC9237A3KDMR	DC-DC-IC	PWM-PWM/PFM, st-dwn, 3.75V±2%, 600mA, 3MHz, Vin>2V, LSST	SOT-25	28dc4	DC1	6g	Tor
6LL	XC6127N31JMR	Vdet-IC	3.1V±0.8%, +Reset ODO, -MR, Rt=400ms	SOT-25	28yx	VD4	6g	Tor
6LL	XC9237A3LDMR	DC-DC-IC	PWM-PWM/PFM, st-dwn, 3.85V±2%, 600mA, 3MHz, Vin>2V, LSST	SOT-25	28dc4	DC1	6g	Tor
6LM	XC6127N31KMR	Vdet-IC	3.1V±0.8%, +Reset ODO, -MR, Rt=800ms	SOT-25	28yx	VD4	6g	Tor
6LM	XC9237A3MDMR	DC-DC-IC	PWM-PWM/PFM, st-dwn, 3.95V±2%, 600mA, 3MHz, Vin>2V, LSST	SOT-25	28dc4	DC1	6g	Tor
6LN	XC6127N32AMR	Vdet-IC	3.2V±0.8%, -Reset ODO, -MR, Rt=50ms	SOT-25	28yx	VD4	6g	Tor
6LP	XC6127N32BMR	Vdet-IC	3.2V±0.8%, -Reset ODO, -MR, Rt=100ms	SOT-25	28yx	VD4	6g	Tor
6LR	XC6127N32CMR	Vdet-IC	3.2V±0.8%, -Reset ODO, -MR, Rt=200ms	SOT-25	28yx	VD4	6g	Tor
6LS	XC6127N32DMR	Vdet-IC	3.2V±0.8%, -Reset ODO, -MR, Rt=400ms	SOT-25	28yx	VD4	6g	Tor
6LT	XC6127N32EMR	Vdet-IC	3.2V±0.8%, -Reset ODO, -MR, Rt=800ms	SOT-25	28yx	VD4	6g	Tor
6LU	XC6127N32FMR	Vdet-IC	3.2V±0.8%, +Reset ODO, -MR, Rt=50ms	SOT-25	28yx	VD4	6g	Tor
6LV	XC6127N32GMR	Vdet-IC	3.2V±0.8%, +Reset ODO, -MR, Rt=100ms	SOT-25	28yx	VD4	6g	Tor
6LX	XC6127N32HMR	Vdet-IC	3.2V±0.8%, +Reset ODO, -MR, Rt=200ms	SOT-25	28yx	VD4	6g	Tor
6LY	XC6127N32JMR	Vdet-IC	3.2V±0.8%, +Reset ODO, -MR, Rt=400ms	SOT-25	28yx	VD4	6g	Tor
6LZ	XC6127N32KMR	Vdet-IC	3.2V±0.8%, +Reset ODO, -MR, Rt=800ms	SOT-25	28yx	VD4	6g	Tor
6M	MIC5366-2.8YMT	LVR-IC	LDO, 2.8V±2%, 150mA, +CE, CL	SC-70-5	28gf	VR4	6g	Mcr
6M	R3111N461C	Vdet-IC	4.6V±2%, -Reset ODO	SOT-23-5	28vdm	VD6	6g	Ric
6M0	XC9237A40DMR	DC-DC-IC	PWM-PWM/PFM, st-dwn, 4.0V±2%, 600mA, 3MHz, Vin>2V, LSST	SOT-25	28dc4	DC1	6g	Tor
6MA	XC6127N33AMR	Vdet-IC	3.3V±0.8%, -Reset ODO, -MR, Rt=50ms	SOT-25	28yx	VD4	6g	Tor
6MB	XC6127N33BMR	Vdet-IC	3.3V±0.8%, -Reset ODO, -MR, Rt=100ms	SOT-25	28yx	VD4	6g	Tor
6MC	XC6127N33CMR	Vdet-IC	3.3V±0.8%, -Reset ODO, -MR, Rt=200ms	SOT-25	28yx	VD4	6g	Tor
6MD	XC6127N33DMR	Vdet-IC	3.3V±0.8%, -Reset ODO, -MR, Rt=400ms	SOT-25	28yx	VD4	6g	Tor
6ME	XC6127N33EMR	Vdet-IC	3.3V±0.8%, -Reset ODO, -MR, Rt=800ms	SOT-25	28yx	VD4	6g	Tor
6MF	XC6127N33FMR	Vdet-IC	3.3V±0.8%, +Reset ODO, -MR, Rt=50ms	SOT-25	28yx	VD4	6g	Tor



SMD code	Type	Function	Short description	Case	Pinout	Sch.	St.	Mnf.
6MH	XC6127N33GMR	Vdet-IC	3.3V±0.8%, +Reset ODO, -MR, Rt=100ms	SOT-25	28yx	VD4	6g	Tor
6MK	XC6127N33HMR	Vdet-IC	3.3V±0.8%, +Reset ODO, -MR, Rt=200ms	SOT-25	28yx	VD4	6g	Tor
6ML	XC6127N33JMR	Vdet-IC	3.3V±0.8%, +Reset ODO, -MR, Rt=400ms	SOT-25	28yx	VD4	6g	Tor
6MN	XC6127N33KMR	Vdet-IC	3.3V±0.8%, +Reset ODO, -MR, Rt=800ms	SOT-25	28yx	VD4	6g	Tor
6MM	XC6127N34AMR	Vdet-IC	3.4V±0.8%, -Reset ODO, -MR, Rt=50ms	SOT-25	28yx	VD4	6g	Tor
6MP	XC6127N34BMR	Vdet-IC	3.4V±0.8%, -Reset ODO, -MR, Rt=100ms	SOT-25	28yx	VD4	6g	Tor
6MR	XC6127N34CMR	Vdet-IC	3.4V±0.8%, -Reset ODO, -MR, Rt=200ms	SOT-25	28yx	VD4	6g	Tor
6MS	XC6127N34DMR	Vdet-IC	3.4V±0.8%, -Reset ODO, -MR, Rt=400ms	SOT-25	28yx	VD4	6g	Tor
6MT	XC6127N34EMR	Vdet-IC	3.4V±0.8%, -Reset ODO, -MR, Rt=800ms	SOT-25	28yx	VD4	6g	Tor
6MU	XC6127N34FMR	Vdet-IC	3.4V±0.8%, +Reset ODO, -MR, Rt=50ms	SOT-25	28yx	VD4	6g	Tor
6MV	XC6127N34GMR	Vdet-IC	3.4V±0.8%, +Reset ODO, -MR, Rt=100ms	SOT-25	28yx	VD4	6g	Tor
6MX	XC6127N34HMR	Vdet-IC	3.4V±0.8%, +Reset ODO, -MR, Rt=200ms	SOT-25	28yx	VD4	6g	Tor
6MY	XC6127N34JMR	Vdet-IC	3.4V±0.8%, +Reset ODO, -MR, Rt=400ms	SOT-25	28yx	VD4	6g	Tor
6MZ	XC6127N34KMR	Vdet-IC	3.4V±0.8%, +Reset ODO, -MR, Rt=800ms	SOT-25	28yx	VD4	6g	Tor
6N	MIC5366-2.85YMT	LVR-IC	LDO, 2.85V±2%, 150mA, +CE, CL	SC-70-5	28gf	VR4	6g	Mcr
6N	R3111N561C	Vdet-IC	5.6V±2%, -Reset ODO	SOT-23-5	28vdm	VD6	6g	Ric
6NA	XC6127N35AMR	Vdet-IC	3.5V±0.8%, -Reset ODO, -MR, Rt=50ms	SOT-25	28yx	VD4	6g	Tor
6NB	XC6127N35BMR	Vdet-IC	3.5V±0.8%, -Reset ODO, -MR, Rt=100ms	SOT-25	28yx	VD4	6g	Tor
6NC	XC6127N35CMR	Vdet-IC	3.5V±0.8%, -Reset ODO, -MR, Rt=200ms	SOT-25	28yx	VD4	6g	Tor
6ND	XC6127N35DMR	Vdet-IC	3.5V±0.8%, -Reset ODO, -MR, Rt=400ms	SOT-25	28yx	VD4	6g	Tor
6NE	XC6127N35EMR	Vdet-IC	3.5V±0.8%, -Reset ODO, -MR, Rt=800ms	SOT-25	28yx	VD4	6g	Tor
6NF	XC6127N35FMR	Vdet-IC	3.5V±0.8%, +Reset ODO, -MR, Rt=50ms	SOT-25	28yx	VD4	6g	Tor
6NH	XC6127N35GMR	Vdet-IC	3.5V±0.8%, +Reset ODO, -MR, Rt=100ms	SOT-25	28yx	VD4	6g	Tor
6NK	XC6127N35HMR	Vdet-IC	3.5V±0.8%, +Reset ODO, -MR, Rt=200ms	SOT-25	28yx	VD4	6g	Tor
6NL	XC6127N35JMR	Vdet-IC	3.5V±0.8%, +Reset ODO, -MR, Rt=400ms	SOT-25	28yx	VD4	6g	Tor
6NM	XC6127N35KMR	Vdet-IC	3.5V±0.8%, +Reset ODO, -MR, Rt=800ms	SOT-25	28yx	VD4	6g	Tor
6NN	XC6127N36AMR	Vdet-IC	3.6V±0.8%, -Reset ODO, -MR, Rt=50ms	SOT-25	28yx	VD4	6g	Tor
6NP	XC6127N36BMR	Vdet-IC	3.6V±0.8%, -Reset ODO, -MR, Rt=100ms	SOT-25	28yx	VD4	6g	Tor
6NR	XC6127N36CMR	Vdet-IC	3.6V±0.8%, -Reset ODO, -MR, Rt=200ms	SOT-25	28yx	VD4	6g	Tor
6NS	XC6127N36DMR	Vdet-IC	3.6V±0.8%, -Reset ODO, -MR, Rt=400ms	SOT-25	28yx	VD4	6g	Tor
6NT	XC6127N36EMR	Vdet-IC	3.6V±0.8%, -Reset ODO, -MR, Rt=800ms	SOT-25	28yx	VD4	6g	Tor
6NU	XC6127N36FMR	Vdet-IC	3.6V±0.8%, +Reset ODO, -MR, Rt=50ms	SOT-25	28yx	VD4	6g	Tor
6NV	XC6127N36GMR	Vdet-IC	3.6V±0.8%, +Reset ODO, -MR, Rt=100ms	SOT-25	28yx	VD4	6g	Tor
6NX	XC6127N36HMR	Vdet-IC	3.6V±0.8%, +Reset ODO, -MR, Rt=200ms	SOT-25	28yx	VD4	6g	Tor
6NY	XC6127N36JMR	Vdet-IC	3.6V±0.8%, +Reset ODO, -MR, Rt=400ms	SOT-25	28yx	VD4	6g	Tor
6NZ	XC6127N36KMR	Vdet-IC	3.6V±0.8%, +Reset ODO, -MR, Rt=800ms	SOT-25	28yx	VD4	6g	Tor
6O	MIC5366-2.9YMT	LVR-IC	LDO, 2.9V±2%, 150mA, +CE, CL	SC-70-5	28gf	VR4	6g	Mcr
6P	MIC5366-3.0YMT	LVR-IC	LDO, 3.0V±2%, 150mA, +CE, CL	SC-70-5	28gf	VR4	6g	Mcr
6PA	XC6127N37AMR	Vdet-IC	3.7V±0.8%, -Reset ODO, -MR, Rt=50ms	SOT-25	28yx	VD4	6g	Tor
6PB	XC6127N37BMR	Vdet-IC	3.7V±0.8%, -Reset ODO, -MR, Rt=100ms	SOT-25	28yx	VD4	6g	Tor
6PC	XC6127N37CMR	Vdet-IC	3.7V±0.8%, -Reset ODO, -MR, Rt=200ms	SOT-25	28yx	VD4	6g	Tor
6PD	XC6127N37DMR	Vdet-IC	3.7V±0.8%, -Reset ODO, -MR, Rt=400ms	SOT-25	28yx	VD4	6g	Tor
6PE	XC6127N37EMR	Vdet-IC	3.7V±0.8%, -Reset ODO, -MR, Rt=800ms	SOT-25	28yx	VD4	6g	Tor
6PF	XC6127N37FMR	Vdet-IC	3.7V±0.8%, +Reset ODO, -MR, Rt=50ms	SOT-25	28yx	VD4	6g	Tor
6PH	XC6127N37GMR	Vdet-IC	3.7V±0.8%, +Reset ODO, -MR, Rt=100ms	SOT-25	28yx	VD4	6g	Tor
6PK	XC6127N37HMR	Vdet-IC	3.7V±0.8%, +Reset ODO, -MR, Rt=200ms	SOT-25	28yx	VD4	6g	Tor
6PL	XC6127N37JMR	Vdet-IC	3.7V±0.8%, +Reset ODO, -MR, Rt=400ms	SOT-25	28yx	VD4	6g	Tor
6PM	XC6127N37KMR	Vdet-IC	3.7V±0.8%, +Reset ODO, -MR, Rt=800ms	SOT-25	28yx	VD4	6g	Tor
6PN	XC6127N38AMR	Vdet-IC	3.8V±0.8%, -Reset ODO, -MR, Rt=50ms	SOT-25	28yx	VD4	6g	Tor
6PP	XC6127N38BMR	Vdet-IC	3.8V±0.8%, -Reset ODO, -MR, Rt=100ms	SOT-25	28yx	VD4	6g	Tor
6PR	XC6127N38CMR	Vdet-IC	3.8V±0.8%, -Reset ODO, -MR, Rt=200ms	SOT-25	28yx	VD4	6g	Tor
6PS	XC6127N38DMR	Vdet-IC	3.8V±0.8%, -Reset ODO, -MR, Rt=400ms	SOT-25	28yx	VD4	6g	Tor
6PT	XC6127N38EMR	Vdet-IC	3.8V±0.8%, -Reset ODO, -MR, Rt=800ms	SOT-25	28yx	VD4	6g	Tor
6PU	XC6127N38FMR	Vdet-IC	3.8V±0.8%, +Reset ODO, -MR, Rt=50ms	SOT-25	28yx	VD4	6g	Tor
6PV	XC6127N38GMR	Vdet-IC	3.8V±0.8%, +Reset ODO, -MR, Rt=100ms	SOT-25	28yx	VD4	6g	Tor
6PX	XC6127N38HMR	Vdet-IC	3.8V±0.8%, +Reset ODO, -MR, Rt=200ms	SOT-25	28yx	VD4	6g	Tor
6PY	XC6127N38JMR	Vdet-IC	3.8V±0.8%, +Reset ODO, -MR, Rt=400ms	SOT-25	28yx	VD4	6g	Tor
6PZ	XC6127N38KMR	Vdet-IC	3.8V±0.8%, +Reset ODO, -MR, Rt=800ms	SOT-25	28yx	VD4	6g	Tor
6Q	R1210N261A	DC/DC-IC	PWM step-up, 2.6V, 35, 100kHz	SOT-23-5	28sc	DC3	6g	Ric
6RA	XC6127N39AMR	Vdet-IC	3.9V±0.8%, -Reset ODO, -MR, Rt=50ms	SOT-25	28yx	VD4	6g	Tor
6RB	XC6127N39BMR	Vdet-IC	3.9V±0.8%, -Reset ODO, -MR, Rt=100ms	SOT-25	28yx	VD4	6g	Tor
6RC	XC6127N39CMR	Vdet-IC	3.9V±0.8%, -Reset ODO, -MR, Rt=200ms	SOT-25	28yx	VD4	6g	Tor
6RD	XC6127N39DMR	Vdet-IC	3.9V±0.8%, -Reset ODO, -MR, Rt=400ms	SOT-25	28yx	VD4	6g	Tor
6RE	XC6127N39EMR	Vdet-IC	3.9V±0.8%, -Reset ODO, -MR, Rt=800ms	SOT-25	28yx	VD4	6g	Tor
6RF	XC6127N39FMR	Vdet-IC	3.9V±0.8%, +Reset ODO, -MR, Rt=50ms	SOT-25	28yx	VD4	6g	Tor
6RH	XC6127N39GMR	Vdet-IC	3.9V±0.8%, +Reset ODO, -MR, Rt=100ms	SOT-25	28yx	VD4	6g	Tor
6RK	XC6127N39HMR	Vdet-IC	3.9V±0.8%, +Reset ODO, -MR, Rt=200ms	SOT-25	28yx	VD4	6g	Tor
6RL	XC6127N39JMR	Vdet-IC	3.9V±0.8%, +Reset ODO, -MR, Rt=400ms	SOT-25	28yx	VD4	6g	Tor
6RM	XC6127N39KMR	Vdet-IC	3.9V±0.8%, +Reset ODO, -MR, Rt=800ms	SOT-25	28yx	VD4	6g	Tor
6RN	XC6127N40AMR	Vdet-IC	4.0V±0.8%, -Reset ODO, -MR, Rt=50ms	SOT-25	28yx	VD4	6g	Tor



SMD code	Type	Function	Short description	Case	Pinout	Sch.	St.	Mnf.
6RP	XC6127N40BMR	Vdet-IC	4.0V±0.8%, -Reset ODO, -MR, Rt=100ms	SOT-25	28yx	VD4	6g	Tor
6RR	XC6127N40CMR	Vdet-IC	4.0V±0.8%, -Reset ODO, -MR, Rt=200ms	SOT-25	28yx	VD4	6g	Tor
6RS	XC6127N40DMR	Vdet-IC	4.0V±0.8%, -Reset ODO, -MR, Rt=400ms	SOT-25	28yx	VD4	6g	Tor
6RT	XC6127N40EMR	Vdet-IC	4.0V±0.8%, -Reset ODO, -MR, Rt=800ms	SOT-25	28yx	VD4	6g	Tor
6RU	XC6127N40FMR	Vdet-IC	4.0V±0.8%, +Reset ODO, -MR, Rt=50ms	SOT-25	28yx	VD4	6g	Tor
6RV	XC6127N40GMR	Vdet-IC	4.0V±0.8%, +Reset ODO, -MR, Rt=100ms	SOT-25	28yx	VD4	6g	Tor
6RX	XC6127N40HMR	Vdet-IC	4.0V±0.8%, +Reset ODO, -MR, Rt=200ms	SOT-25	28yx	VD4	6g	Tor
6RY	XC6127N40JMR	Vdet-IC	4.0V±0.8%, +Reset ODO, -MR, Rt=400ms	SOT-25	28yx	VD4	6g	Tor
6RZ	XC6127N40KMR	Vdet-IC	4.0V±0.8%, +Reset ODO, -MR, Rt=800ms	SOT-25	28yx	VD4	6g	Tor
6S	MIC5366-3.3YMT	LVR-IC	LDO, 3.3V±2%, 150mA, +CE, CL	SC-70-5	28gf	VR4	6g	Mcr
6SA	RN5RF16AA	LVR-IC	LRip, -CE, 1.6V±2%, 1A*	SOT-23-5	28wv	VR6	6g	Ric
6SB	XC6127N41AMR	Vdet-IC	4.1V±0.8%, -Reset ODO, -MR, Rt=50ms	SOT-25	28yx	VD4	6g	Tor
6SB	XC6127N41BMR	Vdet-IC	4.1V±0.8%, -Reset ODO, -MR, Rt=100ms	SOT-25	28yx	VD4	6g	Tor
6SD	XC6127N41CMR	Vdet-IC	4.1V±0.8%, -Reset ODO, -MR, Rt=200ms	SOT-25	28yx	VD4	6g	Tor
6SC	XC6127N41DMR	Vdet-IC	4.1V±0.8%, -Reset ODO, -MR, Rt=400ms	SOT-25	28yx	VD4	6g	Tor
6SE	XC6127N41EMR	Vdet-IC	4.1V±0.8%, -Reset ODO, -MR, Rt=800ms	SOT-25	28yx	VD4	6g	Tor
6SF	XC6127N41FMR	Vdet-IC	4.1V±0.8%, +Reset ODO, -MR, Rt=50ms	SOT-25	28yx	VD4	6g	Tor
6SH	XC6127N41GMR	Vdet-IC	4.1V±0.8%, +Reset ODO, -MR, Rt=100ms	SOT-25	28yx	VD4	6g	Tor
6SK	XC6127N41HMR	Vdet-IC	4.1V±0.8%, +Reset ODO, -MR, Rt=200ms	SOT-25	28yx	VD4	6g	Tor
6SL	XC6127N41JMR	Vdet-IC	4.1V±0.8%, +Reset ODO, -MR, Rt=400ms	SOT-25	28yx	VD4	6g	Tor
6SM	XC6127N41KMR	Vdet-IC	4.1V±0.8%, +Reset ODO, -MR, Rt=800ms	SOT-25	28yx	VD4	6g	Tor
6SN	XC6127N42AMR	Vdet-IC	4.2V±0.8%, -Reset ODO, -MR, Rt=50ms	SOT-25	28yx	VD4	6g	Tor
6SP	XC6127N42BMR	Vdet-IC	4.2V±0.8%, -Reset ODO, -MR, Rt=100ms	SOT-25	28yx	VD4	6g	Tor
6SR	XC6127N42CMR	Vdet-IC	4.2V±0.8%, -Reset ODO, -MR, Rt=200ms	SOT-25	28yx	VD4	6g	Tor
6SS	XC6127N42DMR	Vdet-IC	4.2V±0.8%, -Reset ODO, -MR, Rt=400ms	SOT-25	28yx	VD4	6g	Tor
6ST	XC6127N42EMR	Vdet-IC	4.2V±0.8%, -Reset ODO, -MR, Rt=800ms	SOT-25	28yx	VD4	6g	Tor
6SU	XC6127N42FMR	Vdet-IC	4.2V±0.8%, +Reset ODO, -MR, Rt=50ms	SOT-25	28yx	VD4	6g	Tor
6SV	XC6127N42GMR	Vdet-IC	4.2V±0.8%, +Reset ODO, -MR, Rt=100ms	SOT-25	28yx	VD4	6g	Tor
6SX	XC6127N42HMR	Vdet-IC	4.2V±0.8%, +Reset ODO, -MR, Rt=200ms	SOT-25	28yx	VD4	6g	Tor
6SY	XC6127N42JMR	Vdet-IC	4.2V±0.8%, +Reset ODO, -MR, Rt=400ms	SOT-25	28yx	VD4	6g	Tor
6SZ	XC6127N42KMR	Vdet-IC	4.2V±0.8%, +Reset ODO, -MR, Rt=800ms	SOT-25	28yx	VD4	6g	Tor
6T	RN5RF16BA	LVR-IC	LRip, +CE, 1.6V±2%, 1A*	SOT-23-5	28wv	VR6	6g	Ric
6TA	XC6127N43AMR	Vdet-IC	4.3V±0.8%, -Reset ODO, -MR, Rt=50ms	SOT-25	28yx	VD4	6g	Tor
6TB	XC6127N43BMR	Vdet-IC	4.3V±0.8%, -Reset ODO, -MR, Rt=100ms	SOT-25	28yx	VD4	6g	Tor
6TC	XC6127N43CMR	Vdet-IC	4.3V±0.8%, -Reset ODO, -MR, Rt=200ms	SOT-25	28yx	VD4	6g	Tor
6TD	XC6127N43DMR	Vdet-IC	4.3V±0.8%, -Reset ODO, -MR, Rt=400ms	SOT-25	28yx	VD4	6g	Tor
6TE	XC6127N43EMR	Vdet-IC	4.3V±0.8%, -Reset ODO, -MR, Rt=800ms	SOT-25	28yx	VD4	6g	Tor
6TF	XC6127N43FMR	Vdet-IC	4.3V±0.8%, +Reset ODO, -MR, Rt=50ms	SOT-25	28yx	VD4	6g	Tor
6TH	XC6127N43GMR	Vdet-IC	4.3V±0.8%, +Reset ODO, -MR, Rt=100ms	SOT-25	28yx	VD4	6g	Tor
6TK	XC6127N43HMR	Vdet-IC	4.3V±0.8%, +Reset ODO, -MR, Rt=200ms	SOT-25	28yx	VD4	6g	Tor
6TL	XC6127N43JMR	Vdet-IC	4.3V±0.8%, +Reset ODO, -MR, Rt=400ms	SOT-25	28yx	VD4	6g	Tor
6TM	XC6127N43KMR	Vdet-IC	4.3V±0.8%, +Reset ODO, -MR, Rt=800ms	SOT-25	28yx	VD4	6g	Tor
6TN	XC6127N44AMR	Vdet-IC	4.4V±0.8%, -Reset ODO, -MR, Rt=50ms	SOT-25	28yx	VD4	6g	Tor
6TP	XC6127N44BMR	Vdet-IC	4.4V±0.8%, -Reset ODO, -MR, Rt=100ms	SOT-25	28yx	VD4	6g	Tor
6TR	XC6127N44CMR	Vdet-IC	4.4V±0.8%, -Reset ODO, -MR, Rt=200ms	SOT-25	28yx	VD4	6g	Tor
6TS	XC6127N44DMR	Vdet-IC	4.4V±0.8%, -Reset ODO, -MR, Rt=400ms	SOT-25	28yx	VD4	6g	Tor
6TT	XC6127N44EMR	Vdet-IC	4.4V±0.8%, -Reset ODO, -MR, Rt=800ms	SOT-25	28yx	VD4	6g	Tor
6TU	XC6127N44FMR	Vdet-IC	4.4V±0.8%, +Reset ODO, -MR, Rt=50ms	SOT-25	28yx	VD4	6g	Tor
6TV	XC6127N44GMR	Vdet-IC	4.4V±0.8%, +Reset ODO, -MR, Rt=100ms	SOT-25	28yx	VD4	6g	Tor
6TX	XC6127N44HMR	Vdet-IC	4.4V±0.8%, +Reset ODO, -MR, Rt=200ms	SOT-25	28yx	VD4	6g	Tor
6TY	XC6127N44JMR	Vdet-IC	4.4V±0.8%, +Reset ODO, -MR, Rt=400ms	SOT-25	28yx	VD4	6g	Tor
6TZ	XC6127N44KMR	Vdet-IC	4.4V±0.8%, +Reset ODO, -MR, Rt=800ms	SOT-25	28yx	VD4	6g	Tor
6U	R1210N261C	DC/DC-IC	PWM step-up, 2.6V, 100kHz	SOT-23-5	28sc	DC3	6g	Ric
6UA	XC6127N45AMR	Vdet-IC	4.5V±0.8%, -Reset ODO, -MR, Rt=50ms	SOT-25	28yx	VD4	6g	Tor
6UB	XC6127N45BMR	Vdet-IC	4.5V±0.8%, -Reset ODO, -MR, Rt=100ms	SOT-25	28yx	VD4	6g	Tor
6UC	XC6127N45CMR	Vdet-IC	4.5V±0.8%, -Reset ODO, -MR, Rt=200ms	SOT-25	28yx	VD4	6g	Tor
6UD	XC6127N45DMR	Vdet-IC	4.5V±0.8%, -Reset ODO, -MR, Rt=400ms	SOT-25	28yx	VD4	6g	Tor
6UE	XC6127N45EMR	Vdet-IC	4.5V±0.8%, -Reset ODO, -MR, Rt=800ms	SOT-25	28yx	VD4	6g	Tor
6UF	XC6127N45FMR	Vdet-IC	4.5V±0.8%, +Reset ODO, -MR, Rt=50ms	SOT-25	28yx	VD4	6g	Tor
6UH	XC6127N45GMR	Vdet-IC	4.5V±0.8%, +Reset ODO, -MR, Rt=100ms	SOT-25	28yx	VD4	6g	Tor
6UK	XC6127N45HMR	Vdet-IC	4.5V±0.8%, +Reset ODO, -MR, Rt=200ms	SOT-25	28yx	VD4	6g	Tor
6UL	XC6127N45JMR	Vdet-IC	4.5V±0.8%, +Reset ODO, -MR, Rt=400ms	SOT-25	28yx	VD4	6g	Tor
6UM	XC6127N45KMR	Vdet-IC	4.5V±0.8%, +Reset ODO, -MR, Rt=800ms	SOT-25	28yx	VD4	6g	Tor
6UN	XC6127N46AMR	Vdet-IC	4.6V±0.8%, -Reset ODO, -MR, Rt=50ms	SOT-25	28yx	VD4	6g	Tor
6UP	XC6127N46BMR	Vdet-IC	4.6V±0.8%, -Reset ODO, -MR, Rt=100ms	SOT-25	28yx	VD4	6g	Tor
6UR	XC6127N46CMR	Vdet-IC	4.6V±0.8%, -Reset ODO, -MR, Rt=200ms	SOT-25	28yx	VD4	6g	Tor
6US	XC6127N46DMR	Vdet-IC	4.6V±0.8%, -Reset ODO, -MR, Rt=400ms	SOT-25	28yx	VD4	6g	Tor
6UT	XC6127N46EMR	Vdet-IC	4.6V±0.8%, -Reset ODO, -MR, Rt=800ms	SOT-25	28yx	VD4	6g	Tor
6UU	XC6127N46FMR	Vdet-IC	4.6V±0.8%, +Reset ODO, -MR, Rt=50ms	SOT-25	28yx	VD4	6g	Tor
6UV	XC6127N46GMR	Vdet-IC	4.6V±0.8%, +Reset ODO, -MR, Rt=100ms	SOT-25	28yx	VD4	6g	Tor



SMD code	Type	Function	Short description	Case	Pinout	Sch.	St.	Mnf.
6UX	XC6127N46HMR	Vdet-IC	4.6V±0.8%, +Reset ODO, -MR, Rt=200ms	SOT-25	28yx	VD4	6g	Tor
6UY	XC6127N46JMR	Vdet-IC	4.6V±0.8%, +Reset ODO, -MR, Rt=400ms	SOT-25	28yx	VD4	6g	Tor
6UZ	XC6127N46KMR	Vdet-IC	4.6V±0.8%, +Reset ODO, -MR, Rt=800ms	SOT-25	28yx	VD4	6g	Tor
6VA	XC6127N47AMR	Vdet-IC	4.7V±0.8%, -Reset ODO, -MR, Rt=50ms	SOT-25	28yx	VD4	6g	Tor
6VB	XC6127N47BMR	Vdet-IC	4.7V±0.8%, -Reset ODO, -MR, Rt=100ms	SOT-25	28yx	VD4	6g	Tor
6VC	XC6127N47CMR	Vdet-IC	4.7V±0.8%, -Reset ODO, -MR, Rt=200ms	SOT-25	28yx	VD4	6g	Tor
6VD	XC6127N47DMR	Vdet-IC	4.7V±0.8%, -Reset ODO, -MR, Rt=400ms	SOT-25	28yx	VD4	6g	Tor
6VE	XC6127N47EMR	Vdet-IC	4.7V±0.8%, -Reset ODO, -MR, Rt=800ms	SOT-25	28yx	VD4	6g	Tor
6VF	XC6127N47FMR	Vdet-IC	4.7V±0.8%, +Reset ODO, -MR, Rt=50ms	SOT-25	28yx	VD4	6g	Tor
6VH	XC6127N47GMR	Vdet-IC	4.7V±0.8%, +Reset ODO, -MR, Rt=100ms	SOT-25	28yx	VD4	6g	Tor
6VK	XC6127N47HMR	Vdet-IC	4.7V±0.8%, +Reset ODO, -MR, Rt=200ms	SOT-25	28yx	VD4	6g	Tor
6VL	XC6127N47JMR	Vdet-IC	4.7V±0.8%, +Reset ODO, -MR, Rt=400ms	SOT-25	28yx	VD4	6g	Tor
6VM	XC6127N47KMR	Vdet-IC	4.7V±0.8%, +Reset ODO, -MR, Rt=800ms	SOT-25	28yx	VD4	6g	Tor
6VN	XC6127N48AMR	Vdet-IC	4.8V±0.8%, -Reset ODO, -MR, Rt=50ms	SOT-25	28yx	VD4	6g	Tor
6VP	XC6127N48BMR	Vdet-IC	4.8V±0.8%, -Reset ODO, -MR, Rt=100ms	SOT-25	28yx	VD4	6g	Tor
6VR	XC6127N48CMR	Vdet-IC	4.8V±0.8%, -Reset ODO, -MR, Rt=200ms	SOT-25	28yx	VD4	6g	Tor
6VS	XC6127N48DMR	Vdet-IC	4.8V±0.8%, -Reset ODO, -MR, Rt=400ms	SOT-25	28yx	VD4	6g	Tor
6VT	XC6127N48EMR	Vdet-IC	4.8V±0.8%, -Reset ODO, -MR, Rt=800ms	SOT-25	28yx	VD4	6g	Tor
6VU	XC6127N48FMR	Vdet-IC	4.8V±0.8%, +Reset ODO, -MR, Rt=50ms	SOT-25	28yx	VD4	6g	Tor
6VV	XC6127N48GMR	Vdet-IC	4.8V±0.8%, +Reset ODO, -MR, Rt=100ms	SOT-25	28yx	VD4	6g	Tor
6VX	XC6127N48HMR	Vdet-IC	4.8V±0.8%, +Reset ODO, -MR, Rt=200ms	SOT-25	28yx	VD4	6g	Tor
6VY	XC6127N48JMR	Vdet-IC	4.8V±0.8%, +Reset ODO, -MR, Rt=400ms	SOT-25	28yx	VD4	6g	Tor
6VZ	XC6127N48KMR	Vdet-IC	4.8V±0.8%, +Reset ODO, -MR, Rt=800ms	SOT-25	28yx	VD4	6g	Tor
6W	R1210N361C	DC/DC-IC	PWM step-up, 3.6V, 100kHz	SOT-23-5	28sc	DC3	6g	Ric
6X	R1210N461C	DC/DC-IC	PWM step-up, 4.6V, 100kHz	SOT-23-5	28sc	DC3	6g	Ric
6XA	XC6127N49AMR	Vdet-IC	4.9V±0.8%, -Reset ODO, -MR, Rt=50ms	SOT-25	28yx	VD4	6g	Tor
6XB	XC6127N49BMR	Vdet-IC	4.9V±0.8%, -Reset ODO, -MR, Rt=100ms	SOT-25	28yx	VD4	6g	Tor
6XC	XC6127N49CMR	Vdet-IC	4.9V±0.8%, -Reset ODO, -MR, Rt=200ms	SOT-25	28yx	VD4	6g	Tor
6XD	XC6127N49DMR	Vdet-IC	4.9V±0.8%, -Reset ODO, -MR, Rt=400ms	SOT-25	28yx	VD4	6g	Tor
6XE	XC6127N49EMR	Vdet-IC	4.9V±0.8%, -Reset ODO, -MR, Rt=800ms	SOT-25	28yx	VD4	6g	Tor
6XF	XC6127N49FMR	Vdet-IC	4.9V±0.8%, +Reset ODO, -MR, Rt=50ms	SOT-25	28yx	VD4	6g	Tor
6XH	XC6127N49GMR	Vdet-IC	4.9V±0.8%, +Reset ODO, -MR, Rt=100ms	SOT-25	28yx	VD4	6g	Tor
6XK	XC6127N49HMR	Vdet-IC	4.9V±0.8%, +Reset ODO, -MR, Rt=200ms	SOT-25	28yx	VD4	6g	Tor
6XL	XC6127N49JMR	Vdet-IC	4.9V±0.8%, +Reset ODO, -MR, Rt=400ms	SOT-25	28yx	VD4	6g	Tor
6XM	XC6127N49KMR	Vdet-IC	4.9V±0.8%, +Reset ODO, -MR, Rt=800ms	SOT-25	28yx	VD4	6g	Tor
6XN	XC6127N50AMR	Vdet-IC	5.0V±0.8%, -Reset ODO, -MR, Rt=50ms	SOT-25	28yx	VD4	6g	Tor
6XP	XC6127N50BMR	Vdet-IC	5.0V±0.8%, -Reset ODO, -MR, Rt=100ms	SOT-25	28yx	VD4	6g	Tor
6XR	XC6127N50CMR	Vdet-IC	5.0V±0.8%, -Reset ODO, -MR, Rt=200ms	SOT-25	28yx	VD4	6g	Tor
6XS	XC6127N50DMR	Vdet-IC	5.0V±0.8%, -Reset ODO, -MR, Rt=400ms	SOT-25	28yx	VD4	6g	Tor
6XT	XC6127N50EMR	Vdet-IC	5.0V±0.8%, -Reset ODO, -MR, Rt=800ms	SOT-25	28yx	VD4	6g	Tor
6XU	XC6127N50FMR	Vdet-IC	5.0V±0.8%, +Reset ODO, -MR, Rt=50ms	SOT-25	28yx	VD4	6g	Tor
6XV	XC6127N50GMR	Vdet-IC	5.0V±0.8%, +Reset ODO, -MR, Rt=100ms	SOT-25	28yx	VD4	6g	Tor
6XX	XC6127N50HMR	Vdet-IC	5.0V±0.8%, +Reset ODO, -MR, Rt=200ms	SOT-25	28yx	VD4	6g	Tor
6XY	XC6127N50JMR	Vdet-IC	5.0V±0.8%, +Reset ODO, -MR, Rt=400ms	SOT-25	28yx	VD4	6g	Tor
6XZ	XC6127N50KMR	Vdet-IC	5.0V±0.8%, +Reset ODO, -MR, Rt=800ms	SOT-25	28yx	VD4	6g	Tor
6Y	R1210N561C	DC/DC-IC	PWM step-up, 5.6V, 100kHz	SOT-23-5	28sc	DC3	6g	Ric
6YA	XC6127N51AMR	Vdet-IC	5.1V±0.8%, -Reset ODO, -MR, Rt=50ms	SOT-25	28yx	VD4	6g	Tor
6YB	XC6127N51BMR	Vdet-IC	5.1V±0.8%, -Reset ODO, -MR, Rt=100ms	SOT-25	28yx	VD4	6g	Tor
6YC	XC6127N51CMR	Vdet-IC	5.1V±0.8%, -Reset ODO, -MR, Rt=200ms	SOT-25	28yx	VD4	6g	Tor
6YD	XC6127N51DMR	Vdet-IC	5.1V±0.8%, -Reset ODO, -MR, Rt=400ms	SOT-25	28yx	VD4	6g	Tor
6YE	XC6127N51EMR	Vdet-IC	5.1V±0.8%, -Reset ODO, -MR, Rt=800ms	SOT-25	28yx	VD4	6g	Tor
6YF	XC6127N51FMR	Vdet-IC	5.1V±0.8%, +Reset ODO, -MR, Rt=50ms	SOT-25	28yx	VD4	6g	Tor
6YH	XC6127N51GMR	Vdet-IC	5.1V±0.8%, +Reset ODO, -MR, Rt=100ms	SOT-25	28yx	VD4	6g	Tor
6YK	XC6127N51HMR	Vdet-IC	5.1V±0.8%, +Reset ODO, -MR, Rt=200ms	SOT-25	28yx	VD4	6g	Tor
6YL	XC6127N51JMR	Vdet-IC	5.1V±0.8%, +Reset ODO, -MR, Rt=400ms	SOT-25	28yx	VD4	6g	Tor
6YM	XC6127N51KMR	Vdet-IC	5.1V±0.8%, +Reset ODO, -MR, Rt=800ms	SOT-25	28yx	VD4	6g	Tor
6YN	XC6127N52AMR	Vdet-IC	5.2V±0.8%, -Reset ODO, -MR, Rt=50ms	SOT-25	28yx	VD4	6g	Tor
6YP	XC6127N52BMR	Vdet-IC	5.2V±0.8%, -Reset ODO, -MR, Rt=100ms	SOT-25	28yx	VD4	6g	Tor
6YR	XC6127N52CMR	Vdet-IC	5.2V±0.8%, -Reset ODO, -MR, Rt=200ms	SOT-25	28yx	VD4	6g	Tor
6YS	XC6127N52DMR	Vdet-IC	5.2V±0.8%, -Reset ODO, -MR, Rt=400ms	SOT-25	28yx	VD4	6g	Tor
6YT	XC6127N52EMR	Vdet-IC	5.2V±0.8%, -Reset ODO, -MR, Rt=800ms	SOT-25	28yx	VD4	6g	Tor
6YU	XC6127N52FMR	Vdet-IC	5.2V±0.8%, +Reset ODO, -MR, Rt=50ms	SOT-25	28yx	VD4	6g	Tor
6YV	XC6127N52GMR	Vdet-IC	5.2V±0.8%, +Reset ODO, -MR, Rt=100ms	SOT-25	28yx	VD4	6g	Tor
6YX	XC6127N52HMR	Vdet-IC	5.2V±0.8%, +Reset ODO, -MR, Rt=200ms	SOT-25	28yx	VD4	6g	Tor
6YY	XC6127N52JMR	Vdet-IC	5.2V±0.8%, +Reset ODO, -MR, Rt=400ms	SOT-25	28yx	VD4	6g	Tor
6YZ	XC6127N52KMR	Vdet-IC	5.2V±0.8%, +Reset ODO, -MR, Rt=800ms	SOT-25	28yx	VD4	6g	Tor
6Z	R1210N261D	DC/DC-IC	PWM step-up, 2.6V, 180kHz	SOT-23-5	28sc	DC3	6g	Ric
6ZA	XC6127N53AMR	Vdet-IC	5.3V±0.8%, -Reset ODO, -MR, Rt=50ms	SOT-25	28yx	VD4	6g	Tor
6ZB	XC6127N53BMR	Vdet-IC	5.3V±0.8%, -Reset ODO, -MR, Rt=100ms	SOT-25	28yx	VD4	6g	Tor
6ZC	XC6127N53CMR	Vdet-IC	5.3V±0.8%, -Reset ODO, -MR, Rt=200ms	SOT-25	28yx	VD4	6g	Tor



SMD code	Type	Function	Short description	Case	Pinout	Sch.	St.	Mnf.
62D	XC6127N53DMR	Vdet-IC	5.3V±0.8%, -Reset ODO, -MR, Rt=400ms	SOT-25	28yx	VD4	6g	Tor
62E	XC6127N53EMR	Vdet-IC	5.3V±0.8%, -Reset ODO, -MR, Rt=800ms	SOT-25	28yx	VD4	6g	Tor
62F	XC6127N53FMR	Vdet-IC	5.3V±0.8%, +Reset ODO, -MR, Rt=50ms	SOT-25	28yx	VD4	6g	Tor
62H	XC6127N53GMR	Vdet-IC	5.3V±0.8%, +Reset ODO, -MR, Rt=100ms	SOT-25	28yx	VD4	6g	Tor
62K	XC6127N53HMR	Vdet-IC	5.3V±0.8%, +Reset ODO, -MR, Rt=200ms	SOT-25	28yx	VD4	6g	Tor
62L	XC6127N53JMR	Vdet-IC	5.3V±0.8%, +Reset ODO, -MR, Rt=400ms	SOT-25	28yx	VD4	6g	Tor
62M	XC6127N53KMR	Vdet-IC	5.3V±0.8%, +Reset ODO, -MR, Rt=800ms	SOT-25	28yx	VD4	6g	Tor
62N	XC6127N54AMR	Vdet-IC	5.4V±0.8%, -Reset ODO, -MR, Rt=50ms	SOT-25	28yx	VD4	6g	Tor
62P	XC6127N54BMR	Vdet-IC	5.4V±0.8%, -Reset ODO, -MR, Rt=100ms	SOT-25	28yx	VD4	6g	Tor
62R	XC6127N54CMR	Vdet-IC	5.4V±0.8%, -Reset ODO, -MR, Rt=200ms	SOT-25	28yx	VD4	6g	Tor
62S	XC6127N54DMR	Vdet-IC	5.4V±0.8%, -Reset ODO, -MR, Rt=400ms	SOT-25	28yx	VD4	6g	Tor
62T	XC6127N54EMR	Vdet-IC	5.4V±0.8%, -Reset ODO, -MR, Rt=800ms	SOT-25	28yx	VD4	6g	Tor
62U	XC6127N54FMR	Vdet-IC	5.4V±0.8%, +Reset ODO, -MR, Rt=50ms	SOT-25	28yx	VD4	6g	Tor
62V	XC6127N54GMR	Vdet-IC	5.4V±0.8%, +Reset ODO, -MR, Rt=100ms	SOT-25	28yx	VD4	6g	Tor
62X	XC6127N54HMR	Vdet-IC	5.4V±0.8%, +Reset ODO, -MR, Rt=200ms	SOT-25	28yx	VD4	6g	Tor
62Y	XC6127N54JMR	Vdet-IC	5.4V±0.8%, +Reset ODO, -MR, Rt=400ms	SOT-25	28yx	VD4	6g	Tor
62Z	XC6127N54KMR	Vdet-IC	5.4V±0.8%, +Reset ODO, -MR, Rt=800ms	SOT-25	28yx	VD4	6g	Tor
70	RN5RF20BA	LVR-IC	LRIp, +CE, 2V±2%, 1A*	SOT-23-5	28vw	VR6	6g	Ric
70	RN5RZ20BA	LVR-IC	LDO, LN, +CE, 2V±2%, 100mA	SOT-23-5	28vrt	VR4	6g	Ric
700	XC6111A131MR	Vdet-IC	3.1V±2%, -MR, -Reset PPO, Wt=6.25ms, Rt=3.13ms	SOT-25	28cp	VD17	6g	Tor
701	XC6111A132MR	Vdet-IC	3.2V±2%, -MR, -Reset PPO, Wt=6.25ms, Rt=3.13ms	SOT-25	28cp	VD17	6g	Tor
702	XC6111A133MR	Vdet-IC	3.3V±2%, -MR, -Reset PPO, Wt=6.25ms, Rt=3.13ms	SOT-25	28cp	VD17	6g	Tor
703	XC6111A134MR	Vdet-IC	3.4V±2%, -MR, -Reset PPO, Wt=6.25ms, Rt=3.13ms	SOT-25	28cp	VD17	6g	Tor
704	XC6111A135MR	Vdet-IC	3.5V±2%, -MR, -Reset PPO, Wt=6.25ms, Rt=3.13ms	SOT-25	28cp	VD17	6g	Tor
705	XC6111A136MR	Vdet-IC	3.6V±2%, -MR, -Reset PPO, Wt=6.25ms, Rt=3.13ms	SOT-25	28cp	VD17	6g	Tor
706	XC6111A137MR	Vdet-IC	3.7V±2%, -MR, -Reset PPO, Wt=6.25ms, Rt=3.13ms	SOT-25	28cp	VD17	6g	Tor
707	XC6111A138MR	Vdet-IC	3.8V±2%, -MR, -Reset PPO, Wt=6.25ms, Rt=3.13ms	SOT-25	28cp	VD17	6g	Tor
708	XC6111A139MR	Vdet-IC	3.9V±2%, -MR, -Reset PPO, Wt=6.25ms, Rt=3.13ms	SOT-25	28cp	VD17	6g	Tor
709	XC6111A140MR	Vdet-IC	4.0V±2%, -MR, -Reset PPO, Wt=6.25ms, Rt=3.13ms	SOT-25	28cp	VD17	6g	Tor
709	XC9207A093M	DC/DC-IC	PWM/PFM st-down, 300kHz, 0.9V±2%, 600mA, +CE	SOT-25	28zq	DC1	6g	Tor
70A	RP101N121B	LVR-IC	LDO, LN, +CE, 1.2V±0.8%, 300mA	SOT-23-5	28cx	VR4	6g	Ric
70A	XC6111A141MR	Vdet-IC	4.1V±2%, -MR, -Reset PPO, Wt=6.25ms, Rt=3.13ms	SOT-25	28cp	VD17	6g	Tor
70B	RP101N131B	LVR-IC	LDO, LN, +CE, 1.3V±0.8%, 300mA	SOT-23-5	28cx	VR4	6g	Ric
70B	XC6111A142MR	Vdet-IC	4.2V±2%, -MR, -Reset PPO, Wt=6.25ms, Rt=3.13ms	SOT-25	28cp	VD17	6g	Tor
70C	RP101N151B	LVR-IC	LDO, LN, +CE, 1.5V±0.8%, 300mA	SOT-23-5	28cx	VR4	6g	Ric
70C	XC6111A143MR	Vdet-IC	4.3V±2%, -MR, -Reset PPO, Wt=6.25ms, Rt=3.13ms	SOT-25	28cp	VD17	6g	Tor
70D	RP101N181B	LVR-IC	LDO, LN, +CE, 1.8V±0.8%, 300mA	SOT-23-5	28cx	VR4	6g	Ric
70D	XC6111A144MR	Vdet-IC	4.4V±2%, -MR, -Reset PPO, Wt=6.25ms, Rt=3.13ms	SOT-25	28cp	VD17	6g	Tor
70E	RP101N181B5	LVR-IC	LDO, LN, +CE, 1.85V±0.8%, 300mA	SOT-23-5	28cx	VR4	6g	Ric
70E	XC6111A145MR	Vdet-IC	4.5V±2%, -MR, -Reset PPO, Wt=6.25ms, Rt=3.13ms	SOT-25	28cp	VD17	6g	Tor
70F	RP101N191B	LVR-IC	LDO, LN, +CE, 1.9V±0.8%, 300mA	SOT-23-5	28cx	VR4	6g	Ric
70F	XC6111A116MR	Vdet-IC	1.6V±2%, -MR, -Reset PPO, Wt=6.25ms, Rt=3.13ms	SOT-25	28cp	VD17	6g	Tor
70F	XC6111A146MR	Vdet-IC	4.6V±2%, -MR, -Reset PPO, Wt=6.25ms, Rt=3.13ms	SOT-25	28cp	VD17	6g	Tor
70G	RP101N201B	LVR-IC	LDO, LN, +CE, 2V±0.8%, 300mA	SOT-23-5	28cx	VR4	6g	Ric
70H	RP101N251B	LVR-IC	LDO, LN, +CE, 2.5V±0.8%, 300mA	SOT-23-5	28cx	VR4	6g	Ric
70H	XC6111A117MR	Vdet-IC	1.7V±2%, -MR, -Reset PPO, Wt=6.25ms, Rt=3.13ms	SOT-25	28cp	VD17	6g	Tor
70H	XC6111A147MR	Vdet-IC	4.7V±2%, -MR, -Reset PPO, Wt=6.25ms, Rt=3.13ms	SOT-25	28cp	VD17	6g	Tor
70J	RP101N261B	LVR-IC	LDO, LN, +CE, 2.6V±0.8%, 300mA	SOT-23-5	28cx	VR4	6g	Ric
70K	RP101N271B	LVR-IC	LDO, LN, +CE, 2.7V±0.8%, 300mA	SOT-23-5	28cx	VR4	6g	Ric
70K	XC6111A118MR	Vdet-IC	1.8V±2%, -MR, -Reset PPO, Wt=6.25ms, Rt=3.13ms	SOT-25	28cp	VD17	6g	Tor
70K	XC6111A148MR	Vdet-IC	4.8V±2%, -MR, -Reset PPO, Wt=6.25ms, Rt=3.13ms	SOT-25	28cp	VD17	6g	Tor
70L	RP101N281B	LVR-IC	LDO, LN, +CE, 2.8V±0.8%, 300mA	SOT-23-5	28cx	VR4	6g	Ric
70L	XC6111A119MR	Vdet-IC	1.9V±2%, -MR, -Reset PPO, Wt=6.25ms, Rt=3.13ms	SOT-25	28cp	VD17	6g	Tor
70L	XC6111A149MR	Vdet-IC	4.9V±2%, -MR, -Reset PPO, Wt=6.25ms, Rt=3.13ms	SOT-25	28cp	VD17	6g	Tor
70M	RP101N281B5	LVR-IC	LDO, LN, +CE, 2.85V±0.8%, 300mA	SOT-23-5	28cx	VR4	6g	Ric
70M	XC6111A120MR	Vdet-IC	2.0V±2%, -MR, -Reset PPO, Wt=6.25ms, Rt=3.13ms	SOT-25	28cp	VD17	6g	Tor
70M	XC6111A150MR	Vdet-IC	5.0V±2%, -MR, -Reset PPO, Wt=6.25ms, Rt=3.13ms	SOT-25	28cp	VD17	6g	Tor
70M	XC9207A096M	DC/DC-IC	PWM/PFM st-down, 600kHz, 0.9V±2%, 600mA, +CE	SOT-25	28zq	DC1	6g	Tor
70N	RP101N291B	LVR-IC	LDO, LN, +CE, 2.9V±0.8%, 300mA	SOT-23-5	28cx	VR4	6g	Ric
70N	XC6111A121MR	Vdet-IC	2.1V±2%, -MR, -Reset PPO, Wt=6.25ms, Rt=3.13ms	SOT-25	28cp	VD17	6g	Tor
70P	RP101N301B	LVR-IC	LDO, LN, +CE, 3V±0.8%, 300mA	SOT-23-5	28cx	VR4	6g	Ric
70P	XC6111A122MR	Vdet-IC	2.2V±2%, -MR, -Reset PPO, Wt=6.25ms, Rt=3.13ms	SOT-25	28cp	VD17	6g	Tor
70Q	RP101N311B	LVR-IC	LDO, LN, +CE, 3.1V±0.8%, 300mA	SOT-23-5	28cx	VR4	6g	Ric
70R	RP101N331B	LVR-IC	LDO, LN, +CE, 3.3V±0.8%, 300mA	SOT-23-5	28cx	VR4	6g	Ric
70R	XC6111A123MR	Vdet-IC	2.3V±2%, -MR, -Reset PPO, Wt=6.25ms, Rt=3.13ms	SOT-25	28cp	VD17	6g	Tor
70S	RP101N211B	LVR-IC	LDO, LN, +CE, 2.1V±0.8%, 300mA	SOT-23-5	28cx	VR4	6g	Ric
70S	XC6111A124MR	Vdet-IC	2.4V±2%, -MR, -Reset PPO, Wt=6.25ms, Rt=3.13ms	SOT-25	28cp	VD17	6g	Tor
70T	XC6111A125MR	Vdet-IC	2.5V±2%, -MR, -Reset PPO, Wt=6.25ms, Rt=3.13ms	SOT-25	28cp	VD17	6g	Tor
70U	XC6111A126MR	Vdet-IC	2.6V±2%, -MR, -Reset PPO, Wt=6.25ms, Rt=3.13ms	SOT-25	28cp	VD17	6g	Tor
70V	XC6111A127MR	Vdet-IC	2.7V±2%, -MR, -Reset PPO, Wt=6.25ms, Rt=3.13ms	SOT-25	28cp	VD17	6g	Tor



SMD code	Type	Function	Short description	Case	Pinout	Sch.	St.	Mnf.
70X	XC6111A128MR	Vdet-IC	2.8V±2%, -MR, -Reset PPO, Wt=6.25ms, Rt=3.13ms	SOT-25	28cp	VD17	6g	Tor
70Y	XC6111A129MR	Vdet-IC	2.9V±2%, -MR, -Reset PPO, Wt=6.25ms, Rt=3.13ms	SOT-25	28cp	VD17	6g	Tor
70Z	XC6111A130MR	Vdet-IC	3.0V±2%, -MR, -Reset PPO, Wt=6.25ms, Rt=3.13ms	SOT-25	28cp	VD17	6g	Tor
71	RN5RF21BA	LVR-IC	LRip, +CE, 2.1V±2%, 1A*	SOT-23-5	28vw	VR6	6g	Ric
71	RN5RZ21BA	LVR-IC	LDO, LN, +CE, 2.1V±2%, 100mA	SOT-23-5	28vrt	VR4	6g	Ric
710	XC6111A231MR	Vdet-IC	3.1V±2%, -MR, -Reset PPO, Wt=50ms, Rt=3.13ms	SOT-25	28cp	VD17	6g	Tor
710	XC9207A103M	DC/DC-IC	PWM/PFM st-down, 300kHz, 1.0V±2%, 600mA, +CE	SOT-25	28zq	DC1	6g	Tor
711	XC6111A232MR	Vdet-IC	3.2V±2%, -MR, -Reset PPO, Wt=50ms, Rt=3.13ms	SOT-25	28cp	VD17	6g	Tor
711	XC9207A113M	DC/DC-IC	PWM/PFM st-down, 300kHz, 1.1V±2%, 600mA, +CE	SOT-25	28zq	DC1	6g	Tor
712	XC6111A233MR	Vdet-IC	3.3V±2%, -MR, -Reset PPO, Wt=50ms, Rt=3.13ms	SOT-25	28cp	VD17	6g	Tor
712	XC9207A123M	DC/DC-IC	PWM/PFM st-down, 300kHz, 1.2V±2%, 600mA, +CE	SOT-25	28zq	DC1	6g	Tor
713	XC6111A234MR	Vdet-IC	3.4V±2%, -MR, -Reset PPO, Wt=50ms, Rt=3.13ms	SOT-25	28cp	VD17	6g	Tor
713	XC9207A133M	DC/DC-IC	PWM/PFM st-down, 300kHz, 1.3V±2%, 600mA, +CE	SOT-25	28zq	DC1	6g	Tor
714	XC6111A235MR	Vdet-IC	3.5V±2%, -MR, -Reset PPO, Wt=50ms, Rt=3.13ms	SOT-25	28cp	VD17	6g	Tor
714	XC9207A143M	DC/DC-IC	PWM/PFM st-down, 300kHz, 1.4V±2%, 600mA, +CE	SOT-25	28zq	DC1	6g	Tor
715	R1124N151A	LVR-IC	LDO, LN, -CE, 1.5V±2%, 150mA	SOT-23-5	28vt	VR4	6g	Ric
715	XC6111A236MR	Vdet-IC	3.6V±2%, -MR, -Reset PPO, Wt=50ms, Rt=3.13ms	SOT-25	28cp	VD17	6g	Tor
715	XC9111E151MR	DC/DC-IC	PFM step-up, 100kHz, 1.5V±2.5%, 400mA	SOT-25	28sx	DC4	6g	Tor
715	XC9207A153M	DC/DC-IC	PWM/PFM st-down, 300kHz, 1.5V±2%, 600mA, +CE	SOT-25	28zq	DC1	6g	Tor
716	R1124N161A	LVR-IC	LDO, LN, -CE, 1.6V±2%, 150mA	SOT-23-5	28vt	VR4	6g	Ric
716	XC6111A237MR	Vdet-IC	3.7V±2%, -MR, -Reset PPO, Wt=50ms, Rt=3.13ms	SOT-25	28cp	VD17	6g	Tor
716	XC9111E161MR	DC/DC-IC	PFM step-up, 100kHz, 1.6V±2.5%, 400mA	SOT-25	28sx	DC4	6g	Tor
716	XC9207A163M	DC/DC-IC	PWM/PFM st-down, 300kHz, 1.6V±2%, 600mA, +CE	SOT-25	28zq	DC1	6g	Tor
717	R1124N171A	LVR-IC	LDO, LN, -CE, 1.7V±2%, 150mA	SOT-23-5	28vt	VR4	6g	Ric
717	XC6111A238MR	Vdet-IC	3.8V±2%, -MR, -Reset PPO, Wt=50ms, Rt=3.13ms	SOT-25	28cp	VD17	6g	Tor
717	XC9111E171MR	DC/DC-IC	PFM step-up, 100kHz, 1.7V±2.5%, 400mA	SOT-25	28sx	DC4	6g	Tor
717	XC9207A173M	DC/DC-IC	PWM/PFM st-down, 300kHz, 1.7V±2%, 600mA, +CE	SOT-25	28zq	DC1	6g	Tor
718	R1124N181A	LVR-IC	LDO, LN, -CE, 1.8V±2%, 150mA	SOT-23-5	28vt	VR4	6g	Ric
718	XC6111A239MR	Vdet-IC	3.9V±2%, -MR, -Reset PPO, Wt=50ms, Rt=3.13ms	SOT-25	28cp	VD17	6g	Tor
718	XC9111E181MR	DC/DC-IC	PFM step-up, 100kHz, 1.8V±2.5%, 400mA	SOT-25	28sx	DC4	6g	Tor
718	XC9207A183M	DC/DC-IC	PWM/PFM st-down, 300kHz, 1.8V±2%, 600mA, +CE	SOT-25	28zq	DC1	6g	Tor
719	R1124N191A	LVR-IC	LDO, LN, -CE, 1.9V±2%, 150mA	SOT-23-5	28vt	VR4	6g	Ric
719	XC6111A240MR	Vdet-IC	4.0V±2%, -MR, -Reset PPO, Wt=50ms, Rt=3.13ms	SOT-25	28cp	VD17	6g	Tor
719	XC9111E191MR	DC/DC-IC	PFM step-up, 100kHz, 1.9V±2.5%, 400mA	SOT-25	28sx	DC4	6g	Tor
719	XC9207A193M	DC/DC-IC	PWM/PFM st-down, 300kHz, 1.9V±2%, 600mA, +CE	SOT-25	28zq	DC1	6g	Tor
71A	RP101N121D	LVR-IC	LDO, LN, +CE, CL, 1.2V±0.8%, 300mA	SOT-23-5	28cx	VR4	6g	Ric
71A	XC6111A241MR	Vdet-IC	4.1V±2%, -MR, -Reset PPO, Wt=50ms, Rt=3.13ms	SOT-25	28cp	VD17	6g	Tor
71A	XC9207A106M	DC/DC-IC	PWM/PFM st-down, 600kHz, 1.0V±2%, 600mA, +CE	SOT-25	28zq	DC1	6g	Tor
71B	RP101N131D	LVR-IC	LDO, LN, +CE, CL, 1.3V±0.8%, 300mA	SOT-23-5	28cx	VR4	6g	Ric
71B	XC6111A242MR	Vdet-IC	4.2V±2%, -MR, -Reset PPO, Wt=50ms, Rt=3.13ms	SOT-25	28cp	VD17	6g	Tor
71B	XC9207A116M	DC/DC-IC	PWM/PFM st-down, 600kHz, 1.1V±2%, 600mA, +CE	SOT-25	28zq	DC1	6g	Tor
71C	RP101N151D	LVR-IC	LDO, LN, +CE, CL, 1.5V±0.8%, 300mA	SOT-23-5	28cx	VR4	6g	Ric
71C	XC6111A243MR	Vdet-IC	4.3V±2%, -MR, -Reset PPO, Wt=50ms, Rt=3.13ms	SOT-25	28cp	VD17	6g	Tor
71C	XC9207A126M	DC/DC-IC	PWM/PFM st-down, 600kHz, 1.2V±2%, 600mA, +CE	SOT-25	28zq	DC1	6g	Tor
71D	RP101N181D	LVR-IC	LDO, LN, +CE, CL, 1.8V±0.8%, 300mA	SOT-23-5	28cx	VR4	6g	Ric
71D	XC6111A244MR	Vdet-IC	4.4V±2%, -MR, -Reset PPO, Wt=50ms, Rt=3.13ms	SOT-25	28cp	VD17	6g	Tor
71D	XC9207A136M	DC/DC-IC	PWM/PFM st-down, 600kHz, 1.3V±2%, 600mA, +CE	SOT-25	28zq	DC1	6g	Tor
71E	RP101N181D5	LVR-IC	LDO, LN, +CE, CL, 1.85V±0.8%, 300mA	SOT-23-5	28cx	VR4	6g	Ric
71E	XC6111A245MR	Vdet-IC	4.5V±2%, -MR, -Reset PPO, Wt=50ms, Rt=3.13ms	SOT-25	28cp	VD17	6g	Tor
71E	XC9207A146M	DC/DC-IC	PWM/PFM st-down, 600kHz, 1.4V±2%, 600mA, +CE	SOT-25	28zq	DC1	6g	Tor
71F	RP101N191D	LVR-IC	LDO, LN, +CE, CL, 1.9V±0.8%, 300mA	SOT-23-5	28cx	VR4	6g	Ric
71F	XC6111A216MR	Vdet-IC	1.6V±2%, -MR, -Reset PPO, Wt=50ms, Rt=3.13ms	SOT-25	28cp	VD17	6g	Tor
71E	XC6111A246MR	Vdet-IC	4.6V±2%, -MR, -Reset PPO, Wt=50ms, Rt=3.13ms	SOT-25	28cp	VD17	6g	Tor
71F	XC9207A156M	DC/DC-IC	PWM/PFM st-down, 600kHz, 1.5V±2%, 600mA, +CE	SOT-25	28zq	DC1	6g	Tor
71G	RP101N201D	LVR-IC	LDO, LN, +CE, CL, 2V±0.8%, 300mA	SOT-23-5	28cx	VR4	6g	Ric
71H	RP101N251D	LVR-IC	LDO, LN, +CE, CL, 2.5V±0.8%, 300mA	SOT-23-5	28cx	VR4	6g	Ric
71H	XC6111A217MR	Vdet-IC	1.7V±2%, -MR, -Reset PPO, Wt=50ms, Rt=3.13ms	SOT-25	28cp	VD17	6g	Tor
71H	XC6111A247MR	Vdet-IC	4.7V±2%, -MR, -Reset PPO, Wt=50ms, Rt=3.13ms	SOT-25	28cp	VD17	6g	Tor
71H	XC9207A166M	DC/DC-IC	PWM/PFM st-down, 600kHz, 1.6V±2%, 600mA, +CE	SOT-25	28zq	DC1	6g	Tor
71J	RP101N261D	LVR-IC	LDO, LN, +CE, CL, 2.6V±0.8%, 300mA	SOT-23-5	28cx	VR4	6g	Ric
71K	RP101N271D	LVR-IC	LDO, LN, +CE, CL, 2.7V±0.8%, 300mA	SOT-23-5	28cx	VR4	6g	Ric
71K	XC6111A218MR	Vdet-IC	1.8V±2%, -MR, -Reset PPO, Wt=50ms, Rt=3.13ms	SOT-25	28cp	VD17	6g	Tor
71K	XC6111A248MR	Vdet-IC	4.8V±2%, -MR, -Reset PPO, Wt=50ms, Rt=3.13ms	SOT-25	28cp	VD17	6g	Tor
71K	XC9207A176M	DC/DC-IC	PWM/PFM st-down, 600kHz, 1.7V±2%, 600mA, +CE	SOT-25	28zq	DC1	6g	Tor
71L	RP101N281D	LVR-IC	LDO, LN, +CE, CL, 2.8V±0.8%, 300mA	SOT-23-5	28cx	VR4	6g	Ric
71L	XC6111A219MR	Vdet-IC	1.9V±2%, -MR, -Reset PPO, Wt=50ms, Rt=3.13ms	SOT-25	28cp	VD17	6g	Tor
71L	XC6111A249MR	Vdet-IC	4.9V±2%, -MR, -Reset PPO, Wt=50ms, Rt=3.13ms	SOT-25	28cp	VD17	6g	Tor
71L	XC9207A186M	DC/DC-IC	PWM/PFM st-down, 600kHz, 1.8V±2%, 600mA, +CE	SOT-25	28zq	DC1	6g	Tor
71M	RP101N281D5	LVR-IC	LDO, LN, +CE, CL, 2.85V±0.8%, 300mA	SOT-23-5	28cx	VR4	6g	Ric
71M	XC6111A220MR	Vdet-IC	2.0V±2%, -MR, -Reset PPO, Wt=50ms, Rt=3.13ms	SOT-25	28cp	VD17	6g	Tor



SMD code	Type	Function	Short description	Case	Pinout	Sch.	St.	Mnf.
71M	XC6111A250MR	Vdet-IC	5.0V±2%, -MR, -Reset PPO, Wt=50ms, Rt=3.13ms	SOT-25	28cp	VD17	6g	Tor
71M	XC9207A196M	DC/DC-IC	PWM/PFM st-down, 600kHz, 1.9V±2%, 600mA, +CE	SOT-25	28zq	DC1	6g	Tor
71N	RP101N291D	LVR-IC	LDO, LN, +CE, CL, 2.9V±0.8%, 300mA	SOT-23-5	28cx	VR4	6g	Ric
71N	XC6111A221MR	Vdet-IC	2.1V±2%, -MR, -Reset PPO, Wt=50ms, Rt=3.13ms	SOT-25	28cp	VD17	6g	Tor
71P	RP101N301D	LVR-IC	LDO, LN, +CE, CL, 3V±0.8%, 300mA	SOT-23-5	28cx	VR4	6g	Ric
71P	XC6111A222MR	Vdet-IC	2.2V±2%, -MR, -Reset PPO, Wt=50ms, Rt=3.13ms	SOT-25	28cp	VD17	6g	Tor
71Q	RP101N311D	LVR-IC	LDO, LN, +CE, CL, 3.1V±0.8%, 300mA	SOT-23-5	28cx	VR4	6g	Ric
71R	RP101N331D	LVR-IC	LDO, LN, +CE, CL, 3.3V±0.8%, 300mA	SOT-23-5	28cx	VR4	6g	Ric
71R	XC6111A223MR	Vdet-IC	2.3V±2%, -MR, -Reset PPO, Wt=50ms, Rt=3.13ms	SOT-25	28cp	VD17	6g	Tor
71S	RP101N211D	LVR-IC	LDO, LN, +CE, CL, 2.1V±0.8%, 300mA	SOT-23-5	28cx	VR4	6g	Ric
71S	XC6111A224MR	Vdet-IC	2.4V±2%, -MR, -Reset PPO, Wt=50ms, Rt=3.13ms	SOT-25	28cp	VD17	6g	Tor
71T	XC6111A225MR	Vdet-IC	2.5V±2%, -MR, -Reset PPO, Wt=50ms, Rt=3.13ms	SOT-25	28cp	VD17	6g	Tor
71U	XC6111A226MR	Vdet-IC	2.6V±2%, -MR, -Reset PPO, Wt=50ms, Rt=3.13ms	SOT-25	28cp	VD17	6g	Tor
71V	XC6111A227MR	Vdet-IC	2.7V±2%, -MR, -Reset PPO, Wt=50ms, Rt=3.13ms	SOT-25	28cp	VD17	6g	Tor
71X	XC6111A228MR	Vdet-IC	2.8V±2%, -MR, -Reset PPO, Wt=50ms, Rt=3.13ms	SOT-25	28cp	VD17	6g	Tor
71Y	XC6111A229MR	Vdet-IC	2.9V±2%, -MR, -Reset PPO, Wt=50ms, Rt=3.13ms	SOT-25	28cp	VD17	6g	Tor
71Y	XC9207A1L6M	DC/DC-IC	PWM/PFM st-down, 600kHz, 1.85V±2%, 600mA, +CE	SOT-25	28zq	DC1	6g	Tor
71Z	XC6111A230MR	Vdet-IC	3.0V±2%, -MR, -Reset PPO, Wt=50ms, Rt=3.13ms	SOT-25	28cp	VD17	6g	Tor
71Z	XC9207A1L3M	DC/DC-IC	PWM/PFM st-down, 300kHz, 2.0V±2%, 600mA, +CE	SOT-25	28zq	DC1	6g	Tor
72	RN5RF22BA	LVR-IC	LRlp, +CE, 2.2V±2%, 1A*	SOT-23-5	28vv	VR6	6g	Ric
72	RN5RZ22BA	LVR-IC	LDO, LN, +CE, 2.2V±2%, 100mA	SOT-23-5	28vrt	VR4	6g	Ric
720	R1124N201A	LVR-IC	LDO, LN, -CE, 2V±2%, 150mA	SOT-23-5	28vt	VR4	6g	Ric
720	XC6111A331MR	Vdet-IC	3.1V±2%, -MR, -Reset PPO, Wt=100ms, Rt=3.13ms	SOT-25	28cp	VD17	6g	Tor
720	XC9111E201MR	DC/DC-IC	PFM step-up, 100kHz, 2.0V±2.5%, 400mA	SOT-25	28sx	DC4	6g	Tor
720	XC9207A203M	DC/DC-IC	PWM/PFM st-down, 300kHz, 2.0V±2%, 600mA, +CE	SOT-25	28zq	DC1	6g	Tor
721	R1124N211A	LVR-IC	LDO, LN, -CE, 2.1V±2%, 150mA	SOT-23-5	28vt	VR4	6g	Ric
721	XC6111A332MR	Vdet-IC	3.2V±2%, -MR, -Reset PPO, Wt=100ms, Rt=3.13ms	SOT-25	28cp	VD17	6g	Tor
721	XC9111E211MR	DC/DC-IC	PFM step-up, 100kHz, 2.1V±2.5%, 400mA	SOT-25	28sx	DC4	6g	Tor
721	XC9207A213M	DC/DC-IC	PWM/PFM st-down, 300kHz, 2.1V±2%, 600mA, +CE	SOT-25	28zq	DC1	6g	Tor
722	R1124N221A	LVR-IC	LDO, LN, -CE, 2.2V±2%, 150mA	SOT-23-5	28vt	VR4	6g	Ric
722	XC6111A333MR	Vdet-IC	3.3V±2%, -MR, -Reset PPO, Wt=100ms, Rt=3.13ms	SOT-25	28cp	VD17	6g	Tor
722	XC9111E221MR	DC/DC-IC	PFM step-up, 100kHz, 2.2V±2.5%, 400mA	SOT-25	28sx	DC4	6g	Tor
722	XC9207A223M	DC/DC-IC	PWM/PFM st-down, 300kHz, 2.2V±2%, 600mA, +CE	SOT-25	28zq	DC1	6g	Tor
723	R1124N231A	LVR-IC	LDO, LN, -CE, 2.3V±2%, 150mA	SOT-23-5	28vt	VR4	6g	Ric
723	XC6111A334MR	Vdet-IC	3.4V±2%, -MR, -Reset PPO, Wt=100ms, Rt=3.13ms	SOT-25	28cp	VD17	6g	Tor
723	XC9111E231MR	DC/DC-IC	PFM step-up, 100kHz, 2.3V±2.5%, 400mA	SOT-25	28sx	DC4	6g	Tor
723	XC9207A233M	DC/DC-IC	PWM/PFM st-down, 300kHz, 2.3V±2%, 600mA, +CE	SOT-25	28zq	DC1	6g	Tor
724	R1124N241A	LVR-IC	LDO, LN, -CE, 2.4V±2%, 150mA	SOT-23-5	28vt	VR4	6g	Ric
724	XC6111A335MR	Vdet-IC	3.5V±2%, -MR, -Reset PPO, Wt=100ms, Rt=3.13ms	SOT-25	28cp	VD17	6g	Tor
724	XC9111E241MR	DC/DC-IC	PFM step-up, 100kHz, 2.4V±2.5%, 400mA	SOT-25	28sx	DC4	6g	Tor
724	XC9207A243M	DC/DC-IC	PWM/PFM st-down, 300kHz, 2.4V±2%, 600mA, +CE	SOT-25	28zq	DC1	6g	Tor
725	R1124N251A	LVR-IC	LDO, LN, -CE, 2.5V±2%, 150mA	SOT-23-5	28vt	VR4	6g	Ric
725	XC6111A336MR	Vdet-IC	3.6V±2%, -MR, -Reset PPO, Wt=100ms, Rt=3.13ms	SOT-25	28cp	VD17	6g	Tor
725	XC9111E251MR	DC/DC-IC	PFM step-up, 100kHz, 2.5V±2.5%, 400mA	SOT-25	28sx	DC4	6g	Tor
725	XC9207A253M	DC/DC-IC	PWM/PFM st-down, 300kHz, 2.5V±2%, 600mA, +CE	SOT-25	28zq	DC1	6g	Tor
726	R1124N261A	LVR-IC	LDO, LN, -CE, 2.6V±2%, 150mA	SOT-23-5	28vt	VR4	6g	Ric
726	XC6111A337MR	Vdet-IC	3.7V±2%, -MR, -Reset PPO, Wt=100ms, Rt=3.13ms	SOT-25	28cp	VD17	6g	Tor
726	XC9111E261MR	DC/DC-IC	PFM step-up, 100kHz, 2.6V±2.5%, 400mA	SOT-25	28sx	DC4	6g	Tor
726	XC9207A263M	DC/DC-IC	PWM/PFM st-down, 300kHz, 2.6V±2%, 600mA, +CE	SOT-25	28zq	DC1	6g	Tor
727	R1124N271A	LVR-IC	LDO, LN, -CE, 2.7V±2%, 150mA	SOT-23-5	28vt	VR4	6g	Ric
727	XC6111A338MR	Vdet-IC	3.8V±2%, -MR, -Reset PPO, Wt=100ms, Rt=3.13ms	SOT-25	28cp	VD17	6g	Tor
727	XC9111E271MR	DC/DC-IC	PFM step-up, 100kHz, 2.7V±2.5%, 400mA	SOT-25	28sx	DC4	6g	Tor
727	XC9207A273M	DC/DC-IC	PWM/PFM st-down, 300kHz, 2.7V±2%, 600mA, +CE	SOT-25	28zq	DC1	6g	Tor
728	R1124N281A	LVR-IC	LDO, LN, -CE, 2.8V±2%, 150mA	SOT-23-5	28vt	VR4	6g	Ric
728	XC6111A339MR	Vdet-IC	3.9V±2%, -MR, -Reset PPO, Wt=100ms, Rt=3.13ms	SOT-25	28cp	VD17	6g	Tor
728	XC9111E281MR	DC/DC-IC	PFM step-up, 100kHz, 2.8V±2.5%, 400mA	SOT-25	28sx	DC4	6g	Tor
728	XC9207A283M	DC/DC-IC	PWM/PFM st-down, 300kHz, 2.8V±2%, 600mA, +CE	SOT-25	28zq	DC1	6g	Tor
729	R1124N291A	LVR-IC	LDO, LN, -CE, 2.9V±2%, 150mA	SOT-23-5	28vt	VR4	6g	Ric
729	XC6111A340MR	Vdet-IC	4.0V±2%, -MR, -Reset PPO, Wt=100ms, Rt=3.13ms	SOT-25	28cp	VD17	6g	Tor
729	XC9111E291MR	DC/DC-IC	PFM step-up, 100kHz, 2.9V±2.5%, 400mA	SOT-25	28sx	DC4	6g	Tor
729	XC9207A293M	DC/DC-IC	PWM/PFM st-down, 300kHz, 2.9V±2%, 600mA, +CE	SOT-25	28zq	DC1	6g	Tor
72A	XC6111A341MR	Vdet-IC	4.1V±2%, -MR, -Reset PPO, Wt=100ms, Rt=3.13ms	SOT-25	28cp	VD17	6g	Tor
72A	XC9207A206M	DC/DC-IC	PWM/PFM st-down, 600kHz, 2.0V±2%, 600mA, +CE	SOT-25	28zq	DC1	6g	Tor
72B	XC6111A342MR	Vdet-IC	4.2V±2%, -MR, -Reset PPO, Wt=100ms, Rt=3.13ms	SOT-25	28cp	VD17	6g	Tor
72B	XC9207A216M	DC/DC-IC	PWM/PFM st-down, 600kHz, 2.1V±2%, 600mA, +CE	SOT-25	28zq	DC1	6g	Tor
72C	XC6111A343MR	Vdet-IC	4.3V±2%, -MR, -Reset PPO, Wt=100ms, Rt=3.13ms	SOT-25	28cp	VD17	6g	Tor
72C	XC9207A226M	DC/DC-IC	PWM/PFM st-down, 600kHz, 2.2V±2%, 600mA, +CE	SOT-25	28zq	DC1	6g	Tor
72D	XC6111A344MR	Vdet-IC	4.4V±2%, -MR, -Reset PPO, Wt=100ms, Rt=3.13ms	SOT-25	28cp	VD17	6g	Tor
72D	XC9207A236M	DC/DC-IC	PWM/PFM st-down, 600kHz, 2.3V±2%, 600mA, +CE	SOT-25	28zq	DC1	6g	Tor
72E	XC6111A345MR	Vdet-IC	4.5V±2%, -MR, -Reset PPO, Wt=100ms, Rt=3.13ms	SOT-25	28cp	VD17	6g	Tor



SMD code	Type	Function	Short description	Case	Pinout	Sch.	St.	Mnf.
72E	XC9207A246M	DC/DC-IC	PWM/PFM st-down, 600kHz, 2.4V±2%, 600mA, +CE	SOT-25	28zq	DC1	6g	Tor
72F	XC6111A316MR	Vdet-IC	1.6V±2%, -MR, -Reset PPO, Wt=100ms, Rt=3.13ms	SOT-25	28cp	VD17	6g	Tor
72F	XC6111A346MR	Vdet-IC	4.6V±2%, -MR, -Reset PPO, Wt=100ms, Rt=3.13ms	SOT-25	28cp	VD17	6g	Tor
72F	XC9207A256M	DC/DC-IC	PWM/PFM st-down, 600kHz, 2.5V±2%, 600mA, +CE	SOT-25	28zq	DC1	6g	Tor
72H	XC6111A317MR	Vdet-IC	1.7V±2%, -MR, -Reset PPO, Wt=100ms, Rt=3.13ms	SOT-25	28cp	VD17	6g	Tor
72H	XC6111A347MR	Vdet-IC	4.7V±2%, -MR, -Reset PPO, Wt=100ms, Rt=3.13ms	SOT-25	28cp	VD17	6g	Tor
72H	XC9207A266M	DC/DC-IC	PWM/PFM st-down, 600kHz, 2.6V±2%, 600mA, +CE	SOT-25	28zq	DC1	6g	Tor
72K	XC6111A318MR	Vdet-IC	1.8V±2%, -MR, -Reset PPO, Wt=100ms, Rt=3.13ms	SOT-25	28cp	VD17	6g	Tor
72K	XC6111A348MR	Vdet-IC	4.8V±2%, -MR, -Reset PPO, Wt=100ms, Rt=3.13ms	SOT-25	28cp	VD17	6g	Tor
72K	XC9207A276M	DC/DC-IC	PWM/PFM st-down, 600kHz, 2.7V±2%, 600mA, +CE	SOT-25	28zq	DC1	6g	Tor
72L	XC6111A319MR	Vdet-IC	1.9V±2%, -MR, -Reset PPO, Wt=100ms, Rt=3.13ms	SOT-25	28cp	VD17	6g	Tor
72L	XC6111A349MR	Vdet-IC	4.9V±2%, -MR, -Reset PPO, Wt=100ms, Rt=3.13ms	SOT-25	28cp	VD17	6g	Tor
72L	XC9207A286M	DC/DC-IC	PWM/PFM st-down, 600kHz, 2.8V±2%, 600mA, +CE	SOT-25	28zq	DC1	6g	Tor
72M	XC6111A320MR	Vdet-IC	2.0V±2%, -MR, -Reset PPO, Wt=100ms, Rt=3.13ms	SOT-25	28cp	VD17	6g	Tor
72M	XC6111A350MR	Vdet-IC	5.0V±2%, -MR, -Reset PPO, Wt=100ms, Rt=3.13ms	SOT-25	28cp	VD17	6g	Tor
72M	XC9207A296M	DC/DC-IC	PWM/PFM st-down, 600kHz, 2.9V±2%, 600mA, +CE	SOT-25	28zq	DC1	6g	Tor
72N	XC6111A321MR	Vdet-IC	2.1V±2%, -MR, -Reset PPO, Wt=100ms, Rt=3.13ms	SOT-25	28cp	VD17	6g	Tor
72P	XC6111A322MR	Vdet-IC	2.2V±2%, -MR, -Reset PPO, Wt=100ms, Rt=3.13ms	SOT-25	28cp	VD17	6g	Tor
72R	XC6111A323MR	Vdet-IC	2.3V±2%, -MR, -Reset PPO, Wt=100ms, Rt=3.13ms	SOT-25	28cp	VD17	6g	Tor
72S	XC6111A324MR	Vdet-IC	2.4V±2%, -MR, -Reset PPO, Wt=100ms, Rt=3.13ms	SOT-25	28cp	VD17	6g	Tor
72T	XC6111A325MR	Vdet-IC	2.5V±2%, -MR, -Reset PPO, Wt=100ms, Rt=3.13ms	SOT-25	28cp	VD17	6g	Tor
72U	XC6111A326MR	Vdet-IC	2.6V±2%, -MR, -Reset PPO, Wt=100ms, Rt=3.13ms	SOT-25	28cp	VD17	6g	Tor
72V	XC6111A327MR	Vdet-IC	2.7V±2%, -MR, -Reset PPO, Wt=100ms, Rt=3.13ms	SOT-25	28cp	VD17	6g	Tor
72X	XC6111A328MR	Vdet-IC	2.8V±2%, -MR, -Reset PPO, Wt=100ms, Rt=3.13ms	SOT-25	28cp	VD17	6g	Tor
72Y	XC6111A329MR	Vdet-IC	2.9V±2%, -MR, -Reset PPO, Wt=100ms, Rt=3.13ms	SOT-25	28cp	VD17	6g	Tor
72Y	XC9207A2L6M	DC/DC-IC	PWM/PFM st-down, 600kHz, 2.85V±2%, 600mA, +CE	SOT-25	28zq	DC1	6g	Tor
72Z	XC6111A330MR	Vdet-IC	3.0V±2%, -MR, -Reset PPO, Wt=100ms, Rt=3.13ms	SOT-25	28cp	VD17	6g	Tor
72Z	XC9207A2L3M	DC/DC-IC	PWM/PFM st-down, 300kHz, 2.85V±2%, 600mA, +CE	SOT-25	28zq	DC1	6g	Tor
73	RN5RF23BA	LVR-IC	LRip, +CE, 2.3V±2%, 1A*	SOT-23-5	28vw	VR6	6g	Ric
73	RN5RZ23BA	LVR-IC	LDO, LN, +CE, 2.3V±2%, 100mA	SOT-23-5	28wrt	VR4	6g	Ric
730	R1124N301A	LVR-IC	LDO, LN, -CE, 3V±2%, 150mA	SOT-23-5	28vt	VR4	6g	Ric
730	XC6111A431MR	Vdet-IC	3.1V±2%, -MR, -Reset PPO, Wt=200ms, Rt=3.13ms	SOT-25	28cp	VD17	6g	Tor
730	XC9111E301MR	DC/DC-IC	PFM step-up, 100kHz, 3.0V±2.5%, 400mA	SOT-25	28sx	DC4	6g	Tor
730	XC9207A303M	DC/DC-IC	PWM/PFM st-down, 300kHz, 3.0V±2%, 600mA, +CE	SOT-25	28zq	DC1	6g	Tor
731	R1124N311A	LVR-IC	LDO, LN, -CE, 3.1V±2%, 150mA	SOT-23-5	28vt	VR4	6g	Ric
731	XC6111A432MR	Vdet-IC	3.2V±2%, -MR, -Reset PPO, Wt=200ms, Rt=3.13ms	SOT-25	28cp	VD17	6g	Tor
731	XC9111E311MR	DC/DC-IC	PFM step-up, 100kHz, 3.1V±2.5%, 400mA	SOT-25	28sx	DC4	6g	Tor
731	XC9207A313M	DC/DC-IC	PWM/PFM st-down, 300kHz, 3.1V±2%, 600mA, +CE	SOT-25	28zq	DC1	6g	Tor
732	R1124N321A	LVR-IC	LDO, LN, -CE, 3.2V±2%, 150mA	SOT-23-5	28vt	VR4	6g	Ric
732	XC6111A433MR	Vdet-IC	3.3V±2%, -MR, -Reset PPO, Wt=200ms, Rt=3.13ms	SOT-25	28cp	VD17	6g	Tor
732	XC9111E321MR	DC/DC-IC	PFM step-up, 100kHz, 3.2V±2.5%, 400mA	SOT-25	28sx	DC4	6g	Tor
732	XC9207A323M	DC/DC-IC	PWM/PFM st-down, 300kHz, 3.2V±2%, 600mA, +CE	SOT-25	28zq	DC1	6g	Tor
733	R1124N331A	LVR-IC	LDO, LN, -CE, 3.3V±2%, 150mA	SOT-23-5	28vt	VR4	6g	Ric
733	XC6111A434MR	Vdet-IC	3.4V±2%, -MR, -Reset PPO, Wt=200ms, Rt=3.13ms	SOT-25	28cp	VD17	6g	Tor
733	XC9111E331MR	DC/DC-IC	PFM step-up, 100kHz, 3.3V±2.5%, 400mA	SOT-25	28sx	DC4	6g	Tor
733	XC9207A333M	DC/DC-IC	PWM/PFM st-down, 300kHz, 3.3V±2%, 600mA, +CE	SOT-25	28zq	DC1	6g	Tor
734	R1124N341A	LVR-IC	LDO, LN, -CE, 3.4V±2%, 150mA	SOT-23-5	28vt	VR4	6g	Ric
734	XC6111A435MR	Vdet-IC	3.5V±2%, -MR, -Reset PPO, Wt=200ms, Rt=3.13ms	SOT-25	28cp	VD17	6g	Tor
734	XC9111E341MR	DC/DC-IC	PFM step-up, 100kHz, 3.4V±2.5%, 400mA	SOT-25	28sx	DC4	6g	Tor
734	XC9207A343M	DC/DC-IC	PWM/PFM st-down, 300kHz, 3.4V±2%, 600mA, +CE	SOT-25	28zq	DC1	6g	Tor
735	R1124N351A	LVR-IC	LDO, LN, -CE, 3.5V±2%, 150mA	SOT-23-5	28vt	VR4	6g	Ric
735	XC6111A436MR	Vdet-IC	3.6V±2%, -MR, -Reset PPO, Wt=200ms, Rt=3.13ms	SOT-25	28cp	VD17	6g	Tor
735	XC9111E351MR	DC/DC-IC	PFM step-up, 100kHz, 3.5V±2.5%, 400mA	SOT-25	28sx	DC4	6g	Tor
735	XC9207A353M	DC/DC-IC	PWM/PFM st-down, 300kHz, 3.5V±2%, 600mA, +CE	SOT-25	28zq	DC1	6g	Tor
736	R1124N361A	LVR-IC	LDO, LN, -CE, 3.6V±2%, 150mA	SOT-23-5	28vt	VR4	6g	Ric
736	XC6111A437MR	Vdet-IC	3.7V±2%, -MR, -Reset PPO, Wt=200ms, Rt=3.13ms	SOT-25	28cp	VD17	6g	Tor
736	XC9111E361MR	DC/DC-IC	PFM step-up, 100kHz, 3.6V±2.5%, 400mA	SOT-25	28sx	DC4	6g	Tor
736	XC9207A363M	DC/DC-IC	PWM/PFM st-down, 300kHz, 3.6V±2%, 600mA, +CE	SOT-25	28zq	DC1	6g	Tor
737	R1124N371A	LVR-IC	LDO, LN, -CE, 3.7V±2%, 150mA	SOT-23-5	28vt	VR4	6g	Ric
737	XC6111A438MR	Vdet-IC	3.8V±2%, -MR, -Reset PPO, Wt=200ms, Rt=3.13ms	SOT-25	28cp	VD17	6g	Tor
737	XC9111E371MR	DC/DC-IC	PFM step-up, 100kHz, 3.7V±2.5%, 400mA	SOT-25	28sx	DC4	6g	Tor
737	XC9207A373M	DC/DC-IC	PWM/PFM st-down, 300kHz, 3.7V±2%, 600mA, +CE	SOT-25	28zq	DC1	6g	Tor
738	R1124N381A	LVR-IC	LDO, LN, -CE, 3.8V±2%, 150mA	SOT-23-5	28vt	VR4	6g	Ric
738	XC6111A439MR	Vdet-IC	3.9V±2%, -MR, -Reset PPO, Wt=200ms, Rt=3.13ms	SOT-25	28cp	VD17	6g	Tor
738	XC9111E381MR	DC/DC-IC	PFM step-up, 100kHz, 3.8V±2.5%, 400mA	SOT-25	28sx	DC4	6g	Tor
738	XC9207A383M	DC/DC-IC	PWM/PFM st-down, 300kHz, 3.8V±2%, 600mA, +CE	SOT-25	28zq	DC1	6g	Tor
739	R1124N391A	LVR-IC	LDO, LN, -CE, 3.9V±2%, 150mA	SOT-23-5	28vt	VR4	6g	Ric
739	XC6111A440MR	Vdet-IC	4.0V±2%, -MR, -Reset PPO, Wt=200ms, Rt=3.13ms	SOT-25	28cp	VD17	6g	Tor
739	XC9111E391MR	DC/DC-IC	PFM step-up, 100kHz, 3.9V±2.5%, 400mA	SOT-25	28sx	DC4	6g	Tor
739	XC9207A393M	DC/DC-IC	PWM/PFM st-down, 300kHz, 3.9V±2%, 600mA, +CE	SOT-25	28zq	DC1	6g	Tor



SMD code	Type	Function	Short description	Case	Pinout	Sch.	St.	Mnf.
<u>73A</u>	XC6111A441MR	Vdet-IC	4.1V±2%, -MR, -Reset PPO, Wt=200ms, Rt=3.13ms	SOT-25	28cp	VD17	6g	Tor
<u>73B</u>	XC9207A306M	DC/DC-IC	PWM/PFM st-down, 600kHz, 3.0V±2%, 600mA, +CE	SOT-25	28zq	DC1	6g	Tor
<u>73B</u>	XC6111A442MR	Vdet-IC	4.2V±2%, -MR, -Reset PPO, Wt=200ms, Rt=3.13ms	SOT-25	28cp	VD17	6g	Tor
<u>73B</u>	XC9207A316M	DC/DC-IC	PWM/PFM st-down, 600kHz, 3.1V±2%, 600mA, +CE	SOT-25	28zq	DC1	6g	Tor
<u>73C</u>	XC6111A443MR	Vdet-IC	4.3V±2%, -MR, -Reset PPO, Wt=200ms, Rt=3.13ms	SOT-25	28cp	VD17	6g	Tor
<u>73C</u>	XC9207A326M	DC/DC-IC	PWM/PFM st-down, 600kHz, 3.2V±2%, 600mA, +CE	SOT-25	28zq	DC1	6g	Tor
<u>73D</u>	XC6111A444MR	Vdet-IC	4.4V±2%, -MR, -Reset PPO, Wt=200ms, Rt=3.13ms	SOT-25	28cp	VD17	6g	Tor
<u>73D</u>	XC9207A336M	DC/DC-IC	PWM/PFM st-down, 600kHz, 3.3V±2%, 600mA, +CE	SOT-25	28zq	DC1	6g	Tor
<u>73E</u>	XC6111A445MR	Vdet-IC	4.5V±2%, -MR, -Reset PPO, Wt=200ms, Rt=3.13ms	SOT-25	28cp	VD17	6g	Tor
<u>73E</u>	XC9207A346M	DC/DC-IC	PWM/PFM st-down, 600kHz, 3.4V±2%, 600mA, +CE	SOT-25	28zq	DC1	6g	Tor
<u>73F</u>	XC6111A416MR	Vdet-IC	1.6V±2%, -MR, -Reset PPO, Wt=200ms, Rt=3.13ms	SOT-25	28cp	VD17	6g	Tor
<u>73F</u>	XC6111A446MR	Vdet-IC	4.6V±2%, -MR, -Reset PPO, Wt=200ms, Rt=3.13ms	SOT-25	28cp	VD17	6g	Tor
<u>73F</u>	XC9207A356M	DC/DC-IC	PWM/PFM st-down, 600kHz, 3.5V±2%, 600mA, +CE	SOT-25	28zq	DC1	6g	Tor
<u>73H</u>	XC6111A417MR	Vdet-IC	1.7V±2%, -MR, -Reset PPO, Wt=200ms, Rt=3.13ms	SOT-25	28cp	VD17	6g	Tor
<u>73H</u>	XC6111A447MR	Vdet-IC	4.7V±2%, -MR, -Reset PPO, Wt=200ms, Rt=3.13ms	SOT-25	28cp	VD17	6g	Tor
<u>73H</u>	XC9207A366M	DC/DC-IC	PWM/PFM st-down, 600kHz, 3.6V±2%, 600mA, +CE	SOT-25	28zq	DC1	6g	Tor
<u>73K</u>	XC6111A418MR	Vdet-IC	1.8V±2%, -MR, -Reset PPO, Wt=200ms, Rt=3.13ms	SOT-25	28cp	VD17	6g	Tor
<u>73K</u>	XC6111A448MR	Vdet-IC	4.8V±2%, -MR, -Reset PPO, Wt=200ms, Rt=3.13ms	SOT-25	28cp	VD17	6g	Tor
<u>73K</u>	XC9207A376M	DC/DC-IC	PWM/PFM st-down, 600kHz, 3.7V±2%, 600mA, +CE	SOT-25	28zq	DC1	6g	Tor
<u>73L</u>	XC6111A419MR	Vdet-IC	1.9V±2%, -MR, -Reset PPO, Wt=200ms, Rt=3.13ms	SOT-25	28cp	VD17	6g	Tor
<u>73L</u>	XC6111A449MR	Vdet-IC	4.9V±2%, -MR, -Reset PPO, Wt=200ms, Rt=3.13ms	SOT-25	28cp	VD17	6g	Tor
<u>73L</u>	XC9207A386M	DC/DC-IC	PWM/PFM st-down, 600kHz, 3.8V±2%, 600mA, +CE	SOT-25	28zq	DC1	6g	Tor
<u>73M</u>	XC6111A420MR	Vdet-IC	2.0V±2%, -MR, -Reset PPO, Wt=200ms, Rt=3.13ms	SOT-25	28cp	VD17	6g	Tor
<u>73M</u>	XC6111A450MR	Vdet-IC	5.0V±2%, -MR, -Reset PPO, Wt=200ms, Rt=3.13ms	SOT-25	28cp	VD17	6g	Tor
<u>73M</u>	XC9207A396M	DC/DC-IC	PWM/PFM st-down, 600kHz, 3.9V±2%, 600mA, +CE	SOT-25	28zq	DC1	6g	Tor
<u>73N</u>	XC6111A421MR	Vdet-IC	2.1V±2%, -MR, -Reset PPO, Wt=200ms, Rt=3.13ms	SOT-25	28cp	VD17	6g	Tor
<u>73P</u>	XC6111A422MR	Vdet-IC	2.2V±2%, -MR, -Reset PPO, Wt=200ms, Rt=3.13ms	SOT-25	28cp	VD17	6g	Tor
<u>73P</u>	XC6111A423MR	Vdet-IC	2.3V±2%, -MR, -Reset PPO, Wt=200ms, Rt=3.13ms	SOT-25	28cp	VD17	6g	Tor
<u>73S</u>	XC6111A424MR	Vdet-IC	2.4V±2%, -MR, -Reset PPO, Wt=200ms, Rt=3.13ms	SOT-25	28cp	VD17	6g	Tor
<u>73T</u>	XC6111A425MR	Vdet-IC	2.5V±2%, -MR, -Reset PPO, Wt=200ms, Rt=3.13ms	SOT-25	28cp	VD17	6g	Tor
<u>73U</u>	XC6111A426MR	Vdet-IC	2.6V±2%, -MR, -Reset PPO, Wt=200ms, Rt=3.13ms	SOT-25	28cp	VD17	6g	Tor
<u>73V</u>	XC6111A427MR	Vdet-IC	2.7V±2%, -MR, -Reset PPO, Wt=200ms, Rt=3.13ms	SOT-25	28cp	VD17	6g	Tor
<u>73X</u>	XC6111A428MR	Vdet-IC	2.8V±2%, -MR, -Reset PPO, Wt=200ms, Rt=3.13ms	SOT-25	28cp	VD17	6g	Tor
<u>73Y</u>	XC6111A429MR	Vdet-IC	2.9V±2%, -MR, -Reset PPO, Wt=200ms, Rt=3.13ms	SOT-25	28cp	VD17	6g	Tor
<u>73Z</u>	XC6111A430MR	Vdet-IC	3.0V±2%, -MR, -Reset PPO, Wt=200ms, Rt=3.13ms	SOT-25	28cp	VD17	6g	Tor
<u>74</u>	RN5RF24BA	LVR-IC	LRIp, +CE, 2.4V±2%, 1A*	SOT-23-5	28vw	VR6	6g	Ric
<u>74</u>	RN5RZ24BA	LVR-IC	LDO, LN, +CE, 2.4V±2%, 100mA	SOT-23-5	28vrt	VR4	6g	Ric
<u>740</u>	R1124N401A	LVR-IC	LDO, LN, -CE, 4V±2%, 150mA	SOT-23-5	28vrt	VR4	6g	Ric
<u>740</u>	XC6111A531MR	Vdet-IC	3.1V±2%, -MR, -Reset PPO, Wt=400ms, Rt=3.13ms	SOT-25	28cp	VD17	6g	Tor
<u>740</u>	XC9111E401MR	DC/DC-IC	PFM step-up, 100kHz, 4.0V±2.5%, 400mA	SOT-25	28sx	DC4	6g	Tor
<u>740</u>	XC9207A403M	DC/DC-IC	PWM/PFM st-down, 300kHz, 4.0V±2%, 600mA, +CE	SOT-25	28zq	DC1	6g	Tor
<u>741</u>	R1124N281A5	LVR-IC	LDO, LN, +CE, 2.8V±2%, 150mA	SOT-23-5	28vt	VR4	6g	Ric
<u>741</u>	XC6111A532MR	Vdet-IC	3.2V±2%, -MR, -Reset PPO, Wt=400ms, Rt=3.13ms	SOT-25	28cp	VD17	6g	Tor
<u>741</u>	XC9111E411MR	DC/DC-IC	PFM step-up, 100kHz, 4.1V±2.5%, 400mA	SOT-25	28sx	DC4	6g	Tor
<u>742</u>	XC6111A533MR	Vdet-IC	3.3V±2%, -MR, -Reset PPO, Wt=400ms, Rt=3.13ms	SOT-25	28cp	VD17	6g	Tor
<u>742</u>	XC9111E421MR	DC/DC-IC	PFM step-up, 100kHz, 4.2V±2.5%, 400mA	SOT-25	28sx	DC4	6g	Tor
<u>743</u>	XC6111A534MR	Vdet-IC	3.4V±2%, -MR, -Reset PPO, Wt=400ms, Rt=3.13ms	SOT-25	28cp	VD17	6g	Tor
<u>743</u>	XC9111E431MR	DC/DC-IC	PFM step-up, 100kHz, 4.3V±2.5%, 400mA	SOT-25	28sx	DC4	6g	Tor
<u>744</u>	XC6111A535MR	Vdet-IC	3.5V±2%, -MR, -Reset PPO, Wt=400ms, Rt=3.13ms	SOT-25	28cp	VD17	6g	Tor
<u>744</u>	XC9111E441MR	DC/DC-IC	PFM step-up, 100kHz, 4.4V±2.5%, 400mA	SOT-25	28sx	DC4	6g	Tor
<u>745</u>	XC6111A536MR	Vdet-IC	3.6V±2%, -MR, -Reset PPO, Wt=400ms, Rt=3.13ms	SOT-25	28cp	VD17	6g	Tor
<u>745</u>	XC9111E451MR	DC/DC-IC	PFM step-up, 100kHz, 4.5V±2.5%, 400mA	SOT-25	28sx	DC4	6g	Tor
<u>746</u>	XC6111A537MR	Vdet-IC	3.7V±2%, -MR, -Reset PPO, Wt=400ms, Rt=3.13ms	SOT-25	28cp	VD17	6g	Tor
<u>746</u>	XC9111E461MR	DC/DC-IC	PFM step-up, 100kHz, 4.6V±2.5%, 400mA	SOT-25	28sx	DC4	6g	Tor
<u>747</u>	XC6111A538MR	Vdet-IC	3.8V±2%, -MR, -Reset PPO, Wt=400ms, Rt=3.13ms	SOT-25	28cp	VD17	6g	Tor
<u>747</u>	XC9111E471MR	DC/DC-IC	PFM step-up, 100kHz, 4.7V±2.5%, 400mA	SOT-25	28sx	DC4	6g	Tor
<u>748</u>	XC6111A539MR	Vdet-IC	3.9V±2%, -MR, -Reset PPO, Wt=400ms, Rt=3.13ms	SOT-25	28cp	VD17	6g	Tor
<u>748</u>	XC9111E481MR	DC/DC-IC	PFM step-up, 100kHz, 4.8V±2.5%, 400mA	SOT-25	28sx	DC4	6g	Tor
<u>749</u>	XC6111A540MR	Vdet-IC	4.0V±2%, -MR, -Reset PPO, Wt=400ms, Rt=3.13ms	SOT-25	28cp	VD17	6g	Tor
<u>749</u>	XC9111E491MR	DC/DC-IC	PFM step-up, 100kHz, 4.9V±2.5%, 400mA	SOT-25	28sx	DC4	6g	Tor
<u>74A</u>	XC6111A541MR	Vdet-IC	4.1V±2%, -MR, -Reset PPO, Wt=400ms, Rt=3.13ms	SOT-25	28cp	VD17	6g	Tor
<u>74A</u>	XC9207A406M	DC/DC-IC	PWM/PFM st-down, 600kHz, 4.0V±2%, 600mA, +CE	SOT-25	28zq	DC1	6g	Tor
<u>74B</u>	XC6111A542MR	Vdet-IC	4.2V±2%, -MR, -Reset PPO, Wt=400ms, Rt=3.13ms	SOT-25	28cp	VD17	6g	Tor
<u>74C</u>	XC6111A543MR	Vdet-IC	4.3V±2%, -MR, -Reset PPO, Wt=400ms, Rt=3.13ms	SOT-25	28cp	VD17	6g	Tor
<u>74D</u>	XC6111A544MR	Vdet-IC	4.4V±2%, -MR, -Reset PPO, Wt=400ms, Rt=3.13ms	SOT-25	28cp	VD17	6g	Tor
<u>74E</u>	XC6111A545MR	Vdet-IC	4.5V±2%, -MR, -Reset PPO, Wt=400ms, Rt=3.13ms	SOT-25	28cp	VD17	6g	Tor
<u>74F</u>	XC6111A516MR	Vdet-IC	1.6V±2%, -MR, -Reset PPO, Wt=400ms, Rt=3.13ms	SOT-25	28cp	VD17	6g	Tor
<u>74F</u>	XC6111A546MR	Vdet-IC	4.6V±2%, -MR, -Reset PPO, Wt=400ms, Rt=3.13ms	SOT-25	28cp	VD17	6g	Tor
<u>74H</u>	XC6111A517MR	Vdet-IC	1.7V±2%, -MR, -Reset PPO, Wt=400ms, Rt=3.13ms	SOT-25	28cp	VD17	6g	Tor
<u>74H</u>	XC6111A547MR	Vdet-IC	4.7V±2%, -MR, -Reset PPO, Wt=400ms, Rt=3.13ms	SOT-25	28cp	VD17	6g	Tor



SMD code	Type	Function	Short description	Case	Pinout	Sch.	St.	Mnf.
<u>74K</u>	XC6111A518MR	Vdet-IC	1.8V±2%, -MR, -Reset PPO, Wt=400ms, Rt=3.13ms	SOT-25	28cp	VD17	6g	Tor
<u>74K</u>	XC6111A548MR	Vdet-IC	4.8V±2%, -MR, -Reset PPO, Wt=400ms, Rt=3.13ms	SOT-25	28cp	VD17	6g	Tor
<u>74L</u>	XC6111A519MR	Vdet-IC	1.9V±2%, -MR, -Reset PPO, Wt=400ms, Rt=3.13ms	SOT-25	28cp	VD17	6g	Tor
<u>74L</u>	XC6111A549MR	Vdet-IC	4.9V±2%, -MR, -Reset PPO, Wt=400ms, Rt=3.13ms	SOT-25	28cp	VD17	6g	Tor
<u>74M</u>	XC6111A520MR	Vdet-IC	2.0V±2%, -MR, -Reset PPO, Wt=400ms, Rt=3.13ms	SOT-25	28cp	VD17	6g	Tor
<u>74M</u>	XC6111A550MR	Vdet-IC	5.0V±2%, -MR, -Reset PPO, Wt=400ms, Rt=3.13ms	SOT-25	28cp	VD17	6g	Tor
<u>74N</u>	XC6111A521MR	Vdet-IC	2.1V±2%, -MR, -Reset PPO, Wt=400ms, Rt=3.13ms	SOT-25	28cp	VD17	6g	Tor
<u>74P</u>	XC6111A522MR	Vdet-IC	2.2V±2%, -MR, -Reset PPO, Wt=400ms, Rt=3.13ms	SOT-25	28cp	VD17	6g	Tor
<u>74R</u>	XC6111A523MR	Vdet-IC	2.3V±2%, -MR, -Reset PPO, Wt=400ms, Rt=3.13ms	SOT-25	28cp	VD17	6g	Tor
<u>74S</u>	XC6111A524MR	Vdet-IC	2.4V±2%, -MR, -Reset PPO, Wt=400ms, Rt=3.13ms	SOT-25	28cp	VD17	6g	Tor
<u>74T</u>	XC6111A525MR	Vdet-IC	2.5V±2%, -MR, -Reset PPO, Wt=400ms, Rt=3.13ms	SOT-25	28cp	VD17	6g	Tor
<u>74U</u>	XC6111A526MR	Vdet-IC	2.6V±2%, -MR, -Reset PPO, Wt=400ms, Rt=3.13ms	SOT-25	28cp	VD17	6g	Tor
<u>74V</u>	XC6111A527MR	Vdet-IC	2.7V±2%, -MR, -Reset PPO, Wt=400ms, Rt=3.13ms	SOT-25	28cp	VD17	6g	Tor
<u>74X</u>	XC6111A528MR	Vdet-IC	2.8V±2%, -MR, -Reset PPO, Wt=400ms, Rt=3.13ms	SOT-25	28cp	VD17	6g	Tor
<u>74Y</u>	XC6111A529MR	Vdet-IC	2.9V±2%, -MR, -Reset PPO, Wt=400ms, Rt=3.13ms	SOT-25	28cp	VD17	6g	Tor
<u>74Z</u>	XC6111A530MR	Vdet-IC	3.0V±2%, -MR, -Reset PPO, Wt=400ms, Rt=3.13ms	SOT-25	28cp	VD17	6g	Tor
<u>75</u>	RN5RF25BA	LVR-IC	LRIp, +CE, 2.5V±2%, 1A*	SOT-23-5	28wv	VR6	6g	Ric
<u>75</u>	RN5RZ25BA	LVR-IC	LDO, LN, +CE, 2.5V±2%, 100mA	SOT-23-5	28wrt	VR4	6g	Ric
<u>750</u>	XC6111A631MR	Vdet-IC	3.1V±2%, -MR, -Reset PPO, Wt=1.6s, Rt=3.13ms	SOT-25	28cp	VD17	6g	Tor
<u>750</u>	XC9111E501MR	DC/DC-IC	PFM step-up, 100kHz, 5.0V±2.5%, 400mA	SOT-25	28sx	DC4	6g	Tor
<u>751</u>	XC6111A632MR	Vdet-IC	3.2V±2%, -MR, -Reset PPO, Wt=1.6s, Rt=3.13ms	SOT-25	28cp	VD17	6g	Tor
<u>751</u>	XC9111E511MR	DC/DC-IC	PFM step-up, 100kHz, 5.1V±2.5%, 400mA	SOT-25	28sx	DC4	6g	Tor
<u>752</u>	XC6111A633MR	Vdet-IC	3.3V±2%, -MR, -Reset PPO, Wt=1.6s, Rt=3.13ms	SOT-25	28cp	VD17	6g	Tor
<u>752</u>	XC9111E521MR	DC/DC-IC	PFM step-up, 100kHz, 5.2V±2.5%, 400mA	SOT-25	28sx	DC4	6g	Tor
<u>753</u>	XC6111A634MR	Vdet-IC	3.4V±2%, -MR, -Reset PPO, Wt=1.6s, Rt=3.13ms	SOT-25	28cp	VD17	6g	Tor
<u>753</u>	XC9111E531MR	DC/DC-IC	PFM step-up, 100kHz, 5.3V±2.5%, 400mA	SOT-25	28sx	DC4	6g	Tor
<u>754</u>	XC6111A635MR	Vdet-IC	3.5V±2%, -MR, -Reset PPO, Wt=1.6s, Rt=3.13ms	SOT-25	28cp	VD17	6g	Tor
<u>754</u>	XC9111E541MR	DC/DC-IC	PFM step-up, 100kHz, 5.4V±2.5%, 400mA	SOT-25	28sx	DC4	6g	Tor
<u>755</u>	XC6111A636MR	Vdet-IC	3.6V±2%, -MR, -Reset PPO, Wt=1.6s, Rt=3.13ms	SOT-25	28cp	VD17	6g	Tor
<u>755</u>	XC9111E551MR	DC/DC-IC	PFM step-up, 100kHz, 5.5V±2.5%, 400mA	SOT-25	28sx	DC4	6g	Tor
<u>756</u>	XC6111A637MR	Vdet-IC	3.7V±2%, -MR, -Reset PPO, Wt=1.6s, Rt=3.13ms	SOT-25	28cp	VD17	6g	Tor
<u>756</u>	XC9111E561MR	DC/DC-IC	PFM step-up, 100kHz, 5.6V±2.5%, 400mA	SOT-25	28sx	DC4	6g	Tor
<u>757</u>	XC6111A638MR	Vdet-IC	3.8V±2%, -MR, -Reset PPO, Wt=1.6s, Rt=3.13ms	SOT-25	28cp	VD17	6g	Tor
<u>757</u>	XC9111E571MR	DC/DC-IC	PFM step-up, 100kHz, 5.7V±2.5%, 400mA	SOT-25	28sx	DC4	6g	Tor
<u>758</u>	XC6111A639MR	Vdet-IC	3.9V±2%, -MR, -Reset PPO, Wt=1.6s, Rt=3.13ms	SOT-25	28cp	VD17	6g	Tor
<u>758</u>	XC9111E581MR	DC/DC-IC	PFM step-up, 100kHz, 5.8V±2.5%, 400mA	SOT-25	28sx	DC4	6g	Tor
<u>759</u>	XC6111A640MR	Vdet-IC	4.0V±2%, -MR, -Reset PPO, Wt=1.6s, Rt=3.13ms	SOT-25	28cp	VD17	6g	Tor
<u>759</u>	XC9111E591MR	DC/DC-IC	PFM step-up, 100kHz, 5.9V±2.5%, 400mA	SOT-25	28sx	DC4	6g	Tor
<u>75A</u>	XC6111A641MR	Vdet-IC	4.1V±2%, -MR, -Reset PPO, Wt=1.6s, Rt=3.13ms	SOT-25	28cp	VD17	6g	Tor
<u>75B</u>	XC6111A642MR	Vdet-IC	4.2V±2%, -MR, -Reset PPO, Wt=1.6s, Rt=3.13ms	SOT-25	28cp	VD17	6g	Tor
<u>75C</u>	XC6111A643MR	Vdet-IC	4.3V±2%, -MR, -Reset PPO, Wt=1.6s, Rt=3.13ms	SOT-25	28cp	VD17	6g	Tor
<u>75D</u>	XC6111A644MR	Vdet-IC	4.4V±2%, -MR, -Reset PPO, Wt=1.6s, Rt=3.13ms	SOT-25	28cp	VD17	6g	Tor
<u>75E</u>	XC6111A645MR	Vdet-IC	4.5V±2%, -MR, -Reset PPO, Wt=1.6s, Rt=3.13ms	SOT-25	28cp	VD17	6g	Tor
<u>75F</u>	XC6111A616MR	Vdet-IC	1.6V±2%, -MR, -Reset PPO, Wt=1.6s, Rt=3.13ms	SOT-25	28cp	VD17	6g	Tor
<u>75F</u>	XC6111A646MR	Vdet-IC	4.6V±2%, -MR, -Reset PPO, Wt=1.6s, Rt=3.13ms	SOT-25	28cp	VD17	6g	Tor
<u>75H</u>	XC6111A617MR	Vdet-IC	1.7V±2%, -MR, -Reset PPO, Wt=1.6s, Rt=3.13ms	SOT-25	28cp	VD17	6g	Tor
<u>75H</u>	XC6111A647MR	Vdet-IC	4.7V±2%, -MR, -Reset PPO, Wt=1.6s, Rt=3.13ms	SOT-25	28cp	VD17	6g	Tor
<u>75K</u>	XC6111A618MR	Vdet-IC	1.8V±2%, -MR, -Reset PPO, Wt=1.6s, Rt=3.13ms	SOT-25	28cp	VD17	6g	Tor
<u>75K</u>	XC6111A648MR	Vdet-IC	4.8V±2%, -MR, -Reset PPO, Wt=1.6s, Rt=3.13ms	SOT-25	28cp	VD17	6g	Tor
<u>75L</u>	XC6111A619MR	Vdet-IC	1.9V±2%, -MR, -Reset PPO, Wt=1.6s, Rt=3.13ms	SOT-25	28cp	VD17	6g	Tor
<u>75L</u>	XC6111A649MR	Vdet-IC	4.9V±2%, -MR, -Reset PPO, Wt=1.6s, Rt=3.13ms	SOT-25	28cp	VD17	6g	Tor
<u>75M</u>	XC6111A620MR	Vdet-IC	2.0V±2%, -MR, -Reset PPO, Wt=1.6s, Rt=3.13ms	SOT-25	28cp	VD17	6g	Tor
<u>75M</u>	XC6111A650MR	Vdet-IC	5.0V±2%, -MR, -Reset PPO, Wt=1.6s, Rt=3.13ms	SOT-25	28cp	VD17	6g	Tor
<u>75N</u>	XC6111A621MR	Vdet-IC	2.1V±2%, -MR, -Reset PPO, Wt=1.6s, Rt=3.13ms	SOT-25	28cp	VD17	6g	Tor
<u>75P</u>	XC6111A622MR	Vdet-IC	2.2V±2%, -MR, -Reset PPO, Wt=1.6s, Rt=3.13ms	SOT-25	28cp	VD17	6g	Tor
<u>75R</u>	XC6111A623MR	Vdet-IC	2.3V±2%, -MR, -Reset PPO, Wt=1.6s, Rt=3.13ms	SOT-25	28cp	VD17	6g	Tor
<u>75S</u>	XC6111A624MR	Vdet-IC	2.4V±2%, -MR, -Reset PPO, Wt=1.6s, Rt=3.13ms	SOT-25	28cp	VD17	6g	Tor
<u>75T</u>	XC6111A625MR	Vdet-IC	2.5V±2%, -MR, -Reset PPO, Wt=1.6s, Rt=3.13ms	SOT-25	28cp	VD17	6g	Tor
<u>75U</u>	XC6111A626MR	Vdet-IC	2.6V±2%, -MR, -Reset PPO, Wt=1.6s, Rt=3.13ms	SOT-25	28cp	VD17	6g	Tor
<u>75V</u>	XC6111A627MR	Vdet-IC	2.7V±2%, -MR, -Reset PPO, Wt=1.6s, Rt=3.13ms	SOT-25	28cp	VD17	6g	Tor
<u>75X</u>	XC6111A628MR	Vdet-IC	2.8V±2%, -MR, -Reset PPO, Wt=1.6s, Rt=3.13ms	SOT-25	28cp	VD17	6g	Tor
<u>75Y</u>	XC6111A629MR	Vdet-IC	2.9V±2%, -MR, -Reset PPO, Wt=1.6s, Rt=3.13ms	SOT-25	28cp	VD17	6g	Tor
<u>75Z</u>	XC6111A630MR	Vdet-IC	3.0V±2%, -MR, -Reset PPO, Wt=1.6s, Rt=3.13ms	SOT-25	28cp	VD17	6g	Tor
<u>76</u>	RN5RF26BA	LVR-IC	LRIp, +CE, 2.6V±2%, 1A*	SOT-23-5	28wv	VR6	6g	Ric
<u>76</u>	RN5RZ26BA	LVR-IC	LDO, LN, +CE, 2.6V±2%, 100mA	SOT-23-5	28wrt	VR4	6g	Ric
<u>760</u>	XC6111B231MR	Vdet-IC	3.1V±2%, -MR, -Reset PPO, Wt=50ms, Rt=25ms	SOT-25	28cp	VD17	6g	Tor
<u>760</u>	XC9111E601MR	DC/DC-IC	PFM step-up, 100kHz, 6.0V±2.5%, 400mA	SOT-25	28sx	DC4	6g	Tor
<u>761</u>	XC6111B232MR	Vdet-IC	3.2V±2%, -MR, -Reset PPO, Wt=50ms, Rt=25ms	SOT-25	28cp	VD17	6g	Tor
<u>761</u>	XC9111E611MR	DC/DC-IC	PFM step-up, 100kHz, 6.1V±2.5%, 400mA	SOT-25	28sx	DC4	6g	Tor
<u>762</u>	XC6111B233MR	Vdet-IC	3.3V±2%, -MR, -Reset PPO, Wt=50ms, Rt=25ms	SOT-25	28cp	VD17	6g	Tor



SMD code	Type	Function	Short description	Case	Pinout	Sch.	St.	Mnf.
<u>762</u>	XC09111E621MR	DC/DC-IC	PFM step-up, 100kHz, 6.2V±2.5%, 400mA	SOT-25	28sx	DC4	6g	Tor
<u>763</u>	XC06111B234MR	Vdet-IC	3.4V±2%, -MR, -Reset PPO, Wt=50ms, Rt=25ms	SOT-25	28cp	VD17	6g	Tor
<u>763</u>	XC09111E631MR	DC/DC-IC	PFM step-up, 100kHz, 6.3V±2.5%, 400mA	SOT-25	28sx	DC4	6g	Tor
<u>764</u>	XC06111B235MR	Vdet-IC	3.5V±2%, -MR, -Reset PPO, Wt=50ms, Rt=25ms	SOT-25	28cp	VD17	6g	Tor
<u>764</u>	XC09111E641MR	DC/DC-IC	PFM step-up, 100kHz, 6.4V±2.5%, 400mA	SOT-25	28sx	DC4	6g	Tor
<u>765</u>	XC06111B236MR	Vdet-IC	3.6V±2%, -MR, -Reset PPO, Wt=50ms, Rt=25ms	SOT-25	28cp	VD17	6g	Tor
<u>765</u>	XC09111E651MR	DC/DC-IC	PFM step-up, 100kHz, 6.5V±2.5%, 400mA	SOT-25	28sx	DC4	6g	Tor
<u>766</u>	XC06111B237MR	Vdet-IC	3.7V±2%, -MR, -Reset PPO, Wt=50ms, Rt=25ms	SOT-25	28cp	VD17	6g	Tor
<u>766</u>	XC09111E661MR	DC/DC-IC	PFM step-up, 100kHz, 6.6V±2.5%, 400mA	SOT-25	28sx	DC4	6g	Tor
<u>767</u>	XC06111B238MR	Vdet-IC	3.8V±2%, -MR, -Reset PPO, Wt=50ms, Rt=25ms	SOT-25	28cp	VD17	6g	Tor
<u>767</u>	XC09111E671MR	DC/DC-IC	PFM step-up, 100kHz, 6.7V±2.5%, 400mA	SOT-25	28sx	DC4	6g	Tor
<u>768</u>	XC06111B239MR	Vdet-IC	3.9V±2%, -MR, -Reset PPO, Wt=50ms, Rt=25ms	SOT-25	28cp	VD17	6g	Tor
<u>768</u>	XC09111E681MR	DC/DC-IC	PFM step-up, 100kHz, 6.8V±2.5%, 400mA	SOT-25	28sx	DC4	6g	Tor
<u>769</u>	XC06111B240MR	Vdet-IC	4.0V±2%, -MR, -Reset PPO, Wt=50ms, Rt=25ms	SOT-25	28cp	VD17	6g	Tor
<u>769</u>	XC09111E691MR	DC/DC-IC	PFM step-up, 100kHz, 6.9V±2.5%, 400mA	SOT-25	28sx	DC4	6g	Tor
<u>76A</u>	XC06111B241MR	Vdet-IC	4.1V±2%, -MR, -Reset PPO, Wt=50ms, Rt=25ms	SOT-25	28cp	VD17	6g	Tor
<u>76B</u>	XC06111B242MR	Vdet-IC	4.2V±2%, -MR, -Reset PPO, Wt=50ms, Rt=25ms	SOT-25	28cp	VD17	6g	Tor
<u>76C</u>	XC06111B243MR	Vdet-IC	4.3V±2%, -MR, -Reset PPO, Wt=50ms, Rt=25ms	SOT-25	28cp	VD17	6g	Tor
<u>76D</u>	XC06111B244MR	Vdet-IC	4.4V±2%, -MR, -Reset PPO, Wt=50ms, Rt=25ms	SOT-25	28cp	VD17	6g	Tor
<u>76E</u>	XC06111B245MR	Vdet-IC	4.5V±2%, -MR, -Reset PPO, Wt=50ms, Rt=25ms	SOT-25	28cp	VD17	6g	Tor
<u>76F</u>	XC06111B216MR	Vdet-IC	1.6V±2%, -MR, -Reset PPO, Wt=50ms, Rt=25ms	SOT-25	28cp	VD17	6g	Tor
<u>76F</u>	XC06111B246MR	Vdet-IC	4.6V±2%, -MR, -Reset PPO, Wt=50ms, Rt=25ms	SOT-25	28cp	VD17	6g	Tor
<u>76H</u>	XC06111B217MR	Vdet-IC	1.7V±2%, -MR, -Reset PPO, Wt=50ms, Rt=25ms	SOT-25	28cp	VD17	6g	Tor
<u>76H</u>	XC06111B247MR	Vdet-IC	4.7V±2%, -MR, -Reset PPO, Wt=50ms, Rt=25ms	SOT-25	28cp	VD17	6g	Tor
<u>76K</u>	XC06111B218MR	Vdet-IC	1.8V±2%, -MR, -Reset PPO, Wt=50ms, Rt=25ms	SOT-25	28cp	VD17	6g	Tor
<u>76K</u>	XC06111B248MR	Vdet-IC	4.8V±2%, -MR, -Reset PPO, Wt=50ms, Rt=25ms	SOT-25	28cp	VD17	6g	Tor
<u>76L</u>	XC06111B219MR	Vdet-IC	1.9V±2%, -MR, -Reset PPO, Wt=50ms, Rt=25ms	SOT-25	28cp	VD17	6g	Tor
<u>76L</u>	XC06111B249MR	Vdet-IC	4.9V±2%, -MR, -Reset PPO, Wt=50ms, Rt=25ms	SOT-25	28cp	VD17	6g	Tor
<u>76M</u>	XC06111B220MR	Vdet-IC	2.0V±2%, -MR, -Reset PPO, Wt=50ms, Rt=25ms	SOT-25	28cp	VD17	6g	Tor
<u>76M</u>	XC06111B250MR	Vdet-IC	5.0V±2%, -MR, -Reset PPO, Wt=50ms, Rt=25ms	SOT-25	28cp	VD17	6g	Tor
<u>76N</u>	XC06111B221MR	Vdet-IC	2.1V±2%, -MR, -Reset PPO, Wt=50ms, Rt=25ms	SOT-25	28cp	VD17	6g	Tor
<u>76P</u>	XC06111B222MR	Vdet-IC	2.2V±2%, -MR, -Reset PPO, Wt=50ms, Rt=25ms	SOT-25	28cp	VD17	6g	Tor
<u>76R</u>	XC06111B223MR	Vdet-IC	2.3V±2%, -MR, -Reset PPO, Wt=50ms, Rt=25ms	SOT-25	28cp	VD17	6g	Tor
<u>76S</u>	XC06111B224MR	Vdet-IC	2.4V±2%, -MR, -Reset PPO, Wt=50ms, Rt=25ms	SOT-25	28cp	VD17	6g	Tor
<u>76T</u>	XC06111B225MR	Vdet-IC	2.5V±2%, -MR, -Reset PPO, Wt=50ms, Rt=25ms	SOT-25	28cp	VD17	6g	Tor
<u>76U</u>	XC06111B226MR	Vdet-IC	2.6V±2%, -MR, -Reset PPO, Wt=50ms, Rt=25ms	SOT-25	28cp	VD17	6g	Tor
<u>76V</u>	XC06111B227MR	Vdet-IC	2.7V±2%, -MR, -Reset PPO, Wt=50ms, Rt=25ms	SOT-25	28cp	VD17	6g	Tor
<u>76X</u>	XC06111B228MR	Vdet-IC	2.8V±2%, -MR, -Reset PPO, Wt=50ms, Rt=25ms	SOT-25	28cp	VD17	6g	Tor
<u>76Y</u>	XC06111B229MR	Vdet-IC	2.9V±2%, -MR, -Reset PPO, Wt=50ms, Rt=25ms	SOT-25	28cp	VD17	6g	Tor
<u>76Z</u>	XC06111B230MR	Vdet-IC	3.0V±2%, -MR, -Reset PPO, Wt=50ms, Rt=25ms	SOT-25	28cp	VD17	6g	Tor
<u>77</u>	RN5RF27BA	LVR-IC	LRrp, +CE, 2.7V±2%, 1A*	SOT-23-5	28vww	VR6	6g	Ric
<u>77</u>	RN5RZ27BA	LVR-IC	LDO, LN, +CE, 2.7V±2%, 100mA	SOT-23-5	28vrt	VR4	6g	Ric
<u>770</u>	XC06111B331MR	Vdet-IC	3.1V±2%, -MR, -Reset PPO, Wt=100ms, Rt=25ms	SOT-25	28cp	VD17	6g	Tor
<u>770</u>	XC09111E701MR	DC/DC-IC	PFM step-up, 100kHz, 7.0V±2.5%, 400mA	SOT-25	28sx	DC4	6g	Tor
<u>771</u>	XC06111B321MR	Vdet-IC	3.2V±2%, -MR, -Reset PPO, Wt=100ms, Rt=25ms	SOT-25	28cp	VD17	6g	Tor
<u>772</u>	XC06111B333MR	Vdet-IC	3.3V±2%, -MR, -Reset PPO, Wt=100ms, Rt=25ms	SOT-25	28cp	VD17	6g	Tor
<u>773</u>	XC06111B334MR	Vdet-IC	3.4V±2%, -MR, -Reset PPO, Wt=100ms, Rt=25ms	SOT-25	28cp	VD17	6g	Tor
<u>774</u>	XC06111B335MR	Vdet-IC	3.5V±2%, -MR, -Reset PPO, Wt=100ms, Rt=25ms	SOT-25	28cp	VD17	6g	Tor
<u>775</u>	XC06111B336MR	Vdet-IC	3.6V±2%, -MR, -Reset PPO, Wt=100ms, Rt=25ms	SOT-25	28cp	VD17	6g	Tor
<u>776</u>	XC06111B337MR	Vdet-IC	3.7V±2%, -MR, -Reset PPO, Wt=100ms, Rt=25ms	SOT-25	28cp	VD17	6g	Tor
<u>777</u>	XC06111B338MR	Vdet-IC	3.8V±2%, -MR, -Reset PPO, Wt=100ms, Rt=25ms	SOT-25	28cp	VD17	6g	Tor
<u>778</u>	XC06111B339MR	Vdet-IC	3.9V±2%, -MR, -Reset PPO, Wt=100ms, Rt=25ms	SOT-25	28cp	VD17	6g	Tor
<u>779</u>	XC06111B340MR	Vdet-IC	4.0V±2%, -MR, -Reset PPO, Wt=100ms, Rt=25ms	SOT-25	28cp	VD17	6g	Tor
<u>77A</u>	XC06111B341MR	Vdet-IC	4.1V±2%, -MR, -Reset PPO, Wt=100ms, Rt=25ms	SOT-25	28cp	VD17	6g	Tor
<u>77B</u>	XC06111B342MR	Vdet-IC	4.2V±2%, -MR, -Reset PPO, Wt=100ms, Rt=25ms	SOT-25	28cp	VD17	6g	Tor
<u>77C</u>	XC06111B343MR	Vdet-IC	4.3V±2%, -MR, -Reset PPO, Wt=100ms, Rt=25ms	SOT-25	28cp	VD17	6g	Tor
<u>77D</u>	XC06111B344MR	Vdet-IC	4.4V±2%, -MR, -Reset PPO, Wt=100ms, Rt=25ms	SOT-25	28cp	VD17	6g	Tor
<u>77E</u>	XC06111B345MR	Vdet-IC	4.5V±2%, -MR, -Reset PPO, Wt=100ms, Rt=25ms	SOT-25	28cp	VD17	6g	Tor
<u>77F</u>	XC06111B316MR	Vdet-IC	1.6V±2%, -MR, -Reset PPO, Wt=100ms, Rt=25ms	SOT-25	28cp	VD17	6g	Tor
<u>77F</u>	XC06111B346MR	Vdet-IC	4.6V±2%, -MR, -Reset PPO, Wt=100ms, Rt=25ms	SOT-25	28cp	VD17	6g	Tor
<u>77H</u>	XC06111B317MR	Vdet-IC	1.7V±2%, -MR, -Reset PPO, Wt=100ms, Rt=25ms	SOT-25	28cp	VD17	6g	Tor
<u>77H</u>	XC06111B347MR	Vdet-IC	4.7V±2%, -MR, -Reset PPO, Wt=100ms, Rt=25ms	SOT-25	28cp	VD17	6g	Tor
<u>77K</u>	XC06111B318MR	Vdet-IC	1.8V±2%, -MR, -Reset PPO, Wt=100ms, Rt=25ms	SOT-25	28cp	VD17	6g	Tor
<u>77K</u>	XC06111B348MR	Vdet-IC	4.8V±2%, -MR, -Reset PPO, Wt=100ms, Rt=25ms	SOT-25	28cp	VD17	6g	Tor
<u>77L</u>	XC06111B319MR	Vdet-IC	1.9V±2%, -MR, -Reset PPO, Wt=100ms, Rt=25ms	SOT-25	28cp	VD17	6g	Tor
<u>77L</u>	XC06111B349MR	Vdet-IC	4.9V±2%, -MR, -Reset PPO, Wt=100ms, Rt=25ms	SOT-25	28cp	VD17	6g	Tor
<u>77M</u>	XC06111B320MR	Vdet-IC	2.0V±2%, -MR, -Reset PPO, Wt=100ms, Rt=25ms	SOT-25	28cp	VD17	6g	Tor
<u>77M</u>	XC06111B350MR	Vdet-IC	5.0V±2%, -MR, -Reset PPO, Wt=100ms, Rt=25ms	SOT-25	28cp	VD17	6g	Tor
<u>77N</u>	XC06111B321MR	Vdet-IC	2.1V±2%, -MR, -Reset PPO, Wt=100ms, Rt=25ms	SOT-25	28cp	VD17	6g	Tor
<u>77P</u>	XC06111B322MR	Vdet-IC	2.2V±2%, -MR, -Reset PPO, Wt=100ms, Rt=25ms	SOT-25	28cp	VD17	6g	Tor



SMD code	Type	Function	Short description	Case	Pinout	Sch.	St.	Mnf.
<u>79M</u>	XC6111B520MR	Vdet-IC	2.0V±2%, -MR, -Reset PPO, Wt=400ms, Rt=25ms	SOT-25	28cp	VD17	6g	Tor
<u>79N</u>	XC6111B550MR	Vdet-IC	5.0V±2%, -MR, -Reset PPO, Wt=400ms, Rt=25ms	SOT-25	28cp	VD17	6g	Tor
<u>79O</u>	XC6111B521MR	Vdet-IC	2.1V±2%, -MR, -Reset PPO, Wt=400ms, Rt=25ms	SOT-25	28cp	VD17	6g	Tor
<u>79P</u>	XC6111B522MR	Vdet-IC	2.2V±2%, -MR, -Reset PPO, Wt=400ms, Rt=25ms	SOT-25	28cp	VD17	6g	Tor
<u>79R</u>	XC6111B523MR	Vdet-IC	2.3V±2%, -MR, -Reset PPO, Wt=400ms, Rt=25ms	SOT-25	28cp	VD17	6g	Tor
<u>79S</u>	XC6111B524MR	Vdet-IC	2.4V±2%, -MR, -Reset PPO, Wt=400ms, Rt=25ms	SOT-25	28cp	VD17	6g	Tor
<u>79T</u>	XC6111B525MR	Vdet-IC	2.5V±2%, -MR, -Reset PPO, Wt=400ms, Rt=25ms	SOT-25	28cp	VD17	6g	Tor
<u>79U</u>	XC6111B526MR	Vdet-IC	2.6V±2%, -MR, -Reset PPO, Wt=400ms, Rt=25ms	SOT-25	28cp	VD17	6g	Tor
<u>79V</u>	XC6111B527MR	Vdet-IC	2.7V±2%, -MR, -Reset PPO, Wt=400ms, Rt=25ms	SOT-25	28cp	VD17	6g	Tor
<u>79X</u>	XC6111B528MR	Vdet-IC	2.8V±2%, -MR, -Reset PPO, Wt=400ms, Rt=25ms	SOT-25	28cp	VD17	6g	Tor
<u>79Y</u>	XC6111B529MR	Vdet-IC	2.9V±2%, -MR, -Reset PPO, Wt=400ms, Rt=25ms	SOT-25	28cp	VD17	6g	Tor
<u>79Z</u>	XC6111B530MR	Vdet-IC	3.0V±2%, -MR, -Reset PPO, Wt=400ms, Rt=25ms	SOT-25	28cp	VD17	6g	Tor
<u>7A0</u>	XC6207A312MR	LVR-IC	LDO, 3.1V±2%, 300mA, -CE, Shutdown	SOT-25	28cu	VR4a	6g	Tor
<u>7A0</u>	XC6111B631MR	Vdet-IC	3.1V±2%, -MR, -Reset PPO, Wt=1.6s, Rt=25ms	SOT-25	28cp	VD17	6g	Tor
<u>7A1</u>	XC6207A322MR	LVR-IC	LDO, 3.2V±2%, 300mA, -CE, Shutdown	SOT-25	28cu	VR4a	6g	Tor
<u>7A1</u>	XC6111B632MR	Vdet-IC	3.2V±2%, -MR, -Reset PPO, Wt=1.6s, Rt=25ms	SOT-25	28cp	VD17	6g	Tor
<u>7A2</u>	XC6207A332MR	LVR-IC	LDO, 3.3V±2%, 300mA, -CE, Shutdown	SOT-25	28cu	VR4a	6g	Tor
<u>7A2</u>	XC6111B633MR	Vdet-IC	3.3V±2%, -MR, -Reset PPO, Wt=1.6s, Rt=25ms	SOT-25	28cp	VD17	6g	Tor
<u>7A3</u>	XC6207A342MR	LVR-IC	LDO, 3.4V±2%, 300mA, -CE, Shutdown	SOT-25	28cu	VR4a	6g	Tor
<u>7A3</u>	XC6111B634MR	Vdet-IC	3.4V±2%, -MR, -Reset PPO, Wt=1.6s, Rt=25ms	SOT-25	28cp	VD17	6g	Tor
<u>7A4</u>	XC6207A352MR	LVR-IC	LDO, 3.5V±2%, 300mA, -CE, Shutdown	SOT-25	28cu	VR4a	6g	Tor
<u>7A4</u>	XC6111B635MR	Vdet-IC	3.5V±2%, -MR, -Reset PPO, Wt=1.6s, Rt=25ms	SOT-25	28cp	VD17	6g	Tor
<u>7A5</u>	XC6207A362MR	LVR-IC	LDO, 3.6V±2%, 300mA, -CE, Shutdown	SOT-25	28cu	VR4a	6g	Tor
<u>7A5</u>	XC6111B636MR	Vdet-IC	3.6V±2%, -MR, -Reset PPO, Wt=1.6s, Rt=25ms	SOT-25	28cp	VD17	6g	Tor
<u>7A6</u>	XC6207A372MR	LVR-IC	LDO, 3.7V±2%, 300mA, -CE, Shutdown	SOT-25	28cu	VR4a	6g	Tor
<u>7A6</u>	XC6111B637MR	Vdet-IC	3.7V±2%, -MR, -Reset PPO, Wt=1.6s, Rt=25ms	SOT-25	28cp	VD17	6g	Tor
<u>7A7</u>	XC6207A382MR	LVR-IC	LDO, 3.8V±2%, 300mA, -CE, Shutdown	SOT-25	28cu	VR4a	6g	Tor
<u>7A7</u>	XC6111B638MR	Vdet-IC	3.8V±2%, -MR, -Reset PPO, Wt=1.6s, Rt=25ms	SOT-25	28cp	VD17	6g	Tor
<u>7A8</u>	XC6207A392MR	LVR-IC	LDO, 3.9V±2%, 300mA, -CE, Shutdown	SOT-25	28cu	VR4a	6g	Tor
<u>7A8</u>	XC6111B639MR	Vdet-IC	3.9V±2%, -MR, -Reset PPO, Wt=1.6s, Rt=25ms	SOT-25	28cp	VD17	6g	Tor
<u>7A9</u>	XC6207A402MR	LVR-IC	LDO, 4V±2%, 300mA, -CE, Shutdown	SOT-25	28cu	VR4a	6g	Tor
<u>7A9</u>	XC6111B640MR	Vdet-IC	4.0V±2%, -MR, -Reset PPO, Wt=1.6s, Rt=25ms	SOT-25	28cp	VD17	6g	Tor
<u>7AA</u>	XC6207A412MR	LVR-IC	LDO, 4.1V±2%, 300mA, -CE, Shutdown	SOT-25	28cu	VR4a	6g	Tor
<u>7AA</u>	XC6111B641MR	Vdet-IC	4.1V±2%, -MR, -Reset PPO, Wt=1.6s, Rt=25ms	SOT-25	28cp	VD17	6g	Tor
<u>7AB</u>	XC6207A122MR	LVR-IC	LDO, 1.2V±2%, 300mA, -CE, Shutdown	SOT-25	28cu	VR4a	6g	Tor
<u>7AB</u>	XC6111B642MR	Vdet-IC	4.2V±2%, -MR, -Reset PPO, Wt=1.6s, Rt=25ms	SOT-25	28cp	VD17	6g	Tor
<u>7AB</u>	XC6207A422MR	LVR-IC	LDO, 4.2V±2%, 300mA, -CE, Shutdown	SOT-25	28cu	VR4a	6g	Tor
<u>7AC</u>	XC6207A132MR	LVR-IC	LDO, 1.3V±2%, 300mA, -CE, Shutdown	SOT-25	28cu	VR4a	6g	Tor
<u>7AC</u>	XC6111B643MR	Vdet-IC	4.3V±2%, -MR, -Reset PPO, Wt=1.6s, Rt=25ms	SOT-25	28cp	VD17	6g	Tor
<u>7AC</u>	XC6207A432MR	LVR-IC	LDO, 4.3V±2%, 300mA, -CE, Shutdown	SOT-25	28cu	VR4a	6g	Tor
<u>7AD</u>	XC6207A142MR	LVR-IC	LDO, 1.4V±2%, 300mA, -CE, Shutdown	SOT-25	28cu	VR4a	6g	Tor
<u>7AD</u>	XC6111B644MR	Vdet-IC	4.4V±2%, -MR, -Reset PPO, Wt=1.6s, Rt=25ms	SOT-25	28cp	VD17	6g	Tor
<u>7AD</u>	XC6207A442MR	LVR-IC	LDO, 4.4V±2%, 300mA, -CE, Shutdown	SOT-25	28cu	VR4a	6g	Tor
<u>7AE</u>	XC6207A152MR	LVR-IC	LDO, 1.5V±2%, 300mA, -CE, Shutdown	SOT-25	28cu	VR4a	6g	Tor
<u>7AE</u>	XC6111B645MR	Vdet-IC	4.5V±2%, -MR, -Reset PPO, Wt=1.6s, Rt=25ms	SOT-25	28cp	VD17	6g	Tor
<u>7AE</u>	XC6207A452MR	LVR-IC	LDO, 4.5V±2%, 300mA, -CE, Shutdown	SOT-25	28cu	VR4a	6g	Tor
<u>7AF</u>	XC6207A162MR	LVR-IC	LDO, 1.6V±2%, 300mA, -CE, Shutdown	SOT-25	28cu	VR4a	6g	Tor
<u>7AF</u>	XC6111B616MR	Vdet-IC	1.6V±2%, -MR, -Reset PPO, Wt=1.6s, Rt=25ms	SOT-25	28cp	VD17	6g	Tor
<u>7AE</u>	XC6111B646MR	Vdet-IC	4.6V±2%, -MR, -Reset PPO, Wt=1.6s, Rt=25ms	SOT-25	28cp	VD17	6g	Tor
<u>7AF</u>	XC6207A462MR	LVR-IC	LDO, 4.6V±2%, 300mA, -CE, Shutdown	SOT-25	28cu	VR4a	6g	Tor
<u>7AH</u>	XC6207A172MR	LVR-IC	LDO, 1.7V±2%, 300mA, -CE, Shutdown	SOT-25	28cu	VR4a	6g	Tor
<u>7AH</u>	XC6111B617MR	Vdet-IC	1.7V±2%, -MR, -Reset PPO, Wt=1.6s, Rt=25ms	SOT-25	28cp	VD17	6g	Tor
<u>7AH</u>	XC6111B647MR	Vdet-IC	4.7V±2%, -MR, -Reset PPO, Wt=1.6s, Rt=25ms	SOT-25	28cp	VD17	6g	Tor
<u>7AH</u>	XC6207A472MR	LVR-IC	LDO, 4.7V±2%, 300mA, -CE, Shutdown	SOT-25	28cu	VR4a	6g	Tor
<u>7AK</u>	XC6207A182MR	LVR-IC	LDO, 1.8V±2%, 300mA, -CE, Shutdown	SOT-25	28cu	VR4a	6g	Tor
<u>7AK</u>	XC6111B618MR	Vdet-IC	1.8V±2%, -MR, -Reset PPO, Wt=1.6s, Rt=25ms	SOT-25	28cp	VD17	6g	Tor
<u>7AK</u>	XC6111B648MR	Vdet-IC	4.8V±2%, -MR, -Reset PPO, Wt=1.6s, Rt=25ms	SOT-25	28cp	VD17	6g	Tor
<u>7AK</u>	XC6207A482MR	LVR-IC	LDO, 4.8V±2%, 300mA, -CE, Shutdown	SOT-25	28cu	VR4a	6g	Tor
<u>7AL</u>	XC6207A192MR	LVR-IC	LDO, 1.9V±2%, 300mA, -CE, Shutdown	SOT-25	28cu	VR4a	6g	Tor
<u>7AL</u>	XC6111B619MR	Vdet-IC	1.9V±2%, -MR, -Reset PPO, Wt=1.6s, Rt=25ms	SOT-25	28cp	VD17	6g	Tor
<u>7AL</u>	XC6111B649MR	Vdet-IC	4.9V±2%, -MR, -Reset PPO, Wt=1.6s, Rt=25ms	SOT-25	28cp	VD17	6g	Tor
<u>7AL</u>	XC6207A492MR	LVR-IC	LDO, 4.9V±2%, 300mA, -CE, Shutdown	SOT-25	28cu	VR4a	6g	Tor
<u>7AM</u>	XC6207A202MR	LVR-IC	LDO, 2V±2%, 300mA, -CE, Shutdown	SOT-25	28cu	VR4a	6g	Tor
<u>7AM</u>	XC6111B620MR	Vdet-IC	2.0V±2%, -MR, -Reset PPO, Wt=1.6s, Rt=25ms	SOT-25	28cp	VD17	6g	Tor
<u>7AM</u>	XC6111B650MR	Vdet-IC	5.0V±2%, -MR, -Reset PPO, Wt=1.6s, Rt=25ms	SOT-25	28cp	VD17	6g	Tor
<u>7AM</u>	XC6207A502MR	LVR-IC	LDO, 5.0V±2%, 300mA, -CE, Shutdown	SOT-25	28cu	VR4a	6g	Tor
<u>7AN</u>	XC9207A09CM	DC/DC-IC	PWM/PFM st-down, 1.2MHz, 0.9V±2%, 600mA, +CE	SOT-25	28zq	DC1	6g	Tor
<u>7AN</u>	XC6207A212MR	LVR-IC	LDO, 2.1V±2%, 300mA, -CE, Shutdown	SOT-25	28cu	VR4a	6g	Tor
<u>7AN</u>	XC6111B621MR	Vdet-IC	2.1V±2%, -MR, -Reset PPO, Wt=1.6s, Rt=25ms	SOT-25	28cp	VD17	6g	Tor
<u>7AP</u>	XC6207A222MR	LVR-IC	LDO, 2.2V±2%, 300mA, -CE, Shutdown	SOT-25	28cu	VR4a	6g	Tor



SMD code	Type	Function	Short description	Case	Pinout	Sch.	St.	Mnf.
7AP	XC6111B622MR	Vdet-IC	LDO, 2.2V±2%, -MR, -Reset PPO, Wt=1.6s, Rt=25ms	SOT-25	28cp	VD17	6g	Tor
7AR	XC6207A232MR	LVR-IC	LDO, 2.3V±2%, 300mA, -CE, Shutdown	SOT-25	28cu	VR4a	6g	Tor
7AR	XC6111B623MR	Vdet-IC	LDO, 2.3V±2%, -MR, -Reset PPO, Wt=1.6s, Rt=25ms	SOT-25	28cp	VD17	6g	Tor
7AS	XC6207A242MR	LVR-IC	LDO, 2.4V±2%, 300mA, -CE, Shutdown	SOT-25	28cu	VR4a	6g	Tor
7AS	XC6111B624MR	Vdet-IC	LDO, 2.4V±2%, -MR, -Reset PPO, Wt=1.6s, Rt=25ms	SOT-25	28cp	VD17	6g	Tor
7AT	XC6207A252MR	LVR-IC	LDO, 2.5V±2%, 300mA, -CE, Shutdown	SOT-25	28cu	VR4a	6g	Tor
7AT	XC6111B625MR	Vdet-IC	LDO, 2.5V±2%, -MR, -Reset PPO, Wt=1.6s, Rt=25ms	SOT-25	28cp	VD17	6g	Tor
7AU	XC6207A262MR	LVR-IC	LDO, 2.6V±2%, 300mA, -CE, Shutdown	SOT-25	28cu	VR4a	6g	Tor
7AU	XC6111B626MR	Vdet-IC	LDO, 2.6V±2%, -MR, -Reset PPO, Wt=1.6s, Rt=25ms	SOT-25	28cp	VD17	6g	Tor
7AV	XC6207A272MR	LVR-IC	LDO, 2.7V±2%, 300mA, -CE, Shutdown	SOT-25	28cu	VR4a	6g	Tor
7AV	XC6111B627MR	Vdet-IC	LDO, 2.7V±2%, -MR, -Reset PPO, Wt=1.6s, Rt=25ms	SOT-25	28cp	VD17	6g	Tor
7AX	XC6207A282MR	LVR-IC	LDO, 2.8V±2%, 300mA, -CE, Shutdown	SOT-25	28cu	VR4a	6g	Tor
7AX	XC6111B628MR	Vdet-IC	LDO, 2.8V±2%, -MR, -Reset PPO, Wt=1.6s, Rt=25ms	SOT-25	28cp	VD17	6g	Tor
7AY	XC6207A292MR	LVR-IC	LDO, 2.9V±2%, 300mA, -CE, Shutdown	SOT-25	28cu	VR4a	6g	Tor
7AY	XC6111B629MR	Vdet-IC	LDO, 2.9V±2%, -MR, -Reset PPO, Wt=1.6s, Rt=25ms	SOT-25	28cp	VD17	6g	Tor
7AZ	XC6207A302MR	LVR-IC	LDO, 3.0V±2%, 300mA, -CE, Shutdown	SOT-25	28cu	VR4a	6g	Tor
7AZ	XC6111B630MR	Vdet-IC	LDO, 3.0V±2%, -MR, -Reset PPO, Wt=1.6s, Rt=25ms	SOT-25	28cp	VD17	6g	Tor
7B	R3111N171A	Vdet-IC	1.7V±2%, -Reset PPO	SOT-23-5	28vdm	VD7	6g	Ric
7B	RN5RL27AA	Vdet-IC	2.7V±2.5%, 150mA	SOT-23-5	28vu	VR1	6g	Ric
7B	RN5VD17CA	Vdet-IC	1.7V±2.5%, -Reset ODO	SOT-23-5	28vdo	VD1	6g	Ric
7B0	XC6207B312MR	LVR-IC	LDO, 3.1V±2%, 300mA, -CE, CL, Shutdown	SOT-25	28cu	VR4a	6g	Tor
7B0	XC6111C231MR	Vdet-IC	LDO, 3.1V±2%, -MR, -Reset PPO, Wt=50ms, Rt=50ms	SOT-25	28cp	VD17	6g	Tor
7B1	XC6207B322MR	LVR-IC	LDO, 3.2V±2%, 300mA, -CE, CL, Shutdown	SOT-25	28cu	VR4a	6g	Tor
7B1	XC6111C232MR	Vdet-IC	LDO, 3.2V±2%, -MR, -Reset PPO, Wt=50ms, Rt=50ms	SOT-25	28cp	VD17	6g	Tor
7B2	XC6207B332MR	LVR-IC	LDO, 3.3V±2%, 300mA, -CE, CL, Shutdown	SOT-25	28cu	VR4a	6g	Tor
7B2	XC6111C233MR	Vdet-IC	LDO, 3.3V±2%, -MR, -Reset PPO, Wt=50ms, Rt=50ms	SOT-25	28cp	VD17	6g	Tor
7B3	XC6207B342MR	LVR-IC	LDO, 3.4V±2%, 300mA, -CE, CL, Shutdown	SOT-25	28cu	VR4a	6g	Tor
7B3	XC6111C234MR	Vdet-IC	LDO, 3.4V±2%, -MR, -Reset PPO, Wt=50ms, Rt=50ms	SOT-25	28cp	VD17	6g	Tor
7B4	XC6207B352MR	LVR-IC	LDO, 3.5V±2%, 300mA, -CE, CL, Shutdown	SOT-25	28cu	VR4a	6g	Tor
7B4	XC6111C235MR	Vdet-IC	LDO, 3.5V±2%, -MR, -Reset PPO, Wt=50ms, Rt=50ms	SOT-25	28cp	VD17	6g	Tor
7B5	XC6207B362MR	LVR-IC	LDO, 3.6V±2%, 300mA, -CE, CL, Shutdown	SOT-25	28cu	VR4a	6g	Tor
7B5	XC6111C236MR	Vdet-IC	LDO, 3.6V±2%, -MR, -Reset PPO, Wt=50ms, Rt=50ms	SOT-25	28cp	VD17	6g	Tor
7B6	XC6207B372MR	LVR-IC	LDO, 3.7V±2%, 300mA, -CE, CL, Shutdown	SOT-25	28cu	VR4a	6g	Tor
7B6	XC6111C237MR	Vdet-IC	LDO, 3.7V±2%, -MR, -Reset PPO, Wt=50ms, Rt=50ms	SOT-25	28cp	VD17	6g	Tor
7B7	XC6207B382MR	LVR-IC	LDO, 3.8V±2%, 300mA, -CE, CL, Shutdown	SOT-25	28cu	VR4a	6g	Tor
7B7	XC6111C238MR	Vdet-IC	LDO, 3.8V±2%, -MR, -Reset PPO, Wt=50ms, Rt=50ms	SOT-25	28cp	VD17	6g	Tor
7B8	XC6207B392MR	LVR-IC	LDO, 3.9V±2%, 300mA, -CE, CL, Shutdown	SOT-25	28cu	VR4a	6g	Tor
7B8	XC6111C239MR	Vdet-IC	LDO, 3.9V±2%, -MR, -Reset PPO, Wt=50ms, Rt=50ms	SOT-25	28cp	VD17	6g	Tor
7B9	XC6207B402MR	LVR-IC	LDO, 4.0V±2%, 300mA, -CE, CL, Shutdown	SOT-25	28cu	VR4a	6g	Tor
7B9	XC6111C240MR	Vdet-IC	LDO, 4.0V±2%, -MR, -Reset PPO, Wt=50ms, Rt=50ms	SOT-25	28cp	VD17	6g	Tor
7BA	XC6207B412MR	LVR-IC	LDO, 4.1V±2%, 300mA, -CE, CL, Shutdown	SOT-25	28cu	VR4a	6g	Tor
7BA	XC6111C241MR	Vdet-IC	LDO, 4.1V±2%, -MR, -Reset PPO, Wt=50ms, Rt=50ms	SOT-25	28cp	VD17	6g	Tor
7BA	XC9207A10CM	DC/DC-IC	PWM/PFM st-down, 1.2MHz, 1.0V±2%, 600mA, +CE	SOT-25	28zq	DC1	6g	Tor
7BB	XC6207B122MR	LVR-IC	LDO, 1.2V±2%, 300mA, -CE, CL, Shutdown	SOT-25	28cu	VR4a	6g	Tor
7BB	XC6111C242MR	Vdet-IC	LDO, 4.2V±2%, -MR, -Reset PPO, Wt=50ms, Rt=50ms	SOT-25	28cp	VD17	6g	Tor
7BB	XC6207B422MR	LVR-IC	LDO, 4.2V±2%, 300mA, -CE, CL, Shutdown	SOT-25	28cu	VR4a	6g	Tor
7BB	XC9207A11CM	DC/DC-IC	PWM/PFM st-down, 1.2MHz, 1.1V±2%, 600mA, +CE	SOT-25	28zq	DC1	6g	Tor
7BC	XC6207B132MR	LVR-IC	LDO, 1.3V±2%, 300mA, -CE, CL, Shutdown	SOT-25	28cu	VR4a	6g	Tor
7BC	XC6111C243MR	Vdet-IC	LDO, 4.3V±2%, -MR, -Reset PPO, Wt=50ms, Rt=50ms	SOT-25	28cp	VD17	6g	Tor
7BC	XC6207B432MR	LVR-IC	LDO, 4.3V±2%, 300mA, -CE, CL, Shutdown	SOT-25	28cu	VR4a	6g	Tor
7BC	XC9207A12CM	DC/DC-IC	PWM/PFM st-down, 1.2MHz, 1.2V±2%, 600mA, +CE	SOT-25	28zq	DC1	6g	Tor
7BD	XC6207B142MR	LVR-IC	LDO, 1.4V±2%, 300mA, -CE, CL, Shutdown	SOT-25	28cu	VR4a	6g	Tor
7BD	XC6111C244MR	Vdet-IC	LDO, 4.4V±2%, -MR, -Reset PPO, Wt=50ms, Rt=50ms	SOT-25	28cp	VD17	6g	Tor
7BD	XC6207B442MR	LVR-IC	LDO, 4.4V±2%, 300mA, -CE, CL, Shutdown	SOT-25	28cu	VR4a	6g	Tor
7BD	XC9207A13CM	DC/DC-IC	PWM/PFM st-down, 1.2MHz, 1.3V±2%, 600mA, +CE	SOT-25	28zq	DC1	6g	Tor
7BE	XC6207B152MR	LVR-IC	LDO, 1.5V±2%, 300mA, -CE, CL, Shutdown	SOT-25	28cu	VR4a	6g	Tor
7BE	XC6111C245MR	Vdet-IC	LDO, 4.5V±2%, -MR, -Reset PPO, Wt=50ms, Rt=50ms	SOT-25	28cp	VD17	6g	Tor
7BE	XC6207B452MR	LVR-IC	LDO, 4.5V±2%, 300mA, -CE, CL, Shutdown	SOT-25	28cu	VR4a	6g	Tor
7BE	XC9207A14CM	DC/DC-IC	PWM/PFM st-down, 1.2MHz, 1.4V±2%, 600mA, +CE	SOT-25	28zq	DC1	6g	Tor
7BF	XC6207B162MR	LVR-IC	LDO, 1.6V±2%, 300mA, -CE, CL, Shutdown	SOT-25	28cu	VR4a	6g	Tor
7BF	XC6111C216MR	Vdet-IC	LDO, 1.6V±2%, -MR, -Reset PPO, Wt=50ms, Rt=50ms	SOT-25	28cp	VD17	6g	Tor
7BF	XC6111C246MR	Vdet-IC	LDO, 4.6V±2%, -MR, -Reset PPO, Wt=50ms, Rt=50ms	SOT-25	28cp	VD17	6g	Tor
7BF	XC6207B462MR	LVR-IC	LDO, 4.6V±2%, 300mA, -CE, CL, Shutdown	SOT-25	28cu	VR4a	6g	Tor
7BF	XC9207A15CM	DC/DC-IC	PWM/PFM st-down, 1.2MHz, 1.5V±2%, 600mA, +CE	SOT-25	28zq	DC1	6g	Tor
7BH	XC6207B172MR	LVR-IC	LDO, 1.7V±2%, 300mA, -CE, CL, Shutdown	SOT-25	28cu	VR4a	6g	Tor
7BH	XC6111C217MR	Vdet-IC	LDO, 1.7V±2%, -MR, -Reset PPO, Wt=50ms, Rt=50ms	SOT-25	28cp	VD17	6g	Tor
7BH	XC6111C247MR	Vdet-IC	LDO, 4.7V±2%, -MR, -Reset PPO, Wt=50ms, Rt=50ms	SOT-25	28cp	VD17	6g	Tor
7BH	XC6207B472MR	LVR-IC	LDO, 4.7V±2%, 300mA, -CE, CL, Shutdown	SOT-25	28cu	VR4a	6g	Tor
7BH	XC9207A16CM	DC/DC-IC	PWM/PFM st-down, 1.2MHz, 1.6V±2%, 600mA, +CE	SOT-25	28zq	DC1	6g	Tor
7BK	XC6207B182MR	LVR-IC	LDO, 1.8V±2%, 300mA, -CE, CL, Shutdown	SOT-25	28cu	VR4a	6g	Tor



SMD code	Type	Function	Short description	Case	Pinout	Sch.	St.	Mnf.
7BK	XC6111C218MR	Vdet-IC	1.8V±2%, -MR, -Reset PPO, Wt=50ms, Rt=50ms	SOT-25	28cp	VD17	6g	Tor
7BK	XC6111C248MR	Vdet-IC	4.8V±2%, -MR, -Reset PPO, Wt=50ms, Rt=50ms	SOT-25	28cp	VD17	6g	Tor
7BK	XC6207B482MR	LVR-IC	LDO, 4.8V±2%, 300mA, -CE, CL, Shutdown	SOT-25	28cu	VR4a	6g	Tor
7BK	XC9207A17CM	DC/DC-IC	PWM/PFM st-down, 1.2MHz, 1.7V±2%, 600mA, +CE	SOT-25	28zq	DC1	6g	Tor
7BL	XC6207B192MR	LVR-IC	LDO, 1.9V±2%, 300mA, -CE, CL, Shutdown	SOT-25	28cu	VR4a	6g	Tor
7BL	XC6111C219MR	Vdet-IC	1.9V±2%, -MR, -Reset PPO, Wt=50ms, Rt=50ms	SOT-25	28cp	VD17	6g	Tor
7BL	XC6111C249MR	Vdet-IC	4.9V±2%, -MR, -Reset PPO, Wt=50ms, Rt=50ms	SOT-25	28cp	VD17	6g	Tor
7BL	XC6207B492MR	LVR-IC	LDO, 4.9V±2%, 300mA, -CE, CL, Shutdown	SOT-25	28cu	VR4a	6g	Tor
7BL	XC9207A18CM	DC/DC-IC	PWM/PFM st-down, 1.2MHz, 1.8V±2%, 600mA, +CE	SOT-25	28zq	DC1	6g	Tor
7BM	XC6207B202MR	LVR-IC	LDO, 2V±2%, 300mA, -CE, CL, Shutdown	SOT-25	28cu	VR4a	6g	Tor
7BM	XC6111C220MR	Vdet-IC	2.0V±2%, -MR, -Reset PPO, Wt=50ms, Rt=50ms	SOT-25	28cp	VD17	6g	Tor
7BM	XC6111C250MR	Vdet-IC	5.0V±2%, -MR, -Reset PPO, Wt=50ms, Rt=50ms	SOT-25	28cp	VD17	6g	Tor
7BM	XC6207B502MR	LVR-IC	LDO, 5.0V±2%, 300mA, -CE, CL, Shutdown	SOT-25	28cu	VR4a	6g	Tor
7BM	XC9207A19CM	DC/DC-IC	PWM/PFM st-down, 1.2MHz, 1.9V±2%, 600mA, +CE	SOT-25	28zq	DC1	6g	Tor
7BN	XC6207B212MR	LVR-IC	LDO, 2.1V±2%, 300mA, -CE, CL, Shutdown	SOT-25	28cu	VR4a	6g	Tor
7BN	XC6111C221MR	Vdet-IC	2.1V±2%, -MR, -Reset PPO, Wt=50ms, Rt=50ms	SOT-25	28cp	VD17	6g	Tor
7BP	XC6207B222MR	LVR-IC	LDO, 2.2V±2%, 300mA, -CE, CL, Shutdown	SOT-25	28cu	VR4a	6g	Tor
7BP	XC6111C222MR	Vdet-IC	2.2V±2%, -MR, -Reset PPO, Wt=50ms, Rt=50ms	SOT-25	28cp	VD17	6g	Tor
7BR	XC6207B232MR	LVR-IC	LDO, 2.3V±2%, 300mA, -CE, CL, Shutdown	SOT-25	28cu	VR4a	6g	Tor
7BR	XC6111C223MR	Vdet-IC	2.3V±2%, -MR, -Reset PPO, Wt=50ms, Rt=50ms	SOT-25	28cp	VD17	6g	Tor
7BS	XC6207B242MR	LVR-IC	LDO, 2.4V±2%, 300mA, -CE, CL, Shutdown	SOT-25	28cu	VR4a	6g	Tor
7BS	XC6111C224MR	Vdet-IC	2.4V±2%, -MR, -Reset PPO, Wt=50ms, Rt=50ms	SOT-25	28cp	VD17	6g	Tor
7BT	XC6207B252MR	LVR-IC	LDO, 2.5V±2%, 300mA, -CE, CL, Shutdown	SOT-25	28cu	VR4a	6g	Tor
7BT	XC6111C225MR	Vdet-IC	2.5V±2%, -MR, -Reset PPO, Wt=50ms, Rt=50ms	SOT-25	28cp	VD17	6g	Tor
7BU	XC6207B262MR	LVR-IC	LDO, 2.6V±2%, 300mA, -CE, CL, Shutdown	SOT-25	28cu	VR4a	6g	Tor
7BU	XC6111C226MR	Vdet-IC	2.6V±2%, -MR, -Reset PPO, Wt=50ms, Rt=50ms	SOT-25	28cp	VD17	6g	Tor
7BV	XC6207B272MR	LVR-IC	LDO, 2.7V±2%, 300mA, -CE, CL, Shutdown	SOT-25	28cu	VR4a	6g	Tor
7BV	XC6111C227MR	Vdet-IC	2.7V±2%, -MR, -Reset PPO, Wt=50ms, Rt=50ms	SOT-25	28cp	VD17	6g	Tor
7BX	XC6207B282MR	LVR-IC	LDO, 2.8V±2%, 300mA, -CE, CL, Shutdown	SOT-25	28cu	VR4a	6g	Tor
7BX	XC6111C228MR	Vdet-IC	2.8V±2%, -MR, -Reset PPO, Wt=50ms, Rt=50ms	SOT-25	28cp	VD17	6g	Tor
7BY	XC6207B292MR	LVR-IC	LDO, 2.9V±2%, 300mA, -CE, CL, Shutdown	SOT-25	28cu	VR4a	6g	Tor
7BY	XC6111C229MR	Vdet-IC	2.9V±2%, -MR, -Reset PPO, Wt=50ms, Rt=50ms	SOT-25	28cp	VD17	6g	Tor
7BY	XC9207A1L1CM	DC/DC-IC	PWM/PFM st-down, 1.2MHz, 1.85V±2%, 600mA, +CE	SOT-25	28zq	DC1	6g	Tor
7BZ	XC6207B302MR	LVR-IC	LDO, 3V±2%, 300mA, -CE, CL, Shutdown	SOT-25	28cu	VR4a	6g	Tor
7BZ	XC6111C230MR	Vdet-IC	3.0V±2%, -MR, -Reset PPO, Wt=50ms, Rt=50ms	SOT-25	28cp	VD17	6g	Tor
7C	R3111N271A	Vdet-IC	2.7V±2%, -Reset PPO	SOT-23-5	28vdm	VD7	6g	Ric
7C	RN5RL37AA	LVR-IC	3.7V±2.5%, 150mA	SOT-23-5	28vu	VR1	6g	Ric
7C	RN5VD27CA	Vdet-IC	2.7V±2.5%, -Reset ODO	SOT-23-5	28vdo	VD1	6g	Ric
7C0	XC6111C331MR	Vdet-IC	3.1V±2%, -MR, -Reset PPO, Wt=100ms, Rt=50ms	SOT-25	28cp	VD17	6g	Tor
7C1	XC6111C332MR	Vdet-IC	3.2V±2%, -MR, -Reset PPO, Wt=100ms, Rt=50ms	SOT-25	28cp	VD17	6g	Tor
7C2	XC6111C333MR	Vdet-IC	3.3V±2%, -MR, -Reset PPO, Wt=100ms, Rt=50ms	SOT-25	28cp	VD17	6g	Tor
7C3	XC6111C334MR	Vdet-IC	3.4V±2%, -MR, -Reset PPO, Wt=100ms, Rt=50ms	SOT-25	28cp	VD17	6g	Tor
7C4	XC6111C335MR	Vdet-IC	3.5V±2%, -MR, -Reset PPO, Wt=100ms, Rt=50ms	SOT-25	28cp	VD17	6g	Tor
7C5	XC6111C336MR	Vdet-IC	3.6V±2%, -MR, -Reset PPO, Wt=100ms, Rt=50ms	SOT-25	28cp	VD17	6g	Tor
7C6	XC6111C337MR	Vdet-IC	3.7V±2%, -MR, -Reset PPO, Wt=100ms, Rt=50ms	SOT-25	28cp	VD17	6g	Tor
7C7	XC6111C338MR	Vdet-IC	3.8V±2%, -MR, -Reset PPO, Wt=100ms, Rt=50ms	SOT-25	28cp	VD17	6g	Tor
7C8	XC6111C339MR	Vdet-IC	3.9V±2%, -MR, -Reset PPO, Wt=100ms, Rt=50ms	SOT-25	28cp	VD17	6g	Tor
7C9	XC6111C340MR	Vdet-IC	4.0V±2%, -MR, -Reset PPO, Wt=100ms, Rt=50ms	SOT-25	28cp	VD17	6g	Tor
7CA	XC6111C341MR	Vdet-IC	4.1V±2%, -MR, -Reset PPO, Wt=100ms, Rt=50ms	SOT-25	28cp	VD17	6g	Tor
7CA	XC9207A20CM	DC/DC-IC	PWM/PFM st-down, 1.2MHz, 2.0V±2%, 600mA, +CE	SOT-25	28zq	DC1	6g	Tor
7CB	XC6111C342MR	Vdet-IC	4.2V±2%, -MR, -Reset PPO, Wt=100ms, Rt=50ms	SOT-25	28cp	VD17	6g	Tor
7CB	XC9207A21CM	DC/DC-IC	PWM/PFM st-down, 1.2MHz, 2.1V±2%, 600mA, +CE	SOT-25	28zq	DC1	6g	Tor
7CC	XC6111C343MR	Vdet-IC	4.3V±2%, -MR, -Reset PPO, Wt=100ms, Rt=50ms	SOT-25	28cp	VD17	6g	Tor
7CC	XC9207A22CM	DC/DC-IC	PWM/PFM st-down, 1.2MHz, 2.2V±2%, 600mA, +CE	SOT-25	28zq	DC1	6g	Tor
7CD	XC6111C344MR	Vdet-IC	4.4V±2%, -MR, -Reset PPO, Wt=100ms, Rt=50ms	SOT-25	28cp	VD17	6g	Tor
7CD	XC9207A23CM	DC/DC-IC	PWM/PFM st-down, 1.2MHz, 2.3V±2%, 600mA, +CE	SOT-25	28zq	DC1	6g	Tor
7CE	XC6111C345MR	Vdet-IC	4.5V±2%, -MR, -Reset PPO, Wt=100ms, Rt=50ms	SOT-25	28cp	VD17	6g	Tor
7CE	XC9207A24CM	DC/DC-IC	PWM/PFM st-down, 1.2MHz, 2.4V±2%, 600mA, +CE	SOT-25	28zq	DC1	6g	Tor
7CF	XC6111C316MR	Vdet-IC	1.6V±2%, -MR, -Reset PPO, Wt=100ms, Rt=50ms	SOT-25	28cp	VD17	6g	Tor
7CF	XC6111C346MR	Vdet-IC	4.6V±2%, -MR, -Reset PPO, Wt=100ms, Rt=50ms	SOT-25	28cp	VD17	6g	Tor
7CF	XC9207A25CM	DC/DC-IC	PWM/PFM st-down, 1.2MHz, 2.5V±2%, 600mA, +CE	SOT-25	28zq	DC1	6g	Tor
7CH	XC6111C317MR	Vdet-IC	1.7V±2%, -MR, -Reset PPO, Wt=100ms, Rt=50ms	SOT-25	28cp	VD17	6g	Tor
7CH	XC6111C347MR	Vdet-IC	4.7V±2%, -MR, -Reset PPO, Wt=100ms, Rt=50ms	SOT-25	28cp	VD17	6g	Tor
7CH	XC9207A26CM	DC/DC-IC	PWM/PFM st-down, 1.2MHz, 2.6V±2%, 600mA, +CE	SOT-25	28zq	DC1	6g	Tor
7CK	XC6111C318MR	Vdet-IC	1.8V±2%, -MR, -Reset PPO, Wt=100ms, Rt=50ms	SOT-25	28cp	VD17	6g	Tor
7CK	XC6111C348MR	Vdet-IC	4.8V±2%, -MR, -Reset PPO, Wt=100ms, Rt=50ms	SOT-25	28cp	VD17	6g	Tor
7CK	XC9207A27CM	DC/DC-IC	PWM/PFM st-down, 1.2MHz, 2.7V±2%, 600mA, +CE	SOT-25	28zq	DC1	6g	Tor
7CL	XC6111C319MR	Vdet-IC	1.9V±2%, -MR, -Reset PPO, Wt=100ms, Rt=50ms	SOT-25	28cp	VD17	6g	Tor
7CL	XC6111C349MR	Vdet-IC	4.9V±2%, -MR, -Reset PPO, Wt=100ms, Rt=50ms	SOT-25	28cp	VD17	6g	Tor
7CL	XC9207A28CM	DC/DC-IC	PWM/PFM st-down, 1.2MHz, 2.8V±2%, 600mA, +CE	SOT-25	28zq	DC1	6g	Tor



SMD code	Type	Function	Short description	Case	Pinout	Sch.	St.	Mnf.
7CM	XC6111C320MR	Vdet-IC	2.0V±2%, -MR, -Reset PPO, Wt=100ms, Rt=50ms	SOT-25	28cp	VD17	6g	Tor
7CM	XC6111C350MR	Vdet-IC	5.0V±2%, -MR, -Reset PPO, Wt=100ms, Rt=50ms	SOT-25	28cp	VD17	6g	Tor
7CM	XC9207A29CM	DC/DC-IC	PWM/PFM st-down, 1.2MHz, 2.9V±2%, 600mA, +CE	SOT-25	28zq	DC1	6g	Tor
7CN	XC6111C321MR	Vdet-IC	2.1V±2%, -MR, -Reset PPO, Wt=100ms, Rt=50ms	SOT-25	28cp	VD17	6g	Tor
7CP	XC6111C322MR	Vdet-IC	2.2V±2%, -MR, -Reset PPO, Wt=100ms, Rt=50ms	SOT-25	28cp	VD17	6g	Tor
7CR	XC6111C323MR	Vdet-IC	2.3V±2%, -MR, -Reset PPO, Wt=100ms, Rt=50ms	SOT-25	28cp	VD17	6g	Tor
7CS	XC6111C324MR	Vdet-IC	2.4V±2%, -MR, -Reset PPO, Wt=100ms, Rt=50ms	SOT-25	28cp	VD17	6g	Tor
7CT	XC6111C325MR	Vdet-IC	2.5V±2%, -MR, -Reset PPO, Wt=100ms, Rt=50ms	SOT-25	28cp	VD17	6g	Tor
7CU	XC6111C326MR	Vdet-IC	2.6V±2%, -MR, -Reset PPO, Wt=100ms, Rt=50ms	SOT-25	28cp	VD17	6g	Tor
7CV	XC6111C327MR	Vdet-IC	2.7V±2%, -MR, -Reset PPO, Wt=100ms, Rt=50ms	SOT-25	28cp	VD17	6g	Tor
7CX	XC6111C328MR	Vdet-IC	2.8V±2%, -MR, -Reset PPO, Wt=100ms, Rt=50ms	SOT-25	28cp	VD17	6g	Tor
7CY	XC6111C329MR	Vdet-IC	2.9V±2%, -MR, -Reset PPO, Wt=100ms, Rt=50ms	SOT-25	28cp	VD17	6g	Tor
7CY	XC9207A2LCM	DC/DC-IC	PWM/PFM st-down, 1.2MHz, 2.85V±2%, 600mA, +CE	SOT-25	28zq	DC1	6g	Tor
7CZ	XC6111C330MR	Vdet-IC	3.0V±2%, -MR, -Reset PPO, Wt=100ms, Rt=50ms	SOT-25	28cp	VD17	6g	Tor
7D	R3111N371A	Vdet-IC	3.6V±2%, -Reset PPO	SOT-23-5	28vdm	VD7	6g	Ric
7D	RN5RL47AA	LVR-IC	4.7V±2.5%, 150mA	SOT-23-5	28vu	VR1	6g	Ric
7D	RN5VD37CA	Vdet-IC	3.7V±2.5%, -Reset ODO	SOT-23-5	28vdo	VD1	6g	Ric
7D0	XC6111C431MR	Vdet-IC	3.1V±2%, -MR, -Reset PPO, Wt=200ms, Rt=50ms	SOT-25	28cp	VD17	6g	Tor
7D1	XC6111C432MR	Vdet-IC	3.2V±2%, -MR, -Reset PPO, Wt=200ms, Rt=50ms	SOT-25	28cp	VD17	6g	Tor
7D2	XC6111C433MR	Vdet-IC	3.3V±2%, -MR, -Reset PPO, Wt=200ms, Rt=50ms	SOT-25	28cp	VD17	6g	Tor
7D3	XC6111C434MR	Vdet-IC	3.4V±2%, -MR, -Reset PPO, Wt=200ms, Rt=50ms	SOT-25	28cp	VD17	6g	Tor
7D4	XC6111C435MR	Vdet-IC	3.5V±2%, -MR, -Reset PPO, Wt=200ms, Rt=50ms	SOT-25	28cp	VD17	6g	Tor
7D5	XC6111C436MR	Vdet-IC	3.6V±2%, -MR, -Reset PPO, Wt=200ms, Rt=50ms	SOT-25	28cp	VD17	6g	Tor
7D6	XC6111C437MR	Vdet-IC	3.7V±2%, -MR, -Reset PPO, Wt=200ms, Rt=50ms	SOT-25	28cp	VD17	6g	Tor
7D7	XC6111C438MR	Vdet-IC	3.8V±2%, -MR, -Reset PPO, Wt=200ms, Rt=50ms	SOT-25	28cp	VD17	6g	Tor
7D8	XC6111C439MR	Vdet-IC	3.9V±2%, -MR, -Reset PPO, Wt=200ms, Rt=50ms	SOT-25	28cp	VD17	6g	Tor
7D9	XC6111C440MR	Vdet-IC	4.0V±2%, -MR, -Reset PPO, Wt=200ms, Rt=50ms	SOT-25	28cp	VD17	6g	Tor
7DA	FT532Da	LVR-IC	LDO, 1.8V±2%, 700mA, +CE	SOT-23-5	28cx	VR4	6g	Fmd
7DA	XC6111C441MR	Vdet-IC	4.1V±2%, -MR, -Reset PPO, Wt=200ms, Rt=50ms	SOT-25	28cp	VD17	6g	Tor
7DA	XC9207A30CM	DC/DC-IC	PWM/PFM st-down, 1.2MHz, 3.0V±2%, 600mA, +CE	SOT-25	28zq	DC1	6g	Tor
7Db	FT532Db	LVR-IC	LDO, 1.8V±2%, 700mA, +CE	SOT-23-5	28vc	VR4	6g	Fmd
7DB	XC6111C442MR	Vdet-IC	4.2V±2%, -MR, -Reset PPO, Wt=200ms, Rt=50ms	SOT-25	28cp	VD17	6g	Tor
7DB	XC9207A31CM	DC/DC-IC	PWM/PFM st-down, 1.2MHz, 3.1V±2%, 600mA, +CE	SOT-25	28zq	DC1	6g	Tor
7Dc	FT532Dc	LVR-IC	LDO, 1.8V±2%, 700mA, +CE	SOT-23-5	28xm	VR4	6g	Fmd
7DC	XC6111C443MR	Vdet-IC	4.3V±2%, -MR, -Reset PPO, Wt=200ms, Rt=50ms	SOT-25	28cp	VD17	6g	Tor
7DC	XC9207A32CM	DC/DC-IC	PWM/PFM st-down, 1.2MHz, 3.2V±2%, 600mA, +CE	SOT-25	28zq	DC1	6g	Tor
7Dd	FT532Dd	LVR-IC	LDO, 1.8V±2%, 700mA, +CE	SC-70-5	28cx	VR4	6g	Fmd
7DD	XC6111C444MR	Vdet-IC	4.4V±2%, -MR, -Reset PPO, Wt=200ms, Rt=50ms	SOT-25	28cp	VD17	6g	Tor
7DD	XC9207A33CM	DC/DC-IC	PWM/PFM st-down, 1.2MHz, 3.3V±2%, 600mA, +CE	SOT-25	28zq	DC1	6g	Tor
7De	FT532De	LVR-IC	LDO, 1.8V±2%, 700mA, +CE	SC-70-5	28vc	VR4	6g	Fmd
7DE	XC6111C445MR	Vdet-IC	4.5V±2%, -MR, -Reset PPO, Wt=200ms, Rt=50ms	SOT-25	28cp	VD17	6g	Tor
7DE	XC9207A34CM	DC/DC-IC	PWM/PFM st-down, 1.2MHz, 3.4V±2%, 600mA, +CE	SOT-25	28zq	DC1	6g	Tor
7df	FT532Df	LVR-IC	LDO, 1.8V±2%, 700mA, +CE	SC-70-5	28xm	VR4	6g	Fmd
7DF	XC6111C416MR	Vdet-IC	1.6V±2%, -MR, -Reset PPO, Wt=200ms, Rt=50ms	SOT-25	28cp	VD17	6g	Tor
7DE	XC6111C446MR	Vdet-IC	4.6V±2%, -MR, -Reset PPO, Wt=200ms, Rt=50ms	SOT-25	28cp	VD17	6g	Tor
7DF	XC9207A35CM	DC/DC-IC	PWM/PFM st-down, 1.2MHz, 3.5V±2%, 600mA, +CE	SOT-25	28zq	DC1	6g	Tor
7DH	XC6111C417MR	Vdet-IC	1.7V±2%, -MR, -Reset PPO, Wt=200ms, Rt=50ms	SOT-25	28cp	VD17	6g	Tor
7DH	XC6111C447MR	Vdet-IC	4.7V±2%, -MR, -Reset PPO, Wt=200ms, Rt=50ms	SOT-25	28cp	VD17	6g	Tor
7DH	XC9207A36CM	DC/DC-IC	PWM/PFM st-down, 1.2MHz, 3.6V±2%, 600mA, +CE	SOT-25	28zq	DC1	6g	Tor
7DK	XC6111C418MR	Vdet-IC	1.8V±2%, -MR, -Reset PPO, Wt=200ms, Rt=50ms	SOT-25	28cp	VD17	6g	Tor
7DK	XC6111C448MR	Vdet-IC	4.8V±2%, -MR, -Reset PPO, Wt=200ms, Rt=50ms	SOT-25	28cp	VD17	6g	Tor
7DK	XC9207A37CM	DC/DC-IC	PWM/PFM st-down, 1.2MHz, 3.7V±2%, 600mA, +CE	SOT-25	28zq	DC1	6g	Tor
7DL	XC6111C419MR	Vdet-IC	1.9V±2%, -MR, -Reset PPO, Wt=200ms, Rt=50ms	SOT-25	28cp	VD17	6g	Tor
7DL	XC6111C449MR	Vdet-IC	4.9V±2%, -MR, -Reset PPO, Wt=200ms, Rt=50ms	SOT-25	28cp	VD17	6g	Tor
7DL	XC9207A38CM	DC/DC-IC	PWM/PFM st-down, 1.2MHz, 3.8V±2%, 600mA, +CE	SOT-25	28zq	DC1	6g	Tor
7DM	XC6111C420MR	Vdet-IC	2.0V±2%, -MR, -Reset PPO, Wt=200ms, Rt=50ms	SOT-25	28cp	VD17	6g	Tor
7DM	XC6111C450MR	Vdet-IC	5.0V±2%, -MR, -Reset PPO, Wt=200ms, Rt=50ms	SOT-25	28cp	VD17	6g	Tor
7DM	XC9207A39CM	DC/DC-IC	PWM/PFM st-down, 1.2MHz, 3.9V±2%, 600mA, +CE	SOT-25	28zq	DC1	6g	Tor
7DN	XC6111C421MR	Vdet-IC	2.1V±2%, -MR, -Reset PPO, Wt=200ms, Rt=50ms	SOT-25	28cp	VD17	6g	Tor
7DP	XC6111C422MR	Vdet-IC	2.2V±2%, -MR, -Reset PPO, Wt=200ms, Rt=50ms	SOT-25	28cp	VD17	6g	Tor
7DR	XC6111C423MR	Vdet-IC	2.3V±2%, -MR, -Reset PPO, Wt=200ms, Rt=50ms	SOT-25	28cp	VD17	6g	Tor
7DS	XC6111C424MR	Vdet-IC	2.4V±2%, -MR, -Reset PPO, Wt=200ms, Rt=50ms	SOT-25	28cp	VD17	6g	Tor
7DT	XC6111C425MR	Vdet-IC	2.5V±2%, -MR, -Reset PPO, Wt=200ms, Rt=50ms	SOT-25	28cp	VD17	6g	Tor
7DU	XC6111C426MR	Vdet-IC	2.6V±2%, -MR, -Reset PPO, Wt=200ms, Rt=50ms	SOT-25	28cp	VD17	6g	Tor
7DV	XC6111C427MR	Vdet-IC	2.7V±2%, -MR, -Reset PPO, Wt=200ms, Rt=50ms	SOT-25	28cp	VD17	6g	Tor
7DX	XC6111C428MR	Vdet-IC	2.8V±2%, -MR, -Reset PPO, Wt=200ms, Rt=50ms	SOT-25	28cp	VD17	6g	Tor
7DY	XC6111C429MR	Vdet-IC	2.9V±2%, -MR, -Reset PPO, Wt=200ms, Rt=50ms	SOT-25	28cp	VD17	6g	Tor
7DZ	XC6111C430MR	Vdet-IC	3.0V±2%, -MR, -Reset PPO, Wt=200ms, Rt=50ms	SOT-25	28cp	VD17	6g	Tor
7E	R3111N471A	Vdet-IC	4.7V±2%, -Reset PPO	SOT-23-5	28vdm	VD7	6g	Ric
7E	RN5RL57AA	LVR-IC	5.7V±2.5%, 150mA	SOT-23-5	28vu	VR1	6g	Ric



SMD code	Type	Function	Short description	Case	Pinout	Sch.	St.	Mnf.
7E	RN5VD47CA	Vdet-IC	4.7V±2.5%, -Reset ODO	SOT-23-5	28vdo	VD1	6g	Ric
7E0	X06111C531MR	Vdet-IC	3.1V±2%, -MR, -Reset PPO, Wt=400ms, Rt=50ms	SOT-25	28cp	VD17	6g	Tor
7E1	X06111C532MR	Vdet-IC	3.2V±2%, -MR, -Reset PPO, Wt=400ms, Rt=50ms	SOT-25	28cp	VD17	6g	Tor
7E2	X06111C533MR	Vdet-IC	3.3V±2%, -MR, -Reset PPO, Wt=400ms, Rt=50ms	SOT-25	28cp	VD17	6g	Tor
7E3	X06111C534MR	Vdet-IC	3.4V±2%, -MR, -Reset PPO, Wt=400ms, Rt=50ms	SOT-25	28cp	VD17	6g	Tor
7E4	X06111C535MR	Vdet-IC	3.5V±2%, -MR, -Reset PPO, Wt=400ms, Rt=50ms	SOT-25	28cp	VD17	6g	Tor
7E5	X06111C536MR	Vdet-IC	3.6V±2%, -MR, -Reset PPO, Wt=400ms, Rt=50ms	SOT-25	28cp	VD17	6g	Tor
7E6	X06111C537MR	Vdet-IC	3.7V±2%, -MR, -Reset PPO, Wt=400ms, Rt=50ms	SOT-25	28cp	VD17	6g	Tor
7E7	X06111C538MR	Vdet-IC	3.8V±2%, -MR, -Reset PPO, Wt=400ms, Rt=50ms	SOT-25	28cp	VD17	6g	Tor
7E8	X06111C539MR	Vdet-IC	3.9V±2%, -MR, -Reset PPO, Wt=400ms, Rt=50ms	SOT-25	28cp	VD17	6g	Tor
7E9	X06111C540MR	Vdet-IC	4.0V±2%, -MR, -Reset PPO, Wt=400ms, Rt=50ms	SOT-25	28cp	VD17	6g	Tor
7EA	FT532Ea	LVR-IC	LDO, 2.5V±2%, 700mA, +CE	SOT-23-5	28cx	VR4	6g	Fmd
7EA	X06111C541MR	Vdet-IC	4.1V±2%, -MR, -Reset PPO, Wt=400ms, Rt=50ms	SOT-25	28cp	VD17	6g	Tor
7EA	X08207A40CM	DC/DC-IC	PWM/PFM st-down, 1.2MHz, 4.0V±2%, 600mA, +CE	SOT-25	28zq	DC1	6g	Tor
7Eb	FT532Eb	LVR-IC	LDO, 2.5V±2%, 700mA, +CE	SOT-23-5	28vc	VR4	6g	Fmd
7EB	X06111C542MR	Vdet-IC	4.2V±2%, -MR, -Reset PPO, Wt=400ms, Rt=50ms	SOT-25	28cp	VD17	6g	Tor
7Ec	FT532Ec	LVR-IC	LDO, 2.5V±2%, 700mA, +CE	SOT-23-5	28xm	VR4	6g	Fmd
7EC	X06111C543MR	Vdet-IC	4.3V±2%, -MR, -Reset PPO, Wt=400ms, Rt=50ms	SOT-25	28cp	VD17	6g	Tor
7Ed	FT532Ed	LVR-IC	LDO, 2.5V±2%, 700mA, +CE	SC-70-5	28cx	VR4	6g	Fmd
7ED	X06111C544MR	Vdet-IC	4.4V±2%, -MR, -Reset PPO, Wt=400ms, Rt=50ms	SOT-25	28cp	VD17	6g	Tor
7Ee	FT532Ee	LVR-IC	LDO, 2.5V±2%, 700mA, +CE	SC-70-5	28vc	VR4	6g	Fmd
7EE	X06111C545MR	Vdet-IC	4.5V±2%, -MR, -Reset PPO, Wt=400ms, Rt=50ms	SOT-25	28cp	VD17	6g	Tor
7Ef	FT532Ef	LVR-IC	LDO, 2.5V±2%, 700mA, +CE	SC-70-5	28xm	VR4	6g	Fmd
7EF	X06111C516MR	Vdet-IC	1.6V±2%, -MR, -Reset PPO, Wt=400ms, Rt=50ms	SOT-25	28cp	VD17	6g	Tor
7EE	X06111C546MR	Vdet-IC	4.6V±2%, -MR, -Reset PPO, Wt=400ms, Rt=50ms	SOT-25	28cp	VD17	6g	Tor
7EH	X06111C517MR	Vdet-IC	1.7V±2%, -MR, -Reset PPO, Wt=400ms, Rt=50ms	SOT-25	28cp	VD17	6g	Tor
7EH	X06111C547MR	Vdet-IC	4.7V±2%, -MR, -Reset PPO, Wt=400ms, Rt=50ms	SOT-25	28cp	VD17	6g	Tor
7EK	X06111C518MR	Vdet-IC	1.8V±2%, -MR, -Reset PPO, Wt=400ms, Rt=50ms	SOT-25	28cp	VD17	6g	Tor
7EK	X06111C548MR	Vdet-IC	4.8V±2%, -MR, -Reset PPO, Wt=400ms, Rt=50ms	SOT-25	28cp	VD17	6g	Tor
7EL	X06111C519MR	Vdet-IC	1.9V±2%, -MR, -Reset PPO, Wt=400ms, Rt=50ms	SOT-25	28cp	VD17	6g	Tor
7EL	X06111C549MR	Vdet-IC	4.9V±2%, -MR, -Reset PPO, Wt=400ms, Rt=50ms	SOT-25	28cp	VD17	6g	Tor
7EM	X06111C520MR	Vdet-IC	2.0V±2%, -MR, -Reset PPO, Wt=400ms, Rt=50ms	SOT-25	28cp	VD17	6g	Tor
7EM	X06111C550MR	Vdet-IC	5.0V±2%, -MR, -Reset PPO, Wt=400ms, Rt=50ms	SOT-25	28cp	VD17	6g	Tor
7EN	X06111C521MR	Vdet-IC	2.1V±2%, -MR, -Reset PPO, Wt=400ms, Rt=50ms	SOT-25	28cp	VD17	6g	Tor
7EP	X06111C522MR	Vdet-IC	2.2V±2%, -MR, -Reset PPO, Wt=400ms, Rt=50ms	SOT-25	28cp	VD17	6g	Tor
7ER	X06111C523MR	Vdet-IC	2.3V±2%, -MR, -Reset PPO, Wt=400ms, Rt=50ms	SOT-25	28cp	VD17	6g	Tor
7ES	X06111C524MR	Vdet-IC	2.4V±2%, -MR, -Reset PPO, Wt=400ms, Rt=50ms	SOT-25	28cp	VD17	6g	Tor
7ET	X06111C525MR	Vdet-IC	2.5V±2%, -MR, -Reset PPO, Wt=400ms, Rt=50ms	SOT-25	28cp	VD17	6g	Tor
7EU	X06111C526MR	Vdet-IC	2.6V±2%, -MR, -Reset PPO, Wt=400ms, Rt=50ms	SOT-25	28cp	VD17	6g	Tor
7EV	X06111C527MR	Vdet-IC	2.7V±2%, -MR, -Reset PPO, Wt=400ms, Rt=50ms	SOT-25	28cp	VD17	6g	Tor
7EX	X06111C528MR	Vdet-IC	2.8V±2%, -MR, -Reset PPO, Wt=400ms, Rt=50ms	SOT-25	28cp	VD17	6g	Tor
7EY	X06111C529MR	Vdet-IC	2.9V±2%, -MR, -Reset PPO, Wt=400ms, Rt=50ms	SOT-25	28cp	VD17	6g	Tor
7EZ	X06111C530MR	Vdet-IC	3.0V±2%, -MR, -Reset PPO, Wt=400ms, Rt=50ms	SOT-25	28cp	VD17	6g	Tor
7F	R3111N571A	Vdet-IC	5.7V±2%, -Reset PPO	SOT-23-5	28vdm	VD7	6g	Ric
7F	RN5VD57CA	Vdet-IC	5.7V±2.5%, -Reset ODO	SOT-23-5	28vdo	VD1	6g	Ric
7F0	X06111C631MR	Vdet-IC	3.1V±2%, -MR, -Reset PPO, Wt=1.6s, Rt=50ms	SOT-25	28cp	VD17	6g	Tor
7F1	X06111C632MR	Vdet-IC	3.2V±2%, -MR, -Reset PPO, Wt=1.6s, Rt=50ms	SOT-25	28cp	VD17	6g	Tor
7F2	X06111C633MR	Vdet-IC	3.3V±2%, -MR, -Reset PPO, Wt=1.6s, Rt=50ms	SOT-25	28cp	VD17	6g	Tor
7F3	X06111C634MR	Vdet-IC	3.4V±2%, -MR, -Reset PPO, Wt=1.6s, Rt=50ms	SOT-25	28cp	VD17	6g	Tor
7F4	X06111C635MR	Vdet-IC	3.5V±2%, -MR, -Reset PPO, Wt=1.6s, Rt=50ms	SOT-25	28cp	VD17	6g	Tor
7F5	X06111C636MR	Vdet-IC	3.6V±2%, -MR, -Reset PPO, Wt=1.6s, Rt=50ms	SOT-25	28cp	VD17	6g	Tor
7F6	X06111C637MR	Vdet-IC	3.7V±2%, -MR, -Reset PPO, Wt=1.6s, Rt=50ms	SOT-25	28cp	VD17	6g	Tor
7F7	X06111C638MR	Vdet-IC	3.8V±2%, -MR, -Reset PPO, Wt=1.6s, Rt=50ms	SOT-25	28cp	VD17	6g	Tor
7F8	X06111C639MR	Vdet-IC	3.9V±2%, -MR, -Reset PPO, Wt=1.6s, Rt=50ms	SOT-25	28cp	VD17	6g	Tor
7F9	X06111C640MR	Vdet-IC	4.0V±2%, -MR, -Reset PPO, Wt=1.6s, Rt=50ms	SOT-25	28cp	VD17	6g	Tor
7Fa	FT532Fa	LVR-IC	LDO, 2.7V±2%, 700mA, +CE	SOT-23-5	28cx	VR4	6g	Fmd
7FA	X06111C641MR	Vdet-IC	4.1V±2%, -MR, -Reset PPO, Wt=1.6s, Rt=50ms	SOT-25	28cp	VD17	6g	Tor
7Fb	FT532Fb	LVR-IC	LDO, 2.7V±2%, 700mA, +CE	SOT-23-5	28vc	VR4	6g	Fmd
7FB	X06111C642MR	Vdet-IC	4.2V±2%, -MR, -Reset PPO, Wt=1.6s, Rt=50ms	SOT-25	28cp	VD17	6g	Tor
7Fc	FT532Fc	LVR-IC	LDO, 2.7V±2%, 700mA, +CE	SOT-23-5	28xm	VR4	6g	Fmd
7FC	X06111C643MR	Vdet-IC	4.3V±2%, -MR, -Reset PPO, Wt=1.6s, Rt=50ms	SOT-25	28cp	VD17	6g	Tor
7Fd	FT532Fd	LVR-IC	LDO, 2.7V±2%, 700mA, +CE	SC-70-5	28cx	VR4	6g	Fmd
7FD	X06111C644MR	Vdet-IC	4.4V±2%, -MR, -Reset PPO, Wt=1.6s, Rt=50ms	SOT-25	28cp	VD17	6g	Tor
7Fe	FT532Fe	LVR-IC	LDO, 2.7V±2%, 700mA, +CE	SC-70-5	28vc	VR4	6g	Fmd
7FE	X06111C645MR	Vdet-IC	4.5V±2%, -MR, -Reset PPO, Wt=1.6s, Rt=50ms	SOT-25	28cp	VD17	6g	Tor
7Ff	FT532Ff	LVR-IC	LDO, 2.7V±2%, 700mA, +CE	SC-70-5	28xm	VR4	6g	Fmd
7FF	X06111C616MR	Vdet-IC	1.6V±2%, -MR, -Reset PPO, Wt=1.6s, Rt=50ms	SOT-25	28cp	VD17	6g	Tor
7FF	X06111C646MR	Vdet-IC	4.6V±2%, -MR, -Reset PPO, Wt=1.6s, Rt=50ms	SOT-25	28cp	VD17	6g	Tor
7FH	X06111C617MR	Vdet-IC	1.7V±2%, -MR, -Reset PPO, Wt=1.6s, Rt=50ms	SOT-25	28cp	VD17	6g	Tor
7FH	X06111C647MR	Vdet-IC	4.7V±2%, -MR, -Reset PPO, Wt=1.6s, Rt=50ms	SOT-25	28cp	VD17	6g	Tor



SMD code	Type	Function	Short description	Case	Pinout	Sch.	St.	Mnf.
<u>7FK</u>	XC6111C618MR	Vdet-IC	1.8V±2%, -MR, -Reset PPO, Wt=1.6s, Rt=50ms	SOT-25	28cp	VD17	6g	Tor
<u>7FK</u>	XC6111C648MR	Vdet-IC	4.8V±2%, -MR, -Reset PPO, Wt=1.6s, Rt=50ms	SOT-25	28cp	VD17	6g	Tor
<u>7FL</u>	XC6111C619MR	Vdet-IC	1.9V±2%, -MR, -Reset PPO, Wt=1.6s, Rt=50ms	SOT-25	28cp	VD17	6g	Tor
<u>7FL</u>	XC6111C649MR	Vdet-IC	4.9V±2%, -MR, -Reset PPO, Wt=1.6s, Rt=50ms	SOT-25	28cp	VD17	6g	Tor
<u>7FM</u>	XC6111C620MR	Vdet-IC	2.0V±2%, -MR, -Reset PPO, Wt=1.6s, Rt=50ms	SOT-25	28cp	VD17	6g	Tor
<u>7FM</u>	XC6111C650MR	Vdet-IC	5.0V±2%, -MR, -Reset PPO, Wt=1.6s, Rt=50ms	SOT-25	28cp	VD17	6g	Tor
<u>7FN</u>	XC6111C621MR	Vdet-IC	2.1V±2%, -MR, -Reset PPO, Wt=1.6s, Rt=50ms	SOT-25	28cp	VD17	6g	Tor
<u>7FP</u>	XC6111C622MR	Vdet-IC	2.2V±2%, -MR, -Reset PPO, Wt=1.6s, Rt=50ms	SOT-25	28cp	VD17	6g	Tor
<u>7FR</u>	XC6111C623MR	Vdet-IC	2.3V±2%, -MR, -Reset PPO, Wt=1.6s, Rt=50ms	SOT-25	28cp	VD17	6g	Tor
<u>7FS</u>	XC6111C624MR	Vdet-IC	2.4V±2%, -MR, -Reset PPO, Wt=1.6s, Rt=50ms	SOT-25	28cp	VD17	6g	Tor
<u>7FT</u>	XC6111C625MR	Vdet-IC	2.5V±2%, -MR, -Reset PPO, Wt=1.6s, Rt=50ms	SOT-25	28cp	VD17	6g	Tor
<u>7FU</u>	XC6111C626MR	Vdet-IC	2.6V±2%, -MR, -Reset PPO, Wt=1.6s, Rt=50ms	SOT-25	28cp	VD17	6g	Tor
<u>7FV</u>	XC6111C627MR	Vdet-IC	2.7V±2%, -MR, -Reset PPO, Wt=1.6s, Rt=50ms	SOT-25	28cp	VD17	6g	Tor
<u>7FX</u>	XC6111C628MR	Vdet-IC	2.8V±2%, -MR, -Reset PPO, Wt=1.6s, Rt=50ms	SOT-25	28cp	VD17	6g	Tor
<u>7FY</u>	XC6111C629MR	Vdet-IC	2.9V±2%, -MR, -Reset PPO, Wt=1.6s, Rt=50ms	SOT-25	28cp	VD17	6g	Tor
<u>7FZ</u>	XC6111C630MR	Vdet-IC	3.0V±2%, -MR, -Reset PPO, Wt=1.6s, Rt=50ms	SOT-25	28cp	VD17	6g	Tor
<u>7Ga</u>	FT532Ga	LVR-IC	LDO, 2.8V±2%, 700mA, +CE	SOT-23-5	28cx	VR4	6g	Fmd
<u>7Gb</u>	FT532Gb	LVR-IC	LDO, 2.8V±2%, 700mA, +CE	SOT-23-5	28vc	VR4	6g	Fmd
<u>7Gc</u>	FT532Gc	LVR-IC	LDO, 2.8V±2%, 700mA, +CE	SOT-23-5	28xm	VR4	6g	Fmd
<u>7Gd</u>	FT532Gd	LVR-IC	LDO, 2.8V±2%, 700mA, +CE	SC-70-5	28cx	VR4	6g	Fmd
<u>7Ge</u>	FT532Ge	LVR-IC	LDO, 2.8V±2%, 700mA, +CE	SC-70-5	28vc	VR4	6g	Fmd
<u>7Gf</u>	FT532Gf	LVR-IC	LDO, 2.8V±2%, 700mA, +CE	SC-70-5	28xm	VR4	6g	Fmd
<u>7H0</u>	XC6111D331MR	Vdet-IC	3.1V±2%, -MR, -Reset PPO, Wt=100ms, Rt=100ms	SOT-25	28cp	VD17	6g	Tor
<u>7H1</u>	XC6111D332MR	Vdet-IC	3.2V±2%, -MR, -Reset PPO, Wt=100ms, Rt=100ms	SOT-25	28cp	VD17	6g	Tor
<u>7H2</u>	XC6111D333MR	Vdet-IC	3.3V±2%, -MR, -Reset PPO, Wt=100ms, Rt=100ms	SOT-25	28cp	VD17	6g	Tor
<u>7H3</u>	XC6111D334MR	Vdet-IC	3.4V±2%, -MR, -Reset PPO, Wt=100ms, Rt=100ms	SOT-25	28cp	VD17	6g	Tor
<u>7H4</u>	XC6111D335MR	Vdet-IC	3.5V±2%, -MR, -Reset PPO, Wt=100ms, Rt=100ms	SOT-25	28cp	VD17	6g	Tor
<u>7H5</u>	XC6111D336MR	Vdet-IC	3.6V±2%, -MR, -Reset PPO, Wt=100ms, Rt=100ms	SOT-25	28cp	VD17	6g	Tor
<u>7H6</u>	XC6111D337MR	Vdet-IC	3.7V±2%, -MR, -Reset PPO, Wt=100ms, Rt=100ms	SOT-25	28cp	VD17	6g	Tor
<u>7H7</u>	XC6111D338MR	Vdet-IC	3.8V±2%, -MR, -Reset PPO, Wt=100ms, Rt=100ms	SOT-25	28cp	VD17	6g	Tor
<u>7H8</u>	XC6111D339MR	Vdet-IC	3.9V±2%, -MR, -Reset PPO, Wt=100ms, Rt=100ms	SOT-25	28cp	VD17	6g	Tor
<u>7H9</u>	XC6111D340MR	Vdet-IC	4.0V±2%, -MR, -Reset PPO, Wt=100ms, Rt=100ms	SOT-25	28cp	VD17	6g	Tor
<u>7Ha</u>	FT532Ha	LVR-IC	LDO, 2.85V±2%, 700mA, +CE	SOT-23-5	28cx	VR4	6g	Fmd
<u>7HA</u>	XC6111D341MR	Vdet-IC	4.1V±2%, -MR, -Reset PPO, Wt=100ms, Rt=100ms	SOT-25	28cp	VD17	6g	Tor
<u>7Hb</u>	FT532Hb	LVR-IC	LDO, 2.85V±2%, 700mA, +CE	SOT-23-5	28vc	VR4	6g	Fmd
<u>7HB</u>	XC6111D342MR	Vdet-IC	4.2V±2%, -MR, -Reset PPO, Wt=100ms, Rt=100ms	SOT-25	28cp	VD17	6g	Tor
<u>7Hc</u>	FT532Hc	LVR-IC	LDO, 2.85V±2%, 700mA, +CE	SOT-23-5	28xm	VR4	6g	Fmd
<u>7HC</u>	XC6111D343MR	Vdet-IC	4.3V±2%, -MR, -Reset PPO, Wt=100ms, Rt=100ms	SOT-25	28cp	VD17	6g	Tor
<u>7Hd</u>	FT532Hd	LVR-IC	LDO, 2.85V±2%, 700mA, +CE	SC-70-5	28cx	VR4	6g	Fmd
<u>7HD</u>	XC6111D344MR	Vdet-IC	4.4V±2%, -MR, -Reset PPO, Wt=100ms, Rt=100ms	SOT-25	28cp	VD17	6g	Tor
<u>7He</u>	FT532He	LVR-IC	LDO, 2.85V±2%, 700mA, +CE	SC-70-5	28vc	VR4	6g	Fmd
<u>7HE</u>	XC6111D345MR	Vdet-IC	4.5V±2%, -MR, -Reset PPO, Wt=100ms, Rt=100ms	SOT-25	28cp	VD17	6g	Tor
<u>7Hf</u>	FT532Hf	LVR-IC	LDO, 2.85V±2%, 700mA, +CE	SC-70-5	28xm	VR4	6g	Fmd
<u>7HF</u>	XC6111D316MR	Vdet-IC	1.6V±2%, -MR, -Reset PPO, Wt=100ms, Rt=100ms	SOT-25	28cp	VD17	6g	Tor
<u>7HE</u>	XC6111D346MR	Vdet-IC	4.6V±2%, -MR, -Reset PPO, Wt=100ms, Rt=100ms	SOT-25	28cp	VD17	6g	Tor
<u>7HH</u>	XC6111D317MR	Vdet-IC	1.7V±2%, -MR, -Reset PPO, Wt=100ms, Rt=100ms	SOT-25	28cp	VD17	6g	Tor
<u>7HH</u>	XC6111D347MR	Vdet-IC	4.7V±2%, -MR, -Reset PPO, Wt=100ms, Rt=100ms	SOT-25	28cp	VD17	6g	Tor
<u>7HK</u>	XC6111D318MR	Vdet-IC	1.8V±2%, -MR, -Reset PPO, Wt=100ms, Rt=100ms	SOT-25	28cp	VD17	6g	Tor
<u>7HK</u>	XC6111D348MR	Vdet-IC	4.8V±2%, -MR, -Reset PPO, Wt=100ms, Rt=100ms	SOT-25	28cp	VD17	6g	Tor
<u>7HL</u>	XC6111D319MR	Vdet-IC	1.9V±2%, -MR, -Reset PPO, Wt=100ms, Rt=100ms	SOT-25	28cp	VD17	6g	Tor
<u>7HL</u>	XC6111D349MR	Vdet-IC	4.9V±2%, -MR, -Reset PPO, Wt=100ms, Rt=100ms	SOT-25	28cp	VD17	6g	Tor
<u>7HM</u>	XC6111D320MR	Vdet-IC	2.0V±2%, -MR, -Reset PPO, Wt=100ms, Rt=100ms	SOT-25	28cp	VD17	6g	Tor
<u>7HM</u>	XC6111D350MR	Vdet-IC	5.0V±2%, -MR, -Reset PPO, Wt=100ms, Rt=100ms	SOT-25	28cp	VD17	6g	Tor
<u>7HN</u>	XC6111D321MR	Vdet-IC	2.1V±2%, -MR, -Reset PPO, Wt=100ms, Rt=100ms	SOT-25	28cp	VD17	6g	Tor
<u>7HP</u>	XC6111D322MR	Vdet-IC	2.2V±2%, -MR, -Reset PPO, Wt=100ms, Rt=100ms	SOT-25	28cp	VD17	6g	Tor
<u>7HR</u>	XC6111D323MR	Vdet-IC	2.3V±2%, -MR, -Reset PPO, Wt=100ms, Rt=100ms	SOT-25	28cp	VD17	6g	Tor
<u>7HS</u>	XC6111D324MR	Vdet-IC	2.4V±2%, -MR, -Reset PPO, Wt=100ms, Rt=100ms	SOT-25	28cp	VD17	6g	Tor
<u>7HT</u>	XC6111D325MR	Vdet-IC	2.5V±2%, -MR, -Reset PPO, Wt=100ms, Rt=100ms	SOT-25	28cp	VD17	6g	Tor
<u>7HU</u>	XC6111D326MR	Vdet-IC	2.6V±2%, -MR, -Reset PPO, Wt=100ms, Rt=100ms	SOT-25	28cp	VD17	6g	Tor
<u>7HV</u>	XC6111D327MR	Vdet-IC	2.7V±2%, -MR, -Reset PPO, Wt=100ms, Rt=100ms	SOT-25	28cp	VD17	6g	Tor
<u>7HX</u>	XC6111D328MR	Vdet-IC	2.8V±2%, -MR, -Reset PPO, Wt=100ms, Rt=100ms	SOT-25	28cp	VD17	6g	Tor
<u>7HY</u>	XC6111D329MR	Vdet-IC	2.9V±2%, -MR, -Reset PPO, Wt=100ms, Rt=100ms	SOT-25	28cp	VD17	6g	Tor
<u>7HZ</u>	XC6111D330MR	Vdet-IC	3.0V±2%, -MR, -Reset PPO, Wt=100ms, Rt=100ms	SOT-25	28cp	VD17	6g	Tor
<u>7Ia</u>	FT532Ia	LVR-IC	LDO, 3.0V±2%, 700mA, +CE	SOT-23-5	28cx	VR4	6g	Fmd
<u>7Ib</u>	FT532Ib	LVR-IC	LDO, 3.0V±2%, 700mA, +CE	SOT-23-5	28vc	VR4	6g	Fmd
<u>7Ic</u>	FT532Ic	LVR-IC	LDO, 3.0V±2%, 700mA, +CE	SOT-23-5	28xm	VR4	6g	Fmd
<u>7Id</u>	FT532Id	LVR-IC	LDO, 3.0V±2%, 700mA, +CE	SC-70-5	28cx	VR4	6g	Fmd
<u>7Ie</u>	FT532Ie	LVR-IC	LDO, 3.0V±2%, 700mA, +CE	SC-70-5	28vc	VR4	6g	Fmd
<u>7If</u>	FT532If	LVR-IC	LDO, 3.0V±2%, 700mA, +CE	SC-70-5	28xm	VR4	6g	Fmd
<u>7J</u>	R3111N171C	Vdet-IC	1.7V±2%, -Reset ODO	SOT-23-5	28vdm	VD6	6g	Ric



SMD code	Type	Function	Short description	Case	Pinout	Sch.	St.	Mnf.
7Ja	FT532Ja	LVR-IC	LDO, 3.3V±2%, 700mA, +CE	SOT-23-5	28cx	VR4	6g	Fmd
7Jb	FT532Jb	LVR-IC	LDO, 3.3V±2%, 700mA, +CE	SOT-23-5	28vc	VR4	6g	Fmd
7Jc	FT532Jc	LVR-IC	LDO, 3.3V±2%, 700mA, +CE	SOT-23-5	28xm	VR4	6g	Fmd
7Jd	FT532Jd	LVR-IC	LDO, 3.3V±2%, 700mA, +CE	SC-70-5	28cx	VR4	6g	Fmd
7Je	FT532Je	LVR-IC	LDO, 3.3V±2%, 700mA, +CE	SC-70-5	28vc	VR4	6g	Fmd
7Jf	FT532Jf	LVR-IC	LDO, 3.3V±2%, 700mA, +CE	SC-70-5	28xm	VR4	6g	Fmd
7K	R3111N271C	Vdet-IC	2.7V±2%, -Reset ODO	SOT-23-5	28vdm	VD6	6g	Ric
7K0	X06111D431MR	Vdet-IC	3.1V±2%, -MR, -Reset PPO, Wt=200ms, Rt=100ms	SOT-25	28cp	VD17	6g	Tor
7K1	X06111D432MR	Vdet-IC	3.2V±2%, -MR, -Reset PPO, Wt=200ms, Rt=100ms	SOT-25	28cp	VD17	6g	Tor
7K2	X06111D433MR	Vdet-IC	3.3V±2%, -MR, -Reset PPO, Wt=200ms, Rt=100ms	SOT-25	28cp	VD17	6g	Tor
7K3	X06111D434MR	Vdet-IC	3.4V±2%, -MR, -Reset PPO, Wt=200ms, Rt=100ms	SOT-25	28cp	VD17	6g	Tor
7K4	X06111D435MR	Vdet-IC	3.5V±2%, -MR, -Reset PPO, Wt=200ms, Rt=100ms	SOT-25	28cp	VD17	6g	Tor
7K5	X06111D436MR	Vdet-IC	3.6V±2%, -MR, -Reset PPO, Wt=200ms, Rt=100ms	SOT-25	28cp	VD17	6g	Tor
7K6	X06111D437MR	Vdet-IC	3.7V±2%, -MR, -Reset PPO, Wt=200ms, Rt=100ms	SOT-25	28cp	VD17	6g	Tor
7K7	X06111D438MR	Vdet-IC	3.8V±2%, -MR, -Reset PPO, Wt=200ms, Rt=100ms	SOT-25	28cp	VD17	6g	Tor
7K8	X06111D439MR	Vdet-IC	3.9V±2%, -MR, -Reset PPO, Wt=200ms, Rt=100ms	SOT-25	28cp	VD17	6g	Tor
7K9	X06111D440MR	Vdet-IC	4.0V±2%, -MR, -Reset PPO, Wt=200ms, Rt=100ms	SOT-25	28cp	VD17	6g	Tor
7Ka	FT532Ka	LVR-IC	LDO, 3.6V±2%, 700mA, +CE	SOT-23-5	28cx	VR4	6g	Fmd
7KA	X06111D441MR	Vdet-IC	4.1V±2%, -MR, -Reset PPO, Wt=200ms, Rt=100ms	SOT-25	28cp	VD17	6g	Tor
7Kb	FT532Kb	LVR-IC	LDO, 3.6V±2%, 700mA, +CE	SOT-23-5	28vc	VR4	6g	Fmd
7KB	X06111D442MR	Vdet-IC	4.2V±2%, -MR, -Reset PPO, Wt=200ms, Rt=100ms	SOT-25	28cp	VD17	6g	Tor
7Kc	FT532Kc	LVR-IC	LDO, 3.6V±2%, 700mA, +CE	SOT-23-5	28xm	VR4	6g	Fmd
7KC	X06111D443MR	Vdet-IC	4.3V±2%, -MR, -Reset PPO, Wt=200ms, Rt=100ms	SOT-25	28cp	VD17	6g	Tor
7Kd	FT532Kd	LVR-IC	LDO, 3.6V±2%, 700mA, +CE	SC-70-5	28cx	VR4	6g	Fmd
7KD	X06111D444MR	Vdet-IC	4.4V±2%, -MR, -Reset PPO, Wt=200ms, Rt=100ms	SOT-25	28cp	VD17	6g	Tor
7Ke	FT532Ke	LVR-IC	LDO, 3.6V±2%, 700mA, +CE	SC-70-5	28vc	VR4	6g	Fmd
7KE	X06111D445MR	Vdet-IC	4.5V±2%, -MR, -Reset PPO, Wt=200ms, Rt=100ms	SOT-25	28cp	VD17	6g	Tor
7Kf	FT532Kf	LVR-IC	LDO, 3.6V±2%, 700mA, +CE	SC-70-5	28xm	VR4	6g	Fmd
7KF	X06111D416MR	Vdet-IC	1.6V±2%, -MR, -Reset PPO, Wt=200ms, Rt=100ms	SOT-25	28cp	VD17	6g	Tor
7Kf	X06111D446MR	Vdet-IC	4.6V±2%, -MR, -Reset PPO, Wt=200ms, Rt=100ms	SOT-25	28cp	VD17	6g	Tor
7KH	X06111D417MR	Vdet-IC	1.7V±2%, -MR, -Reset PPO, Wt=200ms, Rt=100ms	SOT-25	28cp	VD17	6g	Tor
7KH	X06111D447MR	Vdet-IC	4.7V±2%, -MR, -Reset PPO, Wt=200ms, Rt=100ms	SOT-25	28cp	VD17	6g	Tor
7KK	X06111D418MR	Vdet-IC	1.8V±2%, -MR, -Reset PPO, Wt=200ms, Rt=100ms	SOT-25	28cp	VD17	6g	Tor
7KK	X06111D448MR	Vdet-IC	4.8V±2%, -MR, -Reset PPO, Wt=200ms, Rt=100ms	SOT-25	28cp	VD17	6g	Tor
7KL	X06111D419MR	Vdet-IC	1.9V±2%, -MR, -Reset PPO, Wt=200ms, Rt=100ms	SOT-25	28cp	VD17	6g	Tor
7KL	X06111D449MR	Vdet-IC	4.9V±2%, -MR, -Reset PPO, Wt=200ms, Rt=100ms	SOT-25	28cp	VD17	6g	Tor
7KM	X06111D420MR	Vdet-IC	2.0V±2%, -MR, -Reset PPO, Wt=200ms, Rt=100ms	SOT-25	28cp	VD17	6g	Tor
7KM	X06111D450MR	Vdet-IC	5.0V±2%, -MR, -Reset PPO, Wt=200ms, Rt=100ms	SOT-25	28cp	VD17	6g	Tor
7KN	X06111D421MR	Vdet-IC	2.1V±2%, -MR, -Reset PPO, Wt=200ms, Rt=100ms	SOT-25	28cp	VD17	6g	Tor
7KP	X06111D422MR	Vdet-IC	2.2V±2%, -MR, -Reset PPO, Wt=200ms, Rt=100ms	SOT-25	28cp	VD17	6g	Tor
7KR	X06111D423MR	Vdet-IC	2.3V±2%, -MR, -Reset PPO, Wt=200ms, Rt=100ms	SOT-25	28cp	VD17	6g	Tor
7KS	X06111D424MR	Vdet-IC	2.4V±2%, -MR, -Reset PPO, Wt=200ms, Rt=100ms	SOT-25	28cp	VD17	6g	Tor
7KT	X06111D425MR	Vdet-IC	2.5V±2%, -MR, -Reset PPO, Wt=200ms, Rt=100ms	SOT-25	28cp	VD17	6g	Tor
7KU	X06111D426MR	Vdet-IC	2.6V±2%, -MR, -Reset PPO, Wt=200ms, Rt=100ms	SOT-25	28cp	VD17	6g	Tor
7KV	X06111D427MR	Vdet-IC	2.7V±2%, -MR, -Reset PPO, Wt=200ms, Rt=100ms	SOT-25	28cp	VD17	6g	Tor
7KX	X06111D428MR	Vdet-IC	2.8V±2%, -MR, -Reset PPO, Wt=200ms, Rt=100ms	SOT-25	28cp	VD17	6g	Tor
7KY	X06111D429MR	Vdet-IC	2.9V±2%, -MR, -Reset PPO, Wt=200ms, Rt=100ms	SOT-25	28cp	VD17	6g	Tor
7KZ	X06111D430MR	Vdet-IC	3.0V±2%, -MR, -Reset PPO, Wt=200ms, Rt=100ms	SOT-25	28cp	VD17	6g	Tor
7L	R3111N371C	Vdet-IC	3.7V±2%, -Reset ODO	SOT-23-5	28vdm	VD6	6g	Ric
7L0	X06111D531MR	Vdet-IC	3.1V±2%, -MR, -Reset PPO, Wt=400ms, Rt=100ms	SOT-25	28cp	VD17	6g	Tor
7L1	X06111D532MR	Vdet-IC	3.2V±2%, -MR, -Reset PPO, Wt=400ms, Rt=100ms	SOT-25	28cp	VD17	6g	Tor
7L2	X06111D533MR	Vdet-IC	3.3V±2%, -MR, -Reset PPO, Wt=400ms, Rt=100ms	SOT-25	28cp	VD17	6g	Tor
7L3	X06111D534MR	Vdet-IC	3.4V±2%, -MR, -Reset PPO, Wt=400ms, Rt=100ms	SOT-25	28cp	VD17	6g	Tor
7L4	X06111D535MR	Vdet-IC	3.5V±2%, -MR, -Reset PPO, Wt=400ms, Rt=100ms	SOT-25	28cp	VD17	6g	Tor
7L5	X06111D536MR	Vdet-IC	3.6V±2%, -MR, -Reset PPO, Wt=400ms, Rt=100ms	SOT-25	28cp	VD17	6g	Tor
7L6	X06111D537MR	Vdet-IC	3.7V±2%, -MR, -Reset PPO, Wt=400ms, Rt=100ms	SOT-25	28cp	VD17	6g	Tor
7L7	X06111D538MR	Vdet-IC	3.8V±2%, -MR, -Reset PPO, Wt=400ms, Rt=100ms	SOT-25	28cp	VD17	6g	Tor
7L8	X06111D539MR	Vdet-IC	3.9V±2%, -MR, -Reset PPO, Wt=400ms, Rt=100ms	SOT-25	28cp	VD17	6g	Tor
7L9	X06111D540MR	Vdet-IC	4.0V±2%, -MR, -Reset PPO, Wt=400ms, Rt=100ms	SOT-25	28cp	VD17	6g	Tor
7LA	X06111D541MR	Vdet-IC	4.1V±2%, -MR, -Reset PPO, Wt=400ms, Rt=100ms	SOT-25	28cp	VD17	6g	Tor
7LB	X06111D542MR	Vdet-IC	4.2V±2%, -MR, -Reset PPO, Wt=400ms, Rt=100ms	SOT-25	28cp	VD17	6g	Tor
7LC	X06111D543MR	Vdet-IC	4.3V±2%, -MR, -Reset PPO, Wt=400ms, Rt=100ms	SOT-25	28cp	VD17	6g	Tor
7LD	X06111D544MR	Vdet-IC	4.4V±2%, -MR, -Reset PPO, Wt=400ms, Rt=100ms	SOT-25	28cp	VD17	6g	Tor
7LE	X06111D545MR	Vdet-IC	4.5V±2%, -MR, -Reset PPO, Wt=400ms, Rt=100ms	SOT-25	28cp	VD17	6g	Tor
7LF	X06111D516MR	Vdet-IC	1.6V±2%, -MR, -Reset PPO, Wt=400ms, Rt=100ms	SOT-25	28cp	VD17	6g	Tor
7LF	X06111D546MR	Vdet-IC	4.6V±2%, -MR, -Reset PPO, Wt=400ms, Rt=100ms	SOT-25	28cp	VD17	6g	Tor
7LH	X06111D517MR	Vdet-IC	1.7V±2%, -MR, -Reset PPO, Wt=400ms, Rt=100ms	SOT-25	28cp	VD17	6g	Tor
7LH	X06111D547MR	Vdet-IC	4.7V±2%, -MR, -Reset PPO, Wt=400ms, Rt=100ms	SOT-25	28cp	VD17	6g	Tor
7LK	X06111D518MR	Vdet-IC	1.8V±2%, -MR, -Reset PPO, Wt=400ms, Rt=100ms	SOT-25	28cp	VD17	6g	Tor
7LK	X06111D548MR	Vdet-IC	4.8V±2%, -MR, -Reset PPO, Wt=400ms, Rt=100ms	SOT-25	28cp	VD17	6g	Tor



SMD Code	Type	Function	Short description	Case	Pinout	Sch.	St.	Mnf.
<u>7LL</u>	XC6111D519MR	Vdet-IC	1.9V±2%, -MR, -Reset PPO, Wt=400ms, Rt=100ms	SOT-25	28cp	VD17	6g	Tor
<u>7LL</u>	XC6111D549MR	Vdet-IC	4.9V±2%, -MR, -Reset PPO, Wt=400ms, Rt=100ms	SOT-25	28cp	VD17	6g	Tor
<u>7LM</u>	XC6111D520MR	Vdet-IC	2.0V±2%, -MR, -Reset PPO, Wt=400ms, Rt=100ms	SOT-25	28cp	VD17	6g	Tor
<u>7LM</u>	XC6111D550MR	Vdet-IC	5.0V±2%, -MR, -Reset PPO, Wt=400ms, Rt=100ms	SOT-25	28cp	VD17	6g	Tor
<u>7LN</u>	XC6111D521MR	Vdet-IC	2.1V±2%, -MR, -Reset PPO, Wt=400ms, Rt=100ms	SOT-25	28cp	VD17	6g	Tor
<u>7LP</u>	XC6111D522MR	Vdet-IC	2.2V±2%, -MR, -Reset PPO, Wt=400ms, Rt=100ms	SOT-25	28cp	VD17	6g	Tor
<u>7LR</u>	XC6111D523MR	Vdet-IC	2.3V±2%, -MR, -Reset PPO, Wt=400ms, Rt=100ms	SOT-25	28cp	VD17	6g	Tor
<u>7LS</u>	XC6111D524MR	Vdet-IC	2.4V±2%, -MR, -Reset PPO, Wt=400ms, Rt=100ms	SOT-25	28cp	VD17	6g	Tor
<u>7LT</u>	XC6111D525MR	Vdet-IC	2.5V±2%, -MR, -Reset PPO, Wt=400ms, Rt=100ms	SOT-25	28cp	VD17	6g	Tor
<u>7LU</u>	XC6111D526MR	Vdet-IC	2.6V±2%, -MR, -Reset PPO, Wt=400ms, Rt=100ms	SOT-25	28cp	VD17	6g	Tor
<u>7LV</u>	XC6111D527MR	Vdet-IC	2.7V±2%, -MR, -Reset PPO, Wt=400ms, Rt=100ms	SOT-25	28cp	VD17	6g	Tor
<u>7LX</u>	XC6111D528MR	Vdet-IC	2.8V±2%, -MR, -Reset PPO, Wt=400ms, Rt=100ms	SOT-25	28cp	VD17	6g	Tor
<u>7LY</u>	XC6111D529MR	Vdet-IC	2.9V±2%, -MR, -Reset PPO, Wt=400ms, Rt=100ms	SOT-25	28cp	VD17	6g	Tor
<u>7LZ</u>	XC6111D530MR	Vdet-IC	3.0V±2%, -MR, -Reset PPO, Wt=400ms, Rt=100ms	SOT-25	28cp	VD17	6g	Tor
<u>7M</u>	R3111N471C	Vdet-IC	4.7V±2%, -Reset ODO	SOT-23-5	28vdm	VD6	6g	Ric
<u>7M0</u>	XC6111D631MR	Vdet-IC	3.1V±2%, -MR, -Reset PPO, Wt=1.6s, Rt=100ms	SOT-25	28cp	VD17	6g	Tor
<u>7M1</u>	XC6111D632MR	Vdet-IC	3.2V±2%, -MR, -Reset PPO, Wt=1.6s, Rt=100ms	SOT-25	28cp	VD17	6g	Tor
<u>7M2</u>	XC6111D633MR	Vdet-IC	3.3V±2%, -MR, -Reset PPO, Wt=1.6s, Rt=100ms	SOT-25	28cp	VD17	6g	Tor
<u>7M3</u>	XC6111D634MR	Vdet-IC	3.4V±2%, -MR, -Reset PPO, Wt=1.6s, Rt=100ms	SOT-25	28cp	VD17	6g	Tor
<u>7M4</u>	XC6111D635MR	Vdet-IC	3.5V±2%, -MR, -Reset PPO, Wt=1.6s, Rt=100ms	SOT-25	28cp	VD17	6g	Tor
<u>7M5</u>	XC6111D636MR	Vdet-IC	3.6V±2%, -MR, -Reset PPO, Wt=1.6s, Rt=100ms	SOT-25	28cp	VD17	6g	Tor
<u>7M6</u>	XC6111D637MR	Vdet-IC	3.7V±2%, -MR, -Reset PPO, Wt=1.6s, Rt=100ms	SOT-25	28cp	VD17	6g	Tor
<u>7M7</u>	XC6111D638MR	Vdet-IC	3.8V±2%, -MR, -Reset PPO, Wt=1.6s, Rt=100ms	SOT-25	28cp	VD17	6g	Tor
<u>7M8</u>	XC6111D639MR	Vdet-IC	3.9V±2%, -MR, -Reset PPO, Wt=1.6s, Rt=100ms	SOT-25	28cp	VD17	6g	Tor
<u>7M9</u>	XC6111D640MR	Vdet-IC	4.0V±2%, -MR, -Reset PPO, Wt=1.6s, Rt=100ms	SOT-25	28cp	VD17	6g	Tor
<u>7MA</u>	XC6111D641MR	Vdet-IC	4.1V±2%, -MR, -Reset PPO, Wt=1.6s, Rt=100ms	SOT-25	28cp	VD17	6g	Tor
<u>7MB</u>	XC6111D642MR	Vdet-IC	4.2V±2%, -MR, -Reset PPO, Wt=1.6s, Rt=100ms	SOT-25	28cp	VD17	6g	Tor
<u>7MC</u>	XC6111D643MR	Vdet-IC	4.3V±2%, -MR, -Reset PPO, Wt=1.6s, Rt=100ms	SOT-25	28cp	VD17	6g	Tor
<u>7MD</u>	XC6111D644MR	Vdet-IC	4.4V±2%, -MR, -Reset PPO, Wt=1.6s, Rt=100ms	SOT-25	28cp	VD17	6g	Tor
<u>7ME</u>	XC6111D645MR	Vdet-IC	4.5V±2%, -MR, -Reset PPO, Wt=1.6s, Rt=100ms	SOT-25	28cp	VD17	6g	Tor
<u>7MF</u>	XC6111D616MR	Vdet-IC	1.6V±2%, -MR, -Reset PPO, Wt=1.6s, Rt=100ms	SOT-25	28cp	VD17	6g	Tor
<u>7MF</u>	XC6111D646MR	Vdet-IC	4.6V±2%, -MR, -Reset PPO, Wt=1.6s, Rt=100ms	SOT-25	28cp	VD17	6g	Tor
<u>7MH</u>	XC6111D617MR	Vdet-IC	1.7V±2%, -MR, -Reset PPO, Wt=1.6s, Rt=100ms	SOT-25	28cp	VD17	6g	Tor
<u>7MH</u>	XC6111D647MR	Vdet-IC	4.7V±2%, -MR, -Reset PPO, Wt=1.6s, Rt=100ms	SOT-25	28cp	VD17	6g	Tor
<u>7MK</u>	XC6111D618MR	Vdet-IC	1.8V±2%, -MR, -Reset PPO, Wt=1.6s, Rt=100ms	SOT-25	28cp	VD17	6g	Tor
<u>7MK</u>	XC6111D648MR	Vdet-IC	4.8V±2%, -MR, -Reset PPO, Wt=1.6s, Rt=100ms	SOT-25	28cp	VD17	6g	Tor
<u>7ML</u>	XC6111D619MR	Vdet-IC	1.9V±2%, -MR, -Reset PPO, Wt=1.6s, Rt=100ms	SOT-25	28cp	VD17	6g	Tor
<u>7ML</u>	XC6111D649MR	Vdet-IC	4.9V±2%, -MR, -Reset PPO, Wt=1.6s, Rt=100ms	SOT-25	28cp	VD17	6g	Tor
<u>7MM</u>	XC6111D620MR	Vdet-IC	2.0V±2%, -MR, -Reset PPO, Wt=1.6s, Rt=100ms	SOT-25	28cp	VD17	6g	Tor
<u>7MN</u>	XC6111D650MR	Vdet-IC	5.0V±2%, -MR, -Reset PPO, Wt=1.6s, Rt=100ms	SOT-25	28cp	VD17	6g	Tor
<u>7MN</u>	XC6111D621MR	Vdet-IC	2.1V±2%, -MR, -Reset PPO, Wt=1.6s, Rt=100ms	SOT-25	28cp	VD17	6g	Tor
<u>7MP</u>	XC6111D622MR	Vdet-IC	2.2V±2%, -MR, -Reset PPO, Wt=1.6s, Rt=100ms	SOT-25	28cp	VD17	6g	Tor
<u>7MR</u>	XC6111D623MR	Vdet-IC	2.3V±2%, -MR, -Reset PPO, Wt=1.6s, Rt=100ms	SOT-25	28cp	VD17	6g	Tor
<u>7MS</u>	XC6111D624MR	Vdet-IC	2.4V±2%, -MR, -Reset PPO, Wt=1.6s, Rt=100ms	SOT-25	28cp	VD17	6g	Tor
<u>7MT</u>	XC6111D625MR	Vdet-IC	2.5V±2%, -MR, -Reset PPO, Wt=1.6s, Rt=100ms	SOT-25	28cp	VD17	6g	Tor
<u>7MU</u>	XC6111D626MR	Vdet-IC	2.6V±2%, -MR, -Reset PPO, Wt=1.6s, Rt=100ms	SOT-25	28cp	VD17	6g	Tor
<u>7MV</u>	XC6111D627MR	Vdet-IC	2.7V±2%, -MR, -Reset PPO, Wt=1.6s, Rt=100ms	SOT-25	28cp	VD17	6g	Tor
<u>7MX</u>	XC6111D628MR	Vdet-IC	2.8V±2%, -MR, -Reset PPO, Wt=1.6s, Rt=100ms	SOT-25	28cp	VD17	6g	Tor
<u>7MY</u>	XC6111D629MR	Vdet-IC	2.9V±2%, -MR, -Reset PPO, Wt=1.6s, Rt=100ms	SOT-25	28cp	VD17	6g	Tor
<u>7MZ</u>	XC6111D630MR	Vdet-IC	3.0V±2%, -MR, -Reset PPO, Wt=1.6s, Rt=100ms	SOT-25	28cp	VD17	6g	Tor
<u>7N</u>	R3111N571C	Vdet-IC	5.7V±2%, -Reset ODO	SOT-23-5	28vdm	VD6	6g	Ric
<u>7N0</u>	XC6207A31AMR	LVR-IC	LDO, 3.15V±2%, 300mA, -CE, Shutdown	SOT-25	28cu	VR4a	6g	Tor
<u>7N1</u>	XC6207A32AMR	LVR-IC	LDO, 3.25V±2%, 300mA, -CE, Shutdown	SOT-25	28cu	VR4a	6g	Tor
<u>7N2</u>	XC6207A33AMR	LVR-IC	LDO, 3.35V±2%, 300mA, -CE, Shutdown	SOT-25	28cu	VR4a	6g	Tor
<u>7N3</u>	XC6207A34AMR	LVR-IC	LDO, 3.45V±2%, 300mA, -CE, Shutdown	SOT-25	28cu	VR4a	6g	Tor
<u>7N4</u>	XC6207A35AMR	LVR-IC	LDO, 3.55V±2%, 300mA, -CE, Shutdown	SOT-25	28cu	VR4a	6g	Tor
<u>7N5</u>	XC6207A36AMR	LVR-IC	LDO, 3.65V±2%, 300mA, -CE, Shutdown	SOT-25	28cu	VR4a	6g	Tor
<u>7N6</u>	XC6207A37AMR	LVR-IC	LDO, 3.75V±2%, 300mA, -CE, Shutdown	SOT-25	28cu	VR4a	6g	Tor
<u>7N7</u>	XC6207A38AMR	LVR-IC	LDO, 3.85V±2%, 300mA, -CE, Shutdown	SOT-25	28cu	VR4a	6g	Tor
<u>7N8</u>	XC6207A39AMR	LVR-IC	LDO, 3.95V±2%, 300mA, -CE, Shutdown	SOT-25	28cu	VR4a	6g	Tor
<u>7N9</u>	XC6207A40AMR	LVR-IC	LDO, 4.05V±2%, 300mA, -CE, Shutdown	SOT-25	28cu	VR4a	6g	Tor
<u>7NA</u>	XC6207A41AMR	LVR-IC	LDO, 4.15V±2%, 300mA, -CE, Shutdown	SOT-25	28cu	VR4a	6g	Tor
<u>7NB</u>	XC6207A42AMR	LVR-IC	LDO, 4.25V±2%, 300mA, -CE, Shutdown	SOT-25	28cu	VR4a	6g	Tor
<u>7NC</u>	XC6207A43AMR	LVR-IC	LDO, 4.35V±2%, 300mA, -CE, Shutdown	SOT-25	28cu	VR4a	6g	Tor
<u>7ND</u>	XC6207A44AMR	LVR-IC	LDO, 4.45V±2%, 300mA, -CE, Shutdown	SOT-25	28cu	VR4a	6g	Tor
<u>7ND</u>	XC6207A44AMR	LVR-IC	LDO, 4.45V±2%, 300mA, -CE, Shutdown	SOT-25	28cu	VR4a	6g	Tor
<u>7NE</u>	XC6207A45AMR	LVR-IC	LDO, 4.55V±2%, 300mA, -CE, Shutdown	SOT-25	28cu	VR4a	6g	Tor



SMD code	Type	Function	Short description	Case	Pinout	Sch.	St.	Mnf.
7NF	XC6207A16AMR	LVR-IC	LDO, 1.65V±2%, 300mA, -CE, Shutdown	SOT-25	28cu	VR4a	6g	Tor
7NF	XC6207A46AMR	LVR-IC	LDO, 4.65V±2%, 300mA, -CE, Shutdown	SOT-25	28cu	VR4a	6g	Tor
7NH	XC6207A17AMR	LVR-IC	LDO, 1.75V±2%, 300mA, -CE, Shutdown	SOT-25	28cu	VR4a	6g	Tor
7NH	XC6207A47AMR	LVR-IC	LDO, 4.75V±2%, 300mA, -CE, Shutdown	SOT-25	28cu	VR4a	6g	Tor
7NK	XC6207A18AMR	LVR-IC	LDO, 1.85V±2%, 300mA, -CE, Shutdown	SOT-25	28cu	VR4a	6g	Tor
7NK	XC6207A48AMR	LVR-IC	LDO, 4.85V±2%, 300mA, -CE, Shutdown	SOT-25	28cu	VR4a	6g	Tor
7NL	XC6207A19AMR	LVR-IC	LDO, 1.95V±2%, 300mA, -CE, Shutdown	SOT-25	28cu	VR4a	6g	Tor
7NL	XC6207A49AMR	LVR-IC	LDO, 4.95V±2%, 300mA, -CE, Shutdown	SOT-25	28cu	VR4a	6g	Tor
7NM	XC6207A20AMR	LVR-IC	LDO, 2.05V±2%, 300mA, -CE, Shutdown	SOT-25	28cu	VR4a	6g	Tor
7NN	XC6207A21AMR	LVR-IC	LDO, 2.15V±2%, 300mA, -CE, Shutdown	SOT-25	28cu	VR4a	6g	Tor
7NP	XC6207A22AMR	LVR-IC	LDO, 2.25V±2%, 300mA, -CE, Shutdown	SOT-25	28cu	VR4a	6g	Tor
7NR	XC6207A23AMR	LVR-IC	LDO, 2.35V±2%, 300mA, -CE, Shutdown	SOT-25	28cu	VR4a	6g	Tor
7NS	XC6207A24AMR	LVR-IC	LDO, 2.45V±2%, 300mA, -CE, Shutdown	SOT-25	28cu	VR4a	6g	Tor
7NT	XC6207A25AMR	LVR-IC	LDO, 2.55V±2%, 300mA, -CE, Shutdown	SOT-25	28cu	VR4a	6g	Tor
7NU	XC6207A26AMR	LVR-IC	LDO, 2.65V±2%, 300mA, -CE, Shutdown	SOT-25	28cu	VR4a	6g	Tor
7NV	XC6207A27AMR	LVR-IC	LDO, 2.75V±2%, 300mA, -CE, Shutdown	SOT-25	28cu	VR4a	6g	Tor
7NX	XC6207A28AMR	LVR-IC	LDO, 2.85V±2%, 300mA, -CE, Shutdown	SOT-25	28cu	VR4a	6g	Tor
7NY	XC6207A29AMR	LVR-IC	LDO, 2.95V±2%, 300mA, -CE, Shutdown	SOT-25	28cu	VR4a	6g	Tor
7NZ	XC6207A30AMR	LVR-IC	LDO, 3.05V±2%, 300mA, -CE, Shutdown	SOT-25	28cu	VR4a	6g	Tor
7P0	XC6207B31AMR	LVR-IC	LDO, 3.15V±2%, 300mA, -CE, CL, Shutdown	SOT-25	28cu	VR4a	6g	Tor
7P0	XC6111E431MR	Vdet-IC	3.1V±2%, -MR, -Reset PPO, Wt=200ms, Rt=200ms	SOT-25	28cp	VD17	6g	Tor
7P1	XC6207B32AMR	LVR-IC	LDO, 3.25V±2%, 300mA, -CE, CL, Shutdown	SOT-25	28cu	VR4a	6g	Tor
7P1	XC6111E432MR	Vdet-IC	3.2V±2%, -MR, -Reset PPO, Wt=200ms, Rt=200ms	SOT-25	28cp	VD17	6g	Tor
7P2	XC6207B33AMR	LVR-IC	LDO, 3.35V±2%, 300mA, -CE, CL, Shutdown	SOT-25	28cu	VR4a	6g	Tor
7P2	XC6111E433MR	Vdet-IC	3.3V±2%, -MR, -Reset PPO, Wt=200ms, Rt=200ms	SOT-25	28cp	VD17	6g	Tor
7P3	XC6207B34AMR	LVR-IC	LDO, 3.45V±2%, 300mA, -CE, CL, Shutdown	SOT-25	28cu	VR4a	6g	Tor
7P3	XC6111E434MR	Vdet-IC	3.4V±2%, -MR, -Reset PPO, Wt=200ms, Rt=200ms	SOT-25	28cp	VD17	6g	Tor
7P4	XC6207B35AMR	LVR-IC	LDO, 3.55V±2%, 300mA, -CE, CL, Shutdown	SOT-25	28cu	VR4a	6g	Tor
7P4	XC6111E435MR	Vdet-IC	3.5V±2%, -MR, -Reset PPO, Wt=200ms, Rt=200ms	SOT-25	28cp	VD17	6g	Tor
7P5	XC6207B36AMR	LVR-IC	LDO, 3.65V±2%, 300mA, -CE, CL, Shutdown	SOT-25	28cu	VR4a	6g	Tor
7P5	XC6111E436MR	Vdet-IC	3.6V±2%, -MR, -Reset PPO, Wt=200ms, Rt=200ms	SOT-25	28cp	VD17	6g	Tor
7P6	XC6207B37AMR	LVR-IC	LDO, 3.75V±2%, 300mA, -CE, CL, Shutdown	SOT-25	28cu	VR4a	6g	Tor
7P6	XC6111E437MR	Vdet-IC	3.7V±2%, -MR, -Reset PPO, Wt=200ms, Rt=200ms	SOT-25	28cp	VD17	6g	Tor
7P7	XC6207B38AMR	LVR-IC	LDO, 3.85V±2%, 300mA, -CE, CL, Shutdown	SOT-25	28cu	VR4a	6g	Tor
7P7	XC6111E438MR	Vdet-IC	3.8V±2%, -MR, -Reset PPO, Wt=200ms, Rt=200ms	SOT-25	28cp	VD17	6g	Tor
7P8	XC6207B39AMR	LVR-IC	LDO, 3.95V±2%, 300mA, -CE, CL, Shutdown	SOT-25	28cu	VR4a	6g	Tor
7P8	XC6111E439MR	Vdet-IC	3.9V±2%, -MR, -Reset PPO, Wt=200ms, Rt=200ms	SOT-25	28cp	VD17	6g	Tor
7P9	XC6207B40AMR	LVR-IC	LDO, 4.05V±2%, 300mA, -CE, CL, Shutdown	SOT-25	28cu	VR4a	6g	Tor
7P9	XC6111E440MR	Vdet-IC	4.0V±2%, -MR, -Reset PPO, Wt=200ms, Rt=200ms	SOT-25	28cp	VD17	6g	Tor
7PA	XC6207B41AMR	LVR-IC	LDO, 4.15V±2%, 300mA, -CE, CL, Shutdown	SOT-25	28cu	VR4a	6g	Tor
7PA	XC6111E441MR	Vdet-IC	4.1V±2%, -MR, -Reset PPO, Wt=200ms, Rt=200ms	SOT-25	28cp	VD17	6g	Tor
7PB	XC6207B12AMR	LVR-IC	LDO, 1.25V±2%, 300mA, -CE, CL, Shutdown	SOT-25	28cu	VR4a	6g	Tor
7PB	XC6111E442MR	Vdet-IC	4.2V±2%, -MR, -Reset PPO, Wt=200ms, Rt=200ms	SOT-25	28cp	VD17	6g	Tor
7PB	XC6207B42AMR	LVR-IC	LDO, 4.25V±2%, 300mA, -CE, CL, Shutdown	SOT-25	28cu	VR4a	6g	Tor
7PC	XC6207B13AMR	LVR-IC	LDO, 1.35V±2%, 300mA, -CE, CL, Shutdown	SOT-25	28cu	VR4a	6g	Tor
7PC	XC6111E443MR	Vdet-IC	4.3V±2%, -MR, -Reset PPO, Wt=200ms, Rt=200ms	SOT-25	28cp	VD17	6g	Tor
7PC	XC6207B43AMR	LVR-IC	LDO, 4.35V±2%, 300mA, -CE, CL, Shutdown	SOT-25	28cu	VR4a	6g	Tor
7PD	XC6207B14AMR	LVR-IC	LDO, 1.45V±2%, 300mA, -CE, CL, Shutdown	SOT-25	28cu	VR4a	6g	Tor
7PD	XC6111E444MR	Vdet-IC	4.4V±2%, -MR, -Reset PPO, Wt=200ms, Rt=200ms	SOT-25	28cp	VD17	6g	Tor
7PD	XC6207B44AMR	LVR-IC	LDO, 4.45V±2%, 300mA, -CE, CL, Shutdown	SOT-25	28cu	VR4a	6g	Tor
7PE	XC6207B15AMR	LVR-IC	LDO, 1.55V±2%, 300mA, -CE, CL, Shutdown	SOT-25	28cu	VR4a	6g	Tor
7PE	XC6111E445MR	Vdet-IC	4.5V±2%, -MR, -Reset PPO, Wt=200ms, Rt=200ms	SOT-25	28cp	VD17	6g	Tor
7PE	XC6207B45AMR	LVR-IC	LDO, 4.55V±2%, 300mA, -CE, CL, Shutdown	SOT-25	28cu	VR4a	6g	Tor
7PF	XC6207B16AMR	LVR-IC	LDO, 1.65V±2%, 300mA, -CE, CL, Shutdown	SOT-25	28cu	VR4a	6g	Tor
7PF	XC6111E416MR	Vdet-IC	1.6V±2%, -MR, -Reset PPO, Wt=200ms, Rt=200ms	SOT-25	28cp	VD17	6g	Tor
7PF	XC6111E446MR	Vdet-IC	4.6V±2%, -MR, -Reset PPO, Wt=200ms, Rt=200ms	SOT-25	28cp	VD17	6g	Tor
7PF	XC6207B46AMR	LVR-IC	LDO, 4.65V±2%, 300mA, -CE, CL, Shutdown	SOT-25	28cu	VR4a	6g	Tor
7PH	XC6207B17AMR	LVR-IC	LDO, 1.75V±2%, 300mA, -CE, CL, Shutdown	SOT-25	28cu	VR4a	6g	Tor
7PH	XC6111E417MR	Vdet-IC	1.7V±2%, -MR, -Reset PPO, Wt=200ms, Rt=200ms	SOT-25	28cp	VD17	6g	Tor
7PH	XC6111E447MR	Vdet-IC	4.7V±2%, -MR, -Reset PPO, Wt=200ms, Rt=200ms	SOT-25	28cp	VD17	6g	Tor
7PH	XC6207B47AMR	LVR-IC	LDO, 4.75V±2%, 300mA, -CE, CL, Shutdown	SOT-25	28cu	VR4a	6g	Tor
7PK	XC6207B18AMR	LVR-IC	LDO, 1.85V±2%, 300mA, -CE, CL, Shutdown	SOT-25	28cu	VR4a	6g	Tor
7PK	XC6111E418MR	Vdet-IC	1.8V±2%, -MR, -Reset PPO, Wt=200ms, Rt=200ms	SOT-25	28cp	VD17	6g	Tor
7PK	XC6111E448MR	Vdet-IC	4.8V±2%, -MR, -Reset PPO, Wt=200ms, Rt=200ms	SOT-25	28cp	VD17	6g	Tor
7PK	XC6207B48AMR	LVR-IC	LDO, 4.85V±2%, 300mA, -CE, CL, Shutdown	SOT-25	28cu	VR4a	6g	Tor
7PL	XC6207B19AMR	LVR-IC	LDO, 1.95V±2%, 300mA, -CE, CL, Shutdown	SOT-25	28cu	VR4a	6g	Tor
7PL	XC6111E419MR	Vdet-IC	1.9V±2%, -MR, -Reset PPO, Wt=200ms, Rt=200ms	SOT-25	28cp	VD17	6g	Tor
7PL	XC6111E449MR	Vdet-IC	4.9V±2%, -MR, -Reset PPO, Wt=200ms, Rt=200ms	SOT-25	28cp	VD17	6g	Tor
7PL	XC6207B49AMR	LVR-IC	LDO, 4.95V±2%, 300mA, -CE, CL, Shutdown	SOT-25	28cu	VR4a	6g	Tor
7PM	XC6207B20AMR	LVR-IC	LDO, 2.05V±2%, 300mA, -CE, CL, Shutdown	SOT-25	28cu	VR4a	6g	Tor



SMD code	Type	Function	Short description	Case	Pinout	Sch.	St.	Mnf.
<u>7PM</u>	XC6111E420MR	Vdet-IC	2.0V±2%, -MR, -Reset PPO, Wt=200ms, Rt=200ms	SOT-25	28cp	VD17	6g	Tor
<u>7PM</u>	XC6111E450MR	Vdet-IC	5.0V±2%, -MR, -Reset PPO, Wt=200ms, Rt=200ms	SOT-25	28cp	VD17	6g	Tor
<u>7PN</u>	XC6207B21AMR	LVR-IC	LDO, 2.15V±2%, 300mA, -CE, CL, Shutdown	SOT-25	28cu	VR4a	6g	Tor
<u>7PN</u>	XC6111E421MR	Vdet-IC	2.1V±2%, -MR, -Reset PPO, Wt=200ms, Rt=200ms	SOT-25	28cp	VD17	6g	Tor
<u>7PP</u>	XC6207B22AMR	LVR-IC	LDO, 2.25V±2%, 300mA, -CE, CL, Shutdown	SOT-25	28cu	VR4a	6g	Tor
<u>7PP</u>	XC6111E422MR	Vdet-IC	2.2V±2%, -MR, -Reset PPO, Wt=200ms, Rt=200ms	SOT-25	28cp	VD17	6g	Tor
<u>7PR</u>	XC6207B23AMR	LVR-IC	LDO, 2.35V±2%, 300mA, -CE, CL, Shutdown	SOT-25	28cu	VR4a	6g	Tor
<u>7PR</u>	XC6111E423MR	Vdet-IC	2.3V±2%, -MR, -Reset PPO, Wt=200ms, Rt=200ms	SOT-25	28cp	VD17	6g	Tor
<u>7PS</u>	XC6207B24AMR	LVR-IC	LDO, 2.45V±2%, 300mA, -CE, CL, Shutdown	SOT-25	28cu	VR4a	6g	Tor
<u>7PS</u>	XC6111E424MR	Vdet-IC	2.4V±2%, -MR, -Reset PPO, Wt=200ms, Rt=200ms	SOT-25	28cp	VD17	6g	Tor
<u>7PT</u>	XC6207B25AMR	LVR-IC	LDO, 2.55V±2%, 300mA, -CE, CL, Shutdown	SOT-25	28cu	VR4a	6g	Tor
<u>7PT</u>	XC6111E425MR	Vdet-IC	2.5V±2%, -MR, -Reset PPO, Wt=200ms, Rt=200ms	SOT-25	28cp	VD17	6g	Tor
<u>7PU</u>	XC6207B26AMR	LVR-IC	LDO, 2.65V±2%, 300mA, -CE, CL, Shutdown	SOT-25	28cu	VR4a	6g	Tor
<u>7PU</u>	XC6111E426MR	Vdet-IC	2.6V±2%, -MR, -Reset PPO, Wt=200ms, Rt=200ms	SOT-25	28cp	VD17	6g	Tor
<u>7PV</u>	XC6207B27AMR	LVR-IC	LDO, 2.75V±2%, 300mA, -CE, CL, Shutdown	SOT-25	28cu	VR4a	6g	Tor
<u>7PV</u>	XC6111E427MR	Vdet-IC	2.7V±2%, -MR, -Reset PPO, Wt=200ms, Rt=200ms	SOT-25	28cp	VD17	6g	Tor
<u>7PX</u>	XC6207B28AMR	LVR-IC	LDO, 2.85V±2%, 300mA, -CE, CL, Shutdown	SOT-25	28cu	VR4a	6g	Tor
<u>7PX</u>	XC6111E428MR	Vdet-IC	2.8V±2%, -MR, -Reset PPO, Wt=200ms, Rt=200ms	SOT-25	28cp	VD17	6g	Tor
<u>7PY</u>	XC6207B29AMR	LVR-IC	LDO, 2.95V±2%, 300mA, -CE, CL, Shutdown	SOT-25	28cu	VR4a	6g	Tor
<u>7PY</u>	XC6111E429MR	Vdet-IC	2.9V±2%, -MR, -Reset PPO, Wt=200ms, Rt=200ms	SOT-25	28cp	VD17	6g	Tor
<u>7PZ</u>	XC6207B30AMR	LVR-IC	LDO, 3.05V±2%, 300mA, -CE, CL, Shutdown	SOT-25	28cu	VR4a	6g	Tor
<u>7PZ</u>	XC6111E430MR	Vdet-IC	3.0V±2%, -MR, -Reset PPO, Wt=200ms, Rt=200ms	SOT-25	28cp	VD17	6g	Tor
<u>7Q</u>	R1210N271A	DC/DC-IC	PWM step-up, 2.7V, 35..100kHz	SOT-23-5	28sc	DC3	6g	Ric
<u>7R0</u>	XC6111E531MR	Vdet-IC	3.1V±2%, -MR, -Reset PPO, Wt=400ms, Rt=200ms	SOT-25	28cp	VD17	6g	Tor
<u>7R1</u>	XC6111E532MR	Vdet-IC	3.2V±2%, -MR, -Reset PPO, Wt=400ms, Rt=200ms	SOT-25	28cp	VD17	6g	Tor
<u>7R2</u>	XC6111E533MR	Vdet-IC	3.3V±2%, -MR, -Reset PPO, Wt=400ms, Rt=200ms	SOT-25	28cp	VD17	6g	Tor
<u>7R3</u>	XC6111E534MR	Vdet-IC	3.4V±2%, -MR, -Reset PPO, Wt=400ms, Rt=200ms	SOT-25	28cp	VD17	6g	Tor
<u>7R4</u>	XC6111E535MR	Vdet-IC	3.5V±2%, -MR, -Reset PPO, Wt=400ms, Rt=200ms	SOT-25	28cp	VD17	6g	Tor
<u>7R5</u>	XC6111E536MR	Vdet-IC	3.6V±2%, -MR, -Reset PPO, Wt=400ms, Rt=200ms	SOT-25	28cp	VD17	6g	Tor
<u>7R6</u>	XC6111E537MR	Vdet-IC	3.7V±2%, -MR, -Reset PPO, Wt=400ms, Rt=200ms	SOT-25	28cp	VD17	6g	Tor
<u>7R7</u>	XC6111E538MR	Vdet-IC	3.8V±2%, -MR, -Reset PPO, Wt=400ms, Rt=200ms	SOT-25	28cp	VD17	6g	Tor
<u>7R8</u>	XC6111E539MR	Vdet-IC	3.9V±2%, -MR, -Reset PPO, Wt=400ms, Rt=200ms	SOT-25	28cp	VD17	6g	Tor
<u>7R9</u>	XC6111E540MR	Vdet-IC	4.0V±2%, -MR, -Reset PPO, Wt=400ms, Rt=200ms	SOT-25	28cp	VD17	6g	Tor
<u>7RA</u>	XC6111E541MR	Vdet-IC	4.1V±2%, -MR, -Reset PPO, Wt=400ms, Rt=200ms	SOT-25	28cp	VD17	6g	Tor
<u>7RB</u>	XC6111E542MR	Vdet-IC	4.2V±2%, -MR, -Reset PPO, Wt=400ms, Rt=200ms	SOT-25	28cp	VD17	6g	Tor
<u>7RC</u>	XC6111E543MR	Vdet-IC	4.3V±2%, -MR, -Reset PPO, Wt=400ms, Rt=200ms	SOT-25	28cp	VD17	6g	Tor
<u>7RD</u>	XC6111E544MR	Vdet-IC	4.4V±2%, -MR, -Reset PPO, Wt=400ms, Rt=200ms	SOT-25	28cp	VD17	6g	Tor
<u>7RE</u>	XC6111E545MR	Vdet-IC	4.5V±2%, -MR, -Reset PPO, Wt=400ms, Rt=200ms	SOT-25	28cp	VD17	6g	Tor
<u>7RF</u>	XC6111E516MR	Vdet-IC	1.6V±2%, -MR, -Reset PPO, Wt=400ms, Rt=200ms	SOT-25	28cp	VD17	6g	Tor
<u>7RE</u>	XC6111E546MR	Vdet-IC	4.6V±2%, -MR, -Reset PPO, Wt=400ms, Rt=200ms	SOT-25	28cp	VD17	6g	Tor
<u>7RH</u>	XC6111E517MR	Vdet-IC	1.7V±2%, -MR, -Reset PPO, Wt=400ms, Rt=200ms	SOT-25	28cp	VD17	6g	Tor
<u>7RH</u>	XC6111E547MR	Vdet-IC	4.7V±2%, -MR, -Reset PPO, Wt=400ms, Rt=200ms	SOT-25	28cp	VD17	6g	Tor
<u>7RK</u>	XC6111E518MR	Vdet-IC	1.8V±2%, -MR, -Reset PPO, Wt=400ms, Rt=200ms	SOT-25	28cp	VD17	6g	Tor
<u>7RK</u>	XC6111E548MR	Vdet-IC	4.8V±2%, -MR, -Reset PPO, Wt=400ms, Rt=200ms	SOT-25	28cp	VD17	6g	Tor
<u>7RL</u>	XC6111E519MR	Vdet-IC	1.9V±2%, -MR, -Reset PPO, Wt=400ms, Rt=200ms	SOT-25	28cp	VD17	6g	Tor
<u>7RL</u>	XC6111E549MR	Vdet-IC	4.9V±2%, -MR, -Reset PPO, Wt=400ms, Rt=200ms	SOT-25	28cp	VD17	6g	Tor
<u>7RM</u>	XC6111E520MR	Vdet-IC	2.0V±2%, -MR, -Reset PPO, Wt=400ms, Rt=200ms	SOT-25	28cp	VD17	6g	Tor
<u>7RM</u>	XC6111E550MR	Vdet-IC	5.0V±2%, -MR, -Reset PPO, Wt=400ms, Rt=200ms	SOT-25	28cp	VD17	6g	Tor
<u>7RN</u>	XC6111E521MR	Vdet-IC	2.1V±2%, -MR, -Reset PPO, Wt=400ms, Rt=200ms	SOT-25	28cp	VD17	6g	Tor
<u>7RP</u>	XC6111E522MR	Vdet-IC	2.2V±2%, -MR, -Reset PPO, Wt=400ms, Rt=200ms	SOT-25	28cp	VD17	6g	Tor
<u>7RR</u>	XC6111E523MR	Vdet-IC	2.3V±2%, -MR, -Reset PPO, Wt=400ms, Rt=200ms	SOT-25	28cp	VD17	6g	Tor
<u>7RS</u>	XC6111E524MR	Vdet-IC	2.4V±2%, -MR, -Reset PPO, Wt=400ms, Rt=200ms	SOT-25	28cp	VD17	6g	Tor
<u>7RT</u>	XC6111E525MR	Vdet-IC	2.5V±2%, -MR, -Reset PPO, Wt=400ms, Rt=200ms	SOT-25	28cp	VD17	6g	Tor
<u>7RU</u>	XC6111E526MR	Vdet-IC	2.6V±2%, -MR, -Reset PPO, Wt=400ms, Rt=200ms	SOT-25	28cp	VD17	6g	Tor
<u>7RV</u>	XC6111E527MR	Vdet-IC	2.7V±2%, -MR, -Reset PPO, Wt=400ms, Rt=200ms	SOT-25	28cp	VD17	6g	Tor
<u>7RX</u>	XC6111E528MR	Vdet-IC	2.8V±2%, -MR, -Reset PPO, Wt=400ms, Rt=200ms	SOT-25	28cp	VD17	6g	Tor
<u>7RY</u>	XC6111E529MR	Vdet-IC	2.9V±2%, -MR, -Reset PPO, Wt=400ms, Rt=200ms	SOT-25	28cp	VD17	6g	Tor
<u>7RZ</u>	XC6111E530MR	Vdet-IC	3.0V±2%, -MR, -Reset PPO, Wt=400ms, Rt=200ms	SOT-25	28cp	VD17	6g	Tor
<u>7S</u>	RN5RF17AA	LVR-IC	LRip, -CE, 1.7V±2%, 1A*	SOT-23-5	28vw	VR6	6g	Ric
<u>7S0</u>	XC6111E631MR	Vdet-IC	3.1V±2%, -MR, -Reset PPO, Wt=1.6s, Rt=200ms	SOT-25	28cp	VD17	6g	Tor
<u>7S00</u>	NC7500M5	CMOS-Logic	2-input NAND gate	SOT-23-5	28Log1	-	6a	F
<u>7S02</u>	NC7502M5	CMOS-Logic	2-input NOR gate	SOT-23-5	28Log2	-	6a	F
<u>7S04</u>	NC7504M5	CMOS-Logic	Inverter	SOT-23-5	28Log6	-	6a	F
<u>7S08</u>	NC7508M5	CMOS-Logic	2-input AND gate	SOT-23-5	28Log3	-	6a	F
<u>7S1</u>	XC6111E632MR	Vdet-IC	3.2V±2%, -MR, -Reset PPO, Wt=1.6s, Rt=200ms	SOT-25	28cp	VD17	6g	Tor
<u>7S14</u>	NC7514M5	CMOS-Logic	Inverting Schmitt-trigger	SOT-23-5	28Log7	-	6a	F
<u>7S2</u>	XC6111E633MR	Vdet-IC	3.3V±2%, -MR, -Reset PPO, Wt=1.6s, Rt=200ms	SOT-25	28cp	VD17	6g	Tor
<u>7S3</u>	XC6111E634MR	Vdet-IC	3.4V±2%, -MR, -Reset PPO, Wt=1.6s, Rt=200ms	SOT-25	28cp	VD17	6g	Tor
<u>7S32</u>	NC7532M5	CMOS-Logic	2-input OR gate	SOT-23-5	28Log4	-	6a	F
<u>7S4</u>	XC6111E635MR	Vdet-IC	3.5V±2%, -MR, -Reset PPO, Wt=1.6s, Rt=200ms	SOT-25	28cp	VD17	6g	Tor



SMD code	Type	Function	Short description	Case	Pinout	Sch.	St.	Mnf.
<u>7S5</u>	XC6111E636MR	Vdet-IC	3.6V±2%, -MR, -Reset PPO, Wt=1.6s, Rt=200ms	SOT-25	28cp	VD17	6g	Tor
<u>7S6</u>	XC6111E637MR	Vdet-IC	3.7V±2%, -MR, -Reset PPO, Wt=1.6s, Rt=200ms	SOT-25	28cp	VD17	6g	Tor
<u>7S7</u>	XC6111E638MR	Vdet-IC	3.8V±2%, -MR, -Reset PPO, Wt=1.6s, Rt=200ms	SOT-25	28cp	VD17	6g	Tor
<u>7S8</u>	XC6111E639MR	Vdet-IC	3.9V±2%, -MR, -Reset PPO, Wt=1.6s, Rt=200ms	SOT-25	28cp	VD17	6g	Tor
<u>7S88</u>	NC7S86M5	CMOS-Logic	2-input EXCLUSIVE-OR gate	SOT-23-5	28/Log5	-	6a	F
<u>7S9</u>	XC6111E640MR	Vdet-IC	4.0V±2%, -MR, -Reset PPO, Wt=1.6s, Rt=200ms	SOT-25	28cp	VD17	6g	Tor
<u>7SA</u>	XC6111E641MR	Vdet-IC	4.1V±2%, -MR, -Reset PPO, Wt=1.6s, Rt=200ms	SOT-25	28cp	VD17	6g	Tor
<u>7SB</u>	XC6111E642MR	Vdet-IC	4.2V±2%, -MR, -Reset PPO, Wt=1.6s, Rt=200ms	SOT-25	28cp	VD17	6g	Tor
<u>7SC</u>	XC6111E643MR	Vdet-IC	4.3V±2%, -MR, -Reset PPO, Wt=1.6s, Rt=200ms	SOT-25	28cp	VD17	6g	Tor
<u>7SD</u>	XC6111E644MR	Vdet-IC	4.4V±2%, -MR, -Reset PPO, Wt=1.6s, Rt=200ms	SOT-25	28cp	VD17	6g	Tor
<u>7SE</u>	XC6111E645MR	Vdet-IC	4.5V±2%, -MR, -Reset PPO, Wt=1.6s, Rt=200ms	SOT-25	28cp	VD17	6g	Tor
<u>7SF</u>	XC6111E616MR	Vdet-IC	1.6V±2%, -MR, -Reset PPO, Wt=1.6s, Rt=200ms	SOT-25	28cp	VD17	6g	Tor
<u>7SF</u>	XC6111E646MR	Vdet-IC	4.6V±2%, -MR, -Reset PPO, Wt=1.6s, Rt=200ms	SOT-25	28cp	VD17	6g	Tor
<u>7SH</u>	XC6111E617MR	Vdet-IC	1.7V±2%, -MR, -Reset PPO, Wt=1.6s, Rt=200ms	SOT-25	28cp	VD17	6g	Tor
<u>7SH</u>	XC6111E647MR	Vdet-IC	4.7V±2%, -MR, -Reset PPO, Wt=1.6s, Rt=200ms	SOT-25	28cp	VD17	6g	Tor
<u>7SK</u>	XC6111E618MR	Vdet-IC	1.8V±2%, -MR, -Reset PPO, Wt=1.6s, Rt=200ms	SOT-25	28cp	VD17	6g	Tor
<u>7SK</u>	XC6111E648MR	Vdet-IC	4.8V±2%, -MR, -Reset PPO, Wt=1.6s, Rt=200ms	SOT-25	28cp	VD17	6g	Tor
<u>7SL</u>	XC6111E619MR	Vdet-IC	1.9V±2%, -MR, -Reset PPO, Wt=1.6s, Rt=200ms	SOT-25	28cp	VD17	6g	Tor
<u>7SL</u>	XC6111E649MR	Vdet-IC	4.9V±2%, -MR, -Reset PPO, Wt=1.6s, Rt=200ms	SOT-25	28cp	VD17	6g	Tor
<u>7SM</u>	XC6111E620MR	Vdet-IC	2.0V±2%, -MR, -Reset PPO, Wt=1.6s, Rt=200ms	SOT-25	28cp	VD17	6g	Tor
<u>7SM</u>	XC6111E650MR	Vdet-IC	5.0V±2%, -MR, -Reset PPO, Wt=1.6s, Rt=200ms	SOT-25	28cp	VD17	6g	Tor
<u>7SN</u>	XC6111E621MR	Vdet-IC	2.1V±2%, -MR, -Reset PPO, Wt=1.6s, Rt=200ms	SOT-25	28cp	VD17	6g	Tor
<u>7SP</u>	XC6111E622MR	Vdet-IC	2.2V±2%, -MR, -Reset PPO, Wt=1.6s, Rt=200ms	SOT-25	28cp	VD17	6g	Tor
<u>7SR</u>	XC6111E623MR	Vdet-IC	2.3V±2%, -MR, -Reset PPO, Wt=1.6s, Rt=200ms	SOT-25	28cp	VD17	6g	Tor
<u>7SS</u>	XC6111E624MR	Vdet-IC	2.4V±2%, -MR, -Reset PPO, Wt=1.6s, Rt=200ms	SOT-25	28cp	VD17	6g	Tor
<u>7ST</u>	XC6111E625MR	Vdet-IC	2.5V±2%, -MR, -Reset PPO, Wt=1.6s, Rt=200ms	SOT-25	28cp	VD17	6g	Tor
<u>7SU</u>	XC6111E626MR	Vdet-IC	2.6V±2%, -MR, -Reset PPO, Wt=1.6s, Rt=200ms	SOT-25	28cp	VD17	6g	Tor
<u>7SU4</u>	NC7SU04M5	CMOS-Logic	Inverter	SOT-23-5	28/Log6	-	6a	F
<u>7SV</u>	XC6111E627MR	Vdet-IC	2.7V±2%, -MR, -Reset PPO, Wt=1.6s, Rt=200ms	SOT-25	28cp	VD17	6g	Tor
<u>7SX</u>	XC6111E628MR	Vdet-IC	2.8V±2%, -MR, -Reset PPO, Wt=1.6s, Rt=200ms	SOT-25	28cp	VD17	6g	Tor
<u>7SY</u>	XC6111E629MR	Vdet-IC	2.9V±2%, -MR, -Reset PPO, Wt=1.6s, Rt=200ms	SOT-25	28cp	VD17	6g	Tor
<u>7SZ</u>	XC6111E630MR	Vdet-IC	3.0V±2%, -MR, -Reset PPO, Wt=1.6s, Rt=200ms	SOT-25	28cp	VD17	6g	Tor
<u>7T</u>	RM5RF17BA	LVR-IC	LRip, +CE, 1.7V±2%, 1A*	SOT-23-5	28vw	VR6	6g	Ric
<u>7T0</u>	XC6111F531MR	Vdet-IC	3.1V±2%, -MR, -Reset PPO, Wt=400ms, Rt=400ms	SOT-25	28cp	VD17	6g	Tor
<u>7T1</u>	XC6111F532MR	Vdet-IC	3.2V±2%, -MR, -Reset PPO, Wt=400ms, Rt=400ms	SOT-25	28cp	VD17	6g	Tor
<u>7T2</u>	XC6111F533MR	Vdet-IC	3.3V±2%, -MR, -Reset PPO, Wt=400ms, Rt=400ms	SOT-25	28cp	VD17	6g	Tor
<u>7T3</u>	XC6111F534MR	Vdet-IC	3.4V±2%, -MR, -Reset PPO, Wt=400ms, Rt=400ms	SOT-25	28cp	VD17	6g	Tor
<u>7T4</u>	XC6111F535MR	Vdet-IC	3.5V±2%, -MR, -Reset PPO, Wt=400ms, Rt=400ms	SOT-25	28cp	VD17	6g	Tor
<u>7T5</u>	XC6111F536MR	Vdet-IC	3.6V±2%, -MR, -Reset PPO, Wt=400ms, Rt=400ms	SOT-25	28cp	VD17	6g	Tor
<u>7T6</u>	XC6111F537MR	Vdet-IC	3.7V±2%, -MR, -Reset PPO, Wt=400ms, Rt=400ms	SOT-25	28cp	VD17	6g	Tor
<u>7T7</u>	XC6111F538MR	Vdet-IC	3.8V±2%, -MR, -Reset PPO, Wt=400ms, Rt=400ms	SOT-25	28cp	VD17	6g	Tor
<u>7T8</u>	XC6111F539MR	Vdet-IC	3.9V±2%, -MR, -Reset PPO, Wt=400ms, Rt=400ms	SOT-25	28cp	VD17	6g	Tor
<u>7T9</u>	XC6111F540MR	Vdet-IC	4.0V±2%, -MR, -Reset PPO, Wt=400ms, Rt=400ms	SOT-25	28cp	VD17	6g	Tor
<u>7TA</u>	XC6111F541MR	Vdet-IC	4.1V±2%, -MR, -Reset PPO, Wt=400ms, Rt=400ms	SOT-25	28cp	VD17	6g	Tor
<u>7TB</u>	XC6111F542MR	Vdet-IC	4.2V±2%, -MR, -Reset PPO, Wt=400ms, Rt=400ms	SOT-25	28cp	VD17	6g	Tor
<u>7TC</u>	XC6111F543MR	Vdet-IC	4.3V±2%, -MR, -Reset PPO, Wt=400ms, Rt=400ms	SOT-25	28cp	VD17	6g	Tor
<u>7TD</u>	XC6111F544MR	Vdet-IC	4.4V±2%, -MR, -Reset PPO, Wt=400ms, Rt=400ms	SOT-25	28cp	VD17	6g	Tor
<u>7TE</u>	XC6111F545MR	Vdet-IC	4.5V±2%, -MR, -Reset PPO, Wt=400ms, Rt=400ms	SOT-25	28cp	VD17	6g	Tor
<u>7TF</u>	XC6111F516MR	Vdet-IC	1.6V±2%, -MR, -Reset PPO, Wt=400ms, Rt=400ms	SOT-25	28cp	VD17	6g	Tor
<u>7TF</u>	XC6111F546MR	Vdet-IC	4.6V±2%, -MR, -Reset PPO, Wt=400ms, Rt=400ms	SOT-25	28cp	VD17	6g	Tor
<u>7TH</u>	XC6111F517MR	Vdet-IC	1.7V±2%, -MR, -Reset PPO, Wt=400ms, Rt=400ms	SOT-25	28cp	VD17	6g	Tor
<u>7TH</u>	XC6111F547MR	Vdet-IC	4.7V±2%, -MR, -Reset PPO, Wt=400ms, Rt=400ms	SOT-25	28cp	VD17	6g	Tor
<u>7TK</u>	XC6111F518MR	Vdet-IC	1.8V±2%, -MR, -Reset PPO, Wt=400ms, Rt=400ms	SOT-25	28cp	VD17	6g	Tor
<u>7TK</u>	XC6111F548MR	Vdet-IC	4.8V±2%, -MR, -Reset PPO, Wt=400ms, Rt=400ms	SOT-25	28cp	VD17	6g	Tor
<u>7TL</u>	XC6111F519MR	Vdet-IC	1.9V±2%, -MR, -Reset PPO, Wt=400ms, Rt=400ms	SOT-25	28cp	VD17	6g	Tor
<u>7TL</u>	XC6111F549MR	Vdet-IC	4.9V±2%, -MR, -Reset PPO, Wt=400ms, Rt=400ms	SOT-25	28cp	VD17	6g	Tor
<u>7TM</u>	XC6111F520MR	Vdet-IC	2.0V±2%, -MR, -Reset PPO, Wt=400ms, Rt=400ms	SOT-25	28cp	VD17	6g	Tor
<u>7TM</u>	XC6111F550MR	Vdet-IC	5.0V±2%, -MR, -Reset PPO, Wt=400ms, Rt=400ms	SOT-25	28cp	VD17	6g	Tor
<u>7TN</u>	XC6111F521MR	Vdet-IC	2.1V±2%, -MR, -Reset PPO, Wt=400ms, Rt=400ms	SOT-25	28cp	VD17	6g	Tor
<u>7TP</u>	XC6111F522MR	Vdet-IC	2.2V±2%, -MR, -Reset PPO, Wt=400ms, Rt=400ms	SOT-25	28cp	VD17	6g	Tor
<u>7TR</u>	XC6111F523MR	Vdet-IC	2.3V±2%, -MR, -Reset PPO, Wt=400ms, Rt=400ms	SOT-25	28cp	VD17	6g	Tor
<u>7TS</u>	XC6111F524MR	Vdet-IC	2.4V±2%, -MR, -Reset PPO, Wt=400ms, Rt=400ms	SOT-25	28cp	VD17	6g	Tor
<u>7TT</u>	XC6111F525MR	Vdet-IC	2.5V±2%, -MR, -Reset PPO, Wt=400ms, Rt=400ms	SOT-25	28cp	VD17	6g	Tor
<u>7TU</u>	XC6111F526MR	Vdet-IC	2.6V±2%, -MR, -Reset PPO, Wt=400ms, Rt=400ms	SOT-25	28cp	VD17	6g	Tor
<u>7TV</u>	XC6111F527MR	Vdet-IC	2.7V±2%, -MR, -Reset PPO, Wt=400ms, Rt=400ms	SOT-25	28cp	VD17	6g	Tor
<u>7TX</u>	XC6111F528MR	Vdet-IC	2.8V±2%, -MR, -Reset PPO, Wt=400ms, Rt=400ms	SOT-25	28cp	VD17	6g	Tor
<u>7TY</u>	XC6111F529MR	Vdet-IC	2.9V±2%, -MR, -Reset PPO, Wt=400ms, Rt=400ms	SOT-25	28cp	VD17	6g	Tor
<u>7TZ</u>	XC6111F530MR	Vdet-IC	3.0V±2%, -MR, -Reset PPO, Wt=400ms, Rt=400ms	SOT-25	28cp	VD17	6g	Tor
<u>7U</u>	R1210N271C	DC/DC-IC	PWM step-up, 2.7V, 100kHz	SOT-23-5	28sc	DC3	6g	Ric
<u>7U0</u>	XC6111F631MR	Vdet-IC	3.1V±2%, -MR, -Reset PPO, Wt=1.6s, Rt=400ms	SOT-25	28cp	VD17	6g	Tor



SMD code	Type	Function	Short description	Case	Pinout	Sch.	St.	Mnf.
7X	R1210N471C	DC/DC-IC	PWM step-up, 4.7V, 100kHz	SOT-23-5	28sc	DC3	6g	Ric
7Y	R1210N571C	DC/DC-IC	PWM step-up, 5.7V, 100kHz	SOT-23-5	28sc	DC3	6g	Ric
7Z	R1210N271D	DC/DC-IC	PWM step-up, 2.7V, 180kHz	SOT-23-5	28sc	DC3	6g	Ric
7Z00	NC7SZ00M5	CMOS-Logic	2-input NAND gate	SOT-23-5	28/Log1	-	6a	F
7Z02	NC7SZ02M5	CMOS-Logic	2-input NOR gate	SOT-23-5	28/Log2	-	6a	F
7Z08	NC7SZ08M5	CMOS-Logic	2-input AND gate	SOT-23-5	28/Log3	-	6a	F
8.2Z	MAZL082H	SA-Z-diode	Quad, 8.2V, 5mA, 200mW	SC-74A	28bc	-	6a	Pan
8.2Z	MAZM082H	SA-Z-diode	Quad, 8.2V, 5mA, 150mW	SSMini5	30bc	-	6a	Pan
8.2Z	MAZZ082H	SA-Z-diode	Quad, 8.2V, 5mA, 200mW	SMini5	30bc	-	6a	Pan
80	RN5RF30BA	LVR-IC	LRip, +CE, 3V±2%, 1A*	SOT-23-5	28vw	VR6	6g	Ric
80	RN5RZ30BA	LVR-IC	LDO, LN, +CE, 3V±2%, 100mA	SOT-23-5	28vrt	VR4	6g	Ric
800	XC6112A131MR	Vdet-IC	3.1V±2%, -MR, -Reset ODO, Wt=6.25ms, Rt=3.13ms	SOT-25	28cp	VD16	6g	Tor
801	XC6112A132MR	Vdet-IC	3.2V±2%, -MR, -Reset ODO, Wt=6.25ms, Rt=3.13ms	SOT-25	28cp	VD16	6g	Tor
802	XC6112A133MR	Vdet-IC	3.3V±2%, -MR, -Reset ODO, Wt=6.25ms, Rt=3.13ms	SOT-25	28cp	VD16	6g	Tor
803	XC6112A134MR	Vdet-IC	3.4V±2%, -MR, -Reset ODO, Wt=6.25ms, Rt=3.13ms	SOT-25	28cp	VD16	6g	Tor
804	XC6112A135MR	Vdet-IC	3.5V±2%, -MR, -Reset ODO, Wt=6.25ms, Rt=3.13ms	SOT-25	28cp	VD16	6g	Tor
805	XC6112A136MR	Vdet-IC	3.6V±2%, -MR, -Reset ODO, Wt=6.25ms, Rt=3.13ms	SOT-25	28cp	VD16	6g	Tor
806	XC6112A137MR	Vdet-IC	3.7V±2%, -MR, -Reset ODO, Wt=6.25ms, Rt=3.13ms	SOT-25	28cp	VD16	6g	Tor
807	XC6112A138MR	Vdet-IC	3.8V±2%, -MR, -Reset ODO, Wt=6.25ms, Rt=3.13ms	SOT-25	28cp	VD16	6g	Tor
808	XC6112A139MR	Vdet-IC	3.9V±2%, -MR, -Reset ODO, Wt=6.25ms, Rt=3.13ms	SOT-25	28cp	VD16	6g	Tor
809	XC6112A140MR	Vdet-IC	4.0V±2%, -MR, -Reset ODO, Wt=6.25ms, Rt=3.13ms	SOT-25	28cp	VD16	6g	Tor
809	XC9208A093M	DC/DC-IC	PWM-PWM/PFM st-down, 300kHz, 0.9V±2%, 600mA, +CE	SOT-25	28zq	DC1	6g	Tor
80A	RP103N121B	LVR-IC	LDO, 1.2V±1%, 150mA, +CE	SOT-23-5	28cx	VR4	6g	Ric
80A	XC6112A141MR	Vdet-IC	4.1V±2%, -MR, -Reset ODO, Wt=6.25ms, Rt=3.13ms	SOT-25	28cp	VD16	6g	Tor
80B	RP103N131B	LVR-IC	LDO, 1.3V±1%, 150mA, +CE	SOT-23-5	28cx	VR4	6g	Ric
80B	XC6112A142MR	Vdet-IC	4.2V±2%, -MR, -Reset ODO, Wt=6.25ms, Rt=3.13ms	SOT-25	28cp	VD16	6g	Tor
80C	RP103N151B	LVR-IC	LDO, 1.5V±1%, 150mA, +CE	SOT-23-5	28cx	VR4	6g	Ric
80C	XC6112A143MR	Vdet-IC	4.3V±2%, -MR, -Reset ODO, Wt=6.25ms, Rt=3.13ms	SOT-25	28cp	VD16	6g	Tor
80D	RP103N181B	LVR-IC	LDO, 1.8V±1%, 150mA, +CE	SOT-23-5	28cx	VR4	6g	Ric
80D	XC6112A144MR	Vdet-IC	4.4V±2%, -MR, -Reset ODO, Wt=6.25ms, Rt=3.13ms	SOT-25	28cp	VD16	6g	Tor
80E	RP103N181B5	LVR-IC	LDO, 1.85V±1%, 150mA, +CE	SOT-23-5	28cx	VR4	6g	Ric
80E	XC6112A145MR	Vdet-IC	4.5V±2%, -MR, -Reset ODO, Wt=6.25ms, Rt=3.13ms	SOT-25	28cp	VD16	6g	Tor
80F	RP103N191B	LVR-IC	LDO, 1.9V±1%, 150mA, +CE	SOT-23-5	28cx	VR4	6g	Ric
80F	XC6112A116MR	Vdet-IC	1.6V±2%, -MR, -Reset ODO, Wt=6.25ms, Rt=3.13ms	SOT-25	28cp	VD16	6g	Tor
80F	XC6112A146MR	Vdet-IC	4.6V±2%, -MR, -Reset ODO, Wt=6.25ms, Rt=3.13ms	SOT-25	28cp	VD16	6g	Tor
80G	RP103N201B	LVR-IC	LDO, 2V±1%, 150mA, +CE	SOT-23-5	28cx	VR4	6g	Ric
80H	RP103N251B	LVR-IC	LDO, 2.5V±1%, 150mA, +CE	SOT-23-5	28cx	VR4	6g	Ric
80H	XC6112A117MR	Vdet-IC	1.7V±2%, -MR, -Reset ODO, Wt=6.25ms, Rt=3.13ms	SOT-25	28cp	VD16	6g	Tor
80H	XC6112A147MR	Vdet-IC	4.7V±2%, -MR, -Reset ODO, Wt=6.25ms, Rt=3.13ms	SOT-25	28cp	VD16	6g	Tor
80J	RP103N261B	LVR-IC	LDO, 2.6V±1%, 150mA, +CE	SOT-23-5	28cx	VR4	6g	Ric
80K	RP103N271B	LVR-IC	LDO, 2.7V±1%, 150mA, +CE	SOT-23-5	28cx	VR4	6g	Ric
80K	XC6112A118MR	Vdet-IC	1.8V±2%, -MR, -Reset ODO, Wt=6.25ms, Rt=3.13ms	SOT-25	28cp	VD16	6g	Tor
80K	XC6112A148MR	Vdet-IC	4.8V±2%, -MR, -Reset ODO, Wt=6.25ms, Rt=3.13ms	SOT-25	28cp	VD16	6g	Tor
80L	RP103N281B	LVR-IC	LDO, 2.8V±1%, 150mA, +CE	SOT-23-5	28cx	VR4	6g	Ric
80L	XC6112A119MR	Vdet-IC	1.9V±2%, -MR, -Reset ODO, Wt=6.25ms, Rt=3.13ms	SOT-25	28cp	VD16	6g	Tor
80L	XC6112A149MR	Vdet-IC	4.9V±2%, -MR, -Reset ODO, Wt=6.25ms, Rt=3.13ms	SOT-25	28cp	VD16	6g	Tor
80M	RP103N281B5	LVR-IC	LDO, 2.85V±1%, 150mA, +CE	SOT-23-5	28cx	VR4	6g	Ric
80M	XC6112A120MR	Vdet-IC	2.0V±2%, -MR, -Reset ODO, Wt=6.25ms, Rt=3.13ms	SOT-25	28cp	VD16	6g	Tor
80M	XC6112A150MR	Vdet-IC	5.0V±2%, -MR, -Reset ODO, Wt=6.25ms, Rt=3.13ms	SOT-25	28cp	VD16	6g	Tor
80M	XC9208A096M	DC/DC-IC	PWM-PWM/PFM st-down, 600kHz, 0.9V±2%, 600mA, +CE	SOT-25	28zq	DC1	6g	Tor
80N	RP103N291B	LVR-IC	LDO, 2.9V±1%, 150mA, +CE	SOT-23-5	28cx	VR4	6g	Ric
80N	XC6112A121MR	Vdet-IC	2.1V±2%, -MR, -Reset ODO, Wt=6.25ms, Rt=3.13ms	SOT-25	28cp	VD16	6g	Tor
80P	RP103N301B	LVR-IC	LDO, 3V±1%, 150mA, +CE	SOT-23-5	28cx	VR4	6g	Ric
80P	XC6112A122MR	Vdet-IC	2.2V±2%, -MR, -Reset ODO, Wt=6.25ms, Rt=3.13ms	SOT-25	28cp	VD16	6g	Tor
80Q	RP103N311B	LVR-IC	LDO, 3.1V±1%, 150mA, +CE	SOT-23-5	28cx	VR4	6g	Ric
80R	RP103N331B	LVR-IC	LDO, 3.3V±1%, 150mA, +CE	SOT-23-5	28cx	VR4	6g	Ric
80R	XC6112A123MR	Vdet-IC	2.3V±2%, -MR, -Reset ODO, Wt=6.25ms, Rt=3.13ms	SOT-25	28cp	VD16	6g	Tor
80S	RP103N231B	LVR-IC	LDO, 2.3V±1%, 150mA, +CE	SOT-23-5	28cx	VR4	6g	Ric
80S	XC6112A124MR	Vdet-IC	2.4V±2%, -MR, -Reset ODO, Wt=6.25ms, Rt=3.13ms	SOT-25	28cp	VD16	6g	Tor
80T	RP103N211B	LVR-IC	LDO, 2.1V±1%, 150mA, +CE	SOT-23-5	28cx	VR4	6g	Ric
80T	XC6112A125MR	Vdet-IC	2.5V±2%, -MR, -Reset ODO, Wt=6.25ms, Rt=3.13ms	SOT-25	28cp	VD16	6g	Tor
80U	RP103N321B	LVR-IC	LDO, 3.2V±1%, 150mA, +CE	SOT-23-5	28cx	VR4	6g	Ric
80U	XC6112A126MR	Vdet-IC	2.6V±2%, -MR, -Reset ODO, Wt=6.25ms, Rt=3.13ms	SOT-25	28cp	VD16	6g	Tor
80V	RP103N291B5	LVR-IC	LDO, 2.95V±1%, 150mA, +CE	SOT-23-5	28cx	VR4	6g	Ric
80V	XC6112A127MR	Vdet-IC	2.7V±2%, -MR, -Reset ODO, Wt=6.25ms, Rt=3.13ms	SOT-25	28cp	VD16	6g	Tor
80W	RP103N221B	LVR-IC	LDO, 2.2V±1%, 150mA, +CE	SOT-23-5	28cx	VR4	6g	Ric
80X	RP103N161B	LVR-IC	LDO, 1.6V±1%, 150mA, +CE	SOT-23-5	28cx	VR4	6g	Ric
80X	XC6112A128MR	Vdet-IC	2.8V±2%, -MR, -Reset ODO, Wt=6.25ms, Rt=3.13ms	SOT-25	28cp	VD16	6g	Tor
80Y	RP103N141B	LVR-IC	LDO, 1.4V±1%, 150mA, +CE	SOT-23-5	28cx	VR4	6g	Ric
80Y	XC6112A129MR	Vdet-IC	2.9V±2%, -MR, -Reset ODO, Wt=6.25ms, Rt=3.13ms	SOT-25	28cp	VD16	6g	Tor



SMD code	Type	Function	Short description	Case	Pinout	Sch.	St.Mnf.
80Z	RP103N171B	LVR-IC	LDO, 1.7V±1%, 150mA, +CE	SOT-23-5	28cx	VR4	6g Ric
80Z	XC6112A130MR	Vdet-IC	3.0V±2%, -MR, -Reset ODO, Wt=6.25ms, Rt=3.13ms	SOT-25	28cp	VD16	6g Tor
81	RN5RF31BA	LVR-IC	LRip, +CE, 3.1V±2%, 1A*	SOT-23-5	28vw	VR6	6g Ric
81	RN5RZ31BA	LVR-IC	LDO, LN, +CE, 3.1V±2%, 100mA	SOT-23-5	28wrt	VR4	6g Ric
810	XC6112A231MR	Vdet-IC	3.1V±2%, -MR, -Reset ODO, Wt=50ms, Rt=3.13ms	SOT-25	28cp	VD16	6g Tor
810	XC9208A103M	DC/DC-IC	PWM-PWM/PFM st-down, 300kHz, 1.0V±2%, 600mA, +CE	SOT-25	28zq	DC1	6g Tor
811	XC6112A232MR	Vdet-IC	3.2V±2%, -MR, -Reset ODO, Wt=50ms, Rt=3.13ms	SOT-25	28cp	VD16	6g Tor
811	XC9208A113M	DC/DC-IC	PWM-PWM/PFM st-down, 300kHz, 1.1V±2%, 600mA, +CE	SOT-25	28zq	DC1	6g Tor
811J	SGM811-JXN5	Vdet-IC	4.0V±1.5%, -Reset ODO, -MR	SOT-23-5	28vd2	VD4	6a Sgm
811L	SGM811-LXN5	Vdet-IC	4.63V±1.5%, -Reset ODO, -MR	SOT-23-5	28vd2	VD4	6a Sgm
811M	SGM811-MXN5	Vdet-IC	4.38V±1.5%, -Reset ODO, -MR	SOT-23-5	28vd2	VD4	6a Sgm
811R	SGM811-RXN5	Vdet-IC	2.63V±1.5%, -Reset ODO, -MR	SOT-23-5	28vd2	VD4	6a Sgm
811S	SGM811-SXN5	Vdet-IC	2.93V±1.5%, -Reset ODO, -MR	SOT-23-5	28vd2	VD4	6a Sgm
811T	SGM811-TXN5	Vdet-IC	3.08V±1.5%, -Reset ODO, -MR	SOT-23-5	28vd2	VD4	6a Sgm
811Z	SGM811-ZXN5	Vdet-IC	2.32V±1.5%, -Reset ODO, -MR	SOT-23-5	28vd2	VD4	6a Sgm
812	XC6112A233MR	Vdet-IC	3.3V±2%, -MR, -Reset ODO, Wt=50ms, Rt=3.13ms	SOT-25	28cp	VD16	6g Tor
812	XC9208A123M	DC/DC-IC	PWM-PWM/PFM st-down, 300kHz, 1.2V±2%, 600mA, +CE	SOT-25	28zq	DC1	6g Tor
812J	SGM812-JXN5	Vdet-IC	4.0V±1.5%, +Reset ODO, -MR	SOT-23-5	28vd2	VD4	6a Sgm
812L	SGM812-LXN5	Vdet-IC	4.63V±1.5%, +Reset ODO, -MR	SOT-23-5	28vd2	VD4	6a Sgm
812M	SGM812-MXN5	Vdet-IC	4.38V±1.5%, +Reset ODO, -MR	SOT-23-5	28vd2	VD4	6a Sgm
812R	SGM812-RXN5	Vdet-IC	2.63V±1.5%, +Reset ODO, -MR	SOT-23-5	28vd2	VD4	6a Sgm
812S	SGM812-SXN5	Vdet-IC	2.93V±1.5%, +Reset ODO, -MR	SOT-23-5	28vd2	VD4	6a Sgm
812T	SGM812-TXN5	Vdet-IC	3.08V±1.5%, +Reset ODO, -MR	SOT-23-5	28vd2	VD4	6a Sgm
812Z	SGM812-ZXN5	Vdet-IC	2.32V±1.5%, +Reset ODO, -MR	SOT-23-5	28vd2	VD4	6a Sgm
813	XC6112A234MR	Vdet-IC	3.4V±2%, -MR, -Reset ODO, Wt=50ms, Rt=3.13ms	SOT-25	28cp	VD16	6g Tor
813	XC9208A133M	DC/DC-IC	PWM-PWM/PFM st-down, 300kHz, 1.3V±2%, 600mA, +CE	SOT-25	28zq	DC1	6g Tor
814	XC6112A235MR	Vdet-IC	3.5V±2%, -MR, -Reset ODO, Wt=50ms, Rt=3.13ms	SOT-25	28cp	VD16	6g Tor
814	XC9208A143M	DC/DC-IC	PWM-PWM/PFM st-down, 300kHz, 1.4V±2%, 600mA, +CE	SOT-25	28zq	DC1	6g Tor
815	R1124N151B	LVR-IC	LDO, LN, +CE, 1.5V±2%, 150mA	SOT-23-5	28vt	VR4	6g Ric
815	XC6112A236MR	Vdet-IC	3.6V±2%, -MR, -Reset ODO, Wt=50ms, Rt=3.13ms	SOT-25	28cp	VD16	6g Tor
815	XC9111F151MR	DC/DC-IC	PFM step-up, 100kHz, 1.5V±2.5%, 400mA	SOT-25	28sy	DC13	6g Tor
815	XC9208A153M	DC/DC-IC	PWM-PWM/PFM st-down, 300kHz, 1.5V±2%, 600mA, +CE	SOT-25	28zq	DC1	6g Tor
816	R1124N161B	LVR-IC	LDO, LN, +CE, 1.6V±2%, 150mA	SOT-23-5	28vt	VR4	6g Ric
816	XC6112A237MR	Vdet-IC	3.7V±2%, -MR, -Reset ODO, Wt=50ms, Rt=3.13ms	SOT-25	28cp	VD16	6g Tor
816	XC9111F161MR	DC/DC-IC	PFM step-up, 100kHz, 1.6V±2.5%, 400mA	SOT-25	28sy	DC13	6g Tor
816	XC9208A163M	DC/DC-IC	PWM-PWM/PFM st-down, 300kHz, 1.6V±2%, 600mA, +CE	SOT-25	28zq	DC1	6g Tor
817	R1124N171B	LVR-IC	LDO, LN, +CE, 1.7V±2%, 150mA	SOT-23-5	28vt	VR4	6g Ric
817	XC6112A238MR	Vdet-IC	3.8V±2%, -MR, -Reset ODO, Wt=50ms, Rt=3.13ms	SOT-25	28cp	VD16	6g Tor
817	XC9111F171MR	DC/DC-IC	PFM step-up, 100kHz, 1.7V±2.5%, 400mA	SOT-25	28sy	DC13	6g Tor
817	XC9208A173M	DC/DC-IC	PWM-PWM/PFM st-down, 300kHz, 1.7V±2%, 600mA, +CE	SOT-25	28zq	DC1	6g Tor
818	R1124N181B	LVR-IC	LDO, LN, +CE, 1.8V±2%, 150mA	SOT-23-5	28vt	VR4	6g Ric
818	XC6112A239MR	Vdet-IC	3.9V±2%, -MR, -Reset ODO, Wt=50ms, Rt=3.13ms	SOT-25	28cp	VD16	6g Tor
818	XC9111F181MR	DC/DC-IC	PFM step-up, 100kHz, 1.8V±2.5%, 400mA	SOT-25	28sy	DC13	6g Tor
818	XC9208A183M	DC/DC-IC	PWM-PWM/PFM st-down, 300kHz, 1.8V±2%, 600mA, +CE	SOT-25	28zq	DC1	6g Tor
819	R1124N191B	LVR-IC	LDO, LN, +CE, 1.9V±2%, 150mA	SOT-23-5	28vt	VR4	6g Ric
819	XC6112A240MR	Vdet-IC	4.0V±2%, -MR, -Reset ODO, Wt=50ms, Rt=3.13ms	SOT-25	28cp	VD16	6g Tor
819	XC9111F191MR	DC/DC-IC	PFM step-up, 100kHz, 1.9V±2.5%, 400mA	SOT-25	28sy	DC13	6g Tor
819	XC9208A193M	DC/DC-IC	PWM-PWM/PFM st-down, 300kHz, 1.9V±2%, 600mA, +CE	SOT-25	28zq	DC1	6g Tor
81A	RP103N121D	LVR-IC	LDO, 1.2V±1%, 150mA, +CE, CL	SOT-23-5	28cx	VR4	6g Ric
81A	XC6112A241MR	Vdet-IC	4.1V±2%, -MR, -Reset ODO, Wt=50ms, Rt=3.13ms	SOT-25	28cp	VD16	6g Tor
81A	XC9208A106M	DC/DC-IC	PWM-PWM/PFM st-down, 600kHz, 1.0V±2%, 600mA, +CE	SOT-25	28zq	DC1	6g Tor
81B	RP103N131D	LVR-IC	LDO, 1.3V±1%, 150mA, +CE, CL	SOT-23-5	28cx	VR4	6g Ric
81B	XC6112A242MR	Vdet-IC	4.2V±2%, -MR, -Reset ODO, Wt=50ms, Rt=3.13ms	SOT-25	28cp	VD16	6g Tor
81B	XC9208A116M	DC/DC-IC	PWM-PWM/PFM st-down, 600kHz, 1.1V±2%, 600mA, +CE	SOT-25	28zq	DC1	6g Tor
81C	RP103N151D	LVR-IC	LDO, 1.5V±1%, 150mA, +CE, CL	SOT-23-5	28cx	VR4	6g Ric
81C	XC6112A243MR	Vdet-IC	4.3V±2%, -MR, -Reset ODO, Wt=50ms, Rt=3.13ms	SOT-25	28cp	VD16	6g Tor
81C	XC9208A126M	DC/DC-IC	PWM-PWM/PFM st-down, 600kHz, 1.2V±2%, 600mA, +CE	SOT-25	28zq	DC1	6g Tor
81D	RP103N181D	LVR-IC	LDO, 1.8V±1%, 150mA, +CE, CL	SOT-23-5	28cx	VR4	6g Ric
81D	XC6112A244MR	Vdet-IC	4.4V±2%, -MR, -Reset ODO, Wt=50ms, Rt=3.13ms	SOT-25	28cp	VD16	6g Tor
81D	XC9208A136M	DC/DC-IC	PWM-PWM/PFM st-down, 600kHz, 1.3V±2%, 600mA, +CE	SOT-25	28zq	DC1	6g Tor
81E	RP103N181D5	LVR-IC	LDO, 1.85V±1%, 150mA, +CE, CL	SOT-23-5	28cx	VR4	6g Ric
81E	XC6112A245MR	Vdet-IC	4.5V±2%, -MR, -Reset ODO, Wt=50ms, Rt=3.13ms	SOT-25	28cp	VD16	6g Tor
81E	XC9208A146M	DC/DC-IC	PWM-PWM/PFM st-down, 600kHz, 1.4V±2%, 600mA, +CE	SOT-25	28zq	DC1	6g Tor
81F	RP103N191D	LVR-IC	LDO, 1.9V±1%, 150mA, +CE, CL	SOT-23-5	28cx	VR4	6g Ric
81F	XC6112A216MR	Vdet-IC	1.6V±2%, -MR, -Reset ODO, Wt=50ms, Rt=3.13ms	SOT-25	28cp	VD16	6g Tor
81F	XC6112A246MR	Vdet-IC	4.6V±2%, -MR, -Reset ODO, Wt=50ms, Rt=3.13ms	SOT-25	28cp	VD16	6g Tor
81F	XC9208A156M	DC/DC-IC	PWM-PWM/PFM st-down, 600kHz, 1.5V±2%, 600mA, +CE	SOT-25	28zq	DC1	6g Tor
81G	RP103N201D	LVR-IC	LDO, 2V±1%, 150mA, +CE, CL	SOT-23-5	28cx	VR4	6g Ric
81H	RP103N251D	LVR-IC	LDO, 2.5V±1%, 150mA, +CE, CL	SOT-23-5	28cx	VR4	6g Ric
81H	XC6112A217MR	Vdet-IC	1.7V±2%, -MR, -Reset ODO, Wt=50ms, Rt=3.13ms	SOT-25	28cp	VD16	6g Tor



SMD code	Type	Function	Short description	Case	Pinout	Sch.	St.	Mnf.
81H	XC6112A247MR	Vdet-IC	4.7V±2%, -MR, -Reset ODO, Wt=50ms, Rt=3.13ms	SOT-25	28cp	VD16	6g	Tor
81H	XC9208A166M	DC/DC-IC	PWM-PWM/PFM st-down, 600kHz, 1.6V±2%, 600mA, +CE	SOT-25	28zq	DC1	6g	Tor
81J	RP103N261D	LVR-IC	LDO, 2.6V±1%, 150mA, +CE, CL	SOT-23-5	28cx	VR4	6g	Ric
81K	RP103N271D	LVR-IC	LDO, 2.7V±1%, 150mA, +CE, CL	SOT-23-5	28cx	VR4	6g	Ric
81K	XC6701B18MR	LVR-IC	1.8V±2%, 150mA, +CE	SOT-25	28hw	VR4	6g	Tor
81K	XC6112A218MR	Vdet-IC	1.8V±2%, -MR, -Reset ODO, Wt=50ms, Rt=3.13ms	SOT-25	28cp	VD16	6g	Tor
81K	XC6112A248MR	Vdet-IC	4.8V±2%, -MR, -Reset ODO, Wt=50ms, Rt=3.13ms	SOT-25	28cp	VD16	6g	Tor
81K	XC9208A176M	DC/DC-IC	PWM-PWM/PFM st-down, 600kHz, 1.7V±2%, 600mA, +CE	SOT-25	28zq	DC1	6g	Tor
81L	RP103N281D	LVR-IC	LDO, 2.8V±1%, 150mA, +CE, CL	SOT-23-5	28cx	VR4	6g	Ric
81L	XC6701B19MR	LVR-IC	1.9V±2%, 150mA, +CE	SOT-25	28hw	VR4	6g	Tor
81L	XC6112A219MR	Vdet-IC	1.9V±2%, -MR, -Reset ODO, Wt=50ms, Rt=3.13ms	SOT-25	28cp	VD16	6g	Tor
81L	XC6112A249MR	Vdet-IC	4.9V±2%, -MR, -Reset ODO, Wt=50ms, Rt=3.13ms	SOT-25	28cp	VD16	6g	Tor
81L	XC9208A186M	DC/DC-IC	PWM-PWM/PFM st-down, 600kHz, 1.8V±2%, 600mA, +CE	SOT-25	28zq	DC1	6g	Tor
81M	RP103N281D5	LVR-IC	LDO, 2.85V±1%, 150mA, +CE, CL	SOT-23-5	28cx	VR4	6g	Ric
81M	XC6701B20MR	LVR-IC	2.0V±2%, 150mA, +CE	SOT-25	28hw	VR4	6g	Tor
81M	XC6112A220MR	Vdet-IC	2.0V±2%, -MR, -Reset ODO, Wt=50ms, Rt=3.13ms	SOT-25	28cp	VD16	6g	Tor
81M	XC6112A250MR	Vdet-IC	5.0V±2%, -MR, -Reset ODO, Wt=50ms, Rt=3.13ms	SOT-25	28cp	VD16	6g	Tor
81M	XC9208A196M	DC/DC-IC	PWM-PWM/PFM st-down, 600kHz, 1.9V±2%, 600mA, +CE	SOT-25	28zq	DC1	6g	Tor
81N	RP103N291D	LVR-IC	LDO, 2.9V±1%, 150mA, +CE, CL	SOT-23-5	28cx	VR4	6g	Ric
81N	XC6701B21MR	LVR-IC	2.1V±2%, 150mA, +CE	SOT-25	28hw	VR4	6g	Tor
81N	XC6112A221MR	Vdet-IC	2.1V±2%, -MR, -Reset ODO, Wt=50ms, Rt=3.13ms	SOT-25	28cp	VD16	6g	Tor
81P	RP103N301D	LVR-IC	LDO, 3V±1%, 150mA, +CE, CL	SOT-23-5	28cx	VR4	6g	Ric
81P	XC6701B22MR	LVR-IC	2.2V±2%, 150mA, +CE	SOT-25	28hw	VR4	6g	Tor
81P	XC6112A222MR	Vdet-IC	2.2V±2%, -MR, -Reset ODO, Wt=50ms, Rt=3.13ms	SOT-25	28cp	VD16	6g	Tor
81Q	RP103N311D	LVR-IC	LDO, 3.1V±1%, 150mA, +CE, CL	SOT-23-5	28cx	VR4	6g	Ric
81R	RP103N331D	LVR-IC	LDO, 3.3V±1%, 150mA, +CE, CL	SOT-23-5	28cx	VR4	6g	Ric
81R	XC6701B23MR	LVR-IC	2.3V±2%, 150mA, +CE	SOT-25	28hw	VR4	6g	Tor
81R	XC6112A223MR	Vdet-IC	2.3V±2%, -MR, -Reset ODO, Wt=50ms, Rt=3.13ms	SOT-25	28cp	VD16	6g	Tor
81S	RP103N231D	LVR-IC	LDO, 2.3V±1%, 150mA, +CE, CL	SOT-23-5	28cx	VR4	6g	Ric
81S	XC6701B24MR	LVR-IC	2.4V±2%, 150mA, +CE	SOT-25	28hw	VR4	6g	Tor
81S	XC6112A224MR	Vdet-IC	2.4V±2%, -MR, -Reset ODO, Wt=50ms, Rt=3.13ms	SOT-25	28cp	VD16	6g	Tor
81T	RP103N211D	LVR-IC	LDO, 2.1V±1%, 150mA, +CE, CL	SOT-23-5	28cx	VR4	6g	Ric
81T	XC6701B25MR	LVR-IC	2.5V±2%, 150mA, +CE	SOT-25	28hw	VR4	6g	Tor
81T	XC6112A225MR	Vdet-IC	2.5V±2%, -MR, -Reset ODO, Wt=50ms, Rt=3.13ms	SOT-25	28cp	VD16	6g	Tor
81U	RP103N321D	LVR-IC	LDO, 3.2V±1%, 150mA, +CE, CL	SOT-23-5	28cx	VR4	6g	Ric
81U	XC6701B26MR	LVR-IC	2.6V±2%, 150mA, +CE	SOT-25	28hw	VR4	6g	Tor
81U	XC6112A226MR	Vdet-IC	2.6V±2%, -MR, -Reset ODO, Wt=50ms, Rt=3.13ms	SOT-25	28cp	VD16	6g	Tor
81V	RP103N291D5	LVR-IC	LDO, 2.95V±1%, 150mA, +CE, CL	SOT-23-5	28cx	VR4	6g	Ric
81V	XC6701B27MR	LVR-IC	2.7V±2%, 150mA, +CE	SOT-25	28hw	VR4	6g	Tor
81V	XC6112A227MR	Vdet-IC	2.7V±2%, -MR, -Reset ODO, Wt=50ms, Rt=3.13ms	SOT-25	28cp	VD16	6g	Tor
81W	RP103N221D	LVR-IC	LDO, 2.2V±1%, 150mA, +CE, CL	SOT-23-5	28cx	VR4	6g	Ric
81X	RP103N161D	LVR-IC	LDO, 1.6V±1%, 150mA, +CE, CL	SOT-23-5	28cx	VR4	6g	Ric
81X	XC6701B28MR	LVR-IC	2.8V±2%, 150mA, +CE	SOT-25	28hw	VR4	6g	Tor
81X	XC6112A228MR	Vdet-IC	2.8V±2%, -MR, -Reset ODO, Wt=50ms, Rt=3.13ms	SOT-25	28cp	VD16	6g	Tor
81Y	RP103N141D	LVR-IC	LDO, 1.4V±1%, 150mA, +CE, CL	SOT-23-5	28cx	VR4	6g	Ric
81Y	XC6701B29MR	LVR-IC	2.9V±2%, 150mA, +CE	SOT-25	28hw	VR4	6g	Tor
81Y	XC6112A229MR	Vdet-IC	2.9V±2%, -MR, -Reset ODO, Wt=50ms, Rt=3.13ms	SOT-25	28cp	VD16	6g	Tor
81Y	XC9208A1L6M	DC/DC-IC	PWM-PWM/PFM st-down, 600kHz, 1.85V±2%, 600mA, +CE	SOT-25	28zq	DC1	6g	Tor
81Z	RP103N171D	LVR-IC	LDO, 1.7V±1%, 150mA, +CE, CL	SOT-23-5	28cx	VR4	6g	Ric
81Z	XC6701B30MR	LVR-IC	3.0V±2%, 150mA, +CE	SOT-25	28hw	VR4	6g	Tor
81Z	XC6112A230MR	Vdet-IC	3.0V±2%, -MR, -Reset ODO, Wt=50ms, Rt=3.13ms	SOT-25	28cp	VD16	6g	Tor
81Z	XC9208A1L3M	DC/DC-IC	PWM-PWM/PFM st-down, 300kHz, 1.85V±2%, 600mA, +CE	SOT-25	28zq	DC1	6g	Tor
82	RN5RF32BA	LVR-IC	L Rtp, +CE, 3.2V±2%, 1A*	SOT-23-5	28vw	VR6	6g	Ric
82	RN5RZ32BA	LVR-IC	LDO, LN, +CE, 3.2V±2%, 100mA	SOT-23-5	28wrt	VR4	6g	Ric
820	R1124N201B	LVR-IC	LDO, LN, +CE, 2V±2%, 150mA	SOT-23-5	28vt	VR4	6g	Ric
820	XC6701B31MR	LVR-IC	3.1V±2%, 150mA, +CE	SOT-25	28hw	VR4	6g	Tor
820	XC6112A331MR	Vdet-IC	3.1V±2%, -MR, -Reset ODO, Wt=100ms, Rt=3.13ms	SOT-25	28cp	VD16	6g	Tor
820	XC9111F201MR	DC/DC-IC	PFM step-up, 100kHz, 2.0V±2.5%, 400mA	SOT-25	28sy	DC13	6g	Tor
820	XC9208A203M	DC/DC-IC	PWM-PWM/PFM st-down, 300kHz, 2.0V±2%, 600mA, +CE	SOT-25	28zq	DC1	6g	Tor
821	R1124N211B	LVR-IC	LDO, LN, +CE, 2.1V±2%, 150mA	SOT-23-5	28vt	VR4	6g	Ric
821	XC6701B32MR	LVR-IC	3.2V±2%, 150mA, +CE	SOT-25	28hw	VR4	6g	Tor
821	XC6112A332MR	Vdet-IC	3.2V±2%, -MR, -Reset ODO, Wt=100ms, Rt=3.13ms	SOT-25	28cp	VD16	6g	Tor
821	XC9111F211MR	DC/DC-IC	PFM step-up, 100kHz, 2.1V±2.5%, 400mA	SOT-25	28sy	DC13	6g	Tor
821	XC9208A213M	DC/DC-IC	PWM-PWM/PFM st-down, 300kHz, 2.1V±2%, 600mA, +CE	SOT-25	28zq	DC1	6g	Tor
822	R1124N221B	LVR-IC	LDO, LN, +CE, 2.2V±2%, 150mA	SOT-23-5	28vt	VR4	6g	Ric
822	XC6701B33MR	LVR-IC	3.3V±2%, 150mA, +CE	SOT-25	28hw	VR4	6g	Tor
822	XC6112A333MR	Vdet-IC	3.3V±2%, -MR, -Reset ODO, Wt=100ms, Rt=3.13ms	SOT-25	28cp	VD16	6g	Tor
822	XC9111F221MR	DC/DC-IC	PFM step-up, 100kHz, 2.2V±2.5%, 400mA	SOT-25	28sy	DC13	6g	Tor
822	XC9208A223M	DC/DC-IC	PWM-PWM/PFM st-down, 300kHz, 2.2V±2%, 600mA, +CE	SOT-25	28zq	DC1	6g	Tor
823	R1124N231B	LVR-IC	LDO, LN, +CE, 2.3V±2%, 150mA	SOT-23-5	28vt	VR4	6g	Ric



SMD code	Type	Function	Short description	Case	Pinout	Sch.	St.	Mnf.
823	XC6701B34MR	LVR-IC	3.4V±2%, 150mA, +CE	SOT-25	28hw	VR4	6g	Tor
823	XC6112A334MR	Vdet-IC	3.4V±2%, -MR, -Reset ODO, Wt=100ms, Rt=3.13ms	SOT-25	28cp	VD16	6g	Tor
823	XC9111F231MR	DC/DC-IC	PFM step-up, 100kHz, 2.3V±2.5%, 400mA	SOT-25	28sy	DC13	6g	Tor
823	XC9208A233M	DC/DC-IC	PWM-PWM/PFM st-down, 300kHz, 2.3V±2%, 600mA, +CE	SOT-25	28zq	DC1	6g	Tor
824	R1124N241B	LVR-IC	LDO, LN, +CE, 2.4V±2%, 150mA	SOT-23-5	28vt	VR4	6g	Ric
824	XC6701B335MR	LVR-IC	3.5V±2%, 150mA, +CE	SOT-25	28hw	VR4	6g	Tor
824	XC6112A335MR	Vdet-IC	3.5V±2%, -MR, -Reset ODO, Wt=100ms, Rt=3.13ms	SOT-25	28cp	VD16	6g	Tor
824	XC9111F241MR	DC/DC-IC	PFM step-up, 100kHz, 2.4V±2.5%, 400mA	SOT-25	28sy	DC13	6g	Tor
824	XC9208A243M	DC/DC-IC	PWM-PWM/PFM st-down, 300kHz, 2.4V±2%, 600mA, +CE	SOT-25	28zq	DC1	6g	Tor
825	R1124N251B	LVR-IC	LDO, LN, +CE, 2.5V±2%, 150mA	SOT-23-5	28vt	VR4	6g	Ric
825	XC6701B36MR	LVR-IC	3.6V±2%, 150mA, +CE	SOT-25	28hw	VR4	6g	Tor
825	XC6112A336MR	Vdet-IC	3.6V±2%, -MR, -Reset ODO, Wt=100ms, Rt=3.13ms	SOT-25	28cp	VD16	6g	Tor
825	XC9111F251MR	DC/DC-IC	PFM step-up, 100kHz, 2.5V±2.5%, 400mA	SOT-25	28sy	DC13	6g	Tor
825	XC9208A253M	DC/DC-IC	PWM-PWM/PFM st-down, 300kHz, 2.5V±2%, 600mA, +CE	SOT-25	28zq	DC1	6g	Tor
826	R1124N261B	LVR-IC	LDO, LN, +CE, 2.6V±2%, 150mA	SOT-23-5	28vt	VR4	6g	Ric
826	XC6701B37MR	LVR-IC	3.7V±2%, 150mA, +CE	SOT-25	28hw	VR4	6g	Tor
826	XC6112A337MR	Vdet-IC	3.7V±2%, -MR, -Reset ODO, Wt=100ms, Rt=3.13ms	SOT-25	28cp	VD16	6g	Tor
826	XC9111F261MR	DC/DC-IC	PFM step-up, 100kHz, 2.6V±2.5%, 400mA	SOT-25	28sy	DC13	6g	Tor
826	XC9208A263M	DC/DC-IC	PWM-PWM/PFM st-down, 300kHz, 2.6V±2%, 600mA, +CE	SOT-25	28zq	DC1	6g	Tor
827	R1124N271B	LVR-IC	LDO, LN, +CE, 2.7V±2%, 150mA	SOT-23-5	28vt	VR4	6g	Ric
827	XC6701B38MR	LVR-IC	3.8V±2%, 150mA, +CE	SOT-25	28hw	VR4	6g	Tor
827	XC6112A338MR	Vdet-IC	3.8V±2%, -MR, -Reset ODO, Wt=100ms, Rt=3.13ms	SOT-25	28cp	VD16	6g	Tor
827	XC9111F271MR	DC/DC-IC	PFM step-up, 100kHz, 2.7V±2.5%, 400mA	SOT-25	28sy	DC13	6g	Tor
827	XC9208A273M	DC/DC-IC	PWM-PWM/PFM st-down, 300kHz, 2.7V±2%, 600mA, +CE	SOT-25	28zq	DC1	6g	Tor
828	R1124N281B	LVR-IC	LDO, LN, +CE, CL, 2.8V±2%, 150mA	SOT-23-5	28vt	VR4	6g	Ric
828	XC6701B39MR	LVR-IC	3.9V±2%, 150mA, +CE	SOT-25	28hw	VR4	6g	Tor
828	XC6112A339MR	Vdet-IC	3.9V±2%, -MR, -Reset ODO, Wt=100ms, Rt=3.13ms	SOT-25	28cp	VD16	6g	Tor
828	XC9111F281MR	DC/DC-IC	PFM step-up, 100kHz, 2.8V±2.5%, 400mA	SOT-25	28sy	DC13	6g	Tor
828	XC9208A283M	DC/DC-IC	PWM-PWM/PFM st-down, 300kHz, 2.8V±2%, 600mA, +CE	SOT-25	28zq	DC1	6g	Tor
829	R1124N291B	LVR-IC	LDO, LN, +CE, 2.9V±2%, 150mA	SOT-23-5	28vt	VR4	6g	Ric
829	XC6701B40MR	LVR-IC	4.0V±2%, 150mA, +CE	SOT-25	28hw	VR4	6g	Tor
829	XC6112A340MR	Vdet-IC	4.0V±2%, -MR, -Reset ODO, Wt=100ms, Rt=3.13ms	SOT-25	28cp	VD16	6g	Tor
829	XC9111F291MR	DC/DC-IC	PFM step-up, 100kHz, 2.9V±2.5%, 400mA	SOT-25	28sy	DC13	6g	Tor
829	XC9208A293M	DC/DC-IC	PWM-PWM/PFM st-down, 300kHz, 2.9V±2%, 600mA, +CE	SOT-25	28zq	DC1	6g	Tor
82A	RP103N241B	LVR-IC	LDO, 2.4V±1%, 150mA, +CE	SOT-23-5	28cx	VR4	6g	Ric
82A	XC6701B41MR	LVR-IC	4.1V±2%, 150mA, +CE	SOT-25	28hw	VR4	6g	Tor
82A	XC6112A341MR	Vdet-IC	4.1V±2%, -MR, -Reset ODO, Wt=100ms, Rt=3.13ms	SOT-25	28cp	VD16	6g	Tor
82A	XC9208A206M	DC/DC-IC	PWM-PWM/PFM st-down, 600kHz, 2.0V±2%, 600mA, +CE	SOT-25	28zq	DC1	6g	Tor
82A1	LX8211-00ISE	LVR-IC	Adjustable, 150mA	SOT-23-5	28sg	VR16	6a	Msc
82B	XC6701B42MR	LVR-IC	4.2V±2%, 150mA, +CE	SOT-25	28hw	VR4	6g	Tor
82B	XC6112A342MR	Vdet-IC	4.2V±2%, -MR, -Reset ODO, Wt=100ms, Rt=3.13ms	SOT-25	28cp	VD16	6g	Tor
82B	XC9208A216M	DC/DC-IC	PWM-PWM/PFM st-down, 600kHz, 2.1V±2%, 600mA, +CE	SOT-25	28zq	DC1	6g	Tor
82B1	LX8211-25ISE	LVR-IC	2.5V±0.25%, 150mA	SOT-23-5	28vrx	VR7	6a	Msc
82C	XC6701B43MR	LVR-IC	4.3V±2%, 150mA, +CE	SOT-25	28hw	VR4	6g	Tor
82C	XC6112A343MR	Vdet-IC	4.3V±2%, -MR, -Reset ODO, Wt=100ms, Rt=3.13ms	SOT-25	28cp	VD16	6g	Tor
82C	XC9208A226M	DC/DC-IC	PWM-PWM/PFM st-down, 600kHz, 2.2V±2%, 600mA, +CE	SOT-25	28zq	DC1	6g	Tor
82D	XC6701B44MR	LVR-IC	4.4V±2%, 150mA, +CE	SOT-25	28hw	VR4	6g	Tor
82D	XC6112A344MR	Vdet-IC	4.4V±2%, -MR, -Reset ODO, Wt=100ms, Rt=3.13ms	SOT-25	28cp	VD16	6g	Tor
82D	XC9208A236M	DC/DC-IC	PWM-PWM/PFM st-down, 600kHz, 2.3V±2%, 600mA, +CE	SOT-25	28zq	DC1	6g	Tor
82D1	LX8211-27ISE	LVR-IC	2.7V±0.25%, 150mA	SOT-23-5	28vrx	VR7	6a	Msc
82E	XC6701B45MR	LVR-IC	4.5V±2%, 150mA, +CE	SOT-25	28hw	VR4	6g	Tor
82E	XC6112A345MR	Vdet-IC	4.5V±2%, -MR, -Reset ODO, Wt=100ms, Rt=3.13ms	SOT-25	28cp	VD16	6g	Tor
82E	XC9208A246M	DC/DC-IC	PWM-PWM/PFM st-down, 600kHz, 2.4V±2%, 600mA, +CE	SOT-25	28zq	DC1	6g	Tor
82E1	LX8211-28ISE	LVR-IC	2.8V±0.25%, 150mA	SOT-23-5	28vrx	VR7	6a	Msc
82F	XC6701B46MR	LVR-IC	4.6V±2%, 150mA, +CE	SOT-25	28hw	VR4	6g	Tor
82F	XC6112A346MR	Vdet-IC	1.6V±2%, -MR, -Reset ODO, Wt=100ms, Rt=3.13ms	SOT-25	28cp	VD16	6g	Tor
82F	XC6112A346MR	Vdet-IC	4.6V±2%, -MR, -Reset ODO, Wt=100ms, Rt=3.13ms	SOT-25	28cp	VD16	6g	Tor
82F	XC9208A256M	DC/DC-IC	PWM-PWM/PFM st-down, 600kHz, 2.5V±2%, 600mA, +CE	SOT-25	28zq	DC1	6g	Tor
82G1	LX8211-30ISE	LVR-IC	3V±0.25%, 150mA	SOT-23-5	28vrx	VR7	6a	Msc
82H	XC6701B47MR	LVR-IC	4.7V±2%, 150mA, +CE	SOT-25	28hw	VR4	6g	Tor
82H	XC6112A347MR	Vdet-IC	1.7V±2%, -MR, -Reset ODO, Wt=100ms, Rt=3.13ms	SOT-25	28cp	VD16	6g	Tor
82H	XC6112A347MR	Vdet-IC	4.7V±2%, -MR, -Reset ODO, Wt=100ms, Rt=3.13ms	SOT-25	28cp	VD16	6g	Tor
82H	XC9208A266M	DC/DC-IC	PWM-PWM/PFM st-down, 600kHz, 2.6V±2%, 600mA, +CE	SOT-25	28zq	DC1	6g	Tor
82K	XC6701B48MR	LVR-IC	4.8V±2%, 150mA, +CE	SOT-25	28hw	VR4	6g	Tor
82K	XC6112A348MR	Vdet-IC	1.8V±2%, -MR, -Reset ODO, Wt=100ms, Rt=3.13ms	SOT-25	28cp	VD16	6g	Tor
82K	XC6112A348MR	Vdet-IC	4.8V±2%, -MR, -Reset ODO, Wt=100ms, Rt=3.13ms	SOT-25	28cp	VD16	6g	Tor
82K	XC9208A276M	DC/DC-IC	PWM-PWM/PFM st-down, 600kHz, 2.7V±2%, 600mA, +CE	SOT-25	28zq	DC1	6g	Tor
82K1	LX8211-33ISE	LVR-IC	3.3V±0.25%, 150mA	SOT-23-5	28vrx	VR7	6a	Msc
82L	XC6701B49MR	LVR-IC	4.9V±2%, 150mA, +CE	SOT-25	28hw	VR4	6g	Tor
82L	XC6112A349MR	Vdet-IC	1.9V±2%, -MR, -Reset ODO, Wt=100ms, Rt=3.13ms	SOT-25	28cp	VD16	6g	Tor



SMD code	Type	Function	Short description	Case	Pinout	Sch.	St.	Mnf.
82L	XC6112A349MR	Vdet-IC	4.9V±2%, -MR, -Reset ODO, Wt=100ms, Rt=3.13ms	SOT-25	28cp	VD16	6g	Tor
82L	XC9208A286M	DC/DC-IC	PWM-PWM/PFM st-down, 600kHz, 2.8V±2%, 600mA, +CE	SOT-25	28zq	DC1	6g	Tor
82M	XC6701B50MR	LVR-IC	5.0V±2%, 150mA, +CE	SOT-25	28hw	VR4	6g	Tor
82M	XC6112A320MR	Vdet-IC	2.0V±2%, -MR, -Reset ODO, Wt=100ms, Rt=3.13ms	SOT-25	28cp	VD16	6g	Tor
82M	XC6112A350MR	Vdet-IC	5.0V±2%, -MR, -Reset ODO, Wt=100ms, Rt=3.13ms	SOT-25	28cp	VD16	6g	Tor
82M	XC9208A296M	DC/DC-IC	PWM-PWM/PFM st-down, 600kHz, 2.9V±2%, 600mA, +CE	SOT-25	28zq	DC1	6g	Tor
82N	XC6701B51MR	LVR-IC	5.1V±2%, 150mA, +CE	SOT-25	28hw	VR4	6g	Tor
82N	XC6112A321MR	Vdet-IC	2.1V±2%, -MR, -Reset ODO, Wt=100ms, Rt=3.13ms	SOT-25	28cp	VD16	6g	Tor
82P	XC6701B52MR	LVR-IC	5.2V±2%, 150mA, +CE	SOT-25	28hw	VR4	6g	Tor
82P	XC6112A322MR	Vdet-IC	2.2V±2%, -MR, -Reset ODO, Wt=100ms, Rt=3.13ms	SOT-25	28cp	VD16	6g	Tor
82R	XC6701B53MR	LVR-IC	5.3V±2%, 150mA, +CE	SOT-25	28hw	VR4	6g	Tor
82R	XC6112A323MR	Vdet-IC	2.3V±2%, -MR, -Reset ODO, Wt=100ms, Rt=3.13ms	SOT-25	28cp	VD16	6g	Tor
82S	XC6701B54MR	LVR-IC	5.4V±2%, 150mA, +CE	SOT-25	28hw	VR4	6g	Tor
82S	XC6112A324MR	Vdet-IC	2.4V±2%, -MR, -Reset ODO, Wt=100ms, Rt=3.13ms	SOT-25	28cp	VD16	6g	Tor
82T	XC6701B55MR	LVR-IC	5.5V±2%, 150mA, +CE	SOT-25	28hw	VR4	6g	Tor
82T	XC6112A325MR	Vdet-IC	2.5V±2%, -MR, -Reset ODO, Wt=100ms, Rt=3.13ms	SOT-25	28cp	VD16	6g	Tor
82U	XC6701B56MR	LVR-IC	5.6V±2%, 150mA, +CE	SOT-25	28hw	VR4	6g	Tor
82U	XC6112A326MR	Vdet-IC	2.6V±2%, -MR, -Reset ODO, Wt=100ms, Rt=3.13ms	SOT-25	28cp	VD16	6g	Tor
82V	XC6701B57MR	LVR-IC	5.7V±2%, 150mA, +CE	SOT-25	28hw	VR4	6g	Tor
82V	XC6112A327MR	Vdet-IC	2.7V±2%, -MR, -Reset ODO, Wt=100ms, Rt=3.13ms	SOT-25	28cp	VD16	6g	Tor
82X	XC6701B58MR	LVR-IC	5.8V±2%, 150mA, +CE	SOT-25	28hw	VR4	6g	Tor
82X	XC6112A328MR	Vdet-IC	2.8V±2%, -MR, -Reset ODO, Wt=100ms, Rt=3.13ms	SOT-25	28cp	VD16	6g	Tor
82Y	XC6701B59MR	LVR-IC	5.9V±2%, 150mA, +CE	SOT-25	28hw	VR4	6g	Tor
82Y	XC6112A329MR	Vdet-IC	2.9V±2%, -MR, -Reset ODO, Wt=100ms, Rt=3.13ms	SOT-25	28cp	VD16	6g	Tor
82Y	XC9208A216M	DC/DC-IC	PWM-PWM/PFM st-down, 600kHz, 2.85V±2%, 600mA, +CE	SOT-25	28zq	DC1	6g	Tor
82Z	XC6701B60MR	LVR-IC	6.0V±2%, 150mA, +CE	SOT-25	28hw	VR4	6g	Tor
82Z	XC6112A330MR	Vdet-IC	3.0V±2%, -MR, -Reset ODO, Wt=100ms, Rt=3.13ms	SOT-25	28cp	VD16	6g	Tor
82Z	XC9208A213M	DC/DC-IC	PWM-PWM/PFM st-down, 300kHz, 2.85V±2%, 600mA, +CE	SOT-25	28zq	DC1	6g	Tor
83	RN5RF33BA	LVR-IC	LRip, +CE, 3.3V±2%, 1A*	SOT-23-5	28wv	VR6	6g	Ric
83	RN5RZ33BA	LVR-IC	LDO, LN, +CE, 3.3V±2%, 100mA	SOT-23-5	28wrt	VR4	6g	Ric
830	R1124N301B	LVR-IC	LDO, LN, +CE, 3V±2%, 150mA	SOT-23-5	28vt	VR4	6g	Ric
830	XC6701B61MR	LVR-IC	6.1V±2%, 150mA, +CE	SOT-25	28hw	VR4	6g	Tor
830	XC6112A431MR	Vdet-IC	3.1V±2%, -MR, -Reset ODO, Wt=200ms, Rt=3.13ms	SOT-25	28cp	VD16	6g	Tor
830	XC9111F301MR	DC/DC-IC	PFM step-up, 100kHz, 3.0V±2.5%, 400mA	SOT-25	28sy	DC13	6g	Tor
830	XC9208A303M	DC/DC-IC	PWM-PWM/PFM st-down, 300kHz, 3.0V±2%, 600mA, +CE	SOT-25	28zq	DC1	6g	Tor
831	R1124N311B	LVR-IC	LDO, LN, +CE, 3.1V±2%, 150mA	SOT-23-5	28vt	VR4	6g	Ric
831	XC6701B62MR	LVR-IC	6.2V±2%, 150mA, +CE	SOT-25	28hw	VR4	6g	Tor
831	XC6112A432MR	Vdet-IC	3.2V±2%, -MR, -Reset ODO, Wt=200ms, Rt=3.13ms	SOT-25	28cp	VD16	6g	Tor
831	XC9111F311MR	DC/DC-IC	PFM step-up, 100kHz, 3.1V±2.5%, 400mA	SOT-25	28sy	DC13	6g	Tor
831	XC9208A313M	DC/DC-IC	PWM-PWM/PFM st-down, 300kHz, 3.1V±2%, 600mA, +CE	SOT-25	28zq	DC1	6g	Tor
832	R1124N321B	LVR-IC	LDO, LN, +CE, 3.2V±2%, 150mA	SOT-23-5	28vt	VR4	6g	Ric
832	XC6701B63MR	LVR-IC	6.3V±2%, 150mA, +CE	SOT-25	28hw	VR4	6g	Tor
832	XC6112A433MR	Vdet-IC	3.3V±2%, -MR, -Reset ODO, Wt=200ms, Rt=3.13ms	SOT-25	28cp	VD16	6g	Tor
832	XC9111F321MR	DC/DC-IC	PFM step-up, 100kHz, 3.2V±2.5%, 400mA	SOT-25	28sy	DC13	6g	Tor
832	XC9208A323M	DC/DC-IC	PWM-PWM/PFM st-down, 300kHz, 3.2V±2%, 600mA, +CE	SOT-25	28zq	DC1	6g	Tor
833	R1124N331B	LVR-IC	LDO, LN, +CE, 3.3V±2%, 150mA	SOT-23-5	28vt	VR4	6g	Ric
833	XC6701B64MR	LVR-IC	6.4V±2%, 150mA, +CE	SOT-25	28hw	VR4	6g	Tor
833	XC6112A434MR	Vdet-IC	3.4V±2%, -MR, -Reset ODO, Wt=200ms, Rt=3.13ms	SOT-25	28cp	VD16	6g	Tor
833	XC9111F331MR	DC/DC-IC	PFM step-up, 100kHz, 3.3V±2.5%, 400mA	SOT-25	28sy	DC13	6g	Tor
833	XC9208A333M	DC/DC-IC	PWM-PWM/PFM st-down, 300kHz, 3.3V±2%, 600mA, +CE	SOT-25	28zq	DC1	6g	Tor
834	R1124N341B	LVR-IC	LDO, LN, +CE, 3.4V±2%, 150mA	SOT-23-5	28vt	VR4	6g	Ric
834	XC6701B65MR	LVR-IC	6.5V±2%, 150mA, +CE	SOT-25	28hw	VR4	6g	Tor
834	XC6112A435MR	Vdet-IC	3.5V±2%, -MR, -Reset ODO, Wt=200ms, Rt=3.13ms	SOT-25	28cp	VD16	6g	Tor
834	XC9111F341MR	DC/DC-IC	PFM step-up, 100kHz, 3.4V±2.5%, 400mA	SOT-25	28sy	DC13	6g	Tor
834	XC9208A343M	DC/DC-IC	PWM-PWM/PFM st-down, 300kHz, 3.4V±2%, 600mA, +CE	SOT-25	28zq	DC1	6g	Tor
835	R1124N351B	LVR-IC	LDO, LN, +CE, 3.5V±2%, 150mA	SOT-23-5	28vt	VR4	6g	Ric
835	XC6701B66MR	LVR-IC	6.6V±2%, 150mA, +CE	SOT-25	28hw	VR4	6g	Tor
835	XC6112A436MR	Vdet-IC	3.6V±2%, -MR, -Reset ODO, Wt=200ms, Rt=3.13ms	SOT-25	28cp	VD16	6g	Tor
835	XC9111F351MR	DC/DC-IC	PFM step-up, 100kHz, 3.5V±2.5%, 400mA	SOT-25	28sy	DC13	6g	Tor
835	XC9208A353M	DC/DC-IC	PWM-PWM/PFM st-down, 300kHz, 3.5V±2%, 600mA, +CE	SOT-25	28zq	DC1	6g	Tor
836	R1124N361B	LVR-IC	LDO, LN, +CE, 3.6V±2%, 150mA	SOT-23-5	28vt	VR4	6g	Ric
836	XC6701B67MR	LVR-IC	6.7V±2%, 150mA, +CE	SOT-25	28hw	VR4	6g	Tor
836	XC6112A437MR	Vdet-IC	3.7V±2%, -MR, -Reset ODO, Wt=200ms, Rt=3.13ms	SOT-25	28cp	VD16	6g	Tor
836	XC9111F361MR	DC/DC-IC	PFM step-up, 100kHz, 3.6V±2.5%, 400mA	SOT-25	28sy	DC13	6g	Tor
836	XC9208A363M	DC/DC-IC	PWM-PWM/PFM st-down, 300kHz, 3.6V±2%, 600mA, +CE	SOT-25	28zq	DC1	6g	Tor
837	R1124N371B	LVR-IC	LDO, LN, +CE, 3.7V±2%, 150mA	SOT-23-5	28vt	VR4	6g	Ric
837	XC6701B68MR	LVR-IC	6.8V±2%, 150mA, +CE	SOT-25	28hw	VR4	6g	Tor
837	XC6112A438MR	Vdet-IC	3.8V±2%, -MR, -Reset ODO, Wt=200ms, Rt=3.13ms	SOT-25	28cp	VD16	6g	Tor
837	XC9111F371MR	DC/DC-IC	PFM step-up, 100kHz, 3.7V±2.5%, 400mA	SOT-25	28sy	DC13	6g	Tor
837	XC9208A373M	DC/DC-IC	PWM-PWM/PFM st-down, 300kHz, 3.7V±2%, 600mA, +CE	SOT-25	28zq	DC1	6g	Tor



SMD code	Type	Function	Short description	Case	Pinout	Sch.	St.	Mnf.
838	R1124N381B	LVR-IC	LDO, LN, +CE, 3.8V±2%, 150mA	SOT-23-5	28vt	VR4	6g	Ric
838	XC6701B69MR	LVR-IC	6.9V±2%, 150mA, +CE	SOT-25	28hw	VR4	6g	Tor
838	XC6112A439MR	Vdet-IC	3.9V±2%, -MR, -Reset ODO, Wt=200ms, Rt=3.13ms	SOT-25	28cp	VD16	6g	Tor
838	XC9111F381MR	DC/DC-IC	PFM step-up, 100kHz, 3.8V±2.5%, 400mA	SOT-25	28sy	DC13	6g	Tor
838	XC9208A383M	DC/DC-IC	PWM-PWM/PPM st-down, 300kHz, 3.8V±2%, 600mA, +CE	SOT-25	28zq	DC1	6g	Tor
839	R1124N391B	LVR-IC	LDO, LN, +CE, 3.9V±2%, 150mA	SOT-23-5	28vt	VR4	6g	Ric
839	XC6701B70MR	LVR-IC	7.0V±2%, 150mA, +CE	SOT-25	28hw	VR4	6g	Tor
839	XC6112A440MR	Vdet-IC	4.0V±2%, -MR, -Reset ODO, Wt=200ms, Rt=3.13ms	SOT-25	28cp	VD16	6g	Tor
839	XC9111F391MR	DC/DC-IC	PFM step-up, 100kHz, 3.9V±2.5%, 400mA	SOT-25	28sy	DC13	6g	Tor
839	XC9208A393M	DC/DC-IC	PWM-PWM/PPM st-down, 300kHz, 3.9V±2%, 600mA, +CE	SOT-25	28zq	DC1	6g	Tor
83A	RP103N241D	LVR-IC	LDO, 2.4V±1%, 150mA, +CE, CL	SOT-23-5	28cx	VR4	6g	Ric
83A	XC6701B71MR	LVR-IC	7.1V±2%, 150mA, +CE	SOT-25	28hw	VR4	6g	Tor
83A	XC6112A441MR	Vdet-IC	4.1V±2%, -MR, -Reset ODO, Wt=200ms, Rt=3.13ms	SOT-25	28cp	VD16	6g	Tor
83A	XC9208A306M	DC/DC-IC	PWM-PWM/PPM st-down, 600kHz, 3.0V±2%, 600mA, +CE	SOT-25	28zq	DC1	6g	Tor
83B	XC6701B72MR	LVR-IC	7.2V±2%, 150mA, +CE	SOT-25	28hw	VR4	6g	Tor
83B	XC6112A442MR	Vdet-IC	4.2V±2%, -MR, -Reset ODO, Wt=200ms, Rt=3.13ms	SOT-25	28cp	VD16	6g	Tor
83B	XC9208A316M	DC/DC-IC	PWM-PWM/PPM st-down, 600kHz, 3.1V±2%, 600mA, +CE	SOT-25	28zq	DC1	6g	Tor
83C	XC6701B73MR	LVR-IC	7.3V±2%, 150mA, +CE	SOT-25	28hw	VR4	6g	Tor
83C	XC6112A443MR	Vdet-IC	4.3V±2%, -MR, -Reset ODO, Wt=200ms, Rt=3.13ms	SOT-25	28cp	VD16	6g	Tor
83C	XC9208A326M	DC/DC-IC	PWM-PWM/PPM st-down, 600kHz, 3.2V±2%, 600mA, +CE	SOT-25	28zq	DC1	6g	Tor
83D	XC6701B74MR	LVR-IC	7.4V±2%, 150mA, +CE	SOT-25	28hw	VR4	6g	Tor
83D	XC6112A444MR	Vdet-IC	4.4V±2%, -MR, -Reset ODO, Wt=200ms, Rt=3.13ms	SOT-25	28cp	VD16	6g	Tor
83D	XC9208A336M	DC/DC-IC	PWM-PWM/PPM st-down, 600kHz, 3.3V±2%, 600mA, +CE	SOT-25	28zq	DC1	6g	Tor
83E	XC6701B75MR	LVR-IC	7.5V±2%, 150mA, +CE	SOT-25	28hw	VR4	6g	Tor
83E	XC6112A445MR	Vdet-IC	4.5V±2%, -MR, -Reset ODO, Wt=200ms, Rt=3.13ms	SOT-25	28cp	VD16	6g	Tor
83E	XC9208A346M	DC/DC-IC	PWM-PWM/PPM st-down, 600kHz, 3.4V±2%, 600mA, +CE	SOT-25	28zq	DC1	6g	Tor
83F	XC6701B76MR	LVR-IC	7.6V±2%, 150mA, +CE	SOT-25	28hw	VR4	6g	Tor
83F	XC6112A416MR	Vdet-IC	1.6V±2%, -MR, -Reset ODO, Wt=200ms, Rt=3.13ms	SOT-25	28cp	VD16	6g	Tor
83F	XC6112A446MR	Vdet-IC	4.6V±2%, -MR, -Reset ODO, Wt=200ms, Rt=3.13ms	SOT-25	28cp	VD16	6g	Tor
83F	XC9208A356M	DC/DC-IC	PWM-PWM/PPM st-down, 600kHz, 3.5V±2%, 600mA, +CE	SOT-25	28zq	DC1	6g	Tor
83H	XC6701B77MR	LVR-IC	7.7V±2%, 150mA, +CE	SOT-25	28hw	VR4	6g	Tor
83H	XC6112A417MR	Vdet-IC	1.7V±2%, -MR, -Reset ODO, Wt=200ms, Rt=3.13ms	SOT-25	28cp	VD16	6g	Tor
83H	XC6112A447MR	Vdet-IC	4.7V±2%, -MR, -Reset ODO, Wt=200ms, Rt=3.13ms	SOT-25	28cp	VD16	6g	Tor
83H	XC9208A366M	DC/DC-IC	PWM-PWM/PPM st-down, 600kHz, 3.6V±2%, 600mA, +CE	SOT-25	28zq	DC1	6g	Tor
83K	XC6701B78MR	LVR-IC	7.8V±2%, 150mA, +CE	SOT-25	28hw	VR4	6g	Tor
83K	XC6112A418MR	Vdet-IC	1.8V±2%, -MR, -Reset ODO, Wt=200ms, Rt=3.13ms	SOT-25	28cp	VD16	6g	Tor
83K	XC6112A448MR	Vdet-IC	4.8V±2%, -MR, -Reset ODO, Wt=200ms, Rt=3.13ms	SOT-25	28cp	VD16	6g	Tor
83K	XC9208A376M	DC/DC-IC	PWM-PWM/PPM st-down, 600kHz, 3.7V±2%, 600mA, +CE	SOT-25	28zq	DC1	6g	Tor
83L	XC6701B79MR	LVR-IC	7.9V±2%, 150mA, +CE	SOT-25	28hw	VR4	6g	Tor
83L	XC6112A419MR	Vdet-IC	1.9V±2%, -MR, -Reset ODO, Wt=200ms, Rt=3.13ms	SOT-25	28cp	VD16	6g	Tor
83L	XC6112A449MR	Vdet-IC	4.9V±2%, -MR, -Reset ODO, Wt=200ms, Rt=3.13ms	SOT-25	28cp	VD16	6g	Tor
83L	XC9208A386M	DC/DC-IC	PWM-PWM/PPM st-down, 600kHz, 3.8V±2%, 600mA, +CE	SOT-25	28zq	DC1	6g	Tor
83M	XC6701B80MR	LVR-IC	8.0V±2%, 150mA, +CE	SOT-25	28hw	VR4	6g	Tor
83M	XC6112A420MR	Vdet-IC	2.0V±2%, -MR, -Reset ODO, Wt=200ms, Rt=3.13ms	SOT-25	28cp	VD16	6g	Tor
83M	XC6112A450MR	Vdet-IC	5.0V±2%, -MR, -Reset ODO, Wt=200ms, Rt=3.13ms	SOT-25	28cp	VD16	6g	Tor
83M	XC9208A396M	DC/DC-IC	PWM-PWM/PPM st-down, 600kHz, 3.9V±2%, 600mA, +CE	SOT-25	28zq	DC1	6g	Tor
83N	XC6701B81MR	LVR-IC	8.1V±2%, 150mA, +CE	SOT-25	28hw	VR4	6g	Tor
83N	XC6112A421MR	Vdet-IC	2.1V±2%, -MR, -Reset ODO, Wt=200ms, Rt=3.13ms	SOT-25	28cp	VD16	6g	Tor
83P	XC6701B82MR	LVR-IC	8.2V±2%, 150mA, +CE	SOT-25	28hw	VR4	6g	Tor
83P	XC6112A422MR	Vdet-IC	2.2V±2%, -MR, -Reset ODO, Wt=200ms, Rt=3.13ms	SOT-25	28cp	VD16	6g	Tor
83R	XC6701B83MR	LVR-IC	8.3V±2%, 150mA, +CE	SOT-25	28hw	VR4	6g	Tor
83R	XC6112A423MR	Vdet-IC	2.3V±2%, -MR, -Reset ODO, Wt=200ms, Rt=3.13ms	SOT-25	28cp	VD16	6g	Tor
83S	XC6701B84MR	LVR-IC	8.4V±2%, 150mA, +CE	SOT-25	28hw	VR4	6g	Tor
83S	XC6112A424MR	Vdet-IC	2.4V±2%, -MR, -Reset ODO, Wt=200ms, Rt=3.13ms	SOT-25	28cp	VD16	6g	Tor
83T	XC6701B85MR	LVR-IC	8.5V±2%, 150mA, +CE	SOT-25	28hw	VR4	6g	Tor
83T	XC6112A425MR	Vdet-IC	2.5V±2%, -MR, -Reset ODO, Wt=200ms, Rt=3.13ms	SOT-25	28cp	VD16	6g	Tor
83U	XC6701B86MR	LVR-IC	8.6V±2%, 150mA, +CE	SOT-25	28hw	VR4	6g	Tor
83U	XC6112A426MR	Vdet-IC	2.6V±2%, -MR, -Reset ODO, Wt=200ms, Rt=3.13ms	SOT-25	28cp	VD16	6g	Tor
83V	XC6701B87MR	LVR-IC	8.7V±2%, 150mA, +CE	SOT-25	28hw	VR4	6g	Tor
83V	XC6112A427MR	Vdet-IC	2.7V±2%, -MR, -Reset ODO, Wt=200ms, Rt=3.13ms	SOT-25	28cp	VD16	6g	Tor
83X	XC6701B88MR	LVR-IC	8.8V±2%, 150mA, +CE	SOT-25	28hw	VR4	6g	Tor
83X	XC6112A428MR	Vdet-IC	2.8V±2%, -MR, -Reset ODO, Wt=200ms, Rt=3.13ms	SOT-25	28cp	VD16	6g	Tor
83Y	XC6701B89MR	LVR-IC	8.9V±2%, 150mA, +CE	SOT-25	28hw	VR4	6g	Tor
83Y	XC6112A429MR	Vdet-IC	2.9V±2%, -MR, -Reset ODO, Wt=200ms, Rt=3.13ms	SOT-25	28cp	VD16	6g	Tor
83Z	XC6701B90MR	LVR-IC	9.0V±2%, 150mA, +CE	SOT-25	28hw	VR4	6g	Tor
83Z	XC6112A430MR	Vdet-IC	3.0V±2%, -MR, -Reset ODO, Wt=200ms, Rt=3.13ms	SOT-25	28cp	VD16	6g	Tor
84	RN5RF34BA	LVR-IC	LrIp, +CE, 3.4V±2%, 1A*	SOT-23-5	28vw	VR6	6g	Ric
84	RN5RZ34BA	LVR-IC	LDO, LN, +CE, 3.4V±2%, 100mA	SOT-23-5	28vt	VR4	6g	Ric
840	R1124N401B	LVR-IC	LDO, LN, +CE, 4V±2%, 150mA	SOT-23-5	28vt	VR4	6g	Ric
840	XC6701B91MR	LVR-IC	9.1V±2%, 150mA, +CE	SOT-25	28hw	VR4	6g	Tor



SMD code	Type	Function	Short description	Case	Pinout	Sch.	St.	Mnf.
840	XC6112A531MR	Vdet-IC	3.1V±2%, -MR, -Reset ODO, Wt=400ms, Rt=3.13ms	SOT-25	28cp	VD16	6g	Tor
840	XC9111F401MR	DC/DC-IC	PFM step-up, 100kHz, 4.0V±2.5%, 400mA	SOT-25	28sy	DC13	6g	Tor
840	XC9208A403M	DC/DC-IC	PWM-PWM/PFM st-down, 300kHz, 4.0V±2%, 600mA, +CE	SOT-25	28zq	DC1	6g	Tor
841	R1124N281B5	LVR-IC	LDO, LN, -CE, 2.8V±2%, 150mA	SOT-23-5	28vt	VR4	6g	Ric
841	XC6701B92MR	LVR-IC	9.2V±2%, 150mA, +CE	SOT-25	28hw	VR4	6g	Tor
841	XC6112A532MR	Vdet-IC	3.2V±2%, -MR, -Reset ODO, Wt=400ms, Rt=3.13ms	SOT-25	28cp	VD16	6g	Tor
841	XC9111F411MR	DC/DC-IC	PFM step-up, 100kHz, 4.1V±2.5%, 400mA	SOT-25	28sy	DC13	6g	Tor
842	XC6701B93MR	LVR-IC	9.3V±2%, 150mA, +CE	SOT-25	28hw	VR4	6g	Tor
842	XC6112A533MR	Vdet-IC	3.3V±2%, -MR, -Reset ODO, Wt=400ms, Rt=3.13ms	SOT-25	28cp	VD16	6g	Tor
842	XC9111F421MR	DC/DC-IC	PFM step-up, 100kHz, 4.2V±2.5%, 400mA	SOT-25	28sy	DC13	6g	Tor
843	XC6701B94MR	LVR-IC	9.4V±2%, 150mA, +CE	SOT-25	28hw	VR4	6g	Tor
843	XC6112A534MR	Vdet-IC	3.4V±2%, -MR, -Reset ODO, Wt=400ms, Rt=3.13ms	SOT-25	28cp	VD16	6g	Tor
843	XC9111F431MR	DC/DC-IC	PFM step-up, 100kHz, 4.3V±2.5%, 400mA	SOT-25	28sy	DC13	6g	Tor
844	XC6701B95MR	LVR-IC	9.5V±2%, 150mA, +CE	SOT-25	28hw	VR4	6g	Tor
844	XC6112A535MR	Vdet-IC	3.5V±2%, -MR, -Reset ODO, Wt=400ms, Rt=3.13ms	SOT-25	28cp	VD16	6g	Tor
844	XC9111F441MR	DC/DC-IC	PFM step-up, 100kHz, 4.4V±2.5%, 400mA	SOT-25	28sy	DC13	6g	Tor
845	XC6701B96MR	LVR-IC	9.6V±2%, 150mA, +CE	SOT-25	28hw	VR4	6g	Tor
845	XC6112A536MR	Vdet-IC	3.6V±2%, -MR, -Reset ODO, Wt=400ms, Rt=3.13ms	SOT-25	28cp	VD16	6g	Tor
845	XC9111F451MR	DC/DC-IC	PFM step-up, 100kHz, 4.5V±2.5%, 400mA	SOT-25	28sy	DC13	6g	Tor
846	XC6701B97MR	LVR-IC	9.7V±2%, 150mA, +CE	SOT-25	28hw	VR4	6g	Tor
846	XC6112A537MR	Vdet-IC	3.7V±2%, -MR, -Reset ODO, Wt=400ms, Rt=3.13ms	SOT-25	28cp	VD16	6g	Tor
846	XC9111F461MR	DC/DC-IC	PFM step-up, 100kHz, 4.6V±2.5%, 400mA	SOT-25	28sy	DC13	6g	Tor
847	XC6701B98MR	LVR-IC	9.8V±2%, 150mA, +CE	SOT-25	28hw	VR4	6g	Tor
847	XC6112A538MR	Vdet-IC	3.8V±2%, -MR, -Reset ODO, Wt=400ms, Rt=3.13ms	SOT-25	28cp	VD16	6g	Tor
847	XC9111F471MR	DC/DC-IC	PFM step-up, 100kHz, 4.7V±2.5%, 400mA	SOT-25	28sy	DC13	6g	Tor
848	XC6701B99MR	LVR-IC	9.9V±2%, 150mA, +CE	SOT-25	28hw	VR4	6g	Tor
848	XC6112A539MR	Vdet-IC	3.9V±2%, -MR, -Reset ODO, Wt=400ms, Rt=3.13ms	SOT-25	28cp	VD16	6g	Tor
848	XC9111F481MR	DC/DC-IC	PFM step-up, 100kHz, 4.8V±2.5%, 400mA	SOT-25	28sy	DC13	6g	Tor
849	XC6701BA0MR	LVR-IC	10.0V±2%, 150mA, +CE	SOT-25	28hw	VR4	6g	Tor
849	XC6112A540MR	Vdet-IC	4.0V±2%, -MR, -Reset ODO, Wt=400ms, Rt=3.13ms	SOT-25	28cp	VD16	6g	Tor
849	XC9111F491MR	DC/DC-IC	PFM step-up, 100kHz, 4.9V±2.5%, 400mA	SOT-25	28sy	DC13	6g	Tor
84A	XC6701BA1MR	LVR-IC	10.1V±2%, 150mA, +CE	SOT-25	28hw	VR4	6g	Tor
84A	XC6112A541MR	Vdet-IC	4.1V±2%, -MR, -Reset ODO, Wt=400ms, Rt=3.13ms	SOT-25	28cp	VD16	6g	Tor
84A	XC9208A406M	DC/DC-IC	PWM-PWM/PFM st-down, 600kHz, 4.0V±2%, 600mA, +CE	SOT-25	28zq	DC1	6g	Tor
84B	XC6701BA2MR	LVR-IC	10.2V±2%, 150mA, +CE	SOT-25	28hw	VR4	6g	Tor
84B	XC6112A542MR	Vdet-IC	4.2V±2%, -MR, -Reset ODO, Wt=400ms, Rt=3.13ms	SOT-25	28cp	VD16	6g	Tor
84C	XC6701BA3MR	LVR-IC	10.3V±2%, 150mA, +CE	SOT-25	28hw	VR4	6g	Tor
84C	XC6112A543MR	Vdet-IC	4.3V±2%, -MR, -Reset ODO, Wt=400ms, Rt=3.13ms	SOT-25	28cp	VD16	6g	Tor
84D	XC6701BA4MR	LVR-IC	10.4V±2%, 150mA, +CE	SOT-25	28hw	VR4	6g	Tor
84D	XC6112A544MR	Vdet-IC	4.4V±2%, -MR, -Reset ODO, Wt=400ms, Rt=3.13ms	SOT-25	28cp	VD16	6g	Tor
84E	XC6701BA5MR	LVR-IC	10.5V±2%, 150mA, +CE	SOT-25	28hw	VR4	6g	Tor
84E	XC6112A545MR	Vdet-IC	4.5V±2%, -MR, -Reset ODO, Wt=400ms, Rt=3.13ms	SOT-25	28cp	VD16	6g	Tor
84F	XC6701BA6MR	LVR-IC	10.6V±2%, 150mA, +CE	SOT-25	28hw	VR4	6g	Tor
84F	XC6112A516MR	Vdet-IC	1.6V±2%, -MR, -Reset ODO, Wt=400ms, Rt=3.13ms	SOT-25	28cp	VD16	6g	Tor
84F	XC6112A546MR	Vdet-IC	4.6V±2%, -MR, -Reset ODO, Wt=400ms, Rt=3.13ms	SOT-25	28cp	VD16	6g	Tor
84H	XC6701BA7MR	LVR-IC	10.7V±2%, 150mA, +CE	SOT-25	28hw	VR4	6g	Tor
84H	XC6112A517MR	Vdet-IC	1.7V±2%, -MR, -Reset ODO, Wt=400ms, Rt=3.13ms	SOT-25	28cp	VD16	6g	Tor
84H	XC6112A547MR	Vdet-IC	4.7V±2%, -MR, -Reset ODO, Wt=400ms, Rt=3.13ms	SOT-25	28cp	VD16	6g	Tor
84K	XC6701BA8MR	LVR-IC	10.8V±2%, 150mA, +CE	SOT-25	28hw	VR4	6g	Tor
84K	XC6112A518MR	Vdet-IC	1.8V±2%, -MR, -Reset ODO, Wt=400ms, Rt=3.13ms	SOT-25	28cp	VD16	6g	Tor
84K	XC6112A548MR	Vdet-IC	4.8V±2%, -MR, -Reset ODO, Wt=400ms, Rt=3.13ms	SOT-25	28cp	VD16	6g	Tor
84L	XC6701BA9MR	LVR-IC	10.9V±2%, 150mA, +CE	SOT-25	28hw	VR4	6g	Tor
84L	XC6112A519MR	Vdet-IC	1.9V±2%, -MR, -Reset ODO, Wt=400ms, Rt=3.13ms	SOT-25	28cp	VD16	6g	Tor
84L	XC6112A549MR	Vdet-IC	4.9V±2%, -MR, -Reset ODO, Wt=400ms, Rt=3.13ms	SOT-25	28cp	VD16	6g	Tor
84M	XC6701BB0MR	LVR-IC	11.0V±2%, 150mA, +CE	SOT-25	28hw	VR4	6g	Tor
84M	XC6112A520MR	Vdet-IC	2.0V±2%, -MR, -Reset ODO, Wt=400ms, Rt=3.13ms	SOT-25	28cp	VD16	6g	Tor
84M	XC6112A550MR	Vdet-IC	5.0V±2%, -MR, -Reset ODO, Wt=400ms, Rt=3.13ms	SOT-25	28cp	VD16	6g	Tor
84N	XC6701BB1MR	LVR-IC	11.1V±2%, 150mA, +CE	SOT-25	28hw	VR4	6g	Tor
84N	XC6112A521MR	Vdet-IC	2.1V±2%, -MR, -Reset ODO, Wt=400ms, Rt=3.13ms	SOT-25	28cp	VD16	6g	Tor
84P	XC6701BB2MR	LVR-IC	11.2V±2%, 150mA, +CE	SOT-25	28hw	VR4	6g	Tor
84P	XC6112A522MR	Vdet-IC	2.2V±2%, -MR, -Reset ODO, Wt=400ms, Rt=3.13ms	SOT-25	28cp	VD16	6g	Tor
84R	XC6701BB3MR	LVR-IC	11.3V±2%, 150mA, +CE	SOT-25	28hw	VR4	6g	Tor
84R	XC6112A523MR	Vdet-IC	2.3V±2%, -MR, -Reset ODO, Wt=400ms, Rt=3.13ms	SOT-25	28cp	VD16	6g	Tor
84S	XC6701BB4MR	LVR-IC	11.4V±2%, 150mA, +CE	SOT-25	28hw	VR4	6g	Tor
84S	XC6112A524MR	Vdet-IC	2.4V±2%, -MR, -Reset ODO, Wt=400ms, Rt=3.13ms	SOT-25	28cp	VD16	6g	Tor
84T	XC6701BB5MR	LVR-IC	11.5V±2%, 150mA, +CE	SOT-25	28hw	VR4	6g	Tor
84T	XC6112A525MR	Vdet-IC	2.5V±2%, -MR, -Reset ODO, Wt=400ms, Rt=3.13ms	SOT-25	28cp	VD16	6g	Tor
84U	XC6701BB6MR	LVR-IC	11.6V±2%, 150mA, +CE	SOT-25	28hw	VR4	6g	Tor
84U	XC6112A526MR	Vdet-IC	2.6V±2%, -MR, -Reset ODO, Wt=400ms, Rt=3.13ms	SOT-25	28cp	VD16	6g	Tor
84V	XC6701BB7MR	LVR-IC	11.7V±2%, 150mA, +CE	SOT-25	28hw	VR4	6g	Tor



SMD code	Type	Function	Short description	Case	Pinout	Sch.	St.	Mnf.
84V	XC6112A527MR	Vdet-IC	2.7V±2%, -MR, -Reset ODO, Wt=400ms, Rt=3.13ms	SOT-25	28cp	VD16	6g	Tor
84X	XC6701BB8MR	LVR-IC	11.8V±2%, 150mA, +CE	SOT-25	28hw	VR4	6g	Tor
84X	XC6112A528MR	Vdet-IC	2.8V±2%, -MR, -Reset ODO, Wt=400ms, Rt=3.13ms	SOT-25	28cp	VD16	6g	Tor
84Y	XC6701BB9MR	LVR-IC	11.9V±2%, 150mA, +CE	SOT-25	28hw	VR4	6g	Tor
84Y	XC6112A529MR	Vdet-IC	2.9V±2%, -MR, -Reset ODO, Wt=400ms, Rt=3.13ms	SOT-25	28cp	VD16	6g	Tor
84Z	XC6701BC0MR	LVR-IC	12.0V±2%, 150mA, +CE	SOT-25	28hw	VR4	6g	Tor
84Z	XC6112A530MR	Vdet-IC	3.0V±2%, -MR, -Reset ODO, Wt=400ms, Rt=3.13ms	SOT-25	28cp	VD16	6g	Tor
85	RN5RF35BA	LVR-IC	LRip, +CE, 3.5V±2%, 1A*	SOT-23-5	28vw	VR6	6g	Ric
85	RN5RZ35BA	LVR-IC	LDO, LN, +CE, 3.5V±2%, 100mA	SOT-23-5	28wrt	VR4	6g	Ric
850	XC6112A631MR	Vdet-IC	3.1V±2%, -MR, -Reset ODO, Wt=1.6s, Rt=3.13ms	SOT-25	28cp	VD16	6g	Tor
850	XC9111F501MR	DC/DC-IC	PFM step-up, 100kHz, 5.0V±2.5%, 400mA	SOT-25	28sy	DC13	6g	Tor
851	XC6112A632MR	Vdet-IC	3.2V±2%, -MR, -Reset ODO, Wt=1.6s, Rt=3.13ms	SOT-25	28cp	VD16	6g	Tor
851	XC9111F511MR	DC/DC-IC	PFM step-up, 100kHz, 5.1V±2.5%, 400mA	SOT-25	28sy	DC13	6g	Tor
852	XC6112A633MR	Vdet-IC	3.3V±2%, -MR, -Reset ODO, Wt=1.6s, Rt=3.13ms	SOT-25	28cp	VD16	6g	Tor
852	XC9111F521MR	DC/DC-IC	PFM step-up, 100kHz, 5.2V±2.5%, 400mA	SOT-25	28sy	DC13	6g	Tor
853	XC6112A634MR	Vdet-IC	3.4V±2%, -MR, -Reset ODO, Wt=1.6s, Rt=3.13ms	SOT-25	28cp	VD16	6g	Tor
853	XC9111F531MR	DC/DC-IC	PFM step-up, 100kHz, 5.3V±2.5%, 400mA	SOT-25	28sy	DC13	6g	Tor
854	XC6112A635MR	Vdet-IC	3.5V±2%, -MR, -Reset ODO, Wt=1.6s, Rt=3.13ms	SOT-25	28cp	VD16	6g	Tor
854	XC9111F541MR	DC/DC-IC	PFM step-up, 100kHz, 5.4V±2.5%, 400mA	SOT-25	28sy	DC13	6g	Tor
855	XC6112A636MR	Vdet-IC	3.6V±2%, -MR, -Reset ODO, Wt=1.6s, Rt=3.13ms	SOT-25	28cp	VD16	6g	Tor
855	XC9111F551MR	DC/DC-IC	PFM step-up, 100kHz, 5.5V±2.5%, 400mA	SOT-25	28sy	DC13	6g	Tor
856	XC6112A637MR	Vdet-IC	3.7V±2%, -MR, -Reset ODO, Wt=1.6s, Rt=3.13ms	SOT-25	28cp	VD16	6g	Tor
856	XC9111F561MR	DC/DC-IC	PFM step-up, 100kHz, 5.6V±2.5%, 400mA	SOT-25	28sy	DC13	6g	Tor
857	XC6112A638MR	Vdet-IC	3.8V±2%, -MR, -Reset ODO, Wt=1.6s, Rt=3.13ms	SOT-25	28cp	VD16	6g	Tor
857	XC9111F571MR	DC/DC-IC	PFM step-up, 100kHz, 5.7V±2.5%, 400mA	SOT-25	28sy	DC13	6g	Tor
858	XC6112A639MR	Vdet-IC	3.9V±2%, -MR, -Reset ODO, Wt=1.6s, Rt=3.13ms	SOT-25	28cp	VD16	6g	Tor
858	XC9111F581MR	DC/DC-IC	PFM step-up, 100kHz, 5.8V±2.5%, 400mA	SOT-25	28sy	DC13	6g	Tor
859	XC6112A640MR	Vdet-IC	4.0V±2%, -MR, -Reset ODO, Wt=1.6s, Rt=3.13ms	SOT-25	28cp	VD16	6g	Tor
859	XC9111F591MR	DC/DC-IC	PFM step-up, 100kHz, 5.9V±2.5%, 400mA	SOT-25	28sy	DC13	6g	Tor
85A	XC6112A641MR	Vdet-IC	4.1V±2%, -MR, -Reset ODO, Wt=1.6s, Rt=3.13ms	SOT-25	28cp	VD16	6g	Tor
85A2	MAS9485AST2	LVR-IC	LDO, 2.8V, 100mA, +CE	SOT-23-5	28vrx	VR7	6a	Mas
85B	XC6112A642MR	Vdet-IC	4.2V±2%, -MR, -Reset ODO, Wt=1.6s, Rt=3.13ms	SOT-25	28cp	VD16	6g	Tor
85C	XC6112A643MR	Vdet-IC	4.3V±2%, -MR, -Reset ODO, Wt=1.6s, Rt=3.13ms	SOT-25	28cp	VD16	6g	Tor
85D	XC6112A644MR	Vdet-IC	4.4V±2%, -MR, -Reset ODO, Wt=1.6s, Rt=3.13ms	SOT-25	28cp	VD16	6g	Tor
85E	XC6112A645MR	Vdet-IC	4.5V±2%, -MR, -Reset ODO, Wt=1.6s, Rt=3.13ms	SOT-25	28cp	VD16	6g	Tor
85F	XC6112A616MR	Vdet-IC	1.6V±2%, -MR, -Reset ODO, Wt=1.6s, Rt=3.13ms	SOT-25	28cp	VD16	6g	Tor
85F	XC6112A646MR	Vdet-IC	4.6V±2%, -MR, -Reset ODO, Wt=1.6s, Rt=3.13ms	SOT-25	28cp	VD16	6g	Tor
85H	XC6112A617MR	Vdet-IC	1.7V±2%, -MR, -Reset ODO, Wt=1.6s, Rt=3.13ms	SOT-25	28cp	VD16	6g	Tor
85H	XC6112A647MR	Vdet-IC	4.7V±2%, -MR, -Reset ODO, Wt=1.6s, Rt=3.13ms	SOT-25	28cp	VD16	6g	Tor
85K	XC6112A618MR	Vdet-IC	1.8V±2%, -MR, -Reset ODO, Wt=1.6s, Rt=3.13ms	SOT-25	28cp	VD16	6g	Tor
85K	XC6112A648MR	Vdet-IC	4.8V±2%, -MR, -Reset ODO, Wt=1.6s, Rt=3.13ms	SOT-25	28cp	VD16	6g	Tor
85L	XC6112A619MR	Vdet-IC	1.9V±2%, -MR, -Reset ODO, Wt=1.6s, Rt=3.13ms	SOT-25	28cp	VD16	6g	Tor
85L	XC6112A649MR	Vdet-IC	4.9V±2%, -MR, -Reset ODO, Wt=1.6s, Rt=3.13ms	SOT-25	28cp	VD16	6g	Tor
85M	XC6112A620MR	Vdet-IC	2.0V±2%, -MR, -Reset ODO, Wt=1.6s, Rt=3.13ms	SOT-25	28cp	VD16	6g	Tor
85M	XC6112A650MR	Vdet-IC	5.0V±2%, -MR, -Reset ODO, Wt=1.6s, Rt=3.13ms	SOT-25	28cp	VD16	6g	Tor
85N	XC6112A621MR	Vdet-IC	2.1V±2%, -MR, -Reset ODO, Wt=1.6s, Rt=3.13ms	SOT-25	28cp	VD16	6g	Tor
85P	XC6112A622MR	Vdet-IC	2.2V±2%, -MR, -Reset ODO, Wt=1.6s, Rt=3.13ms	SOT-25	28cp	VD16	6g	Tor
85R	XC6112A623MR	Vdet-IC	2.3V±2%, -MR, -Reset ODO, Wt=1.6s, Rt=3.13ms	SOT-25	28cp	VD16	6g	Tor
85S	XC6112A624MR	Vdet-IC	2.4V±2%, -MR, -Reset ODO, Wt=1.6s, Rt=3.13ms	SOT-25	28cp	VD16	6g	Tor
85T	XC6112A625MR	Vdet-IC	2.5V±2%, -MR, -Reset ODO, Wt=1.6s, Rt=3.13ms	SOT-25	28cp	VD16	6g	Tor
85U	XC6112A626MR	Vdet-IC	2.6V±2%, -MR, -Reset ODO, Wt=1.6s, Rt=3.13ms	SOT-25	28cp	VD16	6g	Tor
85V	XC6112A627MR	Vdet-IC	2.7V±2%, -MR, -Reset ODO, Wt=1.6s, Rt=3.13ms	SOT-25	28cp	VD16	6g	Tor
85X	XC6112A628MR	Vdet-IC	2.8V±2%, -MR, -Reset ODO, Wt=1.6s, Rt=3.13ms	SOT-25	28cp	VD16	6g	Tor
85Y	XC6112A629MR	Vdet-IC	2.9V±2%, -MR, -Reset ODO, Wt=1.6s, Rt=3.13ms	SOT-25	28cp	VD16	6g	Tor
85Z	XC6112A630MR	Vdet-IC	3.0V±2%, -MR, -Reset ODO, Wt=1.6s, Rt=3.13ms	SOT-25	28cp	VD16	6g	Tor
86	RN5RF36BA	LVR-IC	LRip, +CE, 3.6V±2%, 1A*	SOT-23-5	28vw	VR6	6g	Ric
86	RN5RZ36BA	LVR-IC	LDO, LN, +CE, 3.6V±2%, 100mA	SOT-23-5	28wrt	VR4	6g	Ric
860	XC6112B231MR	Vdet-IC	3.1V±2%, -MR, -Reset ODO, Wt=50ms, Rt=25ms	SOT-25	28wrt	VD16	6g	Tor
860	XC9111F601MR	DC/DC-IC	PFM step-up, 100kHz, 6.0V±2.5%, 400mA	SOT-25	28sy	DC13	6g	Tor
861	XC6112B232MR	Vdet-IC	3.2V±2%, -MR, -Reset ODO, Wt=50ms, Rt=25ms	SOT-25	28cp	VD16	6g	Tor
861	XC9111F611MR	DC/DC-IC	PFM step-up, 100kHz, 6.1V±2.5%, 400mA	SOT-25	28sy	DC13	6g	Tor
862	XC6112B233MR	Vdet-IC	3.3V±2%, -MR, -Reset ODO, Wt=50ms, Rt=25ms	SOT-25	28cp	VD16	6g	Tor
862	XC9111F621MR	DC/DC-IC	PFM step-up, 100kHz, 6.2V±2.5%, 400mA	SOT-25	28sy	DC13	6g	Tor
863	XC6112B234MR	Vdet-IC	3.4V±2%, -MR, -Reset ODO, Wt=50ms, Rt=25ms	SOT-25	28cp	VD16	6g	Tor
863	XC9111F631MR	DC/DC-IC	PFM step-up, 100kHz, 6.3V±2.5%, 400mA	SOT-25	28sy	DC13	6g	Tor
864	XC6112B235MR	Vdet-IC	3.5V±2%, -MR, -Reset ODO, Wt=50ms, Rt=25ms	SOT-25	28cp	VD16	6g	Tor
864	XC9111F641MR	DC/DC-IC	PFM step-up, 100kHz, 6.4V±2.5%, 400mA	SOT-25	28sy	DC13	6g	Tor
865	XC6112B236MR	Vdet-IC	3.6V±2%, -MR, -Reset ODO, Wt=50ms, Rt=25ms	SOT-25	28cp	VD16	6g	Tor
865	XC9111F651MR	DC/DC-IC	PFM step-up, 100kHz, 6.5V±2.5%, 400mA	SOT-25	28sy	DC13	6g	Tor
866	XC6112B237MR	Vdet-IC	3.7V±2%, -MR, -Reset ODO, Wt=50ms, Rt=25ms	SOT-25	28cp	VD16	6g	Tor



SMD code	Type	Function	Short description	Case	Pinout	Sch.	St.	Mnf.
866	XC9111F661MR	DC/DC-IC	PFM step-up, 100kHz, 6.6V±2.5%, 400mA	SOT-25	28sy	DC13	6g	Tor
867	XC6112B238MR	Vdet-IC	3.8V±2%, -MR, -Reset ODO, Wt=50ms, Rt=25ms	SOT-25	28cp	VD16	6g	Tor
867	XC9111F671MR	DC/DC-IC	PFM step-up, 100kHz, 6.7V±2.5%, 400mA	SOT-25	28sy	DC13	6g	Tor
868	XC6112B239MR	Vdet-IC	3.9V±2%, -MR, -Reset ODO, Wt=50ms, Rt=25ms	SOT-25	28cp	VD16	6g	Tor
868	XC9111F681MR	DC/DC-IC	PFM step-up, 100kHz, 6.8V±2.5%, 400mA	SOT-25	28sy	DC13	6g	Tor
869	XC6112B240MR	Vdet-IC	4.0V±2%, -MR, -Reset ODO, Wt=50ms, Rt=25ms	SOT-25	28cp	VD16	6g	Tor
869	XC9111F691MR	DC/DC-IC	PFM step-up, 100kHz, 6.9V±2.5%, 400mA	SOT-25	28sy	DC13	6g	Tor
86A	XC6112B241MR	Vdet-IC	4.1V±2%, -MR, -Reset ODO, Wt=50ms, Rt=25ms	SOT-25	28cp	VD16	6g	Tor
86B	XC6112B242MR	Vdet-IC	4.2V±2%, -MR, -Reset ODO, Wt=50ms, Rt=25ms	SOT-25	28cp	VD16	6g	Tor
86C	XC6112B243MR	Vdet-IC	4.3V±2%, -MR, -Reset ODO, Wt=50ms, Rt=25ms	SOT-25	28cp	VD16	6g	Tor
86D	XC6112B244MR	Vdet-IC	4.4V±2%, -MR, -Reset ODO, Wt=50ms, Rt=25ms	SOT-25	28cp	VD16	6g	Tor
86E	XC6112B245MR	Vdet-IC	4.5V±2%, -MR, -Reset ODO, Wt=50ms, Rt=25ms	SOT-25	28cp	VD16	6g	Tor
86F	XC6112B216MR	Vdet-IC	1.6V±2%, -MR, -Reset ODO, Wt=50ms, Rt=25ms	SOT-25	28cp	VD16	6g	Tor
86F	XC6112B246MR	Vdet-IC	4.6V±2%, -MR, -Reset ODO, Wt=50ms, Rt=25ms	SOT-25	28cp	VD16	6g	Tor
86H	XC6112B217MR	Vdet-IC	1.7V±2%, -MR, -Reset ODO, Wt=50ms, Rt=25ms	SOT-25	28cp	VD16	6g	Tor
86H	XC6112B247MR	Vdet-IC	4.7V±2%, -MR, -Reset ODO, Wt=50ms, Rt=25ms	SOT-25	28cp	VD16	6g	Tor
86K	XC6112B218MR	Vdet-IC	1.8V±2%, -MR, -Reset ODO, Wt=50ms, Rt=25ms	SOT-25	28cp	VD16	6g	Tor
86K	XC6112B248MR	Vdet-IC	4.8V±2%, -MR, -Reset ODO, Wt=50ms, Rt=25ms	SOT-25	28cp	VD16	6g	Tor
86L	XC6112B219MR	Vdet-IC	1.9V±2%, -MR, -Reset ODO, Wt=50ms, Rt=25ms	SOT-25	28cp	VD16	6g	Tor
86L	XC6112B249MR	Vdet-IC	4.9V±2%, -MR, -Reset ODO, Wt=50ms, Rt=25ms	SOT-25	28cp	VD16	6g	Tor
86M	XC6112B220MR	Vdet-IC	2.0V±2%, -MR, -Reset ODO, Wt=50ms, Rt=25ms	SOT-25	28cp	VD16	6g	Tor
86M	XC6112B250MR	Vdet-IC	5.0V±2%, -MR, -Reset ODO, Wt=50ms, Rt=25ms	SOT-25	28cp	VD16	6g	Tor
86N	XC6112B221MR	Vdet-IC	2.1V±2%, -MR, -Reset ODO, Wt=50ms, Rt=25ms	SOT-25	28cp	VD16	6g	Tor
86P	XC6112B222MR	Vdet-IC	2.2V±2%, -MR, -Reset ODO, Wt=50ms, Rt=25ms	SOT-25	28cp	VD16	6g	Tor
86R	XC6112B223MR	Vdet-IC	2.3V±2%, -MR, -Reset ODO, Wt=50ms, Rt=25ms	SOT-25	28cp	VD16	6g	Tor
86S	XC6112B224MR	Vdet-IC	2.4V±2%, -MR, -Reset ODO, Wt=50ms, Rt=25ms	SOT-25	28cp	VD16	6g	Tor
86T	XC6112B225MR	Vdet-IC	2.5V±2%, -MR, -Reset ODO, Wt=50ms, Rt=25ms	SOT-25	28cp	VD16	6g	Tor
86U	XC6112B226MR	Vdet-IC	2.6V±2%, -MR, -Reset ODO, Wt=50ms, Rt=25ms	SOT-25	28cp	VD16	6g	Tor
86V	XC6112B227MR	Vdet-IC	2.7V±2%, -MR, -Reset ODO, Wt=50ms, Rt=25ms	SOT-25	28cp	VD16	6g	Tor
86X	XC6112B228MR	Vdet-IC	2.8V±2%, -MR, -Reset ODO, Wt=50ms, Rt=25ms	SOT-25	28cp	VD16	6g	Tor
86Y	XC6112B229MR	Vdet-IC	2.9V±2%, -MR, -Reset ODO, Wt=50ms, Rt=25ms	SOT-25	28cp	VD16	6g	Tor
86Z	XC6112B230MR	Vdet-IC	3.0V±2%, -MR, -Reset ODO, Wt=50ms, Rt=25ms	SOT-25	28cp	VD16	6g	Tor
87	RM5RF37BA	LVR-IC	LRip, +CE, 3.7V±2%, 1A*	SOT-23-5	28vv	VR6	6g	Ric
87	RM5RZ37BA	LVR-IC	LDO, LN, +CE, 3.7V±2%, 100mA	SOT-23-5	28vrt	VR4	6g	Ric
870	XC6112B331MR	Vdet-IC	3.1V±2%, -MR, -Reset ODO, Wt=100ms, Rt=25ms	SOT-25	28cp	VD16	6g	Tor
870	XC9111F701MR	DC/DC-IC	PFM step-up, 100kHz, 7.0V±2.5%, 400mA	SOT-25	28sy	DC13	6g	Tor
871	XC6112B332MR	Vdet-IC	3.2V±2%, -MR, -Reset ODO, Wt=100ms, Rt=25ms	SOT-25	28cp	VD16	6g	Tor
872	XC6112B333MR	Vdet-IC	3.3V±2%, -MR, -Reset ODO, Wt=100ms, Rt=25ms	SOT-25	28cp	VD16	6g	Tor
873	XC6112B334MR	Vdet-IC	3.4V±2%, -MR, -Reset ODO, Wt=100ms, Rt=25ms	SOT-25	28cp	VD16	6g	Tor
874	XC6112B335MR	Vdet-IC	3.5V±2%, -MR, -Reset ODO, Wt=100ms, Rt=25ms	SOT-25	28cp	VD16	6g	Tor
875	XC6112B336MR	Vdet-IC	3.6V±2%, -MR, -Reset ODO, Wt=100ms, Rt=25ms	SOT-25	28cp	VD16	6g	Tor
876	XC6112B337MR	Vdet-IC	3.7V±2%, -MR, -Reset ODO, Wt=100ms, Rt=25ms	SOT-25	28cp	VD16	6g	Tor
877	XC6112B338MR	Vdet-IC	3.8V±2%, -MR, -Reset ODO, Wt=100ms, Rt=25ms	SOT-25	28cp	VD16	6g	Tor
878	XC6112B339MR	Vdet-IC	3.9V±2%, -MR, -Reset ODO, Wt=100ms, Rt=25ms	SOT-25	28cp	VD16	6g	Tor
879	XC6112B340MR	Vdet-IC	4.0V±2%, -MR, -Reset ODO, Wt=100ms, Rt=25ms	SOT-25	28cp	VD16	6g	Tor
87A	XC6112B341MR	Vdet-IC	4.1V±2%, -MR, -Reset ODO, Wt=100ms, Rt=25ms	SOT-25	28cp	VD16	6g	Tor
87B	XC6112B342MR	Vdet-IC	4.2V±2%, -MR, -Reset ODO, Wt=100ms, Rt=25ms	SOT-25	28cp	VD16	6g	Tor
87C	XC6112B343MR	Vdet-IC	4.3V±2%, -MR, -Reset ODO, Wt=100ms, Rt=25ms	SOT-25	28cp	VD16	6g	Tor
87D	XC6112B344MR	Vdet-IC	4.4V±2%, -MR, -Reset ODO, Wt=100ms, Rt=25ms	SOT-25	28cp	VD16	6g	Tor
87E	XC6112B345MR	Vdet-IC	4.5V±2%, -MR, -Reset ODO, Wt=100ms, Rt=25ms	SOT-25	28cp	VD16	6g	Tor
87F	XC6112B316MR	Vdet-IC	1.6V±2%, -MR, -Reset ODO, Wt=100ms, Rt=25ms	SOT-25	28cp	VD16	6g	Tor
87F	XC6112B346MR	Vdet-IC	4.6V±2%, -MR, -Reset ODO, Wt=100ms, Rt=25ms	SOT-25	28cp	VD16	6g	Tor
87H	XC6112B317MR	Vdet-IC	1.7V±2%, -MR, -Reset ODO, Wt=100ms, Rt=25ms	SOT-25	28cp	VD16	6g	Tor
87H	XC6112B347MR	Vdet-IC	4.7V±2%, -MR, -Reset ODO, Wt=100ms, Rt=25ms	SOT-25	28cp	VD16	6g	Tor
87K	XC6112B318MR	Vdet-IC	1.8V±2%, -MR, -Reset ODO, Wt=100ms, Rt=25ms	SOT-25	28cp	VD16	6g	Tor
87K	XC6112B348MR	Vdet-IC	4.8V±2%, -MR, -Reset ODO, Wt=100ms, Rt=25ms	SOT-25	28cp	VD16	6g	Tor
87L	XC6112B319MR	Vdet-IC	1.9V±2%, -MR, -Reset ODO, Wt=100ms, Rt=25ms	SOT-25	28cp	VD16	6g	Tor
87L	XC6112B349MR	Vdet-IC	4.9V±2%, -MR, -Reset ODO, Wt=100ms, Rt=25ms	SOT-25	28cp	VD16	6g	Tor
87M	XC6112B320MR	Vdet-IC	2.0V±2%, -MR, -Reset ODO, Wt=100ms, Rt=25ms	SOT-25	28cp	VD16	6g	Tor
87M	XC6112B350MR	Vdet-IC	5.0V±2%, -MR, -Reset ODO, Wt=100ms, Rt=25ms	SOT-25	28cp	VD16	6g	Tor
87N	XC6112B321MR	Vdet-IC	2.1V±2%, -MR, -Reset ODO, Wt=100ms, Rt=25ms	SOT-25	28cp	VD16	6g	Tor
87P	XC6112B322MR	Vdet-IC	2.2V±2%, -MR, -Reset ODO, Wt=100ms, Rt=25ms	SOT-25	28cp	VD16	6g	Tor
87R	XC6112B323MR	Vdet-IC	2.3V±2%, -MR, -Reset ODO, Wt=100ms, Rt=25ms	SOT-25	28cp	VD16	6g	Tor
87S	XC6112B324MR	Vdet-IC	2.4V±2%, -MR, -Reset ODO, Wt=100ms, Rt=25ms	SOT-25	28cp	VD16	6g	Tor
87T	XC6112B325MR	Vdet-IC	2.5V±2%, -MR, -Reset ODO, Wt=100ms, Rt=25ms	SOT-25	28cp	VD16	6g	Tor
87U	XC6112B326MR	Vdet-IC	2.6V±2%, -MR, -Reset ODO, Wt=100ms, Rt=25ms	SOT-25	28cp	VD16	6g	Tor
87V	XC6112B327MR	Vdet-IC	2.7V±2%, -MR, -Reset ODO, Wt=100ms, Rt=25ms	SOT-25	28cp	VD16	6g	Tor
87X	XC6112B328MR	Vdet-IC	2.8V±2%, -MR, -Reset ODO, Wt=100ms, Rt=25ms	SOT-25	28cp	VD16	6g	Tor
87Y	XC6112B329MR	Vdet-IC	2.9V±2%, -MR, -Reset ODO, Wt=100ms, Rt=25ms	SOT-25	28cp	VD16	6g	Tor
87Z	XC6112B330MR	Vdet-IC	3.0V±2%, -MR, -Reset ODO, Wt=100ms, Rt=25ms	SOT-25	28cp	VD16	6g	Tor



SMD code	Type	Function	Short description	Case	Pinout	Sch.	St.	Mnf.
89V	XC6112B527MR	Vdet-IC	2.7V±2%, -MR, -Reset ODO, Wt=400ms, Rt=25ms	SOT-25	28cp	VD16	6g	Tor
89X	XC6112B528MR	Vdet-IC	2.8V±2%, -MR, -Reset ODO, Wt=400ms, Rt=25ms	SOT-25	28cp	VD16	6g	Tor
89Y	XC6112B529MR	Vdet-IC	2.9V±2%, -MR, -Reset ODO, Wt=400ms, Rt=25ms	SOT-25	28cp	VD16	6g	Tor
89Z	XC6112B530MR	Vdet-IC	3.0V±2%, -MR, -Reset ODO, Wt=400ms, Rt=25ms	SOT-25	28cp	VD16	6g	Tor
8A0	XC6701BC1MR	LVR-IC	12.1V±2%, 150mA, +CE	SOT-25	28hw	VR4	6g	Tor
8A0	XC6112B631MR	Vdet-IC	3.1V±2%, -MR, -Reset ODO, Wt=1.6s, Rt=25ms	SOT-25	28cp	VD16	6g	Tor
8A1	XC6701BC2MR	LVR-IC	12.2V±2%, 150mA, +CE	SOT-25	28hw	VR4	6g	Tor
8A1	XC6112B632MR	Vdet-IC	3.2V±2%, -MR, -Reset ODO, Wt=1.6s, Rt=25ms	SOT-25	28cp	VD16	6g	Tor
8A2	XC6701BC3MR	LVR-IC	12.3V±2%, 150mA, +CE	SOT-25	28hw	VR4	6g	Tor
8A2	XC6112B633MR	Vdet-IC	3.3V±2%, -MR, -Reset ODO, Wt=1.6s, Rt=25ms	SOT-25	28cp	VD16	6g	Tor
8A3	XC6701BC4MR	LVR-IC	12.4V±2%, 150mA, +CE	SOT-25	28hw	VR4	6g	Tor
8A3	XC6112B634MR	Vdet-IC	3.4V±2%, -MR, -Reset ODO, Wt=1.6s, Rt=25ms	SOT-25	28cp	VD16	6g	Tor
8A4	XC6701BC5MR	LVR-IC	12.5V±2%, 150mA, +CE	SOT-25	28hw	VR4	6g	Tor
8A4	XC6112B635MR	Vdet-IC	3.5V±2%, -MR, -Reset ODO, Wt=1.6s, Rt=25ms	SOT-25	28cp	VD16	6g	Tor
8A5	XC6701BC6MR	LVR-IC	12.6V±2%, 150mA, +CE	SOT-25	28hw	VR4	6g	Tor
8A5	XC6112B636MR	Vdet-IC	3.6V±2%, -MR, -Reset ODO, Wt=1.6s, Rt=25ms	SOT-25	28cp	VD16	6g	Tor
8A6	XC6701BC7MR	LVR-IC	12.7V±2%, 150mA, +CE	SOT-25	28hw	VR4	6g	Tor
8A6	XC6112B637MR	Vdet-IC	3.7V±2%, -MR, -Reset ODO, Wt=1.6s, Rt=25ms	SOT-25	28cp	VD16	6g	Tor
8A7	XC6701BC8MR	LVR-IC	12.8V±2%, 150mA, +CE	SOT-25	28hw	VR4	6g	Tor
8A7	XC6112B638MR	Vdet-IC	3.8V±2%, -MR, -Reset ODO, Wt=1.6s, Rt=25ms	SOT-25	28cp	VD16	6g	Tor
8A8	XC6701BC9MR	LVR-IC	12.9V±2%, 150mA, +CE	SOT-25	28hw	VR4	6g	Tor
8A8	XC6112B639MR	Vdet-IC	3.9V±2%, -MR, -Reset ODO, Wt=1.6s, Rt=25ms	SOT-25	28cp	VD16	6g	Tor
8A9	XC6701BD0MR	LVR-IC	13.0V±2%, 150mA, +CE	SOT-25	28hw	VR4	6g	Tor
8A9	XC6112B640MR	Vdet-IC	4.0V±2%, -MR, -Reset ODO, Wt=1.6s, Rt=25ms	SOT-25	28cp	VD16	6g	Tor
8AA	XC6701BD1MR	LVR-IC	13.1V±2%, 150mA, +CE	SOT-25	28hw	VR4	6g	Tor
8AA	XC6112B641MR	Vdet-IC	4.1V±2%, -MR, -Reset ODO, Wt=1.6s, Rt=25ms	SOT-25	28cp	VD16	6g	Tor
8AB	XC6701BD2MR	LVR-IC	13.2V±2%, 150mA, +CE	SOT-25	28hw	VR4	6g	Tor
8AB	XC6112B642MR	Vdet-IC	4.2V±2%, -MR, -Reset ODO, Wt=1.6s, Rt=25ms	SOT-25	28cp	VD16	6g	Tor
8AC	XC6701BD3MR	LVR-IC	13.3V±2%, 150mA, +CE	SOT-25	28hw	VR4	6g	Tor
8AC	XC6112B643MR	Vdet-IC	4.3V±2%, -MR, -Reset ODO, Wt=1.6s, Rt=25ms	SOT-25	28cp	VD16	6g	Tor
8AD	XC6701BD4MR	LVR-IC	13.4V±2%, 150mA, +CE	SOT-25	28hw	VR4	6g	Tor
8AD	XC6112B644MR	Vdet-IC	4.4V±2%, -MR, -Reset ODO, Wt=1.6s, Rt=25ms	SOT-25	28cp	VD16	6g	Tor
8AE	XC6701BD5MR	LVR-IC	13.5V±2%, 150mA, +CE	SOT-25	28hw	VR4	6g	Tor
8AE	XC6112B645MR	Vdet-IC	4.5V±2%, -MR, -Reset ODO, Wt=1.6s, Rt=25ms	SOT-25	28cp	VD16	6g	Tor
8AF	XC6701BD6MR	LVR-IC	13.6V±2%, 150mA, +CE	SOT-25	28hw	VR4	6g	Tor
8AF	XC6112B646MR	Vdet-IC	4.6V±2%, -MR, -Reset ODO, Wt=1.6s, Rt=25ms	SOT-25	28cp	VD16	6g	Tor
8AH	XC6701BD7MR	LVR-IC	13.7V±2%, 150mA, +CE	SOT-25	28hw	VR4	6g	Tor
8AH	XC6112B647MR	Vdet-IC	4.7V±2%, -MR, -Reset ODO, Wt=1.6s, Rt=25ms	SOT-25	28cp	VD16	6g	Tor
8AH	XC6112B647MR	Vdet-IC	4.7V±2%, -MR, -Reset ODO, Wt=1.6s, Rt=25ms	SOT-25	28cp	VD16	6g	Tor
8AK	XC6701BD8MR	LVR-IC	13.8V±2%, 150mA, +CE	SOT-25	28hw	VR4	6g	Tor
8AK	XC6112B648MR	Vdet-IC	4.8V±2%, -MR, -Reset ODO, Wt=1.6s, Rt=25ms	SOT-25	28cp	VD16	6g	Tor
8AL	XC6701BD9MR	LVR-IC	13.9V±2%, 150mA, +CE	SOT-25	28hw	VR4	6g	Tor
8AL	XC6112B649MR	Vdet-IC	4.9V±2%, -MR, -Reset ODO, Wt=1.6s, Rt=25ms	SOT-25	28cp	VD16	6g	Tor
8AM	XC6701BE0MR	LVR-IC	14.0V±2%, 150mA, +CE	SOT-25	28hw	VR4	6g	Tor
8AM	XC6112B620MR	Vdet-IC	2.0V±2%, -MR, -Reset ODO, Wt=1.6s, Rt=25ms	SOT-25	28cp	VD16	6g	Tor
8AM	XC6112B650MR	Vdet-IC	5.0V±2%, -MR, -Reset ODO, Wt=1.6s, Rt=25ms	SOT-25	28cp	VD16	6g	Tor
8AM	XC9208A09CM	DC/DC-IC	PWM-PWM/PPM st-down, 1.2MHz, 0.9V±2%, 600mA, +CE	SOT-25	26cq	DC1	6g	Tor
8AN	XC6701BE1MR	LVR-IC	14.1V±2%, 150mA, +CE	SOT-25	28hw	VR4	6g	Tor
8AN	XC6112B621MR	Vdet-IC	2.1V±2%, -MR, -Reset ODO, Wt=1.6s, Rt=25ms	SOT-25	28cp	VD16	6g	Tor
8AP	XC6701BE2MR	LVR-IC	14.2V±2%, 150mA, +CE	SOT-25	28hw	VR4	6g	Tor
8AP	XC6112B622MR	Vdet-IC	2.2V±2%, -MR, -Reset ODO, Wt=1.6s, Rt=25ms	SOT-25	28cp	VD16	6g	Tor
8AR	XC6701BE3MR	LVR-IC	14.3V±2%, 150mA, +CE	SOT-25	28hw	VR4	6g	Tor
8AR	XC6112B623MR	Vdet-IC	2.3V±2%, -MR, -Reset ODO, Wt=1.6s, Rt=25ms	SOT-25	28cp	VD16	6g	Tor
8AS	XC6701BE4MR	LVR-IC	14.4V±2%, 150mA, +CE	SOT-25	28hw	VR4	6g	Tor
8AS	XC6112B624MR	Vdet-IC	2.4V±2%, -MR, -Reset ODO, Wt=1.6s, Rt=25ms	SOT-25	28cp	VD16	6g	Tor
8AT	XC6701BE5MR	LVR-IC	14.5V±2%, 150mA, +CE	SOT-25	28hw	VR4	6g	Tor
8AT	XC6112B625MR	Vdet-IC	2.5V±2%, -MR, -Reset ODO, Wt=1.6s, Rt=25ms	SOT-25	28cp	VD16	6g	Tor
8AU	XC6701BE6MR	LVR-IC	14.6V±2%, 150mA, +CE	SOT-25	28hw	VR4	6g	Tor
8AU	XC6112B626MR	Vdet-IC	2.6V±2%, -MR, -Reset ODO, Wt=1.6s, Rt=25ms	SOT-25	28cp	VD16	6g	Tor
8AV	XC6701BE7MR	LVR-IC	14.7V±2%, 150mA, +CE	SOT-25	28hw	VR4	6g	Tor
8AV	XC6112B627MR	Vdet-IC	2.7V±2%, -MR, -Reset ODO, Wt=1.6s, Rt=25ms	SOT-25	28cp	VD16	6g	Tor
8AX	XC6701BE8MR	LVR-IC	14.8V±2%, 150mA, +CE	SOT-25	28hw	VR4	6g	Tor
8AX	XC6112B628MR	Vdet-IC	2.8V±2%, -MR, -Reset ODO, Wt=1.6s, Rt=25ms	SOT-25	28cp	VD16	6g	Tor
8AY	XC6701BE9MR	LVR-IC	14.9V±2%, 150mA, +CE	SOT-25	28hw	VR4	6g	Tor
8AY	XC6112B629MR	Vdet-IC	2.9V±2%, -MR, -Reset ODO, Wt=1.6s, Rt=25ms	SOT-25	28cp	VD16	6g	Tor
8AZ	XC6701BF0MR	LVR-IC	15.0V±2%, 150mA, +CE	SOT-25	28hw	VR4	6g	Tor
8AZ	XC6112B630MR	Vdet-IC	3.0V±2%, -MR, -Reset ODO, Wt=1.6s, Rt=25ms	SOT-25	28cp	VD16	6g	Tor



SMD code	Type	Function	Short description	Case	Pinout	Sch.	St.	Mnf.
8B	R3111N181A	Vdet-IC	1.8V±2%, -Reset PPO	SOT-23-5	28vdm	VD7	6g	Ric
8B	RN5L28AA	LVR-IC	2.8V±2.5%, 150mA	SOT-23-5	28vu	VR1	6g	Ric
8B	RN5VD18CA	Vdet-IC	1.8V±2.5%, -Reset ODO	SOT-23-5	28vdo	VD1	6g	Ric
8B0	XC6701BF1MR	LVR-IC	15.1V±2%, 150mA, +CE	SOT-25	28hw	VR4	6g	Tor
8B0	XC6112C231MR	Vdet-IC	3.1V±2%, -MR, -Reset ODO, Wt=50ms, Rt=50ms	SOT-25	28cp	VD16	6g	Tor
8B1	XC6701BF2MR	LVR-IC	15.2V±2%, 150mA, +CE	SOT-25	28hw	VR4	6g	Tor
8B1	XC6112C232MR	Vdet-IC	3.2V±2%, -MR, -Reset ODO, Wt=50ms, Rt=50ms	SOT-25	28cp	VD16	6g	Tor
8B2	XC6701BF3MR	LVR-IC	15.3V±2%, 150mA, +CE	SOT-25	28hw	VR4	6g	Tor
8B2	XC6112C233MR	Vdet-IC	3.3V±2%, -MR, -Reset ODO, Wt=50ms, Rt=50ms	SOT-25	28cp	VD16	6g	Tor
8B3	XC6701BF4MR	LVR-IC	15.4V±2%, 150mA, +CE	SOT-25	28hw	VR4	6g	Tor
8B3	XC6112C234MR	Vdet-IC	3.4V±2%, -MR, -Reset ODO, Wt=50ms, Rt=50ms	SOT-25	28cp	VD16	6g	Tor
8B4	XC6701BF5MR	LVR-IC	15.5V±2%, 150mA, +CE	SOT-25	28hw	VR4	6g	Tor
8B4	XC6112C235MR	Vdet-IC	3.5V±2%, -MR, -Reset ODO, Wt=50ms, Rt=50ms	SOT-25	28cp	VD16	6g	Tor
8B5	XC6701BF6MR	LVR-IC	15.6V±2%, 150mA, +CE	SOT-25	28hw	VR4	6g	Tor
8B5	XC6112C236MR	Vdet-IC	3.6V±2%, -MR, -Reset ODO, Wt=50ms, Rt=50ms	SOT-25	28cp	VD16	6g	Tor
8B6	XC6701BF7MR	LVR-IC	15.7V±2%, 150mA, +CE	SOT-25	28hw	VR4	6g	Tor
8B6	XC6112C237MR	Vdet-IC	3.7V±2%, -MR, -Reset ODO, Wt=50ms, Rt=50ms	SOT-25	28cp	VD16	6g	Tor
8B7	XC6701BF8MR	LVR-IC	15.8V±2%, 150mA, +CE	SOT-25	28hw	VR4	6g	Tor
8B7	XC6112C238MR	Vdet-IC	3.8V±2%, -MR, -Reset ODO, Wt=50ms, Rt=50ms	SOT-25	28cp	VD16	6g	Tor
8B8	XC6701BF9MR	LVR-IC	15.9V±2%, 150mA, +CE	SOT-25	28hw	VR4	6g	Tor
8B8	XC6112C239MR	Vdet-IC	3.9V±2%, -MR, -Reset ODO, Wt=50ms, Rt=50ms	SOT-25	28cp	VD16	6g	Tor
8B9	XC6701BG0MR	LVR-IC	16.0V±2%, 150mA, +CE	SOT-25	28hw	VR4	6g	Tor
8B9	XC6112C240MR	Vdet-IC	4.0V±2%, -MR, -Reset ODO, Wt=50ms, Rt=50ms	SOT-25	28cp	VD16	6g	Tor
8BA	XC6701BG1MR	LVR-IC	16.1V±2%, 150mA, +CE	SOT-25	28hw	VR4	6g	Tor
8BA	XC6112C241MR	Vdet-IC	4.1V±2%, -MR, -Reset ODO, Wt=50ms, Rt=50ms	SOT-25	28cp	VD16	6g	Tor
8BA	XC9208A10CM	DC/DC-IC	PWM-PWM/PFM st-down, 1.2MHz, 1.0V±2%, 600mA, +CE	SOT-25	28zq	DC1	6g	Tor
8BB	XC6701BG2MR	LVR-IC	16.2V±2%, 150mA, +CE	SOT-25	28hw	VR4	6g	Tor
8BB	XC6112C242MR	Vdet-IC	4.2V±2%, -MR, -Reset ODO, Wt=50ms, Rt=50ms	SOT-25	28cp	VD16	6g	Tor
8BB	XC9208A11CM	DC/DC-IC	PWM-PWM/PFM st-down, 1.2MHz, 1.1V±2%, 600mA, +CE	SOT-25	28zq	DC1	6g	Tor
8BC	XC6701BG3MR	LVR-IC	16.3V±2%, 150mA, +CE	SOT-25	28hw	VR4	6g	Tor
8BC	XC6112C243MR	Vdet-IC	4.3V±2%, -MR, -Reset ODO, Wt=50ms, Rt=50ms	SOT-25	28cp	VD16	6g	Tor
8BC	XC9208A12CM	DC/DC-IC	PWM-PWM/PFM st-down, 1.2MHz, 1.2V±2%, 600mA, +CE	SOT-25	28zq	DC1	6g	Tor
8BD	XC6701BG4MR	LVR-IC	16.4V±2%, 150mA, +CE	SOT-25	28hw	VR4	6g	Tor
8BD	XC6112C244MR	Vdet-IC	4.4V±2%, -MR, -Reset ODO, Wt=50ms, Rt=50ms	SOT-25	28cp	VD16	6g	Tor
8BD	XC9208A13CM	DC/DC-IC	PWM-PWM/PFM st-down, 1.2MHz, 1.3V±2%, 600mA, +CE	SOT-25	28zq	DC1	6g	Tor
8BE	XC6701BG5MR	LVR-IC	16.5V±2%, 150mA, +CE	SOT-25	28hw	VR4	6g	Tor
8BE	XC6112C245MR	Vdet-IC	4.5V±2%, -MR, -Reset ODO, Wt=50ms, Rt=50ms	SOT-25	28cp	VD16	6g	Tor
8BE	XC9208A14CM	DC/DC-IC	PWM-PWM/PFM st-down, 1.2MHz, 1.4V±2%, 600mA, +CE	SOT-25	28zq	DC1	6g	Tor
8BF	XC6701BG6MR	LVR-IC	16.6V±2%, 150mA, +CE	SOT-25	28hw	VR4	6g	Tor
8BF	XC6112C246MR	Vdet-IC	1.6V±2%, -MR, -Reset ODO, Wt=50ms, Rt=50ms	SOT-25	28cp	VD16	6g	Tor
8BF	XC6112C246MR	Vdet-IC	4.6V±2%, -MR, -Reset ODO, Wt=50ms, Rt=50ms	SOT-25	28cp	VD16	6g	Tor
8BF	XC9208A15CM	DC/DC-IC	PWM-PWM/PFM st-down, 1.2MHz, 1.5V±2%, 600mA, +CE	SOT-25	28zq	DC1	6g	Tor
8BH	XC6701BG7MR	LVR-IC	16.7V±2%, 150mA, +CE	SOT-25	28hw	VR4	6g	Tor
8BH	XC6112C217MR	Vdet-IC	1.7V±2%, -MR, -Reset ODO, Wt=50ms, Rt=50ms	SOT-25	28cp	VD16	6g	Tor
8BH	XC6112C247MR	Vdet-IC	4.7V±2%, -MR, -Reset ODO, Wt=50ms, Rt=50ms	SOT-25	28cp	VD16	6g	Tor
8BH	XC9208A16CM	DC/DC-IC	PWM-PWM/PFM st-down, 1.2MHz, 1.6V±2%, 600mA, +CE	SOT-25	28zq	DC1	6g	Tor
8BK	XC6701BG8MR	LVR-IC	16.8V±2%, 150mA, +CE	SOT-25	28hw	VR4	6g	Tor
8BK	XC6112C218MR	Vdet-IC	1.8V±2%, -MR, -Reset ODO, Wt=50ms, Rt=50ms	SOT-25	28cp	VD16	6g	Tor
8BK	XC6112C248MR	Vdet-IC	4.8V±2%, -MR, -Reset ODO, Wt=50ms, Rt=50ms	SOT-25	28cp	VD16	6g	Tor
8BK	XC9208A17CM	DC/DC-IC	PWM-PWM/PFM st-down, 1.2MHz, 1.7V±2%, 600mA, +CE	SOT-25	28zq	DC1	6g	Tor
8BL	XC6701BG9MR	LVR-IC	16.9V±2%, 150mA, +CE	SOT-25	28hw	VR4	6g	Tor
8BL	XC6112C219MR	Vdet-IC	1.9V±2%, -MR, -Reset ODO, Wt=50ms, Rt=50ms	SOT-25	28cp	VD16	6g	Tor
8BL	XC6112C249MR	Vdet-IC	4.9V±2%, -MR, -Reset ODO, Wt=50ms, Rt=50ms	SOT-25	28cp	VD16	6g	Tor
8BL	XC9208A18CM	DC/DC-IC	PWM-PWM/PFM st-down, 1.2MHz, 1.8V±2%, 600mA, +CE	SOT-25	28zq	DC1	6g	Tor
8BM	XC6701BH0MR	LVR-IC	17.0V±2%, 150mA, +CE	SOT-25	28hw	VR4	6g	Tor
8BM	XC6112C220MR	Vdet-IC	2.0V±2%, -MR, -Reset ODO, Wt=50ms, Rt=50ms	SOT-25	28cp	VD16	6g	Tor
8BM	XC6112C250MR	Vdet-IC	5.0V±2%, -MR, -Reset ODO, Wt=50ms, Rt=50ms	SOT-25	28cp	VD16	6g	Tor
8BM	XC9208A19CM	DC/DC-IC	PWM-PWM/PFM st-down, 1.2MHz, 1.9V±2%, 600mA, +CE	SOT-25	28zq	DC1	6g	Tor
8BN	XC6701BH1MR	LVR-IC	17.1V±2%, 150mA, +CE	SOT-25	28hw	VR4	6g	Tor
8BN	XC6112C221MR	Vdet-IC	2.1V±2%, -MR, -Reset ODO, Wt=50ms, Rt=50ms	SOT-25	28cp	VD16	6g	Tor
8BP	XC6701BH2MR	LVR-IC	17.2V±2%, 150mA, +CE	SOT-25	28hw	VR4	6g	Tor
8BP	XC6112C222MR	Vdet-IC	2.2V±2%, -MR, -Reset ODO, Wt=50ms, Rt=50ms	SOT-25	28cp	VD16	6g	Tor
8BR	XC6701BH3MR	LVR-IC	17.3V±2%, 150mA, +CE	SOT-25	28hw	VR4	6g	Tor
8BR	XC6112C223MR	Vdet-IC	2.3V±2%, -MR, -Reset ODO, Wt=50ms, Rt=50ms	SOT-25	28cp	VD16	6g	Tor
8BS	XC6701BH4MR	LVR-IC	17.4V±2%, 150mA, +CE	SOT-25	28hw	VR4	6g	Tor
8BS	XC6112C224MR	Vdet-IC	2.4V±2%, -MR, -Reset ODO, Wt=50ms, Rt=50ms	SOT-25	28cp	VD16	6g	Tor
8BT	XC6701BH5MR	LVR-IC	17.5V±2%, 150mA, +CE	SOT-25	28hw	VR4	6g	Tor
8BT	XC6112C225MR	Vdet-IC	2.5V±2%, -MR, -Reset ODO, Wt=50ms, Rt=50ms	SOT-25	28cp	VD16	6g	Tor
8BU	XC6701BH6MR	LVR-IC	17.6V±2%, 150mA, +CE	SOT-25	28hw	VR4	6g	Tor
8BU	XC6112C226MR	Vdet-IC	2.6V±2%, -MR, -Reset ODO, Wt=50ms, Rt=50ms	SOT-25	28cp	VD16	6g	Tor



SMD code	Type	Function	Short description	Case	Pinout	Sch.	St.	Mnf.
8BV	XC6701BH7MR	LVR-IC	17.7V±2%, 150mA, +CE	SOT-25	28hw	VR4	6g	Tor
8BV	XC6112C227MR	Vdet-IC	2.7V±2%, -MR, -Reset ODO, Wt=50ms, Rt=50ms	SOT-25	28cp	VD16	6g	Tor
8BX	XC6701BH8MR	LVR-IC	17.8V±2%, 150mA, +CE	SOT-25	28hw	VR4	6g	Tor
8BX	XC6112C228MR	Vdet-IC	2.8V±2%, -MR, -Reset ODO, Wt=50ms, Rt=50ms	SOT-25	28cp	VD16	6g	Tor
8BY	XC6701BH9MR	LVR-IC	17.9V±2%, 150mA, +CE	SOT-25	28hw	VR4	6g	Tor
8BY	XC6112C229MR	Vdet-IC	2.9V±2%, -MR, -Reset ODO, Wt=50ms, Rt=50ms	SOT-25	28cp	VD16	6g	Tor
8BY	XC9208A1LCM	DC/DC-IC	PWM-PWM/PFM st-down, 1.2MHz, 1.85V±2%, 600mA, +CE	SOT-25	28zq	DC1	6g	Tor
8BZ	XC6701BJ0MR	LVR-IC	18.0V±2%, 150mA, +CE	SOT-25	28hw	VR4	6g	Tor
8BZ	XC6112C230MR	Vdet-IC	3.0V±2%, -MR, -Reset ODO, Wt=50ms, Rt=50ms	SOT-25	28cp	VD16	6g	Tor
8C	R3111N281A	Vdet-IC	2.8V±2%, -Reset PPO	SOT-23-5	28vdm	VD7	6g	Ric
8C	RN5RL38AA	LVR-IC	3.8V±2.5%, 150mA	SOT-23-5	28vu	VR1	6g	Ric
8C	RN5VD28CA	Vdet-IC	2.8V±2.5%, -Reset ODO	SOT-23-5	28vdo	VD1	6g	Ric
8C0	XC6112C331MR	Vdet-IC	3.1V±2%, -MR, -Reset ODO, Wt=100ms, Rt=50ms	SOT-25	28cp	VD16	6g	Tor
8C1	XC6112C332MR	Vdet-IC	3.2V±2%, -MR, -Reset ODO, Wt=100ms, Rt=50ms	SOT-25	28cp	VD16	6g	Tor
8C2	XC6112C333MR	Vdet-IC	3.3V±2%, -MR, -Reset ODO, Wt=100ms, Rt=50ms	SOT-25	28cp	VD16	6g	Tor
8C3	XC6112C334MR	Vdet-IC	3.4V±2%, -MR, -Reset ODO, Wt=100ms, Rt=50ms	SOT-25	28cp	VD16	6g	Tor
8C4	XC6112C335MR	Vdet-IC	3.5V±2%, -MR, -Reset ODO, Wt=100ms, Rt=50ms	SOT-25	28cp	VD16	6g	Tor
8C5	XC6112C336MR	Vdet-IC	3.6V±2%, -MR, -Reset ODO, Wt=100ms, Rt=50ms	SOT-25	28cp	VD16	6g	Tor
8C6	XC6112C337MR	Vdet-IC	3.7V±2%, -MR, -Reset ODO, Wt=100ms, Rt=50ms	SOT-25	28cp	VD16	6g	Tor
8C7	XC6112C338MR	Vdet-IC	3.8V±2%, -MR, -Reset ODO, Wt=100ms, Rt=50ms	SOT-25	28cp	VD16	6g	Tor
8C8	XC6112C339MR	Vdet-IC	3.9V±2%, -MR, -Reset ODO, Wt=100ms, Rt=50ms	SOT-25	28cp	VD16	6g	Tor
8C9	XC6112C340MR	Vdet-IC	4.0V±2%, -MR, -Reset ODO, Wt=100ms, Rt=50ms	SOT-25	28cp	VD16	6g	Tor
8CA	XC6112C341MR	Vdet-IC	4.1V±2%, -MR, -Reset ODO, Wt=100ms, Rt=50ms	SOT-25	28cp	VD16	6g	Tor
8CA	XC9208A20CM	DC/DC-IC	PWM-PWM/PFM st-down, 1.2MHz, 2.0V±2%, 600mA, +CE	SOT-25	28zq	DC1	6g	Tor
8CB	XC6112C342MR	Vdet-IC	4.2V±2%, -MR, -Reset ODO, Wt=100ms, Rt=50ms	SOT-25	28cp	VD16	6g	Tor
8CB	XC9208A21CM	DC/DC-IC	PWM-PWM/PFM st-down, 1.2MHz, 2.1V±2%, 600mA, +CE	SOT-25	28zq	DC1	6g	Tor
8CC	XC6112C343MR	Vdet-IC	4.3V±2%, -MR, -Reset ODO, Wt=100ms, Rt=50ms	SOT-25	28cp	VD16	6g	Tor
8CC	XC9208A22CM	DC/DC-IC	PWM-PWM/PFM st-down, 1.2MHz, 2.2V±2%, 600mA, +CE	SOT-25	28zq	DC1	6g	Tor
8CD	XC6112C344MR	Vdet-IC	4.4V±2%, -MR, -Reset ODO, Wt=100ms, Rt=50ms	SOT-25	28cp	VD16	6g	Tor
8CD	XC9208A23CM	DC/DC-IC	PWM-PWM/PFM st-down, 1.2MHz, 2.3V±2%, 600mA, +CE	SOT-25	28zq	DC1	6g	Tor
8CE	XC6112C345MR	Vdet-IC	4.5V±2%, -MR, -Reset ODO, Wt=100ms, Rt=50ms	SOT-25	28cp	VD16	6g	Tor
8CE	XC9208A24CM	DC/DC-IC	PWM-PWM/PFM st-down, 1.2MHz, 2.4V±2%, 600mA, +CE	SOT-25	28zq	DC1	6g	Tor
8CF	XC6112C316MR	Vdet-IC	1.6V±2%, -MR, -Reset ODO, Wt=100ms, Rt=50ms	SOT-25	28cp	VD16	6g	Tor
8CF	XC6112C346MR	Vdet-IC	4.6V±2%, -MR, -Reset ODO, Wt=100ms, Rt=50ms	SOT-25	28cp	VD16	6g	Tor
8CF	XC9208A25CM	DC/DC-IC	PWM-PWM/PFM st-down, 1.2MHz, 2.5V±2%, 600mA, +CE	SOT-25	28zq	DC1	6g	Tor
8CH	XC6112C317MR	Vdet-IC	1.7V±2%, -MR, -Reset ODO, Wt=100ms, Rt=50ms	SOT-25	28cp	VD16	6g	Tor
8CH	XC6112C347MR	Vdet-IC	4.7V±2%, -MR, -Reset ODO, Wt=100ms, Rt=50ms	SOT-25	28cp	VD16	6g	Tor
8CH	XC9208A26CM	DC/DC-IC	PWM-PWM/PFM st-down, 1.2MHz, 2.6V±2%, 600mA, +CE	SOT-25	28zq	DC1	6g	Tor
8CK	XC6112C318MR	Vdet-IC	1.8V±2%, -MR, -Reset ODO, Wt=100ms, Rt=50ms	SOT-25	28cp	VD16	6g	Tor
8CK	XC6112C348MR	Vdet-IC	4.8V±2%, -MR, -Reset ODO, Wt=100ms, Rt=50ms	SOT-25	28cp	VD16	6g	Tor
8CK	XC9208A27CM	DC/DC-IC	PWM-PWM/PFM st-down, 1.2MHz, 2.7V±2%, 600mA, +CE	SOT-25	28zq	DC1	6g	Tor
8CL	XC6112C319MR	Vdet-IC	1.9V±2%, -MR, -Reset ODO, Wt=100ms, Rt=50ms	SOT-25	28cp	VD16	6g	Tor
8CL	XC6112C349MR	Vdet-IC	4.9V±2%, -MR, -Reset ODO, Wt=100ms, Rt=50ms	SOT-25	28cp	VD16	6g	Tor
8CL	XC9208A28CM	DC/DC-IC	PWM-PWM/PFM st-down, 1.2MHz, 2.8V±2%, 600mA, +CE	SOT-25	28zq	DC1	6g	Tor
8CM	XC6112C320MR	Vdet-IC	2.0V±2%, -MR, -Reset ODO, Wt=100ms, Rt=50ms	SOT-25	28cp	VD16	6g	Tor
8CM	XC6112C350MR	Vdet-IC	5.0V±2%, -MR, -Reset ODO, Wt=100ms, Rt=50ms	SOT-25	28cp	VD16	6g	Tor
8CM	XC9208A29CM	DC/DC-IC	PWM-PWM/PFM st-down, 1.2MHz, 2.9V±2%, 600mA, +CE	SOT-25	28zq	DC1	6g	Tor
8CN	XC6112C321MR	Vdet-IC	2.1V±2%, -MR, -Reset ODO, Wt=100ms, Rt=50ms	SOT-25	28cp	VD16	6g	Tor
8CP	XC6112C322MR	Vdet-IC	2.2V±2%, -MR, -Reset ODO, Wt=100ms, Rt=50ms	SOT-25	28cp	VD16	6g	Tor
8CR	XC6112C323MR	Vdet-IC	2.3V±2%, -MR, -Reset ODO, Wt=100ms, Rt=50ms	SOT-25	28cp	VD16	6g	Tor
8CS	XC6112C324MR	Vdet-IC	2.4V±2%, -MR, -Reset ODO, Wt=100ms, Rt=50ms	SOT-25	28cp	VD16	6g	Tor
8CT	XC6112C325MR	Vdet-IC	2.5V±2%, -MR, -Reset ODO, Wt=100ms, Rt=50ms	SOT-25	28cp	VD16	6g	Tor
8CU	XC6112C326MR	Vdet-IC	2.6V±2%, -MR, -Reset ODO, Wt=100ms, Rt=50ms	SOT-25	28cp	VD16	6g	Tor
8CV	XC6112C327MR	Vdet-IC	2.7V±2%, -MR, -Reset ODO, Wt=100ms, Rt=50ms	SOT-25	28cp	VD16	6g	Tor
8CX	XC6112C328MR	Vdet-IC	2.8V±2%, -MR, -Reset ODO, Wt=100ms, Rt=50ms	SOT-25	28cp	VD16	6g	Tor
8CY	XC6112C329MR	Vdet-IC	2.9V±2%, -MR, -Reset ODO, Wt=100ms, Rt=50ms	SOT-25	28cp	VD16	6g	Tor
8CY	XC9208A2LCM	DC/DC-IC	PWM-PWM/PFM st-down, 1.2MHz, 2.85V±2%, 600mA, +CE	SOT-25	28zq	DC1	6g	Tor
8CZ	XC6112C330MR	Vdet-IC	3.0V±2%, -MR, -Reset ODO, Wt=100ms, Rt=50ms	SOT-25	28cp	VD16	6g	Tor
8D	R3111N381A	Vdet-IC	3.8V±2%, -Reset PPO	SOT-23-5	28vdm	VD7	6g	Ric
8D	RN5RL48AA	LVR-IC	4.8V±2.5%, 150mA	SOT-23-5	28vu	VR1	6g	Ric
8D	RN5VD38CA	Vdet-IC	3.8V±2.5%, -Reset ODO	SOT-23-5	28vdo	VD1	6g	Ric
8D0	XC6112C431MR	Vdet-IC	3.1V±2%, -MR, -Reset ODO, Wt=200ms, Rt=50ms	SOT-25	28cp	VD16	6g	Tor
8D1	XC6112C432MR	Vdet-IC	3.2V±2%, -MR, -Reset ODO, Wt=200ms, Rt=50ms	SOT-25	28cp	VD16	6g	Tor
8D2	XC6112C433MR	Vdet-IC	3.3V±2%, -MR, -Reset ODO, Wt=200ms, Rt=50ms	SOT-25	28cp	VD16	6g	Tor
8D3	XC6112C434MR	Vdet-IC	3.4V±2%, -MR, -Reset ODO, Wt=200ms, Rt=50ms	SOT-25	28cp	VD16	6g	Tor
8D4	XC6112C435MR	Vdet-IC	3.5V±2%, -MR, -Reset ODO, Wt=200ms, Rt=50ms	SOT-25	28cp	VD16	6g	Tor
8D5	XC6112C436MR	Vdet-IC	3.6V±2%, -MR, -Reset ODO, Wt=200ms, Rt=50ms	SOT-25	28cp	VD16	6g	Tor
8D6	XC6112C437MR	Vdet-IC	3.7V±2%, -MR, -Reset ODO, Wt=200ms, Rt=50ms	SOT-25	28cp	VD16	6g	Tor
8D7	XC6112C438MR	Vdet-IC	3.8V±2%, -MR, -Reset ODO, Wt=200ms, Rt=50ms	SOT-25	28cp	VD16	6g	Tor
8D8	XC6112C439MR	Vdet-IC	3.9V±2%, -MR, -Reset ODO, Wt=200ms, Rt=50ms	SOT-25	28cp	VD16	6g	Tor



SMD code	Type	Function	Short description	Case	Pinout	Sch.	St.	Mnf.
8D9	XC6112C440MR	Vdet-IC	4.0V±2%, -MR, -Reset ODO, Wt=200ms, Rt=50ms	SOT-25	28cp	VD16	6g	Tor
8DA	XC6112C441MR	Vdet-IC	4.1V±2%, -MR, -Reset ODO, Wt=200ms, Rt=50ms	SOT-25	28cp	VD16	6g	Tor
8DA	XC9208A30CM	DC/DC-IC	PWM-PWM/PFM st-down, 1.2MHz, 3.0V±2%, 600mA, +CE	SOT-25	28zq	DC1	6g	Tor
8DB	XC6112C442MR	Vdet-IC	4.2V±2%, -MR, -Reset ODO, Wt=200ms, Rt=50ms	SOT-25	28cp	VD16	6g	Tor
8DB	XC9208A31CM	DC/DC-IC	PWM-PWM/PFM st-down, 1.2MHz, 3.1V±2%, 600mA, +CE	SOT-25	28zq	DC1	6g	Tor
8DC	XC6112C443MR	Vdet-IC	4.3V±2%, -MR, -Reset ODO, Wt=200ms, Rt=50ms	SOT-25	28cp	VD16	6g	Tor
8DC	XC9208A32CM	DC/DC-IC	PWM-PWM/PFM st-down, 1.2MHz, 3.2V±2%, 600mA, +CE	SOT-25	28zq	DC1	6g	Tor
8DD	XC6112C444MR	Vdet-IC	4.4V±2%, -MR, -Reset ODO, Wt=200ms, Rt=50ms	SOT-25	28cp	VD16	6g	Tor
8DD	XC9208A33CM	DC/DC-IC	PWM-PWM/PFM st-down, 1.2MHz, 3.3V±2%, 600mA, +CE	SOT-25	28zq	DC1	6g	Tor
8DE	XC6112C445MR	Vdet-IC	4.5V±2%, -MR, -Reset ODO, Wt=200ms, Rt=50ms	SOT-25	28cp	VD16	6g	Tor
8DE	XC9208A34CM	DC/DC-IC	PWM-PWM/PFM st-down, 1.2MHz, 3.4V±2%, 600mA, +CE	SOT-25	28zq	DC1	6g	Tor
8DF	XC6112C416MR	Vdet-IC	1.6V±2%, -MR, -Reset ODO, Wt=200ms, Rt=50ms	SOT-25	28cp	VD16	6g	Tor
8DF	XC6112C446MR	Vdet-IC	4.6V±2%, -MR, -Reset ODO, Wt=200ms, Rt=50ms	SOT-25	28cp	VD16	6g	Tor
8DF	XC9208A35CM	DC/DC-IC	PWM-PWM/PFM st-down, 1.2MHz, 3.5V±2%, 600mA, +CE	SOT-25	28zq	DC1	6g	Tor
8DH	XC6112C417MR	Vdet-IC	1.7V±2%, -MR, -Reset ODO, Wt=200ms, Rt=50ms	SOT-25	28cp	VD16	6g	Tor
8DH	XC6112C447MR	Vdet-IC	4.7V±2%, -MR, -Reset ODO, Wt=200ms, Rt=50ms	SOT-25	28cp	VD16	6g	Tor
8DH	XC9208A36CM	DC/DC-IC	PWM-PWM/PFM st-down, 1.2MHz, 3.6V±2%, 600mA, +CE	SOT-25	28zq	DC1	6g	Tor
8DK	XC6112C418MR	Vdet-IC	1.8V±2%, -MR, -Reset ODO, Wt=200ms, Rt=50ms	SOT-25	28cp	VD16	6g	Tor
8DK	XC6112C448MR	Vdet-IC	4.8V±2%, -MR, -Reset ODO, Wt=200ms, Rt=50ms	SOT-25	28cp	VD16	6g	Tor
8DK	XC9208A37CM	DC/DC-IC	PWM-PWM/PFM st-down, 1.2MHz, 3.7V±2%, 600mA, +CE	SOT-25	28zq	DC1	6g	Tor
8DL	XC6112C419MR	Vdet-IC	1.9V±2%, -MR, -Reset ODO, Wt=200ms, Rt=50ms	SOT-25	28cp	VD16	6g	Tor
8DL	XC6112C449MR	Vdet-IC	4.9V±2%, -MR, -Reset ODO, Wt=200ms, Rt=50ms	SOT-25	28cp	VD16	6g	Tor
8DL	XC9208A38CM	DC/DC-IC	PWM-PWM/PFM st-down, 1.2MHz, 3.8V±2%, 600mA, +CE	SOT-25	28zq	DC1	6g	Tor
8DM	XC6112C420MR	Vdet-IC	2.0V±2%, -MR, -Reset ODO, Wt=200ms, Rt=50ms	SOT-25	28cp	VD16	6g	Tor
8DM	XC6112C450MR	Vdet-IC	5.0V±2%, -MR, -Reset ODO, Wt=200ms, Rt=50ms	SOT-25	28cp	VD16	6g	Tor
8DM	XC9208A39CM	DC/DC-IC	PWM-PWM/PFM st-down, 1.2MHz, 3.9V±2%, 600mA, +CE	SOT-25	28zq	DC1	6g	Tor
8DN	XC6112C421MR	Vdet-IC	2.1V±2%, -MR, -Reset ODO, Wt=200ms, Rt=50ms	SOT-25	28cp	VD16	6g	Tor
8DP	XC6112C422MR	Vdet-IC	2.2V±2%, -MR, -Reset ODO, Wt=200ms, Rt=50ms	SOT-25	28cp	VD16	6g	Tor
8DR	XC6112C423MR	Vdet-IC	2.3V±2%, -MR, -Reset ODO, Wt=200ms, Rt=50ms	SOT-25	28cp	VD16	6g	Tor
8DS	XC6112C424MR	Vdet-IC	2.4V±2%, -MR, -Reset ODO, Wt=200ms, Rt=50ms	SOT-25	28cp	VD16	6g	Tor
8DT	XC6112C425MR	Vdet-IC	2.5V±2%, -MR, -Reset ODO, Wt=200ms, Rt=50ms	SOT-25	28cp	VD16	6g	Tor
8DU	XC6112C426MR	Vdet-IC	2.6V±2%, -MR, -Reset ODO, Wt=200ms, Rt=50ms	SOT-25	28cp	VD16	6g	Tor
8DV	XC6112C427MR	Vdet-IC	2.7V±2%, -MR, -Reset ODO, Wt=200ms, Rt=50ms	SOT-25	28cp	VD16	6g	Tor
8DX	XC6112C428MR	Vdet-IC	2.8V±2%, -MR, -Reset ODO, Wt=200ms, Rt=50ms	SOT-25	28cp	VD16	6g	Tor
8DY	XC6112C429MR	Vdet-IC	2.9V±2%, -MR, -Reset ODO, Wt=200ms, Rt=50ms	SOT-25	28cp	VD16	6g	Tor
8DZ	XC6112C430MR	Vdet-IC	3.0V±2%, -MR, -Reset ODO, Wt=200ms, Rt=50ms	SOT-25	28cp	VD16	6g	Tor
8E	R3111N481A	Vdet-IC	4.8V±2%, -Reset PPO	SOT-23-5	28vdm	VD7	6g	Ric
8E	RN5RL58AA	LVR-IC	5.8V±2.5%, 150mA	SOT-23-5	28v	VR1	6g	Ric
8E	RN5VD48CA	Vdet-IC	4.8V±2.5%, -Reset ODO	SOT-23-5	28vdo	VD1	6g	Ric
8E0	XC6112C531MR	Vdet-IC	3.1V±2%, -MR, -Reset ODO, Wt=400ms, Rt=50ms	SOT-25	28cp	VD16	6g	Tor
8E1	XC6112C532MR	Vdet-IC	3.2V±2%, -MR, -Reset ODO, Wt=400ms, Rt=50ms	SOT-25	28cp	VD16	6g	Tor
8E2	XC6112C533MR	Vdet-IC	3.3V±2%, -MR, -Reset ODO, Wt=400ms, Rt=50ms	SOT-25	28cp	VD16	6g	Tor
8E3	XC6112C534MR	Vdet-IC	3.4V±2%, -MR, -Reset ODO, Wt=400ms, Rt=50ms	SOT-25	28cp	VD16	6g	Tor
8E4	XC6112C535MR	Vdet-IC	3.5V±2%, -MR, -Reset ODO, Wt=400ms, Rt=50ms	SOT-25	28cp	VD16	6g	Tor
8E5	XC6112C536MR	Vdet-IC	3.6V±2%, -MR, -Reset ODO, Wt=400ms, Rt=50ms	SOT-25	28cp	VD16	6g	Tor
8E6	XC6112C537MR	Vdet-IC	3.7V±2%, -MR, -Reset ODO, Wt=400ms, Rt=50ms	SOT-25	28cp	VD16	6g	Tor
8E7	XC6112C538MR	Vdet-IC	3.8V±2%, -MR, -Reset ODO, Wt=400ms, Rt=50ms	SOT-25	28cp	VD16	6g	Tor
8E8	XC6112C539MR	Vdet-IC	3.9V±2%, -MR, -Reset ODO, Wt=400ms, Rt=50ms	SOT-25	28cp	VD16	6g	Tor
8E9	XC6112C540MR	Vdet-IC	4.0V±2%, -MR, -Reset ODO, Wt=400ms, Rt=50ms	SOT-25	28cp	VD16	6g	Tor
8EA	XC6112C541MR	Vdet-IC	4.1V±2%, -MR, -Reset ODO, Wt=400ms, Rt=50ms	SOT-25	28cp	VD16	6g	Tor
8EA	XC9208A40CM	DC/DC-IC	PWM-PWM/PFM st-down, 1.2MHz, 4.0V±2%, 600mA, +CE	SOT-25	28zq	DC1	6g	Tor
8EB	XC6112C542MR	Vdet-IC	4.2V±2%, -MR, -Reset ODO, Wt=400ms, Rt=50ms	SOT-25	28cp	VD16	6g	Tor
8EC	XC6112C543MR	Vdet-IC	4.3V±2%, -MR, -Reset ODO, Wt=400ms, Rt=50ms	SOT-25	28cp	VD16	6g	Tor
8ED	XC6112C544MR	Vdet-IC	4.4V±2%, -MR, -Reset ODO, Wt=400ms, Rt=50ms	SOT-25	28cp	VD16	6g	Tor
8EE	XC6112C545MR	Vdet-IC	4.5V±2%, -MR, -Reset ODO, Wt=400ms, Rt=50ms	SOT-25	28cp	VD16	6g	Tor
8EF	XC6112C516MR	Vdet-IC	1.6V±2%, -MR, -Reset ODO, Wt=400ms, Rt=50ms	SOT-25	28cp	VD16	6g	Tor
8EF	XC6112C546MR	Vdet-IC	4.6V±2%, -MR, -Reset ODO, Wt=400ms, Rt=50ms	SOT-25	28cp	VD16	6g	Tor
8EH	XC6112C517MR	Vdet-IC	1.7V±2%, -MR, -Reset ODO, Wt=400ms, Rt=50ms	SOT-25	28cp	VD16	6g	Tor
8EH	XC6112C547MR	Vdet-IC	4.7V±2%, -MR, -Reset ODO, Wt=400ms, Rt=50ms	SOT-25	28cp	VD16	6g	Tor
8EK	XC6112C518MR	Vdet-IC	1.8V±2%, -MR, -Reset ODO, Wt=400ms, Rt=50ms	SOT-25	28cp	VD16	6g	Tor
8EK	XC6112C548MR	Vdet-IC	4.8V±2%, -MR, -Reset ODO, Wt=400ms, Rt=50ms	SOT-25	28cp	VD16	6g	Tor
8EL	XC6112C519MR	Vdet-IC	1.9V±2%, -MR, -Reset ODO, Wt=400ms, Rt=50ms	SOT-25	28cp	VD16	6g	Tor
8EL	XC6112C549MR	Vdet-IC	4.9V±2%, -MR, -Reset ODO, Wt=400ms, Rt=50ms	SOT-25	28cp	VD16	6g	Tor
8EM	XC6112C520MR	Vdet-IC	2.0V±2%, -MR, -Reset ODO, Wt=400ms, Rt=50ms	SOT-25	28cp	VD16	6g	Tor
8EM	XC6112C550MR	Vdet-IC	5.0V±2%, -MR, -Reset ODO, Wt=400ms, Rt=50ms	SOT-25	28cp	VD16	6g	Tor
8EN	XC6112C521MR	Vdet-IC	2.1V±2%, -MR, -Reset ODO, Wt=400ms, Rt=50ms	SOT-25	28cp	VD16	6g	Tor
8EP	XC6112C522MR	Vdet-IC	2.2V±2%, -MR, -Reset ODO, Wt=400ms, Rt=50ms	SOT-25	28cp	VD16	6g	Tor
8ER	XC6112C523MR	Vdet-IC	2.3V±2%, -MR, -Reset ODO, Wt=400ms, Rt=50ms	SOT-25	28cp	VD16	6g	Tor
8ES	XC6112C524MR	Vdet-IC	2.4V±2%, -MR, -Reset ODO, Wt=400ms, Rt=50ms	SOT-25	28cp	VD16	6g	Tor
8ET	XC6112C525MR	Vdet-IC	2.5V±2%, -MR, -Reset ODO, Wt=400ms, Rt=50ms	SOT-25	28cp	VD16	6g	Tor



SMD code	Type	Function	Short description	Case	Pinout	Sch.	St.	Mnf.
8PM	XC6112E420MR	Vdet-IC	2.0V±2%, -MR, -Reset ODO, Wt=200ms, Rt=200ms	SOT-25	28cp	VD16	6g	Tor
8PM	XC6112E450MR	Vdet-IC	5.0V±2%, -MR, -Reset ODO, Wt=200ms, Rt=200ms	SOT-25	28cp	VD16	6g	Tor
8PN	XC6112E421MR	Vdet-IC	2.1V±2%, -MR, -Reset ODO, Wt=200ms, Rt=200ms	SOT-25	28cp	VD16	6g	Tor
8PP	XC6112E422MR	Vdet-IC	2.2V±2%, -MR, -Reset ODO, Wt=200ms, Rt=200ms	SOT-25	28cp	VD16	6g	Tor
8PR	XC6112E423MR	Vdet-IC	2.3V±2%, -MR, -Reset ODO, Wt=200ms, Rt=200ms	SOT-25	28cp	VD16	6g	Tor
8PS	XC6112E424MR	Vdet-IC	2.4V±2%, -MR, -Reset ODO, Wt=200ms, Rt=200ms	SOT-25	28cp	VD16	6g	Tor
8PT	XC6112E425MR	Vdet-IC	2.5V±2%, -MR, -Reset ODO, Wt=200ms, Rt=200ms	SOT-25	28cp	VD16	6g	Tor
8PU	XC6112E426MR	Vdet-IC	2.6V±2%, -MR, -Reset ODO, Wt=200ms, Rt=200ms	SOT-25	28cp	VD16	6g	Tor
8PV	XC6112E427MR	Vdet-IC	2.7V±2%, -MR, -Reset ODO, Wt=200ms, Rt=200ms	SOT-25	28cp	VD16	6g	Tor
8PX	XC6112E428MR	Vdet-IC	2.8V±2%, -MR, -Reset ODO, Wt=200ms, Rt=200ms	SOT-25	28cp	VD16	6g	Tor
8PY	XC6112E429MR	Vdet-IC	2.9V±2%, -MR, -Reset ODO, Wt=200ms, Rt=200ms	SOT-25	28cp	VD16	6g	Tor
8PZ	XC6112E430MR	Vdet-IC	3.0V±2%, -MR, -Reset ODO, Wt=200ms, Rt=200ms	SOT-25	28cp	VD16	6g	Tor
8Q	R1210N281A	DC/DC-IC	PWM step-up, 2.8V, 35...100kHz	SOT-23-5	28sc	DC3	6g	Ric
8R0	XC6112E531MR	Vdet-IC	3.1V±2%, -MR, -Reset ODO, Wt=400ms, Rt=200ms	SOT-25	28cp	VD16	6g	Tor
8R1	XC6112E532MR	Vdet-IC	3.2V±2%, -MR, -Reset ODO, Wt=400ms, Rt=200ms	SOT-25	28cp	VD16	6g	Tor
8R2	XC6112E533MR	Vdet-IC	3.3V±2%, -MR, -Reset ODO, Wt=400ms, Rt=200ms	SOT-25	28cp	VD16	6g	Tor
8R3	XC6112E534MR	Vdet-IC	3.4V±2%, -MR, -Reset ODO, Wt=400ms, Rt=200ms	SOT-25	28cp	VD16	6g	Tor
8R4	XC6112E535MR	Vdet-IC	3.5V±2%, -MR, -Reset ODO, Wt=400ms, Rt=200ms	SOT-25	28cp	VD16	6g	Tor
8R5	XC6112E536MR	Vdet-IC	3.6V±2%, -MR, -Reset ODO, Wt=400ms, Rt=200ms	SOT-25	28cp	VD16	6g	Tor
8R6	XC6112E537MR	Vdet-IC	3.7V±2%, -MR, -Reset ODO, Wt=400ms, Rt=200ms	SOT-25	28cp	VD16	6g	Tor
8R7	XC6112E538MR	Vdet-IC	3.8V±2%, -MR, -Reset ODO, Wt=400ms, Rt=200ms	SOT-25	28cp	VD16	6g	Tor
8R8	XC6112E539MR	Vdet-IC	3.9V±2%, -MR, -Reset ODO, Wt=400ms, Rt=200ms	SOT-25	28cp	VD16	6g	Tor
8R9	XC6112E540MR	Vdet-IC	4.0V±2%, -MR, -Reset ODO, Wt=400ms, Rt=200ms	SOT-25	28cp	VD16	6g	Tor
8RA	XC6112E541MR	Vdet-IC	4.1V±2%, -MR, -Reset ODO, Wt=400ms, Rt=200ms	SOT-25	28cp	VD16	6g	Tor
8RB	XC6112E542MR	Vdet-IC	4.2V±2%, -MR, -Reset ODO, Wt=400ms, Rt=200ms	SOT-25	28cp	VD16	6g	Tor
8RC	XC6112E543MR	Vdet-IC	4.3V±2%, -MR, -Reset ODO, Wt=400ms, Rt=200ms	SOT-25	28cp	VD16	6g	Tor
8RD	XC6112E544MR	Vdet-IC	4.4V±2%, -MR, -Reset ODO, Wt=400ms, Rt=200ms	SOT-25	28cp	VD16	6g	Tor
8RE	XC6112E545MR	Vdet-IC	4.5V±2%, -MR, -Reset ODO, Wt=400ms, Rt=200ms	SOT-25	28cp	VD16	6g	Tor
8RF	XC6112E516MR	Vdet-IC	1.6V±2%, -MR, -Reset ODO, Wt=400ms, Rt=200ms	SOT-25	28cp	VD16	6g	Tor
8RE	XC6112E546MR	Vdet-IC	4.6V±2%, -MR, -Reset ODO, Wt=400ms, Rt=200ms	SOT-25	28cp	VD16	6g	Tor
8RH	XC6112E517MR	Vdet-IC	1.7V±2%, -MR, -Reset ODO, Wt=400ms, Rt=200ms	SOT-25	28cp	VD16	6g	Tor
8RH	XC6112E547MR	Vdet-IC	4.7V±2%, -MR, -Reset ODO, Wt=400ms, Rt=200ms	SOT-25	28cp	VD16	6g	Tor
8RK	XC6112E518MR	Vdet-IC	1.8V±2%, -MR, -Reset ODO, Wt=400ms, Rt=200ms	SOT-25	28cp	VD16	6g	Tor
8RK	XC6112E548MR	Vdet-IC	4.8V±2%, -MR, -Reset ODO, Wt=400ms, Rt=200ms	SOT-25	28cp	VD16	6g	Tor
8RL	XC6112E519MR	Vdet-IC	1.9V±2%, -MR, -Reset ODO, Wt=400ms, Rt=200ms	SOT-25	28cp	VD16	6g	Tor
8RL	XC6112E549MR	Vdet-IC	4.9V±2%, -MR, -Reset ODO, Wt=400ms, Rt=200ms	SOT-25	28cp	VD16	6g	Tor
8RM	XC6112E520MR	Vdet-IC	2.0V±2%, -MR, -Reset ODO, Wt=400ms, Rt=200ms	SOT-25	28cp	VD16	6g	Tor
8RM	XC6112E550MR	Vdet-IC	5.0V±2%, -MR, -Reset ODO, Wt=400ms, Rt=200ms	SOT-25	28cp	VD16	6g	Tor
8RN	XC6112E521MR	Vdet-IC	2.1V±2%, -MR, -Reset ODO, Wt=400ms, Rt=200ms	SOT-25	28cp	VD16	6g	Tor
8RP	XC6112E522MR	Vdet-IC	2.2V±2%, -MR, -Reset ODO, Wt=400ms, Rt=200ms	SOT-25	28cp	VD16	6g	Tor
8RR	XC6112E523MR	Vdet-IC	2.3V±2%, -MR, -Reset ODO, Wt=400ms, Rt=200ms	SOT-25	28cp	VD16	6g	Tor
8RS	XC6112E524MR	Vdet-IC	2.4V±2%, -MR, -Reset ODO, Wt=400ms, Rt=200ms	SOT-25	28cp	VD16	6g	Tor
8RT	XC6112E525MR	Vdet-IC	2.5V±2%, -MR, -Reset ODO, Wt=400ms, Rt=200ms	SOT-25	28cp	VD16	6g	Tor
8RU	XC6112E526MR	Vdet-IC	2.6V±2%, -MR, -Reset ODO, Wt=400ms, Rt=200ms	SOT-25	28cp	VD16	6g	Tor
8RV	XC6112E527MR	Vdet-IC	2.7V±2%, -MR, -Reset ODO, Wt=400ms, Rt=200ms	SOT-25	28cp	VD16	6g	Tor
8RX	XC6112E528MR	Vdet-IC	2.8V±2%, -MR, -Reset ODO, Wt=400ms, Rt=200ms	SOT-25	28cp	VD16	6g	Tor
8RY	XC6112E529MR	Vdet-IC	2.9V±2%, -MR, -Reset ODO, Wt=400ms, Rt=200ms	SOT-25	28cp	VD16	6g	Tor
8RZ	XC6112E530MR	Vdet-IC	3.0V±2%, -MR, -Reset ODO, Wt=400ms, Rt=200ms	SOT-25	28cp	VD16	6g	Tor
8S	RN5RF18AA	LVR-IC	LRip, -CE, 1.8V±2%, 1A*	SOT-23-5	28vw	VR6	6g	Ric
8S0	XC6112E631MR	Vdet-IC	3.1V±2%, -MR, -Reset ODO, Wt=1.6s, Rt=200ms	SOT-25	28cp	VD16	6g	Tor
8S00	NC7ST00M5	CMOS-Logic	2-input NAND gate	SOT-23-5	28Log1	-	6a	F
8S02	NC7ST02M5	CMOS-Logic	2-input NOR gate	SOT-23-5	28Log2	-	6a	F
8S04	NC7ST04M5	CMOS-Logic	Inverter	SOT-23-5	28Log6	-	6a	F
8S08	NC7ST08M5	CMOS-Logic	2-input AND gate	SOT-23-5	28Log3	-	6a	F
8S1	XC6112E632MR	Vdet-IC	3.2V±2%, -MR, -Reset ODO, Wt=1.6s, Rt=200ms	SOT-25	28cp	VD16	6g	Tor
8S14	NC7ST14M5	CMOS-Logic	Inverting Schmitt-trigger	SC-59-5	28Log7	-	6a	F
8S2	XC6112E633MR	Vdet-IC	3.3V±2%, -MR, -Reset ODO, Wt=1.6s, Rt=200ms	SOT-25	28cp	VD16	6g	Tor
8S3	XC6112E634MR	Vdet-IC	3.4V±2%, -MR, -Reset ODO, Wt=1.6s, Rt=200ms	SOT-25	28cp	VD16	6g	Tor
8S32	NC7ST32M5	CMOS-Logic	2-input OR gate	SOT-23-5	28Log4	-	6a	F
8S4	XC6112E635MR	Vdet-IC	3.5V±2%, -MR, -Reset ODO, Wt=1.6s, Rt=200ms	SOT-25	28cp	VD16	6g	Tor
8S5	XC6112E636MR	Vdet-IC	3.6V±2%, -MR, -Reset ODO, Wt=1.6s, Rt=200ms	SOT-25	28cp	VD16	6g	Tor
8S6	XC6112E637MR	Vdet-IC	3.7V±2%, -MR, -Reset ODO, Wt=1.6s, Rt=200ms	SOT-25	28cp	VD16	6g	Tor
8S7	XC6112E638MR	Vdet-IC	3.8V±2%, -MR, -Reset ODO, Wt=1.6s, Rt=200ms	SOT-25	28cp	VD16	6g	Tor
8S8	XC6112E639MR	Vdet-IC	3.9V±2%, -MR, -Reset ODO, Wt=1.6s, Rt=200ms	SOT-25	28cp	VD16	6g	Tor
8S86	NC7ST86M5	CMOS-Logic	2-input EXCLUSIVE-OR gate	SOT-23-5	28Log5	-	6a	F
8S9	XC6112E640MR	Vdet-IC	4.0V±2%, -MR, -Reset ODO, Wt=1.6s, Rt=200ms	SOT-25	28cp	VD16	6g	Tor
8S9A	XC6112E641MR	Vdet-IC	4.1V±2%, -MR, -Reset ODO, Wt=1.6s, Rt=200ms	SOT-25	28cp	VD16	6g	Tor
8S9B	XC6112E642MR	Vdet-IC	4.2V±2%, -MR, -Reset ODO, Wt=1.6s, Rt=200ms	SOT-25	28cp	VD16	6g	Tor
8S9C	XC6112E643MR	Vdet-IC	4.3V±2%, -MR, -Reset ODO, Wt=1.6s, Rt=200ms	SOT-25	28cp	VD16	6g	Tor
8S9D	XC6112E644MR	Vdet-IC	4.4V±2%, -MR, -Reset ODO, Wt=1.6s, Rt=200ms	SOT-25	28cp	VD16	6g	Tor



SMD code	Type	Function	Short description	Case	Pinout	Sch.	St.	Mnf.
<u>8SE</u>	XC6112E645MR	Vdet-IC	4.5V±2%, -MR, -Reset ODO, Wt=1.6s, Rt=200ms	SOT-25	28cp	VD16	6g	Tor
<u>8SF</u>	XC6112E616MR	Vdet-IC	1.6V±2%, -MR, -Reset ODO, Wt=1.6s, Rt=200ms	SOT-25	28cp	VD16	6g	Tor
<u>8SF</u>	XC6112E646MR	Vdet-IC	4.6V±2%, -MR, -Reset ODO, Wt=1.6s, Rt=200ms	SOT-25	28cp	VD16	6g	Tor
<u>8SH</u>	XC6112E617MR	Vdet-IC	1.7V±2%, -MR, -Reset ODO, Wt=1.6s, Rt=200ms	SOT-25	28cp	VD16	6g	Tor
<u>8SH</u>	XC6112E647MR	Vdet-IC	4.7V±2%, -MR, -Reset ODO, Wt=1.6s, Rt=200ms	SOT-25	28cp	VD16	6g	Tor
<u>8SK</u>	XC6112E618MR	Vdet-IC	1.8V±2%, -MR, -Reset ODO, Wt=1.6s, Rt=200ms	SOT-25	28cp	VD16	6g	Tor
<u>8SK</u>	XC6112E648MR	Vdet-IC	4.8V±2%, -MR, -Reset ODO, Wt=1.6s, Rt=200ms	SOT-25	28cp	VD16	6g	Tor
<u>8SL</u>	XC6112E619MR	Vdet-IC	1.9V±2%, -MR, -Reset ODO, Wt=1.6s, Rt=200ms	SOT-25	28cp	VD16	6g	Tor
<u>8SL</u>	XC6112E649MR	Vdet-IC	4.9V±2%, -MR, -Reset ODO, Wt=1.6s, Rt=200ms	SOT-25	28cp	VD16	6g	Tor
<u>8SM</u>	XC6112E620MR	Vdet-IC	2.0V±2%, -MR, -Reset ODO, Wt=1.6s, Rt=200ms	SOT-25	28cp	VD16	6g	Tor
<u>8SM</u>	XC6112E650MR	Vdet-IC	5.0V±2%, -MR, -Reset ODO, Wt=1.6s, Rt=200ms	SOT-25	28cp	VD16	6g	Tor
<u>8SN</u>	XC6112E621MR	Vdet-IC	2.1V±2%, -MR, -Reset ODO, Wt=1.6s, Rt=200ms	SOT-25	28cp	VD16	6g	Tor
<u>8SP</u>	XC6112E622MR	Vdet-IC	2.2V±2%, -MR, -Reset ODO, Wt=1.6s, Rt=200ms	SOT-25	28cp	VD16	6g	Tor
<u>8SR</u>	XC6112E623MR	Vdet-IC	2.3V±2%, -MR, -Reset ODO, Wt=1.6s, Rt=200ms	SOT-25	28cp	VD16	6g	Tor
<u>8SS</u>	XC6112E624MR	Vdet-IC	2.4V±2%, -MR, -Reset ODO, Wt=1.6s, Rt=200ms	SOT-25	28cp	VD16	6g	Tor
<u>8ST</u>	XC6112E625MR	Vdet-IC	2.5V±2%, -MR, -Reset ODO, Wt=1.6s, Rt=200ms	SOT-25	28cp	VD16	6g	Tor
<u>8SU</u>	XC6112E626MR	Vdet-IC	2.6V±2%, -MR, -Reset ODO, Wt=1.6s, Rt=200ms	SOT-25	28cp	VD16	6g	Tor
<u>8SV</u>	XC6112E627MR	Vdet-IC	2.7V±2%, -MR, -Reset ODO, Wt=1.6s, Rt=200ms	SOT-25	28cp	VD16	6g	Tor
<u>8SX</u>	XC6112E628MR	Vdet-IC	2.8V±2%, -MR, -Reset ODO, Wt=1.6s, Rt=200ms	SOT-25	28cp	VD16	6g	Tor
<u>8SY</u>	XC6112E629MR	Vdet-IC	2.9V±2%, -MR, -Reset ODO, Wt=1.6s, Rt=200ms	SOT-25	28cp	VD16	6g	Tor
<u>8SZ</u>	XC6112E630MR	Vdet-IC	3.0V±2%, -MR, -Reset ODO, Wt=1.6s, Rt=200ms	SOT-25	28cp	VD16	6g	Tor
<u>8T</u>	RN5RF18BA	LVR-IC	L/Rip, +CE, 1.8V±2%, 1A*	SOT-23-5	28vw	VR6	6g	Ric
<u>8T0</u>	XC6112F531MR	Vdet-IC	3.1V±2%, -MR, -Reset ODO, Wt=400ms, Rt=400ms	SOT-25	28cp	VD16	6g	Tor
<u>8T1</u>	XC6112F532MR	Vdet-IC	3.2V±2%, -MR, -Reset ODO, Wt=400ms, Rt=400ms	SOT-25	28cp	VD16	6g	Tor
<u>8T2</u>	XC6112F533MR	Vdet-IC	3.3V±2%, -MR, -Reset ODO, Wt=400ms, Rt=400ms	SOT-25	28cp	VD16	6g	Tor
<u>8T3</u>	XC6112F534MR	Vdet-IC	3.4V±2%, -MR, -Reset ODO, Wt=400ms, Rt=400ms	SOT-25	28cp	VD16	6g	Tor
<u>8T4</u>	XC6112F535MR	Vdet-IC	3.5V±2%, -MR, -Reset ODO, Wt=400ms, Rt=400ms	SOT-25	28cp	VD16	6g	Tor
<u>8T5</u>	XC6112F536MR	Vdet-IC	3.6V±2%, -MR, -Reset ODO, Wt=400ms, Rt=400ms	SOT-25	28cp	VD16	6g	Tor
<u>8T6</u>	XC6112F537MR	Vdet-IC	3.7V±2%, -MR, -Reset ODO, Wt=400ms, Rt=400ms	SOT-25	28cp	VD16	6g	Tor
<u>8T7</u>	XC6112F538MR	Vdet-IC	3.8V±2%, -MR, -Reset ODO, Wt=400ms, Rt=400ms	SOT-25	28cp	VD16	6g	Tor
<u>8T8</u>	XC6112F539MR	Vdet-IC	3.9V±2%, -MR, -Reset ODO, Wt=400ms, Rt=400ms	SOT-25	28cp	VD16	6g	Tor
<u>8T9</u>	XC6112F540MR	Vdet-IC	4.0V±2%, -MR, -Reset ODO, Wt=400ms, Rt=400ms	SOT-25	28cp	VD16	6g	Tor
<u>8TA</u>	XC6112F541MR	Vdet-IC	4.1V±2%, -MR, -Reset ODO, Wt=400ms, Rt=400ms	SOT-25	28cp	VD16	6g	Tor
<u>8TB</u>	XC6112F542MR	Vdet-IC	4.2V±2%, -MR, -Reset ODO, Wt=400ms, Rt=400ms	SOT-25	28cp	VD16	6g	Tor
<u>8TC</u>	XC6112F543MR	Vdet-IC	4.3V±2%, -MR, -Reset ODO, Wt=400ms, Rt=400ms	SOT-25	28cp	VD16	6g	Tor
<u>8TD</u>	XC6112F544MR	Vdet-IC	4.4V±2%, -MR, -Reset ODO, Wt=400ms, Rt=400ms	SOT-25	28cp	VD16	6g	Tor
<u>8TE</u>	XC6112F545MR	Vdet-IC	4.5V±2%, -MR, -Reset ODO, Wt=400ms, Rt=400ms	SOT-25	28cp	VD16	6g	Tor
<u>8TF</u>	XC6112F516MR	Vdet-IC	1.6V±2%, -MR, -Reset ODO, Wt=400ms, Rt=400ms	SOT-25	28cp	VD16	6g	Tor
<u>8TE</u>	XC6112F546MR	Vdet-IC	4.6V±2%, -MR, -Reset ODO, Wt=400ms, Rt=400ms	SOT-25	28cp	VD16	6g	Tor
<u>8TH</u>	XC6112F517MR	Vdet-IC	1.7V±2%, -MR, -Reset ODO, Wt=400ms, Rt=400ms	SOT-25	28cp	VD16	6g	Tor
<u>8TH</u>	XC6112F547MR	Vdet-IC	4.7V±2%, -MR, -Reset ODO, Wt=400ms, Rt=400ms	SOT-25	28cp	VD16	6g	Tor
<u>8TK</u>	XC6112F518MR	Vdet-IC	1.8V±2%, -MR, -Reset ODO, Wt=400ms, Rt=400ms	SOT-25	28cp	VD16	6g	Tor
<u>8TK</u>	XC6112F548MR	Vdet-IC	4.8V±2%, -MR, -Reset ODO, Wt=400ms, Rt=400ms	SOT-25	28cp	VD16	6g	Tor
<u>8TL</u>	XC6112F519MR	Vdet-IC	1.9V±2%, -MR, -Reset ODO, Wt=400ms, Rt=400ms	SOT-25	28cp	VD16	6g	Tor
<u>8TL</u>	XC6112F549MR	Vdet-IC	4.9V±2%, -MR, -Reset ODO, Wt=400ms, Rt=400ms	SOT-25	28cp	VD16	6g	Tor
<u>8TM</u>	XC6112F520MR	Vdet-IC	2.0V±2%, -MR, -Reset ODO, Wt=400ms, Rt=400ms	SOT-25	28cp	VD16	6g	Tor
<u>8TM</u>	XC6112F550MR	Vdet-IC	5.0V±2%, -MR, -Reset ODO, Wt=400ms, Rt=400ms	SOT-25	28cp	VD16	6g	Tor
<u>8TN</u>	XC6112F521MR	Vdet-IC	2.1V±2%, -MR, -Reset ODO, Wt=400ms, Rt=400ms	SOT-25	28cp	VD16	6g	Tor
<u>8TP</u>	XC6112F522MR	Vdet-IC	2.2V±2%, -MR, -Reset ODO, Wt=400ms, Rt=400ms	SOT-25	28cp	VD16	6g	Tor
<u>8TR</u>	XC6112F523MR	Vdet-IC	2.3V±2%, -MR, -Reset ODO, Wt=400ms, Rt=400ms	SOT-25	28cp	VD16	6g	Tor
<u>8TR</u>	XC6112F524MR	Vdet-IC	2.4V±2%, -MR, -Reset ODO, Wt=400ms, Rt=400ms	SOT-25	28cp	VD16	6g	Tor
<u>8TT</u>	XC6112F525MR	Vdet-IC	2.5V±2%, -MR, -Reset ODO, Wt=400ms, Rt=400ms	SOT-25	28cp	VD16	6g	Tor
<u>8TU</u>	XC6112F526MR	Vdet-IC	2.6V±2%, -MR, -Reset ODO, Wt=400ms, Rt=400ms	SOT-25	28cp	VD16	6g	Tor
<u>8TV</u>	XC6112F527MR	Vdet-IC	2.7V±2%, -MR, -Reset ODO, Wt=400ms, Rt=400ms	SOT-25	28cp	VD16	6g	Tor
<u>8TX</u>	XC6112F528MR	Vdet-IC	2.8V±2%, -MR, -Reset ODO, Wt=400ms, Rt=400ms	SOT-25	28cp	VD16	6g	Tor
<u>8TY</u>	XC6112F529MR	Vdet-IC	2.9V±2%, -MR, -Reset ODO, Wt=400ms, Rt=400ms	SOT-25	28cp	VD16	6g	Tor
<u>8TZ</u>	XC6112F530MR	Vdet-IC	3.0V±2%, -MR, -Reset ODO, Wt=400ms, Rt=400ms	SOT-25	28cp	VD16	6g	Tor
<u>8U</u>	R1210N281C	DC/DC-IC	PWM step-up, 2.8V, 100kHz	SOT-23-5	28sc	DC3	6g	Ric
<u>8U0</u>	XC6112F631MR	Vdet-IC	3.1V±2%, -MR, -Reset ODO, Wt=1.6s, Rt=400ms	SOT-25	28cp	VD16	6g	Tor
<u>8U1</u>	XC6112F632MR	Vdet-IC	3.2V±2%, -MR, -Reset ODO, Wt=1.6s, Rt=400ms	SOT-25	28cp	VD16	6g	Tor
<u>8U2</u>	XC6112F633MR	Vdet-IC	3.3V±2%, -MR, -Reset ODO, Wt=1.6s, Rt=400ms	SOT-25	28cp	VD16	6g	Tor
<u>8U3</u>	XC6112F634MR	Vdet-IC	3.4V±2%, -MR, -Reset ODO, Wt=1.6s, Rt=400ms	SOT-25	28cp	VD16	6g	Tor
<u>8U4</u>	XC6112F635MR	Vdet-IC	3.5V±2%, -MR, -Reset ODO, Wt=1.6s, Rt=400ms	SOT-25	28cp	VD16	6g	Tor
<u>8U5</u>	XC6112F636MR	Vdet-IC	3.6V±2%, -MR, -Reset ODO, Wt=1.6s, Rt=400ms	SOT-25	28cp	VD16	6g	Tor
<u>8U6</u>	XC6112F637MR	Vdet-IC	3.7V±2%, -MR, -Reset ODO, Wt=1.6s, Rt=400ms	SOT-25	28cp	VD16	6g	Tor
<u>8U7</u>	XC6112F638MR	Vdet-IC	3.8V±2%, -MR, -Reset ODO, Wt=1.6s, Rt=400ms	SOT-25	28cp	VD16	6g	Tor
<u>8U8</u>	XC6112F639MR	Vdet-IC	3.9V±2%, -MR, -Reset ODO, Wt=1.6s, Rt=400ms	SOT-25	28cp	VD16	6g	Tor
<u>8U9</u>	XC6112F640MR	Vdet-IC	4.0V±2%, -MR, -Reset ODO, Wt=1.6s, Rt=400ms	SOT-25	28cp	VD16	6g	Tor
<u>8UA</u>	XC6112F641MR	Vdet-IC	4.1V±2%, -MR, -Reset ODO, Wt=1.6s, Rt=400ms	SOT-25	28cp	VD16	6g	Tor
<u>8UB</u>	XC6112F642MR	Vdet-IC	4.2V±2%, -MR, -Reset ODO, Wt=1.6s, Rt=400ms	SOT-25	28cp	VD16	6g	Tor



SMD Code	Type	Function	Short description	Case	Pinout	Sch.	St.	Mnf.
<u>8UC</u>	XC6112F643MR	Vdet-IC	4.3V±2%, -MR, -Reset ODO, Wt=1.6s, Rt=400ms	SOT-25	28cp	VD16	6g	Tor
<u>8UD</u>	XC6112F644MR	Vdet-IC	4.4V±2%, -MR, -Reset ODO, Wt=1.6s, Rt=400ms	SOT-25	28cp	VD16	6g	Tor
<u>8UE</u>	XC6112F645MR	Vdet-IC	4.5V±2%, -MR, -Reset ODO, Wt=1.6s, Rt=400ms	SOT-25	28cp	VD16	6g	Tor
<u>8UF</u>	XC6112F616MR	Vdet-IC	1.6V±2%, -MR, -Reset ODO, Wt=1.6s, Rt=400ms	SOT-25	28cp	VD16	6g	Tor
<u>8UF</u>	XC6112F646MR	Vdet-IC	4.6V±2%, -MR, -Reset ODO, Wt=1.6s, Rt=400ms	SOT-25	28cp	VD16	6g	Tor
<u>8UH</u>	XC6112F617MR	Vdet-IC	1.7V±2%, -MR, -Reset ODO, Wt=1.6s, Rt=400ms	SOT-25	28cp	VD16	6g	Tor
<u>8UH</u>	XC6112F647MR	Vdet-IC	4.7V±2%, -MR, -Reset ODO, Wt=1.6s, Rt=400ms	SOT-25	28cp	VD16	6g	Tor
<u>8UK</u>	XC6112F618MR	Vdet-IC	1.8V±2%, -MR, -Reset ODO, Wt=1.6s, Rt=400ms	SOT-25	28cp	VD16	6g	Tor
<u>8UK</u>	XC6112F648MR	Vdet-IC	4.8V±2%, -MR, -Reset ODO, Wt=1.6s, Rt=400ms	SOT-25	28cp	VD16	6g	Tor
<u>8UL</u>	XC6112F619MR	Vdet-IC	1.9V±2%, -MR, -Reset ODO, Wt=1.6s, Rt=400ms	SOT-25	28cp	VD16	6g	Tor
<u>8UL</u>	XC6112F649MR	Vdet-IC	4.9V±2%, -MR, -Reset ODO, Wt=1.6s, Rt=400ms	SOT-25	28cp	VD16	6g	Tor
<u>8UM</u>	XC6112F620MR	Vdet-IC	2.0V±2%, -MR, -Reset ODO, Wt=1.6s, Rt=400ms	SOT-25	28cp	VD16	6g	Tor
<u>8UM</u>	XC6112F650MR	Vdet-IC	5.0V±2%, -MR, -Reset ODO, Wt=1.6s, Rt=400ms	SOT-25	28cp	VD16	6g	Tor
<u>8UN</u>	XC6112F621MR	Vdet-IC	2.1V±2%, -MR, -Reset ODO, Wt=1.6s, Rt=400ms	SOT-25	28cp	VD16	6g	Tor
<u>8UP</u>	XC6112F622MR	Vdet-IC	2.2V±2%, -MR, -Reset ODO, Wt=1.6s, Rt=400ms	SOT-25	28cp	VD16	6g	Tor
<u>8UR</u>	XC6112F623MR	Vdet-IC	2.3V±2%, -MR, -Reset ODO, Wt=1.6s, Rt=400ms	SOT-25	28cp	VD16	6g	Tor
<u>8US</u>	XC6112F624MR	Vdet-IC	2.4V±2%, -MR, -Reset ODO, Wt=1.6s, Rt=400ms	SOT-25	28cp	VD16	6g	Tor
<u>8UT</u>	XC6112F625MR	Vdet-IC	2.5V±2%, -MR, -Reset ODO, Wt=1.6s, Rt=400ms	SOT-25	28cp	VD16	6g	Tor
<u>8UU</u>	XC6112F626MR	Vdet-IC	2.6V±2%, -MR, -Reset ODO, Wt=1.6s, Rt=400ms	SOT-25	28cp	VD16	6g	Tor
<u>8UV</u>	XC6112F627MR	Vdet-IC	2.7V±2%, -MR, -Reset ODO, Wt=1.6s, Rt=400ms	SOT-25	28cp	VD16	6g	Tor
<u>8UX</u>	XC6112F628MR	Vdet-IC	2.8V±2%, -MR, -Reset ODO, Wt=1.6s, Rt=400ms	SOT-25	28cp	VD16	6g	Tor
<u>8UY</u>	XC6112F629MR	Vdet-IC	2.9V±2%, -MR, -Reset ODO, Wt=1.6s, Rt=400ms	SOT-25	28cp	VD16	6g	Tor
<u>8UZ</u>	XC6112F630MR	Vdet-IC	3.0V±2%, -MR, -Reset ODO, Wt=1.6s, Rt=400ms	SOT-25	28cp	VD16	6g	Tor
<u>8V0</u>	XC6112H631MR	Vdet-IC	3.1V±2%, -MR, -Reset ODO, Wt=1.6s, Rt=1.6s	SOT-25	28cp	VD16	6g	Tor
<u>8V1</u>	XC6112H632MR	Vdet-IC	3.2V±2%, -MR, -Reset ODO, Wt=1.6s, Rt=1.6s	SOT-25	28cp	VD16	6g	Tor
<u>8V2</u>	XC6112H633MR	Vdet-IC	3.3V±2%, -MR, -Reset ODO, Wt=1.6s, Rt=1.6s	SOT-25	28cp	VD16	6g	Tor
<u>8V3</u>	XC6112H634MR	Vdet-IC	3.4V±2%, -MR, -Reset ODO, Wt=1.6s, Rt=1.6s	SOT-25	28cp	VD16	6g	Tor
<u>8V4</u>	XC6112H635MR	Vdet-IC	3.5V±2%, -MR, -Reset ODO, Wt=1.6s, Rt=1.6s	SOT-25	28cp	VD16	6g	Tor
<u>8V5</u>	XC6112H636MR	Vdet-IC	3.6V±2%, -MR, -Reset ODO, Wt=1.6s, Rt=1.6s	SOT-25	28cp	VD16	6g	Tor
<u>8V6</u>	XC6112H637MR	Vdet-IC	3.7V±2%, -MR, -Reset ODO, Wt=1.6s, Rt=1.6s	SOT-25	28cp	VD16	6g	Tor
<u>8V7</u>	XC6112H638MR	Vdet-IC	3.8V±2%, -MR, -Reset ODO, Wt=1.6s, Rt=1.6s	SOT-25	28cp	VD16	6g	Tor
<u>8V8</u>	XC6112H639MR	Vdet-IC	3.9V±2%, -MR, -Reset ODO, Wt=1.6s, Rt=1.6s	SOT-25	28cp	VD16	6g	Tor
<u>8V9</u>	XC6112H640MR	Vdet-IC	4.0V±2%, -MR, -Reset ODO, Wt=1.6s, Rt=1.6s	SOT-25	28cp	VD16	6g	Tor
<u>8VA</u>	XC6112H641MR	Vdet-IC	4.1V±2%, -MR, -Reset ODO, Wt=1.6s, Rt=1.6s	SOT-25	28cp	VD16	6g	Tor
<u>8VB</u>	XC6112H642MR	Vdet-IC	4.2V±2%, -MR, -Reset ODO, Wt=1.6s, Rt=1.6s	SOT-25	28cp	VD16	6g	Tor
<u>8VC</u>	XC6112H643MR	Vdet-IC	4.3V±2%, -MR, -Reset ODO, Wt=1.6s, Rt=1.6s	SOT-25	28cp	VD16	6g	Tor
<u>8VD</u>	XC6112H644MR	Vdet-IC	4.4V±2%, -MR, -Reset ODO, Wt=1.6s, Rt=1.6s	SOT-25	28cp	VD16	6g	Tor
<u>8VE</u>	XC6112H645MR	Vdet-IC	4.5V±2%, -MR, -Reset ODO, Wt=1.6s, Rt=1.6s	SOT-25	28cp	VD16	6g	Tor
<u>8VF</u>	XC6112H616MR	Vdet-IC	1.6V±2%, -MR, -Reset ODO, Wt=1.6s, Rt=1.6s	SOT-25	28cp	VD16	6g	Tor
<u>8VF</u>	XC6112H646MR	Vdet-IC	4.6V±2%, -MR, -Reset ODO, Wt=1.6s, Rt=1.6s	SOT-25	28cp	VD16	6g	Tor
<u>8VH</u>	XC6112H617MR	Vdet-IC	1.7V±2%, -MR, -Reset ODO, Wt=1.6s, Rt=1.6s	SOT-25	28cp	VD16	6g	Tor
<u>8VH</u>	XC6112H647MR	Vdet-IC	4.7V±2%, -MR, -Reset ODO, Wt=1.6s, Rt=1.6s	SOT-25	28cp	VD16	6g	Tor
<u>8VK</u>	XC6112H618MR	Vdet-IC	1.8V±2%, -MR, -Reset ODO, Wt=1.6s, Rt=1.6s	SOT-25	28cp	VD16	6g	Tor
<u>8VK</u>	XC6112H648MR	Vdet-IC	4.8V±2%, -MR, -Reset ODO, Wt=1.6s, Rt=1.6s	SOT-25	28cp	VD16	6g	Tor
<u>8VL</u>	XC6112H619MR	Vdet-IC	1.9V±2%, -MR, -Reset ODO, Wt=1.6s, Rt=1.6s	SOT-25	28cp	VD16	6g	Tor
<u>8VL</u>	XC6112H649MR	Vdet-IC	4.9V±2%, -MR, -Reset ODO, Wt=1.6s, Rt=1.6s	SOT-25	28cp	VD16	6g	Tor
<u>8VM</u>	XC6112H620MR	Vdet-IC	2.0V±2%, -MR, -Reset ODO, Wt=1.6s, Rt=1.6s	SOT-25	28cp	VD16	6g	Tor
<u>8VM</u>	XC6112H650MR	Vdet-IC	5.0V±2%, -MR, -Reset ODO, Wt=1.6s, Rt=1.6s	SOT-25	28cp	VD16	6g	Tor
<u>8VN</u>	XC6112H621MR	Vdet-IC	2.1V±2%, -MR, -Reset ODO, Wt=1.6s, Rt=1.6s	SOT-25	28cp	VD16	6g	Tor
<u>8VP</u>	XC6112H622MR	Vdet-IC	2.2V±2%, -MR, -Reset ODO, Wt=1.6s, Rt=1.6s	SOT-25	28cp	VD16	6g	Tor
<u>8VR</u>	XC6112H623MR	Vdet-IC	2.3V±2%, -MR, -Reset ODO, Wt=1.6s, Rt=1.6s	SOT-25	28cp	VD16	6g	Tor
<u>8VS</u>	XC6112H624MR	Vdet-IC	2.4V±2%, -MR, -Reset ODO, Wt=1.6s, Rt=1.6s	SOT-25	28cp	VD16	6g	Tor
<u>8VT</u>	XC6112H625MR	Vdet-IC	2.5V±2%, -MR, -Reset ODO, Wt=1.6s, Rt=1.6s	SOT-25	28cp	VD16	6g	Tor
<u>8VU</u>	XC6112H626MR	Vdet-IC	2.6V±2%, -MR, -Reset ODO, Wt=1.6s, Rt=1.6s	SOT-25	28cp	VD16	6g	Tor
<u>8VV</u>	XC6112H627MR	Vdet-IC	2.7V±2%, -MR, -Reset ODO, Wt=1.6s, Rt=1.6s	SOT-25	28cp	VD16	6g	Tor
<u>8VX</u>	XC6112H628MR	Vdet-IC	2.8V±2%, -MR, -Reset ODO, Wt=1.6s, Rt=1.6s	SOT-25	28cp	VD16	6g	Tor
<u>8VY</u>	XC6112H629MR	Vdet-IC	2.9V±2%, -MR, -Reset ODO, Wt=1.6s, Rt=1.6s	SOT-25	28cp	VD16	6g	Tor
<u>8VZ</u>	XC6112H630MR	Vdet-IC	3.0V±2%, -MR, -Reset ODO, Wt=1.6s, Rt=1.6s	SOT-25	28cp	VD16	6g	Tor
<u>8W</u>	R1210N381C	DC/DC-IC	PWM step-up, 3.8V, 100kHz	SOT-23-5	28sc	DC3	6g	Ric
<u>8X</u>	R1210N481C	DC/DC-IC	PWM step-up, 4.8V, 100kHz	SOT-23-5	28sc	DC3	6g	Ric
<u>8Y</u>	R1210N581C	DC/DC-IC	PWM step-up, 5.8V, 100kHz	SOT-23-5	28sc	DC3	6g	Ric
<u>8Z</u>	R1210N281D	DC/DC-IC	PWM step-up, 2.8V, 180kHz	SOT-23-5	28sc	DC3	6g	Ric
<u>90</u>	RN5RF40BA	LVR-IC	LRip, +CE, 4V±2%, 1A*	SOT-23-5	28wv	VR6	6g	Ric
<u>90</u>	RN5RZ40BA	LVR-IC	LDO, LN, +CE, 4V±2%, 100mA	SOT-23-5	28wrt	VR4	6g	Ric
<u>900</u>	XC6113A131MR	Vdet-IC	3.1V±2%, -MR, +Reset PPO, Wt=6.25ms, Rt=3.13ms	SOT-25	28cp	VD17	6g	Tor
<u>901</u>	XC6113A132MR	Vdet-IC	3.2V±2%, -MR, +Reset PPO, Wt=6.25ms, Rt=3.13ms	SOT-25	28cp	VD17	6g	Tor
<u>902</u>	XC6223G121MR-G	LVR-IC	LDO, 1.2V±20mV, 300mA, +CE, PDR, ICP	SOT-25	28cx	VR4	6g	Tor
<u>902</u>	XC6113A133MR	Vdet-IC	3.3V±2%, -MR, +Reset PPO, Wt=6.25ms, Rt=3.13ms	SOT-25	28cp	VD17	6g	Tor
<u>903</u>	XC6223G131MR-G	LVR-IC	LDO, 1.3V±20mV, 300mA, +CE, PDR, ICP	SOT-25	28cx	VR4	6g	Tor
<u>903</u>	XC6113A134MR	Vdet-IC	3.4V±2%, -MR, +Reset PPO, Wt=6.25ms, Rt=3.13ms	SOT-25	28cp	VD17	6g	Tor



SMD

code	Type	Function	Short description	Case	Pinout	Sch.	St.	Mnf.
904	XC6223G141MR-G	LVR-IC	LDO, 1.4V±20mV, 300mA, +CE, PDR, ICP	SOT-25	28cx	VR4	6g	Tor
904	XC6113A135MR	Vdet-IC	3.5V±2%, -MR, +Reset PPO, Wt=6.25ms, Rt=3.13ms	SOT-25	28cp	VD17	6g	Tor
905	XC6223G151MR-G	LVR-IC	LDO, 1.5V±20mV, 300mA, +CE, PDR, ICP	SOT-25	28cx	VR4	6g	Tor
905	XC6113A136MR	Vdet-IC	3.6V±2%, -MR, +Reset PPO, Wt=6.25ms, Rt=3.13ms	SOT-25	28cp	VD17	6g	Tor
906	XC6223G161MR-G	LVR-IC	LDO, 1.6V±20mV, 300mA, +CE, PDR, ICP	SOT-25	28cx	VR4	6g	Tor
906	XC6113A137MR	Vdet-IC	3.7V±2%, -MR, +Reset PPO, Wt=6.25ms, Rt=3.13ms	SOT-25	28cp	VD17	6g	Tor
907	XC6223G171MR-G	LVR-IC	LDO, 1.7V±20mV, 300mA, +CE, PDR, ICP	SOT-25	28cx	VR4	6g	Tor
907	XC6113A138MR	Vdet-IC	3.8V±2%, -MR, +Reset PPO, Wt=6.25ms, Rt=3.13ms	SOT-25	28cp	VD17	6g	Tor
908	XC6223G181MR-G	LVR-IC	LDO, 1.8V±20mV, 300mA, +CE, PDR, ICP	SOT-25	28cx	VR4	6g	Tor
908	XC6113A139MR	Vdet-IC	3.9V±2%, -MR, +Reset PPO, Wt=6.25ms, Rt=3.13ms	SOT-25	28cp	VD17	6g	Tor
909	XC6223G191MR-G	LVR-IC	LDO, 1.9V±20mV, 300mA, +CE, PDR, ICP	SOT-25	28cx	VR4	6g	Tor
909	XC6113A140MR	Vdet-IC	4.0V±2%, -MR, +Reset PPO, Wt=6.25ms, Rt=3.13ms	SOT-25	28cp	VD17	6g	Tor
90A	RP104N121B	LVR-IC	LDO, 1.2V±0.8%, 150mA, +CE	SOT-23-5	28cx	VR4	6g	Ric
90A	XC6223G201MR-G	LVR-IC	LDO, 2.0V±1%, 300mA, +CE, PDR, ICP	SOT-25	28cx	VR4	6g	Tor
90A	XC6113A141MR	Vdet-IC	4.1V±2%, -MR, +Reset PPO, Wt=6.25ms, Rt=3.13ms	SOT-25	28cp	VD17	6g	Tor
90B	RP104N131B	LVR-IC	LDO, 1.3V±0.8%, 150mA, +CE	SOT-23-5	28cx	VR4	6g	Ric
90B	XC6223G211MR-G	LVR-IC	LDO, 2.1V±1%, 300mA, +CE, PDR, ICP	SOT-25	28cx	VR4	6g	Tor
90B	XC6113A142MR	Vdet-IC	4.2V±2%, -MR, +Reset PPO, Wt=6.25ms, Rt=3.13ms	SOT-25	28cp	VD17	6g	Tor
90C	RP104N151B	LVR-IC	LDO, 1.5V±0.8%, 150mA, +CE	SOT-23-5	28cx	VR4	6g	Ric
90C	XC6223G221MR-G	LVR-IC	LDO, 2.2V±1%, 300mA, +CE, PDR, ICP	SOT-25	28cx	VR4	6g	Tor
90C	XC6113A143MR	Vdet-IC	4.3V±2%, -MR, +Reset PPO, Wt=6.25ms, Rt=3.13ms	SOT-25	28cp	VD17	6g	Tor
90D	RP104N181B	LVR-IC	LDO, 1.8V±0.8%, 150mA, +CE	SOT-23-5	28cx	VR4	6g	Ric
90D	XC6223G231MR-G	LVR-IC	LDO, 2.3V±1%, 300mA, +CE, PDR, ICP	SOT-25	28cx	VR4	6g	Tor
90D	XC6113A144MR	Vdet-IC	4.4V±2%, -MR, +Reset PPO, Wt=6.25ms, Rt=3.13ms	SOT-25	28cp	VD17	6g	Tor
90E	RP104N181B5	LVR-IC	LDO, 1.85V±0.8%, 150mA, +CE	SOT-23-5	28cx	VR4	6g	Ric
90E	XC6223G241MR-G	LVR-IC	LDO, 2.4V±1%, 300mA, +CE, PDR, ICP	SOT-25	28cx	VR4	6g	Tor
90E	XC6113A145MR	Vdet-IC	4.5V±2%, -MR, +Reset PPO, Wt=6.25ms, Rt=3.13ms	SOT-25	28cp	VD17	6g	Tor
90F	RP104N191B	LVR-IC	LDO, 1.9V±0.8%, 150mA, +CE	SOT-23-5	28cx	VR4	6g	Ric
90F	XC6223G251MR-G	LVR-IC	LDO, 2.5V±1%, 300mA, +CE, PDR, ICP	SOT-25	28cx	VR4	6g	Tor
90F	XC6113A116MR	Vdet-IC	1.6V±2%, -MR, +Reset PPO, Wt=6.25ms, Rt=3.13ms	SOT-25	28cp	VD17	6g	Tor
90F	XC6113A146MR	Vdet-IC	4.6V±2%, -MR, +Reset PPO, Wt=6.25ms, Rt=3.13ms	SOT-25	28cp	VD17	6g	Tor
90G	RP104N201B	LVR-IC	LDO, 2.0V±0.8%, 150mA, +CE	SOT-23-5	28cx	VR4	6g	Ric
90H	RP104N251B	LVR-IC	LDO, 2.5V±0.8%, 150mA, +CE	SOT-23-5	28cx	VR4	6g	Ric
90H	XC6223G261MR-G	LVR-IC	LDO, 2.6V±1%, 300mA, +CE, PDR, ICP	SOT-25	28cx	VR4	6g	Tor
90H	XC6113A117MR	Vdet-IC	1.7V±2%, -MR, +Reset PPO, Wt=6.25ms, Rt=3.13ms	SOT-25	28cp	VD17	6g	Tor
90H	XC6113A147MR	Vdet-IC	4.7V±2%, -MR, +Reset PPO, Wt=6.25ms, Rt=3.13ms	SOT-25	28cp	VD17	6g	Tor
90J	RP104N261B	LVR-IC	LDO, 2.6V±0.8%, 150mA, +CE	SOT-23-5	28cx	VR4	6g	Ric
90K	RP104N271B	LVR-IC	LDO, 2.7V±0.8%, 150mA, +CE	SOT-23-5	28cx	VR4	6g	Ric
90K	XC6223G271MR-G	LVR-IC	LDO, 2.7V±1%, 300mA, +CE, PDR, ICP	SOT-25	28cx	VR4	6g	Tor
90K	XC6113A118MR	Vdet-IC	1.8V±2%, -MR, +Reset PPO, Wt=6.25ms, Rt=3.13ms	SOT-25	28cp	VD17	6g	Tor
90K	XC6113A148MR	Vdet-IC	4.8V±2%, -MR, +Reset PPO, Wt=6.25ms, Rt=3.13ms	SOT-25	28cp	VD17	6g	Tor
90L	RP104N281B	LVR-IC	LDO, 2.8V±0.8%, 150mA, +CE	SOT-23-5	28cx	VR4	6g	Ric
90L	XC6223G281MR-G	LVR-IC	LDO, 2.8V±1%, 300mA, +CE, PDR, ICP	SOT-25	28cx	VR4	6g	Tor
90L	XC6113A119MR	Vdet-IC	1.9V±2%, -MR, +Reset PPO, Wt=6.25ms, Rt=3.13ms	SOT-25	28cp	VD17	6g	Tor
90L	XC6113A149MR	Vdet-IC	4.9V±2%, -MR, +Reset PPO, Wt=6.25ms, Rt=3.13ms	SOT-25	28cp	VD17	6g	Tor
90M	RP104N281B5	LVR-IC	LDO, 2.85V±0.8%, 150mA, +CE	SOT-23-5	28cx	VR4	6g	Ric
90M	XC6223G291MR-G	LVR-IC	LDO, 2.9V±1%, 300mA, +CE, PDR, ICP	SOT-25	28cx	VR4	6g	Tor
90M	XC6113A120MR	Vdet-IC	2.0V±2%, -MR, +Reset PPO, Wt=6.25ms, Rt=3.13ms	SOT-25	28cp	VD17	6g	Tor
90M	XC6113A150MR	Vdet-IC	5.0V±2%, -MR, +Reset PPO, Wt=6.25ms, Rt=3.13ms	SOT-25	28cp	VD17	6g	Tor
90N	RP104N291B	LVR-IC	LDO, 2.9V±0.8%, 150mA, +CE	SOT-23-5	28cx	VR4	6g	Ric
90N	XC6223G301MR-G	LVR-IC	LDO, 3.0V±1%, 300mA, +CE, PDR, ICP	SOT-25	28cx	VR4	6g	Tor
90N	XC6113A121MR	Vdet-IC	2.1V±2%, -MR, +Reset PPO, Wt=6.25ms, Rt=3.13ms	SOT-25	28cp	VD17	6g	Tor
90P	RP104N301B	LVR-IC	LDO, 3.0V±0.8%, 150mA, +CE	SOT-23-5	28cx	VR4	6g	Ric
90P	XC6223G311MR-G	LVR-IC	LDO, 3.1V±1%, 300mA, +CE, PDR, ICP	SOT-25	28cx	VR4	6g	Tor
90P	XC6113A122MR	Vdet-IC	2.2V±2%, -MR, +Reset PPO, Wt=6.25ms, Rt=3.13ms	SOT-25	28cp	VD17	6g	Tor
90Q	RP104N321B	LVR-IC	LDO, 3.2V±0.8%, 150mA, +CE	SOT-23-5	28cx	VR4	6g	Ric
90R	RP104N331B	LVR-IC	LDO, 3.3V±0.8%, 150mA, +CE	SOT-23-5	28cx	VR4	6g	Ric
90R	XC6223G321MR-G	LVR-IC	LDO, 3.2V±1%, 300mA, +CE, PDR, ICP	SOT-25	28cx	VR4	6g	Tor
90R	XC6113A123MR	Vdet-IC	2.3V±2%, -MR, +Reset PPO, Wt=6.25ms, Rt=3.13ms	SOT-25	28cp	VD17	6g	Tor
90S	RP104N311B	LVR-IC	LDO, 3.1V±0.8%, 150mA, +CE	SOT-23-5	28cx	VR4	6g	Ric
90S	XC6223G331MR-G	LVR-IC	LDO, 3.3V±1%, 300mA, +CE, PDR, ICP	SOT-25	28cx	VR4	6g	Tor
90S	XC6113A124MR	Vdet-IC	2.4V±2%, -MR, +Reset PPO, Wt=6.25ms, Rt=3.13ms	SOT-25	28cp	VD17	6g	Tor
90T	RP104N241B	LVR-IC	LDO, 2.4V±0.8%, 150mA, +CE	SOT-23-5	28cx	VR4	6g	Ric
90T	XC6223G341MR-G	LVR-IC	LDO, 3.4V±1%, 300mA, +CE, PDR, ICP	SOT-25	28cx	VR4	6g	Tor
90T	XC6113A125MR	Vdet-IC	2.5V±2%, -MR, +Reset PPO, Wt=6.25ms, Rt=3.13ms	SOT-25	28cp	VD17	6g	Tor
90U	RP104N221B	LVR-IC	LDO, 2.2V±0.8%, 150mA, +CE	SOT-23-5	28cx	VR4	6g	Ric
90U	XC6223G351MR-G	LVR-IC	LDO, 3.5V±1%, 300mA, +CE, PDR, ICP	SOT-25	28cx	VR4	6g	Tor
90U	XC6113A126MR	Vdet-IC	2.6V±2%, -MR, +Reset PPO, Wt=6.25ms, Rt=3.13ms	SOT-25	28cp	VD17	6g	Tor
90V	RP104N231B	LVR-IC	LDO, 2.3V±0.8%, 150mA, +CE	SOT-23-5	28cx	VR4	6g	Ric
90V	XC6223G361MR-G	LVR-IC	LDO, 3.6V±1%, 300mA, +CE, PDR, ICP	SOT-25	28cx	VR4	6g	Tor



SMD code	Type	Function	Short description	Case	Pinout	Sch.	St.	Mnf.
90V	XC6113A127MR	Vdet-IC	2.7V±2%, -MR, +Reset PPO, Wt=6.25ms, Rt=3.13ms	SOT-25	28cp	VD17	6g	Tor
90W	RP104N271B5	LVR-IC	LDO, 2.75V±0.8%, 150mA, +CE	SOT-23-5	28cx	VR4	6g	Ric
90X	RP104N211B	LVR-IC	LDO, 2.1V±0.8%, 150mA, +CE	SOT-23-5	28cx	VR4	6g	Ric
90X	XC6223G371MR-G	LVR-IC	LDO, 3.7V±1%, 300mA, +CE, PDR, ICP	SOT-25	28cx	VR4	6g	Tor
90X	XC6113A128MR	Vdet-IC	2.8V±2%, -MR, +Reset PPO, Wt=6.25ms, Rt=3.13ms	SOT-25	28cp	VD17	6g	Tor
90Y	XC6223G381MR-G	LVR-IC	LDO, 3.8V±1%, 300mA, +CE, PDR, ICP	SOT-25	28cx	VR4	6g	Tor
90Y	XC6113A129MR	Vdet-IC	2.9V±2%, -MR, +Reset PPO, Wt=6.25ms, Rt=3.13ms	SOT-25	28cp	VD17	6g	Tor
90Z	XC6223G391MR-G	LVR-IC	LDO, 3.9V±1%, 300mA, +CE, PDR, ICP	SOT-25	28cx	VR4	6g	Tor
90Z	XC6113A130MR	Vdet-IC	3.0V±2%, -MR, +Reset PPO, Wt=6.25ms, Rt=3.13ms	SOT-25	28cp	VD17	6g	Tor
91	RN5RF41BA	LVR-IC	LRip, +CE, 4.1V±2%, 1A*	SOT-23-5	28vw	VR6	6g	Ric
91	RN5RZ41BA	LVR-IC	LDO, LN, +CE, 4.1V±2%, 100mA	SOT-23-5	28vrt	VR4	6g	Ric
910	XC6223G401MR-G	LVR-IC	LDO, 4.0V±1%, 300mA, +CE, PDR, ICP	SOT-25	28cx	VR4	6g	Tor
910	XC6113A231MR	Vdet-IC	3.1V±2%, -MR, +Reset PPO, Wt=50ms, Rt=3.13ms	SOT-25	28cp	VD17	6g	Tor
911	XC6113A232MR	Vdet-IC	3.2V±2%, -MR, +Reset PPO, Wt=50ms, Rt=3.13ms	SOT-25	28cp	VD17	6g	Tor
912	XC6113A233MR	Vdet-IC	3.3V±2%, -MR, +Reset PPO, Wt=50ms, Rt=3.13ms	SOT-25	28cp	VD17	6g	Tor
913	XC6113A234MR	Vdet-IC	3.4V±2%, -MR, +Reset PPO, Wt=50ms, Rt=3.13ms	SOT-25	28cp	VD17	6g	Tor
914	XC6113A235MR	Vdet-IC	3.5V±2%, -MR, +Reset PPO, Wt=50ms, Rt=3.13ms	SOT-25	28cp	VD17	6g	Tor
915	R1124N151D	LVR-IC	LDO, LN, +CE, CL, 1.5V±2%, 150mA	SOT-23-5	28vt	VR4	6g	Ric
915	XC6113A236MR	Vdet-IC	3.6V±2%, -MR, +Reset PPO, Wt=50ms, Rt=3.13ms	SOT-25	28cp	VD17	6g	Tor
916	R1124N161D	LVR-IC	LDO, LN, +CE, CL, 1.6V±2%, 150mA	SOT-23-5	28vt	VR4	6g	Ric
916	XC6113A237MR	Vdet-IC	3.7V±2%, -MR, +Reset PPO, Wt=50ms, Rt=3.13ms	SOT-25	28cp	VD17	6g	Tor
917	R1124N171D	LVR-IC	LDO, LN, +CE, CL, 1.7V±2%, 150mA	SOT-23-5	28vt	VR4	6g	Ric
917	XC6113A238MR	Vdet-IC	3.8V±2%, -MR, +Reset PPO, Wt=50ms, Rt=3.13ms	SOT-25	28cp	VD17	6g	Tor
918	R1124N181D	LVR-IC	LDO, LN, +CE, CL, 1.8V±2%, 150mA	SOT-23-5	28vt	VR4	6g	Ric
918	XC6113A239MR	Vdet-IC	3.9V±2%, -MR, +Reset PPO, Wt=50ms, Rt=3.13ms	SOT-25	28cp	VD17	6g	Tor
919	R1124N191D	LVR-IC	LDO, LN, +CE, CL, 1.9V±2%, 150mA	SOT-23-5	28vt	VR4	6g	Ric
919	XC6113A240MR	Vdet-IC	4.0V±2%, -MR, +Reset PPO, Wt=50ms, Rt=3.13ms	SOT-25	28cp	VD17	6g	Tor
91A	RP104N121C	LVR-IC	LDO, 1.2V±0.8%, 150mA	SOT-23-5	28ym	VR1	6g	Ric
91A	XC6113A241MR	Vdet-IC	4.1V±2%, -MR, +Reset PPO, Wt=50ms, Rt=3.13ms	SOT-25	28cp	VD17	6g	Tor
91B	RP104N131C	LVR-IC	LDO, 1.3V±0.8%, 150mA	SOT-23-5	28ym	VR1	6g	Ric
91B	XC6113A242MR	Vdet-IC	4.2V±2%, -MR, +Reset PPO, Wt=50ms, Rt=3.13ms	SOT-25	28cp	VD17	6g	Tor
91C	RP104N151C	LVR-IC	LDO, 1.5V±0.8%, 150mA	SOT-23-5	28ym	VR1	6g	Ric
91C	XC6113A243MR	Vdet-IC	4.3V±2%, -MR, +Reset PPO, Wt=50ms, Rt=3.13ms	SOT-25	28cp	VD17	6g	Tor
91D	RP104N181C	LVR-IC	LDO, 1.8V±0.8%, 150mA	SOT-23-5	28ym	VR1	6g	Ric
91D	XC6113A244MR	Vdet-IC	4.4V±2%, -MR, +Reset PPO, Wt=50ms, Rt=3.13ms	SOT-25	28cp	VD17	6g	Tor
91E	RP104N181C5	LVR-IC	LDO, 1.85V±0.8%, 150mA	SOT-23-5	28ym	VR1	6g	Ric
91E	XC6113A245MR	Vdet-IC	4.5V±2%, -MR, +Reset PPO, Wt=50ms, Rt=3.13ms	SOT-25	28cp	VD17	6g	Tor
91F	RP104N191C	LVR-IC	LDO, 1.9V±0.8%, 150mA	SOT-23-5	28ym	VR1	6g	Ric
91F	XC6113A216MR	Vdet-IC	1.6V±2%, -MR, +Reset PPO, Wt=50ms, Rt=3.13ms	SOT-25	28cp	VD17	6g	Tor
91F	XC6113A246MR	Vdet-IC	4.6V±2%, -MR, +Reset PPO, Wt=50ms, Rt=3.13ms	SOT-25	28cp	VD17	6g	Tor
91G	RP104N201C	LVR-IC	LDO, 2.0V±0.8%, 150mA	SOT-23-5	28ym	VR1	6g	Ric
91H	RP104N251C	LVR-IC	LDO, 2.5V±0.8%, 150mA	SOT-23-5	28ym	VR1	6g	Ric
91H	XC6113A217MR	Vdet-IC	1.7V±2%, -MR, +Reset PPO, Wt=50ms, Rt=3.13ms	SOT-25	28cp	VD17	6g	Tor
91H	XC6113A247MR	Vdet-IC	4.7V±2%, -MR, +Reset PPO, Wt=50ms, Rt=3.13ms	SOT-25	28cp	VD17	6g	Tor
91J	RP104N261C	LVR-IC	LDO, 2.6V±0.8%, 150mA	SOT-23-5	28ym	VR1	6g	Ric
91K	RP104N271C	LVR-IC	LDO, 2.7V±0.8%, 150mA	SOT-23-5	28ym	VR1	6g	Ric
91K	XC6113A218MR	Vdet-IC	1.8V±2%, -MR, +Reset PPO, Wt=50ms, Rt=3.13ms	SOT-25	28cp	VD17	6g	Tor
91K	XC6113A248MR	Vdet-IC	4.8V±2%, -MR, +Reset PPO, Wt=50ms, Rt=3.13ms	SOT-25	28cp	VD17	6g	Tor
91L	RP104N281C	LVR-IC	LDO, 2.8V±0.8%, 150mA	SOT-23-5	28ym	VR1	6g	Ric
91L	XC6113A219MR	Vdet-IC	1.9V±2%, -MR, +Reset PPO, Wt=50ms, Rt=3.13ms	SOT-25	28cp	VD17	6g	Tor
91L	XC6113A249MR	Vdet-IC	4.9V±2%, -MR, +Reset PPO, Wt=50ms, Rt=3.13ms	SOT-25	28cp	VD17	6g	Tor
91M	RP104N281C5	LVR-IC	LDO, 2.85V±0.8%, 150mA	SOT-23-5	28ym	VR1	6g	Ric
91M	XC6113A220MR	Vdet-IC	2.0V±2%, -MR, +Reset PPO, Wt=50ms, Rt=3.13ms	SOT-25	28cp	VD17	6g	Tor
91M	XC6113A250MR	Vdet-IC	5.0V±2%, -MR, +Reset PPO, Wt=50ms, Rt=3.13ms	SOT-25	28cp	VD17	6g	Tor
91N	RP104N291C	LVR-IC	LDO, 2.9V±0.8%, 150mA	SOT-23-5	28ym	VR1	6g	Ric
91N	XC6113A221MR	Vdet-IC	2.1V±2%, -MR, +Reset PPO, Wt=50ms, Rt=3.13ms	SOT-25	28cp	VD17	6g	Tor
91P	RP104N301C	LVR-IC	LDO, 3.0V±0.8%, 150mA	SOT-23-5	28ym	VR1	6g	Ric
91P	XC6113A222MR	Vdet-IC	2.2V±2%, -MR, +Reset PPO, Wt=50ms, Rt=3.13ms	SOT-25	28cp	VD17	6g	Tor
91Q	RP104N321C	LVR-IC	LDO, 3.2V±0.8%, 150mA	SOT-23-5	28ym	VR1	6g	Ric
91R	RP104N331C	LVR-IC	LDO, 3.3V±0.8%, 150mA	SOT-23-5	28ym	VR1	6g	Ric
91R	XC6113A223MR	Vdet-IC	2.3V±2%, -MR, +Reset PPO, Wt=50ms, Rt=3.13ms	SOT-25	28cp	VD17	6g	Tor
91S	RP104N311C	LVR-IC	LDO, 3.1V±0.8%, 150mA	SOT-23-5	28ym	VR1	6g	Ric
91S	XC6113A224MR	Vdet-IC	2.4V±2%, -MR, +Reset PPO, Wt=50ms, Rt=3.13ms	SOT-25	28cp	VD17	6g	Tor
91T	RP104N241C	LVR-IC	LDO, 2.4V±0.8%, 150mA	SOT-23-5	28ym	VR1	6g	Ric
91T	XC6113A225MR	Vdet-IC	2.5V±2%, -MR, +Reset PPO, Wt=50ms, Rt=3.13ms	SOT-25	28cp	VD17	6g	Tor
91U	RP104N221C	LVR-IC	LDO, 2.2V±0.8%, 150mA	SOT-23-5	28ym	VR1	6g	Ric
91U	XC6113A226MR	Vdet-IC	2.6V±2%, -MR, +Reset PPO, Wt=50ms, Rt=3.13ms	SOT-25	28cp	VD17	6g	Tor
91V	RP104N231C	LVR-IC	LDO, 2.3V±0.8%, 150mA	SOT-23-5	28ym	VR1	6g	Ric
91V	XC6113A227MR	Vdet-IC	2.7V±2%, -MR, +Reset PPO, Wt=50ms, Rt=3.13ms	SOT-25	28cp	VD17	6g	Tor
91W	RP104N271C5	LVR-IC	LDO, 2.75V±0.8%, 150mA	SOT-23-5	28ym	VR1	6g	Ric



SMD code	Type	Function	Short description	Case	Pinout	Sch.	St.	Mnf.
91X	RP104N211C	LVR-IC	LDO, 2.1V±0.8%, 150mA	SOT-23-5	28ym	VR1	6g	Ric
91X	XC6113A228MR	Vdet-IC	2.8V±2%, -MR, +Reset PPO, Wt=50ms, Rt=3.13ms	SOT-25	28cp	VD17	6g	Tor
91Y	XC6113A229MR	Vdet-IC	2.9V±2%, -MR, +Reset PPO, Wt=50ms, Rt=3.13ms	SOT-25	28cp	VD17	6g	Tor
91Z	XC6113A230MR	Vdet-IC	3.0V±2%, -MR, +Reset PPO, Wt=50ms, Rt=3.13ms	SOT-25	28cp	VD17	6g	Tor
92	RN5RF42BA	LVR-IC	LRip, +CE, 4.2V±2%, 1A*	SOT-23-5	28vw	VR6	6g	Ric
92	RN5RZ42BA	LVR-IC	LDO, LN, +CE, 4.2V±2%, 100mA	SOT-23-5	28vrt	VR4	6g	Ric
920	R1124N201D	LVR-IC	LDO, LN, +CE, CL, 2V±2%, 150mA	SOT-23-5	28vt	VR4	6g	Ric
920	XC6113A331MR	Vdet-IC	3.1V±2%, -MR, +Reset PPO, Wt=100ms, Rt=3.13ms	SOT-25	28cp	VD17	6g	Tor
921	R1124N211D	LVR-IC	LDO, LN, +CE, CL, 2.1V±2%, 150mA	SOT-23-5	28vt	VR4	6g	Ric
921	XC6113A332MR	Vdet-IC	3.2V±2%, -MR, +Reset PPO, Wt=100ms, Rt=3.13ms	SOT-25	28cp	VD17	6g	Tor
922	R1124N221D	LVR-IC	LDO, LN, +CE, CL, 2.2V±2%, 150mA	SOT-23-5	28vt	VR4	6g	Ric
922	XC6223G12BMR-G	LVR-IC	LDO, 1.25V±20mV, 300mA, +CE, PDR, ICP	SOT-25	28cx	VR4	6g	Tor
922	XC6113A333MR	Vdet-IC	3.3V±2%, -MR, +Reset PPO, Wt=100ms, Rt=3.13ms	SOT-25	28cp	VD17	6g	Tor
923	R1124N231D	LVR-IC	LDO, LN, +CE, CL, 2.3V±2%, 150mA	SOT-23-5	28vt	VR4	6g	Ric
923	XC6223G13BMR-G	LVR-IC	LDO, 1.35V±20mV, 300mA, +CE, PDR, ICP	SOT-25	28cx	VR4	6g	Tor
923	XC6113A334MR	Vdet-IC	3.4V±2%, -MR, +Reset PPO, Wt=100ms, Rt=3.13ms	SOT-25	28cp	VD17	6g	Tor
924	R1124N241D	LVR-IC	LDO, LN, +CE, CL, 2.4V±2%, 150mA	SOT-23-5	28vt	VR4	6g	Ric
924	XC6223G14BMR-G	LVR-IC	LDO, 1.45V±20mV, 300mA, +CE, PDR, ICP	SOT-25	28cx	VR4	6g	Tor
924	XC6113A335MR	Vdet-IC	3.5V±2%, -MR, +Reset PPO, Wt=100ms, Rt=3.13ms	SOT-25	28cp	VD17	6g	Tor
925	R1124N251D	LVR-IC	LDO, LN, +CE, CL, 2.5V±2%, 150mA	SOT-23-5	28vt	VR4	6g	Ric
925	XC6223G15BMR-G	LVR-IC	LDO, 1.55V±20mV, 300mA, +CE, PDR, ICP	SOT-25	28cx	VR4	6g	Tor
925	XC6113A336MR	Vdet-IC	3.6V±2%, -MR, +Reset PPO, Wt=100ms, Rt=3.13ms	SOT-25	28cp	VD17	6g	Tor
926	R1124N261D	LVR-IC	LDO, LN, +CE, CL, 2.6V±2%, 150mA	SOT-23-5	28vt	VR4	6g	Ric
926	XC6223G16BMR-G	LVR-IC	LDO, 1.65V±20mV, 300mA, +CE, PDR, ICP	SOT-25	28cx	VR4	6g	Tor
926	XC6113A337MR	Vdet-IC	3.7V±2%, -MR, +Reset PPO, Wt=100ms, Rt=3.13ms	SOT-25	28cp	VD17	6g	Tor
927	R1124N271D	LVR-IC	LDO, LN, +CE, CL, 2.7V±2%, 150mA	SOT-23-5	28vt	VR4	6g	Ric
927	XC6223G17BMR-G	LVR-IC	LDO, 1.75V±20mV, 300mA, +CE, PDR, ICP	SOT-25	28cx	VR4	6g	Tor
927	XC6113A338MR	Vdet-IC	3.8V±2%, -MR, +Reset PPO, Wt=100ms, Rt=3.13ms	SOT-25	28cp	VD17	6g	Tor
928	R1124N281D	LVR-IC	LDO, LN, +CE, 2.8V±2%, 150mA	SOT-23-5	28vt	VR4	6g	Ric
928	XC6223G18BMR-G	LVR-IC	LDO, 1.85V±20mV, 300mA, +CE, PDR, ICP	SOT-25	28cx	VR4	6g	Tor
928	XC6113A339MR	Vdet-IC	3.9V±2%, -MR, +Reset PPO, Wt=100ms, Rt=3.13ms	SOT-25	28cp	VD17	6g	Tor
929	R1124N291D	LVR-IC	LDO, LN, +CE, CL, 2.9V±2%, 150mA	SOT-23-5	28vt	VR4	6g	Ric
929	XC6223G19BMR-G	LVR-IC	LDO, 1.95V±20mV, 300mA, +CE, PDR, ICP	SOT-25	28cx	VR4	6g	Tor
929	XC6113A340MR	Vdet-IC	4.0V±2%, -MR, +Reset PPO, Wt=100ms, Rt=3.13ms	SOT-25	28cp	VD17	6g	Tor
92A	RP104N121D	LVR-IC	LDO, 1.2V±0.8%, 150mA, +CE, CL	SOT-23-5	28cx	VR4	6g	Ric
92A	XC6223G20BMR-G	LVR-IC	LDO, 2.05V±1%, 300mA, +CE, PDR, ICP	SOT-25	28cx	VR4	6g	Tor
92A	XC6113A341MR	Vdet-IC	4.1V±2%, -MR, +Reset PPO, Wt=100ms, Rt=3.13ms	SOT-25	28cp	VD17	6g	Tor
92B	RP104N131D	LVR-IC	LDO, 1.3V±0.8%, 150mA, +CE, CL	SOT-23-5	28cx	VR4	6g	Ric
92B	XC6223G21BMR-G	LVR-IC	LDO, 2.15V±1%, 300mA, +CE, PDR, ICP	SOT-25	28cx	VR4	6g	Tor
92B	XC6113A342MR	Vdet-IC	4.2V±2%, -MR, +Reset PPO, Wt=100ms, Rt=3.13ms	SOT-25	28cp	VD17	6g	Tor
92C	RP104N151D	LVR-IC	LDO, 1.5V±0.8%, 150mA, +CE, CL	SOT-23-5	28cx	VR4	6g	Ric
92C	XC6223G22BMR-G	LVR-IC	LDO, 2.25V±1%, 300mA, +CE, PDR, ICP	SOT-25	28cx	VR4	6g	Tor
92C	XC6113A343MR	Vdet-IC	4.3V±2%, -MR, +Reset PPO, Wt=100ms, Rt=3.13ms	SOT-25	28cp	VD17	6g	Tor
92D	RP104N181D	LVR-IC	LDO, 1.8V±0.8%, 150mA, +CE, CL	SOT-23-5	28cx	VR4	6g	Ric
92D	XC6223G23BMR-G	LVR-IC	LDO, 2.35V±1%, 300mA, +CE, PDR, ICP	SOT-25	28cx	VR4	6g	Tor
92D	XC6113A344MR	Vdet-IC	4.4V±2%, -MR, +Reset PPO, Wt=100ms, Rt=3.13ms	SOT-25	28cp	VD17	6g	Tor
92E	RP104N181D5	LVR-IC	LDO, 1.85V±0.8%, 150mA, +CE, CL	SOT-23-5	28cx	VR4	6g	Ric
92E	XC6223G24BMR-G	LVR-IC	LDO, 2.45V±1%, 300mA, +CE, PDR, ICP	SOT-25	28cx	VR4	6g	Tor
92E	XC6113A345MR	Vdet-IC	4.5V±2%, -MR, +Reset PPO, Wt=100ms, Rt=3.13ms	SOT-25	28cp	VD17	6g	Tor
92F	RP104N191D	LVR-IC	LDO, 1.9V±0.8%, 150mA, +CE, CL	SOT-23-5	28cx	VR4	6g	Ric
92F	XC6223G25BMR-G	LVR-IC	LDO, 2.55V±1%, 300mA, +CE, PDR, ICP	SOT-25	28cx	VR4	6g	Tor
92F	XC6113A316MR	Vdet-IC	1.6V±2%, -MR, +Reset PPO, Wt=100ms, Rt=3.13ms	SOT-25	28cp	VD17	6g	Tor
92F	XC6113A346MR	Vdet-IC	4.6V±2%, -MR, +Reset PPO, Wt=100ms, Rt=3.13ms	SOT-25	28cp	VD17	6g	Tor
92G	RP104N201D	LVR-IC	LDO, 2.0V±0.8%, 150mA, +CE, CL	SOT-23-5	28cx	VR4	6g	Ric
92H	RP104N251D	LVR-IC	LDO, 2.5V±0.8%, 150mA, +CE, CL	SOT-23-5	28cx	VR4	6g	Ric
92H	XC6223G26BMR-G	LVR-IC	LDO, 2.65V±1%, 300mA, +CE, PDR, ICP	SOT-25	28cx	VR4	6g	Tor
92H	XC6113A317MR	Vdet-IC	1.7V±2%, -MR, +Reset PPO, Wt=100ms, Rt=3.13ms	SOT-25	28cp	VD17	6g	Tor
92H	XC6113A347MR	Vdet-IC	4.7V±2%, -MR, +Reset PPO, Wt=100ms, Rt=3.13ms	SOT-25	28cp	VD17	6g	Tor
92J	RP104N261D	LVR-IC	LDO, 2.6V±0.8%, 150mA, +CE, CL	SOT-23-5	28cx	VR4	6g	Ric
92K	RP104N271D	LVR-IC	LDO, 2.7V±0.8%, 150mA, +CE, CL	SOT-23-5	28cx	VR4	6g	Ric
92K	XC6223G27BMR-G	LVR-IC	LDO, 2.75V±1%, 300mA, +CE, PDR, ICP	SOT-25	28cx	VR4	6g	Tor
92K	XC6113A318MR	Vdet-IC	1.8V±2%, -MR, +Reset PPO, Wt=100ms, Rt=3.13ms	SOT-25	28cp	VD17	6g	Tor
92K	XC6113A348MR	Vdet-IC	4.8V±2%, -MR, +Reset PPO, Wt=100ms, Rt=3.13ms	SOT-25	28cp	VD17	6g	Tor
92L	RP104N281D	LVR-IC	LDO, 2.8V±0.8%, 150mA, +CE, CL	SOT-23-5	28cx	VR4	6g	Ric
92L	XC6223G28BMR-G	LVR-IC	LDO, 2.85V±1%, 300mA, +CE, PDR, ICP	SOT-25	28cx	VR4	6g	Tor
92L	XC6113A319MR	Vdet-IC	1.9V±2%, -MR, +Reset PPO, Wt=100ms, Rt=3.13ms	SOT-25	28cp	VD17	6g	Tor
92L	XC6113A349MR	Vdet-IC	4.9V±2%, -MR, +Reset PPO, Wt=100ms, Rt=3.13ms	SOT-25	28cp	VD17	6g	Tor
92M	RP104N281D5	LVR-IC	LDO, 2.85V±0.8%, 150mA, +CE, CL	SOT-23-5	28cx	VR4	6g	Ric
92M	XC6223G29BMR-G	LVR-IC	LDO, 2.95V±1%, 300mA, +CE, PDR, ICP	SOT-25	28cx	VR4	6g	Tor
92M	XC6113A320MR	Vdet-IC	2.0V±2%, -MR, +Reset PPO, Wt=100ms, Rt=3.13ms	SOT-25	28cp	VD17	6g	Tor



SMD code	Type	Function	Short description	Case	Pinout	Sch.	St.Mnf.
92M	XC6113A350MR	Vdet-IC	5.0V±2%, -MR, +Reset PPO, Wt=100ms, Rt=3.13ms	SOT-25	28cp	VD17	6g Tor
92N	RP104N291D	LVR-IC	LDO, 2.9V±0.8%, 150mA, +CE, CL	SOT-23-5	28cx	VR4	6g Ric
92N	XC6223G30BMR-G	LVR-IC	LDO, 3.05V±1%, 300mA, +CE, PDR, ICP	SOT-25	28cx	VR4	6g Tor
92N	XC6113A321MR	Vdet-IC	2.1V±2%, -MR, +Reset PPO, Wt=100ms, Rt=3.13ms	SOT-25	28cp	VD17	6g Tor
92P	RP104N301D	LVR-IC	LDO, 3.0V±0.8%, 150mA, +CE, CL	SOT-23-5	28cx	VR4	6g Ric
92P	XC6223G31BMR-G	LVR-IC	LDO, 3.15V±1%, 300mA, +CE, PDR, ICP	SOT-25	28cx	VR4	6g Tor
92P	XC6113A322MR	Vdet-IC	2.2V±2%, -MR, +Reset PPO, Wt=100ms, Rt=3.13ms	SOT-25	28cp	VD17	6g Tor
92Q	RP104N321D	LVR-IC	LDO, 3.2V±0.8%, 150mA, +CE, CL	SOT-23-5	28cx	VR4	6g Ric
92R	RP104N331D	LVR-IC	LDO, 3.3V±0.8%, 150mA, +CE, CL	SOT-23-5	28cx	VR4	6g Ric
92R	XC6223G32BMR-G	LVR-IC	LDO, 3.25V±1%, 300mA, +CE, PDR, ICP	SOT-25	28cx	VR4	6g Tor
92R	XC6113A323MR	Vdet-IC	2.3V±2%, -MR, +Reset PPO, Wt=100ms, Rt=3.13ms	SOT-25	28cp	VD17	6g Tor
92S	RP104N311D	LVR-IC	LDO, 3.1V±0.8%, 150mA, +CE, CL	SOT-23-5	28cx	VR4	6g Ric
92S	XC6223G33BMR-G	LVR-IC	LDO, 3.35V±1%, 300mA, +CE, PDR, ICP	SOT-25	28cx	VR4	6g Tor
92S	XC6113A324MR	Vdet-IC	2.4V±2%, -MR, +Reset PPO, Wt=100ms, Rt=3.13ms	SOT-25	28cp	VD17	6g Tor
92T	RP104N241D	LVR-IC	LDO, 2.4V±0.8%, 150mA, +CE, CL	SOT-23-5	28cx	VR4	6g Ric
92T	XC6223G34BMR-G	LVR-IC	LDO, 3.45V±1%, 300mA, +CE, PDR, ICP	SOT-25	28cx	VR4	6g Tor
92T	XC6113A325MR	Vdet-IC	2.5V±2%, -MR, +Reset PPO, Wt=100ms, Rt=3.13ms	SOT-25	28cp	VD17	6g Tor
92U	RP104N221D	LVR-IC	LDO, 2.2V±0.8%, 150mA, +CE, CL	SOT-23-5	28cx	VR4	6g Ric
92U	XC6223G35BMR-G	LVR-IC	LDO, 3.55V±1%, 300mA, +CE, PDR, ICP	SOT-25	28cx	VR4	6g Tor
92U	XC6113A326MR	Vdet-IC	2.6V±2%, -MR, +Reset PPO, Wt=100ms, Rt=3.13ms	SOT-25	28cp	VD17	6g Tor
92V	RP104N231D	LVR-IC	LDO, 2.3V±0.8%, 150mA, +CE, CL	SOT-23-5	28cx	VR4	6g Ric
92V	XC6223G36BMR-G	LVR-IC	LDO, 3.65V±1%, 300mA, +CE, PDR, ICP	SOT-25	28cx	VR4	6g Tor
92V	XC6113A327MR	Vdet-IC	2.7V±2%, -MR, +Reset PPO, Wt=100ms, Rt=3.13ms	SOT-25	28cp	VD17	6g Tor
92W	RP104N271D5	LVR-IC	LDO, 2.75V±0.8%, 150mA, +CE, CL	SOT-23-5	28cx	VR4	6g Ric
92X	RP104N211D	LVR-IC	LDO, 2.1V±0.8%, 150mA, +CE, CL	SOT-23-5	28cx	VR4	6g Ric
92X	XC6223G37BMR-G	LVR-IC	LDO, 3.75V±1%, 300mA, +CE, PDR, ICP	SOT-25	28cx	VR4	6g Tor
92X	XC6113A328MR	Vdet-IC	2.8V±2%, -MR, +Reset PPO, Wt=100ms, Rt=3.13ms	SOT-25	28cp	VD17	6g Tor
92Y	XC6223G38BMR-G	LVR-IC	LDO, 3.85V±1%, 300mA, +CE, PDR, ICP	SOT-25	28cx	VR4	6g Tor
92Y	XC6113A329MR	Vdet-IC	2.9V±2%, -MR, +Reset PPO, Wt=100ms, Rt=3.13ms	SOT-25	28cp	VD17	6g Tor
92Z	XC6223G39BMR-G	LVR-IC	LDO, 3.95V±1%, 300mA, +CE, PDR, ICP	SOT-25	28cx	VR4	6g Tor
92Z	XC6113A330MR	Vdet-IC	3.0V±2%, -MR, +Reset PPO, Wt=100ms, Rt=3.13ms	SOT-25	28cp	VD17	6g Tor
93	RN5RF43BA	LVR-IC	L.Rip, +CE, 4.3V±2%, 1A*	SOT-23-5	28vw	VR6	6g Ric
93	RN5RZ43BA	LVR-IC	LDO, LN, +CE, 4.3V±2%, 100mA	SOT-23-5	28wrt	VR4	6g Ric
930	R1124N301D	LVR-IC	LDO, LN, +CE, CL, 3V±2%, 150mA	SOT-23-5	28vt	VR4	6g Ric
930	XC6113A431MR	Vdet-IC	3.1V±2%, -MR, +Reset PPO, Wt=200ms, Rt=3.13ms	SOT-25	28cp	VD17	6g Tor
931	R1124N311D	LVR-IC	LDO, LN, +CE, CL, 3.1V±2%, 150mA	SOT-23-5	28vt	VR4	6g Ric
931	XC6113A432MR	Vdet-IC	3.2V±2%, -MR, +Reset PPO, Wt=200ms, Rt=3.13ms	SOT-25	28cp	VD17	6g Tor
932	R1124N321D	LVR-IC	LDO, LN, +CE, CL, 3.2V±2%, 150mA	SOT-23-5	28vt	VR4	6g Ric
932	XC6223H121MR-G	LVR-IC	LDO, 1.2V±20mV, 300mA, +CE, CL, PDR, ICP	SOT-25	28cx	VR4	6g Tor
932	XC6113A433MR	Vdet-IC	3.3V±2%, -MR, +Reset PPO, Wt=200ms, Rt=3.13ms	SOT-25	28cp	VD17	6g Tor
933	R1124N331D	LVR-IC	LDO, LN, +CE, CL, 3.3V±2%, 150mA	SOT-23-5	28vt	VR4	6g Ric
933	XC6223H131MR-G	LVR-IC	LDO, 1.3V±20mV, 300mA, +CE, CL, PDR, ICP	SOT-25	28cx	VR4	6g Tor
933	XC6113A434MR	Vdet-IC	3.4V±2%, -MR, +Reset PPO, Wt=200ms, Rt=3.13ms	SOT-25	28cp	VD17	6g Tor
934	R1124N341D	LVR-IC	LDO, LN, +CE, CL, 3.4V±2%, 150mA	SOT-23-5	28vt	VR4	6g Ric
934	XC6223H141MR-G	LVR-IC	LDO, 1.4V±20mV, 300mA, +CE, CL, PDR, ICP	SOT-25	28cx	VR4	6g Tor
934	XC6113A435MR	Vdet-IC	3.5V±2%, -MR, +Reset PPO, Wt=200ms, Rt=3.13ms	SOT-25	28cp	VD17	6g Tor
935	R1124N351D	LVR-IC	LDO, LN, +CE, CL, 3.5V±2%, 150mA	SOT-23-5	28vt	VR4	6g Ric
935	XC6223H151MR-G	LVR-IC	LDO, 1.5V±20mV, 300mA, +CE, CL, PDR, ICP	SOT-25	28cx	VR4	6g Tor
935	XC6113A436MR	Vdet-IC	3.6V±2%, -MR, +Reset PPO, Wt=200ms, Rt=3.13ms	SOT-25	28cp	VD17	6g Tor
936	R1124N361D	LVR-IC	LDO, LN, +CE, CL, 3.6V±2%, 150mA	SOT-23-5	28vt	VR4	6g Ric
936	XC6223H161MR-G	LVR-IC	LDO, 1.6V±20mV, 300mA, +CE, CL, PDR, ICP	SOT-25	28cx	VR4	6g Tor
936	XC6113A437MR	Vdet-IC	3.7V±2%, -MR, +Reset PPO, Wt=200ms, Rt=3.13ms	SOT-25	28cp	VD17	6g Tor
937	R1124N371D	LVR-IC	LDO, LN, +CE, CL, 3.7V±2%, 150mA	SOT-23-5	28vt	VR4	6g Ric
937	XC6223H171MR-G	LVR-IC	LDO, 1.7V±20mV, 300mA, +CE, CL, PDR, ICP	SOT-25	28cx	VR4	6g Tor
937	XC6113A438MR	Vdet-IC	3.8V±2%, -MR, +Reset PPO, Wt=200ms, Rt=3.13ms	SOT-25	28cp	VD17	6g Tor
938	R1124N381D	LVR-IC	LDO, LN, +CE, CL, 3.8V±2%, 150mA	SOT-23-5	28vt	VR4	6g Ric
938	XC6223H181MR-G	LVR-IC	LDO, 1.8V±20mV, 300mA, +CE, CL, PDR, ICP	SOT-25	28cx	VR4	6g Tor
938	XC6113A439MR	Vdet-IC	3.9V±2%, -MR, +Reset PPO, Wt=200ms, Rt=3.13ms	SOT-25	28cp	VD17	6g Tor
939	R1124N391D	LVR-IC	LDO, LN, +CE, CL, 3.9V±2%, 150mA	SOT-23-5	28vt	VR4	6g Ric
939	XC6223H191MR-G	LVR-IC	LDO, 1.9V±20mV, 300mA, +CE, CL, PDR, ICP	SOT-25	28cx	VR4	6g Tor
939	XC6113A440MR	Vdet-IC	4.0V±2%, -MR, +Reset PPO, Wt=200ms, Rt=3.13ms	SOT-25	28cp	VD17	6g Tor
93A	XC6223H201MR-G	LVR-IC	LDO, 2.0V±1%, 300mA, +CE, CL, PDR, ICP	SOT-25	28cx	VR4	6g Tor
93A	XC6113A441MR	Vdet-IC	4.1V±2%, -MR, +Reset PPO, Wt=200ms, Rt=3.13ms	SOT-25	28cp	VD17	6g Tor
93B	XC6223H211MR-G	LVR-IC	LDO, 2.1V±1%, 300mA, +CE, CL, PDR, ICP	SOT-25	28cx	VR4	6g Tor
93B	XC6113A442MR	Vdet-IC	4.2V±2%, -MR, +Reset PPO, Wt=200ms, Rt=3.13ms	SOT-25	28cp	VD17	6g Tor
93C	XC6223H221MR-G	LVR-IC	LDO, 2.2V±1%, 300mA, +CE, CL, PDR, ICP	SOT-25	28cx	VR4	6g Tor
93C	XC6113A443MR	Vdet-IC	4.3V±2%, -MR, +Reset PPO, Wt=200ms, Rt=3.13ms	SOT-25	28cp	VD17	6g Tor
93D	XC6223H231MR-G	LVR-IC	LDO, 2.3V±1%, 300mA, +CE, CL, PDR, ICP	SOT-25	28cx	VR4	6g Tor
93D	XC6113A444MR	Vdet-IC	4.4V±2%, -MR, +Reset PPO, Wt=200ms, Rt=3.13ms	SOT-25	28cp	VD17	6g Tor
93E	XC6223H241MR-G	LVR-IC	LDO, 2.4V±1%, 300mA, +CE, CL, PDR, ICP	SOT-25	28cx	VR4	6g Tor



SMD code	Type	Function	Short description	Case	Pinout	Sch.	St.	Mnf.
93E	XC6113A445MR	Vdet-IC	4.5V±2%, -MR, +Reset PPO, Wt=200ms, Rt=3.13ms	SOT-25	28cp	VD17	6g	Tor
93F	XC6223H251MR-G	LVR-IC	LDO, 2.5V±1%, 300mA, +CE, CL, PDR, ICP	SOT-25	28cx	VR4	6g	Tor
93F	XC6113A416MR	Vdet-IC	1.6V±2%, -MR, +Reset PPO, Wt=200ms, Rt=3.13ms	SOT-25	28cp	VD17	6g	Tor
93E	XC6113A446MR	Vdet-IC	4.6V±2%, -MR, +Reset PPO, Wt=200ms, Rt=3.13ms	SOT-25	28cp	VD17	6g	Tor
93H	XC6223H261MR-G	LVR-IC	LDO, 2.6V±1%, 300mA, +CE, CL, PDR, ICP	SOT-25	28cx	VR4	6g	Tor
93H	XC6113A417MR	Vdet-IC	1.7V±2%, -MR, +Reset PPO, Wt=200ms, Rt=3.13ms	SOT-25	28cp	VD17	6g	Tor
93H	XC6113A447MR	Vdet-IC	4.7V±2%, -MR, +Reset PPO, Wt=200ms, Rt=3.13ms	SOT-25	28cp	VD17	6g	Tor
93K	XC6223H271MR-G	LVR-IC	LDO, 2.7V±1%, 300mA, +CE, CL, PDR, ICP	SOT-25	28cx	VR4	6g	Tor
93K	XC6113A418MR	Vdet-IC	1.8V±2%, -MR, +Reset PPO, Wt=200ms, Rt=3.13ms	SOT-25	28cp	VD17	6g	Tor
93K	XC6113A448MR	Vdet-IC	4.8V±2%, -MR, +Reset PPO, Wt=200ms, Rt=3.13ms	SOT-25	28cp	VD17	6g	Tor
93L	XC6223H281MR-G	LVR-IC	LDO, 2.8V±1%, 300mA, +CE, CL, PDR, ICP	SOT-25	28cx	VR4	6g	Tor
93L	XC6113A419MR	Vdet-IC	1.9V±2%, -MR, +Reset PPO, Wt=200ms, Rt=3.13ms	SOT-25	28cp	VD17	6g	Tor
93L	XC6113A449MR	Vdet-IC	4.9V±2%, -MR, +Reset PPO, Wt=200ms, Rt=3.13ms	SOT-25	28cp	VD17	6g	Tor
93M	XC6223H291MR-G	LVR-IC	LDO, 2.9V±1%, 300mA, +CE, CL, PDR, ICP	SOT-25	28cx	VR4	6g	Tor
93M	XC6113A420MR	Vdet-IC	2.0V±2%, -MR, +Reset PPO, Wt=200ms, Rt=3.13ms	SOT-25	28cp	VD17	6g	Tor
93M	XC6113A450MR	Vdet-IC	5.0V±2%, -MR, +Reset PPO, Wt=200ms, Rt=3.13ms	SOT-25	28cp	VD17	6g	Tor
93N	XC6223H301MR-G	LVR-IC	LDO, 3.0V±1%, 300mA, +CE, CL, PDR, ICP	SOT-25	28cx	VR4	6g	Tor
93N	XC6113A421MR	Vdet-IC	2.1V±2%, -MR, +Reset PPO, Wt=200ms, Rt=3.13ms	SOT-25	28cp	VD17	6g	Tor
93P	XC6223H311MR-G	LVR-IC	LDO, 3.1V±1%, 300mA, +CE, CL, PDR, ICP	SOT-25	28cx	VR4	6g	Tor
93P	XC6113A422MR	Vdet-IC	2.2V±2%, -MR, +Reset PPO, Wt=200ms, Rt=3.13ms	SOT-25	28cp	VD17	6g	Tor
93R	XC6223H321MR-G	LVR-IC	LDO, 3.2V±1%, 300mA, +CE, CL, PDR, ICP	SOT-25	28cx	VR4	6g	Tor
93R	XC6113A423MR	Vdet-IC	2.3V±2%, -MR, +Reset PPO, Wt=200ms, Rt=3.13ms	SOT-25	28cp	VD17	6g	Tor
93S	XC6223H331MR-G	LVR-IC	LDO, 3.3V±1%, 300mA, +CE, CL, PDR, ICP	SOT-25	28cx	VR4	6g	Tor
93S	XC6113A424MR	Vdet-IC	2.4V±2%, -MR, +Reset PPO, Wt=200ms, Rt=3.13ms	SOT-25	28cp	VD17	6g	Tor
93T	XC6223H341MR-G	LVR-IC	LDO, 3.4V±1%, 300mA, +CE, CL, PDR, ICP	SOT-25	28cx	VR4	6g	Tor
93T	XC6113A425MR	Vdet-IC	2.5V±2%, -MR, +Reset PPO, Wt=200ms, Rt=3.13ms	SOT-25	28cp	VD17	6g	Tor
93U	XC6223H351MR-G	LVR-IC	LDO, 3.5V±1%, 300mA, +CE, CL, PDR, ICP	SOT-25	28cx	VR4	6g	Tor
93U	XC6113A426MR	Vdet-IC	2.6V±2%, -MR, +Reset PPO, Wt=200ms, Rt=3.13ms	SOT-25	28cp	VD17	6g	Tor
93V	XC6223H361MR-G	LVR-IC	LDO, 3.6V±1%, 300mA, +CE, CL, PDR, ICP	SOT-25	28cx	VR4	6g	Tor
93V	XC6113A427MR	Vdet-IC	2.7V±2%, -MR, +Reset PPO, Wt=200ms, Rt=3.13ms	SOT-25	28cp	VD17	6g	Tor
93X	XC6223H371MR-G	LVR-IC	LDO, 3.7V±1%, 300mA, +CE, CL, PDR, ICP	SOT-25	28cx	VR4	6g	Tor
93X	XC6113A428MR	Vdet-IC	2.8V±2%, -MR, +Reset PPO, Wt=200ms, Rt=3.13ms	SOT-25	28cp	VD17	6g	Tor
93Y	XC6223H381MR-G	LVR-IC	LDO, 3.8V±1%, 300mA, +CE, CL, PDR, ICP	SOT-25	28cx	VR4	6g	Tor
93Y	XC6113A429MR	Vdet-IC	2.9V±2%, -MR, +Reset PPO, Wt=200ms, Rt=3.13ms	SOT-25	28cp	VD17	6g	Tor
93Z	XC6223H391MR-G	LVR-IC	LDO, 3.9V±1%, 300mA, +CE, CL, PDR, ICP	SOT-25	28cx	VR4	6g	Tor
93Z	XC6113A430MR	Vdet-IC	3.0V±2%, -MR, +Reset PPO, Wt=200ms, Rt=3.13ms	SOT-25	28cp	VD17	6g	Tor
94	RN5RF44BA	LVR-IC	LRip, +CE, 4.4V±2%, 1A*	SOT-23-5	28wv	VR6	6g	Ric
94	RN5RZ44BA	LVR-IC	LDO, LN, +CE, 4.4V±2%, 100mA	SOT-23-5	28wrt	VR4	6g	Ric
940	R1124N401D	LVR-IC	LDO, LN, +CE, CL, 4V±2%, 150mA	SOT-23-5	28vt	VR4	6g	Ric
940	XC6223H401MR-G	LVR-IC	LDO, 4.0V±1%, 300mA, +CE, CL, PDR, ICP	SOT-25	28cx	VR4	6g	Tor
940	XC6113A531MR	Vdet-IC	3.1V±2%, -MR, +Reset PPO, Wt=400ms, Rt=3.13ms	SOT-25	28cp	VD17	6g	Tor
941	R1124N281D5	LVR-IC	LDO, LN, +CE, CL, 2.8V±2%, 150mA	SOT-23-5	28vt	VR4	6g	Ric
941	XC6113A532MR	Vdet-IC	3.2V±2%, -MR, +Reset PPO, Wt=400ms, Rt=3.13ms	SOT-25	28cp	VD17	6g	Tor
942	XC6113A533MR	Vdet-IC	3.3V±2%, -MR, +Reset PPO, Wt=400ms, Rt=3.13ms	SOT-25	28cp	VD17	6g	Tor
943	XC6113A534MR	Vdet-IC	3.4V±2%, -MR, +Reset PPO, Wt=400ms, Rt=3.13ms	SOT-25	28cp	VD17	6g	Tor
944	XC6113A535MR	Vdet-IC	3.5V±2%, -MR, +Reset PPO, Wt=400ms, Rt=3.13ms	SOT-25	28cp	VD17	6g	Tor
945	XC6113A536MR	Vdet-IC	3.6V±2%, -MR, +Reset PPO, Wt=400ms, Rt=3.13ms	SOT-25	28cp	VD17	6g	Tor
946	XC6113A537MR	Vdet-IC	3.7V±2%, -MR, +Reset PPO, Wt=400ms, Rt=3.13ms	SOT-25	28cp	VD17	6g	Tor
947	XC6113A538MR	Vdet-IC	3.8V±2%, -MR, +Reset PPO, Wt=400ms, Rt=3.13ms	SOT-25	28cp	VD17	6g	Tor
948	XC6113A539MR	Vdet-IC	3.9V±2%, -MR, +Reset PPO, Wt=400ms, Rt=3.13ms	SOT-25	28cp	VD17	6g	Tor
949	XC6113A540MR	Vdet-IC	4.0V±2%, -MR, +Reset PPO, Wt=400ms, Rt=3.13ms	SOT-25	28cp	VD17	6g	Tor
94A	XC6113A541MR	Vdet-IC	4.1V±2%, -MR, +Reset PPO, Wt=400ms, Rt=3.13ms	SOT-25	28cp	VD17	6g	Tor
94B	XC6113A542MR	Vdet-IC	4.2V±2%, -MR, +Reset PPO, Wt=400ms, Rt=3.13ms	SOT-25	28cp	VD17	6g	Tor
94C	XC6113A543MR	Vdet-IC	4.3V±2%, -MR, +Reset PPO, Wt=400ms, Rt=3.13ms	SOT-25	28cp	VD17	6g	Tor
94D	XC6113A544MR	Vdet-IC	4.4V±2%, -MR, +Reset PPO, Wt=400ms, Rt=3.13ms	SOT-25	28cp	VD17	6g	Tor
94E	XC6113A545MR	Vdet-IC	4.5V±2%, -MR, +Reset PPO, Wt=400ms, Rt=3.13ms	SOT-25	28cp	VD17	6g	Tor
94F	XC6113A516MR	Vdet-IC	1.6V±2%, -MR, +Reset PPO, Wt=400ms, Rt=3.13ms	SOT-25	28cp	VD17	6g	Tor
94E	XC6113A546MR	Vdet-IC	4.6V±2%, -MR, +Reset PPO, Wt=400ms, Rt=3.13ms	SOT-25	28cp	VD17	6g	Tor
94H	XC6113A517MR	Vdet-IC	1.7V±2%, -MR, +Reset PPO, Wt=400ms, Rt=3.13ms	SOT-25	28cp	VD17	6g	Tor
94H	XC6113A547MR	Vdet-IC	4.7V±2%, -MR, +Reset PPO, Wt=400ms, Rt=3.13ms	SOT-25	28cp	VD17	6g	Tor
94K	XC6113A518MR	Vdet-IC	1.8V±2%, -MR, +Reset PPO, Wt=400ms, Rt=3.13ms	SOT-25	28cp	VD17	6g	Tor
94K	XC6113A548MR	Vdet-IC	4.8V±2%, -MR, +Reset PPO, Wt=400ms, Rt=3.13ms	SOT-25	28cp	VD17	6g	Tor
94L	XC6113A519MR	Vdet-IC	1.9V±2%, -MR, +Reset PPO, Wt=400ms, Rt=3.13ms	SOT-25	28cp	VD17	6g	Tor
94L	XC6113A549MR	Vdet-IC	4.9V±2%, -MR, +Reset PPO, Wt=400ms, Rt=3.13ms	SOT-25	28cp	VD17	6g	Tor
94M	XC6113A520MR	Vdet-IC	2.0V±2%, -MR, +Reset PPO, Wt=400ms, Rt=3.13ms	SOT-25	28cp	VD17	6g	Tor
94M	XC6113A550MR	Vdet-IC	5.0V±2%, -MR, +Reset PPO, Wt=400ms, Rt=3.13ms	SOT-25	28cp	VD17	6g	Tor
94N	XC6113A521MR	Vdet-IC	2.1V±2%, -MR, +Reset PPO, Wt=400ms, Rt=3.13ms	SOT-25	28cp	VD17	6g	Tor
94P	XC6113A522MR	Vdet-IC	2.2V±2%, -MR, +Reset PPO, Wt=400ms, Rt=3.13ms	SOT-25	28cp	VD17	6g	Tor
94R	XC6113A523MR	Vdet-IC	2.3V±2%, -MR, +Reset PPO, Wt=400ms, Rt=3.13ms	SOT-25	28cp	VD17	6g	Tor
94S	XC6113A524MR	Vdet-IC	2.4V±2%, -MR, +Reset PPO, Wt=400ms, Rt=3.13ms	SOT-25	28cp	VD17	6g	Tor



SMD code	Type	Function	Short description	Case	Pinout	Sch.	St.	Mnf.
94T	XC6113A525MR	Vdet-IC	2.5V±2%, -MR, +Reset PPO, Wt=400ms, Rt=3.13ms	SOT-25	28cp	VD17	6g	Tor
94U	XC6113A526MR	Vdet-IC	2.6V±2%, -MR, +Reset PPO, Wt=400ms, Rt=3.13ms	SOT-25	28cp	VD17	6g	Tor
94V	XC6113A527MR	Vdet-IC	2.7V±2%, -MR, +Reset PPO, Wt=400ms, Rt=3.13ms	SOT-25	28cp	VD17	6g	Tor
94X	XC6113A528MR	Vdet-IC	2.8V±2%, -MR, +Reset PPO, Wt=400ms, Rt=3.13ms	SOT-25	28cp	VD17	6g	Tor
94Y	XC6113A529MR	Vdet-IC	2.9V±2%, -MR, +Reset PPO, Wt=400ms, Rt=3.13ms	SOT-25	28cp	VD17	6g	Tor
94Z	XC6113A530MR	Vdet-IC	3.0V±2%, -MR, +Reset PPO, Wt=400ms, Rt=3.13ms	SOT-25	28cp	VD17	6g	Tor
95	RN5RF45BA	LVR-IC	LRip, +CE, 4.5V±2%, 1A*	SOT-23-5	28vw	VR6	6g	Ric
95	RN5RZ45BA	LVR-IC	LDO, LN, +CE, 4.5V±2%, 100mA	SOT-23-5	28vrt	VR4	6g	Ric
950	XC6113A631MR	Vdet-IC	3.1V±2%, -MR, +Reset PPO, Wt=1.6s, Rt=3.13ms	SOT-25	28cp	VD17	6g	Tor
951	XC6113A632MR	Vdet-IC	3.2V±2%, -MR, +Reset PPO, Wt=1.6s, Rt=3.13ms	SOT-25	28cp	VD17	6g	Tor
952	XC6223H12BMR-G	LVR-IC	LDO, 1.25V±20mV, 300mA, +CE, CL, PDR, ICP	SOT-25	28cx	VR4	6g	Tor
953	XC6113A633MR	Vdet-IC	3.3V±2%, -MR, +Reset PPO, Wt=1.6s, Rt=3.13ms	SOT-25	28cp	VD17	6g	Tor
953	XC6223H13BMR-G	LVR-IC	LDO, 1.35V±20mV, 300mA, +CE, CL, PDR, ICP	SOT-25	28cx	VR4	6g	Tor
953	XC6113A634MR	Vdet-IC	3.4V±2%, -MR, +Reset PPO, Wt=1.6s, Rt=3.13ms	SOT-25	28cp	VD17	6g	Tor
954	XC6223H14BMR-G	LVR-IC	LDO, 1.45V±20mV, 300mA, +CE, CL, PDR, ICP	SOT-25	28cx	VR4	6g	Tor
954	XC6113A635MR	Vdet-IC	3.5V±2%, -MR, +Reset PPO, Wt=1.6s, Rt=3.13ms	SOT-25	28cp	VD17	6g	Tor
955	XC6223H15BMR-G	LVR-IC	LDO, 1.55V±20mV, 300mA, +CE, CL, PDR, ICP	SOT-25	28cx	VR4	6g	Tor
955	XC6113A636MR	Vdet-IC	3.6V±2%, -MR, +Reset PPO, Wt=1.6s, Rt=3.13ms	SOT-25	28cp	VD17	6g	Tor
956	XC6223H16BMR-G	LVR-IC	LDO, 1.65V±20mV, 300mA, +CE, CL, PDR, ICP	SOT-25	28cx	VR4	6g	Tor
956	XC6113A637MR	Vdet-IC	3.7V±2%, -MR, +Reset PPO, Wt=1.6s, Rt=3.13ms	SOT-25	28cp	VD17	6g	Tor
957	XC6223H17BMR-G	LVR-IC	LDO, 1.75V±20mV, 300mA, +CE, CL, PDR, ICP	SOT-25	28cx	VR4	6g	Tor
957	XC6113A638MR	Vdet-IC	3.8V±2%, -MR, +Reset PPO, Wt=1.6s, Rt=3.13ms	SOT-25	28cp	VD17	6g	Tor
958	XC6223H18BMR-G	LVR-IC	LDO, 1.85V±20mV, 300mA, +CE, CL, PDR, ICP	SOT-25	28cx	VR4	6g	Tor
958	XC6113A639MR	Vdet-IC	3.9V±2%, -MR, +Reset PPO, Wt=1.6s, Rt=3.13ms	SOT-25	28cp	VD17	6g	Tor
959	XC6223H19BMR-G	LVR-IC	LDO, 1.95V±20mV, 300mA, +CE, CL, PDR, ICP	SOT-25	28cx	VR4	6g	Tor
959	XC6113A640MR	Vdet-IC	4.0V±2%, -MR, +Reset PPO, Wt=1.6s, Rt=3.13ms	SOT-25	28cp	VD17	6g	Tor
95A	XC6223H20BMR-G	LVR-IC	LDO, 2.05V±1%, 300mA, +CE, CL, PDR, ICP	SOT-25	28cx	VR4	6g	Tor
95A	XC6113A641MR	Vdet-IC	4.1V±2%, -MR, +Reset PPO, Wt=1.6s, Rt=3.13ms	SOT-25	28cp	VD17	6g	Tor
95B	XC6223H21BMR-G	LVR-IC	LDO, 2.15V±1%, 300mA, +CE, CL, PDR, ICP	SOT-25	28cx	VR4	6g	Tor
95B	XC6113A642MR	Vdet-IC	4.2V±2%, -MR, +Reset PPO, Wt=1.6s, Rt=3.13ms	SOT-25	28cp	VD17	6g	Tor
95C	XC6223H22BMR-G	LVR-IC	LDO, 2.25V±1%, 300mA, +CE, CL, PDR, ICP	SOT-25	28cx	VR4	6g	Tor
95C	XC6113A643MR	Vdet-IC	4.3V±2%, -MR, +Reset PPO, Wt=1.6s, Rt=3.13ms	SOT-25	28cp	VD17	6g	Tor
95D	XC6223H23BMR-G	LVR-IC	LDO, 2.35V±1%, 300mA, +CE, CL, PDR, ICP	SOT-25	28cx	VR4	6g	Tor
95D	XC6113A644MR	Vdet-IC	4.4V±2%, -MR, +Reset PPO, Wt=1.6s, Rt=3.13ms	SOT-25	28cp	VD17	6g	Tor
95E	XC6223H24BMR-G	LVR-IC	LDO, 2.45V±1%, 300mA, +CE, CL, PDR, ICP	SOT-25	28cx	VR4	6g	Tor
95E	XC6113A645MR	Vdet-IC	4.5V±2%, -MR, +Reset PPO, Wt=1.6s, Rt=3.13ms	SOT-25	28cp	VD17	6g	Tor
95F	XC6223H25BMR-G	LVR-IC	LDO, 2.55V±1%, 300mA, +CE, CL, PDR, ICP	SOT-25	28cx	VR4	6g	Tor
95F	XC6113A616MR	Vdet-IC	1.6V±2%, -MR, +Reset PPO, Wt=1.6s, Rt=3.13ms	SOT-25	28cp	VD17	6g	Tor
95F	XC6113A646MR	Vdet-IC	4.6V±2%, -MR, +Reset PPO, Wt=1.6s, Rt=3.13ms	SOT-25	28cp	VD17	6g	Tor
95H	XC6223H26BMR-G	LVR-IC	LDO, 2.65V±1%, 300mA, +CE, CL, PDR, ICP	SOT-25	28cx	VR4	6g	Tor
95H	XC6113A617MR	Vdet-IC	1.7V±2%, -MR, +Reset PPO, Wt=1.6s, Rt=3.13ms	SOT-25	28cp	VD17	6g	Tor
95H	XC6113A647MR	Vdet-IC	4.7V±2%, -MR, +Reset PPO, Wt=1.6s, Rt=3.13ms	SOT-25	28cp	VD17	6g	Tor
95K	XC6223H27BMR-G	LVR-IC	LDO, 2.75V±1%, 300mA, +CE, CL, PDR, ICP	SOT-25	28cx	VR4	6g	Tor
95K	XC6113A618MR	Vdet-IC	1.8V±2%, -MR, +Reset PPO, Wt=1.6s, Rt=3.13ms	SOT-25	28cp	VD17	6g	Tor
95K	XC6113A648MR	Vdet-IC	4.8V±2%, -MR, +Reset PPO, Wt=1.6s, Rt=3.13ms	SOT-25	28cp	VD17	6g	Tor
95L	XC6223H28BMR-G	LVR-IC	LDO, 2.85V±1%, 300mA, +CE, CL, PDR, ICP	SOT-25	28cx	VR4	6g	Tor
95L	XC6113A619MR	Vdet-IC	1.9V±2%, -MR, +Reset PPO, Wt=1.6s, Rt=3.13ms	SOT-25	28cp	VD17	6g	Tor
95L	XC6113A649MR	Vdet-IC	4.9V±2%, -MR, +Reset PPO, Wt=1.6s, Rt=3.13ms	SOT-25	28cp	VD17	6g	Tor
95M	XC6223H29BMR-G	LVR-IC	LDO, 2.95V±1%, 300mA, +CE, CL, PDR, ICP	SOT-25	28cx	VR4	6g	Tor
95M	XC6113A620MR	Vdet-IC	2.0V±2%, -MR, +Reset PPO, Wt=1.6s, Rt=3.13ms	SOT-25	28cp	VD17	6g	Tor
95M	XC6113A650MR	Vdet-IC	5.0V±2%, -MR, +Reset PPO, Wt=1.6s, Rt=3.13ms	SOT-25	28cp	VD17	6g	Tor
95N	XC6223H30BMR-G	LVR-IC	LDO, 3.05V±1%, 300mA, +CE, CL, PDR, ICP	SOT-25	28cx	VR4	6g	Tor
95N	XC6113A621MR	Vdet-IC	2.1V±2%, -MR, +Reset PPO, Wt=1.6s, Rt=3.13ms	SOT-25	28cp	VD17	6g	Tor
95P	XC6223H31BMR-G	LVR-IC	LDO, 3.15V±1%, 300mA, +CE, CL, PDR, ICP	SOT-25	28cx	VR4	6g	Tor
95P	XC6113A622MR	Vdet-IC	2.2V±2%, -MR, +Reset PPO, Wt=1.6s, Rt=3.13ms	SOT-25	28cp	VD17	6g	Tor
95R	XC6223H32BMR-G	LVR-IC	LDO, 3.25V±1%, 300mA, +CE, CL, PDR, ICP	SOT-25	28cx	VR4	6g	Tor
95R	XC6113A623MR	Vdet-IC	2.3V±2%, -MR, +Reset PPO, Wt=1.6s, Rt=3.13ms	SOT-25	28cp	VD17	6g	Tor
95S	XC6223H33BMR-G	LVR-IC	LDO, 3.35V±1%, 300mA, +CE, CL, PDR, ICP	SOT-25	28cx	VR4	6g	Tor
95S	XC6113A624MR	Vdet-IC	2.4V±2%, -MR, +Reset PPO, Wt=1.6s, Rt=3.13ms	SOT-25	28cp	VD17	6g	Tor
95T	XC6223H34BMR-G	LVR-IC	LDO, 3.45V±1%, 300mA, +CE, CL, PDR, ICP	SOT-25	28cx	VR4	6g	Tor
95T	XC6113A625MR	Vdet-IC	2.5V±2%, -MR, +Reset PPO, Wt=1.6s, Rt=3.13ms	SOT-25	28cp	VD17	6g	Tor
95U	XC6223H35BMR-G	LVR-IC	LDO, 3.55V±1%, 300mA, +CE, CL, PDR, ICP	SOT-25	28cx	VR4	6g	Tor
95U	XC6113A626MR	Vdet-IC	2.6V±2%, -MR, +Reset PPO, Wt=1.6s, Rt=3.13ms	SOT-25	28cp	VD17	6g	Tor
95V	XC6223H36BMR-G	LVR-IC	LDO, 3.65V±1%, 300mA, +CE, CL, PDR, ICP	SOT-25	28cx	VR4	6g	Tor
95V	XC6113A627MR	Vdet-IC	2.7V±2%, -MR, +Reset PPO, Wt=1.6s, Rt=3.13ms	SOT-25	28cp	VD17	6g	Tor
95X	XC6223H37BMR-G	LVR-IC	LDO, 3.75V±1%, 300mA, +CE, CL, PDR, ICP	SOT-25	28cx	VR4	6g	Tor
95X	XC6113A628MR	Vdet-IC	2.8V±2%, -MR, +Reset PPO, Wt=1.6s, Rt=3.13ms	SOT-25	28cp	VD17	6g	Tor
95Y	XC6223H38BMR-G	LVR-IC	LDO, 3.85V±1%, 300mA, +CE, CL, PDR, ICP	SOT-25	28cx	VR4	6g	Tor
95Y	XC6113A629MR	Vdet-IC	2.9V±2%, -MR, +Reset PPO, Wt=1.6s, Rt=3.13ms	SOT-25	28cp	VD17	6g	Tor
95Z	XC6223H39BMR-G	LVR-IC	LDO, 3.95V±1%, 300mA, +CE, CL, PDR, ICP	SOT-25	28cx	VR4	6g	Tor



SMD code	Type	Function	Short description	Case	Pinout	Sch.	St.	Mnf.
99P	XC6113B522MR	Vdet-IC	2.2V±2%, -MR, +Reset PPO, Wt=400ms, Rt=25ms	SOT-25	28cp	VD17	6g	Tor
99R	XC6113B523MR	Vdet-IC	2.3V±2%, -MR, +Reset PPO, Wt=400ms, Rt=25ms	SOT-25	28cp	VD17	6g	Tor
99S	XC6113B524MR	Vdet-IC	2.4V±2%, -MR, +Reset PPO, Wt=400ms, Rt=25ms	SOT-25	28cp	VD17	6g	Tor
99T	XC6113B525MR	Vdet-IC	2.5V±2%, -MR, +Reset PPO, Wt=400ms, Rt=25ms	SOT-25	28cp	VD17	6g	Tor
99U	XC6113B526MR	Vdet-IC	2.6V±2%, -MR, +Reset PPO, Wt=400ms, Rt=25ms	SOT-25	28cp	VD17	6g	Tor
99V	XC6113B527MR	Vdet-IC	2.7V±2%, -MR, +Reset PPO, Wt=400ms, Rt=25ms	SOT-25	28cp	VD17	6g	Tor
99X	XC6113B528MR	Vdet-IC	2.8V±2%, -MR, +Reset PPO, Wt=400ms, Rt=25ms	SOT-25	28cp	VD17	6g	Tor
99Y	XC6113B529MR	Vdet-IC	2.9V±2%, -MR, +Reset PPO, Wt=400ms, Rt=25ms	SOT-25	28cp	VD17	6g	Tor
99Z	XC6113B530MR	Vdet-IC	3.0V±2%, -MR, +Reset PPO, Wt=400ms, Rt=25ms	SOT-25	28cp	VD17	6g	Tor
9A	R3111N091A	Vdet-IC	0.9V±2%, -Reset PPO	SOT-23-5	28vdm	VD7	6g	Ric
9A	RN5VD09CA	Vdet-IC	0.9V±2.5%, -Reset ODO	SOT-23-5	28vdo	VD1	6g	Ric
9A0	XC6209A312MR	LVR-IC	LDO, 3.1V±2%, 150mA, +CE, PDR	SOT-25	28cx	VR4	6g	Tor
9A0	XC6601A071MR	LVR-IC	0.7V±20mV, 400mA, +CE, PDR, UVLO	SOT-25	28gj	VR11	6g	Tor
9A0	XC6113B631MR	Vdet-IC	3.1V±2%, -MR, +Reset PPO, Wt=1.6s, Rt=25ms	SOT-25	28cp	VD17	6g	Tor
9A0	XC6209E312MR	LVR-IC	LDO, 3.1V±2%, 300mA, +CE, PDR	SOT-25	28cx	VR4	6g	Tor
9A0	XC6212A312MR	LVR-IC	LDO, 3.1V±2%, 150mA, +CE, PDR	SOT-25	28vt	VR4	6g	Tor
9A1	XC6209A322MR	LVR-IC	LDO, 3.2V±2%, 150mA, +CE, PDR	SOT-25	28cx	VR4	6g	Tor
9A1	XC6601A07BMR	LVR-IC	0.75V±20mV, 400mA, +CE, PDR, UVLO	SOT-25	28gj	VR11	6g	Tor
9A1	XC6113B632MR	Vdet-IC	3.2V±2%, -MR, +Reset PPO, Wt=1.6s, Rt=25ms	SOT-25	28cp	VD17	6g	Tor
9A1	XC6209E322MR	LVR-IC	LDO, 3.2V±2%, 300mA, +CE, PDR	SOT-25	28cx	VR4	6g	Tor
9A1	XC6212A322MR	LVR-IC	LDO, 3.2V±2%, 150mA, +CE, PDR	SOT-25	28vt	VR4	6g	Tor
9A2	XC6209A332MR	LVR-IC	LDO, 3.3V±2%, 150mA, +CE, PDR	SOT-25	28cx	VR4	6g	Tor
9A2	XC6601A081MR	LVR-IC	0.8V±20mV, 400mA, +CE, PDR, UVLO	SOT-25	28gj	VR11	6g	Tor
9A2	XC6113B633MR	Vdet-IC	3.3V±2%, -MR, +Reset PPO, Wt=1.6s, Rt=25ms	SOT-25	28cp	VD17	6g	Tor
9A2	XC6209E332MR	LVR-IC	LDO, 3.3V±2%, 300mA, +CE, PDR	SOT-25	28cx	VR4	6g	Tor
9A2	XC6212A332MR	LVR-IC	LDO, 3.3V±2%, 150mA, +CE, PDR	SOT-25	28vt	VR4	6g	Tor
9A3	XC6209A342MR	LVR-IC	LDO, 3.4V±2%, 150mA, +CE, PDR	SOT-25	28cx	VR4	6g	Tor
9A3	XC6601A08BMR	LVR-IC	0.85V±20mV, 400mA, +CE, PDR, UVLO	SOT-25	28gj	VR11	6g	Tor
9A3	XC6113B634MR	Vdet-IC	3.4V±2%, -MR, +Reset PPO, Wt=1.6s, Rt=25ms	SOT-25	28cp	VD17	6g	Tor
9A3	XC6209E342MR	LVR-IC	LDO, 3.4V±2%, 300mA, +CE, PDR	SOT-25	28cx	VR4	6g	Tor
9A3	XC6212A342MR	LVR-IC	LDO, 3.4V±2%, 150mA, +CE, PDR	SOT-25	28vt	VR4	6g	Tor
9A4	XC6209A352MR	LVR-IC	LDO, 3.5V±2%, 150mA, +CE, PDR	SOT-25	28cx	VR4	6g	Tor
9A4	XC6601A091MR	LVR-IC	0.9V±20mV, 400mA, +CE, PDR, UVLO	SOT-25	28gj	VR11	6g	Tor
9A4	XC6113B635MR	Vdet-IC	3.5V±2%, -MR, +Reset PPO, Wt=1.6s, Rt=25ms	SOT-25	28cp	VD17	6g	Tor
9A4	XC6209E352MR	LVR-IC	LDO, 3.5V±2%, 300mA, +CE, PDR	SOT-25	28cx	VR4	6g	Tor
9A4	XC6212A352MR	LVR-IC	LDO, 3.5V±2%, 150mA, +CE, PDR	SOT-25	28vt	VR4	6g	Tor
9A5	XC6209A362MR	LVR-IC	LDO, 3.6V±2%, 150mA, +CE, PDR	SOT-25	28cx	VR4	6g	Tor
9A5	XC6601A09BMR	LVR-IC	0.95V±20mV, 400mA, +CE, PDR, UVLO	SOT-25	28gj	VR11	6g	Tor
9A5	XC6113B636MR	Vdet-IC	3.6V±2%, -MR, +Reset PPO, Wt=1.6s, Rt=25ms	SOT-25	28cp	VD17	6g	Tor
9A5	XC6209E362MR	LVR-IC	LDO, 3.6V±2%, 300mA, +CE, PDR	SOT-25	28cx	VR4	6g	Tor
9A5	XC6212A362MR	LVR-IC	LDO, 3.6V±2%, 150mA, +CE, PDR	SOT-25	28vt	VR4	6g	Tor
9A6	XC6209A372MR	LVR-IC	LDO, 3.7V±2%, 150mA, +CE, PDR	SOT-25	28cx	VR4	6g	Tor
9A6	XC6601A101MR	LVR-IC	1.0V±20mV, 400mA, +CE, PDR, UVLO	SOT-25	28gj	VR11	6g	Tor
9A6	XC6113B637MR	Vdet-IC	3.7V±2%, -MR, +Reset PPO, Wt=1.6s, Rt=25ms	SOT-25	28cp	VD17	6g	Tor
9A6	XC6209E372MR	LVR-IC	LDO, 3.7V±2%, 300mA, +CE, PDR	SOT-25	28cx	VR4	6g	Tor
9A6	XC6212A372MR	LVR-IC	LDO, 3.7V±2%, 150mA, +CE, PDR	SOT-25	28vt	VR4	6g	Tor
9A7	XC6209A382MR	LVR-IC	LDO, 3.8V±2%, 150mA, +CE, PDR	SOT-25	28cx	VR4	6g	Tor
9A7	XC6601A10BMR	LVR-IC	1.05V±20mV, 400mA, +CE, PDR, UVLO	SOT-25	28gj	VR11	6g	Tor
9A7	XC6113B638MR	Vdet-IC	3.8V±2%, -MR, +Reset PPO, Wt=1.6s, Rt=25ms	SOT-25	28cp	VD17	6g	Tor
9A7	XC6209E382MR	LVR-IC	LDO, 3.8V±2%, 300mA, +CE, PDR	SOT-25	28cx	VR4	6g	Tor
9A7	XC6212A382MR	LVR-IC	LDO, 3.8V±2%, 150mA, +CE, PDR	SOT-25	28vt	VR4	6g	Tor
9A8	XC6209A392MR	LVR-IC	LDO, 3.9V±2%, 150mA, +CE, PDR	SOT-25	28cx	VR4	6g	Tor
9A8	XC6601A111MR	LVR-IC	1.1V±20mV, 400mA, +CE, PDR, UVLO	SOT-25	28gj	VR11	6g	Tor
9A8	XC6113B639MR	Vdet-IC	3.9V±2%, -MR, +Reset PPO, Wt=1.6s, Rt=25ms	SOT-25	28cp	VD17	6g	Tor
9A8	XC6209E392MR	LVR-IC	LDO, 3.9V±2%, 300mA, +CE, PDR	SOT-25	28cx	VR4	6g	Tor
9A8	XC6212A392MR	LVR-IC	LDO, 3.9V±2%, 150mA, +CE, PDR	SOT-25	28vt	VR4	6g	Tor
9A9	XC6209A402MR	LVR-IC	LDO, 4V±2%, 150mA, +CE, PDR	SOT-25	28cx	VR4	6g	Tor
9A9	XC6601A11BMR	LVR-IC	1.15V±20mV, 400mA, +CE, PDR, UVLO	SOT-25	28gj	VR11	6g	Tor
9A9	XC6113B640MR	Vdet-IC	4.0V±2%, -MR, +Reset PPO, Wt=1.6s, Rt=25ms	SOT-25	28cp	VD17	6g	Tor
9A9	XC6209E402MR	LVR-IC	LDO, 4V±2%, 300mA, +CE, PDR	SOT-25	28cx	VR4	6g	Tor
9A9	XC6212A402MR	LVR-IC	LDO, 4V±2%, 150mA, +CE, PDR	SOT-25	28vt	VR4	6g	Tor
9AA	XC6209A412MR	LVR-IC	LDO, 4.1V±2%, 150mA, +CE, PDR	SOT-25	28cx	VR4	6g	Tor
9AA	XC6601A121MR	LVR-IC	1.2V±20mV, 400mA, +CE, PDR, UVLO	SOT-25	28gj	VR11	6g	Tor
9AA	XC6113B641MR	Vdet-IC	4.1V±2%, -MR, +Reset PPO, Wt=1.6s, Rt=25ms	SOT-25	28cp	VD17	6g	Tor
9AA	XC6209E412MR	LVR-IC	LDO, 4.1V±2%, 300mA, +CE, PDR	SOT-25	28cx	VR4	6g	Tor
9AA	XC6212A412MR	LVR-IC	LDO, 4.1V±2%, 150mA, +CE, PDR	SOT-25	28vt	VR4	6g	Tor
9AB	XC6209A422MR	LVR-IC	LDO, 4.2V±2%, 150mA, +CE, PDR	SOT-25	28cx	VR4	6g	Tor
9AB	XC6601A12BMR	LVR-IC	1.25V±20mV, 400mA, +CE, PDR, UVLO	SOT-25	28gj	VR11	6g	Tor
9AB	XC6113B642MR	Vdet-IC	4.2V±2%, -MR, +Reset PPO, Wt=1.6s, Rt=25ms	SOT-25	28cp	VD17	6g	Tor
9AB	XC6209E422MR	LVR-IC	LDO, 4.2V±2%, 300mA, +CE, PDR	SOT-25	28cx	VR4	6g	Tor



SMD Code	Type	Function	Short description	Case	Pinout	Sch.	St.	Mnf.
9AB	XC6212A422MR	LVR-IC	LDO, 4.2V±2%, 150mA, +CE, PDR	SOT-25	28vt	VR4	6g	Tor
9AC	XC6209A432MR	LVR-IC	LDO, 4.3V±2%, 150mA, +CE, PDR	SOT-25	28cx	VR4	6g	Tor
9AC	XC6601A131MR	LVR-IC	1.3V±20mV, 400mA, +CE, PDR, UVLO	SOT-25	28gj	VR11	6g	Tor
9AC	XC6113B643MR	Vdet-IC	4.3V±2%, -MR, +Reset PPO, Wt=1.6s, Rt=25ms	SOT-25	28cp	VD17	6g	Tor
9AC	XC6209E432MR	LVR-IC	LDO, 4.3V±2%, 300mA, +CE, PDR	SOT-25	28cx	VR4	6g	Tor
9AC	XC6212A432MR	LVR-IC	LDO, 4.3V±2%, 150mA, +CE, PDR	SOT-25	28vt	VR4	6g	Tor
9AD	XC6209A442MR	LVR-IC	LDO, 4.4V±2%, 150mA, +CE, PDR	SOT-25	28cx	VR4	6g	Tor
9AD	XC6601A13BMR	LVR-IC	1.35V±20mV, 400mA, +CE, PDR, UVLO	SOT-25	28gj	VR11	6g	Tor
9AD	XC6113B644MR	Vdet-IC	4.4V±2%, -MR, +Reset PPO, Wt=1.6s, Rt=25ms	SOT-25	28cp	VD17	6g	Tor
9AD	XC6209E442MR	LVR-IC	LDO, 4.4V±2%, 300mA, +CE, PDR	SOT-25	28cx	VR4	6g	Tor
9AD	XC6212A442MR	LVR-IC	LDO, 4.4V±2%, 150mA, +CE, PDR	SOT-25	28vt	VR4	6g	Tor
9AE	XC6209A452MR	LVR-IC	LDO, 4.5V±2%, 150mA, +CE, PDR	SOT-25	28cx	VR4	6g	Tor
9AE	XC6601A141MR	LVR-IC	1.4V±20mV, 400mA, +CE, PDR, UVLO	SOT-25	28gj	VR11	6g	Tor
9AE	XC6113B645MR	Vdet-IC	4.5V±2%, -MR, +Reset PPO, Wt=1.6s, Rt=25ms	SOT-25	28cp	VD17	6g	Tor
9AE	XC6209E452MR	LVR-IC	LDO, 4.5V±2%, 300mA, +CE, PDR	SOT-25	28cx	VR4	6g	Tor
9AE	XC6212A452MR	LVR-IC	LDO, 4.5V±2%, 150mA, +CE, PDR	SOT-25	28vt	VR4	6g	Tor
9AF	XC6209A462MR	LVR-IC	LDO, 4.6V±2%, 150mA, +CE, PDR	SOT-25	28cx	VR4	6g	Tor
9AF	XC6601A14BMR	LVR-IC	1.45V±20mV, 400mA, +CE, PDR, UVLO	SOT-25	28gj	VR11	6g	Tor
9AF	XC6113B616MR	Vdet-IC	1.6V±2%, -MR, +Reset PPO, Wt=1.6s, Rt=25ms	SOT-25	28cp	VD17	6g	Tor
9AF	XC6113B646MR	Vdet-IC	4.6V±2%, -MR, +Reset PPO, Wt=1.6s, Rt=25ms	SOT-25	28cp	VD17	6g	Tor
9AF	XC6209E462MR	LVR-IC	LDO, 4.6V±2%, 300mA, +CE, PDR	SOT-25	28cx	VR4	6g	Tor
9AF	XC6212A462MR	LVR-IC	LDO, 4.6V±2%, 150mA, +CE, PDR	SOT-25	28vt	VR4	6g	Tor
9AH	XC6209A472MR	LVR-IC	LDO, 4.7V±2%, 150mA, +CE, PDR	SOT-25	28cx	VR4	6g	Tor
9AH	XC6601A151MR	LVR-IC	1.5V±20mV, 400mA, +CE, PDR, UVLO	SOT-25	28gj	VR11	6g	Tor
9AH	XC6113B617MR	Vdet-IC	1.7V±2%, -MR, +Reset PPO, Wt=1.6s, Rt=25ms	SOT-25	28cp	VD17	6g	Tor
9AH	XC6113B647MR	Vdet-IC	4.7V±2%, -MR, +Reset PPO, Wt=1.6s, Rt=25ms	SOT-25	28cp	VD17	6g	Tor
9AH	XC6209E472MR	LVR-IC	LDO, 4.7V±2%, 300mA, +CE, PDR	SOT-25	28cx	VR4	6g	Tor
9AH	XC6212A472MR	LVR-IC	LDO, 4.7V±2%, 150mA, +CE, PDR	SOT-25	28vt	VR4	6g	Tor
9AK	XC6209A482MR	LVR-IC	LDO, 4.8V±2%, 150mA, +CE, PDR	SOT-25	28cx	VR4	6g	Tor
9AK	XC6601A15BMR	LVR-IC	1.55V±20mV, 400mA, +CE, PDR, UVLO	SOT-25	28gj	VR11	6g	Tor
9AK	XC6113B618MR	Vdet-IC	1.8V±2%, -MR, +Reset PPO, Wt=1.6s, Rt=25ms	SOT-25	28cp	VD17	6g	Tor
9AK	XC6113B648MR	Vdet-IC	4.8V±2%, -MR, +Reset PPO, Wt=1.6s, Rt=25ms	SOT-25	28cp	VD17	6g	Tor
9AK	XC6209E482MR	LVR-IC	LDO, 4.8V±2%, 300mA, +CE, PDR	SOT-25	28cx	VR4	6g	Tor
9AK	XC6212A482MR	LVR-IC	LDO, 4.8V±2%, 150mA, +CE, PDR	SOT-25	28vt	VR4	6g	Tor
9AL	XC6209A492MR	LVR-IC	LDO, 4.9V±2%, 150mA, +CE, PDR	SOT-25	28cx	VR4	6g	Tor
9AL	XC6601A161MR	LVR-IC	1.6V±20mV, 400mA, +CE, PDR, UVLO	SOT-25	28gj	VR11	6g	Tor
9AL	XC6113B619MR	Vdet-IC	1.9V±2%, -MR, +Reset PPO, Wt=1.6s, Rt=25ms	SOT-25	28cp	VD17	6g	Tor
9AL	XC6113B649MR	Vdet-IC	4.9V±2%, -MR, +Reset PPO, Wt=1.6s, Rt=25ms	SOT-25	28cp	VD17	6g	Tor
9AL	XC6209E492MR	LVR-IC	LDO, 4.9V±2%, 300mA, +CE, PDR	SOT-25	28cx	VR4	6g	Tor
9AL	XC6212A492MR	LVR-IC	LDO, 4.9V±2%, 150mA, +CE, PDR	SOT-25	28vt	VR4	6g	Tor
9AM	XC6209A502MR	LVR-IC	LDO, 5V±2%, 150mA, +CE, PDR	SOT-25	28cx	VR4	6g	Tor
9AM	XC6601A16BMR	LVR-IC	1.65V±20mV, 400mA, +CE, PDR, UVLO	SOT-25	28gj	VR11	6g	Tor
9AM	XC6113B620MR	Vdet-IC	2.0V±2%, -MR, +Reset PPO, Wt=1.6s, Rt=25ms	SOT-25	28cp	VD17	6g	Tor
9AM	XC6113B650MR	Vdet-IC	5.0V±2%, -MR, +Reset PPO, Wt=1.6s, Rt=25ms	SOT-25	28cp	VD17	6g	Tor
9AM	XC6209E502MR	LVR-IC	LDO, 5V±2%, 300mA, +CE, PDR	SOT-25	28cx	VR4	6g	Tor
9AM	XC6212A502MR	LVR-IC	LDO, 5V±2%, 150mA, +CE, PDR	SOT-25	28vt	VR4	6g	Tor
9AN	XC6209A512MR	LVR-IC	LDO, 5.1V±2%, 150mA, +CE, PDR	SOT-25	28cx	VR4	6g	Tor
9AN	XC6601A171MR	LVR-IC	1.7V±20mV, 400mA, +CE, PDR, UVLO	SOT-25	28gj	VR11	6g	Tor
9AN	XC6113B621MR	Vdet-IC	2.1V±2%, -MR, +Reset PPO, Wt=1.6s, Rt=25ms	SOT-25	28cp	VD17	6g	Tor
9AN	XC6209E512MR	LVR-IC	LDO, 5.1V±2%, 300mA, +CE, PDR	SOT-25	28cx	VR4	6g	Tor
9AN	XC6212A512MR	LVR-IC	LDO, 5.1V±2%, 150mA, +CE, PDR	SOT-25	28vt	VR4	6g	Tor
9AP	XC6209A522MR	LVR-IC	LDO, 5.2V±2%, 150mA, +CE, PDR	SOT-25	28cx	VR4	6g	Tor
9AP	XC6601A17BMR	LVR-IC	1.75V±20mV, 400mA, +CE, PDR, UVLO	SOT-25	28gj	VR11	6g	Tor
9AP	XC6113B622MR	Vdet-IC	2.2V±2%, -MR, +Reset PPO, Wt=1.6s, Rt=25ms	SOT-25	28cp	VD17	6g	Tor
9AP	XC6209E522MR	LVR-IC	LDO, 5.2V±2%, 300mA, +CE, PDR	SOT-25	28cx	VR4	6g	Tor
9AP	XC6212A522MR	LVR-IC	LDO, 5.2V±2%, 150mA, +CE, PDR	SOT-25	28vt	VR4	6g	Tor
9AR	XC6209A532MR	LVR-IC	LDO, 5.3V±2%, 150mA, +CE, PDR	SOT-25	28cx	VR4	6g	Tor
9AR	XC6601A181MR	LVR-IC	1.8V±20mV, 400mA, +CE, PDR, UVLO	SOT-25	28gj	VR11	6g	Tor
9AR	XC6113B623MR	Vdet-IC	2.3V±2%, -MR, +Reset PPO, Wt=1.6s, Rt=25ms	SOT-25	28cp	VD17	6g	Tor
9AR	XC6209E532MR	LVR-IC	LDO, 5.3V±2%, 300mA, +CE, PDR	SOT-25	28cx	VR4	6g	Tor
9AR	XC6212A532MR	LVR-IC	LDO, 5.3V±2%, 150mA, +CE, PDR	SOT-25	28vt	VR4	6g	Tor
9AS	XC6209A542MR	LVR-IC	LDO, 5.4V±2%, 150mA, +CE, PDR	SOT-25	28cx	VR4	6g	Tor
9AS	XC6113B624MR	Vdet-IC	2.4V±2%, -MR, +Reset PPO, Wt=1.6s, Rt=25ms	SOT-25	28cp	VD17	6g	Tor
9AS	XC6209E542MR	LVR-IC	LDO, 5.4V±2%, 300mA, +CE, PDR	SOT-25	28cx	VR4	6g	Tor
9AS	XC6212A542MR	LVR-IC	LDO, 5.4V±2%, 150mA, +CE, PDR	SOT-25	28vt	VR4	6g	Tor
9AT	XC6209A552MR	LVR-IC	LDO, 5.5V±2%, 150mA, +CE, PDR	SOT-25	28cx	VR4	6g	Tor
9AT	XC6113B625MR	Vdet-IC	2.5V±2%, -MR, +Reset PPO, Wt=1.6s, Rt=25ms	SOT-25	28cp	VD17	6g	Tor
9AT	XC6209E552MR	LVR-IC	LDO, 5.5V±2%, 300mA, +CE, PDR	SOT-25	28cx	VR4	6g	Tor
9AT	XC6212A552MR	LVR-IC	LDO, 5.5V±2%, 150mA, +CE, PDR	SOT-25	28vt	VR4	6g	Tor
9AU	XC6209A562MR	LVR-IC	LDO, 5.6V±2%, 150mA, +CE, PDR	SOT-25	28cx	VR4	6g	Tor



SMD code	Type	Function	Short description	Case	Pinout	Sch.	St.	Mnf.
9AU	XC6113B626MR	Vdet-IC	2.6V±2%, -MR, +Reset PPO, Wt=1.6s, Rt=25ms	SOT-25	28cp	VD17	6g	Tor
9AU	XC6209E562MR	LVR-IC	LDO, 5.6V±2%, 300mA, +CE, PDR	SOT-25	28cx	VR4	6g	Tor
9AU	XC6212A562MR	LVR-IC	LDO, 5.6V±2%, 150mA, +CE, PDR	SOT-25	28vt	VR4	6g	Tor
9AV	XC6209A572MR	LVR-IC	LDO, 5.7V±2%, 150mA, +CE, PDR	SOT-25	28cx	VR4	6g	Tor
9AV	XC6113B627MR	Vdet-IC	2.7V±2%, -MR, +Reset PPO, Wt=1.6s, Rt=25ms	SOT-25	28cp	VD17	6g	Tor
9AV	XC6209E572MR	LVR-IC	LDO, 5.7V±2%, 300mA, +CE, PDR	SOT-25	28cx	VR4	6g	Tor
9AV	XC6212A572MR	LVR-IC	LDO, 5.7V±2%, 150mA, +CE, PDR	SOT-25	28vt	VR4	6g	Tor
9AX	XC6209A582MR	LVR-IC	LDO, 5.8V±2%, 150mA, +CE, PDR	SOT-25	28cx	VR4	6g	Tor
9AX	XC6113B628MR	Vdet-IC	2.8V±2%, -MR, +Reset PPO, Wt=1.6s, Rt=25ms	SOT-25	28cp	VD17	6g	Tor
9AX	XC6209E582MR	LVR-IC	LDO, 5.8V±2%, 300mA, +CE, PDR	SOT-25	28cx	VR4	6g	Tor
9AX	XC6212A582MR	LVR-IC	LDO, 5.8V±2%, 150mA, +CE, PDR	SOT-25	28vt	VR4	6g	Tor
9AY	XC6209A592MR	LVR-IC	LDO, 5.9V±2%, 150mA, +CE, PDR	SOT-25	28cx	VR4	6g	Tor
9AY	XC6113B629MR	Vdet-IC	2.9V±2%, -MR, +Reset PPO, Wt=1.6s, Rt=25ms	SOT-25	28cp	VD17	6g	Tor
9AY	XC6209E592MR	LVR-IC	LDO, 5.9V±2%, 300mA, +CE, PDR	SOT-25	28cx	VR4	6g	Tor
9AY	XC6212A592MR	LVR-IC	LDO, 5.9V±2%, 150mA, +CE, PDR	SOT-25	28vt	VR4	6g	Tor
9AZ	XC6209A602MR	LVR-IC	LDO, 6V±2%, 150mA, +CE, PDR	SOT-25	28cx	VR4	6g	Tor
9AZ	XC6113B630MR	Vdet-IC	3.0V±2%, -MR, +Reset PPO, Wt=1.6s, Rt=25ms	SOT-25	28cp	VD17	6g	Tor
9AZ	XC6209E602MR	LVR-IC	LDO, 6V±2%, 300mA, +CE, PDR	SOT-25	28cx	VR4	6g	Tor
9AZ	XC6212A602MR	LVR-IC	LDO, 6V±2%, 150mA, +CE, PDR	SOT-25	28vt	VR4	6g	Tor
9B	R3111N191A	Vdet-IC	1.9V±2%, -Reset PPO	SOT-23-5	28vdm	VD7	6g	Ric
9B	RN5RL29AA	LVR-IC	2.9V±2.5%, 150mA	SOT-23-5	28vu	VR1	6g	Ric
9B	RN5VD19CA	Vdet-IC	1.9V±2.5%, -Reset ODO	SOT-23-5	28vdo	VD1	6g	Ric
9B0	XC6209B312MR	LVR-IC	LDO, 3.1V±2%, 150mA, +CE	SOT-25	28cx	VR4	6g	Tor
9B0	XC6601B071MR	LVR-IC	0.7V±20mV, 400mA, +CE, UVLO	SOT-25	28gj	VR11	6g	Tor
9B0	XC6113C231MR	Vdet-IC	3.1V±2%, -MR, +Reset PPO, Wt=50ms, Rt=50ms	SOT-25	28cp	VD17	6g	Tor
9B0	XC6209F312MR	LVR-IC	LDO, 3.1V±2%, 300mA, +CE	SOT-25	28cx	VR4	6g	Tor
9B0	XC6212B312MR	LVR-IC	LDO, 3.1V±2%, 150mA, +CE	SOT-25	28vt	VR4	6g	Tor
9B1	XC6209B322MR	LVR-IC	LDO, 3.2V±2%, 150mA, +CE	SOT-25	28cx	VR4	6g	Tor
9B1	XC6601B07BMR	LVR-IC	0.75V±20mV, 400mA, +CE, UVLO	SOT-25	28gj	VR11	6g	Tor
9B1	XC6113C232MR	Vdet-IC	3.2V±2%, -MR, +Reset PPO, Wt=50ms, Rt=50ms	SOT-25	28cp	VD17	6g	Tor
9B1	XC6209F322MR	LVR-IC	LDO, 3.2V±2%, 300mA, +CE	SOT-25	28cx	VR4	6g	Tor
9B1	XC6212B322MR	LVR-IC	LDO, 3.2V±2%, 150mA, +CE	SOT-25	28vt	VR4	6g	Tor
9B2	XC6209B332MR	LVR-IC	LDO, 3.3V±2%, 150mA, +CE	SOT-25	28cx	VR4	6g	Tor
9B2	XC6601B081MR	LVR-IC	0.8V±20mV, 400mA, +CE, UVLO	SOT-25	28gj	VR11	6g	Tor
9B2	XC6113C233MR	Vdet-IC	3.3V±2%, -MR, +Reset PPO, Wt=50ms, Rt=50ms	SOT-25	28cp	VD17	6g	Tor
9B2	XC6209F332MR	LVR-IC	LDO, 3.3V±2%, 300mA, +CE	SOT-25	28cx	VR4	6g	Tor
9B2	XC6212B332MR	LVR-IC	LDO, 3.3V±2%, 150mA, +CE	SOT-25	28vt	VR4	6g	Tor
9B3	XC6209B342MR	LVR-IC	LDO, 3.4V±2%, 150mA, +CE	SOT-25	28cx	VR4	6g	Tor
9B3	XC6601B08BMR	LVR-IC	0.85V±20mV, 400mA, +CE, UVLO	SOT-25	28gj	VR11	6g	Tor
9B3	XC6113C234MR	Vdet-IC	3.4V±2%, -MR, +Reset PPO, Wt=50ms, Rt=50ms	SOT-25	28cp	VD17	6g	Tor
9B3	XC6209F342MR	LVR-IC	LDO, 3.4V±2%, 300mA, +CE	SOT-25	28cx	VR4	6g	Tor
9B3	XC6212B342MR	LVR-IC	LDO, 3.4V±2%, 150mA, +CE	SOT-25	28vt	VR4	6g	Tor
9B4	XC6209B352MR	LVR-IC	LDO, 3.5V±2%, 150mA, +CE	SOT-25	28cx	VR4	6g	Tor
9B4	XC6601B091MR	LVR-IC	0.9V±20mV, 400mA, +CE, UVLO	SOT-25	28gj	VR11	6g	Tor
9B4	XC6113C235MR	Vdet-IC	3.5V±2%, -MR, +Reset PPO, Wt=50ms, Rt=50ms	SOT-25	28cp	VD17	6g	Tor
9B4	XC6209F352MR	LVR-IC	LDO, 3.5V±2%, 300mA, +CE	SOT-25	28cx	VR4	6g	Tor
9B4	XC6212B352MR	LVR-IC	LDO, 3.5V±2%, 150mA, +CE	SOT-25	28vt	VR4	6g	Tor
9B5	XC6209B362MR	LVR-IC	LDO, 3.6V±2%, 150mA, +CE	SOT-25	28cx	VR4	6g	Tor
9B5	XC6601B09BMR	LVR-IC	0.95V±20mV, 400mA, +CE, UVLO	SOT-25	28gj	VR11	6g	Tor
9B5	XC6113C236MR	Vdet-IC	3.6V±2%, -MR, +Reset PPO, Wt=50ms, Rt=50ms	SOT-25	28cp	VD17	6g	Tor
9B5	XC6209F362MR	LVR-IC	LDO, 3.6V±2%, 300mA, +CE	SOT-25	28cx	VR4	6g	Tor
9B5	XC6212B362MR	LVR-IC	LDO, 3.6V±2%, 150mA, +CE	SOT-25	28vt	VR4	6g	Tor
9B6	XC6209B372MR	LVR-IC	LDO, 3.7V±2%, 150mA, +CE	SOT-25	28cx	VR4	6g	Tor
9B6	XC6601B101MR	LVR-IC	1.0V±20mV, 400mA, +CE, UVLO	SOT-25	28gj	VR11	6g	Tor
9B6	XC6113C237MR	Vdet-IC	3.7V±2%, -MR, +Reset PPO, Wt=50ms, Rt=50ms	SOT-25	28cp	VD17	6g	Tor
9B6	XC6209F372MR	LVR-IC	LDO, 3.7V±2%, 300mA, +CE	SOT-25	28cx	VR4	6g	Tor
9B6	XC6212B372MR	LVR-IC	LDO, 3.7V±2%, 150mA, +CE	SOT-25	28vt	VR4	6g	Tor
9B7	XC6209B382MR	LVR-IC	LDO, 3.8V±2%, 150mA, +CE	SOT-25	28cx	VR4	6g	Tor
9B7	XC6601B10BMR	LVR-IC	1.05V±20mV, 400mA, +CE, UVLO	SOT-25	28gj	VR11	6g	Tor
9B7	XC6113C238MR	Vdet-IC	3.8V±2%, -MR, +Reset PPO, Wt=50ms, Rt=50ms	SOT-25	28cp	VD17	6g	Tor
9B7	XC6209F382MR	LVR-IC	LDO, 3.8V±2%, 300mA, +CE	SOT-25	28cx	VR4	6g	Tor
9B7	XC6212B382MR	LVR-IC	LDO, 3.8V±2%, 150mA, +CE	SOT-25	28vt	VR4	6g	Tor
9B8	XC6209B392MR	LVR-IC	LDO, 3.9V±2%, 150mA, +CE	SOT-25	28cx	VR4	6g	Tor
9B8	XC6601B111MR	LVR-IC	1.1V±20mV, 400mA, +CE, UVLO	SOT-25	28gj	VR11	6g	Tor
9B8	XC6113C239MR	Vdet-IC	3.9V±2%, -MR, +Reset PPO, Wt=50ms, Rt=50ms	SOT-25	28cp	VD17	6g	Tor
9B8	XC6209F392MR	LVR-IC	LDO, 3.9V±2%, 300mA, +CE	SOT-25	28cx	VR4	6g	Tor
9B8	XC6212B392MR	LVR-IC	LDO, 3.9V±2%, 150mA, +CE	SOT-25	28vt	VR4	6g	Tor
9B9	XC6209B402MR	LVR-IC	LDO, 4V±2%, 150mA, +CE	SOT-25	28cx	VR4	6g	Tor
9B9	XC6601B11BMR	LVR-IC	1.15V±20mV, 400mA, +CE, UVLO	SOT-25	28gj	VR11	6g	Tor
9B9	XC6113C240MR	Vdet-IC	4.0V±2%, -MR, +Reset PPO, Wt=50ms, Rt=50ms	SOT-25	28cp	VD17	6g	Tor



SMD code	Type	Function	Short description	Case	Pinout	Sch.	St.	Mnf.
9B9	XC6209F402MR	LVR-IC	LDO, 4V±2%, 300mA, +CE	SOT-25	28cx	VR4	6g	Tor
9B9	XC6212B402MR	LVR-IC	LDO, 4V±2%, 150mA, +CE	SOT-25	28xt	VR4	6g	Tor
9BA	XC6209B412MR	LVR-IC	LDO, 4.1V±2%, 150mA, +CE	SOT-25	28cx	VR4	6g	Tor
9BA	XC6601B121MR	LVR-IC	1.2V±20mV, 400mA, +CE, UVLO	SOT-25	28gj	VR11	6g	Tor
9BA	XC6113C241MR	Vdet-IC	4.1V±2%, -MR, +Reset PPO, Wt=50ms, Rt=50ms	SOT-25	28cp	VD17	6g	Tor
9BA	XC6209F412MR	LVR-IC	LDO, 4.1V±2%, 300mA, +CE	SOT-25	28cx	VR4	6g	Tor
9BA	XC6212B412MR	LVR-IC	LDO, 4.1V±2%, 150mA, +CE	SOT-25	28vt	VR4	6g	Tor
9BB	XC6209B422MR	LVR-IC	LDO, 4.2V±2%, 150mA, +CE	SOT-25	28cx	VR4	6g	Tor
9BB	XC6601B12BMR	LVR-IC	1.25V±20mV, 400mA, +CE, UVLO	SOT-25	28gj	VR11	6g	Tor
9BB	XC6113C242MR	Vdet-IC	4.2V±2%, -MR, +Reset PPO, Wt=50ms, Rt=50ms	SOT-25	28cp	VD17	6g	Tor
9BB	XC6209F422MR	LVR-IC	LDO, 4.2V±2%, 300mA, +CE	SOT-25	28cx	VR4	6g	Tor
9BB	XC6212B422MR	LVR-IC	LDO, 4.2V±2%, 150mA, +CE	SOT-25	28vt	VR4	6g	Tor
9BC	XC6209B432MR	LVR-IC	LDO, 4.3V±2%, 150mA, +CE	SOT-25	28cx	VR4	6g	Tor
9BC	XC6601B131MR	LVR-IC	1.3V±20mV, 400mA, +CE, UVLO	SOT-25	28gj	VR11	6g	Tor
9BC	XC6113C243MR	Vdet-IC	4.3V±2%, -MR, +Reset PPO, Wt=50ms, Rt=50ms	SOT-25	28cp	VD17	6g	Tor
9BC	XC6209F432MR	LVR-IC	LDO, 4.3V±2%, 300mA, +CE	SOT-25	28cx	VR4	6g	Tor
9BC	XC6212B432MR	LVR-IC	LDO, 4.3V±2%, 150mA, +CE	SOT-25	28vt	VR4	6g	Tor
9BD	XC6209B442MR	LVR-IC	LDO, 4.4V±2%, 150mA, +CE	SOT-25	28cx	VR4	6g	Tor
9BD	XC6601B13BMR	LVR-IC	1.35V±20mV, 400mA, +CE, UVLO	SOT-25	28gj	VR11	6g	Tor
9BD	XC6113C244MR	Vdet-IC	4.4V±2%, -MR, +Reset PPO, Wt=50ms, Rt=50ms	SOT-25	28cp	VD17	6g	Tor
9BD	XC6209F442MR	LVR-IC	LDO, 4.4V±2%, 300mA, +CE	SOT-25	28cx	VR4	6g	Tor
9BD	XC6212B442MR	LVR-IC	LDO, 4.4V±2%, 150mA, +CE	SOT-25	28vt	VR4	6g	Tor
9BE	XC6209B452MR	LVR-IC	LDO, 4.5V±2%, 150mA, +CE	SOT-25	28cx	VR4	6g	Tor
9BE	XC6601B141MR	LVR-IC	1.4V±20mV, 400mA, +CE, UVLO	SOT-25	28gj	VR11	6g	Tor
9BE	XC6113C245MR	Vdet-IC	4.5V±2%, -MR, +Reset PPO, Wt=50ms, Rt=50ms	SOT-25	28cp	VD17	6g	Tor
9BE	XC6209F452MR	LVR-IC	LDO, 4.5V±2%, 300mA, +CE	SOT-25	28cx	VR4	6g	Tor
9BE	XC6212B452MR	LVR-IC	LDO, 4.5V±2%, 150mA, +CE	SOT-25	28vt	VR4	6g	Tor
9BF	XC6209B462MR	LVR-IC	LDO, 4.6V±2%, 150mA, +CE	SOT-25	28cx	VR4	6g	Tor
9BF	XC6601B14BMR	LVR-IC	1.45V±20mV, 400mA, +CE, UVLO	SOT-25	28gj	VR11	6g	Tor
9BF	XC6113C216MR	Vdet-IC	1.6V±2%, -MR, +Reset PPO, Wt=50ms, Rt=50ms	SOT-25	28cp	VD17	6g	Tor
9BF	XC6113C246MR	Vdet-IC	4.6V±2%, -MR, +Reset PPO, Wt=50ms, Rt=50ms	SOT-25	28cp	VD17	6g	Tor
9BF	XC6209F462MR	LVR-IC	LDO, 4.6V±2%, 300mA, +CE	SOT-25	28cx	VR4	6g	Tor
9BF	XC6212B462MR	LVR-IC	LDO, 4.6V±2%, 150mA, +CE	SOT-25	28vt	VR4	6g	Tor
9BH	XC6209B472MR	LVR-IC	LDO, 4.7V±2%, 150mA, +CE	SOT-25	28cx	VR4	6g	Tor
9BH	XC6601B151MR	LVR-IC	1.5V±20mV, 400mA, +CE, UVLO	SOT-25	28gj	VR11	6g	Tor
9BH	XC6113C217MR	Vdet-IC	1.7V±2%, -MR, +Reset PPO, Wt=50ms, Rt=50ms	SOT-25	28cp	VD17	6g	Tor
9BH	XC6113C247MR	Vdet-IC	4.7V±2%, -MR, +Reset PPO, Wt=50ms, Rt=50ms	SOT-25	28cp	VD17	6g	Tor
9BH	XC6209F472MR	LVR-IC	LDO, 4.7V±2%, 300mA, +CE	SOT-25	28cx	VR4	6g	Tor
9BH	XC6212B472MR	LVR-IC	LDO, 4.7V±2%, 150mA, +CE	SOT-25	28vt	VR4	6g	Tor
9BK	XC6209B482MR	LVR-IC	LDO, 4.8V±2%, 150mA, +CE	SOT-25	28cx	VR4	6g	Tor
9BK	XC6601B15BMR	LVR-IC	1.55V±20mV, 400mA, +CE, UVLO	SOT-25	28gj	VR11	6g	Tor
9BK	XC6113C218MR	Vdet-IC	1.8V±2%, -MR, +Reset PPO, Wt=50ms, Rt=50ms	SOT-25	28cp	VD17	6g	Tor
9BK	XC6113C248MR	Vdet-IC	4.8V±2%, -MR, +Reset PPO, Wt=50ms, Rt=50ms	SOT-25	28cp	VD17	6g	Tor
9BK	XC6209F482MR	LVR-IC	LDO, 4.8V±2%, 300mA, +CE	SOT-25	28cx	VR4	6g	Tor
9BK	XC6212B482MR	LVR-IC	LDO, 4.8V±2%, 150mA, +CE	SOT-25	28vt	VR4	6g	Tor
9BL	XC6209B492MR	LVR-IC	LDO, 4.9V±2%, 150mA, +CE	SOT-25	28cx	VR4	6g	Tor
9BL	XC6601B161MR	LVR-IC	1.6V±20mV, 400mA, +CE, UVLO	SOT-25	28gj	VR11	6g	Tor
9BL	XC6113C219MR	Vdet-IC	1.9V±2%, -MR, +Reset PPO, Wt=50ms, Rt=50ms	SOT-25	28cp	VD17	6g	Tor
9BL	XC6113C249MR	Vdet-IC	4.9V±2%, -MR, +Reset PPO, Wt=50ms, Rt=50ms	SOT-25	28cp	VD17	6g	Tor
9BL	XC6209F492MR	LVR-IC	LDO, 4.9V±2%, 300mA, +CE	SOT-25	28cx	VR4	6g	Tor
9BL	XC6212B492MR	LVR-IC	LDO, 4.9V±2%, 150mA, +CE	SOT-25	28vt	VR4	6g	Tor
9BM	XC6209B502MR	LVR-IC	LDO, 5V±2%, 150mA, +CE	SOT-25	28cx	VR4	6g	Tor
9BM	XC6601B16BMR	LVR-IC	1.65V±20mV, 400mA, +CE, UVLO	SOT-25	28gj	VR11	6g	Tor
9BM	XC6113C220MR	Vdet-IC	2.0V±2%, -MR, +Reset PPO, Wt=50ms, Rt=50ms	SOT-25	28cp	VD17	6g	Tor
9BM	XC6113C250MR	Vdet-IC	5.0V±2%, -MR, +Reset PPO, Wt=50ms, Rt=50ms	SOT-25	28cp	VD17	6g	Tor
9BM	XC6209F502MR	LVR-IC	LDO, 5V±2%, 300mA, +CE	SOT-25	28cx	VR4	6g	Tor
9BM	XC6212B502MR	LVR-IC	LDO, 5V±2%, 150mA, +CE	SOT-25	28vt	VR4	6g	Tor
9BN	XC6209B512MR	LVR-IC	LDO, 5.1V±2%, 150mA, +CE	SOT-25	28cx	VR4	6g	Tor
9BN	XC6601B171MR	LVR-IC	1.7V±20mV, 400mA, +CE, UVLO	SOT-25	28gj	VR11	6g	Tor
9BN	XC6113C221MR	Vdet-IC	2.1V±2%, -MR, +Reset PPO, Wt=50ms, Rt=50ms	SOT-25	28cp	VD17	6g	Tor
9BN	XC6209F512MR	LVR-IC	LDO, 5.1V±2%, 300mA, +CE	SOT-25	28cx	VR4	6g	Tor
9BN	XC6212B512MR	LVR-IC	LDO, 5.1V±2%, 150mA, +CE	SOT-25	28vt	VR4	6g	Tor
9BP	XC6209B522MR	LVR-IC	LDO, 5.2V±2%, 150mA, +CE	SOT-25	28cx	VR4	6g	Tor
9BP	XC6601B17BMR	LVR-IC	1.75V±20mV, 400mA, +CE, UVLO	SOT-25	28gj	VR11	6g	Tor
9BP	XC6113C222MR	Vdet-IC	2.2V±2%, -MR, +Reset PPO, Wt=50ms, Rt=50ms	SOT-25	28cp	VD17	6g	Tor
9BP	XC6209F522MR	LVR-IC	LDO, 5.2V±2%, 300mA, +CE	SOT-25	28cx	VR4	6g	Tor
9BP	XC6212B522MR	LVR-IC	LDO, 5.2V±2%, 150mA, +CE	SOT-25	28vt	VR4	6g	Tor
9BR	XC6209B532MR	LVR-IC	LDO, 5.3V±2%, 150mA, +CE	SOT-25	28cx	VR4	6g	Tor
9BR	XC6601B181MR	LVR-IC	1.8V±20mV, 400mA, +CE, UVLO	SOT-25	28gj	VR11	6g	Tor
9BR	XC6113C223MR	Vdet-IC	2.3V±2%, -MR, +Reset PPO, Wt=50ms, Rt=50ms	SOT-25	28cp	VD17	6g	Tor



SMD code	Type	Function	Short description	Case	Pinout	Sch.	St.	Mnf.
9BR	XC6209F532MR	LVR-IC	LDO, 5.3V±2%, 300mA, +CE	SOT-25	28cx	VR4	6g	Tor
9BR	XC6212B532MR	LVR-IC	LDO, 5.3V±2%, 150mA, +CE	SOT-25	28xt	VR4	6g	Tor
9BS	XC6209B542MR	LVR-IC	LDO, 5.4V±2%, 150mA, +CE	SOT-25	28cx	VR4	6g	Tor
9BS	XC6113C224MR	Vdet-IC	2.4V±2%, -MR, +Reset PPO, Wt=50ms, Rt=50ms	SOT-25	28cp	VD17	6g	Tor
9BS	XC6209F542MR	LVR-IC	LDO, 5.4V±2%, 300mA, +CE	SOT-25	28cx	VR4	6g	Tor
9BS	XC6212B542MR	LVR-IC	LDO, 5.4V±2%, 150mA, +CE	SOT-25	28vt	VR4	6g	Tor
9BT	XC6209B552MR	LVR-IC	LDO, 5.5V±2%, 150mA, +CE	SOT-25	28cx	VR4	6g	Tor
9BT	XC6113C225MR	Vdet-IC	2.5V±2%, -MR, +Reset PPO, Wt=50ms, Rt=50ms	SOT-25	28cp	VD17	6g	Tor
9BT	XC6209F552MR	LVR-IC	LDO, 5.5V±2%, 300mA, +CE	SOT-25	28cx	VR4	6g	Tor
9BT	XC6212B552MR	LVR-IC	LDO, 5.5V±2%, 150mA, +CE	SOT-25	28vt	VR4	6g	Tor
9BU	XC6209B562MR	LVR-IC	LDO, 5.6V±2%, 150mA, +CE	SOT-25	28cx	VR4	6g	Tor
9BU	XC6113C226MR	Vdet-IC	2.6V±2%, -MR, +Reset PPO, Wt=50ms, Rt=50ms	SOT-25	28cp	VD17	6g	Tor
9BU	XC6209F562MR	LVR-IC	LDO, 5.6V±2%, 300mA, +CE	SOT-25	28cx	VR4	6g	Tor
9BU	XC6212B562MR	LVR-IC	LDO, 5.6V±2%, 150mA, +CE	SOT-25	28vt	VR4	6g	Tor
9BV	XC6209B572MR	LVR-IC	LDO, 5.7V±2%, 150mA, +CE	SOT-25	28cx	VR4	6g	Tor
9BV	XC6113C227MR	Vdet-IC	2.7V±2%, -MR, +Reset PPO, Wt=50ms, Rt=50ms	SOT-25	28cp	VD17	6g	Tor
9BV	XC6209F572MR	LVR-IC	LDO, 5.7V±2%, 300mA, +CE	SOT-25	28cx	VR4	6g	Tor
9BV	XC6212B572MR	LVR-IC	LDO, 5.7V±2%, 150mA, +CE	SOT-25	28vt	VR4	6g	Tor
9BX	XC6209B582MR	LVR-IC	LDO, 5.8V±2%, 150mA, +CE	SOT-25	28cx	VR4	6g	Tor
9BX	XC6113C228MR	Vdet-IC	2.8V±2%, -MR, +Reset PPO, Wt=50ms, Rt=50ms	SOT-25	28cp	VD17	6g	Tor
9BX	XC6209F582MR	LVR-IC	LDO, 5.8V±2%, 300mA, +CE	SOT-25	28cx	VR4	6g	Tor
9BX	XC6212B582MR	LVR-IC	LDO, 5.8V±2%, 150mA, +CE	SOT-25	28vt	VR4	6g	Tor
9BY	XC6209B592MR	LVR-IC	LDO, 5.9V±2%, 150mA, +CE	SOT-25	28cx	VR4	6g	Tor
9BY	XC6113C229MR	Vdet-IC	2.9V±2%, -MR, +Reset PPO, Wt=50ms, Rt=50ms	SOT-25	28cp	VD17	6g	Tor
9BY	XC6209F592MR	LVR-IC	LDO, 5.9V±2%, 300mA, +CE	SOT-25	28cx	VR4	6g	Tor
9BY	XC6212B592MR	LVR-IC	LDO, 5.9V±2%, 150mA, +CE	SOT-25	28vt	VR4	6g	Tor
9BZ	XC6209B602MR	LVR-IC	LDO, 6V±2%, 150mA, +CE	SOT-25	28cx	VR4	6g	Tor
9BZ	XC6113C230MR	Vdet-IC	3.0V±2%, -MR, +Reset PPO, Wt=50ms, Rt=50ms	SOT-25	28cp	VD17	6g	Tor
9BZ	XC6209F602MR	LVR-IC	LDO, 6V±2%, 300mA, +CE	SOT-25	28cx	VR4	6g	Tor
9BZ	XC6212B602MR	LVR-IC	LDO, 6V±2%, 150mA, +CE	SOT-25	28vt	VR4	6g	Tor
9C	R3111N291A	Vdet-IC	2.9V±2%, -Reset PPO	SOT-23-5	28vdm	VD7	6g	Ric
9C	RN5RL39AA	LVR-IC	3.9V±2.5%, 150mA	SOT-23-5	28vur	VR1	6g	Ric
9C	RN5VD29CA	Vdet-IC	2.9V±2.5%, -Reset ODO	SOT-23-5	28vdo	VD1	6g	Ric
9C0	XC6209C312MR	LVR-IC	LDO, 3.1V±2%, 150mA, -CE, PDR	SOT-25	28cx	VR4	6g	Tor
9C0	XC6113C331MR	Vdet-IC	3.1V±2%, -MR, +Reset PPO, Wt=100ms, Rt=50ms	SOT-25	28cp	VD17	6g	Tor
9C0	XC6209C312MR	LVR-IC	LDO, 3.1V±2%, 300mA, -CE, PDR	SOT-25	28cx	VR4	6g	Tor
9C0	XC6212C312MR	LVR-IC	LDO, 3.1V±2%, 150mA, -CE, PDR	SOT-25	28vt	VR4	6g	Tor
9C1	XC6209C322MR	LVR-IC	LDO, 3.2V±2%, 150mA, -CE, PDR	SOT-25	28cx	VR4	6g	Tor
9C1	XC6113C332MR	Vdet-IC	3.2V±2%, -MR, +Reset PPO, Wt=100ms, Rt=50ms	SOT-25	28cp	VD17	6g	Tor
9C1	XC6209C322MR	LVR-IC	LDO, 3.2V±2%, 300mA, -CE, PDR	SOT-25	28cx	VR4	6g	Tor
9C1	XC6212C322MR	LVR-IC	LDO, 3.2V±2%, 150mA, -CE, PDR	SOT-25	28vt	VR4	6g	Tor
9C2	XC6209C332MR	LVR-IC	LDO, 3.3V±2%, 150mA, -CE, PDR	SOT-25	28cx	VR4	6g	Tor
9C2	XC6223A121MR-G	LVR-IC	LDO, 1.2V±20mV, 300mA, +CE	SOT-25	28cx	VR4	6g	Tor
9C2	XC6113C333MR	Vdet-IC	3.3V±2%, -MR, +Reset PPO, Wt=100ms, Rt=50ms	SOT-25	28cp	VD17	6g	Tor
9C2	XC6209G332MR	LVR-IC	LDO, 3.3V±2%, 300mA, -CE, PDR	SOT-25	28cx	VR4	6g	Tor
9C2	XC6212C332MR	LVR-IC	LDO, 3.3V±2%, 150mA, -CE, PDR	SOT-25	28vt	VR4	6g	Tor
9C3	XC6209C342MR	LVR-IC	LDO, 3.4V±2%, 150mA, -CE, PDR	SOT-25	28cx	VR4	6g	Tor
9C3	XC6223A131MR-G	LVR-IC	LDO, 1.3V±20mV, 300mA, +CE	SOT-25	28cx	VR4	6g	Tor
9C3	XC6113C334MR	Vdet-IC	3.4V±2%, -MR, +Reset PPO, Wt=100ms, Rt=50ms	SOT-25	28cp	VD17	6g	Tor
9C3	XC6209G342MR	LVR-IC	LDO, 3.4V±2%, 300mA, -CE, PDR	SOT-25	28cx	VR4	6g	Tor
9C3	XC6212C342MR	LVR-IC	LDO, 3.4V±2%, 150mA, -CE, PDR	SOT-25	28vt	VR4	6g	Tor
9C4	XC6209C352MR	LVR-IC	LDO, 3.5V±2%, 150mA, -CE, PDR	SOT-25	28cx	VR4	6g	Tor
9C4	XC6223A141MR-G	LVR-IC	LDO, 1.4V±20mV, 300mA, +CE	SOT-25	28cx	VR4	6g	Tor
9C4	XC6113C335MR	Vdet-IC	3.5V±2%, -MR, +Reset PPO, Wt=100ms, Rt=50ms	SOT-25	28cp	VD17	6g	Tor
9C4	XC6209G352MR	LVR-IC	LDO, 3.5V±2%, 300mA, -CE, PDR	SOT-25	28cx	VR4	6g	Tor
9C4	XC6212C352MR	LVR-IC	LDO, 3.5V±2%, 150mA, -CE, PDR	SOT-25	28vt	VR4	6g	Tor
9C5	XC6209C362MR	LVR-IC	LDO, 3.6V±2%, 150mA, -CE, PDR	SOT-25	28cx	VR4	6g	Tor
9C5	XC6223A151MR-G	LVR-IC	LDO, 1.5V±20mV, 300mA, +CE	SOT-25	28cx	VR4	6g	Tor
9C5	XC6113C336MR	Vdet-IC	3.6V±2%, -MR, +Reset PPO, Wt=100ms, Rt=50ms	SOT-25	28cp	VD17	6g	Tor
9C5	XC6209G362MR	LVR-IC	LDO, 3.6V±2%, 300mA, -CE, PDR	SOT-25	28cx	VR4	6g	Tor
9C5	XC6212C362MR	LVR-IC	LDO, 3.6V±2%, 150mA, -CE, PDR	SOT-25	28vt	VR4	6g	Tor
9C6	XC6209C372MR	LVR-IC	LDO, 3.7V±2%, 150mA, -CE, PDR	SOT-25	28cx	VR4	6g	Tor
9C6	XC6223A161MR-G	LVR-IC	LDO, 1.6V±20mV, 300mA, +CE	SOT-25	28cx	VR4	6g	Tor
9C6	XC6113C337MR	Vdet-IC	3.7V±2%, -MR, +Reset PPO, Wt=100ms, Rt=50ms	SOT-25	28cp	VD17	6g	Tor
9C6	XC6209G372MR	LVR-IC	LDO, 3.7V±2%, 300mA, -CE, PDR	SOT-25	28cx	VR4	6g	Tor
9C6	XC6212C372MR	LVR-IC	LDO, 3.7V±2%, 150mA, -CE, PDR	SOT-25	28vt	VR4	6g	Tor
9C7	XC6209C382MR	LVR-IC	LDO, 3.8V±2%, 150mA, -CE, PDR	SOT-25	28cx	VR4	6g	Tor
9C7	XC6223A171MR-G	LVR-IC	LDO, 1.7V±20mV, 300mA, +CE	SOT-25	28cx	VR4	6g	Tor
9C7	XC6113C338MR	Vdet-IC	3.8V±2%, -MR, +Reset PPO, Wt=100ms, Rt=50ms	SOT-25	28cp	VD17	6g	Tor
9C7	XC6209G382MR	LVR-IC	LDO, 3.8V±2%, 300mA, -CE, PDR	SOT-25	28cx	VR4	6g	Tor



SMD code	Type	Function	Short description	Case	Pinout	Sch.	St.	Mnf.
9C7	XC6212C382MR	LVR-IC	LDO, 3.8V±2%, 150mA, -CE, PDR	SOT-25	28vt	VR4	6g	Tor
9C8	XC6209C392MR	LVR-IC	LDO, 3.9V±2%, 150mA, -CE, PDR	SOT-25	28cx	VR4	6g	Tor
9C8	XC6223A181MR-G	LVR-IC	LDO, 1.8V±20mV, 300mA, +CE	SOT-25	28cx	VR4	6g	Tor
9C8	XC6113C339MR	Vdet-IC	3.9V±2%, -MR, +Reset PPO, Wt=100ms, Rt=50ms	SOT-25	28cp	VD17	6g	Tor
9C8	XC6209G392MR	LVR-IC	LDO, 3.9V±2%, 300mA, -CE, PDR	SOT-25	28cx	VR4	6g	Tor
9C8	XC6212C392MR	LVR-IC	LDO, 3.9V±2%, 150mA, -CE, PDR	SOT-25	28vt	VR4	6g	Tor
9C9	XC6209C402MR	LVR-IC	LDO, 4V±2%, 150mA, -CE, PDR	SOT-25	28cx	VR4	6g	Tor
9C9	XC6223A191MR-G	LVR-IC	LDO, 1.9V±20mV, 300mA, +CE	SOT-25	28cx	VR4	6g	Tor
9C9	XC6113C340MR	Vdet-IC	4.0V±2%, -MR, +Reset PPO, Wt=100ms, Rt=50ms	SOT-25	28cp	VD17	6g	Tor
9C9	XC6209G402MR	LVR-IC	LDO, 4V±2%, 300mA, -CE, PDR	SOT-25	28cx	VR4	6g	Tor
9C9	XC6212C402MR	LVR-IC	LDO, 4V±2%, 150mA, -CE, PDR	SOT-25	28vt	VR4	6g	Tor
9CA	XC6209C412MR	LVR-IC	LDO, 4.1V±2%, 150mA, -CE, PDR	SOT-25	28cx	VR4	6g	Tor
9CA	XC6223A201MR-G	LVR-IC	LDO, 2.0V±1%, 300mA, +CE	SOT-25	28cx	VR4	6g	Tor
9CA	XC6113C341MR	Vdet-IC	4.1V±2%, -MR, +Reset PPO, Wt=100ms, Rt=50ms	SOT-25	28cp	VD17	6g	Tor
9CA	XC6209G412MR	LVR-IC	LDO, 4.1V±2%, 300mA, -CE, PDR	SOT-25	28cx	VR4	6g	Tor
9CA	XC6212C412MR	LVR-IC	LDO, 4.1V±2%, 150mA, -CE, PDR	SOT-25	28vt	VR4	6g	Tor
9CB	XC6209C422MR	LVR-IC	LDO, 4.2V±2%, 150mA, -CE, PDR	SOT-25	28cx	VR4	6g	Tor
9CB	XC6223A211MR-G	LVR-IC	LDO, 2.1V±1%, 300mA, +CE	SOT-25	28cx	VR4	6g	Tor
9CB	XC6113C342MR	Vdet-IC	4.2V±2%, -MR, +Reset PPO, Wt=100ms, Rt=50ms	SOT-25	28cp	VD17	6g	Tor
9CB	XC6209G422MR	LVR-IC	LDO, 4.2V±2%, 300mA, -CE, PDR	SOT-25	28cx	VR4	6g	Tor
9CB	XC6212C422MR	LVR-IC	LDO, 4.2V±2%, 150mA, -CE, PDR	SOT-25	28vt	VR4	6g	Tor
9CC	XC6209C432MR	LVR-IC	LDO, 4.3V±2%, 150mA, -CE, PDR	SOT-25	28cx	VR4	6g	Tor
9CC	XC6223A221MR-G	LVR-IC	LDO, 2.2V±1%, 300mA, +CE	SOT-25	28cx	VR4	6g	Tor
9CC	XC6113C343MR	Vdet-IC	4.3V±2%, -MR, +Reset PPO, Wt=100ms, Rt=50ms	SOT-25	28cp	VD17	6g	Tor
9CC	XC6209G432MR	LVR-IC	LDO, 4.3V±2%, 300mA, -CE, PDR	SOT-25	28cx	VR4	6g	Tor
9CC	XC6212C432MR	LVR-IC	LDO, 4.3V±2%, 150mA, -CE, PDR	SOT-25	28vt	VR4	6g	Tor
9CD	XC6209C442MR	LVR-IC	LDO, 4.4V±2%, 150mA, -CE, PDR	SOT-25	28cx	VR4	6g	Tor
9CD	XC6223A231MR-G	LVR-IC	LDO, 2.3V±1%, 300mA, +CE	SOT-25	28cx	VR4	6g	Tor
9CD	XC6113C344MR	Vdet-IC	4.4V±2%, -MR, +Reset PPO, Wt=100ms, Rt=50ms	SOT-25	28cp	VD17	6g	Tor
9CD	XC6209G442MR	LVR-IC	LDO, 4.4V±2%, 300mA, -CE, PDR	SOT-25	28cx	VR4	6g	Tor
9CD	XC6212C442MR	LVR-IC	LDO, 4.4V±2%, 150mA, -CE, PDR	SOT-25	28vt	VR4	6g	Tor
9CE	XC6209C452MR	LVR-IC	LDO, 4.5V±2%, 150mA, -CE, PDR	SOT-25	28cx	VR4	6g	Tor
9CE	XC6223A241MR-G	LVR-IC	LDO, 2.4V±1%, 300mA, +CE	SOT-25	28cx	VR4	6g	Tor
9CE	XC6113C345MR	Vdet-IC	4.5V±2%, -MR, +Reset PPO, Wt=100ms, Rt=50ms	SOT-25	28cp	VD17	6g	Tor
9CE	XC6209G452MR	LVR-IC	LDO, 4.5V±2%, 300mA, -CE, PDR	SOT-25	28cx	VR4	6g	Tor
9CE	XC6212C452MR	LVR-IC	LDO, 4.5V±2%, 150mA, -CE, PDR	SOT-25	28vt	VR4	6g	Tor
9CF	XC6209C462MR	LVR-IC	LDO, 4.6V±2%, 150mA, -CE, PDR	SOT-25	28cx	VR4	6g	Tor
9CF	XC6223A251MR-G	LVR-IC	LDO, 2.5V±1%, 300mA, +CE	SOT-25	28cx	VR4	6g	Tor
9CF	XC6113C316MR	Vdet-IC	1.6V±2%, -MR, +Reset PPO, Wt=100ms, Rt=50ms	SOT-25	28cp	VD17	6g	Tor
9CF	XC6113C346MR	Vdet-IC	4.6V±2%, -MR, +Reset PPO, Wt=100ms, Rt=50ms	SOT-25	28cp	VD17	6g	Tor
9CF	XC6209G462MR	LVR-IC	LDO, 4.6V±2%, 300mA, -CE, PDR	SOT-25	28cx	VR4	6g	Tor
9CF	XC6212C462MR	LVR-IC	LDO, 4.6V±2%, 150mA, -CE, PDR	SOT-25	28vt	VR4	6g	Tor
9CH	XC6209C472MR	LVR-IC	LDO, 4.7V±2%, 150mA, -CE, PDR	SOT-25	28cx	VR4	6g	Tor
9CH	XC6223A261MR-G	LVR-IC	LDO, 2.6V±1%, 300mA, +CE	SOT-25	28cx	VR4	6g	Tor
9CH	XC6113C317MR	Vdet-IC	1.7V±2%, -MR, +Reset PPO, Wt=100ms, Rt=50ms	SOT-25	28cp	VD17	6g	Tor
9CH	XC6113C347MR	Vdet-IC	4.7V±2%, -MR, +Reset PPO, Wt=100ms, Rt=50ms	SOT-25	28cp	VD17	6g	Tor
9CH	XC6209G472MR	LVR-IC	LDO, 4.7V±2%, 300mA, -CE, PDR	SOT-25	28cx	VR4	6g	Tor
9CH	XC6212C472MR	LVR-IC	LDO, 4.7V±2%, 150mA, -CE, PDR	SOT-25	28vt	VR4	6g	Tor
9CK	XC6209C482MR	LVR-IC	LDO, 4.8V±2%, 150mA, -CE, PDR	SOT-25	28cx	VR4	6g	Tor
9CK	XC6223A271MR-G	LVR-IC	LDO, 2.7V±1%, 300mA, +CE	SOT-25	28cx	VR4	6g	Tor
9CK	XC6113C318MR	Vdet-IC	1.8V±2%, -MR, +Reset PPO, Wt=100ms, Rt=50ms	SOT-25	28cp	VD17	6g	Tor
9CK	XC6113C348MR	Vdet-IC	4.8V±2%, -MR, +Reset PPO, Wt=100ms, Rt=50ms	SOT-25	28cp	VD17	6g	Tor
9CK	XC6209G482MR	LVR-IC	LDO, 4.8V±2%, 300mA, -CE, PDR	SOT-25	28cx	VR4	6g	Tor
9CK	XC6212C482MR	LVR-IC	LDO, 4.8V±2%, 150mA, -CE, PDR	SOT-25	28vt	VR4	6g	Tor
9CL	XC6209C492MR	LVR-IC	LDO, 4.9V±2%, 150mA, -CE, PDR	SOT-25	28cx	VR4	6g	Tor
9CL	XC6223A281MR-G	LVR-IC	LDO, 2.8V±1%, 300mA, +CE	SOT-25	28cx	VR4	6g	Tor
9CL	XC6113C319MR	Vdet-IC	1.9V±2%, -MR, +Reset PPO, Wt=100ms, Rt=50ms	SOT-25	28cp	VD17	6g	Tor
9CL	XC6113C349MR	Vdet-IC	4.9V±2%, -MR, +Reset PPO, Wt=100ms, Rt=50ms	SOT-25	28cp	VD17	6g	Tor
9CL	XC6209G492MR	LVR-IC	LDO, 4.9V±2%, 300mA, -CE, PDR	SOT-25	28cx	VR4	6g	Tor
9CL	XC6212C492MR	LVR-IC	LDO, 4.9V±2%, 150mA, -CE, PDR	SOT-25	28vt	VR4	6g	Tor
9CM	XC6209C502MR	LVR-IC	LDO, 5V±2%, 150mA, -CE, PDR	SOT-25	28cx	VR4	6g	Tor
9CM	XC6223A291MR-G	LVR-IC	LDO, 2.9V±1%, 300mA, +CE	SOT-25	28cx	VR4	6g	Tor
9CM	XC6113C320MR	Vdet-IC	2.0V±2%, -MR, +Reset PPO, Wt=100ms, Rt=50ms	SOT-25	28cp	VD17	6g	Tor
9CM	XC6113C350MR	Vdet-IC	5.0V±2%, -MR, +Reset PPO, Wt=100ms, Rt=50ms	SOT-25	28cp	VD17	6g	Tor
9CM	XC6209G502MR	LVR-IC	LDO, 5V±2%, 300mA, -CE, PDR	SOT-25	28cx	VR4	6g	Tor
9CM	XC6212C502MR	LVR-IC	LDO, 5V±2%, 150mA, -CE, PDR	SOT-25	28vt	VR4	6g	Tor
9CN	XC6209C512MR	LVR-IC	LDO, 5.1V±2%, 150mA, -CE, PDR	SOT-25	28cx	VR4	6g	Tor
9CN	XC6223A301MR-G	LVR-IC	LDO, 3.0V±1%, 300mA, +CE	SOT-25	28cx	VR4	6g	Tor
9CN	XC6113C321MR	Vdet-IC	2.1V±2%, -MR, +Reset PPO, Wt=100ms, Rt=50ms	SOT-25	28cp	VD17	6g	Tor
9CN	XC6209G512MR	LVR-IC	LDO, 5.1V±2%, 300mA, -CE, PDR	SOT-25	28cx	VR4	6g	Tor



SMD code	Type	Function	Short description	Case	Pinout	Sch.	St.	Mnf.
9CN	XC6212C512MR	LVR-IC	LDO, 5.1V±2%, 150mA, -CE, PDR	SOT-25	28vt	VR4	6g	Tor
9CP	XC6209C522MR	LVR-IC	LDO, 5.2V±2%, 150mA, -CE, PDR	SOT-25	28cx	VR4	6g	Tor
9CP	XC6223A311MR-G	LVR-IC	LDO, 3.1V±1%, 300mA, +CE	SOT-25	28cx	VR4	6g	Tor
9CP	XC6113C322MR	Vdet-IC	2.2V±2%, -MR, +Reset PPO, Wt=100ms, Rt=50ms	SOT-25	28cp	VD17	6g	Tor
9CP	XC6209G522MR	LVR-IC	LDO, 5.2V±2%, 300mA, -CE, PDR	SOT-25	28cx	VR4	6g	Tor
9CP	XC6212C522MR	LVR-IC	LDO, 5.2V±2%, 150mA, -CE, PDR	SOT-25	28vt	VR4	6g	Tor
9CR	XC6209C532MR	LVR-IC	LDO, 5.3V±2%, 150mA, -CE, PDR	SOT-25	28cx	VR4	6g	Tor
9CR	XC6223A321MR-G	LVR-IC	LDO, 3.2V±1%, 300mA, +CE	SOT-25	28cx	VR4	6g	Tor
9CR	XC6113C323MR	Vdet-IC	2.3V±2%, -MR, +Reset PPO, Wt=100ms, Rt=50ms	SOT-25	28cp	VD17	6g	Tor
9CR	XC6209G532MR	LVR-IC	LDO, 5.3V±2%, 300mA, -CE, PDR	SOT-25	28cx	VR4	6g	Tor
9CR	XC6212C532MR	LVR-IC	LDO, 5.3V±2%, 150mA, -CE, PDR	SOT-25	28vt	VR4	6g	Tor
9CS	XC6209C542MR	LVR-IC	LDO, 5.4V±2%, 150mA, -CE, PDR	SOT-25	28cx	VR4	6g	Tor
9CS	XC6223A331MR-G	LVR-IC	LDO, 3.3V±1%, 300mA, +CE	SOT-25	28cx	VR4	6g	Tor
9CS	XC6113C324MR	Vdet-IC	2.4V±2%, -MR, +Reset PPO, Wt=100ms, Rt=50ms	SOT-25	28cp	VD17	6g	Tor
9CS	XC6209G542MR	LVR-IC	LDO, 5.4V±2%, 300mA, -CE, PDR	SOT-25	28cx	VR4	6g	Tor
9CS	XC6212C542MR	LVR-IC	LDO, 5.4V±2%, 150mA, -CE, PDR	SOT-25	28vt	VR4	6g	Tor
9CT	XC6209C552MR	LVR-IC	LDO, 5.5V±2%, 150mA, -CE, PDR	SOT-25	28cx	VR4	6g	Tor
9CT	XC6223A341MR-G	LVR-IC	LDO, 3.4V±1%, 300mA, +CE	SOT-25	28cx	VR4	6g	Tor
9CT	XC6113C325MR	Vdet-IC	2.5V±2%, -MR, +Reset PPO, Wt=100ms, Rt=50ms	SOT-25	28cp	VD17	6g	Tor
9CT	XC6209G552MR	LVR-IC	LDO, 5.5V±2%, 300mA, -CE, PDR	SOT-25	28cx	VR4	6g	Tor
9CT	XC6212C552MR	LVR-IC	LDO, 5.5V±2%, 150mA, -CE, PDR	SOT-25	28vt	VR4	6g	Tor
9CU	XC6209C562MR	LVR-IC	LDO, 5.6V±2%, 150mA, -CE, PDR	SOT-25	28cx	VR4	6g	Tor
9CU	XC6223A351MR-G	LVR-IC	LDO, 3.5V±1%, 300mA, +CE	SOT-25	28cx	VR4	6g	Tor
9CU	XC6113C326MR	Vdet-IC	2.6V±2%, -MR, +Reset PPO, Wt=100ms, Rt=50ms	SOT-25	28cp	VD17	6g	Tor
9CU	XC6209G562MR	LVR-IC	LDO, 5.6V±2%, 300mA, -CE, PDR	SOT-25	28cx	VR4	6g	Tor
9CU	XC6212C562MR	LVR-IC	LDO, 5.6V±2%, 150mA, -CE, PDR	SOT-25	28vt	VR4	6g	Tor
9CV	XC6209C572MR	LVR-IC	LDO, 5.7V±2%, 150mA, -CE, PDR	SOT-25	28cx	VR4	6g	Tor
9CV	XC6223A361MR-G	LVR-IC	LDO, 3.6V±1%, 300mA, +CE	SOT-25	28cx	VR4	6g	Tor
9CV	XC6113C327MR	Vdet-IC	2.7V±2%, -MR, +Reset PPO, Wt=100ms, Rt=50ms	SOT-25	28cp	VD17	6g	Tor
9CV	XC6209G572MR	LVR-IC	LDO, 5.7V±2%, 300mA, -CE, PDR	SOT-25	28cx	VR4	6g	Tor
9CV	XC6212C572MR	LVR-IC	LDO, 5.7V±2%, 150mA, -CE, PDR	SOT-25	28vt	VR4	6g	Tor
9CX	XC6209C582MR	LVR-IC	LDO, 5.8V±2%, 150mA, -CE, PDR	SOT-25	28cx	VR4	6g	Tor
9CX	XC6223A371MR-G	LVR-IC	LDO, 3.7V±1%, 300mA, +CE	SOT-25	28cx	VR4	6g	Tor
9CX	XC6113C328MR	Vdet-IC	2.8V±2%, -MR, +Reset PPO, Wt=100ms, Rt=50ms	SOT-25	28cp	VD17	6g	Tor
9CX	XC6209G582MR	LVR-IC	LDO, 5.8V±2%, 300mA, -CE, PDR	SOT-25	28cx	VR4	6g	Tor
9CX	XC6212C582MR	LVR-IC	LDO, 5.8V±2%, 150mA, -CE, PDR	SOT-25	28vt	VR4	6g	Tor
9CY	XC6209C592MR	LVR-IC	LDO, 5.9V±2%, 150mA, -CE, PDR	SOT-25	28cx	VR4	6g	Tor
9CY	XC6223A381MR-G	LVR-IC	LDO, 3.8V±1%, 300mA, +CE	SOT-25	28cx	VR4	6g	Tor
9CY	XC6113C329MR	Vdet-IC	2.9V±2%, -MR, +Reset PPO, Wt=100ms, Rt=50ms	SOT-25	28cp	VD17	6g	Tor
9CY	XC6209G592MR	LVR-IC	LDO, 5.9V±2%, 300mA, -CE, PDR	SOT-25	28cx	VR4	6g	Tor
9CY	XC6212C592MR	LVR-IC	LDO, 5.9V±2%, 150mA, -CE, PDR	SOT-25	28vt	VR4	6g	Tor
9CZ	XC6209C602MR	LVR-IC	LDO, 6V±2%, 150mA, -CE, PDR	SOT-25	28cx	VR4	6g	Tor
9CZ	XC6223A391MR-G	LVR-IC	LDO, 3.9V±1%, 300mA, +CE	SOT-25	28cx	VR4	6g	Tor
9CZ	XC6113C330MR	Vdet-IC	3.0V±2%, -MR, +Reset PPO, Wt=100ms, Rt=50ms	SOT-25	28cp	VD17	6g	Tor
9CZ	XC6209G602MR	LVR-IC	LDO, 6V±2%, 300mA, -CE, PDR	SOT-25	28cx	VR4	6g	Tor
9CZ	XC6212C602MR	LVR-IC	LDO, 6V±2%, 150mA, -CE, PDR	SOT-25	28vt	VR4	6g	Tor
9D	R3111N391A	Vdet-IC	3.9V±2%, -Reset PPO	SOT-23-5	28vdm	VD7	6g	Ric
9D	RN5RL49AA	LVR-IC	4.9V±2.5%, 150mA	SOT-23-5	28vu	VR1	6g	Ric
9D	RN5VD39CA	Vdet-IC	3.9V±2.5%, -Reset ODO	SOT-23-5	28vdo	VD1	6g	Ric
9D0	XC6209D312MR	LVR-IC	LDO, 3.1V±2%, 150mA, -CE	SOT-25	28cx	VR4	6g	Tor
9D0	XC6223A401MR-G	LVR-IC	LDO, 4.0V±1%, 300mA, +CE	SOT-25	28cx	VR4	6g	Tor
9D0	XC6113C431MR	Vdet-IC	3.1V±2%, -MR, +Reset PPO, Wt=200ms, Rt=50ms	SOT-25	28cp	VD17	6g	Tor
9D0	XC6209H312MR	LVR-IC	LDO, 3.1V±2%, 300mA, -CE	SOT-25	28cx	VR4	6g	Tor
9D0	XC6212D312MR	LVR-IC	LDO, 3.1V±2%, 150mA, -CE	SOT-25	28vt	VR4	6g	Tor
9D1	XC6209D322MR	LVR-IC	LDO, 3.2V±2%, 150mA, -CE	SOT-25	28cx	VR4	6g	Tor
9D1	XC6113C432MR	Vdet-IC	3.2V±2%, -MR, +Reset PPO, Wt=200ms, Rt=50ms	SOT-25	28cp	VD17	6g	Tor
9D1	XC6209H322MR	LVR-IC	LDO, 3.2V±2%, 300mA, -CE	SOT-25	28cx	VR4	6g	Tor
9D1	XC6212D322MR	LVR-IC	LDO, 3.2V±2%, 150mA, -CE	SOT-25	28vt	VR4	6g	Tor
9D2	XC6209D332MR	LVR-IC	LDO, 3.3V±2%, 150mA, -CE	SOT-25	28cx	VR4	6g	Tor
9D2	XC6113C433MR	Vdet-IC	3.3V±2%, -MR, +Reset PPO, Wt=200ms, Rt=50ms	SOT-25	28cp	VD17	6g	Tor
9D2	XC6209H332MR	LVR-IC	LDO, 3.3V±2%, 300mA, -CE	SOT-25	28cx	VR4	6g	Tor
9D2	XC6212D332MR	LVR-IC	LDO, 3.3V±2%, 150mA, -CE	SOT-25	28vt	VR4	6g	Tor
9D3	XC6209D342MR	LVR-IC	LDO, 3.4V±2%, 150mA, -CE	SOT-25	28cx	VR4	6g	Tor
9D3	XC6113C434MR	Vdet-IC	3.4V±2%, -MR, +Reset PPO, Wt=200ms, Rt=50ms	SOT-25	28cp	VD17	6g	Tor
9D3	XC6209H342MR	LVR-IC	LDO, 3.4V±2%, 300mA, -CE	SOT-25	28cx	VR4	6g	Tor
9D3	XC6212D342MR	LVR-IC	LDO, 3.4V±2%, 150mA, -CE	SOT-25	28vt	VR4	6g	Tor
9D4	XC6209D352MR	LVR-IC	LDO, 3.5V±2%, 150mA, -CE	SOT-25	28cx	VR4	6g	Tor
9D4	XC6113C435MR	Vdet-IC	3.5V±2%, -MR, +Reset PPO, Wt=200ms, Rt=50ms	SOT-25	28cp	VD17	6g	Tor
9D4	XC6209H352MR	LVR-IC	LDO, 3.5V±2%, 300mA, -CE	SOT-25	28cx	VR4	6g	Tor
9D4	XC6212D352MR	LVR-IC	LDO, 3.5V±2%, 150mA, -CE	SOT-25	28vt	VR4	6g	Tor



SMD code	Type	Function	Short description	Case	Pinout	Sch.	St.	Mnf.
9D5	XC6209D362MR	LVR-IC	LDO, 3.6V±2%, 150mA, -CE	SOT-25	28cx	VR4	6g	Tor
9D5	XC6113C436MR	Vdet-IC	3.6V±2%, -MR, +Reset PPO, Wt=200ms, Rt=50ms	SOT-25	28cp	VD17	6g	Tor
9D5	XC6209H362MR	LVR-IC	LDO, 3.6V±2%, 300mA, -CE	SOT-25	28cx	VR4	6g	Tor
9D5	XC6212D362MR	LVR-IC	LDO, 3.6V±2%, 150mA, -CE	SOT-25	28vt	VR4	6g	Tor
9D6	XC6209D372MR	LVR-IC	LDO, 3.7V±2%, 150mA, -CE	SOT-25	28cx	VR4	6g	Tor
9D6	XC6113C437MR	Vdet-IC	3.7V±2%, -MR, +Reset PPO, Wt=200ms, Rt=50ms	SOT-25	28cp	VD17	6g	Tor
9D6	XC6209H372MR	LVR-IC	LDO, 3.7V±2%, 300mA, -CE	SOT-25	28cx	VR4	6g	Tor
9D6	XC6212D372MR	LVR-IC	LDO, 3.7V±2%, 150mA, -CE	SOT-25	28vt	VR4	6g	Tor
9D7	XC6209D382MR	LVR-IC	LDO, 3.8V±2%, 150mA, -CE	SOT-25	28cx	VR4	6g	Tor
9D7	XC6113C438MR	Vdet-IC	3.8V±2%, -MR, +Reset PPO, Wt=200ms, Rt=50ms	SOT-25	28cp	VD17	6g	Tor
9D7	XC6209H382MR	LVR-IC	LDO, 3.8V±2%, 300mA, -CE	SOT-25	28cx	VR4	6g	Tor
9D7	XC6212D382MR	LVR-IC	LDO, 3.8V±2%, 150mA, -CE	SOT-25	28vt	VR4	6g	Tor
9D8	XC6209D392MR	LVR-IC	LDO, 3.9V±2%, 150mA, -CE	SOT-25	28cx	VR4	6g	Tor
9D8	XC6113C439MR	Vdet-IC	3.9V±2%, -MR, +Reset PPO, Wt=200ms, Rt=50ms	SOT-25	28cp	VD17	6g	Tor
9D8	XC6209H392MR	LVR-IC	LDO, 3.9V±2%, 300mA, -CE	SOT-25	28cx	VR4	6g	Tor
9D8	XC6212D392MR	LVR-IC	LDO, 3.9V±2%, 150mA, -CE	SOT-25	28vt	VR4	6g	Tor
9D9	XC6209D402MR	LVR-IC	LDO, 4V±2%, 150mA, -CE	SOT-25	28cx	VR4	6g	Tor
9D9	XC6113C440MR	Vdet-IC	4.0V±2%, -MR, +Reset PPO, Wt=200ms, Rt=50ms	SOT-25	28cp	VD17	6g	Tor
9D9	XC6209H402MR	LVR-IC	LDO, 4V±2%, 300mA, -CE	SOT-25	28cx	VR4	6g	Tor
9D9	XC6212D402MR	LVR-IC	LDO, 4V±2%, 150mA, -CE	SOT-25	28vt	VR4	6g	Tor
9DA	XC6209D412MR	LVR-IC	LDO, 4.1V±2%, 150mA, -CE	SOT-25	28cx	VR4	6g	Tor
9DA	XC6113C441MR	Vdet-IC	4.1V±2%, -MR, +Reset PPO, Wt=200ms, Rt=50ms	SOT-25	28cp	VD17	6g	Tor
9DA	XC6209H412MR	LVR-IC	LDO, 4.1V±2%, 300mA, -CE	SOT-25	28cx	VR4	6g	Tor
9DA	XC6212D412MR	LVR-IC	LDO, 4.1V±2%, 150mA, -CE	SOT-25	28vt	VR4	6g	Tor
9DB	XC6209D422MR	LVR-IC	LDO, 4.2V±2%, 150mA, -CE	SOT-25	28cx	VR4	6g	Tor
9DB	XC6113C442MR	Vdet-IC	4.2V±2%, -MR, +Reset PPO, Wt=200ms, Rt=50ms	SOT-25	28cp	VD17	6g	Tor
9DB	XC6209H422MR	LVR-IC	LDO, 4.2V±2%, 300mA, -CE	SOT-25	28cx	VR4	6g	Tor
9DB	XC6212D422MR	LVR-IC	LDO, 4.2V±2%, 150mA, -CE	SOT-25	28vt	VR4	6g	Tor
9DC	XC6209D432MR	LVR-IC	LDO, 4.3V±2%, 150mA, -CE	SOT-25	28cx	VR4	6g	Tor
9DC	XC6113C443MR	Vdet-IC	4.3V±2%, -MR, +Reset PPO, Wt=200ms, Rt=50ms	SOT-25	28cp	VD17	6g	Tor
9DC	XC6209H432MR	LVR-IC	LDO, 4.3V±2%, 300mA, -CE	SOT-25	28cx	VR4	6g	Tor
9DC	XC6212D432MR	LVR-IC	LDO, 4.3V±2%, 150mA, -CE	SOT-25	28vt	VR4	6g	Tor
9DD	XC6209D442MR	LVR-IC	LDO, 4.4V±2%, 150mA, -CE	SOT-25	28cx	VR4	6g	Tor
9DD	XC6113C444MR	Vdet-IC	4.4V±2%, -MR, +Reset PPO, Wt=200ms, Rt=50ms	SOT-25	28cp	VD17	6g	Tor
9DD	XC6209H442MR	LVR-IC	LDO, 4.4V±2%, 300mA, -CE	SOT-25	28cx	VR4	6g	Tor
9DD	XC6212D442MR	LVR-IC	LDO, 4.4V±2%, 150mA, -CE	SOT-25	28vt	VR4	6g	Tor
9DE	XC6209D452MR	LVR-IC	LDO, 4.5V±2%, 150mA, -CE	SOT-25	28cx	VR4	6g	Tor
9DE	XC6113C445MR	Vdet-IC	4.5V±2%, -MR, +Reset PPO, Wt=200ms, Rt=50ms	SOT-25	28cp	VD17	6g	Tor
9DE	XC6209H452MR	LVR-IC	LDO, 4.5V±2%, 300mA, -CE	SOT-25	28cx	VR4	6g	Tor
9DE	XC6212D452MR	LVR-IC	LDO, 4.5V±2%, 150mA, -CE	SOT-25	28vt	VR4	6g	Tor
9DF	XC6209D462MR	LVR-IC	LDO, 4.6V±2%, 150mA, -CE	SOT-25	28cx	VR4	6g	Tor
9DF	XC6113C416MR	Vdet-IC	1.6V±2%, -MR, +Reset PPO, Wt=200ms, Rt=50ms	SOT-25	28cp	VD17	6g	Tor
9DF	XC6113C446MR	Vdet-IC	4.6V±2%, -MR, +Reset PPO, Wt=200ms, Rt=50ms	SOT-25	28cp	VD17	6g	Tor
9DF	XC6209H462MR	LVR-IC	LDO, 4.6V±2%, 300mA, -CE	SOT-25	28cx	VR4	6g	Tor
9DF	XC6212D462MR	LVR-IC	LDO, 4.6V±2%, 150mA, -CE	SOT-25	28vt	VR4	6g	Tor
9DH	XC6209D472MR	LVR-IC	LDO, 4.7V±2%, 150mA, -CE	SOT-25	28cx	VR4	6g	Tor
9DH	XC6113C417MR	Vdet-IC	1.7V±2%, -MR, +Reset PPO, Wt=200ms, Rt=50ms	SOT-25	28cp	VD17	6g	Tor
9DH	XC6113C447MR	Vdet-IC	4.7V±2%, -MR, +Reset PPO, Wt=200ms, Rt=50ms	SOT-25	28cp	VD17	6g	Tor
9DH	XC6209H472MR	LVR-IC	LDO, 4.7V±2%, 300mA, -CE	SOT-25	28cx	VR4	6g	Tor
9DH	XC6212D472MR	LVR-IC	LDO, 4.7V±2%, 150mA, -CE	SOT-25	28vt	VR4	6g	Tor
9DK	XC6209D482MR	LVR-IC	LDO, 4.8V±2%, 150mA, -CE	SOT-25	28cx	VR4	6g	Tor
9DK	XC6113C418MR	Vdet-IC	1.8V±2%, -MR, +Reset PPO, Wt=200ms, Rt=50ms	SOT-25	28cp	VD17	6g	Tor
9DK	XC6113C448MR	Vdet-IC	4.8V±2%, -MR, +Reset PPO, Wt=200ms, Rt=50ms	SOT-25	28cp	VD17	6g	Tor
9DK	XC6209H482MR	LVR-IC	LDO, 4.8V±2%, 300mA, -CE	SOT-25	28cx	VR4	6g	Tor
9DK	XC6212D482MR	LVR-IC	LDO, 4.8V±2%, 150mA, -CE	SOT-25	28vt	VR4	6g	Tor
9DL	XC6209D492MR	LVR-IC	LDO, 4.9V±2%, 150mA, -CE	SOT-25	28cx	VR4	6g	Tor
9DL	XC6113C419MR	Vdet-IC	1.9V±2%, -MR, +Reset PPO, Wt=200ms, Rt=50ms	SOT-25	28cp	VD17	6g	Tor
9DL	XC6113C449MR	Vdet-IC	4.9V±2%, -MR, +Reset PPO, Wt=200ms, Rt=50ms	SOT-25	28cp	VD17	6g	Tor
9DL	XC6209H492MR	LVR-IC	LDO, 4.9V±2%, 300mA, -CE	SOT-25	28cx	VR4	6g	Tor
9DL	XC6212D492MR	LVR-IC	LDO, 4.9V±2%, 150mA, -CE	SOT-25	28vt	VR4	6g	Tor
9DM	XC6209D502MR	LVR-IC	LDO, 5V±2%, 150mA, -CE	SOT-25	28cx	VR4	6g	Tor
9DM	XC6113C420MR	Vdet-IC	2.0V±2%, -MR, +Reset PPO, Wt=200ms, Rt=50ms	SOT-25	28cp	VD17	6g	Tor
9DM	XC6113C450MR	Vdet-IC	5.0V±2%, -MR, +Reset PPO, Wt=200ms, Rt=50ms	SOT-25	28cp	VD17	6g	Tor
9DM	XC6209H502MR	LVR-IC	LDO, 5V±2%, 300mA, -CE	SOT-25	28cx	VR4	6g	Tor
9DM	XC6212D502MR	LVR-IC	LDO, 5V±2%, 150mA, -CE	SOT-25	28vt	VR4	6g	Tor
9DN	XC6209D512MR	LVR-IC	LDO, 5.1V±2%, 150mA, -CE	SOT-25	28cx	VR4	6g	Tor
9DN	XC6113C421MR	Vdet-IC	2.1V±2%, -MR, +Reset PPO, Wt=200ms, Rt=50ms	SOT-25	28cp	VD17	6g	Tor
9DN	XC6209H512MR	LVR-IC	LDO, 5.1V±2%, 300mA, -CE	SOT-25	28cx	VR4	6g	Tor
9DN	XC6212D512MR	LVR-IC	LDO, 5.1V±2%, 150mA, -CE	SOT-25	28vt	VR4	6g	Tor
9DP	XC6209D522MR	LVR-IC	LDO, 5.2V±2%, 150mA, -CE	SOT-25	28cx	VR4	6g	Tor



SMD code	Type	Function	Short description	Case	Pinout	Sch.	St.	Mnf.
<u>9DP</u>	XC6113C422MR	Vdet-IC	2.2V±2%, -MR, +Reset PPO, Wt=200ms, Rt=50ms	SOT-25	28cp	VD17	6g	Tor
<u>9DP</u>	XC6209H522MR	LVR-IC	LDO, 5.2V±2%, 300mA, -CE	SOT-25	28cx	VR4	6g	Tor
<u>9DP</u>	XC6212D522MR	LVR-IC	LDO, 5.2V±2%, 150mA, -CE	SOT-25	28vt	VR4	6g	Tor
<u>9DR</u>	XC6209D532MR	LVR-IC	LDO, 5.3V±2%, 150mA, -CE	SOT-25	28cx	VR4	6g	Tor
<u>9DR</u>	XC6113C423MR	Vdet-IC	2.3V±2%, -MR, +Reset PPO, Wt=200ms, Rt=50ms	SOT-25	28cp	VD17	6g	Tor
<u>9DR</u>	XC6209H532MR	LVR-IC	LDO, 5.3V±2%, 300mA, -CE	SOT-25	28cx	VR4	6g	Tor
<u>9DR</u>	XC6212D532MR	LVR-IC	LDO, 5.3V±2%, 150mA, -CE	SOT-25	28vt	VR4	6g	Tor
<u>9DS</u>	XC6209D542MR	LVR-IC	LDO, 5.4V±2%, 150mA, -CE	SOT-25	28cx	VR4	6g	Tor
<u>9DS</u>	XC6113C424MR	Vdet-IC	2.4V±2%, -MR, +Reset PPO, Wt=200ms, Rt=50ms	SOT-25	28cp	VD17	6g	Tor
<u>9DS</u>	XC6209H542MR	LVR-IC	LDO, 5.4V±2%, 300mA, -CE	SOT-25	28cx	VR4	6g	Tor
<u>9DS</u>	XC6212D542MR	LVR-IC	LDO, 5.4V±2%, 150mA, -CE	SOT-25	28vt	VR4	6g	Tor
<u>9DT</u>	XC6209D552MR	LVR-IC	LDO, 5.5V±2%, 150mA, -CE	SOT-25	28cx	VR4	6g	Tor
<u>9DT</u>	XC6113C425MR	Vdet-IC	2.5V±2%, -MR, +Reset PPO, Wt=200ms, Rt=50ms	SOT-25	28cp	VD17	6g	Tor
<u>9DT</u>	XC6209H552MR	LVR-IC	LDO, 5.5V±2%, 300mA, -CE	SOT-25	28cx	VR4	6g	Tor
<u>9DT</u>	XC6212D552MR	LVR-IC	LDO, 5.5V±2%, 150mA, -CE	SOT-25	28vt	VR4	6g	Tor
<u>9DU</u>	XC6209D562MR	LVR-IC	LDO, 5.6V±2%, 150mA, -CE	SOT-25	28cx	VR4	6g	Tor
<u>9DU</u>	XC6113C426MR	Vdet-IC	2.6V±2%, -MR, +Reset PPO, Wt=200ms, Rt=50ms	SOT-25	28cp	VD17	6g	Tor
<u>9DU</u>	XC6209H562MR	LVR-IC	LDO, 5.6V±2%, 300mA, -CE	SOT-25	28cx	VR4	6g	Tor
<u>9DU</u>	XC6212D562MR	LVR-IC	LDO, 5.6V±2%, 150mA, -CE	SOT-25	28vt	VR4	6g	Tor
<u>9DV</u>	XC6209D572MR	LVR-IC	LDO, 5.7V±2%, 150mA, -CE	SOT-25	28cx	VR4	6g	Tor
<u>9DV</u>	XC6113C427MR	Vdet-IC	2.7V±2%, -MR, +Reset PPO, Wt=200ms, Rt=50ms	SOT-25	28cp	VD17	6g	Tor
<u>9DV</u>	XC6209H572MR	LVR-IC	LDO, 5.7V±2%, 300mA, -CE	SOT-25	28cx	VR4	6g	Tor
<u>9DV</u>	XC6212D572MR	LVR-IC	LDO, 5.7V±2%, 150mA, -CE	SOT-25	28vt	VR4	6g	Tor
<u>9DX</u>	XC6209D582MR	LVR-IC	LDO, 5.8V±2%, 150mA, -CE	SOT-25	28cx	VR4	6g	Tor
<u>9DX</u>	XC6113C428MR	Vdet-IC	2.8V±2%, -MR, +Reset PPO, Wt=200ms, Rt=50ms	SOT-25	28cp	VD17	6g	Tor
<u>9DX</u>	XC6209H582MR	LVR-IC	LDO, 5.8V±2%, 300mA, -CE	SOT-25	28cx	VR4	6g	Tor
<u>9DX</u>	XC6212D582MR	LVR-IC	LDO, 5.8V±2%, 150mA, -CE	SOT-25	28vt	VR4	6g	Tor
<u>9DY</u>	XC6209D592MR	LVR-IC	LDO, 5.9V±2%, 150mA, -CE	SOT-25	28cx	VR4	6g	Tor
<u>9DY</u>	XC6113C429MR	Vdet-IC	2.9V±2%, -MR, +Reset PPO, Wt=200ms, Rt=50ms	SOT-25	28cp	VD17	6g	Tor
<u>9DY</u>	XC6209H592MR	LVR-IC	LDO, 5.9V±2%, 300mA, -CE	SOT-25	28cx	VR4	6g	Tor
<u>9DY</u>	XC6212D592MR	LVR-IC	LDO, 5.9V±2%, 150mA, -CE	SOT-25	28vt	VR4	6g	Tor
<u>9DZ</u>	XC6209D602MR	LVR-IC	LDO, 6V±2%, 150mA, -CE	SOT-25	28cx	VR4	6g	Tor
<u>9DZ</u>	XC6113C430MR	Vdet-IC	3.0V±2%, -MR, +Reset PPO, Wt=200ms, Rt=50ms	SOT-25	28cp	VD17	6g	Tor
<u>9DZ</u>	XC6209H602MR	LVR-IC	LDO, 6V±2%, 300mA, -CE	SOT-25	28cx	VR4	6g	Tor
<u>9DZ</u>	XC6212D602MR	LVR-IC	LDO, 6V±2%, 150mA, -CE	SOT-25	28vt	VR4	6g	Tor
<u>9E</u>	R3111N491A	Vdet-IC	4.9V±2%, -Reset PPO	SOT-23-5	28vdm	VD7	6g	Ric
<u>9E</u>	RN5RL59AA	LVR-IC	5.9V±2.5%, 150mA	SOT-23-5	28vu	VR1	6g	Ric
<u>9E</u>	RN5VD49CA	Vdet-IC	4.9V±2.5%, -Reset ODO	SOT-23-5	28vdo	VD1	6g	Ric
<u>9E0</u>	XC6113C531MR	Vdet-IC	3.1V±2%, -MR, +Reset PPO, Wt=400ms, Rt=50ms	SOT-25	28cp	VD17	6g	Tor
<u>9E1</u>	XC6113C532MR	Vdet-IC	3.2V±2%, -MR, +Reset PPO, Wt=400ms, Rt=50ms	SOT-25	28cp	VD17	6g	Tor
<u>9E2</u>	XC6223A12BMR-G	LVR-IC	LDO, 1.25V±20mV, 300mA, +CE	SOT-25	28cx	VR4	6g	Tor
<u>9E2</u>	XC6113C533MR	Vdet-IC	3.3V±2%, -MR, +Reset PPO, Wt=400ms, Rt=50ms	SOT-25	28cp	VD17	6g	Tor
<u>9E3</u>	XC6223A13BMR-G	LVR-IC	LDO, 1.35V±20mV, 300mA, +CE	SOT-25	28cx	VR4	6g	Tor
<u>9E3</u>	XC6113C534MR	Vdet-IC	3.4V±2%, -MR, +Reset PPO, Wt=400ms, Rt=50ms	SOT-25	28cp	VD17	6g	Tor
<u>9E4</u>	XC6223A14BMR-G	LVR-IC	LDO, 1.45V±20mV, 300mA, +CE	SOT-25	28cx	VR4	6g	Tor
<u>9E4</u>	XC6113C535MR	Vdet-IC	3.5V±2%, -MR, +Reset PPO, Wt=400ms, Rt=50ms	SOT-25	28cp	VD17	6g	Tor
<u>9E5</u>	XC6223A15BMR-G	LVR-IC	LDO, 1.55V±20mV, 300mA, +CE	SOT-25	28cx	VR4	6g	Tor
<u>9E5</u>	XC6113C536MR	Vdet-IC	3.6V±2%, -MR, +Reset PPO, Wt=400ms, Rt=50ms	SOT-25	28cp	VD17	6g	Tor
<u>9E6</u>	XC6223A16BMR-G	LVR-IC	LDO, 1.65V±20mV, 300mA, +CE	SOT-25	28cx	VR4	6g	Tor
<u>9E6</u>	XC6113C537MR	Vdet-IC	3.7V±2%, -MR, +Reset PPO, Wt=400ms, Rt=50ms	SOT-25	28cp	VD17	6g	Tor
<u>9E7</u>	XC6223A17BMR-G	LVR-IC	LDO, 1.75V±20mV, 300mA, +CE	SOT-25	28cx	VR4	6g	Tor
<u>9E7</u>	XC6113C538MR	Vdet-IC	3.8V±2%, -MR, +Reset PPO, Wt=400ms, Rt=50ms	SOT-25	28cp	VD17	6g	Tor
<u>9E8</u>	XC6209A09AMR	LVR-IC	LDO, 0.95V±2%, 150mA, +CE, PDR	SOT-25	28cx	VR4	6g	Tor
<u>9E8</u>	XC6223A18BMR-G	LVR-IC	LDO, 1.85V±20mV, 300mA, +CE	SOT-25	28cx	VR4	6g	Tor
<u>9E8</u>	XC6113C539MR	Vdet-IC	3.9V±2%, -MR, +Reset PPO, Wt=400ms, Rt=50ms	SOT-25	28cp	VD17	6g	Tor
<u>9E8</u>	XC6209E09AMR	LVR-IC	LDO, 0.95V±2%, 300mA, +CE, PDR	SOT-25	28cx	VR4	6g	Tor
<u>9E8</u>	XC6212A09AMR	LVR-IC	LDO, 0.95V±2%, 150mA, +CE, PDR	SOT-25	28vt	VR4	6g	Tor
<u>9E9</u>	XC6209A10AMR	LVR-IC	LDO, 1.05V±2%, 150mA, +CE, PDR	SOT-25	28cx	VR4	6g	Tor
<u>9E9</u>	XC6223A19BMR-G	LVR-IC	LDO, 1.95V±20mV, 300mA, +CE	SOT-25	28cx	VR4	6g	Tor
<u>9E9</u>	XC6113C540MR	Vdet-IC	4.0V±2%, -MR, +Reset PPO, Wt=400ms, Rt=50ms	SOT-25	28cp	VD17	6g	Tor
<u>9E9</u>	XC6209E10AMR	LVR-IC	LDO, 1.05V±2%, 300mA, +CE, PDR	SOT-25	28cx	VR4	6g	Tor
<u>9E9</u>	XC6212A10AMR	LVR-IC	LDO, 1.05V±2%, 150mA, +CE, PDR	SOT-25	28vt	VR4	6g	Tor
<u>9EA</u>	XC6209A11AMR	LVR-IC	LDO, 1.15V±2%, 150mA, +CE, PDR	SOT-25	28cx	VR4	6g	Tor
<u>9EA</u>	XC6223A20BMR-G	LVR-IC	LDO, 2.05V±1%, 300mA, +CE	SOT-25	28cx	VR4	6g	Tor
<u>9EA</u>	XC6113C541MR	Vdet-IC	4.1V±2%, -MR, +Reset PPO, Wt=400ms, Rt=50ms	SOT-25	28cp	VD17	6g	Tor
<u>9EA</u>	XC6209E11AMR	LVR-IC	LDO, 1.15V±2%, 300mA, +CE, PDR	SOT-25	28cx	VR4	6g	Tor
<u>9EA</u>	XC6212A11AMR	LVR-IC	LDO, 1.15V±2%, 150mA, +CE, PDR	SOT-25	28vt	VR4	6g	Tor
<u>9EB</u>	XC6209A12AMR	LVR-IC	LDO, 1.25V±2%, 150mA, +CE, PDR	SOT-25	28cx	VR4	6g	Tor
<u>9EB</u>	XC6223A21BMR-G	LVR-IC	LDO, 2.15V±1%, 300mA, +CE	SOT-25	28cx	VR4	6g	Tor
<u>9EB</u>	XC6113C542MR	Vdet-IC	4.2V±2%, -MR, +Reset PPO, Wt=400ms, Rt=50ms	SOT-25	28cp	VD17	6g	Tor



SMD code	Type	Function	Short description	Case	Pinout	Sch.	St.	Mnf.
9EB	XC6209E12AMR	LVR-IC	LDO, 1.25V±2%, 300mA, +CE, PDR	SOT-25	28cx	VR4	6g	Tor
9EB	XC6212A12AMR	LVR-IC	LDO, 1.25V±2%, 150mA, +CE, PDR	SOT-25	28wt	VR4	6g	Tor
9EC	XC6209A13AMR	LVR-IC	LDO, 1.35V±2%, 150mA, +CE, PDR	SOT-25	28cx	VR4	6g	Tor
9EC	XC6223A22BMR-G	LVR-IC	LDO, 2.25V±1%, 300mA, +CE	SOT-25	28cx	VR4	6g	Tor
9EC	XC6113C543MR	Vdet-IC	4.3V±2%, -MR, +Reset PPO, Wt=400ms, Rt=50ms	SOT-25	28cp	VD17	6g	Tor
9EC	XC6209E13AMR	LVR-IC	LDO, 1.35V±2%, 300mA, +CE, PDR	SOT-25	28cx	VR4	6g	Tor
9EC	XC6212A13AMR	LVR-IC	LDO, 1.35V±2%, 150mA, +CE, PDR	SOT-25	28wt	VR4	6g	Tor
9ED	XC6209A14AMR	LVR-IC	LDO, 1.45V±2%, 150mA, +CE, PDR	SOT-25	28cx	VR4	6g	Tor
9ED	XC6223A23BMR-G	LVR-IC	LDO, 2.35V±1%, 300mA, +CE	SOT-25	28cx	VR4	6g	Tor
9ED	XC6113C544MR	Vdet-IC	4.4V±2%, -MR, +Reset PPO, Wt=400ms, Rt=50ms	SOT-25	28cp	VD17	6g	Tor
9ED	XC6209E14AMR	LVR-IC	LDO, 1.45V±2%, 300mA, +CE, PDR	SOT-25	28cx	VR4	6g	Tor
9ED	XC6212A14AMR	LVR-IC	LDO, 1.45V±2%, 150mA, +CE, PDR	SOT-25	28wt	VR4	6g	Tor
9EE	XC6209A15AMR	LVR-IC	LDO, 1.55V±2%, 150mA, +CE, PDR	SOT-25	28cx	VR4	6g	Tor
9EE	XC6223A24BMR-G	LVR-IC	LDO, 2.45V±1%, 300mA, +CE	SOT-25	28cx	VR4	6g	Tor
9EE	XC6113C545MR	Vdet-IC	4.5V±2%, -MR, +Reset PPO, Wt=400ms, Rt=50ms	SOT-25	28cp	VD17	6g	Tor
9EE	XC6209E15AMR	LVR-IC	LDO, 1.55V±2%, 300mA, +CE, PDR	SOT-25	28cx	VR4	6g	Tor
9EE	XC6212A15AMR	LVR-IC	LDO, 1.55V±2%, 150mA, +CE, PDR	SOT-25	28wt	VR4	6g	Tor
9EF	XC6209A16AMR	LVR-IC	LDO, 1.65V±2%, 150mA, +CE, PDR	SOT-25	28cx	VR4	6g	Tor
9EF	XC6223A25BMR-G	LVR-IC	LDO, 2.55V±1%, 300mA, +CE	SOT-25	28cx	VR4	6g	Tor
9EF	XC6113C516MR	Vdet-IC	1.6V±2%, -MR, +Reset PPO, Wt=400ms, Rt=50ms	SOT-25	28cp	VD17	6g	Tor
9EF	XC6113C546MR	Vdet-IC	4.6V±2%, -MR, +Reset PPO, Wt=400ms, Rt=50ms	SOT-25	28cp	VD17	6g	Tor
9EF	XC6209E16AMR	LVR-IC	LDO, 1.65V±2%, 300mA, +CE, PDR	SOT-25	28cx	VR4	6g	Tor
9EF	XC6212A16AMR	LVR-IC	LDO, 1.65V±2%, 150mA, +CE, PDR	SOT-25	28wt	VR4	6g	Tor
9EH	XC6209A17AMR	LVR-IC	LDO, 1.75V±2%, 150mA, +CE, PDR	SOT-25	28cx	VR4	6g	Tor
9EH	XC6223A26BMR-G	LVR-IC	LDO, 2.65V±1%, 300mA, +CE	SOT-25	28cx	VR4	6g	Tor
9EH	XC6113C517MR	Vdet-IC	1.7V±2%, -MR, +Reset PPO, Wt=400ms, Rt=50ms	SOT-25	28cp	VD17	6g	Tor
9EH	XC6113C547MR	Vdet-IC	4.7V±2%, -MR, +Reset PPO, Wt=400ms, Rt=50ms	SOT-25	28cp	VD17	6g	Tor
9EH	XC6209E17AMR	LVR-IC	LDO, 1.75V±2%, 300mA, +CE, PDR	SOT-25	28cx	VR4	6g	Tor
9EH	XC6212A17AMR	LVR-IC	LDO, 1.75V±2%, 150mA, +CE, PDR	SOT-25	28wt	VR4	6g	Tor
9EK	XC6209A18AMR	LVR-IC	LDO, 1.85V±2%, 150mA, +CE, PDR	SOT-25	28cx	VR4	6g	Tor
9EK	XC6223A27BMR-G	LVR-IC	LDO, 2.75V±1%, 300mA, +CE	SOT-25	28cx	VR4	6g	Tor
9EK	XC6113C518MR	Vdet-IC	1.8V±2%, -MR, +Reset PPO, Wt=400ms, Rt=50ms	SOT-25	28cp	VD17	6g	Tor
9EK	XC6113C548MR	Vdet-IC	4.8V±2%, -MR, +Reset PPO, Wt=400ms, Rt=50ms	SOT-25	28cp	VD17	6g	Tor
9EK	XC6209E18AMR	LVR-IC	LDO, 1.85V±2%, 300mA, +CE, PDR	SOT-25	28cx	VR4	6g	Tor
9EK	XC6212A18AMR	LVR-IC	LDO, 1.85V±2%, 150mA, +CE, PDR	SOT-25	28wt	VR4	6g	Tor
9EL	XC6209A19AMR	LVR-IC	LDO, 1.95V±2%, 150mA, +CE, PDR	SOT-25	28cx	VR4	6g	Tor
9EL	XC6223A28BMR-G	LVR-IC	LDO, 2.85V±1%, 300mA, +CE	SOT-25	28cx	VR4	6g	Tor
9EL	XC6113C519MR	Vdet-IC	1.9V±2%, -MR, +Reset PPO, Wt=400ms, Rt=50ms	SOT-25	28cp	VD17	6g	Tor
9EL	XC6113C549MR	Vdet-IC	4.9V±2%, -MR, +Reset PPO, Wt=400ms, Rt=50ms	SOT-25	28cp	VD17	6g	Tor
9EL	XC6209E19AMR	LVR-IC	LDO, 1.95V±2%, 300mA, +CE, PDR	SOT-25	28cx	VR4	6g	Tor
9EL	XC6212A19AMR	LVR-IC	LDO, 1.95V±2%, 150mA, +CE, PDR	SOT-25	28wt	VR4	6g	Tor
9EM	XC6209A20AMR	LVR-IC	LDO, 2.05V±2%, 150mA, +CE, PDR	SOT-25	28cx	VR4	6g	Tor
9EM	XC6223A29BMR-G	LVR-IC	LDO, 2.95V±1%, 300mA, +CE	SOT-25	28cx	VR4	6g	Tor
9EM	XC6113C520MR	Vdet-IC	2.0V±2%, -MR, +Reset PPO, Wt=400ms, Rt=50ms	SOT-25	28cp	VD17	6g	Tor
9EM	XC6113C550MR	Vdet-IC	5.0V±2%, -MR, +Reset PPO, Wt=400ms, Rt=50ms	SOT-25	28cp	VD17	6g	Tor
9EM	XC6209E20AMR	LVR-IC	LDO, 2.05V±2%, 300mA, +CE, PDR	SOT-25	28cx	VR4	6g	Tor
9EM	XC6212A20AMR	LVR-IC	LDO, 2.05V±2%, 150mA, +CE, PDR	SOT-25	28wt	VR4	6g	Tor
9EN	XC6209A21AMR	LVR-IC	LDO, 2.15V±2%, 150mA, +CE, PDR	SOT-25	28cx	VR4	6g	Tor
9EN	XC6223A30BMR-G	LVR-IC	LDO, 3.05V±1%, 300mA, +CE	SOT-25	28cx	VR4	6g	Tor
9EN	XC6113C521MR	Vdet-IC	2.1V±2%, -MR, +Reset PPO, Wt=400ms, Rt=50ms	SOT-25	28cp	VD17	6g	Tor
9EN	XC6209E21AMR	LVR-IC	LDO, 2.15V±2%, 300mA, +CE, PDR	SOT-25	28cx	VR4	6g	Tor
9EN	XC6212A21AMR	LVR-IC	LDO, 2.15V±2%, 150mA, +CE, PDR	SOT-25	28wt	VR4	6g	Tor
9EP	XC6209A22AMR	LVR-IC	LDO, 2.25V±2%, 150mA, +CE, PDR	SOT-25	28cx	VR4	6g	Tor
9EP	XC6223A31BMR-G	LVR-IC	LDO, 3.15V±1%, 300mA, +CE	SOT-25	28cx	VR4	6g	Tor
9EP	XC6113C522MR	Vdet-IC	2.2V±2%, -MR, +Reset PPO, Wt=400ms, Rt=50ms	SOT-25	28cp	VD17	6g	Tor
9EP	XC6209E22AMR	LVR-IC	LDO, 2.25V±2%, 300mA, +CE, PDR	SOT-25	28cx	VR4	6g	Tor
9EP	XC6212A22AMR	LVR-IC	LDO, 2.25V±2%, 150mA, +CE, PDR	SOT-25	28wt	VR4	6g	Tor
9ER	XC6209A23AMR	LVR-IC	LDO, 2.35V±2%, 150mA, +CE, PDR	SOT-25	28cx	VR4	6g	Tor
9ER	XC6223A32BMR-G	LVR-IC	LDO, 3.25V±1%, 300mA, +CE	SOT-25	28cx	VR4	6g	Tor
9ER	XC6113C523MR	Vdet-IC	2.3V±2%, -MR, +Reset PPO, Wt=400ms, Rt=50ms	SOT-25	28cp	VD17	6g	Tor
9ER	XC6209E23AMR	LVR-IC	LDO, 2.35V±2%, 300mA, +CE, PDR	SOT-25	28cx	VR4	6g	Tor
9ER	XC6212A23AMR	LVR-IC	LDO, 2.35V±2%, 150mA, +CE, PDR	SOT-25	28wt	VR4	6g	Tor
9ES	XC6209A24AMR	LVR-IC	LDO, 2.45V±2%, 150mA, +CE, PDR	SOT-25	28cx	VR4	6g	Tor
9ES	XC6223A33BMR-G	LVR-IC	LDO, 3.35V±1%, 300mA, +CE	SOT-25	28cx	VR4	6g	Tor
9ES	XC6113C524MR	Vdet-IC	2.4V±2%, -MR, +Reset PPO, Wt=400ms, Rt=50ms	SOT-25	28cp	VD17	6g	Tor
9ES	XC6209E24AMR	LVR-IC	LDO, 2.45V±2%, 300mA, +CE, PDR	SOT-25	28cx	VR4	6g	Tor
9ES	XC6212A24AMR	LVR-IC	LDO, 2.45V±2%, 150mA, +CE, PDR	SOT-25	28wt	VR4	6g	Tor
9ET	XC6209A25AMR	LVR-IC	LDO, 2.55V±2%, 150mA, +CE, PDR	SOT-25	28cx	VR4	6g	Tor
9ET	XC6223A34BMR-G	LVR-IC	LDO, 3.45V±1%, 300mA, +CE	SOT-25	28cx	VR4	6g	Tor
9ET	XC6113C525MR	Vdet-IC	2.5V±2%, -MR, +Reset PPO, Wt=400ms, Rt=50ms	SOT-25	28cp	VD17	6g	Tor



SMD code	Type	Function	Short description	Case	Pinout	Sch.	St.	Mnf.
9ET	XC6209E25AMR	LVR-IC	LDO, 2.55V±2%, 300mA, +CE, PDR	SOT-25	28cx	VR4	6g	Tor
9ET	XC6212A25AMR	LVR-IC	LDO, 2.55V±2%, 150mA, +CE, PDR	SOT-25	28vt	VR4	6g	Tor
9EU	XC6209A26AMR	LVR-IC	LDO, 2.65V±2%, 150mA, +CE, PDR	SOT-25	28cx	VR4	6g	Tor
9EU	XC6223A35BMR-G	LVR-IC	LDO, 3.55V±1%, 300mA, +CE	SOT-25	28cx	VR4	6g	Tor
9EU	XC6113C526MR	Vdet-IC	2.6V±2%, -MR, +Reset PPO, Wt=400ms, Rt=50ms	SOT-25	28cp	VD17	6g	Tor
9EU	XC6209E26AMR	LVR-IC	LDO, 2.65V±2%, 300mA, +CE, PDR	SOT-25	28cx	VR4	6g	Tor
9EU	XC6212A26AMR	LVR-IC	LDO, 2.65V±2%, 150mA, +CE, PDR	SOT-25	28vt	VR4	6g	Tor
9EV	XC6209A27AMR	LVR-IC	LDO, 2.75V±2%, 150mA, +CE, PDR	SOT-25	28cx	VR4	6g	Tor
9EV	XC6223A36BMR-G	LVR-IC	LDO, 3.65V±1%, 300mA, +CE	SOT-25	28cx	VR4	6g	Tor
9EV	XC6113C527MR	Vdet-IC	2.7V±2%, -MR, +Reset PPO, Wt=400ms, Rt=50ms	SOT-25	28cp	VD17	6g	Tor
9EV	XC6209E27AMR	LVR-IC	LDO, 2.75V±2%, 300mA, +CE, PDR	SOT-25	28cx	VR4	6g	Tor
9EV	XC6212A27AMR	LVR-IC	LDO, 2.75V±2%, 150mA, +CE, PDR	SOT-25	28vt	VR4	6g	Tor
9EX	XC6209A28AMR	LVR-IC	LDO, 2.85V±2%, 150mA, +CE, PDR	SOT-25	28cx	VR4	6g	Tor
9EX	XC6223A37BMR-G	LVR-IC	LDO, 3.75V±1%, 300mA, +CE	SOT-25	28cx	VR4	6g	Tor
9EX	XC6113C528MR	Vdet-IC	2.8V±2%, -MR, +Reset PPO, Wt=400ms, Rt=50ms	SOT-25	28cp	VD17	6g	Tor
9EX	XC6209E28AMR	LVR-IC	LDO, 2.85V±2%, 300mA, +CE, PDR	SOT-25	28cx	VR4	6g	Tor
9EX	XC6212A28AMR	LVR-IC	LDO, 2.85V±2%, 150mA, +CE, PDR	SOT-25	28vt	VR4	6g	Tor
9EY	XC6209A29AMR	LVR-IC	LDO, 2.95V±2%, 150mA, +CE, PDR	SOT-25	28cx	VR4	6g	Tor
9EY	XC6223A38BMR-G	LVR-IC	LDO, 3.85V±1%, 300mA, +CE	SOT-25	28cx	VR4	6g	Tor
9EY	XC6113C529MR	Vdet-IC	2.9V±2%, -MR, +Reset PPO, Wt=400ms, Rt=50ms	SOT-25	28cp	VD17	6g	Tor
9EY	XC6209E29AMR	LVR-IC	LDO, 2.95V±2%, 300mA, +CE, PDR	SOT-25	28cx	VR4	6g	Tor
9EY	XC6212A29AMR	LVR-IC	LDO, 2.95V±2%, 150mA, +CE, PDR	SOT-25	28vt	VR4	6g	Tor
9EZ	XC6209A30AMR	LVR-IC	LDO, 3.05V±2%, 150mA, +CE, PDR	SOT-25	28cx	VR4	6g	Tor
9EZ	XC6223A39BMR-G	LVR-IC	LDO, 3.95V±1%, 300mA, +CE	SOT-25	28cx	VR4	6g	Tor
9EZ	XC6113C530MR	Vdet-IC	3.0V±2%, -MR, +Reset PPO, Wt=400ms, Rt=50ms	SOT-25	28cp	VD17	6g	Tor
9EZ	XC6209E30AMR	LVR-IC	LDO, 3.05V±2%, 300mA, +CE, PDR	SOT-25	28cx	VR4	6g	Tor
9EZ	XC6212A30AMR	LVR-IC	LDO, 3.05V±2%, 150mA, +CE, PDR	SOT-25	28vt	VR4	6g	Tor
9F	R3111N591A	Vdet-IC	5.9V±2%, -Reset PPO	SOT-23-5	28vdm	VD7	6g	Ric
9F	RN5VD59CA	Vdet-IC	5.9V±2.5%, -Reset ODO	SOT-23-5	28vdo	VD1	6g	Ric
9F0	XC6113C631MR	Vdet-IC	3.1V±2%, -MR, +Reset PPO, Wt=1.6s, Rt=50ms	SOT-25	28cp	VD17	6g	Tor
9F1	XC6113C632MR	Vdet-IC	3.2V±2%, -MR, +Reset PPO, Wt=1.6s, Rt=50ms	SOT-25	28cp	VD17	6g	Tor
9F2	XC6223B121MR-G	LVR-IC	LDO, 1.2V±20mV, 300mA, +CE, CL	SOT-25	28cx	VR4	6g	Tor
9F2	XC6113C633MR	Vdet-IC	3.3V±2%, -MR, +Reset PPO, Wt=1.6s, Rt=50ms	SOT-25	28cp	VD17	6g	Tor
9F3	XC6223B131MR-G	LVR-IC	LDO, 1.3V±20mV, 300mA, +CE, CL	SOT-25	28cx	VR4	6g	Tor
9F3	XC6113C634MR	Vdet-IC	3.4V±2%, -MR, +Reset PPO, Wt=1.6s, Rt=50ms	SOT-25	28cp	VD17	6g	Tor
9F4	XC6223B141MR-G	LVR-IC	LDO, 1.4V±20mV, 300mA, +CE, CL	SOT-25	28cx	VR4	6g	Tor
9F4	XC6113C635MR	Vdet-IC	3.5V±2%, -MR, +Reset PPO, Wt=1.6s, Rt=50ms	SOT-25	28cp	VD17	6g	Tor
9F5	XC6223B151MR-G	LVR-IC	LDO, 1.5V±20mV, 300mA, +CE, CL	SOT-25	28cx	VR4	6g	Tor
9F5	XC6113C636MR	Vdet-IC	3.6V±2%, -MR, +Reset PPO, Wt=1.6s, Rt=50ms	SOT-25	28cp	VD17	6g	Tor
9F6	XC6223B161MR-G	LVR-IC	LDO, 1.6V±20mV, 300mA, +CE, CL	SOT-25	28cx	VR4	6g	Tor
9F6	XC6113C637MR	Vdet-IC	3.7V±2%, -MR, +Reset PPO, Wt=1.6s, Rt=50ms	SOT-25	28cp	VD17	6g	Tor
9F7	XC6223B171MR-G	LVR-IC	LDO, 1.7V±20mV, 300mA, +CE, CL	SOT-25	28cx	VR4	6g	Tor
9F7	XC6113C638MR	Vdet-IC	3.8V±2%, -MR, +Reset PPO, Wt=1.6s, Rt=50ms	SOT-25	28cp	VD17	6g	Tor
9F8	XC6209B09AMR	LVR-IC	LDO, 0.95V±2%, 150mA, +CE	SOT-25	28cx	VR4	6g	Tor
9F8	XC6223B181MR-G	LVR-IC	LDO, 1.8V±20mV, 300mA, +CE, CL	SOT-25	28cx	VR4	6g	Tor
9F8	XC6113C639MR	Vdet-IC	3.9V±2%, -MR, +Reset PPO, Wt=1.6s, Rt=50ms	SOT-25	28cp	VD17	6g	Tor
9F8	XC6209F09AMR	LVR-IC	LDO, 0.95V±2%, 300mA, +CE	SOT-25	28cx	VR4	6g	Tor
9F8	XC6212B09AMR	LVR-IC	LDO, 0.95V±2%, 150mA, +CE	SOT-25	28vt	VR4	6g	Tor
9F9	XC6209B10AMR	LVR-IC	LDO, 1.05V±2%, 150mA, +CE	SOT-25	28cx	VR4	6g	Tor
9F9	XC6223B191MR-G	LVR-IC	LDO, 1.9V±20mV, 300mA, +CE, CL	SOT-25	28cx	VR4	6g	Tor
9F9	XC6113C640MR	Vdet-IC	4.0V±2%, -MR, +Reset PPO, Wt=1.6s, Rt=50ms	SOT-25	28cp	VD17	6g	Tor
9F9	XC6209F10AMR	LVR-IC	LDO, 1.05V±2%, 300mA, +CE	SOT-25	28cx	VR4	6g	Tor
9F9	XC6212B10AMR	LVR-IC	LDO, 1.05V±2%, 150mA, +CE	SOT-25	28vt	VR4	6g	Tor
9FA	XC6209B11AMR	LVR-IC	LDO, 1.15V±2%, 150mA, +CE	SOT-25	28cx	VR4	6g	Tor
9FA	XC6223B201MR-G	LVR-IC	LDO, 2.0V±1%, 300mA, +CE, CL	SOT-25	28cx	VR4	6g	Tor
9FA	XC6113C641MR	Vdet-IC	4.1V±2%, -MR, +Reset PPO, Wt=1.6s, Rt=50ms	SOT-25	28cp	VD17	6g	Tor
9FA	XC6209F11AMR	LVR-IC	LDO, 1.15V±2%, 300mA, +CE	SOT-25	28cx	VR4	6g	Tor
9FA	XC6212B11AMR	LVR-IC	LDO, 1.15V±2%, 150mA, +CE	SOT-25	28vt	VR4	6g	Tor
9FB	XC6209B12AMR	LVR-IC	LDO, 1.25V±2%, 150mA, +CE	SOT-25	28cx	VR4	6g	Tor
9FB	XC6223B211MR-G	LVR-IC	LDO, 2.1V±1%, 300mA, +CE, CL	SOT-25	28cx	VR4	6g	Tor
9FB	XC6113C642MR	Vdet-IC	4.2V±2%, -MR, +Reset PPO, Wt=1.6s, Rt=50ms	SOT-25	28cp	VD17	6g	Tor
9FB	XC6209F12AMR	LVR-IC	LDO, 1.25V±2%, 300mA, +CE	SOT-25	28cx	VR4	6g	Tor
9FB	XC6212B12AMR	LVR-IC	LDO, 1.25V±2%, 150mA, +CE	SOT-25	28vt	VR4	6g	Tor
9FC	XC6209B13AMR	LVR-IC	LDO, 1.35V±2%, 150mA, +CE	SOT-25	28cx	VR4	6g	Tor
9FC	XC6223B221MR-G	LVR-IC	LDO, 2.2V±1%, 300mA, +CE, CL	SOT-25	28cx	VR4	6g	Tor
9FC	XC6113C643MR	Vdet-IC	4.3V±2%, -MR, +Reset PPO, Wt=1.6s, Rt=50ms	SOT-25	28cp	VD17	6g	Tor
9FC	XC6209F13AMR	LVR-IC	LDO, 1.35V±2%, 300mA, +CE	SOT-25	28cx	VR4	6g	Tor
9FC	XC6212B13AMR	LVR-IC	LDO, 1.35V±2%, 150mA, +CE	SOT-25	28vt	VR4	6g	Tor
9FD	XC6209B14AMR	LVR-IC	LDO, 1.45V±2%, 150mA, +CE	SOT-25	28cx	VR4	6g	Tor
9FD	XC6223B231MR-G	LVR-IC	LDO, 2.3V±1%, 300mA, +CE, CL	SOT-25	28cx	VR4	6g	Tor



SMD code	Type	Function	Short description	Case	Pinout	Sch.	St.	Mnf.
9FD	XC6113C644MR	Vdet-IC	4.4V±2%, -MR, +Reset PPO, Wt=1.6s, Rt=50ms	SOT-25	28cp	VD17	6g	Tor
9FD	XC6209F14AMR	LVR-IC	LDO, 1.45V±2%, 300mA, +CE	SOT-25	28cx	VR4	6g	Tor
9FD	XC6212B14AMR	LVR-IC	LDO, 1.45V±2%, 150mA, +CE	SOT-25	28vt	VR4	6g	Tor
9FE	XC6209B15AMR	LVR-IC	LDO, 1.55V±2%, 150mA, +CE	SOT-25	28cx	VR4	6g	Tor
9FE	XC6223B211MR-G	LVR-IC	LDO, 2.4V±1%, 300mA, +CE, CL	SOT-25	28cx	VR4	6g	Tor
9FE	XC6113C645MR	Vdet-IC	4.5V±2%, -MR, +Reset PPO, Wt=1.6s, Rt=50ms	SOT-25	28cp	VD17	6g	Tor
9FE	XC6209F15AMR	LVR-IC	LDO, 1.55V±2%, 300mA, +CE	SOT-25	28cx	VR4	6g	Tor
9FE	XC6212B15AMR	LVR-IC	LDO, 1.55V±2%, 150mA, +CE	SOT-25	28vt	VR4	6g	Tor
9FF	XC6209B16AMR	LVR-IC	LDO, 1.65V±2%, 150mA, +CE	SOT-25	28cx	VR4	6g	Tor
9FF	XC6223B251MR-G	LVR-IC	LDO, 2.5V±1%, 300mA, +CE, CL	SOT-25	28cx	VR4	6g	Tor
9FF	XC6113C616MR	Vdet-IC	1.6V±2%, -MR, +Reset PPO, Wt=1.6s, Rt=50ms	SOT-25	28cp	VD17	6g	Tor
9FF	XC6113C646MR	Vdet-IC	4.6V±2%, -MR, +Reset PPO, Wt=1.6s, Rt=50ms	SOT-25	28cp	VD17	6g	Tor
9FF	XC6209F16AMR	LVR-IC	LDO, 1.65V±2%, 300mA, +CE	SOT-25	28cx	VR4	6g	Tor
9FF	XC6212B16AMR	LVR-IC	LDO, 1.65V±2%, 150mA, +CE	SOT-25	28vt	VR4	6g	Tor
9FH	XC6209B17AMR	LVR-IC	LDO, 1.75V±2%, 150mA, +CE	SOT-25	28cx	VR4	6g	Tor
9FH	XC6223B261MR-G	LVR-IC	LDO, 2.6V±1%, 300mA, +CE, CL	SOT-25	28cx	VR4	6g	Tor
9FH	XC6113C617MR	Vdet-IC	1.7V±2%, -MR, +Reset PPO, Wt=1.6s, Rt=50ms	SOT-25	28cp	VD17	6g	Tor
9FH	XC6113C647MR	Vdet-IC	4.7V±2%, -MR, +Reset PPO, Wt=1.6s, Rt=50ms	SOT-25	28cp	VD17	6g	Tor
9FH	XC6209F17AMR	LVR-IC	LDO, 1.75V±2%, 300mA, +CE	SOT-25	28cx	VR4	6g	Tor
9FH	XC6212B17AMR	LVR-IC	LDO, 1.75V±2%, 150mA, +CE	SOT-25	28vt	VR4	6g	Tor
9FK	XC6209B18AMR	LVR-IC	LDO, 1.85V±2%, 150mA, +CE	SOT-25	28cx	VR4	6g	Tor
9FK	XC6223B271MR-G	LVR-IC	LDO, 2.7V±1%, 300mA, +CE, CL	SOT-25	28cx	VR4	6g	Tor
9FK	XC6113C618MR	Vdet-IC	1.8V±2%, -MR, +Reset PPO, Wt=1.6s, Rt=50ms	SOT-25	28cp	VD17	6g	Tor
9FK	XC6113C648MR	Vdet-IC	4.8V±2%, -MR, +Reset PPO, Wt=1.6s, Rt=50ms	SOT-25	28cp	VD17	6g	Tor
9FK	XC6209F18AMR	LVR-IC	LDO, 1.85V±2%, 300mA, +CE	SOT-25	28cx	VR4	6g	Tor
9FK	XC6212B18AMR	LVR-IC	LDO, 1.85V±2%, 150mA, +CE	SOT-25	28vt	VR4	6g	Tor
9FL	XC6209B19AMR	LVR-IC	LDO, 1.95V±2%, 150mA, +CE	SOT-25	28cx	VR4	6g	Tor
9FL	XC6223B281MR-G	LVR-IC	LDO, 2.8V±1%, 300mA, +CE, CL	SOT-25	28cx	VR4	6g	Tor
9FL	XC6113C619MR	Vdet-IC	1.9V±2%, -MR, +Reset PPO, Wt=1.6s, Rt=50ms	SOT-25	28cp	VD17	6g	Tor
9FL	XC6113C649MR	Vdet-IC	4.9V±2%, -MR, +Reset PPO, Wt=1.6s, Rt=50ms	SOT-25	28cp	VD17	6g	Tor
9FL	XC6209F19AMR	LVR-IC	LDO, 1.95V±2%, 300mA, +CE	SOT-25	28cx	VR4	6g	Tor
9FL	XC6212B19AMR	LVR-IC	LDO, 1.95V±2%, 150mA, +CE	SOT-25	28vt	VR4	6g	Tor
9FM	XC6209B20AMR	LVR-IC	LDO, 2.05V±2%, 150mA, +CE	SOT-25	28cx	VR4	6g	Tor
9FM	XC6223B291MR-G	LVR-IC	LDO, 2.9V±1%, 300mA, +CE, CL	SOT-25	28cx	VR4	6g	Tor
9FM	XC6113C620MR	Vdet-IC	2.0V±2%, -MR, +Reset PPO, Wt=1.6s, Rt=50ms	SOT-25	28cp	VD17	6g	Tor
9FM	XC6113C650MR	Vdet-IC	5.0V±2%, -MR, +Reset PPO, Wt=1.6s, Rt=50ms	SOT-25	28cp	VD17	6g	Tor
9FM	XC6209F20AMR	LVR-IC	LDO, 2.05V±2%, 300mA, +CE	SOT-25	28cx	VR4	6g	Tor
9FM	XC6212B20AMR	LVR-IC	LDO, 2.05V±2%, 150mA, +CE	SOT-25	28vt	VR4	6g	Tor
9FN	XC6209B21AMR	LVR-IC	LDO, 2.15V±2%, 150mA, +CE	SOT-25	28cx	VR4	6g	Tor
9FN	XC6223B301MR-G	LVR-IC	LDO, 3.0V±1%, 300mA, +CE, CL	SOT-25	28cx	VR4	6g	Tor
9FN	XC6113C621MR	Vdet-IC	2.1V±2%, -MR, +Reset PPO, Wt=1.6s, Rt=50ms	SOT-25	28cp	VD17	6g	Tor
9FN	XC6209F21AMR	LVR-IC	LDO, 2.15V±2%, 300mA, +CE	SOT-25	28cx	VR4	6g	Tor
9FN	XC6212B21AMR	LVR-IC	LDO, 2.15V±2%, 150mA, +CE	SOT-25	28vt	VR4	6g	Tor
9FP	XC6209B22AMR	LVR-IC	LDO, 2.25V±2%, 150mA, +CE	SOT-25	28cx	VR4	6g	Tor
9FP	XC6223B311MR-G	LVR-IC	LDO, 3.1V±1%, 300mA, +CE, CL	SOT-25	28cx	VR4	6g	Tor
9FP	XC6113C622MR	Vdet-IC	2.2V±2%, -MR, +Reset PPO, Wt=1.6s, Rt=50ms	SOT-25	28cp	VD17	6g	Tor
9FP	XC6209F22AMR	LVR-IC	LDO, 2.25V±2%, 300mA, +CE	SOT-25	28cx	VR4	6g	Tor
9FP	XC6212B22AMR	LVR-IC	LDO, 2.25V±2%, 150mA, +CE	SOT-25	28vt	VR4	6g	Tor
9FR	XC6209B23AMR	LVR-IC	LDO, 2.35V±2%, 150mA, +CE	SOT-25	28cx	VR4	6g	Tor
9FR	XC6223B321MR-G	LVR-IC	LDO, 3.2V±1%, 300mA, +CE, CL	SOT-25	28cx	VR4	6g	Tor
9FR	XC6113C623MR	Vdet-IC	2.3V±2%, -MR, +Reset PPO, Wt=1.6s, Rt=50ms	SOT-25	28cp	VD17	6g	Tor
9FR	XC6209F23AMR	LVR-IC	LDO, 2.35V±2%, 300mA, +CE	SOT-25	28cx	VR4	6g	Tor
9FR	XC6212B23AMR	LVR-IC	LDO, 2.35V±2%, 150mA, +CE	SOT-25	28vt	VR4	6g	Tor
9FS	XC6209B24AMR	LVR-IC	LDO, 2.45V±2%, 150mA, +CE	SOT-25	28cx	VR4	6g	Tor
9FS	XC6223B331MR-G	LVR-IC	LDO, 3.3V±1%, 300mA, +CE, CL	SOT-25	28cx	VR4	6g	Tor
9FS	XC6113C624MR	Vdet-IC	2.4V±2%, -MR, +Reset PPO, Wt=1.6s, Rt=50ms	SOT-25	28cp	VD17	6g	Tor
9FS	XC6209F24AMR	LVR-IC	LDO, 2.45V±2%, 300mA, +CE	SOT-25	28cx	VR4	6g	Tor
9FS	XC6212B24AMR	LVR-IC	LDO, 2.45V±2%, 150mA, +CE	SOT-25	28vt	VR4	6g	Tor
9FT	XC6209B25AMR	LVR-IC	LDO, 2.55V±2%, 150mA, +CE	SOT-25	28cx	VR4	6g	Tor
9FT	XC6223B341MR-G	LVR-IC	LDO, 3.4V±1%, 300mA, +CE, CL	SOT-25	28cx	VR4	6g	Tor
9FT	XC6113C625MR	Vdet-IC	2.5V±2%, -MR, +Reset PPO, Wt=1.6s, Rt=50ms	SOT-25	28cp	VD17	6g	Tor
9FT	XC6209F25AMR	LVR-IC	LDO, 2.55V±2%, 300mA, +CE	SOT-25	28cx	VR4	6g	Tor
9FT	XC6212B25AMR	LVR-IC	LDO, 2.55V±2%, 150mA, +CE	SOT-25	28vt	VR4	6g	Tor
9FU	XC6209B26AMR	LVR-IC	LDO, 2.65V±2%, 150mA, +CE	SOT-25	28cx	VR4	6g	Tor
9FU	XC6223B351MR-G	LVR-IC	LDO, 3.5V±1%, 300mA, +CE, CL	SOT-25	28cx	VR4	6g	Tor
9FU	XC6113C626MR	Vdet-IC	2.6V±2%, -MR, +Reset PPO, Wt=1.6s, Rt=50ms	SOT-25	28cp	VD17	6g	Tor
9FU	XC6209F26AMR	LVR-IC	LDO, 2.65V±2%, 300mA, +CE	SOT-25	28cx	VR4	6g	Tor
9FU	XC6212B26AMR	LVR-IC	LDO, 2.65V±2%, 150mA, +CE	SOT-25	28vt	VR4	6g	Tor
9FV	XC6209B27AMR	LVR-IC	LDO, 2.75V±2%, 150mA, +CE	SOT-25	28cx	VR4	6g	Tor
9FV	XC6223B361MR-G	LVR-IC	LDO, 3.6V±1%, 300mA, +CE, CL	SOT-25	28cx	VR4	6g	Tor



SMD code	Type	Function	Short description	Case	Pinout	Sch.	St.	Mnf.
9FV	XC6113C627MR	Vdet-IC	2.7V±2%, -MR, +Reset PPO, Wt=1.6s, Rt=50ms	SOT-25	28cp	VD17	6g	Tor
9EV	XC6209F27AMR	LVR-IC	LDO, 2.75V±2%, 300mA, +CE	SOT-25	28cx	VR4	6g	Tor
9FV	XC6212B27AMR	LVR-IC	LDO, 2.75V±2%, 150mA, +CE	SOT-25	28vt	VR4	6g	Tor
9FX	XC6209B28AMR	LVR-IC	LDO, 2.85V±2%, 150mA, +CE	SOT-25	28cx	VR4	6g	Tor
9FX	XC6223B371MR-G	LVR-IC	LDO, 3.7V±1%, 300mA, +CE, CL	SOT-25	28cx	VR4	6g	Tor
9FX	XC6113C628MR	Vdet-IC	2.8V±2%, -MR, +Reset PPO, Wt=1.6s, Rt=50ms	SOT-25	28cp	VD17	6g	Tor
9FX	XC6209F28AMR	LVR-IC	LDO, 2.85V±2%, 300mA, +CE	SOT-25	28cx	VR4	6g	Tor
9FX	XC6212B28AMR	LVR-IC	LDO, 2.85V±2%, 150mA, +CE	SOT-25	28vt	VR4	6g	Tor
9FY	XC6209B29AMR	LVR-IC	LDO, 2.95V±2%, 150mA, +CE	SOT-25	28cx	VR4	6g	Tor
9FY	XC6223B381MR-G	LVR-IC	LDO, 3.8V±1%, 300mA, +CE, CL	SOT-25	28cx	VR4	6g	Tor
9FY	XC6113C629MR	Vdet-IC	2.9V±2%, -MR, +Reset PPO, Wt=1.6s, Rt=50ms	SOT-25	28cp	VD17	6g	Tor
9FY	XC6209F29AMR	LVR-IC	LDO, 2.95V±2%, 300mA, +CE	SOT-25	28cx	VR4	6g	Tor
9FY	XC6212B29AMR	LVR-IC	LDO, 2.95V±2%, 150mA, +CE	SOT-25	28vt	VR4	6g	Tor
9FZ	XC6209B30AMR	LVR-IC	LDO, 3.05V±2%, 150mA, +CE	SOT-25	28cx	VR4	6g	Tor
9FZ	XC6223B391MR-G	LVR-IC	LDO, 3.9V±1%, 300mA, +CE, CL	SOT-25	28cx	VR4	6g	Tor
9FZ	XC6113C630MR	Vdet-IC	3.0V±2%, -MR, +Reset PPO, Wt=1.6s, Rt=50ms	SOT-25	28cp	VD17	6g	Tor
9FZ	XC6209F30AMR	LVR-IC	LDO, 3.05V±2%, 300mA, +CE	SOT-25	28cx	VR4	6g	Tor
9FZ	XC6212B30AMR	LVR-IC	LDO, 3.05V±2%, 150mA, +CE	SOT-25	28vt	VR4	6g	Tor
9H	R3111N091C	Vdet-IC	0.9V±2%, -Reset ODO	SOT-23-5	28vdm	VD6	6g	Ric
9H0	XC6223B401MR-G	LVR-IC	LDO, 4.0V±1%, 300mA, +CE, CL	SOT-25	28cx	VR4	6g	Tor
9H0	XC6113D331MR	Vdet-IC	3.1V±2%, -MR, +Reset PPO, Wt=100ms, Rt=100ms	SOT-25	28cp	VD17	6g	Tor
9H1	XC6113D332MR	Vdet-IC	3.2V±2%, -MR, +Reset PPO, Wt=100ms, Rt=100ms	SOT-25	28cp	VD17	6g	Tor
9H2	XC6113D333MR	Vdet-IC	3.3V±2%, -MR, +Reset PPO, Wt=100ms, Rt=100ms	SOT-25	28cp	VD17	6g	Tor
9H3	XC6113D334MR	Vdet-IC	3.4V±2%, -MR, +Reset PPO, Wt=100ms, Rt=100ms	SOT-25	28cp	VD17	6g	Tor
9H4	XC6113D335MR	Vdet-IC	3.5V±2%, -MR, +Reset PPO, Wt=100ms, Rt=100ms	SOT-25	28cp	VD17	6g	Tor
9H5	XC6113D336MR	Vdet-IC	3.6V±2%, -MR, +Reset PPO, Wt=100ms, Rt=100ms	SOT-25	28cp	VD17	6g	Tor
9H6	XC6113D337MR	Vdet-IC	3.7V±2%, -MR, +Reset PPO, Wt=100ms, Rt=100ms	SOT-25	28cp	VD17	6g	Tor
9H7	XC6113D338MR	Vdet-IC	3.8V±2%, -MR, +Reset PPO, Wt=100ms, Rt=100ms	SOT-25	28cp	VD17	6g	Tor
9H8	XC6209C09AMR	LVR-IC	LDO, 0.95V±2%, 150mA, -CE, PDR	SOT-25	28cx	VR4	6g	Tor
9H8	XC6113D339MR	Vdet-IC	3.9V±2%, -MR, +Reset PPO, Wt=100ms, Rt=100ms	SOT-25	28cp	VD17	6g	Tor
9H8	XC6209G09AMR	LVR-IC	LDO, 0.95V±2%, 300mA, -CE, PDR	SOT-25	28cx	VR4	6g	Tor
9H8	XC6212C09AMR	LVR-IC	LDO, 0.95V±2%, 150mA, -CE, PDR	SOT-25	28vt	VR4	6g	Tor
9H9	XC6209C10AMR	LVR-IC	LDO, 1.05V±2%, 150mA, -CE, PDR	SOT-25	28cx	VR4	6g	Tor
9H9	XC6113D340MR	Vdet-IC	4.0V±2%, -MR, +Reset PPO, Wt=100ms, Rt=100ms	SOT-25	28cp	VD17	6g	Tor
9H9	XC6209G10AMR	LVR-IC	LDO, 1.05V±2%, 300mA, -CE, PDR	SOT-25	28cx	VR4	6g	Tor
9H9	XC6212C10AMR	LVR-IC	LDO, 1.05V±2%, 150mA, -CE, PDR	SOT-25	28vt	VR4	6g	Tor
9HA	XC6209C11AMR	LVR-IC	LDO, 1.15V±2%, 150mA, -CE, PDR	SOT-25	28cx	VR4	6g	Tor
9HA	XC6113D341MR	Vdet-IC	4.1V±2%, -MR, +Reset PPO, Wt=100ms, Rt=100ms	SOT-25	28cp	VD17	6g	Tor
9HA	XC6209G11AMR	LVR-IC	LDO, 1.15V±2%, 300mA, -CE, PDR	SOT-25	28cx	VR4	6g	Tor
9HA	XC6212C11AMR	LVR-IC	LDO, 1.15V±2%, 150mA, -CE, PDR	SOT-25	28vt	VR4	6g	Tor
9HB	XC6209C12AMR	LVR-IC	LDO, 1.25V±2%, 150mA, -CE, PDR	SOT-25	28cx	VR4	6g	Tor
9HB	XC6113D342MR	Vdet-IC	4.2V±2%, -MR, +Reset PPO, Wt=100ms, Rt=100ms	SOT-25	28cp	VD17	6g	Tor
9HB	XC6209G12AMR	LVR-IC	LDO, 1.25V±2%, 300mA, -CE, PDR	SOT-25	28cx	VR4	6g	Tor
9HB	XC6212C12AMR	LVR-IC	LDO, 1.25V±2%, 150mA, -CE, PDR	SOT-25	28vt	VR4	6g	Tor
9HC	XC6209C13AMR	LVR-IC	LDO, 1.35V±2%, 150mA, -CE, PDR	SOT-25	28cx	VR4	6g	Tor
9HC	XC6113D343MR	Vdet-IC	4.3V±2%, -MR, +Reset PPO, Wt=100ms, Rt=100ms	SOT-25	28cp	VD17	6g	Tor
9HC	XC6209G13AMR	LVR-IC	LDO, 1.35V±2%, 300mA, -CE, PDR	SOT-25	28cx	VR4	6g	Tor
9HC	XC6212C13AMR	LVR-IC	LDO, 1.35V±2%, 150mA, -CE, PDR	SOT-25	28vt	VR4	6g	Tor
9HD	XC6209C14AMR	LVR-IC	LDO, 1.45V±2%, 150mA, -CE, PDR	SOT-25	28cx	VR4	6g	Tor
9HD	XC6113D344MR	Vdet-IC	4.4V±2%, -MR, +Reset PPO, Wt=100ms, Rt=100ms	SOT-25	28cp	VD17	6g	Tor
9HD	XC6209G14AMR	LVR-IC	LDO, 1.45V±2%, 300mA, -CE, PDR	SOT-25	28cx	VR4	6g	Tor
9HD	XC6212C14AMR	LVR-IC	LDO, 1.45V±2%, 150mA, -CE, PDR	SOT-25	28vt	VR4	6g	Tor
9HE	XC6209C15AMR	LVR-IC	LDO, 1.55V±2%, 150mA, -CE, PDR	SOT-25	28cx	VR4	6g	Tor
9HE	XC6113D345MR	Vdet-IC	4.5V±2%, -MR, +Reset PPO, Wt=100ms, Rt=100ms	SOT-25	28cp	VD17	6g	Tor
9HE	XC6209G15AMR	LVR-IC	LDO, 1.55V±2%, 300mA, -CE, PDR	SOT-25	28cx	VR4	6g	Tor
9HE	XC6212C15AMR	LVR-IC	LDO, 1.55V±2%, 150mA, -CE, PDR	SOT-25	28vt	VR4	6g	Tor
9HF	XC6209C16AMR	LVR-IC	LDO, 1.65V±2%, 150mA, -CE, PDR	SOT-25	28cx	VR4	6g	Tor
9HF	XC6113D316MR	Vdet-IC	1.6V±2%, -MR, +Reset PPO, Wt=100ms, Rt=100ms	SOT-25	28cp	VD17	6g	Tor
9HF	XC6113D346MR	Vdet-IC	4.6V±2%, -MR, +Reset PPO, Wt=100ms, Rt=100ms	SOT-25	28cp	VD17	6g	Tor
9HF	XC6209G16AMR	LVR-IC	LDO, 1.65V±2%, 300mA, -CE, PDR	SOT-25	28cx	VR4	6g	Tor
9HF	XC6212C16AMR	LVR-IC	LDO, 1.65V±2%, 150mA, -CE, PDR	SOT-25	28vt	VR4	6g	Tor
9HH	XC6209C17AMR	LVR-IC	LDO, 1.75V±2%, 150mA, -CE, PDR	SOT-25	28cx	VR4	6g	Tor
9HH	XC6113D317MR	Vdet-IC	1.7V±2%, -MR, +Reset PPO, Wt=100ms, Rt=100ms	SOT-25	28cp	VD17	6g	Tor
9HH	XC6113D347MR	Vdet-IC	4.7V±2%, -MR, +Reset PPO, Wt=100ms, Rt=100ms	SOT-25	28cp	VD17	6g	Tor
9HH	XC6209G17AMR	LVR-IC	LDO, 1.75V±2%, 300mA, -CE, PDR	SOT-25	28cx	VR4	6g	Tor
9HH	XC6212C17AMR	LVR-IC	LDO, 1.75V±2%, 150mA, -CE, PDR	SOT-25	28vt	VR4	6g	Tor
9HK	XC6209C18AMR	LVR-IC	LDO, 1.85V±2%, 150mA, -CE, PDR	SOT-25	28cx	VR4	6g	Tor
9HK	XC6113D318MR	Vdet-IC	1.8V±2%, -MR, +Reset PPO, Wt=100ms, Rt=100ms	SOT-25	28cp	VD17	6g	Tor
9HK	XC6113D348MR	Vdet-IC	4.8V±2%, -MR, +Reset PPO, Wt=100ms, Rt=100ms	SOT-25	28cp	VD17	6g	Tor
9HK	XC6209G18AMR	LVR-IC	LDO, 1.85V±2%, 300mA, -CE, PDR	SOT-25	28cx	VR4	6g	Tor



SMD code	Type	Function	Short description	Case	Pinout	Sch.	St.	Mnf.
9HK	XC6212C18AMR	LVR-IC	LDO, 1.85V±2%, 150mA, -CE, PDR	SOT-25	28vt	VR4	6g	Tor
9HL	XC6209C19AMR	LVR-IC	LDO, 1.95V±2%, 150mA, -CE, PDR	SOT-25	28cx	VR4	6g	Tor
9HL	XC6113D319MR	Vdet-IC	1.9V±2%, -MR, +Reset PPO, Wt=100ms, Rt=100ms	SOT-25	28cp	VD17	6g	Tor
9HL	XC6113D349MR	Vdet-IC	4.9V±2%, -MR, +Reset PPO, Wt=100ms, Rt=100ms	SOT-25	28cp	VD17	6g	Tor
9HL	XC6209G19AMR	LVR-IC	LDO, 1.95V±2%, 300mA, -CE, PDR	SOT-25	28cx	VR4	6g	Tor
9HL	XC6212C19AMR	LVR-IC	LDO, 1.95V±2%, 150mA, -CE, PDR	SOT-25	28vt	VR4	6g	Tor
9HM	XC6209C20AMR	LVR-IC	LDO, 2.05V±2%, 150mA, -CE, PDR	SOT-25	28cx	VR4	6g	Tor
9HM	XC6113D320MR	Vdet-IC	2.0V±2%, -MR, +Reset PPO, Wt=100ms, Rt=100ms	SOT-25	28cp	VD17	6g	Tor
9HM	XC6113D350MR	Vdet-IC	5.0V±2%, -MR, +Reset PPO, Wt=100ms, Rt=100ms	SOT-25	28cp	VD17	6g	Tor
9HM	XC6209G20AMR	LVR-IC	LDO, 2.05V±2%, 300mA, -CE, PDR	SOT-25	28cx	VR4	6g	Tor
9HM	XC6212C20AMR	LVR-IC	LDO, 2.05V±2%, 150mA, -CE, PDR	SOT-25	28vt	VR4	6g	Tor
9HN	XC6209C21AMR	LVR-IC	LDO, 2.15V±2%, 150mA, -CE, PDR	SOT-25	28cx	VR4	6g	Tor
9HN	XC6113D321MR	Vdet-IC	2.1V±2%, -MR, +Reset PPO, Wt=100ms, Rt=100ms	SOT-25	28cp	VD17	6g	Tor
9HN	XC6209G21AMR	LVR-IC	LDO, 2.15V±2%, 300mA, -CE, PDR	SOT-25	28cx	VR4	6g	Tor
9HN	XC6212C21AMR	LVR-IC	LDO, 2.15V±2%, 150mA, -CE, PDR	SOT-25	28vt	VR4	6g	Tor
9HP	XC6209C22AMR	LVR-IC	LDO, 2.25V±2%, 150mA, -CE, PDR	SOT-25	28cx	VR4	6g	Tor
9HP	XC6113D322MR	Vdet-IC	2.2V±2%, -MR, +Reset PPO, Wt=100ms, Rt=100ms	SOT-25	28cp	VD17	6g	Tor
9HP	XC6209G22AMR	LVR-IC	LDO, 2.25V±2%, 300mA, -CE, PDR	SOT-25	28cx	VR4	6g	Tor
9HP	XC6212C22AMR	LVR-IC	LDO, 2.25V±2%, 150mA, -CE, PDR	SOT-25	28vt	VR4	6g	Tor
9HR	XC6209C23AMR	LVR-IC	LDO, 2.35V±2%, 150mA, -CE, PDR	SOT-25	28cx	VR4	6g	Tor
9HR	XC6113D323MR	Vdet-IC	2.3V±2%, -MR, +Reset PPO, Wt=100ms, Rt=100ms	SOT-25	28cp	VD17	6g	Tor
9HR	XC6209G23AMR	LVR-IC	LDO, 2.35V±2%, 300mA, -CE, PDR	SOT-25	28cx	VR4	6g	Tor
9HR	XC6212C23AMR	LVR-IC	LDO, 2.35V±2%, 150mA, -CE, PDR	SOT-25	28vt	VR4	6g	Tor
9HS	XC6209C24AMR	LVR-IC	LDO, 2.45V±2%, 150mA, -CE, PDR	SOT-25	28cx	VR4	6g	Tor
9HS	XC6113D324MR	Vdet-IC	2.4V±2%, -MR, +Reset PPO, Wt=100ms, Rt=100ms	SOT-25	28cp	VD17	6g	Tor
9HS	XC6209G24AMR	LVR-IC	LDO, 2.45V±2%, 300mA, -CE, PDR	SOT-25	28cx	VR4	6g	Tor
9HS	XC6212C24AMR	LVR-IC	LDO, 2.45V±2%, 150mA, -CE, PDR	SOT-25	28vt	VR4	6g	Tor
9HT	XC6209C25AMR	LVR-IC	LDO, 2.55V±2%, 150mA, -CE, PDR	SOT-25	28cx	VR4	6g	Tor
9HT	XC6113D325MR	Vdet-IC	2.5V±2%, -MR, +Reset PPO, Wt=100ms, Rt=100ms	SOT-25	28cp	VD17	6g	Tor
9HT	XC6209G25AMR	LVR-IC	LDO, 2.55V±2%, 300mA, -CE, PDR	SOT-25	28cx	VR4	6g	Tor
9HT	XC6212C25AMR	LVR-IC	LDO, 2.55V±2%, 150mA, -CE, PDR	SOT-25	28vt	VR4	6g	Tor
9HU	XC6209C26AMR	LVR-IC	LDO, 2.65V±2%, 150mA, -CE, PDR	SOT-25	28cx	VR4	6g	Tor
9HU	XC6113D326MR	Vdet-IC	2.6V±2%, -MR, +Reset PPO, Wt=100ms, Rt=100ms	SOT-25	28cp	VD17	6g	Tor
9HU	XC6209G26AMR	LVR-IC	LDO, 2.65V±2%, 300mA, -CE, PDR	SOT-25	28cx	VR4	6g	Tor
9HU	XC6212C26AMR	LVR-IC	LDO, 2.65V±2%, 150mA, -CE, PDR	SOT-25	28vt	VR4	6g	Tor
9HV	XC6209C27AMR	LVR-IC	LDO, 2.75V±2%, 150mA, -CE, PDR	SOT-25	28cx	VR4	6g	Tor
9HV	XC6113D327MR	Vdet-IC	2.7V±2%, -MR, +Reset PPO, Wt=100ms, Rt=100ms	SOT-25	28cp	VD17	6g	Tor
9HV	XC6209G27AMR	LVR-IC	LDO, 2.75V±2%, 300mA, -CE, PDR	SOT-25	28cx	VR4	6g	Tor
9HV	XC6212C27AMR	LVR-IC	LDO, 2.75V±2%, 150mA, -CE, PDR	SOT-25	28vt	VR4	6g	Tor
9HX	XC6209C28AMR	LVR-IC	LDO, 2.85V±2%, 150mA, -CE, PDR	SOT-25	28cx	VR4	6g	Tor
9HX	XC6113D328MR	Vdet-IC	2.8V±2%, -MR, +Reset PPO, Wt=100ms, Rt=100ms	SOT-25	28cp	VD17	6g	Tor
9HX	XC6209G28AMR	LVR-IC	LDO, 2.85V±2%, 300mA, -CE, PDR	SOT-25	28cx	VR4	6g	Tor
9HX	XC6212C28AMR	LVR-IC	LDO, 2.85V±2%, 150mA, -CE, PDR	SOT-25	28vt	VR4	6g	Tor
9HY	XC6209C29AMR	LVR-IC	LDO, 2.95V±2%, 150mA, -CE, PDR	SOT-25	28cx	VR4	6g	Tor
9HY	XC6113D329MR	Vdet-IC	2.9V±2%, -MR, +Reset PPO, Wt=100ms, Rt=100ms	SOT-25	28cp	VD17	6g	Tor
9HY	XC6209G29AMR	LVR-IC	LDO, 2.95V±2%, 300mA, -CE, PDR	SOT-25	28cx	VR4	6g	Tor
9HY	XC6212C29AMR	LVR-IC	LDO, 2.95V±2%, 150mA, -CE, PDR	SOT-25	28vt	VR4	6g	Tor
9HZ	XC6209C30AMR	LVR-IC	LDO, 3.05V±2%, 150mA, -CE, PDR	SOT-25	28cx	VR4	6g	Tor
9HZ	XC6113D330MR	Vdet-IC	3.0V±2%, -MR, +Reset PPO, Wt=100ms, Rt=100ms	SOT-25	28cp	VD17	6g	Tor
9HZ	XC6209G30AMR	LVR-IC	LDO, 3.05V±2%, 300mA, -CE, PDR	SOT-25	28cx	VR4	6g	Tor
9HZ	XC6212C30AMR	LVR-IC	LDO, 3.05V±2%, 150mA, -CE, PDR	SOT-25	28vt	VR4	6g	Tor
9J	R3111N191C	Vdet-IC	1.9V±2%, -Reset ODO	SOT-23-5	28vdm	VD6	6g	Ric
9K	R3111N291C	Vdet-IC	2.9V±2%, -Reset ODO	SOT-23-5	28vdm	VD6	6g	Ric
9K0	XC6113D431MR	Vdet-IC	3.1V±2%, -MR, +Reset PPO, Wt=200ms, Rt=100ms	SOT-25	28cp	VD17	6g	Tor
9K1	XC6113D432MR	Vdet-IC	3.2V±2%, -MR, +Reset PPO, Wt=200ms, Rt=100ms	SOT-25	28cp	VD17	6g	Tor
9K2	XC6223B12BMR-G	LVR-IC	LDO, 1.25V±20mV, 300mA, +CE, CL	SOT-25	28cx	VR4	6g	Tor
9K2	XC6113D433MR	Vdet-IC	3.3V±2%, -MR, +Reset PPO, Wt=200ms, Rt=100ms	SOT-25	28cp	VD17	6g	Tor
9K3	XC6223B13BMR-G	LVR-IC	LDO, 1.35V±20mV, 300mA, +CE, CL	SOT-25	28cx	VR4	6g	Tor
9K3	XC6113D434MR	Vdet-IC	3.4V±2%, -MR, +Reset PPO, Wt=200ms, Rt=100ms	SOT-25	28cp	VD17	6g	Tor
9K4	XC6223B14BMR-G	LVR-IC	LDO, 1.45V±20mV, 300mA, +CE, CL	SOT-25	28cx	VR4	6g	Tor
9K4	XC6113D435MR	Vdet-IC	3.5V±2%, -MR, +Reset PPO, Wt=200ms, Rt=100ms	SOT-25	28cp	VD17	6g	Tor
9K5	XC6223B15BMR-G	LVR-IC	LDO, 1.55V±20mV, 300mA, +CE, CL	SOT-25	28cx	VR4	6g	Tor
9K5	XC6113D436MR	Vdet-IC	3.6V±2%, -MR, +Reset PPO, Wt=200ms, Rt=100ms	SOT-25	28cp	VD17	6g	Tor
9K6	XC6223B16BMR-G	LVR-IC	LDO, 1.65V±20mV, 300mA, +CE, CL	SOT-25	28cx	VR4	6g	Tor
9K6	XC6113D437MR	Vdet-IC	3.7V±2%, -MR, +Reset PPO, Wt=200ms, Rt=100ms	SOT-25	28cp	VD17	6g	Tor
9K7	XC6223B17BMR-G	LVR-IC	LDO, 1.75V±20mV, 300mA, +CE, CL	SOT-25	28cx	VR4	6g	Tor
9K7	XC6113D438MR	Vdet-IC	3.8V±2%, -MR, +Reset PPO, Wt=200ms, Rt=100ms	SOT-25	28cp	VD17	6g	Tor
9K8	XC6209D09AMR	LVR-IC	LDO, 0.95V±2%, 150mA, -CE	SOT-25	28cx	VR4	6g	Tor
9K8	XC6223B18BMR-G	LVR-IC	LDO, 1.85V±20mV, 300mA, +CE, CL	SOT-25	28cx	VR4	6g	Tor
9K8	XC6113D439MR	Vdet-IC	3.9V±2%, -MR, +Reset PPO, Wt=200ms, Rt=100ms	SOT-25	28cp	VD17	6g	Tor



SMD code	Type	Function	Short description	Case	Pinout	Sch.	St.	Mnf.
9K8	XC6209H09AMR	LVR-IC	LDO, 0.95V±2%, 300mA, -CE	SOT-25	28cx	VR4	6g	Tor
9K8	XC6212D09AMR	LVR-IC	LDO, 0.95V±2%, 150mA, -CE	SOT-25	28xt	VR4	6g	Tor
9K9	XC6209D10AMR	LVR-IC	LDO, 1.05V±2%, 150mA, -CE	SOT-25	28cx	VR4	6g	Tor
9K9	XC6223B19BMR-G	LVR-IC	LDO, 1.95V±20mV, 300mA, +CE, CL	SOT-25	28cx	VR4	6g	Tor
9K9	XC6113D440MR	Vdet-IC	4.0V±2%, -MR, +Reset PPO, Wt=200ms, Rt=100ms	SOT-25	28cp	VD17	6g	Tor
9K9	XC6209H10AMR	LVR-IC	LDO, 1.05V±2%, 300mA, -CE	SOT-25	28cx	VR4	6g	Tor
9K9	XC6212D10AMR	LVR-IC	LDO, 1.05V±2%, 150mA, -CE	SOT-25	28vt	VR4	6g	Tor
9KA	XC6209D11AMR	LVR-IC	LDO, 1.15V±2%, 150mA, -CE	SOT-25	28cx	VR4	6g	Tor
9KA	XC6223B20BMR-G	LVR-IC	LDO, 2.05V±1%, 300mA, +CE, CL	SOT-25	28cx	VR4	6g	Tor
9KA	XC6113D441MR	Vdet-IC	4.1V±2%, -MR, +Reset PPO, Wt=200ms, Rt=100ms	SOT-25	28cp	VD17	6g	Tor
9KA	XC6209H11AMR	LVR-IC	LDO, 1.15V±2%, 300mA, -CE	SOT-25	28cx	VR4	6g	Tor
9KA	XC6212D11AMR	LVR-IC	LDO, 1.15V±2%, 150mA, -CE	SOT-25	28vt	VR4	6g	Tor
9KB	XC6209D12AMR	LVR-IC	LDO, 1.25V±2%, 150mA, -CE	SOT-25	28cx	VR4	6g	Tor
9KB	XC6223B21BMR-G	LVR-IC	LDO, 2.15V±1%, 300mA, +CE, CL	SOT-25	28cx	VR4	6g	Tor
9KB	XC6113D442MR	Vdet-IC	4.2V±2%, -MR, +Reset PPO, Wt=200ms, Rt=100ms	SOT-25	28cp	VD17	6g	Tor
9KB	XC6209H12AMR	LVR-IC	LDO, 1.25V±2%, 300mA, -CE	SOT-25	28cx	VR4	6g	Tor
9KB	XC6212D12AMR	LVR-IC	LDO, 1.25V±2%, 150mA, -CE	SOT-25	28vt	VR4	6g	Tor
9KC	XC6209D13AMR	LVR-IC	LDO, 1.35V±2%, 150mA, -CE	SOT-25	28cx	VR4	6g	Tor
9KC	XC6223B22BMR-G	LVR-IC	LDO, 2.25V±1%, 300mA, +CE, CL	SOT-25	28cx	VR4	6g	Tor
9KC	XC6113D443MR	Vdet-IC	4.3V±2%, -MR, +Reset PPO, Wt=200ms, Rt=100ms	SOT-25	28cp	VD17	6g	Tor
9KC	XC6209H13AMR	LVR-IC	LDO, 1.35V±2%, 300mA, -CE	SOT-25	28cx	VR4	6g	Tor
9KC	XC6212D13AMR	LVR-IC	LDO, 1.35V±2%, 150mA, -CE	SOT-25	28vt	VR4	6g	Tor
9KD	XC6209D14AMR	LVR-IC	LDO, 1.45V±2%, 150mA, -CE	SOT-25	28cx	VR4	6g	Tor
9KD	XC6223B23BMR-G	LVR-IC	LDO, 2.35V±1%, 300mA, +CE, CL	SOT-25	28cx	VR4	6g	Tor
9KD	XC6113D444MR	Vdet-IC	4.4V±2%, -MR, +Reset PPO, Wt=200ms, Rt=100ms	SOT-25	28cp	VD17	6g	Tor
9KD	XC6209H14AMR	LVR-IC	LDO, 1.45V±2%, 300mA, -CE	SOT-25	28cx	VR4	6g	Tor
9KD	XC6212D14AMR	LVR-IC	LDO, 1.45V±2%, 150mA, -CE	SOT-25	28vt	VR4	6g	Tor
9KE	XC6209D15AMR	LVR-IC	LDO, 1.55V±2%, 150mA, -CE	SOT-25	28cx	VR4	6g	Tor
9KE	XC6223B24BMR-G	LVR-IC	LDO, 2.45V±1%, 300mA, +CE, CL	SOT-25	28cx	VR4	6g	Tor
9KE	XC6113D445MR	Vdet-IC	4.5V±2%, -MR, +Reset PPO, Wt=200ms, Rt=100ms	SOT-25	28cp	VD17	6g	Tor
9KE	XC6209H15AMR	LVR-IC	LDO, 1.55V±2%, 300mA, -CE	SOT-25	28cx	VR4	6g	Tor
9KE	XC6212D15AMR	LVR-IC	LDO, 1.55V±2%, 150mA, -CE	SOT-25	28vt	VR4	6g	Tor
9KF	XC6209D16AMR	LVR-IC	LDO, 1.65V±2%, 150mA, -CE	SOT-25	28cx	VR4	6g	Tor
9KF	XC6223B25BMR-G	LVR-IC	LDO, 2.55V±1%, 300mA, +CE, CL	SOT-25	28cx	VR4	6g	Tor
9KF	XC6113D416MR	Vdet-IC	1.6V±2%, -MR, +Reset PPO, Wt=200ms, Rt=100ms	SOT-25	28cp	VD17	6g	Tor
9KF	XC6113D446MR	Vdet-IC	4.6V±2%, -MR, +Reset PPO, Wt=200ms, Rt=100ms	SOT-25	28cp	VD17	6g	Tor
9KF	XC6209H16AMR	LVR-IC	LDO, 1.65V±2%, 300mA, -CE	SOT-25	28cx	VR4	6g	Tor
9KF	XC6212D16AMR	LVR-IC	LDO, 1.65V±2%, 150mA, -CE	SOT-25	28vt	VR4	6g	Tor
9KH	XC6209D17AMR	LVR-IC	LDO, 1.75V±2%, 150mA, -CE	SOT-25	28cx	VR4	6g	Tor
9KH	XC6223B26BMR-G	LVR-IC	LDO, 2.65V±1%, 300mA, +CE, CL	SOT-25	28cx	VR4	6g	Tor
9KH	XC6113D417MR	Vdet-IC	1.7V±2%, -MR, +Reset PPO, Wt=200ms, Rt=100ms	SOT-25	28cp	VD17	6g	Tor
9KH	XC6113D447MR	Vdet-IC	4.7V±2%, -MR, +Reset PPO, Wt=200ms, Rt=100ms	SOT-25	28cp	VD17	6g	Tor
9KH	XC6209H17AMR	LVR-IC	LDO, 1.75V±2%, 300mA, -CE	SOT-25	28cx	VR4	6g	Tor
9KH	XC6212D17AMR	LVR-IC	LDO, 1.75V±2%, 150mA, -CE	SOT-25	28vt	VR4	6g	Tor
9KK	XC6209D18AMR	LVR-IC	LDO, 1.85V±2%, 150mA, -CE	SOT-25	28cx	VR4	6g	Tor
9KK	XC6223B27BMR-G	LVR-IC	LDO, 2.75V±1%, 300mA, +CE, CL	SOT-25	28cx	VR4	6g	Tor
9KK	XC6113D418MR	Vdet-IC	1.8V±2%, -MR, +Reset PPO, Wt=200ms, Rt=100ms	SOT-25	28cp	VD17	6g	Tor
9KK	XC6113D448MR	Vdet-IC	4.8V±2%, -MR, +Reset PPO, Wt=200ms, Rt=100ms	SOT-25	28cp	VD17	6g	Tor
9KK	XC6209H18AMR	LVR-IC	LDO, 1.85V±2%, 300mA, -CE	SOT-25	28cx	VR4	6g	Tor
9KK	XC6212D18AMR	LVR-IC	LDO, 1.85V±2%, 150mA, -CE	SOT-25	28vt	VR4	6g	Tor
9KL	XC6209D19AMR	LVR-IC	LDO, 1.95V±2%, 150mA, -CE	SOT-25	28cx	VR4	6g	Tor
9KL	XC6223B28BMR-G	LVR-IC	LDO, 2.85V±1%, 300mA, +CE, CL	SOT-25	28cx	VR4	6g	Tor
9KL	XC6113D419MR	Vdet-IC	1.9V±2%, -MR, +Reset PPO, Wt=200ms, Rt=100ms	SOT-25	28cp	VD17	6g	Tor
9KL	XC6113D449MR	Vdet-IC	4.9V±2%, -MR, +Reset PPO, Wt=200ms, Rt=100ms	SOT-25	28cp	VD17	6g	Tor
9KL	XC6209H19AMR	LVR-IC	LDO, 1.95V±2%, 300mA, -CE	SOT-25	28cx	VR4	6g	Tor
9KL	XC6212D19AMR	LVR-IC	LDO, 1.95V±2%, 150mA, -CE	SOT-25	28vt	VR4	6g	Tor
9KM	XC6209D20AMR	LVR-IC	LDO, 2.05V±2%, 150mA, -CE	SOT-25	28cx	VR4	6g	Tor
9KM	XC6223B29BMR-G	LVR-IC	LDO, 2.95V±1%, 300mA, +CE, CL	SOT-25	28cx	VR4	6g	Tor
9KM	XC6113D420MR	Vdet-IC	2.0V±2%, -MR, +Reset PPO, Wt=200ms, Rt=100ms	SOT-25	28cp	VD17	6g	Tor
9KM	XC6113D450MR	Vdet-IC	5.0V±2%, -MR, +Reset PPO, Wt=200ms, Rt=100ms	SOT-25	28cp	VD17	6g	Tor
9KM	XC6209H20AMR	LVR-IC	LDO, 2.05V±2%, 300mA, -CE	SOT-25	28cx	VR4	6g	Tor
9KM	XC6212D20AMR	LVR-IC	LDO, 2.05V±2%, 150mA, -CE	SOT-25	28vt	VR4	6g	Tor
9KN	XC6209D21AMR	LVR-IC	LDO, 2.15V±2%, 150mA, -CE	SOT-25	28cx	VR4	6g	Tor
9KN	XC6223B30BMR-G	LVR-IC	LDO, 3.05V±1%, 300mA, +CE, CL	SOT-25	28cx	VR4	6g	Tor
9KN	XC6113D421MR	Vdet-IC	2.1V±2%, -MR, +Reset PPO, Wt=200ms, Rt=100ms	SOT-25	28cp	VD17	6g	Tor
9KN	XC6209H21AMR	LVR-IC	LDO, 2.15V±2%, 300mA, -CE	SOT-25	28cx	VR4	6g	Tor
9KN	XC6212D21AMR	LVR-IC	LDO, 2.15V±2%, 150mA, -CE	SOT-25	28vt	VR4	6g	Tor
9KP	XC6209D22AMR	LVR-IC	LDO, 2.25V±2%, 150mA, -CE	SOT-25	28cx	VR4	6g	Tor
9KP	XC6223B31BMR-G	LVR-IC	LDO, 3.15V±1%, 300mA, +CE, CL	SOT-25	28cx	VR4	6g	Tor
9KP	XC6113D422MR	Vdet-IC	2.2V±2%, -MR, +Reset PPO, Wt=200ms, Rt=100ms	SOT-25	28cp	VD17	6g	Tor



SMD code	Type	Function	Short description	Case	Pinout	Sch.	St.	Mnf.
9KP	XC6209H22AMR	LVR-IC	LDO, 2.25V±2%, 300mA, -CE	SOT-25	28cx	VR4	6g	Tor
9KP	XC6212D22AMR	LVR-IC	LDO, 2.25V±2%, 150mA, -CE	SOT-25	28vt	VR4	6g	Tor
9KR	XC6209D23AMR	LVR-IC	LDO, 2.35V±2%, 150mA, -CE	SOT-25	28cx	VR4	6g	Tor
9KR	XC6223B32BMR-G	LVR-IC	LDO, 3.25V±1%, 300mA, +CE, CL	SOT-25	28cx	VR4	6g	Tor
9KR	XC6113D423MR	Vdet-IC	2.3V±2%, -MR, +Reset PPO, Wt=200ms, Rt=100ms	SOT-25	28cp	VD17	6g	Tor
9KR	XC6209H23AMR	LVR-IC	LDO, 2.35V±2%, 300mA, -CE	SOT-25	28cx	VR4	6g	Tor
9KR	XC6212D23AMR	LVR-IC	LDO, 2.35V±2%, 150mA, -CE	SOT-25	28vt	VR4	6g	Tor
9KS	XC6209D24AMR	LVR-IC	LDO, 2.45V±2%, 150mA, -CE	SOT-25	28cx	VR4	6g	Tor
9KS	XC6223B33BMR-G	LVR-IC	LDO, 3.35V±1%, 300mA, +CE, CL	SOT-25	28cx	VR4	6g	Tor
9KS	XC6113D424MR	Vdet-IC	2.4V±2%, -MR, +Reset PPO, Wt=200ms, Rt=100ms	SOT-25	28cp	VD17	6g	Tor
9KS	XC6209H24AMR	LVR-IC	LDO, 2.45V±2%, 300mA, -CE	SOT-25	28cx	VR4	6g	Tor
9KS	XC6212D24AMR	LVR-IC	LDO, 2.45V±2%, 150mA, -CE	SOT-25	28vt	VR4	6g	Tor
9KT	XC6209D25AMR	LVR-IC	LDO, 2.55V±2%, 150mA, -CE	SOT-25	28cx	VR4	6g	Tor
9KT	XC6223B34BMR-G	LVR-IC	LDO, 3.45V±1%, 300mA, +CE, CL	SOT-25	28cx	VR4	6g	Tor
9KT	XC6113D425MR	Vdet-IC	2.5V±2%, -MR, +Reset PPO, Wt=200ms, Rt=100ms	SOT-25	28cp	VD17	6g	Tor
9KT	XC6209H25AMR	LVR-IC	LDO, 2.55V±2%, 300mA, -CE	SOT-25	28cx	VR4	6g	Tor
9KT	XC6212D25AMR	LVR-IC	LDO, 2.55V±2%, 150mA, -CE	SOT-25	28vt	VR4	6g	Tor
9KU	XC6209D26AMR	LVR-IC	LDO, 2.65V±2%, 150mA, -CE	SOT-25	28cx	VR4	6g	Tor
9KU	XC6223B35BMR-G	LVR-IC	LDO, 3.55V±1%, 300mA, +CE, CL	SOT-25	28cx	VR4	6g	Tor
9KU	XC6113D426MR	Vdet-IC	2.6V±2%, -MR, +Reset PPO, Wt=200ms, Rt=100ms	SOT-25	28cp	VD17	6g	Tor
9KU	XC6209H26AMR	LVR-IC	LDO, 2.65V±2%, 300mA, -CE	SOT-25	28cx	VR4	6g	Tor
9KU	XC6212D26AMR	LVR-IC	LDO, 2.65V±2%, 150mA, -CE	SOT-25	28vt	VR4	6g	Tor
9KV	XC6209D27AMR	LVR-IC	LDO, 2.75V±2%, 150mA, -CE	SOT-25	28cx	VR4	6g	Tor
9KV	XC6223B36BMR-G	LVR-IC	LDO, 3.65V±1%, 300mA, +CE, CL	SOT-25	28cx	VR4	6g	Tor
9KV	XC6113D427MR	Vdet-IC	2.7V±2%, -MR, +Reset PPO, Wt=200ms, Rt=100ms	SOT-25	28cp	VD17	6g	Tor
9KV	XC6209H27AMR	LVR-IC	LDO, 2.75V±2%, 300mA, -CE	SOT-25	28cx	VR4	6g	Tor
9KV	XC6212D27AMR	LVR-IC	LDO, 2.75V±2%, 150mA, -CE	SOT-25	28vt	VR4	6g	Tor
9KX	XC6209D28AMR	LVR-IC	LDO, 2.85V±2%, 150mA, -CE	SOT-25	28cx	VR4	6g	Tor
9KX	XC6223B37BMR-G	LVR-IC	LDO, 3.75V±1%, 300mA, +CE, CL	SOT-25	28cx	VR4	6g	Tor
9KX	XC6113D428MR	Vdet-IC	2.8V±2%, -MR, +Reset PPO, Wt=200ms, Rt=100ms	SOT-25	28cp	VD17	6g	Tor
9KX	XC6209H28AMR	LVR-IC	LDO, 2.85V±2%, 300mA, -CE	SOT-25	28cx	VR4	6g	Tor
9KX	XC6212D28AMR	LVR-IC	LDO, 2.85V±2%, 150mA, -CE	SOT-25	28vt	VR4	6g	Tor
9KY	XC6209D29AMR	LVR-IC	LDO, 2.95V±2%, 150mA, -CE	SOT-25	28cx	VR4	6g	Tor
9KY	XC6223B38BMR-G	LVR-IC	LDO, 3.85V±1%, 300mA, +CE, CL	SOT-25	28cx	VR4	6g	Tor
9KY	XC6113D429MR	Vdet-IC	2.9V±2%, -MR, +Reset PPO, Wt=200ms, Rt=100ms	SOT-25	28cp	VD17	6g	Tor
9KY	XC6209H29AMR	LVR-IC	LDO, 2.95V±2%, 300mA, -CE	SOT-25	28cx	VR4	6g	Tor
9KY	XC6212D29AMR	LVR-IC	LDO, 2.95V±2%, 150mA, -CE	SOT-25	28vt	VR4	6g	Tor
9KZ	XC6209D30AMR	LVR-IC	LDO, 3.05V±2%, 150mA, -CE	SOT-25	28cx	VR4	6g	Tor
9KZ	XC6223B39BMR-G	LVR-IC	LDO, 3.95V±1%, 300mA, +CE, CL	SOT-25	28cx	VR4	6g	Tor
9KZ	XC6113D430MR	Vdet-IC	3.0V±2%, -MR, +Reset PPO, Wt=200ms, Rt=100ms	SOT-25	28cp	VD17	6g	Tor
9KZ	XC6209H30AMR	LVR-IC	LDO, 3.05V±2%, 300mA, -CE	SOT-25	28cx	VR4	6g	Tor
9KZ	XC6212D30AMR	LVR-IC	LDO, 3.05V±2%, 150mA, -CE	SOT-25	28vt	VR4	6g	Tor
9L	R3111N391C	Vdet-IC	3.9V±2%, -Reset ODO	SOT-23-5	28vdm	VD6	6g	Ric
9L0	XC6209A31AMR	LVR-IC	LDO, 3.15V±2%, 150mA, +CE, PDR	SOT-25	28cx	VR4	6g	Tor
9L0	XC6113D531MR	Vdet-IC	3.1V±2%, -MR, +Reset PPO, Wt=400ms, Rt=100ms	SOT-25	28cp	VD17	6g	Tor
9L0	XC6209E31AMR	LVR-IC	LDO, 3.15V±2%, 300mA, +CE, PDR	SOT-25	28cx	VR4	6g	Tor
9L0	XC6212A31AMR	LVR-IC	LDO, 3.15V±2%, 150mA, +CE, PDR	SOT-25	28vt	VR4	6g	Tor
9L1	XC6209A32AMR	LVR-IC	LDO, 3.25V±2%, 150mA, +CE, PDR	SOT-25	28cx	VR4	6g	Tor
9L1	XC6113D532MR	Vdet-IC	3.2V±2%, -MR, +Reset PPO, Wt=400ms, Rt=100ms	SOT-25	28cp	VD17	6g	Tor
9L1	XC6209E32AMR	LVR-IC	LDO, 3.25V±2%, 300mA, +CE, PDR	SOT-25	28cx	VR4	6g	Tor
9L1	XC6212A32AMR	LVR-IC	LDO, 3.25V±2%, 150mA, +CE, PDR	SOT-25	28vt	VR4	6g	Tor
9L2	XC6209A33AMR	LVR-IC	LDO, 3.35V±2%, 150mA, +CE, PDR	SOT-25	28cx	VR4	6g	Tor
9L2	XC6223C121MR-G	LVR-IC	LDO, 1.2V±20mV, 300mA, +CE, PDR	SOT-25	28cx	VR4	6g	Tor
9L2	XC6113D533MR	Vdet-IC	3.3V±2%, -MR, +Reset PPO, Wt=400ms, Rt=100ms	SOT-25	28cp	VD17	6g	Tor
9L2	XC6209E33AMR	LVR-IC	LDO, 3.35V±2%, 300mA, +CE, PDR	SOT-25	28cx	VR4	6g	Tor
9L2	XC6212A33AMR	LVR-IC	LDO, 3.35V±2%, 150mA, +CE, PDR	SOT-25	28vt	VR4	6g	Tor
9L3	XC6209A34AMR	LVR-IC	LDO, 3.45V±2%, 150mA, +CE, PDR	SOT-25	28cx	VR4	6g	Tor
9L3	XC6223C131MR-G	LVR-IC	LDO, 1.3V±20mV, 300mA, +CE, PDR	SOT-25	28cx	VR4	6g	Tor
9L3	XC6113D534MR	Vdet-IC	3.4V±2%, -MR, +Reset PPO, Wt=400ms, Rt=100ms	SOT-25	28cp	VD17	6g	Tor
9L3	XC6209E34AMR	LVR-IC	LDO, 3.45V±2%, 300mA, +CE, PDR	SOT-25	28cx	VR4	6g	Tor
9L3	XC6212A34AMR	LVR-IC	LDO, 3.45V±2%, 150mA, +CE, PDR	SOT-25	28vt	VR4	6g	Tor
9L4	XC6209A35AMR	LVR-IC	LDO, 3.55V±2%, 150mA, +CE, PDR	SOT-25	28cx	VR4	6g	Tor
9L4	XC6223C141MR-G	LVR-IC	LDO, 1.4V±20mV, 300mA, +CE, PDR	SOT-25	28cx	VR4	6g	Tor
9L4	XC6113D535MR	Vdet-IC	3.5V±2%, -MR, +Reset PPO, Wt=400ms, Rt=100ms	SOT-25	28cp	VD17	6g	Tor
9L4	XC6209E35AMR	LVR-IC	LDO, 3.55V±2%, 300mA, +CE, PDR	SOT-25	28cx	VR4	6g	Tor
9L4	XC6212A35AMR	LVR-IC	LDO, 3.55V±2%, 150mA, +CE, PDR	SOT-25	28vt	VR4	6g	Tor
9L5	XC6209A36AMR	LVR-IC	LDO, 3.65V±2%, 150mA, +CE, PDR	SOT-25	28cx	VR4	6g	Tor
9L5	XC6223C151MR-G	LVR-IC	LDO, 1.5V±20mV, 300mA, +CE, PDR	SOT-25	28cx	VR4	6g	Tor
9L5	XC6113D536MR	Vdet-IC	3.6V±2%, -MR, +Reset PPO, Wt=400ms, Rt=100ms	SOT-25	28cp	VD17	6g	Tor
9L5	XC6209E36AMR	LVR-IC	LDO, 3.65V±2%, 300mA, +CE, PDR	SOT-25	28cx	VR4	6g	Tor



SMD code	Type	Function	Short description	Case	Pinout	Sch.	St.	Mnf.
9L5	XC6212A36AMR	LVR-IC	LDO, 3.65V±2%, 150mA, +CE, PDR	SOT-25	28vt	VR4	6g	Tor
9L6	XC6209A37AMR	LVR-IC	LDO, 3.75V±2%, 150mA, +CE, PDR	SOT-25	28cx	VR4	6g	Tor
9L6	XC6223C161MR-G	LVR-IC	LDO, 1.6V±20mV, 300mA, +CE, PDR	SOT-25	28cxv	VR4	6g	Tor
9L6	XC6113D537MR	Vdet-IC	3.7V±2%, -MR, +Reset PPO, Wt=400ms, Rt=100ms	SOT-25	28cp	VD17	6g	Tor
9L6	XC6209E37AMR	LVR-IC	LDO, 3.75V±2%, 300mA, +CE, PDR	SOT-25	28cx	VR4	6g	Tor
9L6	XC6212A37AMR	LVR-IC	LDO, 3.75V±2%, 150mA, +CE, PDR	SOT-25	28vt	VR4	6g	Tor
9L7	XC6209A38AMR	LVR-IC	LDO, 3.85V±2%, 150mA, +CE, PDR	SOT-25	28cx	VR4	6g	Tor
9L7	XC6223C171MR-G	LVR-IC	LDO, 1.7V±20mV, 300mA, +CE, PDR	SOT-25	28cx	VR4	6g	Tor
9L7	XC6113D538MR	Vdet-IC	3.8V±2%, -MR, +Reset PPO, Wt=400ms, Rt=100ms	SOT-25	28cp	VD17	6g	Tor
9L7	XC6209E38AMR	LVR-IC	LDO, 3.85V±2%, 300mA, +CE, PDR	SOT-25	28cx	VR4	6g	Tor
9L7	XC6212A38AMR	LVR-IC	LDO, 3.85V±2%, 150mA, +CE, PDR	SOT-25	28vt	VR4	6g	Tor
9L8	XC6209A39AMR	LVR-IC	LDO, 3.95V±2%, 150mA, +CE, PDR	SOT-25	28cx	VR4	6g	Tor
9L8	XC6223C181MR-G	LVR-IC	LDO, 1.8V±20mV, 300mA, +CE, PDR	SOT-25	28cx	VR4	6g	Tor
9L8	XC6113D539MR	Vdet-IC	3.9V±2%, -MR, +Reset PPO, Wt=400ms, Rt=100ms	SOT-25	28cp	VD17	6g	Tor
9L8	XC6209E39AMR	LVR-IC	LDO, 3.95V±2%, 300mA, +CE, PDR	SOT-25	28cx	VR4	6g	Tor
9L8	XC6212A39AMR	LVR-IC	LDO, 3.95V±2%, 150mA, +CE, PDR	SOT-25	28vt	VR4	6g	Tor
9L9	XC6209A40AMR	LVR-IC	LDO, 4.05V±2%, 150mA, +CE, PDR	SOT-25	28cx	VR4	6g	Tor
9L9	XC6223C191MR-G	LVR-IC	LDO, 1.9V±20mV, 300mA, +CE, PDR	SOT-25	28cx	VR4	6g	Tor
9L9	XC6113D540MR	Vdet-IC	4.0V±2%, -MR, +Reset PPO, Wt=400ms, Rt=100ms	SOT-25	28cp	VD17	6g	Tor
9L9	XC6209E40AMR	LVR-IC	LDO, 4.05V±2%, 300mA, +CE, PDR	SOT-25	28cx	VR4	6g	Tor
9L9	XC6212A40AMR	LVR-IC	LDO, 4.05V±2%, 150mA, +CE, PDR	SOT-25	28vt	VR4	6g	Tor
9LA	XC6209A41AMR	LVR-IC	LDO, 4.15V±2%, 150mA, +CE, PDR	SOT-25	28cx	VR4	6g	Tor
9LA	XC6223C201MR-G	LVR-IC	LDO, 2.0V±1%, 300mA, +CE, PDR	SOT-25	28cx	VR4	6g	Tor
9LA	XC6113D541MR	Vdet-IC	4.1V±2%, -MR, +Reset PPO, Wt=400ms, Rt=100ms	SOT-25	28cp	VD17	6g	Tor
9LA	XC6209E41AMR	LVR-IC	LDO, 4.15V±2%, 300mA, +CE, PDR	SOT-25	28cx	VR4	6g	Tor
9LA	XC6212A41AMR	LVR-IC	LDO, 4.15V±2%, 150mA, +CE, PDR	SOT-25	28vt	VR4	6g	Tor
9LB	XC6209A42AMR	LVR-IC	LDO, 4.25V±2%, 150mA, +CE, PDR	SOT-25	28cx	VR4	6g	Tor
9LB	XC6223C211MR-G	LVR-IC	LDO, 2.1V±1%, 300mA, +CE, PDR	SOT-25	28cx	VR4	6g	Tor
9LB	XC6113D542MR	Vdet-IC	4.2V±2%, -MR, +Reset PPO, Wt=400ms, Rt=100ms	SOT-25	28cp	VD17	6g	Tor
9LB	XC6209E42AMR	LVR-IC	LDO, 4.25V±2%, 300mA, +CE, PDR	SOT-25	28cx	VR4	6g	Tor
9LB	XC6212A42AMR	LVR-IC	LDO, 4.25V±2%, 150mA, +CE, PDR	SOT-25	28vt	VR4	6g	Tor
9LC	XC6209A43AMR	LVR-IC	LDO, 4.35V±2%, 150mA, +CE, PDR	SOT-25	28cx	VR4	6g	Tor
9LC	XC6223C221MR-G	LVR-IC	LDO, 2.2V±1%, 300mA, +CE, PDR	SOT-25	28cx	VR4	6g	Tor
9LC	XC6113D543MR	Vdet-IC	4.3V±2%, -MR, +Reset PPO, Wt=400ms, Rt=100ms	SOT-25	28cp	VD17	6g	Tor
9LC	XC6209E43AMR	LVR-IC	LDO, 4.35V±2%, 300mA, +CE, PDR	SOT-25	28cx	VR4	6g	Tor
9LC	XC6212A43AMR	LVR-IC	LDO, 4.35V±2%, 150mA, +CE, PDR	SOT-25	28vt	VR4	6g	Tor
9LD	XC6209A44AMR	LVR-IC	LDO, 4.45V±2%, 150mA, +CE, PDR	SOT-25	28cx	VR4	6g	Tor
9LD	XC6223C231MR-G	LVR-IC	LDO, 2.3V±1%, 300mA, +CE, PDR	SOT-25	28cx	VR4	6g	Tor
9LD	XC6113D544MR	Vdet-IC	4.4V±2%, -MR, +Reset PPO, Wt=400ms, Rt=100ms	SOT-25	28cp	VD17	6g	Tor
9LD	XC6209E44AMR	LVR-IC	LDO, 4.45V±2%, 300mA, +CE, PDR	SOT-25	28cx	VR4	6g	Tor
9LD	XC6212A44AMR	LVR-IC	LDO, 4.45V±2%, 150mA, +CE, PDR	SOT-25	28vt	VR4	6g	Tor
9LE	XC6209A45AMR	LVR-IC	LDO, 4.55V±2%, 150mA, +CE, PDR	SOT-25	28cx	VR4	6g	Tor
9LE	XC6223C241MR-G	LVR-IC	LDO, 2.4V±1%, 300mA, +CE, PDR	SOT-25	28cx	VR4	6g	Tor
9LE	XC6113D545MR	Vdet-IC	4.5V±2%, -MR, +Reset PPO, Wt=400ms, Rt=100ms	SOT-25	28cp	VD17	6g	Tor
9LE	XC6209E45AMR	LVR-IC	LDO, 4.55V±2%, 300mA, +CE, PDR	SOT-25	28cx	VR4	6g	Tor
9LE	XC6212A45AMR	LVR-IC	LDO, 4.55V±2%, 150mA, +CE, PDR	SOT-25	28vt	VR4	6g	Tor
9LF	XC6209A46AMR	LVR-IC	LDO, 4.65V±2%, 150mA, +CE, PDR	SOT-25	28cx	VR4	6g	Tor
9LF	XC6223C251MR-G	LVR-IC	LDO, 2.5V±1%, 300mA, +CE, PDR	SOT-25	28cx	VR4	6g	Tor
9LF	XC6113D516MR	Vdet-IC	1.6V±2%, -MR, +Reset PPO, Wt=400ms, Rt=100ms	SOT-25	28cp	VD17	6g	Tor
9LF	XC6113D546MR	Vdet-IC	4.6V±2%, -MR, +Reset PPO, Wt=400ms, Rt=100ms	SOT-25	28cp	VD17	6g	Tor
9LF	XC6209E46AMR	LVR-IC	LDO, 4.65V±2%, 300mA, +CE, PDR	SOT-25	28cx	VR4	6g	Tor
9LF	XC6212A46AMR	LVR-IC	LDO, 4.65V±2%, 150mA, +CE, PDR	SOT-25	28vt	VR4	6g	Tor
9LH	XC6209A47AMR	LVR-IC	LDO, 4.75V±2%, 150mA, +CE, PDR	SOT-25	28cx	VR4	6g	Tor
9LH	XC6223C261MR-G	LVR-IC	LDO, 2.6V±1%, 300mA, +CE, PDR	SOT-25	28cx	VR4	6g	Tor
9LH	XC6113D517MR	Vdet-IC	1.7V±2%, -MR, +Reset PPO, Wt=400ms, Rt=100ms	SOT-25	28cp	VD17	6g	Tor
9LH	XC6113D547MR	Vdet-IC	4.7V±2%, -MR, +Reset PPO, Wt=400ms, Rt=100ms	SOT-25	28cp	VD17	6g	Tor
9LH	XC6209E47AMR	LVR-IC	LDO, 4.75V±2%, 300mA, +CE, PDR	SOT-25	28cx	VR4	6g	Tor
9LH	XC6212A47AMR	LVR-IC	LDO, 4.75V±2%, 150mA, +CE, PDR	SOT-25	28vt	VR4	6g	Tor
9LK	XC6209A48AMR	LVR-IC	LDO, 4.85V±2%, 150mA, +CE, PDR	SOT-25	28cx	VR4	6g	Tor
9LK	XC6223C271MR-G	LVR-IC	LDO, 2.7V±1%, 300mA, +CE, PDR	SOT-25	28cx	VR4	6g	Tor
9LK	XC6113D518MR	Vdet-IC	1.8V±2%, -MR, +Reset PPO, Wt=400ms, Rt=100ms	SOT-25	28cp	VD17	6g	Tor
9LK	XC6113D548MR	Vdet-IC	4.8V±2%, -MR, +Reset PPO, Wt=400ms, Rt=100ms	SOT-25	28cp	VD17	6g	Tor
9LK	XC6209E48AMR	LVR-IC	LDO, 4.85V±2%, 300mA, +CE, PDR	SOT-25	28cx	VR4	6g	Tor
9LK	XC6212A48AMR	LVR-IC	LDO, 4.85V±2%, 150mA, +CE, PDR	SOT-25	28vt	VR4	6g	Tor
9LL	XC6209A49AMR	LVR-IC	LDO, 4.95V±2%, 150mA, +CE, PDR	SOT-25	28cx	VR4	6g	Tor
9LL	XC6223C281MR-G	LVR-IC	LDO, 2.8V±1%, 300mA, +CE, PDR	SOT-25	28cx	VR4	6g	Tor
9LL	XC6113D519MR	Vdet-IC	1.9V±2%, -MR, +Reset PPO, Wt=400ms, Rt=100ms	SOT-25	28cp	VD17	6g	Tor
9LL	XC6113D549MR	Vdet-IC	4.9V±2%, -MR, +Reset PPO, Wt=400ms, Rt=100ms	SOT-25	28cp	VD17	6g	Tor
9LL	XC6209E49AMR	LVR-IC	LDO, 4.95V±2%, 300mA, +CE, PDR	SOT-25	28cx	VR4	6g	Tor
9LL	XC6212A49AMR	LVR-IC	LDO, 4.95V±2%, 150mA, +CE, PDR	SOT-25	28vt	VR4	6g	Tor



SMD code	Type	Function	Short description	Case	Pinout	Sch.	St.	Mnf.
9LM	XC6209A50AMR	LVR-IC	LDO, 5.05V±2%, 150mA, +CE, PDR	SOT-25	28cx	VR4	6g	Tor
9LM	XC6223C291MR-G	LVR-IC	LDO, 2.9V±1%, 300mA, +CE, PDR	SOT-25	28cx	VR4	6g	Tor
9LM	XC6113D520MR	Vdet-IC	2.0V±2%, -MR, +Reset PPO, Wt=400ms, Rt=100ms	SOT-25	28cp	VD17	6g	Tor
9LM	XC6113D550MR	Vdet-IC	5.0V±2%, -MR, +Reset PPO, Wt=400ms, Rt=100ms	SOT-25	28cp	VD17	6g	Tor
9LM	XC6209E50AMR	LVR-IC	LDO, 5.05V±2%, 300mA, +CE, PDR	SOT-25	28cx	VR4	6g	Tor
9LM	XC6212A50AMR	LVR-IC	LDO, 5.05V±2%, 150mA, +CE, PDR	SOT-25	28vt	VR4	6g	Tor
9LN	XC6209A51AMR	LVR-IC	LDO, 5.15V±2%, 150mA, +CE, PDR	SOT-25	28cx	VR4	6g	Tor
9LN	XC6223C301MR-G	LVR-IC	LDO, 3.0V±1%, 300mA, +CE, PDR	SOT-25	28cx	VR4	6g	Tor
9LN	XC6113D521MR	Vdet-IC	2.1V±2%, -MR, +Reset PPO, Wt=400ms, Rt=100ms	SOT-25	28cp	VD17	6g	Tor
9LN	XC6209E51AMR	LVR-IC	LDO, 5.15V±2%, 300mA, +CE, PDR	SOT-25	28cx	VR4	6g	Tor
9LN	XC6212A51AMR	LVR-IC	LDO, 5.15V±2%, 150mA, +CE, PDR	SOT-25	28vt	VR4	6g	Tor
9LP	XC6209A52AMR	LVR-IC	LDO, 5.25V±2%, 150mA, +CE, PDR	SOT-25	28cx	VR4	6g	Tor
9LP	XC6223C311MR-G	LVR-IC	LDO, 3.1V±1%, 300mA, +CE, PDR	SOT-25	28cx	VR4	6g	Tor
9LP	XC6113D522MR	Vdet-IC	2.2V±2%, -MR, +Reset PPO, Wt=400ms, Rt=100ms	SOT-25	28cp	VD17	6g	Tor
9LP	XC6209E52AMR	LVR-IC	LDO, 5.25V±2%, 300mA, +CE, PDR	SOT-25	28cx	VR4	6g	Tor
9LP	XC6212A52AMR	LVR-IC	LDO, 5.25V±2%, 150mA, +CE, PDR	SOT-25	28vt	VR4	6g	Tor
9LR	XC6209A53AMR	LVR-IC	LDO, 5.35V±2%, 150mA, +CE, PDR	SOT-25	28cx	VR4	6g	Tor
9LR	XC6223C321MR-G	LVR-IC	LDO, 3.2V±1%, 300mA, +CE, PDR	SOT-25	28cx	VR4	6g	Tor
9LR	XC6113D523MR	Vdet-IC	2.3V±2%, -MR, +Reset PPO, Wt=400ms, Rt=100ms	SOT-25	28cp	VD17	6g	Tor
9LR	XC6209E53AMR	LVR-IC	LDO, 5.35V±2%, 300mA, +CE, PDR	SOT-25	28cx	VR4	6g	Tor
9LR	XC6212A53AMR	LVR-IC	LDO, 5.35V±2%, 150mA, +CE, PDR	SOT-25	28vt	VR4	6g	Tor
9LS	XC6209A54AMR	LVR-IC	LDO, 5.45V±2%, 150mA, +CE, PDR	SOT-25	28cx	VR4	6g	Tor
9LS	XC6223C331MR-G	LVR-IC	LDO, 3.3V±1%, 300mA, +CE, PDR	SOT-25	28cx	VR4	6g	Tor
9LS	XC6113D524MR	Vdet-IC	2.4V±2%, -MR, +Reset PPO, Wt=400ms, Rt=100ms	SOT-25	28cp	VD17	6g	Tor
9LS	XC6209E54AMR	LVR-IC	LDO, 5.45V±2%, 300mA, +CE, PDR	SOT-25	28cx	VR4	6g	Tor
9LS	XC6212A54AMR	LVR-IC	LDO, 5.45V±2%, 150mA, +CE, PDR	SOT-25	28vt	VR4	6g	Tor
9LT	XC6209A55AMR	LVR-IC	LDO, 5.55V±2%, 150mA, +CE, PDR	SOT-25	28cx	VR4	6g	Tor
9LT	XC6223C341MR-G	LVR-IC	LDO, 3.4V±1%, 300mA, +CE, PDR	SOT-25	28cx	VR4	6g	Tor
9LT	XC6113D525MR	Vdet-IC	2.5V±2%, -MR, +Reset PPO, Wt=400ms, Rt=100ms	SOT-25	28cp	VD17	6g	Tor
9LT	XC6209E55AMR	LVR-IC	LDO, 5.55V±2%, 300mA, +CE, PDR	SOT-25	28cx	VR4	6g	Tor
9LT	XC6212A55AMR	LVR-IC	LDO, 5.55V±2%, 150mA, +CE, PDR	SOT-25	28vt	VR4	6g	Tor
9LU	XC6209A56AMR	LVR-IC	LDO, 5.65V±2%, 150mA, +CE, PDR	SOT-25	28cx	VR4	6g	Tor
9LU	XC6223C351MR-G	LVR-IC	LDO, 3.5V±1%, 300mA, +CE, PDR	SOT-25	28cx	VR4	6g	Tor
9LU	XC6113D526MR	Vdet-IC	2.6V±2%, -MR, +Reset PPO, Wt=400ms, Rt=100ms	SOT-25	28cp	VD17	6g	Tor
9LU	XC6209E56AMR	LVR-IC	LDO, 5.65V±2%, 300mA, +CE, PDR	SOT-25	28cx	VR4	6g	Tor
9LU	XC6212A56AMR	LVR-IC	LDO, 5.65V±2%, 150mA, +CE, PDR	SOT-25	28vt	VR4	6g	Tor
9LV	XC6209A57AMR	LVR-IC	LDO, 5.75V±2%, 150mA, +CE, PDR	SOT-25	28cx	VR4	6g	Tor
9LV	XC6223C361MR-G	LVR-IC	LDO, 3.6V±1%, 300mA, +CE, PDR	SOT-25	28cx	VR4	6g	Tor
9LV	XC6113D527MR	Vdet-IC	2.7V±2%, -MR, +Reset PPO, Wt=400ms, Rt=100ms	SOT-25	28cp	VD17	6g	Tor
9LV	XC6209E57AMR	LVR-IC	LDO, 5.75V±2%, 300mA, +CE, PDR	SOT-25	28cx	VR4	6g	Tor
9LV	XC6212A57AMR	LVR-IC	LDO, 5.75V±2%, 150mA, +CE, PDR	SOT-25	28vt	VR4	6g	Tor
9LX	XC6209A58AMR	LVR-IC	LDO, 5.85V±2%, 150mA, +CE, PDR	SOT-25	28cx	VR4	6g	Tor
9LX	XC6223C371MR-G	LVR-IC	LDO, 3.7V±1%, 300mA, +CE, PDR	SOT-25	28cx	VR4	6g	Tor
9LX	XC6113D528MR	Vdet-IC	2.8V±2%, -MR, +Reset PPO, Wt=400ms, Rt=100ms	SOT-25	28cp	VD17	6g	Tor
9LX	XC6209E58AMR	LVR-IC	LDO, 5.85V±2%, 300mA, +CE, PDR	SOT-25	28cx	VR4	6g	Tor
9LX	XC6212A58AMR	LVR-IC	LDO, 5.85V±2%, 150mA, +CE, PDR	SOT-25	28vt	VR4	6g	Tor
9LY	XC6209A59AMR	LVR-IC	LDO, 5.95V±2%, 150mA, +CE, PDR	SOT-25	28cx	VR4	6g	Tor
9LY	XC6223C381MR-G	LVR-IC	LDO, 3.8V±1%, 300mA, +CE, PDR	SOT-25	28cx	VR4	6g	Tor
9LY	XC6113D529MR	Vdet-IC	2.9V±2%, -MR, +Reset PPO, Wt=400ms, Rt=100ms	SOT-25	28cp	VD17	6g	Tor
9LY	XC6209E59AMR	LVR-IC	LDO, 5.95V±2%, 300mA, +CE, PDR	SOT-25	28cx	VR4	6g	Tor
9LY	XC6212A59AMR	LVR-IC	LDO, 5.95V±2%, 150mA, +CE, PDR	SOT-25	28vt	VR4	6g	Tor
9LZ	XC6223C391MR-G	LVR-IC	LDO, 3.9V±1%, 300mA, +CE, PDR	SOT-25	28cx	VR4	6g	Tor
9LZ	XC6113D530MR	Vdet-IC	3.0V±2%, -MR, +Reset PPO, Wt=400ms, Rt=100ms	SOT-25	28cp	VD17	6g	Tor
9M	R3111N491C	Vdet-IC	4.9V±2%, -Reset ODO	SOT-23-5	28vdm	VD6	6g	Ric
9M0	XC6209B31AMR	LVR-IC	LDO, 3.15V±2%, 150mA, +CE	SOT-25	28cx	VR4	6g	Tor
9M0	XC6223C401MR-G	LVR-IC	LDO, 4.0V±1%, 300mA, +CE, PDR	SOT-25	28cx	VR4	6g	Tor
9M0	XC6113D631MR	Vdet-IC	3.1V±2%, -MR, +Reset PPO, Wt=1.6s, Rt=100ms	SOT-25	28cp	VD17	6g	Tor
9M0	XC6209F31AMR	LVR-IC	LDO, 3.15V±2%, 300mA, +CE	SOT-25	28cx	VR4	6g	Tor
9M0	XC6212B31AMR	LVR-IC	LDO, 3.15V±2%, 150mA, +CE	SOT-25	28vt	VR4	6g	Tor
9M1	XC6209B32AMR	LVR-IC	LDO, 3.25V±2%, 150mA, +CE	SOT-25	28cx	VR4	6g	Tor
9M1	XC6113D632MR	Vdet-IC	3.2V±2%, -MR, +Reset PPO, Wt=1.6s, Rt=100ms	SOT-25	28cp	VD17	6g	Tor
9M1	XC6209F32AMR	LVR-IC	LDO, 3.25V±2%, 300mA, +CE	SOT-25	28cx	VR4	6g	Tor
9M1	XC6212B32AMR	LVR-IC	LDO, 3.25V±2%, 150mA, +CE	SOT-25	28vt	VR4	6g	Tor
9M2	XC6209B33AMR	LVR-IC	LDO, 3.35V±2%, 150mA, +CE	SOT-25	28cx	VR4	6g	Tor
9M2	XC6113D633MR	Vdet-IC	3.3V±2%, -MR, +Reset PPO, Wt=1.6s, Rt=100ms	SOT-25	28cp	VD17	6g	Tor
9M2	XC6209F33AMR	LVR-IC	LDO, 3.35V±2%, 300mA, +CE	SOT-25	28cx	VR4	6g	Tor
9M2	XC6212B33AMR	LVR-IC	LDO, 3.35V±2%, 150mA, +CE	SOT-25	28vt	VR4	6g	Tor
9M3	XC6209B34AMR	LVR-IC	LDO, 3.45V±2%, 150mA, +CE	SOT-25	28cx	VR4	6g	Tor
9M3	XC6113D634MR	Vdet-IC	3.4V±2%, -MR, +Reset PPO, Wt=1.6s, Rt=100ms	SOT-25	28cp	VD17	6g	Tor
9M3	XC6209F34AMR	LVR-IC	LDO, 3.45V±2%, 300mA, +CE	SOT-25	28cx	VR4	6g	Tor



SMD code	Type	Function	Short description	Case	Pinout	Sch.	St.	Mnf.
9M3	XC6212B34AMR	LVR-IC	LDO, 3.45V±2%, 150mA, +CE	SOT-25	28vt	VR4	6g	Tor
9M4	XC6209B35AMR	LVR-IC	LDO, 3.55V±2%, 150mA, +CE	SOT-25	28cx	VR4	6g	Tor
9M4	XC6113D635MR	Vdet-IC	3.5V±2%, -MR, +Reset PPO, Wt=1.6s, Rt=100ms	SOT-25	28cp	VD17	6g	Tor
9M4	XC6209F35AMR	LVR-IC	LDO, 3.55V±2%, 300mA, +CE	SOT-25	28cx	VR4	6g	Tor
9M4	XC6212B35AMR	LVR-IC	LDO, 3.55V±2%, 150mA, +CE	SOT-25	28vt	VR4	6g	Tor
9M5	XC6209B36AMR	LVR-IC	LDO, 3.65V±2%, 150mA, +CE	SOT-25	28cx	VR4	6g	Tor
9M5	XC6113D636MR	Vdet-IC	3.6V±2%, -MR, +Reset PPO, Wt=1.6s, Rt=100ms	SOT-25	28cp	VD17	6g	Tor
9M5	XC6209F36AMR	LVR-IC	LDO, 3.65V±2%, 300mA, +CE	SOT-25	28cx	VR4	6g	Tor
9M5	XC6212B36AMR	LVR-IC	LDO, 3.65V±2%, 150mA, +CE	SOT-25	28vt	VR4	6g	Tor
9M6	XC6209B37AMR	LVR-IC	LDO, 3.75V±2%, 150mA, +CE	SOT-25	28cx	VR4	6g	Tor
9M6	XC6113D637MR	Vdet-IC	3.7V±2%, -MR, +Reset PPO, Wt=1.6s, Rt=100ms	SOT-25	28cp	VD17	6g	Tor
9M6	XC6209F37AMR	LVR-IC	LDO, 3.75V±2%, 300mA, +CE	SOT-25	28cx	VR4	6g	Tor
9M6	XC6212B37AMR	LVR-IC	LDO, 3.75V±2%, 150mA, +CE	SOT-25	28vt	VR4	6g	Tor
9M7	XC6209B38AMR	LVR-IC	LDO, 3.85V±2%, 150mA, +CE	SOT-25	28cx	VR4	6g	Tor
9M7	XC6113D638MR	Vdet-IC	3.8V±2%, -MR, +Reset PPO, Wt=1.6s, Rt=100ms	SOT-25	28cp	VD17	6g	Tor
9M7	XC6209F38AMR	LVR-IC	LDO, 3.85V±2%, 300mA, +CE	SOT-25	28cx	VR4	6g	Tor
9M7	XC6212B38AMR	LVR-IC	LDO, 3.85V±2%, 150mA, +CE	SOT-25	28vt	VR4	6g	Tor
9M8	XC6209B39AMR	LVR-IC	LDO, 3.95V±2%, 150mA, +CE	SOT-25	28cx	VR4	6g	Tor
9M8	XC6113D639MR	Vdet-IC	3.9V±2%, -MR, +Reset PPO, Wt=1.6s, Rt=100ms	SOT-25	28cp	VD17	6g	Tor
9M8	XC6209F39AMR	LVR-IC	LDO, 3.95V±2%, 300mA, +CE	SOT-25	28cx	VR4	6g	Tor
9M8	XC6212B39AMR	LVR-IC	LDO, 3.95V±2%, 150mA, +CE	SOT-25	28vt	VR4	6g	Tor
9M9	XC6209B40AMR	LVR-IC	LDO, 4.05V±2%, 150mA, +CE	SOT-25	28cx	VR4	6g	Tor
9M9	XC6113D640MR	Vdet-IC	4.0V±2%, -MR, +Reset PPO, Wt=1.6s, Rt=100ms	SOT-25	28cp	VD17	6g	Tor
9M9	XC6209F40AMR	LVR-IC	LDO, 4.05V±2%, 300mA, +CE	SOT-25	28cx	VR4	6g	Tor
9M9	XC6212B40AMR	LVR-IC	LDO, 4.05V±2%, 150mA, +CE	SOT-25	28vt	VR4	6g	Tor
9MA	XC6209B41AMR	LVR-IC	LDO, 4.15V±2%, 150mA, +CE	SOT-25	28cx	VR4	6g	Tor
9MA	XC6113D641MR	Vdet-IC	4.1V±2%, -MR, +Reset PPO, Wt=1.6s, Rt=100ms	SOT-25	28cp	VD17	6g	Tor
9MA	XC6209F41AMR	LVR-IC	LDO, 4.15V±2%, 300mA, +CE	SOT-25	28cx	VR4	6g	Tor
9MA	XC6212B41AMR	LVR-IC	LDO, 4.15V±2%, 150mA, +CE	SOT-25	28vt	VR4	6g	Tor
9MB	XC6209B42AMR	LVR-IC	LDO, 4.25V±2%, 150mA, +CE	SOT-25	28cx	VR4	6g	Tor
9MB	XC6113D642MR	Vdet-IC	4.2V±2%, -MR, +Reset PPO, Wt=1.6s, Rt=100ms	SOT-25	28cp	VD17	6g	Tor
9MB	XC6209F42AMR	LVR-IC	LDO, 4.25V±2%, 300mA, +CE	SOT-25	28cx	VR4	6g	Tor
9MB	XC6212B42AMR	LVR-IC	LDO, 4.25V±2%, 150mA, +CE	SOT-25	28vt	VR4	6g	Tor
9MC	XC6209B43AMR	LVR-IC	LDO, 4.35V±2%, 150mA, +CE	SOT-25	28cx	VR4	6g	Tor
9MC	XC6113D643MR	Vdet-IC	4.3V±2%, -MR, +Reset PPO, Wt=1.6s, Rt=100ms	SOT-25	28cp	VD17	6g	Tor
9MC	XC6209F43AMR	LVR-IC	LDO, 4.35V±2%, 300mA, +CE	SOT-25	28cx	VR4	6g	Tor
9MC	XC6212B43AMR	LVR-IC	LDO, 4.35V±2%, 150mA, +CE	SOT-25	28vt	VR4	6g	Tor
9MD	XC6209B44AMR	LVR-IC	LDO, 4.45V±2%, 150mA, +CE	SOT-25	28cx	VR4	6g	Tor
9MD	XC6113D644MR	Vdet-IC	4.4V±2%, -MR, +Reset PPO, Wt=1.6s, Rt=100ms	SOT-25	28cp	VD17	6g	Tor
9MD	XC6209F44AMR	LVR-IC	LDO, 4.45V±2%, 300mA, +CE	SOT-25	28cx	VR4	6g	Tor
9MD	XC6212B44AMR	LVR-IC	LDO, 4.45V±2%, 150mA, +CE	SOT-25	28vt	VR4	6g	Tor
9ME	XC6209B45AMR	LVR-IC	LDO, 4.55V±2%, 150mA, +CE	SOT-25	28cx	VR4	6g	Tor
9ME	XC6113D645MR	Vdet-IC	4.5V±2%, -MR, +Reset PPO, Wt=1.6s, Rt=100ms	SOT-25	28cp	VD17	6g	Tor
9ME	XC6209F45AMR	LVR-IC	LDO, 4.55V±2%, 300mA, +CE	SOT-25	28cx	VR4	6g	Tor
9ME	XC6212B45AMR	LVR-IC	LDO, 4.55V±2%, 150mA, +CE	SOT-25	28vt	VR4	6g	Tor
9MF	XC6209B46AMR	LVR-IC	LDO, 4.65V±2%, 150mA, +CE	SOT-25	28cx	VR4	6g	Tor
9MF	XC6113D616MR	Vdet-IC	1.6V±2%, -MR, +Reset PPO, Wt=1.6s, Rt=100ms	SOT-25	28cp	VD17	6g	Tor
9MF	XC6113D646MR	Vdet-IC	4.6V±2%, -MR, +Reset PPO, Wt=1.6s, Rt=100ms	SOT-25	28cp	VD17	6g	Tor
9MF	XC6209F46AMR	LVR-IC	LDO, 4.65V±2%, 300mA, +CE	SOT-25	28cx	VR4	6g	Tor
9MF	XC6212B46AMR	LVR-IC	LDO, 4.65V±2%, 150mA, +CE	SOT-25	28vt	VR4	6g	Tor
9MH	XC6209B47AMR	LVR-IC	LDO, 4.75V±2%, 150mA, +CE	SOT-25	28cx	VR4	6g	Tor
9MH	XC6113D617MR	Vdet-IC	1.7V±2%, -MR, +Reset PPO, Wt=1.6s, Rt=100ms	SOT-25	28cp	VD17	6g	Tor
9MH	XC6113D647MR	Vdet-IC	4.7V±2%, -MR, +Reset PPO, Wt=1.6s, Rt=100ms	SOT-25	28cp	VD17	6g	Tor
9MH	XC6209F47AMR	LVR-IC	LDO, 4.75V±2%, 300mA, +CE	SOT-25	28cx	VR4	6g	Tor
9MH	XC6212B47AMR	LVR-IC	LDO, 4.75V±2%, 150mA, +CE	SOT-25	28vt	VR4	6g	Tor
9MK	XC6209B48AMR	LVR-IC	LDO, 4.85V±2%, 150mA, +CE	SOT-25	28cx	VR4	6g	Tor
9MK	XC6113D618MR	Vdet-IC	1.8V±2%, -MR, +Reset PPO, Wt=1.6s, Rt=100ms	SOT-25	28cp	VD17	6g	Tor
9MK	XC6113D648MR	Vdet-IC	4.8V±2%, -MR, +Reset PPO, Wt=1.6s, Rt=100ms	SOT-25	28cp	VD17	6g	Tor
9MK	XC6209F48AMR	LVR-IC	LDO, 4.85V±2%, 300mA, +CE	SOT-25	28cx	VR4	6g	Tor
9MK	XC6212B48AMR	LVR-IC	LDO, 4.85V±2%, 150mA, +CE	SOT-25	28vt	VR4	6g	Tor
9ML	XC6209B49AMR	LVR-IC	LDO, 4.95V±2%, 150mA, +CE	SOT-25	28cx	VR4	6g	Tor
9ML	XC6113D619MR	Vdet-IC	1.9V±2%, -MR, +Reset PPO, Wt=1.6s, Rt=100ms	SOT-25	28cp	VD17	6g	Tor
9ML	XC6113D649MR	Vdet-IC	4.9V±2%, -MR, +Reset PPO, Wt=1.6s, Rt=100ms	SOT-25	28cp	VD17	6g	Tor
9ML	XC6209F49AMR	LVR-IC	LDO, 4.95V±2%, 300mA, +CE	SOT-25	28cx	VR4	6g	Tor
9ML	XC6212B49AMR	LVR-IC	LDO, 4.95V±2%, 150mA, +CE	SOT-25	28vt	VR4	6g	Tor
9MM	XC6209B50AMR	LVR-IC	LDO, 5.05V±2%, 150mA, +CE	SOT-25	28cx	VR4	6g	Tor
9MM	XC6113D620MR	Vdet-IC	2.0V±2%, -MR, +Reset PPO, Wt=1.6s, Rt=100ms	SOT-25	28cp	VD17	6g	Tor
9MM	XC6113D650MR	Vdet-IC	5.0V±2%, -MR, +Reset PPO, Wt=1.6s, Rt=100ms	SOT-25	28cp	VD17	6g	Tor
9MM	XC6209F50AMR	LVR-IC	LDO, 5.05V±2%, 300mA, +CE	SOT-25	28cx	VR4	6g	Tor
9MM	XC6212B50AMR	LVR-IC	LDO, 5.05V±2%, 150mA, +CE	SOT-25	28vt	VR4	6g	Tor



SMD code	Type	Function	Short description	Case	Pinout	Sch.	St.	Mnf.
9MN	XC6209B51AMR	LVR-IC	LDO, 5.15V±2%, 150mA, +CE	SOT-25	28cx	VR4	6g	Tor
9MN	XC6113D621MR	Vdet-IC	2.1V±2%, -MR, +Reset PPO, Wt=1.6s, Rt=100ms	SOT-25	28cp	VD17	6g	Tor
9MN	XC6209F51AMR	LVR-IC	LDO, 5.15V±2%, 300mA, +CE	SOT-25	28cx	VR4	6g	Tor
9MN	XC6212B51AMR	LVR-IC	LDO, 5.15V±2%, 150mA, +CE	SOT-25	28vt	VR4	6g	Tor
9MP	XC6209B52AMR	LVR-IC	LDO, 5.25V±2%, 150mA, +CE	SOT-25	28cx	VR4	6g	Tor
9MP	XC6113D622MR	Vdet-IC	2.2V±2%, -MR, +Reset PPO, Wt=1.6s, Rt=100ms	SOT-25	28cp	VD17	6g	Tor
9MP	XC6209F52AMR	LVR-IC	LDO, 5.25V±2%, 300mA, +CE	SOT-25	28cx	VR4	6g	Tor
9MP	XC6212B52AMR	LVR-IC	LDO, 5.25V±2%, 150mA, +CE	SOT-25	28vt	VR4	6g	Tor
9MR	XC6209B53AMR	LVR-IC	LDO, 5.35V±2%, 150mA, +CE	SOT-25	28cx	VR4	6g	Tor
9MR	XC6113D623MR	Vdet-IC	2.3V±2%, -MR, +Reset PPO, Wt=1.6s, Rt=100ms	SOT-25	28cp	VD17	6g	Tor
9MR	XC6209F53AMR	LVR-IC	LDO, 5.35V±2%, 300mA, +CE	SOT-25	28cx	VR4	6g	Tor
9MR	XC6212B53AMR	LVR-IC	LDO, 5.35V±2%, 150mA, +CE	SOT-25	28vt	VR4	6g	Tor
9MS	XC6209B54AMR	LVR-IC	LDO, 5.45V±2%, 150mA, +CE	SOT-25	28cx	VR4	6g	Tor
9MS	XC6113D624MR	Vdet-IC	2.4V±2%, -MR, +Reset PPO, Wt=1.6s, Rt=100ms	SOT-25	28cp	VD17	6g	Tor
9MS	XC6209F54AMR	LVR-IC	LDO, 5.45V±2%, 300mA, +CE	SOT-25	28cx	VR4	6g	Tor
9MS	XC6212B54AMR	LVR-IC	LDO, 5.45V±2%, 150mA, +CE	SOT-25	28vt	VR4	6g	Tor
9MT	XC6209B55AMR	LVR-IC	LDO, 5.55V±2%, 150mA, +CE	SOT-25	28cx	VR4	6g	Tor
9MT	XC6113D625MR	Vdet-IC	2.5V±2%, -MR, +Reset PPO, Wt=1.6s, Rt=100ms	SOT-25	28cp	VD17	6g	Tor
9MT	XC6209F55AMR	LVR-IC	LDO, 5.55V±2%, 300mA, +CE	SOT-25	28cx	VR4	6g	Tor
9MT	XC6212B55AMR	LVR-IC	LDO, 5.55V±2%, 150mA, +CE	SOT-25	28vt	VR4	6g	Tor
9MU	XC6209B56AMR	LVR-IC	LDO, 5.65V±2%, 150mA, +CE	SOT-25	28cx	VR4	6g	Tor
9MU	XC6113D626MR	Vdet-IC	2.6V±2%, -MR, +Reset PPO, Wt=1.6s, Rt=100ms	SOT-25	28cp	VD17	6g	Tor
9MU	XC6209F56AMR	LVR-IC	LDO, 5.65V±2%, 300mA, +CE	SOT-25	28cx	VR4	6g	Tor
9MU	XC6212B56AMR	LVR-IC	LDO, 5.65V±2%, 150mA, +CE	SOT-25	28vt	VR4	6g	Tor
9MV	XC6209B57AMR	LVR-IC	LDO, 5.75V±2%, 150mA, +CE	SOT-25	28cx	VR4	6g	Tor
9MV	XC6113D627MR	Vdet-IC	2.7V±2%, -MR, +Reset PPO, Wt=1.6s, Rt=100ms	SOT-25	28cp	VD17	6g	Tor
9MV	XC6209F57AMR	LVR-IC	LDO, 5.75V±2%, 300mA, +CE	SOT-25	28cx	VR4	6g	Tor
9MV	XC6212B57AMR	LVR-IC	LDO, 5.75V±2%, 150mA, +CE	SOT-25	28vt	VR4	6g	Tor
9MX	XC6209B58AMR	LVR-IC	LDO, 5.85V±2%, 150mA, +CE	SOT-25	28cx	VR4	6g	Tor
9MX	XC6113D628MR	Vdet-IC	2.8V±2%, -MR, +Reset PPO, Wt=1.6s, Rt=100ms	SOT-25	28cp	VD17	6g	Tor
9MX	XC6209F58AMR	LVR-IC	LDO, 5.85V±2%, 300mA, +CE	SOT-25	28cx	VR4	6g	Tor
9MX	XC6212B58AMR	LVR-IC	LDO, 5.85V±2%, 150mA, +CE	SOT-25	28vt	VR4	6g	Tor
9MY	XC6209B59AMR	LVR-IC	LDO, 5.95V±2%, 150mA, +CE	SOT-25	28cx	VR4	6g	Tor
9MY	XC6113D629MR	Vdet-IC	2.9V±2%, -MR, +Reset PPO, Wt=1.6s, Rt=100ms	SOT-25	28cp	VD17	6g	Tor
9MY	XC6209F59AMR	LVR-IC	LDO, 5.95V±2%, 300mA, +CE	SOT-25	28cx	VR4	6g	Tor
9MY	XC6212B59AMR	LVR-IC	LDO, 5.95V±2%, 150mA, +CE	SOT-25	28vt	VR4	6g	Tor
9MZ	XC6113D630MR	Vdet-IC	3.0V±2%, -MR, +Reset PPO, Wt=1.6s, Rt=100ms	SOT-25	28cp	VD17	6g	Tor
9N	R3111N591C	Vdet-IC	5.9V±2%, -Reset ODO	SOT-23-5	28vdrn	VD06	6g	Ric
9N0	XC6209C31AMR	LVR-IC	LDO, 3.15V±2%, 150mA, -CE, PDR	SOT-25	28cx	VR4	6g	Tor
9N0	XC6209G31AMR	LVR-IC	LDO, 3.15V±2%, 300mA, -CE, PDR	SOT-25	28cx	VR4	6g	Tor
9N0	XC6212C31AMR	LVR-IC	LDO, 3.15V±2%, 150mA, -CE, PDR	SOT-25	28vt	VR4	6g	Tor
9N1	XC6209C32AMR	LVR-IC	LDO, 3.25V±2%, 150mA, -CE, PDR	SOT-25	28cx	VR4	6g	Tor
9N1	XC6209G32AMR	LVR-IC	LDO, 3.25V±2%, 300mA, -CE, PDR	SOT-25	28cx	VR4	6g	Tor
9N1	XC6212C32AMR	LVR-IC	LDO, 3.25V±2%, 150mA, -CE, PDR	SOT-25	28vt	VR4	6g	Tor
9N2	XC6209C33AMR	LVR-IC	LDO, 3.35V±2%, 150mA, -CE, PDR	SOT-25	28cx	VR4	6g	Tor
9N2	XC6223C12BMR-G	LVR-IC	LDO, 1.25V±20mV, 300mA, +CE, PDR	SOT-25	28cx	VR4	6g	Tor
9N2	XC6209G33AMR	LVR-IC	LDO, 3.35V±2%, 300mA, -CE, PDR	SOT-25	28cx	VR4	6g	Tor
9N2	XC6212C33AMR	LVR-IC	LDO, 3.35V±2%, 150mA, -CE, PDR	SOT-25	28vt	VR4	6g	Tor
9N3	XC6209C34AMR	LVR-IC	LDO, 3.45V±2%, 150mA, -CE, PDR	SOT-25	28cx	VR4	6g	Tor
9N3	XC6223C13BMR-G	LVR-IC	LDO, 1.35V±20mV, 300mA, +CE, PDR	SOT-25	28cx	VR4	6g	Tor
9N3	XC6209G34AMR	LVR-IC	LDO, 3.45V±2%, 300mA, -CE, PDR	SOT-25	28cx	VR4	6g	Tor
9N3	XC6212C34AMR	LVR-IC	LDO, 3.45V±2%, 150mA, -CE, PDR	SOT-25	28vt	VR4	6g	Tor
9N4	XC6209C35AMR	LVR-IC	LDO, 3.55V±2%, 150mA, -CE, PDR	SOT-25	28cx	VR4	6g	Tor
9N4	XC6223C14BMR-G	LVR-IC	LDO, 1.45V±20mV, 300mA, +CE, PDR	SOT-25	28cx	VR4	6g	Tor
9N4	XC6209G35AMR	LVR-IC	LDO, 3.55V±2%, 300mA, -CE, PDR	SOT-25	28cx	VR4	6g	Tor
9N4	XC6212C35AMR	LVR-IC	LDO, 3.55V±2%, 150mA, -CE, PDR	SOT-25	28vt	VR4	6g	Tor
9N5	XC6209C36AMR	LVR-IC	LDO, 3.65V±2%, 150mA, -CE, PDR	SOT-25	28cx	VR4	6g	Tor
9N5	XC6223C15BMR-G	LVR-IC	LDO, 1.55V±20mV, 300mA, +CE, PDR	SOT-25	28cx	VR4	6g	Tor
9N5	XC6209G36AMR	LVR-IC	LDO, 3.65V±2%, 300mA, -CE, PDR	SOT-25	28cx	VR4	6g	Tor
9N5	XC6212C36AMR	LVR-IC	LDO, 3.65V±2%, 150mA, -CE, PDR	SOT-25	28vt	VR4	6g	Tor
9N6	XC6209C37AMR	LVR-IC	LDO, 3.75V±2%, 150mA, -CE, PDR	SOT-25	28cx	VR4	6g	Tor
9N6	XC6223C16BMR-G	LVR-IC	LDO, 1.65V±20mV, 300mA, +CE, PDR	SOT-25	28cx	VR4	6g	Tor
9N6	XC6209G37AMR	LVR-IC	LDO, 3.75V±2%, 300mA, -CE, PDR	SOT-25	28cx	VR4	6g	Tor
9N6	XC6212C37AMR	LVR-IC	LDO, 3.75V±2%, 150mA, -CE, PDR	SOT-25	28vt	VR4	6g	Tor
9N7	XC6209C38AMR	LVR-IC	LDO, 3.85V±2%, 150mA, -CE, PDR	SOT-25	28cx	VR4	6g	Tor
9N7	XC6223C17BMR-G	LVR-IC	LDO, 1.75V±20mV, 300mA, +CE, PDR	SOT-25	28cx	VR4	6g	Tor
9N7	XC6209G38AMR	LVR-IC	LDO, 3.85V±2%, 300mA, -CE, PDR	SOT-25	28cx	VR4	6g	Tor
9N7	XC6212C38AMR	LVR-IC	LDO, 3.85V±2%, 150mA, -CE, PDR	SOT-25	28vt	VR4	6g	Tor
9N8	XC6209C39AMR	LVR-IC	LDO, 3.95V±2%, 150mA, -CE, PDR	SOT-25	28cx	VR4	6g	Tor
9N8	XC6223C18BMR-G	LVR-IC	LDO, 1.85V±20mV, 300mA, +CE, PDR	SOT-25	28cx	VR4	6g	Tor



SMD code	Type	Function	Short description	Case	Pinout	Sch.	St.	Mnf.
9N8	XC6209G39AMR	LVR-IC	LDO, 3.95V±2%, 300mA, -CE, PDR	SOT-25	28cx	VR4	6g	Tor
9N8	XC6212C39AMR	LVR-IC	LDO, 3.95V±2%, 150mA, -CE, PDR	SOT-25	28vt	VR4	6g	Tor
9N9	XC6209C40AMR	LVR-IC	LDO, 4.05V±2%, 150mA, -CE, PDR	SOT-25	28cx	VR4	6g	Tor
9N9	XC6223C19BMR-G	LVR-IC	LDO, 1.95V±20mV, 300mA, +CE, PDR	SOT-25	28cx	VR4	6g	Tor
9N9	XC6209G40AMR	LVR-IC	LDO, 4.05V±2%, 300mA, -CE, PDR	SOT-25	28cx	VR4	6g	Tor
9N9	XC6212C40AMR	LVR-IC	LDO, 4.05V±2%, 150mA, -CE, PDR	SOT-25	28vt	VR4	6g	Tor
9NA	XC6209C41AMR	LVR-IC	LDO, 4.15V±2%, 150mA, -CE, PDR	SOT-25	28cx	VR4	6g	Tor
9NA	XC6223C20BMR-G	LVR-IC	LDO, 2.05V±1%, 300mA, +CE, PDR	SOT-25	28cx	VR4	6g	Tor
9NA	XC6209G41AMR	LVR-IC	LDO, 4.15V±2%, 300mA, -CE, PDR	SOT-25	28cx	VR4	6g	Tor
9NA	XC6212C41AMR	LVR-IC	LDO, 4.15V±2%, 150mA, -CE, PDR	SOT-25	28vt	VR4	6g	Tor
9NB	XC6209C42AMR	LVR-IC	LDO, 4.25V±2%, 150mA, -CE, PDR	SOT-25	28cx	VR4	6g	Tor
9NB	XC6223C21BMR-G	LVR-IC	LDO, 2.15V±1%, 300mA, +CE, PDR	SOT-25	28cx	VR4	6g	Tor
9NB	XC6209G42AMR	LVR-IC	LDO, 4.25V±2%, 300mA, -CE, PDR	SOT-25	28cx	VR4	6g	Tor
9NB	XC6212C42AMR	LVR-IC	LDO, 4.25V±2%, 150mA, -CE, PDR	SOT-25	28vt	VR4	6g	Tor
9NC	XC6209C43AMR	LVR-IC	LDO, 4.35V±2%, 150mA, -CE, PDR	SOT-25	28cx	VR4	6g	Tor
9NC	XC6223C22BMR-G	LVR-IC	LDO, 2.25V±1%, 300mA, +CE, PDR	SOT-25	28cx	VR4	6g	Tor
9NC	XC6209G43AMR	LVR-IC	LDO, 4.35V±2%, 300mA, -CE, PDR	SOT-25	28cx	VR4	6g	Tor
9NC	XC6212C43AMR	LVR-IC	LDO, 4.35V±2%, 150mA, -CE, PDR	SOT-25	28vt	VR4	6g	Tor
9ND	XC6209C44AMR	LVR-IC	LDO, 4.45V±2%, 150mA, -CE, PDR	SOT-25	28cx	VR4	6g	Tor
9ND	XC6223C23BMR-G	LVR-IC	LDO, 2.35V±1%, 300mA, +CE, PDR	SOT-25	28cx	VR4	6g	Tor
9ND	XC6209G44AMR	LVR-IC	LDO, 4.45V±2%, 300mA, -CE, PDR	SOT-25	28cx	VR4	6g	Tor
9ND	XC6212C44AMR	LVR-IC	LDO, 4.45V±2%, 150mA, -CE, PDR	SOT-25	28vt	VR4	6g	Tor
9NE	XC6209C45AMR	LVR-IC	LDO, 4.55V±2%, 150mA, -CE, PDR	SOT-25	28cx	VR4	6g	Tor
9NE	XC6223C24BMR-G	LVR-IC	LDO, 2.45V±1%, 300mA, +CE, PDR	SOT-25	28cx	VR4	6g	Tor
9NE	XC6209G45AMR	LVR-IC	LDO, 4.55V±2%, 300mA, -CE, PDR	SOT-25	28cx	VR4	6g	Tor
9NE	XC6212C45AMR	LVR-IC	LDO, 4.55V±2%, 150mA, -CE, PDR	SOT-25	28vt	VR4	6g	Tor
9NF	XC6209C46AMR	LVR-IC	LDO, 4.65V±2%, 150mA, -CE, PDR	SOT-25	28cx	VR4	6g	Tor
9NF	XC6223C25BMR-G	LVR-IC	LDO, 2.55V±1%, 300mA, +CE, PDR	SOT-25	28cx	VR4	6g	Tor
9NF	XC6209G46AMR	LVR-IC	LDO, 4.65V±2%, 300mA, -CE, PDR	SOT-25	28cx	VR4	6g	Tor
9NF	XC6212C46AMR	LVR-IC	LDO, 4.65V±2%, 150mA, -CE, PDR	SOT-25	28vt	VR4	6g	Tor
9NH	XC6209C47AMR	LVR-IC	LDO, 4.75V±2%, 150mA, -CE, PDR	SOT-25	28cx	VR4	6g	Tor
9NH	XC6223C26BMR-G	LVR-IC	LDO, 2.65V±1%, 300mA, +CE, PDR	SOT-25	28cx	VR4	6g	Tor
9NH	XC6209G47AMR	LVR-IC	LDO, 4.75V±2%, 300mA, -CE, PDR	SOT-25	28cx	VR4	6g	Tor
9NH	XC6212C47AMR	LVR-IC	LDO, 4.75V±2%, 150mA, -CE, PDR	SOT-25	28vt	VR4	6g	Tor
9NK	XC6209C48AMR	LVR-IC	LDO, 4.85V±2%, 150mA, -CE, PDR	SOT-25	28cx	VR4	6g	Tor
9NK	XC6223C27BMR-G	LVR-IC	LDO, 2.75V±1%, 300mA, +CE, PDR	SOT-25	28cx	VR4	6g	Tor
9NK	XC6209G48AMR	LVR-IC	LDO, 4.85V±2%, 300mA, -CE, PDR	SOT-25	28cx	VR4	6g	Tor
9NK	XC6212C48AMR	LVR-IC	LDO, 4.85V±2%, 150mA, -CE, PDR	SOT-25	28vt	VR4	6g	Tor
9NL	XC6209C49AMR	LVR-IC	LDO, 4.95V±2%, 150mA, -CE, PDR	SOT-25	28cx	VR4	6g	Tor
9NL	XC6223C28BMR-G	LVR-IC	LDO, 2.85V±1%, 300mA, +CE, PDR	SOT-25	28cx	VR4	6g	Tor
9NL	XC6209G49AMR	LVR-IC	LDO, 4.95V±2%, 300mA, -CE, PDR	SOT-25	28cx	VR4	6g	Tor
9NL	XC6212C49AMR	LVR-IC	LDO, 4.95V±2%, 150mA, -CE, PDR	SOT-25	28vt	VR4	6g	Tor
9NM	XC6209C50AMR	LVR-IC	LDO, 5.05V±2%, 150mA, -CE, PDR	SOT-25	28cx	VR4	6g	Tor
9NM	XC6223C29BMR-G	LVR-IC	LDO, 2.95V±1%, 300mA, +CE, PDR	SOT-25	28cx	VR4	6g	Tor
9NM	XC6209G50AMR	LVR-IC	LDO, 5.05V±2%, 300mA, -CE, PDR	SOT-25	28cx	VR4	6g	Tor
9NM	XC6212C50AMR	LVR-IC	LDO, 5.05V±2%, 150mA, -CE, PDR	SOT-25	28vt	VR4	6g	Tor
9NN	XC6209C51AMR	LVR-IC	LDO, 5.15V±2%, 150mA, -CE, PDR	SOT-25	28cx	VR4	6g	Tor
9NN	XC6223C30BMR-G	LVR-IC	LDO, 3.05V±1%, 300mA, +CE, PDR	SOT-25	28cx	VR4	6g	Tor
9NN	XC6209G51AMR	LVR-IC	LDO, 5.15V±2%, 300mA, -CE, PDR	SOT-25	28cx	VR4	6g	Tor
9NN	XC6212C51AMR	LVR-IC	LDO, 5.15V±2%, 150mA, -CE, PDR	SOT-25	28vt	VR4	6g	Tor
9NP	XC6209C52AMR	LVR-IC	LDO, 5.25V±2%, 150mA, -CE, PDR	SOT-25	28cx	VR4	6g	Tor
9NP	XC6223C31BMR-G	LVR-IC	LDO, 3.15V±1%, 300mA, +CE, PDR	SOT-25	28cx	VR4	6g	Tor
9NP	XC6209G52AMR	LVR-IC	LDO, 5.25V±2%, 300mA, -CE, PDR	SOT-25	28cx	VR4	6g	Tor
9NP	XC6212C52AMR	LVR-IC	LDO, 5.25V±2%, 150mA, -CE, PDR	SOT-25	28vt	VR4	6g	Tor
9NR	XC6209C53AMR	LVR-IC	LDO, 5.35V±2%, 150mA, -CE, PDR	SOT-25	28cx	VR4	6g	Tor
9NR	XC6223C32BMR-G	LVR-IC	LDO, 3.25V±1%, 300mA, +CE, PDR	SOT-25	28cx	VR4	6g	Tor
9NR	XC6209G53AMR	LVR-IC	LDO, 5.35V±2%, 300mA, -CE, PDR	SOT-25	28cx	VR4	6g	Tor
9NR	XC6212C53AMR	LVR-IC	LDO, 5.35V±2%, 150mA, -CE, PDR	SOT-25	28vt	VR4	6g	Tor
9NS	XC6209C54AMR	LVR-IC	LDO, 5.45V±2%, 150mA, -CE, PDR	SOT-25	28cx	VR4	6g	Tor
9NS	XC6223C33BMR-G	LVR-IC	LDO, 3.35V±1%, 300mA, +CE, PDR	SOT-25	28cx	VR4	6g	Tor
9NS	XC6209G54AMR	LVR-IC	LDO, 5.45V±2%, 300mA, -CE, PDR	SOT-25	28cx	VR4	6g	Tor
9NS	XC6212C54AMR	LVR-IC	LDO, 5.45V±2%, 150mA, -CE, PDR	SOT-25	28vt	VR4	6g	Tor
9NT	XC6209C55AMR	LVR-IC	LDO, 5.55V±2%, 150mA, -CE, PDR	SOT-25	28cx	VR4	6g	Tor
9NT	XC6223C34BMR-G	LVR-IC	LDO, 3.45V±1%, 300mA, +CE, PDR	SOT-25	28cx	VR4	6g	Tor
9NT	XC6209G55AMR	LVR-IC	LDO, 5.55V±2%, 300mA, -CE, PDR	SOT-25	28cx	VR4	6g	Tor
9NT	XC6212C55AMR	LVR-IC	LDO, 5.55V±2%, 150mA, -CE, PDR	SOT-25	28vt	VR4	6g	Tor
9NU	XC6209C56AMR	LVR-IC	LDO, 5.65V±2%, 150mA, -CE, PDR	SOT-25	28cx	VR4	6g	Tor
9NU	XC6223C35BMR-G	LVR-IC	LDO, 3.55V±1%, 300mA, +CE, PDR	SOT-25	28cx	VR4	6g	Tor
9NU	XC6209G56AMR	LVR-IC	LDO, 5.65V±2%, 300mA, -CE, PDR	SOT-25	28cx	VR4	6g	Tor
9NU	XC6212C56AMR	LVR-IC	LDO, 5.65V±2%, 150mA, -CE, PDR	SOT-25	28vt	VR4	6g	Tor



SMD code	Type	Function	Short description	Case	Pinout	Sch.	St.	Mnf.
9NV	XC6209C57AMR	LVR-IC	LDO, 5.75V±2%, 150mA, -CE, PDR	SOT-25	28cx	VR4	6g	Tor
9NV	XC6223C36BMR-G	LVR-IC	LDO, 3.65V±1%, 300mA, +CE, PDR	SOT-25	28cx	VR4	6g	Tor
9NV	XC6209G57AMR	LVR-IC	LDO, 5.75V±2%, 300mA, -CE, PDR	SOT-25	28cx	VR4	6g	Tor
9NV	XC6212C57AMR	LVR-IC	LDO, 5.75V±2%, 150mA, -CE, PDR	SOT-25	28vt	VR4	6g	Tor
9NX	XC6209C58AMR	LVR-IC	LDO, 5.85V±2%, 150mA, -CE, PDR	SOT-25	28cx	VR4	6g	Tor
9NX	XC6223C37BMR-G	LVR-IC	LDO, 3.75V±1%, 300mA, +CE, PDR	SOT-25	28cx	VR4	6g	Tor
9NX	XC6209G58AMR	LVR-IC	LDO, 5.85V±2%, 300mA, -CE, PDR	SOT-25	28cx	VR4	6g	Tor
9NX	XC6212C58AMR	LVR-IC	LDO, 5.85V±2%, 150mA, -CE, PDR	SOT-25	28vt	VR4	6g	Tor
9NY	XC6209C59AMR	LVR-IC	LDO, 5.95V±2%, 150mA, -CE, PDR	SOT-25	28cx	VR4	6g	Tor
9NY	XC6223C38BMR-G	LVR-IC	LDO, 3.85V±1%, 300mA, +CE, PDR	SOT-25	28cx	VR4	6g	Tor
9NY	XC6209G59AMR	LVR-IC	LDO, 5.95V±2%, 300mA, -CE, PDR	SOT-25	28cx	VR4	6g	Tor
9NY	XC6212C59AMR	LVR-IC	LDO, 5.95V±2%, 150mA, -CE, PDR	SOT-25	28vt	VR4	6g	Tor
9NZ	XC6223C39BMR-G	LVR-IC	LDO, 3.95V±1%, 300mA, +CE, PDR	SOT-25	28cx	VR4	6g	Tor
9P0	XC6209D31AMR	LVR-IC	LDO, 3.15V±2%, 150mA, -CE	SOT-25	28cx	VR4	6g	Tor
9P0	XC6113E431MR	Vdet-IC	3.1V±2%, -MR, +Reset PPO, Wt=200ms, Rt=200ms	SOT-25	28cp	VD17	6g	Tor
9P0	XC6209H31AMR	LVR-IC	LDO, 3.15V±2%, 300mA, -CE	SOT-25	28cx	VR4	6g	Tor
9P0	XC6212D31AMR	LVR-IC	LDO, 3.15V±2%, 150mA, -CE	SOT-25	28vt	VR4	6g	Tor
9P1	XC6209D32AMR	LVR-IC	LDO, 3.25V±2%, 150mA, -CE	SOT-25	28cx	VR4	6g	Tor
9P1	XC6113E432MR	Vdet-IC	3.2V±2%, -MR, +Reset PPO, Wt=200ms, Rt=200ms	SOT-25	28cp	VD17	6g	Tor
9P1	XC6209H32AMR	LVR-IC	LDO, 3.25V±2%, 300mA, -CE	SOT-25	28cx	VR4	6g	Tor
9P1	XC6212D32AMR	LVR-IC	LDO, 3.25V±2%, 150mA, -CE	SOT-25	28vt	VR4	6g	Tor
9P2	XC6209D33AMR	LVR-IC	LDO, 3.35V±2%, 150mA, -CE	SOT-25	28cx	VR4	6g	Tor
9P2	XC6223D121MR-G	LVR-IC	LDO, 1.2V±20mV, 300mA, +CE, CL, PDR	SOT-25	28cx	VR4	6g	Tor
9P2	XC6113E433MR	Vdet-IC	3.3V±2%, -MR, +Reset PPO, Wt=200ms, Rt=200ms	SOT-25	28cp	VD17	6g	Tor
9P2	XC6209H33AMR	LVR-IC	LDO, 3.35V±2%, 300mA, -CE	SOT-25	28cx	VR4	6g	Tor
9P2	XC6212D33AMR	LVR-IC	LDO, 3.35V±2%, 150mA, -CE	SOT-25	28vt	VR4	6g	Tor
9P3	XC6209D34AMR	LVR-IC	LDO, 3.45V±2%, 150mA, -CE	SOT-25	28cx	VR4	6g	Tor
9P3	XC6223D131MR-G	LVR-IC	LDO, 1.3V±20mV, 300mA, +CE, CL, PDR	SOT-25	28cx	VR4	6g	Tor
9P3	XC6113E434MR	Vdet-IC	3.4V±2%, -MR, +Reset PPO, Wt=200ms, Rt=200ms	SOT-25	28cp	VD17	6g	Tor
9P3	XC6209H34AMR	LVR-IC	LDO, 3.45V±2%, 300mA, -CE	SOT-25	28cx	VR4	6g	Tor
9P3	XC6212D34AMR	LVR-IC	LDO, 3.45V±2%, 150mA, -CE	SOT-25	28vt	VR4	6g	Tor
9P4	XC6209D35AMR	LVR-IC	LDO, 3.55V±2%, 150mA, -CE	SOT-25	28cx	VR4	6g	Tor
9P4	XC6223D141MR-G	LVR-IC	LDO, 1.4V±20mV, 300mA, +CE, CL, PDR	SOT-25	28cx	VR4	6g	Tor
9P4	XC6113E435MR	Vdet-IC	3.5V±2%, -MR, +Reset PPO, Wt=200ms, Rt=200ms	SOT-25	28cp	VD17	6g	Tor
9P4	XC6209H35AMR	LVR-IC	LDO, 3.55V±2%, 300mA, -CE	SOT-25	28cx	VR4	6g	Tor
9P4	XC6212D35AMR	LVR-IC	LDO, 3.55V±2%, 150mA, -CE	SOT-25	28vt	VR4	6g	Tor
9P5	XC6209D36AMR	LVR-IC	LDO, 3.65V±2%, 150mA, -CE	SOT-25	28cx	VR4	6g	Tor
9P5	XC6223D151MR-G	LVR-IC	LDO, 1.5V±20mV, 300mA, +CE, CL, PDR	SOT-25	28cx	VR4	6g	Tor
9P5	XC6113E436MR	Vdet-IC	3.6V±2%, -MR, +Reset PPO, Wt=200ms, Rt=200ms	SOT-25	28cp	VD17	6g	Tor
9P5	XC6209H36AMR	LVR-IC	LDO, 3.65V±2%, 300mA, -CE	SOT-25	28cx	VR4	6g	Tor
9P5	XC6212D36AMR	LVR-IC	LDO, 3.65V±2%, 150mA, -CE	SOT-25	28vt	VR4	6g	Tor
9P6	XC6209D37AMR	LVR-IC	LDO, 3.75V±2%, 150mA, -CE	SOT-25	28cx	VR4	6g	Tor
9P6	XC6223D161MR-G	LVR-IC	LDO, 1.6V±20mV, 300mA, +CE, CL, PDR	SOT-25	28cx	VR4	6g	Tor
9P6	XC6113E437MR	Vdet-IC	3.7V±2%, -MR, +Reset PPO, Wt=200ms, Rt=200ms	SOT-25	28cp	VD17	6g	Tor
9P6	XC6209H37AMR	LVR-IC	LDO, 3.75V±2%, 300mA, -CE	SOT-25	28cx	VR4	6g	Tor
9P6	XC6212D37AMR	LVR-IC	LDO, 3.75V±2%, 150mA, -CE	SOT-25	28vt	VR4	6g	Tor
9P7	XC6209D38AMR	LVR-IC	LDO, 3.85V±2%, 150mA, -CE	SOT-25	28cx	VR4	6g	Tor
9P7	XC6223D171MR-G	LVR-IC	LDO, 1.7V±20mV, 300mA, +CE, CL, PDR	SOT-25	28cx	VR4	6g	Tor
9P7	XC6113E438MR	Vdet-IC	3.8V±2%, -MR, +Reset PPO, Wt=200ms, Rt=200ms	SOT-25	28cp	VD17	6g	Tor
9P7	XC6209H38AMR	LVR-IC	LDO, 3.85V±2%, 300mA, -CE	SOT-25	28cx	VR4	6g	Tor
9P7	XC6212D38AMR	LVR-IC	LDO, 3.85V±2%, 150mA, -CE	SOT-25	28vt	VR4	6g	Tor
9P8	XC6209D39AMR	LVR-IC	LDO, 3.95V±2%, 150mA, -CE	SOT-25	28cx	VR4	6g	Tor
9P8	XC6223D181MR-G	LVR-IC	LDO, 1.8V±20mV, 300mA, +CE, CL, PDR	SOT-25	28cx	VR4	6g	Tor
9P8	XC6113E439MR	Vdet-IC	3.9V±2%, -MR, +Reset PPO, Wt=200ms, Rt=200ms	SOT-25	28cp	VD17	6g	Tor
9P8	XC6209H39AMR	LVR-IC	LDO, 3.95V±2%, 300mA, -CE	SOT-25	28cx	VR4	6g	Tor
9P8	XC6212D39AMR	LVR-IC	LDO, 3.95V±2%, 150mA, -CE	SOT-25	28vt	VR4	6g	Tor
9P9	XC6209D40AMR	LVR-IC	LDO, 4.05V±2%, 150mA, -CE	SOT-25	28cx	VR4	6g	Tor
9P9	XC6223D191MR-G	LVR-IC	LDO, 1.9V±20mV, 300mA, +CE, CL, PDR	SOT-25	28cx	VR4	6g	Tor
9P9	XC6113E440MR	Vdet-IC	4.0V±2%, -MR, +Reset PPO, Wt=200ms, Rt=200ms	SOT-25	28cp	VD17	6g	Tor
9P9	XC6209H40AMR	LVR-IC	LDO, 4.05V±2%, 300mA, -CE	SOT-25	28cx	VR4	6g	Tor
9P9	XC6212D40AMR	LVR-IC	LDO, 4.05V±2%, 150mA, -CE	SOT-25	28vt	VR4	6g	Tor
9PA	XC6209D41AMR	LVR-IC	LDO, 4.15V±2%, 150mA, -CE	SOT-25	28cx	VR4	6g	Tor
9PA	XC6223D201MR-G	LVR-IC	LDO, 2.0V±1%, 300mA, +CE, CL, PDR	SOT-25	28cx	VR4	6g	Tor
9PA	XC6113E441MR	Vdet-IC	4.1V±2%, -MR, +Reset PPO, Wt=200ms, Rt=200ms	SOT-25	28cp	VD17	6g	Tor
9PA	XC6209H41AMR	LVR-IC	LDO, 4.15V±2%, 300mA, -CE	SOT-25	28cx	VR4	6g	Tor
9PA	XC6212D41AMR	LVR-IC	LDO, 4.15V±2%, 150mA, -CE	SOT-25	28vt	VR4	6g	Tor
9PB	XC6209D42AMR	LVR-IC	LDO, 4.25V±2%, 150mA, -CE	SOT-25	28cx	VR4	6g	Tor
9PB	XC6223D211MR-G	LVR-IC	LDO, 2.1V±1%, 300mA, +CE, CL, PDR	SOT-25	28cx	VR4	6g	Tor
9PB	XC6113E442MR	Vdet-IC	4.2V±2%, -MR, +Reset PPO, Wt=200ms, Rt=200ms	SOT-25	28cp	VD17	6g	Tor
9PB	XC6209H42AMR	LVR-IC	LDO, 4.25V±2%, 300mA, -CE	SOT-25	28cx	VR4	6g	Tor



SMD code	Type	Function	Short description	Case	Pinout	Sch.	St.	Mnf.
9PB	XC6212D42AMR	LVR-IC	LDO, 4.25V±2%, 150mA, -CE	SOT-25	28vt	VR4	6g	Tor
9PC	XC6209D43AMR	LVR-IC	LDO, 4.35V±2%, 150mA, -CE	SOT-25	28cx	VR4	6g	Tor
9PC	XC6223D221MR-G	LVR-IC	LDO, 2.2V±1%, 300mA, +CE, CL, PDR	SOT-25	28cx	VR4	6g	Tor
9PC	XC6113E443MR	Vdet-IC	4.3V±2%, -MR, +Reset PPO, Wt=200ms, Rt=200ms	SOT-25	28cp	VD17	6g	Tor
9PC	XC6209H43AMR	LVR-IC	LDO, 4.35V±2%, 300mA, -CE	SOT-25	28cx	VR4	6g	Tor
9PC	XC6212D43AMR	LVR-IC	LDO, 4.35V±2%, 150mA, -CE	SOT-25	28vt	VR4	6g	Tor
9PD	XC6209D44AMR	LVR-IC	LDO, 4.45V±2%, 150mA, -CE	SOT-25	28cx	VR4	6g	Tor
9PD	XC6223D231MR-G	LVR-IC	LDO, 2.3V±1%, 300mA, +CE, CL, PDR	SOT-25	28cx	VR4	6g	Tor
9PD	XC6113E444MR	Vdet-IC	4.4V±2%, -MR, +Reset PPO, Wt=200ms, Rt=200ms	SOT-25	28cp	VD17	6g	Tor
9PD	XC6209H44AMR	LVR-IC	LDO, 4.45V±2%, 300mA, -CE	SOT-25	28cx	VR4	6g	Tor
9PD	XC6212D44AMR	LVR-IC	LDO, 4.45V±2%, 150mA, -CE	SOT-25	28vt	VR4	6g	Tor
9PE	XC6209D45AMR	LVR-IC	LDO, 4.55V±2%, 150mA, -CE	SOT-25	28cx	VR4	6g	Tor
9PE	XC6223D241MR-G	LVR-IC	LDO, 2.4V±1%, 300mA, +CE, CL, PDR	SOT-25	28cx	VR4	6g	Tor
9PE	XC6113E445MR	Vdet-IC	4.5V±2%, -MR, +Reset PPO, Wt=200ms, Rt=200ms	SOT-25	28cp	VD17	6g	Tor
9PE	XC6209H45AMR	LVR-IC	LDO, 4.55V±2%, 300mA, -CE	SOT-25	28cx	VR4	6g	Tor
9PE	XC6212D45AMR	LVR-IC	LDO, 4.55V±2%, 150mA, -CE	SOT-25	28vt	VR4	6g	Tor
9PF	XC6209D46AMR	LVR-IC	LDO, 4.65V±2%, 150mA, -CE	SOT-25	28cx	VR4	6g	Tor
9PF	XC6223D251MR-G	LVR-IC	LDO, 2.5V±1%, 300mA, +CE, CL, PDR	SOT-25	28cx	VR4	6g	Tor
9PF	XC6113E416MR	Vdet-IC	1.6V±2%, -MR, +Reset PPO, Wt=200ms, Rt=200ms	SOT-25	28cp	VD17	6g	Tor
9PF	XC6113E446MR	Vdet-IC	4.6V±2%, -MR, +Reset PPO, Wt=200ms, Rt=200ms	SOT-25	28cp	VD17	6g	Tor
9PF	XC6209H46AMR	LVR-IC	LDO, 4.65V±2%, 300mA, -CE	SOT-25	28cx	VR4	6g	Tor
9PF	XC6212D46AMR	LVR-IC	LDO, 4.65V±2%, 150mA, -CE	SOT-25	28vt	VR4	6g	Tor
9PH	XC6209D47AMR	LVR-IC	LDO, 4.75V±2%, 150mA, -CE	SOT-25	28cx	VR4	6g	Tor
9PH	XC6223D261MR-G	LVR-IC	LDO, 2.6V±1%, 300mA, +CE, CL, PDR	SOT-25	28cx	VR4	6g	Tor
9PH	XC6113E417MR	Vdet-IC	1.7V±2%, -MR, +Reset PPO, Wt=200ms, Rt=200ms	SOT-25	28cp	VD17	6g	Tor
9PH	XC6113E447MR	Vdet-IC	4.7V±2%, -MR, +Reset PPO, Wt=200ms, Rt=200ms	SOT-25	28cp	VD17	6g	Tor
9PH	XC6209H47AMR	LVR-IC	LDO, 4.75V±2%, 300mA, -CE	SOT-25	28cx	VR4	6g	Tor
9PH	XC6212D47AMR	LVR-IC	LDO, 4.75V±2%, 150mA, -CE	SOT-25	28vt	VR4	6g	Tor
9PK	XC6209D48AMR	LVR-IC	LDO, 4.85V±2%, 150mA, -CE	SOT-25	28cx	VR4	6g	Tor
9PK	XC6223D271MR-G	LVR-IC	LDO, 2.7V±1%, 300mA, +CE, CL, PDR	SOT-25	28cx	VR4	6g	Tor
9PK	XC6113E418MR	Vdet-IC	1.8V±2%, -MR, +Reset PPO, Wt=200ms, Rt=200ms	SOT-25	28cp	VD17	6g	Tor
9PK	XC6113E448MR	Vdet-IC	4.8V±2%, -MR, +Reset PPO, Wt=200ms, Rt=200ms	SOT-25	28cp	VD17	6g	Tor
9PK	XC6209H48AMR	LVR-IC	LDO, 4.85V±2%, 300mA, -CE	SOT-25	28cx	VR4	6g	Tor
9PK	XC6212D48AMR	LVR-IC	LDO, 4.85V±2%, 150mA, -CE	SOT-25	28vt	VR4	6g	Tor
9PL	XC6209D49AMR	LVR-IC	LDO, 4.95V±2%, 150mA, -CE	SOT-25	28cx	VR4	6g	Tor
9PL	XC6223D281MR-G	LVR-IC	LDO, 2.8V±1%, 300mA, +CE, CL, PDR	SOT-25	28cx	VR4	6g	Tor
9PL	XC6113E419MR	Vdet-IC	1.9V±2%, -MR, +Reset PPO, Wt=200ms, Rt=200ms	SOT-25	28cp	VD17	6g	Tor
9PL	XC6113E449MR	Vdet-IC	4.9V±2%, -MR, +Reset PPO, Wt=200ms, Rt=200ms	SOT-25	28cp	VD17	6g	Tor
9PL	XC6209H49AMR	LVR-IC	LDO, 4.95V±2%, 300mA, -CE	SOT-25	28cx	VR4	6g	Tor
9PL	XC6212D49AMR	LVR-IC	LDO, 4.95V±2%, 150mA, -CE	SOT-25	28vt	VR4	6g	Tor
9PM	XC6209D50AMR	LVR-IC	LDO, 5.05V±2%, 150mA, -CE	SOT-25	28cx	VR4	6g	Tor
9PM	XC6223D291MR-G	LVR-IC	LDO, 2.9V±1%, 300mA, +CE, CL, PDR	SOT-25	28cx	VR4	6g	Tor
9PM	XC6113E420MR	Vdet-IC	2.0V±2%, -MR, +Reset PPO, Wt=200ms, Rt=200ms	SOT-25	28cp	VD17	6g	Tor
9PM	XC6113E450MR	Vdet-IC	5.0V±2%, -MR, +Reset PPO, Wt=200ms, Rt=200ms	SOT-25	28cp	VD17	6g	Tor
9PM	XC6209H50AMR	LVR-IC	LDO, 5.05V±2%, 300mA, -CE	SOT-25	28cx	VR4	6g	Tor
9PM	XC6212D50AMR	LVR-IC	LDO, 5.05V±2%, 150mA, -CE	SOT-25	28vt	VR4	6g	Tor
9PN	XC6209D51AMR	LVR-IC	LDO, 5.15V±2%, 150mA, -CE	SOT-25	28cx	VR4	6g	Tor
9PN	XC6223D301MR-G	LVR-IC	LDO, 3.0V±1%, 300mA, +CE, CL, PDR	SOT-25	28cx	VR4	6g	Tor
9PN	XC6113E421MR	Vdet-IC	2.1V±2%, -MR, +Reset PPO, Wt=200ms, Rt=200ms	SOT-25	28cp	VD17	6g	Tor
9PN	XC6209H51AMR	LVR-IC	LDO, 5.15V±2%, 300mA, -CE	SOT-25	28cx	VR4	6g	Tor
9PN	XC6212D51AMR	LVR-IC	LDO, 5.15V±2%, 150mA, -CE	SOT-25	28vt	VR4	6g	Tor
9PP	XC6209D52AMR	LVR-IC	LDO, 5.25V±2%, 150mA, -CE	SOT-25	28cx	VR4	6g	Tor
9PP	XC6223D311MR-G	LVR-IC	LDO, 3.1V±1%, 300mA, +CE, CL, PDR	SOT-25	28cx	VR4	6g	Tor
9PP	XC6113E422MR	Vdet-IC	2.2V±2%, -MR, +Reset PPO, Wt=200ms, Rt=200ms	SOT-25	28cp	VD17	6g	Tor
9PP	XC6209H52AMR	LVR-IC	LDO, 5.25V±2%, 300mA, -CE	SOT-25	28cx	VR4	6g	Tor
9PP	XC6212D52AMR	LVR-IC	LDO, 5.25V±2%, 150mA, -CE	SOT-25	28vt	VR4	6g	Tor
9PR	XC6209D53AMR	LVR-IC	LDO, 5.35V±2%, 150mA, -CE	SOT-25	28cx	VR4	6g	Tor
9PR	XC6223D321MR-G	LVR-IC	LDO, 3.2V±1%, 300mA, +CE, CL, PDR	SOT-25	28cx	VR4	6g	Tor
9PR	XC6113E423MR	Vdet-IC	2.3V±2%, -MR, +Reset PPO, Wt=200ms, Rt=200ms	SOT-25	28cp	VD17	6g	Tor
9PR	XC6209H53AMR	LVR-IC	LDO, 5.35V±2%, 300mA, -CE	SOT-25	28cx	VR4	6g	Tor
9PR	XC6212D53AMR	LVR-IC	LDO, 5.35V±2%, 150mA, -CE	SOT-25	28vt	VR4	6g	Tor
9PS	XC6209D54AMR	LVR-IC	LDO, 5.45V±2%, 150mA, -CE	SOT-25	28cx	VR4	6g	Tor
9PS	XC6223D331MR-G	LVR-IC	LDO, 3.3V±1%, 300mA, +CE, CL, PDR	SOT-25	28cx	VR4	6g	Tor
9PS	XC6113E424MR	Vdet-IC	2.4V±2%, -MR, +Reset PPO, Wt=200ms, Rt=200ms	SOT-25	28cp	VD17	6g	Tor
9PS	XC6209H54AMR	LVR-IC	LDO, 5.45V±2%, 300mA, -CE	SOT-25	28cx	VR4	6g	Tor
9PS	XC6212D54AMR	LVR-IC	LDO, 5.45V±2%, 150mA, -CE	SOT-25	28vt	VR4	6g	Tor
9PT	XC6209D55AMR	LVR-IC	LDO, 5.55V±2%, 150mA, -CE	SOT-25	28cx	VR4	6g	Tor
9PT	XC6223D341MR-G	LVR-IC	LDO, 3.4V±1%, 300mA, +CE, CL, PDR	SOT-25	28cx	VR4	6g	Tor
9PT	XC6113E425MR	Vdet-IC	2.5V±2%, -MR, +Reset PPO, Wt=200ms, Rt=200ms	SOT-25	28cp	VD17	6g	Tor
9PT	XC6209H55AMR	LVR-IC	LDO, 5.55V±2%, 300mA, -CE	SOT-25	28cx	VR4	6g	Tor



SMD code	Type	Function	Short description	Case	Pinout	Sch.	St.	Mnf.
<u>9PT</u>	XC6212D55AMR	LVR-IC	LDO, 5.55V±2%, 150mA, -CE	SOT-25	28vt	VR4	6g	Tor
<u>9PU</u>	XC6209D56AMR	LVR-IC	LDO, 5.65V±2%, 150mA, -CE	SOT-25	28cx	VR4	6g	Tor
<u>9PU</u>	XC6223D351MR-G	LVR-IC	LDO, 3.5V±1%, 300mA, +CE, CL, PDR	SOT-25	28cx	VR4	6g	Tor
<u>9PU</u>	XC6113E426MR	Vdet-IC	2.6V±2%, -MR, +Reset PPO, Wt=200ms, Rt=200ms	SOT-25	28cp	VD17	6g	Tor
<u>9PU</u>	XC6209H56AMR	LVR-IC	LDO, 5.65V±2%, 300mA, -CE	SOT-25	28cx	VR4	6g	Tor
<u>9PU</u>	XC6212D56AMR	LVR-IC	LDO, 5.65V±2%, 150mA, -CE	SOT-25	28vt	VR4	6g	Tor
<u>9PV</u>	XC6209D57AMR	LVR-IC	LDO, 5.75V±2%, 150mA, -CE	SOT-25	28cx	VR4	6g	Tor
<u>9PV</u>	XC6223D361MR-G	LVR-IC	LDO, 3.6V±1%, 300mA, +CE, CL, PDR	SOT-25	28cx	VR4	6g	Tor
<u>9PV</u>	XC6113E427MR	Vdet-IC	2.7V±2%, -MR, +Reset PPO, Wt=200ms, Rt=200ms	SOT-25	28cp	VD17	6g	Tor
<u>9PV</u>	XC6209H57AMR	LVR-IC	LDO, 5.75V±2%, 300mA, -CE	SOT-25	28cx	VR4	6g	Tor
<u>9PV</u>	XC6212D57AMR	LVR-IC	LDO, 5.75V±2%, 150mA, -CE	SOT-25	28vt	VR4	6g	Tor
<u>9PX</u>	XC6209D58AMR	LVR-IC	LDO, 5.85V±2%, 150mA, -CE	SOT-25	28cx	VR4	6g	Tor
<u>9PX</u>	XC6223D371MR-G	LVR-IC	LDO, 3.7V±1%, 300mA, +CE, CL, PDR	SOT-25	28cx	VR4	6g	Tor
<u>9PX</u>	XC6113E428MR	Vdet-IC	2.8V±2%, -MR, +Reset PPO, Wt=200ms, Rt=200ms	SOT-25	28cp	VD17	6g	Tor
<u>9PX</u>	XC6209H58AMR	LVR-IC	LDO, 5.85V±2%, 300mA, -CE	SOT-25	28cx	VR4	6g	Tor
<u>9PX</u>	XC6212D58AMR	LVR-IC	LDO, 5.85V±2%, 150mA, -CE	SOT-25	28vt	VR4	6g	Tor
<u>9PY</u>	XC6209D59AMR	LVR-IC	LDO, 5.95V±2%, 150mA, -CE	SOT-25	28cx	VR4	6g	Tor
<u>9PY</u>	XC6223D381MR-G	LVR-IC	LDO, 3.8V±1%, 300mA, +CE, CL, PDR	SOT-25	28cx	VR4	6g	Tor
<u>9PY</u>	XC6113E429MR	Vdet-IC	2.9V±2%, -MR, +Reset PPO, Wt=200ms, Rt=200ms	SOT-25	28cp	VD17	6g	Tor
<u>9PY</u>	XC6209H59AMR	LVR-IC	LDO, 5.95V±2%, 300mA, -CE	SOT-25	28cx	VR4	6g	Tor
<u>9PY</u>	XC6212D59AMR	LVR-IC	LDO, 5.95V±2%, 150mA, -CE	SOT-25	28vt	VR4	6g	Tor
<u>9PZ</u>	XC6223D391MR-G	LVR-IC	LDO, 3.9V±1%, 300mA, +CE, CL, PDR	SOT-25	28cx	VR4	6g	Tor
<u>9PZ</u>	XC6113E430MR	Vdet-IC	3.0V±2%, -MR, +Reset PPO, Wt=200ms, Rt=200ms	SOT-25	28cp	VD17	6g	Tor
<u>9Q</u>	R1210N291A	DC/DC-IC	PWM step-up, 2.9V, 35...100kHz	SOT-23-5	28sc	DC3	6g	Ric
<u>9R0</u>	XC6223D401MR-G	LVR-IC	LDO, 4.0V±1%, 300mA, +CE, CL, PDR	SOT-25	28cx	VR4	6g	Tor
<u>9R0</u>	XC6113E531MR	Vdet-IC	3.1V±2%, -MR, +Reset PPO, Wt=400ms, Rt=200ms	SOT-25	28cp	VD17	6g	Tor
<u>9R1</u>	XC6113E532MR	Vdet-IC	3.2V±2%, -MR, +Reset PPO, Wt=400ms, Rt=200ms	SOT-25	28cp	VD17	6g	Tor
<u>9R2</u>	XC6113E533MR	Vdet-IC	3.3V±2%, -MR, +Reset PPO, Wt=400ms, Rt=200ms	SOT-25	28cp	VD17	6g	Tor
<u>9R3</u>	XC6113E534MR	Vdet-IC	3.4V±2%, -MR, +Reset PPO, Wt=400ms, Rt=200ms	SOT-25	28cp	VD17	6g	Tor
<u>9R4</u>	XC6113E535MR	Vdet-IC	3.5V±2%, -MR, +Reset PPO, Wt=400ms, Rt=200ms	SOT-25	28cp	VD17	6g	Tor
<u>9R5</u>	XC6113E536MR	Vdet-IC	3.6V±2%, -MR, +Reset PPO, Wt=400ms, Rt=200ms	SOT-25	28cp	VD17	6g	Tor
<u>9R6</u>	XC6113E537MR	Vdet-IC	3.7V±2%, -MR, +Reset PPO, Wt=400ms, Rt=200ms	SOT-25	28cp	VD17	6g	Tor
<u>9R7</u>	XC6113E538MR	Vdet-IC	3.8V±2%, -MR, +Reset PPO, Wt=400ms, Rt=200ms	SOT-25	28cp	VD17	6g	Tor
<u>9R8</u>	XC6113E539MR	Vdet-IC	3.9V±2%, -MR, +Reset PPO, Wt=400ms, Rt=200ms	SOT-25	28cp	VD17	6g	Tor
<u>9R9</u>	XC6113E540MR	Vdet-IC	4.0V±2%, -MR, +Reset PPO, Wt=400ms, Rt=200ms	SOT-25	28cp	VD17	6g	Tor
<u>9RA</u>	XC6113E541MR	Vdet-IC	4.1V±2%, -MR, +Reset PPO, Wt=400ms, Rt=200ms	SOT-25	28cp	VD17	6g	Tor
<u>9RB</u>	XC6113E542MR	Vdet-IC	4.2V±2%, -MR, +Reset PPO, Wt=400ms, Rt=200ms	SOT-25	28cp	VD17	6g	Tor
<u>9RC</u>	XC6113E543MR	Vdet-IC	4.3V±2%, -MR, +Reset PPO, Wt=400ms, Rt=200ms	SOT-25	28cp	VD17	6g	Tor
<u>9RD</u>	XC6113E544MR	Vdet-IC	4.4V±2%, -MR, +Reset PPO, Wt=400ms, Rt=200ms	SOT-25	28cp	VD17	6g	Tor
<u>9RE</u>	XC6113E545MR	Vdet-IC	4.5V±2%, -MR, +Reset PPO, Wt=400ms, Rt=200ms	SOT-25	28cp	VD17	6g	Tor
<u>9RF</u>	XC6113E516MR	Vdet-IC	1.6V±2%, -MR, +Reset PPO, Wt=400ms, Rt=200ms	SOT-25	28cp	VD17	6g	Tor
<u>9RF</u>	XC6113E546MR	Vdet-IC	4.6V±2%, -MR, +Reset PPO, Wt=400ms, Rt=200ms	SOT-25	28cp	VD17	6g	Tor
<u>9RH</u>	XC6113E517MR	Vdet-IC	1.7V±2%, -MR, +Reset PPO, Wt=400ms, Rt=200ms	SOT-25	28cp	VD17	6g	Tor
<u>9RH</u>	XC6113E547MR	Vdet-IC	4.7V±2%, -MR, +Reset PPO, Wt=400ms, Rt=200ms	SOT-25	28cp	VD17	6g	Tor
<u>9RK</u>	XC6113E518MR	Vdet-IC	1.8V±2%, -MR, +Reset PPO, Wt=400ms, Rt=200ms	SOT-25	28cp	VD17	6g	Tor
<u>9RK</u>	XC6113E548MR	Vdet-IC	4.8V±2%, -MR, +Reset PPO, Wt=400ms, Rt=200ms	SOT-25	28cp	VD17	6g	Tor
<u>9RL</u>	XC6113E519MR	Vdet-IC	1.9V±2%, -MR, +Reset PPO, Wt=400ms, Rt=200ms	SOT-25	28cp	VD17	6g	Tor
<u>9RL</u>	XC6113E549MR	Vdet-IC	4.9V±2%, -MR, +Reset PPO, Wt=400ms, Rt=200ms	SOT-25	28cp	VD17	6g	Tor
<u>9RM</u>	XC6113E520MR	Vdet-IC	2.0V±2%, -MR, +Reset PPO, Wt=400ms, Rt=200ms	SOT-25	28cp	VD17	6g	Tor
<u>9RM</u>	XC6113E550MR	Vdet-IC	5.0V±2%, -MR, +Reset PPO, Wt=400ms, Rt=200ms	SOT-25	28cp	VD17	6g	Tor
<u>9RN</u>	XC6113E521MR	Vdet-IC	2.1V±2%, -MR, +Reset PPO, Wt=400ms, Rt=200ms	SOT-25	28cp	VD17	6g	Tor
<u>9RP</u>	XC6113E522MR	Vdet-IC	2.2V±2%, -MR, +Reset PPO, Wt=400ms, Rt=200ms	SOT-25	28cp	VD17	6g	Tor
<u>9RR</u>	XC6113E523MR	Vdet-IC	2.3V±2%, -MR, +Reset PPO, Wt=400ms, Rt=200ms	SOT-25	28cp	VD17	6g	Tor
<u>9RS</u>	XC6113E524MR	Vdet-IC	2.4V±2%, -MR, +Reset PPO, Wt=400ms, Rt=200ms	SOT-25	28cp	VD17	6g	Tor
<u>9RT</u>	XC6113E525MR	Vdet-IC	2.5V±2%, -MR, +Reset PPO, Wt=400ms, Rt=200ms	SOT-25	28cp	VD17	6g	Tor
<u>9RU</u>	XC6113E526MR	Vdet-IC	2.6V±2%, -MR, +Reset PPO, Wt=400ms, Rt=200ms	SOT-25	28cp	VD17	6g	Tor
<u>9RV</u>	XC6113E527MR	Vdet-IC	2.7V±2%, -MR, +Reset PPO, Wt=400ms, Rt=200ms	SOT-25	28cp	VD17	6g	Tor
<u>9RX</u>	XC6113E528MR	Vdet-IC	2.8V±2%, -MR, +Reset PPO, Wt=400ms, Rt=200ms	SOT-25	28cp	VD17	6g	Tor
<u>9RY</u>	XC6113E529MR	Vdet-IC	2.9V±2%, -MR, +Reset PPO, Wt=400ms, Rt=200ms	SOT-25	28cp	VD17	6g	Tor
<u>9RZ</u>	XC6113E530MR	Vdet-IC	3.0V±2%, -MR, +Reset PPO, Wt=400ms, Rt=200ms	SOT-25	28cp	VD17	6g	Tor
<u>9S</u>	RN5RF19AA	LVR-IC	LReg, -CE, 1.9V±2%, 1A*	SOT-23-5	28vw	VR6	6g	Ric
<u>9S0</u>	XC6113E631MR	Vdet-IC	3.1V±2%, -MR, +Reset PPO, Wt=1.6s, Rt=200ms	SOT-25	28cp	VD17	6g	Tor
<u>9S1</u>	XC6113E632MR	Vdet-IC	3.2V±2%, -MR, +Reset PPO, Wt=1.6s, Rt=200ms	SOT-25	28cp	VD17	6g	Tor
<u>9S2</u>	XC6223D12BMR-G	LVR-IC	LDO, 1.25V±20mV, 300mA, +CE, CL, PDR	SOT-25	28cx	VR4	6g	Tor
<u>9S2</u>	XC6113E633MR	Vdet-IC	3.3V±2%, -MR, +Reset PPO, Wt=1.6s, Rt=200ms	SOT-25	28cp	VD17	6g	Tor
<u>9S3</u>	XC6223D13BMR-G	LVR-IC	LDO, 1.35V±20mV, 300mA, +CE, CL, PDR	SOT-25	28cx	VR4	6g	Tor
<u>9S3</u>	XC6113E634MR	Vdet-IC	3.4V±2%, -MR, +Reset PPO, Wt=1.6s, Rt=200ms	SOT-25	28cp	VD17	6g	Tor
<u>9S4</u>	XC6223D14BMR-G	LVR-IC	LDO, 1.45V±20mV, 300mA, +CE, CL, PDR	SOT-25	28cx	VR4	6g	Tor
<u>9S4</u>	XC6113E635MR	Vdet-IC	3.5V±2%, -MR, +Reset PPO, Wt=1.6s, Rt=200ms	SOT-25	28cp	VD17	6g	Tor
<u>9S5</u>	XC6223D15BMR-G	LVR-IC	LDO, 1.55V±20mV, 300mA, +CE, CL, PDR	SOT-25	28cx	VR4	6g	Tor



SMD code	Type	Function	Short description	Case	Pinout	Sch.	St.	Mnf.
955	XC6113E636MR	Vdet-IC	3.6V±2%, -MR, +Reset PPO, Wt=1.6s, Rt=200ms	SOT-25	28cp	VD17	6g	Tor
956	XC6223D16BMR-G	LVR-IC	LDO, 1.65V±20mV, 300mA, +CE, CL, PDR	SOT-25	28cx	VR4	6g	Tor
956	XC6113E637MR	Vdet-IC	3.7V±2%, -MR, +Reset PPO, Wt=1.6s, Rt=200ms	SOT-25	28cp	VD17	6g	Tor
957	XC6223D17BMR-G	LVR-IC	LDO, 1.75V±20mV, 300mA, +CE, CL, PDR	SOT-25	28cx	VR4	6g	Tor
957	XC6113E638MR	Vdet-IC	3.8V±2%, -MR, +Reset PPO, Wt=1.6s, Rt=200ms	SOT-25	28cp	VD17	6g	Tor
958	XC6223D18BMR-G	LVR-IC	LDO, 1.85V±20mV, 300mA, +CE, CL, PDR	SOT-25	28cx	VR4	6g	Tor
958	XC6113E639MR	Vdet-IC	3.9V±2%, -MR, +Reset PPO, Wt=1.6s, Rt=200ms	SOT-25	28cp	VD17	6g	Tor
959	XC6223D19BMR-G	LVR-IC	LDO, 1.95V±20mV, 300mA, +CE, CL, PDR	SOT-25	28cx	VR4	6g	Tor
959	XC6113E640MR	Vdet-IC	4.0V±2%, -MR, +Reset PPO, Wt=1.6s, Rt=200ms	SOT-25	28cp	VD17	6g	Tor
95A	XC6223D20BMR-G	LVR-IC	LDO, 2.05V±1%, 300mA, +CE, CL, PDR	SOT-25	28cx	VR4	6g	Tor
95A	XC6113E641MR	Vdet-IC	4.1V±2%, -MR, +Reset PPO, Wt=1.6s, Rt=200ms	SOT-25	28cp	VD17	6g	Tor
95B	XC6223D21BMR-G	LVR-IC	LDO, 2.15V±1%, 300mA, +CE, CL, PDR	SOT-25	28cx	VR4	6g	Tor
95B	XC6113E642MR	Vdet-IC	4.2V±2%, -MR, +Reset PPO, Wt=1.6s, Rt=200ms	SOT-25	28cp	VD17	6g	Tor
95C	XC6223D22BMR-G	LVR-IC	LDO, 2.25V±1%, 300mA, +CE, CL, PDR	SOT-25	28cx	VR4	6g	Tor
95C	XC6113E643MR	Vdet-IC	4.3V±2%, -MR, +Reset PPO, Wt=1.6s, Rt=200ms	SOT-25	28cp	VD17	6g	Tor
95D	XC6223D23BMR-G	LVR-IC	LDO, 2.35V±1%, 300mA, +CE, CL, PDR	SOT-25	28cx	VR4	6g	Tor
95D	XC6113E644MR	Vdet-IC	4.4V±2%, -MR, +Reset PPO, Wt=1.6s, Rt=200ms	SOT-25	28cp	VD17	6g	Tor
95E	XC6223D24BMR-G	LVR-IC	LDO, 2.45V±1%, 300mA, +CE, CL, PDR	SOT-25	28cx	VR4	6g	Tor
95E	XC6113E645MR	Vdet-IC	4.5V±2%, -MR, +Reset PPO, Wt=1.6s, Rt=200ms	SOT-25	28cp	VD17	6g	Tor
95F	XC6223D25BMR-G	LVR-IC	LDO, 2.55V±1%, 300mA, +CE, CL, PDR	SOT-25	28cx	VR4	6g	Tor
95F	XC6113E616MR	Vdet-IC	1.6V±2%, -MR, +Reset PPO, Wt=1.6s, Rt=200ms	SOT-25	28cp	VD17	6g	Tor
95F	XC6113E646MR	Vdet-IC	4.6V±2%, -MR, +Reset PPO, Wt=1.6s, Rt=200ms	SOT-25	28cp	VD17	6g	Tor
95H	XC6223D26BMR-G	LVR-IC	LDO, 2.65V±1%, 300mA, +CE, CL, PDR	SOT-25	28cx	VR4	6g	Tor
95H	XC6113E617MR	Vdet-IC	1.7V±2%, -MR, +Reset PPO, Wt=1.6s, Rt=200ms	SOT-25	28cp	VD17	6g	Tor
95H	XC6113E647MR	Vdet-IC	4.7V±2%, -MR, +Reset PPO, Wt=1.6s, Rt=200ms	SOT-25	28cp	VD17	6g	Tor
95K	XC6223D27BMR-G	LVR-IC	LDO, 2.75V±1%, 300mA, +CE, CL, PDR	SOT-25	28cx	VR4	6g	Tor
95K	XC6113E618MR	Vdet-IC	1.8V±2%, -MR, +Reset PPO, Wt=1.6s, Rt=200ms	SOT-25	28cp	VD17	6g	Tor
95K	XC6113E648MR	Vdet-IC	4.8V±2%, -MR, +Reset PPO, Wt=1.6s, Rt=200ms	SOT-25	28cp	VD17	6g	Tor
95L	XC6223D28BMR-G	LVR-IC	LDO, 2.85V±1%, 300mA, +CE, CL, PDR	SOT-25	28cx	VR4	6g	Tor
95L	XC6113E619MR	Vdet-IC	1.9V±2%, -MR, +Reset PPO, Wt=1.6s, Rt=200ms	SOT-25	28cp	VD17	6g	Tor
95L	XC6113E649MR	Vdet-IC	4.9V±2%, -MR, +Reset PPO, Wt=1.6s, Rt=200ms	SOT-25	28cp	VD17	6g	Tor
95M	XC6223D29BMR-G	LVR-IC	LDO, 2.95V±1%, 300mA, +CE, CL, PDR	SOT-25	28cx	VR4	6g	Tor
95M	XC6113E620MR	Vdet-IC	2.0V±2%, -MR, +Reset PPO, Wt=1.6s, Rt=200ms	SOT-25	28cp	VD17	6g	Tor
95M	XC6113E650MR	Vdet-IC	5.0V±2%, -MR, +Reset PPO, Wt=1.6s, Rt=200ms	SOT-25	28cp	VD17	6g	Tor
95N	XC6223D30BMR-G	LVR-IC	LDO, 3.05V±1%, 300mA, +CE, CL, PDR	SOT-25	28cx	VR4	6g	Tor
95N	XC6113E621MR	Vdet-IC	2.1V±2%, -MR, +Reset PPO, Wt=1.6s, Rt=200ms	SOT-25	28cp	VD17	6g	Tor
95P	XC6223D31BMR-G	LVR-IC	LDO, 3.15V±1%, 300mA, +CE, CL, PDR	SOT-25	28cx	VR4	6g	Tor
95P	XC6113E622MR	Vdet-IC	2.2V±2%, -MR, +Reset PPO, Wt=1.6s, Rt=200ms	SOT-25	28cp	VD17	6g	Tor
95R	XC6223D32BMR-G	LVR-IC	LDO, 3.25V±1%, 300mA, +CE, CL, PDR	SOT-25	28cx	VR4	6g	Tor
95R	XC6113E623MR	Vdet-IC	2.3V±2%, -MR, +Reset PPO, Wt=1.6s, Rt=200ms	SOT-25	28cp	VD17	6g	Tor
95S	XC6223D33BMR-G	LVR-IC	LDO, 3.35V±1%, 300mA, +CE, CL, PDR	SOT-25	28cx	VR4	6g	Tor
95S	XC6113E624MR	Vdet-IC	2.4V±2%, -MR, +Reset PPO, Wt=1.6s, Rt=200ms	SOT-25	28cp	VD17	6g	Tor
95T	XC6223D34BMR-G	LVR-IC	LDO, 3.45V±1%, 300mA, +CE, CL, PDR	SOT-25	28cx	VR4	6g	Tor
95T	XC6113E625MR	Vdet-IC	2.5V±2%, -MR, +Reset PPO, Wt=1.6s, Rt=200ms	SOT-25	28cp	VD17	6g	Tor
95U	XC6223D35BMR-G	LVR-IC	LDO, 3.55V±1%, 300mA, +CE, CL, PDR	SOT-25	28cx	VR4	6g	Tor
95U	XC6113E626MR	Vdet-IC	2.6V±2%, -MR, +Reset PPO, Wt=1.6s, Rt=200ms	SOT-25	28cp	VD17	6g	Tor
95V	XC6223D36BMR-G	LVR-IC	LDO, 3.65V±1%, 300mA, +CE, CL, PDR	SOT-25	28cx	VR4	6g	Tor
95V	XC6113E627MR	Vdet-IC	2.7V±2%, -MR, +Reset PPO, Wt=1.6s, Rt=200ms	SOT-25	28cp	VD17	6g	Tor
95X	XC6223D37BMR-G	LVR-IC	LDO, 3.75V±1%, 300mA, +CE, CL, PDR	SOT-25	28cx	VR4	6g	Tor
95X	XC6113E628MR	Vdet-IC	2.8V±2%, -MR, +Reset PPO, Wt=1.6s, Rt=200ms	SOT-25	28cp	VD17	6g	Tor
95Y	XC6223D38BMR-G	LVR-IC	LDO, 3.85V±1%, 300mA, +CE, CL, PDR	SOT-25	28cx	VR4	6g	Tor
95Y	XC6113E629MR	Vdet-IC	2.9V±2%, -MR, +Reset PPO, Wt=1.6s, Rt=200ms	SOT-25	28cp	VD17	6g	Tor
95Z	XC6223D39BMR-G	LVR-IC	LDO, 3.95V±1%, 300mA, +CE, CL, PDR	SOT-25	28cx	VR4	6g	Tor
95Z	XC6113E630MR	Vdet-IC	3.0V±2%, -MR, +Reset PPO, Wt=1.6s, Rt=200ms	SOT-25	28cp	VD17	6g	Tor
9T	RN5RF19BA	LVR-IC	LRip, +CE, 1.9V±2%, 1A*	SOT-23-5	28vw	VR6	6g	Ric
9T0	XC6113F531MR	Vdet-IC	3.1V±2%, -MR, +Reset PPO, Wt=400ms, Rt=400ms	SOT-25	28cp	VD17	6g	Tor
9T1	XC6113F532MR	Vdet-IC	3.2V±2%, -MR, +Reset PPO, Wt=400ms, Rt=400ms	SOT-25	28cp	VD17	6g	Tor
9T2	XC6223E121MR-G	LVR-IC	LDO, 1.2V±20mV, 300mA, +CE, ICP	SOT-25	28cx	VR4	6g	Tor
9T2	XC6113F533MR	Vdet-IC	3.3V±2%, -MR, +Reset PPO, Wt=400ms, Rt=400ms	SOT-25	28cp	VD17	6g	Tor
9T3	XC6223E131MR-G	LVR-IC	LDO, 1.3V±20mV, 300mA, +CE, ICP	SOT-25	28cx	VR4	6g	Tor
9T3	XC6113F534MR	Vdet-IC	3.4V±2%, -MR, +Reset PPO, Wt=400ms, Rt=400ms	SOT-25	28cp	VD17	6g	Tor
9T4	XC6223E141MR-G	LVR-IC	LDO, 1.4V±20mV, 300mA, +CE, ICP	SOT-25	28cx	VR4	6g	Tor
9T4	XC6113F535MR	Vdet-IC	3.5V±2%, -MR, +Reset PPO, Wt=400ms, Rt=400ms	SOT-25	28cp	VD17	6g	Tor
9T5	XC6223E151MR-G	LVR-IC	LDO, 1.5V±20mV, 300mA, +CE, ICP	SOT-25	28cx	VR4	6g	Tor
9T5	XC6113F536MR	Vdet-IC	3.6V±2%, -MR, +Reset PPO, Wt=400ms, Rt=400ms	SOT-25	28cp	VD17	6g	Tor
9T6	XC6223E161MR-G	LVR-IC	LDO, 1.6V±20mV, 300mA, +CE, ICP	SOT-25	28cx	VR4	6g	Tor
9T6	XC6113F537MR	Vdet-IC	3.7V±2%, -MR, +Reset PPO, Wt=400ms, Rt=400ms	SOT-25	28cp	VD17	6g	Tor
9T7	XC6223E171MR-G	LVR-IC	LDO, 1.7V±20mV, 300mA, +CE, ICP	SOT-25	28cx	VR4	6g	Tor
9T7	XC6113F538MR	Vdet-IC	3.8V±2%, -MR, +Reset PPO, Wt=400ms, Rt=400ms	SOT-25	28cp	VD17	6g	Tor
9T8	XC6223E181MR-G	LVR-IC	LDO, 1.8V±20mV, 300mA, +CE, ICP	SOT-25	28cx	VR4	6g	Tor



SMD code	Type	Function	Short description	Case	Pinout	Sch.	St.	Mnf.
9T8	XC6113F539MR	Vdet-IC	3.9V±2%, -MR, +Reset PPO, Wt=400ms, Rt=400ms	SOT-25	28cp	VD17	6g	Tor
9T9	XC6223E191MR-G	LVR-IC	LDO, 1.9V±20mV, 300mA, +CE, ICP	SOT-25	28cx	VR4	6g	Tor
9T9	XC6113F540MR	Vdet-IC	4.0V±2%, -MR, +Reset PPO, Wt=400ms, Rt=400ms	SOT-25	28cp	VD17	6g	Tor
9TA	XC6223E201MR-G	LVR-IC	LDO, 2.0V±1%, 300mA, +CE, ICP	SOT-25	28cx	VR4	6g	Tor
9TA	XC6113F541MR	Vdet-IC	4.1V±2%, -MR, +Reset PPO, Wt=400ms, Rt=400ms	SOT-25	28cp	VD17	6g	Tor
9TB	XC6223E211MR-G	LVR-IC	LDO, 2.1V±1%, 300mA, +CE, ICP	SOT-25	28cx	VR4	6g	Tor
9TB	XC6113F542MR	Vdet-IC	4.2V±2%, -MR, +Reset PPO, Wt=400ms, Rt=400ms	SOT-25	28cp	VD17	6g	Tor
9TC	XC6223E221MR-G	LVR-IC	LDO, 2.2V±1%, 300mA, +CE, ICP	SOT-25	28cx	VR4	6g	Tor
9TC	XC6113F543MR	Vdet-IC	4.3V±2%, -MR, +Reset PPO, Wt=400ms, Rt=400ms	SOT-25	28cp	VD17	6g	Tor
9TD	XC6223E231MR-G	LVR-IC	LDO, 2.3V±1%, 300mA, +CE, ICP	SOT-25	28cx	VR4	6g	Tor
9TD	XC6113F544MR	Vdet-IC	4.4V±2%, -MR, +Reset PPO, Wt=400ms, Rt=400ms	SOT-25	28cp	VD17	6g	Tor
9TE	XC6223E241MR-G	LVR-IC	LDO, 2.4V±1%, 300mA, +CE, ICP	SOT-25	28cx	VR4	6g	Tor
9TE	XC6113F545MR	Vdet-IC	4.5V±2%, -MR, +Reset PPO, Wt=400ms, Rt=400ms	SOT-25	28cp	VD17	6g	Tor
9TF	XC6223E251MR-G	LVR-IC	LDO, 2.5V±1%, 300mA, +CE, ICP	SOT-25	28cx	VR4	6g	Tor
9TF	XC6113F516MR	Vdet-IC	1.6V±2%, -MR, +Reset PPO, Wt=400ms, Rt=400ms	SOT-25	28cp	VD17	6g	Tor
9TF	XC6113F546MR	Vdet-IC	4.6V±2%, -MR, +Reset PPO, Wt=400ms, Rt=400ms	SOT-25	28cp	VD17	6g	Tor
9TH	XC6223E261MR-G	LVR-IC	LDO, 2.6V±1%, 300mA, +CE, ICP	SOT-25	28cx	VR4	6g	Tor
9TH	XC6113F517MR	Vdet-IC	1.7V±2%, -MR, +Reset PPO, Wt=400ms, Rt=400ms	SOT-25	28cp	VD17	6g	Tor
9TH	XC6113F547MR	Vdet-IC	4.7V±2%, -MR, +Reset PPO, Wt=400ms, Rt=400ms	SOT-25	28cp	VD17	6g	Tor
9TK	XC6223E271MR-G	LVR-IC	LDO, 2.7V±1%, 300mA, +CE, ICP	SOT-25	28cx	VR4	6g	Tor
9TK	XC6113F518MR	Vdet-IC	1.8V±2%, -MR, +Reset PPO, Wt=400ms, Rt=400ms	SOT-25	28cp	VD17	6g	Tor
9TK	XC6113F548MR	Vdet-IC	4.8V±2%, -MR, +Reset PPO, Wt=400ms, Rt=400ms	SOT-25	28cp	VD17	6g	Tor
9TL	XC6223E281MR-G	LVR-IC	LDO, 2.8V±1%, 300mA, +CE, ICP	SOT-25	28cx	VR4	6g	Tor
9TL	XC6113F519MR	Vdet-IC	1.9V±2%, -MR, +Reset PPO, Wt=400ms, Rt=400ms	SOT-25	28cp	VD17	6g	Tor
9TL	XC6113F549MR	Vdet-IC	4.9V±2%, -MR, +Reset PPO, Wt=400ms, Rt=400ms	SOT-25	28cp	VD17	6g	Tor
9TM	XC6223E291MR-G	LVR-IC	LDO, 2.9V±1%, 300mA, +CE, ICP	SOT-25	28cx	VR4	6g	Tor
9TM	XC6113F520MR	Vdet-IC	2.0V±2%, -MR, +Reset PPO, Wt=400ms, Rt=400ms	SOT-25	28cp	VD17	6g	Tor
9TM	XC6113F550MR	Vdet-IC	5.0V±2%, -MR, +Reset PPO, Wt=400ms, Rt=400ms	SOT-25	28cp	VD17	6g	Tor
9TN	XC6223E301MR-G	LVR-IC	LDO, 3.0V±1%, 300mA, +CE, ICP	SOT-25	28cx	VR4	6g	Tor
9TN	XC6113F521MR	Vdet-IC	2.1V±2%, -MR, +Reset PPO, Wt=400ms, Rt=400ms	SOT-25	28cp	VD17	6g	Tor
9TP	XC6223E311MR-G	LVR-IC	LDO, 3.1V±1%, 300mA, +CE, ICP	SOT-25	28cx	VR4	6g	Tor
9TP	XC6113F522MR	Vdet-IC	2.2V±2%, -MR, +Reset PPO, Wt=400ms, Rt=400ms	SOT-25	28cp	VD17	6g	Tor
9TR	XC6223E321MR-G	LVR-IC	LDO, 3.2V±1%, 300mA, +CE, ICP	SOT-25	28cx	VR4	6g	Tor
9TR	XC6113F523MR	Vdet-IC	2.3V±2%, -MR, +Reset PPO, Wt=400ms, Rt=400ms	SOT-25	28cp	VD17	6g	Tor
9TS	XC6223E331MR-G	LVR-IC	LDO, 3.3V±1%, 300mA, +CE, ICP	SOT-25	28cx	VR4	6g	Tor
9TS	XC6113F524MR	Vdet-IC	2.4V±2%, -MR, +Reset PPO, Wt=400ms, Rt=400ms	SOT-25	28cp	VD17	6g	Tor
9TT	XC6223E341MR-G	LVR-IC	LDO, 3.4V±1%, 300mA, +CE, ICP	SOT-25	28cx	VR4	6g	Tor
9TT	XC6113F525MR	Vdet-IC	2.5V±2%, -MR, +Reset PPO, Wt=400ms, Rt=400ms	SOT-25	28cp	VD17	6g	Tor
9TU	XC6223E351MR-G	LVR-IC	LDO, 3.5V±1%, 300mA, +CE, ICP	SOT-25	28cx	VR4	6g	Tor
9TU	XC6113F526MR	Vdet-IC	2.6V±2%, -MR, +Reset PPO, Wt=400ms, Rt=400ms	SOT-25	28cp	VD17	6g	Tor
9TV	XC6223E361MR-G	LVR-IC	LDO, 3.6V±1%, 300mA, +CE, ICP	SOT-25	28cx	VR4	6g	Tor
9TV	XC6113F527MR	Vdet-IC	2.7V±2%, -MR, +Reset PPO, Wt=400ms, Rt=400ms	SOT-25	28cp	VD17	6g	Tor
9TX	XC6223E371MR-G	LVR-IC	LDO, 3.7V±1%, 300mA, +CE, ICP	SOT-25	28cx	VR4	6g	Tor
9TX	XC6113F528MR	Vdet-IC	2.8V±2%, -MR, +Reset PPO, Wt=400ms, Rt=400ms	SOT-25	28cp	VD17	6g	Tor
9TY	XC6223E381MR-G	LVR-IC	LDO, 3.8V±1%, 300mA, +CE, ICP	SOT-25	28cx	VR4	6g	Tor
9TY	XC6113F529MR	Vdet-IC	2.9V±2%, -MR, +Reset PPO, Wt=400ms, Rt=400ms	SOT-25	28cp	VD17	6g	Tor
9TZ	XC6223E391MR-G	LVR-IC	LDO, 3.9V±1%, 300mA, +CE, ICP	SOT-25	28cx	VR4	6g	Tor
9TZ	XC6113F530MR	Vdet-IC	3.0V±2%, -MR, +Reset PPO, Wt=400ms, Rt=400ms	SOT-25	28cp	VD17	6g	Tor
9U	R1210N291C	DC/DC-IC	PWM step-up, 2.9V, 100kHz	SOT-23-5	28sc	DC3	6g	Ric
9U0	XC6223E401MR-G	LVR-IC	LDO, 4.0V±1%, 300mA, +CE, ICP	SOT-25	28cx	VR4	6g	Tor
9U0	XC6113F631MR	Vdet-IC	3.1V±2%, -MR, +Reset PPO, Wt=1.6s, Rt=400ms	SOT-25	28cp	VD17	6g	Tor
9U1	XC6113F632MR	Vdet-IC	3.2V±2%, -MR, +Reset PPO, Wt=1.6s, Rt=400ms	SOT-25	28cp	VD17	6g	Tor
9U2	XC6113F633MR	Vdet-IC	3.3V±2%, -MR, +Reset PPO, Wt=1.6s, Rt=400ms	SOT-25	28cp	VD17	6g	Tor
9U3	XC6113F634MR	Vdet-IC	3.4V±2%, -MR, +Reset PPO, Wt=1.6s, Rt=400ms	SOT-25	28cp	VD17	6g	Tor
9U4	XC6113F635MR	Vdet-IC	3.5V±2%, -MR, +Reset PPO, Wt=1.6s, Rt=400ms	SOT-25	28cp	VD17	6g	Tor
9U5	XC6113F636MR	Vdet-IC	3.6V±2%, -MR, +Reset PPO, Wt=1.6s, Rt=400ms	SOT-25	28cp	VD17	6g	Tor
9U6	XC6113F637MR	Vdet-IC	3.7V±2%, -MR, +Reset PPO, Wt=1.6s, Rt=400ms	SOT-25	28cp	VD17	6g	Tor
9U7	XC6113F638MR	Vdet-IC	3.8V±2%, -MR, +Reset PPO, Wt=1.6s, Rt=400ms	SOT-25	28cp	VD17	6g	Tor
9U8	XC6113F639MR	Vdet-IC	3.9V±2%, -MR, +Reset PPO, Wt=1.6s, Rt=400ms	SOT-25	28cp	VD17	6g	Tor
9U9	XC6113F640MR	Vdet-IC	4.0V±2%, -MR, +Reset PPO, Wt=1.6s, Rt=400ms	SOT-25	28cp	VD17	6g	Tor
9UA	XC6113F641MR	Vdet-IC	4.1V±2%, -MR, +Reset PPO, Wt=1.6s, Rt=400ms	SOT-25	28cp	VD17	6g	Tor
9UB	XC6113F642MR	Vdet-IC	4.2V±2%, -MR, +Reset PPO, Wt=1.6s, Rt=400ms	SOT-25	28cp	VD17	6g	Tor
9UC	XC6113F643MR	Vdet-IC	4.3V±2%, -MR, +Reset PPO, Wt=1.6s, Rt=400ms	SOT-25	28cp	VD17	6g	Tor
9UD	XC6113F644MR	Vdet-IC	4.4V±2%, -MR, +Reset PPO, Wt=1.6s, Rt=400ms	SOT-25	28cp	VD17	6g	Tor
9UE	XC6113F645MR	Vdet-IC	4.5V±2%, -MR, +Reset PPO, Wt=1.6s, Rt=400ms	SOT-25	28cp	VD17	6g	Tor
9UF	XC6113F616MR	Vdet-IC	1.6V±2%, -MR, +Reset PPO, Wt=1.6s, Rt=400ms	SOT-25	28cp	VD17	6g	Tor
9UF	XC6113F646MR	Vdet-IC	4.6V±2%, -MR, +Reset PPO, Wt=1.6s, Rt=400ms	SOT-25	28cp	VD17	6g	Tor
9UH	XC6113F617MR	Vdet-IC	1.7V±2%, -MR, +Reset PPO, Wt=1.6s, Rt=400ms	SOT-25	28cp	VD17	6g	Tor
9UH	XC6113F647MR	Vdet-IC	4.7V±2%, -MR, +Reset PPO, Wt=1.6s, Rt=400ms	SOT-25	28cp	VD17	6g	Tor
9UK	XC6113F618MR	Vdet-IC	1.8V±2%, -MR, +Reset PPO, Wt=1.6s, Rt=400ms	SOT-25	28cp	VD17	6g	Tor



SMD code	Type	Function	Short description	Case	Pinout	Sch.	St.	Mnf.
<u>9U</u> K	XC6113F648MR	Vdet-IC	4.8V±2%, -MR, +Reset PPO, Wt=1.6s, Rt=400ms	SOT-25	28cp	VD17	6g	Tor
<u>9U</u> L	XC6113F619MR	Vdet-IC	1.9V±2%, -MR, +Reset PPO, Wt=1.6s, Rt=400ms	SOT-25	28cp	VD17	6g	Tor
<u>9U</u> ┘	XC6113F649MR	Vdet-IC	4.9V±2%, -MR, +Reset PPO, Wt=1.6s, Rt=400ms	SOT-25	28cp	VD17	6g	Tor
<u>9U</u> M	XC6113F620MR	Vdet-IC	2.0V±2%, -MR, +Reset PPO, Wt=1.6s, Rt=400ms	SOT-25	28cp	VD17	6g	Tor
<u>9U</u> ┘	XC6113F650MR	Vdet-IC	5.0V±2%, -MR, +Reset PPO, Wt=1.6s, Rt=400ms	SOT-25	28cp	VD17	6g	Tor
<u>9U</u> N	XC6113F621MR	Vdet-IC	2.1V±2%, -MR, +Reset PPO, Wt=1.6s, Rt=400ms	SOT-25	28cp	VD17	6g	Tor
<u>9U</u> P	XC6113F622MR	Vdet-IC	2.2V±2%, -MR, +Reset PPO, Wt=1.6s, Rt=400ms	SOT-25	28cp	VD17	6g	Tor
<u>9U</u> R	XC6113F623MR	Vdet-IC	2.3V±2%, -MR, +Reset PPO, Wt=1.6s, Rt=400ms	SOT-25	28cp	VD17	6g	Tor
<u>9U</u> S	XC6113F624MR	Vdet-IC	2.4V±2%, -MR, +Reset PPO, Wt=1.6s, Rt=400ms	SOT-25	28cp	VD17	6g	Tor
<u>9U</u> T	XC6113F625MR	Vdet-IC	2.5V±2%, -MR, +Reset PPO, Wt=1.6s, Rt=400ms	SOT-25	28cp	VD17	6g	Tor
<u>9U</u> U	XC6113F626MR	Vdet-IC	2.6V±2%, -MR, +Reset PPO, Wt=1.6s, Rt=400ms	SOT-25	28cp	VD17	6g	Tor
<u>9U</u> V	XC6113F627MR	Vdet-IC	2.7V±2%, -MR, +Reset PPO, Wt=1.6s, Rt=400ms	SOT-25	28cp	VD17	6g	Tor
<u>9U</u> X	XC6113F628MR	Vdet-IC	2.8V±2%, -MR, +Reset PPO, Wt=1.6s, Rt=400ms	SOT-25	28cp	VD17	6g	Tor
<u>9U</u> Y	XC6113F629MR	Vdet-IC	2.9V±2%, -MR, +Reset PPO, Wt=1.6s, Rt=400ms	SOT-25	28cp	VD17	6g	Tor
<u>9U</u> Z	XC6113F630MR	Vdet-IC	3.0V±2%, -MR, +Reset PPO, Wt=1.6s, Rt=400ms	SOT-25	28cp	VD17	6g	Tor
<u>9V</u> 0	XC6113H631MR	Vdet-IC	3.1V±2%, -MR, +Reset PPO, Wt=1.6s, Rt=1.6s	SOT-25	28cp	VD17	6g	Tor
<u>9V</u> 1	XC6113H632MR	Vdet-IC	3.2V±2%, -MR, +Reset PPO, Wt=1.6s, Rt=1.6s	SOT-25	28cp	VD17	6g	Tor
<u>9V</u> 2	XC6223E12BMR-G	LVR-IC	LDO, 1.25V±20mV, 300mA, +CE, ICP	SOT-25	28cx	VR4	6g	Tor
<u>9V</u> 2	XC6113H633MR	Vdet-IC	3.3V±2%, -MR, +Reset PPO, Wt=1.6s, Rt=1.6s	SOT-25	28cp	VD17	6g	Tor
<u>9V</u> 3	XC6223E13BMR-G	LVR-IC	LDO, 1.35V±20mV, 300mA, +CE, ICP	SOT-25	28cx	VR4	6g	Tor
<u>9V</u> 3	XC6113H634MR	Vdet-IC	3.4V±2%, -MR, +Reset PPO, Wt=1.6s, Rt=1.6s	SOT-25	28cp	VD17	6g	Tor
<u>9V</u> 4	XC6223E14BMR-G	LVR-IC	LDO, 1.45V±20mV, 300mA, +CE, ICP	SOT-25	28cx	VR4	6g	Tor
<u>9V</u> 4	XC6113H635MR	Vdet-IC	3.5V±2%, -MR, +Reset PPO, Wt=1.6s, Rt=1.6s	SOT-25	28cp	VD17	6g	Tor
<u>9V</u> 5	XC6223E15BMR-G	LVR-IC	LDO, 1.55V±20mV, 300mA, +CE, ICP	SOT-25	28cx	VR4	6g	Tor
<u>9V</u> 5	XC6113H636MR	Vdet-IC	3.6V±2%, -MR, +Reset PPO, Wt=1.6s, Rt=1.6s	SOT-25	28cp	VD17	6g	Tor
<u>9V</u> 6	XC6223E16BMR-G	LVR-IC	LDO, 1.65V±20mV, 300mA, +CE, ICP	SOT-25	28cx	VR4	6g	Tor
<u>9V</u> 6	XC6113H637MR	Vdet-IC	3.7V±2%, -MR, +Reset PPO, Wt=1.6s, Rt=1.6s	SOT-25	28cp	VD17	6g	Tor
<u>9V</u> 7	XC6223E17BMR-G	LVR-IC	LDO, 1.75V±20mV, 300mA, +CE, ICP	SOT-25	28cx	VR4	6g	Tor
<u>9V</u> 7	XC6113H638MR	Vdet-IC	3.8V±2%, -MR, +Reset PPO, Wt=1.6s, Rt=1.6s	SOT-25	28cp	VD17	6g	Tor
<u>9V</u> 8	XC6209A092MR	LVR-IC	LDO, 0.9V±2%, 150mA, +CE, PDR	SOT-25	28cx	VR4	6g	Tor
<u>9V</u> 8	XC6223E18BMR-G	LVR-IC	LDO, 1.85V±20mV, 300mA, +CE, ICP	SOT-25	28cx	VR4	6g	Tor
<u>9V</u> 8	XC6113H639MR	Vdet-IC	3.9V±2%, -MR, +Reset PPO, Wt=1.6s, Rt=1.6s	SOT-25	28cp	VD17	6g	Tor
<u>9V</u> 8	XC6209E092MR	LVR-IC	LDO, 0.9V±2%, 300mA, +CE, PDR	SOT-25	28cx	VR4	6g	Tor
<u>9V</u> 8	XC6212A092MR	LVR-IC	LDO, 0.9V±2%, 150mA, +CE, PDR	SOT-25	28vt	VR4	6g	Tor
<u>9V</u> 9	XC6209A102MR	LVR-IC	LDO, 1V±2%, 150mA, +CE, PDR	SOT-25	28cx	VR4	6g	Tor
<u>9V</u> 9	XC6223E19BMR-G	LVR-IC	LDO, 1.95V±20mV, 300mA, +CE, ICP	SOT-25	28cx	VR4	6g	Tor
<u>9V</u> 9	XC6113H640MR	Vdet-IC	4.0V±2%, -MR, +Reset PPO, Wt=1.6s, Rt=1.6s	SOT-25	28cp	VD17	6g	Tor
<u>9V</u> 9	XC6209E102MR	LVR-IC	LDO, 1V±2%, 300mA, +CE, PDR	SOT-25	28cx	VR4	6g	Tor
<u>9V</u> 9	XC6212A102MR	LVR-IC	LDO, 1V±2%, 150mA, +CE, PDR	SOT-25	28vt	VR4	6g	Tor
<u>9V</u> A	XC6209A112MR	LVR-IC	LDO, 1.1V±2%, 150mA, +CE, PDR	SOT-25	28cx	VR4	6g	Tor
<u>9V</u> A	XC6223E20BMR-G	LVR-IC	LDO, 2.05V±1%, 300mA, +CE, ICP	SOT-25	28cx	VR4	6g	Tor
<u>9V</u> A	XC6113H641MR	Vdet-IC	4.1V±2%, -MR, +Reset PPO, Wt=1.6s, Rt=1.6s	SOT-25	28cp	VD17	6g	Tor
<u>9V</u> A	XC6209E112MR	LVR-IC	LDO, 1.1V±2%, 300mA, +CE, PDR	SOT-25	28cx	VR4	6g	Tor
<u>9V</u> A	XC6212A112MR	LVR-IC	LDO, 1.1V±2%, 150mA, +CE, PDR	SOT-25	28vt	VR4	6g	Tor
<u>9V</u> B	XC6209A122MR	LVR-IC	LDO, 1.2V±2%, 150mA, +CE, PDR	SOT-25	28cx	VR4	6g	Tor
<u>9V</u> B	XC6223E21BMR-G	LVR-IC	LDO, 2.15V±1%, 300mA, +CE, ICP	SOT-25	28cx	VR4	6g	Tor
<u>9V</u> B	XC6113H642MR	Vdet-IC	4.2V±2%, -MR, +Reset PPO, Wt=1.6s, Rt=1.6s	SOT-25	28cp	VD17	6g	Tor
<u>9V</u> B	XC6209E122MR	LVR-IC	LDO, 1.2V±2%, 300mA, +CE, PDR	SOT-25	28cx	VR4	6g	Tor
<u>9V</u> B	XC6212A122MR	LVR-IC	LDO, 1.2V±2%, 150mA, +CE, PDR	SOT-25	28vt	VR4	6g	Tor
<u>9V</u> C	XC6209A132MR	LVR-IC	LDO, 1.3V±2%, 150mA, +CE, PDR	SOT-25	28cx	VR4	6g	Tor
<u>9V</u> C	XC6223E22BMR-G	LVR-IC	LDO, 2.25V±1%, 300mA, +CE, ICP	SOT-25	28cx	VR4	6g	Tor
<u>9V</u> C	XC6113H643MR	Vdet-IC	4.3V±2%, -MR, +Reset PPO, Wt=1.6s, Rt=1.6s	SOT-25	28cp	VD17	6g	Tor
<u>9V</u> C	XC6209E132MR	LVR-IC	LDO, 1.3V±2%, 300mA, +CE, PDR	SOT-25	28cx	VR4	6g	Tor
<u>9V</u> C	XC6212A132MR	LVR-IC	LDO, 1.3V±2%, 150mA, +CE, PDR	SOT-25	28vt	VR4	6g	Tor
<u>9V</u> D	XC6209A142MR	LVR-IC	LDO, 1.4V±2%, 150mA, +CE, PDR	SOT-25	28cx	VR4	6g	Tor
<u>9V</u> D	XC6223E23BMR-G	LVR-IC	LDO, 2.35V±1%, 300mA, +CE, ICP	SOT-25	28cx	VR4	6g	Tor
<u>9V</u> D	XC6113H644MR	Vdet-IC	4.4V±2%, -MR, +Reset PPO, Wt=1.6s, Rt=1.6s	SOT-25	28cp	VD17	6g	Tor
<u>9V</u> D	XC6209E142MR	LVR-IC	LDO, 1.4V±2%, 300mA, +CE, PDR	SOT-25	28cx	VR4	6g	Tor
<u>9V</u> D	XC6212A142MR	LVR-IC	LDO, 1.4V±2%, 150mA, +CE, PDR	SOT-25	28vt	VR4	6g	Tor
<u>9V</u> E	XC6209A152MR	LVR-IC	LDO, 1.5V±2%, 150mA, +CE, PDR	SOT-25	28cx	VR4	6g	Tor
<u>9V</u> E	XC6223E24BMR-G	LVR-IC	LDO, 2.45V±1%, 300mA, +CE, ICP	SOT-25	28cx	VR4	6g	Tor
<u>9V</u> E	XC6113H645MR	Vdet-IC	4.5V±2%, -MR, +Reset PPO, Wt=1.6s, Rt=1.6s	SOT-25	28cp	VD17	6g	Tor
<u>9V</u> E	XC6209E152MR	LVR-IC	LDO, 1.5V±2%, 300mA, +CE, PDR	SOT-25	28cx	VR4	6g	Tor
<u>9V</u> E	XC6212A152MR	LVR-IC	LDO, 1.5V±2%, 150mA, +CE, PDR	SOT-25	28vt	VR4	6g	Tor
<u>9V</u> F	XC6209A162MR	LVR-IC	LDO, 1.6V±2%, 150mA, +CE, PDR	SOT-25	28cx	VR4	6g	Tor
<u>9V</u> F	XC6223E25BMR-G	LVR-IC	LDO, 2.55V±1%, 300mA, +CE, ICP	SOT-25	28cx	VR4	6g	Tor
<u>9V</u> F	XC6113H616MR	Vdet-IC	1.6V±2%, -MR, +Reset PPO, Wt=1.6s, Rt=1.6s	SOT-25	28cp	VD17	6g	Tor
<u>9V</u> F	XC6113H646MR	Vdet-IC	4.6V±2%, -MR, +Reset PPO, Wt=1.6s, Rt=1.6s	SOT-25	28cp	VD17	6g	Tor
<u>9V</u> F	XC6209E162MR	LVR-IC	LDO, 1.6V±2%, 300mA, +CE, PDR	SOT-25	28cx	VR4	6g	Tor
<u>9V</u> F	XC6212A162MR	LVR-IC	LDO, 1.6V±2%, 150mA, +CE, PDR	SOT-25	28vt	VR4	6g	Tor



SMD code	Type	Function	Short description	Case	Pinout	Sch.	St.	Mnf.
9VH	XC6209A172MR	LVR-IC	LDO, 1.7V±2%, 150mA, +CE, PDR	SOT-25	28cx	VR4	6g	Tor
9VH	XC6223E26BMR-G	LVR-IC	LDO, 2.65V±1%, 300mA, +CE, ICP	SOT-25	28cx	VR4	6g	Tor
9VH	XC6113H617MR	Vdet-IC	1.7V±2%, -MR, +Reset PPO, Wt=1.6s, Rt=1.6s	SOT-25	28cp	VD17	6g	Tor
9VH	XC6113H647MR	Vdet-IC	4.7V±2%, -MR, +Reset PPO, Wt=1.6s, Rt=1.6s	SOT-25	28cp	VD17	6g	Tor
9VH	XC6209E172MR	LVR-IC	LDO, 1.7V±2%, 300mA, +CE, PDR	SOT-25	28cx	VR4	6g	Tor
9VH	XC6212A172MR	LVR-IC	LDO, 1.7V±2%, 150mA, +CE, PDR	SOT-25	28vt	VR4	6g	Tor
9VK	XC6209A182MR	LVR-IC	LDO, 1.8V±2%, 150mA, +CE, PDR	SOT-25	28cx	VR4	6g	Tor
9VK	XC6223E27BMR-G	LVR-IC	LDO, 2.75V±1%, 300mA, +CE, ICP	SOT-25	28cx	VR4	6g	Tor
9VK	XC6113H618MR	Vdet-IC	1.8V±2%, -MR, +Reset PPO, Wt=1.6s, Rt=1.6s	SOT-25	28cp	VD17	6g	Tor
9VK	XC6113H648MR	Vdet-IC	4.8V±2%, -MR, +Reset PPO, Wt=1.6s, Rt=1.6s	SOT-25	28cp	VD17	6g	Tor
9VK	XC6209E182MR	LVR-IC	LDO, 1.8V±2%, 300mA, +CE, PDR	SOT-25	28cx	VR4	6g	Tor
9VK	XC6212A182MR	LVR-IC	LDO, 1.8V±2%, 150mA, +CE, PDR	SOT-25	28vt	VR4	6g	Tor
9VL	XC6209A192MR	LVR-IC	LDO, 1.9V±2%, 150mA, +CE, PDR	SOT-25	28cx	VR4	6g	Tor
9VL	XC6223E28BMR-G	LVR-IC	LDO, 2.85V±1%, 300mA, +CE, ICP	SOT-25	28cx	VR4	6g	Tor
9VL	XC6113H619MR	Vdet-IC	1.9V±2%, -MR, +Reset PPO, Wt=1.6s, Rt=1.6s	SOT-25	28cp	VD17	6g	Tor
9VL	XC6113H649MR	Vdet-IC	4.9V±2%, -MR, +Reset PPO, Wt=1.6s, Rt=1.6s	SOT-25	28cp	VD17	6g	Tor
9VL	XC6209E192MR	LVR-IC	LDO, 1.9V±2%, 300mA, +CE, PDR	SOT-25	28cx	VR4	6g	Tor
9VL	XC6212A192MR	LVR-IC	LDO, 1.9V±2%, 150mA, +CE, PDR	SOT-25	28vt	VR4	6g	Tor
9VM	XC6209A202MR	LVR-IC	LDO, 2V±2%, 150mA, +CE, PDR	SOT-25	28cx	VR4	6g	Tor
9VM	XC6223E29BMR-G	LVR-IC	LDO, 2.95V±1%, 300mA, +CE, ICP	SOT-25	28cx	VR4	6g	Tor
9VM	XC6113H620MR	Vdet-IC	2.0V±2%, -MR, +Reset PPO, Wt=1.6s, Rt=1.6s	SOT-25	28cp	VD17	6g	Tor
9VM	XC6113H650MR	Vdet-IC	5.0V±2%, -MR, +Reset PPO, Wt=1.6s, Rt=1.6s	SOT-25	28cp	VD17	6g	Tor
9VM	XC6209E202MR	LVR-IC	LDO, 2V±2%, 300mA, +CE, PDR	SOT-25	28cx	VR4	6g	Tor
9VM	XC6212A202MR	LVR-IC	LDO, 2V±2%, 150mA, +CE, PDR	SOT-25	28vt	VR4	6g	Tor
9VN	XC6209A212MR	LVR-IC	LDO, 2.1V±2%, 150mA, +CE, PDR	SOT-25	28cx	VR4	6g	Tor
9VN	XC6223E30BMR-G	LVR-IC	LDO, 3.05V±1%, 300mA, +CE, ICP	SOT-25	28cx	VR4	6g	Tor
9VN	XC6113H621MR	Vdet-IC	2.1V±2%, -MR, +Reset PPO, Wt=1.6s, Rt=1.6s	SOT-25	28cp	VD17	6g	Tor
9VN	XC6209E212MR	LVR-IC	LDO, 2.1V±2%, 300mA, +CE, PDR	SOT-25	28cx	VR4	6g	Tor
9VN	XC6212A212MR	LVR-IC	LDO, 2.1V±2%, 150mA, +CE, PDR	SOT-25	28vt	VR4	6g	Tor
9VP	XC6209A222MR	LVR-IC	LDO, 2.2V±2%, 150mA, +CE, PDR	SOT-25	28cx	VR4	6g	Tor
9VP	XC6223E31BMR-G	LVR-IC	LDO, 3.15V±1%, 300mA, +CE, ICP	SOT-25	28cx	VR4	6g	Tor
9VP	XC6113H622MR	Vdet-IC	2.2V±2%, -MR, +Reset PPO, Wt=1.6s, Rt=1.6s	SOT-25	28cp	VD17	6g	Tor
9VP	XC6209E222MR	LVR-IC	LDO, 2.2V±2%, 300mA, +CE, PDR	SOT-25	28cx	VR4	6g	Tor
9VP	XC6212A222MR	LVR-IC	LDO, 2.2V±2%, 150mA, +CE, PDR	SOT-25	28vt	VR4	6g	Tor
9VR	XC6209A232MR	LVR-IC	LDO, 2.3V±2%, 150mA, +CE, PDR	SOT-25	28cx	VR4	6g	Tor
9VR	XC6223E32BMR-G	LVR-IC	LDO, 3.25V±1%, 300mA, +CE, ICP	SOT-25	28cx	VR4	6g	Tor
9VR	XC6113H623MR	Vdet-IC	2.3V±2%, -MR, +Reset PPO, Wt=1.6s, Rt=1.6s	SOT-25	28cp	VD17	6g	Tor
9VR	XC6209E232MR	LVR-IC	LDO, 2.3V±2%, 300mA, +CE, PDR	SOT-25	28cx	VR4	6g	Tor
9VR	XC6212A232MR	LVR-IC	LDO, 2.3V±2%, 150mA, +CE, PDR	SOT-25	28vt	VR4	6g	Tor
9VS	XC6209A242MR	LVR-IC	LDO, 2.4V±2%, 150mA, +CE, PDR	SOT-25	28cx	VR4	6g	Tor
9VS	XC6223E33BMR-G	LVR-IC	LDO, 3.35V±1%, 300mA, +CE, ICP	SOT-25	28cx	VR4	6g	Tor
9VS	XC6113H624MR	Vdet-IC	2.4V±2%, -MR, +Reset PPO, Wt=1.6s, Rt=1.6s	SOT-25	28cp	VD17	6g	Tor
9VS	XC6209E242MR	LVR-IC	LDO, 2.4V±2%, 300mA, +CE, PDR	SOT-25	28cx	VR4	6g	Tor
9VS	XC6212A242MR	LVR-IC	LDO, 2.4V±2%, 150mA, +CE, PDR	SOT-25	28vt	VR4	6g	Tor
9VT	XC6209A252MR	LVR-IC	LDO, 2.5V±2%, 150mA, +CE, PDR	SOT-25	28cx	VR4	6g	Tor
9VT	XC6223E34BMR-G	LVR-IC	LDO, 3.45V±1%, 300mA, +CE, ICP	SOT-25	28cx	VR4	6g	Tor
9VT	XC6113H625MR	Vdet-IC	2.5V±2%, -MR, +Reset PPO, Wt=1.6s, Rt=1.6s	SOT-25	28cp	VD17	6g	Tor
9VT	XC6209E252MR	LVR-IC	LDO, 2.5V±2%, 300mA, +CE, PDR	SOT-25	28cx	VR4	6g	Tor
9VT	XC6212A252MR	LVR-IC	LDO, 2.5V±2%, 150mA, +CE, PDR	SOT-25	28vt	VR4	6g	Tor
9VU	XC6209A262MR	LVR-IC	LDO, 2.6V±2%, 150mA, +CE, PDR	SOT-25	28cx	VR4	6g	Tor
9VU	XC6223E35BMR-G	LVR-IC	LDO, 3.55V±1%, 300mA, +CE, ICP	SOT-25	28cx	VR4	6g	Tor
9VU	XC6113H626MR	Vdet-IC	2.6V±2%, -MR, +Reset PPO, Wt=1.6s, Rt=1.6s	SOT-25	28cp	VD17	6g	Tor
9VU	XC6209E262MR	LVR-IC	LDO, 2.6V±2%, 300mA, +CE, PDR	SOT-25	28cx	VR4	6g	Tor
9VU	XC6212A262MR	LVR-IC	LDO, 2.6V±2%, 150mA, +CE, PDR	SOT-25	28vt	VR4	6g	Tor
9VV	XC6209A272MR	LVR-IC	LDO, 2.7V±2%, 150mA, +CE, PDR	SOT-25	28cx	VR4	6g	Tor
9VV	XC6223E36BMR-G	LVR-IC	LDO, 3.65V±1%, 300mA, +CE, ICP	SOT-25	28cx	VR4	6g	Tor
9VV	XC6113H627MR	Vdet-IC	2.7V±2%, -MR, +Reset PPO, Wt=1.6s, Rt=1.6s	SOT-25	28cp	VD17	6g	Tor
9VV	XC6209E272MR	LVR-IC	LDO, 2.7V±2%, 300mA, +CE, PDR	SOT-25	28cx	VR4	6g	Tor
9VV	XC6212A272MR	LVR-IC	LDO, 2.7V±2%, 150mA, +CE, PDR	SOT-25	28vt	VR4	6g	Tor
9VX	XC6209A282MR	LVR-IC	LDO, 2.8V±2%, 150mA, +CE, PDR	SOT-25	28cx	VR4	6g	Tor
9VX	XC6223E37BMR-G	LVR-IC	LDO, 3.75V±1%, 300mA, +CE, ICP	SOT-25	28cx	VR4	6g	Tor
9VX	XC6113H628MR	Vdet-IC	2.8V±2%, -MR, +Reset PPO, Wt=1.6s, Rt=1.6s	SOT-25	28cp	VD17	6g	Tor
9VX	XC6209E282MR	LVR-IC	LDO, 2.8V±2%, 300mA, +CE, PDR	SOT-25	28cx	VR4	6g	Tor
9VX	XC6212A282MR	LVR-IC	LDO, 2.8V±2%, 150mA, +CE, PDR	SOT-25	28vt	VR4	6g	Tor
9VY	XC6209A292MR	LVR-IC	LDO, 2.9V±2%, 150mA, +CE, PDR	SOT-25	28cx	VR4	6g	Tor
9VY	XC6223E38BMR-G	LVR-IC	LDO, 3.85V±1%, 300mA, +CE, ICP	SOT-25	28cx	VR4	6g	Tor
9VY	XC6113H629MR	Vdet-IC	2.9V±2%, -MR, +Reset PPO, Wt=1.6s, Rt=1.6s	SOT-25	28cp	VD17	6g	Tor
9VY	XC6209E292MR	LVR-IC	LDO, 2.9V±2%, 300mA, +CE, PDR	SOT-25	28cx	VR4	6g	Tor
9VY	XC6212A292MR	LVR-IC	LDO, 2.9V±2%, 150mA, +CE, PDR	SOT-25	28vt	VR4	6g	Tor
9VZ	XC6209A302MR	LVR-IC	LDO, 3V±2%, 150mA, +CE, PDR	SOT-25	28cx	VR4	6g	Tor



SMD code	Type	Function	Short description	Case	Pinout	Sch.	St.	Mnf.
9VZ	XC6223E39BMR-G	LVR-IC	LDO, 3.95V±1%, 300mA, +CE, ICP	SOT-25	28cx	VR4	6g	Tor
9VZ	XC6113H630MR	Vdet-IC	3.0V±2%, -MR, +Reset PPO, Wt=1.6s, Rt=1.6s	SOT-25	28cp	VD17	6g	Tor
9VZ	XC6209E302MR	LVR-IC	LDO, 3V±2%, 300mA, +CE, PDR	SOT-25	28cx	VR4	6g	Tor
9VZ	XC6212A302MR	LVR-IC	LDO, 3V±2%, 150mA, +CE, PDR	SOT-25	28vt	VR4	6g	Tor
9W	R1210N391C	DC/DC-IC	PWM step-up, 3.9V, 100kHz	SOT-23-5	28sc	DC3	6g	Ric
9X	R1210N491C	DC/DC-IC	PWM step-up, 4.9V, 100kHz	SOT-23-5	28sc	DC3	6g	Ric
9X2	XC6223F121MR-G	LVR-IC	LDO, 1.2V±20mV, 300mA, +CE, CL, ICP	SOT-25	28cx	VR4	6g	Tor
9X3	XC6223F131MR-G	LVR-IC	LDO, 1.3V±20mV, 300mA, +CE, CL, ICP	SOT-25	28cx	VR4	6g	Tor
9X4	XC6223F141MR-G	LVR-IC	LDO, 1.4V±20mV, 300mA, +CE, CL, ICP	SOT-25	28cx	VR4	6g	Tor
9X5	XC6223F151MR-G	LVR-IC	LDO, 1.5V±20mV, 300mA, +CE, CL, ICP	SOT-25	28cx	VR4	6g	Tor
9X6	XC6223F161MR-G	LVR-IC	LDO, 1.6V±20mV, 300mA, +CE, CL, ICP	SOT-25	28cx	VR4	6g	Tor
9X7	XC6223F171MR-G	LVR-IC	LDO, 1.7V±20mV, 300mA, +CE, CL, ICP	SOT-25	28cx	VR4	6g	Tor
9X8	XC6209B092MR	LVR-IC	LDO, 0.9V±2%, 150mA, +CE	SOT-25	28cx	VR4	6g	Tor
9X8	XC6223F181MR-G	LVR-IC	LDO, 1.8V±20mV, 300mA, +CE, CL, ICP	SOT-25	28cx	VR4	6g	Tor
9X8	XC6209F092MR	LVR-IC	LDO, 0.9V±2%, 300mA, +CE	SOT-25	28cx	VR4	6g	Tor
9X8	XC6212B092MR	LVR-IC	LDO, 0.9V±2%, 150mA, +CE	SOT-25	28vt	VR4	6g	Tor
9X9	XC6209B102MR	LVR-IC	LDO, 1V±2%, 150mA, +CE	SOT-25	28cx	VR4	6g	Tor
9X9	XC6223F191MR-G	LVR-IC	LDO, 1.9V±20mV, 300mA, +CE, CL, ICP	SOT-25	28cx	VR4	6g	Tor
9X9	XC6209F102MR	LVR-IC	LDO, 1V±2%, 300mA, +CE	SOT-25	28cx	VR4	6g	Tor
9X9	XC6212B102MR	LVR-IC	LDO, 1V±2%, 150mA, +CE	SOT-25	28vt	VR4	6g	Tor
9XA	XC6209B112MR	LVR-IC	LDO, 1.1V±2%, 150mA, +CE	SOT-25	28cx	VR4	6g	Tor
9XA	XC6223F201MR-G	LVR-IC	LDO, 2.0V±1%, 300mA, +CE, CL, ICP	SOT-25	28cx	VR4	6g	Tor
9XA	XC6209F112MR	LVR-IC	LDO, 1.1V±2%, 300mA, +CE	SOT-25	28cx	VR4	6g	Tor
9XA	XC6212B112MR	LVR-IC	LDO, 1.1V±2%, 150mA, +CE	SOT-25	28vt	VR4	6g	Tor
9XB	XC6209B122MR	LVR-IC	LDO, 1.2V±2%, 150mA, +CE	SOT-25	28cx	VR4	6g	Tor
9XB	XC6223F211MR-G	LVR-IC	LDO, 2.1V±1%, 300mA, +CE, CL, ICP	SOT-25	28cx	VR4	6g	Tor
9XB	XC6209F122MR	LVR-IC	LDO, 1.2V±2%, 300mA, +CE	SOT-25	28cx	VR4	6g	Tor
9XB	XC6212B122MR	LVR-IC	LDO, 1.2V±2%, 150mA, +CE	SOT-25	28vt	VR4	6g	Tor
9XC	XC6209B132MR	LVR-IC	LDO, 1.3V±2%, 150mA, +CE	SOT-25	28cx	VR4	6g	Tor
9XC	XC6223F221MR-G	LVR-IC	LDO, 2.2V±1%, 300mA, +CE, CL, ICP	SOT-25	28cx	VR4	6g	Tor
9XC	XC6209F132MR	LVR-IC	LDO, 1.3V±2%, 300mA, +CE	SOT-25	28cx	VR4	6g	Tor
9XC	XC6212B132MR	LVR-IC	LDO, 1.3V±2%, 150mA, +CE	SOT-25	28vt	VR4	6g	Tor
9XD	XC6209B142MR	LVR-IC	LDO, 1.4V±2%, 150mA, +CE	SOT-25	28cx	VR4	6g	Tor
9XD	XC6223F231MR-G	LVR-IC	LDO, 2.3V±1%, 300mA, +CE, CL, ICP	SOT-25	28cx	VR4	6g	Tor
9XD	XC6209F142MR	LVR-IC	LDO, 1.4V±2%, 300mA, +CE	SOT-25	28cx	VR4	6g	Tor
9XD	XC6212B142MR	LVR-IC	LDO, 1.4V±2%, 150mA, +CE	SOT-25	28vt	VR4	6g	Tor
9XE	XC6209B152MR	LVR-IC	LDO, 1.5V±2%, 150mA, +CE	SOT-25	28cx	VR4	6g	Tor
9XE	XC6223F241MR-G	LVR-IC	LDO, 2.4V±1%, 300mA, +CE, CL, ICP	SOT-25	28cx	VR4	6g	Tor
9XE	XC6209F152MR	LVR-IC	LDO, 1.5V±2%, 300mA, +CE	SOT-25	28cx	VR4	6g	Tor
9XE	XC6212B152MR	LVR-IC	LDO, 1.5V±2%, 150mA, +CE	SOT-25	28vt	VR4	6g	Tor
9XF	XC6209B162MR	LVR-IC	LDO, 1.6V±2%, 150mA, +CE	SOT-25	28cx	VR4	6g	Tor
9XF	XC6223F251MR-G	LVR-IC	LDO, 2.5V±1%, 300mA, +CE, CL, ICP	SOT-25	28cx	VR4	6g	Tor
9XF	XC6209F162MR	LVR-IC	LDO, 1.6V±2%, 300mA, +CE	SOT-25	28cx	VR4	6g	Tor
9XF	XC6212B162MR	LVR-IC	LDO, 1.6V±2%, 150mA, +CE	SOT-25	28vt	VR4	6g	Tor
9XH	XC6209B172MR	LVR-IC	LDO, 1.7V±2%, 150mA, +CE	SOT-25	28cx	VR4	6g	Tor
9XH	XC6223F261MR-G	LVR-IC	LDO, 2.6V±1%, 300mA, +CE, CL, ICP	SOT-25	28cx	VR4	6g	Tor
9XH	XC6209F172MR	LVR-IC	LDO, 1.7V±2%, 300mA, +CE	SOT-25	28cx	VR4	6g	Tor
9XH	XC6212B172MR	LVR-IC	LDO, 1.7V±2%, 150mA, +CE	SOT-25	28vt	VR4	6g	Tor
9XK	XC6209B182MR	LVR-IC	LDO, 1.8V±2%, 150mA, +CE	SOT-25	28cx	VR4	6g	Tor
9XK	XC6223F271MR-G	LVR-IC	LDO, 2.7V±1%, 300mA, +CE, CL, ICP	SOT-25	28cx	VR4	6g	Tor
9XK	XC6209F182MR	LVR-IC	LDO, 1.8V±2%, 300mA, +CE	SOT-25	28cx	VR4	6g	Tor
9XK	XC6212B182MR	LVR-IC	LDO, 1.8V±2%, 150mA, +CE	SOT-25	28vt	VR4	6g	Tor
9XL	XC6209B192MR	LVR-IC	LDO, 1.9V±2%, 150mA, +CE	SOT-25	28cx	VR4	6g	Tor
9XL	XC6223F281MR-G	LVR-IC	LDO, 2.8V±1%, 300mA, +CE, CL, ICP	SOT-25	28cx	VR4	6g	Tor
9XL	XC6209F192MR	LVR-IC	LDO, 1.9V±2%, 300mA, +CE	SOT-25	28cx	VR4	6g	Tor
9XL	XC6212B192MR	LVR-IC	LDO, 1.9V±2%, 150mA, +CE	SOT-25	28vt	VR4	6g	Tor
9XM	XC6209B202MR	LVR-IC	LDO, 2V±2%, 150mA, +CE	SOT-25	28cx	VR4	6g	Tor
9XM	XC6223F291MR-G	LVR-IC	LDO, 2.9V±1%, 300mA, +CE, CL, ICP	SOT-25	28cx	VR4	6g	Tor
9XM	XC6209F202MR	LVR-IC	LDO, 2V±2%, 300mA, +CE	SOT-25	28cx	VR4	6g	Tor
9XM	XC6212B202MR	LVR-IC	LDO, 2V±2%, 150mA, +CE	SOT-25	28vt	VR4	6g	Tor
9XN	XC6209B212MR	LVR-IC	LDO, 2.1V±2%, 150mA, +CE	SOT-25	28cx	VR4	6g	Tor
9XN	XC6223F301MR-G	LVR-IC	LDO, 3.0V±1%, 300mA, +CE, CL, ICP	SOT-25	28cx	VR4	6g	Tor
9XN	XC6209F212MR	LVR-IC	LDO, 2.1V±2%, 300mA, +CE	SOT-25	28cx	VR4	6g	Tor
9XN	XC6212B212MR	LVR-IC	LDO, 2.1V±2%, 150mA, +CE	SOT-25	28vt	VR4	6g	Tor
9XP	XC6209B222MR	LVR-IC	LDO, 2.2V±2%, 150mA, +CE	SOT-25	28cx	VR4	6g	Tor
9XP	XC6223F311MR-G	LVR-IC	LDO, 3.1V±1%, 300mA, +CE, CL, ICP	SOT-25	28cx	VR4	6g	Tor
9XP	XC6209F222MR	LVR-IC	LDO, 2.2V±2%, 300mA, +CE	SOT-25	28cx	VR4	6g	Tor
9XP	XC6212B222MR	LVR-IC	LDO, 2.2V±2%, 150mA, +CE	SOT-25	28vt	VR4	6g	Tor
9XR	XC6209B232MR	LVR-IC	LDO, 2.3V±2%, 150mA, +CE	SOT-25	28cx	VR4	6g	Tor
9XR	XC6223F321MR-G	LVR-IC	LDO, 3.2V±1%, 300mA, +CE, CL, ICP	SOT-25	28cx	VR4	6g	Tor



SMD code	Type	Function	Short description	Case	Pinout	Sch.	St.	Mnf.
9XR	XC6209F232MR	LVR-IC	LDO, 2.3V±2%, 300mA, +CE	SOT-25	28cx	VR4	6g	Tor
9XR	XC6212B232MR	LVR-IC	LDO, 2.3V±2%, 150mA, +CE	SOT-25	28vt	VR4	6g	Tor
9XS	XC6209B242MR	LVR-IC	LDO, 2.4V±2%, 150mA, +CE	SOT-25	28cx	VR4	6g	Tor
9XS	XC6223F331MR-G	LVR-IC	LDO, 3.3V±1%, 300mA, +CE, CL, ICP	SOT-25	28cx	VR4	6g	Tor
9XS	XC6209F242MR	LVR-IC	LDO, 2.4V±2%, 300mA, +CE	SOT-25	28cx	VR4	6g	Tor
9XS	XC6212B242MR	LVR-IC	LDO, 2.4V±2%, 150mA, +CE	SOT-25	28vt	VR4	6g	Tor
9XT	XC6209B252MR	LVR-IC	LDO, 2.5V±2%, 150mA, +CE	SOT-25	28cx	VR4	6g	Tor
9XT	XC6223F341MR-G	LVR-IC	LDO, 3.4V±1%, 300mA, +CE, CL, ICP	SOT-25	28cx	VR4	6g	Tor
9XT	XC6209F252MR	LVR-IC	LDO, 2.5V±2%, 300mA, +CE	SOT-25	28cx	VR4	6g	Tor
9XT	XC6212B252MR	LVR-IC	LDO, 2.5V±2%, 150mA, +CE	SOT-25	28vt	VR4	6g	Tor
9XU	XC6209B262MR	LVR-IC	LDO, 2.6V±2%, 150mA, +CE	SOT-25	28cx	VR4	6g	Tor
9XU	XC6223F351MR-G	LVR-IC	LDO, 3.5V±1%, 300mA, +CE, CL, ICP	SOT-25	28cx	VR4	6g	Tor
9XU	XC6209F262MR	LVR-IC	LDO, 2.6V±2%, 300mA, +CE	SOT-25	28cx	VR4	6g	Tor
9XU	XC6212B262MR	LVR-IC	LDO, 2.6V±2%, 150mA, +CE	SOT-25	28vt	VR4	6g	Tor
9XV	XC6209B272MR	LVR-IC	LDO, 2.7V±2%, 150mA, +CE	SOT-25	28cx	VR4	6g	Tor
9XV	XC6223F361MR-G	LVR-IC	LDO, 3.6V±1%, 300mA, +CE, CL, ICP	SOT-25	28cx	VR4	6g	Tor
9XV	XC6209F272MR	LVR-IC	LDO, 2.7V±2%, 300mA, +CE	SOT-25	28cx	VR4	6g	Tor
9XV	XC6212B272MR	LVR-IC	LDO, 2.7V±2%, 150mA, +CE	SOT-25	28vt	VR4	6g	Tor
9XX	XC6209B282MR	LVR-IC	LDO, 2.8V±2%, 150mA, +CE	SOT-25	28cx	VR4	6g	Tor
9XX	XC6223F371MR-G	LVR-IC	LDO, 3.7V±1%, 300mA, +CE, CL, ICP	SOT-25	28cx	VR4	6g	Tor
9XX	XC6209F282MR	LVR-IC	LDO, 2.8V±2%, 300mA, +CE	SOT-25	28cx	VR4	6g	Tor
9XX	XC6212B282MR	LVR-IC	LDO, 2.8V±2%, 150mA, +CE	SOT-25	28vt	VR4	6g	Tor
9XY	XC6209B292MR	LVR-IC	LDO, 2.9V±2%, 150mA, +CE	SOT-25	28cx	VR4	6g	Tor
9XY	XC6223F381MR-G	LVR-IC	LDO, 3.8V±1%, 300mA, +CE, CL, ICP	SOT-25	28cx	VR4	6g	Tor
9XY	XC6209F292MR	LVR-IC	LDO, 2.9V±2%, 300mA, +CE	SOT-25	28cx	VR4	6g	Tor
9XY	XC6212B292MR	LVR-IC	LDO, 2.9V±2%, 150mA, +CE	SOT-25	28vt	VR4	6g	Tor
9XZ	XC6209B302MR	LVR-IC	LDO, 3V±2%, 150mA, +CE	SOT-25	28cx	VR4	6g	Tor
9XZ	XC6223F391MR-G	LVR-IC	LDO, 3.9V±1%, 300mA, +CE, CL, ICP	SOT-25	28cx	VR4	6g	Tor
9XZ	XC6209F302MR	LVR-IC	LDO, 3V±2%, 300mA, +CE	SOT-25	28cx	VR4	6g	Tor
9XZ	XC6212B302MR	LVR-IC	LDO, 3V±2%, 150mA, +CE	SOT-25	28vt	VR4	6g	Tor
9Y	R1210N51C	DC/DC-IC	PWM step-up, 5.9V, 100kHz	SOT-23-5	28sc	DC3	6g	Ric
9Y0	XC6223F401MR-G	LVR-IC	LDO, 4.0V±1%, 300mA, +CE, CL, ICP	SOT-25	28cx	VR4	6g	Tor
9Y8	XC6209C092MR	LVR-IC	LDO, 0.9V±2%, 150mA, -CE, PDR	SOT-25	28cx	VR4	6g	Tor
9Y8	XC6209G092MR	LVR-IC	LDO, 0.9V±2%, 300mA, -CE, PDR	SOT-25	28cx	VR4	6g	Tor
9Y8	XC6212C092MR	LVR-IC	LDO, 0.9V±2%, 150mA, -CE, PDR	SOT-25	28vt	VR4	6g	Tor
9Y9	XC6209C102MR	LVR-IC	LDO, 1V±2%, 150mA, -CE, PDR	SOT-25	28cx	VR4	6g	Tor
9Y9	XC6209G102MR	LVR-IC	LDO, 1V±2%, 300mA, -CE, PDR	SOT-25	28cx	VR4	6g	Tor
9Y9	XC6212C102MR	LVR-IC	LDO, 1V±2%, 150mA, -CE, PDR	SOT-25	28vt	VR4	6g	Tor
9YA	XC6209C112MR	LVR-IC	LDO, 1.1V±2%, 150mA, -CE, PDR	SOT-25	28cx	VR4	6g	Tor
9YA	XC6209G112MR	LVR-IC	LDO, 1.1V±2%, 300mA, -CE, PDR	SOT-25	28cx	VR4	6g	Tor
9YA	XC6212C112MR	LVR-IC	LDO, 1.1V±2%, 150mA, -CE, PDR	SOT-25	28vt	VR4	6g	Tor
9YB	XC6209C122MR	LVR-IC	LDO, 1.2V±2%, 150mA, -CE, PDR	SOT-25	28cx	VR4	6g	Tor
9YB	XC6209G122MR	LVR-IC	LDO, 1.2V±2%, 300mA, -CE, PDR	SOT-25	28cx	VR4	6g	Tor
9YB	XC6212C122MR	LVR-IC	LDO, 1.2V±2%, 150mA, -CE, PDR	SOT-25	28vt	VR4	6g	Tor
9YC	XC6209C132MR	LVR-IC	LDO, 1.3V±2%, 150mA, -CE, PDR	SOT-25	28cx	VR4	6g	Tor
9YC	XC6209G132MR	LVR-IC	LDO, 1.3V±2%, 300mA, -CE, PDR	SOT-25	28cx	VR4	6g	Tor
9YC	XC6212C132MR	LVR-IC	LDO, 1.3V±2%, 150mA, -CE, PDR	SOT-25	28vt	VR4	6g	Tor
9YD	XC6209C142MR	LVR-IC	LDO, 1.4V±2%, 150mA, -CE, PDR	SOT-25	28cx	VR4	6g	Tor
9YD	XC6209G142MR	LVR-IC	LDO, 1.4V±2%, 300mA, -CE, PDR	SOT-25	28cx	VR4	6g	Tor
9YD	XC6212C142MR	LVR-IC	LDO, 1.4V±2%, 150mA, -CE, PDR	SOT-25	28vt	VR4	6g	Tor
9YE	XC6209C152MR	LVR-IC	LDO, 1.5V±2%, 150mA, -CE, PDR	SOT-25	28cx	VR4	6g	Tor
9YE	XC6209G152MR	LVR-IC	LDO, 1.5V±2%, 300mA, -CE, PDR	SOT-25	28cx	VR4	6g	Tor
9YE	XC6212C152MR	LVR-IC	LDO, 1.5V±2%, 150mA, -CE, PDR	SOT-25	28vt	VR4	6g	Tor
9YF	XC6209C162MR	LVR-IC	LDO, 1.6V±2%, 150mA, -CE, PDR	SOT-25	28cx	VR4	6g	Tor
9YF	XC6209G162MR	LVR-IC	LDO, 1.6V±2%, 300mA, -CE, PDR	SOT-25	28cx	VR4	6g	Tor
9YF	XC6212C162MR	LVR-IC	LDO, 1.6V±2%, 150mA, -CE, PDR	SOT-25	28vt	VR4	6g	Tor
9YH	XC6209C172MR	LVR-IC	LDO, 1.7V±2%, 150mA, -CE, PDR	SOT-25	28cx	VR4	6g	Tor
9YH	XC6209G172MR	LVR-IC	LDO, 1.7V±2%, 300mA, -CE, PDR	SOT-25	28cx	VR4	6g	Tor
9YH	XC6212C172MR	LVR-IC	LDO, 1.7V±2%, 150mA, -CE, PDR	SOT-25	28vt	VR4	6g	Tor
9YK	XC6209C182MR	LVR-IC	LDO, 1.8V±2%, 150mA, -CE, PDR	SOT-25	28cx	VR4	6g	Tor
9YK	XC6209G182MR	LVR-IC	LDO, 1.8V±2%, 300mA, -CE, PDR	SOT-25	28cx	VR4	6g	Tor
9YK	XC6212C182MR	LVR-IC	LDO, 1.8V±2%, 150mA, -CE, PDR	SOT-25	28vt	VR4	6g	Tor
9YL	XC6209C192MR	LVR-IC	LDO, 1.9V±2%, 150mA, -CE, PDR	SOT-25	28cx	VR4	6g	Tor
9YL	XC6209G192MR	LVR-IC	LDO, 1.9V±2%, 300mA, -CE, PDR	SOT-25	28cx	VR4	6g	Tor
9YL	XC6212C192MR	LVR-IC	LDO, 1.9V±2%, 150mA, -CE, PDR	SOT-25	28vt	VR4	6g	Tor
9YM	XC6209C202MR	LVR-IC	LDO, 2V±2%, 150mA, -CE, PDR	SOT-25	28cx	VR4	6g	Tor
9YM	XC6209G202MR	LVR-IC	LDO, 2V±2%, 300mA, -CE, PDR	SOT-25	28cx	VR4	6g	Tor
9YM	XC6212C202MR	LVR-IC	LDO, 2V±2%, 150mA, -CE, PDR	SOT-25	28vt	VR4	6g	Tor
9YN	XC6209C212MR	LVR-IC	LDO, 2.1V±2%, 150mA, -CE, PDR	SOT-25	28cx	VR4	6g	Tor
9YN	XC6209G212MR	LVR-IC	LDO, 2.1V±2%, 300mA, -CE, PDR	SOT-25	28cx	VR4	6g	Tor



SMD code	Type	Function	Short description	Case	Pinout	Sch.	St.	Mnf.
9YN	XC6212C212MR	LVR-IC	LDO, 2.1V±2%, 150mA, -CE, PDR	SOT-25	28vt	VR4	6g	Tor
9YP	XC6209C222MR	LVR-IC	LDO, 2.2V±2%, 150mA, -CE, PDR	SOT-25	28cx	VR4	6g	Tor
9YP	XC6209G222MR	LVR-IC	LDO, 2.2V±2%, 300mA, -CE, PDR	SOT-25	28cx	VR4	6g	Tor
9YP	XC6212C222MR	LVR-IC	LDO, 2.2V±2%, 150mA, -CE, PDR	SOT-25	28vt	VR4	6g	Tor
9YR	XC6209C232MR	LVR-IC	LDO, 2.3V±2%, 150mA, -CE, PDR	SOT-25	28cx	VR4	6g	Tor
9YR	XC6209G232MR	LVR-IC	LDO, 2.3V±2%, 300mA, -CE, PDR	SOT-25	28cx	VR4	6g	Tor
9YR	XC6212C232MR	LVR-IC	LDO, 2.3V±2%, 150mA, -CE, PDR	SOT-25	28vt	VR4	6g	Tor
9YS	XC6209C242MR	LVR-IC	LDO, 2.4V±2%, 150mA, -CE, PDR	SOT-25	28cx	VR4	6g	Tor
9YS	XC6209G242MR	LVR-IC	LDO, 2.4V±2%, 300mA, -CE, PDR	SOT-25	28cx	VR4	6g	Tor
9YS	XC6212C242MR	LVR-IC	LDO, 2.4V±2%, 150mA, -CE, PDR	SOT-25	28vt	VR4	6g	Tor
9YT	XC6209C252MR	LVR-IC	LDO, 2.5V±2%, 150mA, -CE, PDR	SOT-25	28cx	VR4	6g	Tor
9YT	XC6209G252MR	LVR-IC	LDO, 2.5V±2%, 300mA, -CE, PDR	SOT-25	28cx	VR4	6g	Tor
9YT	XC6212C252MR	LVR-IC	LDO, 2.5V±2%, 150mA, -CE, PDR	SOT-25	28vt	VR4	6g	Tor
9YU	XC6209C262MR	LVR-IC	LDO, 2.6V±2%, 150mA, -CE, PDR	SOT-25	28cx	VR4	6g	Tor
9YU	XC6209G262MR	LVR-IC	LDO, 2.6V±2%, 300mA, -CE, PDR	SOT-25	28cx	VR4	6g	Tor
9YU	XC6212C262MR	LVR-IC	LDO, 2.6V±2%, 150mA, -CE, PDR	SOT-25	28vt	VR4	6g	Tor
9YV	XC6209C272MR	LVR-IC	LDO, 2.7V±2%, 150mA, -CE, PDR	SOT-25	28cx	VR4	6g	Tor
9YV	XC6209G272MR	LVR-IC	LDO, 2.7V±2%, 300mA, -CE, PDR	SOT-25	28cx	VR4	6g	Tor
9YV	XC6212C272MR	LVR-IC	LDO, 2.7V±2%, 150mA, -CE, PDR	SOT-25	28vt	VR4	6g	Tor
9YX	XC6209C282MR	LVR-IC	LDO, 2.8V±2%, 150mA, -CE, PDR	SOT-25	28cx	VR4	6g	Tor
9YX	XC6209G282MR	LVR-IC	LDO, 2.8V±2%, 300mA, -CE, PDR	SOT-25	28cx	VR4	6g	Tor
9YX	XC6212C282MR	LVR-IC	LDO, 2.8V±2%, 150mA, -CE, PDR	SOT-25	28vt	VR4	6g	Tor
9YY	XC6209C292MR	LVR-IC	LDO, 2.9V±2%, 150mA, -CE, PDR	SOT-25	28cx	VR4	6g	Tor
9YY	XC6209G292MR	LVR-IC	LDO, 2.9V±2%, 300mA, -CE, PDR	SOT-25	28cx	VR4	6g	Tor
9YY	XC6212C292MR	LVR-IC	LDO, 2.9V±2%, 150mA, -CE, PDR	SOT-25	28vt	VR4	6g	Tor
9YZ	XC6209C302MR	LVR-IC	LDO, 3V±2%, 150mA, -CE, PDR	SOT-25	28cx	VR4	6g	Tor
9YZ	XC6209G302MR	LVR-IC	LDO, 3V±2%, 300mA, -CE, PDR	SOT-25	28cx	VR4	6g	Tor
9YZ	XC6212C302MR	LVR-IC	LDO, 3V±2%, 150mA, -CE, PDR	SOT-25	28vt	VR4	6g	Tor
9Z	R1210N291D	DC/DC-IC	PWM step-up, 2.9V, 180kHz	SOT-23-5	28sc	DC3	6g	Ric
9Z2	XC6223F12BMR-G	LVR-IC	LDO, 1.25V±20mV, 300mA, +CE, CL, ICP	SOT-25	28cx	VR4	6g	Tor
9Z3	XC6223F13BMR-G	LVR-IC	LDO, 1.35V±20mV, 300mA, +CE, CL, ICP	SOT-25	28cx	VR4	6g	Tor
9Z4	XC6223F14BMR-G	LVR-IC	LDO, 1.45V±20mV, 300mA, +CE, CL, ICP	SOT-25	28cx	VR4	6g	Tor
9Z5	XC6223F15BMR-G	LVR-IC	LDO, 1.55V±20mV, 300mA, +CE, CL, ICP	SOT-25	28cx	VR4	6g	Tor
9Z6	XC6223F16BMR-G	LVR-IC	LDO, 1.65V±20mV, 300mA, +CE, CL, ICP	SOT-25	28cx	VR4	6g	Tor
9Z7	XC6223F17BMR-G	LVR-IC	LDO, 1.75V±20mV, 300mA, +CE, CL, ICP	SOT-25	28cx	VR4	6g	Tor
9Z8	XC6209D092MR	LVR-IC	LDO, 0.9V±2%, 150mA, -CE	SOT-25	28cx	VR4	6g	Tor
9Z8	XC6223F18BMR-G	LVR-IC	LDO, 1.85V±20mV, 300mA, +CE, CL, ICP	SOT-25	28cx	VR4	6g	Tor
9Z8	XC6209H092MR	LVR-IC	LDO, 0.9V±2%, 300mA, -CE	SOT-25	28cx	VR4	6g	Tor
9Z8	XC6212D092MR	LVR-IC	LDO, 0.9V±2%, 150mA, -CE	SOT-25	28vt	VR4	6g	Tor
9Z9	XC6209D102MR	LVR-IC	LDO, 1V±2%, 150mA, -CE	SOT-25	28cx	VR4	6g	Tor
9Z9	XC6223F19BMR-G	LVR-IC	LDO, 1.95V±20mV, 300mA, +CE, CL, ICP	SOT-25	28cx	VR4	6g	Tor
9Z9	XC6209H102MR	LVR-IC	LDO, 1V±2%, 300mA, -CE	SOT-25	28cx	VR4	6g	Tor
9Z9	XC6212D102MR	LVR-IC	LDO, 1V±2%, 150mA, -CE	SOT-25	28vt	VR4	6g	Tor
9ZA	XC6209D112MR	LVR-IC	LDO, 1.1V±2%, 150mA, -CE	SOT-25	28cx	VR4	6g	Tor
9ZA	XC6223F20BMR-G	LVR-IC	LDO, 2.05V±1%, 300mA, +CE, CL, ICP	SOT-25	28cx	VR4	6g	Tor
9ZA	XC6209H112MR	LVR-IC	LDO, 1.1V±2%, 300mA, -CE	SOT-25	28cx	VR4	6g	Tor
9ZA	XC6212D112MR	LVR-IC	LDO, 1.1V±2%, 150mA, -CE	SOT-25	28vt	VR4	6g	Tor
9ZB	XC6209D122MR	LVR-IC	LDO, 1.2V±2%, 150mA, -CE	SOT-25	28cx	VR4	6g	Tor
9ZB	XC6223F21BMR-G	LVR-IC	LDO, 2.15V±1%, 300mA, +CE, CL, ICP	SOT-25	28cx	VR4	6g	Tor
9ZB	XC6209H122MR	LVR-IC	LDO, 1.2V±2%, 300mA, -CE	SOT-25	28cx	VR4	6g	Tor
9ZB	XC6212D122MR	LVR-IC	LDO, 1.2V±2%, 150mA, -CE	SOT-25	28vt	VR4	6g	Tor
9ZC	XC6209D132MR	LVR-IC	LDO, 1.3V±2%, 150mA, -CE	SOT-25	28cx	VR4	6g	Tor
9ZC	XC6223F22BMR-G	LVR-IC	LDO, 2.25V±1%, 300mA, +CE, CL, ICP	SOT-25	28cx	VR4	6g	Tor
9ZC	XC6209H132MR	LVR-IC	LDO, 1.3V±2%, 300mA, -CE	SOT-25	28cx	VR4	6g	Tor
9ZC	XC6212D132MR	LVR-IC	LDO, 1.3V±2%, 150mA, -CE	SOT-25	28vt	VR4	6g	Tor
9ZD	XC6209D142MR	LVR-IC	LDO, 1.4V±2%, 150mA, -CE	SOT-25	28cx	VR4	6g	Tor
9ZD	XC6223F23BMR-G	LVR-IC	LDO, 2.35V±1%, 300mA, +CE, CL, ICP	SOT-25	28cx	VR4	6g	Tor
9ZD	XC6209H142MR	LVR-IC	LDO, 1.4V±2%, 300mA, -CE	SOT-25	28cx	VR4	6g	Tor
9ZD	XC6212D142MR	LVR-IC	LDO, 1.4V±2%, 150mA, -CE	SOT-25	28vt	VR4	6g	Tor
9ZE	XC6209D152MR	LVR-IC	LDO, 1.5V±2%, 150mA, -CE	SOT-25	28cx	VR4	6g	Tor
9ZE	XC6223F24BMR-G	LVR-IC	LDO, 2.45V±1%, 300mA, +CE, CL, ICP	SOT-25	28cx	VR4	6g	Tor
9ZE	XC6209H152MR	LVR-IC	LDO, 1.5V±2%, 300mA, -CE	SOT-25	28cx	VR4	6g	Tor
9ZE	XC6212D152MR	LVR-IC	LDO, 1.5V±2%, 150mA, -CE	SOT-25	28vt	VR4	6g	Tor
9ZF	XC6209D162MR	LVR-IC	LDO, 1.6V±2%, 150mA, -CE	SOT-25	28cx	VR4	6g	Tor
9ZF	XC6223F25BMR-G	LVR-IC	LDO, 2.55V±1%, 300mA, +CE, CL, ICP	SOT-25	28cx	VR4	6g	Tor
9ZF	XC6209H162MR	LVR-IC	LDO, 1.6V±2%, 300mA, -CE	SOT-25	28cx	VR4	6g	Tor
9ZF	XC6212D162MR	LVR-IC	LDO, 1.6V±2%, 150mA, -CE	SOT-25	28vt	VR4	6g	Tor
9ZH	XC6209D172MR	LVR-IC	LDO, 1.7V±2%, 150mA, -CE	SOT-25	28cx	VR4	6g	Tor
9ZH	XC6223F26BMR-G	LVR-IC	LDO, 2.65V±1%, 300mA, +CE, CL, ICP	SOT-25	28cx	VR4	6g	Tor
9ZH	XC6209H172MR	LVR-IC	LDO, 1.7V±2%, 300mA, -CE	SOT-25	28cx	VR4	6g	Tor



SMD code	Type	Function	Short description	Case	Pinout	Sch.	St.	Mnf.
9ZH	XC6212D172MR	LVR-IC	LDO, 1.7V±2%, 150mA, -CE	SOT-25	28vt	VR4	6g	Tor
9ZK	XC6209D182MR	LVR-IC	LDO, 1.8V±2%, 150mA, -CE	SOT-25	28cx	VR4	6g	Tor
9ZK	XC6223F27BMR-G	LVR-IC	LDO, 2.75V±1%, 300mA, +CE, CL, ICP	SOT-25	28cx	VR4	6g	Tor
9ZK	XC6209H182MR	LVR-IC	LDO, 1.8V±2%, 300mA, -CE	SOT-25	28cx	VR4	6g	Tor
9ZK	XC6212D182MR	LVR-IC	LDO, 1.8V±2%, 150mA, -CE	SOT-25	28vt	VR4	6g	Tor
9ZL	XC6209D192MR	LVR-IC	LDO, 1.9V±2%, 150mA, -CE	SOT-25	28cx	VR4	6g	Tor
9ZL	XC6223F28BMR-G	LVR-IC	LDO, 2.85V±1%, 300mA, +CE, CL, ICP	SOT-25	28cx	VR4	6g	Tor
9ZL	XC6209H192MR	LVR-IC	LDO, 1.9V±2%, 300mA, -CE	SOT-25	28cx	VR4	6g	Tor
9ZL	XC6212D192MR	LVR-IC	LDO, 1.9V±2%, 150mA, -CE	SOT-25	28vt	VR4	6g	Tor
9ZM	XC6209D202MR	LVR-IC	LDO, 2V±2%, 150mA, -CE	SOT-25	28cx	VR4	6g	Tor
9ZM	XC6223F29BMR-G	LVR-IC	LDO, 2.95V±1%, 300mA, +CE, CL, ICP	SOT-25	28cx	VR4	6g	Tor
9ZM	XC6209H202MR	LVR-IC	LDO, 2V±2%, 300mA, -CE	SOT-25	28cx	VR4	6g	Tor
9ZM	XC6212D202MR	LVR-IC	LDO, 2V±2%, 150mA, -CE	SOT-25	28vt	VR4	6g	Tor
9ZN	XC6209D212MR	LVR-IC	LDO, 2.1V±2%, 150mA, -CE	SOT-25	28cx	VR4	6g	Tor
9ZN	XC6223F30BMR-G	LVR-IC	LDO, 3.05V±1%, 300mA, +CE, CL, ICP	SOT-25	28cx	VR4	6g	Tor
9ZN	XC6209H212MR	LVR-IC	LDO, 2.1V±2%, 300mA, -CE	SOT-25	28cx	VR4	6g	Tor
9ZN	XC6212D212MR	LVR-IC	LDO, 2.1V±2%, 150mA, -CE	SOT-25	28vt	VR4	6g	Tor
9ZP	XC6209D222MR	LVR-IC	LDO, 2.2V±2%, 150mA, -CE	SOT-25	28cx	VR4	6g	Tor
9ZP	XC6223F31BMR-G	LVR-IC	LDO, 3.15V±1%, 300mA, +CE, CL, ICP	SOT-25	28cx	VR4	6g	Tor
9ZP	XC6209H222MR	LVR-IC	LDO, 2.2V±2%, 300mA, -CE	SOT-25	28cx	VR4	6g	Tor
9ZP	XC6212D222MR	LVR-IC	LDO, 2.2V±2%, 150mA, -CE	SOT-25	28vt	VR4	6g	Tor
9ZR	XC6209D232MR	LVR-IC	LDO, 2.3V±2%, 150mA, -CE	SOT-25	28cx	VR4	6g	Tor
9ZR	XC6223F32BMR-G	LVR-IC	LDO, 3.25V±1%, 300mA, +CE, CL, ICP	SOT-25	28cx	VR4	6g	Tor
9ZR	XC6209H232MR	LVR-IC	LDO, 2.3V±2%, 300mA, -CE	SOT-25	28cx	VR4	6g	Tor
9ZR	XC6212D232MR	LVR-IC	LDO, 2.3V±2%, 150mA, -CE	SOT-25	28vt	VR4	6g	Tor
9ZS	XC6209D242MR	LVR-IC	LDO, 2.4V±2%, 150mA, -CE	SOT-25	28cx	VR4	6g	Tor
9ZS	XC6223F33BMR-G	LVR-IC	LDO, 3.35V±1%, 300mA, +CE, CL, ICP	SOT-25	28cx	VR4	6g	Tor
9ZS	XC6209H242MR	LVR-IC	LDO, 2.4V±2%, 300mA, -CE	SOT-25	28cx	VR4	6g	Tor
9ZS	XC6212D242MR	LVR-IC	LDO, 2.4V±2%, 150mA, -CE	SOT-25	28vt	VR4	6g	Tor
9ZT	XC6209D252MR	LVR-IC	LDO, 2.5V±2%, 150mA, -CE	SOT-25	28cx	VR4	6g	Tor
9ZT	XC6223F34BMR-G	LVR-IC	LDO, 3.45V±1%, 300mA, +CE, CL, ICP	SOT-25	28cx	VR4	6g	Tor
9ZT	XC6209H252MR	LVR-IC	LDO, 2.5V±2%, 300mA, -CE	SOT-25	28cx	VR4	6g	Tor
9ZT	XC6212D252MR	LVR-IC	LDO, 2.5V±2%, 150mA, -CE	SOT-25	28vt	VR4	6g	Tor
9ZU	XC6209D262MR	LVR-IC	LDO, 2.6V±2%, 150mA, -CE	SOT-25	28cx	VR4	6g	Tor
9ZU	XC6223F35BMR-G	LVR-IC	LDO, 3.55V±1%, 300mA, +CE, CL, ICP	SOT-25	28cx	VR4	6g	Tor
9ZU	XC6209H262MR	LVR-IC	LDO, 2.6V±2%, 300mA, -CE	SOT-25	28cx	VR4	6g	Tor
9ZU	XC6212D262MR	LVR-IC	LDO, 2.6V±2%, 150mA, -CE	SOT-25	28vt	VR4	6g	Tor
9ZV	XC6209D272MR	LVR-IC	LDO, 2.7V±2%, 150mA, -CE	SOT-25	28cx	VR4	6g	Tor
9ZV	XC6223F36BMR-G	LVR-IC	LDO, 3.65V±1%, 300mA, +CE, CL, ICP	SOT-25	28cx	VR4	6g	Tor
9ZV	XC6209H272MR	LVR-IC	LDO, 2.7V±2%, 300mA, -CE	SOT-25	28cx	VR4	6g	Tor
9ZV	XC6212D272MR	LVR-IC	LDO, 2.7V±2%, 150mA, -CE	SOT-25	28vt	VR4	6g	Tor
9ZX	XC6209D282MR	LVR-IC	LDO, 2.8V±2%, 150mA, -CE	SOT-25	28cx	VR4	6g	Tor
9ZX	XC6223F37BMR-G	LVR-IC	LDO, 3.75V±1%, 300mA, +CE, CL, ICP	SOT-25	28cx	VR4	6g	Tor
9ZX	XC6209H282MR	LVR-IC	LDO, 2.8V±2%, 300mA, -CE	SOT-25	28cx	VR4	6g	Tor
9ZX	XC6212D282MR	LVR-IC	LDO, 2.8V±2%, 150mA, -CE	SOT-25	28vt	VR4	6g	Tor
9ZY	XC6209D292MR	LVR-IC	LDO, 2.9V±2%, 150mA, -CE	SOT-25	28cx	VR4	6g	Tor
9ZY	XC6223F38BMR-G	LVR-IC	LDO, 3.85V±1%, 300mA, +CE, CL, ICP	SOT-25	28cx	VR4	6g	Tor
9ZY	XC6209H292MR	LVR-IC	LDO, 2.9V±2%, 300mA, -CE	SOT-25	28cx	VR4	6g	Tor
9ZY	XC6212D292MR	LVR-IC	LDO, 2.9V±2%, 150mA, -CE	SOT-25	28vt	VR4	6g	Tor
9ZZ	XC6209D302MR	LVR-IC	LDO, 3V±2%, 150mA, -CE	SOT-25	28cx	VR4	6g	Tor
9ZZ	XC6223F39BMR-G	LVR-IC	LDO, 3.95V±1%, 300mA, +CE, CL, ICP	SOT-25	28cx	VR4	6g	Tor
9ZZ	XC6209H302MR	LVR-IC	LDO, 3V±2%, 300mA, -CE	SOT-25	28cx	VR4	6g	Tor
9ZZ	XC6212D302MR	LVR-IC	LDO, 3V±2%, 150mA, -CE	SOT-25	28vt	VR4	6g	Tor
A0	PI74ST1G00CX	CMOS-Logic	2-input NAND gate	SC-70-5	28/Log1	-	6a	Per
A0	PI74ST1G00TX	CMOS-Logic	2-input NAND gate	SOT-23-5	28/Log1	-	6a	Per
A0	R1111N201A	LVR-IC	LDO, LN, -CE, 2V±2%, 200mA	SOT-23-5	28cx	VR4	6g	Ric
A0	TC1014-4.0V RX	LVR-IC	LDO, 4V±2%, 50mA, +CE	SOT-23-5	28vrx	VR7	6g	Mcc
A0-	RT9193-17PU5	LVR-IC	LDO, 1.7V±1%, 300mA, +CE	SC-70-5	28vrx	VR7	6g	Rct
A00	74AHC1G00GV	CMOS-Logic	2-input NAND gate	SOT753	28/Log1	-	6a	Phi
A00	U74AHC1G00-AF5	CMOS-Logic	2-input NAND gate	SOT-23-5	28/Log1	-	6a	Utc
A00	U74AHC1G00-AL5	CMOS-Logic	2-input NAND gate	SOT-353	28/Log1	-	6a	Utc
A00	XC6114A131MR	Vdet-IC	3.1V±2%, ±Reset PPO, Wt=6.25ms, Rt=3.13ms	SOT-25	28xg	VD19	6g	Tor
A001	R3117Q072A	Vdet-IC	0.7V±15mV, -Reset ODO, Sense	SC-88A	28rs	VD11	6m	Ric
A002	R3117Q082A	Vdet-IC	0.8V±15mV, -Reset ODO, Sense	SC-88A	28rs	VD11	6m	Ric
A003	R3117Q092A	Vdet-IC	0.9V±15mV, -Reset ODO, Sense	SC-88A	28rs	VD11	6m	Ric
A004	R3117Q102A	Vdet-IC	1.0V±15mV, -Reset ODO, Sense	SC-88A	28rs	VD11	6m	Ric
A005	R3117Q112A	Vdet-IC	1.1V±15mV, -Reset ODO, Sense	SC-88A	28rs	VD11	6m	Ric
A006	R3117Q122A	Vdet-IC	1.2V±1%, -Reset ODO, Sense	SC-88A	28rs	VD11	6m	Ric
A007	R3117Q132A	Vdet-IC	1.3V±1%, -Reset ODO, Sense	SC-88A	28rs	VD11	6m	Ric
A008	R3117Q142A	Vdet-IC	1.4V±1%, -Reset ODO, Sense	SC-88A	28rs	VD11	6m	Ric



SMD code	Type	Function	Short description	Case	Pinout	Sch.	St.	Mnf.
A009	R3117Q152A	Vdet-IC	1.5V±1%, -Reset ODO, Sense	SC-88A	28rs	VD11	6m	Ric
A00L	U74AHC1G00L-AF5	CMOS-Logic	2-input NAND gate	SOT-23-5	28/Log1	-	6a	Utc
A00L	U74AHC1G00L-AL5	CMOS-Logic	2-input NAND gate	SOT-353	28/Log1	-	6a	Utc
A01	XC6114A132MR	Vdet-IC	3.2V±2%, ±Reset PPO, Wt=6.25ms, Rt=3.13ms	SOT-25	28xg	VD19	6g	Tor
A010	R3117Q162A	Vdet-IC	1.6V±1%, -Reset ODO, Sense	SC-88A	28rs	VD11	6m	Ric
A011	R3117Q172A	Vdet-IC	1.7V±1%, -Reset ODO, Sense	SC-88A	28rs	VD11	6m	Ric
A012	R3117Q182A	Vdet-IC	1.8V±1%, -Reset ODO, Sense	SC-88A	28rs	VD11	6m	Ric
A013	R3117Q192A	Vdet-IC	1.9V±1%, -Reset ODO, Sense	SC-88A	28rs	VD11	6m	Ric
A014	R3117Q202A	Vdet-IC	2.0V±1%, -Reset ODO, Sense	SC-88A	28rs	VD11	6m	Ric
A015	R3117Q212A	Vdet-IC	2.1V±1%, -Reset ODO, Sense	SC-88A	28rs	VD11	6m	Ric
A016	R3117Q222A	Vdet-IC	2.2V±1%, -Reset ODO, Sense	SC-88A	28rs	VD11	6m	Ric
A017	R3117Q232A	Vdet-IC	2.3V±1%, -Reset ODO, Sense	SC-88A	28rs	VD11	6m	Ric
A018	R3117Q242A	Vdet-IC	2.4V±1%, -Reset ODO, Sense	SC-88A	28rs	VD11	6m	Ric
A019	R3117Q252A	Vdet-IC	2.5V±1%, -Reset ODO, Sense	SC-88A	28rs	VD11	6m	Ric
A02	74AHC1G02GV	CMOS-Logic	2-input NOR gate	SOT7753	28/Log2	-	6a	Phi
A02	U74AHC1G02-AF5	CMOS-Logic	2-input NOR gate	SOT-23-5	28/Log2	-	6a	Utc
A02	U74AHC1G02-AL5	CMOS-Logic	2-input NOR gate	SOT-353	28/Log2	-	6a	Utc
A02	XC6114A133MR	Vdet-IC	3.3V±2%, ±Reset PPO, Wt=6.25ms, Rt=3.13ms	SOT-25	28xg	VD19	6g	Tor
A020	R3117Q262A	Vdet-IC	2.6V±1%, -Reset ODO, Sense	SC-88A	28rs	VD11	6m	Ric
A021	R3117Q272A	Vdet-IC	2.7V±1%, -Reset ODO, Sense	SC-88A	28rs	VD11	6m	Ric
A022	R3117Q282A	Vdet-IC	2.8V±1%, -Reset ODO, Sense	SC-88A	28rs	VD11	6m	Ric
A023	R3117Q292A	Vdet-IC	2.9V±1%, -Reset ODO, Sense	SC-88A	28rs	VD11	6m	Ric
A024	R3117Q302A	Vdet-IC	3.0V±1%, -Reset ODO, Sense	SC-88A	28rs	VD11	6m	Ric
A025	R3117Q312A	Vdet-IC	3.1V±1%, -Reset ODO, Sense	SC-88A	28rs	VD11	6m	Ric
A026	R3117Q322A	Vdet-IC	3.2V±1%, -Reset ODO, Sense	SC-88A	28rs	VD11	6m	Ric
A027	R3117Q332A	Vdet-IC	3.3V±1%, -Reset ODO, Sense	SC-88A	28rs	VD11	6m	Ric
A028	R3117Q342A	Vdet-IC	3.4V±1%, -Reset ODO, Sense	SC-88A	28rs	VD11	6m	Ric
A029	R3117Q352A	Vdet-IC	3.5V±1%, -Reset ODO, Sense	SC-88A	28rs	VD11	6m	Ric
A02L	U74AHC1G02L-AF5	CMOS-Logic	2-input NOR gate	SOT-23-5	28/Log2	-	6a	Utc
A02L	U74AHC1G02L-AL5	CMOS-Logic	2-input NOR gate	SOT-353	28/Log2	-	6a	Utc
A03	XC6114A134MR	Vdet-IC	3.4V±2%, ±Reset PPO, Wt=6.25ms, Rt=3.13ms	SOT-25	28xg	VD19	6g	Tor
A030	R3117Q362A	Vdet-IC	3.6V±1%, -Reset ODO, Sense	SC-88A	28rs	VD11	6m	Ric
A031	R3117Q372A	Vdet-IC	3.7V±1%, -Reset ODO, Sense	SC-88A	28rs	VD11	6m	Ric
A032	R3117Q382A	Vdet-IC	3.8V±1%, -Reset ODO, Sense	SC-88A	28rs	VD11	6m	Ric
A033	R3117Q392A	Vdet-IC	3.9V±1%, -Reset ODO, Sense	SC-88A	28rs	VD11	6m	Ric
A034	R3117Q402A	Vdet-IC	4.0V±1%, -Reset ODO, Sense	SC-88A	28rs	VD11	6m	Ric
A035	R3117Q412A	Vdet-IC	4.1V±1%, -Reset ODO, Sense	SC-88A	28rs	VD11	6m	Ric
A036	R3117Q422A	Vdet-IC	4.2V±1%, -Reset ODO, Sense	SC-88A	28rs	VD11	6m	Ric
A037	R3117Q432A	Vdet-IC	4.3V±1%, -Reset ODO, Sense	SC-88A	28rs	VD11	6m	Ric
A038	R3117Q442A	Vdet-IC	4.4V±1%, -Reset ODO, Sense	SC-88A	28rs	VD11	6m	Ric
A039	R3117Q452A	Vdet-IC	4.5V±1%, -Reset ODO, Sense	SC-88A	28rs	VD11	6m	Ric
A04	74AHC1G04GV	CMOS-Logic	Inverter	SOT7753	28/Log6	-	6a	Phi
A04	U74AHC1G04-AF5	CMOS-Logic	Inverter	SOT-23-5	28/Log6	-	6a	Utc
A04	U74AHC1G04-AL5	CMOS-Logic	Inverter	SOT-353	28/Log6	-	6a	Utc
A04	XC6114A135MR	Vdet-IC	3.5V±2%, ±Reset PPO, Wt=6.25ms, Rt=3.13ms	SOT-25	28xg	VD19	6g	Tor
A040	R3117Q462A	Vdet-IC	4.6V±1%, -Reset ODO, Sense	SC-88A	28rs	VD11	6m	Ric
A041	R3117Q472A	Vdet-IC	4.7V±1%, -Reset ODO, Sense	SC-88A	28rs	VD11	6m	Ric
A042	R3117Q482A	Vdet-IC	4.8V±1%, -Reset ODO, Sense	SC-88A	28rs	VD11	6m	Ric
A043	R3117Q492A	Vdet-IC	4.9V±1%, -Reset ODO, Sense	SC-88A	28rs	VD11	6m	Ric
A044	R3117Q502A	Vdet-IC	5.0V±1%, -Reset ODO, Sense	SC-88A	28rs	VD11	6m	Ric
A04L	U74AHC1G04L-AF5	CMOS-Logic	Inverter	SOT-23-5	28/Log6	-	6a	Utc
A04L	U74AHC1G04L-AL5	CMOS-Logic	Inverter	SOT-353	28/Log6	-	6a	Utc
A05	XC6114A136MR	Vdet-IC	3.6V±2%, ±Reset PPO, Wt=6.25ms, Rt=3.13ms	SOT-25	28xg	VD19	6g	Tor
A06	74AHC1G06GV	CMOS-Logic	Inverter (ODO)	SOT7753	28/Log19	-	6a	Phi
A06	XC6114A137MR	Vdet-IC	3.7V±2%, ±Reset PPO, Wt=6.25ms, Rt=3.13ms	SOT-25	28xg	VD19	6g	Tor
A07	74AHC1G07GV	CMOS-Logic	Noninverting buffer/driver (ODO)	SOT7753	28/Log8	-	6a	Phi
A07	XC6114A138MR	Vdet-IC	3.8V±2%, ±Reset PPO, Wt=6.25ms, Rt=3.13ms	SOT-25	28xg	VD19	6g	Tor
A08	74AHC1G08GV	CMOS-Logic	2-input AND gate	SOT7753	28/Log3	-	6a	Phi
A08	RP110N081B	LVR-IC	LDO, 0.8V±1%, 150mA, +CE	SOT-23-5	28cx	VR4	6g	Ric
A08	U74AHC1G08-AF5	CMOS-Logic	2-input AND gate	SOT-23-5	28/Log3	-	6a	Utc
A08	U74AHC1G08-AL5	CMOS-Logic	2-input AND gate	SOT-353	28/Log3	-	6a	Utc
A08	XC6114A139MR	Vdet-IC	3.9V±2%, ±Reset PPO, Wt=6.25ms, Rt=3.13ms	SOT-25	28xg	VD19	6g	Tor
A08	SN74AHC1G08DBV	CMOS-Logic	2-input AND gate	SOT-23-5	28/Log3	-	6a	Ti
A08L	U74AHC1G08G-AF5	CMOS-Logic	2-input AND gate	SOT-23-5	28/Log3	-	6a	Utc
A08L	U74AHC1G08G-AL5	CMOS-Logic	2-input AND gate	SOT-353	28/Log3	-	6a	Utc
A08L	U74AHC1G08L-AF5	CMOS-Logic	2-input AND gate	SOT-23-5	28/Log3	-	6a	Utc
A08L	U74AHC1G08L-AL5	CMOS-Logic	2-input AND gate	SOT-353	28/Log3	-	6a	Utc
A09	74AHC1G09GV	CMOS-Logic	2-input AND gate (ODO)	SOT7753	28/Log9	-	6a	Phi
A09	RP110N091B	LVR-IC	LDO, 0.9V±1%, 150mA, +CE	SOT-23-5	28cx	VR4	6g	Ric
A09	XC6114A140MR	Vdet-IC	4.0V±2%, ±Reset PPO, Wt=6.25ms, Rt=3.13ms	SOT-25	28xg	VD19	6g	Tor



SMD code	Type	Function	Short description	Case	Pinout	Sch.	St.	Mnf.
AOA	XC6114A141MR	Vdet-IC	4.1V±2%, ±Reset PPO, Wt=6.25ms, Rt=3.13ms	SOT-25	28xg	VD19	6g	Tor
AOB	XC6114A142MR	Vdet-IC	4.2V±2%, ±Reset PPO, Wt=6.25ms, Rt=3.13ms	SOT-25	28xg	VD19	6g	Tor
AOC	XC6114A143MR	Vdet-IC	4.3V±2%, ±Reset PPO, Wt=6.25ms, Rt=3.13ms	SOT-25	28xg	VD19	6g	Tor
AOE	XC6114A144MR	Vdet-IC	4.4V±2%, ±Reset PPO, Wt=6.25ms, Rt=3.13ms	SOT-25	28xg	VD19	6g	Tor
AOE	XC6114A145MR	Vdet-IC	4.5V±2%, ±Reset PPO, Wt=6.25ms, Rt=3.13ms	SOT-25	28xg	VD19	6g	Tor
AOF	XC6114A116MR	Vdet-IC	1.6V±2%, ±Reset PPO, Wt=6.25ms, Rt=3.13ms	SOT-25	28xg	VD19	6g	Tor
AOE	XC6114A146MR	Vdet-IC	4.6V±2%, ±Reset PPO, Wt=6.25ms, Rt=3.13ms	SOT-25	28xg	VD19	6g	Tor
AOH	XC6114A117MR	Vdet-IC	1.7V±2%, ±Reset PPO, Wt=6.25ms, Rt=3.13ms	SOT-25	28xg	VD19	6g	Tor
AOH	XC6114A147MR	Vdet-IC	4.7V±2%, ±Reset PPO, Wt=6.25ms, Rt=3.13ms	SOT-25	28xg	VD19	6g	Tor
AOK	XC6114A118MR	Vdet-IC	1.8V±2%, ±Reset PPO, Wt=6.25ms, Rt=3.13ms	SOT-25	28xg	VD19	6g	Tor
AOK	XC6114A148MR	Vdet-IC	4.8V±2%, ±Reset PPO, Wt=6.25ms, Rt=3.13ms	SOT-25	28xg	VD19	6g	Tor
AOI	XC6114A119MR	Vdet-IC	1.9V±2%, ±Reset PPO, Wt=6.25ms, Rt=3.13ms	SOT-25	28xg	VD19	6g	Tor
AOI	XC6114A149MR	Vdet-IC	4.9V±2%, ±Reset PPO, Wt=6.25ms, Rt=3.13ms	SOT-25	28xg	VD19	6g	Tor
AOI	XC6114A120MR	Vdet-IC	2.0V±2%, ±Reset PPO, Wt=6.25ms, Rt=3.13ms	SOT-25	28xg	VD19	6g	Tor
AOI	XC6114A150MR	Vdet-IC	5.0V±2%, ±Reset PPO, Wt=6.25ms, Rt=3.13ms	SOT-25	28xg	VD19	6g	Tor
AOI	XC6114A121MR	Vdet-IC	2.1V±2%, ±Reset PPO, Wt=6.25ms, Rt=3.13ms	SOT-25	28xg	VD19	6g	Tor
AOI	XC6114A122MR	Vdet-IC	2.2V±2%, ±Reset PPO, Wt=6.25ms, Rt=3.13ms	SOT-25	28xg	VD19	6g	Tor
AOI	XC6114A123MR	Vdet-IC	2.3V±2%, ±Reset PPO, Wt=6.25ms, Rt=3.13ms	SOT-25	28xg	VD19	6g	Tor
AOI	XC6114A124MR	Vdet-IC	2.4V±2%, ±Reset PPO, Wt=6.25ms, Rt=3.13ms	SOT-25	28xg	VD19	6g	Tor
AOI	XC6114A125MR	Vdet-IC	2.5V±2%, ±Reset PPO, Wt=6.25ms, Rt=3.13ms	SOT-25	28xg	VD19	6g	Tor
AOI	XC6114A126MR	Vdet-IC	2.6V±2%, ±Reset PPO, Wt=6.25ms, Rt=3.13ms	SOT-25	28xg	VD19	6g	Tor
AOI	XC6114A127MR	Vdet-IC	2.7V±2%, ±Reset PPO, Wt=6.25ms, Rt=3.13ms	SOT-25	28xg	VD19	6g	Tor
AOI	XC6114A128MR	Vdet-IC	2.8V±2%, ±Reset PPO, Wt=6.25ms, Rt=3.13ms	SOT-25	28xg	VD19	6g	Tor
AOI	XC6114A129MR	Vdet-IC	2.9V±2%, ±Reset PPO, Wt=6.25ms, Rt=3.13ms	SOT-25	28xg	VD19	6g	Tor
AOI	XC6114A130MR	Vdet-IC	3.0V±2%, ±Reset PPO, Wt=6.25ms, Rt=3.13ms	SOT-25	28xg	VD19	6g	Tor
A1	1SS308	Si-diode	Quad, Sw, Fast, 85V, 100mA, <2pF, <4ns	SOT-25	28bc	-	6a	Tos
A1	HD74ALVC1G00VS	CMOS-Logic	2-input NAND gate	VSON-5	30/Log1	-	6a	Ren
A1	R1111N211A	LVR-IC	LDO, LN, -CE, 2.1V±2%, 200mA	SOT-23-5	28cx	VR4	6g	Ric
A1	TC1014-2.5VRX	LVR-IC	LDO, 2.5V±2%, 50mA, +CE	SOT-23-5	28vrx	VR7	6g	Mcc
A1-	RT9193-33PU5	LVR-IC	LDO, 3.3V±1%, 300mA, +CE	SC-70-5	28vrx	VR7	6g	Rct
A1-	RT9193-33GU5	LVR-IC	LDO, 3.3V±1%, 300mA, +CE	SC-70-5	28vrx	VR7	6g	Rct
A10	FMA10A	Si-pnp-Digi	Dual, 50V, 100mA, 300mW, 250MHz, R1/R2=1k/10k	SC-74A	28/TD9	-	6a	Rhm
A10	RP110N101B	LVR-IC	LDO, 1.0V±1%, 150mA, +CE	SOT-23-5	28cx	VR4	6g	Ric
A10	UMA10A	Si-pnp-Digi	Dual, 50V, 100mA, 150mW, 250MHz, R1/R2=1k/10k	SC-88A	28/TD9	-	6a	Rhm
A10	XC6114A231MR	Vdet-IC	3.1V±2%, ±Reset PPO, Wt=50ms, Rt=3.13ms	SOT-25	28xg	VD19	6g	Tor
A11	EMA11	Si-pnp-Digi	Dual, 50V, 100mA, 150mW, 250MHz, R1/R2=4.7k/47k	SC-88A	28/TD9	-	6a	Rhm
A11	FMA11A	Si-pnp-Digi	Dual, 50V, 100mA, 300mW, 250MHz, R1/R2=4.7k/47k	SC-74A	28/TD9	-	6a	Rhm
A11	MIC6211BM5	Op-IC	GP, ±4.±16V, Icco=1.3mA, 2.5MHz, 6V/μs	SOT-23-5	28opa	OP1	6g	Mcr
A11	RP110N111B	LVR-IC	LDO, 1.1V±1%, 150mA, +CE	SOT-23-5	28cx	VR4	6g	Ric
A11	UMA11N	Si-pnp-Digi	Dual, 50V, 100mA, 150mW, 250MHz, R1/R2=4.7k/47k	SC-88A	28/TD9	-	6a	Rhm
A11	XC6114A232MR	Vdet-IC	3.2V±2%, ±Reset PPO, Wt=50ms, Rt=3.13ms	SOT-25	28xg	VD19	6g	Tor
A12	RP110N121B	LVR-IC	LDO, 1.2V±1%, 150mA, +CE	SOT-23-5	28cx	VR4	6g	Ric
A12	XC6114A233MR	Vdet-IC	3.3V±2%, ±Reset PPO, Wt=50ms, Rt=3.13ms	SOT-25	28xg	VD19	6g	Tor
A13	MIC711BM5	Op-IC	Rail-to-Rail I/O, 1.8..11V, Icco=15μA, 25kHz	SOT-23-5	28opb	OP1	6g	Mcr
A13	RP110N131B	LVR-IC	LDO, 1.3V±1%, 150mA, +CE	SOT-23-5	28cx	VR4	6g	Ric
A13	XC6114A234MR	Vdet-IC	3.4V±2%, ±Reset PPO, Wt=50ms, Rt=3.13ms	SOT-25	28xg	VD19	6g	Tor
A14	74AHC1G14GV	CMOS-Logic	Inverting Schmitt-trigger	SOT753	28/Log7	-	6a	Phi
A14	MIC7211BM5	Comp-IC	μPower, 2.2..10V, Vgo=120dB, PPO	SOT-23-5	28opb	OP1	6g	Mcr
A14	RP110N141B	LVR-IC	LDO, 1.4V±1%, 150mA, +CE	SOT-23-5	28cx	VR4	6g	Ric
A14	XC6114A235MR	Vdet-IC	3.5V±2%, ±Reset PPO, Wt=50ms, Rt=3.13ms	SOT-25	28xg	VD19	6g	Tor
A15	MIC7221BM5	Comp-IC	μPower, 2.2..10V, Vgo=120dB, ODO	SOT-23-5	28opb	OP1	6g	Mcr
A15	RP110N151B	LVR-IC	LDO, 1.5V±1%, 150mA, +CE	SOT-23-5	28cx	VR4	6g	Ric
A15	XC6114A236MR	Vdet-IC	3.6V±2%, ±Reset PPO, Wt=50ms, Rt=3.13ms	SOT-25	28xg	VD19	6g	Tor
A15	XC6365A152MR	DC/DC-IC	PWM st-down, 180kHz, 1.5V±2.5%, 1A, +CE	SOT-25	28zm	DC7	6g	Tor
A15	XC6367A152MR	DC/DC-IC	PWM step-up, 1.5V±2.5%, 200mA, 180kHz, +CE	SOT-25	28sh	DC11	6g	Tor
A16	CLC404AJM5	Op-IC	Wide-band High-Slew Rate	SOT-23-5	28opa	OP1	6a	Nsc
A16	MIC7201BM5	Op-IC	Instrum, Diff, Amp, 2.2..10V, Icco=0.6mA, Ez=9mV, 400kHz	SOT-23-5	28opb	OP1	6g	Mcr
A16	RP110N161B	LVR-IC	LDO, 1.6V±1%, 150mA, +CE	SOT-23-5	28cx	VR4	6g	Ric
A16	XC6114A237MR	Vdet-IC	3.7V±2%, ±Reset PPO, Wt=50ms, Rt=3.13ms	SOT-25	28xg	VD19	6g	Tor
A16	XC6365A162MR	DC/DC-IC	PWM st-down, 180kHz, 1.6V±2.5%, 1A, +CE	SOT-25	28zm	DC7	6g	Tor
A16	XC6367A162MR	DC/DC-IC	PWM step-up, 1.6V±2.5%, 200mA, 180kHz, +CE	SOT-25	28sh	DC11	6g	Tor
A17	CLC406AJM5	Op-IC	Wide-band LP, ±1.5V..±6V, 1500V/μs, 50mW, Iout=70mA	SOT-23-5	28opa	OP1	6a	Nsc
A17	MIC7300BM5	Op-IC	Rail-to-Rail I/O, 2.2..10V, Icco=0.7mA, 0.5V/μs, 500kHz	SOT-23-5	28opa	OP1	6g	Mcr
A17	RP110N171B	LVR-IC	LDO, 1.7V±1%, 150mA, +CE	SOT-23-5	28cx	VR4	6g	Ric
A17	XC6114A238MR	Vdet-IC	3.8V±2%, ±Reset PPO, Wt=50ms, Rt=3.13ms	SOT-25	28xg	VD19	6g	Tor
A17	XC6365A172MR	DC/DC-IC	PWM st-down, 180kHz, 1.7V±2.5%, 1A, +CE	SOT-25	28zm	DC7	6g	Tor
A17	XC6367A172MR	DC/DC-IC	PWM step-up, 1.7V±2.5%, 200mA, 180kHz, +CE	SOT-25	28sh	DC11	6g	Tor
A18	CLC409AJM5	Op-IC	Very WB, L-Distortion	SOT-23-5	28opa	OP1	6a	Nsc
A18	RP110N181B	LVR-IC	LDO, 1.8V±1%, 150mA, +CE	SOT-23-5	28cx	VR4	6g	Ric
A18	XC6114A239MR	Vdet-IC	3.9V±2%, ±Reset PPO, Wt=50ms, Rt=3.13ms	SOT-25	28xg	VD19	6g	Tor



SMD code	Type	Function	Short description	Case	Pinout	Sch.	St.	Mnf.
A18	XC6365A182MR	DC/DC-IC	PWM st-down, 180kHz, 1.8V±2.5%, 1A, +CE	SOT-25	28zm	DC7	6g	Tor
A18	XC6367A182MR	DC/DC-IC	PWM step-up, 1.8V±2.5%, 200mA, 180kHz, +CE	SOT-25	28sh	DC11	6g	Tor
A19	CLC425AJM5	Op-IC	Ultra LN, WB	SOT-23-5	28opa	OP1	6a	Nsc
A19	RP110N191B	LVR-IC	LDO, 1.9V±1%, 150mA, +CE	SOT-23-5	28cx	VR4	6g	Ric
A19	XC6114A240MR	Vdet-IC	4.0V±2%, ±Reset PPO, Wt=50ms, Rt=3.13ms	SOT-25	28xg	VD19	6g	Tor
A19	XC6365A192MR	DC/DC-IC	PWM st-down, 180kHz, 1.9V±2.5%, 1A, +CE	SOT-25	28zm	DC7	6g	Tor
A19	XC6367A192MR	DC/DC-IC	PWM step-up, 1.9V±2.5%, 200mA, 180kHz, +CE	SOT-25	28sh	DC11	6g	Tor
A1A	APR3121-15B	Vdet-IC	1.5V, -MR, -Reset PPO	SOT-23-5	28vd2	VD5	6k	Ans
A1A	XC6114A241MR	Vdet-IC	4.1V±2%, ±Reset PPO, Wt=50ms, Rt=3.13ms	SOT-25	28xg	VD19	6g	Tor
A1A	XC6365A203MR	DC/DC-IC	PWM st-down, 300kHz, 2.0V±2.5%, 1A, +CE	SOT-25	28zm	DC7	6g	Tor
A1B	APR3121-17B	Vdet-IC	1.75V, -MR, -Reset PPO	SOT-23-5	28vd2	VD5	6k	Ans
A1B	XC6114A242MR	Vdet-IC	4.2V±2%, ±Reset PPO, Wt=50ms, Rt=3.13ms	SOT-25	28xg	VD19	6g	Tor
A1C	APR3121-23B	Vdet-IC	2.32V, -MR, -Reset PPO	SOT-23-5	28vd2	VD5	6k	Ans
A1C	XC6114A243MR	Vdet-IC	4.3V±2%, ±Reset PPO, Wt=50ms, Rt=3.13ms	SOT-25	28xg	VD19	6g	Tor
A1D	APR3121-26B	Vdet-IC	2.63V, -MR, -Reset PPO	SOT-23-5	28vd2	VD5	6k	Ans
A1D	XC6114A244MR	Vdet-IC	4.4V±2%, ±Reset PPO, Wt=50ms, Rt=3.13ms	SOT-25	28xg	VD19	6g	Tor
A1E	APR3121-29B	Vdet-IC	2.93V, -MR, -Reset PPO	SOT-23-5	28vd2	VD5	6k	Ans
A1E	XC6114A245MR	Vdet-IC	4.5V±2%, ±Reset PPO, Wt=50ms, Rt=3.13ms	SOT-25	28xg	VD19	6g	Tor
A1F	APR3121-30B	Vdet-IC	3.08V, -MR, -Reset PPO	SOT-23-5	28vd2	VD5	6k	Ans
A1F	XC6114A216MR	Vdet-IC	1.6V±2%, ±Reset PPO, Wt=50ms, Rt=3.13ms	SOT-25	28xg	VD19	6g	Tor
A1E	XC6114A246MR	Vdet-IC	4.6V±2%, ±Reset PPO, Wt=50ms, Rt=3.13ms	SOT-25	28xg	VD19	6g	Tor
A1F	XC6365A153MR	DC/DC-IC	PWM st-down, 300kHz, 1.5V±2.5%, 1A, +CE	SOT-25	28zm	DC7	6g	Tor
A1F	XC6367A153MR	DC/DC-IC	PWM step-up, 1.5V±2.5%, 200mA, 300kHz, +CE	SOT-25	28sh	DC11	6g	Tor
A1G	APR3121-39B	Vdet-IC	3.9V, -MR, -Reset PPO	SOT-23-5	28vd2	VD5	6k	Ans
A1H	APR3121-43B	Vdet-IC	4.38V, -MR, -Reset PPO	SOT-23-5	28vd2	VD5	6k	Ans
A1H	XC6114A217MR	Vdet-IC	1.7V±2%, ±Reset PPO, Wt=50ms, Rt=3.13ms	SOT-25	28xg	VD19	6g	Tor
A1H	XC6114A247MR	Vdet-IC	4.7V±2%, ±Reset PPO, Wt=50ms, Rt=3.13ms	SOT-25	28xg	VD19	6g	Tor
A1H	XC6365A163MR	DC/DC-IC	PWM st-down, 300kHz, 1.6V±2.5%, 1A, +CE	SOT-25	28zm	DC7	6g	Tor
A1H	XC6367A163MR	DC/DC-IC	PWM step-up, 1.6V±2.5%, 200mA, 300kHz, +CE	SOT-25	28sh	DC11	6g	Tor
A1J	APR3121-46B	Vdet-IC	4.63V, -MR, -Reset PPO	SOT-23-5	28vd2	VD5	6k	Ans
A1K	XC6114A218MR	Vdet-IC	1.8V±2%, ±Reset PPO, Wt=50ms, Rt=3.13ms	SOT-25	28xg	VD19	6g	Tor
A1K	XC6114A248MR	Vdet-IC	4.8V±2%, ±Reset PPO, Wt=50ms, Rt=3.13ms	SOT-25	28xg	VD19	6g	Tor
A1K	XC6365A173MR	DC/DC-IC	PWM st-down, 300kHz, 1.7V±2.5%, 1A, +CE	SOT-25	28zm	DC7	6g	Tor
A1K	XC6367A173MR	DC/DC-IC	PWM step-up, 1.7V±2.5%, 200mA, 300kHz, +CE	SOT-25	28sh	DC11	6g	Tor
A1L	XC6114A219MR	Vdet-IC	1.9V±2%, ±Reset PPO, Wt=50ms, Rt=3.13ms	SOT-25	28xg	VD19	6g	Tor
A1L	XC6114A249MR	Vdet-IC	4.9V±2%, ±Reset PPO, Wt=50ms, Rt=3.13ms	SOT-25	28xg	VD19	6g	Tor
A1L	XC6365A183MR	DC/DC-IC	PWM st-down, 300kHz, 1.8V±2.5%, 1A, +CE	SOT-25	28zm	DC7	6g	Tor
A1L	XC6367A183MR	DC/DC-IC	PWM step-up, 1.8V±2.5%, 200mA, 300kHz, +CE	SOT-25	28sh	DC11	6g	Tor
A1M	XC6114A220MR	Vdet-IC	2.0V±2%, ±Reset PPO, Wt=50ms, Rt=3.13ms	SOT-25	28xg	VD19	6g	Tor
A1M	XC6114A250MR	Vdet-IC	5.0V±2%, ±Reset PPO, Wt=50ms, Rt=3.13ms	SOT-25	28xg	VD19	6g	Tor
A1M	XC6365A193MR	DC/DC-IC	PWM st-down, 300kHz, 1.9V±2.5%, 1A, +CE	SOT-25	28zm	DC7	6g	Tor
A1M	XC6367A193MR	DC/DC-IC	PWM step-up, 1.9V±2.5%, 200mA, 300kHz, +CE	SOT-25	28sh	DC11	6g	Tor
A1N	XC6114A221MR	Vdet-IC	2.1V±2%, ±Reset PPO, Wt=50ms, Rt=3.13ms	SOT-25	28xg	VD19	6g	Tor
A1P	XC6114A222MR	Vdet-IC	2.2V±2%, ±Reset PPO, Wt=50ms, Rt=3.13ms	SOT-25	28xg	VD19	6g	Tor
A1R	XC6114A223MR	Vdet-IC	2.3V±2%, ±Reset PPO, Wt=50ms, Rt=3.13ms	SOT-25	28xg	VD19	6g	Tor
A1S	XC6114A224MR	Vdet-IC	2.4V±2%, ±Reset PPO, Wt=50ms, Rt=3.13ms	SOT-25	28xg	VD19	6g	Tor
A1T	XC6114A225MR	Vdet-IC	2.5V±2%, ±Reset PPO, Wt=50ms, Rt=3.13ms	SOT-25	28xg	VD19	6g	Tor
A1U	XC6114A226MR	Vdet-IC	2.6V±2%, ±Reset PPO, Wt=50ms, Rt=3.13ms	SOT-25	28xg	VD19	6g	Tor
A1V	XC6114A227MR	Vdet-IC	2.7V±2%, ±Reset PPO, Wt=50ms, Rt=3.13ms	SOT-25	28xg	VD19	6g	Tor
A1X	XC6114A228MR	Vdet-IC	2.8V±2%, ±Reset PPO, Wt=50ms, Rt=3.13ms	SOT-25	28xg	VD19	6g	Tor
A1Y	XC6114A229MR	Vdet-IC	2.9V±2%, ±Reset PPO, Wt=50ms, Rt=3.13ms	SOT-25	28xg	VD19	6g	Tor
A1Z	XC6114A230MR	Vdet-IC	3.0V±2%, ±Reset PPO, Wt=50ms, Rt=3.13ms	SOT-25	28xg	VD19	6g	Tor
A2	1SS309	Si-diode	Quad, Sw, Fast, 85V, 100mA, <2pF, <4ns	SOT-25	28bh	-	6a	Tos
A2	AP431Q	Vref-IC	Adjustable, Precision, Shunt, 2.495V±1%	SOT-23-5	28re	RF1	6k	Ans
A2	HD74ALVC1G08V5	CMOS-Logic	2-input AND gate	VSON-5	30/Log3	-	6a	Ren
A2	NLAS4501DF	CMOS-Logic	Bilateral analogic switch	SC-70-5	28/Log16	-	6b	Ons
A2	NLAS4501DT	CMOS-Logic	Bilateral analogic switch	SOT-23-5	28/Log16	-	6b	Ons
A2	PI74ST1G02CX	CMOS-Logic	2-input NOR gate	SC-70-5	28/Log2	-	6a	Per
A2	PI74ST1G02TX	CMOS-Logic	2-input NOR gate	SOT-23-5	28/Log2	-	6a	Per
A2	R1111N221A	LVR-IC	LDO, LN, -CE, 2.2V±2%, 200mA	SOT-23-5	28cx	VR4	6g	Ric
A2	TC1014-2.7VRX	LVR-IC	LDO, 2.7V±2%, 50mA, +CE	SOT-23-5	28wrx	VR7	6g	Mcc
A2-	RT9193-18PU5	LVR-IC	LDO, 1.8V±1%, 300mA, +CE	SC-70-5	28wrx	VR7	6g	Rct
A20	CLC450AJM5	Op-IC	Lo-power, Current Feedback	SOT-23-5	28opa	OP1	6a	Nsc
A20	LMV721M7	Op-IC	Low noise, Vcc=2.7..5V, 10MHz, 2V/μs	SOT-23-5	28opa	OP1	6g	Nsc
A20	RP110N201B	LVR-IC	LDO, 2.0V±1%, 150mA, +CE	SOT-23-5	28cx	VR4	6g	Ric
A20	XC6114A331MR	Vdet-IC	3.1V±2%, ±Reset PPO, Wt=100ms, Rt=3.13ms	SOT-25	28xg	VD19	6g	Tor
A20	XC6365A202MR	DC/DC-IC	PWM st-down, 180kHz, 2.0V±2.5%, 1A, +CE	SOT-25	28zm	DC7	6g	Tor
A20	XC6367A202MR	DC/DC-IC	PWM step-up, 2.0V±2.5%, 200mA, 180kHz, +CE	SOT-25	28sh	DC11	6g	Tor
A21	CLC452AJM5	Op-IC	Lo-power, Current Feedback	SOT-23-5	28opa	OP1	6a	Nsc
A21	RP110N211B	LVR-IC	LDO, 2.1V±1%, 150mA, +CE	SOT-23-5	28cx	VR4	6g	Ric



SMD code	Type	Function	Short description	Case	Pinout	Sch.	St.	Mnf.
<u>A21</u>	XC6114A332MR	Vdet-IC	3.2V±2%, ±Reset PPO, Wt=100ms, Rt=3.13ms	SOT-25	28xg	VD19	6g	Tor
<u>A21</u>	X06365A212MR	DC/DC-IC	PWM st-down, 180kHz, 2.1V±2.5%, 1A, +CE	SOT-25	28zm	DC7	6g	Tor
<u>A21</u>	X06367A212MR	DC/DC-IC	PWM step-up, 2.1V±2.5%, 200mA, 180kHz, +CE	SOT-25	28sh	DC11	6g	Tor
<u>A22</u>	RP110N221B	LVR-IC	LDO, 2.2V±1%, 150mA, +CE	SOT-23-5	28cx	VR4	6g	Ric
<u>A22</u>	XC6114A333MR	Vdet-IC	3.3V±2%, ±Reset PPO, Wt=100ms, Rt=3.13ms	SOT-25	28xg	VD19	6g	Tor
<u>A22</u>	X06365A222MR	DC/DC-IC	PWM st-down, 180kHz, 2.2V±2.5%, 1A, +CE	SOT-25	28zm	DC7	6g	Tor
<u>A22</u>	X06367A222MR	DC/DC-IC	PWM step-up, 2.2V±2.5%, 200mA, 180kHz, +CE	SOT-25	28sh	DC11	6g	Tor
<u>A23</u>	RP110N231B	LVR-IC	LDO, 2.3V±1%, 150mA, +CE	SOT-23-5	28cx	VR4	6g	Ric
<u>A23</u>	XC6114A334MR	Vdet-IC	3.4V±2%, ±Reset PPO, Wt=100ms, Rt=3.13ms	SOT-25	28xg	VD19	6g	Tor
<u>A23</u>	X06365A232MR	DC/DC-IC	PWM st-down, 180kHz, 2.3V±2.5%, 1A, +CE	SOT-25	28zm	DC7	6g	Tor
<u>A23</u>	X06367A232MR	DC/DC-IC	PWM step-up, 2.3V±2.5%, 200mA, 180kHz, +CE	SOT-25	28sh	DC11	6g	Tor
<u>A24</u>	MIC913BM5	Op-IC	Lo-power, ±2.5...±9V, 350MHz	SOT-23-5	280pb	OP1	6g	Mcr
<u>A24</u>	RP110N241B	LVR-IC	LDO, 2.4V±1%, 150mA, +CE	SOT-23-5	28cx	VR4	6g	Ric
<u>A24</u>	XC6114A335MR	Vdet-IC	3.5V±2%, ±Reset PPO, Wt=100ms, Rt=3.13ms	SOT-25	28xg	VD19	6g	Tor
<u>A24</u>	X06365A242MR	DC/DC-IC	PWM st-down, 180kHz, 2.4V±2.5%, 1A, +CE	SOT-25	28zm	DC7	6g	Tor
<u>A24</u>	X06367A242MR	DC/DC-IC	PWM step-up, 2.4V±2.5%, 200mA, 180kHz, +CE	SOT-25	28sh	DC11	6g	Tor
<u>A24</u>	XC9301A242MR	DC/DC-IC	PWM step-up/down, 180kHz, 2.4V±2.5%, 250mA, +CE	SOT-25	28dc8	DC14	6g	Tor
<u>A25</u>	74AHC1G125GV	CMOS-Logic	Bus buffer gate with 3-state output	SOT753	28/Log14	-	6a	Phi
<u>A25</u>	MIC820BC5	Op-IC	Lo-power, ±4.7...±5.25V, Icco=22µA, 5V/µs, 4MHz	SOT-23-5	280pf	OP1	6g	Mcr
<u>A25</u>	RP110N251B	LVR-IC	LDO, 2.5V±1%, 150mA, +CE	SOT-23-5	28cx	VR4	6g	Ric
<u>A25</u>	XC6114A336MR	Vdet-IC	3.6V±2%, ±Reset PPO, Wt=100ms, Rt=3.13ms	SOT-25	28xg	VD19	6g	Tor
<u>A25</u>	X06365A252MR	DC/DC-IC	PWM st-down, 180kHz, 2.5V±2.5%, 1A, +CE	SOT-25	28zm	DC7	6g	Tor
<u>A25</u>	X06367A252MR	DC/DC-IC	PWM step-up, 2.5V±2.5%, 200mA, 180kHz, +CE	SOT-25	28sh	DC11	6g	Tor
<u>A25</u>	XC9301A252MR	DC/DC-IC	PWM step-up/down, 180kHz, 2.5V±2.5%, 250mA, +CE	SOT-25	28dc8	DC14	6g	Tor
<u>A26</u>	74AHC1G126GV	CMOS-Logic	Bus buffer gate with 3-state output	SOT753	28/Log13	-	6a	Phi
<u>A26</u>	MIC914BM5	Op-IC	Lo-power, ±2.5...±9V, Icco=1.25mA, 160MHz	SOT-23-5	280pb	OP1	6g	Mcr
<u>A26</u>	RP110N261B	LVR-IC	LDO, 2.6V±1%, 150mA, +CE	SOT-23-5	28cx	VR4	6g	Ric
<u>A26</u>	XC6114A337MR	Vdet-IC	3.7V±2%, ±Reset PPO, Wt=100ms, Rt=3.13ms	SOT-25	28xg	VD19	6g	Tor
<u>A26</u>	X06365A262MR	DC/DC-IC	PWM st-down, 180kHz, 2.6V±2.5%, 1A, +CE	SOT-25	28zm	DC7	6g	Tor
<u>A26</u>	X06367A262MR	DC/DC-IC	PWM step-up, 2.6V±2.5%, 200mA, 180kHz, +CE	SOT-25	28sh	DC11	6g	Tor
<u>A26</u>	XC9301A262MR	DC/DC-IC	PWM step-up/down, 180kHz, 2.6V±2.5%, 250mA, +CE	SOT-25	28dc8	DC14	6g	Tor
<u>A27</u>	RP110N271B	LVR-IC	LDO, 2.7V±1%, 150mA, +CE	SOT-23-5	28cx	VR4	6g	Ric
<u>A27</u>	XC6114A338MR	Vdet-IC	3.8V±2%, ±Reset PPO, Wt=100ms, Rt=3.13ms	SOT-25	28xg	VD19	6g	Tor
<u>A27</u>	X06365A272MR	DC/DC-IC	PWM st-down, 180kHz, 2.7V±2.5%, 1A, +CE	SOT-25	28zm	DC7	6g	Tor
<u>A27</u>	X06367A272MR	DC/DC-IC	PWM step-up, 2.7V±2.5%, 200mA, 180kHz, +CE	SOT-25	28sh	DC11	6g	Tor
<u>A27</u>	XC9301A272MR	DC/DC-IC	PWM step-up/down, 180kHz, 2.7V±2.5%, 250mA, +CE	SOT-25	28dc8	DC14	6g	Tor
<u>A28</u>	RP110N281B	LVR-IC	LDO, 2.8V±1%, 150mA, +CE	SOT-23-5	28cx	VR4	6g	Ric
<u>A28</u>	XC6114A339MR	Vdet-IC	3.9V±2%, ±Reset PPO, Wt=100ms, Rt=3.13ms	SOT-25	28xg	VD19	6g	Tor
<u>A28</u>	X06365A282MR	DC/DC-IC	PWM st-down, 180kHz, 2.8V±2.5%, 1A, +CE	SOT-25	28zm	DC7	6g	Tor
<u>A28</u>	X06367A282MR	DC/DC-IC	PWM step-up, 2.8V±2.5%, 200mA, 180kHz, +CE	SOT-25	28sh	DC11	6g	Tor
<u>A28</u>	XC9301A282MR	DC/DC-IC	PWM step-up/down, 180kHz, 2.8V±2.5%, 250mA, +CE	SOT-25	28dc8	DC14	6g	Tor
<u>A29</u>	RP110N291B	LVR-IC	LDO, 2.9V±1%, 150mA, +CE	SOT-23-5	28cx	VR4	6g	Ric
<u>A29</u>	XC6114A340MR	Vdet-IC	4.0V±2%, ±Reset PPO, Wt=100ms, Rt=3.13ms	SOT-25	28xg	VD19	6g	Tor
<u>A29</u>	X06365A292MR	DC/DC-IC	PWM st-down, 180kHz, 2.9V±2.5%, 1A, +CE	SOT-25	28zm	DC7	6g	Tor
<u>A29</u>	X06367A292MR	DC/DC-IC	PWM step-up, 2.9V±2.5%, 200mA, 180kHz, +CE	SOT-25	28sh	DC11	6g	Tor
<u>A29</u>	XC9301A292MR	DC/DC-IC	PWM step-up/down, 180kHz, 2.9V±2.5%, 250mA, +CE	SOT-25	28dc8	DC14	6g	Tor
<u>A2A</u>	APR3122-15B	Vdet-IC	1.5V, -MR, +Reset PPO	SOT-23-5	28vd2	VD5	6k	Anp
<u>A2A</u>	XC6114A341MR	Vdet-IC	4.1V±2%, ±Reset PPO, Wt=100ms, Rt=3.13ms	SOT-25	28xg	VD19	6g	Tor
<u>A2A</u>	X06367A203MR	DC/DC-IC	PWM step-up, 2.0V±2.5%, 200mA, 300kHz, +CE	SOT-25	28sh	DC11	6g	Tor
<u>A2B</u>	APR3122-17B	Vdet-IC	1.75V, -MR, +Reset PPO	SOT-23-5	28vd2	VD5	6k	Anp
<u>A2B</u>	XC6114A342MR	Vdet-IC	4.2V±2%, ±Reset PPO, Wt=100ms, Rt=3.13ms	SOT-25	28xg	VD19	6g	Tor
<u>A2B</u>	X06365A213MR	DC/DC-IC	PWM st-down, 300kHz, 2.1V±2.5%, 1A, +CE	SOT-25	28zm	DC7	6g	Tor
<u>A2B</u>	X06367A213MR	DC/DC-IC	PWM step-up, 2.1V±2.5%, 200mA, 300kHz, +CE	SOT-25	28sh	DC11	6g	Tor
<u>A2C</u>	APR3122-23B	Vdet-IC	2.32V, -MR, +Reset PPO	SOT-23-5	28vd2	VD5	6k	Anp
<u>A2C</u>	XC6114A343MR	Vdet-IC	4.3V±2%, ±Reset PPO, Wt=100ms, Rt=3.13ms	SOT-25	28xg	VD19	6g	Tor
<u>A2C</u>	X06365A223MR	DC/DC-IC	PWM st-down, 300kHz, 2.2V±2.5%, 1A, +CE	SOT-25	28zm	DC7	6g	Tor
<u>A2C</u>	X06367A223MR	DC/DC-IC	PWM step-up, 2.2V±2.5%, 200mA, 300kHz, +CE	SOT-25	28sh	DC11	6g	Tor
<u>A2D</u>	APR3122-26B	Vdet-IC	2.63V, -MR, +Reset PPO	SOT-23-5	28vd2	VD5	6k	Anp
<u>A2D</u>	XC6114A344MR	Vdet-IC	4.4V±2%, ±Reset PPO, Wt=100ms, Rt=3.13ms	SOT-25	28xg	VD19	6g	Tor
<u>A2D</u>	X06365A233MR	DC/DC-IC	PWM st-down, 300kHz, 2.3V±2.5%, 1A, +CE	SOT-25	28zm	DC7	6g	Tor
<u>A2D</u>	X06367A233MR	DC/DC-IC	PWM step-up, 2.3V±2.5%, 200mA, 300kHz, +CE	SOT-25	28sh	DC11	6g	Tor
<u>A2E</u>	APR3122-29B	Vdet-IC	2.93V, -MR, +Reset PPO	SOT-23-5	28vd2	VD5	6k	Anp
<u>A2E</u>	XC6114A345MR	Vdet-IC	4.5V±2%, ±Reset PPO, Wt=100ms, Rt=3.13ms	SOT-25	28xg	VD19	6g	Tor
<u>A2E</u>	X06365A243MR	DC/DC-IC	PWM st-down, 300kHz, 2.4V±2.5%, 1A, +CE	SOT-25	28zm	DC7	6g	Tor
<u>A2E</u>	X06367A243MR	DC/DC-IC	PWM step-up, 2.4V±2.5%, 200mA, 300kHz, +CE	SOT-25	28sh	DC11	6g	Tor
<u>A2E</u>	XC9301A243MR	DC/DC-IC	PWM step-up/down, 300kHz, 2.4V±2.5%, 250mA, +CE	SOT-25	28dc8	DC14	6g	Tor
<u>A2F</u>	APR3122-30B	Vdet-IC	3.08V, -MR, +Reset PPO	SOT-23-5	28vd2	VD5	6k	Anp
<u>A2F</u>	XC6114A316MR	Vdet-IC	1.6V±2%, ±Reset PPO, Wt=100ms, Rt=3.13ms	SOT-25	28xg	VD19	6g	Tor
<u>A2F</u>	XC6114A346MR	Vdet-IC	4.6V±2%, ±Reset PPO, Wt=100ms, Rt=3.13ms	SOT-25	28xg	VD19	6g	Tor
<u>A2F</u>	X06365A253MR	DC/DC-IC	PWM st-down, 300kHz, 2.5V±2.5%, 1A, +CE	SOT-25	28zm	DC7	6g	Tor



SMD code	Type	Function	Short description	Case	Pinout	Sch.	St.	Mnf.
A2F	XC6367A253MR	DC/DC-IC	PWM step-up, 2.5V±2.5%, 200mA, 300kHz, +CE	SOT-25	28sh	DC11	6g	Tor
A2F	XC9301A253MR	DC/DC-IC	PWM step-up/down, 300kHz, 2.5V±2.5%, 250mA, +CE	SOT-25	28dc8	DC14	6g	Tor
A2G	APR3122-39B	Vdet-IC	3.9V, -MR, +Reset PPO	SOT-23-5	28vd2	VD5	6k	Anp
A2H	APR3122-43B	Vdet-IC	4.38V, -MR, +Reset PPO	SOT-23-5	28vd2	VD5	6k	Anp
A2H	XC6114A317MR	Vdet-IC	1.7V±2%, ±Reset PPO, Wt=100ms, Rt=3.13ms	SOT-25	28xg	VD19	6g	Tor
A2H	XC6114A347MR	Vdet-IC	4.7V±2%, ±Reset PPO, Wt=100ms, Rt=3.13ms	SOT-25	28xg	VD19	6g	Tor
A2H	XC6365A263MR	DC/DC-IC	PWM st-down, 300kHz, 2.6V±2.5%, 1A, +CE	SOT-25	28zm	DC7	6g	Tor
A2H	XC6367A263MR	DC/DC-IC	PWM step-up, 2.6V±2.5%, 200mA, 300kHz, +CE	SOT-25	28sh	DC11	6g	Tor
A2H	XC9301A263MR	DC/DC-IC	PWM step-up/down, 300kHz, 2.6V±2.5%, 250mA, +CE	SOT-25	28dc8	DC14	6g	Tor
A2J	APR3122-46B	Vdet-IC	4.63V, -MR, +Reset PPO	SOT-23-5	28vd2	VD5	6k	Anp
A2K	XC6114A318MR	Vdet-IC	1.8V±2%, ±Reset PPO, Wt=100ms, Rt=3.13ms	SOT-25	28xg	VD19	6g	Tor
A2K	XC6114A348MR	Vdet-IC	4.8V±2%, ±Reset PPO, Wt=100ms, Rt=3.13ms	SOT-25	28xg	VD19	6g	Tor
A2K	XC6365A273MR	DC/DC-IC	PWM st-down, 300kHz, 2.7V±2.5%, 1A, +CE	SOT-25	28zm	DC7	6g	Tor
A2K	XC6367A273MR	DC/DC-IC	PWM step-up, 2.7V±2.5%, 200mA, 300kHz, +CE	SOT-25	28sh	DC11	6g	Tor
A2K	XC9301A273MR	DC/DC-IC	PWM step-up/down, 300kHz, 2.7V±2.5%, 250mA, +CE	SOT-25	28dc8	DC14	6g	Tor
A2L	XC6114A319MR	Vdet-IC	1.9V±2%, ±Reset PPO, Wt=100ms, Rt=3.13ms	SOT-25	28xg	VD19	6g	Tor
A2L	XC6114A349MR	Vdet-IC	4.9V±2%, ±Reset PPO, Wt=100ms, Rt=3.13ms	SOT-25	28xg	VD19	6g	Tor
A2L	XC6365A283MR	DC/DC-IC	PWM st-down, 300kHz, 2.8V±2.5%, 1A, +CE	SOT-25	28zm	DC7	6g	Tor
A2L	XC6367A283MR	DC/DC-IC	PWM step-up, 2.8V±2.5%, 200mA, 300kHz, +CE	SOT-25	28sh	DC11	6g	Tor
A2L	XC9301A283MR	DC/DC-IC	PWM step-up/down, 300kHz, 2.8V±2.5%, 250mA, +CE	SOT-25	28dc8	DC14	6g	Tor
A2M	XC6114A320MR	Vdet-IC	2.0V±2%, ±Reset PPO, Wt=100ms, Rt=3.13ms	SOT-25	28xg	VD19	6g	Tor
A2M	XC6114A350MR	Vdet-IC	5.0V±2%, ±Reset PPO, Wt=100ms, Rt=3.13ms	SOT-25	28xg	VD19	6g	Tor
A2M	XC6365A293MR	DC/DC-IC	PWM st-down, 300kHz, 2.9V±2.5%, 1A, +CE	SOT-25	28zm	DC7	6g	Tor
A2M	XC6367A293MR	DC/DC-IC	PWM step-up, 2.9V±2.5%, 200mA, 300kHz, +CE	SOT-25	28sh	DC11	6g	Tor
A2M	XC9301A293MR	DC/DC-IC	PWM step-up/down, 300kHz, 2.9V±2.5%, 250mA, +CE	SOT-25	28dc8	DC14	6g	Tor
A2N	XC6114A321MR	Vdet-IC	2.1V±2%, ±Reset PPO, Wt=100ms, Rt=3.13ms	SOT-25	28xg	VD19	6g	Tor
A2P	XC6114A322MR	Vdet-IC	2.2V±2%, ±Reset PPO, Wt=100ms, Rt=3.13ms	SOT-25	28xg	VD19	6g	Tor
A2P	XC6114A323MR	Vdet-IC	2.3V±2%, ±Reset PPO, Wt=100ms, Rt=3.13ms	SOT-25	28xg	VD19	6g	Tor
A2S	XC6114A324MR	Vdet-IC	2.4V±2%, ±Reset PPO, Wt=100ms, Rt=3.13ms	SOT-25	28xg	VD19	6g	Tor
A2T	XC6114A325MR	Vdet-IC	2.5V±2%, ±Reset PPO, Wt=100ms, Rt=3.13ms	SOT-25	28xg	VD19	6g	Tor
A2U	XC6114A326MR	Vdet-IC	2.6V±2%, ±Reset PPO, Wt=100ms, Rt=3.13ms	SOT-25	28xg	VD19	6g	Tor
A2V	XC6114A327MR	Vdet-IC	2.7V±2%, ±Reset PPO, Wt=100ms, Rt=3.13ms	SOT-25	28xg	VD19	6g	Tor
A2X	XC6114A328MR	Vdet-IC	2.8V±2%, ±Reset PPO, Wt=100ms, Rt=3.13ms	SOT-25	28xg	VD19	6g	Tor
A2Y	XC6114A329MR	Vdet-IC	2.9V±2%, ±Reset PPO, Wt=100ms, Rt=3.13ms	SOT-25	28xg	VD19	6g	Tor
A2Z	XC6114A330MR	Vdet-IC	3.0V±2%, ±Reset PPO, Wt=100ms, Rt=3.13ms	SOT-25	28xg	VD19	6g	Tor
A3	AP431AQ	Vref-IC	Adjustable, Precision, Shunt, 2.495V±0.5%	SOT-23-5	28re	RF1	6k	Ana
A3	HD74ALVC1G02VS	CMOS-Logic	2-input NOR gate	VSON-5	30/Log2	-	6a	Ren
A3	NLAST4501DF	CMOS-Logic	Bilateral analogic switch	SC-70-5	28/Log16	-	6b	Ons
A3	NLAST4501DT	CMOS-Logic	Bilateral analogic switch	SOT-23-5	28/Log16	-	6b	Ons
A3	R1111N231A	LVR-IC	LDO, LN, -CE, 2.3V±2%, 200mA	SOT-23-5	28cx	VR4	6g	Ric
A3	TC1014-3.0VRX	LVR-IC	LDO, 3V±2%, 50mA, +CE	SOT-23-5	28vrx	VR7	6g	Mcc
A3-	RT9193-25PU5	LVR-IC	LDO, 2.5V±1%, 300mA, +CE	SC-70-5	28vrx	VR7	6g	Rct
A3=	RT9193-25GU5	LVR-IC	LDO, 2.5V±1%, 300mA, +CE	SC-70-5	28vrx	VR7	6g	Rct
A30	RP110N301B	LVR-IC	LDO, 3.0V±1%, 150mA, +CE	SOT-23-5	28cx	VR4	6g	Ric
A30	XC6114A431MR	Vdet-IC	3.1V±2%, ±Reset PPO, Wt=200ms, Rt=3.13ms	SOT-25	28xg	VD19	6g	Tor
A30	XC6365A302MR	DC/DC-IC	PWM st-down, 180kHz, 3.0V±2.5%, 1A, +CE	SOT-25	28zm	DC7	6g	Tor
A30	XC6367A302MR	DC/DC-IC	PWM step-up, 3.0V±2.5%, 200mA, 180kHz, +CE	SOT-25	28sh	DC11	6g	Tor
A30	XC9301A302MR	DC/DC-IC	PWM step-up/down, 180kHz, 3.0V±2.5%, 250mA, +CE	SOT-25	28dc8	DC14	6g	Tor
A31	OPA631N	Op-IC	Single-supply	SOT-23-5	28opa	OP1	6a	Bb
A31	RP110N311B	LVR-IC	LDO, 3.1V±1%, 150mA, +CE	SOT-23-5	28cx	VR4	6g	Ric
A31	XC6114A432MR	Vdet-IC	3.2V±2%, ±Reset PPO, Wt=200ms, Rt=3.13ms	SOT-25	28xg	VD19	6g	Tor
A31	XC6365A312MR	DC/DC-IC	PWM st-down, 180kHz, 3.1V±2.5%, 1A, +CE	SOT-25	28zm	DC7	6g	Tor
A31	XC6367A312MR	DC/DC-IC	PWM step-up, 3.1V±2.5%, 200mA, 180kHz, +CE	SOT-25	28sh	DC11	6g	Tor
A31	XC9301A312MR	DC/DC-IC	PWM step-up/down, 180kHz, 3.1V±2.5%, 250mA, +CE	SOT-25	28dc8	DC14	6g	Tor
A32	74AHC1G32GV	CMOS-Logic	2-input OR gate	SOT7753	28/Log4	-	6a	Phi
A32	MIC860BC5	Op-IC	Lo-power, ±2.4...±5.25V, Icco=30µA, 4MHz	SOT-23-5	28opf	OP1	6g	Mcr
A32	RP110N321B	LVR-IC	LDO, 3.2V±1%, 150mA, +CE	SOT-23-5	28cx	VR4	6g	Ric
A32	U74AHC1G32-AL5	CMOS-Logic	2-input OR gate	SOT-353	28/Log4	-	6a	Utc
A32	XC6114A433MR	Vdet-IC	3.3V±2%, ±Reset PPO, Wt=200ms, Rt=3.13ms	SOT-25	28xg	VD19	6g	Tor
A32	XC6365A322MR	DC/DC-IC	PWM st-down, 180kHz, 3.2V±2.5%, 1A, +CE	SOT-25	28zm	DC7	6g	Tor
A32	XC6367A322MR	DC/DC-IC	PWM step-up, 3.2V±2.5%, 200mA, 180kHz, +CE	SOT-25	28sh	DC11	6g	Tor
A32	XC9301A322MR	DC/DC-IC	PWM step-up/down, 180kHz, 3.2V±2.5%, 250mA, +CE	SOT-25	28dc8	DC14	6g	Tor
A32A	LMV751M5	Op-IC	Low noise, Vcc=2.7...5V, 4.5MHz, 2V/us	SOT-23-5	28opa	OP1	6g	Nsc
A32A	LMV751MSX	Op-IC	Low noise, Vcc=2.7...5V, 4.5MHz, 2V/us	SOT-23-5	28opa	OP1	6g	Nsc
A33	MIC861BC5	Op-IC	Lo-power, ±2.4...±5.25V, Icco=4.6µA, 400kHz	SOT-23-5	28opf	OP1	6g	Mcr
A33	RP110N331B	LVR-IC	LDO, 3.3V±1%, 150mA, +CE	SOT-23-5	28cx	VR4	6g	Ric
A33	XC6114A434MR	Vdet-IC	3.4V±2%, ±Reset PPO, Wt=200ms, Rt=3.13ms	SOT-25	28xg	VD19	6g	Tor
A33	XC6365A332MR	DC/DC-IC	PWM st-down, 180kHz, 3.3V±2.5%, 1A, +CE	SOT-25	28zm	DC7	6g	Tor
A33	XC6367A332MR	DC/DC-IC	PWM step-up, 3.3V±2.5%, 200mA, 180kHz, +CE	SOT-25	28sh	DC11	6g	Tor
A33	XC9301A332MR	DC/DC-IC	PWM step-up/down, 180kHz, 3.3V±2.5%, 250mA, +CE	SOT-25	28dc8	DC14	6g	Tor



SMD code	Type	Function	Short description	Case	Pinout	Sch.	St.	Mnf.
A34	RP110N341B	LVR-IC	LDO, 3.4V±1%, 150mA, +CE	SOT-23-5	28cx	VR4	6g	Ric
A34	X06114A435MR	Vdet-IC	3.5V±2%, ±Reset PPO, Wt=200ms, Rt=3.13ms	SOT-25	28xg	VD19	6g	Tor
A34	X06367A342MR	DC/DC-IC	PWM st-down, 180kHz, 3.4V±2.5%, 1A, +CE	SOT-25	28zm	DC7	6g	Tor
A34	X06367A342MR	DC/DC-IC	PWM step-up, 3.4V±2.5%, 200mA, 180kHz, +CE	SOT-25	28sh	DC11	6g	Tor
A34	XC9301A342MR	DC/DC-IC	PWM step-up/down, 180kHz, 3.4V±2.5%, 250mA, +CE	SOT-25	28dc8	DC14	6g	Tor
A35	RP110N351B	LVR-IC	LDO, 3.5V±1%, 150mA, +CE	SOT-23-5	28cx	VR4	6g	Ric
A35	X06114A436MR	Vdet-IC	3.6V±2%, ±Reset PPO, Wt=200ms, Rt=3.13ms	SOT-25	28xg	VD19	6g	Tor
A35	X06367A352MR	DC/DC-IC	PWM st-down, 180kHz, 3.5V±2.5%, 1A, +CE	SOT-25	28zm	DC7	6g	Tor
A35	X06367A352MR	DC/DC-IC	PWM step-up, 3.5V±2.5%, 200mA, 180kHz, +CE	SOT-25	28sh	DC11	6g	Tor
A35	XC9301A352MR	DC/DC-IC	PWM step-up/down, 180kHz, 3.5V±2.5%, 250mA, +CE	SOT-25	28dc8	DC14	6g	Tor
A36	OPA336NA	Op-IC	Single-supply, CMOS	SOT-23-5	28opa	OP1	6a	Bb
A36	RP110N361B	LVR-IC	LDO, 3.6V±1%, 150mA, +CE	SOT-23-5	28cx	VR4	6g	Ric
A36	X06114A437MR	Vdet-IC	3.7V±2%, ±Reset PPO, Wt=200ms, Rt=3.13ms	SOT-25	28xg	VD19	6g	Tor
A36	X06367A362MR	DC/DC-IC	PWM st-down, 180kHz, 3.6V±2.5%, 1A, +CE	SOT-25	28zm	DC7	6g	Tor
A36	X06367A362MR	DC/DC-IC	PWM step-up, 3.6V±2.5%, 200mA, 180kHz, +CE	SOT-25	28sh	DC11	6g	Tor
A36	XC9301A362MR	DC/DC-IC	PWM step-up/down, 180kHz, 3.6V±2.5%, 250mA, +CE	SOT-25	28dc8	DC14	6g	Tor
A37	RP110N121B5	LVR-IC	LDO, 1.25V±1%, 150mA, +CE	SOT-23-5	28cx	VR4	6g	Ric
A37	X06114A438MR	Vdet-IC	3.8V±2%, ±Reset PPO, Wt=200ms, Rt=3.13ms	SOT-25	28xg	VD19	6g	Tor
A37	X06367A372MR	DC/DC-IC	PWM st-down, 180kHz, 3.7V±2.5%, 1A, +CE	SOT-25	28zm	DC7	6g	Tor
A37	X06367A372MR	DC/DC-IC	PWM step-up, 3.7V±2.5%, 200mA, 180kHz, +CE	SOT-25	28sh	DC11	6g	Tor
A37	XC9301A372MR	DC/DC-IC	PWM step-up/down, 180kHz, 3.7V±2.5%, 250mA, +CE	SOT-25	28dc8	DC14	6g	Tor
A37A	OPA237NA	Op-IC	GP, Lo-Power, ±1.35...±18V, Icc0=350µA, 1.5MHz	SOT-23-5	28opa	OP1	6a	Bb
A38	OPA338NA	Op-IC	Single-supply, CMOS	SOT-23-5	28opa	OP1	6a	Bb
A38	RP110N181B5	LVR-IC	LDO, 1.85V±1%, 150mA, +CE	SOT-23-5	28cx	VR4	6g	Ric
A38	X06114A439MR	Vdet-IC	3.9V±2%, ±Reset PPO, Wt=200ms, Rt=3.13ms	SOT-25	28xg	VD19	6g	Tor
A38	X06367A382MR	DC/DC-IC	PWM st-down, 180kHz, 3.8V±2.5%, 1A, +CE	SOT-25	28zm	DC7	6g	Tor
A38	X06367A382MR	DC/DC-IC	PWM step-up, 3.8V±2.5%, 200mA, 180kHz, +CE	SOT-25	28sh	DC11	6g	Tor
A38	XC9301A382MR	DC/DC-IC	PWM step-up/down, 180kHz, 3.8V±2.5%, 250mA, +CE	SOT-25	28dc8	DC14	6g	Tor
A39	RP110N281B5	LVR-IC	LDO, 2.85V±1%, 150mA, +CE	SOT-23-5	28cx	VR4	6g	Ric
A39	X06114A440MR	Vdet-IC	4.0V±2%, ±Reset PPO, Wt=200ms, Rt=3.13ms	SOT-25	28xg	VD19	6g	Tor
A39	X06367A392MR	DC/DC-IC	PWM st-down, 180kHz, 3.9V±2.5%, 1A, +CE	SOT-25	28zm	DC7	6g	Tor
A39	X06367A392MR	DC/DC-IC	PWM step-up, 3.9V±2.5%, 200mA, 180kHz, +CE	SOT-25	28sh	DC11	6g	Tor
A39	XC9301A392MR	DC/DC-IC	PWM step-up/down, 180kHz, 3.9V±2.5%, 250mA, +CE	SOT-25	28dc8	DC14	6g	Tor
A39A	APR3123-15B	Vdet-IC	1.5V, -MR, -Reset ODO	SOT-23-5	28vd2	VD4	6k	Anp
A3A	X06114A441MR	Vdet-IC	4.1V±2%, ±Reset PPO, Wt=200ms, Rt=3.13ms	SOT-25	28xg	VD19	6g	Tor
A3A	X06367A303MR	DC/DC-IC	PWM st-down, 300kHz, 3.0V±2.5%, 1A, +CE	SOT-25	28zm	DC7	6g	Tor
A3A	X06367A303MR	DC/DC-IC	PWM step-up, 3.0V±2.5%, 200mA, 300kHz, +CE	SOT-25	28sh	DC11	6g	Tor
A3A	XC9301A303MR	DC/DC-IC	PWM step-up/down, 300kHz, 3.0V±2.5%, 250mA, +CE	SOT-25	28dc8	DC14	6g	Tor
A3B	APR3123-17B	Vdet-IC	1.75V, -MR, -Reset ODO	SOT-23-5	28vd2	VD4	6k	Anp
A3B	X06114A442MR	Vdet-IC	4.2V±2%, ±Reset PPO, Wt=200ms, Rt=3.13ms	SOT-25	28xg	VD19	6g	Tor
A3B	X06367A313MR	DC/DC-IC	PWM st-down, 300kHz, 3.1V±2.5%, 1A, +CE	SOT-25	28zm	DC7	6g	Tor
A3B	X06367A313MR	DC/DC-IC	PWM step-up, 3.1V±2.5%, 200mA, 300kHz, +CE	SOT-25	28sh	DC11	6g	Tor
A3B	XC9301A313MR	DC/DC-IC	PWM step-up/down, 300kHz, 3.1V±2.5%, 250mA, +CE	SOT-25	28dc8	DC14	6g	Tor
A3C	APR3123-23B	Vdet-IC	2.32V, -MR, -Reset ODO	SOT-23-5	28vd2	VD4	6k	Anp
A3C	X06114A443MR	Vdet-IC	4.3V±2%, ±Reset PPO, Wt=200ms, Rt=3.13ms	SOT-25	28xg	VD19	6g	Tor
A3C	X06367A323MR	DC/DC-IC	PWM st-down, 300kHz, 3.2V±2.5%, 1A, +CE	SOT-25	28zm	DC7	6g	Tor
A3C	X06367A323MR	DC/DC-IC	PWM step-up, 3.2V±2.5%, 200mA, 300kHz, +CE	SOT-25	28sh	DC11	6g	Tor
A3C	XC9301A323MR	DC/DC-IC	PWM step-up/down, 300kHz, 3.2V±2.5%, 250mA, +CE	SOT-25	28dc8	DC14	6g	Tor
A3D	APR3123-26B	Vdet-IC	2.63V, -MR, -Reset ODO	SOT-23-5	28vd2	VD4	6k	Anp
A3D	X06114A444MR	Vdet-IC	4.4V±2%, ±Reset PPO, Wt=200ms, Rt=3.13ms	SOT-25	28xg	VD19	6g	Tor
A3D	X06367A333MR	DC/DC-IC	PWM st-down, 300kHz, 3.3V±2.5%, 1A, +CE	SOT-25	28zm	DC7	6g	Tor
A3D	X06367A333MR	DC/DC-IC	PWM step-up, 3.3V±2.5%, 200mA, 300kHz, +CE	SOT-25	28sh	DC11	6g	Tor
A3D	XC9301A333MR	DC/DC-IC	PWM step-up/down, 300kHz, 3.3V±2.5%, 250mA, +CE	SOT-25	28dc8	DC14	6g	Tor
A3E	APR3123-29B	Vdet-IC	2.93V, -MR, -Reset ODO	SOT-23-5	28vd2	VD4	6k	Anp
A3E	X06114A445MR	Vdet-IC	4.5V±2%, ±Reset PPO, Wt=200ms, Rt=3.13ms	SOT-25	28xg	VD19	6g	Tor
A3E	X06367A343MR	DC/DC-IC	PWM st-down, 300kHz, 3.4V±2.5%, 1A, +CE	SOT-25	28zm	DC7	6g	Tor
A3E	X06367A343MR	DC/DC-IC	PWM step-up, 3.4V±2.5%, 200mA, 300kHz, +CE	SOT-25	28sh	DC11	6g	Tor
A3E	XC9301A343MR	DC/DC-IC	PWM step-up/down, 300kHz, 3.4V±2.5%, 250mA, +CE	SOT-25	28dc8	DC14	6g	Tor
A3F	APR3123-30B	Vdet-IC	3.08V, -MR, -Reset ODO	SOT-23-5	28vd2	VD4	6k	Anp
A3F	X06114A416MR	Vdet-IC	1.6V±2%, ±Reset PPO, Wt=200ms, Rt=3.13ms	SOT-25	28xg	VD19	6g	Tor
A3F	X06114A446MR	Vdet-IC	4.6V±2%, ±Reset PPO, Wt=200ms, Rt=3.13ms	SOT-25	28xg	VD19	6g	Tor
A3F	X06367A353MR	DC/DC-IC	PWM st-down, 300kHz, 3.5V±2.5%, 1A, +CE	SOT-25	28zm	DC7	6g	Tor
A3F	X06367A353MR	DC/DC-IC	PWM step-up, 3.5V±2.5%, 200mA, 300kHz, +CE	SOT-25	28sh	DC11	6g	Tor
A3F	XC9301A353MR	DC/DC-IC	PWM step-up/down, 300kHz, 3.5V±2.5%, 250mA, +CE	SOT-25	28dc8	DC14	6g	Tor
A3G	APR3123-39B	Vdet-IC	3.9V, -MR, -Reset ODO	SOT-23-5	28vd2	VD4	6k	Anp
A3H	APR3123-43B	Vdet-IC	4.38V, -MR, -Reset ODO	SOT-23-5	28vd2	VD4	6k	Anp
A3H	X06114A417MR	Vdet-IC	1.7V±2%, ±Reset PPO, Wt=200ms, Rt=3.13ms	SOT-25	28xg	VD19	6g	Tor
A3H	X06114A447MR	Vdet-IC	4.7V±2%, ±Reset PPO, Wt=200ms, Rt=3.13ms	SOT-25	28xg	VD19	6g	Tor
A3H	X06367A363MR	DC/DC-IC	PWM st-down, 300kHz, 3.6V±2.5%, 1A, +CE	SOT-25	28zm	DC7	6g	Tor
A3H	X06367A363MR	DC/DC-IC	PWM step-up, 3.6V±2.5%, 200mA, 300kHz, +CE	SOT-25	28sh	DC11	6g	Tor



SMD code	Type	Function	Short description	Case	Pinout	Sch.	St.	Mnf.
<u>A3H</u>	XC9301A363MR	DC/DC-IC	PWM step-up/down, 300kHz, 3.6V±2.5%, 250mA, +CE	SOT-25	28dc8	DC14	6g	Tor
<u>A3J</u>	APR3123-46B	Vdet-IC	4.63V, -MR, -Reset ODO	SOT-23-5	28vd2	VD4	6k	Anp
<u>A3K</u>	XC6114A418MR	Vdet-IC	1.8V±2%, ±Reset PPO, Wt=200ms, Rt=3.13ms	SOT-25	28xg	VD19	6g	Tor
<u>A3K</u>	XC6114A448MR	Vdet-IC	4.8V±2%, ±Reset PPO, Wt=200ms, Rt=3.13ms	SOT-25	28xg	VD19	6g	Tor
<u>A3K</u>	XC6365A373MR	DC/DC-IC	PWM st-down, 300kHz, 3.7V±2.5%, 1A, +CE	SOT-25	28zm	DC7	6g	Tor
<u>A3K</u>	XC6367A373MR	DC/DC-IC	PWM step-up, 3.7V±2.5%, 200mA, 300kHz, +CE	SOT-25	28sh	DC11	6g	Tor
<u>A3K</u>	XC9301A373MR	DC/DC-IC	PWM step-up/down, 300kHz, 3.7V±2.5%, 250mA, +CE	SOT-25	28dc8	DC14	6g	Tor
<u>A3L</u>	XC6114A419MR	Vdet-IC	1.9V±2%, ±Reset PPO, Wt=200ms, Rt=3.13ms	SOT-25	28xg	VD19	6g	Tor
<u>A3L</u>	XC6114A449MR	Vdet-IC	4.9V±2%, ±Reset PPO, Wt=200ms, Rt=3.13ms	SOT-25	28xg	VD19	6g	Tor
<u>A3L</u>	XC6365A383MR	DC/DC-IC	PWM st-down, 300kHz, 3.8V±2.5%, 1A, +CE	SOT-25	28zm	DC7	6g	Tor
<u>A3L</u>	XC6367A383MR	DC/DC-IC	PWM step-up, 3.8V±2.5%, 200mA, 300kHz, +CE	SOT-25	28sh	DC11	6g	Tor
<u>A3L</u>	XC9301A383MR	DC/DC-IC	PWM step-up/down, 300kHz, 3.8V±2.5%, 250mA, +CE	SOT-25	28dc8	DC14	6g	Tor
<u>A3M</u>	XC6114A420MR	Vdet-IC	2.0V±2%, ±Reset PPO, Wt=200ms, Rt=3.13ms	SOT-25	28xg	VD19	6g	Tor
<u>A3M</u>	XC6114A450MR	Vdet-IC	5.0V±2%, ±Reset PPO, Wt=200ms, Rt=3.13ms	SOT-25	28xg	VD19	6g	Tor
<u>A3M</u>	XC6365A393MR	DC/DC-IC	PWM st-down, 300kHz, 3.9V±2.5%, 1A, +CE	SOT-25	28zm	DC7	6g	Tor
<u>A3M</u>	XC6367A393MR	DC/DC-IC	PWM step-up, 3.9V±2.5%, 200mA, 300kHz, +CE	SOT-25	28sh	DC11	6g	Tor
<u>A3M</u>	XC9301A393MR	DC/DC-IC	PWM step-up/down, 300kHz, 3.9V±2.5%, 250mA, +CE	SOT-25	28dc8	DC14	6g	Tor
<u>A3N</u>	XC6114A421MR	Vdet-IC	2.1V±2%, ±Reset PPO, Wt=200ms, Rt=3.13ms	SOT-25	28xg	VD19	6g	Tor
<u>A3P</u>	XC6114A422MR	Vdet-IC	2.2V±2%, ±Reset PPO, Wt=200ms, Rt=3.13ms	SOT-25	28xg	VD19	6g	Tor
<u>A3R</u>	XC6114A423MR	Vdet-IC	2.3V±2%, ±Reset PPO, Wt=200ms, Rt=3.13ms	SOT-25	28xg	VD19	6g	Tor
<u>A3S</u>	XC6114A424MR	Vdet-IC	2.4V±2%, ±Reset PPO, Wt=200ms, Rt=3.13ms	SOT-25	28xg	VD19	6g	Tor
<u>A3T</u>	XC6114A425MR	Vdet-IC	2.5V±2%, ±Reset PPO, Wt=200ms, Rt=3.13ms	SOT-25	28xg	VD19	6g	Tor
<u>A3U</u>	XC6114A426MR	Vdet-IC	2.6V±2%, ±Reset PPO, Wt=200ms, Rt=3.13ms	SOT-25	28xg	VD19	6g	Tor
<u>A3V</u>	XC6114A427MR	Vdet-IC	2.7V±2%, ±Reset PPO, Wt=200ms, Rt=3.13ms	SOT-25	28xg	VD19	6g	Tor
<u>A3X</u>	XC6114A428MR	Vdet-IC	2.8V±2%, ±Reset PPO, Wt=200ms, Rt=3.13ms	SOT-25	28xg	VD19	6g	Tor
<u>A3Y</u>	XC6114A429MR	Vdet-IC	2.9V±2%, ±Reset PPO, Wt=200ms, Rt=3.13ms	SOT-25	28xg	VD19	6g	Tor
<u>A3Z</u>	XC6114A430MR	Vdet-IC	3.0V±2%, ±Reset PPO, Wt=200ms, Rt=3.13ms	SOT-25	28xg	VD19	6g	Tor
<u>A4</u>	HD74ALVC1G32VS	CMOS-Logic	2-input OR gate	VSON-5	30Log4	-	6a	Ren
<u>A4</u>	PI74ST1G04CX	CMOS-Logic	Inverter	SC-70-5	28/Log6	-	6a	Per
<u>A4</u>	PI74ST1G04TX	CMOS-Logic	Inverter	SOT-23-5	28/Log6	-	6a	Per
<u>A4</u>	R1111N241A	LVR-IC	LDO, LN, -CE, 2.4V±2%, 200mA	SOT-23-5	28xc	VR4	6g	Ric
<u>A40</u>	OPA340NA	Op-IC	Single-supply, Rail-to-Rail	SOT-23-5	28opa	OP1	6a	Bb
<u>A40</u>	XC6114A531MR	Vdet-IC	3.1V±2%, ±Reset PPO, Wt=400ms, Rt=3.13ms	SOT-25	28xg	VD19	6g	Tor
<u>A40</u>	XC6365A402MR	DC/DC-IC	PWM st-down, 180kHz, 4.0V±2.5%, 1A, +CE	SOT-25	28zm	DC7	6g	Tor
<u>A40</u>	XC6367A402MR	DC/DC-IC	PWM step-up, 4.0V±2.5%, 200mA, 180kHz, +CE	SOT-25	28sh	DC11	6g	Tor
<u>A40</u>	XC9301A402MR	DC/DC-IC	PWM step-up/down, 180kHz, 4.0V±2.5%, 250mA, +CE	SOT-25	28dc8	DC14	6g	Tor
<u>A41</u>	XC6114A532MR	Vdet-IC	3.2V±2%, ±Reset PPO, Wt=400ms, Rt=3.13ms	SOT-25	28xg	VD19	6g	Tor
<u>A41</u>	XC6365A412MR	DC/DC-IC	PWM st-down, 180kHz, 4.1V±2.5%, 1A, +CE	SOT-25	28zm	DC7	6g	Tor
<u>A41</u>	XC6367A412MR	DC/DC-IC	PWM step-up, 4.1V±2.5%, 200mA, 180kHz, +CE	SOT-25	28sh	DC11	6g	Tor
<u>A41</u>	XC9301A412MR	DC/DC-IC	PWM step-up/down, 180kHz, 4.1V±2.5%, 250mA, +CE	SOT-25	28dc8	DC14	6g	Tor
<u>A42</u>	OPA642N	Op-IC	Low Distortion, Low Gain	SOT-23-5	28opa	OP1	6a	Bb
<u>A42</u>	XC6114A533MR	Vdet-IC	3.3V±2%, ±Reset PPO, Wt=400ms, Rt=3.13ms	SOT-25	28xg	VD19	6g	Tor
<u>A42</u>	XC6365A422MR	DC/DC-IC	PWM st-down, 180kHz, 4.2V±2.5%, 1A, +CE	SOT-25	28zm	DC7	6g	Tor
<u>A42</u>	XC6367A422MR	DC/DC-IC	PWM step-up, 4.2V±2.5%, 200mA, 180kHz, +CE	SOT-25	28sh	DC11	6g	Tor
<u>A42</u>	XC9301A422MR	DC/DC-IC	PWM step-up/down, 180kHz, 4.2V±2.5%, 250mA, +CE	SOT-25	28dc8	DC14	6g	Tor
<u>A42B</u>	OPA642NB	Op-IC	Low Distortion, Low Gain	SOT-23-5	28opa	OP1	6a	Bb
<u>A43</u>	OPA643N	Op-IC	Wide-band , High Gain, ±4.5V..±5.5V, 1000V/μs, Vg=95dB	SOT-23-5	28opa	OP1	6a	Bb
<u>A43</u>	XC6114A534MR	Vdet-IC	3.4V±2%, ±Reset PPO, Wt=400ms, Rt=3.13ms	SOT-25	28xg	VD19	6g	Tor
<u>A43</u>	XC6365A432MR	DC/DC-IC	PWM st-down, 180kHz, 4.3V±2.5%, 1A, +CE	SOT-25	28zm	DC7	6g	Tor
<u>A43</u>	XC6367A432MR	DC/DC-IC	PWM step-up, 4.3V±2.5%, 200mA, 180kHz, +CE	SOT-25	28sh	DC11	6g	Tor
<u>A43</u>	XC9301A432MR	DC/DC-IC	PWM step-up/down, 180kHz, 4.3V±2.5%, 250mA, +CE	SOT-25	28dc8	DC14	6g	Tor
<u>A43B</u>	OPA643NB	Op-IC	Wide-band , High Gain, ±4.5V..±5.5V, 1000V/μs, Vg=95dB	SOT-23-5	28opa	OP1	6a	Bb
<u>A44</u>	OPA244NA	Op-IC	Single-supply	SOT-23-5	28opa	OP1	6a	Bb
<u>A44</u>	XC6114A535MR	Vdet-IC	3.5V±2%, ±Reset PPO, Wt=400ms, Rt=3.13ms	SOT-25	28xg	VD19	6g	Tor
<u>A44</u>	XC6365A442MR	DC/DC-IC	PWM st-down, 180kHz, 4.4V±2.5%, 1A, +CE	SOT-25	28zm	DC7	6g	Tor
<u>A44</u>	XC6367A442MR	DC/DC-IC	PWM step-up, 4.4V±2.5%, 200mA, 180kHz, +CE	SOT-25	28sh	DC11	6g	Tor
<u>A44</u>	XC9301A442MR	DC/DC-IC	PWM step-up/down, 180kHz, 4.4V±2.5%, 250mA, +CE	SOT-25	28dc8	DC14	6g	Tor
<u>A45</u>	XC6114A536MR	Vdet-IC	3.6V±2%, ±Reset PPO, Wt=400ms, Rt=3.13ms	SOT-25	28xg	VD19	6g	Tor
<u>A45</u>	XC6365A452MR	DC/DC-IC	PWM st-down, 180kHz, 4.5V±2.5%, 1A, +CE	SOT-25	28zm	DC7	6g	Tor
<u>A45</u>	XC6367A452MR	DC/DC-IC	PWM step-up, 4.5V±2.5%, 200mA, 180kHz, +CE	SOT-25	28sh	DC11	6g	Tor
<u>A45</u>	XC9301A452MR	DC/DC-IC	PWM step-up/down, 180kHz, 4.5V±2.5%, 250mA, +CE	SOT-25	28dc8	DC14	6g	Tor
<u>A46</u>	XC6114A537MR	Vdet-IC	3.7V±2%, ±Reset PPO, Wt=400ms, Rt=3.13ms	SOT-25	28xg	VD19	6g	Tor
<u>A46</u>	XC6365A462MR	DC/DC-IC	PWM st-down, 180kHz, 4.6V±2.5%, 1A, +CE	SOT-25	28zm	DC7	6g	Tor
<u>A46</u>	XC6367A462MR	DC/DC-IC	PWM step-up, 4.6V±2.5%, 200mA, 180kHz, +CE	SOT-25	28sh	DC11	6g	Tor
<u>A46</u>	XC9301A462MR	DC/DC-IC	PWM step-up/down, 180kHz, 4.6V±2.5%, 250mA, +CE	SOT-25	28dc8	DC14	6g	Tor
<u>A47</u>	XC6114A538MR	Vdet-IC	3.8V±2%, ±Reset PPO, Wt=400ms, Rt=3.13ms	SOT-25	28xg	VD19	6g	Tor
<u>A47</u>	XC6365A472MR	DC/DC-IC	PWM st-down, 180kHz, 4.7V±2.5%, 1A, +CE	SOT-25	28zm	DC7	6g	Tor
<u>A47</u>	XC6367A472MR	DC/DC-IC	PWM step-up, 4.7V±2.5%, 200mA, 180kHz, +CE	SOT-25	28sh	DC11	6g	Tor
<u>A47</u>	XC9301A472MR	DC/DC-IC	PWM step-up/down, 180kHz, 4.7V±2.5%, 250mA, +CE	SOT-25	28dc8	DC14	6g	Tor
<u>A48</u>	XC6114A539MR	Vdet-IC	3.9V±2%, ±Reset PPO, Wt=400ms, Rt=3.13ms	SOT-25	28xg	VD19	6g	Tor



SMD code	Type	Function	Short description	Case	Pinout	Sch.	St.	Mnf.
A48	XC6365A482MR	DC/DC-IC	PWM st-down, 180kHz, 4.8V±2.5%, 1A, +CE	SOT-25	28zm	DC7	6g	Tor
A48	XC6367A482MR	DC/DC-IC	PWM step-up, 4.8V±2.5%, 200mA, 180kHz, +CE	SOT-25	28sh	DC11	6g	Tor
A48	XC9301A482MR	DC/DC-IC	PWM step-up/down, 180kHz, 4.8V±2.5%, 250mA, +CE	SOT-25	28dc8	DC14	6g	Tor
A49	XC6114A540MR	Vdet-IC	4.0V±2%, ±Reset PPO, Wt=400ms, Rt=3.13ms	SOT-25	28xg	VD19	6g	Tor
A49	XC6365A492MR	DC/DC-IC	PWM st-down, 180kHz, 4.9V±2.5%, 1A, +CE	SOT-25	28zm	DC7	6g	Tor
A49	XC6367A492MR	DC/DC-IC	PWM step-up, 4.9V±2.5%, 200mA, 180kHz, +CE	SOT-25	28sh	DC11	6g	Tor
A49	XC9301A492MR	DC/DC-IC	PWM step-up/down, 180kHz, 4.9V±2.5%, 250mA, +CE	SOT-25	28dc8	DC14	6g	Tor
A4A	XC6114A541MR	Vdet-IC	4.1V±2%, ±Reset PPO, Wt=400ms, Rt=3.13ms	SOT-25	28xg	VD19	6g	Tor
A4A	XC6365A403MR	DC/DC-IC	PWM st-down, 300kHz, 4.0V±2.5%, 1A, +CE	SOT-25	28zm	DC7	6g	Tor
A4A	XC6367A403MR	DC/DC-IC	PWM step-up, 4.0V±2.5%, 200mA, 300kHz, +CE	SOT-25	28sh	DC11	6g	Tor
A4A	XC9301A403MR	DC/DC-IC	PWM step-up/down, 300kHz, 4.0V±2.5%, 250mA, +CE	SOT-25	28dc8	DC14	6g	Tor
A4B	XC6114A542MR	Vdet-IC	4.2V±2%, ±Reset PPO, Wt=400ms, Rt=3.13ms	SOT-25	28xg	VD19	6g	Tor
A4B	XC6365A413MR	DC/DC-IC	PWM st-down, 300kHz, 4.1V±2.5%, 1A, +CE	SOT-25	28zm	DC7	6g	Tor
A4B	XC6367A413MR	DC/DC-IC	PWM step-up, 4.1V±2.5%, 200mA, 300kHz, +CE	SOT-25	28sh	DC11	6g	Tor
A4B	XC9301A413MR	DC/DC-IC	PWM step-up/down, 300kHz, 4.1V±2.5%, 250mA, +CE	SOT-25	28dc8	DC14	6g	Tor
A4C	XC6114A543MR	Vdet-IC	4.3V±2%, ±Reset PPO, Wt=400ms, Rt=3.13ms	SOT-25	28xg	VD19	6g	Tor
A4C	XC6365A423MR	DC/DC-IC	PWM st-down, 300kHz, 4.2V±2.5%, 1A, +CE	SOT-25	28zm	DC7	6g	Tor
A4C	XC6367A423MR	DC/DC-IC	PWM step-up, 4.2V±2.5%, 200mA, 300kHz, +CE	SOT-25	28sh	DC11	6g	Tor
A4C	XC9301A423MR	DC/DC-IC	PWM step-up/down, 300kHz, 4.2V±2.5%, 250mA, +CE	SOT-25	28dc8	DC14	6g	Tor
A4D	XC6114A544MR	Vdet-IC	4.4V±2%, ±Reset PPO, Wt=400ms, Rt=3.13ms	SOT-25	28xg	VD19	6g	Tor
A4D	XC6365A433MR	DC/DC-IC	PWM st-down, 300kHz, 4.3V±2.5%, 1A, +CE	SOT-25	28zm	DC7	6g	Tor
A4D	XC6367A433MR	DC/DC-IC	PWM step-up, 4.3V±2.5%, 200mA, 300kHz, +CE	SOT-25	28sh	DC11	6g	Tor
A4D	XC9301A433MR	DC/DC-IC	PWM step-up/down, 300kHz, 4.3V±2.5%, 250mA, +CE	SOT-25	28dc8	DC14	6g	Tor
A4E	XC6114A545MR	Vdet-IC	4.5V±2%, ±Reset PPO, Wt=400ms, Rt=3.13ms	SOT-25	28xg	VD19	6g	Tor
A4E	XC6365A443MR	DC/DC-IC	PWM st-down, 300kHz, 4.4V±2.5%, 1A, +CE	SOT-25	28zm	DC7	6g	Tor
A4E	XC6367A443MR	DC/DC-IC	PWM step-up, 4.4V±2.5%, 200mA, 300kHz, +CE	SOT-25	28sh	DC11	6g	Tor
A4E	XC9301A443MR	DC/DC-IC	PWM step-up/down, 300kHz, 4.4V±2.5%, 250mA, +CE	SOT-25	28dc8	DC14	6g	Tor
A4F	XC6114A516MR	Vdet-IC	1.6V±2%, ±Reset PPO, Wt=400ms, Rt=3.13ms	SOT-25	28xg	VD19	6g	Tor
A4F	XC6114A546MR	Vdet-IC	4.6V±2%, ±Reset PPO, Wt=400ms, Rt=3.13ms	SOT-25	28xg	VD19	6g	Tor
A4F	XC6365A453MR	DC/DC-IC	PWM st-down, 300kHz, 4.5V±2.5%, 1A, +CE	SOT-25	28zm	DC7	6g	Tor
A4F	XC6367A453MR	DC/DC-IC	PWM step-up, 4.5V±2.5%, 200mA, 300kHz, +CE	SOT-25	28sh	DC11	6g	Tor
A4F	XC9301A453MR	DC/DC-IC	PWM step-up/down, 300kHz, 4.5V±2.5%, 250mA, +CE	SOT-25	28dc8	DC14	6g	Tor
A4H	XC6114A517MR	Vdet-IC	1.7V±2%, ±Reset PPO, Wt=400ms, Rt=3.13ms	SOT-25	28xg	VD19	6g	Tor
A4H	XC6114A547MR	Vdet-IC	4.7V±2%, ±Reset PPO, Wt=400ms, Rt=3.13ms	SOT-25	28xg	VD19	6g	Tor
A4H	XC6365A463MR	DC/DC-IC	PWM st-down, 300kHz, 4.6V±2.5%, 1A, +CE	SOT-25	28zm	DC7	6g	Tor
A4H	XC6367A463MR	DC/DC-IC	PWM step-up, 4.6V±2.5%, 200mA, 300kHz, +CE	SOT-25	28sh	DC11	6g	Tor
A4H	XC9301A463MR	DC/DC-IC	PWM step-up/down, 300kHz, 4.6V±2.5%, 250mA, +CE	SOT-25	28dc8	DC14	6g	Tor
A4K	XC6114A518MR	Vdet-IC	1.8V±2%, ±Reset PPO, Wt=400ms, Rt=3.13ms	SOT-25	28xg	VD19	6g	Tor
A4K	XC6114A548MR	Vdet-IC	4.8V±2%, ±Reset PPO, Wt=400ms, Rt=3.13ms	SOT-25	28xg	VD19	6g	Tor
A4K	XC6365A473MR	DC/DC-IC	PWM st-down, 300kHz, 4.7V±2.5%, 1A, +CE	SOT-25	28zm	DC7	6g	Tor
A4K	XC6367A473MR	DC/DC-IC	PWM step-up, 4.7V±2.5%, 200mA, 300kHz, +CE	SOT-25	28sh	DC11	6g	Tor
A4K	XC9301A473MR	DC/DC-IC	PWM step-up/down, 300kHz, 4.7V±2.5%, 250mA, +CE	SOT-25	28dc8	DC14	6g	Tor
A4L	XC6114A519MR	Vdet-IC	1.9V±2%, ±Reset PPO, Wt=400ms, Rt=3.13ms	SOT-25	28xg	VD19	6g	Tor
A4L	XC6114A549MR	Vdet-IC	4.9V±2%, ±Reset PPO, Wt=400ms, Rt=3.13ms	SOT-25	28xg	VD19	6g	Tor
A4L	XC6365A483MR	DC/DC-IC	PWM st-down, 300kHz, 4.8V±2.5%, 1A, +CE	SOT-25	28zm	DC7	6g	Tor
A4L	XC6367A483MR	DC/DC-IC	PWM step-up, 4.8V±2.5%, 200mA, 300kHz, +CE	SOT-25	28sh	DC11	6g	Tor
A4L	XC9301A483MR	DC/DC-IC	PWM step-up/down, 300kHz, 4.8V±2.5%, 250mA, +CE	SOT-25	28dc8	DC14	6g	Tor
A4M	XC6114A520MR	Vdet-IC	2.0V±2%, ±Reset PPO, Wt=400ms, Rt=3.13ms	SOT-25	28xg	VD19	6g	Tor
A4M	XC6114A550MR	Vdet-IC	5.0V±2%, ±Reset PPO, Wt=400ms, Rt=3.13ms	SOT-25	28xg	VD19	6g	Tor
A4M	XC6365A493MR	DC/DC-IC	PWM st-down, 300kHz, 4.9V±2.5%, 1A, +CE	SOT-25	28zm	DC7	6g	Tor
A4M	XC6367A493MR	DC/DC-IC	PWM step-up, 4.9V±2.5%, 200mA, 300kHz, +CE	SOT-25	28sh	DC11	6g	Tor
A4M	XC9301A493MR	DC/DC-IC	PWM step-up/down, 300kHz, 4.9V±2.5%, 250mA, +CE	SOT-25	28dc8	DC14	6g	Tor
A4N	XC6114A521MR	Vdet-IC	2.1V±2%, ±Reset PPO, Wt=400ms, Rt=3.13ms	SOT-25	28xg	VD19	6g	Tor
A4P	XC6114A522MR	Vdet-IC	2.2V±2%, ±Reset PPO, Wt=400ms, Rt=3.13ms	SOT-25	28xg	VD19	6g	Tor
A4R	XC6114A523MR	Vdet-IC	2.3V±2%, ±Reset PPO, Wt=400ms, Rt=3.13ms	SOT-25	28xg	VD19	6g	Tor
A4S	XC6114A524MR	Vdet-IC	2.4V±2%, ±Reset PPO, Wt=400ms, Rt=3.13ms	SOT-25	28xg	VD19	6g	Tor
A4T	XC6114A525MR	Vdet-IC	2.5V±2%, ±Reset PPO, Wt=400ms, Rt=3.13ms	SOT-25	28xg	VD19	6g	Tor
A4U	XC6114A526MR	Vdet-IC	2.6V±2%, ±Reset PPO, Wt=400ms, Rt=3.13ms	SOT-25	28xg	VD19	6g	Tor
A4V	XC6114A527MR	Vdet-IC	2.7V±2%, ±Reset PPO, Wt=400ms, Rt=3.13ms	SOT-25	28xg	VD19	6g	Tor
A4X	XC6114A528MR	Vdet-IC	2.8V±2%, ±Reset PPO, Wt=400ms, Rt=3.13ms	SOT-25	28xg	VD19	6g	Tor
A4Y	XC6114A529MR	Vdet-IC	2.9V±2%, ±Reset PPO, Wt=400ms, Rt=3.13ms	SOT-25	28xg	VD19	6g	Tor
A4Z	XC6114A530MR	Vdet-IC	3.0V±2%, ±Reset PPO, Wt=400ms, Rt=3.13ms	SOT-25	28xg	VD19	6g	Tor
A5	HD74ALVC1G04VS	CMOS-Logic	Inverter	VSON-5	30/Log6	-	6a	Ren
A5	R111N251A	LVR-IC	LDO, LN, -CE, 2.5V±2%, 200mA	SOT-23-5	28xc	VR4	6g	Ric
A5	TC1014-3.3VRX	LVR-IC	LDO, 3.3V±2%, 50mA, +CE	SOT-23-5	28vrx	VR7	6g	Mcc
A5-	RT9198-18PU5	LVR-IC	LDO, 1.8V±1%, 300mA, +CE	SC-70-5	28xm	VR4	6a	Rct
A50	OPA650N	Op-IC	Low-power	SOT-23-5	28opa	OP1	6a	Bb
A50	XC6114A631MR	Vdet-IC	3.1V±2%, ±Reset PPO, Wt=1.6s, Rt=3.13ms	SOT-25	28xg	VD19	6g	Tor
A50	XC6365A502MR	DC/DC-IC	PWM st-down, 180kHz, 5.0V±2.5%, 1A, +CE	SOT-25	28zm	DC7	6g	Tor
A50	XC6367A502MR	DC/DC-IC	PWM step-up, 5.0V±2.5%, 200mA, 180kHz, +CE	SOT-25	28sh	DC11	6g	Tor



SMD code	Type	Function	Short description	Case	Pinout	Sch.	St.	Mnf.
A50	XC9301A502MR	DC/DC-IC	PWM step-up/down, 180kHz, 5.0V±2.5%, 250mA, +CE	SOT-25	28dc8	DC14	6g	Tor
A50B	OPA650NB	Op-IC	Lo-power	SOT-23-5	28opa	OP1	6a	Bb
A51	MIC6251BM5	Op-IC	Instrum, Diff, Amp, 4.32V, +2, -1, -1 gain, 2MHz, 6V/μs	SOT-23-5	28opa	OP1	6g	Mcr
A51	OPA651N	Op-IC	Lo-power	SOT-23-5	28opa	OP1	6a	Bb
A51	XC6114A632MR	Vdet-IC	3.2V±2%, ±Reset PPO, Wt=1.6s, Rt=3.13ms	SOT-25	28xg	VD19	6g	Tor
A51	XC6365A512MR	DC/DC-IC	PWM st-down, 180kHz, 5.1V±2.5%, 1A, +CE	SOT-25	28zm	DC7	6g	Tor
A51	XC6367A512MR	DC/DC-IC	PWM step-up, 5.1V±2.5%, 200mA, 180kHz, +CE	SOT-25	28sh	DC11	6g	Tor
A51	XC9301A512MR	DC/DC-IC	PWM step-up/down, 180kHz, 5.1V±2.5%, 250mA, +CE	SOT-25	28dc8	DC14	6g	Tor
A51B	OPA651NB	Op-IC	Lo-power	SOT-23-5	28opa	OP1	6a	Bb
A52	MIC6252BM5	Op-IC	Instrum, Diff, Amp, 4.32V, +0.5, +1 gain, 2MHz, 6V/μs	SOT-23-5	28opa	OP1	6g	Mcr
A52	XC6114A633MR	Vdet-IC	3.3V±2%, ±Reset PPO, Wt=1.6s, Rt=3.13ms	SOT-25	28xg	VD19	6g	Tor
A52	XC6365A522MR	DC/DC-IC	PWM st-down, 180kHz, 5.2V±2.5%, 1A, +CE	SOT-25	28zm	DC7	6g	Tor
A52	XC6367A522MR	DC/DC-IC	PWM step-up, 5.2V±2.5%, 200mA, 180kHz, +CE	SOT-25	28sh	DC11	6g	Tor
A52	XC9301A522MR	DC/DC-IC	PWM step-up/down, 180kHz, 5.2V±2.5%, 250mA, +CE	SOT-25	28dc8	DC14	6g	Tor
A53	XC6114A634MR	Vdet-IC	3.4V±2%, ±Reset PPO, Wt=1.6s, Rt=3.13ms	SOT-25	28xg	VD19	6g	Tor
A53	XC6365A532MR	DC/DC-IC	PWM st-down, 180kHz, 5.3V±2.5%, 1A, +CE	SOT-25	28zm	DC7	6g	Tor
A53	XC6367A532MR	DC/DC-IC	PWM step-up, 5.3V±2.5%, 200mA, 180kHz, +CE	SOT-25	28sh	DC11	6g	Tor
A53	XC9301A532MR	DC/DC-IC	PWM step-up/down, 180kHz, 5.3V±2.5%, 250mA, +CE	SOT-25	28dc8	DC14	6g	Tor
A54	XC6114A635MR	Vdet-IC	3.5V±2%, ±Reset PPO, Wt=1.6s, Rt=3.13ms	SOT-25	28xg	VD19	6g	Tor
A54	XC6365A542MR	DC/DC-IC	PWM st-down, 180kHz, 5.4V±2.5%, 1A, +CE	SOT-25	28zm	DC7	6g	Tor
A54	XC6367A542MR	DC/DC-IC	PWM step-up, 5.4V±2.5%, 200mA, 180kHz, +CE	SOT-25	28sh	DC11	6g	Tor
A54	XC9301A542MR	DC/DC-IC	PWM step-up/down, 180kHz, 5.4V±2.5%, 250mA, +CE	SOT-25	28dc8	DC14	6g	Tor
A55	XC6114A636MR	Vdet-IC	3.6V±2%, ±Reset PPO, Wt=1.6s, Rt=3.13ms	SOT-25	28xg	VD19	6g	Tor
A55	XC6365A552MR	DC/DC-IC	PWM st-down, 180kHz, 5.5V±2.5%, 1A, +CE	SOT-25	28zm	DC7	6g	Tor
A55	XC6367A552MR	DC/DC-IC	PWM step-up, 5.5V±2.5%, 200mA, 180kHz, +CE	SOT-25	28sh	DC11	6g	Tor
A55	XC9301A552MR	DC/DC-IC	PWM step-up/down, 180kHz, 5.5V±2.5%, 250mA, +CE	SOT-25	28dc8	DC14	6g	Tor
A56	XC6114A637MR	Vdet-IC	3.7V±2%, ±Reset PPO, Wt=1.6s, Rt=3.13ms	SOT-25	28xg	VD19	6g	Tor
A56	XC6365A562MR	DC/DC-IC	PWM st-down, 180kHz, 5.6V±2.5%, 1A, +CE	SOT-25	28zm	DC7	6g	Tor
A56	XC6367A562MR	DC/DC-IC	PWM step-up, 5.6V±2.5%, 200mA, 180kHz, +CE	SOT-25	28sh	DC11	6g	Tor
A56	XC9301A562MR	DC/DC-IC	PWM step-up/down, 180kHz, 5.6V±2.5%, 250mA, +CE	SOT-25	28dc8	DC14	6g	Tor
A57	XC6114A638MR	Vdet-IC	3.8V±2%, ±Reset PPO, Wt=1.6s, Rt=3.13ms	SOT-25	28xg	VD19	6g	Tor
A57	XC6365A572MR	DC/DC-IC	PWM st-down, 180kHz, 5.7V±2.5%, 1A, +CE	SOT-25	28zm	DC7	6g	Tor
A57	XC6367A572MR	DC/DC-IC	PWM step-up, 5.7V±2.5%, 200mA, 180kHz, +CE	SOT-25	28sh	DC11	6g	Tor
A57	XC9301A572MR	DC/DC-IC	PWM step-up/down, 180kHz, 5.7V±2.5%, 250mA, +CE	SOT-25	28dc8	DC14	6g	Tor
A58	OPA658N	Op-IC	Wide-band Current Feedback	SOT-23-5	28opa	OP1	6a	Bb
A58	XC6114A639MR	Vdet-IC	3.9V±2%, ±Reset PPO, Wt=1.6s, Rt=3.13ms	SOT-25	28xg	VD19	6g	Tor
A58	XC6365A582MR	DC/DC-IC	PWM st-down, 180kHz, 5.8V±2.5%, 1A, +CE	SOT-25	28zm	DC7	6g	Tor
A58	XC6367A582MR	DC/DC-IC	PWM step-up, 5.8V±2.5%, 200mA, 180kHz, +CE	SOT-25	28sh	DC11	6g	Tor
A58	XC9301A582MR	DC/DC-IC	PWM step-up/down, 180kHz, 5.8V±2.5%, 250mA, +CE	SOT-25	28dc8	DC14	6g	Tor
A58B	OPA658NB	Op-IC	Wide-band Current Feedback	SOT-23-5	28opa	OP1	6a	Bb
A59	XC6114A640MR	Vdet-IC	4.0V±2%, ±Reset PPO, Wt=1.6s, Rt=3.13ms	SOT-25	28xg	VD19	6g	Tor
A59	XC6365A592MR	DC/DC-IC	PWM st-down, 180kHz, 5.9V±2.5%, 1A, +CE	SOT-25	28zm	DC7	6g	Tor
A59	XC6367A592MR	DC/DC-IC	PWM step-up, 5.9V±2.5%, 200mA, 180kHz, +CE	SOT-25	28sh	DC11	6g	Tor
A59	XC9301A592MR	DC/DC-IC	PWM step-up/down, 180kHz, 5.9V±2.5%, 250mA, +CE	SOT-25	28dc8	DC14	6g	Tor
A5A	XC6114A641MR	Vdet-IC	4.1V±2%, ±Reset PPO, Wt=1.6s, Rt=3.13ms	SOT-25	28xg	VD19	6g	Tor
A5A	XC6365A503MR	DC/DC-IC	PWM st-down, 300kHz, 5.0V±2.5%, 1A, +CE	SOT-25	28zm	DC7	6g	Tor
A5A	XC6367A503MR	DC/DC-IC	PWM step-up, 5.0V±2.5%, 200mA, 300kHz, +CE	SOT-25	28sh	DC11	6g	Tor
A5A	XC9301A503MR	DC/DC-IC	PWM step-up/down, 300kHz, 5.0V±2.5%, 250mA, +CE	SOT-25	28dc8	DC14	6g	Tor
A5B	XC6114A642MR	Vdet-IC	4.2V±2%, ±Reset PPO, Wt=1.6s, Rt=3.13ms	SOT-25	28xg	VD19	6g	Tor
A5B	XC6365A513MR	DC/DC-IC	PWM st-down, 300kHz, 5.1V±2.5%, 1A, +CE	SOT-25	28zm	DC7	6g	Tor
A5B	XC6367A513MR	DC/DC-IC	PWM step-up, 5.1V±2.5%, 200mA, 300kHz, +CE	SOT-25	28sh	DC11	6g	Tor
A5B	XC9301A513MR	DC/DC-IC	PWM step-up/down, 300kHz, 5.1V±2.5%, 250mA, +CE	SOT-25	28dc8	DC14	6g	Tor
A5C	XC6114A643MR	Vdet-IC	4.3V±2%, ±Reset PPO, Wt=1.6s, Rt=3.13ms	SOT-25	28xg	VD19	6g	Tor
A5C	XC6365A523MR	DC/DC-IC	PWM st-down, 300kHz, 5.2V±2.5%, 1A, +CE	SOT-25	28zm	DC7	6g	Tor
A5C	XC6367A523MR	DC/DC-IC	PWM step-up, 5.2V±2.5%, 200mA, 300kHz, +CE	SOT-25	28sh	DC11	6g	Tor
A5C	XC9301A523MR	DC/DC-IC	PWM step-up/down, 300kHz, 5.2V±2.5%, 250mA, +CE	SOT-25	28dc8	DC14	6g	Tor
A5D	XC6114A644MR	Vdet-IC	4.4V±2%, ±Reset PPO, Wt=1.6s, Rt=3.13ms	SOT-25	28xg	VD19	6g	Tor
A5D	XC6365A533MR	DC/DC-IC	PWM st-down, 300kHz, 5.3V±2.5%, 1A, +CE	SOT-25	28zm	DC7	6g	Tor
A5D	XC6367A533MR	DC/DC-IC	PWM step-up, 5.3V±2.5%, 200mA, 300kHz, +CE	SOT-25	28sh	DC11	6g	Tor
A5D	XC9301A533MR	DC/DC-IC	PWM step-up/down, 300kHz, 5.3V±2.5%, 250mA, +CE	SOT-25	28dc8	DC14	6g	Tor
A5E	XC6114A645MR	Vdet-IC	4.5V±2%, ±Reset PPO, Wt=1.6s, Rt=3.13ms	SOT-25	28xg	VD19	6g	Tor
A5E	XC6365A543MR	DC/DC-IC	PWM st-down, 300kHz, 5.4V±2.5%, 1A, +CE	SOT-25	28zm	DC7	6g	Tor
A5E	XC6367A543MR	DC/DC-IC	PWM step-up, 5.4V±2.5%, 200mA, 300kHz, +CE	SOT-25	28sh	DC11	6g	Tor
A5E	XC9301A543MR	DC/DC-IC	PWM step-up/down, 300kHz, 5.4V±2.5%, 250mA, +CE	SOT-25	28dc8	DC14	6g	Tor
A5F	XC6114A616MR	Vdet-IC	1.6V±2%, ±Reset PPO, Wt=1.6s, Rt=3.13ms	SOT-25	28xg	VD19	6g	Tor
A5F	XC6114A646MR	Vdet-IC	4.6V±2%, ±Reset PPO, Wt=1.6s, Rt=3.13ms	SOT-25	28xg	VD19	6g	Tor
A5F	XC6365A553MR	DC/DC-IC	PWM st-down, 300kHz, 5.5V±2.5%, 1A, +CE	SOT-25	28zm	DC7	6g	Tor
A5F	XC6367A553MR	DC/DC-IC	PWM step-up, 5.5V±2.5%, 200mA, 300kHz, +CE	SOT-25	28sh	DC11	6g	Tor
A5F	XC9301A553MR	DC/DC-IC	PWM step-up/down, 300kHz, 5.5V±2.5%, 250mA, +CE	SOT-25	28dc8	DC14	6g	Tor
A5H	XC6114A617MR	Vdet-IC	1.7V±2%, ±Reset PPO, Wt=1.6s, Rt=3.13ms	SOT-25	28xg	VD19	6g	Tor



SMD code	Type	Function	Short description	Case	Pinout	Sch.	St.	Mnf.
Ā5H	XC6114A647MR	Vdet-IC	4.7V±2%, ±Reset PPO, Wt=1.6s, Rt=3.13ms	SOT-25	28xg	VD19	6g	Tor
A5H	XC6365A563MR	DC/DC-IC	PWM st-down, 300kHz, 5.6V±2.5%, 1A, +CE	SOT-25	28zm	DC7	6g	Tor
A5H	XC6367A563MR	DC/DC-IC	PWM step-up, 5.6V±2.5%, 200mA, 300kHz, +CE	SOT-25	28sh	DC11	6g	Tor
A5H	XC9301A563MR	DC/DC-IC	PWM step-up/down, 300kHz, 5.6V±2.5%, 250mA, +CE	SOT-25	28dc8	DC14	6g	Tor
Ā5K	XC6114A618MR	Vdet-IC	1.8V±2%, ±Reset PPO, Wt=1.6s, Rt=3.13ms	SOT-25	28xg	VD19	6g	Tor
Ā5K	XC6114A648MR	Vdet-IC	4.8V±2%, ±Reset PPO, Wt=1.6s, Rt=3.13ms	SOT-25	28xg	VD19	6g	Tor
A5K	XC6365A573MR	DC/DC-IC	PWM st-down, 300kHz, 5.7V±2.5%, 1A, +CE	SOT-25	28zm	DC7	6g	Tor
A5K	XC6367A573MR	DC/DC-IC	PWM step-up, 5.7V±2.5%, 200mA, 300kHz, +CE	SOT-25	28sh	DC11	6g	Tor
A5K	XC9301A573MR	DC/DC-IC	PWM step-up/down, 300kHz, 5.7V±2.5%, 250mA, +CE	SOT-25	28dc8	DC14	6g	Tor
Ā5L	XC6114A619MR	Vdet-IC	1.9V±2%, ±Reset PPO, Wt=1.6s, Rt=3.13ms	SOT-25	28xg	VD19	6g	Tor
Ā5L	XC6114A649MR	Vdet-IC	4.9V±2%, ±Reset PPO, Wt=1.6s, Rt=3.13ms	SOT-25	28xg	VD19	6g	Tor
A5L	XC6365A583MR	DC/DC-IC	PWM st-down, 300kHz, 5.8V±2.5%, 1A, +CE	SOT-25	28zm	DC7	6g	Tor
A5L	XC6367A583MR	DC/DC-IC	PWM step-up, 5.8V±2.5%, 200mA, 300kHz, +CE	SOT-25	28sh	DC11	6g	Tor
A5L	XC9301A583MR	DC/DC-IC	PWM step-up/down, 300kHz, 5.8V±2.5%, 250mA, +CE	SOT-25	28dc8	DC14	6g	Tor
Ā5M	XC6114A620MR	Vdet-IC	2.0V±2%, ±Reset PPO, Wt=1.6s, Rt=3.13ms	SOT-25	28xg	VD19	6g	Tor
Ā5M	XC6114A650MR	Vdet-IC	5.0V±2%, ±Reset PPO, Wt=1.6s, Rt=3.13ms	SOT-25	28xg	VD19	6g	Tor
A5M	XC6365A593MR	DC/DC-IC	PWM st-down, 300kHz, 5.9V±2.5%, 1A, +CE	SOT-25	28zm	DC7	6g	Tor
A5M	XC6367A593MR	DC/DC-IC	PWM step-up, 5.9V±2.5%, 200mA, 300kHz, +CE	SOT-25	28sh	DC11	6g	Tor
A5M	XC9301A593MR	DC/DC-IC	PWM step-up/down, 300kHz, 5.9V±2.5%, 250mA, +CE	SOT-25	28dc8	DC14	6g	Tor
Ā5N	XC6114A621MR	Vdet-IC	2.1V±2%, ±Reset PPO, Wt=1.6s, Rt=3.13ms	SOT-25	28xg	VD19	6g	Tor
Ā5P	XC6114A622MR	Vdet-IC	2.2V±2%, ±Reset PPO, Wt=1.6s, Rt=3.13ms	SOT-25	28xg	VD19	6g	Tor
Ā5R	XC6114A623MR	Vdet-IC	2.3V±2%, ±Reset PPO, Wt=1.6s, Rt=3.13ms	SOT-25	28xg	VD19	6g	Tor
Ā5S	XC6114A624MR	Vdet-IC	2.4V±2%, ±Reset PPO, Wt=1.6s, Rt=3.13ms	SOT-25	28xg	VD19	6g	Tor
Ā5T	XC6114A625MR	Vdet-IC	2.5V±2%, ±Reset PPO, Wt=1.6s, Rt=3.13ms	SOT-25	28xg	VD19	6g	Tor
Ā5U	XC6114A626MR	Vdet-IC	2.6V±2%, ±Reset PPO, Wt=1.6s, Rt=3.13ms	SOT-25	28xg	VD19	6g	Tor
Ā5V	XC6114A627MR	Vdet-IC	2.7V±2%, ±Reset PPO, Wt=1.6s, Rt=3.13ms	SOT-25	28xg	VD19	6g	Tor
Ā5X	XC6114A628MR	Vdet-IC	2.8V±2%, ±Reset PPO, Wt=1.6s, Rt=3.13ms	SOT-25	28xg	VD19	6g	Tor
Ā5Y	XC6114A629MR	Vdet-IC	2.9V±2%, ±Reset PPO, Wt=1.6s, Rt=3.13ms	SOT-25	28xg	VD19	6g	Tor
Ā5Z	XC6114A630MR	Vdet-IC	3.0V±2%, ±Reset PPO, Wt=1.6s, Rt=3.13ms	SOT-25	28xg	VD19	6g	Tor
A6	R1111N261A	LVR-IC	LDO, LN, -CE, 2.6V±2%, 200mA	SOT-23-5	28xc	VR4	6g	Ric
A6	RT9198-25PU5	LVR-IC	LDO, 2.5V±1%, 300mA, +CE	SC-70-5	28xm	VR4	6a	Rct
Ā60	XC6114B231MR	Vdet-IC	3.1V±2%, ±Reset PPO, Wt=50ms, Rt=25ms	SOT-25	28xg	VD19	6g	Tor
Ā60	XC6365A602MR	DC/DC-IC	PWM st-down, 180kHz, 6.0V±2.5%, 1A, +CE	SOT-25	28zm	DC7	6g	Tor
A60	XC6367A602MR	DC/DC-IC	PWM step-up, 6.0V±2.5%, 200mA, 180kHz, +CE	SOT-25	28sh	DC11	6g	Tor
A60	XC9301A602MR	DC/DC-IC	PWM step-up/down, 180kHz, 6.0V±2.5%, 250mA, +CE	SOT-25	28dc8	DC14	6g	Tor
A61	XC6114B232MR	Vdet-IC	3.2V±2%, ±Reset PPO, Wt=50ms, Rt=25ms	SOT-25	28xg	VD19	6g	Tor
A61	XC6367A612MR	DC/DC-IC	PWM step-up, 6.1V±2.5%, 200mA, 180kHz, +CE	SOT-25	28sh	DC11	6g	Tor
Ā62	XC6114B233MR	Vdet-IC	3.3V±2%, ±Reset PPO, Wt=50ms, Rt=25ms	SOT-25	28xg	VD19	6g	Tor
A62	XC6367A622MR	DC/DC-IC	PWM step-up, 6.2V±2.5%, 200mA, 180kHz, +CE	SOT-25	28sh	DC11	6g	Tor
A63	XC6114B234MR	Vdet-IC	3.4V±2%, ±Reset PPO, Wt=50ms, Rt=25ms	SOT-25	28xg	VD19	6g	Tor
A63	XC6367A632MR	DC/DC-IC	PWM step-up, 6.3V±2.5%, 200mA, 180kHz, +CE	SOT-25	28sh	DC11	6g	Tor
Ā64	XC6114B235MR	Vdet-IC	3.5V±2%, ±Reset PPO, Wt=50ms, Rt=25ms	SOT-25	28xg	VD19	6g	Tor
A64	XC6367A642MR	DC/DC-IC	PWM step-up, 6.4V±2.5%, 200mA, 180kHz, +CE	SOT-25	28sh	DC11	6g	Tor
Ā65	XC6114B236MR	Vdet-IC	3.6V±2%, ±Reset PPO, Wt=50ms, Rt=25ms	SOT-25	28xg	VD19	6g	Tor
A65	XC6367A652MR	DC/DC-IC	PWM step-up, 6.5V±2.5%, 200mA, 180kHz, +CE	SOT-25	28sh	DC11	6g	Tor
A66	74AHC1G66GV	CMOS-Logic	Bilateral analogic switch	SOT753	28/Log16	-	6a	Phi
A66	U74AHC1G66-AF5	CMOS-Logic	Bilateral analogic switch	SOT-23-5	28/Log16	-	6a	Utc
A66	U74AHC1G66-AL5	CMOS-Logic	Bilateral analogic switch	SOT-353	28/Log16	-	6a	Utc
Ā66	XC6114B237MR	Vdet-IC	3.7V±2%, ±Reset PPO, Wt=50ms, Rt=25ms	SOT-25	28xg	VD19	6g	Tor
A66L	U74AHC1G66L-AF5	CMOS-Logic	Bilateral analogic switch	SOT-23-5	28/Log16	-	6a	Utc
A66L	U74AHC1G66L-AL5	CMOS-Logic	Bilateral analogic switch	SOT-353	28/Log16	-	6a	Utc
Ā67	XC6114B238MR	Vdet-IC	3.8V±2%, ±Reset PPO, Wt=50ms, Rt=25ms	SOT-25	28xg	VD19	6g	Tor
Ā68	XC6114B239MR	Vdet-IC	3.9V±2%, ±Reset PPO, Wt=50ms, Rt=25ms	SOT-25	28xg	VD19	6g	Tor
Ā69	XC6114B240MR	Vdet-IC	4.0V±2%, ±Reset PPO, Wt=50ms, Rt=25ms	SOT-25	28xg	VD19	6g	Tor
Ā6A	XC6114B241MR	Vdet-IC	4.1V±2%, ±Reset PPO, Wt=50ms, Rt=25ms	SOT-25	28xg	VD19	6g	Tor
A6A	XC6365A603MR	DC/DC-IC	PWM st-down, 300kHz, 6.0V±2.5%, 1A, +CE	SOT-25	28zm	DC7	6g	Tor
A6A	XC6367A603MR	DC/DC-IC	PWM step-up, 6.0V±2.5%, 200mA, 300kHz, +CE	SOT-25	28sh	DC11	6g	Tor
A6A	XC9301A603MR	DC/DC-IC	PWM step-up/down, 300kHz, 6.0V±2.5%, 250mA, +CE	SOT-25	28dc8	DC14	6g	Tor
Ā6B	XC6114B242MR	Vdet-IC	4.2V±2%, ±Reset PPO, Wt=50ms, Rt=25ms	SOT-25	28xg	VD19	6g	Tor
A6B	XC6367A613MR	DC/DC-IC	PWM step-up, 6.1V±2.5%, 200mA, 300kHz, +CE	SOT-25	28sh	DC11	6g	Tor
Ā6C	XC6114B243MR	Vdet-IC	4.3V±2%, ±Reset PPO, Wt=50ms, Rt=25ms	SOT-25	28xg	VD19	6g	Tor
A6C	XC6367A623MR	DC/DC-IC	PWM step-up, 6.2V±2.5%, 200mA, 300kHz, +CE	SOT-25	28sh	DC11	6g	Tor
Ā6D	XC6114B244MR	Vdet-IC	4.4V±2%, ±Reset PPO, Wt=50ms, Rt=25ms	SOT-25	28xg	VD19	6g	Tor
A6D	XC6367A633MR	DC/DC-IC	PWM step-up, 6.3V±2.5%, 200mA, 300kHz, +CE	SOT-25	28sh	DC11	6g	Tor
Ā6E	XC6114B245MR	Vdet-IC	4.5V±2%, ±Reset PPO, Wt=50ms, Rt=25ms	SOT-25	28xg	VD19	6g	Tor
A6E	XC6367A643MR	DC/DC-IC	PWM step-up, 6.4V±2.5%, 200mA, 300kHz, +CE	SOT-25	28sh	DC11	6g	Tor
Ā6F	XC6114B216MR	Vdet-IC	1.6V±2%, ±Reset PPO, Wt=50ms, Rt=25ms	SOT-25	28xg	VD19	6g	Tor
Ā6F	XC6114B246MR	Vdet-IC	4.6V±2%, ±Reset PPO, Wt=50ms, Rt=25ms	SOT-25	28xg	VD19	6g	Tor
A6F	XC6367A653MR	DC/DC-IC	PWM step-up, 6.5V±2.5%, 200mA, 300kHz, +CE	SOT-25	28sh	DC11	6g	Tor
Ā6H	XC6114B217MR	Vdet-IC	1.7V±2%, ±Reset PPO, Wt=50ms, Rt=25ms	SOT-25	28xg	VD19	6g	Tor



SMD code	Type	Function	Short description	Case	Pinout	Sch.	St.	Mnf.
A6H	XC6114B247MR	Vdet-IC	4.7V±2%, ±Reset PPO, Wt=50ms, Rt=25ms	SOT-25	28xg	VD19	6g	Tor
A6K	XC6114B218MR	Vdet-IC	1.8V±2%, ±Reset PPO, Wt=50ms, Rt=25ms	SOT-25	28xg	VD19	6g	Tor
A6K	XC6114B248MR	Vdet-IC	4.8V±2%, ±Reset PPO, Wt=50ms, Rt=25ms	SOT-25	28xg	VD19	6g	Tor
A6L	XC6114B219MR	Vdet-IC	1.9V±2%, ±Reset PPO, Wt=50ms, Rt=25ms	SOT-25	28xg	VD19	6g	Tor
A6L	XC6114B249MR	Vdet-IC	4.9V±2%, ±Reset PPO, Wt=50ms, Rt=25ms	SOT-25	28xg	VD19	6g	Tor
A6M	XC6114B220MR	Vdet-IC	2.0V±2%, ±Reset PPO, Wt=50ms, Rt=25ms	SOT-25	28xg	VD19	6g	Tor
A6M	XC6114B250MR	Vdet-IC	5.0V±2%, ±Reset PPO, Wt=50ms, Rt=25ms	SOT-25	28xg	VD19	6g	Tor
A6N	XC6114B221MR	Vdet-IC	2.1V±2%, ±Reset PPO, Wt=50ms, Rt=25ms	SOT-25	28xg	VD19	6g	Tor
A6P	XC6114B222MR	Vdet-IC	2.2V±2%, ±Reset PPO, Wt=50ms, Rt=25ms	SOT-25	28xg	VD19	6g	Tor
A6R	XC6114B223MR	Vdet-IC	2.3V±2%, ±Reset PPO, Wt=50ms, Rt=25ms	SOT-25	28xg	VD19	6g	Tor
A6S	XC6114B224MR	Vdet-IC	2.4V±2%, ±Reset PPO, Wt=50ms, Rt=25ms	SOT-25	28xg	VD19	6g	Tor
A6T	XC6114B225MR	Vdet-IC	2.5V±2%, ±Reset PPO, Wt=50ms, Rt=25ms	SOT-25	28xg	VD19	6g	Tor
A6U	XC6114B226MR	Vdet-IC	2.6V±2%, ±Reset PPO, Wt=50ms, Rt=25ms	SOT-25	28xg	VD19	6g	Tor
A6V	XC6114B227MR	Vdet-IC	2.7V±2%, ±Reset PPO, Wt=50ms, Rt=25ms	SOT-25	28xg	VD19	6g	Tor
A6X	XC6114B228MR	Vdet-IC	2.8V±2%, ±Reset PPO, Wt=50ms, Rt=25ms	SOT-25	28xg	VD19	6g	Tor
A6Y	XC6114B229MR	Vdet-IC	2.9V±2%, ±Reset PPO, Wt=50ms, Rt=25ms	SOT-25	28xg	VD19	6g	Tor
A6Z	XC6114B230MR	Vdet-IC	3.0V±2%, ±Reset PPO, Wt=50ms, Rt=25ms	SOT-25	28xg	VD19	6g	Tor
a7	74AUP1T57GW	CMOS-Logic	Configurable gate with voltage-level translator	SOT-353-1	28/Log79	-	6a	Phi
A7	EMA7	Si-pnp-Digi	Dual, 50V, 100mA, 150mW, 250MHz, R1/R2=4.7k/10k	EMT5	30/TD9	-	6a	Rhm
A7	FMA7A	Si-pnp-Digi	Dual, 50V, 100mA, 300mW, 250MHz, R1/R2=4.7k/10k	SC-74A	28/TD9	-	6a	Rhm
A7	R1111N271A	LVR-IC	LDO, LN, -CE, 2.7V±2%, 200mA	SOT-23-5	28cx	VR4	6g	Ric
A7	TC1014-5.0VRX	LVR-IC	LDO, 5V±2%, 50mA, +CE	SOT-23-5	28vrx	VR7	6g	Mcc
A7	UMA7N	Si-pnp-Digi	Dual, 50V, 100mA, 150mW, 250MHz, R1/R2=4.7k/10k	SC-88A	28/TD9	-	6a	Rhm
A7-	RT9198-28PU5	LVR-IC	LDO, 2.8V±1%, 300mA, +CE	SC-70-5	28xm	VR4	6a	Rct
A7Q	XC6114B331MR	Vdet-IC	3.1V±2%, ±Reset PPO, Wt=100ms, Rt=25ms	SOT-25	28xg	VD19	6g	Tor
A71	XC6114B332MR	Vdet-IC	3.2V±2%, ±Reset PPO, Wt=100ms, Rt=25ms	SOT-25	28xg	VD19	6g	Tor
A72	XC6114B333MR	Vdet-IC	3.3V±2%, ±Reset PPO, Wt=100ms, Rt=25ms	SOT-25	28xg	VD19	6g	Tor
A73	XC6114B334MR	Vdet-IC	3.4V±2%, ±Reset PPO, Wt=100ms, Rt=25ms	SOT-25	28xg	VD19	6g	Tor
A74	LMV931MG	Op-IC	Lo-power, Vcc=1.8..5V, 1.4MHz, 0.35V/µs	SOT-23-5	28opf	OP1	6g	Nsc
A74	XC6114B335MR	Vdet-IC	3.5V±2%, ±Reset PPO, Wt=100ms, Rt=25ms	SOT-25	28xg	VD19	6g	Tor
A75	XC6114B336MR	Vdet-IC	3.6V±2%, ±Reset PPO, Wt=100ms, Rt=25ms	SOT-25	28xg	VD19	6g	Tor
A76	XC6114B337MR	Vdet-IC	3.7V±2%, ±Reset PPO, Wt=100ms, Rt=25ms	SOT-25	28xg	VD19	6g	Tor
A77	XC6114B338MR	Vdet-IC	3.8V±2%, ±Reset PPO, Wt=100ms, Rt=25ms	SOT-25	28xg	VD19	6g	Tor
A78	XC6114B339MR	Vdet-IC	3.9V±2%, ±Reset PPO, Wt=100ms, Rt=25ms	SOT-25	28xg	VD19	6g	Tor
A79	74AHC1G79GV	CMOS-Logic	Positive edge-triggered D-type flip-flop	SOT753	28/Log20	-	6a	Phi
A79A	XC6114B340MR	Vdet-IC	4.0V±2%, ±Reset PPO, Wt=100ms, Rt=25ms	SOT-25	28xg	VD19	6g	Tor
A79A	LMV931MF	Op-IC	Lo-power, Vcc=1.8..5V, 1.4MHz, 0.35V/µs	SOT-23-5	28opf	OP1	6g	Nsc
A7A	XC6114B341MR	Vdet-IC	4.1V±2%, ±Reset PPO, Wt=100ms, Rt=25ms	SOT-25	28xg	VD19	6g	Tor
A7B	XC6114B342MR	Vdet-IC	4.2V±2%, ±Reset PPO, Wt=100ms, Rt=25ms	SOT-25	28xg	VD19	6g	Tor
A7C	XC6114B343MR	Vdet-IC	4.3V±2%, ±Reset PPO, Wt=100ms, Rt=25ms	SOT-25	28xg	VD19	6g	Tor
A7D	XC6114B344MR	Vdet-IC	4.4V±2%, ±Reset PPO, Wt=100ms, Rt=25ms	SOT-25	28xg	VD19	6g	Tor
A7E	XC6114B345MR	Vdet-IC	4.5V±2%, ±Reset PPO, Wt=100ms, Rt=25ms	SOT-25	28xg	VD19	6g	Tor
A7F	XC6114B316MR	Vdet-IC	1.6V±2%, ±Reset PPO, Wt=100ms, Rt=25ms	SOT-25	28xg	VD19	6g	Tor
A7F	XC6114B346MR	Vdet-IC	4.6V±2%, ±Reset PPO, Wt=100ms, Rt=25ms	SOT-25	28xg	VD19	6g	Tor
A7H	XC6114B317MR	Vdet-IC	1.7V±2%, ±Reset PPO, Wt=100ms, Rt=25ms	SOT-25	28xg	VD19	6g	Tor
A7H	XC6114B347MR	Vdet-IC	4.7V±2%, ±Reset PPO, Wt=100ms, Rt=25ms	SOT-25	28xg	VD19	6g	Tor
A7K	XC6114B318MR	Vdet-IC	1.8V±2%, ±Reset PPO, Wt=100ms, Rt=25ms	SOT-25	28xg	VD19	6g	Tor
A7K	XC6114B348MR	Vdet-IC	4.8V±2%, ±Reset PPO, Wt=100ms, Rt=25ms	SOT-25	28xg	VD19	6g	Tor
A7L	XC6114B319MR	Vdet-IC	1.9V±2%, ±Reset PPO, Wt=100ms, Rt=25ms	SOT-25	28xg	VD19	6g	Tor
A7L	XC6114B349MR	Vdet-IC	4.9V±2%, ±Reset PPO, Wt=100ms, Rt=25ms	SOT-25	28xg	VD19	6g	Tor
A7M	XC6114B320MR	Vdet-IC	2.0V±2%, ±Reset PPO, Wt=100ms, Rt=25ms	SOT-25	28xg	VD19	6g	Tor
A7M	XC6114B350MR	Vdet-IC	5.0V±2%, ±Reset PPO, Wt=100ms, Rt=25ms	SOT-25	28xg	VD19	6g	Tor
A7N	XC6114B321MR	Vdet-IC	2.1V±2%, ±Reset PPO, Wt=100ms, Rt=25ms	SOT-25	28xg	VD19	6g	Tor
A7P	XC6114B322MR	Vdet-IC	2.2V±2%, ±Reset PPO, Wt=100ms, Rt=25ms	SOT-25	28xg	VD19	6g	Tor
A7R	XC6114B323MR	Vdet-IC	2.3V±2%, ±Reset PPO, Wt=100ms, Rt=25ms	SOT-25	28xg	VD19	6g	Tor
A7S	XC6114B324MR	Vdet-IC	2.4V±2%, ±Reset PPO, Wt=100ms, Rt=25ms	SOT-25	28xg	VD19	6g	Tor
A7T	XC6114B325MR	Vdet-IC	2.5V±2%, ±Reset PPO, Wt=100ms, Rt=25ms	SOT-25	28xg	VD19	6g	Tor
A7U	XC6114B326MR	Vdet-IC	2.6V±2%, ±Reset PPO, Wt=100ms, Rt=25ms	SOT-25	28xg	VD19	6g	Tor
A7V	XC6114B327MR	Vdet-IC	2.7V±2%, ±Reset PPO, Wt=100ms, Rt=25ms	SOT-25	28xg	VD19	6g	Tor
A7X	XC6114B328MR	Vdet-IC	2.8V±2%, ±Reset PPO, Wt=100ms, Rt=25ms	SOT-25	28xg	VD19	6g	Tor
A7Y	XC6114B329MR	Vdet-IC	2.9V±2%, ±Reset PPO, Wt=100ms, Rt=25ms	SOT-25	28xg	VD19	6g	Tor
A7Z	XC6114B330MR	Vdet-IC	3.0V±2%, ±Reset PPO, Wt=100ms, Rt=25ms	SOT-25	28xg	VD19	6g	Tor
a8	74AUP1T58GW	CMOS-Logic	Configurable gate with voltage-level translator	SOT-353-1	28/Log80	-	6a	Phi
A8	EMA8	Si-pnp-Digi	Dual, 50V, 100mA, 150mW, 250MHz, R1/R2=10k/47k	EMT5	30/TD9	-	6a	Rhm
A8	FMA8A	Si-pnp-Digi	Dual, 50V, 100mA, 300mW, 250MHz, R1/R2=10k/47k	SC-74A	28/TD9	-	6a	Rhm
A8	HD74ALVC1G86VS	CMOS-Logic	2-input EXCLUSIVE-OR gate	VSON-5	30/Log5	-	6a	Per
A8	PI74ST1G08CX	CMOS-Logic	2-input AND gate	SC-70-5	28/Log3	-	6a	Ren
A8	PI74ST1G08TX	CMOS-Logic	2-input AND gate	SOT-23-5	28/Log3	-	6a	Per
A8	R1111N281A	LVR-IC	LDO, LN, -CE, 2.8V±2%, 200mA	SOT-23-5	28cx	VR4	6g	Ric
A8	TC1014-2.85VRX	LVR-IC	LDO, 2.85V±2%, 50mA, +CE	SOT-23-5	28vrx	VR7	6g	Mcc



SMD code	Type	Function	Short description	Case	Pinout	Sch.	St.	Mnf.
A8	UMA8N	Si-pnp-Digi	Dual, 50V, 100mA, 150mW, 250MHz, R1/R2=10k/47k	SC-88A	28/TD9	-	6a	Rhm
A8-	RT9198-30PU5	LVR-IC	LDO, 3.0V±1%, 300mA, +CE	SC-70-5	28xm	VR4	6a	Rct
A80	XC6114B431MR	Vdet-IC	3.1V±2%, ±Reset PPO, Wt=200ms, Rt=25ms	SOT-25	28xg	VD19	6g	Tor
A81	XC6114B432MR	Vdet-IC	3.2V±2%, ±Reset PPO, Wt=200ms, Rt=25ms	SOT-25	28xg	VD19	6g	Tor
A82	XC6114B433MR	Vdet-IC	3.3V±2%, ±Reset PPO, Wt=200ms, Rt=25ms	SOT-25	28xg	VD19	6g	Tor
A83	XC6114B434MR	Vdet-IC	3.4V±2%, ±Reset PPO, Wt=200ms, Rt=25ms	SOT-25	28xg	VD19	6g	Tor
A84	XC6114B435MR	Vdet-IC	3.5V±2%, ±Reset PPO, Wt=200ms, Rt=25ms	SOT-25	28xg	VD19	6g	Tor
A85	XC6114B436MR	Vdet-IC	3.6V±2%, ±Reset PPO, Wt=200ms, Rt=25ms	SOT-25	28xg	VD19	6g	Tor
A86	74AHC1G86GV	CMOS-Logic	2-input EXCLUSIVE-OR gate	SOT753	28/Log5	-	6a	Phi
A86	OPA686N	Op-IC	Wide-band LN, Current Feedback	SOT-23-5	28opa	OP1	6a	Bb
A86	U74AHC1G86-AF5	CMOS-Logic	2-input EXCLUSIVE-OR gate	SOT-23-5	28/Log5	-	6a	Utc
A86	U74AHC1G86-AL5	CMOS-Logic	2-input EXCLUSIVE-OR gate	SOT-353	28/Log5	-	6a	Utc
A86	XC6114B437MR	Vdet-IC	3.7V±2%, ±Reset PPO, Wt=200ms, Rt=25ms	SOT-25	28xg	VD19	6g	Tor
A86L	U74AHC1G86L-AF5	CMOS-Logic	2-input EXCLUSIVE-OR gate	SOT-23-5	28/Log5	-	6a	Utc
A86L	U74AHC1G86L-AL5	CMOS-Logic	2-input EXCLUSIVE-OR gate	SOT-353	28/Log5	-	6a	Utc
A87	XC6114B438MR	Vdet-IC	3.8V±2%, ±Reset PPO, Wt=200ms, Rt=25ms	SOT-25	28xg	VD19	6g	Tor
A88	XC6114B439MR	Vdet-IC	3.9V±2%, ±Reset PPO, Wt=200ms, Rt=25ms	SOT-25	28xg	VD19	6g	Tor
A89	XC6114B440MR	Vdet-IC	4.0V±2%, ±Reset PPO, Wt=200ms, Rt=25ms	SOT-25	28xg	VD19	6g	Tor
A8A	XC6108C08AMR	Vdet-IC	0.8V±2%, Hysteresis, -Reset PPO	SOT-25	28rm	VD15	6g	Tor
A8A	XC6114B441MR	Vdet-IC	4.1V±2%, ±Reset PPO, Wt=200ms, Rt=25ms	SOT-25	28xg	VD19	6g	Tor
A8B	XC6108C08BMR	Vdet-IC	0.8V±2%, -Reset PPO	SOT-25	28rm	VD15	6g	Tor
A8B	XC6114B442MR	Vdet-IC	4.2V±2%, ±Reset PPO, Wt=200ms, Rt=25ms	SOT-25	28xg	VD19	6g	Tor
A8C	XC6108C08CMR	Vdet-IC	0.8V±2%, Hysteresis, -Reset PPO	SOT-25	28rk	VD15	6g	Tor
A8C	XC6114B443MR	Vdet-IC	4.3V±2%, ±Reset PPO, Wt=200ms, Rt=25ms	SOT-25	28xg	VD19	6g	Tor
A8D	XC6108C08DMR	Vdet-IC	0.8V±2%, -Reset PPO	SOT-25	28rk	VD15	6g	Tor
A8D	XC6114B444MR	Vdet-IC	4.4V±2%, ±Reset PPO, Wt=200ms, Rt=25ms	SOT-25	28xg	VD19	6g	Tor
A8E	XC6114B445MR	Vdet-IC	4.5V±2%, ±Reset PPO, Wt=200ms, Rt=25ms	SOT-25	28xg	VD19	6g	Tor
A8F	XC6114B416MR	Vdet-IC	1.6V±2%, ±Reset PPO, Wt=200ms, Rt=25ms	SOT-25	28xg	VD19	6g	Tor
A8F	XC6114B446MR	Vdet-IC	4.6V±2%, ±Reset PPO, Wt=200ms, Rt=25ms	SOT-25	28xg	VD19	6g	Tor
A8H	XC6114B417MR	Vdet-IC	1.7V±2%, ±Reset PPO, Wt=200ms, Rt=25ms	SOT-25	28xg	VD19	6g	Tor
A8H	XC6114B447MR	Vdet-IC	4.7V±2%, ±Reset PPO, Wt=200ms, Rt=25ms	SOT-25	28xg	VD19	6g	Tor
A8K	XC6114B418MR	Vdet-IC	1.8V±2%, ±Reset PPO, Wt=200ms, Rt=25ms	SOT-25	28xg	VD19	6g	Tor
A8K	XC6114B448MR	Vdet-IC	4.8V±2%, ±Reset PPO, Wt=200ms, Rt=25ms	SOT-25	28xg	VD19	6g	Tor
A8L	XC6114B419MR	Vdet-IC	1.9V±2%, ±Reset PPO, Wt=200ms, Rt=25ms	SOT-25	28xg	VD19	6g	Tor
A8L	XC6114B449MR	Vdet-IC	4.9V±2%, ±Reset PPO, Wt=200ms, Rt=25ms	SOT-25	28xg	VD19	6g	Tor
A8M	XC6114B420MR	Vdet-IC	2.0V±2%, ±Reset PPO, Wt=200ms, Rt=25ms	SOT-25	28xg	VD19	6g	Tor
A8M	XC6114B450MR	Vdet-IC	5.0V±2%, ±Reset PPO, Wt=200ms, Rt=25ms	SOT-25	28xg	VD19	6g	Tor
A8N	XC6114B421MR	Vdet-IC	2.1V±2%, ±Reset PPO, Wt=200ms, Rt=25ms	SOT-25	28xg	VD19	6g	Tor
A8P	XC6114B422MR	Vdet-IC	2.2V±2%, ±Reset PPO, Wt=200ms, Rt=25ms	SOT-25	28xg	VD19	6g	Tor
A8R	XC6114B423MR	Vdet-IC	2.3V±2%, ±Reset PPO, Wt=200ms, Rt=25ms	SOT-25	28xg	VD19	6g	Tor
A8S	XC6114B424MR	Vdet-IC	2.4V±2%, ±Reset PPO, Wt=200ms, Rt=25ms	SOT-25	28xg	VD19	6g	Tor
A8T	XC6114B425MR	Vdet-IC	2.5V±2%, ±Reset PPO, Wt=200ms, Rt=25ms	SOT-25	28xg	VD19	6g	Tor
A8U	XC6114B426MR	Vdet-IC	2.6V±2%, ±Reset PPO, Wt=200ms, Rt=25ms	SOT-25	28xg	VD19	6g	Tor
A8V	XC6114B427MR	Vdet-IC	2.7V±2%, ±Reset PPO, Wt=200ms, Rt=25ms	SOT-25	28xg	VD19	6g	Tor
A8X	XC6114B428MR	Vdet-IC	2.8V±2%, ±Reset PPO, Wt=200ms, Rt=25ms	SOT-25	28xg	VD19	6g	Tor
A8Y	XC6114B429MR	Vdet-IC	2.9V±2%, ±Reset PPO, Wt=200ms, Rt=25ms	SOT-25	28xg	VD19	6g	Tor
A8Z	XC6114B430MR	Vdet-IC	3.0V±2%, ±Reset PPO, Wt=200ms, Rt=25ms	SOT-25	28xg	VD19	6g	Tor
A9	74AHC1G09GV	CMOS-Logic	2-input AND gate (ODO)	SOT-353-1	28/Log9	-	6a	Phi
A9	FMA9A	Si-pnp-Digi	Dual, 50V, 100mA, 300mW, 250MHz, R1/R2=10k/10k	SC-74A	28/TD9	-	6a	Rhm
A9	HD74ALVC1G66VS	CMOS-Logic	Bilateral analogic switch	VSON-5	30/Log16	-	6a	Ren
A9	R1111N291A	LVR-IC	LDO, LN, -CE, 2.9V±2%, 200mA	SOT-23-5	28xc	VR4	6g	Ric
A9	TC1014-3.6VRX	LVR-IC	LDO, 3.6V±2%, 50mA, +CE	SOT-23-5	28vrx	VR7	6g	Mcc
A9	RN5VD09AA	Vdet-IC	0.9V±2.5%, -Reset PPO	SOT-23-5	28vdo	VD3	6g	Ric
A9-	RT9198-33PU5	LVR-IC	LDO, 3.3V±1%, 300mA, +CE	SC-70-5	28xm	VR4	6a	Rct
A90	XC6114B531MR	Vdet-IC	3.1V±2%, ±Reset PPO, Wt=400ms, Rt=25ms	SOT-25	28xg	VD19	6g	Tor
A91	XC6114B532MR	Vdet-IC	3.2V±2%, ±Reset PPO, Wt=400ms, Rt=25ms	SOT-25	28xg	VD19	6g	Tor
A92	XC6114B533MR	Vdet-IC	3.3V±2%, ±Reset PPO, Wt=400ms, Rt=25ms	SOT-25	28xg	VD19	6g	Tor
A93	XC6114B534MR	Vdet-IC	3.4V±2%, ±Reset PPO, Wt=400ms, Rt=25ms	SOT-25	28xg	VD19	6g	Tor
A94	XC6114B535MR	Vdet-IC	3.5V±2%, ±Reset PPO, Wt=400ms, Rt=25ms	SOT-25	28xg	VD19	6g	Tor
A95	XC6114B536MR	Vdet-IC	3.6V±2%, ±Reset PPO, Wt=400ms, Rt=25ms	SOT-25	28xg	VD19	6g	Tor
A96	XC6114B537MR	Vdet-IC	3.7V±2%, ±Reset PPO, Wt=400ms, Rt=25ms	SOT-25	28xg	VD19	6g	Tor
A97	XC6114B538MR	Vdet-IC	3.8V±2%, ±Reset PPO, Wt=400ms, Rt=25ms	SOT-25	28xg	VD19	6g	Tor
A98	XC6114B539MR	Vdet-IC	3.9V±2%, ±Reset PPO, Wt=400ms, Rt=25ms	SOT-25	28xg	VD19	6g	Tor
A99	XC6114B540MR	Vdet-IC	4.0V±2%, ±Reset PPO, Wt=400ms, Rt=25ms	SOT-25	28xg	VD19	6g	Tor
A9A	XC6108C09AMR	Vdet-IC	0.9V±2%, Hysteresis, -Reset PPO	SOT-25	28rm	VD15	6g	Tor
A9A	XC6114B541MR	Vdet-IC	4.1V±2%, ±Reset PPO, Wt=400ms, Rt=25ms	SOT-25	28xg	VD19	6g	Tor
A9B	XC6108C09BMR	Vdet-IC	0.9V±2%, -Reset PPO	SOT-25	28rm	VD15	6g	Tor
A9B	XC6114B542MR	Vdet-IC	4.2V±2%, ±Reset PPO, Wt=400ms, Rt=25ms	SOT-25	28xg	VD19	6g	Tor
A9C	XC6108C09CMR	Vdet-IC	0.9V±2%, Hysteresis, -Reset PPO	SOT-25	28rk	VD15	6g	Tor
A9C	XC6114B543MR	Vdet-IC	4.3V±2%, ±Reset PPO, Wt=400ms, Rt=25ms	SOT-25	28xg	VD19	6g	Tor



SMD code	Type	Function	Short description	Case	Pinout	Sch.	St.	Mnf.
A9D	XC6108C09DMR	Vdet-IC	0.9V±2%, -Reset PPO	SOT-25	28rk	VD15	6g	Tor
A9D	XC6114B544MR	Vdet-IC	4.4V±2%, ±Reset PPO, Wt=400ms, Rt=25ms	SOT-25	28xg	VD19	6g	Tor
A9E	XC6114B545MR	Vdet-IC	4.5V±2%, ±Reset PPO, Wt=400ms, Rt=25ms	SOT-25	28xg	VD19	6g	Tor
A9F	XC6114B516MR	Vdet-IC	1.6V±2%, ±Reset PPO, Wt=400ms, Rt=25ms	SOT-25	28xg	VD19	6g	Tor
A9F	XC6114B546MR	Vdet-IC	4.6V±2%, ±Reset PPO, Wt=400ms, Rt=25ms	SOT-25	28xg	VD19	6g	Tor
A9H	XC6114B517MR	Vdet-IC	1.7V±2%, ±Reset PPO, Wt=400ms, Rt=25ms	SOT-25	28xg	VD19	6g	Tor
A9H	XC6114B547MR	Vdet-IC	4.7V±2%, ±Reset PPO, Wt=400ms, Rt=25ms	SOT-25	28xg	VD19	6g	Tor
A9K	XC6114B518MR	Vdet-IC	1.8V±2%, ±Reset PPO, Wt=400ms, Rt=25ms	SOT-25	28xg	VD19	6g	Tor
A9K	XC6114B548MR	Vdet-IC	4.8V±2%, ±Reset PPO, Wt=400ms, Rt=25ms	SOT-25	28xg	VD19	6g	Tor
A9L	XC6114B519MR	Vdet-IC	1.9V±2%, ±Reset PPO, Wt=400ms, Rt=25ms	SOT-25	28xg	VD19	6g	Tor
A9L	XC6114B549MR	Vdet-IC	4.9V±2%, ±Reset PPO, Wt=400ms, Rt=25ms	SOT-25	28xg	VD19	6g	Tor
A9M	XC6114B520MR	Vdet-IC	2.0V±2%, ±Reset PPO, Wt=400ms, Rt=25ms	SOT-25	28xg	VD19	6g	Tor
A9M	XC6114B550MR	Vdet-IC	5.0V±2%, ±Reset PPO, Wt=400ms, Rt=25ms	SOT-25	28xg	VD19	6g	Tor
A9N	XC6114B521MR	Vdet-IC	2.1V±2%, ±Reset PPO, Wt=400ms, Rt=25ms	SOT-25	28xg	VD19	6g	Tor
A9P	XC6114B522MR	Vdet-IC	2.2V±2%, ±Reset PPO, Wt=400ms, Rt=25ms	SOT-25	28xg	VD19	6g	Tor
A9R	XC6114B523MR	Vdet-IC	2.3V±2%, ±Reset PPO, Wt=400ms, Rt=25ms	SOT-25	28xg	VD19	6g	Tor
A9S	XC6114B524MR	Vdet-IC	2.4V±2%, ±Reset PPO, Wt=400ms, Rt=25ms	SOT-25	28xg	VD19	6g	Tor
A9T	XC6114B525MR	Vdet-IC	2.5V±2%, ±Reset PPO, Wt=400ms, Rt=25ms	SOT-25	28xg	VD19	6g	Tor
A9U	XC6114B526MR	Vdet-IC	2.6V±2%, ±Reset PPO, Wt=400ms, Rt=25ms	SOT-25	28xg	VD19	6g	Tor
A9V	XC6114B527MR	Vdet-IC	2.7V±2%, ±Reset PPO, Wt=400ms, Rt=25ms	SOT-25	28xg	VD19	6g	Tor
A9X	XC6114B528MR	Vdet-IC	2.8V±2%, ±Reset PPO, Wt=400ms, Rt=25ms	SOT-25	28xg	VD19	6g	Tor
A9Y	XC6114B529MR	Vdet-IC	2.9V±2%, ±Reset PPO, Wt=400ms, Rt=25ms	SOT-25	28xg	VD19	6g	Tor
A9Z	XC6114B530MR	Vdet-IC	3.0V±2%, ±Reset PPO, Wt=400ms, Rt=25ms	SOT-25	28xg	VD19	6g	Tor
AA	µPA501T	Si-pnp	Dual, 60V, 100mA, 180MHz	SOT-23-5	28/T12	-	6a	Nec
AA	µPA571T	Si-pnp	Dual, 60V, 100mA, 180MHz	SOT-23-5	28/T12	-	6a	Nec
AA	74AHC1G00GW	CMOS-Logic	2-input NAND gate	SOT-353	28/Log1	-	6a	Phi
AA	HD74ALVC1G14V5	CMOS-Logic	Inverting Schmitt-trigger	VSON-5	30/Log7	-	6a	Ren
AA	PI74ST1G125CX	CMOS-Logic	Bus buffer gate with 3-state output	SC-70-5	28/Log14	-	6a	Per
AA	PI74ST1G125TX	CMOS-Logic	Bus buffer gate with 3-state output	SOT-23-5	28/Log14	-	6a	Per
AA	RN5RT20AA	LVR-IC	LDO, 2V±2%, 150mA, -CE	SOT-23-5	28vrt	VR4	6g	Ric
AA	SIP823LEU	Vdet-IC	4.63V±1.5%, MR, Strobe, -Reset PPO	SOT-23-5	28cp	VD17	6k	Vs
AA-	RT9198-15PU5	LVR-IC	LDO, 1.5V±1%, 300mA, +CE	SC-70-5	28xm	VR4	6a	Rct
AA0	XC6211A312MR	LVR-IC	LDO, 3.1V±2%, 240mA, +CE, PDR	SOT-25	28vc	VR4	6g	Tor
AA0	XC6114B631MR	Vdet-IC	3.1V±2%, ±Reset PPO, Wt=1.6s, Rt=25ms	SOT-25	28xg	VD19	6g	Tor
AA1	XC6211A322MR	LVR-IC	LDO, 3.2V±2%, 240mA, +CE, PDR	SOT-25	28vc	VR4	6g	Tor
AA1	XC6114B632MR	Vdet-IC	3.2V±2%, ±Reset PPO, Wt=1.6s, Rt=25ms	SOT-25	28xg	VD19	6g	Tor
AA2	XC6211A332MR	LVR-IC	LDO, 3.3V±2%, 240mA, +CE, PDR	SOT-25	28vc	VR4	6g	Tor
AA2	XC6114B633MR	Vdet-IC	3.3V±2%, ±Reset PPO, Wt=1.6s, Rt=25ms	SOT-25	28xg	VD19	6g	Tor
AA3	XC6211A342MR	LVR-IC	LDO, 3.4V±2%, 240mA, +CE, PDR	SOT-25	28vc	VR4	6g	Tor
AA3	XC6114B634MR	Vdet-IC	3.4V±2%, ±Reset PPO, Wt=1.6s, Rt=25ms	SOT-25	28xg	VD19	6g	Tor
AA4	XC6211A352MR	LVR-IC	LDO, 3.5V±2%, 240mA, +CE, PDR	SOT-25	28vc	VR4	6g	Tor
AA4	XC6114B635MR	Vdet-IC	3.5V±2%, ±Reset PPO, Wt=1.6s, Rt=25ms	SOT-25	28xg	VD19	6g	Tor
AA5	XC6211A362MR	LVR-IC	LDO, 3.6V±2%, 240mA, +CE, PDR	SOT-25	28vc	VR4	6g	Tor
AA5	XC6114B636MR	Vdet-IC	3.6V±2%, ±Reset PPO, Wt=1.6s, Rt=25ms	SOT-25	28xg	VD19	6g	Tor
AA6	XC6211A372MR	LVR-IC	LDO, 3.7V±2%, 240mA, +CE, PDR	SOT-25	28vc	VR4	6g	Tor
AA6	XC6114B637MR	Vdet-IC	3.7V±2%, ±Reset PPO, Wt=1.6s, Rt=25ms	SOT-25	28xg	VD19	6g	Tor
AA7	XC6211A382MR	LVR-IC	LDO, 3.8V±2%, 240mA, +CE, PDR	SOT-25	28vc	VR4	6g	Tor
AA7	XC6114B638MR	Vdet-IC	3.8V±2%, ±Reset PPO, Wt=1.6s, Rt=25ms	SOT-25	28xg	VD19	6g	Tor
AA8	XC6211A392MR	LVR-IC	LDO, 3.9V±2%, 240mA, +CE, PDR	SOT-25	28vc	VR4	6g	Tor
AA8	XC6114B639MR	Vdet-IC	3.9V±2%, ±Reset PPO, Wt=1.6s, Rt=25ms	SOT-25	28xg	VD19	6g	Tor
AA9	XC6211A402MR	LVR-IC	LDO, 4V±2%, 240mA, +CE, PDR	SOT-25	28vc	VR4	6g	Tor
AA9	XC6114B640MR	Vdet-IC	4.0V±2%, ±Reset PPO, Wt=1.6s, Rt=25ms	SOT-25	28xg	VD19	6g	Tor
AAA	RP107N101B	LVR-IC	LDO, 1.0V±1%, 200mA, +CE	SOT-23-5	28cx	VR4	6g	Ric
AAA	XC6211A412MR	LVR-IC	LDO, 4.1V±2%, 240mA, +CE, PDR	SOT-25	28vc	VR4	6g	Tor
AAA	XC6114B641MR	Vdet-IC	4.1V±2%, ±Reset PPO, Wt=1.6s, Rt=25ms	SOT-25	28xg	VD19	6g	Tor
AAAA	MAX8877EZK15-T	LVR-IC	LDO, 1.5V±1.4%, 150mA, +CE	SOT-23-5T	28vrx	VR7	6k	Max
AAAB	MAX8877EZK18-T	LVR-IC	LDO, 1.8V±1.4%, 150mA, +CE	SOT-23-5T	28vrx	VR7	6k	Max
AAAC	MAX8877EZK25-T	LVR-IC	LDO, 2.5V±1.4%, 150mA, +CE	SOT-23-5T	28vrx	VR7	6k	Max
AAAD	MAX8877EZK28-T	LVR-IC	LDO, 2.8V±1.4%, 150mA, +CE	SOT-23-5T	28vrx	VR7	6k	Max
AAAE	MAX8877EZK30-T	LVR-IC	LDO, 3.0V±1.4%, 150mA, +CE	SOT-23-5T	28vrx	VR7	6k	Max
AAAF	MAX8877EZK32-T	LVR-IC	LDO, 3.15V±1.4%, 150mA, +CE	SOT-23-5T	28vrx	VR7	6k	Max
AAAG	MAX8877EZK33-T	LVR-IC	LDO, 3.3V±1.4%, 150mA, +CE	SOT-23-5T	28vrx	VR7	6k	Max
AAAH	MAX8877EZK36-T	LVR-IC	LDO, 3.6V±1.4%, 150mA, +CE	SOT-23-5T	28vrx	VR7	6k	Max
AAAI	MAX8877EZK50-T	LVR-IC	LDO, 5.0V±1.4%, 150mA, +CE	SOT-23-5T	28vrx	VR7	6k	Max
AAAJ	MAX8878EZK15-T	LVR-IC	LDO, 1.5V±1.4%, 150mA, +CE, CL	SOT-23-5T	28vrx	VR7	6k	Max
AAAK	MAX8878EZK18-T	LVR-IC	LDO, 1.8V±1.4%, 150mA, +CE, CL	SOT-23-5T	28vrx	VR7	6k	Max
AAAL	MAX8878EZK25-T	LVR-IC	LDO, 2.5V±1.4%, 150mA, +CE, CL	SOT-23-5T	28vrx	VR7	6k	Max
AAAM	MAX8878EZK28-T	LVR-IC	LDO, 2.8V±1.4%, 150mA, +CE, CL	SOT-23-5T	28vrx	VR7	6k	Max
AAAN	MAX8878EZK30-T	LVR-IC	LDO, 3.0V±1.4%, 150mA, +CE, CL	SOT-23-5T	28vrx	VR7	6k	Max
AAAO	MAX8878EZK32-T	LVR-IC	LDO, 3.15V±1.4%, 150mA, +CE, CL	SOT-23-5T	28vrx	VR7	6k	Max



SMD code	Type	Function	Short description	Case	Pinout	Sch.	St.	Mnf.
AAAP	MAX8878EZK33-T	LVR-IC	LDO, 3.3V±1.4%, 150mA, +CE, CL	SOT-23-5T	28vrx	VR7	6k	Max
AAAQ	MAX8878EZK36-T	LVR-IC	LDO, 3.6V±1.4%, 150mA, +CE, CL	SOT-23-5T	28vrx	VR7	6k	Max
AAAR	MAX8878EZK50-T	LVR-IC	LDO, 5.0V±1.4%, 150mA, +CE, CL	SOT-23-5T	28vrx	VR7	6k	Max
AAB	RP107N111B	LVR-IC	LDO, 1.1V±1%, 200mA, +CE	SOT-23-5	28cx	VR4	6g	Ric
AAB	XC6211A422MR	LVR-IC	LDO, 4.2V±2%, 240mA, +CE, PDR	SOT-25	28vc	VR4	6g	Tor
ĀAB	XC6114B642MR	Vdet-IC	4.2V±2%, ±Reset PPO, Wt=1.6s, Rt=25ms	SOT-25	28xg	VD19	6g	Tor
AABE	MAX8863TEUK-T	LVR-IC	LDO, 3.15V±1.4%, 120mA, +CE, Set	SOT-23-5	28vrv	VR5	6k	Max
AABF	MAX8863SEUK-T	LVR-IC	LDO, 2.84V±1.4%, 120mA, +CE, Set	SOT-23-5	28vrv	VR5	6k	Max
AABG	MAX8864TEUK-T	LVR-IC	LDO, 3.15V±1.4%, 120mA, +CE, Set	SOT-23-5	28vrv	VR5	6k	Max
AABH	MAX8864SEUK-T	LVR-IC	LDO, 2.84V±1.4%, 120mA, +CE, Set	SOT-23-5	28vrv	VR5	6k	Max
AABV	MAX8863REUK-T	LVR-IC	LDO, 2.8V±1.4%, 120mA, +CE, Set	SOT-23-5	28vrv	VR5	6k	Max
AABW	MAX8864REUK-T	LVR-IC	LDO, 2.8V±1.4%, 120mA, +CE, Set	SOT-23-5	28vrv	VR5	6k	Max
AABY	MAX4165EUK-T	Op-IC	GP, ±1.35...±3.25V, 5MHz, Icco=1.2mA, Vg=120dB	SOT-23-5	28opa	OP1	6k	Max
AAC	PAM3101DAB150	LVR-IC	LDO, 1.5V±2%, 300mA, +CE	SOT-23-5	28vrx	VR7	6k	Pam
AAC	PAM3101DUB150	LVR-IC	LDO, 1.5V±2%, 300mA, +CE	SC-70-5L	28vrx	VR7	6k	Pam
AAC	RP107N121B	LVR-IC	LDO, 1.2V±1%, 200mA, +CE	SOT-23-5	28cx	VR4	6g	Ric
AAC	XC6211A432MR	LVR-IC	LDO, 4.3V±2%, 240mA, +CE, PDR	SOT-25	28vc	VR4	6g	Tor
ĀAC	XC6114B643MR	Vdet-IC	4.3V±2%, ±Reset PPO, Wt=1.6s, Rt=25ms	SOT-25	28xg	VD19	6g	Tor
AAD	RP107N131B	LVR-IC	LDO, 1.3V±1%, 200mA, +CE	SOT-23-5	28cx	VR4	6g	Ric
AAD	XC6211A442MR	LVR-IC	LDO, 4.4V±2%, 240mA, +CE, PDR	SOT-25	28vc	VR4	6g	Tor
ĀAD	XC6114B644MR	Vdet-IC	4.4V±2%, ±Reset PPO, Wt=1.6s, Rt=25ms	SOT-25	28xg	VD19	6g	Tor
AAE	PAM3101DAB180	LVR-IC	LDO, 1.8V±2%, 300mA, +CE	SOT-23-5	28vrx	VR7	6k	Pam
AAE	PAM3101DUB180	LVR-IC	LDO, 1.8V±2%, 300mA, +CE	SC-70-5L	28vrx	VR7	6k	Pam
AAE	RP107N141B	LVR-IC	LDO, 1.4V±1%, 200mA, +CE	SOT-23-5	28cx	VR4	6g	Ric
AAE	XC6211A452MR	LVR-IC	LDO, 4.5V±2%, 240mA, +CE, PDR	SOT-25	28vc	VR4	6g	Tor
ĀAE	XC6114B645MR	Vdet-IC	4.5V±2%, ±Reset PPO, Wt=1.6s, Rt=25ms	SOT-25	28xg	VD19	6g	Tor
AAF	RP107N151B	LVR-IC	LDO, 1.5V±1%, 200mA, +CE	SOT-23-5	28cx	VR4	6g	Ric
AAF	XC6211A462MR	LVR-IC	LDO, 4.6V±2%, 240mA, +CE, PDR	SOT-25	28vc	VR4	6g	Tor
ĀAF	XC6114B616MR	Vdet-IC	1.6V±2%, ±Reset PPO, Wt=1.6s, Rt=25ms	SOT-25	28xg	VD19	6g	Tor
ĀAF	XC6114B646MR	Vdet-IC	4.6V±2%, ±Reset PPO, Wt=1.6s, Rt=25ms	SOT-25	28xg	VD19	6g	Tor
AAG	PAM3101DAB250	LVR-IC	LDO, 2.5V±2%, 300mA, +CE	SOT-23-5	28vrx	VR7	6k	Pam
AAG	PAM3101DUB250	LVR-IC	LDO, 2.5V±2%, 300mA, +CE	SC-70-5L	28vrx	VR7	6k	Pam
AAG	RP107N161B	LVR-IC	LDO, 1.6V±1%, 200mA, +CE	SOT-23-5	28cx	VR4	6g	Ric
AAH	PAM3101DAB280	LVR-IC	LDO, 2.8V±2%, 300mA, +CE	SOT-23-5	28vrx	VR7	6k	Pam
AAH	PAM3101DUB280	LVR-IC	LDO, 2.8V±2%, 300mA, +CE	SC-70-5L	28vrx	VR7	6k	Pam
AAH	RP107N171B	LVR-IC	LDO, 1.7V±1%, 200mA, +CE	SOT-23-5	28cx	VR4	6g	Ric
AAH	XC6211A472MR	LVR-IC	LDO, 4.7V±2%, 240mA, +CE, PDR	SOT-25	28vc	VR4	6g	Tor
ĀAH	XC6114B617MR	Vdet-IC	1.7V±2%, ±Reset PPO, Wt=1.6s, Rt=25ms	SOT-25	28xg	VD19	6g	Tor
ĀAH	XC6114B647MR	Vdet-IC	4.7V±2%, ±Reset PPO, Wt=1.6s, Rt=25ms	SOT-25	28xg	VD19	6g	Tor
AAI	PAM3101DAB285	LVR-IC	LDO, 2.85V±2%, 300mA, +CE	SOT-23-5	28vrx	VR7	6k	Pam
AAI	PAM3101DUB285	LVR-IC	LDO, 2.85V±2%, 300mA, +CE	SC-70-5L	28vrx	VR7	6k	Pam
AAJ	PAM3101DAB300	LVR-IC	LDO, 3.0V±2%, 300mA, +CE	SOT-23-5	28vrx	VR7	6k	Pam
AAJ	PAM3101DUB300	LVR-IC	LDO, 3.0V±2%, 300mA, +CE	SC-70-5L	28vrx	VR7	6k	Pam
AAJ	RP107N181B	LVR-IC	LDO, 1.8V±1%, 200mA, +CE	SOT-23-5	28cx	VR4	6g	Ric
AAK	PAM3101DAB330	LVR-IC	LDO, 3.3V±2%, 300mA, +CE	SOT-23-5	28vrx	VR7	6k	Pam
AAK	PAM3101DUB330	LVR-IC	LDO, 3.3V±2%, 300mA, +CE	SC-70-5L	28vrx	VR7	6k	Pam
AAK	RP107N191B	LVR-IC	LDO, 1.9V±1%, 200mA, +CE	SOT-23-5	28cx	VR4	6g	Ric
AAK	XC6211A482MR	LVR-IC	LDO, 4.8V±2%, 240mA, +CE, PDR	SOT-25	28vc	VR4	6g	Tor
ĀAK	XC6114B618MR	Vdet-IC	1.8V±2%, ±Reset PPO, Wt=1.6s, Rt=25ms	SOT-25	28xg	VD19	6g	Tor
ĀAK	XC6114B648MR	Vdet-IC	4.8V±2%, ±Reset PPO, Wt=1.6s, Rt=25ms	SOT-25	28xg	VD19	6g	Tor
AAL	RP107N201B	LVR-IC	LDO, 2.0V±1%, 200mA, +CE	SOT-23-5	28cx	VR4	6g	Ric
AAL	XC6211A492MR	LVR-IC	LDO, 4.9V±2%, 240mA, +CE, PDR	SOT-25	28vc	VR4	6g	Tor
ĀAL	XC6114B619MR	Vdet-IC	1.9V±2%, ±Reset PPO, Wt=1.6s, Rt=25ms	SOT-25	28xg	VD19	6g	Tor
ĀAL	XC6114B649MR	Vdet-IC	4.9V±2%, ±Reset PPO, Wt=1.6s, Rt=25ms	SOT-25	28xg	VD19	6g	Tor
AAM	PAM3101DBA400	LVR-IC	LDO, 4.0V±2%, 300mA, +CE	SOT-23-5	28vrx	VR7	6k	Pam
AAM	PAM3101DUB400	LVR-IC	LDO, 4.0V±2%, 300mA, +CEA	SC-70-5L	28vrx	VR7	6k	Pam
AAM	RP107N211B	LVR-IC	LDO, 2.1V±1%, 200mA, +CE	SOT-23-5	28cx	VR4	6g	Ric
AAM	XC6211A502MR	LVR-IC	LDO, 5V±2%, 240mA, +CE, PDR	SOT-25	28vc	VR4	6g	Tor
ĀAM	XC6114B620MR	Vdet-IC	2.0V±2%, ±Reset PPO, Wt=1.6s, Rt=25ms	SOT-25	28xg	VD19	6g	Tor
ĀAM	XC6114B650MR	Vdet-IC	5.0V±2%, ±Reset PPO, Wt=1.6s, Rt=25ms	SOT-25	28xg	VD19	6g	Tor
AAN	RP107N221B	LVR-IC	LDO, 2.2V±1%, 200mA, +CE	SOT-23-5	28cx	VR4	6g	Ric
ĀAN	XC6114B621MR	Vdet-IC	2.1V±2%, ±Reset PPO, Wt=1.6s, Rt=25ms	SOT-25	28xg	VD19	6g	Tor
AAO	PAM3101DAB380	LVR-IC	LDO, 3.8V±2%, 300mA, +CE	SOT-23-5	28vrx	VR7	6k	Pam
AAO	PAM3101DUB380	LVR-IC	LDO, 3.8V±2%, 300mA, +CE	SC-70-5L	28vrx	VR7	6k	Pam
AAP	PAM3101DAB310	LVR-IC	LDO, 3.1V±2%, 300mA, +CE	SOT-23-5	28vrx	VR7	6k	Pam
AAP	PAM3101DUB310	LVR-IC	LDO, 3.1V±2%, 300mA, +CE	SC-70-5L	28vrx	VR7	6k	Pam
AAP	RP107N231B	LVR-IC	LDO, 2.3V±1%, 200mA, +CE	SOT-23-5	28cx	VR4	6g	Ric
ĀAP	XC6114B622MR	Vdet-IC	2.2V±2%, ±Reset PPO, Wt=1.6s, Rt=25ms	SOT-25	28xg	VD19	6g	Tor
AAQ	PAM3101DAB290	LVR-IC	LDO, 2.9V±2%, 300mA, +CE	SOT-23-5	28vrx	VR7	6k	Pam
AAQ	PAM3101DUB290	LVR-IC	LDO, 2.9V±2%, 300mA, +CE	SC-70-5L	28vrx	VR7	6k	Pam



SMD code	Type	Function	Short description	Case	Pinout	Sch.	St.	Mnf.
AAQ	RP107N241B	LVR-IC	LDO, 2.4V±1%, 200mA, +CE	SOT-23-5	28cx	VR4	6g	Ric
AAR	RP107N251B	LVR-IC	LDO, 2.5V±1%, 200mA, +CE	SOT-23-5	28cx	VR4	6g	Ric
ĀAR	XC6114B623MR	Vdet-IC	2.3V±2%, ±Reset PPO, Wt=1.6s, Rt=25ms	SOT-25	28xg	VD19	6g	Tor
AAS	RP107N261B	LVR-IC	LDO, 2.6V±1%, 200mA, +CE	SOT-23-5	28cx	VR4	6g	Ric
ĀAS	XC6114B624MR	Vdet-IC	2.4V±2%, ±Reset PPO, Wt=1.6s, Rt=25ms	SOT-25	28xg	VD19	6g	Tor
AAT	PAM3101DBA475	LVR-IC	LDO, 4.75V±2%, 300mA, +CE	SOT-23-5	28vrx	VR7	6k	Pam
AAT	PAM3101UB475	LVR-IC	LDO, 4.75V±2%, 300mA, +CE	SC-70-5L	28vrx	VR7	6k	Pam
AAT	RP107N271B	LVR-IC	LDO, 2.7V±1%, 200mA, +CE	SOT-23-5	28cx	VR4	6g	Ric
ĀAT	XC6114B625MR	Vdet-IC	2.5V±2%, ±Reset PPO, Wt=1.6s, Rt=25ms	SOT-25	28xg	VD19	6g	Tor
AAU	RP107N281B	LVR-IC	LDO, 2.8V±1%, 200mA, +CE	SOT-23-5	28cx	VR4	6g	Ric
ĀAU	XC6114B626MR	Vdet-IC	2.6V±2%, ±Reset PPO, Wt=1.6s, Rt=25ms	SOT-25	28xg	VD19	6g	Tor
AAV	RP107N291B	LVR-IC	LDO, 2.9V±1%, 200mA, +CE	SOT-23-5	28cx	VR4	6g	Ric
ĀAV	XC6114B627MR	Vdet-IC	2.7V±2%, ±Reset PPO, Wt=1.6s, Rt=25ms	SOT-25	28xg	VD19	6g	Tor
AAW	RP107N301B	LVR-IC	LDO, 3.0V±1%, 200mA, +CE	SOT-23-5	28cx	VR4	6g	Ric
AAx	RP107N311B	LVR-IC	LDO, 3.1V±1%, 200mA, +CE	SOT-23-5	28cx	VR4	6g	Ric
ĀAx	XC6114B628MR	Vdet-IC	2.8V±2%, ±Reset PPO, Wt=1.6s, Rt=25ms	SOT-25	28xg	VD19	6g	Tor
AAy	RP107N321B	LVR-IC	LDO, 3.2V±1%, 200mA, +CE	SOT-23-5	28cx	VR4	6g	Ric
ĀAy	XC6114B629MR	Vdet-IC	2.9V±2%, ±Reset PPO, Wt=1.6s, Rt=25ms	SOT-25	28xg	VD19	6g	Tor
AAZ	RP107N331B	LVR-IC	LDO, 3.3V±1%, 200mA, +CE	SOT-23-5	28cx	VR4	6g	Ric
ĀAZ	XC6114B630MR	Vdet-IC	3.0V±2%, ±Reset PPO, Wt=1.6s, Rt=25ms	SOT-25	28xg	VD19	6g	Tor
AB	74AHC1G02GW	CMOS-Logic	2-input NOR gate	SOT-353	28/Log2	-	6a	Phi
AB	HD74ALVC1G125VS	CMOS-Logic	Bus buffer gate with 3-state output	VSON-5	30/Log14	-	6a	Ren
AB	PI74ST1G126CX	CMOS-Logic	Bus buffer gate with 3-state output	SC-70-5	28/Log13	-	6a	Per
AB	PI74ST1G126TX	CMOS-Logic	Bus buffer gate with 3-state output	SOT-23-5	28/Log13	-	6a	Per
AB	RN5RT21AA	LVR-IC	LDO, 2.1V±2%, 150mA, -CE	SOT-23-5	28vt	VR4	6g	Ric
AB	SIP823MEU	Vdet-IC	4.38V±1.5%, MR, Strobe, -Reset PPO	SOT-23-5	28cp	VD17	6k	Vs
AB-	RT9193-15PU5	LVR-IC	LDO, 1.5V±1%, 300mA, +CE	SC-70-5	28vrx	VR7	6g	Rct
AB0	XC6211B312MR	LVR-IC	LDO, 3.1V±2%, 240mA, +CE	SOT-25	28vc	VR4	6g	Tor
ĀB0	XC6114C231MR	Vdet-IC	3.1V±2%, ±Reset PPO, Wt=50ms, Rt=50ms	SOT-25	28xg	VD19	6g	Tor
AB1	XC6211B322MR	LVR-IC	LDO, 3.2V±2%, 240mA, +CE	SOT-25	28vc	VR4	6g	Tor
ĀB1	XC6114C232MR	Vdet-IC	3.2V±2%, ±Reset PPO, Wt=50ms, Rt=50ms	SOT-25	28xg	VD19	6g	Tor
AB15	AMC7635-1.5DB	LVR-IC	LDO, 1.5V±1.5%, 300mA, +CE	SOT-23-5	28vrx	VR7	6a	Adt
AB15	AMC7635-1.5Y	LVR-IC	LDO, 1.5V±1.5%, 300mA, +CE	TSOT-23-5	28vrx	VR7	6a	Adt
AB15	AMC7635-1.5DB	LVR-IC	LDO, 1.5V±1.5%, 300mA, +CE	SOT-23-5	28vrx	VR7	6a	Adt
AB15	AMC7635-1.5Y	LVR-IC	LDO, 1.5V±1.5%, 300mA, +CE	TSOT-23-5	28vrx	VR7	6a	Adt
ĀB18	AMC7635-1.8DB	LVR-IC	LDO, 1.8V±1.5%, 300mA, +CE	SOT-23-5	28vrx	VR7	6a	Adt
AB18	AMC7635-1.8Y	LVR-IC	LDO, 1.8V±1.5%, 300mA, +CE	TSOT-23-5	28vrx	VR7	6a	Adt
AB18	AMC8878-1.8DBT	LVR-IC	LDO, 1.8V±1.4%, 150mA, +CE	SOT-23-5	28vrx	VR7	6a	Adt
AB18	AMC7635-1.8DB	LVR-IC	LDO, 1.8V±1.5%, 300mA, +CE	SOT-23-5	28vrx	VR7	6a	Adt
AB18	AMC7635-1.8Y	LVR-IC	LDO, 1.8V±1.5%, 300mA, +CE	TSOT-23-5	28vrx	VR7	6a	Adt
AB2	XC6211B332MR	LVR-IC	LDO, 3.3V±2%, 240mA, +CE	SOT-25	28vc	VR4	6g	Tor
ĀB2	XC6114C233MR	Vdet-IC	3.3V±2%, ±Reset PPO, Wt=50ms, Rt=50ms	SOT-25	28xg	VD19	6g	Tor
AB20	AMC7635-2.0DB	LVR-IC	LDO, 2.0V±1.5%, 300mA, +CE	SOT-23-5	28vrx	VR7	6a	Adt
AB20	AMC7635-2.0Y	LVR-IC	LDO, 2.0V±1.5%, 300mA, +CE	TSOT-23-5	28vrx	VR7	6a	Adt
AB20	AMC8878-2.0DBT	LVR-IC	LDO, 2.0V±1.4%, 150mA, +CE	SOT-23-5	28vrx	VR7	6a	Adt
AB20	AMC7635-2.0DB	LVR-IC	LDO, 2.0V±1.5%, 300mA, +CE	SOT-23-5	28vrx	VR7	6a	Adt
AB20	AMC7635-2.0Y	LVR-IC	LDO, 2.0V±1.5%, 300mA, +CE	TSOT-23-5	28vrx	VR7	6a	Adt
AB25	AMC7635-2.5DB	LVR-IC	LDO, 2.5V±1.5%, 300mA, +CE	SOT-23-5	28vrx	VR7	6a	Adt
AB25	AMC7635-2.5Y	LVR-IC	LDO, 2.5V±1.5%, 300mA, +CE	TSOT-23-5	28vrx	VR7	6a	Adt
AB25	AMC8878-2.5DBT	LVR-IC	LDO, 2.5V±1.4%, 150mA, +CE	SOT-23-5	28vrx	VR7	6a	Adt
AB25	AMC7635-2.5DB	LVR-IC	LDO, 2.5V±1.5%, 300mA, +CE	SOT-23-5	28vrx	VR7	6a	Adt
AB25	AMC7635-2.5Y	LVR-IC	LDO, 2.5V±1.5%, 300mA, +CE	TSOT-23-5	28vrx	VR7	6a	Adt
AB27	AMC7635-2.7DB	LVR-IC	LDO, 2.7V±1.5%, 300mA, +CE	SOT-23-5	28vrx	VR7	6a	Adt
AB27	AMC7635-2.7Y	LVR-IC	LDO, 2.7V±1.5%, 300mA, +CE	TSOT-23-5	28vrx	VR7	6a	Adt
AB27	AMC7635-2.7DB	LVR-IC	LDO, 2.7V±1.5%, 300mA, +CE	SOT-23-5	28vrx	VR7	6a	Adt
AB27	AMC7635-2.7Y	LVR-IC	LDO, 2.7V±1.5%, 300mA, +CE	TSOT-23-5	28vrx	VR7	6a	Adt
AB28	AMC7635-2.8DB	LVR-IC	LDO, 2.8V±1.5%, 300mA, +CE	SOT-23-5	28vrx	VR7	6a	Adt
AB28	AMC7635-2.8Y	LVR-IC	LDO, 2.8V±1.5%, 300mA, +CE	TSOT-23-5	28vrx	VR7	6a	Adt
AB28	AMC8878-2.8DBT	LVR-IC	LDO, 2.8V±1.4%, 150mA, +CE	SOT-23-5	28vrx	VR7	6a	Adt
AB28	AMC7635-2.8DB	LVR-IC	LDO, 2.8V±1.5%, 300mA, +CE	SOT-23-5	28vrx	VR7	6a	Adt
AB28	AMC7635-2.8Y	LVR-IC	LDO, 2.8V±1.5%, 300mA, +CE	TSOT-23-5	28vrx	VR7	6a	Adt
AB285	AMC7635-2.85DB	LVR-IC	LDO, 2.85V±1.5%, 300mA, +CE	SOT-23-5	28vrx	VR7	6a	Adt
AB285	AMC7635-2.85Y	LVR-IC	LDO, 2.85V±1.5%, 300mA, +CE	TSOT-23-5	28vrx	VR7	6a	Adt
AB285	AMC7635-2.85DB	LVR-IC	LDO, 2.85V±1.5%, 300mA, +CE	SOT-23-5	28vrx	VR7	6a	Adt
AB285	AMC7635-2.85Y	LVR-IC	LDO, 2.85V±1.5%, 300mA, +CE	TSOT-23-5	28vrx	VR7	6a	Adt
AB29	AMC7635-2.9DB	LVR-IC	LDO, 2.9V±1.5%, 300mA, +CE	SOT-23-5	28vrx	VR7	6a	Adt
AB29	AMC7635-2.9Y	LVR-IC	LDO, 2.9V±1.5%, 300mA, +CE	TSOT-23-5	28vrx	VR7	6a	Adt
AB29	AMC7635-2.9DB	LVR-IC	LDO, 2.9V±1.5%, 300mA, +CE	SOT-23-5	28vrx	VR7	6a	Adt
AB29	AMC7635-2.9Y	LVR-IC	LDO, 2.9V±1.5%, 300mA, +CE	TSOT-23-5	28vrx	VR7	6a	Adt
AB29	AMC8878-2.85DBT	LVR-IC	LDO, 2.85V±1.4%, 150mA, +CE	SOT-23-5	28vrx	VR7	6a	Adt



SMD code	Type	Function	Short description	Case	Pinout	Sch.	St.	Mnf.
AB3	XC6211B342MR	LVR-IC	LDO, 3.4V±2%, 240mA, +CE	SOT-25	28vc	VR4	6g	Tor
AB3	XC6114C234MR	Vdet-IC	3.4V±2%, ±Reset PPO, Wt=50ms, Rt=50ms	SOT-25	28xg	VD19	6g	Tor
AB30	AMC7635-3.0DB	LVR-IC	LDO, 3.0V±1.5%, 300mA, +CE	SOT-23-5	28vrx	VR7	6a	Adt
AB30	AMC7635-3.0Y	LVR-IC	LDO, 3.0V±1.5%, 300mA, +CE	TSOT-23-5	28vrx	VR7	6a	Adt
AB30	AMC8878-3.0DBT	LVR-IC	LDO, 3.0V±1.4%, 150mA, +CE	SOT-23-5	28vrx	VR7	6a	Adt
AB30	AMC7635-3.0DB	LVR-IC	LDO, 3.0V±1.5%, 300mA, +CE	SOT-23-5	28vrx	VR7	6a	Adt
AB30	AMC7635-3.0Y	LVR-IC	LDO, 3.0V±1.5%, 300mA, +CE	TSOT-23-5	28vrx	VR7	6a	Adt
AB31	AMC7635-3.1DB	LVR-IC	LDO, 3.1V±1.5%, 300mA, +CE	SOT-23-5	28vrx	VR7	6a	Adt
AB31	AMC7635-3.1Y	LVR-IC	LDO, 3.1V±1.5%, 300mA, +CE	TSOT-23-5	28vrx	VR7	6a	Adt
AB31	AMC7635-3.1DB	LVR-IC	LDO, 3.1V±1.5%, 300mA, +CE	SOT-23-5	28vrx	VR7	6a	Adt
AB31	AMC7635-3.1Y	LVR-IC	LDO, 3.1V±1.5%, 300mA, +CE	TSOT-23-5	28vrx	VR7	6a	Adt
AB32	AMC8878-3.2DBT	LVR-IC	LDO, 3.2V±1.4%, 150mA, +CE	SOT-23-5	28vrx	VR7	6a	Adt
AB33	AMC7635-3.3DB	LVR-IC	LDO, 3.3V±1.5%, 300mA, +CE	SOT-23-5	28vrx	VR7	6a	Adt
AB33	AMC7635-3.3Y	LVR-IC	LDO, 3.3V±1.5%, 300mA, +CE	TSOT-23-5	28vrx	VR7	6a	Adt
AB33	AMC8878-3.3DBT	LVR-IC	LDO, 3.3V±1.4%, 150mA, +CE	SOT-23-5	28vrx	VR7	6a	Adt
AB33	AMC7635-3.3DB	LVR-IC	LDO, 3.3V±1.5%, 300mA, +CE	SOT-23-5	28vrx	VR7	6a	Adt
AB33	AMC7635-3.3Y	LVR-IC	LDO, 3.3V±1.5%, 300mA, +CE	TSOT-23-5	28vrx	VR7	6a	Adt
AB4	XC6211B352MR	LVR-IC	LDO, 3.5V±2%, 240mA, +CE	SOT-25	28vc	VR4	6g	Tor
AB4	XC6114C235MR	Vdet-IC	3.5V±2%, ±Reset PPO, Wt=50ms, Rt=50ms	SOT-25	28xg	VD19	6g	Tor
AB5	XC6211B362MR	LVR-IC	LDO, 3.6V±2%, 240mA, +CE	SOT-25	28vc	VR4	6g	Tor
AB5	XC6114C236MR	Vdet-IC	3.6V±2%, ±Reset PPO, Wt=50ms, Rt=50ms	SOT-25	28xg	VD19	6g	Tor
AB5	XC6365A151MR	DC/DC-IC	PWM st-down, 100kHz, 1.5V±2.5%, 1A, +CE	SOT-25	28zm	DC7	6g	Tor
AB5	XC6367A151MR	DC/DC-IC	PWM step-up, 1.5V±2.5%, 200mA, 100kHz, +CE	SOT-25	28sh	DC11	6g	Tor
AB50	AMC8878-5.0DBT	LVR-IC	LDO, 5.0V±1.4%, 150mA, +CE	SOT-23-5	28vrx	VR7	6a	Adt
AB6	XC6211B372MR	LVR-IC	LDO, 3.7V±2%, 240mA, +CE	SOT-25	28vc	VR4	6g	Tor
AB6	XC6114C237MR	Vdet-IC	3.7V±2%, ±Reset PPO, Wt=50ms, Rt=50ms	SOT-25	28xg	VD19	6g	Tor
AB6	XC6365A161MR	DC/DC-IC	PWM st-down, 100kHz, 1.6V±2.5%, 1A, +CE	SOT-25	28zm	DC7	6g	Tor
AB6	XC6367A161MR	DC/DC-IC	PWM step-up, 1.6V±2.5%, 200mA, 100kHz, +CE	SOT-25	28sh	DC11	6g	Tor
AB7	XC6211B382MR	LVR-IC	LDO, 3.8V±2%, 240mA, +CE	SOT-25	28vc	VR4	6g	Tor
AB7	XC6114C238MR	Vdet-IC	3.8V±2%, ±Reset PPO, Wt=50ms, Rt=50ms	SOT-25	28xg	VD19	6g	Tor
AB7	XC6365A171MR	DC/DC-IC	PWM st-down, 100kHz, 1.7V±2.5%, 1A, +CE	SOT-25	28zm	DC7	6g	Tor
AB7	XC6367A171MR	DC/DC-IC	PWM step-up, 1.7V±2.5%, 200mA, 100kHz, +CE	SOT-25	28sh	DC11	6g	Tor
AB8	XC6211B392MR	LVR-IC	LDO, 3.9V±2%, 240mA, +CE	SOT-25	28vc	VR4	6g	Tor
AB8	XC6114C239MR	Vdet-IC	3.9V±2%, ±Reset PPO, Wt=50ms, Rt=50ms	SOT-25	28xg	VD19	6g	Tor
AB8	XC6365A181MR	DC/DC-IC	PWM st-down, 100kHz, 1.8V±2.5%, 1A, +CE	SOT-25	28zm	DC7	6g	Tor
AB8	XC6367A181MR	DC/DC-IC	PWM step-up, 1.8V±2.5%, 200mA, 100kHz, +CE	SOT-25	28sh	DC11	6g	Tor
AB9	XC6211B402MR	LVR-IC	LDO, 4V±2%, 240mA, +CE	SOT-25	28vc	VR4	6g	Tor
AB9	XC6114C240MR	Vdet-IC	4.0V±2%, ±Reset PPO, Wt=50ms, Rt=50ms	SOT-25	28xg	VD19	6g	Tor
AB9	XC6365A191MR	DC/DC-IC	PWM st-down, 100kHz, 1.9V±2.5%, 1A, +CE	SOT-25	28zm	DC7	6g	Tor
AB9	XC6367A191MR	DC/DC-IC	PWM step-up, 1.9V±2.5%, 200mA, 100kHz, +CE	SOT-25	28sh	DC11	6g	Tor
ABA	RP107N101D	LVR-IC	LDO, 1.0V±1%, 200mA, +CE, CL	SOT-23-5	28cx	VR4	6g	Ric
ABA	XC6211B412MR	LVR-IC	LDO, 4.1V±2%, 240mA, +CE	SOT-25	28vc	VR4	6g	Tor
ABA	XC6114C241MR	Vdet-IC	4.1V±2%, ±Reset PPO, Wt=50ms, Rt=50ms	SOT-25	28xg	VD19	6g	Tor
ABAA	V6300ASP5B	Vdet-IC	2.0V, -Reset PPO, 50ms	SOT-23-5	28vdr	VD7	6a	Em
ABAB	V6300BSP5B	Vdet-IC	2.4V, -Reset PPO, 50ms	SOT-23-5	28vdr	VD7	6a	Em
ABAC	V6300CSP5B	Vdet-IC	2.8V, -Reset PPO, 50ms	SOT-23-5	28vdr	VD7	6a	Em
ABAD	V6300DSP5B	Vdet-IC	3.5V, -Reset PPO, 50ms	SOT-23-5	28vdr	VD7	6a	Em
ABAE	V6300ESP5B	Vdet-IC	4V, -Reset PPO, 50ms	SOT-23-5	28vdr	VD7	6a	Em
ABAF	V6300FSP5B	Vdet-IC	4.5V, -Reset PPO, 50ms	SOT-23-5	28vdr	VD7	6a	Em
ABAG	V6300GSP5B	Vdet-IC	2.0V, +Reset PPO, 50ms	SOT-23-5	28vdo	VD3	6a	Em
ABAH	V6300HSP5B	Vdet-IC	2.4V, +Reset PPO, 50ms	SOT-23-5	28vdo	VD3	6a	Em
ABAI	V6300ISP5B	Vdet-IC	2.8V, +Reset PPO, 50ms	SOT-23-5	28vdo	VD3	6a	Em
ABAJ	V6300JSP5B	Vdet-IC	3.5V, +Reset PPO, 50ms	SOT-23-5	28vdo	VD3	6a	Em
ABAK	V6300KSP5B	Vdet-IC	4V, +Reset PPO, 50ms	SOT-23-5	28vdo	VD3	6a	Em
ABAL	V6300LSP5B	Vdet-IC	4.5V, +Reset PPO, 50ms	SOT-23-5	28vdo	VD3	6a	Em
ABAM	V6300MSP5B	Vdet-IC	2.0V, -Reset ODO, 50ms	SOT-23-5	28vdr	VD6	6a	Em
ABAN	V6300NSP5B	Vdet-IC	2.4V, -Reset ODO, 50ms	SOT-23-5	28vdr	VD6	6a	Em
ABAO	MAX6306UK50D1-T	Vdet-IC	5.0V±1.5%, -MR, -Reset ODO, 1ms	SOT-23-5	28ek	VD4	6k	Max
ABAO	V6300OSP5B	Vdet-IC	2.8V, -Reset ODO, 50ms	SOT-23-5	28vdr	VD6	6a	Em
ABAP	MAX6306UK50D2-T	Vdet-IC	5.0V±1.5%, -MR, -Reset ODO, 20ms	SOT-23-5	28ek	VD4	6k	Max
ABAP	V6300PSP5B	Vdet-IC	3.5V, -Reset ODO, 50ms	SOT-23-5	28vdr	VD6	6a	Em
ABAQ	MAX6306UK50D3-T	Vdet-IC	5.0V±1.5%, -MR, -Reset ODO, 140ms	SOT-23-5	28ek	VD4	6k	Max
ABAQ	V6300QSP5B	Vdet-IC	4V, -Reset ODO, 50ms	SOT-23-5	28vdr	VD6	6a	Em
ABAR	MAX6306UK50D4-T	Vdet-IC	5.0V±1.5%, -MR, -Reset ODO, 1120ms	SOT-23-5	28ek	VD4	6k	Max
ABAR	V6300RSP5B	Vdet-IC	4.5V, -Reset ODO, 50ms	SOT-23-5	28vdr	VD6	6a	Em
ABAS	MAX6306UK49D1-T	Vdet-IC	4.9V±1.5%, -MR, -Reset ODO, 1ms	SOT-23-5	28ek	VD4	6k	Max
ABAT	MAX6306UK49D2-T	Vdet-IC	4.9V±1.5%, -MR, -Reset ODO, 20ms	SOT-23-5	28ek	VD4	6k	Max
ABAU	MAX6306UK49D3-T	Vdet-IC	4.9V±1.5%, -MR, -Reset ODO, 140ms	SOT-23-5	28ek	VD4	6k	Max
ABAV	MAX6306UK49D4-T	Vdet-IC	4.9V±1.5%, -MR, -Reset ODO, 1120ms	SOT-23-5	28ek	VD4	6k	Max
ABAV	MAX6309UK30D2-T	Vdet-IC	3.0V±1.5%, -MR, -Reset PPO, 20ms	SOT-23-5	28ek	VD5	6k	Max



SMD code	Type	Function	Short description	Case	Pinout	Sch.	St.	Mnf.
ABAW	MAX6306UK48D1-T	Vdet-IC	4.8V±1.5%, -MR, -Reset ODO, 1ms	SOT-23-5	28ek	VD4	6k	Max
ABAX	MAX6306UK48D2-T	Vdet-IC	4.8V±1.5%, -MR, -Reset ODO, 20ms	SOT-23-5	28ek	VD4	6k	Max
ABAY	MAX6306UK48D3-T	Vdet-IC	4.8V±1.5%, -MR, -Reset ODO, 140ms	SOT-23-5	28ek	VD4	6k	Max
ABAZ	MAX6306UK48D4-T	Vdet-IC	4.8V±1.5%, -MR, -Reset ODO, 1120ms	SOT-23-5	28ek	VD4	6k	Max
ABB	RP107N111D	LVR-IC	LDO, 1.1V±1%, 200mA, +CE, CL	SOT-23-5	28cx	VR4	6g	Ric
ABB	XC6211B422MR	LVR-IC	LDO, 4.2V±2%, 240mA, +CE	SOT-25	28vc	VR4	6g	Tor
ABB	XC6114C242MR	Vdet-IC	4.2V±2%, ±Reset PPO, Wt=50ms, Rt=50ms	SOT-25	28xg	VD19	6g	Tor
ABBA	MAX6306UK47D1-T	Vdet-IC	4.7V±1.5%, -MR, -Reset ODO, 1ms	SOT-23-5	28ek	VD4	6k	Max
ABBB	MAX6306UK47D2-T	Vdet-IC	4.7V±1.5%, -MR, -Reset ODO, 20ms	SOT-23-5	28ek	VD4	6k	Max
ABBC	MAX6306UK47D3-T	Vdet-IC	4.7V±1.5%, -MR, -Reset ODO, 140ms	SOT-23-5	28ek	VD4	6k	Max
ABBD	MAX6306UK47D4-T	Vdet-IC	4.7V±1.5%, -MR, -Reset ODO, 1120ms	SOT-23-5	28ek	VD4	6k	Max
ABBE	MAX6306UK46D1-T	Vdet-IC	4.6V±1.5%, -MR, -Reset ODO, 1ms	SOT-23-5	28ek	VD4	6k	Max
ABBF	MAX6306UK46D2-T	Vdet-IC	4.6V±1.5%, -MR, -Reset ODO, 20ms	SOT-23-5	28ek	VD4	6k	Max
ABBG	MAX6306UK46D3-T	Vdet-IC	4.6V±1.5%, -MR, -Reset ODO, 140ms	SOT-23-5	28ek	VD4	6k	Max
ABBH	MAX6306UK46D4-T	Vdet-IC	4.6V±1.5%, -MR, -Reset ODO, 1120ms	SOT-23-5	28ek	VD4	6k	Max
ABBI	MAX6306UK45D1-T	Vdet-IC	4.5V±1.5%, -MR, -Reset ODO, 1ms	SOT-23-5	28ek	VD4	6k	Max
ABBJ	MAX6306UK45D2-T	Vdet-IC	4.5V±1.5%, -MR, -Reset ODO, 20ms	SOT-23-5	28ek	VD4	6k	Max
ABBK	MAX6306UK45D3-T	Vdet-IC	4.5V±1.5%, -MR, -Reset ODO, 140ms	SOT-23-5	28ek	VD4	6k	Max
ABBL	MAX6306UK45D4-T	Vdet-IC	4.5V±1.5%, -MR, -Reset ODO, 1120ms	SOT-23-5	28ek	VD4	6k	Max
ABBM	MAX6306UK44D1-T	Vdet-IC	4.4V±1.5%, -MR, -Reset ODO, 1ms	SOT-23-5	28ek	VD4	6k	Max
ABBN	MAX6306UK44D2-T	Vdet-IC	4.4V±1.5%, -MR, -Reset ODO, 20ms	SOT-23-5	28ek	VD4	6k	Max
ABBO	MAX6306UK44D3-T	Vdet-IC	4.4V±1.5%, -MR, -Reset ODO, 140ms	SOT-23-5	28ek	VD4	6k	Max
ABBP	MAX6306UK44D4-T	Vdet-IC	4.4V±1.5%, -MR, -Reset ODO, 1120ms	SOT-23-5	28ek	VD4	6k	Max
ABBQ	MAX6306UK43D1-T	Vdet-IC	4.3V±1.5%, -MR, -Reset ODO, 1ms	SOT-23-5	28ek	VD4	6k	Max
ABBR	MAX6306UK43D2-T	Vdet-IC	4.3V±1.5%, -MR, -Reset ODO, 20ms	SOT-23-5	28ek	VD4	6k	Max
ABBS	MAX6306UK43D3-T	Vdet-IC	4.3V±1.5%, -MR, -Reset ODO, 140ms	SOT-23-5	28ek	VD4	6k	Max
ABBT	MAX6306UK43D4-T	Vdet-IC	4.3V±1.5%, -MR, -Reset ODO, 1120ms	SOT-23-5	28ek	VD4	6k	Max
ABBU	MAX6306UK42D1-T	Vdet-IC	4.2V±1.5%, -MR, -Reset ODO, 1ms	SOT-23-5	28ek	VD4	6k	Max
ABBV	MAX6306UK42D2-T	Vdet-IC	4.2V±1.5%, -MR, -Reset ODO, 20ms	SOT-23-5	28ek	VD4	6k	Max
ABBW	MAX6306UK42D3-T	Vdet-IC	4.2V±1.5%, -MR, -Reset ODO, 140ms	SOT-23-5	28ek	VD4	6k	Max
ABBX	MAX6306UK42D4-T	Vdet-IC	4.2V±1.5%, -MR, -Reset ODO, 1120ms	SOT-23-5	28ek	VD4	6k	Max
ABBY	MAX6306UK41D1-T	Vdet-IC	4.1V±1.5%, -MR, -Reset ODO, 1ms	SOT-23-5	28ek	VD4	6k	Max
ABBZ	MAX6306UK41D2-T	Vdet-IC	4.1V±1.5%, -MR, -Reset ODO, 20ms	SOT-23-5	28ek	VD4	6k	Max
ABC	RP107N121D	LVR-IC	LDO, 1.2V±1%, 200mA, +CE, CL	SOT-23-5	28cx	VR4	6g	Ric
ABC	XC6211B432MR	LVR-IC	LDO, 4.3V±2%, 240mA, +CE	SOT-25	28vc	VR4	6g	Tor
ABC	XC6114C243MR	Vdet-IC	4.3V±2%, ±Reset PPO, Wt=50ms, Rt=50ms	SOT-25	28xg	VD19	6g	Tor
ABCA	MAX6306UK41D3-T	Vdet-IC	4.1V±1.5%, -MR, -Reset ODO, 140ms	SOT-23-5	28ek	VD4	6k	Max
ABCB	MAX6306UK41D4-T	Vdet-IC	4.1V±1.5%, -MR, -Reset ODO, 1120ms	SOT-23-5	28ek	VD4	6k	Max
ABCC	MAX6306UK40D1-T	Vdet-IC	4.0V±1.5%, -MR, -Reset ODO, 1ms	SOT-23-5	28ek	VD4	6k	Max
ABCD	MAX6306UK40D2-T	Vdet-IC	4.0V±1.5%, -MR, -Reset ODO, 20ms	SOT-23-5	28ek	VD4	6k	Max
ABCE	MAX6306UK40D3-T	Vdet-IC	4.0V±1.5%, -MR, -Reset ODO, 140ms	SOT-23-5	28ek	VD4	6k	Max
ABCF	MAX6306UK40D4-T	Vdet-IC	4.0V±1.5%, -MR, -Reset ODO, 1120ms	SOT-23-5	28ek	VD4	6k	Max
ABCG	MAX6306UK39D1-T	Vdet-IC	3.9V±1.5%, -MR, -Reset ODO, 1ms	SOT-23-5	28ek	VD4	6k	Max
ABCH	MAX6306UK39D2-T	Vdet-IC	3.9V±1.5%, -MR, -Reset ODO, 20ms	SOT-23-5	28ek	VD4	6k	Max
ABCI	MAX6306UK39D3-T	Vdet-IC	3.9V±1.5%, -MR, -Reset ODO, 140ms	SOT-23-5	28ek	VD4	6k	Max
ABCJ	MAX6306UK39D4-T	Vdet-IC	3.9V±1.5%, -MR, -Reset ODO, 1120ms	SOT-23-5	28ek	VD4	6k	Max
ABCK	MAX6306UK38D1-T	Vdet-IC	3.8V±1.5%, -MR, -Reset ODO, 1ms	SOT-23-5	28ek	VD4	6k	Max
ABCL	MAX6306UK38D2-T	Vdet-IC	3.8V±1.5%, -MR, -Reset ODO, 20ms	SOT-23-5	28ek	VD4	6k	Max
ABCM	MAX6306UK38D3-T	Vdet-IC	3.8V±1.5%, -MR, -Reset ODO, 140ms	SOT-23-5	28ek	VD4	6k	Max
ABCN	MAX6306UK38D4-T	Vdet-IC	3.8V±1.5%, -MR, -Reset ODO, 1120ms	SOT-23-5	28ek	VD4	6k	Max
ABCO	MAX6306UK37D1-T	Vdet-IC	3.7V±1.5%, -MR, -Reset ODO, 1ms	SOT-23-5	28ek	VD4	6k	Max
ABCP	MAX6306UK37D2-T	Vdet-IC	3.7V±1.5%, -MR, -Reset ODO, 20ms	SOT-23-5	28ek	VD4	6k	Max
ABCQ	MAX6306UK37D3-T	Vdet-IC	3.7V±1.5%, -MR, -Reset ODO, 140ms	SOT-23-5	28ek	VD4	6k	Max
ABCR	MAX6306UK37D4-T	Vdet-IC	3.7V±1.5%, -MR, -Reset ODO, 1120ms	SOT-23-5	28ek	VD4	6k	Max
ABCS	MAX6306UK36D1-T	Vdet-IC	3.6V±1.5%, -MR, -Reset ODO, 1ms	SOT-23-5	28ek	VD4	6k	Max
ABCT	MAX6306UK36D2-T	Vdet-IC	3.6V±1.5%, -MR, -Reset ODO, 20ms	SOT-23-5	28ek	VD4	6k	Max
ABCU	MAX6306UK36D3-T	Vdet-IC	3.6V±1.5%, -MR, -Reset ODO, 140ms	SOT-23-5	28ek	VD4	6k	Max
ABCV	MAX6306UK36D4-T	Vdet-IC	3.6V±1.5%, -MR, -Reset ODO, 1120ms	SOT-23-5	28ek	VD4	6k	Max
ABCW	MAX6306UK35D1-T	Vdet-IC	3.5V±1.5%, -MR, -Reset ODO, 1ms	SOT-23-5	28ek	VD4	6k	Max
ABCX	MAX6306UK35D2-T	Vdet-IC	3.5V±1.5%, -MR, -Reset ODO, 20ms	SOT-23-5	28ek	VD4	6k	Max
ABCY	MAX6306UK35D3-T	Vdet-IC	3.5V±1.5%, -MR, -Reset ODO, 140ms	SOT-23-5	28ek	VD4	6k	Max
ABCZ	MAX6306UK35D4-T	Vdet-IC	3.5V±1.5%, -MR, -Reset ODO, 1120ms	SOT-23-5	28ek	VD4	6k	Max
ABD	RP107N131D	LVR-IC	LDO, 1.3V±1%, 200mA, +CE, CL	SOT-23-5	28cx	VR4	6g	Ric
ABD	XC6211B442MR	LVR-IC	LDO, 4.4V±2%, 240mA, +CE	SOT-25	28vc	VR4	6g	Tor
ABD	XC6114C244MR	Vdet-IC	4.4V±2%, ±Reset PPO, Wt=50ms, Rt=50ms	SOT-25	28xg	VD19	6g	Tor
ABDA	MAX6306UK34D1-T	Vdet-IC	3.4V±1.5%, -MR, -Reset ODO, 1ms	SOT-23-5	28ek	VD4	6k	Max
ABDB	MAX6306UK34D2-T	Vdet-IC	3.4V±1.5%, -MR, -Reset ODO, 20ms	SOT-23-5	28ek	VD4	6k	Max
ABDC	MAX6306UK34D3-T	Vdet-IC	3.4V±1.5%, -MR, -Reset ODO, 140ms	SOT-23-5	28ek	VD4	6k	Max
ABDD	MAX6306UK34D4-T	Vdet-IC	3.4V±1.5%, -MR, -Reset ODO, 1120ms	SOT-23-5	28ek	VD4	6k	Max
ABDE	MAX6306UK33D1-T	Vdet-IC	3.3V±1.5%, -MR, -Reset ODO, 1ms	SOT-23-5	28ek	VD4	6k	Max



SMD code	Type	Function	Short description	Case	Pinout	Sch.	St.	Mnf.
ABDF	MAX6306UK33D2-T	Vdet-IC	3.3V±1.5%, -MR, -Reset ODO, 20ms	SOT-23-5	28ek	VD4	6k	Max
ABDG	MAX6306UK33D3-T	Vdet-IC	3.3V±1.5%, -MR, -Reset ODO, 140ms	SOT-23-5	28ek	VD4	6k	Max
ABDH	MAX6306UK33D4-T	Vdet-IC	3.3V±1.5%, -MR, -Reset ODO, 1120ms	SOT-23-5	28ek	VD4	6k	Max
ABDI	MAX6306UK32D1-T	Vdet-IC	3.2V±1.5%, -MR, -Reset ODO, 1ms	SOT-23-5	28ek	VD4	6k	Max
ABDJ	MAX6306UK32D2-T	Vdet-IC	3.2V±1.5%, -MR, -Reset ODO, 20ms	SOT-23-5	28ek	VD4	6k	Max
ABDK	MAX6306UK32D3-T	Vdet-IC	3.2V±1.5%, -MR, -Reset ODO, 140ms	SOT-23-5	28ek	VD4	6k	Max
ABDL	MAX6306UK32D4-T	Vdet-IC	3.2V±1.5%, -MR, -Reset ODO, 1120ms	SOT-23-5	28ek	VD4	6k	Max
ABDM	MAX6306UK31D1-T	Vdet-IC	3.1V±1.5%, -MR, -Reset ODO, 1ms	SOT-23-5	28ek	VD4	6k	Max
ABDN	MAX6306UK31D2-T	Vdet-IC	3.1V±1.5%, -MR, -Reset ODO, 20ms	SOT-23-5	28ek	VD4	6k	Max
ABDO	MAX6306UK31D3-T	Vdet-IC	3.1V±1.5%, -MR, -Reset ODO, 140ms	SOT-23-5	28ek	VD4	6k	Max
ABDP	MAX6306UK31D4-T	Vdet-IC	3.1V±1.5%, -MR, -Reset ODO, 1120ms	SOT-23-5	28ek	VD4	6k	Max
ABDQ	MAX6306UK30D1-T	Vdet-IC	3.0V±1.5%, -MR, -Reset ODO, 1ms	SOT-23-5	28ek	VD4	6k	Max
ABDR	MAX6306UK30D2-T	Vdet-IC	3.0V±1.5%, -MR, -Reset ODO, 20ms	SOT-23-5	28ek	VD4	6k	Max
ABDS	MAX6306UK30D3-T	Vdet-IC	3.0V±1.5%, -MR, -Reset ODO, 140ms	SOT-23-5	28ek	VD4	6k	Max
ABDT	MAX6306UK30D4-T	Vdet-IC	3.0V±1.5%, -MR, -Reset ODO, 1120ms	SOT-23-5	28ek	VD4	6k	Max
ABDU	MAX6306UK29D1-T	Vdet-IC	2.9V±1.5%, -MR, -Reset ODO, 1ms	SOT-23-5	28ek	VD4	6k	Max
ABDV	MAX6306UK29D2-T	Vdet-IC	2.9V±1.5%, -MR, -Reset ODO, 20ms	SOT-23-5	28ek	VD4	6k	Max
ABDW	MAX6306UK29D3-T	Vdet-IC	2.9V±1.5%, -MR, -Reset ODO, 140ms	SOT-23-5	28ek	VD4	6k	Max
ABDX	MAX6306UK29D4-T	Vdet-IC	2.9V±1.5%, -MR, -Reset ODO, 1120ms	SOT-23-5	28ek	VD4	6k	Max
ABDY	MAX6306UK28D1-T	Vdet-IC	2.8V±1.5%, -MR, -Reset ODO, 1ms	SOT-23-5	28ek	VD4	6k	Max
ABDZ	MAX6306UK28D2-T	Vdet-IC	2.8V±1.5%, -MR, -Reset ODO, 20ms	SOT-23-5	28ek	VD4	6k	Max
ABE	RP107N141D	LVR-IC	LDO, 1.4V±1%, 200mA, +CE, CL	SOT-23-5	28cx	VR4	6g	Ric
ABE	XC6211B452MR	LVR-IC	LDO, 4.5V±2%, 240mA, +CE	SOT-25	28vc	VR4	6g	Tor
ĀBE	XC6114C245MR	Vdet-IC	4.5V±2%, ±Reset PPO, Wt=50ms, Rt=50ms	SOT-25	28gx	VD19	6g	Tor
ABEA	MAX6306UK28D3-T	Vdet-IC	2.8V±1.5%, -MR, -Reset ODO, 140ms	SOT-23-5	28ek	VD4	6k	Max
ABEB	MAX6306UK28D4-T	Vdet-IC	2.8V±1.5%, -MR, -Reset ODO, 1120ms	SOT-23-5	28ek	VD4	6k	Max
ABEC	MAX6306UK27D1-T	Vdet-IC	2.7V±1.5%, -MR, -Reset ODO, 1ms	SOT-23-5	28ek	VD4	6k	Max
ABED	MAX6306UK27D2-T	Vdet-IC	2.7V±1.5%, -MR, -Reset ODO, 20ms	SOT-23-5	28ek	VD4	6k	Max
ABEE	MAX6306UK27D3-T	Vdet-IC	2.7V±1.5%, -MR, -Reset ODO, 140ms	SOT-23-5	28ek	VD4	6k	Max
ABEF	MAX6306UK27D4-T	Vdet-IC	2.7V±1.5%, -MR, -Reset ODO, 1120ms	SOT-23-5	28ek	VD4	6k	Max
ABEG	MAX6306UK26D1-T	Vdet-IC	2.6V±1.5%, -MR, -Reset ODO, 1ms	SOT-23-5	28ek	VD4	6k	Max
ABEH	MAX6306UK26D2-T	Vdet-IC	2.6V±1.5%, -MR, -Reset ODO, 20ms	SOT-23-5	28ek	VD4	6k	Max
ABEI	MAX6306UK26D3-T	Vdet-IC	2.6V±1.5%, -MR, -Reset ODO, 140ms	SOT-23-5	28ek	VD4	6k	Max
ABEJ	MAX6306UK26D4-T	Vdet-IC	2.6V±1.5%, -MR, -Reset ODO, 1120ms	SOT-23-5	28ek	VD4	6k	Max
ABEK	MAX6306UK25D1-T	Vdet-IC	2.5V±1.5%, -MR, -Reset ODO, 1ms	SOT-23-5	28ek	VD4	6k	Max
ABEL	MAX6306UK25D2-T	Vdet-IC	2.5V±1.5%, -MR, -Reset ODO, 20ms	SOT-23-5	28ek	VD4	6k	Max
ABEM	MAX6306UK25D3-T	Vdet-IC	2.5V±1.5%, -MR, -Reset ODO, 140ms	SOT-23-5	28ek	VD4	6k	Max
ABEN	MAX6306UK25D4-T	Vdet-IC	2.5V±1.5%, -MR, -Reset ODO, 1120ms	SOT-23-5	28ek	VD4	6k	Max
ABEO	MAX6307UK50D1-T	Vdet-IC	5.0V±1.5%, OVIn, -Reset ODO, 1ms	SOT-23-5	28em	VD13	6k	Max
ABEP	MAX6307UK50D2-T	Vdet-IC	5.0V±1.5%, OVIn, -Reset ODO, 20ms	SOT-23-5	28em	VD13	6k	Max
ABEQ	MAX6307UK50D3-T	Vdet-IC	5.0V±1.5%, OVIn, -Reset ODO, 140ms	SOT-23-5	28em	VD13	6k	Max
ABER	MAX6307UK50D4-T	Vdet-IC	5.0V±1.5%, OVIn, -Reset ODO, 1120ms	SOT-23-5	28em	VD13	6k	Max
ABES	MAX6307UK49D1-T	Vdet-IC	4.9V±1.5%, OVIn, -Reset ODO, 1ms	SOT-23-5	28em	VD13	6k	Max
ABET	MAX6307UK49D2-T	Vdet-IC	4.9V±1.5%, OVIn, -Reset ODO, 20ms	SOT-23-5	28em	VD13	6k	Max
ABEU	MAX6307UK49D3-T	Vdet-IC	4.9V±1.5%, OVIn, -Reset ODO, 140ms	SOT-23-5	28em	VD13	6k	Max
ABEV	MAX6307UK49D4-T	Vdet-IC	4.9V±1.5%, OVIn, -Reset ODO, 1120ms	SOT-23-5	28em	VD13	6k	Max
ABEW	MAX6307UK48D1-T	Vdet-IC	4.8V±1.5%, OVIn, -Reset ODO, 1ms	SOT-23-5	28em	VD13	6k	Max
ABEX	MAX6307UK48D2-T	Vdet-IC	4.8V±1.5%, OVIn, -Reset ODO, 20ms	SOT-23-5	28em	VD13	6k	Max
ABEY	MAX6307UK48D3-T	Vdet-IC	4.8V±1.5%, OVIn, -Reset ODO, 140ms	SOT-23-5	28em	VD13	6k	Max
ABEZ	MAX6307UK48D4-T	Vdet-IC	4.8V±1.5%, OVIn, -Reset ODO, 1120ms	SOT-23-5	28em	VD13	6k	Max
ABF	LM4041AIX3-1.2	Vref-IC	Precision, Shunt, 1.225V, 0.1%	SC-70-5	28dq	RF1	6k	Max
ABF	RP107N151D	LVR-IC	LDO, 1.5V±1%, 200mA, +CE, CL	SOT-23-5	28cx	VR4	6g	Ric
ABF	XC6211B462MR	LVR-IC	LDO, 4.6V±2%, 240mA, +CE	SOT-25	28vc	VR4	6g	Tor
ĀBF	XC6114C216MR	Vdet-IC	1.6V±2%, ±Reset PPO, Wt=50ms, Rt=50ms	SOT-25	28gx	VD19	6g	Tor
ĀBF	XC6114C246MR	Vdet-IC	4.6V±2%, ±Reset PPO, Wt=50ms, Rt=50ms	SOT-25	28gx	VD19	6g	Tor
ABF	XC6365A155MR	DC/DC-IC	PWM st-down, 500kHz, 1.5V±2.5%, 1A, +CE	SOT-25	28zm	DC7	6g	Tor
ABF	XC6367A155MR	DC/DC-IC	PWM step-up, 1.5V±2.5%, 200mA, 500kHz, +CE	SOT-25	28sh	DC11	6g	Tor
ABFA	MAX6307UK47D1-T	Vdet-IC	4.7V±1.5%, OVIn, -Reset ODO, 1ms	SOT-23-5	28em	VD13	6k	Max
ABFB	MAX6307UK47D2-T	Vdet-IC	4.7V±1.5%, OVIn, -Reset ODO, 20ms	SOT-23-5	28em	VD13	6k	Max
ABFC	MAX6307UK47D3-T	Vdet-IC	4.7V±1.5%, OVIn, -Reset ODO, 140ms	SOT-23-5	28em	VD13	6k	Max
ABFD	MAX6307UK47D4-T	Vdet-IC	4.7V±1.5%, OVIn, -Reset ODO, 1120ms	SOT-23-5	28em	VD13	6k	Max
ABFE	MAX6307UK46D1-T	Vdet-IC	4.6V±1.5%, OVIn, -Reset ODO, 1ms	SOT-23-5	28em	VD13	6k	Max
ABFF	MAX6307UK46D2-T	Vdet-IC	4.6V±1.5%, OVIn, -Reset ODO, 20ms	SOT-23-5	28em	VD13	6k	Max
ABFG	MAX6307UK46D3-T	Vdet-IC	4.6V±1.5%, OVIn, -Reset ODO, 140ms	SOT-23-5	28em	VD13	6k	Max
ABFH	MAX6307UK46D4-T	Vdet-IC	4.6V±1.5%, OVIn, -Reset ODO, 1120ms	SOT-23-5	28em	VD13	6k	Max
ABFI	MAX6307UK45D1-T	Vdet-IC	4.5V±1.5%, OVIn, -Reset ODO, 1ms	SOT-23-5	28em	VD13	6k	Max
ABFJ	MAX6307UK45D2-T	Vdet-IC	4.5V±1.5%, OVIn, -Reset ODO, 20ms	SOT-23-5	28em	VD13	6k	Max
ABFK	MAX6307UK45D3-T	Vdet-IC	4.5V±1.5%, OVIn, -Reset ODO, 140ms	SOT-23-5	28em	VD13	6k	Max
ABFL	MAX6307UK45D4-T	Vdet-IC	4.5V±1.5%, OVIn, -Reset ODO, 1120ms	SOT-23-5	28em	VD13	6k	Max
ABFM	MAX6307UK44D1-T	Vdet-IC	4.4V±1.5%, OVIn, -Reset ODO, 1ms	SOT-23-5	28em	VD13	6k	Max



SMD code	Type	Function	Short description	Case	Pinout	Sch.	St.	Mnf.
ABFN	MAX6307UK44D2-T	Vdet-IC	4.4V±1.5%, OVIn, -Reset ODO, 20ms	SOT-23-5	28em	VD13	6k	Max
ABFO	MAX6307UK44D3-T	Vdet-IC	4.4V±1.5%, OVIn, -Reset ODO, 140ms	SOT-23-5	28em	VD13	6k	Max
ABFP	MAX6307UK44D4-T	Vdet-IC	4.4V±1.5%, OVIn, -Reset ODO, 1120ms	SOT-23-5	28em	VD13	6k	Max
ABFQ	MAX6307UK43D1-T	Vdet-IC	4.3V±1.5%, OVIn, -Reset ODO, 1ms	SOT-23-5	28em	VD13	6k	Max
ABFR	MAX6307UK43D2-T	Vdet-IC	4.3V±1.5%, OVIn, -Reset ODO, 20ms	SOT-23-5	28em	VD13	6k	Max
ABFS	MAX6307UK43D3-T	Vdet-IC	4.3V±1.5%, OVIn, -Reset ODO, 140ms	SOT-23-5	28em	VD13	6k	Max
ABFT	MAX6307UK43D4-T	Vdet-IC	4.3V±1.5%, OVIn, -Reset ODO, 1120ms	SOT-23-5	28em	VD13	6k	Max
ABFU	MAX6307UK42D1-T	Vdet-IC	4.2V±1.5%, OVIn, -Reset ODO, 1ms	SOT-23-5	28em	VD13	6k	Max
ABFV	MAX6307UK42D2-T	Vdet-IC	4.2V±1.5%, OVIn, -Reset ODO, 20ms	SOT-23-5	28em	VD13	6k	Max
ABFW	MAX6307UK42D3-T	Vdet-IC	4.2V±1.5%, OVIn, -Reset ODO, 140ms	SOT-23-5	28em	VD13	6k	Max
ABFX	MAX6307UK42D4-T	Vdet-IC	4.2V±1.5%, OVIn, -Reset ODO, 1120ms	SOT-23-5	28em	VD13	6k	Max
ABFY	MAX6307UK41D1-T	Vdet-IC	4.1V±1.5%, OVIn, -Reset ODO, 1ms	SOT-23-5	28em	VD13	6k	Max
ABFZ	MAX6307UK41D2-T	Vdet-IC	4.1V±1.5%, OVIn, -Reset ODO, 20ms	SOT-23-5	28em	VD13	6k	Max
ABG	LM4041BIX3-1.2	Vref-IC	Precision, Shunt, 1.225V, 0.2%	SC-70-5	28dq	RF1	6k	Max
ABG	RP107N161D	LVR-IC	LDO, 1.6V±1%, 200mA, +CE, CL	SOT-23-5	28cx	VR4	6g	Ric
ABGA	MAX6307UK41D3-T	Vdet-IC	4.1V±1.5%, OVIn, -Reset ODO, 140ms	SOT-23-5	28em	VD13	6k	Max
ABGB	MAX6307UK41D4-T	Vdet-IC	4.1V±1.5%, OVIn, -Reset ODO, 1120ms	SOT-23-5	28em	VD13	6k	Max
ABGC	MAX6307UK40D1-T	Vdet-IC	4.0V±1.5%, OVIn, -Reset ODO, 1ms	SOT-23-5	28em	VD13	6k	Max
ABGD	MAX6307UK40D2-T	Vdet-IC	4.0V±1.5%, OVIn, -Reset ODO, 20ms	SOT-23-5	28em	VD13	6k	Max
ABGE	MAX6307UK40D3-T	Vdet-IC	4.0V±1.5%, OVIn, -Reset ODO, 140ms	SOT-23-5	28em	VD13	6k	Max
ABGF	MAX6307UK40D4-T	Vdet-IC	4.0V±1.5%, OVIn, -Reset ODO, 1120ms	SOT-23-5	28em	VD13	6k	Max
ABGG	MAX6307UK39D1-T	Vdet-IC	3.9V±1.5%, OVIn, -Reset ODO, 1ms	SOT-23-5	28em	VD13	6k	Max
ABGH	MAX6307UK39D2-T	Vdet-IC	3.9V±1.5%, OVIn, -Reset ODO, 20ms	SOT-23-5	28em	VD13	6k	Max
ABGI	MAX6307UK39D3-T	Vdet-IC	3.9V±1.5%, OVIn, -Reset ODO, 140ms	SOT-23-5	28em	VD13	6k	Max
ABGJ	MAX6307UK39D4-T	Vdet-IC	3.9V±1.5%, OVIn, -Reset ODO, 1120ms	SOT-23-5	28em	VD13	6k	Max
ABGK	MAX6307UK38D1-T	Vdet-IC	3.8V±1.5%, OVIn, -Reset ODO, 1ms	SOT-23-5	28em	VD13	6k	Max
ABGL	MAX6307UK38D2-T	Vdet-IC	3.8V±1.5%, OVIn, -Reset ODO, 20ms	SOT-23-5	28em	VD13	6k	Max
ABGM	MAX6307UK38D3-T	Vdet-IC	3.8V±1.5%, OVIn, -Reset ODO, 140ms	SOT-23-5	28em	VD13	6k	Max
ABGN	MAX6307UK38D4-T	Vdet-IC	3.8V±1.5%, OVIn, -Reset ODO, 1120ms	SOT-23-5	28em	VD13	6k	Max
ABGO	MAX6307UK37D1-T	Vdet-IC	3.7V±1.5%, OVIn, -Reset ODO, 1ms	SOT-23-5	28em	VD13	6k	Max
ABGP	MAX6307UK37D2-T	Vdet-IC	3.7V±1.5%, OVIn, -Reset ODO, 20ms	SOT-23-5	28em	VD13	6k	Max
ABGQ	MAX6307UK37D3-T	Vdet-IC	3.7V±1.5%, OVIn, -Reset ODO, 140ms	SOT-23-5	28em	VD13	6k	Max
ABGR	MAX6307UK37D4-T	Vdet-IC	3.7V±1.5%, OVIn, -Reset ODO, 1120ms	SOT-23-5	28em	VD13	6k	Max
ABGS	MAX6307UK36D1-T	Vdet-IC	3.6V±1.5%, OVIn, -Reset ODO, 1ms	SOT-23-5	28em	VD13	6k	Max
ABGT	MAX6307UK36D2-T	Vdet-IC	3.6V±1.5%, OVIn, -Reset ODO, 20ms	SOT-23-5	28em	VD13	6k	Max
ABGU	MAX6307UK36D3-T	Vdet-IC	3.6V±1.5%, OVIn, -Reset ODO, 140ms	SOT-23-5	28em	VD13	6k	Max
ABGV	MAX6307UK36D4-T	Vdet-IC	3.6V±1.5%, OVIn, -Reset ODO, 1120ms	SOT-23-5	28em	VD13	6k	Max
ABGW	MAX6307UK35D1-T	Vdet-IC	3.5V±1.5%, OVIn, -Reset ODO, 1ms	SOT-23-5	28em	VD13	6k	Max
ABGX	MAX6307UK35D2-T	Vdet-IC	3.5V±1.5%, OVIn, -Reset ODO, 20ms	SOT-23-5	28em	VD13	6k	Max
ABGY	MAX6307UK35D3-T	Vdet-IC	3.5V±1.5%, OVIn, -Reset ODO, 140ms	SOT-23-5	28em	VD13	6k	Max
ABGZ	MAX6307UK35D4-T	Vdet-IC	3.5V±1.5%, OVIn, -Reset ODO, 1120ms	SOT-23-5	28em	VD13	6k	Max
ABH	LM4041DIX3-1.2	Vref-IC	Precision, Shunt, 1.225V, 0.5%	SC-70-5	28dq	RF1	6k	Max
ABH	RP107N171D	LVR-IC	LDO, 1.7V±1%, 200mA, +CE, CL	SOT-23-5	28cx	VR4	6g	Ric
ABH	XC6211B472MR	LVR-IC	LDO, 4.7V±2%, 240mA, +CE	SOT-25	28vc	VR4	6g	Tor
ĀBH	XC6114C217MR	Vdet-IC	1.7V±2%, ±Reset PPO, Wt=50ms, Rt=50ms	SOT-25	28xg	VD19	6g	Tor
ĀBH	XC6114C247MR	Vdet-IC	4.7V±2%, ±Reset PPO, Wt=50ms, Rt=50ms	SOT-25	28xg	VD19	6g	Tor
ABH	XC6365A165MR	DC/DC-IC	PWM st-down, 500kHz, 1.6V±2.5%, 1A, +CE	SOT-25	28zm	DC7	6g	Tor
ABH	XC6367A165MR	DC/DC-IC	PWM step-up, 1.6V±2.5%, 200mA, 500kHz, +CE	SOT-25	28sh	DC11	6g	Tor
ABHA	MAX6307UK34D1-T	Vdet-IC	3.4V±1.5%, OVIn, -Reset ODO, 1ms	SOT-23-5	28em	VD13	6k	Max
ABHB	MAX6307UK34D2-T	Vdet-IC	3.4V±1.5%, OVIn, -Reset ODO, 20ms	SOT-23-5	28em	VD13	6k	Max
ABHC	MAX6307UK34D3-T	Vdet-IC	3.4V±1.5%, OVIn, -Reset ODO, 140ms	SOT-23-5	28em	VD13	6k	Max
ABHD	MAX6307UK34D4-T	Vdet-IC	3.4V±1.5%, OVIn, -Reset ODO, 1120ms	SOT-23-5	28em	VD13	6k	Max
ABHE	MAX6307UK33D1-T	Vdet-IC	3.3V±1.5%, OVIn, -Reset ODO, 1ms	SOT-23-5	28em	VD13	6k	Max
ABHF	MAX6307UK33D2-T	Vdet-IC	3.3V±1.5%, OVIn, -Reset ODO, 20ms	SOT-23-5	28em	VD13	6k	Max
ABHG	MAX6307UK33D3-T	Vdet-IC	3.3V±1.5%, OVIn, -Reset ODO, 140ms	SOT-23-5	28em	VD13	6k	Max
ABHH	MAX6307UK33D4-T	Vdet-IC	3.3V±1.5%, OVIn, -Reset ODO, 1120ms	SOT-23-5	28em	VD13	6k	Max
ABHI	MAX6307UK32D1-T	Vdet-IC	3.2V±1.5%, OVIn, -Reset ODO, 1ms	SOT-23-5	28em	VD13	6k	Max
ABHJ	MAX6307UK32D2-T	Vdet-IC	3.2V±1.5%, OVIn, -Reset ODO, 20ms	SOT-23-5	28em	VD13	6k	Max
ABHK	MAX6307UK32D3-T	Vdet-IC	3.2V±1.5%, OVIn, -Reset ODO, 140ms	SOT-23-5	28em	VD13	6k	Max
ABHL	MAX6307UK32D4-T	Vdet-IC	3.2V±1.5%, OVIn, -Reset ODO, 1120ms	SOT-23-5	28em	VD13	6k	Max
ABHM	MAX6307UK31D1-T	Vdet-IC	3.1V±1.5%, OVIn, -Reset ODO, 1ms	SOT-23-5	28em	VD13	6k	Max
ABHN	MAX6307UK31D2-T	Vdet-IC	3.1V±1.5%, OVIn, -Reset ODO, 20ms	SOT-23-5	28em	VD13	6k	Max
ABHO	MAX6307UK31D3-T	Vdet-IC	3.1V±1.5%, OVIn, -Reset ODO, 140ms	SOT-23-5	28em	VD13	6k	Max
ABHP	MAX6307UK31D4-T	Vdet-IC	3.1V±1.5%, OVIn, -Reset ODO, 1120ms	SOT-23-5	28em	VD13	6k	Max
ABHQ	MAX6307UK30D1-T	Vdet-IC	3.0V±1.5%, OVIn, -Reset ODO, 1ms	SOT-23-5	28em	VD13	6k	Max
ABHR	MAX6307UK30D2-T	Vdet-IC	3.0V±1.5%, OVIn, -Reset ODO, 20ms	SOT-23-5	28em	VD13	6k	Max
ABHS	MAX6307UK30D3-T	Vdet-IC	3.0V±1.5%, OVIn, -Reset ODO, 140ms	SOT-23-5	28em	VD13	6k	Max
ABHT	MAX6307UK30D4-T	Vdet-IC	3.0V±1.5%, OVIn, -Reset ODO, 1120ms	SOT-23-5	28em	VD13	6k	Max
ABHU	MAX6307UK29D1-T	Vdet-IC	2.9V±1.5%, OVIn, -Reset ODO, 1ms	SOT-23-5	28em	VD13	6k	Max
ABHV	MAX6307UK29D2-T	Vdet-IC	2.9V±1.5%, OVIn, -Reset ODO, 20ms	SOT-23-5	28em	VD13	6k	Max



SMD code	Type	Function	Short description	Case	Pinout	Sch.	St.	Mnf.
ABHW	MAX6307UK29D3-T	Vdet-IC	2.9V±1.5%, OVIn, -Reset ODO, 140ms	SOT-23-5	28em	VD13	6k	Max
ABHX	MAX6307UK29D4-T	Vdet-IC	2.9V±1.5%, OVIn, -Reset ODO, 1120ms	SOT-23-5	28em	VD13	6k	Max
ABHY	MAX6307UK28D1-T	Vdet-IC	2.8V±1.5%, OVIn, -Reset ODO, 1ms	SOT-23-5	28em	VD13	6k	Max
ABHZ	MAX6307UK28D2-T	Vdet-IC	2.8V±1.5%, OVIn, -Reset ODO, 20ms	SOT-23-5	28em	VD13	6k	Max
ABIA	MAX6307UK28D3-T	Vdet-IC	2.8V±1.5%, OVIn, -Reset ODO, 140ms	SOT-23-5	28em	VD13	6k	Max
ABIB	MAX6307UK28D4-T	Vdet-IC	2.8V±1.5%, OVIn, -Reset ODO, 1120ms	SOT-23-5	28em	VD13	6k	Max
ABIC	MAX6307UK27D1-T	Vdet-IC	2.7V±1.5%, OVIn, -Reset ODO, 1ms	SOT-23-5	28em	VD13	6k	Max
ABID	MAX6307UK27D2-T	Vdet-IC	2.7V±1.5%, OVIn, -Reset ODO, 20ms	SOT-23-5	28em	VD13	6k	Max
ABIE	MAX6307UK27D3-T	Vdet-IC	2.7V±1.5%, OVIn, -Reset ODO, 140ms	SOT-23-5	28em	VD13	6k	Max
ABIF	MAX6307UK27D4-T	Vdet-IC	2.7V±1.5%, OVIn, -Reset ODO, 1120ms	SOT-23-5	28em	VD13	6k	Max
ABIG	MAX6307UK26D1-T	Vdet-IC	2.6V±1.5%, OVIn, -Reset ODO, 1ms	SOT-23-5	28em	VD13	6k	Max
ABIH	MAX6307UK26D2-T	Vdet-IC	2.6V±1.5%, OVIn, -Reset ODO, 20ms	SOT-23-5	28em	VD13	6k	Max
ABII	MAX6307UK26D3-T	Vdet-IC	2.6V±1.5%, OVIn, -Reset ODO, 140ms	SOT-23-5	28em	VD13	6k	Max
ABIJ	MAX6307UK26D4-T	Vdet-IC	2.6V±1.5%, OVIn, -Reset ODO, 1120ms	SOT-23-5	28em	VD13	6k	Max
ABIK	MAX6307UK25D1-T	Vdet-IC	2.5V±1.5%, OVIn, -Reset ODO, 1ms	SOT-23-5	28em	VD13	6k	Max
ABIL	MAX6307UK25D2-T	Vdet-IC	2.5V±1.5%, OVIn, -Reset ODO, 20ms	SOT-23-5	28em	VD13	6k	Max
ABIM	MAX6307UK25D3-T	Vdet-IC	2.5V±1.5%, OVIn, -Reset ODO, 140ms	SOT-23-5	28em	VD13	6k	Max
ABIN	MAX6307UK25D4-T	Vdet-IC	2.5V±1.5%, OVIn, -Reset ODO, 1120ms	SOT-23-5	28em	VD13	6k	Max
ABIS	MAX6309UK50D1-T	Vdet-IC	5.0V±1.5%, -MR, -Reset PPO, 1ms	SOT-23-5	28ek	VD5	6k	Max
ABIT	MAX6309UK50D2-T	Vdet-IC	5.0V±1.5%, -MR, -Reset PPO, 20ms	SOT-23-5	28ek	VD5	6k	Max
ABIU	MAX6309UK50D3-T	Vdet-IC	5.0V±1.5%, -MR, -Reset PPO, 140ms	SOT-23-5	28ek	VD5	6k	Max
ABIV	MAX6309UK50D4-T	Vdet-IC	5.0V±1.5%, -MR, -Reset PPO, 1120ms	SOT-23-5	28ek	VD5	6k	Max
ABIW	MAX6309UK49D1-T	Vdet-IC	4.9V±1.5%, -MR, -Reset PPO, 1ms	SOT-23-5	28ek	VD5	6k	Max
ABIX	MAX6309UK49D2-T	Vdet-IC	4.9V±1.5%, -MR, -Reset PPO, 20ms	SOT-23-5	28ek	VD5	6k	Max
ABIY	MAX6309UK49D3-T	Vdet-IC	4.9V±1.5%, -MR, -Reset PPO, 140ms	SOT-23-5	28ek	VD5	6k	Max
ABIZ	MAX6309UK49D4-T	Vdet-IC	4.9V±1.5%, -MR, -Reset PPO, 1120ms	SOT-23-5	28ek	VD5	6k	Max
ABJ	LM4040AIX3-2.1	Vref-IC	Precision, Shunt, 2.048V, 0.1%	SC-70-5	28dq	RF1	6k	Max
ABJ	RP107N181D	LVR-IC	LDO, 1.8V±1%, 200mA, +CE, CL	SOT-23-5	28cx	VR4	6g	Ric
ABJA	MAX6309UK48D1-T	Vdet-IC	4.8V±1.5%, -MR, -Reset PPO, 1ms	SOT-23-5	28ek	VD5	6k	Max
ABJB	MAX6309UK48D2-T	Vdet-IC	4.8V±1.5%, -MR, -Reset PPO, 20ms	SOT-23-5	28ek	VD5	6k	Max
ABJC	MAX6309UK48D3-T	Vdet-IC	4.8V±1.5%, -MR, -Reset PPO, 140ms	SOT-23-5	28ek	VD5	6k	Max
ABJD	MAX6309UK48D4-T	Vdet-IC	4.8V±1.5%, -MR, -Reset PPO, 1120ms	SOT-23-5	28ek	VD5	6k	Max
ABJE	MAX6309UK47D1-T	Vdet-IC	4.7V±1.5%, -MR, -Reset PPO, 1ms	SOT-23-5	28ek	VD5	6k	Max
ABJF	MAX6309UK47D2-T	Vdet-IC	4.7V±1.5%, -MR, -Reset PPO, 20ms	SOT-23-5	28ek	VD5	6k	Max
ABJG	MAX6309UK47D3-T	Vdet-IC	4.7V±1.5%, -MR, -Reset PPO, 140ms	SOT-23-5	28ek	VD5	6k	Max
ABJH	MAX6309UK47D4-T	Vdet-IC	4.7V±1.5%, -MR, -Reset PPO, 1120ms	SOT-23-5	28ek	VD5	6k	Max
ABJI	MAX6309UK46D1-T	Vdet-IC	4.6V±1.5%, -MR, -Reset PPO, 1ms	SOT-23-5	28ek	VD5	6k	Max
ABJJ	MAX6309UK46D2-T	Vdet-IC	4.6V±1.5%, -MR, -Reset PPO, 20ms	SOT-23-5	28ek	VD5	6k	Max
ABJK	MAX6309UK46D3-T	Vdet-IC	4.6V±1.5%, -MR, -Reset PPO, 140ms	SOT-23-5	28ek	VD5	6k	Max
ABJL	MAX6309UK46D4-T	Vdet-IC	4.6V±1.5%, -MR, -Reset PPO, 1120ms	SOT-23-5	28ek	VD5	6k	Max
ABJM	MAX6309UK45D1-T	Vdet-IC	4.5V±1.5%, -MR, -Reset PPO, 1ms	SOT-23-5	28ek	VD5	6k	Max
ABJN	MAX6309UK45D2-T	Vdet-IC	4.5V±1.5%, -MR, -Reset PPO, 20ms	SOT-23-5	28ek	VD5	6k	Max
ABJO	MAX6309UK45D3-T	Vdet-IC	4.5V±1.5%, -MR, -Reset PPO, 140ms	SOT-23-5	28ek	VD5	6k	Max
ABJP	MAX6309UK45D4-T	Vdet-IC	4.5V±1.5%, -MR, -Reset PPO, 1120ms	SOT-23-5	28ek	VD5	6k	Max
ABJQ	MAX6309UK44D1-T	Vdet-IC	4.4V±1.5%, -MR, -Reset PPO, 1ms	SOT-23-5	28ek	VD5	6k	Max
ABJR	MAX6309UK44D2-T	Vdet-IC	4.4V±1.5%, -MR, -Reset PPO, 20ms	SOT-23-5	28ek	VD5	6k	Max
ABJS	MAX6309UK44D3-T	Vdet-IC	4.4V±1.5%, -MR, -Reset PPO, 140ms	SOT-23-5	28ek	VD5	6k	Max
ABJT	MAX6309UK44D4-T	Vdet-IC	4.4V±1.5%, -MR, -Reset PPO, 1120ms	SOT-23-5	28ek	VD5	6k	Max
ABJU	MAX6309UK43D1-T	Vdet-IC	4.3V±1.5%, -MR, -Reset PPO, 1ms	SOT-23-5	28ek	VD5	6k	Max
ABJV	MAX6309UK43D2-T	Vdet-IC	4.3V±1.5%, -MR, -Reset PPO, 20ms	SOT-23-5	28ek	VD5	6k	Max
ABJW	MAX6309UK43D3-T	Vdet-IC	4.3V±1.5%, -MR, -Reset PPO, 140ms	SOT-23-5	28ek	VD5	6k	Max
ABJX	MAX6309UK43D4-T	Vdet-IC	4.3V±1.5%, -MR, -Reset PPO, 1120ms	SOT-23-5	28ek	VD5	6k	Max
ABJY	MAX6309UK42D1-T	Vdet-IC	4.2V±1.5%, -MR, -Reset PPO, 1ms	SOT-23-5	28ek	VD5	6k	Max
ABJZ	MAX6309UK42D2-T	Vdet-IC	4.2V±1.5%, -MR, -Reset PPO, 20ms	SOT-23-5	28ek	VD5	6k	Max
ABK	LM4040BIX3-2.1	Vref-IC	Precision, Shunt, 2.048V, 0.2%	SC-70-5	28dq	RF1	6k	Max
ABK	RP107N191D	LVR-IC	LDO, 1.9V±1%, 200mA, +CE, CL	SOT-23-5	28cx	VR4	6g	Ric
ABK	XC6211B482MR	LVR-IC	LDO, 4.8V±2%, 240mA, +CE	SOT-25	28vc	VR4	6g	Tor
ABK	XC6114C218MR	Vdet-IC	1.8V±2%, ±Reset PPO, Wt=50ms, Rt=50ms	SOT-25	28gv	VD19	6g	Tor
ABK	XC6114C248MR	Vdet-IC	4.8V±2%, ±Reset PPO, Wt=50ms, Rt=50ms	SOT-25	28gv	VD19	6g	Tor
ABK	XC6365A175MR	DC/DC-IC	PWM st-down, 500kHz, 1.7V±2.5%, 1A, +CE	SOT-25	28zm	DC7	6g	Tor
ABK	XC6367A175MR	DC/DC-IC	PWM step-up, 1.7V±2.5%, 200mA, 500kHz, +CE	SOT-25	28sh	DC11	6g	Tor
ABKA	MAX6309UK42D3-T	Vdet-IC	4.2V±1.5%, -MR, -Reset PPO, 140ms	SOT-23-5	28ek	VD5	6k	Max
ABKB	MAX6309UK42D4-T	Vdet-IC	4.2V±1.5%, -MR, -Reset PPO, 1120ms	SOT-23-5	28ek	VD5	6k	Max
ABKC	MAX6309UK41D1-T	Vdet-IC	4.1V±1.5%, -MR, -Reset PPO, 1ms	SOT-23-5	28ek	VD5	6k	Max
ABKD	MAX6309UK41D2-T	Vdet-IC	4.1V±1.5%, -MR, -Reset PPO, 20ms	SOT-23-5	28ek	VD5	6k	Max
ABKE	MAX6309UK41D3-T	Vdet-IC	4.1V±1.5%, -MR, -Reset PPO, 140ms	SOT-23-5	28ek	VD5	6k	Max
ABKF	MAX6309UK41D4-T	Vdet-IC	4.1V±1.5%, -MR, -Reset PPO, 1120ms	SOT-23-5	28ek	VD5	6k	Max
ABKG	MAX6309UK40D1-T	Vdet-IC	4.0V±1.5%, -MR, -Reset PPO, 1ms	SOT-23-5	28ek	VD5	6k	Max
ABKH	MAX6309UK40D2-T	Vdet-IC	4.0V±1.5%, -MR, -Reset PPO, 20ms	SOT-23-5	28ek	VD5	6k	Max
ABKI	MAX6309UK40D3-T	Vdet-IC	4.0V±1.5%, -MR, -Reset PPO, 140ms	SOT-23-5	28ek	VD5	6k	Max



SMD code	Type	Function	Short description	Case	Pinout	Sch.	St.	Mnf.
ABKJ	MAX6309UK40D4-T	Vdet-IC	4.0V±1.5%, -MR, -Reset PPO, 1120ms	SOT-23-5	28ek	VD5	6k	Max
ABKK	MAX6309UK39D1-T	Vdet-IC	3.9V±1.5%, -MR, -Reset PPO, 1ms	SOT-23-5	28ek	VD5	6k	Max
ABKL	MAX6309UK39D2-T	Vdet-IC	3.9V±1.5%, -MR, -Reset PPO, 20ms	SOT-23-5	28ek	VD5	6k	Max
ABKM	MAX6309UK39D3-T	Vdet-IC	3.9V±1.5%, -MR, -Reset PPO, 140ms	SOT-23-5	28ek	VD5	6k	Max
ABKN	MAX6309UK39D4-T	Vdet-IC	3.9V±1.5%, -MR, -Reset PPO, 1120ms	SOT-23-5	28ek	VD5	6k	Max
ABKO	MAX6309UK38D1-T	Vdet-IC	3.8V±1.5%, -MR, -Reset PPO, 1ms	SOT-23-5	28ek	VD5	6k	Max
ABKP	MAX6309UK38D2-T	Vdet-IC	3.8V±1.5%, -MR, -Reset PPO, 20ms	SOT-23-5	28ek	VD5	6k	Max
ABKQ	MAX6309UK38D3-T	Vdet-IC	3.8V±1.5%, -MR, -Reset PPO, 140ms	SOT-23-5	28ek	VD5	6k	Max
ABKR	MAX6309UK38D4-T	Vdet-IC	3.8V±1.5%, -MR, -Reset PPO, 1120ms	SOT-23-5	28ek	VD5	6k	Max
ABKS	MAX6309UK37D1-T	Vdet-IC	3.7V±1.5%, -MR, -Reset PPO, 1ms	SOT-23-5	28ek	VD5	6k	Max
ABKT	MAX6309UK37D2-T	Vdet-IC	3.7V±1.5%, -MR, -Reset PPO, 20ms	SOT-23-5	28ek	VD5	6k	Max
ABKU	MAX6309UK37D3-T	Vdet-IC	3.7V±1.5%, -MR, -Reset PPO, 140ms	SOT-23-5	28ek	VD5	6k	Max
ABKV	MAX6309UK37D4-T	Vdet-IC	3.7V±1.5%, -MR, -Reset PPO, 1120ms	SOT-23-5	28ek	VD5	6k	Max
ABKW	MAX6309UK36D1-T	Vdet-IC	3.6V±1.5%, -MR, -Reset PPO, 1ms	SOT-23-5	28ek	VD5	6k	Max
ABKX	MAX6309UK36D2-T	Vdet-IC	3.6V±1.5%, -MR, -Reset PPO, 20ms	SOT-23-5	28ek	VD5	6k	Max
ABKY	MAX6309UK36D3-T	Vdet-IC	3.6V±1.5%, -MR, -Reset PPO, 140ms	SOT-23-5	28ek	VD5	6k	Max
ABKZ	MAX6309UK36D4-T	Vdet-IC	3.6V±1.5%, -MR, -Reset PPO, 1120ms	SOT-23-5	28ek	VD5	6k	Max
ABL	LM4040CIX3-2.1	Vref-IC	Shunt, 2.048V, 0.5%	SC-70-5	28dq	RF1	6k	Max
ABL	RP107N201D	LVR-IC	LDO, 2.0V±1%, 200mA, +CE, CL	SOT-23-5	28cx	VR4	6g	Ric
ABL	XC6211B492MR	LVR-IC	LDO, 4.9V±2%, 240mA, +CE	SOT-25	28vc	VR4	6g	Tor
ABL	XC6114C219MR	Vdet-IC	1.9V±2%, ±Reset PPO, Wt=50ms, Rt=50ms	SOT-25	28xg	VD19	6g	Tor
ABL	XC6114C249MR	Vdet-IC	4.9V±2%, ±Reset PPO, Wt=50ms, Rt=50ms	SOT-25	28xg	VD19	6g	Tor
ABL	XC6365A185MR	DC/DC-IC	PWM st-down, 500kHz, 1.8V±2.5%, 1A, +CE	SOT-25	28zm	DC7	6g	Tor
ABL	XC6367A185MR	DC/DC-IC	PWM step-up, 1.8V±2.5%, 200mA, 500kHz, +CE	SOT-25	28sh	DC11	6g	Tor
ABLA	MAX6309UK35D1-T	Vdet-IC	3.5V±1.5%, -MR, -Reset PPO, 1ms	SOT-23-5	28ek	VD5	6k	Max
ABLB	MAX6309UK35D2-T	Vdet-IC	3.5V±1.5%, -MR, -Reset PPO, 20ms	SOT-23-5	28ek	VD5	6k	Max
ABLC	MAX6309UK35D3-T	Vdet-IC	3.5V±1.5%, -MR, -Reset PPO, 140ms	SOT-23-5	28ek	VD5	6k	Max
ABLD	MAX6309UK35D4-T	Vdet-IC	3.5V±1.5%, -MR, -Reset PPO, 1120ms	SOT-23-5	28ek	VD5	6k	Max
ABLE	MAX6309UK34D1-T	Vdet-IC	3.4V±1.5%, -MR, -Reset PPO, 1ms	SOT-23-5	28ek	VD5	6k	Max
ABLF	MAX6309UK34D2-T	Vdet-IC	3.4V±1.5%, -MR, -Reset PPO, 20ms	SOT-23-5	28ek	VD5	6k	Max
ABLG	MAX6309UK34D3-T	Vdet-IC	3.4V±1.5%, -MR, -Reset PPO, 140ms	SOT-23-5	28ek	VD5	6k	Max
ABLH	MAX6309UK34D4-T	Vdet-IC	3.4V±1.5%, -MR, -Reset PPO, 1120ms	SOT-23-5	28ek	VD5	6k	Max
ABLI	MAX6309UK33D1-T	Vdet-IC	3.3V±1.5%, -MR, -Reset PPO, 1ms	SOT-23-5	28ek	VD5	6k	Max
ABLJ	MAX6309UK33D2-T	Vdet-IC	3.3V±1.5%, -MR, -Reset PPO, 20ms	SOT-23-5	28ek	VD5	6k	Max
ABLK	MAX6309UK33D3-T	Vdet-IC	3.3V±1.5%, -MR, -Reset PPO, 140ms	SOT-23-5	28ek	VD5	6k	Max
ABLL	MAX6309UK33D4-T	Vdet-IC	3.3V±1.5%, -MR, -Reset PPO, 1120ms	SOT-23-5	28ek	VD5	6k	Max
ABLM	MAX6309UK32D1-T	Vdet-IC	3.2V±1.5%, -MR, -Reset PPO, 1ms	SOT-23-5	28ek	VD5	6k	Max
ABLN	MAX6309UK32D2-T	Vdet-IC	3.2V±1.5%, -MR, -Reset PPO, 20ms	SOT-23-5	28ek	VD5	6k	Max
ABLO	MAX6309UK32D3-T	Vdet-IC	3.2V±1.5%, -MR, -Reset PPO, 140ms	SOT-23-5	28ek	VD5	6k	Max
ABLP	MAX6309UK32D4-T	Vdet-IC	3.2V±1.5%, -MR, -Reset PPO, 1120ms	SOT-23-5	28ek	VD5	6k	Max
ABLQ	MAX6309UK31D1-T	Vdet-IC	3.1V±1.5%, -MR, -Reset PPO, 1ms	SOT-23-5	28ek	VD5	6k	Max
ABLR	MAX6309UK31D2-T	Vdet-IC	3.1V±1.5%, -MR, -Reset PPO, 20ms	SOT-23-5	28ek	VD5	6k	Max
ABLS	MAX6309UK31D3-T	Vdet-IC	3.1V±1.5%, -MR, -Reset PPO, 140ms	SOT-23-5	28ek	VD5	6k	Max
ABLT	MAX6309UK31D4-T	Vdet-IC	3.1V±1.5%, -MR, -Reset PPO, 1120ms	SOT-23-5	28ek	VD5	6k	Max
ABLU	MAX6309UK30D1-T	Vdet-IC	3.0V±1.5%, -MR, -Reset PPO, 1ms	SOT-23-5	28ek	VD5	6k	Max
ABLW	MAX6309UK30D3-T	Vdet-IC	3.0V±1.5%, -MR, -Reset PPO, 140ms	SOT-23-5	28ek	VD5	6k	Max
ABLX	MAX6309UK30D4-T	Vdet-IC	3.0V±1.5%, -MR, -Reset PPO, 1120ms	SOT-23-5	28ek	VD5	6k	Max
ABLY	MAX6309UK29D1-T	Vdet-IC	2.9V±1.5%, -MR, -Reset PPO, 1ms	SOT-23-5	28ek	VD5	6k	Max
ABLZ	MAX6309UK29D2-T	Vdet-IC	2.9V±1.5%, -MR, -Reset PPO, 20ms	SOT-23-5	28ek	VD5	6k	Max
ABM	LM4040DIX3-2.1	Vref-IC	Shunt, 2.048V, 1%	SC-70-5	28dq	RF1	6k	Max
ABM	RP107N211D	LVR-IC	LDO, 2.1V±1%, 200mA, +CE, CL	SOT-23-5	28cx	VR4	6g	Ric
ABM	XC6211B502MR	LVR-IC	LDO, 5V±2%, 240mA, +CE	SOT-25	28vc	VR4	6g	Tor
ABM	XC6114C220MR	Vdet-IC	2.0V±2%, ±Reset PPO, Wt=50ms, Rt=50ms	SOT-25	28xg	VD19	6g	Tor
ABM	XC6114C250MR	Vdet-IC	5.0V±2%, ±Reset PPO, Wt=50ms, Rt=50ms	SOT-25	28xg	VD19	6g	Tor
ABM	XC6365A195MR	DC/DC-IC	PWM st-down, 500kHz, 1.9V±2.5%, 1A, +CE	SOT-25	28zm	DC7	6g	Tor
ABM	XC6367A195MR	DC/DC-IC	PWM step-up, 1.9V±2.5%, 200mA, 500kHz, +CE	SOT-25	28sh	DC11	6g	Tor
ABMA	MAX6309UK29D3-T	Vdet-IC	2.9V±1.5%, -MR, -Reset PPO, 140ms	SOT-23-5	28ek	VD5	6k	Max
ABMB	MAX6309UK29D4-T	Vdet-IC	2.9V±1.5%, -MR, -Reset PPO, 1120ms	SOT-23-5	28ek	VD5	6k	Max
ABMC	MAX6309UK28D1-T	Vdet-IC	2.8V±1.5%, -MR, -Reset PPO, 1ms	SOT-23-5	28ek	VD5	6k	Max
ABMD	MAX6309UK28D2-T	Vdet-IC	2.8V±1.5%, -MR, -Reset PPO, 20ms	SOT-23-5	28ek	VD5	6k	Max
ABME	MAX6309UK28D3-T	Vdet-IC	2.8V±1.5%, -MR, -Reset PPO, 140ms	SOT-23-5	28ek	VD5	6k	Max
ABMF	MAX6309UK28D4-T	Vdet-IC	2.8V±1.5%, -MR, -Reset PPO, 1120ms	SOT-23-5	28ek	VD5	6k	Max
ABMG	MAX6309UK27D1-T	Vdet-IC	2.7V±1.5%, -MR, -Reset PPO, 1ms	SOT-23-5	28ek	VD5	6k	Max
ABMH	MAX6309UK27D2-T	Vdet-IC	2.7V±1.5%, -MR, -Reset PPO, 20ms	SOT-23-5	28ek	VD5	6k	Max
ABMI	MAX6309UK27D3-T	Vdet-IC	2.7V±1.5%, -MR, -Reset PPO, 140ms	SOT-23-5	28ek	VD5	6k	Max
ABMJ	MAX6309UK27D4-T	Vdet-IC	2.7V±1.5%, -MR, -Reset PPO, 1120ms	SOT-23-5	28ek	VD5	6k	Max
ABMK	MAX6309UK26D1-T	Vdet-IC	2.6V±1.5%, -MR, -Reset PPO, 1ms	SOT-23-5	28ek	VD5	6k	Max
ABML	MAX6309UK26D2-T	Vdet-IC	2.6V±1.5%, -MR, -Reset PPO, 20ms	SOT-23-5	28ek	VD5	6k	Max
ABMM	MAX6309UK26D3-T	Vdet-IC	2.6V±1.5%, -MR, -Reset PPO, 140ms	SOT-23-5	28ek	VD5	6k	Max
ABMN	MAX6309UK26D4-T	Vdet-IC	2.6V±1.5%, -MR, -Reset PPO, 1120ms	SOT-23-5	28ek	VD5	6k	Max



SMD code	Type	Function	Short description	Case	Pinout	Sch.	St.	Mnf.
ABMO	MAX6309UK25D1-T	Vdet-IC	2.5V±1.5%, -MR, -Reset PPO, 1ms	SOT-23-5	28ek	VD5	6k	Max
ABMP	MAX6309UK25D2-T	Vdet-IC	2.5V±1.5%, -MR, -Reset PPO, 20ms	SOT-23-5	28ek	VD5	6k	Max
ABMQ	MAX6309UK25D3-T	Vdet-IC	2.5V±1.5%, -MR, -Reset PPO, 140ms	SOT-23-5	28ek	VD5	6k	Max
ABMR	MAX6309UK25D4-T	Vdet-IC	2.5V±1.5%, -MR, -Reset PPO, 1120ms	SOT-23-5	28ek	VD5	6k	Max
ABMS	MAX6310UK50D1-T	Vdet-IC	5.0V±1.5%, OVIn, -Reset PPO, 1ms	SOT-23-5	28em	VD18	6k	Max
ABMT	MAX6310UK50D2-T	Vdet-IC	5.0V±1.5%, OVIn, -Reset PPO, 20ms	SOT-23-5	28em	VD18	6k	Max
ABMU	MAX6310UK50D3-T	Vdet-IC	5.0V±1.5%, OVIn, -Reset PPO, 140ms	SOT-23-5	28em	VD18	6k	Max
ABMV	MAX6310UK50D4-T	Vdet-IC	5.0V±1.5%, OVIn, -Reset PPO, 1120ms	SOT-23-5	28em	VD18	6k	Max
ABMW	MAX6310UK49D1-T	Vdet-IC	4.9V±1.5%, OVIn, -Reset PPO, 1ms	SOT-23-5	28em	VD18	6k	Max
ABMX	MAX6310UK49D2-T	Vdet-IC	4.9V±1.5%, OVIn, -Reset PPO, 20ms	SOT-23-5	28em	VD18	6k	Max
ABMY	MAX6310UK49D3-T	Vdet-IC	4.9V±1.5%, OVIn, -Reset PPO, 140ms	SOT-23-5	28em	VD18	6k	Max
ABMZ	MAX6310UK49D4-T	Vdet-IC	4.9V±1.5%, OVIn, -Reset PPO, 1120ms	SOT-23-5	28em	VD18	6k	Max
ABN	LM4040AIX3-2.5	Vref-IC	Precision, Shunt, 2.500V, 0.1%	SC-70-5	28dq	RF1	6k	Max
ABN	RP107N22D1	LVR-IC	LDO, 2.2V±1%, 200mA, +CE, CL	SOT-23-5	28cx	VR4	6g	Ric
ĀBN	XC6114C221MR	Vdet-IC	2.1V±2%, ±Reset PPO, Wt=50ms, Rt=50ms	SOT-25	28xg	VD19	6g	Tor
ABNA	MAX6310UK48D1-T	Vdet-IC	4.8V±1.5%, OVIn, -Reset PPO, 1ms	SOT-23-5	28em	VD18	6k	Max
ABNB	MAX6310UK48D2-T	Vdet-IC	4.8V±1.5%, OVIn, -Reset PPO, 20ms	SOT-23-5	28em	VD18	6k	Max
ABNC	MAX6310UK48D3-T	Vdet-IC	4.8V±1.5%, OVIn, -Reset PPO, 140ms	SOT-23-5	28em	VD18	6k	Max
ABND	MAX6310UK48D4-T	Vdet-IC	4.8V±1.5%, OVIn, -Reset PPO, 1120ms	SOT-23-5	28em	VD18	6k	Max
ABNE	MAX6310UK47D1-T	Vdet-IC	4.7V±1.5%, OVIn, -Reset PPO, 1ms	SOT-23-5	28em	VD18	6k	Max
ABNF	MAX6310UK47D2-T	Vdet-IC	4.7V±1.5%, OVIn, -Reset PPO, 20ms	SOT-23-5	28em	VD18	6k	Max
ABNG	MAX6310UK47D3-T	Vdet-IC	4.7V±1.5%, OVIn, -Reset PPO, 140ms	SOT-23-5	28em	VD18	6k	Max
ABNH	MAX6310UK47D4-T	Vdet-IC	4.7V±1.5%, OVIn, -Reset PPO, 1120ms	SOT-23-5	28em	VD18	6k	Max
ABNI	MAX6310UK46D1-T	Vdet-IC	4.6V±1.5%, OVIn, -Reset PPO, 1ms	SOT-23-5	28em	VD18	6k	Max
ABNJ	MAX6310UK46D2-T	Vdet-IC	4.6V±1.5%, OVIn, -Reset PPO, 20ms	SOT-23-5	28em	VD18	6k	Max
ABNK	MAX6310UK46D3-T	Vdet-IC	4.6V±1.5%, OVIn, -Reset PPO, 140ms	SOT-23-5	28em	VD18	6k	Max
ABNL	MAX6310UK46D4-T	Vdet-IC	4.6V±1.5%, OVIn, -Reset PPO, 1120ms	SOT-23-5	28em	VD18	6k	Max
ABNM	MAX6310UK45D1-T	Vdet-IC	4.5V±1.5%, OVIn, -Reset PPO, 1ms	SOT-23-5	28em	VD18	6k	Max
ABNN	MAX6310UK45D2-T	Vdet-IC	4.5V±1.5%, OVIn, -Reset PPO, 20ms	SOT-23-5	28em	VD18	6k	Max
ABNO	MAX6310UK45D3-T	Vdet-IC	4.5V±1.5%, OVIn, -Reset PPO, 140ms	SOT-23-5	28em	VD18	6k	Max
ABNP	MAX6310UK45D4-T	Vdet-IC	4.5V±1.5%, OVIn, -Reset PPO, 1120ms	SOT-23-5	28em	VD18	6k	Max
ABNQ	MAX6310UK44D1-T	Vdet-IC	4.4V±1.5%, OVIn, -Reset PPO, 1ms	SOT-23-5	28em	VD18	6k	Max
ABNR	MAX6310UK44D2-T	Vdet-IC	4.4V±1.5%, OVIn, -Reset PPO, 20ms	SOT-23-5	28em	VD18	6k	Max
ABNS	MAX6310UK44D3-T	Vdet-IC	4.4V±1.5%, OVIn, -Reset PPO, 140ms	SOT-23-5	28em	VD18	6k	Max
ABNT	MAX6310UK44D4-T	Vdet-IC	4.4V±1.5%, OVIn, -Reset PPO, 1120ms	SOT-23-5	28em	VD18	6k	Max
ABNU	MAX6310UK43D1-T	Vdet-IC	4.3V±1.5%, OVIn, -Reset PPO, 1ms	SOT-23-5	28em	VD18	6k	Max
ABNV	MAX6310UK43D2-T	Vdet-IC	4.3V±1.5%, OVIn, -Reset PPO, 20ms	SOT-23-5	28em	VD18	6k	Max
ABNW	MAX6310UK43D3-T	Vdet-IC	4.3V±1.5%, OVIn, -Reset PPO, 140ms	SOT-23-5	28em	VD18	6k	Max
ABNX	MAX6310UK43D4-T	Vdet-IC	4.3V±1.5%, OVIn, -Reset PPO, 1120ms	SOT-23-5	28em	VD18	6k	Max
ABNY	MAX6310UK42D1-T	Vdet-IC	4.2V±1.5%, OVIn, -Reset PPO, 1ms	SOT-23-5	28em	VD18	6k	Max
ABNZ	MAX6310UK42D2-T	Vdet-IC	4.2V±1.5%, OVIn, -Reset PPO, 20ms	SOT-23-5	28em	VD18	6k	Max
ABO	LM4040BIX3-2.5	Vref-IC	Precision, Shunt, 2.500V, 0.2%	SC-70-5	28dq	RF1	6k	Max
ABOA	MAX6310UK42D3-T	Vdet-IC	4.2V±1.5%, OVIn, -Reset PPO, 140ms	SOT-23-5	28em	VD18	6k	Max
ABOB	MAX6310UK42D4-T	Vdet-IC	4.2V±1.5%, OVIn, -Reset PPO, 1120ms	SOT-23-5	28em	VD18	6k	Max
ABOC	MAX6310UK41D1-T	Vdet-IC	4.1V±1.5%, OVIn, -Reset PPO, 1ms	SOT-23-5	28em	VD18	6k	Max
ABOD	MAX6310UK41D2-T	Vdet-IC	4.1V±1.5%, OVIn, -Reset PPO, 20ms	SOT-23-5	28em	VD18	6k	Max
ABOE	MAX6310UK41D3-T	Vdet-IC	4.1V±1.5%, OVIn, -Reset PPO, 140ms	SOT-23-5	28em	VD18	6k	Max
ABOF	MAX6310UK41D4-T	Vdet-IC	4.1V±1.5%, OVIn, -Reset PPO, 1120ms	SOT-23-5	28em	VD18	6k	Max
ABOG	MAX6310UK40D1-T	Vdet-IC	4.0V±1.5%, OVIn, -Reset PPO, 1ms	SOT-23-5	28em	VD18	6k	Max
ABOH	MAX6310UK40D2-T	Vdet-IC	4.0V±1.5%, OVIn, -Reset PPO, 20ms	SOT-23-5	28em	VD18	6k	Max
ABOI	MAX6310UK40D3-T	Vdet-IC	4.0V±1.5%, OVIn, -Reset PPO, 140ms	SOT-23-5	28em	VD18	6k	Max
ABOJ	MAX6310UK40D4-T	Vdet-IC	4.0V±1.5%, OVIn, -Reset PPO, 1120ms	SOT-23-5	28em	VD18	6k	Max
ABOK	MAX6310UK39D1-T	Vdet-IC	3.9V±1.5%, OVIn, -Reset PPO, 1ms	SOT-23-5	28em	VD18	6k	Max
ABOL	MAX6310UK39D2-T	Vdet-IC	3.9V±1.5%, OVIn, -Reset PPO, 20ms	SOT-23-5	28em	VD18	6k	Max
ABOM	MAX6310UK39D3-T	Vdet-IC	3.9V±1.5%, OVIn, -Reset PPO, 140ms	SOT-23-5	28em	VD18	6k	Max
ABON	MAX6310UK39D4-T	Vdet-IC	3.9V±1.5%, OVIn, -Reset PPO, 1120ms	SOT-23-5	28em	VD18	6k	Max
ABOO	MAX6310UK38D1-T	Vdet-IC	3.8V±1.5%, OVIn, -Reset PPO, 1ms	SOT-23-5	28em	VD18	6k	Max
ABOP	MAX6310UK38D2-T	Vdet-IC	3.8V±1.5%, OVIn, -Reset PPO, 20ms	SOT-23-5	28em	VD18	6k	Max
ABOQ	MAX6310UK38D3-T	Vdet-IC	3.8V±1.5%, OVIn, -Reset PPO, 140ms	SOT-23-5	28em	VD18	6k	Max
ABOR	MAX6310UK38D4-T	Vdet-IC	3.8V±1.5%, OVIn, -Reset PPO, 1120ms	SOT-23-5	28em	VD18	6k	Max
ABOS	MAX6310UK37D1-T	Vdet-IC	3.7V±1.5%, OVIn, -Reset PPO, 1ms	SOT-23-5	28em	VD18	6k	Max
ABOT	MAX6310UK37D2-T	Vdet-IC	3.7V±1.5%, OVIn, -Reset PPO, 20ms	SOT-23-5	28em	VD18	6k	Max
ABOU	MAX6310UK37D3-T	Vdet-IC	3.7V±1.5%, OVIn, -Reset PPO, 140ms	SOT-23-5	28em	VD18	6k	Max
ABOV	MAX6310UK37D4-T	Vdet-IC	3.7V±1.5%, OVIn, -Reset PPO, 1120ms	SOT-23-5	28em	VD18	6k	Max
ABOW	MAX6310UK36D1-T	Vdet-IC	3.6V±1.5%, OVIn, -Reset PPO, 1ms	SOT-23-5	28em	VD18	6k	Max
ABOX	MAX6310UK36D2-T	Vdet-IC	3.6V±1.5%, OVIn, -Reset PPO, 20ms	SOT-23-5	28em	VD18	6k	Max
ABOY	MAX6310UK36D3-T	Vdet-IC	3.6V±1.5%, OVIn, -Reset PPO, 140ms	SOT-23-5	28em	VD18	6k	Max
ABOZ	MAX6310UK36D4-T	Vdet-IC	3.6V±1.5%, OVIn, -Reset PPO, 1120ms	SOT-23-5	28em	VD18	6k	Max
ABP	LM4040CIX3-2.5	Vref-IC	Shunt, 2.500V, 0.5%	SC-70-5	28dq	RF1	6k	Max
ABP	RP107N23D1	LVR-IC	LDO, 2.3V±1%, 200mA, +CE, CL	SOT-23-5	28cx	VR4	6g	Ric



SMD code	Type	Function	Short description	Case	Pinout	Sch.	St.	Mnf.
ABP	XC6114C222MR	Vdet-IC	2.2V±2%, ±Reset PPO, Wt=50ms, Rt=50ms	SOT-25	28xg	VD19	6g	Tor
ABPA	MAX6310UK35D1-T	Vdet-IC	3.5V±1.5%, OVIn, -Reset PPO, 1ms	SOT-23-5	28em	VD18	6k	Max
ABPB	MAX6310UK35D2-T	Vdet-IC	3.5V±1.5%, OVIn, -Reset PPO, 20ms	SOT-23-5	28em	VD18	6k	Max
ABPC	MAX6310UK35D3-T	Vdet-IC	3.5V±1.5%, OVIn, -Reset PPO, 140ms	SOT-23-5	28em	VD18	6k	Max
ABPD	MAX6310UK35D4-T	Vdet-IC	3.5V±1.5%, OVIn, -Reset PPO, 1120ms	SOT-23-5	28em	VD18	6k	Max
ABPE	MAX6310UK34D1-T	Vdet-IC	3.4V±1.5%, OVIn, -Reset PPO, 1ms	SOT-23-5	28em	VD18	6k	Max
ABPF	MAX6310UK34D2-T	Vdet-IC	3.4V±1.5%, OVIn, -Reset PPO, 20ms	SOT-23-5	28em	VD18	6k	Max
ABPG	MAX6310UK34D3-T	Vdet-IC	3.4V±1.5%, OVIn, -Reset PPO, 140ms	SOT-23-5	28em	VD18	6k	Max
ABPH	MAX6310UK34D4-T	Vdet-IC	3.4V±1.5%, OVIn, -Reset PPO, 1120ms	SOT-23-5	28em	VD18	6k	Max
ABPI	MAX6310UK33D1-T	Vdet-IC	3.3V±1.5%, OVIn, -Reset PPO, 1ms	SOT-23-5	28em	VD18	6k	Max
ABPJ	MAX6310UK33D2-T	Vdet-IC	3.3V±1.5%, OVIn, -Reset PPO, 20ms	SOT-23-5	28em	VD18	6k	Max
ABPK	MAX6310UK33D3-T	Vdet-IC	3.3V±1.5%, OVIn, -Reset PPO, 140ms	SOT-23-5	28em	VD18	6k	Max
ABPL	MAX6310UK33D4-T	Vdet-IC	3.3V±1.5%, OVIn, -Reset PPO, 1120ms	SOT-23-5	28em	VD18	6k	Max
ABPM	MAX6310UK32D1-T	Vdet-IC	3.2V±1.5%, OVIn, -Reset PPO, 1ms	SOT-23-5	28em	VD18	6k	Max
ABPN	MAX6310UK32D2-T	Vdet-IC	3.2V±1.5%, OVIn, -Reset PPO, 20ms	SOT-23-5	28em	VD18	6k	Max
ABPO	MAX6310UK32D3-T	Vdet-IC	3.2V±1.5%, OVIn, -Reset PPO, 140ms	SOT-23-5	28em	VD18	6k	Max
ABPP	MAX6310UK32D4-T	Vdet-IC	3.2V±1.5%, OVIn, -Reset PPO, 1120ms	SOT-23-5	28em	VD18	6k	Max
ABPQ	MAX6310UK31D1-T	Vdet-IC	3.1V±1.5%, OVIn, -Reset PPO, 1ms	SOT-23-5	28em	VD18	6k	Max
ABPR	MAX6310UK31D2-T	Vdet-IC	3.1V±1.5%, OVIn, -Reset PPO, 20ms	SOT-23-5	28em	VD18	6k	Max
ABPS	MAX6310UK31D3-T	Vdet-IC	3.1V±1.5%, OVIn, -Reset PPO, 140ms	SOT-23-5	28em	VD18	6k	Max
ABPT	MAX6310UK31D4-T	Vdet-IC	3.1V±1.5%, OVIn, -Reset PPO, 1120ms	SOT-23-5	28em	VD18	6k	Max
ABPU	MAX6310UK30D1-T	Vdet-IC	3.0V±1.5%, OVIn, -Reset PPO, 1ms	SOT-23-5	28em	VD18	6k	Max
ABPV	MAX6310UK30D2-T	Vdet-IC	3.0V±1.5%, OVIn, -Reset PPO, 20ms	SOT-23-5	28em	VD18	6k	Max
ABPW	MAX6310UK30D3-T	Vdet-IC	3.0V±1.5%, OVIn, -Reset PPO, 140ms	SOT-23-5	28em	VD18	6k	Max
ABPX	MAX6310UK30D4-T	Vdet-IC	3.0V±1.5%, OVIn, -Reset PPO, 1120ms	SOT-23-5	28em	VD18	6k	Max
ABPY	MAX6310UK29D1-T	Vdet-IC	2.9V±1.5%, OVIn, -Reset PPO, 1ms	SOT-23-5	28em	VD18	6k	Max
ABPZ	MAX6310UK29D2-T	Vdet-IC	2.9V±1.5%, OVIn, -Reset PPO, 20ms	SOT-23-5	28em	VD18	6k	Max
ABQ	LM4040DIX3-2.5	Vref-IC	Shunt, 2.500V, 1%	SC-70-5	28dq	RF1	6k	Max
ABQ	RP107N241D	LVR-IC	LDO, 2.4V±1%, 200mA, +CE, CL	SOT-23-5	28cx	VR4	6g	Ric
ABQA	MAX6310UK29D3-T	Vdet-IC	2.9V±1.5%, OVIn, -Reset PPO, 140ms	SOT-23-5	28em	VD18	6k	Max
ABQB	MAX6310UK29D4-T	Vdet-IC	2.9V±1.5%, OVIn, -Reset PPO, 1120ms	SOT-23-5	28em	VD18	6k	Max
ABQC	MAX6310UK28D1-T	Vdet-IC	2.8V±1.5%, OVIn, -Reset PPO, 1ms	SOT-23-5	28em	VD18	6k	Max
ABQD	MAX6310UK28D2-T	Vdet-IC	2.8V±1.5%, OVIn, -Reset PPO, 20ms	SOT-23-5	28em	VD18	6k	Max
ABQE	MAX6310UK28D3-T	Vdet-IC	2.8V±1.5%, OVIn, -Reset PPO, 140ms	SOT-23-5	28em	VD18	6k	Max
ABQF	MAX6310UK28D4-T	Vdet-IC	2.8V±1.5%, OVIn, -Reset PPO, 1120ms	SOT-23-5	28em	VD18	6k	Max
ABQG	MAX6310UK27D1-T	Vdet-IC	2.7V±1.5%, OVIn, -Reset PPO, 1ms	SOT-23-5	28em	VD18	6k	Max
ABQH	MAX6310UK27D2-T	Vdet-IC	2.7V±1.5%, OVIn, -Reset PPO, 20ms	SOT-23-5	28em	VD18	6k	Max
ABQI	MAX6310UK27D3-T	Vdet-IC	2.7V±1.5%, OVIn, -Reset PPO, 140ms	SOT-23-5	28em	VD18	6k	Max
ABQJ	MAX6310UK27D4-T	Vdet-IC	2.7V±1.5%, OVIn, -Reset PPO, 1120ms	SOT-23-5	28em	VD18	6k	Max
ABQL	MAX6310UK26D1-T	Vdet-IC	2.6V±1.5%, OVIn, -Reset PPO, 1ms	SOT-23-5	28em	VD18	6k	Max
ABQM	MAX6310UK26D2-T	Vdet-IC	2.6V±1.5%, OVIn, -Reset PPO, 20ms	SOT-23-5	28em	VD18	6k	Max
ABQN	MAX6310UK26D3-T	Vdet-IC	2.6V±1.5%, OVIn, -Reset PPO, 140ms	SOT-23-5	28em	VD18	6k	Max
ABQO	MAX6310UK26D4-T	Vdet-IC	2.6V±1.5%, OVIn, -Reset PPO, 1120ms	SOT-23-5	28em	VD18	6k	Max
ABQQ	MAX6310UK25D1-T	Vdet-IC	2.5V±1.5%, OVIn, -Reset PPO, 1ms	SOT-23-5	28em	VD18	6k	Max
ABQP	MAX6310UK25D2-T	Vdet-IC	2.5V±1.5%, OVIn, -Reset PPO, 20ms	SOT-23-5	28em	VD18	6k	Max
ABQR	MAX6310UK25D3-T	Vdet-IC	2.5V±1.5%, OVIn, -Reset PPO, 140ms	SOT-23-5	28em	VD18	6k	Max
ABQS	MAX6310UK25D4-T	Vdet-IC	2.5V±1.5%, OVIn, -Reset PPO, 1120ms	SOT-23-5	28em	VD18	6k	Max
ABQX	MAX6312UK50D2-T	Vdet-IC	5.0V±2.5%, -MR, +Reset PPO, 20ms	SOT-23-5	28ek	VD5	6k	Max
ABQY	MAX6312UK50D3-T	Vdet-IC	5.0V±2.5%, -MR, +Reset PPO, 140ms	SOT-23-5	28ek	VD5	6k	Max
ABQZ	MAX6312UK50D4-T	Vdet-IC	5.0V±2.5%, -MR, +Reset PPO, 1120ms	SOT-23-5	28ek	VD5	6k	Max
ABR	AME8800AEEV	LVR-IC	LDO, 3.3V±1.5%, 300mA	SOT-25	28vu	VR1	6k	Ame
ABR	AME8800AEEVL	LVR-IC	LDO, 3.3V±1.5%, 300mA	TSOT-25	28vu	VR1	6k	Ame
ABR	LM4040AIX3-3.0	Vref-IC	Precision, Shunt, 3.00V, 0.1%	SC-70-5	28dq	RF1	6k	Max
ABR	RP107N251D	LVR-IC	LDO, 2.5V±1%, 200mA, +CE, CL	SOT-23-5	28cx	VR4	6g	Ric
ABR	AME8800AEEVY	LVR-IC	LDO, 3.3V±1.5%, 300mA	TSOT-25	28vu	VR1	6k	Ame
ABR	AME8800AEEVZ	LVR-IC	LDO, 3.3V±1.5%, 300mA	SOT-25	28vu	VR1	6k	Ame
ABR	XC6114C223MR	Vdet-IC	2.3V±2%, ±Reset PPO, Wt=50ms, Rt=50ms	SOT-25	28xg	VD19	6g	Tor
ABRA	MAX6312UK49D1-T	Vdet-IC	4.9V±2.5%, -MR, +Reset PPO, 1ms	SOT-23-5	28ek	VD5	6k	Max
ABRB	MAX6312UK49D2-T	Vdet-IC	4.9V±2.5%, -MR, +Reset PPO, 20ms	SOT-23-5	28ek	VD5	6k	Max
ABRC	MAX6312UK49D3-T	Vdet-IC	4.9V±2.5%, -MR, +Reset PPO, 140ms	SOT-23-5	28ek	VD5	6k	Max
ABRD	MAX6312UK49D4-T	Vdet-IC	4.9V±2.5%, -MR, +Reset PPO, 1120ms	SOT-23-5	28ek	VD5	6k	Max
ABRE	MAX6312UK48D1-T	Vdet-IC	4.8V±2.5%, -MR, +Reset PPO, 1ms	SOT-23-5	28ek	VD5	6k	Max
ABRF	MAX6312UK48D2-T	Vdet-IC	4.8V±2.5%, -MR, +Reset PPO, 20ms	SOT-23-5	28ek	VD5	6k	Max
ABRG	MAX6312UK48D3-T	Vdet-IC	4.8V±2.5%, -MR, +Reset PPO, 140ms	SOT-23-5	28ek	VD5	6k	Max
ABRH	MAX6312UK48D4-T	Vdet-IC	4.8V±2.5%, -MR, +Reset PPO, 1120ms	SOT-23-5	28ek	VD5	6k	Max
ABRI	MAX6312UK47D1-T	Vdet-IC	4.7V±2.5%, -MR, +Reset PPO, 1ms	SOT-23-5	28ek	VD5	6k	Max
ABRJ	MAX6312UK47D2-T	Vdet-IC	4.7V±2.5%, -MR, +Reset PPO, 20ms	SOT-23-5	28ek	VD5	6k	Max
ABRK	MAX6312UK47D3-T	Vdet-IC	4.7V±2.5%, -MR, +Reset PPO, 140ms	SOT-23-5	28ek	VD5	6k	Max
ABRL	MAX6312UK47D4-T	Vdet-IC	4.7V±2.5%, -MR, +Reset PPO, 1120ms	SOT-23-5	28ek	VD5	6k	Max
ABRM	MAX6312UK46D1-T	Vdet-IC	4.6V±2.5%, -MR, +Reset PPO, 1ms	SOT-23-5	28ek	VD5	6k	Max



SMD code	Type	Function	Short description	Case	Pinout	Sch.	St.	Mnf.
ABRN	MAX6312UK46D2-T	Vdet-IC	4.6V±2.5%, -MR, +Reset PPO, 20ms	SOT-23-5	28ek	VD5	6k	Max
ABRO	MAX6312UK46D3-T	Vdet-IC	4.6V±2.5%, -MR, +Reset PPO, 140ms	SOT-23-5	28ek	VD5	6k	Max
ABRP	MAX6312UK46D4-T	Vdet-IC	4.6V±2.5%, -MR, +Reset PPO, 1120ms	SOT-23-5	28ek	VD5	6k	Max
ABRQ	MAX6312UK45D1-T	Vdet-IC	4.5V±2.5%, -MR, +Reset PPO, 1ms	SOT-23-5	28ek	VD5	6k	Max
ABRR	MAX6312UK45D2-T	Vdet-IC	4.5V±2.5%, -MR, +Reset PPO, 20ms	SOT-23-5	28ek	VD5	6k	Max
ABRS	MAX6312UK45D3-T	Vdet-IC	4.5V±2.5%, -MR, +Reset PPO, 140ms	SOT-23-5	28ek	VD5	6k	Max
ABRT	MAX6312UK45D4-T	Vdet-IC	4.5V±2.5%, -MR, +Reset PPO, 1120ms	SOT-23-5	28ek	VD5	6k	Max
ABRU	MAX6312UK44D1-T	Vdet-IC	4.4V±2.5%, -MR, +Reset PPO, 1ms	SOT-23-5	28ek	VD5	6k	Max
ABRV	MAX6312UK44D2-T	Vdet-IC	4.4V±2.5%, -MR, +Reset PPO, 20ms	SOT-23-5	28ek	VD5	6k	Max
ABRW	MAX6312UK44D3-T	Vdet-IC	4.4V±2.5%, -MR, +Reset PPO, 140ms	SOT-23-5	28ek	VD5	6k	Max
ABRX	MAX6312UK44D4-T	Vdet-IC	4.4V±2.5%, -MR, +Reset PPO, 1120ms	SOT-23-5	28ek	VD5	6k	Max
ABRY	MAX6312UK43D1-T	Vdet-IC	4.3V±2.5%, -MR, +Reset PPO, 1ms	SOT-23-5	28ek	VD5	6k	Max
ABRZ	MAX6312UK43D2-T	Vdet-IC	4.3V±2.5%, -MR, +Reset PPO, 20ms	SOT-23-5	28ek	VD5	6k	Max
ABS	AME8800BEEV	LVR-IC	LDO, 3.0V±1.5%, 300mA	SOT-25	28vu	VR1	6k	Ame
ABS	AME8800BEEVL	LVR-IC	LDO, 3.0V±1.5%, 300mA	TSOT-25	28vu	VR1	6k	Ame
ABS	LM4040BIX3-3.0	Vref-IC	Precision, Shunt, 3.00V, 0.2%	SC-70-5	28dq	RF1	6k	Max
ABS	RP107N261D	LVR-IC	LDO, 2.6V±1%, 200mA, +CE, CL	SOT-23-5	28cx	VR4	6g	Ric
ĀBS	AME8800BEEVY	LVR-IC	LDO, 3.0V±1.5%, 300mA	TSOT-25	28vu	VR1	6k	Ame
ĀBS	AME8800BEEVZ	LVR-IC	LDO, 3.0V±1.5%, 300mA	SOT-25	28vu	VR1	6k	Ame
ĀBS	XC6114C224MR	Vdet-IC	2.4V±2%, ±Reset PPO, Wt=50ms, Rt=50ms	SOT-25	28xg	VD19	6g	Tor
ABSA	MAX6312UK43D3-T	Vdet-IC	4.3V±2.5%, -MR, +Reset PPO, 140ms	SOT-23-5	28ek	VD5	6k	Max
ABSB	MAX6312UK43D4-T	Vdet-IC	4.3V±2.5%, -MR, +Reset PPO, 1120ms	SOT-23-5	28ek	VD5	6k	Max
ABSC	MAX6312UK42D1-T	Vdet-IC	4.2V±2.5%, -MR, +Reset PPO, 1ms	SOT-23-5	28ek	VD5	6k	Max
ABSD	MAX6312UK42D2-T	Vdet-IC	4.2V±2.5%, -MR, +Reset PPO, 20ms	SOT-23-5	28ek	VD5	6k	Max
ABSE	MAX6312UK42D3-T	Vdet-IC	4.2V±2.5%, -MR, +Reset PPO, 140ms	SOT-23-5	28ek	VD5	6k	Max
ABSF	MAX6312UK42D4-T	Vdet-IC	4.2V±2.5%, -MR, +Reset PPO, 1120ms	SOT-23-5	28ek	VD5	6k	Max
ABSG	MAX6312UK41D1-T	Vdet-IC	4.1V±2.5%, -MR, +Reset PPO, 1ms	SOT-23-5	28ek	VD5	6k	Max
ABSH	MAX6312UK41D2-T	Vdet-IC	4.1V±2.5%, -MR, +Reset PPO, 20ms	SOT-23-5	28ek	VD5	6k	Max
ABSI	MAX6312UK41D3-T	Vdet-IC	4.1V±2.5%, -MR, +Reset PPO, 140ms	SOT-23-5	28ek	VD5	6k	Max
ABSJ	MAX6312UK41D4-T	Vdet-IC	4.1V±2.5%, -MR, +Reset PPO, 1120ms	SOT-23-5	28ek	VD5	6k	Max
ABSK	MAX6312UK40D1-T	Vdet-IC	4.0V±2.5%, -MR, +Reset PPO, 1ms	SOT-23-5	28ek	VD5	6k	Max
ABSL	MAX6312UK40D2-T	Vdet-IC	4.0V±2.5%, -MR, +Reset PPO, 20ms	SOT-23-5	28ek	VD5	6k	Max
ABSM	MAX6312UK40D3-T	Vdet-IC	4.0V±2.5%, -MR, +Reset PPO, 140ms	SOT-23-5	28ek	VD5	6k	Max
ABSN	MAX6312UK40D4-T	Vdet-IC	4.0V±2.5%, -MR, +Reset PPO, 1120ms	SOT-23-5	28ek	VD5	6k	Max
ABSO	MAX6312UK39D1-T	Vdet-IC	3.9V±2.5%, -MR, +Reset PPO, 1ms	SOT-23-5	28ek	VD5	6k	Max
ABSP	MAX6312UK39D2-T	Vdet-IC	3.9V±2.5%, -MR, +Reset PPO, 20ms	SOT-23-5	28ek	VD5	6k	Max
ABSQ	MAX6312UK39D3-T	Vdet-IC	3.9V±2.5%, -MR, +Reset PPO, 140ms	SOT-23-5	28ek	VD5	6k	Max
ABSR	MAX6312UK39D4-T	Vdet-IC	3.9V±2.5%, -MR, +Reset PPO, 1120ms	SOT-23-5	28ek	VD5	6k	Max
ABSS	MAX6312UK38D1-T	Vdet-IC	3.8V±2.5%, -MR, +Reset PPO, 1ms	SOT-23-5	28ek	VD5	6k	Max
ABST	MAX6312UK38D2-T	Vdet-IC	3.8V±2.5%, -MR, +Reset PPO, 20ms	SOT-23-5	28ek	VD5	6k	Max
ABSU	MAX6312UK38D3-T	Vdet-IC	3.8V±2.5%, -MR, +Reset PPO, 140ms	SOT-23-5	28ek	VD5	6k	Max
ABSV	MAX6312UK38D4-T	Vdet-IC	3.8V±2.5%, -MR, +Reset PPO, 1120ms	SOT-23-5	28ek	VD5	6k	Max
ABSW	MAX6312UK37D1-T	Vdet-IC	3.7V±2.5%, -MR, +Reset PPO, 1ms	SOT-23-5	28ek	VD5	6k	Max
ABSX	MAX6312UK37D2-T	Vdet-IC	3.7V±2.5%, -MR, +Reset PPO, 20ms	SOT-23-5	28ek	VD5	6k	Max
ABSY	MAX6312UK37D3-T	Vdet-IC	3.7V±2.5%, -MR, +Reset PPO, 140ms	SOT-23-5	28ek	VD5	6k	Max
ABSZ	MAX6312UK37D4-T	Vdet-IC	3.7V±2.5%, -MR, +Reset PPO, 1120ms	SOT-23-5	28ek	VD5	6k	Max
ABT	AME8800CEEV	LVR-IC	LDO, 2.8V±1.5%, 300mA	SOT-25	28vu	VR1	6k	Ame
ABT	AME8800CEEVL	LVR-IC	LDO, 2.8V±1.5%, 300mA	TSOT-25	28vu	VR1	6k	Ame
ABT	LM4040CIX3-3.0	Vref-IC	Shunt, 3.00V, 0.5%	SC-70-5	28dq	RF1	6k	Max
ABT	RP107N271D	LVR-IC	LDO, 2.7V±1%, 200mA, +CE, CL	SOT-23-5	28cx	VR4	6g	Ric
ĀBT	AME8800CEEVY	LVR-IC	LDO, 2.8V±1.5%, 300mA	TSOT-25	28vu	VR1	6k	Ame
ĀBT	AME8800CEEVZ	LVR-IC	LDO, 2.8V±1.5%, 300mA	SOT-25	28vu	VR1	6k	Ame
ĀBT	XC6114C225MR	Vdet-IC	2.5V±2%, ±Reset PPO, Wt=50ms, Rt=50ms	SOT-25	28xg	VD19	6g	Tor
ABTA	MAX6312UK36D1-T	Vdet-IC	3.6V±2.5%, -MR, +Reset PPO, 1ms	SOT-23-5	28ek	VD5	6k	Max
ABTB	MAX6312UK36D2-T	Vdet-IC	3.6V±2.5%, -MR, +Reset PPO, 20ms	SOT-23-5	28ek	VD5	6k	Max
ABTC	MAX6312UK36D3-T	Vdet-IC	3.6V±2.5%, -MR, +Reset PPO, 140ms	SOT-23-5	28ek	VD5	6k	Max
ABTD	MAX6312UK36D4-T	Vdet-IC	3.6V±2.5%, -MR, +Reset PPO, 1120ms	SOT-23-5	28ek	VD5	6k	Max
ABTE	MAX6312UK35D1-T	Vdet-IC	3.5V±2.5%, -MR, +Reset PPO, 1ms	SOT-23-5	28ek	VD5	6k	Max
ABTF	MAX6312UK35D2-T	Vdet-IC	3.5V±2.5%, -MR, +Reset PPO, 20ms	SOT-23-5	28ek	VD5	6k	Max
ABTG	MAX6312UK35D3-T	Vdet-IC	3.5V±2.5%, -MR, +Reset PPO, 140ms	SOT-23-5	28ek	VD5	6k	Max
ABTH	MAX6312UK35D4-T	Vdet-IC	3.5V±2.5%, -MR, +Reset PPO, 1120ms	SOT-23-5	28ek	VD5	6k	Max
ABTI	MAX6312UK34D1-T	Vdet-IC	3.4V±2.5%, -MR, +Reset PPO, 1ms	SOT-23-5	28ek	VD5	6k	Max
ABTJ	MAX6312UK34D2-T	Vdet-IC	3.4V±2.5%, -MR, +Reset PPO, 20ms	SOT-23-5	28ek	VD5	6k	Max
ABTK	MAX6312UK34D3-T	Vdet-IC	3.4V±2.5%, -MR, +Reset PPO, 140ms	SOT-23-5	28ek	VD5	6k	Max
ABTL	MAX6312UK34D4-T	Vdet-IC	3.4V±2.5%, -MR, +Reset PPO, 1120ms	SOT-23-5	28ek	VD5	6k	Max
ABTM	MAX6312UK33D1-T	Vdet-IC	3.3V±2.5%, -MR, +Reset PPO, 1ms	SOT-23-5	28ek	VD5	6k	Max
ABTN	MAX6312UK33D2-T	Vdet-IC	3.3V±2.5%, -MR, +Reset PPO, 20ms	SOT-23-5	28ek	VD5	6k	Max
ABTO	MAX6312UK33D3-T	Vdet-IC	3.3V±2.5%, -MR, +Reset PPO, 140ms	SOT-23-5	28ek	VD5	6k	Max
ABTP	MAX6312UK33D4-T	Vdet-IC	3.3V±2.5%, -MR, +Reset PPO, 1120ms	SOT-23-5	28ek	VD5	6k	Max
ABTQ	MAX6312UK32D1-T	Vdet-IC	3.2V±2.5%, -MR, +Reset PPO, 1ms	SOT-23-5	28ek	VD5	6k	Max



SMD code	Type	Function	Short description	Case	Pinout	Sch.	St.	Mnf.
ABTR	MAX6312UK32D2-T	Vdet-IC	3.2V±2.5%, -MR, +Reset PPO, 20ms	SOT-23-5	28ek	VD5	6k	Max
ABTS	MAX6312UK32D3-T	Vdet-IC	3.2V±2.5%, -MR, +Reset PPO, 140ms	SOT-23-5	28ek	VD5	6k	Max
ABTT	MAX6312UK32D4-T	Vdet-IC	3.2V±2.5%, -MR, +Reset PPO, 1120ms	SOT-23-5	28ek	VD5	6k	Max
ABTU	MAX6312UK31D1-T	Vdet-IC	3.1V±2.5%, -MR, +Reset PPO, 1ms	SOT-23-5	28ek	VD5	6k	Max
ABTV	MAX6312UK31D2-T	Vdet-IC	3.1V±2.5%, -MR, +Reset PPO, 20ms	SOT-23-5	28ek	VD5	6k	Max
ABTW	MAX6312UK31D3-T	Vdet-IC	3.1V±2.5%, -MR, +Reset PPO, 140ms	SOT-23-5	28ek	VD5	6k	Max
ABTX	MAX6312UK31D4-T	Vdet-IC	3.1V±2.5%, -MR, +Reset PPO, 1120ms	SOT-23-5	28ek	VD5	6k	Max
ABTY	MAX6312UK30D1-T	Vdet-IC	3.0V±2.5%, -MR, +Reset PPO, 1ms	SOT-23-5	28ek	VD5	6k	Max
ABTZ	MAX6312UK30D2-T	Vdet-IC	3.0V±2.5%, -MR, +Reset PPO, 20ms	SOT-23-5	28ek	VD5	6k	Max
ABU	AME8800DEEV	LVR-IC	LDO, 2.5V±1.5%, 300mA	SOT-25	28vu	VR1	6k	Ame
ABU	LM4040DIX3-3.0	Vref-IC	Shunt, 3.00V, 1%	SC-70-5	28dq	RF1	6k	Max
ABU	RP107N281D	LVR-IC	LDO, 2.8V±1%, 200mA, +CE, CL	SOT-23-5	28cx	VR4	6g	Ric
ĀBU	AME8800DEEVL	LVR-IC	LDO, 2.5V±1.5%, 300mA	TSOT-25	28vu	VR1	6k	Ame
ĀBU	AME8800DEEVZ	LVR-IC	LDO, 2.5V±1.5%, 300mA	SOT-25	28vu	VR1	6k	Ame
ĀBU	XC6114C226MR	Vdet-IC	2.6V±2%, ±Reset PPO, Wt=50ms, Rt=50ms	SOT-25	28xg	VD19	6g	Tor
ABUA	MAX6312UK30D3-T	Vdet-IC	3.0V±2.5%, -MR, +Reset PPO, 140ms	SOT-23-5	28ek	VD5	6k	Max
ABUB	MAX6312UK30D4-T	Vdet-IC	3.0V±2.5%, -MR, +Reset PPO, 1120ms	SOT-23-5	28ek	VD5	6k	Max
ABUC	MAX6312UK29D1-T	Vdet-IC	2.9V±2.5%, -MR, +Reset PPO, 1ms	SOT-23-5	28ek	VD5	6k	Max
ABUD	MAX6312UK29D2-T	Vdet-IC	2.9V±2.5%, -MR, +Reset PPO, 20ms	SOT-23-5	28ek	VD5	6k	Max
ABUE	MAX6312UK29D3-T	Vdet-IC	2.9V±2.5%, -MR, +Reset PPO, 140ms	SOT-23-5	28ek	VD5	6k	Max
ABUF	MAX6312UK29D4-T	Vdet-IC	2.9V±2.5%, -MR, +Reset PPO, 1120ms	SOT-23-5	28ek	VD5	6k	Max
ABUG	MAX6312UK28D1-T	Vdet-IC	2.8V±2.5%, -MR, +Reset PPO, 1ms	SOT-23-5	28ek	VD5	6k	Max
ABUH	MAX6312UK28D2-T	Vdet-IC	2.8V±2.5%, -MR, +Reset PPO, 20ms	SOT-23-5	28ek	VD5	6k	Max
ABUI	MAX6312UK28D3-T	Vdet-IC	2.8V±2.5%, -MR, +Reset PPO, 140ms	SOT-23-5	28ek	VD5	6k	Max
ABUJ	MAX6312UK28D4-T	Vdet-IC	2.8V±2.5%, -MR, +Reset PPO, 1120ms	SOT-23-5	28ek	VD5	6k	Max
ABUK	MAX6312UK27D1-T	Vdet-IC	2.7V±2.5%, -MR, +Reset PPO, 1ms	SOT-23-5	28ek	VD5	6k	Max
ABUL	MAX6312UK27D2-T	Vdet-IC	2.7V±2.5%, -MR, +Reset PPO, 20ms	SOT-23-5	28ek	VD5	6k	Max
ABUM	MAX6312UK27D3-T	Vdet-IC	2.7V±2.5%, -MR, +Reset PPO, 140ms	SOT-23-5	28ek	VD5	6k	Max
ABUN	MAX6312UK27D4-T	Vdet-IC	2.7V±2.5%, -MR, +Reset PPO, 1120ms	SOT-23-5	28ek	VD5	6k	Max
ABUO	MAX6312UK26D1-T	Vdet-IC	2.6V±2.5%, -MR, +Reset PPO, 1ms	SOT-23-5	28ek	VD5	6k	Max
ABUP	MAX6312UK26D2-T	Vdet-IC	2.6V±2.5%, -MR, +Reset PPO, 20ms	SOT-23-5	28ek	VD5	6k	Max
ABUQ	MAX6312UK26D3-T	Vdet-IC	2.6V±2.5%, -MR, +Reset PPO, 140ms	SOT-23-5	28ek	VD5	6k	Max
ABUR	MAX6312UK26D4-T	Vdet-IC	2.6V±2.5%, -MR, +Reset PPO, 1120ms	SOT-23-5	28ek	VD5	6k	Max
ABUS	MAX6312UK25D1-T	Vdet-IC	2.5V±2.5%, -MR, +Reset PPO, 1ms	SOT-23-5	28ek	VD5	6k	Max
ABUT	MAX6312UK25D2-T	Vdet-IC	2.5V±2.5%, -MR, +Reset PPO, 20ms	SOT-23-5	28ek	VD5	6k	Max
ABUU	MAX6312UK25D3-T	Vdet-IC	2.5V±2.5%, -MR, +Reset PPO, 140ms	SOT-23-5	28ek	VD5	6k	Max
ABUV	MAX6312UK25D4-T	Vdet-IC	2.5V±2.5%, -MR, +Reset PPO, 1120ms	SOT-23-5	28ek	VD5	6k	Max
ABUW	MAX6313UK50D1-T	Vdet-IC	5.0V±2.5%, OVIn, +Reset PPO, 1ms	SOT-23-5	28em	VD18	6k	Max
ABUX	MAX6313UK50D2-T	Vdet-IC	5.0V±2.5%, OVIn, +Reset PPO, 20ms	SOT-23-5	28em	VD18	6k	Max
ABUY	MAX6313UK50D3-T	Vdet-IC	5.0V±2.5%, OVIn, +Reset PPO, 140ms	SOT-23-5	28em	VD18	6k	Max
ABUZ	MAX6313UK50D4-T	Vdet-IC	5.0V±2.5%, OVIn, +Reset PPO, 1120ms	SOT-23-5	28em	VD18	6k	Max
ABV	AME8800EEEV	LVR-IC	LDO, 3.8V±1.5%, 300mA	SOT-25	28vu	VR1	6k	Ame
ABV	AME8800EEEVL	LVR-IC	LDO, 3.8V±1.5%, 300mA	TSOT-25	28vu	VR1	6k	Ame
ABV	LM4040AIX3-4.1	Vref-IC	Precision, Shunt, 4.096V, 0.1%	SC-70-5	28dq	RF1	6k	Max
ABV	RP107N291D	LVR-IC	LDO, 2.9V±1%, 200mA, +CE, CL	SOT-23-5	28cx	VR4	6g	Ric
ĀBV	AME8800EEEVY	LVR-IC	LDO, 3.8V±1.5%, 300mA	TSOT-25	28vu	VR1	6k	Ame
ĀBV	AME8800EEEVZ	LVR-IC	LDO, 3.8V±1.5%, 300mA	SOT-25	28vu	VR1	6k	Ame
ĀBV	XC6114C227MR	Vdet-IC	2.7V±2%, ±Reset PPO, Wt=50ms, Rt=50ms	SOT-25	28xg	VD19	6g	Tor
ABVA	MAX6313UK49D1-T	Vdet-IC	4.9V±2.5%, OVIn, +Reset PPO, 1ms	SOT-23-5	28em	VD18	6k	Max
ABVB	MAX6313UK49D2-T	Vdet-IC	4.9V±2.5%, OVIn, +Reset PPO, 20ms	SOT-23-5	28em	VD18	6k	Max
ABVC	MAX6313UK49D3-T	Vdet-IC	4.9V±2.5%, OVIn, +Reset PPO, 140ms	SOT-23-5	28em	VD18	6k	Max
ABVD	MAX6313UK49D4-T	Vdet-IC	4.9V±2.5%, OVIn, +Reset PPO, 1120ms	SOT-23-5	28em	VD18	6k	Max
ABVE	MAX6313UK48D1-T	Vdet-IC	4.8V±2.5%, OVIn, +Reset PPO, 1ms	SOT-23-5	28em	VD18	6k	Max
ABVF	MAX6313UK48D2-T	Vdet-IC	4.8V±2.5%, OVIn, +Reset PPO, 20ms	SOT-23-5	28em	VD18	6k	Max
ABVG	MAX6313UK48D3-T	Vdet-IC	4.8V±2.5%, OVIn, +Reset PPO, 140ms	SOT-23-5	28em	VD18	6k	Max
ABVH	MAX6313UK48D4-T	Vdet-IC	4.8V±2.5%, OVIn, +Reset PPO, 1120ms	SOT-23-5	28em	VD18	6k	Max
ABVI	MAX6313UK47D1-T	Vdet-IC	4.7V±2.5%, OVIn, +Reset PPO, 1ms	SOT-23-5	28em	VD18	6k	Max
ABVJ	MAX6313UK47D2-T	Vdet-IC	4.7V±2.5%, OVIn, +Reset PPO, 20ms	SOT-23-5	28em	VD18	6k	Max
ABVK	MAX6313UK47D3-T	Vdet-IC	4.7V±2.5%, OVIn, +Reset PPO, 140ms	SOT-23-5	28em	VD18	6k	Max
ABVL	MAX6313UK47D4-T	Vdet-IC	4.7V±2.5%, OVIn, +Reset PPO, 1120ms	SOT-23-5	28em	VD18	6k	Max
ABVM	MAX6313UK46D1-T	Vdet-IC	4.6V±2.5%, OVIn, +Reset PPO, 1ms	SOT-23-5	28em	VD18	6k	Max
ABVN	MAX6313UK46D2-T	Vdet-IC	4.6V±2.5%, OVIn, +Reset PPO, 20ms	SOT-23-5	28em	VD18	6k	Max
ABVO	MAX6313UK46D3-T	Vdet-IC	4.6V±2.5%, OVIn, +Reset PPO, 140ms	SOT-23-5	28em	VD18	6k	Max
ABVP	MAX6313UK46D4-T	Vdet-IC	4.6V±2.5%, OVIn, +Reset PPO, 1120ms	SOT-23-5	28em	VD18	6k	Max
ABVQ	MAX6313UK45D1-T	Vdet-IC	4.5V±2.5%, OVIn, +Reset PPO, 1ms	SOT-23-5	28em	VD18	6k	Max
ABVR	MAX6313UK45D2-T	Vdet-IC	4.5V±2.5%, OVIn, +Reset PPO, 20ms	SOT-23-5	28em	VD18	6k	Max
ABVS	MAX6313UK45D3-T	Vdet-IC	4.5V±2.5%, OVIn, +Reset PPO, 140ms	SOT-23-5	28em	VD18	6k	Max
ABVT	MAX6313UK45D4-T	Vdet-IC	4.5V±2.5%, OVIn, +Reset PPO, 1120ms	SOT-23-5	28em	VD18	6k	Max
ABVU	MAX6313UK44D1-T	Vdet-IC	4.4V±2.5%, OVIn, +Reset PPO, 1ms	SOT-23-5	28em	VD18	6k	Max
ABVV	MAX6313UK44D2-T	Vdet-IC	4.4V±2.5%, OVIn, +Reset PPO, 20ms	SOT-23-5	28em	VD18	6k	Max



SMD code	Type	Function	Short description	Case	Pinout	Sch.	St.	Mnf.
ABVW	MAX6313UK44D3-T	Vdet-IC	4.4V±2.5%, OVIn, +Reset PPO, 140ms	SOT-23-5	28em	VD18	6k	Max
ABVX	MAX6313UK44D4-T	Vdet-IC	4.4V±2.5%, OVIn, +Reset PPO, 1120ms	SOT-23-5	28em	VD18	6k	Max
ABVY	MAX6313UK43D1-T	Vdet-IC	4.3V±2.5%, OVIn, +Reset PPO, 1ms	SOT-23-5	28em	VD18	6k	Max
ABVZ	MAX6313UK43D2-T	Vdet-IC	4.3V±2.5%, OVIn, +Reset PPO, 20ms	SOT-23-5	28em	VD18	6k	Max
ABW	AME8800FEEV	LVR-IC	LDO, 3.6V±1.5%, 300mA	SOT-25	28vu	VR1	6k	Ame
ABW	AME8800FEEVL	LVR-IC	LDO, 3.6V±1.5%, 300mA	TSOT-25	28vu	VR1	6k	Ame
ABW	LM4040BIX3-4.1	Vref-IC	Precision, Shunt, 4.096V, 0.2%	SC-70-5	28dq	RF1	6k	Max
ABW	RP107N301D	LVR-IC	LDO, 3.0V±1%, 200mA, +CE, CL	SOT-23-5	28cx	VR4	6g	Ric
ABW	AME8800FEEVY	LVR-IC	LDO, 3.6V±1.5%, 300mA	TSOT-25	28vu	VR1	6k	Ame
ABW	AME8800FEEVZ	LVR-IC	LDO, 3.6V±1.5%, 300mA	SOT-25	28vu	VR1	6k	Ame
ABWA	MAX6313UK43D3-T	Vdet-IC	4.3V±2.5%, OVIn, +Reset PPO, 140ms	SOT-23-5	28em	VD18	6k	Max
ABWB	MAX6313UK43D4-T	Vdet-IC	4.3V±2.5%, OVIn, +Reset PPO, 1120ms	SOT-23-5	28em	VD18	6k	Max
ABWC	MAX6313UK42D1-T	Vdet-IC	4.2V±2.5%, OVIn, +Reset PPO, 1ms	SOT-23-5	28em	VD18	6k	Max
ABWD	MAX6313UK42D2-T	Vdet-IC	4.2V±2.5%, OVIn, +Reset PPO, 20ms	SOT-23-5	28em	VD18	6k	Max
ABWE	MAX6313UK42D3-T	Vdet-IC	4.2V±2.5%, OVIn, +Reset PPO, 140ms	SOT-23-5	28em	VD18	6k	Max
ABWF	MAX6313UK42D4-T	Vdet-IC	4.2V±2.5%, OVIn, +Reset PPO, 1120ms	SOT-23-5	28em	VD18	6k	Max
ABWG	MAX6313UK41D1-T	Vdet-IC	4.1V±2.5%, OVIn, +Reset PPO, 1ms	SOT-23-5	28em	VD18	6k	Max
ABWH	MAX6313UK41D2-T	Vdet-IC	4.1V±2.5%, OVIn, +Reset PPO, 20ms	SOT-23-5	28em	VD18	6k	Max
ABWI	MAX6313UK41D3-T	Vdet-IC	4.1V±2.5%, OVIn, +Reset PPO, 140ms	SOT-23-5	28em	VD18	6k	Max
ABWJ	MAX6313UK41D4-T	Vdet-IC	4.1V±2.5%, OVIn, +Reset PPO, 1120ms	SOT-23-5	28em	VD18	6k	Max
ABWK	MAX6313UK40D1-T	Vdet-IC	4.0V±2.5%, OVIn, +Reset PPO, 1ms	SOT-23-5	28em	VD18	6k	Max
ABWL	MAX6313UK40D2-T	Vdet-IC	4.0V±2.5%, OVIn, +Reset PPO, 20ms	SOT-23-5	28em	VD18	6k	Max
ABWM	MAX6313UK40D3-T	Vdet-IC	4.0V±2.5%, OVIn, +Reset PPO, 140ms	SOT-23-5	28em	VD18	6k	Max
ABWN	MAX6313UK40D4-T	Vdet-IC	4.0V±2.5%, OVIn, +Reset PPO, 1120ms	SOT-23-5	28em	VD18	6k	Max
ABWO	MAX6313UK39D1-T	Vdet-IC	3.9V±2.5%, OVIn, +Reset PPO, 1ms	SOT-23-5	28em	VD18	6k	Max
ABWP	MAX6313UK39D2-T	Vdet-IC	3.9V±2.5%, OVIn, +Reset PPO, 20ms	SOT-23-5	28em	VD18	6k	Max
ABWQ	MAX6313UK39D3-T	Vdet-IC	3.9V±2.5%, OVIn, +Reset PPO, 140ms	SOT-23-5	28em	VD18	6k	Max
ABWR	MAX6313UK39D4-T	Vdet-IC	3.9V±2.5%, OVIn, +Reset PPO, 1120ms	SOT-23-5	28em	VD18	6k	Max
ABWS	MAX6313UK38D1-T	Vdet-IC	3.8V±2.5%, OVIn, +Reset PPO, 1ms	SOT-23-5	28em	VD18	6k	Max
ABWT	MAX6313UK38D2-T	Vdet-IC	3.8V±2.5%, OVIn, +Reset PPO, 20ms	SOT-23-5	28em	VD18	6k	Max
ABWU	MAX6313UK38D3-T	Vdet-IC	3.8V±2.5%, OVIn, +Reset PPO, 140ms	SOT-23-5	28em	VD18	6k	Max
ABWV	MAX6313UK38D4-T	Vdet-IC	3.8V±2.5%, OVIn, +Reset PPO, 1120ms	SOT-23-5	28em	VD18	6k	Max
ABWW	MAX6313UK37D1-T	Vdet-IC	3.7V±2.5%, OVIn, +Reset PPO, 1ms	SOT-23-5	28em	VD18	6k	Max
ABWX	MAX6313UK37D2-T	Vdet-IC	3.7V±2.5%, OVIn, +Reset PPO, 20ms	SOT-23-5	28em	VD18	6k	Max
ABWY	MAX6313UK37D3-T	Vdet-IC	3.7V±2.5%, OVIn, +Reset PPO, 140ms	SOT-23-5	28em	VD18	6k	Max
ABWZ	MAX6313UK37D4-T	Vdet-IC	3.7V±2.5%, OVIn, +Reset PPO, 1120ms	SOT-23-5	28em	VD18	6k	Max
ABX	LM4040CIX3-4.1	Vref-IC	Shunt, 4.096V, 0.5%	SC-70-5	28dq	RF1	6k	Max
ABX	RP107N311D	LVR-IC	LDO, 3.1V±1%, 200mA, +CE, CL	SOT-23-5	28cx	VR4	6g	Ric
ĀBX	XC6114C228MR	Vdet-IC	2.8V±2%, ±Reset PPO, Wt=50ms, Rt=50ms	SOT-25	28xg	VD19	6g	Tor
ABXA	MAX6313UK36D1-T	Vdet-IC	3.6V±2.5%, OVIn, +Reset PPO, 1ms	SOT-23-5	28em	VD18	6k	Max
ABXB	MAX6313UK36D2-T	Vdet-IC	3.6V±2.5%, OVIn, +Reset PPO, 20ms	SOT-23-5	28em	VD18	6k	Max
ABXC	MAX6313UK36D3-T	Vdet-IC	3.6V±2.5%, OVIn, +Reset PPO, 140ms	SOT-23-5	28em	VD18	6k	Max
ABXD	MAX6313UK36D4-T	Vdet-IC	3.6V±2.5%, OVIn, +Reset PPO, 1120ms	SOT-23-5	28em	VD18	6k	Max
ABXE	MAX6313UK35D1-T	Vdet-IC	3.5V±2.5%, OVIn, +Reset PPO, 1ms	SOT-23-5	28em	VD18	6k	Max
ABXF	MAX6313UK35D2-T	Vdet-IC	3.5V±2.5%, OVIn, +Reset PPO, 20ms	SOT-23-5	28em	VD18	6k	Max
ABXG	MAX6313UK35D3-T	Vdet-IC	3.5V±2.5%, OVIn, +Reset PPO, 140ms	SOT-23-5	28em	VD18	6k	Max
ABXH	MAX6313UK35D4-T	Vdet-IC	3.5V±2.5%, OVIn, +Reset PPO, 1120ms	SOT-23-5	28em	VD18	6k	Max
ABXI	MAX6313UK34D1-T	Vdet-IC	3.4V±2.5%, OVIn, +Reset PPO, 1ms	SOT-23-5	28em	VD18	6k	Max
ABXJ	MAX6313UK34D2-T	Vdet-IC	3.4V±2.5%, OVIn, +Reset PPO, 20ms	SOT-23-5	28em	VD18	6k	Max
ABXK	MAX6313UK34D3-T	Vdet-IC	3.4V±2.5%, OVIn, +Reset PPO, 140ms	SOT-23-5	28em	VD18	6k	Max
ABXL	MAX6313UK34D4-T	Vdet-IC	3.4V±2.5%, OVIn, +Reset PPO, 1120ms	SOT-23-5	28em	VD18	6k	Max
ABXM	MAX6313UK33D1-T	Vdet-IC	3.3V±2.5%, OVIn, +Reset PPO, 1ms	SOT-23-5	28em	VD18	6k	Max
ABXN	MAX6313UK33D2-T	Vdet-IC	3.3V±2.5%, OVIn, +Reset PPO, 20ms	SOT-23-5	28em	VD18	6k	Max
ABXO	MAX6313UK33D3-T	Vdet-IC	3.3V±2.5%, OVIn, +Reset PPO, 140ms	SOT-23-5	28em	VD18	6k	Max
ABXP	MAX6313UK33D4-T	Vdet-IC	3.3V±2.5%, OVIn, +Reset PPO, 1120ms	SOT-23-5	28em	VD18	6k	Max
ABXQ	MAX6313UK32D1-T	Vdet-IC	3.2V±2.5%, OVIn, +Reset PPO, 1ms	SOT-23-5	28em	VD18	6k	Max
ABXR	MAX6313UK32D2-T	Vdet-IC	3.2V±2.5%, OVIn, +Reset PPO, 20ms	SOT-23-5	28em	VD18	6k	Max
ABXS	MAX6313UK32D3-T	Vdet-IC	3.2V±2.5%, OVIn, +Reset PPO, 140ms	SOT-23-5	28em	VD18	6k	Max
ABXT	MAX6313UK32D4-T	Vdet-IC	3.2V±2.5%, OVIn, +Reset PPO, 1120ms	SOT-23-5	28em	VD18	6k	Max
ABXU	MAX6313UK31D1-T	Vdet-IC	3.1V±2.5%, OVIn, +Reset PPO, 1ms	SOT-23-5	28em	VD18	6k	Max
ABXV	MAX6313UK31D2-T	Vdet-IC	3.1V±2.5%, OVIn, +Reset PPO, 20ms	SOT-23-5	28em	VD18	6k	Max
ABXW	MAX6313UK31D3-T	Vdet-IC	3.1V±2.5%, OVIn, +Reset PPO, 140ms	SOT-23-5	28em	VD18	6k	Max
ABXX	MAX6313UK31D4-T	Vdet-IC	3.1V±2.5%, OVIn, +Reset PPO, 1120ms	SOT-23-5	28em	VD18	6k	Max
ABXY	MAX6313UK30D1-T	Vdet-IC	3.0V±2.5%, OVIn, +Reset PPO, 1ms	SOT-23-5	28em	VD18	6k	Max
ABXZ	MAX6313UK30D2-T	Vdet-IC	3.0V±2.5%, OVIn, +Reset PPO, 20ms	SOT-23-5	28em	VD18	6k	Max
ABY	LM4040DIX3-4.1	Vref-IC	Shunt, 4.096V, 1%	SC-70-5	28dq	RF1	6k	Max
ABY	RP107N321D	LVR-IC	LDO, 3.2V±1%, 200mA, +CE, CL	SOT-23-5	28cx	VR4	6g	Ric
ĀBY	XC6114C229MR	Vdet-IC	2.9V±2%, ±Reset PPO, Wt=50ms, Rt=50ms	SOT-25	28xg	VD19	6g	Tor
ABYA	MAX6313UK30D3-T	Vdet-IC	3.0V±2.5%, OVIn, +Reset PPO, 140ms	SOT-23-5	28em	VD18	6k	Max
ABYB	MAX6313UK30D4-T	Vdet-IC	3.0V±2.5%, OVIn, +Reset PPO, 1120ms	SOT-23-5	28em	VD18	6k	Max



SMD code	Type	Function	Short description	Case	Pinout	Sch.	St.	Mnf.
ABYC	MAX6313UK29D1-T	Vdet-IC	2.9V±2.5%, OVIn, +Reset PPO, 1ms	SOT-23-5	28em	VD18	6k	Max
ABYD	MAX6313UK29D2-T	Vdet-IC	2.9V±2.5%, OVIn, +Reset PPO, 20ms	SOT-23-5	28em	VD18	6k	Max
ABYE	MAX6313UK29D3-T	Vdet-IC	2.9V±2.5%, OVIn, +Reset PPO, 140ms	SOT-23-5	28em	VD18	6k	Max
ABYF	MAX6313UK29D4-T	Vdet-IC	2.9V±2.5%, OVIn, +Reset PPO, 1120ms	SOT-23-5	28em	VD18	6k	Max
ABYG	MAX6313UK28D1-T	Vdet-IC	2.8V±2.5%, OVIn, +Reset PPO, 1ms	SOT-23-5	28em	VD18	6k	Max
ABYH	MAX6313UK28D2-T	Vdet-IC	2.8V±2.5%, OVIn, +Reset PPO, 20ms	SOT-23-5	28em	VD18	6k	Max
ABYI	MAX6313UK28D3-T	Vdet-IC	2.8V±2.5%, OVIn, +Reset PPO, 140ms	SOT-23-5	28em	VD18	6k	Max
ABYJ	MAX6313UK28D4-T	Vdet-IC	2.8V±2.5%, OVIn, +Reset PPO, 1120ms	SOT-23-5	28em	VD18	6k	Max
ABYK	MAX6313UK27D1-T	Vdet-IC	2.7V±2.5%, OVIn, +Reset PPO, 1ms	SOT-23-5	28em	VD18	6k	Max
ABYL	MAX6313UK27D2-T	Vdet-IC	2.7V±2.5%, OVIn, +Reset PPO, 20ms	SOT-23-5	28em	VD18	6k	Max
ABYM	MAX6313UK27D3-T	Vdet-IC	2.7V±2.5%, OVIn, +Reset PPO, 140ms	SOT-23-5	28em	VD18	6k	Max
ABYN	MAX6313UK27D4-T	Vdet-IC	2.7V±2.5%, OVIn, +Reset PPO, 1120ms	SOT-23-5	28em	VD18	6k	Max
ABYO	MAX6313UK26D1-T	Vdet-IC	2.6V±2.5%, OVIn, +Reset PPO, 1ms	SOT-23-5	28em	VD18	6k	Max
ABYP	MAX6313UK26D2-T	Vdet-IC	2.6V±2.5%, OVIn, +Reset PPO, 20ms	SOT-23-5	28em	VD18	6k	Max
ABYQ	MAX6313UK26D3-T	Vdet-IC	2.6V±2.5%, OVIn, +Reset PPO, 140ms	SOT-23-5	28em	VD18	6k	Max
ABYR	MAX6313UK26D4-T	Vdet-IC	2.6V±2.5%, OVIn, +Reset PPO, 1120ms	SOT-23-5	28em	VD18	6k	Max
ABYS	MAX6313UK25D1-T	Vdet-IC	2.5V±2.5%, OVIn, +Reset PPO, 1ms	SOT-23-5	28em	VD18	6k	Max
ABYT	MAX6313UK25D2-T	Vdet-IC	2.5V±2.5%, OVIn, +Reset PPO, 20ms	SOT-23-5	28em	VD18	6k	Max
ABYU	MAX6313UK25D3-T	Vdet-IC	2.5V±2.5%, OVIn, +Reset PPO, 140ms	SOT-23-5	28em	VD18	6k	Max
ABYV	MAX6313UK25D4-T	Vdet-IC	2.5V±2.5%, OVIn, +Reset PPO, 1120ms	SOT-23-5	28em	VD18	6k	Max
ABZ	LM4040AIX3-5.0	Vref-IC	Precision, Shunt, 5.00V, 0.1%	SC-70-5	28dq	RF1	6k	Max
ABZ	RP107N331D	LVR-IC	LDO, 3.3V±1%, 200mA, +CE, CL	SOT-23-5	28cx	VR4	6g	Ric
ABZ	XC6114C230MR	Vdet-IC	3.0V±2%, ±Reset PPO, Wt=50ms, Rt=50ms	SOT-25	28xg	VD19	6g	Tor
ABZD	MAX1615UK	LVR-IC	3.3/5.0V±2%, 40mA	SOT-23-5	28	-	6a	Max
ABZE	MAX1616UK	LVR-IC	Adj. 1.24..28V±2%, 40mA	SOT-23-5	28	-	6a	Max
ABZF	MAX6501UKP035	Tdet-IC	+35°C, -ODO	SOT-23-5	28lc	-	6k	Max
ABZG	MAX6502UKP035	Tdet-IC	+35°C, PPO	SOT-23-5	28hf	-	6k	Max
ABZP	MAX4012EUK-T	Op-IC	High Speed, 3..12V, 200MHz, 600V/μs	SOT-23-5	28opa	OP1	6k	Max
ABZR	MAX6501UKP045	Tdet-IC	+45°C, -ODO	SOT-23-5	28lc	-	6k	Max
ABZS	MAX6501UKP065	Tdet-IC	+65°C, -ODO	SOT-23-5	28lc	-	6k	Max
ABZT	MAX6501UKP095	Tdet-IC	+95°C, -ODO	SOT-23-5	28lc	-	6k	Max
ABZU	MAX6502UKP045	Tdet-IC	+45°C, PPO	SOT-23-5	28hf	-	6k	Max
ABZV	MAX6502UKP065	Tdet-IC	+65°C, PPO	SOT-23-5	28hf	-	6k	Max
ABZW	MAX6502UKP095	Tdet-IC	+95°C, PPO	SOT-23-5	28hf	-	6k	Max
ABZX	MAX6503UKP005	Tdet-IC	+5°C, -ODO	SOT-23-5	28lc	-	6k	Max
ABZY	MAX6504UKP005	Tdet-IC	+5°C, PPO	SOT-23-5	28hf	-	6k	Max
AC	74AHC1G04GW	CMOS-Logic	Inverter	SOT-353	28/Log6	-	6a	Phi
AC	HD74ALVC1G126V5	CMOS-Logic	Bus buffer gate with 3-state output	VSON-5	30/Log13	-	6a	Ren
AC	RN5RT22AA	LVR-IC	LDO, 2.2V±2%, 150mA, -CE	SOT-23-5	28vrt	VR4	6g	Ric
AC	SiP823TEU	Vdet-IC	3.08V±1.5%, MR, Strobe, -Reset PPO	SOT-23-5	28cp	VD17	6k	Vs
AC-	RT9193-28PU5	LVR-IC	LDO, 2.8V±1%, 300mA, +CE	SC-70-5	28vrx	VR7	6g	Rct
AC=	RT9193-28GU5	LVR-IC	LDO, 2.8V±1%, 300mA, +CE	SC-70-5	28vrx	VR7	6g	Rct
AC0	XC6211C312MR	LVR-IC	LDO, 3.1V±2%, 240mA, -CE, PDR	SOT-25	28vc	VR4	6g	Tor
AC0	XC6114C331MR	Vdet-IC	3.1V±2%, ±Reset PPO, Wt=100ms, Rt=50ms	SOT-25	28xg	VD19	6g	Tor
AC0	XC6365A201MR	DC/DC-IC	PWM st-down, 100kHz, 2.0V±2.5%, 1A, +CE	SOT-25	28zm	DC7	6g	Tor
AC0	XC6367A201MR	DC/DC-IC	PWM step-up, 2.0V±2.5%, 200mA, 100kHz, +CE	SOT-25	28sh	DC11	6g	Tor
AC1	XC6211C322MR	LVR-IC	LDO, 3.2V±2%, 240mA, -CE, PDR	SOT-25	28vc	VR4	6g	Tor
AC1	XC6114C332MR	Vdet-IC	3.2V±2%, ±Reset PPO, Wt=100ms, Rt=50ms	SOT-25	28xg	VD19	6g	Tor
AC1	XC6365A211MR	DC/DC-IC	PWM st-down, 100kHz, 2.1V±2.5%, 1A, +CE	SOT-25	28zm	DC7	6g	Tor
AC1	XC6367A211MR	DC/DC-IC	PWM step-up, 2.1V±2.5%, 200mA, 100kHz, +CE	SOT-25	28sh	DC11	6g	Tor
AC18	AMC8879-1.8DBT	LVR-IC	LDO, 1.8V±1.4%, 150mA, +CE	SOT-23-5	28un	VR7	6a	Adt
AC2	XC6211C332MR	LVR-IC	LDO, 3.3V±2%, 240mA, -CE, PDR	SOT-25	28vc	VR4	6g	Tor
AC2	XC6114C333MR	Vdet-IC	3.3V±2%, ±Reset PPO, Wt=100ms, Rt=50ms	SOT-25	28xg	VD19	6g	Tor
AC2	XC6365A221MR	DC/DC-IC	PWM st-down, 100kHz, 2.2V±2.5%, 1A, +CE	SOT-25	28zm	DC7	6g	Tor
AC2	XC6367A221MR	DC/DC-IC	PWM step-up, 2.2V±2.5%, 200mA, 100kHz, +CE	SOT-25	28sh	DC11	6g	Tor
AC20	AMC8879-2.0DBT	LVR-IC	LDO, 2.0V±1.4%, 150mA, +CE	SOT-23-5	28un	VR7	6a	Adt
AC25	AMC8879-2.5DBT	LVR-IC	LDO, 2.5V±1.4%, 150mA, +CE	SOT-23-5	28un	VR7	6a	Adt
AC28	AMC8879-2.8DBT	LVR-IC	LDO, 2.8V±1.4%, 150mA, +CE	SOT-23-5	28un	VR7	6a	Adt
AC2U	AMC8879-2.85DBT	LVR-IC	LDO, 2.85V±1.4%, 150mA, +CE	SOT-23-5	28un	VR7	6a	Adt
AC3	XC6211C342MR	LVR-IC	LDO, 3.4V±2%, 240mA, -CE, PDR	SOT-25	28vc	VR4	6g	Tor
AC3	XC6114C334MR	Vdet-IC	3.4V±2%, ±Reset PPO, Wt=100ms, Rt=50ms	SOT-25	28xg	VD19	6g	Tor
AC3	XC6365A231MR	DC/DC-IC	PWM st-down, 100kHz, 2.3V±2.5%, 1A, +CE	SOT-25	28zm	DC7	6g	Tor
AC3	XC6367A231MR	DC/DC-IC	PWM step-up, 2.3V±2.5%, 200mA, 100kHz, +CE	SOT-25	28sh	DC11	6g	Tor
AC30	AMC8879-3.0DBT	LVR-IC	LDO, 3.0V±1.4%, 150mA, +CE	SOT-23-5	28un	VR7	6a	Adt
AC32	AMC8879-3.2DBT	LVR-IC	LDO, 3.2V±1.4%, 150mA, +CE	SOT-23-5	28un	VR7	6a	Adt
AC33	AMC8879-3.3DBT	LVR-IC	LDO, 3.3V±1.4%, 150mA, +CE	SOT-23-5	28un	VR7	6a	Adt
AC4	XC6211C352MR	LVR-IC	LDO, 3.5V±2%, 240mA, -CE, PDR	SOT-25	28vc	VR4	6g	Tor
AC4	XC6114C335MR	Vdet-IC	3.5V±2%, ±Reset PPO, Wt=100ms, Rt=50ms	SOT-25	28xg	VD19	6g	Tor
AC4	XC6365A241MR	DC/DC-IC	PWM st-down, 100kHz, 2.4V±2.5%, 1A, +CE	SOT-25	28zm	DC7	6g	Tor
AC4	XC6367A241MR	DC/DC-IC	PWM step-up, 2.4V±2.5%, 200mA, 100kHz, +CE	SOT-25	28sh	DC11	6g	Tor



SMD code	Type	Function	Short description	Case	Pinout	Sch.	St.	Mnf.
AC5	XC6211C362MR	LVR-IC	LDO, 3.6V±2%, 240mA, -CE, PDR	SOT-25	28vc	VR4	6g	Tor
AC5	XC6114C336MR	Vdet-IC	3.6V±2%, ±Reset PPO, Wt=100ms, Rt=50ms	SOT-25	28xg	VD19	6g	Tor
AC5	XC6365A251MR	DC/DC-IC	PWM st-down, 100kHz, 2.5V±2.5%, 1A, +CE	SOT-25	28zm	DC7	6g	Tor
AC5	XC6367A251MR	DC/DC-IC	PWM step-up, 2.5V±2.5%, 200mA, 100kHz, +CE	SOT-25	28sh	DC11	6g	Tor
AC50	AMC8879-5.0DBT	LVR-IC	LDO, 5.0V±1.4%, 150mA, +CE	SOT-23-5	28un	VR7	6a	Adt
AC6	XC6211C372MR	LVR-IC	LDO, 3.7V±2%, 240mA, -CE, PDR	SOT-25	28vc	VR4	6g	Tor
AC6	XC6114C337MR	Vdet-IC	3.7V±2%, ±Reset PPO, Wt=100ms, Rt=50ms	SOT-25	28xg	VD19	6g	Tor
AC6	XC6365A261MR	DC/DC-IC	PWM st-down, 100kHz, 2.6V±2.5%, 1A, +CE	SOT-25	28zm	DC7	6g	Tor
AC6	XC6367A261MR	DC/DC-IC	PWM step-up, 2.6V±2.5%, 200mA, 100kHz, +CE	SOT-25	28sh	DC11	6g	Tor
AC7	XC6211C382MR	LVR-IC	LDO, 3.8V±2%, 240mA, -CE, PDR	SOT-25	28vc	VR4	6g	Tor
AC7	XC6114C338MR	Vdet-IC	3.8V±2%, ±Reset PPO, Wt=100ms, Rt=50ms	SOT-25	28xg	VD19	6g	Tor
AC7	XC6365A271MR	DC/DC-IC	PWM st-down, 100kHz, 2.7V±2.5%, 1A, +CE	SOT-25	28zm	DC7	6g	Tor
AC7	XC6367A271MR	DC/DC-IC	PWM step-up, 2.7V±2.5%, 200mA, 100kHz, +CE	SOT-25	28sh	DC11	6g	Tor
AC8	XC6211C392MR	LVR-IC	LDO, 3.9V±2%, 240mA, -CE, PDR	SOT-25	28vc	VR4	6g	Tor
AC8	XC6114C339MR	Vdet-IC	3.9V±2%, ±Reset PPO, Wt=100ms, Rt=50ms	SOT-25	28xg	VD19	6g	Tor
AC8	XC6365A281MR	DC/DC-IC	PWM st-down, 100kHz, 2.8V±2.5%, 1A, +CE	SOT-25	28zm	DC7	6g	Tor
AC8	XC6367A281MR	DC/DC-IC	PWM step-up, 2.8V±2.5%, 200mA, 100kHz, +CE	SOT-25	28sh	DC11	6g	Tor
AC9	XC6211C402MR	LVR-IC	LDO, 4V±2%, 240mA, -CE, PDR	SOT-25	28vc	VR4	6g	Tor
AC9	XC6114C340MR	Vdet-IC	4.0V±2%, ±Reset PPO, Wt=100ms, Rt=50ms	SOT-25	28xg	VD19	6g	Tor
AC9	XC6365A291MR	DC/DC-IC	PWM st-down, 100kHz, 2.9V±2.5%, 1A, +CE	SOT-25	28zm	DC7	6g	Tor
AC9	XC6367A291MR	DC/DC-IC	PWM step-up, 2.9V±2.5%, 200mA, 100kHz, +CE	SOT-25	28sh	DC11	6g	Tor
ACA	LM4040BIX3-5.0	Vref-IC	Precision, Shunt, 5.00V, 0.2%	SC-70-5	28dq	RF1	6k	Max
ACA	XC6211C412MR	LVR-IC	LDO, 4.1V±2%, 240mA, -CE, PDR	SOT-25	28vc	VR4	6g	Tor
ACA	XC6114C341MR	Vdet-IC	4.1V±2%, ±Reset PPO, Wt=100ms, Rt=50ms	SOT-25	28xg	VD19	6g	Tor
ACA	XC6365A205MR	DC/DC-IC	PWM st-down, 500kHz, 2.0V±2.5%, 1A, +CE	SOT-25	28zm	DC7	6g	Tor
ACA	XC6367A205MR	DC/DC-IC	PWM step-up, 2.0V±2.5%, 200mA, 500kHz, +CE	SOT-25	28sh	DC11	6g	Tor
ACAA	V6301ASP5B	Vdet-IC	2.0V, -Reset PPO, 290ms	SOT-23-5	28vdr	VD7	6a	Em
ACAB	MAX999EUK-T	Comp-IC	U-High Speed, Vcc=2.7..5.5V, Icco=5mA, <5ns	SOT-23-5	28ca	-	6k	Max
ACAB	V6301BSP5B	Vdet-IC	2.4V, -Reset PPO, 290ms	SOT-23-5	28vdr	VD7	6a	Em
ACAC	V6301CSP5B	Vdet-IC	2.8V, -Reset PPO, 290ms	SOT-23-5	28vdr	VD7	6a	Em
ACAD	V6301DSP5B	Vdet-IC	3.5V, -Reset PPO, 290ms	SOT-23-5	28vdr	VD7	6a	Em
ACAE	V6301ESP5B	Vdet-IC	4V, -Reset PPO, 290ms	SOT-23-5	28vdr	VD7	6a	Em
ACAF	V6301FSP5B	Vdet-IC	4.5V, -Reset PPO, 290ms	SOT-23-5	28vdr	VD7	6a	Em
ACAG	MAX6501UKP115	Tdet-IC	+115°C, -ODO	SOT-23-5	28lc	-	6k	Max
ACAG	V6301GSP5B	Vdet-IC	2.0V, +Reset PPO, 290ms	SOT-23-5	28vdo	VD3	6a	Em
ACAH	V6301HSP5B	Vdet-IC	2.4V, +Reset PPO, 290ms	SOT-23-5	28vdo	VD3	6a	Em
ACAI	V6301ISP5B	Vdet-IC	2.8V, +Reset PPO, 290ms	SOT-23-5	28vdo	VD3	6a	Em
ACAJ	V6301JSP5B	Vdet-IC	3.5V, +Reset PPO, 290ms	SOT-23-5	28vdo	VD3	6a	Em
ACAK	V6301KSP5B	Vdet-IC	4V, +Reset PPO, 290ms	SOT-23-5	28vdo	VD3	6a	Em
ACAL	V6301LSP5B	Vdet-IC	4.5V, +Reset PPO, 290ms	SOT-23-5	28vdo	VD3	6a	Em
ACAM	MAX6503UKP015	Tdet-IC	+15°C, ODO	SOT-23-5	28lc	-	6k	Max
ACAM	V6301MSP5B	Vdet-IC	2.0V, -Reset ODO, 290ms	SOT-23-5	28vdr	VD6	6a	Em
ACAN	MAX6503UKN005	Tdet-IC	-5°C, -ODO	SOT-23-5	28lc	-	6k	Max
ACAN	V6301NSP5B	Vdet-IC	2.4V, -Reset ODO, 290ms	SOT-23-5	28vdr	VD6	6a	Em
ACAO	V6301OSP5B	Vdet-IC	2.8V, -Reset ODO, 290ms	SOT-23-5	28vdr	VD6	6a	Em
ACAP	MAX6503UKN025	Tdet-IC	-25°C, -ODO	SOT-23-5	28lc	-	6k	Max
ACAP	V6301PSP5B	Vdet-IC	3.5V, -Reset ODO, 290ms	SOT-23-5	28vdr	VD6	6a	Em
ACAQ	MAX6503UKN035	Tdet-IC	-35°C, -ODO	SOT-23-5	28lc	-	6k	Max
ACAQ	V6301QSP5B	Vdet-IC	4V, -Reset ODO, 290ms	SOT-23-5	28vdr	VD6	6a	Em
ACAR	V6301RSP5B	Vdet-IC	4.5V, -Reset ODO, 290ms	SOT-23-5	28vdr	VD6	6a	Em
ACAT	MAX6504UKN005	Tdet-IC	-5°C, PPO	SOT-23-5	28hf	-	6k	Max
ACAV	MAX6504UKN025	Tdet-IC	-25°C, PPO	SOT-23-5	28hf	-	6k	Max
ACAW	MAX6504UKN035	Tdet-IC	-35°C, PPO	SOT-23-5	28hf	-	6k	Max
ACAX	MAX6504UKN045	Tdet-IC	-45°C, PPO	SOT-23-5	28hf	-	6k	Max
ACAY	MAX8867EUK25-T	LVR-IC	LDO, 2.5V±1.4%, 150mA, +CE	SOT-23-5	28sp	VR7	6a	Max
ACAZ	MAX8867EUK28-T	LVR-IC	LDO, 2.8V±1.4%, 150mA, +CE	SOT-23-5	28sp	VR7	6a	Max
ACB	LM4040CIX3-5.0	Vref-IC	Shunt, 5.00V, 0.5%	SC-70-5	28dq	RF1	6k	Max
ACB	XC6211C422MR	LVR-IC	LDO, 4.2V±2%, 240mA, -CE, PDR	SOT-25	28vc	VR4	6g	Tor
ACB	XC6114C342MR	Vdet-IC	4.2V±2%, ±Reset PPO, Wt=100ms, Rt=50ms	SOT-25	28xg	VD19	6g	Tor
ACB	XC6365A215MR	DC/DC-IC	PWM st-down, 500kHz, 2.1V±2.5%, 1A, +CE	SOT-25	28zm	DC7	6g	Tor
ACB	XC6367A215MR	DC/DC-IC	PWM step-up, 2.1V±2.5%, 200mA, 500kHz, +CE	SOT-25	28sh	DC11	6g	Tor
ACBA	MAX8867EUK29-T	LVR-IC	LDO, 2.84V±1.4%, 150mA, +CE	SOT-23-5	28sp	VR7	6a	Max
ACBB	MAX8867EUK30-T	LVR-IC	LDO, 3.0V±1.4%, 150mA, +CE	SOT-23-5	28sp	VR7	6a	Max
ACBC	MAX8867EUK32-T	LVR-IC	LDO, 3.15V±1.4%, 150mA, +CE	SOT-23-5	28sp	VR7	6a	Max
ACBD	MAX8867EUK33-T	LVR-IC	LDO, 3.3V±1.4%, 150mA, +CE	SOT-23-5	28sp	VR7	6a	Max
ACBE	MAX8867EUK50-T	LVR-IC	LDO, 5.0V±1.4%, 150mA, +CE	SOT-23-5	28sp	VR7	6a	Max
ACBF	MAX8868EUK25-T	LVR-IC	LDO, 2.5V±1.4%, 150mA, +CE, CL	SOT-23-5	28sp	VR7	6a	Max
ACBG	MAX8868EUK28-T	LVR-IC	LDO, 2.8V±1.4%, 150mA, +CE, CL	SOT-23-5	28sp	VR7	6a	Max
ACBH	MAX8868EUK29-T	LVR-IC	LDO, 2.84V±1.4%, 150mA, +CE, CL	SOT-23-5	28sp	VR7	6a	Max
ACBI	MAX8868EUK30-T	LVR-IC	LDO, 3.0V±1.4%, 150mA, +CE, CL	SOT-23-5	28sp	VR7	6a	Max



SMD code	Type	Function	Short description	Case	Pinout	Sch.	St.	Mnf.
ACBJ	MAX8868EUK32-T	LVR-IC	LDO, 3.15V±1.4%, 150mA, +CE, CL	SOT-23-5	28sp	VR7	6a	Max
ACBK	MAX8868EUK33-T	LVR-IC	LDO, 3.3V±1.4%, 150mA, +CE, CL	SOT-23-5	28sp	VR7	6a	Max
ACBL	MAX8868EUK50-T	LVR-IC	LDO, 5.0V±1.4%, 150mA, +CE, CL	SOT-23-5	28sp	VR7	6a	Max
ACBM	MAX8877EUK25-T	LVR-IC	LDO, 2.5V±1.4%, 150mA, +CE	SOT-23-5	28vrx	VR7	6k	Max
ACBN	MAX8877EUK28-T	LVR-IC	LDO, 2.8V±1.4%, 150mA, +CE	SOT-23-5	28vrx	VR7	6k	Max
ACBO	MAX8877EUK29-T	LVR-IC	LDO, 2.84V±1.4%, 150mA, +CE	SOT-23-5	28vrx	VR7	6k	Max
ACBP	MAX8877EUK30-T	LVR-IC	LDO, 3.0V±1.4%, 150mA, +CE	SOT-23-5	28vrx	VR7	6k	Max
ACBQ	MAX8877EUK32-T	LVR-IC	LDO, 3.15V±1.4%, 150mA, +CE	SOT-23-5	28vrx	VR7	6k	Max
ACBR	MAX8877EUK33-T	LVR-IC	LDO, 3.3V±1.4%, 150mA, +CE	SOT-23-5	28vrx	VR7	6k	Max
ACBS	MAX8877EUK50-T	LVR-IC	LDO, 5.0V±1.4%, 150mA, +CE	SOT-23-5	28vrx	VR7	6k	Max
ACBT	MAX8878EUK25-T	LVR-IC	LDO, 2.5V±1.4%, 150mA, +CE, CL	SOT-23-5	28vrx	VR7	6k	Max
ACBU	MAX8878EUK28-T	LVR-IC	LDO, 2.8V±1.4%, 150mA, +CE, CL	SOT-23-5	28vrx	VR7	6k	Max
ACBV	MAX8878EUK29-T	LVR-IC	LDO, 2.84V±1.4%, 150mA, +CE, CL	SOT-23-5	28vrx	VR7	6k	Max
ACBW	MAX8878EUK30-T	LVR-IC	LDO, 3.0V±1.4%, 150mA, +CE, CL	SOT-23-5	28vrx	VR7	6k	Max
ACBX	MAX8878EUK32-T	LVR-IC	LDO, 3.15V±1.4%, 150mA, +CE, CL	SOT-23-5	28vrx	VR7	6k	Max
ACBY	MAX8878EUK33-T	LVR-IC	LDO, 3.3V±1.4%, 150mA, +CE, CL	SOT-23-5	28vrx	VR7	6k	Max
ACBZ	MAX8878EUK50-T	LVR-IC	LDO, 5.0V±1.4%, 150mA, +CE, CL	SOT-23-5	28vrx	VR7	6k	Max
ACC	LM4040DIX3-5.0	Vref-IC	Shunt, 5.00V, 1%	SC-70-5	28dq	RF1	6k	Max
ACC	XC6211C432MR	LVR-IC	LDO, 4.3V±2%, 240mA, -CE, PDR	SOT-25	28vc	VR4	6g	Tor
ACC	XC6114C343MR	Vdet-IC	4.3V±2%, ±Reset PPO, Wt=100ms, Rt=50ms	SOT-25	28xg	VD19	6g	Tor
ACC	XC6365A225MR	DC/DC-IC	PWM st-down, 500kHz, 2.2V±2.5%, 1A, +CE	SOT-25	28zm	DC7	6g	Tor
ACC	XC6367A225MR	DC/DC-IC	PWM step-up, 2.2V±2.5%, 200mA, 500kHz, +CE	SOT-25	28sh	DC11	6g	Tor
ACCO	MAX4104EUK-T	Op-IC	LN, ±3.5. ±5.5V, Icco=20mA, 400V/μs(625MHz)	SOT-23-5	28opa	OP1	6k	Max
ACCP	MAX4105EUK-T	Op-IC	LN, ±3.5. ±5.5V, Icco=20mA, 1400V/μs(410MHz)	SOT-23-5	28opa	OP1	6k	Max
ACCC	MAX4304EUK-T	Op-IC	LN, ±3.5. ±5.5V, Icco=20mA, 1000V/μs(730MHz)	SOT-23-5	28opa	OP1	6k	Max
ACCR	MAX4305EUK-T	Op-IC	LN, ±3.5. ±5.5V, Icco=20mA, 1400V/μs(340MHz)	SOT-23-5	28opa	OP1	6k	Max
ACD	MAX8867EUK36-T	LVR-IC	LDO, 3.6V±1.4%, 150mA, +CE	SOT-23-5	28sp	VR7	6a	Max
ACDZ	XC6211C442MR	LVR-IC	LDO, 4.4V±2%, 240mA, -CE, PDR	SOT-25	28vc	VR4	6g	Tor
ACD	XC6114C344MR	Vdet-IC	4.4V±2%, ±Reset PPO, Wt=100ms, Rt=50ms	SOT-25	28xg	VD19	6g	Tor
ACD	XC6365A235MR	DC/DC-IC	PWM st-down, 500kHz, 2.3V±2.5%, 1A, +CE	SOT-25	28zm	DC7	6g	Tor
ACD	XC6367A235MR	DC/DC-IC	PWM step-up, 2.3V±2.5%, 200mA, 500kHz, +CE	SOT-25	28sh	DC11	6g	Tor
ACDA	MAX8868EUK36-T	LVR-IC	LDO, 3.6V±1.4%, 150mA, +CE, CL	SOT-23-5	28sp	VR7	6a	Max
ACDB	MAX8877EUK36-T	LVR-IC	LDO, 3.6V±1.4%, 150mA, +CE	SOT-23-5	28vrx	VR7	6k	Max
ACDC	MAX8878EUK36-T	LVR-IC	LDO, 3.6V±1.4%, 150mA, +CE, CL	SOT-23-5	28vrx	VR7	6k	Max
ACDP	MAX6501UKP085	Tdet-IC	+85°C, -ODO	SOT-23-5	28lc	-	6k	Max
ACDS	MAX4174ABUK	Op-IC	Fixed-gain, Vcc=2.5. 5.2V, 0.7V/μs, Vg=0.25V/V	SOT-23-5	28opa	OP1	6k	Max
ACDT	MAX4174ACUK	Op-IC	Fixed-gain, Vcc=2.5. 5.2V, 0.7V/μs, Vg=0.5V/V	SOT-23-5	28opa	OP1	6k	Max
ACDU	MAX4174ADUK	Op-IC	Fixed-gain, Vcc=2.5. 5.2V, 0.7V/μs, Vg=1V/V	SOT-23-5	28opa	OP1	6k	Max
ACDV	MAX4174AEUK	Op-IC	Fixed-gain, Vcc=2.5. 5.2V, 0.7V/μs, Vg=1.25V/V	SOT-23-5	28opa	OP1	6k	Max
ACDW	MAX4174AFUK	Op-IC	Fixed-gain, Vcc=2.5. 5.2V, 0.7V/μs, Vg=1.5V/V	SOT-23-5	28opa	OP1	6k	Max
ACDX	MAX4174AGUK	Op-IC	Fixed-gain, Vcc=2.5. 5.2V, 0.7V/μs, Vg=2V/V	SOT-23-5	28opa	OP1	6k	Max
ACDY	MAX4174AHUK	Op-IC	Fixed-gain, Vcc=2.5. 5.2V, 0.7V/μs, Vg=2.5V/V	SOT-23-5	28opa	OP1	6k	Max
ACDZ	MAX4174AJUK	Op-IC	Fixed-gain, Vcc=2.5. 5.2V, 0.7V/μs, Vg=3V/V	SOT-23-5	28opa	OP1	6k	Max
ACE	AME8800GEEV	LVR-IC	LDO, 3.5V±1.5%, 300mA	SOT-25	28vu	VR1	6k	Ame
ACE	AME8800GEEVL	LVR-IC	LDO, 3.5V±1.5%, 300mA	TSOT-25	28vu	VR1	6k	Ame
ACE	XC6211C452MR	LVR-IC	LDO, 4.5V±2%, 240mA, -CE, PDR	SOT-25	28vc	VR4	6g	Tor
ACE	AME8800GEEVY	LVR-IC	LDO, 3.5V±1.5%, 300mA	TSOT-25	28vu	VR1	6k	Ame
ACE	AME8800GEEVZ	LVR-IC	LDO, 3.5V±1.5%, 300mA	SOT-25	28vu	VR1	6k	Ame
ACE	XC6114C345MR	Vdet-IC	4.5V±2%, ±Reset PPO, Wt=100ms, Rt=50ms	SOT-25	28xg	VD19	6g	Tor
ACE	XC6365A245MR	DC/DC-IC	PWM st-down, 500kHz, 2.4V±2.5%, 1A, +CE	SOT-25	28zm	DC7	6g	Tor
ACE	XC6367A245MR	DC/DC-IC	PWM step-up, 2.4V±2.5%, 200mA, 500kHz, +CE	SOT-25	28sh	DC11	6g	Tor
ACEA	MAX4174AKUK	Op-IC	Fixed-gain, Vcc=2.5. 5.2V, 0.7V/μs, Vg=4V/V	SOT-23-5	28opa	OP1	6k	Max
ACEB	MAX4174ALUK	Op-IC	Fixed-gain, Vcc=2.5. 5.2V, 0.7V/μs, Vg=5V/V	SOT-23-5	28opa	OP1	6k	Max
ACEC	MAX4174AMUK	Op-IC	Fixed-gain, Vcc=2.5. 5.2V, 0.7V/μs, Vg=6V/V	SOT-23-5	28opa	OP1	6k	Max
ACED	MAX4174ANUK	Op-IC	Fixed-gain, Vcc=2.5. 5.2V, 0.7V/μs, Vg=8V/V	SOT-23-5	28opa	OP1	6k	Max
ACEE	MAX4174AOUK	Op-IC	Fixed-gain, Vcc=2.5. 5.2V, 0.7V/μs, Vg=9V/V	SOT-23-5	28opa	OP1	6k	Max
ACEF	MAX4174BAUK	Op-IC	Fixed-gain, Vcc=2.5. 5.2V, 0.7V/μs, Vg=10V/V	SOT-23-5	28opa	OP1	6k	Max
ACEG	MAX4174BBUK	Op-IC	Fixed-gain, Vcc=2.5. 5.2V, 0.7V/μs, Vg=12.5V/V	SOT-23-5	28opa	OP1	6k	Max
ACEH	MAX4174BCUK	Op-IC	Fixed-gain, Vcc=2.5. 5.2V, 0.7V/μs, Vg=15V/V	SOT-23-5	28opa	OP1	6k	Max
ACEI	MAX4174BDUK	Op-IC	Fixed-gain, Vcc=2.5. 5.2V, 0.7V/μs, Vg=20V/V	SOT-23-5	28opa	OP1	6k	Max
ACEJ	MAX4174BEUK	Op-IC	Fixed-gain, Vcc=2.5. 5.2V, 0.7V/μs, Vg=24V/V	SOT-23-5	28opa	OP1	6k	Max
ACEK	MAX4174BFUK	Op-IC	Fixed-gain, Vcc=2.5. 5.2V, 0.7V/μs, Vg=25V/V	SOT-23-5	28opa	OP1	6k	Max
ACEL	MAX4174BGUK	Op-IC	Fixed-gain, Vcc=2.5. 5.2V, 0.7V/μs, Vg=30V/V	SOT-23-5	28opa	OP1	6k	Max
ACEM	MAX4174BHUK	Op-IC	Fixed-gain, Vcc=2.5. 5.2V, 0.7V/μs, Vg=40V/V	SOT-23-5	28opa	OP1	6k	Max
ACEN	MAX4174BJUK	Op-IC	Fixed-gain, Vcc=2.5. 5.2V, 0.7V/μs, Vg=49V/V	SOT-23-5	28opa	OP1	6k	Max
ACEO	MAX4174BKUK	Op-IC	Fixed-gain, Vcc=2.5. 5.2V, 0.7V/μs, Vg=50V/V	SOT-23-5	28opa	OP1	6k	Max
ACEP	MAX4174BLUK	Op-IC	Fixed-gain, Vcc=2.5. 5.2V, 0.7V/μs, Vg=60V/V	SOT-23-5	28opa	OP1	6k	Max
ACEQ	MAX4174BMUK	Op-IC	Fixed-gain, Vcc=2.5. 5.2V, 0.7V/μs, Vg=80V/V	SOT-23-5	28opa	OP1	6k	Max
ACER	MAX4174BNUK	Op-IC	Fixed-gain, Vcc=2.5. 5.2V, 0.7V/μs, Vg=99V/V	SOT-23-5	28opa	OP1	6k	Max
ACES	MAX4174CAUK	Op-IC	Fixed-gain, Vcc=2.5. 5.2V, 0.7V/μs, Vg=100V/V	SOT-23-5	28opa	OP1	6k	Max



SMD code	Type	Function	Short description	Case	Pinout	Sch.	St.	Mnf.
ACET	MAX4175ABUK	Op-IC	Fixed-gain, Vcc=2.5..5.2V, 0.7V/μs, Vg=0.25V/V	SOT-23-5	28opa	OP1	6k	Max
ACEU	MAX4175ACUK	Op-IC	Fixed-gain, Vcc=2.5..5.2V, 0.7V/μs, Vg=0.5V/V	SOT-23-5	28opa	OP1	6k	Max
ACEV	MAX4175ADUK	Op-IC	Fixed-gain, Vcc=2.5..5.2V, 0.7V/μs, Vg=1V/V	SOT-23-5	28opa	OP1	6k	Max
ACEW	MAX4175AEUK	Op-IC	Fixed-gain, Vcc=2.5..5.2V, 0.7V/μs, Vg=1.25V/V	SOT-23-5	28opa	OP1	6k	Max
ACEX	MAX4175AFUK	Op-IC	Fixed-gain, Vcc=2.5..5.2V, 0.7V/μs, Vg=1.5V/V	SOT-23-5	28opa	OP1	6k	Max
ACEY	MAX4175AGUK	Op-IC	Fixed-gain, Vcc=2.5..5.2V, 0.7V/μs, Vg=2V/V	SOT-23-5	28opa	OP1	6k	Max
ACEZ	MAX4175AHUK	Op-IC	Fixed-gain, Vcc=2.5..5.2V, 0.7V/μs, Vg=2.5V/V	SOT-23-5	28opa	OP1	6k	Max
ACF	XC6211C462MR	LVR-IC	LDO, 4.6V±2%, 240mA, -CE, PDR	SOT-25	28vc	VR4	6g	Tor
ACF	XC6114C316MR	Vdet-IC	1.6V±2%, ±Reset PPO, Wt=100ms, Rt=50ms	SOT-25	28xg	VD19	6g	Tor
ACF	XC6114C346MR	Vdet-IC	4.6V±2%, ±Reset PPO, Wt=100ms, Rt=50ms	SOT-25	28xg	VD19	6g	Tor
ACF	XC6365A255MR	DC/DC-IC	PWM st-down, 500kHz, 2.5V±2.5%, 1A, +CE	SOT-25	28zm	DC7	6g	Tor
ACF	XC6367A255MR	DC/DC-IC	PWM step-up, 2.5V±2.5%, 200mA, 500kHz, +CE	SOT-25	28sh	DC11	6g	Tor
ACFA	MAX4175AJUK	Op-IC	Fixed-gain, Vcc=2.5..5.2V, 0.7V/μs, Vg=3V/V	SOT-23-5	28opa	OP1	6k	Max
ACFB	MAX4175AKUK	Op-IC	Fixed-gain, Vcc=2.5..5.2V, 0.7V/μs, Vg=4V/V	SOT-23-5	28opa	OP1	6k	Max
ACFC	MAX4175ALUK	Op-IC	Fixed-gain, Vcc=2.5..5.2V, 0.7V/μs, Vg=5V/V	SOT-23-5	28opa	OP1	6k	Max
ACFD	MAX4175AMUK	Op-IC	Fixed-gain, Vcc=2.5..5.2V, 0.7V/μs, Vg=6V/V	SOT-23-5	28opa	OP1	6k	Max
ACFE	MAX4175ANUK	Op-IC	Fixed-gain, Vcc=2.5..5.2V, 0.7V/μs, Vg=8V/V	SOT-23-5	28opa	OP1	6k	Max
ACFF	MAX4175AOUK	Op-IC	Fixed-gain, Vcc=2.5..5.2V, 0.7V/μs, Vg=9V/V	SOT-23-5	28opa	OP1	6k	Max
ACFG	MAX4175BAUK	Op-IC	Fixed-gain, Vcc=2.5..5.2V, 0.7V/μs, Vg=10V/V	SOT-23-5	28opa	OP1	6k	Max
ACFH	MAX4175BBUK	Op-IC	Fixed-gain, Vcc=2.5..5.2V, 0.7V/μs, Vg=12.5V/V	SOT-23-5	28opa	OP1	6k	Max
ACFI	MAX4175BCUK	Op-IC	Fixed-gain, Vcc=2.5..5.2V, 0.7V/μs, Vg=15V/V	SOT-23-5	28opa	OP1	6k	Max
ACFJ	MAX4175BDUK	Op-IC	Fixed-gain, Vcc=2.5..5.2V, 0.7V/μs, Vg=20V/V	SOT-23-5	28opa	OP1	6k	Max
ACFK	MAX4175BEUK	Op-IC	Fixed-gain, Vcc=2.5..5.2V, 0.7V/μs, Vg=24V/V	SOT-23-5	28opa	OP1	6k	Max
ACFL	MAX4175BFUK	Op-IC	Fixed-gain, Vcc=2.5..5.2V, 0.7V/μs, Vg=25V/V	SOT-23-5	28opa	OP1	6k	Max
ACFM	MAX4175BGUK	Op-IC	Fixed-gain, Vcc=2.5..5.2V, 0.7V/μs, Vg=30V/V	SOT-23-5	28opa	OP1	6k	Max
ACFN	MAX4175BHUK	Op-IC	Fixed-gain, Vcc=2.5..5.2V, 0.7V/μs, Vg=40V/V	SOT-23-5	28opa	OP1	6k	Max
ACFO	MAX4175BJUK	Op-IC	Fixed-gain, Vcc=2.5..5.2V, 0.7V/μs, Vg=49V/V	SOT-23-5	28opa	OP1	6k	Max
ACFP	MAX4175BKUK	Op-IC	Fixed-gain, Vcc=2.5..5.2V, 0.7V/μs, Vg=50V/V	SOT-23-5	28opa	OP1	6k	Max
ACFQ	MAX4175BLUK	Op-IC	Fixed-gain, Vcc=2.5..5.2V, 0.7V/μs, Vg=60V/V	SOT-23-5	28opa	OP1	6k	Max
ACFR	MAX4175BMUK	Op-IC	Fixed-gain, Vcc=2.5..5.2V, 0.7V/μs, Vg=80V/V	SOT-23-5	28opa	OP1	6k	Max
ACFS	MAX4175BNUK	Op-IC	Fixed-gain, Vcc=2.5..5.2V, 0.7V/μs, Vg=99V/V	SOT-23-5	28opa	OP1	6k	Max
ACFT	MAX4175CAUK	Op-IC	Fixed-gain, Vcc=2.5..5.2V, 0.7V/μs, Vg=100V/V	SOT-23-5	28opa	OP1	6k	Max
ACFU	MAX6501UKP05	Tdet-IC	+105°C, -ODO	SOT-23-5	28lc	-	6k	Max
ACFV	MAX6501UKP075	Tdet-IC	+75°C, -ODO	SOT-23-5	28lc	-	6k	Max
ACFW	MAX6501UKP055	Tdet-IC	+55°C, -ODO	SOT-23-5	28lc	-	6k	Max
ACFX	MAX6503UKN015	Tdet-IC	-15°C, -ODO	SOT-23-5	28lc	-	6k	Max
ACFY	MAX6502UKP115	Tdet-IC	+115°C, PPO	SOT-23-5	28lc	-	6k	Max
ACFZ	MAX6502UKP105	Tdet-IC	+105°C, PPO	SOT-23-5	28lc	-	6k	Max
ACG	NCV301LSN33T1	Vdet-IC	3.3V±1.5%, -Reset ODO	TSOP-5	28vdm	VD6	6k	Ons
ACGA	MAX6502UKP085	Tdet-IC	+85°C, PPO	SOT-23-5	28hf	-	6k	Max
ACGB	MAX6502UKP075	Tdet-IC	+75°C, PPO	SOT-23-5	28hf	-	6k	Max
ACGC	MAX6502UKP055	Tdet-IC	+55°C, PPO	SOT-23-5	28hf	-	6k	Max
ACGD	MAX6504UKN015	Tdet-IC	-15°C, PPO	SOT-23-5	28hf	-	6k	Max
ACGF	MAX4040EUK-T	Op-IC	μPower, ±1.2..±2.75V, Icco=10μA, Vg=94dB	SOT-23-5	28opa	OP1	6k	Max
ACGO	MAX6501UKP125	Tdet-IC	+125°C, -ODO	SOT-23-5	28lc	-	6k	Max
ACH	XC6211C472MR	LVR-IC	LDO, 4.7V±2%, 240mA, -CE, PDR	SOT-25	28vc	VR4	6g	Tor
ACH	XC6114C317MR	Vdet-IC	1.7V±2%, ±Reset PPO, Wt=100ms, Rt=50ms	SOT-25	28xg	VD19	6g	Tor
ACH	XC6114C347MR	Vdet-IC	4.7V±2%, ±Reset PPO, Wt=100ms, Rt=50ms	SOT-25	28xg	VD19	6g	Tor
ACH	XC6365A265MR	DC/DC-IC	PWM st-down, 500kHz, 2.6V±2.5%, 1A, +CE	SOT-25	28zm	DC7	6g	Tor
ACH	XC6367A265MR	DC/DC-IC	PWM step-up, 2.6V±2.5%, 200mA, 500kHz, +CE	SOT-25	28sh	DC11	6g	Tor
ACHF	MAX8867EUK27-T	LVR-IC	LDO, 2.7V±1.4%, 150mA, +CE	SOT-23-5	28sp	VR7	6a	Max
ACJ	NCV302LSN30T1	Vdet-IC	3.0V±1.5%, -Reset PPO	TSOP-5	28vdo	VD3	6k	Ons
ACK	XC6211C482MR	LVR-IC	LDO, 4.8V±2%, 240mA, -CE, PDR	SOT-25	28vc	VR4	6g	Tor
ACK	XC6114C318MR	Vdet-IC	1.8V±2%, ±Reset PPO, Wt=100ms, Rt=50ms	SOT-25	28xg	VD19	6g	Tor
ACK	XC6114C348MR	Vdet-IC	4.8V±2%, ±Reset PPO, Wt=100ms, Rt=50ms	SOT-25	28xg	VD19	6g	Tor
ACK	XC6365A275MR	DC/DC-IC	PWM st-down, 500kHz, 2.7V±2.5%, 1A, +CE	SOT-25	28zm	DC7	6g	Tor
ACK	XC6367A275MR	DC/DC-IC	PWM step-up, 2.7V±2.5%, 200mA, 500kHz, +CE	SOT-25	28sh	DC11	6g	Tor
ACL	XC6211C492MR	LVR-IC	LDO, 4.9V±2%, 240mA, -CE, PDR	SOT-25	28vc	VR4	6g	Tor
ACL	XC6114C319MR	Vdet-IC	1.9V±2%, ±Reset PPO, Wt=100ms, Rt=50ms	SOT-25	28xg	VD19	6g	Tor
ACL	XC6114C349MR	Vdet-IC	4.9V±2%, ±Reset PPO, Wt=100ms, Rt=50ms	SOT-25	28xg	VD19	6g	Tor
ACL	XC6365A285MR	DC/DC-IC	PWM st-down, 500kHz, 2.8V±2.5%, 1A, +CE	SOT-25	28zm	DC7	6g	Tor
ACL	XC6367A285MR	DC/DC-IC	PWM step-up, 2.8V±2.5%, 200mA, 500kHz, +CE	SOT-25	28sh	DC11	6g	Tor
ACM	XC6211C502MR	LVR-IC	LDO, 5V±2%, 240mA, -CE, PDR	SOT-25	28vc	VR4	6g	Tor
ACM	XC6114C320MR	Vdet-IC	2.0V±2%, ±Reset PPO, Wt=100ms, Rt=50ms	SOT-25	28xg	VD19	6g	Tor
ACM	XC6114C350MR	Vdet-IC	5.0V±2%, ±Reset PPO, Wt=100ms, Rt=50ms	SOT-25	28xg	VD19	6g	Tor
ACM	XC6365A295MR	DC/DC-IC	PWM st-down, 500kHz, 2.9V±2.5%, 1A, +CE	SOT-25	28zm	DC7	6g	Tor
ACM	XC6367A295MR	DC/DC-IC	PWM step-up, 2.9V±2.5%, 200mA, 500kHz, +CE	SOT-25	28sh	DC11	6g	Tor
ACN	XC6114C321MR	Vdet-IC	2.1V±2%, ±Reset PPO, Wt=100ms, Rt=50ms	SOT-25	28xg	VD19	6g	Tor
ACP	XC6114C322MR	Vdet-IC	2.2V±2%, ±Reset PPO, Wt=100ms, Rt=50ms	SOT-25	28xg	VD19	6g	Tor
ACR	NCV301LSN42T1	Vdet-IC	4.2V±1.5%, -Reset ODO	TSOP-5	28vdm	VD6	6k	Ons



SMD code	Type	Function	Short description	Case	Pinout	Sch.	St.	Mnf.
<u>ACR</u>	XC6114C323MR	Vdet-IC	2.3V±2%, ±Reset PPO, Wt=100ms, Rt=50ms	SOT-25	28xg	VD19	6g	Tor
<u>ACS</u>	XC6114C324MR	Vdet-IC	2.4V±2%, ±Reset PPO, Wt=100ms, Rt=50ms	SOT-25	28xg	VD19	6g	Tor
<u>ACT</u>	XC6114C325MR	Vdet-IC	2.5V±2%, ±Reset PPO, Wt=100ms, Rt=50ms	SOT-25	28xg	VD19	6g	Tor
<u>ACU</u>	XC6114C326MR	Vdet-IC	2.6V±2%, ±Reset PPO, Wt=100ms, Rt=50ms	SOT-25	28xg	VD19	6g	Tor
<u>ACV</u>	XC6114C327MR	Vdet-IC	2.7V±2%, ±Reset PPO, Wt=100ms, Rt=50ms	SOT-25	28xg	VD19	6g	Tor
<u>ACX</u>	XC6114C328MR	Vdet-IC	2.8V±2%, ±Reset PPO, Wt=100ms, Rt=50ms	SOT-25	28xg	VD19	6g	Tor
<u>ACY</u>	XC6114C329MR	Vdet-IC	2.9V±2%, ±Reset PPO, Wt=100ms, Rt=50ms	SOT-25	28xg	VD19	6g	Tor
<u>ACZ</u>	XC6114C330MR	Vdet-IC	3.0V±2%, ±Reset PPO, Wt=100ms, Rt=50ms	SOT-25	28xg	VD19	6g	Tor
<u>AD</u>	74AHC1GU04GW	CMOS-Logic	Inverter	SC-88A	28/Log6	-	6a	Phi
<u>AD</u>	HD74ALVC1G06VS	CMOS-Logic	Inverter (ODO)	VSON-5	30/Log19	-	6a	Ren
<u>AD</u>	PI74ST1G32CX	CMOS-Logic	2-input OR gate	SC-70-5	28/Log4	-	6a	Per
<u>AD</u>	PI74ST1G32TX	CMOS-Logic	2-input OR gate	SOT-23-5	28/Log4	-	6a	Per
<u>AD</u>	RN5RT23AA	LVR-IC	LDO, 2.3V±2%, 150mA, -CE	SOT-23-5	28vrt	VR4	6g	Ric
<u>AD</u>	SiP8233SEU	Vdet-IC	2.93V±1.5%, MR, Strobe, -Reset PPO	SOT-23-5	28cp	VD17	6k	Vs
<u>AD</u>	XP01110	Si-pnp-Digi	Dual, 50V, 100mA, 150mW, 80MHz, R1=47k	SMini5	30/TD9	-	6a	Pan
<u>AD</u>	XP1110	Si-pnp-Digi	Dual, 50V, 100mA, 150mW, 80MHz, R1=47k	SMini5	30/TD9	-	6a	Pan
<u>AD-</u>	RT9193-30PU5	LVR-IC	LDO, 3.0V±1%, 300mA, +CE	SC-70-5	28vrx	VR7	6g	Rct
<u>AD0</u>	XC6211D312MR	LVR-IC	LDO, 3.1V±2%, 240mA, -CE	SOT-25	28vc	VR4	6g	Tor
<u>AD0</u>	XC6114C431MR	Vdet-IC	3.1V±2%, ±Reset PPO, Wt=200ms, Rt=50ms	SOT-25	28xg	VD19	6g	Tor
<u>AD0</u>	XC6365A301MR	DC/DC-IC	PWM st-down, 100kHz, 3.0V±2.5%, 1A, +CE	SOT-25	28zm	DC7	6g	Tor
<u>AD0</u>	XC6367A301MR	DC/DC-IC	PWM step-up, 3.0V±2.5%, 200mA, 100kHz, +CE	SOT-25	28sh	DC11	6g	Tor
<u>AD1</u>	XC6211D322MR	LVR-IC	LDO, 3.2V±2%, 240mA, -CE	SOT-25	28vc	VR4	6g	Tor
<u>AD1</u>	XC6114C432MR	Vdet-IC	3.2V±2%, ±Reset PPO, Wt=200ms, Rt=50ms	SOT-25	28xg	VD19	6g	Tor
<u>AD1</u>	XC6365A311MR	DC/DC-IC	PWM st-down, 100kHz, 3.1V±2.5%, 1A, +CE	SOT-25	28zm	DC7	6g	Tor
<u>AD1</u>	XC6367A311MR	DC/DC-IC	PWM step-up, 3.1V±2.5%, 200mA, 100kHz, +CE	SOT-25	28sh	DC11	6g	Tor
<u>AD2</u>	XC6211D332MR	LVR-IC	LDO, 3.3V±2%, 240mA, -CE	SOT-25	28vc	VR4	6g	Tor
<u>AD2</u>	XC6114C433MR	Vdet-IC	3.3V±2%, ±Reset PPO, Wt=200ms, Rt=50ms	SOT-25	28xg	VD19	6g	Tor
<u>AD2</u>	XC6365A321MR	DC/DC-IC	PWM st-down, 100kHz, 3.2V±2.5%, 1A, +CE	SOT-25	28zm	DC7	6g	Tor
<u>AD2</u>	XC6367A321MR	DC/DC-IC	PWM step-up, 3.2V±2.5%, 200mA, 100kHz, +CE	SOT-25	28sh	DC11	6g	Tor
<u>AD3</u>	XC6211D342MR	LVR-IC	LDO, 3.4V±2%, 240mA, -CE	SOT-25	28vc	VR4	6g	Tor
<u>AD3</u>	XC6114C434MR	Vdet-IC	3.4V±2%, ±Reset PPO, Wt=200ms, Rt=50ms	SOT-25	28xg	VD19	6g	Tor
<u>AD3</u>	XC6365A331MR	DC/DC-IC	PWM st-down, 100kHz, 3.3V±2.5%, 1A, +CE	SOT-25	28zm	DC7	6g	Tor
<u>AD3</u>	XC6367A331MR	DC/DC-IC	PWM step-up, 3.3V±2.5%, 200mA, 100kHz, +CE	SOT-25	28sh	DC11	6g	Tor
<u>AD4</u>	XC6211D352MR	LVR-IC	LDO, 3.5V±2%, 240mA, -CE	SOT-25	28vc	VR4	6g	Tor
<u>AD4</u>	XC6114C435MR	Vdet-IC	3.5V±2%, ±Reset PPO, Wt=200ms, Rt=50ms	SOT-25	28xg	VD19	6g	Tor
<u>AD4</u>	XC6365A341MR	DC/DC-IC	PWM st-down, 100kHz, 3.4V±2.5%, 1A, +CE	SOT-25	28zm	DC7	6g	Tor
<u>AD4</u>	XC6367A341MR	DC/DC-IC	PWM step-up, 3.4V±2.5%, 200mA, 100kHz, +CE	SOT-25	28sh	DC11	6g	Tor
<u>AD5</u>	XC6211D362MR	LVR-IC	LDO, 3.6V±2%, 240mA, -CE	SOT-25	28vc	VR4	6g	Tor
<u>AD5</u>	XC6114C436MR	Vdet-IC	3.6V±2%, ±Reset PPO, Wt=200ms, Rt=50ms	SOT-25	28xg	VD19	6g	Tor
<u>AD5</u>	XC6365A351MR	DC/DC-IC	PWM st-down, 100kHz, 3.5V±2.5%, 1A, +CE	SOT-25	28zm	DC7	6g	Tor
<u>AD5</u>	XC6367A351MR	DC/DC-IC	PWM step-up, 3.5V±2.5%, 200mA, 100kHz, +CE	SOT-25	28sh	DC11	6g	Tor
<u>AD6</u>	XC6211D372MR	LVR-IC	LDO, 3.7V±2%, 240mA, -CE	SOT-25	28vc	VR4	6g	Tor
<u>AD6</u>	XC6114C437MR	Vdet-IC	3.7V±2%, ±Reset PPO, Wt=200ms, Rt=50ms	SOT-25	28xg	VD19	6g	Tor
<u>AD6</u>	XC6365A361MR	DC/DC-IC	PWM st-down, 100kHz, 3.6V±2.5%, 1A, +CE	SOT-25	28zm	DC7	6g	Tor
<u>AD6</u>	XC6367A361MR	DC/DC-IC	PWM step-up, 3.6V±2.5%, 200mA, 100kHz, +CE	SOT-25	28sh	DC11	6g	Tor
<u>AD7</u>	XC6211D382MR	LVR-IC	LDO, 3.8V±2%, 240mA, -CE	SOT-25	28vc	VR4	6g	Tor
<u>AD7</u>	XC6114C438MR	Vdet-IC	3.8V±2%, ±Reset PPO, Wt=200ms, Rt=50ms	SOT-25	28xg	VD19	6g	Tor
<u>AD7</u>	XC6365A371MR	DC/DC-IC	PWM st-down, 100kHz, 3.7V±2.5%, 1A, +CE	SOT-25	28zm	DC7	6g	Tor
<u>AD7</u>	XC6367A371MR	DC/DC-IC	PWM step-up, 3.7V±2.5%, 200mA, 100kHz, +CE	SOT-25	28sh	DC11	6g	Tor
<u>AD8</u>	XC6211D392MR	LVR-IC	LDO, 3.9V±2%, 240mA, -CE	SOT-25	28vc	VR4	6g	Tor
<u>AD8</u>	XC6114C439MR	Vdet-IC	3.9V±2%, ±Reset PPO, Wt=200ms, Rt=50ms	SOT-25	28xg	VD19	6g	Tor
<u>AD8</u>	XC6365A381MR	DC/DC-IC	PWM st-down, 100kHz, 3.8V±2.5%, 1A, +CE	SOT-25	28zm	DC7	6g	Tor
<u>AD8</u>	XC6367A381MR	DC/DC-IC	PWM step-up, 3.8V±2.5%, 200mA, 100kHz, +CE	SOT-25	28sh	DC11	6g	Tor
<u>AD9</u>	XC6211D402MR	LVR-IC	LDO, 4V±2%, 240mA, -CE	SOT-25	28vc	VR4	6g	Tor
<u>AD9</u>	XC6114C440MR	Vdet-IC	4.0V±2%, ±Reset PPO, Wt=200ms, Rt=50ms	SOT-25	28xg	VD19	6g	Tor
<u>AD9</u>	XC6365A391MR	DC/DC-IC	PWM st-down, 100kHz, 3.9V±2.5%, 1A, +CE	SOT-25	28zm	DC7	6g	Tor
<u>AD9</u>	XC6367A391MR	DC/DC-IC	PWM step-up, 3.9V±2.5%, 200mA, 100kHz, +CE	SOT-25	28sh	DC11	6g	Tor
<u>ADA</u>	XC6211D412MR	LVR-IC	LDO, 4.1V±2%, 240mA, -CE	SOT-25	28vc	VR4	6g	Tor
<u>ADA</u>	XC6114C441MR	Vdet-IC	4.1V±2%, ±Reset PPO, Wt=200ms, Rt=50ms	SOT-25	28xg	VD19	6g	Tor
<u>ADA</u>	XC6365A305MR	DC/DC-IC	PWM st-down, 500kHz, 3.0V±2.5%, 1A, +CE	SOT-25	28zm	DC7	6g	Tor
<u>ADA</u>	XC6367A305MR	DC/DC-IC	PWM step-up, 3.0V±2.5%, 200mA, 500kHz, +CE	SOT-25	28sh	DC11	6g	Tor
<u>ADAA</u>	V6310ASP5B	Vdet-IC	2.0V, -Reset PPO, 50ms	SOT-23-5	28vdr	VD7	6a	Em
<u>ADAB</u>	V6310BSP5B	Vdet-IC	2.4V, -Reset PPO, 50ms	SOT-23-5	28vdr	VD7	6a	Em
<u>ADAC</u>	V6310CSP5B	Vdet-IC	2.8V, -Reset PPO, 50ms	SOT-23-5	28vdr	VD7	6a	Em
<u>ADAD</u>	V6310DSP5B	Vdet-IC	3.5V, -Reset PPO, 50ms	SOT-23-5	28vdr	VD7	6a	Em
<u>ADAE</u>	V6310ESP5B	Vdet-IC	4V, -Reset PPO, 50ms	SOT-23-5	28vdr	VD7	6a	Em
<u>ADAF</u>	V6310FSP5B	Vdet-IC	4.5V, -Reset PPO, 50ms	SOT-23-5	28vdr	VD7	6a	Em
<u>ADAG</u>	V6310GSP5B	Vdet-IC	2.0V, +Reset PPO, 50ms	SOT-23-5	28vdo	VD3	6a	Em
<u>ADAH</u>	V6310HSP5B	Vdet-IC	2.4V, +Reset PPO, 50ms	SOT-23-5	28vdo	VD3	6a	Em
<u>ADAI</u>	V6310ISP5B	Vdet-IC	2.8V, +Reset PPO, 50ms	SOT-23-5	28vdo	VD3	6a	Em



SMD code	Type	Function	Short description	Case	Pinout	Sch.	St.	Mnf.
ADAJ	V6310JSP5B	Vdet-IC	3.5V, +Reset PPO, 50ms	SOT-23-5	28vdo	VD3	6a	Em
ADAK	V6310KSP5B	Vdet-IC	4V, +Reset PPO, 50ms	SOT-23-5	28vdo	VD3	6a	Em
ADAL	V6310LSP5B	Vdet-IC	4.5V, +Reset PPO, 50ms	SOT-23-5	28vdo	VD3	6a	Em
ADAM	V6310MSP5B	Vdet-IC	2.0V, -Reset ODO, 50ms	SOT-23-5	28vdr	VD6	6a	Em
ADAN	V6310NSP5B	Vdet-IC	2.4V, -Reset ODO, 50ms	SOT-23-5	28vdr	VD6	6a	Em
ADAO	V6310OSP5B	Vdet-IC	2.8V, -Reset ODO, 50ms	SOT-23-5	28vdr	VD6	6a	Em
ADAP	V6310PSP5B	Vdet-IC	3.5V, -Reset ODO, 50ms	SOT-23-5	28vdr	VD6	6a	Em
ADAQ	V6310QSP5B	Vdet-IC	4V, -Reset ODO, 50ms	SOT-23-5	28vdr	VD6	6a	Em
ADAR	V6310RSP5B	Vdet-IC	4.5V, -Reset ODO, 50ms	SOT-23-5	28vdr	VD6	6a	Em
ADB	XC6211D422MR	LVR-IC	LDO, 4.2V±2%, 240mA, -CE	SOT-25	28vc	VR4	6g	Tor
ADB	XC6114C442MR	Vdet-IC	4.2V±2%, ±Reset PPO, Wt=200ms, Rt=50ms	SOT-25	28xg	VD19	6g	Tor
ADB	XC6365A315MR	DC/DC-IC	PWM st-down, 500kHz, 3.1V±2.5%, 1A, +CE	SOT-25	28zm	DC7	6g	Tor
ADB	XC6367A315MR	DC/DC-IC	PWM step-up, 3.1V±2.5%, 200mA, 500kHz, +CE	SOT-25	28sh	DC11	6g	Tor
ADC	NCV303LSN11T1	Vdet-IC	1.1V±1.5%, -Reset ODO	TSOP-5	28vdo	VD1	6k	Ons
ADC	XC6211D432MR	LVR-IC	LDO, 4.3V±2%, 240mA, -CE	SOT-25	28vc	VR4	6g	Tor
ADC	XC6114C443MR	Vdet-IC	4.3V±2%, ±Reset PPO, Wt=200ms, Rt=50ms	SOT-25	28xg	VD19	6g	Tor
ADC	XC6365A325MR	DC/DC-IC	PWM st-down, 500kHz, 3.2V±2.5%, 1A, +CE	SOT-25	28zm	DC7	6g	Tor
ADC	XC6367A325MR	DC/DC-IC	PWM step-up, 3.2V±2.5%, 200mA, 500kHz, +CE	SOT-25	28sh	DC11	6g	Tor
ADD	NCV303LSN22T1	Vdet-IC	2.2V±1.5%, -Reset ODO	TSOP-5	28vdo	VD1	6k	Ons
ADD	XC6211D442MR	LVR-IC	LDO, 4.4V±2%, 240mA, -CE	SOT-25	28vc	VR4	6g	Tor
ADD	XC6114C444MR	Vdet-IC	4.4V±2%, ±Reset PPO, Wt=200ms, Rt=50ms	SOT-25	28xg	VD19	6g	Tor
ADD	XC6365A335MR	DC/DC-IC	PWM st-down, 500kHz, 3.3V±2.5%, 1A, +CE	SOT-25	28zm	DC7	6g	Tor
ADD	XC6367A335MR	DC/DC-IC	PWM step-up, 3.3V±2.5%, 200mA, 500kHz, +CE	SOT-25	28sh	DC11	6g	Tor
ADE	XC6211D452MR	LVR-IC	LDO, 4.5V±2%, 240mA, -CE	SOT-25	28vc	VR4	6g	Tor
ADE	XC6114C445MR	Vdet-IC	4.5V±2%, ±Reset PPO, Wt=200ms, Rt=50ms	SOT-25	28xg	VD19	6g	Tor
ADE	XC6365A345MR	DC/DC-IC	PWM st-down, 500kHz, 3.4V±2.5%, 1A, +CE	SOT-25	28zm	DC7	6g	Tor
ADE	XC6367A345MR	DC/DC-IC	PWM step-up, 3.4V±2.5%, 200mA, 500kHz, +CE	SOT-25	28sh	DC11	6g	Tor
ADF	XC6211D462MR	LVR-IC	LDO, 4.6V±2%, 240mA, -CE	SOT-25	28vc	VR4	6g	Tor
ADF	XC6114C416MR	Vdet-IC	1.6V±2%, ±Reset PPO, Wt=200ms, Rt=50ms	SOT-25	28xg	VD19	6g	Tor
ADF	XC6114C446MR	Vdet-IC	4.6V±2%, ±Reset PPO, Wt=200ms, Rt=50ms	SOT-25	28xg	VD19	6g	Tor
ADF	XC6365A355MR	DC/DC-IC	PWM st-down, 500kHz, 3.5V±2.5%, 1A, +CE	SOT-25	28zm	DC7	6g	Tor
ADF	XC6367A355MR	DC/DC-IC	PWM step-up, 3.5V±2.5%, 200mA, 500kHz, +CE	SOT-25	28sh	DC11	6g	Tor
ADH	XC6211D472MR	LVR-IC	LDO, 4.7V±2%, 240mA, -CE	SOT-25	28vc	VR4	6g	Tor
ADH	XC6114C417MR	Vdet-IC	1.7V±2%, ±Reset PPO, Wt=200ms, Rt=50ms	SOT-25	28xg	VD19	6g	Tor
ADH	XC6114C447MR	Vdet-IC	4.7V±2%, ±Reset PPO, Wt=200ms, Rt=50ms	SOT-25	28xg	VD19	6g	Tor
ADH	XC6365A365MR	DC/DC-IC	PWM st-down, 500kHz, 3.6V±2.5%, 1A, +CE	SOT-25	28zm	DC7	6g	Tor
ADH	XC6367A365MR	DC/DC-IC	PWM step-up, 3.6V±2.5%, 200mA, 500kHz, +CE	SOT-25	28sh	DC11	6g	Tor
ADIZ	MAX6503UKN045	Tdet-IC	-45°C, -ODO	SOT-23-5	28lc	-	6k	Max
ADJA	MAX4076AAUK	Op-IC	µPower, ±1.2...±2.75V, Icco= 37µA, Vg=117dB	SOT-23-5	28opa	OP1	6k	Max
ADJB	MAX4074ABUK-T	Op-IC	µPower, ±1.2...±2.75V, Icco= 37µA, Vg=0.25V/V	SOT-23-5	28opa	OP1	6k	Max
ADJC	MAX4074ACUK-T	Op-IC	µPower, ±1.2...±2.75V, Icco= 37µA, Vg=0.5V/V	SOT-23-5	28opa	OP1	6k	Max
ADJD	MAX4074ADUK-T	Op-IC	µPower, ±1.2...±2.75V, Icco= 37µA, Vg=1V/V	SOT-23-5	28opa	OP1	6k	Max
ADJE	MAX4074AEUK-T	Op-IC	µPower, ±1.2...±2.75V, Icco= 37µA, Vg=1.25V/V	SOT-23-5	28opa	OP1	6k	Max
ADJF	MAX4074AFUK-T	Op-IC	µPower, ±1.2...±2.75V, Icco= 37µA, Vg=1.5V/V	SOT-23-5	28opa	OP1	6k	Max
ADJG	MAX4074AGUK-T	Op-IC	µPower, ±1.2...±2.75V, Icco= 37µA, Vg=2V/V	SOT-23-5	28opa	OP1	6k	Max
ADJH	MAX4074AHUK-T	Op-IC	µPower, ±1.2...±2.75V, Icco= 37µA, Vg=2.5V/V	SOT-23-5	28opa	OP1	6k	Max
ADJI	MAX4074AJUK-T	Op-IC	µPower, ±1.2...±2.75V, Icco= 37µA, Vg=3V/V	SOT-23-5	28opa	OP1	6k	Max
ADJJ	MAX4074AKUK-T	Op-IC	µPower, ±1.2...±2.75V, Icco= 37µA, Vg=4V/V	SOT-23-5	28opa	OP1	6k	Max
ADJK	MAX4074ALUK-T	Op-IC	µPower, ±1.2...±2.75V, Icco= 37µA, Vg=5V/V	SOT-23-5	28opa	OP1	6k	Max
ADJL	MAX4074AMUK-T	Op-IC	µPower, ±1.2...±2.75V, Icco= 37µA, Vg=6V/V	SOT-23-5	28opa	OP1	6k	Max
ADJM	MAX4074ANUK-T	Op-IC	µPower, ±1.2...±2.75V, Icco= 37µA, Vg=8V/V	SOT-23-5	28opa	OP1	6k	Max
ADJN	MAX4074AOUK-T	Op-IC	µPower, ±1.2...±2.75V, Icco= 37µA, Vg=9V/V	SOT-23-5	28opa	OP1	6k	Max
ADJO	MAX4074BAUK-T	Op-IC	µPower, ±1.2...±2.75V, Icco= 37µA, Vg=10V/V	SOT-23-5	28opa	OP1	6k	Max
ADJP	MAX4074BBUK-T	Op-IC	µPower, ±1.2...±2.75V, Icco= 37µA, Vg=12.5V/V	SOT-23-5	28opa	OP1	6k	Max
ADJQ	MAX4074BCUK-T	Op-IC	µPower, ±1.2...±2.75V, Icco= 37µA, Vg=15V/V	SOT-23-5	28opa	OP1	6k	Max
ADJR	MAX4074BDUK-T	Op-IC	µPower, ±1.2...±2.75V, Icco= 37µA, Vg=20V/V	SOT-23-5	28opa	OP1	6k	Max
ADJS	MAX4074BEUK-T	Op-IC	µPower, ±1.2...±2.75V, Icco= 37µA, Vg=24V/V	SOT-23-5	28opa	OP1	6k	Max
ADJT	MAX4074BFUK-T	Op-IC	µPower, ±1.2...±2.75V, Icco= 37µA, Vg=25V/V	SOT-23-5	28opa	OP1	6k	Max
ADJU	MAX4074BGUK-T	Op-IC	µPower, ±1.2...±2.75V, Icco= 37µA, Vg=30V/V	SOT-23-5	28opa	OP1	6k	Max
ADJV	MAX4074BHUK-T	Op-IC	µPower, ±1.2...±2.75V, Icco= 37µA, Vg=40V/V	SOT-23-5	28opa	OP1	6k	Max
ADJW	MAX4074BJUK-T	Op-IC	µPower, ±1.2...±2.75V, Icco= 37µA, Vg=49V/V	SOT-23-5	28opa	OP1	6k	Max
ADJX	MAX4074BKUK-T	Op-IC	µPower, ±1.2...±2.75V, Icco= 37µA, Vg=50V/V	SOT-23-5	28opa	OP1	6k	Max
ADJY	MAX4074BLUK-T	Op-IC	µPower, ±1.2...±2.75V, Icco= 37µA, Vg=60V/V	SOT-23-5	28opa	OP1	6k	Max
ADJZ	MAX4074BMUK-T	Op-IC	µPower, ±1.2...±2.75V, Icco= 37µA, Vg=79V/V	SOT-23-5	28opa	OP1	6k	Max
ADK	XC6211D482MR	LVR-IC	LDO, 4.8V±2%, 240mA, -CE	SOT-25	28vc	VR4	6g	Tor
ADK	XC6114C418MR	Vdet-IC	1.8V±2%, ±Reset PPO, Wt=200ms, Rt=50ms	SOT-25	28xg	VD19	6g	Tor
ADK	XC6114C448MR	Vdet-IC	4.8V±2%, ±Reset PPO, Wt=200ms, Rt=50ms	SOT-25	28xg	VD19	6g	Tor
ADK	XC6365A375MR	DC/DC-IC	PWM st-down, 500kHz, 3.7V±2.5%, 1A, +CE	SOT-25	28zm	DC7	6g	Tor
ADK	XC6367A375MR	DC/DC-IC	PWM step-up, 3.7V±2.5%, 200mA, 500kHz, +CE	SOT-25	28sh	DC11	6g	Tor
ADKA	MAX4074BNUK-T	Op-IC	µPower, ±1.2...±2.75V, Icco= 37µA, Vg=99V/V	SOT-23-5	28opa	OP1	6k	Max



SMD code	Type	Function	Short description	Case	Pinout	Sch.	St.	Mnf.
ADKB	MAX4074CAUK-T	Op-IC	μ Power, $\pm 1.2... \pm 2.75V$, $I_{cco} = 37\mu A$, $V_g = 100VVV$	SOT-23-5	28opa	OP1	6k	Max
ADKD	MAX8867EUK40-T	LVR-IC	LDO, 4.0V $\pm 1.4\%$, 150mA, +CE	SOT-23-5	28sp	VR7	6a	Max
ADKE	MAX6504UKP015	Tdet-IC	+15°C, PPO	SOT-23-5	28hf	-	6k	Max
ADL	XC6211D492MR	LVR-IC	LDO, 4.9V $\pm 2\%$, 240mA, -CE	SOT-25	28vc	VR4	6g	Tor
ADL	XC6114C419MR	Vdet-IC	1.9V $\pm 2\%$, \pm Reset PPO, Wt=200ms, Rt=50ms	SOT-25	28xg	VD19	6g	Tor
ADL	XC6114C449MR	Vdet-IC	4.9V $\pm 2\%$, \pm Reset PPO, Wt=200ms, Rt=50ms	SOT-25	28xg	VD19	6g	Tor
ADL	XC6365A385MR	DC/DC-IC	PWM st-down, 500kHz, 3.8V $\pm 2.5\%$, 1A, +CE	SOT-25	28zm	DC7	6g	Tor
ADL	XC6367A385MR	DC/DC-IC	PWM step-up, 3.8V $\pm 2.5\%$, 200mA, 500kHz, +CE	SOT-25	28sh	DC11	6g	Tor
ADM	XC6211D502MR	LVR-IC	LDO, 5V $\pm 2\%$, 240mA, -CE	SOT-25	28vc	VR4	6g	Tor
ADM	XC6114C420MR	Vdet-IC	2.0V $\pm 2\%$, \pm Reset PPO, Wt=200ms, Rt=50ms	SOT-25	28xg	VD19	6g	Tor
ADM	XC6114C450MR	Vdet-IC	5.0V $\pm 2\%$, \pm Reset PPO, Wt=200ms, Rt=50ms	SOT-25	28xg	VD19	6g	Tor
ADM	XC6365A395MR	DC/DC-IC	PWM st-down, 500kHz, 3.9V $\pm 2.5\%$, 1A, +CE	SOT-25	28zm	DC7	6g	Tor
ADM	XC6367A395MR	DC/DC-IC	PWM step-up, 3.9V $\pm 2.5\%$, 200mA, 500kHz, +CE	SOT-25	28sh	DC11	6g	Tor
ADN	XC6114C421MR	Vdet-IC	2.1V $\pm 2\%$, \pm Reset PPO, Wt=200ms, Rt=50ms	SOT-25	28xg	VD19	6g	Tor
ADP	XC6114C422MR	Vdet-IC	2.2V $\pm 2\%$, \pm Reset PPO, Wt=200ms, Rt=50ms	SOT-25	28xg	VD19	6g	Tor
ADPM	MAX8877EZK29-T	LVR-IC	LDO, 2.84V $\pm 1.4\%$, 150mA, +CE	SOT-23-5T	28vrx	VR7	6k	Max
ADPO	MAX8878EZK29-T	LVR-IC	LDO, 2.84V $\pm 1.4\%$, 150mA, +CE, CL	SOT-23-5T	28vrx	VR7	6k	Max
ADQM	MAX8867EZK25-T	LVR-IC	LDO, 2.5V $\pm 1.4\%$, 150mA, +CE	SOT-23-5T	28sp	VR7	6a	Max
ADQN	MAX8867EZK27-T	LVR-IC	LDO, 2.7V $\pm 1.4\%$, 150mA, +CE	SOT-23-5T	28sp	VR7	6a	Max
ADQO	MAX8867EZK28-T	LVR-IC	LDO, 2.8V $\pm 1.4\%$, 150mA, +CE	SOT-23-5T	28sp	VR7	6a	Max
ADQP	MAX8867EZK29-T	LVR-IC	LDO, 2.84V $\pm 1.4\%$, 150mA, +CE	SOT-23-5T	28sp	VR7	6a	Max
ADQQ	MAX8867EZK30-T	LVR-IC	LDO, 3.0V $\pm 1.4\%$, 150mA, +CE	SOT-23-5T	28sp	VR7	6a	Max
ADQR	MAX8867EZK32-T	LVR-IC	LDO, 3.15V $\pm 1.4\%$, 150mA, +CE	SOT-23-5T	28sp	VR7	6a	Max
ADQS	MAX8867EZK33-T	LVR-IC	LDO, 3.3V $\pm 1.4\%$, 150mA, +CE	SOT-23-5T	28sp	VR7	6a	Max
ADQT	MAX8867EZK36-T	LVR-IC	LDO, 3.6V $\pm 1.4\%$, 150mA, +CE	SOT-23-5T	28sp	VR7	6a	Max
ADQT	MAX8877EUK18-T	LVR-IC	LDO, 1.8V $\pm 1.4\%$, 150mA, +CE	SOT-23-5	28vrx	VR7	6k	Max
ADQU	MAX8867EZK40-T	LVR-IC	LDO, 4.0V $\pm 1.4\%$, 150mA, +CE	SOT-23-5T	28sp	VR7	6a	Max
ADQV	MAX8867EZK50-T	LVR-IC	LDO, 5.0V $\pm 1.4\%$, 150mA, +CE	SOT-23-5T	28sp	VR7	6a	Max
ADQV	MAX8878EUK15-T	LVR-IC	LDO, 1.5V $\pm 1.4\%$, 150mA, +CE, CL	SOT-23-5	28vrx	VR7	6k	Max
ADQW	MAX8868EZK25-T	LVR-IC	LDO, 2.5V $\pm 1.4\%$, 150mA, +CE, CL	SOT-23-5T	28sp	VR7	6a	Max
ADQX	MAX8868EZK28-T	LVR-IC	LDO, 2.8V $\pm 1.4\%$, 150mA, +CE, CL	SOT-23-5T	28sp	VR7	6a	Max
ADQY	MAX8868EZK29-T	LVR-IC	LDO, 2.84V $\pm 1.4\%$, 150mA, +CE, CL	SOT-23-5T	28sp	VR7	6a	Max
ADQZ	MAX8868EZK30-T	LVR-IC	LDO, 3.0V $\pm 1.4\%$, 150mA, +CE, CL	SOT-23-5T	28sp	VR7	6a	Max
ADR	XC6114C423MR	Vdet-IC	2.3V $\pm 2\%$, \pm Reset PPO, Wt=200ms, Rt=50ms	SOT-25	28xg	VD19	6g	Tor
ADRA	MAX8868EZK32-T	LVR-IC	LDO, 3.15V $\pm 1.4\%$, 150mA, +CE, CL	SOT-23-5T	28sp	VR7	6a	Max
ADRB	MAX8868EZK33-T	LVR-IC	LDO, 3.3V $\pm 1.4\%$, 150mA, +CE, CL	SOT-23-5T	28sp	VR7	6a	Max
ADRC	MAX8868EZK36-T	LVR-IC	LDO, 3.6V $\pm 1.4\%$, 150mA, +CE, CL	SOT-23-5T	28sp	VR7	6a	Max
ADRD	MAX8868EZK50-T	LVR-IC	LDO, 5.0V $\pm 1.4\%$, 150mA, +CE, CL	SOT-23-5T	28sp	VR7	6a	Max
ADRG	MAX8877EUK15-T	LVR-IC	LDO, 1.5V $\pm 1.4\%$, 150mA, +CE	SOT-23-5	28vrx	VR7	6k	Max
ADRH	MAX8878EUK18-T	LVR-IC	LDO, 1.8V $\pm 1.4\%$, 150mA, +CE, CL	SOT-23-5	28vrx	VR7	6k	Max
ADS	XC6114C424MR	Vdet-IC	2.4V $\pm 2\%$, \pm Reset PPO, Wt=200ms, Rt=50ms	SOT-25	28xg	VD19	6g	Tor
ADT	XC6114C425MR	Vdet-IC	2.5V $\pm 2\%$, \pm Reset PPO, Wt=200ms, Rt=50ms	SOT-25	28xg	VD19	6g	Tor
ADU	XC6114C426MR	Vdet-IC	2.6V $\pm 2\%$, \pm Reset PPO, Wt=200ms, Rt=50ms	SOT-25	28xg	VD19	6g	Tor
ADV	XC6114C427MR	Vdet-IC	2.7V $\pm 2\%$, \pm Reset PPO, Wt=200ms, Rt=50ms	SOT-25	28xg	VD19	6g	Tor
ADX	XC6114C428MR	Vdet-IC	2.8V $\pm 2\%$, \pm Reset PPO, Wt=200ms, Rt=50ms	SOT-25	28xg	VD19	6g	Tor
ADY	XC6114C429MR	Vdet-IC	2.9V $\pm 2\%$, \pm Reset PPO, Wt=200ms, Rt=50ms	SOT-25	28xg	VD19	6g	Tor
ADZ	XC6114C430MR	Vdet-IC	3.0V $\pm 2\%$, \pm Reset PPO, Wt=200ms, Rt=50ms	SOT-25	28xg	VD19	6g	Tor
AE	74AHC1G08GW	CMOS-Logic	2-input AND gate	SOT-353	28/Log3	-	6a	Phi
AE	HD74ALVC1G07VS	CMOS-Logic	Noninverting buffer/driver (ODO)	VSON-5	30/Log8	-	6a	Ren
AE	PI74ST1G79CX	CMOS-Logic	Positive edge-triggered D-type flip-flop	SC-70-5	28/Log20	-	6a	Per
AE	PI74ST1G79TX	CMOS-Logic	Positive edge-triggered D-type flip-flop	SOT-23-5	28/Log20	-	6a	Per
AE	RN5RT24AA	LVR-IC	LDO, 2.4V $\pm 2\%$, 150mA, -CE	SOT-23-5	28vrt	VR4	6g	Ric
AE	SiP823REU	Vdet-IC	2.63V $\pm 1.5\%$, MR, Strobe, -Reset PPO	SOT-23-5	28cp	VD17	6k	Vs
AE-	RT9193-31PU5	LVR-IC	LDO, 3.1V $\pm 1\%$, 300mA, +CE	SC-70-5	28vrx	VR7	6g	Rct
AE_	SN74AHC1G08DCK	CMOS-Logic	2-input AND gate	SC-70-5	28/Log3	-	6a	Ti
AE_	SN74AHC1G08DRL	CMOS-Logic	2-input AND gate	SOT-553	30/Log3	-	6a	Ti
AE0	XC6114C531MR	Vdet-IC	3.1V $\pm 2\%$, \pm Reset PPO, Wt=400ms, Rt=50ms	SOT-25	28xg	VD19	6g	Tor
AE0	XC6365A401MR	DC/DC-IC	PWM st-down, 100kHz, 4.0V $\pm 2.5\%$, 1A, +CE	SOT-25	28zm	DC7	6g	Tor
AE0	XC6367A401MR	DC/DC-IC	PWM step-up, 4.0V $\pm 2.5\%$, 200mA, 100kHz, +CE	SOT-25	28sh	DC11	6g	Tor
AE08	RP109Q082B	LVR-IC	LDO, 0.8V $\pm 1\%$, 150mA, +CE	SC-88A	28xm	VR4	6m	Ric
AE09	RP109Q092B	LVR-IC	LDO, 0.9V $\pm 1\%$, 150mA, +CE	SC-88A	28xm	VR4	6m	Ric
AE1	XC6114C532MR	Vdet-IC	3.2V $\pm 2\%$, \pm Reset PPO, Wt=400ms, Rt=50ms	SOT-25	28xg	VD19	6g	Tor
AE1	XC6365A411MR	DC/DC-IC	PWM st-down, 100kHz, 4.1V $\pm 2.5\%$, 1A, +CE	SOT-25	28zm	DC7	6g	Tor
AE1	XC6367A411MR	DC/DC-IC	PWM step-up, 4.1V $\pm 2.5\%$, 200mA, 100kHz, +CE	SOT-25	28sh	DC11	6g	Tor
AE10	RP109Q102B	LVR-IC	LDO, 1.0V $\pm 1\%$, 150mA, +CE	SC-88A	28xm	VR4	6m	Ric
AE11	RP109Q112B	LVR-IC	LDO, 1.1V $\pm 1\%$, 150mA, +CE	SC-88A	28xm	VR4	6m	Ric
AE12	RP109Q122B	LVR-IC	LDO, 1.2V $\pm 1\%$, 150mA, +CE	SC-88A	28xm	VR4	6m	Ric
AE13	RP109Q132B	LVR-IC	LDO, 1.3V $\pm 1\%$, 150mA, +CE	SC-88A	28xm	VR4	6m	Ric
AE14	RP109Q142B	LVR-IC	LDO, 1.4V $\pm 1\%$, 150mA, +CE	SC-88A	28xm	VR4	6m	Ric
AE15	RP109Q152B	LVR-IC	LDO, 1.5V $\pm 1\%$, 150mA, +CE	SC-88A	28xm	VR4	6m	Ric



SMD code	Type	Function	Short description	Case	Pinout	Sch.	St.	Mnf.
AE16	RP109Q162B	LVR-IC	LDO, 1.6V±1%, 150mA, +CE	SC-88A	28xm	VR4	6m	Ric
AE17	RP109Q172B	LVR-IC	LDO, 1.7V±1%, 150mA, +CE	SC-88A	28xm	VR4	6m	Ric
AE18	RP109Q182B	LVR-IC	LDO, 1.8V±1%, 150mA, +CE	SC-88A	28xm	VR4	6m	Ric
AE19	RP109Q192B	LVR-IC	LDO, 1.9V±1%, 150mA, +CE	SC-88A	28xm	VR4	6m	Ric
AE2	XC6114C533MR	Vdet-IC	3.3V±2%, ±Reset PPO, Wt=400ms, Rt=50ms	SOT-25	28xg	VD19	6g	Tor
AE2	XC6365A421MR	DC/DC-IC	PWM st-down, 100kHz, 4.2V±2.5%, 1A, +CE	SOT-25	28zm	DC7	6g	Tor
AE2	XC6367A421MR	DC/DC-IC	PWM step-up, 4.2V±2.5%, 200mA, 100kHz, +CE	SOT-25	28sh	DC11	6g	Tor
AE20	RP109Q202B	LVR-IC	LDO, 2.0V±1%, 150mA, +CE	SC-88A	28xm	VR4	6m	Ric
AE21	RP109Q212B	LVR-IC	LDO, 2.1V±1%, 150mA, +CE	SC-88A	28xm	VR4	6m	Ric
AE22	RP109Q222B	LVR-IC	LDO, 2.2V±1%, 150mA, +CE	SC-88A	28xm	VR4	6m	Ric
AE23	RP109Q232B	LVR-IC	LDO, 2.3V±1%, 150mA, +CE	SC-88A	28xm	VR4	6m	Ric
AE24	RP109Q242B	LVR-IC	LDO, 2.4V±1%, 150mA, +CE	SC-88A	28xm	VR4	6m	Ric
AE25	RP109Q252B	LVR-IC	LDO, 2.5V±1%, 150mA, +CE	SC-88A	28xm	VR4	6m	Ric
AE26	RP109Q262B	LVR-IC	LDO, 2.6V±1%, 150mA, +CE	SC-88A	28xm	VR4	6m	Ric
AE27	RP109Q272B	LVR-IC	LDO, 2.7V±1%, 150mA, +CE	SC-88A	28xm	VR4	6m	Ric
AE28	RP109Q282B	LVR-IC	LDO, 2.8V±1%, 150mA, +CE	SC-88A	28xm	VR4	6m	Ric
AE29	RP109Q292B	LVR-IC	LDO, 2.9V±1%, 150mA, +CE	SC-88A	28xm	VR4	6m	Ric
AE3	XC6114C534MR	Vdet-IC	3.4V±2%, ±Reset PPO, Wt=400ms, Rt=50ms	SOT-25	28xg	VD19	6g	Tor
AE3	XC6365A431MR	DC/DC-IC	PWM st-down, 100kHz, 4.3V±2.5%, 1A, +CE	SOT-25	28zm	DC7	6g	Tor
AE3	XC6367A431MR	DC/DC-IC	PWM step-up, 4.3V±2.5%, 200mA, 100kHz, +CE	SOT-25	28sh	DC11	6g	Tor
AE30	RP109Q302B	LVR-IC	LDO, 3.0V±1%, 150mA, +CE	SC-88A	28xm	VR4	6m	Ric
AE31	RP109Q312B	LVR-IC	LDO, 3.1V±1%, 150mA, +CE	SC-88A	28xm	VR4	6m	Ric
AE32	RP109Q322B	LVR-IC	LDO, 3.2V±1%, 150mA, +CE	SC-88A	28xm	VR4	6m	Ric
AE33	RP109Q332B	LVR-IC	LDO, 3.3V±1%, 150mA, +CE	SC-88A	28xm	VR4	6m	Ric
AE34	RP109Q342B	LVR-IC	LDO, 3.4V±1%, 150mA, +CE	SC-88A	28xm	VR4	6m	Ric
AE35	RP109Q352B	LVR-IC	LDO, 3.5V±1%, 150mA, +CE	SC-88A	28xm	VR4	6m	Ric
AE36	RP109Q362B	LVR-IC	LDO, 3.6V±1%, 150mA, +CE	SC-88A	28xm	VR4	6m	Ric
AE37	RP109Q122B5	LVR-IC	LDO, 1.25V±1%, 150mA, +CE	SC-88A	28xm	VR4	6m	Ric
AE38	RP109Q182B5	LVR-IC	LDO, 1.85V±1%, 150mA, +CE	SC-88A	28xm	VR4	6m	Ric
AE39	RP109Q282B5	LVR-IC	LDO, 2.85V±1%, 150mA, +CE	SC-88A	28xm	VR4	6m	Ric
AE4	U74AHC1G14-AF5	CMOS-Logic	Inverting Schmitt-trigger	SOT-23-5	28/Log7	-	6a	Ult
AE4	XC6114C535MR	Vdet-IC	3.5V±2%, ±Reset PPO, Wt=400ms, Rt=50ms	SOT-25	28xg	VD19	6g	Tor
AE4	XC6365A441MR	DC/DC-IC	PWM st-down, 100kHz, 4.4V±2.5%, 1A, +CE	SOT-25	28zm	DC7	6g	Tor
AE4	XC6367A441MR	DC/DC-IC	PWM step-up, 4.4V±2.5%, 200mA, 100kHz, +CE	SOT-25	28sh	DC11	6g	Tor
AE40	RP109Q342B5	LVR-IC	LDO, 3.45V±1%, 150mA, +CE	SC-88A	28xm	VR4	6m	Ric
AE5	XC6114C536MR	Vdet-IC	3.6V±2%, ±Reset PPO, Wt=400ms, Rt=50ms	SOT-25	28xg	VD19	6g	Tor
AE5	XC6365A451MR	DC/DC-IC	PWM st-down, 100kHz, 4.5V±2.5%, 1A, +CE	SOT-25	28zm	DC7	6g	Tor
AE5	XC6367A451MR	DC/DC-IC	PWM step-up, 4.5V±2.5%, 200mA, 100kHz, +CE	SOT-25	28sh	DC11	6g	Tor
AE6	XC6114C537MR	Vdet-IC	3.7V±2%, ±Reset PPO, Wt=400ms, Rt=50ms	SOT-25	28xg	VD19	6g	Tor
AE6	XC6365A461MR	DC/DC-IC	PWM st-down, 100kHz, 4.6V±2.5%, 1A, +CE	SOT-25	28zm	DC7	6g	Tor
AE6	XC6367A461MR	DC/DC-IC	PWM step-up, 4.6V±2.5%, 200mA, 100kHz, +CE	SOT-25	28sh	DC11	6g	Tor
AE7	XC6114C538MR	Vdet-IC	3.8V±2%, ±Reset PPO, Wt=400ms, Rt=50ms	SOT-25	28xg	VD19	6g	Tor
AE7	XC6365A471MR	DC/DC-IC	PWM st-down, 100kHz, 4.7V±2.5%, 1A, +CE	SOT-25	28zm	DC7	6g	Tor
AE7	XC6367A471MR	DC/DC-IC	PWM step-up, 4.7V±2.5%, 200mA, 100kHz, +CE	SOT-25	28sh	DC11	6g	Tor
AE8	XC6211A09AMR	LVR-IC	LDO, 0.95V±2%, 150mA, +CE, PDR	SOT-25	28vc	VR4	6g	Tor
AE8	XC6114C539MR	Vdet-IC	3.9V±2%, ±Reset PPO, Wt=400ms, Rt=50ms	SOT-25	28xg	VD19	6g	Tor
AE8	XC6365A481MR	DC/DC-IC	PWM st-down, 100kHz, 4.8V±2.5%, 1A, +CE	SOT-25	28zm	DC7	6g	Tor
AE8	XC6367A481MR	DC/DC-IC	PWM step-up, 4.8V±2.5%, 200mA, 100kHz, +CE	SOT-25	28sh	DC11	6g	Tor
AE9	XC6211A10AMR	LVR-IC	LDO, 1.05V±2%, 150mA, +CE, PDR	SOT-25	28vc	VR4	6g	Tor
AE9	XC6114C540MR	Vdet-IC	4.0V±2%, ±Reset PPO, Wt=400ms, Rt=50ms	SOT-25	28xg	VD19	6g	Tor
AE9	XC6365A491MR	DC/DC-IC	PWM st-down, 100kHz, 4.9V±2.5%, 1A, +CE	SOT-25	28zm	DC7	6g	Tor
AE9	XC6367A491MR	DC/DC-IC	PWM step-up, 4.9V±2.5%, 200mA, 100kHz, +CE	SOT-25	28sh	DC11	6g	Tor
AEA	XC6211A11AMR	LVR-IC	LDO, 1.15V±2%, 150mA, +CE, PDR	SOT-25	28vc	VR4	6g	Tor
AEA	XC6114C541MR	Vdet-IC	4.1V±2%, ±Reset PPO, Wt=400ms, Rt=50ms	SOT-25	28xg	VD19	6g	Tor
AEA	XC6365A405MR	DC/DC-IC	PWM st-down, 500kHz, 4.0V±2.5%, 1A, +CE	SOT-25	28zm	DC7	6g	Tor
AEA	XC6367A405MR	DC/DC-IC	PWM step-up, 4.0V±2.5%, 200mA, 500kHz, +CE	SOT-25	28sh	DC11	6g	Tor
AEA0	MAX6445UK46L	Vdet-IC	4.6V±1.5%, ±MR, -Reset PPO	SOT-23-5	28cq	-	6k	Max
AEA0	MAX6446UK29L	Vdet-IC	2.9V±1.5%, ±MR, -Reset ODO	SOT-23-5	28cq	-	6k	Max
AEA0	MAX6447UK26L	Vdet-IC	2.6V±1.5%, ±MR, -Reset PPO	SOT-23-5	28cq	-	6k	Max
AEB	XC6211A12AMR	LVR-IC	LDO, 1.25V±2%, 150mA, +CE, PDR	SOT-25	28vc	VR4	6g	Tor
AEB	XC6114C542MR	Vdet-IC	4.2V±2%, ±Reset PPO, Wt=400ms, Rt=50ms	SOT-25	28xg	VD19	6g	Tor
AEB	XC6365A415MR	DC/DC-IC	PWM st-down, 500kHz, 4.1V±2.5%, 1A, +CE	SOT-25	28zm	DC7	6g	Tor
AEB	XC6367A415MR	DC/DC-IC	PWM step-up, 4.1V±2.5%, 200mA, 500kHz, +CE	SOT-25	28sh	DC11	6g	Tor
AEC	XC6211A13AMR	LVR-IC	LDO, 1.35V±2%, 150mA, +CE, PDR	SOT-25	28vc	VR4	6g	Tor
AEC	XC6114C543MR	Vdet-IC	4.3V±2%, ±Reset PPO, Wt=400ms, Rt=50ms	SOT-25	28xg	VD19	6g	Tor
AEC	XC6365A425MR	DC/DC-IC	PWM st-down, 500kHz, 4.2V±2.5%, 1A, +CE	SOT-25	28zm	DC7	6g	Tor
AEC	XC6367A425MR	DC/DC-IC	PWM step-up, 4.2V±2.5%, 200mA, 500kHz, +CE	SOT-25	28sh	DC11	6g	Tor
AED	XC6211A14AMR	LVR-IC	LDO, 1.45V±2%, 150mA, +CE, PDR	SOT-25	28vc	VR4	6g	Tor
AED	XC6114C544MR	Vdet-IC	4.4V±2%, ±Reset PPO, Wt=400ms, Rt=50ms	SOT-25	28xg	VD19	6g	Tor
AED	XC6365A435MR	DC/DC-IC	PWM st-down, 500kHz, 4.3V±2.5%, 1A, +CE	SOT-25	28zm	DC7	6g	Tor



SMD code	Type	Function	Short description	Case	Pinout	Sch.	St.	Mnf.
AED	XC6367A435MR	DC/DC-IC	PWM step-up, 4.3V±2.5%, 200mA, 500kHz, +CE	SOT-25	28sh	DC11	6g	Tor
AEE	AME8800HEEV	LVR-IC	LDO, 2.7V±1.5%, 300mA	SOT-25	28vu	VR1	6k	Ame
AEE	AME8800HEEVL	LVR-IC	LDO, 2.7V±1.5%, 300mA	TSOT-25	28vu	VR1	6k	Ame
AEE	XC6211A15AMR	LVR-IC	LDO, 1.55V±2%, 150mA, +CE, PDR	SOT-25	28vc	VR4	6g	Tor
ĀEE	AME8800HEEVY	LVR-IC	LDO, 2.7V±1.5%, 300mA	TSOT-25	28vu	VR1	6k	Ame
ĀEE	AME8800HEEVZ	LVR-IC	LDO, 2.7V±1.5%, 300mA	SOT-25	28vu	VR1	6k	Ame
ĀEE	XC6114C545MR	Vdet-IC	4.5V±2%, ±Reset PPO, Wt=400ms, Rt=50ms	SOT-25	28xg	VD19	6g	Tor
AEE	XC6365A445MR	DC/DC-IC	PWM st-down, 500kHz, 4.4V±2.5%, 1A, +CE	SOT-25	28zm	DC7	6g	Tor
AEE	XC6367A445MR	DC/DC-IC	PWM step-up, 4.4V±2.5%, 200mA, 500kHz, +CE	SOT-25	28xm	DC11	6g	Tor
AEEF	MAX6445UK16L	Vdet-IC	1.6V±1.5%, ±MR, -Reset PPO	SOT-23-5	28cq	-	6k	Max
AEEG	MAX6445UK23L	Vdet-IC	2.3V±1.5%, ±MR, -Reset PPO	SOT-23-5	28cq	-	6k	Max
AEEH	MAX6445UK26L	Vdet-IC	2.6V±1.5%, ±MR, -Reset PPO	SOT-23-5	28cq	-	6k	Max
AEEI	MAX6445UK29L	Vdet-IC	2.9V±1.5%, ±MR, -Reset PPO	SOT-23-5	28cq	-	6k	Max
AEEJ	MAX6447UK16L	Vdet-IC	1.6V±1.5%, ±MR, -Reset PPO	SOT-23-5	28cq	-	6k	Max
AEEK	MAX6447UK23L	Vdet-IC	2.3V±1.5%, ±MR, -Reset PPO	SOT-23-5	28cq	-	6k	Max
AEEL	MAX6447UK29L	Vdet-IC	2.9V±1.5%, ±MR, -Reset PPO	SOT-23-5	28cq	-	6k	Max
AEEM	MAX6447UK46L	Vdet-IC	4.6V±1.5%, ±MR, -Reset PPO	SOT-23-5	28cq	-	6k	Max
AEEN	MAX6446UK16L	Vdet-IC	1.6V±1.5%, ±MR, -Reset ODO	SOT-23-5	28cq	-	6k	Max
AEOO	MAX6446UK23L	Vdet-IC	2.3V±1.5%, ±MR, -Reset ODO	SOT-23-5	28cq	-	6k	Max
AEEP	MAX6446UK26L	Vdet-IC	2.6V±1.5%, ±MR, -Reset ODO	SOT-23-5	28cq	-	6k	Max
AEEQ	MAX6446UK46L	Vdet-IC	4.6V±1.5%, ±MR, -Reset ODO	SOT-23-5	28cq	-	6k	Max
AEER	MAX6448UK16L	Vdet-IC	1.6V±1.5%, ±MR, -Reset ODO	SOT-23-5	28cq	-	6k	Max
AEEs	MAX6448UK23L	Vdet-IC	2.3V±1.5%, ±MR, -Reset ODO	SOT-23-5	28cq	-	6k	Max
AEEt	MAX6448UK26L	Vdet-IC	2.6V±1.5%, ±MR, -Reset ODO	SOT-23-5	28cq	-	6k	Max
AEEU	MAX6448UK29L	Vdet-IC	2.9V±1.5%, ±MR, -Reset ODO	SOT-23-5	28cq	-	6k	Max
AEEV	MAX6448UK46L	Vdet-IC	4.6V±1.5%, ±MR, -Reset ODO	SOT-23-5	28cq	-	6k	Max
AEF	XC6211A16AMR	LVR-IC	LDO, 1.65V±2%, 150mA, +CE, PDR	SOT-25	28vc	VR4	6g	Tor
ĀEF	XC6114C516MR	Vdet-IC	1.6V±2%, ±Reset PPO, Wt=400ms, Rt=50ms	SOT-25	28xg	VD19	6g	Tor
ĀEF	XC6114C546MR	Vdet-IC	4.6V±2%, ±Reset PPO, Wt=400ms, Rt=50ms	SOT-25	28xg	VD19	6g	Tor
AEF	XC6365A455MR	DC/DC-IC	PWM st-down, 500kHz, 4.5V±2.5%, 1A, +CE	SOT-25	28zm	DC7	6g	Tor
ĀEF	XC6367A455MR	DC/DC-IC	PWM step-up, 4.5V±2.5%, 200mA, 500kHz, +CE	SOT-25	28sh	DC11	6g	Tor
ĀEFA	MAX1615AUK	LVR-IC	3.3V5.0V±2%, 40mA	SOT-23-5	28	-	6a	Max
AEFB	MAX1616AUK	LVR-IC	Adj. 1.24, 2.8V±2%, 40mA	SOT-23-5	28	-	6a	Max
AEH	XC6211A17AMR	LVR-IC	LDO, 1.75V±2%, 150mA, +CE, PDR	SOT-25	28vc	VR4	6g	Tor
ĀEH	XC6114C517MR	Vdet-IC	1.7V±2%, ±Reset PPO, Wt=400ms, Rt=50ms	SOT-25	28xg	VD19	6g	Tor
ĀEH	XC6114C547MR	Vdet-IC	4.7V±2%, ±Reset PPO, Wt=400ms, Rt=50ms	SOT-25	28xg	VD19	6g	Tor
AEH	XC6365A465MR	DC/DC-IC	PWM st-down, 500kHz, 4.6V±2.5%, 1A, +CE	SOT-25	28zm	DC7	6g	Tor
ĀEH	XC6367A465MR	DC/DC-IC	PWM step-up, 4.6V±2.5%, 200mA, 500kHz, +CE	SOT-25	28xm	DC11	6g	Tor
AEJN	MAX6754UKLD3	Vdet-IC	5.0V±1.5%, -MR, -Reset PPO, 200ms	SOT-23-5	28	-	6a	Max
AEJO	MAX6754UKTD3	Vdet-IC	3.3V±1.5%, -MR, -Reset PPO, 200ms	SOT-23-5	28	-	6a	Max
AEJQ	MAX6754UKZD0	Vdet-IC	2.5V±1.5%, -MR, -Reset PPO, 20μs	SOT-23-5	28	-	6a	Max
AEJR	MAX6754UKWD3	Vdet-IC	1.8V±1.5%, -MR, -Reset PPO, 200ms	SOT-23-5	28	-	6a	Max
AEJS	MAX6755UKLD3	Vdet-IC	5.0V±1.5%, -MR, +Reset PPO, 200ms	SOT-23-5	28	-	6a	Max
AEJT	MAX6755UKTD3	Vdet-IC	3.3V±1.5%, -MR, +Reset PPO, 200ms	SOT-23-5	28	-	6a	Max
AEJW	MAX6755UKWD3	Vdet-IC	1.8V±1.5%, -MR, +Reset PPO, 200ms	SOT-23-5	28	-	6a	Max
AEJX	MAX6756UKLD0	Vdet-IC	5.0V±1.5%, -MR, +Reset ODO, 20μs	SOT-23-5	28	-	6a	Max
AEJY	MAX6756UKTD0	Vdet-IC	3.3V±1.5%, -MR, +Reset ODO, 20μs	SOT-23-5	28	-	6a	Max
AEJK	XC6211A18AMR	LVR-IC	LDO, 1.85V±2%, 240mA, +CE, PDR	SOT-25	28vc	VR4	6g	Tor
ĀEK	XC6114C518MR	Vdet-IC	1.8V±2%, ±Reset PPO, Wt=400ms, Rt=50ms	SOT-25	28xg	VD19	6g	Tor
ĀEK	XC6114C548MR	Vdet-IC	4.8V±2%, ±Reset PPO, Wt=400ms, Rt=50ms	SOT-25	28xg	VD19	6g	Tor
ĀEK	XC6365A475MR	DC/DC-IC	PWM st-down, 500kHz, 4.7V±2.5%, 1A, +CE	SOT-25	28zm	DC7	6g	Tor
ĀEK	XC6367A475MR	DC/DC-IC	PWM step-up, 4.7V±2.5%, 200mA, 500kHz, +CE	SOT-25	28sh	DC11	6g	Tor
AEKA	MAX6756UKZD3	Vdet-IC	2.5V±1.5%, -MR, +Reset ODO, 200ms	SOT-23-5	28	-	6a	Max
AEKB	MAX6756UKWD0	Vdet-IC	1.8V±1.5%, -MR, +Reset ODO, 20μs	SOT-23-5	28	-	6a	Max
AEKV	MAX6755UKZD0	Vdet-IC	2.5V±1.5%, -MR, +Reset PPO, 20μs	SOT-23-5	28	-	6a	Max
AEL	XC6211A19AMR	LVR-IC	LDO, 1.95V±2%, 240mA, +CE, PDR	SOT-25	28vc	VR4	6g	Tor
ĀEL	XC6114C519MR	Vdet-IC	1.9V±2%, ±Reset PPO, Wt=400ms, Rt=50ms	SOT-25	28xg	VD19	6g	Tor
ĀEL	XC6114C549MR	Vdet-IC	4.9V±2%, ±Reset PPO, Wt=400ms, Rt=50ms	SOT-25	28xg	VD19	6g	Tor
AEL	XC6365A485MR	DC/DC-IC	PWM st-down, 500kHz, 4.8V±2.5%, 1A, +CE	SOT-25	28zm	DC7	6g	Tor
ĀEL	XC6367A485MR	DC/DC-IC	PWM step-up, 4.8V±2.5%, 200mA, 500kHz, +CE	SOT-25	28sh	DC11	6g	Tor
AEM	AME8800IEEV	LVR-IC	LDO, 3.4V±1.5%, 300mA	SOT-25	28vu	VR1	6k	Ame
AEM	AME8800IEEVL	LVR-IC	LDO, 3.4V±1.5%, 300mA	TSOT-25	28vu	VR1	6k	Ame
AEM	XC6211A20AMR	LVR-IC	LDO, 2.05V±2%, 240mA, +CE, PDR	SOT-25	28vc	VR4	6g	Tor
ĀEM	AME8800IEEVY	LVR-IC	LDO, 3.4V±1.5%, 300mA	TSOT-25	28vu	VR1	6k	Ame
ĀEM	AME8800IEEVZ	LVR-IC	LDO, 3.4V±1.5%, 300mA	SOT-25	28vu	VR1	6k	Ame
ĀEM	XC6114C520MR	Vdet-IC	2.0V±2%, ±Reset PPO, Wt=400ms, Rt=50ms	SOT-25	28xg	VD19	6g	Tor
ĀEM	XC6114C550MR	Vdet-IC	5.0V±2%, ±Reset PPO, Wt=400ms, Rt=50ms	SOT-25	28xg	VD19	6g	Tor
AEM	XC6365A495MR	DC/DC-IC	PWM st-down, 500kHz, 4.9V±2.5%, 1A, +CE	SOT-25	28zm	DC7	6g	Tor
AEM	XC6367A495MR	DC/DC-IC	PWM step-up, 4.9V±2.5%, 200mA, 500kHz, +CE	SOT-25	28sh	DC11	6g	Tor
AEN	XC6211A21AMR	LVR-IC	LDO, 2.15V±2%, 240mA, +CE, PDR	SOT-25	28vc	VR4	6g	Tor



SMD code	Type	Function	Short description	Case	Pinout	Sch.	St.	Mnf.
ĀEN	XC6114C521MR	Vdet-IC	2.1V±2%, ±Reset PPO, Wt=400ms, Rt=50ms	SOT-25	28xg	VD19	6g	Tor
AEOC	MAX6754UKLD0	Vdet-IC	5.0V±1.5%, -MR, -Reset PPO, 20µs	SOT-23-5	28	-	6a	Max
AEOD	MAX6754UKTD0	Vdet-IC	3.3V±1.5%, -MR, -Reset PPO, 20µs	SOT-23-5	28	-	6a	Max
AEOF	MAX6754UKZD3	Vdet-IC	2.5V±1.5%, -MR, -Reset PPO, 200ms	SOT-23-5	28	-	6a	Max
AEOG	MAX6754UKWDD0	Vdet-IC	1.8V±1.5%, -MR, -Reset PPO, 20µs	SOT-23-5	28	-	6a	Max
AEOH	MAX6755UKLD0	Vdet-IC	5.0V±1.5%, -MR, +Reset PPO, 20µs	SOT-23-5	28	-	6a	Max
AEOI	MAX6755UKTD0	Vdet-IC	3.3V±1.5%, -MR, +Reset PPO, 20µs	SOT-23-5	28	-	6a	Max
AEOK	MAX6755UKZD3	Vdet-IC	2.5V±1.5%, -MR, +Reset PPO, 200ms	SOT-23-5	28	-	6a	Max
AEOL	MAX6755UKWDD0	Vdet-IC	1.8V±1.5%, -MR, +Reset PPO, 20µs	SOT-23-5	28	-	6a	Max
AEOM	MAX6756UKLD3	Vdet-IC	5.0V±1.5%, -MR, +Reset ODO, 200ms	SOT-23-5	28	-	6a	Max
AEON	MAX6756UKTD3	Vdet-IC	3.3V±1.5%, -MR, +Reset ODO, 200ms	SOT-23-5	28	-	6a	Max
AEOP	MAX6756UKZD0	Vdet-IC	2.5V±1.5%, -MR, +Reset ODO, 20µs	SOT-23-5	28	-	6a	Max
AEQQ	MAX6756UKWDD3	Vdet-IC	1.8V±1.5%, -MR, +Reset ODO, 200ms	SOT-23-5	28	-	6a	Max
AEP	XC6211A22AMR	LVR-IC	LDO, 2.25V±2%, 240mA, +CE, PDR	SOT-25	28vc	VR4	6g	Tor
ĀEP	XC6114C522MR	Vdet-IC	2.2V±2%, ±Reset PPO, Wt=400ms, Rt=50ms	SOT-25	28xg	VD19	6g	Tor
AER	XC6211A23AMR	LVR-IC	LDO, 2.35V±2%, 240mA, +CE, PDR	SOT-25	28vc	VR4	6g	Tor
ĀER	XC6114C523MR	Vdet-IC	2.3V±2%, ±Reset PPO, Wt=400ms, Rt=50ms	SOT-25	28xg	VD19	6g	Tor
AES	XC6211A24AMR	LVR-IC	LDO, 2.45V±2%, 240mA, +CE, PDR	SOT-25	28vc	VR4	6g	Tor
ĀES	XC6114C524MR	Vdet-IC	2.4V±2%, ±Reset PPO, Wt=400ms, Rt=50ms	SOT-25	28xg	VD19	6g	Tor
AET	XC6211A25AMR	LVR-IC	LDO, 2.55V±2%, 240mA, +CE, PDR	SOT-25	28vc	VR4	6g	Tor
ĀET	XC6114C525MR	Vdet-IC	2.5V±2%, ±Reset PPO, Wt=400ms, Rt=50ms	SOT-25	28xg	VD19	6g	Tor
AEU	XC6211A26AMR	LVR-IC	LDO, 2.65V±2%, 240mA, +CE, PDR	SOT-25	28vc	VR4	6g	Tor
ĀEU	XC6114C526MR	Vdet-IC	2.6V±2%, ±Reset PPO, Wt=400ms, Rt=50ms	SOT-25	28xg	VD19	6g	Tor
AEV	XC6211A27AMR	LVR-IC	LDO, 2.75V±2%, 240mA, +CE, PDR	SOT-25	28vc	VR4	6g	Tor
ĀEV	XC6114C527MR	Vdet-IC	2.7V±2%, ±Reset PPO, Wt=400ms, Rt=50ms	SOT-25	28xg	VD19	6g	Tor
AEX	XC6211A28AMR	LVR-IC	LDO, 2.85V±2%, 240mA, +CE, PDR	SOT-25	28vc	VR4	6g	Tor
ĀEX	XC6114C528MR	Vdet-IC	2.8V±2%, ±Reset PPO, Wt=400ms, Rt=50ms	SOT-25	28xg	VD19	6g	Tor
AEY	XC6211A29AMR	LVR-IC	LDO, 2.95V±2%, 240mA, +CE, PDR	SOT-25	28vc	VR4	6g	Tor
ĀEY	XC6114C529MR	Vdet-IC	2.9V±2%, ±Reset PPO, Wt=400ms, Rt=50ms	SOT-25	28xg	VD19	6g	Tor
AEZ	XC6211A30AMR	LVR-IC	LDO, 3.05V±2%, 240mA, +CE, PDR	SOT-25	28vc	VR4	6g	Tor
ĀEZ	XC6114C530MR	Vdet-IC	3.0V±2%, ±Reset PPO, Wt=400ms, Rt=50ms	SOT-25	28xg	VD19	6g	Tor
AF	74AHC1G14GW	CMOS-Logic	Inverting Schmitt-trigger	SOT-353	28/Log7	-	6a	Phi
AF	HD74ALVC1G79VS	CMOS-Logic	Positive edge-triggered D-type flip-flop	VSON-5	30/Log20	-	6a	Ren
AF	RN5RT25AA	LVR-IC	LDO, 2.5V±2%, 150mA, -CE	SOT-23-5	28vrt	VR4	6g	Ric
AF-	RT9198-18PU5R	LVR-IC	LDO, 1.8V±1%, 300mA, +CE	SC-70-5	28xc	VR4	6a	Rct
ĀF0	XC6114C631MR	Vdet-IC	3.1V±2%, ±Reset PPO, Wt=1.6s, Rt=50ms	SOT-25	28xg	VD19	6g	Tor
ĀF0	XC6365A501MR	DC/DC-IC	PWM st-down, 100kHz, 5.0V±2.5%, 1A, +CE	SOT-25	28zm	DC7	6g	Tor
AF0	XC6367A501MR	DC/DC-IC	PWM step-up, 5.0V±2.5%, 200mA, 100kHz, +CE	SOT-25	28sh	DC11	6g	Tor
AF08	RP109Q082D	LVR-IC	LDO, 0.8V±1%, 150mA, +CE, CL	SC-88A	28xm	VR4	6m	Ric
AF09	RP109Q092D	LVR-IC	LDO, 0.9V±1%, 150mA, +CE, CL	SC-88A	28xm	VR4	6m	Ric
ĀF1	XC6114C632MR	Vdet-IC	3.2V±2%, ±Reset PPO, Wt=1.6s, Rt=50ms	SOT-25	28xg	VD19	6g	Tor
ĀF1	XC6365A511MR	DC/DC-IC	PWM st-down, 100kHz, 5.1V±2.5%, 1A, +CE	SOT-25	28zm	DC7	6g	Tor
AF1	XC6367A511MR	DC/DC-IC	PWM step-up, 5.1V±2.5%, 200mA, 100kHz, +CE	SOT-25	28sh	DC11	6g	Tor
AF10	RP109Q102D	LVR-IC	LDO, 1.0V±1%, 150mA, +CE, CL	SC-88A	28xm	VR4	6m	Ric
AF11	RP109Q112D	LVR-IC	LDO, 1.1V±1%, 150mA, +CE, CL	SC-88A	28xm	VR4	6m	Ric
AF12	RP109Q122D	LVR-IC	LDO, 1.2V±1%, 150mA, +CE, CL	SC-88A	28xm	VR4	6m	Ric
AF13	RP109Q132D	LVR-IC	LDO, 1.3V±1%, 150mA, +CE, CL	SC-88A	28xm	VR4	6m	Ric
AF14	RP109Q142D	LVR-IC	LDO, 1.4V±1%, 150mA, +CE, CL	SC-88A	28xm	VR4	6m	Ric
AF15	RP109Q152D	LVR-IC	LDO, 1.5V±1%, 150mA, +CE, CL	SC-88A	28xm	VR4	6m	Ric
AF16	RP109Q162D	LVR-IC	LDO, 1.6V±1%, 150mA, +CE, CL	SC-88A	28xm	VR4	6m	Ric
AF17	RP109Q172D	LVR-IC	LDO, 1.7V±1%, 150mA, +CE, CL	SC-88A	28xm	VR4	6m	Ric
AF18	RP109Q182D	LVR-IC	LDO, 1.8V±1%, 150mA, +CE, CL	SC-88A	28xm	VR4	6m	Ric
AF19	RP109Q192D	LVR-IC	LDO, 1.9V±1%, 150mA, +CE, CL	SC-88A	28xm	VR4	6m	Ric
ĀF2	XC6114C633MR	Vdet-IC	3.3V±2%, ±Reset PPO, Wt=1.6s, Rt=50ms	SOT-25	28xg	VD19	6g	Tor
AF2	XC6365A521MR	DC/DC-IC	PWM st-down, 100kHz, 5.2V±2.5%, 1A, +CE	SOT-25	28zm	DC7	6g	Tor
AF2	XC6367A521MR	DC/DC-IC	PWM step-up, 5.2V±2.5%, 200mA, 100kHz, +CE	SOT-25	28sh	DC11	6g	Tor
AF20	RP109Q202D	LVR-IC	LDO, 2.0V±1%, 150mA, +CE, CL	SC-88A	28xm	VR4	6m	Ric
AF21	RP109Q212D	LVR-IC	LDO, 2.1V±1%, 150mA, +CE, CL	SC-88A	28xm	VR4	6m	Ric
AF22	RP109Q222D	LVR-IC	LDO, 2.2V±1%, 150mA, +CE, CL	SC-88A	28xm	VR4	6m	Ric
AF23	RP109Q232D	LVR-IC	LDO, 2.3V±1%, 150mA, +CE, CL	SC-88A	28xm	VR4	6m	Ric
AF24	RP109Q242D	LVR-IC	LDO, 2.4V±1%, 150mA, +CE, CL	SC-88A	28xm	VR4	6m	Ric
AF25	RP109Q252D	LVR-IC	LDO, 2.5V±1%, 150mA, +CE, CL	SC-88A	28xm	VR4	6m	Ric
AF26	RP109Q262D	LVR-IC	LDO, 2.6V±1%, 150mA, +CE, CL	SC-88A	28xm	VR4	6m	Ric
AF27	RP109Q272D	LVR-IC	LDO, 2.7V±1%, 150mA, +CE, CL	SC-88A	28xm	VR4	6m	Ric
AF28	RP109Q282D	LVR-IC	LDO, 2.8V±1%, 150mA, +CE, CL	SC-88A	28xm	VR4	6m	Ric
AF29	RP109Q292D	LVR-IC	LDO, 2.9V±1%, 150mA, +CE, CL	SC-88A	28xm	VR4	6m	Ric
ĀF3	XC6114C634MR	Vdet-IC	3.4V±2%, ±Reset PPO, Wt=1.6s, Rt=50ms	SOT-25	28xg	VD19	6g	Tor
AF3	XC6365A531MR	DC/DC-IC	PWM st-down, 100kHz, 5.3V±2.5%, 1A, +CE	SOT-25	28zm	DC7	6g	Tor
AF3	XC6367A531MR	DC/DC-IC	PWM step-up, 5.3V±2.5%, 200mA, 100kHz, +CE	SOT-25	28sh	DC11	6g	Tor
AF30	RP109Q302D	LVR-IC	LDO, 3.0V±1%, 150mA, +CE, CL	SC-88A	28xm	VR4	6m	Ric



SMD code	Type	Function	Short description	Case	Pinout	Sch.	St.	Mnf.
AF31	RP109Q312D	LVR-IC	LDO, 3.1V±1%, 150mA, +CE, CL	SC-88A	28xm	VR4	6m	Ric
AF32	RP109Q322D	LVR-IC	LDO, 3.2V±1%, 150mA, +CE, CL	SC-88A	28xm	VR4	6m	Ric
AF33	RP109Q332D	LVR-IC	LDO, 3.3V±1%, 150mA, +CE, CL	SC-88A	28xm	VR4	6m	Ric
AF34	RP109Q342D	LVR-IC	LDO, 3.4V±1%, 150mA, +CE, CL	SC-88A	28xm	VR4	6m	Ric
AF35	RP109Q352D	LVR-IC	LDO, 3.5V±1%, 150mA, +CE, CL	SC-88A	28xm	VR4	6m	Ric
AF36	RP109Q362D	LVR-IC	LDO, 3.6V±1%, 150mA, +CE, CL	SC-88A	28xm	VR4	6m	Ric
AF37	RP109Q122D5	LVR-IC	LDO, 1.25V±1%, 150mA, +CE, CL	SC-88A	28xm	VR4	6m	Ric
AF38	RP109Q182D5	LVR-IC	LDO, 1.85V±1%, 150mA, +CE, CL	SC-88A	28xm	VR4	6m	Ric
AF39	RP109Q282D5	LVR-IC	LDO, 2.85V±1%, 150mA, +CE, CL	SC-88A	28xm	VR4	6m	Ric
AF4	XC6114C635MR	Vdet-IC	3.5V±2%, ±Reset PPO, Wt=1.6s, Rt=50ms	SOT-25	28xg	VD19	6g	Tor
AF4	XC6365A541MR	DC/DC-IC	PWM st-down, 100kHz, 5.4V±2.5%, 1A, +CE	SOT-25	28zm	DC7	6g	Tor
AF4	XC6367A541MR	DC/DC-IC	PWM step-up, 5.4V±2.5%, 200mA, 100kHz, +CE	SOT-25	28sh	DC11	6g	Tor
AF40	RP109Q342D5	LVR-IC	LDO, 3.45V±1%, 150mA, +CE, CL	SC-88A	28xm	VR4	6m	Ric
AF5	XC6114C636MR	Vdet-IC	3.6V±2%, ±Reset PPO, Wt=1.6s, Rt=50ms	SOT-25	28xg	VD19	6g	Tor
AF5	XC6365A551MR	DC/DC-IC	PWM st-down, 100kHz, 5.5V±2.5%, 1A, +CE	SOT-25	28zm	DC7	6g	Tor
AF5	XC6367A551MR	DC/DC-IC	PWM step-up, 5.5V±2.5%, 200mA, 100kHz, +CE	SOT-25	28sh	DC11	6g	Tor
AF6	XC6114C637MR	Vdet-IC	3.7V±2%, ±Reset PPO, Wt=1.6s, Rt=50ms	SOT-25	28xg	VD19	6g	Tor
AF6	XC6365A561MR	DC/DC-IC	PWM st-down, 100kHz, 5.6V±2.5%, 1A, +CE	SOT-25	28zm	DC7	6g	Tor
AF6	XC6367A561MR	DC/DC-IC	PWM step-up, 5.6V±2.5%, 200mA, 100kHz, +CE	SOT-25	28sh	DC11	6g	Tor
AF7	XC6114C638MR	Vdet-IC	3.8V±2%, ±Reset PPO, Wt=1.6s, Rt=50ms	SOT-25	28xg	VD19	6g	Tor
AF7	XC6365A571MR	DC/DC-IC	PWM st-down, 100kHz, 5.7V±2.5%, 1A, +CE	SOT-25	28zm	DC7	6g	Tor
AF7	XC6367A571MR	DC/DC-IC	PWM step-up, 5.7V±2.5%, 200mA, 100kHz, +CE	SOT-25	28sh	DC11	6g	Tor
AF8	XC6211B09AMR	LVR-IC	LDO, 0.95V±2%, 150mA, +CE	SOT-25	28vc	VR4	6g	Tor
AF8	XC6114C639MR	Vdet-IC	3.9V±2%, ±Reset PPO, Wt=1.6s, Rt=50ms	SOT-25	28xg	VD19	6g	Tor
AF8	XC6365A581MR	DC/DC-IC	PWM st-down, 100kHz, 5.8V±2.5%, 1A, +CE	SOT-25	28zm	DC7	6g	Tor
AF8	XC6367A581MR	DC/DC-IC	PWM step-up, 5.8V±2.5%, 200mA, 100kHz, +CE	SOT-25	28sh	DC11	6g	Tor
AF9	XC6211B10AMR	LVR-IC	LDO, 1.05V±2%, 150mA, +CE	SOT-25	28vc	VR4	6g	Tor
AF9	XC6114C640MR	Vdet-IC	4.0V±2%, ±Reset PPO, Wt=1.6s, Rt=50ms	SOT-25	28xg	VD19	6g	Tor
AF9	XC6365A591MR	DC/DC-IC	PWM st-down, 100kHz, 5.9V±2.5%, 1A, +CE	SOT-25	28zm	DC7	6g	Tor
AF9	XC6367A591MR	DC/DC-IC	PWM step-up, 5.9V±2.5%, 200mA, 100kHz, +CE	SOT-25	28sh	DC11	6g	Tor
AFA	XC6211B11AMR	LVR-IC	LDO, 1.15V±2%, 150mA, +CE	SOT-25	28vc	VR4	6g	Tor
AFA	XC6114C641MR	Vdet-IC	4.1V±2%, ±Reset PPO, Wt=1.6s, Rt=50ms	SOT-25	28xg	VD19	6g	Tor
AFA	XC6365A505MR	DC/DC-IC	PWM st-down, 500kHz, 5.0V±2.5%, 1A, +CE	SOT-25	28zm	DC7	6g	Tor
AFA	XC6367A505MR	DC/DC-IC	PWM step-up, 5.0V±2.5%, 200mA, 500kHz, +CE	SOT-25	28sh	DC11	6g	Tor
AFB	XC6211B12AMR	LVR-IC	LDO, 1.25V±2%, 150mA, +CE	SOT-25	28vc	VR4	6g	Tor
AFB	XC6114C642MR	Vdet-IC	4.2V±2%, ±Reset PPO, Wt=1.6s, Rt=50ms	SOT-25	28xg	VD19	6g	Tor
AFB	XC6365A515MR	DC/DC-IC	PWM st-down, 500kHz, 5.1V±2.5%, 1A, +CE	SOT-25	28zm	DC7	6g	Tor
AFB	XC6367A515MR	DC/DC-IC	PWM step-up, 5.1V±2.5%, 200mA, 500kHz, +CE	SOT-25	28sh	DC11	6g	Tor
AFC	XC6211B13AMR	LVR-IC	LDO, 1.35V±2%, 150mA, +CE	SOT-25	28vc	VR4	6g	Tor
AFC	XC6114C643MR	Vdet-IC	4.3V±2%, ±Reset PPO, Wt=1.6s, Rt=50ms	SOT-25	28xg	VD19	6g	Tor
AFC	XC6365A525MR	DC/DC-IC	PWM st-down, 500kHz, 5.2V±2.5%, 1A, +CE	SOT-25	28zm	DC7	6g	Tor
AFC	XC6367A525MR	DC/DC-IC	PWM step-up, 5.2V±2.5%, 200mA, 500kHz, +CE	SOT-25	28sh	DC11	6g	Tor
AFD	XC6211B14AMR	LVR-IC	LDO, 1.45V±2%, 150mA, +CE	SOT-25	28vc	VR4	6g	Tor
AFD	XC6114C644MR	Vdet-IC	4.4V±2%, ±Reset PPO, Wt=1.6s, Rt=50ms	SOT-25	28xg	VD19	6g	Tor
AFD	XC6365A535MR	DC/DC-IC	PWM st-down, 500kHz, 5.3V±2.5%, 1A, +CE	SOT-25	28zm	DC7	6g	Tor
AFD	XC6367A535MR	DC/DC-IC	PWM step-up, 5.3V±2.5%, 200mA, 500kHz, +CE	SOT-25	28sh	DC11	6g	Tor
AFE	XC6211B15AMR	LVR-IC	LDO, 1.55V±2%, 150mA, +CE	SOT-25	28vc	VR4	6g	Tor
AFE	XC6114C645MR	Vdet-IC	4.5V±2%, ±Reset PPO, Wt=1.6s, Rt=50ms	SOT-25	28xg	VD19	6g	Tor
AFE	XC6365A545MR	DC/DC-IC	PWM st-down, 500kHz, 5.4V±2.5%, 1A, +CE	SOT-25	28zm	DC7	6g	Tor
AFE	XC6367A545MR	DC/DC-IC	PWM step-up, 5.4V±2.5%, 200mA, 500kHz, +CE	SOT-25	28sh	DC11	6g	Tor
AFF	XC6211B16AMR	LVR-IC	LDO, 1.65V±2%, 150mA, +CE	SOT-25	28vc	VR4	6g	Tor
AFF	XC6114C616MR	Vdet-IC	1.6V±2%, ±Reset PPO, Wt=1.6s, Rt=50ms	SOT-25	28xg	VD19	6g	Tor
AFE	XC6114C646MR	Vdet-IC	4.6V±2%, ±Reset PPO, Wt=1.6s, Rt=50ms	SOT-25	28xg	VD19	6g	Tor
AFF	XC6365A555MR	DC/DC-IC	PWM st-down, 500kHz, 5.5V±2.5%, 1A, +CE	SOT-25	28zm	DC7	6g	Tor
AFF	XC6367A555MR	DC/DC-IC	PWM step-up, 5.5V±2.5%, 200mA, 500kHz, +CE	SOT-25	28sh	DC11	6g	Tor
AFH	XC6211B17AMR	LVR-IC	LDO, 1.75V±2%, 150mA, +CE	SOT-25	28vc	VR4	6g	Tor
AFH	XC6114C617MR	Vdet-IC	1.7V±2%, ±Reset PPO, Wt=1.6s, Rt=50ms	SOT-25	28xg	VD19	6g	Tor
AFH	XC6114C647MR	Vdet-IC	4.7V±2%, ±Reset PPO, Wt=1.6s, Rt=50ms	SOT-25	28xg	VD19	6g	Tor
AFH	XC6365A565MR	DC/DC-IC	PWM st-down, 500kHz, 5.6V±2.5%, 1A, +CE	SOT-25	28zm	DC7	6g	Tor
AFH	XC6367A565MR	DC/DC-IC	PWM step-up, 5.6V±2.5%, 200mA, 500kHz, +CE	SOT-25	28sh	DC11	6g	Tor
AFK	XC6211B18AMR	LVR-IC	LDO, 1.85V±2%, 240mA, +CE	SOT-25	28vc	VR4	6g	Tor
AFK	XC6114C618MR	Vdet-IC	1.8V±2%, ±Reset PPO, Wt=1.6s, Rt=50ms	SOT-25	28xg	VD19	6g	Tor
AFK	XC6114C648MR	Vdet-IC	4.8V±2%, ±Reset PPO, Wt=1.6s, Rt=50ms	SOT-25	28xg	VD19	6g	Tor
AFK	XC6365A575MR	DC/DC-IC	PWM st-down, 500kHz, 5.7V±2.5%, 1A, +CE	SOT-25	28zm	DC7	6g	Tor
AFK	XC6367A575MR	DC/DC-IC	PWM step-up, 5.7V±2.5%, 200mA, 500kHz, +CE	SOT-25	28sh	DC11	6g	Tor
AFL	XC6211B19AMR	LVR-IC	LDO, 1.95V±2%, 240mA, +CE	SOT-25	28vc	VR4	6g	Tor
AFL	XC6114C619MR	Vdet-IC	1.9V±2%, ±Reset PPO, Wt=1.6s, Rt=50ms	SOT-25	28xg	VD19	6g	Tor
AFL	XC6114C649MR	Vdet-IC	4.9V±2%, ±Reset PPO, Wt=1.6s, Rt=50ms	SOT-25	28xg	VD19	6g	Tor
AFL	XC6365A585MR	DC/DC-IC	PWM st-down, 500kHz, 5.8V±2.5%, 1A, +CE	SOT-25	28zm	DC7	6g	Tor
AFL	XC6367A585MR	DC/DC-IC	PWM step-up, 5.8V±2.5%, 200mA, 500kHz, +CE	SOT-25	28sh	DC11	6g	Tor



SMD code	Type	Function	Short description	Case	Pinout	Sch.	St.	Mnf.
AFM	XC6211B20AMR	LVR-IC	LDO, 2.05V±2%, 240mA, +CE	SOT-25	28vc	VR4	6g	Tor
AFM	XC6114C620MR	Vdet-IC	2.0V±2%, ±Reset PPO, Wt=1.6s, Rt=50ms	SOT-25	28xg	VD19	6g	Tor
AFM	XC6114C650MR	Vdet-IC	5.0V±2%, ±Reset PPO, Wt=1.6s, Rt=50ms	SOT-25	28xg	VD19	6g	Tor
AFM	XC6365A959MR	DC/DC-IC	PWM st-down, 500kHz, 5.9V±2.5%, 1A, +CE	SOT-25	28zm	DC7	6g	Tor
AFM	XC6367A959MR	DC/DC-IC	PWM step-up, 5.9V±2.5%, 200mA, 500kHz, +CE	SOT-25	28sh	DC11	6g	Tor
AFN	XC6211B21AMR	LVR-IC	LDO, 2.15V±2%, 240mA, +CE	SOT-25	28vc	VR4	6g	Tor
AFN	XC6114C621MR	Vdet-IC	2.1V±2%, ±Reset PPO, Wt=1.6s, Rt=50ms	SOT-25	28xg	VD19	6g	Tor
AFP	XC6211B22AMR	LVR-IC	LDO, 2.25V±2%, 240mA, +CE	SOT-25	28vc	VR4	6g	Tor
AFP	XC6114C622MR	Vdet-IC	2.2V±2%, ±Reset PPO, Wt=1.6s, Rt=50ms	SOT-25	28xg	VD19	6g	Tor
AFR	XC6211B23AMR	LVR-IC	LDO, 2.35V±2%, 240mA, +CE	SOT-25	28vc	VR4	6g	Tor
AFR	XC6114C623MR	Vdet-IC	2.3V±2%, ±Reset PPO, Wt=1.6s, Rt=50ms	SOT-25	28xg	VD19	6g	Tor
AFS	XC6211B24AMR	LVR-IC	LDO, 2.45V±2%, 240mA, +CE	SOT-25	28vc	VR4	6g	Tor
AFS	XC6114C624MR	Vdet-IC	2.4V±2%, ±Reset PPO, Wt=1.6s, Rt=50ms	SOT-25	28xg	VD19	6g	Tor
AFT	XC6211B25AMR	LVR-IC	LDO, 2.55V±2%, 240mA, +CE	SOT-25	28vc	VR4	6g	Tor
AFT	XC6114C625MR	Vdet-IC	2.5V±2%, ±Reset PPO, Wt=1.6s, Rt=50ms	SOT-25	28xg	VD19	6g	Tor
AFU	XC6211B26AMR	LVR-IC	LDO, 2.65V±2%, 240mA, +CE	SOT-25	28vc	VR4	6g	Tor
AFU	XC6114C626MR	Vdet-IC	2.6V±2%, ±Reset PPO, Wt=1.6s, Rt=50ms	SOT-25	28xg	VD19	6g	Tor
AFV	XC6211B27AMR	LVR-IC	LDO, 2.75V±2%, 240mA, +CE	SOT-25	28vc	VR4	6g	Tor
AFV	XC6114C627MR	Vdet-IC	2.7V±2%, ±Reset PPO, Wt=1.6s, Rt=50ms	SOT-25	28xg	VD19	6g	Tor
AFX	XC6211B28AMR	LVR-IC	LDO, 2.85V±2%, 240mA, +CE	SOT-25	28vc	VR4	6g	Tor
AFX	XC6114C628MR	Vdet-IC	2.8V±2%, ±Reset PPO, Wt=1.6s, Rt=50ms	SOT-25	28xg	VD19	6g	Tor
AFY	XC6211B29AMR	LVR-IC	LDO, 2.95V±2%, 240mA, +CE	SOT-25	28vc	VR4	6g	Tor
AFY	XC6114C629MR	Vdet-IC	2.9V±2%, ±Reset PPO, Wt=1.6s, Rt=50ms	SOT-25	28xg	VD19	6g	Tor
AFZ	XC6211B30AMR	LVR-IC	LDO, 3.05V±2%, 240mA, +CE	SOT-25	28vc	VR4	6g	Tor
AFZ	XC6114C630MR	Vdet-IC	3.0V±2%, ±Reset PPO, Wt=1.6s, Rt=50ms	SOT-25	28xg	VD19	6g	Tor
AG	74AHC1G32GW	CMOS-Logic	2-input OR gate	SOT-353	28/Log4	-	6a	Phi
AG	AP4311Q	Vref-IC	Adjustable, Precision, Shunt, 2.495V±1%	SOT-23-5	28re	RF1	6k	Ana
AG	HD74ALVC1G80VS	CMOS-Logic	Positive edge-triggered D-type flip-flop	VSON-5	30/Log21	-	6a	Ren
AG	PI74ST1G86CX	CMOS-Logic	2-input EXCLUSIVE-OR gate	SC-70-5	28/Log5	-	6a	Per
AG	PI74ST1G86TX	CMOS-Logic	2-input EXCLUSIVE-OR gate	SOT-23-5	28/Log5	-	6a	Per
AG	RN5RT26AA	LVR-IC	LDO, 2.6V±2%, 150mA, -CE	SOT-23-5	28vrt	VR4	6g	Ric
AG	SiP823ZEU	Vdet-IC	2.32V±1.5%, MR, Strobe, -Reset PPO	SOT-23-5	28rcp	VD17	6k	Vs
AG-	RT9198-27PU5	LVR-IC	LDO, 2.7V±1%, 300mA, +CE	SC-70-5	28xm	VR4	6a	Rct
AG08	RP114Q082B	LVR-IC	LDO, 0.8V±1%, 300mA, +CE	SC-88A	28xm	VR4	6m	Ric
AG09	RP114Q092B	LVR-IC	LDO, 0.9V±1%, 300mA, +CE	SC-88A	28xm	VR4	6m	Ric
AG10	RP114Q102B	LVR-IC	LDO, 1.0V±1%, 300mA, +CE	SC-88A	28xm	VR4	6m	Ric
AG11	RP114Q112B	LVR-IC	LDO, 1.1V±1%, 300mA, +CE	SC-88A	28xm	VR4	6m	Ric
AG12	RP114Q122B	LVR-IC	LDO, 1.2V±1%, 300mA, +CE	SC-88A	28xm	VR4	6m	Ric
AG13	RP114Q132B	LVR-IC	LDO, 1.3V±1%, 300mA, +CE	SC-88A	28xm	VR4	6m	Ric
AG14	RP114Q142B	LVR-IC	LDO, 1.4V±1%, 300mA, +CE	SC-88A	28xm	VR4	6m	Ric
AG15	RP114Q152B	LVR-IC	LDO, 1.5V±1%, 300mA, +CE	SC-88A	28xm	VR4	6m	Ric
AG16	RP114Q162B	LVR-IC	LDO, 1.6V±1%, 300mA, +CE	SC-88A	28xm	VR4	6m	Ric
AG17	RP114Q172B	LVR-IC	LDO, 1.7V±1%, 300mA, +CE	SC-88A	28xm	VR4	6m	Ric
AG18	RP114Q182B	LVR-IC	LDO, 1.8V±1%, 300mA, +CE	SC-88A	28xm	VR4	6m	Ric
AG19	RP114Q192B	LVR-IC	LDO, 1.9V±1%, 300mA, +CE	SC-88A	28xm	VR4	6m	Ric
AG20	RP114Q202B	LVR-IC	LDO, 2.0V±1%, 300mA, +CE	SC-88A	28xm	VR4	6m	Ric
AG21	RP114Q212B	LVR-IC	LDO, 2.1V±1%, 300mA, +CE	SC-88A	28xm	VR4	6m	Ric
AG22	RP114Q222B	LVR-IC	LDO, 2.2V±1%, 300mA, +CE	SC-88A	28xm	VR4	6m	Ric
AG23	RP114Q232B	LVR-IC	LDO, 2.3V±1%, 300mA, +CE	SC-88A	28xm	VR4	6m	Ric
AG24	RP114Q242B	LVR-IC	LDO, 2.4V±1%, 300mA, +CE	SC-88A	28xm	VR4	6m	Ric
AG25	RP114Q252B	LVR-IC	LDO, 2.5V±1%, 300mA, +CE	SC-88A	28xm	VR4	6m	Ric
AG26	RP114Q262B	LVR-IC	LDO, 2.6V±1%, 300mA, +CE	SC-88A	28xm	VR4	6m	Ric
AG27	RP114Q272B	LVR-IC	LDO, 2.7V±1%, 300mA, +CE	SC-88A	28xm	VR4	6m	Ric
AG28	RP114Q282B	LVR-IC	LDO, 2.8V±1%, 300mA, +CE	SC-88A	28xm	VR4	6m	Ric
AG29	RP114Q292B	LVR-IC	LDO, 2.9V±1%, 300mA, +CE	SC-88A	28xm	VR4	6m	Ric
AG30	RP114Q302B	LVR-IC	LDO, 3.0V±1%, 300mA, +CE	SC-88A	28xm	VR4	6m	Ric
AG31	RP114Q312B	LVR-IC	LDO, 3.1V±1%, 300mA, +CE	SC-88A	28xm	VR4	6m	Ric
AG32	RP114Q322B	LVR-IC	LDO, 3.2V±1%, 300mA, +CE	SC-88A	28xm	VR4	6m	Ric
AG33	RP114Q332B	LVR-IC	LDO, 3.3V±1%, 300mA, +CE	SC-88A	28xm	VR4	6m	Ric
AG34	RP114Q342B	LVR-IC	LDO, 3.4V±1%, 300mA, +CE	SC-88A	28xm	VR4	6m	Ric
AG35	RP114Q352B	LVR-IC	LDO, 3.5V±1%, 300mA, +CE	SC-88A	28xm	VR4	6m	Ric
AG36	RP114Q362B	LVR-IC	LDO, 3.6V±1%, 300mA, +CE	SC-88A	28xm	VR4	6m	Ric
AG37	RP114Q122B5	LVR-IC	LDO, 1.25V±1%, 300mA, +CE	SC-88A	28xm	VR4	6m	Ric
AG38	RP114Q182B5	LVR-IC	LDO, 1.85V±1%, 300mA, +CE	SC-88A	28xm	VR4	6m	Ric
AG39	RP114Q282B5	LVR-IC	LDO, 2.85V±1%, 300mA, +CE	SC-88A	28xm	VR4	6m	Ric
AG40	RP114Q342B5	LVR-IC	LDO, 3.45V±1%, 300mA, +CE	SC-88A	28xm	VR4	6m	Ric
AGO	AME8800JEEV	LVR-IC	LDO, 2.85V±1.5%, 300mA	SOT-25	28v9	VR1	6k	Ame
AGO	AME8800JEEVL	LVR-IC	LDO, 2.85V±1.5%, 300mA	TSOT-25	28vu	VR1	6k	Ame
AGO	AME8800JEEVY	LVR-IC	LDO, 2.85V±1.5%, 300mA	TSOT-25	28vu	VR1	6k	Ame
AGO	AME8800JEEVZ	LVR-IC	LDO, 2.85V±1.5%, 300mA	SOT-25	28vu	VR1	6k	Ame



SMD code	Type	Function	Short description	Case	Pinout	Sch.	St.	Mnf.
AGU	ISL88011H546Z	Vdet-IC	4.64V -Reset/AMR, +Reset PPO	SOT-23-5	28vd3	-	6a	Itt
AGV	ISL88011H544Z	Vdet-IC	4.38V -Reset/AMR, +Reset PPO	SOT-23-5	28vd3	-	6a	Itt
AGW	ISL88011H531Z	Vdet-IC	3.09V -Reset/AMR, +Reset PPO	SOT-23-5	28vd3	-	6a	Itt
AGX	ISL88011H529Z	Vdet-IC	2.92V -Reset/AMR, +Reset PPO	SOT-23-5	28vd3	-	6a	Itt
AGY	ISL88011H526Z	Vdet-IC	2.63V -Reset/AMR, +Reset PPO	SOT-23-5	28vd3	-	6a	Itt
AGZ	ISL88011H523Z	Vdet-IC	2.32V -Reset/AMR, +Reset PPO	SOT-23-5	28vd3	-	6a	Itt
AH	74AHC1G86GW	CMOS-Logic	2-input EXCLUSIVE-OR gate	SOT-353	28Log5	-	6a	Phi
AH	AP431AQ	Vref-IC	Adjustable, Precision, Shunt, 2.495V±0.5%	SOT-23-5	28re	RF1	6k	Ana
AH	HD74ALVC1G240VS	CMOS-Logic	Bus buffer inverted with 3-state output	VSON-5	30Log22	-	6a	Ren
AH	RN5RT27AA	LVR-IC	LDO, 2.7V±2%, 150mA, -CE	SOT-23-5	28vrt	VR4	6g	Ric
AH	SiP823YEU	Vdet-IC	2.19V±1.5%, MR, Strobe, -Reset PPO	SOT-23-5	28cp	VD17	6k	Vs
AH-	RT9198-32PU5	LVR-IC	LDO, 3.2V±1%, 300mA, +CE	SC-70-5	28xm	VR4	6a	Rct
AH0	XC6114D331MR	Vdet-IC	3.1V±2%, ±Reset PPO, Wt=100ms, Rt=100ms	SOT-25	28xg	VD19	6g	Tor
AH0	XC6365A601MR	DC/DC-IC	PWM st-down, 100kHz, 6.0V±2.5%, 1A, +CE	SOT-25	28zm	DC7	6g	Tor
AH0	XC6367A601MR	DC/DC-IC	PWM step-up, 6.0V±2.5%, 200mA, 100kHz, +CE	SOT-25	28sh	DC11	6g	Tor
AH08	RP114Q082D	LVR-IC	LDO, 0.8V±1%, 300mA, +CE, CL	SC-88A	28xm	VR4	6m	Ric
AH09	RP114Q092D	LVR-IC	LDO, 0.9V±1%, 300mA, +CE, CL	SC-88A	28xm	VR4	6m	Ric
AH1	XC6114D332MR	Vdet-IC	3.2V±2%, ±Reset PPO, Wt=100ms, Rt=100ms	SOT-25	28xg	VD19	6g	Tor
AH1	XC6367A611MR	DC/DC-IC	PWM step-up, 6.1V±2.5%, 200mA, 100kHz, +CE	SOT-25	28sh	DC11	6g	Tor
AH10	RP114Q102D	LVR-IC	LDO, 1.0V±1%, 300mA, +CE, CL	SC-88A	28xm	VR4	6m	Ric
AH11	RP114Q112D	LVR-IC	LDO, 1.1V±1%, 300mA, +CE, CL	SC-88A	28xm	VR4	6m	Ric
AH12	RP114Q122D	LVR-IC	LDO, 1.2V±1%, 300mA, +CE, CL	SC-88A	28xm	VR4	6m	Ric
AH13	RP114Q132D	LVR-IC	LDO, 1.3V±1%, 300mA, +CE, CL	SC-88A	28xm	VR4	6m	Ric
AH14	RP114Q142D	LVR-IC	LDO, 1.4V±1%, 300mA, +CE, CL	SC-88A	28xm	VR4	6m	Ric
AH15	RP114Q152D	LVR-IC	LDO, 1.5V±1%, 300mA, +CE, CL	SC-88A	28xm	VR4	6m	Ric
AH16	RP114Q162D	LVR-IC	LDO, 1.6V±1%, 300mA, +CE, CL	SC-88A	28xm	VR4	6m	Ric
AH17	RP114Q172D	LVR-IC	LDO, 1.7V±1%, 300mA, +CE, CL	SC-88A	28xm	VR4	6m	Ric
AH18	RP114Q182D	LVR-IC	LDO, 1.8V±1%, 300mA, +CE, CL	SC-88A	28xm	VR4	6m	Ric
AH19	RP114Q192D	LVR-IC	LDO, 1.9V±1%, 300mA, +CE, CL	SC-88A	28xm	VR4	6m	Ric
AH2	XC6114D333MR	Vdet-IC	3.3V±2%, ±Reset PPO, Wt=100ms, Rt=100ms	SOT-25	28xg	VD19	6g	Tor
AH2	XC6367A621MR	DC/DC-IC	PWM step-up, 6.2V±2.5%, 200mA, 100kHz, +CE	SOT-25	28sh	DC11	6g	Tor
AH20	RP114Q202D	LVR-IC	LDO, 2.0V±1%, 300mA, +CE, CL	SC-88A	28xm	VR4	6m	Ric
AH21	RP114Q212D	LVR-IC	LDO, 2.1V±1%, 300mA, +CE, CL	SC-88A	28xm	VR4	6m	Ric
AH22	RP114Q222D	LVR-IC	LDO, 2.2V±1%, 300mA, +CE, CL	SC-88A	28xm	VR4	6m	Ric
AH23	RP114Q232D	LVR-IC	LDO, 2.3V±1%, 300mA, +CE, CL	SC-88A	28xm	VR4	6m	Ric
AH24	RP114Q242D	LVR-IC	LDO, 2.4V±1%, 300mA, +CE, CL	SC-88A	28xm	VR4	6m	Ric
AH25	RP114Q252D	LVR-IC	LDO, 2.5V±1%, 300mA, +CE, CL	SC-88A	28xm	VR4	6m	Ric
AH26	RP114Q262D	LVR-IC	LDO, 2.6V±1%, 300mA, +CE, CL	SC-88A	28xm	VR4	6m	Ric
AH27	RP114Q272D	LVR-IC	LDO, 2.7V±1%, 300mA, +CE, CL	SC-88A	28xm	VR4	6m	Ric
AH28	RP114Q282D	LVR-IC	LDO, 2.8V±1%, 300mA, +CE, CL	SC-88A	28xm	VR4	6m	Ric
AH29	RP114Q292D	LVR-IC	LDO, 2.9V±1%, 300mA, +CE, CL	SC-88A	28xm	VR4	6m	Ric
AH3	XC6114D334MR	Vdet-IC	3.4V±2%, ±Reset PPO, Wt=100ms, Rt=100ms	SOT-25	28xg	VD19	6g	Tor
AH3	XC6367A631MR	DC/DC-IC	PWM step-up, 6.3V±2.5%, 200mA, 100kHz, +CE	SOT-25	28sh	DC11	6g	Tor
AH30	RP114Q302D	LVR-IC	LDO, 3.0V±1%, 300mA, +CE, CL	SC-88A	28xm	VR4	6m	Ric
AH31	RP114Q312D	LVR-IC	LDO, 3.1V±1%, 300mA, +CE, CL	SC-88A	28xm	VR4	6m	Ric
AH32	RP114Q322D	LVR-IC	LDO, 3.2V±1%, 300mA, +CE, CL	SC-88A	28xm	VR4	6m	Ric
AH33	RP114Q332D	LVR-IC	LDO, 3.3V±1%, 300mA, +CE, CL	SC-88A	28xm	VR4	6m	Ric
AH34	RP114Q342D	LVR-IC	LDO, 3.4V±1%, 300mA, +CE, CL	SC-88A	28xm	VR4	6m	Ric
AH35	RP114Q352D	LVR-IC	LDO, 3.5V±1%, 300mA, +CE, CL	SC-88A	28xm	VR4	6m	Ric
AH36	RP114Q362D	LVR-IC	LDO, 3.6V±1%, 300mA, +CE, CL	SC-88A	28xm	VR4	6m	Ric
AH37	RP114Q122D5	LVR-IC	LDO, 1.25V±1%, 300mA, +CE, CL	SC-88A	28xm	VR4	6m	Ric
AH38	RP114Q182D5	LVR-IC	LDO, 1.85V±1%, 300mA, +CE, CL	SC-88A	28xm	VR4	6m	Ric
AH39	RP114Q282D5	LVR-IC	LDO, 2.85V±1%, 300mA, +CE, CL	SC-88A	28xm	VR4	6m	Ric
AH4	XC6114D335MR	Vdet-IC	3.5V±2%, ±Reset PPO, Wt=100ms, Rt=100ms	SOT-25	28xg	VD19	6g	Tor
AH4	XC6367A641MR	DC/DC-IC	PWM step-up, 6.4V±2.5%, 200mA, 100kHz, +CE	SOT-25	28sh	DC11	6g	Tor
AH40	RP114Q342D5	LVR-IC	LDO, 3.45V±1%, 300mA, +CE, CL	SC-88A	28xm	VR4	6m	Ric
AH5	XC6114D336MR	Vdet-IC	3.6V±2%, ±Reset PPO, Wt=100ms, Rt=100ms	SOT-25	28xg	VD19	6g	Tor
AH5	XC6367A651MR	DC/DC-IC	PWM step-up, 6.5V±2.5%, 200mA, 100kHz, +CE	SOT-25	28sh	DC11	6g	Tor
AH6	XC6114D337MR	Vdet-IC	3.7V±2%, ±Reset PPO, Wt=100ms, Rt=100ms	SOT-25	28xg	VD19	6g	Tor
AH7	XC6114D338MR	Vdet-IC	3.8V±2%, ±Reset PPO, Wt=100ms, Rt=100ms	SOT-25	28xg	VD19	6g	Tor
AH8	XC6211C09AMR	LVR-IC	LDO, 0.95V±2%, 150mA, -CE, PDR	SOT-25	28vc	VR4	6g	Tor
AH8	XC6114D339MR	Vdet-IC	3.9V±2%, ±Reset PPO, Wt=100ms, Rt=100ms	SOT-25	28xg	VD19	6g	Tor
AH9	XC6211C10AMR	LVR-IC	LDO, 1.05V±2%, 150mA, -CE, PDR	SOT-25	28vc	VR4	6g	Tor
AH9	XC6114D340MR	Vdet-IC	4.0V±2%, ±Reset PPO, Wt=100ms, Rt=100ms	SOT-25	28xg	VD19	6g	Tor
AHA	XC6211C11AMR	LVR-IC	LDO, 1.15V±2%, 150mA, -CE, PDR	SOT-25	28vc	VR4	6g	Tor
AHA	XC6114D341MR	Vdet-IC	4.1V±2%, ±Reset PPO, Wt=100ms, Rt=100ms	SOT-25	28xg	VD19	6g	Tor
AHA	XC6365A605MR	DC/DC-IC	PWM st-down, 500kHz, 6.0V±2.5%, 1A, +CE	SOT-25	28zm	DC7	6g	Tor
AHA	XC6367A605MR	DC/DC-IC	PWM step-up, 6.0V±2.5%, 200mA, 500kHz, +CE	SOT-25	28sh	DC11	6g	Tor
AHB	XC6211C12AMR	LVR-IC	LDO, 1.25V±2%, 150mA, -CE, PDR	SOT-25	28vc	VR4	6g	Tor
AHB	XC6114D342MR	Vdet-IC	4.2V±2%, ±Reset PPO, Wt=100ms, Rt=100ms	SOT-25	28xg	VD19	6g	Tor



SMD code	Type	Function	Short description	Case	Pinout	Sch.	St.	Mnf.
AHB	XC6367A615MR	DC/DC-IC	PWM step-up, 6.1V±2.5%, 200mA, 500kHz, +CE	SOT-25	28sh	DC11	6g	Tor
AHC	XC6211C13AMR	LVR-IC	LDO, 1.35V±2%, 150mA, -CE, PDR	SOT-25	28vc	VR4	6g	Tor
AHC	XC6114D343MR	Vdet-IC	4.3V±2%, ±Reset PPO, Wt=100ms, Rt=100ms	SOT-25	28xg	VD19	6g	Tor
AHC	XC6367A625MR	DC/DC-IC	PWM step-up, 6.2V±2.5%, 200mA, 500kHz, +CE	SOT-25	28sh	DC11	6g	Tor
AHD	XC6211C14AMR	LVR-IC	LDO, 1.45V±2%, 150mA, -CE, PDR	SOT-25	28vc	VR4	6g	Tor
AHD	XC6114D344MR	Vdet-IC	4.4V±2%, ±Reset PPO, Wt=100ms, Rt=100ms	SOT-25	28xg	VD19	6g	Tor
AHD	XC6367A635MR	DC/DC-IC	PWM step-up, 6.3V±2.5%, 200mA, 500kHz, +CE	SOT-25	28sh	DC11	6g	Tor
AHE	ISL88011H522Z	Vdet-IC	2.19V, -Reset/AMR, +Reset PPO	SOT-23-5	28vd3	-	6a	Itt
AHE	XC6211C15AMR	LVR-IC	LDO, 1.55V±2%, 150mA, -CE, PDR	SOT-25	28vc	VR4	6g	Tor
AHE	XC6114D345MR	Vdet-IC	4.5V±2%, ±Reset PPO, Wt=100ms, Rt=100ms	SOT-25	28xg	VD19	6g	Tor
AHE	XC6367A645MR	DC/DC-IC	PWM step-up, 6.4V±2.5%, 200mA, 500kHz, +CE	SOT-25	28sh	DC11	6g	Tor
AHF	ISL88012IH546Z	Vdet-IC	4.64V -Reset/AMR, +Reset PPO	SOT-23-5	28vd4	-	6a	Itt
AHF	XC6211C16AMR	LVR-IC	LDO, 1.65V±2%, 150mA, -CE, PDR	SOT-25	28vc	VR4	6g	Tor
AHF	XC6114D316MR	Vdet-IC	1.6V±2%, ±Reset PPO, Wt=100ms, Rt=100ms	SOT-25	28xg	VD19	6g	Tor
AHF	XC6114D346MR	Vdet-IC	4.6V±2%, ±Reset PPO, Wt=100ms, Rt=100ms	SOT-25	28xg	VD19	6g	Tor
AHF	XC6367A655MR	DC/DC-IC	PWM step-up, 6.5V±2.5%, 200mA, 500kHz, +CE	SOT-25	28sh	DC11	6g	Tor
AHG	ISL88012IH544Z	Vdet-IC	4.38V -Reset/AMR, +Reset PPO	SOT-23-5	28vd4	-	6a	Itt
AHH	ISL88012IH531Z	Vdet-IC	3.09V -Reset/AMR, +Reset PPO	SOT-23-5	28vd4	-	6a	Itt
AHH	XC6211C17AMR	LVR-IC	LDO, 1.75V±2%, 150mA, -CE, PDR	SOT-25	28vc	VR4	6g	Tor
AHH	XC6114D317MR	Vdet-IC	1.7V±2%, ±Reset PPO, Wt=100ms, Rt=100ms	SOT-25	28xg	VD19	6g	Tor
AHH	XC6114D347MR	Vdet-IC	4.7V±2%, ±Reset PPO, Wt=100ms, Rt=100ms	SOT-25	28xg	VD19	6g	Tor
AHI	ISL88012IH529Z	Vdet-IC	2.92V -Reset/AMR, +Reset PPO	SOT-23-5	28vd4	-	6a	Itt
AHJ	ISL88012IH526Z	Vdet-IC	2.63V -Reset/AMR, +Reset PPO	SOT-23-5	28vd4	-	6a	Itt
AHK	ISL88012IH523Z	Vdet-IC	2.32V -Reset/AMR, +Reset PPO	SOT-23-5	28vd4	-	6a	Itt
AHK	XC6211C18AMR	LVR-IC	LDO, 1.85V±2%, 240mA, -CE, PDR	SOT-25	28vc	VR4	6g	Tor
AHK	XC6114D318MR	Vdet-IC	1.8V±2%, ±Reset PPO, Wt=100ms, Rt=100ms	SOT-25	28xg	VD19	6g	Tor
AHK	XC6114D348MR	Vdet-IC	4.8V±2%, ±Reset PPO, Wt=100ms, Rt=100ms	SOT-25	28xg	VD19	6g	Tor
AHL	ISL88012IH522Z	Vdet-IC	2.19V -Reset/AMR, +Reset PPO	SOT-23-5	28vd4	-	6a	Itt
AHL	XC6211C19AMR	LVR-IC	LDO, 1.95V±2%, 240mA, -CE, PDR	SOT-25	28vc	VR4	6g	Tor
AHL	XC6114D319MR	Vdet-IC	1.9V±2%, ±Reset PPO, Wt=100ms, Rt=100ms	SOT-25	28xg	VD19	6g	Tor
AHL	XC6114D349MR	Vdet-IC	4.9V±2%, ±Reset PPO, Wt=100ms, Rt=100ms	SOT-25	28xg	VD19	6g	Tor
AHM	ISL88013IH546Z	Vdet-IC	4.64V -Reset/AMR, +Reset PPO	SOT-23-5	28vd5	-	6a	Itt
AHM	XC6211C20AMR	LVR-IC	LDO, 2.05V±2%, 240mA, -CE, PDR	SOT-25	28vc	VR4	6g	Tor
AHM	XC6114D320MR	Vdet-IC	2.0V±2%, ±Reset PPO, Wt=100ms, Rt=100ms	SOT-25	28xg	VD19	6g	Tor
AHM	XC6114D350MR	Vdet-IC	5.0V±2%, ±Reset PPO, Wt=100ms, Rt=100ms	SOT-25	28xg	VD19	6g	Tor
AHN	ISL88013IH544Z	Vdet-IC	4.38V -Reset/AMR, +Reset PPO	SOT-23-5	28vd5	-	6a	Itt
AHN	XC6211C21AMR	LVR-IC	LDO, 2.15V±2%, 240mA, -CE, PDR	SOT-25	28vc	VR4	6g	Tor
AHN	XC6114D321MR	Vdet-IC	2.1V±2%, ±Reset PPO, Wt=100ms, Rt=100ms	SOT-25	28xg	VD19	6g	Tor
AHO	ISL88013IH531Z	Vdet-IC	3.09V -Reset/AMR, +Reset PPO	SOT-23-5	28vd5	-	6a	Itt
AHP	ISL88013IH529Z	Vdet-IC	2.92V -Reset/AMR, +Reset PPO	SOT-23-5	28vd5	-	6a	Itt
AHP	XC6211C22AMR	LVR-IC	LDO, 2.25V±2%, 240mA, -CE, PDR	SOT-25	28vc	VR4	6g	Tor
AHP	XC6114D322MR	Vdet-IC	2.2V±2%, ±Reset PPO, Wt=100ms, Rt=100ms	SOT-25	28xg	VD19	6g	Tor
AHQ	AME8800KEEV	LVR-IC	LDO, 3.7V±1.5%, 300mA	SOT-25	28vu	VR1	6k	Ame
AHQ	AME8800KEEVL	LVR-IC	LDO, 3.7V±1.5%, 300mA	TSOT-25	28vu	VR1	6k	Ame
AHQ	ISL88013IH526Z	Vdet-IC	2.63V -Reset/AMR, +Reset PPO	SOT-23-5	28vd5	-	6a	Itt
AHQ	AME8800KEEVY	LVR-IC	LDO, 3.7V±1.5%, 300mA	TSOT-25	28vu	VR1	6k	Ame
AHQ	AME8800KEEVZ	LVR-IC	LDO, 3.7V±1.5%, 300mA	SOT-25	28vu	VR1	6k	Ame
AHR	ISL88013IH523Z	Vdet-IC	2.32V -Reset/AMR, +Reset PPO	SOT-23-5	28vd5	-	6a	Itt
AHR	XC6211C23AMR	LVR-IC	LDO, 2.35V±2%, 240mA, -CE, PDR	SOT-25	28vc	VR4	6g	Tor
AHR	XC6114D323MR	Vdet-IC	2.3V±2%, ±Reset PPO, Wt=100ms, Rt=100ms	SOT-25	28xg	VD19	6g	Tor
AHS	ISL88013IH522Z	Vdet-IC	2.19V -Reset/AMR, +Reset PPO	SOT-23-5	28vd5	-	6a	Itt
AHS	XC6211C24AMR	LVR-IC	LDO, 2.45V±2%, 240mA, -CE, PDR	SOT-25	28vc	VR4	6g	Tor
AHS	XC6114D324MR	Vdet-IC	2.4V±2%, ±Reset PPO, Wt=100ms, Rt=100ms	SOT-25	28xg	VD19	6g	Tor
AHT	ISL88014IH5Z	Vdet-IC	Adj. int. Voltage Detector, -Reset/AMR ODO	SOT-23-5	28vd6	-	6a	Itt
AHT	XC6211C25AMR	LVR-IC	LDO, 2.55V±2%, 240mA, -CE, PDR	SOT-25	28vc	VR4	6g	Tor
AHT	XC6114D325MR	Vdet-IC	2.5V±2%, ±Reset PPO, Wt=100ms, Rt=100ms	SOT-25	28xg	VD19	6g	Tor
AHU	ISL88015IH5Z	Vdet-IC	Adj. int. Voltage Detector, -Reset/AMR ODO	SOT-23-5	28vd7	-	6a	Itt
AHU	XC6211C26AMR	LVR-IC	LDO, 2.65V±2%, 240mA, -CE, PDR	SOT-25	28vc	VR4	6g	Tor
AHU	XC6114D326MR	Vdet-IC	2.6V±2%, ±Reset PPO, Wt=100ms, Rt=100ms	SOT-25	28xg	VD19	6g	Tor
AHV	XC6211C27AMR	LVR-IC	LDO, 2.75V±2%, 240mA, -CE, PDR	SOT-25	28vc	VR4	6g	Tor
AHV	XC6114D327MR	Vdet-IC	2.7V±2%, ±Reset PPO, Wt=100ms, Rt=100ms	SOT-25	28xg	VD19	6g	Tor
AHX	XC6211C28AMR	LVR-IC	LDO, 2.85V±2%, 240mA, -CE, PDR	SOT-25	28vc	VR4	6g	Tor
AHX	XC6114D328MR	Vdet-IC	2.8V±2%, ±Reset PPO, Wt=100ms, Rt=100ms	SOT-25	28xg	VD19	6g	Tor
AHY	XC6211C29AMR	LVR-IC	LDO, 2.95V±2%, 240mA, -CE, PDR	SOT-25	28vc	VR4	6g	Tor
AHY	XC6114D329MR	Vdet-IC	2.9V±2%, ±Reset PPO, Wt=100ms, Rt=100ms	SOT-25	28xg	VD19	6g	Tor
AHZ	XC6211C30AMR	LVR-IC	LDO, 3.05V±2%, 240mA, -CE, PDR	SOT-25	28vc	VR4	6g	Tor
AHZ	XC6114D330MR	Vdet-IC	3.0V±2%, ±Reset PPO, Wt=100ms, Rt=100ms	SOT-25	28xg	VD19	6g	Tor
AI	MAX823LEUK	Vdet-IC	4.63V±1.5%, -MR, Strobe, -Reset PPO	SOT-23-5	28cp	VD17	6k	Max
AI	SiP824LEU	Vdet-IC	4.63V±1.5%, Strobe, ±Reset PPO	SOT-23-5	28xq	-	6k	Vs
AJ	MAX823MEUK	Vdet-IC	4.38V±1.5%, -MR, Strobe, -Reset PPO	SOT-23-5	28cp	VD17	6k	Max



SMD code	Type	Function	Short description	Case	Pinout	Sch.	St.	Mnf.
AJ	RN5RT28AA	LVR-IC	LDO, 2.8V±2%, 150mA, -CE	SOT-23-5	28vrt	VR4	6g	Ric
AJ-	RT9198-31PU5	LVR-IC	LDO, 3.1V±1%, 300mA, +CE	SC-70-5	28xm	VR4	6a	Rct
AJ01	R3118Q062A	Vdet-IC	0.6V±22.5mV, -Reset ODO, Sense	SC-88A	28z5	VD14	6m	Ric
AJ02	R3118Q072A	Vdet-IC	0.7V±22.5mV, -Reset ODO, Sense	SC-88A	28z5	VD14	6m	Ric
AJ03	R3118Q082A	Vdet-IC	0.8V±22.5mV, -Reset ODO, Sense	SC-88A	28z5	VD14	6m	Ric
AJ04	R3118Q092A	Vdet-IC	0.9V±22.5mV, -Reset ODO, Sense	SC-88A	28z5	VD14	6m	Ric
AJ05	R3118Q102A	Vdet-IC	1.0V±22.5mV, -Reset ODO, Sense	SC-88A	28z5	VD14	6m	Ric
AJ06	R3118Q112A	Vdet-IC	1.1V±22.5mV, -Reset ODO, Sense	SC-88A	28z5	VD14	6m	Ric
AJ07	R3118Q122A	Vdet-IC	1.2V±22.5mV, -Reset ODO, Sense	SC-88A	28z5	VD14	6m	Ric
AJ08	R3118Q132A	Vdet-IC	1.3V±22.5mV, -Reset ODO, Sense	SC-88A	28z5	VD14	6m	Ric
AJ09	R3118Q142A	Vdet-IC	1.4V±22.5mV, -Reset ODO, Sense	SC-88A	28z5	VD14	6m	Ric
AJ10	R3118Q152A	Vdet-IC	1.5V±22.5mV, -Reset ODO, Sense	SC-88A	28z5	VD14	6m	Ric
AJ11	R3118Q162A	Vdet-IC	1.6V±1.5%, -Reset ODO, Sense	SC-88A	28z5	VD14	6m	Ric
AJ12	R3118Q172A	Vdet-IC	1.7V±1.5%, -Reset ODO, Sense	SC-88A	28z5	VD14	6m	Ric
AJ13	R3118Q182A	Vdet-IC	1.8V±1.5%, -Reset ODO, Sense	SC-88A	28z5	VD14	6m	Ric
AJ14	R3118Q192A	Vdet-IC	1.9V±1.5%, -Reset ODO, Sense	SC-88A	28z5	VD14	6m	Ric
AJ15	R3118Q202A	Vdet-IC	2.0V±1.5%, -Reset ODO, Sense	SC-88A	28z5	VD14	6m	Ric
AJ16	R3118Q212A	Vdet-IC	2.1V±1.5%, -Reset ODO, Sense	SC-88A	28z5	VD14	6m	Ric
AJ17	R3118Q222A	Vdet-IC	2.2V±1.5%, -Reset ODO, Sense	SC-88A	28z5	VD14	6m	Ric
AJ18	R3118Q232A	Vdet-IC	2.3V±1.5%, -Reset ODO, Sense	SC-88A	28z5	VD14	6m	Ric
AJ19	R3118Q242A	Vdet-IC	2.4V±1.5%, -Reset ODO, Sense	SC-88A	28z5	VD14	6m	Ric
AJ20	R3118Q252A	Vdet-IC	2.5V±1.5%, -Reset ODO, Sense	SC-88A	28z5	VD14	6m	Ric
AJ21	R3118Q262A	Vdet-IC	2.6V±1.5%, -Reset ODO, Sense	SC-88A	28z5	VD14	6m	Ric
AJ22	R3118Q272A	Vdet-IC	2.7V±1.5%, -Reset ODO, Sense	SC-88A	28z5	VD14	6m	Ric
AJ23	R3118Q282A	Vdet-IC	2.8V±1.5%, -Reset ODO, Sense	SC-88A	28z5	VD14	6m	Ric
AJ24	R3118Q292A	Vdet-IC	2.9V±1.5%, -Reset ODO, Sense	SC-88A	28z5	VD14	6m	Ric
AJ25	R3118Q302A	Vdet-IC	3.0V±1.5%, -Reset ODO, Sense	SC-88A	28z5	VD14	6m	Ric
AJ26	R3118Q312A	Vdet-IC	3.1V±1.5%, -Reset ODO, Sense	SC-88A	28z5	VD14	6m	Ric
AJ27	R3118Q322A	Vdet-IC	3.2V±1.5%, -Reset ODO, Sense	SC-88A	28z5	VD14	6m	Ric
AJ28	R3118Q332A	Vdet-IC	3.3V±1.5%, -Reset ODO, Sense	SC-88A	28z5	VD14	6m	Ric
AJ29	R3118Q342A	Vdet-IC	3.4V±1.5%, -Reset ODO, Sense	SC-88A	28z5	VD14	6m	Ric
AJ30	R3118Q352A	Vdet-IC	3.5V±1.5%, -Reset ODO, Sense	SC-88A	28z5	VD14	6m	Ric
AJ31	R3118Q362A	Vdet-IC	3.6V±1.5%, -Reset ODO, Sense	SC-88A	28z5	VD14	6m	Ric
AJ32	R3118Q372A	Vdet-IC	3.7V±1.5%, -Reset ODO, Sense	SC-88A	28z5	VD14	6m	Ric
AJ33	R3118Q382A	Vdet-IC	3.8V±1.5%, -Reset ODO, Sense	SC-88A	28z5	VD14	6m	Ric
AJ34	R3118Q392A	Vdet-IC	3.9V±1.5%, -Reset ODO, Sense	SC-88A	28z5	VD14	6m	Ric
AJ35	R3118Q402A	Vdet-IC	4.0V±1.5%, -Reset ODO, Sense	SC-88A	28z5	VD14	6m	Ric
AJ36	R3118Q412A	Vdet-IC	4.1V±1.5%, -Reset ODO, Sense	SC-88A	28z5	VD14	6m	Ric
AJ37	R3118Q422A	Vdet-IC	4.2V±1.5%, -Reset ODO, Sense	SC-88A	28z5	VD14	6m	Ric
AJ38	R3118Q432A	Vdet-IC	4.3V±1.5%, -Reset ODO, Sense	SC-88A	28z5	VD14	6m	Ric
AJ39	R3118Q442A	Vdet-IC	4.4V±1.5%, -Reset ODO, Sense	SC-88A	28z5	VD14	6m	Ric
AJ40	R3118Q452A	Vdet-IC	4.5V±1.5%, -Reset ODO, Sense	SC-88A	28z5	VD14	6m	Ric
AJ41	R3118Q462A	Vdet-IC	4.6V±1.5%, -Reset ODO, Sense	SC-88A	28z5	VD14	6m	Ric
AJ42	R3118Q472A	Vdet-IC	4.7V±1.5%, -Reset ODO, Sense	SC-88A	28z5	VD14	6m	Ric
AJ43	R3118Q482A	Vdet-IC	4.8V±1.5%, -Reset ODO, Sense	SC-88A	28z5	VD14	6m	Ric
AJ44	R3118Q492A	Vdet-IC	4.9V±1.5%, -Reset ODO, Sense	SC-88A	28z5	VD14	6m	Ric
AJ45	R3118Q502A	Vdet-IC	5.0V±1.5%, -Reset ODO, Sense	SC-88A	28z5	VD14	6m	Ric
AJE3	FAN2512S33X	LVR-IC	LDO, 3.3V±2%, 150mA, +CE	SOT-23-5	28vrx	VR7	6b	F
AJU	AME8800LEEV	LVR-IC	LDO, 1.5V±1.5%, 300mA	SOT-25	28vu	VR1	6k	Ame
AJU	AME8800LEEV	LVR-IC	LDO, 1.5V±1.5%, 300mA	TSOT-25	28vu	VR1	6k	Ame
ĀJU	AME8800LEEVY	LVR-IC	LDO, 1.5V±1.5%, 300mA	TSOT-25	28vu	VR1	6k	Ame
ĀJU	AME8800LEEVZ	LVR-IC	LDO, 1.5V±1.5%, 300mA	SOT-25	28vu	VR1	6k	Ame
AJV	AME8800MEEV	LVR-IC	LDO, 1.8V±1.5%, 300mA	SOT-25	28vu	VR1	6k	Ame
AJV	AME8800MEEVL	LVR-IC	LDO, 1.8V±1.5%, 300mA	TSOT-25	28vu	VR1	6k	Ame
ĀJV	AME8800MEEVY	LVR-IC	LDO, 1.8V±1.5%, 300mA	TSOT-25	28vu	VR1	6k	Ame
ĀJV	AME8800MEEVZ	LVR-IC	LDO, 1.8V±1.5%, 300mA	SOT-25	28vu	VR1	6k	Ame
AK	MAX823TEUK	Vdet-IC	3.08V±1.5%, -MR, Strobe, -Reset PPO	SOT-23-5	28cp	VD17	6k	Max
AK	RN5RT29AA	LVR-IC	LDO, 2.9V±2%, 150mA, -CE	SOT-23-5	28vrt	VR4	6g	Rct
AK	SiP824MEU	Vdet-IC	4.38V±1.5%, Strobe, ±Reset PPO	SOT-23-5	28xq	-	6k	Vs
AK-	RT9198-25PU5R	LVR-IC	LDO, 2.5V±1%, 300mA, +CE	SC-70-5	28cx	VR4	6a	Rct
ĀK0	XC6114D431MR	Vdet-IC	3.1V±2%, ±Reset PPO, Wt=200ms, Rt=100ms	SOT-25	28xg	VD19	6g	Tor
AK01	R3118Q062C	Vdet-IC	0.6V±22.5mV, -Reset PPO, Sense	SC-88A	28z5	VD15	6m	Ric
AK02	R3118Q072C	Vdet-IC	0.7V±22.5mV, -Reset PPO, Sense	SC-88A	28z5	VD15	6m	Ric
AK03	R3118Q082C	Vdet-IC	0.8V±22.5mV, -Reset PPO, Sense	SC-88A	28z5	VD15	6m	Ric
AK04	R3118Q092C	Vdet-IC	0.9V±22.5mV, -Reset PPO, Sense	SC-88A	28z5	VD15	6m	Ric
AK05	R3118Q102C	Vdet-IC	1.0V±22.5mV, -Reset PPO, Sense	SC-88A	28z5	VD15	6m	Ric
AK06	R3118Q112C	Vdet-IC	1.1V±22.5mV, -Reset PPO, Sense	SC-88A	28z5	VD15	6m	Ric
AK07	R3118Q122C	Vdet-IC	1.2V±22.5mV, -Reset PPO, Sense	SC-88A	28z5	VD15	6m	Ric
AK08	R3118Q132C	Vdet-IC	1.3V±22.5mV, -Reset PPO, Sense	SC-88A	28z5	VD15	6m	Ric
AK09	R3118Q142C	Vdet-IC	1.4V±22.5mV, -Reset PPO, Sense	SC-88A	28z5	VD15	6m	Ric



SMD code	Type	Function	Short description	Case	Pinout	Sch.	St.	Mnf.
AK1	XC6114D432MR	Vdet-IC	3.2V±2%, ±Reset PPO, Wt=200ms, Rt=100ms	SOT-25	28xg	VD19	6g	Tor
AK10	R3118Q152C	Vdet-IC	1.5V±22.5mV, -Reset PPO, Sense	SC-88A	28z5	VD15	6m	Ric
AK11	R3118Q162C	Vdet-IC	1.6V±1.5%, -Reset PPO, Sense	SC-88A	28z5	VD15	6m	Ric
AK12	R3118Q172C	Vdet-IC	1.7V±1.5%, -Reset PPO, Sense	SC-88A	28z5	VD15	6m	Ric
AK13	R3118Q182C	Vdet-IC	1.8V±1.5%, -Reset PPO, Sense	SC-88A	28z5	VD15	6m	Ric
AK14	R3118Q192C	Vdet-IC	1.9V±1.5%, -Reset PPO, Sense	SC-88A	28z5	VD15	6m	Ric
AK15	R3118Q202C	Vdet-IC	2.0V±1.5%, -Reset PPO, Sense	SC-88A	28z5	VD15	6m	Ric
AK16	R3118Q212C	Vdet-IC	2.1V±1.5%, -Reset PPO, Sense	SC-88A	28z5	VD15	6m	Ric
AK17	R3118Q222C	Vdet-IC	2.2V±1.5%, -Reset PPO, Sense	SC-88A	28z5	VD15	6m	Ric
AK18	R3118Q232C	Vdet-IC	2.3V±1.5%, -Reset PPO, Sense	SC-88A	28z5	VD15	6m	Ric
AK19	R3118Q242C	Vdet-IC	2.4V±1.5%, -Reset PPO, Sense	SC-88A	28z5	VD15	6m	Ric
AK2	XC6114D433MR	Vdet-IC	3.3V±2%, ±Reset PPO, Wt=200ms, Rt=100ms	SOT-25	28xg	VD19	6g	Tor
AK20	R3118Q252C	Vdet-IC	2.5V±1.5%, -Reset PPO, Sense	SC-88A	28z5	VD15	6m	Ric
AK21	R3118Q262C	Vdet-IC	2.6V±1.5%, -Reset PPO, Sense	SC-88A	28z5	VD15	6m	Ric
AK22	R3118Q272C	Vdet-IC	2.7V±1.5%, -Reset PPO, Sense	SC-88A	28z5	VD15	6m	Ric
AK23	R3118Q282C	Vdet-IC	2.7V±1.5%, -Reset PPO, Sense	SC-88A	28z5	VD15	6m	Ric
AK24	R3118Q292C	Vdet-IC	2.8V±1.5%, -Reset PPO, Sense	SC-88A	28z5	VD15	6m	Ric
AK25	R3118Q302C	Vdet-IC	3.0V±1.5%, -Reset PPO, Sense	SC-88A	28z5	VD15	6m	Ric
AK26	R3118Q312C	Vdet-IC	3.1V±1.5%, -Reset PPO, Sense	SC-88A	28z5	VD15	6m	Ric
AK27	R3118Q322C	Vdet-IC	3.2V±1.5%, -Reset PPO, Sense	SC-88A	28z5	VD15	6m	Ric
AK28	R3118Q332C	Vdet-IC	3.3V±1.5%, -Reset PPO, Sense	SC-88A	28z5	VD15	6m	Ric
AK29	R3118Q342C	Vdet-IC	3.4V±1.5%, -Reset PPO, Sense	SC-88A	28z5	VD15	6m	Ric
AK3	XC6114D434MR	Vdet-IC	3.4V±2%, ±Reset PPO, Wt=200ms, Rt=100ms	SOT-25	28xg	VD19	6g	Tor
AK30	R3118Q352C	Vdet-IC	3.5V±1.5%, -Reset PPO, Sense	SC-88A	28z5	VD15	6m	Ric
AK31	R3118Q362C	Vdet-IC	3.6V±1.5%, -Reset PPO, Sense	SC-88A	28z5	VD15	6m	Ric
AK32	R3118Q372C	Vdet-IC	3.7V±1.5%, -Reset PPO, Sense	SC-88A	28z5	VD15	6m	Ric
AK33	R3118Q382C	Vdet-IC	3.8V±1.5%, -Reset PPO, Sense	SC-88A	28z5	VD15	6m	Ric
AK34	R3118Q392C	Vdet-IC	3.9V±1.5%, -Reset PPO, Sense	SC-88A	28z5	VD15	6m	Ric
AK35	R3118Q402C	Vdet-IC	4.0V±1.5%, -Reset PPO, Sense	SC-88A	28z5	VD15	6m	Ric
AK36	R3118Q412C	Vdet-IC	4.1V±1.5%, -Reset PPO, Sense	SC-88A	28z5	VD15	6m	Ric
AK37	R3118Q422C	Vdet-IC	4.2V±1.5%, -Reset PPO, Sense	SC-88A	28z5	VD15	6m	Ric
AK38	R3118Q432C	Vdet-IC	4.3V±1.5%, -Reset PPO, Sense	SC-88A	28z5	VD15	6m	Ric
AK39	R3118Q442C	Vdet-IC	4.4V±1.5%, -Reset PPO, Sense	SC-88A	28z5	VD15	6m	Ric
AK4	XC6114D435MR	Vdet-IC	3.5V±2%, ±Reset PPO, Wt=200ms, Rt=100ms	SOT-25	28xg	VD19	6g	Tor
AK40	R3118Q452C	Vdet-IC	4.5V±1.5%, -Reset PPO, Sense	SC-88A	28z5	VD15	6m	Ric
AK41	R3118Q462C	Vdet-IC	4.6V±1.5%, -Reset PPO, Sense	SC-88A	28z5	VD15	6m	Ric
AK42	R3118Q472C	Vdet-IC	4.7V±1.5%, -Reset PPO, Sense	SC-88A	28z5	VD15	6m	Ric
AK43	R3118Q482C	Vdet-IC	4.8V±1.5%, -Reset PPO, Sense	SC-88A	28z5	VD15	6m	Ric
AK44	R3118Q492C	Vdet-IC	4.9V±1.5%, -Reset PPO, Sense	SC-88A	28z5	VD15	6m	Ric
AK45	R3118Q502C	Vdet-IC	5.0V±1.5%, -Reset PPO, Sense	SC-88A	28z5	VD15	6m	Ric
AK5	XC6114D436MR	Vdet-IC	3.6V±2%, ±Reset PPO, Wt=200ms, Rt=100ms	SOT-25	28xg	VD19	6g	Tor
AK6	XC6114D437MR	Vdet-IC	3.7V±2%, ±Reset PPO, Wt=200ms, Rt=100ms	SOT-25	28xg	VD19	6g	Tor
AK7	XC6114D438MR	Vdet-IC	3.8V±2%, ±Reset PPO, Wt=200ms, Rt=100ms	SOT-25	28xg	VD19	6g	Tor
AK8	XC6211D09AMR	LVR-IC	LDO, 0.95V±2%, 150mA, -CE	SOT-25	28vc	VR4	6g	Tor
AK8	XC6114D439MR	Vdet-IC	3.9V±2%, ±Reset PPO, Wt=200ms, Rt=100ms	SOT-25	28xg	VD19	6g	Tor
AK9	XC6211D10AMR	LVR-IC	LDO, 1.05V±2%, 150mA, -CE	SOT-25	28vc	VR4	6g	Tor
AK9	XC6114D440MR	Vdet-IC	4.0V±2%, ±Reset PPO, Wt=200ms, Rt=100ms	SOT-25	28xg	VD19	6g	Tor
AKA	XC6211D11AMR	LVR-IC	LDO, 1.15V±2%, 150mA, -CE	SOT-25	28vc	VR4	6g	Tor
AKA	XC6114D441MR	Vdet-IC	4.1V±2%, ±Reset PPO, Wt=200ms, Rt=100ms	SOT-25	28xg	VD19	6g	Tor
AKB	XC6211D12AMR	LVR-IC	LDO, 1.25V±2%, 150mA, -CE	SOT-25	28vc	VR4	6g	Tor
AKB	XC6114D442MR	Vdet-IC	4.2V±2%, ±Reset PPO, Wt=200ms, Rt=100ms	SOT-25	28xg	VD19	6g	Tor
AKC	XC6211D13AMR	LVR-IC	LDO, 1.35V±2%, 150mA, -CE	SOT-25	28vc	VR4	6g	Tor
AKC	XC6114D443MR	Vdet-IC	4.3V±2%, ±Reset PPO, Wt=200ms, Rt=100ms	SOT-25	28xg	VD19	6g	Tor
AKD	XC6211D14AMR	LVR-IC	LDO, 1.45V±2%, 150mA, -CE	SOT-25	28vc	VR4	6g	Tor
AKD	XC6114D444MR	Vdet-IC	4.4V±2%, ±Reset PPO, Wt=200ms, Rt=100ms	SOT-25	28xg	VD19	6g	Tor
AKE	XC6211D15AMR	LVR-IC	LDO, 1.55V±2%, 150mA, -CE	SOT-25	28vc	VR4	6g	Tor
AKE	XC6114D445MR	Vdet-IC	4.5V±2%, ±Reset PPO, Wt=200ms, Rt=100ms	SOT-25	28xg	VD19	6g	Tor
AKF	XC6211D16AMR	LVR-IC	LDO, 1.65V±2%, 150mA, -CE	SOT-25	28vc	VR4	6g	Tor
AKF	XC6114D446MR	Vdet-IC	4.6V±2%, ±Reset PPO, Wt=200ms, Rt=100ms	SOT-25	28xg	VD19	6g	Tor
AKH	XC6211D17AMR	LVR-IC	LDO, 1.75V±2%, 150mA, -CE	SOT-25	28vc	VR4	6g	Tor
AKH	XC6114D447MR	Vdet-IC	4.7V±2%, ±Reset PPO, Wt=200ms, Rt=100ms	SOT-25	28xg	VD19	6g	Tor
AKH	XC6114D447MR	Vdet-IC	4.7V±2%, ±Reset PPO, Wt=200ms, Rt=100ms	SOT-25	28xg	VD19	6g	Tor
AKI	AME8800NEEV	LVR-IC	LDO, 2.9V±1.5%, 300mA	SOT-25	28vu	VR1	6k	Ame
AKI	AME8800NEEVL	LVR-IC	LDO, 2.9V±1.5%, 300mA	TSOT-25	28vu	VR1	6k	Ame
AKI	AME8800NEEVY	LVR-IC	LDO, 2.9V±1.5%, 300mA	TSOT-25	28vu	VR1	6k	Ame
AKI	AME8800NEEVZ	LVR-IC	LDO, 2.9V±1.5%, 300mA	SOT-25	28vu	VR1	6k	Ame
AKJ	AME8800EEV	LVR-IC	LDO, 3.1V±1.5%, 300mA	SOT-25	28vu	VR1	6k	Ame
AKJ	AME8800EEVL	LVR-IC	LDO, 3.1V±1.5%, 300mA	TSOT-25	28vu	VR1	6k	Ame
AKJ	AME8800EEVY	LVR-IC	LDO, 3.1V±1.5%, 300mA	TSOT-25	28vu	VR1	6k	Ame



SMD code	Type	Function	Short description	Case	Pinout	Sch.	St.	Mnf.
AKJ	AME8800OEEVZ	LVR-IC	LDO, 3.1V±1.5%, 300mA	SOT-25	28vu	VR1	6k	Ame
AKK	XC6211D18AMR	LVR-IC	LDO, 1.85V±2%, 240mA, -CE	SOT-25	28vc	VR4	6g	Tor
AKK	XC6114D418MR	Vdet-IC	1.8V±2%, ±Reset PPO, Wt=200ms, Rt=100ms	SOT-25	28xg	VD19	6g	Tor
AKK	XC6114D448MR	Vdet-IC	4.8V±2%, ±Reset PPO, Wt=200ms, Rt=100ms	SOT-25	28xg	VD19	6g	Tor
AKL	XC6211D19AMR	LVR-IC	LDO, 1.95V±2%, 240mA, -CE	SOT-25	28vc	VR4	6g	Tor
AKL	XC6114D419MR	Vdet-IC	1.9V±2%, ±Reset PPO, Wt=200ms, Rt=100ms	SOT-25	28xg	VD19	6g	Tor
AKL	XC6114D449MR	Vdet-IC	4.9V±2%, ±Reset PPO, Wt=200ms, Rt=100ms	SOT-25	28xg	VD19	6g	Tor
AKM	XC6211D20AMR	LVR-IC	LDO, 2.05V±2%, 240mA, -CE	SOT-25	28vc	VR4	6g	Tor
AKM	XC6114D420MR	Vdet-IC	2.0V±2%, ±Reset PPO, Wt=200ms, Rt=100ms	SOT-25	28xg	VD19	6g	Tor
AKM	XC6114D450MR	Vdet-IC	5.0V±2%, ±Reset PPO, Wt=200ms, Rt=100ms	SOT-25	28xg	VD19	6g	Tor
AKN	XC6211D21AMR	LVR-IC	LDO, 2.15V±2%, 240mA, -CE	SOT-25	28vc	VR4	6g	Tor
AKN	XC6114D421MR	Vdet-IC	2.1V±2%, ±Reset PPO, Wt=200ms, Rt=100ms	SOT-25	28xg	VD19	6g	Tor
AKP	XC6211D22AMR	LVR-IC	LDO, 2.25V±2%, 240mA, -CE	SOT-25	28vc	VR4	6g	Tor
AKP	XC6114D422MR	Vdet-IC	2.2V±2%, ±Reset PPO, Wt=200ms, Rt=100ms	SOT-25	28xg	VD19	6g	Tor
AKR	XC6211D23AMR	LVR-IC	LDO, 2.35V±2%, 240mA, -CE	SOT-25	28vc	VR4	6g	Tor
AKR	XC6114D423MR	Vdet-IC	2.3V±2%, ±Reset PPO, Wt=200ms, Rt=100ms	SOT-25	28xg	VD19	6g	Tor
AKS	XC6211D24AMR	LVR-IC	LDO, 2.45V±2%, 240mA, -CE	SOT-25	28vc	VR4	6g	Tor
AKS	XC6114D424MR	Vdet-IC	2.4V±2%, ±Reset PPO, Wt=200ms, Rt=100ms	SOT-25	28xg	VD19	6g	Tor
AKT	XC6211D25AMR	LVR-IC	LDO, 2.55V±2%, 240mA, -CE	SOT-25	28vc	VR4	6g	Tor
AKT	XC6114D425MR	Vdet-IC	2.5V±2%, ±Reset PPO, Wt=200ms, Rt=100ms	SOT-25	28xg	VD19	6g	Tor
AKU	XC6211D26AMR	LVR-IC	LDO, 2.65V±2%, 240mA, -CE	SOT-25	28vc	VR4	6g	Tor
AKU	XC6114D426MR	Vdet-IC	2.6V±2%, ±Reset PPO, Wt=200ms, Rt=100ms	SOT-25	28xg	VD19	6g	Tor
AKV	XC6211D27AMR	LVR-IC	LDO, 2.75V±2%, 240mA, -CE	SOT-25	28vc	VR4	6g	Tor
AKV	XC6114D427MR	Vdet-IC	2.7V±2%, ±Reset PPO, Wt=200ms, Rt=100ms	SOT-25	28xg	VD19	6g	Tor
AKX	XC6211D28AMR	LVR-IC	LDO, 2.85V±2%, 240mA, -CE	SOT-25	28vc	VR4	6g	Tor
AKX	XC6114D428MR	Vdet-IC	2.8V±2%, ±Reset PPO, Wt=200ms, Rt=100ms	SOT-25	28xg	VD19	6g	Tor
AKY	XC6211D29AMR	LVR-IC	LDO, 2.95V±2%, 240mA, -CE	SOT-25	28vc	VR4	6g	Tor
AKY	XC6114D429MR	Vdet-IC	2.9V±2%, ±Reset PPO, Wt=200ms, Rt=100ms	SOT-25	28xg	VD19	6g	Tor
AKZ	XC6211D30AMR	LVR-IC	LDO, 3.05V±2%, 240mA, -CE	SOT-25	28vc	VR4	6g	Tor
AKZ	XC6114D430MR	Vdet-IC	3.0V±2%, ±Reset PPO, Wt=200ms, Rt=100ms	SOT-25	28xg	VD19	6g	Tor
AL	74AHC1G66GW	CMOS-Logic	Bilateral analogic switch	SOT-353	28/Log16	-	6a	Phi
AL	MAX823SEUK	Vdet-IC	2.93V±1.5%, -MR, Strobe, -Reset PPO	SOT-23-5	28cp	VD17	6k	Max
AL	R1112N201A	LVR-IC	LDO, LN, -CE, 2V±2%, 150mA	SOT-23-5	28cx	VR4	6g	Ric
AL	SIP824TEU	Vdet-IC	3.08V±1.5%, Strobe, ±Reset PPO	SOT-23-5	28xq	-	6k	Vs
AL-	RT9193-35PU5	LVR-IC	LDO, 3.5V±1%, 300mA, +CE	SC-70-5	28vrx	VR7	6g	Rct
AL0	XC6211A31AMR	LVR-IC	LDO, 3.15V±2%, 240mA, +CE, PDR	SOT-25	28vc	VR4	6g	Tor
AL0	XC6114D531MR	Vdet-IC	3.1V±2%, ±Reset PPO, Wt=400ms, Rt=100ms	SOT-25	28xg	VD19	6g	Tor
AL01	R3117Q074A	Vdet-IC	0.7V±15mV, -Reset ODO, Sense	SC-88A	28rs	VD11	6m	Ric
AL02	R3117Q084A	Vdet-IC	0.8V±15mV, -Reset ODO, Sense	SC-88A	28rs	VD11	6m	Ric
AL03	R3117Q094A	Vdet-IC	0.9V±15mV, -Reset ODO, Sense	SC-88A	28rs	VD11	6m	Ric
AL04	R3117Q104A	Vdet-IC	1.0V±15mV, -Reset ODO, Sense	SC-88A	28rs	VD11	6m	Ric
AL05	R3117Q114A	Vdet-IC	1.1V±15mV, -Reset ODO, Sense	SC-88A	28rs	VD11	6m	Ric
AL06	R3117Q124A	Vdet-IC	1.2V±15mV, -Reset ODO, Sense	SC-88A	28rs	VD11	6m	Ric
AL07	R3117Q134A	Vdet-IC	1.3V±15mV, -Reset ODO, Sense	SC-88A	28rs	VD11	6m	Ric
AL08	R3117Q144A	Vdet-IC	1.4V±15mV, -Reset ODO, Sense	SC-88A	28rs	VD11	6m	Ric
AL09	R3117Q154A	Vdet-IC	1.5V±15mV, -Reset ODO, Sense	SC-88A	28rs	VD11	6m	Ric
AL1	XC6211A32AMR	LVR-IC	LDO, 3.25V±2%, 240mA, +CE, PDR	SOT-25	28vc	VR4	6g	Tor
AL1	XC6114D532MR	Vdet-IC	3.2V±2%, ±Reset PPO, Wt=400ms, Rt=100ms	SOT-25	28xg	VD19	6g	Tor
AL10	R3117Q164A	Vdet-IC	1.6V±1%, -Reset ODO, Sense	SC-88A	28rs	VD11	6m	Ric
AL11	R3117Q174A	Vdet-IC	1.7V±1%, -Reset ODO, Sense	SC-88A	28rs	VD11	6m	Ric
AL12	R3117Q184A	Vdet-IC	1.8V±1%, -Reset ODO, Sense	SC-88A	28rs	VD11	6m	Ric
AL13	R3117Q194A	Vdet-IC	1.9V±1%, -Reset ODO, Sense	SC-88A	28rs	VD11	6m	Ric
AL14	R3117Q204A	Vdet-IC	2.0V±1%, -Reset ODO, Sense	SC-88A	28rs	VD11	6m	Ric
AL15	R3117Q214A	Vdet-IC	2.1V±1%, -Reset ODO, Sense	SC-88A	28rs	VD11	6m	Ric
AL16	R3117Q224A	Vdet-IC	2.2V±1%, -Reset ODO, Sense	SC-88A	28rs	VD11	6m	Ric
AL17	R3117Q234A	Vdet-IC	2.3V±1%, -Reset ODO, Sense	SC-88A	28rs	VD11	6m	Ric
AL18	R3117Q244A	Vdet-IC	2.4V±1%, -Reset ODO, Sense	SC-88A	28rs	VD11	6m	Ric
AL19	R3117Q254A	Vdet-IC	2.5V±1%, -Reset ODO, Sense	SC-88A	28rs	VD11	6m	Ric
AL2	XC6211A33AMR	LVR-IC	LDO, 3.35V±2%, 240mA, +CE, PDR	SOT-25	28vc	VR4	6g	Tor
AL2	XC6114D533MR	Vdet-IC	3.3V±2%, ±Reset PPO, Wt=400ms, Rt=100ms	SOT-25	28xg	VD19	6g	Tor
AL20	R3117Q264A	Vdet-IC	2.6V±1%, -Reset ODO, Sense	SC-88A	28rs	VD11	6m	Ric
AL21	R3117Q274A	Vdet-IC	2.7V±1%, -Reset ODO, Sense	SC-88A	28rs	VD11	6m	Ric
AL22	R3117Q284A	Vdet-IC	2.8V±1%, -Reset ODO, Sense	SC-88A	28rs	VD11	6m	Ric
AL23	R3117Q294A	Vdet-IC	2.9V±1%, -Reset ODO, Sense	SC-88A	28rs	VD11	6m	Ric
AL24	R3117Q304A	Vdet-IC	3.0V±1%, -Reset ODO, Sense	SC-88A	28rs	VD11	6m	Ric
AL25	R3117Q314A	Vdet-IC	3.1V±1%, -Reset ODO, Sense	SC-88A	28rs	VD11	6m	Ric
AL26	R3117Q324A	Vdet-IC	3.2V±1%, -Reset ODO, Sense	SC-88A	28rs	VD11	6m	Ric
AL27	R3117Q334A	Vdet-IC	3.3V±1%, -Reset ODO, Sense	SC-88A	28rs	VD11	6m	Ric
AL28	R3117Q344A	Vdet-IC	3.4V±1%, -Reset ODO, Sense	SC-88A	28rs	VD11	6m	Ric
AL29	R3117Q354A	Vdet-IC	3.5V±1%, -Reset ODO, Sense	SC-88A	28rs	VD11	6m	Ric



SMD code	Type	Function	Short description	Case	Pinout	Sch.	St.	Mnf.
AL3	XC6211A34AMR	LVR-IC	LDO, 3.45V±2%, 240mA, +CE, PDR	SOT-25	28vc	VR4	6g	Tor
AL3	XC6114D534MR	Vdet-IC	3.4V±2%, ±Reset PPO, Wt=400ms, Rt=100ms	SOT-25	28xg	VD19	6g	Tor
AL30	R3117Q364A	Vdet-IC	3.6V±1%, -Reset ODO, Sense	SC-88A	28rs	VD11	6m	Ric
AL31	R3117Q374A	Vdet-IC	3.7V±1%, -Reset ODO, Sense	SC-88A	28rs	VD11	6m	Ric
AL32	R3117Q384A	Vdet-IC	3.8V±1%, -Reset ODO, Sense	SC-88A	28rs	VD11	6m	Ric
AL33	R3117Q394A	Vdet-IC	3.9V±1%, -Reset ODO, Sense	SC-88A	28rs	VD11	6m	Ric
AL34	R3117Q404A	Vdet-IC	4.0V±1%, -Reset ODO, Sense	SC-88A	28rs	VD11	6m	Ric
AL35	R3117Q414A	Vdet-IC	4.1V±1%, -Reset ODO, Sense	SC-88A	28rs	VD11	6m	Ric
AL36	R3117Q424A	Vdet-IC	4.2V±1%, -Reset ODO, Sense	SC-88A	28rs	VD11	6m	Ric
AL37	R3117Q434A	Vdet-IC	4.3V±1%, -Reset ODO, Sense	SC-88A	28rs	VD11	6m	Ric
AL38	R3117Q444A	Vdet-IC	4.4V±1%, -Reset ODO, Sense	SC-88A	28rs	VD11	6m	Ric
AL39	R3117Q454A	Vdet-IC	4.5V±1%, -Reset ODO, Sense	SC-88A	28rs	VD11	6m	Ric
AL4	XC6211A35AMR	LVR-IC	LDO, 3.55V±2%, 240mA, +CE, PDR	SOT-25	28vc	VR4	6g	Tor
AL4	XC6114D535MR	Vdet-IC	3.5V±2%, ±Reset PPO, Wt=400ms, Rt=100ms	SOT-25	28xg	VD19	6g	Tor
AL40	R3117Q464A	Vdet-IC	4.6V±1%, -Reset ODO, Sense	SC-88A	28rs	VD11	6m	Ric
AL41	R3117Q474A	Vdet-IC	4.7V±1%, -Reset ODO, Sense	SC-88A	28rs	VD11	6m	Ric
AL42	R3117Q484A	Vdet-IC	4.8V±1%, -Reset ODO, Sense	SC-88A	28rs	VD11	6m	Ric
AL43	R3117Q494A	Vdet-IC	4.9V±1%, -Reset ODO, Sense	SC-88A	28rs	VD11	6m	Ric
AL44	R3117Q504A	Vdet-IC	5.0V±1%, -Reset ODO, Sense	SC-88A	28rs	VD11	6m	Ric
AL5	XC6211A36AMR	LVR-IC	LDO, 3.65V±2%, 240mA, +CE, PDR	SOT-25	28vc	VR4	6g	Tor
AL5	XC6114D536MR	Vdet-IC	3.6V±2%, ±Reset PPO, Wt=400ms, Rt=100ms	SOT-25	28xg	VD19	6g	Tor
AL6	XC6211A37AMR	LVR-IC	LDO, 3.75V±2%, 240mA, +CE, PDR	SOT-25	28vc	VR4	6g	Tor
AL6	XC6114D537MR	Vdet-IC	3.7V±2%, ±Reset PPO, Wt=400ms, Rt=100ms	SOT-25	28xg	VD19	6g	Tor
AL7	XC6211A38AMR	LVR-IC	LDO, 3.85V±2%, 240mA, +CE, PDR	SOT-25	28vc	VR4	6g	Tor
AL7	XC6114D538MR	Vdet-IC	3.8V±2%, ±Reset PPO, Wt=400ms, Rt=100ms	SOT-25	28xg	VD19	6g	Tor
AL8	XC6211A39AMR	LVR-IC	LDO, 3.95V±2%, 240mA, +CE, PDR	SOT-25	28vc	VR4	6g	Tor
AL8	XC6114D539MR	Vdet-IC	3.9V±2%, ±Reset PPO, Wt=400ms, Rt=100ms	SOT-25	28xg	VD19	6g	Tor
AL9	XC6211A40AMR	LVR-IC	LDO, 4.05V±2%, 240mA, +CE, PDR	SOT-25	28vc	VR4	6g	Tor
AL9	XC6114D540MR	Vdet-IC	4.0V±2%, ±Reset PPO, Wt=400ms, Rt=100ms	SOT-25	28xg	VD19	6g	Tor
ALA	XC6211A41AMR	LVR-IC	LDO, 4.15V±2%, 240mA, +CE, PDR	SOT-25	28vc	VR4	6g	Tor
ALA	XC6114D541MR	Vdet-IC	4.1V±2%, ±Reset PPO, Wt=400ms, Rt=100ms	SOT-25	28xg	VD19	6g	Tor
ALB	XC6211A42AMR	LVR-IC	LDO, 4.25V±2%, 240mA, +CE, PDR	SOT-25	28vc	VR4	6g	Tor
ALB	XC6114D542MR	Vdet-IC	4.2V±2%, ±Reset PPO, Wt=400ms, Rt=100ms	SOT-25	28xg	VD19	6g	Tor
ALC	XC6211A43AMR	LVR-IC	LDO, 4.35V±2%, 240mA, +CE, PDR	SOT-25	28vc	VR4	6g	Tor
ALC	XC6114D543MR	Vdet-IC	4.3V±2%, ±Reset PPO, Wt=400ms, Rt=100ms	SOT-25	28xg	VD19	6g	Tor
ALD	XC6211A44AMR	LVR-IC	LDO, 4.45V±2%, 240mA, +CE, PDR	SOT-25	28vc	VR4	6g	Tor
ALD	XC6114D544MR	Vdet-IC	4.4V±2%, ±Reset PPO, Wt=400ms, Rt=100ms	SOT-25	28xg	VD19	6g	Tor
ALE	XC6211A45AMR	LVR-IC	LDO, 4.55V±2%, 240mA, +CE, PDR	SOT-25	28vc	VR4	6g	Tor
ALE	XC6114D545MR	Vdet-IC	4.5V±2%, ±Reset PPO, Wt=400ms, Rt=100ms	SOT-25	28xg	VD19	6g	Tor
ALF	XC6211A46AMR	LVR-IC	LDO, 4.65V±2%, 240mA, +CE, PDR	SOT-25	28vc	VR4	6g	Tor
ALF	XC6114D516MR	Vdet-IC	1.6V±2%, ±Reset PPO, Wt=400ms, Rt=100ms	SOT-25	28xg	VD19	6g	Tor
ALF	XC6114D546MR	Vdet-IC	4.6V±2%, ±Reset PPO, Wt=400ms, Rt=100ms	SOT-25	28xg	VD19	6g	Tor
ALH	XC6211A47AMR	LVR-IC	LDO, 4.75V±2%, 240mA, +CE, PDR	SOT-25	28vc	VR4	6g	Tor
ALH	XC6114D517MR	Vdet-IC	1.7V±2%, ±Reset PPO, Wt=400ms, Rt=100ms	SOT-25	28xg	VD19	6g	Tor
ALH	XC6114D547MR	Vdet-IC	4.7V±2%, ±Reset PPO, Wt=400ms, Rt=100ms	SOT-25	28xg	VD19	6g	Tor
ALK	XC6211A48AMR	LVR-IC	LDO, 4.85V±2%, 240mA, +CE, PDR	SOT-25	28vc	VR4	6g	Tor
ALK	XC6114D518MR	Vdet-IC	1.8V±2%, ±Reset PPO, Wt=400ms, Rt=100ms	SOT-25	28xg	VD19	6g	Tor
ALK	XC6114D548MR	Vdet-IC	4.8V±2%, ±Reset PPO, Wt=400ms, Rt=100ms	SOT-25	28xg	VD19	6g	Tor
ALL	XC6211A49AMR	LVR-IC	LDO, 4.95V±2%, 240mA, +CE, PDR	SOT-25	28vc	VR4	6g	Tor
ALL	XC6114D519MR	Vdet-IC	1.9V±2%, ±Reset PPO, Wt=400ms, Rt=100ms	SOT-25	28xg	VD19	6g	Tor
ALL	XC6114D549MR	Vdet-IC	4.9V±2%, ±Reset PPO, Wt=400ms, Rt=100ms	SOT-25	28xg	VD19	6g	Tor
ALM	XC6114D520MR	Vdet-IC	2.0V±2%, ±Reset PPO, Wt=400ms, Rt=100ms	SOT-25	28xg	VD19	6g	Tor
ALM	XC6114D550MR	Vdet-IC	5.0V±2%, ±Reset PPO, Wt=400ms, Rt=100ms	SOT-25	28xg	VD19	6g	Tor
ALN	TPS62220DDC	DC/DC-IC	PWM step-down, adjustable, 400mA, 1.25MHz	SOT-23-5	28yj	-	6k	Ti
ALN	XC6114D521MR	Vdet-IC	2.1V±2%, ±Reset PPO, Wt=400ms, Rt=100ms	SOT-25	28xg	VD19	6g	Tor
ALO	TPS62221DDC	DC/DC-IC	PWM step-down, 1.5V, 400mA, 1.25MHz	SOT-23-5	28yj	-	6k	Ti
ALP	XC6114D522MR	Vdet-IC	2.2V±2%, ±Reset PPO, Wt=400ms, Rt=100ms	SOT-25	28xg	VD19	6g	Tor
ALQ	TPS62224DDC	DC/DC-IC	PWM step-down, 1.6V, 400mA, 1.25MHz	SOT-23-5	28yj	-	6k	Ti
ALR	XC6114D523MR	Vdet-IC	2.3V±2%, ±Reset PPO, Wt=400ms, Rt=100ms	SOT-25	28xg	VD19	6g	Tor
ALS	XC6114D524MR	Vdet-IC	2.4V±2%, ±Reset PPO, Wt=400ms, Rt=100ms	SOT-25	28xg	VD19	6g	Tor
ALT	XC6114D525MR	Vdet-IC	2.5V±2%, ±Reset PPO, Wt=400ms, Rt=100ms	SOT-25	28xg	VD19	6g	Tor
ALU	XC6114D526MR	Vdet-IC	2.6V±2%, ±Reset PPO, Wt=400ms, Rt=100ms	SOT-25	28xg	VD19	6g	Tor
ALV	XC6114D527MR	Vdet-IC	2.7V±2%, ±Reset PPO, Wt=400ms, Rt=100ms	SOT-25	28xg	VD19	6g	Tor
ALX	TPS62223DDC	DC/DC-IC	PWM step-down, 2.3V, 400mA, 1.25MHz	SOT-23-5	28yj	-	6k	Ti
ALX	XC6114D528MR	Vdet-IC	2.8V±2%, ±Reset PPO, Wt=400ms, Rt=100ms	SOT-25	28xg	VD19	6g	Tor
ALY	XC6114D529MR	Vdet-IC	2.9V±2%, ±Reset PPO, Wt=400ms, Rt=100ms	SOT-25	28xg	VD19	6g	Tor
ALZ	XC6114D530MR	Vdet-IC	3.0V±2%, ±Reset PPO, Wt=400ms, Rt=100ms	SOT-25	28xg	VD19	6g	Tor
AM	74AHC1G125GVW	CMOS-Logic	Bus buffer gate with 3-state output	SOT-353	28/Log14	-	6a	Phi
AM	MAX823REUK	Vdet-IC	2.63V±1.5%, -MR, Strobe, -Reset PPO	SOT-23-5	28cp	VD17	6k	Max
AM	R1112N211A	LVR-IC	LDO, LN, -CE, 2.1V±2%, 150mA	SOT-23-5	28cx	VR4	6g	Ric



SMD code	Type	Function	Short description	Case	Pinout	Sch.	St.	Mnf.
AM	SiP824SEU	Vdet-IC	2.93V±1.5%, Strobe, ±Reset PPO	SOT-23-5	28xq	-	6k	Vs
AM-	RT9193-1HPU5	LVR-IC	LDO, 1.85V±1%, 300mA, +CE	SC-70-5	28vrx	VR7	6g	Rct
AM0	XC6211B31AMR	LVR-IC	LDO, 3.15V±2%, 240mA, +CE	SOT-25	28vc	VR4	6g	Tor
AM0	XC6114D631MR	Vdet-IC	3.1V±2%, ±Reset PPO, Wt=1.6s, Rt=100ms	SOT-25	28xg	VD19	6g	Tor
AM01	R3117Q074C	Vdet-IC	0.7V±15mV, -Reset PPO, Sense	SC-88A	28rs	VD12	6m	Ric
AM02	R3117Q084C	Vdet-IC	0.8V±15mV, -Reset PPO, Sense	SC-88A	28rs	VD12	6m	Ric
AM03	R3117Q094C	Vdet-IC	0.9V±15mV, -Reset PPO, Sense	SC-88A	28rs	VD12	6m	Ric
AM04	R3117Q104C	Vdet-IC	1.0V±15mV, -Reset PPO, Sense	SC-88A	28rs	VD12	6m	Ric
AM05	R3117Q114C	Vdet-IC	1.1V±15mV, -Reset PPO, Sense	SC-88A	28rs	VD12	6m	Ric
AM06	R3117Q124C	Vdet-IC	1.2V±15mV, -Reset PPO, Sense	SC-88A	28rs	VD12	6m	Ric
AM07	R3117Q134C	Vdet-IC	1.3V±15mV, -Reset PPO, Sense	SC-88A	28rs	VD12	6m	Ric
AM08	R3117Q144C	Vdet-IC	1.4V±15mV, -Reset PPO, Sense	SC-88A	28rs	VD12	6m	Ric
AM09	R3117Q154C	Vdet-IC	1.5V±15mV, -Reset PPO, Sense	SC-88A	28rs	VD12	6m	Ric
AM1	XC6211B32AMR	LVR-IC	LDO, 3.25V±2%, 240mA, +CE	SOT-25	28vc	VR4	6g	Tor
AM1	XC6114D632MR	Vdet-IC	3.2V±2%, ±Reset PPO, Wt=1.6s, Rt=100ms	SOT-25	28xg	VD19	6g	Tor
AM10	R3117Q164C	Vdet-IC	1.6V±1%, -Reset PPO, Sense	SC-88A	28rs	VD12	6m	Ric
AM11	R3117Q174C	Vdet-IC	1.7V±1%, -Reset PPO, Sense	SC-88A	28rs	VD12	6m	Ric
AM12	R3117Q184C	Vdet-IC	1.8V±1%, -Reset PPO, Sense	SC-88A	28rs	VD12	6m	Ric
AM13	R3117Q194C	Vdet-IC	1.9V±1%, -Reset PPO, Sense	SC-88A	28rs	VD12	6m	Ric
AM14	R3117Q204C	Vdet-IC	2.0V±1%, -Reset PPO, Sense	SC-88A	28rs	VD12	6m	Ric
AM15	R3117Q214C	Vdet-IC	2.1V±1%, -Reset PPO, Sense	SC-88A	28rs	VD12	6m	Ric
AM16	R3117Q224C	Vdet-IC	2.2V±1%, -Reset PPO, Sense	SC-88A	28rs	VD12	6m	Ric
AM17	R3117Q234C	Vdet-IC	2.3V±1%, -Reset PPO, Sense	SC-88A	28rs	VD12	6m	Ric
AM18	R3117Q244C	Vdet-IC	2.4V±1%, -Reset PPO, Sense	SC-88A	28rs	VD12	6m	Ric
AM19	R3117Q254C	Vdet-IC	2.5V±1%, -Reset PPO, Sense	SC-88A	28rs	VD12	6m	Ric
AM2	XC6211B33AMR	LVR-IC	LDO, 3.35V±2%, 240mA, +CE	SOT-25	28vc	VR4	6g	Tor
AM2	XC6114D633MR	Vdet-IC	3.3V±2%, ±Reset PPO, Wt=1.6s, Rt=100ms	SOT-25	28xg	VD19	6g	Tor
AM20	R3117Q264C	Vdet-IC	2.6V±1%, -Reset PPO, Sense	SC-88A	28rs	VD12	6m	Ric
AM21	R3117Q274C	Vdet-IC	2.7V±1%, -Reset PPO, Sense	SC-88A	28rs	VD12	6m	Ric
AM22	R3117Q284C	Vdet-IC	2.8V±1%, -Reset PPO, Sense	SC-88A	28rs	VD12	6m	Ric
AM23	R3117Q294C	Vdet-IC	2.9V±1%, -Reset PPO, Sense	SC-88A	28rs	VD12	6m	Ric
AM24	R3117Q304C	Vdet-IC	3.0V±1%, -Reset PPO, Sense	SC-88A	28rs	VD12	6m	Ric
AM25	R3117Q314C	Vdet-IC	3.1V±1%, -Reset PPO, Sense	SC-88A	28rs	VD12	6m	Ric
AM26	R3117Q324C	Vdet-IC	3.2V±1%, -Reset PPO, Sense	SC-88A	28rs	VD12	6m	Ric
AM27	R3117Q334C	Vdet-IC	3.3V±1%, -Reset PPO, Sense	SC-88A	28rs	VD12	6m	Ric
AM28	R3117Q344C	Vdet-IC	3.4V±1%, -Reset PPO, Sense	SC-88A	28rs	VD12	6m	Ric
AM29	R3117Q354C	Vdet-IC	3.5V±1%, -Reset PPO, Sense	SC-88A	28rs	VD12	6m	Ric
AM3	XC6211B34AMR	LVR-IC	LDO, 3.45V±2%, 240mA, +CE	SOT-25	28vc	VR4	6g	Tor
AM3	XC6114D634MR	Vdet-IC	3.4V±2%, ±Reset PPO, Wt=1.6s, Rt=100ms	SOT-25	28xg	VD19	6g	Tor
AM30	R3117Q364C	Vdet-IC	3.6V±1%, -Reset PPO, Sense	SC-88A	28rs	VD12	6m	Ric
AM31	R3117Q374C	Vdet-IC	3.7V±1%, -Reset PPO, Sense	SC-88A	28rs	VD12	6m	Ric
AM32	R3117Q384C	Vdet-IC	3.8V±1%, -Reset PPO, Sense	SC-88A	28rs	VD12	6m	Ric
AM33	R3117Q394C	Vdet-IC	3.9V±1%, -Reset PPO, Sense	SC-88A	28rs	VD12	6m	Ric
AM34	R3117Q404C	Vdet-IC	4.0V±1%, -Reset PPO, Sense	SC-88A	28rs	VD12	6m	Ric
AM35	R3117Q414C	Vdet-IC	4.1V±1%, -Reset PPO, Sense	SC-88A	28rs	VD12	6m	Ric
AM36	R3117Q424C	Vdet-IC	4.2V±1%, -Reset PPO, Sense	SC-88A	28rs	VD12	6m	Ric
AM37	R3117Q434C	Vdet-IC	4.3V±1%, -Reset PPO, Sense	SC-88A	28rs	VD12	6m	Ric
AM38	R3117Q444C	Vdet-IC	4.4V±1%, -Reset PPO, Sense	SC-88A	28rs	VD12	6m	Ric
AM39	R3117Q454C	Vdet-IC	4.5V±1%, -Reset PPO, Sense	SC-88A	28rs	VD12	6m	Ric
AM4	XC6211B35AMR	LVR-IC	LDO, 3.55V±2%, 240mA, +CE	SOT-25	28vc	VR4	6g	Tor
AM4	XC6114D635MR	Vdet-IC	3.5V±2%, ±Reset PPO, Wt=1.6s, Rt=100ms	SOT-25	28xg	VD19	6g	Tor
AM40	R3117Q464C	Vdet-IC	4.6V±1%, -Reset PPO, Sense	SC-88A	28rs	VD12	6m	Ric
AM41	R3117Q474C	Vdet-IC	4.7V±1%, -Reset PPO, Sense	SC-88A	28rs	VD12	6m	Ric
AM42	R3117Q484C	Vdet-IC	4.8V±1%, -Reset PPO, Sense	SC-88A	28rs	VD12	6m	Ric
AM43	R3117Q494C	Vdet-IC	4.9V±1%, -Reset PPO, Sense	SC-88A	28rs	VD12	6m	Ric
AM44	R3117Q504C	Vdet-IC	5.0V±1%, -Reset PPO, Sense	SC-88A	28rs	VD12	6m	Ric
AM5	XC6211B36AMR	LVR-IC	LDO, 3.65V±2%, 240mA, +CE	SOT-25	28vc	VR4	6g	Tor
AM5	XC6114D636MR	Vdet-IC	3.6V±2%, ±Reset PPO, Wt=1.6s, Rt=100ms	SOT-25	28xg	VD19	6g	Tor
AM6	XC6211B37AMR	LVR-IC	LDO, 3.75V±2%, 240mA, +CE	SOT-25	28vc	VR4	6g	Tor
AM6	XC6114D637MR	Vdet-IC	3.7V±2%, ±Reset PPO, Wt=1.6s, Rt=100ms	SOT-25	28xg	VD19	6g	Tor
AM7	XC6211B38AMR	LVR-IC	LDO, 3.85V±2%, 240mA, +CE	SOT-25	28vc	VR4	6g	Tor
AM7	XC6114D638MR	Vdet-IC	3.8V±2%, ±Reset PPO, Wt=1.6s, Rt=100ms	SOT-25	28xg	VD19	6g	Tor
AM8	XC6211B39AMR	LVR-IC	LDO, 3.95V±2%, 240mA, +CE	SOT-25	28vc	VR4	6g	Tor
AM8	XC6114D639MR	Vdet-IC	3.9V±2%, ±Reset PPO, Wt=1.6s, Rt=100ms	SOT-25	28xg	VD19	6g	Tor
AM9	XC6211B40AMR	LVR-IC	LDO, 4.05V±2%, 240mA, +CE	SOT-25	28vc	VR4	6g	Tor
AM9	XC6114D640MR	Vdet-IC	4.0V±2%, ±Reset PPO, Wt=1.6s, Rt=100ms	SOT-25	28xg	VD19	6g	Tor
AM9A	XC6211B41AMR	LVR-IC	LDO, 4.15V±2%, 240mA, +CE	SOT-25	28vc	VR4	6g	Tor
AM9A	XC6114D641MR	Vdet-IC	4.1V±2%, ±Reset PPO, Wt=1.6s, Rt=100ms	SOT-25	28xg	VD19	6g	Tor
AM9B	XC6211B42AMR	LVR-IC	LDO, 4.25V±2%, 240mA, +CE	SOT-25	28vc	VR4	6g	Tor
AM9B	XC6114D642MR	Vdet-IC	4.2V±2%, ±Reset PPO, Wt=1.6s, Rt=100ms	SOT-25	28xg	VD19	6g	Tor



SMD code	Type	Function	Short description	Case	Pinout	Sch.	St.	Mnf.
AMC	XC6211B43AMR	LVR-IC	LDO, 4.35V±2%, 240mA, +CE	SOT-25	28vc	VR4	6g	Tor
AMC	XC6114D643MR	Vdet-IC	4.3V±2%, ±Reset PPO, Wt=1.6s, Rt=100ms	SOT-25	28xg	VD19	6g	Tor
AMD	XC6211B44AMR	LVR-IC	LDO, 4.45V±2%, 240mA, +CE	SOT-25	28vc	VR4	6g	Tor
AMD	XC6114D644MR	Vdet-IC	4.4V±2%, ±Reset PPO, Wt=1.6s, Rt=100ms	SOT-25	28xg	VD19	6g	Tor
AME	XC6211B45AMR	LVR-IC	LDO, 4.55V±2%, 240mA, +CE	SOT-25	28vc	VR4	6g	Tor
AME	XC6114D645MR	Vdet-IC	4.5V±2%, ±Reset PPO, Wt=1.6s, Rt=100ms	SOT-25	28xg	VD19	6g	Tor
AMF	XC6211B46AMR	LVR-IC	LDO, 4.65V±2%, 240mA, +CE	SOT-25	28vc	VR4	6g	Tor
AMF	XC6114D646MR	Vdet-IC	1.6V±2%, ±Reset PPO, Wt=1.6s, Rt=100ms	SOT-25	28xg	VD19	6g	Tor
AMF	XC6114D646MR	Vdet-IC	4.6V±2%, ±Reset PPO, Wt=1.6s, Rt=100ms	SOT-25	28xg	VD19	6g	Tor
AMH	XC6211B47AMR	LVR-IC	LDO, 4.75V±2%, 240mA, +CE	SOT-25	28vc	VR4	6g	Tor
AMH	XC6114D647MR	Vdet-IC	1.7V±2%, ±Reset PPO, Wt=1.6s, Rt=100ms	SOT-25	28xg	VD19	6g	Tor
AMH	XC6114D647MR	Vdet-IC	4.7V±2%, ±Reset PPO, Wt=1.6s, Rt=100ms	SOT-25	28xg	VD19	6g	Tor
AMK	XC6211B48AMR	LVR-IC	LDO, 4.85V±2%, 240mA, +CE	SOT-25	28vc	VR4	6g	Tor
AMK	XC6114D648MR	Vdet-IC	1.8V±2%, ±Reset PPO, Wt=1.6s, Rt=100ms	SOT-25	28xg	VD19	6g	Tor
AMK	XC6114D648MR	Vdet-IC	4.8V±2%, ±Reset PPO, Wt=1.6s, Rt=100ms	SOT-25	28xg	VD19	6g	Tor
AML	XC6211B49AMR	LVR-IC	LDO, 4.95V±2%, 240mA, +CE	SOT-25	28vc	VR4	6g	Tor
AML	XC6114D649MR	Vdet-IC	1.9V±2%, ±Reset PPO, Wt=1.6s, Rt=100ms	SOT-25	28xg	VD19	6g	Tor
AML	XC6114D649MR	Vdet-IC	4.9V±2%, ±Reset PPO, Wt=1.6s, Rt=100ms	SOT-25	28xg	VD19	6g	Tor
AMM	XC6114D620MR	Vdet-IC	2.0V±2%, ±Reset PPO, Wt=1.6s, Rt=100ms	SOT-25	28xg	VD19	6g	Tor
AMM	XC6114D650MR	Vdet-IC	5.0V±2%, ±Reset PPO, Wt=1.6s, Rt=100ms	SOT-25	28xg	VD19	6g	Tor
AMN	XC6114D621MR	Vdet-IC	2.1V±2%, ±Reset PPO, Wt=1.6s, Rt=100ms	SOT-25	28xg	VD19	6g	Tor
AMP	XC6114D622MR	Vdet-IC	2.2V±2%, ±Reset PPO, Wt=1.6s, Rt=100ms	SOT-25	28xg	VD19	6g	Tor
AMP	XC6114D623MR	Vdet-IC	2.3V±2%, ±Reset PPO, Wt=1.6s, Rt=100ms	SOT-25	28xg	VD19	6g	Tor
AMS	XC6114D624MR	Vdet-IC	2.4V±2%, ±Reset PPO, Wt=1.6s, Rt=100ms	SOT-25	28xg	VD19	6g	Tor
AMT	XC6114D625MR	Vdet-IC	2.5V±2%, ±Reset PPO, Wt=1.6s, Rt=100ms	SOT-25	28xg	VD19	6g	Tor
AMU	XC6114D626MR	Vdet-IC	2.6V±2%, ±Reset PPO, Wt=1.6s, Rt=100ms	SOT-25	28xg	VD19	6g	Tor
AMV	XC6114D627MR	Vdet-IC	2.7V±2%, ±Reset PPO, Wt=1.6s, Rt=100ms	SOT-25	28xg	VD19	6g	Tor
AMX	XC6114D628MR	Vdet-IC	2.8V±2%, ±Reset PPO, Wt=1.6s, Rt=100ms	SOT-25	28xg	VD19	6g	Tor
AMY	XC6114D629MR	Vdet-IC	2.9V±2%, ±Reset PPO, Wt=1.6s, Rt=100ms	SOT-25	28xg	VD19	6g	Tor
AMZ	XC6114D630MR	Vdet-IC	3.0V±2%, ±Reset PPO, Wt=1.6s, Rt=100ms	SOT-25	28xg	VD19	6g	Tor
aN	74AUP1G34GW	CMOS-Logic	Noninverting buffer	SOT-353-1	28/Log10	-	6a	Phi
AN	74AHC1G126GW	CMOS-Logic	Bus buffer gate with 3-state output	SOT-353	28/Log13	-	6a	Phi
AN	MAX824LEUK	Vdet-IC	4.63V±1.5%, Strobe, ±Reset PPO	SOT-23-5	28xg	-	6k	Max
AN	R111N221A	LVR-IC	LDO, LN, -CE, 2.2V±2%, 150mA	SOT-23-5	28cx	VR4	6g	Ric
AN	SiP824REU	Vdet-IC	2.63V±1.5%, Strobe, ±Reset PPO	SOT-23-5	28xg	-	6k	Vs
AN-	RT9193-27PU5	LVR-IC	LDO, 2.7V±1%, 300mA, +CE	SC-70-5	28vrx	VR7	6g	Rct
AN0	XC6211C31AMR	LVR-IC	LDO, 3.15V±2%, 240mA, -CE, PDR	SOT-25	28vc	VR4	6g	Tor
AN08	RP110Q082B	LVR-IC	LDO, 0.8V±1%, 150mA, +CE	SC-88A	28vc	VR4	6m	Ric
AN09	RP110Q092B	LVR-IC	LDO, 0.9V±1%, 150mA, +CE	SC-88A	28vc	VR4	6m	Ric
AN1	XC6211C32AMR	LVR-IC	LDO, 3.25V±2%, 240mA, -CE, PDR	SOT-25	28vc	VR4	6g	Tor
AN10	RP110Q102B	LVR-IC	LDO, 1.0V±1%, 150mA, +CE	SC-88A	28vc	VR4	6m	Ric
AN11	RP110Q112B	LVR-IC	LDO, 1.1V±1%, 150mA, +CE	SC-88A	28vc	VR4	6m	Ric
AN12	RP110Q122B	LVR-IC	LDO, 1.2V±1%, 150mA, +CE	SC-88A	28vc	VR4	6m	Ric
AN13	RP110Q132B	LVR-IC	LDO, 1.3V±1%, 150mA, +CE	SC-88A	28vc	VR4	6m	Ric
AN14	RP110Q142B	LVR-IC	LDO, 1.4V±1%, 150mA, +CE	SC-88A	28vc	VR4	6m	Ric
AN15	RP110Q152B	LVR-IC	LDO, 1.5V±1%, 150mA, +CE	SC-88A	28vc	VR4	6m	Ric
AN16	RP110Q162B	LVR-IC	LDO, 1.6V±1%, 150mA, +CE	SC-88A	28vc	VR4	6m	Ric
AN17	RP110Q172B	LVR-IC	LDO, 1.7V±1%, 150mA, +CE	SC-88A	28vc	VR4	6m	Ric
AN18	RP110Q182B	LVR-IC	LDO, 1.8V±1%, 150mA, +CE	SC-88A	28vc	VR4	6m	Ric
AN19	RP110Q192B	LVR-IC	LDO, 1.9V±1%, 150mA, +CE	SC-88A	28vc	VR4	6m	Ric
AN2	XC6211C33AMR	LVR-IC	LDO, 3.35V±2%, 240mA, -CE, PDR	SOT-25	28vc	VR4	6g	Tor
AN20	RP110Q202B	LVR-IC	LDO, 2.0V±1%, 150mA, +CE	SC-88A	28vc	VR4	6m	Ric
AN21	RP110Q212B	LVR-IC	LDO, 2.1V±1%, 150mA, +CE	SC-88A	28vc	VR4	6m	Ric
AN22	RP110Q222B	LVR-IC	LDO, 2.2V±1%, 150mA, +CE	SC-88A	28vc	VR4	6m	Ric
AN23	RP110Q232B	LVR-IC	LDO, 2.3V±1%, 150mA, +CE	SC-88A	28vc	VR4	6m	Ric
AN24	RP110Q242B	LVR-IC	LDO, 2.4V±1%, 150mA, +CE	SC-88A	28vc	VR4	6m	Ric
AN25	RP110Q252B	LVR-IC	LDO, 2.5V±1%, 150mA, +CE	SC-88A	28vc	VR4	6m	Ric
AN26	RP110Q262B	LVR-IC	LDO, 2.6V±1%, 150mA, +CE	SC-88A	28vc	VR4	6m	Ric
AN27	RP110Q272B	LVR-IC	LDO, 2.7V±1%, 150mA, +CE	SC-88A	28vc	VR4	6m	Ric
AN28	RP110Q282B	LVR-IC	LDO, 2.8V±1%, 150mA, +CE	SC-88A	28vc	VR4	6m	Ric
AN29	RP110Q292B	LVR-IC	LDO, 2.9V±1%, 150mA, +CE	SC-88A	28vc	VR4	6m	Ric
AN3	XC6211C34AMR	LVR-IC	LDO, 3.45V±2%, 240mA, -CE, PDR	SOT-25	28vc	VR4	6g	Tor
AN30	RP110Q302B	LVR-IC	LDO, 3.0V±1%, 150mA, +CE	SC-88A	28vc	VR4	6m	Ric
AN31	RP110Q312B	LVR-IC	LDO, 3.1V±1%, 150mA, +CE	SC-88A	28vc	VR4	6m	Ric
AN32	RP110Q322B	LVR-IC	LDO, 3.2V±1%, 150mA, +CE	SC-88A	28vc	VR4	6m	Ric
AN33	RP110Q332B	LVR-IC	LDO, 3.3V±1%, 150mA, +CE	SC-88A	28vc	VR4	6m	Ric
AN34	RP110Q342B	LVR-IC	LDO, 3.4V±1%, 150mA, +CE	SC-88A	28vc	VR4	6m	Ric
AN35	RP110Q352B	LVR-IC	LDO, 3.5V±1%, 150mA, +CE	SC-88A	28vc	VR4	6m	Ric
AN36	RP110Q362B	LVR-IC	LDO, 3.6V±1%, 150mA, +CE	SC-88A	28vc	VR4	6m	Ric
AN37	RP110Q122B5	LVR-IC	LDO, 1.25V±1%, 150mA, +CE	SC-88A	28vc	VR4	6m	Ric



SMD code	Type	Function	Short description	Case	Pinout	Sch.	St.Mnf.
AN38	RP110Q182B5	LVR-IC	LDO, 1.85V±1%, 150mA, +CE	SC-88A	28vc	VR4	6m Ric
AN39	RP110Q282B5	LVR-IC	LDO, 2.85V±1%, 150mA, +CE	SC-88A	28vc	VR4	6m Ric
AN4	XC6211C35AMR	LVR-IC	LDO, 3.55V±2%, 240mA, -CE, PDR	SOT-25	28vc	VR4	6g Tor
AN5	XC6211C36AMR	LVR-IC	LDO, 3.65V±2%, 240mA, -CE, PDR	SOT-25	28vc	VR4	6g Tor
AN6	XC6211C37AMR	LVR-IC	LDO, 3.75V±2%, 240mA, -CE, PDR	SOT-25	28vc	VR4	6g Tor
AN7	XC6211C38AMR	LVR-IC	LDO, 3.85V±2%, 240mA, -CE, PDR	SOT-25	28vc	VR4	6g Tor
AN8	XC6211C39AMR	LVR-IC	LDO, 3.95V±2%, 240mA, -CE, PDR	SOT-25	28vc	VR4	6g Tor
AN9	XC6211C40AMR	LVR-IC	LDO, 4.05V±2%, 240mA, -CE, PDR	SOT-25	28vc	VR4	6g Tor
ANA	XC6211C41AMR	LVR-IC	LDO, 4.15V±2%, 240mA, -CE, PDR	SOT-25	28vc	VR4	6g Tor
ANB	XC6211C42AMR	LVR-IC	LDO, 4.25V±2%, 240mA, -CE, PDR	SOT-25	28vc	VR4	6g Tor
ANC	XC6211C43AMR	LVR-IC	LDO, 4.35V±2%, 240mA, -CE, PDR	SOT-25	28vc	VR4	6g Tor
AND	XC6211C44AMR	LVR-IC	LDO, 4.45V±2%, 240mA, -CE, PDR	SOT-25	28vc	VR4	6g Tor
ANE	XC6211C45AMR	LVR-IC	LDO, 4.55V±2%, 240mA, -CE, PDR	SOT-25	28vc	VR4	6g Tor
ANF	XC6211C46AMR	LVR-IC	LDO, 4.65V±2%, 240mA, -CE, PDR	SOT-25	28vc	VR4	6g Tor
ANH	XC6211C47AMR	LVR-IC	LDO, 4.75V±2%, 240mA, -CE, PDR	SOT-25	28vc	VR4	6g Tor
ANK	XC6211C48AMR	LVR-IC	LDO, 4.85V±2%, 240mA, -CE, PDR	SOT-25	28vc	VR4	6g Tor
ANL	XC6211C49AMR	LVR-IC	LDO, 4.95V±2%, 240mA, -CE, PDR	SOT-25	28vc	VR4	6g Tor
AO	MAX824MEUK	Vdet-IC	4.38V±1.5%, Strobe, ±Reset PPO	SOT-23-5	28xq	-	6k Max
AO	PT7M7811LTA	Vdet-IC	4.63V±1.5%, -Reset PPO, -MR	SOT-23-5	28vd2	VD5	6k Pti
AO	SiP824ZEU	Vdet-IC	2.32V±1.5%, Strobe, ±Reset PPO	SOT-23-5	28xq	-	6k Vs
AO	PT7M7811LTAE	Vdet-IC	4.63V±1.5%, -Reset PPO, -MR, Lead free	SOT-23-5	28vd2	VD5	6k Pti
AP	74AHC1G79GW	CMOS-Logic	Positive edge-triggered D-type flip-flop	SOT-353	28dLog20	-	6a Phi
AP	MAX824TEUK	Vdet-IC	3.08V±1.5%, Strobe, ±Reset PPO	SOT-23-5	28xq	-	6k Max
AP	PT7M7811MTA	Vdet-IC	4.38V±1.5%, -Reset PPO, -MR	SOT-23-5	28vd2	VD5	6k Pti
AP	R1112N231A	LVR-IC	LDO, LN, -CE, 2.3V±2%, 150mA	SOT-23-5	28xc	VR4	6g Ric
AP	SiP824YEU	Vdet-IC	2.19V±1.5%, Strobe, ±Reset PPO	SOT-23-5	28xq	-	6k Vs
AP	PT7M7811MTAE	Vdet-IC	4.38V±1.5%, -Reset PPO, -MR, Lead free	SOT-23-5	28vd2	VD5	6k Pti
AP0	XC6211D31AMR	LVR-IC	LDO, 3.15V±2%, 240mA, -CE	SOT-25	28vc	VR4	6g Tor
AP0	XC6114E431MR	Vdet-IC	3.1V±2%, ±Reset PPO, Wt=200ms, Rt=200ms	SOT-25	28xg	VD19	6g Tor
AP08	RP110Q082C	LVR-IC	LDO, 0.8V±1%, 150mA	SC-88A	28y2	VR1	6m Ric
AP09	RP110Q092C	LVR-IC	LDO, 0.9V±1%, 150mA	SC-88A	28y2	VR1	6m Ric
AP1	XC6211D32AMR	LVR-IC	LDO, 3.25V±2%, 240mA, -CE	SOT-25	28vc	VR4	6g Tor
AP1	XC6114E432MR	Vdet-IC	3.2V±2%, ±Reset PPO, Wt=200ms, Rt=200ms	SOT-25	28xg	VD19	6g Tor
AP10	RP110Q102C	LVR-IC	LDO, 1.0V±1%, 150mA	SC-88A	28y2	VR1	6m Ric
AP11	RP110Q112C	LVR-IC	LDO, 1.1V±1%, 150mA	SC-88A	28y2	VR1	6m Ric
AP12	RP110Q122C	LVR-IC	LDO, 1.2V±1%, 150mA	SC-88A	28y2	VR1	6m Ric
AP13	RP110Q132C	LVR-IC	LDO, 1.3V±1%, 150mA	SC-88A	28y2	VR1	6m Ric
AP14	RP110Q142C	LVR-IC	LDO, 1.4V±1%, 150mA	SC-88A	28y2	VR1	6m Ric
AP15	RP110Q152C	LVR-IC	LDO, 1.5V±1%, 150mA	SC-88A	28y2	VR1	6m Ric
AP16	RP110Q162C	LVR-IC	LDO, 1.6V±1%, 150mA	SC-88A	28y2	VR1	6m Ric
AP17	RP110Q172C	LVR-IC	LDO, 1.7V±1%, 150mA	SC-88A	28y2	VR1	6m Ric
AP18	RP110Q182C	LVR-IC	LDO, 1.8V±1%, 150mA	SC-88A	28y2	VR1	6m Ric
AP19	RP110Q192C	LVR-IC	LDO, 1.9V±1%, 150mA	SC-88A	28y2	VR1	6m Ric
AP2	XC6211D33AMR	LVR-IC	LDO, 3.35V±2%, 240mA, -CE	SOT-25	28vc	VR4	6g Tor
AP2	XC6114E433MR	Vdet-IC	3.3V±2%, ±Reset PPO, Wt=200ms, Rt=200ms	SOT-25	28xg	VD19	6g Tor
AP20	RP110Q202C	LVR-IC	LDO, 2.0V±1%, 150mA	SC-88A	28y2	VR1	6m Ric
AP21	RP110Q212C	LVR-IC	LDO, 2.1V±1%, 150mA	SC-88A	28y2	VR1	6m Ric
AP22	RP110Q222C	LVR-IC	LDO, 2.2V±1%, 150mA	SC-88A	28y2	VR1	6m Ric
AP23	RP110Q232C	LVR-IC	LDO, 2.3V±1%, 150mA	SC-88A	28y2	VR1	6m Ric
AP24	RP110Q242C	LVR-IC	LDO, 2.4V±1%, 150mA	SC-88A	28y2	VR1	6m Ric
AP25	RP110Q252C	LVR-IC	LDO, 2.5V±1%, 150mA	SC-88A	28y2	VR1	6m Ric
AP26	RP110Q262C	LVR-IC	LDO, 2.6V±1%, 150mA	SC-88A	28y2	VR1	6m Ric
AP27	RP110Q272C	LVR-IC	LDO, 2.7V±1%, 150mA	SC-88A	28y2	VR1	6m Ric
AP28	RP110Q282C	LVR-IC	LDO, 2.8V±1%, 150mA	SC-88A	28y2	VR1	6m Ric
AP29	RP110Q292C	LVR-IC	LDO, 2.9V±1%, 150mA	SC-88A	28y2	VR1	6m Ric
AP3	XC6211D34AMR	LVR-IC	LDO, 3.45V±2%, 240mA, -CE	SOT-25	28vc	VR4	6g Tor
AP3	XC6114E434MR	Vdet-IC	3.4V±2%, ±Reset PPO, Wt=200ms, Rt=200ms	SOT-25	28xg	VD19	6g Tor
AP30	RP110Q302C	LVR-IC	LDO, 3.0V±1%, 150mA	SC-88A	28y2	VR1	6m Ric
AP31	RP110Q312C	LVR-IC	LDO, 3.1V±1%, 150mA	SC-88A	28y2	VR1	6m Ric
AP32	RP110Q322C	LVR-IC	LDO, 3.2V±1%, 150mA	SC-88A	28y2	VR1	6m Ric
AP33	RP110Q332C	LVR-IC	LDO, 3.3V±1%, 150mA	SC-88A	28y2	VR1	6m Ric
AP34	RP110Q342C	LVR-IC	LDO, 3.4V±1%, 150mA	SC-88A	28y2	VR1	6m Ric
AP35	RP110Q352C	LVR-IC	LDO, 3.5V±1%, 150mA	SC-88A	28y2	VR1	6m Ric
AP36	RP110Q362C	LVR-IC	LDO, 3.6V±1%, 150mA	SC-88A	28y2	VR1	6m Ric
AP37	RP110Q122C5	LVR-IC	LDO, 1.25V±1%, 150mA	SC-88A	28y2	VR1	6m Ric
AP38	RP110Q182C5	LVR-IC	LDO, 1.85V±1%, 150mA	SC-88A	28y2	VR1	6m Ric
AP39	RP110Q282C5	LVR-IC	LDO, 2.85V±1%, 150mA	SC-88A	28y2	VR1	6m Ric
AP4	XC6211D35AMR	LVR-IC	LDO, 3.55V±2%, 240mA, -CE	SOT-25	28vc	VR4	6g Tor
AP4	XC6114E435MR	Vdet-IC	3.5V±2%, ±Reset PPO, Wt=200ms, Rt=200ms	SOT-25	28xg	VD19	6g Tor
AP5	XC6211D36AMR	LVR-IC	LDO, 3.65V±2%, 240mA, -CE	SOT-25	28vc	VR4	6g Tor



SMD code	Type	Function	Short description	Case	Pinout	Sch.	St.	Mnf.
AP5	XC6114E436MR	Vdet-IC	3.6V±2%, ±Reset PPO, Wt=200ms, Rt=200ms	SOT-25	28xg	VD19	6g	Tor
AP6	XC6211D37AMR	LVR-IC	LDO, 3.75V±2%, 240mA, -CE	SOT-25	28vc	VR4	6g	Tor
AP6	XC6114E437MR	Vdet-IC	3.7V±2%, ±Reset PPO, Wt=200ms, Rt=200ms	SOT-25	28xg	VD19	6g	Tor
AP7	XC6211D38AMR	LVR-IC	LDO, 3.85V±2%, 240mA, -CE	SOT-25	28vc	VR4	6g	Tor
AP7	XC6114E438MR	Vdet-IC	3.8V±2%, ±Reset PPO, Wt=200ms, Rt=200ms	SOT-25	28xg	VD19	6g	Tor
AP8	XC6211D39AMR	LVR-IC	LDO, 3.95V±2%, 240mA, -CE	SOT-25	28vc	VR4	6g	Tor
AP8	XC6114E439MR	Vdet-IC	3.9V±2%, ±Reset PPO, Wt=200ms, Rt=200ms	SOT-25	28xg	VD19	6g	Tor
AP9	XC6211D40AMR	LVR-IC	LDO, 4.05V±2%, 240mA, -CE	SOT-25	28vc	VR4	6g	Tor
AP9	XC6114E440MR	Vdet-IC	4.0V±2%, ±Reset PPO, Wt=200ms, Rt=200ms	SOT-25	28xg	VD19	6g	Tor
APA	XC6211D41AMR	LVR-IC	LDO, 4.15V±2%, 240mA, -CE	SOT-25	28vc	VR4	6g	Tor
APA	XC6114E441MR	Vdet-IC	4.1V±2%, ±Reset PPO, Wt=200ms, Rt=200ms	SOT-25	28xg	VD19	6g	Tor
APB	XC6211D42AMR	LVR-IC	LDO, 4.25V±2%, 240mA, -CE	SOT-25	28vc	VR4	6g	Tor
APB	XC6114E442MR	Vdet-IC	4.2V±2%, ±Reset PPO, Wt=200ms, Rt=200ms	SOT-25	28xg	VD19	6g	Tor
APC	XC6211D43AMR	LVR-IC	LDO, 4.35V±2%, 240mA, -CE	SOT-25	28vc	VR4	6g	Tor
APC	XC6114E443MR	Vdet-IC	4.3V±2%, ±Reset PPO, Wt=200ms, Rt=200ms	SOT-25	28xg	VD19	6g	Tor
APD	XC6211D44AMR	LVR-IC	LDO, 4.45V±2%, 240mA, -CE	SOT-25	28vc	VR4	6g	Tor
APD	XC6114E444MR	Vdet-IC	4.4V±2%, ±Reset PPO, Wt=200ms, Rt=200ms	SOT-25	28xg	VD19	6g	Tor
APE	XC6211D45AMR	LVR-IC	LDO, 4.55V±2%, 240mA, -CE	SOT-25	28vc	VR4	6g	Tor
APE	XC6114E445MR	Vdet-IC	4.5V±2%, ±Reset PPO, Wt=200ms, Rt=200ms	SOT-25	28xg	VD19	6g	Tor
APF	XC6211D46AMR	LVR-IC	LDO, 4.65V±2%, 240mA, -CE	SOT-25	28vc	VR4	6g	Tor
APF	XC6114E416MR	Vdet-IC	1.6V±2%, ±Reset PPO, Wt=200ms, Rt=200ms	SOT-25	28xg	VD19	6g	Tor
APF	XC6114E446MR	Vdet-IC	4.6V±2%, ±Reset PPO, Wt=200ms, Rt=200ms	SOT-25	28xg	VD19	6g	Tor
APH	XC6211D47AMR	LVR-IC	LDO, 4.75V±2%, 240mA, -CE	SOT-25	28vc	VR4	6g	Tor
APH	XC6114E417MR	Vdet-IC	1.7V±2%, ±Reset PPO, Wt=200ms, Rt=200ms	SOT-25	28xg	VD19	6g	Tor
APH	XC6114E447MR	Vdet-IC	4.7V±2%, ±Reset PPO, Wt=200ms, Rt=200ms	SOT-25	28xg	VD19	6g	Tor
APK	XC6211D48AMR	LVR-IC	LDO, 4.85V±2%, 240mA, -CE	SOT-25	28vc	VR4	6g	Tor
APK	XC6114E418MR	Vdet-IC	1.8V±2%, ±Reset PPO, Wt=200ms, Rt=200ms	SOT-25	28xg	VD19	6g	Tor
APK	XC6114E448MR	Vdet-IC	4.8V±2%, ±Reset PPO, Wt=200ms, Rt=200ms	SOT-25	28xg	VD19	6g	Tor
APL	XC6211D49AMR	LVR-IC	LDO, 4.95V±2%, 240mA, -CE	SOT-25	28vc	VR4	6g	Tor
APL	XC6114E419MR	Vdet-IC	1.9V±2%, ±Reset PPO, Wt=200ms, Rt=200ms	SOT-25	28xg	VD19	6g	Tor
APL	XC6114E449MR	Vdet-IC	4.9V±2%, ±Reset PPO, Wt=200ms, Rt=200ms	SOT-25	28xg	VD19	6g	Tor
APM	XC6114E420MR	Vdet-IC	2.0V±2%, ±Reset PPO, Wt=200ms, Rt=200ms	SOT-25	28xg	VD19	6g	Tor
APM	XC6114E450MR	Vdet-IC	5.0V±2%, ±Reset PPO, Wt=200ms, Rt=200ms	SOT-25	28xg	VD19	6g	Tor
APN	XC6114E421MR	Vdet-IC	2.1V±2%, ±Reset PPO, Wt=200ms, Rt=200ms	SOT-25	28xg	VD19	6g	Tor
APP	TPS62222DDC	DC/DC-IC	PWM step-down, 1.8V, 400mA, 1.25MHz	SOT-23-5	28yj	-	6k	Ti
APP	XC6114E422MR	Vdet-IC	2.2V±2%, ±Reset PPO, Wt=200ms, Rt=200ms	SOT-25	28xg	VD19	6g	Tor
APP	XC6114E423MR	Vdet-IC	2.3V±2%, ±Reset PPO, Wt=200ms, Rt=200ms	SOT-25	28xg	VD19	6g	Tor
APS	XC6114E424MR	Vdet-IC	2.4V±2%, ±Reset PPO, Wt=200ms, Rt=200ms	SOT-25	28xg	VD19	6g	Tor
APT	XC6114E425MR	Vdet-IC	2.5V±2%, ±Reset PPO, Wt=200ms, Rt=200ms	SOT-25	28xg	VD19	6g	Tor
APU	XC6114E426MR	Vdet-IC	2.6V±2%, ±Reset PPO, Wt=200ms, Rt=200ms	SOT-25	28xg	VD19	6g	Tor
APV	XC6114E427MR	Vdet-IC	2.7V±2%, ±Reset PPO, Wt=200ms, Rt=200ms	SOT-25	28xg	VD19	6g	Tor
APX	XC6114E428MR	Vdet-IC	2.8V±2%, ±Reset PPO, Wt=200ms, Rt=200ms	SOT-25	28xg	VD19	6g	Tor
APY	XC6114E429MR	Vdet-IC	2.9V±2%, ±Reset PPO, Wt=200ms, Rt=200ms	SOT-25	28xg	VD19	6g	Tor
APZ	XC6114E430MR	Vdet-IC	3.0V±2%, ±Reset PPO, Wt=200ms, Rt=200ms	SOT-25	28xg	VD19	6g	Tor
AQ	MAX8245EUK	Vdet-IC	2.93V±1.5%, Strobe, ±Reset PPO	SOT-23-5	28xq	-	6k	Max
AQ	PT7M7811TTA	Vdet-IC	3.08V±1.5%, -Reset PPO, -MR	SOT-23-5	28vd2	VD5	6k	Pti
AQ	R111N241A	LVR-IC	LDO, LN, -CE, 2.4V±2%, 150mA	SOT-23-5	28xc	VR4	6g	Ric
AQ	PT7M7811TTAE	Vdet-IC	3.08V±1.5%, -Reset PPO, -MR, Lead free	SOT-23-5	28vd2	VD5	6k	Pti
AQ08	RP110Q082D	LVR-IC	LDO, 0.8V±1%, 150mA, +CE, CL	SC-88A	28vc	VR4	6m	Ric
AQ09	RP110Q092D	LVR-IC	LDO, 0.9V±1%, 150mA, +CE, CL	SC-88A	28vc	VR4	6m	Ric
AQ10	RP110Q102D	LVR-IC	LDO, 1.0V±1%, 150mA, +CE, CL	SC-88A	28vc	VR4	6m	Ric
AQ11	RP110Q112D	LVR-IC	LDO, 1.1V±1%, 150mA, +CE, CL	SC-88A	28vc	VR4	6m	Ric
AQ12	RP110Q122D	LVR-IC	LDO, 1.2V±1%, 150mA, +CE, CL	SC-88A	28vc	VR4	6m	Ric
AQ13	RP110Q132D	LVR-IC	LDO, 1.3V±1%, 150mA, +CE, CL	SC-88A	28vc	VR4	6m	Ric
AQ14	RP110Q142D	LVR-IC	LDO, 1.4V±1%, 150mA, +CE, CL	SC-88A	28vc	VR4	6m	Ric
AQ15	RP110Q152D	LVR-IC	LDO, 1.5V±1%, 150mA, +CE, CL	SC-88A	28vc	VR4	6m	Ric
AQ16	RP110Q162D	LVR-IC	LDO, 1.6V±1%, 150mA, +CE, CL	SC-88A	28vc	VR4	6m	Ric
AQ17	RP110Q172D	LVR-IC	LDO, 1.7V±1%, 150mA, +CE, CL	SC-88A	28vc	VR4	6m	Ric
AQ18	RP110Q182D	LVR-IC	LDO, 1.8V±1%, 150mA, +CE, CL	SC-88A	28vc	VR4	6m	Ric
AQ19	RP110Q192D	LVR-IC	LDO, 1.9V±1%, 150mA, +CE, CL	SC-88A	28vc	VR4	6m	Ric
AQ20	RP110Q202D	LVR-IC	LDO, 2.0V±1%, 150mA, +CE, CL	SC-88A	28vc	VR4	6m	Ric
AQ21	RP110Q212D	LVR-IC	LDO, 2.1V±1%, 150mA, +CE, CL	SC-88A	28vc	VR4	6m	Ric
AQ22	RP110Q222D	LVR-IC	LDO, 2.2V±1%, 150mA, +CE, CL	SC-88A	28vc	VR4	6m	Ric
AQ23	RP110Q232D	LVR-IC	LDO, 2.3V±1%, 150mA, +CE, CL	SC-88A	28vc	VR4	6m	Ric
AQ24	RP110Q242D	LVR-IC	LDO, 2.4V±1%, 150mA, +CE, CL	SC-88A	28vc	VR4	6m	Ric
AQ25	RP110Q252D	LVR-IC	LDO, 2.5V±1%, 150mA, +CE, CL	SC-88A	28vc	VR4	6m	Ric
AQ26	RP110Q262D	LVR-IC	LDO, 2.6V±1%, 150mA, +CE, CL	SC-88A	28vc	VR4	6m	Ric
AQ27	RP110Q272D	LVR-IC	LDO, 2.7V±1%, 150mA, +CE, CL	SC-88A	28vc	VR4	6m	Ric
AQ28	RP110Q282D	LVR-IC	LDO, 2.8V±1%, 150mA, +CE, CL	SC-88A	28vc	VR4	6m	Ric
AQ29	RP110Q292D	LVR-IC	LDO, 2.9V±1%, 150mA, +CE, CL	SC-88A	28vc	VR4	6m	Ric



SMD code	Type	Function	Short description	Case	Pinout	Sch.	St.	Mnf.
AQ30	RP110Q302D	LVR-IC	LDO, 3.0V±1%, 150mA, +CE, CL	SC-88A	28vc	VR4	6m	Ric
AQ31	RP110Q312D	LVR-IC	LDO, 3.1V±1%, 150mA, +CE, CL	SC-88A	28vc	VR4	6m	Ric
AQ32	RP110Q322D	LVR-IC	LDO, 3.2V±1%, 150mA, +CE, CL	SC-88A	28vc	VR4	6m	Ric
AQ33	RP110Q332D	LVR-IC	LDO, 3.3V±1%, 150mA, +CE, CL	SC-88A	28vc	VR4	6m	Ric
AQ34	RP110Q342D	LVR-IC	LDO, 3.4V±1%, 150mA, +CE, CL	SC-88A	28vc	VR4	6m	Ric
AQ35	RP110Q352D	LVR-IC	LDO, 3.5V±1%, 150mA, +CE, CL	SC-88A	28vc	VR4	6m	Ric
AQ36	RP110Q362D	LVR-IC	LDO, 3.6V±1%, 150mA, +CE, CL	SC-88A	28vc	VR4	6m	Ric
AQ37	RP110Q122D5	LVR-IC	LDO, 1.25V±1%, 150mA, +CE, CL	SC-88A	28vc	VR4	6m	Ric
AQ38	RP110Q182D5	LVR-IC	LDO, 1.85V±1%, 150mA, +CE, CL	SC-88A	28vc	VR4	6m	Ric
AQ39	RP110Q282D5	LVR-IC	LDO, 2.85V±1%, 150mA, +CE, CL	SC-88A	28vc	VR4	6m	Ric
ÄQW	AME8800SEEVY	LVR-IC	LDO, 5.0V±1.5%, 300mA	TSOT-25	28vu	VR1	6k	Ame
ÄQW	AME8800SEEVZ	LVR-IC	LDO, 5.0V±1.5%, 300mA	SOT-25	28vu	VR1	6k	Ame
aR	74AUP1T98GW	CMOS-Logic	Configurable gate with voltage-level translator	SOT-353-1	28/Log82	-	6a	Phi
AR	74AHC1G06GW	CMOS-Logic	Inverter (ODO)	SOT-353	28/Log19	-	6a	Phi
AR	AT1201-50XR	LVR-IC	LDO, LN, +CE, 5V±2%, 150mA	SOT-23-5	28un	VR7	6a	Ath
AR	MAX824REUK	Vdet-IC	2.63V±1.5%, Strobe, ±Reset PPO	SOT-23-5	28xq	-	6k	Max
AR	PT7M7811STA	Vdet-IC	2.93V±1.5%, -Reset PPO, -MR	SOT-23-5	28vd2	VD5	6k	Pti
AR	R1112N251A	LVR-IC	LDO, LN, -CE, 2.5V±2%, 150mA	SOT-23-5	28xc	VR4	6g	Ric
AR	SiP825LEU	Vdet-IC	4.63V±1.5%, MR, ±Reset PPO	SOT-23-5	28xf	VD21	6k	Vs
ÄR	PT7M7811STAE	Vdet-IC	2.93V±1.5%, -Reset PPO, -MR, Lead free	SOT-23-5	28vd2	VD5	6k	Pti
AR-	RT9193-2HPU5	LVR-IC	LDO, 2.85V±1%, 300mA, +CE	SC-70-5	28vrx	VR7	6g	Rct
ÄR0	XC6114E531MR	Vdet-IC	3.1V±2%, ±Reset PPO, Wt=400ms, Rt=200ms	SOT-25	28xg	VD19	6g	Tor
ÄR1	XC6114E532MR	Vdet-IC	3.2V±2%, ±Reset PPO, Wt=400ms, Rt=200ms	SOT-25	28xg	VD19	6g	Tor
ÄR2	XC6114E533MR	Vdet-IC	3.3V±2%, ±Reset PPO, Wt=400ms, Rt=200ms	SOT-25	28xg	VD19	6g	Tor
ÄR3	XC6114E534MR	Vdet-IC	3.4V±2%, ±Reset PPO, Wt=400ms, Rt=200ms	SOT-25	28xg	VD19	6g	Tor
ÄR4	XC6114E535MR	Vdet-IC	3.5V±2%, ±Reset PPO, Wt=400ms, Rt=200ms	SOT-25	28xg	VD19	6g	Tor
ÄR5	XC6114E536MR	Vdet-IC	3.6V±2%, ±Reset PPO, Wt=400ms, Rt=200ms	SOT-25	28xg	VD19	6g	Tor
ÄR6	XC6114E537MR	Vdet-IC	3.7V±2%, ±Reset PPO, Wt=400ms, Rt=200ms	SOT-25	28xg	VD19	6g	Tor
ÄR7	XC6114E538MR	Vdet-IC	3.8V±2%, ±Reset PPO, Wt=400ms, Rt=200ms	SOT-25	28xg	VD19	6g	Tor
ÄR8	XC6114E539MR	Vdet-IC	3.9V±2%, ±Reset PPO, Wt=400ms, Rt=200ms	SOT-25	28xg	VD19	6g	Tor
ÄR9	XC6114E540MR	Vdet-IC	4.0V±2%, ±Reset PPO, Wt=400ms, Rt=200ms	SOT-25	28xg	VD19	6g	Tor
ÄRA	XC6114E541MR	Vdet-IC	4.1V±2%, ±Reset PPO, Wt=400ms, Rt=200ms	SOT-25	28xg	VD19	6g	Tor
ÄRB	XC6114E542MR	Vdet-IC	4.2V±2%, ±Reset PPO, Wt=400ms, Rt=200ms	SOT-25	28xg	VD19	6g	Tor
ÄRC	XC6114E543MR	Vdet-IC	4.3V±2%, ±Reset PPO, Wt=400ms, Rt=200ms	SOT-25	28xg	VD19	6g	Tor
ÄRD	XC6114E544MR	Vdet-IC	4.4V±2%, ±Reset PPO, Wt=400ms, Rt=200ms	SOT-25	28xg	VD19	6g	Tor
ÄRE	XC6114E545MR	Vdet-IC	4.5V±2%, ±Reset PPO, Wt=400ms, Rt=200ms	SOT-25	28xg	VD19	6g	Tor
ÄRF	XC6114E516MR	Vdet-IC	1.6V±2%, ±Reset PPO, Wt=400ms, Rt=200ms	SOT-25	28xg	VD19	6g	Tor
ÄRF	XC6114E546MR	Vdet-IC	4.6V±2%, ±Reset PPO, Wt=400ms, Rt=200ms	SOT-25	28xg	VD19	6g	Tor
ÄRH	XC6114E517MR	Vdet-IC	1.7V±2%, ±Reset PPO, Wt=400ms, Rt=200ms	SOT-25	28xg	VD19	6g	Tor
ÄRH	XC6114E547MR	Vdet-IC	4.7V±2%, ±Reset PPO, Wt=400ms, Rt=200ms	SOT-25	28xg	VD19	6g	Tor
ÄRK	XC6114E518MR	Vdet-IC	1.8V±2%, ±Reset PPO, Wt=400ms, Rt=200ms	SOT-25	28xg	VD19	6g	Tor
ÄRK	XC6114E548MR	Vdet-IC	4.8V±2%, ±Reset PPO, Wt=400ms, Rt=200ms	SOT-25	28xg	VD19	6g	Tor
ÄRL	XC6114E519MR	Vdet-IC	1.9V±2%, ±Reset PPO, Wt=400ms, Rt=200ms	SOT-25	28xg	VD19	6g	Tor
ÄRL	XC6114E549MR	Vdet-IC	4.9V±2%, ±Reset PPO, Wt=400ms, Rt=200ms	SOT-25	28xg	VD19	6g	Tor
ÄRM	XC6114E520MR	Vdet-IC	2.0V±2%, ±Reset PPO, Wt=400ms, Rt=200ms	SOT-25	28xg	VD19	6g	Tor
ÄRM	XC6114E550MR	Vdet-IC	5.0V±2%, ±Reset PPO, Wt=400ms, Rt=200ms	SOT-25	28xg	VD19	6g	Tor
ÄRN	XC6114E521MR	Vdet-IC	2.1V±2%, ±Reset PPO, Wt=400ms, Rt=200ms	SOT-25	28xg	VD19	6g	Tor
ÄRP	XC6114E522MR	Vdet-IC	2.2V±2%, ±Reset PPO, Wt=400ms, Rt=200ms	SOT-25	28xg	VD19	6g	Tor
ÄRR	XC6114E523MR	Vdet-IC	2.3V±2%, ±Reset PPO, Wt=400ms, Rt=200ms	SOT-25	28xg	VD19	6g	Tor
ÄRS	XC6114E524MR	Vdet-IC	2.4V±2%, ±Reset PPO, Wt=400ms, Rt=200ms	SOT-25	28xg	VD19	6g	Tor
ÄRT	XC6114E525MR	Vdet-IC	2.5V±2%, ±Reset PPO, Wt=400ms, Rt=200ms	SOT-25	28xg	VD19	6g	Tor
ÄRU	XC6114E526MR	Vdet-IC	2.6V±2%, ±Reset PPO, Wt=400ms, Rt=200ms	SOT-25	28xg	VD19	6g	Tor
ÄRV	XC6114E527MR	Vdet-IC	2.7V±2%, ±Reset PPO, Wt=400ms, Rt=200ms	SOT-25	28xg	VD19	6g	Tor
ÄRX	AME8510AEEVBDD29	Vdet-IC	2.93V±1.5%, -Reset ODO, -MR, Strobe	SOT-23-5	28cp	VD16	6k	Ame
ÄRX	XC6114E528MR	Vdet-IC	2.8V±2%, ±Reset PPO, Wt=400ms, Rt=200ms	SOT-25	28xg	VD19	6g	Tor
ÄRY	XC6114E529MR	Vdet-IC	2.9V±2%, ±Reset PPO, Wt=400ms, Rt=200ms	SOT-25	28xg	VD19	6g	Tor
ÄRZ	XC6114E530MR	Vdet-IC	3.0V±2%, ±Reset PPO, Wt=400ms, Rt=200ms	SOT-25	28xg	VD19	6g	Tor
AS	74AHC1G07GW	CMOS-Logic	Noninverting buffer/driver (ODO)	SOT-353	28/Log8	-	6a	Phi
AS	MAX825LEUK	Vdet-IC	4.63V±1.5%, -MR, ±Reset PPO	SOT-23-5	28xf	VD21	6k	Max
AS	PT7M7811RTA	Vdet-IC	2.63V±1.5%, -Reset PPO, -MR	SOT-23-5	28vd2	VD5	6k	Pti
AS	R1112N261A	LVR-IC	LDO, LN, -CE, 2.6V±2%, 150mA	SOT-23-5	28xcx	VR4	6g	Ric
AS	RT9167-50CB	LVR-IC	LDO, 5.0V±2%, 300mA, +CE	SOT-23-5	28vrx	VR7	6g	Rct
AS	SiP825MEU	Vdet-IC	4.38V±1.5%, MR, ±Reset PPO	SOT-23-5	28xf	VD21	6k	Vs
ÄS	PT7M7811RTAE	Vdet-IC	2.63V±1.5%, -Reset PPO, -MR, Lead free	SOT-23-5	28vd2	VD5	6k	Pti
AS-	RT9167-50PB	LVR-IC	LDO, 5.0V±2%, 300mA, +CE	SOT-23-5	28vrx	VR7	6g	Rct
AS-	RT9193T-33PU5	LVR-IC	LDO, 3.3V±1%, 300mA, +CE	SC-70-5	28vrx	VR7	6g	Rct
ÄS0	XC6114E631MR	Vdet-IC	3.1V±2%, ±Reset PPO, Wt=1.6s, Rt=200ms	SOT-25	28xg	VD19	6g	Tor
ÄS1	XC6114E632MR	Vdet-IC	3.2V±2%, ±Reset PPO, Wt=1.6s, Rt=200ms	SOT-25	28xg	VD19	6g	Tor
ÄS2	XC6114E633MR	Vdet-IC	3.3V±2%, ±Reset PPO, Wt=1.6s, Rt=200ms	SOT-25	28xg	VD19	6g	Tor
ÄS3	XC6114E634MR	Vdet-IC	3.4V±2%, ±Reset PPO, Wt=1.6s, Rt=200ms	SOT-25	28xg	VD19	6g	Tor



SMD code	Type	Function	Short description	Case	Pinout	Sch.	St.	Mnf.
<u>AS4</u>	XC6114E635MR	Vdet-IC	3.5V±2%, ±Reset PPO, Wt=1.6s, Rt=200ms	SOT-25	28xg	VD19	6g	Tor
<u>AS5</u>	XC6114E636MR	Vdet-IC	3.6V±2%, ±Reset PPO, Wt=1.6s, Rt=200ms	SOT-25	28xg	VD19	6g	Tor
<u>AS6</u>	XC6114E637MR	Vdet-IC	3.7V±2%, ±Reset PPO, Wt=1.6s, Rt=200ms	SOT-25	28xg	VD19	6g	Tor
<u>AS7</u>	XC6114E638MR	Vdet-IC	3.8V±2%, ±Reset PPO, Wt=1.6s, Rt=200ms	SOT-25	28xg	VD19	6g	Tor
<u>AS8</u>	XC6114E639MR	Vdet-IC	3.9V±2%, ±Reset PPO, Wt=1.6s, Rt=200ms	SOT-25	28xg	VD19	6g	Tor
<u>AS9</u>	XC6114E640MR	Vdet-IC	4.0V±2%, ±Reset PPO, Wt=1.6s, Rt=200ms	SOT-25	28xg	VD19	6g	Tor
<u>ASA</u>	XC6114E641MR	Vdet-IC	4.1V±2%, ±Reset PPO, Wt=1.6s, Rt=200ms	SOT-25	28xg	VD19	6g	Tor
<u>ASB</u>	XC6114E642MR	Vdet-IC	4.2V±2%, ±Reset PPO, Wt=1.6s, Rt=200ms	SOT-25	28xg	VD19	6g	Tor
<u>ASC</u>	XC6114E643MR	Vdet-IC	4.3V±2%, ±Reset PPO, Wt=1.6s, Rt=200ms	SOT-25	28xg	VD19	6g	Tor
<u>ASD</u>	XC6114E644MR	Vdet-IC	4.4V±2%, ±Reset PPO, Wt=1.6s, Rt=200ms	SOT-25	28xg	VD19	6g	Tor
<u>ASE</u>	XC6114E645MR	Vdet-IC	4.5V±2%, ±Reset PPO, Wt=1.6s, Rt=200ms	SOT-25	28xg	VD19	6g	Tor
<u>ASF</u>	XC6114E616MR	Vdet-IC	1.6V±2%, ±Reset PPO, Wt=1.6s, Rt=200ms	SOT-25	28xg	VD19	6g	Tor
<u>ASF</u>	XC6114E646MR	Vdet-IC	4.6V±2%, ±Reset PPO, Wt=1.6s, Rt=200ms	SOT-25	28xg	VD19	6g	Tor
<u>ASH</u>	XC6114E617MR	Vdet-IC	1.7V±2%, ±Reset PPO, Wt=1.6s, Rt=200ms	SOT-25	28xg	VD19	6g	Tor
<u>ASH</u>	XC6114E647MR	Vdet-IC	4.7V±2%, ±Reset PPO, Wt=1.6s, Rt=200ms	SOT-25	28xg	VD19	6g	Tor
<u>ASK</u>	XC6114E618MR	Vdet-IC	1.8V±2%, ±Reset PPO, Wt=1.6s, Rt=200ms	SOT-25	28xg	VD19	6g	Tor
<u>ASK</u>	XC6114E648MR	Vdet-IC	4.8V±2%, ±Reset PPO, Wt=1.6s, Rt=200ms	SOT-25	28xg	VD19	6g	Tor
<u>ASL</u>	XC6114E619MR	Vdet-IC	1.9V±2%, ±Reset PPO, Wt=1.6s, Rt=200ms	SOT-25	28xg	VD19	6g	Tor
<u>ASL</u>	XC6114E649MR	Vdet-IC	4.9V±2%, ±Reset PPO, Wt=1.6s, Rt=200ms	SOT-25	28xg	VD19	6g	Tor
<u>ASM</u>	AME8510AEEVAFE31	Vdet-IC	3.08V±1.5%, -Reset PPO, -MR, Strobe	SOT-23-5	28cp	VD17	6k	Ame
<u>ASM</u>	XC6114E620MR	Vdet-IC	2.0V±2%, ±Reset PPO, Wt=1.6s, Rt=200ms	SOT-25	28xg	VD19	6g	Tor
<u>ASM</u>	XC6114E650MR	Vdet-IC	5.0V±2%, ±Reset PPO, Wt=1.6s, Rt=200ms	SOT-25	28xg	VD19	6g	Tor
<u>ASN</u>	XC6114E621MR	Vdet-IC	2.1V±2%, ±Reset PPO, Wt=1.6s, Rt=200ms	SOT-25	28xg	VD19	6g	Tor
<u>ASP</u>	XC6114E622MR	Vdet-IC	2.2V±2%, ±Reset PPO, Wt=1.6s, Rt=200ms	SOT-25	28xg	VD19	6g	Tor
<u>ASR</u>	XC6114E623MR	Vdet-IC	2.3V±2%, ±Reset PPO, Wt=1.6s, Rt=200ms	SOT-25	28xg	VD19	6g	Tor
<u>ASS</u>	XC6114E624MR	Vdet-IC	2.4V±2%, ±Reset PPO, Wt=1.6s, Rt=200ms	SOT-25	28xg	VD19	6g	Tor
<u>AST</u>	XC6114E625MR	Vdet-IC	2.5V±2%, ±Reset PPO, Wt=1.6s, Rt=200ms	SOT-25	28xg	VD19	6g	Tor
<u>ASU</u>	XC6114E626MR	Vdet-IC	2.6V±2%, ±Reset PPO, Wt=1.6s, Rt=200ms	SOT-25	28xg	VD19	6g	Tor
<u>ASV</u>	XC6114E627MR	Vdet-IC	2.7V±2%, ±Reset PPO, Wt=1.6s, Rt=200ms	SOT-25	28xg	VD19	6g	Tor
<u>ASX</u>	XC6114E628MR	Vdet-IC	2.8V±2%, ±Reset PPO, Wt=1.6s, Rt=200ms	SOT-25	28xg	VD19	6g	Tor
<u>ASY</u>	XC6114E629MR	Vdet-IC	2.9V±2%, ±Reset PPO, Wt=1.6s, Rt=200ms	SOT-25	28xg	VD19	6g	Tor
<u>ASZ</u>	XC6114E630MR	Vdet-IC	3.0V±2%, ±Reset PPO, Wt=1.6s, Rt=200ms	SOT-25	28xg	VD19	6g	Tor
<u>AT</u>	MAX825MEUK	Vdet-IC	4.38V±1.5%, -MR, ±Reset PPO	SOT-23-5	28xf	VD21	6k	Max
<u>AT</u>	PT7M7811ZTA	Vdet-IC	2.32V±1.5%, -Reset PPO, -MR	SOT-23-5	28vd2	VD5	6k	Pti
<u>AT</u>	R1112N271A	LVR-IC	LDO, LN, -CE, 2.7V±2%, 150mA	SOT-23-5	28cx	VR4	6g	Ric
<u>AT</u>	SiP825TEU	Vdet-IC	3.08V±1.5%, MR, ±Reset PPO	SOT-23-5	28xf	VD21	6k	Vs
<u>AT</u>	PT7M7811ZTAE	Vdet-IC	2.32V±1.5%, -Reset PPO, -MR, Lead free	SOT-23-5	28vd2	VD5	6k	Pti
<u>AT-</u>	RT9198-2HPU5	LVR-IC	LDO, 2.85V±1%, 300mA, +CE	SC-70-5	28xm	VR4	6a	Rct
<u>AT0</u>	XC6114F531MR	Vdet-IC	3.1V±2%, ±Reset PPO, Wt=400ms, Rt=400ms	SOT-25	28xg	VD19	6g	Tor
<u>AT1</u>	XC6114F532MR	Vdet-IC	3.2V±2%, ±Reset PPO, Wt=400ms, Rt=400ms	SOT-25	28xg	VD19	6g	Tor
<u>AT2</u>	XC6114F533MR	Vdet-IC	3.3V±2%, ±Reset PPO, Wt=400ms, Rt=400ms	SOT-25	28xg	VD19	6g	Tor
<u>AT3</u>	XC6114F534MR	Vdet-IC	3.4V±2%, ±Reset PPO, Wt=400ms, Rt=400ms	SOT-25	28xg	VD19	6g	Tor
<u>AT4</u>	XC6114F535MR	Vdet-IC	3.5V±2%, ±Reset PPO, Wt=400ms, Rt=400ms	SOT-25	28xg	VD19	6g	Tor
<u>AT5</u>	XC6114F536MR	Vdet-IC	3.6V±2%, ±Reset PPO, Wt=400ms, Rt=400ms	SOT-25	28xg	VD19	6g	Tor
<u>AT6</u>	XC6114F537MR	Vdet-IC	3.7V±2%, ±Reset PPO, Wt=400ms, Rt=400ms	SOT-25	28xg	VD19	6g	Tor
<u>AT7</u>	XC6114F538MR	Vdet-IC	3.8V±2%, ±Reset PPO, Wt=400ms, Rt=400ms	SOT-25	28xg	VD19	6g	Tor
<u>AT8</u>	XC6114F539MR	Vdet-IC	3.9V±2%, ±Reset PPO, Wt=400ms, Rt=400ms	SOT-25	28xg	VD19	6g	Tor
<u>AT9</u>	XC6114F540MR	Vdet-IC	4.0V±2%, ±Reset PPO, Wt=400ms, Rt=400ms	SOT-25	28xg	VD19	6g	Tor
<u>ATA</u>	XC6114F541MR	Vdet-IC	4.1V±2%, ±Reset PPO, Wt=400ms, Rt=400ms	SOT-25	28xg	VD19	6g	Tor
<u>ATB</u>	XC6114F542MR	Vdet-IC	4.2V±2%, ±Reset PPO, Wt=400ms, Rt=400ms	SOT-25	28xg	VD19	6g	Tor
<u>ATC</u>	AME8520AEEVEFE26	Vdet-IC	2.63V±1.5%, ±Reset PPO, Strobe	SOT-23-5	28xq	VD19	6k	Ame
<u>ATC</u>	AME8520AEEVEFE26Z	Vdet-IC	2.63V±1.5%, ±Reset PPO, Strobe, lead free	SOT-23-5	28xq	VD19	6k	Ame
<u>ATC</u>	XC6114F543MR	Vdet-IC	4.3V±2%, ±Reset PPO, Wt=400ms, Rt=400ms	SOT-25	28xg	VD19	6g	Tor
<u>ATD</u>	XC6114F544MR	Vdet-IC	4.4V±2%, ±Reset PPO, Wt=400ms, Rt=400ms	SOT-25	28xg	VD19	6g	Tor
<u>ATE</u>	XC6114F545MR	Vdet-IC	4.5V±2%, ±Reset PPO, Wt=400ms, Rt=400ms	SOT-25	28xg	VD19	6g	Tor
<u>ATF</u>	XC6114F516MR	Vdet-IC	1.6V±2%, ±Reset PPO, Wt=400ms, Rt=400ms	SOT-25	28xg	VD19	6g	Tor
<u>ATF</u>	XC6114F546MR	Vdet-IC	4.6V±2%, ±Reset PPO, Wt=400ms, Rt=400ms	SOT-25	28xg	VD19	6g	Tor
<u>ATG</u>	AME8510AEEVAFE26	Vdet-IC	2.63V±1.5%, -Reset PPO, -MR, Strobe	SOT-23-5	28cp	VD17	6k	Ame
<u>ATH</u>	XC6114F517MR	Vdet-IC	1.7V±2%, ±Reset PPO, Wt=400ms, Rt=400ms	SOT-25	28xg	VD19	6g	Tor
<u>ATH</u>	XC6114F547MR	Vdet-IC	4.7V±2%, ±Reset PPO, Wt=400ms, Rt=400ms	SOT-25	28xg	VD19	6g	Tor
<u>ATI</u>	MAX8891EXK15+T	LVR-IC	LDO, 1.5V±3%, 200mA, +CE	SC-70-5	28cx	VR4	6a	Max
<u>ATJ</u>	AME8520AEEVEFE45	Vdet-IC	4.50V±1.5%, ±Reset PPO, Strobe	SOT-23-5	28xq	VD19	6k	Ame
<u>ATJ</u>	MAX8891EXK18+T	LVR-IC	LDO, 1.8V±3%, 200mA, +CE	SC-70-5	28cx	VR4	6a	Max
<u>ATJ</u>	AME8520AEEVEFE45Z	Vdet-IC	4.50V±1.5%, ±Reset PPO, Strobe, lead free	SOT-23-5	28xq	VD19	6k	Ame
<u>ATK</u>	AME8520AEEVEFE42	Vdet-IC	4.20V±1.5%, ±Reset PPO, Strobe	SOT-23-5	28xq	VD19	6k	Ame
<u>ATK</u>	AME8520AEEVEFE42Z	Vdet-IC	4.20V±1.5%, ±Reset PPO, Strobe, lead free	SOT-23-5	28xq	VD19	6k	Ame
<u>ATK</u>	XC6114F518MR	Vdet-IC	1.8V±2%, ±Reset PPO, Wt=400ms, Rt=400ms	SOT-25	28xg	VD19	6g	Tor
<u>ATK</u>	XC6114F548MR	Vdet-IC	4.8V±2%, ±Reset PPO, Wt=400ms, Rt=400ms	SOT-25	28xg	VD19	6g	Tor
<u>ATL</u>	AME8520AEEVEFE31	Vdet-IC	3.08V±1.5%, ±Reset PPO, Strobe	SOT-23-5	28xq	VD19	6k	Ame
<u>ATL</u>	MAX8891EXK25+T	LVR-IC	LDO, 2.5V±3%, 200mA, +CE	SC-70-5	28cx	VR4	6a	Max



SMD code	Type	Function	Short description	Case	Pinout	Sch.	St.	Mnf.
<u>ATL</u>	AME8520AEEVEFE31Z	Vdet-IC	3.08V±1.5%, ±Reset PPO, Strobe, lead free	SOT-23-5	28xq	VD19	6k	Ame
<u>ATL</u>	XC6114F519MR	Vdet-IC	1.9V±2%, ±Reset PPO, Wt=400ms, Rt=400ms	SOT-25	28xg	VD19	6g	Tor
<u>ATL</u>	XC6114F549MR	Vdet-IC	4.9V±2%, ±Reset PPO, Wt=400ms, Rt=400ms	SOT-25	28xg	VD19	6g	Tor
<u>ATM</u>	AME8530AEEVEFX45	Vdet-IC	4.50V±1.5%, ±Reset PPO -MR	SOT-23-5	28xf	VD21	6k	Ame
<u>ATM</u>	MAX8891EXK26+T	LVR-IC	LDO, 2.6V±3%, 200mA, +CE	SC-70-5	28cx	VR4	6a	Max
<u>ATM</u>	AME8530AEEVEFX45Z	Vdet-IC	4.50V±1.5%, ±Reset PPO -MR, lead free	SOT-23-5	28xf	VD21	6k	Ame
<u>ATM</u>	XC6114F520MR	Vdet-IC	2.0V±2%, ±Reset PPO, Wt=400ms, Rt=400ms	SOT-25	28xg	VD19	6g	Tor
<u>ATM</u>	XC6114F550MR	Vdet-IC	5.0V±2%, ±Reset PPO, Wt=400ms, Rt=400ms	SOT-25	28xg	VD19	6g	Tor
<u>ATN</u>	AME8530AEEVEFX31	Vdet-IC	3.08V±1.5%, ±Reset PPO -MR	SOT-23-5	28xf	VD21	6k	Ame
<u>ATN</u>	AME8530AEEVEFX31Z	Vdet-IC	3.08V±1.5%, ±Reset PPO -MR, lead free	SOT-23-5	28xf	VD21	6k	Ame
<u>ATN</u>	XC6114F521MR	Vdet-IC	2.1V±2%, ±Reset PPO, Wt=400ms, Rt=400ms	SOT-25	28xg	VD19	6g	Tor
<u>ATO</u>	MAX8891EXK28+T	LVR-IC	LDO, 2.8V±3%, 200mA, +CE	SC-70-5	28cx	VR4	6a	Max
<u>ATP</u>	MAX8891EXK29+T	LVR-IC	LDO, 2.85V±3%, 200mA, +CE	SC-70-5	28cx	VR4	6a	Max
<u>ATP</u>	XC6114F522MR	Vdet-IC	2.2V±2%, ±Reset PPO, Wt=400ms, Rt=400ms	SOT-25	28xg	VD19	6g	Tor
<u>ATR</u>	MAX8891EXK31+T	LVR-IC	LDO, 3.1V±3%, 200mA, +CE	SC-70-5	28cx	VR4	6a	Max
<u>ATR</u>	XC6114F523MR	Vdet-IC	2.3V±2%, ±Reset PPO, Wt=400ms, Rt=400ms	SOT-25	28xg	VD19	6g	Tor
<u>ATS</u>	MAX8891EXK33+T	LVR-IC	LDO, 3.3V±3%, 200mA, +CE	SC-70-5	28cx	VR4	6a	Max
<u>ATS</u>	XC6114F524MR	Vdet-IC	2.4V±2%, ±Reset PPO, Wt=400ms, Rt=400ms	SOT-25	28xg	VD19	6g	Tor
<u>ATT</u>	XC6114F525MR	Vdet-IC	2.5V±2%, ±Reset PPO, Wt=400ms, Rt=400ms	SOT-25	28xg	VD19	6g	Tor
<u>ATU</u>	AME8510AEEVEFE31	Vdet-IC	3.08V±1.5%, -Reset PPO, -MR, Strobe	SOT-23-5	28cp	VD17	6k	Ame
<u>ATU</u>	MAX8891EXK45+T	LVR-IC	LDO, 4.5V±3%, 200mA, +CE	SC-70-5	28cx	VR4	6a	Max
<u>ATU</u>	XC6114F526MR	Vdet-IC	2.6V±2%, ±Reset PPO, Wt=400ms, Rt=400ms	SOT-25	28xg	VD19	6g	Tor
<u>ATV</u>	AME8520AEEVEFE29	Vdet-IC	2.93V±1.5%, ±Reset PPO, Strobe	SOT-23-5	28xq	VD19	6k	Ame
<u>ATV</u>	MAX8891EXK89+T	LVR-IC	LDO, 2.9V±3%, 200mA, +CE	SC-70-5	28cx	VR4	6a	Max
<u>ATV</u>	AME8520AEEVEFE29Z	Vdet-IC	2.93V±1.5%, ±Reset PPO, Strobe, lead free	SOT-23-5	28xq	VD19	6k	Ame
<u>ATV</u>	XC6114F527MR	Vdet-IC	2.7V±2%, ±Reset PPO, Wt=400ms, Rt=400ms	SOT-25	28xg	VD19	6g	Tor
<u>ATW</u>	AME8520AEEVEFE44	Vdet-IC	4.38V±1.5%, ±Reset PPO, Strobe	SOT-23-5	28xq	VD19	6k	Ame
<u>ATW</u>	MAX8892EXK+T	LVR-IC	LDO, Adjustable 1.5...3.0V, 200mA, +CE	SC-70-5	28sg	VR16	6a	Max
<u>ATW</u>	AME8520AEEVEFE44Z	Vdet-IC	4.38V±1.5%, ±Reset PPO, Strobe, lead free	SOT-23-5	28xq	VD19	6k	Ame
<u>ATX</u>	AME8510AEEVAFE29	Vdet-IC	2.93V±1.5%, -Reset PPO, -MR, Strobe	SOT-23-5	28cp	VD17	6k	Ame
<u>ATX</u>	XC6114F528MR	Vdet-IC	2.8V±2%, ±Reset PPO, Wt=400ms, Rt=400ms	SOT-25	28xg	VD19	6g	Tor
<u>ATY</u>	XC6114F529MR	Vdet-IC	2.9V±2%, ±Reset PPO, Wt=400ms, Rt=400ms	SOT-25	28xg	VD19	6g	Tor
<u>ATZ</u>	XC6114F530MR	Vdet-IC	3.0V±2%, ±Reset PPO, Wt=400ms, Rt=400ms	SOT-25	28xg	VD19	6g	Tor
<u>AU</u>	MAX825TEUK	Vdet-IC	3.08V±1.5%, -MR, ±Reset PPO	SOT-23-5	28xf	VD21	6k	Max
<u>AU</u>	PT7M7811YTA	Vdet-IC	2.20V±1.5%, -Reset PPO, -MR	SOT-23-5	28vd2	VD5	6k	Pti
<u>AU</u>	R1112N281A	LVR-IC	LDO, LN, -CE, 2.8V±2%, 150mA	SOT-23-5	28cx	VR4	6g	Ric
<u>AU</u>	PT7M7811YTAE	Vdet-IC	2.20V±1.5%, -Reset PPO, -MR, Lead free	SOT-23-5	28vd2	VD5	6k	Pti
<u>AU-</u>	RT9198-30PU5R	LVR-IC	LDO, 3.0V±1%, 300mA, +CE	SC-70-5	28cx	VR4	6a	Rct
<u>AU0</u>	XC6114F631MR	Vdet-IC	3.1V±2%, ±Reset PPO, Wt=1.6s, Rt=400ms	SOT-25	28xg	VD19	6g	Tor
<u>AU1</u>	XC6114F632MR	Vdet-IC	3.2V±2%, ±Reset PPO, Wt=1.6s, Rt=400ms	SOT-25	28xg	VD19	6g	Tor
<u>AU2</u>	XC6114F633MR	Vdet-IC	3.3V±2%, ±Reset PPO, Wt=1.6s, Rt=400ms	SOT-25	28xg	VD19	6g	Tor
<u>AU3</u>	XC6114F634MR	Vdet-IC	3.4V±2%, ±Reset PPO, Wt=1.6s, Rt=400ms	SOT-25	28xg	VD19	6g	Tor
<u>AU4</u>	74AHC1GU04GV	CMOS-Logic	Inverter	SOT753	28LLog6	-	6a	Phi
<u>AU4</u>	XC6114F635MR	Vdet-IC	3.5V±2%, ±Reset PPO, Wt=1.6s, Rt=400ms	SOT-25	28xg	VD19	6g	Tor
<u>AU5</u>	XC6114F636MR	Vdet-IC	3.6V±2%, ±Reset PPO, Wt=1.6s, Rt=400ms	SOT-25	28xg	VD19	6g	Tor
<u>AU6</u>	XC6114F637MR	Vdet-IC	3.7V±2%, ±Reset PPO, Wt=1.6s, Rt=400ms	SOT-25	28xg	VD19	6g	Tor
<u>AU7</u>	XC6114F638MR	Vdet-IC	3.8V±2%, ±Reset PPO, Wt=1.6s, Rt=400ms	SOT-25	28xg	VD19	6g	Tor
<u>AU8</u>	XC6114F639MR	Vdet-IC	3.9V±2%, ±Reset PPO, Wt=1.6s, Rt=400ms	SOT-25	28xg	VD19	6g	Tor
<u>AU9</u>	XC6114F640MR	Vdet-IC	4.0V±2%, ±Reset PPO, Wt=1.6s, Rt=400ms	SOT-25	28xg	VD19	6g	Tor
<u>AUA</u>	XC6114F641MR	Vdet-IC	4.1V±2%, ±Reset PPO, Wt=1.6s, Rt=400ms	SOT-25	28xg	VD19	6g	Tor
<u>AUB</u>	XC6114F642MR	Vdet-IC	4.2V±2%, ±Reset PPO, Wt=1.6s, Rt=400ms	SOT-25	28xg	VD19	6g	Tor
<u>AUC</u>	XC6114F643MR	Vdet-IC	4.3V±2%, ±Reset PPO, Wt=1.6s, Rt=400ms	SOT-25	28xg	VD19	6g	Tor
<u>AUD</u>	XC6114F644MR	Vdet-IC	4.4V±2%, ±Reset PPO, Wt=1.6s, Rt=400ms	SOT-25	28xg	VD19	6g	Tor
<u>AUE</u>	XC6114F645MR	Vdet-IC	4.5V±2%, ±Reset PPO, Wt=1.6s, Rt=400ms	SOT-25	28xg	VD19	6g	Tor
<u>AUF</u>	AME8500BEEVAK27	Vdet-IC	2.7V±1.5%, -Reset PPO, 1.5ms	SOT-23-5	28vdm	VD7	6k	Ame
<u>AUF</u>	AME8500BEEVAK27Z	Vdet-IC	2.7V±1.5%, -Reset PPO, 1.5ms, lead free	SOT-23-5	28vdm	VD7	6k	Ame
<u>AUF</u>	XC6114F616MR	Vdet-IC	1.6V±2%, ±Reset PPO, Wt=1.6s, Rt=400ms	SOT-25	28xg	VD19	6g	Tor
<u>AUE</u>	XC6114F646MR	Vdet-IC	4.6V±2%, ±Reset PPO, Wt=1.6s, Rt=400ms	SOT-25	28xg	VD19	6g	Tor
<u>AUH</u>	XC6114F617MR	Vdet-IC	1.7V±2%, ±Reset PPO, Wt=1.6s, Rt=400ms	SOT-25	28xg	VD19	6g	Tor
<u>AUH</u>	XC6114F647MR	Vdet-IC	4.7V±2%, ±Reset PPO, Wt=1.6s, Rt=400ms	SOT-25	28xg	VD19	6g	Tor
<u>AUK</u>	XC6114F618MR	Vdet-IC	1.8V±2%, ±Reset PPO, Wt=1.6s, Rt=400ms	SOT-25	28xg	VD19	6g	Tor
<u>AUK</u>	XC6114F648MR	Vdet-IC	4.8V±2%, ±Reset PPO, Wt=1.6s, Rt=400ms	SOT-25	28xg	VD19	6g	Tor
<u>AUL</u>	XC6114F619MR	Vdet-IC	1.9V±2%, ±Reset PPO, Wt=1.6s, Rt=400ms	SOT-25	28xg	VD19	6g	Tor
<u>AUL</u>	XC6114F649MR	Vdet-IC	4.9V±2%, ±Reset PPO, Wt=1.6s, Rt=400ms	SOT-25	28xg	VD19	6g	Tor
<u>AUM</u>	XC6114F620MR	Vdet-IC	2.0V±2%, ±Reset PPO, Wt=1.6s, Rt=400ms	SOT-25	28xg	VD19	6g	Tor
<u>AUM</u>	XC6114F650MR	Vdet-IC	5.0V±2%, ±Reset PPO, Wt=1.6s, Rt=400ms	SOT-25	28xg	VD19	6g	Tor
<u>AUN</u>	XC6114F621MR	Vdet-IC	2.1V±2%, ±Reset PPO, Wt=1.6s, Rt=400ms	SOT-25	28xg	VD19	6g	Tor
<u>AUP</u>	XC6114F622MR	Vdet-IC	2.2V±2%, ±Reset PPO, Wt=1.6s, Rt=400ms	SOT-25	28xg	VD19	6g	Tor
<u>AUR</u>	XC6114F623MR	Vdet-IC	2.3V±2%, ±Reset PPO, Wt=1.6s, Rt=400ms	SOT-25	28xg	VD19	6g	Tor
<u>AUS</u>	AME8530AEEVEFX29	Vdet-IC	2.93V±1.5%, ±Reset PPO -MR	SOT-23-5	28xf	VD21	6k	Ame



SMD code	Type	Function	Short description	Case	Pinout	Sch.	St.Mnf.
ĀUS	AME8530AEEVEFX29Z	Vdet-IC	2.93V±1.5%, ±Reset PPO -MR, lead free	SOT-23-5	28xf	VD21	6k Ame
ĀUS	X06114F624MR	Vdet-IC	2.4V±2%, ±Reset PPO, Wt=1.6s, Rt=400ms	SOT-25	28xg	VD19	6g Tor
ĀUT	X06114F625MR	Vdet-IC	2.5V±2%, ±Reset PPO, Wt=1.6s, Rt=400ms	SOT-25	28xg	VD19	6g Tor
ĀUJ	X06114F626MR	Vdet-IC	2.6V±2%, ±Reset PPO, Wt=1.6s, Rt=400ms	SOT-25	28xg	VD19	6g Tor
ĀUO	X06114F627MR	Vdet-IC	2.7V±2%, ±Reset PPO, Wt=1.6s, Rt=400ms	SOT-25	28xg	VD19	6g Tor
ĀUV	X06114F627MR	Vdet-IC	2.7V±2%, ±Reset PPO, Wt=1.6s, Rt=400ms	SOT-25	28xg	VD19	6g Tor
ĀUX	X06114F628MR	Vdet-IC	2.8V±2%, ±Reset PPO, Wt=1.6s, Rt=400ms	SOT-25	28xg	VD19	6g Tor
ĀUY	X06114F629MR	Vdet-IC	2.9V±2%, ±Reset PPO, Wt=1.6s, Rt=400ms	SOT-25	28xg	VD19	6g Tor
ĀUZ	X06114F630MR	Vdet-IC	3.0V±2%, ±Reset PPO, Wt=1.6s, Rt=400ms	SOT-25	28xg	VD19	6g Tor
ĀVZ	MAX825SEUK	Vdet-IC	2.93V±1.5%, -MR, ±Reset PPO	SOT-23-5	28xf	VD21	6k Max
AV	PT7M7812LTA	Vdet-IC	4.63V±1.5%, +Reset PPO, -MR	SOT-23-5	28vd2	VD5	6k Pti
AV	R1112N291A	LVR-IC	LDO, LN, -CE, 2.9V±2%, 150mA	SOT-23-5	28cx	VR4	6g Rics
AV	SiP825SEU	Vdet-IC	2.93V±1.5%, MR, ±Reset PPO	SOT-23-5	28xf	VD21	6k Vc
ĀV	PT7M7812LTAE	Vdet-IC	4.63V±1.5%, +Reset PPO, -MR, Lead free	SOT-23-5	28vd2	VD5	6k Pti
AV-	RT9013-15PU5	LVR-IC	LDO, 1.5V±2%, 500mA, +CE	SC-70-5	28cx	VR4	6g Rct
ĀV0	X06114H631MR	Vdet-IC	3.1V±2%, ±Reset PPO, Wt=1.6s, Rt=1.6s	SOT-25	28xg	VD19	6g Tor
ĀV1	X06114H632MR	Vdet-IC	3.2V±2%, ±Reset PPO, Wt=1.6s, Rt=1.6s	SOT-25	28xg	VD19	6g Tor
ĀV2	X06114H633MR	Vdet-IC	3.3V±2%, ±Reset PPO, Wt=1.6s, Rt=1.6s	SOT-25	28xg	VD19	6g Tor
ĀV3	X06114H634MR	Vdet-IC	3.4V±2%, ±Reset PPO, Wt=1.6s, Rt=1.6s	SOT-25	28xg	VD19	6g Tor
ĀV4	X06114H635MR	Vdet-IC	3.5V±2%, ±Reset PPO, Wt=1.6s, Rt=1.6s	SOT-25	28xg	VD19	6g Tor
ĀV5	X06114H636MR	Vdet-IC	3.6V±2%, ±Reset PPO, Wt=1.6s, Rt=1.6s	SOT-25	28xg	VD19	6g Tor
ĀV6	X06114H637MR	Vdet-IC	3.7V±2%, ±Reset PPO, Wt=1.6s, Rt=1.6s	SOT-25	28xg	VD19	6g Tor
ĀV7	X06114H638MR	Vdet-IC	3.8V±2%, ±Reset PPO, Wt=1.6s, Rt=1.6s	SOT-25	28xg	VD19	6g Tor
AV8	X06211A092MR	LVR-IC	LDO, 0.9V±2%, 150mA, +CE, PDR	SOT-25	28vc	VR4	6g Tor
ĀV8	X06114H639MR	Vdet-IC	3.9V±2%, ±Reset PPO, Wt=1.6s, Rt=1.6s	SOT-25	28xg	VD19	6g Tor
AV9	X06211A102MR	LVR-IC	LDO, 1V±2%, 150mA, +CE, PDR	SOT-25	28vc	VR4	6g Tor
ĀV9	X06114H640MR	Vdet-IC	4.0V±2%, ±Reset PPO, Wt=1.6s, Rt=1.6s	SOT-25	28xg	VD19	6g Tor
AVA	X06211A112MR	LVR-IC	LDO, 1.1V±2%, 150mA, +CE, PDR	SOT-25	28vc	VR4	6g Tor
ĀVA	X06114H641MR	Vdet-IC	4.1V±2%, ±Reset PPO, Wt=1.6s, Rt=1.6s	SOT-25	28xg	VD19	6g Tor
AVB	X06211A122MR	LVR-IC	LDO, 1.2V±2%, 150mA, +CE, PDR	SOT-25	28vc	VR4	6g Tor
ĀVB	X06114H642MR	Vdet-IC	4.2V±2%, ±Reset PPO, Wt=1.6s, Rt=1.6s	SOT-25	28xg	VD19	6g Tor
AVC	X06211A132MR	LVR-IC	LDO, 1.3V±2%, 150mA, +CE, PDR	SOT-25	28vc	VR4	6g Tor
ĀVC	X06114H643MR	Vdet-IC	4.3V±2%, ±Reset PPO, Wt=1.6s, Rt=1.6s	SOT-25	28xg	VD19	6g Tor
AVD	X06211A142MR	LVR-IC	LDO, 1.4V±2%, 150mA, +CE, PDR	SOT-25	28vc	VR4	6g Tor
ĀVD	X06114H644MR	Vdet-IC	4.4V±2%, ±Reset PPO, Wt=1.6s, Rt=1.6s	SOT-25	28xg	VD19	6g Tor
AVE	AME8530AEEVAFX29	Vdet-IC	2.93V±1.5%, ±Reset PPO, -MR	SOT-23-5	28xf	VD21	6k Ame
AVE	X06211A152MR	LVR-IC	LDO, 1.5V±2%, 150mA, +CE, PDR	SOT-25	28vc	VR4	6g Tor
ĀVE	AME8530AEEVAFX29Z	Vdet-IC	2.93V±1.5%, ±Reset PPO, -MR, lead free	SOT-23-5	28xf	VD21	6k Ame
ĀVE	X06114H645MR	Vdet-IC	4.5V±2%, ±Reset PPO, Wt=1.6s, Rt=1.6s	SOT-25	28xg	VD19	6g Tor
AVF	AME8530AEEVAFX31	Vdet-IC	3.08V±1.5%, ±Reset PPO -MR	SOT-23-5	28xf	VD21	6k Ame
AVF	X06211A162MR	LVR-IC	LDO, 1.6V±2%, 150mA, +CE, PDR	SOT-25	28vc	VR4	6g Tor
ĀVF	AME8530AEEVAFX31Z	Vdet-IC	3.08V±1.5%, ±Reset PPO -MR, lead free	SOT-23-5	28xf	VD21	6k Ame
ĀVF	X06114H616MR	Vdet-IC	1.6V±2%, ±Reset PPO, Wt=1.6s, Rt=1.6s	SOT-25	28xg	VD19	6g Tor
ĀVE	X06114H646MR	Vdet-IC	4.6V±2%, ±Reset PPO, Wt=1.6s, Rt=1.6s	SOT-25	28xg	VD19	6g Tor
AVH	X06211A172MR	LVR-IC	LDO, 1.7V±2%, 150mA, +CE, PDR	SOT-25	28vc	VR4	6g Tor
ĀVH	X06114H617MR	Vdet-IC	1.7V±2%, ±Reset PPO, Wt=1.6s, Rt=1.6s	SOT-25	28xg	VD19	6g Tor
ĀVH	X06114H647MR	Vdet-IC	4.7V±2%, ±Reset PPO, Wt=1.6s, Rt=1.6s	SOT-25	28xg	VD19	6g Tor
AVK	X06211A182MR	LVR-IC	LDO, 1.8V±2%, 240mA, +CE, PDR	SOT-25	28vc	VR4	6g Tor
ĀVK	X06114H618MR	Vdet-IC	1.8V±2%, ±Reset PPO, Wt=1.6s, Rt=1.6s	SOT-25	28xg	VD19	6g Tor
ĀVK	X06114H648MR	Vdet-IC	4.8V±2%, ±Reset PPO, Wt=1.6s, Rt=1.6s	SOT-25	28xg	VD19	6g Tor
AVL	X06211A192MR	LVR-IC	LDO, 1.9V±2%, 240mA, +CE, PDR	SOT-25	28vc	VR4	6g Tor
ĀVL	X06114H619MR	Vdet-IC	1.9V±2%, ±Reset PPO, Wt=1.6s, Rt=1.6s	SOT-25	28xg	VD19	6g Tor
ĀVL	X06114H649MR	Vdet-IC	4.9V±2%, ±Reset PPO, Wt=1.6s, Rt=1.6s	SOT-25	28xg	VD19	6g Tor
AVM	X06211A202MR	LVR-IC	LDO, 2V±2%, 240mA, +CE, PDR	SOT-25	28vc	VR4	6g Tor
ĀVM	X06114H620MR	Vdet-IC	2.0V±2%, ±Reset PPO, Wt=1.6s, Rt=1.6s	SOT-25	28xg	VD19	6g Tor
ĀVM	X06114H650MR	Vdet-IC	5.0V±2%, ±Reset PPO, Wt=1.6s, Rt=1.6s	SOT-25	28xg	VD19	6g Tor
AVN	X06211A212MR	LVR-IC	LDO, 2.1V±2%, 240mA, +CE, PDR	SOT-25	28vc	VR4	6g Tor
ĀVN	X06114H621MR	Vdet-IC	2.1V±2%, ±Reset PPO, Wt=1.6s, Rt=1.6s	SOT-25	28xg	VD19	6g Tor
AVP	X06211A222MR	LVR-IC	LDO, 2.2V±2%, 240mA, +CE, PDR	SOT-25	28vc	VR4	6g Tor
ĀVP	X06114H622MR	Vdet-IC	2.2V±2%, ±Reset PPO, Wt=1.6s, Rt=1.6s	SOT-25	28xg	VD19	6g Tor
AVR	X06211A232MR	LVR-IC	LDO, 2.3V±2%, 240mA, +CE, PDR	SOT-25	28vc	VR4	6g Tor
ĀVR	X06114H623MR	Vdet-IC	2.3V±2%, ±Reset PPO, Wt=1.6s, Rt=1.6s	SOT-25	28xg	VD19	6g Tor
AVS	X06211A242MR	LVR-IC	LDO, 2.4V±2%, 240mA, +CE, PDR	SOT-25	28vc	VR4	6g Tor
ĀVS	X06114H624MR	Vdet-IC	2.4V±2%, ±Reset PPO, Wt=1.6s, Rt=1.6s	SOT-25	28xg	VD19	6g Tor
AVT	X06211A252MR	LVR-IC	LDO, 2.5V±2%, 240mA, +CE, PDR	SOT-25	28vc	VR4	6g Tor
ĀVT	X06114H625MR	Vdet-IC	2.5V±2%, ±Reset PPO, Wt=1.6s, Rt=1.6s	SOT-25	28xg	VD19	6g Tor
AVU	X06211A262MR	LVR-IC	LDO, 2.6V±2%, 240mA, +CE, PDR	SOT-25	28vc	VR4	6g Tor
ĀVU	X06114H626MR	Vdet-IC	2.6V±2%, ±Reset PPO, Wt=1.6s, Rt=1.6s	SOT-25	28xg	VD19	6g Tor
AVV	X06211A272MR	LVR-IC	LDO, 2.7V±2%, 240mA, +CE, PDR	SOT-25	28vc	VR4	6g Tor
ĀVV	X06114H627MR	Vdet-IC	2.7V±2%, ±Reset PPO, Wt=1.6s, Rt=1.6s	SOT-25	28xg	VD19	6g Tor
AVX	X06211A282MR	LVR-IC	LDO, 2.8V±2%, 240mA, +CE, PDR	SOT-25	28vc	VR4	6g Tor



SMD code	Type	Function	Short description	Case	Pinout	Sch.	St.	Mnf.
AVX	XC6114H628MR	Vdet-IC	2.8V±2%, ±Reset PPO, Wt=1.6s, Rt=1.6s	SOT-25	28xg	VD19	6g	Tor
AVY	XC6211A292MR	LVR-IC	LDO, 2.9V±2%, 240mA, +CE, PDR	SOT-25	28vc	VR4	6g	Tor
AVY	XC6114H629MR	Vdet-IC	2.9V±2%, ±Reset PPO, Wt=1.6s, Rt=1.6s	SOT-25	28xg	VD19	6g	Tor
AVZ	XC6211A302MR	LVR-IC	LDO, 3V±2%, 240mA, +CE, PDR	SOT-25	28vc	VR4	6g	Tor
AVZ	XC6114H630MR	Vdet-IC	3.0V±2%, ±Reset PPO, Wt=1.6s, Rt=1.6s	SOT-25	28xg	VD19	6g	Tor
AW	MX825REUK	Vdet-IC	2.63V±1.5%, -MR, ±Reset PPO	SOT-23-5	28xf	VD21	6k	Max
AW	PT7M7812MTA	Vdet-IC	4.38V±1.5%, +Reset PPO, -MR	SOT-23-5	28vd2	VD5	6k	Pti
AW	SiP825REU	Vdet-IC	2.63V±1.5%, MR, ±Reset PPO	SOT-23-5	28xf	VD21	6k	Vs
AW	PT7M7812MTAE	Vdet-IC	4.38V±1.5%, +Reset PPO, -MR, Lead free	SOT-23-5	28vd2	VD5	6k	Pti
AW-	RT9013-18PU5	LVR-IC	LDO, 1.8V±2%, 500mA, +CE	SC-70-5	28cx	VR4	6g	Rct
AWG	AME8861AEEV300	LVR-IC	LDO, 3.0V±1.5%, 600mA, +CE	SOT-25	28vrx	VR7	6k	Ame
AWG	AME8861AEEV300L	LVR-IC	LDO, 3.0V±1.5%, 600mA, +CE	TSOT-25	28vrx	VR7	6k	Ame
AWG	AME8861AEEV300Y	LVR-IC	LDO, 3.0V±1.5%, 600mA, +CE	TSOT-25	28vrx	VR7	6k	Ame
AWG	AME8861AEEV300Z	LVR-IC	LDO, 3.0V±1.5%, 600mA, +CE	SOT-25	28vrx	VR7	6k	Ame
AWS	AME8520AEEVFE22	Vdet-IC	2.19V±1.5%, ±Reset PPO, Strobe	SOT-23-5	28bxq	VD19	6k	Ame
AWS	AME8520AEEVFE22Z	Vdet-IC	2.19V±1.5%, ±Reset PPO, Strobe, lead free	SOT-23-5	28bxq	VD19	6k	Ame
AWW	AME8530AEEVFX26	Vdet-IC	2.63V±1.5%, +Reset PPO -MR	SOT-23-5	28xf	VD21	6k	Ame
AWW	AME8530AEEVFX26Z	Vdet-IC	2.63V±1.5%, ±Reset PPO -MR, lead free	SOT-23-5	28xf	VD21	6k	Ame
AWY	AME8510AEEVAFE22	Vdet-IC	2.19V±1.5%, -Reset PPO, -MR, Strobe	SOT-23-5	28cp	VD17	6k	Ame
AX	AT1201-50X	LVR-IC	LDO, LN, +CE, 5V±2%, 150mA	SOT-23-5	28vrx	VR7	6a	Atr
AX	PT7M7812TTA	Vdet-IC	3.08V±1.5%, +Reset PPO, -MR	SOT-23-5	28vd2	VD5	6k	Pti
AX	SiP825ZEU	Vdet-IC	2.32V±1.5%, MR, ±Reset PPO	SOT-23-5	28xf	VD21	6k	Vs
AX	PT7M7812TTAE	Vdet-IC	3.08V±1.5%, +Reset PPO, -MR, Lead free	SOT-23-5	28vd2	VD5	6k	Pti
AX-	RT9013-25PU5	LVR-IC	LDO, 2.5V±2%, 500mA, +CE	SC-70-5	28cx	VR4	6g	Rct
AX8	XC6211B092MR	LVR-IC	LDO, 0.9V±2%, 150mA, +CE	SOT-25	28vc	VR4	6g	Tor
AX9	XC6211B102MR	LVR-IC	LDO, 1V±2%, 150mA, +CE	SOT-25	28vc	VR4	6g	Tor
AXA	XC6211B112MR	LVR-IC	LDO, 1.1V±2%, 150mA, +CE	SOT-25	28vc	VR4	6g	Tor
AXB	AME8861AEEV330	LVR-IC	LDO, 3.3V±1.5%, 600mA, +CE	SOT-25	28vrx	VR7	6k	Ame
AXB	AME8861AEEV330L	LVR-IC	LDO, 3.3V±1.5%, 600mA, +CE	TSOT-25	28vrx	VR7	6k	Ame
AXB	XC6211B122MR	LVR-IC	LDO, 1.2V±2%, 150mA, +CE	SOT-25	28vc	VR4	6g	Tor
AXB	AME8861AEEV330Y	LVR-IC	LDO, 3.3V±1.5%, 600mA, +CE	TSOT-25	28vrx	VR7	6k	Ame
AXB	AME8861AEEV330Z	LVR-IC	LDO, 3.3V±1.5%, 600mA, +CE	SOT-25	28vrx	VR7	6k	Ame
AXC	AME8861AEEV250	LVR-IC	LDO, 2.5V±1.5%, 600mA, +CE	SOT-25	28vrx	VR7	6k	Ame
AXC	AME8861AEEV250L	LVR-IC	LDO, 2.5V±1.5%, 600mA, +CE	TSOT-25	28vrx	VR7	6k	Ame
AXC	XC6211B132MR	LVR-IC	LDO, 1.3V±2%, 150mA, +CE	SOT-25	28vc	VR4	6g	Tor
AXC	AME8861AEEV250Y	LVR-IC	LDO, 2.5V±1.5%, 600mA, +CE	TSOT-25	28vrx	VR7	6k	Ame
AXC	AME8861AEEV250Z	LVR-IC	LDO, 2.5V±1.5%, 600mA, +CE	SOT-25	28vrx	VR7	6k	Ame
AXD	XC6211B142MR	LVR-IC	LDO, 1.4V±2%, 150mA, +CE	SOT-25	28vc	VR4	6g	Tor
AXE	XC6211B152MR	LVR-IC	LDO, 1.5V±2%, 150mA, +CE	SOT-25	28vc	VR4	6g	Tor
AXF	XC6211B162MR	LVR-IC	LDO, 1.6V±2%, 150mA, +CE	SOT-25	28vc	VR4	6g	Tor
AXH	XC6211B172MR	LVR-IC	LDO, 1.7V±2%, 150mA, +CE	SOT-25	28vc	VR4	6g	Tor
AXK	XC6211B182MR	LVR-IC	LDO, 1.8V±2%, 240mA, +CE	SOT-25	28vc	VR4	6g	Tor
AXL	XC6211B192MR	LVR-IC	LDO, 1.9V±2%, 240mA, +CE	SOT-25	28vc	VR4	6g	Tor
AXM	XC6211B202MR	LVR-IC	LDO, 2V±2%, 240mA, +CE	SOT-25	28vc	VR4	6g	Tor
AXN	XC6211B212MR	LVR-IC	LDO, 2.1V±2%, 240mA, +CE	SOT-25	28vc	VR4	6g	Tor
AXO	AME8550AEEVC190Y	Vdet-IC	1.9V±2%, -Reset PPO	TSOT-25	28za	VD3	6g	Ame
AXO	AME8550AEEVC190Z	Vdet-IC	1.9V±2%, -Reset PPO	SOT-25	28za	VD3	6g	Ame
AXO	AME8550AEEVC190L	Vdet-IC	1.9V±2%, -Reset PPO	SOT-25	28za	VD3	6g	Ame
AXP	AME8550BEEVC190Y	Vdet-IC	1.9V±2%, -Reset PPO	TSOT-25	28vdo	VD3	6g	Ame
AXP	AME8550BEEVC190Z	Vdet-IC	1.9V±2%, -Reset PPO	SOT-25	28vdo	VD3	6g	Ame
AXP	XC6211B222MR	LVR-IC	LDO, 2.2V±2%, 240mA, +CE	SOT-25	28vc	VR4	6g	Tor
AXP	AME8550BEEVC190L	Vdet-IC	1.9V±2%, -Reset PPO	SOT-25	28vdo	VD3	6g	Ame
AXR	AME8550CEEVB210Y	Vdet-IC	2.1V±2%, -Reset ODO	TSOT-25	28vdm	VD6	6g	Ame
AXR	AME8550CEEVB210Z	Vdet-IC	2.1V±2%, -Reset ODO	SOT-25	28vdm	VD6	6g	Ame
AXR	XC6211B232MR	LVR-IC	LDO, 2.3V±2%, 240mA, +CE	SOT-25	28vc	VR4	6g	Tor
AXR	AME8550CEEVB210L	Vdet-IC	2.1V±2%, -Reset ODO	SOT-25	28vdm	VD6	6g	Ame
AXS	AME8550CEEVB220Y	Vdet-IC	2.2V±2%, -Reset ODO	TSOT-25	28vdm	VD6	6g	Ame
AXS	AME8550CEEVB220Z	Vdet-IC	2.2V±2%, -Reset ODO	SOT-25	28vdm	VD6	6g	Ame
AXS	XC6211B242MR	LVR-IC	LDO, 2.4V±2%, 240mA, +CE	SOT-25	28vc	VR4	6g	Tor
AXS	AME8550CEEVB220L	Vdet-IC	2.2V±2%, -Reset ODO	SOT-25	28vdm	VD6	6g	Ame
AXT	XC6211B252MR	LVR-IC	LDO, 2.5V±2%, 240mA, +CE	SOT-25	28vc	VR4	6g	Tor
AXU	AME8550CEEVA240Y	Vdet-IC	2.4V±2%, -Reset PPO	TSOT-25	28vdm	VD7	6g	Ame
AXU	AME8550CEEVA240Z	Vdet-IC	2.4V±2%, -Reset PPO	SOT-25	28vdm	VD1	6g	Ame
AXU	XC6211B262MR	LVR-IC	LDO, 2.6V±2%, 240mA, +CE	SOT-25	28vc	VR4	6g	Tor
AXU	AME8550CEEVA240L	Vdet-IC	2.4V±2%, -Reset PPO	SOT-25	28vdm	VD1	6g	Ame
AXV	XC6211B272MR	LVR-IC	LDO, 2.7V±2%, 240mA, +CE	SOT-25	28vc	VR4	6g	Tor
AXW	AME8550CEEVB240Y	Vdet-IC	2.4V±2%, -Reset ODO	TSOT-25	28vdm	VD6	6g	Ame
AXW	AME8550CEEVB240Z	Vdet-IC	2.4V±2%, -Reset ODO	SOT-25	28vdm	VD6	6g	Ame
AXW	AME8550CEEVB240L	Vdet-IC	2.4V±2%, -Reset ODO	SOT-25	28vdm	VD6	6g	Ame
AXX	AME8550AEEVD240Y	Vdet-IC	2.4V±2%, -Reset ODO	TSOT-25	28za	VD1	6g	Ame



SMD code	Type	Function	Short description	Case	Pinout	Sch.	St.	Mnf.
AXX	AME8550AEEVD240Z	Vdet-IC	2.4V±2%, -Reset ODO	SOT-25	28za	VD1	6g	Ame
AXX	XC6211B282MR	LVR-IC	LDO, 2.8V±2%, 240mA, +CE	SOT-25	28vc	VR4	6g	Tor
ĀXX	AME8550AEEVD240L	Vdet-IC	2.4V±2%, -Reset ODO	SOT-25	28za	VD1	6g	Ame
AXY	AME8550BEEVD240Y	Vdet-IC	2.4V±2%, -Reset ODO	TSOT-25	28vdo	VD1	6g	Ame
AXY	AME8550BEEVD240Z	Vdet-IC	2.4V±2%, -Reset ODO	SOT-25	28vdo	VD1	6g	Ame
AXY	XC6211B292MR	LVR-IC	LDO, 2.9V±2%, 240mA, +CE	SOT-25	28vc	VR4	6g	Tor
ĀXY	AME8550BEEVD240L	Vdet-IC	2.4V±2%, -Reset ODO	SOT-25	28vdo	VD1	6g	Ame
AXZ	XC6211B302MR	LVR-IC	LDO, 3V±2%, 240mA, +CE	SOT-25	28vc	VR4	6g	Tor
AY	PT7M7812STA	Vdet-IC	2.93V±1.5%, +Reset PPO, -MR	SOT-23-5	28vd2	VD5	6k	Pti
AY	SIP825YEU	Vdet-IC	2.19V±1.5%, MR, ±Reset PPO	SOT-23-5	28xf	VD21	6k	Vs
AY	TC1014-1.8VRX	LVR-IC	LDO, 1.8V±2%, 50mA, +CE	SOT-23-5	28vrx	VR7	6g	Mcc
ĀY_	PT7M7812STAE	Vdet-IC	2.93V±1.5%, +Reset PPO, -MR, Lead free	SOT-23-5	28vd2	VD5	6k	Pti
AY-	RT9013-28PU5	LVR-IC	LDO, 2.8V±2%, 500mA, +CE	SC-70-5	28cx	VR4	6g	Rct
AY=	RT9013-28GU5	LVR-IC	LDO, 2.8V±2%, 500mA, +CE	SC-70-5	28cx	VR4	6g	Rct
AY8	XC6211C092MR	LVR-IC	LDO, 0.9V±2%, 150mA, -CE, PDR	SOT-25	28vc	VR4	6g	Tor
AY9	XC6211C102MR	LVR-IC	LDO, 1V±2%, 150mA, -CE, PDR	SOT-25	28vc	VR4	6g	Tor
AYA	AME8550CEEVB250Y	Vdet-IC	2.5V±2%, -Reset ODO	TSOT-25	28vdm	VD6	6g	Ame
AYA	AME8550CEEVB250Z	Vdet-IC	2.5V±2%, -Reset ODO	SOT-25	28vdm	VD6	6g	Ame
AYA	XC6211C112MR	LVR-IC	LDO, 1.1V±2%, 150mA, -CE, PDR	SOT-25	28vc	VR4	6g	Tor
ĀYA	AME8550CEEVB250L	Vdet-IC	2.5V±2%, -Reset ODO	SOT-25	28vdm	VD6	6g	Ame
AYB	XC6211C122MR	LVR-IC	LDO, 1.2V±2%, 150mA, -CE, PDR	SOT-25	28vc	VR4	6g	Tor
AYC	AME8550CEEVB280Y	Vdet-IC	2.8V±2%, -Reset ODO	TSOT-25	28vdm	VD6	6g	Ame
ĀYC	AME8550CEEVB280Z	Vdet-IC	2.8V±2%, -Reset ODO	SOT-25	28vdm	VD6	6g	Ame
AYC	XC6211C132MR	LVR-IC	LDO, 1.3V±2%, 150mA, -CE, PDR	SOT-25	28vc	VR4	6g	Tor
AYC	AME8550CEEVB280L	Vdet-IC	2.8V±2%, -Reset ODO	SOT-25	28vdm	VD6	6g	Ame
AYD	AME8550AEEVC290Y	Vdet-IC	2.9V±2%, -Reset PPO	TSOT-25	28za	VD3	6g	Ame
AYD	AME8550AEEVC290Z	Vdet-IC	2.9V±2%, -Reset PPO	SOT-25	28za	VD3	6g	Ame
AYD	XC6211C142MR	LVR-IC	LDO, 1.4V±2%, 150mA, -CE, PDR	SOT-25	28vc	VR4	6g	Tor
ĀYD	AME8550AEEVC290L	Vdet-IC	2.9V±2%, -Reset PPO	SOT-25	28za	VD3	6g	Ame
AYE	AME8550BEEVC290Y	Vdet-IC	2.9V±2%, -Reset PPO	TSOT-25	28vdo	VD3	6g	Ame
AYE	AME8550BEEVC290Z	Vdet-IC	2.9V±2%, -Reset PPO	SOT-25	28vdo	VD3	6g	Ame
AYE	XC6211C152MR	LVR-IC	LDO, 1.5V±2%, 150mA, -CE, PDR	SOT-25	28vc	VR4	6g	Tor
ĀYE	AME8550BEEVC290L	Vdet-IC	2.9V±2%, -Reset PPO	SOT-25	28vdo	VD3	6g	Ame
AYF	XC6211C162MR	LVR-IC	LDO, 1.6V±2%, 150mA, -CE, PDR	SOT-25	28vc	VR4	6g	Tor
AYG	AME8550CEEVA300Y	Vdet-IC	3.0V±2%, -Reset PPO	TSOT-25	28vdm	VD7	6g	Ame
AYG	AME8550CEEVA300Z	Vdet-IC	3.0V±2%, -Reset PPO	SOT-25	28vdm	VD7	6g	Ame
ĀYG	AME8550CEEVA300L	Vdet-IC	3.0V±2%, -Reset PPO	SOT-25	28vdm	VD7	6g	Ame
AYH	XC6211C172MR	LVR-IC	LDO, 1.7V±2%, 150mA, -CE, PDR	SOT-25	28vc	VR4	6g	Tor
AYI	AME8550CEEVB340Y	Vdet-IC	3.4V±2%, -Reset ODO	TSOT-25	28vdm	VD6	6g	Ame
AYI	AME8550CEEVB340Z	Vdet-IC	3.4V±2%, -Reset ODO	SOT-25	28vdm	VD6	6g	Ame
ĀYI	AME8550CEEVB340L	Vdet-IC	3.4V±2%, -Reset ODO	SOT-25	28vdm	VD6	6g	Ame
AYJ	AME8550AEEVD360Y	Vdet-IC	3.6V±2%, -Reset ODO	TSOT-25	28za	VD1	6g	Ame
AYJ	AME8550AEEVD360Z	Vdet-IC	3.6V±2%, -Reset ODO	SOT-25	28za	VD1	6g	Ame
ĀYJ	AME8550AEEVD360L	Vdet-IC	3.6V±2%, -Reset ODO	SOT-25	28za	VD1	6g	Ame
AYK	AME8550BEEVD360Y	Vdet-IC	3.6V±2%, -Reset ODO	TSOT-25	28vdo	VD1	6g	Ame
AYK	AME8550BEEVD360Z	Vdet-IC	3.6V±2%, -Reset ODO	SOT-25	28vdo	VD1	6g	Ame
AYK	XC6211C182MR	LVR-IC	LDO, 1.8V±2%, 240mA, -CE, PDR	SOT-25	28vc	VR4	6g	Tor
ĀYK	AME8550BEEVD360L	Vdet-IC	3.6V±2%, -Reset ODO	SOT-25	28vdo	VD1	6g	Ame
AYL	XC6211C192MR	LVR-IC	LDO, 1.9V±2%, 240mA, -CE, PDR	SOT-25	28vc	VR4	6g	Tor
AYM	AME8550CEEVB440Y	Vdet-IC	4.4V±2%, -Reset ODO	TSOT-25	28vdm	VD6	6g	Ame
AYM	AME8550CEEVB440Z	Vdet-IC	4.4V±2%, -Reset ODO	SOT-25	28vdm	VD6	6g	Ame
AYM	XC6211C202MR	LVR-IC	LDO, 2V±2%, 240mA, -CE, PDR	SOT-25	28vc	VR4	6g	Tor
ĀYM	AME8550CEEVB440L	Vdet-IC	4.4V±2%, -Reset ODO	SOT-25	28vdm	VD6	6g	Ame
AYN	AME8550AEEVC460Y	Vdet-IC	4.6V±2%, -Reset PPO	TSOT-25	28za	VD3	6g	Ame
AYN	AME8550AEEVC460Z	Vdet-IC	4.6V±2%, -Reset PPO	SOT-25	28za	VD3	6g	Ame
AYN	XC6211C212MR	LVR-IC	LDO, 2.1V±2%, 240mA, -CE, PDR	SOT-25	28vc	VR4	6g	Tor
ĀYN	AME8550AEEVC460L	Vdet-IC	4.6V±2%, -Reset PPO	SOT-25	28za	VD3	6g	Ame
AYO	AME8550BEEVC460Y	Vdet-IC	4.6V±2%, -Reset PPO	TSOT-25	28vdo	VD3	6g	Ame
AYO	AME8550BEEVC460Z	Vdet-IC	4.6V±2%, -Reset PPO	SOT-25	28vdo	VD3	6g	Ame
ĀYO	AME8550BEEVC460L	Vdet-IC	4.6V±2%, -Reset PPO	SOT-25	28vdo	VD3	6g	Ame
AYP	XC6211C222MR	LVR-IC	LDO, 2.2V±2%, 240mA, -CE, PDR	SOT-25	28vc	VR4	6g	Tor
AYR	XC6211C232MR	LVR-IC	LDO, 2.3V±2%, 240mA, -CE, PDR	SOT-25	28vc	VR4	6g	Tor
AYS	AME8550CEEVB270Y	Vdet-IC	2.7V±2%, -Reset ODO	TSOT-25	28vdm	VD6	6g	Ame
AYS	AME8550CEEVB270Z	Vdet-IC	2.7V±2%, -Reset ODO	SOT-25	28vdm	VD6	6g	Ame
AYS	XC6211C242MR	LVR-IC	LDO, 2.4V±2%, 240mA, -CE, PDR	SOT-25	28vc	VR4	6g	Tor
ĀYS	AME8550CEEVB270L	Vdet-IC	2.7V±2%, -Reset ODO	SOT-25	28vdm	VD6	6g	Ame
AYT	AME8550AEEVD230Y	Vdet-IC	2.3V±2%, -Reset ODO	TSOT-25	28za	VD1	6g	Ame
AYT	AME8550AEEVD230Z	Vdet-IC	2.3V±2%, -Reset ODO	SOT-25	28za	VD1	6g	Ame
AYT	XC6211C252MR	LVR-IC	LDO, 2.5V±2%, 240mA, -CE, PDR	SOT-25	28vc	VR4	6g	Tor
ĀYT	AME8550AEEVD230L	Vdet-IC	2.3V±2%, -Reset ODO	SOT-25	28za	VD1	6g	Ame



SMD code	Type	Function	Short description	Case	Pinout	Sch.	St.	Mnf.
AYU	AME8550BEEVD230Y	Vdet-IC	2.3V±2%, -Reset ODO	TSOT-25	28vdo	VD1	6g	Ame
AYU	AME8550BEEVD230Z	Vdet-IC	2.3V±2%, -Reset ODO	SOT-25	28vdo	VD1	6g	Ame
AYU	XC6211C262MR	LVR-IC	LDO, 2.6V±2%, 240mA, -CE, PDR	SOT-25	28vc	VR4	6g	Tor
ĀYU	AME8550BEEVD230L	Vdet-IC	2.3V±2%, -Reset ODO	SOT-25	28vdo	VD1	6g	Ame
AYV	AME8550AEEVD260Y	Vdet-IC	2.6V±2%, -Reset ODO	TSOT-25	28za	VD1	6g	Ame
AYV	AME8550AEEVD260Z	Vdet-IC	2.6V±2%, -Reset ODO	SOT-25	28za	VD1	6g	Ame
AYV	XC6211C272MR	LVR-IC	LDO, 2.7V±2%, 240mA, -CE, PDR	SOT-25	28vc	VR4	6g	Tor
ĀYV	AME8550AEEVD260L	Vdet-IC	2.6V±2%, -Reset ODO	SOT-25	28za	VD1	6g	Ame
AYW	AME8550BEEVD260Y	Vdet-IC	2.6V±2%, -Reset ODO	TSOT-25	28vdo	VD1	6g	Ame
AYW	AME8550BEEVD260Z	Vdet-IC	2.6V±2%, -Reset ODO	SOT-25	28vdo	VD1	6g	Ame
ĀYW	AME8550BEEVD260L	Vdet-IC	2.6V±2%, -Reset ODO	SOT-25	28vdo	VD1	6g	Ame
AYX	AME8550AEEVD270Y	Vdet-IC	2.7V±2%, -Reset ODO	TSOT-25	28za	VD1	6g	Ame
AYX	AME8550AEEVD270Z	Vdet-IC	2.7V±2%, -Reset ODO	SOT-25	28za	VD1	6g	Ame
ĀYX	AME8550AEEVD270L	Vdet-IC	2.7V±2%, -Reset ODO	SOT-25	28vc	VR4	6g	Tor
AYY	AME8550BEEVD270Y	Vdet-IC	2.7V±2%, -Reset ODO	TSOT-25	28vdo	VD1	6g	Ame
AYY	AME8550BEEVD270Z	Vdet-IC	2.7V±2%, -Reset ODO	SOT-25	28vdo	VD1	6g	Ame
ĀYY	AME8550BEEVD270L	Vdet-IC	2.7V±2%, -Reset ODO	SOT-25	28vc	VR4	6g	Tor
AYZ	XC6211C302MR	LVR-IC	LDO, 3V±2%, 240mA, -CE, PDR	SOT-25	28vc	VR4	6g	Tor
AZ	PT7M7812RTA	Vdet-IC	2.63V±1.5%, +Reset PPO, -MR	SOT-23-5	28vd2	VD5	6k	Pti
AZ	TC1014-2.8Vrx	LVR-IC	LDO, 2.8V±2%, 50mA, +CE	SOT-23-5	28vrx	VR7	6g	Mcc
ĀZ	PT7M7812RTAE	Vdet-IC	2.63V±1.5%, +Reset PPO, -MR, Lead free	SOT-23-5	28vd2	VD5	6k	Pti
AZ-	RT9013-30PU5	LVR-IC	LDO, 3.0V±2%, 500mA, +CE	SC-70-5	28cx	VR4	6g	Rct
AZ8	XC6211D092MR	LVR-IC	LDO, 0.9V±2%, 150mA, -CE	SOT-25	28vc	VR4	6g	Tor
AZ9	XC6211D102MR	LVR-IC	LDO, 1V±2%, 150mA, -CE	SOT-25	28vc	VR4	6g	Tor
AZA	XC6211D112MR	LVR-IC	LDO, 1.1V±2%, 150mA, -CE	SOT-25	28vc	VR4	6g	Tor
AZB	XC6211D122MR	LVR-IC	LDO, 1.2V±2%, 150mA, -CE	SOT-25	28vc	VR4	6g	Tor
AZC	XC6211D132MR	LVR-IC	LDO, 1.3V±2%, 150mA, -CE	SOT-25	28vc	VR4	6g	Tor
AZD	XC6211D142MR	LVR-IC	LDO, 1.4V±2%, 150mA, -CE	SOT-25	28vc	VR4	6g	Tor
AZE	XC6211D152MR	LVR-IC	LDO, 1.5V±2%, 150mA, -CE	SOT-25	28vc	VR4	6g	Tor
AZF	AME8550BEEVD190Y	Vdet-IC	1.9V±2%, -Reset ODO	TSOT-25	28vdo	VD1	6g	Ame
ĀZF	AME8550BEEVD190Z	Vdet-IC	1.9V±2%, -Reset ODO	SOT-25	28vdo	VD1	6g	Ame
AZF	XC6211D162MR	LVR-IC	LDO, 1.6V±2%, 150mA, -CE	SOT-25	28vc	VR4	6g	Tor
AZF	AME8550BEEVD190L	Vdet-IC	1.9V±2%, -Reset ODO	SOT-25	28vdo	VD1	6g	Ame
AZH	XC6211D172MR	LVR-IC	LDO, 1.7V±2%, 150mA, -CE	SOT-25	28vc	VR4	6g	Tor
AZK	AME8550AEEVD190Y	Vdet-IC	1.9V±2%, -Reset ODO	TSOT-25	28za	VD1	6g	Ame
ĀZK	AME8550AEEVD190Z	Vdet-IC	1.9V±2%, -Reset ODO	SOT-25	28za	VD1	6g	Ame
AZK	XC6211D182MR	LVR-IC	LDO, 1.8V±2%, 240mA, -CE	SOT-25	28vc	VR4	6g	Tor
AZK	AME8550AEEVD190L	Vdet-IC	1.9V±2%, -Reset ODO	SOT-25	28za	VD1	6g	Ame
AZL	XC6211D192MR	LVR-IC	LDO, 1.9V±2%, 240mA, -CE	SOT-25	28vc	VR4	6g	Tor
AZM	XC6211D202MR	LVR-IC	LDO, 2V±2%, 240mA, -CE	SOT-25	28vc	VR4	6g	Tor
AZN	XC6211D212MR	LVR-IC	LDO, 2.1V±2%, 240mA, -CE	SOT-25	28vc	VR4	6g	Tor
AZP	XC6211D222MR	LVR-IC	LDO, 2.2V±2%, 240mA, -CE	SOT-25	28vc	VR4	6g	Tor
AZR	XC6211D232MR	LVR-IC	LDO, 2.3V±2%, 240mA, -CE	SOT-25	28vc	VR4	6g	Tor
AZS	XC6211D242MR	LVR-IC	LDO, 2.4V±2%, 240mA, -CE	SOT-25	28vc	VR4	6g	Tor
AZT	XC6211D252MR	LVR-IC	LDO, 2.5V±2%, 240mA, -CE	SOT-25	28vc	VR4	6g	Tor
AZU	XC6211D262MR	LVR-IC	LDO, 2.6V±2%, 240mA, -CE	SOT-25	28vc	VR4	6g	Tor
AZV	XC6211D272MR	LVR-IC	LDO, 2.7V±2%, 240mA, -CE	SOT-25	28vc	VR4	6g	Tor
AZX	AME8550BEEVD420Y	Vdet-IC	4.2V±2%, -Reset ODO	TSOT-25	28vdo	VD1	6g	Ame
AZX	AME8550BEEVD420Z	Vdet-IC	4.2V±2%, -Reset ODO	SOT-25	28vdo	VD1	6g	Ame
AZX	XC6211D282MR	LVR-IC	LDO, 2.8V±2%, 240mA, -CE	SOT-25	28vc	VR4	6g	Tor
ĀZX	AME8550BEEVD420L	Vdet-IC	4.2V±2%, -Reset ODO	SOT-25	28vdo	VD1	6g	Ame
AZY	XC6211D292MR	LVR-IC	LDO, 2.9V±2%, 240mA, -CE	SOT-25	28vc	VR4	6g	Tor
AZZ	XC6211D302MR	LVR-IC	LDO, 3V±2%, 240mA, -CE	SOT-25	28vc	VR4	6g	Tor
B0	PI74STX1G00CX	CMOS-Logic	2-input NAND gate	SC-70-5	28/Log1	-	6a	Per
B0	PI74STX1G00TX	CMOS-Logic	2-input NAND gate	SOT-23-5	28/Log1	-	6a	Per
B0	R1111N301A	LVR-IC	LDO, LN, -CE, 3V±2%, 200mA	SOT-23-5	28cx	VR4	6g	Ric
B0	TC1015-4.0Vrx	LVR-IC	LDO, 4V±2%, 100mA, +CE	SOT-23-5	28vrx	VR7	6g	Mcc
B0	RN5VD10AA	Vdet-IC	1.0V±2.5%, -Reset PPO	SOT-23-5	28vdo	VD3	6g	Ric
B0-	RT9013-31PU5	LVR-IC	LDO, 3.1V±2%, 500mA, +CE	SC-70-5	28cx	VR4	6g	Rct
B00	R1152N100B	LVR-IC	Boost, +CE, 10V±2%, 150mA	SOT-23-5	28vrf	VR6	6g	Ric
B00	XC6115A131MR	Vdet-IC	3.1V±2%, +Rst PPO, -Rst Odo, Wt=6.25ms, Rt=3.13ms	SOT-25	28gx	VD20	6g	Ric
B001	R3117Q072C	Vdet-IC	0.7V±15mV, -Reset PPO, Sense	SC-88A	28rs	VD12	6m	Ric
B002	R3117Q082C	Vdet-IC	0.8V±15mV, -Reset PPO, Sense	SC-88A	28rs	VD12	6m	Ric
B003	R3117Q092C	Vdet-IC	0.9V±15mV, -Reset PPO, Sense	SC-88A	28rs	VD12	6m	Ric
B004	R3117Q102C	Vdet-IC	1.0V±15mV, -Reset PPO, Sense	SC-88A	28rs	VD12	6m	Ric
B005	R3117Q112C	Vdet-IC	1.1V±15mV, -Reset PPO, Sense	SC-88A	28rs	VD12	6m	Ric
B006	R3117Q122C	Vdet-IC	1.2V±1%, -Reset PPO, Sense	SC-88A	28rs	VD12	6m	Ric
B007	R3117Q132C	Vdet-IC	1.3V±1%, -Reset PPO, Sense	SC-88A	28rs	VD12	6m	Ric



SMD code	Type	Function	Short description	Case	Pinout	Sch.	St.Mnf.
B008	R3117Q142C	Vdet-IC	1.4V±1%, -Reset PPO, Sense	SC-88A	28rs	VD12	6m Ric
B009	R3117Q152C	Vdet-IC	1.5V±1%, -Reset PPO, Sense	SC-88A	28rs	VD12	6m Ric
B01	R1152N101B	LVR-IC	Boost, +CE, 10.1V±2%, 150mA	SOT-23-5	28vrf	VR6	6g Ric
B01	XC6115A132MR	Vdet-IC	3.2V±2%, +Rst PPO, -Rst ODO, Wt=6.25ms, Rt=3.13ms	SOT-25	28xg	VD20	6g Tor
B010	R3117Q162C	Vdet-IC	1.6V±1%, -Reset PPO, Sense	SC-88A	28rs	VD12	6m Ric
B011	R3117Q172C	Vdet-IC	1.7V±1%, -Reset PPO, Sense	SC-88A	28rs	VD12	6m Ric
B012	R3117Q182C	Vdet-IC	1.8V±1%, -Reset PPO, Sense	SC-88A	28rs	VD12	6m Ric
B013	R3117Q192C	Vdet-IC	1.9V±1%, -Reset PPO, Sense	SC-88A	28rs	VD12	6m Ric
B014	R3117Q202C	Vdet-IC	2.0V±1%, -Reset PPO, Sense	SC-88A	28rs	VD12	6m Ric
B015	R3117Q212C	Vdet-IC	2.1V±1%, -Reset PPO, Sense	SC-88A	28rs	VD12	6m Ric
B016	R3117Q222C	Vdet-IC	2.2V±1%, -Reset PPO, Sense	SC-88A	28rs	VD12	6m Ric
B017	R3117Q232C	Vdet-IC	2.3V±1%, -Reset PPO, Sense	SC-88A	28rs	VD12	6m Ric
B018	R3117Q242C	Vdet-IC	2.4V±1%, -Reset PPO, Sense	SC-88A	28rs	VD12	6m Ric
B019	R3117Q252C	Vdet-IC	2.5V±1%, -Reset PPO, Sense	SC-88A	28rs	VD12	6m Ric
B02	R1152N102B	LVR-IC	Boost, +CE, 10.2V±2%, 150mA	SOT-23-5	28vrf	VR6	6g Ric
B02	XC6115A133MR	Vdet-IC	3.3V±2%, +Rst PPO, -Rst ODO, Wt=6.25ms, Rt=3.13ms	SOT-25	28xg	VD20	6g Tor
B020	R3117Q262C	Vdet-IC	2.6V±1%, -Reset PPO, Sense	SC-88A	28rs	VD12	6m Ric
B021	R3117Q272C	Vdet-IC	2.7V±1%, -Reset PPO, Sense	SC-88A	28rs	VD12	6m Ric
B022	R3117Q282C	Vdet-IC	2.8V±1%, -Reset PPO, Sense	SC-88A	28rs	VD12	6m Ric
B023	R3117Q292C	Vdet-IC	2.9V±1%, -Reset PPO, Sense	SC-88A	28rs	VD12	6m Ric
B024	R3117Q302C	Vdet-IC	3.0V±1%, -Reset PPO, Sense	SC-88A	28rs	VD12	6m Ric
B025	R3117Q312C	Vdet-IC	3.1V±1%, -Reset PPO, Sense	SC-88A	28rs	VD12	6m Ric
B026	R3117Q322C	Vdet-IC	3.2V±1%, -Reset PPO, Sense	SC-88A	28rs	VD12	6m Ric
B027	R3117Q332C	Vdet-IC	3.3V±1%, -Reset PPO, Sense	SC-88A	28rs	VD12	6m Ric
B028	R3117Q342C	Vdet-IC	3.4V±1%, -Reset PPO, Sense	SC-88A	28rs	VD12	6m Ric
B029	R3117Q352C	Vdet-IC	3.5V±1%, -Reset PPO, Sense	SC-88A	28rs	VD12	6m Ric
B03	R1152N103B	LVR-IC	Boost, +CE, 10.3V±2%, 150mA	SOT-23-5	28vrf	VR6	6g Ric
B03	XC6115A134MR	Vdet-IC	3.4V±2%, +Rst PPO, -Rst ODO, Wt=6.25ms, Rt=3.13ms	SOT-25	28xg	VD20	6g Tor
B030	R3117Q362C	Vdet-IC	3.6V±1%, -Reset PPO, Sense	SC-88A	28rs	VD12	6m Ric
B031	R3117Q372C	Vdet-IC	3.7V±1%, -Reset PPO, Sense	SC-88A	28rs	VD12	6m Ric
B032	R3117Q382C	Vdet-IC	3.8V±1%, -Reset PPO, Sense	SC-88A	28rs	VD12	6m Ric
B033	R3117Q392C	Vdet-IC	3.9V±1%, -Reset PPO, Sense	SC-88A	28rs	VD12	6m Ric
B034	R3117Q402C	Vdet-IC	4.0V±1%, -Reset PPO, Sense	SC-88A	28rs	VD12	6m Ric
B035	R3117Q412C	Vdet-IC	4.1V±1%, -Reset PPO, Sense	SC-88A	28rs	VD12	6m Ric
B036	R3117Q422C	Vdet-IC	4.2V±1%, -Reset PPO, Sense	SC-88A	28rs	VD12	6m Ric
B037	R3117Q432C	Vdet-IC	4.3V±1%, -Reset PPO, Sense	SC-88A	28rs	VD12	6m Ric
B038	R3117Q442C	Vdet-IC	4.4V±1%, -Reset PPO, Sense	SC-88A	28rs	VD12	6m Ric
B039	R3117Q452C	Vdet-IC	4.5V±1%, -Reset PPO, Sense	SC-88A	28rs	VD12	6m Ric
B04	R1152N104B	LVR-IC	Boost, +CE, 10.4V±2%, 150mA	SOT-23-5	28vrf	VR6	6g Ric
B04	XC6115A135MR	Vdet-IC	3.5V±2%, +Rst PPO, -Rst ODO, Wt=6.25ms, Rt=3.13ms	SOT-25	28xg	VD20	6g Tor
B040	R3117Q462C	Vdet-IC	4.6V±1%, -Reset PPO, Sense	SC-88A	28rs	VD12	6m Ric
B041	R3117Q472C	Vdet-IC	4.7V±1%, -Reset PPO, Sense	SC-88A	28rs	VD12	6m Ric
B042	R3117Q482C	Vdet-IC	4.8V±1%, -Reset PPO, Sense	SC-88A	28rs	VD12	6m Ric
B043	R3117Q492C	Vdet-IC	4.9V±1%, -Reset PPO, Sense	SC-88A	28rs	VD12	6m Ric
B044	R3117Q502C	Vdet-IC	5.0V±1%, -Reset PPO, Sense	SC-88A	28rs	VD12	6m Ric
B05	R1152N105B	LVR-IC	Boost, +CE, 10.5V±2%, 150mA	SOT-23-5	28vrf	VR6	6g Ric
B05	XC6115A136MR	Vdet-IC	3.6V±2%, +Rst PPO, -Rst ODO, Wt=6.25ms, Rt=3.13ms	SOT-25	28xg	VD20	6g Tor
B06	R1152N106B	LVR-IC	Boost, +CE, 10.6V±2%, 150mA	SOT-23-5	28vrf	VR6	6g Ric
B06	XC6115A137MR	Vdet-IC	3.7V±2%, +Rst PPO, -Rst ODO, Wt=6.25ms, Rt=3.13ms	SOT-25	28xg	VD20	6g Tor
B07	R1152N107B	LVR-IC	Boost, +CE, 10.7V±2%, 150mA	SOT-23-5	28vrf	VR6	6g Ric
B07	XC6115A138MR	Vdet-IC	3.8V±2%, +Rst PPO, -Rst ODO, Wt=6.25ms, Rt=3.13ms	SOT-25	28xg	VD20	6g Tor
B08	R1152N108B	LVR-IC	Boost, +CE, 10.8V±2%, 150mA	SOT-23-5	28vrf	VR6	6g Ric
B08	RP110N081C	LVR-IC	LDO, 0.8V±1%, 150mA	SOT-23-5	28ym	VR1	6g Ric
B08	XC6115A139MR	Vdet-IC	3.9V±2%, +Rst PPO, -Rst ODO, Wt=6.25ms, Rt=3.13ms	SOT-25	28xg	VD20	6g Tor
B08	SN74AHC1G08DBV	CMOS-Logic	2-input AND gate	SOT-23-5	28/Log3	-	6a TI
B09	R1152N109B	LVR-IC	Boost, +CE, 10.9V±2%, 150mA	SOT-23-5	28vrf	VR6	6g Ric
B09	RP110N091C	LVR-IC	LDO, 0.9V±1%, 150mA	SOT-23-5	28ym	VR1	6g Ric
B09	XC6115A140MR	Vdet-IC	4.0V±2%, +Rst PPO, -Rst ODO, Wt=6.25ms, Rt=3.13ms	SOT-25	28xg	VD20	6g Tor
B0A	R3114N071A	Vdet-IC	0.7V±0.8%, -Reset ODO	SOT-23-5	28vdm	VD6	6g Ric
B0A	XC6108C10AMR	Vdet-IC	1.0V±2%, Hysteresis, -Reset PPO	SOT-25	28rm	VD15	6g Tor
B0A	XC6115A141MR	Vdet-IC	4.1V±2%, +Rst PPO, -Rst ODO, Wt=6.25ms, Rt=3.13ms	SOT-25	28xg	VD20	6g Tor
B0B	R3114N081A	Vdet-IC	0.8V±0.8%, -Reset ODO	SOT-23-5	28vdm	VD6	6g Ric
B0B	XC6108C10BMR	Vdet-IC	1.0V±2%, -Reset PPO	SOT-25	28rm	VD15	6g Tor
B0B	XC6115A142MR	Vdet-IC	4.2V±2%, +Rst PPO, -Rst ODO, Wt=6.25ms, Rt=3.13ms	SOT-25	28xg	VD20	6g Tor
B0C	R3114N091A	Vdet-IC	0.9V±0.8%, -Reset ODO	SOT-23-5	28vdm	VD6	6g Ric
B0C	XC6108C10CMR	Vdet-IC	1.0V±2%, Hysteresis, -Reset PPO	SOT-25	28rk	VD15	6g Tor
B0C	XC6115A143MR	Vdet-IC	4.3V±2%, +Rst PPO, -Rst ODO, Wt=6.25ms, Rt=3.13ms	SOT-25	28xg	VD20	6g Tor
B0D	R3114N101A	Vdet-IC	1.0V±0.8%, -Reset ODO	SOT-23-5	28vdm	VD6	6g Ric
B0D	XC6108C10DMR	Vdet-IC	1.0V±2%, -Reset PPO	SOT-25	28rk	VD15	6g Tor
B0D	XC6115A144MR	Vdet-IC	4.4V±2%, +Rst PPO, -Rst ODO, Wt=6.25ms, Rt=3.13ms	SOT-25	28xg	VD20	6g Tor



SMD code	Type	Function	Short description	Case	Pinout	Sch.	St.	Mnf.
B0E	R3114N111A	Vdet-IC	1.1V±0.8%, -Reset ODO	SOT-23-5	28vdm	VD6	6g	Ric
B0E	XC6115A145MR	Vdet-IC	4.5V±2%, +Rst PPO, -Rst ODO, Wt=6.25ms, Rt=3.13ms	SOT-25	28xg	VD20	6g	Tor
B0F	R3114N121A	Vdet-IC	1.2V±0.8%, -Reset ODO	SOT-23-5	28vdm	VD6	6g	Ric
B0F	XC6115A116MR	Vdet-IC	1.6V±2%, +Rst PPO, -Rst ODO, Wt=6.25ms, Rt=3.13ms	SOT-25	28xg	VD20	6g	Tor
B0E	XC6115A146MR	Vdet-IC	4.6V±2%, +Rst PPO, -Rst ODO, Wt=6.25ms, Rt=3.13ms	SOT-25	28xg	VD20	6g	Tor
B0G	R3114N131A	Vdet-IC	1.3V±0.8%, -Reset ODO	SOT-23-5	28vdm	VD6	6g	Ric
B0H	R3114N141A	Vdet-IC	1.4V±0.8%, -Reset ODO	SOT-23-5	28vdm	VD6	6g	Ric
B0H	XC6115A117MR	Vdet-IC	1.7V±2%, +Rst PPO, -Rst ODO, Wt=6.25ms, Rt=3.13ms	SOT-25	28xg	VD20	6g	Tor
B0H	XC6115A147MR	Vdet-IC	4.7V±2%, +Rst PPO, -Rst ODO, Wt=6.25ms, Rt=3.13ms	SOT-25	28xg	VD20	6g	Tor
B0J	R3114N151A	Vdet-IC	1.5V±0.8%, -Reset ODO	SOT-23-5	28vdm	VD6	6g	Ric
B0K	R3114N161A	Vdet-IC	1.6V±0.8%, -Reset ODO	SOT-23-5	28vdm	VD6	6g	Ric
B0K	XC6115A118MR	Vdet-IC	1.8V±2%, +Rst PPO, -Rst ODO, Wt=6.25ms, Rt=3.13ms	SOT-25	28xg	VD20	6g	Tor
B0K	XC6115A148MR	Vdet-IC	4.8V±2%, +Rst PPO, -Rst ODO, Wt=6.25ms, Rt=3.13ms	SOT-25	28xg	VD20	6g	Tor
B0L	R3114N171A	Vdet-IC	1.7V±0.8%, -Reset ODO	SOT-23-5	28vdm	VD6	6g	Ric
B0L	XC6115A119MR	Vdet-IC	1.9V±2%, +Rst PPO, -Rst ODO, Wt=6.25ms, Rt=3.13ms	SOT-25	28xg	VD20	6g	Tor
B0L	XC6115A149MR	Vdet-IC	4.9V±2%, +Rst PPO, -Rst ODO, Wt=6.25ms, Rt=3.13ms	SOT-25	28xg	VD20	6g	Tor
B0M	R3114N181A	Vdet-IC	1.8V±0.8%, -Reset ODO	SOT-23-5	28vdm	VD6	6g	Ric
B0M	XC6115A120MR	Vdet-IC	2.0V±2%, +Rst PPO, -Rst ODO, Wt=6.25ms, Rt=3.13ms	SOT-25	28xg	VD20	6g	Tor
B0M	XC6115A150MR	Vdet-IC	5.0V±2%, +Rst PPO, -Rst ODO, Wt=6.25ms, Rt=3.13ms	SOT-25	28xg	VD20	6g	Tor
B0N	R3114N191A	Vdet-IC	1.9V±0.8%, -Reset ODO	SOT-23-5	28vdm	VD6	6g	Ric
B0N	XC6115A121MR	Vdet-IC	2.1V±2%, +Rst PPO, -Rst ODO, Wt=6.25ms, Rt=3.13ms	SOT-25	28xg	VD20	6g	Tor
B0P	R3114N201A	Vdet-IC	2.0V±0.8%, -Reset ODO	SOT-23-5	28vdm	VD6	6g	Ric
B0P	XC6115A122MR	Vdet-IC	2.2V±2%, +Rst PPO, -Rst ODO, Wt=6.25ms, Rt=3.13ms	SOT-25	28xg	VD20	6g	Tor
B0Q	R3114N211A	Vdet-IC	2.1V±0.8%, -Reset ODO	SOT-23-5	28vdm	VD6	6g	Ric
B0R	R3114N221A	Vdet-IC	2.2V±0.8%, -Reset ODO	SOT-23-5	28vdm	VD6	6g	Ric
B0R	XC6115A123MR	Vdet-IC	2.3V±2%, +Rst PPO, -Rst ODO, Wt=6.25ms, Rt=3.13ms	SOT-25	28xg	VD20	6g	Tor
B0S	R3114N231A	Vdet-IC	2.3V±0.8%, -Reset ODO	SOT-23-5	28vdm	VD6	6g	Ric
B0S	XC6115A124MR	Vdet-IC	2.4V±2%, +Rst PPO, -Rst ODO, Wt=6.25ms, Rt=3.13ms	SOT-25	28xg	VD20	6g	Tor
B0T	R3114N241A	Vdet-IC	2.4V±0.8%, -Reset ODO	SOT-23-5	28vdm	VD6	6g	Ric
B0T	XC6115A125MR	Vdet-IC	2.5V±2%, +Rst PPO, -Rst ODO, Wt=6.25ms, Rt=3.13ms	SOT-25	28xg	VD20	6g	Tor
B0U	R3114N251A	Vdet-IC	2.5V±0.8%, -Reset ODO	SOT-23-5	28vdm	VD6	6g	Ric
B0U	XC6115A126MR	Vdet-IC	2.6V±2%, +Rst PPO, -Rst ODO, Wt=6.25ms, Rt=3.13ms	SOT-25	28xg	VD20	6g	Tor
B0V	R3114N261A	Vdet-IC	2.6V±0.8%, -Reset ODO	SOT-23-5	28vdm	VD6	6g	Ric
B0V	XC6115A127MR	Vdet-IC	2.7V±2%, +Rst PPO, -Rst ODO, Wt=6.25ms, Rt=3.13ms	SOT-25	28xg	VD20	6g	Tor
B0W	R3114N271A	Vdet-IC	2.7V±0.8%, -Reset ODO	SOT-23-5	28vdm	VD6	6g	Ric
B0X	R3114N281A	Vdet-IC	2.8V±0.8%, -Reset ODO	SOT-23-5	28vdm	VD6	6g	Ric
B0X	XC6115A128MR	Vdet-IC	2.8V±2%, +Rst PPO, -Rst ODO, Wt=6.25ms, Rt=3.13ms	SOT-25	28xg	VD20	6g	Tor
B0Y	R3114N291A	Vdet-IC	2.9V±0.8%, -Reset ODO	SOT-23-5	28vdm	VD6	6g	Ric
B0Y	XC6115A129MR	Vdet-IC	2.9V±2%, +Rst PPO, -Rst ODO, Wt=6.25ms, Rt=3.13ms	SOT-25	28xg	VD20	6g	Tor
B0Z	R3114N301A	Vdet-IC	3V±0.8%, -Reset ODO	SOT-23-5	28vdm	VD6	6g	Ric
B0Z	XC6115A130MR	Vdet-IC	3.0V±2%, +Rst PPO, -Rst ODO, Wt=6.25ms, Rt=3.13ms	SOT-25	28xg	VD20	6g	Tor
B1	BD4745G	Vdet-IC	4.5V, -Reset ODO	SMP5	28v dq	VD6	6a	Rhm
B1	R1111N311A	LVR-IC	LDO, LN, -CE, 3.1V±2%, 200mA	SOT-23-5	28cx	VR4	6g	Ric
B1	TC1015-2.5VRX	LVR-IC	LDO, 2.5V±2%, 100mA, +CE	SOT-23-5	28vrx	VR7	6g	Mcc
B1	RN5VD11AA	Vdet-IC	1.1V±2.5%, -Reset PPO	SOT-23-5	28vdo	VD3	6g	Ric
B1-	RT9013-33PU5	LVR-IC	LDO, 3.3V±2%, 500mA, +CE	SC-70-5	28cx	VR4	6g	Rct
B10	MIC6270BM5	Comp-IC	Precision, 2.63V, Vofs=$\pm 3mV$, Icco=300μA	SOT-23-5	28opa	OP1	6g	Mcr
B10	R1152N110B	LVR-IC	Boost, +CE, 11V±2%, 150mA	SOT-23-5	28vrf	VR6	6g	Ric
B10	RP110N101C	LVR-IC	LDO, 1.0V±1%, 150mA	SOT-23-5	28ym	VR1	6g	Ric
B10	XC6115A231MR	Vdet-IC	3.1V±2%, +Rst PPO, -Rst ODO, Wt=50ms, Rt=3.13ms	SOT-25	28xg	VD20	6g	Tor
B11	AIC1747-11GJ5	LVR-IC	LDO, 1.1V±2%, 300mA, +CE	SC-70-5	28vrx	VR7	6a	Aic
B11	R1152N111B	LVR-IC	Boost, +CE, 11.1V±2%, 150mA	SOT-23-5	28vrf	VR6	6g	Ric
B11	RP110N111C	LVR-IC	LDO, 1.1V±1%, 150mA	SOT-23-5	28ym	VR1	6g	Ric
B11	XC6115A232MR	Vdet-IC	3.2V±2%, +Rst PPO, -Rst ODO, Wt=50ms, Rt=3.13ms	SOT-25	28xg	VD20	6g	Tor
B110	XC6365B101MR	DC/DC-IC	PWM st-down, 100kHz, Adj. 1.5-6V±2.5%, 1A, +CE	SOT-25	28zn	DC18	6g	Tor
B12	AIC1747-12GJ5	LVR-IC	LDO, 1.2V±2%, 300mA, +CE	SC-70-5	28vrx	VR7	6a	Aic
B12	R1152N112B	LVR-IC	Boost, +CE, 11.2V±2%, 150mA	SOT-23-5	28vrf	VR6	6g	Ric
B12	RP110N121C	LVR-IC	LDO, 1.2V±1%, 150mA	SOT-23-5	28ym	VR1	6g	Ric
B12	XC6115A233MR	Vdet-IC	3.3V±2%, +Rst PPO, -Rst ODO, Wt=50ms, Rt=3.13ms	SOT-25	28xg	VD20	6g	Tor
B13	AIC1747-13GJ5	LVR-IC	LDO, 1.3V±2%, 300mA, +CE	SC-70-5	28vrx	VR7	6a	Aic
B13	R1152N113B	LVR-IC	Boost, +CE, 11.3V±2%, 150mA	SOT-23-5	28vrf	VR6	6g	Ric
B13	RP110N131C	LVR-IC	LDO, 1.3V±1%, 150mA	SOT-23-5	28ym	VR1	6g	Ric
B13	XC6115A234MR	Vdet-IC	3.4V±2%, +Rst PPO, -Rst ODO, Wt=50ms, Rt=3.13ms	SOT-25	28xg	VD20	6g	Tor
B14	R1152N114B	LVR-IC	Boost, +CE, 11.4V±2%, 150mA	SOT-23-5	28vrf	VR6	6g	Ric
B14	RP110N141C	LVR-IC	LDO, 1.4V±1%, 150mA	SOT-23-5	28ym	VR1	6g	Ric
B14	XC6115A235MR	Vdet-IC	3.5V±2%, +Rst PPO, -Rst ODO, Wt=50ms, Rt=3.13ms	SOT-25	28xg	VD20	6g	Tor
B15	AIC1747-15GJ5	LVR-IC	LDO, 1.5V±2%, 300mA, +CE	SC-70-5	28vrx	VR7	6a	Aic
B15	R1152N115B	LVR-IC	Boost, +CE, 11.5V±2%, 150mA	SOT-23-5	28vrf	VR6	6g	Ric
B15	RP110N151C	LVR-IC	LDO, 1.5V±1%, 150mA	SOT-23-5	28ym	VR1	6g	Ric
B15	XC6115A236MR	Vdet-IC	3.6V±2%, +Rst PPO, -Rst ODO, Wt=50ms, Rt=3.13ms	SOT-25	28xg	VD20	6g	Tor



SMD code	Type	Function	Short description	Case	Pinout	Sch.	St.	Mnf.
B16	R1152N116B	LVR-IC	Boost, +CE, 11.6V±2%, 150mA	SOT-23-5	28vrf	VR6	6g	Ric
B16	RP110N161C	LVR-IC	LDO, 1.6V±1%, 150mA	SOT-23-5	28ym	VR1	6g	Gic
B16	XC6115A237MR	Vdet-IC	3.7V±2%, +Rst PPO, -Rst ODO, Wt=50ms, Rt=3.13ms	SOT-25	28xg	VD20	6g	Tor
B17	R1152N117B	LVR-IC	Boost, +CE, 11.7V±2%, 150mA	SOT-23-5	28vrf	VR6	6g	Ric
B17	RP110N171C	LVR-IC	LDO, 1.7V±1%, 150mA	SOT-23-5	28ym	VR1	6g	Ric
B17	XC6115A238MR	Vdet-IC	3.8V±2%, +Rst PPO, -Rst ODO, Wt=50ms, Rt=3.13ms	SOT-25	28xg	VD20	6g	Tor
B18	AIC1747-18GJ5	LVR-IC	LDO, 1.8V±2%, 300mA, -CE	SC-70-5	28vrx	VR7	6a	Aic
B18	R1152N118B	LVR-IC	Boost, +CE, 11.8V±2%, 150mA	SOT-23-5	28vrf	VR6	6g	Ric
B18	RP110N181C	LVR-IC	LDO, 1.8V±1%, 150mA	SOT-23-5	28ym	VR1	6g	Ric
B18	XC6115A239MR	Vdet-IC	3.9V±2%, +Rst PPO, -Rst ODO, Wt=50ms, Rt=3.13ms	SOT-25	28xg	VD20	6g	Tor
B19	R1152N119B	LVR-IC	Boost, +CE, 11.9V±2%, 150mA	SOT-23-5	28vrf	VR6	6g	Ric
B19	RP110N191C	LVR-IC	LDO, 1.9V±1%, 150mA	SOT-23-5	28ym	VR1	6g	Ric
B19	XC6115A240MR	Vdet-IC	4.0V±2%, +Rst PPO, -Rst ODO, Wt=50ms, Rt=3.13ms	SOT-25	28xg	VD20	6g	Tor
B1A	R3114N071C	Vdet-IC	0.7V±0.8%, -Reset PPO	SOT-23-5	28vdm	VD7	6g	Ric
B1A	XC6108C11AMR	Vdet-IC	1.1V±2%, Hysteresis, -Reset PPO	SOT-25	28rm	VD15	6g	Tor
B1A	XC6115A241MR	Vdet-IC	4.1V±2%, +Rst PPO, -Rst ODO, Wt=50ms, Rt=3.13ms	SOT-25	28xg	VD20	6g	Tor
B1B	R3114N081C	Vdet-IC	0.8V±0.8%, -Reset PPO	SOT-23-5	28vdm	VD7	6g	Ric
B1B	XC6108C11BMR	Vdet-IC	1.1V±2%, -Reset PPO	SOT-25	28rm	VD15	6g	Tor
B1B	XC6115A242MR	Vdet-IC	4.2V±2%, +Rst PPO, -Rst ODO, Wt=50ms, Rt=3.13ms	SOT-25	28xg	VD20	6g	Tor
B1C	R3114N091C	Vdet-IC	0.9V±0.8%, -Reset PPO	SOT-23-5	28vdm	VD7	6g	Ric
B1C	XC6108C11CMR	Vdet-IC	1.1V±2%, Hysteresis, -Reset PPO	SOT-25	28rk	VD15	6g	Tor
B1C	XC6115A243MR	Vdet-IC	4.3V±2%, +Rst PPO, -Rst ODO, Wt=50ms, Rt=3.13ms	SOT-25	28xg	VD20	6g	Tor
B1D	R3114N101C	Vdet-IC	1.0V±0.8%, -Reset PPO	SOT-23-5	28vdm	VD7	6g	Ric
B1D	XC6108C11DMR	Vdet-IC	1.1V±2%, -Reset PPO	SOT-25	28rk	VD15	6g	Tor
B1D	XC6115A244MR	Vdet-IC	4.4V±2%, +Rst PPO, -Rst ODO, Wt=50ms, Rt=3.13ms	SOT-25	28xg	VD20	6g	Tor
B1E	R3114N111C	Vdet-IC	1.1V±0.8%, -Reset PPO	SOT-23-5	28vdm	VD7	6g	Ric
B1E	XC6115A245MR	Vdet-IC	4.5V±2%, +Rst PPO, -Rst ODO, Wt=50ms, Rt=3.13ms	SOT-25	28xg	VD20	6g	Tor
B1F	R3114N121C	Vdet-IC	1.2V±0.8%, -Reset PPO	SOT-23-5	28vdm	VD7	6g	Ric
B1F	XC6115A216MR	Vdet-IC	1.6V±2%, +Rst PPO, -Rst ODO, Wt=50ms, Rt=3.13ms	SOT-25	28xg	VD20	6g	Tor
B1F	XC6115A246MR	Vdet-IC	4.6V±2%, +Rst PPO, -Rst ODO, Wt=50ms, Rt=3.13ms	SOT-25	28xg	VD20	6g	Tor
B1G	R3114N131C	Vdet-IC	1.3V±0.8%, -Reset PPO	SOT-23-5	28vdm	VD7	6g	Ric
B1H	R3114N141C	Vdet-IC	1.4V±0.8%, -Reset PPO	SOT-23-5	28vdm	VD7	6g	Ric
B1H	XC6115A217MR	Vdet-IC	1.7V±2%, +Rst PPO, -Rst ODO, Wt=50ms, Rt=3.13ms	SOT-25	28xg	VD20	6g	Tor
B1H	XC6115A247MR	Vdet-IC	4.7V±2%, +Rst PPO, -Rst ODO, Wt=50ms, Rt=3.13ms	SOT-25	28xg	VD20	6g	Tor
B1J	R3114N151C	Vdet-IC	1.5V±0.8%, -Reset PPO	SOT-23-5	28vdm	VD7	6g	Ric
B1K	R3114N161C	Vdet-IC	1.6V±0.8%, -Reset PPO	SOT-23-5	28vdm	VD7	6g	Ric
B1K	XC6115A218MR	Vdet-IC	1.8V±2%, +Rst PPO, -Rst ODO, Wt=50ms, Rt=3.13ms	SOT-25	28xg	VD20	6g	Tor
B1K	XC6115A248MR	Vdet-IC	4.8V±2%, +Rst PPO, -Rst ODO, Wt=50ms, Rt=3.13ms	SOT-25	28xg	VD20	6g	Tor
B1L	R3114N171C	Vdet-IC	1.7V±0.8%, -Reset PPO	SOT-23-5	28vdm	VD7	6g	Ric
B1L	XC6115A219MR	Vdet-IC	1.9V±2%, +Rst PPO, -Rst ODO, Wt=50ms, Rt=3.13ms	SOT-25	28xg	VD20	6g	Tor
B1L	XC6115A249MR	Vdet-IC	4.9V±2%, +Rst PPO, -Rst ODO, Wt=50ms, Rt=3.13ms	SOT-25	28xg	VD20	6g	Tor
B1M	R3114N181C	Vdet-IC	1.8V±0.8%, -Reset PPO	SOT-23-5	28vdm	VD7	6g	Ric
B1M	XC6115A220MR	Vdet-IC	2.0V±2%, +Rst PPO, -Rst ODO, Wt=50ms, Rt=3.13ms	SOT-25	28xg	VD20	6g	Tor
B1M	XC6115A250MR	Vdet-IC	5.0V±2%, +Rst PPO, -Rst ODO, Wt=50ms, Rt=3.13ms	SOT-25	28xg	VD20	6g	Tor
B1N	R3114N191C	Vdet-IC	1.9V±0.8%, -Reset PPO	SOT-23-5	28vdm	VD7	6g	Ric
B1N	XC6115A221MR	Vdet-IC	2.1V±2%, +Rst PPO, -Rst ODO, Wt=50ms, Rt=3.13ms	SOT-25	28xg	VD20	6g	Tor
B1P	R3114N201C	Vdet-IC	2.0V±0.8%, -Reset PPO	SOT-23-5	28vdm	VD7	6g	Ric
B1P	XC6115A222MR	Vdet-IC	2.2V±2%, +Rst PPO, -Rst ODO, Wt=50ms, Rt=3.13ms	SOT-25	28xg	VD20	6g	Tor
B1Q	R3114N211C	Vdet-IC	2.1V±0.8%, -Reset PPO	SOT-23-5	28vdm	VD7	6g	Ric
B1R	R3114N221C	Vdet-IC	2.2V±0.8%, -Reset PPO	SOT-23-5	28vdm	VD7	6g	Ric
B1R	XC6115A223MR	Vdet-IC	2.3V±2%, +Rst PPO, -Rst ODO, Wt=50ms, Rt=3.13ms	SOT-25	28xg	VD20	6g	Tor
B1S	R3114N231C	Vdet-IC	2.3V±0.8%, -Reset PPO	SOT-23-5	28vdm	VD7	6g	Ric
B1S	XC6115A224MR	Vdet-IC	2.4V±2%, +Rst PPO, -Rst ODO, Wt=50ms, Rt=3.13ms	SOT-25	28xg	VD20	6g	Tor
B1T	R3114N241C	Vdet-IC	2.4V±0.8%, -Reset PPO	SOT-23-5	28vdm	VD7	6g	Ric
B1T	XC6115A225MR	Vdet-IC	2.5V±2%, +Rst PPO, -Rst ODO, Wt=50ms, Rt=3.13ms	SOT-25	28xg	VD20	6g	Tor
B1U	R3114N251C	Vdet-IC	2.5V±0.8%, -Reset PPO	SOT-23-5	28vdm	VD7	6g	Ric
B1U	XC6115A226MR	Vdet-IC	2.6V±2%, +Rst PPO, -Rst ODO, Wt=50ms, Rt=3.13ms	SOT-25	28xg	VD20	6g	Tor
B1V	R3114N261C	Vdet-IC	2.6V±0.8%, -Reset PPO	SOT-23-5	28vdm	VD7	6g	Ric
B1V	XC6115A227MR	Vdet-IC	2.7V±2%, +Rst PPO, -Rst ODO, Wt=50ms, Rt=3.13ms	SOT-25	28xg	VD20	6g	Tor
B1W	R3114N271C	Vdet-IC	2.7V±0.8%, -Reset PPO	SOT-23-5	28vdm	VD7	6g	Ric
B1X	R3114N281C	Vdet-IC	2.8V±0.8%, -Reset PPO	SOT-23-5	28vdm	VD7	6g	Ric
B1X	XC6115A228MR	Vdet-IC	2.8V±2%, +Rst PPO, -Rst ODO, Wt=50ms, Rt=3.13ms	SOT-25	28xg	VD20	6g	Tor
B1Y	R3114N291C	Vdet-IC	2.9V±0.8%, -Reset PPO	SOT-23-5	28vdm	VD7	6g	Ric
B1Y	XC6115A229MR	Vdet-IC	2.9V±2%, +Rst PPO, -Rst ODO, Wt=50ms, Rt=3.13ms	SOT-25	28xg	VD20	6g	Tor
B1Z	R3114N301C	Vdet-IC	3V±0.8%, -Reset PPO	SOT-23-5	28vdm	VD7	6g	Ric
B1Z	XC6115A230MR	Vdet-IC	3.0V±2%, +Rst PPO, -Rst ODO, Wt=50ms, Rt=3.13ms	SOT-25	28xg	VD20	6g	Tor
B2	BD4746G	Vdet-IC	4.6V, -Reset ODO	SMP5	28vdlq	VD6	6a	Rhm
B2	PI74STX1G02CX	CMOS-Logic	2-input NOR gate	SC-70-5	28/Log2	-	6a	Per
B2	PI74STX1G02TX	CMOS-Logic	2-input NOR gate	SOT-23-5	28/Log2	-	6a	Per
B2	R1111N321A	LVR-IC	LDO, LN, -CE, 3.2V±2%, 200mA	SOT-23-5	28cx	VR4	6g	Ric



SMD
code

Type

Function

Short description

Case

Pinout

Sch. St.

Mnf.

SMD code	Type	Function	Short description	Case	Pinout	Sch. St.	Mnf.
B2	TC1015-2.7VRX	LVR-IC	LDO, 2.7V±2%, 100mA, +CE	SOT-23-5	28vrx	VR7	6g Mcc
B2	RN5VD12AA	Vdet-IC	1.2V±2.5%, -Reset PPO	SOT-23-5	28vdo	VD3	6g Ric
B2-	RT9198-26PU5	LVR-IC	LDO, 2.6V±1%, 300mA, +CE	SC-70-5	28xm	VR4	6a Rct
B20	AIC1747-20GJ5	LVR-IC	LDO, 2.0V±2%, 300mA, +CE	SC-70-5	28vrx	VR7	6a Aic
B20	R1152N120B	LVR-IC	Boost, +CE, 12V±2%, 150mA	SOT-23-5	28vrf	VR6	6g Ric
B20	RP110N201C	LVR-IC	LDO, 2.0V±1%, 150mA	SOT-23-5	28ym	VR1	6g Ric
B20	XC6115A331MR	Vdet-IC	3.1V±2%, +Rst PPO, -Rst ODO, Wt=100ms, Rt=3.13ms	SOT-25	28xg	VD20	6g Tor
B21	RP110N211C	LVR-IC	LDO, 2.1V±1%, 150mA	SOT-23-5	28ym	VR1	6g Ric
B21	XC6115A332MR	Vdet-IC	3.2V±2%, +Rst PPO, -Rst ODO, Wt=100ms, Rt=3.13ms	SOT-25	28xg	VD20	6g Tor
B210	XC6365B102MR	DC/DC-IC	PWM st-down, 180kHz, Adj. 1.5-6V±2.5%, 1A, +CE	SOT-25	28zn	DC18	6g Tor
B22	RP110N221C	LVR-IC	LDO, 2.2V±1%, 150mA	SOT-23-5	28ym	VR1	6g Ric
B22	XC6115A333MR	Vdet-IC	3.3V±2%, +Rst PPO, -Rst ODO, Wt=100ms, Rt=3.13ms	SOT-25	28xg	VD20	6g Tor
B23	RP110N231C	LVR-IC	LDO, 2.3V±1%, 150mA	SOT-23-5	28ym	VR1	6g Ric
B23	XC6115A334MR	Vdet-IC	3.4V±2%, +Rst PPO, -Rst ODO, Wt=100ms, Rt=3.13ms	SOT-25	28xg	VD20	6g Tor
B24	RP110N241C	LVR-IC	LDO, 2.4V±1%, 150mA	SOT-23-5	28ym	VR1	6g Ric
B24	XC6115A335MR	Vdet-IC	3.5V±2%, +Rst PPO, -Rst ODO, Wt=100ms, Rt=3.13ms	SOT-25	28xg	VD20	6g Tor
b25	74CBTLV1G125GV	CMOS-Logic	Bus buffer gate with 3-state output	SOT753	28/Log14	-	6a Phi
B25	AIC1747-25GJ5	LVR-IC	LDO, 2.5V±2%, 300mA, +CE	SC-70-5	28vrx	VR7	6a Aic
B25	R1152N025B	LVR-IC	Boost, +CE, 2.5V±2%, 150mA	SOT-23-5	28vrf	VR6	6g Ric
B25	RP110N251C	LVR-IC	LDO, 2.5V±1%, 150mA	SOT-23-5	28ym	VR1	6g Ric
B25	XC6115A336MR	Vdet-IC	3.6V±2%, +Rst PPO, -Rst ODO, Wt=100ms, Rt=3.13ms	SOT-25	28xg	VD20	6g Tor
B26	R1152N026B	LVR-IC	Boost, +CE, 2.6V±2%, 150mA	SOT-23-5	28vrf	VR6	6g Ric
B26	RP110N261C	LVR-IC	LDO, 2.6V±1%, 150mA	SOT-23-5	28ym	VR1	6g Ric
B26	XC6115A337MR	Vdet-IC	3.7V±2%, +Rst PPO, -Rst ODO, Wt=100ms, Rt=3.13ms	SOT-25	28xg	VD20	6g Tor
B27	AIC1747-27GJ5	LVR-IC	LDO, 2.7V±2%, 300mA, +CE	SC-70-5	28vrx	VR7	6a Aic
B27	R1152N027B	LVR-IC	Boost, +CE, 2.7V±2%, 150mA	SOT-23-5	28vrf	VR6	6g Ric
B27	RP110N271C	LVR-IC	LDO, 2.7V±1%, 150mA	SOT-23-5	28ym	VR1	6g Ric
B27	XC6115A338MR	Vdet-IC	3.8V±2%, +Rst PPO, -Rst ODO, Wt=100ms, Rt=3.13ms	SOT-25	28xg	VD20	6g Tor
B28	R1152N028B	LVR-IC	Boost, +CE, 2.8V±2%, 150mA	SOT-23-5	28vrf	VR6	6g Ric
B28	RP110N281C	LVR-IC	LDO, 2.8V±1%, 150mA	SOT-23-5	28ym	VR1	6g Ric
B28	XC6115A339MR	Vdet-IC	3.9V±2%, +Rst PPO, -Rst ODO, Wt=100ms, Rt=3.13ms	SOT-25	28xg	VD20	6g Tor
B29	R1152N029B	LVR-IC	Boost, +CE, 2.9V±2%, 150mA	SOT-23-5	28vrf	VR6	6g Ric
B29	RP110N291C	LVR-IC	LDO, 2.9V±1%, 150mA	SOT-23-5	28ym	VR1	6g Ric
B29	XC6115A340MR	Vdet-IC	4.0V±2%, +Rst PPO, -Rst ODO, Wt=100ms, Rt=3.13ms	SOT-25	28xg	VD20	6g Tor
B2A	XC6108C12AMR	Vdet-IC	1.2V±2%, Hysteresis, -Reset PPO	SOT-25	28rm	VD15	6g Tor
B2A	XC6115A341MR	Vdet-IC	4.1V±2%, +Rst PPO, -Rst ODO, Wt=100ms, Rt=3.13ms	SOT-25	28xg	VD20	6g Tor
B2B	XC6108C12BMR	Vdet-IC	1.2V±2%, -Reset PPO	SOT-25	28rm	VD15	6g Tor
B2B	XC6115A342MR	Vdet-IC	4.2V±2%, +Rst PPO, -Rst ODO, Wt=100ms, Rt=3.13ms	SOT-25	28xg	VD20	6g Tor
B2C	XC6108C12CMR	Vdet-IC	1.2V±2%, Hysteresis, -Reset PPO	SOT-25	28rk	VD15	6g Tor
B2C	XC6115A343MR	Vdet-IC	4.3V±2%, +Rst PPO, -Rst ODO, Wt=100ms, Rt=3.13ms	SOT-25	28xg	VD20	6g Tor
B2D	XC6108C12DMR	Vdet-IC	1.2V±2%, -Reset PPO	SOT-25	28rk	VD15	6g Tor
B2D	XC6115A344MR	Vdet-IC	4.4V±2%, +Rst PPO, -Rst ODO, Wt=100ms, Rt=3.13ms	SOT-25	28xg	VD20	6g Tor
B2E	XC6115A345MR	Vdet-IC	4.5V±2%, +Rst PPO, -Rst ODO, Wt=100ms, Rt=3.13ms	SOT-25	28xg	VD20	6g Tor
B2F	XC6115A316MR	Vdet-IC	1.6V±2%, +Rst PPO, -Rst ODO, Wt=100ms, Rt=3.13ms	SOT-25	28xg	VD20	6g Tor
B2E	XC6115A346MR	Vdet-IC	4.6V±2%, +Rst PPO, -Rst ODO, Wt=100ms, Rt=3.13ms	SOT-25	28xg	VD20	6g Tor
B2H	XC6115A317MR	Vdet-IC	1.7V±2%, +Rst PPO, -Rst ODO, Wt=100ms, Rt=3.13ms	SOT-25	28xg	VD20	6g Tor
B2H	XC6115A347MR	Vdet-IC	4.7V±2%, +Rst PPO, -Rst ODO, Wt=100ms, Rt=3.13ms	SOT-25	28xg	VD20	6g Tor
B2J	AIC1747-285GJ5	LVR-IC	LDO, 2.85V±2%, 300mA, +CE	SC-70-5	28vrx	VR7	6a Aic
B2K	XC6115A318MR	Vdet-IC	1.8V±2%, +Rst PPO, -Rst ODO, Wt=100ms, Rt=3.13ms	SOT-25	28xg	VD20	6g Tor
B2K	XC6115A348MR	Vdet-IC	4.8V±2%, +Rst PPO, -Rst ODO, Wt=100ms, Rt=3.13ms	SOT-25	28xg	VD20	6g Tor
B2L	XC6115A319MR	Vdet-IC	1.9V±2%, +Rst PPO, -Rst ODO, Wt=100ms, Rt=3.13ms	SOT-25	28xg	VD20	6g Tor
B2L	XC6115A349MR	Vdet-IC	4.9V±2%, +Rst PPO, -Rst ODO, Wt=100ms, Rt=3.13ms	SOT-25	28xg	VD20	6g Tor
B2M	XC6115A320MR	Vdet-IC	2.0V±2%, +Rst PPO, -Rst ODO, Wt=100ms, Rt=3.13ms	SOT-25	28xg	VD20	6g Tor
B2M	XC6115A350MR	Vdet-IC	5.0V±2%, +Rst PPO, -Rst ODO, Wt=100ms, Rt=3.13ms	SOT-25	28xg	VD20	6g Tor
B2N	XC6115A321MR	Vdet-IC	2.1V±2%, +Rst PPO, -Rst ODO, Wt=100ms, Rt=3.13ms	SOT-25	28xg	VD20	6g Tor
B2P	XC6115A322MR	Vdet-IC	2.2V±2%, +Rst PPO, -Rst ODO, Wt=100ms, Rt=3.13ms	SOT-25	28xg	VD20	6g Tor
B2P	XC6115A323MR	Vdet-IC	2.3V±2%, +Rst PPO, -Rst ODO, Wt=100ms, Rt=3.13ms	SOT-25	28xg	VD20	6g Tor
B2S	XC6115A324MR	Vdet-IC	2.4V±2%, +Rst PPO, -Rst ODO, Wt=100ms, Rt=3.13ms	SOT-25	28xg	VD20	6g Tor
B2T	XC6115A325MR	Vdet-IC	2.5V±2%, +Rst PPO, -Rst ODO, Wt=100ms, Rt=3.13ms	SOT-25	28xg	VD20	6g Tor
B2U	XC6115A326MR	Vdet-IC	2.6V±2%, +Rst PPO, -Rst ODO, Wt=100ms, Rt=3.13ms	SOT-25	28xg	VD20	6g Tor
B2V	XC6115A327MR	Vdet-IC	2.7V±2%, +Rst PPO, -Rst ODO, Wt=100ms, Rt=3.13ms	SOT-25	28xg	VD20	6g Tor
B2X	XC6115A328MR	Vdet-IC	2.8V±2%, +Rst PPO, -Rst ODO, Wt=100ms, Rt=3.13ms	SOT-25	28xg	VD20	6g Tor
B2Y	XC6115A329MR	Vdet-IC	2.9V±2%, +Rst PPO, -Rst ODO, Wt=100ms, Rt=3.13ms	SOT-25	28xg	VD20	6g Tor
B2Z	XC6115A330MR	Vdet-IC	3.0V±2%, +Rst PPO, -Rst ODO, Wt=100ms, Rt=3.13ms	SOT-25	28xg	VD20	6g Tor
B3	BD4727G	Vdet-IC	2.7V, -Reset ODO	SMP5	28v dq	VD6	6a Rhm
B3	R111N331A	LVR-IC	LDO, LN, -CE, 3.3V±2%, 200mA	SOT-23-5	28cx	VR4	6g Ric
B3	TC1015-3.0VRX	LVR-IC	LDO, 3V±2%, 100mA, +CE	SOT-23-5	28vrx	VR7	6g Mcc
B3	RN5VD13AA	Vdet-IC	1.3V±2.5%, -Reset PPO	SOT-23-5	28vdo	VD3	6g Ric
B3-	RT9198T-28PU5R	LVR-IC	LDO, 2.85V±1%, 300mA, +CE	SC-70-5	28xm	VR4	6a Rct
B30	AIC1747-30GJ5	LVR-IC	LDO, 3.0V±2%, 300mA, +CE	SC-70-5	28vrx	VR7	6a Aic



SMD code	Type	Function	Short description	Case	Pinout	Sch.	St.	Mnf.
B30	R1152N030B	LVR-IC	Boost, +CE, 3V±2%, 150mA	SOT-23-5	28vrf	VR6	6g	Ric
B30	RP110N301C	LVR-IC	LDO, 3.0V±1%, 150mA	SOT-23-5	28ym	VR1	6g	Ric
B30	XC6115A431MR	Vdet-IC	3.1V±2%, +Rst PPO, -Rst ODO, Wt=200ms, Rt=3.13ms	SOT-25	28xg	VD20	6g	Tor
B31	R1152N031B	LVR-IC	Boost, +CE, 3.1V±2%, 150mA	SOT-23-5	28vrf	VR6	6g	Ric
B31	RP110N311C	LVR-IC	LDO, 3.1V±1%, 150mA	SOT-23-5	28ym	VR1	6g	Ric
B31	XC6115A432MR	Vdet-IC	3.2V±2%, +Rst PPO, -Rst ODO, Wt=200ms, Rt=3.13ms	SOT-25	28xg	VD20	6g	Tor
B310	XC6365B103MR	DC/DC-IC	PWM st-down, 300kHz, Adj. 1.5..6V±2.5%, 1A, +CE	SOT-25	28zn	DC18	6g	Tor
B32	R1152N032B	LVR-IC	Boost, +CE, 3.2V±2%, 150mA	SOT-23-5	28vrf	VR6	6g	Ric
B32	RP110N321C	LVR-IC	LDO, 3.2V±1%, 150mA	SOT-23-5	28ym	VR1	6g	Ric
B32	XC6115A433MR	Vdet-IC	3.3V±2%, +Rst PPO, -Rst ODO, Wt=200ms, Rt=3.13ms	SOT-25	28xg	VD20	6g	Tor
B33	AIC1747-33GJ5	LVR-IC	LDO, 3.3V±2%, 300mA, +CE	SC-70-5	28vrx	VR7	6a	Aic
B33	R1152N033B	LVR-IC	Boost, +CE, 3.3V±2%, 150mA	SOT-23-5	28vrf	VR6	6g	Ric
B33	RP110N331C	LVR-IC	LDO, 3.3V±1%, 150mA	SOT-23-5	28ym	VR1	6g	Ric
B33	XC6115A434MR	Vdet-IC	3.4V±2%, +Rst PPO, -Rst ODO, Wt=200ms, Rt=3.13ms	SOT-25	28xg	VD20	6g	Tor
B34	OPA634N	Op-IC	Wide-band, single-supply: +3..+5V, 150MHz, Iout=80mA	SOT-23-5	28opa	OP1	6a	Bb
B34	R1152N034B	LVR-IC	Boost, +CE, 3.4V±2%, 150mA	SOT-23-5	28vrf	VR6	6g	Ric
B34	RP110N341C	LVR-IC	LDO, 3.4V±1%, 150mA	SOT-23-5	28ym	VR1	6g	Ric
B34	XC6115A435MR	Vdet-IC	3.5V±2%, +Rst PPO, -Rst ODO, Wt=200ms, Rt=3.13ms	SOT-25	28xg	VD20	6g	Tor
B35	AIC1747-35GJ5	LVR-IC	LDO, 3.5V±2%, 300mA, +CE	SC-70-5	28vrx	VR7	6a	Aic
B35	R1152N035B	LVR-IC	Boost, +CE, 3.5V±2%, 150mA	SOT-23-5	28vrf	VR6	6g	Ric
B35	RP110N351C	LVR-IC	LDO, 3.5V±1%, 150mA	SOT-23-5	28ym	VR1	6g	Ric
B35	XC6115A436MR	Vdet-IC	3.6V±2%, +Rst PPO, -Rst ODO, Wt=200ms, Rt=3.13ms	SOT-25	28xg	VD20	6g	Tor
B36	R1152N036B	LVR-IC	Boost, +CE, 3.6V±2%, 150mA	SOT-23-5	28vrf	VR6	6g	Ric
B36	RP110N361C	LVR-IC	LDO, 3.6V±1%, 150mA	SOT-23-5	28ym	VR1	6g	Ric
B36	XC6115A437MR	Vdet-IC	3.7V±2%, +Rst PPO, -Rst ODO, Wt=200ms, Rt=3.13ms	SOT-25	28xg	VD20	6g	Tor
B37	AIC1747-37GJ5	LVR-IC	LDO, 3.7V±2%, 300mA, +CE	SC-70-5	28vrx	VR7	6a	Aic
B37	R1152N037B	LVR-IC	Boost, +CE, 3.7V±2%, 150mA	SOT-23-5	28vrf	VR6	6g	Ric
B37	RP110N121C5	LVR-IC	LDO, 1.25V±1%, 150mA	SOT-23-5	28ym	VR1	6g	Ric
B37	XC6115A438MR	Vdet-IC	3.8V±2%, +Rst PPO, -Rst ODO, Wt=200ms, Rt=3.13ms	SOT-25	28xg	VD20	6g	Tor
B38	AIC1747-38GJ5	LVR-IC	LDO, 3.8V±2%, 300mA, +CE	SC-70-5	28vrx	VR7	6a	Aic
B38	R1152N038B	LVR-IC	Boost, +CE, 3.8V±2%, 150mA	SOT-23-5	28vrf	VR6	6g	Ric
B38	RP110N181C5	LVR-IC	LDO, 1.85V±1%, 150mA	SOT-23-5	28ym	VR1	6g	Ric
B38	XC6115A439MR	Vdet-IC	3.9V±2%, +Rst PPO, -Rst ODO, Wt=200ms, Rt=3.13ms	SOT-25	28xg	VD20	6g	Tor
B39	R1152N039B	LVR-IC	Boost, +CE, 3.9V±2%, 150mA	SOT-23-5	28vrf	VR6	6g	Ric
B39	RP110N281C5	LVR-IC	LDO, 2.85V±1%, 150mA	SOT-23-5	28ym	VR1	6g	Ric
B39	XC6115A440MR	Vdet-IC	4.0V±2%, +Rst PPO, -Rst ODO, Wt=200ms, Rt=3.13ms	SOT-25	28xg	VD20	6g	Tor
B3A	XC6108C13AMR	Vdet-IC	1.3V±2%, Hysteresis, -Reset PPO	SOT-25	28rm	VD15	6g	Tor
B3A	XC6115A441MR	Vdet-IC	4.1V±2%, +Rst PPO, -Rst ODO, Wt=200ms, Rt=3.13ms	SOT-25	28xg	VD20	6g	Tor
B3B	XC6108C13BMR	Vdet-IC	1.3V±2%, -Reset PPO	SOT-25	28rm	VD15	6g	Tor
B3B	XC6115A442MR	Vdet-IC	4.2V±2%, +Rst PPO, -Rst ODO, Wt=200ms, Rt=3.13ms	SOT-25	28xg	VD20	6g	Tor
B3B	XC6108C13CMR	Vdet-IC	1.3V±2%, Hysteresis, -Reset PPO	SOT-25	28rk	VD15	6g	Tor
B3C	XC6115A443MR	Vdet-IC	4.3V±2%, +Rst PPO, -Rst ODO, Wt=200ms, Rt=3.13ms	SOT-25	28xg	VD20	6g	Tor
B3D	XC6108C13DMR	Vdet-IC	1.3V±2%, -Reset PPO	SOT-25	28rk	VD15	6g	Tor
B3D	XC6115A444MR	Vdet-IC	4.4V±2%, +Rst PPO, -Rst ODO, Wt=200ms, Rt=3.13ms	SOT-25	28xg	VD20	6g	Tor
B3E	XC6115A445MR	Vdet-IC	4.5V±2%, +Rst PPO, -Rst ODO, Wt=200ms, Rt=3.13ms	SOT-25	28xg	VD20	6g	Tor
B3F	XC6115A416MR	Vdet-IC	1.6V±2%, +Rst PPO, -Rst ODO, Wt=200ms, Rt=3.13ms	SOT-25	28xg	VD20	6g	Tor
B3F	XC6115A446MR	Vdet-IC	4.6V±2%, +Rst PPO, -Rst ODO, Wt=200ms, Rt=3.13ms	SOT-25	28xg	VD20	6g	Tor
B3H	XC6115A417MR	Vdet-IC	1.7V±2%, +Rst PPO, -Rst ODO, Wt=200ms, Rt=3.13ms	SOT-25	28xg	VD20	6g	Tor
B3H	XC6115A447MR	Vdet-IC	4.7V±2%, +Rst PPO, -Rst ODO, Wt=200ms, Rt=3.13ms	SOT-25	28xg	VD20	6g	Tor
B3K	XC6115A418MR	Vdet-IC	1.8V±2%, +Rst PPO, -Rst ODO, Wt=200ms, Rt=3.13ms	SOT-25	28xg	VD20	6g	Tor
B3K	XC6115A448MR	Vdet-IC	4.8V±2%, +Rst PPO, -Rst ODO, Wt=200ms, Rt=3.13ms	SOT-25	28xg	VD20	6g	Tor
B3L	XC6115A419MR	Vdet-IC	1.9V±2%, +Rst PPO, -Rst ODO, Wt=200ms, Rt=3.13ms	SOT-25	28xg	VD20	6g	Tor
B3L	XC6115A449MR	Vdet-IC	4.9V±2%, +Rst PPO, -Rst ODO, Wt=200ms, Rt=3.13ms	SOT-25	28xg	VD20	6g	Tor
B3M	XC6115A420MR	Vdet-IC	2.0V±2%, +Rst PPO, -Rst ODO, Wt=200ms, Rt=3.13ms	SOT-25	28xg	VD20	6g	Tor
B3M	XC6115A450MR	Vdet-IC	5.0V±2%, +Rst PPO, -Rst ODO, Wt=200ms, Rt=3.13ms	SOT-25	28xg	VD20	6g	Tor
B3N	XC6115A421MR	Vdet-IC	2.1V±2%, +Rst PPO, -Rst ODO, Wt=200ms, Rt=3.13ms	SOT-25	28xg	VD20	6g	Tor
B3P	XC6115A422MR	Vdet-IC	2.2V±2%, +Rst PPO, -Rst ODO, Wt=200ms, Rt=3.13ms	SOT-25	28xg	VD20	6g	Tor
B3R	XC6115A423MR	Vdet-IC	2.3V±2%, +Rst PPO, -Rst ODO, Wt=200ms, Rt=3.13ms	SOT-25	28xg	VD20	6g	Tor
B3S	XC6115A424MR	Vdet-IC	2.4V±2%, +Rst PPO, -Rst ODO, Wt=200ms, Rt=3.13ms	SOT-25	28xg	VD20	6g	Tor
B3T	XC6115A425MR	Vdet-IC	2.5V±2%, +Rst PPO, -Rst ODO, Wt=200ms, Rt=3.13ms	SOT-25	28xg	VD20	6g	Tor
B3U	XC6115A426MR	Vdet-IC	2.6V±2%, +Rst PPO, -Rst ODO, Wt=200ms, Rt=3.13ms	SOT-25	28xg	VD20	6g	Tor
B3V	XC6115A427MR	Vdet-IC	2.7V±2%, +Rst PPO, -Rst ODO, Wt=200ms, Rt=3.13ms	SOT-25	28xg	VD20	6g	Tor
B3X	XC6115A428MR	Vdet-IC	2.8V±2%, +Rst PPO, -Rst ODO, Wt=200ms, Rt=3.13ms	SOT-25	28xg	VD20	6g	Tor
B3Y	XC6115A429MR	Vdet-IC	2.9V±2%, +Rst PPO, -Rst ODO, Wt=200ms, Rt=3.13ms	SOT-25	28xg	VD20	6g	Tor
B3Z	XC6115A430MR	Vdet-IC	3.0V±2%, +Rst PPO, -Rst ODO, Wt=200ms, Rt=3.13ms	SOT-25	28xg	VD20	6g	Tor
B4	BD4733G	Vdet-IC	3.3V, -Reset ODO	SMPS5	28vqd	VD6	6a	Rhm
B4	PI74STX1G04CX	CMOS-Logic	Inverter	SC-70-5	28LLog6	-	6a	Per
B4	PI74STX1G04TX	CMOS-Logic	Inverter	SOT-23-5	28LLog6	-	6a	Per
B4	R1111N341A	LVR-IC	LDO, LN, -CE, 3.4V±2%, 200mA	SOT-23-5	28cx	VR4	6g	Ric
B4	RN5VD14AA	Vdet-IC	1.4V±2.5%, -Reset PPO	SOT-23-5	28vdo	VD3	6g	Ric



SMD code	Type	Function	Short description	Case	Pinout	Sch.	St.	Mnf.
B4-	RT9198T-33PU5	LVR-IC	LDO, 3.3V±1%, 300mA, +CE	SC-70-5	28xm	VR4	6a	Rct
B40	R1152N040B	LVR-IC	Boost, +CE, 4V±2%, 150mA	SOT-23-5	28urf	VR6	6g	Ric
B40	XC6115A531MR	Vdet-IC	3.1V±2%, +Rst PPO, -Rst ODO, Wt=400ms, Rt=3.13ms	SOT-25	28xg	VD20	6g	Tor
B41	R1152N041B	LVR-IC	Boost, +CE, 4.1V±2%, 150mA	SOT-23-5	28urf	VR6	6g	Ric
B41	XC6115A532MR	Vdet-IC	3.2V±2%, +Rst PPO, -Rst ODO, Wt=400ms, Rt=3.13ms	SOT-25	28xg	VD20	6g	Tor
B410	XC6365B105MR	DC/DC-IC	PWM st-down, 500KHz, Adj. 1.5..6V±2.5%, 1A, +CE	SOT-25	28zn	DC18	6g	Tor
B42	OPA342NA	Op-IC	Lo-power, Rail-to-Rail	SOT-23-5	28opa	OP1	6a	Bb
B42	R1152N042B	LVR-IC	Boost, +CE, 4.2V±2%, 150mA	SOT-23-5	28urf	VR6	6g	Ric
B42	XC6115A533MR	Vdet-IC	3.3V±2%, +Rst PPO, -Rst ODO, Wt=400ms, Rt=3.13ms	SOT-25	28xg	VD20	6g	Tor
B43	OPA343NA	Op-IC	Single-supply, Rail-to-Rail	SOT-23-5	28opa	OP1	6a	Bb
B43	R1152N043B	LVR-IC	Boost, +CE, 4.3V±2%, 150mA	SOT-23-5	28urf	VR6	6g	Ric
B43	XC6115A534MR	Vdet-IC	3.4V±2%, +Rst PPO, -Rst ODO, Wt=400ms, Rt=3.13ms	SOT-25	28xg	VD20	6g	Tor
B44	R1152N044B	LVR-IC	Boost, +CE, 4.4V±2%, 150mA	SOT-23-5	28urf	VR6	6g	Ric
B44	XC6115A535MR	Vdet-IC	3.5V±2%, +Rst PPO, -Rst ODO, Wt=400ms, Rt=3.13ms	SOT-25	28xg	VD20	6g	Tor
B45	R1152N045B	LVR-IC	Boost, +CE, 4.5V±2%, 150mA	SOT-23-5	28urf	VR6	6g	Ric
B45	XC6115A536MR	Vdet-IC	3.6V±2%, +Rst PPO, -Rst ODO, Wt=400ms, Rt=3.13ms	SOT-25	28xg	VD20	6g	Tor
B46	R1152N046B	LVR-IC	Boost, +CE, 4.6V±2%, 150mA	SOT-23-5	28urf	VR6	6g	Ric
B46	XC6115A537MR	Vdet-IC	3.7V±2%, +Rst PPO, -Rst ODO, Wt=400ms, Rt=3.13ms	SOT-25	28xg	VD20	6g	Tor
B47	R1152N047B	LVR-IC	Boost, +CE, 4.7V±2%, 150mA	SOT-23-5	28urf	VR6	6g	Ric
B47	XC6115A538MR	Vdet-IC	3.8V±2%, +Rst PPO, -Rst ODO, Wt=400ms, Rt=3.13ms	SOT-25	28xg	VD20	6g	Tor
B48	R1152N048B	LVR-IC	Boost, +CE, 4.8V±2%, 150mA	SOT-23-5	28urf	VR6	6g	Ric
B48	XC6115A539MR	Vdet-IC	3.9V±2%, +Rst PPO, -Rst ODO, Wt=400ms, Rt=3.13ms	SOT-25	28xg	VD20	6g	Tor
B49	R1152N049B	LVR-IC	Boost, +CE, 4.9V±2%, 150mA	SOT-23-5	28urf	VR6	6g	Ric
B49	XC6115A540MR	Vdet-IC	4.0V±2%, +Rst PPO, -Rst ODO, Wt=400ms, Rt=3.13ms	SOT-25	28xg	VD20	6g	Tor
B4A	XC6108C14AMR	Vdet-IC	1.4V±2%, Hysteresis, -Reset PPO	SOT-25	28rm	VD15	6g	Tor
B4A	XC6115A541MR	Vdet-IC	4.1V±2%, +Rst PPO, -Rst ODO, Wt=400ms, Rt=3.13ms	SOT-25	28xg	VD20	6g	Tor
B4B	XC6108C14BMR	Vdet-IC	1.4V±2%, -Reset PPO	SOT-25	28rm	VD15	6g	Tor
B4B	XC6115A542MR	Vdet-IC	4.2V±2%, +Rst PPO, -Rst ODO, Wt=400ms, Rt=3.13ms	SOT-25	28xg	VD20	6g	Tor
B4C	XC6108C14CMR	Vdet-IC	1.4V±2%, Hysteresis, -Reset PPO	SOT-25	28rk	VD15	6g	Tor
B4C	XC6115A543MR	Vdet-IC	4.3V±2%, +Rst PPO, -Rst ODO, Wt=400ms, Rt=3.13ms	SOT-25	28xg	VD20	6g	Tor
B4D	XC6108C14DMR	Vdet-IC	1.4V±2%, -Reset PPO	SOT-25	28rk	VD15	6g	Tor
B4D	XC6115A544MR	Vdet-IC	4.4V±2%, +Rst PPO, -Rst ODO, Wt=400ms, Rt=3.13ms	SOT-25	28xg	VD20	6g	Tor
B4E	XC6115A545MR	Vdet-IC	4.5V±2%, +Rst PPO, -Rst ODO, Wt=400ms, Rt=3.13ms	SOT-25	28xg	VD20	6g	Tor
B4F	XC6115A516MR	Vdet-IC	1.6V±2%, +Rst PPO, -Rst ODO, Wt=400ms, Rt=3.13ms	SOT-25	28xg	VD20	6g	Tor
B4F	XC6115A546MR	Vdet-IC	4.6V±2%, +Rst PPO, -Rst ODO, Wt=400ms, Rt=3.13ms	SOT-25	28xg	VD20	6g	Tor
B4H	XC6115A517MR	Vdet-IC	1.7V±2%, +Rst PPO, -Rst ODO, Wt=400ms, Rt=3.13ms	SOT-25	28xg	VD20	6g	Tor
B4H	XC6115A547MR	Vdet-IC	4.7V±2%, +Rst PPO, -Rst ODO, Wt=400ms, Rt=3.13ms	SOT-25	28xg	VD20	6g	Tor
B4K	XC6115A518MR	Vdet-IC	1.8V±2%, +Rst PPO, -Rst ODO, Wt=400ms, Rt=3.13ms	SOT-25	28xg	VD20	6g	Tor
B4K	XC6115A548MR	Vdet-IC	4.8V±2%, +Rst PPO, -Rst ODO, Wt=400ms, Rt=3.13ms	SOT-25	28xg	VD20	6g	Tor
B4L	XC6115A519MR	Vdet-IC	1.9V±2%, +Rst PPO, -Rst ODO, Wt=400ms, Rt=3.13ms	SOT-25	28xg	VD20	6g	Tor
B4L	XC6115A549MR	Vdet-IC	4.9V±2%, +Rst PPO, -Rst ODO, Wt=400ms, Rt=3.13ms	SOT-25	28xg	VD20	6g	Tor
B4M	XC6115A520MR	Vdet-IC	2.0V±2%, +Rst PPO, -Rst ODO, Wt=400ms, Rt=3.13ms	SOT-25	28xg	VD20	6g	Tor
B4M	XC6115A550MR	Vdet-IC	5.0V±2%, +Rst PPO, -Rst ODO, Wt=400ms, Rt=3.13ms	SOT-25	28xg	VD20	6g	Tor
B4N	XC6115A521MR	Vdet-IC	2.1V±2%, +Rst PPO, -Rst ODO, Wt=400ms, Rt=3.13ms	SOT-25	28xg	VD20	6g	Tor
B4P	XC6115A522MR	Vdet-IC	2.2V±2%, +Rst PPO, -Rst ODO, Wt=400ms, Rt=3.13ms	SOT-25	28xg	VD20	6g	Tor
B4R	XC6115A523MR	Vdet-IC	2.3V±2%, +Rst PPO, -Rst ODO, Wt=400ms, Rt=3.13ms	SOT-25	28xg	VD20	6g	Tor
B4S	XC6115A524MR	Vdet-IC	2.4V±2%, +Rst PPO, -Rst ODO, Wt=400ms, Rt=3.13ms	SOT-25	28xg	VD20	6g	Tor
B4T	XC6115A525MR	Vdet-IC	2.5V±2%, +Rst PPO, -Rst ODO, Wt=400ms, Rt=3.13ms	SOT-25	28xg	VD20	6g	Tor
B4U	XC6115A526MR	Vdet-IC	2.6V±2%, +Rst PPO, -Rst ODO, Wt=400ms, Rt=3.13ms	SOT-25	28xg	VD20	6g	Tor
B4V	XC6115A527MR	Vdet-IC	2.7V±2%, +Rst PPO, -Rst ODO, Wt=400ms, Rt=3.13ms	SOT-25	28xg	VD20	6g	Tor
B4X	XC6115A528MR	Vdet-IC	2.8V±2%, +Rst PPO, -Rst ODO, Wt=400ms, Rt=3.13ms	SOT-25	28xg	VD20	6g	Tor
B4Y	XC6115A529MR	Vdet-IC	2.9V±2%, +Rst PPO, -Rst ODO, Wt=400ms, Rt=3.13ms	SOT-25	28xg	VD20	6g	Tor
B4Z	XC6115A530MR	Vdet-IC	3.0V±2%, +Rst PPO, -Rst ODO, Wt=400ms, Rt=3.13ms	SOT-25	28xg	VD20	6g	Tor
B5	R111N351A	LVR-IC	LDO, LN, -CE, 3.5V±2%, 200mA	SOT-23-5	28xcx	VR4	6g	Ric
B5	TC1015-3.3VRX	LVR-IC	LDO, 3.3V±2%, 100mA, +CE	SOT-23-5	28vrx	VR7	6g	Mcc
B5	RN5VD15AA	Vdet-IC	1.5V±2.5%, -Reset PPO	SOT-23-5	28vdo	VD3	6g	Ric
B50	R1152N050B	LVR-IC	Boost, +CE, 5V±2%, 150mA	SOT-23-5	28urf	VR6	6g	Ric
B50	XC6115A631MR	Vdet-IC	3.1V±2%, +Rst PPO, -Rst ODO, Wt=1.6s, Rt=3.13ms	SOT-25	28xg	VD20	6g	Tor
B51	R1152N051B	LVR-IC	Boost, +CE, 5.1V±2%, 150mA	SOT-23-5	28urf	VR6	6g	Ric
B51	XC6115A632MR	Vdet-IC	3.2V±2%, +Rst PPO, -Rst ODO, Wt=1.6s, Rt=3.13ms	SOT-25	28xg	VD20	6g	Tor
B52	R1152N052B	LVR-IC	Boost, +CE, 5.2V±2%, 150mA	SOT-23-5	28urf	VR6	6g	Ric
B52	XC6115A633MR	Vdet-IC	3.3V±2%, +Rst PPO, -Rst ODO, Wt=1.6s, Rt=3.13ms	SOT-25	28xg	VD20	6g	Tor
B53	R1152N053B	LVR-IC	Boost, +CE, 5.3V±2%, 150mA	SOT-23-5	28urf	VR6	6g	Ric
B53	XC6115A634MR	Vdet-IC	3.4V±2%, +Rst PPO, -Rst ODO, Wt=1.6s, Rt=3.13ms	SOT-25	28xg	VD20	6g	Tor
B54	R1152N054B	LVR-IC	Boost, +CE, 5.4V±2%, 150mA	SOT-23-5	28urf	VR6	6g	Ric
B54	XC6115A635MR	Vdet-IC	3.5V±2%, +Rst PPO, -Rst ODO, Wt=1.6s, Rt=3.13ms	SOT-25	28xg	VD20	6g	Tor
B55	R1152N055B	LVR-IC	Boost, +CE, 5.5V±2%, 150mA	SOT-23-5	28urf	VR6	6g	Ric
B55	XC6115A636MR	Vdet-IC	3.6V±2%, +Rst PPO, -Rst ODO, Wt=1.6s, Rt=3.13ms	SOT-25	28xg	VD20	6g	Tor
B56	R1152N056B	LVR-IC	Boost, +CE, 5.6V±2%, 150mA	SOT-23-5	28urf	VR6	6g	Ric
B56	XC6115A637MR	Vdet-IC	3.7V±2%, +Rst PPO, -Rst ODO, Wt=1.6s, Rt=3.13ms	SOT-25	28xg	VD20	6g	Tor



SMD code	Type	Function	Short description	Case	Pinout	Sch.	St.	Mnf.
B57	R1152N057B	LVR-IC	Boost, +CE, 5.7V±2%, 150mA	SOT-23-5	28vrf	VR6	6g	Ric
B57	X06115A638MR	Vdet-IC	3.8V±2%, +Rst PPO, -Rst ODO, Wt=1.6s, Rt=3.13ms	SOT-25	28xg	VD20	6g	Tor
B58	R1152N058B	LVR-IC	Boost, +CE, 5.8V±2%, 150mA	SOT-23-5	28vrf	VR6	6g	Ric
B58	X06115A639MR	Vdet-IC	3.9V±2%, +Rst PPO, -Rst ODO, Wt=1.6s, Rt=3.13ms	SOT-25	28xg	VD20	6g	Tor
B59	R1152N059B	LVR-IC	Boost, +CE, 5.9V±2%, 150mA	SOT-23-5	28vrf	VR6	6g	Ric
B59	X06115A640MR	Vdet-IC	4.0V±2%, +Rst PPO, -Rst ODO, Wt=1.6s, Rt=3.13ms	SOT-25	28xg	VD20	6g	Tor
B5A	X06108C15AMR	Vdet-IC	1.5V±2%, Hysteresis, -Reset PPO	SOT-25	28rm	VD15	6g	Tor
B5A	X06115A641MR	Vdet-IC	4.1V±2%, +Rst PPO, -Rst ODO, Wt=1.6s, Rt=3.13ms	SOT-25	28xg	VD20	6g	Tor
B5B	X06108C15BMR	Vdet-IC	1.5V±2%, -Reset PPO	SOT-25	28rm	VD15	6g	Tor
B5B	X06115A642MR	Vdet-IC	4.2V±2%, +Rst PPO, -Rst ODO, Wt=1.6s, Rt=3.13ms	SOT-25	28xg	VD20	6g	Tor
B5C	X06108C15CMR	Vdet-IC	1.5V±2%, Hysteresis, -Reset PPO	SOT-25	28rk	VD15	6g	Tor
B5C	X06115A643MR	Vdet-IC	4.3V±2%, +Rst PPO, -Rst ODO, Wt=1.6s, Rt=3.13ms	SOT-25	28xg	VD20	6g	Tor
B5D	X06108C15DMR	Vdet-IC	1.5V±2%, -Reset PPO	SOT-25	28rk	VD15	6g	Tor
B5D	X06115A644MR	Vdet-IC	4.4V±2%, +Rst PPO, -Rst ODO, Wt=1.6s, Rt=3.13ms	SOT-25	28xg	VD20	6g	Tor
B5E	X06115A645MR	Vdet-IC	4.5V±2%, +Rst PPO, -Rst ODO, Wt=1.6s, Rt=3.13ms	SOT-25	28xg	VD20	6g	Tor
B5F	X06115A616MR	Vdet-IC	1.6V±2%, +Rst PPO, -Rst ODO, Wt=1.6s, Rt=3.13ms	SOT-25	28xg	VD20	6g	Tor
B5F	X06115A646MR	Vdet-IC	4.6V±2%, +Rst PPO, -Rst ODO, Wt=1.6s, Rt=3.13ms	SOT-25	28xg	VD20	6g	Tor
B5H	X06115A617MR	Vdet-IC	1.7V±2%, +Rst PPO, -Rst ODO, Wt=1.6s, Rt=3.13ms	SOT-25	28xg	VD20	6g	Tor
B5H	X06115A647MR	Vdet-IC	4.7V±2%, +Rst PPO, -Rst ODO, Wt=1.6s, Rt=3.13ms	SOT-25	28xg	VD20	6g	Tor
B5K	X06115A618MR	Vdet-IC	1.8V±2%, +Rst PPO, -Rst ODO, Wt=1.6s, Rt=3.13ms	SOT-25	28xg	VD20	6g	Tor
B5K	X06115A648MR	Vdet-IC	4.8V±2%, +Rst PPO, -Rst ODO, Wt=1.6s, Rt=3.13ms	SOT-25	28xg	VD20	6g	Tor
B5L	X06115A619MR	Vdet-IC	1.9V±2%, +Rst PPO, -Rst ODO, Wt=1.6s, Rt=3.13ms	SOT-25	28xg	VD20	6g	Tor
B5L	X06115A649MR	Vdet-IC	4.9V±2%, +Rst PPO, -Rst ODO, Wt=1.6s, Rt=3.13ms	SOT-25	28xg	VD20	6g	Tor
B5M	X06115A620MR	Vdet-IC	2.0V±2%, +Rst PPO, -Rst ODO, Wt=1.6s, Rt=3.13ms	SOT-25	28xg	VD20	6g	Tor
B5M	X06115A650MR	Vdet-IC	5.0V±2%, +Rst PPO, -Rst ODO, Wt=1.6s, Rt=3.13ms	SOT-25	28xg	VD20	6g	Tor
B5N	X06115A621MR	Vdet-IC	2.1V±2%, +Rst PPO, -Rst ODO, Wt=1.6s, Rt=3.13ms	SOT-25	28xg	VD20	6g	Tor
B5P	X06115A622MR	Vdet-IC	2.2V±2%, +Rst PPO, -Rst ODO, Wt=1.6s, Rt=3.13ms	SOT-25	28xg	VD20	6g	Tor
B5P	X06115A623MR	Vdet-IC	2.3V±2%, +Rst PPO, -Rst ODO, Wt=1.6s, Rt=3.13ms	SOT-25	28xg	VD20	6g	Tor
B5S	X06115A624MR	Vdet-IC	2.4V±2%, +Rst PPO, -Rst ODO, Wt=1.6s, Rt=3.13ms	SOT-25	28xg	VD20	6g	Tor
B5T	X06115A625MR	Vdet-IC	2.5V±2%, +Rst PPO, -Rst ODO, Wt=1.6s, Rt=3.13ms	SOT-25	28xg	VD20	6g	Tor
B5U	X06115A626MR	Vdet-IC	2.6V±2%, +Rst PPO, -Rst ODO, Wt=1.6s, Rt=3.13ms	SOT-25	28xg	VD20	6g	Tor
B5V	X06115A627MR	Vdet-IC	2.7V±2%, +Rst PPO, -Rst ODO, Wt=1.6s, Rt=3.13ms	SOT-25	28xg	VD20	6g	Tor
B5X	X06115A628MR	Vdet-IC	2.8V±2%, +Rst PPO, -Rst ODO, Wt=1.6s, Rt=3.13ms	SOT-25	28xg	VD20	6g	Tor
B5Y	X06115A629MR	Vdet-IC	2.9V±2%, +Rst PPO, -Rst ODO, Wt=1.6s, Rt=3.13ms	SOT-25	28xg	VD20	6g	Tor
B5Z	X06115A630MR	Vdet-IC	3.0V±2%, +Rst PPO, -Rst ODO, Wt=1.6s, Rt=3.13ms	SOT-25	28xg	VD20	6g	Tor
B6	R1111N361A	LVR-IC	LDO, LN, -CE, 3.6V±2%, 200mA	SOT-23-5	28cx	VR4	6g	Ric
B6	RN5VD16AA	LVR-IC	1.6V±2.5%, -Reset PPO	SOT-23-5	28vdo	VD3	6g	Ric
B60	R1152N060B	LVR-IC	Boost, +CE, 6V±2%, 150mA	SOT-23-5	28vrf	VR6	6g	Ric
B60	X06115B231MR	Vdet-IC	3.1V±2%, +Rst PPO, -Rst ODO, Wt=50ms, Rt=25ms	SOT-25	28xg	VD20	6g	Tor
B61	R1152N061B	LVR-IC	Boost, +CE, 6.1V±2%, 150mA	SOT-23-5	28vrf	VR6	6g	Ric
B61	X06115B232MR	Vdet-IC	3.2V±2%, +Rst PPO, -Rst ODO, Wt=50ms, Rt=25ms	SOT-25	28xg	VD20	6g	Tor
B62	R1152N062B	LVR-IC	Boost, +CE, 6.2V±2%, 150mA	SOT-23-5	28vrf	VR6	6g	Ric
B62	S-80841CLMC	Vdet-IC	4.1V, -Reset PPO	SOT-23-5	28vdm	VD7	6a	Sii
B62	X06115B233MR	Vdet-IC	3.3V±2%, +Rst PPO, -Rst ODO, Wt=50ms, Rt=25ms	SOT-25	28xg	VD20	6g	Tor
B63	R1152N063B	LVR-IC	Boost, +CE, 6.3V±2%, 150mA	SOT-23-5	28vrf	VR6	6g	Ric
B63	S-80842CLMC	Vdet-IC	4.2V, -Reset PPO	SOT-23-5	28vdm	VD7	6a	Sii
B63	X06115B234MR	Vdet-IC	3.4V±2%, +Rst PPO, -Rst ODO, Wt=50ms, Rt=25ms	SOT-25	28xg	VD20	6g	Tor
B64	R1152N064B	LVR-IC	Boost, +CE, 6.4V±2%, 150mA	SOT-23-5	28vrf	VR6	6g	Ric
B64	S-80843CLMC	Vdet-IC	4.3V, -Reset PPO	SOT-23-5	28vdm	VD7	6a	Sii
B64	X06115B235MR	Vdet-IC	3.5V±2%, +Rst PPO, -Rst ODO, Wt=50ms, Rt=25ms	SOT-25	28xg	VD20	6g	Tor
B65	R1152N065B	LVR-IC	Boost, +CE, 6.5V±2%, 150mA	SOT-23-5	28vrf	VR6	6g	Ric
B65	S-80844CLMC	Vdet-IC	4.4V, -Reset PPO	SOT-23-5	28vdm	VD7	6a	Sii
B65	X06115B236MR	Vdet-IC	3.6V±2%, +Rst PPO, -Rst ODO, Wt=50ms, Rt=25ms	SOT-25	28xg	VD20	6g	Tor
B66	R1152N066B	LVR-IC	Boost, +CE, 6.6V±2%, 150mA	SOT-23-5	28vrf	VR6	6g	Ric
B66	S-80845CLMC	Vdet-IC	4.5V, -Reset PPO	SOT-23-5	28vdm	VD7	6a	Sii
B66	X06115B237MR	Vdet-IC	3.7V±2%, +Rst PPO, -Rst ODO, Wt=50ms, Rt=25ms	SOT-25	28xg	VD20	6g	Tor
B67	R1152N067B	LVR-IC	Boost, +CE, 6.7V±2%, 150mA	SOT-23-5	28vrf	VR6	6g	Ric
B67	S-80846CLMC	Vdet-IC	4.6V, -Reset PPO	SOT-23-5	28vdm	VD7	6a	Sii
B67	X06115B238MR	Vdet-IC	3.8V±2%, +Rst PPO, -Rst ODO, Wt=50ms, Rt=25ms	SOT-25	28xg	VD20	6g	Tor
B68	R1152N068B	LVR-IC	Boost, +CE, 6.8V±2%, 150mA	SOT-23-5	28vrf	VR6	6g	Ric
B68	S-80847CLMC	Vdet-IC	4.7V, -Reset PPO	SOT-23-5	28vdm	VD7	6a	Sii
B68	X06115B239MR	Vdet-IC	3.9V±2%, +Rst PPO, -Rst ODO, Wt=50ms, Rt=25ms	SOT-25	28xg	VD20	6g	Tor
B69	R1152N069B	LVR-IC	Boost, +CE, 6.9V±2%, 150mA	SOT-23-5	28vrf	VR6	6g	Ric
B69	S-80848CLMC	Vdet-IC	4.8V, -Reset PPO	SOT-23-5	28vdm	VD7	6a	Sii
B69	X06115B240MR	Vdet-IC	4.0V±2%, +Rst PPO, -Rst ODO, Wt=50ms, Rt=25ms	SOT-25	28xg	VD20	6g	Tor
B6A	S-80815CLMC	Vdet-IC	1.5V, -Reset PPO	SOT-23-5	28vdm	VD7	6a	Sii
B6A	X06108C16AMR	Vdet-IC	1.6V±2%, Hysteresis, -Reset PPO	SOT-25	28rm	VD15	6g	Tor
B6A	X06115B241MR	Vdet-IC	4.1V±2%, +Rst PPO, -Rst ODO, Wt=50ms, Rt=25ms	SOT-25	28xg	VD20	6g	Tor
B6B	S-80816CLMC	Vdet-IC	1.6V, -Reset PPO	SOT-23-5	28vdm	VD7	6a	Sii
B6B	X06108C16BMR	Vdet-IC	1.6V±2%, -Reset PPO	SOT-25	28rm	VD15	6g	Tor



SMD code	Type	Function	Short description	Case	Pinout	Sch.	St.	Mnf.
B6B	XC6115B242MR	Vdet-IC	4.2V±2%, +Rst PPO, -Rst ODO, Wt=50ms, Rt=25ms	SOT-25	28xg	VD20	6g	Tor
B6C	S-80817CLMC	Vdet-IC	1.7V, -Reset PPO	SOT-23-5	28vdm	VD7	6a	Sii
B6C	XC6108C16CMR	Vdet-IC	1.6V±2%, Hysteresis, -Reset PPO	SOT-25	28rk	VD15	6g	Tor
B6C	XC6115B243MR	Vdet-IC	4.3V±2%, +Rst PPO, -Rst ODO, Wt=50ms, Rt=25ms	SOT-25	28xg	VD20	6g	Tor
B6D	S-80818CLMC	Vdet-IC	1.8V, -Reset PPO	SOT-23-5	28vdm	VD7	6a	Sii
B6D	XC6108C16DMR	Vdet-IC	1.6V±2%, -Reset PPO	SOT-25	28rk	VD15	6g	Tor
B6D	XC6115B244MR	Vdet-IC	4.4V±2%, +Rst PPO, -Rst ODO, Wt=50ms, Rt=25ms	SOT-25	28xg	VD20	6g	Tor
B6E	S-80819CLMC	Vdet-IC	1.9V, -Reset PPO	SOT-23-5	28vdm	VD7	6a	Sii
B6E	XC6115B245MR	Vdet-IC	4.5V±2%, +Rst PPO, -Rst ODO, Wt=50ms, Rt=25ms	SOT-25	28xg	VD20	6g	Tor
B6F	S-80820CLMC	Vdet-IC	2.0V, -Reset PPO	SOT-23-5	28vdm	VD7	6a	Sii
B6F	XC6115B216MR	Vdet-IC	1.6V±2%, +Rst PPO, -Rst ODO, Wt=50ms, Rt=25ms	SOT-25	28xg	VD20	6g	Tor
B6F	XC6115B246MR	Vdet-IC	4.6V±2%, +Rst PPO, -Rst ODO, Wt=50ms, Rt=25ms	SOT-25	28xg	VD20	6g	Tor
B6G	S-80821CLMC	Vdet-IC	2.1V, -Reset PPO	SOT-23-5	28vdm	VD7	6a	Sii
B6H	S-80822CLMC	Vdet-IC	2.2V, -Reset PPO	SOT-23-5	28vdm	VD7	6a	Sii
B6H	XC6115B217MR	Vdet-IC	1.7V±2%, +Rst PPO, -Rst ODO, Wt=50ms, Rt=25ms	SOT-25	28xg	VD20	6g	Tor
B6H	XC6115B247MR	Vdet-IC	4.7V±2%, +Rst PPO, -Rst ODO, Wt=50ms, Rt=25ms	SOT-25	28xg	VD20	6g	Tor
B6I	S-80823CLMC	Vdet-IC	2.3V, -Reset PPO	SOT-23-5	28vdm	VD7	6a	Sii
B6J	S-80824CLMC	Vdet-IC	2.4V, -Reset PPO	SOT-23-5	28vdm	VD7	6a	Sii
B6K	S-80825CLMC	Vdet-IC	2.5V, -Reset PPO	SOT-23-5	28vdm	VD7	6a	Sii
B6K	XC6115B218MR	Vdet-IC	1.8V±2%, +Rst PPO, -Rst ODO, Wt=50ms, Rt=25ms	SOT-25	28xg	VD20	6g	Tor
B6K	XC6115B248MR	Vdet-IC	4.8V±2%, +Rst PPO, -Rst ODO, Wt=50ms, Rt=25ms	SOT-25	28xg	VD20	6g	Tor
B6L	S-80826CLMC	Vdet-IC	2.6V, -Reset PPO	SOT-23-5	28vdm	VD7	6a	Sii
B6L	XC6115B219MR	Vdet-IC	1.9V±2%, +Rst PPO, -Rst ODO, Wt=50ms, Rt=25ms	SOT-25	28xg	VD20	6g	Tor
B6L	XC6115B249MR	Vdet-IC	4.9V±2%, +Rst PPO, -Rst ODO, Wt=50ms, Rt=25ms	SOT-25	28xg	VD20	6g	Tor
B6M	S-80827CLMC	Vdet-IC	2.7V, -Reset PPO	SOT-23-5	28vdm	VD7	6a	Sii
B6M	XC6115B220MR	Vdet-IC	2.0V±2%, +Rst PPO, -Rst ODO, Wt=50ms, Rt=25ms	SOT-25	28xg	VD20	6g	Tor
B6M	XC6115B250MR	Vdet-IC	5.0V±2%, +Rst PPO, -Rst ODO, Wt=50ms, Rt=25ms	SOT-25	28xg	VD20	6g	Tor
B6N	S-80828CLMC	Vdet-IC	2.8V, -Reset PPO	SOT-23-5	28vdm	VD7	6a	Sii
B6N	XC6115B221MR	Vdet-IC	2.1V±2%, +Rst PPO, -Rst ODO, Wt=50ms, Rt=25ms	SOT-25	28xg	VD20	6g	Tor
B6O	S-80829CLMC	Vdet-IC	2.9V, -Reset PPO	SOT-23-5	28vdm	VD7	6a	Sii
B6P	S-80830CLMC	Vdet-IC	3.0V, -Reset PPO	SOT-23-5	28vdm	VD7	6a	Sii
B6P	XC6115B222MR	Vdet-IC	2.2V±2%, +Rst PPO, -Rst ODO, Wt=50ms, Rt=25ms	SOT-25	28xg	VD20	6g	Tor
B6Q	S-80831CLMC	Vdet-IC	3.1V, -Reset PPO	SOT-23-5	28vdm	VD7	6a	Sii
B6Q	S-80832CLMC	Vdet-IC	3.2V, -Reset PPO	SOT-23-5	28vdm	VD7	6a	Sii
B6R	XC6115B223MR	Vdet-IC	2.3V±2%, +Rst PPO, -Rst ODO, Wt=50ms, Rt=25ms	SOT-25	28xg	VD20	6g	Tor
B6S	S-80833CLMC	Vdet-IC	3.3V, -Reset PPO	SOT-23-5	28vdm	VD7	6a	Sii
B6S	XC6115B224MR	Vdet-IC	2.4V±2%, +Rst PPO, -Rst ODO, Wt=50ms, Rt=25ms	SOT-25	28xg	VD20	6g	Tor
B6T	S-80834CLMC	Vdet-IC	3.4V, -Reset PPO	SOT-23-5	28vdm	VD7	6a	Sii
B6T	XC6115B225MR	Vdet-IC	2.5V±2%, +Rst PPO, -Rst ODO, Wt=50ms, Rt=25ms	SOT-25	28xg	VD20	6g	Tor
B6U	S-80835CLMC	Vdet-IC	3.5V, -Reset PPO	SOT-23-5	28vdm	VD7	6a	Sii
B6U	XC6115B226MR	Vdet-IC	2.6V±2%, +Rst PPO, -Rst ODO, Wt=50ms, Rt=25ms	SOT-25	28xg	VD20	6g	Tor
B6V	S-80836CLMC	Vdet-IC	3.6V, -Reset PPO	SOT-23-5	28vdm	VD7	6a	Sii
B6V	XC6115B227MR	Vdet-IC	2.7V±2%, +Rst PPO, -Rst ODO, Wt=50ms, Rt=25ms	SOT-25	28xg	VD20	6g	Tor
B6W	S-80837CLMC	Vdet-IC	3.7V, -Reset PPO	SOT-23-5	28vdm	VD7	6a	Sii
B6X	S-80838CLMC	Vdet-IC	3.8V, -Reset PPO	SOT-23-5	28vdm	VD7	6a	Sii
B6X	XC6115B228MR	Vdet-IC	2.8V±2%, +Rst PPO, -Rst ODO, Wt=50ms, Rt=25ms	SOT-25	28xg	VD20	6g	Tor
B6Y	S-80839CLMC	Vdet-IC	3.9V, -Reset PPO	SOT-23-5	28vdm	VD7	6a	Sii
B6Y	XC6115B229MR	Vdet-IC	2.9V±2%, +Rst PPO, -Rst ODO, Wt=50ms, Rt=25ms	SOT-25	28xg	VD20	6g	Tor
B6Z	S-80840CLMC	Vdet-IC	4.0V, -Reset PPO	SOT-23-5	28vdm	VD7	6a	Sii
B6Z	XC6115B230MR	Vdet-IC	3.0V±2%, +Rst PPO, -Rst ODO, Wt=50ms, Rt=25ms	SOT-25	28xg	VD20	6g	Tor
B7	AP432Q	Vref-IC	Adjustable, Precision, Shunt, 1.24V±1%	SOT-23-5	28re	RF1	6k	Ana
B7	R111N371A	LVR-IC	LDO, LN, -CE, 3.7V±2%, 200mA	SOT-23-5	28cx	VR4	6g	Ric
B7	TC1015-5.0VRX	LVR-IC	LDO, 5V±2%, 100mA, +CE	SOT-23-5	28vrx	VR7	6g	Mcc
B7	RN5VD17AA	Vdet-IC	1.7V±2.5%, -Reset PPO	SOT-23-5	28vdo	VD3	6g	Ric
B7=	RT9193-25GJ5	LVR-IC	LDO, 2.5V±1%, 300mA, +CE	TSOT-23-5	28vrx	VR7	6g	Rct
B70	R1152N070B	LVR-IC	Boost, +CE, 7V±2%, 150mA	SOT-23-5	28vrf	VR6	6g	Ric
B70	XC6115B331MR	Vdet-IC	3.1V±2%, +Rst PPO, -Rst ODO, Wt=100ms, Rt=25ms	SOT-25	28xg	VD20	6g	Tor
B71	R1152N071B	LVR-IC	Boost, +CE, 7.1V±2%, 150mA	SOT-23-5	28vrf	VR6	6g	Ric
B71	XC6115B332MR	Vdet-IC	3.2V±2%, +Rst PPO, -Rst ODO, Wt=100ms, Rt=25ms	SOT-25	28xg	VD20	6g	Tor
B72	R1152N072B	LVR-IC	Boost, +CE, 7.2V±2%, 150mA	SOT-23-5	28vrf	VR6	6g	Ric
B72	XC6115B333MR	Vdet-IC	3.3V±2%, +Rst PPO, -Rst ODO, Wt=100ms, Rt=25ms	SOT-25	28xg	VD20	6g	Tor
B73	R1152N073B	LVR-IC	Boost, +CE, 7.3V±2%, 150mA	SOT-23-5	28vrf	VR6	6g	Ric
B73	XC6115B334MR	Vdet-IC	3.4V±2%, +Rst PPO, -Rst ODO, Wt=100ms, Rt=25ms	SOT-25	28xg	VD20	6g	Tor
B74	R1152N074B	LVR-IC	Boost, +CE, 7.4V±2%, 150mA	SOT-23-5	28vrf	VR6	6g	Ric
B74	XC6115B335MR	Vdet-IC	3.5V±2%, +Rst PPO, -Rst ODO, Wt=100ms, Rt=25ms	SOT-25	28xg	VD20	6g	Tor
B75	R1152N075B	LVR-IC	Boost, +CE, 7.5V±2%, 150mA	SOT-23-5	28vrf	VR6	6g	Ric
B75	XC6115B336MR	Vdet-IC	3.6V±2%, +Rst PPO, -Rst ODO, Wt=100ms, Rt=25ms	SOT-25	28xg	VD20	6g	Tor
B76	R1152N076B	LVR-IC	Boost, +CE, 7.6V±2%, 150mA	SOT-23-5	28vrf	VR6	6g	Ric
B76	XC6115B337MR	Vdet-IC	3.7V±2%, +Rst PPO, -Rst ODO, Wt=100ms, Rt=25ms	SOT-25	28xg	VD20	6g	Tor
B77	R1152N077B	LVR-IC	Boost, +CE, 7.7V±2%, 150mA	SOT-23-5	28vrf	VR6	6g	Ric



SMD code	Type	Function	Short description	Case	Pinout	Sch.	St.	Mnf.
B77	XC6115B338MR	Vdet-IC	3.8V±2%, +Rst PPO, -Rst ODO, Wt=100ms, Rt=25ms	SOT-25	28xg	VD20	6g	Tor
B78	R1152N078B	LVR-IC	Boost, +CE, 7.8V±2%, 150mA	SOT-23-5	28vrf	VR6	6g	Ric
B78	XC6115B339MR	Vdet-IC	3.9V±2%, +Rst PPO, -Rst ODO, Wt=100ms, Rt=25ms	SOT-25	28xg	VD20	6g	Tor
B79	R1152N079B	LVR-IC	Boost, +CE, 7.9V±2%, 150mA	SOT-23-5	28vrf	VR6	6g	Ric
B79	XC6115B340MR	Vdet-IC	4.0V±2%, +Rst PPO, -Rst ODO, Wt=100ms, Rt=25ms	SOT-25	28xg	VD20	6g	Tor
B7A	S-80849CLMC	Vdet-IC	4.9V, -Reset PPO	SOT-23-5	28vdm	VD7	6a	Sii
B7A	XC6108C17AMR	Vdet-IC	1.7V±2%, Hysteresis, -Reset PPO	SOT-25	28rm	VD15	6g	Tor
B7A	XC6115B341MR	Vdet-IC	4.1V±2%, +Rst PPO, -Rst ODO, Wt=100ms, Rt=25ms	SOT-25	28xg	VD20	6g	Tor
B7B	S-80850CLMC	Vdet-IC	5.0V, -Reset PPO	SOT-23-5	28vdm	VD7	6a	Sii
B7B	XC6108C17BMR	Vdet-IC	1.7V±2%, -Reset PPO	SOT-25	28rm	VD15	6g	Tor
B7B	XC6115B342MR	Vdet-IC	4.2V±2%, +Rst PPO, -Rst ODO, Wt=100ms, Rt=25ms	SOT-25	28xg	VD20	6g	Tor
B7C	S-80851CLMC	Vdet-IC	5.1V, -Reset PPO	SOT-23-5	28vdm	VD7	6a	Sii
B7C	XC6108C17CMR	Vdet-IC	1.7V±2%, Hysteresis, -Reset PPO	SOT-25	28rk	VD15	6g	Tor
B7C	XC6115B343MR	Vdet-IC	4.3V±2%, +Rst PPO, -Rst ODO, Wt=100ms, Rt=25ms	SOT-25	28xg	VD20	6g	Tor
B7D	S-80852CLMC	Vdet-IC	5.2V, -Reset PPO	SOT-23-5	28vdm	VD7	6a	Sii
B7D	XC6108C17DMR	Vdet-IC	1.7V±2%, -Reset PPO	SOT-25	28rk	VD15	6g	Tor
B7D	XC6115B344MR	Vdet-IC	4.4V±2%, +Rst PPO, -Rst ODO, Wt=100ms, Rt=25ms	SOT-25	28xg	VD20	6g	Tor
B7E	S-80853CLMC	Vdet-IC	5.3V, -Reset PPO	SOT-23-5	28vdm	VD7	6a	Sii
B7E	XC6115B345MR	Vdet-IC	4.5V±2%, +Rst PPO, -Rst ODO, Wt=100ms, Rt=25ms	SOT-25	28xg	VD20	6g	Tor
B7F	S-80854CLMC	Vdet-IC	5.4V, -Reset PPO	SOT-23-5	28vdm	VD7	6a	Sii
B7F	XC6115B316MR	Vdet-IC	1.6V±2%, +Rst PPO, -Rst ODO, Wt=100ms, Rt=25ms	SOT-25	28xg	VD20	6g	Tor
B7F	XC6115B346MR	Vdet-IC	4.6V±2%, +Rst PPO, -Rst ODO, Wt=100ms, Rt=25ms	SOT-25	28xg	VD20	6g	Tor
B7G	S-80855CLMC	Vdet-IC	5.5V, -Reset PPO	SOT-23-5	28vdm	VD7	6a	Sii
B7H	S-80856CLMC	Vdet-IC	5.6V, -Reset PPO	SOT-23-5	28vdm	VD7	6a	Sii
B7H	XC6115B317MR	Vdet-IC	1.7V±2%, +Rst PPO, -Rst ODO, Wt=100ms, Rt=25ms	SOT-25	28xg	VD20	6g	Tor
B7H	XC6115B347MR	Vdet-IC	4.7V±2%, +Rst PPO, -Rst ODO, Wt=100ms, Rt=25ms	SOT-25	28xg	VD20	6g	Tor
B7I	S-80857CLMC	Vdet-IC	5.7V, -Reset PPO	SOT-23-5	28vdm	VD7	6a	Sii
B7J	S-80858CLMC	Vdet-IC	5.8V, -Reset PPO	SOT-23-5	28vdm	VD7	6a	Sii
B7K	S-80859CLMC	Vdet-IC	5.9V, -Reset PPO	SOT-23-5	28vdm	VD7	6a	Sii
B7K	XC6115B318MR	Vdet-IC	1.8V±2%, +Rst PPO, -Rst ODO, Wt=100ms, Rt=25ms	SOT-25	28xg	VD20	6g	Tor
B7K	XC6115B348MR	Vdet-IC	4.8V±2%, +Rst PPO, -Rst ODO, Wt=100ms, Rt=25ms	SOT-25	28xg	VD20	6g	Tor
B7L	S-80860CLMC	Vdet-IC	6.0V, -Reset PPO	SOT-23-5	28vdm	VD7	6a	Sii
B7L	XC6115B319MR	Vdet-IC	1.9V±2%, +Rst PPO, -Rst ODO, Wt=100ms, Rt=25ms	SOT-25	28xg	VD20	6g	Tor
B7L	XC6115B349MR	Vdet-IC	4.9V±2%, +Rst PPO, -Rst ODO, Wt=100ms, Rt=25ms	SOT-25	28xg	VD20	6g	Tor
B7M	XC6115B320MR	Vdet-IC	2.0V±2%, +Rst PPO, -Rst ODO, Wt=100ms, Rt=25ms	SOT-25	28xg	VD20	6g	Tor
B7M	XC6115B350MR	Vdet-IC	5.0V±2%, +Rst PPO, -Rst ODO, Wt=100ms, Rt=25ms	SOT-25	28xg	VD20	6g	Tor
B7N	XC6115B321MR	Vdet-IC	2.1V±2%, +Rst PPO, -Rst ODO, Wt=100ms, Rt=25ms	SOT-25	28xg	VD20	6g	Tor
B7P	XC6115B322MR	Vdet-IC	2.2V±2%, +Rst PPO, -Rst ODO, Wt=100ms, Rt=25ms	SOT-25	28xg	VD20	6g	Tor
B7R	XC6115B323MR	Vdet-IC	2.3V±2%, +Rst PPO, -Rst ODO, Wt=100ms, Rt=25ms	SOT-25	28xg	VD20	6g	Tor
B7S	XC6115B324MR	Vdet-IC	2.4V±2%, +Rst PPO, -Rst ODO, Wt=100ms, Rt=25ms	SOT-25	28xg	VD20	6g	Tor
B7T	XC6115B325MR	Vdet-IC	2.5V±2%, +Rst PPO, -Rst ODO, Wt=100ms, Rt=25ms	SOT-25	28xg	VD20	6g	Tor
B7U	XC6115B326MR	Vdet-IC	2.6V±2%, +Rst PPO, -Rst ODO, Wt=100ms, Rt=25ms	SOT-25	28xg	VD20	6g	Tor
B7V	XC6115B327MR	Vdet-IC	2.7V±2%, +Rst PPO, -Rst ODO, Wt=100ms, Rt=25ms	SOT-25	28xg	VD20	6g	Tor
B7X	XC6115B328MR	Vdet-IC	2.8V±2%, +Rst PPO, -Rst ODO, Wt=100ms, Rt=25ms	SOT-25	28xg	VD20	6g	Tor
B7Y	XC6115B329MR	Vdet-IC	2.9V±2%, +Rst PPO, -Rst ODO, Wt=100ms, Rt=25ms	SOT-25	28xg	VD20	6g	Tor
B7Z	XC6115B330MR	Vdet-IC	3.0V±2%, +Rst PPO, -Rst ODO, Wt=100ms, Rt=25ms	SOT-25	28xg	VD20	6g	Tor
B8	AP432AQ	Vref-IC	Adjustable, Precision, Shunt, 1.24V±0.5%	SOT-23-5	28re	RF1	6k	Ana
B8	PI74STX1G08CX	CMOS-Logic	2-input AND gate	SC-70-5	28/Log3	-	6a	Per
B8	PI74STX1G08TX	CMOS-Logic	2-input AND gate	SOT-23-5	28/Log3	-	6a	Per
B8	R1111N381A	LVR-IC	LDO, LN, -CE, 3.8V±2%, 200mA	SOT-23-5	28cx	VR4	6g	Ric
B8	TC1015-2.85VFX	LVR-IC	LDO, 2.85V±2%, 100mA, +CE	SOT-23-5	28vrx	VR7	6g	Mcc
B8	RN5VD18AA	Vdet-IC	1.8V±2.5%, -Reset PPO	SOT-23-5	28vdo	VD3	6g	Ric
B8-	RT9198-32PU5R	LVR-IC	LDO, 3.2V±1%, 300mA, +CE	SC-70-5	28cx	VR4	6a	Rct
B8=	RT9198-25GJ5R	LVR-IC	LDO, 2.5V±1%, 300mA, +CE	TSOT-23-5	28bcx	VR4	6a	Rct
B80	R1152N080B	LVR-IC	Boost, +CE, 8V±2%, 150mA	SOT-23-5	28vrf	VR6	6g	Ric
B80	XC6115B431MR	Vdet-IC	3.1V±2%, +Rst PPO, -Rst ODO, Wt=200ms, Rt=25ms	SOT-25	28xg	VD20	6g	Tor
B81	R1152N081B	LVR-IC	Boost, +CE, 8.1V±2%, 150mA	SOT-23-5	28vrf	VR6	6g	Ric
B81	XC6115B432MR	Vdet-IC	3.2V±2%, +Rst PPO, -Rst ODO, Wt=200ms, Rt=25ms	SOT-25	28xg	VD20	6g	Tor
B82	R1152N082B	LVR-IC	Boost, +CE, 8.2V±2%, 150mA	SOT-23-5	28vrf	VR6	6g	Ric
B82	S-80841CNMC	Vdet-IC	4.1V, -Reset ODO	SOT-23-5	28vdm	VD6	6a	Sii
B82	XC6115B433MR	Vdet-IC	3.3V±2%, +Rst PPO, -Rst ODO, Wt=200ms, Rt=25ms	SOT-25	28xg	VD20	6g	Tor
B83	R1152N083B	LVR-IC	Boost, +CE, 8.3V±2%, 150mA	SOT-23-5	28vrf	VR6	6g	Ric
B83	S-80842CNMC	Vdet-IC	4.2V, -Reset ODO	SOT-23-5	28vdm	VD6	6a	Sii
B83	XC6115B434MR	Vdet-IC	3.4V±2%, +Rst PPO, -Rst ODO, Wt=200ms, Rt=25ms	SOT-25	28xg	VD20	6g	Tor
B84	R1152N084B	LVR-IC	Boost, +CE, 8.4V±2%, 150mA	SOT-23-5	28vrf	VR6	6g	Ric
B84	S-80843CNMC	Vdet-IC	4.3V, -Reset ODO	SOT-23-5	28vdm	VD6	6a	Sii
B84	XC6115B435MR	Vdet-IC	3.5V±2%, +Rst PPO, -Rst ODO, Wt=200ms, Rt=25ms	SOT-25	28xg	VD20	6g	Tor
B85	R1152N085B	LVR-IC	Boost, +CE, 8.5V±2%, 150mA	SOT-23-5	28vrf	VR6	6g	Ric
B85	S-80844CNMC	Vdet-IC	4.4V, -Reset ODO	SOT-23-5	28vdm	VD6	6a	Sii
B85	XC6115B436MR	Vdet-IC	3.6V±2%, +Rst PPO, -Rst ODO, Wt=200ms, Rt=25ms	SOT-25	28xg	VD20	6g	Tor



SMD code	Type	Function	Short description	Case	Pinout	Sch.	St.	Mnf.
B86	R1152N086B	LVR-IC	Boost, +CE, 8.6V±2%, 150mA	SOT-23-5	28vrf	VR6	6g	Ric
B86	S-80845CNMC	Vdet-IC	4.5V, -Reset ODO	SOT-23-5	28vdm	VD6	6a	Sii
B86	XC6115B437MR	Vdet-IC	3.7V±2%, +Rst PPO, -Rst ODO, Wt=200ms, Rt=25ms	SOT-25	28xg	VD20	6g	Tor
B87	R1152N087B	LVR-IC	Boost, +CE, 8.7V±2%, 150mA	SOT-23-5	28vrf	VR6	6g	Ric
B87	S-80846CNMC	Vdet-IC	4.6V, -Reset ODO	SOT-23-5	28vdm	VD6	6a	Sii
B87	XC6115B438MR	Vdet-IC	3.8V±2%, +Rst PPO, -Rst ODO, Wt=200ms, Rt=25ms	SOT-25	28xg	VD20	6g	Tor
B88	R1152N088B	LVR-IC	Boost, +CE, 8.8V±2%, 150mA	SOT-23-5	28vrf	VR6	6g	Ric
B88	S-80847CNMC	Vdet-IC	4.7V, -Reset ODO	SOT-23-5	28vdm	VD6	6a	Sii
B88	XC6115B439MR	Vdet-IC	3.9V±2%, +Rst PPO, -Rst ODO, Wt=200ms, Rt=25ms	SOT-25	28xg	VD20	6g	Tor
B89	R1152N089B	LVR-IC	Boost, +CE, 8.9V±2%, 150mA	SOT-23-5	28vrf	VR6	6g	Ric
B89	S-80848CNMC	Vdet-IC	4.8V, -Reset ODO	SOT-23-5	28vdm	VD6	6a	Sii
B89	XC6115B440MR	Vdet-IC	4.0V±2%, +Rst PPO, -Rst ODO, Wt=200ms, Rt=25ms	SOT-25	28xg	VD20	6g	Tor
B8A	S-80815CNMC	Vdet-IC	1.5V, -Reset ODO	SOT-23-5	28vdm	VD6	6a	Sii
B8A	XC6108C18AMR	Vdet-IC	1.8V±2%, Hysteresis, -Reset PPO	SOT-25	28rm	VD15	6g	Tor
B8A	XC6115B441MR	Vdet-IC	4.1V±2%, +Rst PPO, -Rst ODO, Wt=200ms, Rt=25ms	SOT-25	28xg	VD20	6g	Tor
B8B	S-80816CNMC	Vdet-IC	1.6V, -Reset ODO	SOT-23-5	28vdm	VD6	6a	Sii
B8B	XC6108C18BMR	Vdet-IC	1.8V±2%, -Reset PPO	SOT-25	28rm	VD15	6g	Tor
B8B	XC6115B442MR	Vdet-IC	4.2V±2%, +Rst PPO, -Rst ODO, Wt=200ms, Rt=25ms	SOT-25	28xg	VD20	6g	Tor
B8C	S-80817CNMC	Vdet-IC	1.7V, -Reset ODO	SOT-23-5	28vdm	VD6	6a	Sii
B8C	XC6108C18CMR	Vdet-IC	1.8V±2%, Hysteresis, -Reset PPO	SOT-25	28rk	VD15	6g	Tor
B8C	XC6115B443MR	Vdet-IC	4.3V±2%, +Rst PPO, -Rst ODO, Wt=200ms, Rt=25ms	SOT-25	28xg	VD20	6g	Tor
B8D	S-80818CNMC	Vdet-IC	1.8V, -Reset ODO	SOT-23-5	28vdm	VD6	6a	Sii
B8D	XC6108C18DMR	Vdet-IC	1.8V±2%, -Reset PPO	SOT-25	28rk	VD15	6g	Tor
B8D	XC6115B444MR	Vdet-IC	4.4V±2%, +Rst PPO, -Rst ODO, Wt=200ms, Rt=25ms	SOT-25	28xg	VD20	6g	Tor
B8E	S-80819CNMC	Vdet-IC	1.9V, -Reset ODO	SOT-23-5	28vdm	VD6	6a	Sii
B8E	XC6115B445MR	Vdet-IC	4.5V±2%, +Rst PPO, -Rst ODO, Wt=200ms, Rt=25ms	SOT-25	28xg	VD20	6g	Tor
B8F	S-80820CNMC	Vdet-IC	2.0V, -Reset ODO	SOT-23-5	28vdm	VD6	6a	Sii
B8F	XC6115B416MR	Vdet-IC	1.6V±2%, +Rst PPO, -Rst ODO, Wt=200ms, Rt=25ms	SOT-25	28xg	VD20	6g	Tor
B8F	XC6115B446MR	Vdet-IC	4.6V±2%, +Rst PPO, -Rst ODO, Wt=200ms, Rt=25ms	SOT-25	28xg	VD20	6g	Tor
B8G	S-80821CNMC	Vdet-IC	2.1V, -Reset ODO	SOT-23-5	28vdm	VD6	6a	Sii
B8G	S-80822CNMC	Vdet-IC	2.2V, -Reset ODO	SOT-23-5	28vdm	VD6	6a	Sii
B8H	XC6115B417MR	Vdet-IC	1.7V±2%, +Rst PPO, -Rst ODO, Wt=200ms, Rt=25ms	SOT-25	28xg	VD20	6g	Tor
B8H	XC6115B447MR	Vdet-IC	4.7V±2%, +Rst PPO, -Rst ODO, Wt=200ms, Rt=25ms	SOT-25	28xg	VD20	6g	Tor
B8I	S-80823CNMC	Vdet-IC	2.3V, -Reset ODO	SOT-23-5	28vdm	VD6	6a	Sii
B8J	S-80824CNMC	Vdet-IC	2.4V, -Reset ODO	SOT-23-5	28vdm	VD6	6a	Sii
B8K	S-80825CNMC	Vdet-IC	2.5V, -Reset ODO	SOT-23-5	28vdm	VD6	6a	Sii
B8K	XC6115B418MR	Vdet-IC	1.8V±2%, +Rst PPO, -Rst ODO, Wt=200ms, Rt=25ms	SOT-25	28xg	VD20	6g	Tor
B8K	XC6115B448MR	Vdet-IC	4.8V±2%, +Rst PPO, -Rst ODO, Wt=200ms, Rt=25ms	SOT-25	28xg	VD20	6g	Tor
B8L	S-80826CNMC	Vdet-IC	2.6V, -Reset ODO	SOT-23-5	28vdm	VD6	6a	Sii
B8L	XC6115B419MR	Vdet-IC	1.9V±2%, +Rst PPO, -Rst ODO, Wt=200ms, Rt=25ms	SOT-25	28xg	VD20	6g	Tor
B8L	XC6115B449MR	Vdet-IC	4.9V±2%, +Rst PPO, -Rst ODO, Wt=200ms, Rt=25ms	SOT-25	28xg	VD20	6g	Tor
B8M	S-80827CNMC	Vdet-IC	2.7V, -Reset ODO	SOT-23-5	28vdm	VD6	6a	Sii
B8M	XC6115B420MR	Vdet-IC	2.0V±2%, +Rst PPO, -Rst ODO, Wt=200ms, Rt=25ms	SOT-25	28xg	VD20	6g	Tor
B8M	XC6115B450MR	Vdet-IC	5.0V±2%, +Rst PPO, -Rst ODO, Wt=200ms, Rt=25ms	SOT-25	28xg	VD20	6g	Tor
B8N	S-80828CNMC	Vdet-IC	2.8V, -Reset ODO	SOT-23-5	28vdm	VD6	6a	Sii
B8N	XC6115B421MR	Vdet-IC	2.1V±2%, +Rst PPO, -Rst ODO, Wt=200ms, Rt=25ms	SOT-25	28xg	VD20	6g	Tor
B8O	S-80829CNMC	Vdet-IC	2.9V, -Reset ODO	SOT-23-5	28vdm	VD6	6a	Sii
B8P	S-80830CNMC	Vdet-IC	3.0V, -Reset ODO	SOT-23-5	28vdm	VD6	6a	Sii
B8P	XC6115B422MR	Vdet-IC	2.2V±2%, +Rst PPO, -Rst ODO, Wt=200ms, Rt=25ms	SOT-25	28xg	VD20	6g	Tor
B8Q	S-80831CNMC	Vdet-IC	3.1V, -Reset ODO	SOT-23-5	28vdm	VD6	6a	Sii
B8R	S-80832CNMC	Vdet-IC	3.2V, -Reset ODO	SOT-23-5	28vdm	VD6	6a	Sii
B8R	XC6115B423MR	Vdet-IC	2.3V±2%, +Rst PPO, -Rst ODO, Wt=200ms, Rt=25ms	SOT-25	28xg	VD20	6g	Tor
B8S	S-80833CNMC	Vdet-IC	3.3V, -Reset ODO	SOT-23-5	28vdm	VD6	6a	Sii
B8S	XC6115B424MR	Vdet-IC	2.4V±2%, +Rst PPO, -Rst ODO, Wt=200ms, Rt=25ms	SOT-25	28xg	VD20	6g	Tor
B8T	S-80834CNMC	Vdet-IC	3.4V, -Reset ODO	SOT-23-5	28vdm	VD6	6a	Sii
B8T	XC6115B425MR	Vdet-IC	2.5V±2%, +Rst PPO, -Rst ODO, Wt=200ms, Rt=25ms	SOT-25	28xg	VD20	6g	Tor
B8U	S-80835CNMC	Vdet-IC	3.5V, -Reset ODO	SOT-23-5	28vdm	VD6	6a	Sii
B8U	XC6115B426MR	Vdet-IC	2.6V±2%, +Rst PPO, -Rst ODO, Wt=200ms, Rt=25ms	SOT-25	28xg	VD20	6g	Tor
B8V	S-80836CNMC	Vdet-IC	3.6V, -Reset ODO	SOT-23-5	28vdm	VD6	6a	Sii
B8V	XC6115B427MR	Vdet-IC	2.7V±2%, +Rst PPO, -Rst ODO, Wt=200ms, Rt=25ms	SOT-25	28xg	VD20	6g	Tor
B8W	S-80837CNMC	Vdet-IC	3.7V, -Reset ODO	SOT-23-5	28vdm	VD6	6a	Sii
B8X	S-80838CNMC	Vdet-IC	3.8V, -Reset ODO	SOT-23-5	28vdm	VD6	6a	Sii
B8X	XC6115B428MR	Vdet-IC	2.8V±2%, +Rst PPO, -Rst ODO, Wt=200ms, Rt=25ms	SOT-25	28xg	VD20	6g	Tor
B8Y	S-80839CNMC	Vdet-IC	3.9V, -Reset ODO	SOT-23-5	28vdm	VD6	6a	Sii
B8Y	XC6115B429MR	Vdet-IC	2.9V±2%, +Rst PPO, -Rst ODO, Wt=200ms, Rt=25ms	SOT-25	28xg	VD20	6g	Tor
B8Z	S-80840CNMC	Vdet-IC	4.0V, -Reset ODO	SOT-23-5	28vdm	VD6	6a	Sii
B8Z	XC6115B430MR	Vdet-IC	3.0V±2%, +Rst PPO, -Rst ODO, Wt=200ms, Rt=25ms	SOT-25	28xg	VD20	6g	Tor
B9	R1111N391A	LVR-IC	LDO, LN, -CE, 3.9V±2%, 200mA	SOT-23-5	28cx	VR4	6g	Ric
B9	TC1015-3.6VRX	LVR-IC	LDO, 3.6V±2%, 100mA, +CE	SOT-23-5	28vrx	VR7	6g	Mcc
B9	RN5VD19AA	Vdet-IC	1.9V±2.5%, -Reset PPO	SOT-23-5	28vdo	VD3	6g	Ric



SMD code	Type	Function	Short description	Case	Pinout	Sch.	St.	Mnf.
B89	RT9198-28PU5R	LVR-IC	LDO, 2.8V±1%, 300mA, +CE	SC-70-5	28cx	VR4	6a	Rct
B90	R1152N090B	LVR-IC	Boost, +CE, 9V±2%, 150mA	SOT-23-5	28wrf	VR6	6g	Ric
B90	XC6115B531MR	Vdet-IC	3.1V±2%, +Rst PPO, -Rst ODO, Wt=400ms, Rt=25ms	SOT-25	28xg	VD20	6g	Tor
B91	R1152N091B	LVR-IC	Boost, +CE, 9.1V±2%, 150mA	SOT-23-5	28wrf	VR6	6g	Ric
B91	XC6115B532MR	Vdet-IC	3.2V±2%, +Rst PPO, -Rst ODO, Wt=400ms, Rt=25ms	SOT-25	28xg	VD20	6g	Tor
B92	R1152N092B	LVR-IC	Boost, +CE, 9.2V±2%, 150mA	SOT-23-5	28wrf	VR6	6g	Ric
B92	XC6115B533MR	Vdet-IC	3.3V±2%, +Rst PPO, -Rst ODO, Wt=400ms, Rt=25ms	SOT-25	28xg	VD20	6g	Tor
B93	R1152N093B	LVR-IC	Boost, +CE, 9.3V±2%, 150mA	SOT-23-5	28wrf	VR6	6g	Ric
B93	XC6115B534MR	Vdet-IC	3.4V±2%, +Rst PPO, -Rst ODO, Wt=400ms, Rt=25ms	SOT-25	28xg	VD20	6g	Tor
B94	R1152N094B	LVR-IC	Boost, +CE, 9.4V±2%, 150mA	SOT-23-5	28wrf	VR6	6g	Ric
B94	XC6115B535MR	Vdet-IC	3.5V±2%, +Rst PPO, -Rst ODO, Wt=400ms, Rt=25ms	SOT-25	28xg	VD20	6g	Tor
B95	R1152N095B	LVR-IC	Boost, +CE, 9.5V±2%, 150mA	SOT-23-5	28wrf	VR6	6g	Ric
B95	XC6115B536MR	Vdet-IC	3.6V±2%, +Rst PPO, -Rst ODO, Wt=400ms, Rt=25ms	SOT-25	28xg	VD20	6g	Tor
B96	R1152N096B	LVR-IC	Boost, +CE, 9.6V±2%, 150mA	SOT-23-5	28wrf	VR6	6g	Ric
B96	XC6115B537MR	Vdet-IC	3.7V±2%, +Rst PPO, -Rst ODO, Wt=400ms, Rt=25ms	SOT-25	28xg	VD20	6g	Tor
B97	R1152N097B	LVR-IC	Boost, +CE, 9.7V±2%, 150mA	SOT-23-5	28wrf	VR6	6g	Ric
B97	XC6115B538MR	Vdet-IC	3.8V±2%, +Rst PPO, -Rst ODO, Wt=400ms, Rt=25ms	SOT-25	28xg	VD20	6g	Tor
B98	R1152N098B	LVR-IC	Boost, +CE, 9.8V±2%, 150mA	SOT-23-5	28wrf	VR6	6g	Ric
B98	XC6115B539MR	Vdet-IC	3.9V±2%, +Rst PPO, -Rst ODO, Wt=400ms, Rt=25ms	SOT-25	28xg	VD20	6g	Tor
B99	R1152N099B	LVR-IC	Boost, +CE, 9.9V±2%, 150mA	SOT-23-5	28wrf	VR6	6g	Ric
B99	XC6115B540MR	Vdet-IC	4.0V±2%, +Rst PPO, -Rst ODO, Wt=400ms, Rt=25ms	SOT-25	28xg	VD20	6g	Tor
B9A	S-80849CNMC	Vdet-IC	4.9V, -Reset ODO	SOT-23-5	28vdm	VD6	6a	Sii
B9A	XC6108C19AMR	Vdet-IC	1.9V±2%, Hysteresis, -Reset PPO	SOT-25	28rm	VD15	6g	Tor
B9A	XC6115B541MR	Vdet-IC	4.1V±2%, +Rst PPO, -Rst ODO, Wt=400ms, Rt=25ms	SOT-25	28xg	VD20	6g	Tor
B9B	S-80850CNMC	Vdet-IC	5.0V, -Reset ODO	SOT-23-5	28vdm	VD6	6a	Sii
B9B	XC6108C19BMR	Vdet-IC	1.9V±2%, -Reset PPO	SOT-25	28rm	VD15	6g	Tor
B9B	XC6115B542MR	Vdet-IC	4.2V±2%, +Rst PPO, -Rst ODO, Wt=400ms, Rt=25ms	SOT-25	28xg	VD20	6g	Tor
B9C	S-80851CNMC	Vdet-IC	5.1V, -Reset ODO	SOT-23-5	28vdm	VD6	6a	Sii
B9C	XC6108C19CMR	Vdet-IC	1.9V±2%, Hysteresis, -Reset PPO	SOT-25	28rk	VD15	6g	Tor
B9C	XC6115B543MR	Vdet-IC	4.3V±2%, +Rst PPO, -Rst ODO, Wt=400ms, Rt=25ms	SOT-25	28xg	VD20	6g	Tor
B9D	S-80852CNMC	Vdet-IC	5.2V, -Reset ODO	SOT-23-5	28vdm	VD6	6a	Sii
B9D	XC6108C19DMR	Vdet-IC	1.9V±2%, -Reset PPO	SOT-25	28rk	VD15	6g	Tor
B9D	XC6115B544MR	Vdet-IC	4.4V±2%, +Rst PPO, -Rst ODO, Wt=400ms, Rt=25ms	SOT-25	28xg	VD20	6g	Tor
B9E	S-80853CNMC	Vdet-IC	5.3V, -Reset ODO	SOT-23-5	28vdm	VD6	6a	Sii
B9E	XC6115B545MR	Vdet-IC	4.5V±2%, +Rst PPO, -Rst ODO, Wt=400ms, Rt=25ms	SOT-25	28xg	VD20	6g	Tor
B9F	S-80854CNMC	Vdet-IC	5.4V, -Reset ODO	SOT-23-5	28vdm	VD6	6a	Sii
B9F	XC6115B516MR	Vdet-IC	1.6V±2%, +Rst PPO, -Rst ODO, Wt=400ms, Rt=25ms	SOT-25	28xg	VD20	6g	Tor
B9F	XC6115B546MR	Vdet-IC	4.6V±2%, +Rst PPO, -Rst ODO, Wt=400ms, Rt=25ms	SOT-25	28xg	VD20	6g	Tor
B9G	S-80855CNMC	Vdet-IC	5.5V, -Reset ODO	SOT-23-5	28vdm	VD6	6a	Sii
B9H	S-80856CNMC	Vdet-IC	5.6V, -Reset ODO	SOT-23-5	28vdm	VD6	6a	Sii
B9H	XC6115B517MR	Vdet-IC	1.7V±2%, +Rst PPO, -Rst ODO, Wt=400ms, Rt=25ms	SOT-25	28xg	VD20	6g	Tor
B9H	XC6115B547MR	Vdet-IC	4.7V±2%, +Rst PPO, -Rst ODO, Wt=400ms, Rt=25ms	SOT-25	28xg	VD20	6g	Tor
B9I	S-80857CNMC	Vdet-IC	5.7V, -Reset ODO	SOT-23-5	28vdm	VD6	6a	Sii
B9J	S-80858CNMC	Vdet-IC	5.8V, -Reset ODO	SOT-23-5	28vdm	VD6	6a	Sii
B9K	S-80859CNMC	Vdet-IC	5.9V, -Reset ODO	SOT-23-5	28vdm	VD6	6a	Sii
B9K	XC6115B518MR	Vdet-IC	1.8V±2%, +Rst PPO, -Rst ODO, Wt=400ms, Rt=25ms	SOT-25	28xg	VD20	6g	Tor
B9K	XC6115B548MR	Vdet-IC	4.8V±2%, +Rst PPO, -Rst ODO, Wt=400ms, Rt=25ms	SOT-25	28xg	VD20	6g	Tor
B9L	S-80860CNMC	Vdet-IC	6.0V, -Reset ODO	SOT-23-5	28vdm	VD6	6a	Sii
B9L	XC6115B519MR	Vdet-IC	1.9V±2%, +Rst PPO, -Rst ODO, Wt=400ms, Rt=25ms	SOT-25	28xg	VD20	6g	Tor
B9L	XC6115B549MR	Vdet-IC	4.9V±2%, +Rst PPO, -Rst ODO, Wt=400ms, Rt=25ms	SOT-25	28xg	VD20	6g	Tor
B9M	XC6115B520MR	Vdet-IC	2.0V±2%, +Rst PPO, -Rst ODO, Wt=400ms, Rt=25ms	SOT-25	28xg	VD20	6g	Tor
B9M	XC6115B550MR	Vdet-IC	5.0V±2%, +Rst PPO, -Rst ODO, Wt=400ms, Rt=25ms	SOT-25	28xg	VD20	6g	Tor
B9N	XC6115B521MR	Vdet-IC	2.1V±2%, +Rst PPO, -Rst ODO, Wt=400ms, Rt=25ms	SOT-25	28xg	VD20	6g	Tor
B9P	XC6115B522MR	Vdet-IC	2.2V±2%, +Rst PPO, -Rst ODO, Wt=400ms, Rt=25ms	SOT-25	28xg	VD20	6g	Tor
B9R	XC6115B523MR	Vdet-IC	2.3V±2%, +Rst PPO, -Rst ODO, Wt=400ms, Rt=25ms	SOT-25	28xg	VD20	6g	Tor
B9S	XC6115B524MR	Vdet-IC	2.4V±2%, +Rst PPO, -Rst ODO, Wt=400ms, Rt=25ms	SOT-25	28xg	VD20	6g	Tor
B9T	XC6115B525MR	Vdet-IC	2.5V±2%, +Rst PPO, -Rst ODO, Wt=400ms, Rt=25ms	SOT-25	28xg	VD20	6g	Tor
B9U	XC6115B526MR	Vdet-IC	2.6V±2%, +Rst PPO, -Rst ODO, Wt=400ms, Rt=25ms	SOT-25	28xg	VD20	6g	Tor
B9V	XC6115B527MR	Vdet-IC	2.7V±2%, +Rst PPO, -Rst ODO, Wt=400ms, Rt=25ms	SOT-25	28xg	VD20	6g	Tor
B9X	XC6115B528MR	Vdet-IC	2.8V±2%, +Rst PPO, -Rst ODO, Wt=400ms, Rt=25ms	SOT-25	28xg	VD20	6g	Tor
B9Y	XC6115B529MR	Vdet-IC	2.9V±2%, +Rst PPO, -Rst ODO, Wt=400ms, Rt=25ms	SOT-25	28xg	VD20	6g	Tor
B9Z	XC6115B530MR	Vdet-IC	3.0V±2%, +Rst PPO, -Rst ODO, Wt=400ms, Rt=25ms	SOT-25	28xg	VD20	6g	Tor
BA	µPA500T	Si-npn	Dual, 60V, 100mA, 250MHz	SOT-23-5	28/T11	-	6a	Nec
BA	µPA570T	Si-npn	Dual, 60V, 100mA, 250MHz	SOT-23-5	28/T11	-	6a	Nec
BA	BD4719G	Vdet-IC	1.9V, -Reset ODO	SMP5	28v dq	VD6	6a	Rhm
BA	PI745TX1G125CX	CMOS-Logic	Bus buffer gate with 3-state output	SC-70-5	28/Log14	-	6a	Per
BA	PI745TX1G125TX	CMOS-Logic	Bus buffer gate with 3-state output	SOT-23-5	28/Log14	-	6a	Per
BA	PT7M7812ZTA	Vdet-IC	2.32V±1.5%, +Reset PPO, -MR	SOT-23-5	28v d2	VD5	6k	Pti
BA	RN5RT30AA	LVR-IC	LDO, 3V±2%, 150mA, -CE	SOT-23-5	28wrt	VR4	6g	Ric
BA	V6300ASP5B	Vdet-IC	2.0V, -Reset PPO, 50ms	SOT-23-5	28vdr	VD7	6a	Em



SMD code	Type	Function	Short description	Case	Pinout	Sch.	St.	Mnf.
BA	PT7M7812ZTAE	Vdet-IC	2.32V±1.5%, +Reset PPO, -MR, Lead free	SOT-23-5	28vd2	VD5	6k	Pti
BA-	RT9193-29PU5	LVR-IC	LDO, 2.9V±1%, 300mA, +CE	SC-70-5	28vrx	VR7	6g	Rct
BA0	XC6115B631MR	Vdet-IC	3.1V±2%, +Rst PPO, -Rst ODO, Wt=1.6s, Rt=25ms	SOT-25	28xg	VD20	6g	Tor
BA1	XC6115B632MR	Vdet-IC	3.2V±2%, +Rst PPO, -Rst ODO, Wt=1.6s, Rt=25ms	SOT-25	28xg	VD20	6g	Tor
BA2	XC6115B633MR	Vdet-IC	3.3V±2%, +Rst PPO, -Rst ODO, Wt=1.6s, Rt=25ms	SOT-25	28xg	VD20	6g	Tor
BA3	XC6115B634MR	Vdet-IC	3.4V±2%, +Rst PPO, -Rst ODO, Wt=1.6s, Rt=25ms	SOT-25	28xg	VD20	6g	Tor
BA4	XC6115B635MR	Vdet-IC	3.5V±2%, +Rst PPO, -Rst ODO, Wt=1.6s, Rt=25ms	SOT-25	28xg	VD20	6g	Tor
BA5	XC6115B636MR	Vdet-IC	3.6V±2%, +Rst PPO, -Rst ODO, Wt=1.6s, Rt=25ms	SOT-25	28xg	VD20	6g	Tor
BA6	XC6115B637MR	Vdet-IC	3.7V±2%, +Rst PPO, -Rst ODO, Wt=1.6s, Rt=25ms	SOT-25	28xg	VD20	6g	Tor
BA7	XC6115B638MR	Vdet-IC	3.8V±2%, +Rst PPO, -Rst ODO, Wt=1.6s, Rt=25ms	SOT-25	28xg	VD20	6g	Tor
BA8	XC6115B639MR	Vdet-IC	3.9V±2%, +Rst PPO, -Rst ODO, Wt=1.6s, Rt=25ms	SOT-25	28xg	VD20	6g	Tor
BA9	XC6115B640MR	Vdet-IC	4.0V±2%, +Rst PPO, -Rst ODO, Wt=1.6s, Rt=25ms	SOT-25	28xg	VD20	6g	Tor
BAA	RP107N341B	LVR-IC	LDO, 3.4V±1%, 200mA, +CE	SOT-23-5	28cx	VR4	6g	Ric
BAA	S-816A25AMC	LVR-IC	2.5V±2%, -CE, Ext, tranz	SOT-23-5	28vr9	VR6	6a	Sii
BAA	XC6115B641MR	Vdet-IC	4.1V±2%, +Rst PPO, -Rst ODO, Wt=1.6s, Rt=25ms	SOT-25	28xg	VD20	6g	Tor
BAB	RP107N351B	LVR-IC	LDO, 3.5V±1%, 200mA, +CE	SOT-23-5	28cx	VR4	6g	Ric
BAB	S-816A26AMC	LVR-IC	2.6V±2%, -CE, Ext, tranz	SOT-23-5	28vr9	VR6	6a	Sii
BAB	XC6115B642MR	Vdet-IC	4.2V±2%, +Rst PPO, -Rst ODO, Wt=1.6s, Rt=25ms	SOT-25	28xg	VD20	6g	Tor
BAC	AME8510AEEVAFE46	Vdet-IC	4.63V±1.5%, +Reset PPO, -MR, Strobe	SOT-23-5	28cp	VD17	6k	Ame
BAC	RP107N361B	LVR-IC	LDO, 3.6V±1%, 200mA, +CE	SOT-23-5	28cx	VR4	6g	Ric
BAC	S-816A27AMC	LVR-IC	2.7V±2%, -CE, Ext, tranz	SOT-23-5	28vr9	VR6	6a	Sii
BAC	XC6115B643MR	Vdet-IC	4.3V±2%, +Rst PPO, -Rst ODO, Wt=1.6s, Rt=25ms	SOT-25	28xg	VD20	6g	Tor
BAD	AME8520AEEVEFE46	Vdet-IC	4.63V±1.5%, ±Reset PPO, Strobe	SOT-23-5	28xq	VD19	6k	Ame
BAD	RP107N371B	LVR-IC	LDO, 3.7V±1%, 200mA, +CE	SOT-23-5	28cx	VR4	6g	Ric
BAD	S-816A28AMC	LVR-IC	2.8V±2%, -CE, Ext, tranz	SOT-23-5	28vr9	VR6	6a	Sii
BAD	AME8520AEEVEFE46Z	Vdet-IC	4.63V±1.5%, ±Reset PPO, Strobe, lead free	SOT-23-5	28xq	VD19	6k	Ame
BAD	XC6115B644MR	Vdet-IC	4.4V±2%, +Rst PPO, -Rst ODO, Wt=1.6s, Rt=25ms	SOT-25	28xg	VD20	6g	Tor
BAE	AME8530AEEVEFX46	Vdet-IC	4.63V±1.5%, ±Reset PPO -MR	SOT-23-5	28xf	VD21	6k	Ame
BAE	RP107N381B	LVR-IC	LDO, 3.8V±1%, 200mA, +CE	SOT-23-5	28cx	VR4	6g	Ric
BAE	S-816A29AMC	LVR-IC	2.9V±2%, -CE, Ext, tranz	SOT-23-5	28vr9	VR6	6a	Sii
BAE	AME8530AEEVEFX46Z	Vdet-IC	4.63V±1.5%, ±Reset PPO -MR, lead free	SOT-23-5	28xf	VD21	6k	Ame
BAE	XC6115B645MR	Vdet-IC	4.5V±2%, +Rst PPO, -Rst ODO, Wt=1.6s, Rt=25ms	SOT-25	28xg	VD20	6g	Tor
BAF	RP107N391B	LVR-IC	LDO, 3.9V±1%, 200mA, +CE	SOT-23-5	28cx	VR4	6g	Ric
BAF	S-816A30AMC	LVR-IC	3.0V±2%, -CE, Ext, tranz	SOT-23-5	28vr9	VR6	6a	Sii
BAF	XC6115B616MR	Vdet-IC	1.6V±2%, +Rst PPO, -Rst ODO, Wt=1.6s, Rt=25ms	SOT-25	28xg	VD20	6g	Tor
BAF	XC6115B646MR	Vdet-IC	4.6V±2%, +Rst PPO, -Rst ODO, Wt=1.6s, Rt=25ms	SOT-25	28xg	VD20	6g	Tor
BAG	RP107N401B	LVR-IC	LDO, 4.0V±1%, 200mA, +CE	SOT-23-5	28cx	VR4	6g	Ric
BAG	S-816A31AMC	LVR-IC	3.1V±2%, -CE, Ext, tranz	SOT-23-5	28vr9	VR6	6a	Sii
BAH	RP107N411B	LVR-IC	LDO, 4.1V±1%, 200mA, +CE	SOT-23-5	28cx	VR4	6g	Ric
BAH	S-816A32AMC	LVR-IC	3.2V±2%, -CE, Ext, tranz	SOT-23-5	28vr9	VR6	6a	Sii
BAH	XC6115B617MR	Vdet-IC	1.7V±2%, +Rst PPO, -Rst ODO, Wt=1.6s, Rt=25ms	SOT-25	28xg	VD20	6g	Tor
BAH	XC6115B647MR	Vdet-IC	4.7V±2%, +Rst PPO, -Rst ODO, Wt=1.6s, Rt=25ms	SOT-25	28xg	VD20	6g	Tor
BAI	S-816A33AMC	LVR-IC	3.3V±2%, -CE, Ext, tranz	SOT-23-5	28vr9	VR6	6a	Sii
BAJ	RP107N421B	LVR-IC	LDO, 4.2V±1%, 200mA, +CE	SOT-23-5	28cx	VR4	6g	Ric
BAJ	S-816A34AMC	LVR-IC	3.4V±2%, -CE, Ext, tranz	SOT-23-5	28vr9	VR6	6a	Sii
BAK	RP107N121B5	LVR-IC	LDO, 1.25V±1%, 200mA, +CE	SOT-23-5	28cx	VR4	6g	Ric
BAK	S-816A35AMC	LVR-IC	3.5V±2%, -CE, Ext, tranz	SOT-23-5	28vr9	VR6	6a	Sii
BAK	XC6115B618MR	Vdet-IC	1.8V±2%, +Rst PPO, -Rst ODO, Wt=1.6s, Rt=25ms	SOT-25	28xg	VD20	6g	Tor
BAK	XC6115B648MR	Vdet-IC	4.8V±2%, +Rst PPO, -Rst ODO, Wt=1.6s, Rt=25ms	SOT-25	28xg	VD20	6g	Tor
BAL	RP107N181B5	LVR-IC	LDO, 1.85V±1%, 200mA, +CE	SOT-23-5	28cx	VR4	6g	Ric
BAL	S-816A36AMC	LVR-IC	3.6V±2%, -CE, Ext, tranz	SOT-23-5	28vr9	VR6	6a	Sii
BAL	XC6115B619MR	Vdet-IC	1.9V±2%, +Rst PPO, -Rst ODO, Wt=1.6s, Rt=25ms	SOT-25	28xg	VD20	6g	Tor
BAL	XC6115B649MR	Vdet-IC	4.9V±2%, +Rst PPO, -Rst ODO, Wt=1.6s, Rt=25ms	SOT-25	28xg	VD20	6g	Tor
BAM	RP107N281B5	LVR-IC	LDO, 2.85V±1%, 200mA, +CE	SOT-23-5	28cx	VR4	6g	Ric
BAM	S-816A37AMC	LVR-IC	3.7V±2%, -CE, Ext, tranz	SOT-23-5	28vr9	VR6	6a	Sii
BAM	XC6115B620MR	Vdet-IC	2.0V±2%, +Rst PPO, -Rst ODO, Wt=1.6s, Rt=25ms	SOT-25	28xg	VD20	6g	Tor
BAM	XC6115B650MR	Vdet-IC	5.0V±2%, +Rst PPO, -Rst ODO, Wt=1.6s, Rt=25ms	SOT-25	28xg	VD20	6g	Tor
BAN	S-816A38AMC	LVR-IC	3.8V±2%, -CE, Ext, tranz	SOT-23-5	28vr9	VR6	6a	Sii
BAN	XC6115B621MR	Vdet-IC	2.1V±2%, +Rst PPO, -Rst ODO, Wt=1.6s, Rt=25ms	SOT-25	28xg	VD20	6g	Tor
BAO	S-816A39AMC	LVR-IC	3.9V±2%, -CE, Ext, tranz	SOT-23-5	28vr9	VR6	6a	Sii
BAP	S-816A40AMC	LVR-IC	4.0V±2%, -CE, Ext, tranz	SOT-23-5	28vr9	VR6	6a	Sii
BAP	XC6115B622MR	Vdet-IC	2.2V±2%, +Rst PPO, -Rst ODO, Wt=1.6s, Rt=25ms	SOT-25	28xg	VD20	6g	Tor
BAQ	S-816A41AMC	LVR-IC	4.1V±2%, -CE, Ext, tranz	SOT-23-5	28vr9	VR6	6a	Sii
BAR	S-816A42AMC	LVR-IC	4.2V±2%, -CE, Ext, tranz	SOT-23-5	28vr9	VR6	6a	Sii
BAR	XC6115B623MR	Vdet-IC	2.3V±2%, +Rst PPO, -Rst ODO, Wt=1.6s, Rt=25ms	SOT-25	28xg	VD20	6g	Tor
BAS	S-816A43AMC	LVR-IC	4.3V±2%, -CE, Ext, tranz	SOT-23-5	28vr9	VR6	6a	Sii
BAS	XC6115B624MR	Vdet-IC	2.4V±2%, +Rst PPO, -Rst ODO, Wt=1.6s, Rt=25ms	SOT-25	28xg	VD20	6g	Tor
BAT	S-816A44AMC	LVR-IC	4.4V±2%, -CE, Ext, tranz	SOT-23-5	28vr9	VR6	6a	Sii
BAT	XC6115B625MR	Vdet-IC	2.5V±2%, +Rst PPO, -Rst ODO, Wt=1.6s, Rt=25ms	SOT-25	28xg	VD20	6g	Tor
BAU	S-816A45AMC	LVR-IC	4.5V±2%, -CE, Ext, tranz	SOT-23-5	28vr9	VR6	6a	Sii



SMD code	Type	Function	Short description	Case	Pinout	Sch.	St.	Mnf.
BAU	XC6115B626MR	Vdet-IC	2.6V±2%, +Rst PPO, -Rst ODO, Wt=1.6s, Rt=25ms	SOT-25	28xg	VD20	6g	Tor
BAV	S-816A46AMC	LVR-IC	4.6V±2%, -CE, Ext, tranz	SOT-23-5	28vr9	VR6	6a	Sii
BAV	XC6115B627MR	Vdet-IC	2.7V±2%, +Rst PPO, -Rst ODO, Wt=1.6s, Rt=25ms	SOT-25	28xg	VD20	6g	Tor
BAW	S-816A47AMC	LVR-IC	4.7V±2%, -CE, Ext, tranz	SOT-23-5	28vr9	VR6	6a	Sii
BAX	S-816A48AMC	LVR-IC	4.8V±2%, -CE, Ext, tranz	SOT-23-5	28vr9	VR6	6a	Sii
BAX	XC6115B628MR	Vdet-IC	2.8V±2%, +Rst PPO, -Rst ODO, Wt=1.6s, Rt=25ms	SOT-25	28xg	VD20	6g	Tor
BAY	S-816A49AMC	LVR-IC	4.9V±2%, -CE, Ext, tranz	SOT-23-5	28vr9	VR6	6a	Sii
BAZ	XC6115B629MR	Vdet-IC	2.9V±2%, +Rst PPO, -Rst ODO, Wt=1.6s, Rt=25ms	SOT-25	28xg	VD20	6g	Tor
BAZ	S-816A50AMC	LVR-IC	5.0V±2%, -CE, Ext, tranz	SOT-23-5	28vr9	VR6	6a	Sii
BAZ	XC6115B630MR	Vdet-IC	3.0V±2%, +Rst PPO, -Rst ODO, Wt=1.6s, Rt=25ms	SOT-25	28xg	VD20	6g	Tor
BB	BD4720G	Vdet-IC	2.0V, -Reset ODO	SIMP5	28vdq	VD6	6a	Rhm
BB	PI745TX1G126CX	CMOS-Logic	Bus buffer gate with 3-state output	SC-70-5	28/Log13	-	6a	Per
BB	PI745TX1G126TX	CMOS-Logic	Bus buffer gate with 3-state output	SOT-23-5	28/Log13	-	6a	Per
BB	PT7M7812YTA	Vdet-IC	2.20V±1.5%, +Reset PPO, -MR	SOT-23-5	28vd2	VD5	6k	Pti
BB	RN5RT31AA	LVR-IC	LDO, 3.1V±2%, 150mA, -CE	SOT-23-5	28vt	VR4	6g	Ric
BB	V6300BSP5B	Vdet-IC	2.4V, -Reset PPO, 50ms	SOT-23-5	28vdr	VD7	6a	Em
BB	PT7M7812YTAE	Vdet-IC	2.20V±1.5%, +Reset PPO, -MR, Lead free	SOT-23-5	28vd2	VD5	6k	Pti
BB-	RT9013-12PU5	LVR-IC	LDO, 1.2V±2%, 500mA, +CE	SC-70-5	28cx	VR4	6g	Rct
BB0	XC6115C231MR	Vdet-IC	3.1V±2%, +Rst PPO, -Rst ODO, Wt=50ms, Rt=50ms	SOT-25	28xg	VD20	6g	Tor
BB1	XC6115C232MR	Vdet-IC	3.2V±2%, +Rst PPO, -Rst ODO, Wt=50ms, Rt=50ms	SOT-25	28xg	VD20	6g	Tor
BB2	XC6115C233MR	Vdet-IC	3.3V±2%, +Rst PPO, -Rst ODO, Wt=50ms, Rt=50ms	SOT-25	28xg	VD20	6g	Tor
BB3	XC6115C234MR	Vdet-IC	3.4V±2%, +Rst PPO, -Rst ODO, Wt=50ms, Rt=50ms	SOT-25	28xg	VD20	6g	Tor
BB4	XC6115C235MR	Vdet-IC	3.5V±2%, +Rst PPO, -Rst ODO, Wt=50ms, Rt=50ms	SOT-25	28xg	VD20	6g	Tor
BB5	XC6115C236MR	Vdet-IC	3.6V±2%, +Rst PPO, -Rst ODO, Wt=50ms, Rt=50ms	SOT-25	28xg	VD20	6g	Tor
BB6	XC6115C237MR	Vdet-IC	3.7V±2%, +Rst PPO, -Rst ODO, Wt=50ms, Rt=50ms	SOT-25	28xg	VD20	6g	Tor
BB7	XC6115C238MR	Vdet-IC	3.8V±2%, +Rst PPO, -Rst ODO, Wt=50ms, Rt=50ms	SOT-25	28xg	VD20	6g	Tor
BB8	XC6115C239MR	Vdet-IC	3.9V±2%, +Rst PPO, -Rst ODO, Wt=50ms, Rt=50ms	SOT-25	28xg	VD20	6g	Tor
BB9	XC6115C240MR	Vdet-IC	4.0V±2%, +Rst PPO, -Rst ODO, Wt=50ms, Rt=50ms	SOT-25	28xg	VD20	6g	Tor
BBA	RP107N341D	LVR-IC	LDO, 3.4V±1%, 200mA, +CE, CL	SOT-23-5	28cx	VR4	6g	Ric
BBA	S-816A51AMC	LVR-IC	5.1V±2%, -CE, Ext, tranz	SOT-23-5	28vr9	VR6	6a	Sii
BBA	XC6115C241MR	Vdet-IC	4.1V±2%, +Rst PPO, -Rst ODO, Wt=50ms, Rt=50ms	SOT-25	28xg	VD20	6g	Tor
BBB	RP107N351D	LVR-IC	LDO, 3.5V±1%, 200mA, +CE, CL	SOT-23-5	28cx	VR4	6g	Ric
BBB	S-816A52AMC	LVR-IC	5.2V±2%, -CE, Ext, tranz	SOT-23-5	28vr9	VR6	6a	Sii
BBB	XC6115C242MR	Vdet-IC	4.2V±2%, +Rst PPO, -Rst ODO, Wt=50ms, Rt=50ms	SOT-25	28xg	VD20	6g	Tor
BBB	RP107N361D	LVR-IC	LDO, 3.6V±1%, 200mA, +CE, CL	SOT-23-5	28cx	VR4	6g	Ric
BBB	S-816A53AMC	LVR-IC	5.3V±2%, -CE, Ext, tranz	SOT-23-5	28vr9	VR6	6a	Sii
BBB	XC6115C243MR	Vdet-IC	4.3V±2%, +Rst PPO, -Rst ODO, Wt=50ms, Rt=50ms	SOT-25	28xg	VD20	6g	Tor
BBB	RP107N371D	LVR-IC	LDO, 3.7V±1%, 200mA, +CE, CL	SOT-23-5	28cx	VR4	6g	Ric
BBB	S-816A54AMC	LVR-IC	5.4V±2%, -CE, Ext, tranz	SOT-23-5	28vr9	VR6	6a	Sii
BBB	XC6115C244MR	Vdet-IC	4.4V±2%, +Rst PPO, -Rst ODO, Wt=50ms, Rt=50ms	SOT-25	28xg	VD20	6g	Tor
BBB	RP107N381D	LVR-IC	LDO, 3.8V±1%, 200mA, +CE, CL	SOT-23-5	28cx	VR4	6g	Ric
BBB	S-816A55AMC	LVR-IC	5.5V±2%, -CE, Ext, tranz	SOT-23-5	28vr9	VR6	6a	Sii
BBB	XC6115C245MR	Vdet-IC	4.5V±2%, +Rst PPO, -Rst ODO, Wt=50ms, Rt=50ms	SOT-25	28xg	VD20	6g	Tor
BBB	RP107N391D	LVR-IC	LDO, 3.9V±1%, 200mA, +CE, CL	SOT-23-5	28cx	VR4	6g	Ric
BBB	S-816A56AMC	LVR-IC	5.6V±2%, -CE, Ext, tranz	SOT-23-5	28vr9	VR6	6a	Sii
BBB	XC6115C216MR	Vdet-IC	1.6V±2%, +Rst PPO, -Rst ODO, Wt=50ms, Rt=50ms	SOT-25	28xg	VD20	6g	Tor
BBB	XC6115C246MR	Vdet-IC	4.6V±2%, +Rst PPO, -Rst ODO, Wt=50ms, Rt=50ms	SOT-25	28xg	VD20	6g	Tor
BBB	RP107N401D	LVR-IC	LDO, 4.0V±1%, 200mA, +CE, CL	SOT-23-5	28cx	VR4	6g	Ric
BBB	S-816A57AMC	LVR-IC	5.7V±2%, -CE, Ext, tranz	SOT-23-5	28vr9	VR6	6a	Sii
BBB	RP107N411D	LVR-IC	LDO, 4.1V±1%, 200mA, +CE, CL	SOT-23-5	28cx	VR4	6g	Ric
BBB	S-816A58AMC	LVR-IC	5.8V±2%, -CE, Ext, tranz	SOT-23-5	28vr9	VR6	6a	Sii
BBB	XC6115C217MR	Vdet-IC	1.7V±2%, +Rst PPO, -Rst ODO, Wt=50ms, Rt=50ms	SOT-25	28xg	VD20	6g	Tor
BBB	XC6115C247MR	Vdet-IC	4.7V±2%, +Rst PPO, -Rst ODO, Wt=50ms, Rt=50ms	SOT-25	28xg	VD20	6g	Tor
BBB	S-816A59AMC	LVR-IC	5.9V±2%, -CE, Ext, tranz	SOT-23-5	28vr9	VR6	6a	Sii
BBB	RP107N421D	LVR-IC	LDO, 4.2V±1%, 200mA, +CE, CL	SOT-23-5	28cx	VR4	6g	Ric
BBB	S-816A60AMC	LVR-IC	6.0V±2%, -CE, Ext, tranz	SOT-23-5	28vr9	VR6	6a	Sii
BBB	RP107N121D5	LVR-IC	LDO, 1.25V±1%, 200mA, +CE, CL	SOT-23-5	28cx	VR4	6g	Ric
BBB	XC6115C218MR	Vdet-IC	1.8V±2%, +Rst PPO, -Rst ODO, Wt=50ms, Rt=50ms	SOT-25	28xg	VD20	6g	Tor
BBB	XC6115C248MR	Vdet-IC	4.8V±2%, +Rst PPO, -Rst ODO, Wt=50ms, Rt=50ms	SOT-25	28xg	VD20	6g	Tor
BBB	RP107N181D5	LVR-IC	LDO, 1.85V±1%, 200mA, +CE, CL	SOT-23-5	28cx	VR4	6g	Ric
BBB	XC6115C219MR	Vdet-IC	1.9V±2%, +Rst PPO, -Rst ODO, Wt=50ms, Rt=50ms	SOT-25	28xg	VD20	6g	Tor
BBB	XC6115C249MR	Vdet-IC	4.9V±2%, +Rst PPO, -Rst ODO, Wt=50ms, Rt=50ms	SOT-25	28xg	VD20	6g	Tor
BBB	RP107N281D5	LVR-IC	LDO, 2.85V±1%, 200mA, +CE, CL	SOT-23-5	28cx	VR4	6g	Ric
BBB	XC6115C220MR	Vdet-IC	2.0V±2%, +Rst PPO, -Rst ODO, Wt=50ms, Rt=50ms	SOT-25	28xg	VD20	6g	Tor
BBB	XC6115C250MR	Vdet-IC	5.0V±2%, +Rst PPO, -Rst ODO, Wt=50ms, Rt=50ms	SOT-25	28xg	VD20	6g	Tor
BBB	XC6115C221MR	Vdet-IC	2.1V±2%, +Rst PPO, -Rst ODO, Wt=50ms, Rt=50ms	SOT-25	28xg	VD20	6g	Tor
BBB	XC6115C222MR	Vdet-IC	2.2V±2%, +Rst PPO, -Rst ODO, Wt=50ms, Rt=50ms	SOT-25	28xg	VD20	6g	Tor
BBB	XC6115C223MR	Vdet-IC	2.3V±2%, +Rst PPO, -Rst ODO, Wt=50ms, Rt=50ms	SOT-25	28xg	VD20	6g	Tor
BBB	XC6115C224MR	Vdet-IC	2.4V±2%, +Rst PPO, -Rst ODO, Wt=50ms, Rt=50ms	SOT-25	28xg	VD20	6g	Tor
BBB	XC6115C225MR	Vdet-IC	2.5V±2%, +Rst PPO, -Rst ODO, Wt=50ms, Rt=50ms	SOT-25	28xg	VD20	6g	Tor



SMD code	Type	Function	Short description	Case	Pinout	Sch.	St.	Mnf.
BBU	XC6115C226MR	Vdet-IC	2.6V±2%, +Rst PPO, -Rst ODO, Wt=50ms, Rt=50ms	SOT-25	28xg	VD20	6g	Tor
BBV	XC6115C227MR	Vdet-IC	2.7V±2%, +Rst PPO, -Rst ODO, Wt=50ms, Rt=50ms	SOT-25	28xg	VD20	6g	Tor
BBX	XC6115C228MR	Vdet-IC	2.8V±2%, +Rst PPO, -Rst ODO, Wt=50ms, Rt=50ms	SOT-25	28xg	VD20	6g	Tor
BBY	XC6115C229MR	Vdet-IC	2.9V±2%, +Rst PPO, -Rst ODO, Wt=50ms, Rt=50ms	SOT-25	28xg	VD20	6g	Tor
BBZ	XC6115C230MR	Vdet-IC	3.0V±2%, +Rst PPO, -Rst ODO, Wt=50ms, Rt=50ms	SOT-25	28xg	VD20	6g	Tor
BC	BD4721G	Vdet-IC	2.1V, -Reset ODO	SIMP5	28vdq	VD6	6a	Rhm
BC	PI74STX1G14CX	CMOS-Logic	Inverting Schmitt-trigger	SC-70-5	28LLog7	-	6a	Per
BC	PI74STX1G14TX	CMOS-Logic	Inverting Schmitt-trigger	SOT-23-5	28LLog7	-	6a	Per
BC	RN5RT32AA	LVR-IC	LDO, 3.2V±2%, 150mA, -CE	SOT-23-5	28vrt	VR4	6g	Ric
BC	V6300CSP5B	Vdet-IC	2.8V, -Reset PPO, 50ms	SOT-23-5	28vdr	VD7	6a	Em
BC-	RT9013-1HPU5	LVR-IC	LDO, 1.85V±2%, 500mA, +CE	SC-70-5	28cx	VR4	6g	Rct
BC0	XC6115C331MR	Vdet-IC	3.1V±2%, +Rst PPO, -Rst ODO, Wt=100ms, Rt=50ms	SOT-25	28xg	VD20	6g	Tor
BC1	XC6115C332MR	Vdet-IC	3.2V±2%, +Rst PPO, -Rst ODO, Wt=100ms, Rt=50ms	SOT-25	28xg	VD20	6g	Tor
BC2	XC6115C333MR	Vdet-IC	3.3V±2%, +Rst PPO, -Rst ODO, Wt=100ms, Rt=50ms	SOT-25	28xg	VD20	6g	Tor
BC3	XC6115C334MR	Vdet-IC	3.4V±2%, +Rst PPO, -Rst ODO, Wt=100ms, Rt=50ms	SOT-25	28xg	VD20	6g	Tor
BC4	XC6115C335MR	Vdet-IC	3.5V±2%, +Rst PPO, -Rst ODO, Wt=100ms, Rt=50ms	SOT-25	28xg	VD20	6g	Tor
BC5	XC6115C336MR	Vdet-IC	3.6V±2%, +Rst PPO, -Rst ODO, Wt=100ms, Rt=50ms	SOT-25	28xg	VD20	6g	Tor
BC6	XC6115C337MR	Vdet-IC	3.7V±2%, +Rst PPO, -Rst ODO, Wt=100ms, Rt=50ms	SOT-25	28xg	VD20	6g	Tor
BC7	XC6115C338MR	Vdet-IC	3.8V±2%, +Rst PPO, -Rst ODO, Wt=100ms, Rt=50ms	SOT-25	28xg	VD20	6g	Tor
BC8	XC6115C339MR	Vdet-IC	3.9V±2%, +Rst PPO, -Rst ODO, Wt=100ms, Rt=50ms	SOT-25	28xg	VD20	6g	Tor
BC9	XC6115C340MR	Vdet-IC	4.0V±2%, +Rst PPO, -Rst ODO, Wt=100ms, Rt=50ms	SOT-25	28xg	VD20	6g	Tor
BCA	XC6115C341MR	Vdet-IC	4.1V±2%, +Rst PPO, -Rst ODO, Wt=100ms, Rt=50ms	SOT-25	28xg	VD20	6g	Tor
BCB	XC6115C342MR	Vdet-IC	4.2V±2%, +Rst PPO, -Rst ODO, Wt=100ms, Rt=50ms	SOT-25	28xg	VD20	6g	Tor
BCC	XC6115C343MR	Vdet-IC	4.3V±2%, +Rst PPO, -Rst ODO, Wt=100ms, Rt=50ms	SOT-25	28xg	VD20	6g	Tor
BCD	XC6115C344MR	Vdet-IC	4.4V±2%, +Rst PPO, -Rst ODO, Wt=100ms, Rt=50ms	SOT-25	28xg	VD20	6g	Tor
BCE	XC6115C345MR	Vdet-IC	4.5V±2%, +Rst PPO, -Rst ODO, Wt=100ms, Rt=50ms	SOT-25	28xg	VD20	6g	Tor
BCF	XC6115C316MR	Vdet-IC	1.6V±2%, +Rst PPO, -Rst ODO, Wt=100ms, Rt=50ms	SOT-25	28xg	VD20	6g	Tor
BCG	XC6115C346MR	Vdet-IC	4.6V±2%, +Rst PPO, -Rst ODO, Wt=100ms, Rt=50ms	SOT-25	28xg	VD20	6g	Tor
BCH	XC6115C317MR	Vdet-IC	1.7V±2%, +Rst PPO, -Rst ODO, Wt=100ms, Rt=50ms	SOT-25	28xg	VD20	6g	Tor
BCH	XC6115C347MR	Vdet-IC	4.7V±2%, +Rst PPO, -Rst ODO, Wt=100ms, Rt=50ms	SOT-25	28xg	VD20	6g	Tor
BCK	S-814A20AMC	LVR-IC	LDO, 2.0V±2%, 150mA, +CE	SOT-23-5	28cx	VR4	6g	Sii
BCK	XC6115C318MR	Vdet-IC	1.8V±2%, +Rst PPO, -Rst ODO, Wt=100ms, Rt=50ms	SOT-25	28xg	VD20	6g	Tor
BCK	XC6115C348MR	Vdet-IC	4.8V±2%, +Rst PPO, -Rst ODO, Wt=100ms, Rt=50ms	SOT-25	28xg	VD20	6g	Tor
BCL	S-814A21AMC	LVR-IC	LDO, 2.1V±2%, 150mA, +CE	SOT-23-5	28cx	VR4	6g	Sii
BCL	XC6115C319MR	Vdet-IC	1.9V±2%, +Rst PPO, -Rst ODO, Wt=100ms, Rt=50ms	SOT-25	28xg	VD20	6g	Tor
BCL	XC6115C349MR	Vdet-IC	4.9V±2%, +Rst PPO, -Rst ODO, Wt=100ms, Rt=50ms	SOT-25	28xg	VD20	6g	Tor
BCM	S-814A22AMC	LVR-IC	LDO, 2.2V±2%, 150mA, +CE	SOT-23-5	28cx	VR4	6g	Sii
BCM	XC6115C320MR	Vdet-IC	2.0V±2%, +Rst PPO, -Rst ODO, Wt=100ms, Rt=50ms	SOT-25	28xg	VD20	6g	Tor
BCM	XC6115C350MR	Vdet-IC	5.0V±2%, +Rst PPO, -Rst ODO, Wt=100ms, Rt=50ms	SOT-25	28xg	VD20	6g	Tor
BCN	AME8550BEEVC210Y	Vdet-IC	2.1V±2%, -Reset PPO	TSOT-25	28vdo	VD3	6g	Ame
BCN	AME8550BEEVC210Z	Vdet-IC	2.1V±2%, -Reset PPO	SOT-25	28vdo	VD3	6g	Ame
BCN	S-814A23AMC	LVR-IC	LDO, 2.3V±2%, 150mA, +CE	SOT-23-5	28cx	VR4	6g	Sii
BCN	AME8550BEEVC210L	Vdet-IC	2.1V±2%, -Reset PPO	SOT-25	28vdo	VD3	6g	Ame
BCN	XC6115C321MR	Vdet-IC	2.1V±2%, +Rst PPO, -Rst ODO, Wt=100ms, Rt=50ms	SOT-25	28xg	VD20	6g	Tor
BCO	S-814A24AMC	LVR-IC	LDO, 2.4V±2%, 150mA, +CE	SOT-23-5	28cx	VR4	6g	Sii
BCP	S-814A25AMC	LVR-IC	LDO, 2.5V±2%, 150mA, +CE	SOT-23-5	28cx	VR4	6g	Sii
BCP	XC6115C322MR	Vdet-IC	2.2V±2%, +Rst PPO, -Rst ODO, Wt=100ms, Rt=50ms	SOT-25	28xg	VD20	6g	Tor
BCQ	S-814A26AMC	LVR-IC	LDO, 2.6V±2%, 150mA, +CE	SOT-23-5	28cx	VR4	6g	Sii
BCR	S-814A27AMC	LVR-IC	LDO, 2.7V±2%, 150mA, +CE	SOT-23-5	28cx	VR4	6g	Sii
BCR	XC6115C323MR	Vdet-IC	2.3V±2%, +Rst PPO, -Rst ODO, Wt=100ms, Rt=50ms	SOT-25	28xg	VD20	6g	Tor
BCS	S-814A28AMC	LVR-IC	LDO, 2.8V±2%, 150mA, +CE	SOT-23-5	28cx	VR4	6g	Sii
BCS	XC6115C324MR	Vdet-IC	2.4V±2%, +Rst PPO, -Rst ODO, Wt=100ms, Rt=50ms	SOT-25	28xg	VD20	6g	Tor
BCT	S-814A29AMC	LVR-IC	LDO, 2.9V±2%, 150mA, +CE	SOT-23-5	28cx	VR4	6g	Sii
BCT	XC6115C325MR	Vdet-IC	2.5V±2%, +Rst PPO, -Rst ODO, Wt=100ms, Rt=50ms	SOT-25	28xg	VD20	6g	Tor
BCU	S-814A30AMC	LVR-IC	LDO, 3.0V±2%, 150mA, +CE	SOT-23-5	28cx	VR4	6g	Sii
BCU	XC6115C326MR	Vdet-IC	2.6V±2%, +Rst PPO, -Rst ODO, Wt=100ms, Rt=50ms	SOT-25	28xg	VD20	6g	Tor
BCV	S-814A31AMC	LVR-IC	LDO, 3.1V±2%, 150mA, +CE	SOT-23-5	28cx	VR4	6g	Sii
BCV	XC6115C327MR	Vdet-IC	2.7V±2%, +Rst PPO, -Rst ODO, Wt=100ms, Rt=50ms	SOT-25	28xg	VD20	6g	Tor
BCW	AME8510AEEVBFE23	Vdet-IC	2.32V±1.5%, -Reset ODO, -MR, Strobe	SOT-23-5	28cp	VD16	6k	Ame
BCW	S-814A32AMC	LVR-IC	LDO, 3.2V±2%, 150mA, +CE	SOT-23-5	28cx	VR4	6g	Sii
BCX	AME8510AEEVBFE46	Vdet-IC	4.63V±1.5%, -Reset ODO, -MR, Strobe	SOT-23-5	28cp	VD16	6k	Ame
BCX	S-814A33AMC	LVR-IC	LDO, 3.3V±2%, 150mA, +CE	SOT-23-5	28cx	VR4	6g	Sii
BCX	XC6115C328MR	Vdet-IC	2.8V±2%, +Rst PPO, -Rst ODO, Wt=100ms, Rt=50ms	SOT-25	28xg	VD20	6g	Tor
BCY	S-814A34AMC	LVR-IC	LDO, 3.4V±2%, 150mA, +CE	SOT-23-5	28cx	VR4	6g	Sii
BCY	XC6115C329MR	Vdet-IC	2.9V±2%, +Rst PPO, -Rst ODO, Wt=100ms, Rt=50ms	SOT-25	28xg	VD20	6g	Tor
BCZ	S-814A35AMC	LVR-IC	LDO, 3.5V±2%, 150mA, +CE	SOT-23-5	28cx	VR4	6g	Sii
BCZ	XC6115C330MR	Vdet-IC	3.0V±2%, +Rst PPO, -Rst ODO, Wt=100ms, Rt=50ms	SOT-25	28xg	VD20	6g	Tor
BD	BD4722G	Vdet-IC	2.2V, -Reset ODO	SIMP5	28vdq	VD6	6a	Rhm
BD	PI74STX1G32CX	CMOS-Logic	2-input OR gate	SC-70-5	28LLog4	-	6a	Per
BD	PI74STX1G32TX	CMOS-Logic	2-input OR gate	SOT-23-5	28LLog4	-	6a	Per



SMD code	Type	Function	Short description	Case	Pinout	Sch.	St.	Mnf.
BD	RN5RT33AA	LVR-IC	LDO, 3.3V±2%, 150mA, -CE	SOT-23-5	28vrt	VR4	6g	Ric
BD	V6300DSP5B	Vdet-IC	3.5V, -Reset PPO, 50ms	SOT-23-5	28vdr	VD7	6a	Em
BD-	RT9013-2HPU5	LVR-IC	LDO, 2.85V±2%, 500mA, +CE	SC-70-5	28cx	VR4	6g	Rct
BD0	XC6115C431MR	Vdet-IC	3.1V±2%, +Rst PPO, -Rst ODO, Wt=200ms, Rt=50ms	SOT-25	28xg	VD20	6g	Tor
BD1	XC6115C432MR	Vdet-IC	3.2V±2%, +Rst PPO, -Rst ODO, Wt=200ms, Rt=50ms	SOT-25	28xg	VD20	6g	Tor
BD2	XC6115C433MR	Vdet-IC	3.3V±2%, +Rst PPO, -Rst ODO, Wt=200ms, Rt=50ms	SOT-25	28xg	VD20	6g	Tor
BD3	XC6115C434MR	Vdet-IC	3.4V±2%, +Rst PPO, -Rst ODO, Wt=200ms, Rt=50ms	SOT-25	28xg	VD20	6g	Tor
BD4	XC6115C435MR	Vdet-IC	3.5V±2%, +Rst PPO, -Rst ODO, Wt=200ms, Rt=50ms	SOT-25	28xg	VD20	6g	Tor
BD5	XC6115C436MR	Vdet-IC	3.6V±2%, +Rst PPO, -Rst ODO, Wt=200ms, Rt=50ms	SOT-25	28xg	VD20	6g	Tor
BD6	XC6115C437MR	Vdet-IC	3.7V±2%, +Rst PPO, -Rst ODO, Wt=200ms, Rt=50ms	SOT-25	28xg	VD20	6g	Tor
BD7	XC6115C438MR	Vdet-IC	3.8V±2%, +Rst PPO, -Rst ODO, Wt=200ms, Rt=50ms	SOT-25	28xg	VD20	6g	Tor
BD8	XC6115C439MR	Vdet-IC	3.9V±2%, +Rst PPO, -Rst ODO, Wt=200ms, Rt=50ms	SOT-25	28xg	VD20	6g	Tor
BD9	XC6115C440MR	Vdet-IC	4.0V±2%, +Rst PPO, -Rst ODO, Wt=200ms, Rt=50ms	SOT-25	28xg	VD20	6g	Tor
BDA	AME8520AEEVEED46	Vdet-IC	4.63V±1.5%, ±Reset PPO, Strobe	SOT-23-5	28xq	VD19	6k	Ame
BDA	S-814A36AMC	LVR-IC	LDO, 3.6V±2%, 150mA, +CE	SOT-23-5	28cx	VR4	6g	Sii
BDA	AME8520AEEVEED46Z	Vdet-IC	4.63V±1.5%, ±Reset PPO, Strobe, lead free	SOT-23-5	28xq	VD19	6k	Ame
BDA	XC6115C441MR	Vdet-IC	4.1V±2%, +Rst PPO, -Rst ODO, Wt=200ms, Rt=50ms	SOT-25	28xg	VD20	6g	Tor
BDB	S-814A37AMC	LVR-IC	LDO, 3.7V±2%, 150mA, +CE	SOT-23-5	28cx	VR4	6g	Sii
BDB	XC6115C442MR	Vdet-IC	4.2V±2%, +Rst PPO, -Rst ODO, Wt=200ms, Rt=50ms	SOT-25	28xg	VD20	6g	Tor
BDC	S-814A38AMC	LVR-IC	LDO, 3.8V±2%, 150mA, +CE	SOT-23-5	28cx	VR4	6g	Sii
BDQ	XC6115C443MR	Vdet-IC	4.3V±2%, +Rst PPO, -Rst ODO, Wt=200ms, Rt=50ms	SOT-25	28xg	VD20	6g	Tor
BDD	S-814A39AMC	LVR-IC	LDO, 3.9V±2%, 150mA, +CE	SOT-23-5	28cx	VR4	6g	Sii
BDQ	XC6115C444MR	Vdet-IC	4.4V±2%, +Rst PPO, -Rst ODO, Wt=200ms, Rt=50ms	SOT-25	28xg	VD20	6g	Tor
BDE	S-814A40AMC	LVR-IC	LDO, 4.0V±2%, 150mA, +CE	SOT-23-5	28cx	VR4	6g	Sii
BDQ	XC6115C445MR	Vdet-IC	4.5V±2%, +Rst PPO, -Rst ODO, Wt=200ms, Rt=50ms	SOT-25	28xg	VD20	6g	Tor
BDF	S-814A41AMC	LVR-IC	LDO, 4.1V±2%, 150mA, +CE	SOT-23-5	28cx	VR4	6g	Sii
BDQ	XC6115C446MR	Vdet-IC	4.6V±2%, +Rst PPO, -Rst ODO, Wt=200ms, Rt=50ms	SOT-25	28xg	VD20	6g	Tor
BDQ	XC6115C446MR	Vdet-IC	4.6V±2%, +Rst PPO, -Rst ODO, Wt=200ms, Rt=50ms	SOT-25	28xg	VD20	6g	Tor
BDG	AME8550AEIVD280Z	Vdet-IC	2.8V±2%, -Reset PPO	SC-70-5	28z9	VD2	6g	Ame
BDG	S-814A42AMC	LVR-IC	LDO, 4.2V±2%, 150mA, +CE	SOT-23-5	28cx	VR4	6g	Sii
BDG	AME8550AEIVD280L	Vdet-IC	2.8V±2%, -Reset PPO	SC-70-5	28z9	VD2	6g	Ame
BDH	AME8550BEEVC240Y	Vdet-IC	2.4V±2%, -Reset PPO	TSOT-25	28vdo	VD3	6g	Ame
BDH	AME8550BEEVC240Z	Vdet-IC	2.4V±2%, -Reset PPO	SOT-25	28vdo	VD3	6g	Ame
BDH	S-814A43AMC	LVR-IC	LDO, 4.3V±2%, 150mA, +CE	SOT-23-5	28cx	VR4	6g	Sii
BDH	AME8550BEEVC240L	Vdet-IC	2.4V±2%, -Reset PPO	SOT-25	28vdo	VD3	6g	Ame
BDH	XC6115C417MR	Vdet-IC	1.7V±2%, +Rst PPO, -Rst ODO, Wt=200ms, Rt=50ms	SOT-25	28xg	VD20	6g	Tor
BDH	XC6115C447MR	Vdet-IC	4.7V±2%, +Rst PPO, -Rst ODO, Wt=200ms, Rt=50ms	SOT-25	28xg	VD20	6g	Tor
BDI	S-814A44AMC	LVR-IC	LDO, 4.4V±2%, 150mA, +CE	SOT-23-5	28cx	VR4	6g	Sii
BDJ	S-814A45AMC	LVR-IC	LDO, 4.5V±2%, 150mA, +CE	SOT-23-5	28cx	VR4	6g	Sii
BDK	S-814A46AMC	LVR-IC	LDO, 4.6V±2%, 150mA, +CE	SOT-23-5	28cx	VR4	6g	Sii
BDK	XC6115C418MR	Vdet-IC	1.8V±2%, +Rst PPO, -Rst ODO, Wt=200ms, Rt=50ms	SOT-25	28xg	VD20	6g	Tor
BDK	XC6115C448MR	Vdet-IC	4.8V±2%, +Rst PPO, -Rst ODO, Wt=200ms, Rt=50ms	SOT-25	28xg	VD20	6g	Tor
BDL	S-814A47AMC	LVR-IC	LDO, 4.7V±2%, 150mA, +CE	SOT-23-5	28cx	VR4	6g	Sii
BDL	XC6115C419MR	Vdet-IC	1.9V±2%, +Rst PPO, -Rst ODO, Wt=200ms, Rt=50ms	SOT-25	28xg	VD20	6g	Tor
BDL	XC6115C449MR	Vdet-IC	4.9V±2%, +Rst PPO, -Rst ODO, Wt=200ms, Rt=50ms	SOT-25	28xg	VD20	6g	Tor
BDM	S-814A48AMC	LVR-IC	LDO, 4.8V±2%, 150mA, +CE	SOT-23-5	28cx	VR4	6g	Sii
BDM	XC6115C420MR	Vdet-IC	2.0V±2%, +Rst PPO, -Rst ODO, Wt=200ms, Rt=50ms	SOT-25	28xg	VD20	6g	Tor
BDM	XC6115C450MR	Vdet-IC	5.0V±2%, +Rst PPO, -Rst ODO, Wt=200ms, Rt=50ms	SOT-25	28xg	VD20	6g	Tor
BDN	S-814A49AMC	LVR-IC	LDO, 4.9V±2%, 150mA, +CE	SOT-23-5	28cx	VR4	6g	Sii
BDN	XC6115C421MR	Vdet-IC	2.1V±2%, +Rst PPO, -Rst ODO, Wt=200ms, Rt=50ms	SOT-25	28xg	VD20	6g	Tor
BDO	S-814A50AMC	LVR-IC	LDO, 5.0V±2%, 150mA, +CE	SOT-23-5	28cx	VR4	6g	Sii
BDP	S-814A51AMC	LVR-IC	LDO, 5.1V±2%, 150mA, +CE	SOT-23-5	28cx	VR4	6g	Sii
BDP	XC6115C422MR	Vdet-IC	2.2V±2%, +Rst PPO, -Rst ODO, Wt=200ms, Rt=50ms	SOT-25	28xg	VD20	6g	Tor
BDQ	S-814A52AMC	LVR-IC	LDO, 5.2V±2%, 150mA, +CE	SOT-23-5	28cx	VR4	6g	Sii
BDR	S-814A53AMC	LVR-IC	LDO, 5.3V±2%, 150mA, +CE	SOT-23-5	28cx	VR4	6g	Sii
BDR	XC6115C423MR	Vdet-IC	2.3V±2%, +Rst PPO, -Rst ODO, Wt=200ms, Rt=50ms	SOT-25	28xg	VD20	6g	Tor
BDS	S-814A54AMC	LVR-IC	LDO, 5.4V±2%, 150mA, +CE	SOT-23-5	28cx	VR4	6g	Sii
BDS	XC6115C424MR	Vdet-IC	2.4V±2%, +Rst PPO, -Rst ODO, Wt=200ms, Rt=50ms	SOT-25	28xg	VD20	6g	Tor
BDT	S-814A55AMC	LVR-IC	LDO, 5.5V±2%, 150mA, +CE	SOT-23-5	28cx	VR4	6g	Sii
BDT	XC6115C425MR	Vdet-IC	2.5V±2%, +Rst PPO, -Rst ODO, Wt=200ms, Rt=50ms	SOT-25	28xg	VD20	6g	Tor
BDU	S-814A56AMC	LVR-IC	LDO, 5.6V±2%, 150mA, +CE	SOT-23-5	28cx	VR4	6g	Sii
BDU	XC6115C426MR	Vdet-IC	2.6V±2%, +Rst PPO, -Rst ODO, Wt=200ms, Rt=50ms	SOT-25	28xg	VD20	6g	Tor
BDV	S-814A57AMC	LVR-IC	LDO, 5.7V±2%, 150mA, +CE	SOT-23-5	28cx	VR4	6g	Sii
BDV	XC6115C427MR	Vdet-IC	2.7V±2%, +Rst PPO, -Rst ODO, Wt=200ms, Rt=50ms	SOT-25	28xg	VD20	6g	Tor
BDW	S-814A58AMC	LVR-IC	LDO, 5.8V±2%, 150mA, +CE	SOT-23-5	28cx	VR4	6g	Sii
BDX	S-814A59AMC	LVR-IC	LDO, 5.9V±2%, 150mA, +CE	SOT-23-5	28cx	VR4	6g	Sii
BDX	XC6115C428MR	Vdet-IC	2.8V±2%, +Rst PPO, -Rst ODO, Wt=200ms, Rt=50ms	SOT-25	28xg	VD20	6g	Tor
BDY	S-814A60AMC	LVR-IC	LDO, 6.0V±2%, 150mA, +CE	SOT-23-5	28cx	VR4	6g	Sii
BDY	XC6115C429MR	Vdet-IC	2.9V±2%, +Rst PPO, -Rst ODO, Wt=200ms, Rt=50ms	SOT-25	28xg	VD20	6g	Tor
BDZ	XC6115C430MR	Vdet-IC	3.0V±2%, +Rst PPO, -Rst ODO, Wt=200ms, Rt=50ms	SOT-25	28xg	VD20	6g	Tor



SMD code	Type	Function	Short description	Case	Pinout	Sch.	St.	Mnf.
BE	BD4723G	Vdet-IC	2.3V, -Reset ODO	SMP5	28vdq	VD6	6a	Rhm
BE	PI74STX1G79CX	CMOS-Logic	Positive edge-triggered D-type flip-flop	SC-70-5	28/Log20	-	6a	Per
BE	PI74STX1G79TX	CMOS-Logic	Positive edge-triggered D-type flip-flop	SOT-23-5	28/Log20	-	6a	Per
BE	RN5RT34AA	LVR-IC	LDO, 3.4V±2%, 150mA, -CE	SOT-23-5	28vrt	VR4	6g	Ric
BE	V6300ESP5B	Vdet-IC	4V, -Reset PPO, 50ms	SOT-23-5	28vdr	VD7	6a	Em
BE_	SN74AHTC1G08DCK	CMOS-Logic	2-input AND gate	SC-70-5	28/Log3	-	6a	Ti
BE_	SN74AHTC1G08DRL	CMOS-Logic	2-input AND gate	SOT-553	30/Log3	-	6a	Ti
BE0	X06115C531MR	Vdet-IC	3.1V±2%, +Rst PPO, -Rst ODO, Wt=400ms, Rt=50ms	SOT-25	28xg	VD20	6g	Tor
BE1	X06115C532MR	Vdet-IC	3.2V±2%, +Rst PPO, -Rst ODO, Wt=400ms, Rt=50ms	SOT-25	28xg	VD20	6g	Tor
BE2	X06115C533MR	Vdet-IC	3.3V±2%, +Rst PPO, -Rst ODO, Wt=400ms, Rt=50ms	SOT-25	28xg	VD20	6g	Tor
BE3	X06115C534MR	Vdet-IC	3.4V±2%, +Rst PPO, -Rst ODO, Wt=400ms, Rt=50ms	SOT-25	28xg	VD20	6g	Tor
BE4	X06115C535MR	Vdet-IC	3.5V±2%, +Rst PPO, -Rst ODO, Wt=400ms, Rt=50ms	SOT-25	28xg	VD20	6g	Tor
BE5	X06115C536MR	Vdet-IC	3.6V±2%, +Rst PPO, -Rst ODO, Wt=400ms, Rt=50ms	SOT-25	28xg	VD20	6g	Tor
BE6	X06115C537MR	Vdet-IC	3.7V±2%, +Rst PPO, -Rst ODO, Wt=400ms, Rt=50ms	SOT-25	28xg	VD20	6g	Tor
BE7	X06115C538MR	Vdet-IC	3.8V±2%, +Rst PPO, -Rst ODO, Wt=400ms, Rt=50ms	SOT-25	28xg	VD20	6g	Tor
BE8	X06115C539MR	Vdet-IC	3.9V±2%, +Rst PPO, -Rst ODO, Wt=400ms, Rt=50ms	SOT-25	28xg	VD20	6g	Tor
BE9	X06115C540MR	Vdet-IC	4.0V±2%, +Rst PPO, -Rst ODO, Wt=400ms, Rt=50ms	SOT-25	28xg	VD20	6g	Tor
BEA	AME8550CEEVB300Y	Vdet-IC	3.0V±2%, -Reset ODO	TSOT-25	28vdm	VD6	6g	Ame
BEA	AME8550CEEVB300Z	Vdet-IC	3.0V±2%, -Reset ODO	SOT-25	28vdm	VD6	6g	Ame
BEA	AME8550CEEVB300L	Vdet-IC	3.0V±2%, -Reset ODO	SOT-25	28vdm	VD6	6g	Ame
BEA	X06115C541MR	Vdet-IC	4.1V±2%, +Rst PPO, -Rst ODO, Wt=400ms, Rt=50ms	SOT-25	28xg	VD20	6g	Tor
BEB	X06115C542MR	Vdet-IC	4.2V±2%, +Rst PPO, -Rst ODO, Wt=400ms, Rt=50ms	SOT-25	28xg	VD20	6g	Tor
BEc	X06115C543MR	Vdet-IC	4.3V±2%, +Rst PPO, -Rst ODO, Wt=400ms, Rt=50ms	SOT-25	28xg	VD20	6g	Tor
BED	AME8500BEEVB31	Vdet-IC	3.08V±1.5%, -Reset ODO, 150ms	SOT-23-5	28vdm	VD6	6k	Ame
BED	AME8500BEEVB31Z	Vdet-IC	3.08V±1.5%, -Reset ODO, 150ms, lead free	SOT-23-5	28vdm	VD6	6k	Ame
BED	X06115C544MR	Vdet-IC	4.4V±2%, +Rst PPO, -Rst ODO, Wt=400ms, Rt=50ms	SOT-25	28xg	VD20	6g	Tor
BEe	X06115C545MR	Vdet-IC	4.5V±2%, +Rst PPO, -Rst ODO, Wt=400ms, Rt=50ms	SOT-25	28xg	VD20	6g	Tor
BEF	X06115C546MR	Vdet-IC	1.6V±2%, +Rst PPO, -Rst ODO, Wt=400ms, Rt=50ms	SOT-25	28xg	VD20	6g	Tor
BEF	X06115C546MR	Vdet-IC	4.6V±2%, +Rst PPO, -Rst ODO, Wt=400ms, Rt=50ms	SOT-25	28xg	VD20	6g	Tor
BEH	X06115C547MR	Vdet-IC	1.7V±2%, +Rst PPO, -Rst ODO, Wt=400ms, Rt=50ms	SOT-25	28xg	VD20	6g	Tor
BEH	X06115C547MR	Vdet-IC	4.7V±2%, +Rst PPO, -Rst ODO, Wt=400ms, Rt=50ms	SOT-25	28xg	VD20	6g	Tor
BEK	X06115C548MR	Vdet-IC	1.8V±2%, +Rst PPO, -Rst ODO, Wt=400ms, Rt=50ms	SOT-25	28xg	VD20	6g	Tor
BEK	X06115C548MR	Vdet-IC	4.8V±2%, +Rst PPO, -Rst ODO, Wt=400ms, Rt=50ms	SOT-25	28xg	VD20	6g	Tor
BEL	X06115C549MR	Vdet-IC	1.9V±2%, +Rst PPO, -Rst ODO, Wt=400ms, Rt=50ms	SOT-25	28xg	VD20	6g	Tor
BEL	X06115C549MR	Vdet-IC	4.9V±2%, +Rst PPO, -Rst ODO, Wt=400ms, Rt=50ms	SOT-25	28xg	VD20	6g	Tor
BEM	X06115C520MR	Vdet-IC	2.0V±2%, +Rst PPO, -Rst ODO, Wt=400ms, Rt=50ms	SOT-25	28xg	VD20	6g	Tor
BEM	X06115C550MR	Vdet-IC	5.0V±2%, +Rst PPO, -Rst ODO, Wt=400ms, Rt=50ms	SOT-25	28xg	VD20	6g	Tor
BEN	X06115C521MR	Vdet-IC	2.1V±2%, +Rst PPO, -Rst ODO, Wt=400ms, Rt=50ms	SOT-25	28xg	VD20	6g	Tor
BEP	X06115C522MR	Vdet-IC	2.2V±2%, +Rst PPO, -Rst ODO, Wt=400ms, Rt=50ms	SOT-25	28xg	VD20	6g	Tor
BER	X06115C523MR	Vdet-IC	2.3V±2%, +Rst PPO, -Rst ODO, Wt=400ms, Rt=50ms	SOT-25	28xg	VD20	6g	Tor
BES	X06115C524MR	Vdet-IC	2.4V±2%, +Rst PPO, -Rst ODO, Wt=400ms, Rt=50ms	SOT-25	28xg	VD20	6g	Tor
BET	X06115C525MR	Vdet-IC	2.5V±2%, +Rst PPO, -Rst ODO, Wt=400ms, Rt=50ms	SOT-25	28xg	VD20	6g	Tor
BEU	X06115C526MR	Vdet-IC	2.6V±2%, +Rst PPO, -Rst ODO, Wt=400ms, Rt=50ms	SOT-25	28xg	VD20	6g	Tor
BEV	X06115C527MR	Vdet-IC	2.7V±2%, +Rst PPO, -Rst ODO, Wt=400ms, Rt=50ms	SOT-25	28xg	VD20	6g	Tor
BEX	X06115C528MR	Vdet-IC	2.8V±2%, +Rst PPO, -Rst ODO, Wt=400ms, Rt=50ms	SOT-25	28xg	VD20	6g	Tor
BEY	X06115C529MR	Vdet-IC	2.9V±2%, +Rst PPO, -Rst ODO, Wt=400ms, Rt=50ms	SOT-25	28xg	VD20	6g	Tor
BEZ	X06115C530MR	Vdet-IC	3.0V±2%, +Rst PPO, -Rst ODO, Wt=400ms, Rt=50ms	SOT-25	28xg	VD20	6g	Tor
BF	BD4724G	Vdet-IC	2.4V, -Reset ODO	SMP5	28vdq	VD6	6a	Rhm
BF	RN5RT35AA	LVR-IC	LDO, 3.5V±2%, 150mA, -CE	SOT-23-5	28vrt	VR4	6g	Ric
BF	V6300FSP5B	Vdet-IC	4.5V, -Reset PPO, 50ms	SOT-23-5	28vdr	VD7	6a	Em
BF0	X06115C631MR	Vdet-IC	3.1V±2%, +Rst PPO, -Rst ODO, Wt=1.6s, Rt=50ms	SOT-25	28xg	VD20	6g	Tor
BF1	X06115C632MR	Vdet-IC	3.2V±2%, +Rst PPO, -Rst ODO, Wt=1.6s, Rt=50ms	SOT-25	28xg	VD20	6g	Tor
BF2	X06115C633MR	Vdet-IC	3.3V±2%, +Rst PPO, -Rst ODO, Wt=1.6s, Rt=50ms	SOT-25	28xg	VD20	6g	Tor
BF3	X06115C634MR	Vdet-IC	3.4V±2%, +Rst PPO, -Rst ODO, Wt=1.6s, Rt=50ms	SOT-25	28xg	VD20	6g	Tor
BF4	X06115C635MR	Vdet-IC	3.5V±2%, +Rst PPO, -Rst ODO, Wt=1.6s, Rt=50ms	SOT-25	28xg	VD20	6g	Tor
BF5	X06115C636MR	Vdet-IC	3.6V±2%, +Rst PPO, -Rst ODO, Wt=1.6s, Rt=50ms	SOT-25	28xg	VD20	6g	Tor
BF6	X06115C637MR	Vdet-IC	3.7V±2%, +Rst PPO, -Rst ODO, Wt=1.6s, Rt=50ms	SOT-25	28xg	VD20	6g	Tor
BF7	X06115C638MR	Vdet-IC	3.8V±2%, +Rst PPO, -Rst ODO, Wt=1.6s, Rt=50ms	SOT-25	28xg	VD20	6g	Tor
BF8	X06115C639MR	Vdet-IC	3.9V±2%, +Rst PPO, -Rst ODO, Wt=1.6s, Rt=50ms	SOT-25	28xg	VD20	6g	Tor
BF9	X06115C640MR	Vdet-IC	4.0V±2%, +Rst PPO, -Rst ODO, Wt=1.6s, Rt=50ms	SOT-25	28xg	VD20	6g	Tor
BFA	X06115C641MR	Vdet-IC	4.1V±2%, +Rst PPO, -Rst ODO, Wt=1.6s, Rt=50ms	SOT-25	28xg	VD20	6g	Tor
BFB	X06115C642MR	Vdet-IC	4.2V±2%, +Rst PPO, -Rst ODO, Wt=1.6s, Rt=50ms	SOT-25	28xg	VD20	6g	Tor
BFC	X06115C643MR	Vdet-IC	4.3V±2%, +Rst PPO, -Rst ODO, Wt=1.6s, Rt=50ms	SOT-25	28xg	VD20	6g	Tor
BFD	X06115C644MR	Vdet-IC	4.4V±2%, +Rst PPO, -Rst ODO, Wt=1.6s, Rt=50ms	SOT-25	28xg	VD20	6g	Tor
BFE	X06115C645MR	Vdet-IC	4.5V±2%, +Rst PPO, -Rst ODO, Wt=1.6s, Rt=50ms	SOT-25	28xg	VD20	6g	Tor
BFf	X06115C616MR	Vdet-IC	1.6V±2%, +Rst PPO, -Rst ODO, Wt=1.6s, Rt=50ms	SOT-25	28xg	VD20	6g	Tor
BFf	X06115C646MR	Vdet-IC	4.6V±2%, +Rst PPO, -Rst ODO, Wt=1.6s, Rt=50ms	SOT-25	28xg	VD20	6g	Tor
BFH	X06115C617MR	Vdet-IC	1.7V±2%, +Rst PPO, -Rst ODO, Wt=1.6s, Rt=50ms	SOT-25	28xg	VD20	6g	Tor
BFH	X06115C647MR	Vdet-IC	4.7V±2%, +Rst PPO, -Rst ODO, Wt=1.6s, Rt=50ms	SOT-25	28xg	VD20	6g	Tor
BFK	X06115C618MR	Vdet-IC	1.8V±2%, +Rst PPO, -Rst ODO, Wt=1.6s, Rt=50ms	SOT-25	28xg	VD20	6g	Tor



SMD code	Type	Function	Short description	Case	Pinout	Sch.	St.	Mnf.
BFK	XC6115C648MR	Vdet-IC	4.8V±2%, +Rst PPO, -Rst ODO, Wt=1.6s, Rt=50ms	SOT-25	28xg	VD20	6g	Tor
BFK	XC6115C619MR	Vdet-IC	1.9V±2%, +Rst PPO, -Rst ODO, Wt=1.6s, Rt=50ms	SOT-25	28xg	VD20	6g	Tor
BFL	XC6115C649MR	Vdet-IC	4.9V±2%, +Rst PPO, -Rst ODO, Wt=1.6s, Rt=50ms	SOT-25	28xg	VD20	6g	Tor
BFM	XC6115C620MR	Vdet-IC	2.0V±2%, +Rst PPO, -Rst ODO, Wt=1.6s, Rt=50ms	SOT-25	28xg	VD20	6g	Tor
BFM	XC6115C650MR	Vdet-IC	5.0V±2%, +Rst PPO, -Rst ODO, Wt=1.6s, Rt=50ms	SOT-25	28xg	VD20	6g	Tor
BFN	AME8861AEEV180Y	LVR-IC	LDO, 1.8V±1.5%, 600mA, +CE	TSOT-25	28vrx	VR7	6k	Ame
BFN	AME8861AEEV180Z	LVR-IC	LDO, 1.8V±1.5%, 600mA, +CE	SOT-25	28vrx	VR7	6k	Ame
BFN	XC6115C621MR	Vdet-IC	2.1V±2%, +Rst PPO, -Rst ODO, Wt=1.6s, Rt=50ms	SOT-25	28xg	VD20	6g	Tor
BFP	XC6115C622MR	Vdet-IC	2.2V±2%, +Rst PPO, -Rst ODO, Wt=1.6s, Rt=50ms	SOT-25	28xg	VD20	6g	Tor
BFR	XC6115C623MR	Vdet-IC	2.3V±2%, +Rst PPO, -Rst ODO, Wt=1.6s, Rt=50ms	SOT-25	28xg	VD20	6g	Tor
BFS	XC6115C624MR	Vdet-IC	2.4V±2%, +Rst PPO, -Rst ODO, Wt=1.6s, Rt=50ms	SOT-25	28xg	VD20	6g	Tor
BFT	XC6115C625MR	Vdet-IC	2.5V±2%, +Rst PPO, -Rst ODO, Wt=1.6s, Rt=50ms	SOT-25	28xg	VD20	6g	Tor
BFU	XC6115C626MR	Vdet-IC	2.6V±2%, +Rst PPO, -Rst ODO, Wt=1.6s, Rt=50ms	SOT-25	28xg	VD20	6g	Tor
BFV	XC6115C627MR	Vdet-IC	2.7V±2%, +Rst PPO, -Rst ODO, Wt=1.6s, Rt=50ms	SOT-25	28xg	VD20	6g	Tor
BFW	RP170N291D	LVR-IC	LDO, 2.9V±1%, 300mA, +CE, CL	SOT-23-5	28cx	VR4	6g	Ric
BFX	RP170N301D	LVR-IC	LDO, 3.0V±1%, 300mA, +CE, CL	SOT-23-5	28cx	VR4	6g	Ric
BFX	XC6115C628MR	Vdet-IC	2.8V±2%, +Rst PPO, -Rst ODO, Wt=1.6s, Rt=50ms	SOT-25	28xg	VD20	6g	Tor
BFY	XC6115C629MR	Vdet-IC	2.9V±2%, +Rst PPO, -Rst ODO, Wt=1.6s, Rt=50ms	SOT-25	28xg	VD20	6g	Tor
BFZ	XC6115C630MR	Vdet-IC	3.0V±2%, +Rst PPO, -Rst ODO, Wt=1.6s, Rt=50ms	SOT-25	28xg	VD20	6g	Tor
BG	AP432IQ	Vref-IC	Adjustable, Precision, Shunt, 1.24V±1%	SOT-23-5	28re	RF1	6k	Ana
BG	BD4725G	Vdet-IC	2.5V, -Reset ODO	SMP5	28v dq	VD6	6a	Rhm
BG	PI74STX1G86CX	CMOS-Logic	2-input EXCLUSIVE-OR gate	SC-70-5	28/Log5	-	6a	Per
BG	PI74STX1G86TX	CMOS-Logic	2-input EXCLUSIVE-OR gate	SOT-23-5	28/Log5	-	6a	Per
BG	RN5RT36AA	LVR-IC	LDO, 3.6V±2%, 150mA, -CE	SOT-23-5	28vrt	VR4	6g	Ric
BG	V6300GSP5B	Vdet-IC	2.0V, +Reset PPO, 50ms	SOT-23-5	28vdo	VD3	6a	Em
BG-	RT9193-32PU5	LVR-IC	LDO, 3.2V±1%, 300mA, +CE	SC-70-5	28vrx	VR7	6g	Rct
BGA	S-818A20AMC	LVR-IC	LDO, 2.0V±2%, 200mA, +CE	SOT-23-5	28cx	VR4	6g	Sii
BGB	S-818A21AMC	LVR-IC	LDO, 2.1V±2%, 200mA, +CE	SOT-23-5	28cx	VR4	6g	Sii
BGC	S-818A22AMC	LVR-IC	LDO, 2.2V±2%, 200mA, +CE	SOT-23-5	28cx	VR4	6g	Sii
BGD	S-818A23AMC	LVR-IC	LDO, 2.3V±2%, 200mA, +CE	SOT-23-5	28cx	VR4	6g	Sii
BGE	S-818A24AMC	LVR-IC	LDO, 2.4V±2%, 200mA, +CE	SOT-23-5	28cx	VR4	6g	Sii
BGF	S-818A25AMC	LVR-IC	LDO, 2.5V±2%, 200mA, +CE	SOT-23-5	28cx	VR4	6g	Sii
BGG	S-818A26AMC	LVR-IC	LDO, 2.6V±2%, 200mA, +CE	SOT-23-5	28cx	VR4	6g	Sii
BGH	S-818A27AMC	LVR-IC	LDO, 2.7V±2%, 200mA, +CE	SOT-23-5	28cx	VR4	6g	Sii
BGI	S-818A28AMC	LVR-IC	LDO, 2.8V±2%, 200mA, +CE	SOT-23-5	28cx	VR4	6g	Sii
BGJ	S-818A29AMC	LVR-IC	LDO, 2.9V±2%, 200mA, +CE	SOT-23-5	28cx	VR4	6g	Sii
BGK	S-818A30AMC	LVR-IC	LDO, 3.0V±2%, 200mA, +CE	SOT-23-5	28cx	VR4	6g	Sii
BGL	S-818A31AMC	LVR-IC	LDO, 3.1V±2%, 200mA, +CE	SOT-23-5	28cx	VR4	6g	Sii
BGM	S-818A32AMC	LVR-IC	LDO, 3.2V±2%, 200mA, +CE	SOT-23-5	28cx	VR4	6g	Sii
BGN	S-818A33AMC	LVR-IC	LDO, 3.3V±2%, 200mA, +CE	SOT-23-5	28cx	VR4	6g	Sii
BGO	S-818A34AMC	LVR-IC	LDO, 3.4V±2%, 200mA, +CE	SOT-23-5	28cx	VR4	6g	Sii
BGP	S-818A35AMC	LVR-IC	LDO, 3.5V±2%, 200mA, +CE	SOT-23-5	28cx	VR4	6g	Sii
BGQ	S-818A36AMC	LVR-IC	LDO, 3.6V±2%, 200mA, +CE	SOT-23-5	28cx	VR4	6g	Sii
BGR	S-818A37AMC	LVR-IC	LDO, 3.7V±2%, 200mA, +CE	SOT-23-5	28cx	VR4	6g	Sii
BGS	S-818A38AMC	LVR-IC	LDO, 3.8V±2%, 200mA, +CE	SOT-23-5	28cx	VR4	6g	Sii
BGT	S-818A39AMC	LVR-IC	LDO, 3.9V±2%, 200mA, +CE	SOT-23-5	28cx	VR4	6g	Sii
BGU	S-818A40AMC	LVR-IC	LDO, 4.0V±2%, 200mA, +CE	SOT-23-5	28cx	VR4	6g	Sii
BGV	S-818A41AMC	LVR-IC	LDO, 4.1V±2%, 200mA, +CE	SOT-23-5	28cx	VR4	6g	Sii
BGW	S-818A42AMC	LVR-IC	LDO, 4.2V±2%, 200mA, +CE	SOT-23-5	28cx	VR4	6g	Sii
BGX	S-818A43AMC	LVR-IC	LDO, 4.3V±2%, 200mA, +CE	SOT-23-5	28cx	VR4	6g	Sii
BGY	S-818A44AMC	LVR-IC	LDO, 4.4V±2%, 200mA, +CE	SOT-23-5	28cx	VR4	6g	Sii
BGZ	S-818A45AMC	LVR-IC	LDO, 4.5V±2%, 200mA, +CE	SOT-23-5	28cx	VR4	6g	Sii
BH	AP432IAQ	Vref-IC	Adjustable, Precision, Shunt, 1.24V±0.5%	SOT-23-5	28re	RF1	6k	Ana
BH	BD4726G	Vdet-IC	2.6V, -Reset ODO	SMP5	28v dq	VD6	6a	Rhm
BH	PI74STX1GU04C	CMOS-Logic	Inverter	SC-70-5	28/Log6	-	6a	Per
BH	PI74STX1GU04T	CMOS-Logic	Inverter	SOT-23-5	28/Log6	-	6a	Per
BH	RN5RT37AA	LVR-IC	LDO, 3.7V±2%, 150mA, -CE	SOT-23-5	28vrt	VR4	6g	Ric
BH	V6300HSP5B	Vdet-IC	2.4V, +Reset PPO, 50ms	SOT-23-5	28vdo	VD3	6a	Em
BH	PI74STX1GU04CE	CMOS-Logic	Inverter	SC-70-5	28/Log6	-	6a	Per
BH	PI74STX1GU04TE	CMOS-Logic	Inverter	SOT-23-5	28/Log6	-	6a	Per
BH0	XC6115D331MR	Vdet-IC	3.1V±2%, +Rst PPO, -Rst ODO, Wt=100ms, Rt=100ms	SOT-25	28xg	VD20	6g	Tor
BH1	XC6115D332MR	Vdet-IC	3.2V±2%, +Rst PPO, -Rst ODO, Wt=100ms, Rt=100ms	SOT-25	28xg	VD20	6g	Tor
BH2	XC6115D333MR	Vdet-IC	3.3V±2%, +Rst PPO, -Rst ODO, Wt=100ms, Rt=100ms	SOT-25	28xg	VD20	6g	Tor
BH3	XC6115D334MR	Vdet-IC	3.4V±2%, +Rst PPO, -Rst ODO, Wt=100ms, Rt=100ms	SOT-25	28xg	VD20	6g	Tor
BH4	XC6115D335MR	Vdet-IC	3.5V±2%, +Rst PPO, -Rst ODO, Wt=100ms, Rt=100ms	SOT-25	28xg	VD20	6g	Tor
BH5	XC6115D336MR	Vdet-IC	3.6V±2%, +Rst PPO, -Rst ODO, Wt=100ms, Rt=100ms	SOT-25	28xg	VD20	6g	Tor
BH6	XC6115D337MR	Vdet-IC	3.7V±2%, +Rst PPO, -Rst ODO, Wt=100ms, Rt=100ms	SOT-25	28xg	VD20	6g	Tor
BH7	XC6115D338MR	Vdet-IC	3.8V±2%, +Rst PPO, -Rst ODO, Wt=100ms, Rt=100ms	SOT-25	28xg	VD20	6g	Tor
BH8	XC6115D339MR	Vdet-IC	3.9V±2%, +Rst PPO, -Rst ODO, Wt=100ms, Rt=100ms	SOT-25	28xg	VD20	6g	Tor
BH9	XC6115D340MR	Vdet-IC	4.0V±2%, +Rst PPO, -Rst ODO, Wt=100ms, Rt=100ms	SOT-25	28xg	VD20	6g	Tor



SMD code	Type	Function	Short description	Case	Pinout	Sch.	St.	Mnf.
BHA	S-818A46AMC	LVR-IC	LDO, 4.6V±2%, 200mA, +CE	SOT-23-5	28cx	VR4	6g	Sii
BHA	XC6115D341MR	Vdet-IC	4.1V±2%, +Rst PPO, -Rst ODO, Wt=100ms, Rt=100ms	SOT-25	28xg	VD20	6g	Tor
BHB	S-818A47AMC	LVR-IC	LDO, 4.7V±2%, 200mA, +CE	SOT-23-5	28cx	VR4	6g	Sii
BHB	XC6115D342MR	Vdet-IC	4.2V±2%, +Rst PPO, -Rst ODO, Wt=100ms, Rt=100ms	SOT-25	28xg	VD20	6g	Tor
BHC	S-818A48AMC	LVR-IC	LDO, 4.8V±2%, 200mA, +CE	SOT-23-5	28cx	VR4	6g	Sii
BHC	XC6115D343MR	Vdet-IC	4.3V±2%, +Rst PPO, -Rst ODO, Wt=100ms, Rt=100ms	SOT-25	28xg	VD20	6g	Tor
BHD	S-818A49AMC	LVR-IC	LDO, 4.9V±2%, 200mA, +CE	SOT-23-5	28cx	VR4	6g	Sii
BHD	XC6115D344MR	Vdet-IC	4.4V±2%, +Rst PPO, -Rst ODO, Wt=100ms, Rt=100ms	SOT-25	28xg	VD20	6g	Tor
BHE	S-818A50AMC	LVR-IC	LDO, 5.0V±2%, 200mA, +CE	SOT-23-5	28cx	VR4	6g	Sii
BHE	XC6115D345MR	Vdet-IC	4.5V±2%, +Rst PPO, -Rst ODO, Wt=100ms, Rt=100ms	SOT-25	28xg	VD20	6g	Tor
BHF	S-818A51AMC	LVR-IC	LDO, 5.1V±2%, 200mA, +CE	SOT-23-5	28cx	VR4	6g	Sii
BHF	XC6115D316MR	Vdet-IC	1.6V±2%, +Rst PPO, -Rst ODO, Wt=100ms, Rt=100ms	SOT-25	28xg	VD20	6g	Tor
BHF	XC6115D346MR	Vdet-IC	4.6V±2%, +Rst PPO, -Rst ODO, Wt=100ms, Rt=100ms	SOT-25	28xg	VD20	6g	Tor
BHG	S-818A52AMC	LVR-IC	LDO, 5.2V±2%, 200mA, +CE	SOT-23-5	28cx	VR4	6g	Sii
BHH	S-818A53AMC	LVR-IC	LDO, 5.3V±2%, 200mA, +CE	SOT-23-5	28cx	VR4	6g	Sii
BHH	XC6115D317MR	Vdet-IC	1.7V±2%, +Rst PPO, -Rst ODO, Wt=100ms, Rt=100ms	SOT-25	28xg	VD20	6g	Tor
BHH	XC6115D347MR	Vdet-IC	4.7V±2%, +Rst PPO, -Rst ODO, Wt=100ms, Rt=100ms	SOT-25	28xg	VD20	6g	Tor
BHI	S-818A54AMC	LVR-IC	LDO, 5.4V±2%, 200mA, +CE	SOT-23-5	28cx	VR4	6g	Sii
BHI	S-818A55AMC	LVR-IC	LDO, 5.5V±2%, 200mA, +CE	SOT-23-5	28cx	VR4	6g	Sii
BHK	S-818A56AMC	LVR-IC	LDO, 5.6V±2%, 200mA, +CE	SOT-23-5	28cx	VR4	6g	Sii
BHK	XC6115D318MR	Vdet-IC	1.8V±2%, +Rst PPO, -Rst ODO, Wt=100ms, Rt=100ms	SOT-25	28xg	VD20	6g	Tor
BHK	XC6115D348MR	Vdet-IC	4.8V±2%, +Rst PPO, -Rst ODO, Wt=100ms, Rt=100ms	SOT-25	28xg	VD20	6g	Tor
BHL	S-818A57AMC	LVR-IC	LDO, 5.7V±2%, 200mA, +CE	SOT-23-5	28cx	VR4	6g	Sii
BHL	XC6115D319MR	Vdet-IC	1.9V±2%, +Rst PPO, -Rst ODO, Wt=100ms, Rt=100ms	SOT-25	28xg	VD20	6g	Tor
BHL	XC6115D349MR	Vdet-IC	4.9V±2%, +Rst PPO, -Rst ODO, Wt=100ms, Rt=100ms	SOT-25	28xg	VD20	6g	Tor
BHM	S-818A58AMC	LVR-IC	LDO, 5.8V±2%, 200mA, +CE	SOT-23-5	28cx	VR4	6g	Sii
BHM	XC6115D320MR	Vdet-IC	2.0V±2%, +Rst PPO, -Rst ODO, Wt=100ms, Rt=100ms	SOT-25	28xg	VD20	6g	Tor
BHM	XC6115D350MR	Vdet-IC	5.0V±2%, +Rst PPO, -Rst ODO, Wt=100ms, Rt=100ms	SOT-25	28xg	VD20	6g	Tor
BHN	S-818A59AMC	LVR-IC	LDO, 5.9V±2%, 200mA, +CE	SOT-23-5	28cx	VR4	6g	Sii
BHN	XC6115D321MR	Vdet-IC	2.1V±2%, +Rst PPO, -Rst ODO, Wt=100ms, Rt=100ms	SOT-25	28xg	VD20	6g	Tor
BHO	S-818A60AMC	LVR-IC	LDO, 6.0V±2%, 200mA, +CE	SOT-23-5	28cx	VR4	6g	Sii
BHP	XC6115D322MR	Vdet-IC	2.2V±2%, +Rst PPO, -Rst ODO, Wt=100ms, Rt=100ms	SOT-25	28xg	VD20	6g	Tor
BHR	XC6115D323MR	Vdet-IC	2.3V±2%, +Rst PPO, -Rst ODO, Wt=100ms, Rt=100ms	SOT-25	28xg	VD20	6g	Tor
BHS	XC6115D324MR	Vdet-IC	2.4V±2%, +Rst PPO, -Rst ODO, Wt=100ms, Rt=100ms	SOT-25	28xg	VD20	6g	Tor
BHT	XC6115D325MR	Vdet-IC	2.5V±2%, +Rst PPO, -Rst ODO, Wt=100ms, Rt=100ms	SOT-25	28xg	VD20	6g	Tor
BHU	XC6115D326MR	Vdet-IC	2.6V±2%, +Rst PPO, -Rst ODO, Wt=100ms, Rt=100ms	SOT-25	28xg	VD20	6g	Tor
BHV	XC6115D327MR	Vdet-IC	2.7V±2%, +Rst PPO, -Rst ODO, Wt=100ms, Rt=100ms	SOT-25	28xg	VD20	6g	Tor
BHX	XC6115D328MR	Vdet-IC	2.8V±2%, +Rst PPO, -Rst ODO, Wt=100ms, Rt=100ms	SOT-25	28xg	VD20	6g	Tor
BHY	XC6115D329MR	Vdet-IC	2.9V±2%, +Rst PPO, -Rst ODO, Wt=100ms, Rt=100ms	SOT-25	28xg	VD20	6g	Tor
BHZ	XC6115D330MR	Vdet-IC	3.0V±2%, +Rst PPO, -Rst ODO, Wt=100ms, Rt=100ms	SOT-25	28xg	VD20	6g	Tor
BI	PI74STX1GU04AC	CMOS-Logic	Inverter	SC-70-5	28/Log6	-	6a	Per
BI	PI74STX1GU04AT	CMOS-Logic	Inverter	SOT-23-5	28/Log6	-	6a	Per
BI	V6300ISP5B	Vdet-IC	2.8V, +Reset PPO, 50ms	SOT-23-5	28vdo	VD3	6a	Em
BI	PI74STX1GU04ACE	CMOS-Logic	Inverter	SC-70-5	28/Log6	-	6a	Per
BI	PI74STX1GU04ATE	CMOS-Logic	Inverter	SOT-23-5	28/Log6	-	6a	Per
BJ	BD4728G	Vdet-IC	2.8V, -Reset ODO	SMP5	28vdq	VD6	6a	Rhm
BJ	PT7M7823LTA	Vdet-IC	4.63V±1.5%, -Reset PPO, -MR, WD	SOT-23-5	28cp	VD17	6k	Pti
BJ	RN5RT38AA	LVR-IC	LDO, 3.8V±2%, 150mA, -CE	SOT-23-5	28br	VR4	6g	Ric
BJ	V6300JSP5B	Vdet-IC	3.5V, +Reset PPO, 50ms	SOT-23-5	28vdo	VD3	6a	Em
BJ	PT7M7823LTAE	Vdet-IC	4.63V±1.5%, -Reset PPO, -MR, WD, Lead free	SOT-23-5	28cp	VD17	6k	Pti
BJ-	RT9198-35PU5	LVR-IC	LDO, 3.5V±1%, 300mA, +CE	SC-70-5	28xm	VR4	6a	Rct
BK	BD4729G	Vdet-IC	2.9V, -Reset ODO	SMP5	28vdq	VD6	6a	Rhm
BK	PT7M7823MTA	Vdet-IC	4.38V±1.5%, -Reset PPO, -MR, WD	SOT-23-5	28cp	VD17	6k	Pti
BK	RN5RT39AA	LVR-IC	LDO, 3.9V±2%, 150mA, -CE	SOT-23-5	28brt	VR4	6g	Ric
BK	V6300KSP5B	Vdet-IC	4V, +Reset PPO, 50ms	SOT-23-5	28vdo	VD3	6a	Em
BK	PT7M7823MTAE	Vdet-IC	4.38V±1.5%, -Reset PPO, -MR, WD, Lead free	SOT-23-5	28cp	VD17	6k	Pti
BK-	RT9013-27PU5	LVR-IC	LDO, 2.7V±2%, 500mA, +CE	SC-70-5	28cx	VR4	6g	Rct
BK-	RT9193-28GJ5	LVR-IC	LDO, 2.8V±1%, 300mA, +CE	TSOT-23-5	28vrx	VR7	6g	Rct
BK0	XC6115D431MR	Vdet-IC	3.1V±2%, +Rst PPO, -Rst ODO, Wt=200ms, Rt=100ms	SOT-25	28xg	VD20	6g	Tor
BK1	XC6115D432MR	Vdet-IC	3.2V±2%, +Rst PPO, -Rst ODO, Wt=200ms, Rt=100ms	SOT-25	28xg	VD20	6g	Tor
BK2	XC6115D433MR	Vdet-IC	3.3V±2%, +Rst PPO, -Rst ODO, Wt=200ms, Rt=100ms	SOT-25	28xg	VD20	6g	Tor
BK3	XC6115D434MR	Vdet-IC	3.4V±2%, +Rst PPO, -Rst ODO, Wt=200ms, Rt=100ms	SOT-25	28xg	VD20	6g	Tor
BK4	XC6115D435MR	Vdet-IC	3.5V±2%, +Rst PPO, -Rst ODO, Wt=200ms, Rt=100ms	SOT-25	28xg	VD20	6g	Tor
BK5	XC6115D436MR	Vdet-IC	3.6V±2%, +Rst PPO, -Rst ODO, Wt=200ms, Rt=100ms	SOT-25	28xg	VD20	6g	Tor
BK6	XC6115D437MR	Vdet-IC	3.7V±2%, +Rst PPO, -Rst ODO, Wt=200ms, Rt=100ms	SOT-25	28xg	VD20	6g	Tor
BK7	XC6115D438MR	Vdet-IC	3.8V±2%, +Rst PPO, -Rst ODO, Wt=200ms, Rt=100ms	SOT-25	28xg	VD20	6g	Tor
BK8	XC6115D439MR	Vdet-IC	3.9V±2%, +Rst PPO, -Rst ODO, Wt=200ms, Rt=100ms	SOT-25	28xg	VD20	6g	Tor
BK9	XC6115D440MR	Vdet-IC	4.0V±2%, +Rst PPO, -Rst ODO, Wt=200ms, Rt=100ms	SOT-25	28xg	VD20	6g	Tor
BKA	XC6115D441MR	Vdet-IC	4.1V±2%, +Rst PPO, -Rst ODO, Wt=200ms, Rt=100ms	SOT-25	28xg	VD20	6g	Tor
BKB	XC6115D442MR	Vdet-IC	4.2V±2%, +Rst PPO, -Rst ODO, Wt=200ms, Rt=100ms	SOT-25	28xg	VD20	6g	Tor



SMD code	Type	Function	Short description	Case	Pinout	Sch.	St.	Mnf.
BKC	XC6115D443MR	Vdet-IC	4.3V±2%, +Rst PPO, -Rst ODO, Wt=200ms, Rt=100ms	SOT-25	28xg	VD20	6g	Tor
BKD	XC6115D444MR	Vdet-IC	4.4V±2%, +Rst PPO, -Rst ODO, Wt=200ms, Rt=100ms	SOT-25	28xg	VD20	6g	Tor
BKE	XC6115D445MR	Vdet-IC	4.5V±2%, +Rst PPO, -Rst ODO, Wt=200ms, Rt=100ms	SOT-25	28xg	VD20	6g	Tor
BKF	XC6115D416MR	Vdet-IC	1.6V±2%, +Rst PPO, -Rst ODO, Wt=200ms, Rt=100ms	SOT-25	28xg	VD20	6g	Tor
BKF	XC6115D446MR	Vdet-IC	4.6V±2%, +Rst PPO, -Rst ODO, Wt=200ms, Rt=100ms	SOT-25	28xg	VD20	6g	Tor
BKH	XC6115D417MR	Vdet-IC	1.7V±2%, +Rst PPO, -Rst ODO, Wt=200ms, Rt=100ms	SOT-25	28xg	VD20	6g	Tor
BKH	XC6115D447MR	Vdet-IC	4.7V±2%, +Rst PPO, -Rst ODO, Wt=200ms, Rt=100ms	SOT-25	28xg	VD20	6g	Tor
BKK	XC6115D418MR	Vdet-IC	1.8V±2%, +Rst PPO, -Rst ODO, Wt=200ms, Rt=100ms	SOT-25	28xg	VD20	6g	Tor
BKK	XC6115D448MR	Vdet-IC	4.8V±2%, +Rst PPO, -Rst ODO, Wt=200ms, Rt=100ms	SOT-25	28xg	VD20	6g	Tor
BKL	XC6115D419MR	Vdet-IC	1.9V±2%, +Rst PPO, -Rst ODO, Wt=200ms, Rt=100ms	SOT-25	28xg	VD20	6g	Tor
BKL	XC6115D449MR	Vdet-IC	4.9V±2%, +Rst PPO, -Rst ODO, Wt=200ms, Rt=100ms	SOT-25	28xg	VD20	6g	Tor
BKM	XC6115D420MR	Vdet-IC	2.0V±2%, +Rst PPO, -Rst ODO, Wt=200ms, Rt=100ms	SOT-25	28xg	VD20	6g	Tor
BKM	XC6115D450MR	Vdet-IC	5.0V±2%, +Rst PPO, -Rst ODO, Wt=200ms, Rt=100ms	SOT-25	28xg	VD20	6g	Tor
BKN	XC6115D421MR	Vdet-IC	2.1V±2%, +Rst PPO, -Rst ODO, Wt=200ms, Rt=100ms	SOT-25	28xg	VD20	6g	Tor
BKO	AME8550BEEVD280Y	Vdet-IC	2.8V±2%, -Reset ODO	TSOT-25	28vdo	VD1	6g	Ame
BKO	AME8550BEEVD280Z	Vdet-IC	2.8V±2%, -Reset ODO	SOT-25	28vdo	VD1	6g	Ame
BKO	AME8550BEEVD280L	Vdet-IC	2.8V±2%, -Reset ODO	SOT-25	28vdo	VD1	6g	Ame
BKP	XC6115D422MR	Vdet-IC	2.2V±2%, +Rst PPO, -Rst ODO, Wt=200ms, Rt=100ms	SOT-25	28xg	VD20	6g	Tor
BKR	XC6115D423MR	Vdet-IC	2.3V±2%, +Rst PPO, -Rst ODO, Wt=200ms, Rt=100ms	SOT-25	28xg	VD20	6g	Tor
BKS	XC6115D424MR	Vdet-IC	2.4V±2%, +Rst PPO, -Rst ODO, Wt=200ms, Rt=100ms	SOT-25	28xg	VD20	6g	Tor
BKT	XC6115D425MR	Vdet-IC	2.5V±2%, +Rst PPO, -Rst ODO, Wt=200ms, Rt=100ms	SOT-25	28xg	VD20	6g	Tor
BKU	AME8550CEEVA270Z	Vdet-IC	2.7V±2%, -Reset PPO	SOT-25	28vdm	VD7	6g	Ame
BKU	AME8550CEEVA270L	Vdet-IC	2.7V±2%, -Reset PPO	SOT-25	28vdm	VD7	6g	Ame
BKV	XC6115D426MR	Vdet-IC	2.6V±2%, +Rst PPO, -Rst ODO, Wt=200ms, Rt=100ms	SOT-25	28xg	VD20	6g	Tor
BKV	XC6115D427MR	Vdet-IC	2.7V±2%, +Rst PPO, -Rst ODO, Wt=200ms, Rt=100ms	SOT-25	28xg	VD20	6g	Tor
BKX	XC6115D428MR	Vdet-IC	2.8V±2%, +Rst PPO, -Rst ODO, Wt=200ms, Rt=100ms	SOT-25	28xg	VD20	6g	Tor
BKY	XC6115D429MR	Vdet-IC	2.9V±2%, +Rst PPO, -Rst ODO, Wt=200ms, Rt=100ms	SOT-25	28xg	VD20	6g	Tor
BKZ	XC6115D430MR	Vdet-IC	3.0V±2%, +Rst PPO, -Rst ODO, Wt=200ms, Rt=100ms	SOT-25	28xg	VD20	6g	Tor
BL	BD4730G	Vdet-IC	3V, -Reset ODO	SMP5	28v dq	VD6	6a	Rhm
BL	PT7M7823TTA	Vdet-IC	3.08V±1.5%, -Reset PPO, -MR, WD	SOT-23-5	28cp	VD17	6k	Pti
BL	R1112N301A	LVR-IC	LDO, LN, -CE, 3V±2%, 150mA	SOT-23-5	28cx	VR4	6a	Ric
BL	V6300LSP5B	Vdet-IC	4.5V, +Reset PPO, 50ms	SOT-23-5	28vdo	VD3	6g	Em
BL	PT7M7823TTAE	Vdet-IC	3.08V±1.5%, -Reset PPO, -MR, WD, Lead free	SOT-23-5	28cp	VD17	6k	Pti
BL0	XC6115D531MR	Vdet-IC	3.1V±2%, +Rst PPO, -Rst ODO, Wt=400ms, Rt=100ms	SOT-25	28xg	VD20	6g	Tor
BL1	XC6115D532MR	Vdet-IC	3.2V±2%, +Rst PPO, -Rst ODO, Wt=400ms, Rt=100ms	SOT-25	28xg	VD20	6g	Tor
BL2	XC6115D533MR	Vdet-IC	3.3V±2%, +Rst PPO, -Rst ODO, Wt=400ms, Rt=100ms	SOT-25	28xg	VD20	6g	Tor
BL3	XC6115D534MR	Vdet-IC	3.4V±2%, +Rst PPO, -Rst ODO, Wt=400ms, Rt=100ms	SOT-25	28xg	VD20	6g	Tor
BL4	XC6115D535MR	Vdet-IC	3.5V±2%, +Rst PPO, -Rst ODO, Wt=400ms, Rt=100ms	SOT-25	28xg	VD20	6g	Tor
BL5	XC6115D536MR	Vdet-IC	3.6V±2%, +Rst PPO, -Rst ODO, Wt=400ms, Rt=100ms	SOT-25	28xg	VD20	6g	Tor
BL6	XC6115D537MR	Vdet-IC	3.7V±2%, +Rst PPO, -Rst ODO, Wt=400ms, Rt=100ms	SOT-25	28xg	VD20	6g	Tor
BL7	XC6115D538MR	Vdet-IC	3.8V±2%, +Rst PPO, -Rst ODO, Wt=400ms, Rt=100ms	SOT-25	28xg	VD20	6g	Tor
BL8	XC6115D539MR	Vdet-IC	3.9V±2%, +Rst PPO, -Rst ODO, Wt=400ms, Rt=100ms	SOT-25	28xg	VD20	6g	Tor
BL9	XC6115D540MR	Vdet-IC	4.0V±2%, +Rst PPO, -Rst ODO, Wt=400ms, Rt=100ms	SOT-25	28xg	VD20	6g	Tor
BLA	XC6115D541MR	Vdet-IC	4.1V±2%, +Rst PPO, -Rst ODO, Wt=400ms, Rt=100ms	SOT-25	28xg	VD20	6g	Tor
BLB	XC6115D542MR	Vdet-IC	4.2V±2%, +Rst PPO, -Rst ODO, Wt=400ms, Rt=100ms	SOT-25	28xg	VD20	6g	Tor
BLC	XC6115D543MR	Vdet-IC	4.3V±2%, +Rst PPO, -Rst ODO, Wt=400ms, Rt=100ms	SOT-25	28xg	VD20	6g	Tor
BLD	XC6115D544MR	Vdet-IC	4.4V±2%, +Rst PPO, -Rst ODO, Wt=400ms, Rt=100ms	SOT-25	28xg	VD20	6g	Tor
BLE	XC6115D545MR	Vdet-IC	4.5V±2%, +Rst PPO, -Rst ODO, Wt=400ms, Rt=100ms	SOT-25	28xg	VD20	6g	Tor
BLF	XC6115D516MR	Vdet-IC	1.6V±2%, +Rst PPO, -Rst ODO, Wt=400ms, Rt=100ms	SOT-25	28xg	VD20	6g	Tor
BLF	XC6115D546MR	Vdet-IC	4.6V±2%, +Rst PPO, -Rst ODO, Wt=400ms, Rt=100ms	SOT-25	28xg	VD20	6g	Tor
BLH	XC6115D517MR	Vdet-IC	1.7V±2%, +Rst PPO, -Rst ODO, Wt=400ms, Rt=100ms	SOT-25	28xg	VD20	6g	Tor
BLH	XC6115D547MR	Vdet-IC	4.7V±2%, +Rst PPO, -Rst ODO, Wt=400ms, Rt=100ms	SOT-25	28xg	VD20	6g	Tor
BLK	XC6115D518MR	Vdet-IC	1.8V±2%, +Rst PPO, -Rst ODO, Wt=400ms, Rt=100ms	SOT-25	28xg	VD20	6g	Tor
BLK	XC6115D548MR	Vdet-IC	4.8V±2%, +Rst PPO, -Rst ODO, Wt=400ms, Rt=100ms	SOT-25	28xg	VD20	6g	Tor
BLL	XC6115D519MR	Vdet-IC	1.9V±2%, +Rst PPO, -Rst ODO, Wt=400ms, Rt=100ms	SOT-25	28xg	VD20	6g	Tor
BLL	XC6115D549MR	Vdet-IC	4.9V±2%, +Rst PPO, -Rst ODO, Wt=400ms, Rt=100ms	SOT-25	28xg	VD20	6g	Tor
BLM	XC6115D520MR	Vdet-IC	2.0V±2%, +Rst PPO, -Rst ODO, Wt=400ms, Rt=100ms	SOT-25	28xg	VD20	6g	Tor
BLM	XC6115D550MR	Vdet-IC	5.0V±2%, +Rst PPO, -Rst ODO, Wt=400ms, Rt=100ms	SOT-25	28xg	VD20	6g	Tor
BLN	XC6115D521MR	Vdet-IC	2.1V±2%, +Rst PPO, -Rst ODO, Wt=400ms, Rt=100ms	SOT-25	28xg	VD20	6g	Tor
BLP	XC6115D522MR	Vdet-IC	2.2V±2%, +Rst PPO, -Rst ODO, Wt=400ms, Rt=100ms	SOT-25	28xg	VD20	6g	Tor
BLR	AME8550BEEVC270Z	Vdet-IC	2.7V±2%, -Reset PPO	SOT-25	28vdo	VD3	6g	Ame
BLR	AME8550BEEVC270L	Vdet-IC	2.7V±2%, -Reset PPO	SOT-25	28vdo	VD3	6g	Ame
BLR	XC6115D523MR	Vdet-IC	2.3V±2%, +Rst PPO, -Rst ODO, Wt=400ms, Rt=100ms	SOT-25	28xg	VD20	6g	Tor
BLS	XC6115D524MR	Vdet-IC	2.4V±2%, +Rst PPO, -Rst ODO, Wt=400ms, Rt=100ms	SOT-25	28xg	VD20	6g	Tor
BLT	XC6115D525MR	Vdet-IC	2.5V±2%, +Rst PPO, -Rst ODO, Wt=400ms, Rt=100ms	SOT-25	28xg	VD20	6g	Tor
BLU	XC6115D526MR	Vdet-IC	2.6V±2%, +Rst PPO, -Rst ODO, Wt=400ms, Rt=100ms	SOT-25	28xg	VD20	6g	Tor
BLV	XC6115D527MR	Vdet-IC	2.7V±2%, +Rst PPO, -Rst ODO, Wt=400ms, Rt=100ms	SOT-25	28xg	VD20	6g	Tor
BLX	XC6115D528MR	Vdet-IC	2.8V±2%, +Rst PPO, -Rst ODO, Wt=400ms, Rt=100ms	SOT-25	28xg	VD20	6g	Tor
BLY	XC6115D529MR	Vdet-IC	2.9V±2%, +Rst PPO, -Rst ODO, Wt=400ms, Rt=100ms	SOT-25	28xg	VD20	6g	Tor
BLZ	XC6115D530MR	Vdet-IC	3.0V±2%, +Rst PPO, -Rst ODO, Wt=400ms, Rt=100ms	SOT-25	28xg	VD20	6g	Tor



SMD code	Type	Function	Short description	Case	Pinout	Sch.	St.	Mnf.
bM	74CBTLV1G125GW	CMOS-Logic	Bus buffer gate with 3-state output	SOT-353-1	28/Log14	-	6a	Phi
BM	BD4731G	Vdet-IC	3.1V, -Reset ODO	SMP5	28vdq	VD6	6a	Rhm
BM	PT7M7823STA	Vdet-IC	2.93V±1.5%, -Reset PPO, -MR, WD	SOT-23-5	28cp	VD17	6k	Pti
BM	R1112N311A	LVR-IC	LDO, LN, -CE, 3.1V±2%, 150mA	SOT-23-5	28cx	VR4	6g	Ric
BM	V6300MSP5B	Vdet-IC	2.0V, -Reset ODO, 50ms	SOT-23-5	28vdr	VD6	6a	Em
BM	PT7M7823TAE	Vdet-IC	2.93V±1.5%, -Reset PPO, -MR, WD, Lead free	SOT-23-5	28cp	VD17	6k	Pti
BM0	XC6115D631MR	Vdet-IC	3.1V±2%, +Rst PPO, -Rst ODO, Wt=1.6s, Rt=100ms	SOT-25	28xg	VD20	6g	Tor
BM1	XC6115D632MR	Vdet-IC	3.2V±2%, +Rst PPO, -Rst ODO, Wt=1.6s, Rt=100ms	SOT-25	28xg	VD20	6g	Tor
BM2	XC6115D633MR	Vdet-IC	3.3V±2%, +Rst PPO, -Rst ODO, Wt=1.6s, Rt=100ms	SOT-25	28xg	VD20	6g	Tor
BM3	XC6115D634MR	Vdet-IC	3.4V±2%, +Rst PPO, -Rst ODO, Wt=1.6s, Rt=100ms	SOT-25	28xg	VD20	6g	Tor
BM4	XC6115D635MR	Vdet-IC	3.5V±2%, +Rst PPO, -Rst ODO, Wt=1.6s, Rt=100ms	SOT-25	28xg	VD20	6g	Tor
BM5	XC6115D636MR	Vdet-IC	3.6V±2%, +Rst PPO, -Rst ODO, Wt=1.6s, Rt=100ms	SOT-25	28xg	VD20	6g	Tor
BM6	XC6115D637MR	Vdet-IC	3.7V±2%, +Rst PPO, -Rst ODO, Wt=1.6s, Rt=100ms	SOT-25	28xg	VD20	6g	Tor
BM7	XC6115D638MR	Vdet-IC	3.8V±2%, +Rst PPO, -Rst ODO, Wt=1.6s, Rt=100ms	SOT-25	28xg	VD20	6g	Tor
BM8	XC6115D639MR	Vdet-IC	3.9V±2%, +Rst PPO, -Rst ODO, Wt=1.6s, Rt=100ms	SOT-25	28xg	VD20	6g	Tor
BM9	XC6115D640MR	Vdet-IC	4.0V±2%, +Rst PPO, -Rst ODO, Wt=1.6s, Rt=100ms	SOT-25	28xg	VD20	6g	Tor
BMA	XC6115D641MR	Vdet-IC	4.1V±2%, +Rst PPO, -Rst ODO, Wt=1.6s, Rt=100ms	SOT-25	28xg	VD20	6g	Tor
BMB	XC6115D642MR	Vdet-IC	4.2V±2%, +Rst PPO, -Rst ODO, Wt=1.6s, Rt=100ms	SOT-25	28xg	VD20	6g	Tor
BMC	XC6115D643MR	Vdet-IC	4.3V±2%, +Rst PPO, -Rst ODO, Wt=1.6s, Rt=100ms	SOT-25	28xg	VD20	6g	Tor
BMD	XC6115D644MR	Vdet-IC	4.4V±2%, +Rst PPO, -Rst ODO, Wt=1.6s, Rt=100ms	SOT-25	28xg	VD20	6g	Tor
BME	XC6115D645MR	Vdet-IC	4.5V±2%, +Rst PPO, -Rst ODO, Wt=1.6s, Rt=100ms	SOT-25	28xg	VD20	6g	Tor
BMF	XC6115D616MR	Vdet-IC	1.6V±2%, +Rst PPO, -Rst ODO, Wt=1.6s, Rt=100ms	SOT-25	28xg	VD20	6g	Tor
BMF	XC6115D646MR	Vdet-IC	4.6V±2%, +Rst PPO, -Rst ODO, Wt=1.6s, Rt=100ms	SOT-25	28xg	VD20	6g	Tor
BMH	XC6115D617MR	Vdet-IC	1.7V±2%, +Rst PPO, -Rst ODO, Wt=1.6s, Rt=100ms	SOT-25	28xg	VD20	6g	Tor
BMH	XC6115D647MR	Vdet-IC	4.7V±2%, +Rst PPO, -Rst ODO, Wt=1.6s, Rt=100ms	SOT-25	28xg	VD20	6g	Tor
BMK	XC6115D618MR	Vdet-IC	1.8V±2%, +Rst PPO, -Rst ODO, Wt=1.6s, Rt=100ms	SOT-25	28xg	VD20	6g	Tor
BMK	XC6115D648MR	Vdet-IC	4.8V±2%, +Rst PPO, -Rst ODO, Wt=1.6s, Rt=100ms	SOT-25	28xg	VD20	6g	Tor
BML	XC6115D619MR	Vdet-IC	1.9V±2%, +Rst PPO, -Rst ODO, Wt=1.6s, Rt=100ms	SOT-25	28xg	VD20	6g	Tor
BML	XC6115D649MR	Vdet-IC	4.9V±2%, +Rst PPO, -Rst ODO, Wt=1.6s, Rt=100ms	SOT-25	28xg	VD20	6g	Tor
BMN	XC6115D620MR	Vdet-IC	2.0V±2%, +Rst PPO, -Rst ODO, Wt=1.6s, Rt=100ms	SOT-25	28xg	VD20	6g	Tor
BMN	XC6115D650MR	Vdet-IC	5.0V±2%, +Rst PPO, -Rst ODO, Wt=1.6s, Rt=100ms	SOT-25	28xg	VD20	6g	Tor
BMN	XC6115D621MR	Vdet-IC	2.1V±2%, +Rst PPO, -Rst ODO, Wt=1.6s, Rt=100ms	SOT-25	28xg	VD20	6g	Tor
BMP	XC6115D622MR	Vdet-IC	2.2V±2%, +Rst PPO, -Rst ODO, Wt=1.6s, Rt=100ms	SOT-25	28xg	VD20	6g	Tor
BMR	XC6115D623MR	Vdet-IC	2.3V±2%, +Rst PPO, -Rst ODO, Wt=1.6s, Rt=100ms	SOT-25	28xg	VD20	6g	Tor
BMS	XC6115D624MR	Vdet-IC	2.4V±2%, +Rst PPO, -Rst ODO, Wt=1.6s, Rt=100ms	SOT-25	28xg	VD20	6g	Tor
BMT	XC6115D625MR	Vdet-IC	2.5V±2%, +Rst PPO, -Rst ODO, Wt=1.6s, Rt=100ms	SOT-25	28xg	VD20	6g	Tor
BMU	XC6115D626MR	Vdet-IC	2.6V±2%, +Rst PPO, -Rst ODO, Wt=1.6s, Rt=100ms	SOT-25	28xg	VD20	6g	Tor
BMV	XC6115D627MR	Vdet-IC	2.7V±2%, +Rst PPO, -Rst ODO, Wt=1.6s, Rt=100ms	SOT-25	28xg	VD20	6g	Tor
BMX	XC6115D628MR	Vdet-IC	2.8V±2%, +Rst PPO, -Rst ODO, Wt=1.6s, Rt=100ms	SOT-25	28xg	VD20	6g	Tor
BMX	XC6115D629MR	Vdet-IC	2.9V±2%, +Rst PPO, -Rst ODO, Wt=1.6s, Rt=100ms	SOT-25	28xg	VD20	6g	Tor
BMZ	XC6115D630MR	Vdet-IC	3.0V±2%, +Rst PPO, -Rst ODO, Wt=1.6s, Rt=100ms	SOT-25	28xg	VD20	6g	Tor
BN	BD4732G	Vdet-IC	3.2V, -Reset ODO	SMP5	28vdq	VD6	6a	Rhm
BN	PT7M7823RTA	Vdet-IC	2.63V±1.5%, -Reset PPO, -MR, WD	SOT-23-5	28cp	VD17	6k	Pti
BN	R1112N321A	LVR-IC	LDO, LN, -CE, 3.2V±2%, 150mA	SOT-23-5	28cx	VR4	6g	Ric
BN	V6300NSP5B	Vdet-IC	2.4V, -Reset ODO, 50ms	SOT-23-5	28vdr	VD6	6a	Em
BN	PT7M7823RTAE	Vdet-IC	2.63V±1.5%, -Reset PPO, -MR, WD, Lead free	SOT-23-5	28cp	VD17	6k	Pti
BO	PT7M7823ZTA	Vdet-IC	2.32V±1.5%, -Reset PPO, -MR, WD	SOT-23-5	28cp	VD17	6k	Pti
BO	V6300OSP5B	Vdet-IC	2.8V, -Reset ODO, 50ms	SOT-23-5	28vdr	VD6	6a	Em
BO	PT7M7823ZTAE	Vdet-IC	2.32V±1.5%, -Reset PPO, -MR, WD, Lead free	SOT-23-5	28cp	VD17	6k	Pti
BP	BD4734G	Vdet-IC	3.4V, -Reset ODO	SMP5	28vdq	VD6	6a	Rhm
BP	PT7M7823YTA	Vdet-IC	2.20V±1.5%, -Reset PPO, -MR, WD	SOT-23-5	28cp	VD17	6k	Pti
BP	R1112N331A	LVR-IC	LDO, LN, -CE, 3.3V±2%, 150mA	SOT-23-5	28cx	VR4	6g	Ric
BP	V6300PSP5B	Vdet-IC	3.5V, -Reset ODO, 50ms	SOT-23-5	28vdr	VD6	6a	Em
BP	PT7M7823YTAE	Vdet-IC	2.20V±1.5%, -Reset PPO, -MR, WD, Lead free	SOT-23-5	28cp	VD17	6k	Pti
BP-	RT9193-20PU5	LVR-IC	LDO, 2.0V±1%, 300mA, +CE	SC-70-5	28vrx	VR7	6g	Rct
BP0	XC6115E431MR	Vdet-IC	3.1V±2%, +Rst PPO, -Rst ODO, Wt=200ms, Rt=200ms	SOT-25	28xg	VD20	6g	Tor
BP1	XC6115E432MR	Vdet-IC	3.2V±2%, +Rst PPO, -Rst ODO, Wt=200ms, Rt=200ms	SOT-25	28xg	VD20	6g	Tor
BP2	XC6115E433MR	Vdet-IC	3.3V±2%, +Rst PPO, -Rst ODO, Wt=200ms, Rt=200ms	SOT-25	28xg	VD20	6g	Tor
BP3	XC6115E434MR	Vdet-IC	3.4V±2%, +Rst PPO, -Rst ODO, Wt=200ms, Rt=200ms	SOT-25	28xg	VD20	6g	Tor
BP4	XC6115E435MR	Vdet-IC	3.5V±2%, +Rst PPO, -Rst ODO, Wt=200ms, Rt=200ms	SOT-25	28xg	VD20	6g	Tor
BP5	XC6115E436MR	Vdet-IC	3.6V±2%, +Rst PPO, -Rst ODO, Wt=200ms, Rt=200ms	SOT-25	28xg	VD20	6g	Tor
BP6	XC6115E437MR	Vdet-IC	3.7V±2%, +Rst PPO, -Rst ODO, Wt=200ms, Rt=200ms	SOT-25	28xg	VD20	6g	Tor
BP7	XC6115E438MR	Vdet-IC	3.8V±2%, +Rst PPO, -Rst ODO, Wt=200ms, Rt=200ms	SOT-25	28xg	VD20	6g	Tor
BP8	XC6115E439MR	Vdet-IC	3.9V±2%, +Rst PPO, -Rst ODO, Wt=200ms, Rt=200ms	SOT-25	28xg	VD20	6g	Tor
BP9	XC6115E440MR	Vdet-IC	4.0V±2%, +Rst PPO, -Rst ODO, Wt=200ms, Rt=200ms	SOT-25	28xg	VD20	6g	Tor
BPA	XC6115E441MR	Vdet-IC	4.1V±2%, +Rst PPO, -Rst ODO, Wt=200ms, Rt=200ms	SOT-25	28xg	VD20	6g	Tor
BPB	XC6115E442MR	Vdet-IC	4.2V±2%, +Rst PPO, -Rst ODO, Wt=200ms, Rt=200ms	SOT-25	28xg	VD20	6g	Tor
BPC	XC6115E443MR	Vdet-IC	4.3V±2%, +Rst PPO, -Rst ODO, Wt=200ms, Rt=200ms	SOT-25	28xg	VD20	6g	Tor
BPD	XC6115E444MR	Vdet-IC	4.4V±2%, +Rst PPO, -Rst ODO, Wt=200ms, Rt=200ms	SOT-25	28xg	VD20	6g	Tor
BPE	XC6115E445MR	Vdet-IC	4.5V±2%, +Rst PPO, -Rst ODO, Wt=200ms, Rt=200ms	SOT-25	28xg	VD20	6g	Tor



SMD code	Type	Function	Short description	Case	Pinout	Sch.	St.	Mnf.
BP F	XC6115E416MR	Vdet-IC	1.6V±2%, +Rst PPO, -Rst ODO, Wt=200ms, Rt=200ms	SOT-25	28xg	VD20	6g	Tor
BP F	XC6115E446MR	Vdet-IC	4.6V±2%, +Rst PPO, -Rst ODO, Wt=200ms, Rt=200ms	SOT-25	28xg	VD20	6g	Tor
BP H	XC6115E417MR	Vdet-IC	1.7V±2%, +Rst PPO, -Rst ODO, Wt=200ms, Rt=200ms	SOT-25	28xg	VD20	6g	Tor
BP H	XC6115E447MR	Vdet-IC	4.7V±2%, +Rst PPO, -Rst ODO, Wt=200ms, Rt=200ms	SOT-25	28xg	VD20	6g	Tor
BP K	XC6115E418MR	Vdet-IC	1.8V±2%, +Rst PPO, -Rst ODO, Wt=200ms, Rt=200ms	SOT-25	28xg	VD20	6g	Tor
BP K	XC6115E448MR	Vdet-IC	4.8V±2%, +Rst PPO, -Rst ODO, Wt=200ms, Rt=200ms	SOT-25	28xg	VD20	6g	Tor
BP L	XC6115E419MR	Vdet-IC	1.9V±2%, +Rst PPO, -Rst ODO, Wt=200ms, Rt=200ms	SOT-25	28xg	VD20	6g	Tor
BP L	XC6115E449MR	Vdet-IC	4.9V±2%, +Rst PPO, -Rst ODO, Wt=200ms, Rt=200ms	SOT-25	28xg	VD20	6g	Tor
BP M	XC6115E420MR	Vdet-IC	2.0V±2%, +Rst PPO, -Rst ODO, Wt=200ms, Rt=200ms	SOT-25	28xg	VD20	6g	Tor
BP M	XC6115E450MR	Vdet-IC	5.0V±2%, +Rst PPO, -Rst ODO, Wt=200ms, Rt=200ms	SOT-25	28xg	VD20	6g	Tor
BP N	XC6115E421MR	Vdet-IC	2.1V±2%, +Rst PPO, -Rst ODO, Wt=200ms, Rt=200ms	SOT-25	28xg	VD20	6g	Tor
BP P	XC6115E422MR	Vdet-IC	2.2V±2%, +Rst PPO, -Rst ODO, Wt=200ms, Rt=200ms	SOT-25	28xg	VD20	6g	Tor
BP R	XC6115E423MR	Vdet-IC	2.3V±2%, +Rst PPO, -Rst ODO, Wt=200ms, Rt=200ms	SOT-25	28xg	VD20	6g	Tor
BP S	XC6115E424MR	Vdet-IC	2.4V±2%, +Rst PPO, -Rst ODO, Wt=200ms, Rt=200ms	SOT-25	28xg	VD20	6g	Tor
BP T	XC6115E425MR	Vdet-IC	2.5V±2%, +Rst PPO, -Rst ODO, Wt=200ms, Rt=200ms	SOT-25	28xg	VD20	6g	Tor
BP U	XC6115E426MR	Vdet-IC	2.6V±2%, +Rst PPO, -Rst ODO, Wt=200ms, Rt=200ms	SOT-25	28xg	VD20	6g	Tor
BP V	XC6115E427MR	Vdet-IC	2.7V±2%, +Rst PPO, -Rst ODO, Wt=200ms, Rt=200ms	SOT-25	28xg	VD20	6g	Tor
BP X	XC6115E428MR	Vdet-IC	2.8V±2%, +Rst PPO, -Rst ODO, Wt=200ms, Rt=200ms	SOT-25	28xg	VD20	6g	Tor
BP Y	XC6115E429MR	Vdet-IC	2.9V±2%, +Rst PPO, -Rst ODO, Wt=200ms, Rt=200ms	SOT-25	28xg	VD20	6g	Tor
BP Z	XC6115E430MR	Vdet-IC	3.0V±2%, +Rst PPO, -Rst ODO, Wt=200ms, Rt=200ms	SOT-25	28xg	VD20	6g	Tor
BQ	BD4735G	Vdet-IC	3.5V, -Reset ODO	SMP5	28vdq	VD6	6a	Rhm
BQ	PT7M7824LTA	Vdet-IC	4.63V±1.5%, ±Reset PPO, WD	SOT-23-5	28xg	VD19	6k	Pti
BQ	R1112N341A	LVR-IC	LDO, LN, -CE, 3.4V±2%, 150mA	SOT-23-5	28cx	VR4	6g	Ric
BQ	V6300QSP5B	Vdet-IC	4V, -Reset ODO, 50ms	SOT-23-5	28vdr	VD6	6a	Pti
BQ	PT7M7824LTAE	Vdet-IC	4.63V±1.5%, ±Reset PPO, WD, Lead free	SOT-23-5	28xg	VD19	6k	Em
BR	AT1201-33XR	LVR-IC	LDO, LN, +CE, 3.3V±2%, 150mA	SOT-23-5	28un	VR7	6a	Atr
BR	BD4736G	Vdet-IC	3.6V, -Reset ODO	SMP5	28vdq	VD6	6a	Rhm
BR	PT7M7824MTA	Vdet-IC	4.38V±1.5%, ±Reset PPO, WD	SOT-23-5	28xg	VD19	6k	Pti
BR	R1112N351A	LVR-IC	LDO, LN, -CE, 3.5V±2%, 150mA	SOT-23-5	28cx	VR4	6g	Ric
BR	V6300RSP5B	Vdet-IC	4.5V, -Reset ODO, 50ms	SOT-23-5	28vdr	VD6	6a	Em
BR	PT7M7824MTAE	Vdet-IC	4.38V±1.5%, ±Reset PPO, WD, Lead free	SOT-23-5	28xg	VD19	6k	Pti
BR	RT9198-15PU5R	LVR-IC	LDO, 1.5V±1%, 300mA, +CE	SC-70-5	28cx	VR4	6a	Rct
BR 0	XC6115E531MR	Vdet-IC	3.1V±2%, +Rst PPO, -Rst ODO, Wt=400ms, Rt=200ms	SOT-25	28xg	VD20	6g	Tor
BR 1	XC6115E532MR	Vdet-IC	3.2V±2%, +Rst PPO, -Rst ODO, Wt=400ms, Rt=200ms	SOT-25	28xg	VD20	6g	Tor
BR 2	XC6115E533MR	Vdet-IC	3.3V±2%, +Rst PPO, -Rst ODO, Wt=400ms, Rt=200ms	SOT-25	28xg	VD20	6g	Tor
BR 3	XC6115E534MR	Vdet-IC	3.4V±2%, +Rst PPO, -Rst ODO, Wt=400ms, Rt=200ms	SOT-25	28xg	VD20	6g	Tor
BR 4	XC6115E535MR	Vdet-IC	3.5V±2%, +Rst PPO, -Rst ODO, Wt=400ms, Rt=200ms	SOT-25	28xg	VD20	6g	Tor
BR 5	XC6115E536MR	Vdet-IC	3.6V±2%, +Rst PPO, -Rst ODO, Wt=400ms, Rt=200ms	SOT-25	28xg	VD20	6g	Tor
BR 6	XC6115E537MR	Vdet-IC	3.7V±2%, +Rst PPO, -Rst ODO, Wt=400ms, Rt=200ms	SOT-25	28xg	VD20	6g	Tor
BR 7	XC6115E538MR	Vdet-IC	3.8V±2%, +Rst PPO, -Rst ODO, Wt=400ms, Rt=200ms	SOT-25	28xg	VD20	6g	Tor
BR 8	XC6115E539MR	Vdet-IC	3.9V±2%, +Rst PPO, -Rst ODO, Wt=400ms, Rt=200ms	SOT-25	28xg	VD20	6g	Tor
BR 9	XC6115E540MR	Vdet-IC	4.0V±2%, +Rst PPO, -Rst ODO, Wt=400ms, Rt=200ms	SOT-25	28xg	VD20	6g	Tor
BR A	XC6115E541MR	Vdet-IC	4.1V±2%, +Rst PPO, -Rst ODO, Wt=400ms, Rt=200ms	SOT-25	28xg	VD20	6g	Tor
BR B	XC6115E542MR	Vdet-IC	4.2V±2%, +Rst PPO, -Rst ODO, Wt=400ms, Rt=200ms	SOT-25	28xg	VD20	6g	Tor
BR C	XC6115E543MR	Vdet-IC	4.3V±2%, +Rst PPO, -Rst ODO, Wt=400ms, Rt=200ms	SOT-25	28xg	VD20	6g	Tor
BR D	XC6115E544MR	Vdet-IC	4.4V±2%, +Rst PPO, -Rst ODO, Wt=400ms, Rt=200ms	SOT-25	28xg	VD20	6g	Tor
BR E	XC6115E545MR	Vdet-IC	4.5V±2%, +Rst PPO, -Rst ODO, Wt=400ms, Rt=200ms	SOT-25	28xg	VD20	6g	Tor
BR F	XC6115E516MR	Vdet-IC	1.6V±2%, +Rst PPO, -Rst ODO, Wt=400ms, Rt=200ms	SOT-25	28xg	VD20	6g	Tor
BR F	XC6115E546MR	Vdet-IC	4.6V±2%, +Rst PPO, -Rst ODO, Wt=400ms, Rt=200ms	SOT-25	28xg	VD20	6g	Tor
BR H	XC6115E517MR	Vdet-IC	1.7V±2%, +Rst PPO, -Rst ODO, Wt=400ms, Rt=200ms	SOT-25	28xg	VD20	6g	Tor
BR H	XC6115E547MR	Vdet-IC	4.7V±2%, +Rst PPO, -Rst ODO, Wt=400ms, Rt=200ms	SOT-25	28xg	VD20	6g	Tor
BR K	XC6115E518MR	Vdet-IC	1.8V±2%, +Rst PPO, -Rst ODO, Wt=400ms, Rt=200ms	SOT-25	28xg	VD20	6g	Tor
BR K	XC6115E548MR	Vdet-IC	4.8V±2%, +Rst PPO, -Rst ODO, Wt=400ms, Rt=200ms	SOT-25	28xg	VD20	6g	Tor
BR L	XC6115E519MR	Vdet-IC	1.9V±2%, +Rst PPO, -Rst ODO, Wt=400ms, Rt=200ms	SOT-25	28xg	VD20	6g	Tor
BR L	XC6115E549MR	Vdet-IC	4.9V±2%, +Rst PPO, -Rst ODO, Wt=400ms, Rt=200ms	SOT-25	28xg	VD20	6g	Tor
BR M	XC6115E520MR	Vdet-IC	2.0V±2%, +Rst PPO, -Rst ODO, Wt=400ms, Rt=200ms	SOT-25	28xg	VD20	6g	Tor
BR M	XC6115E550MR	Vdet-IC	5.0V±2%, +Rst PPO, -Rst ODO, Wt=400ms, Rt=200ms	SOT-25	28xg	VD20	6g	Tor
BR N	XC6115E521MR	Vdet-IC	2.1V±2%, +Rst PPO, -Rst ODO, Wt=400ms, Rt=200ms	SOT-25	28xg	VD20	6g	Tor
BR P	XC6115E522MR	Vdet-IC	2.2V±2%, +Rst PPO, -Rst ODO, Wt=400ms, Rt=200ms	SOT-25	28xg	VD20	6g	Tor
BR R	XC6115E523MR	Vdet-IC	2.3V±2%, +Rst PPO, -Rst ODO, Wt=400ms, Rt=200ms	SOT-25	28xg	VD20	6g	Tor
BR S	XC6115E524MR	Vdet-IC	2.4V±2%, +Rst PPO, -Rst ODO, Wt=400ms, Rt=200ms	SOT-25	28xg	VD20	6g	Tor
BR T	XC6115E525MR	Vdet-IC	2.5V±2%, +Rst PPO, -Rst ODO, Wt=400ms, Rt=200ms	SOT-25	28xg	VD20	6g	Tor
BR U	XC6115E526MR	Vdet-IC	2.6V±2%, +Rst PPO, -Rst ODO, Wt=400ms, Rt=200ms	SOT-25	28xg	VD20	6g	Tor
BR V	AME8550AEIVD300Z	Vdet-IC	3.0V±2%, -Reset PPO	SC-70-5	28z9	VD2	6g	Ame
BR V	AME8550AEIVD300L	Vdet-IC	3.0V±2%, -Reset PPO	SC-70-5	28z9	VD2	6g	Ame
BR V	XC6115E527MR	Vdet-IC	2.7V±2%, +Rst PPO, -Rst ODO, Wt=400ms, Rt=200ms	SOT-25	28xg	VD20	6g	Tor
BR W	AME8550AEIVD340Z	Vdet-IC	3.4V±2%, -Reset PPO	SC-70-5	28z9	VD2	6g	Ame
BR W	AME8550AEIVD340L	Vdet-IC	3.4V±2%, -Reset PPO	SC-70-5	28z9	VD2	6g	Ame
BR X	XC6115E528MR	Vdet-IC	2.8V±2%, +Rst PPO, -Rst ODO, Wt=400ms, Rt=200ms	SOT-25	28xg	VD20	6g	Tor
BR Y	XC6115E529MR	Vdet-IC	2.9V±2%, +Rst PPO, -Rst ODO, Wt=400ms, Rt=200ms	SOT-25	28xg	VD20	6g	Tor



SMD code	Type	Function	Short description	Case	Pinout	Sch.	St.	Mnf.
BRZ	XC6115E530MR	Vdet-IC	3.0V±2%, +Rst PPO, -Rst ODO, Wt=400ms, Rt=200ms	SOT-25	28xg	VD20	6g	Tor
BS	BD4737G	Vdet-IC	3.7V, -Reset ODO	SMP5	28v dq	VD6	6a	Rhm
BS	PT7M7824TTA	Vdet-IC	3.08V±1.5%, ±Reset PPO, WD	SOT-23-5	28xg	VD19	6k	Pti
BS	R1112N361A	LVR-IC	LDO, LN, -CE, 3.6V±2%, 150mA	SOT-23-5	28xc	VR4	6g	Pti
BS	PT7M7824TTAE	Vdet-IC	3.08V±1.5%, ±Reset PPO, WD, Lead free	SOT-23-5	28xg	VD19	6k	Pti
BS-	RT9198-29PU5R	LVR-IC	LDO, 2.9V±1%, 300mA, +CE	SC-70-5	28cx	VR4	6a	Rct
BS0	XC6115E631MR	Vdet-IC	3.1V±2%, +Rst PPO, -Rst ODO, Wt=1.6s, Rt=200ms	SOT-25	28xg	VD20	6g	Tor
BS1	XC6115E632MR	Vdet-IC	3.2V±2%, +Rst PPO, -Rst ODO, Wt=1.6s, Rt=200ms	SOT-25	28xg	VD20	6g	Tor
BS2	XC6115E633MR	Vdet-IC	3.3V±2%, +Rst PPO, -Rst ODO, Wt=1.6s, Rt=200ms	SOT-25	28xg	VD20	6g	Tor
BS3	XC6115E634MR	Vdet-IC	3.4V±2%, +Rst PPO, -Rst ODO, Wt=1.6s, Rt=200ms	SOT-25	28xg	VD20	6g	Tor
BS4	XC6115E635MR	Vdet-IC	3.5V±2%, +Rst PPO, -Rst ODO, Wt=1.6s, Rt=200ms	SOT-25	28xg	VD20	6g	Tor
BS5	XC6115E636MR	Vdet-IC	3.6V±2%, +Rst PPO, -Rst ODO, Wt=1.6s, Rt=200ms	SOT-25	28xg	VD20	6g	Tor
BS6	XC6115E637MR	Vdet-IC	3.7V±2%, +Rst PPO, -Rst ODO, Wt=1.6s, Rt=200ms	SOT-25	28xg	VD20	6g	Tor
BS7	XC6115E638MR	Vdet-IC	3.8V±2%, +Rst PPO, -Rst ODO, Wt=1.6s, Rt=200ms	SOT-25	28xg	VD20	6g	Tor
BS8	XC6115E639MR	Vdet-IC	3.9V±2%, +Rst PPO, -Rst ODO, Wt=1.6s, Rt=200ms	SOT-25	28xg	VD20	6g	Tor
BS9	XC6115E640MR	Vdet-IC	4.0V±2%, +Rst PPO, -Rst ODO, Wt=1.6s, Rt=200ms	SOT-25	28xg	VD20	6g	Tor
BSA	XC6115E641MR	Vdet-IC	4.1V±2%, +Rst PPO, -Rst ODO, Wt=1.6s, Rt=200ms	SOT-25	28xg	VD20	6g	Tor
BSB	XC6115E642MR	Vdet-IC	4.2V±2%, +Rst PPO, -Rst ODO, Wt=1.6s, Rt=200ms	SOT-25	28xg	VD20	6g	Tor
BSC	XC6115E643MR	Vdet-IC	4.3V±2%, +Rst PPO, -Rst ODO, Wt=1.6s, Rt=200ms	SOT-25	28xg	VD20	6g	Tor
BSD	XC6115E644MR	Vdet-IC	4.4V±2%, +Rst PPO, -Rst ODO, Wt=1.6s, Rt=200ms	SOT-25	28xg	VD20	6g	Tor
BSE	XC6115E645MR	Vdet-IC	4.5V±2%, +Rst PPO, -Rst ODO, Wt=1.6s, Rt=200ms	SOT-25	28xg	VD20	6g	Tor
BSF	XC6115E646MR	Vdet-IC	4.6V±2%, +Rst PPO, -Rst ODO, Wt=1.6s, Rt=200ms	SOT-25	28xg	VD20	6g	Tor
BSG	XC6115E647MR	Vdet-IC	4.7V±2%, +Rst PPO, -Rst ODO, Wt=1.6s, Rt=200ms	SOT-25	28xg	VD20	6g	Tor
BSH	XC6115E648MR	Vdet-IC	4.8V±2%, +Rst PPO, -Rst ODO, Wt=1.6s, Rt=200ms	SOT-25	28xg	VD20	6g	Tor
BSI	XC6115E649MR	Vdet-IC	4.9V±2%, +Rst PPO, -Rst ODO, Wt=1.6s, Rt=200ms	SOT-25	28xg	VD20	6g	Tor
BSJ	XC6115E650MR	Vdet-IC	5.0V±2%, +Rst PPO, -Rst ODO, Wt=1.6s, Rt=200ms	SOT-25	28xg	VD20	6g	Tor
BSK	XC6115E651MR	Vdet-IC	2.1V±2%, +Rst PPO, -Rst ODO, Wt=1.6s, Rt=200ms	SOT-25	28xg	VD20	6g	Tor
BSL	XC6115E652MR	Vdet-IC	2.2V±2%, +Rst PPO, -Rst ODO, Wt=1.6s, Rt=200ms	SOT-25	28xg	VD20	6g	Tor
BSM	XC6115E653MR	Vdet-IC	2.3V±2%, +Rst PPO, -Rst ODO, Wt=1.6s, Rt=200ms	SOT-25	28xg	VD20	6g	Tor
BSN	XC6115E654MR	Vdet-IC	2.4V±2%, +Rst PPO, -Rst ODO, Wt=1.6s, Rt=200ms	SOT-25	28xg	VD20	6g	Tor
BSO	XC6115E655MR	Vdet-IC	2.5V±2%, +Rst PPO, -Rst ODO, Wt=1.6s, Rt=200ms	SOT-25	28xg	VD20	6g	Tor
BS1	XC6115E656MR	Vdet-IC	2.6V±2%, +Rst PPO, -Rst ODO, Wt=1.6s, Rt=200ms	SOT-25	28xg	VD20	6g	Tor
BS2	XC6115E657MR	Vdet-IC	2.7V±2%, +Rst PPO, -Rst ODO, Wt=1.6s, Rt=200ms	SOT-25	28xg	VD20	6g	Tor
BS3	XC6115E658MR	Vdet-IC	2.8V±2%, +Rst PPO, -Rst ODO, Wt=1.6s, Rt=200ms	SOT-25	28xg	VD20	6g	Tor
BS4	XC6115E659MR	Vdet-IC	2.9V±2%, +Rst PPO, -Rst ODO, Wt=1.6s, Rt=200ms	SOT-25	28xg	VD20	6g	Tor
BS5	XC6115E660MR	Vdet-IC	3.0V±2%, +Rst PPO, -Rst ODO, Wt=1.6s, Rt=200ms	SOT-25	28xg	VD20	6g	Tor
BT	BD4738G	Vdet-IC	3.8V, -Reset ODO	SMP5	28v dq	VD6	6a	Rhm
BT	PT7M7824STA	Vdet-IC	2.93V±1.5%, ±Reset PPO, WD	SOT-23-5	28xg	VD19	6k	Pti
BT	R1112N371A	LVR-IC	LDO, LN, -CE, 3.7V±2%, 150mA	SOT-23-5	28cx	VR4	6g	Pti
BT	TC1015-2.6VRX	LVR-IC	LDO, 2.6V±2%, 100mA, +CE	SOT-23-5	28vrx	VR7	6g	Mcc
BT	PT7M7824STAE	Vdet-IC	2.93V±1.5%, ±Reset PPO, WD, Lead free	SOT-23-5	28xg	VD19	6k	Pti
BT-	RT9198-29PU5R	LVR-IC	LDO, 2.85V±1%, 300mA, +CE	SC-70-5	28cx	VR4	6a	Rct
BT0	XC6115F531MR	Vdet-IC	3.1V±2%, +Rst PPO, -Rst ODO, Wt=400ms, Rt=400ms	SOT-25	28xg	VD20	6g	Tor
BT1	XC6115F532MR	Vdet-IC	3.2V±2%, +Rst PPO, -Rst ODO, Wt=400ms, Rt=400ms	SOT-25	28xg	VD20	6g	Tor
BT2	XC6115F533MR	Vdet-IC	3.3V±2%, +Rst PPO, -Rst ODO, Wt=400ms, Rt=400ms	SOT-25	28xg	VD20	6g	Tor
BT3	XC6115F534MR	Vdet-IC	3.4V±2%, +Rst PPO, -Rst ODO, Wt=400ms, Rt=400ms	SOT-25	28xg	VD20	6g	Tor
BT4	XC6115F535MR	Vdet-IC	3.5V±2%, +Rst PPO, -Rst ODO, Wt=400ms, Rt=400ms	SOT-25	28xg	VD20	6g	Tor
BT5	XC6115F536MR	Vdet-IC	3.6V±2%, +Rst PPO, -Rst ODO, Wt=400ms, Rt=400ms	SOT-25	28xg	VD20	6g	Tor
BT6	XC6115F537MR	Vdet-IC	3.7V±2%, +Rst PPO, -Rst ODO, Wt=400ms, Rt=400ms	SOT-25	28xg	VD20	6g	Tor
BT7	XC6115F538MR	Vdet-IC	3.8V±2%, +Rst PPO, -Rst ODO, Wt=400ms, Rt=400ms	SOT-25	28xg	VD20	6g	Tor
BT8	XC6115F539MR	Vdet-IC	3.9V±2%, +Rst PPO, -Rst ODO, Wt=400ms, Rt=400ms	SOT-25	28xg	VD20	6g	Tor
BT9	XC6115F540MR	Vdet-IC	4.0V±2%, +Rst PPO, -Rst ODO, Wt=400ms, Rt=400ms	SOT-25	28xg	VD20	6g	Tor
BT A	XC6115F541MR	Vdet-IC	4.1V±2%, +Rst PPO, -Rst ODO, Wt=400ms, Rt=400ms	SOT-25	28xg	VD20	6g	Tor
BT B	XC6115F542MR	Vdet-IC	4.2V±2%, +Rst PPO, -Rst ODO, Wt=400ms, Rt=400ms	SOT-25	28xg	VD20	6g	Tor
BT C	XC6115F543MR	Vdet-IC	4.3V±2%, +Rst PPO, -Rst ODO, Wt=400ms, Rt=400ms	SOT-25	28xg	VD20	6g	Tor
BT D	XC6115F544MR	Vdet-IC	4.4V±2%, +Rst PPO, -Rst ODO, Wt=400ms, Rt=400ms	SOT-25	28xg	VD20	6g	Tor
BT E	XC6115F545MR	Vdet-IC	4.5V±2%, +Rst PPO, -Rst ODO, Wt=400ms, Rt=400ms	SOT-25	28xg	VD20	6g	Tor
BT F	XC6115F546MR	Vdet-IC	4.6V±2%, +Rst PPO, -Rst ODO, Wt=400ms, Rt=400ms	SOT-25	28xg	VD20	6g	Tor
BT G	XC6115F547MR	Vdet-IC	4.7V±2%, +Rst PPO, -Rst ODO, Wt=400ms, Rt=400ms	SOT-25	28xg	VD20	6g	Tor
BT H	XC6115F548MR	Vdet-IC	4.8V±2%, +Rst PPO, -Rst ODO, Wt=400ms, Rt=400ms	SOT-25	28xg	VD20	6g	Tor
BT I	XC6115F549MR	Vdet-IC	4.9V±2%, +Rst PPO, -Rst ODO, Wt=400ms, Rt=400ms	SOT-25	28xg	VD20	6g	Tor
BT L	XC6115F550MR	Vdet-IC	5.0V±2%, +Rst PPO, -Rst ODO, Wt=400ms, Rt=400ms	SOT-25	28xg	VD20	6g	Tor



SMD code	Type	Function	Short description	Case	Pinout	Sch.	St.	Mnf.
BTM	XC6115F520MR	Vdet-IC	2.0V±2%, +Rst PPO, -Rst ODO, Wt=400ms, Rt=400ms	SOT-25	28xg	VD20	6g	Tor
BTM	XC6115F550MR	Vdet-IC	5.0V±2%, +Rst PPO, -Rst ODO, Wt=400ms, Rt=400ms	SOT-25	28xg	VD20	6g	Tor
BTN	XC6115F521MR	Vdet-IC	2.1V±2%, +Rst PPO, -Rst ODO, Wt=400ms, Rt=400ms	SOT-25	28xg	VD20	6g	Tor
BTP	XC6115F522MR	Vdet-IC	2.2V±2%, +Rst PPO, -Rst ODO, Wt=400ms, Rt=400ms	SOT-25	28xg	VD20	6g	Tor
BTR	AME8550AEIVD360Z	Vdet-IC	3.6V±2%, -Reset PPO	SC-70-5	28z9	VD2	6g	Ame
BTR	AME8550AEIVD360L	Vdet-IC	3.6V±2%, -Reset PPO	SC-70-5	28z9	VD2	6g	Ame
BTR	XC6115F523MR	Vdet-IC	2.3V±2%, +Rst PPO, -Rst ODO, Wt=400ms, Rt=400ms	SOT-25	28xg	VD20	6g	Tor
BTS	XC6115F524MR	Vdet-IC	2.4V±2%, +Rst PPO, -Rst ODO, Wt=400ms, Rt=400ms	SOT-25	28xg	VD20	6g	Tor
BTT	AME8550BEEVD370Z	Vdet-IC	3.7V±2%, -Reset ODO	SOT-25	28vdo	VD1	6g	Ame
BTT	AME8550BEEVD370L	Vdet-IC	3.7V±2%, -Reset ODO	SOT-25	28vdo	VD1	6g	Ame
BTU	XC6115F525MR	Vdet-IC	2.5V±2%, +Rst PPO, -Rst ODO, Wt=400ms, Rt=400ms	SOT-25	28xg	VD20	6g	Tor
BTU	XC6115F526MR	Vdet-IC	2.6V±2%, +Rst PPO, -Rst ODO, Wt=400ms, Rt=400ms	SOT-25	28xg	VD20	6g	Tor
BTV	XC6115F527MR	Vdet-IC	2.7V±2%, +Rst PPO, -Rst ODO, Wt=400ms, Rt=400ms	SOT-25	28xg	VD20	6g	Tor
BTX	XC6115F528MR	Vdet-IC	2.8V±2%, +Rst PPO, -Rst ODO, Wt=400ms, Rt=400ms	SOT-25	28xg	VD20	6g	Tor
BTY	XC6115F529MR	Vdet-IC	2.9V±2%, +Rst PPO, -Rst ODO, Wt=400ms, Rt=400ms	SOT-25	28xg	VD20	6g	Tor
BTZ	XC6115F530MR	Vdet-IC	3.0V±2%, +Rst PPO, -Rst ODO, Wt=400ms, Rt=400ms	SOT-25	28xg	VD20	6g	Tor
BU	BD4739G	Vdet-IC	3.9V, -Reset ODO	SMP5	28vdk	VD6	6a	Rhm
BU	PT7M7824RTA	Vdet-IC	2.63V±1.5%, ±Reset PPO, WD	SOT-23-5	28xg	VD19	6k	Pti
BU	R1112N381A	LVR-IC	LDO, LN, -CE, 3.8V±2%, 150mA	SOT-23-5	28cx	VR4	6g	Ric
BU	PT7M7824RTAE	Vdet-IC	2.63V±1.5%, ±Reset PPO, WD, Lead free	SOT-23-5	28xg	VD19	6k	Pti
BU-	RT9198-31PU5R	LVR-IC	LDO, 3.1V±1%, 300mA, +CE	SC-70-5	28cx	VR4	6a	Rct
BU0	XC6115F631MR	Vdet-IC	3.1V±2%, +Rst PPO, -Rst ODO, Wt=1.6s, Rt=400ms	SOT-25	28xg	VD20	6g	Tor
BU1	XC6115F632MR	Vdet-IC	3.2V±2%, +Rst PPO, -Rst ODO, Wt=1.6s, Rt=400ms	SOT-25	28xg	VD20	6g	Tor
BU2	XC6115F633MR	Vdet-IC	3.3V±2%, +Rst PPO, -Rst ODO, Wt=1.6s, Rt=400ms	SOT-25	28xg	VD20	6g	Tor
BU3	XC6115F634MR	Vdet-IC	3.4V±2%, +Rst PPO, -Rst ODO, Wt=1.6s, Rt=400ms	SOT-25	28xg	VD20	6g	Tor
BU4	XC6115F635MR	Vdet-IC	3.5V±2%, +Rst PPO, -Rst ODO, Wt=1.6s, Rt=400ms	SOT-25	28xg	VD20	6g	Tor
BU5	XC6115F636MR	Vdet-IC	3.6V±2%, +Rst PPO, -Rst ODO, Wt=1.6s, Rt=400ms	SOT-25	28xg	VD20	6g	Tor
BU6	XC6115F637MR	Vdet-IC	3.7V±2%, +Rst PPO, -Rst ODO, Wt=1.6s, Rt=400ms	SOT-25	28xg	VD20	6g	Tor
BU7	XC6115F638MR	Vdet-IC	3.8V±2%, +Rst PPO, -Rst ODO, Wt=1.6s, Rt=400ms	SOT-25	28xg	VD20	6g	Tor
BU8	XC6115F639MR	Vdet-IC	3.9V±2%, +Rst PPO, -Rst ODO, Wt=1.6s, Rt=400ms	SOT-25	28xg	VD20	6g	Tor
BU9	XC6115F640MR	Vdet-IC	4.0V±2%, +Rst PPO, -Rst ODO, Wt=1.6s, Rt=400ms	SOT-25	28xg	VD20	6g	Tor
BUA	XC6115F641MR	Vdet-IC	4.1V±2%, +Rst PPO, -Rst ODO, Wt=1.6s, Rt=400ms	SOT-25	28xg	VD20	6g	Tor
BUB	XC6115F642MR	Vdet-IC	4.2V±2%, +Rst PPO, -Rst ODO, Wt=1.6s, Rt=400ms	SOT-25	28xg	VD20	6g	Tor
BUc	XC6115F643MR	Vdet-IC	4.3V±2%, +Rst PPO, -Rst ODO, Wt=1.6s, Rt=400ms	SOT-25	28xg	VD20	6g	Tor
BUd	XC6115F644MR	Vdet-IC	4.4V±2%, +Rst PPO, -Rst ODO, Wt=1.6s, Rt=400ms	SOT-25	28xg	VD20	6g	Tor
BUe	XC6115F645MR	Vdet-IC	4.5V±2%, +Rst PPO, -Rst ODO, Wt=1.6s, Rt=400ms	SOT-25	28xg	VD20	6g	Tor
BUf	XC6115F616MR	Vdet-IC	1.6V±2%, +Rst PPO, -Rst ODO, Wt=1.6s, Rt=400ms	SOT-25	28xg	VD20	6g	Tor
BUf	XC6115F646MR	Vdet-IC	4.6V±2%, +Rst PPO, -Rst ODO, Wt=1.6s, Rt=400ms	SOT-25	28xg	VD20	6g	Tor
BUH	XC6115F617MR	Vdet-IC	1.7V±2%, +Rst PPO, -Rst ODO, Wt=1.6s, Rt=400ms	SOT-25	28xg	VD20	6g	Tor
BUH	XC6115F647MR	Vdet-IC	4.7V±2%, +Rst PPO, -Rst ODO, Wt=1.6s, Rt=400ms	SOT-25	28xg	VD20	6g	Tor
BUK	XC6115F618MR	Vdet-IC	1.8V±2%, +Rst PPO, -Rst ODO, Wt=1.6s, Rt=400ms	SOT-25	28xg	VD20	6g	Tor
BUK	XC6115F648MR	Vdet-IC	4.8V±2%, +Rst PPO, -Rst ODO, Wt=1.6s, Rt=400ms	SOT-25	28xg	VD20	6g	Tor
BUL	XC6115F619MR	Vdet-IC	1.9V±2%, +Rst PPO, -Rst ODO, Wt=1.6s, Rt=400ms	SOT-25	28xg	VD20	6g	Tor
BUL	XC6115F649MR	Vdet-IC	4.9V±2%, +Rst PPO, -Rst ODO, Wt=1.6s, Rt=400ms	SOT-25	28xg	VD20	6g	Tor
BUM	XC6115F620MR	Vdet-IC	2.0V±2%, +Rst PPO, -Rst ODO, Wt=1.6s, Rt=400ms	SOT-25	28xg	VD20	6g	Tor
BUM	XC6115F650MR	Vdet-IC	5.0V±2%, +Rst PPO, -Rst ODO, Wt=1.6s, Rt=400ms	SOT-25	28xg	VD20	6g	Tor
BUN	XC6115F621MR	Vdet-IC	2.1V±2%, +Rst PPO, -Rst ODO, Wt=1.6s, Rt=400ms	SOT-25	28xg	VD20	6g	Tor
BUP	XC6115F622MR	Vdet-IC	2.2V±2%, +Rst PPO, -Rst ODO, Wt=1.6s, Rt=400ms	SOT-25	28xg	VD20	6g	Tor
BUR	XC6115F623MR	Vdet-IC	2.3V±2%, +Rst PPO, -Rst ODO, Wt=1.6s, Rt=400ms	SOT-25	28xg	VD20	6g	Tor
BUS	XC6115F624MR	Vdet-IC	2.4V±2%, +Rst PPO, -Rst ODO, Wt=1.6s, Rt=400ms	SOT-25	28xg	VD20	6g	Tor
BUT	XC6115F625MR	Vdet-IC	2.5V±2%, +Rst PPO, -Rst ODO, Wt=1.6s, Rt=400ms	SOT-25	28xg	VD20	6g	Tor
BUU	XC6115F626MR	Vdet-IC	2.6V±2%, +Rst PPO, -Rst ODO, Wt=1.6s, Rt=400ms	SOT-25	28xg	VD20	6g	Tor
BUV	XC6115F627MR	Vdet-IC	2.7V±2%, +Rst PPO, -Rst ODO, Wt=1.6s, Rt=400ms	SOT-25	28xg	VD20	6g	Tor
BUX	XC6115F628MR	Vdet-IC	2.8V±2%, +Rst PPO, -Rst ODO, Wt=1.6s, Rt=400ms	SOT-25	28xg	VD20	6g	Tor
BUY	XC6115F629MR	Vdet-IC	2.9V±2%, +Rst PPO, -Rst ODO, Wt=1.6s, Rt=400ms	SOT-25	28xg	VD20	6g	Tor
BUZ	XC6115F630MR	Vdet-IC	3.0V±2%, +Rst PPO, -Rst ODO, Wt=1.6s, Rt=400ms	SOT-25	28xg	VD20	6g	Tor
BV	BD4740G	Vdet-IC	4V, -Reset ODO	SMP5	28vdk	VD6	6a	Rhm
BV	PT7M7824ZTA	Vdet-IC	2.32V±1.5%, ±Reset PPO, WD	SOT-23-5	28xg	VD19	6k	Pti
BV	R1112N391A	LVR-IC	LDO, LN, -CE, 3.9V±2%, 150mA	SOT-23-5	28cx	VR4	6g	Ric
BV	PT7M7824ZTAE	Vdet-IC	2.32V±1.5%, ±Reset PPO, WD, Lead free	SOT-23-5	28xg	VD19	6k	Pti
BV0	XC6115H631MR	Vdet-IC	3.1V±2%, +Rst PPO, -Rst ODO, Wt=1.6s, Rt=1.6s	SOT-25	28xg	VD20	6g	Tor
BV1	XC6115H632MR	Vdet-IC	3.2V±2%, +Rst PPO, -Rst ODO, Wt=1.6s, Rt=1.6s	SOT-25	28xg	VD20	6g	Tor
BV2	XC6115H633MR	Vdet-IC	3.3V±2%, +Rst PPO, -Rst ODO, Wt=1.6s, Rt=1.6s	SOT-25	28xg	VD20	6g	Tor
BV3	XC6115H634MR	Vdet-IC	3.4V±2%, +Rst PPO, -Rst ODO, Wt=1.6s, Rt=1.6s	SOT-25	28xg	VD20	6g	Tor
BV4	XC6115H635MR	Vdet-IC	3.5V±2%, +Rst PPO, -Rst ODO, Wt=1.6s, Rt=1.6s	SOT-25	28xg	VD20	6g	Tor
BV5	XC6115H636MR	Vdet-IC	3.6V±2%, +Rst PPO, -Rst ODO, Wt=1.6s, Rt=1.6s	SOT-25	28xg	VD20	6g	Tor
BV6	XC6115H637MR	Vdet-IC	3.7V±2%, +Rst PPO, -Rst ODO, Wt=1.6s, Rt=1.6s	SOT-25	28xg	VD20	6g	Tor
BV7	XC6115H638MR	Vdet-IC	3.8V±2%, +Rst PPO, -Rst ODO, Wt=1.6s, Rt=1.6s	SOT-25	28xg	VD20	6g	Tor
BV8	XC6115H639MR	Vdet-IC	3.9V±2%, +Rst PPO, -Rst ODO, Wt=1.6s, Rt=1.6s	SOT-25	28xg	VD20	6g	Tor
BV9	XC6115H640MR	Vdet-IC	4.0V±2%, +Rst PPO, -Rst ODO, Wt=1.6s, Rt=1.6s	SOT-25	28xg	VD20	6g	Tor



SMD code	Type	Function	Short description	Case	Pinout	Sch.	St.	Mnf.
BVA	XC6115H641MR	Vdet-IC	4.1V±2%, +Rst PPO, -Rst ODO, Wt=1.6s, Rt=1.6s	SOT-25	28xg	VD20	6g	Tor
BVB	XC6115H642MR	Vdet-IC	4.2V±2%, +Rst PPO, -Rst ODO, Wt=1.6s, Rt=1.6s	SOT-25	28xg	VD20	6g	Tor
BVC	XC6115H643MR	Vdet-IC	4.3V±2%, +Rst PPO, -Rst ODO, Wt=1.6s, Rt=1.6s	SOT-25	28xg	VD20	6g	Tor
BVD	XC6115H644MR	Vdet-IC	4.4V±2%, +Rst PPO, -Rst ODO, Wt=1.6s, Rt=1.6s	SOT-25	28xg	VD20	6g	Tor
BVE	XC6115H645MR	Vdet-IC	4.5V±2%, +Rst PPO, -Rst ODO, Wt=1.6s, Rt=1.6s	SOT-25	28xg	VD20	6g	Tor
BVF	XC6115H646MR	Vdet-IC	4.6V±2%, +Rst PPO, -Rst ODO, Wt=1.6s, Rt=1.6s	SOT-25	28xg	VD20	6g	Tor
BVG	XC6115H647MR	Vdet-IC	4.7V±2%, +Rst PPO, -Rst ODO, Wt=1.6s, Rt=1.6s	SOT-25	28xg	VD20	6g	Tor
BVH	XC6115H648MR	Vdet-IC	4.8V±2%, +Rst PPO, -Rst ODO, Wt=1.6s, Rt=1.6s	SOT-25	28xg	VD20	6g	Tor
BVI	XC6115H649MR	Vdet-IC	4.9V±2%, +Rst PPO, -Rst ODO, Wt=1.6s, Rt=1.6s	SOT-25	28xg	VD20	6g	Tor
BVJ	XC6115H650MR	Vdet-IC	5.0V±2%, +Rst PPO, -Rst ODO, Wt=1.6s, Rt=1.6s	SOT-25	28xg	VD20	6g	Tor
BVK	XC6115H651MR	Vdet-IC	5.1V±2%, +Rst PPO, -Rst ODO, Wt=1.6s, Rt=1.6s	SOT-25	28xg	VD20	6g	Tor
BVL	XC6115H652MR	Vdet-IC	5.2V±2%, +Rst PPO, -Rst ODO, Wt=1.6s, Rt=1.6s	SOT-25	28xg	VD20	6g	Tor
BVM	XC6115H653MR	Vdet-IC	5.3V±2%, +Rst PPO, -Rst ODO, Wt=1.6s, Rt=1.6s	SOT-25	28xg	VD20	6g	Tor
BVN	XC6115H654MR	Vdet-IC	5.4V±2%, +Rst PPO, -Rst ODO, Wt=1.6s, Rt=1.6s	SOT-25	28xg	VD20	6g	Tor
BVO	XC6115H655MR	Vdet-IC	5.5V±2%, +Rst PPO, -Rst ODO, Wt=1.6s, Rt=1.6s	SOT-25	28xg	VD20	6g	Tor
BVP	XC6115H656MR	Vdet-IC	5.6V±2%, +Rst PPO, -Rst ODO, Wt=1.6s, Rt=1.6s	SOT-25	28xg	VD20	6g	Tor
BVQ	XC6115H657MR	Vdet-IC	5.7V±2%, +Rst PPO, -Rst ODO, Wt=1.6s, Rt=1.6s	SOT-25	28xg	VD20	6g	Tor
BVR	XC6115H658MR	Vdet-IC	5.8V±2%, +Rst PPO, -Rst ODO, Wt=1.6s, Rt=1.6s	SOT-25	28xg	VD20	6g	Tor
BVS	XC6115H659MR	Vdet-IC	5.9V±2%, +Rst PPO, -Rst ODO, Wt=1.6s, Rt=1.6s	SOT-25	28xg	VD20	6g	Tor
BVT	XC6115H660MR	Vdet-IC	6.0V±2%, +Rst PPO, -Rst ODO, Wt=1.6s, Rt=1.6s	SOT-25	28xg	VD20	6g	Tor
BVU	XC6115H661MR	Vdet-IC	6.1V±2%, +Rst PPO, -Rst ODO, Wt=1.6s, Rt=1.6s	SOT-25	28xg	VD20	6g	Tor
BVV	XC6115H662MR	Vdet-IC	6.2V±2%, +Rst PPO, -Rst ODO, Wt=1.6s, Rt=1.6s	SOT-25	28xg	VD20	6g	Tor
BVW	XC6115H663MR	Vdet-IC	6.3V±2%, +Rst PPO, -Rst ODO, Wt=1.6s, Rt=1.6s	SOT-25	28xg	VD20	6g	Tor
BVX	XC6115H664MR	Vdet-IC	6.4V±2%, +Rst PPO, -Rst ODO, Wt=1.6s, Rt=1.6s	SOT-25	28xg	VD20	6g	Tor
BVY	XC6115H665MR	Vdet-IC	6.5V±2%, +Rst PPO, -Rst ODO, Wt=1.6s, Rt=1.6s	SOT-25	28xg	VD20	6g	Tor
BVZ	XC6115H666MR	Vdet-IC	6.6V±2%, +Rst PPO, -Rst ODO, Wt=1.6s, Rt=1.6s	SOT-25	28xg	VD20	6g	Tor
BW	BD4741G	Vdet-IC	4.1V, -Reset ODO	SMP5	28vdq	VD6	6a	Rhm
BWA	PT7M7824YTA	Vdet-IC	2.20V±1.5%, ±Reset PPO, WD	SOT-23-5	28xg	VD19	6k	Pti
BWB	PT7M7824YTAE	Vdet-IC	2.20V±1.5%, ±Reset PPO, WD, Lead free	SOT-23-5	28xg	VD19	6k	Pti
BX	AT1201-33X	LVR-IC	LDO, LN, +CE, 3.3V±2%, 150mA	SOT-23-5	28vrx	VR7	6a	Atr
BXA	BD4742G	Vdet-IC	4.2V, -Reset ODO	SMP5	28vdq	VD6	6a	Rhm
BXB	PT7M7825LTA	Vdet-IC	4.63V±1.5%, ±Reset PPO, -MR	SOT-23-5	28xf	VD21	6k	Pti
BXB	PT7M7825LTAE	Vdet-IC	4.63V±1.5%, ±Reset PPO, -MR, Lead free	SOT-23-5	28xf	VD21	6k	Pti
BXC	RT9198-26PU5R	LVR-IC	LDO, 2.6V±1%, 300mA, +CE	SC-70-5	28cx	VR4	6a	Rct
BY	BD4743G	Vdet-IC	4.3V, -Reset ODO	SMP5	28vdq	VD6	6a	Rhm
BYA	PT7M7825MTA	Vdet-IC	4.38V±1.5%, ±Reset PPO, -MR	SOT-23-5	28xf	VD21	6k	Pti
BYB	TC1015-1.8VRX	LVR-IC	LDO, 1.8V±2%, 100mA, +CE	SOT-23-5	28vrx	VR7	6g	Mcc
BYC	PT7M7825MTAE	Vdet-IC	4.38V±1.5%, ±Reset PPO, -MR, Lead free	SOT-23-5	28xf	VD21	6k	Pti
BYD	RT9013A-15PU5	LVR-IC	LDO, 1.5V±2%, 500mA, +CE	SC-70-5	28cx	VR4	6g	Rct
BZ	BD4744G	Vdet-IC	4.4V, -Reset ODO	SMP5	28vdq	VD6	6a	Rhm
BZA	PT7M7825TTA	Vdet-IC	3.08V±1.5%, ±Reset PPO, -MR	SOT-23-5	28xf	VD21	6k	Pti
BZB	TC1015-2.8VRX	LVR-IC	LDO, 2.8V±2%, 100mA, +CE	SOT-23-5	28vrx	VR7	6g	Mcc
BZC	PT7M7825TTAE	Vdet-IC	3.08V±1.5%, ±Reset PPO, -MR, Lead free	SOT-23-5	28xf	VD21	6k	Pti
BZD	RT9013A-35PU5	LVR-IC	LDO, 3.5V±2%, 500mA, +CE	SC-70-5	28cx	VR4	6g	Rct
C0	BH33NB1WHFV	LVR-IC	LDO, 3.3V, 150mA, +CE	HVSOF5	30ur3	VR4	6e	Rhm
C0A	PI74STX1GT00CX	CMOS-Logic	2-input NAND gate	SC-70-5	28Log1	-	6a	Per
C0B	PI74STX1GT00TX	CMOS-Logic	2-input NAND gate	SOT-23-5	28Log1	-	6a	Per
C0C	R111N401A	LVR-IC	LDO, LN, -CE, 4V±2%, 200mA	SOT-23-5	28cx	VR4	6g	Ric
C0D	Si91842DT-22	LVR-IC	LDO, LN, +CE, -Error, 2.2V±1.5%, 150mA	SOT-23-5	28w	VR17	6k	Vs
C0E	TC1054-4.0VCT713	LVR-IC	LDO, 4.0V±2%, 50mA, +CE, -Error	SOT-23-5	28w	VR8	6g	Mcc
C0F	RN5VD20AA	Vdet-IC	2.0V±2.5%, -Reset PPO	SOT-23-5	28vdo	VD3	6g	Ric
C0G	RT9013B-15PU5	LVR-IC	LDO, 1.5V±2%, 500mA, +CE	SC-70-5	28cx	VR4	6g	Rct
C0H	74AHCT1G00GV	CMOS-Logic	2-input NAND gate	SOT753	28Log1	-	6a	Phi
C0I	RP200Q082B	LVR-IC	LDO, 0.8V±1.0%, 300mA, +CE, AE(mode)	SC-88A	28hv	VR10	6m	Ric
C0J	RP200Q092B	LVR-IC	LDO, 0.9V±1.0%, 300mA, +CE, AE(mode)	SC-88A	28hv	VR10	6m	Ric
C0K	RP200Q102B	LVR-IC	LDO, 1.0V±1.0%, 300mA, +CE, AE(mode)	SC-88A	28hv	VR10	6m	Ric
C0L	RP200Q112B	LVR-IC	LDO, 1.1V±1.0%, 300mA, +CE, AE(mode)	SC-88A	28hv	VR10	6m	Ric
C0M	RP200Q122B	LVR-IC	LDO, 1.2V±1.0%, 300mA, +CE, AE(mode)	SC-88A	28hv	VR10	6m	Ric
C0N	RP200Q132B	LVR-IC	LDO, 1.3V±1.0%, 300mA, +CE, AE(mode)	SC-88A	28hv	VR10	6m	Ric
C0O	RP200Q142B	LVR-IC	LDO, 1.4V±1.0%, 300mA, +CE, AE(mode)	SC-88A	28hv	VR10	6m	Ric
C0P	RP200Q152B	LVR-IC	LDO, 1.5V±1.0%, 300mA, +CE, AE(mode)	SC-88A	28hv	VR10	6m	Ric
C0Q	RP200Q162B	LVR-IC	LDO, 1.6V±1.0%, 300mA, +CE, AE(mode)	SC-88A	28hv	VR10	6m	Ric
C0R	RP200Q172B	LVR-IC	LDO, 1.7V±1.0%, 300mA, +CE, AE(mode)	SC-88A	28hv	VR10	6m	Ric
C0S	RP200Q182B	LVR-IC	LDO, 1.8V±1.0%, 300mA, +CE, AE(mode)	SC-88A	28hv	VR10	6m	Ric
C0T	RP200Q192B	LVR-IC	LDO, 1.9V±1.0%, 300mA, +CE, AE(mode)	SC-88A	28hv	VR10	6m	Ric
C0U	74AHCT1G02GV	CMOS-Logic	2-input NOR gate	SOT753	28Log2	-	6a	Phi
C0V	RP200Q202B	LVR-IC	LDO, 2.0V±1.0%, 300mA, +CE, AE(mode)	SC-88A	28hv	VR10	6m	Ric
C0W	RP200Q212B	LVR-IC	LDO, 2.1V±1.0%, 300mA, +CE, AE(mode)	SC-88A	28hv	VR10	6m	Ric
C0X	RP200Q222B	LVR-IC	LDO, 2.2V±1.0%, 300mA, +CE, AE(mode)	SC-88A	28hv	VR10	6m	Ric
C0Y	RP200Q232B	LVR-IC	LDO, 2.3V±1.0%, 300mA, +CE, AE(mode)	SC-88A	28hv	VR10	6m	Ric
C0Z	RP200Q242B	LVR-IC	LDO, 2.4V±1.0%, 300mA, +CE, AE(mode)	SC-88A	28hv	VR10	6m	Ric



SMD code	Type	Function	Short description	Case	Pinout	Sch.	St.Mnf.
C025	RP200Q252B	LVR-IC	LDO, 2.5V±1.0%, 300mA, +CE, AE(mode)	SC-88A	28hv	VR10	6m Ric
C026	RP200Q262B	LVR-IC	LDO, 2.6V±1.0%, 300mA, +CE, AE(mode)	SC-88A	28hv	VR10	6m Ric
C027	RP200Q272B	LVR-IC	LDO, 2.7V±1.0%, 300mA, +CE, AE(mode)	SC-88A	28hv	VR10	6m Ric
C028	RP200Q282B	LVR-IC	LDO, 2.8V±1.0%, 300mA, +CE, AE(mode)	SC-88A	28hv	VR10	6m Ric
C029	RP200Q292B	LVR-IC	LDO, 2.9V±1.0%, 300mA, +CE, AE(mode)	SC-88A	28hv	VR10	6m Ric
C030	RP200Q302B	LVR-IC	LDO, 3V±1.0%, 300mA, +CE, AE(mode)	SC-88A	28hv	VR10	6m Ric
C031	RP200Q312B	LVR-IC	LDO, 3.1V±1.0%, 300mA, +CE, AE(mode)	SC-88A	28hv	VR10	6m Ric
C032	RP200Q322B	LVR-IC	LDO, 3.2V±1.0%, 300mA, +CE, AE(mode)	SC-88A	28hv	VR10	6m Ric
C033	RP200Q332B	LVR-IC	LDO, 3.3V±1.0%, 300mA, +CE, AE(mode)	SC-88A	28hv	VR10	6m Ric
C034	RP200Q342B	LVR-IC	LDO, 3.4V±1.0%, 300mA, +CE, AE(mode)	SC-88A	28hv	VR10	6m Ric
C035	RP200Q352B	LVR-IC	LDO, 3.5V±1.0%, 300mA, +CE, AE(mode)	SC-88A	28hv	VR10	6m Ric
C036	RP200Q362B	LVR-IC	LDO, 3.6V±1.0%, 300mA, +CE, AE(mode)	SC-88A	28hv	VR10	6m Ric
C037	RP200Q372B	LVR-IC	LDO, 3.7V±1.0%, 300mA, +CE, AE(mode)	SC-88A	28hv	VR10	6m Ric
C038	RP200Q382B	LVR-IC	LDO, 3.8V±1.0%, 300mA, +CE, AE(mode)	SC-88A	28hv	VR10	6m Ric
C039	RP200Q392B	LVR-IC	LDO, 3.9V±1.0%, 300mA, +CE, AE(mode)	SC-88A	28hv	VR10	6m Ric
C04	74AHCT1G04GV	CMOS-Logic	Inverter	SOT753	28/Log6	-	6a Phi
C040	RP200Q402B	LVR-IC	LDO, 4V±1.0%, 300mA, +CE, AE(mode)	SC-88A	28hv	VR10	6m Ric
C06	74AHCT1G06GV	CMOS-Logic	Inverter (ODO)	SOT753	28/Log19	-	6a Phi
C07	74AHCT1G07GV	CMOS-Logic	Noninverting buffer/driver (ODO)	SOT753	28/Log8	-	6a Phi
C08	74AHCT1G08GV	CMOS-Logic	2-input AND gate	SOT753	28/Log3	-	6a Phi
C08	RP110N081D	LVR-IC	LDO, 0.8V±1%, 150mA, +CE, CL	SOT-23-5	28cx	VR4	6g Ric
C09	RP110N091D	LVR-IC	LDO, 0.9V±1%, 150mA, +CE, CL	SOT-23-5	28cx	VR4	6g Ric
C0A	R3114N311A	Vdet-IC	3.1V±0.8%, -Reset ODO	SOT-23-5	28vdm	VD6	6g Ric
C0B	XC6108C20AMR	Vdet-IC	2.0V±2%, Hysteresis, -Reset PPO	SOT-25	28rm	VD15	6g Tor
C0B	R3114N321A	Vdet-IC	3.2V±0.8%, -Reset ODO	SOT-23-5	28vdm	VD6	6g Ric
C0B	XC6108C20BMR	Vdet-IC	2.0V±2%, -Reset PPO	SOT-25	28rm	VD15	6g Tor
C0C	R3114N331A	Vdet-IC	3.3V±0.8%, -Reset ODO	SOT-23-5	28vdm	VD6	6g Ric
C0C	XC6108C20CMR	Vdet-IC	2.0V±2%, Hysteresis, -Reset PPO	SOT-25	28rk	VD15	6g Tor
C0D	R3114N341A	Vdet-IC	3.4V±0.8%, -Reset ODO	SOT-23-5	28vdm	VD6	6g Ric
C0D	XC6108C20DMR	Vdet-IC	2.0V±2%, -Reset PPO	SOT-25	28rk	VD15	6g Tor
C0E	R3114N351A	Vdet-IC	3.5V±0.8%, -Reset ODO	SOT-23-5	28vdm	VD6	6g Ric
C0F	R3114N361A	Vdet-IC	3.6V±0.8%, -Reset ODO	SOT-23-5	28vdm	VD6	6g Ric
C0G	R3114N371A	Vdet-IC	3.7V±0.8%, -Reset ODO	SOT-23-5	28vdm	VD6	6g Ric
C0H	R3114N381A	Vdet-IC	3.8V±0.8%, -Reset ODO	SOT-23-5	28vdm	VD6	6g Ric
C0J	R3114N391A	Vdet-IC	3.9V±0.8%, -Reset ODO	SOT-23-5	28vdm	VD6	6g Ric
C0K	R3114N401A	Vdet-IC	4V±0.8%, -Reset ODO	SOT-23-5	28vdm	VD6	6g Ric
C0L	R3114N411A	Vdet-IC	4.1V±0.8%, -Reset ODO	SOT-23-5	28vdm	VD6	6g Ric
C0M	R3114N421A	Vdet-IC	4.2V±0.8%, -Reset ODO	SOT-23-5	28vdm	VD6	6g Ric
C0N	R3114N431A	Vdet-IC	4.3V±0.8%, -Reset ODO	SOT-23-5	28vdm	VD6	6g Ric
C0P	R3114N441A	Vdet-IC	4.4V±0.8%, -Reset ODO	SOT-23-5	28vdm	VD6	6g Ric
C0Q	R3114N451A	Vdet-IC	4.5V±0.8%, -Reset ODO	SOT-23-5	28vdm	VD6	6g Ric
C0R	R3114N461A	Vdet-IC	4.6V±0.8%, -Reset ODO	SOT-23-5	28vdm	VD6	6g Ric
C0S	R3114N471A	Vdet-IC	4.7V±0.8%, -Reset ODO	SOT-23-5	28vdm	VD6	6g Ric
C0T	R3114N481A	Vdet-IC	4.8V±0.8%, -Reset ODO	SOT-23-5	28vdm	VD6	6g Ric
C0U	R3114N491A	Vdet-IC	4.9V±0.8%, -Reset ODO	SOT-23-5	28vdm	VD6	6g Ric
C0V	R3114N501A	Vdet-IC	5V±0.8%, -Reset ODO	SOT-23-5	28vdm	VD6	6g Ric
C1	R1111N411A	LVR-IC	LDO, LN, -CE, 4.1V±2%, 200mA	SOT-23-5	28cx	VR4	6g Ric
C1	TC1054-2.5VCT713	LVR-IC	LDO, 2.5V±2%, 50mA, +CE, -Error	SOT-23-5	28w	VR8	6g Mcc
C1	TC4S11F	CMOS-Logic	2-input NAND gate	SSOP-5	28/Log1	-	6a Tos
C1	RN5VD21AA	Vdet-IC	2.1V±2.5%, -Reset PPO	SOT-23-5	28vdo	VD3	6g Ric
C1-	RT9013B-18PU5	LVR-IC	LDO, 1.8V±2%, 500mA, +CE	SC-70-5	28cx	VR4	6g Rct
C1-	RT9169-25PB	LVR-IC	LDO, 2.5V±2%, 100mA, -CE	SOT-23-5	28cx	VR4	6g Rct
C10	RP110N101D	LVR-IC	LDO, 1.0V±1%, 150mA, +CE, CL	SOT-23-5	28cx	VR4	6g Ric
C11	RP110N111D	LVR-IC	LDO, 1.1V±1%, 150mA, +CE, CL	SOT-23-5	28cx	VR4	6g Ric
C12	R1180N121B	LVR-IC	LDO, 1.2V±2%, 150mA, +CE	SOT-23-5	28cx	VR4	6g Ric
C12	RP110N121D	LVR-IC	LDO, 1.2V±1%, 150mA, +CE, CL	SOT-23-5	28cx	VR4	6g Ric
C13	R1180N131B	LVR-IC	LDO, 1.3V±2%, 150mA, +CE	SOT-23-5	28cx	VR4	6g Ric
C13	RP110N131D	LVR-IC	LDO, 1.3V±1%, 150mA, +CE, CL	SOT-23-5	28cx	VR4	6g Ric
C14	74AHCT1G14GV	CMOS-Logic	Inverting Schmitt-trigger	SOT753	28/Log7	-	6a Phi
C14	R1180N141B	LVR-IC	LDO, 1.4V±2%, 150mA, +CE	SOT-23-5	28cx	VR4	6g Ric
C14	RP110N141D	LVR-IC	LDO, 1.4V±1%, 150mA, +CE, CL	SOT-23-5	28cx	VR4	6g Ric
C15	88C15-AF5	Vdet-IC	1.5V±2%, -Reset PPO	SOT-23-5	28vdo	VD3	6a Utc
C15	R1180N151B	LVR-IC	LDO, 1.5V±2%, 150mA, +CE	SOT-23-5	28cx	VR4	6g Ric
C15	RP110N151D	LVR-IC	LDO, 1.5V±1%, 150mA, +CE, CL	SOT-23-5	28cx	VR4	6g Ric
C15	XC6365C152MR	DC/DC-IC	PWM st-down, 180kHz, 1.5V±2.5%, 1A, +CE, soft start	SOT-25	28zm	DC7	6g Tor
C15	XC6367C152MR	DC/DC-IC	PWM step-up, 1.5V±2.5%, 200mA, 180kHz, +CE, soft start	SOT-25	28sh	DC11	6g Tor
C15G	88C15G-AF5	Vdet-IC	1.5V±2%, -Reset PPO, halogen free	SOT-23-5	28vdo	VD3	6a Utc
C15L	88C15L-AF5	Vdet-IC	1.5V±2%, -Reset PPO, lead free	SOT-23-5	28vdo	VD3	6a Utc
C16	88C16-AF5	Vdet-IC	1.6V±2%, -Reset PPO	SOT-23-5	28vdo	VD3	6a Utc
C16	R1180N161B	LVR-IC	LDO, 1.6V±2%, 150mA, +CE	SOT-23-5	28cx	VR4	6g Ric



SMD code	Type	Function	Short description	Case	Pinout	Sch.	St.	Mnf.
C16	RP110N161D	LVR-IC	LDO, 1.6V±1%, 150mA, +CE, CL	SOT-23-5	28cx	VR4	6g	Ric
C16	X06365C162MR	DC/DC-IC	PWM st-down, 180kHz, 1.6V±2.5%, 1A, +CE, soft start	SOT-25	28zm	DC7	6g	Tor
C16	X06367C162MR	DC/DC-IC	PWM step-up, 1.6V±2.5%, 200mA, 180kHz, +CE, soft start	SOT-25	28sh	DC11	6g	Tor
C16G	88C16G-AF5	Vdet-IC	1.6V±2%, -Reset PPO, halogen free	SOT-23-5	28vdo	VD3	6a	Utc
C16L	88C16L-AF5	Vdet-IC	1.6V±2%, -Reset PPO, lead free	SOT-23-5	28vdo	VD3	6a	Utc
C17	88C17-AF5	Vdet-IC	1.7V±2%, -Reset PPO	SOT-23-5	28vdo	VD3	6a	Utc
C17	R1180N171B	LVR-IC	LDO, 1.7V±2%, 150mA, +CE	SOT-23-5	28cx	VR4	6g	Ric
C17	RP110N171D	LVR-IC	LDO, 1.7V±1%, 150mA, +CE, CL	SOT-23-5	28cx	VR4	6g	Ric
C17	X06365C172MR	DC/DC-IC	PWM st-down, 180kHz, 1.7V±2.5%, 1A, +CE, soft start	SOT-25	28zm	DC7	6g	Tor
C17	X06367C172MR	DC/DC-IC	PWM step-up, 1.7V±2.5%, 200mA, 180kHz, +CE, soft start	SOT-25	28sh	DC11	6g	Tor
C17_	SN74LVC1G17QDBV	CMOS-Logic	Schmitt-trigger	SOT-23-5	28/Log11	-	6a	Ti
C17G	88C17G-AF5	Vdet-IC	1.7V±2%, -Reset PPO, halogen free	SOT-23-5	28vdo	VD3	6a	Utc
C17L	88C17L-AF5	Vdet-IC	1.7V±2%, -Reset PPO, lead free	SOT-23-5	28vdo	VD3	6a	Utc
C18	88C18-AF5	Vdet-IC	1.8V±2%, -Reset PPO	SOT-23-5	28vdo	VD3	6a	Utc
C18	R1180N181B	LVR-IC	LDO, 1.8V±2%, 150mA, +CE	SOT-23-5	28cx	VR4	6g	Ric
C18	RP110N181D	LVR-IC	LDO, 1.8V±1%, 150mA, +CE, CL	SOT-23-5	28cx	VR4	6g	Ric
C18	X06365C182MR	DC/DC-IC	PWM st-down, 180kHz, 1.8V±2.5%, 1A, +CE, soft start	SOT-25	28zm	DC7	6g	Tor
C18	X06367C182MR	DC/DC-IC	PWM step-up, 1.8V±2.5%, 200mA, 180kHz, +CE, soft start	SOT-25	28sh	DC11	6g	Tor
C18G	88C18G-AF5	Vdet-IC	1.8V±2%, -Reset PPO, halogen free	SOT-23-5	28vdo	VD3	6a	Utc
C18L	88C18L-AF5	Vdet-IC	1.8V±2%, -Reset PPO, lead free	SOT-23-5	28vdo	VD3	6a	Utc
C19	88C19-AF5	Vdet-IC	1.9V±2%, -Reset PPO	SOT-23-5	28vdo	VD3	6a	Utc
C19	R1180N191B	LVR-IC	LDO, 1.9V±2%, 150mA, +CE	SOT-23-5	28cx	VR4	6g	Ric
C19	RP110N191D	LVR-IC	LDO, 1.9V±1%, 150mA, +CE, CL	SOT-23-5	28cx	VR4	6g	Ric
C19	X06365C192MR	DC/DC-IC	PWM st-down, 180kHz, 1.9V±2.5%, 1A, +CE, soft start	SOT-25	28zm	DC7	6g	Tor
C19	X06367C192MR	DC/DC-IC	PWM step-up, 1.9V±2.5%, 200mA, 180kHz, +CE, soft start	SOT-25	28sh	DC11	6g	Tor
C19G	88C19G-AF5	Vdet-IC	1.9V±2%, -Reset PPO, halogen free	SOT-23-5	28vdo	VD3	6a	Utc
C19L	88C19L-AF5	Vdet-IC	1.9V±2%, -Reset PPO, lead free	SOT-23-5	28vdo	VD3	6a	Utc
C1A	R3114N311C	Vdet-IC	3.1V±0.8%, -Reset PPO	SOT-23-5	28vdm	VD7	6g	Ric
C1A	X06108C21AMR	Vdet-IC	2.1V±2%, Hysteresis, -Reset PPO	SOT-25	28rm	VD15	6g	Tor
C1B	R3114N321C	Vdet-IC	3.2V±0.8%, -Reset PPO	SOT-23-5	28vdm	VD7	6g	Ric
C1B	X06108C21BMR	Vdet-IC	2.1V±2%, -Reset PPO	SOT-25	28rm	VD15	6g	Tor
C1C	R3114N331C	Vdet-IC	3.3V±0.8%, -Reset PPO	SOT-23-5	28vdm	VD7	6g	Ric
C1C	X06108C21CMR	Vdet-IC	2.1V±2%, Hysteresis, -Reset PPO	SOT-25	28rk	VD15	6g	Tor
C1D	R3114N341C	Vdet-IC	3.4V±0.8%, -Reset PPO	SOT-23-5	28vdm	VD7	6g	Ric
C1D	X06108C21DMR	Vdet-IC	2.1V±2%, -Reset PPO	SOT-25	28rk	VD15	6g	Tor
C1E	R3114N351C	Vdet-IC	3.5V±0.8%, -Reset PPO	SOT-23-5	28vdm	VD7	6g	Ric
C1F	R3114N361C	Vdet-IC	3.6V±0.8%, -Reset PPO	SOT-23-5	28vdm	VD7	6g	Ric
C1F	X06365C153MR	DC/DC-IC	PWM st-down, 300kHz, 1.5V±2.5%, 1A, +CE, soft start	SOT-25	28zm	DC7	6g	Tor
C1F	X06367C153MR	DC/DC-IC	PWM step-up, 1.5V±2.5%, 200mA, 300kHz, +CE, soft start	SOT-25	28sh	DC11	6g	Tor
C1G	R3114N371C	Vdet-IC	3.7V±0.8%, -Reset PPO	SOT-23-5	28vdm	VD7	6g	Ric
C1H	R3114N381C	Vdet-IC	3.8V±0.8%, -Reset PPO	SOT-23-5	28vdm	VD7	6g	Ric
C1H	X06365C163MR	DC/DC-IC	PWM st-down, 300kHz, 1.6V±2.5%, 1A, +CE, soft start	SOT-25	28zm	DC7	6g	Tor
C1H	X06367C163MR	DC/DC-IC	PWM step-up, 1.6V±2.5%, 200mA, 300kHz, +CE, soft start	SOT-25	28sh	DC11	6g	Tor
C1J	R3114N391C	Vdet-IC	3.9V±0.8%, -Reset PPO	SOT-23-5	28vdm	VD7	6g	Ric
C1K	R3114N401C	Vdet-IC	4V±0.8%, -Reset PPO	SOT-23-5	28vdm	VD7	6g	Ric
C1K	X06365C173MR	DC/DC-IC	PWM st-down, 300kHz, 1.7V±2.5%, 1A, +CE, soft start	SOT-25	28zm	DC7	6g	Tor
C1K	X06367C173MR	DC/DC-IC	PWM step-up, 1.7V±2.5%, 200mA, 300kHz, +CE, soft start	SOT-25	28sh	DC11	6g	Tor
C1L	R3114N411C	Vdet-IC	4.1V±0.8%, -Reset PPO	SOT-23-5	28vdm	VD7	6g	Ric
C1L	X06365C183MR	DC/DC-IC	PWM st-down, 300kHz, 1.8V±2.5%, 1A, +CE, soft start	SOT-25	28zm	DC7	6g	Tor
C1L	X06367C183MR	DC/DC-IC	PWM step-up, 1.8V±2.5%, 200mA, 300kHz, +CE, soft start	SOT-25	28sh	DC11	6g	Tor
C1M	R3114N421C	Vdet-IC	4.2V±0.8%, -Reset PPO	SOT-23-5	28vdm	VD7	6g	Ric
C1M	X06365C193MR	DC/DC-IC	PWM st-down, 300kHz, 1.9V±2.5%, 1A, +CE, soft start	SOT-25	28zm	DC7	6g	Tor
C1M	X06367C193MR	DC/DC-IC	PWM step-up, 1.9V±2.5%, 200mA, 300kHz, +CE, soft start	SOT-25	28sh	DC11	6g	Tor
C1N	R3114N431C	Vdet-IC	4.3V±0.8%, -Reset PPO	SOT-23-5	28vdm	VD7	6g	Ric
C1P	R3114N441C	Vdet-IC	4.4V±0.8%, -Reset PPO	SOT-23-5	28vdm	VD7	6g	Ric
C1Q	R3114N451C	Vdet-IC	4.5V±0.8%, -Reset PPO	SOT-23-5	28vdm	VD7	6g	Ric
C1R	R3114N461C	Vdet-IC	4.6V±0.8%, -Reset PPO	SOT-23-5	28vdm	VD7	6g	Ric
C1S	R3114N471C	Vdet-IC	4.7V±0.8%, -Reset PPO	SOT-23-5	28vdm	VD7	6g	Ric
C1T	R3114N481C	Vdet-IC	4.8V±0.8%, -Reset PPO	SOT-23-5	28vdm	VD7	6g	Ric
C1U	R3114N491C	Vdet-IC	4.9V±0.8%, -Reset PPO	SOT-23-5	28vdm	VD7	6g	Ric
C1V	R3114N501C	Vdet-IC	5V±0.8%, -Reset PPO	SOT-23-5	28vdm	VD7	6g	Ric
C2	PI74STX1GT02CX	CMOS-Logic	2-input NOR gate	SC-70-5	28/Log2	-	6a	Per
C2	PI74STX1GT02TX	CMOS-Logic	2-input NOR gate	SOT-23-5	28/Log2	-	6a	Per
C2	R1111N421A	LVR-IC	LDO, LN, -CE, 4.2V±2%, 200mA	SOT-23-5	28cx	VR4	6g	Ric
C2	TC1054-2.7VCT713	LVR-IC	LDO, 2.7V±2%, 50mA, +CE, -Error	SOT-23-5	28w	VR8	6g	Mcc
C2	TC48B1F	CMOS-Logic	2-input AND gate	SSOP-5	28/Log3	-	6a	Tos
C2	RN5VD22AA	Vdet-IC	2.2V±2.5%, -Reset PPO	SOT-23-5	28vdo	VD3	6g	Ric
C2-	RT9013B-25PU5	LVR-IC	LDO, 2.8V±2%, 500mA, +CE	SC-70-5	28cx	VR4	6g	Rct
C20	88C20-AF5	Vdet-IC	2.0V±2%, -Reset PPO	SOT-23-5	28vdo	VD3	6a	Utc
C20	R1180N201B	LVR-IC	LDO, 2V±2%, 150mA, +CE	SOT-23-5	28cx	VR4	6g	Ric



SMD code	Type	Function	Short description	Case	Pinout	Sch.	St.	Mnf.
C20	RP110N201D	LVR-IC	LDO, 2.0V±1%, 150mA, +CE, CL	SOT-23-5	28cx	VR4	6g	Ric
C20	X06365C202MR	DC/DC-IC	PWM st-down, 180kHz, 2.0V±2.5%, 1A, +CE, soft start	SOT-25	28zm	DC7	6g	Tor
C20	X06367C202MR	DC/DC-IC	PWM step-up, 2.0V±2.5%, 200mA, 180kHz, +CE, soft start	SOT-25	28sh	DC11	6g	Tor
C20G	88C20G-AF5	Vdet-IC	2.0V±2%, -Reset PPO, halogen free	SOT-23-5	28vdo	VD3	6a	Utc
C20L	88C20L-AF5	Vdet-IC	2.0V±2%, -Reset PPO, lead free	SOT-23-5	28vdo	VD3	6a	Utc
C21	88C21-AF5	Vdet-IC	2.1V±2%, -Reset PPO	SOT-23-5	28vdo	VD3	6a	Utc
C21	R1180N211B	LVR-IC	LDO, 2.1V±2%, 150mA, +CE	SOT-23-5	28cx	VR4	6g	Ric
C21	RP110N211D	LVR-IC	LDO, 2.1V±1%, 150mA, +CE, CL	SOT-23-5	28cx	VR4	6g	Ric
C21	X06365C212MR	DC/DC-IC	PWM st-down, 180kHz, 2.1V±2.5%, 1A, +CE, soft start	SOT-25	28zm	DC7	6g	Tor
C21	X06367C212MR	DC/DC-IC	PWM step-up, 2.1V±2.5%, 200mA, 180kHz, +CE, soft start	SOT-25	28sh	DC11	6g	Tor
C21G	88C21G-AF5	Vdet-IC	2.1V±2%, -Reset PPO, halogen free	SOT-23-5	28vdo	VD3	6a	Utc
C21L	88C21L-AF5	Vdet-IC	2.1V±2%, -Reset PPO, lead free	SOT-23-5	28vdo	VD3	6a	Utc
C22	88C22-AF5	Vdet-IC	2.2V±2%, -Reset PPO	SOT-23-5	28vdo	VD3	6a	Utc
C22	R1180N221B	LVR-IC	LDO, 2.2V±2%, 150mA, +CE	SOT-23-5	28cx	VR4	6g	Ric
C22	RP110N221D	LVR-IC	LDO, 2.2V±1%, 150mA, +CE, CL	SOT-23-5	28cx	VR4	6g	Ric
C22	X06365C222MR	DC/DC-IC	PWM st-down, 180kHz, 2.2V±2.5%, 1A, +CE, soft start	SOT-25	28zm	DC7	6g	Tor
C22	X06367C222MR	DC/DC-IC	PWM step-up, 2.2V±2.5%, 200mA, 180kHz, +CE, soft start	SOT-25	28sh	DC11	6g	Tor
C22G	88C22G-AF5	Vdet-IC	2.2V±2%, -Reset PPO, halogen free	SOT-23-5	28vdo	VD3	6a	Utc
C22L	88C22L-AF5	Vdet-IC	2.2V±2%, -Reset PPO, lead free	SOT-23-5	28vdo	VD3	6a	Utc
C23	88C23-AF5	Vdet-IC	2.3V±2%, -Reset PPO	SOT-23-5	28vdo	VD3	6a	Utc
C23	R1180N231B	LVR-IC	LDO, 2.3V±2%, 150mA, +CE	SOT-23-5	28cx	VR4	6g	Ric
C23	RP110N231D	LVR-IC	LDO, 2.3V±1%, 150mA, +CE, CL	SOT-23-5	28cx	VR4	6g	Ric
C23	X06365C232MR	DC/DC-IC	PWM st-down, 180kHz, 2.3V±2.5%, 1A, +CE, soft start	SOT-25	28zm	DC7	6g	Tor
C23	X06367C232MR	DC/DC-IC	PWM step-up, 2.3V±2.5%, 200mA, 180kHz, +CE, soft start	SOT-25	28sh	DC11	6g	Tor
C23G	88C23G-AF5	Vdet-IC	2.3V±2%, -Reset PPO, halogen free	SOT-23-5	28vdo	VD3	6a	Utc
C23L	88C23L-AF5	Vdet-IC	2.3V±2%, -Reset PPO, lead free	SOT-23-5	28vdo	VD3	6a	Utc
C24	88C24-AF5	Vdet-IC	2.4V±2%, -Reset PPO	SOT-23-5	28vdo	VD3	6a	Utc
C24	R1180N241B	LVR-IC	LDO, 2.4V±2%, 150mA, +CE	SOT-23-5	28cx	VR4	6g	Ric
C24	RP110N241D	LVR-IC	LDO, 2.4V±1%, 150mA, +CE, CL	SOT-23-5	28cx	VR4	6g	Ric
C24	X06365C242MR	DC/DC-IC	PWM st-down, 180kHz, 2.4V±2.5%, 1A, +CE, soft start	SOT-25	28zm	DC7	6g	Tor
C24	X06367C242MR	DC/DC-IC	PWM step-up, 2.4V±2.5%, 200mA, 180kHz, +CE, soft start	SOT-25	28sh	DC11	6g	Tor
C24G	88C24G-AF5	Vdet-IC	2.4V±2%, -Reset PPO, halogen free	SOT-23-5	28vdo	VD3	6a	Utc
C24L	88C24L-AF5	Vdet-IC	2.4V±2%, -Reset PPO, lead free	SOT-23-5	28vdo	VD3	6a	Utc
C25	74AHCT1G125GV	CMOS-Logic	Bus buffer gate with 3-state output	SOT753	28/Log14	-	6a	Phi
C25	88C25-AF5	Vdet-IC	2.5V±2%, -Reset PPO	SOT-23-5	28vdo	VD3	6a	Utc
C25	R1180N251B	LVR-IC	LDO, 2.5V±2%, 150mA, +CE	SOT-23-5	28cx	VR4	6g	Ric
C25	RP110N251D	LVR-IC	LDO, 2.5V±1%, 150mA, +CE, CL	SOT-23-5	28cx	VR4	6g	Ric
C25	X06365C252MR	DC/DC-IC	PWM st-down, 180kHz, 2.5V±2.5%, 1A, +CE, soft start	SOT-25	28zm	DC7	6g	Tor
C25	X06367C252MR	DC/DC-IC	PWM step-up, 2.5V±2.5%, 200mA, 180kHz, +CE, soft start	SOT-25	28sh	DC11	6g	Tor
C25G	88C25G-AF5	Vdet-IC	2.5V±2%, -Reset PPO, halogen free	SOT-23-5	28vdo	VD3	6a	Utc
C25L	88C25L-AF5	Vdet-IC	2.5V±2%, -Reset PPO, lead free	SOT-23-5	28vdo	VD3	6a	Utc
C26	74AHCT1G126GV	CMOS-Logic	Bus buffer gate with 3-state output	SOT753	28/Log13	-	6a	Phi
C26	88C26-AF5	Vdet-IC	2.6V±2%, -Reset PPO	SOT-23-5	28vdo	VD3	6a	Utc
C26	R1180N261B	LVR-IC	LDO, 2.6V±2%, 150mA, +CE	SOT-23-5	28cx	VR4	6g	Ric
C26	RP110N261D	LVR-IC	LDO, 2.6V±1%, 150mA, +CE, CL	SOT-23-5	28cx	VR4	6g	Ric
C26	X06365C262MR	DC/DC-IC	PWM st-down, 180kHz, 2.6V±2.5%, 1A, +CE, soft start	SOT-25	28zm	DC7	6g	Tor
C26	X06367C262MR	DC/DC-IC	PWM step-up, 2.6V±2.5%, 200mA, 180kHz, +CE, soft start	SOT-25	28sh	DC11	6g	Tor
C26G	88C26G-AF5	Vdet-IC	2.6V±2%, -Reset PPO, halogen free	SOT-23-5	28vdo	VD3	6a	Utc
C26L	88C26L-AF5	Vdet-IC	2.6V±2%, -Reset PPO, lead free	SOT-23-5	28vdo	VD3	6a	Utc
C27	88C27-AF5	Vdet-IC	2.7V±2%, -Reset PPO	SOT-23-5	28vdo	VD3	6a	Utc
C27	R1180N271B	LVR-IC	LDO, 2.7V±2%, 150mA, +CE	SOT-23-5	28cx	VR4	6g	Ric
C27	RP110N271D	LVR-IC	LDO, 2.7V±1%, 150mA, +CE, CL	SOT-23-5	28cx	VR4	6g	Ric
C27	X06365C272MR	DC/DC-IC	PWM st-down, 180kHz, 2.7V±2.5%, 1A, +CE, soft start	SOT-25	28zm	DC7	6g	Tor
C27	X06367C272MR	DC/DC-IC	PWM step-up, 2.7V±2.5%, 200mA, 180kHz, +CE, soft start	SOT-25	28sh	DC11	6g	Tor
C27G	88C27G-AF5	Vdet-IC	2.7V±2%, -Reset PPO, halogen free	SOT-23-5	28vdo	VD3	6a	Utc
C27L	88C27L-AF5	Vdet-IC	2.7V±2%, -Reset PPO, lead free	SOT-23-5	28vdo	VD3	6a	Utc
C28	88C28-AF5	Vdet-IC	2.8V±2%, -Reset PPO	SOT-23-5	28vdo	VD3	6a	Utc
C28	R1180N281B	LVR-IC	LDO, 2.8V±2%, 150mA, +CE	SOT-23-5	28cx	VR4	6g	Ric
C28	RP110N281D	LVR-IC	LDO, 2.8V±1%, 150mA, +CE, CL	SOT-23-5	28cx	VR4	6g	Ric
C28	X06365C282MR	DC/DC-IC	PWM st-down, 180kHz, 2.8V±2.5%, 1A, +CE, soft start	SOT-25	28zm	DC7	6g	Tor
C28	X06367C282MR	DC/DC-IC	PWM step-up, 2.8V±2.5%, 200mA, 180kHz, +CE, soft start	SOT-25	28sh	DC11	6g	Tor
C28G	88C28G-AF5	Vdet-IC	2.8V±2%, -Reset PPO, halogen free	SOT-23-5	28vdo	VD3	6a	Utc
C28L	88C28L-AF5	Vdet-IC	2.8V±2%, -Reset PPO, lead free	SOT-23-5	28vdo	VD3	6a	Utc
C29	88C29-AF5	Vdet-IC	2.9V±2%, -Reset PPO	SOT-23-5	28vdo	VD3	6a	Utc
C29	R1180N291B	LVR-IC	LDO, 2.9V±2%, 150mA, +CE	SOT-23-5	28cx	VR4	6g	Ric
C29	RP110N291D	LVR-IC	LDO, 2.9V±1%, 150mA, +CE, CL	SOT-23-5	28cx	VR4	6g	Ric
C29	X06365C292MR	DC/DC-IC	PWM st-down, 180kHz, 2.9V±2.5%, 1A, +CE, soft start	SOT-25	28zm	DC7	6g	Tor
C29	X06367C292MR	DC/DC-IC	PWM step-up, 2.9V±2.5%, 200mA, 180kHz, +CE, soft start	SOT-25	28sh	DC11	6g	Tor
C29G	88C29G-AF5	Vdet-IC	2.9V±2%, -Reset PPO, halogen free	SOT-23-5	28vdo	VD3	6a	Utc
C29L	88C29L-AF5	Vdet-IC	2.9V±2%, -Reset PPO, lead free	SOT-23-5	28vdo	VD3	6a	Utc



SMD code	Type	Function	Short description	Case	Pinout	Sch.	St.	Mnf.
C2A	S-812C20AMC-C2AT2G	LVR-IC	2.0V±2%, 50mA	SOT-23-5	28vu	VR1	6r	Sii
C2A	XG6108C22AMR	Vdet-IC	2.2V±2%, Hysteresis, -Reset PPO	SOT-25	28rm	VD15	6g	Tor
C2A	XG6365C203MR	DC/DC-IC	PWM st-down, 300kHz, 2.0V±2.5%, 1A, +CE, soft start	SOT-25	28zm	DC7	6g	Tor
C2A	XG6367C203MR	DC/DC-IC	PWM step-up, 2.0V±2.5%, 200mA, 300kHz, +CE, soft start	SOT-25	28sh	DC11	6g	Tor
C2B	S-812C21AMC-C2BT2G	LVR-IC	2.1V±2%, 50mA	SOT-23-5	28vu	VR1	6r	Sii
C2B	XG6108C22BMR	Vdet-IC	2.2V±2%, -Reset PPO	SOT-25	28rm	VD15	6g	Tor
C2B	XG6365C213MR	DC/DC-IC	PWM st-down, 300kHz, 2.1V±2.5%, 1A, +CE, soft start	SOT-25	28zm	DC7	6g	Tor
C2B	XG6367C213MR	DC/DC-IC	PWM step-up, 2.1V±2.5%, 200mA, 300kHz, +CE, soft start	SOT-25	28sh	DC11	6g	Tor
C2C	S-812C22AMC-C2CT2G	LVR-IC	2.2V±2%, 50mA	SOT-23-5	28vu	VR1	6r	Sii
C2C	XG6108C22CMR	Vdet-IC	2.2V±2%, Hysteresis, -Reset PPO	SOT-25	28rk	VD15	6g	Tor
C2C	XG6365C223MR	DC/DC-IC	PWM st-down, 300kHz, 2.2V±2.5%, 1A, +CE, soft start	SOT-25	28zm	DC7	6g	Tor
C2C	XG6367C223MR	DC/DC-IC	PWM step-up, 2.2V±2.5%, 200mA, 300kHz, +CE, soft start	SOT-25	28sh	DC11	6g	Tor
C2D	S-812C23AMC-C2DT2G	LVR-IC	2.3V±2%, 50mA	SOT-23-5	28vu	VR1	6r	Sii
C2D	XG6108C22DMR	Vdet-IC	2.2V±2%, -Reset PPO	SOT-25	28rk	VD15	6g	Tor
C2D	XG6365C233MR	DC/DC-IC	PWM st-down, 300kHz, 2.3V±2.5%, 1A, +CE, soft start	SOT-25	28zm	DC7	6g	Tor
C2D	XG6367C233MR	DC/DC-IC	PWM step-up, 2.3V±2.5%, 200mA, 300kHz, +CE, soft start	SOT-25	28sh	DC11	6g	Tor
C2E	S-812C24AMC-C2ET2G	LVR-IC	2.4V±2%, 50mA	SOT-23-5	28vu	VR1	6r	Sii
C2E	XG6365C243MR	DC/DC-IC	PWM st-down, 300kHz, 2.4V±2.5%, 1A, +CE, soft start	SOT-25	28zm	DC7	6g	Tor
C2E	XG6367C243MR	DC/DC-IC	PWM step-up, 2.4V±2.5%, 200mA, 300kHz, +CE, soft start	SOT-25	28sh	DC11	6g	Tor
C2F	S-812C25AMC-C2FT2G	LVR-IC	2.5V±2%, 50mA	SOT-23-5	28vu	VR1	6r	Sii
C2F	XG6365C253MR	DC/DC-IC	PWM st-down, 300kHz, 2.5V±2.5%, 1A, +CE, soft start	SOT-25	28zm	DC7	6g	Tor
C2F	XG6367C253MR	DC/DC-IC	PWM step-up, 2.5V±2.5%, 200mA, 300kHz, +CE, soft start	SOT-25	28sh	DC11	6g	Tor
C2G	S-812C26AMC-C2GT2G	LVR-IC	2.6V±2%, 50mA	SOT-23-5	28vu	VR1	6r	Sii
C2H	S-812C27AMC-C2HT2G	LVR-IC	2.7V±2%, 50mA	SOT-23-5	28vu	VR1	6r	Sii
C2H	XG6365C263MR	DC/DC-IC	PWM st-down, 300kHz, 2.6V±2.5%, 1A, +CE, soft start	SOT-25	28zm	DC7	6g	Tor
C2H	XG6367C263MR	DC/DC-IC	PWM step-up, 2.6V±2.5%, 200mA, 300kHz, +CE, soft start	SOT-25	28sh	DC11	6g	Tor
C2I	S-812C28AMC-C2IT2G	LVR-IC	2.8V±2%, 50mA	SOT-23-5	28vu	VR1	6r	Sii
C2J	S-812C29AMC-C2JT2G	LVR-IC	2.9V±2%, 50mA	SOT-23-5	28vu	VR1	6r	Sii
C2K	S-812C30AMC-C2KT2G	LVR-IC	3.0V±2%, 50mA	SOT-23-5	28vu	VR1	6r	Sii
C2K	XG6365C273MR	DC/DC-IC	PWM st-down, 300kHz, 2.7V±2.5%, 1A, +CE, soft start	SOT-25	28zm	DC7	6g	Tor
C2K	XG6367C273MR	DC/DC-IC	PWM step-up, 2.7V±2.5%, 200mA, 300kHz, +CE, soft start	SOT-25	28sh	DC11	6g	Tor
C2L	S-812C31AMC-C2LT2G	LVR-IC	3.1V±2%, 50mA	SOT-23-5	28vu	VR1	6r	Sii
C2L	XG6365C283MR	DC/DC-IC	PWM st-down, 300kHz, 2.8V±2.5%, 1A, +CE, soft start	SOT-25	28zm	DC7	6g	Tor
C2L	XG6367C283MR	DC/DC-IC	PWM step-up, 2.8V±2.5%, 200mA, 300kHz, +CE, soft start	SOT-25	28sh	DC11	6g	Tor
C2M	S-812C32AMC-C2MT2G	LVR-IC	3.2V±2%, 50mA	SOT-23-5	28vu	VR1	6r	Sii
C2M	XG6365C293MR	DC/DC-IC	PWM st-down, 300kHz, 2.9V±2.5%, 1A, +CE, soft start	SOT-25	28zm	DC7	6g	Tor
C2M	XG6367C293MR	DC/DC-IC	PWM step-up, 2.9V±2.5%, 200mA, 300kHz, +CE, soft start	SOT-25	28sh	DC11	6g	Tor
C2N	S-812C33AMC-C2NT2G	LVR-IC	3.3V±2%, 50mA	SOT-23-5	28vu	VR1	6r	Sii
C2O	S-812C34AMC-C2OT2G	LVR-IC	3.4V±2%, 50mA	SOT-23-5	28vu	VR1	6r	Sii
C2P	S-812C35AMC-C2PT2G	LVR-IC	3.5V±2%, 50mA	SOT-23-5	28vu	VR1	6r	Sii
C2Q	S-812C36AMC-C2QT2G	LVR-IC	3.6V±2%, 50mA	SOT-23-5	28vu	VR1	6r	Sii
C2R	S-812C37AMC-C2RT2G	LVR-IC	3.7V±2%, 50mA	SOT-23-5	28vu	VR1	6r	Sii
C2S	S-812C38AMC-C2ST2G	LVR-IC	3.8V±2%, 50mA	SOT-23-5	28vu	VR1	6r	Sii
C2T	S-812C39AMC-C2TT2G	LVR-IC	3.9V±2%, 50mA	SOT-23-5	28vu	VR1	6r	Sii
C2U	S-812C40AMC-C2UT2G	LVR-IC	4.0V±2%, 50mA	SOT-23-5	28vu	VR1	6r	Sii
C2V	S-812C41AMC-C2VT2G	LVR-IC	4.1V±2%, 50mA	SOT-23-5	28vu	VR1	6r	Sii
C2W	S-812C42AMC-C2WT2G	LVR-IC	4.2V±2%, 50mA	SOT-23-5	28vu	VR1	6r	Sii
C2X	S-812C43AMC-C2XT2G	LVR-IC	4.3V±2%, 50mA	SOT-23-5	28vu	VR1	6r	Sii
C2Y	S-812C44AMC-C2YT2G	LVR-IC	4.4V±2%, 50mA	SOT-23-5	28vu	VR1	6r	Sii
C2Z	S-812C45AMC-C2ZT2G	LVR-IC	4.5V±2%, 50mA	SOT-23-5	28vu	VR1	6r	Sii
C3	R1111N431A	LVR-IC	LDO, LN, -CE, 4.3V±2%, 200mA	SOT-23-5	28cx	VR4	6g	Ric
C3	RT9169-30CB	LVR-IC	LDO, 3.0V±2%, 100mA, -CE	SOT-23-5	28cx	VR4	6g	Rct
C3	TC1054-3.0VCT713	LVR-IC	LDO, 3.0V±2%, 50mA, +CE, -Error	SOT-23-5	VR8	6g	Mcc	
C3	TC4501F	CMOS-Logic	2-input NOR gate	SSOP-5	28LLog2	-	6a	Tos
C3	RN5VD23AA	Vdet-IC	2.3V±2.5%, -Reset PPO	SOT-23-5	28vdo	VD3	6g	Ric
C3-	RT9013B-28PU5	LVR-IC	LDO, 2.8V±2%, 500mA, +CE	SC-70-5	28cx	VR4	6g	Rct
C3-	RT9169-30PB	LVR-IC	LDO, 3.0V±2%, 100mA, -CE	SOT-23-5	28cx	VR4	6g	Rct
C30	88C30-AF5	Vdet-IC	3.0V±2%, -Reset PPO	SOT-23-5	28vdo	VD3	6a	Utc
C30	R1180N301B	LVR-IC	LDO, 3V±2%, 150mA, +CE	SOT-23-5	28cx	VR4	6g	Ric
C30	RP110N301D	LVR-IC	LDO, 3.0V±1%, 150mA, +CE, CL	SOT-23-5	28cx	VR4	6g	Ric
C30	XG6365C302MR	DC/DC-IC	PWM st-down, 180kHz, 3.0V±2.5%, 1A, +CE, soft start	SOT-25	28zm	DC7	6g	Tor
C30	XG6367C302MR	DC/DC-IC	PWM step-up, 3.0V±2.5%, 200mA, 180kHz, +CE, soft start	SOT-25	28sh	DC11	6g	Tor
C30G	88C30G-AF5	Vdet-IC	3.0V±2%, -Reset PPO, halogen free	SOT-23-5	28vdo	VD3	6a	Utc
C30L	88C30L-AF5	Vdet-IC	3.0V±2%, -Reset PPO, lead free	SOT-23-5	28vdo	VD3	6a	Utc
C31	88C31-AF5	Vdet-IC	3.1V±2%, -Reset PPO	SOT-23-5	28vdo	VD3	6a	Utc
C31	R1180N311B	LVR-IC	LDO, 3.1V±2%, 150mA, +CE	SOT-23-5	28cx	VR4	6g	Ric
C31	RP110N311D	LVR-IC	LDO, 3.1V±1%, 150mA, +CE, CL	SOT-23-5	28cx	VR4	6g	Ric
C31	XG6365C312MR	DC/DC-IC	PWM st-down, 180kHz, 3.1V±2.5%, 1A, +CE, soft start	SOT-25	28zm	DC7	6g	Tor
C31	XG6367C312MR	DC/DC-IC	PWM step-up, 3.1V±2.5%, 200mA, 180kHz, +CE, soft start	SOT-25	28sh	DC11	6g	Tor
C31G	88C31G-AF5	Vdet-IC	3.1V±2%, -Reset PPO, halogen free	SOT-23-5	28vdo	VD3	6a	Utc



SMD code	Type	Function	Short description	Case	Pinout	Sch.	St.	Mnf.
C31L	88C31L-AF5	Vdet-IC	3.1V±2%, -Reset PPO, lead free	SOT-23-5	28vdo	VD3	6a	Utc
C32	74AHCT1G32GV	CMOS-Logic	2-input OR gate	SOT753	28/Log4	-	6a	Phi
C32	88C32-AF5	Vdet-IC	3.2V±2%, -Reset PPO	SOT-23-5	28vdo	VD3	6a	Utc
C32	R1180N321B	LVR-IC	LDO, 3.2V±2%, 150mA, +CE	SOT-23-5	28cx	VR4	6g	Ric
C32	RP110N321D	LVR-IC	LDO, 3.2V±1%, 150mA, +CE, CL	SOT-23-5	28cx	VR4	6g	Ric
C32	X06365C322MR	DC/DC-IC	PWM st-down, 180kHz, 3.2V±2.5%, 1A, +CE, soft start	SOT-25	28zm	DC7	6g	Tor
C32	X06367C322MR	DC/DC-IC	PWM step-up, 3.2V±2.5%, 200mA, 180kHz, +CE, soft start	SOT-25	28sh	DC11	6g	Tor
C32G	88C32G-AF5	Vdet-IC	3.2V±2%, -Reset PPO, halogen free	SOT-23-5	28vdo	VD3	6a	Utc
C32L	88C32L-AF5	Vdet-IC	3.2V±2%, -Reset PPO, lead free	SOT-23-5	28vdo	VD3	6a	Utc
C33	88C33-AF5	Vdet-IC	3.3V±2%, -Reset PPO	SOT-23-5	28vdo	VD3	6a	Utc
C33	LMS33460	Vdet-IC	3V, -Reset ODO	SC-70-5	28vqd	VD6	6a	Nsc
C33	R1180N331B	LVR-IC	LDO, 3.3V±2%, 150mA, +CE	SOT-23-5	28cx	VR4	6g	Ric
C33	RP110N331D	LVR-IC	LDO, 3.3V±1%, 150mA, +CE, CL	SOT-23-5	28cx	VR4	6g	Ric
C33	X06365C332MR	DC/DC-IC	PWM st-down, 180kHz, 3.3V±2.5%, 1A, +CE, soft start	SOT-25	28zm	DC7	6g	Tor
C33	X06367C332MR	DC/DC-IC	PWM step-up, 3.3V±2.5%, 200mA, 180kHz, +CE, soft start	SOT-25	28sh	DC11	6g	Tor
C33G	88C33G-AF5	Vdet-IC	3.3V±2%, -Reset PPO, halogen free	SOT-23-5	28vdo	VD3	6a	Utc
C33L	88C33L-AF5	Vdet-IC	3.3V±2%, -Reset PPO, lead free	SOT-23-5	28vdo	VD3	6a	Utc
C34	88C34-AF5	Vdet-IC	3.4V±2%, -Reset PPO	SOT-23-5	28vdo	VD3	6a	Utc
C34	R1180N341B	LVR-IC	LDO, 3.4V±2%, 150mA, +CE	SOT-23-5	28cx	VR4	6g	Ric
C34	RP110N341D	LVR-IC	LDO, 3.4V±1%, 150mA, +CE, CL	SOT-23-5	28cx	VR4	6g	Ric
C34	X06365C342MR	DC/DC-IC	PWM st-down, 180kHz, 3.4V±2.5%, 1A, +CE, soft start	SOT-25	28zm	DC7	6g	Tor
C34	X06367C342MR	DC/DC-IC	PWM step-up, 3.4V±2.5%, 200mA, 180kHz, +CE, soft start	SOT-25	28sh	DC11	6g	Tor
C34G	88C34G-AF5	Vdet-IC	3.4V±2%, -Reset PPO, halogen free	SOT-23-5	28vdo	VD3	6a	Utc
C34L	88C34L-AF5	Vdet-IC	3.4V±2%, -Reset PPO, lead free	SOT-23-5	28vdo	VD3	6a	Utc
C35	88C35-AF5	Vdet-IC	3.5V±2%, -Reset PPO	SOT-23-5	28vdo	VD3	6a	Utc
C35	R1180N351B	LVR-IC	LDO, 3.5V±2%, 150mA, +CE	SOT-23-5	28cx	VR4	6g	Ric
C35	RP110N351D	LVR-IC	LDO, 3.5V±1%, 150mA, +CE, CL	SOT-23-5	28cx	VR4	6g	Ric
C35	X06365C352MR	DC/DC-IC	PWM st-down, 180kHz, 3.5V±2.5%, 1A, +CE, soft start	SOT-25	28zm	DC7	6g	Tor
C35	X06367C352MR	DC/DC-IC	PWM step-up, 3.5V±2.5%, 200mA, 180kHz, +CE, soft start	SOT-25	28sh	DC11	6g	Tor
C35G	88C35G-AF5	Vdet-IC	3.5V±2%, -Reset PPO, halogen free	SOT-23-5	28vdo	VD3	6a	Utc
C35L	88C35L-AF5	Vdet-IC	3.5V±2%, -Reset PPO, lead free	SOT-23-5	28vdo	VD3	6a	Utc
C36	88C36-AF5	Vdet-IC	3.6V±2%, -Reset PPO	SOT-23-5	28vdo	VD3	6a	Utc
C36	R1180N361B	LVR-IC	LDO, 3.6V±2%, 150mA, +CE	SOT-23-5	28cx	VR4	6g	Ric
C36	RP110N361D	LVR-IC	LDO, 3.6V±1%, 150mA, +CE, CL	SOT-23-5	28cx	VR4	6g	Ric
C36	X06365C362MR	DC/DC-IC	PWM st-down, 180kHz, 3.6V±2.5%, 1A, +CE, soft start	SOT-25	28zm	DC7	6g	Tor
C36	X06367C362MR	DC/DC-IC	PWM step-up, 3.6V±2.5%, 200mA, 180kHz, +CE, soft start	SOT-25	28sh	DC11	6g	Tor
C36G	88C36G-AF5	Vdet-IC	3.6V±2%, -Reset PPO, halogen free	SOT-23-5	28vdo	VD3	6a	Utc
C36L	88C36L-AF5	Vdet-IC	3.6V±2%, -Reset PPO, lead free	SOT-23-5	28vdo	VD3	6a	Utc
C37	88C37-AF5	Vdet-IC	3.7V±2%, -Reset PPO	SOT-23-5	28vdo	VD3	6a	Utc
C37	OPA337NA	Op-IC	Single-supply, CMOS	SOT-23-5	28opa	OP1	6a	Bb
C37	RP110N121D5	LVR-IC	LDO, 1.25V±1%, 150mA, +CE, CL	SOT-23-5	28cx	VR4	6g	Ric
C37	X06365C372MR	DC/DC-IC	PWM st-down, 180kHz, 3.7V±2.5%, 1A, +CE, soft start	SOT-25	28zm	DC7	6g	Tor
C37	X06367C372MR	DC/DC-IC	PWM step-up, 3.7V±2.5%, 200mA, 180kHz, +CE, soft start	SOT-25	28sh	DC11	6g	Tor
C37G	88C37G-AF5	Vdet-IC	3.7V±2%, -Reset PPO, halogen free	SOT-23-5	28vdo	VD3	6a	Utc
C37L	88C37L-AF5	Vdet-IC	3.7V±2%, -Reset PPO, lead free	SOT-23-5	28vdo	VD3	6a	Utc
C38	88C38-AF5	Vdet-IC	3.8V±2%, -Reset PPO	SOT-23-5	28vdo	VD3	6a	Utc
C38	RP110N181D5	LVR-IC	LDO, 1.85V±1%, 150mA, +CE, CL	SOT-23-5	28cx	VR4	6g	Ric
C38	X06365C382MR	DC/DC-IC	PWM st-down, 180kHz, 3.8V±2.5%, 1A, +CE, soft start	SOT-25	28zm	DC7	6g	Tor
C38	X06367C382MR	DC/DC-IC	PWM step-up, 3.8V±2.5%, 200mA, 180kHz, +CE, soft start	SOT-25	28sh	DC11	6g	Tor
C38_	SN74LVC1G38DBV	CMOS-Logic	2-input NAND gate (ODO)	SOT-23-5	28/Log17	-	6a	Ti
C38G	88C38G-AF5	Vdet-IC	3.8V±2%, -Reset PPO, halogen free	SOT-23-5	28vdo	VD3	6a	Utc
C38L	88C38L-AF5	Vdet-IC	3.8V±2%, -Reset PPO, lead free	SOT-23-5	28vdo	VD3	6a	Utc
C39	88C39-AF5	Vdet-IC	3.9V±2%, -Reset PPO	SOT-23-5	28vdo	VD3	6a	Utc
C39	RP110N281D5	LVR-IC	LDO, 2.85V±1%, 150mA, +CE, CL	SOT-23-5	28cx	VR4	6g	Ric
C39	X06365C392MR	DC/DC-IC	PWM st-down, 180kHz, 3.9V±2.5%, 1A, +CE, soft start	SOT-25	28zm	DC7	6g	Tor
C39	X06367C392MR	DC/DC-IC	PWM step-up, 3.9V±2.5%, 200mA, 180kHz, +CE, soft start	SOT-25	28sh	DC11	6g	Tor
C39G	88C39G-AF5	Vdet-IC	3.9V±2%, -Reset PPO, halogen free	SOT-23-5	28vdo	VD3	6a	Utc
C39L	88C39L-AF5	Vdet-IC	3.9V±2%, -Reset PPO, lead free	SOT-23-5	28vdo	VD3	6a	Utc
C3A	S-812C46AMC-C3AT2G	LVR-IC	4.6V±2%, 50mA	SOT-23-5	28vu	VR1	6r	Sii
C3A	X06108C23AMR	Vdet-IC	2.3V±2%, Hysteresis, -Reset PPO	SOT-25	28rm	VD15	6g	Tor
C3A	X06365C303MR	DC/DC-IC	PWM st-down, 300kHz, 3.0V±2.5%, 1A, +CE, soft start	SOT-25	28zm	DC7	6g	Tor
C3A	X06367C303MR	DC/DC-IC	PWM step-up, 3.0V±2.5%, 200mA, 300kHz, +CE, soft start	SOT-25	28sh	DC11	6g	Tor
C3B	S-812C47AMC-C3BT2G	LVR-IC	4.7V±2%, 50mA	SOT-23-5	28vu	VR1	6r	Sii
C3B	X06108C23BMR	Vdet-IC	2.3V±2%, -Reset PPO	SOT-25	28rm	VD15	6g	Tor
C3B	X06365C313MR	DC/DC-IC	PWM st-down, 300kHz, 3.1V±2.5%, 1A, +CE, soft start	SOT-25	28zm	DC7	6g	Tor
C3B	X06367C313MR	DC/DC-IC	PWM step-up, 3.1V±2.5%, 200mA, 300kHz, +CE, soft start	SOT-25	28sh	DC11	6g	Tor
C3B	S-812C48AMC-C3CT2G	LVR-IC	4.8V±2%, 50mA	SOT-23-5	28vu	VR1	6r	Sii
C3C	X06108C23CMR	Vdet-IC	2.3V±2%, Hysteresis, -Reset PPO	SOT-25	28rk	VD15	6g	Tor
C3C	X06365C323MR	DC/DC-IC	PWM st-down, 300kHz, 3.2V±2.5%, 1A, +CE, soft start	SOT-25	28zm	DC7	6g	Tor
C3C	X06367C323MR	DC/DC-IC	PWM step-up, 3.2V±2.5%, 200mA, 300kHz, +CE, soft start	SOT-25	28sh	DC11	6g	Tor



SMD code	Type	Function	Short description	Case	Pinout	Sch.	St.	Mnf.
C3D	S-812C49AMC-C3DT2G	LVR-IC	4.9V±2%, 50mA	SOT-23-5	28vu	VR1	6r	Sii
C3D	XO6108C23DMR	Vdet-IC	2.3V±2%, -Reset PPO	SOT-25	28rk	VD15	6g	Tor
C3D	XO6365C333MR	DC/DC-IC	PWM st-down, 300kHz, 3.3V±2.5%, 1A, +CE, soft start	SOT-25	28zm	DC7	6g	Tor
C3D	XO6367C333MR	DC/DC-IC	PWM step-up, 3.3V±2.5%, 200mA, 300kHz, +CE, soft start	SOT-25	28sh	DC11	6g	Tor
C3E	S-812C50AMC-C3ET2G	LVR-IC	5.0V±2%, 50mA	SOT-23-5	28vu	VR1	6r	Sii
C3E	XO6365C343MR	DC/DC-IC	PWM st-down, 300kHz, 3.4V±2.5%, 1A, +CE, soft start	SOT-25	28zm	DC7	6g	Tor
C3E	XO6367C343MR	DC/DC-IC	PWM step-up, 3.4V±2.5%, 200mA, 300kHz, +CE, soft start	SOT-25	28sh	DC11	6g	Tor
C3F	S-812C51AMC-C3FT2G	LVR-IC	5.1V±2%, 50mA	SOT-23-5	28vu	VR1	6r	Sii
C3F	XO6365C353MR	DC/DC-IC	PWM st-down, 300kHz, 3.5V±2.5%, 1A, +CE, soft start	SOT-25	28zm	DC7	6g	Tor
C3F	XO6367C353MR	DC/DC-IC	PWM step-up, 3.5V±2.5%, 200mA, 300kHz, +CE, soft start	SOT-25	28sh	DC11	6g	Tor
C3G	S-812C52AMC-C3GT2G	LVR-IC	5.2V±2%, 50mA	SOT-23-5	28vu	VR1	6r	Sii
C3H	S-812C53AMC-C3HT2G	LVR-IC	5.3V±2%, 50mA	SOT-23-5	28vu	VR1	6r	Sii
C3H	XO6365C363MR	DC/DC-IC	PWM st-down, 300kHz, 3.6V±2.5%, 1A, +CE, soft start	SOT-25	28zm	DC7	6g	Tor
C3H	XO6367C363MR	DC/DC-IC	PWM step-up, 3.6V±2.5%, 200mA, 300kHz, +CE, soft start	SOT-25	28sh	DC11	6g	Tor
C3I	S-812C54AMC-C3IT2G	LVR-IC	5.4V±2%, 50mA	SOT-23-5	28vu	VR1	6r	Sii
C3J	S-812C55AMC-C3JT2G	LVR-IC	5.5V±2%, 50mA	SOT-23-5	28vu	VR1	6r	Sii
C3K	S-812C56AMC-C3KT2G	LVR-IC	5.6V±2%, 50mA	SOT-23-5	28vu	VR1	6r	Sii
C3K	XO6365C373MR	DC/DC-IC	PWM st-down, 300kHz, 3.7V±2.5%, 1A, +CE, soft start	SOT-25	28zm	DC7	6g	Tor
C3K	XO6367C373MR	DC/DC-IC	PWM step-up, 3.7V±2.5%, 200mA, 300kHz, +CE, soft start	SOT-25	28sh	DC11	6g	Tor
C3L	S-812C57AMC-C3LT2G	LVR-IC	5.7V±2%, 50mA	SOT-23-5	28vu	VR1	6r	Sii
C3L	XO6365C383MR	DC/DC-IC	PWM st-down, 300kHz, 3.8V±2.5%, 1A, +CE, soft start	SOT-25	28zm	DC7	6g	Tor
C3L	XO6367C383MR	DC/DC-IC	PWM step-up, 3.8V±2.5%, 200mA, 300kHz, +CE, soft start	SOT-25	28sh	DC11	6g	Tor
C3M	S-812C58AMC-C3MT2G	LVR-IC	5.8V±2%, 50mA	SOT-23-5	28vu	VR1	6r	Sii
C3M	XO6365C393MR	DC/DC-IC	PWM st-down, 300kHz, 3.9V±2.5%, 1A, +CE, soft start	SOT-25	28zm	DC7	6g	Tor
C3M	XO6367C393MR	DC/DC-IC	PWM step-up, 3.9V±2.5%, 200mA, 300kHz, +CE, soft start	SOT-25	28sh	DC11	6g	Tor
C3N	S-812C59AMC-C3NT2G	LVR-IC	5.9V±2%, 50mA	SOT-23-5	28vu	VR1	6r	Sii
C3O	S-812C60AMC-C3OT2G	LVR-IC	6.0V±2%, 50mA	SOT-23-5	28vu	VR1	6r	Sii
C4	PI74STX1GT04CX	CMOS-Logic	Inverter	SC-70-5	28/Log6	-	6a	Per
C4	PI74STX1GT04TX	CMOS-Logic	Inverter	SOT-23-5	28/Log6	-	6a	Per
C4	R1111N441A	LVR-IC	LDO, LN, -CE, 4.4V±2%, 200mA	SOT-23-5	28cx	VR4	6g	Ric
C4	TC1054-3.3VCT713	LVR-IC	LDO, 3.3V±2%, 50mA, +CE, -Error	SOT-23-5	28w	VR8	6g	Mcc
C4	TC4S71F	CMOS-Logic	2-input OR gate	SSOP-5	28/Log4	-	6a	Tos
C4	RN5VD24AA	Vdet-IC	2.4V±2.5%, -Reset PPO	SOT-23-5	28vdo	VD3	6g	Ric
C4	RT9013B-2HPU5	LVR-IC	LDO, 2.85V±2%, 500mA, +CE	SC-70-5	28cx	VR4	6g	Rct
C40	88C40-AF5	Vdet-IC	4.0V±2%, -Reset PPO	SOT-23-5	28vdo	VD3	6a	Utc
C40	XO6365C402MR	DC/DC-IC	PWM st-down, 180kHz, 4.0V±2.5%, 1A, +CE, soft start	SOT-25	28zm	DC7	6g	Tor
C40	XO6367C402MR	DC/DC-IC	PWM step-up, 4.0V±2.5%, 200mA, 180kHz, +CE, soft start	SOT-25	28sh	DC11	6g	Tor
C40G	88C40G-AF5	Vdet-IC	4.0V±2%, -Reset PPO, halogen free	SOT-23-5	28vdo	VD3	6a	Utc
C40L	88C40L-AF5	Vdet-IC	4.0V±2%, -Reset PPO, lead free	SOT-23-5	28vdo	VD3	6a	Utc
C41	88C41-AF5	Vdet-IC	4.1V±2%, -Reset PPO	SOT-23-5	28vdo	VD3	6a	Utc
C41	XO6365C412MR	DC/DC-IC	PWM st-down, 180kHz, 4.1V±2.5%, 1A, +CE, soft start	SOT-25	28zm	DC7	6g	Tor
C41	XO6367C412MR	DC/DC-IC	PWM step-up, 4.1V±2.5%, 200mA, 180kHz, +CE, soft start	SOT-25	28sh	DC11	6g	Tor
C41G	88C41G-AF5	Vdet-IC	4.1V±2%, -Reset PPO, halogen free	SOT-23-5	28vdo	VD3	6a	Utc
C41L	88C41L-AF5	Vdet-IC	4.1V±2%, -Reset PPO, lead free	SOT-23-5	28vdo	VD3	6a	Utc
C42	88C42-AF5	Vdet-IC	4.2V±2%, -Reset PPO	SOT-23-5	28vdo	VD3	6a	Utc
C42	XO6365C422MR	DC/DC-IC	PWM st-down, 180kHz, 4.2V±2.5%, 1A, +CE, soft start	SOT-25	28zm	DC7	6g	Tor
C42	XO6367C422MR	DC/DC-IC	PWM step-up, 4.2V±2.5%, 200mA, 180kHz, +CE, soft start	SOT-25	28sh	DC11	6g	Tor
C42G	88C42G-AF5	Vdet-IC	4.2V±2%, -Reset PPO, halogen free	SOT-23-5	28vdo	VD3	6a	Utc
C42L	88C42L-AF5	Vdet-IC	4.2V±2%, -Reset PPO, lead free	SOT-23-5	28vdo	VD3	6a	Utc
C43	88C43-AF5	Vdet-IC	4.3V±2%, -Reset PPO	SOT-23-5	28vdo	VD3	6a	Utc
C43	XO6365C432MR	DC/DC-IC	PWM st-down, 180kHz, 4.3V±2.5%, 1A, +CE, soft start	SOT-25	28zm	DC7	6g	Tor
C43	XO6367C432MR	DC/DC-IC	PWM step-up, 4.3V±2.5%, 200mA, 180kHz, +CE, soft start	SOT-25	28sh	DC11	6g	Tor
C43G	88C43G-AF5	Vdet-IC	4.3V±2%, -Reset PPO, halogen free	SOT-23-5	28vdo	VD3	6a	Utc
C43L	88C43L-AF5	Vdet-IC	4.3V±2%, -Reset PPO, lead free	SOT-23-5	28vdo	VD3	6a	Utc
C44	88C44-AF5	Vdet-IC	4.4V±2%, -Reset PPO	SOT-23-5	28vdo	VD3	6a	Utc
C44	XO6365C442MR	DC/DC-IC	PWM st-down, 180kHz, 4.4V±2.5%, 1A, +CE, soft start	SOT-25	28zm	DC7	6g	Tor
C44	XO6367C442MR	DC/DC-IC	PWM step-up, 4.4V±2.5%, 200mA, 180kHz, +CE, soft start	SOT-25	28sh	DC11	6g	Tor
C44G	88C44G-AF5	Vdet-IC	4.4V±2%, -Reset PPO, halogen free	SOT-23-5	28vdo	VD3	6a	Utc
C44L	88C44L-AF5	Vdet-IC	4.4V±2%, -Reset PPO, lead free	SOT-23-5	28vdo	VD3	6a	Utc
C45	88C45-AF5	Vdet-IC	4.5V±2%, -Reset PPO	SOT-23-5	28vdo	VD3	6a	Utc
C45	XO6365C452MR	DC/DC-IC	PWM st-down, 180kHz, 4.5V±2.5%, 1A, +CE, soft start	SOT-25	28zm	DC7	6g	Tor
C45	XO6367C452MR	DC/DC-IC	PWM step-up, 4.5V±2.5%, 200mA, 180kHz, +CE, soft start	SOT-25	28sh	DC11	6g	Tor
C45G	88C45G-AF5	Vdet-IC	4.5V±2%, -Reset PPO, halogen free	SOT-23-5	28vdo	VD3	6a	Utc
C45L	88C45L-AF5	Vdet-IC	4.5V±2%, -Reset PPO, lead free	SOT-23-5	28vdo	VD3	6a	Utc
C46	88C46-AF5	Vdet-IC	4.6V±2%, -Reset PPO	SOT-23-5	28vdo	VD3	6a	Utc
C46	XO6365C462MR	DC/DC-IC	PWM st-down, 180kHz, 4.6V±2.5%, 1A, +CE, soft start	SOT-25	28zm	DC7	6g	Tor
C46	XO6367C462MR	DC/DC-IC	PWM step-up, 4.6V±2.5%, 200mA, 180kHz, +CE, soft start	SOT-25	28sh	DC11	6g	Tor
C46G	88C46G-AF5	Vdet-IC	4.6V±2%, -Reset PPO, halogen free	SOT-23-5	28vdo	VD3	6a	Utc
C46L	88C46L-AF5	Vdet-IC	4.6V±2%, -Reset PPO, lead free	SOT-23-5	28vdo	VD3	6a	Utc
C47	88C47-AF5	Vdet-IC	4.7V±2%, -Reset PPO	SOT-23-5	28vdo	VD3	6a	Utc



SMD code	Type	Function	Short description	Case	Pinout	Sch.	St.	Mnf.
C47	XC6365C472MR	DC/DC-IC	PWM st-down, 180kHz, 4.7V±2.5%, 1A, +CE, soft start	SOT-25	28zm	DC7	6g	Tor
C47	XC6367C472MR	DC/DC-IC	PWM step-up, 4.7V±2.5%, 200mA, 180kHz, +CE, soft start	SOT-25	28sh	DC11	6g	Tor
C47G	88C47G-AF5	Vdet-IC	4.7V±2%, -Reset PPO, halogen free	SOT-23-5	28vdo	VD3	6a	Utc
C47L	88C47L-AF5	Vdet-IC	4.7V±2%, -Reset PPO, lead free	SOT-23-5	28vdo	VD3	6a	Utc
C48	88C48-AF5	Vdet-IC	4.8V±2%, -Reset PPO	SOT-23-5	28vdo	VD3	6a	Utc
C48	XC6365C482MR	DC/DC-IC	PWM st-down, 180kHz, 4.8V±2.5%, 1A, +CE, soft start	SOT-25	28zm	DC7	6g	Tor
C48	XC6367C482MR	DC/DC-IC	PWM step-up, 4.8V±2.5%, 200mA, 180kHz, +CE, soft start	SOT-25	28sh	DC11	6g	Tor
C48G	88C48G-AF5	Vdet-IC	4.8V±2%, -Reset PPO, halogen free	SOT-23-5	28vdo	VD3	6a	Utc
C48L	88C48L-AF5	Vdet-IC	4.8V±2%, -Reset PPO, lead free	SOT-23-5	28vdo	VD3	6a	Utc
C49	88C49-AF5	Vdet-IC	4.9V±2%, -Reset PPO	SOT-23-5	28vdo	VD3	6a	Utc
C49	XC6365C492MR	DC/DC-IC	PWM st-down, 180kHz, 4.9V±2.5%, 1A, +CE, soft start	SOT-25	28zm	DC7	6g	Tor
C49	XC6367C492MR	DC/DC-IC	PWM step-up, 4.9V±2.5%, 200mA, 180kHz, +CE, soft start	SOT-25	28sh	DC11	6g	Tor
C49G	88C49G-AF5	Vdet-IC	4.9V±2%, -Reset PPO, halogen free	SOT-23-5	28vdo	VD3	6a	Utc
C49L	88C49L-AF5	Vdet-IC	4.9V±2%, -Reset PPO, lead free	SOT-23-5	28vdo	VD3	6a	Utc
C4A	S-812C20BMC-C4AT2G	LVR-IC	2.0V±2%, 50mA, +CE	SOT-23-5	28vrt	VR4	6r	Sii
C4A	XC6108C24AMR	Vdet-IC	2.4V±2%, Hysteresis, -Reset PPO	SOT-25	28rm	VD15	6g	Tor
C4A	XC6365C403MR	DC/DC-IC	PWM st-down, 300kHz, 4.0V±2.5%, 1A, +CE, soft start	SOT-25	28zm	DC7	6g	Tor
C4A	XC6367C403MR	DC/DC-IC	PWM step-up, 4.0V±2.5%, 200mA, 300kHz, +CE, soft start	SOT-25	28sh	DC11	6g	Tor
C4B	S-812C21BMC-C4BT2G	LVR-IC	2.1V±2%, 50mA, +CE	SOT-23-5	28vrt	VR4	6r	Sii
C4B	XC6108C24BMR	Vdet-IC	2.4V±2%, -Reset PPO	SOT-25	28rm	VD15	6g	Tor
C4B	XC6365C413MR	DC/DC-IC	PWM st-down, 300kHz, 4.1V±2.5%, 1A, +CE, soft start	SOT-25	28zm	DC7	6g	Tor
C4B	XC6367C413MR	DC/DC-IC	PWM step-up, 4.1V±2.5%, 200mA, 300kHz, +CE, soft start	SOT-25	28sh	DC11	6g	Tor
C4C	S-812C22BMC-C4CT2G	LVR-IC	2.2V±2%, 50mA, +CE	SOT-23-5	28vrt	VR4	6r	Sii
C4C	XC6108C24CMR	Vdet-IC	2.4V±2%, Hysteresis, -Reset PPO	SOT-25	28rk	VD15	6g	Tor
C4C	XC6365C423MR	DC/DC-IC	PWM st-down, 300kHz, 4.2V±2.5%, 1A, +CE, soft start	SOT-25	28zm	DC7	6g	Tor
C4C	XC6367C423MR	DC/DC-IC	PWM step-up, 4.2V±2.5%, 200mA, 300kHz, +CE, soft start	SOT-25	28sh	DC11	6g	Tor
C4D	S-812C23BMC-C4DT2G	LVR-IC	2.3V±2%, 50mA, +CE	SOT-23-5	28vrt	VR4	6r	Sii
C4D	XC6108C24DMR	Vdet-IC	2.4V±2%, -Reset PPO	SOT-25	28rk	VD15	6g	Tor
C4D	XC6365C433MR	DC/DC-IC	PWM st-down, 300kHz, 4.3V±2.5%, 1A, +CE, soft start	SOT-25	28zm	DC7	6g	Tor
C4D	XC6367C433MR	DC/DC-IC	PWM step-up, 4.3V±2.5%, 200mA, 300kHz, +CE, soft start	SOT-25	28sh	DC11	6g	Tor
C4E	S-812C24BMC-C4ET2G	LVR-IC	2.4V±2%, 50mA, +CE	SOT-23-5	28vrt	VR4	6r	Sii
C4E	XC6365C443MR	DC/DC-IC	PWM st-down, 300kHz, 4.4V±2.5%, 1A, +CE, soft start	SOT-25	28zm	DC7	6g	Tor
C4E	XC6367C443MR	DC/DC-IC	PWM step-up, 4.4V±2.5%, 200mA, 300kHz, +CE, soft start	SOT-25	28sh	DC11	6g	Tor
C4F	S-812C25BMC-C4FT2G	LVR-IC	2.5V±2%, 50mA, +CE	SOT-23-5	28vrt	VR4	6r	Sii
C4F	XC6365C453MR	DC/DC-IC	PWM st-down, 300kHz, 4.5V±2.5%, 1A, +CE, soft start	SOT-25	28zm	DC7	6g	Tor
C4F	XC6367C453MR	DC/DC-IC	PWM step-up, 4.5V±2.5%, 200mA, 300kHz, +CE, soft start	SOT-25	28sh	DC11	6g	Tor
C4G	S-812C26BMC-C4GT2G	LVR-IC	2.6V±2%, 50mA, +CE	SOT-23-5	28vrt	VR4	6r	Sii
C4H	S-812C27BMC-C4HT2G	LVR-IC	2.7V±2%, 50mA, +CE	SOT-23-5	28vrt	VR4	6r	Sii
C4H	XC6365C463MR	DC/DC-IC	PWM st-down, 300kHz, 4.6V±2.5%, 1A, +CE, soft start	SOT-25	28zm	DC7	6g	Tor
C4H	XC6367C463MR	DC/DC-IC	PWM step-up, 4.6V±2.5%, 200mA, 300kHz, +CE, soft start	SOT-25	28sh	DC11	6g	Tor
C4I	S-812C28BMC-C4IT2G	LVR-IC	2.8V±2%, 50mA, +CE	SOT-23-5	28vrt	VR4	6r	Sii
C4J	S-812C29BMC-C4JT2G	LVR-IC	2.9V±2%, 50mA, +CE	SOT-23-5	28vrt	VR4	6r	Sii
C4K	S-812C30BMC-C4KT2G	LVR-IC	3.0V±2%, 50mA, +CE	SOT-23-5	28vrt	VR4	6r	Sii
C4K	XC6365C473MR	DC/DC-IC	PWM st-down, 300kHz, 4.7V±2.5%, 1A, +CE, soft start	SOT-25	28zm	DC7	6g	Tor
C4K	XC6367C473MR	DC/DC-IC	PWM step-up, 4.7V±2.5%, 200mA, 300kHz, +CE, soft start	SOT-25	28sh	DC11	6g	Tor
C4L	S-812C31BMC-C4LT2G	LVR-IC	3.1V±2%, 50mA, +CE	SOT-23-5	28vrt	VR4	6r	Sii
C4L	XC6365C483MR	DC/DC-IC	PWM st-down, 300kHz, 4.8V±2.5%, 1A, +CE, soft start	SOT-25	28zm	DC7	6g	Tor
C4L	XC6367C483MR	DC/DC-IC	PWM step-up, 4.8V±2.5%, 200mA, 300kHz, +CE, soft start	SOT-25	28sh	DC11	6g	Tor
C4M	S-812C32BMC-C4MT2G	LVR-IC	3.2V±2%, 50mA, +CE	SOT-23-5	28vrt	VR4	6r	Sii
C4M	XC6365C493MR	DC/DC-IC	PWM st-down, 300kHz, 4.9V±2.5%, 1A, +CE, soft start	SOT-25	28zm	DC7	6g	Tor
C4M	XC6367C493MR	DC/DC-IC	PWM step-up, 4.9V±2.5%, 200mA, 300kHz, +CE, soft start	SOT-25	28sh	DC11	6g	Tor
C4N	S-812C33BMC-C4NT2G	LVR-IC	3.3V±2%, 50mA, +CE	SOT-23-5	28vrt	VR4	6r	Sii
C4O	S-812C34BMC-C4OT2G	LVR-IC	3.4V±2%, 50mA, +CE	SOT-23-5	28vrt	VR4	6r	Sii
C4P	S-812C35BMC-C4PT2G	LVR-IC	3.5V±2%, 50mA, +CE	SOT-23-5	28vrt	VR4	6r	Sii
C4Q	S-812C36BMC-C4QT2G	LVR-IC	3.6V±2%, 50mA, +CE	SOT-23-5	28vrt	VR4	6r	Sii
C4R	S-812C37BMC-C4RT2G	LVR-IC	3.7V±2%, 50mA, +CE	SOT-23-5	28vrt	VR4	6r	Sii
C4S	S-812C38BMC-C4ST2G	LVR-IC	3.8V±2%, 50mA, +CE	SOT-23-5	28vrt	VR4	6r	Sii
C4T	S-812C39BMC-C4TT2G	LVR-IC	3.9V±2%, 50mA, +CE	SOT-23-5	28vrt	VR4	6r	Sii
C4U	S-812C40BMC-C4UT2G	LVR-IC	4.0V±2%, 50mA, +CE	SOT-23-5	28vrt	VR4	6r	Sii
C4V	S-812C41BMC-C4VT2G	LVR-IC	4.1V±2%, 50mA, +CE	SOT-23-5	28vrt	VR4	6r	Sii
C4W	S-812C42BMC-C4WT2G	LVR-IC	4.2V±2%, 50mA, +CE	SOT-23-5	28vrt	VR4	6r	Sii
C4X	S-812C43BMC-C4XT2G	LVR-IC	4.3V±2%, 50mA, +CE	SOT-23-5	28vrt	VR4	6r	Sii
C4Y	S-812C44BMC-C4YT2G	LVR-IC	4.4V±2%, 50mA, +CE	SOT-23-5	28vrt	VR4	6r	Sii
C4Z	S-812C45BMC-C4ZT2G	LVR-IC	4.5V±2%, 50mA, +CE	SOT-23-5	28vrt	VR4	6r	Sii
C5	R1111N451A	LVR-IC	LDO, LN, -CE, 4.5V±2%, 200mA	SOT-23-5	28cx	VR4	6g	Ric
C5	RN5VD25AA	Vdet-IC	2.5V±2.5%, -Reset PPO	SOT-23-5	28vdo	VD3	6g	Toc
C5	TC4569F	CMOS-Logic	Inverter	SSOP-5	28LLog6	-	6a	Ric
C5-	RT9013B-33PU5	LVR-IC	LDO, 3.5V±2%, 500mA, +CE	SC-70-5	28cx	VR4	6g	Rct
C50	88C50-AF5	Vdet-IC	5.0V±2%, -Reset PPO	SOT-23-5	28vdo	VD3	6a	Utc
C50	XC6365C502MR	DC/DC-IC	PWM st-down, 180kHz, 5.0V±2.5%, 1A, +CE, soft start	SOT-25	28zm	DC7	6g	Tor



SMD code	Type	Function	Short description	Case	Pinout	Sch.	St.	Mnf.
C50	XC6367C502MR	DC/DC-IC	PWM step-up, 5.0V±2.5%, 200mA, 180kHz, +CE, soft start	SOT-25	28sh	DC11	6g	Tor
C50G	88C50G-AF5	Vdet-IC	5.0V±2%, -Reset PPO, halogen free	SOT-23-5	28vdo	VD3	6a	Utc
C50L	88C50L-AF5	Vdet-IC	5.0V±2%, -Reset PPO, lead free	SOT-23-5	28vdo	VD3	6a	Utc
C51	88C51-AF5	Vdet-IC	5.1V±2%, -Reset PPO	SOT-23-5	28vdo	VD3	6a	Utc
C51	XC6365C512MR	DC/DC-IC	PWM st-down, 180kHz, 5.1V±2.5%, 1A, +CE, soft start	SOT-25	28zm	DC7	6g	Tor
C51	XC6367C512MR	DC/DC-IC	PWM step-up, 5.1V±2.5%, 200mA, 180kHz, +CE, soft start	SOT-25	28sh	DC11	6g	Tor
C51G	88C51G-AF5	Vdet-IC	5.1V±2%, -Reset PPO, halogen free	SOT-23-5	28vdo	VD3	6a	Utc
C51L	88C51L-AF5	Vdet-IC	5.1V±2%, -Reset PPO, lead free	SOT-23-5	28vdo	VD3	6a	Utc
C52	88C52-AF5	Vdet-IC	5.2V±2%, -Reset PPO	SOT-23-5	28vdo	VD3	6a	Utc
C52	XC6365C522MR	DC/DC-IC	PWM st-down, 180kHz, 5.2V±2.5%, 1A, +CE, soft start	SOT-25	28zm	DC7	6g	Tor
C52	XC6367C522MR	DC/DC-IC	PWM step-up, 5.2V±2.5%, 200mA, 180kHz, +CE, soft start	SOT-25	28sh	DC11	6g	Tor
C52G	88C52G-AF5	Vdet-IC	5.2V±2%, -Reset PPO, halogen free	SOT-23-5	28vdo	VD3	6a	Utc
C52L	88C52L-AF5	Vdet-IC	5.2V±2%, -Reset PPO, lead free	SOT-23-5	28vdo	VD3	6a	Utc
C53	88C53-AF5	Vdet-IC	5.3V±2%, -Reset PPO	SOT-23-5	28vdo	VD3	6a	Utc
C53	XC6365C532MR	DC/DC-IC	PWM st-down, 180kHz, 5.3V±2.5%, 1A, +CE, soft start	SOT-25	28zm	DC7	6g	Tor
C53	XC6367C532MR	DC/DC-IC	PWM step-up, 5.3V±2.5%, 200mA, 180kHz, +CE, soft start	SOT-25	28sh	DC11	6g	Tor
C53G	88C53G-AF5	Vdet-IC	5.3V±2%, -Reset PPO, halogen free	SOT-23-5	28vdo	VD3	6a	Utc
C53L	88C53L-AF5	Vdet-IC	5.3V±2%, -Reset PPO, lead free	SOT-23-5	28vdo	VD3	6a	Utc
C54	88C54-AF5	Vdet-IC	5.4V±2%, -Reset PPO	SOT-23-5	28vdo	VD3	6a	Utc
C54	XC6365C542MR	DC/DC-IC	PWM st-down, 180kHz, 5.4V±2.5%, 1A, +CE, soft start	SOT-25	28zm	DC7	6g	Tor
C54	XC6367C542MR	DC/DC-IC	PWM step-up, 5.4V±2.5%, 200mA, 180kHz, +CE, soft start	SOT-25	28sh	DC11	6g	Tor
C54G	88C54G-AF5	Vdet-IC	5.4V±2%, -Reset PPO, halogen free	SOT-23-5	28vdo	VD3	6a	Utc
C54L	88C54L-AF5	Vdet-IC	5.4V±2%, -Reset PPO, lead free	SOT-23-5	28vdo	VD3	6a	Utc
C55	88C55-AF5	Vdet-IC	5.5V±2%, -Reset PPO	SOT-23-5	28vdo	VD3	6a	Utc
C55	XC6365C552MR	DC/DC-IC	PWM st-down, 180kHz, 5.5V±2.5%, 1A, +CE, soft start	SOT-25	28zm	DC7	6g	Tor
C55	XC6367C552MR	DC/DC-IC	PWM step-up, 5.5V±2.5%, 200mA, 180kHz, +CE, soft start	SOT-25	28sh	DC11	6g	Tor
C55G	88C55G-AF5	Vdet-IC	5.5V±2%, -Reset PPO, halogen free	SOT-23-5	28vdo	VD3	6a	Utc
C55L	88C55L-AF5	Vdet-IC	5.5V±2%, -Reset PPO, lead free	SOT-23-5	28vdo	VD3	6a	Utc
C56	88C56-AF5	Vdet-IC	5.6V±2%, -Reset PPO	SOT-23-5	28vdo	VD3	6a	Utc
C56	XC6365C562MR	DC/DC-IC	PWM st-down, 180kHz, 5.6V±2.5%, 1A, +CE, soft start	SOT-25	28zm	DC7	6g	Tor
C56	XC6367C562MR	DC/DC-IC	PWM step-up, 5.6V±2.5%, 200mA, 180kHz, +CE, soft start	SOT-25	28sh	DC11	6g	Tor
C56G	88C56G-AF5	Vdet-IC	5.6V±2%, -Reset PPO, halogen free	SOT-23-5	28vdo	VD3	6a	Utc
C56L	88C56L-AF5	Vdet-IC	5.6V±2%, -Reset PPO, lead free	SOT-23-5	28vdo	VD3	6a	Utc
C57	88C57-AF5	Vdet-IC	5.7V±2%, -Reset PPO	SOT-23-5	28vdo	VD3	6a	Utc
C57	XC6365C572MR	DC/DC-IC	PWM st-down, 180kHz, 5.7V±2.5%, 1A, +CE, soft start	SOT-25	28zm	DC7	6g	Tor
C57	XC6367C572MR	DC/DC-IC	PWM step-up, 5.7V±2.5%, 200mA, 180kHz, +CE, soft start	SOT-25	28sh	DC11	6g	Tor
C57G	88C57G-AF5	Vdet-IC	5.7V±2%, -Reset PPO, halogen free	SOT-23-5	28vdo	VD3	6a	Utc
C57L	88C57L-AF5	Vdet-IC	5.7V±2%, -Reset PPO, lead free	SOT-23-5	28vdo	VD3	6a	Utc
C58	88C58-AF5	Vdet-IC	5.8V±2%, -Reset PPO	SOT-23-5	28vdo	VD3	6a	Utc
C58	XC6365C582MR	DC/DC-IC	PWM st-down, 180kHz, 5.8V±2.5%, 1A, +CE, soft start	SOT-25	28zm	DC7	6g	Tor
C58	XC6367C582MR	DC/DC-IC	PWM step-up, 5.8V±2.5%, 200mA, 180kHz, +CE, soft start	SOT-25	28sh	DC11	6g	Tor
C58G	88C58G-AF5	Vdet-IC	5.8V±2%, -Reset PPO, halogen free	SOT-23-5	28vdo	VD3	6a	Utc
C58L	88C58L-AF5	Vdet-IC	5.8V±2%, -Reset PPO, lead free	SOT-23-5	28vdo	VD3	6a	Utc
C59	88C59-AF5	Vdet-IC	5.9V±2%, -Reset PPO	SOT-23-5	28vdo	VD3	6a	Utc
C59	XC6365C592MR	DC/DC-IC	PWM st-down, 180kHz, 5.9V±2.5%, 1A, +CE, soft start	SOT-25	28zm	DC7	6g	Tor
C59	XC6367C592MR	DC/DC-IC	PWM step-up, 5.9V±2.5%, 200mA, 180kHz, +CE, soft start	SOT-25	28sh	DC11	6g	Tor
C59G	88C59G-AF5	Vdet-IC	5.9V±2%, -Reset PPO, halogen free	SOT-23-5	28vdo	VD3	6a	Utc
C59L	88C59L-AF5	Vdet-IC	5.9V±2%, -Reset PPO, lead free	SOT-23-5	28vdo	VD3	6a	Utc
C5A	S-812C46BMC-C5AT2G	LVR-IC	4.6V±2%, 50mA, +CE	SOT-23-5	28vrt	VR4	6r	Sii
C5A	XC6108C25AMR	Vdet-IC	2.5V±2%, Hysteresis, -Reset PPO	SOT-25	28rm	VD15	6g	Tor
C5A	XC6365C503MR	DC/DC-IC	PWM st-down, 300kHz, 5.0V±2.5%, 1A, +CE, soft start	SOT-25	28zm	DC7	6g	Tor
C5A	XC6367C503MR	DC/DC-IC	PWM step-up, 5.0V±2.5%, 200mA, 300kHz, +CE, soft start	SOT-25	28sh	DC11	6g	Tor
C5B	S-812C47BMC-C5BT2G	LVR-IC	4.7V±2%, 50mA, +CE	SOT-23-5	28vrt	VR4	6r	Sii
C5B	XC6108C25BMR	Vdet-IC	2.5V±2%, -Reset PPO	SOT-25	28rm	VD15	6g	Tor
C5B	XC6365C513MR	DC/DC-IC	PWM st-down, 300kHz, 5.1V±2.5%, 1A, +CE, soft start	SOT-25	28zm	DC7	6g	Tor
C5B	XC6367C513MR	DC/DC-IC	PWM step-up, 5.1V±2.5%, 200mA, 300kHz, +CE, soft start	SOT-25	28sh	DC11	6g	Tor
C5C	S-812C48BMC-C5CT2G	LVR-IC	4.8V±2%, 50mA, +CE	SOT-23-5	28vrt	VR4	6r	Sii
C5C	XC6108C25CMR	Vdet-IC	2.5V±2%, Hysteresis, -Reset PPO	SOT-25	28rk	VD15	6g	Tor
C5C	XC6365C523MR	DC/DC-IC	PWM st-down, 300kHz, 5.2V±2.5%, 1A, +CE, soft start	SOT-25	28zm	DC7	6g	Tor
C5C	XC6367C523MR	DC/DC-IC	PWM step-up, 5.2V±2.5%, 200mA, 300kHz, +CE, soft start	SOT-25	28sh	DC11	6g	Tor
C5D	S-812C49BMC-C5DT2G	LVR-IC	4.9V±2%, 50mA, +CE	SOT-23-5	28vrt	VR4	6r	Sii
C5D	XC6108C25DMR	Vdet-IC	2.5V±2%, -Reset PPO	SOT-25	28rk	VD15	6g	Tor
C5D	XC6365C533MR	DC/DC-IC	PWM st-down, 300kHz, 5.3V±2.5%, 1A, +CE, soft start	SOT-25	28zm	DC7	6g	Tor
C5D	XC6367C533MR	DC/DC-IC	PWM step-up, 5.3V±2.5%, 200mA, 300kHz, +CE, soft start	SOT-25	28sh	DC11	6g	Tor
C5E	S-812C50BMC-C5ET2G	LVR-IC	5.0V±2%, 50mA, +CE	SOT-23-5	28vrt	VR4	6r	Sii
C5E	XC6365C543MR	DC/DC-IC	PWM st-down, 300kHz, 5.4V±2.5%, 1A, +CE, soft start	SOT-25	28zm	DC7	6g	Tor
C5E	XC6367C543MR	DC/DC-IC	PWM step-up, 5.4V±2.5%, 200mA, 300kHz, +CE, soft start	SOT-25	28sh	DC11	6g	Tor
C5F	S-812C51BMC-C5FT2G	LVR-IC	5.1V±2%, 50mA, +CE	SOT-23-5	28vrt	VR4	6r	Sii
C5F	XC6365C553MR	DC/DC-IC	PWM st-down, 300kHz, 5.5V±2.5%, 1A, +CE, soft start	SOT-25	28zm	DC7	6g	Tor
C5F	XC6367C553MR	DC/DC-IC	PWM step-up, 5.5V±2.5%, 200mA, 300kHz, +CE, soft start	SOT-25	28sh	DC11	6g	Tor



SMD code	Type	Function	Short description	Case	Pinout	Sch.	St.	Mnf.
C5G	S-812C52BMC-C5GT2G	LVR-IC	5.2V±2%, 50mA, +CE	SOT-23-5	28vrt	VR4	6r	Sii
C5H	S-812C53BMC-C5HT2G	LVR-IC	5.3V±2%, 50mA, +CE	SOT-23-5	28vrt	VR4	6r	Sii
C5H	XC6365C563MR	DC/DC-IC	PWM st-down, 300kHz, 5.6V±2.5%, 1A, +CE, soft start	SOT-25	28zm	DC7	6g	Tor
C5H	XC6367C563MR	DC/DC-IC	PWM step-up, 5.6V±2.5%, 200mA, 300kHz, +CE, soft start	SOT-25	28sh	DC11	6g	Tor
C5I	S-812C54BMC-C5IT2G	LVR-IC	5.4V±2%, 50mA, +CE	SOT-23-5	28vrt	VR4	6r	Sii
C5J	S-812C55BMC-C5JT2G	LVR-IC	5.5V±2%, 50mA, +CE	SOT-23-5	28vrt	VR4	6r	Sii
C5K	S-812C56BMC-C5KT2G	LVR-IC	5.6V±2%, 50mA, +CE	SOT-23-5	28vrt	VR4	6r	Sii
C5K	XC6365C573MR	DC/DC-IC	PWM st-down, 300kHz, 5.7V±2.5%, 1A, +CE, soft start	SOT-25	28zm	DC7	6g	Tor
C5K	XC6367C573MR	DC/DC-IC	PWM step-up, 5.7V±2.5%, 200mA, 300kHz, +CE, soft start	SOT-25	28sh	DC11	6g	Tor
C5L	S-812C57BMC-C5LT2G	LVR-IC	5.7V±2%, 50mA, +CE	SOT-23-5	28vrt	VR4	6r	Sii
C5L	XC6365C583MR	DC/DC-IC	PWM st-down, 300kHz, 5.8V±2.5%, 1A, +CE, soft start	SOT-25	28zm	DC7	6g	Tor
C5L	XC6367C583MR	DC/DC-IC	PWM step-up, 5.8V±2.5%, 200mA, 300kHz, +CE, soft start	SOT-25	28sh	DC11	6g	Tor
C5M	S-812C58BMC-C5MT2G	LVR-IC	5.8V±2%, 50mA, +CE	SOT-23-5	28vrt	VR4	6r	Sii
C5M	XC6365C593MR	DC/DC-IC	PWM st-down, 300kHz, 5.9V±2.5%, 1A, +CE, soft start	SOT-25	28zm	DC7	6g	Tor
C5M	XC6367C593MR	DC/DC-IC	PWM step-up, 5.9V±2.5%, 200mA, 300kHz, +CE, soft start	SOT-25	28sh	DC11	6g	Tor
C5N	S-812C59BMC-C5NT2G	LVR-IC	5.9V±2%, 50mA, +CE	SOT-23-5	28vrt	VR4	6r	Sii
C5O	S-812C60BMC-C5OT2G	LVR-IC	6.0V±2%, 50mA, +CE	SOT-23-5	28vrt	VR4	6r	Sii
C6	R1111N461A	LVR-IC	LDO, LN, -CE, 4.6V±2%, 200mA	SOT-23-5	28cx	VR4	6g	Ric
C6	RN5VD26AA	Vdet-IC	2.6V±2.5%, -Reset PPO	SOT-23-5	28vdo	VD3	6g	Ric
C6	TC1054-5.0VCT713	LVR-IC	LDO, 5.0V±2%, 50mA, +CE, -Error	SOT-23-5	28w	VR8	6g	Mcc
C6	TC4SU69F	CMOS-Logic	Inverter	SSOP-5	28/Log6	-	6a	Tos
C6-	RT9013B-35PU5	LVR-IC	LDO, 3.5V±2%, 500mA, +CE	SC-70-5	28cx	VR4	6g	Rct
C6-	RT9169-45PB	LVR-IC	LDO, 4.5V±2%, 100mA, -CE	SOT-23-5	28cx	VR4	6g	Rct
C60	88C60-AF5	Vdet-IC	6.0V±2%, -Reset PPO	SOT-23-5	28vdo	VD3	6a	Utc
C60	XC6365C602MR	DC/DC-IC	PWM st-down, 180kHz, 6.0V±2.5%, 1A, +CE, soft start	SOT-25	28zm	DC7	6g	Tor
C60	XC6367C602MR	DC/DC-IC	PWM step-up, 6.0V±2.5%, 200mA, 180kHz, +CE, soft start	SOT-25	28sh	DC11	6g	Tor
C60G	88C60G-AF5	Vdet-IC	6.0V±2%, -Reset PPO, halogen free	SOT-23-5	28vdo	VD3	6a	Utc
C60L	88C60L-AF5	Vdet-IC	6.0V±2%, -Reset PPO, lead free	SOT-23-5	28vdo	VD3	6a	Utc
C61	XC6367C612MR	DC/DC-IC	PWM step-up, 6.1V±2.5%, 200mA, 180kHz, +CE, soft start	SOT-25	28sh	DC11	6g	Tor
C62	XC6367C622MR	DC/DC-IC	PWM step-up, 6.2V±2.5%, 200mA, 180kHz, +CE, soft start	SOT-25	28sh	DC11	6g	Tor
C63	XC6367C632MR	DC/DC-IC	PWM step-up, 6.3V±2.5%, 200mA, 180kHz, +CE, soft start	SOT-25	28sh	DC11	6g	Tor
C64	XC6367C642MR	DC/DC-IC	PWM step-up, 6.4V±2.5%, 200mA, 180kHz, +CE, soft start	SOT-25	28sh	DC11	6g	Tor
C65	XC6367C652MR	DC/DC-IC	PWM step-up, 6.5V±2.5%, 200mA, 180kHz, +CE, soft start	SOT-25	28sh	DC11	6g	Tor
C66	74AHCT1G66GV	CMOS-Logic	Bilateral analogic switch	SOT753	28/Log16	-	6a	Phi
C6A	XC6108C26AMR	Vdet-IC	2.6V±2%, Hysteresis, -Reset PPO	SOT-25	28rm	VD15	6g	Tor
C6A	XC6365C603MR	DC/DC-IC	PWM st-down, 300kHz, 6.0V±2.5%, 1A, +CE, soft start	SOT-25	28zm	DC7	6g	Tor
C6A	XC6367C603MR	DC/DC-IC	PWM step-up, 6.0V±2.5%, 200mA, 300kHz, +CE, soft start	SOT-25	28sh	DC11	6g	Tor
C6B	XC6108C26BMR	Vdet-IC	2.6V±2%, -Reset PPO	SOT-25	28rm	VD15	6g	Tor
C6B	XC6367C613MR	DC/DC-IC	PWM step-up, 6.1V±2.5%, 200mA, 300kHz, +CE, soft start	SOT-25	28sh	DC11	6g	Tor
C6C	XC6108C26CMR	Vdet-IC	2.6V±2%, Hysteresis, -Reset PPO	SOT-25	28rk	VD15	6g	Tor
C6C	XC6367C623MR	DC/DC-IC	PWM step-up, 6.2V±2.5%, 200mA, 300kHz, +CE, soft start	SOT-25	28sh	DC11	6g	Tor
C6D	XC6108C26DMR	Vdet-IC	2.6V±2%, -Reset PPO	SOT-25	28rk	VD15	6g	Tor
C6D	XC6367C633MR	DC/DC-IC	PWM step-up, 6.3V±2.5%, 200mA, 300kHz, +CE, soft start	SOT-25	28sh	DC11	6g	Tor
C6E	XC6367C643MR	DC/DC-IC	PWM step-up, 6.4V±2.5%, 200mA, 300kHz, +CE, soft start	SOT-25	28sh	DC11	6g	Tor
C6F	XC6367C653MR	DC/DC-IC	PWM step-up, 6.5V±2.5%, 200mA, 300kHz, +CE, soft start	SOT-25	28sh	DC11	6g	Tor
C7	R1111N471A	LVR-IC	LDO, LN, -CE, 4.7V±2%, 200mA	SOT-23-5	28cx	VR4	6g	Ric
C7	RN5VD27AA	Vdet-IC	2.7V±2.5%, -Reset PPO	SOT-23-5	28vdo	VD3	6g	Ric
C7	RT9169-40CB	LVR-IC	LDO, 4.0V±2%, 100mA, -CE	SOT-23-5	28cx	VR4	6g	Rct
C7	TC4SU11F	CMOS-Logic	2-input NAND gate	SSOP-5	28/Log1	-	6a	Tos
C7_	SN74LVC1G17QDCK	CMOS-Logic	Schmitt-trigger	SC-70-5	28/Log11	-	6a	Th
C79	74AHCT1G79GV	CMOS-Logic	Positive edge-triggered D-type flip-flop	SOT753	28/Log20	-	6a	Phi
C7A	XC6108C27AMR	Vdet-IC	2.7V±2%, Hysteresis, -Reset PPO	SOT-25	28rm	VD15	6g	Tor
C7B	XC6108C27BMR	Vdet-IC	2.7V±2%, -Reset PPO	SOT-25	28rm	VD15	6g	Tor
C7C	XC6108C27CMR	Vdet-IC	2.7V±2%, Hysteresis, -Reset PPO	SOT-25	28rk	VD15	6g	Tor
C7D	XC6108C27DMR	Vdet-IC	2.7V±2%, -Reset PPO	SOT-25	28rk	VD15	6g	Tor
C8	PI74STX1GT08CX	CMOS-Logic	2-input AND gate	SC-70-5	28/Log3	-	6a	Per
C8	PI74STX1GT08TX	CMOS-Logic	2-input AND gate	SOT-23-5	28/Log3	-	6a	Per
C8	R1111N481A	LVR-IC	LDO, LN, -CE, 4.8V±2%, 200mA	SOT-23-5	28cx	VR4	6g	Ric
C8	RN5VD28AA	Vdet-IC	2.8V±2.5%, -Reset PPO	SOT-23-5	28vdo	VD3	6g	Ric
C8	RT9169-13CB	LVR-IC	LDO, 1.3V±2%, 100mA, -CE	SOT-23-5	28cx	VR4	6g	Rct
C8	Si91842DT-18	LVR-IC	LDO, LN, +CE, -Error, 1.8V±1.5%, 150mA	SOT-23-5	28w	VR17	6k	Vs
C8	TC1054-2.85VCT713	LVR-IC	LDO, 2.85V±2%, 50mA, +CE, -Error	SOT-23-5	28w	VR8	6g	Mcc
C8	TC4S30F	CMOS-Logic	2-input EXCLUSIVE OR gate	SSOP-5	28/Log5	-	6a	Tos
C8-	RT9169-13PB	LVR-IC	LDO, 1.3V±2%, 100mA, -CE	SOT-23-5	28cx	VR4	6g	Rct
C86	74AHCT1G86GV	CMOS-Logic	2-input EXCLUSIVE-OR gate	SOT753	28/Log5	-	6a	Phi
C8A	XC6108C28AMR	Vdet-IC	2.8V±2%, Hysteresis, -Reset PPO	SOT-25	28rm	VD15	6g	Tor
C8B	XC6108C28BMR	Vdet-IC	2.8V±2%, -Reset PPO	SOT-25	28rm	VD15	6g	Tor
C8C	XC6108C28CMR	Vdet-IC	2.8V±2%, Hysteresis, -Reset PPO	SOT-25	28rk	VD15	6g	Tor
C8D	XC6108C28DMR	Vdet-IC	2.8V±2%, -Reset PPO	SOT-25	28rk	VD15	6g	Tor
C9	R1111N491A	LVR-IC	LDO, LN, -CE, 4.9V±2%, 200mA	SOT-23-5	28cx	VR4	6g	Ric



SMD code	Type	Function	Short description	Case	Pinout	Sch.	St.	Mnf.
C8	RN5VD29AA	Vdet-IC	2.9V±2.5%, -Reset PPO	SOT-23-5	28vdo	VD3	6g	Ric
C9	RT9169-15CB	LVR-IC	LDO, 1.5V±2%, 100mA, -CE	SOT-23-5	28cx	VR4	6g	Rct
C9	Si91842DT-20	LVR-IC	LDO, LN, +CE, -Error, 2V±1.5%, 150mA	SOT-23-5	28w	VR17	6k	Vs
C9	TC1054-3.6VCT713	LVR-IC	LDO, 3.6V±2%, 50mA, +CE, -Error	SOT-23-5	28w	VR8	6g	Mcc
C9-	RT9169-15PB	LVR-IC	LDO, 1.5V±2%, 100mA, -CE	SOT-23-5	28cx	VR4	6g	Rct
C9A	XC6108C29AMR	Vdet-IC	2.9V±2%, Hysteresis, -Reset PPO	SOT-25	28rm	VD15	6g	Pti
C9B	XC6108C29BMR	Vdet-IC	2.9V±2%, -Reset PPO	SOT-25	28rm	VD15	6g	Tor
C9C	XC6108C29CMR	Vdet-IC	2.9V±2%, Hysteresis, -Reset PPO	SOT-25	28rk	VD15	6g	Tor
C9D	XC6108C29DMR	Vdet-IC	2.9V±2%, -Reset PPO	SOT-25	28rk	VD15	6g	Tor
CA	µPA503T	p-MOSFET-e*	Dual, V-MOS, 50V, 100mA, <60Ω(10mA)	SOT-23-5	28fb	-	6a	Nec
CA	74AHCT1G00GW	CMOS-Logic	2-input NAND gate	SOT-353	28/Log1	-	6a	Phi
CA	PI74STX1GT125CX	CMOS-Logic	Bus buffer gate with 3-state output	SC-70-5	28/Log14	-	6a	Per
CA	PI74STX1GT125TX	CMOS-Logic	Bus buffer gate with 3-state output	SOT-23-5	28/Log14	-	6a	Per
CA	PT7M7825STA	Vdet-IC	2.93V±1.5%, ±Reset PPO, -MR	SOT-23-5	28xf	VD21	6k	Pti
CA	PT7M7825STAE	Vdet-IC	2.93V±1.5%, ±Reset PPO, -MR, Lead free	SOT-23-5	28xf	VD21	6k	Pti
CA	RN5RT40AA	LVR-IC	LDO, 4V±2%, 150mA, -CE	SOT-23-5	28vrt	VR4	6g	Ric
CA	TC7S584F	CMOS-Logic	Inverting Schmitt-trigger	SSOP-5	28/Log7	-	6a	Tos
CA	V6301ASP5B	Vdet-IC	2.0V, -Reset PPO, 290ms	SOT-23-5	28vdr	VD7	6a	Em
CA0	XC6116A031MR	Vdet-IC	3.1V±2%, -MR, ±Reset PPO, Rt=3.13ms	SOT-25	28xf	VD21	6g	Tor
CA1	XC6116A032MR	Vdet-IC	3.2V±2%, -MR, ±Reset PPO, Rt=3.13ms	SOT-25	28xf	VD21	6g	Tor
CA2	XC6116A033MR	Vdet-IC	3.3V±2%, -MR, ±Reset PPO, Rt=3.13ms	SOT-25	28xf	VD21	6g	Tor
CA3	XC6116A034MR	Vdet-IC	3.4V±2%, -MR, ±Reset PPO, Rt=3.13ms	SOT-25	28xf	VD21	6g	Tor
CA4	XC6116A035MR	Vdet-IC	3.5V±2%, -MR, ±Reset PPO, Rt=3.13ms	SOT-25	28xf	VD21	6g	Tor
CA5	XC6116A036MR	Vdet-IC	3.6V±2%, -MR, ±Reset PPO, Rt=3.13ms	SOT-25	28xf	VD21	6g	Tor
CA6	XC6116A037MR	Vdet-IC	3.7V±2%, -MR, ±Reset PPO, Rt=3.13ms	SOT-25	28xf	VD21	6g	Tor
CA7	XC6116A038MR	Vdet-IC	3.8V±2%, -MR, ±Reset PPO, Rt=3.13ms	SOT-25	28xf	VD21	6g	Tor
CA8	XC6116A039MR	Vdet-IC	3.9V±2%, -MR, ±Reset PPO, Rt=3.13ms	SOT-25	28xf	VD21	6g	Tor
CA8	XC9235B08CMR	DC-DC-IC	PWM, st-dwn, 0.8V±2%, 600mA, 1.2MHz, Vin>2V, HSST, CL	SOT-25	28dc4	DC1	6g	Tor
CA9	XC6116A040MR	Vdet-IC	4.0V±2%, -MR, ±Reset PPO, Rt=3.13ms	SOT-25	28xf	VD21	6g	Tor
CA9	XC9235B09CMR	DC-DC-IC	PWM, st-dwn, 0.9V±2%, 600mA, 1.2MHz, Vin>2V, HSST, CL	SOT-25	28dc4	DC1	6g	Tor
CAA	RP106N071B	LVR-IC	LDO, 0.7V±0.8%, 400mA, +CE	SOT-23-5	28cx	VR4	6g	Ric
CAA	XC6116A041MR	Vdet-IC	4.1V±2%, -MR, ±Reset PPO, Rt=3.13ms	SOT-25	28xf	VD21	6g	Tor
CAB	RP106N081B	LVR-IC	LDO, 0.8V±0.8%, 400mA, +CE	SOT-23-5	28cx	VR4	6g	Ric
CAB	XC6116A042MR	Vdet-IC	4.2V±2%, -MR, ±Reset PPO, Rt=3.13ms	SOT-25	28xf	VD21	6g	Tor
CAC	RP106N091B	LVR-IC	LDO, 0.9V±0.8%, 400mA, +CE	SOT-23-5	28cx	VR4	6g	Ric
CAC	XC6116A043MR	Vdet-IC	4.3V±2%, -MR, ±Reset PPO, Rt=3.13ms	SOT-25	28xf	VD21	6g	Tor
CAD	RP106N101B	LVR-IC	LDO, 1.0V±0.8%, 400mA, +CE	SOT-23-5	28cx	VR4	6g	Ric
CAD	XC6116A044MR	Vdet-IC	4.4V±2%, -MR, ±Reset PPO, Rt=3.13ms	SOT-25	28xf	VD21	6g	Tor
CAE	RP106N111B	LVR-IC	LDO, 1.1V±0.8%, 400mA, +CE	SOT-23-5	28cx	VR4	6g	Ric
CAE	XC6116A045MR	Vdet-IC	4.5V±2%, -MR, ±Reset PPO, Rt=3.13ms	SOT-25	28xf	VD21	6g	Tor
CAF	RP106N121B	LVR-IC	LDO, 1.2V±0.8%, 400mA, +CE	SOT-23-5	28cx	VR4	6g	Ric
CAF	XC6116A016MR	Vdet-IC	1.6V±2%, -MR, ±Reset PPO, Rt=3.13ms	SOT-25	28xf	VD21	6g	Tor
CAF	XC6116A046MR	Vdet-IC	4.6V±2%, -MR, ±Reset PPO, Rt=3.13ms	SOT-25	28xf	VD21	6g	Tor
CAH	RP106N131B	LVR-IC	LDO, 1.3V±0.8%, 400mA, +CE	SOT-23-5	28cx	VR4	6g	Ric
CAH	RP106N141B	LVR-IC	LDO, 1.4V±0.8%, 400mA, +CE	SOT-23-5	28cx	VR4	6g	Ric
CAH	XC6116A017MR	Vdet-IC	1.7V±2%, -MR, ±Reset PPO, Rt=3.13ms	SOT-25	28xf	VD21	6g	Tor
CAH	XC6116A047MR	Vdet-IC	4.7V±2%, -MR, ±Reset PPO, Rt=3.13ms	SOT-25	28xf	VD21	6g	Tor
CAJ	RP106N151B	LVR-IC	LDO, 1.5V±0.8%, 400mA, +CE	SOT-23-5	28cx	VR4	6g	Ric
CAK	RP106N161B	LVR-IC	LDO, 1.6V±0.8%, 400mA, +CE	SOT-23-5	28cx	VR4	6g	Ric
CAK	XC6116A018MR	Vdet-IC	1.8V±2%, -MR, ±Reset PPO, Rt=3.13ms	SOT-25	28xf	VD21	6g	Tor
CAK	XC6116A048MR	Vdet-IC	4.8V±2%, -MR, ±Reset PPO, Rt=3.13ms	SOT-25	28xf	VD21	6g	Tor
CAL	RP106N171B	LVR-IC	LDO, 1.7V±0.8%, 400mA, +CE	SOT-23-5	28cx	VR4	6g	Ric
CAL	XC6116A019MR	Vdet-IC	1.9V±2%, -MR, ±Reset PPO, Rt=3.13ms	SOT-25	28xf	VD21	6g	Tor
CAL	XC6116A049MR	Vdet-IC	4.9V±2%, -MR, ±Reset PPO, Rt=3.13ms	SOT-25	28xf	VD21	6g	Tor
CAL	XC9235B0LCMR	DC-DC-IC	PWM, st-dwn, 0.85V±2%, 600mA, 1.2MHz, Vin>2V, HSST, CL	SOT-25	28dc4	DC1	6g	Tor
CAM	RP106N181B	LVR-IC	LDO, 1.8V±0.8%, 400mA, +CE	SOT-23-5	28cx	VR4	6g	Ric
CAM	XC6116A020MR	Vdet-IC	2.0V±2%, -MR, ±Reset PPO, Rt=3.13ms	SOT-25	28xf	VD21	6g	Tor
CAM	XC6116A050MR	Vdet-IC	5.0V±2%, -MR, ±Reset PPO, Rt=3.13ms	SOT-25	28xf	VD21	6g	Tor
CAM	XC9235B0MCMR	DC-DC-IC	PWM, st-dwn, 0.95V±2%, 600mA, 1.2MHz, Vin>2V, HSST, CL	SOT-25	28dc4	DC1	6g	Tor
CAN	RP106N101B5	LVR-IC	LDO, 1.05V±0.8%, 400mA, +CE	SOT-23-5	28cx	VR4	6g	Ric
CAN	XC6116A021MR	Vdet-IC	2.1V±2%, -MR, ±Reset PPO, Rt=3.13ms	SOT-25	28xf	VD21	6g	Tor
CAP	RP106N121B5	LVR-IC	LDO, 1.25V±0.8%, 400mA, +CE	SOT-23-5	28cx	VR4	6g	Ric
CAP	XC6116A022MR	Vdet-IC	2.2V±2%, -MR, ±Reset PPO, Rt=3.13ms	SOT-25	28xf	VD21	6g	Tor
CAQ	RP106N181B5	LVR-IC	LDO, 1.85V±0.8%, 400mA, +CE	SOT-23-5	28cx	VR4	6g	Ric
CAR	NCV303LSN31T1	Vdet-IC	3.1V±1.5%, -Reset ODO	TSOP-5	28vdo	VD1	6k	Ons
CAR	RP106N111B5	LVR-IC	LDO, 1.15V±0.8%, 400mA, +CE	SOT-23-5	28cx	VR4	6g	Ric
CAR	XC6116A023MR	Vdet-IC	2.3V±2%, -MR, ±Reset PPO, Rt=3.13ms	SOT-25	28xf	VD21	6g	Tor
CAS	XC6116A024MR	Vdet-IC	2.4V±2%, -MR, ±Reset PPO, Rt=3.13ms	SOT-25	28xf	VD21	6g	Tor
CAT	NCV303LSN34T1	Vdet-IC	3.4V±1.5%, -Reset ODO	TSOP-5	28vdo	VD1	6k	Ons
CAT	XC6116A025MR	Vdet-IC	2.5V±2%, -MR, ±Reset PPO, Rt=3.13ms	SOT-25	28xf	VD21	6g	Tor



SMD code	Type	Function	Short description	Case	Pinout	Sch.	St.	Mnf.
CAU	XC6116A026MR	Vdet-IC	2.6V±2%, -MR, ±Reset PPO, Rt=3.13ms	SOT-25	28xf	VD21	6g	Tor
CAV	XC6116A027MR	Vdet-IC	2.7V±2%, -MR, ±Reset PPO, Rt=3.13ms	SOT-25	28xf	VD21	6g	Tor
CAX	XC6116A028MR	Vdet-IC	2.8V±2%, -MR, ±Reset PPO, Rt=3.13ms	SOT-25	28xf	VD21	6g	Tor
CAZ	XC6116A029MR	Vdet-IC	2.9V±2%, -MR, ±Reset PPO, Rt=3.13ms	SOT-25	28xf	VD21	6g	Tor
CAZ	XC6116A030MR	Vdet-IC	3.0V±2%, -MR, ±Reset PPO, Rt=3.13ms	SOT-25	28xf	VD21	6g	Tor
CB	µPA573T	p-MOSFET-e*	Dual, V-MOS, 30V, ±100mA, <25Q(10mA)	SOT-23-5	28fb	-	6a	Nec
CB	74AHCT1G02GW	CMOS-Logic	2-input NOR gate	SOT-353	28LLog2	-	6a	Phi
CB	PI74STX1GT126CX	CMOS-Logic	Bus buffer gate with 3-state output	SC-70-5	28/Log13	-	6a	Per
CB	PI74STX1GT126TX	CMOS-Logic	Bus buffer gate with 3-state output	SOT-23-5	28/Log13	-	6a	Per
CB	PT7M7825RTA	Vdet-IC	2.63V±1.5%, ±Reset PPO, -MR	SOT-23-5	28xf	VD21	6k	Pti
CB	RN5RT41AA	LVR-IC	LDO, 4.1V±2%, 150mA, -CE	SOT-23-5	28vrt	VR4	6g	Ric
CB	RT9167A-50CB	LVR-IC	LDO, 5.0V±2%, 600mA, +CE	SOT-23-5	28vrx	VR7	6g	Rct
CB	V6301BSP5B	Vdet-IC	2.4V, -Reset PPO, 290ms	SOT-23-5	28vdr	VD7	6a	Em
CB	PT7M7825RTAE	Vdet-IC	2.63V±1.5%, ±Reset PPO, -MR, Lead free	SOT-23-5	28xf	VD21	6k	Pti
CB-	RT9013A-18PU5	LVR-IC	LDO, 1.8V±2%, 500mA, +CE	SC-70-5	28cx	VR4	6g	Rct
CB-	RT9167A-50PB	LVR-IC	LDO, 5.0V±2%, 600mA, +CE	SOT-23-5	28vrx	VR7	6g	Rct
CB-	XC62GR2112M	LVR-IC	2.1V±2%, 150mA, +CE	SOT-25	28ew	VR4	6g	Tor
CB-	XC62GP2112M	LVR-IC	2.1V±2%, 150mA, -CE	SOT-25	28ew	VR4	6g	Tor
CB+	XC62GR2122M	LVR-IC	2.1V±2%, 150mA, +CE, HS response	SOT-25	28ew	VR4	6g	Tor
CB+	XC62GP2122M	LVR-IC	2.1V±2%, 150mA, -CE, HS response	SOT-25	28ew	VR4	6g	Tor
CB0	XC6213B312MR	LVR-IC	LDO, 3.1V±2%, 150mA, +CE	SOT-25	28cx	VR4	6g	Tor
CB0	XC9235B10CMR	DC-DC-IC	PWM, st-dwn, 1.0V±2%, 600mA, 1.2MHz, Vin>2V, HSST, CL	SOT-25	28dc4	DC1	6g	Tor
CB0	XC6116B031MR	Vdet-IC	3.1V±2%, -MR, ±Reset PPO, Rt=25ms	SOT-25	28xf	VD21	6g	Tor
CB1	XC6213B322MR	LVR-IC	LDO, 3.2V±2%, 150mA, -CE	SOT-25	28cx	VR4	6g	Tor
CB1	XC9235B11CMR	DC-DC-IC	PWM, st-dwn, 1.1V±2%, 600mA, 1.2MHz, Vin>2V, HSST, CL	SOT-25	28dc4	DC1	6g	Tor
CB1	XC6116B032MR	Vdet-IC	3.2V±2%, -MR, ±Reset PPO, Rt=25ms	SOT-25	28xf	VD21	6g	Tor
CB2	XC6213B332MR	LVR-IC	LDO, 3.3V±2%, 150mA, +CE	SOT-25	28cx	VR4	6g	Tor
CB2	XC9235B12CMR	DC-DC-IC	PWM, st-dwn, 1.2V±2%, 600mA, 1.2MHz, Vin>2V, HSST, CL	SOT-25	28dc4	DC1	6g	Tor
CB2	XC6116B033MR	Vdet-IC	3.3V±2%, -MR, ±Reset PPO, Rt=25ms	SOT-25	28xf	VD21	6g	Tor
CB3	XC6213B342MR	LVR-IC	LDO, 3.4V±2%, 150mA, +CE	SOT-25	28cx	VR4	6g	Tor
CB3	XC9235B13CMR	DC-DC-IC	PWM, st-dwn, 1.3V±2%, 600mA, 1.2MHz, Vin>2V, HSST, CL	SOT-25	28dc4	DC1	6g	Tor
CB3	XC6116B034MR	Vdet-IC	3.4V±2%, -MR, ±Reset PPO, Rt=25ms	SOT-25	28xf	VD21	6g	Tor
CB4	XC6213B352MR	LVR-IC	LDO, 3.5V±2%, 150mA, +CE	SOT-25	28cx	VR4	6g	Tor
CB4	XC9235B14CMR	DC-DC-IC	PWM, st-dwn, 1.4V±2%, 600mA, 1.2MHz, Vin>2V, HSST, CL	SOT-25	28dc4	DC1	6g	Tor
CB4	XC6116B035MR	Vdet-IC	3.5V±2%, -MR, ±Reset PPO, Rt=25ms	SOT-25	28xf	VD21	6g	Tor
CB5	XC6213B362MR	LVR-IC	LDO, 3.6V±2%, 150mA, +CE	SOT-25	28cx	VR4	6g	Tor
CB5	XC9235B15CMR	DC-DC-IC	PWM, st-dwn, 1.5V±2%, 600mA, 1.2MHz, Vin>2V, HSST, CL	SOT-25	28dc4	DC1	6g	Tor
CB5	XC6116B036MR	Vdet-IC	3.6V±2%, -MR, ±Reset PPO, Rt=25ms	SOT-25	28xf	VD21	6g	Tor
CB5	XC6365C151MR	DC/DC-IC	PWM st-down, 100kHz, 1.5V±2.5%, 1A, +CE, soft start	SOT-25	28zm	DC7	6g	Tor
CB5	XC6367C151MR	DC/DC-IC	PWM step-up, 1.5V±2.5%, 200mA, 100kHz, +CE, soft start	SOT-25	28sh	DC11	6g	Tor
CB6	XC6213B372MR	LVR-IC	LDO, 3.7V±2%, 150mA, +CE	SOT-25	28cx	VR4	6g	Tor
CB6	XC9235B16CMR	DC-DC-IC	PWM, st-dwn, 1.6V±2%, 600mA, 1.2MHz, Vin>2V, HSST, CL	SOT-25	28dc4	DC1	6g	Tor
CB6	XC6116B037MR	Vdet-IC	3.7V±2%, -MR, ±Reset PPO, Rt=25ms	SOT-25	28xf	VD21	6g	Tor
CB6	XC6365C161MR	DC/DC-IC	PWM st-down, 100kHz, 1.6V±2.5%, 1A, +CE, soft start	SOT-25	28zm	DC7	6g	Tor
CB6	XC6367C161MR	DC/DC-IC	PWM step-up, 1.6V±2.5%, 200mA, 100kHz, +CE, soft start	SOT-25	28sh	DC11	6g	Tor
CB7	XC6213B382MR	LVR-IC	LDO, 3.8V±2%, 150mA, +CE	SOT-25	28cx	VR4	6g	Tor
CB7	XC9235B17CMR	DC-DC-IC	PWM, st-dwn, 1.7V±2%, 600mA, 1.2MHz, Vin>2V, HSST, CL	SOT-25	28dc4	DC1	6g	Tor
CB7	XC6116B038MR	Vdet-IC	3.8V±2%, -MR, ±Reset PPO, Rt=25ms	SOT-25	28xf	VD21	6g	Tor
CB7	XC6365C171MR	DC/DC-IC	PWM st-down, 100kHz, 1.7V±2.5%, 1A, +CE, soft start	SOT-25	28zm	DC7	6g	Tor
CB7	XC6367C171MR	DC/DC-IC	PWM step-up, 1.7V±2.5%, 200mA, 100kHz, +CE, soft start	SOT-25	28sh	DC11	6g	Tor
CB8	XC6213B392MR	LVR-IC	LDO, 3.9V±2%, 150mA, +CE	SOT-25	28cx	VR4	6g	Tor
CB8	XC9235B18CMR	DC-DC-IC	PWM, st-dwn, 1.8V±2%, 600mA, 1.2MHz, Vin>2V, HSST, CL	SOT-25	28dc4	DC1	6g	Tor
CB8	XC6116B039MR	Vdet-IC	3.9V±2%, -MR, ±Reset PPO, Rt=25ms	SOT-25	28xf	VD21	6g	Tor
CB8	XC6365C181MR	DC/DC-IC	PWM st-down, 100kHz, 1.8V±2.5%, 1A, +CE, soft start	SOT-25	28zm	DC7	6g	Tor
CB8	XC6367C181MR	DC/DC-IC	PWM step-up, 1.8V±2.5%, 200mA, 100kHz, +CE, soft start	SOT-25	28sh	DC11	6g	Tor
CB9	XC6213B402MR	LVR-IC	LDO, 4V±2%, 150mA, +CE	SOT-25	28cx	VR4	6g	Tor
CB9	XC9235B19CMR	DC-DC-IC	PWM, st-dwn, 1.9V±2%, 600mA, 1.2MHz, Vin>2V, HSST, CL	SOT-25	28dc4	DC1	6g	Tor
CB9	XC6116B040MR	Vdet-IC	4.0V±2%, -MR, ±Reset PPO, Rt=25ms	SOT-25	28xf	VD21	6g	Tor
CB9	XC6365C191MR	DC/DC-IC	PWM st-down, 100kHz, 1.9V±2.5%, 1A, +CE, soft start	SOT-25	28zm	DC7	6g	Tor
CB9	XC6367C191MR	DC/DC-IC	PWM step-up, 1.9V±2.5%, 200mA, 100kHz, +CE, soft start	SOT-25	28sh	DC11	6g	Tor
CBA	RP106N071D	LVR-IC	LDO, 0.7V±0.8%, 400mA, +CE, CL	SOT-23-5	28cx	VR4	6g	Ric
CBA	XC6213B412MR	LVR-IC	LDO, 4.1V±2%, 150mA, +CE	SOT-25	28cx	VR4	6g	Tor
CBA	XC9235B1ACMR	DC-DC-IC	PWM, st-dwn, 1.05V±2%, 600mA, 1.2MHz, Vin>2V, HSST, CL	SOT-25	28dc4	DC1	6g	Tor
CBA	XC6116B041MR	Vdet-IC	4.1V±2%, -MR, ±Reset PPO, Rt=25ms	SOT-25	28xf	VD21	6g	Tor
CBB	RP106N081D	LVR-IC	LDO, 0.8V±0.8%, 400mA, +CE, CL	SOT-23-5	28cx	VR4	6g	Ric
CBB	XC6213B422MR	LVR-IC	LDO, 4.2V±2%, 150mA, +CE	SOT-25	28cx	VR4	6g	Tor
CBB	XC9235B1BCMR	DC-DC-IC	PWM, st-dwn, 1.15V±2%, 600mA, 1.2MHz, Vin>2V, HSST, CL	SOT-25	28dc4	DC1	6g	Tor
CBB	XC6116B042MR	Vdet-IC	4.2V±2%, -MR, ±Reset PPO, Rt=25ms	SOT-25	28xf	VD21	6g	Tor
CBC	RP106N091D	LVR-IC	LDO, 0.9V±0.8%, 400mA, +CE, CL	SOT-23-5	28cx	VR4	6g	Ric
CBC	XC6213B432MR	LVR-IC	LDO, 4.3V±2%, 150mA, +CE	SOT-25	28cx	VR4	6g	Tor



SMD code	Type	Function	Short description	Case	Pinout	Sch.	St.	Mnf.
CB C	XC9235B1CCMR	DC-DC-IC	PWM, st-dwn, 1.25V±2%, 600mA, 1.2MHz, Vin>2V, HSST, CL	SOT-25	28dc4	DC1	6g	Tor
CB C	XO6116B043MR	Vdet-IC	4.3V±2%, -MR, ±Reset PPO, Rt=25ms	SOT-25	28xf	VD21	6g	Tor
CB D	RP106N101D	LVR-IC	LDO, 1.0V±0.8%, 400mA, +CE, CL	SOT-23-5	28cx	VR4	6g	Ric
CB D	XC6213B442MR	LVR-IC	LDO, 4.4V±2%, 150mA, +CE	SOT-25	28cx	VR4	6g	Tor
CB D	XC9235B1DCMR	DC-DC-IC	PWM, st-dwn, 1.35V±2%, 600mA, 1.2MHz, Vin>2V, HSST, CL	SOT-25	28dc4	DC1	6g	Tor
CB D	XO6116B044MR	Vdet-IC	4.4V±2%, -MR, ±Reset PPO, Rt=25ms	SOT-25	28xf	VD21	6g	Tor
CB E	RP106N111D	LVR-IC	LDO, 1.1V±0.8%, 400mA, +CE, CL	SOT-23-5	28cx	VR4	6g	Ric
CB E	XC6213B452MR	LVR-IC	LDO, 4.5V±2%, 150mA, +CE	SOT-25	28cx	VR4	6g	Tor
CB E	XC9235B1ECMR	DC-DC-IC	PWM, st-dwn, 1.45V±2%, 600mA, 1.2MHz, Vin>2V, HSST, CL	SOT-25	28dc4	DC1	6g	Tor
CB E	XO6116B045MR	Vdet-IC	4.5V±2%, -MR, ±Reset PPO, Rt=25ms	SOT-25	28xf	VD21	6g	Tor
CB F	RP106N121D	LVR-IC	LDO, 1.2V±0.8%, 400mA, +CE, CL	SOT-23-5	28cx	VR4	6g	Ric
CB F	XC6213B462MR	LVR-IC	LDO, 4.6V±2%, 150mA, +CE	SOT-25	28cx	VR4	6g	Tor
CB F	XC9235B1FCMR	DC-DC-IC	PWM, st-dwn, 1.55V±2%, 600mA, 1.2MHz, Vin>2V, HSST, CL	SOT-25	28dc4	DC1	6g	Tor
CB F	XO6116B016MR	Vdet-IC	1.6V±2%, -MR, ±Reset PPO, Rt=25ms	SOT-25	28xf	VD21	6g	Tor
CB F	XO6116B046MR	Vdet-IC	4.6V±2%, -MR, ±Reset PPO, Rt=25ms	SOT-25	28xf	VD21	6g	Tor
CB F	XC6365C155MR	DC/DC-IC	PWM st-down, 500kHz, 1.5V±2.5%, 1A, +CE, soft start	SOT-25	28zm	DC7	6g	Tor
CB F	XC6367C155MR	DC/DC-IC	PWM step-up, 1.5V±2.5%, 200mA, 500kHz, +CE, soft start	SOT-25	28sh	DC11	6g	Tor
CB G	RP106N131D	LVR-IC	LDO, 1.3V±0.8%, 400mA, +CE, CL	SOT-23-5	28cx	VR4	6g	Ric
CB G	RP106N141D	LVR-IC	LDO, 1.4V±0.8%, 400mA, +CE, CL	SOT-23-5	28cx	VR4	6g	Ric
CB H	XC6213B472MR	LVR-IC	LDO, 4.7V±2%, 150mA, +CE	SOT-25	28cx	VR4	6g	Tor
CB H	XC9235B1HCMR	DC-DC-IC	PWM, st-dwn, 1.65V±2%, 600mA, 1.2MHz, Vin>2V, HSST, CL	SOT-25	28dc4	DC1	6g	Tor
CB H	XO6116B017MR	Vdet-IC	1.7V±2%, -MR, ±Reset PPO, Rt=25ms	SOT-25	28xf	VD21	6g	Tor
CB H	XO6116B047MR	Vdet-IC	4.7V±2%, -MR, ±Reset PPO, Rt=25ms	SOT-25	28xf	VD21	6g	Tor
CB H	XC6365C165MR	DC/DC-IC	PWM st-down, 500kHz, 1.6V±2.5%, 1A, +CE, soft start	SOT-25	28zm	DC7	6g	Tor
CB H	XC6367C165MR	DC/DC-IC	PWM step-up, 1.6V±2.5%, 200mA, 500kHz, +CE, soft start	SOT-25	28sh	DC11	6g	Tor
CB J	RP106N151D	LVR-IC	LDO, 1.5V±0.8%, 400mA, +CE, CL	SOT-23-5	28cx	VR4	6g	Ric
CB K	RP106N161D	LVR-IC	LDO, 1.6V±0.8%, 400mA, +CE, CL	SOT-23-5	28cx	VR4	6g	Ric
CB K	XC6213B482MR	LVR-IC	LDO, 4.8V±2%, 150mA, +CE	SOT-25	28cx	VR4	6g	Tor
CB K	XC9235B1KCMR	DC-DC-IC	PWM, st-dwn, 1.75V±2%, 600mA, 1.2MHz, Vin>2V, HSST, CL	SOT-25	28dc4	DC1	6g	Tor
CB K	XO6116B018MR	Vdet-IC	1.8V±2%, -MR, ±Reset PPO, Rt=25ms	SOT-25	28xf	VD21	6g	Tor
CB K	XO6116B048MR	Vdet-IC	4.8V±2%, -MR, ±Reset PPO, Rt=25ms	SOT-25	28xf	VD21	6g	Tor
CB K	XC6365C175MR	DC/DC-IC	PWM st-down, 500kHz, 1.7V±2.5%, 1A, +CE, soft start	SOT-25	28zm	DC7	6g	Tor
CB K	XC6367C175MR	DC/DC-IC	PWM step-up, 1.7V±2.5%, 200mA, 500kHz, +CE, soft start	SOT-25	28sh	DC11	6g	Tor
CB L	RP106N171D	LVR-IC	LDO, 1.7V±0.8%, 400mA, +CE, CL	SOT-23-5	28cx	VR4	6g	Ric
CB L	XC6213B492MR	LVR-IC	LDO, 4.9V±2%, 150mA, +CE	SOT-25	28cx	VR4	6g	Tor
CB L	XC9235B1LCMR	DC-DC-IC	PWM, st-dwn, 1.85V±2%, 600mA, 1.2MHz, Vin>2V, HSST, CL	SOT-25	28dc4	DC1	6g	Tor
CB L	XO6116B019MR	Vdet-IC	1.9V±2%, -MR, ±Reset PPO, Rt=25ms	SOT-25	28xf	VD21	6g	Tor
CB L	XO6116B049MR	Vdet-IC	4.9V±2%, -MR, ±Reset PPO, Rt=25ms	SOT-25	28xf	VD21	6g	Tor
CB L	XC6365C185MR	DC/DC-IC	PWM st-down, 500kHz, 1.8V±2.5%, 1A, +CE, soft start	SOT-25	28zm	DC7	6g	Tor
CB L	XC6367C185MR	DC/DC-IC	PWM step-up, 1.8V±2.5%, 200mA, 500kHz, +CE, soft start	SOT-25	28sh	DC11	6g	Tor
CB M	RP106N181D	LVR-IC	LDO, 1.8V±0.8%, 400mA, +CE, CL	SOT-23-5	28cx	VR4	6g	Ric
CB M	XC6213B502MR	LVR-IC	LDO, 5V±2%, 150mA, +CE	SOT-25	28cx	VR4	6g	Tor
CB M	XC9235B1MCMR	DC-DC-IC	PWM, st-dwn, 1.95V±2%, 600mA, 1.2MHz, Vin>2V, HSST, CL	SOT-25	28dc4	DC1	6g	Tor
CB M	XO6116B020MR	Vdet-IC	2.0V±2%, -MR, ±Reset PPO, Rt=25ms	SOT-25	28xf	VD21	6g	Tor
CB M	XO6116B050MR	Vdet-IC	5.0V±2%, -MR, ±Reset PPO, Rt=25ms	SOT-25	28xf	VD21	6g	Tor
CB M	XC6365C195MR	DC/DC-IC	PWM st-down, 500kHz, 1.9V±2.5%, 1A, +CE, soft start	SOT-25	28zm	DC7	6g	Tor
CB M	XC6367C195MR	DC/DC-IC	PWM step-up, 1.9V±2.5%, 200mA, 500kHz, +CE, soft start	SOT-25	28sh	DC11	6g	Tor
CB N	RP106N101D5	LVR-IC	LDO, 1.05V±0.8%, 400mA, +CE, CL	SOT-23-5	28cx	VR4	6g	Ric
CB N	XO6116B021MR	Vdet-IC	2.1V±2%, -MR, ±Reset PPO, Rt=25ms	SOT-25	28xf	VD21	6g	Tor
CB P	RP106N121D5	LVR-IC	LDO, 1.25V±0.8%, 400mA, +CE, CL	SOT-23-5	28cx	VR4	6g	Ric
CB P	XO6116B022MR	Vdet-IC	2.2V±2%, -MR, ±Reset PPO, Rt=25ms	SOT-25	28xf	VD21	6g	Tor
CB Q	RP106N181D5	LVR-IC	LDO, 1.85V±0.8%, 400mA, +CE, CL	SOT-23-5	28cx	VR4	6g	Ric
CB R	RP106N111D5	LVR-IC	LDO, 1.15V±0.8%, 400mA, +CE, CL	SOT-23-5	28cx	VR4	6g	Ric
CB R	XO6116B023MR	Vdet-IC	2.3V±2%, -MR, ±Reset PPO, Rt=25ms	SOT-25	28xf	VD21	6g	Tor
CB S	XO6116B024MR	Vdet-IC	2.4V±2%, -MR, ±Reset PPO, Rt=25ms	SOT-25	28xf	VD21	6g	Tor
CB T	XO6116B025MR	Vdet-IC	2.5V±2%, -MR, ±Reset PPO, Rt=25ms	SOT-25	28xf	VD21	6g	Tor
CB U	XO6116B026MR	Vdet-IC	2.6V±2%, -MR, ±Reset PPO, Rt=25ms	SOT-25	28xf	VD21	6g	Tor
CB V	XO6116B027MR	Vdet-IC	2.7V±2%, -MR, ±Reset PPO, Rt=25ms	SOT-25	28xf	VD21	6g	Tor
CB X	XO6116B028MR	Vdet-IC	2.8V±2%, -MR, ±Reset PPO, Rt=25ms	SOT-25	28xf	VD21	6g	Tor
CB Y	XO6116B029MR	Vdet-IC	2.9V±2%, -MR, ±Reset PPO, Rt=25ms	SOT-25	28xf	VD21	6g	Tor
CB Z	XO6116B030MR	Vdet-IC	3.0V±2%, -MR, ±Reset PPO, Rt=25ms	SOT-25	28xf	VD21	6g	Tor
CC	74AHCT1G04GW	CMOS-Logic	Inverter	SOT-353	28/Log6	-	6a	Phi
CC	PT7M7825ZTA	Vdet-IC	2.32V±1.5%, ±Reset PPO, -MR	SOT-23-5	28xf	VD21	6k	Pti
CC	RN5RT42AA	LVR-IC	LDO, 4.2V±2%, 150mA, -CE	SOT-23-5	28wrt	VR4	6g	Ric
CC	V6301CSP5B	Vdet-IC	2.8V, -Reset PPO, 290ms	SOT-23-5	28vdr	VD7	6a	Em
CC	PT7M7825ZTAE	Vdet-IC	2.32V±1.5%, ±Reset PPO, -MR, Lead free	SOT-23-5	28xf	VD21	6k	Pti
CC-	XC62GR2212M	LVR-IC	2.2V±2%, 150mA, +CE	SOT-25	28ew	VR4	6g	Tor
CC-	XC62GP2212M	LVR-IC	2.2V±2%, 150mA, -CE	SOT-25	28ew	VR4	6g	Tor
CC	SN74LVCG204DCK	CMOS-Logic	Dual inverters	SC-70-5	28/Log24	-	6a	Ti
CC+	XC62GR2222M	LVR-IC	2.2V±2%, 150mA, +CE, HS response	SOT-25	28ew	VR4	6g	Tor



SMD code	Type	Function	Short description	Case	Pinout	Sch.	St.	Mnf.
CC+	XC62GP2222M	LVR-IC	2.2V±2%, 150mA, -CE, HS response	SOT-25	28ew	VR4	6g	Tor
CC=	RT9013A-26GU5	LVR-IC	LDO, 2.6V±2%, 500mA, +CE	SC-70-5	28cx	VR4	6g	Rct
CC0	XC9235B20CMR	DC-DC-IC	PWM, st-dwn, 2.0V±2%, 600mA, 1.2MHz, Vin>2V, HSST, CL	SOT-25	28dc4	DC1	6g	Tor
CC0	XC6116C031MR	Vdet-IC	3.1V±2%, -MR, ±Reset PPO, Rt=50ms	SOT-25	28xf	VD21	6g	Tor
CC0	XC6365C201MR	DC/DC-IC	PWM st-dwn, 100kHz, 2.0V±2.5%, 1A, +CE, soft start	SOT-25	28zm	DC7	6g	Tor
CC0	XC6367C201MR	DC/DC-IC	PWM step-up, 2.0V±2.5%, 200mA, 100kHz, +CE, soft start	SOT-25	28sh	DC11	6g	Tor
CC1	XC9235B21CMR	DC-DC-IC	PWM, st-dwn, 2.1V±2%, 600mA, 1.2MHz, Vin>2V, HSST, CL	SOT-25	28dc4	DC1	6g	Tor
CC1	XC6116C032MR	Vdet-IC	3.2V±2%, -MR, ±Reset PPO, Rt=50ms	SOT-25	28xf	VD21	6g	Tor
CC1	XC6365C211MR	DC/DC-IC	PWM st-dwn, 100kHz, 2.1V±2.5%, 1A, +CE, soft start	SOT-25	28zm	DC7	6g	Tor
CC1	XC6367C211MR	DC/DC-IC	PWM step-up, 2.1V±2.5%, 200mA, 100kHz, +CE, soft start	SOT-25	28sh	DC11	6g	Tor
CC2	XC9235B22CMR	DC-DC-IC	PWM, st-dwn, 2.2V±2%, 600mA, 1.2MHz, Vin>2V, HSST, CL	SOT-25	28dc4	DC1	6g	Tor
CC2	XC6116C033MR	Vdet-IC	3.3V±2%, -MR, ±Reset PPO, Rt=50ms	SOT-25	28xf	VD21	6g	Tor
CC2	XC6365C221MR	DC/DC-IC	PWM st-dwn, 100kHz, 2.2V±2.5%, 1A, +CE, soft start	SOT-25	28zm	DC7	6g	Tor
CC2	XC6367C221MR	DC/DC-IC	PWM step-up, 2.2V±2.5%, 200mA, 100kHz, +CE, soft start	SOT-25	28sh	DC11	6g	Tor
CC3	XC9235B23CMR	DC-DC-IC	PWM, st-dwn, 2.3V±2%, 600mA, 1.2MHz, Vin>2V, HSST, CL	SOT-25	28dc4	DC1	6g	Tor
CC3	XC6116C034MR	Vdet-IC	3.4V±2%, -MR, ±Reset PPO, Rt=50ms	SOT-25	28xf	VD21	6g	Tor
CC3	XC6365C231MR	DC/DC-IC	PWM st-dwn, 100kHz, 2.3V±2.5%, 1A, +CE, soft start	SOT-25	28zm	DC7	6g	Tor
CC3	XC6367C231MR	DC/DC-IC	PWM step-up, 2.3V±2.5%, 200mA, 100kHz, +CE, soft start	SOT-25	28sh	DC11	6g	Tor
CC4	XC9235B24CMR	DC-DC-IC	PWM, st-dwn, 2.4V±2%, 600mA, 1.2MHz, Vin>2V, HSST, CL	SOT-25	28dc4	DC1	6g	Tor
CC4	XC6116C035MR	Vdet-IC	3.5V±2%, -MR, ±Reset PPO, Rt=50ms	SOT-25	28xf	VD21	6g	Tor
CC4	XC6365C241MR	DC/DC-IC	PWM st-dwn, 100kHz, 2.4V±2.5%, 1A, +CE, soft start	SOT-25	28zm	DC7	6g	Tor
CC4	XC6367C241MR	DC/DC-IC	PWM step-up, 2.4V±2.5%, 200mA, 100kHz, +CE, soft start	SOT-25	28sh	DC11	6g	Tor
CC5	XC9235B25CMR	DC-DC-IC	PWM, st-dwn, 2.5V±2%, 600mA, 1.2MHz, Vin>2V, HSST, CL	SOT-25	28dc4	DC1	6g	Tor
CC5	XC6116C036MR	Vdet-IC	3.6V±2%, -MR, ±Reset PPO, Rt=50ms	SOT-25	28xf	VD21	6g	Tor
CC5	XC6365C251MR	DC/DC-IC	PWM st-dwn, 100kHz, 2.5V±2.5%, 1A, +CE, soft start	SOT-25	28zm	DC7	6g	Tor
CC5	XC6367C251MR	DC/DC-IC	PWM step-up, 2.5V±2.5%, 200mA, 100kHz, +CE, soft start	SOT-25	28sh	DC11	6g	Tor
CC6	XC9235B26CMR	DC-DC-IC	PWM, st-dwn, 2.6V±2%, 600mA, 1.2MHz, Vin>2V, HSST, CL	SOT-25	28dc4	DC1	6g	Tor
CC6	XC6116C037MR	Vdet-IC	3.7V±2%, -MR, ±Reset PPO, Rt=50ms	SOT-25	28xf	VD21	6g	Tor
CC6	XC6365C261MR	DC/DC-IC	PWM st-dwn, 100kHz, 2.6V±2.5%, 1A, +CE, soft start	SOT-25	28zm	DC7	6g	Tor
CC6	XC6367C261MR	DC/DC-IC	PWM step-up, 2.6V±2.5%, 200mA, 100kHz, +CE, soft start	SOT-25	28sh	DC11	6g	Tor
CC7	XC9235B27CMR	DC-DC-IC	PWM, st-dwn, 2.7V±2%, 600mA, 1.2MHz, Vin>2V, HSST, CL	SOT-25	28dc4	DC1	6g	Tor
CC7	XC6116C038MR	Vdet-IC	3.8V±2%, -MR, ±Reset PPO, Rt=50ms	SOT-25	28xf	VD21	6g	Tor
CC7	XC6365C271MR	DC/DC-IC	PWM st-dwn, 100kHz, 2.7V±2.5%, 1A, +CE, soft start	SOT-25	28zm	DC7	6g	Tor
CC7	XC6367C271MR	DC/DC-IC	PWM step-up, 2.7V±2.5%, 200mA, 100kHz, +CE, soft start	SOT-25	28sh	DC11	6g	Tor
CC8	XC9235B28CMR	DC-DC-IC	PWM, st-dwn, 2.8V±2%, 600mA, 1.2MHz, Vin>2V, HSST, CL	SOT-25	28dc4	DC1	6g	Tor
CC8	XC6116C039MR	Vdet-IC	3.9V±2%, -MR, ±Reset PPO, Rt=50ms	SOT-25	28xf	VD21	6g	Tor
CC8	XC6365C281MR	DC/DC-IC	PWM st-dwn, 100kHz, 2.8V±2.5%, 1A, +CE, soft start	SOT-25	28zm	DC7	6g	Tor
CC8	XC6367C281MR	DC/DC-IC	PWM step-up, 2.8V±2.5%, 200mA, 100kHz, +CE, soft start	SOT-25	28sh	DC11	6g	Tor
CC9	XC9235B29CMR	DC-DC-IC	PWM, st-dwn, 2.9V±2%, 600mA, 1.2MHz, Vin>2V, HSST, CL	SOT-25	28dc4	DC1	6g	Tor
CC9	XC6116C040MR	Vdet-IC	4.0V±2%, -MR, ±Reset PPO, Rt=50ms	SOT-25	28xf	VD21	6g	Tor
CC9	XC6365C291MR	DC/DC-IC	PWM st-dwn, 100kHz, 2.9V±2.5%, 1A, +CE, soft start	SOT-25	28zm	DC7	6g	Tor
CC9	XC6367C291MR	DC/DC-IC	PWM step-up, 2.9V±2.5%, 200mA, 100kHz, +CE, soft start	SOT-25	28sh	DC11	6g	Tor
CCA	XC9235B2ACMR	DC-DC-IC	PWM, st-dwn, 2.05V±2%, 600mA, 1.2MHz, Vin>2V, HSST, CL	SOT-25	28dc4	DC1	6g	Tor
CCA	XC6116C041MR	Vdet-IC	4.1V±2%, -MR, ±Reset PPO, Rt=50ms	SOT-25	28xf	VD21	6g	Tor
CCA	XC6365C205MR	DC/DC-IC	PWM st-dwn, 500kHz, 2.0V±2.5%, 1A, +CE, soft start	SOT-25	28zm	DC7	6g	Tor
CCA	XC6367C205MR	DC/DC-IC	PWM step-up, 2.0V±2.5%, 200mA, 500kHz, +CE, soft start	SOT-25	28sh	DC11	6g	Tor
CCB	XC9235B2BCMR	DC-DC-IC	PWM, st-dwn, 2.15V±2%, 600mA, 1.2MHz, Vin>2V, HSST, CL	SOT-25	28dc4	DC1	6g	Tor
CCB	XC6116C042MR	Vdet-IC	4.2V±2%, -MR, ±Reset PPO, Rt=50ms	SOT-25	28xf	VD21	6g	Tor
CCB	XC6365C215MR	DC/DC-IC	PWM st-dwn, 500kHz, 2.1V±2.5%, 1A, +CE, soft start	SOT-25	28zm	DC7	6g	Tor
CCB	XC6367C215MR	DC/DC-IC	PWM step-up, 2.1V±2.5%, 200mA, 500kHz, +CE, soft start	SOT-25	28sh	DC11	6g	Tor
CCB	XC9235B2CCMR	DC-DC-IC	PWM, st-dwn, 2.25V±2%, 600mA, 1.2MHz, Vin>2V, HSST, CL	SOT-25	28dc4	DC1	6g	Tor
CCB	XC6116C043MR	Vdet-IC	4.3V±2%, -MR, ±Reset PPO, Rt=50ms	SOT-25	28xf	VD21	6g	Tor
CCB	XC6365C225MR	DC/DC-IC	PWM st-dwn, 500kHz, 2.2V±2.5%, 1A, +CE, soft start	SOT-25	28zm	DC7	6g	Tor
CCB	XC6367C225MR	DC/DC-IC	PWM step-up, 2.2V±2.5%, 200mA, 500kHz, +CE, soft start	SOT-25	28sh	DC11	6g	Tor
CCD	XC9235B2DCMR	DC-DC-IC	PWM, st-dwn, 2.35V±2%, 600mA, 1.2MHz, Vin>2V, HSST, CL	SOT-25	28dc4	DC1	6g	Tor
CCD	XC6116C044MR	Vdet-IC	4.4V±2%, -MR, ±Reset PPO, Rt=50ms	SOT-25	28xf	VD21	6g	Tor
CCD	XC6365C235MR	DC/DC-IC	PWM st-dwn, 500kHz, 2.3V±2.5%, 1A, +CE, soft start	SOT-25	28zm	DC7	6g	Tor
CCD	XC6367C235MR	DC/DC-IC	PWM step-up, 2.3V±2.5%, 200mA, 500kHz, +CE, soft start	SOT-25	28sh	DC11	6g	Tor
CCE	XC9235B2ECMR	DC-DC-IC	PWM, st-dwn, 2.45V±2%, 600mA, 1.2MHz, Vin>2V, HSST, CL	SOT-25	28dc4	DC1	6g	Tor
CCE	XC6116C045MR	Vdet-IC	4.5V±2%, -MR, ±Reset PPO, Rt=50ms	SOT-25	28xf	VD21	6g	Tor
CCE	XC6365C245MR	DC/DC-IC	PWM st-dwn, 500kHz, 2.4V±2.5%, 1A, +CE, soft start	SOT-25	28zm	DC7	6g	Tor
CCE	XC6367C245MR	DC/DC-IC	PWM step-up, 2.4V±2.5%, 200mA, 500kHz, +CE, soft start	SOT-25	28sh	DC11	6g	Tor
CCF	XC9235B2FCMR	DC-DC-IC	PWM, st-dwn, 2.55V±2%, 600mA, 1.2MHz, Vin>2V, HSST, CL	SOT-25	28dc4	DC1	6g	Tor
CCF	XC6116C016MR	Vdet-IC	1.6V±2%, -MR, ±Reset PPO, Rt=50ms	SOT-25	28xf	VD21	6g	Tor
CCF	XC6116C046MR	Vdet-IC	4.6V±2%, -MR, ±Reset PPO, Rt=50ms	SOT-25	28xf	VD21	6g	Tor
CCF	XC6365C255MR	DC/DC-IC	PWM st-dwn, 500kHz, 2.5V±2.5%, 1A, +CE, soft start	SOT-25	28zm	DC7	6g	Tor
CCF	XC6367C255MR	DC/DC-IC	PWM step-up, 2.5V±2.5%, 200mA, 500kHz, +CE, soft start	SOT-25	28sh	DC11	6g	Tor
CH	XC9235B2HCMR	DC-DC-IC	PWM, st-dwn, 2.65V±2%, 600mA, 1.2MHz, Vin>2V, HSST, CL	SOT-25	28dc4	DC1	6g	Tor
CH	XC6116C017MR	Vdet-IC	1.7V±2%, -MR, ±Reset PPO, Rt=50ms	SOT-25	28xf	VD21	6g	Tor
CH	XC6116C047MR	Vdet-IC	4.7V±2%, -MR, ±Reset PPO, Rt=50ms	SOT-25	28xf	VD21	6g	Tor



SMD code	Type	Function	Short description	Case	Pinout	Sch.	St.	Mnf.
<u>CC</u> H	XC6365C265MR	DC/DC-IC	PWM st-down, 500kHz, 2.6V±2.5%, 1A, +CE, soft start	SOT-25	28zm	DC7	6g	Tor
<u>CC</u> H	XC6367C265MR	DC/DC-IC	PWM step-up, 2.6V±2.5%, 200mA, 500kHz, +CE, soft start	SOT-25	28sh	DC11	6g	Tor
<u>CC</u> K	XC9235B2KCMR	DC-DC-IC	PWM, st-dwn, 2.75V±2%, 600mA, 1.2MHz, Vin>2V, HSST, CL	SOT-25	28dc4	DC1	6g	Tor
<u>CC</u> K	XC6116C018MR	Vdet-IC	1.8V±2%, -MR, ±Reset PPO, Rt=50ms	SOT-25	28xf	VD21	6g	Tor
<u>CC</u> K	XC6116C048MR	Vdet-IC	4.8V±2%, -MR, ±Reset PPO, Rt=50ms	SOT-25	28xf	VD21	6g	Tor
<u>CC</u> K	XC6365C275MR	DC/DC-IC	PWM st-down, 500kHz, 2.7V±2.5%, 1A, +CE, soft start	SOT-25	28zm	DC7	6g	Tor
<u>CC</u> K	XC6367C275MR	DC/DC-IC	PWM step-up, 2.7V±2.5%, 200mA, 500kHz, +CE, soft start	SOT-25	28sh	DC11	6g	Tor
<u>CC</u> L	XC9235B2LCMR	DC-DC-IC	PWM, st-dwn, 2.85V±2%, 600mA, 1.2MHz, Vin>2V, HSST, CL	SOT-25	28dc4	DC1	6g	Tor
<u>CC</u> L	XC6116C019MR	Vdet-IC	1.9V±2%, -MR, ±Reset PPO, Rt=50ms	SOT-25	28xf	VD21	6g	Tor
<u>CC</u> L	XC6116C049MR	Vdet-IC	4.9V±2%, -MR, ±Reset PPO, Rt=50ms	SOT-25	28xf	VD21	6g	Tor
<u>CC</u> L	XC6365C285MR	DC/DC-IC	PWM st-down, 500kHz, 2.8V±2.5%, 1A, +CE, soft start	SOT-25	28zm	DC7	6g	Tor
<u>CC</u> L	XC6367C285MR	DC/DC-IC	PWM step-up, 2.8V±2.5%, 200mA, 500kHz, +CE, soft start	SOT-25	28sh	DC11	6g	Tor
<u>CC</u> M	XC9235B2MCMR	DC-DC-IC	PWM, st-dwn, 2.95V±2%, 600mA, 1.2MHz, Vin>2V, HSST, CL	SOT-25	28dc4	DC1	6g	Tor
<u>CC</u> M	XC6116C020MR	Vdet-IC	2.0V±2%, -MR, ±Reset PPO, Rt=50ms	SOT-25	28xf	VD21	6g	Tor
<u>CC</u> M	XC6116C050MR	Vdet-IC	5.0V±2%, -MR, ±Reset PPO, Rt=50ms	SOT-25	28xf	VD21	6g	Tor
<u>CC</u> M	XC6365C295MR	DC/DC-IC	PWM st-down, 500kHz, 2.9V±2.5%, 1A, +CE, soft start	SOT-25	28zm	DC7	6g	Tor
<u>CC</u> M	XC6367C295MR	DC/DC-IC	PWM step-up, 2.9V±2.5%, 200mA, 500kHz, +CE, soft start	SOT-25	28sh	DC11	6g	Tor
<u>CC</u> N	XC6116C021MR	Vdet-IC	2.1V±2%, -MR, ±Reset PPO, Rt=50ms	SOT-25	28xf	VD21	6g	Tor
<u>CC</u> P	XC6116C022MR	Vdet-IC	2.2V±2%, -MR, ±Reset PPO, Rt=50ms	SOT-25	28xf	VD21	6g	Tor
<u>CC</u> R	XC6116C023MR	Vdet-IC	2.3V±2%, -MR, ±Reset PPO, Rt=50ms	SOT-25	28xf	VD21	6g	Tor
<u>CC</u> S	XC6116C024MR	Vdet-IC	2.4V±2%, -MR, ±Reset PPO, Rt=50ms	SOT-25	28xf	VD21	6g	Tor
<u>CC</u> T	XC6116C025MR	Vdet-IC	2.5V±2%, -MR, ±Reset PPO, Rt=50ms	SOT-25	28xf	VD21	6g	Tor
<u>CC</u> U	XC6116C026MR	Vdet-IC	2.6V±2%, -MR, ±Reset PPO, Rt=50ms	SOT-25	28xf	VD21	6g	Tor
<u>CC</u> V	XC6116C027MR	Vdet-IC	2.7V±2%, -MR, ±Reset PPO, Rt=50ms	SOT-25	28xf	VD21	6g	Tor
<u>CC</u> X	XC6116C028MR	Vdet-IC	2.8V±2%, -MR, ±Reset PPO, Rt=50ms	SOT-25	28xf	VD21	6g	Tor
<u>CC</u> Y	XC6116C029MR	Vdet-IC	2.9V±2%, -MR, ±Reset PPO, Rt=50ms	SOT-25	28xf	VD21	6g	Tor
<u>CC</u> Z	XC6116C030MR	Vdet-IC	3.0V±2%, -MR, ±Reset PPO, Rt=50ms	SOT-25	28xf	VD21	6g	Tor
<u>CD</u>	BH25FB1WG	LVR-IC	LDO, 2.5V, 150mA, +CE	SSOP-5	30cx	VR4	6c	Rhm
<u>CD</u>	BH25FB1WHFV	LVR-IC	LDO, 2.5V, 150mA, +CE	HVSOF5	30vr3	VR4	6e	Rhm
<u>CD</u>	PI74STX1GT32CX	CMOS-Logic	2-input OR gate	SC-70-5	28/Log4	-	6a	Per
<u>CD</u>	PI74STX1GT32TX	CMOS-Logic	2-input OR gate	SOT-23-5	28/Log4	-	6a	Per
<u>CD</u>	PT7M7825YTA	Vdet-IC	2.20V±1.5%, ±Reset PPO, -MR	SOT-23-5	28xf	VD21	6k	Pti
<u>CD</u>	RN5RT43AA	LVR-IC	LDO, 4.3V±2%, 150mA, -CE	SOT-23-5	28vrt	VR4	6g	Ric
<u>CD</u>	V6301D5P5B	Vdet-IC	3.5V, -Reset PPO, 290ms	SOT-23-5	28vdr	VD7	6a	Em
<u>CD</u>	PT7M7825YTAE	Vdet-IC	2.20V±1.5%, ±Reset PPO, -MR, Lead free	SOT-23-5	28xf	VD21	6k	Pti
<u>CD</u>	XC62GR2312M	LVR-IC	2.3V±2%, 150mA, +CE	SOT-25	28ew	VR4	6g	Tor
<u>CD</u>	XC62GP2312M	LVR-IC	2.3V±2%, 150mA, -CE	SOT-25	28ew	VR4	6g	Tor
<u>CD</u> +	XC62GR2322M	LVR-IC	2.3V±2%, 150mA, +CE, HS response	SOT-25	28ew	VR4	6g	Tor
<u>CD</u> +	XC62GP2322M	LVR-IC	2.3V±2%, 150mA, -CE, HS response	SOT-25	28ew	VR4	6g	Tor
<u>CD</u> -	RT9013-1BGU5	LVR-IC	LDO, 1.25V±2%, 500mA, +CE	SC-70-5	28cx	VR4	6g	Rct
<u>CD</u> 0	XC9235B30CMR	DC-DC-IC	PWM, st-dwn, 3.0V±2%, 600mA, 1.2MHz, Vin>2V, HSST, CL	SOT-25	28dc4	DC1	6g	Tor
<u>CD</u> 0	XC6116D031MR	Vdet-IC	3.1V±2%, -MR, ±Reset PPO, Rt=100ms	SOT-25	28xf	VD21	6g	Tor
<u>CD</u> 0	XC6365C301MR	DC/DC-IC	PWM st-down, 100kHz, 3.0V±2.5%, 1A, +CE, soft start	SOT-25	28zm	DC7	6g	Tor
<u>CD</u> 0	XC6367C301MR	DC/DC-IC	PWM step-up, 3.0V±2.5%, 200mA, 100kHz, +CE, soft start	SOT-25	28sh	DC11	6g	Tor
<u>CD</u> 1	XC9235B31CMR	DC-DC-IC	PWM, st-dwn, 3.1V±2%, 600mA, 1.2MHz, Vin>2V, HSST, CL	SOT-25	28dc4	DC1	6g	Tor
<u>CD</u> 1	XC6116D032MR	Vdet-IC	3.2V±2%, -MR, ±Reset PPO, Rt=100ms	SOT-25	28xf	VD21	6g	Tor
<u>CD</u> 1	XC6365C311MR	DC/DC-IC	PWM st-down, 100kHz, 3.1V±2.5%, 1A, +CE, soft start	SOT-25	28zm	DC7	6g	Tor
<u>CD</u> 1	XC6367C311MR	DC/DC-IC	PWM step-up, 3.1V±2.5%, 200mA, 100kHz, +CE, soft start	SOT-25	28sh	DC11	6g	Tor
<u>CD</u> 2	XC9235B32CMR	DC-DC-IC	PWM, st-dwn, 3.2V±2%, 600mA, 1.2MHz, Vin>2V, HSST, CL	SOT-25	28dc4	DC1	6g	Tor
<u>CD</u> 2	XC6116D033MR	Vdet-IC	3.3V±2%, -MR, ±Reset PPO, Rt=100ms	SOT-25	28xf	VD21	6g	Tor
<u>CD</u> 2	XC6365C321MR	DC/DC-IC	PWM st-down, 100kHz, 3.2V±2.5%, 1A, +CE, soft start	SOT-25	28zm	DC7	6g	Tor
<u>CD</u> 2	XC6367C321MR	DC/DC-IC	PWM step-up, 3.2V±2.5%, 200mA, 100kHz, +CE, soft start	SOT-25	28sh	DC11	6g	Tor
<u>CD</u> 3	XC9235B33CMR	DC-DC-IC	PWM, st-dwn, 3.3V±2%, 600mA, 1.2MHz, Vin>2V, HSST, CL	SOT-25	28dc4	DC1	6g	Tor
<u>CD</u> 3	XC6116D034MR	Vdet-IC	3.4V±2%, -MR, ±Reset PPO, Rt=100ms	SOT-25	28xf	VD21	6g	Tor
<u>CD</u> 3	XC6365C331MR	DC/DC-IC	PWM st-down, 100kHz, 3.3V±2.5%, 1A, +CE, soft start	SOT-25	28zm	DC7	6g	Tor
<u>CD</u> 3	XC6367C331MR	DC/DC-IC	PWM step-up, 3.3V±2.5%, 200mA, 100kHz, +CE, soft start	SOT-25	28sh	DC11	6g	Tor
<u>CD</u> 4	XC9235B34CMR	DC-DC-IC	PWM, st-dwn, 3.4V±2%, 600mA, 1.2MHz, Vin>2V, HSST, CL	SOT-25	28dc4	DC1	6g	Tor
<u>CD</u> 4	XC6116D035MR	Vdet-IC	3.5V±2%, -MR, ±Reset PPO, Rt=100ms	SOT-25	28xf	VD21	6g	Tor
<u>CD</u> 4	XC6365C341MR	DC/DC-IC	PWM st-down, 100kHz, 3.4V±2.5%, 1A, +CE, soft start	SOT-25	28zm	DC7	6g	Tor
<u>CD</u> 4	XC6367C341MR	DC/DC-IC	PWM step-up, 3.4V±2.5%, 200mA, 100kHz, +CE, soft start	SOT-25	28sh	DC11	6g	Tor
<u>CD</u> 5	XC9235B35CMR	DC-DC-IC	PWM, st-dwn, 3.5V±2%, 600mA, 1.2MHz, Vin>2V, HSST, CL	SOT-25	28dc4	DC1	6g	Tor
<u>CD</u> 5	XC6116D036MR	Vdet-IC	3.6V±2%, -MR, ±Reset PPO, Rt=100ms	SOT-25	28xf	VD21	6g	Tor
<u>CD</u> 5	XC6365C351MR	DC/DC-IC	PWM st-down, 100kHz, 3.5V±2.5%, 1A, +CE, soft start	SOT-25	28zm	DC7	6g	Tor
<u>CD</u> 5	XC6367C351MR	DC/DC-IC	PWM step-up, 3.5V±2.5%, 200mA, 100kHz, +CE, soft start	SOT-25	28sh	DC11	6g	Tor
<u>CD</u> 6	XC9235B36CMR	DC-DC-IC	PWM, st-dwn, 3.6V±2%, 600mA, 1.2MHz, Vin>2V, HSST, CL	SOT-25	28dc4	DC1	6g	Tor
<u>CD</u> 6	XC6116D037MR	Vdet-IC	3.7V±2%, -MR, ±Reset PPO, Rt=100ms	SOT-25	28xf	VD21	6g	Tor
<u>CD</u> 6	XC6365C361MR	DC/DC-IC	PWM st-down, 100kHz, 3.6V±2.5%, 1A, +CE, soft start	SOT-25	28zm	DC7	6g	Tor
<u>CD</u> 6	XC6367C361MR	DC/DC-IC	PWM step-up, 3.6V±2.5%, 200mA, 100kHz, +CE, soft start	SOT-25	28sh	DC11	6g	Tor
<u>CD</u> 7	XC9235B37CMR	DC-DC-IC	PWM, st-dwn, 3.7V±2%, 600mA, 1.2MHz, Vin>2V, HSST, CL	SOT-25	28dc4	DC1	6g	Tor
<u>CD</u> 7	XC6116D038MR	Vdet-IC	3.8V±2%, -MR, ±Reset PPO, Rt=100ms	SOT-25	28xf	VD21	6g	Tor



SMD

SMD code	Type	Function	Short description	Case	Pinout	Sch.	St.	Mnf.
CD7	XC6365C371MR	DC/DC-IC	PWM st-down, 100kHz, 3.7V±2.5%, 1A, +CE, soft start	SOT-25	28zm	DC7	6g	Tor
CD7	XC6367C371MR	DC/DC-IC	PWM step-up, 3.7V±2.5%, 200mA, 100kHz, +CE, soft start	SOT-25	28sh	DC11	6g	Tor
CD8	XC9235B38CMR	DC-DC-IC	PWM, st-dwn, 3.8V±2%, 600mA, 1.2MHz, Vin>2V, HSST, CL	SOT-25	28dc4	DC1	6g	Tor
CD8	XC6116D039MR	Vdet-IC	3.9V±2%, -MR, ±Reset PPO, Rt=100ms	SOT-25	28xf	VD21	6g	Tor
CD8	XC6365C381MR	DC/DC-IC	PWM st-down, 100kHz, 3.8V±2.5%, 1A, +CE, soft start	SOT-25	28zm	DC7	6g	Tor
CD8	XC6367C381MR	DC/DC-IC	PWM step-up, 3.8V±2.5%, 200mA, 100kHz, +CE, soft start	SOT-25	28sh	DC11	6g	Tor
CD9	XC9235B39CMR	DC-DC-IC	PWM, st-dwn, 3.9V±2%, 600mA, 1.2MHz, Vin>2V, HSST, CL	SOT-25	28dc4	DC1	6g	Tor
CD9	XC6116D040MR	Vdet-IC	4.0V±2%, -MR, ±Reset PPO, Rt=100ms	SOT-25	28xf	VD21	6g	Tor
CD9	XC6365C391MR	DC/DC-IC	PWM st-down, 100kHz, 3.9V±2.5%, 1A, +CE, soft start	SOT-25	28zm	DC7	6g	Tor
CD9	XC6367C391MR	DC/DC-IC	PWM step-up, 3.9V±2.5%, 200mA, 100kHz, +CE, soft start	SOT-25	28sh	DC11	6g	Tor
CD9	XC9235B3ACMR	DC-DC-IC	PWM, st-dwn, 3.05V±2%, 600mA, 1.2MHz, Vin>2V, HSST, CL	SOT-25	28dc4	DC1	6g	Tor
CD9	XC6116D041MR	Vdet-IC	4.1V±2%, -MR, ±Reset PPO, Rt=100ms	SOT-25	28xf	VD21	6g	Tor
CD9	XC6365C305MR	DC/DC-IC	PWM st-down, 500kHz, 3.0V±2.5%, 1A, +CE, soft start	SOT-25	28zm	DC7	6g	Tor
CD9	XC6367C305MR	DC/DC-IC	PWM step-up, 3.0V±2.5%, 200mA, 500kHz, +CE, soft start	SOT-25	28sh	DC11	6g	Tor
CD9	XC9235B3BCMR	DC-DC-IC	PWM, st-dwn, 3.15V±2%, 600mA, 1.2MHz, Vin>2V, HSST, CL	SOT-25	28dc4	DC1	6g	Tor
CD9	XC6116D042MR	Vdet-IC	4.2V±2%, -MR, ±Reset PPO, Rt=100ms	SOT-25	28xf	VD21	6g	Tor
CD9	XC6365C315MR	DC/DC-IC	PWM st-down, 500kHz, 3.1V±2.5%, 1A, +CE, soft start	SOT-25	28zm	DC7	6g	Tor
CD9	XC6367C315MR	DC/DC-IC	PWM step-up, 3.1V±2.5%, 200mA, 500kHz, +CE, soft start	SOT-25	28sh	DC11	6g	Tor
CD9	XC9235B3CCMR	DC-DC-IC	PWM, st-dwn, 3.25V±2%, 600mA, 1.2MHz, Vin>2V, HSST, CL	SOT-25	28dc4	DC1	6g	Tor
CD9	XC6116D043MR	Vdet-IC	4.3V±2%, -MR, ±Reset PPO, Rt=100ms	SOT-25	28xf	VD21	6g	Tor
CD9	XC6365C325MR	DC/DC-IC	PWM st-down, 500kHz, 3.2V±2.5%, 1A, +CE, soft start	SOT-25	28zm	DC7	6g	Tor
CD9	XC6367C325MR	DC/DC-IC	PWM step-up, 3.2V±2.5%, 200mA, 500kHz, +CE, soft start	SOT-25	28sh	DC11	6g	Tor
CD9	XC9235B3DCMR	DC-DC-IC	PWM, st-dwn, 3.35V±2%, 600mA, 1.2MHz, Vin>2V, HSST, CL	SOT-25	28dc4	DC1	6g	Tor
CD9	XC6116D044MR	Vdet-IC	4.4V±2%, -MR, ±Reset PPO, Rt=100ms	SOT-25	28xf	VD21	6g	Tor
CD9	XC6365C335MR	DC/DC-IC	PWM st-down, 500kHz, 3.3V±2.5%, 1A, +CE, soft start	SOT-25	28zm	DC7	6g	Tor
CD9	XC6367C335MR	DC/DC-IC	PWM step-up, 3.3V±2.5%, 200mA, 500kHz, +CE, soft start	SOT-25	28sh	DC11	6g	Tor
CD9	XC9235B3ECMR	DC-DC-IC	PWM, st-dwn, 3.45V±2%, 600mA, 1.2MHz, Vin>2V, HSST, CL	SOT-25	28dc4	DC1	6g	Tor
CD9	XC6116D045MR	Vdet-IC	4.5V±2%, -MR, ±Reset PPO, Rt=100ms	SOT-25	28xf	VD21	6g	Tor
CD9	XC6365C345MR	DC/DC-IC	PWM st-down, 500kHz, 3.4V±2.5%, 1A, +CE, soft start	SOT-25	28zm	DC7	6g	Tor
CD9	XC6367C345MR	DC/DC-IC	PWM step-up, 3.4V±2.5%, 200mA, 500kHz, +CE, soft start	SOT-25	28sh	DC11	6g	Tor
CD9	XC9235B3FCMR	DC-DC-IC	PWM, st-dwn, 3.55V±2%, 600mA, 1.2MHz, Vin>2V, HSST, CL	SOT-25	28dc4	DC1	6g	Tor
CD9	XC6116D016MR	Vdet-IC	1.6V±2%, -MR, ±Reset PPO, Rt=100ms	SOT-25	28xf	VD21	6g	Tor
CD9	XC6116D046MR	Vdet-IC	4.6V±2%, -MR, ±Reset PPO, Rt=100ms	SOT-25	28xf	VD21	6g	Tor
CD9	XC6365C355MR	DC/DC-IC	PWM st-down, 500kHz, 3.5V±2.5%, 1A, +CE, soft start	SOT-25	28zm	DC7	6g	Tor
CD9	XC6367C355MR	DC/DC-IC	PWM step-up, 3.5V±2.5%, 200mA, 500kHz, +CE, soft start	SOT-25	28sh	DC11	6g	Tor
CD9	XC9235B3HCMR	DC-DC-IC	PWM, st-dwn, 3.65V±2%, 600mA, 1.2MHz, Vin>2V, HSST, CL	SOT-25	28dc4	DC1	6g	Tor
CD9	XC6116D017MR	Vdet-IC	1.7V±2%, -MR, ±Reset PPO, Rt=100ms	SOT-25	28xf	VD21	6g	Tor
CD9	XC6116D047MR	Vdet-IC	4.7V±2%, -MR, ±Reset PPO, Rt=100ms	SOT-25	28xf	VD21	6g	Tor
CD9	XC6365C365MR	DC/DC-IC	PWM st-down, 500kHz, 3.6V±2.5%, 1A, +CE, soft start	SOT-25	28zm	DC7	6g	Tor
CD9	XC6367C365MR	DC/DC-IC	PWM step-up, 3.6V±2.5%, 200mA, 500kHz, +CE, soft start	SOT-25	28sh	DC11	6g	Tor
CD9	XC9235B3KCMR	DC-DC-IC	PWM, st-dwn, 3.75V±2%, 600mA, 1.2MHz, Vin>2V, HSST, CL	SOT-25	28dc4	DC1	6g	Tor
CD9	XC6116D018MR	Vdet-IC	1.8V±2%, -MR, ±Reset PPO, Rt=100ms	SOT-25	28xf	VD21	6g	Tor
CD9	XC6116D048MR	Vdet-IC	4.8V±2%, -MR, ±Reset PPO, Rt=100ms	SOT-25	28xf	VD21	6g	Tor
CD9	XC6365C375MR	DC/DC-IC	PWM st-down, 500kHz, 3.7V±2.5%, 1A, +CE, soft start	SOT-25	28zm	DC7	6g	Tor
CD9	XC6367C375MR	DC/DC-IC	PWM step-up, 3.7V±2.5%, 200mA, 500kHz, +CE, soft start	SOT-25	28sh	DC11	6g	Tor
CD9	XC9235B3LCMR	DC-DC-IC	PWM, st-dwn, 3.85V±2%, 600mA, 1.2MHz, Vin>2V, HSST, CL	SOT-25	28dc4	DC1	6g	Tor
CD9	XC6116D019MR	Vdet-IC	1.9V±2%, -MR, ±Reset PPO, Rt=100ms	SOT-25	28xf	VD21	6g	Tor
CD9	XC6116D049MR	Vdet-IC	4.9V±2%, -MR, ±Reset PPO, Rt=100ms	SOT-25	28xf	VD21	6g	Tor
CD9	XC6365C385MR	DC/DC-IC	PWM st-down, 500kHz, 3.8V±2.5%, 1A, +CE, soft start	SOT-25	28zm	DC7	6g	Tor
CD9	XC6367C385MR	DC/DC-IC	PWM step-up, 3.8V±2.5%, 200mA, 500kHz, +CE, soft start	SOT-25	28sh	DC11	6g	Tor
CD9	XC9235B3MCMR	DC-DC-IC	PWM, st-dwn, 3.95V±2%, 600mA, 1.2MHz, Vin>2V, HSST, CL	SOT-25	28dc4	DC1	6g	Tor
CD9	XC6116D020MR	Vdet-IC	2.0V±2%, -MR, ±Reset PPO, Rt=100ms	SOT-25	28xf	VD21	6g	Tor
CD9	XC6116D050MR	Vdet-IC	5.0V±2%, -MR, ±Reset PPO, Rt=100ms	SOT-25	28xf	VD21	6g	Tor
CD9	XC6365C395MR	DC/DC-IC	PWM st-down, 500kHz, 3.9V±2.5%, 1A, +CE, soft start	SOT-25	28zm	DC7	6g	Tor
CD9	XC6367C395MR	DC/DC-IC	PWM step-up, 3.9V±2.5%, 200mA, 500kHz, +CE, soft start	SOT-25	28sh	DC11	6g	Tor
CD9	XC6116D021MR	Vdet-IC	2.1V±2%, -MR, ±Reset PPO, Rt=100ms	SOT-25	28xf	VD21	6g	Tor
CD9	XC6116D022MR	Vdet-IC	2.2V±2%, -MR, ±Reset PPO, Rt=100ms	SOT-25	28xf	VD21	6g	Tor
CD9	XC6116D023MR	Vdet-IC	2.3V±2%, -MR, ±Reset PPO, Rt=100ms	SOT-25	28xf	VD21	6g	Tor
CD9	XC6116D024MR	Vdet-IC	2.4V±2%, -MR, ±Reset PPO, Rt=100ms	SOT-25	28xf	VD21	6g	Tor
CD9	XC6116D025MR	Vdet-IC	2.5V±2%, -MR, ±Reset PPO, Rt=100ms	SOT-25	28xf	VD21	6g	Tor
CD9	XC6116D026MR	Vdet-IC	2.6V±2%, -MR, ±Reset PPO, Rt=100ms	SOT-25	28xf	VD21	6g	Tor
CD9	XC6116D027MR	Vdet-IC	2.7V±2%, -MR, ±Reset PPO, Rt=100ms	SOT-25	28xf	VD21	6g	Tor
CD9	XC6116D028MR	Vdet-IC	2.8V±2%, -MR, ±Reset PPO, Rt=100ms	SOT-25	28xf	VD21	6g	Tor
CD9	XC6116D029MR	Vdet-IC	2.9V±2%, -MR, ±Reset PPO, Rt=100ms	SOT-25	28xf	VD21	6g	Tor
CD9	XC6116D030MR	Vdet-IC	3.0V±2%, -MR, ±Reset PPO, Rt=100ms	SOT-25	28xf	VD21	6g	Tor
CE	74AHCT1G08GVW	CMOS-Logic	2-input AND gate	SOT-353	28fLog3	-	6a	Phi
CE	BH28FB1WG	LVR-IC	LDO, 2.8V, 150mA, +CE	SSOP-5	30cx	VR4	6	Rhm
CE	BH28FB1WHFV	LVR-IC	LDO, 2.8V, 150mA, +CE	HVSOP5	30vr3	VR4	6e	Rhm
CE	RN5RT44AA	LVR-IC	LDO, 4.4V±2%, 150mA, -CE	SOT-23-5	28vrt	VR4	6g	Ric
CE	RT9169-33CB	LVR-IC	LDO, 3.3V±2%, 100mA, -CE	SOT-23-5	28cx	VR4	6g	Ric



SMD
code

Type

Function

Short description

Case

Pinout

Sch.

St.Mnf.

SMD code	Type	Function	Short description	Case	Pinout	Sch.	St.Mnf.
CE	V6301ESP5B	Vdet-IC	4V, -Reset PPO, 290ms	SOT-23-5	28vdr	VD7	6a Em
CE-	XC62GR2412M	LVR-IC	2.4V±2%, 150mA, +CE	SOT-25	28ew	VR4	6g Tor
CE-	XC62GP2412M	LVR-IC	2.4V±2%, 150mA, -CE	SOT-25	28ew	VR4	6g Tor
CE+	XC62GR2422M	LVR-IC	2.4V±2%, 150mA, +CE, HS response	SOT-25	28ew	VR4	6g Tor
CE+	XC62GP2422M	LVR-IC	2.4V±2%, 150mA, -CE, HS response	SOT-25	28ew	VR4	6g Tor
CE0	XC9235B40CMR	DC/DC-IC	PWM, st-dwn, 4.0V±2.5%, 600mA, 1.2MHz, Vin>2V, HSST, CL	SOT-25	28dc4	DC1	6g Tor
CE0	XC6116E031MR	Vdet-IC	3.1V±2%, -MR, ±Reset PPO, Rt=200ms	SOT-25	28xf	VD21	6g Tor
CE0	XC6365C401MR	DC/DC-IC	PWM st-down, 100kHz, 4.0V±2.5%, 1A, +CE, soft start	SOT-25	28zm	DC7	6g Tor
CE0	XC6367C401MR	DC/DC-IC	PWM step-up, 4.0V±2.5%, 200mA, 100kHz, +CE, soft start	SOT-25	28sh	DC11	6g Tor
CE1	XC6116E032MR	Vdet-IC	3.2V±2%, -MR, ±Reset PPO, Rt=200ms	SOT-25	28xf	VD21	6g Tor
CE1	XC6365C411MR	DC/DC-IC	PWM st-down, 100kHz, 4.1V±2.5%, 1A, +CE, soft start	SOT-25	28zm	DC7	6g Tor
CE1	XC6367C411MR	DC/DC-IC	PWM step-up, 4.1V±2.5%, 200mA, 100kHz, +CE, soft start	SOT-25	28sh	DC11	6g Tor
CE2	XC6116E033MR	Vdet-IC	3.3V±2%, -MR, ±Reset PPO, Rt=200ms	SOT-25	28xf	VD21	6g Tor
CE2	XC6365C421MR	DC/DC-IC	PWM st-down, 100kHz, 4.2V±2.5%, 1A, +CE, soft start	SOT-25	28zm	DC7	6g Tor
CE2	XC6367C421MR	DC/DC-IC	PWM step-up, 4.2V±2.5%, 200mA, 100kHz, +CE, soft start	SOT-25	28sh	DC11	6g Tor
CE3	XC6116E034MR	Vdet-IC	3.4V±2%, -MR, ±Reset PPO, Rt=200ms	SOT-25	28xf	VD21	6g Tor
CE3	XC6365C431MR	DC/DC-IC	PWM st-down, 100kHz, 4.3V±2.5%, 1A, +CE, soft start	SOT-25	28zm	DC7	6g Tor
CE3	XC6367C431MR	DC/DC-IC	PWM step-up, 4.3V±2.5%, 200mA, 100kHz, +CE, soft start	SOT-25	28sh	DC11	6g Tor
CE4	XC6116E035MR	Vdet-IC	3.5V±2%, -MR, ±Reset PPO, Rt=200ms	SOT-25	28xf	VD21	6g Tor
CE4	XC6365C441MR	DC/DC-IC	PWM st-down, 100kHz, 4.4V±2.5%, 1A, +CE, soft start	SOT-25	28zm	DC7	6g Tor
CE4	XC6367C441MR	DC/DC-IC	PWM step-up, 4.4V±2.5%, 200mA, 100kHz, +CE, soft start	SOT-25	28sh	DC11	6g Tor
CE5	XC6116E036MR	Vdet-IC	3.6V±2%, -MR, ±Reset PPO, Rt=200ms	SOT-25	28xf	VD21	6g Tor
CE5	XC6365C451MR	DC/DC-IC	PWM st-down, 100kHz, 4.5V±2.5%, 1A, +CE, soft start	SOT-25	28zm	DC7	6g Tor
CE5	XC6367C451MR	DC/DC-IC	PWM step-up, 4.5V±2.5%, 200mA, 100kHz, +CE, soft start	SOT-25	28sh	DC11	6g Tor
CE6	XC6116E037MR	Vdet-IC	3.7V±2%, -MR, ±Reset PPO, Rt=200ms	SOT-25	28xf	VD21	6g Tor
CE6	XC6365C461MR	DC/DC-IC	PWM st-down, 100kHz, 4.6V±2.5%, 1A, +CE, soft start	SOT-25	28zm	DC7	6g Tor
CE6	XC6367C461MR	DC/DC-IC	PWM step-up, 4.6V±2.5%, 200mA, 100kHz, +CE, soft start	SOT-25	28sh	DC11	6g Tor
CE7	XC6116E038MR	Vdet-IC	3.8V±2%, -MR, ±Reset PPO, Rt=200ms	SOT-25	28xf	VD21	6g Tor
CE7	XC6365C471MR	DC/DC-IC	PWM st-down, 100kHz, 4.7V±2.5%, 1A, +CE, soft start	SOT-25	28zm	DC7	6g Tor
CE7	XC6367C471MR	DC/DC-IC	PWM step-up, 4.7V±2.5%, 200mA, 100kHz, +CE, soft start	SOT-25	28sh	DC11	6g Tor
CE8	XC6116E039MR	Vdet-IC	3.9V±2%, -MR, ±Reset PPO, Rt=200ms	SOT-25	28xf	VD21	6g Tor
CE8	XC6365C481MR	DC/DC-IC	PWM st-down, 100kHz, 4.8V±2.5%, 1A, +CE, soft start	SOT-25	28zm	DC7	6g Tor
CE8	XC6367C481MR	DC/DC-IC	PWM step-up, 4.8V±2.5%, 200mA, 100kHz, +CE, soft start	SOT-25	28sh	DC11	6g Tor
CE9	XC6116E040MR	Vdet-IC	4.0V±2%, -MR, ±Reset PPO, Rt=200ms	SOT-25	28xf	VD21	6g Tor
CE9	XC6365C491MR	DC/DC-IC	PWM st-down, 100kHz, 4.9V±2.5%, 1A, +CE, soft start	SOT-25	28zm	DC7	6g Tor
CE9	XC6367C491MR	DC/DC-IC	PWM step-up, 4.9V±2.5%, 200mA, 100kHz, +CE, soft start	SOT-25	28sh	DC11	6g Tor
CEA	XC6116E041MR	Vdet-IC	4.1V±2%, -MR, ±Reset PPO, Rt=200ms	SOT-25	28xf	VD21	6g Tor
CEA	XC6365C405MR	DC/DC-IC	PWM st-down, 500kHz, 4.0V±2.5%, 1A, +CE, soft start	SOT-25	28zm	DC7	6g Tor
CEA	XC6367C405MR	DC/DC-IC	PWM step-up, 4.0V±2.5%, 200mA, 500kHz, +CE, soft start	SOT-25	28sh	DC11	6g Tor
CEB	XC6116E042MR	Vdet-IC	4.2V±2%, -MR, ±Reset PPO, Rt=200ms	SOT-25	28xf	VD21	6g Tor
CEB	XC6365C415MR	DC/DC-IC	PWM st-down, 500kHz, 4.1V±2.5%, 1A, +CE, soft start	SOT-25	28zm	DC7	6g Tor
CEB	XC6367C415MR	DC/DC-IC	PWM step-up, 4.1V±2.5%, 200mA, 500kHz, +CE, soft start	SOT-25	28sh	DC11	6g Tor
CEC	XC6116E043MR	Vdet-IC	4.3V±2%, -MR, ±Reset PPO, Rt=200ms	SOT-25	28xf	VD21	6g Tor
CEC	XC6365C425MR	DC/DC-IC	PWM st-down, 500kHz, 4.2V±2.5%, 1A, +CE, soft start	SOT-25	28zm	DC7	6g Tor
CEC	XC6367C425MR	DC/DC-IC	PWM step-up, 4.2V±2.5%, 200mA, 500kHz, +CE, soft start	SOT-25	28sh	DC11	6g Tor
CED	XC6116E044MR	Vdet-IC	4.4V±2%, -MR, ±Reset PPO, Rt=200ms	SOT-25	28xf	VD21	6g Tor
CED	XC6365C435MR	DC/DC-IC	PWM st-down, 500kHz, 4.3V±2.5%, 1A, +CE, soft start	SOT-25	28zm	DC7	6g Tor
CED	XC6367C435MR	DC/DC-IC	PWM step-up, 4.3V±2.5%, 200mA, 500kHz, +CE, soft start	SOT-25	28sh	DC11	6g Tor
CEE	XC6116E045MR	Vdet-IC	4.5V±2%, -MR, ±Reset PPO, Rt=200ms	SOT-25	28xf	VD21	6g Tor
CEE	XC6365C445MR	DC/DC-IC	PWM st-down, 500kHz, 4.4V±2.5%, 1A, +CE, soft start	SOT-25	28zm	DC7	6g Tor
CEE	XC6367C445MR	DC/DC-IC	PWM step-up, 4.4V±2.5%, 200mA, 500kHz, +CE, soft start	SOT-25	28sh	DC11	6g Tor
CEF	XC6116E016MR	Vdet-IC	1.6V±2%, -MR, ±Reset PPO, Rt=200ms	SOT-25	28xf	VD21	6g Tor
CEF	XC6116E046MR	Vdet-IC	4.6V±2%, -MR, ±Reset PPO, Rt=200ms	SOT-25	28xf	VD21	6g Tor
CEF	XC6365C455MR	DC/DC-IC	PWM st-down, 500kHz, 4.5V±2.5%, 1A, +CE, soft start	SOT-25	28zm	DC7	6g Tor
CEF	XC6367C455MR	DC/DC-IC	PWM step-up, 4.5V±2.5%, 200mA, 500kHz, +CE, soft start	SOT-25	28sh	DC11	6g Tor
CEH	XC6116E017MR	Vdet-IC	1.7V±2%, -MR, ±Reset PPO, Rt=200ms	SOT-25	28xf	VD21	6g Tor
CEH	XC6116E047MR	Vdet-IC	4.7V±2%, -MR, ±Reset PPO, Rt=200ms	SOT-25	28xf	VD21	6g Tor
CEH	XC6365C465MR	DC/DC-IC	PWM st-down, 500kHz, 4.6V±2.5%, 1A, +CE, soft start	SOT-25	28zm	DC7	6g Tor
CEH	XC6367C465MR	DC/DC-IC	PWM step-up, 4.6V±2.5%, 200mA, 500kHz, +CE, soft start	SOT-25	28sh	DC11	6g Tor
CEK	XC6116E018MR	Vdet-IC	1.8V±2%, -MR, ±Reset PPO, Rt=200ms	SOT-25	28xf	VD21	6g Tor
CEK	XC6116E048MR	Vdet-IC	4.8V±2%, -MR, ±Reset PPO, Rt=200ms	SOT-25	28xf	VD21	6g Tor
CEK	XC6365C475MR	DC/DC-IC	PWM st-down, 500kHz, 4.7V±2.5%, 1A, +CE, soft start	SOT-25	28zm	DC7	6g Tor
CEK	XC6367C475MR	DC/DC-IC	PWM step-up, 4.7V±2.5%, 200mA, 500kHz, +CE, soft start	SOT-25	28sh	DC11	6g Tor
CEL	XC6116E019MR	Vdet-IC	1.9V±2%, -MR, ±Reset PPO, Rt=200ms	SOT-25	28xf	VD21	6g Tor
CEL	XC6116E049MR	Vdet-IC	4.9V±2%, -MR, ±Reset PPO, Rt=200ms	SOT-25	28xf	VD21	6g Tor
CEL	XC6365C485MR	DC/DC-IC	PWM st-down, 500kHz, 4.8V±2.5%, 1A, +CE, soft start	SOT-25	28zm	DC7	6g Tor
CEL	XC6367C485MR	DC/DC-IC	PWM step-up, 4.8V±2.5%, 200mA, 500kHz, +CE, soft start	SOT-25	28sh	DC11	6g Tor
CEM	XC6116E020MR	Vdet-IC	2.0V±2%, -MR, ±Reset PPO, Rt=200ms	SOT-25	28xf	VD21	6g Tor
CEM	XC6116E050MR	Vdet-IC	5.0V±2%, -MR, ±Reset PPO, Rt=200ms	SOT-25	28xf	VD21	6g Tor
CEM	XC6365C495MR	DC/DC-IC	PWM st-down, 500kHz, 4.9V±2.5%, 1A, +CE, soft start	SOT-25	28zm	DC7	6g Tor



SMD code	Type	Function	Short description	Case	Pinout	Sch.	St.	Mnf.
CEM	XC6367C495MR	DC/DC-IC	PWM step-up, 4.9V±2.5%, 200mA, 500kHz, +CE, soft start	SOT-25	28sh	DC11	6g	Tor
CEN	XC6116E021MR	Vdet-IC	2.1V±2%, -MR, ±Reset PPO, Rt=200ms	SOT-25	28xf	VD21	6g	Tor
CEP	XC6116E022MR	Vdet-IC	2.2V±2%, -MR, ±Reset PPO, Rt=200ms	SOT-25	28xf	VD21	6g	Tor
CER	XC6116E023MR	Vdet-IC	2.3V±2%, -MR, ±Reset PPO, Rt=200ms	SOT-25	28xf	VD21	6g	Tor
CES	XC6116E024MR	Vdet-IC	2.4V±2%, -MR, ±Reset PPO, Rt=200ms	SOT-25	28xf	VD21	6g	Tor
CEt	XC6116E025MR	Vdet-IC	2.5V±2%, -MR, ±Reset PPO, Rt=200ms	SOT-25	28xf	VD21	6g	Tor
CEU	XC6116E026MR	Vdet-IC	2.6V±2%, -MR, ±Reset PPO, Rt=200ms	SOT-25	28xf	VD21	6g	Tor
CEV	XC6116E027MR	Vdet-IC	2.7V±2%, -MR, ±Reset PPO, Rt=200ms	SOT-25	28xf	VD21	6g	Tor
CEX	XC6116E028MR	Vdet-IC	2.8V±2%, -MR, ±Reset PPO, Rt=200ms	SOT-25	28xf	VD21	6g	Tor
CEY	XC6116E029MR	Vdet-IC	2.9V±2%, -MR, ±Reset PPO, Rt=200ms	SOT-25	28xf	VD21	6g	Tor
CEZ	XC6116E030MR	Vdet-IC	3.0V±2%, -MR, ±Reset PPO, Rt=200ms	SOT-25	28xf	VD21	6g	Tor
CF	74AHCT1G14GW	CMOS-Logic	Inverting Schmitt-trigger	SOT-353	28Lxog7	-	6a	Phi
CF	BH29FB1WG	LVR-IC	LDO, 2.9V, 150mA, +CE	SSOP-5	30cx	VR4	6c	Rhm
CF	BH29FB1WHFV	LVR-IC	LDO, 2.9V, 150mA, +CE	HVSOP5	30w3	VR4	6e	Rhm
CF	RN5RT45AA	LVR-IC	LDO, 4.5V±2%, 150mA, -CE	SOT-23-5	28wrt	VR4	6g	Ric
CF	V6301FSP5B	Vdet-IC	4.5V, -Reset PPO, 290ms	SOT-23-5	28vdr	VD7	6a	Em
CF-	XC62GR2512M	LVR-IC	2.5V±2%, 150mA, +CE	SOT-25	28ew	VR4	6g	Tor
CF-	XC62GP2512M	LVR-IC	2.5V±2%, 150mA, -CE	SOT-25	28ew	VR4	6g	Tor
CF+	XC62GR2522M	LVR-IC	2.5V±2%, 150mA, +CE, HS response	SOT-25	28ew	VR4	6g	Tor
CF+	XC62GP2522M	LVR-IC	2.5V±2%, 150mA, -CE, HS response	SOT-25	28ew	VR4	6g	Tor
CF0	XC6116F031MR	Vdet-IC	3.1V±2%, -MR, ±Reset PPO, Rt=400ms	SOT-25	28xf	VD21	6g	Tor
CF0	XC6365C501MR	DC/DC-IC	PWM st-down, 100kHz, 5.0V±2.5%, 1A, +CE, soft start	SOT-25	28zm	DC7	6g	Tor
CF0	XC6367C501MR	DC/DC-IC	PWM step-up, 5.0V±2.5%, 200mA, 100kHz, +CE, soft start	SOT-25	28sh	DC11	6g	Tor
CF1	XC6116F032MR	Vdet-IC	3.2V±2%, -MR, ±Reset PPO, Rt=400ms	SOT-25	28xf	VD21	6g	Tor
CF1	XC6365C511MR	DC/DC-IC	PWM st-down, 100kHz, 5.1V±2.5%, 1A, +CE, soft start	SOT-25	28zm	DC7	6g	Tor
CF1	XC6367C511MR	DC/DC-IC	PWM step-up, 5.1V±2.5%, 200mA, 100kHz, +CE, soft start	SOT-25	28sh	DC11	6g	Tor
CF2	XC6116F033MR	Vdet-IC	3.3V±2%, -MR, ±Reset PPO, Rt=400ms	SOT-25	28xf	VD21	6g	Tor
CF2	XC6365C521MR	DC/DC-IC	PWM st-down, 100kHz, 5.2V±2.5%, 1A, +CE, soft start	SOT-25	28zm	DC7	6g	Tor
CF2	XC6367C521MR	DC/DC-IC	PWM step-up, 5.2V±2.5%, 200mA, 100kHz, +CE, soft start	SOT-25	28sh	DC11	6g	Tor
CF3	XC6116F034MR	Vdet-IC	3.4V±2%, -MR, ±Reset PPO, Rt=400ms	SOT-25	28xf	VD21	6g	Tor
CF3	XC6365C531MR	DC/DC-IC	PWM st-down, 100kHz, 5.3V±2.5%, 1A, +CE, soft start	SOT-25	28zm	DC7	6g	Tor
CF3	XC6367C531MR	DC/DC-IC	PWM step-up, 5.3V±2.5%, 200mA, 100kHz, +CE, soft start	SOT-25	28sh	DC11	6g	Tor
CF4	XC6116F035MR	Vdet-IC	3.5V±2%, -MR, ±Reset PPO, Rt=400ms	SOT-25	28xf	VD21	6g	Tor
CF4	XC6365C541MR	DC/DC-IC	PWM st-down, 100kHz, 5.4V±2.5%, 1A, +CE, soft start	SOT-25	28zm	DC7	6g	Tor
CF4	XC6367C541MR	DC/DC-IC	PWM step-up, 5.4V±2.5%, 200mA, 100kHz, +CE, soft start	SOT-25	28sh	DC11	6g	Tor
CF5	XC6116F036MR	Vdet-IC	3.6V±2%, -MR, ±Reset PPO, Rt=400ms	SOT-25	28xf	VD21	6g	Tor
CF5	XC6365C551MR	DC/DC-IC	PWM st-down, 100kHz, 5.5V±2.5%, 1A, +CE, soft start	SOT-25	28zm	DC7	6g	Tor
CF5	XC6367C551MR	DC/DC-IC	PWM step-up, 5.5V±2.5%, 200mA, 100kHz, +CE, soft start	SOT-25	28sh	DC11	6g	Tor
CF6	XC6116F037MR	Vdet-IC	3.7V±2%, -MR, ±Reset PPO, Rt=400ms	SOT-25	28xf	VD21	6g	Tor
CF6	XC6365C561MR	DC/DC-IC	PWM st-down, 100kHz, 5.6V±2.5%, 1A, +CE, soft start	SOT-25	28zm	DC7	6g	Tor
CF6	XC6367C561MR	DC/DC-IC	PWM step-up, 5.6V±2.5%, 200mA, 100kHz, +CE, soft start	SOT-25	28sh	DC11	6g	Tor
CF7	XC6116F038MR	Vdet-IC	3.8V±2%, -MR, ±Reset PPO, Rt=400ms	SOT-25	28xf	VD21	6g	Tor
CF7	XC6365C571MR	DC/DC-IC	PWM st-down, 100kHz, 5.7V±2.5%, 1A, +CE, soft start	SOT-25	28zm	DC7	6g	Tor
CF7	XC6367C571MR	DC/DC-IC	PWM step-up, 5.7V±2.5%, 200mA, 100kHz, +CE, soft start	SOT-25	28sh	DC11	6g	Tor
CF8	XC9235B08D1MR	DC-DC-IC	PWM, st-dwn, 0.8V±2%, 600mA, 3MHz, Vin>2V, HSST, CL	SOT-25	28dc4	DC1	6g	Tor
CF8	XC6116F039MR	Vdet-IC	3.9V±2%, -MR, ±Reset PPO, Rt=400ms	SOT-25	28xf	VD21	6g	Tor
CF8	XC6365C581MR	DC/DC-IC	PWM st-down, 100kHz, 5.8V±2.5%, 1A, +CE, soft start	SOT-25	28zm	DC7	6g	Tor
CF8	XC6367C581MR	DC/DC-IC	PWM step-up, 5.8V±2.5%, 200mA, 100kHz, +CE, soft start	SOT-25	28sh	DC11	6g	Tor
CF9	XC9235B09D1MR	DC-DC-IC	PWM, st-dwn, 0.9V±2%, 600mA, 3MHz, Vin>2V, HSST, CL	SOT-25	28dc4	DC1	6g	Tor
CF9	XC6116F040MR	Vdet-IC	4.0V±2%, -MR, ±Reset PPO, Rt=400ms	SOT-25	28xf	VD21	6g	Tor
CF9	XC6365C591MR	DC/DC-IC	PWM st-down, 100kHz, 5.9V±2.5%, 1A, +CE, soft start	SOT-25	28zm	DC7	6g	Tor
CF9	XC6367C591MR	DC/DC-IC	PWM step-up, 5.9V±2.5%, 200mA, 100kHz, +CE, soft start	SOT-25	28sh	DC11	6g	Tor
CFA	XC6116F041MR	Vdet-IC	4.1V±2%, -MR, ±Reset PPO, Rt=400ms	SOT-25	28xf	VD21	6g	Tor
CFA	XC6365C505MR	DC/DC-IC	PWM st-down, 500kHz, 5.0V±2.5%, 1A, +CE, soft start	SOT-25	28zm	DC7	6g	Tor
CFA	XC6367C505MR	DC/DC-IC	PWM step-up, 5.0V±2.5%, 200mA, 500kHz, +CE, soft start	SOT-25	28sh	DC11	6g	Tor
CFB	XC6213B12AMR	LVR-IC	LDO, 1.25V±2%, 150mA, +CE	SOT-25	28cx	VR4	6g	Tor
CFB	XC6116F042MR	Vdet-IC	4.2V±2%, -MR, ±Reset PPO, Rt=400ms	SOT-25	28xf	VD21	6g	Tor
CFB	XC6365C515MR	DC/DC-IC	PWM st-down, 500kHz, 5.1V±2.5%, 1A, +CE, soft start	SOT-25	28zm	DC7	6g	Tor
CFB	XC6367C515MR	DC/DC-IC	PWM step-up, 5.1V±2.5%, 200mA, 500kHz, +CE, soft start	SOT-25	28sh	DC11	6g	Tor
CFC	XC6213B13AMR	LVR-IC	LDO, 1.35V±2%, 150mA, +CE	SOT-25	28cx	VR4	6g	Tor
CFC	XC6116F043MR	Vdet-IC	4.3V±2%, -MR, ±Reset PPO, Rt=400ms	SOT-25	28xf	VD21	6g	Tor
CFC	XC6365C525MR	DC/DC-IC	PWM st-down, 500kHz, 5.2V±2.5%, 1A, +CE, soft start	SOT-25	28zm	DC7	6g	Tor
CFC	XC6367C525MR	DC/DC-IC	PWM step-up, 5.2V±2.5%, 200mA, 500kHz, +CE, soft start	SOT-25	28sh	DC11	6g	Tor
CFD	XC6213B14AMR	LVR-IC	LDO, 1.45V±2%, 150mA, +CE	SOT-25	28cx	VR4	6g	Tor
CFD	XC6116F044MR	Vdet-IC	4.4V±2%, -MR, ±Reset PPO, Rt=400ms	SOT-25	28xf	VD21	6g	Tor
CFD	XC6365C535MR	DC/DC-IC	PWM st-down, 500kHz, 5.3V±2.5%, 1A, +CE, soft start	SOT-25	28zm	DC7	6g	Tor
CFD	XC6367C535MR	DC/DC-IC	PWM step-up, 5.3V±2.5%, 200mA, 500kHz, +CE, soft start	SOT-25	28sh	DC11	6g	Tor
CFE	XC6213B15AMR	LVR-IC	LDO, 1.55V±2%, 150mA, +CE	SOT-25	28cx	VR4	6g	Tor
CFE	XC6116F045MR	Vdet-IC	4.5V±2%, -MR, ±Reset PPO, Rt=400ms	SOT-25	28xf	VD21	6g	Tor
CFE	XC6365C545MR	DC/DC-IC	PWM st-down, 500kHz, 5.4V±2.5%, 1A, +CE, soft start	SOT-25	28zm	DC7	6g	Tor



SMD code	Type	Function	Short description	Case	Pinout	Sch.	St.	Mnf.
CFE	XC6367C545MR	DC/DC-IC	PWM step-up, 5.4V±2.5%, 200mA, 500kHz, +CE, soft start	SOT-25	28sh	DC11	6g	Tor
CFF	XG6213B16AMR	LVR-IC	LDO, 1.65V±2%, 150mA, +CE	SOT-25	28cx	VR4	6g	Tor
CFE	XC6116F016MR	Vdet-IC	1.6V±2%, -MR, ±Reset PPO, Rt=400ms	SOT-25	28xf	VD21	6g	Tor
CFE	XC6116F046MR	Vdet-IC	4.6V±2%, -MR, ±Reset PPO, Rt=400ms	SOT-25	28xf	VD21	6g	Tor
CFE	XC6365C555MR	DC/DC-IC	PWM st-down, 500kHz, 5.5V±2.5%, 1A, +CE, soft start	SOT-25	28zm	DC7	6g	Tor
CFE	XC6367C555MR	DC/DC-IC	PWM step-up, 5.5V±2.5%, 200mA, 500kHz, +CE, soft start	SOT-25	28sh	DC11	6g	Tor
CFH	XG6213B17AMR	LVR-IC	LDO, 1.75V±2%, 150mA, +CE	SOT-25	28cx	VR4	6g	Tor
CFH	XC6116F017MR	Vdet-IC	1.7V±2%, -MR, ±Reset PPO, Rt=400ms	SOT-25	28xf	VD21	6g	Tor
CFH	XC6116F047MR	Vdet-IC	4.7V±2%, -MR, ±Reset PPO, Rt=400ms	SOT-25	28xf	VD21	6g	Tor
CFH	XC6365C565MR	DC/DC-IC	PWM st-down, 500kHz, 5.6V±2.5%, 1A, +CE, soft start	SOT-25	28zm	DC7	6g	Tor
CFH	XC6367C565MR	DC/DC-IC	PWM step-up, 5.6V±2.5%, 200mA, 500kHz, +CE, soft start	SOT-25	28sh	DC11	6g	Tor
CFK	XG6213B18AMR	LVR-IC	LDO, 1.85V±2%, 150mA, +CE	SOT-25	28cx	VR4	6g	Tor
CFK	XC6116F018MR	Vdet-IC	1.8V±2%, -MR, ±Reset PPO, Rt=400ms	SOT-25	28xf	VD21	6g	Tor
CFK	XC6116F048MR	Vdet-IC	4.8V±2%, -MR, ±Reset PPO, Rt=400ms	SOT-25	28xf	VD21	6g	Tor
CFK	XC6365C575MR	DC/DC-IC	PWM st-down, 500kHz, 5.7V±2.5%, 1A, +CE, soft start	SOT-25	28zm	DC7	6g	Tor
CFK	XC6367C575MR	DC/DC-IC	PWM step-up, 5.7V±2.5%, 200mA, 500kHz, +CE, soft start	SOT-25	28sh	DC11	6g	Tor
CFL	XG6213B19AMR	LVR-IC	LDO, 1.95V±2%, 150mA, +CE	SOT-25	28cx	VR4	6g	Tor
CFL	XC9235B0LDMR	DC-DC-IC	PWM, st-down, 0.85V±2%, 600mA, 3MHz, Vin>2V, HSST, CL	SOT-25	28dc4	DC1	6g	Tor
CFL	XC6116F019MR	Vdet-IC	1.9V±2%, -MR, ±Reset PPO, Rt=400ms	SOT-25	28xf	VD21	6g	Tor
CFL	XC6116F049MR	Vdet-IC	4.9V±2%, -MR, ±Reset PPO, Rt=400ms	SOT-25	28xf	VD21	6g	Tor
CFL	XC6365C585MR	DC/DC-IC	PWM st-down, 500kHz, 5.8V±2.5%, 1A, +CE, soft start	SOT-25	28zm	DC7	6g	Tor
CFL	XC6367C585MR	DC/DC-IC	PWM step-up, 5.8V±2.5%, 200mA, 500kHz, +CE, soft start	SOT-25	28sh	DC11	6g	Tor
CFM	XG6213B20AMR	LVR-IC	LDO, 2.05V±2%, 150mA, +CE	SOT-25	28cx	VR4	6g	Tor
CFM	XC9235B0MDMR	DC-DC-IC	PWM, st-down, 0.95V±2%, 600mA, 3MHz, Vin>2V, HSST, CL	SOT-25	28dc4	DC1	6g	Tor
CFM	XC6116F020MR	Vdet-IC	2.0V±2%, -MR, ±Reset PPO, Rt=400ms	SOT-25	28xf	VD21	6g	Tor
CFM	XC6116F050MR	Vdet-IC	5.0V±2%, -MR, ±Reset PPO, Rt=400ms	SOT-25	28xf	VD21	6g	Tor
CFM	XC6365C595MR	DC/DC-IC	PWM st-down, 500kHz, 5.9V±2.5%, 1A, +CE, soft start	SOT-25	28zm	DC7	6g	Tor
CFM	XC6367C595MR	DC/DC-IC	PWM step-up, 5.9V±2.5%, 200mA, 500kHz, +CE, soft start	SOT-25	28sh	DC11	6g	Tor
CFN	XG6213B21AMR	LVR-IC	LDO, 2.15V±2%, 150mA, +CE	SOT-25	28cx	VR4	6g	Tor
CFN	XC6116F021MR	Vdet-IC	2.1V±2%, -MR, ±Reset PPO, Rt=400ms	SOT-25	28xf	VD21	6g	Tor
CFP	XG6213B22AMR	LVR-IC	LDO, 2.25V±2%, 150mA, +CE	SOT-25	28cx	VR4	6g	Tor
CFP	XC6116F022MR	Vdet-IC	2.2V±2%, -MR, ±Reset PPO, Rt=400ms	SOT-25	28xf	VD21	6g	Tor
CFR	XG6213B23AMR	LVR-IC	LDO, 2.35V±2%, 150mA, +CE	SOT-25	28cx	VR4	6g	Tor
CFR	XC6116F023MR	Vdet-IC	2.3V±2%, -MR, ±Reset PPO, Rt=400ms	SOT-25	28xf	VD21	6g	Tor
CFR	XG6213B24AMR	LVR-IC	LDO, 2.45V±2%, 150mA, +CE	SOT-25	28cx	VR4	6g	Tor
CFR	XC6116F024MR	Vdet-IC	2.4V±2%, -MR, ±Reset PPO, Rt=400ms	SOT-25	28xf	VD21	6g	Tor
CFT	XC6213B25AMR	LVR-IC	LDO, 2.55V±2%, 150mA, +CE	SOT-25	28cx	VR4	6g	Tor
CFT	XC6116F025MR	Vdet-IC	2.5V±2%, -MR, ±Reset PPO, Rt=400ms	SOT-25	28xf	VD21	6g	Tor
CFU	XG6213B26AMR	LVR-IC	LDO, 2.65V±2%, 150mA, +CE	SOT-25	28cx	VR4	6g	Tor
CFU	XC6116F026MR	Vdet-IC	2.6V±2%, -MR, ±Reset PPO, Rt=400ms	SOT-25	28xf	VD21	6g	Tor
CFV	XG6213B27AMR	LVR-IC	LDO, 2.75V±2%, 150mA, +CE	SOT-25	28cx	VR4	6g	Tor
CFV	XC6116F027MR	Vdet-IC	2.7V±2%, -MR, ±Reset PPO, Rt=400ms	SOT-25	28xf	VD21	6g	Tor
CFX	XG6213B28AMR	LVR-IC	LDO, 2.85V±2%, 150mA, +CE	SOT-25	28cx	VR4	6g	Tor
CFX	XC6116F028MR	Vdet-IC	2.8V±2%, -MR, ±Reset PPO, Rt=400ms	SOT-25	28xf	VD21	6g	Tor
CFY	XG6213B29AMR	LVR-IC	LDO, 2.95V±2%, 150mA, +CE	SOT-25	28cx	VR4	6g	Tor
CFY	XC6116F029MR	Vdet-IC	2.9V±2%, -MR, ±Reset PPO, Rt=400ms	SOT-25	28xf	VD21	6g	Tor
CFZ	XC6213B30AMR	LVR-IC	LDO, 3.05V±2%, 150mA, +CE	SOT-25	28cx	VR4	6g	Tor
CFZ	XC6116F030MR	Vdet-IC	3.0V±2%, -MR, ±Reset PPO, Rt=400ms	SOT-25	28xf	VD21	6g	Tor
CG	74AHCT1G32GW	CMOS-Logic	2-input OR gate	SOT-353	28/Log4	-	6a	Phi
CG	BH30FB1WG	LVR-IC	LDO, 3.0V, 150mA, +CE	SSOP-5	30cx	VR4	6c	Rhm
CG	BH30FB1WHFV	LVR-IC	LDO, 3.0V, 150mA, +CE	HVSOF5	30vr3	VR4	6e	Rhm
CG	PI74STX1GT86CX	CMOS-Logic	2-input EXCLUSIVE-OR gate	SC-70-5	28/Log5	-	6a	Per
CG	PI74STX1GT86TX	CMOS-Logic	2-input EXCLUSIVE-OR gate	SOT-23-5	28/Log5	-	6a	Per
CG	RN5RT46AA	LVR-IC	LDO, 4.6V±2%, 150mA, -CE	SOT-23-5	28vr1	VR4	6g	Ric
CG	V6301GSP5B	Vdet-IC	2.0V, +Reset PPO, 290ms	SOT-23-5	28vdo	VD3	6a	Em
CH	74AHCT1G86GW	CMOS-Logic	2-input EXCLUSIVE-OR gate	SOT-353	28/Log5	-	6a	Phi
CH	BH31FB1WG	LVR-IC	LDO, 3.1V, 150mA, +CE	SSOP-5	30cx	VR4	6c	Rhm
CH	BH31FB1WHFV	LVR-IC	LDO, 3.1V, 150mA, +CE	HVSOF5	30vr3	VR4	6e	Rhm
CH	RN5RT47AA	LVR-IC	LDO, 4.7V±2%, 150mA, -CE	SOT-23-5	28vr1	VR4	6g	Ric
CH	V6301HSP5B	Vdet-IC	2.4V, +Reset PPO, 290ms	SOT-23-5	28vdo	VD3	6a	Em
CH-	XC62GR2612M	LVR-IC	2.6V±2%, 150mA, +CE	SOT-25	28ew	VR4	6g	Tor
CH-	XC62GP2612M	LVR-IC	2.6V±2%, 150mA, -CE	SOT-25	28ew	VR4	6g	Tor
CH+	XC62GR2622M	LVR-IC	2.6V±2%, 150mA, +CE, HS response	SOT-25	28ew	VR4	6g	Tor
CH+	XC62GP2622M	LVR-IC	2.6V±2%, 150mA, -CE, HS response	SOT-25	28ew	VR4	6g	Tor
CH=	RT9013-13GU5	LVR-IC	LDO, 1.3V±2%, 500mA, +CE	SC-70-5	28cx	VR4	6g	Rct
CH0	XC9235B10DMR	DC-DC-IC	PWM, st-down, 1.0V±2%, 600mA, 3MHz, Vin>2V, HSST, CL	SOT-25	28dc4	DC1	6g	Tor
CH0	XC6116H031MR	Vdet-IC	3.1V±2%, -MR, ±Reset PPO, Rt=1.6s	SOT-25	28xf	VD21	6g	Tor
CH0	XC6365C601MR	DC/DC-IC	PWM st-down, 100kHz, 6.0V±2.5%, 1A, +CE, soft start	SOT-25	28zm	DC7	6g	Tor
CH0	XC6367C601MR	DC/DC-IC	PWM step-up, 6.0V±2.5%, 200mA, 100kHz, +CE, soft start	SOT-25	28sh	DC11	6g	Tor
CH1	XC9235B11DMR	DC-DC-IC	PWM, st-down, 1.1V±2%, 600mA, 3MHz, Vin>2V, HSST, CL	SOT-25	28dc4	DC1	6g	Tor



SMD code	Type	Function	Short description	Case	Pinout	Sch.	St.	Mnf.
CH1	XC6116H032MR	Vdet-IC	3.2V±2%, -MR, ±Reset PPO, Rt=1.6s	SOT-25	28xf	VD21	6g	Tor
CH1	XC6367C611MR	DC/DC-IC	PWM step-up, 6.1V±2.5%, 200mA, 100kHz, +CE, soft start	SOT-25	28sh	DC11	6g	Tor
CH2	XC9235B12DMR	DC-DC-IC	PWM, st-dwn, 1.2V±2%, 600mA, 3MHz, Vin>2V, HSST, CL	SOT-25	28dc4	DC1	6g	Tor
CH2	XC6116H033MR	Vdet-IC	3.3V±2%, -MR, ±Reset PPO, Rt=1.6s	SOT-25	28xf	VD21	6g	Tor
CH2	XC6367C621MR	DC/DC-IC	PWM step-up, 6.2V±2.5%, 200mA, 100kHz, +CE, soft start	SOT-25	28sh	DC11	6g	Tor
CH3	XC9235B13DMR	DC-DC-IC	PWM, st-dwn, 1.3V±2%, 600mA, 3MHz, Vin>2V, HSST, CL	SOT-25	28dc4	DC1	6g	Tor
CH3	XC6116H034MR	Vdet-IC	3.4V±2%, -MR, ±Reset PPO, Rt=1.6s	SOT-25	28xf	VD21	6g	Tor
CH3	XC6367C631MR	DC/DC-IC	PWM step-up, 6.3V±2.5%, 200mA, 100kHz, +CE, soft start	SOT-25	28sh	DC11	6g	Tor
CH4	XC9235B14DMR	DC-DC-IC	PWM, st-dwn, 1.4V±2%, 600mA, 3MHz, Vin>2V, HSST, CL	SOT-25	28dc4	DC1	6g	Tor
CH4	XC6116H035MR	Vdet-IC	3.5V±2%, -MR, ±Reset PPO, Rt=1.6s	SOT-25	28xf	VD21	6g	Tor
CH4	XC6367C641MR	DC/DC-IC	PWM step-up, 6.4V±2.5%, 200mA, 100kHz, +CE, soft start	SOT-25	28sh	DC11	6g	Tor
CH5	XC9235B15DMR	DC-DC-IC	PWM, st-dwn, 1.5V±2%, 600mA, 3MHz, Vin>2V, HSST, CL	SOT-25	28dc4	DC1	6g	Tor
CH5	XC6116H036MR	Vdet-IC	3.6V±2%, -MR, ±Reset PPO, Rt=1.6s	SOT-25	28xf	VD21	6g	Tor
CH5	XC6367C651MR	DC/DC-IC	PWM step-up, 6.5V±2.5%, 200mA, 100kHz, +CE, soft start	SOT-25	28sh	DC11	6g	Tor
CH6	XC9235B16DMR	DC-DC-IC	PWM, st-dwn, 1.6V±2%, 600mA, 3MHz, Vin>2V, HSST, CL	SOT-25	28dc4	DC1	6g	Tor
CH6	XC6116H037MR	Vdet-IC	3.7V±2%, -MR, ±Reset PPO, Rt=1.6s	SOT-25	28xf	VD21	6g	Tor
CH7	XC9235B17DMR	DC-DC-IC	PWM, st-dwn, 1.7V±2%, 600mA, 3MHz, Vin>2V, HSST, CL	SOT-25	28dc4	DC1	6g	Tor
CH7	XC6116H038MR	Vdet-IC	3.8V±2%, -MR, ±Reset PPO, Rt=1.6s	SOT-25	28xf	VD21	6g	Tor
CH8	XC9235B18DMR	DC-DC-IC	PWM, st-dwn, 1.8V±2%, 600mA, 3MHz, Vin>2V, HSST, CL	SOT-25	28dc4	DC1	6g	Tor
CH8	XC6116H039MR	Vdet-IC	3.9V±2%, -MR, ±Reset PPO, Rt=1.6s	SOT-25	28xf	VD21	6g	Tor
CH9	XC9235B19DMR	DC-DC-IC	PWM, st-dwn, 1.9V±2%, 600mA, 3MHz, Vin>2V, HSST, CL	SOT-25	28dc4	DC1	6g	Tor
CH9	XC6116H040MR	Vdet-IC	4.0V±2%, -MR, ±Reset PPO, Rt=1.6s	SOT-25	28xf	VD21	6g	Tor
CHA	XC9235B1ADMR	DC-DC-IC	PWM, st-dwn, 1.05V±2%, 600mA, 3MHz, Vin>2V, HSST, CL	SOT-25	28dc4	DC1	6g	Tor
CHA	XC6116H041MR	Vdet-IC	4.1V±2%, -MR, ±Reset PPO, Rt=1.6s	SOT-25	28xf	VD21	6g	Tor
CHA	XC6365C605MR	DC/DC-IC	PWM st-dwn, 500kHz, 6.0V±2.5%, 1A, +CE, soft start	SOT-25	28zm	DC7	6g	Tor
CHA	XC6367C605MR	DC/DC-IC	PWM step-up, 6.0V±2.5%, 200mA, 500kHz, +CE, soft start	SOT-25	28sh	DC11	6g	Tor
CHB	XC9235B18DMR	DC-DC-IC	PWM, st-dwn, 1.15V±2%, 600mA, 3MHz, Vin>2V, HSST, CL	SOT-25	28dc4	DC1	6g	Tor
CHB	XC6116H042MR	Vdet-IC	4.2V±2%, -MR, ±Reset PPO, Rt=1.6s	SOT-25	28xf	VD21	6g	Tor
CHB	XC6367C615MR	DC/DC-IC	PWM step-up, 6.1V±2.5%, 200mA, 500kHz, +CE, soft start	SOT-25	28sh	DC11	6g	Tor
CHC	XC9235B1CDMR	DC-DC-IC	PWM, st-dwn, 1.25V±2%, 600mA, 3MHz, Vin>2V, HSST, CL	SOT-25	28dc4	DC1	6g	Tor
CHC	XC6116H043MR	Vdet-IC	4.3V±2%, -MR, ±Reset PPO, Rt=1.6s	SOT-25	28xf	VD21	6g	Tor
CHC	XC6367C625MR	DC/DC-IC	PWM step-up, 6.2V±2.5%, 200mA, 500kHz, +CE, soft start	SOT-25	28sh	DC11	6g	Tor
CHD	XC9235B1DDMR	DC-DC-IC	PWM, st-dwn, 1.35V±2%, 600mA, 3MHz, Vin>2V, HSST, CL	SOT-25	28dc4	DC1	6g	Tor
CHD	XC6116H044MR	Vdet-IC	4.4V±2%, -MR, ±Reset PPO, Rt=1.6s	SOT-25	28xf	VD21	6g	Tor
CHD	XC6367C635MR	DC/DC-IC	PWM step-up, 6.3V±2.5%, 200mA, 500kHz, +CE, soft start	SOT-25	28sh	DC11	6g	Tor
CHE	XC9235B1EDMR	DC-DC-IC	PWM, st-dwn, 1.45V±2%, 600mA, 3MHz, Vin>2V, HSST, CL	SOT-25	28dc4	DC1	6g	Tor
CHE	XC6116H045MR	Vdet-IC	4.5V±2%, -MR, ±Reset PPO, Rt=1.6s	SOT-25	28xf	VD21	6g	Tor
CHE	XC6367C645MR	DC/DC-IC	PWM step-up, 6.4V±2.5%, 200mA, 500kHz, +CE, soft start	SOT-25	28sh	DC11	6g	Tor
CHF	XC9235B1FDMR	DC-DC-IC	PWM, st-dwn, 1.55V±2%, 600mA, 3MHz, Vin>2V, HSST, CL	SOT-25	28dc4	DC1	6g	Tor
CHF	XC6116H016MR	Vdet-IC	1.6V±2%, -MR, ±Reset PPO, Rt=1.6s	SOT-25	28xf	VD21	6g	Tor
CHF	XC6116H046MR	Vdet-IC	4.6V±2%, -MR, ±Reset PPO, Rt=1.6s	SOT-25	28xf	VD21	6g	Tor
CHE	XC6367C655MR	DC/DC-IC	PWM step-up, 6.5V±2.5%, 200mA, 500kHz, +CE, soft start	SOT-25	28sh	DC11	6g	Tor
CHH	XC9235B1HDMR	DC-DC-IC	PWM, st-dwn, 1.65V±2%, 600mA, 3MHz, Vin>2V, HSST, CL	SOT-25	28dc4	DC1	6g	Tor
CHH	XC6116H017MR	Vdet-IC	1.7V±2%, -MR, ±Reset PPO, Rt=1.6s	SOT-25	28xf	VD21	6g	Tor
CHH	XC6116H047MR	Vdet-IC	4.7V±2%, -MR, ±Reset PPO, Rt=1.6s	SOT-25	28xf	VD21	6g	Tor
CHK	XC9235B1KDMR	DC-DC-IC	PWM, st-dwn, 1.75V±2%, 600mA, 3MHz, Vin>2V, HSST, CL	SOT-25	28dc4	DC1	6g	Tor
CHK	XC6116H018MR	Vdet-IC	1.8V±2%, -MR, ±Reset PPO, Rt=1.6s	SOT-25	28xf	VD21	6g	Tor
CHK	XC6116H048MR	Vdet-IC	4.8V±2%, -MR, ±Reset PPO, Rt=1.6s	SOT-25	28xf	VD21	6g	Tor
CHL	XC9235B1LDMR	DC-DC-IC	PWM, st-dwn, 1.85V±2%, 600mA, 3MHz, Vin>2V, HSST, CL	SOT-25	28dc4	DC1	6g	Tor
CHL	XC6116H019MR	Vdet-IC	1.9V±2%, -MR, ±Reset PPO, Rt=1.6s	SOT-25	28xf	VD21	6g	Tor
CHL	XC6116H049MR	Vdet-IC	4.9V±2%, -MR, ±Reset PPO, Rt=1.6s	SOT-25	28xf	VD21	6g	Tor
CHM	XC9235B1MDMR	DC-DC-IC	PWM, st-dwn, 1.95V±2%, 600mA, 3MHz, Vin>2V, HSST, CL	SOT-25	28dc4	DC1	6g	Tor
CHM	XC6116H020MR	Vdet-IC	2.0V±2%, -MR, ±Reset PPO, Rt=1.6s	SOT-25	28xf	VD21	6g	Tor
CHM	XC6116H050MR	Vdet-IC	5.0V±2%, -MR, ±Reset PPO, Rt=1.6s	SOT-25	28xf	VD21	6g	Tor
CHN	XC6116H021MR	Vdet-IC	2.1V±2%, -MR, ±Reset PPO, Rt=1.6s	SOT-25	28xf	VD21	6g	Tor
CHP	XC6116H022MR	Vdet-IC	2.2V±2%, -MR, ±Reset PPO, Rt=1.6s	SOT-25	28xf	VD21	6g	Tor
CHR	XC6116H023MR	Vdet-IC	2.3V±2%, -MR, ±Reset PPO, Rt=1.6s	SOT-25	28xf	VD21	6g	Tor
CHS	XC6116H024MR	Vdet-IC	2.4V±2%, -MR, ±Reset PPO, Rt=1.6s	SOT-25	28xf	VD21	6g	Tor
CHT	XC6116H025MR	Vdet-IC	2.5V±2%, -MR, ±Reset PPO, Rt=1.6s	SOT-25	28xf	VD21	6g	Tor
CHU	XC6116H026MR	Vdet-IC	2.6V±2%, -MR, ±Reset PPO, Rt=1.6s	SOT-25	28xf	VD21	6g	Tor
CHV	XC6116H027MR	Vdet-IC	2.7V±2%, -MR, ±Reset PPO, Rt=1.6s	SOT-25	28xf	VD21	6g	Tor
CHX	XC6116H028MR	Vdet-IC	2.8V±2%, -MR, ±Reset PPO, Rt=1.6s	SOT-25	28xf	VD21	6g	Tor
CHY	XC6116H029MR	Vdet-IC	2.9V±2%, -MR, ±Reset PPO, Rt=1.6s	SOT-25	28xf	VD21	6g	Tor
CHZ	XC6116H030MR	Vdet-IC	3.0V±2%, -MR, ±Reset PPO, Rt=1.6s	SOT-25	28xf	VD21	6g	Tor
CI	V6301ISP5B	Vdet-IC	2.8V, +Reset PPO, 290ms	SOT-23-5	28vdo	VD3	6a	Em
CJ	BH33FB1WG	LVR-IC	LDO, 3.3V, 150mA, +CE	SSOP-5	28cx	VR4	6c	Rhm
CJ	BH33FB1WHFV	LVR-IC	LDO, 3.3V, 150mA, +CE	HVSOF5	30vr3	VR4	6e	Rhm
CJ	RN5RT48AA	LVR-IC	LDO, 4.8V±2%, 150mA, -CE	SOT-23-5	28vrt	VR4	6g	Ric
CJ	V6301JSP5B	Vdet-IC	3.5V, +Reset PPO, 290ms	SOT-23-5	28vdo	VD3	6a	Em
CJ-	RT9169-20PB	LVR-IC	LDO, 2.2V±2%, 100mA, -CE	SOT-23-5	28cx	VR4	6g	Rct



SMD code	Type	Function	Short description	Case	Pinout	Sch.	St.	Mnf.
CK	BH15LB1WG	LVR-IC	LDO, 1.5V, 150mA, +CE	SSOP-5	28cx	VR4	6c	Rhm
CK	BH15LB1WHFV	LVR-IC	LDO, 1.5V, 150mA, +CE	HVSOF5	30v3	VR4	6e	Rhm
CK	RN5RT49AA	LVR-IC	LDO, 4.9V±2%, 150mA, -CE	SOT-23-5	28vrt	VR4	6g	Ric
CK	RT9169-18CB	LVR-IC	LDO, 1.8V±2%, 100mA, -CE	SOT-23-5	28cx	VR4	6g	Rct
CK	V6301KSP5B	Vdet-IC	4V, +Reset PPO, 290ms	SOT-23-5	28vdo	VD3	6a	Em
CK-	RT9169-18PB	LVR-IC	LDO, 1.8V±2%, 100mA, -CE	SOT-23-5	28cx	VR4	6g	Rct
CK-	XC62GR2712M	LVR-IC	2.7V±2%, 150mA, +CE	SOT-25	28ew	VR4	6g	Tor
CK-	XC62GP2712M	LVR-IC	2.7V±2%, 150mA, -CE	SOT-25	28ew	VR4	6g	Tor
CK+	XC62GR2722M	LVR-IC	2.7V±2%, 150mA, +CE, HS response	SOT-25	28ew	VR4	6g	Tor
CK+	XC62GP2722M	LVR-IC	2.7V±2%, 150mA, -CE, HS response	SOT-25	28ew	VR4	6g	Tor
CK0	XC9235B20DMR	DC-DC-IC	PWM, st-dwn, 2.0V±2%, 600mA, 3MHz, Vin>2V, HSST, CL	SOT-25	28dc4	DC1	6g	Tor
CK1	XC9235B21DMR	DC-DC-IC	PWM, st-dwn, 2.1V±2%, 600mA, 3MHz, Vin>2V, HSST, CL	SOT-25	28dc4	DC1	6g	Tor
CK2	XC9235B22DMR	DC-DC-IC	PWM, st-dwn, 2.2V±2%, 600mA, 3MHz, Vin>2V, HSST, CL	SOT-25	28dc4	DC1	6g	Tor
CK3	XC9235B23DMR	DC-DC-IC	PWM, st-dwn, 2.3V±2%, 600mA, 3MHz, Vin>2V, HSST, CL	SOT-25	28dc4	DC1	6g	Tor
CK4	XC9235B24DMR	DC-DC-IC	PWM, st-dwn, 2.4V±2%, 600mA, 3MHz, Vin>2V, HSST, CL	SOT-25	28dc4	DC1	6g	Tor
CK5	XC9235B25DMR	DC-DC-IC	PWM, st-dwn, 2.5V±2%, 600mA, 3MHz, Vin>2V, HSST, CL	SOT-25	28dc4	DC1	6g	Tor
CK6	XC9235B26DMR	DC-DC-IC	PWM, st-dwn, 2.6V±2%, 600mA, 3MHz, Vin>2V, HSST, CL	SOT-25	28dc4	DC1	6g	Tor
CK7	XC9235B27DMR	DC-DC-IC	PWM, st-dwn, 2.7V±2%, 600mA, 3MHz, Vin>2V, HSST, CL	SOT-25	28dc4	DC1	6g	Tor
CK8	XC9235B28DMR	DC-DC-IC	PWM, st-dwn, 2.8V±2%, 600mA, 3MHz, Vin>2V, HSST, CL	SOT-25	28dc4	DC1	6g	Tor
CK9	XC9235B29DMR	DC-DC-IC	PWM, st-dwn, 2.9V±2%, 600mA, 3MHz, Vin>2V, HSST, CL	SOT-25	28dc4	DC1	6g	Tor
CKA	XC9235B2ADM	DC-DC-IC	PWM, st-dwn, 2.05V±2%, 600mA, 3MHz, Vin>2V, HSST, CL	SOT-25	28dc4	DC1	6g	Tor
CKB	XC9235B2BDMR	DC-DC-IC	PWM, st-dwn, 2.15V±2%, 600mA, 3MHz, Vin>2V, HSST, CL	SOT-25	28dc4	DC1	6g	Tor
CKC	XC9235B2CDMR	DC-DC-IC	PWM, st-dwn, 2.25V±2%, 600mA, 3MHz, Vin>2V, HSST, CL	SOT-25	28dc4	DC1	6g	Tor
CKD	XC9235B2DDMR	DC-DC-IC	PWM, st-dwn, 2.35V±2%, 600mA, 3MHz, Vin>2V, HSST, CL	SOT-25	28dc4	DC1	6g	Tor
CKE	XC9235B2EDMR	DC-DC-IC	PWM, st-dwn, 2.45V±2%, 600mA, 3MHz, Vin>2V, HSST, CL	SOT-25	28dc4	DC1	6g	Tor
CKF	XC9235B2FDMR	DC-DC-IC	PWM, st-dwn, 2.55V±2%, 600mA, 3MHz, Vin>2V, HSST, CL	SOT-25	28dc4	DC1	6g	Tor
CKH	XC9235B2HDMR	DC-DC-IC	PWM, st-dwn, 2.65V±2%, 600mA, 3MHz, Vin>2V, HSST, CL	SOT-25	28dc4	DC1	6g	Tor
CKK	XC9235B2KDMR	DC-DC-IC	PWM, st-dwn, 2.75V±2%, 600mA, 3MHz, Vin>2V, HSST, CL	SOT-25	28dc4	DC1	6g	Tor
CKL	XC9235B2LDMR	DC-DC-IC	PWM, st-dwn, 2.85V±2%, 600mA, 3MHz, Vin>2V, HSST, CL	SOT-25	28dc4	DC1	6g	Tor
CKM	XC9235B2MDMR	DC-DC-IC	PWM, st-dwn, 2.95V±2%, 600mA, 3MHz, Vin>2V, HSST, CL	SOT-25	28dc4	DC1	6g	Tor
CL	74AHCT1G66GW	CMOS-Logic	Bilateral analogic switch	SOT-353	28/Log16	-	6a	Phi
CL	BH18LB1WG	LVR-IC	LDO, 1.8V, 150mA, +CE	SSOP-5	28cx	VR4	6c	Rhm
CL	BH18LB1WHFV	LVR-IC	LDO, 1.8V, 150mA, +CE	HVSOF5	30v3	VR4	6e	Rhm
CL	R1112N401A	LVR-IC	LDO, LN, -CE, 4V±2%, 150mA	SOT-23-5	28cx	VR4	6g	Ric
CL	V6301LSP5B	Vdet-IC	4.5V, +Reset PPO, 290ms	SOT-23-5	28vdo	VD3	6a	Em
CL-	XC62GR2812M	LVR-IC	2.8V±2%, 150mA, +CE	SOT-25	28ew	VR4	6g	Tor
CL-	XC62GP2812M	LVR-IC	2.8V±2%, 150mA, -CE	SOT-25	28ew	VR4	6g	Tor
CL+	XC62GR2822M	LVR-IC	2.8V±2%, 150mA, +CE, HS response	SOT-25	28ew	VR4	6g	Tor
CL+	XC62GP2822M	LVR-IC	2.8V±2%, 150mA, -CE, HS response	SOT-25	28ew	VR4	6g	Tor
CL=	RT9013A-30GU5	LVR-IC	LDO, 3.0V±2%, 500mA, +CE	SC-70-5	28cx	VR4	6g	Rct
CL0	XC9235B30DMR	DC-DC-IC	PWM, st-dwn, 3.0V±2%, 600mA, 3MHz, Vin>2V, HSST, CL	SOT-25	28dc4	DC1	6g	Tor
CL1	XC9235B31DMR	DC-DC-IC	PWM, st-dwn, 3.1V±2%, 600mA, 3MHz, Vin>2V, HSST, CL	SOT-25	28dc4	DC1	6g	Tor
CL2	XC9235B32DMR	DC-DC-IC	PWM, st-dwn, 3.2V±2%, 600mA, 3MHz, Vin>2V, HSST, CL	SOT-25	28dc4	DC1	6g	Tor
CL3	XC9235B33DMR	DC-DC-IC	PWM, st-dwn, 3.3V±2%, 600mA, 3MHz, Vin>2V, HSST, CL	SOT-25	28dc4	DC1	6g	Tor
CL4	XC9235B34DMR	DC-DC-IC	PWM, st-dwn, 3.4V±2%, 600mA, 3MHz, Vin>2V, HSST, CL	SOT-25	28dc4	DC1	6g	Tor
CL5	XC9235B35DMR	DC-DC-IC	PWM, st-dwn, 3.5V±2%, 600mA, 3MHz, Vin>2V, HSST, CL	SOT-25	28dc4	DC1	6g	Tor
CL6	XC9235B36DMR	DC-DC-IC	PWM, st-dwn, 3.6V±2%, 600mA, 3MHz, Vin>2V, HSST, CL	SOT-25	28dc4	DC1	6g	Tor
CL7	XC9235B37DMR	DC-DC-IC	PWM, st-dwn, 3.7V±2%, 600mA, 3MHz, Vin>2V, HSST, CL	SOT-25	28dc4	DC1	6g	Tor
CL8	XC9235B38DMR	DC-DC-IC	PWM, st-dwn, 3.8V±2%, 600mA, 3MHz, Vin>2V, HSST, CL	SOT-25	28dc4	DC1	6g	Tor
CL9	XC9235B39DMR	DC-DC-IC	PWM, st-dwn, 3.9V±2%, 600mA, 3MHz, Vin>2V, HSST, CL	SOT-25	28dc4	DC1	6g	Tor
CLA	XC9235B3ADM	DC-DC-IC	PWM, st-dwn, 3.05V±2%, 600mA, 3MHz, Vin>2V, HSST, CL	SOT-25	28dc4	DC1	6g	Tor
CLB	XC9235B3BDMR	DC-DC-IC	PWM, st-dwn, 3.15V±2%, 600mA, 3MHz, Vin>2V, HSST, CL	SOT-25	28dc4	DC1	6g	Tor
CLC	XC9235B3CDMR	DC-DC-IC	PWM, st-dwn, 3.25V±2%, 600mA, 3MHz, Vin>2V, HSST, CL	SOT-25	28dc4	DC1	6g	Tor
CLD	XC9235B3DDMR	DC-DC-IC	PWM, st-dwn, 3.35V±2%, 600mA, 3MHz, Vin>2V, HSST, CL	SOT-25	28dc4	DC1	6g	Tor
CLE	XC9235B3EDMR	DC-DC-IC	PWM, st-dwn, 3.45V±2%, 600mA, 3MHz, Vin>2V, HSST, CL	SOT-25	28dc4	DC1	6g	Tor
CLF	XC9235B3FDMR	DC-DC-IC	PWM, st-dwn, 3.55V±2%, 600mA, 3MHz, Vin>2V, HSST, CL	SOT-25	28dc4	DC1	6g	Tor
CLH	XC9235B3HDMR	DC-DC-IC	PWM, st-dwn, 3.65V±2%, 600mA, 3MHz, Vin>2V, HSST, CL	SOT-25	28dc4	DC1	6g	Tor
CLK	XC9235B3KDMR	DC-DC-IC	PWM, st-dwn, 3.75V±2%, 600mA, 3MHz, Vin>2V, HSST, CL	SOT-25	28dc4	DC1	6g	Tor
CLL	XC9235B3LDMR	DC-DC-IC	PWM, st-dwn, 3.85V±2%, 600mA, 3MHz, Vin>2V, HSST, CL	SOT-25	28dc4	DC1	6g	Tor
CLM	XC9235B3MDMR	DC-DC-IC	PWM, st-dwn, 3.95V±2%, 600mA, 3MHz, Vin>2V, HSST, CL	SOT-25	28dc4	DC1	6g	Tor
CM	74AHCT1G125GW	CMOS-Logic	Bus buffer gate with 3-state output	SOT-353	28/Log14	-	6a	Phi
CM	BH1JLB1WHFV	LVR-IC	LDO, 1.85V, 150mA, +CE	HVSOF5	30v3	VR4	6e	Rhm
CM	R1112N411A	LVR-IC	LDO, LN, -CE, 4.1V±2%, 150mA	SOT-23-5	28cx	VR4	6g	Ric
CM	V6301MSP5B	Vdet-IC	2.0V, -Reset ODO, 290ms	SOT-23-5	28vdr	VD6	6a	Em
CM-	XC62GR2912M	LVR-IC	2.9V±2%, 150mA, +CE	SOT-25	28ew	VR4	6g	Tor
CM-	XC62GP2912M	LVR-IC	2.9V±2%, 150mA, -CE	SOT-25	28ew	VR4	6g	Tor
CM+	XC62GR2922M	LVR-IC	2.9V±2%, 150mA, +CE, HS response	SOT-25	28ew	VR4	6g	Tor
CM+	XC62GP2922M	LVR-IC	2.9V±2%, 150mA, -CE, HS response	SOT-25	28ew	VR4	6g	Tor
CM=	RT9013B-12GU5	LVR-IC	LDO, 1.2V±2%, 500mA, +CE	SC-70-5	28cx	VR4	6g	Rct
CM0	XC6213B31AMR	LVR-IC	LDO, 3.15V±2%, 150mA, +CE	SOT-25	28cx	VR4	6g	Tor



SMD code	Type	Function	Short description	Case	Pinout	Sch.	St.	Mnf.
CM0	XC6213B40DMR	DC-DC-IC	PWM, st-dwn, 4.0V±2%, 600mA, 3MHz, Vin>2V, HSST, CL	SOT-25	28dc4	DC1	6g	Tor
CM1	XC6213B32AMR	LVR-IC	LDO, 3.25V±2%, 150mA, +CE	SOT-25	28cx	VR4	6g	Tor
CM2	XC6213B33AMR	LVR-IC	LDO, 3.35V±2%, 150mA, +CE	SOT-25	28cx	VR4	6g	Tor
CM3	XC6213B34AMR	LVR-IC	LDO, 3.45V±2%, 150mA, +CE	SOT-25	28cx	VR4	6g	Tor
CM4	XC6213B35AMR	LVR-IC	LDO, 3.55V±2%, 150mA, +CE	SOT-25	28cx	VR4	6g	Tor
CM5	XC6213B36AMR	LVR-IC	LDO, 3.65V±2%, 150mA, +CE	SOT-25	28cx	VR4	6g	Tor
CM6	XC6213B37AMR	LVR-IC	LDO, 3.75V±2%, 150mA, +CE	SOT-25	28cx	VR4	6g	Tor
CM7	XC6213B38AMR	LVR-IC	LDO, 3.85V±2%, 150mA, +CE	SOT-25	28cx	VR4	6g	Tor
CM8	XC6213B39AMR	LVR-IC	LDO, 3.95V±2%, 150mA, +CE	SOT-25	28cx	VR4	6g	Tor
CM9	XC6213B40AMR	LVR-IC	LDO, 4.05V±2%, 150mA, +CE	SOT-25	28cx	VR4	6g	Tor
CMA	XC6213B41AMR	LVR-IC	LDO, 4.15V±2%, 150mA, +CE	SOT-25	28cx	VR4	6g	Tor
CMB	XC6213B42AMR	LVR-IC	LDO, 4.25V±2%, 150mA, +CE	SOT-25	28cx	VR4	6g	Tor
CMC	XC6213B43AMR	LVR-IC	LDO, 4.35V±2%, 150mA, +CE	SOT-25	28cx	VR4	6g	Tor
CMD	XC6213B44AMR	LVR-IC	LDO, 4.45V±2%, 150mA, +CE	SOT-25	28cx	VR4	6g	Tor
CME	XC6213B45AMR	LVR-IC	LDO, 4.55V±2%, 150mA, +CE	SOT-25	28cx	VR4	6g	Tor
CMF	XC6213B46AMR	LVR-IC	LDO, 4.65V±2%, 150mA, +CE	SOT-25	28cx	VR4	6g	Tor
CMH	XC6213B47AMR	LVR-IC	LDO, 4.75V±2%, 150mA, +CE	SOT-25	28cx	VR4	6g	Tor
CMK	XC6213B48AMR	LVR-IC	LDO, 4.85V±2%, 150mA, +CE	SOT-25	28cx	VR4	6g	Tor
CML	XC6213B49AMR	LVR-IC	LDO, 4.95V±2%, 150mA, +CE	SOT-25	28cx	VR4	6g	Tor
CN	74AHCT1G126GW	CMOS-Logic	Bus buffer gate with 3-state output	SOT-353	28/Log13	-	6a	Phi
CN	R1112N421A	LVR-IC	LDO, LN, -CE, 4.2V±2%, 150mA	SOT-23-5	28cx	VR4	6g	Ric
CN	V6301NSP5B	Vdet-IC	2.4V, -Reset ODO, 290ms	SOT-23-5	28vdr	VD6	6a	Em
CO	V6301OSP5B	Vdet-IC	2.8V, -Reset ODO, 290ms	SOT-23-5	28vdr	VD6	6a	Em
CP	74AHCT1G79GW	CMOS-Logic	Positive edge-triggered D-type flip-flop	SOT-353	28/Log20	-	6a	Phi
CP	R1112N431A	LVR-IC	LDO, LN, -CE, 4.3V±2%, 150mA	SOT-23-5	28cx	VR4	6g	Ric
CP	V6301PSP5B	Vdet-IC	3.5V, -Reset ODO, 290ms	SOT-23-5	28vdr	VD6	6a	Em
CQ	R1112N441A	LVR-IC	LDO, LN, -CE, 4.4V±2%, 150mA	SOT-23-5	28cx	VR4	6g	Ric
CQ	V6301QSP5B	Vdet-IC	4V, -Reset ODO, 290ms	SOT-23-5	28vdr	VD6	6a	Em
CR	74AHCT1G06GW	CMOS-Logic	Inverter (ODO)	SOT-353	28/Log19	-	6a	Phi
CR	AT1201-30XR	LVR-IC	LDO, LN, +CE, 3V±2%, 150mA	SOT-23-5	28un	VR7	6a	Atr
CR	R1112N451A	LVR-IC	LDO, LN, -CE, 4.5V±2%, 150mA	SOT-23-5	28cx	VR4	6g	Ric
CR	V6301RSP5B	Vdet-IC	4.5V, -Reset ODO, 290ms	SOT-23-5	28vdr	VD6	6a	Em
CS	74AHCT1G07GW	CMOS-Logic	Noninverting buffer/driver (ODO)	SOT-353	28/Log8	-	6a	Phi
CS	R1112N461A	LVR-IC	LDO, LN, -CE, 4.6V±2%, 150mA	SOT-23-5	28cx	VR4	6g	Ric
CS-	RT9193-27PB	LVR-IC	LDO, 2.7V±1%, 300mA, +CE	SOT-23-5	28vrx	VR7	6g	Rct
CS=	RT9193-27GB	LVR-IC	LDO, 2.7V±1%, 300mA, +CE	SOT-23-5	28vrx	VR7	6g	Rct
CT	R1112N471A	LVR-IC	LDO, LN, -CE, 4.7V±2%, 150mA	SOT-23-5	28cx	VR4	6g	Ric
CT-	RT9198-27PB	LVR-IC	LDO, 2.7V±1%, 300mA, +CE	SOT-23-5	28xm	VR4	6a	Rct
CJ	R1112N481A	LVR-IC	LDO, LN, -CE, 4.8V±2%, 150mA	SOT-23-5	28cx	VR4	6g	Ric
CJ-	RT9193-2HPB	LVR-IC	LDO, 2.85V±1%, 300mA, +CE	SOT-23-5	28vrx	VR7	6g	Rct
CJ=	RT9193-2HGB	LVR-IC	LDO, 2.85V±1%, 300mA, +CE	SOT-23-5	28vrx	VR7	6g	Rct
CJD	S-817A14AMC-CUDT2G	LVR-IC	1.4V±2%, 50mA	SOT-23-5	28vu	VR1	6r	Sii
CJF	S-817A16AMC-CUFT2G	LVR-IC	1.6V±2%, 50mA	SOT-23-5	28vu	VR1	6r	Sii
CV	BH25NB1WHFV	LVR-IC	LDO, 2.5V, 150mA, +CE	HVSOF5	30v3	VR4	6e	Rhm
CV	R1112N491A	LVR-IC	LDO, LN, -CE, 4.9V±2%, 150mA	SOT-23-5	28cx	VR4	6g	Ric
CW	BH28NB1WHFV	LVR-IC	LDO, 2.8V, 150mA, +CE	HVSOF5	30v3	VR4	6e	Rhm
CW-	RT9198-31PB	LVR-IC	LDO, 3.1V±1%, 300mA, +CE	SOT-23-5	28xm	VR4	6a	Rct
CWA	S-817B11AMC-CWAT2G	LVR-IC	1.1V±2%, 50mA	SOT-23-5	28vu	VR1	6r	Sii
CWB	S-817B12AMC-CWBT2G	LVR-IC	1.2V±2%, 50mA	SOT-23-5	28vu	VR1	6r	Sii
CWC	S-817B13AMC-CWCT2G	LVR-IC	1.3V±2%, 50mA	SOT-23-5	28vu	VR1	6r	Sii
CWD	S-817B14AMC-CWDT2G	LVR-IC	1.4V±2%, 50mA	SOT-23-5	28vu	VR1	6r	Sii
CWE	S-817B15AMC-CWET2G	LVR-IC	1.5V±2%, 50mA	SOT-23-5	28vu	VR1	6r	Sii
CWF	S-817B16AMC-CWFT2G	LVR-IC	1.6V±2%, 50mA	SOT-23-5	28vu	VR1	6r	Sii
CWG	S-817B17AMC-CWGT2G	LVR-IC	1.7V±2%, 50mA	SOT-23-5	28vu	VR1	6r	Sii
CWH	S-817B18AMC-CWHT2G	LVR-IC	1.8V±2%, 50mA	SOT-23-5	28vu	VR1	6r	Sii
CWI	S-817B19AMC-CWIT2G	LVR-IC	1.9V±2%, 50mA	SOT-23-5	28vu	VR1	6r	Sii
CWJ	S-817B20AMC-CWJT2G	LVR-IC	2.0V±2%, 50mA	SOT-23-5	28vu	VR1	6r	Sii
CWK	S-817B21AMC-CWKT2G	LVR-IC	2.1V±2%, 50mA	SOT-23-5	28vu	VR1	6r	Sii
CWL	S-817B22AMC-CWLT2G	LVR-IC	2.2V±2%, 50mA	SOT-23-5	28vu	VR1	6r	Sii
CWM	S-817B23AMC-CWMT2G	LVR-IC	2.3V±2%, 50mA	SOT-23-5	28vu	VR1	6r	Sii
CWN	S-817B24AMC-CWNT2G	LVR-IC	2.4V±2%, 50mA	SOT-23-5	28vu	VR1	6r	Sii
CWO	S-817B25AMC-CWOT2G	LVR-IC	2.5V±2%, 50mA	SOT-23-5	28vu	VR1	6r	Sii
CWP	S-817B26AMC-CWPT2G	LVR-IC	2.6V±2%, 50mA	SOT-23-5	28vu	VR1	6r	Sii
CWQ	S-817B27AMC-CWQT2G	LVR-IC	2.7V±2%, 50mA	SOT-23-5	28vu	VR1	6r	Sii
CWR	S-817B28AMC-CWRT2G	LVR-IC	2.8V±2%, 50mA	SOT-23-5	28vu	VR1	6r	Sii
CWS	S-817B29AMC-CWST2G	LVR-IC	2.9V±2%, 50mA	SOT-23-5	28vu	VR1	6r	Sii
CWT	S-817B30AMC-CWTT2G	LVR-IC	3.0V±2%, 50mA	SOT-23-5	28vu	VR1	6r	Sii
CWU	S-817B31AMC-CWUT2G	LVR-IC	3.1V±2%, 50mA	SOT-23-5	28vu	VR1	6r	Sii
CWV	S-817B32AMC-CWVT2G	LVR-IC	3.2V±2%, 50mA	SOT-23-5	28vu	VR1	6r	Sii
CWW	S-817B33AMC-CWWT2G	LVR-IC	3.3V±2%, 50mA	SOT-23-5	28vu	VR1	6r	Sii



SMD code	Type	Function	Short description	Case	Pinout	Sch.	St.	Mnf.
CWX	S-817B34AMC-CWXT2G	LVR-IC	3.4V±2%, 50mA	SOT-23-5	28vu	VR1	6r	Sii
CWY	S-817B35AMC-CWYT2G	LVR-IC	3.5V±2%, 50mA	SOT-23-5	28vu	VR1	6r	Sii
CWZ	S-817B36AMC-CWZT2G	LVR-IC	3.6V±2%, 50mA	SOT-23-5	28vu	VR1	6r	Sii
CX	AT1201-30X	LVR-IC	LDO, LN, +CE, 3V±2%, 150mA	SOT-23-5	28vrx	VR7	6a	Atr
CX	BH29NB1WHFV	LVR-IC	LDO, 2.9V, 150mA, +CE	HVSOF5	30v3	VR4	6e	Rhm
CXA	S-817B37AMC-CXAT2G	LVR-IC	3.7V±2%, 50mA	SOT-23-5	28vu	VR1	6r	Sii
CXB	S-817B38AMC-CXBT2G	LVR-IC	3.8V±2%, 50mA	SOT-23-5	28vu	VR1	6r	Sii
CXB	XC6213B122MR	LVR-IC	LDO, 1.2V±2%, 150mA, +CE	SOT-25	28cx	VR4	6g	Tor
CXC	S-817B39AMC-CXCT2G	LVR-IC	3.9V±2%, 50mA	SOT-23-5	28vu	VR1	6r	Sii
CXC	XC6213B132MR	LVR-IC	LDO, 1.3V±2%, 150mA, +CE	SOT-25	28cx	VR4	6g	Tor
CXD	S-817B40AMC-CXDT2G	LVR-IC	4.0V±2%, 50mA	SOT-23-5	28vu	VR1	6r	Sii
CXD	XC6213B142MR	LVR-IC	LDO, 1.4V±2%, 150mA, +CE	SOT-25	28cx	VR4	6g	Tor
CXE	S-817B41AMC-CXET2G	LVR-IC	4.1V±2%, 50mA	SOT-23-5	28vu	VR1	6r	Sii
CXE	XC6213B152MR	LVR-IC	LDO, 1.5V±2%, 150mA, +CE	SOT-25	28cx	VR4	6g	Tor
CXF	S-817B42AMC-CXFT2G	LVR-IC	4.2V±2%, 50mA	SOT-23-5	28vu	VR1	6r	Sii
CXF	XC6213B162MR	LVR-IC	LDO, 1.6V±2%, 150mA, +CE	SOT-25	28cx	VR4	6g	Tor
CXG	S-817B43AMC-CXGT2G	LVR-IC	4.3V±2%, 50mA	SOT-23-5	28vu	VR1	6r	Sii
CXH	S-817B44AMC-CXHT2G	LVR-IC	4.4V±2%, 50mA	SOT-23-5	28vu	VR1	6r	Sii
CXH	XC6213B172MR	LVR-IC	LDO, 1.7V±2%, 150mA, +CE	SOT-25	28cx	VR4	6g	Tor
CXI	S-817B45AMC-CXIT2G	LVR-IC	4.5V±2%, 50mA	SOT-23-5	28vu	VR1	6r	Sii
CXJ	S-817B46AMC-CXJT2G	LVR-IC	4.6V±2%, 50mA	SOT-23-5	28vu	VR1	6r	Sii
CXK	S-817B47AMC-CXKT2G	LVR-IC	4.7V±2%, 50mA	SOT-23-5	28vu	VR1	6r	Sii
CXK	XC6213B182MR	LVR-IC	LDO, 1.8V±2%, 150mA, +CE	SOT-25	28cx	VR4	6g	Tor
CXL	S-817B48AMC-CXLT2G	LVR-IC	4.8V±2%, 50mA	SOT-23-5	28vu	VR1	6r	Sii
CXL	XC6213B192MR	LVR-IC	LDO, 1.9V±2%, 150mA, +CE	SOT-25	28cx	VR4	6g	Tor
CXM	S-817B49AMC-CXMT2G	LVR-IC	4.9V±2%, 50mA	SOT-23-5	28vu	VR1	6r	Sii
CXM	XC6213B202MR	LVR-IC	LDO, 2.0V±2%, 150mA, +CE	SOT-25	28cx	VR4	6g	Tor
CXN	S-817B50AMC-CXNT2G	LVR-IC	5.0V±2%, 75mA	SOT-23-5	28vu	VR1	6r	Sii
CXN	XC6213B212MR	LVR-IC	LDO, 2.1V±2%, 150mA, +CE	SOT-25	28cx	VR4	6g	Tor
CXO	S-817B51AMC-CXOT2G	LVR-IC	5.1V±2%, 75mA	SOT-23-5	28vu	VR1	6r	Sii
CXP	S-817B52AMC-CXPT2G	LVR-IC	5.2V±2%, 75mA	SOT-23-5	28vu	VR1	6r	Sii
CXP	XC6213B222MR	LVR-IC	LDO, 2.2V±2%, 150mA, +CE	SOT-25	28cx	VR4	6g	Tor
CXQ	S-817B53AMC-CXQT2G	LVR-IC	5.3V±2%, 75mA	SOT-23-5	28vu	VR1	6r	Sii
CXR	S-817B54AMC-CXRT2G	LVR-IC	5.4V±2%, 75mA	SOT-23-5	28vu	VR1	6r	Sii
CXR	XC6213B232MR	LVR-IC	LDO, 2.3V±2%, 150mA, +CE	SOT-25	28cx	VR4	6g	Tor
CXS	S-817B55AMC-CXST2G	LVR-IC	5.5V±2%, 75mA	SOT-23-5	28vu	VR1	6r	Sii
CXS	XC6213B242MR	LVR-IC	LDO, 2.4V±2%, 150mA, +CE	SOT-25	28cx	VR4	6g	Tor
CXT	S-817B56AMC-CXTT2G	LVR-IC	5.6V±2%, 75mA	SOT-23-5	28vu	VR1	6r	Sii
CXT	XC6213B252MR	LVR-IC	LDO, 2.5V±2%, 150mA, +CE	SOT-25	28cx	VR4	6g	Tor
CXU	S-817B57AMC-CXUT2G	LVR-IC	5.7V±2%, 75mA	SOT-23-5	28vu	VR1	6r	Sii
CXU	XC6213B262MR	LVR-IC	LDO, 2.6V±2%, 150mA, +CE	SOT-25	28cx	VR4	6g	Tor
CXV	S-817B58AMC-CXVT2G	LVR-IC	5.8V±2%, 75mA	SOT-23-5	28vu	VR1	6r	Sii
CXV	XC6213B272MR	LVR-IC	LDO, 2.7V±2%, 150mA, +CE	SOT-25	28cx	VR4	6g	Tor
CXW	S-817B59AMC-CXWT2G	LVR-IC	5.9V±2%, 75mA	SOT-23-5	28vu	VR1	6r	Sii
CXX	S-817B60AMC-CXXT2G	LVR-IC	6.0V±2%, 75mA	SOT-23-5	28vu	VR1	6r	Sii
CXX	XC6213B282MR	LVR-IC	LDO, 2.8V±2%, 150mA, +CE	SOT-25	28cx	VR4	6g	Tor
CXY	XC6213B292MR	LVR-IC	LDO, 2.9V±2%, 150mA, +CE	SOT-25	28cx	VR4	6g	Tor
CXZ	XC6213B302MR	LVR-IC	LDO, 3.0V±2%, 150mA, +CE	SOT-25	28cx	VR4	6g	Tor
CY	BH30NB1WHFV	LVR-IC	LDO, 3.0V, 150mA, +CE	HVSOF5	30v3	VR4	6e	Rhm
CY	TC1054-1.8VCT713	LVR-IC	LDO, 1.8V±2%, 50mA, +CE, -Error	SOT-23-5	28w	VR8	6g	Mcc
CZ	BH31NB1WHFV	LVR-IC	LDO, 3.1V, 150mA, +CE	HVSOF5	30v3	VR4	6e	Rhm
CZ	RT9167-50CBR	LVR-IC	LDO, 5.0V±2%, 300mA, +CE	SOT-23-5	28v1	VR7	6g	Rct
CZ	TC1054-2.8VCT713	LVR-IC	LDO, 2.8V±2%, 50mA, +CE, -Error	SOT-23-5	28w	VR8	6g	Mcc
D0	AP131-41TW	LVR-IC	LDO, 4.1V±2%, 300mA, +CE	TSOT-23-5L	28vrx	VR4	6a	Ana
D0	AP131-41W	LVR-IC	LDO, 4.1V±2%, 300mA, +CE	SOT-23-5L	28vrx	VR4	6k	Ana
D0	R111N1501A	LVR-IC	LDO, LN, -CE, 5V±2%, 200mA	SOT-23-5	28cx	VR4	6g	Ric
D0	Si91842DT-36	LVR-IC	LDO, LN, +CE, -Error, 3.6V±1.5%, 150mA	SOT-23-5	28w	VR17	6k	Vs
D0	TC1055-4.0VCT713	LVR-IC	LDO, 4.0V±2%, 100mA, +CE, -Error	SOT-23-5	28w	VR8	6g	Mcc
D0	RN5VD30AA	Vdet-IC	3V±2.5%, -Reset PPO	SOT-23-5	28vdx	VD3	6g	Ric
D0-	RT9193-31PB	LVR-IC	LDO, 3.1V±1%, 300mA, +CE	SOT-23-5	28vrx	VR7	6g	Rct
D0=	RT9193-31GB	LVR-IC	LDO, 3.1V±1%, 300mA, +CE	SOT-23-5	28vrx	VR7	6g	Rct
D008	RP200Q082D	LVR-IC	LDO, 0.8V±1.0%, 300mA, +CE, CL, AE(mode)	SC-88A	28hv	VR10	6m	Ric
D009	RP200Q092D	LVR-IC	LDO, 0.9V±1.0%, 300mA, +CE, CL, AE(mode)	SC-88A	28hv	VR10	6m	Ric
D00A	LM3411AM5-3.3	LVR-IC	Precision Secondary Regulator/Driver, 3.3V	SOT-23-5	28vi	-	6g	Nsc
D00B	LM3411M5-3.3	LVR-IC	Precision Secondary Regulator/Driver 3.3V	SOT-23-5	28vi	-	6g	Nsc
D010	RP200Q102D	LVR-IC	LDO, 1.0V±1.0%, 300mA, +CE, CL, AE(mode)	SC-88A	28hv	VR10	6m	Ric
D011	RP200Q112D	LVR-IC	LDO, 1.1V±1.0%, 300mA, +CE, CL, AE(mode)	SC-88A	28hv	VR10	6m	Ric
D012	RP200Q122D	LVR-IC	LDO, 1.2V±1.0%, 300mA, +CE, CL, AE(mode)	SC-88A	28hv	VR10	6m	Ric
D013	RP200Q132D	LVR-IC	LDO, 1.3V±1.0%, 300mA, +CE, CL, AE(mode)	SC-88A	28hv	VR10	6m	Ric
D014	RP200Q142D	LVR-IC	LDO, 1.4V±1.0%, 300mA, +CE, CL, AE(mode)	SC-88A	28hv	VR10	6m	Ric



SMD code	Type	Function	Short description	Case	Pinout	Sch.	St.	Mnf.
D015	RP200Q152D	LVR-IC	LDO, 1.5V±1.0%, 300mA, +CE, CL, AE(mode)	SC-88A	28hv	VR10	6m	Ric
D016	RP200Q162D	LVR-IC	LDO, 1.6V±1.0%, 300mA, +CE, CL, AE(mode)	SC-88A	28hv	VR10	6m	Ric
D017	RP200Q172D	LVR-IC	LDO, 1.7V±1.0%, 300mA, +CE, CL, AE(mode)	SC-88A	28hv	VR10	6m	Ric
D018	RP200Q182D	LVR-IC	LDO, 1.8V±1.0%, 300mA, +CE, CL, AE(mode)	SC-88A	28hv	VR10	6m	Ric
D019	RP200Q192D	LVR-IC	LDO, 1.9V±1.0%, 300mA, +CE, CL, AE(mode)	SC-88A	28hv	VR10	6m	Ric
D01A	LM3411AM5-5.0	LVR-IC	Precision Secondary Regulator/Driver, 5V	SOT-23-5	28vi	-	6g	Nsc
D01B	LM3411M5-5.0	LVR-IC	Precision Secondary Regulator/Driver, 5V	SOT-23-5	28vi	-	6g	Nsc
D020	RP200Q202D	LVR-IC	LDO, 2.0V±1.0%, 300mA, +CE, CL, AE(mode)	SC-88A	28hv	VR10	6m	Ric
D021	RP200Q212D	LVR-IC	LDO, 2.1V±1.0%, 300mA, +CE, CL, AE(mode)	SC-88A	28hv	VR10	6m	Ric
D022	RP200Q222D	LVR-IC	LDO, 2.2V±1.0%, 300mA, +CE, CL, AE(mode)	SC-88A	28hv	VR10	6m	Ric
D023	RP200Q232D	LVR-IC	LDO, 2.3V±1.0%, 300mA, +CE, CL, AE(mode)	SC-88A	28hv	VR10	6m	Ric
D024	RP200Q242D	LVR-IC	LDO, 2.4V±1.0%, 300mA, +CE, CL, AE(mode)	SC-88A	28hv	VR10	6m	Ric
D025	RP200Q252D	LVR-IC	LDO, 2.5V±1.0%, 300mA, +CE, CL, AE(mode)	SC-88A	28hv	VR10	6m	Ric
D026	RP200Q262D	LVR-IC	LDO, 2.6V±1.0%, 300mA, +CE, CL, AE(mode)	SC-88A	28hv	VR10	6m	Ric
D027	RP200Q272D	LVR-IC	LDO, 2.7V±1.0%, 300mA, +CE, CL, AE(mode)	SC-88A	28hv	VR10	6m	Ric
D028	RP200Q282D	LVR-IC	LDO, 2.8V±1.0%, 300mA, +CE, CL, AE(mode)	SC-88A	28hv	VR10	6m	Ric
D029	RP200Q292D	LVR-IC	LDO, 2.9V±1.0%, 300mA, +CE, CL, AE(mode)	SC-88A	28hv	VR10	6m	Ric
D02A	LM3420AM5-4.2	BM-IC	Li-Ion charge controller, 4.2V	SOT-23-5	28vi	-	6g	Nsc
D02B	LM3420M5-4.2	BM-IC	Li-Ion charge controller, 4.2V	SOT-23-5	28vi	-	6g	Nsc
D030	RP200Q302D	LVR-IC	LDO, 3.0V±1.0%, 300mA, +CE, CL, AE(mode)	SC-88A	28hv	VR10	6m	Ric
D031	RP200Q312D	LVR-IC	LDO, 3.1V±1.0%, 300mA, +CE, CL, AE(mode)	SC-88A	28hv	VR10	6m	Ric
D032	RP200Q322D	LVR-IC	LDO, 3.2V±1.0%, 300mA, +CE, CL, AE(mode)	SC-88A	28hv	VR10	6m	Ric
D033	RP200Q332D	LVR-IC	LDO, 3.3V±1.0%, 300mA, +CE, CL, AE(mode)	SC-88A	28hv	VR10	6m	Ric
D034	RP200Q342D	LVR-IC	LDO, 3.4V±1.0%, 300mA, +CE, CL, AE(mode)	SC-88A	28hv	VR10	6m	Ric
D035	RP200Q352D	LVR-IC	LDO, 3.5V±1.0%, 300mA, +CE, CL, AE(mode)	SC-88A	28hv	VR10	6m	Ric
D036	RP200Q362D	LVR-IC	LDO, 3.6V±1.0%, 300mA, +CE, CL, AE(mode)	SC-88A	28hv	VR10	6m	Ric
D037	RP200Q372D	LVR-IC	LDO, 3.7V±1.0%, 300mA, +CE, CL, AE(mode)	SC-88A	28hv	VR10	6m	Ric
D038	RP200Q382D	LVR-IC	LDO, 3.8V±1.0%, 300mA, +CE, CL, AE(mode)	SC-88A	28hv	VR10	6m	Ric
D039	RP200Q392D	LVR-IC	LDO, 3.9V±1.0%, 300mA, +CE, CL, AE(mode)	SC-88A	28hv	VR10	6m	Ric
D03A	LM3420AM5-8.4	BM-IC	Li-Ion charge controller, 8.4V	SOT-23-5	28vi	-	6g	Nsc
D03B	LM3420M5-8.4	BM-IC	Li-Ion charge controller, 8.4V	SOT-23-5	28vi	-	6g	Nsc
D040	RP200Q402D	LVR-IC	LDO, 4.0V±1.0%, 300mA, +CE, CL, AE(mode)	SC-88A	28hv	VR10	6m	Ric
D04A	LM3420AM5-12.6	BM-IC	Li-Ion charge controller, 12.6V	SOT-23-5	28vi	-	6g	Nsc
D04B	LM3420M5-12.6	BM-IC	Li-Ion charge controller, 12.6V	SOT-23-5	28vi	-	6g	Nsc
D05A	LM3420AM5-16.8	BM-IC	Li-Ion charge controller, 16.8V	SOT-23-5	28vi	-	6g	Nsc
D05B	LM3420M5-16.8	BM-IC	Li-Ion charge controller, 16.8V	SOT-23-5	28vi	-	6g	Nsc
D06A	LM3460M5-1.5	LIN-IC	Controller for GTLP GTL Bus Termination	SOT-23-5	28vi	-	6g	Nsc
D07A	LM3420AM5-8.2	BM-IC	Li-Ion charge controller, 8.2V	SOT-23-5	28vi	-	6g	Nsc
D07B	LM3420M5-8.2	BM-IC	Li-Ion charge controller, 8.2V	SOT-23-5	28vi	-	6g	Nsc
D09A	LM3460M5-1.2	LIN-IC	Controller for GTLP GTL Bus Termination	SOT-23-5	28vi	-	6g	Nsc
D0A	R3116N071A	Vdet-IC	0.7V±0.8%, -Reset ODO	SOT-23-5	28vdo	VD1	6g	Ric
D0A	XC6108C30AMR	Vdet-IC	3.0V±2%, Hysteresis, -Reset PPO	SOT-25	28rm	VD15	6g	Tor
D0B	R3116N081A	Vdet-IC	0.8V±0.8%, -Reset ODO	SOT-23-5	28vdo	VD1	6g	Ric
D0B	XC6108C30BMR	Vdet-IC	3.0V±2%, -Reset PPO	SOT-25	28rm	VD15	6g	Tor
D0C	R3116N091A	Vdet-IC	0.9V±0.8%, -Reset ODO	SOT-23-5	28vdo	VD1	6g	Ric
D0C	XC6108C30CMR	Vdet-IC	3.0V±2%, Hysteresis, -Reset PPO	SOT-25	28rk	VD15	6g	Tor
D0D	R3116N101A	Vdet-IC	1.0V±0.8%, -Reset ODO	SOT-23-5	28vdo	VD1	6g	Ric
D0D	XC6108C30DMR	Vdet-IC	3.0V±2%, -Reset PPO	SOT-25	28rk	VD15	6g	Tor
D0E	R3116N111A	Vdet-IC	1.1V±0.8%, -Reset ODO	SOT-23-5	28vdo	VD1	6g	Ric
D0F	R3116N121A	Vdet-IC	1.2V±0.8%, -Reset ODO	SOT-23-5	28vdo	VD1	6g	Ric
D0G	R3116N131A	Vdet-IC	1.3V±0.8%, -Reset ODO	SOT-23-5	28vdo	VD1	6g	Ric
D0H	R3116N141A	Vdet-IC	1.4V±0.8%, -Reset ODO	SOT-23-5	28vdo	VD1	6g	Ric
D0J	R3116N151A	Vdet-IC	1.5V±0.8%, -Reset ODO	SOT-23-5	28vdo	VD1	6g	Ric
D0K	R3116N161A	Vdet-IC	1.6V±0.8%, -Reset ODO	SOT-23-5	28vdo	VD1	6g	Ric
D0L	R3116N171A	Vdet-IC	1.7V±0.8%, -Reset ODO	SOT-23-5	28vdo	VD1	6g	Ric
D0M	R3116N181A	Vdet-IC	1.8V±0.8%, -Reset ODO	SOT-23-5	28vdo	VD1	6g	Ric
D0N	R3116N191A	Vdet-IC	1.9V±0.8%, -Reset ODO	SOT-23-5	28vdo	VD1	6g	Ric
D0P	R3116N201A	Vdet-IC	2.0V±0.8%, -Reset ODO	SOT-23-5	28vdo	VD1	6g	Ric
D0Q	R3116N211A	Vdet-IC	2.1V±0.8%, -Reset ODO	SOT-23-5	28vdo	VD1	6g	Ric
D0R	R3116N221A	Vdet-IC	2.2V±0.8%, -Reset ODO	SOT-23-5	28vdo	VD1	6g	Ric
D0S	R3116N231A	Vdet-IC	2.3V±0.8%, -Reset ODO	SOT-23-5	28vdo	VD1	6g	Ric
D0T	R3116N241A	Vdet-IC	2.4V±0.8%, -Reset ODO	SOT-23-5	28vdo	VD1	6g	Ric
D0U	R3116N251A	Vdet-IC	2.5V±0.8%, -Reset ODO	SOT-23-5	28vdo	VD1	6g	Ric
D0V	R3116N261A	Vdet-IC	2.6V±0.8%, -Reset ODO	SOT-23-5	28vdo	VD1	6g	Ric
D0W	R3116N271A	Vdet-IC	2.7V±0.8%, -Reset ODO	SOT-23-5	28vdo	VD1	6g	Ric
D0X	R3116N281A	Vdet-IC	2.8V±0.8%, -Reset ODO	SOT-23-5	28vdo	VD1	6g	Ric
D0Y	R3116N291A	Vdet-IC	2.9V±0.8%, -Reset ODO	SOT-23-5	28vdo	VD1	6g	Ric
D0Z	R3116N301A	Vdet-IC	3V±0.8%, -Reset ODO	SOT-23-5	28vdo	VD1	6g	Ric
D1	AP131-42TW	LVR-IC	LDO, 4.2V±2%, 300mA, +CE	TSOT-23-5L	28vrx	VR4	6a	Ana
D1	AP131-42W	LVR-IC	LDO, 4.2V±2%, 300mA, +CE	SOT-23-5L	28vrx	VR4	6k	Ana



SMD code	Type	Function	Short description	Case	Pinout	Sch.	St.	Mnf.
D1	Si91842DT-25	LVR-IC	LDO, LN, +CE, -Error, 2.5V±1.5%, 150mA	SOT-23-5	28w	VR17	6k	Vs
D1	TC1055-2.5VCT713	LVR-IC	LDO, 2.5V±2%, 100mA, +CE, -Error	SOT-23-5	28w	VR8	6g	Mcc
D1	RN5VD31AA	Vdet-IC	3.1V±2.5%, -Reset PPO	SOT-23-5	28vdo	VD3	6g	Ric
D10B	LM3620M5-4	BM-IC	Li-Ion charge controller	SOT-23-5	28vce	-	6g	Nsc
D11	AIC1746-11GJ5	LVR-IC	LDO, 1.1V±2%, 150mA, +CE	SC-70-5	28vrx	VR7	6a	Aic
D110	XC6365D101MR	DC/DC-IC	PWM st-down, 100kHz, Adj. 1.5..6V±2.5%, 1A, +CE, soft start	SOT-25	28zn	DC18	6g	Tor
D11B	LM3620M5-8	BM-IC	Li-Ion charge controller	SOT-23-5	28vce	-	6g	Nsc
D12	AIC1746-12GJ5	LVR-IC	LDO, 1.2V±2%, 150mA, +CE	SC-70-5	28vrx	VR7	6a	Aic
D12	R1180N121C	LVR-IC	LDO, 1.2V±2%, 150mA	SOT-23-5	28ym	VR1	6g	Ric
D13	AIC1746-13GJ5	LVR-IC	LDO, 1.3V±2%, 150mA, +CE	SC-70-5	28vrx	VR7	6a	Aic
D13	R1180N131C	LVR-IC	LDO, 1.3V±2%, 150mA	SOT-23-5	28ym	VR1	6g	Ric
D14	R1180N141C	LVR-IC	LDO, 1.4V±2%, 150mA	SOT-23-5	28ym	VR1	6g	Ric
D15	AIC1746-15GJ5	LVR-IC	LDO, 1.5V±2%, 150mA, +CE	SC-70-5	28vrx	VR7	6a	Aic
D15	R1180N151C	LVR-IC	LDO, 1.5V±2%, 150mA	SOT-23-5	28ym	VR1	6g	Ric
D16	R1180N161C	LVR-IC	LDO, 1.6V±2%, 150mA	SOT-23-5	28ym	VR1	6g	Ric
D18	AIC1746-18GJ5	LVR-IC	LDO, 1.8V±2%, 150mA, +CE	SC-70-5	28vrx	VR7	6a	Aic
D1A	R3116N071C	Vdet-IC	0.7V±0.8%, -Reset PPO	SOT-23-5	28vdo	VD3	6g	Ric
D1A	XC6108C31AMR	Vdet-IC	3.1V±2%, Hysteresis, -Reset PPO	SOT-25	28rm	VD15	6g	Tor
D1B	R3116N081C	Vdet-IC	0.8V±0.8%, -Reset PPO	SOT-23-5	28vdo	VD3	6g	Ric
D1B	XC6108C31BMR	Vdet-IC	3.1V±2%, -Reset PPO	SOT-25	28rm	VD15	6g	Tor
D1C	R3116N091C	Vdet-IC	0.9V±0.8%, -Reset PPO	SOT-23-5	28vdo	VD3	6g	Ric
D1C	XC6108C31CMR	Vdet-IC	3.1V±2%, Hysteresis, -Reset PPO	SOT-25	28rk	VD15	6g	Tor
D1D	R3116N101C	Vdet-IC	1.0V±0.8%, -Reset PPO	SOT-23-5	28vdo	VD3	6g	Ric
D1D	XC6108C31DMR	Vdet-IC	3.1V±2%, -Reset PPO	SOT-25	28rk	VD15	6g	Tor
D1E	R3116N111C	Vdet-IC	1.1V±0.8%, -Reset PPO	SOT-23-5	28vdo	VD3	6g	Ric
D1F	R3116N121C	Vdet-IC	1.2V±0.8%, -Reset PPO	SOT-23-5	28vdo	VD3	6g	Ric
D1G	R3116N131C	Vdet-IC	1.3V±0.8%, -Reset PPO	SOT-23-5	28vdo	VD3	6g	Ric
D1H	R3116N141C	Vdet-IC	1.4V±0.8%, -Reset PPO	SOT-23-5	28vdo	VD3	6g	Ric
D1J	R3116N151C	Vdet-IC	1.5V±0.8%, -Reset PPO	SOT-23-5	28vdo	VD3	6g	Ric
D1K	R3116N161C	Vdet-IC	1.6V±0.8%, -Reset PPO	SOT-23-5	28vdo	VD3	6g	Ric
D1L	R3116N171C	Vdet-IC	1.7V±0.8%, -Reset PPO	SOT-23-5	28vdo	VD3	6g	Ric
D1M	R3116N181C	Vdet-IC	1.8V±0.8%, -Reset PPO	SOT-23-5	28vdo	VD3	6g	Ric
D1N	R3116N191C	Vdet-IC	1.9V±0.8%, -Reset PPO	SOT-23-5	28vdo	VD3	6g	Ric
D1P	R3116N201C	Vdet-IC	2.0V±0.8%, -Reset PPO	SOT-23-5	28vdo	VD3	6g	Ric
D1Q	R3116N211C	Vdet-IC	2.1V±0.8%, -Reset PPO	SOT-23-5	28vdo	VD3	6g	Ric
D1R	R3116N221C	Vdet-IC	2.2V±0.8%, -Reset PPO	SOT-23-5	28vdo	VD3	6g	Ric
D1S	R3116N231C	Vdet-IC	2.3V±0.8%, -Reset PPO	SOT-23-5	28vdo	VD3	6g	Ric
D1T	R3116N241C	Vdet-IC	2.4V±0.8%, -Reset PPO	SOT-23-5	28vdo	VD3	6g	Ric
D1U	R3116N251C	Vdet-IC	2.5V±0.8%, -Reset PPO	SOT-23-5	28vdo	VD3	6g	Ric
D1V	R3116N261C	Vdet-IC	2.6V±0.8%, -Reset PPO	SOT-23-5	28vdo	VD3	6g	Ric
D1W	R3116N271C	Vdet-IC	2.7V±0.8%, -Reset PPO	SOT-23-5	28vdo	VD3	6g	Ric
D1X	R3116N281C	Vdet-IC	2.8V±0.8%, -Reset PPO	SOT-23-5	28vdo	VD3	6g	Ric
D1Y	R3116N291C	Vdet-IC	2.9V±0.8%, -Reset PPO	SOT-23-5	28vdo	VD3	6g	Ric
D1Z	R3116N301C	Vdet-IC	3V±0.8%, -Reset PPO	SOT-23-5	28vdo	VD3	6g	Ric
D2	AP131-43TW	LVR-IC	LDO, 4.3V±2%, 300mA, +CE	TSOT-23-5L	28vrx	VR4	6a	Ana
D2	AP131-43W	LVR-IC	LDO, 4.3V±2%, 300mA, +CE	SOT-23-5L	28vrx	VR4	6k	Ana
D2	Si91842DT-26	LVR-IC	LDO, LN, +CE, -Error, 2.6V±1.5%, 150mA	SOT-23-5	28w	VR17	6k	Vs
D2	TC1055-2.7VCT713	LVR-IC	LDO, 2.7V±2%, 100mA, +CE, -Error	SOT-23-5	28w	VR8	6g	Mcc
D2	RN5VD32AA	Vdet-IC	3.2V±2.5%, -Reset PPO	SOT-23-5	28vdo	VD3	6g	Ric
D20	AIC1746-20GJ5	LVR-IC	LDO, 2.0V±2%, 150mA, +CE	SC-70-5	28vrx	VR7	6a	Aic
D20	R1180N201C	LVR-IC	LDO, 2V±2%, 150mA	SOT-23-5	28ym	VR1	6g	Ric
D21	R1180N211C	LVR-IC	LDO, 2.1V±2%, 150mA	SOT-23-5	28ym	VR1	6g	Ric
D210	XC6365D102MR	DC/DC-IC	PWM st-down, 180kHz, Adj. 1.5..6V±2.5%, 1A, +CE, soft start	SOT-25	28zn	DC18	6g	Tor
D22	R1180N221C	LVR-IC	LDO, 2.2V±2%, 150mA	SOT-23-5	28ym	VR1	6g	Ric
D23	R1180N231C	LVR-IC	LDO, 2.3V±2%, 150mA	SOT-23-5	28ym	VR1	6g	Ric
D24	R1180N241C	LVR-IC	LDO, 2.4V±2%, 150mA	SOT-23-5	28ym	VR1	6g	Ric
D25	AIC1746-25GJ5	LVR-IC	LDO, 2.5V±2%, 150mA, +CE	SC-70-5	28vrx	VR7	6a	Aic
D25	R1180N251C	LVR-IC	LDO, 2.5V±2%, 150mA	SOT-23-5	28ym	VR1	6g	Ric
D25B	LP3470M5-2.63	Vdet-IC	2.63V, -Reset Open Drain Output	SOT-23-5	28ui	VD2	6g	Nsc
D25C	LP3470IM5-2.63	Vdet-IC	2.63V, -Reset Open Drain Output	SOT-23-5	28ui	VD2	6g	Nsc
D26	R1180N261C	LVR-IC	LDO, 2.6V±2%, 150mA	SOT-23-5	28ym	VR1	6g	Ric
D26B	LP3470M5-2.93	Vdet-IC	2.93V, -Reset Open Drain Output	SOT-23-5	28ui	VD2	6g	Nsc
D26C	LP3470IM5-2.93	Vdet-IC	2.93V, -Reset Open Drain Output	SOT-23-5	28ui	VD2	6g	Nsc
D27	AIC1746-27GJ5	LVR-IC	LDO, 2.7V±2%, 150mA, +CE	SC-70-5	28vrx	VR7	6a	Aic
D27	R1180N171C	LVR-IC	LDO, 1.7V±2%, 150mA	SOT-23-5	28ym	VR1	6g	Ric
D28	R1180N181C	LVR-IC	LDO, 1.8V±2%, 150mA	SOT-23-5	28ym	VR1	6g	Ric
D28B	LP3470M5-3.08	Vdet-IC	3.08V, -Reset Open Drain Output	SOT-23-5	28ui	VD2	6g	Nsc
D28C	LP3470IM5-3.08	Vdet-IC	3.08V, -Reset Open Drain Output	SOT-23-5	28ui	VD2	6g	Nsc
D29	R1180N191C	LVR-IC	LDO, 1.9V±2%, 150mA	SOT-23-5	28ym	VR1	6g	Ric
D29B	LP3470M5-4.00	Vdet-IC	4.0V, -Reset Open Drain Output	SOT-23-5	28ui	VD2	6g	Nsc



SMD code	Type	Function	Short description	Case	Pinout	Sch.	St.	Mnf.
D29C	LP3470IM5-4.00	Vdet-IC	4.0V, -Reset Open Drain Output	SOT-23-5	28ui	VD2	6g	Nsc
D2A	XC6108C32AMR	Vdet-IC	3.2V±2%, Hysteresis, -Reset PPO	SOT-25	28rm	VD15	6g	Tor
D2B	XC6108C32BMR	Vdet-IC	3.2V±2%, -Reset PPO	SOT-25	28rm	VD15	6g	Tor
D2C	XC6108C32CMR	Vdet-IC	3.2V±2%, Hysteresis, -Reset PPO	SOT-25	28rk	VD15	6g	Tor
D2D	XC6108C32DMR	Vdet-IC	3.2V±2%, -Reset PPO	SOT-25	28rk	VD15	6g	Tor
D2J	AIC1746-285GJ5	LVR-IC	LDO, 2.85V±2%, 150mA, +CE	SC-70-5	28vrx	VR7	6a	Aic
D3	AP131-44TW	LVR-IC	LDO, 4.4V±2%, 300mA, +CE	TSOT-23-5L	28vrx	VR4	6a	Ana
D3	AP131-44W	LVR-IC	LDO, 4.4V±2%, 300mA, +CE	SOT-23-5L	28vrx	VR4	6k	Ana
D3	Si91842DT-27	LVR-IC	LDO, LN, +CE, -Error, 2.7V±1.5%, 150mA	SOT-23-5	28w	VR17	6k	Vs
D3	TC1055-3.0VCT713	LVR-IC	LDO, 3.0V±2%, 100mA, +CE, -Error	SOT-23-5	28w	VR8	6g	Mcc
D3	RN5VD33AA	Vdet-IC	3.3V±2.5%, -Reset PPO	SOT-23-5	28vdo	VD3	6g	Ric
D30	AIC1746-30GJ5	LVR-IC	LDO, 3.0V±2%, 150mA, +CE	SC-70-5	28vrx	VR7	6a	Aic
D30	R1180N301C	LVR-IC	LDO, 3V±2%, 150mA	SOT-23-5	28ym	VR1	6g	Ric
D30B	LP3470M5-4.38	Vdet-IC	4.38V, -Reset Open Drain Output	SOT-23-5	28ui	VD2	6g	Nsc
D30C	LP3470IM5-4.38	Vdet-IC	4.38V, -Reset Open Drain Output	SOT-23-5	28ui	VD2	6g	Nsc
D31	R1180N311C	LVR-IC	LDO, 3.1V±2%, 150mA	SOT-23-5	28ym	VR1	6g	Ric
D310	XC6365D103MR	DC/DC-IC	PWM st-down, 300kHz, Adj. 1.5..6V±2.5%, 1A, +CE, soft start	SOT-25	28zn	DC18	6g	Tor
D31B	LP3470M5-4.63	Vdet-IC	4.63V, -Reset Open Drain Output	SOT-23-5	28ui	VD2	6g	Nsc
D31C	LP3470IM5-4.63	Vdet-IC	4.63V, -Reset Open Drain Output	SOT-23-5	28ui	VD2	6g	Nsc
D32	R1180N321C	LVR-IC	LDO, 3.2V±2%, 150mA	SOT-23-5	28ym	VR1	6g	Ric
D33	AIC1746-33GJ5	LVR-IC	LDO, 3.3V±2%, 150mA, +CE	SC-70-5	28vrx	VR7	6a	Aic
D33	R1180N331C	LVR-IC	LDO, 3.3V±2%, 150mA	SOT-23-5	28ym	VR1	6g	Ric
D34	R1180N341C	LVR-IC	LDO, 3.4V±2%, 150mA	SOT-23-5	28ym	VR1	6g	Ric
D35	AIC1746-35GJ5	LVR-IC	LDO, 3.5V±2%, 150mA, +CE	SC-70-5	28vrx	VR7	6a	Aic
D35	R1180N351C	LVR-IC	LDO, 3.5V±2%, 150mA	SOT-23-5	28ym	VR1	6g	Ric
D36	R1180N361C	LVR-IC	LDO, 3.6V±2%, 150mA	SOT-23-5	28ym	VR1	6g	Ric
D37	AIC1746-37GJ5	LVR-IC	LDO, 3.7V±2%, 150mA, +CE	SC-70-5	28vrx	VR7	6a	Aic
D37	R1180N271C	LVR-IC	LDO, 2.7V±2%, 150mA	SOT-23-5	28ym	VR1	6g	Ric
D37B	LP3470M5-3.65	Vdet-IC	3.65V, -Reset Open Drain Output	SOT-23-5	28ui	VD2	6g	Nsc
D37C	LP3470IM5-3.65	Vdet-IC	3.65V, -Reset Open Drain Output	SOT-23-5	28ui	VD2	6g	Nsc
D38	AIC1746-38GJ5	LVR-IC	LDO, 3.8V±2%, 150mA, +CE	SC-70-5	28vrx	VR7	6a	Aic
D38	R1180N281C	LVR-IC	LDO, 2.8V±2%, 150mA	SOT-23-5	28ym	VR1	6g	Ric
D39	R1180N291C	LVR-IC	LDO, 2.9V±2%, 150mA	SOT-23-5	28ym	VR1	6g	Ric
D3A	XC6108C33AMR	Vdet-IC	3.3V±2%, Hysteresis, -Reset PPO	SOT-25	28rm	VD15	6g	Tor
D3B	XC6108C33BMR	Vdet-IC	3.3V±2%, -Reset PPO	SOT-25	28rm	VD15	6g	Tor
D3C	XC6108C33CMR	Vdet-IC	3.3V±2%, Hysteresis, -Reset PPO	SOT-25	28rk	VD15	6g	Tor
D3D	XC6108C33DMR	Vdet-IC	3.3V±2%, -Reset PPO	SOT-25	28rk	VD15	6g	Tor
D4	AP131-45TW	LVR-IC	LDO, 4.5V±2%, 300mA, +CE	TSOT-23-5L	28vrx	VR4	6a	Ana
D4	AP131-45W	LVR-IC	LDO, 4.5V±2%, 300mA, +CE	SOT-23-5L	28vrx	VR4	6k	Ana
D4	Si91842DT-28	LVR-IC	LDO, LN, +CE, -Error, 2.8V±1.5%, 150mA	SOT-23-5	28w	VR17	6k	Vs
D4	TC1055-3.3VCT713	LVR-IC	LDO, 3.3V±2%, 100mA, +CE, -Error	SOT-23-5	28w	VR8	6g	Mcc
D4	RN5VD34AA	Vdet-IC	3.4V±2.5%, -Reset PPO	SOT-23-5	28vdo	VD3	6g	Ric
D410	XC6365D105MR	DC/DC-IC	PWM st-down, 500kHz, Adj. 1.5..6V±2.5%, 1A, +CE, soft start	SOT-25	28zn	DC18	6g	Tor
D4A	XC6108C34AMR	Vdet-IC	3.4V±2%, Hysteresis, -Reset PPO	SOT-25	28rm	VD15	6g	Tor
D4B	XC6108C34BMR	Vdet-IC	3.4V±2%, -Reset PPO	SOT-25	28rm	VD15	6g	Tor
D4C	XC6108C34CMR	Vdet-IC	3.4V±2%, Hysteresis, -Reset PPO	SOT-25	28rk	VD15	6g	Tor
D4D	XC6108C34DMR	Vdet-IC	3.4V±2%, -Reset PPO	SOT-25	28rk	VD15	6g	Tor
D5	AP131-46TW	LVR-IC	LDO, 4.6V±2%, 300mA, +CE	TSOT-23-5L	28vrx	VR4	6a	Ana
D5	AP131-46W	LVR-IC	LDO, 4.6V±2%, 300mA, +CE	SOT-23-5L	28vrx	VR4	6k	Ana
D5	Si91842DT-285	LVR-IC	LDO, LN, +CE, -Error, 2.85V±1.5%, 150mA	SOT-23-5	28w	VR17	6k	Vs
D5	RN5VD35AA	Vdet-IC	3.5V±2.5%, -Reset PPO	SOT-23-5	28vdo	VD3	6g	Ric
D53	OPA353NA	Op-IC	High-Speed, Single-supply, Rail-to-Rail	SOT-23-5	28opa	OP1	6a	Bb
D5A	XC6108C35AMR	Vdet-IC	3.5V±2%, Hysteresis, -Reset PPO	SOT-25	28rm	VD15	6g	Tor
D5B	XC6108C35BMR	Vdet-IC	3.5V±2%, -Reset PPO	SOT-25	28rm	VD15	6g	Tor
D5C	XC6108C35CMR	Vdet-IC	3.5V±2%, Hysteresis, -Reset PPO	SOT-25	28rk	VD15	6g	Tor
D5D	XC6108C35DMR	Vdet-IC	3.5V±2%, -Reset PPO	SOT-25	28rk	VD15	6g	Tor
D6	AP131-47TW	LVR-IC	LDO, 4.7V±2%, 300mA, +CE	TSOT-23-5L	28vrx	VR4	6a	Ana
D6	AP131-47W	LVR-IC	LDO, 4.7V±2%, 300mA, +CE	SOT-23-5L	28vrx	VR4	6k	Ana
D6	Si91842DT-29	LVR-IC	LDO, LN, +CE, -Error, 2.9V±1.5%, 150mA	SOT-23-5	28w	VR17	6k	Vs
D6	TC1055-5.0VCT713	LVR-IC	LDO, 5.0V±2%, 100mA, +CE, -Error	SOT-23-5	28w	VR8	6g	Mcc
D6	RN5VD36AA	Vdet-IC	3.6V±2.5%, -Reset PPO	SOT-23-5	28vdo	VD3	6g	Ric
D6A	XC6108C36AMR	Vdet-IC	3.6V±2%, Hysteresis, -Reset PPO	SOT-25	28rm	VD15	6g	Tor
D6B	XC6108C36BMR	Vdet-IC	3.6V±2%, -Reset PPO	SOT-25	28rm	VD15	6g	Tor
D6C	XC6108C36CMR	Vdet-IC	3.6V±2%, Hysteresis, -Reset PPO	SOT-25	28rk	VD15	6g	Tor
D6D	XC6108C36DMR	Vdet-IC	3.6V±2%, -Reset PPO	SOT-25	28rk	VD15	6g	Tor
D7	AP131-48TW	LVR-IC	LDO, 4.8V±2%, 300mA, +CE	TSOT-23-5L	28vrx	VR4	6a	Ana
D7	AP131-48W	LVR-IC	LDO, 4.8V±2%, 300mA, +CE	SOT-23-5L	28vrx	VR4	6k	Ana
D7	Si91842DT-30	LVR-IC	LDO, LN, +CE, -Error, 3V±1.5%, 150mA	SOT-23-5	28w	VR17	6k	Vs
D7	RN5VD37AA	Vdet-IC	3.7V±2.5%, -Reset PPO	SOT-23-5	28vdo	VD3	6g	Ric
D7_	SN74LVC1G38DCK	CMOS-Logic	2-input NAND gate (ODO)	SC-70-5	28Log17	-	6a	Ti



SMD code	Type	Function	Short description	Case	Pinout	Sch.	St.	Mnf.
D7A	XC6108C37AMR	Vdet-IC	3.7V±2%, Hysteresis, -Reset PPO	SOT-25	28rm	VD15	6g	Tor
D7B	XC6108C37BMR	Vdet-IC	3.7V±2%, -Reset PPO	SOT-25	28rm	VD15	6g	Tor
D7C	XC6108C37CMR	Vdet-IC	3.7V±2%, Hysteresis, -Reset PPO	SOT-25	28rk	VD15	6g	Tor
D7D	XC6108C37DMR	Vdet-IC	3.7V±2%, -Reset PPO	SOT-25	28rk	VD15	6g	Tor
D8	AP131-49TW	LVR-IC	LDO, 4.9V±2%, 300mA, +CE	TSOT-23-5L	28vrx	VR4	6a	Ana
D8	AP131-49W	LVR-IC	LDO, 4.9V±2%, 300mA, +CE	SOT-23-5L	28vrx	VR4	6k	Ana
D8	Si91842DT-33	LVR-IC	LDO, LN, +CE, -Error, 3.3V±1.5%, 150mA	SOT-23-5	28w	VR17	6k	Vs
D8	TC1055-2.85VCT713	LVR-IC	LDO, 2.85V±2%, 100mA, +CE, -Error	SOT-23-5	28w	VR8	6g	Mcc
D8	RN5VD38AA	Vdet-IC	3.8V±2.5%, -Reset PPO	SOT-23-5	28vdo	VD3	6g	Ric
D8A	XC6108C38AMR	Vdet-IC	3.8V±2%, Hysteresis, -Reset PPO	SOT-25	28rm	VD15	6g	Tor
D8B	XC6108C38BMR	Vdet-IC	3.8V±2%, -Reset PPO	SOT-25	28rm	VD15	6g	Tor
D8C	XC6108C38CMR	Vdet-IC	3.8V±2%, Hysteresis, -Reset PPO	SOT-25	28rk	VD15	6g	Tor
D8D	XC6108C38DMR	Vdet-IC	3.8V±2%, -Reset PPO	SOT-25	28rk	VD15	6g	Tor
D9	AP131-50TW	LVR-IC	LDO, 5V±2%, 300mA, +CE	TSOT-23-5L	28vrx	VR4	6a	Ana
D9	AP131-50W	LVR-IC	LDO, 5V±2%, 300mA, +CE	SOT-23-5L	28vrx	VR4	6k	Ana
D9	Si91842DT-35	LVR-IC	LDO, LN, +CE, -Error, 3.5V±1.5%, 150mA	SOT-23-5	28w	VR17	6k	Vs
D9	TC1055-3.6VCT713	LVR-IC	LDO, 3.6V±2%, 100mA, +CE, -Error	SOT-23-5	28w	VR8	6g	Mcc
D9	RN5VD39AA	Vdet-IC	3.9V±2.5%, -Reset PPO	SOT-23-5	28vdo	VD3	6g	Ric
D9A	XC6108C39AMR	Vdet-IC	3.9V±2%, Hysteresis, -Reset PPO	SOT-25	28rm	VD15	6g	Tor
D9B	XC6108C39BMR	Vdet-IC	3.9V±2%, -Reset PPO	SOT-25	28rm	VD15	6g	Tor
D9C	XC6108C39CMR	Vdet-IC	3.9V±2%, Hysteresis, -Reset PPO	SOT-25	28rk	VD15	6g	Tor
D9D	XC6108C39DMR	Vdet-IC	3.9V±2%, -Reset PPO	SOT-25	28rk	VD15	6g	Tor
DA	µPA502T	n-MOSFET-e*	Dual, V-MOS, 50V, 100mA, <25Q(10mA)	SOT-23-5	28fb	-	6a	Nec
DA	AP131-15TW	LVR-IC	LDO, 1.5V±2%, 300mA, +CE	TSOT-23-5L	28vrx	VR4	6a	Ana
DA	AP131-15W	LVR-IC	LDO, 1.5V±2%, 300mA, +CE	SOT-23-5L	28vrx	VR4	6k	Ana
DA	RN5RT50AA	LVR-IC	LDO, 5V±2%, 150mA, -CE	SOT-23-5	28vrt	VR4	6g	Ric
DA	V6310ASP5B	Vdet-IC	2.0V, -Reset PPO, 50ms	SOT-23-5	28vdr	VD7	6a	Em
DA-	XC62GR3012M	LVR-IC	3.0V±2%, 150mA, +CE	SOT-25	28w	VR4	6g	Tor
DA-	XC62GP3012M	LVR-IC	3.0V±2%, 150mA, -CE	SOT-25	28ew	VR4	6g	Tor
DA+	XC62GR3022M	LVR-IC	3.0V±2%, 150mA, +CE, HS response	SOT-25	28ew	VR4	6g	Tor
DA+	XC62GP3022M	LVR-IC	3.0V±2%, 150mA, -CE, HS response	SOT-25	28ew	VR4	6g	Tor
DA0	XC6117A031MR	Vdet-IC	3.1V±2%, -MR, +Rst PPO, -Rst ODO, Rt=3.13ms	SOT-25	28xf	VD22	6g	Tor
DA1	XC6117A032MR	Vdet-IC	3.2V±2%, -MR, +Rst PPO, -Rst ODO, Rt=3.13ms	SOT-25	28xf	VD22	6g	Tor
DA2	XC6117A033MR	Vdet-IC	3.3V±2%, -MR, +Rst PPO, -Rst ODO, Rt=3.13ms	SOT-25	28xf	VD22	6g	Tor
DA3	XC6117A034MR	Vdet-IC	3.4V±2%, -MR, +Rst PPO, -Rst ODO, Rt=3.13ms	SOT-25	28xf	VD22	6g	Tor
DA4	XC6117A035MR	Vdet-IC	3.5V±2%, -MR, +Rst PPO, -Rst ODO, Rt=3.13ms	SOT-25	28xf	VD22	6g	Tor
DA5	XC6117A036MR	Vdet-IC	3.6V±2%, -MR, +Rst PPO, -Rst ODO, Rt=3.13ms	SOT-25	28xf	VD22	6g	Tor
DA6	XC6117A037MR	Vdet-IC	3.7V±2%, -MR, +Rst PPO, -Rst ODO, Rt=3.13ms	SOT-25	28xf	VD22	6g	Tor
DA7	XC6117A038MR	Vdet-IC	3.8V±2%, -MR, +Rst PPO, -Rst ODO, Rt=3.13ms	SOT-25	28xf	VD22	6g	Tor
DA8	XC9236B08CMR	DC-DC-IC	PWM/PPM, st-dwn, 0.8V±2%, 600mA, 1.2MHz, Vin>2V, HSST, CL	SOT-25	28dc4	DC1	6g	Tor
DA8	XC6117A039MR	Vdet-IC	3.9V±2%, -MR, +Rst PPO, -Rst ODO, Rt=3.13ms	SOT-25	28xf	VD22	6g	Tor
DA9	XC9236B09CMR	DC-DC-IC	PWM/PPM, st-dwn, 0.9V±2%, 600mA, 1.2MHz, Vin>2V, HSST, CL	SOT-25	28dc4	DC1	6g	Tor
DA9	XC6117A040MR	Vdet-IC	4.0V±2%, -MR, +Rst PPO, -Rst ODO, Rt=3.13ms	SOT-25	28xf	VD22	6g	Tor
DA A	RP201N081B	LVR-IC	LDO, 0.8V±1%, 150mA, +CE, AE(Mode)	SOT-23-5	28x9	VR12	6g	Ric
DA A	XC6117A041MR	Vdet-IC	4.1V±2%, -MR, +Rst PPO, -Rst ODO, Rt=3.13ms	SOT-25	28xf	VD22	6g	Tor
DA B	RP201N091B	LVR-IC	LDO, 0.9V±1%, 150mA, +CE, AE(Mode)	SOT-23-5	28x9	VR12	6g	Ric
DA B	XC6117A042MR	Vdet-IC	4.2V±2%, -MR, +Rst PPO, -Rst ODO, Rt=3.13ms	SOT-25	28xf	VD22	6g	Tor
DA C	RP201N101B	LVR-IC	LDO, 1.0V±1%, 150mA, +CE, AE(Mode)	SOT-23-5	28x9	VR12	6g	Ric
DA C	XC6117A043MR	Vdet-IC	4.3V±2%, -MR, +Rst PPO, -Rst ODO, Rt=3.13ms	SOT-25	28xf	VD22	6g	Tor
DA D	RP201N111B	LVR-IC	LDO, 1.1V±1%, 150mA, +CE, AE(Mode)	SOT-23-5	28x9	VR12	6g	Ric
DA D	XC6117A044MR	Vdet-IC	4.4V±2%, -MR, +Rst PPO, -Rst ODO, Rt=3.13ms	SOT-25	28xf	VD22	6g	Tor
DA E	RP201N121B	LVR-IC	LDO, 1.2V±1%, 150mA, +CE, AE(Mode)	SOT-23-5	28x9	VR12	6g	Ric
DA E	XC6117A045MR	Vdet-IC	4.5V±2%, -MR, +Rst PPO, -Rst ODO, Rt=3.13ms	SOT-25	28xf	VD22	6g	Tor
DA F	RP201N131B	LVR-IC	LDO, 1.3V±1%, 150mA, +CE, AE(Mode)	SOT-23-5	28x9	VR12	6g	Ric
DA F	XC6117A016MR	Vdet-IC	1.6V±2%, -MR, +Rst PPO, -Rst ODO, Rt=3.13ms	SOT-25	28xf	VD22	6g	Tor
DA F	XC6117A046MR	Vdet-IC	4.6V±2%, -MR, +Rst PPO, -Rst ODO, Rt=3.13ms	SOT-25	28xf	VD22	6g	Tor
DA G	RP201N141B	LVR-IC	LDO, 1.4V±1%, 150mA, +CE, AE(Mode)	SOT-23-5	28x9	VR12	6g	Ric
DA H	RP201N151B	LVR-IC	LDO, 1.5V±1%, 150mA, +CE, AE(Mode)	SOT-23-5	28x9	VR12	6g	Ric
DA H	XC6117A017MR	Vdet-IC	1.7V±2%, -MR, +Rst PPO, -Rst ODO, Rt=3.13ms	SOT-25	28xf	VD22	6g	Tor
DA H	XC6117A047MR	Vdet-IC	4.7V±2%, -MR, +Rst PPO, -Rst ODO, Rt=3.13ms	SOT-25	28xf	VD22	6g	Tor
DA J	RP201N161B	LVR-IC	LDO, 1.6V±1%, 150mA, +CE, AE(Mode)	SOT-23-5	28x9	VR12	6g	Ric
DA K	RP201N171B	LVR-IC	LDO, 1.7V±1%, 150mA, +CE, AE(Mode)	SOT-23-5	28x9	VR12	6g	Ric
DA K	XC6117A018MR	Vdet-IC	1.8V±2%, -MR, +Rst PPO, -Rst ODO, Rt=3.13ms	SOT-25	28xf	VD22	6g	Tor
DA K	XC6117A048MR	Vdet-IC	4.8V±2%, -MR, +Rst PPO, -Rst ODO, Rt=3.13ms	SOT-25	28xf	VD22	6g	Tor
DA L	RP201N181B	LVR-IC	LDO, 1.8V±1%, 150mA, +CE, AE(Mode)	SOT-23-5	28x9	VR12	6g	Ric
DA L	XC9236B0LCMR	DC-DC-IC	PWM/PPM, st-dwn, 0.85V±2%, 600mA, 1.2MHz, Vin>2V, HSST, CL	SOT-25	28dc4	DC1	6g	Tor
DA L	XC6117A019MR	Vdet-IC	1.9V±2%, -MR, +Rst PPO, -Rst ODO, Rt=3.13ms	SOT-25	28xf	VD22	6g	Tor
DA L	XC6117A049MR	Vdet-IC	4.9V±2%, -MR, +Rst PPO, -Rst ODO, Rt=3.13ms	SOT-25	28xf	VD22	6g	Tor
DAM	RP201N191B	LVR-IC	LDO, 1.9V±1%, 150mA, +CE, AE(Mode)	SOT-23-5	28x9	VR12	6g	Ric
DAM	XC9236B0MCMR	DC-DC-IC	PWM/PPM, st-dwn, 0.95V±2%, 600mA, 1.2MHz, Vin>2V, HSST, CL	SOT-25	28dc4	DC1	6g	Tor



SMD
code

Type

Function

Short description

Case

Pinout

Sch. St.Mnf.

DA	XC6117A020MR	Vdet-IC	2.0V±2%, -MR, +Rst PPO, -Rst ODO, Rt=3.13ms	SOT-25	28xf	VD22	6g	Tor
DAM	XC6117A050MR	Vdet-IC	5.0V±2%, -MR, +Rst PPO, -Rst ODO, Rt=3.13ms	SOT-25	28xf	VD22	6g	Tor
DAN	RP201N201B	LVR-IC	LDO, 2.0V±1%, 150mA, +CE, AE(Mode)	SOT-23-5	28x9	VR12	6g	Ric
DAN	XC6117A021MR	Vdet-IC	2.1V±2%, -MR, +Rst PPO, -Rst ODO, Rt=3.13ms	SOT-25	28xf	VD22	6g	Tor
DAP	RP201N211B	LVR-IC	LDO, 2.1V±1%, 150mA, +CE, AE(Mode)	SOT-23-5	28x9	VR12	6g	Ric
DAP	XC6117A022MR	Vdet-IC	2.2V±2%, -MR, +Rst PPO, -Rst ODO, Rt=3.13ms	SOT-25	28xf	VD22	6g	Tor
DAQ	RP201N221B	LVR-IC	LDO, 2.2V±1%, 150mA, +CE, AE(Mode)	SOT-23-5	28x9	VR12	6g	Ric
DAR	RP201N231B	LVR-IC	LDO, 2.3V±1%, 150mA, +CE, AE(Mode)	SOT-23-5	28x9	VR12	6g	Ric
DAR	XC6117A023MR	Vdet-IC	2.3V±2%, -MR, +Rst PPO, -Rst ODO, Rt=3.13ms	SOT-25	28xf	VD22	6g	Tor
DAS	RP201N241B	LVR-IC	LDO, 2.4V±1%, 150mA, +CE, AE(Mode)	SOT-23-5	28x9	VR12	6g	Ric
DAS	XC6117A024MR	Vdet-IC	2.4V±2%, -MR, +Rst PPO, -Rst ODO, Rt=3.13ms	SOT-25	28xf	VD22	6g	Tor
DAT	RP201N251B	LVR-IC	LDO, 2.5V±1%, 150mA, +CE, AE(Mode)	SOT-23-5	28x9	VR12	6g	Ric
DAT	XC6117A025MR	Vdet-IC	2.5V±2%, -MR, +Rst PPO, -Rst ODO, Rt=3.13ms	SOT-25	28xf	VD22	6g	Tor
DAU	RP201N261B	LVR-IC	LDO, 2.6V±1%, 150mA, +CE, AE(Mode)	SOT-23-5	28x9	VR12	6g	Ric
DAU	XC6117A026MR	Vdet-IC	2.6V±2%, -MR, +Rst PPO, -Rst ODO, Rt=3.13ms	SOT-25	28xf	VD22	6g	Tor
DAV	RP201N271B	LVR-IC	LDO, 2.7V±1%, 150mA, +CE, AE(Mode)	SOT-23-5	28x9	VR12	6g	Ric
DAV	XC6117A027MR	Vdet-IC	2.7V±2%, -MR, +Rst PPO, -Rst ODO, Rt=3.13ms	SOT-25	28xf	VD22	6g	Tor
DAW	RP201N281B	LVR-IC	LDO, 2.8V±1%, 150mA, +CE, AE(Mode)	SOT-23-5	28x9	VR12	6g	Ric
DAX	RP201N291B	LVR-IC	LDO, 2.9V±1%, 150mA, +CE, AE(Mode)	SOT-23-5	28x9	VR12	6g	Ric
DAX	XC6117A028MR	Vdet-IC	2.8V±2%, -MR, +Rst PPO, -Rst ODO, Rt=3.13ms	SOT-25	28xf	VD22	6g	Tor
DAY	RP201N301B	LVR-IC	LDO, 3.0V±1%, 150mA, +CE, AE(Mode)	SOT-23-5	28x9	VR12	6g	Ric
DAY	XC6117A029MR	Vdet-IC	2.9V±2%, -MR, +Rst PPO, -Rst ODO, Rt=3.13ms	SOT-25	28xf	VD22	6g	Tor
DAZ	RP201N311B	LVR-IC	LDO, 3.1V±1%, 150mA, +CE, AE(Mode)	SOT-23-5	28x9	VR12	6g	Ric
DAZ	XC6117A030MR	Vdet-IC	3.0V±2%, -MR, +Rst PPO, -Rst ODO, Rt=3.13ms	SOT-25	28xf	VD22	6g	Tor
DB	µPA572T	n-MOSFET- ^a	Dual, V-MOS, 30V, ±100mA, <8Q(10mA)	SOT-23-5	28fb	-	6a	Nec
DB	AP131-16TW	LVR-IC	LDO, 1.6V±2%, 300mA, +CE	TSOT-23-5L	28vrx	VR4	6a	Ana
DB	AP131-16W	LVR-IC	LDO, 1.6V±2%, 300mA, +CE	SOT-23-5L	28vrx	VR4	6k	Ana
DB	RN5RT51AA	LVR-IC	LDO, 5.1V±2%, 150mA, -CE	SOT-23-5	28wrt	VR4	6g	Ric
DB	V6310BSP5B	Vdet-IC	2.4V, -Reset PPO, 50ms	SOT-23-5	28vdr	VD7	6a	Em
DB-	XC62GR3112M	LVR-IC	3.1V±2%, 150mA, +CE	SOT-25	28ew	VR4	6g	Tor
DB-	XC62GP3112M	LVR-IC	3.1V±2%, 150mA, -CE	SOT-25	28ew	VR4	6g	Tor
DB+	XC62GR3122M	LVR-IC	3.1V±2%, 150mA, +CE, HS response	SOT-25	28ew	VR4	6g	Tor
DB+	XC62GP3122M	LVR-IC	3.1V±2%, 150mA, -CE, HS response	SOT-25	28ew	VR4	6g	Tor
DB0	XC9236B10CMR	DC-DC-IC	PWM/PFM, st-dwn, 1.0V±2%, 600mA, 1.2MHz, Vin>2V, HSST, CL	SOT-25	28dc4	DC1	6g	Tor
DB0	XC6117B031MR	Vdet-IC	3.1V±2%, -MR, +Rst PPO, -Rst ODO, Rt=25ms	SOT-25	28xf	VD22	6g	Tor
DB1	XC9236B11CMR	DC-DC-IC	PWM/PFM, st-dwn, 1.1V±2%, 600mA, 1.2MHz, Vin>2V, HSST, CL	SOT-25	28dc4	DC1	6g	Tor
DB1	XC6117B032MR	Vdet-IC	3.2V±2%, -MR, +Rst PPO, -Rst ODO, Rt=25ms	SOT-25	28xf	VD22	6g	Tor
DB2	XC9236B12CMR	DC-DC-IC	PWM/PFM, st-dwn, 1.2V±2%, 600mA, 1.2MHz, Vin>2V, HSST, CL	SOT-25	28dc4	DC1	6g	Tor
DB2	XC6117B033MR	Vdet-IC	3.3V±2%, -MR, +Rst PPO, -Rst ODO, Rt=25ms	SOT-25	28xf	VD22	6g	Tor
DB3	XC9236B13CMR	DC-DC-IC	PWM/PFM, st-dwn, 1.3V±2%, 600mA, 1.2MHz, Vin>2V, HSST, CL	SOT-25	28dc4	DC1	6g	Tor
DB3	XC6117B034MR	Vdet-IC	3.4V±2%, -MR, +Rst PPO, -Rst ODO, Rt=25ms	SOT-25	28xf	VD22	6g	Tor
DB4	XC9236B14CMR	DC-DC-IC	PWM/PFM, st-dwn, 1.4V±2%, 600mA, 1.2MHz, Vin>2V, HSST, CL	SOT-25	28dc4	DC1	6g	Tor
DB4	XC6117B035MR	Vdet-IC	3.5V±2%, -MR, +Rst PPO, -Rst ODO, Rt=25ms	SOT-25	28xf	VD22	6g	Tor
DB5	XC9236B15CMR	DC-DC-IC	PWM/PFM, st-dwn, 1.5V±2%, 600mA, 1.2MHz, Vin>2V, HSST, CL	SOT-25	28dc4	DC1	6g	Tor
DB5	XC6117B036MR	Vdet-IC	3.6V±2%, -MR, +Rst PPO, -Rst ODO, Rt=25ms	SOT-25	28xf	VD22	6g	Tor
DB6	XC9236B16CMR	DC-DC-IC	PWM/PFM, st-dwn, 1.6V±2%, 600mA, 1.2MHz, Vin>2V, HSST, CL	SOT-25	28dc4	DC1	6g	Tor
DB6	XC6117B037MR	Vdet-IC	3.7V±2%, -MR, +Rst PPO, -Rst ODO, Rt=25ms	SOT-25	28xf	VD22	6g	Tor
DB7	XC9236B17CMR	DC-DC-IC	PWM/PFM, st-dwn, 1.7V±2%, 600mA, 1.2MHz, Vin>2V, HSST, CL	SOT-25	28dc4	DC1	6g	Tor
DB7	XC6117B038MR	Vdet-IC	3.8V±2%, -MR, +Rst PPO, -Rst ODO, Rt=25ms	SOT-25	28xf	VD22	6g	Tor
DB8	XC9236B18CMR	DC-DC-IC	PWM/PFM, st-dwn, 1.8V±2%, 600mA, 1.2MHz, Vin>2V, HSST, CL	SOT-25	28dc4	DC1	6g	Tor
DB8	XC6117B039MR	Vdet-IC	3.9V±2%, -MR, +Rst PPO, -Rst ODO, Rt=25ms	SOT-25	28xf	VD22	6g	Tor
DB9	XC9236B19CMR	DC-DC-IC	PWM/PFM, st-dwn, 1.9V±2%, 600mA, 1.2MHz, Vin>2V, HSST, CL	SOT-25	28dc4	DC1	6g	Tor
DB9	XC6117B040MR	Vdet-IC	4.0V±2%, -MR, +Rst PPO, -Rst ODO, Rt=25ms	SOT-25	28xf	VD22	6g	Tor
DBA	RP201N081D	LVR-IC	LDO, 0.8V±1%, 150mA, +CE, CL, AE(Mode)	SOT-23-5	28x9	VR12	6g	Ric
DBA	XC9236B1ACMR	DC-DC-IC	PWM/PFM, st-dwn, 1.05V±2%, 600mA, 1.2MHz, Vin>2V, HSST, CL	SOT-25	28dc4	DC1	6g	Tor
DBA	XC6117B041MR	Vdet-IC	4.1V±2%, -MR, +Rst PPO, -Rst ODO, Rt=25ms	SOT-25	28xf	VD22	6g	Tor
DBB	RP201N091D	LVR-IC	LDO, 0.9V±1%, 150mA, +CE, CL, AE(Mode)	SOT-23-5	28x9	VR12	6g	Ric
DBB	XC9236B1BCMR	DC-DC-IC	PWM/PFM, st-dwn, 1.15V±2%, 600mA, 1.2MHz, Vin>2V, HSST, CL	SOT-25	28dc4	DC1	6g	Tor
DBB	XC6117B042MR	Vdet-IC	4.2V±2%, -MR, +Rst PPO, -Rst ODO, Rt=25ms	SOT-25	28xf	VD22	6g	Tor
DBC	RP201N101D	LVR-IC	LDO, 1.0V±1%, 150mA, +CE, CL, AE(Mode)	SOT-23-5	28x9	VR12	6g	Ric
DBC	XC9236B1CCMR	DC-DC-IC	PWM/PFM, st-dwn, 1.25V±2%, 600mA, 1.2MHz, Vin>2V, HSST, CL	SOT-25	28dc4	DC1	6g	Tor
DBC	XC6117B043MR	Vdet-IC	4.3V±2%, -MR, +Rst PPO, -Rst ODO, Rt=25ms	SOT-25	28xf	VD22	6g	Tor
DBD	RP201N111D	LVR-IC	LDO, 1.1V±1%, 150mA, +CE, CL, AE(Mode)	SOT-23-5	28x9	VR12	6g	Ric
DBD	XC9236B1DCMR	DC-DC-IC	PWM/PFM, st-dwn, 1.35V±2%, 600mA, 1.2MHz, Vin>2V, HSST, CL	SOT-25	28dc4	DC1	6g	Tor
DBD	XC6117B044MR	Vdet-IC	4.4V±2%, -MR, +Rst PPO, -Rst ODO, Rt=25ms	SOT-25	28xf	VD22	6g	Tor
DBE	RP201N121D	LVR-IC	LDO, 1.2V±1%, 150mA, +CE, CL, AE(Mode)	SOT-23-5	28x9	VR12	6g	Ric
DBE	XC9236B1ECMR	DC-DC-IC	PWM/PFM, st-dwn, 1.45V±2%, 600mA, 1.2MHz, Vin>2V, HSST, CL	SOT-25	28dc4	DC1	6g	Tor
DBE	XC6117B045MR	Vdet-IC	4.5V±2%, -MR, +Rst PPO, -Rst ODO, Rt=25ms	SOT-25	28xf	VD22	6g	Tor
DBF	RP201N131D	LVR-IC	LDO, 1.3V±1%, 150mA, +CE, CL, AE(Mode)	SOT-23-5	28x9	VR12	6g	Ric
DBF	XC9236B1FCMR	DC-DC-IC	PWM/PFM, st-dwn, 1.55V±2%, 600mA, 1.2MHz, Vin>2V, HSST, CL	SOT-25	28dc4	DC1	6g	Tor



SMD code	Type	Function	Short description	Case	Pinout	Sch.	St.	Mnf.
DBF	XC6117B016MR	Vdet-IC	1.6V±2%, -MR, +Rst PPO, -Rst ODO, Rt=25ms	SOT-25	28xf	VD22	6g	Tor
DBE	XC6117B046MR	Vdet-IC	4.6V±2%, -MR, +Rst PPO, -Rst ODO, Rt=25ms	SOT-25	28xf	VD22	6g	Tor
DBG	RP201N141D	LVR-IC	LDO, 1.4V±1%, 150mA, +CE, CL, AE(Mode)	SOT-23-5	28x9	VR12	6g	Ric
DBH	RP201N151D	LVR-IC	LDO, 1.5V±1%, 150mA, +CE, CL, AE(Mode)	SOT-23-5	28x9	VR12	6g	Ric
DBI	XC9236B1HCMR	DC-DC-IC	PWM/PFM, st-dwn, 1.65V±2%, 600mA, 1.2MHz, Vin>2V, HSST, CL	SOT-25	28dc4	DC1	6g	Tor
DBH	XC6117B017MR	Vdet-IC	1.7V±2%, -MR, +Rst PPO, -Rst ODO, Rt=25ms	SOT-25	28xf	VD22	6g	Tor
DBH	XC6117B047MR	Vdet-IC	4.7V±2%, -MR, +Rst PPO, -Rst ODO, Rt=25ms	SOT-25	28xf	VD22	6g	Tor
DBJ	RP201N161D	LVR-IC	LDO, 1.6V±1%, 150mA, +CE, CL, AE(Mode)	SOT-23-5	28x9	VR12	6g	Ric
DBK	RP201N171D	LVR-IC	LDO, 1.7V±1%, 150mA, +CE, CL, AE(Mode)	SOT-23-5	28x9	VR12	6g	Ric
DBK	XC9236B1KCMR	DC-DC-IC	PWM/PFM, st-dwn, 1.75V±2%, 600mA, 1.2MHz, Vin>2V, HSST, CL	SOT-25	28dc4	DC1	6g	Tor
DBK	XC6117B018MR	Vdet-IC	1.8V±2%, -MR, +Rst PPO, -Rst ODO, Rt=25ms	SOT-25	28xf	VD22	6g	Tor
DBK	XC6117B048MR	Vdet-IC	4.8V±2%, -MR, +Rst PPO, -Rst ODO, Rt=25ms	SOT-25	28xf	VD22	6g	Tor
DBL	RP201N181D	LVR-IC	LDO, 1.8V±1%, 150mA, +CE, CL, AE(Mode)	SOT-23-5	28x9	VR12	6g	Ric
DBL	XC9236B1LCMR	DC-DC-IC	PWM/PFM, st-dwn, 1.85V±2%, 600mA, 1.2MHz, Vin>2V, HSST, CL	SOT-25	28dc4	DC1	6g	Tor
DBL	XC6117B019MR	Vdet-IC	1.9V±2%, -MR, +Rst PPO, -Rst ODO, Rt=25ms	SOT-25	28xf	VD22	6g	Tor
DBL	XC6117B049MR	Vdet-IC	4.9V±2%, -MR, +Rst PPO, -Rst ODO, Rt=25ms	SOT-25	28xf	VD22	6g	Tor
DBM	RP201N191D	LVR-IC	LDO, 1.9V±1%, 150mA, +CE, CL, AE(Mode)	SOT-23-5	28x9	VR12	6g	Ric
DBM	XC9236B1MCMR	DC-DC-IC	PWM/PFM, st-dwn, 1.95V±2%, 600mA, 1.2MHz, Vin>2V, HSST, CL	SOT-25	28dc4	DC1	6g	Tor
DBM	XC6117B020MR	Vdet-IC	2.0V±2%, -MR, +Rst PPO, -Rst ODO, Rt=25ms	SOT-25	28xf	VD22	6g	Tor
DBM	XC6117B050MR	Vdet-IC	5.0V±2%, -MR, +Rst PPO, -Rst ODO, Rt=25ms	SOT-25	28xf	VD22	6g	Tor
DBN	RP201N201D	LVR-IC	LDO, 2.0V±1%, 150mA, +CE, CL, AE(Mode)	SOT-23-5	28x9	VR12	6g	Ric
DBN	XC6117B021MR	Vdet-IC	2.1V±2%, -MR, +Rst PPO, -Rst ODO, Rt=25ms	SOT-25	28xf	VD22	6g	Tor
DBP	RP201N211D	LVR-IC	LDO, 2.1V±1%, 150mA, +CE, CL, AE(Mode)	SOT-23-5	28x9	VR12	6g	Ric
DBP	XC6117B022MR	Vdet-IC	2.2V±2%, -MR, +Rst PPO, -Rst ODO, Rt=25ms	SOT-25	28xf	VD22	6g	Tor
DBQ	RP201N221D	LVR-IC	LDO, 2.2V±1%, 150mA, +CE, CL, AE(Mode)	SOT-23-5	28x9	VR12	6g	Ric
DBR	RP201N231D	LVR-IC	LDO, 2.3V±1%, 150mA, +CE, CL, AE(Mode)	SOT-23-5	28x9	VR12	6g	Ric
DBR	XC6117B023MR	Vdet-IC	2.3V±2%, -MR, +Rst PPO, -Rst ODO, Rt=25ms	SOT-25	28xf	VD22	6g	Tor
DBS	RP201N241D	LVR-IC	LDO, 2.4V±1%, 150mA, +CE, CL, AE(Mode)	SOT-23-5	28x9	VR12	6g	Ric
DBS	XC6117B024MR	Vdet-IC	2.4V±2%, -MR, +Rst PPO, -Rst ODO, Rt=25ms	SOT-25	28xf	VD22	6g	Tor
DBT	RP201N251D	LVR-IC	LDO, 2.5V±1%, 150mA, +CE, CL, AE(Mode)	SOT-23-5	28x9	VR12	6g	Ric
DBT	XC6117B025MR	Vdet-IC	2.5V±2%, -MR, +Rst PPO, -Rst ODO, Rt=25ms	SOT-25	28xf	VD22	6g	Tor
DBU	RP201N261D	LVR-IC	LDO, 2.6V±1%, 150mA, +CE, CL, AE(Mode)	SOT-23-5	28x9	VR12	6g	Ric
DBU	XC6117B026MR	Vdet-IC	2.6V±2%, -MR, +Rst PPO, -Rst ODO, Rt=25ms	SOT-25	28xf	VD22	6g	Tor
DBV	RP201N271D	LVR-IC	LDO, 2.7V±1%, 150mA, +CE, CL, AE(Mode)	SOT-23-5	28x9	VR12	6g	Ric
DBV	XC6117B027MR	Vdet-IC	2.7V±2%, -MR, +Rst PPO, -Rst ODO, Rt=25ms	SOT-25	28xf	VD22	6g	Tor
DBW	RP201N281D	LVR-IC	LDO, 2.8V±1%, 150mA, +CE, CL, AE(Mode)	SOT-23-5	28x9	VR12	6g	Ric
DBX	RP201N291D	LVR-IC	LDO, 2.9V±1%, 150mA, +CE, CL, AE(Mode)	SOT-23-5	28x9	VR12	6g	Ric
DBX	XC6117B028MR	Vdet-IC	2.8V±2%, -MR, +Rst PPO, -Rst ODO, Rt=25ms	SOT-25	28xf	VD22	6g	Tor
DBY	RP201N301D	LVR-IC	LDO, 3.0V±1%, 150mA, +CE, CL, AE(Mode)	SOT-23-5	28x9	VR12	6g	Ric
DBY	XC6117B029MR	Vdet-IC	2.9V±2%, -MR, +Rst PPO, -Rst ODO, Rt=25ms	SOT-25	28xf	VD22	6g	Tor
DBZ	RP201N311D	LVR-IC	LDO, 3.1V±1%, 150mA, +CE, CL, AE(Mode)	SOT-23-5	28x9	VR12	6g	Ric
DBZ	XC6117B030MR	Vdet-IC	3.0V±2%, -MR, +Rst PPO, -Rst ODO, Rt=25ms	SOT-25	28xf	VD22	6g	Tor
DC	AP131-17TW	LVR-IC	LDO, 1.7V±2%, 300mA, +CE	TSOT-23-5L	28vrx	VR4	6a	Ana
DC	AP131-17W	LVR-IC	LDO, 1.7V±2%, 300mA, +CE	SOT-23-5L	28vrx	VR4	6k	Ana
DC	RN5RT52AA	LVR-IC	LDO, 5.2V±2%, 150mA, -CE	SOT-23-5	28vrt	VR4	6g	Ric
DC	V6310CSP5B	Vdet-IC	2.8V, -Reset PPO, 50ms	SOT-23-5	28vdr	VD7	6a	Em
DC-	RT9193-18PB	LVR-IC	LDO, 1.8V±1%, 300mA, +CE	SOT-23-5	28vrx	VR7	6g	Rct
DC-	XC62GR3212M	LVR-IC	3.2V±2%, 150mA, +CE	SOT-25	28ew	VR4	6g	Tor
DC-	XC62GP3212M	LVR-IC	3.2V±2%, 150mA, -CE	SOT-25	28ew	VR4	6g	Tor
DC+	XC62GR3222M	LVR-IC	3.2V±2%, 150mA, +CE, HS response	SOT-25	28ew	VR4	6g	Tor
DC+	XC62GP3222M	LVR-IC	3.2V±2%, 150mA, -CE, HS response	SOT-25	28ew	VR4	6g	Tor
DC-	RT9193-18GB	LVR-IC	LDO, 1.8V±1%, 300mA, +CE	SOT-23-5	28vrx	VR7	6g	Rct
DC0	XC9236B20CMR	DC-DC-IC	PWM/PFM, st-dwn, 2.0V±2%, 600mA, 1.2MHz, Vin>2V, HSST, CL	SOT-25	28dc4	DC1	6g	Tor
DC0	XC6117C031MR	Vdet-IC	3.1V±2%, -MR, +Rst PPO, -Rst ODO, Rt=50ms	SOT-25	28xf	VD22	6g	Tor
DC1	XC9236B21CMR	DC-DC-IC	PWM/PFM, st-dwn, 2.1V±2%, 600mA, 1.2MHz, Vin>2V, HSST, CL	SOT-25	28dc4	DC1	6g	Tor
DC1	XC6117C032MR	Vdet-IC	3.2V±2%, -MR, +Rst PPO, -Rst ODO, Rt=50ms	SOT-25	28xf	VD22	6g	Tor
DC2	XC9236B22CMR	DC-DC-IC	PWM/PFM, st-dwn, 2.2V±2%, 600mA, 1.2MHz, Vin>2V, HSST, CL	SOT-25	28dc4	DC1	6g	Tor
DC2	XC6117C033MR	Vdet-IC	3.3V±2%, -MR, +Rst PPO, -Rst ODO, Rt=50ms	SOT-25	28xf	VD22	6g	Tor
DC3	XC9236B23CMR	DC-DC-IC	PWM/PFM, st-dwn, 2.3V±2%, 600mA, 1.2MHz, Vin>2V, HSST, CL	SOT-25	28dc4	DC1	6g	Tor
DC3	XC6117C034MR	Vdet-IC	3.4V±2%, -MR, +Rst PPO, -Rst ODO, Rt=50ms	SOT-25	28xf	VD22	6g	Tor
DC4	XC9236B24CMR	DC-DC-IC	PWM/PFM, st-dwn, 2.4V±2%, 600mA, 1.2MHz, Vin>2V, HSST, CL	SOT-25	28dc4	DC1	6g	Tor
DC4	XC6117C035MR	Vdet-IC	3.5V±2%, -MR, +Rst PPO, -Rst ODO, Rt=50ms	SOT-25	28xf	VD22	6g	Tor
DC5	XC9236B25CMR	DC-DC-IC	PWM/PFM, st-dwn, 2.5V±2%, 600mA, 1.2MHz, Vin>2V, HSST, CL	SOT-25	28dc4	DC1	6g	Tor
DC5	XC6117C036MR	Vdet-IC	3.6V±2%, -MR, +Rst PPO, -Rst ODO, Rt=50ms	SOT-25	28xf	VD22	6g	Tor
DC6	XC9236B26CMR	DC-DC-IC	PWM/PFM, st-dwn, 2.6V±2%, 600mA, 1.2MHz, Vin>2V, HSST, CL	SOT-25	28dc4	DC1	6g	Tor
DC6	XC6117C037MR	Vdet-IC	3.7V±2%, -MR, +Rst PPO, -Rst ODO, Rt=50ms	SOT-25	28xf	VD22	6g	Tor
DC7	XC9236B27CMR	DC-DC-IC	PWM/PFM, st-dwn, 2.7V±2%, 600mA, 1.2MHz, Vin>2V, HSST, CL	SOT-25	28dc4	DC1	6g	Tor
DC7	XC6117C038MR	Vdet-IC	3.8V±2%, -MR, +Rst PPO, -Rst ODO, Rt=50ms	SOT-25	28xf	VD22	6g	Tor
DC8	XC9236B28CMR	DC-DC-IC	PWM/PFM, st-dwn, 2.8V±2%, 600mA, 1.2MHz, Vin>2V, HSST, CL	SOT-25	28dc4	DC1	6g	Tor
DC8	XC6117C039MR	Vdet-IC	3.9V±2%, -MR, +Rst PPO, -Rst ODO, Rt=50ms	SOT-25	28xf	VD22	6g	Tor



SMD code	Type	Function	Short description	Case	Pinout	Sch.	St.	Mnf.
DC9	XC9236B29CMR	DC-DC-IC	PWM/PFM, st-dwn, 2.9V±2%, 600mA, 1.2MHz, Vin>2V, HSST, CL	SOT-25	28dc4	DC1	6g	Tor
DC9	X06117C040MR	Vdet-IC	4.0V±2%, -MR, +Rst PPO, -Rst ODO, Rt=50ms	SOT-25	28xf	VD22	6g	Tor
DCA	XC9236B2ACMR	DC-DC-IC	PWM/PFM, st-dwn, 2.05V±2%, 600mA, 1.2MHz, Vin>2V, HSST, CL	SOT-25	28dc4	DC1	6g	Tor
DCA	X06117C041MR	Vdet-IC	4.1V±2%, -MR, +Rst PPO, -Rst ODO, Rt=50ms	SOT-25	28xf	VD22	6g	Tor
DCB	XC9236B2BCMR	DC-DC-IC	PWM/PFM, st-dwn, 2.15V±2%, 600mA, 1.2MHz, Vin>2V, HSST, CL	SOT-25	28dc4	DC1	6g	Tor
DCB	X06117C042MR	Vdet-IC	4.2V±2%, -MR, +Rst PPO, -Rst ODO, Rt=50ms	SOT-25	28xf	VD22	6g	Tor
DCC	XC9236B2CCMR	DC-DC-IC	PWM/PFM, st-dwn, 2.25V±2%, 600mA, 1.2MHz, Vin>2V, HSST, CL	SOT-25	28dc4	DC1	6g	Tor
DCC	X06117C043MR	Vdet-IC	4.3V±2%, -MR, +Rst PPO, -Rst ODO, Rt=50ms	SOT-25	28xf	VD22	6g	Tor
DCD	XC9236B2DCMR	DC-DC-IC	PWM/PFM, st-dwn, 2.35V±2%, 600mA, 1.2MHz, Vin>2V, HSST, CL	SOT-25	28dc4	DC1	6g	Tor
DCD	X06117C044MR	Vdet-IC	4.4V±2%, -MR, +Rst PPO, -Rst ODO, Rt=50ms	SOT-25	28xf	VD22	6g	Tor
DCE	XC9236B2ECMR	DC-DC-IC	PWM/PFM, st-dwn, 2.45V±2%, 600mA, 1.2MHz, Vin>2V, HSST, CL	SOT-25	28dc4	DC1	6g	Tor
DCE	X06117C045MR	Vdet-IC	4.5V±2%, -MR, +Rst PPO, -Rst ODO, Rt=50ms	SOT-25	28xf	VD22	6g	Tor
DCF	XC9236B2FCMR	DC-DC-IC	PWM/PFM, st-dwn, 2.55V±2%, 600mA, 1.2MHz, Vin>2V, HSST, CL	SOT-25	28dc4	DC1	6g	Tor
DCF	X06117C016MR	Vdet-IC	1.6V±2%, -MR, +Rst PPO, -Rst ODO, Rt=50ms	SOT-25	28xf	VD22	6g	Tor
DCF	X06117C046MR	Vdet-IC	4.6V±2%, -MR, +Rst PPO, -Rst ODO, Rt=50ms	SOT-25	28xf	VD22	6g	Tor
DCH	XC9236B2HCMR	DC-DC-IC	PWM/PFM, st-dwn, 2.65V±2%, 600mA, 1.2MHz, Vin>2V, HSST, CL	SOT-25	28dc4	DC1	6g	Tor
DCH	X06117C017MR	Vdet-IC	1.7V±2%, -MR, +Rst PPO, -Rst ODO, Rt=50ms	SOT-25	28xf	VD22	6g	Tor
DCH	X06117C047MR	Vdet-IC	4.7V±2%, -MR, +Rst PPO, -Rst ODO, Rt=50ms	SOT-25	28xf	VD22	6g	Tor
DCK	XC9236B2KCMR	DC-DC-IC	PWM/PFM, st-dwn, 2.75V±2%, 600mA, 1.2MHz, Vin>2V, HSST, CL	SOT-25	28dc4	DC1	6g	Tor
DCK	X06117C018MR	Vdet-IC	1.8V±2%, -MR, +Rst PPO, -Rst ODO, Rt=50ms	SOT-25	28xf	VD22	6g	Tor
DKK	X06117C048MR	Vdet-IC	4.8V±2%, -MR, +Rst PPO, -Rst ODO, Rt=50ms	SOT-25	28xf	VD22	6g	Tor
DCL	XC9236B2LCMR	DC-DC-IC	PWM/PFM, st-dwn, 2.85V±2%, 600mA, 1.2MHz, Vin>2V, HSST, CL	SOT-25	28dc4	DC1	6g	Tor
DCL	X06117C019MR	Vdet-IC	1.9V±2%, -MR, +Rst PPO, -Rst ODO, Rt=50ms	SOT-25	28xf	VD22	6g	Tor
DCL	X06117C049MR	Vdet-IC	4.9V±2%, -MR, +Rst PPO, -Rst ODO, Rt=50ms	SOT-25	28xf	VD22	6g	Tor
DCM	XC9236B2MCMR	DC-DC-IC	PWM/PFM, st-dwn, 2.95V±2%, 600mA, 1.2MHz, Vin>2V, HSST, CL	SOT-25	28dc4	DC1	6g	Tor
DCM	X06117C020MR	Vdet-IC	2.0V±2%, -MR, +Rst PPO, -Rst ODO, Rt=50ms	SOT-25	28xf	VD22	6g	Tor
DCM	X06117C050MR	Vdet-IC	5.0V±2%, -MR, +Rst PPO, -Rst ODO, Rt=50ms	SOT-25	28xf	VD22	6g	Tor
DCN	X06117C021MR	Vdet-IC	2.1V±2%, -MR, +Rst PPO, -Rst ODO, Rt=50ms	SOT-25	28xf	VD22	6g	Tor
DCP	X06117C022MR	Vdet-IC	2.2V±2%, -MR, +Rst PPO, -Rst ODO, Rt=50ms	SOT-25	28xf	VD22	6g	Tor
DCR	X06117C023MR	Vdet-IC	2.3V±2%, -MR, +Rst PPO, -Rst ODO, Rt=50ms	SOT-25	28xf	VD22	6g	Tor
DCS	X06117C024MR	Vdet-IC	2.4V±2%, -MR, +Rst PPO, -Rst ODO, Rt=50ms	SOT-25	28xf	VD22	6g	Tor
DCS	X06117C025MR	Vdet-IC	2.5V±2%, -MR, +Rst PPO, -Rst ODO, Rt=50ms	SOT-25	28xf	VD22	6g	Tor
DCU	X06117C026MR	Vdet-IC	2.6V±2%, -MR, +Rst PPO, -Rst ODO, Rt=50ms	SOT-25	28xf	VD22	6g	Tor
DCV	X06117C027MR	Vdet-IC	2.7V±2%, -MR, +Rst PPO, -Rst ODO, Rt=50ms	SOT-25	28xf	VD22	6g	Tor
DCV	X06117C028MR	Vdet-IC	2.8V±2%, -MR, +Rst PPO, -Rst ODO, Rt=50ms	SOT-25	28xf	VD22	6g	Tor
DCY	X06117C029MR	Vdet-IC	2.9V±2%, -MR, +Rst PPO, -Rst ODO, Rt=50ms	SOT-25	28xf	VD22	6g	Tor
DCZ	X06117C030MR	Vdet-IC	3.0V±2%, -MR, +Rst PPO, -Rst ODO, Rt=50ms	SOT-25	28xf	VD22	6g	Tor
DD	AP131-18TW	LVR-IC	LDO, 1.8V±2%, 300mA, +CE	TSOT-23-5L	28vrx	VR4	6a	Ana
DD	AP131-18W	LVR-IC	LDO, 1.8V±2%, 300mA, +CE	SOT-23-5L	28vrx	VR4	6k	Ana
DD	BD4823FVE	Vdet-IC	2.3V, +Reset ODO	VSOFF-5	30vdu	VD6	6c	Rhm
DD	BD4823G	Vdet-IC	2.3V, +Reset ODO	SSOP-5	28vdm	VD6	6c	Rhm
DD	RN5RT53AA	LVR-IC	LDO, 5.3V±2%, 150mA, -CE	SOT-23-5	28vrt	VR4	6g	Ric
DD	V6310D5P5B	Vdet-IC	3.5V, -Reset PPO, 50ms	SOT-23-5	28vdr	VD7	6a	Em
DD-	X062GR3312M	LVR-IC	3.3V±2%, 150mA, +CE	SOT-25	28ew	VR4	6g	Tor
DD-	X062GP3312M	LVR-IC	3.3V±2%, 150mA, -CE	SOT-25	28ew	VR4	6g	Tor
DD+	X062GR3322M	LVR-IC	3.3V±2%, 150mA, +CE, HS response	SOT-25	28ew	VR4	6g	Tor
DD+	X062GP3322M	LVR-IC	3.3V±2%, 150mA, -CE, HS response	SOT-25	28ew	VR4	6g	Tor
DD0	XC9236B30CMR	DC-DC-IC	PWM/PFM, st-dwn, 3.0V±2%, 600mA, 1.2MHz, Vin>2V, HSST, CL	SOT-25	28dc4	DC1	6g	Tor
DD0	X06117D031MR	Vdet-IC	3.1V±2%, -MR, +Rst PPO, -Rst ODO, Rt=100ms	SOT-25	28xf	VD22	6g	Tor
DD1	XC9236B31CMR	DC-DC-IC	PWM/PFM, st-dwn, 3.1V±2%, 600mA, 1.2MHz, Vin>2V, HSST, CL	SOT-25	28dc4	DC1	6g	Tor
DD1	X06117D032MR	Vdet-IC	3.2V±2%, -MR, +Rst PPO, -Rst ODO, Rt=100ms	SOT-25	28xf	VD22	6g	Tor
DD2	XC9236B32CMR	DC-DC-IC	PWM/PFM, st-dwn, 3.2V±2%, 600mA, 1.2MHz, Vin>2V, HSST, CL	SOT-25	28dc4	DC1	6g	Tor
DD2	X06117D033MR	Vdet-IC	3.3V±2%, -MR, +Rst PPO, -Rst ODO, Rt=100ms	SOT-25	28xf	VD22	6g	Tor
DD3	XC9236B33CMR	DC-DC-IC	PWM/PFM, st-dwn, 3.3V±2%, 600mA, 1.2MHz, Vin>2V, HSST, CL	SOT-25	28dc4	DC1	6g	Tor
DD3	X06117D034MR	Vdet-IC	3.4V±2%, -MR, +Rst PPO, -Rst ODO, Rt=100ms	SOT-25	28xf	VD22	6g	Tor
DD4	XC9236B34CMR	DC-DC-IC	PWM/PFM, st-dwn, 3.4V±2%, 600mA, 1.2MHz, Vin>2V, HSST, CL	SOT-25	28dc4	DC1	6g	Tor
DD4	X06117D035MR	Vdet-IC	3.5V±2%, -MR, +Rst PPO, -Rst ODO, Rt=100ms	SOT-25	28xf	VD22	6g	Tor
DD5	XC9236B35CMR	DC-DC-IC	PWM/PFM, st-dwn, 3.5V±2%, 600mA, 1.2MHz, Vin>2V, HSST, CL	SOT-25	28dc4	DC1	6g	Tor
DD5	X06117D036MR	Vdet-IC	3.6V±2%, -MR, +Rst PPO, -Rst ODO, Rt=100ms	SOT-25	28xf	VD22	6g	Tor
DD6	XC9236B36CMR	DC-DC-IC	PWM/PFM, st-dwn, 3.6V±2%, 600mA, 1.2MHz, Vin>2V, HSST, CL	SOT-25	28dc4	DC1	6g	Tor
DD6	X06117D037MR	Vdet-IC	3.7V±2%, -MR, +Rst PPO, -Rst ODO, Rt=100ms	SOT-25	28xf	VD22	6g	Tor
DD7	XC9236B37CMR	DC-DC-IC	PWM/PFM, st-dwn, 3.7V±2%, 600mA, 1.2MHz, Vin>2V, HSST, CL	SOT-25	28dc4	DC1	6g	Tor
DD7	X06117D038MR	Vdet-IC	3.8V±2%, -MR, +Rst PPO, -Rst ODO, Rt=100ms	SOT-25	28xf	VD22	6g	Tor
DD8	XC9236B38CMR	DC-DC-IC	PWM/PFM, st-dwn, 3.8V±2%, 600mA, 1.2MHz, Vin>2V, HSST, CL	SOT-25	28dc4	DC1	6g	Tor
DD8	X06117D039MR	Vdet-IC	3.9V±2%, -MR, +Rst PPO, -Rst ODO, Rt=100ms	SOT-25	28xf	VD22	6g	Tor
DD9	XC9236B39CMR	DC-DC-IC	PWM/PFM, st-dwn, 3.9V±2%, 600mA, 1.2MHz, Vin>2V, HSST, CL	SOT-25	28dc4	DC1	6g	Tor
DD9	X06117D040MR	Vdet-IC	4.0V±2%, -MR, +Rst PPO, -Rst ODO, Rt=100ms	SOT-25	28xf	VD22	6g	Tor
DDA	XC9236B3ACMR	DC-DC-IC	PWM/PFM, st-dwn, 3.05V±2%, 600mA, 1.2MHz, Vin>2V, HSST, CL	SOT-25	28dc4	DC1	6g	Tor
DDA	X06117D041MR	Vdet-IC	4.1V±2%, -MR, +Rst PPO, -Rst ODO, Rt=100ms	SOT-25	28xf	VD22	6g	Tor
DDB	XC9236B3BCMR	DC-DC-IC	PWM/PFM, st-dwn, 3.15V±2%, 600mA, 1.2MHz, Vin>2V, HSST, CL	SOT-25	28dc4	DC1	6g	Tor



SMD code	Type	Function	Short description	Case	Pinout	Sch.	St.	Mnf.
DDB	XC6117D042MR	Vdet-IC	4.2V±2%, -MR, +Rst PPO, -Rst ODO, Rt=100ms	SOT-25	28xf	VD22	6g	Tor
DDC	XC9236B3CCMR	DC-DC-IC	PWM/PFM, st-dwn, 3.25V±2%, 600mA, 1.2MHz, Vin>2V, HSST, CL	SOT-25	28dc4	DC1	6g	Tor
DDC	XC6117D043MR	Vdet-IC	4.3V±2%, -MR, +Rst PPO, -Rst ODO, Rt=100ms	SOT-25	28xf	VD22	6g	Tor
DDD	XC9236B3DCMR	DC-DC-IC	PWM/PFM, st-dwn, 3.35V±2%, 600mA, 1.2MHz, Vin>2V, HSST, CL	SOT-25	28dc4	DC1	6g	Tor
DDD	XC6117D044MR	Vdet-IC	4.4V±2%, -MR, +Rst PPO, -Rst ODO, Rt=100ms	SOT-25	28xf	VD22	6g	Tor
DOE	XC9236B3ECMR	DC-DC-IC	PWM/PFM, st-dwn, 3.45V±2%, 600mA, 1.2MHz, Vin>2V, HSST, CL	SOT-25	28dc4	DC1	6g	Tor
DOE	XC6117D045MR	Vdet-IC	4.5V±2%, -MR, +Rst PPO, -Rst ODO, Rt=100ms	SOT-25	28xf	VD22	6g	Tor
DOF	XC9236B3FCMR	DC-DC-IC	PWM/PFM, st-dwn, 3.55V±2%, 600mA, 1.2MHz, Vin>2V, HSST, CL	SOT-25	28dc4	DC1	6g	Tor
DOF	XC6117D016MR	Vdet-IC	1.6V±2%, -MR, +Rst PPO, -Rst ODO, Rt=100ms	SOT-25	28xf	VD22	6g	Tor
DOF	XC6117D046MR	Vdet-IC	4.6V±2%, -MR, +Rst PPO, -Rst ODO, Rt=100ms	SOT-25	28xf	VD22	6g	Tor
DOH	XC9236B3HCMR	DC-DC-IC	PWM/PFM, st-dwn, 3.65V±2%, 600mA, 1.2MHz, Vin>2V, HSST, CL	SOT-25	28dc4	DC1	6g	Tor
DOH	XC6117D017MR	Vdet-IC	1.7V±2%, -MR, +Rst PPO, -Rst ODO, Rt=100ms	SOT-25	28xf	VD22	6g	Tor
DOH	XC6117D047MR	Vdet-IC	4.7V±2%, -MR, +Rst PPO, -Rst ODO, Rt=100ms	SOT-25	28xf	VD22	6g	Tor
DDK	XC9236B3KCMR	DC-DC-IC	PWM/PFM, st-dwn, 3.75V±2%, 600mA, 1.2MHz, Vin>2V, HSST, CL	SOT-25	28dc4	DC1	6g	Tor
DDK	XC6117D018MR	Vdet-IC	1.8V±2%, -MR, +Rst PPO, -Rst ODO, Rt=100ms	SOT-25	28xf	VD22	6g	Tor
DDK	XC6117D048MR	Vdet-IC	4.8V±2%, -MR, +Rst PPO, -Rst ODO, Rt=100ms	SOT-25	28xf	VD22	6g	Tor
DDL	XC9236B3LCMR	DC-DC-IC	PWM/PFM, st-dwn, 3.85V±2%, 600mA, 1.2MHz, Vin>2V, HSST, CL	SOT-25	28dc4	DC1	6g	Tor
DDL	XC6117D019MR	Vdet-IC	1.9V±2%, -MR, +Rst PPO, -Rst ODO, Rt=100ms	SOT-25	28xf	VD22	6g	Tor
DDL	XC6117D049MR	Vdet-IC	4.9V±2%, -MR, +Rst PPO, -Rst ODO, Rt=100ms	SOT-25	28xf	VD22	6g	Tor
DDM	XC9236B3MCMR	DC-DC-IC	PWM/PFM, st-dwn, 3.95V±2%, 600mA, 1.2MHz, Vin>2V, HSST, CL	SOT-25	28dc4	DC1	6g	Tor
DDM	XC6117D020MR	Vdet-IC	2.0V±2%, -MR, +Rst PPO, -Rst ODO, Rt=100ms	SOT-25	28xf	VD22	6g	Tor
DDM	XC6117D050MR	Vdet-IC	5.0V±2%, -MR, +Rst PPO, -Rst ODO, Rt=100ms	SOT-25	28xf	VD22	6g	Tor
DDN	XC6117D021MR	Vdet-IC	2.1V±2%, -MR, +Rst PPO, -Rst ODO, Rt=100ms	SOT-25	28xf	VD22	6g	Tor
DDP	XC6117D022MR	Vdet-IC	2.2V±2%, -MR, +Rst PPO, -Rst ODO, Rt=100ms	SOT-25	28xf	VD22	6g	Tor
DDR	XC6117D023MR	Vdet-IC	2.3V±2%, -MR, +Rst PPO, -Rst ODO, Rt=100ms	SOT-25	28xf	VD22	6g	Tor
DDS	XC6117D024MR	Vdet-IC	2.4V±2%, -MR, +Rst PPO, -Rst ODO, Rt=100ms	SOT-25	28xf	VD22	6g	Tor
DDT	XC6117D025MR	Vdet-IC	2.5V±2%, -MR, +Rst PPO, -Rst ODO, Rt=100ms	SOT-25	28xf	VD22	6g	Tor
DDU	XC6117D026MR	Vdet-IC	2.6V±2%, -MR, +Rst PPO, -Rst ODO, Rt=100ms	SOT-25	28xf	VD22	6g	Tor
DDV	XC6117D027MR	Vdet-IC	2.7V±2%, -MR, +Rst PPO, -Rst ODO, Rt=100ms	SOT-25	28xf	VD22	6g	Tor
DDX	XC6117D028MR	Vdet-IC	2.8V±2%, -MR, +Rst PPO, -Rst ODO, Rt=100ms	SOT-25	28xf	VD22	6g	Tor
DDY	XC6117D029MR	Vdet-IC	2.9V±2%, -MR, +Rst PPO, -Rst ODO, Rt=100ms	SOT-25	28xf	VD22	6g	Tor
DDZ	XC6117D030MR	Vdet-IC	3.0V±2%, -MR, +Rst PPO, -Rst ODO, Rt=100ms	SOT-25	28xf	VD22	6g	Tor
DE	AP131-19TW	LVR-IC	LDO, 1.9V±2%, 300mA, +CE	TSOT-23-5L	28vrx	VR4	6a	Ana
DE	AP131-19W	LVR-IC	LDO, 1.9V±2%, 300mA, +CE	SOT-23-5L	28vrx	VR4	6k	Ana
DE	BD4824FVE	Vdet-IC	2.4V, +Reset ODO	VSOFF-5	30vudv	VD6	6c	Rhm
DE	BD4824G	Vdet-IC	2.4V, +Reset ODO	SSOP-5	28vdm	VD6	6c	Rhm
DE	RN5RT54AA	LVR-IC	LDO, 5.4V±2%, 150mA, -CE	SOT-23-5	28vrt	VR4	6g	Ric
DE	V6310ESP5B	Vdet-IC	4V, -Reset PPO, 50ms	SOT-23-5	28vdr	VD7	6a	Em
DE-	RT9193-33PB	LVR-IC	LDO, 3.3V±1%, 300mA, +CE	SOT-23-5	28vrx	VR7	6g	Rct
DE-	XC62GR3412M	LVR-IC	3.4V±2%, 150mA, +CE	SOT-25	28ew	VR4	6g	Tor
DE-	XC62GP3412M	LVR-IC	3.4V±2%, 150mA, -CE	SOT-25	28ew	VR4	6g	Tor
DE+	XC62GR3422M	LVR-IC	3.4V±2%, 150mA, +CE, HS response	SOT-25	28ew	VR4	6g	Tor
DE+	XC62GP3422M	LVR-IC	3.4V±2%, 150mA, -CE, HS response	SOT-25	28ew	VR4	6g	Tor
DE=	RT9193-33GB	LVR-IC	LDO, 3.3V±1%, 300mA, +CE	SOT-23-5	28vrx	VR7	6g	Rct
DE0	XC9236B40CMR	DC-DC-IC	PWM/PFM, st-dwn, 4.0V±2%, 600mA, 1.2MHz, Vin>2V, HSST, CL	SOT-25	28dc4	DC1	6g	Tor
DE1	XC6117E031MR	Vdet-IC	3.1V±2%, -MR, +Rst PPO, -Rst ODO, Rt=200ms	SOT-25	28xf	VD22	6g	Tor
DE1	XC6117E032MR	Vdet-IC	3.2V±2%, -MR, +Rst PPO, -Rst ODO, Rt=200ms	SOT-25	28xf	VD22	6g	Tor
DE2	XC6117E033MR	Vdet-IC	3.3V±2%, -MR, +Rst PPO, -Rst ODO, Rt=200ms	SOT-25	28xf	VD22	6g	Tor
DE3	XC6117E034MR	Vdet-IC	3.4V±2%, -MR, +Rst PPO, -Rst ODO, Rt=200ms	SOT-25	28xf	VD22	6g	Tor
DE4	XC6117E035MR	Vdet-IC	3.5V±2%, -MR, +Rst PPO, -Rst ODO, Rt=200ms	SOT-25	28xf	VD22	6g	Tor
DE5	XC6117E036MR	Vdet-IC	3.6V±2%, -MR, +Rst PPO, -Rst ODO, Rt=200ms	SOT-25	28xf	VD22	6g	Tor
DE6	XC6117E037MR	Vdet-IC	3.7V±2%, -MR, +Rst PPO, -Rst ODO, Rt=200ms	SOT-25	28xf	VD22	6g	Tor
DE7	XC6117E038MR	Vdet-IC	3.8V±2%, -MR, +Rst PPO, -Rst ODO, Rt=200ms	SOT-25	28xf	VD22	6g	Tor
DE8	XC6117E039MR	Vdet-IC	3.9V±2%, -MR, +Rst PPO, -Rst ODO, Rt=200ms	SOT-25	28xf	VD22	6g	Tor
DE9	XC6117E040MR	Vdet-IC	4.0V±2%, -MR, +Rst PPO, -Rst ODO, Rt=200ms	SOT-25	28xf	VD22	6g	Tor
DEA	XC6117E041MR	Vdet-IC	4.1V±2%, -MR, +Rst PPO, -Rst ODO, Rt=200ms	SOT-25	28xf	VD22	6g	Tor
DEB	XC6117E042MR	Vdet-IC	4.2V±2%, -MR, +Rst PPO, -Rst ODO, Rt=200ms	SOT-25	28xf	VD22	6g	Tor
DEC	XC6117E043MR	Vdet-IC	4.3V±2%, -MR, +Rst PPO, -Rst ODO, Rt=200ms	SOT-25	28xf	VD22	6g	Tor
DED	XC6117E044MR	Vdet-IC	4.4V±2%, -MR, +Rst PPO, -Rst ODO, Rt=200ms	SOT-25	28xf	VD22	6g	Tor
DEE	XC6117E045MR	Vdet-IC	4.5V±2%, -MR, +Rst PPO, -Rst ODO, Rt=200ms	SOT-25	28xf	VD22	6g	Tor
DEF	XC6117E016MR	Vdet-IC	1.6V±2%, -MR, +Rst PPO, -Rst ODO, Rt=200ms	SOT-25	28xf	VD22	6g	Tor
DEF	XC6117E046MR	Vdet-IC	4.6V±2%, -MR, +Rst PPO, -Rst ODO, Rt=200ms	SOT-25	28xf	VD22	6g	Tor
DEH	XC6117E017MR	Vdet-IC	1.7V±2%, -MR, +Rst PPO, -Rst ODO, Rt=200ms	SOT-25	28xf	VD22	6g	Tor
DEH	XC6117E047MR	Vdet-IC	4.7V±2%, -MR, +Rst PPO, -Rst ODO, Rt=200ms	SOT-25	28xf	VD22	6g	Tor
DEK	XC6117E018MR	Vdet-IC	1.8V±2%, -MR, +Rst PPO, -Rst ODO, Rt=200ms	SOT-25	28xf	VD22	6g	Tor
DEK	XC6117E048MR	Vdet-IC	4.8V±2%, -MR, +Rst PPO, -Rst ODO, Rt=200ms	SOT-25	28xf	VD22	6g	Tor
DEL	XC6117E019MR	Vdet-IC	1.9V±2%, -MR, +Rst PPO, -Rst ODO, Rt=200ms	SOT-25	28xf	VD22	6g	Tor
DEL	XC6117E049MR	Vdet-IC	4.9V±2%, -MR, +Rst PPO, -Rst ODO, Rt=200ms	SOT-25	28xf	VD22	6g	Tor
DEM	XC6117E020MR	Vdet-IC	2.0V±2%, -MR, +Rst PPO, -Rst ODO, Rt=200ms	SOT-25	28xf	VD22	6g	Tor
DEM	XC6117E050MR	Vdet-IC	5.0V±2%, -MR, +Rst PPO, -Rst ODO, Rt=200ms	SOT-25	28xf	VD22	6g	Tor



SMD code	Type	Function	Short description	Case	Pinout	Sch.	St.	Mnf.
DEN	XC6117E021MR	Vdet-IC	2.1V±2%, -MR, +Rst PPO, -Rst ODO, Rt=200ms	SOT-25	28xf	VD22	6g	Tor
DEP	XC6117E022MR	Vdet-IC	2.2V±2%, -MR, +Rst PPO, -Rst ODO, Rt=200ms	SOT-25	28xf	VD22	6g	Tor
DER	XC6117E023MR	Vdet-IC	2.3V±2%, -MR, +Rst PPO, -Rst ODO, Rt=200ms	SOT-25	28xf	VD22	6g	Tor
DES	XC6117E024MR	Vdet-IC	2.4V±2%, -MR, +Rst PPO, -Rst ODO, Rt=200ms	SOT-25	28xf	VD22	6g	Tor
DET	XC6117E025MR	Vdet-IC	2.5V±2%, -MR, +Rst PPO, -Rst ODO, Rt=200ms	SOT-25	28xf	VD22	6g	Tor
DEU	XC6117E026MR	Vdet-IC	2.6V±2%, -MR, +Rst PPO, -Rst ODO, Rt=200ms	SOT-25	28xf	VD22	6g	Tor
DEV	XC6117E027MR	Vdet-IC	2.7V±2%, -MR, +Rst PPO, -Rst ODO, Rt=200ms	SOT-25	28xf	VD22	6g	Tor
DEX	XC6117E028MR	Vdet-IC	2.8V±2%, -MR, +Rst PPO, -Rst ODO, Rt=200ms	SOT-25	28xf	VD22	6g	Tor
DEY	XC6117E029MR	Vdet-IC	2.9V±2%, -MR, +Rst PPO, -Rst ODO, Rt=200ms	SOT-25	28xf	VD22	6g	Tor
DEZ	XC6117E030MR	Vdet-IC	3.0V±2%, -MR, +Rst PPO, -Rst ODO, Rt=200ms	SOT-25	28xf	VD22	6g	Tor
DF	AP131-20TW	LVR-IC	LDO, 2V±2%, 300mA, +CE	TSOT-23-5L	28vrx	VR4	6a	Ana
DF	AP131-20W	LVR-IC	LDO, 2V±2%, 300mA, +CE	SOT-23-5L	28vrx	VR4	6k	Ana
DF	BD4825FVE	Vdet-IC	2.5V, +Reset ODO	VSO5F-5	30vvdv	VD6	6c	Rhm
DF	BD4825G	Vdet-IC	2.5V, +Reset ODO	SSOP-5	28vdm	VD6	6c	Rhm
DF	RN5RT55AA	LVR-IC	LDO, 5.5V±2%, 150mA, -CE	SOT-23-5	28vrt	VR4	6g	Ric
DF	V6310FSP5B	Vdet-IC	4.5V, -Reset PPO, 50ms	SOT-23-5	28vdr	VD7	6a	Em
DF-	XC62GR3512M	LVR-IC	3.5V±2%, 150mA, +CE	SOT-25	28ew	VR4	6g	Tor
DF-	XC62GP3512M	LVR-IC	3.5V±2%, 150mA, -CE	SOT-25	28ew	VR4	6g	Tor
DF+	XC62GR3522M	LVR-IC	3.5V±2%, 150mA, +CE, HS response	SOT-25	28ew	VR4	6g	Tor
DF+	XC62GP3522M	LVR-IC	3.5V±2%, 150mA, -CE, HS response	SOT-25	28ew	VR4	6g	Tor
DF0	XC6117F031MR	Vdet-IC	3.1V±2%, -MR, +Rst PPO, -Rst ODO, Rt=400ms	SOT-25	28xf	VD22	6g	Tor
DF1	XC6117F032MR	Vdet-IC	3.2V±2%, -MR, +Rst PPO, -Rst ODO, Rt=400ms	SOT-25	28xf	VD22	6g	Tor
DF2	XC6117F033MR	Vdet-IC	3.3V±2%, -MR, +Rst PPO, -Rst ODO, Rt=400ms	SOT-25	28xf	VD22	6g	Tor
DF3	XC6117F034MR	Vdet-IC	3.4V±2%, -MR, +Rst PPO, -Rst ODO, Rt=400ms	SOT-25	28xf	VD22	6g	Tor
DF4	XC6117F035MR	Vdet-IC	3.5V±2%, -MR, +Rst PPO, -Rst ODO, Rt=400ms	SOT-25	28xf	VD22	6g	Tor
DF5	XC6117F036MR	Vdet-IC	3.6V±2%, -MR, +Rst PPO, -Rst ODO, Rt=400ms	SOT-25	28xf	VD22	6g	Tor
DF6	XC6117F037MR	Vdet-IC	3.7V±2%, -MR, +Rst PPO, -Rst ODO, Rt=400ms	SOT-25	28xf	VD22	6g	Tor
DF7	XC6117F038MR	Vdet-IC	3.8V±2%, -MR, +Rst PPO, -Rst ODO, Rt=400ms	SOT-25	28xf	VD22	6g	Tor
DF8	XC9236B08DMR	DC-DC-IC	PWM/PPM, st-dwn, 0.8V±2%, 600mA, 3MHz, Vin>2V, HSST, CL	SOT-25	28dc4	DC1	6g	Tor
DF8	XC6117F039MR	Vdet-IC	3.9V±2%, -MR, +Rst PPO, -Rst ODO, Rt=400ms	SOT-25	28xf	VD22	6g	Tor
DF9	XC9236B09DMR	DC-DC-IC	PWM/PPM, st-dwn, 0.9V±2%, 600mA, 3MHz, Vin>2V, HSST, CL	SOT-25	28dc4	DC1	6g	Tor
DF9	XC6117F040MR	Vdet-IC	4.0V±2%, -MR, +Rst PPO, -Rst ODO, Rt=400ms	SOT-25	28xf	VD22	6g	Tor
DFa	XC6117F041MR	Vdet-IC	4.1V±2%, -MR, +Rst PPO, -Rst ODO, Rt=400ms	SOT-25	28xf	VD22	6g	Tor
DFb	XC6117F042MR	Vdet-IC	4.2V±2%, -MR, +Rst PPO, -Rst ODO, Rt=400ms	SOT-25	28xf	VD22	6g	Tor
DFc	XC6117F043MR	Vdet-IC	4.3V±2%, -MR, +Rst PPO, -Rst ODO, Rt=400ms	SOT-25	28xf	VD22	6g	Tor
DFd	XC6117F044MR	Vdet-IC	4.4V±2%, -MR, +Rst PPO, -Rst ODO, Rt=400ms	SOT-25	28xf	VD22	6g	Tor
DFe	XC6117F045MR	Vdet-IC	4.5V±2%, -MR, +Rst PPO, -Rst ODO, Rt=400ms	SOT-25	28xf	VD22	6g	Tor
DFf	XC6117F016MR	Vdet-IC	1.6V±2%, -MR, +Rst PPO, -Rst ODO, Rt=400ms	SOT-25	28xf	VD22	6g	Tor
DFe	XC6117F046MR	Vdet-IC	4.6V±2%, -MR, +Rst PPO, -Rst ODO, Rt=400ms	SOT-25	28xf	VD22	6g	Tor
DFh	XC6117F017MR	Vdet-IC	1.7V±2%, -MR, +Rst PPO, -Rst ODO, Rt=400ms	SOT-25	28xf	VD22	6g	Tor
DFh	XC6117F047MR	Vdet-IC	4.7V±2%, -MR, +Rst PPO, -Rst ODO, Rt=400ms	SOT-25	28xf	VD22	6g	Tor
DFk	XC6117F018MR	Vdet-IC	1.8V±2%, -MR, +Rst PPO, -Rst ODO, Rt=400ms	SOT-25	28xf	VD22	6g	Tor
DFk	XC6117F048MR	Vdet-IC	4.8V±2%, -MR, +Rst PPO, -Rst ODO, Rt=400ms	SOT-25	28xf	VD22	6g	Tor
DFl	XC9236B0LDMR	DC-DC-IC	PWM/PPM, st-dwn, 0.85V±2%, 600mA, 3MHz, Vin>2V, HSST, CL	SOT-25	28dc4	DC1	6g	Tor
DFl	XC6117F019MR	Vdet-IC	1.9V±2%, -MR, +Rst PPO, -Rst ODO, Rt=400ms	SOT-25	28xf	VD22	6g	Tor
DFl	XC6117F049MR	Vdet-IC	4.9V±2%, -MR, +Rst PPO, -Rst ODO, Rt=400ms	SOT-25	28xf	VD22	6g	Tor
DFm	XC9236B0MDMR	DC-DC-IC	PWM/PPM, st-dwn, 0.95V±2%, 600mA, 3MHz, Vin>2V, HSST, CL	SOT-25	28dc4	DC1	6g	Tor
DFm	XC6117F020MR	Vdet-IC	2.0V±2%, -MR, +Rst PPO, -Rst ODO, Rt=400ms	SOT-25	28xf	VD22	6g	Tor
DFm	XC6117F050MR	Vdet-IC	5.0V±2%, -MR, +Rst PPO, -Rst ODO, Rt=400ms	SOT-25	28xf	VD22	6g	Tor
DFn	XC6117F021MR	Vdet-IC	2.1V±2%, -MR, +Rst PPO, -Rst ODO, Rt=400ms	SOT-25	28xf	VD22	6g	Tor
DFp	XC6117F022MR	Vdet-IC	2.2V±2%, -MR, +Rst PPO, -Rst ODO, Rt=400ms	SOT-25	28xf	VD22	6g	Tor
DFr	XC6117F023MR	Vdet-IC	2.3V±2%, -MR, +Rst PPO, -Rst ODO, Rt=400ms	SOT-25	28xf	VD22	6g	Tor
DFs	XC6117F024MR	Vdet-IC	2.4V±2%, -MR, +Rst PPO, -Rst ODO, Rt=400ms	SOT-25	28xf	VD22	6g	Tor
DFt	XC6117F025MR	Vdet-IC	2.5V±2%, -MR, +Rst PPO, -Rst ODO, Rt=400ms	SOT-25	28xf	VD22	6g	Tor
DFu	XC6117F026MR	Vdet-IC	2.6V±2%, -MR, +Rst PPO, -Rst ODO, Rt=400ms	SOT-25	28xf	VD22	6g	Tor
DFv	XC6117F027MR	Vdet-IC	2.7V±2%, -MR, +Rst PPO, -Rst ODO, Rt=400ms	SOT-25	28xf	VD22	6g	Tor
DFx	XC6117F028MR	Vdet-IC	2.8V±2%, -MR, +Rst PPO, -Rst ODO, Rt=400ms	SOT-25	28xf	VD22	6g	Tor
DFy	XC6117F029MR	Vdet-IC	2.9V±2%, -MR, +Rst PPO, -Rst ODO, Rt=400ms	SOT-25	28xf	VD22	6g	Tor
DFz	XC6117F030MR	Vdet-IC	3.0V±2%, -MR, +Rst PPO, -Rst ODO, Rt=400ms	SOT-25	28xf	VD22	6g	Tor
DG	AP131-21TW	LVR-IC	LDO, 2.1V±2%, 300mA, +CE	TSOT-23-5L	28vrx	VR4	6a	Ana
DG	AP131-21W	LVR-IC	LDO, 2.1V±2%, 300mA, +CE	SOT-23-5L	28vrx	VR4	6k	Ana
DG	BD4826FVE	Vdet-IC	2.6V, +Reset ODO	VSO5F-5	30vvdv	VD6	6c	Rhm
DG	BD4826G	Vdet-IC	2.6V, +Reset ODO	SSOP-5	28vdm	VD6	6c	Rhm
DG	RN5RT56AA	LVR-IC	LDO, 5.6V±2%, 150mA, -CE	SOT-23-5	28vrt	VR4	6g	Ric
DG	V6310GSP5B	Vdet-IC	2.0V, +Reset PPO, 50ms	SOT-23-5	28vdo	VD3	6a	Em
DH	AP131-22TW	LVR-IC	LDO, 2.2V±2%, 300mA, +CE	TSOT-23-5L	28vrx	VR4	6a	Ana
DH	AP131-22W	LVR-IC	LDO, 2.2V±2%, 300mA, +CE	SOT-23-5L	28vrx	VR4	6k	Ana
DH	BD4827FVE	Vdet-IC	2.7V, +Reset ODO	VSO5F-5	30vvdv	VD6	6c	Rhm
DH	BD4827G	Vdet-IC	2.7V, +Reset ODO	SSOP-5	28vdm	VD6	6c	Rhm
DH	RN5RT57AA	LVR-IC	LDO, 5.7V±2%, 150mA, -CE	SOT-23-5	28vrt	VR4	6g	Ric



SMD code	Type	Function	Short description	Case	Pinout	Sch.	St.	Mnf.
DH	V6310HSP5B	Vdet-IC	2.4V, +Reset PPO, 50ms	SOT-23-5	28vdo	VD3	6a	Em
DH-	RT9193-25PB	LVR-IC	LDO, 2.5V±1%, 300mA, +CE	SOT-23-5	28vrx	VR7	6g	Rct
DH-	XC62GR3612M	LVR-IC	3.6V±2%, 150mA, +CE	SOT-25	28ew	VR4	6g	Tor
DH-	XC62GP3612M	LVR-IC	3.6V±2%, 150mA, -CE	SOT-25	28ew	VR4	6g	Tor
DH+	XC62GR3622M	LVR-IC	3.6V±2%, 150mA, +CE, HS response	SOT-25	28ew	VR4	6g	Tor
DH+	XC62GP3622M	LVR-IC	3.6V±2%, 150mA, -CE, HS response	SOT-25	28ew	VR4	6g	Tor
DH=	RT9193-25GB	LVR-IC	LDO, 2.5V±1%, 300mA, +CE	SOT-23-5	28vrx	VR7	6g	Rct
DH0	XC9236B10DMR	DC-DC-IC	PWM/PFM, st-dwn, 1.0V±2%, 600mA, 3MHz, Vin>2V, HSST, CL	SOT-25	28dc4	DC1	6g	Tor
DH0	XC6117H031MR	Vdet-IC	3.1V±2%, -MR, +Rst PPO, -Rst ODO, Rt=1.6s	SOT-25	28xf	VD22	6g	Tor
DH1	XC9236B11DMR	DC-DC-IC	PWM/PFM, st-dwn, 1.1V±2%, 600mA, 3MHz, Vin>2V, HSST, CL	SOT-25	28dc4	DC1	6g	Tor
DH1	XC6117H032MR	Vdet-IC	3.2V±2%, -MR, +Rst PPO, -Rst ODO, Rt=1.6s	SOT-25	28xf	VD22	6g	Tor
DH2	XC9236B12DMR	DC-DC-IC	PWM/PFM, st-dwn, 1.2V±2%, 600mA, 3MHz, Vin>2V, HSST, CL	SOT-25	28dc4	DC1	6g	Tor
DH2	XC6117H033MR	Vdet-IC	3.3V±2%, -MR, +Rst PPO, -Rst ODO, Rt=1.6s	SOT-25	28xf	VD22	6g	Tor
DH3	XC9236B13DMR	DC-DC-IC	PWM/PFM, st-dwn, 1.3V±2%, 600mA, 3MHz, Vin>2V, HSST, CL	SOT-25	28dc4	DC1	6g	Tor
DH3	XC6117H034MR	Vdet-IC	3.4V±2%, -MR, +Rst PPO, -Rst ODO, Rt=1.6s	SOT-25	28xf	VD22	6g	Tor
DH4	XC9236B14DMR	DC-DC-IC	PWM/PFM, st-dwn, 1.4V±2%, 600mA, 3MHz, Vin>2V, HSST, CL	SOT-25	28dc4	DC1	6g	Tor
DH4	XC6117H035MR	Vdet-IC	3.5V±2%, -MR, +Rst PPO, -Rst ODO, Rt=1.6s	SOT-25	28xf	VD22	6g	Tor
DH5	XC9236B15DMR	DC-DC-IC	PWM/PFM, st-dwn, 1.5V±2%, 600mA, 3MHz, Vin>2V, HSST, CL	SOT-25	28dc4	DC1	6g	Tor
DH5	XC6117H036MR	Vdet-IC	3.6V±2%, -MR, +Rst PPO, -Rst ODO, Rt=1.6s	SOT-25	28xf	VD22	6g	Tor
DH6	XC9236B16DMR	DC-DC-IC	PWM/PFM, st-dwn, 1.6V±2%, 600mA, 3MHz, Vin>2V, HSST, CL	SOT-25	28dc4	DC1	6g	Tor
DH6	XC6117H037MR	Vdet-IC	3.7V±2%, -MR, +Rst PPO, -Rst ODO, Rt=1.6s	SOT-25	28xf	VD22	6g	Tor
DH7	XC9236B17DMR	DC-DC-IC	PWM/PFM, st-dwn, 1.7V±2%, 600mA, 3MHz, Vin>2V, HSST, CL	SOT-25	28dc4	DC1	6g	Tor
DH7	XC6117H038MR	Vdet-IC	3.8V±2%, -MR, +Rst PPO, -Rst ODO, Rt=1.6s	SOT-25	28xf	VD22	6g	Tor
DH8	XC9236B18DMR	DC-DC-IC	PWM/PFM, st-dwn, 1.8V±2%, 600mA, 3MHz, Vin>2V, HSST, CL	SOT-25	28dc4	DC1	6g	Tor
DH8	XC6117H039MR	Vdet-IC	3.9V±2%, -MR, +Rst PPO, -Rst ODO, Rt=1.6s	SOT-25	28xf	VD22	6g	Tor
DH9	XC9236B19DMR	DC-DC-IC	PWM/PFM, st-dwn, 1.9V±2%, 600mA, 3MHz, Vin>2V, HSST, CL	SOT-25	28dc4	DC1	6g	Tor
DH9	XC6117H040MR	Vdet-IC	4.0V±2%, -MR, +Rst PPO, -Rst ODO, Rt=1.6s	SOT-25	28xf	VD22	6g	Tor
DHA	XC9236B1ADMR	DC-DC-IC	PWM/PFM, st-dwn, 1.05V±2%, 600mA, 3MHz, Vin>2V, HSST, CL	SOT-25	28dc4	DC1	6g	Tor
DHA	XC6117H041MR	Vdet-IC	4.1V±2%, -MR, +Rst PPO, -Rst ODO, Rt=1.6s	SOT-25	28xf	VD22	6g	Tor
DHB	XC9236B1BDMR	DC-DC-IC	PWM/PFM, st-dwn, 1.15V±2%, 600mA, 3MHz, Vin>2V, HSST, CL	SOT-25	28dc4	DC1	6g	Tor
DHB	XC6117H042MR	Vdet-IC	4.2V±2%, -MR, +Rst PPO, -Rst ODO, Rt=1.6s	SOT-25	28xf	VD22	6g	Tor
DHC	XC9236B1CDMR	DC-DC-IC	PWM/PFM, st-dwn, 1.25V±2%, 600mA, 3MHz, Vin>2V, HSST, CL	SOT-25	28dc4	DC1	6g	Tor
DHC	XC6117H043MR	Vdet-IC	4.3V±2%, -MR, +Rst PPO, -Rst ODO, Rt=1.6s	SOT-25	28xf	VD22	6g	Tor
DHD	XC9236B1DDMR	DC-DC-IC	PWM/PFM, st-dwn, 1.35V±2%, 600mA, 3MHz, Vin>2V, HSST, CL	SOT-25	28dc4	DC1	6g	Tor
DHD	XC6117H044MR	Vdet-IC	4.4V±2%, -MR, +Rst PPO, -Rst ODO, Rt=1.6s	SOT-25	28xf	VD22	6g	Tor
DHE	XC9236B1EDMR	DC-DC-IC	PWM/PFM, st-dwn, 1.45V±2%, 600mA, 3MHz, Vin>2V, HSST, CL	SOT-25	28dc4	DC1	6g	Tor
DHE	XC6117H045MR	Vdet-IC	4.5V±2%, -MR, +Rst PPO, -Rst ODO, Rt=1.6s	SOT-25	28xf	VD22	6g	Tor
DHF	XC9236B1FDMR	DC-DC-IC	PWM/PFM, st-dwn, 1.55V±2%, 600mA, 3MHz, Vin>2V, HSST, CL	SOT-25	28dc4	DC1	6g	Tor
DHF	XC6117H016MR	Vdet-IC	1.6V±2%, -MR, +Rst PPO, -Rst ODO, Rt=1.6s	SOT-25	28xf	VD22	6g	Tor
DHF	XC6117H046MR	Vdet-IC	4.6V±2%, -MR, +Rst PPO, -Rst ODO, Rt=1.6s	SOT-25	28xf	VD22	6g	Tor
DHH	XC9236B1HDMR	DC-DC-IC	PWM/PFM, st-dwn, 1.65V±2%, 600mA, 3MHz, Vin>2V, HSST, CL	SOT-25	28dc4	DC1	6g	Tor
DHH	XC6117H017MR	Vdet-IC	1.7V±2%, -MR, +Rst PPO, -Rst ODO, Rt=1.6s	SOT-25	28xf	VD22	6g	Tor
DHH	XC6117H047MR	Vdet-IC	4.7V±2%, -MR, +Rst PPO, -Rst ODO, Rt=1.6s	SOT-25	28xf	VD22	6g	Tor
DHK	XC9236B1KDMR	DC-DC-IC	PWM/PFM, st-dwn, 1.75V±2%, 600mA, 3MHz, Vin>2V, HSST, CL	SOT-25	28dc4	DC1	6g	Tor
DHK	XC6117H018MR	Vdet-IC	1.8V±2%, -MR, +Rst PPO, -Rst ODO, Rt=1.6s	SOT-25	28xf	VD22	6g	Tor
DHK	XC6117H048MR	Vdet-IC	4.8V±2%, -MR, +Rst PPO, -Rst ODO, Rt=1.6s	SOT-25	28xf	VD22	6g	Tor
DHL	XC9236B1LDMR	DC-DC-IC	PWM/PFM, st-dwn, 1.85V±2%, 600mA, 3MHz, Vin>2V, HSST, CL	SOT-25	28dc4	DC1	6g	Tor
DHL	XC6117H019MR	Vdet-IC	1.9V±2%, -MR, +Rst PPO, -Rst ODO, Rt=1.6s	SOT-25	28xf	VD22	6g	Tor
DHL	XC6117H049MR	Vdet-IC	4.9V±2%, -MR, +Rst PPO, -Rst ODO, Rt=1.6s	SOT-25	28xf	VD22	6g	Tor
DHM	XC9236B1MDMR	DC-DC-IC	PWM/PFM, st-dwn, 1.95V±2%, 600mA, 3MHz, Vin>2V, HSST, CL	SOT-25	28dc4	DC1	6g	Tor
DHM	XC6117H020MR	Vdet-IC	2.0V±2%, -MR, +Rst PPO, -Rst ODO, Rt=1.6s	SOT-25	28xf	VD22	6g	Tor
DHM	XC6117H050MR	Vdet-IC	5.0V±2%, -MR, +Rst PPO, -Rst ODO, Rt=1.6s	SOT-25	28xf	VD22	6g	Tor
DHN	XC6117H021MR	Vdet-IC	2.1V±2%, -MR, +Rst PPO, -Rst ODO, Rt=1.6s	SOT-25	28xf	VD22	6g	Tor
DHP	XC6117H022MR	Vdet-IC	2.2V±2%, -MR, +Rst PPO, -Rst ODO, Rt=1.6s	SOT-25	28xf	VD22	6g	Tor
DHR	XC6117H023MR	Vdet-IC	2.3V±2%, -MR, +Rst PPO, -Rst ODO, Rt=1.6s	SOT-25	28xf	VD22	6g	Tor
DHS	XC6117H024MR	Vdet-IC	2.4V±2%, -MR, +Rst PPO, -Rst ODO, Rt=1.6s	SOT-25	28xf	VD22	6g	Tor
DHT	XC6117H025MR	Vdet-IC	2.5V±2%, -MR, +Rst PPO, -Rst ODO, Rt=1.6s	SOT-25	28xf	VD22	6g	Tor
DHU	XC6117H026MR	Vdet-IC	2.6V±2%, -MR, +Rst PPO, -Rst ODO, Rt=1.6s	SOT-25	28xf	VD22	6g	Tor
DHV	XC6117H027MR	Vdet-IC	2.7V±2%, -MR, +Rst PPO, -Rst ODO, Rt=1.6s	SOT-25	28xf	VD22	6g	Tor
DHX	XC6117H028MR	Vdet-IC	2.8V±2%, -MR, +Rst PPO, -Rst ODO, Rt=1.6s	SOT-25	28xf	VD22	6g	Tor
DHY	XC6117H029MR	Vdet-IC	2.9V±2%, -MR, +Rst PPO, -Rst ODO, Rt=1.6s	SOT-25	28xf	VD22	6g	Tor
DHZ	XC6117H030MR	Vdet-IC	3.0V±2%, -MR, +Rst PPO, -Rst ODO, Rt=1.6s	SOT-25	28xf	VD22	6g	Tor
DI	AP131-23TV	LVR-IC	LDO, 2.3V±2%, 300mA, +CE	TSOT-23-5L	28vrx	VR4	6a	Ana
DI	AP131-23W	LVR-IC	LDO, 2.3V±2%, 300mA, +CE	SOT-23-5L	28vrx	VR4	6k	Ana
DI	V6310ISP5B	Vdet-IC	2.8V, +Reset PPO, 50ms	SOT-23-5	28vdo	VD3	6a	Em
DJ	AP131-24TV	LVR-IC	LDO, 2.4V±2%, 300mA, +CE	TSOT-23-5L	28vrx	VR4	6a	Ana
DJ	AP131-24W	LVR-IC	LDO, 2.4V±2%, 300mA, +CE	SOT-23-5L	28vrx	VR4	6k	Ana
DJ	BD4828FVE	Vdet-IC	2.8V, +Reset ODO	VSO5-F	30vdv	VD6	6c	Rhm
DJ	BD4828G	Vdet-IC	2.8V, +Reset ODO	SSOP-5	28vdm	VD6	6c	Rhm
DJ	RN5RT58AA	LVR-IC	LDO, 5.8V±2%, 150mA, -CE	SOT-23-5	28vrt	VR4	6g	Ric



SMD code	Type	Function	Short description	Case	Pinout	Sch.	St.	Mnf.
DJ	V6310JSP5B	Vdet-IC	3.5V, +Reset PPO, 50ms	SOT-23-5	28vdo	VD3	6a	Em
DJ-	RT9193-28PB	LVR-IC	LDO, 2.8V±1%, 300mA, +CE	SOT-23-5	28vrx	VR7	6g	Rct
DJ=	RT9193-28GB	LVR-IC	LDO, 2.8V±1%, 300mA, +CE	SOT-23-5	28vrx	VR7	6g	Rct
DK	AP131-25TW	LVR-IC	LDO, 2.5V±2%, 300mA, +CE	TSOT-23-5L	28vrx	VR4	6a	Ana
DK	AP131-25W	LVR-IC	LDO, 2.5V±2%, 300mA, +CE	SOT-23-5L	28vrx	VR4	6k	Ana
DK	BD4829FVE	Vdet-IC	2.9V, +Reset ODO	VSOFF-5	30vdv	VD6	6c	Rhm
DK	BD4829G	Vdet-IC	2.9V, +Reset ODO	SSOP-5	28vdm	VD6	6c	Rhm
DK	RN5RT59AA	LVR-IC	LDO, 5.9V±2%, 150mA, -CE	SOT-23-5	28vrt	VR4	6g	Ric
DK	V6310KSP5B	Vdet-IC	4V, +Reset PPO, 50ms	SOT-23-5	28vdo	VD3	6a	Em
DK-	RT9193-30PB	LVR-IC	LDO, 3.0V±1%, 300mA, +CE	SOT-23-5	28vrx	VR7	6g	Rct
DK-	XC62GR3712M	LVR-IC	3.7V±2%, 150mA, +CE	SOT-25	28ew	VR4	6g	Tor
DK-	XC62GF3712M	LVR-IC	3.7V±2%, 150mA, -CE	SOT-25	28ew	VR4	6g	Tor
DK+	XC62GR3722M	LVR-IC	3.7V±2%, 150mA, +CE, HS response	SOT-25	28ew	VR4	6g	Tor
DK+	XC62GF3722M	LVR-IC	3.7V±2%, 150mA, -CE, HS response	SOT-25	28ew	VR4	6g	Tor
DK=	RT9193-30GB	LVR-IC	LDO, 3.3V±1%, 300mA, +CE	SOT-23-5	28vrx	VR7	6g	Rct
DK0	XC9236B20DMR	DC-DC-IC	PWM/PPM, st-dwn, 2.0V±2%, 600mA, 3MHz, Vin>2V, HSST, CL	SOT-25	28dc4	DC1	6g	Tor
DK1	XC9236B21DMR	DC-DC-IC	PWM/PPM, st-dwn, 2.1V±2%, 600mA, 3MHz, Vin>2V, HSST, CL	SOT-25	28dc4	DC1	6g	Tor
DK2	XC9236B22DMR	DC-DC-IC	PWM/PPM, st-dwn, 2.2V±2%, 600mA, 3MHz, Vin>2V, HSST, CL	SOT-25	28dc4	DC1	6g	Tor
DK3	XC9236B23DMR	DC-DC-IC	PWM/PPM, st-dwn, 2.3V±2%, 600mA, 3MHz, Vin>2V, HSST, CL	SOT-25	28dc4	DC1	6g	Tor
DK4	XC9236B24DMR	DC-DC-IC	PWM/PPM, st-dwn, 2.4V±2%, 600mA, 3MHz, Vin>2V, HSST, CL	SOT-25	28dc4	DC1	6g	Tor
DK5	XC9236B25DMR	DC-DC-IC	PWM/PPM, st-dwn, 2.5V±2%, 600mA, 3MHz, Vin>2V, HSST, CL	SOT-25	28dc4	DC1	6g	Tor
DK6	XC9236B26DMR	DC-DC-IC	PWM/PPM, st-dwn, 2.6V±2%, 600mA, 3MHz, Vin>2V, HSST, CL	SOT-25	28dc4	DC1	6g	Tor
DK7	XC9236B27DMR	DC-DC-IC	PWM/PPM, st-dwn, 2.7V±2%, 600mA, 3MHz, Vin>2V, HSST, CL	SOT-25	28dc4	DC1	6g	Tor
DK8	XC9236B28DMR	DC-DC-IC	PWM/PPM, st-dwn, 2.8V±2%, 600mA, 3MHz, Vin>2V, HSST, CL	SOT-25	28dc4	DC1	6g	Tor
DK9	XC9236B29DMR	DC-DC-IC	PWM/PPM, st-dwn, 2.9V±2%, 600mA, 3MHz, Vin>2V, HSST, CL	SOT-25	28dc4	DC1	6g	Tor
DKA	XC9236B2ADMR	DC-DC-IC	PWM/PPM, st-dwn, 2.05V±2%, 600mA, 3MHz, Vin>2V, HSST, CL	SOT-25	28dc4	DC1	6g	Tor
DKB	XC9236B2BDMR	DC-DC-IC	PWM/PPM, st-dwn, 2.15V±2%, 600mA, 3MHz, Vin>2V, HSST, CL	SOT-25	28dc4	DC1	6g	Tor
DKC	XC9236B2CDMR	DC-DC-IC	PWM/PPM, st-dwn, 2.25V±2%, 600mA, 3MHz, Vin>2V, HSST, CL	SOT-25	28dc4	DC1	6g	Tor
DKD	XC9236B2DDMR	DC-DC-IC	PWM/PPM, st-dwn, 2.35V±2%, 600mA, 3MHz, Vin>2V, HSST, CL	SOT-25	28dc4	DC1	6g	Tor
DKE	XC9236B2EDMR	DC-DC-IC	PWM/PPM, st-dwn, 2.45V±2%, 600mA, 3MHz, Vin>2V, HSST, CL	SOT-25	28dc4	DC1	6g	Tor
DKF	XC9236B2FDMR	DC-DC-IC	PWM/PPM, st-dwn, 2.55V±2%, 600mA, 3MHz, Vin>2V, HSST, CL	SOT-25	28dc4	DC1	6g	Tor
DKH	XC9236B2HDMR	DC-DC-IC	PWM/PPM, st-dwn, 2.65V±2%, 600mA, 3MHz, Vin>2V, HSST, CL	SOT-25	28dc4	DC1	6g	Tor
DKK	XC9236B2KDMR	DC-DC-IC	PWM/PPM, st-dwn, 2.75V±2%, 600mA, 3MHz, Vin>2V, HSST, CL	SOT-25	28dc4	DC1	6g	Tor
DKL	XC9236B2LDMR	DC-DC-IC	PWM/PPM, st-dwn, 2.85V±2%, 600mA, 3MHz, Vin>2V, HSST, CL	SOT-25	28dc4	DC1	6g	Tor
DKM	XC9236B2MDMR	DC-DC-IC	PWM/PPM, st-dwn, 2.95V±2%, 600mA, 3MHz, Vin>2V, HSST, CL	SOT-25	28dc4	DC1	6g	Tor
dL	NX3V1G66GW	CMOS-Logic	Single-pole single-throw analog switch	SOT-353-1	28Log16	-	6a	Phi
DL	AP131-26TW	LVR-IC	LDO, 2.6V±2%, 300mA, +CE	TSOT-23-5L	28vrx	VR4	6a	Ana
DL	AP131-26W	LVR-IC	LDO, 2.6V±2%, 300mA, +CE	SOT-23-5L	28vrx	VR4	6k	Ana
DL	BD4830FVE	Vdet-IC	3V, +Reset ODO	VSOFF-5	30vdv	VD6	6c	Rhm
DL	BD4830G	Vdet-IC	3V, +Reset ODO	SSOP-5	28vdm	VD6	6c	Rhm
DL	NX3L1G66GW	CMOS-Logic	Single-pole single-throw analog switch	SOT-353-1	28Log16	-	6a	Phi
DL	R1112N501A	LVR-IC	LDO, LN, -CE, 5V±2%, 150mA	SOT-23-5	28cx	VR4	6g	Ric
DL	V6310LSP5B	Vdet-IC	4.5V, +Reset PPO, 50ms	SOT-23-5	28vdo	VD3	6a	Em
DL-	RT9198-33PB	LVR-IC	LDO, 3.3V±1%, 300mA, +CE	SOT-23-5	28xm	VR4	6a	Rct
DL-	XC62GR3812M	LVR-IC	3.8V±2%, 150mA, +CE	SOT-25	28ew	VR4	6g	Tor
DL-	XC62GF3812M	LVR-IC	3.8V±2%, 150mA, -CE	SOT-25	28ew	VR4	6g	Tor
DL+	XC62GR3822M	LVR-IC	3.8V±2%, 150mA, +CE, HS response	SOT-25	28ew	VR4	6g	Tor
DL+	XC62GF3822M	LVR-IC	3.8V±2%, 150mA, -CE, HS response	SOT-25	28ew	VR4	6g	Tor
DL=	RT9198-33GB	LVR-IC	LDO, 3.3V±1%, 300mA, +CE	SOT-23-5	28xm	VR4	6a	Rct
DL0	XC9236B30DMR	DC-DC-IC	PWM/PPM, st-dwn, 3.0V±2%, 600mA, 3MHz, Vin>2V, HSST, CL	SOT-25	28dc4	DC1	6g	Tor
DL1	XC9236B31DMR	DC-DC-IC	PWM/PPM, st-dwn, 3.1V±2%, 600mA, 3MHz, Vin>2V, HSST, CL	SOT-25	28dc4	DC1	6g	Tor
DL2	XC9236B32DMR	DC-DC-IC	PWM/PPM, st-dwn, 3.2V±2%, 600mA, 3MHz, Vin>2V, HSST, CL	SOT-25	28dc4	DC1	6g	Tor
DL3	XC9236B33DMR	DC-DC-IC	PWM/PPM, st-dwn, 3.3V±2%, 600mA, 3MHz, Vin>2V, HSST, CL	SOT-25	28dc4	DC1	6g	Tor
DL4	XC9236B34DMR	DC-DC-IC	PWM/PPM, st-dwn, 3.4V±2%, 600mA, 3MHz, Vin>2V, HSST, CL	SOT-25	28dc4	DC1	6g	Tor
DL5	XC9236B35DMR	DC-DC-IC	PWM/PPM, st-dwn, 3.5V±2%, 600mA, 3MHz, Vin>2V, HSST, CL	SOT-25	28dc4	DC1	6g	Tor
DL6	XC9236B36DMR	DC-DC-IC	PWM/PPM, st-dwn, 3.6V±2%, 600mA, 3MHz, Vin>2V, HSST, CL	SOT-25	28dc4	DC1	6g	Tor
DL7	XC9236B37DMR	DC-DC-IC	PWM/PPM, st-dwn, 3.7V±2%, 600mA, 3MHz, Vin>2V, HSST, CL	SOT-25	28dc4	DC1	6g	Tor
DL8	XC9236B38DMR	DC-DC-IC	PWM/PPM, st-dwn, 3.8V±2%, 600mA, 3MHz, Vin>2V, HSST, CL	SOT-25	28dc4	DC1	6g	Tor
DL9	XC9236B39DMR	DC-DC-IC	PWM/PPM, st-dwn, 3.9V±2%, 600mA, 3MHz, Vin>2V, HSST, CL	SOT-25	28dc4	DC1	6g	Tor
DLA	XC9236B3ADMR	DC-DC-IC	PWM/PPM, st-dwn, 3.05V±2%, 600mA, 3MHz, Vin>2V, HSST, CL	SOT-25	28dc4	DC1	6g	Tor
DLB	XC9236B3BDMR	DC-DC-IC	PWM/PPM, st-dwn, 3.15V±2%, 600mA, 3MHz, Vin>2V, HSST, CL	SOT-25	28dc4	DC1	6g	Tor
DLC	XC9236B3CDMR	DC-DC-IC	PWM/PPM, st-dwn, 3.25V±2%, 600mA, 3MHz, Vin>2V, HSST, CL	SOT-25	28dc4	DC1	6g	Tor
DLD	XC9236B3DDMR	DC-DC-IC	PWM/PPM, st-dwn, 3.35V±2%, 600mA, 3MHz, Vin>2V, HSST, CL	SOT-25	28dc4	DC1	6g	Tor
DLE	XC9236B3EDMR	DC-DC-IC	PWM/PPM, st-dwn, 3.45V±2%, 600mA, 3MHz, Vin>2V, HSST, CL	SOT-25	28dc4	DC1	6g	Tor
DLF	XC9236B3FDMR	DC-DC-IC	PWM/PPM, st-dwn, 3.55V±2%, 600mA, 3MHz, Vin>2V, HSST, CL	SOT-25	28dc4	DC1	6g	Tor
DLH	XC9236B3HDMR	DC-DC-IC	PWM/PPM, st-dwn, 3.65V±2%, 600mA, 3MHz, Vin>2V, HSST, CL	SOT-25	28dc4	DC1	6g	Tor
DLK	XC9236B3KDMR	DC-DC-IC	PWM/PPM, st-dwn, 3.75V±2%, 600mA, 3MHz, Vin>2V, HSST, CL	SOT-25	28dc4	DC1	6g	Tor
DLL	XC9236B3LDMR	DC-DC-IC	PWM/PPM, st-dwn, 3.85V±2%, 600mA, 3MHz, Vin>2V, HSST, CL	SOT-25	28dc4	DC1	6g	Tor
DLM	XC9236B3MDMR	DC-DC-IC	PWM/PPM, st-dwn, 3.95V±2%, 600mA, 3MHz, Vin>2V, HSST, CL	SOT-25	28dc4	DC1	6g	Tor
DM	AP131-27TW	LVR-IC	LDO, 2.7V±2%, 300mA, +CE	TSOT-23-5L	28vrx	VR4	6a	Ana



SMD code	Type	Function	Short description	Case	Pinout	Sch.	St.	Mnf.
DM	AP131-27W	LVR-IC	LDO, 2.7V±2%, 300mA, +CE	SOT-23-5L	28vrx	VR4	6k	Ana
DM	BD4831FVE	Vdet-IC	3.1V, +Reset ODO	VSOFF-5	30vdv	VD6	6c	Rhm
DM	BD4831G	Vdet-IC	3.1V, +Reset ODO	SSOP-5	28vdm	VD6	6c	Rhm
DM	V6310MSP5B	Vdet-IC	2.0V, -Reset ODO, 50ms	SOT-23-5	28vdr	VD6	6a	Em
DM-	RT9198-15PB	LVR-IC	LDO, 1.5V±1%, 300mA, +CE	SOT-23-5	28xm	VR4	6a	Rct
DM-	XC62GR3912M	LVR-IC	3.9V±2%, 150mA, +CE	SOT-25	28ew	VR4	6g	Tor
DM-	XC62GP3912M	LVR-IC	3.9V±2%, 150mA, -CE	SOT-25	28ew	VR4	6g	Tor
DM+	XC62GR3922M	LVR-IC	3.9V±2%, 150mA, +CE, HS response	SOT-25	28ew	VR4	6g	Tor
DM+	XC62GP3922M	LVR-IC	3.9V±2%, 150mA, -CE, HS response	SOT-25	28ew	VR4	6g	Tor
DM0	XC9236B40DMR	DC-DC-IC	PWM/PFM, st-dwn, 4.0V±2%, 600mA, 3MHz, Vin>2V, HSST, CL	SOT-25	28dc4	DC1	6g	Tor
DN	AIC1647CJ	LDR-IC	1.2 MHz PWM White LED driver, OVP 4.2V	TSOT-23-5	28sq	LD3	6a	Aic
DN	AP131-28TW	LVR-IC	LDO, 2.8V±2%, 300mA, +CE	TSOT-23-5L	28vrx	VR4	6a	Ana
DN	AP131-28W	LVR-IC	LDO, 2.8V±2%, 300mA, +CE	SOT-23-5L	28vrx	VR4	6k	Ana
DN	BD4832FVE	Vdet-IC	3.2V, +Reset ODO	VSOFF-5	30vdv	VD6	6c	Rhm
DN	BD4832G	Vdet-IC	3.2V, +Reset ODO	SSOP-5	28vdm	VD6	6c	Rhm
DN	V6310NSP5B	Vdet-IC	2.4V, -Reset ODO, 50ms	SOT-23-5	28vdr	VD6	6a	Em
DN-	RT9198-18PB	LVR-IC	LDO, 1.8V±1%, 300mA, +CE	SOT-23-5	28xm	VR4	6a	Rct
DNP	AIC1647PJ	LDR-IC	1.2 MHz PWM White LED driver, OVP 4.2V	TSOT-23-5	28sq	LD3	6a	Aic
dO	NX3V1T66GW	CMOS-Logic	Single-pole single-throw analog switch	SOT-353-1	28/Log16	-	6a	Phi
DO	AP131-29TW	LVR-IC	LDO, 2.9V±2%, 300mA, +CE	TSOT-23-5L	28vrx	VR4	6a	Ana
DO	AP131-29W	LVR-IC	LDO, 2.9V±2%, 300mA, +CE	SOT-23-5L	28vrx	VR4	6k	Ana
DO	NX3L1T66GW	CMOS-Logic	Single-pole single-throw analog switch	SOT-353-1	28/Log16	-	6a	Phi
DO	V6310OSP5B	Vdet-IC	2.8V, -Reset ODO, 50ms	SOT-23-5	28vdr	VD6	6a	Em
DP	AP131-30TW	LVR-IC	LDO, 3V±2%, 300mA, +CE	TSOT-23-5L	28vrx	VR4	6a	Ana
DP	AP131-30W	LVR-IC	LDO, 3V±2%, 300mA, +CE	SOT-23-5L	28vrx	VR4	6k	Ana
DP	BD4833FVE	Vdet-IC	3.3V, +Reset ODO	VSOFF-5	30vdv	VD6	6c	Rhm
DP	BD4833G	Vdet-IC	3.3V, +Reset ODO	SSOP-5	28vdm	VD6	6c	Rhm
DP	V6310PSP5B	Vdet-IC	3.5V, -Reset ODO, 50ms	SOT-23-5	28vdr	VD6	6a	Em
DP-	RT9198-25PB	LVR-IC	LDO, 2.5V±1%, 300mA, +CE	SOT-23-5	28xm	VR4	6a	Rct
DQ	AP131-31TW	LVR-IC	LDO, 3.1V±2%, 300mA, +CE	TSOT-23-5L	28vrx	VR4	6a	Ana
DQ	AP131-31W	LVR-IC	LDO, 3.1V±2%, 300mA, +CE	SOT-23-5L	28vrx	VR4	6k	Ana
DQ	BD4834FVE	Vdet-IC	3.4V, +Reset ODO	VSOFF-5	30vdv	VD6	6c	Rhm
DQ	BD4834G	Vdet-IC	3.4V, +Reset ODO	SSOP-5	28vdm	VD6	6c	Rhm
DQ	V6310QSP5B	Vdet-IC	4V, -Reset ODO, 50ms	SOT-23-5	28vdr	VD6	6a	Em
DQ-	RT9198-28PB	LVR-IC	LDO, 2.8V±1%, 300mA, +CE	SOT-23-5	28xm	VR4	6a	Rct
DR	AP131-32TW	LVR-IC	LDO, 3.2V±2%, 300mA, +CE	TSOT-23-5L	28vrx	VR4	6a	Ana
DR	AP131-32W	LVR-IC	LDO, 3.2V±2%, 300mA, +CE	SOT-23-5L	28vrx	VR4	6k	Ana
DR	AT1201-28XR	LVR-IC	LDO, LN, +CE, 2.8V±2%, 150mA	SOT-23-5	28un	VR7	6a	Atr
DR	BD4835FVE	Vdet-IC	3.5V, +Reset ODO	VSOFF-5	30vdv	VD6	6c	Rhm
DR	BD4835G	Vdet-IC	3.5V, +Reset ODO	SSOP-5	28vdm	VD6	6c	Rhm
DR	V6310RSP5B	Vdet-IC	4.5V, -Reset ODO, 50ms	SOT-23-5	28vdr	VD6	6a	Em
DR-	RT9198-30PB	LVR-IC	LDO, 3.0V±1%, 300mA, +CE	SOT-23-5	28xm	VR4	6a	Rct
DS	AP131-33TW	LVR-IC	LDO, 3.3V±2%, 300mA, +CE	TSOT-23-5L	28vrx	VR4	6a	Ana
DS	AP131-33W	LVR-IC	LDO, 3.3V±2%, 300mA, +CE	SOT-23-5L	28vrx	VR4	6k	Ana
DS	BD4836FVE	Vdet-IC	3.6V, +Reset ODO	VSOFF-5	30vdv	VD6	6c	Rhm
DS	BD4836G	Vdet-IC	3.6V, +Reset ODO	SSOP-5	28vdm	VD6	6c	Rhm
DS-	RT9193-15PB	LVR-IC	LDO, 1.5V±1%, 300mA, +CE	SOT-23-5	28vrx	VR7	6g	Rct
DS=	RT9193-15GB	LVR-IC	LDO, 1.5V±1%, 300mA, +CE	SOT-23-5	28vrx	VR7	6g	Rct
DT	AP131-34TW	LVR-IC	LDO, 3.4V±2%, 300mA, +CE	TSOT-23-5L	28vrx	VR4	6a	Ana
DT	AP131-34W	LVR-IC	LDO, 3.4V±2%, 300mA, +CE	SOT-23-5L	28vrx	VR4	6k	Ana
DT	BD4837FVE	Vdet-IC	3.7V, +Reset ODO	VSOFF-5	30vdv	VD6	6c	Rhm
DT	BD4837G	Vdet-IC	3.7V, +Reset ODO	SSOP-5	28vdm	VD6	6c	Rhm
DT-	RT9198-18PBR	LVR-IC	LDO, 1.8V±1%, 300mA, +CE	SOT-23-5	28cx	VR4	6a	Rct
DT=	RT9198-18GBR	LVR-IC	LDO, 1.8V±1%, 300mA, +CE	SOT-23-5	28cx	VR4	6a	Rct
DU	AP131-35TW	LVR-IC	LDO, 3.5V±2%, 300mA, +CE	TSOT-23-5L	28vrx	VR4	6a	Ana
DU	AP131-35W	LVR-IC	LDO, 3.5V±2%, 300mA, +CE	SOT-23-5L	28vrx	VR4	6k	Ana
DU	BD4838FVE	Vdet-IC	3.8V, +Reset ODO	VSOFF-5	30vdv	VD6	6c	Rhm
DU	BD4838G	Vdet-IC	3.8V, +Reset ODO	SSOP-5	28vdm	VD6	6c	Rhm
DU-	RT9198-25PBR	LVR-IC	LDO, 2.5V±1%, 300mA, +CE	SOT-23-5	28cx	VR4	6a	Rct
DU=	RT9198-25GBR	LVR-IC	LDO, 2.5V±1%, 300mA, +CE	SOT-23-5	28cx	VR4	6a	Rct
DV	AP131-36TW	LVR-IC	LDO, 3.6V±2%, 300mA, +CE	TSOT-23-5L	28vrx	VR4	6a	Ana
DV	AP131-36W	LVR-IC	LDO, 3.6V±2%, 300mA, +CE	SOT-23-5L	28vrx	VR4	6k	Ana
DV	BD4839FVE	Vdet-IC	3.9V, +Reset ODO	VSOFF-5	30vdv	VD6	6c	Rhm
DV	BD4839G	Vdet-IC	3.9V, +Reset ODO	SSOP-5	28vdm	VD6	6c	Rhm
DV-	RT9198-28PBR	LVR-IC	LDO, 2.8V±1%, 300mA, +CE	SOT-23-5	28cx	VR4	6a	Rct
DV=	RT9198-28GBR	LVR-IC	LDO, 2.8V±1%, 300mA, +CE	SOT-23-5	28cx	VR4	6a	Rct
DW	AP131-37TW	LVR-IC	LDO, 3.7V±2%, 300mA, +CE	TSOT-23-5L	28vrx	VR4	6a	Ana
DW	AP131-37W	LVR-IC	LDO, 3.7V±2%, 300mA, +CE	SOT-23-5L	28vrx	VR4	6k	Ana
DW-	RT9198-30PBR	LVR-IC	LDO, 3.0V±1%, 300mA, +CE	SOT-23-5	28cx	VR4	6a	Rct
DW=	RT9198-30GBR	LVR-IC	LDO, 3.0V±1%, 300mA, +CE	SOT-23-5	28xm	VR4	6a	Rct



SMD code	Type	Function	Short description	Case	Pinout	Sch.	St.	Mnf.
DX	AP131-38TW	LVR-IC	LDO, 3.8V±2%, 300mA, +CE	TSOT-23-5L	28vrx	VR4	6a	Ana
DX	AP131-38W	LVR-IC	LDO, 3.8V±2%, 300mA, +CE	SOT-23-5L	28vrx	VR4	6k	Ana
DX	AT1201-28X	LVR-IC	LDO, LN, +CE, 2.8V±2%, 150mA	SOT-23-5	28vrx	VR7	6a	Atr
DX-	RT9198-33PBR	LVR-IC	LDO, 3.3V±1%, 300mA, +CE	SOT-23-5	28xc	VR4	6a	Rct
DX=	RT9198-33GBR	LVR-IC	LDO, 3.3V±1%, 300mA, +CE	SOT-23-5	28xm	VR4	6a	Rct
DY	AP131-39TW	LVR-IC	LDO, 3.9V±2%, 300mA, +CE	TSOT-23-5L	28vrx	VR4	6a	Ana
DY	AP131-39W	LVR-IC	LDO, 3.9V±2%, 300mA, +CE	SOT-23-5L	28vrx	VR4	6k	Ana
DY	TC1055-1.8VCT713	LVR-IC	LDO, 1.8V±2%, 100mA, +CE, -Error	SOT-23-5	28w	VR8	6g	Mcc
DY-	RT9198-32PB	LVR-IC	LDO, 3.2V±1%, 300mA, +CE	SOT-23-5	28xm	VR4	6a	Rct
DZ	AP131-40TW	LVR-IC	LDO, 4V±2%, 300mA, +CE	TSOT-23-5L	28vrx	VR4	6a	Ana
DZ	AP131-40W	LVR-IC	LDO, 4V±2%, 300mA, +CE	SOT-23-5L	28vrx	VR4	6k	Ana
DZ	TC1055-2.8VCT713	LVR-IC	LDO, 2.8V±2%, 100mA, +CE, -Error	SOT-23-5	28w	VR8	6g	Mcc
DZ-	RT9193-32PB	LVR-IC	LDO, 3.2V±1%, 300mA, +CE	SOT-23-5	28vrx	VR7	6g	Rct
E0	RT9167-15CB	LVR-IC	LDO, 1.5V±2%, 300mA, +CE	SOT-23-5	28vrx	VR7	6g	Rct
E0	RN5VD40AA	Vdet-IC	4V±2.5%, -Reset PPO	SOT-23-5	28vdo	VD3	6g	Ric
E0-	RT9167-15PB	LVR-IC	LDO, 1.5V±2%, 300mA, +CE	SOT-23-5	28vrx	VR7	6g	Rct
E001	RP105Q062B	LVR-IC	LDO, 0.6V±15mV, 400mA, +CE	SC-88A	28zf	VR11	6m	Ric
E002	RP105Q072B	LVR-IC	LDO, 0.7V±15mV, 400mA, +CE	SC-88A	28zf	VR11	6m	Ric
E003	RP105Q082B	LVR-IC	LDO, 0.8V±15mV, 400mA, +CE	SC-88A	28zf	VR11	6m	Ric
E004	RP105Q092B	LVR-IC	LDO, 0.9V±15mV, 400mA, +CE	SC-88A	28zf	VR11	6m	Ric
E005	RP105Q102B	LVR-IC	LDO, 1.0V±15mV, 400mA, +CE	SC-88A	28zf	VR11	6m	Ric
E006	RP105Q122B	LVR-IC	LDO, 1.2V±15mV, 400mA, +CE	SC-88A	28zf	VR11	6m	Ric
E007	RP105Q132B	LVR-IC	LDO, 1.3V±15mV, 400mA, +CE	SC-88A	28zf	VR11	6m	Ric
E008	RP105Q142B	LVR-IC	LDO, 1.4V±15mV, 400mA, +CE	SC-88A	28zf	VR11	6m	Ric
E009	RP105Q152B	LVR-IC	LDO, 1.5V±15mV, 400mA, +CE	SC-88A	28zf	VR11	6m	Ric
E010	RP105Q112B	LVR-IC	LDO, 1.1V±15mV, 400mA, +CE	SC-88A	28zf	VR11	6m	Ric
E0A	R3116N311A	Vdet-IC	3.1V±0.8%, -Reset ODO	SOT-23-5	28vdo	VD1	6g	Ric
E0A	XC6108C40AMR	Vdet-IC	4.0V±2%, Hysteresis, -Reset PPO	SOT-25	28rm	VD15	6g	Tor
E0B	R3116N321A	Vdet-IC	3.2V±0.8%, -Reset ODO	SOT-23-5	28vdo	VD1	6g	Ric
E0B	XC6108C40BMR	Vdet-IC	4.0V±2%, -Reset PPO	SOT-25	28rm	VD15	6g	Tor
E0C	R3116N331A	Vdet-IC	3.3V±0.8%, -Reset ODO	SOT-23-5	28vdo	VD1	6g	Ric
E0C	XC6108C40CMR	Vdet-IC	4.0V±2%, Hysteresis, -Reset PPO	SOT-25	28rk	VD15	6g	Tor
E0D	R3116N341A	Vdet-IC	3.4V±0.8%, -Reset ODO	SOT-23-5	28vdo	VD1	6g	Ric
E0D	XC6108C40DMR	Vdet-IC	4.0V±2%, -Reset PPO	SOT-25	28rk	VD15	6g	Tor
E0E	R3116N351A	Vdet-IC	3.5V±0.8%, -Reset ODO	SOT-23-5	28vdo	VD1	6g	Ric
E0F	R3116N361A	Vdet-IC	3.6V±0.8%, -Reset ODO	SOT-23-5	28vdo	VD1	6g	Ric
E0G	R3116N371A	Vdet-IC	3.7V±0.8%, -Reset ODO	SOT-23-5	28vdo	VD1	6g	Ric
E0H	R3116N381A	Vdet-IC	3.8V±0.8%, -Reset ODO	SOT-23-5	28vdo	VD1	6g	Ric
E0J	R3116N391A	Vdet-IC	3.9V±0.8%, -Reset ODO	SOT-23-5	28vdo	VD1	6g	Ric
E0K	R3116N401A	Vdet-IC	4V±0.8%, -Reset ODO	SOT-23-5	28vdo	VD1	6g	Ric
E0L	R3116N411A	Vdet-IC	4.1V±0.8%, -Reset ODO	SOT-23-5	28vdo	VD1	6g	Ric
E0M	R3116N421A	Vdet-IC	4.2V±0.8%, -Reset ODO	SOT-23-5	28vdo	VD1	6g	Ric
E0N	R3116N431A	Vdet-IC	4.3V±0.8%, -Reset ODO	SOT-23-5	28vdo	VD1	6g	Ric
E0P	R3116N441A	Vdet-IC	4.4V±0.8%, -Reset ODO	SOT-23-5	28vdo	VD1	6g	Ric
E0Q	R3116N451A	Vdet-IC	4.5V±0.8%, -Reset ODO	SOT-23-5	28vdo	VD1	6g	Ric
E0R	R3116N461A	Vdet-IC	4.6V±0.8%, -Reset ODO	SOT-23-5	28vdo	VD1	6g	Ric
E0S	R3116N471A	Vdet-IC	4.7V±0.8%, -Reset ODO	SOT-23-5	28vdo	VD1	6g	Ric
E0T	R3116N481A	Vdet-IC	4.8V±0.8%, -Reset ODO	SOT-23-5	28vdo	VD1	6g	Ric
E0U	R3116N491A	Vdet-IC	4.9V±0.8%, -Reset ODO	SOT-23-5	28vdo	VD1	6g	Ric
E0V	R3116N501A	Vdet-IC	5.0V±0.8%, -Reset ODO	SOT-23-5	28vdo	VD1	6g	Ric
E1	CH471EPT	Si-diode	Dual, SBD, 40V, 100mA, Vf<0.55V(100mA)	SOT-23-5	28bg	-	6a	Chm
E1	ELM74S00B	CMOS-Logic	2-input NAND gate	SOT-25	28Log1	-	6g	Elm
E1	RT9167-16CB	LVR-IC	LDO, 1.6V±2%, 300mA, +CE	SOT-23-5	28vrx	VR7	6g	Rct
E1	Si91842DT-50	LVR-IC	LDO, LN, +CE, -Error, 5V±1.5%, 150mA	SOT-23-5	28w	VR17	6k	Vs
E1	TC7S00F	CMOS-Logic	2-input NAND gate	SSOP-5	28Log1	-	6a	Tos
E1	TC7S00FU	CMOS-Logic	2-input NAND gate	SC-70-5	28Log1	-	6a	Tos
E1	RN5VD41AA	Vdet-IC	4.1V±2.5%, -Reset PPO	SOT-23-5	28vdo	VD3	6g	Ric
E10	R1224N102E	DC/DC-IC	PWMVFM step-down, 1V, 300kHz	SOT-23-5	28ud	DC7	6g	Ric
E12	R1224N122E	DC/DC-IC	PWMVFM step-down, 1.2V, 300kHz	SOT-23-5	28ud	DC7	6g	Ric
E15	R1224N152E	DC/DC-IC	PWMVFM step-down, 1.5V, 300kHz	SOT-23-5	28ud	DC7	6g	Ric
E15	XC6367E152MR	DC/DC-IC	PWM step-up, 1.5V±2.5%, 200mA, 180kHz, +CE	SOT-25	28sd	DC10	6g	Tor
E16	XC6367E162MR	DC/DC-IC	PWM step-up, 1.6V±2.5%, 200mA, 180kHz, +CE	SOT-25	28sd	DC10	6g	Tor
E17	XC6367E172MR	DC/DC-IC	PWM step-up, 1.7V±2.5%, 200mA, 180kHz, +CE	SOT-25	28sd	DC10	6g	Tor
E18	R1224N182E	DC/DC-IC	PWMVFM step-down, 1.8V, 300kHz	SOT-23-5	28ud	DC7	6g	Ric
E18	XC6367E182MR	DC/DC-IC	PWM step-up, 1.8V±2.5%, 200mA, 180kHz, +CE	SOT-25	28sd	DC10	6g	Tor
E19	XC6367E192MR	DC/DC-IC	PWM step-up, 1.9V±2.5%, 200mA, 180kHz, +CE	SOT-25	28sd	DC10	6g	Tor
E1A	R3116N311C	Vdet-IC	3.1V±0.8%, -Reset PPO	SOT-23-5	28vdo	VD3	6g	Ric
E1A	XC6108C41AMR	Vdet-IC	4.1V±2%, Hysteresis, -Reset PPO	SOT-25	28rm	VD15	6g	Tor
E1B	R3116N321C	Vdet-IC	3.2V±0.8%, -Reset PPO	SOT-23-5	28vdo	VD3	6g	Ric
E1B	XC6108C41BMR	Vdet-IC	4.1V±2%, -Reset PPO	SOT-25	28rm	VD15	6g	Tor



SMD code	Type	Function	Short description	Case	Pinout	Sch.	St.	Mnf.
E1C	R3116N331C	Vdet-IC	3.3V±0.8%, -Reset PPO	SOT-23-5	28vdo	VD3	6g	Ric
E1C	X06108C41CMR	Vdet-IC	4.1V±2%, Hysteresis, -Reset PPO	SOT-25	28rk	VD15	6g	Tor
E1D	R3116N341C	Vdet-IC	3.4V±0.8%, -Reset PPO	SOT-23-5	28vdo	VD3	6g	Ric
E1D	X06108C41DMR	Vdet-IC	4.1V±2%, -Reset PPO	SOT-25	28rk	VD15	6g	Tor
E1E	R3116N351C	Vdet-IC	3.5V±0.8%, -Reset PPO	SOT-23-5	28vdo	VD3	6g	Ric
E1F	R3116N361C	Vdet-IC	3.6V±0.8%, -Reset PPO	SOT-23-5	28vdo	VD3	6g	Ric
E1F	X06367E153MR	DC/DC-IC	PWM step-up, 1.5V±2.5%, 200mA, 300kHz, +CE	SOT-25	28sd	DC10	6g	Tor
E1G	R3116N371C	Vdet-IC	3.7V±0.8%, -Reset PPO	SOT-23-5	28vdo	VD3	6g	Ric
E1H	R3116N381C	Vdet-IC	3.8V±0.8%, -Reset PPO	SOT-23-5	28vdo	VD3	6g	Ric
E1H	X06367E163MR	DC/DC-IC	PWM step-up, 1.6V±2.5%, 200mA, 300kHz, +CE	SOT-25	28sd	DC10	6g	Tor
E1J	R3116N391C	Vdet-IC	3.9V±0.8%, -Reset PPO	SOT-23-5	28vdo	VD3	6g	Ric
E1K	R3116N401C	Vdet-IC	4V±0.8%, -Reset PPO	SOT-23-5	28vdo	VD3	6g	Ric
E1K	X06367E173MR	DC/DC-IC	PWM step-up, 1.7V±2.5%, 200mA, 300kHz, +CE	SOT-25	28sd	DC10	6g	Tor
E1L	R3116N411C	Vdet-IC	4.1V±0.8%, -Reset PPO	SOT-23-5	28vdo	VD3	6g	Ric
E1L	X06367E183MR	DC/DC-IC	PWM step-up, 1.8V±2.5%, 200mA, 300kHz, +CE	SOT-25	28sd	DC10	6g	Tor
E1M	R3116N421C	Vdet-IC	4.2V±0.8%, -Reset PPO	SOT-23-5	28vdo	VD3	6g	Ric
E1M	X06367E193MR	DC/DC-IC	PWM step-up, 1.9V±2.5%, 200mA, 300kHz, +CE	SOT-25	28sd	DC10	6g	Tor
E1N	R3116N431C	Vdet-IC	4.3V±0.8%, -Reset PPO	SOT-23-5	28vdo	VD3	6g	Ric
E1P	R3116N441C	Vdet-IC	4.4V±0.8%, -Reset PPO	SOT-23-5	28vdo	VD3	6g	Ric
E1Q	R3116N451C	Vdet-IC	4.5V±0.8%, -Reset PPO	SOT-23-5	28vdo	VD3	6g	Ric
E1R	AP2121AK-1.3TRE1	LVR-IC	LDO, 1.3V±2%, 200mA, +CE	SOT-23-5	28cx	VR4	6k	Bcd
E1R	R3116N461C	Vdet-IC	4.6V±0.8%, -Reset PPO	SOT-23-5	28vdo	VD3	6g	Ric
E1S	R3116N471C	Vdet-IC	4.7V±0.8%, -Reset PPO	SOT-23-5	28vdo	VD3	6g	Ric
E1T	AP2121AK-1.2TRE1	LVR-IC	LDO, 1.2V±2%, 200mA, +CE	SOT-23-5	28cx	VR4	6k	Bcd
E1T	R3116N481C	Vdet-IC	4.8V±0.8%, -Reset PPO	SOT-23-5	28vdo	VD3	6g	Ric
E1U	AP2121AK-1.8TRE1	LVR-IC	LDO, 1.8V±2%, 200mA, +CE	SOT-23-5	28cx	VR4	6k	Bcd
E1U	R3116N491C	Vdet-IC	4.9V±0.8%, -Reset PPO	SOT-23-5	28vdo	VD3	6g	Ric
E1V	AP2121AK-2.5TRE1	LVR-IC	LDO, 2.5V±2%, 200mA, +CE	SOT-23-5	28cx	VR4	6k	Bcd
E1V	R3116N501C	Vdet-IC	5.0V±0.8%, -Reset PPO	SOT-23-5	28vdo	VD3	6g	Ric
E1W	AP2121AK-2.8TRE1	LVR-IC	LDO, 2.8V±2%, 200mA, +CE	SOT-23-5	28cx	VR4	6k	Bcd
E1X	AP2121AK-3.0TRE1	LVR-IC	LDO, 3.0V±2%, 200mA, +CE	SOT-23-5	28cx	VR4	6k	Bcd
E1Y	AP2121AK-3.3TRE1	LVR-IC	LDO, 3.3V±2%, 200mA, +CE	SOT-23-5	28cx	VR4	6k	Bcd
E1Z	AP2121AK-1.5TRE1	LVR-IC	LDO, 1.5V±2%, 200mA, +CE	SOT-23-5	28cx	VR4	6k	Bcd
E2	ELM74S08B	CMOS-Logic	2-input AND gate	SOT-25	28/Log3	-	6g	Elm
E2	RT9167-17CB	LVR-IC	LDO, 1.7V±2%, 300mA, +CE	SOT-23-5	28vrx	VR7	6g	Rct
E2	TC7S08F	CMOS-Logic	2-input AND gate	SSOP-5	28/Log3	-	6a	Tos
E2	TC7S08FU	CMOS-Logic	2-input AND gate	SC-70-5	28/Log3	-	6a	Tos
E2	RN5VD42AA	Vdet-IC	4.2V±2.5%, -Reset PPO	SOT-23-5	28vdo	VD3	6g	Ric
E2-	RT9167-17PB	LVR-IC	LDO, 1.7V±2%, 300mA, +CE	SOT-23-5	28vrx	VR7	6g	Rct
E20	X06367E202MR	DC/DC-IC	PWM step-up, 2.0V±2.5%, 200mA, 180kHz, +CE	SOT-25	28sd	DC10	6g	Tor
E21	X06367E212MR	DC/DC-IC	PWM step-up, 2.1V±2.5%, 200mA, 180kHz, +CE	SOT-25	28sd	DC10	6g	Tor
E22	X06367E222MR	DC/DC-IC	PWM step-up, 2.2V±2.5%, 200mA, 180kHz, +CE	SOT-25	28sd	DC10	6g	Tor
E23	X06367E232MR	DC/DC-IC	PWM step-up, 2.3V±2.5%, 200mA, 180kHz, +CE	SOT-25	28sd	DC10	6g	Tor
E24	X06367E242MR	DC/DC-IC	PWM step-up, 2.4V±2.5%, 200mA, 180kHz, +CE	SOT-25	28sd	DC10	6g	Tor
E25	R1224N252E	DC/DC-IC	PWM/FM step-down, 2.5V, 300kHz	SOT-23-5	28ud	DC7	6g	Ric
E25	X06367E252MR	DC/DC-IC	PWM step-up, 2.5V±2.5%, 200mA, 180kHz, +CE	SOT-25	28sd	DC10	6g	Tor
E26	X06367E262MR	DC/DC-IC	PWM step-up, 2.6V±2.5%, 200mA, 180kHz, +CE	SOT-25	28sd	DC10	6g	Tor
E27	X06367E272MR	DC/DC-IC	PWM step-up, 2.7V±2.5%, 200mA, 180kHz, +CE	SOT-25	28sd	DC10	6g	Tor
E28	X06367E282MR	DC/DC-IC	PWM step-up, 2.8V±2.5%, 200mA, 180kHz, +CE	SOT-25	28sd	DC10	6g	Tor
E29	X06367E292MR	DC/DC-IC	PWM step-up, 2.9V±2.5%, 200mA, 180kHz, +CE	SOT-25	28sd	DC10	6g	Tor
E2A	X06108C42AMR	Vdet-IC	4.2V±2%, Hysteresis, -Reset PPO	SOT-25	28rm	VD15	6g	Tor
E2A	X06367E203MR	DC/DC-IC	PWM step-up, 2.0V±2.5%, 200mA, 300kHz, +CE	SOT-25	28sd	DC10	6g	Tor
E2B	X06108C42BMR	Vdet-IC	4.2V±2%, -Reset PPO	SOT-25	28rm	VD15	6g	Tor
E2B	X06367E213MR	DC/DC-IC	PWM step-up, 2.1V±2.5%, 200mA, 300kHz, +CE	SOT-25	28sd	DC10	6g	Tor
E2C	X06108C42CMR	Vdet-IC	4.2V±2%, Hysteresis, -Reset PPO	SOT-25	28rk	VD15	6g	Tor
E2C	X06367E223MR	DC/DC-IC	PWM step-up, 2.2V±2.5%, 200mA, 300kHz, +CE	SOT-25	28sd	DC10	6g	Tor
E2D	X06108C42DMR	Vdet-IC	4.2V±2%, -Reset PPO	SOT-25	28rk	VD15	6g	Tor
E2D	X06367E233MR	DC/DC-IC	PWM step-up, 2.3V±2.5%, 200mA, 300kHz, +CE	SOT-25	28sd	DC10	6g	Tor
E2E	X06367E243MR	DC/DC-IC	PWM step-up, 2.4V±2.5%, 200mA, 300kHz, +CE	SOT-25	28sd	DC10	6g	Tor
E2F	X06367E253MR	DC/DC-IC	PWM step-up, 2.5V±2.5%, 200mA, 300kHz, +CE	SOT-25	28sd	DC10	6g	Tor
E2H	X06367E263MR	DC/DC-IC	PWM step-up, 2.6V±2.5%, 200mA, 300kHz, +CE	SOT-25	28sd	DC10	6g	Tor
E2K	X06367E273MR	DC/DC-IC	PWM step-up, 2.7V±2.5%, 200mA, 300kHz, +CE	SOT-25	28sd	DC10	6g	Tor
E2L	X06367E283MR	DC/DC-IC	PWM step-up, 2.8V±2.5%, 200mA, 300kHz, +CE	SOT-25	28sd	DC10	6g	Tor
E2M	X06367E293MR	DC/DC-IC	PWM step-up, 2.9V±2.5%, 200mA, 300kHz, +CE	SOT-25	28sd	DC10	6g	Tor
e3	NX3V1T384GW	CMOS-Logic	Single-pole single-throw analog switch	SOT-353-1	28/Log86	-	6a	Phi
E3	ELM74S02B	CMOS-Logic	2-input NOR gate	SOT-25	28/Log2	-	6g	Elm
E3	RT9167-18CB	LVR-IC	LDO, 1.8V±2%, 300mA, +CE	SOT-23-5	28vrx	VR7	6g	Rct
E3	TC7S02F	CMOS-Logic	2-input NOR gate	SSOP-5	28/Log2	-	6a	Tos
E3	TC7S02FU	CMOS-Logic	2-input NOR gate	SC-70-5	28/Log2	-	6a	Tos
E3	RN5VD43AA	Vdet-IC	4.3V±2.5%, -Reset PPO	SOT-23-5	28vdo	VD3	6g	Ric



SMD code	Type	Function	Short description	Case	Pinout	Sch.	St.	Mnf.
E3-	RT9167-18PB	LVR-IC	LDO, 1.8V±2%, 300mA, +CE	SOT-23-5	28vrx	VR7	6g	Rct
E30	R1224N302E	DC/DC-IC	PWM/VFM step-down, 3V, 300kHz	SOT-23-5	28ud	DC7	6g	Ric
E30	XC6367E302MR	DC/DC-IC	PWM step-up, 3.0V±2.5%, 200mA, 180kHz, +CE	SOT-25	28sd	DC10	6g	Tor
E31	XC6367E312MR	DC/DC-IC	PWM step-up, 3.1V±2.5%, 200mA, 180kHz, +CE	SOT-25	28sd	DC10	6g	Tor
E32	XC6367E322MR	DC/DC-IC	PWM step-up, 3.2V±2.5%, 200mA, 180kHz, +CE	SOT-25	28sd	DC10	6g	Tor
E33	R1224N332E	DC/DC-IC	PWM/VFM step-down, 3.3V, 300kHz	SOT-23-5	28ud	DC7	6g	Ric
E33	XC6367E332MR	DC/DC-IC	PWM step-up, 3.3V±2.5%, 200mA, 180kHz, +CE	SOT-25	28sd	DC10	6g	Tor
E34	XC6367E342MR	DC/DC-IC	PWM step-up, 3.4V±2.5%, 200mA, 180kHz, +CE	SOT-25	28sd	DC10	6g	Tor
E35	XC6367E352MR	DC/DC-IC	PWM step-up, 3.5V±2.5%, 200mA, 180kHz, +CE	SOT-25	28sd	DC10	6g	Tor
E36	XC6367E362MR	DC/DC-IC	PWM step-up, 3.6V±2.5%, 200mA, 180kHz, +CE	SOT-25	28sd	DC10	6g	Tor
E37	OPA137N	Op-IC	FET-Input, ±2.25V, ±18V, 1MHz	SOT-23-5	28opa	OP1	6a	Bb
E37	XC6367E372MR	DC/DC-IC	PWM step-up, 3.7V±2.5%, 200mA, 180kHz, +CE	SOT-25	28sd	DC10	6g	Tor
E38	XC6367E382MR	DC/DC-IC	PWM step-up, 3.8V±2.5%, 200mA, 180kHz, +CE	SOT-25	28sd	DC10	6g	Tor
E39	XC6367E392MR	DC/DC-IC	PWM step-up, 3.9V±2.5%, 200mA, 180kHz, +CE	SOT-25	28sd	DC10	6g	Tor
E3A	XC6108C43AMR	Vdet-IC	4.3V±2%, Hysteresis, -Reset PPO	SOT-25	28rm	VD15	6g	Tor
E3A	XC6367E303MR	DC/DC-IC	PWM step-up, 3.0V±2.5%, 200mA, 300kHz, +CE	SOT-25	28sd	DC10	6g	Tor
E3B	XC6108C43BMR	Vdet-IC	4.3V±2%, -Reset PPO	SOT-25	28rm	VD15	6g	Tor
E3B	XC6367E313MR	DC/DC-IC	PWM step-up, 3.1V±2.5%, 200mA, 300kHz, +CE	SOT-25	28sd	DC10	6g	Tor
E3C	XC6108C43CMR	Vdet-IC	4.3V±2%, Hysteresis, -Reset PPO	SOT-25	28rk	VD15	6g	Tor
E3C	XC6367E323MR	DC/DC-IC	PWM step-up, 3.2V±2.5%, 200mA, 300kHz, +CE	SOT-25	28sd	DC10	6g	Tor
E3D	XC6108C43DMR	Vdet-IC	4.3V±2%, -Reset PPO	SOT-25	28rk	VD15	6g	Tor
E3D	XC6367E333MR	DC/DC-IC	PWM step-up, 3.3V±2.5%, 200mA, 300kHz, +CE	SOT-25	28sd	DC10	6g	Tor
E3E	XC6367E343MR	DC/DC-IC	PWM step-up, 3.4V±2.5%, 200mA, 300kHz, +CE	SOT-25	28sd	DC10	6g	Tor
E3F	XC6367E353MR	DC/DC-IC	PWM step-up, 3.5V±2.5%, 200mA, 300kHz, +CE	SOT-25	28sd	DC10	6g	Tor
E3H	XC6367E363MR	DC/DC-IC	PWM step-up, 3.6V±2.5%, 200mA, 300kHz, +CE	SOT-25	28sd	DC10	6g	Tor
E3K	XC6367E373MR	DC/DC-IC	PWM step-up, 3.7V±2.5%, 200mA, 300kHz, +CE	SOT-25	28sd	DC10	6g	Tor
E3L	XC6367E383MR	DC/DC-IC	PWM step-up, 3.8V±2.5%, 200mA, 300kHz, +CE	SOT-25	28sd	DC10	6g	Tor
E3M	XC6367E393MR	DC/DC-IC	PWM step-up, 3.9V±2.5%, 200mA, 300kHz, +CE	SOT-25	28sd	DC10	6g	Tor
E3Z	AP2121AK-3.2TRE1	LVR-IC	LDO, 3.2V±2%, 200mA, +CE	SOT-23-5	28cx	VR4	6k	Bcd
E4	ELM74S32B	CMOS-Logic	2-input OR gate	SOT-25	28Log4	-	6g	Elm
E4	RT9167-19CB	LVR-IC	LDO, 1.9V±2%, 300mA, +CE	SOT-23-5	28vrx	VR7	6g	Rct
E4	TC7S32F	CMOS-Logic	2-input OR gate	SSOP-5	28Log4	-	6a	Tos
E4	TC7S32FU	CMOS-Logic	2-input OR gate	SC-70-5	28Log4	-	6a	Tos
E4	RN5VD44AA	Vdet-IC	4.4V±2.5%, -Reset PPO	SOT-23-5	28vdo	VD3	6g	Ric
E40	XC6367E402MR	DC/DC-IC	PWM step-up, 4.0V±2.5%, 200mA, 180kHz, +CE	SOT-25	28sd	DC10	6g	Tor
E41	XC6367E412MR	DC/DC-IC	PWM step-up, 4.1V±2.5%, 200mA, 180kHz, +CE	SOT-25	28sd	DC10	6g	Tor
E42	XC6367E422MR	DC/DC-IC	PWM step-up, 4.2V±2.5%, 200mA, 180kHz, +CE	SOT-25	28sd	DC10	6g	Tor
E43	XC6367E432MR	DC/DC-IC	PWM step-up, 4.3V±2.5%, 200mA, 180kHz, +CE	SOT-25	28sd	DC10	6g	Tor
E44	XC6367E442MR	DC/DC-IC	PWM step-up, 4.4V±2.5%, 200mA, 180kHz, +CE	SOT-25	28sd	DC10	6g	Tor
E45	XC6367E452MR	DC/DC-IC	PWM step-up, 4.5V±2.5%, 200mA, 180kHz, +CE	SOT-25	28sd	DC10	6g	Tor
E46	XC6367E462MR	DC/DC-IC	PWM step-up, 4.6V±2.5%, 200mA, 180kHz, +CE	SOT-25	28sd	DC10	6g	Tor
E47	XC6367E472MR	DC/DC-IC	PWM step-up, 4.7V±2.5%, 200mA, 180kHz, +CE	SOT-25	28sd	DC10	6g	Tor
E48	XC6367E482MR	DC/DC-IC	PWM step-up, 4.8V±2.5%, 200mA, 180kHz, +CE	SOT-25	28sd	DC10	6g	Tor
E49	XC6367E492MR	DC/DC-IC	PWM step-up, 4.9V±2.5%, 200mA, 180kHz, +CE	SOT-25	28sd	DC10	6g	Tor
E4A	XC6108C44AMR	Vdet-IC	4.4V±2%, Hysteresis, -Reset PPO	SOT-25	28rm	VD15	6g	Tor
E4A	XC6367E403MR	DC/DC-IC	PWM step-up, 4.0V±2.5%, 200mA, 300kHz, +CE	SOT-25	28sd	DC10	6g	Tor
E4B	XC6108C44BMR	Vdet-IC	4.4V±2%, -Reset PPO	SOT-25	28rm	VD15	6g	Tor
E4B	XC6367E413MR	DC/DC-IC	PWM step-up, 4.1V±2.5%, 200mA, 300kHz, +CE	SOT-25	28sd	DC10	6g	Tor
E4C	XC6108C44CMR	Vdet-IC	4.4V±2%, Hysteresis, -Reset PPO	SOT-25	28rk	VD15	6g	Tor
E4C	XC6367E423MR	DC/DC-IC	PWM step-up, 4.2V±2.5%, 200mA, 300kHz, +CE	SOT-25	28sd	DC10	6g	Tor
E4D	XC6108C44DMR	Vdet-IC	4.4V±2%, -Reset PPO	SOT-25	28rk	VD15	6g	Tor
E4D	XC6367E433MR	DC/DC-IC	PWM step-up, 4.3V±2.5%, 200mA, 300kHz, +CE	SOT-25	28sd	DC10	6g	Tor
E4E	XC6367E443MR	DC/DC-IC	PWM step-up, 4.4V±2.5%, 200mA, 300kHz, +CE	SOT-25	28sd	DC10	6g	Tor
E4F	XC6367E453MR	DC/DC-IC	PWM step-up, 4.5V±2.5%, 200mA, 300kHz, +CE	SOT-25	28sd	DC10	6g	Tor
E4H	XC6367E463MR	DC/DC-IC	PWM step-up, 4.6V±2.5%, 200mA, 300kHz, +CE	SOT-25	28sd	DC10	6g	Tor
E4K	XC6367E473MR	DC/DC-IC	PWM step-up, 4.7V±2.5%, 200mA, 300kHz, +CE	SOT-25	28sd	DC10	6g	Tor
E4L	XC6367E483MR	DC/DC-IC	PWM step-up, 4.8V±2.5%, 200mA, 300kHz, +CE	SOT-25	28sd	DC10	6g	Tor
E4M	XC6367E493MR	DC/DC-IC	PWM step-up, 4.9V±2.5%, 200mA, 300kHz, +CE	SOT-25	28sd	DC10	6g	Tor
E5	ELM7S04B	CMOS-Logic	Inverter	SOT-25	28Log6	-	6g	Elm
E5	R1111N151A	LVR-IC	LDO, LN, -CE, 1.5V±2%, 200mA	SOT-23-5	28cx	VR4	6g	Ric
E5	RT9167-20CB	LVR-IC	LDO, 2.0V±2%, 300mA, +CE	SOT-23-5	28vrx	VR7	6g	Rct
E5	TC7S04F	CMOS-Logic	Inverter	SSOP-5	28Log6	-	6a	Tos
E5	TC7S04FU	CMOS-Logic	Inverter	SC-70-5	28Log6	-	6a	Tos
E5	RN5VD45AA	Vdet-IC	4.5V±2.5%, -Reset PPO	SOT-23-5	28vdo	VD3	6g	Ric
E5-	RT9167-20PB	LVR-IC	LDO, 2.0V±2%, 300mA, +CE	SOT-23-5	28vrx	VR7	6g	Rct
E50	R1224N502E	DC/DC-IC	PWM/VFM step-down, 5V, 300kHz	SOT-23-5	28ud	DC7	6g	Ric
E50	XC6367E502MR	DC/DC-IC	PWM step-up, 5.0V±2.5%, 200mA, 180kHz, +CE	SOT-25	28sd	DC10	6g	Tor
E51	XC6367E512MR	DC/DC-IC	PWM step-up, 5.1V±2.5%, 200mA, 180kHz, +CE	SOT-25	28sd	DC10	6g	Tor
E52	XC6367E522MR	DC/DC-IC	PWM step-up, 5.2V±2.5%, 200mA, 180kHz, +CE	SOT-25	28sd	DC10	6g	Tor
E53	XC6367E532MR	DC/DC-IC	PWM step-up, 5.3V±2.5%, 200mA, 180kHz, +CE	SOT-25	28sd	DC10	6g	Tor



SMD code	Type	Function	Short description	Case	Pinout	Sch.	St.	Mnf.
E54	XC6367E542MR	DC/DC-IC	PWM step-up, 5.4V±2.5%, 200mA, 180kHz, +CE	SOT-25	28sd	DC10	6g	Tor
E55	R1224N552E	DC/DC-IC	PWM/VFM step-down, 5.5V, 300kHz	SOT-23-5	28ud	DC7	6g	Ric
E55	XC6367E552MR	DC/DC-IC	PWM step-up, 5.5V±2.5%, 200mA, 180kHz, +CE	SOT-25	28sd	DC10	6g	Tor
E56	XC6367E562MR	DC/DC-IC	PWM step-up, 5.6V±2.5%, 200mA, 180kHz, +CE	SOT-25	28sd	DC10	6g	Tor
E57	XC6367E572MR	DC/DC-IC	PWM step-up, 5.7V±2.5%, 200mA, 180kHz, +CE	SOT-25	28sd	DC10	6g	Tor
E58	XC6367E582MR	DC/DC-IC	PWM step-up, 5.8V±2.5%, 200mA, 180kHz, +CE	SOT-25	28sd	DC10	6g	Tor
E59	XC6367E592MR	DC/DC-IC	PWM step-up, 5.9V±2.5%, 200mA, 180kHz, +CE	SOT-25	28sd	DC10	6g	Tor
E5A	XC6108C45AMR	Vdet-IC	4.5V±2%, Hysteresis, -Reset PPO	SOT-25	28rm	VD15	6g	Tor
E5A	XC6367E503MR	DC/DC-IC	PWM step-up, 5.0V±2.5%, 200mA, 300kHz, +CE	SOT-25	28sd	DC10	6g	Tor
E5B	XC6108C45BMR	Vdet-IC	4.5V±2%, -Reset PPO	SOT-25	28rm	VD15	6g	Tor
E5B	XC6367E513MR	DC/DC-IC	PWM step-up, 5.1V±2.5%, 200mA, 300kHz, +CE	SOT-25	28sd	DC10	6g	Tor
E5C	XC6108C45CMR	Vdet-IC	4.5V±2%, Hysteresis, -Reset PPO	SOT-25	28rk	VD15	6g	Tor
E5C	XC6367E523MR	DC/DC-IC	PWM step-up, 5.2V±2.5%, 200mA, 300kHz, +CE	SOT-25	28sd	DC10	6g	Tor
E5D	XC6108C45DMR	Vdet-IC	4.5V±2%, -Reset PPO	SOT-25	28rk	VD15	6g	Tor
E5D	XC6367E533MR	DC/DC-IC	PWM step-up, 5.3V±2.5%, 200mA, 300kHz, +CE	SOT-25	28sd	DC10	6g	Tor
E5E	XC6367E543MR	DC/DC-IC	PWM step-up, 5.4V±2.5%, 200mA, 300kHz, +CE	SOT-25	28sd	DC10	6g	Tor
E5F	XC6367E553MR	DC/DC-IC	PWM step-up, 5.5V±2.5%, 200mA, 300kHz, +CE	SOT-25	28sd	DC10	6g	Tor
E5H	XC6367E563MR	DC/DC-IC	PWM step-up, 5.6V±2.5%, 200mA, 300kHz, +CE	SOT-25	28sd	DC10	6g	Tor
E5K	XC6367E573MR	DC/DC-IC	PWM step-up, 5.7V±2.5%, 200mA, 300kHz, +CE	SOT-25	28sd	DC10	6g	Tor
E5L	XC6367E583MR	DC/DC-IC	PWM step-up, 5.8V±2.5%, 200mA, 300kHz, +CE	SOT-25	28sd	DC10	6g	Tor
E5M	XC6367E593MR	DC/DC-IC	PWM step-up, 5.9V±2.5%, 200mA, 300kHz, +CE	SOT-25	28sd	DC10	6g	Tor
E6	ELM7SU04B	CMOS-Logic	Unbuffered Inverter	SOT-25	28/Log6	-	6g	Elm
E6	R1111N161A	LVR-IC	LDO, LN, -CE, 1.6V±2%, 200mA	SOT-23-5	28cx	VR4	6g	Ric
E6	RT9167-21CB	LVR-IC	LDO, 2.1V±2%, 300mA, +CE	SOT-23-5	28vrx	VR7	6g	Rct
E6	TC7SU04F	CMOS-Logic	Inverter	SSOP-5	28/Log6	-	6a	Tos
E6	TC7SU04FU	CMOS-Logic	Inverter	SC-70-5	28/Log6	-	6a	Tos
E6	RN5VD46AA	Vdet-IC	4.6V±2.5%, -Reset PPO	SOT-23-5	28vdo	VD3	6g	Ric
E60	R1224N602E	DC/DC-IC	PWM/VFM step-down, 6V, 300kHz	SOT-23-5	28ud	DC7	6g	Ric
E60	XC6367E602MR	DC/DC-IC	PWM step-up, 6.0V±2.5%, 200mA, 180kHz, +CE	SOT-25	28sd	DC10	6g	Tor
E61	XC6367E612MR	DC/DC-IC	PWM step-up, 6.1V±2.5%, 200mA, 180kHz, +CE	SOT-25	28sd	DC10	6g	Tor
E62	XC6367E622MR	DC/DC-IC	PWM step-up, 6.2V±2.5%, 200mA, 180kHz, +CE	SOT-25	28sd	DC10	6g	Tor
E63	XC6367E632MR	DC/DC-IC	PWM step-up, 6.3V±2.5%, 200mA, 180kHz, +CE	SOT-25	28sd	DC10	6g	Tor
E64	XC6367E642MR	DC/DC-IC	PWM step-up, 6.4V±2.5%, 200mA, 180kHz, +CE	SOT-25	28sd	DC10	6g	Tor
E65	XC6367E652MR	DC/DC-IC	PWM step-up, 6.5V±2.5%, 200mA, 180kHz, +CE	SOT-25	28sd	DC10	6g	Tor
E6A	XC6108C46AMR	Vdet-IC	4.6V±2%, Hysteresis, -Reset PPO	SOT-25	28rm	VD15	6g	Tor
E6A	XC6367E603MR	DC/DC-IC	PWM step-up, 6.0V±2.5%, 200mA, 300kHz, +CE	SOT-25	28sd	DC10	6g	Tor
E6B	XC6108C46BMR	Vdet-IC	4.6V±2%, -Reset PPO	SOT-25	28rm	VD15	6g	Tor
E6B	XC6367E613MR	DC/DC-IC	PWM step-up, 6.1V±2.5%, 200mA, 300kHz, +CE	SOT-25	28sd	DC10	6g	Tor
E6C	XC6108C46CMR	Vdet-IC	4.6V±2%, Hysteresis, -Reset PPO	SOT-25	28rk	VD15	6g	Tor
E6C	XC6367E623MR	DC/DC-IC	PWM step-up, 6.2V±2.5%, 200mA, 300kHz, +CE	SOT-25	28sd	DC10	6g	Tor
E6D	XC6108C46DMR	Vdet-IC	4.6V±2%, -Reset PPO	SOT-25	28rk	VD15	6g	Tor
E6D	XC6367E633MR	DC/DC-IC	PWM step-up, 6.3V±2.5%, 200mA, 300kHz, +CE	SOT-25	28sd	DC10	6g	Tor
E6E	XC6367E643MR	DC/DC-IC	PWM step-up, 6.4V±2.5%, 200mA, 300kHz, +CE	SOT-25	28sd	DC10	6g	Tor
E6F	XC6367E653MR	DC/DC-IC	PWM step-up, 6.5V±2.5%, 200mA, 300kHz, +CE	SOT-25	28sd	DC10	6g	Tor
E7	R1111N171A	LVR-IC	LDO, LN, -CE, 1.7V±2%, 200mA	SOT-23-5	28cx	VR4	6g	Ric
E7	RT9167-22CB	LVR-IC	LDO, 2.2V±2%, 300mA, +CE	SOT-23-5	28vrx	VR7	6g	Rct
E7	RN5VD47AA	Vdet-IC	4.7V±2.5%, -Reset PPO	SOT-23-5	28vdo	VD3	6g	Ric
E7A	XC6108C47AMR	Vdet-IC	4.7V±2%, Hysteresis, -Reset PPO	SOT-25	28rm	VD15	6g	Tor
E7B	XC6108C47BMR	Vdet-IC	4.7V±2%, -Reset PPO	SOT-25	28rm	VD15	6g	Tor
E7C	XC6108C47CMR	Vdet-IC	4.7V±2%, Hysteresis, -Reset PPO	SOT-25	28rk	VD15	6g	Tor
E7D	XC6108C47DMR	Vdet-IC	4.7V±2%, -Reset PPO	SOT-25	28rk	VD15	6g	Tor
E8	ELM7S86B	CMOS-Logic	2-input EXCLUSIVE-OR gate	SOT-25	28/Log5	-	6g	Elm
E8	R1111N181A	LVR-IC	LDO, LN, -CE, 1.8V±2%, 200mA	SOT-23-5	28cx	VR4	6g	Ric
E8	RT9167-23CB	LVR-IC	LDO, 2.3V±2%, 300mA, +CE	SOT-23-5	28vrx	VR7	6g	Rct
E8	TC7S86F	CMOS-Logic	2-input EXCLUSIVE-OR gate	SSOP-5	28/Log5	-	6a	Tos
E8	TC7S86FU	CMOS-Logic	2-input EXCLUSIVE-OR gate	SC-70-5	28/Log5	-	6a	Tos
E8	RN5VD48AA	Vdet-IC	4.8V±2.5%, -Reset PPO	SOT-23-5	28vdo	VD3	6g	Ric
E8A	XC6108C48AMR	Vdet-IC	4.8V±2%, Hysteresis, -Reset PPO	SOT-25	28rm	VD15	6g	Tor
E8B	XC6108C48BMR	Vdet-IC	4.8V±2%, -Reset PPO	SOT-25	28rm	VD15	6g	Tor
E8C	XC6108C48CMR	Vdet-IC	4.8V±2%, Hysteresis, -Reset PPO	SOT-25	28rk	VD15	6g	Tor
E8D	XC6108C48DMR	Vdet-IC	4.8V±2%, -Reset PPO	SOT-25	28rk	VD15	6g	Tor
E9	ELM7S86B	CMOS-Logic	Bilateral analogic switch	SOT-25	28/Log16	-	6g	Elm
E9	R1111N191A	LVR-IC	LDO, LN, -CE, 1.9V±2%, 200mA	SOT-23-5	28cx	VR4	6g	Ric
E9	RT9167-24CB	LVR-IC	LDO, 2.4V±2%, 300mA, +CE	SOT-23-5	28vrx	VR7	6g	Rct
E9	RN5VD49AA	Vdet-IC	4.9V±2.5%, -Reset PPO	SOT-23-5	28vdo	VD3	6g	Ric
E9A	XC6108C49AMR	Vdet-IC	4.9V±2%, Hysteresis, -Reset PPO	SOT-25	28rm	VD15	6g	Tor
E9B	XC6108C49BMR	Vdet-IC	4.9V±2%, -Reset PPO	SOT-25	28rm	VD15	6g	Tor
E9C	XC6108C49CMR	Vdet-IC	4.9V±2%, Hysteresis, -Reset PPO	SOT-25	28rk	VD15	6g	Tor
E9D	XC6108C49DMR	Vdet-IC	4.9V±2%, -Reset PPO	SOT-25	28rk	VD15	6g	Tor
EA	µPA504T	Si-nlp	Dual, 60V, 100mA, 180/250MHz	SOT-23-5	28td	-	6a	Nec



SMD code	Type	Function	Short description	Case	Pinout	Sch.	St.	Mnf.
EA	μPA574T	Si-n/p	Dual, 60V, 100mA, 180/250MHz	SOT-23-5	28td	-	6a	Nec
EA	BD4840FVE	Vdet-IC	4V, +Reset ODO	VSOFF-5	30vdv	VD6	6c	Rhm
EA	BD4840G	Vdet-IC	4V, +Reset ODO	SSOP-5	28vdm	VD6	6c	Rhm
EA	ELM7S14B	CMOS-Logic	Inverting Schmitt-trigger	SOT-25	28/Log7	-	6g	Elm
EA	RN5RT60AA	LVR-IC	LDO, 6V±2%, 150mA, -CE	SOT-23-5	28vrt	VR4	6g	Ric
EA	RT9167-25CB	LVR-IC	LDO, 2.5V±2%, 300mA, +CE	SOT-23-5	28vrx	VR7	6g	Rct
EA	TC7S14F	CMOS-Logic	Inverting Schmitt-trigger	SSOP-5	28/Log7	-	6a	Tos
EA	TC7S14FU	CMOS-Logic	Inverting Schmitt-trigger	SC-70-5	28/Log7	-	6a	Tos
EA-	RT9167-25PB	LVR-IC	LDO, 2.5V±2%, 300mA, +CE	SOT-23-5	28vrx	VR7	6g	Rct
ĒA-	XC62GR4012M	LVR-IC	4.0V±2%, 150mA, +CE	SOT-25	28ew	VR4	6g	Tor
EA-	XC62GP4012M	LVR-IC	4.0V±2%, 150mA, -CE	SOT-25	28ew	VR4	6g	Tor
EA+	XC62GR4022M	LVR-IC	4.0V±2%, 150mA, +CE, HS response	SOT-25	28ew	VR4	6g	Tor
ĒA+	XC62GP4022M	LVR-IC	4.0V±2%, 150mA, -CE, HS response	SOT-25	28ew	VR4	6g	Tor
EA25x	G5130-25T11U	DC/DC-IC	PSM step-up, 2.5V±2%, +CE	SOT-23-5	28sc	DC3	6g	Gmt
EA26x	G5130-26T11U	DC/DC-IC	PSM step-up, 2.6V±2%, +CE	SOT-23-5	28sc	DC3	6g	Gmt
EA27x	G5130-27T11U	DC/DC-IC	PSM step-up, 2.7V±2%, +CE	SOT-23-5	28sc	DC3	6g	Gmt
EA28x	G5130-28T11U	DC/DC-IC	PSM step-up, 2.8V±2%, +CE	SOT-23-5	28sc	DC3	6g	Gmt
EA29x	G5130-29T11U	DC/DC-IC	PSM step-up, 2.9V±2%, +CE	SOT-23-5	28sc	DC3	6g	Gmt
EA30x	G5130-30T11U	DC/DC-IC	PSM step-up, 3.0V±2%, +CE	SOT-23-5	28sc	DC3	6g	Gmt
EA31x	G5130-31T11U	DC/DC-IC	PSM step-up, 3.1V±2%, +CE	SOT-23-5	28sc	DC3	6g	Gmt
EA32x	G5130-32T11U	DC/DC-IC	PSM step-up, 3.2V±2%, +CE	SOT-23-5	28sc	DC3	6g	Gmt
EA33x	G5130-33T11U	DC/DC-IC	PSM step-up, 3.3V±2%, +CE	SOT-23-5	28sc	DC3	6g	Gmt
EA34x	G5130-34T11U	DC/DC-IC	PSM step-up, 3.4V±2%, +CE	SOT-23-5	28sc	DC3	6g	Gmt
EA35x	G5130-35T11U	DC/DC-IC	PSM step-up, 3.5V±2%, +CE	SOT-23-5	28sc	DC3	6g	Gmt
EA36x	G5130-36T11U	DC/DC-IC	PSM step-up, 3.6V±2%, +CE	SOT-23-5	28sc	DC3	6g	Gmt
EA37x	G5130-37T11U	DC/DC-IC	PSM step-up, 3.7V±2%, +CE	SOT-23-5	28sc	DC3	6g	Gmt
EA38x	G5130-38T11U	DC/DC-IC	PSM step-up, 3.8V±2%, +CE	SOT-23-5	28sc	DC3	6g	Gmt
EA39x	G5130-39T11U	DC/DC-IC	PSM step-up, 3.9V±2%, +CE	SOT-23-5	28sc	DC3	6g	Gmt
EA40x	G5130-40T11U	DC/DC-IC	PSM step-up, 4.0V±2%, +CE	SOT-23-5	28sc	DC3	6g	Gmt
EA41x	G5130-41T11U	DC/DC-IC	PSM step-up, 4.1V±2%, +CE	SOT-23-5	28sc	DC3	6g	Gmt
EA42x	G5130-42T11U	DC/DC-IC	PSM step-up, 4.2V±2%, +CE	SOT-23-5	28sc	DC3	6g	Gmt
EA43x	G5130-43T11U	DC/DC-IC	PSM step-up, 4.3V±2%, +CE	SOT-23-5	28sc	DC3	6g	Gmt
EA44x	G5130-44T11U	DC/DC-IC	PSM step-up, 4.4V±2%, +CE	SOT-23-5	28sc	DC3	6g	Gmt
EA45x	G5130-45T11U	DC/DC-IC	PSM step-up, 4.5V±2%, +CE	SOT-23-5	28sc	DC3	6g	Gmt
EA46x	G5130-46T11U	DC/DC-IC	PSM step-up, 4.6V±2%, +CE	SOT-23-5	28sc	DC3	6g	Gmt
EA47x	G5130-47T11U	DC/DC-IC	PSM step-up, 4.7V±2%, +CE	SOT-23-5	28sc	DC3	6g	Gmt
EA48x	G5130-48T11U	DC/DC-IC	PSM step-up, 4.8V±2%, +CE	SOT-23-5	28sc	DC3	6g	Gmt
EA49x	G5130-49T11U	DC/DC-IC	PSM step-up, 4.9V±2%, +CE	SOT-23-5	28sc	DC3	6g	Gmt
EA50x	G5130-50T11U	DC/DC-IC	PSM step-up, 5.0V±2%, +CE	SOT-23-5	28sc	DC3	6g	Gmt
EA8	XC9237B08CMR	DC-DC-IC	PWM-PWM/PFM, st-dwn, 0.8V±2%, 600mA, 1.2MHz, Vin>2V, HSST, CL	SOT-25	28dc4	DC1	6g	Tor
EA9	XC9237B09CMR	DC-DC-IC	PWM-PWM/PFM, st-dwn, 0.9V±2%, 600mA, 1.2MHz, Vin>2V, HSST, CL	SOT-25	28dc4	DC1	6g	Tor
EAA	RP201N321B	LVR-IC	LDO, 3.2V±1%, 150mA, +CE, AE(Mode)	SOT-23-5	28x9	VR12	6g	Ric
EAB	RP201N331B	LVR-IC	LDO, 3.3V±1%, 150mA, +CE, AE(Mode)	SOT-23-5	28x9	VR12	6g	Ric
EAC	RP201N341B	LVR-IC	LDO, 3.4V±1%, 150mA, +CE, AE(Mode)	SOT-23-5	28x9	VR12	6g	Ric
EAD	RP201N351B	LVR-IC	LDO, 3.5V±1%, 150mA, +CE, AE(Mode)	SOT-23-5	28x9	VR12	6g	Ric
EAE	RP201N361B	LVR-IC	LDO, 3.6V±1%, 150mA, +CE, AE(Mode)	SOT-23-5	28x9	VR12	6g	Ric
EAF	RP201N371B	LVR-IC	LDO, 3.7V±1%, 150mA, +CE, AE(Mode)	SOT-23-5	28x9	VR12	6g	Ric
EAG	RP201N381B	LVR-IC	LDO, 3.8V±1%, 150mA, +CE, AE(Mode)	SOT-23-5	28x9	VR12	6g	Ric
EAH	RP201N391B	LVR-IC	LDO, 3.9V±1%, 150mA, +CE, AE(Mode)	SOT-23-5	28x9	VR12	6g	Ric
EAJ	RP201N401B	LVR-IC	LDO, 4.0V±1%, 150mA, +CE, AE(Mode)	SOT-23-5	28x9	VR12	6g	Ric
EAK	RP201N281B5	LVR-IC	LDO, 2.85V±1%, 150mA, +CE, AE(Mode)	SOT-23-5	28x9	VR12	6g	Ric
EAL	XC9237B0L0CMR	DC-DC-IC	PWM-PWM/PFM, st-dwn, 0.85V±2%, 600mA, 1.2MHz, Vin>2V, HSST, CL	SOT-25	28dc4	DC1	6g	Tor
EAM	XC9237B0M0CMR	DC-DC-IC	PWM-PWM/PFM, st-dwn, 0.95V±2%, 600mA, 1.2MHz, Vin>2V, HSST, CL	SOT-25	28dc4	DC1	6g	Tor
EB	BD4841FVE	Vdet-IC	4.1V, +Reset ODO	VSOFF-5	30vdv	VD6	6c	Rhm
EB	BD4841G	Vdet-IC	4.1V, +Reset ODO	SSOP-5	28vdm	VD6	6c	Rhm
EB-	RT9167-26CB	LVR-IC	LDO, 2.6V±2%, 300mA, +CE	SOT-23-5	28vrx	VR7	6g	Rct
EB-	RT9167-26PB	LVR-IC	LDO, 2.6V±2%, 300mA, +CE	SOT-23-5	28vrx	VR7	6g	Rct
EB-	XC62GR4112M	LVR-IC	4.1V±2%, 150mA, +CE	SOT-25	28ew	VR4	6g	Tor
ĒB-	XC62GP4112M	LVR-IC	4.1V±2%, 150mA, -CE	SOT-25	28ew	VR4	6g	Tor
EB+	XC62GR4122M	LVR-IC	4.1V±2%, 150mA, +CE, HS response	SOT-25	28ew	VR4	6g	Tor
ĒB+	XC62GP4122M	LVR-IC	4.1V±2%, 150mA, -CE, HS response	SOT-25	28ew	VR4	6g	Tor
EB0	XC9237B10CMR	DC-DC-IC	PWM-PWM/PFM, st-dwn, 1.0V±2%, 600mA, 1.2MHz, Vin>2V, HSST, CL	SOT-25	28dc4	DC1	6g	Tor
EB1	XC9237B11CMR	DC-DC-IC	PWM-PWM/PFM, st-dwn, 1.1V±2%, 600mA, 1.2MHz, Vin>2V, HSST, CL	SOT-25	28dc4	DC1	6g	Tor
EB2	XC9237B12CMR	DC-DC-IC	PWM-PWM/PFM, st-dwn, 1.2V±2%, 600mA, 1.2MHz, Vin>2V, HSST, CL	SOT-25	28dc4	DC1	6g	Tor
EB25x	G5131-25T11U	DC/DC-IC	PSM step-up, 2.5V±2%, +CE, ext, transistor	SOT-23-5	28sd	DC6	6g	Gmt
EB26x	G5131-26T11U	DC/DC-IC	PSM step-up, 2.6V±2%, +CE, ext, transistor	SOT-23-5	28sd	DC6	6g	Gmt
EB27x	G5131-27T11U	DC/DC-IC	PSM step-up, 2.7V±2%, +CE, ext, transistor	SOT-23-5	28sd	DC6	6g	Gmt
EB28x	G5131-28T11U	DC/DC-IC	PSM step-up, 2.8V±2%, +CE, ext, transistor	SOT-23-5	28sd	DC6	6g	Gmt
EB29x	G5131-29T11U	DC/DC-IC	PSM step-up, 2.9V±2%, +CE, ext, transistor	SOT-23-5	28sd	DC6	6g	Gmt
EB3	XC9237B13CMR	DC-DC-IC	PWM-PWM/PFM, st-dwn, 1.3V±2%, 600mA, 1.2MHz, Vin>2V, HSST, CL	SOT-25	28dc4	DC1	6g	Tor



SMD code	Type	Function	Short description	Case	Pinout	Sch.	St.	Mnf.
EB30x	G5131-30T11U	DC/DC-IC	PSM step-up, 3.0V±2%, +CE, ext, transistor	SOT-23-5	28sd	DC6	6g	Gmt
EB31x	G5131-31T11U	DC/DC-IC	PSM step-up, 3.1V±2%, +CE, ext, transistor	SOT-23-5	28sd	DC6	6g	Gmt
EB32x	G5131-32T11U	DC/DC-IC	PSM step-up, 3.2V±2%, +CE, ext, transistor	SOT-23-5	28sd	DC6	6g	Gmt
EB33x	G5131-33T11U	DC/DC-IC	PSM step-up, 3.3V±2%, +CE, ext, transistor	SOT-23-5	28sd	DC6	6g	Gmt
EB34x	G5131-34T11U	DC/DC-IC	PSM step-up, 3.4V±2%, +CE, ext, transistor	SOT-23-5	28sd	DC6	6g	Gmt
EB35x	G5131-35T11U	DC/DC-IC	PSM step-up, 3.5V±2%, +CE, ext, transistor	SOT-23-5	28sd	DC6	6g	Gmt
EB36x	G5131-36T11U	DC/DC-IC	PSM step-up, 3.6V±2%, +CE, ext, transistor	SOT-23-5	28sd	DC6	6g	Gmt
EB37x	G5131-37T11U	DC/DC-IC	PSM step-up, 3.7V±2%, +CE, ext, transistor	SOT-23-5	28sd	DC6	6g	Gmt
EB38x	G5131-38T11U	DC/DC-IC	PSM step-up, 3.8V±2%, +CE, ext, transistor	SOT-23-5	28sd	DC6	6g	Gmt
EB39x	G5131-39T11U	DC/DC-IC	PSM step-up, 3.9V±2%, +CE, ext, transistor	SOT-23-5	28sd	DC6	6g	Gmt
EB4	XC9237B14CMR	DC-DC-IC	PWM-PWM/PFM, st-dwn, 1.4V±2%, 600mA, 1.2MHz, Vin>2V, HSST, CL	SOT-25	28dc4	DC1	6g	Tor
EB40x	G5131-40T11U	DC/DC-IC	PSM step-up, 4.0V±2%, +CE, ext, transistor	SOT-23-5	28sd	DC6	6g	Gmt
EB41x	G5131-41T11U	DC/DC-IC	PSM step-up, 4.1V±2%, +CE, ext, transistor	SOT-23-5	28sd	DC6	6g	Gmt
EB42x	G5131-42T11U	DC/DC-IC	PSM step-up, 4.2V±2%, +CE, ext, transistor	SOT-23-5	28sd	DC6	6g	Gmt
EB43x	G5131-43T11U	DC/DC-IC	PSM step-up, 4.3V±2%, +CE, ext, transistor	SOT-23-5	28sd	DC6	6g	Gmt
EB44x	G5131-44T11U	DC/DC-IC	PSM step-up, 4.4V±2%, +CE, ext, transistor	SOT-23-5	28sd	DC6	6g	Gmt
EB45x	G5131-45T11U	DC/DC-IC	PSM step-up, 4.5V±2%, +CE, ext, transistor	SOT-23-5	28sd	DC6	6g	Gmt
EB46x	G5131-46T11U	DC/DC-IC	PSM step-up, 4.6V±2%, +CE, ext, transistor	SOT-23-5	28sd	DC6	6g	Gmt
EB47x	G5131-47T11U	DC/DC-IC	PSM step-up, 4.7V±2%, +CE, ext, transistor	SOT-23-5	28sd	DC6	6g	Gmt
EB48x	G5131-48T11U	DC/DC-IC	PSM step-up, 4.8V±2%, +CE, ext, transistor	SOT-23-5	28sd	DC6	6g	Gmt
EB49x	G5131-49T11U	DC/DC-IC	PSM step-up, 4.9V±2%, +CE, ext, transistor	SOT-23-5	28sd	DC6	6g	Gmt
EB5	XC9237B15CMR	DC-DC-IC	PWM-PWM/PFM, st-dwn, 1.5V±2%, 600mA, 1.2MHz, Vin>2V, HSST, CL	SOT-25	28dc4	DC1	6g	Tor
EB5	XC6367E151MR	DC/DC-IC	PWM step-up, 1.5V±2.5%, 200mA, 100kHz, +CE	SOT-25	28sd	DC10	6g	Tor
EB50x	G5131-50T11U	DC/DC-IC	PSM step-up, 5.0V±2%, +CE, ext, transistor	SOT-23-5	28sd	DC6	6g	Gmt
EB6	XC9237B16CMR	DC-DC-IC	PWM-PWM/PFM, st-dwn, 1.6V±2%, 600mA, 1.2MHz, Vin>2V, HSST, CL	SOT-25	28dc4	DC1	6g	Tor
EB6	XC6367E161MR	DC/DC-IC	PWM step-up, 1.6V±2.5%, 200mA, 100kHz, +CE	SOT-25	28sd	DC10	6g	Tor
EB7	XC9237B17CMR	DC-DC-IC	PWM-PWM/PFM, st-dwn, 1.7V±2%, 600mA, 1.2MHz, Vin>2V, HSST, CL	SOT-25	28dc4	DC1	6g	Tor
EB7	XC6367E171MR	DC/DC-IC	PWM step-up, 1.7V±2.5%, 200mA, 100kHz, +CE	SOT-25	28sd	DC10	6g	Tor
EB8	XC9237B18CMR	DC-DC-IC	PWM-PWM/PFM, st-dwn, 1.8V±2%, 600mA, 1.2MHz, Vin>2V, HSST, CL	SOT-25	28dc4	DC1	6g	Tor
EB8	XC6367E181MR	DC/DC-IC	PWM step-up, 1.8V±2.5%, 200mA, 100kHz, +CE	SOT-25	28sd	DC10	6g	Tor
EB9	XC9237B19CMR	DC-DC-IC	PWM-PWM/PFM, st-dwn, 1.9V±2%, 600mA, 1.2MHz, Vin>2V, HSST, CL	SOT-25	28dc4	DC1	6g	Tor
EB9	XC6367E191MR	DC/DC-IC	PWM step-up, 1.9V±2.5%, 200mA, 100kHz, +CE	SOT-25	28sd	DC10	6g	Tor
EBA	RP201N321D	LVR-IC	LDO, 3.2V±1%, 150mA, +CE, CL, AE(Mode)	SOT-23-5	28x9	VR12	6g	Ric
EBA	XC9237B1A1CMR	DC-DC-IC	PWM-PWM/PFM, st-dwn, 1.05V±2%, 600mA, 1.2MHz, Vin>2V, HSST, CL	SOT-25	28dc4	DC1	6g	Tor
EBB	RP201N331D	LVR-IC	LDO, 3.3V±1%, 150mA, +CE, CL, AE(Mode)	SOT-23-5	28x9	VR12	6g	Ric
EBB	XC9237B1B1CMR	DC-DC-IC	PWM-PWM/PFM, st-dwn, 1.15V±2%, 600mA, 1.2MHz, Vin>2V, HSST, CL	SOT-25	28dc4	DC1	6g	Tor
EBC	RP201N341D	LVR-IC	LDO, 3.4V±1%, 150mA, +CE, CL, AE(Mode)	SOT-23-5	28x9	VR12	6g	Ric
EBC	XC9237B1C1CMR	DC-DC-IC	PWM-PWM/PFM, st-dwn, 1.25V±2%, 600mA, 1.2MHz, Vin>2V, HSST, CL	SOT-25	28dc4	DC1	6g	Tor
EBD	RP201N351D	LVR-IC	LDO, 3.5V±1%, 150mA, +CE, CL, AE(Mode)	SOT-23-5	28x9	VR12	6g	Ric
EBD	XC9237B1D1CMR	DC-DC-IC	PWM-PWM/PFM, st-dwn, 1.35V±2%, 600mA, 1.2MHz, Vin>2V, HSST, CL	SOT-25	28dc4	DC1	6g	Tor
EBE	RP201N361D	LVR-IC	LDO, 3.6V±1%, 150mA, +CE, CL, AE(Mode)	SOT-23-5	28x9	VR12	6g	Ric
EBE	XC9237B1E1CMR	DC-DC-IC	PWM-PWM/PFM, st-dwn, 1.45V±2%, 600mA, 1.2MHz, Vin>2V, HSST, CL	SOT-25	28dc4	DC1	6g	Tor
EBF	RP201N371D	LVR-IC	LDO, 3.7V±1%, 150mA, +CE, CL, AE(Mode)	SOT-23-5	28x9	VR12	6g	Ric
EBF	XC9237B1F1CMR	DC-DC-IC	PWM-PWM/PFM, st-dwn, 1.55V±2%, 600mA, 1.2MHz, Vin>2V, HSST, CL	SOT-25	28dc4	DC1	6g	Tor
EBF	XC6367E155MR	DC/DC-IC	PWM step-up, 1.5V±2.5%, 200mA, 500kHz, +CE	SOT-25	28sd	DC10	6g	Tor
EBG	RP201N381D	LVR-IC	LDO, 3.8V±1%, 150mA, +CE, CL, AE(Mode)	SOT-23-5	28x9	VR12	6g	Ric
EBH	RP201N391D	LVR-IC	LDO, 3.9V±1%, 150mA, +CE, CL, AE(Mode)	SOT-23-5	28x9	VR12	6g	Ric
EBH	XC9237B1H1CMR	DC-DC-IC	PWM-PWM/PFM, st-dwn, 1.65V±2%, 600mA, 1.2MHz, Vin>2V, HSST, CL	SOT-25	28dc4	DC1	6g	Tor
EBH	XC6367E165MR	DC/DC-IC	PWM step-up, 1.6V±2.5%, 200mA, 500kHz, +CE	SOT-25	28sd	DC10	6g	Tor
EBJ	RP201N401D	LVR-IC	LDO, 4.0V±1%, 150mA, +CE, CL, AE(Mode)	SOT-23-5	28x9	VR12	6g	Ric
EBK	RP201N281D5	LVR-IC	LDO, 2.85V±1%, 150mA, +CE, CL, AE(Mode)	SOT-23-5	28x9	VR12	6g	Ric
EBK	XC9237B1K1CMR	DC-DC-IC	PWM-PWM/PFM, st-dwn, 1.75V±2%, 600mA, 1.2MHz, Vin>2V, HSST, CL	SOT-25	28dc4	DC1	6g	Tor
EBK	XC6367E175MR	DC/DC-IC	PWM step-up, 1.7V±2.5%, 200mA, 500kHz, +CE	SOT-25	28sd	DC10	6g	Tor
EBL	XC9237B1L1CMR	DC-DC-IC	PWM-PWM/PFM, st-dwn, 1.85V±2%, 600mA, 1.2MHz, Vin>2V, HSST, CL	SOT-25	28dc4	DC1	6g	Tor
EBL	XC6367E185MR	DC/DC-IC	PWM step-up, 1.8V±2.5%, 200mA, 500kHz, +CE	SOT-25	28sd	DC10	6g	Tor
EBM	XC9237B1M1CMR	DC-DC-IC	PWM-PWM/PFM, st-dwn, 1.95V±2%, 600mA, 1.2MHz, Vin>2V, HSST, CL	SOT-25	28dc4	DC1	6g	Tor
EBM	XC6367E195MR	DC/DC-IC	PWM step-up, 1.9V±2.5%, 200mA, 500kHz, +CE	SOT-25	28sd	DC10	6g	Tor
EC	BD4842FVE	Vdet-IC	4.2V, +Reset ODO	VSO5	30xdv	VD6	6c	Rhm
EC	BD4842G	Vdet-IC	4.2V, +Reset ODO	SSOP-5	28vdm	VD6	6c	Rhm
EC	RT9167-27CB	LVR-IC	LDO, 2.7V±2%, 300mA, +CE	SOT-23-5	28vrx	VR7	6g	Rct
EC-	RT9167-27PB	LVR-IC	LDO, 2.7V±2%, 300mA, +CE	SOT-23-5	28vrx	VR7	6g	Rct
ĒC-	XC62GR4212M	LVR-IC	4.2V±2%, 150mA, +CE	SOT-25	28ew	VR4	6g	Tor
EC-	XC62GP4212M	LVR-IC	4.2V±2%, 150mA, -CE	SOT-25	28ew	VR4	6g	Tor
EC+	XC62GR4222M	LVR-IC	4.2V±2%, 150mA, +CE, HS response	SOT-25	28ew	VR4	6g	Tor
ĒC+	XC62GP4222M	LVR-IC	4.2V±2%, 150mA, -CE, HS response	SOT-25	28ew	VR4	6g	Tor
EC0	XC9237B20CMR	DC-DC-IC	PWM-PWM/PFM, st-dwn, 2.0V±2%, 600mA, 1.2MHz, Vin>2V, HSST, CL	SOT-25	28dc4	DC1	6g	Tor
EC0	XC6367E201MR	DC/DC-IC	PWM step-up, 2.0V±2.5%, 200mA, 100kHz, +CE	SOT-25	28sd	DC10	6g	Tor
EC1	XC9237B21CMR	DC-DC-IC	PWM-PWM/PFM, st-dwn, 2.1V±2%, 600mA, 1.2MHz, Vin>2V, HSST, CL	SOT-25	28dc4	DC1	6g	Tor
EC1	XC6367E211MR	DC/DC-IC	PWM step-up, 2.1V±2.5%, 200mA, 100kHz, +CE	SOT-25	28sd	DC10	6g	Tor
EC18	AIC1730-18CV	LVR-IC	LDO, 1.8V±1%, 150mA, +CE	SOT-23-5	28vrx	VR7	6g	Aic



SMD code	Type	Function	Short description	Case	Pinout	Sch.	St.	Mnf.
ED	BD4843G	Vdet-IC	4.3V, +Reset ODO	SSOP-5	28vdm	VD6	6c	Rhm
ED	RT9167-28CB	LVR-IC	LDO, 2.8V±2%, 300mA, +CE	SOT-23-5	28vrx	VR7	6c	Rct
ED-	XC62GR4312M	LVR-IC	4.3V±2%, 150mA, +CE	SOT-25	28ew	VR4	6g	Tor
ED-	XC62GP4312M	LVR-IC	4.3V±2%, 150mA, -CE	SOT-25	28ew	VR4	6g	Tor
ED+	XC62GR4322M	LVR-IC	4.3V±2%, 150mA, +CE, HS response	SOT-25	28ew	VR4	6g	Tor
ED+	XC62GP4322M	LVR-IC	4.3V±2%, 150mA, -CE, HS response	SOT-25	28ew	VR4	6g	Tor
ED0	XC9237B30CMR	DC-DC-IC	PWM-PWM/PFM, st-dwn, 3.0V±2.5%, 600mA, 1.2MHz, Vin>2V, HSST, CL	SOT-25	28dc4	DC1	6g	Tor
ED0	XC6367E301MR	DC/DC-IC	PWM step-up, 3.0V±2.5%, 200mA, 100kHz, +CE	SOT-25	28sd	DC10	6g	Tor
ED1	XC9237B31CMR	DC-DC-IC	PWM-PWM/PFM, st-dwn, 3.1V±2.5%, 600mA, 1.2MHz, Vin>2V, HSST, CL	SOT-25	28dc4	DC1	6g	Tor
ED1	XC6367E311MR	DC/DC-IC	PWM step-up, 3.1V±2.5%, 200mA, 100kHz, +CE	SOT-25	28sd	DC10	6g	Tor
ED13	AIC1731-13CV	LVR-IC	LDO, 1.3V±2%, 300mA, +CE	SOT-23-5	28vrx	VR7	6a	Aic
ED13G	AIC1731-13CVG	LVR-IC	LDO, 1.3V±2%, 300mA, +CE	SOT-23-5	28vrx	VR7	6a	Aic
ED13P	AIC1731-13CVP	LVR-IC	LDO, 1.3V±2%, 300mA, +CE	SOT-23-5	28vrx	VR7	6a	Aic
ED15	AIC1731-15CV	LVR-IC	LDO, 1.5V±2%, 300mA, +CE	SOT-23-5	28vrx	VR7	6a	Aic
ED15G	AIC1731-15CVG	LVR-IC	LDO, 1.5V±2%, 300mA, +CE	SOT-23-5	28vrx	VR7	6a	Aic
ED15P	AIC1731-15CVP	LVR-IC	LDO, 1.5V±2%, 300mA, +CE	SOT-23-5	28vrx	VR7	6a	Aic
ED18	AIC1731-18CV	LVR-IC	LDO, 1.8V±2%, 300mA, +CE	SOT-23-5	28vrx	VR7	6a	Aic
ED18G	AIC1731-18CVG	LVR-IC	LDO, 1.8V±2%, 300mA, +CE	SOT-23-5	28vrx	VR7	6a	Aic
ED18P	AIC1731-18CVP	LVR-IC	LDO, 1.8V±2%, 300mA, +CE	SOT-23-5	28vrx	VR7	6a	Aic
ED2	XC9237B32CMR	DC-DC-IC	PWM-PWM/PFM, st-dwn, 3.2V±2.5%, 600mA, 1.2MHz, Vin>2V, HSST, CL	SOT-25	28dc4	DC1	6g	Tor
ED2	XC6367E321MR	DC/DC-IC	PWM step-up, 3.2V±2.5%, 200mA, 100kHz, +CE	SOT-25	28sd	DC10	6g	Tor
ED25	AIC1731-25CV	LVR-IC	LDO, 2.5V±2%, 300mA, +CE	SOT-23-5	28vrx	VR7	6a	Aic
ED25G	AIC1731-25CVG	LVR-IC	LDO, 2.5V±2%, 300mA, +CE	SOT-23-5	28vrx	VR7	6a	Aic
ED25P	AIC1731-25CVP	LVR-IC	LDO, 2.5V±2%, 300mA, +CE	SOT-23-5	28vrx	VR7	6a	Aic
ED28	AIC1731-28CV	LVR-IC	LDO, 2.8V±2%, 300mA, +CE	SOT-23-5	28vrx	VR7	6a	Aic
ED28G	AIC1731-28CVG	LVR-IC	LDO, 2.8V±2%, 300mA, +CE	SOT-23-5	28vrx	VR7	6a	Aic
ED28P	AIC1731-28CVP	LVR-IC	LDO, 2.8V±2%, 300mA, +CE	SOT-23-5	28vrx	VR7	6a	Aic
ED3	XC9237B33CMR	DC-DC-IC	PWM-PWM/PFM, st-dwn, 3.3V±2.5%, 600mA, 1.2MHz, Vin>2V, HSST, CL	SOT-25	28dc4	DC1	6g	Tor
ED3	XC6367E331MR	DC/DC-IC	PWM step-up, 3.3V±2.5%, 200mA, 100kHz, +CE	SOT-25	28sd	DC10	6g	Tor
ED30	AIC1731-30CV	LVR-IC	LDO, 3.0V±2%, 300mA, +CE	SOT-23-5	28vrx	VR7	6a	Aic
ED30G	AIC1731-30CVG	LVR-IC	LDO, 3.0V±2%, 300mA, +CE	SOT-23-5	28vrx	VR7	6a	Aic
ED30P	AIC1731-30CVP	LVR-IC	LDO, 3.0V±2%, 300mA, +CE	SOT-23-5	28vrx	VR7	6a	Aic
ED33	AIC1731-33CV	LVR-IC	LDO, 3.3V±2%, 300mA, +CE	SOT-23-5	28vrx	VR7	6a	Aic
ED33G	AIC1731-33CVG	LVR-IC	LDO, 3.3V±2%, 300mA, +CE	SOT-23-5	28vrx	VR7	6a	Aic
ED33P	AIC1731-33CVP	LVR-IC	LDO, 3.3V±2%, 300mA, +CE	SOT-23-5	28vrx	VR7	6a	Aic
ED4	XC9237B34CMR	DC-DC-IC	PWM-PWM/PFM, st-dwn, 3.4V±2.5%, 600mA, 1.2MHz, Vin>2V, HSST, CL	SOT-25	28dc4	DC1	6g	Tor
ED4	XC6367E341MR	DC/DC-IC	PWM step-up, 3.4V±2.5%, 200mA, 100kHz, +CE	SOT-25	28sd	DC10	6g	Tor
ED5	XC9237B35CMR	DC-DC-IC	PWM-PWM/PFM, st-dwn, 3.5V±2.5%, 600mA, 1.2MHz, Vin>2V, HSST, CL	SOT-25	28dc4	DC1	6g	Tor
ED5	XC6367E351MR	DC/DC-IC	PWM step-up, 3.5V±2.5%, 200mA, 100kHz, +CE	SOT-25	28sd	DC10	6g	Tor
ED6	XC9237B36CMR	DC-DC-IC	PWM-PWM/PFM, st-dwn, 3.6V±2.5%, 600mA, 1.2MHz, Vin>2V, HSST, CL	SOT-25	28dc4	DC1	6g	Tor
ED6	XC6367E361MR	DC/DC-IC	PWM step-up, 3.6V±2.5%, 200mA, 100kHz, +CE	SOT-25	28sd	DC10	6g	Tor
ED7	XC9237B37CMR	DC-DC-IC	PWM-PWM/PFM, st-dwn, 3.7V±2.5%, 600mA, 1.2MHz, Vin>2V, HSST, CL	SOT-25	28dc4	DC1	6g	Tor
ED7	XC6367E371MR	DC/DC-IC	PWM step-up, 3.7V±2.5%, 200mA, 100kHz, +CE	SOT-25	28sd	DC10	6g	Tor
ED8	XC9237B38CMR	DC-DC-IC	PWM-PWM/PFM, st-dwn, 3.8V±2.5%, 600mA, 1.2MHz, Vin>2V, HSST, CL	SOT-25	28dc4	DC1	6g	Tor
ED8	XC6367E381MR	DC/DC-IC	PWM step-up, 3.8V±2.5%, 200mA, 100kHz, +CE	SOT-25	28sd	DC10	6g	Tor
ED9	XC9237B39CMR	DC-DC-IC	PWM-PWM/PFM, st-dwn, 3.9V±2.5%, 600mA, 1.2MHz, Vin>2V, HSST, CL	SOT-25	28dc4	DC1	6g	Tor
ED9	XC6367E391MR	DC/DC-IC	PWM step-up, 3.9V±2.5%, 200mA, 100kHz, +CE	SOT-25	28sd	DC10	6g	Tor
EDA	XC9237B3ACMR	DC-DC-IC	PWM-PWM/PFM, st-dwn, 3.05V±2%, 600mA, 1.2MHz, Vin>2V, HSST, CL	SOT-25	28dc4	DC1	6g	Tor
EDA	XC6367E305MR	DC/DC-IC	PWM step-up, 3.0V±2.5%, 200mA, 500kHz, +CE	SOT-25	28sd	DC10	6g	Tor
EDB	XC9237B3BCMR	DC-DC-IC	PWM-PWM/PFM, st-dwn, 3.15V±2%, 600mA, 1.2MHz, Vin>2V, HSST, CL	SOT-25	28dc4	DC1	6g	Tor
EDB	XC6367E315MR	DC/DC-IC	PWM step-up, 3.1V±2.5%, 200mA, 500kHz, +CE	SOT-25	28sd	DC10	6g	Tor
EDC	XC9237B3CCMR	DC-DC-IC	PWM-PWM/PFM, st-dwn, 3.25V±2%, 600mA, 1.2MHz, Vin>2V, HSST, CL	SOT-25	28dc4	DC1	6g	Tor
EDC	XC6367E325MR	DC/DC-IC	PWM step-up, 3.2V±2.5%, 200mA, 500kHz, +CE	SOT-25	28sd	DC10	6g	Tor
EDD	XC9237B3DCMR	DC-DC-IC	PWM-PWM/PFM, st-dwn, 3.35V±2%, 600mA, 1.2MHz, Vin>2V, HSST, CL	SOT-25	28dc4	DC1	6g	Tor
EDD	XC6367E335MR	DC/DC-IC	PWM step-up, 3.3V±2.5%, 200mA, 500kHz, +CE	SOT-25	28sd	DC10	6g	Tor
EDE	XC9237B3ECMR	DC-DC-IC	PWM-PWM/PFM, st-dwn, 3.45V±2%, 600mA, 1.2MHz, Vin>2V, HSST, CL	SOT-25	28dc4	DC1	6g	Tor
EDE	XC6367E345MR	DC/DC-IC	PWM step-up, 3.4V±2.5%, 200mA, 500kHz, +CE	SOT-25	28sd	DC10	6g	Tor
EDF	XC9237B3FCMR	DC-DC-IC	PWM-PWM/PFM, st-dwn, 3.55V±2%, 600mA, 1.2MHz, Vin>2V, HSST, CL	SOT-25	28dc4	DC1	6g	Tor
EDF	XC6367E355MR	DC/DC-IC	PWM step-up, 3.5V±2.5%, 200mA, 500kHz, +CE	SOT-25	28sd	DC10	6g	Tor
EDH	XC9237B3HCMR	DC-DC-IC	PWM-PWM/PFM, st-dwn, 3.65V±2%, 600mA, 1.2MHz, Vin>2V, HSST, CL	SOT-25	28dc4	DC1	6g	Tor
EDH	XC6367E365MR	DC/DC-IC	PWM step-up, 3.6V±2.5%, 200mA, 500kHz, +CE	SOT-25	28sd	DC10	6g	Tor
EDK	XC9237B3KCMR	DC-DC-IC	PWM-PWM/PFM, st-dwn, 3.75V±2%, 600mA, 1.2MHz, Vin>2V, HSST, CL	SOT-25	28dc4	DC1	6g	Tor
EDK	XC6367E375MR	DC/DC-IC	PWM step-up, 3.7V±2.5%, 200mA, 500kHz, +CE	SOT-25	28sd	DC10	6g	Tor
EDL	XC9237B3LCLMR	DC-DC-IC	PWM-PWM/PFM, st-dwn, 3.85V±2%, 600mA, 1.2MHz, Vin>2V, HSST, CL	SOT-25	28dc4	DC1	6g	Tor
EDL	XC6367E385MR	DC/DC-IC	PWM step-up, 3.8V±2.5%, 200mA, 500kHz, +CE	SOT-25	28sd	DC10	6g	Tor
EDM	XC9237B3MCMR	DC-DC-IC	PWM-PWM/PFM, st-dwn, 3.95V±2%, 600mA, 1.2MHz, Vin>2V, HSST, CL	SOT-25	28dc4	DC1	6g	Tor
EDM	XC6367E395MR	DC/DC-IC	PWM step-up, 3.9V±2.5%, 200mA, 500kHz, +CE	SOT-25	28sd	DC10	6g	Tor
EE	BD4844FVE	Vdet-IC	4.4V, +Reset ODO	VSOFF-5	30vdv	VD6	6c	Rhm
EE	BD4844G	Vdet-IC	4.4V, +Reset ODO	SSOP-5	28vdm	VD6	6c	Rhm
EE	RT9167-29CB	LVR-IC	LDO, 2.9V±2%, 300mA, +CE	SOT-23-5	28vrx	VR7	6g	Rct



SMD code	Type	Function	Short description	Case	Pinout	Sch.	St.	Mnf.
EE-	RT9167-29PB	LVR-IC	LDO, 2.9V±2%, 300mA, +CE	SOT-23-5	28vrx	VR7	6g	Rct
EE-	XC62GR4412M	LVR-IC	4.4V±2%, 150mA, +CE	SOT-25	28ew	VR4	6g	Tor
ĒE-	XC62GP4412M	LVR-IC	4.4V±2%, 150mA, -CE	SOT-25	28ew	VR4	6g	Tor
EE+	XC62GR4422M	LVR-IC	4.4V±2%, 150mA, +CE, HS response	SOT-25	28ew	VR4	6g	Tor
ĒE+	XC62GP4422M	LVR-IC	4.4V±2%, 150mA, -CE, HS response	SOT-25	28ew	VR4	6g	Tor
EE0	XC9237B40C1MR	DC/DC-IC	PWM-PWM/PPM, st-dwn, 4.0V±2%, 600mA, 1.2MHz, Vin>2V, HSST, CL	SOT-25	28dc4	DC1	6g	Tor
ĒE0	XC6367E401MR	DC/DC-IC	PWM step-up, 4.0V±2.5%, 200mA, 100kHz, +CE	SOT-25	28sd	DC10	6g	Tor
EE1	XC6367E411MR	DC/DC-IC	PWM step-up, 4.1V±2.5%, 200mA, 100kHz, +CE	SOT-25	28sd	DC10	6g	Tor
EE13	AIC1733-13CV	LVR-IC	LDO, 1.3V±2%, 500mA, +CE	SOT-23-5	28vrx	VR7	6a	Aic
EE13G	AIC1733-13CVG	LVR-IC	LDO, 1.3V±2%, 500mA, +CE	SOT-23-5	28vrx	VR7	6a	Aic
EE13P	AIC1733-13CVP	LVR-IC	LDO, 1.3V±2%, 500mA, +CE	SOT-23-5	28vrx	VR7	6a	Aic
EE15	AIC1733-15CV	LVR-IC	LDO, 1.5V±2%, 500mA, +CE	SOT-23-5	28vrx	VR7	6a	Aic
EE15G	AIC1733-15CVG	LVR-IC	LDO, 1.5V±2%, 500mA, +CE	SOT-23-5	28vrx	VR7	6a	Aic
EE15P	AIC1733-15CVP	LVR-IC	LDO, 1.5V±2%, 500mA, +CE	SOT-23-5	28vrx	VR7	6a	Aic
EE18	AIC1733-18CV	LVR-IC	LDO, 1.8V±2%, 500mA, +CE	SOT-23-5	28vrx	VR7	6a	Aic
EE18G	AIC1733-18CVG	LVR-IC	LDO, 1.8V±2%, 500mA, +CE	SOT-23-5	28vrx	VR7	6a	Aic
EE18P	AIC1733-18CVP	LVR-IC	LDO, 1.8V±2%, 500mA, +CE	SOT-23-5	28vrx	VR7	6a	Aic
EE2	XC6367E421MR	DC/DC-IC	PWM step-up, 4.2V±2.5%, 200mA, 100kHz, +CE	SOT-25	28sd	DC10	6g	Tor
EE25	AIC1733-25CV	LVR-IC	LDO, 2.5V±2%, 500mA, +CE	SOT-23-5	28vrx	VR7	6a	Aic
EE25G	AIC1733-25CVG	LVR-IC	LDO, 2.5V±2%, 500mA, +CE	SOT-23-5	28vrx	VR7	6a	Aic
EE25P	AIC1733-25CVP	LVR-IC	LDO, 2.5V±2%, 500mA, +CE	SOT-23-5	28vrx	VR7	6a	Aic
EE28	AIC1733-28CV	LVR-IC	LDO, 2.8V±2%, 500mA, +CE	SOT-23-5	28vrx	VR7	6a	Aic
EE28G	AIC1733-28CVG	LVR-IC	LDO, 2.8V±2%, 500mA, +CE	SOT-23-5	28vrx	VR7	6a	Aic
EE28P	AIC1733-28CVP	LVR-IC	LDO, 2.8V±2%, 500mA, +CE	SOT-23-5	28vrx	VR7	6a	Aic
EE3	XC6367E431MR	DC/DC-IC	PWM step-up, 4.3V±2.5%, 200mA, 100kHz, +CE	SOT-25	28sd	DC10	6g	Tor
EE30	AIC1733-30CV	LVR-IC	LDO, 3.0V±2%, 500mA, +CE	SOT-23-5	28vrx	VR7	6a	Aic
EE30G	AIC1733-30CVG	LVR-IC	LDO, 3.0V±2%, 500mA, +CE	SOT-23-5	28vrx	VR7	6a	Aic
EE30P	AIC1733-30CVP	LVR-IC	LDO, 3.0V±2%, 500mA, +CE	SOT-23-5	28vrx	VR7	6a	Aic
EE33	AIC1733-33CV	LVR-IC	LDO, 3.3V±2%, 500mA, +CE	SOT-23-5	28vrx	VR7	6a	Aic
EE33G	AIC1733-33CVG	LVR-IC	LDO, 3.3V±2%, 500mA, +CE	SOT-23-5	28vrx	VR7	6a	Aic
EE33P	AIC1733-33CVP	LVR-IC	LDO, 3.3V±2%, 500mA, +CE	SOT-23-5	28vrx	VR7	6a	Aic
EE4	XC6367E441MR	DC/DC-IC	PWM step-up, 4.4V±2.5%, 200mA, 100kHz, +CE	SOT-25	28sd	DC10	6g	Tor
EE5	XC6367E451MR	DC/DC-IC	PWM step-up, 4.5V±2.5%, 200mA, 100kHz, +CE	SOT-25	28sd	DC10	6g	Tor
EE6	XC6367E461MR	DC/DC-IC	PWM step-up, 4.6V±2.5%, 200mA, 100kHz, +CE	SOT-25	28sd	DC10	6g	Tor
EE7	XC6367E471MR	DC/DC-IC	PWM step-up, 4.7V±2.5%, 200mA, 100kHz, +CE	SOT-25	28sd	DC10	6g	Tor
EE8	XC6367E481MR	DC/DC-IC	PWM step-up, 4.8V±2.5%, 200mA, 100kHz, +CE	SOT-25	28sd	DC10	6g	Tor
EE9	XC6367E491MR	DC/DC-IC	PWM step-up, 4.9V±2.5%, 200mA, 100kHz, +CE	SOT-25	28sd	DC10	6g	Tor
ĒEA	XC6367E405MR	DC/DC-IC	PWM step-up, 4.0V±2.5%, 200mA, 500kHz, +CE	SOT-25	28sd	DC10	6g	Tor
ĒEB	XC6367E415MR	DC/DC-IC	PWM step-up, 4.1V±2.5%, 200mA, 500kHz, +CE	SOT-25	28sd	DC10	6g	Tor
ĒEC	XC6367E425MR	DC/DC-IC	PWM step-up, 4.2V±2.5%, 200mA, 500kHz, +CE	SOT-25	28sd	DC10	6g	Tor
ĒED	XC6367E435MR	DC/DC-IC	PWM step-up, 4.3V±2.5%, 200mA, 500kHz, +CE	SOT-25	28sd	DC10	6g	Tor
ĒEE	XC6367E445MR	DC/DC-IC	PWM step-up, 4.4V±2.5%, 200mA, 500kHz, +CE	SOT-25	28sd	DC10	6g	Tor
ĒEF	XC6367E455MR	DC/DC-IC	PWM step-up, 4.5V±2.5%, 200mA, 500kHz, +CE	SOT-25	28sd	DC10	6g	Tor
ĒEH	XC6367E465MR	DC/DC-IC	PWM step-up, 4.6V±2.5%, 200mA, 500kHz, +CE	SOT-25	28sd	DC10	6g	Tor
ĒEK	XC6367E475MR	DC/DC-IC	PWM step-up, 4.7V±2.5%, 200mA, 500kHz, +CE	SOT-25	28sd	DC10	6g	Tor
ĒEL	XC6367E485MR	DC/DC-IC	PWM step-up, 4.8V±2.5%, 200mA, 500kHz, +CE	SOT-25	28sd	DC10	6g	Tor
ĒEM	XC6367E495MR	DC/DC-IC	PWM step-up, 4.9V±2.5%, 200mA, 500kHz, +CE	SOT-25	28sd	DC10	6g	Tor
EF	BD4845FVE	Vdet-IC	4.5V, +Reset ODO	VSOFF-5	30vdu	VD6	6c	Rhm
EF	BD4845G	Vdet-IC	4.5V, +Reset ODO	SSOP-5	28vdm	VD6	6c	Rhm
EF	RT9167-30CB	LVR-IC	LDO, 3.0V±2%, 300mA, +CE	SOT-23-5	28vrx	VR7	6g	Rct
EF-	RT9167-30PB	LVR-IC	LDO, 3.0V±2%, 300mA, +CE	SOT-23-5	28vrx	VR7	6g	Rct
ĒF-	XC62GR4512M	LVR-IC	4.5V±2%, 150mA, +CE	SOT-25	28ew	VR4	6g	Tor
EF-	XC62GP4512M	LVR-IC	4.5V±2%, 150mA, -CE	SOT-25	28ew	VR4	6g	Tor
ĒF+	XC62GR4522M	LVR-IC	4.5V±2%, 150mA, +CE, HS response	SOT-25	28ew	VR4	6g	Tor
ĒF+	XC62GP4522M	LVR-IC	4.5V±2%, 150mA, -CE, HS response	SOT-25	28ew	VR4	6g	Tor
EF0	XC6367E501MR	DC/DC-IC	PWM step-up, 5.0V±2.5%, 200mA, 100kHz, +CE	SOT-25	28sd	DC10	6g	Tor
EF1	XC6367E511MR	DC/DC-IC	PWM step-up, 5.1V±2.5%, 200mA, 100kHz, +CE	SOT-25	28sd	DC10	6g	Tor
EF2	XC6367E521MR	DC/DC-IC	PWM step-up, 5.2V±2.5%, 200mA, 100kHz, +CE	SOT-25	28sd	DC10	6g	Tor
EF3	XC6367E531MR	DC/DC-IC	PWM step-up, 5.3V±2.5%, 200mA, 100kHz, +CE	SOT-25	28sd	DC10	6g	Tor
EF4	XC6367E541MR	DC/DC-IC	PWM step-up, 5.4V±2.5%, 200mA, 100kHz, +CE	SOT-25	28sd	DC10	6g	Tor
EF5	XC6367E551MR	DC/DC-IC	PWM step-up, 5.5V±2.5%, 200mA, 100kHz, +CE	SOT-25	28sd	DC10	6g	Tor
ĒF6	XC6367E561MR	DC/DC-IC	PWM step-up, 5.6V±2.5%, 200mA, 100kHz, +CE	SOT-25	28sd	DC10	6g	Tor
EF7	XC6367E571MR	DC/DC-IC	PWM step-up, 5.7V±2.5%, 200mA, 100kHz, +CE	SOT-25	28sd	DC10	6g	Tor
EF8	XC9237B08D1MR	DC-DC-IC	PWM-PWM/PPM, st-dwn, 0.8V±2%, 600mA, 3MHz, Vin>2V, HSST, CL	SOT-25	28dc4	DC1	6g	Tor
EF8	XC6367E581MR	DC/DC-IC	PWM step-up, 5.8V±2.5%, 200mA, 100kHz, +CE	SOT-25	28sd	DC10	6g	Tor
EF9	XC9237B09D1MR	DC-DC-IC	PWM-PWM/PPM, st-dwn, 0.9V±2%, 600mA, 3MHz, Vin>2V, HSST, CL	SOT-25	28dc4	DC1	6g	Tor
EF9	XC6367E591MR	DC/DC-IC	PWM step-up, 5.9V±2.5%, 200mA, 100kHz, +CE	SOT-25	28sd	DC10	6g	Tor
ĒFA	XC6367E505MR	DC/DC-IC	PWM step-up, 5.0V±2.5%, 200mA, 500kHz, +CE	SOT-25	28sd	DC10	6g	Tor
ĒFB	XC6367E515MR	DC/DC-IC	PWM step-up, 5.1V±2.5%, 200mA, 500kHz, +CE	SOT-25	28sd	DC10	6g	Tor
ĒFC	XC6367E525MR	DC/DC-IC	PWM step-up, 5.2V±2.5%, 200mA, 500kHz, +CE	SOT-25	28sd	DC10	6g	Tor



SMD code	Type	Function	Short description	Case	Pinout	Sch.	St.	Mnf.
EFD	XC6367E535MR	DC/DC-IC	PWM step-up, 5.3V±2.5%, 200mA, 500kHz, +CE	SOT-25	28sd	DC10	6g	Tor
EFE	XC6367E545MR	DC/DC-IC	PWM step-up, 5.4V±2.5%, 200mA, 500kHz, +CE	SOT-25	28sd	DC10	6g	Tor
EFF	XC6367E555MR	DC/DC-IC	PWM step-up, 5.5V±2.5%, 200mA, 500kHz, +CE	SOT-25	28sd	DC10	6g	Tor
EFH	XC6367E565MR	DC/DC-IC	PWM step-up, 5.6V±2.5%, 200mA, 500kHz, +CE	SOT-25	28sd	DC10	6g	Tor
EFK	XC6367E575MR	DC/DC-IC	PWM step-up, 5.7V±2.5%, 200mA, 500kHz, +CE	SOT-25	28sd	DC10	6g	Tor
EFL	XC9237B0LD1MR	DC-DC-IC	PWM-PWM/PFM, st-dwn, 0.85V±2%, 600mA, 3MHz, Vin>2V, HSST, CL	SOT-25	28dc4	DC1	6g	Tor
EFL	XC6367E585MR	DC/DC-IC	PWM step-up, 5.8V±2.5%, 200mA, 500kHz, +CE	SOT-25	28sd	DC10	6g	Tor
EFM	XC9237B0MDMR	DC-DC-IC	PWM-PWM/PFM, st-dwn, 0.95V±2%, 600mA, 3MHz, Vin>2V, HSST, CL	SOT-25	28dc4	DC1	6g	Tor
EFM	XC6367E595MR	DC/DC-IC	PWM step-up, 5.9V±2.5%, 200mA, 500kHz, +CE	SOT-25	28sd	DC10	6g	Tor
EG	BD4846FVE	Vdet-IC	4.6V, +Reset ODO	VSOFF-5	30vdv	VD6	6c	Rhm
EG	BD4846G	Vdet-IC	4.6V, +Reset ODO	SSOP-5	28vdm	VD6	6c	Rhm
EG	RT9167-31CB	LVR-IC	LDO, 3.1V±2%, 300mA, +CE	SOT-23-5	28vrx	VR7	6g	Rct
EG	RT9167-31PB	LVR-IC	LDO, 3.1V±2%, 300mA, +CE	SOT-23-5	28vrx	VR7	6g	Rct
EH	BD4847FVE	Vdet-IC	4.7V, +Reset ODO	VSOFF-5	30vdv	VD6	6c	Rhm
EH	BD4847G	Vdet-IC	4.7V, +Reset ODO	SSOP-5	28vdm	VD6	6c	Rhm
EH	RT9167-32CB	LVR-IC	LDO, 3.2V±2%, 300mA, +CE	SOT-23-5	28vrx	VR7	6g	Rct
EH	TPS62228DDC	DC/DC-IC	PWM step-down, 1.875V, 400mA, 1.25MHz	SOT-23-5	28yj	-	6k	Ti
EH-	RT9167-32PB	LVR-IC	LDO, 3.2V±2%, 300mA, +CE	SOT-23-5	28vrx	VR7	6g	Rct
EH-	XC62GR4612M	LVR-IC	4.6V±2%, 150mA, +CE	SOT-25	28ew	VR4	6g	Tor
EH-	XC62GP4612M	LVR-IC	4.6V±2%, 150mA, -CE	SOT-25	28ew	VR4	6g	Tor
EH+	XC62GR4622M	LVR-IC	4.6V±2%, 150mA, +CE, HS response	SOT-25	28ew	VR4	6g	Tor
EH+	XC62GP4622M	LVR-IC	4.6V±2%, 150mA, -CE, HS response	SOT-25	28ew	VR4	6g	Tor
EH0	XC9237B10DMR	DC-DC-IC	PWM-PWM/PFM, st-dwn, 1.0V±2%, 600mA, 3MHz, Vin>2V, HSST, CL	SOT-25	28dc4	DC1	6g	Tor
EH0	XC6367E601MR	DC/DC-IC	PWM step-up, 6.0V±2.5%, 200mA, 100kHz, +CE	SOT-25	28sd	DC10	6g	Tor
EH1	XC9237B11DMR	DC-DC-IC	PWM-PWM/PFM, st-dwn, 1.1V±2%, 600mA, 3MHz, Vin>2V, HSST, CL	SOT-25	28dc4	DC1	6g	Tor
EH1	XC6367E611MR	DC/DC-IC	PWM step-up, 6.1V±2.5%, 200mA, 100kHz, +CE	SOT-25	28sd	DC10	6g	Tor
EH2	XC9237B12DMR	DC-DC-IC	PWM-PWM/PFM, st-dwn, 1.2V±2%, 600mA, 3MHz, Vin>2V, HSST, CL	SOT-25	28dc4	DC1	6g	Tor
EH2	XC6367E621MR	DC/DC-IC	PWM step-up, 6.2V±2.5%, 200mA, 100kHz, +CE	SOT-25	28sd	DC10	6g	Tor
EH3	XC9237B13DMR	DC-DC-IC	PWM-PWM/PFM, st-dwn, 1.3V±2%, 600mA, 3MHz, Vin>2V, HSST, CL	SOT-25	28dc4	DC1	6g	Tor
EH3	XC6367E631MR	DC/DC-IC	PWM step-up, 6.3V±2.5%, 200mA, 100kHz, +CE	SOT-25	28sd	DC10	6g	Tor
EH4	XC9237B14DMR	DC-DC-IC	PWM-PWM/PFM, st-dwn, 1.4V±2%, 600mA, 3MHz, Vin>2V, HSST, CL	SOT-25	28dc4	DC1	6g	Tor
EH4	XC6367E641MR	DC/DC-IC	PWM step-up, 6.4V±2.5%, 200mA, 100kHz, +CE	SOT-25	28sd	DC10	6g	Tor
EH5	XC9237B15DMR	DC-DC-IC	PWM-PWM/PFM, st-dwn, 1.5V±2%, 600mA, 3MHz, Vin>2V, HSST, CL	SOT-25	28dc4	DC1	6g	Tor
EH5	XC6367E651MR	DC/DC-IC	PWM step-up, 6.5V±2.5%, 200mA, 100kHz, +CE	SOT-25	28sd	DC10	6g	Tor
EH6	XC9237B16DMR	DC-DC-IC	PWM-PWM/PFM, st-dwn, 1.6V±2%, 600mA, 3MHz, Vin>2V, HSST, CL	SOT-25	28dc4	DC1	6g	Tor
EH7	XC9237B17DMR	DC-DC-IC	PWM-PWM/PFM, st-dwn, 1.7V±2%, 600mA, 3MHz, Vin>2V, HSST, CL	SOT-25	28dc4	DC1	6g	Tor
EH8	XC9237B18DMR	DC-DC-IC	PWM-PWM/PFM, st-dwn, 1.8V±2%, 600mA, 3MHz, Vin>2V, HSST, CL	SOT-25	28dc4	DC1	6g	Tor
EH9	XC9237B19DMR	DC-DC-IC	PWM-PWM/PFM, st-dwn, 1.9V±2%, 600mA, 3MHz, Vin>2V, HSST, CL	SOT-25	28dc4	DC1	6g	Tor
EHA	XC9237B1ADMR	DC-DC-IC	PWM-PWM/PFM, st-dwn, 1.05V±2%, 600mA, 3MHz, Vin>2V, HSST, CL	SOT-25	28dc4	DC1	6g	Tor
EHA	XC6367E605MR	DC/DC-IC	PWM step-up, 6.0V±2.5%, 200mA, 500kHz, +CE	SOT-25	28sd	DC10	6g	Tor
EHB	XC9237B1BDMR	DC-DC-IC	PWM-PWM/PFM, st-dwn, 1.15V±2%, 600mA, 3MHz, Vin>2V, HSST, CL	SOT-25	28dc4	DC1	6g	Tor
EHB	XC6367E615MR	DC/DC-IC	PWM step-up, 6.1V±2.5%, 200mA, 500kHz, +CE	SOT-25	28sd	DC10	6g	Tor
EHC	XC9237B1CDMR	DC-DC-IC	PWM-PWM/PFM, st-dwn, 1.25V±2%, 600mA, 3MHz, Vin>2V, HSST, CL	SOT-25	28dc4	DC1	6g	Tor
EHC	XC6367E625MR	DC/DC-IC	PWM step-up, 6.2V±2.5%, 200mA, 500kHz, +CE	SOT-25	28sd	DC10	6g	Tor
EHD	XC9237B1DDMR	DC-DC-IC	PWM-PWM/PFM, st-dwn, 1.35V±2%, 600mA, 3MHz, Vin>2V, HSST, CL	SOT-25	28dc4	DC1	6g	Tor
EHD	XC6367E635MR	DC/DC-IC	PWM step-up, 6.3V±2.5%, 200mA, 500kHz, +CE	SOT-25	28sd	DC10	6g	Tor
EHE	XC9237B1EDMR	DC-DC-IC	PWM-PWM/PFM, st-dwn, 1.45V±2%, 600mA, 3MHz, Vin>2V, HSST, CL	SOT-25	28dc4	DC1	6g	Tor
EHE	XC6367E645MR	DC/DC-IC	PWM step-up, 6.4V±2.5%, 200mA, 500kHz, +CE	SOT-25	28sd	DC10	6g	Tor
EHF	XC9237B1FDMR	DC-DC-IC	PWM-PWM/PFM, st-dwn, 1.55V±2%, 600mA, 3MHz, Vin>2V, HSST, CL	SOT-25	28dc4	DC1	6g	Tor
EHF	XC6367E655MR	DC/DC-IC	PWM step-up, 6.5V±2.5%, 200mA, 500kHz, +CE	SOT-25	28sd	DC10	6g	Tor
EHH	XC9237B1HDMR	DC-DC-IC	PWM-PWM/PFM, st-dwn, 1.65V±2%, 600mA, 3MHz, Vin>2V, HSST, CL	SOT-25	28dc4	DC1	6g	Tor
EHK	XC9237B1KDMR	DC-DC-IC	PWM-PWM/PFM, st-dwn, 1.75V±2%, 600mA, 3MHz, Vin>2V, HSST, CL	SOT-25	28dc4	DC1	6g	Tor
EHL	XC9237B1LD1MR	DC-DC-IC	PWM-PWM/PFM, st-dwn, 1.85V±2%, 600mA, 3MHz, Vin>2V, HSST, CL	SOT-25	28dc4	DC1	6g	Tor
EHM	XC9237B1MDMR	DC-DC-IC	PWM-PWM/PFM, st-dwn, 1.95V±2%, 600mA, 3MHz, Vin>2V, HSST, CL	SOT-25	28dc4	DC1	6g	Tor
EJ	BD4848FVE	Vdet-IC	4.8V, +Reset ODO	VSOFF-5	30vdv	VD6	6c	Rhm
EJ	BD4848G	Vdet-IC	4.8V, +Reset ODO	SSOP-5	28vdm	VD6	6c	Rhm
EJ	RT9167-33CB	LVR-IC	LDO, 3.3V±2%, 300mA, +CE	SOT-23-5	28vrx	VR7	6g	Rct
EJ	TPS62229DDC	DC/DC-IC	PWM step-down, 1.7V, 400mA, 1.25MHz	SOT-23-5	28yj	-	6k	Ti
EJ-	RT9167-33PB	LVR-IC	LDO, 3.3V±2%, 300mA, +CE	SOT-23-5	28vrx	VR7	6g	Rct
EJ-	RT9167-33GB	LVR-IC	LDO, 3.3V±2%, 300mA, +CE	SOT-23-5	28vrx	VR7	6g	Rct
EK	BD4849FVE	Vdet-IC	4.9V, +Reset ODO	VSOFF-5	30vdv	VD6	6c	Rhm
EK	BD4849G	Vdet-IC	4.9V, +Reset ODO	SSOP-5	28vdm	VD6	6c	Rhm
EK	RT9167-34CB	LVR-IC	LDO, 3.4V±2%, 300mA, +CE	SOT-23-5	28vrx	VR7	6g	Rct
EK-	XC62GR4712M	LVR-IC	4.7V±2%, 150mA, +CE	SOT-25	28ew	VR4	6g	Tor
EK-	XC62GP4712M	LVR-IC	4.7V±2%, 150mA, -CE	SOT-25	28ew	VR4	6g	Tor
EK+	XC62GR4722M	LVR-IC	4.7V±2%, 150mA, +CE, HS response	SOT-25	28ew	VR4	6g	Tor
EK+	XC62GP4722M	LVR-IC	4.7V±2%, 150mA, -CE, HS response	SOT-25	28ew	VR4	6g	Tor
EK0	XC9237B20DMR	DC-DC-IC	PWM-PWM/PFM, st-dwn, 2.0V±2%, 600mA, 3MHz, Vin>2V, HSST, CL	SOT-25	28dc4	DC1	6g	Tor
EK1	XC9237B21DMR	DC-DC-IC	PWM-PWM/PFM, st-dwn, 2.1V±2%, 600mA, 3MHz, Vin>2V, HSST, CL	SOT-25	28dc4	DC1	6g	Tor
EK2	XC9237B22DMR	DC-DC-IC	PWM-PWM/PFM, st-dwn, 2.2V±2%, 600mA, 3MHz, Vin>2V, HSST, CL	SOT-25	28dc4	DC1	6g	Tor



SMD code	Type	Function	Short description	Case	Pinout	Sch.	St.	Mnf.
EK3	XC9237B23DMR	DC-DC-IC	PWM-PWM/PFM, st-dwn, 2.3V±2%, 600mA, 3MHz, Vin>2V, HSST, CL	SOT-25	28dc4	DC1	6g	Tor
EK4	XC9237B24DMR	DC-DC-IC	PWM-PWM/PFM, st-dwn, 2.4V±2%, 600mA, 3MHz, Vin>2V, HSST, CL	SOT-25	28dc4	DC1	6g	Tor
EK5	XC9237B25DMR	DC-DC-IC	PWM-PWM/PFM, st-dwn, 2.5V±2%, 600mA, 3MHz, Vin>2V, HSST, CL	SOT-25	28dc4	DC1	6g	Tor
EK6	XC9237B26DMR	DC-DC-IC	PWM-PWM/PFM, st-dwn, 2.6V±2%, 600mA, 3MHz, Vin>2V, HSST, CL	SOT-25	28dc4	DC1	6g	Tor
EK7	XC9237B27DMR	DC-DC-IC	PWM-PWM/PFM, st-dwn, 2.7V±2%, 600mA, 3MHz, Vin>2V, HSST, CL	SOT-25	28dc4	DC1	6g	Tor
EK8	XC9237B28DMR	DC-DC-IC	PWM-PWM/PFM, st-dwn, 2.8V±2%, 600mA, 3MHz, Vin>2V, HSST, CL	SOT-25	28dc4	DC1	6g	Tor
EK9	XC9237B29DMR	DC-DC-IC	PWM-PWM/PFM, st-dwn, 2.9V±2%, 600mA, 3MHz, Vin>2V, HSST, CL	SOT-25	28dc4	DC1	6g	Tor
EKA	XC9237B2ADM	DC-DC-IC	PWM-PWM/PFM, st-dwn, 2.05V±2%, 600mA, 3MHz, Vin>2V, HSST, CL	SOT-25	28dc4	DC1	6g	Tor
EKB	XC9237B2BDMR	DC-DC-IC	PWM-PWM/PFM, st-dwn, 2.15V±2%, 600mA, 3MHz, Vin>2V, HSST, CL	SOT-25	28dc4	DC1	6g	Tor
EKC	XC9237B2CDMR	DC-DC-IC	PWM-PWM/PFM, st-dwn, 2.25V±2%, 600mA, 3MHz, Vin>2V, HSST, CL	SOT-25	28dc4	DC1	6g	Tor
EKD	XC9237B2DDMR	DC-DC-IC	PWM-PWM/PFM, st-dwn, 2.35V±2%, 600mA, 3MHz, Vin>2V, HSST, CL	SOT-25	28dc4	DC1	6g	Tor
EKE	XC9237B2EDMR	DC-DC-IC	PWM-PWM/PFM, st-dwn, 2.45V±2%, 600mA, 3MHz, Vin>2V, HSST, CL	SOT-25	28dc4	DC1	6g	Tor
EKF	XC9237B2FDMR	DC-DC-IC	PWM-PWM/PFM, st-dwn, 2.55V±2%, 600mA, 3MHz, Vin>2V, HSST, CL	SOT-25	28dc4	DC1	6g	Tor
EKH	XC9237B2HDMR	DC-DC-IC	PWM-PWM/PFM, st-dwn, 2.65V±2%, 600mA, 3MHz, Vin>2V, HSST, CL	SOT-25	28dc4	DC1	6g	Tor
EKK	XC9237B2KDMR	DC-DC-IC	PWM-PWM/PFM, st-dwn, 2.75V±2%, 600mA, 3MHz, Vin>2V, HSST, CL	SOT-25	28dc4	DC1	6g	Tor
EKL	XC9237B2LDMR	DC-DC-IC	PWM-PWM/PFM, st-dwn, 2.85V±2%, 600mA, 3MHz, Vin>2V, HSST, CL	SOT-25	28dc4	DC1	6g	Tor
EKM	XC9237B2MDMR	DC-DC-IC	PWM-PWM/PFM, st-dwn, 2.95V±2%, 600mA, 3MHz, Vin>2V, HSST, CL	SOT-25	28dc4	DC1	6g	Tor
eL	NX3V1G384GW	CMOS-Logic	Single-pole single-throw analog switch	SOT-353-1	28/Log86	-	6a	Phi
EL	BD4850FVE	Vdet-IC	5V, +Reset ODO	VSOFF-5	30vdu	VD6	6c	Rhm
EL	BD4850G	Vdet-IC	5V, +Reset ODO	SSOP-5	28vdm	VD6	6c	Rhm
EL	RT9167-35CB	LVR-IC	LDO, 3.5V±2%, 300mA, +CE	SOT-23-5	28vrx	VR7	6g	Rct
EL-	RT9167-35PB	LVR-IC	LDO, 3.5V±2%, 300mA, +CE	SOT-23-5	28vrx	VR7	6g	Rct
EL-	XC62GR4812M	LVR-IC	4.8V±2%, 150mA, +CE	SOT-25	28ew	VR4	6g	Tor
EL-	XC62GP4812M	LVR-IC	4.8V±2%, 150mA, -CE	SOT-25	28ew	VR4	6g	Tor
EL+	XC62GR4822M	LVR-IC	4.8V±2%, 150mA, +CE, HS response	SOT-25	28ew	VR4	6g	Tor
EL+	XC62GP4822M	LVR-IC	4.8V±2%, 150mA, -CE, HS response	SOT-25	28ew	VR4	6g	Tor
EL0	XC9237B30DMR	DC-DC-IC	PWM-PWM/PFM, st-dwn, 3.0V±2%, 600mA, 3MHz, Vin>2V, HSST, CL	SOT-25	28dc4	DC1	6g	Tor
EL1	XC9237B31DMR	DC-DC-IC	PWM-PWM/PFM, st-dwn, 3.1V±2%, 600mA, 3MHz, Vin>2V, HSST, CL	SOT-25	28dc4	DC1	6g	Tor
EL2	XC9237B32DMR	DC-DC-IC	PWM-PWM/PFM, st-dwn, 3.2V±2%, 600mA, 3MHz, Vin>2V, HSST, CL	SOT-25	28dc4	DC1	6g	Tor
EL3	XC9237B33DMR	DC-DC-IC	PWM-PWM/PFM, st-dwn, 3.3V±2%, 600mA, 3MHz, Vin>2V, HSST, CL	SOT-25	28dc4	DC1	6g	Tor
EL4	XC9237B34DMR	DC-DC-IC	PWM-PWM/PFM, st-dwn, 3.4V±2%, 600mA, 3MHz, Vin>2V, HSST, CL	SOT-25	28dc4	DC1	6g	Tor
EL5	XC9237B35DMR	DC-DC-IC	PWM-PWM/PFM, st-dwn, 3.5V±2%, 600mA, 3MHz, Vin>2V, HSST, CL	SOT-25	28dc4	DC1	6g	Tor
EL6	XC9237B36DMR	DC-DC-IC	PWM-PWM/PFM, st-dwn, 3.6V±2%, 600mA, 3MHz, Vin>2V, HSST, CL	SOT-25	28dc4	DC1	6g	Tor
EL7	XC9237B37DMR	DC-DC-IC	PWM-PWM/PFM, st-dwn, 3.7V±2%, 600mA, 3MHz, Vin>2V, HSST, CL	SOT-25	28dc4	DC1	6g	Tor
EL8	XC9237B38DMR	DC-DC-IC	PWM-PWM/PFM, st-dwn, 3.8V±2%, 600mA, 3MHz, Vin>2V, HSST, CL	SOT-25	28dc4	DC1	6g	Tor
EL9	XC9237B39DMR	DC-DC-IC	PWM-PWM/PFM, st-dwn, 3.9V±2%, 600mA, 3MHz, Vin>2V, HSST, CL	SOT-25	28dc4	DC1	6g	Tor
ELA	XC9237B3ADM	DC-DC-IC	PWM-PWM/PFM, st-dwn, 3.05V±2%, 600mA, 3MHz, Vin>2V, HSST, CL	SOT-25	28dc4	DC1	6g	Tor
ELB	XC9237B3BDMR	DC-DC-IC	PWM-PWM/PFM, st-dwn, 3.15V±2%, 600mA, 3MHz, Vin>2V, HSST, CL	SOT-25	28dc4	DC1	6g	Tor
ELC	XC9237B3CDMR	DC-DC-IC	PWM-PWM/PFM, st-dwn, 3.25V±2%, 600mA, 3MHz, Vin>2V, HSST, CL	SOT-25	28dc4	DC1	6g	Tor
ELD	XC9237B3DDMR	DC-DC-IC	PWM-PWM/PFM, st-dwn, 3.35V±2%, 600mA, 3MHz, Vin>2V, HSST, CL	SOT-25	28dc4	DC1	6g	Tor
ELE	XC9237B3EDMR	DC-DC-IC	PWM-PWM/PFM, st-dwn, 3.45V±2%, 600mA, 3MHz, Vin>2V, HSST, CL	SOT-25	28dc4	DC1	6g	Tor
ELF	XC9237B3FDMR	DC-DC-IC	PWM-PWM/PFM, st-dwn, 3.55V±2%, 600mA, 3MHz, Vin>2V, HSST, CL	SOT-25	28dc4	DC1	6g	Tor
ELH	XC9237B3HDMR	DC-DC-IC	PWM-PWM/PFM, st-dwn, 3.65V±2%, 600mA, 3MHz, Vin>2V, HSST, CL	SOT-25	28dc4	DC1	6g	Tor
ELK	XC9237B3KDMR	DC-DC-IC	PWM-PWM/PFM, st-dwn, 3.75V±2%, 600mA, 3MHz, Vin>2V, HSST, CL	SOT-25	28dc4	DC1	6g	Tor
ELL	XC9237B3LDMR	DC-DC-IC	PWM-PWM/PFM, st-dwn, 3.85V±2%, 600mA, 3MHz, Vin>2V, HSST, CL	SOT-25	28dc4	DC1	6g	Tor
ELM	XC9237B3MDMR	DC-DC-IC	PWM-PWM/PFM, st-dwn, 3.95V±2%, 600mA, 3MHz, Vin>2V, HSST, CL	SOT-25	28dc4	DC1	6g	Tor
EM	BD4851FVE	Vdet-IC	5.1V, +Reset ODO	VSOFF-5	30vdu	VD6	6c	Rhm
EM	BD4851G	Vdet-IC	5.1V, +Reset ODO	SSOP-5	28vdm	VD6	6c	Rhm
EM	RT9167-36CB	LVR-IC	LDO, 3.6V±2%, 300mA, +CE	SOT-23-5	28vrx	VR7	6g	Rct
EM-	RT9167-36PB	LVR-IC	LDO, 3.6V±2%, 300mA, +CE	SOT-23-5	28vrx	VR7	6g	Rct
EM-	XC62GR4912M	LVR-IC	4.9V±2%, 150mA, +CE	SOT-25	28ew	VR4	6g	Tor
EM-	XC62GP4912M	LVR-IC	4.9V±2%, 150mA, -CE	SOT-25	28ew	VR4	6g	Tor
EM+	XC62GR4922M	LVR-IC	4.9V±2%, 150mA, +CE, HS response	SOT-25	28ew	VR4	6g	Tor
EM+	XC62GP4922M	LVR-IC	4.9V±2%, 150mA, -CE, HS response	SOT-25	28ew	VR4	6g	Tor
EM0	XC9237B40DMR	DC-DC-IC	PWM-PWM/PFM, st-dwn, 4.0V±2%, 600mA, 3MHz, Vin>2V, HSST, CL	SOT-25	28dc4	DC1	6g	Tor
EN	BD4852FVE	Vdet-IC	5.2V, +Reset ODO	VSOFF-5	30vdu	VD6	6c	Rhm
EN	BD4852G	Vdet-IC	5.2V, +Reset ODO	SSOP-5	28vdm	VD6	6c	Rhm
EN	RT9167-37CB	LVR-IC	LDO, 3.7V±2%, 300mA, +CE	SOT-23-5	28vrx	VR7	6g	Rct
EP	BD4853FVE	Vdet-IC	5.3V, +Reset ODO	VSOFF-5	30vdu	VD6	6c	Rhm
EP	BD4853G	Vdet-IC	5.3V, +Reset ODO	SSOP-5	28vdm	VD6	6c	Rhm
EP	RT9167-38CB	LVR-IC	LDO, 3.8V±2%, 300mA, +CE	SOT-23-5	28vrx	VR7	6g	Rct
EQ	BD4854FVE	Vdet-IC	5.4V, +Reset ODO	VSOFF-5	30vdu	VD6	6c	Rhm
EQ	BD4854G	Vdet-IC	5.4V, +Reset ODO	SSOP-5	28vdm	VD6	6c	Rhm
EQ	RT9167-39CB	LVR-IC	LDO, 3.8V±2%, 300mA, +CE	SOT-23-5	28vrx	VR7	6g	Rct
ER	AT1201-27XR	LVR-IC	LDO, LN, +CE, 2.7V±2%, 150mA	SOT-23-5	28un	VR7	6a	Atr
ER	BD4855FVE	Vdet-IC	5.5V, +Reset ODO	VSOFF-5	30vdu	VD6	6c	Rhm
ER	BD4855G	Vdet-IC	5.5V, +Reset ODO	SSOP-5	28vdm	VD6	6c	Rhm
ER	R1112N151A	LVR-IC	LDO, LN, -CE, 1.5V±2%, 150mA	SOT-23-5	28cx	VR4	6g	Ric
ER	RT9167-40CB	LVR-IC	LDO, 4.0V±2%, 300mA, +CE	SOT-23-5	28vrx	VR7	6g	Rct
ER-	RT9167-40PB	LVR-IC	LDO, 4.0V±2%, 300mA, +CE	SOT-23-5	28vrx	VR7	6g	Rct



SMD code	Type	Function	Short description	Case	Pinout	Sch.	St.	Mnf.
ER15	AIC1742-15ACV	LVR-IC	LDO, 1.5V±2%, 150mA, +CE	SOT-23-5	28vrx	VR7	6a	Aic
ER15P	AIC1742-15APV	LVR-IC	LDO, 1.5V±2%, 150mA, +CE	SOT-23-5	28vrx	VR7	6a	Aic
ER18	AIC1742-18ACV	LVR-IC	LDO, 1.8V±2%, 150mA, +CE	SOT-23-5	28vrx	VR7	6a	Aic
ER18P	AIC1742-18APV	LVR-IC	LDO, 1.8V±2%, 150mA, +CE	SOT-23-5	28vrx	VR7	6a	Aic
ER20	AIC1742-20ACV	LVR-IC	LDO, 2.2V±2%, 150mA, +CE	SOT-23-5	28vrx	VR7	6a	Aic
ER20P	AIC1742-20APV	LVR-IC	LDO, 2.2V±2%, 150mA, +CE	SOT-23-5	28vrx	VR7	6a	Aic
ER25	AIC1742-25ACV	LVR-IC	LDO, 2.5V±2%, 150mA, +CE	SOT-23-5	28vrx	VR7	6a	Aic
ER25P	AIC1742-25APV	LVR-IC	LDO, 2.5V±2%, 150mA, +CE	SOT-23-5	28vrx	VR7	6a	Aic
ER28	AIC1742-28ACV	LVR-IC	LDO, 2.8V±2%, 150mA, +CE	SOT-23-5	28vrx	VR7	6a	Aic
ER28P	AIC1742-28APV	LVR-IC	LDO, 2.8V±2%, 150mA, +CE	SOT-23-5	28vrx	VR7	6a	Aic
ER29	AIC1742-29ACV	LVR-IC	LDO, 2.9V±2%, 150mA, +CE	SOT-23-5	28vrx	VR7	6a	Aic
ER29P	AIC1742-29APV	LVR-IC	LDO, 2.9V±2%, 150mA, +CE	SOT-23-5	28vrx	VR7	6a	Aic
ER2J	AIC1742-285ACV	LVR-IC	LDO, 2.85V±2%, 150mA, +CE	SOT-23-5	28vrx	VR7	6a	Aic
ER2JP	AIC1742-285APV	LVR-IC	LDO, 2.85V±2%, 150mA, +CE	SOT-23-5	28vrx	VR7	6a	Aic
ER30	AIC1742-30ACV	LVR-IC	LDO, 3.0V±2%, 150mA, +CE	SOT-23-5	28vrx	VR7	6a	Aic
ER30P	AIC1742-30APV	LVR-IC	LDO, 3.0V±2%, 150mA, +CE	SOT-23-5	28vrx	VR7	6a	Aic
ER33	AIC1742-33ACV	LVR-IC	LDO, 3.3V±2%, 150mA, +CE	SOT-23-5	28vrx	VR7	6a	Aic
ER33P	AIC1742-33APV	LVR-IC	LDO, 3.3V±2%, 150mA, +CE	SOT-23-5	28vrx	VR7	6a	Aic
ES	BD4856FVE	Vdet-IC	5.6V, +Reset ODO	VSOF-5	30vdv	VD6	6c	Rhm
ES	BD4856G	Vdet-IC	5.6V, +Reset ODO	SSOP-5	28vdm	VD6	6c	Rhm
ES	R1112N161A	LVR-IC	LDO, LN, -CE, 1.6V±2%, 150mA	SOT-23-5	28cx	VR4	6g	Ric
ES	RT9167-41CB	LVR-IC	LDO, 4.1V±2%, 300mA, +CE	SOT-23-5	28vrx	VR7	6g	Rct
ES-	RT9167-41PB	LVR-IC	LDO, 4.1V±2%, 300mA, +CE	SOT-23-5	28vrx	VR7	6g	Rct
ES15	AIC1742-15BCV	LVR-IC	LDO, 1.5V±2%, 150mA, +CE	SOT-23-5	28vr1	VR7	6a	Aic
ES15P	AIC1742-15BPV	LVR-IC	LDO, 1.5V±2%, 150mA, +CE	SOT-23-5	28vr1	VR7	6a	Aic
ES18	AIC1742-18BCV	LVR-IC	LDO, 1.8V±2%, 150mA, +CE	SOT-23-5	28vr1	VR7	6a	Aic
ES18P	AIC1742-18BPV	LVR-IC	LDO, 1.8V±2%, 150mA, +CE	SOT-23-5	28vr1	VR7	6a	Aic
ES20	AIC1742-20BCV	LVR-IC	LDO, 2.2V±2%, 150mA, +CE	SOT-23-5	28vr1	VR7	6a	Aic
ES20P	AIC1742-20BPV	LVR-IC	LDO, 2.2V±2%, 150mA, +CE	SOT-23-5	28vr1	VR7	6a	Aic
ES25	AIC1742-25BCV	LVR-IC	LDO, 2.5V±2%, 150mA, +CE	SOT-23-5	28vr1	VR7	6a	Aic
ES25P	AIC1742-25BPV	LVR-IC	LDO, 2.5V±2%, 150mA, +CE	SOT-23-5	28vr1	VR7	6a	Aic
ES28	AIC1742-28BCV	LVR-IC	LDO, 2.8V±2%, 150mA, +CE	SOT-23-5	28vr1	VR7	6a	Aic
ES28P	AIC1742-28BPV	LVR-IC	LDO, 2.8V±2%, 150mA, +CE	SOT-23-5	28vr1	VR7	6a	Aic
ES29	AIC1742-29BCV	LVR-IC	LDO, 2.9V±2%, 150mA, +CE	SOT-23-5	28vr1	VR7	6a	Aic
ES29P	AIC1742-29BPV	LVR-IC	LDO, 2.9V±2%, 150mA, +CE	SOT-23-5	28vr1	VR7	6a	Aic
ES2J	AIC1742-285BCV	LVR-IC	LDO, 2.85V±2%, 150mA, +CE	SOT-23-5	28vr1	VR7	6a	Aic
ES2JP	AIC1742-285BPV	LVR-IC	LDO, 2.85V±2%, 150mA, +CE	SOT-23-5	28vr1	VR7	6a	Aic
ES30	AIC1742-30BCV	LVR-IC	LDO, 3.0V±2%, 150mA, +CE	SOT-23-5	28vr1	VR7	6a	Aic
ES30P	AIC1742-30BPV	LVR-IC	LDO, 3.0V±2%, 150mA, +CE	SOT-23-5	28vr1	VR7	6a	Aic
ES33	AIC1742-33BCV	LVR-IC	LDO, 3.3V±2%, 150mA, +CE	SOT-23-5	28vr1	VR7	6a	Aic
ES33P	AIC1742-33BPV	LVR-IC	LDO, 3.3V±2%, 150mA, +CE	SOT-23-5	28vr1	VR7	6a	Aic
ET	BD4857FVE	Vdet-IC	5.7V, +Reset ODO	VSOF-5	30vdv	VD6	6c	Rhm
ET	BD4857G	Vdet-IC	5.7V, +Reset ODO	SSOP-5	28vdm	VD6	6c	Rhm
ET	R1112N171A	LVR-IC	LDO, LN, -CE, 1.7V±2%, 150mA	SOT-23-5	28cx	VR4	6g	Ric
ET	RT9167-42CB	LVR-IC	LDO, 4.2V±2%, 300mA, +CE	SOT-23-5	28vrx	VR7	6g	Rct
ET-	RT9167-42PB	LVR-IC	LDO, 4.2V±2%, 300mA, +CE	SOT-23-5	28vrx	VR7	6g	Rct
ET8	XC6215B092MR	LVR-IC	LDO, 0.9V±2%, 200mA, +CE	SOT-25	28cx	VR4	6g	Tor
ET9	XC6215B102MR	LVR-IC	LDO, 1V±2%, 200mA, +CE	SOT-25	28cx	VR4	6g	Tor
ETA	XC6215B112MR	LVR-IC	LDO, 1.1V±2%, 200mA, +CE	SOT-25	28cx	VR4	6g	Tor
ETB	XC6215B122MR	LVR-IC	LDO, 1.2V±2%, 200mA, +CE	SOT-25	28cx	VR4	6g	Tor
ETC	XC6215B132MR	LVR-IC	LDO, 1.3V±2%, 200mA, +CE	SOT-25	28cx	VR4	6g	Tor
ETD	XC6215B142MR	LVR-IC	LDO, 1.4V±2%, 200mA, +CE	SOT-25	28cx	VR4	6g	Tor
ETE	XC6215B152MR	LVR-IC	LDO, 1.5V±2%, 200mA, +CE	SOT-25	28cx	VR4	6g	Tor
ETF	XC6215B162MR	LVR-IC	LDO, 1.6V±2%, 200mA, +CE	SOT-25	28cx	VR4	6g	Tor
ETH	XC6215B172MR	LVR-IC	LDO, 1.7V±2%, 200mA, +CE	SOT-25	28cx	VR4	6g	Tor
ETK	XC6215B182MR	LVR-IC	LDO, 1.8V±2%, 200mA, +CE	SOT-25	28cx	VR4	6g	Tor
ETL	XC6215B192MR	LVR-IC	LDO, 1.9V±2%, 200mA, +CE	SOT-25	28cx	VR4	6g	Tor
ETM	XC6215B202MR	LVR-IC	LDO, 2V±2%, 200mA, +CE	SOT-25	28cx	VR4	6g	Tor
ETN	XC6215B212MR	LVR-IC	LDO, 2.1V±2%, 200mA, +CE	SOT-25	28cx	VR4	6g	Tor
ETP	XC6215B222MR	LVR-IC	LDO, 2.2V±2%, 200mA, +CE	SOT-25	28cx	VR4	6g	Tor
ETR	XC6215B232MR	LVR-IC	LDO, 2.3V±2%, 200mA, +CE	SOT-25	28cx	VR4	6g	Tor
ETS	XC6215B242MR	LVR-IC	LDO, 2.4V±2%, 200mA, +CE	SOT-25	28cx	VR4	6g	Tor
ETT	XC6215B252MR	LVR-IC	LDO, 2.5V±2%, 200mA, +CE	SOT-25	28cx	VR4	6g	Tor
ETU	XC6215B262MR	LVR-IC	LDO, 2.6V±2%, 200mA, +CE	SOT-25	28cx	VR4	6g	Tor
ETV	XC6215B272MR	LVR-IC	LDO, 2.7V±2%, 200mA, +CE	SOT-25	28cx	VR4	6g	Tor
ETX	XC6215B282MR	LVR-IC	LDO, 2.8V±2%, 200mA, +CE	SOT-25	28cx	VR4	6g	Tor
ETY	XC6215B292MR	LVR-IC	LDO, 2.9V±2%, 200mA, +CE	SOT-25	28cx	VR4	6g	Tor
ETZ	XC6215B302MR	LVR-IC	LDO, 3V±2%, 200mA, +CE	SOT-25	28cx	VR4	6g	Tor
EU	AP1621BW	DC/DC-IC	PWMVFM step-down, (2.2..8V)	SOT-23-5L	28ul	-	6a	Ana
EU	BD4858FVE	Vdet-IC	5.8V, +Reset ODO	VSOF-5	30vdv	VD6	6c	Rhm



SMD code	Type	Function	Short description	Case	Pinout	Sch.	St.	Mnf.
EU	BD4858G	Vdet-IC	5.8V, +Reset ODO	SSOP-5	28vdm	VD6	6c	Rhm
EU	R1112N181A	LVR-IC	LDO, LN, -CE, 1.8V±2%, 150mA	SOT-23-5	28cx	VR4	6g	Ric
EU	RT9167-43CB	LVR-IC	LDO, 4.3V±2%, 300mA, +CE	SOT-23-5	28vrx	VR7	6g	Rct
EU0	XC6215B312MR	LVR-IC	LDO, 3.1V±2%, 200mA, +CE	SOT-25	28cx	VR4	6g	Tor
EU1	XC6215B322MR	LVR-IC	LDO, 3.2V±2%, 200mA, +CE	SOT-25	28cx	VR4	6g	Tor
EU2	XC6215B332MR	LVR-IC	LDO, 3.3V±2%, 200mA, +CE	SOT-25	28cx	VR4	6g	Tor
EU3	XC6215B342MR	LVR-IC	LDO, 3.4V±2%, 200mA, +CE	SOT-25	28cx	VR4	6g	Tor
EU4	XC6215B352MR	LVR-IC	LDO, 3.5V±2%, 200mA, +CE	SOT-25	28cx	VR4	6g	Tor
EU5	XC6215B362MR	LVR-IC	LDO, 3.6V±2%, 200mA, +CE	SOT-25	28cx	VR4	6g	Tor
EU6	XC6215B372MR	LVR-IC	LDO, 3.7V±2%, 200mA, +CE	SOT-25	28cx	VR4	6g	Tor
EU7	XC6215B382MR	LVR-IC	LDO, 3.8V±2%, 200mA, +CE	SOT-25	28cx	VR4	6g	Tor
EU8	XC6215B392MR	LVR-IC	LDO, 3.9V±2%, 200mA, +CE	SOT-25	28cx	VR4	6g	Tor
EU9	XC6215B402MR	LVR-IC	LDO, 4V±2%, 200mA, +CE	SOT-25	28cx	VR4	6g	Tor
EUA	XC6215B412MR	LVR-IC	LDO, 4.1V±2%, 200mA, +CE	SOT-25	28cx	VR4	6g	Tor
EUB	XC6215B422MR	LVR-IC	LDO, 4.2V±2%, 200mA, +CE	SOT-25	28cx	VR4	6g	Tor
EUC	XC6215B432MR	LVR-IC	LDO, 4.3V±2%, 200mA, +CE	SOT-25	28cx	VR4	6g	Tor
EUd	XC6215B442MR	LVR-IC	LDO, 4.4V±2%, 200mA, +CE	SOT-25	28cx	VR4	6g	Tor
EUE	XC6215B452MR	LVR-IC	LDO, 4.5V±2%, 200mA, +CE	SOT-25	28cx	VR4	6g	Tor
EUF	XC6215B462MR	LVR-IC	LDO, 4.6V±2%, 200mA, +CE	SOT-25	28cx	VR4	6g	Tor
EUH	XC6215B472MR	LVR-IC	LDO, 4.7V±2%, 200mA, +CE	SOT-25	28cx	VR4	6g	Tor
EUK	XC6215B482MR	LVR-IC	LDO, 4.8V±2%, 200mA, +CE	SOT-25	28cx	VR4	6g	Tor
EUL	XC6215B492MR	LVR-IC	LDO, 4.9V±2%, 200mA, +CE	SOT-25	28cx	VR4	6g	Tor
EUM	XC6215B502MR	LVR-IC	LDO, 5V±2%, 200mA, +CE	SOT-25	28cx	VR4	6g	Tor
EV	1S241	PIN-diode	Dual, VHF/UHF, 50V, 50mA, <0.23pF, 5Q(100MHz)	SOT-23-5	28ds	-	6a	San
EV	BD4859FVE	Vdet-IC	5.9V, +Reset ODO	VSOF-5	30vdu	VD6	6c	Rhm
EV	BD4859G	Vdet-IC	5.9V, +Reset ODO	SSOP-5	28vdm	VD6	6c	Rhm
EV	R1112N191A	LVR-IC	LDO, LN, -CE, 1.9V±2%, 150mA	SOT-23-5	28cx	VR4	6g	Ric
EW	AAT3511GV-2.63-C-C	Vdet-IC	2.63V±1.5%, -MR, ±Reset PPO	SOT-23-5	28cp	VD17	6k	Ant
EW	AP1625W	DC/DC-IC	PWM/VFM step-down, (2.2..8V)	SOT-23-5L	28uq	-	6a	Ana
EW	BD4860FVE	Vdet-IC	6V, +Reset ODO	VSOF-5	30vdu	VD6	6c	Rhm
EW	BD4860G	Vdet-IC	6V, +Reset ODO	SSOP-5	28vdm	VD6	6c	Rhm
EW	RT9167-45CB	LVR-IC	LDO, 4.5V±2%, 300mA, +CE	SOT-23-5	28vrx	VR7	6g	Rct
EW-	RT9167-45PB	LVR-IC	LDO, 4.5V±2%, 300mA, +CE	SOT-23-5	28vrx	VR7	6g	Rct
EX	AAT3515IGV-2.63-B-C	Vdet-IC	2.63V±1.5%, -MR, ±Reset PPO, 20ms	SOT-23-5	28xf	VD21	6k	Ant
EX	AP1621AW	DC/DC-IC	PWM/VFM step-down, (2.2..8V)	SOT-23-5L	28uk	-	6a	Ana
EX	AT1201-27X	LVR-IC	LDO, LN, +CE, 2.7V±2%, 150mA	SOT-23-5	28vrx	VR7	6a	Atr
EX	RT9167-46CB	LVR-IC	LDO, 4.6V±2%, 300mA, +CE	SOT-23-5	28vrx	VR7	6g	Rct
EY	RT9167-47CB	LVR-IC	LDO, 4.7V±2%, 300mA, +CE	SOT-23-5	28vrx	VR7	6g	Rct
EY-	RT9167-47PB	LVR-IC	LDO, 4.7V±2%, 300mA, +CE	SOT-23-5	28vrx	VR7	6g	Rct
EZ	RT9167-48CB	LVR-IC	LDO, 4.8V±2%, 300mA, +CE	SOT-23-5	28vrx	VR7	6g	Rct
F0	R111N201B	LVR-IC	LDO, LN, +CE, 2V±2%, 200mA	SOT-23-5	28cx	VR4	6g	Ric
F0	Si91844DT-26	LVR-IC	LDO, LN, +CE, -Error, 2.6V±1.5%, 150mA	SOT-23-5	28w	VR17	6k	Vs
F0	RN5VD50AA	Vdet-IC	5V±2.5%, -Reset PPO	SOT-23-5	28vdo	VD3	6g	Ric
F00	74AUC1G00GV	CMOS-Logic	2-input NAND gate	SOT753	28Log1	-	6a	Phi
F001	RP105Q062D	LVR-IC	LDO, 0.6V±15mV, 400mA, +CE, CL	SC-88A	28zf	VR11	6m	Ric
F002	RP105Q072D	LVR-IC	LDO, 0.7V±15mV, 400mA, +CE, CL	SC-88A	28zf	VR11	6m	Ric
F003	RP105Q082D	LVR-IC	LDO, 0.8V±15mV, 400mA, +CE, CL	SC-88A	28zf	VR11	6m	Ric
F004	RP105Q092D	LVR-IC	LDO, 0.9V±15mV, 400mA, +CE, CL	SC-88A	28zf	VR11	6m	Ric
F005	RP105Q102D	LVR-IC	LDO, 1.0V±15mV, 400mA, +CE, CL	SC-88A	28zf	VR11	6m	Ric
F006	RP105Q122D	LVR-IC	LDO, 1.2V±15mV, 400mA, +CE, CL	SC-88A	28zf	VR11	6m	Ric
F007	RP105Q132D	LVR-IC	LDO, 1.3V±15mV, 400mA, +CE, CL	SC-88A	28zf	VR11	6m	Ric
F008	RP105Q142D	LVR-IC	LDO, 1.4V±15mV, 400mA, +CE, CL	SC-88A	28zf	VR11	6m	Ric
F009	RP105Q152D	LVR-IC	LDO, 1.5V±15mV, 400mA, +CE, CL	SC-88A	28zf	VR11	6m	Ric
F010	RP105Q112D	LVR-IC	LDO, 1.1V±15mV, 400mA, +CE, CL	SC-88A	28zf	VR11	6m	Ric
F02	XC7SH02GV	CMOS-Logic	2-input NOR gate	SOT753	28/Log2	-	6a	Phi
F02	74AUC1G02GV	CMOS-Logic	2-input NOR gate	SOT753	28/Log2	-	6a	Phi
F04	XC7SH04GV	CMOS-Logic	Inverter	SOT753	28/Log6	-	6a	Phi
F04	74AUC1G04GV	CMOS-Logic	Inverter	SOT753	28/Log6	-	6a	Phi
F05	SMF05	TVS	Quad, Vbr=5V, 12A, 200W(1ms)	SC-70-5L	28bc	-	6a	Smt
F08	XC7SH08GV	CMOS-Logic	2-input AND gate	SOT753	28/Log3	-	6a	Phi
F08	74AUC1G08GV	CMOS-Logic	2-input AND gate	SOT753	28/Log3	-	6a	Phi
F0A	R1118N081B	LVR-IC	0.8V±1%, 150mA, +CE	SOT-23-5	28cx	VR4	6g	Ric
F0A	XC6108C50AMR	Vdet-IC	5.0V±2%, Hysteresis, -Reset PPO	SOT-25	28rm	VD15	6g	Tor
F0B	R1118N091B	LVR-IC	0.9V±1%, 150mA, +CE	SOT-23-5	28cx	VR4	6g	Ric
F0B	XC6108C50BMR	Vdet-IC	5.0V±2%, -Reset PPO	SOT-25	28rm	VD15	6g	Tor
F0C	R1118N101B	LVR-IC	1.0V±1%, 150mA, +CE	SOT-23-5	28cx	VR4	6g	Ric
F0C	XC6108C50CMR	Vdet-IC	5.0V±2%, Hysteresis, -Reset PPO	SOT-25	28rk	VD15	6g	Tor
F0D	R1118N111B	LVR-IC	1.1V±1%, 150mA, +CE	SOT-23-5	28cx	VR4	6g	Ric
F0D	XC6108C50DMR	Vdet-IC	5.0V±2%, -Reset PPO	SOT-25	28rk	VD15	6g	Tor
F0E	R1118N121B	LVR-IC	1.2V±1%, 150mA, +CE	SOT-23-5	28cx	VR4	6g	Ric



SMD code	Type	Function	Short description	Case	Pinout	Sch.	St.	Mnf.
F0F	R1118N121B5	LVR-IC	1.25V±1%, 150mA, +CE	SOT-23-5	28cx	VR4	6g	Ric
F0G	R1118N131B	LVR-IC	1.3V±1%, 150mA, +CE	SOT-23-5	28cx	VR4	6g	Ric
F0H	R1118N141B	LVR-IC	1.4V±1%, 150mA, +CE	SOT-23-5	28cx	VR4	6g	Ric
F0J	R1118N151B	LVR-IC	1.5V±1%, 150mA, +CE	SOT-23-5	28cx	VR4	6g	Ric
F0K	R1118N161B	LVR-IC	1.6V±1%, 150mA, +CE	SOT-23-5	28cx	VR4	6g	Ric
F0L	R1118N171B	LVR-IC	1.7V±1%, 150mA, +CE	SOT-23-5	28cx	VR4	6g	Ric
F0M	R1118N181B	LVR-IC	1.8V±1%, 150mA, +CE	SOT-23-5	28cx	VR4	6g	Ric
F0N	R1118N181B5	LVR-IC	1.85V±1%, 150mA, +CE	SOT-23-5	28cx	VR4	6g	Ric
F0P	R1118N191B	LVR-IC	1.9V±1%, 150mA, +CE	SOT-23-5	28cx	VR4	6g	Ric
F0Q	R1118N201B	LVR-IC	2.0V±1%, 150mA, +CE	SOT-23-5	28cx	VR4	6g	Ric
F0R	R1118N211B	LVR-IC	2.1V±1%, 150mA, +CE	SOT-23-5	28cx	VR4	6g	Ric
F0S	R1118N221B	LVR-IC	2.2V±1%, 150mA, +CE	SOT-23-5	28cx	VR4	6g	Ric
F0T	R1118N231B	LVR-IC	2.3V±1%, 150mA, +CE	SOT-23-5	28cx	VR4	6g	Ric
F0U	R1118N241B	LVR-IC	2.4V±1%, 150mA, +CE	SOT-23-5	28cx	VR4	6g	Ric
F0V	R1118N251B	LVR-IC	2.5V±1%, 150mA, +CE	SOT-23-5	28cx	VR4	6g	Ric
F0W	R1118N261B	LVR-IC	2.6V±1%, 150mA, +CE	SOT-23-5	28cx	VR4	6g	Ric
F0X	R1118N271B	LVR-IC	2.7V±1%, 150mA, +CE	SOT-23-5	28cx	VR4	6g	Ric
F0Y	R1118N281B	LVR-IC	2.8V±1%, 150mA, +CE	SOT-23-5	28cx	VR4	6g	Ric
F0Z	R1118N281B5	LVR-IC	2.85V±1%, 150mA, +CE	SOT-23-5	28cx	VR4	6g	Ric
F1	ELM7SH00MB	CMOS-Logic	2-input NAND gate	SOT-25	28/Log1	-	6g	Elm
F1	ELM7SH00TB	CMOS-Logic	2-input NAND gate	SC-88A	28/Log1	-	6g	Elm
F1	HD74HCT1G00CM	CMOS-Logic	2-input NAND gate	CMPAK-5	28/Log1	-	6a	Ren
F1	R1111N211B	LVR-IC	LDO, LN, +CE, 2.1V±2%, 200mA	SOT-23-5	28cx	VR4	6g	Ric
F1	RN5VD51AA	Vdet-IC	5.1V±2.5%, -Reset PPO	SOT-23-5	28vdo	VD3	6g	Ric
F10	R1224N102F	DC/DC-IC	PWMV/FM step-down, 1V, 500kHz	SOT-23-5	28ud	DC7	6g	Ric
F12	R1224N122F	DC/DC-IC	PWMV/FM step-down, 1.2V, 500kHz	SOT-23-5	28ud	DC7	6g	Ric
F12	SMF12	TVS	Quad, Vbr=12V, 8A, 200W(1ms)	SC-70-5L	28bc	-	6a	Smt
F14	XC7SH14GV	CMOS-Logic	Inverting Schmitt-trigger	SOT753	28/Log7	-	6a	Phi
F15	R1224N152F	DC/DC-IC	PWMV/FM step-down, 1.5V, 500kHz	SOT-23-5	28ud	DC7	6g	Ric
F15	XC6367F152MR	DC/DC-IC	PWM step-up, 1.5V±2.5%, 200mA, 180kHz, +CE, soft start	SOT-25	28sd	DC10	6g	Tor
F16	XC6367F162MR	DC/DC-IC	PWM step-up, 1.6V±2.5%, 200mA, 180kHz, +CE, soft start	SOT-25	28sd	DC10	6g	Tor
F17	XC6367F172MR	DC/DC-IC	PWM step-up, 1.7V±2.5%, 200mA, 180kHz, +CE, soft start	SOT-25	28sd	DC10	6g	Tor
F18	R1224N182F	DC/DC-IC	PWMV/FM step-down, 1.8V, 500kHz	SOT-23-5	28ud	DC7	6g	Ric
F18	XC6367F182MR	DC/DC-IC	PWM step-up, 1.8V±2.5%, 200mA, 180kHz, +CE, soft start	SOT-25	28sd	DC10	6g	Tor
F19	XC6367F192MR	DC/DC-IC	PWM step-up, 1.9V±2.5%, 200mA, 180kHz, +CE, soft start	SOT-25	28sd	DC10	6g	Tor
F1A	R1118N081D	LVR-IC	0.8V±1%, 150mA, +CE, CL	SOT-23-5	28cx	VR4	6g	Ric
F1B	R1118N091D	LVR-IC	0.9V±1%, 150mA, +CE, CL	SOT-23-5	28cx	VR4	6g	Ric
F1C	R1118N101D	LVR-IC	1.0V±1%, 150mA, +CE, CL	SOT-23-5	28cx	VR4	6g	Ric
F1D	R1118N111D	LVR-IC	1.1V±1%, 150mA, +CE, CL	SOT-23-5	28cx	VR4	6g	Ric
F1E	R1118N121D	LVR-IC	1.2V±1%, 150mA, +CE, CL	SOT-23-5	28cx	VR4	6g	Ric
F1F	R1118N121D5	LVR-IC	1.25V±1%, 150mA, +CE, CL	SOT-23-5	28cx	VR4	6g	Ric
F1F	XC6367F153MR	DC/DC-IC	PWM step-up, 1.5V±2.5%, 200mA, 300kHz, +CE, soft start	SOT-25	28sd	DC10	6g	Tor
F1G	R1118N131D	LVR-IC	1.3V±1%, 150mA, +CE, CL	SOT-23-5	28cx	VR4	6g	Ric
F1H	R1118N141D	LVR-IC	1.4V±1%, 150mA, +CE, CL	SOT-23-5	28cx	VR4	6g	Ric
F1H	XC6367F163MR	DC/DC-IC	PWM step-up, 1.6V±2.5%, 200mA, 300kHz, +CE, soft start	SOT-25	28sd	DC10	6g	Tor
F1J	R1118N151D	LVR-IC	1.5V±1%, 150mA, +CE, CL	SOT-23-5	28cx	VR4	6g	Ric
F1K	R1118N161D	LVR-IC	1.6V±1%, 150mA, +CE, CL	SOT-23-5	28cx	VR4	6g	Ric
F1K	XC6367F173MR	DC/DC-IC	PWM step-up, 1.7V±2.5%, 200mA, 300kHz, +CE, soft start	SOT-25	28sd	DC10	6g	Tor
F1L	R1118N171D	LVR-IC	1.7V±1%, 150mA, +CE, CL	SOT-23-5	28cx	VR4	6g	Ric
F1L	XC6367F183MR	DC/DC-IC	PWM step-up, 1.8V±2.5%, 200mA, 300kHz, +CE, soft start	SOT-25	28sd	DC10	6g	Tor
F1M	R1118N181D	LVR-IC	1.8V±1%, 150mA, +CE, CL	SOT-23-5	28cx	VR4	6g	Ric
F1M	XC6367F193MR	DC/DC-IC	PWM step-up, 1.9V±2.5%, 200mA, 300kHz, +CE, soft start	SOT-25	28sd	DC10	6g	Tor
F1N	R1118N181D5	LVR-IC	1.85V±1%, 150mA, +CE, CL	SOT-23-5	28cx	VR4	6g	Ric
F1P	R1118N191D	LVR-IC	1.9V±1%, 150mA, +CE, CL	SOT-23-5	28cx	VR4	6g	Ric
F1Q	R1118N201D	LVR-IC	2.0V±1%, 150mA, +CE, CL	SOT-23-5	28cx	VR4	6g	Ric
F1R	R1118N211D	LVR-IC	2.1V±1%, 150mA, +CE, CL	SOT-23-5	28cx	VR4	6g	Ric
F1S	R1118N221D	LVR-IC	2.2V±1%, 150mA, +CE, CL	SOT-23-5	28cx	VR4	6g	Ric
F1T	R1118N231D	LVR-IC	2.3V±1%, 150mA, +CE, CL	SOT-23-5	28cx	VR4	6g	Ric
F1U	R1118N241D	LVR-IC	2.4V±1%, 150mA, +CE, CL	SOT-23-5	28cx	VR4	6g	Ric
F1V	R1118N251D	LVR-IC	2.5V±1%, 150mA, +CE, CL	SOT-23-5	28cx	VR4	6g	Ric
F1W	R1118N261D	LVR-IC	2.6V±1%, 150mA, +CE, CL	SOT-23-5	28cx	VR4	6g	Ric
F1X	R1118N271D	LVR-IC	2.7V±1%, 150mA, +CE, CL	SOT-23-5	28cx	VR4	6g	Ric
F1Y	R1118N281D	LVR-IC	2.8V±1%, 150mA, +CE, CL	SOT-23-5	28cx	VR4	6g	Ric
F1Z	R1118N281D5	LVR-IC	2.85V±1%, 150mA, +CE, CL	SOT-23-5	28cx	VR4	6g	Ric
F2	ELM74SH08MB	CMOS-Logic	2-input AND gate	SOT-25	28/Log3	-	6g	Elm
F2	ELM74SH08TB	CMOS-Logic	2-input AND gate	SC-88A	28/Log3	-	6g	Elm
F2	HD74HCT1G08CM	CMOS-Logic	2-input AND gate	CMPAK-5	28/Log3	-	6a	Ren
F2	R1111N221B	LVR-IC	LDO, LN, +CE, 2.2V±2%, 200mA	SOT-23-5	28cx	VR4	6g	Ric
F2	RN5VD52AA	Vdet-IC	5.2V±2.5%, -Reset PPO	SOT-23-5	28vdo	VD3	6g	Ric
F20	XC6367F202MR	DC/DC-IC	PWM step-up, 2.0V±2.5%, 200mA, 180kHz, +CE, soft start	SOT-25	28sd	DC10	6g	Tor



SMD code	Type	Function	Short description	Case	Pinout	Sch.	St.	Mnf.
F229CG	UR6225G-29-AF5-C	LVR-IC	2.9V±2%, 100mA, halogen free	SOT-23-5	28ym	VR1	6a	Utc
F229CL	UR6225L-29-AF5-C	LVR-IC	2.9V±2%, 100mA, lead free	SOT-23-5	28ym	VR1	6a	Utc
F229FG	UR6225G-29-AF5-F	LVR-IC	2.9V±2%, 100mA, halogen free	SOT-23-5	28vu	VR1	6a	Utc
F229FL	UR6225L-29-AF5-F	LVR-IC	2.9V±2%, 100mA, lead free	SOT-23-5	28vu	VR1	6a	Utc
F23	XC6367F232MR	DC/DC-IC	PWM step-up, 2.3V±2.5%, 200mA, 180kHz, +CE, soft start	SOT-25	28sd	DC10	6g	Tor
F230CG	UR6225G-30-AF5-C	LVR-IC	3.0V±2%, 100mA, halogen free	SOT-23-5	28ym	VR1	6a	Utc
F230CL	UR6225L-30-AF5-C	LVR-IC	3.0V±2%, 100mA, lead free	SOT-23-5	28ym	VR1	6a	Utc
F230FG	UR6225G-30-AF5-F	LVR-IC	3.0V±2%, 100mA, halogen free	SOT-23-5	28vu	VR1	6a	Utc
F230FL	UR6225L-30-AF5-F	LVR-IC	3.0V±2%, 100mA, lead free	SOT-23-5	28vu	VR1	6a	Utc
F231CG	UR6225G-31-AF5-C	LVR-IC	3.1V±2%, 100mA, halogen free	SOT-23-5	28ym	VR1	6a	Utc
F231CL	UR6225L-31-AF5-C	LVR-IC	3.1V±2%, 100mA, lead free	SOT-23-5	28ym	VR1	6a	Utc
F231FG	UR6225G-31-AF5-F	LVR-IC	3.1V±2%, 100mA, halogen free	SOT-23-5	28vu	VR1	6a	Utc
F231FL	UR6225L-31-AF5-F	LVR-IC	3.1V±2%, 100mA, lead free	SOT-23-5	28vu	VR1	6a	Utc
F232CG	UR6225G-32-AF5-C	LVR-IC	3.2V±2%, 100mA, halogen free	SOT-23-5	28ym	VR1	6a	Utc
F232CL	UR6225L-32-AF5-C	LVR-IC	3.2V±2%, 100mA, lead free	SOT-23-5	28ym	VR1	6a	Utc
F232FG	UR6225G-32-AF5-F	LVR-IC	3.2V±2%, 100mA, halogen free	SOT-23-5	28vu	VR1	6a	Utc
F232FL	UR6225L-32-AF5-F	LVR-IC	3.2V±2%, 100mA, lead free	SOT-23-5	28vu	VR1	6a	Utc
F233CG	UR6225G-33-AF5-C	LVR-IC	3.3V±2%, 100mA, halogen free	SOT-23-5	28ym	VR1	6a	Utc
F233CL	UR6225L-33-AF5-C	LVR-IC	3.3V±2%, 100mA, lead free	SOT-23-5	28ym	VR1	6a	Utc
F233FG	UR6225G-33-AF5-F	LVR-IC	3.3V±2%, 100mA, halogen free	SOT-23-5	28vu	VR1	6a	Utc
F233FL	UR6225L-33-AF5-F	LVR-IC	3.3V±2%, 100mA, lead free	SOT-23-5	28vu	VR1	6a	Utc
F234CG	UR6225G-34-AF5-C	LVR-IC	3.4V±2%, 100mA, halogen free	SOT-23-5	28ym	VR1	6a	Utc
F234CL	UR6225L-34-AF5-C	LVR-IC	3.4V±2%, 100mA, lead free	SOT-23-5	28ym	VR1	6a	Utc
F234FG	UR6225G-34-AF5-F	LVR-IC	3.4V±2%, 100mA, halogen free	SOT-23-5	28vu	VR1	6a	Utc
F234FL	UR6225L-34-AF5-F	LVR-IC	3.4V±2%, 100mA, lead free	SOT-23-5	28vu	VR1	6a	Utc
F235CG	UR6225G-35-AF5-C	LVR-IC	3.5V±2%, 100mA, halogen free	SOT-23-5	28ym	VR1	6a	Utc
F235CL	UR6225L-35-AF5-C	LVR-IC	3.5V±2%, 100mA, lead free	SOT-23-5	28ym	VR1	6a	Utc
F235FG	UR6225G-35-AF5-F	LVR-IC	3.5V±2%, 100mA, halogen free	SOT-23-5	28vu	VR1	6a	Utc
F235FL	UR6225L-35-AF5-F	LVR-IC	3.5V±2%, 100mA, lead free	SOT-23-5	28vu	VR1	6a	Utc
F236CG	UR6225G-36-AF5-C	LVR-IC	3.6V±2%, 100mA, halogen free	SOT-23-5	28ym	VR1	6a	Utc
F236CL	UR6225L-36-AF5-C	LVR-IC	3.6V±2%, 100mA, lead free	SOT-23-5	28ym	VR1	6a	Utc
F236FG	UR6225G-36-AF5-F	LVR-IC	3.6V±2%, 100mA, halogen free	SOT-23-5	28vu	VR1	6a	Utc
F236FL	UR6225L-36-AF5-F	LVR-IC	3.6V±2%, 100mA, lead free	SOT-23-5	28vu	VR1	6a	Utc
F237CG	UR6225G-37-AF5-C	LVR-IC	3.7V±2%, 100mA, halogen free	SOT-23-5	28ym	VR1	6a	Utc
F237CL	UR6225L-37-AF5-C	LVR-IC	3.7V±2%, 100mA, lead free	SOT-23-5	28ym	VR1	6a	Utc
F237FG	UR6225G-37-AF5-F	LVR-IC	3.7V±2%, 100mA, halogen free	SOT-23-5	28vu	VR1	6a	Utc
F237FL	UR6225L-37-AF5-F	LVR-IC	3.7V±2%, 100mA, lead free	SOT-23-5	28vu	VR1	6a	Utc
F238CG	UR6225G-38-AF5-C	LVR-IC	3.8V±2%, 100mA, halogen free	SOT-23-5	28ym	VR1	6a	Utc
F238CL	UR6225L-38-AF5-C	LVR-IC	3.8V±2%, 100mA, lead free	SOT-23-5	28ym	VR1	6a	Utc
F238FG	UR6225G-38-AF5-F	LVR-IC	3.8V±2%, 100mA, halogen free	SOT-23-5	28vu	VR1	6a	Utc
F238FL	UR6225L-38-AF5-F	LVR-IC	3.8V±2%, 100mA, lead free	SOT-23-5	28vu	VR1	6a	Utc
F239CG	UR6225G-39-AF5-C	LVR-IC	3.9V±2%, 100mA, halogen free	SOT-23-5	28ym	VR1	6a	Utc
F239CL	UR6225L-39-AF5-C	LVR-IC	3.9V±2%, 100mA, lead free	SOT-23-5	28ym	VR1	6a	Utc
F239FG	UR6225G-39-AF5-F	LVR-IC	3.9V±2%, 100mA, halogen free	SOT-23-5	28vu	VR1	6a	Utc
F239FL	UR6225L-39-AF5-F	LVR-IC	3.9V±2%, 100mA, lead free	SOT-23-5	28vu	VR1	6a	Utc
F24	XC6367F242MR	DC/DC-IC	PWM step-up, 2.4V±2.5%, 200mA, 180kHz, +CE, soft start	SOT-25	28sd	DC10	6g	Tor
F240CG	UR6225G-40-AF5-C	LVR-IC	4.0V±2%, 100mA, halogen free	SOT-23-5	28ym	VR1	6a	Utc
F240CL	UR6225L-40-AF5-C	LVR-IC	4.0V±2%, 100mA, lead free	SOT-23-5	28ym	VR1	6a	Utc
F240FG	UR6225G-40-AF5-F	LVR-IC	4.0V±2%, 100mA, halogen free	SOT-23-5	28vu	VR1	6a	Utc
F240FL	UR6225L-40-AF5-F	LVR-IC	4.0V±2%, 100mA, lead free	SOT-23-5	28vu	VR1	6a	Utc
F241CG	UR6225G-41-AF5-C	LVR-IC	4.1V±2%, 100mA, halogen free	SOT-23-5	28ym	VR1	6a	Utc
F241CL	UR6225L-41-AF5-C	LVR-IC	4.1V±2%, 100mA, lead free	SOT-23-5	28ym	VR1	6a	Utc
F241FG	UR6225G-41-AF5-F	LVR-IC	4.1V±2%, 100mA, halogen free	SOT-23-5	28vu	VR1	6a	Utc
F241FL	UR6225L-41-AF5-F	LVR-IC	4.1V±2%, 100mA, lead free	SOT-23-5	28vu	VR1	6a	Utc
F242CG	UR6225G-42-AF5-C	LVR-IC	4.2V±2%, 100mA, halogen free	SOT-23-5	28ym	VR1	6a	Utc
F242CL	UR6225L-42-AF5-C	LVR-IC	4.2V±2%, 100mA, lead free	SOT-23-5	28ym	VR1	6a	Utc
F242FG	UR6225G-42-AF5-F	LVR-IC	4.2V±2%, 100mA, halogen free	SOT-23-5	28vu	VR1	6a	Utc
F242FL	UR6225L-42-AF5-F	LVR-IC	4.2V±2%, 100mA, lead free	SOT-23-5	28vu	VR1	6a	Utc
F243CG	UR6225G-43-AF5-C	LVR-IC	4.3V±2%, 100mA, halogen free	SOT-23-5	28ym	VR1	6a	Utc
F243CL	UR6225L-43-AF5-C	LVR-IC	4.3V±2%, 100mA, lead free	SOT-23-5	28ym	VR1	6a	Utc
F243FG	UR6225G-43-AF5-F	LVR-IC	4.3V±2%, 100mA, halogen free	SOT-23-5	28vu	VR1	6a	Utc
F243FL	UR6225L-43-AF5-F	LVR-IC	4.3V±2%, 100mA, lead free	SOT-23-5	28vu	VR1	6a	Utc
F244CG	UR6225G-44-AF5-C	LVR-IC	4.4V±2%, 100mA, halogen free	SOT-23-5	28ym	VR1	6a	Utc
F244CL	UR6225L-44-AF5-C	LVR-IC	4.4V±2%, 100mA, lead free	SOT-23-5	28ym	VR1	6a	Utc
F244FG	UR6225G-44-AF5-F	LVR-IC	4.4V±2%, 100mA, halogen free	SOT-23-5	28vu	VR1	6a	Utc
F244FL	UR6225L-44-AF5-F	LVR-IC	4.4V±2%, 100mA, lead free	SOT-23-5	28vu	VR1	6a	Utc
F245CG	UR6225G-45-AF5-C	LVR-IC	4.5V±2%, 100mA, halogen free	SOT-23-5	28ym	VR1	6a	Utc
F245CL	UR6225L-45-AF5-C	LVR-IC	4.5V±2%, 100mA, lead free	SOT-23-5	28ym	VR1	6a	Utc
F245FG	UR6225G-45-AF5-F	LVR-IC	4.5V±2%, 100mA, halogen free	SOT-23-5	28vu	VR1	6a	Utc
F245FL	UR6225L-45-AF5-F	LVR-IC	4.5V±2%, 100mA, lead free	SOT-23-5	28vu	VR1	6a	Utc



SMD code	Type	Function	Short description	Case	Pinout	Sch.	St.	Mnf.
F246CG	UR6225G-46-AF5-C	LVR-IC	4.6V±2%, 100mA, halogen free	SOT-23-5	28ym	VR1	6a	Utc
F246CL	UR6225L-46-AF5-C	LVR-IC	4.6V±2%, 100mA, lead free	SOT-23-5	28ym	VR1	6a	Utc
F246FG	UR6225G-46-AF5-F	LVR-IC	4.6V±2%, 100mA, halogen free	SOT-23-5	28vu	VR1	6a	Utc
F246FL	UR6225L-46-AF5-F	LVR-IC	4.6V±2%, 100mA, lead free	SOT-23-5	28vu	VR1	6a	Utc
F247CG	UR6225G-47-AF5-C	LVR-IC	4.7V±2%, 100mA, halogen free	SOT-23-5	28ym	VR1	6a	Utc
F247CL	UR6225L-47-AF5-C	LVR-IC	4.7V±2%, 100mA, lead free	SOT-23-5	28ym	VR1	6a	Utc
F247FG	UR6225G-47-AF5-F	LVR-IC	4.7V±2%, 100mA, halogen free	SOT-23-5	28vu	VR1	6a	Utc
F247FL	UR6225L-47-AF5-F	LVR-IC	4.7V±2%, 100mA, lead free	SOT-23-5	28vu	VR1	6a	Utc
F248CG	UR6225G-48-AF5-C	LVR-IC	4.8V±2%, 100mA, halogen free	SOT-23-5	28ym	VR1	6a	Utc
F248CL	UR6225L-48-AF5-C	LVR-IC	4.8V±2%, 100mA, lead free	SOT-23-5	28ym	VR1	6a	Utc
F248FG	UR6225G-48-AF5-F	LVR-IC	4.8V±2%, 100mA, halogen free	SOT-23-5	28vu	VR1	6a	Utc
F248FL	UR6225L-48-AF5-F	LVR-IC	4.8V±2%, 100mA, lead free	SOT-23-5	28vu	VR1	6a	Utc
F249CG	UR6225G-49-AF5-C	LVR-IC	4.9V±2%, 100mA, halogen free	SOT-23-5	28ym	VR1	6a	Utc
F249CL	UR6225L-49-AF5-C	LVR-IC	4.9V±2%, 100mA, lead free	SOT-23-5	28ym	VR1	6a	Utc
F249FG	UR6225G-49-AF5-F	LVR-IC	4.9V±2%, 100mA, halogen free	SOT-23-5	28vu	VR1	6a	Utc
F249FL	UR6225L-49-AF5-F	LVR-IC	4.9V±2%, 100mA, lead free	SOT-23-5	28vu	VR1	6a	Utc
I25	XC7SH125GV	CMOS-Logic	Bus buffer gate with 3-state output	SOT753	28/Log14	-	6a	Phi
F25	R1224N252F	DC/DC-IC	PWM/VFM step-down, 2.5V, 500kHz	SOT-23-5	28ud	DC7	6g	Ric
F25	XC6367F252MR	DC/DC-IC	PWM step-up, 2.5V±2.5%, 200mA, 180kHz, +CE, soft start	SOT-25	28sd	DC10	6g	Tor
F250CG	UR6225G-50-AF5-C	LVR-IC	5.0V±2%, 100mA, halogen free	SOT-23-5	28ym	VR1	6a	Utc
F250CL	UR6225L-50-AF5-C	LVR-IC	5.0V±2%, 100mA, lead free	SOT-23-5	28ym	VR1	6a	Utc
F250FG	UR6225G-50-AF5-F	LVR-IC	5.0V±2%, 100mA, halogen free	SOT-23-5	28vu	VR1	6a	Utc
F250FL	UR6225L-50-AF5-F	LVR-IC	5.0V±2%, 100mA, lead free	SOT-23-5	28vu	VR1	6a	Utc
F251CG	UR6225G-51-AF5-C	LVR-IC	5.1V±2%, 100mA, halogen free	SOT-23-5	28ym	VR1	6a	Utc
F251CL	UR6225L-51-AF5-C	LVR-IC	5.1V±2%, 100mA, lead free	SOT-23-5	28ym	VR1	6a	Utc
F251FG	UR6225G-51-AF5-F	LVR-IC	5.1V±2%, 100mA, halogen free	SOT-23-5	28vu	VR1	6a	Utc
F251FL	UR6225L-51-AF5-F	LVR-IC	5.1V±2%, 100mA, lead free	SOT-23-5	28vu	VR1	6a	Utc
F252CG	UR6225G-52-AF5-C	LVR-IC	5.2V±2%, 100mA, halogen free	SOT-23-5	28ym	VR1	6a	Utc
F252CL	UR6225L-52-AF5-C	LVR-IC	5.2V±2%, 100mA, lead free	SOT-23-5	28ym	VR1	6a	Utc
F252FG	UR6225G-52-AF5-F	LVR-IC	5.2V±2%, 100mA, halogen free	SOT-23-5	28vu	VR1	6a	Utc
F252FL	UR6225L-52-AF5-F	LVR-IC	5.2V±2%, 100mA, lead free	SOT-23-5	28vu	VR1	6a	Utc
F253CG	UR6225G-53-AF5-C	LVR-IC	5.3V±2%, 100mA, halogen free	SOT-23-5	28ym	VR1	6a	Utc
F253CL	UR6225L-53-AF5-C	LVR-IC	5.3V±2%, 100mA, lead free	SOT-23-5	28ym	VR1	6a	Utc
F253FG	UR6225G-53-AF5-F	LVR-IC	5.3V±2%, 100mA, halogen free	SOT-23-5	28vu	VR1	6a	Utc
F253FL	UR6225L-53-AF5-F	LVR-IC	5.3V±2%, 100mA, lead free	SOT-23-5	28vu	VR1	6a	Utc
F254CG	UR6225G-54-AF5-C	LVR-IC	5.4V±2%, 100mA, halogen free	SOT-23-5	28ym	VR1	6a	Utc
F254CL	UR6225L-54-AF5-C	LVR-IC	5.4V±2%, 100mA, lead free	SOT-23-5	28ym	VR1	6a	Utc
F254FG	UR6225G-54-AF5-F	LVR-IC	5.4V±2%, 100mA, halogen free	SOT-23-5	28vu	VR1	6a	Utc
F254FL	UR6225L-54-AF5-F	LVR-IC	5.4V±2%, 100mA, lead free	SOT-23-5	28vu	VR1	6a	Utc
F255CG	UR6225G-55-AF5-C	LVR-IC	5.5V±2%, 100mA, halogen free	SOT-23-5	28ym	VR1	6a	Utc
F255CL	UR6225L-55-AF5-C	LVR-IC	5.5V±2%, 100mA, lead free	SOT-23-5	28ym	VR1	6a	Utc
F255FG	UR6225G-55-AF5-F	LVR-IC	5.5V±2%, 100mA, halogen free	SOT-23-5	28vu	VR1	6a	Utc
F255FL	UR6225L-55-AF5-F	LVR-IC	5.5V±2%, 100mA, lead free	SOT-23-5	28vu	VR1	6a	Utc
F256CG	UR6225G-56-AF5-C	LVR-IC	5.6V±2%, 100mA, halogen free	SOT-23-5	28ym	VR1	6a	Utc
F256CL	UR6225L-56-AF5-C	LVR-IC	5.6V±2%, 100mA, lead free	SOT-23-5	28ym	VR1	6a	Utc
F256FG	UR6225G-56-AF5-F	LVR-IC	5.6V±2%, 100mA, halogen free	SOT-23-5	28vu	VR1	6a	Utc
F256FL	UR6225L-56-AF5-F	LVR-IC	5.6V±2%, 100mA, lead free	SOT-23-5	28vu	VR1	6a	Utc
F257CG	UR6225G-57-AF5-C	LVR-IC	5.7V±2%, 100mA, halogen free	SOT-23-5	28ym	VR1	6a	Utc
F257CL	UR6225L-57-AF5-C	LVR-IC	5.7V±2%, 100mA, lead free	SOT-23-5	28ym	VR1	6a	Utc
F257FG	UR6225G-57-AF5-F	LVR-IC	5.7V±2%, 100mA, halogen free	SOT-23-5	28vu	VR1	6a	Utc
F257FL	UR6225L-57-AF5-F	LVR-IC	5.7V±2%, 100mA, lead free	SOT-23-5	28vu	VR1	6a	Utc
F258CG	UR6225G-58-AF5-C	LVR-IC	5.8V±2%, 100mA, halogen free	SOT-23-5	28ym	VR1	6a	Utc
F258CL	UR6225L-58-AF5-C	LVR-IC	5.8V±2%, 100mA, lead free	SOT-23-5	28ym	VR1	6a	Utc
F258FG	UR6225G-58-AF5-F	LVR-IC	5.8V±2%, 100mA, halogen free	SOT-23-5	28vu	VR1	6a	Utc
F258FL	UR6225L-58-AF5-F	LVR-IC	5.8V±2%, 100mA, lead free	SOT-23-5	28vu	VR1	6a	Utc
F259CG	UR6225G-59-AF5-C	LVR-IC	5.9V±2%, 100mA, halogen free	SOT-23-5	28ym	VR1	6a	Utc
F259CL	UR6225L-59-AF5-C	LVR-IC	5.9V±2%, 100mA, lead free	SOT-23-5	28ym	VR1	6a	Utc
F259FG	UR6225G-59-AF5-F	LVR-IC	5.9V±2%, 100mA, halogen free	SOT-23-5	28vu	VR1	6a	Utc
F259FL	UR6225L-59-AF5-F	LVR-IC	5.9V±2%, 100mA, lead free	SOT-23-5	28vu	VR1	6a	Utc
F26	XC6367F262MR	DC/DC-IC	PWM step-up, 2.6V±2.5%, 200mA, 180kHz, +CE, soft start	SOT-25	28sd	DC10	6g	Tor
F260CG	UR6225G-60-AF5-C	LVR-IC	6.0V±2%, 100mA, halogen free	SOT-23-5	28ym	VR1	6a	Utc
F260CL	UR6225L-60-AF5-C	LVR-IC	6.0V±2%, 100mA, lead free	SOT-23-5	28ym	VR1	6a	Utc
F260FG	UR6225G-60-AF5-F	LVR-IC	6.0V±2%, 100mA, halogen free	SOT-23-5	28vu	VR1	6a	Utc
F260FL	UR6225L-60-AF5-F	LVR-IC	6.0V±2%, 100mA, lead free	SOT-23-5	28vu	VR1	6a	Utc
F27	XC6367F272MR	DC/DC-IC	PWM step-up, 2.7V±2.5%, 200mA, 180kHz, +CE, soft start	SOT-25	28sd	DC10	6g	Tor
F28	XC6367F282MR	DC/DC-IC	PWM step-up, 2.8V±2.5%, 200mA, 180kHz, +CE, soft start	SOT-25	28sd	DC10	6g	Tor
F29	XC6367F292MR	DC/DC-IC	PWM step-up, 2.9V±2.5%, 200mA, 180kHz, +CE, soft start	SOT-25	28sd	DC10	6g	Tor
F2A	XC6367F203MR	DC/DC-IC	PWM step-up, 2.0V±2.5%, 200mA, 300kHz, +CE, soft start	SOT-25	28sd	DC10	6g	Tor
F2B	XC6367F213MR	DC/DC-IC	PWM step-up, 2.1V±2.5%, 200mA, 300kHz, +CE, soft start	SOT-25	28sd	DC10	6g	Tor
F2C	XC6367F223MR	DC/DC-IC	PWM step-up, 2.2V±2.5%, 200mA, 300kHz, +CE, soft start	SOT-25	28sd	DC10	6g	Tor



SMD code	Type	Function	Short description	Case	Pinout	Sch.	St.	Mnf.
F2D	XC6367F233MR	DC/DC-IC	PWM step-up, 2.3V±2.5%, 200mA, 300kHz, +CE, soft start	SOT-25	28sd	DC10	6g	Tor
F2E	XC6367F243MR	DC/DC-IC	PWM step-up, 2.4V±2.5%, 200mA, 300kHz, +CE, soft start	SOT-25	28sd	DC10	6g	Tor
F2F	XC6367F253MR	DC/DC-IC	PWM step-up, 2.5V±2.5%, 200mA, 300kHz, +CE, soft start	SOT-25	28sd	DC10	6g	Tor
F2H	XC6367F263MR	DC/DC-IC	PWM step-up, 2.6V±2.5%, 200mA, 300kHz, +CE, soft start	SOT-25	28sd	DC10	6g	Tor
F2JCG	UR6225G-285-AF5-C	LVR-IC	2.85V±2%, 100mA, halogen free	SOT-23-5	28ym	VR1	6a	Ult
F2JCL	UR6225L-285-AF5-C	LVR-IC	2.85V±2%, 100mA, lead free	SOT-23-5	28ym	VR1	6a	Ult
F2JFG	UR6225G-285-AF5-F	LVR-IC	2.85V±2%, 100mA, halogen free	SOT-23-5	28vu	VR1	6a	Ult
F2JFL	UR6225L-285-AF5-F	LVR-IC	2.85V±2%, 100mA, lead free	SOT-23-5	28vu	VR1	6a	Ult
F2K	XC6367F273MR	DC/DC-IC	PWM step-up, 2.7V±2.5%, 200mA, 300kHz, +CE, soft start	SOT-25	28sd	DC10	6g	Tor
F2L	XC6367F283MR	DC/DC-IC	PWM step-up, 2.8V±2.5%, 200mA, 300kHz, +CE, soft start	SOT-25	28sd	DC10	6g	Tor
F2M	XC6367F293MR	DC/DC-IC	PWM step-up, 2.9V±2.5%, 200mA, 300kHz, +CE, soft start	SOT-25	28sd	DC10	6g	Tor
F3	ELM74SH02MB	CMOS-Logic	2-input NOR gate	SOT-25	28/Log2	-	6g	Elm
F3	ELM74SH02TB	CMOS-Logic	2-input NOR gate	SC-88A	28/Log2	-	6g	Elm
F3	HD74HCT1G02CM	CMOS-Logic	2-input NOR gate	CMPAK-5	28/Log2	-	6a	Ren
F3	R1111N213B	LVR-IC	LDO, LN, +CE, 2.3V±2%, 200mA	SOT-23-5	28cx	VR4	6g	Ric
F3	RN5VD53AA	Vdet-IC	5.3V±2.5%, -Reset PPO	SOT-23-5	28vdo	VD3	6g	Ric
F30	R1224N302F	DC/DC-IC	PWM/FM step-down, 3V, 500kHz	SOT-23-5	28ud	DC7	6g	Ric
F30	XC6367F302MR	DC/DC-IC	PWM step-up, 3.0V±2.5%, 200mA, 180kHz, +CE, soft start	SOT-25	28sd	DC10	6g	Tor
F31	XC6367F312MR	DC/DC-IC	PWM step-up, 3.1V±2.5%, 200mA, 180kHz, +CE, soft start	SOT-25	28sd	DC10	6g	Tor
F32	XC75H32GV	CMOS-Logic	2-input OR gate	SOT753	28/Log4	-	6a	Phi
F32	74AUC1G32GV	CMOS-Logic	2-input OR gate	SOT753	28/Log4	-	6a	Phi
F32	XC6367F322MR	DC/DC-IC	PWM step-up, 3.2V±2.5%, 200mA, 180kHz, +CE, soft start	SOT-25	28sd	DC10	6g	Tor
F33	R1224N332F	DC/DC-IC	PWM/FM step-down, 3.3V, 500kHz	SOT-23-5	28ud	DC7	6g	Ric
F33	XC6367F332MR	DC/DC-IC	PWM step-up, 3.3V±2.5%, 200mA, 180kHz, +CE, soft start	SOT-25	28sd	DC10	6g	Tor
F34	XC6367F342MR	DC/DC-IC	PWM step-up, 3.4V±2.5%, 200mA, 180kHz, +CE, soft start	SOT-25	28sd	DC10	6g	Tor
F35	XC6367F352MR	DC/DC-IC	PWM step-up, 3.5V±2.5%, 200mA, 180kHz, +CE, soft start	SOT-25	28sd	DC10	6g	Tor
F36	XC6367F362MR	DC/DC-IC	PWM step-up, 3.6V±2.5%, 200mA, 180kHz, +CE, soft start	SOT-25	28sd	DC10	6g	Tor
F37	XC6367F372MR	DC/DC-IC	PWM step-up, 3.7V±2.5%, 200mA, 180kHz, +CE, soft start	SOT-25	28sd	DC10	6g	Tor
F38	XC6367F382MR	DC/DC-IC	PWM step-up, 3.8V±2.5%, 200mA, 180kHz, +CE, soft start	SOT-25	28sd	DC10	6g	Tor
F39	XC6367F392MR	DC/DC-IC	PWM step-up, 3.9V±2.5%, 200mA, 180kHz, +CE, soft start	SOT-25	28sd	DC10	6g	Tor
F3A	XC6367F303MR	DC/DC-IC	PWM step-up, 3.0V±2.5%, 200mA, 300kHz, +CE, soft start	SOT-25	28sd	DC10	6g	Tor
F3B	XC6367F313MR	DC/DC-IC	PWM step-up, 3.1V±2.5%, 200mA, 300kHz, +CE, soft start	SOT-25	28sd	DC10	6g	Tor
F3C	XC6367F323MR	DC/DC-IC	PWM step-up, 3.2V±2.5%, 200mA, 300kHz, +CE, soft start	SOT-25	28sd	DC10	6g	Tor
F3D	XC6367F333MR	DC/DC-IC	PWM step-up, 3.3V±2.5%, 200mA, 300kHz, +CE, soft start	SOT-25	28sd	DC10	6g	Tor
F3E	XC6367F343MR	DC/DC-IC	PWM step-up, 3.4V±2.5%, 200mA, 300kHz, +CE, soft start	SOT-25	28sd	DC10	6g	Tor
F3F	XC6367F353MR	DC/DC-IC	PWM step-up, 3.5V±2.5%, 200mA, 300kHz, +CE, soft start	SOT-25	28sd	DC10	6g	Tor
F3H	XC6367F363MR	DC/DC-IC	PWM step-up, 3.6V±2.5%, 200mA, 300kHz, +CE, soft start	SOT-25	28sd	DC10	6g	Tor
F3K	XC6367F373MR	DC/DC-IC	PWM step-up, 3.7V±2.5%, 200mA, 300kHz, +CE, soft start	SOT-25	28sd	DC10	6g	Tor
F3L	XC6367F383MR	DC/DC-IC	PWM step-up, 3.8V±2.5%, 200mA, 300kHz, +CE, soft start	SOT-25	28sd	DC10	6g	Tor
F3M	XC6367F393MR	DC/DC-IC	PWM step-up, 3.9V±2.5%, 200mA, 300kHz, +CE, soft start	SOT-25	28sd	DC10	6g	Tor
F4	ELM74SH32MB	CMOS-Logic	2-input OR gate	SOT-25	28/Log4	-	6g	Elm
F4	ELM74SH32TB	CMOS-Logic	2-input OR gate	SC-88A	28/Log4	-	6g	Elm
F4	HD74HCT1G32CM	CMOS-Logic	2-input OR gate	CMPAK-5	28/Log4	-	6a	Ren
F4	R1111N241B	LVR-IC	LDO, LN, +CE, 2.4V±2%, 200mA	SOT-23-5	28cx	VR4	6g	Ric
F4	RN5VD54AA	Vdet-IC	5.4V±2.5%, -Reset PPO	SOT-23-5	28vdo	VD3	6g	Ric
F40	XC6367F402MR	DC/DC-IC	PWM step-up, 4.0V±2.5%, 200mA, 180kHz, +CE, soft start	SOT-25	28sd	DC10	6g	Tor
F41	XC6367F412MR	DC/DC-IC	PWM step-up, 4.1V±2.5%, 200mA, 180kHz, +CE, soft start	SOT-25	28sd	DC10	6g	Tor
F42	XC6367F422MR	DC/DC-IC	PWM step-up, 4.2V±2.5%, 200mA, 180kHz, +CE, soft start	SOT-25	28sd	DC10	6g	Tor
F43	XC6367F432MR	DC/DC-IC	PWM step-up, 4.3V±2.5%, 200mA, 180kHz, +CE, soft start	SOT-25	28sd	DC10	6g	Tor
F44	XC6367F442MR	DC/DC-IC	PWM step-up, 4.4V±2.5%, 200mA, 180kHz, +CE, soft start	SOT-25	28sd	DC10	6g	Tor
F45	XC6367F452MR	DC/DC-IC	PWM step-up, 4.5V±2.5%, 200mA, 180kHz, +CE, soft start	SOT-25	28sd	DC10	6g	Tor
F46	XC6367F462MR	DC/DC-IC	PWM step-up, 4.6V±2.5%, 200mA, 180kHz, +CE, soft start	SOT-25	28sd	DC10	6g	Tor
F47	XC6367F472MR	DC/DC-IC	PWM step-up, 4.7V±2.5%, 200mA, 180kHz, +CE, soft start	SOT-25	28sd	DC10	6g	Tor
F48	XC6367F482MR	DC/DC-IC	PWM step-up, 4.8V±2.5%, 200mA, 180kHz, +CE, soft start	SOT-25	28sd	DC10	6g	Tor
F49	XC6367F492MR	DC/DC-IC	PWM step-up, 4.9V±2.5%, 200mA, 180kHz, +CE, soft start	SOT-25	28sd	DC10	6g	Tor
F4A	XC6367F403MR	DC/DC-IC	PWM step-up, 4.0V±2.5%, 200mA, 300kHz, +CE, soft start	SOT-25	28sd	DC10	6g	Tor
F4B	XC6367F413MR	DC/DC-IC	PWM step-up, 4.1V±2.5%, 200mA, 300kHz, +CE, soft start	SOT-25	28sd	DC10	6g	Tor
F4C	XC6367F423MR	DC/DC-IC	PWM step-up, 4.2V±2.5%, 200mA, 300kHz, +CE, soft start	SOT-25	28sd	DC10	6g	Tor
F4D	XC6367F433MR	DC/DC-IC	PWM step-up, 4.3V±2.5%, 200mA, 300kHz, +CE, soft start	SOT-25	28sd	DC10	6g	Tor
F4E	XC6367F443MR	DC/DC-IC	PWM step-up, 4.4V±2.5%, 200mA, 300kHz, +CE, soft start	SOT-25	28sd	DC10	6g	Tor
F4F	XC6367F453MR	DC/DC-IC	PWM step-up, 4.5V±2.5%, 200mA, 300kHz, +CE, soft start	SOT-25	28sd	DC10	6g	Tor
F4H	XC6367F463MR	DC/DC-IC	PWM step-up, 4.6V±2.5%, 200mA, 300kHz, +CE, soft start	SOT-25	28sd	DC10	6g	Tor
F4K	XC6367F473MR	DC/DC-IC	PWM step-up, 4.7V±2.5%, 200mA, 300kHz, +CE, soft start	SOT-25	28sd	DC10	6g	Tor
F4L	XC6367F483MR	DC/DC-IC	PWM step-up, 4.8V±2.5%, 200mA, 300kHz, +CE, soft start	SOT-25	28sd	DC10	6g	Tor
F4M	XC6367F493MR	DC/DC-IC	PWM step-up, 4.9V±2.5%, 200mA, 300kHz, +CE, soft start	SOT-25	28sd	DC10	6g	Tor
F5	ELM75H04MB	CMOS-Logic	Inverter	SOT-25	28/Log6	-	6g	Elm
F5	ELM75H04TB	CMOS-Logic	Inverter	SC-88A	28/Log6	-	6g	Elm
F5	HD74HCT1G04CM	CMOS-Logic	Inverter	CMPAK-5	28/Log6	-	6a	Ren
F5	MC78P25N	LVR-IC	LDO, LN, +CE, 2.5V±2.5%, 100mA	SOT-23-5	28cx	VR4	6b	Ons
F5	R1111N251B	LVR-IC	LDO, LN, +CE, 2.5V±2%, 200mA	SOT-23-5	28cx	VR4	6g	Ric



SMD code	Type	Function	Short description	Case	Pinout	Sch.	St.	Mnf.
F5	RN5VD55AA	Vdet-IC	5.5V±2.5%, -Reset PPO	SOT-23-5	28vdo	VD3	6g	Ric
F50	R1224N502F	DC/DC-IC	PWMVFM step-down, 5V, 500kHz	SOT-23-5	28ud	DC7	6g	Ric
F50	XC6367F502MR	DC/DC-IC	PWM step-up, 5.0V±2.5%, 200mA, 180kHz, +CE, soft start	SOT-25	28sd	DC10	6g	Tor
F51	XC6367F512MR	DC/DC-IC	PWM step-up, 5.1V±2.5%, 200mA, 180kHz, +CE, soft start	SOT-25	28sd	DC10	6g	Tor
F52	XC6367F522MR	DC/DC-IC	PWM step-up, 5.2V±2.5%, 200mA, 180kHz, +CE, soft start	SOT-25	28sd	DC10	6g	Tor
F53	XC6367F532MR	DC/DC-IC	PWM step-up, 5.3V±2.5%, 200mA, 180kHz, +CE, soft start	SOT-25	28sd	DC10	6g	Tor
F54	XC6367F542MR	DC/DC-IC	PWM step-up, 5.4V±2.5%, 200mA, 180kHz, +CE, soft start	SOT-25	28sd	DC10	6g	Tor
F55	R1224N552F	DC/DC-IC	PWMVFM step-down, 5.5V, 500kHz	SOT-23-5	28ud	DC7	6g	Ric
F55	XC6367F552MR	DC/DC-IC	PWM step-up, 5.5V±2.5%, 200mA, 180kHz, +CE, soft start	SOT-25	28sd	DC10	6g	Tor
F56	XC6367F562MR	DC/DC-IC	PWM step-up, 5.6V±2.5%, 200mA, 180kHz, +CE, soft start	SOT-25	28sd	DC10	6g	Tor
F57	XC6367F572MR	DC/DC-IC	PWM step-up, 5.7V±2.5%, 200mA, 180kHz, +CE, soft start	SOT-25	28sd	DC10	6g	Tor
F58	XC6367F582MR	DC/DC-IC	PWM step-up, 5.8V±2.5%, 200mA, 180kHz, +CE, soft start	SOT-25	28sd	DC10	6g	Tor
F59	XC6367F592MR	DC/DC-IC	PWM step-up, 5.9V±2.5%, 200mA, 180kHz, +CE, soft start	SOT-25	28sd	DC10	6g	Tor
F5A	XC6367F503MR	DC/DC-IC	PWM step-up, 5.0V±2.5%, 200mA, 300kHz, +CE, soft start	SOT-25	28sd	DC10	6g	Tor
F5B	XC6367F513MR	DC/DC-IC	PWM step-up, 5.1V±2.5%, 200mA, 300kHz, +CE, soft start	SOT-25	28sd	DC10	6g	Tor
F5C	XC6367F523MR	DC/DC-IC	PWM step-up, 5.2V±2.5%, 200mA, 300kHz, +CE, soft start	SOT-25	28sd	DC10	6g	Tor
F5D	XC6367F533MR	DC/DC-IC	PWM step-up, 5.3V±2.5%, 200mA, 300kHz, +CE, soft start	SOT-25	28sd	DC10	6g	Tor
F5E	XC6367F543MR	DC/DC-IC	PWM step-up, 5.4V±2.5%, 200mA, 300kHz, +CE, soft start	SOT-25	28sd	DC10	6g	Tor
F5F	XC6367F553MR	DC/DC-IC	PWM step-up, 5.5V±2.5%, 200mA, 300kHz, +CE, soft start	SOT-25	28sd	DC10	6g	Tor
F5H	XC6367F563MR	DC/DC-IC	PWM step-up, 5.6V±2.5%, 200mA, 300kHz, +CE, soft start	SOT-25	28sd	DC10	6g	Tor
F5K	XC6367F573MR	DC/DC-IC	PWM step-up, 5.7V±2.5%, 200mA, 300kHz, +CE, soft start	SOT-25	28sd	DC10	6g	Tor
F5L	XC6367F583MR	DC/DC-IC	PWM step-up, 5.8V±2.5%, 200mA, 300kHz, +CE, soft start	SOT-25	28sd	DC10	6g	Tor
F5M	XC6367F593MR	DC/DC-IC	PWM step-up, 5.9V±2.5%, 200mA, 300kHz, +CE, soft start	SOT-25	28sd	DC10	6g	Tor
F6	ELM7SHU04MB	CMOS-Logic	Unbuffered Inverter	SOT-25	28/Log6	-	6g	Elm
F6	ELM7SHU04TB	CMOS-Logic	Unbuffered Inverter	SC-88A	28/Log6	-	6g	Elm
F6	R1111N261B	LVR-IC	LDO, LN, +CE, 2.6V±2%, 200mA	SOT-23-5	28cx	VR4	6g	Ric
F6	Si91844DT-18	LVR-IC	LDO, LN, +CE, -Error, 1.8V±1.5%, 150mA	SOT-23-5	28w	VR17	6k	Vs
F6	RN5VD56AA	Vdet-IC	5.6V±2.5%, -Reset PPO	SOT-23-5	28vdo	VD3	6g	Ric
F60	R1224N602F	DC/DC-IC	PWMVFM step-down, 6V, 500kHz	SOT-23-5	28ud	DC7	6g	Ric
F60	XC6367F602MR	DC/DC-IC	PWM step-up, 6.0V±2.5%, 200mA, 180kHz, +CE, soft start	SOT-25	28sd	DC10	6g	Tor
F61	XC6367F612MR	DC/DC-IC	PWM step-up, 6.1V±2.5%, 200mA, 180kHz, +CE, soft start	SOT-25	28sd	DC10	6g	Tor
F62	XC6367F622MR	DC/DC-IC	PWM step-up, 6.2V±2.5%, 200mA, 180kHz, +CE, soft start	SOT-25	28sd	DC10	6g	Tor
F63	XC6367F632MR	DC/DC-IC	PWM step-up, 6.3V±2.5%, 200mA, 180kHz, +CE, soft start	SOT-25	28sd	DC10	6g	Tor
F64	XC6367F642MR	DC/DC-IC	PWM step-up, 6.4V±2.5%, 200mA, 180kHz, +CE, soft start	SOT-25	28sd	DC10	6g	Tor
F65	XC6367F652MR	DC/DC-IC	PWM step-up, 6.5V±2.5%, 200mA, 180kHz, +CE, soft start	SOT-25	28sd	DC10	6g	Tor
F6A	XC6367F603MR	DC/DC-IC	PWM step-up, 6.0V±2.5%, 200mA, 300kHz, +CE, soft start	SOT-25	28sd	DC10	6g	Tor
F6B	XC6367F613MR	DC/DC-IC	PWM step-up, 6.1V±2.5%, 200mA, 300kHz, +CE, soft start	SOT-25	28sd	DC10	6g	Tor
F6C	XC6367F623MR	DC/DC-IC	PWM step-up, 6.2V±2.5%, 200mA, 300kHz, +CE, soft start	SOT-25	28sd	DC10	6g	Tor
F6D	XC6367F633MR	DC/DC-IC	PWM step-up, 6.3V±2.5%, 200mA, 300kHz, +CE, soft start	SOT-25	28sd	DC10	6g	Tor
F6E	XC6367F643MR	DC/DC-IC	PWM step-up, 6.4V±2.5%, 200mA, 300kHz, +CE, soft start	SOT-25	28sd	DC10	6g	Tor
F6F	XC6367F653MR	DC/DC-IC	PWM step-up, 6.5V±2.5%, 200mA, 300kHz, +CE, soft start	SOT-25	28sd	DC10	6g	Tor
F7	R1111N271B	LVR-IC	LDO, LN, +CE, 2.7V±2%, 200mA	SOT-23-5	28cx	VR4	6g	Ric
F7	Si91844DT-20	LVR-IC	LDO, LN, +CE, -Error, 2V±1.5%, 150mA	SOT-23-5	28w	VR17	6k	Vs
F7	RN5VD57AA	Vdet-IC	5.7V±2.5%, -Reset PPO	SOT-23-5	28vdo	VD3	6g	Ric
F8	ELM7SH86MB	CMOS-Logic	2-input EXCLUSIVE-OR gate	SOT-25	28/Log5	-	6g	Elm
F8	ELM7SH86TB	CMOS-Logic	2-input EXCLUSIVE-OR gate	SC-88A	28/Log5	-	6g	Elm
F8	HD74HCT1G86CM	CMOS-Logic	2-input EXCLUSIVE-OR gate	CMPAK-5	28/Log5	-	6a	Ren
F8	MC78PC28N	LVR-IC	LDO, LN, +CE, 2.8V±2.5%, 100mA	SOT-23-5	28cx	VR4	6b	Ons
F8	R1111N281B	LVR-IC	LDO, LN, +CE, 2.8V±2%, 200mA	SOT-23-5	28cx	VR4	6g	Ric
F8	Si91844DT-22	LVR-IC	LDO, LN, +CE, -Error, 2.2V±1.5%, 150mA	SOT-23-5	28w	VR17	6k	Vs
F8	RN5VD58AA	Vdet-IC	5.8V±2.5%, -Reset PPO	SOT-23-5	28vdo	VD3	6g	Ric
F86	XC7SH86GV	CMOS-Logic	2-input EXCLUSIVE-OR gate	SOT753	28/Log5	-	6a	Phi
F9	ELM7SH66MB	CMOS-Logic	Bilateral analogic switch	SOT-25	28/Log16	-	6g	Elm
F9	ELM7SH66TB	CMOS-Logic	Bilateral analogic switch	SC-88A	28/Log16	-	6g	Elm
F9	HD74HCT1G66CM	CMOS-Logic	Bilateral analogic switch	CMPAK-5	28/Log16	-	6a	Ren
F9	R1111N291B	LVR-IC	LDO, LN, +CE, 2.9V±2%, 200mA	SOT-23-5	28cx	VR4	6g	Ric
F9	Si91844DT-25	LVR-IC	LDO, LN, +CE, -Error, 2.5V±1.5%, 150mA	SOT-23-5	28w	VR17	6k	Vs
F9	RN5VD59AA	Vdet-IC	5.9V±2.5%, -Reset PPO	SOT-23-5	28vdo	VD3	6g	Ric
FA	µPA505T	n/p-MOSFET-e	Dual, V-MOS, p+n-MOSFET, 50V, 100mA, <60/25Ω	SOT-23-5	28fb	-	6a	Nec
FA	74AUC1G00GW	CMOS-Logic	2-input NAND gate	SOT-353	28/Log1	-	6a	Phi
FA	ELM7SH14MB	CMOS-Logic	Inverting Schmitt-trigger	SOT-25	28/Log7	-	6g	Elm
FA	ELM7SH14TB	CMOS-Logic	Inverting Schmitt-trigger	SC-88A	28/Log7	-	6g	Elm
FA	HD74HCT1G14CM	CMOS-Logic	Inverting Schmitt-trigger	CMPAK-5	28/Log7	-	6a	Ren
FA-	XC62GR5012M	LVR-IC	5.0V±2%, 150mA, +CE	SOT-25	28ew	VR4	6g	Tor
FA-	XC62GP5012M	LVR-IC	5.0V±2%, 150mA, -CE	SOT-25	28ew	VR4	6g	Tor
FA+	XC62GR5022M	LVR-IC	5.0V±2%, 150mA, +CE, HS response	SOT-25	28ew	VR4	6g	Tor
FA+	XC62GP5022M	LVR-IC	5.0V±2%, 150mA, -CE, HS response	SOT-25	28ew	VR4	6g	Tor
FAA	RP170N121B	LVR-IC	LDO, 1.2V±1%, 300mA, +CE	SOT-23-5	28cx	VR4	6g	Ric
FAB	RP170N121B5	LVR-IC	LDO, 1.25V±1%, 300mA, +CE	SOT-23-5	28cx	VR4	6g	Ric
FAC	RP170N131B	LVR-IC	LDO, 1.3V±1%, 300mA, +CE	SOT-23-5	28cx	VR4	6g	Ric



SMD code	Type	Function	Short description	Case	Pinout	Sch.	St.	Mnf.
FAD	RP170N141B	LVR-IC	LDO, 1.4V±1%, 300mA, +CE	SOT-23-5	28cx	VR4	6g	Ric
FAE	RP170N151B	LVR-IC	LDO, 1.5V±1%, 300mA, +CE	SOT-23-5	28cx	VR4	6g	Ric
FAF	RP170N161B	LVR-IC	LDO, 1.6V±1%, 300mA, +CE	SOT-23-5	28cx	VR4	6g	Ric
FAG	RP170N171B	LVR-IC	LDO, 1.7V±1%, 300mA, +CE	SOT-23-5	28cx	VR4	6g	Ric
FAH	RP170N181B	LVR-IC	LDO, 1.8V±1%, 300mA, +CE	SOT-23-5	28cx	VR4	6g	Ric
FAJ	RP170N181B5	LVR-IC	LDO, 1.85V±1%, 300mA, +CE	SOT-23-5	28cx	VR4	6g	Ric
FAK	RP170N191B	LVR-IC	LDO, 1.9V±1%, 300mA, +CE	SOT-23-5	28cx	VR4	6g	Ric
FAL	RP170N201B	LVR-IC	LDO, 2.0V±1%, 300mA, +CE	SOT-23-5	28cx	VR4	6g	Ric
FAM	RP170N211B	LVR-IC	LDO, 2.1V±1%, 300mA, +CE	SOT-23-5	28cx	VR4	6g	Ric
FAN	PAM8101AAB	LIN-IC	AF PA, BTL, class-D, 2.5..6V, 1W(5V/8Ω)	SOT-25	28	AFP1	-	Pam
FAN	RP170N221B	LVR-IC	LDO, 2.2V±1%, 300mA, +CE	SOT-23-5	28cx	VR4	6g	Ric
FAP	RP170N231B	LVR-IC	LDO, 2.3V±1%, 300mA, +CE	SOT-23-5	28cx	VR4	6g	Ric
FAQ	RP170N241B	LVR-IC	LDO, 2.4V±1%, 300mA, +CE	SOT-23-5	28cx	VR4	6g	Ric
FAR	RP170N251B	LVR-IC	LDO, 2.5V±1%, 300mA, +CE	SOT-23-5	28cx	VR4	6g	Ric
FAS	RP170N261B	LVR-IC	LDO, 2.6V±1%, 300mA, +CE	SOT-23-5	28cx	VR4	6g	Ric
FAT	RP170N271B	LVR-IC	LDO, 2.7V±1%, 300mA, +CE	SOT-23-5	28cx	VR4	6g	Ric
FAV	RP170N281B5	LVR-IC	LDO, 2.85V±1%, 300mA, +CE	SOT-23-5	28cx	VR4	6g	Ric
FAW	RP170N291B	LVR-IC	LDO, 2.9V±1%, 300mA, +CE	SOT-23-5	28cx	VR4	6g	Ric
FAX	RP170N301B	LVR-IC	LDO, 3.0V±1%, 300mA, +CE	SOT-23-5	28cx	VR4	6g	Ric
FAY	RP170N281B	LVR-IC	LDO, 2.8V±1%, 300mA, +CE	SOT-23-5	28cx	VR4	6g	Ric
FAY	RP170N311B	LVR-IC	LDO, 3.1V±1%, 300mA, +CE	SOT-23-5	28cx	VR4	6g	Ric
FAZ	RP170N321B	LVR-IC	LDO, 3.2V±1%, 300mA, +CE	SOT-23-5	28cx	VR4	6g	Ric
IB	XC7SH02GW	CMOS-Logic	2-input NOR gate	SOT-353-1	28/Log2	-	6a	Phi
FB	74AUC1G02GW	CMOS-Logic	2-input NOR gate	SOT-353	28/Log2	-	6a	Phi
FB5	XC6367F151MR	DC/DC-IC	PWM step-up, 1.5V±2.5%, 200mA, 100kHz, +CE, soft start	SOT-25	28sd	DC10	6g	Tor
FB6	XC6367F161MR	DC/DC-IC	PWM step-up, 1.6V±2.5%, 200mA, 100kHz, +CE, soft start	SOT-25	28sd	DC10	6g	Tor
FB7	XC6367F171MR	DC/DC-IC	PWM step-up, 1.7V±2.5%, 200mA, 100kHz, +CE, soft start	SOT-25	28sd	DC10	6g	Tor
FB8	XC6367F181MR	DC/DC-IC	PWM step-up, 1.8V±2.5%, 200mA, 100kHz, +CE, soft start	SOT-25	28sd	DC10	6g	Tor
FB9	XC6367F191MR	DC/DC-IC	PWM step-up, 1.9V±2.5%, 200mA, 100kHz, +CE, soft start	SOT-25	28sd	DC10	6g	Tor
FBA	RP170N121D	LVR-IC	LDO, 1.2V±1%, 300mA, +CE, CL	SOT-23-5	28cx	VR4	6g	Ric
FBA	XC9133B02AMR	LDR-IC	PWM step-up, Adj. 2.5...17.5V/LED backlight driver	SOT-25	28sq	LD3	6g	Tor
FBB	RP170N121D5	LVR-IC	LDO, 1.25V±1%, 300mA, +CE, CL	SOT-23-5	28cx	VR4	6g	Ric
FBC	RP170N131D	LVR-IC	LDO, 1.3V±1%, 300mA, +CE, CL	SOT-23-5	28cx	VR4	6g	Ric
FBD	RP170N141D	LVR-IC	LDO, 1.4V±1%, 300mA, +CE, CL	SOT-23-5	28cx	VR4	6g	Ric
FBE	RP170N151D	LVR-IC	LDO, 1.5V±1%, 300mA, +CE, CL	SOT-23-5	28cx	VR4	6g	Ric
FBF	RP170N161D	LVR-IC	LDO, 1.6V±1%, 300mA, +CE, CL	SOT-23-5	28cx	VR4	6g	Ric
EBF	XC6367F155MR	DC/DC-IC	PWM step-up, 1.5V±2.5%, 200mA, 500kHz, +CE, soft start	SOT-25	28sd	DC10	6g	Tor
FBG	RP170N171D	LVR-IC	LDO, 1.7V±1%, 300mA, +CE, CL	SOT-23-5	28cx	VR4	6g	Ric
FBH	RP170N181D	LVR-IC	LDO, 1.8V±1%, 300mA, +CE, CL	SOT-23-5	28cx	VR4	6g	Ric
FBH	XC6367F165MR	DC/DC-IC	PWM step-up, 1.6V±2.5%, 200mA, 500kHz, +CE, soft start	SOT-25	28sd	DC10	6g	Tor
FBJ	RP170N181D5	LVR-IC	LDO, 1.85V±1%, 300mA, +CE, CL	SOT-23-5	28cx	VR4	6g	Ric
FBK	RP170N191D	LVR-IC	LDO, 1.9V±1%, 300mA, +CE, CL	SOT-23-5	28cx	VR4	6g	Ric
FBK	XC6367F175MR	DC/DC-IC	PWM step-up, 1.7V±2.5%, 200mA, 500kHz, +CE, soft start	SOT-25	28sd	DC10	6g	Tor
FBL	RP170N201D	LVR-IC	LDO, 2.0V±1%, 300mA, +CE, CL	SOT-23-5	28cx	VR4	6g	Ric
EBL	XC6367F185MR	DC/DC-IC	PWM step-up, 1.8V±2.5%, 200mA, 500kHz, +CE, soft start	SOT-25	28sd	DC10	6g	Tor
FBM	RP170N211D	LVR-IC	LDO, 2.1V±1%, 300mA, +CE, CL	SOT-23-5	28cx	VR4	6g	Ric
FBM	XC6367F195MR	DC/DC-IC	PWM step-up, 1.9V±2.5%, 200mA, 500kHz, +CE, soft start	SOT-25	28sd	DC10	6g	Tor
FBN	RP170N221D	LVR-IC	LDO, 2.2V±1%, 300mA, +CE, CL	SOT-23-5	28cx	VR4	6g	Ric
FBP	RP170N231D	LVR-IC	LDO, 2.3V±1%, 300mA, +CE, CL	SOT-23-5	28cx	VR4	6g	Ric
FBQ	RP170N241D	LVR-IC	LDO, 2.4V±1%, 300mA, +CE, CL	SOT-23-5	28cx	VR4	6g	Ric
FBR	RP170N251D	LVR-IC	LDO, 2.5V±1%, 300mA, +CE, CL	SOT-23-5	28cx	VR4	6g	Ric
FBS	RP170N261D	LVR-IC	LDO, 2.6V±1%, 300mA, +CE, CL	SOT-23-5	28cx	VR4	6g	Ric
FBT	RP170N271D	LVR-IC	LDO, 2.7V±1%, 300mA, +CE, CL	SOT-23-5	28cx	VR4	6g	Ric
FBV	RP170N281D5	LVR-IC	LDO, 2.85V±1%, 300mA, +CE, CL	SOT-23-5	28cx	VR4	6g	Ric
FBY	RP170N281D	LVR-IC	LDO, 2.8V±1%, 300mA, +CE, CL	SOT-23-5	28cx	VR4	6g	Ric
FBY	RP170N311D	LVR-IC	LDO, 3.1V±1%, 300mA, +CE, CL	SOT-23-5	28cx	VR4	6g	Ric
FBZ	RP170N321D	LVR-IC	LDO, 3.2V±1%, 300mA, +CE, CL	SOT-23-5	28cx	VR4	6g	Ric
IC	XC7SH04GW	CMOS-Logic	Inverter	SOT-353-1	28/Log6	-	6a	Phi
FC	74AUC1G04GW	CMOS-Logic	Inverter	SOT-353	28/Log6	-	6a	Phi
EC0	XC6367F201MR	DC/DC-IC	PWM step-up, 2.0V±2.5%, 200mA, 100kHz, +CE, soft start	SOT-25	28sd	DC10	6g	Tor
EC1	XC6367F211MR	DC/DC-IC	PWM step-up, 2.1V±2.5%, 200mA, 100kHz, +CE, soft start	SOT-25	28sd	DC10	6g	Tor
EC2	XC6367F221MR	DC/DC-IC	PWM step-up, 2.2V±2.5%, 200mA, 100kHz, +CE, soft start	SOT-25	28sd	DC10	6g	Tor
EC3	XC6367F231MR	DC/DC-IC	PWM step-up, 2.3V±2.5%, 200mA, 100kHz, +CE, soft start	SOT-25	28sd	DC10	6g	Tor
EC4	XC6367F241MR	DC/DC-IC	PWM step-up, 2.4V±2.5%, 200mA, 100kHz, +CE, soft start	SOT-25	28sd	DC10	6g	Tor
EC5	XC6367F251MR	DC/DC-IC	PWM step-up, 2.5V±2.5%, 200mA, 100kHz, +CE, soft start	SOT-25	28sd	DC10	6g	Tor
EC6	XC6367F261MR	DC/DC-IC	PWM step-up, 2.6V±2.5%, 200mA, 100kHz, +CE, soft start	SOT-25	28sd	DC10	6g	Tor
EC7	XC6367F271MR	DC/DC-IC	PWM step-up, 2.7V±2.5%, 200mA, 100kHz, +CE, soft start	SOT-25	28sd	DC10	6g	Tor
EC8	XC6367F281MR	DC/DC-IC	PWM step-up, 2.8V±2.5%, 200mA, 100kHz, +CE, soft start	SOT-25	28sd	DC10	6g	Tor
EC9	XC6367F291MR	DC/DC-IC	PWM step-up, 2.9V±2.5%, 200mA, 100kHz, +CE, soft start	SOT-25	28sd	DC10	6g	Tor
ECA	XC6367F205MR	DC/DC-IC	PWM step-up, 2.0V±2.5%, 200mA, 500kHz, +CE, soft start	SOT-25	28sd	DC10	6g	Tor



SMD code	Type	Function	Short description	Case	Pinout	Sch.	St.	Mnf.
FCB	XC6367F215MR	DC/DC-IC	PWM step-up, 2.1V±2.5%, 200mA, 500kHz, +CE, soft start	SOT-25	28sd	DC10	6g	Tor
FCC	XC6367F225MR	DC/DC-IC	PWM step-up, 2.2V±2.5%, 200mA, 500kHz, +CE, soft start	SOT-25	28sd	DC10	6g	Tor
FCD	XC6367F235MR	DC/DC-IC	PWM step-up, 2.3V±2.5%, 200mA, 500kHz, +CE, soft start	SOT-25	28sd	DC10	6g	Tor
FCE	XC6367F245MR	DC/DC-IC	PWM step-up, 2.4V±2.5%, 200mA, 500kHz, +CE, soft start	SOT-25	28sd	DC10	6g	Tor
FCF	XC6367F255MR	DC/DC-IC	PWM step-up, 2.5V±2.5%, 200mA, 500kHz, +CE, soft start	SOT-25	28sd	DC10	6g	Tor
FCH	XC6367F265MR	DC/DC-IC	PWM step-up, 2.6V±2.5%, 200mA, 500kHz, +CE, soft start	SOT-25	28sd	DC10	6g	Tor
FCK	XC6367F275MR	DC/DC-IC	PWM step-up, 2.7V±2.5%, 200mA, 500kHz, +CE, soft start	SOT-25	28sd	DC10	6g	Tor
FCL	XC6367F285MR	DC/DC-IC	PWM step-up, 2.8V±2.5%, 200mA, 500kHz, +CE, soft start	SOT-25	28sd	DC10	6g	Tor
FCM	XC6367F295MR	DC/DC-IC	PWM step-up, 2.9V±2.5%, 200mA, 500kHz, +CE, soft start	SOT-25	28sd	DC10	6g	Tor
ID	XC7SHU04GW	CMOS-Logic	Inverter	SOT-353-1	28/Log6	-	6a	Phi
FD	BD4923FVE	Vdet-IC	2.3V, +Reset PPO	VSOF-5	30vdm	VD7	6c	Rhm
FD	BD4923G	Vdet-IC	2.3V, +Reset PPO	SSOP-5	28vdm	VD7	6c	Rhm
FD0	XC6367F301MR	DC/DC-IC	PWM step-up, 3.0V±2.5%, 200mA, 100kHz, +CE, soft start	SOT-25	28sd	DC10	6g	Tor
FD1	XC6367F311MR	DC/DC-IC	PWM step-up, 3.1V±2.5%, 200mA, 100kHz, +CE, soft start	SOT-25	28sd	DC10	6g	Tor
FD11G	AIC1747-11GK5	LVR-IC	LDO, 1.1V±2%, 300mA, +CE	TSOT-23-5	28vrx	VR7	6a	Aic
FD11P	AIC1747-11PK5	LVR-IC	LDO, 1.1V±2%, 300mA, +CE	TSOT-23-5	28vrx	VR7	6a	Aic
FD12G	AIC1747-12GK5	LVR-IC	LDO, 1.2V±2%, 300mA, +CE	TSOT-23-5	28vrx	VR7	6a	Aic
FD12P	AIC1747-12PK5	LVR-IC	LDO, 1.2V±2%, 300mA, +CE	TSOT-23-5	28vrx	VR7	6a	Aic
FD13G	AIC1747-13GK5	LVR-IC	LDO, 1.3V±2%, 300mA, +CE	TSOT-23-5	28vrx	VR7	6a	Aic
FD13P	AIC1747-13PK5	LVR-IC	LDO, 1.3V±2%, 300mA, +CE	TSOT-23-5	28vrx	VR7	6a	Aic
FD15G	AIC1747-15GK5	LVR-IC	LDO, 1.5V±2%, 300mA, +CE	TSOT-23-5	28vrx	VR7	6a	Aic
FD15P	AIC1747-15PK5	LVR-IC	LDO, 1.5V±2%, 300mA, +CE	TSOT-23-5	28vrx	VR7	6a	Aic
FD18G	AIC1747-18GK5	LVR-IC	LDO, 1.8V±2%, 300mA, +CE	TSOT-23-5	28vrx	VR7	6a	Aic
FD18P	AIC1747-18PK5	LVR-IC	LDO, 1.8V±2%, 300mA, +CE	TSOT-23-5	28vrx	VR7	6a	Aic
FD2	XC6367F321MR	DC/DC-IC	PWM step-up, 3.2V±2.5%, 200mA, 100kHz, +CE, soft start	SOT-25	28sd	DC10	6g	Tor
FD20G	AIC1747-20GK5	LVR-IC	LDO, 2.0V±2%, 300mA, +CE	TSOT-23-5	28vrx	VR7	6a	Aic
FD20P	AIC1747-20PK5	LVR-IC	LDO, 2.0V±2%, 300mA, +CE	TSOT-23-5	28vrx	VR7	6a	Aic
FD25G	AIC1747-25GK5	LVR-IC	LDO, 2.5V±2%, 300mA, +CE	TSOT-23-5	28vrx	VR7	6a	Aic
FD25P	AIC1747-25PK5	LVR-IC	LDO, 2.5V±2%, 300mA, +CE	TSOT-23-5	28vrx	VR7	6a	Aic
FD27G	AIC1747-27GK5	LVR-IC	LDO, 2.7V±2%, 300mA, +CE	TSOT-23-5	28vrx	VR7	6a	Aic
FD27P	AIC1747-27PK5	LVR-IC	LDO, 2.7V±2%, 300mA, +CE	TSOT-23-5	28vrx	VR7	6a	Aic
FD2JG	AIC1747-285GK5	LVR-IC	LDO, 2.85V±2%, 300mA, +CE	TSOT-23-5	28vrx	VR7	6a	Aic
FD2JP	AIC1747-285PK5	LVR-IC	LDO, 2.85V±2%, 300mA, +CE	TSOT-23-5	28vrx	VR7	6a	Aic
FD3	XC6367F331MR	DC/DC-IC	PWM step-up, 3.3V±2.5%, 200mA, 100kHz, +CE, soft start	SOT-25	28sd	DC10	6g	Tor
FD30G	AIC1747-30GK5	LVR-IC	LDO, 3.0V±2%, 300mA, +CE	TSOT-23-5	28vrx	VR7	6a	Aic
FD30P	AIC1747-30PK5	LVR-IC	LDO, 3.0V±2%, 300mA, +CE	TSOT-23-5	28vrx	VR7	6a	Aic
FD33G	AIC1747-33GK5	LVR-IC	LDO, 3.3V±2%, 300mA, +CE	TSOT-23-5	28vrx	VR7	6a	Aic
FD33P	AIC1747-33PK5	LVR-IC	LDO, 3.3V±2%, 300mA, +CE	TSOT-23-5	28vrx	VR7	6a	Aic
FD35G	AIC1747-35GK5	LVR-IC	LDO, 3.5V±2%, 300mA, +CE	TSOT-23-5	28vrx	VR7	6a	Aic
FD35P	AIC1747-35PK5	LVR-IC	LDO, 3.5V±2%, 300mA, +CE	TSOT-23-5	28vrx	VR7	6a	Aic
FD37G	AIC1747-37GK5	LVR-IC	LDO, 3.7V±2%, 300mA, +CE	TSOT-23-5	28vrx	VR7	6a	Aic
FD37P	AIC1747-37PK5	LVR-IC	LDO, 3.7V±2%, 300mA, +CE	TSOT-23-5	28vrx	VR7	6a	Aic
FD38G	AIC1747-38GK5	LVR-IC	LDO, 3.8V±2%, 300mA, +CE	TSOT-23-5	28vrx	VR7	6a	Aic
FD38P	AIC1747-38PK5	LVR-IC	LDO, 3.8V±2%, 300mA, +CE	TSOT-23-5	28vrx	VR7	6a	Aic
FD4	XC6367F341MR	DC/DC-IC	PWM step-up, 3.4V±2.5%, 200mA, 100kHz, +CE, soft start	SOT-25	28sd	DC10	6g	Tor
FD5	XC6367F351MR	DC/DC-IC	PWM step-up, 3.5V±2.5%, 200mA, 100kHz, +CE, soft start	SOT-25	28sd	DC10	6g	Tor
FD6	XC6367F361MR	DC/DC-IC	PWM step-up, 3.6V±2.5%, 200mA, 100kHz, +CE, soft start	SOT-25	28sd	DC10	6g	Tor
FD7	XC6367F371MR	DC/DC-IC	PWM step-up, 3.7V±2.5%, 200mA, 100kHz, +CE, soft start	SOT-25	28sd	DC10	6g	Tor
FD8	XC6367F381MR	DC/DC-IC	PWM step-up, 3.8V±2.5%, 200mA, 100kHz, +CE, soft start	SOT-25	28sd	DC10	6g	Tor
FD9	XC6367F391MR	DC/DC-IC	PWM step-up, 3.9V±2.5%, 200mA, 100kHz, +CE, soft start	SOT-25	28sd	DC10	6g	Tor
FD9A	XC6367F305MR	DC/DC-IC	PWM step-up, 3.0V±2.5%, 200mA, 500kHz, +CE, soft start	SOT-25	28sd	DC10	6g	Tor
FDB	XC6367F315MR	DC/DC-IC	PWM step-up, 3.1V±2.5%, 200mA, 500kHz, +CE, soft start	SOT-25	28sd	DC10	6g	Tor
FDC	XC6367F325MR	DC/DC-IC	PWM step-up, 3.2V±2.5%, 200mA, 500kHz, +CE, soft start	SOT-25	28sd	DC10	6g	Tor
FDD	XC6367F335MR	DC/DC-IC	PWM step-up, 3.3V±2.5%, 200mA, 500kHz, +CE, soft start	SOT-25	28sd	DC10	6g	Tor
FDE	XC6367F345MR	DC/DC-IC	PWM step-up, 3.4V±2.5%, 200mA, 500kHz, +CE, soft start	SOT-25	28sd	DC10	6g	Tor
FD	XC6367F355MR	DC/DC-IC	PWM step-up, 3.5V±2.5%, 200mA, 500kHz, +CE, soft start	SOT-25	28sd	DC10	6g	Tor
FDH	XC6367F365MR	DC/DC-IC	PWM step-up, 3.6V±2.5%, 200mA, 500kHz, +CE, soft start	SOT-25	28sd	DC10	6g	Tor
FDK	XC6367F375MR	DC/DC-IC	PWM step-up, 3.7V±2.5%, 200mA, 500kHz, +CE, soft start	SOT-25	28sd	DC10	6g	Tor
FDL	XC6367F385MR	DC/DC-IC	PWM step-up, 3.8V±2.5%, 200mA, 500kHz, +CE, soft start	SOT-25	28sd	DC10	6g	Tor
FDM	XC6367F395MR	DC/DC-IC	PWM step-up, 3.9V±2.5%, 200mA, 500kHz, +CE, soft start	SOT-25	28sd	DC10	6g	Tor
IE	XC7SH08GW	CMOS-Logic	2-input AND gate	SOT-353-1	28/Log3	-	6a	Phi
FE	74AUC1G08GW	CMOS-Logic	2-input AND gate	SOT-353	28/Log3	-	6a	Phi
FE	BD4924FVE	Vdet-IC	2.4V, +Reset PPO	VSOF-5	30vdm	VD7	6c	Rhm
FE	BD4924G	Vdet-IC	2.4V, +Reset PPO	SSOP-5	28vdm	VD7	6c	Rhm
FE0	XC6367F401MR	DC/DC-IC	PWM step-up, 4.0V±2.5%, 200mA, 100kHz, +CE, soft start	SOT-25	28sd	DC10	6g	Tor
FE1	XC6367F411MR	DC/DC-IC	PWM step-up, 4.1V±2.5%, 200mA, 100kHz, +CE, soft start	SOT-25	28sd	DC10	6g	Tor
FE2	XC6367F421MR	DC/DC-IC	PWM step-up, 4.2V±2.5%, 200mA, 100kHz, +CE, soft start	SOT-25	28sd	DC10	6g	Tor
FE3	XC6367F431MR	DC/DC-IC	PWM step-up, 4.3V±2.5%, 200mA, 100kHz, +CE, soft start	SOT-25	28sd	DC10	6g	Tor
FE4	XC6367F441MR	DC/DC-IC	PWM step-up, 4.4V±2.5%, 200mA, 100kHz, +CE, soft start	SOT-25	28sd	DC10	6g	Tor
FE5	XC6367F451MR	DC/DC-IC	PWM step-up, 4.5V±2.5%, 200mA, 100kHz, +CE, soft start	SOT-25	28sd	DC10	6g	Tor



SMD code	Type	Function	Short description	Case	Pinout	Sch.	St.	Mnf.
FE6	XC6367F461MR	DC/DC-IC	PWM step-up, 4.6V±2.5%, 200mA, 100kHz, +CE, soft start	SOT-25	28sd	DC10	6g	Tor
FE7	XC6367F471MR	DC/DC-IC	PWM step-up, 4.7V±2.5%, 200mA, 100kHz, +CE, soft start	SOT-25	28sd	DC10	6g	Tor
FE8	XC6367F481MR	DC/DC-IC	PWM step-up, 4.8V±2.5%, 200mA, 100kHz, +CE, soft start	SOT-25	28sd	DC10	6g	Tor
FE9	XC6367F491MR	DC/DC-IC	PWM step-up, 4.9V±2.5%, 200mA, 100kHz, +CE, soft start	SOT-25	28sd	DC10	6g	Tor
FEA	XC6367F405MR	DC/DC-IC	PWM step-up, 4.0V±2.5%, 200mA, 500kHz, +CE, soft start	SOT-25	28sd	DC10	6g	Tor
FEB	XC6367F415MR	DC/DC-IC	PWM step-up, 4.1V±2.5%, 200mA, 500kHz, +CE, soft start	SOT-25	28sd	DC10	6g	Tor
FEC	XC6367F425MR	DC/DC-IC	PWM step-up, 4.2V±2.5%, 200mA, 500kHz, +CE, soft start	SOT-25	28sd	DC10	6g	Tor
FED	XC6367F435MR	DC/DC-IC	PWM step-up, 4.3V±2.5%, 200mA, 500kHz, +CE, soft start	SOT-25	28sd	DC10	6g	Tor
FEF	XC6367F445MR	DC/DC-IC	PWM step-up, 4.4V±2.5%, 200mA, 500kHz, +CE, soft start	SOT-25	28sd	DC10	6g	Tor
FEF	XC6367F455MR	DC/DC-IC	PWM step-up, 4.5V±2.5%, 200mA, 500kHz, +CE, soft start	SOT-25	28sd	DC10	6g	Tor
FEH	XC6367F465MR	DC/DC-IC	PWM step-up, 4.6V±2.5%, 200mA, 500kHz, +CE, soft start	SOT-25	28sd	DC10	6g	Tor
FEK	XC6367F475MR	DC/DC-IC	PWM step-up, 4.7V±2.5%, 200mA, 500kHz, +CE, soft start	SOT-25	28sd	DC10	6g	Tor
EEL	XC6367F485MR	DC/DC-IC	PWM step-up, 4.8V±2.5%, 200mA, 500kHz, +CE, soft start	SOT-25	28sd	DC10	6g	Tor
FEM	XC6367F495MR	DC/DC-IC	PWM step-up, 4.9V±2.5%, 200mA, 500kHz, +CE, soft start	SOT-25	28sd	DC10	6g	Tor
IF	XC7SH14GW	CMOS-Logic	Inverting Schmitt-trigger	SOT-353-1	28/Log7	-	6a	Phi
FF	BD4925FVE	Vdet-IC	2.5V, +Reset PPO	VSOFF-5	30vdv	VD7	6c	Rhm
FF	BD4925G	Vdet-IC	2.5V, +Reset PPO	SSOP-5	28vdm	VD7	6c	Rhm
FF0	XC6367F501MR	DC/DC-IC	PWM step-up, 5.0V±2.5%, 200mA, 100kHz, +CE, soft start	SOT-25	28sd	DC10	6g	Tor
FF1	XC6367F511MR	DC/DC-IC	PWM step-up, 5.1V±2.5%, 200mA, 100kHz, +CE, soft start	SOT-25	28sd	DC10	6g	Tor
FF11G	AIC1747-11GV5	LVR-IC	LDO, 1.1V±2%, 300mA, +CE	SOT-23-5	28vrx	VR7	6a	Aic
FF11P	AIC1747-11PV5	LVR-IC	LDO, 1.1V±2%, 300mA, +CE	SOT-23-5	28vrx	VR7	6a	Aic
FF12G	AIC1747-12GV5	LVR-IC	LDO, 1.2V±2%, 300mA, +CE	SOT-23-5	28vrx	VR7	6a	Aic
FF12P	AIC1747-12PV5	LVR-IC	LDO, 1.2V±2%, 300mA, +CE	SOT-23-5	28vrx	VR7	6a	Aic
FF13G	AIC1747-13GV5	LVR-IC	LDO, 1.3V±2%, 300mA, +CE	SOT-23-5	28vrx	VR7	6a	Aic
FF13P	AIC1747-13PV5	LVR-IC	LDO, 1.3V±2%, 300mA, +CE	SOT-23-5	28vrx	VR7	6a	Aic
FF15G	AIC1747-15GV5	LVR-IC	LDO, 1.5V±2%, 300mA, +CE	SOT-23-5	28vrx	VR7	6a	Aic
FF15P	AIC1747-15PV5	LVR-IC	LDO, 1.5V±2%, 300mA, +CE	SOT-23-5	28vrx	VR7	6a	Aic
FF18G	AIC1747-18GV5	LVR-IC	LDO, 1.8V±2%, 300mA, +CE	SOT-23-5	28vrx	VR7	6a	Aic
FF18P	AIC1747-18PV5	LVR-IC	LDO, 1.8V±2%, 300mA, +CE	SOT-23-5	28vrx	VR7	6a	Aic
FF2	XC6367F521MR	DC/DC-IC	PWM step-up, 5.2V±2.5%, 200mA, 100kHz, +CE, soft start	SOT-25	28sd	DC10	6g	Tor
FF20G	AIC1747-20GV5	LVR-IC	LDO, 2.0V±2%, 300mA, +CE	SOT-23-5	28vrx	VR7	6a	Aic
FF20P	AIC1747-20PV5	LVR-IC	LDO, 2.0V±2%, 300mA, +CE	SOT-23-5	28vrx	VR7	6a	Aic
FF25G	AIC1747-25GV5	LVR-IC	LDO, 2.5V±2%, 300mA, +CE	SOT-23-5	28vrx	VR7	6a	Aic
FF25P	AIC1747-25PV5	LVR-IC	LDO, 2.5V±2%, 300mA, +CE	SOT-23-5	28vrx	VR7	6a	Aic
FF27G	AIC1747-27GV5	LVR-IC	LDO, 2.7V±2%, 300mA, +CE	SOT-23-5	28vrx	VR7	6a	Aic
FF27P	AIC1747-27PV5	LVR-IC	LDO, 2.7V±2%, 300mA, +CE	SOT-23-5	28vrx	VR7	6a	Aic
FF2JG	AIC1747-285GV5	LVR-IC	LDO, 2.85V±2%, 300mA, +CE	SOT-23-5	28vrx	VR7	6a	Aic
FF2JP	AIC1747-285PV5	LVR-IC	LDO, 2.85V±2%, 300mA, +CE	SOT-23-5	28vrx	VR7	6a	Aic
FF3	XC6367F531MR	DC/DC-IC	PWM step-up, 5.3V±2.5%, 200mA, 100kHz, +CE, soft start	SOT-25	28sd	DC10	6g	Tor
FF30G	AIC1747-30GV5	LVR-IC	LDO, 3.0V±2%, 300mA, +CE	SOT-23-5	28vrx	VR7	6a	Aic
FF30P	AIC1747-30PV5	LVR-IC	LDO, 3.0V±2%, 300mA, +CE	SOT-23-5	28vrx	VR7	6a	Aic
FF33G	AIC1747-33GV5	LVR-IC	LDO, 3.3V±2%, 300mA, +CE	SOT-23-5	28vrx	VR7	6a	Aic
FF33P	AIC1747-33PV5	LVR-IC	LDO, 3.3V±2%, 300mA, +CE	SOT-23-5	28vrx	VR7	6a	Aic
FF35G	AIC1747-35GV5	LVR-IC	LDO, 3.5V±2%, 300mA, +CE	SOT-23-5	28vrx	VR7	6a	Aic
FF35P	AIC1747-35PV5	LVR-IC	LDO, 3.5V±2%, 300mA, +CE	SOT-23-5	28vrx	VR7	6a	Aic
FF37G	AIC1747-37GV5	LVR-IC	LDO, 3.7V±2%, 300mA, +CE	SOT-23-5	28vrx	VR7	6a	Aic
FF37P	AIC1747-37PV5	LVR-IC	LDO, 3.7V±2%, 300mA, +CE	SOT-23-5	28vrx	VR7	6a	Aic
FF38G	AIC1747-38GV5	LVR-IC	LDO, 3.8V±2%, 300mA, +CE	SOT-23-5	28vrx	VR7	6a	Aic
FF38P	AIC1747-38PV5	LVR-IC	LDO, 3.8V±2%, 300mA, +CE	SOT-23-5	28vrx	VR7	6a	Aic
FF4	XC6367F541MR	DC/DC-IC	PWM step-up, 5.4V±2.5%, 200mA, 100kHz, +CE, soft start	SOT-25	28sd	DC10	6g	Tor
FF5	XC6367F551MR	DC/DC-IC	PWM step-up, 5.5V±2.5%, 200mA, 100kHz, +CE, soft start	SOT-25	28sd	DC10	6g	Tor
FF6	XC6367F561MR	DC/DC-IC	PWM step-up, 5.6V±2.5%, 200mA, 100kHz, +CE, soft start	SOT-25	28sd	DC10	6g	Tor
FF7	XC6367F571MR	DC/DC-IC	PWM step-up, 5.7V±2.5%, 200mA, 100kHz, +CE, soft start	SOT-25	28sd	DC10	6g	Tor
FF8	XC6367F581MR	DC/DC-IC	PWM step-up, 5.8V±2.5%, 200mA, 100kHz, +CE, soft start	SOT-25	28sd	DC10	6g	Tor
FF9	XC6367F591MR	DC/DC-IC	PWM step-up, 5.9V±2.5%, 200mA, 100kHz, +CE, soft start	SOT-25	28sd	DC10	6g	Tor
FFA	XC6367F505MR	DC/DC-IC	PWM step-up, 5.0V±2.5%, 200mA, 500kHz, +CE, soft start	SOT-25	28sd	DC10	6g	Tor
FFB	XC6367F515MR	DC/DC-IC	PWM step-up, 5.1V±2.5%, 200mA, 500kHz, +CE, soft start	SOT-25	28sd	DC10	6g	Tor
FFC	XC6367F525MR	DC/DC-IC	PWM step-up, 5.2V±2.5%, 200mA, 500kHz, +CE, soft start	SOT-25	28sd	DC10	6g	Tor
FFD	XC6367F535MR	DC/DC-IC	PWM step-up, 5.3V±2.5%, 200mA, 500kHz, +CE, soft start	SOT-25	28sd	DC10	6g	Tor
FFE	XC6367F545MR	DC/DC-IC	PWM step-up, 5.4V±2.5%, 200mA, 500kHz, +CE, soft start	SOT-25	28sd	DC10	6g	Tor
FFF	XC6367F555MR	DC/DC-IC	PWM step-up, 5.5V±2.5%, 200mA, 500kHz, +CE, soft start	SOT-25	28sd	DC10	6g	Tor
FFH	XC6367F565MR	DC/DC-IC	PWM step-up, 5.6V±2.5%, 200mA, 500kHz, +CE, soft start	SOT-25	28sd	DC10	6g	Tor
FFK	XC6367F575MR	DC/DC-IC	PWM step-up, 5.7V±2.5%, 200mA, 500kHz, +CE, soft start	SOT-25	28sd	DC10	6g	Tor
FFL	XC6367F585MR	DC/DC-IC	PWM step-up, 5.8V±2.5%, 200mA, 500kHz, +CE, soft start	SOT-25	28sd	DC10	6g	Tor
FFM	XC6367F595MR	DC/DC-IC	PWM step-up, 5.9V±2.5%, 200mA, 500kHz, +CE, soft start	SOT-25	28sd	DC10	6g	Tor
IG	XC7SH32GW	CMOS-Logic	2-input OR gate	SOT-353-1	28/Log4	-	6a	Phi
FG	74AUC1G32GW	CMOS-Logic	2-input OR gate	SOT-353	28/Log4	-	6a	Phi
FG	BD4926FVE	Vdet-IC	2.6V, +Reset PPO	VSOFF-5	30vdv	VD7	6c	Rhm
FG	BD4926G	Vdet-IC	2.6V, +Reset PPO	SSOP-5	28vdm	VD7	6c	Rhm
IH	XC7SH86GW	CMOS-Logic	2-input EXCLUSIVE-OR gate	SOT-353-1	28/Log5	-	6a	Phi



SMD code	Type	Function	Short description	Case	Pinout	Sch.	St.	Mnf.
FH	BD4927FVE	Vdet-IC	2.7V, +Reset PPO	VSOFF-5	30vdu	VD7	6c	Rhm
FH	BD4927G	Vdet-IC	2.7V, +Reset PPO	SSOP-5	28vdm	VD7	6c	Rhm
FH0	XC6367F601MR	DC/DC-IC	PWM step-up, 6.0V±2.5%, 200mA, 100kHz, +CE, soft start	SOT-25	28sd	DC10	6g	Tor
FH1	XC6367F611MR	DC/DC-IC	PWM step-up, 6.1V±2.5%, 200mA, 100kHz, +CE, soft start	SOT-25	28sd	DC10	6g	Tor
FH2	XC6367F621MR	DC/DC-IC	PWM step-up, 6.2V±2.5%, 200mA, 100kHz, +CE, soft start	SOT-25	28sd	DC10	6g	Tor
FH3	XC6367F631MR	DC/DC-IC	PWM step-up, 6.3V±2.5%, 200mA, 100kHz, +CE, soft start	SOT-25	28sd	DC10	6g	Tor
FH4	XC6367F641MR	DC/DC-IC	PWM step-up, 6.4V±2.5%, 200mA, 100kHz, +CE, soft start	SOT-25	28sd	DC10	6g	Tor
FH5	XC6367F651MR	DC/DC-IC	PWM step-up, 6.5V±2.5%, 200mA, 100kHz, +CE, soft start	SOT-25	28sd	DC10	6g	Tor
FHA	XC6367F605MR	DC/DC-IC	PWM step-up, 6.0V±2.5%, 200mA, 500kHz, +CE, soft start	SOT-25	28sd	DC10	6g	Tor
FHB	XC6367F615MR	DC/DC-IC	PWM step-up, 6.1V±2.5%, 200mA, 500kHz, +CE, soft start	SOT-25	28sd	DC10	6g	Tor
FHC	XC6367F625MR	DC/DC-IC	PWM step-up, 6.2V±2.5%, 200mA, 500kHz, +CE, soft start	SOT-25	28sd	DC10	6g	Tor
FHD	XC6367F635MR	DC/DC-IC	PWM step-up, 6.3V±2.5%, 200mA, 500kHz, +CE, soft start	SOT-25	28sd	DC10	6g	Tor
FHE	XC6367F645MR	DC/DC-IC	PWM step-up, 6.4V±2.5%, 200mA, 500kHz, +CE, soft start	SOT-25	28sd	DC10	6g	Tor
FHF	XC6367F655MR	DC/DC-IC	PWM step-up, 6.5V±2.5%, 200mA, 500kHz, +CE, soft start	SOT-25	28sd	DC10	6g	Tor
FJ	BD4928FVE	Vdet-IC	2.8V, +Reset PPO	VSOFF-5	30vdu	VD7	6c	Rhm
FJ	BD4928G	Vdet-IC	2.8V, +Reset PPO	SSOP-5	28vdm	VD7	6c	Rhm
FK	BD4929FVE	Vdet-IC	2.9V, +Reset PPO	VSOFF-5	30vdu	VD7	6c	Rhm
FK	BD4929G	Vdet-IC	2.9V, +Reset PPO	SSOP-5	28vdm	VD7	6c	Rhm
FL	BD4930FVE	Vdet-IC	3V, +Reset PPO	VSOFF-5	30vdu	VD7	6c	Rhm
FL	BD4930G	Vdet-IC	3V, +Reset PPO	SSOP-5	28vdm	VD7	6c	Rhm
FL	R1112N201B	LVR-IC	LDO, LN, +CE, 2V±2%, 150mA	SOT-23-5	28cx	VR4	6g	Ric
FM	XC7SH125GW	CMOS-Logic	Bus buffer gate with 3-state output	SOT-353-1	28/Log14	-	6a	Phi
FM	BD4931FVE	Vdet-IC	3.1V, +Reset PPO	VSOFF-5	30vdu	VD7	6c	Rhm
FM	BD4931G	Vdet-IC	3.1V, +Reset PPO	SSOP-5	28vdm	VD7	6c	Rhm
FM	R1112N211B	LVR-IC	LDO, LN, +CE, 2.1V±2%, 150mA	SOT-23-5	28cx	VR4	6g	Ric
FM11G	AIC1746-11GK5	LVR-IC	LDO, 1.1V±2%, 150mA, +CE	TSOT-23-5	28vrx	VR7	6a	Aic
FM11P	AIC1746-11PK5	LVR-IC	LDO, 1.1V±2%, 150mA, +CE	TSOT-23-5	28vrx	VR7	6a	Aic
FM12G	AIC1746-12GK5	LVR-IC	LDO, 1.2V±2%, 150mA, +CE	TSOT-23-5	28vrx	VR7	6a	Aic
FM12P	AIC1746-12PK5	LVR-IC	LDO, 1.2V±2%, 150mA, +CE	TSOT-23-5	28vrx	VR7	6a	Aic
FM13G	AIC1746-13GK5	LVR-IC	LDO, 1.3V±2%, 150mA, +CE	TSOT-23-5	28vrx	VR7	6a	Aic
FM13P	AIC1746-13PK5	LVR-IC	LDO, 1.3V±2%, 150mA, +CE	TSOT-23-5	28vrx	VR7	6a	Aic
FM15G	AIC1746-15GK5	LVR-IC	LDO, 1.5V±2%, 150mA, +CE	TSOT-23-5	28vrx	VR7	6a	Aic
FM15P	AIC1746-15PK5	LVR-IC	LDO, 1.5V±2%, 150mA, +CE	TSOT-23-5	28vrx	VR7	6a	Aic
FM18G	AIC1746-18GK5	LVR-IC	LDO, 1.8V±2%, 150mA, +CE	TSOT-23-5	28vrx	VR7	6a	Aic
FM18P	AIC1746-18PK5	LVR-IC	LDO, 1.8V±2%, 150mA, +CE	TSOT-23-5	28vrx	VR7	6a	Aic
FM20G	AIC1746-20GK5	LVR-IC	LDO, 2.0V±2%, 150mA, +CE	TSOT-23-5	28vrx	VR7	6a	Aic
FM20P	AIC1746-20PK5	LVR-IC	LDO, 2.0V±2%, 150mA, +CE	TSOT-23-5	28vrx	VR7	6a	Aic
FM25G	AIC1746-25GK5	LVR-IC	LDO, 2.5V±2%, 150mA, +CE	TSOT-23-5	28vrx	VR7	6a	Aic
FM25P	AIC1746-25PK5	LVR-IC	LDO, 2.5V±2%, 150mA, +CE	TSOT-23-5	28vrx	VR7	6a	Aic
FM27G	AIC1746-27GK5	LVR-IC	LDO, 2.7V±2%, 150mA, +CE	TSOT-23-5	28vrx	VR7	6a	Aic
FM27P	AIC1746-27PK5	LVR-IC	LDO, 2.7V±2%, 150mA, +CE	TSOT-23-5	28vrx	VR7	6a	Aic
FM2JG	AIC1746-285GK5	LVR-IC	LDO, 2.85V±2%, 150mA, +CE	TSOT-23-5	28vrx	VR7	6a	Aic
FM2JP	AIC1746-285PK5	LVR-IC	LDO, 2.85V±2%, 150mA, +CE	TSOT-23-5	28vrx	VR7	6a	Aic
FM30G	AIC1746-30GK5	LVR-IC	LDO, 3.0V±2%, 150mA, +CE	TSOT-23-5	28vrx	VR7	6a	Aic
FM30P	AIC1746-30PK5	LVR-IC	LDO, 3.0V±2%, 150mA, +CE	TSOT-23-5	28vrx	VR7	6a	Aic
FM33G	AIC1746-33GK5	LVR-IC	LDO, 3.3V±2%, 150mA, +CE	TSOT-23-5	28vrx	VR7	6a	Aic
FM33P	AIC1746-33PK5	LVR-IC	LDO, 3.3V±2%, 150mA, +CE	TSOT-23-5	28vrx	VR7	6a	Aic
FM35G	AIC1746-35GK5	LVR-IC	LDO, 3.5V±2%, 150mA, +CE	TSOT-23-5	28vrx	VR7	6a	Aic
FM35P	AIC1746-35PK5	LVR-IC	LDO, 3.5V±2%, 150mA, +CE	TSOT-23-5	28vrx	VR7	6a	Aic
FM37G	AIC1746-37GK5	LVR-IC	LDO, 3.7V±2%, 150mA, +CE	TSOT-23-5	28vrx	VR7	6a	Aic
FM37P	AIC1746-37PK5	LVR-IC	LDO, 3.7V±2%, 150mA, +CE	TSOT-23-5	28vrx	VR7	6a	Aic
FM38G	AIC1746-38GK5	LVR-IC	LDO, 3.8V±2%, 150mA, +CE	TSOT-23-5	28vrx	VR7	6a	Aic
FM38P	AIC1746-38PK5	LVR-IC	LDO, 3.8V±2%, 150mA, +CE	TSOT-23-5	28vrx	VR7	6a	Aic
FN	BD4932FVE	Vdet-IC	3.2V, +Reset PPO	VSOFF-5	30vdu	VD7	6c	Rhm
FN	BD4932G	Vdet-IC	3.2V, +Reset PPO	SSOP-5	28vdm	VD7	6c	Rhm
FN	R1112N221B	LVR-IC	LDO, LN, +CE, 2.2V±2%, 150mA	SOT-23-5	28cx	VR4	6g	Ric
FO11G	AIC1746-11GV5	LVR-IC	LDO, 1.1V±2%, 150mA, +CE	SOT-23-5	28vrx	VR7	6a	Aic
FO11P	AIC1746-11PV5	LVR-IC	LDO, 1.1V±2%, 150mA, +CE	SOT-23-5	28vrx	VR7	6a	Aic
FO12G	AIC1746-12GV5	LVR-IC	LDO, 1.2V±2%, 150mA, +CE	SOT-23-5	28vrx	VR7	6a	Aic
FO12P	AIC1746-12PV5	LVR-IC	LDO, 1.2V±2%, 150mA, +CE	SOT-23-5	28vrx	VR7	6a	Aic
FO13G	AIC1746-13GV5	LVR-IC	LDO, 1.3V±2%, 150mA, +CE	SOT-23-5	28vrx	VR7	6a	Aic
FO13P	AIC1746-13PV5	LVR-IC	LDO, 1.3V±2%, 150mA, +CE	SOT-23-5	28vrx	VR7	6a	Aic
FO15G	AIC1746-15GV5	LVR-IC	LDO, 1.5V±2%, 150mA, +CE	SOT-23-5	28vrx	VR7	6a	Aic
FO15P	AIC1746-15PV5	LVR-IC	LDO, 1.5V±2%, 150mA, +CE	SOT-23-5	28vrx	VR7	6a	Aic
FO18G	AIC1746-18GV5	LVR-IC	LDO, 1.8V±2%, 150mA, +CE	SOT-23-5	28vrx	VR7	6a	Aic
FO18P	AIC1746-18PV5	LVR-IC	LDO, 1.8V±2%, 150mA, +CE	SOT-23-5	28vrx	VR7	6a	Aic
FO20G	AIC1746-20GV5	LVR-IC	LDO, 2.0V±2%, 150mA, +CE	SOT-23-5	28vrx	VR7	6a	Aic
FO20P	AIC1746-20PV5	LVR-IC	LDO, 2.0V±2%, 150mA, +CE	SOT-23-5	28vrx	VR7	6a	Aic
FO25G	AIC1746-25GV5	LVR-IC	LDO, 2.5V±2%, 150mA, +CE	SOT-23-5	28vrx	VR7	6a	Aic
FO25P	AIC1746-25PV5	LVR-IC	LDO, 2.5V±2%, 150mA, +CE	SOT-23-5	28vrx	VR7	6a	Aic



SMD code	Type	Function	Short description	Case	Pinout	Sch.	St.	Mnf.
F027G	AIC1746-27GV5	LVR-IC	LDO, 2.7V±2%, 150mA, +CE	SOT-23-5	28vrx	VR7	6a	Aic
F027P	AIC1746-27PV5	LVR-IC	LDO, 2.7V±2%, 150mA, +CE	SOT-23-5	28vrx	VR7	6a	Aic
F02JG	AIC1746-285GV5	LVR-IC	LDO, 2.85V±2%, 150mA, +CE	SOT-23-5	28vrx	VR7	6a	Aic
F02JP	AIC1746-285PV5	LVR-IC	LDO, 2.85V±2%, 150mA, +CE	SOT-23-5	28vrx	VR7	6a	Aic
F030G	AIC1746-30GV5	LVR-IC	LDO, 3.0V±2%, 150mA, +CE	SOT-23-5	28vrx	VR7	6a	Aic
F030P	AIC1746-30PV5	LVR-IC	LDO, 3.0V±2%, 150mA, +CE	SOT-23-5	28vrx	VR7	6a	Aic
F033G	AIC1746-33GV5	LVR-IC	LDO, 3.3V±2%, 150mA, +CE	SOT-23-5	28vrx	VR7	6a	Aic
F033P	AIC1746-33PV5	LVR-IC	LDO, 3.3V±2%, 150mA, +CE	SOT-23-5	28vrx	VR7	6a	Aic
F035G	AIC1746-35GV5	LVR-IC	LDO, 3.5V±2%, 150mA, +CE	SOT-23-5	28vrx	VR7	6a	Aic
F035P	AIC1746-35PV5	LVR-IC	LDO, 3.5V±2%, 150mA, +CE	SOT-23-5	28vrx	VR7	6a	Aic
F037G	AIC1746-37GV5	LVR-IC	LDO, 3.7V±2%, 150mA, +CE	SOT-23-5	28vrx	VR7	6a	Aic
F037P	AIC1746-37PV5	LVR-IC	LDO, 3.7V±2%, 150mA, +CE	SOT-23-5	28vrx	VR7	6a	Aic
F038G	AIC1746-38GV5	LVR-IC	LDO, 3.8V±2%, 150mA, +CE	SOT-23-5	28vrx	VR7	6a	Aic
F038P	AIC1746-38PV5	LVR-IC	LDO, 3.8V±2%, 150mA, +CE	SOT-23-5	28vrx	VR7	6a	Aic
FP	BD4933FVE	Vdet-IC	3.3V, +Reset PPO	VSOFF-5	30vdx	VD7	6c	Rhm
FP	BD4933G	Vdet-IC	3.3V, +Reset PPO	SSOP-5	28vdm	VD7	6c	Rhm
FP	R1112N231B	LVR-IC	LDO, LN, +CE, 2.3V±2%, 150mA	SOT-23-5	28cx	VR4	6g	Ric
FQ	BD4934FVE	Vdet-IC	3.4V, +Reset PPO	VSOFF-5	30vdx	VD7	6c	Rhm
FQ	BD4934G	Vdet-IC	3.4V, +Reset PPO	SSOP-5	28vdm	VD7	6c	Rhm
FQ	R1112N241B	LVR-IC	LDO, LN, +CE, 2.4V±2%, 150mA	SOT-23-5	28cx	VR4	6g	Ric
FR	AT1201-45XR	LVR-IC	LDO, LN, +CE, 4.5V±2%, 150mA	SOT-23-5	28un	VR7	6a	Atr
FR	BD4935FVE	Vdet-IC	3.5V, +Reset PPO	VSOFF-5	30vdx	VD7	6c	Rhm
FR	BD4935G	Vdet-IC	3.5V, +Reset PPO	SSOP-5	28vdm	VD7	6c	Rhm
FR	R1112N251B	LVR-IC	LDO, LN, +CE, 2.5V±2%, 150mA	SOT-23-5	28cx	VR4	6g	Ric
FR0	XC6901D091MR-G	LVR-IC	-0.9V±1.5%, 200mA, +CE, CL	SOT-25	28ew	VR7	6g	Tor
FR1	XC6901D101MR-G	LVR-IC	-1.0V±1.5%, 200mA, +CE, CL	SOT-25	28ew	VR7	6g	Tor
FR2	XC6901D111MR-G	LVR-IC	-1.1V±1.5%, 200mA, +CE, CL	SOT-25	28ew	VR7	6g	Tor
FR3	XC6901D121MR-G	LVR-IC	-1.2V±1.5%, 200mA, +CE, CL	SOT-25	28ew	VR7	6g	Tor
FR4	XC6901D131MR-G	LVR-IC	-1.3V±1.5%, 200mA, +CE, CL	SOT-25	28ew	VR7	6g	Tor
FR5	XC6901D141MR-G	LVR-IC	-1.4V±1.5%, 200mA, +CE, CL	SOT-25	28ew	VR7	6g	Tor
FR6	XC6901D151MR-G	LVR-IC	-1.5V±1.5%, 200mA, +CE, CL	SOT-25	28ew	VR7	6g	Tor
FR7	XC6901D161MR-G	LVR-IC	-1.6V±1.5%, 200mA, +CE, CL	SOT-25	28ew	VR7	6g	Tor
FR8	XC6901D171MR-G	LVR-IC	-1.7V±1.5%, 200mA, +CE, CL	SOT-25	28ew	VR7	6g	Tor
FR9	XC6901D181MR-G	LVR-IC	-1.8V±1.5%, 200mA, +CE, CL	SOT-25	28ew	VR7	6g	Tor
FRA	XC6901D191MR-G	LVR-IC	-1.9V±1.5%, 200mA, +CE, CL	SOT-25	28ew	VR7	6g	Tor
FRB	XC6901D201MR-G	LVR-IC	-2.0V±1.5%, 200mA, +CE, CL	SOT-25	28ew	VR7	6g	Tor
FRC	XC6901D211MR-G	LVR-IC	-2.1V±1.5%, 200mA, +CE, CL	SOT-25	28ew	VR7	6g	Tor
FRD	XC6901D221MR-G	LVR-IC	-2.2V±1.5%, 200mA, +CE, CL	SOT-25	28ew	VR7	6g	Tor
FRE	XC6901D231MR-G	LVR-IC	-2.3V±1.5%, 200mA, +CE, CL	SOT-25	28ew	VR7	6g	Tor
FRF	XC6901D241MR-G	LVR-IC	-2.4V±1.5%, 200mA, +CE, CL	SOT-25	28ew	VR7	6g	Tor
FRH	XC6901D251MR-G	LVR-IC	-2.5V±1.5%, 200mA, +CE, CL	SOT-25	28ew	VR7	6g	Tor
FRJ	XC6901D261MR-G	LVR-IC	-2.6V±1.5%, 200mA, +CE, CL	SOT-25	28ew	VR7	6g	Tor
FRL	XC6901D271MR-G	LVR-IC	-2.7V±1.5%, 200mA, +CE, CL	SOT-25	28ew	VR7	6g	Tor
FRM	XC6901D281MR-G	LVR-IC	-2.8V±1.5%, 200mA, +CE, CL	SOT-25	28ew	VR7	6g	Tor
FRN	XC6901D291MR-G	LVR-IC	-2.9V±1.5%, 200mA, +CE, CL	SOT-25	28ew	VR7	6g	Tor
FRP	XC6901D301MR-G	LVR-IC	-3.0V±1.5%, 200mA, +CE, CL	SOT-25	28ew	VR7	6g	Tor
FRR	XC6901D311MR-G	LVR-IC	-3.1V±1.5%, 200mA, +CE, CL	SOT-25	28ew	VR7	6g	Tor
FRS	XC6901D321MR-G	LVR-IC	-3.2V±1.5%, 200mA, +CE, CL	SOT-25	28ew	VR7	6g	Tor
FRT	XC6901D331MR-G	LVR-IC	-3.3V±1.5%, 200mA, +CE, CL	SOT-25	28ew	VR7	6g	Tor
FRU	XC6901D341MR-G	LVR-IC	-3.4V±1.5%, 200mA, +CE, CL	SOT-25	28ew	VR7	6g	Tor
FRV	XC6901D351MR-G	LVR-IC	-3.5V±1.5%, 200mA, +CE, CL	SOT-25	28ew	VR7	6g	Tor
FRX	XC6901D361MR-G	LVR-IC	-3.6V±1.5%, 200mA, +CE, CL	SOT-25	28ew	VR7	6g	Tor
FRY	XC6901D371MR-G	LVR-IC	-3.7V±1.5%, 200mA, +CE, CL	SOT-25	28ew	VR7	6g	Tor
FRZ	XC6901D381MR-G	LVR-IC	-3.8V±1.5%, 200mA, +CE, CL	SOT-25	28ew	VR7	6g	Tor
FS	BD4936FVE	Vdet-IC	3.6V, +Reset PPO	VSOFF-5	30vdx	VD7	6c	Rhm
FS	BD4936G	Vdet-IC	3.6V, +Reset PPO	SSOP-5	28vdm	VD7	6c	Rhm
FS	R1112N261B	LVR-IC	LDO, LN, +CE, 2.6V±2%, 150mA	SOT-23-5	28cx	VR4	6g	Ric
FS0	XC6901D391MR-G	LVR-IC	-3.9V±1.5%, 200mA, +CE, CL	SOT-25	28ew	VR7	6g	Tor
FS1	XC6901D401MR-G	LVR-IC	-4.0V±1.5%, 200mA, +CE, CL	SOT-25	28ew	VR7	6g	Tor
FS2	XC6901D411MR-G	LVR-IC	-4.1V±1.5%, 200mA, +CE, CL	SOT-25	28ew	VR7	6g	Tor
FS3	XC6901D421MR-G	LVR-IC	-4.2V±1.5%, 200mA, +CE, CL	SOT-25	28ew	VR7	6g	Tor
FS4	XC6901D431MR-G	LVR-IC	-4.3V±1.5%, 200mA, +CE, CL	SOT-25	28ew	VR7	6g	Tor
FS5	XC6901D441MR-G	LVR-IC	-4.4V±1.5%, 200mA, +CE, CL	SOT-25	28ew	VR7	6g	Tor
FS6	XC6901D451MR-G	LVR-IC	-4.5V±1.5%, 200mA, +CE, CL	SOT-25	28ew	VR7	6g	Tor
FS7	XC6901D461MR-G	LVR-IC	-4.6V±1.5%, 200mA, +CE, CL	SOT-25	28ew	VR7	6g	Tor
FS8	XC6901D471MR-G	LVR-IC	-4.7V±1.5%, 200mA, +CE, CL	SOT-25	28ew	VR7	6g	Tor
FS9	XC6901D481MR-G	LVR-IC	-4.8V±1.5%, 200mA, +CE, CL	SOT-25	28ew	VR7	6g	Tor
FSA	XC6901D491MR-G	LVR-IC	-4.9V±1.5%, 200mA, +CE, CL	SOT-25	28ew	VR7	6g	Tor
FSB	XC6901D501MR-G	LVR-IC	-5.0V±1.5%, 200mA, +CE, CL	SOT-25	28ew	VR7	6g	Tor
FSC	XC6901D511MR-G	LVR-IC	-5.1V±1.5%, 200mA, +CE, CL	SOT-25	28ew	VR7	6g	Tor



SMD code	Type	Function	Short description	Case	Pinout	Sch.	St.	Mnf.
FUH	XC6901DB51MR-G	LVR-IC	-11.5V±1.5%, 200mA, +CE, CL	SOT-25	28ew	VR7	6g	Tor
FUK	XC6901DB61MR-G	LVR-IC	-11.6V±1.5%, 200mA, +CE, CL	SOT-25	28ew	VR7	6g	Tor
FUL	XC6901DB71MR-G	LVR-IC	-11.7V±1.5%, 200mA, +CE, CL	SOT-25	28ew	VR7	6g	Tor
FUM	XC6901DB81MR-G	LVR-IC	-11.8V±1.5%, 200mA, +CE, CL	SOT-25	28ew	VR7	6g	Tor
FUN	XC6901DB91MR-G	LVR-IC	-11.9V±1.5%, 200mA, +CE, CL	SOT-25	28ew	VR7	6g	Tor
FUP	XC6901DC01MR-G	LVR-IC	-12.0V±1.5%, 200mA, +CE, CL	SOT-25	28ew	VR7	6g	Tor
FV	BD4939FVE	Vdet-IC	3.9V, +Reset PPO	VSOFF-5	30vdv	VD7	6c	Rhm
FV	BD4939G	Vdet-IC	3.9V, +Reset PPO	SSOP-5	28vdm	VD7	6c	Rhm
FV	R1112N291B	LVR-IC	LDO, LN, +CE, 2.9V±2%, 150mA	SOT-23-5	28cx	VR4	6g	Aic
FV11G	AIC1747-11GV5N	LVR-IC	LDO, 1.1V±2%, 300mA, +CE	SOT-23-5	28cx	VR4	6a	Aic
FV11P	AIC1747-11PV5N	LVR-IC	LDO, 1.1V±2%, 300mA, +CE	SOT-23-5	28cx	VR4	6a	Aic
FV12G	AIC1747-12GV5N	LVR-IC	LDO, 1.2V±2%, 300mA, +CE	SOT-23-5	28cx	VR4	6a	Aic
FV12P	AIC1747-12PV5N	LVR-IC	LDO, 1.2V±2%, 300mA, +CE	SOT-23-5	28cx	VR4	6a	Aic
FV13G	AIC1747-13GV5N	LVR-IC	LDO, 1.3V±2%, 300mA, +CE	SOT-23-5	28cx	VR4	6a	Aic
FV13P	AIC1747-13PV5N	LVR-IC	LDO, 1.3V±2%, 300mA, +CE	SOT-23-5	28cx	VR4	6a	Aic
FV15G	AIC1747-15GV5N	LVR-IC	LDO, 1.5V±2%, 300mA, +CE	SOT-23-5	28cx	VR4	6a	Aic
FV15P	AIC1747-15PV5N	LVR-IC	LDO, 1.5V±2%, 300mA, +CE	SOT-23-5	28cx	VR4	6a	Aic
FV18G	AIC1747-18GV5N	LVR-IC	LDO, 1.8V±2%, 300mA, +CE	SOT-23-5	28cx	VR4	6a	Aic
FV18P	AIC1747-18PV5N	LVR-IC	LDO, 1.8V±2%, 300mA, +CE	SOT-23-5	28cx	VR4	6a	Aic
FV20G	AIC1747-20GV5N	LVR-IC	LDO, 2.0V±2%, 300mA, +CE	SOT-23-5	28cx	VR4	6a	Aic
FV20P	AIC1747-20PV5N	LVR-IC	LDO, 2.0V±2%, 300mA, +CE	SOT-23-5	28cx	VR4	6a	Aic
FV25G	AIC1747-25GV5N	LVR-IC	LDO, 2.5V±2%, 300mA, +CE	SOT-23-5	28cx	VR4	6a	Aic
FV25P	AIC1747-25PV5N	LVR-IC	LDO, 2.5V±2%, 300mA, +CE	SOT-23-5	28cx	VR4	6a	Aic
FV27G	AIC1747-27GV5N	LVR-IC	LDO, 2.7V±2%, 300mA, +CE	SOT-23-5	28cx	VR4	6a	Aic
FV27P	AIC1747-27PV5N	LVR-IC	LDO, 2.7V±2%, 300mA, +CE	SOT-23-5	28cx	VR4	6a	Aic
FV2JG	AIC1747-285GV5N	LVR-IC	LDO, 2.85V±2%, 300mA, +CE	SOT-23-5	28cx	VR4	6a	Aic
FV2JP	AIC1747-285PV5N	LVR-IC	LDO, 2.85V±2%, 300mA, +CE	SOT-23-5	28cx	VR4	6a	Aic
FV30G	AIC1747-30GV5N	LVR-IC	LDO, 3.0V±2%, 300mA, +CE	SOT-23-5	28cx	VR4	6a	Aic
FV30P	AIC1747-30PV5N	LVR-IC	LDO, 3.0V±2%, 300mA, +CE	SOT-23-5	28cx	VR4	6a	Aic
FV33G	AIC1747-33GV5N	LVR-IC	LDO, 3.3V±2%, 300mA, +CE	SOT-23-5	28cx	VR4	6a	Aic
FV33P	AIC1747-33PV5N	LVR-IC	LDO, 3.3V±2%, 300mA, +CE	SOT-23-5	28cx	VR4	6a	Aic
FV35G	AIC1747-35GV5N	LVR-IC	LDO, 3.5V±2%, 300mA, +CE	SOT-23-5	28cx	VR4	6a	Aic
FV35P	AIC1747-35PV5N	LVR-IC	LDO, 3.5V±2%, 300mA, +CE	SOT-23-5	28cx	VR4	6a	Aic
FV37G	AIC1747-37GV5N	LVR-IC	LDO, 3.7V±2%, 300mA, +CE	SOT-23-5	28cx	VR4	6a	Aic
FV37P	AIC1747-37PV5N	LVR-IC	LDO, 3.7V±2%, 300mA, +CE	SOT-23-5	28cx	VR4	6a	Aic
FV38G	AIC1747-38GV5N	LVR-IC	LDO, 3.8V±2%, 300mA, +CE	SOT-23-5	28cx	VR4	6a	Aic
FV38P	AIC1747-38PV5N	LVR-IC	LDO, 3.8V±2%, 300mA, +CE	SOT-23-5	28cx	VR4	6a	Aic
FW11G	AIC1746-11GV5N	LVR-IC	LDO, 1.1V±2%, 150mA, +CE	SOT-23-5	28cx	VR4	6a	Aic
FW11P	AIC1746-11PV5N	LVR-IC	LDO, 1.1V±2%, 150mA, +CE	SOT-23-5	28cx	VR4	6a	Aic
FW12G	AIC1746-12GV5N	LVR-IC	LDO, 1.2V±2%, 150mA, +CE	SOT-23-5	28cx	VR4	6a	Aic
FW12P	AIC1746-12PV5N	LVR-IC	LDO, 1.2V±2%, 150mA, +CE	SOT-23-5	28cx	VR4	6a	Aic
FW13G	AIC1746-13GV5N	LVR-IC	LDO, 1.3V±2%, 150mA, +CE	SOT-23-5	28cx	VR4	6a	Aic
FW13P	AIC1746-13PV5N	LVR-IC	LDO, 1.3V±2%, 150mA, +CE	SOT-23-5	28cx	VR4	6a	Aic
FW15G	AIC1746-15GV5N	LVR-IC	LDO, 1.5V±2%, 150mA, +CE	SOT-23-5	28cx	VR4	6a	Aic
FW15P	AIC1746-15PV5N	LVR-IC	LDO, 1.5V±2%, 150mA, +CE	SOT-23-5	28cx	VR4	6a	Aic
FW18G	AIC1746-18GV5N	LVR-IC	LDO, 1.8V±2%, 150mA, +CE	SOT-23-5	28cx	VR4	6a	Aic
FW18P	AIC1746-18PV5N	LVR-IC	LDO, 1.8V±2%, 150mA, +CE	SOT-23-5	28cx	VR4	6a	Aic
FW20G	AIC1746-20GV5N	LVR-IC	LDO, 2.0V±2%, 150mA, +CE	SOT-23-5	28cx	VR4	6a	Aic
FW20P	AIC1746-20PV5N	LVR-IC	LDO, 2.0V±2%, 150mA, +CE	SOT-23-5	28cx	VR4	6a	Aic
FW25G	AIC1746-25GV5N	LVR-IC	LDO, 2.5V±2%, 150mA, +CE	SOT-23-5	28cx	VR4	6a	Aic
FW25P	AIC1746-25PV5N	LVR-IC	LDO, 2.5V±2%, 150mA, +CE	SOT-23-5	28cx	VR4	6a	Aic
FW27G	AIC1746-27GV5N	LVR-IC	LDO, 2.7V±2%, 150mA, +CE	SOT-23-5	28cx	VR4	6a	Aic
FW27P	AIC1746-27PV5N	LVR-IC	LDO, 2.7V±2%, 150mA, +CE	SOT-23-5	28cx	VR4	6a	Aic
FW2JG	AIC1746-285GV5N	LVR-IC	LDO, 2.85V±2%, 150mA, +CE	SOT-23-5	28cx	VR4	6a	Aic
FW2JP	AIC1746-285PV5N	LVR-IC	LDO, 2.85V±2%, 150mA, +CE	SOT-23-5	28cx	VR4	6a	Aic
FW30G	AIC1746-30GV5N	LVR-IC	LDO, 3.0V±2%, 150mA, +CE	SOT-23-5	28cx	VR4	6a	Aic
FW30P	AIC1746-30PV5N	LVR-IC	LDO, 3.0V±2%, 150mA, +CE	SOT-23-5	28cx	VR4	6a	Aic
FW33G	AIC1746-33GV5N	LVR-IC	LDO, 3.3V±2%, 150mA, +CE	SOT-23-5	28cx	VR4	6a	Aic
FW33P	AIC1746-33PV5N	LVR-IC	LDO, 3.3V±2%, 150mA, +CE	SOT-23-5	28cx	VR4	6a	Aic
FW35G	AIC1746-35GV5N	LVR-IC	LDO, 3.5V±2%, 150mA, +CE	SOT-23-5	28cx	VR4	6a	Aic
FW35P	AIC1746-35PV5N	LVR-IC	LDO, 3.5V±2%, 150mA, +CE	SOT-23-5	28cx	VR4	6a	Aic
FW37G	AIC1746-37GV5N	LVR-IC	LDO, 3.7V±2%, 150mA, +CE	SOT-23-5	28cx	VR4	6a	Aic
FW37P	AIC1746-37PV5N	LVR-IC	LDO, 3.7V±2%, 150mA, +CE	SOT-23-5	28cx	VR4	6a	Aic
FW38G	AIC1746-38GV5N	LVR-IC	LDO, 3.8V±2%, 150mA, +CE	SOT-23-5	28cx	VR4	6a	Aic
FW38P	AIC1746-38PV5N	LVR-IC	LDO, 3.8V±2%, 150mA, +CE	SOT-23-5	28cx	VR4	6a	Aic
FX	AT1201-45X	LVR-IC	LDO, LN, +CE, 4.5V±2%, 150mA	SOT-23-5	28vrx	VR7	6a	Atr
FY11G	AIC1746-11GK5N	LVR-IC	LDO, 1.1V±2%, 150mA, +CE	TSOT-23-5	28cx	VR4	6a	Aic
FY11P	AIC1746-11PK5N	LVR-IC	LDO, 1.1V±2%, 150mA, +CE	TSOT-23-5	28cx	VR4	6a	Aic
FY12G	AIC1746-12GK5N	LVR-IC	LDO, 1.2V±2%, 150mA, +CE	TSOT-23-5	28cx	VR4	6a	Aic
FY12P	AIC1746-12PK5N	LVR-IC	LDO, 1.2V±2%, 150mA, +CE	TSOT-23-5	28cx	VR4	6a	Aic



SMD code	Type	Function	Short description	Case	Pinout	Sch.	St.	Mnf.
FY13G	AIC1746-13GK5N	LVR-IC	LDO, 1.3V±2%, 150mA, +CE	TSOT-23-5	28cx	VR4	6a	Aic
FY13P	AIC1746-13PK5N	LVR-IC	LDO, 1.3V±2%, 150mA, +CE	TSOT-23-5	28cx	VR4	6a	Aic
FY15G	AIC1746-15GK5N	LVR-IC	LDO, 1.5V±2%, 150mA, +CE	TSOT-23-5	28cx	VR4	6a	Aic
FY15P	AIC1746-15PK5N	LVR-IC	LDO, 1.5V±2%, 150mA, +CE	TSOT-23-5	28cx	VR4	6a	Aic
FY18G	AIC1746-18GK5N	LVR-IC	LDO, 1.8V±2%, 150mA, +CE	TSOT-23-5	28cx	VR4	6a	Aic
FY18P	AIC1746-18PK5N	LVR-IC	LDO, 1.8V±2%, 150mA, +CE	TSOT-23-5	28cx	VR4	6a	Aic
FY20G	AIC1746-20GK5N	LVR-IC	LDO, 2.0V±2%, 150mA, +CE	TSOT-23-5	28cx	VR4	6a	Aic
FY20P	AIC1746-20PK5N	LVR-IC	LDO, 2.0V±2%, 150mA, +CE	TSOT-23-5	28cx	VR4	6a	Aic
FY25G	AIC1746-25GK5N	LVR-IC	LDO, 2.5V±2%, 150mA, +CE	TSOT-23-5	28cx	VR4	6a	Aic
FY25P	AIC1746-25PK5N	LVR-IC	LDO, 2.5V±2%, 150mA, +CE	TSOT-23-5	28cx	VR4	6a	Aic
FY27G	AIC1746-27GK5N	LVR-IC	LDO, 2.7V±2%, 150mA, +CE	TSOT-23-5	28cx	VR4	6a	Aic
FY27P	AIC1746-27PK5N	LVR-IC	LDO, 2.7V±2%, 150mA, +CE	TSOT-23-5	28cx	VR4	6a	Aic
FY2JG	AIC1746-285GK5N	LVR-IC	LDO, 2.85V±2%, 150mA, +CE	TSOT-23-5	28cx	VR4	6a	Aic
FY2JP	AIC1746-285PK5N	LVR-IC	LDO, 2.85V±2%, 150mA, +CE	TSOT-23-5	28cx	VR4	6a	Aic
FY30G	AIC1746-30GK5N	LVR-IC	LDO, 3.0V±2%, 150mA, +CE	TSOT-23-5	28cx	VR4	6a	Aic
FY30P	AIC1746-30PK5N	LVR-IC	LDO, 3.0V±2%, 150mA, +CE	TSOT-23-5	28cx	VR4	6a	Aic
FY33G	AIC1746-33GK5N	LVR-IC	LDO, 3.3V±2%, 150mA, +CE	TSOT-23-5	28cx	VR4	6a	Aic
FY33P	AIC1746-33PK5N	LVR-IC	LDO, 3.3V±2%, 150mA, +CE	TSOT-23-5	28cx	VR4	6a	Aic
FY35G	AIC1746-35GK5N	LVR-IC	LDO, 3.5V±2%, 150mA, +CE	TSOT-23-5	28cx	VR4	6a	Aic
FY35P	AIC1746-35PK5N	LVR-IC	LDO, 3.5V±2%, 150mA, +CE	TSOT-23-5	28cx	VR4	6a	Aic
FY37G	AIC1746-37GK5N	LVR-IC	LDO, 3.7V±2%, 150mA, +CE	TSOT-23-5	28cx	VR4	6a	Aic
FY37P	AIC1746-37PK5N	LVR-IC	LDO, 3.7V±2%, 150mA, +CE	TSOT-23-5	28cx	VR4	6a	Aic
FY38G	AIC1746-38GK5N	LVR-IC	LDO, 3.8V±2%, 150mA, +CE	TSOT-23-5	28cx	VR4	6a	Aic
FY38P	AIC1746-38PK5N	LVR-IC	LDO, 3.8V±2%, 150mA, +CE	TSOT-23-5	28cx	VR4	6a	Aic
FZ	AP1521W	LDR-IC	Step-up DC-DC converter for LED drive (3.3V, 5V)	SOT-23-5L	28sq	LD3	6a	Ana
FZ11G	AIC1747-11GK5N	LVR-IC	LDO, 1.1V±2%, 300mA, +CE	TSOT-23-5	28cx	VR4	6a	Aic
FZ11P	AIC1747-11PK5N	LVR-IC	LDO, 1.1V±2%, 300mA, +CE	TSOT-23-5	28cx	VR4	6a	Aic
FZ12G	AIC1747-12GK5N	LVR-IC	LDO, 1.2V±2%, 300mA, +CE	TSOT-23-5	28cx	VR4	6a	Aic
FZ12P	AIC1747-12PK5N	LVR-IC	LDO, 1.2V±2%, 300mA, +CE	TSOT-23-5	28cx	VR4	6a	Aic
FZ13G	AIC1747-13GK5N	LVR-IC	LDO, 1.3V±2%, 300mA, +CE	TSOT-23-5	28cx	VR4	6a	Aic
FZ13P	AIC1747-13PK5N	LVR-IC	LDO, 1.3V±2%, 300mA, +CE	TSOT-23-5	28cx	VR4	6a	Aic
FZ15G	AIC1747-15GK5N	LVR-IC	LDO, 1.5V±2%, 300mA, +CE	TSOT-23-5	28cx	VR4	6a	Aic
FZ15P	AIC1747-15PK5N	LVR-IC	LDO, 1.5V±2%, 300mA, +CE	TSOT-23-5	28cx	VR4	6a	Aic
FZ18G	AIC1747-18GK5N	LVR-IC	LDO, 1.8V±2%, 300mA, +CE	TSOT-23-5	28cx	VR4	6a	Aic
FZ18P	AIC1747-18PK5N	LVR-IC	LDO, 1.8V±2%, 300mA, +CE	TSOT-23-5	28cx	VR4	6a	Aic
FZ20G	AIC1747-20GK5N	LVR-IC	LDO, 2.0V±2%, 300mA, +CE	TSOT-23-5	28cx	VR4	6a	Aic
FZ20P	AIC1747-20PK5N	LVR-IC	LDO, 2.0V±2%, 300mA, +CE	TSOT-23-5	28cx	VR4	6a	Aic
FZ25G	AIC1747-25GK5N	LVR-IC	LDO, 2.5V±2%, 300mA, +CE	TSOT-23-5	28cx	VR4	6a	Aic
FZ25P	AIC1747-25PK5N	LVR-IC	LDO, 2.5V±2%, 300mA, +CE	TSOT-23-5	28cx	VR4	6a	Aic
FZ27G	AIC1747-27GK5N	LVR-IC	LDO, 2.7V±2%, 300mA, +CE	TSOT-23-5	28cx	VR4	6a	Aic
FZ27P	AIC1747-27PK5N	LVR-IC	LDO, 2.7V±2%, 300mA, +CE	TSOT-23-5	28cx	VR4	6a	Aic
FZ2JG	AIC1747-285GK5N	LVR-IC	LDO, 2.85V±2%, 300mA, +CE	TSOT-23-5	28cx	VR4	6a	Aic
FZ2JP	AIC1747-285PK5N	LVR-IC	LDO, 2.85V±2%, 300mA, +CE	TSOT-23-5	28cx	VR4	6a	Aic
FZ30G	AIC1747-30GK5N	LVR-IC	LDO, 3.0V±2%, 300mA, +CE	TSOT-23-5	28cx	VR4	6a	Aic
FZ30P	AIC1747-30PK5N	LVR-IC	LDO, 3.0V±2%, 300mA, +CE	TSOT-23-5	28cx	VR4	6a	Aic
FZ33G	AIC1747-33GK5N	LVR-IC	LDO, 3.3V±2%, 300mA, +CE	TSOT-23-5	28cx	VR4	6a	Aic
FZ33P	AIC1747-33PK5N	LVR-IC	LDO, 3.3V±2%, 300mA, +CE	TSOT-23-5	28cx	VR4	6a	Aic
FZ35G	AIC1747-35GK5N	LVR-IC	LDO, 3.5V±2%, 300mA, +CE	TSOT-23-5	28cx	VR4	6a	Aic
FZ35P	AIC1747-35PK5N	LVR-IC	LDO, 3.5V±2%, 300mA, +CE	TSOT-23-5	28cx	VR4	6a	Aic
FZ37G	AIC1747-37GK5N	LVR-IC	LDO, 3.7V±2%, 300mA, +CE	TSOT-23-5	28cx	VR4	6a	Aic
FZ37P	AIC1747-37PK5N	LVR-IC	LDO, 3.7V±2%, 300mA, +CE	TSOT-23-5	28cx	VR4	6a	Aic
FZ38G	AIC1747-38GK5N	LVR-IC	LDO, 3.8V±2%, 300mA, +CE	TSOT-23-5	28cx	VR4	6a	Aic
FZ38P	AIC1747-38PK5N	LVR-IC	LDO, 3.8V±2%, 300mA, +CE	TSOT-23-5	28cx	VR4	6a	Aic
G0	FP6801-27CS5P	Vdet-IC	2.7V±2%, -Reset PPO	SOT-23-5	28vdo	VD3	6a	Fit
G0	MC78PC30N	LVR-IC	LDO, LN, +CE, 3V±2.5%, 100mA	SOT-23-5	28cx	VR4	6b	Ons
G0	R1111N301B	LVR-IC	LDO, LN, +CE, 3V±2%, 200mA	SOT-23-5	28cx	VR4	6g	Ric
G0	RN5VD60AA	Vdet-IC	6V±2.5%, -Reset PPO	SOT-23-5	28vdo	VD3	6g	Ric
G001	RP103Q122B	LVR-IC	LDO, 1.2V±1%, 150mA, +CE	SC-88A	28xm	VR4	6m	Ric
G002	RP103Q132B	LVR-IC	LDO, 1.3V±1%, 150mA, +CE	SC-88A	28xm	VR4	6m	Ric
G003	RP103Q152B	LVR-IC	LDO, 1.5V±1%, 150mA, +CE	SC-88A	28xm	VR4	6m	Ric
G004	RP103Q182B	LVR-IC	LDO, 1.8V±1%, 150mA, +CE	SC-88A	28xm	VR4	6m	Ric
G005	RP103Q182B5	LVR-IC	LDO, 1.85V±1%, 150mA, +CE	SC-88A	28xm	VR4	6m	Ric
G006	RP103Q192B	LVR-IC	LDO, 1.9V±1%, 150mA, +CE	SC-88A	28xm	VR4	6m	Ric
G007	RP103Q202B	LVR-IC	LDO, 2.0V±1%, 150mA, +CE	SC-88A	28xm	VR4	6m	Ric
G008	RP103Q212B	LVR-IC	LDO, 2.1V±1%, 150mA, +CE	SC-88A	28xm	VR4	6m	Ric
G009	RP103Q232B	LVR-IC	LDO, 2.3V±1%, 150mA, +CE	SC-88A	28xm	VR4	6m	Ric
G010	RP103Q252B	LVR-IC	LDO, 2.5V±1%, 150mA, +CE	SC-88A	28xm	VR4	6m	Ric
G011	RP103Q262B	LVR-IC	LDO, 2.6V±1%, 150mA, +CE	SC-88A	28xm	VR4	6m	Ric
G012	RP103Q272B	LVR-IC	LDO, 2.7V±1%, 150mA, +CE	SC-88A	28xm	VR4	6m	Ric
G013	RP103Q282B	LVR-IC	LDO, 2.8V±1%, 150mA, +CE	SC-88A	28xm	VR4	6m	Ric



SMD code	Type	Function	Short description	Case	Pinout	Sch.	St.	Mnf.
G014	RP103Q282B5	LVR-IC	LDO, 2.85V±1%, 150mA, +CE	SC-88A	28xm	VR4	6m	Ric
G015	RP103Q292B	LVR-IC	LDO, 2.9V±1%, 150mA, +CE	SC-88A	28xm	VR4	6m	Ric
G016	RP103Q302B	LVR-IC	LDO, 3.0V±1%, 150mA, +CE	SC-88A	28xm	VR4	6m	Ric
G017	RP103Q312B	LVR-IC	LDO, 3.1V±1%, 150mA, +CE	SC-88A	28xm	VR4	6m	Ric
G018	RP103Q322B	LVR-IC	LDO, 3.2V±1%, 150mA, +CE	SC-88A	28xm	VR4	6m	Ric
G019	RP103Q332B	LVR-IC	LDO, 3.3V±1%, 150mA, +CE	SC-88A	28xm	VR4	6m	Ric
g02	XC7SET02GV	CMOS-Logic	2-input NOR gate	SOT753	28/Log2	-	6a	Phi
G020	RP103Q292B5	LVR-IC	LDO, 2.9V±1%, 150mA, +CE	SC-88A	28xm	VR4	6m	Ric
G021	RP103Q222B	LVR-IC	LDO, 2.2V±1%, 150mA, +CE	SC-88A	28xm	VR4	6m	Ric
G022	RP103Q162B	LVR-IC	LDO, 1.6V±1%, 150mA, +CE	SC-88A	28xm	VR4	6m	Ric
G023	RP103Q142B	LVR-IC	LDO, 1.4V±1%, 150mA, +CE	SC-88A	28xm	VR4	6m	Ric
G024	RP103Q172B	LVR-IC	LDO, 1.7V±1%, 150mA, +CE	SC-88A	28xm	VR4	6m	Ric
G025	RP103Q242B	LVR-IC	LDO, 2.4V±1%, 150mA, +CE	SC-88A	28xm	VR4	6m	Ric
g04	XC7SET04GV	CMOS-Logic	Inverter	SOT753	28/Log6	-	6a	Phi
g08	XC7SET08GV	CMOS-Logic	2-input AND gate	SOT753	28/Log3	-	6a	Phi
G0A	R1118N291B	LVR-IC	2.9V±1%, 150mA, +CE	SOT-23-5	28cx	VR4	6g	Ric
G0B	R1118N301B	LVR-IC	3V±1%, 150mA, +CE	SOT-23-5	28cx	VR4	6g	Ric
G0C	R1118N311B	LVR-IC	3.1V±1%, 150mA, +CE	SOT-23-5	28cx	VR4	6g	Ric
G0D	R1118N321B	LVR-IC	3.2V±1%, 150mA, +CE	SOT-23-5	28cx	VR4	6g	Ric
G0E	R1118N331B	LVR-IC	3.3V±1%, 150mA, +CE	SOT-23-5	28cx	VR4	6g	Ric
G0F	R1118N341B	LVR-IC	3.4V±1%, 150mA, +CE	SOT-23-5	28cx	VR4	6g	Ric
G0G	R1118N351B	LVR-IC	3.5V±1%, 150mA, +CE	SOT-23-5	28cx	VR4	6g	Ric
G0H	R1118N361B	LVR-IC	3.6V±1%, 150mA, +CE	SOT-23-5	28cx	VR4	6g	Ric
G0J	R1118N371B	LVR-IC	3.7V±1%, 150mA, +CE	SOT-23-5	28cx	VR4	6g	Ric
G0K	R1118N381B	LVR-IC	3.8V±1%, 150mA, +CE	SOT-23-5	28cx	VR4	6g	Ric
G0L	R1118N391B	LVR-IC	3.9V±1%, 150mA, +CE	SOT-23-5	28cx	VR4	6g	Ric
G0M	R1118N401B	LVR-IC	4V±1%, 150mA, +CE	SOT-23-5	28cx	VR4	6g	Ric
G0N	R1118N411B	LVR-IC	4.1V±1%, 150mA, +CE	SOT-23-5	28cx	VR4	6g	Ric
G0P	R1118N421B	LVR-IC	4.2V±1%, 150mA, +CE	SOT-23-5	28cx	VR4	6g	Ric
G1	FP6801-24NS5P	Vdet-IC	2.4V±2%, -Reset ODO	SOT-23-5	28vdo	VD1	6a	Fit
G1	R1111N311B	LVR-IC	LDO, LN, +CE, 3.1V±2%, 200mA	SOT-23-5	28cx	VR4	6g	Rs
G1	Si91844DT-27	LVR-IC	LDO, LN, +CE, -Error, 2.7V±1.5%, 150mA	SOT-23-5	28w	VR17	6k	Vs
G1	TC7SET00F	CMOS-Logic	2-input NAND gate	SSOP-5	28/Log1	-	6a	Tos
G1	TC7SET00FU	CMOS-Logic	2-input NAND gate	SC-70-5	28/Log1	-	6a	Tos
G10	R1224N102G	DC/DC-IC	PWM step-down, 1V, 300kHz	SOT-23-5	28ud	DC7	6g	Ric
G12	R1224N122G	DC/DC-IC	PWM step-down, 1.2V, 300kHz	SOT-23-5	28ud	DC7	6g	Ric
g14	XC7SET14GV	CMOS-Logic	Inverting Schmitt-trigger	SOT753	28/Log7	-	6a	Phi
G15	R1224N152G	DC/DC-IC	PWM step-down, 1.5V, 300kHz	SOT-23-5	28ud	DC7	6g	Ric
G18	R1224N182G	DC/DC-IC	PWM step-down, 1.8V, 300kHz	SOT-23-5	28ud	DC7	6g	Ric
G1A	R1118N291D	LVR-IC	2.9V±1%, 150mA, +CE, CL	SOT-23-5	28cx	VR4	6g	Ric
G1B	R1118N301D	LVR-IC	3V±1%, 150mA, +CE, CL	SOT-23-5	28cx	VR4	6g	Ric
G1C	R1118N311D	LVR-IC	3.1V±1%, 150mA, +CE, CL	SOT-23-5	28cx	VR4	6g	Ric
G1D	R1118N321D	LVR-IC	3.2V±1%, 150mA, +CE, CL	SOT-23-5	28cx	VR4	6g	Ric
G1E	R1118N331D	LVR-IC	3.3V±1%, 150mA, +CE, CL	SOT-23-5	28cx	VR4	6g	Ric
G1F	R1118N341D	LVR-IC	3.4V±1%, 150mA, +CE, CL	SOT-23-5	28cx	VR4	6g	Ric
G1G	R1118N351D	LVR-IC	3.5V±1%, 150mA, +CE, CL	SOT-23-5	28cx	VR4	6g	Ric
G1H	R1118N361D	LVR-IC	3.6V±1%, 150mA, +CE, CL	SOT-23-5	28cx	VR4	6g	Ric
G1J	R1118N371D	LVR-IC	3.7V±1%, 150mA, +CE, CL	SOT-23-5	28cx	VR4	6g	Ric
G1K	R1118N381D	LVR-IC	3.8V±1%, 150mA, +CE, CL	SOT-23-5	28cx	VR4	6g	Ric
G1L	R1118N391D	LVR-IC	3.9V±1%, 150mA, +CE, CL	SOT-23-5	28cx	VR4	6g	Ric
G1M	R1118N401D	LVR-IC	4V±1%, 150mA, +CE, CL	SOT-23-5	28cx	VR4	6g	Ric
G1N	R1118N411D	LVR-IC	4.1V±1%, 150mA, +CE, CL	SOT-23-5	28cx	VR4	6g	Ric
G1P	R1118N421D	LVR-IC	4.2V±1%, 150mA, +CE, CL	SOT-23-5	28cx	VR4	6g	Ric
G1R	AP2121AK-1.3TRG1	LVR-IC	LDO, 1.3V±2%, 200mA, +CE	SOT-23-5	28cx	VR4	6k	Bcd
G1T	AP2121AK-1.2TRG1	LVR-IC	LDO, 1.2V±2%, 200mA, +CE	SOT-23-5	28cx	VR4	6k	Bcd
G1U	AP2121AK-1.8TRG1	LVR-IC	LDO, 1.8V±2%, 200mA, +CE	SOT-23-5	28cx	VR4	6k	Bcd
G1V	AP2121AK-2.5TRG1	LVR-IC	LDO, 2.5V±2%, 200mA, +CE	SOT-23-5	28cx	VR4	6k	Bcd
G1W	AP2121AK-2.8TRG1	LVR-IC	LDO, 2.8V±2%, 200mA, +CE	SOT-23-5	28cx	VR4	6k	Bcd
G1X	AP2121AK-3.0TRG1	LVR-IC	LDO, 3.0V±2%, 200mA, +CE	SOT-23-5	28cx	VR4	6k	Bcd
G1Y	AP2121AK-3.3TRG1	LVR-IC	LDO, 3.3V±2%, 200mA, +CE	SOT-23-5	28cx	VR4	6k	Bcd
G1Z	AP2121AK-1.5TRG1	LVR-IC	LDO, 1.5V±2%, 200mA, +CE	SOT-23-5	28cx	VR4	6k	Bcd
G2	FP6801-27NS5P	Vdet-IC	2.7V±2%, -Reset ODO	SOT-23-5	28vdo	VD1	6a	Fit
G2	R1111N321B	LVR-IC	LDO, LN, +CE, 3.2V±2%, 200mA	SOT-23-5	28cx	VR4	6g	Ric
G2	Si91844DT-28	LVR-IC	LDO, LN, +CE, -Error, 2.8V±1.5%, 150mA	SOT-23-5	28w	VR17	6k	Vs
G2	TC7SET08F	CMOS-Logic	2-input AND gate	SSOP-5	28/Log3	-	6a	Tos
g2	TC7SET08FU	CMOS-Logic	2-input AND gate	SC-70-5	28/Log3	-	6a	Tos
g25	XC7SET125GV	CMOS-Logic	Bus buffer gate with 3-state output	SOT753	28/Log14	-	6a	Phi
G25	R1224N252G	DC/DC-IC	PWM step-down, 2.5V, 300kHz	SOT-23-5	28ud	DC7	6g	Ric
G3	MC78P33N	LVR-IC	LDO, LN, +CE, 3.3V±2.5%, 100mA	SOT-23-5	28cx	VR4	6b	Ons
G3	R1111N331B	LVR-IC	LDO, LN, +CE, 3.3V±2%, 200mA	SOT-23-5	28cx	VR4	6g	Ric



SMD code	Type	Function	Short description	Case	Pinout	Sch.	St.	Mnf.
G3	Si91844DT-285	LVR-IC	LDO, LN, +CE, -Error, 2.85V±1.5%, 150mA	SOT-23-5	28w	VR17	6k	Vs
G3	TC7SET02F	CMOS-Logic	2-input NOR gate	SSOP-5	28/Log2	-	6a	Tos
G3	TC7SET02FU	CMOS-Logic	2-input NOR gate	SC-70-5	28/Log2	-	6a	Tos
G30	R1224N302G	DC/DC-IC	PWM step-down, 3V, 300kHz	SOT-23-5	28ud	DC7	6g	Ric
g32	XC7SET32GV	CMOS-Logic	2-input OR gate	SOT753	28/Log4	-	6a	Phi
G33	R1224N332G	DC/DC-IC	PWM step-down, 3.3V, 300kHz	SOT-23-5	28ud	DC7	6g	Ric
G3Z	AP2121AK-3.2TRG1	LVR-IC	LDO, LN, +CE, 200mA, +CE	SOT-23-5	28cx	VR4	6k	Bcd
G4	R1111N341B	LVR-IC	LDO, LN, +CE, 3.4V±2%, 200mA	SOT-23-5	28cx	VR4	6g	Ric
G4	Si91844DT-29	LVR-IC	LDO, LN, +CE, -Error, 2.9V±1.5%, 150mA	SOT-23-5	28w	VR17	6k	Vs
G4	TC7SET32F	CMOS-Logic	2-input OR gate	SSOP-5	28/Log4	-	6a	Tos
G4	TC7SET32FU	CMOS-Logic	2-input OR gate	SC-70-5	28/Log4	-	6a	Tos
G5	R1111N351B	LVR-IC	LDO, LN, +CE, 3.5V±2%, 200mA	SOT-23-5	28cx	VR4	6g	Ric
G5	Si91844DT-30	LVR-IC	LDO, LN, +CE, -Error, 3V±1.5%, 150mA	SOT-23-5	28w	VR17	6k	Vs
G5	TC7SET04F	CMOS-Logic	Inverter	SSOP-5	28/Log6	-	6a	Tos
G5	TC7SET04FU	CMOS-Logic	Inverter	SC-70-5	28/Log6	-	6a	Tos
G50	R1224N502G	DC/DC-IC	PWM step-down, 5V, 300kHz	SOT-23-5	28ud	DC7	6g	Ric
G55	R1224N552G	DC/DC-IC	PWM step-down, 5.5V, 300kHz	SOT-23-5	28ud	DC7	6g	Ric
G6	R1111N361B	LVR-IC	LDO, LN, +CE, 3.6V±2%, 200mA	SOT-23-5	28cx	VR4	6g	Ric
G6	Si91844DT-33	LVR-IC	LDO, LN, +CE, -Error, 3.3V±1.5%, 150mA	SOT-23-5	28w	VR17	6k	Vs
G60	R1224N602G	DC/DC-IC	PWM step-down, 6V, 300kHz	SOT-23-5	28ud	DC7	6g	Ric
G60	S-80930CLMC	Vdet-IC	3.0V±2%, -Reset ODO	SOT-23-5	28vdo	VD1	6d	Sii
G61	S-80931CLMC	Vdet-IC	3.1V±2%, -Reset ODO	SOT-23-5	28vdo	VD1	6d	Sii
G62	S-80932CLMC	Vdet-IC	3.2V±2%, -Reset ODO	SOT-23-5	28vdo	VD1	6d	Sii
G63	S-80933CLMC	Vdet-IC	3.3V±2%, -Reset ODO	SOT-23-5	28vdo	VD1	6d	Sii
G64	S-80934CLMC	Vdet-IC	3.4V±2%, -Reset ODO	SOT-23-5	28vdo	VD1	6d	Sii
G65	S-80935CLMC	Vdet-IC	3.5V±2%, -Reset ODO	SOT-23-5	28vdo	VD1	6d	Sii
G66	S-80936CLMC	Vdet-IC	3.6V±2%, -Reset ODO	SOT-23-5	28vdo	VD1	6d	Sii
G67	S-80937CLMC	Vdet-IC	3.7V±2%, -Reset ODO	SOT-23-5	28vdo	VD1	6d	Sii
G68	S-80938CLMC	Vdet-IC	3.8V±2%, -Reset ODO	SOT-23-5	28vdo	VD1	6d	Sii
G69	S-80939CLMC	Vdet-IC	3.9V±2%, -Reset ODO	SOT-23-5	28vdo	VD1	6d	Sii
G6H	S-80913CLMC	Vdet-IC	1.3V±2%, -Reset ODO	SOT-23-5	28vdo	VD1	6d	Sii
G6J	S-80914CLMC	Vdet-IC	1.4V±2%, -Reset ODO	SOT-23-5	28vdo	VD1	6d	Sii
G6K	S-80915CLMC	Vdet-IC	1.5V±2%, -Reset ODO	SOT-23-5	28vdo	VD1	6d	Sii
G6L	S-80916CLMC	Vdet-IC	1.6V±2%, -Reset ODO	SOT-23-5	28vdo	VD1	6d	Sii
G6M	S-80917CLMC	Vdet-IC	1.7V±2%, -Reset ODO	SOT-23-5	28vdo	VD1	6d	Sii
G6N	S-80918CLMC	Vdet-IC	1.8V±2%, -Reset ODO	SOT-23-5	28vdo	VD1	6d	Sii
G6P	S-80919CLMC	Vdet-IC	1.9V±2%, -Reset ODO	SOT-23-5	28vdo	VD1	6d	Sii
G6Q	S-80920CLMC	Vdet-IC	2.0V±2%, -Reset ODO	SOT-23-5	28vdo	VD1	6d	Sii
G6R	S-80921CLMC	Vdet-IC	2.1V±2%, -Reset ODO	SOT-23-5	28vdo	VD1	6d	Sii
G6S	S-80922CLMC	Vdet-IC	2.2V±2%, -Reset ODO	SOT-23-5	28vdo	VD1	6d	Sii
G6T	S-80923CLMC	Vdet-IC	2.3V±2%, -Reset ODO	SOT-23-5	28vdo	VD1	6d	Sii
G6U	S-80924CLMC	Vdet-IC	2.4V±2%, -Reset ODO	SOT-23-5	28vdo	VD1	6d	Sii
G6V	S-80925CLMC	Vdet-IC	2.5V±2%, -Reset ODO	SOT-23-5	28vdo	VD1	6d	Sii
G6W	S-80926CLMC	Vdet-IC	2.6V±2%, -Reset ODO	SOT-23-5	28vdo	VD1	6d	Sii
G6X	S-80927CLMC	Vdet-IC	2.7V±2%, -Reset ODO	SOT-23-5	28vdo	VD1	6d	Sii
G6Y	S-80928CLMC	Vdet-IC	2.8V±2%, -Reset ODO	SOT-23-5	28vdo	VD1	6d	Sii
G6Z	S-80929CLMC	Vdet-IC	2.9V±2%, -Reset ODO	SOT-23-5	28vdo	VD1	6d	Sii
G7	R1111N371B	LVR-IC	LDO, LN, +CE, 3.7V±2%, 200mA	SOT-23-5	28cx	VR4	6g	Ric
G7	Si91844DT-35	LVR-IC	LDO, LN, +CE, -Error, 3.5V±1.5%, 150mA	SOT-23-5	28w	VR17	6k	Vs
G7A	S-80940CLMC	Vdet-IC	4.0V±2%, -Reset ODO	SOT-23-5	28vdo	VD1	6d	Sii
G7B	S-80941CLMC	Vdet-IC	4.1V±2%, -Reset ODO	SOT-23-5	28vdo	VD1	6d	Sii
G7C	S-80942CLMC	Vdet-IC	4.2V±2%, -Reset ODO	SOT-23-5	28vdo	VD1	6d	Sii
G7D	S-80943CLMC	Vdet-IC	4.3V±2%, -Reset ODO	SOT-23-5	28vdo	VD1	6d	Sii
G7E	S-80944CLMC	Vdet-IC	4.4V±2%, -Reset ODO	SOT-23-5	28vdo	VD1	6d	Sii
G7F	S-80945CLMC	Vdet-IC	4.5V±2%, -Reset ODO	SOT-23-5	28vdo	VD1	6d	Sii
G7G	S-80946CLMC	Vdet-IC	4.6V±2%, -Reset ODO	SOT-23-5	28vdo	VD1	6d	Sii
G7H	S-80947CLMC	Vdet-IC	4.7V±2%, -Reset ODO	SOT-23-5	28vdo	VD1	6d	Sii
G7J	S-80948CLMC	Vdet-IC	4.8V±2%, -Reset ODO	SOT-23-5	28vdo	VD1	6d	Sii
G7K	S-80949CLMC	Vdet-IC	4.9V±2%, -Reset ODO	SOT-23-5	28vdo	VD1	6d	Sii
G7L	S-80950CLMC	Vdet-IC	5.0V±2%, -Reset ODO	SOT-23-5	28vdo	VD1	6d	Sii
G7M	S-80951CLMC	Vdet-IC	5.1V±2%, -Reset ODO	SOT-23-5	28vdo	VD1	6d	Sii
G7N	S-80952CLMC	Vdet-IC	5.2V±2%, -Reset ODO	SOT-23-5	28vdo	VD1	6d	Sii
G7P	S-80953CLMC	Vdet-IC	5.3V±2%, -Reset ODO	SOT-23-5	28vdo	VD1	6d	Sii
G7Q	S-80954CLMC	Vdet-IC	5.4V±2%, -Reset ODO	SOT-23-5	28vdo	VD1	6d	Sii
G7R	S-80955CLMC	Vdet-IC	5.5V±2%, -Reset ODO	SOT-23-5	28vdo	VD1	6d	Sii
G7S	S-80956CLMC	Vdet-IC	5.6V±2%, -Reset ODO	SOT-23-5	28vdo	VD1	6d	Sii
G7T	S-80957CLMC	Vdet-IC	5.7V±2%, -Reset ODO	SOT-23-5	28vdo	VD1	6d	Sii
G7U	S-80958CLMC	Vdet-IC	5.8V±2%, -Reset ODO	SOT-23-5	28vdo	VD1	6d	Sii
G7V	S-80959CLMC	Vdet-IC	5.9V±2%, -Reset ODO	SOT-23-5	28vdo	VD1	6d	Sii
G7W	S-80960CLMC	Vdet-IC	6.0V±2%, -Reset ODO	SOT-23-5	28vdo	VD1	6d	Sii



SMD code	Type	Function	Short description	Case	Pinout	Sch.	St.	Mnf.
G8	R1111N381B	LVR-IC	LDO, LN, +CE, 3.8V±2%, 200mA	SOT-23-5	28cx	VR4	6g	Ric
G8	Si91844DT-36	LVR-IC	LDO, LN, +CE, -Error, 3.6V±1.5%, 150mA	SOT-23-5	28w	VR17	6k	Vs
G8	TC7SET86F	CMOS-Logic	2-input EXCLUSIVE-OR gate	SSOP-5	28/Log5	-	6a	Tos
G8	TC7SET86FU	CMOS-Logic	2-input EXCLUSIVE-OR gate	SC-70-5	28/Log5	-	6a	Tos
G80	S-80930CNMC	Vdet-IC	3.0V±2%, -Reset PPO	SOT-23-5	28vdo	VD3	6d	Sii
G81	S-80931CNMC	Vdet-IC	3.1V±2%, -Reset PPO	SOT-23-5	28vdo	VD3	6d	Sii
G82	S-80932CNMC	Vdet-IC	3.2V±2%, -Reset PPO	SOT-23-5	28vdo	VD3	6d	Sii
G83	S-80933CNMC	Vdet-IC	3.3V±2%, -Reset PPO	SOT-23-5	28vdo	VD3	6d	Sii
G84	S-80934CNMC	Vdet-IC	3.4V±2%, -Reset PPO	SOT-23-5	28vdo	VD3	6d	Sii
G85	S-80935CNMC	Vdet-IC	3.5V±2%, -Reset PPO	SOT-23-5	28vdo	VD3	6d	Sii
G86	XC7SET86GV	CMOS-Logic	2-input EXCLUSIVE-OR gate	SOT753	28/Log5	-	6a	Phi
G86	S-80936CNMC	Vdet-IC	3.6V±2%, -Reset PPO	SOT-23-5	28vdo	VD3	6d	Sii
G87	S-80937CNMC	Vdet-IC	3.7V±2%, -Reset PPO	SOT-23-5	28vdo	VD3	6d	Sii
G88	S-80938CNMC	Vdet-IC	3.8±V2.0%, -Reset PPO	SOT-23-5	28vdo	VD3	6d	Sii
G89	S-80939CNMC	Vdet-IC	3.9V±2%, -Reset PPO	SOT-23-5	28vdo	VD3	6d	Sii
G8H	S-80913CNMC	Vdet-IC	1.3V±2%, -Reset PPO	SOT-23-5	28vdo	VD3	6d	Sii
G8J	S-80914CNMC	Vdet-IC	1.4V±2%, -Reset PPO	SOT-23-5	28vdo	VD3	6d	Sii
G8K	S-80915CNMC	Vdet-IC	1.5V±2%, -Reset PPO	SOT-23-5	28vdo	VD3	6d	Sii
G8L	S-80916CNMC	Vdet-IC	1.6V±2%, -Reset PPO	SOT-23-5	28vdo	VD3	6d	Sii
G8M	S-80917CNMC	Vdet-IC	1.7V±2%, -Reset PPO	SOT-23-5	28vdo	VD3	6d	Sii
G8N	S-80918CNMC	Vdet-IC	1.8V±2%, -Reset PPO	SOT-23-5	28vdo	VD3	6d	Sii
G8P	S-80919CNMC	Vdet-IC	1.9V±2%, -Reset PPO	SOT-23-5	28vdo	VD3	6d	Sii
G8Q	S-80920CNMC	Vdet-IC	2.0V±2%, -Reset PPO	SOT-23-5	28vdo	VD3	6d	Sii
G8R	S-80921CNMC	Vdet-IC	2.1V±2%, -Reset PPO	SOT-23-5	28vdo	VD3	6d	Sii
G8S	S-80922CNMC	Vdet-IC	2.2V±2%, -Reset PPO	SOT-23-5	28vdo	VD3	6d	Sii
G8T	S-80923CNMC	Vdet-IC	2.3V±2%, -Reset PPO	SOT-23-5	28vdo	VD3	6d	Sii
G8U	S-80924CNMC	Vdet-IC	2.4V±2%, -Reset PPO	SOT-23-5	28vdo	VD3	6d	Sii
G8V	S-80925CNMC	Vdet-IC	2.5V±2%, -Reset PPO	SOT-23-5	28vdo	VD3	6d	Sii
G8W	S-80926CNMC	Vdet-IC	2.6V±2%, -Reset PPO	SOT-23-5	28vdo	VD3	6d	Sii
G8X	S-80927CNMC	Vdet-IC	2.7V±2%, -Reset PPO	SOT-23-5	28vdo	VD3	6d	Sii
G8Y	S-80928CNMC	Vdet-IC	2.8V±2%, -Reset PPO	SOT-23-5	28vdo	VD3	6d	Sii
G8Z	S-80929CNMC	Vdet-IC	2.9V±2%, -Reset PPO	SOT-23-5	28vdo	VD3	6d	Sii
G9	R1111N391B	LVR-IC	LDO, LN, +CE, 3.9V±2%, 200mA	SOT-23-5	28cx	VR4	6g	Ric
G9	Si91844DT-50	LVR-IC	LDO, LN, +CE, -Error, 5V±1.5%, 150mA	SOT-23-5	28w	VR17	6k	Vs
G9A	S-80940CNMC	Vdet-IC	4.0V±2%, -Reset PPO	SOT-23-5	28vdo	VD3	6d	Sii
G9B	S-80941CNMC	Vdet-IC	4.1V±2%, -Reset PPO	SOT-23-5	28vdo	VD3	6d	Sii
G9C	S-80942CNMC	Vdet-IC	4.2V±2%, -Reset PPO	SOT-23-5	28vdo	VD3	6d	Sii
G9D	S-80943CNMC	Vdet-IC	4.3V±2%, -Reset PPO	SOT-23-5	28vdo	VD3	6d	Sii
G9E	S-80944CNMC	Vdet-IC	4.4V±2%, -Reset PPO	SOT-23-5	28vdo	VD3	6d	Sii
G9F	S-80945CNMC	Vdet-IC	4.5V±2%, -Reset PPO	SOT-23-5	28vdo	VD3	6d	Sii
G9G	S-80946CNMC	Vdet-IC	4.6V±2%, -Reset PPO	SOT-23-5	28vdo	VD3	6d	Sii
G9H	S-80947CNMC	Vdet-IC	4.7V±2%, -Reset PPO	SOT-23-5	28vdo	VD3	6d	Sii
G9J	S-80948CNMC	Vdet-IC	4.8V±2%, -Reset PPO	SOT-23-5	28vdo	VD3	6d	Sii
G9K	S-80949CNMC	Vdet-IC	4.9V±2%, -Reset PPO	SOT-23-5	28vdo	VD3	6d	Sii
G9L	S-80950CNMC	Vdet-IC	5.0V±2%, -Reset PPO	SOT-23-5	28vdo	VD3	6d	Sii
G9M	S-80951CNMC	Vdet-IC	5.1V±2%, -Reset PPO	SOT-23-5	28vdo	VD3	6d	Sii
G9N	S-80952CNMC	Vdet-IC	5.2V±2%, -Reset PPO	SOT-23-5	28vdo	VD3	6d	Sii
G9P	S-80953CNMC	Vdet-IC	5.3V±2%, -Reset PPO	SOT-23-5	28vdo	VD3	6d	Sii
G9Q	S-80954CNMC	Vdet-IC	5.4V±2%, -Reset PPO	SOT-23-5	28vdo	VD3	6d	Sii
G9R	S-80955CNMC	Vdet-IC	5.5V±2%, -Reset PPO	SOT-23-5	28vdo	VD3	6d	Sii
G9S	S-80956CNMC	Vdet-IC	5.6V±2%, -Reset PPO	SOT-23-5	28vdo	VD3	6d	Sii
G9T	S-80957CNMC	Vdet-IC	5.7V±2%, -Reset PPO	SOT-23-5	28vdo	VD3	6d	Sii
G9U	S-80958CNMC	Vdet-IC	5.8V±2%, -Reset PPO	SOT-23-5	28vdo	VD3	6d	Sii
G9V	S-80959CNMC	Vdet-IC	5.9V±2%, -Reset PPO	SOT-23-5	28vdo	VD3	6d	Sii
G9W	S-80960CNMC	Vdet-IC	6.0V±2%, -Reset PPO	SOT-23-5	28vdo	VD3	6d	Sii
Ga	FP6801-22CS5P	Vdet-IC	2.2V±2%, -Reset PPO	SOT-23-5	28vdo	VD3	6a	Fit
GA	BD4940FVE	Vdet-IC	4V, +Reset PPO	VSO-5	30vdv	VD7	6c	Rhm
GA	BD4940G	Vdet-IC	4V, +Reset PPO	SSOP-5	28vdm	VD7	6c	Rhm
GA	IDT74ALVC1G00DY	CMOS-Logic	2-input NAND gate	SO5-1	28/Log1	-	6g	ldt
GAA	RP170N331B	LVR-IC	LDO, 3.3V±1%, 300mA, +CE	SOT-23-5	28cx	VR4	6g	Ric
GAB	RP170N341B	LVR-IC	LDO, 3.4V±1%, 300mA, +CE	SOT-23-5	28cx	VR4	6g	Ric
GAC	RP170N351B	LVR-IC	LDO, 3.5V±1%, 300mA, +CE	SOT-23-5	28cx	VR4	6g	Ric
GAD	RP170N361B	LVR-IC	LDO, 3.6V±1%, 300mA, +CE	SOT-23-5	28cx	VR4	6g	Ric
GAE	RP170N371B	LVR-IC	LDO, 3.7V±1%, 300mA, +CE	SOT-23-5	28cx	VR4	6g	Ric
GAF	RP170N381B	LVR-IC	LDO, 3.8V±1%, 300mA, +CE	SOT-23-5	28cx	VR4	6g	Ric
GAG	RP170N391B	LVR-IC	LDO, 3.9V±1%, 300mA, +CE	SOT-23-5	28cx	VR4	6g	Ric
GAH	RP170N401B	LVR-IC	LDO, 4.0V±1%, 300mA, +CE	SOT-23-5	28cx	VR4	6g	Ric
GAJ	RP170N411B	LVR-IC	LDO, 4.1V±1%, 300mA, +CE	SOT-23-5	28cx	VR4	6g	Ric
GAK	RP170N421B	LVR-IC	LDO, 4.2V±1%, 300mA, +CE	SOT-23-5	28cx	VR4	6g	Ric
GAL	RP170N431B	LVR-IC	LDO, 4.3V±1%, 300mA, +CE	SOT-23-5	28cx	VR4	6g	Ric



SMD code	Type	Function	Short description	Case	Pinout	Sch.	St.	Mnf.
GAM	RP170N441B	LVR-IC	LDO, 4.4V±1%, 300mA, +CE	SOT-23-5	28cx	VR4	6g	Ric
GAN	RP170N451B	LVR-IC	LDO, 4.5V±1%, 300mA, +CE	SOT-23-5	28cx	VR4	6g	Ric
GAP	RP170N461B	LVR-IC	LDO, 4.6V±1%, 300mA, +CE	SOT-23-5	28cx	VR4	6g	Ric
GAQ	RP170N471B	LVR-IC	LDO, 4.7V±1%, 300mA, +CE	SOT-23-5	28cx	VR4	6g	Ric
GAR	RP170N481B	LVR-IC	LDO, 4.8V±1%, 300mA, +CE	SOT-23-5	28cx	VR4	6g	Ric
GAS	RP170N491B	LVR-IC	LDO, 4.9V±1%, 300mA, +CE	SOT-23-5	28cx	VR4	6g	Ric
GAT	RP170N501B	LVR-IC	LDO, 5.0V±1%, 300mA, +CE	SOT-23-5	28cx	VR4	6g	Ric
GAU	RP170N511B	LVR-IC	LDO, 5.1V±1%, 300mA, +CE	SOT-23-5	28cx	VR4	6g	Ric
GAV	RP170N521B	LVR-IC	LDO, 5.2V±1%, 300mA, +CE	SOT-23-5	28cx	VR4	6g	Ric
GAW	RP170N531B	LVR-IC	LDO, 5.3V±1%, 300mA, +CE	SOT-23-5	28cx	VR4	6g	Ric
GAX	RP170N541B	LVR-IC	LDO, 5.4V±1%, 300mA, +CE	SOT-23-5	28cx	VR4	6g	Ric
GAY	RP170N551B	LVR-IC	LDO, 5.5V±1%, 300mA, +CE	SOT-23-5	28cx	VR4	6g	Ric
GAZ	RP170N561B	LVR-IC	LDO, 5.6V±1%, 300mA, +CE	SOT-23-5	28cx	VR4	6g	Ric
gB	XC7SET02GW	CMOS-Logic	2-input NOR gate	SOT353-1	28/Log2	-	6a	Phi
Gb	FP6801-26CS5P	Vdet-IC	2.6V±2%, -Reset PPO	SOT-23-5	28vdo	VD3	6a	Fit
GB	BD4941FVE	Vdet-IC	4.1V, +Reset PPO	VSOFF-5	30vdv	VD7	6c	Rhm
GB	BD4941G	Vdet-IC	4.1V, +Reset PPO	SSOP-5	28vdm	VD7	6c	Rhm
GB	IDT74ALVC1G02DY	CMOS-Logic	2-input NOR gate	SO5-1	28/Log2	-	6g	Idt
GB1	RP170N471D	LVR-IC	LDO, 4.7V±1%, 300mA, +CE, CL	SOT-23-5	28cx	VR4	6g	Ric
GBA	RP170N331D	LVR-IC	LDO, 3.3V±1%, 300mA, +CE, CL	SOT-23-5	28cx	VR4	6g	Ric
GBB	RP170N341D	LVR-IC	LDO, 3.4V±1%, 300mA, +CE, CL	SOT-23-5	28cx	VR4	6g	Ric
GBB	RP170N351D	LVR-IC	LDO, 3.5V±1%, 300mA, +CE, CL	SOT-23-5	28cx	VR4	6g	Ric
GBD	RP170N361D	LVR-IC	LDO, 3.6V±1%, 300mA, +CE, CL	SOT-23-5	28cx	VR4	6g	Ric
GBE	RP170N371D	LVR-IC	LDO, 3.7V±1%, 300mA, +CE, CL	SOT-23-5	28cx	VR4	6g	Ric
GBF	RP170N381D	LVR-IC	LDO, 3.8V±1%, 300mA, +CE, CL	SOT-23-5	28cx	VR4	6g	Ric
GBG	RP170N391D	LVR-IC	LDO, 3.9V±1%, 300mA, +CE, CL	SOT-23-5	28cx	VR4	6g	Ric
GBH	RP170N401D	LVR-IC	LDO, 4.0V±1%, 300mA, +CE, CL	SOT-23-5	28cx	VR4	6g	Ric
GBJ	RP170N411D	LVR-IC	LDO, 4.1V±1%, 300mA, +CE, CL	SOT-23-5	28cx	VR4	6g	Ric
GBK	RP170N421D	LVR-IC	LDO, 4.2V±1%, 300mA, +CE, CL	SOT-23-5	28cx	VR4	6g	Ric
GBL	RP170N431D	LVR-IC	LDO, 4.3V±1%, 300mA, +CE, CL	SOT-23-5	28cx	VR4	6g	Ric
GBM	RP170N441D	LVR-IC	LDO, 4.4V±1%, 300mA, +CE, CL	SOT-23-5	28cx	VR4	6g	Ric
GBN	RP170N451D	LVR-IC	LDO, 4.5V±1%, 300mA, +CE, CL	SOT-23-5	28cx	VR4	6g	Ric
GBP	RP170N461D	LVR-IC	LDO, 4.6V±1%, 300mA, +CE, CL	SOT-23-5	28cx	VR4	6g	Ric
GBR	RP170N481D	LVR-IC	LDO, 4.8V±1%, 300mA, +CE, CL	SOT-23-5	28cx	VR4	6g	Ric
GBS	RP170N491D	LVR-IC	LDO, 4.9V±1%, 300mA, +CE, CL	SOT-23-5	28cx	VR4	6g	Ric
GBT	RP170N501D	LVR-IC	LDO, 5.0V±1%, 300mA, +CE, CL	SOT-23-5	28cx	VR4	6g	Ric
GBU	RP170N511D	LVR-IC	LDO, 5.1V±1%, 300mA, +CE, CL	SOT-23-5	28cx	VR4	6g	Ric
GBV	RP170N521D	LVR-IC	LDO, 5.2V±1%, 300mA, +CE, CL	SOT-23-5	28cx	VR4	6g	Ric
GBW	RP170N531D	LVR-IC	LDO, 5.3V±1%, 300mA, +CE, CL	SOT-23-5	28cx	VR4	6g	Ric
GBX	RP170N541D	LVR-IC	LDO, 5.4V±1%, 300mA, +CE, CL	SOT-23-5	28cx	VR4	6g	Ric
GBY	RP170N551D	LVR-IC	LDO, 5.5V±1%, 300mA, +CE, CL	SOT-23-5	28cx	VR4	6g	Ric
GBZ	RP170N561D	LVR-IC	LDO, 5.6V±1%, 300mA, +CE, CL	SOT-23-5	28cx	VR4	6g	Ric
gC	XC7SET04GW	CMOS-Logic	Inverter	SOT-353-1	28/Log6	-	6a	Phi
GC	BD4942FVE	Vdet-IC	4.2V, +Reset PPO	VSOFF-5	30vdv	VD7	6c	Rhm
GC	BD4942G	Vdet-IC	4.2V, +Reset PPO	SSOP-5	28vdm	VD7	6c	Rhm
GC	IDT74ALVC1G04DY	CMOS-Logic	Inverter	SO5-1	28/Log6	-	6g	Idt
Gd	FP6801-29CS5P	Vdet-IC	2.9V±2%, -Reset PPO	SOT-23-5	28vdo	VD3	6a	Fit
GD	BD4943FVE	Vdet-IC	4.3V, +Reset PPO	VSOFF-5	30vdv	VD7	6c	Rhm
GD	BD4943G	Vdet-IC	4.3V, +Reset PPO	SSOP-5	28vdm	VD7	6c	Rhm
GD	IDT74ALVC1GU04DY	CMOS-Logic	Inverter	SO5-1	28/Log6	-	6g	Idt
gE	XC7SET08GW	CMOS-Logic	2-input AND gate	SOT-353-1	28/Log3	-	6a	Phi
Ge	FP6801-31CS5P	Vdet-IC	3.1V±2%, -Reset PPO	SOT-23-5	28vdo	VD3	6a	Fit
GE	BD4944FVE	Vdet-IC	4.4V, +Reset PPO	VSOFF-5	30vdv	VD7	6c	Rhm
GE	BD4944G	Vdet-IC	4.4V, +Reset PPO	SSOP-5	28vdm	VD7	6c	Rhm
GE	IDT74ALVC1G08DY	CMOS-Logic	2-input AND gate	SO5-1	28/Log3	-	6g	Idt
GE08G	AIC1748BH-08GV5	LVR-IC	LDO, 0.8V±2%, 600mA, +CE	SOT-23-5	28vrx	VR7	6a	Aic
GE09G	AIC1748BH-09GV5	LVR-IC	LDO, 0.9V±2%, 600mA, +CE	SOT-23-5	28vrx	VR7	6a	Aic
GE10G	AIC1748BH-10GV5	LVR-IC	LDO, 1.0V±2%, 600mA, +CE	SOT-23-5	28vrx	VR7	6a	Aic
GE11G	AIC1748BH-11GV5	LVR-IC	LDO, 1.1V±2%, 600mA, +CE	SOT-23-5	28vrx	VR7	6a	Aic
GE12G	AIC1748BH-12GV5	LVR-IC	LDO, 1.2V±2%, 600mA, +CE	SOT-23-5	28vrx	VR7	6a	Aic
GE13G	AIC1748BH-13GV5	LVR-IC	LDO, 1.3V±2%, 600mA, +CE	SOT-23-5	28vrx	VR7	6a	Aic
GE14G	AIC1748BH-14GV5	LVR-IC	LDO, 1.4V±2%, 600mA, +CE	SOT-23-5	28vrx	VR7	6a	Aic
GE15G	AIC1748BH-15GV5	LVR-IC	LDO, 1.5V±2%, 600mA, +CE	SOT-23-5	28vrx	VR7	6a	Aic
GE16G	AIC1748BH-16GV5	LVR-IC	LDO, 1.6V±2%, 600mA, +CE	SOT-23-5	28vrx	VR7	6a	Aic
GE17G	AIC1748BH-17GV5	LVR-IC	LDO, 1.7V±2%, 600mA, +CE	SOT-23-5	28vrx	VR7	6a	Aic
GE18G	AIC1748BH-18GV5	LVR-IC	LDO, 1.8V±2%, 600mA, +CE	SOT-23-5	28vrx	VR7	6a	Aic
GE19G	AIC1748BH-19GV5	LVR-IC	LDO, 1.9V±2%, 600mA, +CE	SOT-23-5	28vrx	VR7	6a	Aic
GE20G	AIC1748BH-20GV5	LVR-IC	LDO, 2.0V±2%, 600mA, +CE	SOT-23-5	28vrx	VR7	6a	Aic
GE21G	AIC1748BH-21GV5	LVR-IC	LDO, 2.1V±2%, 600mA, +CE	SOT-23-5	28vrx	VR7	6a	Aic
GE22G	AIC1748BH-22GV5	LVR-IC	LDO, 2.2V±2%, 600mA, +CE	SOT-23-5	28vrx	VR7	6a	Aic



SMD code	Type	Function	Short description	Case	Pinout	Sch.	St.	Mnf.
GE23G	AIC1748BH-23GV5	LVR-IC	LDO, 2.3V±2%, 600mA, +CE	SOT-23-5	28vrx	VR7	6a	Aic
GE24G	AIC1748BH-24GV5	LVR-IC	LDO, 2.4V±2%, 600mA, +CE	SOT-23-5	28vrx	VR7	6a	Aic
GE25G	AIC1748BH-25GV5	LVR-IC	LDO, 2.5V±2%, 600mA, +CE	SOT-23-5	28vrx	VR7	6a	Aic
GE26G	AIC1748BH-26GV5	LVR-IC	LDO, 2.6V±2%, 600mA, +CE	SOT-23-5	28vrx	VR7	6a	Aic
GE27G	AIC1748BH-27GV5	LVR-IC	LDO, 2.7V±2%, 600mA, +CE	SOT-23-5	28vrx	VR7	6a	Aic
GE28G	AIC1748BH-28GV5	LVR-IC	LDO, 2.8V±2%, 600mA, +CE	SOT-23-5	28vrx	VR7	6a	Aic
GE29G	AIC1748BH-29GV5	LVR-IC	LDO, 2.9V±2%, 600mA, +CE	SOT-23-5	28vrx	VR7	6a	Aic
GE2JG	AIC1748BH-285GV5	LVR-IC	LDO, 2.85V±2%, 600mA, +CE	SOT-23-5	28vrx	VR7	6a	Aic
GE30G	AIC1748BH-30GV5	LVR-IC	LDO, 3.0V±2%, 600mA, +CE	SOT-23-5	28vrx	VR7	6a	Aic
GE31G	AIC1748BH-32GV5	LVR-IC	LDO, 3.1V±2%, 600mA, +CE	SOT-23-5	28vrx	VR7	6a	Aic
GE32G	AIC1748BH-33GV5	LVR-IC	LDO, 3.2V±2%, 600mA, +CE	SOT-23-5	28vrx	VR7	6a	Aic
GE33G	AIC1748BH-33GV5	LVR-IC	LDO, 3.3V±2%, 600mA, +CE	SOT-23-5	28vrx	VR7	6a	Aic
gF	XC7SET14GW	CMOS-Logic	Inverting Schmitt-trigger	SOT-353-1	28/Log7	-	6a	Phi
Gf	FP6801-21CS5P	Vdet-IC	2.1V±2%, -Reset PPO	SOT-23-5	28vdo	VD3	6a	Fit
GF	BD4945FVE	Vdet-IC	4.5V, +Reset PPO	VSO5-5	30vdo	VD7	6c	Rhm
GF	BD4945G	Vdet-IC	4.5V, +Reset PPO	SSOP-5	28vdm	VD7	6c	Rhm
GF	IDT74ALVC1G14DY	CMOS-Logic	Inverting Schmitt-trigger	S05-1	28/Log7	-	6g	ldt
GF08G	AIC1748BL-08GV5	LVR-IC	LDO, 0.8V±2%, 600mA, -CE	SOT-23-5	28vrx	VR7	6a	Aic
GF09G	AIC1748BL-09GV5	LVR-IC	LDO, 0.9V±2%, 600mA, -CE	SOT-23-5	28vrx	VR7	6a	Aic
GF10G	AIC1748BL-10GV5	LVR-IC	LDO, 1.0V±2%, 600mA, -CE	SOT-23-5	28vrx	VR7	6a	Aic
GF11G	AIC1748BL-11GV5	LVR-IC	LDO, 1.1V±2%, 600mA, -CE	SOT-23-5	28vrx	VR7	6a	Aic
GF12G	AIC1748BL-12GV5	LVR-IC	LDO, 1.2V±2%, 600mA, -CE	SOT-23-5	28vrx	VR7	6a	Aic
GF13G	AIC1748BL-13GV5	LVR-IC	LDO, 1.3V±2%, 600mA, -CE	SOT-23-5	28vrx	VR7	6a	Aic
GF14G	AIC1748BL-14GV5	LVR-IC	LDO, 1.4V±2%, 600mA, -CE	SOT-23-5	28vrx	VR7	6a	Aic
GF15G	AIC1748BL-15GV5	LVR-IC	LDO, 1.5V±2%, 600mA, -CE	SOT-23-5	28vrx	VR7	6a	Aic
GF16G	AIC1748BL-16GV5	LVR-IC	LDO, 1.6V±2%, 600mA, -CE	SOT-23-5	28vrx	VR7	6a	Aic
GF17G	AIC1748BL-17GV5	LVR-IC	LDO, 1.7V±2%, 600mA, -CE	SOT-23-5	28vrx	VR7	6a	Aic
GF18G	AIC1748BL-18GV5	LVR-IC	LDO, 1.8V±2%, 600mA, -CE	SOT-23-5	28vrx	VR7	6a	Aic
GF19G	AIC1748BL-19GV5	LVR-IC	LDO, 1.9V±2%, 600mA, -CE	SOT-23-5	28vrx	VR7	6a	Aic
GF20G	AIC1748BL-20GV5	LVR-IC	LDO, 2.0V±2%, 600mA, -CE	SOT-23-5	28vrx	VR7	6a	Aic
GF21G	AIC1748BL-21GV5	LVR-IC	LDO, 2.1V±2%, 600mA, -CE	SOT-23-5	28vrx	VR7	6a	Aic
GF22G	AIC1748BL-22GV5	LVR-IC	LDO, 2.2V±2%, 600mA, -CE	SOT-23-5	28vrx	VR7	6a	Aic
GF23G	AIC1748BL-23GV5	LVR-IC	LDO, 2.3V±2%, 600mA, -CE	SOT-23-5	28vrx	VR7	6a	Aic
GF24G	AIC1748BL-24GV5	LVR-IC	LDO, 2.4V±2%, 600mA, -CE	SOT-23-5	28vrx	VR7	6a	Aic
GF25G	AIC1748BL-25GV5	LVR-IC	LDO, 2.5V±2%, 600mA, -CE	SOT-23-5	28vrx	VR7	6a	Aic
GF26G	AIC1748BL-26GV5	LVR-IC	LDO, 2.6V±2%, 600mA, -CE	SOT-23-5	28vrx	VR7	6a	Aic
GF27G	AIC1748BL-27GV5	LVR-IC	LDO, 2.7V±2%, 600mA, -CE	SOT-23-5	28vrx	VR7	6a	Aic
GF28G	AIC1748BL-28GV5	LVR-IC	LDO, 2.8V±2%, 600mA, -CE	SOT-23-5	28vrx	VR7	6a	Aic
GF29G	AIC1748BL-29GV5	LVR-IC	LDO, 2.9V±2%, 600mA, -CE	SOT-23-5	28vrx	VR7	6a	Aic
GF2JG	AIC1748BL-285GV5	LVR-IC	LDO, 2.85V±2%, 600mA, -CE	SOT-23-5	28vrx	VR7	6a	Aic
GF30G	AIC1748BL-30GV5	LVR-IC	LDO, 3.0V±2%, 600mA, -CE	SOT-23-5	28vrx	VR7	6a	Aic
GF31G	AIC1748BL-32GV5	LVR-IC	LDO, 3.1V±2%, 600mA, -CE	SOT-23-5	28vrx	VR7	6a	Aic
GF32G	AIC1748BL-33GV5	LVR-IC	LDO, 3.2V±2%, 600mA, -CE	SOT-23-5	28vrx	VR7	6a	Aic
GF33G	AIC1748BL-33GV5	LVR-IC	LDO, 3.3V±2%, 600mA, -CE	SOT-23-5	28vrx	VR7	6a	Aic
gG	XC7SET32GW	CMOS-Logic	2-input OR gate	SOT-353-1	28/Log4	-	6a	Phi
GG	BD4946FVE	Vdet-IC	4.6V, +Reset PPO	VSO5-5	30vdo	VD7	6c	Rhm
GG	BD4946G	Vdet-IC	4.6V, +Reset PPO	SSOP-5	28vdm	VD7	6c	Rhm
GG	IDT74ALVC1G32DY	CMOS-Logic	2-input OR gate	S05-1	28/Log4	-	6g	ldt
GGG	AIC1748AH-285GV5	LVR-IC	LDO, Adjustable 0.8..4.5V, 600mA, +CE	SOT-23-5	28sg	VR5	6a	Aic
gH	XC7SET86GW	CMOS-Logic	2-input EXCLUSIVE-OR gate	SOT-353-1	28/Log5	-	6a	Phi
Gh	FP6801-21NS5P	Vdet-IC	2.1V±2%, -Reset ODO	SOT-23-5	28vdo	VD1	6a	Fit
GH	BD4947FVE	Vdet-IC	4.7V, +Reset PPO	VSO5-5	30vdo	VD7	6c	Rhm
GH	BD4947G	Vdet-IC	4.7V, +Reset PPO	SSOP-5	28vdm	VD7	6c	Rhm
GH	IDT74ALVC1G86DY	CMOS-Logic	2-input EXCLUSIVE-OR gate	S05-1	28/Log5	-	6g	ldt
GHG	AIC1748AL-285GV5	LVR-IC	LDO, Adjustable 0.8..4.5V, 600mA, -CE	SOT-23-5	28sg	VR5	6a	Aic
GJ	BD4948FVE	Vdet-IC	4.8V, +Reset PPO	VSO5-5	30vdo	VD7	6c	Rhm
GJ	BD4948G	Vdet-IC	4.8V, +Reset PPO	SSOP-5	28vdm	VD7	6c	Rhm
GJ-	RT9198-15PV	LVR-IC	LDO, 1.5V±1%, 300mA, +CE	SOT-23-5	28xm	VR4	6a	Rct
Gk	FP6801-22NS5P	Vdet-IC	2.2V±2%, -Reset ODO	SOT-23-5	28vdo	VD1	6a	Fit
GK	BD4949FVE	Vdet-IC	4.9V, +Reset PPO	VSO5-5	30vdo	VD7	6c	Rhm
GK	BD4949G	Vdet-IC	4.9V, +Reset PPO	SSOP-5	28vdm	VD7	6c	Rhm
GL	BD4950FVE	Vdet-IC	5V, +Reset PPO	VSO5-5	30vdo	VD7	6c	Rhm
GL	BD4950G	Vdet-IC	5V, +Reset PPO	SSOP-5	28vdm	VD7	6c	Rhm
GL	R1112N301B	LVR-IC	LDO, LN, +CE, 3V±2%, 150mA	SOT-23-5	28cx	VR4	6g	Ric
gM	XC7SET125GW	CMOS-Logic	Bus buffer gate with 3-state output	SOT-353-1	28/Log14	-	6a	Phi
Gm	FP6801-26NS5P	Vdet-IC	2.6V±2%, -Reset ODO	SOT-23-5	28vdo	VD1	6a	Fit
GM	BD4951FVE	Vdet-IC	5.1V, +Reset PPO	VSO5-5	30vdo	VD7	6c	Rhm
GM	BD4951G	Vdet-IC	5.1V, +Reset PPO	SSOP-5	28vdm	VD7	6c	Rhm
GM	IDT74ALVC1G125DY	CMOS-Logic	Bus buffer gate with 3-state output	S05-1	28/Log14	-	6g	ldt
GM	R1112N311B	LVR-IC	LDO, LN, +CE, 3.1V±2%, 150mA	SOT-23-5	28cx	VR4	6g	Ric



SMD code	Type	Function	Short description	Case	Pinout	Sch.	St.	Mnf.
GN	FP6801-29NS5P	Vdet-IC	2.9V±2%, -Reset ODO	SOT-23-5	28vdo	VD1	6a	Fit
GN	BD4952FVE	Vdet-IC	5.2V, +Reset PPO	VSOFF-5	30vdv	VD7	6c	Rhm
GN	BD4952G	Vdet-IC	5.2V, +Reset PPO	SSOP-5	28vdm	VD7	6c	Rhm
GN	IDT74ALVC1G126DY	CMOS-Logic	Bus buffer gate with 3-state output	SO5-1	28/Log13	-	6g	ldt
GN	R1112N321B	LVR-IC	LDO, LN, +CE, 3.2V±2%, 150mA	SOT-23-5	28xc	VR4	6g	Ric
GP	BD4953FVE	Vdet-IC	5.3V, +Reset PPO	VSOFF-5	30vdv	VD7	6c	Rhm
GP	BD4953G	Vdet-IC	5.3V, +Reset PPO	SSOP-5	28vdm	VD7	6c	Rhm
GP	R1112N331B	LVR-IC	LDO, LN, +CE, 3.3V±2%, 150mA	SOT-23-5	28xc	VR4	6g	Ric
GQ	BD4954FVE	Vdet-IC	5.4V, +Reset PPO	VSOFF-5	30vdv	VD7	6c	Rhm
GQ	BD4954G	Vdet-IC	5.4V, +Reset PPO	SSOP-5	28vdm	VD7	6c	Rhm
GQ	R1112N341B	LVR-IC	LDO, LN, +CE, 3.4V±2%, 150mA	SOT-23-5	28xc	VR4	6g	Ric
Gr	FP6801-31NS5P	Vdet-IC	3.1V±2%, -Reset ODO	SOT-23-5	28vdo	VD1	6a	Fit
GR	AT1201-25XR	LVR-IC	LDO, LN, +CE, 2.5V±2%, 150mA	SOT-23-5	28un	VR7	6a	Atr
GR	BD4955FVE	Vdet-IC	5.5V, +Reset PPO	VSOFF-5	30vdv	VD7	6c	Rhm
GR	BD4955G	Vdet-IC	5.5V, +Reset PPO	SSOP-5	28vdm	VD7	6c	Rhm
GR	IDT74ALVC1G79DY	CMOS-Logic	Positive edge-triggered D-type flip-flop	SO5-1	28/Log20	-	6g	ldt
GR	R1112N351B	LVR-IC	LDO, LN, +CE, 3.5V±2%, 150mA	SOT-23-5	28xc	VR4	6g	Ric
GS	BD4956FVE	Vdet-IC	5.6V, +Reset PPO	VSOFF-5	30vdv	VD7	6c	Rhm
GS	BD4956G	Vdet-IC	5.6V, +Reset PPO	SSOP-5	28vdm	VD7	6c	Rhm
GS	R1112N361B	LVR-IC	LDO, LN, +CE, 3.6V±2%, 150mA	SOT-23-5	28xc	VR4	6g	Ric
GT	BD4957FVE	Vdet-IC	5.7V, +Reset PPO	VSOFF-5	30vdv	VD7	6c	Rhm
GT	BD4957G	Vdet-IC	5.7V, +Reset PPO	SSOP-5	28vdm	VD7	6c	Rhm
GT	IDT74ALVC1G06DY	CMOS-Logic	Inverter (ODO)	SO5-1	28/Log19	-	6g	ldt
GT	R1112N371B	LVR-IC	LDO, LN, +CE, 3.7V±2%, 150mA	SOT-23-5	28xc	VR4	6g	Ric
GU	BD4958FVE	Vdet-IC	5.8V, +Reset PPO	VSOFF-5	30vdv	VD7	6c	Rhm
GU	BD4958G	Vdet-IC	5.8V, +Reset PPO	SSOP-5	28vdm	VD7	6c	Rhm
GU	R1112N381B	LVR-IC	LDO, LN, +CE, 3.8V±2%, 150mA	SOT-23-5	28xc	VR4	6g	Ric
GV	BD4959FVE	Vdet-IC	5.9V, +Reset PPO	VSOFF-5	30vdv	VD7	6c	Rhm
GV	BD4959G	Vdet-IC	5.9V, +Reset PPO	SSOP-5	28vdm	VD7	6c	Rhm
GV	IDT74ALVC1G07DY	CMOS-Logic	Noninverting buffer/driver (ODO)	SO5-1	28/Log8	-	6g	ldt
GV	R1112N391B	LVR-IC	LDO, LN, +CE, 3.9V±2%, 150mA	SOT-23-5	28xc	VR4	6g	Ric
GW	BD4960FVE	Vdet-IC	6V, +Reset PPO	VSOFF-5	30vdv	VD7	6c	Rhm
GW	BD4960G	Vdet-IC	6V, +Reset PPO	SSOP-5	28vdm	VD7	6c	Rhm
GX	AT1201-25X	LVR-IC	LDO, LN, +CE, 2.5V±2%, 150mA	SOT-23-5	28vrx	VR7	6a	Atr
GY	IDT74ALVC1G132DY	CMOS-Logic	2-input NAND Schmitt-trigger	SO5-1	28/Log12	-	6g	ldt
GZ	FP6801-24CS5P	Vdet-IC	2.4V±2%, -Reset PPO	SOT-23-5	28vdo	VD3	6a	Fit
H0	R1111N401B	LVR-IC	LDO, LN, +CE, 4V±2%, 200mA	SOT-23-5	28xc	VR4	6g	Ric
H00	74HC1G00GV	CMOS-Logic	2-input NAND gate	SOT753	28/Log1	-	6a	Phi
H001	RP103Q122D	LVR-IC	LDO, 1.2V±1%, 150mA, +CE, CL	SC-88A	28xm	VR4	6m	Ric
H002	RP103Q132D	LVR-IC	LDO, 1.3V±1%, 150mA, +CE, CL	SC-88A	28xm	VR4	6m	Ric
H003	RP103Q152D	LVR-IC	LDO, 1.5V±1%, 150mA, +CE, CL	SC-88A	28xm	VR4	6m	Ric
H004	RP103Q182D	LVR-IC	LDO, 1.8V±1%, 150mA, +CE, CL	SC-88A	28xm	VR4	6m	Ric
H005	RP103Q182D5	LVR-IC	LDO, 1.85V±1%, 150mA, +CE, CL	SC-88A	28xm	VR4	6m	Ric
H006	RP103Q192D	LVR-IC	LDO, 1.9V±1%, 150mA, +CE, CL	SC-88A	28xm	VR4	6m	Ric
H007	RP103Q202D	LVR-IC	LDO, 2.0V±1%, 150mA, +CE, CL	SC-88A	28xm	VR4	6m	Ric
H008	RP103Q212D	LVR-IC	LDO, 2.1V±1%, 150mA, +CE, CL	SC-88A	28xm	VR4	6m	Ric
H009	RP103Q232D	LVR-IC	LDO, 2.3V±1%, 150mA, +CE, CL	SC-88A	28xm	VR4	6m	Ric
H010	RP103Q252D	LVR-IC	LDO, 2.5V±1%, 150mA, +CE, CL	SC-88A	28xm	VR4	6m	Ric
H011	RP103Q262D	LVR-IC	LDO, 2.6V±1%, 150mA, +CE, CL	SC-88A	28xm	VR4	6m	Ric
H012	RP103Q272D	LVR-IC	LDO, 2.7V±1%, 150mA, +CE, CL	SC-88A	28xm	VR4	6m	Ric
H013	RP103Q282D	LVR-IC	LDO, 2.8V±1%, 150mA, +CE, CL	SC-88A	28xm	VR4	6m	Ric
H014	RP103Q282D5	LVR-IC	LDO, 2.85V±1%, 150mA, +CE, CL	SC-88A	28xm	VR4	6m	Ric
H015	RP103Q292D	LVR-IC	LDO, 2.9V±1%, 150mA, +CE, CL	SC-88A	28xm	VR4	6m	Ric
H016	RP103Q302D	LVR-IC	LDO, 3.0V±1%, 150mA, +CE, CL	SC-88A	28xm	VR4	6m	Ric
H017	RP103Q312D	LVR-IC	LDO, 3.1V±1%, 150mA, +CE, CL	SC-88A	28xm	VR4	6m	Ric
H018	RP103Q322D	LVR-IC	LDO, 3.2V±1%, 150mA, +CE, CL	SC-88A	28xm	VR4	6m	Ric
H019	RP103Q332D	LVR-IC	LDO, 3.3V±1%, 150mA, +CE, CL	SC-88A	28xm	VR4	6m	Ric
H02	74HC1G02GV	CMOS-Logic	2-input NOR gate	SOT753	28/Log2	-	6a	Phi
H02	U7SH02-AF5	CMOS-Logic	2-input NOR gate	SOT-23-5	28/Log2	-	6a	Utc
H02	U7SH02-AL5	CMOS-Logic	2-input NOR gate	SOT-353	28/Log2	-	6a	Utc
H020	RP103Q292D5	LVR-IC	LDO, 2.95V±1%, 150mA, +CE, CL	SC-88A	28xm	VR4	6m	Ric
H021	RP103Q222D	LVR-IC	LDO, 2.2V±1%, 150mA, +CE, CL	SC-88A	28xm	VR4	6m	Ric
H022	RP103Q162D	LVR-IC	LDO, 1.6V±1%, 150mA, +CE, CL	SC-88A	28xm	VR4	6m	Ric
H023	RP103Q142D	LVR-IC	LDO, 1.4V±1%, 150mA, +CE, CL	SC-88A	28xm	VR4	6m	Ric
H024	RP103Q172D	LVR-IC	LDO, 1.7V±1%, 150mA, +CE, CL	SC-88A	28xm	VR4	6m	Ric
H025	RP103Q242D	LVR-IC	LDO, 2.4V±1%, 150mA, +CE, CL	SC-88A	28xm	VR4	6m	Ric
H02L	U7SH02L-AF5	CMOS-Logic	2-input NOR gate	SOT-23-5	28/Log2	-	6a	Utc
H02L	U7SH02L-AL5	CMOS-Logic	2-input NOR gate	SOT-353	28/Log2	-	6a	Utc
H04	74HC1G04GV	CMOS-Logic	Inverter	SOT753	28/Log6	-	6a	Phi
H07_	SN74AUP1G07DBV	CMOS-Logic	Noninverting buffer/driver (ODO)	SOT-23-5	28/Log8	-	6a	Ti



SMD code	Type	Function	Short description	Case	Pinout	Sch.	St.	Mnf.
H08	74HC1G08GV	CMOS-Logic	2-input AND gate	SOT753	28/Log3	-	6a	Phi
H08	U7SH08-AF5	CMOS-Logic	2-input AND gate	SOT-23-5	28/Log3	-	6a	Ute
H08	U7SH08-AL5	CMOS-Logic	2-input AND gate	SOT-353	28/Log3	-	6a	Ute
H08	XC6220A081MR	LVR-IC	LDO, 0.8V±20mV, 1A, +CE	SOT-25	28cx	VR4	6g	Tor
H08L	U7SH08L-AF5	CMOS-Logic	2-input AND gate	SOT-23-5	28/Log3	-	6a	Ute
H08L	U7SH08L-AL5	CMOS-Logic	2-input AND gate	SOT-353	28/Log3	-	6a	Ute
H09	XC6220A091MR	LVR-IC	LDO, 0.9V±20mV, 1A, +CE	SOT-25	28cx	VR4	6g	Tor
H0A	RP130N121A	LVR-IC	LDO, LN, -CE, 1.2V±1%, 150mA	SOT-23-5	28cx	VR4	6g	Ric
H0A	XC6220A101MR	LVR-IC	LDO, 1V±20mV, 1A, +CE	SOT-25	28cx	VR4	6g	Tor
H0B	RP130N131A	LVR-IC	LDO, LN, -CE, 1.3V±1%, 150mA	SOT-23-5	28cx	VR4	6g	Ric
H0B	XC6220A111MR	LVR-IC	LDO, 1.1V±20mV, 1A, +CE	SOT-25	28cx	VR4	6g	Tor
H0C	RP130N141A	LVR-IC	LDO, LN, -CE, 1.4V±1%, 150mA	SOT-23-5	28cx	VR4	6g	Ric
H0C	XC6220A121MR	LVR-IC	LDO, 1.2V±20mV, 1A, +CE	SOT-25	28cx	VR4	6g	Tor
H0D	RP130N151A	LVR-IC	LDO, LN, -CE, 1.5V±1%, 150mA	SOT-23-5	28cx	VR4	6g	Ric
H0D	XC6220A131MR	LVR-IC	LDO, 1.3V±20mV, 1A, +CE	SOT-25	28cx	VR4	6g	Tor
H0E	RP130N161A	LVR-IC	LDO, LN, -CE, 1.6V±1%, 150mA	SOT-23-5	28cx	VR4	6g	Ric
H0E	XC6220A141MR	LVR-IC	LDO, 1.4V±20mV, 1A, +CE	SOT-25	28cx	VR4	6g	Tor
H0F	RP130N171A	LVR-IC	LDO, LN, -CE, 1.7V±1%, 150mA	SOT-23-5	28cx	VR4	6g	Ric
H0F	XC6220A151MR	LVR-IC	LDO, 1.5V±20mV, 1A, +CE	SOT-25	28cx	VR4	6g	Tor
H0G	RP130N181A	LVR-IC	LDO, LN, -CE, 1.8V±1%, 150mA	SOT-23-5	28cx	VR4	6g	Ric
H0H	RP130N181A5	LVR-IC	LDO, LN, -CE, 1.85V±1%, 150mA	SOT-23-5	28cx	VR4	6g	Ric
H0H	XC6220A161MR	LVR-IC	LDO, 1.6V±20mV, 1A, +CE	SOT-25	28cx	VR4	6g	Tor
H0J	RP130N191A	LVR-IC	LDO, LN, -CE, 1.9V±1%, 150mA	SOT-23-5	28cx	VR4	6g	Ric
H0K	RP130N201A	LVR-IC	LDO, LN, -CE, 2V±1%, 150mA	SOT-23-5	28cx	VR4	6g	Ric
H0K	XC6220A171MR	LVR-IC	LDO, 1.7V±20mV, 1A, +CE	SOT-25	28cx	VR4	6g	Tor
H0L	RP130N211A	LVR-IC	LDO, LN, -CE, 2.1V±1%, 150mA	SOT-23-5	28cx	VR4	6g	Ric
H0L	XC6220A181MR	LVR-IC	LDO, 1.8V±20mV, 1A, +CE	SOT-25	28cx	VR4	6g	Tor
H0M	RP130N221A	LVR-IC	LDO, LN, -CE, 2.2V±1%, 150mA	SOT-23-5	28cx	VR4	6g	Ric
H0M	XC6220A191MR	LVR-IC	LDO, 1.9V±20mV, 1A, +CE	SOT-25	28cx	VR4	6g	Tor
H0N	RP130N231A	LVR-IC	LDO, LN, -CE, 2.3V±1%, 150mA	SOT-23-5	28cx	VR4	6g	Ric
H0N	XC6220A201MR	LVR-IC	LDO, 2V±1%, 1A, +CE	SOT-25	28cx	VR4	6g	Tor
H0P	RP130N241A	LVR-IC	LDO, LN, -CE, 2.4V±1%, 150mA	SOT-23-5	28cx	VR4	6g	Ric
H0P	XC6220A211MR	LVR-IC	LDO, 2.1V±1%, 1A, +CE	SOT-25	28cx	VR4	6g	Tor
H0Q	RP130N251A	LVR-IC	LDO, LN, -CE, 2.5V±1%, 150mA	SOT-23-5	28cx	VR4	6g	Ric
H0Q	RP130N261A	LVR-IC	LDO, LN, -CE, 2.6V±1%, 150mA	SOT-23-5	28cx	VR4	6g	Ric
H0R	XC6220A221MR	LVR-IC	LDO, 2.2V±1%, 1A, +CE	SOT-25	28cx	VR4	6g	Tor
H0S	RP130N271A	LVR-IC	LDO, LN, -CE, 2.7V±1%, 150mA	SOT-23-5	28cx	VR4	6g	Ric
H0S	XC6220A231MR	LVR-IC	LDO, 2.3V±1%, 1A, +CE	SOT-25	28cx	VR4	6g	Tor
H0T	RP130N281A	LVR-IC	LDO, LN, -CE, 2.8V±1%, 150mA	SOT-23-5	28cx	VR4	6g	Ric
H0T	XC6220A241MR	LVR-IC	LDO, 2.4V±1%, 1A, +CE	SOT-25	28cx	VR4	6g	Tor
H0U	RP130N281A5	LVR-IC	LDO, LN, -CE, 2.85V±1%, 150mA	SOT-23-5	28cx	VR4	6g	Ric
H0U	XC6220A251MR	LVR-IC	LDO, 2.5V±1%, 1A, +CE	SOT-25	28cx	VR4	6g	Tor
H0V	RP130N291A	LVR-IC	LDO, LN, -CE, 2.9V±1%, 150mA	SOT-23-5	28cx	VR4	6g	Ric
H0V	XC6220A261MR	LVR-IC	LDO, 2.6V±1%, 1A, +CE	SOT-25	28cx	VR4	6g	Tor
H0W	RP130N301A	LVR-IC	LDO, LN, -CE, 3V±1%, 150mA	SOT-23-5	28cx	VR4	6g	Ric
H0X	RP130N311A	LVR-IC	LDO, LN, -CE, 3.1V±1%, 150mA	SOT-23-5	28cx	VR4	6g	Ric
H0X	XC6220A271MR	LVR-IC	LDO, 2.7V±1%, 1A, +CE	SOT-25	28cx	VR4	6g	Tor
H0Y	RP130N321A	LVR-IC	LDO, LN, -CE, 3.2V±1%, 150mA	SOT-23-5	28cx	VR4	6g	Ric
H0Y	XC6220A281MR	LVR-IC	LDO, 2.8V±1%, 1A, +CE	SOT-25	28cx	VR4	6g	Tor
H0Z	RP130N331A	LVR-IC	LDO, LN, -CE, 3.3V±1%, 150mA	SOT-23-5	28cx	VR4	6g	Ric
H0Z	XC6220A291MR	LVR-IC	LDO, 2.9V±1%, 1A, +CE	SOT-25	28cx	VR4	6g	Tor
H1	HD74HC1G00CM	CMOS-Logic	2-input NAND gate	CMPAK-5	28/Log1	-	6a	Ren
H1	HD74UH00EL	CMOS-Logic	2-input NAND gate	MPAK-5	28/Log1	-	6g	Ren
H1	MC74HC1G00DF	CMOS-Logic	2-input NAND gate	SOT-353	28/Log1	-	6b	Ons
H1	MC74HC1G00DT	CMOS-Logic	2-input NAND gate	SOT-23-5	28/Log1	-	6b	Ons
H1	R1111N411B	LVR-IC	LDO, LN, +CE, 4.1V±2%, 200mA	SOT-23-5	28cx	VR4	6g	Ric
H1	TC7SH00F	CMOS-Logic	2-input NAND gate	SSOP-5	28/Log1	-	6a	Tos
H1	TC7SH00FU	CMOS-Logic	2-input NAND gate	SC-70-5	28/Log1	-	6a	Tos
H10	R1224N102H	DC/DC-IC	PWM step-down, 1V, 500kHz	SOT-23-5	28ud	DC7	6g	Ric
H12	R1224N122H	DC/DC-IC	PWM step-down, 1.2V, 500kHz	SOT-23-5	28ud	DC7	6g	Ric
H14	74HC1G14GV	CMOS-Logic	Inverting Schmitt-trigger	SOT753	28/Log7	-	6a	Phi
H15	R1224N152H	DC/DC-IC	PWM step-down, 1.5V, 500kHz	SOT-23-5	28ud	DC7	6g	Ric
H18	R1224N182H	DC/DC-IC	PWM step-down, 1.8V, 500kHz	SOT-23-5	28ud	DC7	6g	Ric
H18	XC6220A08BMR	LVR-IC	LDO, 0.85V±20mV, 1A, +CE	SOT-25	28cx	VR4	6g	Tor
H19	XC6220A09BMR	LVR-IC	LDO, 0.95V±20mV, 1A, +CE	SOT-25	28cx	VR4	6g	Tor
H1A	RP130N121B	LVR-IC	LDO, LN, +CE, 1.2V±1%, 150mA	SOT-23-5	28cx	VR4	6g	Ric
H1A	XC6220A10BMR	LVR-IC	LDO, 1.05V±20mV, 1A, +CE	SOT-25	28cx	VR4	6g	Tor
H1B	RP130N131B	LVR-IC	LDO, LN, +CE, 1.3V±1%, 150mA	SOT-23-5	28cx	VR4	6g	Ric
H1B	XC6220A11BMR	LVR-IC	LDO, 1.15V±20mV, 1A, +CE	SOT-25	28cx	VR4	6g	Tor
H1C	RP130N141B	LVR-IC	LDO, LN, +CE, 1.4V±1%, 150mA	SOT-23-5	28cx	VR4	6g	Ric



SMD code	Type	Function	Short description	Case	Pinout	Sch.	St.	Mnf.
H1C	XC6220A12BMR	LVR-IC	LDO, 1.25V±20mV, 1A, +CE	SOT-25	28cx	VR4	6g	Tor
H1D	RP130N151B	LVR-IC	LDO, LN, +CE, 1.5V±1%, 150mA	SOT-23-5	28cx	VR4	6g	Ric
H1D	XC6220A13BMR	LVR-IC	LDO, 1.35V±20mV, 1A, +CE	SOT-25	28cx	VR4	6g	Tor
H1E	RP130N161B	LVR-IC	LDO, LN, +CE, 1.6V±1%, 150mA	SOT-23-5	28cx	VR4	6g	Ric
H1E	XC6220A14BMR	LVR-IC	LDO, 1.45V±20mV, 1A, +CE	SOT-25	28cx	VR4	6g	Tor
H1F	RP130N171B	LVR-IC	LDO, LN, +CE, 1.7V±1%, 150mA	SOT-23-5	28cx	VR4	6g	Ric
H1F	XC6220A15BMR	LVR-IC	LDO, 1.55V±20mV, 1A, +CE	SOT-25	28cx	VR4	6g	Tor
H1G	RP130N181B	LVR-IC	LDO, LN, +CE, 1.8V±1%, 150mA	SOT-23-5	28cx	VR4	6g	Ric
H1H	RP130N181B5	LVR-IC	LDO, LN, +CE, 1.85V±1%, 150mA	SOT-23-5	28cx	VR4	6g	Ric
H1H	XC6220A16BMR	LVR-IC	LDO, 1.65V±20mV, 1A, +CE	SOT-25	28cx	VR4	6g	Tor
H1J	RP130N191B	LVR-IC	LDO, LN, +CE, 1.9V±1%, 150mA	SOT-23-5	28cx	VR4	6g	Ric
H1K	RP130N201B	LVR-IC	LDO, LN, +CE, 2V±1%, 150mA	SOT-23-5	28cx	VR4	6g	Ric
H1K	XC6220A17BMR	LVR-IC	LDO, 1.75V±20mV, 1A, +CE	SOT-25	28cx	VR4	6g	Tor
H1L	RP130N211B	LVR-IC	LDO, LN, +CE, 2.1V±1%, 150mA	SOT-23-5	28cx	VR4	6g	Ric
H1L	XC6220A18BMR	LVR-IC	LDO, 1.85V±20mV, 1A, +CE	SOT-25	28cx	VR4	6g	Tor
H1M	RP130N221B	LVR-IC	LDO, LN, +CE, 2.2V±1%, 150mA	SOT-23-5	28cx	VR4	6g	Ric
H1M	XC6220A19BMR	LVR-IC	LDO, 1.95V±20mV, 1A, +CE	SOT-25	28cx	VR4	6g	Tor
H1N	RP130N231B	LVR-IC	LDO, LN, +CE, 2.3V±1%, 150mA	SOT-23-5	28cx	VR4	6g	Ric
H1N	XC6220A20BMR	LVR-IC	LDO, 2.05V±1%, 1A, +CE	SOT-25	28cx	VR4	6g	Tor
H1P	RP130N241B	LVR-IC	LDO, LN, +CE, 2.4V±1%, 150mA	SOT-23-5	28cx	VR4	6g	Ric
H1P	XC6220A21BMR	LVR-IC	LDO, 2.15V±1%, 1A, +CE	SOT-25	28cx	VR4	6g	Tor
H1Q	RP130N251B	LVR-IC	LDO, LN, +CE, 2.5V±1%, 150mA	SOT-23-5	28cx	VR4	6g	Ric
H1R	RP130N261B	LVR-IC	LDO, LN, +CE, 2.6V±1%, 150mA	SOT-23-5	28cx	VR4	6g	Ric
H1R	XC6220A22BMR	LVR-IC	LDO, 2.25V±1%, 1A, +CE	SOT-25	28cx	VR4	6g	Tor
H1S	RP130N271B	LVR-IC	LDO, LN, +CE, 2.7V±1%, 150mA	SOT-23-5	28cx	VR4	6g	Ric
H1S	XC6220A23BMR	LVR-IC	LDO, 2.35V±1%, 1A, +CE	SOT-25	28cx	VR4	6g	Tor
H1T	RP130N281B	LVR-IC	LDO, LN, +CE, 2.8V±1%, 150mA	SOT-23-5	28cx	VR4	6g	Ric
H1T	XC6220A24BMR	LVR-IC	LDO, 2.45V±1%, 1A, +CE	SOT-25	28cx	VR4	6g	Tor
H1U	RP130N281B5	LVR-IC	LDO, LN, +CE, 2.85V±1%, 150mA	SOT-23-5	28cx	VR4	6g	Ric
H1U	XC6220A25BMR	LVR-IC	LDO, 2.55V±1%, 1A, +CE	SOT-25	28cx	VR4	6g	Tor
H1V	RP130N291B	LVR-IC	LDO, LN, +CE, 2.9V±1%, 150mA	SOT-23-5	28cx	VR4	6g	Ric
H1V	XC6220A26BMR	LVR-IC	LDO, 2.65V±1%, 1A, +CE	SOT-25	28cx	VR4	6g	Tor
H1W	RP130N301B	LVR-IC	LDO, LN, +CE, 3V±1%, 150mA	SOT-23-5	28cx	VR4	6g	Ric
H1X	RP130N311B	LVR-IC	LDO, LN, +CE, 3.1V±1%, 150mA	SOT-23-5	28cx	VR4	6g	Ric
H1X	XC6220A27BMR	LVR-IC	LDO, 2.75V±1%, 1A, +CE	SOT-25	28cx	VR4	6g	Tor
H1Y	RP130N321B	LVR-IC	LDO, LN, +CE, 3.2V±1%, 150mA	SOT-23-5	28cx	VR4	6g	Ric
H1Y	XC6220A28BMR	LVR-IC	LDO, 2.85V±1%, 1A, +CE	SOT-25	28cx	VR4	6g	Tor
H1Z	RP130N331B	LVR-IC	LDO, LN, +CE, 3.3V±1%, 150mA	SOT-23-5	28cx	VR4	6g	Ric
H1Z	XC6220A29BMR	LVR-IC	LDO, 2.95V±1%, 1A, +CE	SOT-25	28cx	VR4	6g	Tor
H2	HD74HC1G08CM	CMOS-Logic	2-input AND gate	CMCPAK-5	28/Log3	-	6a	Ren
H2	HD74UH08EL	CMOS-Logic	2-input AND gate	MPAK-5	28/Log3	-	6g	Ren
H2	MC74HC1G08DF	CMOS-Logic	2-input AND gate	SC-70-5	28/Log3	-	6b	Ons
H2	MC74HC1G08DT	CMOS-Logic	2-input AND gate	SOT-23-5	28/Log3	-	6b	Ons
H2	R1111N421B	LVR-IC	LDO, LN, +CE, 4.2V±2%, 200mA	SOT-23-5	28cx	VR4	6g	Ric
H2	TC7SH08F	CMOS-Logic	2-input AND gate	SSOP-5	28/Log3	-	6a	Tos
H2	TC7SH08FU	CMOS-Logic	2-input AND gate	SC-70-5	28/Log3	-	6a	Tos
H20	XC6220A301MR	LVR-IC	LDO, 3V±1%, 1A, +CE	SOT-25	28cx	VR4	6g	Tor
H21	XC6220A311MR	LVR-IC	LDO, 3.1V±1%, 1A, +CE	SOT-25	28cx	VR4	6g	Tor
H22	XC6220A321MR	LVR-IC	LDO, 3.2V±1%, 1A, +CE	SOT-25	28cx	VR4	6g	Tor
H23	XC6220A331MR	LVR-IC	LDO, 3.3V±1%, 1A, +CE	SOT-25	28cx	VR4	6g	Tor
H24	XC6220A341MR	LVR-IC	LDO, 3.4V±1%, 1A, +CE	SOT-25	28cx	VR4	6g	Tor
H25	74HC1G125GV	CMOS-Logic	Bus buffer gate with 3-state output	SOT7753	28/Log14	-	6a	Phi
H25	R1224N252H	DC/DC-IC	PWM step-down, 2.5V, 500kHz	SOT-23-5	28ud	DC7	6g	Ric
H25	XC6220A351MR	LVR-IC	LDO, 3.5V±1%, 1A, +CE	SOT-25	28cx	VR4	6g	Tor
H26	74HC1G126GV	CMOS-Logic	Bus buffer gate with 3-state output	SOT7753	28/Log13	-	6a	Phi
H26	XC6220A361MR	LVR-IC	LDO, 3.6V±1%, 1A, +CE	SOT-25	28cx	VR4	6g	Tor
H27	XC6220A371MR	LVR-IC	LDO, 3.7V±1%, 1A, +CE	SOT-25	28cx	VR4	6g	Tor
H28	XC6220A381MR	LVR-IC	LDO, 3.8V±1%, 1A, +CE	SOT-25	28cx	VR4	6g	Tor
H29	XC6220A391MR	LVR-IC	LDO, 3.9V±1%, 1A, +CE	SOT-25	28cx	VR4	6g	Tor
H2A	RP130N121D	LVR-IC	LDO, LN, +CE, CL, 1.2V±1%, 150mA	SOT-23-5	28cx	VR4	6g	Ric
H2A	XC6220A401MR	LVR-IC	LDO, 4V±1%, 1A, +CE	SOT-25	28cx	VR4	6g	Tor
H2B	RP130N131D	LVR-IC	LDO, LN, +CE, CL, 1.3V±1%, 150mA	SOT-23-5	28cx	VR4	6g	Ric
H2B	XC6220A411MR	LVR-IC	LDO, 4.1V±1%, 1A, +CE	SOT-25	28cx	VR4	6g	Tor
H2C	RP130N141D	LVR-IC	LDO, LN, +CE, CL, 1.4V±1%, 150mA	SOT-23-5	28cx	VR4	6g	Ric
H2C	XC6220A421MR	LVR-IC	LDO, 4.2V±1%, 1A, +CE	SOT-25	28cx	VR4	6g	Tor
H2D	RP130N151D	LVR-IC	LDO, LN, +CE, CL, 1.5V±1%, 150mA	SOT-23-5	28cx	VR4	6g	Ric
H2D	XC6220A431MR	LVR-IC	LDO, 4.3V±1%, 1A, +CE	SOT-25	28cx	VR4	6g	Tor
H2E	RP130N161D	LVR-IC	LDO, LN, +CE, CL, 1.6V±1%, 150mA	SOT-23-5	28cx	VR4	6g	Ric
H2E	XC6220A441MR	LVR-IC	LDO, 4.4V±1%, 1A, +CE	SOT-25	28cx	VR4	6g	Tor
H2F	RP130N171D	LVR-IC	LDO, LN, +CE, CL, 1.7V±1%, 150mA	SOT-23-5	28cx	VR4	6g	Ric



SMD code	Type	Function	Short description	Case	Pinout	Sch.	St.	Mnf.
H2F	XC6220A451MR	LVR-IC	LDO, 4.5V±1%, 1A, +CE	SOT-25	28cx	VR4	6g	Tor
H2G	RP130N181D	LVR-IC	LDO, LN, +CE, CL, 1.8V±1%, 150mA	SOT-23-5	28cx	VR4	6g	Ric
H2H	RP130N181D5	LVR-IC	LDO, LN, +CE, CL, 1.85V±1%, 150mA	SOT-23-5	28cx	VR4	6g	Ric
H2H	XC6220A461MR	LVR-IC	LDO, 4.6V±1%, 1A, +CE	SOT-25	28cx	VR4	6g	Tor
H2J	RP130N191D	LVR-IC	LDO, LN, +CE, CL, 1.9V±1%, 150mA	SOT-23-5	28cx	VR4	6g	Ric
H2K	RP130N201D	LVR-IC	LDO, LN, +CE, CL, 2V±1%, 150mA	SOT-23-5	28cx	VR4	6g	Ric
H2K	XC6220A471MR	LVR-IC	LDO, 4.7V±1%, 1A, +CE	SOT-25	28cx	VR4	6g	Tor
H2L	RP130N211D	LVR-IC	LDO, LN, +CE, CL, 2.1V±1%, 150mA	SOT-23-5	28cx	VR4	6g	Ric
H2L	XC6220A481MR	LVR-IC	LDO, 4.8V±1%, 1A, +CE	SOT-25	28cx	VR4	6g	Tor
H2M	RP130N221D	LVR-IC	LDO, LN, +CE, CL, 2.2V±1%, 150mA	SOT-23-5	28cx	VR4	6g	Ric
H2M	XC6220A491MR	LVR-IC	LDO, 4.9V±1%, 1A, +CE	SOT-25	28cx	VR4	6g	Tor
H2N	RP130N231D	LVR-IC	LDO, LN, +CE, CL, 2.3V±1%, 150mA	SOT-23-5	28cx	VR4	6g	Ric
H2N	XC6220A501MR	LVR-IC	LDO, 5V±1%, 1A, +CE	SOT-25	28cx	VR4	6g	Tor
H2P	RP130N241D	LVR-IC	LDO, LN, +CE, CL, 2.4V±1%, 150mA	SOT-23-5	28cx	VR4	6g	Ric
H2Q	RP130N251D	LVR-IC	LDO, LN, +CE, CL, 2.5V±1%, 150mA	SOT-23-5	28cx	VR4	6g	Ric
H2R	RP130N261D	LVR-IC	LDO, LN, +CE, CL, 2.6V±1%, 150mA	SOT-23-5	28cx	VR4	6g	Ric
H2S	RP130N271D	LVR-IC	LDO, LN, +CE, CL, 2.7V±1%, 150mA	SOT-23-5	28cx	VR4	6g	Ric
H2T	RP130N281D	LVR-IC	LDO, LN, +CE, CL, 2.8V±1%, 150mA	SOT-23-5	28cx	VR4	6g	Ric
H2U	RP130N281D5	LVR-IC	LDO, LN, +CE, CL, 2.85V±1%, 150mA	SOT-23-5	28cx	VR4	6g	Ric
H2V	RP130N291D	LVR-IC	LDO, LN, +CE, CL, 2.9V±1%, 150mA	SOT-23-5	28cx	VR4	6g	Ric
H2W	RP130N301D	LVR-IC	LDO, LN, +CE, CL, 3V±1%, 150mA	SOT-23-5	28cx	VR4	6g	Ric
H2X	RP130N311D	LVR-IC	LDO, LN, +CE, CL, 3.1V±1%, 150mA	SOT-23-5	28cx	VR4	6g	Ric
H2Y	RP130N321D	LVR-IC	LDO, LN, +CE, CL, 3.2V±1%, 150mA	SOT-23-5	28cx	VR4	6g	Ric
H2Z	RP130N331D	LVR-IC	LDO, LN, +CE, CL, 3.3V±1%, 150mA	SOT-23-5	28cx	VR4	6g	Ric
H3	HD74HC1G02CM	CMOS-Logic	2-input NOR gate	CMPAK-5	28/Log2	-	6a	Ren
H3	HD74UH02EL	CMOS-Logic	2-input NOR gate	MPAK-5	28/Log2	-	6g	Ren
H3	MC74HC1G02DF	CMOS-Logic	2-input NOR gate	SOT-353	28/Log2	-	6b	Ons
H3	MC74HC1G02DT	CMOS-Logic	2-input NOR gate	SOT-23-5	28/Log2	-	6b	Ons
H3	R1111N431B	LVR-IC	LDO, LN, +CE, 4.3V±2%, 200mA	SOT-23-5	28cx	VR4	6g	Ric
H3	TC7SH02F	CMOS-Logic	2-input NOR gate	SSOP-5	28/Log2	-	6a	Tos
H3	TC7SH02FU	CMOS-Logic	2-input NOR gate	SC-70-5	28/Log2	-	6a	Tos
H30	R1224N302H	DC/DC-IC	PWM step-down, 3V, 500kHz	SOT-23-5	28ud	DC7	6g	Ric
H30	XC6220A30BMR	LVR-IC	LDO, 3.05V±1%, 1A, +CE	SOT-25	28cx	VR4	6g	Tor
H31	XC6220A31BMR	LVR-IC	LDO, 3.15V±1%, 1A, +CE	SOT-25	28cx	VR4	6g	Tor
H32	74HC1G32GV	CMOS-Logic	2-input OR gate	SOT753	28/Log4	-	6a	Phi
H32	U7SH32-AF5	CMOS-Logic	2-input OR gate	SOT-23-5	28/Log4	-	6a	Ulc
H32	U7SH32-AL5	CMOS-Logic	2-input OR gate	SOT-353	28/Log4	-	6a	Ulc
H32	XC6220A32BMR	LVR-IC	LDO, 3.25V±1%, 1A, +CE	SOT-25	28cx	VR4	6g	Tor
H32L	U7SH32L-AF5	CMOS-Logic	2-input OR gate	SOT-23-5	28/Log4	-	6a	Ulc
H32L	U7SH32L-AL5	CMOS-Logic	2-input OR gate	SOT-353	28/Log4	-	6a	Ulc
H33	R1224N332H	DC/DC-IC	PWM step-down, 3.3V, 500kHz	SOT-23-5	28ud	DC7	6g	Ric
H33	XC6220A33BMR	LVR-IC	LDO, 3.35V±1%, 1A, +CE	SOT-25	28cx	VR4	6g	Tor
H34	XC6220A34BMR	LVR-IC	LDO, 3.45V±1%, 1A, +CE	SOT-25	28cx	VR4	6g	Tor
H35	XC6220A35BMR	LVR-IC	LDO, 3.55V±1%, 1A, +CE	SOT-25	28cx	VR4	6g	Tor
H36	XC6220A36BMR	LVR-IC	LDO, 3.65V±1%, 1A, +CE	SOT-25	28cx	VR4	6g	Tor
H37	XC6220A37BMR	LVR-IC	LDO, 3.75V±1%, 1A, +CE	SOT-25	28cx	VR4	6g	Tor
H38	XC6220A38BMR	LVR-IC	LDO, 3.85V±1%, 1A, +CE	SOT-25	28cx	VR4	6g	Tor
H39	XC6220A39BMR	LVR-IC	LDO, 3.95V±1%, 1A, +CE	SOT-25	28cx	VR4	6g	Tor
H3A	XC6220A40BMR	LVR-IC	LDO, 4.05V±1%, 1A, +CE	SOT-25	28cx	VR4	6g	Tor
H3B	XC6220A41BMR	LVR-IC	LDO, 4.15V±1%, 1A, +CE	SOT-25	28cx	VR4	6g	Tor
H3C	XC6220A42BMR	LVR-IC	LDO, 4.25V±1%, 1A, +CE	SOT-25	28cx	VR4	6g	Tor
H3D	XC6220A43BMR	LVR-IC	LDO, 4.35V±1%, 1A, +CE	SOT-25	28cx	VR4	6g	Tor
H3E	XC6220A44BMR	LVR-IC	LDO, 4.45V±1%, 1A, +CE	SOT-25	28cx	VR4	6g	Tor
H3F	XC6220A45BMR	LVR-IC	LDO, 4.55V±1%, 1A, +CE	SOT-25	28cx	VR4	6g	Tor
H3H	XC6220A46BMR	LVR-IC	LDO, 4.65V±1%, 1A, +CE	SOT-25	28cx	VR4	6g	Tor
H3K	XC6220A47BMR	LVR-IC	LDO, 4.75V±1%, 1A, +CE	SOT-25	28cx	VR4	6g	Tor
H3L	XC6220A48BMR	LVR-IC	LDO, 4.85V±1%, 1A, +CE	SOT-25	28cx	VR4	6g	Tor
H3M	XC6220A49BMR	LVR-IC	LDO, 4.95V±1%, 1A, +CE	SOT-25	28cx	VR4	6g	Tor
H4	HD74HC1G32CM	CMOS-Logic	2-input OR gate	CMPAK-5	28/Log4	-	6a	Ren
H4	HD74UH32EL	CMOS-Logic	2-input OR gate	MPAK-5	28/Log4	-	6g	Ren
H4	MC74HC1G32DF	CMOS-Logic	2-input OR gate	SOT-353	28/Log4	-	6b	Ons
H4	MC74HC1G32DT	CMOS-Logic	2-input OR gate	SOT-23-5	28/Log4	-	6b	Ons
H4	R1111N441B	LVR-IC	LDO, LN, +CE, 4.4V±2%, 200mA	SOT-23-5	28cx	VR4	6g	Ric
H4	TC7SH32F	CMOS-Logic	2-input OR gate	SSOP-5	28/Log4	-	6a	Tos
H4	TC7SH32FU	CMOS-Logic	2-input OR gate	SC-70-5	28/Log4	-	6a	Tos
H48	XC6220B081MR	LVR-IC	LDO, 0.8V±20mV, 1A, +CE, CL	SOT-25	28cx	VR4	6g	Tor
H49	XC6220B091MR	LVR-IC	LDO, 0.9V±20mV, 1A, +CE, CL	SOT-25	28cx	VR4	6g	Tor
H4A	XC6220B101MR	LVR-IC	LDO, 1V±20mV, 1A, +CE, CL	SOT-25	28cx	VR4	6g	Tor
H4B	XC6220B111MR	LVR-IC	LDO, 1.1V±20mV, 1A, +CE, CL	SOT-25	28cx	VR4	6g	Tor
H4C	XC6220B121MR	LVR-IC	LDO, 1.2V±20mV, 1A, +CE, CL	SOT-25	28cx	VR4	6g	Tor



SMD code	Type	Function	Short description	Case	Pinout	Sch.	St.Mnf.
H4D	XC6220B131MR	LVR-IC	LDO, 1.3V±20mV, 1A, +CE, CL	SOT-25	28cx	VR4	6g Tor
H4E	XC6220B141MR	LVR-IC	LDO, 1.4V±20mV, 1A, +CE, CL	SOT-25	28cx	VR4	6g Tor
H4F	XC6220B151MR	LVR-IC	LDO, 1.5V±20mV, 1A, +CE, CL	SOT-25	28cx	VR4	6g Tor
H4H	XC6220B161MR	LVR-IC	LDO, 1.6V±20mV, 1A, +CE, CL	SOT-25	28cx	VR4	6g Tor
H4K	XC6220B171MR	LVR-IC	LDO, 1.7V±20mV, 1A, +CE, CL	SOT-25	28cx	VR4	6g Tor
H4L	XC6220B181MR	LVR-IC	LDO, 1.8V±20mV, 1A, +CE, CL	SOT-25	28cx	VR4	6g Tor
H4M	XC6220B191MR	LVR-IC	LDO, 1.9V±20mV, 1A, +CE, CL	SOT-25	28cx	VR4	6g Tor
H4N	XC6220B201MR	LVR-IC	LDO, 2.0V±1%, 1A, +CE, CL	SOT-25	28cx	VR4	6g Tor
H4P	XC6220B211MR	LVR-IC	LDO, 2.1V±1%, 1A, +CE, CL	SOT-25	28cx	VR4	6g Tor
H4R	XC6220B221MR	LVR-IC	LDO, 2.2V±1%, 1A, +CE, CL	SOT-25	28cx	VR4	6g Tor
H4S	XC6220B231MR	LVR-IC	LDO, 2.3V±1%, 1A, +CE, CL	SOT-25	28cx	VR4	6g Tor
H4T	XC6220B241MR	LVR-IC	LDO, 2.4V±1%, 1A, +CE, CL	SOT-25	28cx	VR4	6g Tor
H4U	XC6220B251MR	LVR-IC	LDO, 2.5V±1%, 1A, +CE, CL	SOT-25	28cx	VR4	6g Tor
H4V	XC6220B261MR	LVR-IC	LDO, 2.6V±1%, 1A, +CE, CL	SOT-25	28cx	VR4	6g Tor
H4X	XC6220B271MR	LVR-IC	LDO, 2.7V±1%, 1A, +CE, CL	SOT-25	28cx	VR4	6g Tor
H4Y	XC6220B281MR	LVR-IC	LDO, 2.8V±1%, 1A, +CE, CL	SOT-25	28cx	VR4	6g Tor
H4Z	XC6220B291MR	LVR-IC	LDO, 2.9V±1%, 1A, +CE, CL	SOT-25	28cx	VR4	6g Tor
H5	HD74HC1G04CM	CMOS-Logic	Inverter	CMPAK-5	28/Log6	-	6a Ren
H5	HD74UH04EL	CMOS-Logic	Inverter	MPAK-5	28/Log6	-	6g Ren
H5	MC74HC1G04DF	CMOS-Logic	Inverter	SOT-353	28/Log6	-	6b Ons
H5	MC74HC1G04DT	CMOS-Logic	Inverter	SOT-23-5	28/Log6	-	6b Ons
H5	R1111N451B	LVR-IC	LDO, LN, +CE, 4.5V±2%, 200mA	SOT-23-5	28cx	VR4	6g Ric
H5	TC7SH04F	CMOS-Logic	Inverter	SSOP-5	28/Log6	-	6a Tos
H5	TC7SH04FU	CMOS-Logic	Inverter	SC-70-5	28/Log6	-	6a Tos
H50	R1224N502H	DC/DC-IC	PWM step-down, 5V, 500kHz	SOT-23-5	28ud	DC7	6g Ric
H55	R1224N552H	DC/DC-IC	PWM step-down, 5.5V, 500kHz	SOT-23-5	28ud	DC7	6g Ric
H58	XC6220B08BMR	LVR-IC	LDO, 0.85V±20mV, 1A, +CE, CL	SOT-25	28cx	VR4	6g Tor
H59	XC6220B09BMR	LVR-IC	LDO, 0.95V±20mV, 1A, +CE, CL	SOT-25	28cx	VR4	6g Tor
H5A	XC6220B10BMR	LVR-IC	LDO, 1.05V±20mV, 1A, +CE, CL	SOT-25	28cx	VR4	6g Tor
H5B	XC6220B11BMR	LVR-IC	LDO, 1.15V±20mV, 1A, +CE, CL	SOT-25	28cx	VR4	6g Tor
H5C	XC6220B12BMR	LVR-IC	LDO, 1.25V±20mV, 1A, +CE, CL	SOT-25	28cx	VR4	6g Tor
H5D	XC6220B13BMR	LVR-IC	LDO, 1.35V±20mV, 1A, +CE, CL	SOT-25	28cx	VR4	6g Tor
H5E	XC6220B14BMR	LVR-IC	LDO, 1.45V±20mV, 1A, +CE, CL	SOT-25	28cx	VR4	6g Tor
H5F	XC6220B15BMR	LVR-IC	LDO, 1.55V±20mV, 1A, +CE, CL	SOT-25	28cx	VR4	6g Tor
H5H	XC6220B16BMR	LVR-IC	LDO, 1.65V±20mV, 1A, +CE, CL	SOT-25	28cx	VR4	6g Tor
H5K	XC6220B17BMR	LVR-IC	LDO, 1.75V±20mV, 1A, +CE, CL	SOT-25	28cx	VR4	6g Tor
H5L	XC6220B18BMR	LVR-IC	LDO, 1.85V±20mV, 1A, +CE, CL	SOT-25	28cx	VR4	6g Tor
H5M	XC6220B19BMR	LVR-IC	LDO, 1.95V±20mV, 1A, +CE, CL	SOT-25	28cx	VR4	6g Tor
H5N	XC6220B20BMR	LVR-IC	LDO, 2.05V±1%, 1A, +CE, CL	SOT-25	28cx	VR4	6g Tor
H5P	XC6220B21BMR	LVR-IC	LDO, 2.15V±1%, 1A, +CE, CL	SOT-25	28cx	VR4	6g Tor
H5R	XC6220B22BMR	LVR-IC	LDO, 2.25V±1%, 1A, +CE, CL	SOT-25	28cx	VR4	6g Tor
H5S	XC6220B23BMR	LVR-IC	LDO, 2.35V±1%, 1A, +CE, CL	SOT-25	28cx	VR4	6g Tor
H5T	XC6220B24BMR	LVR-IC	LDO, 2.45V±1%, 1A, +CE, CL	SOT-25	28cx	VR4	6g Tor
H5U	XC6220B25BMR	LVR-IC	LDO, 2.55V±1%, 1A, +CE, CL	SOT-25	28cx	VR4	6g Tor
H5V	XC6220B26BMR	LVR-IC	LDO, 2.65V±1%, 1A, +CE, CL	SOT-25	28cx	VR4	6g Tor
H5X	XC6220B27BMR	LVR-IC	LDO, 2.75V±1%, 1A, +CE, CL	SOT-25	28cx	VR4	6g Tor
H5Y	XC6220B28BMR	LVR-IC	LDO, 2.85V±1%, 1A, +CE, CL	SOT-25	28cx	VR4	6g Tor
H5Z	XC6220B29BMR	LVR-IC	LDO, 2.95V±1%, 1A, +CE, CL	SOT-25	28cx	VR4	6g Tor
H6	HD74HC1GU04CM	CMOS-Logic	Inverter	CMPAK-5	28/Log6	-	6a Ren
H6	MC74HC1GU04DF	CMOS-Logic	Inverter	SOT-353	28/Log6	-	6b Ons
H6	MC74HC1GU04DT	CMOS-Logic	Inverter	SOT-23-5	28/Log6	-	6b Ons
H6	R1111N461B	LVR-IC	LDO, LN, +CE, 4.6V±2%, 200mA	SOT-23-5	28cx	VR4	6g Ric
H6	TC7SHU04F	CMOS-Logic	Inverter	SSOP-5	28/Log6	-	6a Tos
H6	TC7SHU04FU	CMOS-Logic	Inverter	SC-70-5	28/Log6	-	6a Tos
H60	R1224N602H	DC/DC-IC	PWM step-down, 6V, 500kHz	SOT-23-5	28ud	DC7	6g Ric
H60	XC6220B301MR	LVR-IC	LDO, 3.0V±1%, 1A, +CE, CL	SOT-25	28cx	VR4	6g Tor
H61	XC6220B311MR	LVR-IC	LDO, 3.1V±1%, 1A, +CE, CL	SOT-25	28cx	VR4	6g Tor
H62	XC6220B321MR	LVR-IC	LDO, 3.2V±1%, 1A, +CE, CL	SOT-25	28cx	VR4	6g Tor
H63	XC6220B331MR	LVR-IC	LDO, 3.3V±1%, 1A, +CE, CL	SOT-25	28cx	VR4	6g Tor
H64	XC6220B341MR	LVR-IC	LDO, 3.4V±1%, 1A, +CE, CL	SOT-25	28cx	VR4	6g Tor
H65	XC6220B351MR	LVR-IC	LDO, 3.5V±1%, 1A, +CE, CL	SOT-25	28cx	VR4	6g Tor
H66	74HC1G66GV	CMOS-Logic	Bilateral analogic switch	SOT753	28/Log16	-	6a Phi
H66	XC6220B361MR	LVR-IC	LDO, 3.6V±1%, 1A, +CE, CL	SOT-25	28cx	VR4	6g Tor
H67	XC6220B371MR	LVR-IC	LDO, 3.7V±1%, 1A, +CE, CL	SOT-25	28cx	VR4	6g Tor
H68	XC6220B381MR	LVR-IC	LDO, 3.8V±1%, 1A, +CE, CL	SOT-25	28cx	VR4	6g Tor
H69	XC6220B391MR	LVR-IC	LDO, 3.9V±1%, 1A, +CE, CL	SOT-25	28cx	VR4	6g Tor
H6A	XC6220B401MR	LVR-IC	LDO, 4.0V±1%, 1A, +CE, CL	SOT-25	28cx	VR4	6g Tor
H6B	XC6220B411MR	LVR-IC	LDO, 4.1V±1%, 1A, +CE, CL	SOT-25	28cx	VR4	6g Tor
H6C	XC6220B421MR	LVR-IC	LDO, 4.2V±1%, 1A, +CE, CL	SOT-25	28cx	VR4	6g Tor
H6D	XC6220B431MR	LVR-IC	LDO, 4.3V±1%, 1A, +CE, CL	SOT-25	28cx	VR4	6g Tor



SMD code	Type	Function	Short description	Case	Pinout	Sch.	St.	Mnf.
H6E	XC6220B441MR	LVR-IC	LDO, 4.4V±1%, 1A, +CE, CL	SOT-25	28cx	VR4	6g	Tor
H6F	XC6220B451MR	LVR-IC	LDO, 4.5V±1%, 1A, +CE, CL	SOT-25	28cx	VR4	6g	Tor
H6H	XC6220B461MR	LVR-IC	LDO, 4.6V±1%, 1A, +CE, CL	SOT-25	28cx	VR4	6g	Tor
H6K	XC6220B471MR	LVR-IC	LDO, 4.7V±1%, 1A, +CE, CL	SOT-25	28cx	VR4	6g	Tor
H6L	XC6220B481MR	LVR-IC	LDO, 4.8V±1%, 1A, +CE, CL	SOT-25	28cx	VR4	6g	Tor
H6M	XC6220B491MR	LVR-IC	LDO, 4.9V±1%, 1A, +CE, CL	SOT-25	28cx	VR4	6g	Tor
H6N	XC6220B501MR	LVR-IC	LDO, 5V±1%, 1A, +CE, CL	SOT-25	28cx	VR4	6g	Tor
H7	R1111N471B	LVR-IC	LDO, LN, +CE, 4.7V±2%, 200mA	SOT-23-5	28cx	VR4	6g	Ric
H70	XC6220B30BMR	LVR-IC	LDO, 3.05V±1%, 1A, +CE, CL	SOT-25	28cx	VR4	6g	Tor
H71	XC6220B31BMR	LVR-IC	LDO, 3.15V±1%, 1A, +CE, CL	SOT-25	28cx	VR4	6g	Tor
H72	XC6220B32BMR	LVR-IC	LDO, 3.25V±1%, 1A, +CE, CL	SOT-25	28cx	VR4	6g	Tor
H73	XC6220B33BMR	LVR-IC	LDO, 3.35V±1%, 1A, +CE, CL	SOT-25	28cx	VR4	6g	Tor
H74	XC6220B34BMR	LVR-IC	LDO, 3.45V±1%, 1A, +CE, CL	SOT-25	28cx	VR4	6g	Tor
H75	XC6220B35BMR	LVR-IC	LDO, 3.55V±1%, 1A, +CE, CL	SOT-25	28cx	VR4	6g	Tor
H76	XC6220B36BMR	LVR-IC	LDO, 3.65V±1%, 1A, +CE, CL	SOT-25	28cx	VR4	6g	Tor
H77	XC6220B37BMR	LVR-IC	LDO, 3.75V±1%, 1A, +CE, CL	SOT-25	28cx	VR4	6g	Tor
H78	XC6220B38BMR	LVR-IC	LDO, 3.85V±1%, 1A, +CE, CL	SOT-25	28cx	VR4	6g	Tor
H79	XC6220B39BMR	LVR-IC	LDO, 3.95V±1%, 1A, +CE, CL	SOT-25	28cx	VR4	6g	Tor
H79_	SN74AUP1G79DBV	CMOS-Logic	Positive edge-triggered D-type flip-flop	SOT-23-5	28/Log20	-	6a	Ti
H7A	XC6220B40BMR	LVR-IC	LDO, 4.05V±1%, 1A, +CE, CL	SOT-25	28cx	VR4	6g	Tor
H7B	XC6220B41BMR	LVR-IC	LDO, 4.15V±1%, 1A, +CE, CL	SOT-25	28cx	VR4	6g	Tor
H7C	XC6220B42BMR	LVR-IC	LDO, 4.25V±1%, 1A, +CE, CL	SOT-25	28cx	VR4	6g	Tor
H7D	XC6220B43BMR	LVR-IC	LDO, 4.35V±1%, 1A, +CE, CL	SOT-25	28cx	VR4	6g	Tor
H7E	XC6220B44BMR	LVR-IC	LDO, 4.45V±1%, 1A, +CE, CL	SOT-25	28cx	VR4	6g	Tor
H7F	XC6220B45BMR	LVR-IC	LDO, 4.55V±1%, 1A, +CE, CL	SOT-25	28cx	VR4	6g	Tor
H7H	XC6220B46BMR	LVR-IC	LDO, 4.65V±1%, 1A, +CE, CL	SOT-25	28cx	VR4	6g	Tor
H7K	XC6220B47BMR	LVR-IC	LDO, 4.75V±1%, 1A, +CE, CL	SOT-25	28cx	VR4	6g	Tor
H7L	XC6220B48BMR	LVR-IC	LDO, 4.85V±1%, 1A, +CE, CL	SOT-25	28cx	VR4	6g	Tor
H7M	XC6220B49BMR	LVR-IC	LDO, 4.95V±1%, 1A, +CE, CL	SOT-25	28cx	VR4	6g	Tor
H8	HD74HC1G86CM	CMOS-Logic	2-input EXCLUSIVE-OR gate	CMPAK-5	28/Log5	-	6a	Ren
H8	R1111N481B	LVR-IC	LDO, LN, +CE, 4.8V±2%, 200mA	SOT-23-5	28cx	VR4	6g	Ric
H8	TC7SH86F	CMOS-Logic	2-input EXCLUSIVE-OR gate	SSOP-5	28/Log5	-	6a	Tos
H8	TC7SH86FU	CMOS-Logic	2-input EXCLUSIVE-OR gate	SC-70-5	28/Log5	-	6a	Tos
H80_	SN74AUP1G80DBV	CMOS-Logic	Positive edge-triggered D-type flip-flop	SOT-23-5	28/Log21	-	6a	Ti
H86	74HC1G86GV	CMOS-Logic	2-input EXCLUSIVE-OR gate	SOT753	28/Log5	-	6a	Phi
H88	XC6220C081MR	LVR-IC	LDO, 0.8V±20mV, 1A, +CE, PDR	SOT-25	28cx	VR4	6g	Tor
H89	XC6220C091MR	LVR-IC	LDO, 0.9V±20mV, 1A, +CE, PDR	SOT-25	28cx	VR4	6g	Tor
H8A	XC6220C101MR	LVR-IC	LDO, 1V±20mV, 1A, +CE, PDR	SOT-25	28cx	VR4	6g	Tor
H8B	XC6220C111MR	LVR-IC	LDO, 1.1V±20mV, 1A, +CE, PDR	SOT-25	28cx	VR4	6g	Tor
H8C	XC6220C121MR	LVR-IC	LDO, 1.2V±20mV, 1A, +CE, PDR	SOT-25	28cx	VR4	6g	Tor
H8D	XC6220C131MR	LVR-IC	LDO, 1.3V±20mV, 1A, +CE, PDR	SOT-25	28cx	VR4	6g	Tor
H8E	XC6220C141MR	LVR-IC	LDO, 1.4V±20mV, 1A, +CE, PDR	SOT-25	28cx	VR4	6g	Tor
H8F	XC6220C151MR	LVR-IC	LDO, 1.5V±20mV, 1A, +CE, PDR	SOT-25	28cx	VR4	6g	Tor
H8H	XC6220C161MR	LVR-IC	LDO, 1.6V±20mV, 1A, +CE, PDR	SOT-25	28cx	VR4	6g	Tor
H8K	XC6220C171MR	LVR-IC	LDO, 1.7V±20mV, 1A, +CE, PDR	SOT-25	28cx	VR4	6g	Tor
H8L	XC6220C181MR	LVR-IC	LDO, 1.8V±20mV, 1A, +CE, PDR	SOT-25	28cx	VR4	6g	Tor
H8M	XC6220C191MR	LVR-IC	LDO, 1.9V±20mV, 1A, +CE, PDR	SOT-25	28cx	VR4	6g	Tor
H8N	XC6220C201MR	LVR-IC	LDO, 2V±1%, 1A, +CE, PDR	SOT-25	28cx	VR4	6g	Tor
H8P	XC6220C211MR	LVR-IC	LDO, 2.1V±1%, 1A, +CE, PDR	SOT-25	28cx	VR4	6g	Tor
H8R	XC6220C221MR	LVR-IC	LDO, 2.2V±1%, 1A, +CE, PDR	SOT-25	28cx	VR4	6g	Tor
H8S	XC6220C231MR	LVR-IC	LDO, 2.3V±1%, 1A, +CE, PDR	SOT-25	28cx	VR4	6g	Tor
H8T	XC6220C241MR	LVR-IC	LDO, 2.4V±1%, 1A, +CE, PDR	SOT-25	28cx	VR4	6g	Tor
H8U	XC6220C251MR	LVR-IC	LDO, 2.5V±1%, 1A, +CE, PDR	SOT-25	28cx	VR4	6g	Tor
H8V	XC6220C261MR	LVR-IC	LDO, 2.6V±1%, 1A, +CE, PDR	SOT-25	28cx	VR4	6g	Tor
H8X	XC6220C271MR	LVR-IC	LDO, 2.7V±1%, 1A, +CE, PDR	SOT-25	28cx	VR4	6g	Tor
H8Y	XC6220C281MR	LVR-IC	LDO, 2.8V±1%, 1A, +CE, PDR	SOT-25	28cx	VR4	6g	Tor
H8Z	XC6220C291MR	LVR-IC	LDO, 2.9V±1%, 1A, +CE, PDR	SOT-25	28cx	VR4	6g	Tor
H9	HD74HC1G66CM	CMOS-Logic	Bilateral analogic switch	CMPAK-5	28/Log16	-	6a	Ren
H9	HD74UH4066EL	CMOS-Logic	Bilateral analogic switch	MPAK-5	28/Log16	-	6g	Ren
H9	R1111N491B	LVR-IC	LDO, LN, +CE, 4.9V±2%, 200mA	SOT-23-5	28cx	VR4	6g	Ric
H98	XC6220C08BMR	LVR-IC	LDO, 0.85V±20mV, 1A, +CE, PDR	SOT-25	28cx	VR4	6g	Tor
H99	XC6220C09BMR	LVR-IC	LDO, 0.95V±20mV, 1A, +CE, PDR	SOT-25	28cx	VR4	6g	Tor
H9A	XC6220C10BMR	LVR-IC	LDO, 1.05V±20mV, 1A, +CE, PDR	SOT-25	28cx	VR4	6g	Tor
H9B	XC6220C11BMR	LVR-IC	LDO, 1.15V±20mV, 1A, +CE, PDR	SOT-25	28cx	VR4	6g	Tor
H9C	XC6220C12BMR	LVR-IC	LDO, 1.25V±20mV, 1A, +CE, PDR	SOT-25	28cx	VR4	6g	Tor
H9D	XC6220C13BMR	LVR-IC	LDO, 1.35V±20mV, 1A, +CE, PDR	SOT-25	28cx	VR4	6g	Tor
H9E	XC6220C14BMR	LVR-IC	LDO, 1.45V±20mV, 1A, +CE, PDR	SOT-25	28cx	VR4	6g	Tor
H9F	XC6220C15BMR	LVR-IC	LDO, 1.55V±20mV, 1A, +CE, PDR	SOT-25	28cx	VR4	6g	Tor
H9H	XC6220C16BMR	LVR-IC	LDO, 1.65V±20mV, 1A, +CE, PDR	SOT-25	28cx	VR4	6g	Tor
H9K	XC6220C17BMR	LVR-IC	LDO, 1.75V±20mV, 1A, +CE, PDR	SOT-25	28cx	VR4	6g	Tor



SMD code	Type	Function	Short description	Case	Pinout	Sch.	St.Mnf.
H8L	XC6220C18BMR	LVR-IC	LDO, 1.85V±20mV, 1A, +CE, PDR	SOT-25	28cx	VR4	6g Tor
H8M	XC6220C19BMR	LVR-IC	LDO, 1.95V±20mV, 1A, +CE, PDR	SOT-25	28cx	VR4	6g Tor
H8N	XC6220C20BMR	LVR-IC	LDO, 2.05V±1%, 1A, +CE, PDR	SOT-25	28cx	VR4	6g Tor
H8P	XC6220C21BMR	LVR-IC	LDO, 2.15V±1%, 1A, +CE, PDR	SOT-25	28cx	VR4	6g Tor
H8R	XC6220C22BMR	LVR-IC	LDO, 2.25V±1%, 1A, +CE, PDR	SOT-25	28cx	VR4	6g Tor
H8S	XC6220C23BMR	LVR-IC	LDO, 2.35V±1%, 1A, +CE, PDR	SOT-25	28cx	VR4	6g Tor
H8T	XC6220C24BMR	LVR-IC	LDO, 2.45V±1%, 1A, +CE, PDR	SOT-25	28cx	VR4	6g Tor
H8U	XC6220C25BMR	LVR-IC	LDO, 2.55V±1%, 1A, +CE, PDR	SOT-25	28cx	VR4	6g Tor
H8V	XC6220C26BMR	LVR-IC	LDO, 2.65V±1%, 1A, +CE, PDR	SOT-25	28cx	VR4	6g Tor
H8X	XC6220C27BMR	LVR-IC	LDO, 2.75V±1%, 1A, +CE, PDR	SOT-25	28cx	VR4	6g Tor
H8Y	XC6220C28BMR	LVR-IC	LDO, 2.85V±1%, 1A, +CE, PDR	SOT-25	28cx	VR4	6g Tor
H8Z	XC6220C29BMR	LVR-IC	LDO, 2.95V±1%, 1A, +CE, PDR	SOT-25	28cx	VR4	6g Tor
HA	74HC1G00GW	CMOS-Logic	2-input NAND gate	SOT-353	28/Log1	-	6a Phi
HA	BU4809FWE	Vdet-IC	0.9V, -Reset ODO	VSOFF-5	30vk	VD6	6c Rhm
HA	BU4809G	Vdet-IC	0.9V, -Reset ODO	SSOP-5	28vdm	VD6	6c Rhm
HA	HD74HC1G14CM	CMOS-Logic	Inverting Schmitt-trigger	CMPAK-5	28/Log7	-	6a Ren
HA	KRA551F	Si-pnp-Digi	Dual, Sw, 20V, 50mA, 50mW, R1/R2=4.7k/4.7k	TFSV	30/TD9	-	6a Kec
HA	MC74HC1G14DF	CMOS-Logic	Inverting Schmitt-trigger	SC-70-5	28/Log7	-	6b Ons
HA	MC74HC1G14DT	CMOS-Logic	Inverting Schmitt-trigger	SOT-23-5	28/Log7	-	6b Ons
HA	TC6501P045VCT	Tdet-IC	45°C±0.5°C, -Tover ODO, Hysteresis	SOT-23-5	28	-	6a Mcc
HA	TC7SH14F	CMOS-Logic	Inverting Schmitt-trigger	SSOP-5	28/Log7	-	6a Tos
HA	TC7SH14FU	CMOS-Logic	Inverting Schmitt-trigger	SC-70-5	28/Log7	-	6a Tos
HA0	XC6220C301MR	LVR-IC	LDO, 3V±1%, 1A, +CE, PDR	SOT-25	28cx	VR4	6g Tor
HA1	XC6220C311MR	LVR-IC	LDO, 3.1V±1%, 1A, +CE, PDR	SOT-25	28cx	VR4	6g Tor
HA2	XC6220C321MR	LVR-IC	LDO, 3.2V±1%, 1A, +CE, PDR	SOT-25	28cx	VR4	6g Tor
HA3	XC6220C331MR	LVR-IC	LDO, 3.3V±1%, 1A, +CE, PDR	SOT-25	28cx	VR4	6g Tor
HA4	XC6220C341MR	LVR-IC	LDO, 3.4V±1%, 1A, +CE, PDR	SOT-25	28cx	VR4	6g Tor
HA5	XC6220C351MR	LVR-IC	LDO, 3.5V±1%, 1A, +CE, PDR	SOT-25	28cx	VR4	6g Tor
HA6	XC6220C361MR	LVR-IC	LDO, 3.6V±1%, 1A, +CE, PDR	SOT-25	28cx	VR4	6g Tor
HA7	XC6220C371MR	LVR-IC	LDO, 3.7V±1%, 1A, +CE, PDR	SOT-25	28cx	VR4	6g Tor
HA8	XC6220C381MR	LVR-IC	LDO, 3.8V±1%, 1A, +CE, PDR	SOT-25	28cx	VR4	6g Tor
HA9	XC6220C391MR	LVR-IC	LDO, 3.9V±1%, 1A, +CE, PDR	SOT-25	28cx	VR4	6g Tor
HAA	RP170N571B	LVR-IC	LDO, 5.7V±1%, 300mA, +CE	SOT-23-5	28cx	VR4	6g Ric
HAA	XC6220C401MR	LVR-IC	LDO, 4V±1%, 1A, +CE, PDR	SOT-25	28cx	VR4	6g Tor
HAB	RP170N581B	LVR-IC	LDO, 5.8V±1%, 300mA, +CE	SOT-23-5	28cx	VR4	6g Ric
HAB	XC6220C411MR	LVR-IC	LDO, 4.1V±1%, 1A, +CE, PDR	SOT-25	28cx	VR4	6g Tor
HAC	RP170N591B	LVR-IC	LDO, 5.9V±1%, 300mA, +CE	SOT-23-5	28cx	VR4	6g Ric
HAC	XC6220C421MR	LVR-IC	LDO, 4.2V±1%, 1A, +CE, PDR	SOT-25	28cx	VR4	6g Tor
HAD	RP170N601B	LVR-IC	LDO, 6.0V±1%, 300mA, +CE	SOT-23-5	28cx	VR4	6g Ric
HAD	XC6220C431MR	LVR-IC	LDO, 4.3V±1%, 1A, +CE, PDR	SOT-25	28cx	VR4	6g Tor
HAE	XC6220C441MR	LVR-IC	LDO, 4.4V±1%, 1A, +CE, PDR	SOT-25	28cx	VR4	6g Tor
HAF	XC6220C451MR	LVR-IC	LDO, 4.5V±1%, 1A, +CE, PDR	SOT-25	28cx	VR4	6g Tor
HAH	XC6220C461MR	LVR-IC	LDO, 4.6V±1%, 1A, +CE, PDR	SOT-25	28cx	VR4	6g Tor
HAK	XC6220C471MR	LVR-IC	LDO, 4.7V±1%, 1A, +CE, PDR	SOT-25	28cx	VR4	6g Tor
HAL	XC6220C481MR	LVR-IC	LDO, 4.8V±1%, 1A, +CE, PDR	SOT-25	28cx	VR4	6g Tor
HAM	XC6220C491MR	LVR-IC	LDO, 4.9V±1%, 1A, +CE, PDR	SOT-25	28cx	VR4	6g Tor
HAN	XC6220C501MR	LVR-IC	LDO, 5V±1%, 1A, +CE, PDR	SOT-25	28cx	VR4	6g Tor
HB	74HC1G02GW	CMOS-Logic	2-input NOR gate	SOT-353	28/Log2	-	6a Phi
HB	BU4810FWE	Vdet-IC	1.0V, -Reset ODO	VSOFF-5	30vk	VD6	6c Rhm
HB	BU4810G	Vdet-IC	1.0V, -Reset ODO	SSOP-5	28vdm	VD6	6c Rhm
HB	KRA552F	Si-pnp-Digi	Dual, Sw, 20V, 50mA, 50mW, R1/R2=10k/10k	TFSV	30/TD9	-	6a Kec
HB	TC7SH125F	CMOS-Logic	Bus buffer gate with 3-state output	SSOP-5	28/Log14	-	6a Tos
HB	TC7SH125FE	CMOS-Logic	Bus buffer gate with 3-state output	SOT-553	30/Log14	-	6a Tos
HB	TC7SH125FU	CMOS-Logic	Bus buffer gate with 3-state output	SC-70-5	28/Log14	-	6a Tos
HB0	XC6220C30BMR	LVR-IC	LDO, 3.05V±1%, 1A, +CE, PDR	SOT-25	28cx	VR4	6g Tor
HB1	XC6220C31BMR	LVR-IC	LDO, 3.15V±1%, 1A, +CE, PDR	SOT-25	28cx	VR4	6g Tor
HB2	XC6220C32BMR	LVR-IC	LDO, 3.25V±1%, 1A, +CE, PDR	SOT-25	28cx	VR4	6g Tor
HB3	XC6220C33BMR	LVR-IC	LDO, 3.35V±1%, 1A, +CE, PDR	SOT-25	28cx	VR4	6g Tor
HB4	XC6220C34BMR	LVR-IC	LDO, 3.45V±1%, 1A, +CE, PDR	SOT-25	28cx	VR4	6g Tor
HB5	XC6220C35BMR	LVR-IC	LDO, 3.55V±1%, 1A, +CE, PDR	SOT-25	28cx	VR4	6g Tor
HB6	XC6220C36BMR	LVR-IC	LDO, 3.65V±1%, 1A, +CE, PDR	SOT-25	28cx	VR4	6g Tor
HB7	XC6220C37BMR	LVR-IC	LDO, 3.75V±1%, 1A, +CE, PDR	SOT-25	28cx	VR4	6g Tor
HB8	XC6220C38BMR	LVR-IC	LDO, 3.85V±1%, 1A, +CE, PDR	SOT-25	28cx	VR4	6g Tor
HB9	XC6220C39BMR	LVR-IC	LDO, 3.95V±1%, 1A, +CE, PDR	SOT-25	28cx	VR4	6g Tor
HBA	RP170N571D	LVR-IC	LDO, 5.7V±1%, 300mA, +CE, CL	SOT-23-5	28cx	VR4	6g Ric
HBA	XC6220C40BMR	LVR-IC	LDO, 4.05V±1%, 1A, +CE, PDR	SOT-25	28cx	VR4	6g Tor
HBB	RP170N581D	LVR-IC	LDO, 5.8V±1%, 300mA, +CE, CL	SOT-23-5	28cx	VR4	6g Ric
HBB	XC6220C41BMR	LVR-IC	LDO, 4.15V±1%, 1A, +CE, PDR	SOT-25	28cx	VR4	6g Tor
HBC	RP170N591D	LVR-IC	LDO, 5.9V±1%, 300mA, +CE, CL	SOT-23-5	28cx	VR4	6g Ric
HBC	XC6220C42BMR	LVR-IC	LDO, 4.25V±1%, 1A, +CE, PDR	SOT-25	28cx	VR4	6g Tor



SMD
code

SMD code	Type	Funcion	Short description	Case	Pinout	Sch.	St.	Mnf.
HBD	RP170N601D	LVR-IC	LDO, 6.0V±1%, 300mA, +CE, CL	SOT-23-5	28cx	VR4	6g	Ric
HBD	XC6220C43BMR	LVR-IC	LDO, 4.35V±1%, 1A, +CE, PDR	SOT-25	28cx	VR4	6g	Tor
HBE	XC6220C44BMR	LVR-IC	LDO, 4.45V±1%, 1A, +CE, PDR	SOT-25	28cx	VR4	6g	Tor
HBF	XC6220C45BMR	LVR-IC	LDO, 4.55V±1%, 1A, +CE, PDR	SOT-25	28cx	VR4	6g	Tor
HBH	XC6220C46BMR	LVR-IC	LDO, 4.65V±1%, 1A, +CE, PDR	SOT-25	28cx	VR4	6g	Tor
HBK	XC6220C47BMR	LVR-IC	LDO, 4.75V±1%, 1A, +CE, PDR	SOT-25	28cx	VR4	6g	Tor
HBL	XC6220C48BMR	LVR-IC	LDO, 4.85V±1%, 1A, +CE, PDR	SOT-25	28cx	VR4	6g	Tor
HBM	XC6220C49BMR	LVR-IC	LDO, 4.95V±1%, 1A, +CE, PDR	SOT-25	28cx	VR4	6g	Tor
HC	74HC1G04GW	CMOS-Logic	Inverter	SOT-353	28/Log6	-	6a	Phi
HC	BU4811FWE	Vdet-IC	1.1V, -Reset ODO	VSOFF-5	30vk	VD6	6c	Rhm
HC	BU4811G	Vdet-IC	1.1V, -Reset ODO	SSOP-5	28vdm	VD6	6c	Rhm
HC	KRA553F	Si-pnp-Digi	Dual, Sw, 20V, 50mA, 50mW, R1/R2=22k/22k	TFSV	30/TD9	-	6a	Kec
HC	TC6501P065VCT	Tdet-IC	65°C±0.5°C, -Tover ODO, Hysteresis	SOT-23-5	28	-	6a	Mcc
HC8	XC6220D081MR	LVR-IC	LDO, 0.8V±20mV, 1A, +CE, CL, PDR	SOT-25	28cx	VR4	6g	Tor
HC9	XC6220D091MR	LVR-IC	LDO, 0.9V±20mV, 1A, +CE, CL, PDR	SOT-25	28cx	VR4	6g	Tor
HCA	XC6220D101MR	LVR-IC	LDO, 1V±20mV, 1A, +CE, CL, PDR	SOT-25	28cx	VR4	6g	Tor
HCB	XC6220D111MR	LVR-IC	LDO, 1.1V±20mV, 1A, +CE, CL, PDR	SOT-25	28cx	VR4	6g	Tor
HCC	XC6220D121MR	LVR-IC	LDO, 1.2V±20mV, 1A, +CE, CL, PDR	SOT-25	28cx	VR4	6g	Tor
HCD	XC6220D131MR	LVR-IC	LDO, 1.3V±20mV, 1A, +CE, CL, PDR	SOT-25	28cx	VR4	6g	Tor
HCE	XC6220D141MR	LVR-IC	LDO, 1.4V±20mV, 1A, +CE, CL, PDR	SOT-25	28cx	VR4	6g	Tor
HCF	XC6220D151MR	LVR-IC	LDO, 1.5V±20mV, 1A, +CE, CL, PDR	SOT-25	28cx	VR4	6g	Tor
HCH	XC6220D161MR	LVR-IC	LDO, 1.6V±20mV, 1A, +CE, CL, PDR	SOT-25	28cx	VR4	6g	Tor
HCK	XC6220D171MR	LVR-IC	LDO, 1.7V±20mV, 1A, +CE, CL, PDR	SOT-25	28cx	VR4	6g	Tor
HCL	XC6220D181MR	LVR-IC	LDO, 1.8V±20mV, 1A, +CE, CL, PDR	SOT-25	28cx	VR4	6g	Tor
HCM	XC6220D191MR	LVR-IC	LDO, 1.9V±20mV, 1A, +CE, CL, PDR	SOT-25	28cx	VR4	6g	Tor
HCN	XC6220D201MR	LVR-IC	LDO, 2V±1%, 1A, +CE, CL, PDR	SOT-25	28cx	VR4	6g	Tor
HCP	XC6220D211MR	LVR-IC	LDO, 2.1V±1%, 1A, +CE, CL, PDR	SOT-25	28cx	VR4	6g	Tor
HCR	XC6220D221MR	LVR-IC	LDO, 2.2V±1%, 1A, +CE, CL, PDR	SOT-25	28cx	VR4	6g	Tor
HCS	XC6220D231MR	LVR-IC	LDO, 2.3V±1%, 1A, +CE, CL, PDR	SOT-25	28cx	VR4	6g	Tor
HCT	XC6220D241MR	LVR-IC	LDO, 2.4V±1%, 1A, +CE, CL, PDR	SOT-25	28cx	VR4	6g	Tor
HCU	XC6220D251MR	LVR-IC	LDO, 2.5V±1%, 1A, +CE, CL, PDR	SOT-25	28cx	VR4	6g	Tor
HCV	XC6220D261MR	LVR-IC	LDO, 2.6V±1%, 1A, +CE, CL, PDR	SOT-25	28cx	VR4	6g	Tor
HCX	XC6220D271MR	LVR-IC	LDO, 2.7V±1%, 1A, +CE, CL, PDR	SOT-25	28cx	VR4	6g	Tor
HCY	XC6220D281MR	LVR-IC	LDO, 2.8V±1%, 1A, +CE, CL, PDR	SOT-25	28cx	VR4	6g	Tor
HCZ	XC6220D291MR	LVR-IC	LDO, 2.9V±1%, 1A, +CE, CL, PDR	SOT-25	28cx	VR4	6g	Tor
HD	74HC1G04GW	CMOS-Logic	Inverter	SOT-353	28/Log6	-	6a	Phi
HD	BU4812FWE	Vdet-IC	1.2V, -Reset ODO	VSOFF-5	30vk	VD6	6c	Rhm
HD	BU4812G	Vdet-IC	1.2V, -Reset ODO	SSOP-5	28vdm	VD6	6c	Rhm
HD	KRA554F	Si-pnp-Digi	Dual, Sw, 20V, 50mA, 50mW, R1/R2=47k/47k	TFSV	30/TD9	-	6a	Kec
HD	TC6501P075VCT	Tdet-IC	75°C±0.5°C, -Tover ODO, Hysteresis	SOT-23-5	28	-	6a	Mcc
HD8	XC6220D08BMR	LVR-IC	LDO, 0.85V±20mV, 1A, +CE, CL, PDR	SOT-25	28cx	VR4	6g	Tor
HD9	XC6220D09BMR	LVR-IC	LDO, 0.95V±20mV, 1A, +CE, CL, PDR	SOT-25	28cx	VR4	6g	Tor
HDA	XC6220D10BMR	LVR-IC	LDO, 1.05V±20mV, 1A, +CE, CL, PDR	SOT-25	28cx	VR4	6g	Tor
HDB	XC6220D11BMR	LVR-IC	LDO, 1.15V±20mV, 1A, +CE, CL, PDR	SOT-25	28cx	VR4	6g	Tor
HDC	XC6220D12BMR	LVR-IC	LDO, 1.25V±20mV, 1A, +CE, CL, PDR	SOT-25	28cx	VR4	6g	Tor
HDD	XC6220D13BMR	LVR-IC	LDO, 1.35V±20mV, 1A, +CE, CL, PDR	SOT-25	28cx	VR4	6g	Tor
HDE	XC6220D14BMR	LVR-IC	LDO, 1.45V±20mV, 1A, +CE, CL, PDR	SOT-25	28cx	VR4	6g	Tor
HDF	XC6220D15BMR	LVR-IC	LDO, 1.55V±20mV, 1A, +CE, CL, PDR	SOT-25	28cx	VR4	6g	Tor
HDH	XC6220D16BMR	LVR-IC	LDO, 1.65V±20mV, 1A, +CE, CL, PDR	SOT-25	28cx	VR4	6g	Tor
HDK	XC6220D17BMR	LVR-IC	LDO, 1.75V±20mV, 1A, +CE, CL, PDR	SOT-25	28cx	VR4	6g	Tor
HDL	XC6220D18BMR	LVR-IC	LDO, 1.85V±20mV, 1A, +CE, CL, PDR	SOT-25	28cx	VR4	6g	Tor
HDM	XC6220D19BMR	LVR-IC	LDO, 1.95V±20mV, 1A, +CE, CL, PDR	SOT-25	28cx	VR4	6g	Tor
HDN	XC6220D20BMR	LVR-IC	LDO, 2.05V±1%, 1A, +CE, CL, PDR	SOT-25	28cx	VR4	6g	Tor
HDP	XC6220D21BMR	LVR-IC	LDO, 2.15V±1%, 1A, +CE, CL, PDR	SOT-25	28cx	VR4	6g	Tor
HDR	XC6220D22BMR	LVR-IC	LDO, 2.25V±1%, 1A, +CE, CL, PDR	SOT-25	28cx	VR4	6g	Tor
HDS	XC6220D23BMR	LVR-IC	LDO, 2.35V±1%, 1A, +CE, CL, PDR	SOT-25	28cx	VR4	6g	Tor
HDT	XC6220D24BMR	LVR-IC	LDO, 2.45V±1%, 1A, +CE, CL, PDR	SOT-25	28cx	VR4	6g	Tor
HDO	XC6220D25BMR	LVR-IC	LDO, 2.55V±1%, 1A, +CE, CL, PDR	SOT-25	28cx	VR4	6g	Tor
HDV	XC6220D26BMR	LVR-IC	LDO, 2.65V±1%, 1A, +CE, CL, PDR	SOT-25	28cx	VR4	6g	Tor
HDX	XC6220D27BMR	LVR-IC	LDO, 2.75V±1%, 1A, +CE, CL, PDR	SOT-25	28cx	VR4	6g	Tor
HDY	XC6220D28BMR	LVR-IC	LDO, 2.85V±1%, 1A, +CE, CL, PDR	SOT-25	28cx	VR4	6g	Tor
HDZ	XC6220D29BMR	LVR-IC	LDO, 2.95V±1%, 1A, +CE, CL, PDR	SOT-25	28cx	VR4	6g	Tor
HE	74HC1G08GW	CMOS-Logic	2-input AND gate	SOT-353	28/Log3	-	6a	Phi
HE	AAT3515IGV-2.63-C	Vdet-IC	2.63V±1.5%, -MR, ±Reset PPO, 140ms	SOT-23-5	28xf	VD21	6k	Ant
HE	BU4813FWE	Vdet-IC	1.3V, -Reset ODO	VSOFF-5	30vk	VD6	6c	Rhm
HE	BU4813G	Vdet-IC	1.3V, -Reset ODO	SSOP-5	28vdm	VD6	6c	Rhm
HE0	XC6220D301MR	LVR-IC	LDO, 3V±1%, 1A, +CE, CL, PDR	SOT-25	28cx	VR4	6g	Tor
HE1	XC6220D311MR	LVR-IC	LDO, 3.1V±1%, 1A, +CE, CL, PDR	SOT-25	28cx	VR4	6g	Tor
HE2	XC6220D321MR	LVR-IC	LDO, 3.2V±1%, 1A, +CE, CL, PDR	SOT-25	28cx	VR4	6g	Tor
HE3	XC6220D331MR	LVR-IC	LDO, 3.3V±1%, 1A, +CE, CL, PDR	SOT-25	28cx	VR4	6g	Tor



SMD code	Type	Function	Short description	Case	Pinout	Sch.	St.	Mnf.
HE4	XC6220D341MR	LVR-IC	LDO, 3.4V±1%, 1A, +CE, CL, PDR	SOT-25	28cx	VR4	6g	Tor
HE5	XC6220D351MR	LVR-IC	LDO, 3.5V±1%, 1A, +CE, CL, PDR	SOT-25	28cx	VR4	6g	Tor
HE6	XC6220D361MR	LVR-IC	LDO, 3.6V±1%, 1A, +CE, CL, PDR	SOT-25	28cx	VR4	6g	Tor
HE7	XC6220D371MR	LVR-IC	LDO, 3.7V±1%, 1A, +CE, CL, PDR	SOT-25	28cx	VR4	6g	Tor
HE8	XC6220D381MR	LVR-IC	LDO, 3.8V±1%, 1A, +CE, CL, PDR	SOT-25	28cx	VR4	6g	Tor
HE9	XC6220D391MR	LVR-IC	LDO, 3.9V±1%, 1A, +CE, CL, PDR	SOT-25	28cx	VR4	6g	Tor
HEA	XC6220D401MR	LVR-IC	LDO, 4V±1%, 1A, +CE, CL, PDR	SOT-25	28cx	VR4	6g	Tor
HEB	XC6220D411MR	LVR-IC	LDO, 4.1V±1%, 1A, +CE, CL, PDR	SOT-25	28cx	VR4	6g	Tor
HEC	XC6220D421MR	LVR-IC	LDO, 4.2V±1%, 1A, +CE, CL, PDR	SOT-25	28cx	VR4	6g	Tor
HED	XC6220D431MR	LVR-IC	LDO, 4.3V±1%, 1A, +CE, CL, PDR	SOT-25	28cx	VR4	6g	Tor
HEE	XC6220D441MR	LVR-IC	LDO, 4.4V±1%, 1A, +CE, CL, PDR	SOT-25	28cx	VR4	6g	Tor
HEF	XC6220D451MR	LVR-IC	LDO, 4.5V±1%, 1A, +CE, CL, PDR	SOT-25	28cx	VR4	6g	Tor
HEH	XC6220D461MR	LVR-IC	LDO, 4.6V±1%, 1A, +CE, CL, PDR	SOT-25	28cx	VR4	6g	Tor
HEK	XC6220D471MR	LVR-IC	LDO, 4.7V±1%, 1A, +CE, CL, PDR	SOT-25	28cx	VR4	6g	Tor
HEL	XC6220D481MR	LVR-IC	LDO, 4.8V±1%, 1A, +CE, CL, PDR	SOT-25	28cx	VR4	6g	Tor
HEM	XC6220D491MR	LVR-IC	LDO, 4.9V±1%, 1A, +CE, CL, PDR	SOT-25	28cx	VR4	6g	Tor
HEN	XC6220D501MR	LVR-IC	LDO, 5V±1%, 1A, +CE, CL, PDR	SOT-25	28cx	VR4	6g	Tor
HF	74HC1G14GW	CMOS-Logic	Inverting Schmitt-trigger	SOT-353	28/Log7	-	6a	Phi
HF	AAT3513IGV-2.63-C-C	Vdet-IC	2.63V±1.5%, ±Reset PPO	SOT-23-5	28xq	-	6k	Ant
HF	BU4814FWE	Vdet-IC	1.4V, -Reset ODO	VSOFF-5	30vk	VD6	6c	Rhm
HF	BU4814G	Vdet-IC	1.4V, -Reset ODO	SSOP-5	28vdm	VD6	6c	Rhm
HF	TC6501P095VCT	Tdet-IC	95°C±0.5°C, -Tover ODO, Hysteresis	SOT-23-5	28	-	6a	Mcc
HF0	XC6220D30BMR	LVR-IC	LDO, 3.05V±1%, 1A, +CE, CL, PDR	SOT-25	28cx	VR4	6g	Tor
HF1	XC6220D31BMR	LVR-IC	LDO, 3.15V±1%, 1A, +CE, CL, PDR	SOT-25	28cx	VR4	6g	Tor
HF2	XC6220D32BMR	LVR-IC	LDO, 3.25V±1%, 1A, +CE, CL, PDR	SOT-25	28cx	VR4	6g	Tor
HF3	XC6220D33BMR	LVR-IC	LDO, 3.35V±1%, 1A, +CE, CL, PDR	SOT-25	28cx	VR4	6g	Tor
HF4	XC6220D34BMR	LVR-IC	LDO, 3.45V±1%, 1A, +CE, CL, PDR	SOT-25	28cx	VR4	6g	Tor
HF5	XC6220D35BMR	LVR-IC	LDO, 3.55V±1%, 1A, +CE, CL, PDR	SOT-25	28cx	VR4	6g	Tor
HF6	XC6220D36BMR	LVR-IC	LDO, 3.65V±1%, 1A, +CE, CL, PDR	SOT-25	28cx	VR4	6g	Tor
HF7	XC6220D37BMR	LVR-IC	LDO, 3.75V±1%, 1A, +CE, CL, PDR	SOT-25	28cx	VR4	6g	Tor
HF8	XC6220D38BMR	LVR-IC	LDO, 3.85V±1%, 1A, +CE, CL, PDR	SOT-25	28cx	VR4	6g	Tor
HF9	XC6220D39BMR	LVR-IC	LDO, 3.95V±1%, 1A, +CE, CL, PDR	SOT-25	28cx	VR4	6g	Tor
HFA	XC6220D40BMR	LVR-IC	LDO, 4.05V±1%, 1A, +CE, CL, PDR	SOT-25	28cx	VR4	6g	Tor
HFB	XC6220D41BMR	LVR-IC	LDO, 4.15V±1%, 1A, +CE, CL, PDR	SOT-25	28cx	VR4	6g	Tor
HFC	XC6220D42BMR	LVR-IC	LDO, 4.25V±1%, 1A, +CE, CL, PDR	SOT-25	28cx	VR4	6g	Tor
HFD	XC6220D43BMR	LVR-IC	LDO, 4.35V±1%, 1A, +CE, CL, PDR	SOT-25	28cx	VR4	6g	Tor
HFE	XC6220D44BMR	LVR-IC	LDO, 4.45V±1%, 1A, +CE, CL, PDR	SOT-25	28cx	VR4	6g	Tor
HFF	XC6220D45BMR	LVR-IC	LDO, 4.55V±1%, 1A, +CE, CL, PDR	SOT-25	28cx	VR4	6g	Tor
HFH	XC6220D46BMR	LVR-IC	LDO, 4.65V±1%, 1A, +CE, CL, PDR	SOT-25	28cx	VR4	6g	Tor
HFK	XC6220D47BMR	LVR-IC	LDO, 4.75V±1%, 1A, +CE, CL, PDR	SOT-25	28cx	VR4	6g	Tor
HFL	XC6220D48BMR	LVR-IC	LDO, 4.85V±1%, 1A, +CE, CL, PDR	SOT-25	28cx	VR4	6g	Tor
HFM	XC6220D49BMR	LVR-IC	LDO, 4.95V±1%, 1A, +CE, CL, PDR	SOT-25	28cx	VR4	6g	Tor
HG	74HC1G32GW	CMOS-Logic	2-input OR gate	SOT-353	28/Log4	-	6a	Phi
HG	AAT3510IGV-3.08-C-C	Vdet-IC	3.08V±1.5%, -MR, -Reset PPO	SOT-23-5	28cp	VD17	6k	Ant
HG	BU4815FWE	Vdet-IC	1.5V, -Reset ODO	VSOFF-5	30vk	VD6	6c	Rhm
HG	BU4815G	Vdet-IC	1.5V, -Reset ODO	SSOP-5	28vdm	VD6	6c	Rhm
HG	KRA557F	Si-pnp-Digi	Dual, Sw, 20V, 50mA, 50mW, R1/R2=10k/47k	TFSV	30/TD9	-	6a	Kec
HG	TC6501P105VCT	Tdet-IC	105°C±0.5°C, -Tover ODO, Hysteresis	SOT-23-5	28	-	6a	Mcc
HH	74HC1G86GW	CMOS-Logic	2-input EXCLUSIVE-OR gate	SOT-353	28/Log5	-	6a	Phi
HH	AAT3510IGV-4.38-C-C	Vdet-IC	4.38V±1.5%, -MR, -Reset PPO	SOT-23-5	28cp	VD17	6k	Ant
HH	BU4816FWE	Vdet-IC	1.6V, -Reset ODO	VSOFF-5	30vk	VD6	6c	Rhm
HH	BU4816G	Vdet-IC	1.6V, -Reset ODO	SSOP-5	28vdm	VD6	6c	Rhm
HH	KRA558F	Si-pnp-Digi	Dual, Sw, 20V, 50mA, 50mW, R1/R2=22k/47k	TFSV	30/TD9	-	6a	Kec
HH	TC6501P115VCT	Tdet-IC	115°C±0.5°C, -Tover ODO, Hysteresis	SOT-23-5	28	-	6a	Mcc
HI	AAT3515IGV-2.93-B	Vdet-IC	2.93V±1.5%, -MR, ±Reset PPO, 20ms	SOT-23-5	28xf	VD21	6k	Ant
HJ	BU4817FWE	Vdet-IC	1.7V, -Reset ODO	VSOFF-5	30vk	VD6	6c	Rhm
HJ	BU4817G	Vdet-IC	1.7V, -Reset ODO	SSOP-5	28vdm	VD6	6c	Rhm
HJ	KRA559F	Si-pnp-Digi	Dual, Sw, 20V, 50mA, 50mW, R1/R2=47k/22k	TFSV	30/TD9	-	6a	Kec
HJ	TC6501P125VCT	Tdet-IC	125°C±0.5°C, -Tover ODO, Hysteresis	SOT-23-5	28	-	6a	Mcc
HK	BU4818FWE	Vdet-IC	1.8V, -Reset ODO	VSOFF-5	30vk	VD6	6c	Rhm
HK	BU4818G	Vdet-IC	1.8V, -Reset ODO	SSOP-5	28vdm	VD6	6c	Rhm
HK	KRA560F	Si-pnp-Digi	Dual, Sw, 20V, 50mA, 50mW, R1=4.7k	TFSV	30/TD9	-	6a	Kec
HL	74HC1G66GW	CMOS-Logic	Bilateral analogic switch	SOT-353	28/Log16	-	6a	Phi
HL	BU4819FWE	Vdet-IC	1.9V, -Reset ODO	VSOFF-5	30vk	VD6	6c	Rhm
HL	BU4819G	Vdet-IC	1.9V, -Reset ODO	SSOP-5	28vdm	VD6	6c	Rhm
HL	KRA561F	Si-pnp-Digi	Dual, Sw, 20V, 50mA, 50mW, R1=10k	TFSV	30/TD9	-	6a	Kec
HL	R1112N401B	LVR-IC	LDO, LN, +CE, 4V±2%, 150mA	SOT-23-5	28cx	VR4	6g	Ric
HM	74HC1G125GW	CMOS-Logic	Bus buffer gate with 3-state output	SOT-353	28/Log14	-	6a	Phi
HM	BU4820FWE	Vdet-IC	2.0V, -Reset ODO	VSOFF-5	30vk	VD6	6c	Rhm
HM	BU4820G	Vdet-IC	2.0V, -Reset ODO	SSOP-5	28vdm	VD6	6c	Rhm



SMD code	Type	Function	Short description	Case	Pinout	Sch.	St.	Mnf.
HM	R1112N411B	LVR-IC	LDO, LN, +CE, 4.1V±2%, 150mA	SOT-23-5	28cx	VR4	6g	Ric
HN	74HC1G126GW	CMOS-Logic	Bus buffer gate with 3-state output	SOT-353	28/Log13	-	6a	Phi
HN	BU4821FWE	Vdet-IC	2.1V, -Reset ODO	VSOFF-5	30vk	VD6	6c	Rhm
HN	BU4821G	Vdet-IC	2.1V, -Reset ODO	SSOP-5	28vdm	VD6	6c	Rhm
HN	KRA563F	Si-pnp-Digi	Dual, Sw, 20V, 50mA, 50mW, R1=22k	TFSV	30/TD9	-	6a	Kec
HN	R1112N421B	LVR-IC	LDO, LN, +CE, 4.2V±2%, 150mA	SOT-23-5	28cx	VR4	6g	Ric
HP	BU4822FWE	Vdet-IC	2.2V, -Reset ODO	VSOFF-5	30vk	VD6	6c	Rhm
HP	BU4822G	Vdet-IC	2.2V, -Reset ODO	SSOP-5	28vdm	VD6	6c	Rhm
HP	KRA564F	Si-pnp-Digi	Dual, Sw, 20V, 50mA, 50mW, R1=47k	TFSV	30/TD9	-	6a	Kec
HP	R1112N431B	LVR-IC	LDO, LN, +CE, 4.3V±2%, 150mA	SOT-23-5	28cx	VR4	6g	Ric
HQ	BU4823FWE	Vdet-IC	2.3V, -Reset ODO	VSOFF-5	30vk	VD6	6c	Rhm
HQ	BU4823G	Vdet-IC	2.3V, -Reset ODO	SSOP-5	28vdm	VD6	6c	Rhm
HQ	R1112N441B	LVR-IC	LDO, LN, +CE, 4.4V±2%, 150mA	SOT-23-5	28cx	VR4	6g	Ric
HR	BU4824FWE	Vdet-IC	2.4V, -Reset ODO	VSOFF-5	30vk	VD6	6c	Rhm
HR	BU4824G	Vdet-IC	2.4V, -Reset ODO	SSOP-5	28vdm	VD6	6c	Rhm
HR	R1112N451B	LVR-IC	LDO, LN, +CE, 4.5V±2%, 150mA	SOT-23-5	28cx	VR4	6g	Ric
HS	BU4825FWE	Vdet-IC	2.5V, -Reset ODO	VSOFF-5	30vk	VD6	6c	Rhm
HS	BU4825G	Vdet-IC	2.5V, -Reset ODO	SSOP-5	28vdm	VD6	6c	Rhm
HS	R1112N461B	LVR-IC	LDO, LN, +CE, 4.6V±2%, 150mA	SOT-23-5	28cx	VR4	6g	Ric
HT	BU4826FWE	Vdet-IC	2.6V, -Reset ODO	VSOFF-5	30vk	VD6	6c	Rhm
HT	BU4826G	Vdet-IC	2.6V, -Reset ODO	SSOP-5	28vdm	VD6	6c	Rhm
HT	R1112N471B	LVR-IC	LDO, LN, +CE, 4.7V±2%, 150mA	SOT-23-5	28cx	VR4	6g	Ric
HU	AAT3510IGV-2.93-C-C	Vdet-IC	2.93V±1.5%, -MR, -Reset PPO	SOT-23-5	28cp	VD17	6k	Ant
HU	BU4827FWE	Vdet-IC	2.7V, -Reset ODO	VSOFF-5	30vk	VD6	6c	Rhm
HU	BU4827G	Vdet-IC	2.7V, -Reset ODO	SSOP-5	28vdm	VD6	6c	Rhm
HU	R1112N481B	LVR-IC	LDO, LN, +CE, 4.8V±2%, 150mA	SOT-23-5	28cx	VR4	6g	Ric
HU4	74HC1GU04GV	CMOS-Logic	Inverter	SOT753	28/Log6	-	6a	Phi
HV	AAT3510IGV-2.63-C-C	Vdet-IC	2.63V±1.5%, -MR, -Reset PPO	SOT-23-5	28cp	VD17	6k	Ant
HV	BU4828FWE	Vdet-IC	2.8V, -Reset ODO	VSOFF-5	30vk	VD6	6c	Rhm
HV	BU4828G	Vdet-IC	2.8V, -Reset ODO	SSOP-5	28vdm	VD6	6c	Rhm
HV	R1112N491B	LVR-IC	LDO, LN, +CE, 4.9V±2%, 150mA	SOT-23-5	28cx	VR4	6g	Ric
HV	TC6501P120VCT	Tdet-IC	120°C±0.5°C, -Tover ODO, Hysteresis	SOT-23-5	28	-	6a	Mcc
HV_	SN74AUP1G07DCK	CMOS-Logic	Noninverting buffer/driver (ODO)	SC-70-5	28/Log8	-	6a	Ti
HW	BU4829FWE	Vdet-IC	2.9V, -Reset ODO	VSOFF-5	30vk	VD6	6c	Rhm
HW	BU4829G	Vdet-IC	2.9V, -Reset ODO	SSOP-5	28vdm	VD6	6c	Rhm
HW	TC7SH125FS	CMOS-Logic	Bus buffer gate with 3-state output	SOM-5	30/Log14	-	6a	Tos
HW_	SN74AUP1G79DCK	CMOS-Logic	Positive edge-triggered D-type flip-flop	SC-70-5	28/Log20	-	6a	Ti
HW_	SN74AUP1G79DRL	CMOS-Logic	Positive edge-triggered D-type flip-flop	SOT-553	30/Log20	-	6a	Ti
HX	BU4830FWE	Vdet-IC	3V, -Reset ODO	VSOFF-5	30vk	VD6	6c	Rhm
HX	BU4830G	Vdet-IC	3V, -Reset ODO	SSOP-5	28vdm	VD6	6c	Rhm
HX_	SN74AUP1G80DCK	CMOS-Logic	Positive edge-triggered D-type flip-flop	SC-70-5	28/Log21	-	6a	Ti
HY	BU4831FWE	Vdet-IC	3.1V, -Reset ODO	VSOFF-5	30vk	VD6	6c	Rhm
HY	BU4831G	Vdet-IC	3.1V, -Reset ODO	SSOP-5	28vdm	VD6	6c	Rhm
HZ	BU4832FWE	Vdet-IC	3.2V, -Reset ODO	VSOFF-5	30vk	VD6	6c	Rhm
HZ	BU4832G	Vdet-IC	3.2V, -Reset ODO	SSOP-5	28vdm	VD6	6c	Rhm
I0	RT9167-15CBR	LVR-IC	LDO, 1.5V±2%, 300mA, +CE	SOT-23-5	28vr1	VR7	6g	Rct
I1	RT9167-16CBR	LVR-IC	LDO, 1.6V±2%, 300mA, +CE	SOT-23-5	28vr1	VR7	6g	Rct
I2	RT9167-17CBR	LVR-IC	LDO, 1.7V±2%, 300mA, +CE	SOT-23-5	28vr1	VR7	6g	Rct
I3	RT9167-18CBR	LVR-IC	LDO, 1.8V±2%, 300mA, +CE	SOT-23-5	28vr1	VR7	6g	Rct
I4	RT9167-19CBR	LVR-IC	LDO, 1.9V±2%, 300mA, +CE	SOT-23-5	28vr1	VR7	6g	Rct
I5	RT9167-20CBR	LVR-IC	LDO, 2.0V±2%, 300mA, +CE	SOT-23-5	28vr1	VR7	6g	Rct
I6	RT9167-21CBR	LVR-IC	LDO, 2.1V±2%, 300mA, +CE	SOT-23-5	28vr1	VR7	6g	Rct
I7	RT9167-22CBR	LVR-IC	LDO, 2.2V±2%, 300mA, +CE	SOT-23-5	28vr1	VR7	6g	Rct
I8	RT9167-23CBR	LVR-IC	LDO, 2.3V±2%, 300mA, +CE	SOT-23-5	28vr1	VR7	6g	Rct
I9	RT9167-24CBR	LVR-IC	LDO, 2.4V±2%, 300mA, +CE	SOT-23-5	28vr1	VR7	6g	Rct
IA	RT9167-25CBR	LVR-IC	LDO, 2.5V±2%, 300mA, +CE	SOT-23-5	28vr1	VR7	6g	Rct
IB	RT9167-26CBR	LVR-IC	LDO, 2.6V±2%, 300mA, +CE	SOT-23-5	28vr1	VR7	6g	Rct
IC	RT9167-27CBR	LVR-IC	LDO, 2.7V±2%, 300mA, +CE	SOT-23-5	28vr1	VR7	6g	Rct
ID	RT9167-28CBR	LVR-IC	LDO, 2.8V±2%, 300mA, +CE	SOT-23-5	28vr1	VR7	6g	Rct
IE	RT9167-29CBR	LVR-IC	LDO, 2.9V±2%, 300mA, +CE	SOT-23-5	28vr1	VR7	6g	Rct
IF	RT9167-30CBR	LVR-IC	LDO, 3.0V±2%, 300mA, +CE	SOT-23-5	28vr1	VR7	6g	Rct
IG	RT9167-31CBR	LVR-IC	LDO, 3.1V±2%, 300mA, +CE	SOT-23-5	28vr1	VR7	6g	Rct
IH	RT9167-32CBR	LVR-IC	LDO, 3.2V±2%, 300mA, +CE	SOT-23-5	28vr1	VR7	6g	Rct
IJ	RT9167-33CBR	LVR-IC	LDO, 3.3V±2%, 300mA, +CE	SOT-23-5	28vr1	VR7	6g	Rct
IJ-	RT9167-33PBR	LVR-IC	LDO, 3.3V±2%, 300mA, +CE	SOT-23-5	28vr1	VR7	6g	Rct
IK	RT9167-34CBR	LVR-IC	LDO, 3.4V±2%, 300mA, +CE	SOT-23-5	28vr1	VR7	6g	Rct
IL	RT9167-35CBR	LVR-IC	LDO, 3.5V±2%, 300mA, +CE	SOT-23-5	28vr1	VR7	6g	Rct
IM	RT9167-36CBR	LVR-IC	LDO, 3.6V±2%, 300mA, +CE	SOT-23-5	28vr1	VR7	6g	Rct
IN	AAT3517IGV-2.63-C-C	Vdet-IC	2.63V±1.5%, -MR, -Reset PPO	SOT-23-5	28cp	VD17	6k	Ant
IN	RT9167-37CBR	LVR-IC	LDO, 3.7V±2%, 300mA, +CE	SOT-23-5	28vr1	VR7	6g	Rct



SMD code	Type	Function	Short description	Case	Pinout	Sch.	St.	Mnf.
IQ	AAT3517IGV-2.93-C-C	Vdet-IC	2.93V±1.5%, -MR, -Reset PPO	SOT-23-5	28cp	VD17	6k	Ant
IR	RT9167-40CBR	LVR-IC	LDO, 4.0V±2%, 300mA, +CE	SOT-23-5	28vr1	VR7	6g	Rct
IT-	RT9167-42PBR	LVR-IC	LDO, 4.2V±2%, 300mA, +CE	SOT-23-5	28vr1	VR7	6g	Rct
JO	MC78PC50N	LVR-IC	LDO, LN, +CE, 5V±2.5%, 100mA	SOT-23-5	28cx	VR4	6b	Ons
JO	R1111N501B	LVR-IC	LDO, LN, +CE, 5V±2%, 200mA	SOT-23-5	28cx	VR4	6g	Ric
JO	RN5RG20AA	LVR-IC	Ext. transistor, 2V±2.5% 1A*	SOT-23-5	28vw	VR6	6g	Ric
JO	RT9167A-15CB	LVR-IC	LDO, 1.5V±2%, 600mA, +CE	SOT-23-5	28vrx	VR7	6g	Rct
JO-	RT9167A-15PB	LVR-IC	LDO, 1.5V±2%, 600mA, +CE	SOT-23-5	28vrx	VR7	6g	Rct
JO0	R1154N100B	LVR-IC	LDO, 10V±2%, 150mA, +CE	SOT-23-5	28vrd	VR4	6g	Ric
JO01	RP113Q122B	LVR-IC	LDO, 1.2V±1%, 150mA, +CE	SC-88A	28cx	VR4	6m	Ric
JO02	RP113Q132B	LVR-IC	LDO, 1.3V±1%, 150mA, +CE	SC-88A	28cx	VR4	6m	Ric
JO03	RP113Q152B	LVR-IC	LDO, 1.5V±1%, 150mA, +CE	SC-88A	28cx	VR4	6m	Ric
JO04	RP113Q182B	LVR-IC	LDO, 1.8V±1%, 150mA, +CE	SC-88A	28cx	VR4	6m	Ric
JO05	RP113Q182B5	LVR-IC	LDO, 1.85V±1%, 150mA, +CE	SC-88A	28cx	VR4	6m	Ric
JO06	RP113Q192B	LVR-IC	LDO, 1.9V±1%, 150mA, +CE	SC-88A	28cx	VR4	6m	Ric
JO07	RP113Q202B	LVR-IC	LDO, 2.0V±1%, 150mA, +CE	SC-88A	28cx	VR4	6m	Ric
JO08	RP113Q212B	LVR-IC	LDO, 2.1V±1%, 150mA, +CE	SC-88A	28cx	VR4	6m	Ric
JO09	RP113Q232B	LVR-IC	LDO, 2.3V±1%, 150mA, +CE	SC-88A	28cx	VR4	6m	Ric
JO1	R1154N101B	LVR-IC	LDO, 10.1V±2%, 150mA, +CE	SOT-23-5	28vrd	VR4	6g	Ric
JO10	RP113Q252B	LVR-IC	LDO, 2.5V±1%, 150mA, +CE	SC-88A	28cx	VR4	6m	Ric
JO11	RP113Q262B	LVR-IC	LDO, 2.6V±1%, 150mA, +CE	SC-88A	28cx	VR4	6m	Ric
JO12	RP113Q272B	LVR-IC	LDO, 2.7V±1%, 150mA, +CE	SC-88A	28cx	VR4	6m	Ric
JO13	RP113Q282B	LVR-IC	LDO, 2.8V±1%, 150mA, +CE	SC-88A	28cx	VR4	6m	Ric
JO14	RP113Q282B5	LVR-IC	LDO, 2.85V±1%, 150mA, +CE	SC-88A	28cx	VR4	6m	Ric
JO15	RP113Q292B	LVR-IC	LDO, 2.9V±1%, 150mA, +CE	SC-88A	28cx	VR4	6m	Ric
JO16	RP113Q302B	LVR-IC	LDO, 3.0V±1%, 150mA, +CE	SC-88A	28cx	VR4	6m	Ric
JO17	RP113Q312B	LVR-IC	LDO, 3.1V±1%, 150mA, +CE	SC-88A	28cx	VR4	6m	Ric
JO18	RP113Q322B	LVR-IC	LDO, 3.2V±1%, 150mA, +CE	SC-88A	28cx	VR4	6m	Ric
JO19	RP113Q332B	LVR-IC	LDO, 3.3V±1%, 150mA, +CE	SC-88A	28cx	VR4	6m	Ric
JO2	R1154N102B	LVR-IC	LDO, 10.2V±2%, 150mA, +CE	SOT-23-5	28vrd	VR4	6g	Ric
JO3	R1154N103B	LVR-IC	LDO, 10.3V±2%, 150mA, +CE	SOT-23-5	28vrd	VR4	6g	Ric
JO4	R1154N104B	LVR-IC	LDO, 10.4V±2%, 150mA, +CE	SOT-23-5	28vrd	VR4	6g	Ric
JO5	R1154N105B	LVR-IC	LDO, 10.5V±2%, 150mA, +CE	SOT-23-5	28vrd	VR4	6g	Ric
JO6	R1154N106B	LVR-IC	LDO, 10.6V±2%, 150mA, +CE	SOT-23-5	28vrd	VR4	6g	Ric
JO7	R1154N107B	LVR-IC	LDO, 10.7V±2%, 150mA, +CE	SOT-23-5	28vrd	VR4	6g	Ric
JO8	R1154N108B	LVR-IC	LDO, 10.8V±2%, 150mA, +CE	SOT-23-5	28vrd	VR4	6g	Ric
JO9	R1154N109B	LVR-IC	LDO, 10.9V±2%, 150mA, +CE	SOT-23-5	28vrd	VR4	6g	Ric
JOA	RP130N341A	LVR-IC	LDO, LN, -CE, 3.4V±1%, 150mA	SOT-23-5	28cx	VR4	6g	Ric
JOB	RP130N351A	LVR-IC	LDO, LN, -CE, 3.5V±1%, 150mA	SOT-23-5	28cx	VR4	6g	Ric
JOc	RP130N361A	LVR-IC	LDO, LN, -CE, 3.6V±1%, 150mA	SOT-23-5	28cx	VR4	6g	Ric
JOd	RP130N371A	LVR-IC	LDO, LN, -CE, 3.7V±1%, 150mA	SOT-23-5	28cx	VR4	6g	Ric
JOE	RP130N381A	LVR-IC	LDO, LN, -CE, 3.8V±1%, 150mA	SOT-23-5	28cx	VR4	6g	Ric
JOF	RP130N391A	LVR-IC	LDO, LN, -CE, 3.9V±1%, 150mA	SOT-23-5	28cx	VR4	6g	Ric
JOg	RP130N401A	LVR-IC	LDO, LN, -CE, 4V±1%, 150mA	SOT-23-5	28cx	VR4	6g	Ric
JOH	RP130N411A	LVR-IC	LDO, LN, -CE, 4.1V±1%, 150mA	SOT-23-5	28cx	VR4	6g	Ric
JOJ	RP130N421A	LVR-IC	LDO, LN, -CE, 4.2V±1%, 150mA	SOT-23-5	28cx	VR4	6g	Ric
JOk	RP130N431A	LVR-IC	LDO, LN, -CE, 4.3V±1%, 150mA	SOT-23-5	28cx	VR4	6g	Ric
JOl	RP130N441A	LVR-IC	LDO, LN, -CE, 4.4V±1%, 150mA	SOT-23-5	28cx	VR4	6g	Ric
JOm	RP130N451A	LVR-IC	LDO, LN, -CE, 4.5V±1%, 150mA	SOT-23-5	28cx	VR4	6g	Ric
JOn	RP130N461A	LVR-IC	LDO, LN, -CE, 4.6V±1%, 150mA	SOT-23-5	28cx	VR4	6g	Ric
JOp	RP130N471A	LVR-IC	LDO, LN, -CE, 4.7V±1%, 150mA	SOT-23-5	28cx	VR4	6g	Ric
JOq	RP130N481A	LVR-IC	LDO, LN, -CE, 4.8V±1%, 150mA	SOT-23-5	28cx	VR4	6g	Ric
JOr	RP130N491A	LVR-IC	LDO, LN, -CE, 4.9V±1%, 150mA	SOT-23-5	28cx	VR4	6g	Ric
JOS	RP130N501A	LVR-IC	LDO, LN, -CE, 5V±1%, 150mA	SOT-23-5	28cx	VR4	6g	Ric
J1	RN5RG21AA	LVR-IC	Ext. transistor, 2.1V±2.5% 1A*	SOT-23-5	28vw	VR6	6g	Ric
J1	RT9167A-16CB	LVR-IC	LDO, 1.6V±2%, 600mA, +CE	SOT-23-5	28vrx	VR7	6g	Rct
J1	TC7SZ00F	CMOS-Logic	2-input NAND gate	SSOP-5	28/Log1	-	6a	Tos
J1	TC7SZ00FU	CMOS-Logic	2-input NAND gate	SC-70-5	28/Log1	-	6a	Tos
J10	R1154N110B	LVR-IC	LDO, 11V±2%, 150mA, +CE	SOT-23-5	28vrd	VR4	6g	Ric
J11	R1154N111B	LVR-IC	LDO, 11.1V±2%, 150mA, +CE	SOT-23-5	28vrd	VR4	6g	Ric
J12	R1154N112B	LVR-IC	LDO, 11.2V±2%, 150mA, +CE	SOT-23-5	28vrd	VR4	6g	Ric
J13	R1154N113B	LVR-IC	LDO, 11.3V±2%, 150mA, +CE	SOT-23-5	28vrd	VR4	6g	Ric
J14	R1154N114B	LVR-IC	LDO, 11.4V±2%, 150mA, +CE	SOT-23-5	28vrd	VR4	6g	Ric
J15	R1154N115B	LVR-IC	LDO, 11.5V±2%, 150mA, +CE	SOT-23-5	28vrd	VR4	6g	Ric
J15	TK71215M	LVR-IC	LDO, 1.5V±1%, 160mA	SOT-23-5	28y3	VR24	3a	Tok
J16	R1154N116B	LVR-IC	LDO, 11.6V±2%, 150mA, +CE	SOT-23-5	28vrd	VR4	6g	Ric
J17	R1154N117B	LVR-IC	LDO, 11.7V±2%, 150mA, +CE	SOT-23-5	28vrd	VR4	6g	Ric
J18	R1154N118B	LVR-IC	LDO, 11.8V±2%, 150mA, +CE	SOT-23-5	28vrd	VR4	6g	Ric
J19	R1154N119B	LVR-IC	LDO, 11.9V±2%, 150mA, +CE	SOT-23-5	28vrd	VR4	6g	Ric
J1A	RP130N341B	LVR-IC	LDO, LN, +CE, 3.4V±1%, 150mA	SOT-23-5	28cx	VR4	6g	Ric



SMD code	Type	Function	Short description	Case	Pinout	Sch.	St.	Mnf.
J1B	RP130N351B	LVR-IC	LDO, LN, +CE, 3.5V±1%, 150mA	SOT-23-5	28cx	VR4	6g	Ric
J1C	RP130N361B	LVR-IC	LDO, LN, +CE, 3.6V±1%, 150mA	SOT-23-5	28cx	VR4	6g	Ric
J1D	RP130N371B	LVR-IC	LDO, LN, +CE, 3.7V±1%, 150mA	SOT-23-5	28cx	VR4	6g	Ric
J1E	RP130N381B	LVR-IC	LDO, LN, +CE, 3.8V±1%, 150mA	SOT-23-5	28cx	VR4	6g	Ric
J1F	RP130N391B	LVR-IC	LDO, LN, +CE, 3.9V±1%, 150mA	SOT-23-5	28cx	VR4	6g	Ric
J1G	RP130N401B	LVR-IC	LDO, LN, +CE, 4V±1%, 150mA	SOT-23-5	28cx	VR4	6g	Ric
J1H	RP130N411B	LVR-IC	LDO, LN, +CE, 4.1V±1%, 150mA	SOT-23-5	28cx	VR4	6g	Ric
J1J	RP130N421B	LVR-IC	LDO, LN, +CE, 4.2V±1%, 150mA	SOT-23-5	28cx	VR4	6g	Ric
J1K	RP130N431B	LVR-IC	LDO, LN, +CE, 4.3V±1%, 150mA	SOT-23-5	28cx	VR4	6g	Ric
J1L	RP130N441B	LVR-IC	LDO, LN, +CE, 4.4V±1%, 150mA	SOT-23-5	28cx	VR4	6g	Ric
J1M	RP130N451B	LVR-IC	LDO, LN, +CE, 4.5V±1%, 150mA	SOT-23-5	28cx	VR4	6g	Ric
J1N	RP130N461B	LVR-IC	LDO, LN, +CE, 4.6V±1%, 150mA	SOT-23-5	28cx	VR4	6g	Ric
J1P	RP130N471B	LVR-IC	LDO, LN, +CE, 4.7V±1%, 150mA	SOT-23-5	28cx	VR4	6g	Ric
J1Q	RP130N481B	LVR-IC	LDO, LN, +CE, 4.8V±1%, 150mA	SOT-23-5	28cx	VR4	6g	Ric
J1R	RP130N491B	LVR-IC	LDO, LN, +CE, 4.9V±1%, 150mA	SOT-23-5	28cx	VR4	6g	Ric
J1S	RP130N501B	LVR-IC	LDO, LN, +CE, +CE, 5V±1%, 150mA	SOT-23-5	28cx	VR4	6g	Ric
J2	RN5RG22AA	LVR-IC	Ext. transistor, 2.2V±2.5% 1A*	SOT-23-5	28vw	VR6	6g	Ric
J2	RT9167A-17CB	LVR-IC	LDO, 1.7V±2%, 600mA, +CE	SOT-23-5	28vrx	VR7	6g	Rct
J2	TC7SZ08F	CMOS-Logic	2-input AND gate	SSOP-5	28/Log3	-	6a	Tos
J2	TC7SZ08FU	CMOS-Logic	2-input AND gate	SC-70-5	28/Log3	-	6a	Tos
J20	R1154N120B	LVR-IC	LDO, 12V±2%, 150mA, +CE	SOT-23-5	28vrd	VR4	6g	Ric
J20	TK71220M	LVR-IC	LDO, 2.0V±1%, 160mA	SOT-23-5	28y3	VR24	3a	Tok
J24	R1154N001C	LVR-IC	LDO, Adjustable, 150mA, +CE	SOT-23-5	28vrg	VR16	6g	Ric
J25	R1154N025B	LVR-IC	LDO, 2.5V±2%, 150mA, +CE	SOT-23-5	28vrd	VR4	6g	Ric
J25	TK71225M	LVR-IC	LDO, 2.5V±1%, 160mA	SOT-23-5	28y3	VR24	3a	Tok
J26	R1154N026B	LVR-IC	LDO, 2.6V±2%, 150mA, +CE	SOT-23-5	28vrd	VR4	6g	Ric
J27	R1154N027B	LVR-IC	LDO, 2.7V±2%, 150mA, +CE	SOT-23-5	28vrd	VR4	6g	Ric
J27	TK71227M	LVR-IC	LDO, 2.7V±1%, 160mA	SOT-23-5	28y3	VR24	3a	Tok
J28	R1154N028B	LVR-IC	LDO, 2.8V±2%, 150mA, +CE	SOT-23-5	28vrd	VR4	6g	Ric
J29	R1154N029B	LVR-IC	LDO, 2.9V±2%, 150mA, +CE	SOT-23-5	28vrd	VR4	6g	Ric
J2A	RP130N341D	LVR-IC	LDO, LN, +CE, CL, 3.4V±1%, 150mA	SOT-23-5	28cx	VR4	6g	Ric
J2B	RP130N351D	LVR-IC	LDO, LN, +CE, CL, 3.5V±1%, 150mA	SOT-23-5	28cx	VR4	6g	Ric
J2C	RP130N361D	LVR-IC	LDO, LN, +CE, CL, 3.6V±1%, 150mA	SOT-23-5	28cx	VR4	6g	Ric
J2D	RP130N371D	LVR-IC	LDO, LN, +CE, CL, 3.7V±1%, 150mA	SOT-23-5	28cx	VR4	6g	Ric
J2E	RP130N381D	LVR-IC	LDO, LN, +CE, CL, 3.8V±1%, 150mA	SOT-23-5	28cx	VR4	6g	Ric
J2F	RP130N391D	LVR-IC	LDO, LN, +CE, CL, 3.9V±1%, 150mA	SOT-23-5	28cx	VR4	6g	Ric
J2G	RP130N401D	LVR-IC	LDO, LN, +CE, CL, 4V±1%, 150mA	SOT-23-5	28cx	VR4	6g	Ric
J2H	RP130N411D	LVR-IC	LDO, LN, +CE, CL, 4.1V±1%, 150mA	SOT-23-5	28cx	VR4	6g	Ric
J2J	RP130N421D	LVR-IC	LDO, LN, +CE, CL, 4.2V±1%, 150mA	SOT-23-5	28cx	VR4	6g	Ric
J2K	RP130N431D	LVR-IC	LDO, LN, +CE, CL, 4.3V±1%, 150mA	SOT-23-5	28cx	VR4	6g	Ric
J2L	RP130N441D	LVR-IC	LDO, LN, +CE, CL, 4.4V±1%, 150mA	SOT-23-5	28cx	VR4	6g	Ric
J2M	RP130N451D	LVR-IC	LDO, LN, +CE, CL, 4.5V±1%, 150mA	SOT-23-5	28cx	VR4	6g	Ric
J2N	RP130N461D	LVR-IC	LDO, LN, +CE, CL, 4.6V±1%, 150mA	SOT-23-5	28cx	VR4	6g	Ric
J2P	RP130N471D	LVR-IC	LDO, LN, +CE, CL, 4.7V±1%, 150mA	SOT-23-5	28cx	VR4	6g	Ric
J2Q	RP130N481D	LVR-IC	LDO, LN, +CE, CL, 4.8V±1%, 150mA	SOT-23-5	28cx	VR4	6g	Ric
J2R	RP130N491D	LVR-IC	LDO, LN, +CE, CL, 4.9V±1%, 150mA	SOT-23-5	28cx	VR4	6g	Ric
J2S	RP130N501D	LVR-IC	LDO, LN, +CE, CL, 5V±1%, 150mA	SOT-23-5	28cx	VR4	6g	Ric
J3	RN5RG23AA	LVR-IC	Ext. transistor, 2.3V±2.5% 1A*	SOT-23-5	28vww	VR6	6g	Ric
J3	RT9167A-18CB	LVR-IC	LDO, 1.8V±2%, 600mA, +CE	SOT-23-5	28vrx	VR7	6g	Rct
J3	TC7SZ20F	CMOS-Logic	2-input NOR gate	SSOP-5	28/Log2	-	6a	Tos
J3	TC7SZ20FU	CMOS-Logic	2-input NOR gate	SC-70-5	28/Log2	-	6a	Tos
J3-	RT9167A-18PB	LVR-IC	LDO, 1.8V±2%, 600mA, +CE	SOT-23-5	28vrx	VR7	6g	Rct
J3=	RT9167A-18GB	LVR-IC	LDO, 1.8V±2%, 600mA, +CE	SOT-23-5	28vrx	VR7	6g	Rct
J30	R1154N030B	LVR-IC	LDO, 3V±2%, 150mA, +CE	SOT-23-5	28vrd	VR4	6g	Ric
J30	TK71230M	LVR-IC	LDO, 3.0V±1%, 160mA	SOT-23-5	28y3	VR24	3a	Tok
J31	R1154N031B	LVR-IC	LDO, 3.1V±2%, 150mA, +CE	SOT-23-5	28vrd	VR4	6g	Ric
J32	R1154N032B	LVR-IC	LDO, 3.2V±2%, 150mA, +CE	SOT-23-5	28vrd	VR4	6g	Ric
J33	R1154N033B	LVR-IC	LDO, 3.3V±2%, 150mA, +CE	SOT-23-5	28vrd	VR4	6g	Ric
J34	R1154N034B	LVR-IC	LDO, 3.4V±2%, 150mA, +CE	SOT-23-5	28vrd	VR4	6g	Ric
J35	R1154N035B	LVR-IC	LDO, 3.5V±2%, 150mA, +CE	SOT-23-5	28vrd	VR4	6g	Ric
J35	TK71235M	LVR-IC	LDO, 3.5V±1%, 160mA	SOT-23-5	28y3	VR24	3a	Tok
J36	R1154N036B	LVR-IC	LDO, 3.6V±2%, 150mA, +CE	SOT-23-5	28vrd	VR4	6g	Ric
J37	R1154N037B	LVR-IC	LDO, 3.7V±2%, 150mA, +CE	SOT-23-5	28vrd	VR4	6g	Ric
J38	R1154N038B	LVR-IC	LDO, 3.8V±2%, 150mA, +CE	SOT-23-5	28vrd	VR4	6g	Ric
J39	R1154N039B	LVR-IC	LDO, 3.9V±2%, 150mA, +CE	SOT-23-5	28vrd	VR4	6g	Ric
J4	RN5RG24AA	LVR-IC	Ext. transistor, 2.4V±2.5% 1A*	SOT-23-5	28vww	VR6	6g	Ric
J4	RT9167A-19CB	LVR-IC	LDO, 1.9V±2%, 600mA, +CE	SOT-23-5	28vrx	VR7	6g	Rct
J4	TC7SZ32F	CMOS-Logic	2-input OR gate	SSOP-5	28/Log4	-	6a	Tos
J4	TC7SZ32FU	CMOS-Logic	2-input OR gate	SC-70-5	28/Log4	-	6a	Tos
J40	R1154N040B	LVR-IC	LDO, 4V±2%, 150mA, +CE	SOT-23-5	28vrd	VR4	6g	Ric



SMD code	Type	Function	Short description	Case	Pinout	Sch.	St.	Mnf.
J40	TK71240M	LVR-IC	LDO, 4.0V±1%, 160mA	SOT-23-5	28y3	VR24	3a	Tok
J41	R1154N041B	LVR-IC	LDO, 4.1V±2%, 150mA, +CE	SOT-23-5	28vrd	VR4	6g	Ric
J42	R1154N042B	LVR-IC	LDO, 4.2V±2%, 150mA, +CE	SOT-23-5	28vrd	VR4	6g	Ric
J43	R1154N043B	LVR-IC	LDO, 4.3V±2%, 150mA, +CE	SOT-23-5	28vrd	VR4	6g	Ric
J44	R1154N044B	LVR-IC	LDO, 4.4V±2%, 150mA, +CE	SOT-23-5	28vrd	VR4	6g	Ric
J45	R1154N045B	LVR-IC	LDO, 4.5V±2%, 150mA, +CE	SOT-23-5	28vrd	VR4	6g	Ric
J45	TK71245M	LVR-IC	LDO, 4.5V±1%, 160mA	SOT-23-5	28y3	VR24	3a	Tok
J46	R1154N046B	LVR-IC	LDO, 4.6V±2%, 150mA, +CE	SOT-23-5	28vrd	VR4	6g	Ric
J47	R1154N047B	LVR-IC	LDO, 4.7V±2%, 150mA, +CE	SOT-23-5	28vrd	VR4	6g	Ric
J47	TK71247M	LVR-IC	LDO, 4.7V±1%, 160mA	SOT-23-5	28y3	VR24	3a	Tok
J48	R1154N048B	LVR-IC	LDO, 4.8V±2%, 150mA, +CE	SOT-23-5	28vrd	VR4	6g	Ric
J49	R1154N049B	LVR-IC	LDO, 4.9V±2%, 150mA, +CE	SOT-23-5	28vrd	VR4	6g	Ric
J5	RN5RG25AA	LVR-IC	Ext, transistor, 2.5V±2.5% 1A*	SOT-23-5	28vw	VR6	6g	Ric
J5	RT9167A-20CB	LVR-IC	LDO, 2.0V±2%, 600mA, +CE	SOT-23-5	28vrx	VR7	6g	Rct
J5	TC7SZ04F	CMOS-Logic	Inverter	SSOP-5	28/Log6	-	6a	Tos
J5	TC7SZ04FU	CMOS-Logic	Inverter	SC-70-5	28/Log6	-	6a	Tos
J5-	RT9167A-20PB	LVR-IC	LDO, 2.0V±2%, 600mA, +CE	SOT-23-5	28vrx	VR7	6g	Rct
J50	R1154N050B	LVR-IC	LDO, 5V±2%, 150mA, +CE	SOT-23-5	28vrd	VR4	6g	Ric
J50	TK71250M	LVR-IC	LDO, 5.0V±1%, 160mA	SOT-23-5	28y3	VR24	3a	Tok
J51	R1154N051B	LVR-IC	LDO, 5.1V±2%, 150mA, +CE	SOT-23-5	28vrd	VR4	6g	Ric
J52	R1154N052B	LVR-IC	LDO, 5.2V±2%, 150mA, +CE	SOT-23-5	28vrd	VR4	6g	Ric
J53	R1154N053B	LVR-IC	LDO, 5.3V±2%, 150mA, +CE	SOT-23-5	28vrd	VR4	6g	Ric
J54	R1154N054B	LVR-IC	LDO, 5.4V±2%, 150mA, +CE	SOT-23-5	28vrd	VR4	6g	Ric
J55	R1154N055B	LVR-IC	LDO, 5.5V±2%, 150mA, +CE	SOT-23-5	28vrd	VR4	6g	Ric
J56	R1154N056B	LVR-IC	LDO, 5.6V±2%, 150mA, +CE	SOT-23-5	28vrd	VR4	6g	Ric
J57	R1154N057B	LVR-IC	LDO, 5.7V±2%, 150mA, +CE	SOT-23-5	28vrd	VR4	6g	Ric
J58	R1154N058B	LVR-IC	LDO, 5.8V±2%, 150mA, +CE	SOT-23-5	28vrd	VR4	6g	Ric
J59	R1154N059B	LVR-IC	LDO, 5.9V±2%, 150mA, +CE	SOT-23-5	28vrd	VR4	6g	Ric
J6	RN5RG26AA	LVR-IC	Ext, transistor, 2.6V±2.5% 1A*	SOT-23-5	28vw	VR6	6g	Ric
J6	RT9167A-21CB	LVR-IC	LDO, 2.1V±2%, 600mA, +CE	SOT-23-5	28vrx	VR7	6g	Rct
J6	TC7SZU04F	CMOS-Logic	Inverter	SSOP-5	28/Log6	-	6a	Tos
J6	TC7SZU04FU	CMOS-Logic	Inverter	SC-70-5	28/Log6	-	6a	Tos
J60	R1154N060B	LVR-IC	LDO, 6V±2%, 150mA, +CE	SOT-23-5	28vrd	VR4	6g	Ric
J61	R1154N061B	LVR-IC	LDO, 6.1V±2%, 150mA, +CE	SOT-23-5	28vrd	VR4	6g	Ric
J62	R1154N062B	LVR-IC	LDO, 6.2V±2%, 150mA, +CE	SOT-23-5	28vrd	VR4	6g	Ric
J63	R1154N063B	LVR-IC	LDO, 6.3V±2%, 150mA, +CE	SOT-23-5	28vrd	VR4	6g	Ric
J64	R1154N064B	LVR-IC	LDO, 6.4V±2%, 150mA, +CE	SOT-23-5	28vrd	VR4	6g	Ric
J65	R1154N065B	LVR-IC	LDO, 6.5V±2%, 150mA, +CE	SOT-23-5	28vrd	VR4	6g	Ric
J66	R1154N066B	LVR-IC	LDO, 6.6V±2%, 150mA, +CE	SOT-23-5	28vrd	VR4	6g	Ric
J67	R1154N067B	LVR-IC	LDO, 6.7V±2%, 150mA, +CE	SOT-23-5	28vrd	VR4	6g	Ric
J68	R1154N068B	LVR-IC	LDO, 6.8V±2%, 150mA, +CE	SOT-23-5	28vrd	VR4	6g	Ric
J69	R1154N069B	LVR-IC	LDO, 6.9V±2%, 150mA, +CE	SOT-23-5	28vrd	VR4	6g	Ric
J7	RN5RG27AA	LVR-IC	Ext, transistor, 2.7V±2.5% 1A*	SOT-23-5	28vw	VR6	6g	Ric
J7	RT9167A-22CB	LVR-IC	LDO, 2.2V±2%, 600mA, +CE	SOT-23-5	28vrx	VR7	6g	Rct
J70	R1154N070B	LVR-IC	LDO, 7V±2%, 150mA, +CE	SOT-23-5	28vrd	VR4	6g	Ric
J71	R1154N071B	LVR-IC	LDO, 7.1V±2%, 150mA, +CE	SOT-23-5	28vrd	VR4	6g	Ric
J72	R1154N072B	LVR-IC	LDO, 7.2V±2%, 150mA, +CE	SOT-23-5	28vrd	VR4	6g	Ric
J73	R1154N073B	LVR-IC	LDO, 7.3V±2%, 150mA, +CE	SOT-23-5	28vrd	VR4	6g	Ric
J74	R1154N074B	LVR-IC	LDO, 7.4V±2%, 150mA, +CE	SOT-23-5	28vrd	VR4	6g	Ric
J75	R1154N075B	LVR-IC	LDO, 7.5V±2%, 150mA, +CE	SOT-23-5	28vrd	VR4	6g	Ric
J76	R1154N076B	LVR-IC	LDO, 7.6V±2%, 150mA, +CE	SOT-23-5	28vrd	VR4	6g	Ric
J77	R1154N077B	LVR-IC	LDO, 7.7V±2%, 150mA, +CE	SOT-23-5	28vrd	VR4	6g	Ric
J78	R1154N078B	LVR-IC	LDO, 7.8V±2%, 150mA, +CE	SOT-23-5	28vrd	VR4	6g	Ric
J79	R1154N079B	LVR-IC	LDO, 7.9V±2%, 150mA, +CE	SOT-23-5	28vrd	VR4	6g	Ric
J8	RN5RG28AA	LVR-IC	Ext, transistor, 2.8V±2.5% 1A*	SOT-23-5	28vw	VR6	6g	Ric
J8	RT9167A-23CB	LVR-IC	LDO, 2.3V±2%, 600mA, +CE	SOT-23-5	28vrx	VR7	6g	Rct
J8	Si9184ZDT-12	LVR-IC	LDO, LN, +CE, -Error, 1.2V±2%, 150mA	SOT-23-5	28w	VR17	6k	Vs
J80	R1154N080B	LVR-IC	LDO, 8V±2%, 150mA, +CE	SOT-23-5	28vrd	VR4	6g	Ric
J81	R1154N081B	LVR-IC	LDO, 8.1V±2%, 150mA, +CE	SOT-23-5	28vrd	VR4	6g	Ric
J82	R1154N082B	LVR-IC	LDO, 8.2V±2%, 150mA, +CE	SOT-23-5	28vrd	VR4	6g	Ric
J83	R1154N083B	LVR-IC	LDO, 8.3V±2%, 150mA, +CE	SOT-23-5	28vrd	VR4	6g	Ric
J84	R1154N084B	LVR-IC	LDO, 8.4V±2%, 150mA, +CE	SOT-23-5	28vrd	VR4	6g	Ric
J85	R1154N085B	LVR-IC	LDO, 8.5V±2%, 150mA, +CE	SOT-23-5	28vrd	VR4	6g	Ric
J86	R1154N086B	LVR-IC	LDO, 8.6V±2%, 150mA, +CE	SOT-23-5	28vrd	VR4	6g	Ric
J87	R1154N087B	LVR-IC	LDO, 8.7V±2%, 150mA, +CE	SOT-23-5	28vrd	VR4	6g	Ric
J88	R1154N088B	LVR-IC	LDO, 8.8V±2%, 150mA, +CE	SOT-23-5	28vrd	VR4	6g	Ric
J89	R1154N089B	LVR-IC	LDO, 8.9V±2%, 150mA, +CE	SOT-23-5	28vrd	VR4	6g	Ric
J9	RN5RG29AA	LVR-IC	Ext, transistor, 2.9V±2.5% 1A*	SOT-23-5	28vw	VR6	6g	Ric
J9	RT9167A-24CB	LVR-IC	LDO, 2.4V±2%, 600mA, +CE	SOT-23-5	28vrx	VR7	6g	Rct
J9	TC7SB66FU	CMOS-Logic	Bilateral analogic switch	SOT-353	28/Log16	-	6a	Tos



SMD code	Type	Function	Short description	Case	Pinout	Sch.	St.	Mnf.
J90	R1154N090B	LVR-IC	LDO, 9V±2%, 150mA, +CE	SOT-23-5	28vrd	VR4	6g	Ric
J91	R1154N091B	LVR-IC	LDO, 9.1V±2%, 150mA, +CE	SOT-23-5	28vrd	VR4	6g	Ric
J92	R1154N092B	LVR-IC	LDO, 9.2V±2%, 150mA, +CE	SOT-23-5	28vrd	VR4	6g	Ric
J93	R1154N093B	LVR-IC	LDO, 9.3V±2%, 150mA, +CE	SOT-23-5	28vrd	VR4	6g	Ric
J94	R1154N094B	LVR-IC	LDO, 9.4V±2%, 150mA, +CE	SOT-23-5	28vrd	VR4	6g	Ric
J95	R1154N095B	LVR-IC	LDO, 9.5V±2%, 150mA, +CE	SOT-23-5	28vrd	VR4	6g	Ric
J96	R1154N096B	LVR-IC	LDO, 9.6V±2%, 150mA, +CE	SOT-23-5	28vrd	VR4	6g	Ric
J97	R1154N097B	LVR-IC	LDO, 9.7V±2%, 150mA, +CE	SOT-23-5	28vrd	VR4	6g	Ric
J98	R1154N098B	LVR-IC	LDO, 9.8V±2%, 150mA, +CE	SOT-23-5	28vrd	VR4	6g	Ric
J99	R1154N099B	LVR-IC	LDO, 9.9V±2%, 150mA, +CE	SOT-23-5	28vrd	VR4	6g	Ric
JA	BU4833FWE	Vdet-IC	3.3V, -Reset ODO	VSOF-5	30vk	VD6	6c	Rhm
JA	BU4833G	Vdet-IC	3.3V, -Reset ODO	SSOP-5	28vdm	VD6	6c	Rhm
JA	IDT74ALVCH1G00DY	CMOS-Logic	2-input NAND gate	SO5-1	28/Log1	-	6g	Idt
JA	KRC651F	Si-npn-Digi	Dual, Sw, 2.0V, 50mA, 50mW, R1/R2=4.7k/4.7k	TFSV	30/TD6	-	6a	Kea
JA	RT9167A-25CB	LVR-IC	LDO, 2.5V±2%, 600mA, +CE	SOT-23-5	28vrx	VR7	6g	Rct
JA	TC6502P045VCT	Tdet-IC	45°C±0.5°C, +T over ODO, Hysteresis	SOT-23-5	28	-	6a	Mcc
JA=	RT9167A-25GB	LVR-IC	LDO, 2.5V±2%, 600mA, +CE	SOT-23-5	28vrx	VR7	6g	Rct
JA2	S-80141ALMC	Vdet-IC	4.1V, -Reset PPO, 50ms	SOT-23-5	28yd	VD4	6a	Sii
JA3	S-80142ALMC	Vdet-IC	4.2V, -Reset PPO, 50ms	SOT-23-5	28yd	VD4	6a	Sii
JA4	S-80143ALMC	Vdet-IC	4.3V, -Reset PPO, 50ms	SOT-23-5	28yd	VD4	6a	Sii
JA5	S-80144ALMC	Vdet-IC	4.4V, -Reset PPO, 50ms	SOT-23-5	28yd	VD4	6a	Sii
JA6	S-80145ALMC	Vdet-IC	4.5V, -Reset PPO, 50ms	SOT-23-5	28yd	VD4	6a	Sii
JA7	S-80146ALMC	Vdet-IC	4.6V, -Reset PPO, 50ms	SOT-23-5	28yd	VD4	6a	Sii
JA8	S-80147ALMC	Vdet-IC	4.7V, -Reset PPO, 50ms	SOT-23-5	28yd	VD4	6a	Sii
JA9	S-80148ALMC	Vdet-IC	4.8V, -Reset PPO, 50ms	SOT-23-5	28yd	VD4	6a	Sii
JAA	RP171N121B	LVR-IC	LDO, 1.2V±1%, 150mA, +CE	SOT-23-5	28cx	VR4	6g	Ric
JAB	RP171N121B5	LVR-IC	LDO, 1.25V±1%, 150mA, +CE	SOT-23-5	28cx	VR4	6g	Ric
JAC	RP171N131B	LVR-IC	LDO, 1.3V±1%, 150mA, +CE	SOT-23-5	28cx	VR4	6g	Ric
JAD	RP171N141B	LVR-IC	LDO, 1.4V±1%, 150mA, +CE	SOT-23-5	28cx	VR4	6g	Ric
JAE	RP171N151B	LVR-IC	LDO, 1.5V±1%, 150mA, +CE	SOT-23-5	28cx	VR4	6g	Ric
JAF	RP171N161B	LVR-IC	LDO, 1.6V±1%, 150mA, +CE	SOT-23-5	28cx	VR4	6g	Ric
JAG	RP171N171B	LVR-IC	LDO, 1.7V±1%, 150mA, +CE	SOT-23-5	28cx	VR4	6g	Ric
JAH	RP171N181B	LVR-IC	LDO, 1.8V±1%, 150mA, +CE	SOT-23-5	28cx	VR4	6g	Ric
JAH	S-80122ALMC	Vdet-IC	2.2V, -Reset PPO, 50ms	SOT-23-5	28yd	VD4	6a	Sii
JAI	S-80123ALMC	Vdet-IC	2.3V, -Reset PPO, 50ms	SOT-23-5	28yd	VD4	6a	Sii
JAJ	RP171N181B5	LVR-IC	LDO, 1.85V±1%, 150mA, +CE	SOT-23-5	28cx	VR4	6g	Ric
JAJ	S-80124ALMC	Vdet-IC	2.4V, -Reset PPO, 50ms	SOT-23-5	28yd	VD4	6a	Sii
JAK	RP171N191B	LVR-IC	LDO, 1.9V±1%, 150mA, +CE	SOT-23-5	28cx	VR4	6g	Ric
JAK	S-80125ALMC	Vdet-IC	2.5V, -Reset PPO, 50ms	SOT-23-5	28yd	VD4	6a	Sii
JAL	RP171N201B	LVR-IC	LDO, 2.0V±1%, 150mA, +CE	SOT-23-5	28cx	VR4	6g	Ric
JAL	S-80126ALMC	Vdet-IC	2.6V, -Reset PPO, 50ms	SOT-23-5	28yd	VD4	6a	Sii
JAM	RP171N211B	LVR-IC	LDO, 2.1V±1%, 150mA, +CE	SOT-23-5	28cx	VR4	6g	Ric
JAM	S-80127ALMC	Vdet-IC	2.7V, -Reset PPO, 50ms	SOT-23-5	28yd	VD4	6a	Sii
JAN	RP171N221B	LVR-IC	LDO, 2.2V±1%, 150mA, +CE	SOT-23-5	28cx	VR4	6g	Ric
JAN	S-80128ALMC	Vdet-IC	2.8V, -Reset PPO, 50ms	SOT-23-5	28yd	VD4	6a	Sii
JAO	S-80129ALMC	Vdet-IC	2.9V, -Reset PPO, 50ms	SOT-23-5	28yd	VD4	6a	Sii
JAP	RP171N231B	LVR-IC	LDO, 2.3V±1%, 150mA, +CE	SOT-23-5	28cx	VR4	6g	Ric
JAP	S-80130ALMC	Vdet-IC	3.0V, -Reset PPO, 50ms	SOT-23-5	28yd	VD4	6a	Sii
JAQ	RP171N241B	LVR-IC	LDO, 2.4V±1%, 150mA, +CE	SOT-23-5	28cx	VR4	6g	Ric
JAQ	S-80131ALMC	Vdet-IC	3.1V, -Reset PPO, 50ms	SOT-23-5	28yd	VD4	6a	Sii
JAR	RP171N251B	LVR-IC	LDO, 2.5V±1%, 150mA, +CE	SOT-23-5	28cx	VR4	6g	Ric
JAR	S-80132ALMC	Vdet-IC	3.2V, -Reset PPO, 50ms	SOT-23-5	28yd	VD4	6a	Sii
JAS	RP171N261B	LVR-IC	LDO, 2.6V±1%, 150mA, +CE	SOT-23-5	28cx	VR4	6g	Ric
JAS	S-80133ALMC	Vdet-IC	3.3V, -Reset PPO, 50ms	SOT-23-5	28yd	VD4	6a	Sii
JAT	RP171N271B	LVR-IC	LDO, 2.7V±1%, 150mA, +CE	SOT-23-5	28cx	VR4	6g	Ric
JAT	S-80134ALMC	Vdet-IC	3.4V, -Reset PPO, 50ms	SOT-23-5	28yd	VD4	6a	Sii
JAU	RP171N281B	LVR-IC	LDO, 2.8V±1%, 150mA, +CE	SOT-23-5	28cx	VR4	6g	Ric
JAU	S-80135ALMC	Vdet-IC	3.5V, -Reset PPO, 50ms	SOT-23-5	28yd	VD4	6a	Sii
JAV	RP171N281B5	LVR-IC	LDO, 2.85V±1%, 150mA, +CE	SOT-23-5	28cx	VR4	6g	Ric
JAV	S-80136ALMC	Vdet-IC	3.6V, -Reset PPO, 50ms	SOT-23-5	28yd	VD4	6a	Sii
JAW	RP171N291B	LVR-IC	LDO, 2.9V±1%, 150mA, +CE	SOT-23-5	28cx	VR4	6g	Ric
JAW	S-80137ALMC	Vdet-IC	3.7V, -Reset PPO, 50ms	SOT-23-5	28yd	VD4	6a	Sii
JAX	RP171N301B	LVR-IC	LDO, 3.0V±1%, 150mA, +CE	SOT-23-5	28cx	VR4	6g	Ric
JAX	S-80138ALMC	Vdet-IC	3.8V, -Reset PPO, 50ms	SOT-23-5	28yd	VD4	6a	Sii
JAY	RP171N311B	LVR-IC	LDO, 3.1V±1%, 150mA, +CE	SOT-23-5	28cx	VR4	6g	Ric
JAY	S-80139ALMC	Vdet-IC	3.9V, -Reset PPO, 50ms	SOT-23-5	28yd	VD4	6a	Sii
JAZ	RP171N321B	LVR-IC	LDO, 3.2V±1%, 150mA, +CE	SOT-23-5	28cx	VR4	6g	Ric
JAZ	S-80140ALMC	Vdet-IC	4.0V, -Reset PPO, 50ms	SOT-23-5	28yd	VD4	6a	Sii
JB	BU4834FWE	Vdet-IC	3.4V, -Reset ODO	VSOF-5	30vk	VD6	6c	Rhm
JB	BU4834G	Vdet-IC	3.4V, -Reset ODO	SSOP-5	28vdm	VD6	6c	Rhm



SMD code	Type	Function	Short description	Case	Pinout	Sch.	St.Mnf.
JB	IDT74ALVCH1G02DY	CMOS-Logic	2-input NOR gate	S05-1	28/Log2	-	6g ldt
JB	KRC652F	Si-npn-Digi	Dual, Sw, 20V, 50mA, 50mW, R1/R2=10k/10k	TFSV	30/TD6	-	6a Kec
JB	RT9167A-26CB	LVR-IC	LDO, 2.6V±2%, 600mA, +CE	SOT-23-5	28vrx	VR7	6g Rct
JB	TC7SZ125F	CMOS-Logic	Bus buffer gate with 3-state output	SSOP-5	28/Log14	-	6a Tos
JB	TC7SZ125FU	CMOS-Logic	Bus buffer gate with 3-state output	SC-70-5	28/Log14	-	6a Tos
JBA	RP171N121D	LVR-IC	LDO, 1.2V±1%, 150mA, +CE, CL	SOT-23-5	28cx	VR4	6g Ric
JBA	S-80149ALMC	Vdet-IC	4.9V, -Reset PPO, 50ms	SOT-23-5	28yd	VD4	6a Sii
JBB	RP171N121D5	LVR-IC	LDO, 1.25V±1%, 150mA, +CE, CL	SOT-23-5	28cx	VR4	6g Ric
JBB	S-80150ALMC	Vdet-IC	5.0V, -Reset PPO, 50ms	SOT-23-5	28yd	VD4	6a Sii
JBC	RP171N131D	LVR-IC	LDO, 1.3V±1%, 150mA, +CE, CL	SOT-23-5	28cx	VR4	6g Ric
JBC	S-80151ALMC	Vdet-IC	5.1V, -Reset PPO, 50ms	SOT-23-5	28yd	VD4	6a Sii
JBD	RP171N141D	LVR-IC	LDO, 1.4V±1%, 150mA, +CE, CL	SOT-23-5	28cx	VR4	6g Ric
JBD	S-80152ALMC	Vdet-IC	5.2V, -Reset PPO, 50ms	SOT-23-5	28yd	VD4	6a Sii
JBE	RP171N151D	LVR-IC	LDO, 1.5V±1%, 150mA, +CE, CL	SOT-23-5	28cx	VR4	6g Ric
JBE	S-80153ALMC	Vdet-IC	5.3V, -Reset PPO, 50ms	SOT-23-5	28yd	VD4	6a Sii
JBF	RP171N161D	LVR-IC	LDO, 1.6V±1%, 150mA, +CE, CL	SOT-23-5	28cx	VR4	6g Ric
JBF	S-80154ALMC	Vdet-IC	5.4V, -Reset PPO, 50ms	SOT-23-5	28yd	VD4	6a Sii
JBG	RP171N171D	LVR-IC	LDO, 1.7V±1%, 150mA, +CE, CL	SOT-23-5	28cx	VR4	6g Ric
JBG	S-80155ALMC	Vdet-IC	5.5V, -Reset PPO, 50ms	SOT-23-5	28yd	VD4	6a Sii
JBH	RP171N181D	LVR-IC	LDO, 1.8V±1%, 150mA, +CE, CL	SOT-23-5	28cx	VR4	6g Ric
JBH	S-80156ALMC	Vdet-IC	5.6V, -Reset PPO, 50ms	SOT-23-5	28yd	VD4	6a Sii
JBI	S-80157ALMC	Vdet-IC	5.7V, -Reset PPO, 50ms	SOT-23-5	28yd	VD4	6a Sii
JBJ	RP171N181D5	LVR-IC	LDO, 1.85V±1%, 150mA, +CE, CL	SOT-23-5	28cx	VR4	6g Ric
JBJ	S-80158ALMC	Vdet-IC	5.8V, -Reset PPO, 50ms	SOT-23-5	28yd	VD4	6a Sii
JBK	RP171N191D	LVR-IC	LDO, 1.9V±1%, 150mA, +CE, CL	SOT-23-5	28cx	VR4	6g Ric
JBK	S-80159ALMC	Vdet-IC	5.9V, -Reset PPO, 50ms	SOT-23-5	28yd	VD4	6a Sii
JBL	RP171N201D	LVR-IC	LDO, 2.0V±1%, 150mA, +CE, CL	SOT-23-5	28cx	VR4	6g Ric
JBL	S-80160ALMC	Vdet-IC	6.0V, -Reset PPO, 50ms	SOT-23-5	28yd	VD4	6a Sii
JBM	RP171N211D	LVR-IC	LDO, 2.1V±1%, 150mA, +CE, CL	SOT-23-5	28cx	VR4	6g Ric
JBN	RP171N221D	LVR-IC	LDO, 2.2V±1%, 150mA, +CE, CL	SOT-23-5	28cx	VR4	6g Ric
JBP	RP171N231D	LVR-IC	LDO, 2.3V±1%, 150mA, +CE, CL	SOT-23-5	28cx	VR4	6g Ric
JBQ	RP171N241D	LVR-IC	LDO, 2.4V±1%, 150mA, +CE, CL	SOT-23-5	28cx	VR4	6g Ric
JBR	RP171N251D	LVR-IC	LDO, 2.5V±1%, 150mA, +CE, CL	SOT-23-5	28cx	VR4	6g Ric
JBS	RP171N261D	LVR-IC	LDO, 2.6V±1%, 150mA, +CE, CL	SOT-23-5	28cx	VR4	6g Ric
JBT	RP171N271D	LVR-IC	LDO, 2.7V±1%, 150mA, +CE, CL	SOT-23-5	28cx	VR4	6g Ric
JBU	RP171N281D	LVR-IC	LDO, 2.8V±1%, 150mA, +CE, CL	SOT-23-5	28cx	VR4	6g Ric
JBV	RP171N281D5	LVR-IC	LDO, 2.85V±1%, 150mA, +CE, CL	SOT-23-5	28cx	VR4	6g Ric
JBW	RP171N291D	LVR-IC	LDO, 2.9V±1%, 150mA, +CE, CL	SOT-23-5	28cx	VR4	6g Ric
JBX	RP171N301D	LVR-IC	LDO, 3.0V±1%, 150mA, +CE, CL	SOT-23-5	28cx	VR4	6g Ric
JBY	RP171N311D	LVR-IC	LDO, 3.1V±1%, 150mA, +CE, CL	SOT-23-5	28cx	VR4	6g Ric
JBZ	RP171N321D	LVR-IC	LDO, 3.2V±1%, 150mA, +CE, CL	SOT-23-5	28cx	VR4	6g Ric
JC	BU4835FWE	Vdet-IC	3.5V, -Reset ODO	VSOFF-5	30vk	VD6	6c Rhm
JC	BU4835G	Vdet-IC	3.5V, -Reset ODO	SSOP-5	28vdm	VD6	6c Rhm
JC	IDT74ALVCH1G04DY	CMOS-Logic	Inverter	S05-1	28/Log6	-	6g ldt
JC	KRC653F	Si-npn-Digi	Dual, Sw, 20V, 50mA, 50mW, R1/R2=22k/22k	TFSV	30/TD6	-	6a Kec
JC	RT9167A-27CB	LVR-IC	LDO, 2.7V±2%, 600mA, +CE	SOT-23-5	28vrx	VR7	6g Rct
JC	TC6502P065VCT	Tdet-IC	65°C±0.5°C, +Tover ODO, Hysteresis	SOT-23-5	28	-	6a Mcc
JC	TC7SZ126F	CMOS-Logic	Bus buffer gate with 3-state output	SSOP-5	28/Log13	-	6a Tos
JC	TC7SZ126FU	CMOS-Logic	Bus buffer gate with 3-state output	SC-70-5	28/Log13	-	6a Tos
JC2	S-80141ANMC	Vdet-IC	4.1V, -Reset ODO, 50ms	SOT-23-5	28yd	VD1	6a Sii
JC3	S-80142ANMC	Vdet-IC	4.2V, -Reset ODO, 50ms	SOT-23-5	28yd	VD1	6a Sii
JC4	S-80143ANMC	Vdet-IC	4.3V, -Reset ODO, 50ms	SOT-23-5	28yd	VD1	6a Sii
JC5	S-80144ANMC	Vdet-IC	4.4V, -Reset ODO, 50ms	SOT-23-5	28yd	VD1	6a Sii
JC6	S-80145ANMC	Vdet-IC	4.5V, -Reset ODO, 50ms	SOT-23-5	28yd	VD1	6a Sii
JC7	S-80146ANMC	Vdet-IC	4.6V, -Reset ODO, 50ms	SOT-23-5	28yd	VD1	6a Sii
JC8	S-80147ANMC	Vdet-IC	4.7V, -Reset ODO, 50ms	SOT-23-5	28yd	VD1	6a Sii
JC9	S-80148ANMC	Vdet-IC	4.8V, -Reset ODO, 50ms	SOT-23-5	28yd	VD1	6a Sii
JCH	S-80122ANMC	Vdet-IC	2.2V, -Reset ODO, 50ms	SOT-23-5	28yd	VD1	6a Sii
JCI	S-80123ANMC	Vdet-IC	2.3V, -Reset ODO, 50ms	SOT-23-5	28yd	VD1	6a Sii
JCJ	S-80124ANMC	Vdet-IC	2.4V, -Reset ODO, 50ms	SOT-23-5	28yd	VD1	6a Sii
JCK	S-80125ANMC	Vdet-IC	2.5V, -Reset ODO, 50ms	SOT-23-5	28yd	VD1	6a Sii
JCL	S-80126ANMC	Vdet-IC	2.6V, -Reset ODO, 50ms	SOT-23-5	28yd	VD1	6a Sii
JCM	S-80127ANMC	Vdet-IC	2.7V, -Reset ODO, 50ms	SOT-23-5	28yd	VD1	6a Sii
JCN	S-80128ANMC	Vdet-IC	2.8V, -Reset ODO, 50ms	SOT-23-5	28yd	VD1	6a Sii
JCO	S-80129ANMC	Vdet-IC	2.9V, -Reset ODO, 50ms	SOT-23-5	28yd	VD1	6a Sii
JCP	S-80130ANMC	Vdet-IC	3.0V, -Reset ODO, 50ms	SOT-23-5	28yd	VD1	6a Sii
JCQ	S-80131ANMC	Vdet-IC	3.1V, -Reset ODO, 50ms	SOT-23-5	28yd	VD1	6a Sii
JCR	S-80132ANMC	Vdet-IC	3.2V, -Reset ODO, 50ms	SOT-23-5	28yd	VD1	6a Sii
JCS	S-80133ANMC	Vdet-IC	3.3V, -Reset ODO, 50ms	SOT-23-5	28yd	VD1	6a Sii
JCT	S-80134ANMC	Vdet-IC	3.4V, -Reset ODO, 50ms	SOT-23-5	28yd	VD1	6a Sii



SMD code	Type	Function	Short description	Case	Pinout	Sch.	St.	Mnf.
JCU	S-80135ANMC	Vdet-IC	3.5V, -Reset ODO, 50ms	SOT-23-5	28yd	VD1	6a	Sii
JCV	S-80136ANMC	Vdet-IC	3.6V, -Reset ODO, 50ms	SOT-23-5	28yd	VD1	6a	Sii
JCW	S-80137ANMC	Vdet-IC	3.7V, -Reset ODO, 50ms	SOT-23-5	28yd	VD1	6a	Sii
JCX	S-80138ANMC	Vdet-IC	3.8V, -Reset ODO, 50ms	SOT-23-5	28yd	VD1	6a	Sii
JCY	S-80139ANMC	Vdet-IC	3.9V, -Reset ODO, 50ms	SOT-23-5	28yd	VD1	6a	Sii
JCZ	S-80140ANMC	Vdet-IC	4.0V, -Reset ODO, 50ms	SOT-23-5	28yd	VD1	6a	Sii
JD	BU4836FWE	Vdet-IC	3.6V, -Reset ODO	VSO5-5	30wk	VD6	6c	Rhm
JD	BU4836G	Vdet-IC	3.6V, -Reset ODO	SSOP-5	28vdm	VD6	6c	Rhm
JD	IDT74ALVCH1GU04DY	CMOS-Logic	Inverter	SO5-1	28/Log6	-	6g	Idt
JD	KRC654F	Si-npn-Digi	Dual, Sw, 20V, 50mA, 50mW, R1/R2=47k/47k	TFSV	30/TD6	-	6a	Kec
JD	RT9167A-30CB	LVR-IC	LDO, 3.0V±2%, 600mA, +CE	SOT-23-5	28vrx	VR7	6g	Rct
JD	TC6502P075VCT	Tdet-IC	75°C±0.5°C, +Tover ODO, Hysteresis	SOT-23-5	28	-	6a	Mcc
JD-	RT9167A-30PB	LVR-IC	LDO, 3.0V±2%, 600mA, +CE	SOT-23-5	28vrx	VR7	6g	Rct
JD=	RT9167A-30GB	LVR-IC	LDO, 3.0V±2%, 600mA, +CE	SOT-23-5	28vrx	VR7	6g	Rct
JDA	S-80149ANMC	Vdet-IC	4.9V, -Reset ODO, 50ms	SOT-23-5	28yd	VD1	6a	Sii
JDB	S-80150ANMC	Vdet-IC	5.0V, -Reset ODO, 50ms	SOT-23-5	28yd	VD1	6a	Sii
JDC	S-80151ANMC	Vdet-IC	5.1V, -Reset ODO, 50ms	SOT-23-5	28yd	VD1	6a	Sii
JDD	S-80152ANMC	Vdet-IC	5.2V, -Reset ODO, 50ms	SOT-23-5	28yd	VD1	6a	Sii
JDE	S-80153ANMC	Vdet-IC	5.3V, -Reset ODO, 50ms	SOT-23-5	28yd	VD1	6a	Sii
JDF	S-80154ANMC	Vdet-IC	5.4V, -Reset ODO, 50ms	SOT-23-5	28yd	VD1	6a	Sii
JDG	S-80155ANMC	Vdet-IC	5.5V, -Reset ODO, 50ms	SOT-23-5	28yd	VD1	6a	Sii
JDH	S-80156ANMC	Vdet-IC	5.6V, -Reset ODO, 50ms	SOT-23-5	28yd	VD1	6a	Sii
JDI	S-80157ANMC	Vdet-IC	5.7V, -Reset ODO, 50ms	SOT-23-5	28yd	VD1	6a	Sii
JDJ	S-80158ANMC	Vdet-IC	5.8V, -Reset ODO, 50ms	SOT-23-5	28yd	VD1	6a	Sii
JDK	S-80159ANMC	Vdet-IC	5.9V, -Reset ODO, 50ms	SOT-23-5	28yd	VD1	6a	Sii
JDL	S-80160ANMC	Vdet-IC	6.0V, -Reset ODO, 50ms	SOT-23-5	28yd	VD1	6a	Sii
JE	BU4837FWE	Vdet-IC	3.7V, -Reset ODO	VSO5-5	30wk	VD6	6c	Rhm
JE	BU4837G	Vdet-IC	3.7V, -Reset ODO	SSOP-5	28vdm	VD6	6c	Rhm
JE	IDT74ALVCH1G08DY	CMOS-Logic	2-input AND gate	SO5-1	28/Log3	-	6g	Idt
JE	RT9167A-29CB	LVR-IC	LDO, 2.9V±2%, 600mA, +CE	SOT-23-5	28vrx	VR7	6g	Rct
JE	TC7SZ05F	CMOS-Logic	Inverter (ODO)	SSOP-5	28/Log19	-	6a	Tos
JE	TC7SZ05FU	CMOS-Logic	Inverter (ODO)	SC-70-5	28/Log19	-	6a	Tos
JE-	RT9167A-29PB	LVR-IC	LDO, 2.9V±2%, 600mA, +CE	SOT-23-5	28vrx	VR7	6g	Rct
JE2	S-80141BLMC	Vdet-IC	4.1V, -Reset PPO, 100ms	SOT-23-5	28yd	VD4	6a	Sii
JE3	S-80142BLMC	Vdet-IC	4.2V, -Reset PPO, 100ms	SOT-23-5	28yd	VD4	6a	Sii
JE4	S-80143BLMC	Vdet-IC	4.3V, -Reset PPO, 100ms	SOT-23-5	28yd	VD4	6a	Sii
JE5	S-80144BLMC	Vdet-IC	4.4V, -Reset PPO, 100ms	SOT-23-5	28yd	VD4	6a	Sii
JE6	S-80145BLMC	Vdet-IC	4.5V, -Reset PPO, 100ms	SOT-23-5	28yd	VD4	6a	Sii
JE7	S-80146BLMC	Vdet-IC	4.6V, -Reset PPO, 100ms	SOT-23-5	28yd	VD4	6a	Sii
JE8	S-80147BLMC	Vdet-IC	4.7V, -Reset PPO, 100ms	SOT-23-5	28yd	VD4	6a	Sii
JE9	S-80148BLMC	Vdet-IC	4.8V, -Reset PPO, 100ms	SOT-23-5	28yd	VD4	6a	Sii
JEH	S-80122BLMC	Vdet-IC	2.2V, -Reset PPO, 100ms	SOT-23-5	28yd	VD4	6a	Sii
JEI	S-80123BLMC	Vdet-IC	2.3V, -Reset PPO, 100ms	SOT-23-5	28yd	VD4	6a	Sii
JEJ	S-80124BLMC	Vdet-IC	2.4V, -Reset PPO, 100ms	SOT-23-5	28yd	VD4	6a	Sii
JEK	S-80125BLMC	Vdet-IC	2.5V, -Reset PPO, 100ms	SOT-23-5	28yd	VD4	6a	Sii
JEL	S-80126BLMC	Vdet-IC	2.6V, -Reset PPO, 100ms	SOT-23-5	28yd	VD4	6a	Sii
JEM	S-80127BLMC	Vdet-IC	2.7V, -Reset PPO, 100ms	SOT-23-5	28yd	VD4	6a	Sii
JEN	S-80128BLMC	Vdet-IC	2.8V, -Reset PPO, 100ms	SOT-23-5	28yd	VD4	6a	Sii
JEO	S-80129BLMC	Vdet-IC	2.9V, -Reset PPO, 100ms	SOT-23-5	28yd	VD4	6a	Sii
JEP	S-80130BLMC	Vdet-IC	3.0V, -Reset PPO, 100ms	SOT-23-5	28yd	VD4	6a	Sii
JEQ	S-80131BLMC	Vdet-IC	3.1V, -Reset PPO, 100ms	SOT-23-5	28yd	VD4	6a	Sii
JER	S-80132BLMC	Vdet-IC	3.2V, -Reset PPO, 100ms	SOT-23-5	28yd	VD4	6a	Sii
JES	S-80133BLMC	Vdet-IC	3.3V, -Reset PPO, 100ms	SOT-23-5	28yd	VD4	6a	Sii
JET	S-80134BLMC	Vdet-IC	3.4V, -Reset PPO, 100ms	SOT-23-5	28yd	VD4	6a	Sii
JEU	S-80135BLMC	Vdet-IC	3.5V, -Reset PPO, 100ms	SOT-23-5	28yd	VD4	6a	Sii
JEV	S-80136BLMC	Vdet-IC	3.6V, -Reset PPO, 100ms	SOT-23-5	28yd	VD4	6a	Sii
JEW	S-80137BLMC	Vdet-IC	3.7V, -Reset PPO, 100ms	SOT-23-5	28yd	VD4	6a	Sii
JEX	S-80138BLMC	Vdet-IC	3.8V, -Reset PPO, 100ms	SOT-23-5	28yd	VD4	6a	Sii
JEY	S-80139BLMC	Vdet-IC	3.9V, -Reset PPO, 100ms	SOT-23-5	28yd	VD4	6a	Sii
JEZ	S-80140BLMC	Vdet-IC	4.0V, -Reset PPO, 100ms	SOT-23-5	28yd	VD4	6a	Sii
JF	BU4838FWE	Vdet-IC	3.8V, -Reset ODO	VSO5-5	30wk	VD6	6c	Rhm
JF	BU4838G	Vdet-IC	3.8V, -Reset ODO	SSOP-5	28vdm	VD6	6c	Rhm
JF	IDT74ALVCH1G14DY	CMOS-Logic	Inverting Schmitt-trigger	SO5-1	28/Log7	-	6g	Idt
JF	RT9167A-28CB	LVR-IC	LDO, 2.8V±2%, 600mA, +CE	SOT-23-5	28vrx	VR7	6g	Rct
JF	TC6502P095VCT	Tdet-IC	95°C±0.5°C, +Tover ODO, Hysteresis	SOT-23-5	28	-	6a	Mcc
JF	TC7SB384FU	CMOS-Logic	Bilateral analogic switch	SOT-353	28/Log86	-	6a	Tos
JF-	RT9167A-28PB	LVR-IC	LDO, 2.8V±2%, 600mA, +CE	SOT-23-5	28vrx	VR7	6g	Rct
JFA	S-80149BLMC	Vdet-IC	4.9V, -Reset PPO, 100ms	SOT-23-5	28yd	VD4	6a	Sii
JFB	S-80150BLMC	Vdet-IC	5.0V, -Reset PPO, 100ms	SOT-23-5	28yd	VD4	6a	Sii
JFC	S-80151BLMC	Vdet-IC	5.1V, -Reset PPO, 100ms	SOT-23-5	28yd	VD4	6a	Sii



SMD code	Type	Function	Short description	Case	Pinout	Sch.	St.	Mnf.
JFD	S-80152BLMC	Vdet-IC	5.2V, -Reset PPO, 100ms	SOT-23-5	28yd	VD4	6a	Sii
JFE	S-80153BLMC	Vdet-IC	5.3V, -Reset PPO, 100ms	SOT-23-5	28yd	VD4	6a	Sii
JFF	S-80154BLMC	Vdet-IC	5.4V, -Reset PPO, 100ms	SOT-23-5	28yd	VD4	6a	Sii
JFG	S-80155BLMC	Vdet-IC	5.5V, -Reset PPO, 100ms	SOT-23-5	28yd	VD4	6a	Sii
JFH	S-80156BLMC	Vdet-IC	5.6V, -Reset PPO, 100ms	SOT-23-5	28yd	VD4	6a	Sii
JFI	S-80157BLMC	Vdet-IC	5.7V, -Reset PPO, 100ms	SOT-23-5	28yd	VD4	6a	Sii
JFJ	S-80158BLMC	Vdet-IC	5.8V, -Reset PPO, 100ms	SOT-23-5	28yd	VD4	6a	Sii
JFK	S-80159BLMC	Vdet-IC	5.9V, -Reset PPO, 100ms	SOT-23-5	28yd	VD4	6a	Sii
JFL	S-80160BLMC	Vdet-IC	6.0V, -Reset PPO, 100ms	SOT-23-5	28yd	VD4	6a	Sii
JG	BU4839FWE	Vdet-IC	3.9V, -Reset ODO	VSO5-5	30vk	VD6	6c	Rhm
JG	BU4839G	Vdet-IC	3.9V, -Reset ODO	SSOP-5	28vdm	VD6	6c	Rhm
JG	IDT74ALVCH1G32DY	CMOS-Logic	2-input OR gate	S05-1	28Log4	-	6g	ldt
JG	KRC657F	Si-npn-Digi	Dual, Sw, 20V, 50mA, 50mW, R1/R2=10k/47k	TFSV	30/TD6	-	6a	Kec
JG	RT9167A-31CB	LVR-IC	LDO, 3.1V±2%, 600mA, +CE	SOT-23-5	28vrx	VR7	6g	Rct
JG-	RT9167A-31PB	LVR-IC	LDO, 3.1V±2%, 600mA, +CE	SOT-23-5	28vrx	VR7	6g	Rct
JG2	S-80141BNMC	Vdet-IC	4.1V, -Reset ODO, 100ms	SOT-23-5	28yd	VD1	6a	Sii
JG3	S-80142BNMC	Vdet-IC	4.2V, -Reset ODO, 100ms	SOT-23-5	28yd	VD1	6a	Sii
JG4	S-80143BNMC	Vdet-IC	4.3V, -Reset ODO, 100ms	SOT-23-5	28yd	VD1	6a	Sii
JG5	S-80144BNMC	Vdet-IC	4.4V, -Reset ODO, 100ms	SOT-23-5	28yd	VD1	6a	Sii
JG6	S-80145BNMC	Vdet-IC	4.5V, -Reset ODO, 100ms	SOT-23-5	28yd	VD1	6a	Sii
JG7	S-80146BNMC	Vdet-IC	4.6V, -Reset ODO, 100ms	SOT-23-5	28yd	VD1	6a	Sii
JG8	S-80147BNMC	Vdet-IC	4.7V, -Reset ODO, 100ms	SOT-23-5	28yd	VD1	6a	Sii
JG9	S-80148BNMC	Vdet-IC	4.8V, -Reset ODO, 100ms	SOT-23-5	28yd	VD1	6a	Sii
JGH	S-80122BNMC	Vdet-IC	2.2V, -Reset ODO, 100ms	SOT-23-5	28yd	VD1	6a	Sii
JGI	S-80123BNMC	Vdet-IC	2.3V, -Reset ODO, 100ms	SOT-23-5	28yd	VD1	6a	Sii
JGJ	S-80124BNMC	Vdet-IC	2.4V, -Reset ODO, 100ms	SOT-23-5	28yd	VD1	6a	Sii
JGK	S-80125BNMC	Vdet-IC	2.5V, -Reset ODO, 100ms	SOT-23-5	28yd	VD1	6a	Sii
JGL	S-80126BNMC	Vdet-IC	2.6V, -Reset ODO, 100ms	SOT-23-5	28yd	VD1	6a	Sii
JGM	S-80127BNMC	Vdet-IC	2.7V, -Reset ODO, 100ms	SOT-23-5	28yd	VD1	6a	Sii
JGN	S-80128BNMC	Vdet-IC	2.8V, -Reset ODO, 100ms	SOT-23-5	28yd	VD1	6a	Sii
JGO	S-80129BNMC	Vdet-IC	2.9V, -Reset ODO, 100ms	SOT-23-5	28yd	VD1	6a	Sii
JGP	S-80130BNMC	Vdet-IC	3.0V, -Reset ODO, 100ms	SOT-23-5	28yd	VD1	6a	Sii
JGQ	S-80131BNMC	Vdet-IC	3.1V, -Reset ODO, 100ms	SOT-23-5	28yd	VD1	6a	Sii
JGR	S-80132BNMC	Vdet-IC	3.2V, -Reset ODO, 100ms	SOT-23-5	28yd	VD1	6a	Sii
JGS	S-80133BNMC	Vdet-IC	3.3V, -Reset ODO, 100ms	SOT-23-5	28yd	VD1	6a	Sii
JGT	S-80134BNMC	Vdet-IC	3.4V, -Reset ODO, 100ms	SOT-23-5	28yd	VD1	6a	Sii
JGU	S-80135BNMC-	Vdet-IC	3.5V, -Reset ODO, 100ms	SOT-23-5	28yd	VD1	6a	Sii
JGV	S-80136BNMC	Vdet-IC	3.6V, -Reset ODO, 100ms	SOT-23-5	28yd	VD1	6a	Sii
JGW	S-80137BNMC	Vdet-IC	3.7V, -Reset ODO, 100ms	SOT-23-5	28yd	VD1	6a	Sii
JGX	S-80138BNMC	Vdet-IC	3.8V, -Reset ODO, 100ms	SOT-23-5	28yd	VD1	6a	Sii
JGY	S-80139BNMC	Vdet-IC	3.9V, -Reset ODO, 100ms	SOT-23-5	28yd	VD1	6a	Sii
JGZ	S-80140BNMC	Vdet-IC	4.0V, -Reset ODO, 100ms	SOT-23-5	28yd	VD1	6a	Sii
JH	BU4840FWE	Vdet-IC	4V, -Reset ODO	VSO5-5	30vk	VD6	6c	Rhm
JH	BU4840G	Vdet-IC	4V, -Reset ODO	SSOP-5	28vdm	VD6	6c	Rhm
JH	IDT74ALVCH1G86DY	CMOS-Logic	2-input EXCLUSIVE-OR gate	S05-1	28Log5	-	6g	ldt
JH	KRC658F	Si-npn-Digi	Dual, Sw, 20V, 50mA, 50mW, R1/R2=22k/47k	TFSV	30/TD6	-	6a	Kec
JH	RT9167A-32CB	LVR-IC	LDO, 3.2V±2%, 600mA, +CE	SOT-23-5	28vrx	VR7	6g	Rct
JH	TC6502P115VCT	Tdet-IC	115°C±0.5°C, +Tover ODO, Hysteresis	SOT-23-5	28	-	6a	Mcc
JHA	S-80149BNMC	Vdet-IC	4.9V, -Reset ODO, 100ms	SOT-23-5	28yd	VD1	6a	Sii
JHB	S-80150BNMC	Vdet-IC	5.0V, -Reset ODO, 100ms	SOT-23-5	28yd	VD1	6a	Sii
JHC	S-80151BNMC	Vdet-IC	5.1V, -Reset ODO, 100ms	SOT-23-5	28yd	VD1	6a	Sii
JHD	S-80152BNMC	Vdet-IC	5.2V, -Reset ODO, 100ms	SOT-23-5	28yd	VD1	6a	Sii
JHE	S-80153BNMC	Vdet-IC	5.3V, -Reset ODO, 100ms	SOT-23-5	28yd	VD1	6a	Sii
JHF	S-80154BNMC	Vdet-IC	5.4V, -Reset ODO, 100ms	SOT-23-5	28yd	VD1	6a	Sii
JHG	S-80155BNMC	Vdet-IC	5.5V, -Reset ODO, 100ms	SOT-23-5	28yd	VD1	6a	Sii
JHH	S-80156BNMC	Vdet-IC	5.6V, -Reset ODO, 100ms	SOT-23-5	28yd	VD1	6a	Sii
JHI	S-80157BNMC	Vdet-IC	5.7V, -Reset ODO, 100ms	SOT-23-5	28yd	VD1	6a	Sii
JHJ	S-80158BNMC	Vdet-IC	5.8V, -Reset ODO, 100ms	SOT-23-5	28yd	VD1	6a	Sii
JHK	S-80159BNMC	Vdet-IC	5.9V, -Reset ODO, 100ms	SOT-23-5	28yd	VD1	6a	Sii
JHL	S-80160BNMC	Vdet-IC	6.0V, -Reset ODO, 100ms	SOT-23-5	28yd	VD1	6a	Sii
JI2	S-80141CLMC	Vdet-IC	4.1V, -Reset PPO, 200ms	SOT-23-5	28yd	VD4	6a	Sii
JI3	S-80142CLMC	Vdet-IC	4.2V, -Reset PPO, 200ms	SOT-23-5	28yd	VD4	6a	Sii
JI4	S-80143CLMC	Vdet-IC	4.3V, -Reset PPO, 200ms	SOT-23-5	28yd	VD4	6a	Sii
JI5	S-80144CLMC	Vdet-IC	4.4V, -Reset PPO, 200ms	SOT-23-5	28yd	VD4	6a	Sii
JI6	S-80145CLMC	Vdet-IC	4.5V, -Reset PPO, 200ms	SOT-23-5	28yd	VD4	6a	Sii
JI7	S-80146CLMC	Vdet-IC	4.6V, -Reset PPO, 200ms	SOT-23-5	28yd	VD4	6a	Sii
JI8	S-80147CLMC	Vdet-IC	4.7V, -Reset PPO, 200ms	SOT-23-5	28yd	VD4	6a	Sii
JI9	S-80148CLMC	Vdet-IC	4.8V, -Reset PPO, 200ms	SOT-23-5	28yd	VD4	6a	Sii
JIH	S-80122CLMC	Vdet-IC	2.2V, -Reset PPO, 200ms	SOT-23-5	28yd	VD4	6a	Sii
JII	S-80123CLMC	Vdet-IC	2.3V, -Reset PPO, 200ms	SOT-23-5	28yd	VD4	6a	Sii



SMD code	Type	Function	Short description	Case	Pinout	Sch.	St.Mnf.
JJJ	S-80124CLMC	Vdet-IC	2.4V, -Reset PPO, 200ms	SOT-23-5	28yd	VD4	6a Sii
JJK	S-80125CLMC	Vdet-IC	2.5V, -Reset PPO, 200ms	SOT-23-5	28yd	VD4	6a Sii
JJL	S-80126CLMC	Vdet-IC	2.6V, -Reset PPO, 200ms	SOT-23-5	28yd	VD4	6a Sii
JJM	S-80127CLMC	Vdet-IC	2.7V, -Reset PPO, 200ms	SOT-23-5	28yd	VD4	6a Sii
JJN	S-80128CLMC	Vdet-IC	2.8V, -Reset PPO, 200ms	SOT-23-5	28yd	VD4	6a Sii
JJO	S-80129CLMC	Vdet-IC	2.9V, -Reset PPO, 200ms	SOT-23-5	28yd	VD4	6a Sii
JJP	S-80130CLMC	Vdet-IC	3.0V, -Reset PPO, 200ms	SOT-23-5	28yd	VD4	6a Sii
JJQ	S-80131CLMC	Vdet-IC	3.1V, -Reset PPO, 200ms	SOT-23-5	28yd	VD4	6a Sii
JJR	S-80132CLMC	Vdet-IC	3.2V, -Reset PPO, 200ms	SOT-23-5	28yd	VD4	6a Sii
JJS	S-80133CLMC	Vdet-IC	3.3V, -Reset PPO, 200ms	SOT-23-5	28yd	VD4	6a Sii
JJT	S-80134CLMC	Vdet-IC	3.4V, -Reset PPO, 200ms	SOT-23-5	28yd	VD4	6a Sii
JJU	S-80135CLMC	Vdet-IC	3.5V, -Reset PPO, 200ms	SOT-23-5	28yd	VD4	6a Sii
JJV	S-80136CLMC	Vdet-IC	3.6V, -Reset PPO, 200ms	SOT-23-5	28yd	VD4	6a Sii
JJW	S-80137CLMC	Vdet-IC	3.7V, -Reset PPO, 200ms	SOT-23-5	28yd	VD4	6a Sii
JJX	S-80138CLMC	Vdet-IC	3.8V, -Reset PPO, 200ms	SOT-23-5	28yd	VD4	6a Sii
JJY	S-80139CLMC	Vdet-IC	3.9V, -Reset PPO, 200ms	SOT-23-5	28yd	VD4	6a Sii
JJZ	S-80140CLMC	Vdet-IC	4.0V, -Reset PPO, 200ms	SOT-23-5	28yd	VD4	6a Sii
JJ	BU4841FWE	Vdet-IC	4.1V, -Reset ODO	VSOF-5	30vk	VD6	6c Rhm
JJ	BU4841G	Vdet-IC	4.1V, -Reset ODO	SSOP-5	28vdm	VD6	6c Rhm
JJ	KRC659F	Si-npn-Digi	Dual, Sw, 20V, 50mA, 50mW, R1/R2=47k/22k	TFSV	30/TD6	-	6a Kec
JJ	RT9167A-33CB	LVR-IC	LDO, 3.3V±2%, 600mA, +CE	SOT-23-5	28vrx	VR7	6g Rct
JJ	TC6502P125VCT	Tdet-IC	125°C±0.5°C, +Tover ODO, Hysteresis	SOT-23-5	28	-	6a Mcc
JJ-	RT9167A-33PB	LVR-IC	LDO, 3.3V±2%, 600mA, +CE	SOT-23-5	28vrx	VR7	6g Rct
JJ=	RT9167A-33GB	LVR-IC	LDO, 3.3V±2%, 600mA, +CE	SOT-23-5	28vrx	VR7	6g Rct
JJA	S-80149CLMC	Vdet-IC	4.9V, -Reset PPO, 200ms	SOT-23-5	28yd	VD4	6a Sii
JJB	S-80150CLMC	Vdet-IC	5.0V, -Reset PPO, 200ms	SOT-23-5	28yd	VD4	6a Sii
JJC	S-80151CLMC	Vdet-IC	5.1V, -Reset PPO, 200ms	SOT-23-5	28yd	VD4	6a Sii
JJD	S-80152CLMC	Vdet-IC	5.2V, -Reset PPO, 200ms	SOT-23-5	28yd	VD4	6a Sii
JJE	S-80153CLMC	Vdet-IC	5.3V, -Reset PPO, 200ms	SOT-23-5	28yd	VD4	6a Sii
JJF	S-80154CLMC	Vdet-IC	5.4V, -Reset PPO, 200ms	SOT-23-5	28yd	VD4	6a Sii
JJG	S-80155CLMC	Vdet-IC	5.5V, -Reset PPO, 200ms	SOT-23-5	28yd	VD4	6a Sii
JJH	S-80156CLMC	Vdet-IC	5.6V, -Reset PPO, 200ms	SOT-23-5	28yd	VD4	6a Sii
JJI	S-80157CLMC	Vdet-IC	5.7V, -Reset PPO, 200ms	SOT-23-5	28yd	VD4	6a Sii
JJJ	S-80158CLMC	Vdet-IC	5.8V, -Reset PPO, 200ms	SOT-23-5	28yd	VD4	6a Sii
JJK	S-80159CLMC	Vdet-IC	5.9V, -Reset PPO, 200ms	SOT-23-5	28yd	VD4	6a Sii
JJL	S-80160CLMC	Vdet-IC	6.0V, -Reset PPO, 200ms	SOT-23-5	28yd	VD4	6a Sii
JK	BU4842FWE	Vdet-IC	4.2V, -Reset ODO	VSOF-5	30vk	VD6	6c Rhm
JK	BU4842G	Vdet-IC	4.2V, -Reset ODO	SSOP-5	28vdm	VD6	6c Rhm
JK	KRC660F	Si-npn-Digi	Dual, Sw, 20V, 50mA, 50mW, R1=4.7k	TFSV	30/TD6	-	6a Kec
JK	RT9167A-34CB	LVR-IC	LDO, 3.4V±2%, 600mA, +CE	SOT-23-5	28vrx	VR7	6g Rct
JK	TC7SB385FU	CMOS-Logic	Bilateral analogic switch	SOT-353	28/Log16	-	6a Tos
JK2	S-80141CNMC	Vdet-IC	4.1V, -Reset ODO, 200ms	SOT-23-5	28yd	VD1	6a Sii
JK3	S-80142CNMC	Vdet-IC	4.2V, -Reset ODO, 200ms	SOT-23-5	28yd	VD1	6a Sii
JK4	S-80143CNMC	Vdet-IC	4.3V, -Reset ODO, 200ms	SOT-23-5	28yd	VD1	6a Sii
JK5	S-80144CNMC	Vdet-IC	4.4V, -Reset ODO, 200ms	SOT-23-5	28yd	VD1	6a Sii
JK6	S-80145CNMC	Vdet-IC	4.5V, -Reset ODO, 200ms	SOT-23-5	28yd	VD1	6a Sii
JK7	S-80146CNMC	Vdet-IC	4.6V, -Reset ODO, 200ms	SOT-23-5	28yd	VD1	6a Sii
JK8	S-80147CNMC	Vdet-IC	4.7V, -Reset ODO, 200ms	SOT-23-5	28yd	VD1	6a Sii
JK9	S-80148CNMC	Vdet-IC	4.8V, -Reset ODO, 200ms	SOT-23-5	28yd	VD1	6a Sii
JKH	S-80122CNMC	Vdet-IC	2.2V, -Reset ODO, 200ms	SOT-23-5	28yd	VD1	6a Sii
JKI	S-80123CNMC	Vdet-IC	2.3V, -Reset ODO, 200ms	SOT-23-5	28yd	VD1	6a Sii
JKJ	S-80124CNMC	Vdet-IC	2.4V, -Reset ODO, 200ms	SOT-23-5	28yd	VD1	6a Sii
JKK	S-80125CNMC	Vdet-IC	2.5V, -Reset ODO, 200ms	SOT-23-5	28yd	VD1	6a Sii
JKL	S-80126CNMC	Vdet-IC	2.6V, -Reset ODO, 200ms	SOT-23-5	28yd	VD1	6a Sii
JKM	S-80127CNMC	Vdet-IC	2.7V, -Reset ODO, 200ms	SOT-23-5	28yd	VD1	6a Sii
JKN	S-80128CNMC	Vdet-IC	2.8V, -Reset ODO, 200ms	SOT-23-5	28yd	VD1	6a Sii
JKO	S-80129CNMC	Vdet-IC	2.9V, -Reset ODO, 200ms	SOT-23-5	28yd	VD1	6a Sii
JKP	S-80130CNMC	Vdet-IC	3.0V, -Reset ODO, 200ms	SOT-23-5	28yd	VD1	6a Sii
JKQ	S-80131CNMC	Vdet-IC	3.1V, -Reset ODO, 200ms	SOT-23-5	28yd	VD1	6a Sii
JKR	S-80132CNMC	Vdet-IC	3.2V, -Reset ODO, 200ms	SOT-23-5	28yd	VD1	6a Sii
JKS	S-80133CNMC	Vdet-IC	3.3V, -Reset ODO, 200ms	SOT-23-5	28yd	VD1	6a Sii
JKT	S-80134CNMC	Vdet-IC	3.4V, -Reset ODO, 200ms	SOT-23-5	28yd	VD1	6a Sii
JKU	S-80135CNMC	Vdet-IC	3.5V, -Reset ODO, 200ms	SOT-23-5	28yd	VD1	6a Sii
JKV	S-80136CNMC	Vdet-IC	3.6V, -Reset ODO, 200ms	SOT-23-5	28yd	VD1	6a Sii
JKW	S-80137CNMC	Vdet-IC	3.7V, -Reset ODO, 200ms	SOT-23-5	28yd	VD1	6a Sii
JKX	S-80138CNMC	Vdet-IC	3.8V, -Reset ODO, 200ms	SOT-23-5	28yd	VD1	6a Sii
JKY	S-80139CNMC	Vdet-IC	3.9V, -Reset ODO, 200ms	SOT-23-5	28yd	VD1	6a Sii
JKZ	S-80140CNMC	Vdet-IC	4.0V, -Reset ODO, 200ms	SOT-23-5	28yd	VD1	6a Sii
JL	BU4843FWE	Vdet-IC	4.3V, -Reset ODO	VSOF-5	30vk	VD6	6c Rhm
JL	BU4843G	Vdet-IC	4.3V, -Reset ODO	SSOP-5	28vdm	VD6	6c Rhm



SMD code	Type	Function	Short description	Case	Pinout	Sch.	St.	Mnf.
JL	KRC661F	Si-npn-Digi	Dual, Sw, 20V, 50mA, 50mW, R1=10k	TFSV	30/TD6	-	6a	Kec
JL	R1112N501B	LVR-IC	LDO, LN, +CE, 5V±2%, 150mA	SOT-23-5	28cx	VR4	6g	Ric
JL	RT9167A-35CB	LVR-IC	LDO, 3.5V±2%, 600mA, +CE	SOT-23-5	28vrx	VR7	6g	Rct
JL-	RT9167A-35PB	LVR-IC	LDO, 3.5V±2%, 600mA, +CE	SOT-23-5	28vrx	VR7	6g	Rct
JLA	S-80149CNMC	Vdet-IC	4.9V, -Reset ODO, 200ms	SOT-23-5	28yd	VD1	6a	Sii
JLB	S-80150CNMC	Vdet-IC	5.0V, -Reset ODO, 200ms	SOT-23-5	28yd	VD1	6a	Sii
JLC	S-80151CNMC	Vdet-IC	5.1V, -Reset ODO, 200ms	SOT-23-5	28yd	VD1	6a	Sii
JLD	S-80152CNMC	Vdet-IC	5.2V, -Reset ODO, 200ms	SOT-23-5	28yd	VD1	6a	Sii
JLE	S-80153CNMC	Vdet-IC	5.3V, -Reset ODO, 200ms	SOT-23-5	28yd	VD1	6a	Sii
JLF	S-80154CNMC	Vdet-IC	5.4V, -Reset ODO, 200ms	SOT-23-5	28yd	VD1	6a	Sii
JLG	S-80155CNMC	Vdet-IC	5.5V, -Reset ODO, 200ms	SOT-23-5	28yd	VD1	6a	Sii
JLH	S-80156CNMC	Vdet-IC	5.6V, -Reset ODO, 200ms	SOT-23-5	28yd	VD1	6a	Sii
JLI	S-80157CNMC	Vdet-IC	5.7V, -Reset ODO, 200ms	SOT-23-5	28yd	VD1	6a	Sii
JLJ	S-80158CNMC	Vdet-IC	5.8V, -Reset ODO, 200ms	SOT-23-5	28yd	VD1	6a	Sii
JLK	S-80159CNMC	Vdet-IC	5.9V, -Reset ODO, 200ms	SOT-23-5	28yd	VD1	6a	Sii
JLL	S-80160CNMC	Vdet-IC	6.0V, -Reset ODO, 200ms	SOT-23-5	28yd	VD1	6a	Sii
JM	BU4844FWE	Vdet-IC	4.4V, -Reset ODO	VSO5-5	30vk	VD6	6c	Rhm
JM	BU4844G	Vdet-IC	4.4V, -Reset ODO	SSOP-5	28vdm	VD6	6c	Rhm
JM	IDT74ALVCH1G125DY	CMOS-Logic	Bus buffer gate with 3-state output	S05-1	28/Log14	-	6g	Idt
JM	RT9167A-36CB	LVR-IC	LDO, 3.6V±2%, 600mA, +CE	SOT-23-5	28vrx	VR7	6g	Rct
JN	AAT3515IGV-3.08-C	Vdet-IC	3.08V±1.5%, -MR, ±Reset PPO, 140ms	SOT-23-5	28xf	VD21	6k	Ant
JN	BU4845FWE	Vdet-IC	4.5V, -Reset ODO	VSO5-5	30vk	VD6	6c	Rhm
JN	BU4845G	Vdet-IC	4.5V, -Reset ODO	SSOP-5	28vdm	VD6	6c	Rhm
JN	IDT74ALVCH1G126DY	CMOS-Logic	Bus buffer gate with 3-state output	S05-1	28/Log13	-	6g	Idt
JN	KRC663F	Si-npn-Digi	Dual, Sw, 20V, 50mA, 50mW, R1=22k	TFSV	30/TD6	-	6a	Kec
JN	RT9167A-37CB	LVR-IC	LDO, 3.7V±2%, 600mA, +CE	SOT-23-5	28vrx	VR7	6g	Rct
JN	TC7SBL384AFU	CMOS-Logic	Bilateral analogic switch with level shifting	SOT-353	28/Log86	-	6a	Tos
JO	AAT3512IGV-2.63-C-C	Vdet-IC	2.63V±1.5%, -MR, +Reset PPO	SOT-23-5	28cp	VD17	6k	Ant
JO	TC7SBL384CFU	CMOS-Logic	Bilateral analogic switch with level shifting	SOT-353	28/Log86	-	6a	Tos
JP	BU4846FWE	Vdet-IC	4.6V, -Reset ODO	VSO5-5	30vk	VD6	6c	Rhm
JP	BU4846G	Vdet-IC	4.6V, -Reset ODO	SSOP-5	28vdm	VD6	6c	Rhm
JP	KRC664F	Si-npn-Digi	Dual, Sw, 20V, 50mA, 50mW, R1=47k	TFSV	30/TD6	-	6a	Kec
JP	RT9167A-38CB	LVR-IC	LDO, 3.8V±2%, 600mA, +CE	SOT-23-5	28vrx	VR7	6g	Rct
JQ	BU4847FWE	Vdet-IC	4.7V, -Reset ODO	VSO5-5	30vk	VD6	6c	Rhm
JQ	BU4847G	Vdet-IC	4.7V, -Reset ODO	SSOP-5	28vdm	VD6	6c	Rhm
JR	BU4848FWE	Vdet-IC	4.8V, -Reset ODO	VSO5-5	30vk	VD6	6c	Rhm
JR	BU4848G	Vdet-IC	4.8V, -Reset ODO	SSOP-5	28vdm	VD6	6c	Rhm
JR	IDT74ALVCH1G79DY	CMOS-Logic	Positive edge-triggered D-type flip-flop	S05-1	28/Log20	-	6g	Idt
JS	BU4909FWE	Vdet-IC	0.9V, +Reset PPO	VSO5-5	30vk	VD7	6c	Rhm
JS	BU4909G	Vdet-IC	0.9V, +Reset PPO	SSOP-5	28vdm	VD7	6c	Rhm
JS	TC7SBD384AFU	CMOS-Logic	Bilateral analogic switch with level shifting	SOT-353	28/Log86	-	6a	Tos
JT	BU4910FWE	Vdet-IC	1.0V, +Reset PPO	VSO5-5	30vk	VD7	6c	Rhm
JT	BU4910G	Vdet-IC	1.0V, +Reset PPO	SSOP-5	28vdm	VD7	6c	Rhm
JT	IDT74ALVCH1G06DY	CMOS-Logic	Inverter (ODO)	S05-1	28/Log19	-	6g	Idt
JT	TC7SBD385AFU	CMOS-Logic	Bilateral analogic switch with level shifting	SOT-353	28/Log16	-	6a	Tos
JT-	RT9167A-42PB	LVR-IC	LDO, 4.2V±2%, 600mA, +CE	SOT-23-5	28vrx	VR7	6g	Rct
JU	BU4911FWE	Vdet-IC	1.1V, +Reset PPO	VSO5-5	30vk	VD7	6c	Rhm
JU	BU4911G	Vdet-IC	1.1V, +Reset PPO	SSOP-5	28vdm	VD7	6c	Rhm
JV	BU4912FWE	Vdet-IC	1.2V, +Reset PPO	VSO5-5	30vk	VD7	6c	Rhm
JV	BU4912G	Vdet-IC	1.2V, +Reset PPO	SSOP-5	28vdm	VD7	6c	Rhm
JV	IDT74ALVCH1G07DY	CMOS-Logic	Noninverting buffer/driver (ODO)	S05-1	28/Log8	-	6g	Idt
JV	TC7SBL66CFU	CMOS-Logic	Bilateral analogic switch	SOT-353	28/Log16	-	6a	Tos
JW	BU4913FWE	Vdet-IC	1.3V, +Reset PPO	VSO5-5	30vk	VD7	6c	Rhm
JW	BU4913G	Vdet-IC	1.3V, +Reset PPO	SSOP-5	28vdm	VD7	6c	Rhm
JW	RT9167A-45CB	LVR-IC	LDO, 4.3V±2%, 600mA, +CE	SOT-23-5	28vrx	VR7	6g	Rct
JW-	RT9167A-45PB	LVR-IC	LDO, 4.3V±2%, 600mA, +CE	SOT-23-5	28vrx	VR7	6g	Rct
JX	BU4914FWE	Vdet-IC	1.4V, +Reset PPO	VSO5-5	30vk	VD7	6c	Rhm
JX	BU4914G	Vdet-IC	1.4V, +Reset PPO	SSOP-5	28vdm	VD7	6c	Rhm
JY	BU4915FWE	Vdet-IC	1.5V, +Reset PPO	VSO5-5	30vk	VD7	6c	Rhm
JY	BU4915G	Vdet-IC	1.5V, +Reset PPO	SSOP-5	28vdm	VD7	6c	Rhm
JY	IDT74ALVCH1G132DY	CMOS-Logic	2-input NAND Schmitt-trigger	S05-1	28/Log12	-	6g	Idt
JZ	BU4916FWE	Vdet-IC	1.6V, +Reset PPO	VSO5-5	30vk	VD7	6c	Rhm
JZ	BU4916G	Vdet-IC	1.6V, +Reset PPO	SSOP-5	28vdm	VD7	6c	Rhm
K0	RN5RG30AA	LVR-IC	Ext. transistor, 3V±2.5% 1A*	SOT-23-5	28vww	VR6	6g	Ric
K0	RT9167A-15CBR	LVR-IC	LDO, 1.5V±2%, 600mA, +CE	SOT-23-5	28vr1	VR7	6g	Rct
K0	RN5RY201A	DC/DC-IC	VFM step-up, 2V±2.5%, 150mW, <180kHz	SOT-23-5	28vd	DC5	6g	Ric
K001	RP113Q122D	LVR-IC	LDO, 1.2V±1%, 150mA, +CE, CL	SC-88A	28cx	VR4	6m	Ric
K002	RP113Q132D	LVR-IC	LDO, 1.3V±1%, 150mA, +CE, CL	SC-88A	28cx	VR4	6m	Ric
K003	RP113Q152D	LVR-IC	LDO, 1.5V±1%, 150mA, +CE, CL	SC-88A	28cx	VR4	6m	Ric
K004	RP113Q182D	LVR-IC	LDO, 1.8V±1%, 150mA, +CE, CL	SC-88A	28cx	VR4	6m	Ric



SMD code	Type	Function	Short description	Case	Pinout	Sch.	St.	Mnf.
K005	RP113Q182D5	LVR-IC	LDO, 1.85V±1%, 150mA, +CE, CL	SC-88A	28cx	VR4	6m	Ric
K006	RP113Q192D	LVR-IC	LDO, 1.9V±1%, 150mA, +CE, CL	SC-88A	28cx	VR4	6m	Ric
K007	RP113Q202D	LVR-IC	LDO, 2.0V±1%, 150mA, +CE, CL	SC-88A	28cx	VR4	6m	Ric
K008	RP113Q212D	LVR-IC	LDO, 2.1V±1%, 150mA, +CE, CL	SC-88A	28cx	VR4	6m	Ric
K009	RP113Q232D	LVR-IC	LDO, 2.3V±1%, 150mA, +CE, CL	SC-88A	28cx	VR4	6m	Ric
K010	RP113Q252D	LVR-IC	LDO, 2.5V±1%, 150mA, +CE, CL	SC-88A	28cx	VR4	6m	Ric
K011	RP113Q262D	LVR-IC	LDO, 2.6V±1%, 150mA, +CE, CL	SC-88A	28cx	VR4	6m	Ric
K012	RP113Q272D	LVR-IC	LDO, 2.7V±1%, 150mA, +CE, CL	SC-88A	28cx	VR4	6m	Ric
K013	RP113Q282D	LVR-IC	LDO, 2.8V±1%, 150mA, +CE, CL	SC-88A	28cx	VR4	6m	Ric
K014	RP113Q282D5	LVR-IC	LDO, 2.85V±1%, 150mA, +CE, CL	SC-88A	28cx	VR4	6m	Ric
K015	RP113Q292D	LVR-IC	LDO, 2.9V±1%, 150mA, +CE, CL	SC-88A	28cx	VR4	6m	Ric
K016	RP113Q302D	LVR-IC	LDO, 3.0V±1%, 150mA, +CE, CL	SC-88A	28cx	VR4	6m	Ric
K017	RP113Q312D	LVR-IC	LDO, 3.1V±1%, 150mA, +CE, CL	SC-88A	28cx	VR4	6m	Ric
K018	RP113Q322D	LVR-IC	LDO, 3.2V±1%, 150mA, +CE, CL	SC-88A	28cx	VR4	6m	Ric
K019	RP113Q332D	LVR-IC	LDO, 3.3V±1%, 150mA, +CE, CL	SC-88A	28cx	VR4	6m	Ric
K0A	RP400N181A	DC/DC-IC	PWM st-up, 700kHz, 1.8V±2%, 200mA, +CE	SOT-23-5	28zr	DC19	6g	Ric
K0B	RP400N191A	DC/DC-IC	PWM st-up, 700kHz, 1.9V±2%, 200mA, +CE	SOT-23-5	28zr	DC19	6g	Ric
K0C	RP400N201A	DC/DC-IC	PWM st-up, 700kHz, 2.0V±2%, 200mA, +CE	SOT-23-5	28zr	DC19	6g	Ric
K0D	RP400N211A	DC/DC-IC	PWM st-up, 700kHz, 2.1V±2%, 200mA, +CE	SOT-23-5	28zr	DC19	6g	Ric
K0E	RP400N221A	DC/DC-IC	PWM st-up, 700kHz, 2.2V±2%, 200mA, +CE	SOT-23-5	28zr	DC19	6g	Ric
K0F	RP400N231A	DC/DC-IC	PWM st-up, 700kHz, 2.3V±2%, 200mA, +CE	SOT-23-5	28zr	DC19	6g	Ric
K0G	RP400N241A	DC/DC-IC	PWM st-up, 700kHz, 2.4V±2%, 200mA, +CE	SOT-23-5	28zr	DC19	6g	Ric
K0H	RP400N251A	DC/DC-IC	PWM st-up, 700kHz, 2.5V±2%, 200mA, +CE	SOT-23-5	28zr	DC19	6g	Ric
K0J	RP400N261A	DC/DC-IC	PWM st-up, 700kHz, 2.6V±2%, 200mA, +CE	SOT-23-5	28zr	DC19	6g	Ric
K0K	RP400N271A	DC/DC-IC	PWM st-up, 700kHz, 2.7V±2%, 200mA, +CE	SOT-23-5	28zr	DC19	6g	Ric
K0L	RP400N281A	DC/DC-IC	PWM st-up, 700kHz, 2.8V±2%, 200mA, +CE	SOT-23-5	28zr	DC19	6g	Ric
K0M	RP400N291A	DC/DC-IC	PWM st-up, 700kHz, 2.9V±2%, 200mA, +CE	SOT-23-5	28zr	DC19	6g	Ric
K0N	RP400N301A	DC/DC-IC	PWM st-up, 700kHz, 3.0V±2%, 200mA, +CE	SOT-23-5	28zr	DC19	6g	Ric
K0P	RP400N311A	DC/DC-IC	PWM st-up, 700kHz, 3.1V±2%, 200mA, +CE	SOT-23-5	28zr	DC19	6g	Ric
K0Q	RP400N321A	DC/DC-IC	PWM st-up, 700kHz, 3.2V±2%, 200mA, +CE	SOT-23-5	28zr	DC19	6g	Ric
K0R	RP400N331A	DC/DC-IC	PWM st-up, 700kHz, 3.3V±2%, 200mA, +CE	SOT-23-5	28zr	DC19	6g	Ric
K0S	RP400N341A	DC/DC-IC	PWM st-up, 700kHz, 3.4V±2%, 200mA, +CE	SOT-23-5	28zr	DC19	6g	Ric
K0T	RP400N351A	DC/DC-IC	PWM st-up, 700kHz, 3.5V±2%, 200mA, +CE	SOT-23-5	28zr	DC19	6g	Ric
K0U	RP400N361A	DC/DC-IC	PWM st-up, 700kHz, 3.6V±2%, 200mA, +CE	SOT-23-5	28zr	DC19	6g	Ric
K0V	RP400N371A	DC/DC-IC	PWM st-up, 700kHz, 3.7V±2%, 200mA, +CE	SOT-23-5	28zr	DC19	6g	Ric
K0W	RP400N381A	DC/DC-IC	PWM st-up, 700kHz, 3.8V±2%, 200mA, +CE	SOT-23-5	28zr	DC19	6g	Ric
K0X	RP400N391A	DC/DC-IC	PWM st-up, 700kHz, 3.9V±2%, 200mA, +CE	SOT-23-5	28zr	DC19	6g	Ric
K0Y	RP400N401A	DC/DC-IC	PWM st-up, 700kHz, 4.0V±2%, 200mA, +CE	SOT-23-5	28zr	DC19	6g	Ric
K0Z	RP400N411A	DC/DC-IC	PWM st-up, 700kHz, 4.1V±2%, 200mA, +CE	SOT-23-5	28zr	DC19	6g	Ric
K1	RT5RG31AA	LVR-IC	Ext. transistor, 3.1V±2.5% 1A*	SOT-23-5	28vw	VR6	6g	Ric
K1	RT9167A-16CBR	LVR-IC	LDO, 1.6V±2%, 600mA, +CE	SOT-23-5	28w1	VR7	6g	Rct
K1	RN5RY211A	DC/DC-IC	VFM step-up, 2.1V±2.5%, 150mW, <180kHz	SOT-23-5	28vd	DC5	6g	Ric
K15	XC6366A152MR	DC/DC-IC	PWM/PFM st-down, 180kHz, 1.5V±2.5%, 1A, +CE	SOT-25	28zm	DC7	6g	Tor
K15	XC6366A152MR	DC/DC-IC	PWM/PFM step-up, 1.5V±2.5%, 200mA, 180kHz, +CE	SOT-25	28sh	DC11	6g	Tor
K16	XC6366A162MR	DC/DC-IC	PWM/PFM st-down, 180kHz, 1.6V±2.5%, 1A, +CE	SOT-25	28zm	DC7	6g	Tor
K16	XC6366A162MR	DC/DC-IC	PWM/PFM step-up, 1.6V±2.5%, 200mA, 180kHz, +CE	SOT-25	28sh	DC11	6g	Tor
K17	XC6366A172MR	DC/DC-IC	PWM/PFM st-down, 180kHz, 1.7V±2.5%, 1A, +CE	SOT-25	28zm	DC7	6g	Tor
K17	XC6366A172MR	DC/DC-IC	PWM/PFM step-up, 1.7V±2.5%, 200mA, 180kHz, +CE	SOT-25	28sh	DC11	6g	Tor
K18	XC6366A182MR	DC/DC-IC	PWM/PFM st-down, 180kHz, 1.8V±2.5%, 1A, +CE	SOT-25	28zm	DC7	6g	Tor
K18	XC6366A182MR	DC/DC-IC	PWM/PFM step-up, 1.8V±2.5%, 200mA, 180kHz, +CE	SOT-25	28sh	DC11	6g	Tor
K19	XC6366A192MR	DC/DC-IC	PWM/PFM st-down, 180kHz, 1.9V±2.5%, 1A, +CE	SOT-25	28zm	DC7	6g	Tor
K19	XC6366A192MR	DC/DC-IC	PWM/PFM step-up, 1.9V±2.5%, 200mA, 180kHz, +CE	SOT-25	28sh	DC11	6g	Tor
K1A	RP400N181C	DC/DC-IC	PWM st-up, 700kHz, 1.8V±2%, 200mA, +CE	SOT-23-5	28zr	DC19	6g	Ric
K1A	XC6366A203MR	DC/DC-IC	PWM/PFM st-down, 300kHz, 2.0V±2.5%, 1A, +CE	SOT-25	28zm	DC7	6g	Tor
K1B	RP400N191C	DC/DC-IC	PWM st-up, 700kHz, 1.9V±2%, 200mA, +CE	SOT-23-5	28zr	DC19	6g	Ric
K1C	RP400N201C	DC/DC-IC	PWM st-up, 700kHz, 2.0V±2%, 200mA, +CE	SOT-23-5	28zr	DC19	6g	Ric
K1D	RP400N211C	DC/DC-IC	PWM st-up, 700kHz, 2.1V±2%, 200mA, +CE	SOT-23-5	28zr	DC19	6g	Ric
K1E	RP400N221C	DC/DC-IC	PWM st-up, 700kHz, 2.2V±2%, 200mA, +CE	SOT-23-5	28zr	DC19	6g	Ric
K1F	RP400N231C	DC/DC-IC	PWM st-up, 700kHz, 2.3V±2%, 200mA, +CE	SOT-23-5	28zr	DC19	6g	Ric
K1F	XC6366A153MR	DC/DC-IC	PWM/PFM st-down, 300kHz, 1.5V±2.5%, 1A, +CE	SOT-25	28zm	DC7	6g	Tor
K1F	XC6366A153MR	DC/DC-IC	PWM/PFM step-up, 1.5V±2.5%, 200mA, 300kHz, +CE	SOT-25	28sh	DC11	6g	Tor
K1G	RP400N241C	DC/DC-IC	PWM st-up, 700kHz, 2.4V±2%, 200mA, +CE	SOT-23-5	28zr	DC19	6g	Ric
K1H	RP400N251C	DC/DC-IC	PWM st-up, 700kHz, 2.5V±2%, 200mA, +CE	SOT-23-5	28zr	DC19	6g	Ric
K1H	XC6366A163MR	DC/DC-IC	PWM/PFM st-down, 300kHz, 1.6V±2.5%, 1A, +CE	SOT-25	28zm	DC7	6g	Tor
K1H	XC6366A163MR	DC/DC-IC	PWM/PFM step-up, 1.6V±2.5%, 200mA, 300kHz, +CE	SOT-25	28sh	DC11	6g	Tor
K1J	RP400N261C	DC/DC-IC	PWM st-up, 700kHz, 2.6V±2%, 200mA, +CE	SOT-23-5	28zr	DC19	6g	Ric
K1K	RP400N271C	DC/DC-IC	PWM st-up, 700kHz, 2.7V±2%, 200mA, +CE	SOT-23-5	28zr	DC19	6g	Ric
K1K	XC6366A173MR	DC/DC-IC	PWM/PFM st-down, 300kHz, 1.7V±2.5%, 1A, +CE	SOT-25	28zm	DC7	6g	Tor
K1K	XC6366A173MR	DC/DC-IC	PWM/PFM step-up, 1.7V±2.5%, 200mA, 300kHz, +CE	SOT-25	28sh	DC11	6g	Tor
K1L	RP400N281C	DC/DC-IC	PWM st-up, 700kHz, 2.8V±2%, 200mA, +CE	SOT-23-5	28zr	DC19	6g	Ric



SMD code	Type	Function	Short description	Case	Pinout	Sch.	St.	Mnf.
K1L	XC6366A183MR	DC/DC-IC	PWM/PFM st-down, 300kHz, 1.8V±2.5%, 1A, +CE	SOT-25	28zm	DC7	6g	Tor
K1L	XC6366A183MR	DC/DC-IC	PWM/PFM step-up, 1.8V±2.5%, 200mA, 300kHz, +CE	SOT-25	28sh	DC11	6g	Tor
K1M	RP400N291C	DC/DC-IC	PWM st-up, 700kHz, 2.9V±2%, 200mA, +CE	SOT-23-5	28zr	DC19	6g	Ric
K1M	XC6366A193MR	DC/DC-IC	PWM/PFM st-down, 300kHz, 1.9V±2.5%, 1A, +CE	SOT-25	28zm	DC7	6g	Tor
K1M	XC6366A193MR	DC/DC-IC	PWM/PFM step-up, 1.9V±2.5%, 200mA, 300kHz, +CE	SOT-25	28sh	DC11	6g	Tor
K1N	RP400N301C	DC/DC-IC	PWM st-up, 700kHz, 3.0V±2%, 200mA, +CE	SOT-23-5	28zr	DC19	6g	Ric
K1P	RP400N311C	DC/DC-IC	PWM st-up, 700kHz, 3.1V±2%, 200mA, +CE	SOT-23-5	28zr	DC19	6g	Ric
K1Q	RP400N321C	DC/DC-IC	PWM st-up, 700kHz, 3.2V±2%, 200mA, +CE	SOT-23-5	28zr	DC19	6g	Ric
K1R	RP400N331C	DC/DC-IC	PWM st-up, 700kHz, 3.3V±2%, 200mA, +CE	SOT-23-5	28zr	DC19	6g	Ric
K1S	RP400N341C	DC/DC-IC	PWM st-up, 700kHz, 3.4V±2%, 200mA, +CE	SOT-23-5	28zr	DC19	6g	Ric
K1T	RP400N351C	DC/DC-IC	PWM st-up, 700kHz, 3.5V±2%, 200mA, +CE	SOT-23-5	28zr	DC19	6g	Ric
K1U	RP400N361C	DC/DC-IC	PWM st-up, 700kHz, 3.6V±2%, 200mA, +CE	SOT-23-5	28zr	DC19	6g	Ric
K1V	RP400N371C	DC/DC-IC	PWM st-up, 700kHz, 3.7V±2%, 200mA, +CE	SOT-23-5	28zr	DC19	6g	Ric
K1W	RP400N381C	DC/DC-IC	PWM st-up, 700kHz, 3.8V±2%, 200mA, +CE	SOT-23-5	28zr	DC19	6g	Ric
K1X	RP400N391C	DC/DC-IC	PWM st-up, 700kHz, 3.9V±2%, 200mA, +CE	SOT-23-5	28zr	DC19	6g	Ric
K1Y	RP400N401C	DC/DC-IC	PWM st-up, 700kHz, 4.0V±2%, 200mA, +CE	SOT-23-5	28zr	DC19	6g	Ric
K1Z	RP400N411C	DC/DC-IC	PWM st-up, 700kHz, 4.1V±2%, 200mA, +CE	SOT-23-5	28zr	DC19	6g	Ric
K2	RN5RG32AA	LVR-IC	Ext. transistor, 3.2V±2.5% 1A*	SOT-23-5	28vw	VR6	6g	Ric
K2	RT9167A-17CBR	LVR-IC	LDO, 1.7V±2%, 600mA, +CE	SOT-23-5	28w1	VR7	6g	Rct
K2	RN5RY221A	DC/DC-IC	VFM step-up, 2.2V±2.5%, 150mW, <180kHz	SOT-23-5	28vd	DC5	6g	Ric
K20	XC6366A202MR	DC/DC-IC	PWM/PFM st-down, 180kHz, 2.0V±2.5%, 1A, +CE	SOT-25	28zm	DC7	6g	Tor
K20	XC6366A202MR	DC/DC-IC	PWM/PFM step-up, 2.0V±2.5%, 200mA, 180kHz, +CE	SOT-25	28sh	DC11	6g	Tor
K21	XC6366A212MR	DC/DC-IC	PWM/PFM st-down, 180kHz, 2.1V±2.5%, 1A, +CE	SOT-25	28zm	DC7	6g	Tor
K21	XC6366A212MR	DC/DC-IC	PWM/PFM step-up, 2.1V±2.5%, 200mA, 180kHz, +CE	SOT-25	28sh	DC11	6g	Tor
K22	XC6366A222MR	DC/DC-IC	PWM/PFM st-down, 180kHz, 2.2V±2.5%, 1A, +CE	SOT-25	28zm	DC7	6g	Tor
K22	XC6366A222MR	DC/DC-IC	PWM/PFM step-up, 2.2V±2.5%, 200mA, 180kHz, +CE	SOT-25	28sh	DC11	6g	Tor
K23	XC6366A232MR	DC/DC-IC	PWM/PFM st-down, 180kHz, 2.3V±2.5%, 1A, +CE	SOT-25	28zm	DC7	6g	Tor
K23	XC6366A232MR	DC/DC-IC	PWM/PFM step-up, 2.3V±2.5%, 200mA, 180kHz, +CE	SOT-25	28sh	DC11	6g	Tor
K24	XC6366A242MR	DC/DC-IC	PWM/PFM st-down, 180kHz, 2.4V±2.5%, 1A, +CE	SOT-25	28zm	DC7	6g	Tor
K24	XC6366A242MR	DC/DC-IC	PWM/PFM step-up, 2.4V±2.5%, 200mA, 180kHz, +CE	SOT-25	28sh	DC11	6g	Tor
K24	XC9302A242MR	DC/DC-IC	PWM/PFM step-up/down, 180kHz, 2.4V±2.5%, 250mA, +CE	SOT-25	28dc8	DC14	6g	Tor
K25	XC6366A252MR	DC/DC-IC	PWM/PFM st-down, 180kHz, 2.5V±2.5%, 1A, +CE	SOT-25	28zm	DC7	6g	Tor
K25	XC6366A252MR	DC/DC-IC	PWM/PFM step-up, 2.5V±2.5%, 200mA, 180kHz, +CE	SOT-25	28sh	DC11	6g	Tor
K25	XC9302A252MR	DC/DC-IC	PWM/PFM step-up/down, 180kHz, 2.5V±2.5%, 250mA, +CE	SOT-25	28dc8	DC14	6g	Tor
K26	XC6366A262MR	DC/DC-IC	PWM/PFM st-down, 180kHz, 2.6V±2.5%, 1A, +CE	SOT-25	28zm	DC7	6g	Tor
K26	XC6366A262MR	DC/DC-IC	PWM/PFM step-up, 2.6V±2.5%, 200mA, 180kHz, +CE	SOT-25	28sh	DC11	6g	Tor
K26	XC9302A262MR	DC/DC-IC	PWM/PFM step-up/down, 180kHz, 2.6V±2.5%, 250mA, +CE	SOT-25	28dc8	DC14	6g	Tor
K27	XC6366A272MR	DC/DC-IC	PWM/PFM st-down, 180kHz, 2.7V±2.5%, 1A, +CE	SOT-25	28zm	DC7	6g	Tor
K27	XC6366A272MR	DC/DC-IC	PWM/PFM step-up, 2.7V±2.5%, 200mA, 180kHz, +CE	SOT-25	28sh	DC11	6g	Tor
K27	XC9302A272MR	DC/DC-IC	PWM/PFM step-up/down, 180kHz, 2.7V±2.5%, 250mA, +CE	SOT-25	28dc8	DC14	6g	Tor
K28	XC6366A282MR	DC/DC-IC	PWM/PFM st-down, 180kHz, 2.8V±2.5%, 1A, +CE	SOT-25	28zm	DC7	6g	Tor
K28	XC6366A282MR	DC/DC-IC	PWM/PFM step-up, 2.8V±2.5%, 200mA, 180kHz, +CE	SOT-25	28sh	DC11	6g	Tor
K28	XC9302A282MR	DC/DC-IC	PWM/PFM step-up/down, 180kHz, 2.8V±2.5%, 250mA, +CE	SOT-25	28dc8	DC14	6g	Tor
K29	XC6366A292MR	DC/DC-IC	PWM/PFM st-down, 180kHz, 2.9V±2.5%, 1A, +CE	SOT-25	28zm	DC7	6g	Tor
K29	XC6366A292MR	DC/DC-IC	PWM/PFM step-up, 2.9V±2.5%, 200mA, 180kHz, +CE	SOT-25	28sh	DC11	6g	Tor
K29	XC9302A292MR	DC/DC-IC	PWM/PFM step-up/down, 180kHz, 2.9V±2.5%, 250mA, +CE	SOT-25	28dc8	DC14	6g	Tor
K2A	RP400N181B	DC/DC-IC	PWM st-up, 700kHz, 1.8V±2%, 200mA	SOT-23-5	28zs	DC4	6g	Ric
K2A	XC6366A203MR	DC/DC-IC	PWM/PFM step-up, 2.0V±2.5%, 200mA, 300kHz, +CE	SOT-25	28sh	DC11	6g	Tor
K2B	RP400N191B	DC/DC-IC	PWM st-up, 700kHz, 1.9V±2%, 200mA	SOT-23-5	28zs	DC4	6g	Ric
K2B	XC6366A213MR	DC/DC-IC	PWM/PFM st-down, 300kHz, 2.1V±2.5%, 1A, +CE	SOT-25	28zm	DC7	6g	Tor
K2B	XC6366A213MR	DC/DC-IC	PWM/PFM step-up, 2.1V±2.5%, 200mA, 300kHz, +CE	SOT-25	28sh	DC11	6g	Tor
K2C	RP400N201B	DC/DC-IC	PWM st-up, 700kHz, 2.0V±2%, 200mA	SOT-23-5	28zs	DC4	6g	Ric
K2C	XC6366A223MR	DC/DC-IC	PWM/PFM st-down, 300kHz, 2.2V±2.5%, 1A, +CE	SOT-25	28zm	DC7	6g	Tor
K2C	XC6366A223MR	DC/DC-IC	PWM/PFM step-up, 2.2V±2.5%, 200mA, 300kHz, +CE	SOT-25	28sh	DC11	6g	Tor
K2D	RP400N211B	DC/DC-IC	PWM st-up, 700kHz, 2.1V±2%, 200mA	SOT-23-5	28zs	DC4	6g	Ric
K2D	XC6366A233MR	DC/DC-IC	PWM/PFM st-down, 300kHz, 2.3V±2.5%, 1A, +CE	SOT-25	28zm	DC7	6g	Tor
K2D	XC6366A233MR	DC/DC-IC	PWM/PFM step-up, 2.3V±2.5%, 200mA, 300kHz, +CE	SOT-25	28sh	DC11	6g	Tor
K2E	RP400N221B	DC/DC-IC	PWM st-up, 700kHz, 2.2V±2%, 200mA	SOT-23-5	28zs	DC4	6g	Ric
K2E	XC6366A243MR	DC/DC-IC	PWM/PFM st-down, 300kHz, 2.4V±2.5%, 1A, +CE	SOT-25	28zm	DC7	6g	Tor
K2E	XC6366A243MR	DC/DC-IC	PWM/PFM step-up, 2.4V±2.5%, 200mA, 300kHz, +CE	SOT-25	28sh	DC11	6g	Tor
K2E	XC9302A243MR	DC/DC-IC	PWM/PFM step-up/down, 300kHz, 2.4V±2.5%, 250mA, +CE	SOT-25	28dc8	DC14	6g	Tor
K2F	RP400N231B	DC/DC-IC	PWM st-up, 700kHz, 2.3V±2%, 200mA	SOT-23-5	28zs	DC4	6g	Ric
K2F	XC6366A253MR	DC/DC-IC	PWM/PFM st-down, 300kHz, 2.5V±2.5%, 1A, +CE	SOT-25	28zm	DC7	6g	Tor
K2F	XC6366A253MR	DC/DC-IC	PWM/PFM step-up, 2.5V±2.5%, 200mA, 300kHz, +CE	SOT-25	28sh	DC11	6g	Tor
K2F	XC9302A253MR	DC/DC-IC	PWM/PFM step-up/down, 300kHz, 2.5V±2.5%, 250mA, +CE	SOT-25	28dc8	DC14	6g	Tor
K2G	RP400N241B	DC/DC-IC	PWM st-up, 700kHz, 2.4V±2%, 200mA	SOT-23-5	28zs	DC4	6g	Ric
K2H	RP400N251B	DC/DC-IC	PWM st-up, 700kHz, 2.5V±2%, 200mA	SOT-23-5	28zs	DC4	6g	Ric
K2H	XC6366A263MR	DC/DC-IC	PWM/PFM st-down, 300kHz, 2.6V±2.5%, 1A, +CE	SOT-25	28zm	DC7	6g	Tor
K2H	XC6366A263MR	DC/DC-IC	PWM/PFM step-up, 2.6V±2.5%, 200mA, 300kHz, +CE	SOT-25	28sh	DC11	6g	Tor
K2H	XC9302A263MR	DC/DC-IC	PWM/PFM step-up/down, 300kHz, 2.6V±2.5%, 250mA, +CE	SOT-25	28dc8	DC14	6g	Tor



SMD code	Type	Function	Short description	Case	Pinout	Sch.	St.	Mnf.
K2J	RP400N261B	DC/DC-IC	PWM st-up, 700kHz, 2.6V±2%, 200mA	SOT-23-5	28zs	DC4	6g	Ric
K2K	RP400N271B	DC/DC-IC	PWM st-up, 700kHz, 2.7V±2%, 200mA	SOT-23-5	28zs	DC4	6g	Ric
K2K	XC6366A273MR	DC/DC-IC	PWM/PFM st-down, 300kHz, 2.7V±2.5%, 1A, +CE	SOT-25	28zm	DC7	6g	Tor
K2K	XC6368A273MR	DC/DC-IC	PWM/PFM step-up, 2.7V±2.5%, 200mA, 300kHz, +CE	SOT-25	28sh	DC11	6g	Tor
K2L	XC9302A273MR	DC/DC-IC	PWM/PFM step-up/down, 300kHz, 2.7V±2.5%, 250mA, +CE	SOT-25	28dc8	DC14	6g	Tor
K2L	RP400N281B	DC/DC-IC	PWM st-up, 700kHz, 2.8V±2%, 200mA	SOT-23-5	28zs	DC4	6g	Ric
K2L	XC6366A283MR	DC/DC-IC	PWM/PFM st-down, 300kHz, 2.8V±2.5%, 1A, +CE	SOT-25	28zm	DC7	6g	Tor
K2L	XC6368A283MR	DC/DC-IC	PWM/PFM step-up, 2.8V±2.5%, 200mA, 300kHz, +CE	SOT-25	28sh	DC11	6g	Tor
K2L	XC9302A283MR	DC/DC-IC	PWM/PFM step-up/down, 300kHz, 2.8V±2.5%, 250mA, +CE	SOT-25	28dc8	DC14	6g	Tor
K2M	RP400N291B	DC/DC-IC	PWM st-up, 700kHz, 2.9V±2%, 200mA	SOT-23-5	28zs	DC4	6g	Ric
K2M	XC6366A293MR	DC/DC-IC	PWM/PFM st-down, 300kHz, 2.9V±2.5%, 1A, +CE	SOT-25	28zm	DC7	6g	Tor
K2M	XC6368A293MR	DC/DC-IC	PWM/PFM step-up, 2.9V±2.5%, 200mA, 300kHz, +CE	SOT-25	28sh	DC11	6g	Tor
K2M	XC9302A293MR	DC/DC-IC	PWM/PFM step-up/down, 300kHz, 2.9V±2.5%, 250mA, +CE	SOT-25	28dc8	DC14	6g	Tor
K2N	RP400N301B	DC/DC-IC	PWM st-up, 700kHz, 3.0V±2%, 200mA	SOT-23-5	28zs	DC4	6g	Ric
K2P	RP400N311B	DC/DC-IC	PWM st-up, 700kHz, 3.1V±2%, 200mA	SOT-23-5	28zs	DC4	6g	Ric
K2Q	RP400N321B	DC/DC-IC	PWM st-up, 700kHz, 3.2V±2%, 200mA	SOT-23-5	28zs	DC4	6g	Ric
K2R	RP400N331B	DC/DC-IC	PWM st-up, 700kHz, 3.3V±2%, 200mA	SOT-23-5	28zs	DC4	6g	Ric
K2S	RP400N341B	DC/DC-IC	PWM st-up, 700kHz, 3.4V±2%, 200mA	SOT-23-5	28zs	DC4	6g	Ric
K2T	RP400N351B	DC/DC-IC	PWM st-up, 700kHz, 3.5V±2%, 200mA	SOT-23-5	28zs	DC4	6g	Ric
K2U	RP400N361B	DC/DC-IC	PWM st-up, 700kHz, 3.6V±2%, 200mA	SOT-23-5	28zs	DC4	6g	Ric
K2V	RP400N371B	DC/DC-IC	PWM st-up, 700kHz, 3.7V±2%, 200mA	SOT-23-5	28zs	DC4	6g	Ric
K2W	RP400N381B	DC/DC-IC	PWM st-up, 700kHz, 3.8V±2%, 200mA	SOT-23-5	28zs	DC4	6g	Ric
K2X	RP400N391B	DC/DC-IC	PWM st-up, 700kHz, 3.9V±2%, 200mA	SOT-23-5	28zs	DC4	6g	Ric
K2Y	RP400N401B	DC/DC-IC	PWM st-up, 700kHz, 4.0V±2%, 200mA	SOT-23-5	28zs	DC4	6g	Ric
K2Z	RP400N411B	DC/DC-IC	PWM st-up, 700kHz, 4.1V±2%, 200mA	SOT-23-5	28zs	DC4	6g	Ric
K3	RN5RG33AA	LVR-IC	Ext. transistor, 3.3V±2.5% 1A*	SOT-23-5	28vw	VR6	6g	Ric
K3	RT9167A-18CBR	LVR-IC	LDO, 1.8V±2%, 600mA, +CE	SOT-23-5	28v1	VR7	6g	Rct
K3	RN5RY231A	DC/DC-IC	VFM step-up, 2.3V±2.5%, 150mW, <180kHz	SOT-23-5	28wd	DC5	6g	Ric
K30	XC6366A302MR	DC/DC-IC	PWM/PFM st-down, 180kHz, 3.0V±2.5%, 1A, +CE	SOT-25	28zm	DC7	6g	Tor
K30	XC6368A302MR	DC/DC-IC	PWM/PFM step-up, 3.0V±2.5%, 200mA, 180kHz, +CE	SOT-25	28sh	DC11	6g	Tor
K30	XC9302A302MR	DC/DC-IC	PWM/PFM step-up/down, 180kHz, 3.0V±2.5%, 250mA, +CE	SOT-25	28dc8	DC14	6g	Tor
K301	TSH70CLT	Op-IC	Wide-band LP, St-by, ±5V, 70MHz	SOT-23-5	28opa	OP1	6d	Ste
K31	XC6366A312MR	DC/DC-IC	PWM/PFM st-down, 180kHz, 3.1V±2.5%, 1A, +CE	SOT-25	28zm	DC7	6g	Tor
K31	XC6368A312MR	DC/DC-IC	PWM/PFM step-up, 3.1V±2.5%, 200mA, 180kHz, +CE	SOT-25	28sh	DC11	6g	Tor
K31	XC9302A312MR	DC/DC-IC	PWM/PFM step-up/down, 180kHz, 3.1V±2.5%, 250mA, +CE	SOT-25	28dc8	DC14	6g	Tor
K32	XC6366A322MR	DC/DC-IC	PWM/PFM st-down, 180kHz, 3.2V±2.5%, 1A, +CE	SOT-25	28zm	DC7	6g	Tor
K32	XC6368A322MR	DC/DC-IC	PWM/PFM step-up, 3.2V±2.5%, 200mA, 180kHz, +CE	SOT-25	28sh	DC11	6g	Tor
K32	XC9302A322MR	DC/DC-IC	PWM/PFM step-up/down, 180kHz, 3.2V±2.5%, 250mA, +CE	SOT-25	28dc8	DC14	6g	Tor
K33	XC6366A332MR	DC/DC-IC	PWM/PFM st-down, 180kHz, 3.3V±2.5%, 1A, +CE	SOT-25	28zm	DC7	6g	Tor
K33	XC6368A332MR	DC/DC-IC	PWM/PFM step-up, 3.3V±2.5%, 200mA, 180kHz, +CE	SOT-25	28sh	DC11	6g	Tor
K33	XC9302A332MR	DC/DC-IC	PWM/PFM step-up/down, 180kHz, 3.3V±2.5%, 250mA, +CE	SOT-25	28dc8	DC14	6g	Tor
K34	XC6366A342MR	DC/DC-IC	PWM/PFM st-down, 180kHz, 3.4V±2.5%, 1A, +CE	SOT-25	28zm	DC7	6g	Tor
K34	XC6368A342MR	DC/DC-IC	PWM/PFM step-up, 3.4V±2.5%, 200mA, 180kHz, +CE	SOT-25	28sh	DC11	6g	Tor
K34	XC9302A342MR	DC/DC-IC	PWM/PFM step-up/down, 180kHz, 3.4V±2.5%, 250mA, +CE	SOT-25	28dc8	DC14	6g	Tor
K35	XC6366A352MR	DC/DC-IC	PWM/PFM st-down, 180kHz, 3.5V±2.5%, 1A, +CE	SOT-25	28zm	DC7	6g	Tor
K35	XC6368A352MR	DC/DC-IC	PWM/PFM step-up, 3.5V±2.5%, 200mA, 180kHz, +CE	SOT-25	28sh	DC11	6g	Tor
K35	XC9302A352MR	DC/DC-IC	PWM/PFM step-up/down, 180kHz, 3.5V±2.5%, 250mA, +CE	SOT-25	28dc8	DC14	6g	Tor
K36	XC6366A362MR	DC/DC-IC	PWM/PFM st-down, 180kHz, 3.6V±2.5%, 1A, +CE	SOT-25	28zm	DC7	6g	Tor
K36	XC6368A362MR	DC/DC-IC	PWM/PFM step-up, 3.6V±2.5%, 200mA, 180kHz, +CE	SOT-25	28sh	DC11	6g	Tor
K36	XC9302A362MR	DC/DC-IC	PWM/PFM step-up/down, 180kHz, 3.6V±2.5%, 250mA, +CE	SOT-25	28dc8	DC14	6g	Tor
K37	XC6366A372MR	DC/DC-IC	PWM/PFM st-down, 180kHz, 3.7V±2.5%, 1A, +CE	SOT-25	28zm	DC7	6g	Tor
K37	XC6368A372MR	DC/DC-IC	PWM/PFM step-up, 3.7V±2.5%, 200mA, 180kHz, +CE	SOT-25	28sh	DC11	6g	Tor
K37	XC9302A372MR	DC/DC-IC	PWM/PFM step-up/down, 180kHz, 3.7V±2.5%, 250mA, +CE	SOT-25	28dc8	DC14	6g	Tor
K38	XC6366A382MR	DC/DC-IC	PWM/PFM st-down, 180kHz, 3.8V±2.5%, 1A, +CE	SOT-25	28zm	DC7	6g	Tor
K38	XC6368A382MR	DC/DC-IC	PWM/PFM step-up, 3.8V±2.5%, 200mA, 180kHz, +CE	SOT-25	28sh	DC11	6g	Tor
K38	XC9302A382MR	DC/DC-IC	PWM/PFM step-up/down, 180kHz, 3.8V±2.5%, 250mA, +CE	SOT-25	28dc8	DC14	6g	Tor
K39	XC6366A392MR	DC/DC-IC	PWM/PFM st-down, 180kHz, 3.9V±2.5%, 1A, +CE	SOT-25	28zm	DC7	6g	Tor
K39	XC6368A392MR	DC/DC-IC	PWM/PFM step-up, 3.9V±2.5%, 200mA, 180kHz, +CE	SOT-25	28sh	DC11	6g	Tor
K39	XC9302A392MR	DC/DC-IC	PWM/PFM step-up/down, 180kHz, 3.9V±2.5%, 250mA, +CE	SOT-25	28dc8	DC14	6g	Tor
K3A	XC6366A303MR	DC/DC-IC	PWM/PFM st-down, 300kHz, 3.0V±2.5%, 1A, +CE	SOT-25	28zm	DC7	6g	Tor
K3A	XC6368A303MR	DC/DC-IC	PWM/PFM step-up, 3.0V±2.5%, 200mA, 300kHz, +CE	SOT-25	28sh	DC11	6g	Tor
K3A	XC9302A303MR	DC/DC-IC	PWM/PFM step-up/down, 300kHz, 3.0V±2.5%, 250mA, +CE	SOT-25	28dc8	DC14	6g	Tor
K3B	XC6366A313MR	DC/DC-IC	PWM/PFM st-down, 300kHz, 3.1V±2.5%, 1A, +CE	SOT-25	28zm	DC7	6g	Tor
K3B	XC6368A313MR	DC/DC-IC	PWM/PFM step-up, 3.1V±2.5%, 200mA, 300kHz, +CE	SOT-25	28sh	DC11	6g	Tor
K3B	XC9302A313MR	DC/DC-IC	PWM/PFM step-up/down, 300kHz, 3.1V±2.5%, 250mA, +CE	SOT-25	28dc8	DC14	6g	Tor
K3C	XC6366A323MR	DC/DC-IC	PWM/PFM st-down, 300kHz, 3.2V±2.5%, 1A, +CE	SOT-25	28zm	DC7	6g	Tor
K3C	XC6368A323MR	DC/DC-IC	PWM/PFM step-up, 3.2V±2.5%, 200mA, 300kHz, +CE	SOT-25	28sh	DC11	6g	Tor
K3C	XC9302A323MR	DC/DC-IC	PWM/PFM step-up/down, 300kHz, 3.2V±2.5%, 250mA, +CE	SOT-25	28dc8	DC14	6g	Tor
K3D	XC6366A333MR	DC/DC-IC	PWM/PFM st-down, 300kHz, 3.3V±2.5%, 1A, +CE	SOT-25	28zm	DC7	6g	Tor
K3D	XC6368A333MR	DC/DC-IC	PWM/PFM step-up, 3.3V±2.5%, 200mA, 300kHz, +CE	SOT-25	28sh	DC11	6g	Tor



SMD code	Type	Function	Short description	Case	Pinout	Sch.	St.	Mnf.
K3D	XC9302A333MR	DC/DC-IC	PWM/PFM step-up/down, 300kHz, 3.3V±2.5%, 250mA, +CE	SOT-25	28dc8	DC14	6g	Tor
K3E	Xc6366A343MR	DC/DC-IC	PWM/PFM st-down, 300kHz, 3.4V±2.5%, 1A, +CE	SOT-25	28zm	DC7	6g	Tor
K3E	Xc6368A343MR	DC/DC-IC	PWM/PFM step-up, 3.4V±2.5%, 200mA, 300kHz, +CE	SOT-25	28sh	DC11	6g	Tor
K3E	XC9302A343MR	DC/DC-IC	PWM/PFM step-up/down, 300kHz, 3.4V±2.5%, 250mA, +CE	SOT-25	28dc8	DC14	6g	Tor
K3F	Xc6366A353MR	DC/DC-IC	PWM/PFM st-down, 300kHz, 3.5V±2.5%, 1A, +CE	SOT-25	28zm	DC7	6g	Tor
K3F	Xc6368A353MR	DC/DC-IC	PWM/PFM step-up, 3.5V±2.5%, 200mA, 300kHz, +CE	SOT-25	28sh	DC11	6g	Tor
K3E	XC9302A353MR	DC/DC-IC	PWM/PFM step-up/down, 300kHz, 3.5V±2.5%, 250mA, +CE	SOT-25	28dc8	DC14	6g	Tor
K3H	Xc6366A363MR	DC/DC-IC	PWM/PFM st-down, 300kHz, 3.6V±2.5%, 1A, +CE	SOT-25	28zm	DC7	6g	Tor
K3H	Xc6368A363MR	DC/DC-IC	PWM/PFM step-up, 3.6V±2.5%, 200mA, 300kHz, +CE	SOT-25	28sh	DC11	6g	Tor
K3H	XC9302A363MR	DC/DC-IC	PWM/PFM step-up/down, 300kHz, 3.6V±2.5%, 250mA, +CE	SOT-25	28dc8	DC14	6g	Tor
K3K	Xc6366A373MR	DC/DC-IC	PWM/PFM st-down, 300kHz, 3.7V±2.5%, 1A, +CE	SOT-25	28zm	DC7	6g	Tor
K3K	Xc6368A373MR	DC/DC-IC	PWM/PFM step-up, 3.7V±2.5%, 200mA, 300kHz, +CE	SOT-25	28sh	DC11	6g	Tor
K3K	XC9302A373MR	DC/DC-IC	PWM/PFM step-up/down, 300kHz, 3.7V±2.5%, 250mA, +CE	SOT-25	28dc8	DC14	6g	Tor
K3L	Xc6366A383MR	DC/DC-IC	PWM/PFM st-down, 300kHz, 3.8V±2.5%, 1A, +CE	SOT-25	28zm	DC7	6g	Tor
K3L	Xc6368A383MR	DC/DC-IC	PWM/PFM step-up, 3.8V±2.5%, 200mA, 300kHz, +CE	SOT-25	28sh	DC11	6g	Tor
K3L	XC9302A383MR	DC/DC-IC	PWM/PFM step-up/down, 300kHz, 3.8V±2.5%, 250mA, +CE	SOT-25	28dc8	DC14	6g	Tor
K3M	Xc6366A393MR	DC/DC-IC	PWM/PFM st-down, 300kHz, 3.9V±2.5%, 1A, +CE	SOT-25	28zm	DC7	6g	Tor
K3M	Xc6368A393MR	DC/DC-IC	PWM/PFM step-up, 3.9V±2.5%, 200mA, 300kHz, +CE	SOT-25	28sh	DC11	6g	Tor
K3M	XC9302A393MR	DC/DC-IC	PWM/PFM step-up/down, 300kHz, 3.9V±2.5%, 250mA, +CE	SOT-25	28dc8	DC14	6g	Tor
K4	RN5RG34AA	LVR-IC	Ext. transistor, 3.4V±2.5% 1A*	SOT-23-5	28vw	VR6	6g	Ric
K4	RT9167A-19CBR	LVR-IC	LDO, 1.9V±2%, 600mA, +CE	SOT-23-5	28vr1	VR7	6g	Rct
K4	RN5RY241A	DC/DC-IC	VFM step-up, 2.4V±2.5%, 150mW, <180kHz	SOT-23-5	28vd	DC5	6g	Ric
K40	Xc6366A402MR	DC/DC-IC	PWM/PFM st-down, 180kHz, 4.0V±2.5%, 1A, +CE	SOT-25	28zm	DC7	6g	Tor
K40	Xc6368A402MR	DC/DC-IC	PWM/PFM step-up, 4.0V±2.5%, 200mA, 180kHz, +CE	SOT-25	28sh	DC11	6g	Tor
K40	XC9302A402MR	DC/DC-IC	PWM/PFM step-up/down, 180kHz, 4.0V±2.5%, 250mA, +CE	SOT-25	28dc8	DC14	6g	Tor
K41	Xc6366A412MR	DC/DC-IC	PWM/PFM st-down, 180kHz, 4.1V±2.5%, 1A, +CE	SOT-25	28zm	DC7	6g	Tor
K41	Xc6368A412MR	DC/DC-IC	PWM/PFM step-up, 4.1V±2.5%, 200mA, 180kHz, +CE	SOT-25	28sh	DC11	6g	Tor
K41	XC9302A412MR	DC/DC-IC	PWM/PFM step-up/down, 180kHz, 4.1V±2.5%, 250mA, +CE	SOT-25	28dc8	DC14	6g	Tor
K42	Xc6366A422MR	DC/DC-IC	PWM/PFM st-down, 180kHz, 4.2V±2.5%, 1A, +CE	SOT-25	28zm	DC7	6g	Tor
K42	Xc6368A422MR	DC/DC-IC	PWM/PFM step-up, 4.2V±2.5%, 200mA, 180kHz, +CE	SOT-25	28sh	DC11	6g	Tor
K42	XC9302A422MR	DC/DC-IC	PWM/PFM step-up/down, 180kHz, 4.2V±2.5%, 250mA, +CE	SOT-25	28dc8	DC14	6g	Tor
K43	Xc6366A432MR	DC/DC-IC	PWM/PFM st-down, 180kHz, 4.3V±2.5%, 1A, +CE	SOT-25	28zm	DC7	6g	Tor
K43	Xc6368A432MR	DC/DC-IC	PWM/PFM step-up, 4.3V±2.5%, 200mA, 180kHz, +CE	SOT-25	28sh	DC11	6g	Tor
K43	XC9302A432MR	DC/DC-IC	PWM/PFM step-up/down, 180kHz, 4.3V±2.5%, 250mA, +CE	SOT-25	28dc8	DC14	6g	Tor
K44	Xc6366A442MR	DC/DC-IC	PWM/PFM st-down, 180kHz, 4.4V±2.5%, 1A, +CE	SOT-25	28zm	DC7	6g	Tor
K44	Xc6368A442MR	DC/DC-IC	PWM/PFM step-up, 4.4V±2.5%, 200mA, 180kHz, +CE	SOT-25	28sh	DC11	6g	Tor
K44	XC9302A442MR	DC/DC-IC	PWM/PFM step-up/down, 180kHz, 4.4V±2.5%, 250mA, +CE	SOT-25	28dc8	DC14	6g	Tor
K45	Xc6366A452MR	DC/DC-IC	PWM/PFM st-down, 180kHz, 4.5V±2.5%, 1A, +CE	SOT-25	28zm	DC7	6g	Tor
K45	Xc6368A452MR	DC/DC-IC	PWM/PFM step-up, 4.5V±2.5%, 200mA, 180kHz, +CE	SOT-25	28sh	DC11	6g	Tor
K45	XC9302A452MR	DC/DC-IC	PWM/PFM step-up/down, 180kHz, 4.5V±2.5%, 250mA, +CE	SOT-25	28dc8	DC14	6g	Tor
K46	Xc6366A462MR	DC/DC-IC	PWM/PFM st-down, 180kHz, 4.6V±2.5%, 1A, +CE	SOT-25	28zm	DC7	6g	Tor
K46	Xc6368A462MR	DC/DC-IC	PWM/PFM step-up, 4.6V±2.5%, 200mA, 180kHz, +CE	SOT-25	28sh	DC11	6g	Tor
K46	XC9302A462MR	DC/DC-IC	PWM/PFM step-up/down, 180kHz, 4.6V±2.5%, 250mA, +CE	SOT-25	28dc8	DC14	6g	Tor
K47	Xc6366A472MR	DC/DC-IC	PWM/PFM st-down, 180kHz, 4.7V±2.5%, 1A, +CE	SOT-25	28zm	DC7	6g	Tor
K47	Xc6368A472MR	DC/DC-IC	PWM/PFM step-up, 4.7V±2.5%, 200mA, 180kHz, +CE	SOT-25	28sh	DC11	6g	Tor
K47	XC9302A472MR	DC/DC-IC	PWM/PFM step-up/down, 180kHz, 4.7V±2.5%, 250mA, +CE	SOT-25	28dc8	DC14	6g	Tor
K48	Xc6366A482MR	DC/DC-IC	PWM/PFM st-down, 180kHz, 4.8V±2.5%, 1A, +CE	SOT-25	28zm	DC7	6g	Tor
K48	Xc6368A482MR	DC/DC-IC	PWM/PFM step-up, 4.8V±2.5%, 200mA, 180kHz, +CE	SOT-25	28sh	DC11	6g	Tor
K48	XC9302A482MR	DC/DC-IC	PWM/PFM step-up/down, 180kHz, 4.8V±2.5%, 250mA, +CE	SOT-25	28dc8	DC14	6g	Tor
K49	Xc6366A492MR	DC/DC-IC	PWM/PFM st-down, 180kHz, 4.9V±2.5%, 1A, +CE	SOT-25	28zm	DC7	6g	Tor
K49	Xc6368A492MR	DC/DC-IC	PWM/PFM step-up, 4.9V±2.5%, 200mA, 180kHz, +CE	SOT-25	28sh	DC11	6g	Tor
K49	XC9302A492MR	DC/DC-IC	PWM/PFM step-up/down, 180kHz, 4.9V±2.5%, 250mA, +CE	SOT-25	28dc8	DC14	6g	Tor
K4A	Xc6366A403MR	DC/DC-IC	PWM/PFM st-down, 300kHz, 4.0V±2.5%, 1A, +CE	SOT-25	28zm	DC7	6g	Tor
K4A	Xc6368A403MR	DC/DC-IC	PWM/PFM step-up, 4.0V±2.5%, 200mA, 300kHz, +CE	SOT-25	28sh	DC11	6g	Tor
K4A	XC9302A403MR	DC/DC-IC	PWM/PFM step-up/down, 300kHz, 4.0V±2.5%, 250mA, +CE	SOT-25	28dc8	DC14	6g	Tor
K4B	Xc6366A413MR	DC/DC-IC	PWM/PFM st-down, 300kHz, 4.1V±2.5%, 1A, +CE	SOT-25	28zm	DC7	6g	Tor
K4B	Xc6368A413MR	DC/DC-IC	PWM/PFM step-up, 4.1V±2.5%, 200mA, 300kHz, +CE	SOT-25	28sh	DC11	6g	Tor
K4B	XC9302A413MR	DC/DC-IC	PWM/PFM step-up/down, 300kHz, 4.1V±2.5%, 250mA, +CE	SOT-25	28dc8	DC14	6g	Tor
K4C	Xc6366A423MR	DC/DC-IC	PWM/PFM st-down, 300kHz, 4.2V±2.5%, 1A, +CE	SOT-25	28zm	DC7	6g	Tor
K4C	Xc6368A423MR	DC/DC-IC	PWM/PFM step-up, 4.2V±2.5%, 200mA, 300kHz, +CE	SOT-25	28sh	DC11	6g	Tor
K4C	XC9302A423MR	DC/DC-IC	PWM/PFM step-up/down, 300kHz, 4.2V±2.5%, 250mA, +CE	SOT-25	28dc8	DC14	6g	Tor
K4D	Xc6366A433MR	DC/DC-IC	PWM/PFM st-down, 300kHz, 4.3V±2.5%, 1A, +CE	SOT-25	28zm	DC7	6g	Tor
K4D	Xc6368A433MR	DC/DC-IC	PWM/PFM step-up, 4.3V±2.5%, 200mA, 300kHz, +CE	SOT-25	28sh	DC11	6g	Tor
K4D	XC9302A433MR	DC/DC-IC	PWM/PFM step-up/down, 300kHz, 4.3V±2.5%, 250mA, +CE	SOT-25	28dc8	DC14	6g	Tor
K4E	Xc6366A443MR	DC/DC-IC	PWM/PFM st-down, 300kHz, 4.4V±2.5%, 1A, +CE	SOT-25	28zm	DC7	6g	Tor
K4E	Xc6368A443MR	DC/DC-IC	PWM/PFM step-up, 4.4V±2.5%, 200mA, 300kHz, +CE	SOT-25	28sh	DC11	6g	Tor
K4E	XC9302A443MR	DC/DC-IC	PWM/PFM step-up/down, 300kHz, 4.4V±2.5%, 250mA, +CE	SOT-25	28dc8	DC14	6g	Tor
K4F	Xc6366A453MR	DC/DC-IC	PWM/PFM st-down, 300kHz, 4.5V±2.5%, 1A, +CE	SOT-25	28zm	DC7	6g	Tor
K4F	Xc6368A453MR	DC/DC-IC	PWM/PFM step-up, 4.5V±2.5%, 200mA, 300kHz, +CE	SOT-25	28sh	DC11	6g	Tor
K4F	XC9302A453MR	DC/DC-IC	PWM/PFM step-up/down, 300kHz, 4.5V±2.5%, 250mA, +CE	SOT-25	28dc8	DC14	6g	Tor



SMD code	Type	Function	Short description	Case	Pinout	Sch.	St.	Mnf.
K4H	XC6366A463MR	DC/DC-IC	PWM/PFM st-down, 300kHz, 4.6V±2.5%, 1A, +CE	SOT-25	28zm	DC7	6g	Tor
K4H	XC6368A463MR	DC/DC-IC	PWM/PFM step-up, 4.6V±2.5%, 200mA, 300kHz, +CE	SOT-25	28sh	DC11	6g	Tor
K4H	XC9302A463MR	DC/DC-IC	PWM/PFM step-up/down, 300kHz, 4.6V±2.5%, 250mA, +CE	SOT-25	28dc8	DC14	6g	Tor
K4K	XC6366A473MR	DC/DC-IC	PWM/PFM st-down, 300kHz, 4.7V±2.5%, 1A, +CE	SOT-25	28zm	DC7	6g	Tor
K4K	XC6368A473MR	DC/DC-IC	PWM/PFM step-up, 4.7V±2.5%, 200mA, 300kHz, +CE	SOT-25	28sh	DC11	6g	Tor
K4K	XC9302A473MR	DC/DC-IC	PWM/PFM step-up/down, 300kHz, 4.7V±2.5%, 250mA, +CE	SOT-25	28dc8	DC14	6g	Tor
K4L	XC6366A483MR	DC/DC-IC	PWM/PFM st-down, 300kHz, 4.8V±2.5%, 1A, +CE	SOT-25	28zm	DC7	6g	Tor
K4L	XC6368A483MR	DC/DC-IC	PWM/PFM step-up, 4.8V±2.5%, 200mA, 300kHz, +CE	SOT-25	28sh	DC11	6g	Tor
K4L	XC9302A483MR	DC/DC-IC	PWM/PFM step-up/down, 300kHz, 4.8V±2.5%, 250mA, +CE	SOT-25	28dc8	DC14	6g	Tor
K4M	XC6366A493MR	DC/DC-IC	PWM/PFM st-down, 300kHz, 4.9V±2.5%, 1A, +CE	SOT-25	28zm	DC7	6g	Tor
K4M	XC6368A493MR	DC/DC-IC	PWM/PFM step-up, 4.9V±2.5%, 200mA, 300kHz, +CE	SOT-25	28sh	DC11	6g	Tor
K4M	XC9302A493MR	DC/DC-IC	PWM/PFM step-up/down, 300kHz, 4.9V±2.5%, 250mA, +CE	SOT-25	28dc8	DC14	6g	Tor
K5	R1111N151B	LVR-IC	LDO, LN, +CE, 1.5V±2%, 200mA	SOT-23-5	28cx	VR4	6g	Ric
K5	RN5RG35AA	LVR-IC	Ext. transistor, 3.5V±2.5% 1A*	SOT-23-5	28vw	VR6	6g	Ric
K5	RT9167A-20CBR	LVR-IC	LDO, 2.0V±2%, 600mA, +CE	SOT-23-5	28ur1	VR7	6g	Rct
K5	RN5RY251A	DC/DC-IC	VFM step-up, 2.5V±2.5%, 150mW, <180kHz	SOT-23-5	28vd	DC5	6g	Ric
K50	XC6366A502MR	DC/DC-IC	PWM/PFM st-down, 180kHz, 5.0V±2.5%, 1A, +CE	SOT-25	28zm	DC7	6g	Tor
K50	XC6368A502MR	DC/DC-IC	PWM/PFM step-up, 5.0V±2.5%, 200mA, 180kHz, +CE	SOT-25	28sh	DC11	6g	Tor
K50	XC9302A502MR	DC/DC-IC	PWM/PFM step-up/down, 180kHz, 5.0V±2.5%, 250mA, +CE	SOT-25	28dc8	DC14	6g	Tor
K51	XC6366A512MR	DC/DC-IC	PWM/PFM st-down, 180kHz, 5.1V±2.5%, 1A, +CE	SOT-25	28zm	DC7	6g	Tor
K51	XC6368A512MR	DC/DC-IC	PWM/PFM step-up, 5.1V±2.5%, 200mA, 180kHz, +CE	SOT-25	28sh	DC11	6g	Tor
K51	XC9302A512MR	DC/DC-IC	PWM/PFM step-up/down, 180kHz, 5.1V±2.5%, 250mA, +CE	SOT-25	28dc8	DC14	6g	Tor
K52	XC6366A522MR	DC/DC-IC	PWM/PFM st-down, 180kHz, 5.2V±2.5%, 1A, +CE	SOT-25	28zm	DC7	6g	Tor
K52	XC6368A522MR	DC/DC-IC	PWM/PFM step-up, 5.2V±2.5%, 200mA, 180kHz, +CE	SOT-25	28sh	DC11	6g	Tor
K52	XC9302A522MR	DC/DC-IC	PWM/PFM step-up/down, 180kHz, 5.2V±2.5%, 250mA, +CE	SOT-25	28dc8	DC14	6g	Tor
K53	XC6366A532MR	DC/DC-IC	PWM/PFM st-down, 180kHz, 5.3V±2.5%, 1A, +CE	SOT-25	28zm	DC7	6g	Tor
K53	XC6368A532MR	DC/DC-IC	PWM/PFM step-up, 5.3V±2.5%, 200mA, 180kHz, +CE	SOT-25	28sh	DC11	6g	Tor
K53	XC9302A532MR	DC/DC-IC	PWM/PFM step-up/down, 180kHz, 5.3V±2.5%, 250mA, +CE	SOT-25	28dc8	DC14	6g	Tor
K54	XC6366A542MR	DC/DC-IC	PWM/PFM st-down, 180kHz, 5.4V±2.5%, 1A, +CE	SOT-25	28zm	DC7	6g	Tor
K54	XC6368A542MR	DC/DC-IC	PWM/PFM step-up, 5.4V±2.5%, 200mA, 180kHz, +CE	SOT-25	28sh	DC11	6g	Tor
K54	XC9302A542MR	DC/DC-IC	PWM/PFM step-up/down, 180kHz, 5.4V±2.5%, 250mA, +CE	SOT-25	28dc8	DC14	6g	Tor
K55	XC6366A552MR	DC/DC-IC	PWM/PFM st-down, 180kHz, 5.5V±2.5%, 1A, +CE	SOT-25	28zm	DC7	6g	Tor
K55	XC6368A552MR	DC/DC-IC	PWM/PFM step-up, 5.5V±2.5%, 200mA, 180kHz, +CE	SOT-25	28sh	DC11	6g	Tor
K55	XC9302A552MR	DC/DC-IC	PWM/PFM step-up/down, 180kHz, 5.5V±2.5%, 250mA, +CE	SOT-25	28dc8	DC14	6g	Tor
K56	XC6366A562MR	DC/DC-IC	PWM/PFM st-down, 180kHz, 5.6V±2.5%, 1A, +CE	SOT-25	28zm	DC7	6g	Tor
K56	XC6368A562MR	DC/DC-IC	PWM/PFM step-up, 5.6V±2.5%, 200mA, 180kHz, +CE	SOT-25	28sh	DC11	6g	Tor
K56	XC9302A562MR	DC/DC-IC	PWM/PFM step-up/down, 180kHz, 5.6V±2.5%, 250mA, +CE	SOT-25	28dc8	DC14	6g	Tor
K57	XC6366A572MR	DC/DC-IC	PWM/PFM st-down, 180kHz, 5.7V±2.5%, 1A, +CE	SOT-25	28zm	DC7	6g	Tor
K57	XC6368A572MR	DC/DC-IC	PWM/PFM step-up, 5.7V±2.5%, 200mA, 180kHz, +CE	SOT-25	28sh	DC11	6g	Tor
K57	XC9302A572MR	DC/DC-IC	PWM/PFM step-up/down, 180kHz, 5.7V±2.5%, 250mA, +CE	SOT-25	28dc8	DC14	6g	Tor
K58	XC6366A582MR	DC/DC-IC	PWM/PFM st-down, 180kHz, 5.8V±2.5%, 1A, +CE	SOT-25	28zm	DC7	6g	Tor
K58	XC6368A582MR	DC/DC-IC	PWM/PFM step-up, 5.8V±2.5%, 200mA, 180kHz, +CE	SOT-25	28sh	DC11	6g	Tor
K58	XC9302A582MR	DC/DC-IC	PWM/PFM step-up/down, 180kHz, 5.8V±2.5%, 250mA, +CE	SOT-25	28dc8	DC14	6g	Tor
K59	XC6366A592MR	DC/DC-IC	PWM/PFM st-down, 180kHz, 5.9V±2.5%, 1A, +CE	SOT-25	28zm	DC7	6g	Tor
K59	XC6368A592MR	DC/DC-IC	PWM/PFM step-up, 5.9V±2.5%, 200mA, 180kHz, +CE	SOT-25	28sh	DC11	6g	Tor
K59	XC9302A592MR	DC/DC-IC	PWM/PFM step-up/down, 180kHz, 5.9V±2.5%, 250mA, +CE	SOT-25	28dc8	DC14	6g	Tor
K5A	XC6366A503MR	DC/DC-IC	PWM/PFM st-down, 300kHz, 5.0V±2.5%, 1A, +CE	SOT-25	28zm	DC7	6g	Tor
K5A	XC6368A503MR	DC/DC-IC	PWM/PFM step-up, 5.0V±2.5%, 200mA, 300kHz, +CE	SOT-25	28sh	DC11	6g	Tor
K5A	XC9302A503MR	DC/DC-IC	PWM/PFM step-up/down, 300kHz, 5.0V±2.5%, 250mA, +CE	SOT-25	28dc8	DC14	6g	Tor
K5B	XC6366A513MR	DC/DC-IC	PWM/PFM st-down, 300kHz, 5.1V±2.5%, 1A, +CE	SOT-25	28zm	DC7	6g	Tor
K5B	XC6368A513MR	DC/DC-IC	PWM/PFM step-up, 5.1V±2.5%, 200mA, 300kHz, +CE	SOT-25	28sh	DC11	6g	Tor
K5B	XC9302A513MR	DC/DC-IC	PWM/PFM step-up/down, 300kHz, 5.1V±2.5%, 250mA, +CE	SOT-25	28dc8	DC14	6g	Tor
K5C	XC6366A523MR	DC/DC-IC	PWM/PFM st-down, 300kHz, 5.2V±2.5%, 1A, +CE	SOT-25	28zm	DC7	6g	Tor
K5C	XC6368A523MR	DC/DC-IC	PWM/PFM step-up, 5.2V±2.5%, 200mA, 300kHz, +CE	SOT-25	28sh	DC11	6g	Tor
K5C	XC9302A523MR	DC/DC-IC	PWM/PFM step-up/down, 300kHz, 5.2V±2.5%, 250mA, +CE	SOT-25	28dc8	DC14	6g	Tor
K5D	XC6366A533MR	DC/DC-IC	PWM/PFM st-down, 300kHz, 5.3V±2.5%, 1A, +CE	SOT-25	28zm	DC7	6g	Tor
K5D	XC6368A533MR	DC/DC-IC	PWM/PFM step-up, 5.3V±2.5%, 200mA, 300kHz, +CE	SOT-25	28sh	DC11	6g	Tor
K5D	XC9302A533MR	DC/DC-IC	PWM/PFM step-up/down, 300kHz, 5.3V±2.5%, 250mA, +CE	SOT-25	28dc8	DC14	6g	Tor
K5E	XC6366A543MR	DC/DC-IC	PWM/PFM st-down, 300kHz, 5.4V±2.5%, 1A, +CE	SOT-25	28zm	DC7	6g	Tor
K5E	XC6368A543MR	DC/DC-IC	PWM/PFM step-up, 5.4V±2.5%, 200mA, 300kHz, +CE	SOT-25	28sh	DC11	6g	Tor
K5E	XC9302A543MR	DC/DC-IC	PWM/PFM step-up/down, 300kHz, 5.4V±2.5%, 250mA, +CE	SOT-25	28dc8	DC14	6g	Tor
K5F	XC6366A553MR	DC/DC-IC	PWM/PFM st-down, 300kHz, 5.5V±2.5%, 1A, +CE	SOT-25	28zm	DC7	6g	Tor
K5F	XC6368A553MR	DC/DC-IC	PWM/PFM step-up, 5.5V±2.5%, 200mA, 300kHz, +CE	SOT-25	28sh	DC11	6g	Tor
K5F	XC9302A553MR	DC/DC-IC	PWM/PFM step-up/down, 300kHz, 5.5V±2.5%, 250mA, +CE	SOT-25	28dc8	DC14	6g	Tor
K5H	XC6366A563MR	DC/DC-IC	PWM/PFM st-down, 300kHz, 5.6V±2.5%, 1A, +CE	SOT-25	28zm	DC7	6g	Tor
K5H	XC6368A563MR	DC/DC-IC	PWM/PFM step-up, 5.6V±2.5%, 200mA, 300kHz, +CE	SOT-25	28sh	DC11	6g	Tor
K5H	XC9302A563MR	DC/DC-IC	PWM/PFM step-up/down, 300kHz, 5.6V±2.5%, 250mA, +CE	SOT-25	28dc8	DC14	6g	Tor
K5K	XC6366A573MR	DC/DC-IC	PWM/PFM st-down, 300kHz, 5.7V±2.5%, 1A, +CE	SOT-25	28zm	DC7	6g	Tor
K5K	XC6368A573MR	DC/DC-IC	PWM/PFM step-up, 5.7V±2.5%, 200mA, 300kHz, +CE	SOT-25	28sh	DC11	6g	Tor
K5K	XC9302A573MR	DC/DC-IC	PWM/PFM step-up/down, 300kHz, 5.7V±2.5%, 250mA, +CE	SOT-25	28dc8	DC14	6g	Tor



SMD code	Type	Function	Short description	Case	Pinout	Sch.	St.	Mnf.
K5L	XC6366A583MR	DC/DC-IC	PWM/PFM st-down, 300kHz, 5.8V±2.5%, 1A, +CE	SOT-25	28zm	DC7	6g	Tor
K5L	XC6368A583MR	DC/DC-IC	PWM/PFM step-up, 5.8V±2.5%, 200mA, 300kHz, +CE	SOT-25	28sh	DC11	6g	Tor
K5L	XC9302A583MR	DC/DC-IC	PWM/PFM step-up/down, 300kHz, 5.8V±2.5%, 250mA, +CE	SOT-25	28dc8	DC14	6g	Tor
K5M	XC6366A593MR	DC/DC-IC	PWM/PFM st-down, 300kHz, 5.9V±2.5%, 1A, +CE	SOT-25	28zm	DC7	6g	Tor
K5M	XC6368A593MR	DC/DC-IC	PWM/PFM step-up, 5.9V±2.5%, 200mA, 300kHz, +CE	SOT-25	28sh	DC11	6g	Tor
K5M	XC9302A593MR	DC/DC-IC	PWM/PFM step-up/down, 300kHz, 5.9V±2.5%, 250mA, +CE	SOT-25	28dc8	DC14	6g	Tor
K6	R1111N161B	LVR-IC	LDO, LN, +CE, 1.6V±2%, 200mA	SOT-23-5	28cx	VR4	6g	Ric
K6	RN5RG36AA	LVR-IC	Ext. transistor, 3.6V±2.5% 1A*	SOT-23-5	28vw	VR6	6g	Ric
K6	RT9167A-21CBR	LVR-IC	LDO, 2.1V±2%, 600mA, +CE	SOT-23-5	28vr1	VR7	6g	Rct
K6	RN5RY261A	DC/DC-IC	VFM step-up, 2.6V±2.5%, 150mW, <180kHz	SOT-23-5	28vd	DC5	6g	Ric
K60	XC6366A602MR	DC/DC-IC	PWM/PFM st-down, 180kHz, 6.0V±2.5%, 1A, +CE	SOT-25	28zm	DC7	6g	Tor
K60	XC6368A602MR	DC/DC-IC	PWM/PFM step-up, 6.0V±2.5%, 200mA, 180kHz, +CE	SOT-25	28sh	DC11	6g	Tor
K60	XC9302A602MR	DC/DC-IC	PWM/PFM step-up/down, 180kHz, 6.0V±2.5%, 250mA, +CE	SOT-25	28dc8	DC14	6g	Tor
K61	XC6368A612MR	DC/DC-IC	PWM/PFM step-up, 6.1V±2.5%, 200mA, 180kHz, +CE	SOT-25	28sh	DC11	6g	Tor
K62	XC6368A622MR	DC/DC-IC	PWM/PFM step-up, 6.2V±2.5%, 200mA, 180kHz, +CE	SOT-25	28sh	DC11	6g	Tor
K63	XC6368A632MR	DC/DC-IC	PWM/PFM step-up, 6.3V±2.5%, 200mA, 180kHz, +CE	SOT-25	28sh	DC11	6g	Tor
K64	XC6368A642MR	DC/DC-IC	PWM/PFM step-up, 6.4V±2.5%, 200mA, 180kHz, +CE	SOT-25	28sh	DC11	6g	Tor
K65	XC6368A652MR	DC/DC-IC	PWM/PFM step-up, 6.5V±2.5%, 200mA, 180kHz, +CE	SOT-25	28sh	DC11	6g	Tor
K6A	XC6366A603MR	DC/DC-IC	PWM/PFM st-down, 300kHz, 6.0V±2.5%, 1A, +CE	SOT-25	28zm	DC7	6g	Tor
K6A	XC6368A603MR	DC/DC-IC	PWM/PFM step-up, 6.0V±2.5%, 200mA, 300kHz, +CE	SOT-25	28sh	DC11	6g	Tor
K6A	XC9302A603MR	DC/DC-IC	PWM/PFM step-up/down, 300kHz, 6.0V±2.5%, 250mA, +CE	SOT-25	28dc8	DC14	6g	Tor
K6B	XC6368A613MR	DC/DC-IC	PWM/PFM step-up, 6.1V±2.5%, 200mA, 300kHz, +CE	SOT-25	28sh	DC11	6g	Tor
K6C	XC6368A623MR	DC/DC-IC	PWM/PFM step-up, 6.2V±2.5%, 200mA, 300kHz, +CE	SOT-25	28sh	DC11	6g	Tor
K6D	XC6368A633MR	DC/DC-IC	PWM/PFM step-up, 6.3V±2.5%, 200mA, 300kHz, +CE	SOT-25	28sh	DC11	6g	Tor
K6E	XC6368A643MR	DC/DC-IC	PWM/PFM step-up, 6.4V±2.5%, 200mA, 300kHz, +CE	SOT-25	28sh	DC11	6g	Tor
K6F	XC6368A653MR	DC/DC-IC	PWM/PFM step-up, 6.5V±2.5%, 200mA, 300kHz, +CE	SOT-25	28sh	DC11	6g	Tor
K7	R1111N171B	LVR-IC	LDO, LN, +CE, 1.7V±2%, 200mA	SOT-23-5	28cx	VR4	6g	Ric
K7	RN5RG37AA	LVR-IC	Ext. transistor, 3.7V±2.5% 1A*	SOT-23-5	28vw	VR6	6g	Ric
K7	RT9167A-22CBR	LVR-IC	LDO, 2.2V±2%, 600mA, +CE	SOT-23-5	28vr1	VR7	6g	Rct
K7	RN5RY271A	DC/DC-IC	VFM step-up, 2.7V±2.5%, 150mW, <180kHz	SOT-23-5	28vd	DC5	6g	Ric
K8	MC78PC18N	LVR-IC	LDO, LN, +CE, 1.8V±2.5%, 100mA	SOT-23-5	28cx	VR4	6b	Ons
K8	R1111N181B	LVR-IC	LDO, LN, +CE, 1.8V±2%, 200mA	SOT-23-5	28cx	VR4	6g	Ric
K8	RN5RG38AA	LVR-IC	Ext. transistor, 3.8V±2.5% 1A*	SOT-23-5	28vw	VR6	6g	Ric
K8	RT9167A-23CBR	LVR-IC	LDO, 2.3V±2%, 600mA, +CE	SOT-23-5	28vr1	VR7	6g	Rct
K8	RN5RY281A	DC/DC-IC	VFM step-up, 2.8V±2.5%, 150mW, <180kHz	SOT-23-5	28vd	DC5	6g	Ric
K8A	XC6108N08AMR	Vdet-IC	0.8V±2%, Hysteresis, -Reset ODO	SOT-25	28rm	VD14	6g	Tor
K8B	XC6108N08BMR	Vdet-IC	0.8V±2%, -Reset ODO	SOT-25	28rm	VD14	6g	Tor
K8C	XC6108N08CMR	Vdet-IC	0.8V±2%, Hysteresis, -Reset ODO	SOT-25	28rk	VD14	6g	Tor
K8D	XC6108N08DMR	Vdet-IC	0.8V±2%, -Reset ODO	SOT-25	28rk	VD14	6g	Tor
K9	R1111N191B	LVR-IC	LDO, LN, +CE, 1.9V±2%, 200mA	SOT-23-5	28cx	VR4	6g	Ric
K9	RN5RG39AA	LVR-IC	Ext. transistor, 3.9V±2.5% 1A*	SOT-23-5	28vw	VR6	6g	Ric
K9	RT9167A-24CBR	LVR-IC	LDO, 2.4V±2%, 600mA, +CE	SOT-23-5	28vr1	VR7	6g	Rct
K9	RN5RY291A	DC/DC-IC	VFM step-up, 2.9V±2.5%, 150mW, <180kHz	SOT-23-5	28vd	DC5	6g	Ric
K9A	XC6108N09AMR	Vdet-IC	0.9V±2%, Hysteresis, -Reset ODO	SOT-25	28rm	VD14	6g	Tor
K9B	XC6108N09BMR	Vdet-IC	0.9V±2%, -Reset ODO	SOT-25	28rm	VD14	6g	Tor
K9C	XC6108N09CMR	Vdet-IC	0.9V±2%, Hysteresis, -Reset ODO	SOT-25	28rk	VD14	6g	Tor
K9D	XC6108N09DMR	Vdet-IC	0.9V±2%, -Reset ODO	SOT-25	28rk	VD14	6g	Tor
KA	BU4917FWE	Vdet-IC	1.7V, +Reset PPO	VSOFF-5	30vk	VD7	6c	Rhm
KA	BU4917G	Vdet-IC	1.7V, +Reset PPO	SSOP-5	28vdm	VD7	6c	Rhm
KA	RT9167A-25CBR	LVR-IC	LDO, 2.5V±2%, 600mA, +CE	SOT-23-5	28vr1	VR7	6g	Rct
KA	TC6503N015VCT	Tdet-IC	-15°C±0.5°C, -Tunder ODO, Hysteresis	SOT-23-5	28	-	6a	Mcc
KA4	MMBD4448HCQW	Si-diode	Quad, Sw, Fast, 75V, 500mA, Vf<1.25V(150mA), <4ns	SOT-353	30bh	-	6l	Di
KA5	MMBD4448HAQW	Si-diode	Quad, Sw, Fast, 75V, 500mA, Vf<1.25V(150mA), <4ns	SOT-353	30bc	-	6l	Di
KA8	XC9235C08CMR	DC-DC-IC	PWM, st-dwn, 0.8V±2%, 600mA, 1.2MHz, Vin>2V, LSST, CL	SOT-25	28dc4	DC1	6g	Tor
KA9	XC9235C09CMR	DC-DC-IC	PWM, st-dwn, 0.9V±2%, 600mA, 1.2MHz, Vin>2V, LSST, CL	SOT-25	28dc4	DC1	6g	Tor
KAA	RP171N331B	LVR-IC	LDO, 3.3V±1%, 150mA, +CE	SOT-23-5	28cx	VR4	6g	Ric
KAB	RP171N341B	LVR-IC	LDO, 3.4V±1%, 150mA, +CE	SOT-23-5	28cx	VR4	6g	Ric
KAC	RP171N351B	LVR-IC	LDO, 3.5V±1%, 150mA, +CE	SOT-23-5	28cx	VR4	6g	Ric
KAD	RP171N361B	LVR-IC	LDO, 3.6V±1%, 150mA, +CE	SOT-23-5	28cx	VR4	6g	Ric
KAE	RP171N371B	LVR-IC	LDO, 3.7V±1%, 150mA, +CE	SOT-23-5	28cx	VR4	6g	Ric
KAF	RP171N381B	LVR-IC	LDO, 3.8V±1%, 150mA, +CE	SOT-23-5	28cx	VR4	6g	Ric
KAG	RP171N391B	LVR-IC	LDO, 3.9V±1%, 150mA, +CE	SOT-23-5	28cx	VR4	6g	Ric
KAH	RP171N401B	LVR-IC	LDO, 4.0V±1%, 150mA, +CE	SOT-23-5	28cx	VR4	6g	Ric
KAJ	RP171N411B	LVR-IC	LDO, 4.1V±1%, 150mA, +CE	SOT-23-5	28cx	VR4	6g	Ric
KAK	RP171N421B	LVR-IC	LDO, 4.2V±1%, 150mA, +CE	SOT-23-5	28cx	VR4	6g	Ric
KAL	RP171N431B	LVR-IC	LDO, 4.3V±1%, 150mA, +CE	SOT-23-5	28cx	VR4	6g	Ric
KAL	XC9235C0LCMR	DC-DC-IC	PWM, st-dwn, 0.85V±2%, 600mA, 1.2MHz, Vin>2V, LSST, CL	SOT-25	28dc4	DC1	6g	Tor
KAM	RP171N441B	LVR-IC	LDO, 4.4V±1%, 150mA, +CE	SOT-23-5	28cx	VR4	6g	Ric
KAM	XC9235C0MCMR	DC-DC-IC	PWM, st-dwn, 0.95V±2%, 600mA, 1.2MHz, Vin>2V, LSST, CL	SOT-25	28dc4	DC1	6g	Tor
KAN	RP171N451B	LVR-IC	LDO, 4.5V±1%, 150mA, +CE	SOT-23-5	28cx	VR4	6g	Ric



SMD code	Type	Function	Short description	Case	Pinout	Sch.	St.	Mnf.
KAP	RP171N461B	LVR-IC	LDO, 4.6V±1%, 150mA, +CE	SOT-23-5	28cx	VR4	6g	Ric
KAQ	RP171N471B	LVR-IC	LDO, 4.7V±1%, 150mA, +CE	SOT-23-5	28cx	VR4	6g	Ric
KAR	RP171N481B	LVR-IC	LDO, 4.8V±1%, 150mA, +CE	SOT-23-5	28cx	VR4	6g	Ric
KAS	RP171N491B	LVR-IC	LDO, 4.9V±1%, 150mA, +CE	SOT-23-5	28cx	VR4	6g	Ric
KAT	RP171N501B	LVR-IC	LDO, 5.0V±1%, 150mA, +CE	SOT-23-5	28cx	VR4	6g	Ric
KAU	RP171N511B	LVR-IC	LDO, 5.1V±1%, 150mA, +CE	SOT-23-5	28cx	VR4	6g	Ric
KAV	RP171N521B	LVR-IC	LDO, 5.2V±1%, 150mA, +CE	SOT-23-5	28cx	VR4	6g	Ric
KAW	RP171N531B	LVR-IC	LDO, 5.3V±1%, 150mA, +CE	SOT-23-5	28cx	VR4	6g	Ric
KAX	RP171N541B	LVR-IC	LDO, 5.4V±1%, 150mA, +CE	SOT-23-5	28cx	VR4	6g	Ric
KAY	RP171N551B	LVR-IC	LDO, 5.5V±1%, 150mA, +CE	SOT-23-5	28cx	VR4	6g	Ric
KAZ	RP171N561B	LVR-IC	LDO, 5.6V±1%, 150mA, +CE	SOT-23-5	28cx	VR4	6g	Ric
KB	BU4918FWE	Vdet-IC	1.8V, +Reset PPO	VSOFF-5	30vk	VD7	6c	Rhm
KB	BU4918G	Vdet-IC	1.8V, +Reset PPO	SSOP-5	28vdm	VD7	6c	Rhm
KB	RT9167A-26CBR	LVR-IC	LDO, 2.6V±2%, 600mA, +CE	SOT-23-5	28v1	VR7	6g	Rct
KB	TC6503P005VCT	Tdet-IC	5°C±0.5°C, -Tunder ODO, Hysteresis	SOT-23-5	28r	-	6a	Mcc
KB0	XC9235C10CMR	DC-DC-IC	PWM, st-dwn, 1.0V±2%, 600mA, 1.2MHz, Vin>2V, LSST, CL	SOT-25	28dc4	DC1	6g	Tor
KB1	XC9235C11CMR	DC-DC-IC	PWM, st-dwn, 1.1V±2%, 600mA, 1.2MHz, Vin>2V, LSST, CL	SOT-25	28dc4	DC1	6g	Tor
KB2	XC9235C12CMR	DC-DC-IC	PWM, st-dwn, 1.2V±2%, 600mA, 1.2MHz, Vin>2V, LSST, CL	SOT-25	28dc4	DC1	6g	Tor
KB25	MIC5205-2.5YM5	LVR-IC	LDO, 2.5V±1%, 150mA, +CE	SOT-23-5	28wrx	VR7	6g	Mcr
KB3	XC9235C13CMR	DC-DC-IC	PWM, st-dwn, 1.3V±2%, 600mA, 1.2MHz, Vin>2V, LSST, CL	SOT-25	28dc4	DC1	6g	Tor
KB4	XC9235C14CMR	DC-DC-IC	PWM, st-dwn, 1.4V±2%, 600mA, 1.2MHz, Vin>2V, LSST, CL	SOT-25	28dc4	DC1	6g	Tor
KB5	XC9235C15CMR	DC-DC-IC	PWM, st-dwn, 1.5V±2%, 600mA, 1.2MHz, Vin>2V, LSST, CL	SOT-25	28dc4	DC1	6g	Tor
KB5	XC6366A151MR	DC/DC-IC	PWM/PFM st-dwn, 100kHz, 1.5V±2.5%, 1A, +CE	SOT-25	28zm	DC7	6g	Tor
KB5	XC6366A151MR	DC/DC-IC	PWM/PFM step-up, 1.5V±2.5%, 200mA, 100kHz, +CE	SOT-25	28sh	DC11	6g	Tor
KB6	XC9235C16CMR	DC-DC-IC	PWM, st-dwn, 1.6V±2%, 600mA, 1.2MHz, Vin>2V, LSST, CL	SOT-25	28dc4	DC1	6g	Tor
KB6	XC6366A161MR	DC/DC-IC	PWM/PFM st-dwn, 100kHz, 1.6V±2.5%, 1A, +CE	SOT-25	28zm	DC7	6g	Tor
KB6	XC6366A161MR	DC/DC-IC	PWM/PFM step-up, 1.6V±2.5%, 200mA, 100kHz, +CE	SOT-25	28sh	DC11	6g	Tor
KB7	XC9235C17CMR	DC-DC-IC	PWM, st-dwn, 1.7V±2%, 600mA, 1.2MHz, Vin>2V, LSST, CL	SOT-25	28dc4	DC1	6g	Tor
KB7	XC6366A171MR	DC/DC-IC	PWM/PFM st-dwn, 100kHz, 1.7V±2.5%, 1A, +CE	SOT-25	28zm	DC7	6g	Tor
KB7	XC6366A171MR	DC/DC-IC	PWM/PFM step-up, 1.7V±2.5%, 200mA, 100kHz, +CE	SOT-25	28sh	DC11	6g	Tor
KB8	XC9235C18CMR	DC-DC-IC	PWM, st-dwn, 1.8V±2%, 600mA, 1.2MHz, Vin>2V, LSST, CL	SOT-25	28dc4	DC1	6g	Tor
KB8	XC6366A181MR	DC/DC-IC	PWM/PFM st-dwn, 100kHz, 1.8V±2.5%, 1A, +CE	SOT-25	28zm	DC7	6g	Tor
KB8	XC6366A181MR	DC/DC-IC	PWM/PFM step-up, 1.8V±2.5%, 200mA, 100kHz, +CE	SOT-25	28sh	DC11	6g	Tor
KB9	XC9235C19CMR	DC-DC-IC	PWM, st-dwn, 1.9V±2%, 600mA, 1.2MHz, Vin>2V, LSST, CL	SOT-25	28dc4	DC1	6g	Tor
KB9	XC6366A191MR	DC/DC-IC	PWM/PFM st-dwn, 100kHz, 1.9V±2.5%, 1A, +CE	SOT-25	28zm	DC7	6g	Tor
KB9	XC6366A191MR	DC/DC-IC	PWM/PFM step-up, 1.9V±2.5%, 200mA, 100kHz, +CE	SOT-25	28sh	DC11	6g	Tor
KBA	RP171N331D	LVR-IC	LDO, 3.3V±1%, 150mA, +CE, CL	SOT-23-5	28cx	VR4	6g	Ric
KBA	XC9235C1ACMR	DC-DC-IC	PWM, st-dwn, 1.05V±2%, 600mA, 1.2MHz, Vin>2V, LSST, CL	SOT-25	28dc4	DC1	6g	Tor
KBB	RP171N341D	LVR-IC	LDO, 3.4V±1%, 150mA, +CE, CL	SOT-23-5	28cx	VR4	6g	Ric
KBB	XC9235C1BCMR	DC-DC-IC	PWM, st-dwn, 1.15V±2%, 600mA, 1.2MHz, Vin>2V, LSST, CL	SOT-25	28dc4	DC1	6g	Tor
KBC	RP171N351D	LVR-IC	LDO, 3.5V±1%, 150mA, +CE, CL	SOT-23-5	28cx	VR4	6g	Ric
KBC	XC9235C1CCMR	DC-DC-IC	PWM, st-dwn, 1.25V±2%, 600mA, 1.2MHz, Vin>2V, LSST, CL	SOT-25	28dc4	DC1	6g	Tor
KBD	RP171N361D	LVR-IC	LDO, 3.6V±1%, 150mA, +CE, CL	SOT-23-5	28cx	VR4	6g	Ric
KBD	XC9235C1DCMR	DC-DC-IC	PWM, st-dwn, 1.35V±2%, 600mA, 1.2MHz, Vin>2V, LSST, CL	SOT-25	28dc4	DC1	6g	Tor
KBE	RP171N371D	LVR-IC	LDO, 3.7V±1%, 150mA, +CE, CL	SOT-23-5	28cx	VR4	6g	Ric
KBE	XC9235C1ECMR	DC-DC-IC	PWM, st-dwn, 1.45V±2%, 600mA, 1.2MHz, Vin>2V, LSST, CL	SOT-25	28dc4	DC1	6g	Tor
KBF	RP171N381D	LVR-IC	LDO, 3.8V±1%, 150mA, +CE, CL	SOT-23-5	28cx	VR4	6g	Ric
KBF	XC9235C1FCMR	DC-DC-IC	PWM, st-dwn, 1.55V±2%, 600mA, 1.2MHz, Vin>2V, LSST, CL	SOT-25	28dc4	DC1	6g	Tor
KBF	XC6366A155MR	DC/DC-IC	PWM/PFM st-dwn, 500kHz, 1.5V±2.5%, 1A, +CE	SOT-25	28zm	DC7	6g	Tor
KBF	XC6366A155MR	DC/DC-IC	PWM/PFM step-up, 1.5V±2.5%, 200mA, 500kHz, +CE	SOT-25	28sh	DC11	6g	Tor
KBG	RP171N391D	LVR-IC	LDO, 3.9V±1%, 150mA, +CE, CL	SOT-23-5	28cx	VR4	6g	Ric
KBH	RP171N401D	LVR-IC	LDO, 4.0V±1%, 150mA, +CE, CL	SOT-23-5	28cx	VR4	6g	Ric
KBH	XC9235C1HCMR	DC-DC-IC	PWM, st-dwn, 1.65V±2%, 600mA, 1.2MHz, Vin>2V, LSST, CL	SOT-25	28dc4	DC1	6g	Tor
KBH	XC6366A165MR	DC/DC-IC	PWM/PFM st-dwn, 500kHz, 1.6V±2.5%, 1A, +CE	SOT-25	28zm	DC7	6g	Tor
KBH	XC6366A165MR	DC/DC-IC	PWM/PFM step-up, 1.6V±2.5%, 200mA, 500kHz, +CE	SOT-25	28sh	DC11	6g	Tor
KBJ	RP171N411D	LVR-IC	LDO, 4.1V±1%, 150mA, +CE, CL	SOT-23-5	28cx	VR4	6g	Ric
KBK	RP171N421D	LVR-IC	LDO, 4.2V±1%, 150mA, +CE, CL	SOT-23-5	28cx	VR4	6g	Ric
KBK	XC9235C1KCMR	DC-DC-IC	PWM, st-dwn, 1.75V±2%, 600mA, 1.2MHz, Vin>2V, LSST, CL	SOT-25	28dc4	DC1	6g	Tor
KBK	XC6366A175MR	DC/DC-IC	PWM/PFM st-dwn, 500kHz, 1.7V±2.5%, 1A, +CE	SOT-25	28zm	DC7	6g	Tor
KBK	XC6366A175MR	DC/DC-IC	PWM/PFM step-up, 1.7V±2.5%, 200mA, 500kHz, +CE	SOT-25	28sh	DC11	6g	Tor
KBL	RP171N431D	LVR-IC	LDO, 4.3V±1%, 150mA, +CE, CL	SOT-23-5	28cx	VR4	6g	Ric
KB�	XC9235C1LCMR	DC-DC-IC	PWM, st-dwn, 1.85V±2%, 600mA, 1.2MHz, Vin>2V, LSST, CL	SOT-25	28dc4	DC1	6g	Tor
KB�	XC6366A185MR	DC/DC-IC	PWM/PFM st-dwn, 500kHz, 1.8V±2.5%, 1A, +CE	SOT-25	28zm	DC7	6g	Tor
KB�	XC6366A185MR	DC/DC-IC	PWM/PFM step-up, 1.8V±2.5%, 200mA, 500kHz, +CE	SOT-25	28sh	DC11	6g	Tor
KBM	RP171N441D	LVR-IC	LDO, 4.4V±1%, 150mA, +CE, CL	SOT-23-5	28cx	VR4	6g	Ric
KBM	XC9235C1MCMR	DC-DC-IC	PWM, st-dwn, 1.95V±2%, 600mA, 1.2MHz, Vin>2V, LSST, CL	SOT-25	28dc4	DC1	6g	Tor
KBM	XC6366A195MR	DC/DC-IC	PWM/PFM st-dwn, 500kHz, 1.9V±2.5%, 1A, +CE	SOT-25	28zm	DC7	6g	Tor
KBM	XC6366A195MR	DC/DC-IC	PWM/PFM step-up, 1.9V±2.5%, 200mA, 500kHz, +CE	SOT-25	28sh	DC11	6g	Tor
KBN	RP171N451D	LVR-IC	LDO, 4.5V±1%, 150mA, +CE, CL	SOT-23-5	28cx	VR4	6g	Ric
KBP	RP171N461D	LVR-IC	LDO, 4.6V±1%, 150mA, +CE, CL	SOT-23-5	28cx	VR4	6g	Ric



SMD code	Type	Function	Short description	Case	Pinout	Sch.	St.	Mnf.
KBQ	RP171N471D	LVR-IC	LDO, 4.7V±1%, 150mA, +CE, CL	SOT-23-5	28cx	VR4	6g	Ric
KBR	RP171N481D	LVR-IC	LDO, 4.8V±1%, 150mA, +CE, CL	SOT-23-5	28cx	VR4	6g	Ric
KBS	RP171N491D	LVR-IC	LDO, 4.9V±1%, 150mA, +CE, CL	SOT-23-5	28cx	VR4	6g	Ric
KBT	RP171N501D	LVR-IC	LDO, 5.0V±1%, 150mA, +CE, CL	SOT-23-5	28cx	VR4	6g	Ric
KBU	RP171N511D	LVR-IC	LDO, 5.1V±1%, 150mA, +CE, CL	SOT-23-5	28cx	VR4	6g	Ric
KBV	RP171N521D	LVR-IC	LDO, 5.2V±1%, 150mA, +CE, CL	SOT-23-5	28cx	VR4	6g	Ric
KBW	RP171N531D	LVR-IC	LDO, 5.3V±1%, 150mA, +CE, CL	SOT-23-5	28cx	VR4	6g	Ric
KBX	RP171N541D	LVR-IC	LDO, 5.4V±1%, 150mA, +CE, CL	SOT-23-5	28cx	VR4	6g	Ric
KBY	RP171N551D	LVR-IC	LDO, 5.5V±1%, 150mA, +CE, CL	SOT-23-5	28cx	VR4	6g	Ric
KBZ	RP171N561D	LVR-IC	LDO, 5.6V±1%, 150mA, +CE, CL	SOT-23-5	28cx	VR4	6g	Ric
KC	BU4919FWE	Vdet-IC	1.9V, +Reset PPO	VSO5-5	30vk	VD7	6c	Rhm
KC	BU4919G	Vdet-IC	1.9V, +Reset PPO	SSOP-5	28vdm	VD7	6c	Rhm
KC	RT9167A-27CBR	LVR-IC	LDO, 2.7V±2%, 600mA, +CE	SOT-23-5	28vr1	VR7	6g	Rct
KCO	XC9235C20CMR	DC-DC-IC	PWM, st-dwn, 2.0V±2%, 600mA, 1.2MHz, Vin>2V, LSST, CL	SOT-25	28dc4	DC1	6g	Tor
KCO	XC6368A201MR	DC/DC-IC	PWM/PFM st-down, 100kHz, 2.0V±2.5%, 1A, +CE	SOT-25	28zm	DC7	6g	Tor
KCO	XC6368A201MR	DC/DC-IC	PWM/PFM step-up, 2.0V±2.5%, 200mA, 100kHz, +CE	SOT-25	28sh	DC11	6g	Tor
KC1	XC9235C21CMR	DC-DC-IC	PWM, st-dwn, 2.1V±2%, 600mA, 1.2MHz, Vin>2V, LSST, CL	SOT-25	28dc4	DC1	6g	Tor
KC1	XC6368A211MR	DC/DC-IC	PWM/PFM st-down, 100kHz, 2.1V±2.5%, 1A, +CE	SOT-25	28zm	DC7	6g	Tor
KC1	XC6368A211MR	DC/DC-IC	PWM/PFM step-up, 2.1V±2.5%, 200mA, 100kHz, +CE	SOT-25	28sh	DC11	6g	Tor
KC2	XC9235C22CMR	DC-DC-IC	PWM, st-dwn, 2.2V±2%, 600mA, 1.2MHz, Vin>2V, LSST, CL	SOT-25	28dc4	DC1	6g	Tor
KC2	XC6368A221MR	DC/DC-IC	PWM/PFM st-down, 100kHz, 2.2V±2.5%, 1A, +CE	SOT-25	28zm	DC7	6g	Tor
KC2	XC6368A221MR	DC/DC-IC	PWM/PFM step-up, 2.2V±2.5%, 200mA, 100kHz, +CE	SOT-25	28sh	DC11	6g	Tor
KC3	XC9235C23CMR	DC-DC-IC	PWM, st-dwn, 2.3V±2%, 600mA, 1.2MHz, Vin>2V, LSST, CL	SOT-25	28dc4	DC1	6g	Tor
KC3	XC6368A231MR	DC/DC-IC	PWM/PFM st-down, 100kHz, 2.3V±2.5%, 1A, +CE	SOT-25	28zm	DC7	6g	Tor
KC3	XC6368A231MR	DC/DC-IC	PWM/PFM step-up, 2.3V±2.5%, 200mA, 100kHz, +CE	SOT-25	28sh	DC11	6g	Tor
KC4	XC9235C24CMR	DC-DC-IC	PWM, st-dwn, 2.4V±2%, 600mA, 1.2MHz, Vin>2V, LSST, CL	SOT-25	28dc4	DC1	6g	Tor
KC4	XC6368A241MR	DC/DC-IC	PWM/PFM st-down, 100kHz, 2.4V±2.5%, 1A, +CE	SOT-25	28zm	DC7	6g	Tor
KC4	XC6368A241MR	DC/DC-IC	PWM/PFM step-up, 2.4V±2.5%, 200mA, 100kHz, +CE	SOT-25	28sh	DC11	6g	Tor
KC5	XC9235C25CMR	DC-DC-IC	PWM, st-dwn, 2.5V±2%, 600mA, 1.2MHz, Vin>2V, LSST, CL	SOT-25	28dc4	DC1	6g	Tor
KC5	XC6368A251MR	DC/DC-IC	PWM/PFM st-down, 100kHz, 2.5V±2.5%, 1A, +CE	SOT-25	28zm	DC7	6g	Tor
KC5	XC6368A251MR	DC/DC-IC	PWM/PFM step-up, 2.5V±2.5%, 200mA, 100kHz, +CE	SOT-25	28sh	DC11	6g	Tor
KC6	XC9235C26CMR	DC-DC-IC	PWM, st-dwn, 2.6V±2%, 600mA, 1.2MHz, Vin>2V, LSST, CL	SOT-25	28dc4	DC1	6g	Tor
KC6	XC6368A261MR	DC/DC-IC	PWM/PFM st-down, 100kHz, 2.6V±2.5%, 1A, +CE	SOT-25	28zm	DC7	6g	Tor
KC6	XC6368A261MR	DC/DC-IC	PWM/PFM step-up, 2.6V±2.5%, 200mA, 100kHz, +CE	SOT-25	28sh	DC11	6g	Tor
KC7	XC9235C27CMR	DC-DC-IC	PWM, st-dwn, 2.7V±2%, 600mA, 1.2MHz, Vin>2V, LSST, CL	SOT-25	28dc4	DC1	6g	Tor
KC7	XC6368A271MR	DC/DC-IC	PWM/PFM st-down, 100kHz, 2.7V±2.5%, 1A, +CE	SOT-25	28zm	DC7	6g	Tor
KC7	XC6368A271MR	DC/DC-IC	PWM/PFM step-up, 2.7V±2.5%, 200mA, 100kHz, +CE	SOT-25	28sh	DC11	6g	Tor
KC8	XC9235C28CMR	DC-DC-IC	PWM, st-dwn, 2.8V±2%, 600mA, 1.2MHz, Vin>2V, LSST, CL	SOT-25	28dc4	DC1	6g	Tor
KC8	XC6368A281MR	DC/DC-IC	PWM/PFM st-down, 100kHz, 2.8V±2.5%, 1A, +CE	SOT-25	28zm	DC7	6g	Tor
KC8	XC6368A281MR	DC/DC-IC	PWM/PFM step-up, 2.8V±2.5%, 200mA, 100kHz, +CE	SOT-25	28sh	DC11	6g	Tor
KC9	XC9235C29CMR	DC-DC-IC	PWM, st-dwn, 2.9V±2%, 600mA, 1.2MHz, Vin>2V, LSST, CL	SOT-25	28dc4	DC1	6g	Tor
KC9	XC6368A291MR	DC/DC-IC	PWM/PFM st-down, 100kHz, 2.9V±2.5%, 1A, +CE	SOT-25	28zm	DC7	6g	Tor
KC9	XC6368A291MR	DC/DC-IC	PWM/PFM step-up, 2.9V±2.5%, 200mA, 100kHz, +CE	SOT-25	28sh	DC11	6g	Tor
KCA	XC9235C2ACMR	DC-DC-IC	PWM, st-dwn, 2.05V±2%, 600mA, 1.2MHz, Vin>2V, LSST, CL	SOT-25	28dc4	DC1	6g	Tor
KCA	XC6368A205MR	DC/DC-IC	PWM/PFM st-down, 500kHz, 2.0V±2.5%, 1A, +CE	SOT-25	28zm	DC7	6g	Tor
KCA	XC6368A205MR	DC/DC-IC	PWM/PFM step-up, 2.0V±2.5%, 200mA, 500kHz, +CE	SOT-25	28sh	DC11	6g	Tor
KCB	XC9235C2BCMR	DC-DC-IC	PWM, st-dwn, 2.15V±2%, 600mA, 1.2MHz, Vin>2V, LSST, CL	SOT-25	28dc4	DC1	6g	Tor
KCB	XC6368A215MR	DC/DC-IC	PWM/PFM st-down, 500kHz, 2.1V±2.5%, 1A, +CE	SOT-25	28zm	DC7	6g	Tor
KCB	XC6368A215MR	DC/DC-IC	PWM/PFM step-up, 2.1V±2.5%, 200mA, 500kHz, +CE	SOT-25	28sh	DC11	6g	Tor
KCC	XC9235C2CCMR	DC-DC-IC	PWM, st-dwn, 2.25V±2%, 600mA, 1.2MHz, Vin>2V, LSST, CL	SOT-25	28dc4	DC1	6g	Tor
KCC	XC6368A225MR	DC/DC-IC	PWM/PFM st-down, 500kHz, 2.2V±2.5%, 1A, +CE	SOT-25	28zm	DC7	6g	Tor
KCC	XC6368A225MR	DC/DC-IC	PWM/PFM step-up, 2.2V±2.5%, 200mA, 500kHz, +CE	SOT-25	28sh	DC11	6g	Tor
KCD	XC9235C2DCMR	DC-DC-IC	PWM, st-dwn, 2.35V±2%, 600mA, 1.2MHz, Vin>2V, LSST, CL	SOT-25	28dc4	DC1	6g	Tor
KCD	XC6368A235MR	DC/DC-IC	PWM/PFM st-down, 500kHz, 2.3V±2.5%, 1A, +CE	SOT-25	28zm	DC7	6g	Tor
KCD	XC6368A235MR	DC/DC-IC	PWM/PFM step-up, 2.3V±2.5%, 200mA, 500kHz, +CE	SOT-25	28sh	DC11	6g	Tor
KCE	XC9235C2ECMR	DC-DC-IC	PWM, st-dwn, 2.45V±2%, 600mA, 1.2MHz, Vin>2V, LSST, CL	SOT-25	28dc4	DC1	6g	Tor
KCE	XC6368A245MR	DC/DC-IC	PWM/PFM st-down, 500kHz, 2.4V±2.5%, 1A, +CE	SOT-25	28zm	DC7	6g	Tor
KCE	XC6368A245MR	DC/DC-IC	PWM/PFM step-up, 2.4V±2.5%, 200mA, 500kHz, +CE	SOT-25	28sh	DC11	6g	Tor
KCF	XC9235C2FCMR	DC-DC-IC	PWM, st-dwn, 2.55V±2%, 600mA, 1.2MHz, Vin>2V, LSST, CL	SOT-25	28dc4	DC1	6g	Tor
KCF	XC6368A255MR	DC/DC-IC	PWM/PFM st-down, 500kHz, 2.5V±2.5%, 1A, +CE	SOT-25	28zm	DC7	6g	Tor
KCF	XC6368A255MR	DC/DC-IC	PWM/PFM step-up, 2.5V±2.5%, 200mA, 500kHz, +CE	SOT-25	28sh	DC11	6g	Tor
KCH	XC9235C2HCMR	DC-DC-IC	PWM, st-dwn, 2.65V±2%, 600mA, 1.2MHz, Vin>2V, LSST, CL	SOT-25	28dc4	DC1	6g	Tor
KCH	XC6368A265MR	DC/DC-IC	PWM/PFM st-down, 500kHz, 2.6V±2.5%, 1A, +CE	SOT-25	28zm	DC7	6g	Tor
KCH	XC6368A265MR	DC/DC-IC	PWM/PFM step-up, 2.6V±2.5%, 200mA, 500kHz, +CE	SOT-25	28sh	DC11	6g	Tor
KCK	XC9235C2KCMR	DC-DC-IC	PWM, st-dwn, 2.75V±2%, 600mA, 1.2MHz, Vin>2V, LSST, CL	SOT-25	28dc4	DC1	6g	Tor
KCK	XC6368A275MR	DC/DC-IC	PWM/PFM st-down, 500kHz, 2.7V±2.5%, 1A, +CE	SOT-25	28zm	DC7	6g	Tor
KCK	XC6368A275MR	DC/DC-IC	PWM/PFM step-up, 2.7V±2.5%, 200mA, 500kHz, +CE	SOT-25	28sh	DC11	6g	Tor
KCL	XC9235C2LCMR	DC-DC-IC	PWM, st-dwn, 2.85V±2%, 600mA, 1.2MHz, Vin>2V, LSST, CL	SOT-25	28dc4	DC1	6g	Tor
KCL	XC6368A285MR	DC/DC-IC	PWM/PFM st-down, 500kHz, 2.8V±2.5%, 1A, +CE	SOT-25	28zm	DC7	6g	Tor
KCL	XC6368A285MR	DC/DC-IC	PWM/PFM step-up, 2.8V±2.5%, 200mA, 500kHz, +CE	SOT-25	28sh	DC11	6g	Tor



SMD code	Type	Function	Short description	Case	Pinout	Sch.	St.	Mnf.
KCM	XC9235C2MCMR	DC-DC-IC	PWM, st-dwn, 2.95V±2%, 600mA, 1.2MHz, Vin>2V, LSST, CL	SOT-25	28dc4	DC1	6g	Tor
KCM	X06366A295MR	DC/DC-IC	PWM/PFM st-dwn, 500kHz, 2.9V±2.5%, 1A, +CE	SOT-25	28zm	DC7	6g	Tor
KCM	X06368A295MR	DC/DC-IC	PWM/PFM step-up, 2.9V±2.5%, 200mA, 500kHz, +CE	SOT-25	28sh	DC11	6g	Tor
KD	BU4920FWE	Vdet-IC	2.0V, +Reset PPO	VSOFF-5	30vk	VD7	6c	Rhm
KD	BU4920G	Vdet-IC	2.0V, +Reset PPO	SSOP-5	28vdm	VD7	6c	Rhm
KD	RT9167A-28CBR	LVR-IC	LDO, 2.8V±2%, 600mA, +CE	SOT-23-5	28vr1	VR7	6g	Rct
KD0	XC9235C30CMR	DC-DC-IC	PWM, st-dwn, 3.0V±2%, 600mA, 1.2MHz, Vin>2V, LSST, CL	SOT-25	28dc4	DC1	6g	Tor
KD0	X06366A301MR	DC/DC-IC	PWM/PFM st-dwn, 100kHz, 3.0V±2.5%, 1A, +CE	SOT-25	28zm	DC7	6g	Tor
KD0	X06368A301MR	DC/DC-IC	PWM/PFM step-up, 3.0V±2.5%, 200mA, 100kHz, +CE	SOT-25	28sh	DC11	6g	Tor
KD1	XC9235C31CMR	DC-DC-IC	PWM, st-dwn, 3.1V±2%, 600mA, 1.2MHz, Vin>2V, LSST, CL	SOT-25	28dc4	DC1	6g	Tor
KD1	X06366A311MR	DC/DC-IC	PWM/PFM st-dwn, 100kHz, 3.1V±2.5%, 1A, +CE	SOT-25	28zm	DC7	6g	Tor
KD1	X06368A311MR	DC/DC-IC	PWM/PFM step-up, 3.1V±2.5%, 200mA, 100kHz, +CE	SOT-25	28sh	DC11	6g	Tor
KD2	XC9235C32CMR	DC-DC-IC	PWM, st-dwn, 3.2V±2%, 600mA, 1.2MHz, Vin>2V, LSST, CL	SOT-25	28dc4	DC1	6g	Tor
KD2	X06366A321MR	DC/DC-IC	PWM/PFM st-dwn, 100kHz, 3.2V±2.5%, 1A, +CE	SOT-25	28zm	DC7	6g	Tor
KD2	X06368A321MR	DC/DC-IC	PWM/PFM step-up, 3.2V±2.5%, 200mA, 100kHz, +CE	SOT-25	28sh	DC11	6g	Tor
KD3	XC9235C33CMR	DC-DC-IC	PWM, st-dwn, 3.3V±2%, 600mA, 1.2MHz, Vin>2V, LSST, CL	SOT-25	28dc4	DC1	6g	Tor
KD3	X06366A331MR	DC/DC-IC	PWM/PFM st-dwn, 100kHz, 3.3V±2.5%, 1A, +CE	SOT-25	28zm	DC7	6g	Tor
KD3	X06368A331MR	DC/DC-IC	PWM/PFM step-up, 3.3V±2.5%, 200mA, 100kHz, +CE	SOT-25	28sh	DC11	6g	Tor
KD4	XC9235C34CMR	DC-DC-IC	PWM, st-dwn, 3.4V±2%, 600mA, 1.2MHz, Vin>2V, LSST, CL	SOT-25	28dc4	DC1	6g	Tor
KD4	X06366A341MR	DC/DC-IC	PWM/PFM st-dwn, 100kHz, 3.4V±2.5%, 1A, +CE	SOT-25	28zm	DC7	6g	Tor
KD4	X06368A341MR	DC/DC-IC	PWM/PFM step-up, 3.4V±2.5%, 200mA, 100kHz, +CE	SOT-25	28sh	DC11	6g	Tor
KD5	XC9235C35CMR	DC-DC-IC	PWM, st-dwn, 3.5V±2%, 600mA, 1.2MHz, Vin>2V, LSST, CL	SOT-25	28dc4	DC1	6g	Tor
KD5	X06366A351MR	DC/DC-IC	PWM/PFM st-dwn, 100kHz, 3.5V±2.5%, 1A, +CE	SOT-25	28zm	DC7	6g	Tor
KD5	X06368A351MR	DC/DC-IC	PWM/PFM step-up, 3.5V±2.5%, 200mA, 100kHz, +CE	SOT-25	28sh	DC11	6g	Tor
KD6	XC9235C36CMR	DC-DC-IC	PWM, st-dwn, 3.6V±2%, 600mA, 1.2MHz, Vin>2V, LSST, CL	SOT-25	28dc4	DC1	6g	Tor
KD6	X06366A361MR	DC/DC-IC	PWM/PFM st-dwn, 100kHz, 3.6V±2.5%, 1A, +CE	SOT-25	28zm	DC7	6g	Tor
KD6	X06368A361MR	DC/DC-IC	PWM/PFM step-up, 3.6V±2.5%, 200mA, 100kHz, +CE	SOT-25	28sh	DC11	6g	Tor
KD7	XC9235C37CMR	DC-DC-IC	PWM, st-dwn, 3.7V±2%, 600mA, 1.2MHz, Vin>2V, LSST, CL	SOT-25	28dc4	DC1	6g	Tor
KD7	X06366A371MR	DC/DC-IC	PWM/PFM st-dwn, 100kHz, 3.7V±2.5%, 1A, +CE	SOT-25	28zm	DC7	6g	Tor
KD7	X06368A371MR	DC/DC-IC	PWM/PFM step-up, 3.7V±2.5%, 200mA, 100kHz, +CE	SOT-25	28sh	DC11	6g	Tor
KD8	XC9235C38CMR	DC-DC-IC	PWM, st-dwn, 3.8V±2%, 600mA, 1.2MHz, Vin>2V, LSST, CL	SOT-25	28dc4	DC1	6g	Tor
KD8	X06366A381MR	DC/DC-IC	PWM/PFM st-dwn, 100kHz, 3.8V±2.5%, 1A, +CE	SOT-25	28zm	DC7	6g	Tor
KD8	X06368A381MR	DC/DC-IC	PWM/PFM step-up, 3.8V±2.5%, 200mA, 100kHz, +CE	SOT-25	28sh	DC11	6g	Tor
KD9	XC9235C39CMR	DC-DC-IC	PWM, st-dwn, 3.9V±2%, 600mA, 1.2MHz, Vin>2V, LSST, CL	SOT-25	28dc4	DC1	6g	Tor
KD9	X06366A391MR	DC/DC-IC	PWM/PFM st-dwn, 100kHz, 3.9V±2.5%, 1A, +CE	SOT-25	28zm	DC7	6g	Tor
KD9	X06368A391MR	DC/DC-IC	PWM/PFM step-up, 3.9V±2.5%, 200mA, 100kHz, +CE	SOT-25	28sh	DC11	6g	Tor
KDA	XC9235C3ACMR	DC-DC-IC	PWM, st-dwn, 3.05V±2%, 600mA, 1.2MHz, Vin>2V, LSST, CL	SOT-25	28dc4	DC1	6g	Tor
KDA	X06366A305MR	DC/DC-IC	PWM/PFM st-dwn, 500kHz, 3.0V±2.5%, 1A, +CE	SOT-25	28zm	DC7	6g	Tor
KDA	X06368A305MR	DC/DC-IC	PWM/PFM step-up, 3.0V±2.5%, 200mA, 500kHz, +CE	SOT-25	28sh	DC11	6g	Tor
KDB	XC9235C3BCMR	DC-DC-IC	PWM, st-dwn, 3.15V±2%, 600mA, 1.2MHz, Vin>2V, LSST, CL	SOT-25	28dc4	DC1	6g	Tor
KDB	X06366A315MR	DC/DC-IC	PWM/PFM st-dwn, 500kHz, 3.1V±2.5%, 1A, +CE	SOT-25	28zm	DC7	6g	Tor
KDB	X06368A315MR	DC/DC-IC	PWM/PFM step-up, 3.1V±2.5%, 200mA, 500kHz, +CE	SOT-25	28sh	DC11	6g	Tor
KDC	XC9235C3CCMR	DC-DC-IC	PWM, st-dwn, 3.25V±2%, 600mA, 1.2MHz, Vin>2V, LSST, CL	SOT-25	28dc4	DC1	6g	Tor
KDC	X06366A325MR	DC/DC-IC	PWM/PFM st-dwn, 500kHz, 3.2V±2.5%, 1A, +CE	SOT-25	28zm	DC7	6g	Tor
KDC	X06368A325MR	DC/DC-IC	PWM/PFM step-up, 3.2V±2.5%, 200mA, 500kHz, +CE	SOT-25	28sh	DC11	6g	Tor
KDD	XC9235C3DCMR	DC-DC-IC	PWM, st-dwn, 3.35V±2%, 600mA, 1.2MHz, Vin>2V, LSST, CL	SOT-25	28dc4	DC1	6g	Tor
KDD	X06366A335MR	DC/DC-IC	PWM/PFM st-dwn, 500kHz, 3.3V±2.5%, 1A, +CE	SOT-25	28zm	DC7	6g	Tor
KDD	X06368A335MR	DC/DC-IC	PWM/PFM step-up, 3.3V±2.5%, 200mA, 500kHz, +CE	SOT-25	28sh	DC11	6g	Tor
KDE	XC9235C3ECMR	DC-DC-IC	PWM, st-dwn, 3.45V±2%, 600mA, 1.2MHz, Vin>2V, LSST, CL	SOT-25	28dc4	DC1	6g	Tor
KDE	X06366A345MR	DC/DC-IC	PWM/PFM st-dwn, 500kHz, 3.4V±2.5%, 1A, +CE	SOT-25	28zm	DC7	6g	Tor
KDE	X06368A345MR	DC/DC-IC	PWM/PFM step-up, 3.4V±2.5%, 200mA, 500kHz, +CE	SOT-25	28sh	DC11	6g	Tor
KDF	XC9235C3FCMR	DC-DC-IC	PWM, st-dwn, 3.55V±2%, 600mA, 1.2MHz, Vin>2V, LSST, CL	SOT-25	28dc4	DC1	6g	Tor
KDF	X06366A355MR	DC/DC-IC	PWM/PFM st-dwn, 500kHz, 3.5V±2.5%, 1A, +CE	SOT-25	28zm	DC7	6g	Tor
KDF	X06368A355MR	DC/DC-IC	PWM/PFM step-up, 3.5V±2.5%, 200mA, 500kHz, +CE	SOT-25	28sh	DC11	6g	Tor
KDH	XC9235C3HCMR	DC-DC-IC	PWM, st-dwn, 3.65V±2%, 600mA, 1.2MHz, Vin>2V, LSST, CL	SOT-25	28dc4	DC1	6g	Tor
KDH	X06366A365MR	DC/DC-IC	PWM/PFM st-dwn, 500kHz, 3.6V±2.5%, 1A, +CE	SOT-25	28zm	DC7	6g	Tor
KDH	X06368A365MR	DC/DC-IC	PWM/PFM step-up, 3.6V±2.5%, 200mA, 500kHz, +CE	SOT-25	28sh	DC11	6g	Tor
KDK	XC9235C3KCMR	DC-DC-IC	PWM, st-dwn, 3.75V±2%, 600mA, 1.2MHz, Vin>2V, LSST, CL	SOT-25	28dc4	DC1	6g	Tor
KDK	X06366A375MR	DC/DC-IC	PWM/PFM st-dwn, 500kHz, 3.7V±2.5%, 1A, +CE	SOT-25	28zm	DC7	6g	Tor
KDK	X06368A375MR	DC/DC-IC	PWM/PFM step-up, 3.7V±2.5%, 200mA, 500kHz, +CE	SOT-25	28sh	DC11	6g	Tor
KDL	XC9235C3LCMR	DC-DC-IC	PWM, st-dwn, 3.85V±2%, 600mA, 1.2MHz, Vin>2V, LSST, CL	SOT-25	28dc4	DC1	6g	Tor
KDL	X06366A385MR	DC/DC-IC	PWM/PFM st-dwn, 500kHz, 3.8V±2.5%, 1A, +CE	SOT-25	28zm	DC7	6g	Tor
KDL	X06368A385MR	DC/DC-IC	PWM/PFM step-up, 3.8V±2.5%, 200mA, 500kHz, +CE	SOT-25	28sh	DC11	6g	Tor
KDM	XC9235C3MCMR	DC-DC-IC	PWM, st-dwn, 3.95V±2%, 600mA, 1.2MHz, Vin>2V, LSST, CL	SOT-25	28dc4	DC1	6g	Tor
KDM	X06366A395MR	DC/DC-IC	PWM/PFM st-dwn, 500kHz, 3.9V±2.5%, 1A, +CE	SOT-25	28zm	DC7	6g	Tor
KDM	X06368A395MR	DC/DC-IC	PWM/PFM step-up, 3.9V±2.5%, 200mA, 500kHz, +CE	SOT-25	28sh	DC11	6g	Tor
KE	BU4921FWE	Vdet-IC	2.1V, +Reset PPO	VSOFF-5	30vk	VD7	6c	Rhm
KE	BU4921G	Vdet-IC	2.1V, +Reset PPO	SSOP-5	28vdm	VD7	6c	Rhm
KE	RT9167A-29CBR	LVR-IC	LDO, 2.9V±2%, 600mA, +CE	SOT-23-5	28vr1	VR7	6g	Rct
KE0	XC9235C40CMR	DC-DC-IC	PWM, st-dwn, 4.0V±2%, 600mA, 1.2MHz, Vin>2V, LSST, CL	SOT-25	28dc4	DC1	6g	Tor



SMD code	Type	Function	Short description	Case	Pinout	Sch.	St.	Mnf.
KE0	XC6366A401MR	DC/DC-IC	PWM/PFM st-down, 100kHz, 4.0V±2.5%, 1A, +CE	SOT-25	28zm	DC7	6g	Tor
KE0	XC6366A401MR	DC/DC-IC	PWM/PFM step-up, 4.0V±2.5%, 200mA, 100kHz, +CE	SOT-25	28sh	DC11	6g	Tor
KE1	XC6366A411MR	DC/DC-IC	PWM/PFM st-down, 100kHz, 4.1V±2.5%, 1A, +CE	SOT-25	28zm	DC7	6g	Tor
KE1	XC6366A411MR	DC/DC-IC	PWM/PFM step-up, 4.1V±2.5%, 200mA, 100kHz, +CE	SOT-25	28sh	DC11	6g	Tor
KE2	XC6366A421MR	DC/DC-IC	PWM/PFM st-down, 100kHz, 4.2V±2.5%, 1A, +CE	SOT-25	28zm	DC7	6g	Tor
KE2	XC6366A421MR	DC/DC-IC	PWM/PFM step-up, 4.2V±2.5%, 200mA, 100kHz, +CE	SOT-25	28sh	DC11	6g	Tor
KE3	XC6366A431MR	DC/DC-IC	PWM/PFM st-down, 100kHz, 4.3V±2.5%, 1A, +CE	SOT-25	28zm	DC7	6g	Tor
KE3	XC6366A431MR	DC/DC-IC	PWM/PFM step-up, 4.3V±2.5%, 200mA, 100kHz, +CE	SOT-25	28sh	DC11	6g	Tor
KE4	XC6366A441MR	DC/DC-IC	PWM/PFM st-down, 100kHz, 4.4V±2.5%, 1A, +CE	SOT-25	28zm	DC7	6g	Tor
KE4	XC6366A441MR	DC/DC-IC	PWM/PFM step-up, 4.4V±2.5%, 200mA, 100kHz, +CE	SOT-25	28sh	DC11	6g	Tor
KE5	XC6366A451MR	DC/DC-IC	PWM/PFM st-down, 100kHz, 4.5V±2.5%, 1A, +CE	SOT-25	28zm	DC7	6g	Tor
KE5	XC6366A451MR	DC/DC-IC	PWM/PFM step-up, 4.5V±2.5%, 200mA, 100kHz, +CE	SOT-25	28sh	DC11	6g	Tor
KE6	XC6366A461MR	DC/DC-IC	PWM/PFM st-down, 100kHz, 4.6V±2.5%, 1A, +CE	SOT-25	28zm	DC7	6g	Tor
KE6	XC6366A461MR	DC/DC-IC	PWM/PFM step-up, 4.6V±2.5%, 200mA, 100kHz, +CE	SOT-25	28sh	DC11	6g	Tor
KE7	XC6366A471MR	DC/DC-IC	PWM/PFM st-down, 100kHz, 4.7V±2.5%, 1A, +CE	SOT-25	28zm	DC7	6g	Tor
KE7	XC6366A471MR	DC/DC-IC	PWM/PFM step-up, 4.7V±2.5%, 200mA, 100kHz, +CE	SOT-25	28sh	DC11	6g	Tor
KE8	XC6366A481MR	DC/DC-IC	PWM/PFM st-down, 100kHz, 4.8V±2.5%, 1A, +CE	SOT-25	28zm	DC7	6g	Tor
KE8	XC6366A481MR	DC/DC-IC	PWM/PFM step-up, 4.8V±2.5%, 200mA, 100kHz, +CE	SOT-25	28sh	DC11	6g	Tor
KE9	XC6366A491MR	DC/DC-IC	PWM/PFM st-down, 100kHz, 4.9V±2.5%, 1A, +CE	SOT-25	28zm	DC7	6g	Tor
KE9	XC6366A491MR	DC/DC-IC	PWM/PFM step-up, 4.9V±2.5%, 200mA, 100kHz, +CE	SOT-25	28sh	DC11	6g	Tor
KEA	XC6366A405MR	DC/DC-IC	PWM/PFM st-down, 500kHz, 4.0V±2.5%, 1A, +CE	SOT-25	28zm	DC7	6g	Tor
KEA	XC6366A405MR	DC/DC-IC	PWM/PFM step-up, 4.0V±2.5%, 200mA, 500kHz, +CE	SOT-25	28sh	DC11	6g	Tor
KEB	XC6366A415MR	DC/DC-IC	PWM/PFM st-down, 500kHz, 4.1V±2.5%, 1A, +CE	SOT-25	28zm	DC7	6g	Tor
KEB	XC6366A415MR	DC/DC-IC	PWM/PFM step-up, 4.1V±2.5%, 200mA, 500kHz, +CE	SOT-25	28sh	DC11	6g	Tor
KEC	XC6366A425MR	DC/DC-IC	PWM/PFM st-down, 500kHz, 4.2V±2.5%, 1A, +CE	SOT-25	28zm	DC7	6g	Tor
KEC	XC6366A425MR	DC/DC-IC	PWM/PFM step-up, 4.2V±2.5%, 200mA, 500kHz, +CE	SOT-25	28sh	DC11	6g	Tor
KED	XC6366A435MR	DC/DC-IC	PWM/PFM st-down, 500kHz, 4.3V±2.5%, 1A, +CE	SOT-25	28zm	DC7	6g	Tor
KED	XC6366A435MR	DC/DC-IC	PWM/PFM step-up, 4.3V±2.5%, 200mA, 500kHz, +CE	SOT-25	28sh	DC11	6g	Tor
KEE	XC6366A445MR	DC/DC-IC	PWM/PFM st-down, 500kHz, 4.4V±2.5%, 1A, +CE	SOT-25	28zm	DC7	6g	Tor
KEE	XC6366A445MR	DC/DC-IC	PWM/PFM step-up, 4.4V±2.5%, 200mA, 500kHz, +CE	SOT-25	28sh	DC11	6g	Tor
KEF	XC6366A455MR	DC/DC-IC	PWM/PFM st-down, 500kHz, 4.5V±2.5%, 1A, +CE	SOT-25	28zm	DC7	6g	Tor
KEF	XC6366A455MR	DC/DC-IC	PWM/PFM step-up, 4.5V±2.5%, 200mA, 500kHz, +CE	SOT-25	28sh	DC11	6g	Tor
KEH	XC6366A465MR	DC/DC-IC	PWM/PFM st-down, 500kHz, 4.6V±2.5%, 1A, +CE	SOT-25	28zm	DC7	6g	Tor
KEH	XC6366A465MR	DC/DC-IC	PWM/PFM step-up, 4.6V±2.5%, 200mA, 500kHz, +CE	SOT-25	28sh	DC11	6g	Tor
KEK	XC6366A475MR	DC/DC-IC	PWM/PFM st-down, 500kHz, 4.7V±2.5%, 1A, +CE	SOT-25	28zm	DC7	6g	Tor
KEK	XC6366A475MR	DC/DC-IC	PWM/PFM step-up, 4.7V±2.5%, 200mA, 500kHz, +CE	SOT-25	28sh	DC11	6g	Tor
KEJ	XC6366A485MR	DC/DC-IC	PWM/PFM st-down, 500kHz, 4.8V±2.5%, 1A, +CE	SOT-25	28zm	DC7	6g	Tor
KEJ	XC6366A485MR	DC/DC-IC	PWM/PFM step-up, 4.8V±2.5%, 200mA, 500kHz, +CE	SOT-25	28sh	DC11	6g	Tor
KEM	XC6366A495MR	DC/DC-IC	PWM/PFM st-down, 500kHz, 4.9V±2.5%, 1A, +CE	SOT-25	28zm	DC7	6g	Tor
KEM	XC6366A495MR	DC/DC-IC	PWM/PFM step-up, 4.9V±2.5%, 200mA, 500kHz, +CE	SOT-25	28sh	DC11	6g	Tor
KF	BU4922FWE	Vdet-IC	2.2V, +Reset PPO	VSOFF-5	30vk	VD7	6c	Rhm
KF	BU4922G	Vdet-IC	2.2V, +Reset PPO	SSOP-5	28vdm	VD7	6c	Rhm
KF	RT9167A-30CBR	LVR-IC	LDO, 3.0V±2%, 600mA, +CE	SOT-23-5	28v1	VR7	6g	Rct
KF0	XC6366A501MR	DC/DC-IC	PWM/PFM st-down, 100kHz, 5.0V±2.5%, 1A, +CE	SOT-25	28zm	DC7	6g	Tor
KF0	XC6366A501MR	DC/DC-IC	PWM/PFM step-up, 5.0V±2.5%, 200mA, 100kHz, +CE	SOT-25	28sh	DC11	6g	Tor
KF1	XC6366A511MR	DC/DC-IC	PWM/PFM st-down, 100kHz, 5.1V±2.5%, 1A, +CE	SOT-25	28zm	DC7	6g	Tor
KF1	XC6366A511MR	DC/DC-IC	PWM/PFM step-up, 5.1V±2.5%, 200mA, 100kHz, +CE	SOT-25	28sh	DC11	6g	Tor
KF2	XC6366A521MR	DC/DC-IC	PWM/PFM st-down, 100kHz, 5.2V±2.5%, 1A, +CE	SOT-25	28zm	DC7	6g	Tor
KF2	XC6366A521MR	DC/DC-IC	PWM/PFM step-up, 5.2V±2.5%, 200mA, 100kHz, +CE	SOT-25	28sh	DC11	6g	Tor
KF3	XC6366A531MR	DC/DC-IC	PWM/PFM st-down, 100kHz, 5.3V±2.5%, 1A, +CE	SOT-25	28zm	DC7	6g	Tor
KF3	XC6366A531MR	DC/DC-IC	PWM/PFM step-up, 5.3V±2.5%, 200mA, 100kHz, +CE	SOT-25	28sh	DC11	6g	Tor
KF4	XC6366A541MR	DC/DC-IC	PWM/PFM st-down, 100kHz, 5.4V±2.5%, 1A, +CE	SOT-25	28zm	DC7	6g	Tor
KF4	XC6366A541MR	DC/DC-IC	PWM/PFM step-up, 5.4V±2.5%, 200mA, 100kHz, +CE	SOT-25	28sh	DC11	6g	Tor
KF5	XC6366A551MR	DC/DC-IC	PWM/PFM st-down, 100kHz, 5.5V±2.5%, 1A, +CE	SOT-25	28zm	DC7	6g	Tor
KF5	XC6366A551MR	DC/DC-IC	PWM/PFM step-up, 5.5V±2.5%, 200mA, 100kHz, +CE	SOT-25	28sh	DC11	6g	Tor
KF6	XC6366A561MR	DC/DC-IC	PWM/PFM st-down, 100kHz, 5.6V±2.5%, 1A, +CE	SOT-25	28zm	DC7	6g	Tor
KF6	XC6366A561MR	DC/DC-IC	PWM/PFM step-up, 5.6V±2.5%, 200mA, 100kHz, +CE	SOT-25	28sh	DC11	6g	Tor
KF7	XC6366A571MR	DC/DC-IC	PWM/PFM st-down, 100kHz, 5.7V±2.5%, 1A, +CE	SOT-25	28zm	DC7	6g	Tor
KF7	XC6366A571MR	DC/DC-IC	PWM/PFM step-up, 5.7V±2.5%, 200mA, 100kHz, +CE	SOT-25	28sh	DC11	6g	Tor
KF8	XC9235C08DMR	DC-DC-IC	PWM, st-down, 0.8V±2%, 600mA, 3MHz, Vin>2V, LSST, CL	SOT-25	28dc4	DC1	6g	Tor
KF8	XC6366A581MR	DC/DC-IC	PWM/PFM st-down, 100kHz, 5.8V±2.5%, 1A, +CE	SOT-25	28zm	DC7	6g	Tor
KF8	XC6366A581MR	DC/DC-IC	PWM/PFM step-up, 5.8V±2.5%, 200mA, 100kHz, +CE	SOT-25	28sh	DC11	6g	Tor
KF9	XC9235C09DMR	DC-DC-IC	PWM, st-down, 0.9V±2%, 600mA, 3MHz, Vin>2V, LSST, CL	SOT-25	28dc4	DC1	6g	Tor
KF9	XC6366A591MR	DC/DC-IC	PWM/PFM st-down, 100kHz, 5.9V±2.5%, 1A, +CE	SOT-25	28zm	DC7	6g	Tor
KF9	XC6366A591MR	DC/DC-IC	PWM/PFM step-up, 5.9V±2.5%, 200mA, 100kHz, +CE	SOT-25	28sh	DC11	6g	Tor
KFA	XC6366A505MR	DC/DC-IC	PWM/PFM st-down, 500kHz, 5.0V±2.5%, 1A, +CE	SOT-25	28zm	DC7	6g	Tor
KFA	XC6366A505MR	DC/DC-IC	PWM/PFM step-up, 5.0V±2.5%, 200mA, 500kHz, +CE	SOT-25	28sh	DC11	6g	Tor
KFB	XC6366A515MR	DC/DC-IC	PWM/PFM st-down, 500kHz, 5.1V±2.5%, 1A, +CE	SOT-25	28zm	DC7	6g	Tor
KFB	XC6366A515MR	DC/DC-IC	PWM/PFM step-up, 5.1V±2.5%, 200mA, 500kHz, +CE	SOT-25	28sh	DC11	6g	Tor
KFC	XC6366A525MR	DC/DC-IC	PWM/PFM st-down, 500kHz, 5.2V±2.5%, 1A, +CE	SOT-25	28zm	DC7	6g	Tor



SMD code	Type	Function	Short description	Case	Pinout	Sch.	St.	Mnf.
KFC	XC6368A525MR	DC/DC-IC	PWM/PFM step-up, 5.2V±2.5%, 200mA, 500kHz, +CE	SOT-25	28sh	DC11	6g	Tor
KFD	XC6366A535MR	DC/DC-IC	PWM/PFM st-down, 500kHz, 5.3V±2.5%, 1A, +CE	SOT-25	28zm	DC7	6g	Tor
KFE	XC6368A535MR	DC/DC-IC	PWM/PFM step-up, 5.3V±2.5%, 200mA, 500kHz, +CE	SOT-25	28sh	DC11	6g	Tor
KFF	XC6366A545MR	DC/DC-IC	PWM/PFM st-down, 500kHz, 5.4V±2.5%, 1A, +CE	SOT-25	28zm	DC7	6g	Tor
KFH	XC6368A545MR	DC/DC-IC	PWM/PFM step-up, 5.4V±2.5%, 200mA, 500kHz, +CE	SOT-25	28sh	DC11	6g	Tor
KFG	XC6366A555MR	DC/DC-IC	PWM/PFM st-down, 500kHz, 5.5V±2.5%, 1A, +CE	SOT-25	28zm	DC7	6g	Tor
KFH	XC6368A555MR	DC/DC-IC	PWM/PFM step-up, 5.5V±2.5%, 200mA, 500kHz, +CE	SOT-25	28sh	DC11	6g	Tor
KFI	XC6366A565MR	DC/DC-IC	PWM/PFM st-down, 500kHz, 5.6V±2.5%, 1A, +CE	SOT-25	28zm	DC7	6g	Tor
KFJ	XC6368A565MR	DC/DC-IC	PWM/PFM step-up, 5.6V±2.5%, 200mA, 500kHz, +CE	SOT-25	28sh	DC11	6g	Tor
KFK	XC6366A575MR	DC/DC-IC	PWM/PFM st-down, 500kHz, 5.7V±2.5%, 1A, +CE	SOT-25	28zm	DC7	6g	Tor
KFL	XC6368A575MR	DC/DC-IC	PWM/PFM step-up, 5.7V±2.5%, 200mA, 500kHz, +CE	SOT-25	28sh	DC11	6g	Tor
KFM	XC9235C0LDMR	DC-DC-IC	PWM, st-dwn, 0.85V±2%, 600mA, 3MHz, Vin>2V, LSST, CL	SOT-25	28dc4	DC1	6g	Tor
KFN	XC6366A585MR	DC/DC-IC	PWM/PFM st-down, 500kHz, 5.8V±2.5%, 1A, +CE	SOT-25	28zm	DC7	6g	Tor
KFO	XC6368A585MR	DC/DC-IC	PWM/PFM step-up, 5.8V±2.5%, 200mA, 500kHz, +CE	SOT-25	28sh	DC11	6g	Tor
KFP	XC9235C0MDMR	DC-DC-IC	PWM, st-dwn, 0.95V±2%, 600mA, 3MHz, Vin>2V, LSST, CL	SOT-25	28dc4	DC1	6g	Tor
KFQ	XC6366A595MR	DC/DC-IC	PWM/PFM st-down, 500kHz, 5.9V±2.5%, 1A, +CE	SOT-25	28zm	DC7	6g	Tor
KFR	XC6368A595MR	DC/DC-IC	PWM/PFM step-up, 5.9V±2.5%, 200mA, 500kHz, +CE	SOT-25	28sh	DC11	6g	Tor
KG	BU4923FWE	Vdet-IC	2.3V, +Reset PPO	VSOFF-5	30vk	VD7	6c	Rhm
KG	BU4923G	Vdet-IC	2.3V, +Reset PPO	SSOP-5	28vdm	VD7	6c	Rhm
KG	RT9167A-31CBR	LVR-IC	LDO, 3.1V±2%, 600mA, +CE	SOT-23-5	28v1	VR7	6g	Rct
KH	BU4924FWE	Vdet-IC	2.4V, +Reset PPO	VSOFF-5	30vk	VD7	6c	Rhm
KH	BU4924G	Vdet-IC	2.4V, +Reset PPO	SSOP-5	28vdm	VD7	6c	Rhm
KH	RT9167A-32CBR	LVR-IC	LDO, 3.2V±2%, 600mA, +CE	SOT-23-5	28v1	VR7	6g	Rct
KHO	XC9235C10DMR	DC-DC-IC	PWM, st-dwn, 1.0V±2%, 600mA, 3MHz, Vin>2V, LSST, CL	SOT-25	28dc4	DC1	6g	Tor
KHI	XC6366A601MR	DC/DC-IC	PWM/PFM st-down, 100kHz, 6.0V±2.5%, 1A, +CE	SOT-25	28zm	DC7	6g	Tor
KHJ	XC6368A601MR	DC/DC-IC	PWM/PFM step-up, 6.0V±2.5%, 200mA, 100kHz, +CE	SOT-25	28sh	DC11	6g	Tor
KHK	XC9235C11DMR	DC-DC-IC	PWM, st-dwn, 1.1V±2%, 600mA, 3MHz, Vin>2V, LSST, CL	SOT-25	28dc4	DC1	6g	Tor
KHL	XC6368A611MR	DC/DC-IC	PWM/PFM step-up, 6.1V±2.5%, 200mA, 100kHz, +CE	SOT-25	28sh	DC11	6g	Tor
KHM	XC9235C12DMR	DC-DC-IC	PWM, st-dwn, 1.2V±2%, 600mA, 3MHz, Vin>2V, LSST, CL	SOT-25	28dc4	DC1	6g	Tor
KHN	XC6368A621MR	DC/DC-IC	PWM/PFM step-up, 6.2V±2.5%, 200mA, 100kHz, +CE	SOT-25	28sh	DC11	6g	Tor
KHO	XC9235C13DMR	DC-DC-IC	PWM, st-dwn, 1.3V±2%, 600mA, 3MHz, Vin>2V, LSST, CL	SOT-25	28dc4	DC1	6g	Tor
KHI	XC6368A631MR	DC/DC-IC	PWM/PFM step-up, 6.3V±2.5%, 200mA, 100kHz, +CE	SOT-25	28sh	DC11	6g	Tor
KHJ	XC9235C14DMR	DC-DC-IC	PWM, st-dwn, 1.4V±2%, 600mA, 3MHz, Vin>2V, LSST, CL	SOT-25	28dc4	DC1	6g	Tor
KHK	XC6368A641MR	DC/DC-IC	PWM/PFM step-up, 6.4V±2.5%, 200mA, 100kHz, +CE	SOT-25	28sh	DC11	6g	Tor
KHL	XC9235C15DMR	DC-DC-IC	PWM, st-dwn, 1.5V±2%, 600mA, 3MHz, Vin>2V, LSST, CL	SOT-25	28dc4	DC1	6g	Tor
KHM	XC6368A651MR	DC/DC-IC	PWM/PFM step-up, 6.5V±2.5%, 200mA, 100kHz, +CE	SOT-25	28sh	DC11	6g	Tor
KHN	XC9235C16DMR	DC-DC-IC	PWM, st-dwn, 1.6V±2%, 600mA, 3MHz, Vin>2V, LSST, CL	SOT-25	28dc4	DC1	6g	Tor
KHO	XC9235C17DMR	DC-DC-IC	PWM, st-dwn, 1.7V±2%, 600mA, 3MHz, Vin>2V, LSST, CL	SOT-25	28dc4	DC1	6g	Tor
KHP	XC9235C18DMR	DC-DC-IC	PWM, st-dwn, 1.8V±2%, 600mA, 3MHz, Vin>2V, LSST, CL	SOT-25	28dc4	DC1	6g	Tor
KHQ	XC9235C19DMR	DC-DC-IC	PWM, st-dwn, 1.9V±2%, 600mA, 3MHz, Vin>2V, LSST, CL	SOT-25	28dc4	DC1	6g	Tor
KHR	XC9235C1ADM	DC-DC-IC	PWM, st-dwn, 1.05V±2%, 600mA, 3MHz, Vin>2V, LSST, CL	SOT-25	28dc4	DC1	6g	Tor
KHS	XC6366A605MR	DC/DC-IC	PWM/PFM st-down, 500kHz, 6.0V±2.5%, 1A, +CE	SOT-25	28zm	DC7	6g	Tor
KHT	XC6368A605MR	DC/DC-IC	PWM/PFM step-up, 6.0V±2.5%, 200mA, 500kHz, +CE	SOT-25	28sh	DC11	6g	Tor
KHU	XC9235C1BDMR	DC-DC-IC	PWM, st-dwn, 1.15V±2%, 600mA, 3MHz, Vin>2V, LSST, CL	SOT-25	28dc4	DC1	6g	Tor
KHV	XC6368A615MR	DC/DC-IC	PWM/PFM step-up, 6.1V±2.5%, 200mA, 500kHz, +CE	SOT-25	28sh	DC11	6g	Tor
KHW	XC9235C1CDMR	DC-DC-IC	PWM, st-dwn, 1.25V±2%, 600mA, 3MHz, Vin>2V, LSST, CL	SOT-25	28dc4	DC1	6g	Tor
KHX	XC6368A625MR	DC/DC-IC	PWM/PFM step-up, 6.2V±2.5%, 200mA, 500kHz, +CE	SOT-25	28sh	DC11	6g	Tor
KHY	XC9235C1DDMR	DC-DC-IC	PWM, st-dwn, 1.35V±2%, 600mA, 3MHz, Vin>2V, LSST, CL	SOT-25	28dc4	DC1	6g	Tor
KHZ	XC6368A635MR	DC/DC-IC	PWM/PFM step-up, 6.3V±2.5%, 200mA, 500kHz, +CE	SOT-25	28sh	DC11	6g	Tor
KIA	XC9235C1EDMR	DC-DC-IC	PWM, st-dwn, 1.45V±2%, 600mA, 3MHz, Vin>2V, LSST, CL	SOT-25	28dc4	DC1	6g	Tor
KIB	XC6368A645MR	DC/DC-IC	PWM/PFM step-up, 6.4V±2.5%, 200mA, 500kHz, +CE	SOT-25	28sh	DC11	6g	Tor
KIC	XC9235C1FDMR	DC-DC-IC	PWM, st-dwn, 1.55V±2%, 600mA, 3MHz, Vin>2V, LSST, CL	SOT-25	28dc4	DC1	6g	Tor
KID	XC6368A655MR	DC/DC-IC	PWM/PFM step-up, 6.5V±2.5%, 200mA, 500kHz, +CE	SOT-25	28sh	DC11	6g	Tor
KIE	XC9235C1HDMR	DC-DC-IC	PWM, st-dwn, 1.65V±2%, 600mA, 3MHz, Vin>2V, LSST, CL	SOT-25	28dc4	DC1	6g	Tor
KIF	XC9235C1KDMR	DC-DC-IC	PWM, st-dwn, 1.75V±2%, 600mA, 3MHz, Vin>2V, LSST, CL	SOT-25	28dc4	DC1	6g	Tor
KIG	XC9235C1LDMR	DC-DC-IC	PWM, st-dwn, 1.85V±2%, 600mA, 3MHz, Vin>2V, LSST, CL	SOT-25	28dc4	DC1	6g	Tor
KIH	XC9235C1MDMR	DC-DC-IC	PWM, st-dwn, 1.95V±2%, 600mA, 3MHz, Vin>2V, LSST, CL	SOT-25	28dc4	DC1	6g	Tor
KIJ	BU4925FWE	Vdet-IC	2.5V, +Reset PPO	VSOFF-5	30vk	VD7	6c	Rhm
KIJ	BU4925G	Vdet-IC	2.5V, +Reset PPO	SSOP-5	28vdm	VD7	6c	Rhm
KIK	RT9167A-33CBR	LVR-IC	LDO, 3.3V±2%, 600mA, +CE	SOT-23-5	28v1	VR7	6g	Rct
KIL	RT9167A-33PBR	LVR-IC	LDO, 3.3V±2%, 600mA, +CE	SOT-23-5	28v1	VR7	6g	Rct
KIM	BU4926FWE	Vdet-IC	2.6V, +Reset PPO	VSOFF-5	30vk	VD7	6c	Rhm
KIN	BU4926G	Vdet-IC	2.6V, +Reset PPO	SSOP-5	28vdm	VD7	6c	Rhm
KIO	RT9167A-34CBR	LVR-IC	LDO, 3.4V±2%, 600mA, +CE	SOT-23-5	28v1	VR7	6g	Rct
KIP	XC9235C20DMR	DC-DC-IC	PWM, st-dwn, 2.0V±2%, 600mA, 3MHz, Vin>2V, LSST, CL	SOT-25	28dc4	DC1	6g	Tor
KIQ	XC9235C21DMR	DC-DC-IC	PWM, st-dwn, 2.1V±2%, 600mA, 3MHz, Vin>2V, LSST, CL	SOT-25	28dc4	DC1	6g	Tor
KIR	XC9235C22DMR	DC-DC-IC	PWM, st-dwn, 2.2V±2%, 600mA, 3MHz, Vin>2V, LSST, CL	SOT-25	28dc4	DC1	6g	Tor
KIS	XC9235C23DMR	DC-DC-IC	PWM, st-dwn, 2.3V±2%, 600mA, 3MHz, Vin>2V, LSST, CL	SOT-25	28dc4	DC1	6g	Tor
KIT	XC9235C24DMR	DC-DC-IC	PWM, st-dwn, 2.4V±2%, 600mA, 3MHz, Vin>2V, LSST, CL	SOT-25	28dc4	DC1	6g	Tor
KIU	XC9235C25DMR	DC-DC-IC	PWM, st-dwn, 2.5V±2%, 600mA, 3MHz, Vin>2V, LSST, CL	SOT-25	28dc4	DC1	6g	Tor



SMD code	Type	Function	Short description	Case	Pinout	Sch.	St.	Mnf.
KK6	XC9235C26DMR	DC-DC-IC	PWM, st-dwn, 2.6V±2%, 600mA, 3MHz, Vin>2V, LSST, CL	SOT-25	28dc4	DC1	6g	Tor
KK7	XC9235C27DMR	DC-DC-IC	PWM, st-dwn, 2.7V±2%, 600mA, 3MHz, Vin>2V, LSST, CL	SOT-25	28dc4	DC1	6g	Tor
KK8	XC9235C28DMR	DC-DC-IC	PWM, st-dwn, 2.8V±2%, 600mA, 3MHz, Vin>2V, LSST, CL	SOT-25	28dc4	DC1	6g	Tor
KK9	XC9235C29DMR	DC-DC-IC	PWM, st-dwn, 2.9V±2%, 600mA, 3MHz, Vin>2V, LSST, CL	SOT-25	28dc4	DC1	6g	Tor
KKa	XC9235C2ADMR	DC-DC-IC	PWM, st-dwn, 2.05V±2%, 600mA, 3MHz, Vin>2V, LSST, CL	SOT-25	28dc4	DC1	6g	Tor
KKb	XC9235C2BDMR	DC-DC-IC	PWM, st-dwn, 2.15V±2%, 600mA, 3MHz, Vin>2V, LSST, CL	SOT-25	28dc4	DC1	6g	Tor
KKc	XC9235C2CDMR	DC-DC-IC	PWM, st-dwn, 2.25V±2%, 600mA, 3MHz, Vin>2V, LSST, CL	SOT-25	28dc4	DC1	6g	Tor
KKd	XC9235C2DDMR	DC-DC-IC	PWM, st-dwn, 2.35V±2%, 600mA, 3MHz, Vin>2V, LSST, CL	SOT-25	28dc4	DC1	6g	Tor
KKe	XC9235C2EDMR	DC-DC-IC	PWM, st-dwn, 2.45V±2%, 600mA, 3MHz, Vin>2V, LSST, CL	SOT-25	28dc4	DC1	6g	Tor
KKf	XC9235C2FDMR	DC-DC-IC	PWM, st-dwn, 2.55V±2%, 600mA, 3MHz, Vin>2V, LSST, CL	SOT-25	28dc4	DC1	6g	Tor
KKH	XC9235C2HDMR	DC-DC-IC	PWM, st-dwn, 2.65V±2%, 600mA, 3MHz, Vin>2V, LSST, CL	SOT-25	28dc4	DC1	6g	Tor
KKK	XC9235C2IDMR	DC-DC-IC	PWM, st-dwn, 2.75V±2%, 600mA, 3MHz, Vin>2V, LSST, CL	SOT-25	28dc4	DC1	6g	Tor
KKL	XC9235C2LDMR	DC-DC-IC	PWM, st-dwn, 2.85V±2%, 600mA, 3MHz, Vin>2V, LSST, CL	SOT-25	28dc4	DC1	6g	Tor
KKM	XC9235C2MDMR	DC-DC-IC	PWM, st-dwn, 2.95V±2%, 600mA, 3MHz, Vin>2V, LSST, CL	SOT-25	28dc4	DC1	6g	Tor
KL	AAT3515IGV-2.93-C	Vdet-IC	2.93V±1.5%, -MR, ±Reset PPO, 140ms	SOT-23-5	28xf	VD21	6k	Ant
KL	BU4927FWE	Vdet-IC	2.7V, +Reset PPO	VSOFF-5	30vk	VD7	6c	Rhm
KL	BU4927G	Vdet-IC	2.7V, +Reset PPO	SSOP-5	28vdm	VD7	6c	Rhm
KL	RT9167A-35CBR	LVR-IC	LDO, 3.5V±2%, 600mA, +CE	SOT-23-5	28vr1	VR7	6g	Rct
KL0	XC9235C30DMR	DC-DC-IC	PWM, st-dwn, 3.0V±2%, 600mA, 3MHz, Vin>2V, LSST, CL	SOT-25	28dc4	DC1	6g	Tor
KL1	XC9235C31DMR	DC-DC-IC	PWM, st-dwn, 3.1V±2%, 600mA, 3MHz, Vin>2V, LSST, CL	SOT-25	28dc4	DC1	6g	Tor
KL2	XC9235C32DMR	DC-DC-IC	PWM, st-dwn, 3.2V±2%, 600mA, 3MHz, Vin>2V, LSST, CL	SOT-25	28dc4	DC1	6g	Tor
KL3	XC9235C33DMR	DC-DC-IC	PWM, st-dwn, 3.3V±2%, 600mA, 3MHz, Vin>2V, LSST, CL	SOT-25	28dc4	DC1	6g	Tor
KL4	XC9235C34DMR	DC-DC-IC	PWM, st-dwn, 3.4V±2%, 600mA, 3MHz, Vin>2V, LSST, CL	SOT-25	28dc4	DC1	6g	Tor
KL5	XC9235C35DMR	DC-DC-IC	PWM, st-dwn, 3.5V±2%, 600mA, 3MHz, Vin>2V, LSST, CL	SOT-25	28dc4	DC1	6g	Tor
KL6	XC9235C36DMR	DC-DC-IC	PWM, st-dwn, 3.6V±2%, 600mA, 3MHz, Vin>2V, LSST, CL	SOT-25	28dc4	DC1	6g	Tor
KL7	XC9235C37DMR	DC-DC-IC	PWM, st-dwn, 3.7V±2%, 600mA, 3MHz, Vin>2V, LSST, CL	SOT-25	28dc4	DC1	6g	Tor
KL8	XC9235C38DMR	DC-DC-IC	PWM, st-dwn, 3.8V±2%, 600mA, 3MHz, Vin>2V, LSST, CL	SOT-25	28dc4	DC1	6g	Tor
KL9	XC9235C39DMR	DC-DC-IC	PWM, st-dwn, 3.9V±2%, 600mA, 3MHz, Vin>2V, LSST, CL	SOT-25	28dc4	DC1	6g	Tor
KLa	XC9235C3ADMR	DC-DC-IC	PWM, st-dwn, 3.05V±2%, 600mA, 3MHz, Vin>2V, LSST, CL	SOT-25	28dc4	DC1	6g	Tor
KLb	XC9235C3BDMR	DC-DC-IC	PWM, st-dwn, 3.15V±2%, 600mA, 3MHz, Vin>2V, LSST, CL	SOT-25	28dc4	DC1	6g	Tor
KLc	XC9235C3CDMR	DC-DC-IC	PWM, st-dwn, 3.25V±2%, 600mA, 3MHz, Vin>2V, LSST, CL	SOT-25	28dc4	DC1	6g	Tor
KLd	XC9235C3DDMR	DC-DC-IC	PWM, st-dwn, 3.35V±2%, 600mA, 3MHz, Vin>2V, LSST, CL	SOT-25	28dc4	DC1	6g	Tor
KLf	XC9235C3EDMR	DC-DC-IC	PWM, st-dwn, 3.45V±2%, 600mA, 3MHz, Vin>2V, LSST, CL	SOT-25	28dc4	DC1	6g	Tor
KLf	XC9235C3FDMR	DC-DC-IC	PWM, st-dwn, 3.55V±2%, 600mA, 3MHz, Vin>2V, LSST, CL	SOT-25	28dc4	DC1	6g	Tor
KLH	XC9235C3HDMR	DC-DC-IC	PWM, st-dwn, 3.65V±2%, 600mA, 3MHz, Vin>2V, LSST, CL	SOT-25	28dc4	DC1	6g	Tor
KLK	XC9235C3IDMR	DC-DC-IC	PWM, st-dwn, 3.75V±2%, 600mA, 3MHz, Vin>2V, LSST, CL	SOT-25	28dc4	DC1	6g	Tor
KLl	XC9235C3LDMR	DC-DC-IC	PWM, st-dwn, 3.85V±2%, 600mA, 3MHz, Vin>2V, LSST, CL	SOT-25	28dc4	DC1	6g	Tor
KLm	XC9235C3MDMR	DC-DC-IC	PWM, st-dwn, 3.95V±2%, 600mA, 3MHz, Vin>2V, LSST, CL	SOT-25	28dc4	DC1	6g	Tor
KM	AAT3515IGV-4.38-C	Vdet-IC	4.38V±1.5%, -MR, ±Reset PPO, 140ms	SOT-23-5	28xf	VD21	6k	Ant
KM	BU4928FWE	Vdet-IC	2.8V, +Reset PPO	VSOFF-5	30vk	VD7	6c	Rhm
KM	BU4928G	Vdet-IC	2.8V, +Reset PPO	SSOP-5	28vdm	VD7	6c	Rhm
KM	RT9167A-36CBR	LVR-IC	LDO, 3.6V±2%, 600mA, +CE	SOT-23-5	28vr1	VR7	6g	Rct
KM-	RT9167A-36PBR	LVR-IC	LDO, 3.6V±2%, 600mA, +CE	SOT-23-5	28vr1	VR7	6g	Rct
KM0	XC9235C40DMR	DC-DC-IC	PWM, st-dwn, 4.0V±2%, 600mA, 3MHz, Vin>2V, LSST, CL	SOT-25	28dc4	DC1	6g	Tor
KN	BU4929FWE	Vdet-IC	2.9V, +Reset PPO	VSOFF-5	30vk	VD7	6c	Rhm
KN	BU4929G	Vdet-IC	2.9V, +Reset PPO	SSOP-5	28vdm	VD7	6c	Rhm
KN	RT9167A-37CBR	LVR-IC	LDO, 3.7V±2%, 600mA, +CE	SOT-23-5	28vr1	VR7	6g	Rct
KP	BU4930FWE	Vdet-IC	3V, +Reset PPO	VSOFF-5	30vk	VD7	6c	Rhm
KP	BU4930G	Vdet-IC	3V, +Reset PPO	SSOP-5	28vdm	VD7	6c	Rhm
KQ	BU4931FWE	Vdet-IC	3.1V, +Reset PPO	VSOFF-5	30vk	VD7	6c	Rhm
KQ	BU4931G	Vdet-IC	3.1V, +Reset PPO	SSOP-5	28vdm	VD7	6c	Rhm
KR	BU4932FWE	Vdet-IC	3.2V, +Reset PPO	VSOFF-5	30vk	VD7	6c	Rhm
KR	BU4932G	Vdet-IC	3.2V, +Reset PPO	SSOP-5	28vdm	VD7	6c	Rhm
KR	R1112N151B	LVR-IC	LDO, LN, +CE, 1.5V±2%, 150mA	SOT-23-5	28cx	VR4	6g	Ric
KS	BU4933FWE	Vdet-IC	3.3V, +Reset PPO	VSOFF-5	30vk	VD7	6c	Rhm
KS	BU4933G	Vdet-IC	3.3V, +Reset PPO	SSOP-5	28vdm	VD7	6c	Rhm
KS	R1112N161B	LVR-IC	LDO, LN, +CE, 1.6V±2%, 150mA	SOT-23-5	28cx	VR4	6g	Ric
KT	BU4934FWE	Vdet-IC	3.4V, +Reset PPO	VSOFF-5	30vk	VD7	6c	Rhm
KT	BU4934G	Vdet-IC	3.4V, +Reset PPO	SSOP-5	28vdm	VD7	6c	Rhm
KT	R1112N171B	LVR-IC	LDO, LN, +CE, 1.7V±2%, 150mA	SOT-23-5	28cx	VR4	6g	Ric
KJ	BU4935FWE	Vdet-IC	3.5V, +Reset PPO	VSOFF-5	30vk	VD7	6c	Rhm
KJ	BU4935G	Vdet-IC	3.5V, +Reset PPO	SSOP-5	28vdm	VD7	6c	Rhm
KJ	R1112N181B	LVR-IC	LDO, LN, +CE, 1.8V±2%, 150mA	SOT-23-5	28cx	VR4	6g	Ric
KV	BU4936FWE	Vdet-IC	3.6V, +Reset PPO	VSOFF-5	30vk	VD7	6c	Rhm
KV	BU4936G	Vdet-IC	3.6V, +Reset PPO	SSOP-5	28vdm	VD7	6c	Rhm
KV	R1112N191B	LVR-IC	LDO, LN, +CE, 1.9V±2%, 150mA	SOT-23-5	28cx	VR4	6g	Ric
KV12	MIC5248-1.2YM5	LVR-IC	LDO, 1.2V±1%, 150mA, +CE, Error	SOT-23-5	28bw	VR8	6g	lMcR
KW	BU4937FWE	Vdet-IC	3.7V, +Reset PPO	VSOFF-5	30vk	VD7	6c	Rhm
KW	BU4937G	Vdet-IC	3.7V, +Reset PPO	SSOP-5	28vdm	VD7	6c	Rhm
KW	RT9167A-45CBR	LVR-IC	LDO, 4.3V±2%, 600mA, +CE	SOT-23-5	28vr1	VR7	6g	Rct



SMD code	Type	Function	Short description	Case	Pinout	Sch.	St.	Mnf.
KW25	MIC5255-2.5YM5	LVR-IC	LDO, 2.5V±1%, 150mA, +CE	SOT-23-5	28vrX	VR7	6g	Mcr
KX	BU4938FWE	Vdet-IC	3.8V, +Reset PPO	VSOFF-5	30vk	VD7	6c	Rhm
KX	BU4938G	Vdet-IC	3.8V, +Reset PPO	SSOP-5	28vdm	VD7	6c	Rhm
KY	BU4939FWE	Vdet-IC	3.9V, +Reset PPO	VSOFF-5	30vk	VD7	6c	Rhm
KY	BU4939G	Vdet-IC	3.9V, +Reset PPO	SSOP-5	28vdm	VD7	6c	Rhm
KY-	RT9198-26PV	LVR-IC	LDO, 2.6V±1%, 300mA, +CE	SOT-23-5	28xm	VR4	6a	Rct
KZ	BU4940FWE	Vdet-IC	4V, +Reset PPO	VSOFF-5	30vk	VD7	6c	Rhm
KZ	BU4940G	Vdet-IC	4V, +Reset PPO	SSOP-5	28vdm	VD7	6c	Rhm
L0	R1121N201A	LVR-IC	LDO, LN, -CE, 2V±2%, 150mA	SOT-23-5	28vt	VR4	6g	Ric
L0	RN5RG40AA	LVR-IC	Ext. transistor, 4V±2.5% 1A*	SOT-23-5	28vw	VR6	6g	Ric
L0	RT9168-15CBR	LVR-IC	LDO, 1.5V±2%, 200mA, +CE	SOT-23-5	28vt	VR4	6g	Rct
L0	RN5RY301A	DC/DC-IC	VFM step-up, 3V±2.5%, 150mW, <180kHz	SOT-23-5	28vd	DC5	6g	Ric
L001	R3134Q10EA	Vdet-IC	1.0V±1.8%, -Reset ODO, -MR	SC-88A	28z8	VD4	6m	Ric
L002	R3134Q11EA	Vdet-IC	1.1V±1.8%, -Reset ODO, -MR	SC-88A	28z8	VD4	6m	Ric
L003	R3134Q12EA	Vdet-IC	1.2V±1.8%, -Reset ODO, -MR	SC-88A	28z8	VD4	6m	Ric
L004	R3134Q13EA	Vdet-IC	1.3V±1.8%, -Reset ODO, -MR	SC-88A	28z8	VD4	6m	Ric
L005	R3134Q14EA	Vdet-IC	1.4V±1.8%, -Reset ODO, -MR	SC-88A	28z8	VD4	6m	Ric
L006	R3134Q15EA	Vdet-IC	1.5V±1.8%, -Reset ODO, -MR	SC-88A	28z8	VD4	6m	Ric
L007	R3134Q16EA	Vdet-IC	1.6V±1.8%, -Reset ODO, -MR	SC-88A	28z8	VD4	6m	Ric
L008	R3134Q17EA	Vdet-IC	1.7V±1.8%, -Reset ODO, -MR	SC-88A	28z8	VD4	6m	Ric
L009	R3134Q18EA	Vdet-IC	1.8V±1.8%, -Reset ODO, -MR	SC-88A	28z8	VD4	6m	Ric
L00A	LP2980AIM5-3.3	LVR-IC	ULDO, 3.3V±0.5%, 50mA, +CE	SOT-23-5	28cx	VR4	6g	Nsc
L00B	LP2980IM5-3.3	LVR-IC	ULDO, 3.3V±1%, 50mA, +CE	SOT-23-5	28cx	VR4	6g	Nsc
L010	R3134Q19EA	Vdet-IC	1.9V±1.8%, -Reset ODO, -MR	SC-88A	28z8	VD4	6m	Ric
L011	R3134Q20EA	Vdet-IC	2.0V±1.8%, -Reset ODO, -MR	SC-88A	28z8	VD4	6m	Ric
L012	R3134Q21EA	Vdet-IC	2.1V±1.8%, -Reset ODO, -MR	SC-88A	28z8	VD4	6m	Ric
L013	R3134Q22EA	Vdet-IC	2.2V±1.8%, -Reset ODO, -MR	SC-88A	28z8	VD4	6m	Ric
L014	R3134Q23EA	Vdet-IC	2.3V±1.8%, -Reset ODO, -MR	SC-88A	28z8	VD4	6m	Ric
L015	R3134Q24EA	Vdet-IC	2.4V±1.8%, -Reset ODO, -MR	SC-88A	28z8	VD4	6m	Ric
L016	R3134Q25EA	Vdet-IC	2.5V±1.8%, -Reset ODO, -MR	SC-88A	28z8	VD4	6m	Ric
L017	R3134Q26EA	Vdet-IC	2.6V±1.8%, -Reset ODO, -MR	SC-88A	28z8	VD4	6m	Ric
L018	R3134Q27EA	Vdet-IC	2.7V±1.8%, -Reset ODO, -MR	SC-88A	28z8	VD4	6m	Ric
L019	R3134Q28EA	Vdet-IC	2.8V±1.8%, -Reset ODO, -MR	SC-88A	28z8	VD4	6m	Ric
L01A	LP2980AIM5-5.0	LVR-IC	ULDO, 5.0V±0.5%, 50mA, +CE	SOT-23-5	28cx	VR4	6g	Nsc
L01B	LP2980BIM5-5.0	LVR-IC	Ultra-LDO, +CE, 5V±0.5%, 50mA	SOT-23-5	28cx	VR4	6g	Nsc
L01B	LP2980IM5-5.0	LVR-IC	ULDO, 5.0V±1%, 50mA, +CE	SOT-23-5	28cx	VR4	6g	Nsc
L020	R3134Q29EA	Vdet-IC	2.9V±1.8%, -Reset ODO, -MR	SC-88A	28z8	VD4	6m	Ric
L021	R3134Q30EA	Vdet-IC	3.0V±1.8%, -Reset ODO, -MR	SC-88A	28z8	VD4	6m	Ric
L022	R3134Q31EA	Vdet-IC	3.1V±1.8%, -Reset ODO, -MR	SC-88A	28z8	VD4	6m	Ric
L023	R3134Q32EA	Vdet-IC	3.2V±1.8%, -Reset ODO, -MR	SC-88A	28z8	VD4	6m	Ric
L024	R3134Q33EA	Vdet-IC	3.3V±1.8%, -Reset ODO, -MR	SC-88A	28z8	VD4	6m	Ric
L025	R3134Q34EA	Vdet-IC	3.4V±1.8%, -Reset ODO, -MR	SC-88A	28z8	VD4	6m	Ric
L026	R3134Q35EA	Vdet-IC	3.5V±1.8%, -Reset ODO, -MR	SC-88A	28z8	VD4	6m	Ric
L027	R3134Q36EA	Vdet-IC	3.6V±1.8%, -Reset ODO, -MR	SC-88A	28z8	VD4	6m	Ric
L028	R3134Q37EA	Vdet-IC	3.7V±1.8%, -Reset ODO, -MR	SC-88A	28z8	VD4	6m	Ric
L029	R3134Q38EA	Vdet-IC	3.8V±1.8%, -Reset ODO, -MR	SC-88A	28z8	VD4	6m	Ric
L02A	LP2980AIM5-3.0	LVR-IC	ULDO, 3.0V±0.5%, 50mA, +CE	SOT-23-5	28cx	VR4	6g	Nsc
L02B	LP2980IM5-3.0	LVR-IC	ULDO, 3.0V±1%, 50mA, +CE	SOT-23-5	28cx	VR4	6g	Nsc
L030	R3134Q39EA	Vdet-IC	3.9V±1.8%, -Reset ODO, -MR	SC-88A	28z8	VD4	6m	Ric
L031	R3134Q40EA	Vdet-IC	4.0V±1.8%, -Reset ODO, -MR	SC-88A	28z8	VD4	6m	Ric
L032	R3134Q41EA	Vdet-IC	4.1V±1.8%, -Reset ODO, -MR	SC-88A	28z8	VD4	6m	Ric
L033	R3134Q42EA	Vdet-IC	4.2V±1.8%, -Reset ODO, -MR	SC-88A	28z8	VD4	6m	Ric
L034	R3134Q43EA	Vdet-IC	4.3V±1.8%, -Reset ODO, -MR	SC-88A	28z8	VD4	6m	Ric
L035	R3134Q44EA	Vdet-IC	4.4V±1.8%, -Reset ODO, -MR	SC-88A	28z8	VD4	6m	Ric
L036	R3134Q45EA	Vdet-IC	4.5V±1.8%, -Reset ODO, -MR	SC-88A	28z8	VD4	6m	Ric
L037	R3134Q46EA	Vdet-IC	4.6V±1.8%, -Reset ODO, -MR	SC-88A	28z8	VD4	6m	Ric
L038	R3134Q47EA	Vdet-IC	4.7V±1.8%, -Reset ODO, -MR	SC-88A	28z8	VD4	6m	Ric
L039	R3134Q48EA	Vdet-IC	4.8V±1.8%, -Reset ODO, -MR	SC-88A	28z8	VD4	6m	Ric
L03A	LP2981AIM5-5.0	LVR-IC	Ultra-LDO, +CE, 5V±0.5%, 100mA	SOT-23-5	28cx	VR4	6g	Nsc
L03B	LP2981IM5-5.0	LVR-IC	Ultra-LDO, +CE, 5V±2%, 100mA	SOT-23-5	28cx	VR4	6g	Nsc
L040	R3134Q49EA	Vdet-IC	4.9V±1.8%, -Reset ODO, -MR	SC-88A	28z8	VD4	6m	Ric
L041	R3134Q50EA	Vdet-IC	5.0V±1.8%, -Reset ODO, -MR	SC-88A	28z8	VD4	6m	Ric
L042	R3134Q23EA2	Vdet-IC	2.32V±1.8%, -Reset ODO, -MR	SC-88A	28z8	VD4	6m	Ric
L043	R3134Q26EA3	Vdet-IC	2.63V±1.8%, -Reset ODO, -MR	SC-88A	28z8	VD4	6m	Ric
L044	R3134Q29EA3	Vdet-IC	2.93V±1.8%, -Reset ODO, -MR	SC-88A	28z8	VD4	6m	Ric
L045	R3134Q30EA8	Vdet-IC	3.08V±1.8%, -Reset ODO, -MR	SC-88A	28z8	VD4	6m	Ric
L046	R3134Q43EA8	Vdet-IC	4.38V±1.8%, -Reset ODO, -MR	SC-88A	28z8	VD4	6m	Ric
L047	R3134Q46EA3	Vdet-IC	4.63V±1.8%, -Reset ODO, -MR	SC-88A	28z8	VD4	6m	Ric
L04A	LP2981AIM5-3.3	LVR-IC	Ultra-LDO, +CE, 3.3V±0.5%, 100mA	SOT-23-5	28cx	VR4	6g	Nsc
L04B	LP2981IM5-3.3	LVR-IC	Ultra-LDO, +CE, 3.3V±2%, 100mA	SOT-23-5	28cx	VR4	6g	Nsc



SMD code	Type	Function	Short description	Case	Pinout	Sch.	St.	Mnf.
L05A	LP2981AIM5-3.0	LVR-IC	Ultra-LDO, +CE, 3V±0.5%, 100mA	SOT-23-5	28cx	VR4	6g	Nsc
L05B	LP2981IM5-3.0	LVR-IC	Ultra-LDO, +CE, 3V±2%, 100mA	SOT-23-5	28cx	VR4	6g	Nsc
L09	82C09-AF5-B	Vdet-IC	0.9V±2% -Reset PPO	SOT-23-5	28vda	VD7	6a	Utc
L09G	82C09G-AF5-B	Vdet-IC	0.9V±2% -Reset PPO, halogen free	SOT-23-5	28vda	VD7	6a	Utc
L09L	82C09L-AF5-B	Vdet-IC	0.9V±2% -Reset PPO, lead free	SOT-23-5	28vda	VD7	6a	Utc
L0A	RP400N421A	DC/DC-IC	PWM st-up, 700kHz, 4.2V±2%, 200mA, +CE	SOT-23-5	28zr	DC19	6g	Ric
L0A	XC6108N10AMR	Vdet-IC	1.0V±2%, Hysteresis, -Reset ODO	SOT-25	28rm	VD14	6g	Tor
L0B	RP400N431A	DC/DC-IC	PWM st-up, 700kHz, 4.3V±2%, 200mA, +CE	SOT-23-5	28zr	DC19	6g	Ric
L0B	XC6108N10BMR	Vdet-IC	1.0V±2%, -Reset ODO	SOT-25	28rm	VD14	6g	Tor
L0BA	LP2982AIM5-3.6	LVR-IC	Ultra-LDO, +CE, 3.6V, 50mA	SOT-23-5	28vrx	VR7	6g	Nsc
L0BB	LP2982IM5-3.6	LVR-IC	Ultra-LDO, +CE, 3.6V 50mA	SOT-23-5	28vrx	VR7	6g	Nsc
L0C	RP400N441A	DC/DC-IC	PWM st-up, 700kHz, 4.4V±2%, 200mA, +CE	SOT-23-5	28zr	DC19	6g	Ric
L0C	XC6108N10CMR	Vdet-IC	1.0V±2%, Hysteresis, -Reset ODO	SOT-25	28rk	VD14	6g	Tor
L0CA	LP2981AIM5-2.5	LVR-IC	Ultra-LDO, +CE, 2.5V±0.5%, 100mA	SOT-23-5	28cx	VR4	6g	Nsc
L0CB	LP2981IM5-2.5	LVR-IC	Ultra-LDO, +CE, 2.5V±2%, 100mA	SOT-23-5	28cx	VR4	6g	Nsc
L0D	RP400N451A	DC/DC-IC	PWM st-up, 700kHz, 4.5V±2%, 200mA, +CE	SOT-23-5	28zr	DC19	6g	Ric
L0D	XC6108N10DMR	Vdet-IC	1.0V±2%, -Reset ODO	SOT-25	28rk	VD14	6g	Tor
L0DA	LP2981AIM5-2.7	LVR-IC	Ultra-LDO, +CE, 2.7V±0.5%, 100mA	SOT-23-5	28cx	VR4	6g	Nsc
L0DB	LP2981IM5-2.7	LVR-IC	Ultra-LDO, +CE, 2.7V±2%, 100mA	SOT-23-5	28cx	VR4	6g	Nsc
L0E	RP400N461A	DC/DC-IC	PWM st-up, 700kHz, 4.6V±2%, 200mA, +CE	SOT-23-5	28zr	DC19	6g	Ric
L0F	RP400N471A	DC/DC-IC	PWM st-up, 700kHz, 4.7V±2%, 200mA, +CE	SOT-23-5	28zr	DC19	6g	Ric
L0G	RP400N481A	DC/DC-IC	PWM st-up, 700kHz, 4.8V±2%, 200mA, +CE	SOT-23-5	28zr	DC19	6g	Ric
L0GA	LP2981AIM5-4.7	LVR-IC	Ultra-LDO, +CE, 4.7V±0.5%, 100mA	SOT-23-5	28cx	VR4	6g	Nsc
L0GB	LP2981IM5-4.7	LVR-IC	Ultra-LDO, +CE, 4.7V±2%, 100mA	SOT-23-5	28cx	VR4	6g	Nsc
L0H	RP400N491A	DC/DC-IC	PWM st-up, 700kHz, 4.9V±2%, 200mA, +CE	SOT-23-5	28zr	DC19	6g	Ric
L0HA	LP2982AIM5-4.7	LVR-IC	Ultra-LDO, +CE, 4.7V 50mA	SOT-23-5	28vrx	VR7	6g	Nsc
L0HB	LP2982IM5-4.7	LVR-IC	Ultra-LDO, +CE, 4.7V, 50mA	SOT-23-5	28vrx	VR7	6g	Nsc
L0J	RP400N501A	DC/DC-IC	PWM st-up, 700kHz, 5.0V±2%, 200mA, +CE	SOT-23-5	28zr	DC19	6g	Ric
L0JA	LP2981AIM5-3.6	LVR-IC	Ultra-LDO, +CE, 3.6V±0.5%, 100mA	SOT-23-5	28cx	VR4	6g	Nsc
L0JB	LP2981IM5-3.6	LVR-IC	Ultra-LDO, +CE, 3.6V±2%, 100mA	SOT-23-5	28cx	VR4	6g	Nsc
L0KA	LP2985AIM5-2.8	LVR-IC	ULDO, 2.8V±1%, 150mA, +CE	SOT-23-5	28vrx	VR7	6g	Nsc
L0KB	LP2985IM5-2.8	LVR-IC	ULDO, 2.8V±2.5%, 150mA, +CE	SOT-23-5	28vrx	VR7	6g	Nsc
L0NA	LP2980AIM5-2.5	LVR-IC	ULDO, 2.5V±0.5%, 50mA, +CE	SOT-23-5	28cx	VR4	6g	Nsc
L0NB	LP2980IM5-2.5	LVR-IC	ULDO, 2.5V±1%, 50mA, +CE	SOT-23-5	28cx	VR4	6g	Nsc
L0OA	LP2985AIM5-3.0	LVR-IC	ULDO, 3.0V±1%, 150mA, +CE	SOT-23-5	28vrx	VR7	6g	Nsc
L0OB	LP2985IM5-3.0	LVR-IC	ULDO, 3.0V±2.5%, 150mA, +CE	SOT-23-5	28vrx	VR7	6g	Nsc
L0PA	LP2985AIM5-3.1	LVR-IC	ULDO, 3.1V±1%, 150mA, +CE	SOT-23-5	28vrx	VR7	6g	Nsc
L0PB	LP2985IM5-3.1	LVR-IC	ULDO, 3.1V±2.5%, 150mA, +CE	SOT-23-5	28vrx	VR7	6g	Nsc
L0QA	LP2985AIM5-3.2	LVR-IC	Ultra-LDO, LN, 3.2V, 150mA	SOT-23-5	28vrx	VR7	6g	Nsc
L0QB	LP2985IM5-3.2	LVR-IC	ULDO, 3.2V±2.5%, 150mA, +CE	SOT-23-5	28vrx	VR7	6g	Nsc
L0RA	LP2985AIM5-3.3	LVR-IC	ULDO, 3.2V±1%, 150mA, +CE	SOT-23-5	28vrx	VR7	6g	Nsc
L0RB	LP2985IM5-3.3	LVR-IC	ULDO, 3.3V±2.5%, 150mA, +CE	SOT-23-5	28vrx	VR7	6g	Nsc
L0SA	LP2985AIM5-3.6	LVR-IC	ULDO, 3.6V±1%, 150mA, +CE	SOT-23-5	28vrx	VR7	6g	Nsc
L0SB	LP2985IM5-3.6	LVR-IC	ULDO, 3.6V±2.5%, 150mA, +CE	SOT-23-5	28vrx	VR7	6g	Nsc
L0TA	LP2985AIM5-4.0	LVR-IC	ULDO, 4.0V±1%, 150mA, +CE	SOT-23-5	28vrx	VR7	6g	Nsc
L0TB	LP2985IM5-4.0	LVR-IC	ULDO, 4.0V±2.5%, 150mA, +CE	SOT-23-5	28vrx	VR7	6g	Nsc
L0UA	LP2985AIM5-5.0	LVR-IC	ULDO, 5.0V±1%, 150mA, +CE	SOT-23-5	28vrx	VR7	6g	Nsc
L0UB	LP2985IM5-5.0	LVR-IC	ULDO, 5.0V±2.5%, 150mA, +CE	SOT-23-5	28vrx	VR7	6g	Nsc
L0VA	LP2981AIM5-2.9	LVR-IC	Ultra-LDO, +CE, 2.9V±0.5%, 100mA	SOT-23-5	28cx	VR4	6g	Nsc
L0VB	LP2981IM5-2.9	LVR-IC	Ultra-LDO, +CE, 2.9V±2%, 100mA	SOT-23-5	28cx	VR4	6g	Nsc
L0XA	LP2980AIM5-4.5	LVR-IC	Ultra-LDO, +CE, 4.5V±0.5%, 50mA	SOT-23-5	28cx	VR4	6g	Nsc
L0XB	LP2980BIM5-4.5	LVR-IC	Ultra-LDO, +CE, 4.5V±1%, 50mA	SOT-23-5	28cx	VR4	6g	Nsc
L0YA	LP2985AIM5-3.8	LVR-IC	ULDO, 3.8V±1%, 150mA, +CE	SOT-23-5	28vrx	VR7	6g	Nsc
L0YB	LP2985IM5-3.8	LVR-IC	ULDO, 3.8V±2.5%, 150mA, +CE	SOT-23-5	28vrx	VR7	6g	Nsc
L0ZA	LP2981AIM5-4.0	LVR-IC	Ultra-LDO, +CE, 4V±0.5%, 100mA	SOT-23-5	28cx	VR4	6g	Nsc
L0ZB	LP2981IM5-4.0	LVR-IC	Ultra-LDO, +CE, 4V±2%, 100mA	SOT-23-5	28cx	VR4	6g	Nsc
L1	HD74LV1G00ACM	CMOS-Logic	2-input NAND gate	CMPAK-5	28/Log1	-	6a	Ren
L1	HD74LV1G00AVS	CMOS-Logic	2-input NAND gate	VSON-5	30/Log1	-	6a	Ren
L1	NL17SZ00DF	CMOS-Logic	2-input NAND gate	SOT-353	28/Log1	-	6b	Ons
L1	R1121N211A	LVR-IC	LDO, LN, -CE, 2.1V±2%, 150mA	SOT-23-5	28vt	VR4	6g	Ric
L1	RN5RG41AA	LVR-IC	Ext. transistor, 4.1V±2.5% 1A*	SOT-23-5	28vw	VR6	6g	Ric
L1	RT9168-16CBR	LVR-IC	LDO, 1.6V±2%, 200mA, +CE	SOT-23-5	28vt	VR4	6g	Rct
L1	TC7SL00F	CMOS-Logic	2-input NAND gate	SSOP-5	28/Log1	-	6a	Tos
L1	TC7SL00FU	CMOS-Logic	2-input NAND gate	SC-70-5	28/Log1	-	6a	Tos
L1	RN5RY311A	DC/DC-IC	VFM step-up, 3.1V±2.5%, 150mW, <180kHz	SOT-23-5	28vd	DC5	6g	Ric
L10	82C10-AF5-B	Vdet-IC	1.0V±2% -Reset PPO	SOT-23-5	28vda	VD7	6a	Utc
L10	R1224N102L	DC/DC-IC	PWM/FM step-down, 1V, 180kHz	SOT-23-5	28ud	DC7	6g	Ric
L10G	82C10G-AF5-B	Vdet-IC	1.0V±2% -Reset PPO, halogen free	SOT-23-5	28vda	VD7	6a	Utc
L10L	82C10L-AF5-B	Vdet-IC	1.0V±2% -Reset PPO, lead free	SOT-23-5	28vda	VD7	6a	Utc
L11	82C11-AF5-B	Vdet-IC	1.1V±2% -Reset PPO	SOT-23-5	28vda	VD7	6a	Utc



SMD code	Type	Function	Short description	Case	Pinout	Sch.	St.	Mnf.
L110	XC6366B101MR	DC/DC-IC	PWM/PFM st-down, 100kHz, Adj. 1.5..6V±2.5%, 1A, +CE	SOT-25	28zn	DC18	6g	Tor
L11G	82C11G-AF5-B	Vdet-IC	1.1V±2% -Reset PPO, halogen free	SOT-23-5	28vda	VD7	6a	Utc
L11L	82C11L-AF5-B	Vdet-IC	1.1V±2% -Reset PPO, lead free	SOT-23-5	28vda	VD7	6a	Utc
L12	82C12-AF5-B	Vdet-IC	1.2V±2% -Reset PPO	SOT-23-5	28vda	VD7	6a	Utc
L12	R1224N122L	DC/DC-IC	PWM/VFM step-down, 1.2V, 180kHz	SOT-23-5	28ud	DC7	6g	Ric
L12A	LP2980AIM5-2.9	LVR-IC	ULDO, 2.9V±0.5%, 50mA, +CE	SOT-23-5	28cx	VR4	6g	Nsc
L12B	LP2980BIM5-2.9	LVR-IC	Ultra-LDO, +CE, 2.9V±1%, 50mA	SOT-23-5	28cx	VR4	6g	Nsc
L12B	LP2980IM5-2.9	LVR-IC	ULDO, 2.9V±1%, 50mA, +CE	SOT-23-5	28cx	VR4	6g	Nsc
L12G	82C12G-AF5-B	Vdet-IC	1.2V±2% -Reset PPO, halogen free	SOT-23-5	28vda	VD7	6a	Utc
L12L	82C12L-AF5-B	Vdet-IC	1.2V±2% -Reset PPO, lead free	SOT-23-5	28vda	VD7	6a	Utc
L13	82C13-AF5-B	Vdet-IC	1.3V±2% -Reset PPO	SOT-23-5	28vda	VD7	6a	Utc
L13	TK11613SCL	LVR-IC	LDO, 1.3V±2%, 150mA, +CE, -30..+80°C	SOT-23-5	28vrx	VR7	6k	Tok
L13A	LP2980AIM5-2.8	LVR-IC	ULDO, 2.8V±0.5%, 50mA, +CE	SOT-23-5	28cx	VR4	6g	Nsc
L13B	LP2980BIM5-2.8	LVR-IC	Ultra-LDO, +CE, 2.8V±1%, 50mA	SOT-23-5	28cx	VR4	6g	Nsc
L13B	LP2980IM5-2.8	LVR-IC	ULDO, 2.8V±1%, 50mA, +CE	SOT-23-5	28cx	VR4	6g	Nsc
L13G	82C13G-AF5-B	Vdet-IC	1.3V±2% -Reset PPO, halogen free	SOT-23-5	28vda	VD7	6a	Utc
L13L	82C13L-AF5-B	Vdet-IC	1.3V±2% -Reset PPO, lead free	SOT-23-5	28vda	VD7	6a	Utc
L14	82C14-AF5-B	Vdet-IC	1.4V±2% -Reset PPO	SOT-23-5	28vda	VD7	6a	Utc
L14	TK11614SCL	LVR-IC	LDO, 1.4V±2%, 150mA, +CE, -30..+80°C	SOT-23-5	28vrx	VR7	6k	Tok
L14G	82C14G-AF5-B	Vdet-IC	1.4V±2% -Reset PPO, halogen free	SOT-23-5	28vda	VD7	6a	Utc
L14L	82C14L-AF5-B	Vdet-IC	1.4V±2% -Reset PPO, lead free	SOT-23-5	28vda	VD7	6a	Utc
L15	82C15-AF5-B	Vdet-IC	1.5V±2% -Reset PPO	SOT-23-5	28vda	VD7	6a	Utc
L15	R1224N152L	DC/DC-IC	PWM/VFM step-down, 1.5V, 180kHz	SOT-23-5	28ud	DC7	6g	Ric
L15	TK11615SCL	LVR-IC	LDO, 1.5V±2%, 150mA, +CE, -30..+80°C	SOT-23-5	28vrx	VR7	6k	Tok
L15G	82C15G-AF5-B	Vdet-IC	1.5V±2% -Reset PPO, halogen free	SOT-23-5	28vda	VD7	6a	Utc
L15L	82C15L-AF5-B	Vdet-IC	1.5V±2% -Reset PPO, lead free	SOT-23-5	28vda	VD7	6a	Utc
L16	82C16-AF5-B	Vdet-IC	1.6V±2% -Reset PPO	SOT-23-5	28vda	VD7	6a	Utc
L16	TK11616SCL	LVR-IC	LDO, 1.6V±2%, 150mA, +CE, -30..+80°C	SOT-23-5	28vrx	VR7	6k	Tok
L16G	82C16G-AF5-B	Vdet-IC	1.6V±2% -Reset PPO, halogen free	SOT-23-5	28vda	VD7	6a	Utc
L16L	82C16L-AF5-B	Vdet-IC	1.6V±2% -Reset PPO, lead free	SOT-23-5	28vda	VD7	6a	Utc
L17	82C17-AF5-B	Vdet-IC	1.7V±2% -Reset PPO	SOT-23-5	28vda	VD7	6a	Utc
L17	TK11617SCL	LVR-IC	LDO, 1.7V±2%, 150mA, +CE, -30..+80°C	SOT-23-5	28vrx	VR7	6k	Tok
L17G	82C17G-AF5-B	Vdet-IC	1.7V±2% -Reset PPO, halogen free	SOT-23-5	28vda	VD7	6a	Utc
L17L	82C17L-AF5-B	Vdet-IC	1.7V±2% -Reset PPO, lead free	SOT-23-5	28vda	VD7	6a	Utc
L18	82C18-AF5-B	Vdet-IC	1.8V±2% -Reset PPO	SOT-23-5	28vda	VD7	6a	Utc
L18	R1224N182L	DC/DC-IC	PWM/VFM step-down, 1.8V, 180kHz	SOT-23-5	28ud	DC7	6g	Ric
L18	TK11618SCL	LVR-IC	LDO, 1.8V±2%, 150mA, +CE, -30..+80°C	SOT-23-5	28vrx	VR7	6k	Tok
L18A	LP2982AIM5-5.0	LVR-IC	Ultra-LDO, +CE, 5V 50mA	SOT-23-5	28vrx	VR7	6g	Nsc
L18B	LP2982IM5-5.0	LVR-IC	Ultra-LDO, +CE, 5V 50mA	SOT-23-5	28vrx	VR7	6g	Nsc
L18G	82C18G-AF5-B	Vdet-IC	1.8V±2% -Reset PPO, halogen free	SOT-23-5	28vda	VD7	6a	Utc
L18L	82C18L-AF5-B	Vdet-IC	1.8V±2% -Reset PPO, lead free	SOT-23-5	28vda	VD7	6a	Utc
L19	82C19-AF5-B	Vdet-IC	1.9V±2% -Reset PPO	SOT-23-5	28vda	VD7	6a	Utc
L19	TK11619SCL	LVR-IC	LDO, 1.9V±2%, 150mA, +CE, -30..+80°C	SOT-23-5	28vrx	VR7	6k	Tok
L19A	LP2982AIM5-3.3	LVR-IC	Ultra-LDO, +CE, 3.3V, 50mA	SOT-23-5	28vrx	VR7	6g	Nsc
L19B	LP2982IM5-3.3	LVR-IC	Ultra-LDO, +CE, 3.3V 50mA	SOT-23-5	28vrx	VR7	6g	Nsc
L19G	82C19G-AF5-B	Vdet-IC	1.9V±2% -Reset PPO, halogen free	SOT-23-5	28vda	VD7	6a	Utc
L19L	82C19L-AF5-B	Vdet-IC	1.9V±2% -Reset PPO, lead free	SOT-23-5	28vda	VD7	6a	Utc
L1A	RP400N421C	DC/DC-IC	PWM st-up, 700kHz, 4.2V±2%, 200mA, +CE	SOT-23-5	28zr	DC19	6g	Ric
L1A	XC6108N11AMR	Vdet-IC	1.1V±2%, Hysteresis, -Reset ODO	SOT-25	28fm	VD14	6g	Tor
L1B	RP400N431C	DC/DC-IC	PWM st-up, 700kHz, 4.3V±2%, 200mA, +CE	SOT-23-5	28zr	DC19	6g	Ric
L1B	XC6108N11BMR	Vdet-IC	1.1V±2%, -Reset ODO	SOT-25	28rm	VD14	6g	Ric
L1C	RP400N441C	DC/DC-IC	PWM st-up, 700kHz, 4.4V±2%, 200mA, +CE	SOT-23-5	28zr	DC19	6g	Ric
L1C	XC6108N11CMR	Vdet-IC	1.1V±2%, Hysteresis, -Reset ODO	SOT-25	28rk	VD14	6g	Tor
L1D	RP400N451C	DC/DC-IC	PWM st-up, 700kHz, 4.5V±2%, 200mA, +CE	SOT-23-5	28zr	DC19	6g	Ric
L1D	XC6108N11DMR	Vdet-IC	1.1V±2%, -Reset ODO	SOT-25	28rk	VD14	6g	Tor
L1E	RP400N461C	DC/DC-IC	PWM st-up, 700kHz, 4.6V±2%, 200mA, +CE	SOT-23-5	28zr	DC19	6g	Ric
L1F	RP400N471C	DC/DC-IC	PWM st-up, 700kHz, 4.7V±2%, 200mA, +CE	SOT-23-5	28zr	DC19	6g	Ric
L1G	RP400N481C	DC/DC-IC	PWM st-up, 700kHz, 4.8V±2%, 200mA, +CE	SOT-23-5	28zr	DC19	6g	Ric
L1H	RP400N491C	DC/DC-IC	PWM st-up, 700kHz, 4.9V±2%, 200mA, +CE	SOT-23-5	28zr	DC19	6g	Ric
L1J	RP400N501C	DC/DC-IC	PWM st-up, 700kHz, 5.0V±2%, 200mA, +CE	SOT-23-5	28zr	DC19	6g	Ric
L2	HD74LV1G08ACM	CMOS-Logic	2-input AND gate	CMPAK-5	28/Log3	-	6a	Ren
L2	HD74LV1G08AVS	CMOS-Logic	2-input AND gate	VSON-5	30/Log3	-	6a	Ren
L2	NL17SZ08DF	CMOS-Logic	2-input AND gate	SC-70-5	28/Log3	-	6b	Ons
L2	R1121N221A	LVR-IC	LDO, LN, -CE, 2.2V±2%, 150mA	SOT-23-5	28vt	VR4	6g	Ric
L2	RN5RG42AA	LVR-IC	Ext. transistor, 4.2V±2.5% 1A*	SOT-23-5	28vw	VR6	6g	Ric
L2	RT9168-17CBR	LVR-IC	LDO, 1.7V±2%, 200mA, +CE	SOT-23-5	28vt	VR4	6g	Ric
L2	TC7SL08F	CMOS-Logic	2-input AND gate	SSOP-5	28/Log3	-	6a	Tos
L2	TC7SL08FU	CMOS-Logic	2-input AND gate	SC-70-5	28/Log3	-	6a	Tos
L2	RN5RY321A	DC/DC-IC	VFM step-up, 3.2V±2.5%, 150mW, <180kHz	SOT-23-5	28vd	DC5	6g	Ric
L20	82C20-AF5-B	Vdet-IC	2.0V±2% -Reset PPO	SOT-23-5	28vda	VD7	6a	Utc



SMD code	Type	Function	Short description	Case	Pinout	Sch.	St.	Mnf.
L20	TK71620SCL	LVR-IC	LDO, 2V±2%, 150mA, +CE, -30...+80°C	SOT-23-5	28vrx	VR7	6k	Tok
L20A	LP2982AIM5-3.0	LVR-IC	Ultra-LDO, +CE, 3V, 50mA	SOT-23-5	28vrx	VR7	6g	Nsc
L20B	LP2982IM5-3.0	LVR-IC	Ultra-LDO, +CE, 3V, 50mA	SOT-23-5	28vrx	VR7	6g	Nsc
L20G	82C20G-AF5-B	Vdet-IC	2.0V±2% -Reset PPO, halogen free	SOT-23-5	28vda	VD7	6a	Utc
L20L	82C20L-AF5-B	Vdet-IC	2.0V±2% -Reset PPO, lead free	SOT-23-5	28vda	VD7	6a	Utc
L21	82C21-AF5-B	Vdet-IC	2.1V±2% -Reset PPO	SOT-23-5	28vda	VD7	6a	Utc
L21	TK71621SCL	LVR-IC	LDO, 2.1V±2%, 150mA, +CE, -30...+80°C	SOT-23-5	28vrx	VR7	6k	Tok
L210	XC6366B102MR	DC/DC-IC	PWM/PFM st-down, 180kHz, Adj. 1.5..6V±2.5%, 1A, +CE	SOT-25	28zn	DC18	6g	Tor
L215	MIC5235-1.5BM5	LVR-IC	LDO, 1.5V±2%, 150mA, +CE	SOT-23-5	28cx	VR4	6g	Mcr
L218	MIC5235-1.8BM5	LVR-IC	LDO, 1.8V±2%, 150mA, +CE	SOT-23-5	28cx	VR4	6g	Mcr
L21A	LP2980AIM5-3.8	LVR-IC	ULDO, 3.8V±0.5%, 50mA, +CE	SOT-23-5	28cx	VR4	6g	Nsc
L21B	LP2980BIM5-3.8	LVR-IC	Ultra-LDO, +CE, 3.8V±1%, 50mA	SOT-23-5	28cx	VR4	6g	Nsc
L21B	LP2980IM5-3.8	LVR-IC	ULDO, 3.8V±1%, 50mA, +CE	SOT-23-5	28cx	VR4	6g	Nsc
L21G	82C21G-AF5-B	Vdet-IC	2.1V±2% -Reset PPO, halogen free	SOT-23-5	28vda	VD7	6a	Utc
L21L	82C21L-AF5-B	Vdet-IC	2.1V±2% -Reset PPO, lead free	SOT-23-5	28vda	VD7	6a	Utc
L22	82C22-AF5-B	Vdet-IC	2.2V±2% -Reset PPO	SOT-23-5	28vda	VD7	6a	Utc
L22	TK71622SCL	LVR-IC	LDO, 2.2V±2%, 150mA, +CE, -30...+80°C	SOT-23-5	28vrx	VR7	6k	Tok
L225	MIC5235-2.5BM5	LVR-IC	LDO, 2.5V±2%, 150mA, +CE	SOT-23-5	28cx	VR4	6g	Mcr
L227	MIC5235-2.7BM5	LVR-IC	LDO, 2.7V±2%, 150mA, +CE	SOT-23-5	28cx	VR4	6g	Mcr
L22G	82C22G-AF5-B	Vdet-IC	2.2V±2% -Reset PPO, halogen free	SOT-23-5	28vda	VD7	6a	Utc
L22L	82C22L-AF5-B	Vdet-IC	2.2V±2% -Reset PPO, lead free	SOT-23-5	28vda	VD7	6a	Utc
L23	82C23-AF5-B	Vdet-IC	2.3V±2% -Reset PPO	SOT-23-5	28vda	VD7	6a	Utc
L23	LP5951MF-1.3	LVR-IC	LDO, 1.3V±2%, 150mA, +CE	SC-70-5	28cx	VR4	6a	Nsc
L23	TK71623SCL	LVR-IC	LDO, 2.3V±2%, 150mA, +CE, -30...+80°C	SOT-23-5	28vrx	VR7	6k	Tok
L230	MIC5235-3.0BM5	LVR-IC	LDO, 3.0V±2%, 150mA, +CE	SOT-23-5	28cx	VR4	6g	Mcr
L233	MIC5235-3.3BM5	LVR-IC	LDO, 3.3V±2%, 150mA, +CE	SOT-23-5	28cx	VR4	6g	Mcr
L23G	82C23G-AF5-B	Vdet-IC	2.3V±2% -Reset PPO, halogen free	SOT-23-5	28vda	VD7	6a	Utc
L23L	82C23L-AF5-B	Vdet-IC	2.3V±2% -Reset PPO, lead free	SOT-23-5	28vda	VD7	6a	Utc
L24	82C24-AF5-B	Vdet-IC	2.4V±2% -Reset PPO	SOT-23-5	28vda	VD7	6a	Utc
L24	TK71624SCL	LVR-IC	LDO, 2.4V±2%, 150mA, +CE, -30...+80°C	SOT-23-5	28vrx	VR7	6k	Tok
L24G	82C24G-AF5-B	Vdet-IC	2.4V±2% -Reset PPO, halogen free	SOT-23-5	28vda	VD7	6a	Utc
L24L	82C24L-AF5-B	Vdet-IC	2.4V±2% -Reset PPO, lead free	SOT-23-5	28vda	VD7	6a	Utc
L25	82C25-AF5-B	Vdet-IC	2.5V±2% -Reset PPO	SOT-23-5	28vda	VD7	6a	Utc
L25	MC33761SNT1-25	LVR-IC	LDO, ULN, +CE, 2.5V±1.5%, 80mA	SOT-23-5	28cx	VR4	6b	Ons
L25	R1224N25L	DC/DC-IC	PWM/FM step-down, 2.5V, 180kHz	SOT-23-5	28ud	DC7	6g	Ric
L25	TK71625SCL	LVR-IC	LDO, 2.5V±2%, 150mA, +CE, -30...+80°C	SOT-23-5	28vrx	VR7	6k	Tok
L250	MIC5235-5.0BM5	LVR-IC	LDO, 5.0V±2%, 150mA, +CE	SOT-23-5	28cx	VR4	6g	Mcr
L25A	LP2980AIM5-4.0	LVR-IC	Ultra-LDO, +CE, 4V±0.5%, 50mA	SOT-23-5	28cx	VR4	6g	Nsc
L25B	LP2980BIM5-4.0	LVR-IC	Ultra-LDO, +CE, 4V±1%, 50mA	SOT-23-5	28cx	VR4	6g	Nsc
L25G	82C25G-AF5-B	Vdet-IC	2.5V±2% -Reset PPO, halogen free	SOT-23-5	28vda	VD7	6a	Utc
L25L	82C25L-AF5-B	Vdet-IC	2.5V±2% -Reset PPO, lead free	SOT-23-5	28vda	VD7	6a	Utc
L26	82C26-AF5-B	Vdet-IC	2.6V±2% -Reset PPO	SOT-23-5	28vda	VD7	6a	Utc
L26	TK71626SCL	LVR-IC	LDO, 2.6V±2%, 150mA, +CE, -30...+80°C	SOT-23-5	28vrx	VR7	6k	Tok
L26A	LP2980AIM5-2.7	LVR-IC	Ultra-LDO, +CE, 2.7V±0.5%, 50mA	SOT-23-5	28cx	VR4	6g	Nsc
L26B	LP2980BIM5-2.7	LVR-IC	Ultra-LDO, +CE, 2.7V±1%, 50mA	SOT-23-5	28cx	VR4	6g	Nsc
L26G	82C26G-AF5-B	Vdet-IC	2.6V±2% -Reset PPO, halogen free	SOT-23-5	28vda	VD7	6a	Utc
L26L	82C26L-AF5-B	Vdet-IC	2.6V±2% -Reset PPO, lead free	SOT-23-5	28vda	VD7	6a	Utc
L27	82C27-AF5-B	Vdet-IC	2.7V±2% -Reset PPO	SOT-23-5	28vda	VD7	6a	Utc
L27	TK71627SCL	LVR-IC	LDO, 2.7V±2%, 150mA, +CE, -30...+80°C	SOT-23-5	28vrx	VR7	6k	Tok
L27A	LP2980AIM5-3.5	LVR-IC	Ultra-LDO, +CE, 3.5V±0.5%, 50mA	SOT-23-5	28cx	VR4	6g	Nsc
L27B	LP2980BIM5-3.5	LVR-IC	Ultra-LDO, +CE, 3.5V±1%, 50mA	SOT-23-5	28cx	VR4	6g	Nsc
L27G	82C27G-AF5-B	Vdet-IC	2.7V±2% -Reset PPO, halogen free	SOT-23-5	28vda	VD7	6a	Utc
L27L	82C27L-AF5-B	Vdet-IC	2.7V±2% -Reset PPO, lead free	SOT-23-5	28vda	VD7	6a	Utc
L28	82C28-AF5-B	Vdet-IC	2.8V±2% -Reset PPO	SOT-23-5	28vda	VD7	6a	Utc
L28	MC33761SNT1-28	LVR-IC	LDO, ULN, +CE, 2.8V±1.5%, 80mA	SOT-23-5	28cx	VR4	6b	Ons
L28	TK71628SCL	LVR-IC	LDO, 2.8V±2%, 150mA, +CE, -30...+80°C	SOT-23-5	28vrx	VR7	6k	Tok
L28A	LP2980AIM5-3.6	LVR-IC	Ultra-LDO, +CE, 3.6V±0.5%, 50mA	SOT-23-5	28cx	VR4	6g	Nsc
L28B	LP2980BIM5-3.6	LVR-IC	Ultra-LDO, +CE, 3.6V±1%, 50mA	SOT-23-5	28cx	VR4	6g	Nsc
L28G	82C28G-AF5-B	Vdet-IC	2.8V±2% -Reset PPO, halogen free	SOT-23-5	28vda	VD7	6a	Utc
L28L	82C28L-AF5-B	Vdet-IC	2.8V±2% -Reset PPO, lead free	SOT-23-5	28vda	VD7	6a	Utc
L29	82C29-AF5-B	Vdet-IC	2.9V±2% -Reset PPO	SOT-23-5	28vda	VD7	6a	Utc
L29	TK71629SCL	LVR-IC	LDO, 2.9V±2%, 150mA, +CE, -30...+80°C	SOT-23-5	28vrx	VR7	6k	Tok
L29A	LP2982AIM5-4.0	LVR-IC	Ultra-LDO, +CE, 4V, 50mA	SOT-23-5	28vrx	VR7	6g	Nsc
L29B	LP2982IM5-4.0	LVR-IC	Ultra-LDO, +CE, 4V, 50mA	SOT-23-5	28vrx	VR7	6g	Nsc
L29G	82C29G-AF5-B	Vdet-IC	2.9V±2% -Reset PPO, halogen free	SOT-23-5	28vda	VD7	6a	Utc
L29L	82C29L-AF5-B	Vdet-IC	2.9V±2% -Reset PPO, lead free	SOT-23-5	28vda	VD7	6a	Utc
L2A	RP400N421B	DC/DC-IC	PWM st-up, 700kHz, 4.2V±2%, 200mA	SOT-23-5	28zs	DC4	6g	Ric
L2A	XC6108N12AMR	Vdet-IC	1.2V±2%, Hysteresis, -Reset ODO	SOT-25	28rm	VD14	6g	Tor
L2AA	MIC5235BM5	LVR-IC	LDO, Adjustable 0.9..5.0V, 150mA	SOT-23-5	28sg	VR16	6g	Mcr
L2B	LP5951MF-1.5	LVR-IC	LDO, 1.5V±2%, 150mA, +CE	SC-70-5	28cx	VR4	6a	Nsc



SMD code	Type	Function	Short description	Case	Pinout	Sch.	St.	Mnf.
L2B	RP400N431B	DC/DC-IC	PWM st-up, 700kHz, 4.3V±2%, 200mA	SOT-23-5	28zs	DC4	6g	Ric
L2B	XC6108N12BMR	Vdet-IC	1.2V±2%, -Reset ODO	SOT-25	28rm	VD14	6g	Tor
L2C	RP400N441B	DC/DC-IC	PWM st-up, 700kHz, 4.4V±2%, 200mA	SOT-23-5	28zs	DC4	6g	Ric
L2C	XC6108N12CMR	Vdet-IC	1.2V±2%, Hysteresis, -Reset ODO	SOT-25	28rk	VD14	6g	Tor
L2D	RP400N451B	DC/DC-IC	PWM st-up, 700kHz, 4.5V±2%, 200mA	SOT-23-5	28zs	DC4	6g	Ric
L2D	XC6108N12DMR	Vdet-IC	1.2V±2%, -Reset ODO	SOT-25	28rk	VD14	6g	Tor
L2E	RP400N461B	DC/DC-IC	PWM st-up, 700kHz, 4.6V±2%, 200mA	SOT-23-5	28zs	DC4	6g	Ric
L2F	RP400N471B	DC/DC-IC	PWM st-up, 700kHz, 4.7V±2%, 200mA	SOT-23-5	28zs	DC4	6g	Ric
L2G	RP400N481B	DC/DC-IC	PWM st-up, 700kHz, 4.8V±2%, 200mA	SOT-23-5	28zs	DC4	6g	Ric
L2H	RP400N491B	DC/DC-IC	PWM st-up, 700kHz, 4.9V±2%, 200mA	SOT-23-5	28zs	DC4	6g	Ric
L2J	RP400N501B	DC/DC-IC	PWM st-up, 700kHz, 5.0V±2%, 200mA	SOT-23-5	28zs	DC4	6g	Ric
L3	HD74LV1G02ACM	CMOS-Logic	2-input NOR gate	CMPAK-5	28/Log2	-	6a	Ren
L3	HD74LV1G02AVS	CMOS-Logic	2-input NOR gate	VSON-5	30/Log2	-	6a	Ren
L3	NL17SZ02DF	CMOS-Logic	2-input NOR gate	SOT-353	28/Log2	-	6b	Ons
L3	R1121N231A	LVR-IC	LDO, LN, -CE, 2.3V±2%, 150mA	SOT-23-5	28vt	VR4	6g	Ric
L3	RN5RG43AA	LVR-IC	Ext. transistor, 4.3V±2.5% 1A*	SOT-23-5	28vw	VR6	6g	Ric
L3	RT9168-18CBR	LVR-IC	LDO, 1.8V±2%, 200mA, +CE	SOT-23-5	28vt	VR4	6g	Rct
L3	TC7SL02F	CMOS-Logic	2-input NOR gate	SSOP-5	28/Log2	-	6a	Tos
L3	TC7SL02FU	CMOS-Logic	2-input NOR gate	SC-70-5	28/Log2	-	6a	Tos
L3	RN5RY331A	DC/DC-IC	VFM step-up, 3.3V±2.5%, 150mW, <180kHz	SOT-23-5	28vd	DC5	6g	Ric
L30	82C30-AF5-B	Vdet-IC	3.0V±2% -Reset PPO	SOT-23-5	28vda	VD7	6a	Utc
L30	MC33761SNT1-30	LVR-IC	LDO, ULN, +CE, 3V±1.5%, 80mA	SOT-23-5	28vcx	VR4	6b	Ons
L30	R1224N302L	DC/DC-IC	PWM/VFM step-down, 3V, 180kHz	SOT-23-5	28ud	DC7	6g	Ric
L30	TK17630SCL	LVR-IC	LDO, 3V±2%, 150mA, +CE, -30...+80°C	SOT-23-5	28vrx	VR7	6k	Tok
L30A	LP2980AIM5-3.1	LVR-IC	Ultra-LDO, +CE, 3.1V±0.5%, 50mA	SOT-23-5	28vcx	VR4	6g	Nsc
L30B	LP2980BIM5-3.1	LVR-IC	Ultra-LDO, +CE, 3.1V±1%, 50mA	SOT-23-5	28cx	VR4	6g	Nsc
L30G	82C30G-AF5-B	Vdet-IC	3.0V±2% -Reset PPO, halogen free	SOT-23-5	28vda	VD7	6a	Utc
L30L	82C30L-AF5-B	Vdet-IC	3.0V±2% -Reset PPO, lead free	SOT-23-5	28vda	VD7	6a	Utc
L31	82C31-AF5-B	Vdet-IC	3.1V±2% -Reset PPO	SOT-23-5	28vda	VD7	6a	Utc
L31	TK17631SCL	LVR-IC	LDO, 3.1V±2%, 150mA, +CE, -30...+80°C	SOT-23-5	28vrx	VR7	6k	Tok
L310	XC6366B103MR	DC/DC-IC	PWM/PPM st-down, 300kHz, Adj. 1.5..6V±2.5%, 1A, +CE	SOT-25	28zn	DC18	6g	Tor
L318	MIC5233-1.8BIM5	LVR-IC	LDO, 1.8V±2%, 150mA, +CE	SOT-23-5	28cx	VR4	6g	Mcr
L31A	LP2980AIM5-3.2	LVR-IC	ULDO, 3.2V±0.5%, 50mA, +CE	SOT-23-5	28cx	VR4	6g	Nsc
L31B	LP2980BIM5-3.2	LVR-IC	ULDO, 3.2V±1%, 50mA, +CE	SOT-23-5	28cx	VR4	6g	Nsc
L31G	82C31G-AF5-B	Vdet-IC	3.1V±2% -Reset PPO, halogen free	SOT-23-5	28vda	VD7	6a	Utc
L31L	82C31L-AF5-B	Vdet-IC	3.1V±2% -Reset PPO, lead free	SOT-23-5	28vda	VD7	6a	Utc
L32	82C32-AF5-B	Vdet-IC	3.2V±2% -Reset PPO	SOT-23-5	28vda	VD7	6a	Utc
L32	TK17632SCL	LVR-IC	LDO, 3.2V±2%, 150mA, +CE, -30...+80°C	SOT-23-5	28vrx	VR7	6k	Tok
L325	MIC5233-2.5BIM5	LVR-IC	LDO, 2.5V±2%, 150mA, +CE	SOT-23-5	28cx	VR4	6g	Mcr
L32G	82C32G-AF5-B	Vdet-IC	3.2V±2% -Reset PPO, halogen free	SOT-23-5	28vda	VD7	6a	Utc
L32L	82C32L-AF5-B	Vdet-IC	3.2V±2% -Reset PPO, lead free	SOT-23-5	28vda	VD7	6a	Utc
L33	82C33-AF5-B	Vdet-IC	3.3V±2% -Reset PPO	SOT-23-5	28vda	VD7	6a	Utc
L33	R1224N332L	DC/DC-IC	PWM/FM step-down, 3.3V, 180kHz	SOT-23-5	28ud	DC7	6g	Ric
L33	TK17633SCL	LVR-IC	LDO, 3.3V±2%, 150mA, +CE, -30...+80°C	SOT-23-5	28vrx	VR7	6k	Tok
L330	MIC5233-3.0BIM5	LVR-IC	LDO, 3.0V±2%, 150mA, +CE	SOT-23-5	28cx	VR4	6g	Mcr
L333	MIC5233-3.3BIM5	LVR-IC	LDO, 3.3V±2%, 150mA, +CE	SOT-23-5	28cx	VR4	6g	Mcr
L33G	82C33G-AF5-B	Vdet-IC	3.3V±2% -Reset PPO, halogen free	SOT-23-5	28vda	VD7	6a	Utc
L33L	82C33L-AF5-B	Vdet-IC	3.3V±2% -Reset PPO, lead free	SOT-23-5	28vda	VD7	6a	Utc
L34	82C34-AF5-B	Vdet-IC	3.4V±2% -Reset PPO	SOT-23-5	28vda	VD7	6a	Utc
L34	TK17634SCL	LVR-IC	LDO, 3.4V±2%, 150mA, +CE, -30...+80°C	SOT-23-5	28vrx	VR7	6k	Tok
L34G	82C34G-AF5-B	Vdet-IC	3.4V±2% -Reset PPO, halogen free	SOT-23-5	28vda	VD7	6a	Utc
L34L	82C34L-AF5-B	Vdet-IC	3.4V±2% -Reset PPO, lead free	SOT-23-5	28vda	VD7	6a	Utc
L35	82C35-AF5-B	Vdet-IC	3.5V±2% -Reset PPO	SOT-23-5	28vda	VD7	6a	Utc
L35	TK17635SCL	LVR-IC	LDO, 3.5V±2%, 150mA, +CE, -30...+80°C	SOT-23-5	28vrx	VR7	6k	Tok
L350	MIC5233-5.0BIM5	LVR-IC	LDO, 5.9V±2%, 150mA, +CE	SOT-23-5	28cx	VR4	6g	Mcr
L35A	LP2981AIM5-3.2	LVR-IC	Ultra-LDO, +CE, 3.2V±0.5%, 100mA	SOT-23-5	28cx	VR4	6g	Nsc
L35B	LP2981IM5-3.2	LVR-IC	Ultra-LDO, +CE, 3.2V±2%, 100mA	SOT-23-5	28cx	VR4	6g	Nsc
L35G	82C35G-AF5-B	Vdet-IC	3.5V±2% -Reset PPO, halogen free	SOT-23-5	28vda	VD7	6a	Utc
L35L	82C35L-AF5-B	Vdet-IC	3.5V±2% -Reset PPO, lead free	SOT-23-5	28vda	VD7	6a	Utc
L36	82C36-AF5-B	Vdet-IC	3.6V±2% -Reset PPO	SOT-23-5	28vda	VD7	6a	Utc
L36	TK17636SCL	LVR-IC	LDO, 3.6V±2%, 150mA, +CE, -30...+80°C	SOT-23-5	28vrx	VR7	6k	Tok
L36A	LP2981AIM5-3.8	LVR-IC	Ultra-LDO, +CE, 3.8V±0.5%, 100mA	SOT-23-5	28cx	VR4	6g	Nsc
L36B	LP2981IM5-3.8	LVR-IC	Ultra-LDO, +CE, 3.8V±2%, 100mA	SOT-23-5	28cx	VR4	6g	Nsc
L36G	82C36G-AF5-B	Vdet-IC	3.6V±2% -Reset PPO, halogen free	SOT-23-5	28vda	VD7	6a	Utc
L36L	82C36L-AF5-B	Vdet-IC	3.6V±2% -Reset PPO, lead free	SOT-23-5	28vda	VD7	6a	Utc
L37	82C37-AF5-B	Vdet-IC	3.7V±2% -Reset PPO	SOT-23-5	28vda	VD7	6a	Utc
L37	TK17637SCL	LVR-IC	LDO, 3.7V±2%, 150mA, +CE, -30...+80°C	SOT-23-5	28vrx	VR7	6k	Tok
L37A	LP2980AIM5-4.7	LVR-IC	ULDO, 4.7V±0.5%, 50mA, +CE	SOT-23-5	28cx	VR4	6g	Nsc
L37B	LP2980IM5-4.7	LVR-IC	ULDO, 4.7V±1%, 50mA, +CE	SOT-23-5	28cx	VR4	6g	Nsc
L37G	82C37G-AF5-B	Vdet-IC	3.7V±2% -Reset PPO, halogen free	SOT-23-5	28vda	VD7	6a	Utc



SMD code	Type	Function	Short description	Case	Pinout	Sch.	St.	Mnf.
L37L	82C37L-AF5-B	Vdet-IC	3.7V±2% -Reset PPO, lead free	SOT-23-5	28vda	VD7	6a	Utc
L38	82C38-AF5-B	Vdet-IC	3.8V±2% -Reset PPO	SOT-23-5	28vda	VD7	6a	Utc
L38	TK71638SCL	LVR-IC	LDO, 3.8V±2%, 150mA, +CE, -30...+80°C	SOT-23-5	28vrx	VR7	6k	Tok
L38A	LP2981AIM5-3.1	LVR-IC	Ultra-LDO, +CE, 3.1V±0.5%, 100mA	SOT-23-5	28cx	VR4	6g	Nsc
L38B	LP2981IM5-3.1	LVR-IC	Ultra-LDO, +CE, 3.1V±2%, 100mA	SOT-23-5	28cx	VR4	6g	Nsc
L38G	82C38G-AF5-B	Vdet-IC	3.8V±2% -Reset PPO, halogen free	SOT-23-5	28vda	VD7	6a	Utc
L38L	82C38L-AF5-B	Vdet-IC	3.8V±2% -Reset PPO, lead free	SOT-23-5	28vda	VD7	6a	Utc
L39	82C39-AF5-B	Vdet-IC	3.9V±2% -Reset PPO	SOT-23-5	28vda	VD7	6a	Utc
L39	TK71639SCL	LVR-IC	LDO, 3.9V±2%, 150mA, +CE, -30...+80°C	SOT-23-5	28vrx	VR7	6k	Tok
L39G	82C39G-AF5-B	Vdet-IC	3.9V±2% -Reset PPO, halogen free	SOT-23-5	28vda	VD7	6a	Utc
L39L	82C39L-AF5-B	Vdet-IC	3.9V±2% -Reset PPO, lead free	SOT-23-5	28vda	VD7	6a	Utc
L3A	XC6108N13AMR	Vdet-IC	1.3V±2%, Hysteresis, -Reset ODO	SOT-25	28rm	VD14	6g	Tor
L3AA	MIC5233-BM5	LVR-IC	LDO, Adjustable, 150mA, +CE	SOT-23-5	28sg	VR16	6g	Mcr
L3B	LP5951MF-1.8	LVR-IC	LDO, 1.8V±2%, 150mA, +CE	SC-70-5	28cx	VR4	6a	Nsc
L3B	XC6108N13BMR	Vdet-IC	1.3V±2%, -Reset ODO	SOT-25	28rm	VD14	6g	Tor
L3C	XC6108N13CMR	Vdet-IC	1.3V±2%, Hysteresis, -Reset ODO	SOT-25	28rk	VD14	6g	Tor
L3D	XC6108N13DMR	Vdet-IC	1.3V±2%, -Reset ODO	SOT-25	28rk	VD14	6g	Tor
L4	HD74LV1G32ACM	CMOS-Logic	2-input OR gate	CMPAK-5	28/Log4	-	6a	Ren
L4	HD74LV1G32AVS	CMOS-Logic	2-input OR gate	VSON-5	30/Log4	-	6a	Ren
L4	KTC601E-Y	Si-npn	Dual GP, 50V, 150mA, 100mW, B=120..240, 80MHz	TESV	30/T11	-	6l	Kec
L4	KTC601U-Y	Si-npn	Dual GP, 50V, 150mA, 100mW, B=120..240, 80MHz	USV	28/T11	-	6l	Kec
L4	NL17SZ32DF	CMOS-Logic	2-input OR gate	SOT-353	28/Log4	-	6b	Ons
L4	R1121N241A	LVR-IC	LDO, LN, -CE, 2.4V±2%, 150mA	SOT-23-5	28vt	VR4	6g	Ric
L4	RN5RG44AA	LVR-IC	Ext. transistor, 4.4V±2.5% 1A*	SOT-23-5	28vw	VR6	6g	Ric
L4	RT9168-19CBR	LVR-IC	LDO, 1.9V±2%, 200mA, +CE	SOT-23-5	28vt	VR4	6g	Rct
L4	TC7SL32F	CMOS-Logic	2-input OR gate	SSOP-5	28/Log4	-	6a	Tos
L4	TC7SL32FU	CMOS-Logic	2-input OR gate	SC-70-5	28/Log4	-	6a	Tos
L4	RN5RY341A	DC/DC-IC	VFM step-up, 3.4V±2.5%, 150mW, <180kHz	SOT-23-5	28vd	DC5	6g	Ric
L40	82C40-AF5-B	Vdet-IC	4.0V±2% -Reset PPO	SOT-23-5	28vda	VD7	6a	Utc
L40	TK71640SCL	LVR-IC	LDO, 4V±2%, 150mA, +CE, -30...+80°C	SOT-23-5	28vrx	VR7	6k	Tok
L409	MIC5238-0.9BM5	LVR-IC	LDO, 0.9V±2%, 150mA, +CE	SOT-23-5	28ze	VR11	6g	Mcr
L40G	82C40G-AF5-B	Vdet-IC	4.0V±2% -Reset PPO, halogen free	SOT-23-5	28vda	VD7	6a	Utc
L40L	82C40L-AF5-B	Vdet-IC	4.0V±2% -Reset PPO, lead free	SOT-23-5	28vda	VD7	6a	Utc
L41	82C41-AF5-B	Vdet-IC	4.1V±2% -Reset PPO	SOT-23-5	28vda	VD7	6a	Utc
L41	TK71641SCL	LVR-IC	LDO, 4.1V±2%, 150mA, +CE, -30...+80°C	SOT-23-5	28vrx	VR7	6k	Tok
L410	MIC5238-1.0BM5	LVR-IC	LDO, 1.0V±2%, 150mA, +CE	SOT-23-5	28ze	VR11	6g	Mcr
L411	MIC5238-1.1BM5	LVR-IC	LDO, 1.1V±2%, 150mA, +CE	SOT-23-5	28ze	VR11	6g	Mcr
L412	MIC5238-1.2BM5	LVR-IC	LDO, 1.2V±2%, 150mA, +CE	SOT-23-5	28ze	VR11	6g	Mcr
L413	MIC5238-1.3BM5	LVR-IC	LDO, 1.3V±2%, 150mA, +CE	SOT-23-5	28ze	VR11	6g	Mcr
L41G	82C41G-AF5-B	Vdet-IC	4.1V±2% -Reset PPO, halogen free	SOT-23-5	28vda	VD7	6a	Utc
L41L	82C41L-AF5-B	Vdet-IC	4.1V±2% -Reset PPO, lead free	SOT-23-5	28vda	VD7	6a	Utc
L42	82C42-AF5-B	Vdet-IC	4.2V±2% -Reset PPO	SOT-23-5	28vda	VD7	6a	Utc
L42	TK71642SCL	LVR-IC	LDO, 4.2V±2%, 150mA, +CE, -30...+80°C	SOT-23-5	28vrx	VR7	6k	Tok
L42G	82C42G-AF5-B	Vdet-IC	4.2V±2% -Reset PPO, halogen free	SOT-23-5	28vda	VD7	6a	Utc
L42L	82C42L-AF5-B	Vdet-IC	4.2V±2% -Reset PPO, lead free	SOT-23-5	28vda	VD7	6a	Utc
L43	82C43-AF5-B	Vdet-IC	4.3V±2% -Reset PPO	SOT-23-5	28vda	VD7	6a	Utc
L43	TK71643SCL	LVR-IC	LDO, 4.3V±2%, 150mA, +CE, -30...+80°C	SOT-23-5	28vrx	VR7	6k	Tok
L43G	82C43G-AF5-B	Vdet-IC	4.3V±2% -Reset PPO, halogen free	SOT-23-5	28vda	VD7	6a	Utc
L43L	82C43L-AF5-B	Vdet-IC	4.3V±2% -Reset PPO, lead free	SOT-23-5	28vda	VD7	6a	Utc
L44	82C44-AF5-B	Vdet-IC	4.4V±2% -Reset PPO	SOT-23-5	28vda	VD7	6a	Utc
L44	TK71644SCL	LVR-IC	LDO, 4.4V±2%, 150mA, +CE, -30...+80°C	SOT-23-5	28vrx	VR7	6k	Tok
L44G	82C44G-AF5-B	Vdet-IC	4.4V±2% -Reset PPO, halogen free	SOT-23-5	28vda	VD7	6a	Utc
L44L	82C44L-AF5-B	Vdet-IC	4.4V±2% -Reset PPO, lead free	SOT-23-5	28vda	VD7	6a	Utc
L45	82C45-AF5-B	Vdet-IC	4.5V±2% -Reset PPO	SOT-23-5	28vda	VD7	6a	Utc
L45	TK71645SCL	LVR-IC	LDO, 4.5V±2%, 150mA, +CE, -30...+80°C	SOT-23-5	28vrx	VR7	6k	Tok
L45G	82C45G-AF5-B	Vdet-IC	4.5V±2% -Reset PPO, halogen free	SOT-23-5	28vda	VD7	6a	Utc
L45L	82C45L-AF5-B	Vdet-IC	4.5V±2% -Reset PPO, lead free	SOT-23-5	28vda	VD7	6a	Utc
L46	82C46-AF5-B	Vdet-IC	4.6V±2% -Reset PPO	SOT-23-5	28vda	VD7	6a	Utc
L46	TK71646SCL	LVR-IC	LDO, 4.6V±2%, 150mA, +CE, -30...+80°C	SOT-23-5	28vrx	VR7	6k	Tok
L46G	82C46G-AF5-B	Vdet-IC	4.6V±2% -Reset PPO, halogen free	SOT-23-5	28vda	VD7	6a	Utc
L46L	82C46L-AF5-B	Vdet-IC	4.6V±2% -Reset PPO, lead free	SOT-23-5	28vda	VD7	6a	Utc
L47	82C47-AF5-B	Vdet-IC	4.7V±2% -Reset PPO	SOT-23-5	28vda	VD7	6a	Utc
L47	TK71647SCL	LVR-IC	LDO, 4.7V±2%, 150mA, +CE, -30...+80°C	SOT-23-5	28vrx	VR7	6k	Tok
L47G	82C47G-AF5-B	Vdet-IC	4.7V±2% -Reset PPO, halogen free	SOT-23-5	28vda	VD7	6a	Utc
L47L	82C47L-AF5-B	Vdet-IC	4.7V±2% -Reset PPO, lead free	SOT-23-5	28vda	VD7	6a	Utc
L48	82C48-AF5-B	Vdet-IC	4.8V±2% -Reset PPO	SOT-23-5	28vda	VD7	6a	Utc
L48	TK71648SCL	LVR-IC	LDO, 4.8V±2%, 150mA, +CE, -30...+80°C	SOT-23-5	28vrx	VR7	6k	Tok
L48A	LP2980AIM5-2.6	LVR-IC	Ultra-LDO, +CE, 2.6V±0.5%, 50mA	SOT-23-5	28cx	VR4	6g	Nsc
L48B	LP2980BIM5-2.6	LVR-IC	Ultra-LDO, +CE, 2.6V±1%, 50mA	SOT-23-5	28cx	VR4	6g	Nsc
L48G	82C48G-AF5-B	Vdet-IC	4.8V±2% -Reset PPO, halogen free	SOT-23-5	28vda	VD7	6a	Utc



SMD code	Type	Function	Short description	Case	Pinout	Sch.	St.	Mnf.
L48L	82C48L-AF5-B	Vdet-IC	4.8V±2% -Reset PPO, lead free	SOT-23-5	28vda	VD7	6a	Utc
L49	82C49-AF5-B	Vdet-IC	4.9V±2% -Reset PPO	SOT-23-5	28vda	VD7	6a	Utc
L49	TK71649SCL	LVR-IC	LDO, 4.9V±2%, 150mA, +CE, -30...+80°C	SOT-23-5	28vrx	VR7	6k	Tok
L49G	82C49G-AF5-B	Vdet-IC	4.9V±2% -Reset PPO, halogen free	SOT-23-5	28vda	VD7	6a	Utc
L49L	82C49L-AF5-B	Vdet-IC	4.9V±2% -Reset PPO, lead free	SOT-23-5	28vda	VD7	6a	Utc
L4A	XC6108N14AMR	Vdet-IC	1.4V±2%, Hysteresis, -Reset ODO	SOT-25	28rm	VD14	6g	Tor
L4B	LP5951MF-2.0	LVR-IC	LDO, 2.0V±2%, 150mA, +CE	SC-70-5	28cx	VR4	6a	Nsc
L4B	XC6108N14BMR	Vdet-IC	1.4V±2%, -Reset ODO	SOT-25	28rm	VD14	6g	Tor
L4C	XC6108N14CMR	Vdet-IC	1.4V±2%, Hysteresis, -Reset ODO	SOT-25	28rk	VD14	6g	Tor
L4D	XC6108N14DMR	Vdet-IC	1.4V±2%, -Reset ODO	SOT-25	28rk	VD14	6g	Tor
L5	HD74LV1G04ACM	CMOS-Logic	Inverter	CMPAK-5	28/Log6	-	6a	Ren
L5	HD74LV1G04AVS	CMOS-Logic	Inverter	VSON-5	30/Log6	-	6a	Ren
L5	R1121N251A	LVR-IC	LDO, LN, -CE, 2.5V±2%, 150mA	SOT-23-5	28vt	VR4	6g	Ric
L5	RN5RG45AA	LVR-IC	Ext. transistor, 4.5V±2.5% 1A*	SOT-23-5	28vw	VR6	6g	Ric
L5	RT9168-20CBR	LVR-IC	LDO, 2.0V±2%, 200mA, +CE	SOT-23-5	28vt	VR4	6g	Rct
L5	TC7SL04F	CMOS-Logic	Inverter	SSOP-5	28/Log6	-	6a	Tos
L5	TC7SL04FU	CMOS-Logic	Inverter	SC-70-5	28/Log6	-	6a	Tos
L5	RN5RY351A	DC/DC-IC	VFM step-up, 3.5V±2.5%, 150mW, <180kHz	SOT-23-5	28vd	DC5	6g	Ric
L50	82C50-AF5-B	Vdet-IC	5.0V±2% -Reset PPO	SOT-23-5	28vda	VD7	6a	Utc
L50	MC33761SNT1-50	LVR-IC	LDO, ULN, +CE, 5V±1.5%, 80mA	SOT-23-5	28cx	VR4	6b	Ons
L50	R1224N502L	DC/DC-IC	PWM/VFM step-down, 5V, 180kHz	SOT-23-5	28ud	DC7	6g	Ric
L50	TK71650SCL	LVR-IC	LDO, 5V±2%, 150mA, +CE, -30...+80°C	SOT-23-5	28vrx	VR7	6k	Tok
L50G	82C50G-AF5-B	Vdet-IC	5.0V±2% -Reset PPO, halogen free	SOT-23-5	28vda	VD7	6a	Utc
L50L	82C50L-AF5-B	Vdet-IC	5.0V±2% -Reset PPO, lead free	SOT-23-5	28vda	VD7	6a	Utc
L51	82C51-AF5-B	Vdet-IC	5.1V±2% -Reset PPO	SOT-23-5	28vda	VD7	6a	Utc
L51	TK71651SCL	LVR-IC	LDO, 5.1V±2%, 150mA, +CE, -30...+80°C	SOT-23-5	28vrx	VR7	6k	Tok
L510	XC6366B105MR	DC/DC-IC	PWM/PFM st-down, 500kHz, Adj. 1.5...6V±2.5%, 1A, +CE	SOT-25	28zn	DC18	6g	Tor
L51G	82C51G-AF5-B	Vdet-IC	5.1V±2% -Reset PPO, halogen free	SOT-23-5	28vda	VD7	6a	Utc
L51L	82C51L-AF5-B	Vdet-IC	5.1V±2% -Reset PPO, lead free	SOT-23-5	28vda	VD7	6a	Utc
L52	82C52-AF5-B	Vdet-IC	5.2V±2% -Reset PPO	SOT-23-5	28vda	VD7	6a	Utc
L52	TK71652SCL	LVR-IC	LDO, 5.2V±2%, 150mA, +CE, -30...+80°C	SOT-23-5	28vrx	VR7	6k	Tok
L52G	82C52G-AF5-B	Vdet-IC	5.2V±2% -Reset PPO, halogen free	SOT-23-5	28vda	VD7	6a	Utc
L52L	82C52L-AF5-B	Vdet-IC	5.2V±2% -Reset PPO, lead free	SOT-23-5	28vda	VD7	6a	Utc
L53	82C53-AF5-B	Vdet-IC	5.3V±2% -Reset PPO	SOT-23-5	28vda	VD7	6a	Utc
L53	TK71653SCL	LVR-IC	LDO, 5.3V±2%, 150mA, +CE, -30...+80°C	SOT-23-5	28vrx	VR7	6k	Tok
L53G	82C53G-AF5-B	Vdet-IC	5.3V±2% -Reset PPO, halogen free	SOT-23-5	28vda	VD7	6a	Utc
L53L	82C53L-AF5-B	Vdet-IC	5.3V±2% -Reset PPO, lead free	SOT-23-5	28vda	VD7	6a	Utc
L54	82C54-AF5-B	Vdet-IC	5.4V±2% -Reset PPO	SOT-23-5	28vda	VD7	6a	Utc
L54	TK71654SCL	LVR-IC	LDO, 5.4V±2%, 150mA, +CE, -30...+80°C	SOT-23-5	28vrx	VR7	6k	Tok
L54G	82C54G-AF5-B	Vdet-IC	5.4V±2% -Reset PPO, halogen free	SOT-23-5	28vda	VD7	6a	Utc
L54L	82C54L-AF5-B	Vdet-IC	5.4V±2% -Reset PPO, lead free	SOT-23-5	28vda	VD7	6a	Utc
L55	82C55-AF5-B	Vdet-IC	5.5V±2% -Reset PPO	SOT-23-5	28vda	VD7	6a	Utc
L55	R1224N552L	DC/DC-IC	PWM/VFM step-down, 5.5V, 180kHz	SOT-23-5	28ud	DC7	6g	Ric
L55G	82C55G-AF5-B	Vdet-IC	5.5V±2% -Reset PPO, halogen free	SOT-23-5	28vda	VD7	6a	Utc
L55L	82C55L-AF5-B	Vdet-IC	5.5V±2% -Reset PPO, lead free	SOT-23-5	28vda	VD7	6a	Utc
L56	82C56-AF5-B	Vdet-IC	5.6V±2% -Reset PPO	SOT-23-5	28vda	VD7	6a	Utc
L56G	82C56G-AF5-B	Vdet-IC	5.6V±2% -Reset PPO, halogen free	SOT-23-5	28vda	VD7	6a	Utc
L56L	82C56L-AF5-B	Vdet-IC	5.6V±2% -Reset PPO, lead free	SOT-23-5	28vda	VD7	6a	Utc
L57	82C57-AF5-B	Vdet-IC	5.7V±2% -Reset PPO	SOT-23-5	28vda	VD7	6a	Utc
L57G	82C57G-AF5-B	Vdet-IC	5.7V±2% -Reset PPO, halogen free	SOT-23-5	28vda	VD7	6a	Utc
L57L	82C57L-AF5-B	Vdet-IC	5.7V±2% -Reset PPO, lead free	SOT-23-5	28vda	VD7	6a	Utc
L58	82C58-AF5-B	Vdet-IC	5.8V±2% -Reset PPO	SOT-23-5	28vda	VD7	6a	Utc
L58A	LP2982AIM5-2.5	LVR-IC	Ultra-LDO, +CE, 2.5V, 50mA	SOT-23-5	28vrx	VR7	6g	Nsc
L58B	LP2982IMS-2.5	LVR-IC	Ultra-LDO, +CE, 2.5V 50mA	SOT-23-5	28vrx	VR7	6g	Nsc
L58G	82C58G-AF5-B	Vdet-IC	5.8V±2% -Reset PPO, halogen free	SOT-23-5	28vda	VD7	6a	Utc
L58L	82C58L-AF5-B	Vdet-IC	5.8V±2% -Reset PPO, lead free	SOT-23-5	28vda	VD7	6a	Utc
L59	82C59-AF5-B	Vdet-IC	5.9V±2% -Reset PPO	SOT-23-5	28vda	VD7	6a	Utc
L59G	82C59G-AF5-B	Vdet-IC	5.9V±2% -Reset PPO, halogen free	SOT-23-5	28vda	VD7	6a	Utc
L59L	82C59L-AF5-B	Vdet-IC	5.9V±2% -Reset PPO, lead free	SOT-23-5	28vda	VD7	6a	Utc
L5A	XC6108N15AMR	Vdet-IC	1.5V±2%, Hysteresis, -Reset ODO	SOT-25	28rm	VD14	6g	Tor
L5B	LP5951MF-2.5	LVR-IC	LDO, 2.5V±2%, 150mA, +CE	SC-70-5	28cx	VR4	6a	Nsc
L5B	XC6108N15BMR	Vdet-IC	1.5V±2%, -Reset ODO	SOT-25	28rm	VD14	6g	Tor
L5C	XC6108N15CMR	Vdet-IC	1.5V±2%, Hysteresis, -Reset ODO	SOT-25	28rk	VD14	6g	Tor
L5D	XC6108N15DMR	Vdet-IC	1.5V±2%, -Reset ODO	SOT-25	28rk	VD14	6g	Tor
L6	HD74LV1G04ACM	CMOS-Logic	Inverter	CMPAK-5	28/Log6	-	6a	Ren
L6	HD74LV1G04AVS	CMOS-Logic	Inverter	VSON-5	30/Log6	-	6a	Ren
L6	KTC601E-GR	Si-npn	Dual GP, 50V, 150mA, 100mW, B=200..400, 80MHz	TESV	30/T11	-	6l	Kec
L6	KTC601U-GR	Si-npn	Dual GP, 50V, 150mA, 100mW, B=200..400, 80MHz	USV	28/T11	-	6l	Kec
L6	NL17SZ04DF	CMOS-Logic	Inverter	SOT-353	28/Log6	-	6b	Ons
L6	R1121N261A	LVR-IC	LDO, LN, -CE, 2.6V±2%, 150mA	SOT-23-5	28vt	VR4	6g	Ric



SMD code	Type	Function	Short description	Case	Pinout	Sch.	St.	Mnf.
L6	RN5RG46AA	LVR-IC	Ext. transistor, 4.6V±2.5% 1A*	SOT-23-5	28vw	VR6	6g	Ric
L6	RT9168-21C1BR	LVR-IC	LDO, 2.1V±2%, 200mA, +CE	SOT-23-5	28vt	VR4	6g	Rct
L6	TC7SLU04F	CMOS-Logic	Inverter	SSOP-5	28/Log6	-	6a	Tos
L6	TC7SLU04FU	CMOS-Logic	Inverter	SC-70-5	28/Log6	-	6a	Tos
L6	RN5RY361A	DC/DC-IC	VFM step-up, 3.6V±2.5%, 150mW, <180kHz	SOT-23-5	28vd	DC5	6g	Ric
L60	82C60-AF5-B	Vdet-IC	6.0V±2% -Reset PPO	SOT-23-5	28vda	VD7	6a	Utc
L60	R1224N602L	DC/DC-IC	PWM/VFM step-down, 6V, 180kHz	SOT-23-5	28ud	DC7	6g	Ric
L60A	LP2982AIM5-2.8	LVR-IC	Ultra-LDO, +CE, 2.8V, 50mA	SOT-23-5	28vrx	VR7	6g	Nsc
L60B	LP2982IM5-2.8	LVR-IC	Ultra-LDO, +CE, 2.8V, 50mA	SOT-23-5	28vrx	VR7	6g	Nsc
L60G	82C60G-AF5-B	Vdet-IC	6.0V±2% -Reset PPO, halogen free	SOT-23-5	28vda	VD7	6a	Utc
L60L	82C60L-AF5-B	Vdet-IC	6.0V±2% -Reset PPO, lead free	SOT-23-5	28vda	VD7	6a	Utc
L618	MIC5252-1.8BM5	LVR-IC	LDO, LN, +CE, 1.8V±1%, 150mA	SOT-23-5	28vrx	VR7	6g	Mcr
L625	MIC5252-2.5BM5	LVR-IC	LDO, LN, +CE, 2.5V±1%, 150mA	SOT-23-5	28vrx	VR7	6g	Mcr
L628	MIC5252-2.8BM5	LVR-IC	LDO, LN, +CE, 2.8V±1%, 150mA	SOT-23-5	28vrx	VR7	6g	Mcr
L62J	MIC5252-2.85BM5	LVR-IC	LDO, LN, +CE, 2.85V±1%, 150mA	SOT-23-5	28vrx	VR7	6g	Mcr
L630	MIC5252-3.0BM5	LVR-IC	LDO, LN, +CE, 3V±1%, 150mA	SOT-23-5	28vrx	VR7	6g	Mcr
L64H	MIC5252-4.75BM5	LVR-IC	LDO, LN, +CE, 4.75V±1%, 150mA	SOT-23-5	28vrx	VR7	6g	Mcr
L6A	S-1112B15MC	LVR-IC	LDO, 1.5V±1.0%, 150mA, +CE	SOT-23-5	28cx	VR4	6a	Sii
L6A	S-1112B15PN	LVR-IC	LDO, 1.5V±1.0%, 150mA, +CE	SOM-5	30vr3	VR4	6a	Sii
L6A	XC6108N16AMR	Vdet-IC	1.6V±2%, Hysteresis, -Reset ODO	SOT-25	28rm	VD14	6g	Tor
L6B	LP5951MF-2.8	LVR-IC	LDO, 2.8V±2%, 150mA, +CE	SC-70-5	28cx	VR4	6a	Nsc
L6B	S-1112B16MC	LVR-IC	LDO, 1.6V±1.0%, 150mA, +CE	SOT-23-5	28cx	VR4	6a	Sii
L6B	S-1112B16PN	LVR-IC	LDO, 1.6V±1.0%, 150mA, +CE	SOM-5	30vr3	VR4	6a	Sii
L6B	XC6108N16BMR	Vdet-IC	1.6V±2%, -Reset ODO	SOT-25	28rm	VD14	6g	Tor
L6C	S-1112B17MC	LVR-IC	LDO, 1.7V±1.0%, 150mA, +CE	SOT-23-5	28cx	VR4	6a	Sii
L6C	S-1112B17PN	LVR-IC	LDO, 1.7V±1.0%, 150mA, +CE	SOM-5	30vr3	VR4	6a	Sii
L6C	XC6108N16CMR	Vdet-IC	1.6V±2%, Hysteresis, -Reset ODO	SOT-25	28rk	VD14	6g	Tor
L6D	S-1112B18MC	LVR-IC	LDO, 1.8V±1.0%, 150mA, +CE	SOT-23-5	28cx	VR4	6a	Sii
L6D	S-1112B18PN	LVR-IC	LDO, 1.8V±1.0%, 150mA, +CE	SOM-5	30vr3	VR4	6a	Sii
L6D	XC6108N16DMR	Vdet-IC	1.6V±2%, -Reset ODO	SOT-25	28rk	VD14	6g	Tor
L6E	S-1112B19MC	LVR-IC	LDO, 1.9V±1.0%, 150mA, +CE	SOT-23-5	28cx	VR4	6a	Sii
L6E	S-1112B19PN	LVR-IC	LDO, 1.9V±1.0%, 150mA, +CE	SOM-5	30vr3	VR4	6a	Sii
L6F	S-1112B20MC	LVR-IC	LDO, 2.0V±1.0%, 150mA, +CE	SOT-23-5	28cx	VR4	6a	Sii
L6F	S-1112B20PN	LVR-IC	LDO, 2.0V±1.0%, 150mA, +CE	SOM-5	30vr3	VR4	6a	Sii
L6G	S-1112B21MC	LVR-IC	LDO, 2.1V±1.0%, 150mA, +CE	SOT-23-5	28cx	VR4	6a	Sii
L6G	S-1112B21PN	LVR-IC	LDO, 2.1V±1.0%, 150mA, +CE	SOM-5	30vr3	VR4	6a	Sii
L6H	S-1112B22MC	LVR-IC	LDO, 2.2V±1.0%, 150mA, +CE	SOT-23-5	28cx	VR4	6a	Sii
L6H	S-1112B22PN	LVR-IC	LDO, 2.2V±1.0%, 150mA, +CE	SOM-5	30vr3	VR4	6a	Sii
L6I	S-1112B23MC	LVR-IC	LDO, 2.3V±1.0%, 150mA, +CE	SOT-23-5	28cx	VR4	6a	Sii
L6I	S-1112B23PN	LVR-IC	LDO, 2.3V±1.0%, 150mA, +CE	SOM-5	30vr3	VR4	6a	Sii
L6J	S-1112B24MC	LVR-IC	LDO, 2.4V±1.0%, 150mA, +CE	SOT-23-5	28cx	VR4	6a	Sii
L6J	S-1112B24PN	LVR-IC	LDO, 2.4V±1.0%, 150mA, +CE	SOM-5	30vr3	VR4	6a	Sii
L6K	S-1112B25MC	LVR-IC	LDO, 2.5V±1.0%, 150mA, +CE	SOT-23-5	28cx	VR4	6a	Sii
L6K	S-1112B25PN	LVR-IC	LDO, 2.5V±1.0%, 150mA, +CE	SOM-5	30vr3	VR4	6a	Sii
L6L	S-1112B26MC	LVR-IC	LDO, 2.6V±1.0%, 150mA, +CE	SOT-23-5	28cx	VR4	6a	Sii
L6L	S-1112B26PN	LVR-IC	LDO, 2.6V±1.0%, 150mA, +CE	SOM-5	30vr3	VR4	6a	Sii
L6M	S-1112B27MC	LVR-IC	LDO, 2.7V±1.0%, 150mA, +CE	SOT-23-5	28cx	VR4	6a	Sii
L6M	S-1112B27PN	LVR-IC	LDO, 2.7V±1.0%, 150mA, +CE	SOM-5	30vr3	VR4	6a	Sii
L6N	S-1112B28MC	LVR-IC	LDO, 2.8V±1.0%, 150mA, +CE	SOT-23-5	28cx	VR4	6a	Sii
L6N	S-1112B28PN	LVR-IC	LDO, 2.8V±1.0%, 150mA, +CE	SOM-5	30vr3	VR4	6a	Sii
L6O	S-1112B29MC	LVR-IC	LDO, 2.9V±1.0%, 150mA, +CE	SOT-23-5	28cx	VR4	6a	Sii
L6O	S-1112B29PN	LVR-IC	LDO, 2.9V±1.0%, 150mA, +CE	SOM-5	30vr3	VR4	6a	Sii
L6P	S-1112B30MC	LVR-IC	LDO, 3.0V±1.0%, 150mA, +CE	SOT-23-5	28cx	VR4	6a	Sii
L6P	S-1112B30PN	LVR-IC	LDO, 3.0V±1.0%, 150mA, +CE	SOM-5	30vr3	VR4	6a	Sii
L6Q	S-1112B31MC	LVR-IC	LDO, 3.1V±1.0%, 150mA, +CE	SOT-23-5	28cx	VR4	6a	Sii
L6Q	S-1112B31PN	LVR-IC	LDO, 3.1V±1.0%, 150mA, +CE	SOM-5	30vr3	VR4	6a	Sii
L6R	S-1112B32MC	LVR-IC	LDO, 3.2V±1.0%, 150mA, +CE	SOT-23-5	28cx	VR4	6a	Sii
L6R	S-1112B32PN	LVR-IC	LDO, 3.2V±1.0%, 150mA, +CE	SOM-5	30vr3	VR4	6a	Sii
L6S	S-1112B33MC	LVR-IC	LDO, 3.3V±1.0%, 150mA, +CE	SOT-23-5	28cx	VR4	6a	Sii
L6S	S-1112B33PN	LVR-IC	LDO, 3.3V±1.0%, 150mA, +CE	SOM-5	30vr3	VR4	6a	Sii
L6T	S-1112B34MC	LVR-IC	LDO, 3.4V±1.0%, 150mA, +CE	SOT-23-5	28cx	VR4	6a	Sii
L6T	S-1112B34PN	LVR-IC	LDO, 3.4V±1.0%, 150mA, +CE	SOM-5	30vr3	VR4	6a	Sii
L6U	S-1112B35MC	LVR-IC	LDO, 3.5V±1.0%, 150mA, +CE	SOT-23-5	28cx	VR4	6a	Sii
L6U	S-1112B35PN	LVR-IC	LDO, 3.5V±1.0%, 150mA, +CE	SOM-5	30vr3	VR4	6a	Sii
L6V	S-1112B36MC	LVR-IC	LDO, 3.6V±1.0%, 150mA, +CE	SOT-23-5	28cx	VR4	6a	Sii
L6V	S-1112B36PN	LVR-IC	LDO, 3.6V±1.0%, 150mA, +CE	SOM-5	30vr3	VR4	6a	Sii
L6W	S-1112B37MC	LVR-IC	LDO, 3.7V±1.0%, 150mA, +CE	SOT-23-5	28cx	VR4	6a	Sii
L6W	S-1112B37PN	LVR-IC	LDO, 3.7V±1.0%, 150mA, +CE	SOM-5	30vr3	VR4	6a	Sii
L6X	S-1112B38MC	LVR-IC	LDO, 3.8V±1.0%, 150mA, +CE	SOT-23-5	28cx	VR4	6a	Sii
L6X	S-1112B38PN	LVR-IC	LDO, 3.8V±1.0%, 150mA, +CE	SOM-5	30vr3	VR4	6a	Sii



SMD code	Type	Function	Short description	Case	Pinout	Sch.	St.	Mnf.
L6Y	S-1112B39MC	LVR-IC	LDO, 3.9V±1.0%, 150mA, +CE	SOT-23-5	28cx	VR4	6a	Sii
L6Y	S-1112B39PN	LVR-IC	LDO, 3.9V±1.0%, 150mA, +CE	SOM-5	30vr3	VR4	6a	Sii
L6Z	S-1112B40MC	LVR-IC	LDO, 4.0V±1.0%, 150mA, +CE	SOT-23-5	28cx	VR4	6a	Sii
L6Z	S-1112B40PN	LVR-IC	LDO, 4.0V±1.0%, 150mA, +CE	SOM-5	30vr3	VR4	6a	Sii
L7	R1121N271A	LVR-IC	LDO, LN, -CE, 2.7V±2%, 150mA	SOT-23-5	28vt	VR4	6g	Ric
L7	RN5RG47AA	LVR-IC	Ext. transistor, 4.7V±2.5% 1A*	SOT-23-5	28vw	VR6	6g	Ric
L7	RT9168-22CBR	LVR-IC	LDO, 2.2V±2%, 200mA, +CE	SOT-23-5	28vt	VR4	6g	Rct
L7	RN5RY371A	DC/DC-IC	VFM step-up, 3.7V±2.5%, 150mW, <180kHz	SOT-23-5	28vd	DC5	6g	Ric
L76A	LP2982AIM5-3.8	LVR-IC	Ultra-LDO, +CE, 3.8V, 50mA	SOT-23-5	28vrx	VR7	6g	Nsc
L76B	LP2982IM5-3.8	LVR-IC	Ultra-LDO, +CE, 3.8V 50mA	SOT-23-5	28vrx	VR7	6g	Nsc
L77A	LP2981AIM5-2.8	LVR-IC	Ultra-LDO, +CE, 2.8V±0.5%, 100mA	SOT-23-5	28cx	VR4	6g	Nsc
L77B	LP2981IM5-2.8	LVR-IC	Ultra-LDO, +CE, 2.8V±2%, 100mA	SOT-23-5	28cx	VR4	6g	Nsc
L78B	LM3490IM5-3.3	LVR-IC	Quasi-LDO, 3.3V, 100mA	SOT-23-5	28vw	VR6	6g	Nsc
L79B	LM3490IM5-5.0	LVR-IC	Quasi-LDO, 5V, 100mA	SOT-23-5	28vw	VR6	6g	Nsc
L7A	S-1112B41MC	LVR-IC	LDO, 4.1V±1.0%, 150mA, +CE	SOT-23-5	28cx	VR4	6a	Sii
L7A	S-1112B41PN	LVR-IC	LDO, 4.1V±1.0%, 150mA, +CE	SOM-5	30vr3	VR4	6a	Sii
L7A	XC6108N17AMR	Vdet-IC	1.7V±2%, Hysteresis, -Reset ODO	SOT-25	28rm	VD14	6g	Tor
L7B	LP5951MF-3.0	LVR-IC	LDO, 3.0V±2%, 150mA, +CE	SC-70-5	28cx	VR4	6a	Nsc
L7B	S-1112B42MC	LVR-IC	LDO, 4.2V±1.0%, 150mA, +CE	SOT-23-5	28cx	VR4	6a	Sii
L7B	S-1112B42PN	LVR-IC	LDO, 4.2V±1.0%, 150mA, +CE	SOM-5	30vr3	VR4	6a	Sii
L7B	XC6108N17BMR	Vdet-IC	1.7V±2%, -Reset ODO	SOT-25	28rm	VD14	6g	Tor
L7C	S-1112B43MC	LVR-IC	LDO, 4.3V±1.0%, 150mA, +CE	SOT-23-5	28cx	VR4	6a	Sii
L7C	S-1112B43PN	LVR-IC	LDO, 4.3V±1.0%, 150mA, +CE	SOM-5	30vr3	VR4	6a	Sii
L7C	XC6108N17CMR	Vdet-IC	1.7V±2%, Hysteresis, -Reset ODO	SOT-25	28rk	VD14	6g	Tor
L7D	S-1112B44MC	LVR-IC	LDO, 4.4V±1.0%, 150mA, +CE	SOT-23-5	28cx	VR4	6a	Sii
L7D	S-1112B44PN	LVR-IC	LDO, 4.4V±1.0%, 150mA, +CE	SOM-5	30vr3	VR4	6a	Sii
L7D	XC6108N17DMR	Vdet-IC	1.7V±2%, -Reset ODO	SOT-25	28rk	VD14	6g	Tor
L7E	S-1112B45MC	LVR-IC	LDO, 4.5V±1.0%, 150mA, +CE	SOT-23-5	28cx	VR4	6a	Sii
L7E	S-1112B45PN	LVR-IC	LDO, 4.5V±1.0%, 150mA, +CE	SOM-5	30vr3	VR4	6a	Sii
L7F	S-1112B46MC	LVR-IC	LDO, 4.6V±1.0%, 150mA, +CE	SOT-23-5	28cx	VR4	6a	Sii
L7F	S-1112B46PN	LVR-IC	LDO, 4.6V±1.0%, 150mA, +CE	SOM-5	30vr3	VR4	6a	Sii
L7G	S-1112B47MC	LVR-IC	LDO, 4.7V±1.0%, 150mA, +CE	SOT-23-5	28cx	VR4	6a	Sii
L7G	S-1112B47PN	LVR-IC	LDO, 4.7V±1.0%, 150mA, +CE	SOM-5	30vr3	VR4	6a	Sii
L7H	S-1112B48MC	LVR-IC	LDO, 4.8V±1.0%, 150mA, +CE	SOT-23-5	28cx	VR4	6a	Sii
L7H	S-1112B48PN	LVR-IC	LDO, 4.8V±1.0%, 150mA, +CE	SOM-5	30vr3	VR4	6a	Sii
L7I	S-1112B49MC	LVR-IC	LDO, 4.9V±1.0%, 150mA, +CE	SOT-23-5	28cx	VR4	6a	Sii
L7I	S-1112B49PN	LVR-IC	LDO, 4.9V±1.0%, 150mA, +CE	SOM-5	30vr3	VR4	6a	Sii
L7J	S-1112B50MC	LVR-IC	LDO, 5.0V±1.0%, 150mA, +CE	SOT-23-5	28cx	VR4	6a	Sii
L7J	S-1112B50PN	LVR-IC	LDO, 5.0V±1.0%, 150mA, +CE	SOM-5	30vr3	VR4	6a	Sii
L7K	S-1112B51MC	LVR-IC	LDO, 5.1V±1.0%, 150mA, +CE	SOT-23-5	28cx	VR4	6a	Sii
L7K	S-1112B51PN	LVR-IC	LDO, 5.1V±1.0%, 150mA, +CE	SOM-5	30vr3	VR4	6a	Sii
L7L	S-1112B52MC	LVR-IC	LDO, 5.2V±1.0%, 150mA, +CE	SOT-23-5	28cx	VR4	6a	Sii
L7L	S-1112B52PN	LVR-IC	LDO, 5.2V±1.0%, 150mA, +CE	SOM-5	30vr3	VR4	6a	Sii
L7M	S-1112B53MC	LVR-IC	LDO, 5.3V±1.0%, 150mA, +CE	SOT-23-5	28cx	VR4	6a	Sii
L7M	S-1112B53PN	LVR-IC	LDO, 5.3V±1.0%, 150mA, +CE	SOM-5	30vr3	VR4	6a	Sii
L7N	S-1112B54MC	LVR-IC	LDO, 5.4V±1.0%, 150mA, +CE	SOT-23-5	28cx	VR4	6a	Sii
L7N	S-1112B54PN	LVR-IC	LDO, 5.4V±1.0%, 150mA, +CE	SOM-5	30vr3	VR4	6a	Sii
L7O	S-1112B55MC	LVR-IC	LDO, 5.5V±1.0%, 150mA, +CE	SOT-23-5	28cx	VR4	6a	Sii
L7O	S-1112B55PI	LVR-IC	LDO, 5.5V±1.0%, 150mA, +CE	SOM-5	30vr3	VR4	6a	Sii
L7O	S-1112B55PN	LVR-IC	LDO, 5.5V±1.0%, 150mA, +CE	SOM-5	30vr3	VR4	6a	Sii
L7P	S-1112B2JMC	LVR-IC	LDO, 2.85V±1.0%, 150mA, +CE	SOT-23-5	28cx	VR4	6a	Sii
L7P	S-1112B2JPN	LVR-IC	LDO, 2.85V±1.0%, 150mA, +CE	SOM-5	30vr3	VR4	6a	Sii
L8	HD74LV1G86ACM	CMOS-Logic	2-input EXCLUSIVE-OR gate	CMPAK-5	28fLog5	-	6a	Ren
L8	HD74LV1G86AVS	CMOS-Logic	2-input EXCLUSIVE-OR gate	VSON-5	30fLog5	-	6a	Ren
L8	R1121N281A	LVR-IC	LDO, LN, -CE, 2.8V±2%, 150mA	SOT-23-5	28vt	VR4	6g	Ric
L8	RN5RG48AA	LVR-IC	Ext. transistor, 4.8V±2.5% 1A*	SOT-23-5	28vw	VR6	6g	Ric
L8	RT9168-23CBR	LVR-IC	LDO, 2.3V±2%, 200mA, +CE	SOT-23-5	28vt	VR4	6g	Rct
L8	RN5RY381A	DC/DC-IC	VFM step-up, 3.8V±2.5%, 150mW, <180kHz	SOT-23-5	28vd	DC5	6g	Ric
L80B	LM3490IM5-12	LVR-IC	Quasi-LDO, 12V, 100mA	SOT-23-5	28vw	VR6	6g	Nsc
L81B	LM3490IM5-15	LVR-IC	Quasi-LDO, 15V, 100mA	SOT-23-5	28vw	VR6	6g	Nsc
L8A	S-1122B15MC	LVR-IC	LDO, 1.5V±1.0%, 150mA, +CE	SOT-23-5	28vt	VR4	6a	Sii
L8A	S-1122B15PN	LVR-IC	LDO, 1.5V±1.0%, 150mA, +CE	SOM-5	30vr4	VR4	6a	Sii
L8A	XC6108N18AMR	Vdet-IC	1.8V±2%, Hysteresis, -Reset ODO	SOT-25	28rm	VD14	6g	Tor
L8A	XC6118C08AMR-G	Vdet-IC	0.8V±30mV, ±Reset PPO, Sense, hysteresis 5%, Cd	SOT-25	28mg	VD15	6g	Tor
L8B	S-1122B16MC	LVR-IC	LDO, 1.6V±1.0%, 150mA, +CE	SOT-23-5	28vt	VR4	6a	Sii
L8B	S-1122B16PN	LVR-IC	LDO, 1.6V±1.0%, 150mA, +CE	SOM-5	30vr4	VR4	6a	Sii
L8B	XC6108N18BMR	Vdet-IC	1.8V±2%, -Reset ODO	SOT-25	28rm	VD14	6g	Tor
L8B	XC6118C08BMR-G	Vdet-IC	0.8V±30mV, ±Reset PPO, Sense, hysteresis <1%, Cd	SOT-25	28mg	VD15	6g	Tor
L8C	S-1122B17MC	LVR-IC	LDO, 1.7V±1.0%, 150mA, +CE	SOT-23-5	28vt	VR4	6a	Sii
L8C	S-1122B17PN	LVR-IC	LDO, 1.7V±1.0%, 150mA, +CE	SOM-5	30vr4	VR4	6a	Sii



SMD code	Type	Function	Short description	Case	Pinout	Sch.	St.	Mnf.
L8C	XC6108N18CMR	Vdet-IC	1.8V±2%, Hysteresis, -Reset ODO	SOT-25	28rk	VD14	6g	Tor
L8C	XC6118C08CMR-G	Vdet-IC	0.8V±30mV, ±Reset PPO, Sense, hysteresis 5%	SOT-25	28mf	VD12	6g	Tor
L8D	S-1122B18MC	LVR-IC	LDO, 1.8V±1.0%, 150mA, +CE	SOT-23-5	28vt	VR4	6a	Sii
L8D	S-1122B18PN	LVR-IC	LDO, 1.8V±1.0%, 150mA, +CE	SOM-5	30vr4	VR4	6a	Sii
L8D	XC6108N18DMR	Vdet-IC	1.8V±2%, -Reset ODO	SOT-25	28rk	VD14	6g	Tor
L8D	XC6118C08DMR-G	Vdet-IC	0.8V±30mV, ±Reset PPO, Sense, hysteresis <1%	SOT-25	28mf	VD12	6g	Tor
L8E	S-1122B19MC	LVR-IC	LDO, 1.9V±1.0%, 150mA, +CE	SOT-23-5	28vt	VR4	6a	Sii
L8E	S-1122B19PN	LVR-IC	LDO, 1.9V±1.0%, 150mA, +CE	SOM-5	30vr4	VR4	6a	Sii
L8F	S-1122B20MC	LVR-IC	LDO, 2.0V±1.0%, 150mA, +CE	SOT-23-5	28vt	VR4	6a	Sii
L8F	S-1122B20PN	LVR-IC	LDO, 2.0V±1.0%, 150mA, +CE	SOM-5	30vr4	VR4	6a	Sii
L8G	S-1122B21MC	LVR-IC	LDO, 2.1V±1.0%, 150mA, +CE	SOT-23-5	28vt	VR4	6a	Sii
L8G	S-1122B21PN	LVR-IC	LDO, 2.1V±1.0%, 150mA, +CE	SOM-5	30vr4	VR4	6a	Sii
L8H	S-1122B22MC	LVR-IC	LDO, 2.2V±1.0%, 150mA, +CE	SOT-23-5	28vt	VR4	6a	Sii
L8H	S-1122B22PN	LVR-IC	LDO, 2.2V±1.0%, 150mA, +CE	SOM-5	30vr4	VR4	6a	Sii
L8I	S-1122B23MC	LVR-IC	LDO, 2.3V±1.0%, 150mA, +CE	SOT-23-5	28vt	VR4	6a	Sii
L8I	S-1122B23PN	LVR-IC	LDO, 2.3V±1.0%, 150mA, +CE	SOM-5	30vr4	VR4	6a	Sii
L8J	S-1122B24MC	LVR-IC	LDO, 2.4V±1.0%, 150mA, +CE	SOT-23-5	28vt	VR4	6a	Sii
L8J	S-1122B24PN	LVR-IC	LDO, 2.4V±1.0%, 150mA, +CE	SOM-5	30vr4	VR4	6a	Sii
L8K	S-1122B25MC	LVR-IC	LDO, 2.5V±1.0%, 150mA, +CE	SOT-23-5	28vt	VR4	6a	Sii
L8K	S-1122B25PN	LVR-IC	LDO, 2.5V±1.0%, 150mA, +CE	SOM-5	30vr4	VR4	6a	Sii
L8L	S-1122B26MC	LVR-IC	LDO, 2.6V±1.0%, 150mA, +CE	SOT-23-5	28vt	VR4	6a	Sii
L8L	S-1122B26PN	LVR-IC	LDO, 2.6V±1.0%, 150mA, +CE	SOM-5	30vr4	VR4	6a	Sii
L8M	S-1122B27MC	LVR-IC	LDO, 2.7V±1.0%, 150mA, +CE	SOT-23-5	28vt	VR4	6a	Sii
L8M	S-1122B27PN	LVR-IC	LDO, 2.7V±1.0%, 150mA, +CE	SOM-5	30vr4	VR4	6a	Sii
L8N	S-1122B28MC	LVR-IC	LDO, 2.8V±1.0%, 150mA, +CE	SOT-23-5	28vt	VR4	6a	Sii
L8N	S-1122B28PN	LVR-IC	LDO, 2.8V±1.0%, 150mA, +CE	SOM-5	30vr4	VR4	6a	Sii
L8O	S-1122B29MC	LVR-IC	LDO, 2.9V±1.0%, 150mA, +CE	SOT-23-5	28vt	VR4	6a	Sii
L8O	S-1122B29PN	LVR-IC	LDO, 2.9V±1.0%, 150mA, +CE	SOM-5	30vr4	VR4	6a	Sii
L8P	S-1122B30MC	LVR-IC	LDO, 3.0V±1.0%, 150mA, +CE	SOT-23-5	28vt	VR4	6a	Sii
L8P	S-1122B30PN	LVR-IC	LDO, 3.0V±1.0%, 150mA, +CE	SOM-5	30vr4	VR4	6a	Sii
L8Q	S-1122B31MC	LVR-IC	LDO, 3.1V±1.0%, 150mA, +CE	SOT-23-5	28vt	VR4	6a	Sii
L8Q	S-1122B31PN	LVR-IC	LDO, 3.1V±1.0%, 150mA, +CE	SOM-5	30vr4	VR4	6a	Sii
L8R	S-1122B32MC	LVR-IC	LDO, 3.2V±1.0%, 150mA, +CE	SOT-23-5	28vt	VR4	6a	Sii
L8R	S-1122B32PN	LVR-IC	LDO, 3.2V±1.0%, 150mA, +CE	SOM-5	30vr4	VR4	6a	Sii
L8S	S-1122B33MC	LVR-IC	LDO, 3.3V±1.0%, 150mA, +CE	SOT-23-5	28vt	VR4	6a	Sii
L8S	S-1122B33PN	LVR-IC	LDO, 3.3V±1.0%, 150mA, +CE	SOM-5	30vr4	VR4	6a	Sii
L8T	S-1122B34MC	LVR-IC	LDO, 3.4V±1.0%, 150mA, +CE	SOT-23-5	28vt	VR4	6a	Sii
L8T	S-1122B34PN	LVR-IC	LDO, 3.4V±1.0%, 150mA, +CE	SOM-5	30vr4	VR4	6a	Sii
L8U	S-1122B35MC	LVR-IC	LDO, 3.5V±1.0%, 150mA, +CE	SOT-23-5	28vt	VR4	6a	Sii
L8U	S-1122B35PN	LVR-IC	LDO, 3.5V±1.0%, 150mA, +CE	SOM-5	30vr4	VR4	6a	Sii
L8V	S-1122B36MC	LVR-IC	LDO, 3.6V±1.0%, 150mA, +CE	SOT-23-5	28vt	VR4	6a	Sii
L8V	S-1122B36PN	LVR-IC	LDO, 3.6V±1.0%, 150mA, +CE	SOM-5	30vr4	VR4	6a	Sii
L8W	S-1122B37MC	LVR-IC	LDO, 3.7V±1.0%, 150mA, +CE	SOT-23-5	28vt	VR4	6a	Sii
L8W	S-1122B37PN	LVR-IC	LDO, 3.7V±1.0%, 150mA, +CE	SOM-5	30vr4	VR4	6a	Sii
L8X	S-1122B38MC	LVR-IC	LDO, 3.8V±1.0%, 150mA, +CE	SOT-23-5	28vt	VR4	6a	Sii
L8X	S-1122B38PN	LVR-IC	LDO, 3.8V±1.0%, 150mA, +CE	SOM-5	30vr4	VR4	6a	Sii
L8Y	S-1122B39MC	LVR-IC	LDO, 3.9V±1.0%, 150mA, +CE	SOT-23-5	28vt	VR4	6a	Sii
L8Y	S-1122B39PN	LVR-IC	LDO, 3.9V±1.0%, 150mA, +CE	SOM-5	30vr4	VR4	6a	Sii
L8Z	S-1122B40MC	LVR-IC	LDO, 4.0V±1.0%, 150mA, +CE	SOT-23-5	28vt	VR4	6a	Sii
L8Z	S-1122B40PN	LVR-IC	LDO, 4.0V±1.0%, 150mA, +CE	SOM-5	30vr4	VR4	6a	Sii
L9	HD74LV1G66ACM	CMOS-Logic	Bilateral analogic switch	CMPAK-5	28/Log16	-	6a	Ren
L9	HD74LV1G66AVS	CMOS-Logic	Bilateral analogic switch	VSON-5	30/Log16	-	6a	Ren
L9	R1121N291A	LVR-IC	LDO, LN, -CE, 2.9V±2%, 150mA	SOT-23-5	28vt	VR4	6g	Ric
L9	RN5RG49AA	LVR-IC	Ext. transistor, 4.9V±2.5% 1A*	SOT-23-5	28ww	VR6	6g	Ric
L9	RT9168-24CBR	LVR-IC	LDO, 2.4V±2%, 200mA, +CE	SOT-23-5	28vt	VR4	6g	Rct
L9	RN5RY391A	DC/DC-IC	VFM step-up, 3.9V±2.5%, 150mW, <180kHz	SOT-23-5	28vd	DC5	6g	Ric
L9A	S-1122B41MC	LVR-IC	LDO, 4.1V±1.0%, 150mA, +CE	SOT-23-5	28vt	VR4	6a	Sii
L9A	S-1122B41PN	LVR-IC	LDO, 4.1V±1.0%, 150mA, +CE	SOM-5	30vr4	VR4	6a	Sii
L9A	XC6108N19AMR	Vdet-IC	1.9V±2%, Hysteresis, -Reset ODO	SOT-25	28rm	VD14	6g	Tor
L9A	XC6118C09AMR-G	Vdet-IC	0.9V±30mV, ±Reset PPO, Sense, hysteresis 5%, Cd	SOT-25	28mg	VD15	6g	Tor
L9B	S-1122B42MC	LVR-IC	LDO, 4.2V±1.0%, 150mA, +CE	SOT-23-5	28vt	VR4	6a	Sii
L9B	S-1122B42PN	LVR-IC	LDO, 4.2V±1.0%, 150mA, +CE	SOM-5	30vr4	VR4	6a	Sii
L9B	XC6108N19BMR	Vdet-IC	1.9V±2%, -Reset ODO	SOT-25	28rm	VD14	6g	Tor
L9B	XC6118C09BMR-G	Vdet-IC	0.9V±30mV, ±Reset PPO, Sense, hysteresis <1%, Cd	SOT-25	28mg	VD15	6g	Tor
L9C	S-1122B43MC	LVR-IC	LDO, 4.3V±1.0%, 150mA, +CE	SOT-23-5	28vt	VR4	6a	Sii
L9C	S-1122B43PN	LVR-IC	LDO, 4.3V±1.0%, 150mA, +CE	SOM-5	30vr4	VR4	6a	Sii
L9C	XC6108N19CMR	Vdet-IC	1.9V±2%, Hysteresis, -Reset ODO	SOT-25	28rk	VD14	6g	Tor
L9C	XC6118C09CMR-G	Vdet-IC	0.9V±30mV, ±Reset PPO, Sense, hysteresis 5%	SOT-25	28mf	VD12	6g	Tor
L9D	S-1122B44MC	LVR-IC	LDO, 4.4V±1.0%, 150mA, +CE	SOT-23-5	28vt	VR4	6a	Sii
L9D	S-1122B44PN	LVR-IC	LDO, 4.4V±1.0%, 150mA, +CE	SOM-5	30vr4	VR4	6a	Sii



SMD code	Type	Function	Short description	Case	Pinout	Sch.	St.	Mnf.
L9D	XC6108N19DMR	Vdet-IC	1.9V±2%, -Reset ODO	SOT-25	28rk	VD14	6g	Tor
L9D	XC6118C09DMR-G	Vdet-IC	0.9V±30mV, ±Reset PPO, Sense, hysteresis <1%	SOT-25	28mf	VD12	6g	Tor
L9E	S-1122B45MC	LVR-IC	LDO, 4.5V±1.0%, 150mA, +CE	SOT-23-5	28vt	VR4	6a	Sii
L9E	S-1122B45PN	LVR-IC	LDO, 4.5V±1.0%, 150mA, +CE	SOM-5	30vr4	VR4	6a	Sii
L9F	S-1122B46MC	LVR-IC	LDO, 4.6V±1.0%, 150mA, +CE	SOT-23-5	28vt	VR4	6a	Sii
L9F	S-1122B46PN	LVR-IC	LDO, 4.6V±1.0%, 150mA, +CE	SOM-5	30vr4	VR4	6a	Sii
L9G	S-1122B47MC	LVR-IC	LDO, 4.7V±1.0%, 150mA, +CE	SOT-23-5	28vt	VR4	6a	Sii
L9G	S-1122B47PN	LVR-IC	LDO, 4.7V±1.0%, 150mA, +CE	SOM-5	30vr4	VR4	6a	Sii
L9H	S-1122B48MC	LVR-IC	LDO, 4.8V±1.0%, 150mA, +CE	SOT-23-5	28vt	VR4	6a	Sii
L9H	S-1122B48PN	LVR-IC	LDO, 4.8V±1.0%, 150mA, +CE	SOM-5	30vr4	VR4	6a	Sii
L9I	S-1122B49MC	LVR-IC	LDO, 4.9V±1.0%, 150mA, +CE	SOT-23-5	28vt	VR4	6a	Sii
L9I	S-1122B49PN	LVR-IC	LDO, 4.9V±1.0%, 150mA, +CE	SOM-5	30vr4	VR4	6a	Sii
L9J	S-1122B50MC	LVR-IC	LDO, 5.0V±1.0%, 150mA, +CE	SOT-23-5	28vt	VR4	6a	Sii
L9J	S-1122B50PN	LVR-IC	LDO, 5.0V±1.0%, 150mA, +CE	SOM-5	30vr4	VR4	6a	Sii
L9K	S-1122B51MC	LVR-IC	LDO, 5.1V±1.0%, 150mA, +CE	SOT-23-5	28vt	VR4	6a	Sii
L9K	S-1122B51PN	LVR-IC	LDO, 5.1V±1.0%, 150mA, +CE	SOM-5	30vr4	VR4	6a	Sii
L9L	S-1122B52MC	LVR-IC	LDO, 5.2V±1.0%, 150mA, +CE	SOT-23-5	28vt	VR4	6a	Sii
L9L	S-1122B52PN	LVR-IC	LDO, 5.2V±1.0%, 150mA, +CE	SOM-5	30vr4	VR4	6a	Sii
L9M	S-1122B53MC	LVR-IC	LDO, 5.3V±1.0%, 150mA, +CE	SOT-23-5	28vt	VR4	6a	Sii
L9M	S-1122B53PN	LVR-IC	LDO, 5.3V±1.0%, 150mA, +CE	SOM-5	30vr4	VR4	6a	Sii
L9N	S-1122B54MC	LVR-IC	LDO, 5.4V±1.0%, 150mA, +CE	SOT-23-5	28vt	VR4	6a	Sii
L9N	S-1122B54PN	LVR-IC	LDO, 5.4V±1.0%, 150mA, +CE	SOM-5	30vr4	VR4	6a	Sii
L9O	S-1122B55MC	LVR-IC	LDO, 5.5V±1.0%, 150mA, +CE	SOT-23-5	28vt	VR4	6a	Sii
L9O	S-1122B55PN	LVR-IC	LDO, 5.5V±1.0%, 150mA, +CE	SOM-5	30vr4	VR4	6a	Sii
La	AX6603-330B	LVR-IC	LDO, 3.3V±2%, 300mA, +CE	SOT-23-5	28vrx	VR7	6k	Axl
La	AX6603-120B	LVR-IC	LDO, 1.2V±2%, 300mA, +CE	SOT-23-5	28vrx	VR7	6k	Axl
LA	BU4941FWE	Vdet-IC	4.1V, +Reset PPO	VSOFF-5	30vk	VD7	6c	Rhm
LA	BU4941G	Vdet-IC	4.1V, +Reset PPO	SSOP-5	28vdm	VD7	6c	Rhm
LA	HD74LV1G14ACM	CMOS-Logic	Inverting Schmitt-trigger	CMPAK-5	28/Log7	-	6a	Ren
LA	HD74LV1G14AVS	CMOS-Logic	Inverting Schmitt-trigger	VSON-5	30/Log7	-	6a	Ren
LA	IDT74LVC1G00ADY	CMOS-Logic	2-input NAND gate	SO5-1	28/Log1	-	6g	Idt
LA	NL17SZ14DF	CMOS-Logic	Inverting Schmitt-trigger	SC-70-5	28/Log7	-	6b	Ons
LA	RT9168-25CBR	LVR-IC	LDO, 2.5V±2%, 200mA, +CE	SOT-23-5	28vt	VR4	6g	Rct
LA	TC6604N015VCT	Tdet-IC	-15°C±0.5°C, +Tunder ODO, Hysteresis	SOT-23-5	28	-	6a	Mcc
LA0	XC6219A312MR	LVR-IC	LDO, 3.1V±2%, 240mA, +CE, PDR	SOT-25	28cx	VR4	6g	Tor
LA1	XC6219A322MR	LVR-IC	LDO, 3.2V±2%, 240mA, +CE, PDR	SOT-25	28cx	VR4	6g	Tor
LA2	XC6219A332MR	LVR-IC	LDO, 3.3V±2%, 240mA, +CE, PDR	SOT-25	28cx	VR4	6g	Tor
LA3	XC6219A342MR	LVR-IC	LDO, 3.4V±2%, 240mA, +CE, PDR	SOT-25	28cx	VR4	6g	Tor
LA4	XC6219A352MR	LVR-IC	LDO, 3.5V±2%, 240mA, +CE, PDR	SOT-25	28cx	VR4	6g	Tor
LA5	XC6219A362MR	LVR-IC	LDO, 3.6V±2%, 240mA, +CE, PDR	SOT-25	28cx	VR4	6g	Tor
LA6	XC6219A372MR	LVR-IC	LDO, 3.7V±2%, 240mA, +CE, PDR	SOT-25	28cx	VR4	6g	Tor
LA7	XC6219A382MR	LVR-IC	LDO, 3.8V±2%, 240mA, +CE, PDR	SOT-25	28cx	VR4	6g	Tor
LA7A	LP2985AIM5-4.5	LVR-IC	ULDO, 4.5V±1%, 150mA, +CE	SOT-23-5	28vrx	VR7	6g	Nsc
LA7B	LP2985IM5X-4.5	LVR-IC	ULDO, 4.5V±2.5%, 150mA, +CE	SOT-23-5	28vrx	VR7	6g	Nsc
LA8	XC6219A392MR	LVR-IC	LDO, 3.9V±2%, 240mA, +CE, PDR	SOT-25	28cx	VR4	6g	Tor
LA8	XC9236C08CMR	DC-DC-IC	PWM/PFM, st-dwn, 0.8V±2%, 600mA, 1.2MHz, Vin>2V, LSST, CL	SOT-25	28dc4	DC1	6g	Tor
LA9	XC6219A402MR	LVR-IC	LDO, 4V±2%, 240mA, +CE, PDR	SOT-25	28cx	VR4	6g	Tor
LA9	XC9236C09CMR	DC-DC-IC	PWM/PFM, st-dwn, 0.9V±2%, 600mA, 1.2MHz, Vin>2V, LSST, CL	SOT-25	28dc4	DC1	6g	Tor
LAa	RP171N571B	LVR-IC	LDO, 5.7V±1%, 150mA, +CE	SOT-23-5	28cx	VR4	6g	Ric
LAa	XC6219A412MR	LVR-IC	LDO, 4.1V±2%, 240mA, +CE, PDR	SOT-25	28cx	VR4	6g	Tor
LAB	LP5951MF-3.3	LVR-IC	LDO, 3.3V±2%, 150mA, +CE	SC-70-5	28cx	VR4	6a	Nsc
LAB	MIC5213-5.0BC5	LVR-IC	LDO, 5V±3%, 150mA, +CE	SOT-23-5	28xm	VR4	6g	Mcr
LAB	RP171N581B	LVR-IC	LDO, 5.8V±1%, 150mA, +CE	SOT-23-5	28cx	VR4	6g	Ric
LAB	XC6219A422MR	LVR-IC	LDO, 4.2V±2%, 240mA, +CE, PDR	SOT-25	28cx	VR4	6g	Tor
LAC	RP171N591B	LVR-IC	LDO, 5.9V±1%, 150mA, +CE	SOT-23-5	28cx	VR4	6g	Ric
LAC	XC6219A432MR	LVR-IC	LDO, 4.3V±2%, 240mA, +CE, PDR	SOT-25	28cx	VR4	6g	Tor
LAD	MIC5213-3.6BC5	LVR-IC	LDO, 3.6V±3%, 150mA, +CE	SOT-23-5	28xm	VR4	6g	Mcr
LAD	RP171N601B	LVR-IC	LDO, 6.0V±1%, 150mA, +CE	SOT-23-5	28cx	VR4	6g	Ric
LAD	XC6219A442MR	LVR-IC	LDO, 4.4V±2%, 240mA, +CE, PDR	SOT-25	28cx	VR4	6g	Tor
LAE	MIC5213-3.3BC5	LVR-IC	LDO, 3.3V±3%, 150mA, +CE	SOT-23-5	28xm	VR4	6g	Mcr
LAE	XC6219A452MR	LVR-IC	LDO, 4.5V±2%, 240mA, +CE, PDR	SOT-25	28cx	VR4	6g	Tor
LAF	XC6219A462MR	LVR-IC	LDO, 4.6V±2%, 240mA, +CE, PDR	SOT-25	28cx	VR4	6g	Tor
LAG	MIC5213-3.0BC5	LVR-IC	LDO, 3V±3%, 150mA, +CE	SOT-23-5	28xm	VR4	6g	Mcr
LAGA	LP2980AIM5-1.8	LVR-IC	Ultra-LDO, +CE, 1.8V±0.5%, 50mA	SOT-23-5	28cx	VR4	6g	Nsc
LAGB	LP2980IM5-1.8	LVR-IC	Ultra-LDO, +CE, 1.8V±2%, 50mA	SOT-23-5	28cx	VR4	6g	Nsc
LAH	XC6219A472MR	LVR-IC	LDO, 4.7V±2%, 240mA, +CE, PDR	SOT-25	28cx	VR4	6g	Tor
LAIA	LP2985AIM5-3.5	LVR-IC	ULDO, 3.4V±1%, 150mA, +CE	SOT-23-5	28vrx	VR7	6g	Nsc
LAJ	MIC5213-2.8BC5	LVR-IC	LDO, 2.8V±3%, 150mA, +CE	SOT-23-5	28xm	VR4	6g	Mcr
LAJA	LP2985AIM5-4.7	LVR-IC	Ultra-LDO, LN, 4.7V, 150mA	SOT-23-5	28vrx	VR7	6g	Nsc
LAK	XC6219A482MR	LVR-IC	LDO, 4.8V±2%, 240mA, +CE, PDR	SOT-25	28cx	VR4	6g	Tor



SMD code	Type	Function	Short description	Case	Pinout	Sch.	St.	Mnf.
LAKA	LP2985AIM5-4.8	LVR-IC	Ultra-LDO, LN, 4.8V, 150mA	SOT-23-5	28vrx	VR7	6g	Nsc
LAL	MIC5213-2.7BC5	LVR-IC	LDO, 2.7V±3%, 150mA, +CE	SOT-23-5	28xm	VR4	6g	Mcr
LAL	XC6219A492MR	LVR-IC	LDO, 4.9V±2%, 240mA, +CE, PDR	SOT-25	28cx	VR4	6g	Tor
LAL	XC9236C0LCMR	DC-DC-IC	PWM/PPM, st-dwn, 0.85V±2%, 600mA, 1.2MHz, Vin>2V, LSST, CL	SOT-25	28dc4	DC1	6g	Tor
LALA	LP2985AIM5-2.7	LVR-IC	ULDO, 2.7V±1%, 150mA, +CE	SOT-23-5	28vrx	VR7	6g	Nsc
LALB	LP2985IMS-2.7	LVR-IC	ULDO, 2.7V±2.5%, 150mA, +CE	SOT-23-5	28vrx	VR7	6g	Nsc
LAM	MIC5213-2.5BC5	LVR-IC	LDO, 2.5V±3%, 150mA, +CE	SOT-23-5	28xm	VR4	6g	Mcr
LAM	XC6219A502MR	LVR-IC	LDO, 5V±2%, 240mA, +CE, PDR	SOT-25	28cx	VR4	6g	Tor
LAM	XC9236C0CMR	DC-DC-IC	PWM/PPM, st-dwn, 0.95V±2%, 600mA, 1.2MHz, Vin>2V, LSST, CL	SOT-25	28dc4	DC1	6g	Tor
LAN	MIC5213-1.8BC5	LVR-IC	LDO, 1.8V±3%, 150mA, +CE	SOT-23-5	28xm	VR4	6g	Mcr
LANA	LP2980AIM5-1.5	LVR-IC	Ultra-LDO, +CE, 1.5V±0.5%, 50mA	SOT-23-5	28cx	VR4	6g	Nsc
LANB	LP2980IMS-1.5	LVR-IC	Ultra-LDO, +CE, 1.5V±2%, 50mA	SOT-23-5	28cx	VR4	6g	Nsc
LAO	NCP551SN15T1	LVR-IC	LDO, Low Iq, +CE, 1.5V±2%, 150mA	SOT-353	30cx	VR4	6b	Ons
LAP	NCP551SN18T1	LVR-IC	LDO, Low Iq, +CE, 1.8V±2%, 150mA	SOT-353	30cx	VR4	6b	Ons
LAQ	MIC5213-2.6BC5	LVR-IC	LDO, 2.6V±3%, 150mA, +CE	SOT-23-5	28xm	VR4	6g	Mcr
LAQ	NCP551SN25T1	LVR-IC	LDO, Low Iq, +CE, 2.5V±2%, 150mA	SOT-353	30cx	VR4	6b	Ons
LAR	NCP551SN27T1	LVR-IC	LDO, Low Iq, +CE, 2.7V±2%, 150mA	SOT-353	30cx	VR4	6b	Ons
LAS	NCP551SN28T1	LVR-IC	LDO, Low Iq, +CE, 2.8V±2%, 150mA	SOT-353	30cx	VR4	6b	Ons
LAT	NCP551SN30T1	LVR-IC	LDO, Low Iq, +CE, 3V±2%, 150mA	SOT-353	30cx	VR4	6b	Ons
LAU	NCP551SN33T1	LVR-IC	LDO, Low Iq, +CE, 3.3V±2%, 150mA	SOT-353	30cx	VR4	6b	Ons
LAUA	LP2985AIM-2.5	LVR-IC	ULDO, 2.5V±1%, 150mA, +CE	SOT-23-5	28vrx	VR7	6g	Nsc
LAUB	LP2985IMS-2.5	LVR-IC	ULDO, 2.5V±2.5%, 150mA, +CE	SOT-23-5	28vrx	VR7	6g	Nsc
LAV	NCP551SN50T1	LVR-IC	LDO, Low Iq, +CE, 5V±2%, 150mA	SOT-353	30cx	VR4	6b	Ons
LAXA	LP2985AIM5-2.9	LVR-IC	ULDO, 2.9V±1%, 150mA, +CE	SOT-23-5	28vrx	VR7	6g	Nsc
LAXB	LP2985IMS-2.9	LVR-IC	ULDO, 2.9V±2.5%, 150mA, +CE	SOT-23-5	28vrx	VR7	6g	Nsc
LAZB	LP3961EMP-3.3	LVR-IC	Ultra-LDO, 3.3V, 800mA, -CE	SOT-223-5	27vrx	VR17	6a	Nsc
Lb	AX6603-340B	LVR-IC	LDO, 3.4V±2%, 300mA, +CE	SOT-23-5	28vrx	VR7	6k	Axl
LB	AX6603-130B	LVR-IC	LDO, 1.3V±2%, 300mA, +CE	SOT-23-5	28vrx	VR7	6k	Axl
LB	BU4942FWE	Vdet-IC	4.2V, +Reset PPO	VSOFF-5	30vk	VD7	6c	Rhm
LB	BU4942G	Vdet-IC	4.2V, +Reset PPO	SSOP-5	28vdm	VD7	6c	Rhm
LB	HD74LV1G125ACM	CMOS-Logic	Bus buffer gate with 3-state output	CMPAK-5	28/Log14	-	6a	Ren
LB	HD74LV1G125AVS	CMOS-Logic	Bus buffer gate with 3-state output	VSON-5	30/Log14	-	6a	Ren
LB	IDT74LV1G01ADY	CMOS-Logic	2-input NOR gate	S05-1	28/Log2	-	6g	Idt
LB	RT9168-26CBR	LVR-IC	LDO, 2.6V±2%, 200mA, +CE	SOT-23-5	28v	VR4	6g	Rct
LB	TC6504P005VCT	Tdet-IC	5°C±0.5°C, +Tunder ODO, Hysteresis	SOT-23-5	28t	-	6a	Mcc
LB0	XC6219B312MR	LVR-IC	LDO, 3.1V±2%, 240mA, +CE	SOT-25	28cx	VR4	6g	Tor
LB0	XC9236C10CMR	DC-DC-IC	PWM/PPM, st-dwn, 1.0V±2%, 600mA, 1.2MHz, Vin>2V, LSST, CL	SOT-25	28dc4	DC1	6g	Tor
LB1	XC6219B322MR	LVR-IC	LDO, 3.2V±2%, 240mA, +CE	SOT-25	28cx	VR4	6g	Tor
LB1	XC9236C11CMR	DC-DC-IC	PWM/PPM, st-dwn, 1.1V±2%, 600mA, 1.2MHz, Vin>2V, LSST, CL	SOT-25	28dc4	DC1	6g	Tor
LB2	XC6219B332MR	LVR-IC	LDO, 3.3V±2%, 240mA, +CE	SOT-25	28cx	VR4	6g	Tor
LB2	XC9236C12CMR	DC-DC-IC	PWM/PPM, st-dwn, 1.2V±2%, 600mA, 1.2MHz, Vin>2V, LSST, CL	SOT-25	28dc4	DC1	6g	Tor
LB25	MIC5205-2.5BM5	LVR-IC	LDO, 2.5V±1%, 150mA, +CE	SOT-23-5	28vrx	VR7	6g	Mcr
LB27	MIC5205-2.7BM5	LVR-IC	LDO, 2.7V±1%, 150mA, +CE	SOT-23-5	28vrx	VR7	6g	Mcr
LB28	MIC5205-2.8BM5	LVR-IC	LDO, 2.8V±1%, 150mA, +CE	SOT-23-5	28vrx	VR7	6g	Mcr
LB29	MIC5205-2.9BM5	LVR-IC	LDO, 2.9V±1%, 150mA, +CE	SOT-23-5	28vrx	VR7	6g	Mcr
LB2J	MIC5205-2.85BM5	LVR-IC	LDO, 2.85V±1%, 150mA, +CE	SOT-23-5	28vrx	VR7	6g	Mcr
LB3	XC6219B342MR	LVR-IC	LDO, 3.4V±2%, 240mA, +CE	SOT-25	28cx	VR4	6g	Tor
LB3	XC9236C13CMR	DC-DC-IC	PWM/PPM, st-dwn, 1.3V±2%, 600mA, 1.2MHz, Vin>2V, LSST, CL	SOT-25	28dc4	DC1	6g	Tor
LB30	MIC5205-3.0BM5	LVR-IC	LDO, 3V±1%, 150mA, +CE	SOT-23-5	28vrx	VR7	6g	Mcr
LB31	MIC5205-3.1BM5	LVR-IC	LDO, 3.1V±1%, 150mA, +CE	SOT-23-5	28vrx	VR7	6g	Mcr
LB32	MIC5205-3.2BM5	LVR-IC	LDO, 3.2V±1%, 150mA, +CE	SOT-23-5	28vrx	VR7	6g	Mcr
LB33	MIC5205-3.3BM5	LVR-IC	LDO, 3.3V±1%, 150mA, +CE	SOT-23-5	28vrx	VR7	6g	Mcr
LB36	MIC5205-3.6BM5	LVR-IC	LDO, 3.6V±1%, 150mA, +CE	SOT-23-5	28vrx	VR7	6g	Mcr
LB38	MIC5205-3.8BM5	LVR-IC	LDO, 3.8V±1%, 150mA, +CE	SOT-23-5	28vrx	VR7	6g	Mcr
LB4	XC6219B352MR	LVR-IC	LDO, 3.5V±2%, 240mA, +CE	SOT-25	28cx	VR4	6g	Tor
LB4	XC9236C14CMR	DC-DC-IC	PWM/PPM, st-dwn, 1.4V±2%, 600mA, 1.2MHz, Vin>2V, LSST, CL	SOT-25	28dc4	DC1	6g	Tor
LB40	MIC5205-4.0BM5	LVR-IC	LDO, 4V±1%, 150mA, +CE	SOT-23-5	28vrx	VR7	6g	Mcr
LB48	MIC5205-4.8BM5	LVR-IC	LDO, 4.8V±1%, 150mA, +CE	SOT-23-5	28vrx	VR7	6g	Mcr
LB5	XC6219B362MR	LVR-IC	LDO, 3.6V±2%, 240mA, +CE	SOT-25	28cx	VR4	6g	Tor
LB5	XC9236C15CMR	DC-DC-IC	PWM/PPM, st-dwn, 1.5V±2%, 600mA, 1.2MHz, Vin>2V, LSST, CL	SOT-25	28dc4	DC1	6g	Tor
LB50	MIC5205-5.0BM5	LVR-IC	LDO, 5V±1%, 150mA, +CE	SOT-23-5	28vrx	VR7	6g	Mcr
LB6	XC6219B372MR	LVR-IC	LDO, 3.7V±2%, 240mA, +CE	SOT-25	28cx	VR4	6g	Tor
LB6	XC9236C16CMR	DC-DC-IC	PWM/PPM, st-dwn, 1.6V±2%, 600mA, 1.2MHz, Vin>2V, LSST, CL	SOT-25	28dc4	DC1	6g	Tor
LB7	XC6219B382MR	LVR-IC	LDO, 3.8V±2%, 240mA, +CE	SOT-25	28cx	VR4	6g	Tor
LB7	XC9236C17CMR	DC-DC-IC	PWM/PPM, st-dwn, 1.7V±2%, 600mA, 1.2MHz, Vin>2V, LSST, CL	SOT-25	28dc4	DC1	6g	Tor
LB8	XC6219B392MR	LVR-IC	LDO, 3.9V±2%, 240mA, +CE	SOT-25	28cx	VR4	6g	Tor
LB8	XC9236C18CMR	DC-DC-IC	PWM/PPM, st-dwn, 1.8V±2%, 600mA, 1.2MHz, Vin>2V, LSST, CL	SOT-25	28dc4	DC1	6g	Tor
LB9	XC6219B402MR	LVR-IC	LDO, 4V±2%, 240mA, +CE	SOT-25	28cx	VR4	6g	Tor
LB9	XC9236C19CMR	DC-DC-IC	PWM/PPM, st-dwn, 1.9V±2%, 600mA, 1.2MHz, Vin>2V, LSST, CL	SOT-25	28dc4	DC1	6g	Tor
LBA	RP171N571D	LVR-IC	LDO, 5.7V±1%, 150mA, +CE, CL	SOT-23-5	28cx	VR4	6g	Ric



SMD code	Type	Function	Short description	Case	Pinout	Sch.	St.	Mnf.
LBA	XC6219B412MR	LVR-IC	LDO, 4.1V±2%, 240mA, +CE	SOT-25	28cx	VR4	6g	Tor
LBA	XC9236C1ACMR	DC-DC-IC	PWM/PPM, st-dwn, 1.05V±2%, 600mA, 1.2MHz, Vin>2V, LSST, CL	SOT-25	28dc4	DC1	6g	Tor
LBAB	LP3961EMP-1.8	LVR-IC	Ultra-LDO, -CE, 1.8V, 0.8A	SOT-223-5	27vrz	VR17	6a	Nsc
LBB	RP171N581D	LVR-IC	LDO, 5.8V±1%, 150mA, +CE, CL	SOT-23-5	28cx	VR4	6g	Ric
LBB	XC6219B422MR	LVR-IC	LDO, 4.2V±2%, 240mA, +CE	SOT-25	28cx	VR4	6g	Tor
LBB	XC9236C1BCMR	DC-DC-IC	PWM/PPM, st-dwn, 1.15V±2%, 600mA, 1.2MHz, Vin>2V, LSST, CL	SOT-25	28dc4	DC1	6g	Tor
LBBB	LP3961EMP-2.5	LVR-IC	Ultra-LDO, -CE, 2.5V, 0.8A	SOT-223-5	27vrz	VR17	6a	Nsc
LBC	RP171N591D	LVR-IC	LDO, 5.9V±1%, 150mA, +CE, CL	SOT-23-5	28cx	VR4	6g	Ric
LBC	XC6219B432MR	LVR-IC	LDO, 4.3V±2%, 240mA, +CE	SOT-25	28cx	VR4	6g	Tor
LBC	XC9236C1CCMR	DC-DC-IC	PWM/PPM, st-dwn, 1.25V±2%, 600mA, 1.2MHz, Vin>2V, LSST, CL	SOT-25	28dc4	DC1	6g	Tor
LBCB	LP3962EMP-1.8	LVR-IC	Ultra-LDO, -CE, 1.8V, 1.5A	SOT-223-5	27vrz	VR17	6a	Nsc
LBD	RP171N601D	LVR-IC	LDO, 6.0V±1%, 150mA, +CE, CL	SOT-23-5	28cx	VR4	6g	Ric
LBD	XC6219B442MR	LVR-IC	LDO, 4.4V±2%, 240mA, +CE	SOT-25	28cx	VR4	6g	Tor
LBD	XC9236C1DCMR	DC-DC-IC	PWM/PPM, st-dwn, 1.35V±2%, 600mA, 1.2MHz, Vin>2V, LSST, CL	SOT-25	28dc4	DC1	6g	Tor
LDBB	LP3962EMP-2.5	LVR-IC	Ultra-LDO, -CE, 2.5V, 1.5A	SOT-223-5	27vrz	VR17	6a	Nsc
LBE	XC6219B452MR	LVR-IC	LDO, 4.5V±2%, 240mA, +CE	SOT-25	28cx	VR4	6g	Tor
LBE	XC9236C1ECMR	DC-DC-IC	PWM/PPM, st-dwn, 1.45V±2%, 600mA, 1.2MHz, Vin>2V, LSST, CL	SOT-25	28dc4	DC1	6g	Tor
LBEB	LP3962EMP-3.3	LVR-IC	Ultra-LDO, -CE, 3.3V, 1.5A	SOT-223-5	27vrz	VR17	6a	Nsc
LBF	XC6219B462MR	LVR-IC	LDO, 4.6V±2%, 240mA, +CE	SOT-25	28cx	VR4	6g	Tor
LBF	XC9236C1FCMR	DC-DC-IC	PWM/PPM, st-dwn, 1.55V±2%, 600mA, 1.2MHz, Vin>2V, LSST, CL	SOT-25	28dc4	DC1	6g	Tor
LBFB	LP3964EMP-1.8	LVR-IC	Ultra-LDO, -CE, 1.8V, 0.8A	SOT-223-5	27vry	VR18	6a	Nsc
LBH	XC6219B472MR	LVR-IC	LDO, 4.7V±2%, 240mA, +CE	SOT-25	28cx	VR4	6g	Tor
LBH	XC9236C1HCMR	DC-DC-IC	PWM/PPM, st-dwn, 1.65V±2%, 600mA, 1.2MHz, Vin>2V, LSST, CL	SOT-25	28dc4	DC1	6g	Tor
LBHB	LP3964EMP-2.5	LVR-IC	Ultra-LDO, -CE, 2.5V, 0.8A	SOT-223-5	27vry	VR18	6a	Nsc
LBIB	LP2985IM5-3.5	LVR-IC	Ultra-LDO, LN, 3.5V, 150mA	SOT-23-5	28vrx	VR7	6g	Nsc
LBJB	LP2985IM5-4.7	LVR-IC	Ultra-LDO, LN, 4.7V, 150mA	SOT-23-5	28vrx	VR7	6g	Nsc
LBJB	LP3964EMP-3.3	LVR-IC	Ultra-LDO, -CE, 3.3V, 0.8A	SOT-223-5	27vry	VR18	6a	Nsc
LBK	XC6219B482MR	LVR-IC	LDO, 4.8V±2%, 240mA, +CE	SOT-25	28cx	VR4	6g	Tor
LBK	XC9236C1KCMR	DC-DC-IC	PWM/PPM, st-dwn, 1.75V±2%, 600mA, 1.2MHz, Vin>2V, LSST, CL	SOT-25	28dc4	DC1	6g	Tor
LBKB	LP2985IM5-4.8	LVR-IC	Ultra-LDO, LN, 4.8V, 150mA	SOT-23-5	28vrx	VR7	6g	Nsc
LBKB	LP3965EMP-1.8	LVR-IC	Ultra-LDO, -CE, 1.8V, 1.5A	SOT-223-5	27vry	VR18	6a	Nsc
LBL	XC6219B492MR	LVR-IC	LDO, 4.9V±2%, 240mA, +CE	SOT-25	28cx	VR4	6g	Tor
LBL	XC9236C1LCMR	DC-DC-IC	PWM/PPM, st-dwn, 1.85V±2%, 600mA, 1.2MHz, Vin>2V, LSST, CL	SOT-25	28dc4	DC1	6g	Tor
LBLB	LP2985IM5-2.7	LVR-IC	ULDO, LN, 2.7V±2.5%, 150mA	SOT-23-5	28vrx	VR7	6g	Nsc
LBLB	LP3965EMP-2.5	LVR-IC	Ultra-LDO, -CE, 2.5V, 1.5A	SOT-223-5	27vry	VR18	6a	Nsc
LBM	XC6219B502MR	LVR-IC	LDO, 5V±2%, 240mA, +CE	SOT-25	28cx	VR4	6g	Tor
LBM	XC9236C1MCMR	DC-DC-IC	PWM/PPM, st-dwn, 1.95V±2%, 600mA, 1.2MHz, Vin>2V, LSST, CL	SOT-25	28dc4	DC1	6g	Tor
LBNB	LP3965EMP-3.3	LVR-IC	Ultra-LDO, -CE, 3.3V, 1.5A	SOT-223-5	27vry	VR18	6a	Nsc
LBSB	LP3961EMP-5.0	LVR-IC	Ultra-LDO, -CE, 5V, 0.8A	SOT-223-5	27vrz	VR17	6a	Nsc
LBTB	LP3962EMP-5.0	LVR-IC	Ultra-LDO, -CE, 5V, 1.5A	SOT-223-5	27vrz	VR17	6a	Nsc
LBU	NCP511SN15T1	LVR-IC	LDO, Low Iq, +CE, 1.5V±2%, 150mA	SOT-23-5	28cx	VR4	6b	Ons
LBUB	LP3964EMP-5.0	LVR-IC	Ultra-LDO, -CE, 5V, 0.8A	SOT-223-5	27vry	VR18	6a	Nsc
LBV	NCP511SN18T1	LVR-IC	LDO, Low Iq, +CE, 1.8V±2%, 150mA	SOT-23-5	28cx	VR4	6b	Ons
LBVB	LP3965EMP-5.0	LVR-IC	Ultra-LDO, -CE, 5V, 1.5A	SOT-223-5	27vry	VR18	6a	Nsc
LBW	NCP511SN25T1	LVR-IC	LDO, Low Iq, +CE, 2.5V±2%, 150mA	SOT-23-5	28cx	VR4	6b	Ons
LBX	NCP511SN27T1	LVR-IC	LDO, Low Iq, +CE, 2.7V±2%, 150mA	SOT-23-5	28cx	VR4	6b	Ons
LBY	NCP511SN28T1	LVR-IC	LDO, Low Iq, +CE, 2.8V±2%, 150mA	SOT-23-5	28cx	VR4	6b	Ons
LBZ	NCP511SN30T1	LVR-IC	LDO, Low Iq, +CE, 3V±2%, 150mA	SOT-23-5	28cx	VR4	6b	Ons
LC	AX6603-140B	LVR-IC	LDO, 1.4V±2%, 300mA, +CE	SOT-23-5	28vrx	VR7	6k	Axl
LC	BU4943FWE	Vdet-IC	4.3V, +Reset PPO	VSOF-5	30vk	VD7	6c	Rhm
LC	BU4943G	Vdet-IC	4.3V, +Reset PPO	SSOF-5	28vdm	VD7	6c	Rhm
LC	HD74LV1G126ACM	CMOS-Logic	Bus buffer gate with 3-state output	CMPAK-5	28Log1	-	6a	Ren
LC	HD74LV1G126AVS	CMOS-Logic	Bus buffer gate with 3-state output	VSON-5	30Log13	-	6a	Ren
LC	IDT74LVC1G04ADY	CMOS-Logic	Inverter	S05-1	28Log6	-	6g	Idt
LC	RT9168-27CBR	LVR-IC	LDO, 2.7V±2%, 200mA, +CE	SOT-23-5	28vt	VR4	6g	Rct
LC0	XC6219C312MR	LVR-IC	LDO, 3.1V±2%, 240mA, -CE, PDR	SOT-25	28cx	VR4	6g	Tor
LC0	XC9236C20CMR	DC-DC-IC	PWM/PPM, st-dwn, 2.0V±2%, 600mA, 1.2MHz, Vin>2V, LSST, CL	SOT-25	28dc4	DC1	6g	Tor
LC1	XC6219C322MR	LVR-IC	LDO, 3.2V±2%, 240mA, -CE, PDR	SOT-25	28cx	VR4	6g	Tor
LC1	XC9236C21CMR	DC-DC-IC	PWM/PPM, st-dwn, 2.1V±2%, 600mA, 1.2MHz, Vin>2V, LSST, CL	SOT-25	28dc4	DC1	6g	Tor
LC2	XC6219C332MR	LVR-IC	LDO, 3.3V±2%, 240mA, -CE, PDR	SOT-25	28cx	VR4	6g	Tor
LC2	XC9236C22CMR	DC-DC-IC	PWM/PPM, st-dwn, 2.2V±2%, 600mA, 1.2MHz, Vin>2V, LSST, CL	SOT-25	28dc4	DC1	6g	Tor
LC3	XC6219C342MR	LVR-IC	LDO, 3.4V±2%, 240mA, -CE, PDR	SOT-25	28cx	VR4	6g	Tor
LC3	XC9236C23CMR	DC-DC-IC	PWM/PPM, st-dwn, 2.3V±2%, 600mA, 1.2MHz, Vin>2V, LSST, CL	SOT-25	28dc4	DC1	6g	Tor
LC4	XC6219C352MR	LVR-IC	LDO, 3.5V±2%, 240mA, -CE, PDR	SOT-25	28cx	VR4	6g	Tor
LC4	XC9236C24CMR	DC-DC-IC	PWM/PPM, st-dwn, 2.4V±2%, 600mA, 1.2MHz, Vin>2V, LSST, CL	SOT-25	28dc4	DC1	6g	Tor
LC5	XC6219C362MR	LVR-IC	LDO, 3.6V±2%, 240mA, -CE, PDR	SOT-25	28cx	VR4	6g	Tor
LC5	XC9236C25CMR	DC-DC-IC	PWM/PPM, st-dwn, 2.5V±2%, 600mA, 1.2MHz, Vin>2V, LSST, CL	SOT-25	28dc4	DC1	6g	Tor
LC6	XC6219C372MR	LVR-IC	LDO, 3.7V±2%, 240mA, -CE, PDR	SOT-25	28cx	VR4	6g	Tor
LC6	XC9236C26CMR	DC-DC-IC	PWM/PPM, st-dwn, 2.6V±2%, 600mA, 1.2MHz, Vin>2V, LSST, CL	SOT-25	28dc4	DC1	6g	Tor
LC7	XC6219C382MR	LVR-IC	LDO, 3.8V±2%, 240mA, -CE, PDR	SOT-25	28cx	VR4	6g	Tor



SMD code	Type	Function	Short description	Case	Pinout	Sch.	St.	Mnf.
LC7	XC9236C27CMR	DC-DC-IC	PWM/PFM, st-dwn, 2.7V±2%, 600mA, 1.2MHz, Vin>2V, LSST, CL	SOT-25	28dc4	DC1	6g	Tor
LC8	XG6219C392MR	LVR-IC	LDO, 3.9V±2%, 240mA, -CE, PDR	SOT-25	28cx	VR4	6g	Tor
LC8	XC9236C28CMR	DC-DC-IC	PWM/PFM, st-dwn, 2.8V±2%, 600mA, 1.2MHz, Vin>2V, LSST, CL	SOT-25	28dc4	DC1	6g	Tor
LC9	XG6219C402MR	LVR-IC	LDO, 4V±2%, 240mA, -CE, PDR	SOT-25	28cx	VR4	6g	Tor
LC9	XC9236C29CMR	DC-DC-IC	PWM/PFM, st-dwn, 2.9V±2%, 600mA, 1.2MHz, Vin>2V, LSST, CL	SOT-25	28dc4	DC1	6g	Tor
LCA	NCP511SN33T1	LVR-IC	LDO, Low Iq, +CE, 3.3V±2%, 150mA	SOT-23-5	28cx	VR4	6b	Ons
LCA	XG6219C412MR	LVR-IC	LDO, 4.1V±2%, 240mA, -CE, PDR	SOT-25	28cx	VR4	6g	Tor
LCA	XC9236C2ACMR	DC-DC-IC	PWM/PFM, st-dwn, 2.05V±2%, 600mA, 1.2MHz, Vin>2V, LSST, CL	SOT-25	28dc4	DC1	6g	Tor
LCB	NCP511SN50T1	LVR-IC	LDO, Low Iq, +CE, 5V±2%, 150mA	SOT-23-5	28cx	VR4	6b	Ons
LCB	XG6219C422MR	LVR-IC	LDO, 4.2V±2%, 240mA, -CE, PDR	SOT-25	28cx	VR4	6g	Tor
LCB	XC9236C2BCMR	DC-DC-IC	PWM/PFM, st-dwn, 2.15V±2%, 600mA, 1.2MHz, Vin>2V, LSST, CL	SOT-25	28dc4	DC1	6g	Tor
LCC	NCP502SQ15T1	LVR-IC	Low Iq, +CE, 1.5V±2%, 80mA	SOT-353	30cx	VR4	6b	Ons
LCC	XG6219C432MR	LVR-IC	LDO, 4.3V±2%, 240mA, -CE, PDR	SOT-25	28cx	VR4	6g	Tor
LCC	XC9236C2CCMR	DC-DC-IC	PWM/PFM, st-dwn, 2.25V±2%, 600mA, 1.2MHz, Vin>2V, LSST, CL	SOT-25	28dc4	DC1	6g	Tor
LCD	NCP502SQ18T1	LVR-IC	Low Iq, +CE, 1.8V±2%, 80mA	SOT-353	30cx	VR4	6b	Ons
LCD	XG6219C442MR	LVR-IC	LDO, 4.4V±2%, 240mA, -CE, PDR	SOT-25	28cx	VR4	6g	Tor
LCD	XC9236C2DCMR	DC-DC-IC	PWM/PFM, st-dwn, 2.35V±2%, 600mA, 1.2MHz, Vin>2V, LSST, CL	SOT-25	28dc4	DC1	6g	Tor
LCE	NCP502SQ25T1	LVR-IC	Low Iq, +CE, 2.5V±2%, 80mA	SOT-353	30cx	VR4	6b	Ons
LCE	XG6219C452MR	LVR-IC	LDO, 4.5V±2%, 240mA, -CE, PDR	SOT-25	28cx	VR4	6g	Tor
LCE	XC9236C2ECMR	DC-DC-IC	PWM/PFM, st-dwn, 2.45V±2%, 600mA, 1.2MHz, Vin>2V, LSST, CL	SOT-25	28dc4	DC1	6g	Tor
LCEA	LP2985AIM5-2.6	LVR-IC	ULDO, 2.6V±1%, 150mA, +CE	SOT-23-5	28vrx	VR7	6g	Nsc
LCF	NCP502SQ27T1	LVR-IC	Low Iq, +CE, 2.7V±2%, 80mA	SOT-353	30cx	VR4	6b	Ons
LCF	XG6219C462MR	LVR-IC	LDO, 4.6V±2%, 240mA, -CE, PDR	SOT-25	28cx	VR4	6g	Tor
LCF	XC9236C2FCMR	DC-DC-IC	PWM/PFM, st-dwn, 2.55V±2%, 600mA, 1.2MHz, Vin>2V, LSST, CL	SOT-25	28dc4	DC1	6g	Tor
LCG	NCP502SQ28T1	LVR-IC	Low Iq, +CE, 2.8V±2%, 80mA	SOT-353	30cx	VR4	6b	Ons
LCH	NCP502SQ30T1	LVR-IC	Low Iq, +CE, 3V±2%, 80mA	SOT-353	30cx	VR4	6b	Ons
LCH	XG6219C472MR	LVR-IC	LDO, 4.7V±2%, 240mA, -CE, PDR	SOT-25	28cx	VR4	6g	Tor
LCH	XC9236C2HCMR	DC-DC-IC	PWM/PFM, st-dwn, 2.65V±2%, 600mA, 1.2MHz, Vin>2V, LSST, CL	SOT-25	28dc4	DC1	6g	Tor
LCI	NCP502SQ33T1	LVR-IC	Low Iq, +CE, 3.3V±2%, 80mA	SOT-353	30cx	VR4	6b	Ons
LCJ	NCP502SQ50T1	LVR-IC	Low Iq, +CE, 5V±2%, 80mA	SOT-353	30cx	VR4	6b	Ons
LCK	NCP512SQ15T1	LVR-IC	Low Iq, +CE, 1.5V±2%, 80mA	SOT-353	30cx	VR4	6b	Ons
LCK	XG6219C482MR	LVR-IC	LDO, 4.8V±2%, 240mA, -CE, PDR	SOT-25	28cx	VR4	6g	Tor
LCK	XC9236C2KCMR	DC-DC-IC	PWM/PFM, st-dwn, 2.75V±2%, 600mA, 1.2MHz, Vin>2V, LSST, CL	SOT-25	28dc4	DC1	6g	Tor
LCL	NCP512SQ18T1	LVR-IC	Low Iq, +CE, 1.8V±2%, 80mA	SOT-353	30cx	VR4	6b	Ons
LCL	XG6219C492MR	LVR-IC	LDO, 4.9V±2%, 240mA, -CE, PDR	SOT-25	28cx	VR4	6g	Tor
LCL	XC9236C2LCMR	DC-DC-IC	PWM/PFM, st-dwn, 2.85V±2%, 600mA, 1.2MHz, Vin>2V, LSST, CL	SOT-25	28dc4	DC1	6g	Tor
LCM	NCP512SQ25T1	LVR-IC	Low Iq, +CE, 2.5V±2%, 80mA	SOT-353	30cx	VR4	6b	Ons
LCM	XG6219C502MR	LVR-IC	LDO, 5V±2%, 240mA, -CE, PDR	SOT-25	28cx	VR4	6g	Tor
LCM	XC9236C2MCMR	DC-DC-IC	PWM/PFM, st-dwn, 2.95V±2%, 600mA, 1.2MHz, Vin>2V, LSST, CL	SOT-25	28dc4	DC1	6g	Tor
LCN	NCP512SQ27T1	LVR-IC	Low Iq, +CE, 2.7V±2%, 80mA	SOT-353	30cx	VR4	6b	Ons
LCO	NCP512SQ28T1	LVR-IC	Low Iq, +CE, 2.8V±2%, 80mA	SOT-353	30cx	VR4	6b	Ons
LCP	NCP512SQ30T1	LVR-IC	Low Iq, +CE, 3V±2%, 80mA	SOT-353	30cx	VR4	6b	Ons
LCQ	NCP512SQ33T1	LVR-IC	Low Iq, +CE, 3.3V±2%, 80mA	SOT-353	30cx	VR4	6b	Ons
LCR	NCP512SQ50T1	LVR-IC	Low Iq, +CE, 5V±2%, 80mA	SOT-353	30cx	VR4	6b	Ons
LCS	NCP500SN18T1	LVR-IC	LDO, LN, +CE, 1.8V±2.5%, 150mA	SOT-353	30cx	VR4	6b	Ons
LCU	NCP500SN27T1	LVR-IC	LDO, LN, +CE, 2.7V±2.5%, 150mA	SOT-353	30cx	VR4	6b	Ons
LCV	NCP500SN28T1	LVR-IC	LDO, LN, +CE, 2.8V±2.5%, 150mA	SOT-353	30cx	VR4	6b	Ons
LCW	NCP500SN30T1	LVR-IC	LDO, LN, +CE, 3V±2.5%, 150mA	SOT-353	30cx	VR4	6b	Ons
LCX	NCP500SN33T1	LVR-IC	LDO, LN, +CE, 3.3V±2.5%, 150mA	SOT-353	30cx	VR4	6b	Ons
LCY	NCP500SN50T1	LVR-IC	LDO, LN, +CE, 5V±2.5%, 150mA	SOT-353	30cx	VR4	6b	Ons
LD	AX6603-350B	LVR-IC	LDO, 3.5V±2%, 300mA, +CE	SOT-23-5	28vrx	VR7	6k	Axl
LD	AX6603-150B	LVR-IC	LDO, 1.5V±2%, 300mA, +CE	SOT-23-5	28vrx	VR7	6k	Axl
LD	BU4944FWE	Vdet-IC	4.4V, +Reset PPO	VSOP-5	30vk	VD7	6c	Rhm
LD	BU4944G	Vdet-IC	4.4V, +Reset PPO	SSOP-5	28vdm	VD7	6c	Rhm
LD	IDT74LVC1GU04ADY	CMOS-Logic	Inverter	SO5-1	28/Log6	-	6g	Idt
LD	RT9168-28CBR	LVR-IC	LDO, 2.8V±2%, 200mA, +CE	SOT-23-5	28vt	VR4	6g	Rct
LD0	XG6219D312MR	LVR-IC	LDO, 3.1V±2%, 240mA, -CE	SOT-25	28cx	VR4	6g	Tor
LD0	XC9236C30CMR	DC-DC-IC	PWM/PFM, st-dwn, 3.0V±2%, 600mA, 1.2MHz, Vin>2V, LSST, CL	SOT-25	28dc4	DC1	6g	Tor
LD0	BL8534CB5TR30	DC/DC-IC	PFM step-up, 3.0±2%, 200mA, +CE	SOT-23-5	28sc	DC3	5g	Shb
LD0	BL8534CB5TR40	DC/DC-IC	PFM step-up, 4.0±2%, 200mA, +CE	SOT-23-5	28sc	DC3	5g	Shb
LD0	BL8534CB5TR50	DC/DC-IC	PFM step-up, 5.0±2%, 200mA, +CE	SOT-23-5	28sc	DC3	5g	Shb
LD0	BL8534CB5TR60	DC/DC-IC	PFM step-up, 6.0±2%, 200mA, +CE	SOT-23-5	28sc	DC3	5g	Shb
LD1	XG6219D322MR	LVR-IC	LDO, 3.2V±2%, 240mA, -CE	SOT-25	28cx	VR4	6g	Tor
LD1	XC9236C31CMR	DC-DC-IC	PWM/PFM, st-dwn, 3.1V±2%, 600mA, 1.2MHz, Vin>2V, LSST, CL	SOT-25	28dc4	DC1	6g	Tor
LD2	XG6219D332MR	LVR-IC	LDO, 3.3V±2%, 240mA, -CE	SOT-25	28cx	VR4	6g	Tor
LD2	XC9236C32CMR	DC-DC-IC	PWM/PFM, st-dwn, 3.2V±2%, 600mA, 1.2MHz, Vin>2V, LSST, CL	SOT-25	28dc4	DC1	6g	Tor
LD2	BL8534CB5TR42	DC/DC-IC	PFM step-up, 4.2±2%, 200mA, +CE	SOT-23-5	28sc	DC3	5g	Shb
LD25	MIC5206-2.5BM5	LVR-IC	LDO, LN, +CE, -Error, 2.5V±1%, 150mA	SOT-23-5	28w	VR17	6g	Mcr
LD27	MIC5206-2.7BM5	LVR-IC	LDO, LN, +CE, -Error, 2.7V±1%, 150mA	SOT-23-5	28w	VR17	6g	Mcr
LD29	MIC5206-2.9BM5	LVR-IC	LDO, LN, +CE, -Error, 2.9V±1%, 150mA	SOT-23-5	28w	VR17	6g	Mcr



SMD code	Type	Function	Short description	Case	Pinout	Sch.	St.	Mnf.
LD2J	MIC5206-2.85BM5	LVR-IC	LDO, LN, +CE, -Error, 2.8V±1%, 150mA	SOT-23-5	28w	VR17	6g	Mcr
LD3	XC6219D342MR	LVR-IC	LDO, 3.4V±2%, 240mA, -CE	SOT-25	28cx	VR4	6g	Tor
LD3	XC9236C33CMR	DC-DC-IC	PWM/PPM, st-dwn, 3.3V±2%, 600mA, 1.2MHz, Vin>2V, LSST, CL	SOT-25	28dc4	DC1	6g	Tor
LD3	BL8534CB5TR33	DC/DC-IC	PFM step-up, 3.3±2%, 200mA, +CE	SOT-23-5	28sc	DC3	5g	Shb
LD30	MIC5206-3.0BM5	LVR-IC	LDO, LN, +CE, -Error, 3V±1%, 150mA	SOT-23-5	28w	VR17	6g	Mcr
LD32	MIC5206-3.2BM5	LVR-IC	LDO, LN, +CE, -Error, 3.2V±1%, 150mA	SOT-23-5	28w	VR17	6g	Mcr
LD33	MIC5206-3.3BM5	LVR-IC	LDO, LN, +CE, -Error, 3.3V±1%, 150mA	SOT-23-5	28w	VR17	6g	Mcr
LD34	MIC5206-3.4BM5	LVR-IC	LDO, LN, +CE, -Error, 3.4V±1%, 150mA	SOT-23-5	28w	VR17	6g	Mcr
LD36	MIC5206-3.6BM5	LVR-IC	LDO, LN, +CE, -Error, 3.6V±1%, 150mA	SOT-23-5	28w	VR17	6g	Mcr
LD38	MIC5206-3.8BM5	LVR-IC	LDO, LN, +CE, -Error, 3.8V±1%, 150mA	SOT-23-5	28w	VR17	6g	Mcr
LD4	XC6219D352MR	LVR-IC	LDO, 3.5V±2%, 240mA, -CE	SOT-25	28cx	VR4	6g	Tor
LD4	XC9236C34CMR	DC-DC-IC	PWM/PPM, st-dwn, 3.4V±2%, 600mA, 1.2MHz, Vin>2V, LSST, CL	SOT-25	28dc4	DC1	6g	Tor
LD40	MIC5206-4.0BM5	LVR-IC	LDO, LN, +CE, -Error, 4V±1%, 150mA	SOT-23-5	28w	VR17	6g	Mcr
LD41	MIC5206-4.15BM5	LVR-IC	LDO, LN, +CE, -Error, 4.1V±1%, 150mA	SOT-23-5	28w	VR17	6g	Mcr
LD45	XC6219D362MR	LVR-IC	LDO, 3.6V±2%, 240mA, -CE	SOT-25	28cx	VR4	6g	Tor
LD5	XC9236C35CMR	DC-DC-IC	PWM/PPM, st-dwn, 3.5V±2%, 600mA, 1.2MHz, Vin>2V, LSST, CL	SOT-25	28dc4	DC1	6g	Tor
LD5	BL8534CB5TR25	DC/DC-IC	PFM step-up, 2.5±2%, 200mA, +CE	SOT-23-5	28sc	DC3	5g	Shb
LD5	BL8534CB5TR45	DC/DC-IC	PFM step-up, 4.5±2%, 200mA, +CE	SOT-23-5	28sc	DC3	5g	Shb
LD50	MIC5206-5.0BM5	LVR-IC	LDO, LN, +CE, -Error, 5V±1%, 150mA	SOT-23-5	28w	VR17	6g	Mcr
LD6	XC6219D372MR	LVR-IC	LDO, 3.7V±2%, 240mA, -CE	SOT-25	28cx	VR4	6g	Tor
LD6	XC9236C36CMR	DC-DC-IC	PWM/PPM, st-dwn, 3.6V±2%, 600mA, 1.2MHz, Vin>2V, LSST, CL	SOT-25	28dc4	DC1	6g	Tor
LD6	BL8534CB5TR36	DC/DC-IC	PFM step-up, 3.6±2%, 200mA, +CE	SOT-23-5	28sc	DC3	5g	Shb
LD7	XC6219D382MR	LVR-IC	LDO, 3.8V±2%, 240mA, -CE	SOT-25	28cx	VR4	6g	Tor
LD7	XC9236C37CMR	DC-DC-IC	PWM/PPM, st-dwn, 3.7V±2%, 600mA, 1.2MHz, Vin>2V, LSST, CL	SOT-25	28dc4	DC1	6g	Tor
LD7	BL8534CB5TR27	DC/DC-IC	PFM step-up, 2.7±2%, 200mA, +CE	SOT-23-5	28sc	DC3	5g	Shb
LD8	XC6219D392MR	LVR-IC	LDO, 3.9V±2%, 240mA, -CE	SOT-25	28cx	VR4	6g	Tor
LD8	XC9236C38CMR	DC-DC-IC	PWM/PPM, st-dwn, 3.8V±2%, 600mA, 1.2MHz, Vin>2V, LSST, CL	SOT-25	28dc4	DC1	6g	Tor
LD8	BL8534CB5TR28	DC/DC-IC	PFM step-up, 2.8±2%, 200mA, +CE	SOT-23-5	28sc	DC3	5g	Shb
LD8	BL8534CB5TR38	DC/DC-IC	PFM step-up, 3.8±2%, 200mA, +CE	SOT-23-5	28sc	DC3	5g	Shb
LD9	XC6219D402MR	LVR-IC	LDO, 4V±2%, 240mA, -CE	SOT-25	28cx	VR4	6g	Tor
LD9	XC9236C39CMR	DC-DC-IC	PWM/PPM, st-dwn, 3.9V±2%, 600mA, 1.2MHz, Vin>2V, LSST, CL	SOT-25	28dc4	DC1	6g	Tor
LDA	NCP561SN15T1	LVR-IC	LDO, Low Iq, +CE, 1.5V±2%, 150mA	SOT-353	30cx	VR4	6b	Ons
LDA	XC6219D412MR	LVR-IC	LDO, 4.1V±2%, 240mA, -CE	SOT-25	28cx	VR4	6g	Tor
LDA	XC9236C3ACMR	DC-DC-IC	PWM/PPM, st-dwn, 3.05V±2%, 600mA, 1.2MHz, Vin>2V, LSST, CL	SOT-25	28dc4	DC1	6g	Tor
LDB	XC6219D422MR	LVR-IC	LDO, 4.2V±2%, 240mA, -CE	SOT-25	28cx	VR4	6g	Tor
LDB	XC9236C3BCMR	DC-DC-IC	PWM/PPM, st-dwn, 3.15V±2%, 600mA, 1.2MHz, Vin>2V, LSST, CL	SOT-25	28dc4	DC1	6g	Tor
LDC	NCP561SN25T1	LVR-IC	LDO, Low Iq, +CE, 2.5V±2%, 150mA	SOT-353	30cx	VR4	6b	Ons
LDC	XC6219D432MR	LVR-IC	LDO, 4.3V±2%, 240mA, -CE	SOT-25	28cx	VR4	6g	Tor
LDC	XC9236C3CCMR	DC-DC-IC	PWM/PPM, st-dwn, 3.25V±2%, 600mA, 1.2MHz, Vin>2V, LSST, CL	SOT-25	28dc4	DC1	6g	Tor
LDD	NCP561SN28T1	LVR-IC	LDO, Low Iq, +CE, 2.8V±2%, 150mA	SOT-353	30cx	VR4	6b	Ons
LDD	XC6219D442MR	LVR-IC	LDO, 4.4V±2%, 240mA, -CE	SOT-25	28cx	VR4	6g	Tor
LDD	XC9236C3DCMR	DC-DC-IC	PWM/PPM, st-dwn, 3.35V±2%, 600mA, 1.2MHz, Vin>2V, LSST, CL	SOT-25	28dc4	DC1	6g	Tor
LDE	NCP561SN30T1	LVR-IC	LDO, Low Iq, +CE, 3V±2%, 150mA	SOT-353	30cx	VR4	6b	Ons
LDE	XC6219D452MR	LVR-IC	LDO, 4.5V±2%, 240mA, -CE	SOT-25	28cx	VR4	6g	Tor
LDE	XC9236C3ECMR	DC-DC-IC	PWM/PPM, st-dwn, 3.45V±2%, 600mA, 1.2MHz, Vin>2V, LSST, CL	SOT-25	28dc4	DC1	6g	Tor
LDF	NCP561SN33T1	LVR-IC	LDO, Low Iq, +CE, 3.3V±2%, 150mA	SOT-353	30cx	VR4	6b	Ons
LDF	XC6219D462MR	LVR-IC	LDO, 4.6V±2%, 240mA, -CE	SOT-25	28cx	VR4	6g	Tor
LDF	XC9236C3FCMR	DC-DC-IC	PWM/PPM, st-dwn, 3.55V±2%, 600mA, 1.2MHz, Vin>2V, LSST, CL	SOT-25	28dc4	DC1	6g	Tor
LDH	NCP561SN50T1	LVR-IC	LDO, Low Iq, +CE, 5V±2%, 150mA	SOT-353	30cx	VR4	6b	Ons
LDH	XC6219D472MR	LVR-IC	LDO, 4.7V±2%, 240mA, -CE	SOT-25	28cx	VR4	6g	Tor
LDH	XC9236C3HCMR	DC-DC-IC	PWM/PPM, st-dwn, 3.65V±2%, 600mA, 1.2MHz, Vin>2V, LSST, CL	SOT-25	28dc4	DC1	6g	Tor
LDK	XC6219D482MR	LVR-IC	LDO, 4.8V±2%, 240mA, -CE	SOT-25	28cx	VR4	6g	Tor
LDK	XC9236C3KCMR	DC-DC-IC	PWM/PPM, st-dwn, 3.75V±2%, 600mA, 1.2MHz, Vin>2V, LSST, CL	SOT-25	28dc4	DC1	6g	Tor
LDL	XC6219D492MR	LVR-IC	LDO, 4.9V±2%, 240mA, -CE	SOT-25	28cx	VR4	6g	Tor
LDL	XC9236C3LCMR	DC-DC-IC	PWM/PPM, st-dwn, 3.85V±2%, 600mA, 1.2MHz, Vin>2V, LSST, CL	SOT-25	28dc4	DC1	6g	Tor
LDM	XC6219D502MR	LVR-IC	LDO, 5V±2%, 240mA, -CE	SOT-25	28cx	VR4	6g	Tor
LDM	XC9236C3MCMR	DC-DC-IC	PWM/PPM, st-dwn, 3.95V±2%, 600mA, 1.2MHz, Vin>2V, LSST, CL	SOT-25	28dc4	DC1	6g	Tor
LDZ	NCP5426SNT13T1	LVR-IC	LDO, Low Iq, +CE, UVLO, 1.3V±2%, 150mA	SOT-23-5	28vc	VR4	6b	Ons
Le	AX6603-360B	LVR-IC	LDO, 3.6V±2%, 300mA, +CE	SOT-23-5	28vrx	VR7	6k	Axl
LE	AX6603-160B	LVR-IC	LDO, 1.6V±2%, 300mA, +CE	SOT-23-5	28vrx	VR7	6k	Axl
LE	BU4945FWE	Vdet-IC	4.5V, +Reset PPO	VSOFF-5	30vk	VD7	6c	Rhm
LE	BU4945G	Vdet-IC	4.5V, +Reset PPO	SSOP-5	28vdm	VD7	6c	Rhm
LE	IDT74LVC1G08ADY	CMOS-Logic	2-input AND gate	SO5-1	28/Log3	-	6g	Idt
LE	RT9168-29CBR	LVR-IC	LDO, 2.9V±2%, 200mA, +CE	SOT-23-5	28v	VR4	6g	Rct
LE0	XC9236C40CMR	DC-DC-IC	PWM/PPM, st-dwn, 4.0V±2%, 600mA, 1.2MHz, Vin>2V, LSST, CL	SOT-25	28dc4	DC1	6g	Tor
LE13	MIC5207-1.3BM5	LVR-IC	LDO, LN, +CE, 1.3V	SOT-23-5	28vrx	VR7	6g	Mcr
LE18	MIC5207-1.8BM5	LVR-IC	LDO, LN, +CE, 1.8V	SOT-23-5	28vrx	VR7	6g	Mcr
LE25	MIC5207-2.5BM5	LVR-IC	LDO, LN, 2.5V±2%, +CE	SOT-23-5	28vrx	VR7	6g	Mcr
LE28	MIC5207-2.8BM5	LVR-IC	LDO, LN, +CE, 2.8V	SOT-23-5	28vrx	VR7	6g	Mcr
LE29	MIC5207-2.9BM5	LVR-IC	LDO, LN, +CE, 2.9V	SOT-23-5	28vrx	VR7	6g	Mcr



SMD code	Type	Function	Short description	Case	Pinout	Sch.	St.	Mnf.
LE30	MIC5207-3.0BM5	LVR-IC	LDO, LN, +CE, 3V	SOT-23-5	28vrx	VR7	6g	Mcr
LE31	MIC5207-3.1BM5	LVR-IC	LDO, LN, +CE, 3.1V	SOT-23-5	28vrx	VR7	6g	Mcr
LE32	MIC5207-3.2BM5	LVR-IC	LDO, LN, +CE, 3.2V	SOT-23-5	28vrx	VR7	6g	Mcr
LE33	MIC5207-3.3BM5	LVR-IC	LDO, LN, +CE, 3.3V	SOT-23-5	28vrx	VR7	6g	Mcr
LE36	MIC5207-3.6BM5	LVR-IC	LDO, LN, +CE, 3.6V	SOT-23-5	28vrx	VR7	6g	Mcr
LE38	MIC5207-3.8BM5	LVR-IC	LDO, LN, +CE, 3.8V	SOT-23-5	28vrx	VR7	6g	Mcr
LE40	MIC5207-4.0BM5	LVR-IC	LDO, LN, +CE, 4V	SOT-23-5	28vrx	VR7	6g	Mcr
LE50	MIC5207-5.0BM5	LVR-IC	LDO, LN, +CE, 5V	SOT-23-5	28vrx	VR7	6g	Mcr
LE8	XC6219A09AMR	LVR-IC	LDO, 0.95V±2%, 150mA, +CE, PDR	SOT-25	28cx	VR4	6g	Tor
LE9	XC6219A10AMR	LVR-IC	LDO, 1.05V±2%, 150mA, +CE, PDR	SOT-25	28cx	VR4	6g	Tor
LEA	XC6219A11AMR	LVR-IC	LDO, 1.15V±2%, 150mA, +CE, PDR	SOT-25	28cx	VR4	6g	Tor
LEB	XC6219A12AMR	LVR-IC	LDO, 1.25V±2%, 150mA, +CE, PDR	SOT-25	28cx	VR4	6g	Tor
LEC	XC6219A13AMR	LVR-IC	LDO, 1.35V±2%, 150mA, +CE, PDR	SOT-25	28cx	VR4	6g	Tor
LED	XC6219A14AMR	LVR-IC	LDO, 1.45V±2%, 150mA, +CE, PDR	SOT-25	28cx	VR4	6g	Tor
LEE	XC6219A15AMR	LVR-IC	LDO, 1.55V±2%, 150mA, +CE, PDR	SOT-25	28cx	VR4	6g	Tor
LEF	XC6219A16AMR	LVR-IC	LDO, 1.65V±2%, 150mA, +CE, PDR	SOT-25	28cx	VR4	6g	Tor
LEH	XC6219A17AMR	LVR-IC	LDO, 1.75V±2%, 150mA, +CE, PDR	SOT-25	28cx	VR4	6g	Tor
LEK	XC6219A18AMR	LVR-IC	LDO, 1.85V±2%, 240mA, +CE, PDR	SOT-25	28cx	VR4	6g	Tor
LEL	XC6219A19AMR	LVR-IC	LDO, 1.95V±2%, 240mA, +CE, PDR	SOT-25	28cx	VR4	6g	Tor
LEM	XC6219A20AMR	LVR-IC	LDO, 2.05V±2%, 240mA, +CE, PDR	SOT-25	28cx	VR4	6g	Tor
LEN	XC6219A21AMR	LVR-IC	LDO, 2.15V±2%, 240mA, +CE, PDR	SOT-25	28cx	VR4	6g	Tor
LEP	XC6219A22AMR	LVR-IC	LDO, 2.25V±2%, 240mA, +CE, PDR	SOT-25	28cx	VR4	6g	Tor
LER	XC6219A23AMR	LVR-IC	LDO, 2.35V±2%, 240mA, +CE, PDR	SOT-25	28cx	VR4	6g	Tor
LES	XC6219A24AMR	LVR-IC	LDO, 2.45V±2%, 240mA, +CE, PDR	SOT-25	28cx	VR4	6g	Tor
LET	XC6219A25AMR	LVR-IC	LDO, 2.55V±2%, 240mA, +CE, PDR	SOT-25	28cx	VR4	6g	Tor
LEU	XC6219A26AMR	LVR-IC	LDO, 2.65V±2%, 240mA, +CE, PDR	SOT-25	28cx	VR4	6g	Tor
LEV	NCP561SN18T1	LVR-IC	LDO, Low Iq, +CE, 1.8V±2%, 150mA	SOT-353	30cx	VR4	6b	Ons
LEV	XC6219A27AMR	LVR-IC	LDO, 2.75V±2%, 240mA, +CE, PDR	SOT-25	28cx	VR4	6g	Tor
LEX	NCP561SN27T1	LVR-IC	LDO, Low Iq, +CE, 2.7V±2%, 150mA	SOT-353	30cx	VR4	6b	Ons
LEX	XC6219A28AMR	LVR-IC	LDO, 2.85V±2%, 240mA, +CE, PDR	SOT-25	28cx	VR4	6g	Tor
LEY	XC6219A29AMR	LVR-IC	LDO, 2.95V±2%, 240mA, +CE, PDR	SOT-25	28cx	VR4	6g	Tor
LEZ	XC6219A30AMR	LVR-IC	LDO, 3.05V±2%, 240mA, +CE, PDR	SOT-25	28cx	VR4	6g	Tor
Lf	AX6603-370B	LVR-IC	LDO, 3.7V±2%, 300mA, +CE	SOT-23-5	28vrx	VR7	6k	Axl
LF	AX6603-170B	LVR-IC	LDO, 1.7V±2%, 300mA, +CE	SOT-23-5	28vrx	VR7	6k	Axl
LF	BU4946FWE	Vdet-IC	4.6V, +Reset PPO	VSO-5	30wk	VD7	6c	Rhm
LF	BU4946G	Vdet-IC	4.6V, +Reset PPO	SSOP-5	28vdm	VD7	6c	Rhm
LF	IDT74LVC1G14ADY	CMOS-Logic	Inverting Schmitt-trigger	SO5-1	28/Log7	-	6g	ldt
LF	RT9168-30C8R	LVR-IC	LDO, 3.0V±2%, 200mA, +CE	SOT-23-5	28v	VR4	6g	Rct
LF6A	LP2985AIM5-6.1	LVR-IC	ULDO, 6.1V±1%, 150mA, +CE	SOT-23-5	28vrx	VR7	6g	Nsc
LF6B	LP2985IM5-6.1	LVR-IC	ULDO, 6.1V±2.5%, 150mA, +CE	SOT-23-5	28vrx	VR7	6g	Nsc
LF8	XC6219B09AMR	LVR-IC	LDO, 0.95V±2%, 150mA, +CE	SOT-25	28cx	VR4	6g	Tor
LF8	XC9236C08DMR	DC-DC-IC	PWM/PFM, st-dwn, 0.8V±2%, 600mA, 3MHz, Vin>2V, LSST, CL	SOT-25	28dc4	DC1	6g	Tor
LF9	XC6219B10AMR	LVR-IC	LDO, 1.05V±2%, 150mA, +CE	SOT-25	28cx	VR4	6g	Tor
LF9	XC9236C09DMR	DC-DC-IC	PWM/PFM, st-dwn, 0.9V±2%, 600mA, 3MHz, Vin>2V, LSST, CL	SOT-25	28dc4	DC1	6g	Tor
LFA	XC6219B11AMR	LVR-IC	LDO, 1.15V±2%, 150mA, +CE	SOT-25	28cx	VR4	6g	Tor
LFB	XC6219B12AMR	LVR-IC	LDO, 1.25V±2%, 150mA, +CE	SOT-25	28cx	VR4	6g	Tor
LFC	XC6219B13AMR	LVR-IC	LDO, 1.35V±2%, 150mA, +CE	SOT-25	28cx	VR4	6g	Tor
LFD	XC6219B14AMR	LVR-IC	LDO, 1.45V±2%, 150mA, +CE	SOT-25	28cx	VR4	6g	Tor
LFE	XC6219B15AMR	LVR-IC	LDO, 1.55V±2%, 150mA, +CE	SOT-25	28cx	VR4	6g	Tor
LFF	XC6219B16AMR	LVR-IC	LDO, 1.65V±2%, 150mA, +CE	SOT-25	28cx	VR4	6g	Tor
LFH	XC6219B17AMR	LVR-IC	LDO, 1.75V±2%, 150mA, +CE	SOT-25	28cx	VR4	6g	Tor
LFK	XC6219B18AMR	LVR-IC	LDO, 1.85V±2%, 240mA, +CE	SOT-25	28cx	VR4	6g	Tor
LFL	XC6219B19AMR	LVR-IC	LDO, 1.95V±2%, 240mA, +CE	SOT-25	28cx	VR4	6g	Tor
LFL	XC9236C0LD8MR	DC-DC-IC	PWM/PFM, st-dwn, 0.85V±2%, 600mA, 3MHz, Vin>2V, LSST, CL	SOT-25	28dc4	DC1	6g	Tor
LFM	XC6219B20AMR	LVR-IC	LDO, 2.05V±2%, 240mA, +CE	SOT-25	28cx	VR4	6g	Tor
LFM	XC9236C0MD8MR	DC-DC-IC	PWM/PFM, st-dwn, 0.95V±2%, 600mA, 3MHz, Vin>2V, LSST, CL	SOT-25	28dc4	DC1	6g	Tor
LFN	XC6219B21AMR	LVR-IC	LDO, 2.15V±2%, 240mA, +CE	SOT-25	28cx	VR4	6g	Tor
LFO	NCP512SQ31T1	LVR-IC	Low Iq, +CE, 3.1V±2%, 80mA	SOT-353	30cx	VR4	6b	Ons
LFP	XC6219B22AMR	LVR-IC	LDO, 2.25V±2%, 240mA, +CE	SOT-25	28cx	VR4	6g	Tor
LFR	XC6219B23AMR	LVR-IC	LDO, 2.35V±2%, 240mA, +CE	SOT-25	28cx	VR4	6g	Tor
LFS	XC6219B24AMR	LVR-IC	LDO, 2.45V±2%, 240mA, +CE	SOT-25	28cx	VR4	6g	Tor
LFT	XC6219B25AMR	LVR-IC	LDO, 2.55V±2%, 240mA, +CE	SOT-25	28cx	VR4	6g	Tor
LFU	XC6219B26AMR	LVR-IC	LDO, 2.65V±2%, 240mA, +CE	SOT-25	28cx	VR4	6g	Tor
LFV	XC6219B27AMR	LVR-IC	LDO, 2.75V±2%, 240mA, +CE	SOT-25	28cx	VR4	6g	Tor
LFX	XC6219B28AMR	LVR-IC	LDO, 2.85V±2%, 240mA, +CE	SOT-25	28cx	VR4	6g	Tor
LFY	XC6219B29AMR	LVR-IC	LDO, 2.95V±2%, 240mA, +CE	SOT-25	28cx	VR4	6g	Tor
LFZ	XC6219B30AMR	LVR-IC	LDO, 3.05V±2%, 240mA, +CE	SOT-25	28cx	VR4	6g	Tor
Lg	AX6603-380B	LVR-IC	LDO, 3.8V±2%, 300mA, +CE	SOT-23-5	28vrx	VR7	6k	Axl
LG	25C4207-GR	Si-npn	Dual, AF, 60V, 150mA, 300mW, B=200..400, >80MHz	SOT-25	28/T11	-	6a	Tos
LG	25C4944-GR	Si-npn	Dual, AF, 60V, 150mA, 200mW, B=200..400, >80MHz	SOT-25	28/T11	-	6a	Tos



SMD code	Type	Function	Short description	Case	Pinout	Sch.	St.	Mnf.
LG	AX6603-180B	LVR-IC	LDO, 1.8V±2%, 300mA, +CE	SOT-23-5	28vrx	VR7	6k	Axl
LG	BU4947FWE	Vdet-IC	4.7V, +Reset PPO	VSOFF-5	30vk	VD7	6c	Rhm
LG	BU4947G	Vdet-IC	4.7V, +Reset PPO	SSOP-5	28vdm	VD7	6c	Rhm
LG	IDT74LVC1G32ADY	CMOS-Logic	2-input OR gate	S05-1	28/Log4	-	6g	ldt
LG	RT9168-31CBR	LVR-IC	LDO, 3.1V±2%, 200mA, +CE	SOT-23-5	28vt	VR4	6g	Rct
LG18	MIC5219-1.8BM5	LVR-IC	LDO, 1.8V±1%, 500mA, +CE	SOT-23-5	28vrx	VR7	6g	Mcr
LG25	MIC5219-2.5BM5	LVR-IC	LDO, 2.5V±1%, 500mA, +CE	SOT-23-5	28vrx	VR7	6g	Mcr
LG26	MIC5219-2.6BM5	LVR-IC	LDO, 2.6V±1%, 500mA, +CE	SOT-23-5	28vrx	VR7	6g	Mcr
LG27	MIC5219-2.7BM5	LVR-IC	LDO, 2.7V±1%, 500mA, +CE	SOT-23-5	28vrx	VR7	6g	Mcr
LG28	MIC5219-2.8BM5	LVR-IC	LDO, 2.8V±1%, 500mA, +CE	SOT-23-5	28vrx	VR7	6g	Mcr
LG29	MIC5219-2.9BM5	LVR-IC	LDO, 2.9V±1%, 500mA, +CE	SOT-23-5	28vrx	VR7	6g	Mcr
LG2J	MIC5219-2.85BM5	LVR-IC	LDO, 2.85V±1%, 500mA, +CE	SOT-23-5	28vrx	VR7	6g	Mcr
LG30	MIC5219-3.0BM5	LVR-IC	LDO, 3V±1%, 500mA, +CE	SOT-23-5	28vrx	VR7	6g	Mcr
LG31	MIC5219-3.1BM5	LVR-IC	LDO, 3.1V±1%, 500mA, +CE	SOT-23-5	28vrx	VR7	6g	Mcr
LG33	MIC5219-3.3BM5	LVR-IC	LDO, 3.3V±1%, 500mA, +CE	SOT-23-5	28vrx	VR7	6g	Mcr
LG36	MIC5219-3.6BM5	LVR-IC	LDO, 3.6V±1%, 500mA, +CE	SOT-23-5	28vrx	VR7	6g	Mcr
LG50	MIC5219-5.0BM5	LVR-IC	LDO, 5V±1%, 500mA, +CE	SOT-23-5	28vrx	VR7	6g	Mcr
Lh	AX6603-390B	LVR-IC	LDO, 3.9V±3%, 300mA, +CE	SOT-23-5	28vrx	VR7	6k	Axl
LH	AX6603-190B	LVR-IC	LDO, 1.9V±2%, 300mA, +CE	SOT-23-5	28vrx	VR7	6k	Axl
LH	BU4948FWE	Vdet-IC	4.8V, +Reset PPO	VSOFF-5	30vk	VD7	6c	Rhm
LH	BU4948G	Vdet-IC	4.8V, +Reset PPO	SSOP-5	28vdm	VD7	6c	Rhm
LH	IDT74LVC1G86ADY	CMOS-Logic	2-input EXCLUSIVE-OR gate	S05-1	28/Log5	-	6g	ldt
LH	RT9168-32CBR	LVR-IC	LDO, 3.2V±2%, 200mA, +CE	SOT-23-5	28vt	VR4	6g	Rct
LHO	XC9236C10DMR	DC-DC-IC	PWM/PFM, st-dwn, 1.0V±2%, 600mA, 3MHz, Vin>2V, LSST, CL	SOT-25	28dc4	DC1	6g	Tor
LH1	XC9236C11DMR	DC-DC-IC	PWM/PFM, st-dwn, 1.1V±2%, 600mA, 3MHz, Vin>2V, LSST, CL	SOT-25	28dc4	DC1	6g	Tor
LH2	XC9236C12DMR	DC-DC-IC	PWM/PFM, st-dwn, 1.2V±2%, 600mA, 3MHz, Vin>2V, LSST, CL	SOT-25	28dc4	DC1	6g	Tor
LH25	MIC5216-2.5BM5	LVR-IC	LDO, 2.5V±1%, 500mA, +CE, Flag	SOT-23-5	28ei	VR23	6g	Mcr
LH3	XC9236C13DMR	DC-DC-IC	PWM/PFM, st-dwn, 1.3V±2%, 600mA, 3MHz, Vin>2V, LSST, CL	SOT-25	28dc4	DC1	6g	Tor
LH30	MIC5216-3.0BM5	LVR-IC	LDO, 3V±1%, 500mA, +CE, Flag	SOT-23-5	28ei	VR23	6g	Mcr
LH33	MIC5216-3.3BM5	LVR-IC	LDO, 3.3V±1%, 500mA, +CE, Flag	SOT-23-5	28ei	VR23	6g	Mcr
LH36	MIC5216-3.6BM5	LVR-IC	LDO, 3.6V±1%, 500mA, +CE, Flag	SOT-23-5	28ei	VR23	6g	Mcr
LH38	MIC5216-3.8BM5	LVR-IC	LDO, 3.8V±1%, 500mA, +CE, Flag	SOT-23-5	28ei	VR23	6g	Mcr
LH4	XC9236C14DMR	DC-DC-IC	PWM/PFM, st-dwn, 1.4V±2%, 600mA, 3MHz, Vin>2V, LSST, CL	SOT-25	28dc4	DC1	6g	Tor
LH40	MIC5216-4.0BM5	LVR-IC	LDO, 4V±1%, 500mA, +CE, Flag	SOT-23-5	28ei	VR23	6g	Mcr
LH5	XC9236C15DMR	DC-DC-IC	PWM/PFM, st-dwn, 1.5V±2%, 600mA, 3MHz, Vin>2V, LSST, CL	SOT-25	28dc4	DC1	6g	Tor
LH50	MIC5216-5.0BM5	LVR-IC	LDO, 5V±1%, 500mA, +CE, Flag	SOT-23-5	28ei	VR23	6g	Mcr
LH6	XC9236C16DMR	DC-DC-IC	PWM/PFM, st-dwn, 1.6V±2%, 600mA, 3MHz, Vin>2V, LSST, CL	SOT-25	28dc4	DC1	6g	Tor
LH7	XC9236C17DMR	DC-DC-IC	PWM/PFM, st-dwn, 1.7V±2%, 600mA, 3MHz, Vin>2V, LSST, CL	SOT-25	28dc4	DC1	6g	Tor
LH8	XC6219C09AMR	LVR-IC	LDO, 0.95V±2%, 150mA, -CE, PDR	SOT-25	28cx	VR4	6g	Tor
LH8	XC9236C18DMR	DC-DC-IC	PWM/PFM, st-dwn, 1.8V±2%, 600mA, 3MHz, Vin>2V, LSST, CL	SOT-25	28dc4	DC1	6g	Tor
LH9	XC6219C10AMR	LVR-IC	LDO, 1.05V±2%, 150mA, -CE, PDR	SOT-25	28cx	VR4	6g	Tor
LH9	XC9236C19DMR	DC-DC-IC	PWM/PFM, st-dwn, 1.9V±2%, 600mA, 3MHz, Vin>2V, LSST, CL	SOT-25	28dc4	DC1	6g	Tor
LHA	XC6219C11AMR	LVR-IC	LDO, 1.15V±2%, 150mA, -CE, PDR	SOT-25	28cx	VR4	6g	Tor
LHA	XC9236C1ADMR	DC-DC-IC	PWM/PFM, st-dwn, 1.05V±2%, 600mA, 3MHz, Vin>2V, LSST, CL	SOT-25	28dc4	DC1	6g	Tor
LHB	XC6219C12AMR	LVR-IC	LDO, 1.25V±2%, 150mA, -CE, PDR	SOT-25	28cx	VR4	6g	Tor
LHB	XC9236C1BDMR	DC-DC-IC	PWM/PFM, st-dwn, 1.15V±2%, 600mA, 3MHz, Vin>2V, LSST, CL	SOT-25	28dc4	DC1	6g	Tor
LHC	XC6219C13AMR	LVR-IC	LDO, 1.35V±2%, 150mA, -CE, PDR	SOT-25	28cx	VR4	6g	Tor
LHC	XC9236C1CDMR	DC-DC-IC	PWM/PFM, st-dwn, 1.25V±2%, 600mA, 3MHz, Vin>2V, LSST, CL	SOT-25	28dc4	DC1	6g	Tor
LHD	XC6219C14AMR	LVR-IC	LDO, 1.45V±2%, 150mA, -CE, PDR	SOT-25	28cx	VR4	6g	Tor
LHD	XC9236C1DDMR	DC-DC-IC	PWM/PFM, st-dwn, 1.35V±2%, 600mA, 3MHz, Vin>2V, LSST, CL	SOT-25	28dc4	DC1	6g	Tor
LHE	XC6219C15AMR	LVR-IC	LDO, 1.55V±2%, 150mA, -CE, PDR	SOT-25	28cx	VR4	6g	Tor
LHE	XC9236C1EDMR	DC-DC-IC	PWM/PFM, st-dwn, 1.45V±2%, 600mA, 3MHz, Vin>2V, LSST, CL	SOT-25	28dc4	DC1	6g	Tor
LHF	XC6219C16AMR	LVR-IC	LDO, 1.65V±2%, 150mA, -CE, PDR	SOT-25	28cx	VR4	6g	Tor
LHF	XC9236C1FDMR	DC-DC-IC	PWM/PFM, st-dwn, 1.55V±2%, 600mA, 3MHz, Vin>2V, LSST, CL	SOT-25	28dc4	DC1	6g	Tor
LHH	XC6219C17AMR	LVR-IC	LDO, 1.75V±2%, 150mA, -CE, PDR	SOT-25	28cx	VR4	6g	Tor
LHH	XC9236C1HDMR	DC-DC-IC	PWM/PFM, st-dwn, 1.65V±2%, 600mA, 3MHz, Vin>2V, LSST, CL	SOT-25	28dc4	DC1	6g	Tor
LHK	XC6219C18AMR	LVR-IC	LDO, 1.85V±2%, 240mA, -CE, PDR	SOT-25	28cx	VR4	6g	Tor
LHK	XC9236C1KDMR	DC-DC-IC	PWM/PFM, st-dwn, 1.75V±2%, 600mA, 3MHz, Vin>2V, LSST, CL	SOT-25	28dc4	DC1	6g	Tor
LHL	XC6219C19AMR	LVR-IC	LDO, 1.95V±2%, 240mA, -CE, PDR	SOT-25	28cx	VR4	6g	Tor
LHL	XC9236C1LDMR	DC-DC-IC	PWM/PFM, st-dwn, 1.85V±2%, 600mA, 3MHz, Vin>2V, LSST, CL	SOT-25	28dc4	DC1	6g	Tor
LHM	XC6219C20AMR	LVR-IC	LDO, 2.05V±2%, 240mA, -CE, PDR	SOT-25	28cx	VR4	6g	Tor
LHM	XC9236C1MDMR	DC-DC-IC	PWM/PFM, st-dwn, 1.95V±2%, 600mA, 3MHz, Vin>2V, LSST, CL	SOT-25	28dc4	DC1	6g	Tor
LHN	XC6219C21AMR	LVR-IC	LDO, 2.15V±2%, 240mA, -CE, PDR	SOT-25	28cx	VR4	6g	Tor
LHP	XC6219C22AMR	LVR-IC	LDO, 2.25V±2%, 240mA, -CE, PDR	SOT-25	28cx	VR4	6g	Tor
LHR	XC6219C23AMR	LVR-IC	LDO, 2.35V±2%, 240mA, -CE, PDR	SOT-25	28cx	VR4	6g	Tor
LHS	XC6219C24AMR	LVR-IC	LDO, 2.45V±2%, 240mA, -CE, PDR	SOT-25	28cx	VR4	6g	Tor
LHT	XC6219C25AMR	LVR-IC	LDO, 2.55V±2%, 240mA, -CE, PDR	SOT-25	28cx	VR4	6g	Tor
LHU	XC6219C26AMR	LVR-IC	LDO, 2.65V±2%, 240mA, -CE, PDR	SOT-25	28cx	VR4	6g	Tor
LHV	XC6219C27AMR	LVR-IC	LDO, 2.75V±2%, 240mA, -CE, PDR	SOT-25	28cx	VR4	6g	Tor
LHX	XC6219C28AMR	LVR-IC	LDO, 2.85V±2%, 240mA, -CE, PDR	SOT-25	28cx	VR4	6g	Tor



SMD code	Type	Function	Short description	Case	Pinout	Sch.	St.	Mnf.
LHY	XC6219C29AMR	LVR-IC	LDO, 2.95V±2%, 240mA, -CE, PDR	SOT-25	28cx	VR4	6g	Tor
LHZ	XC6219C30AMR	LVR-IC	LDO, 3.05V±2%, 240mA, -CE, PDR	SOT-25	28cx	VR4	6g	Tor
LJ	AX6603-200B	LVR-IC	LDO, 2.0V±2%, 300mA, +CE	SOT-23-5	28vrx	VR7	6k	Axl
LJ	RT9168-33CBR	LVR-IC	LDO, 3.3V±2%, 200mA, +CE	SOT-23-5	28vt	VR4	6g	Rct
LJ-	RT9168-33PBR	LVR-IC	LDO, 3.3V±2%, 200mA, +CE	SOT-23-5	28vt	VR4	6g	Rct
Lk	AX6603-400B	LVR-IC	LDO, 4.0V±3%, 300mA, +CE	SOT-23-5	28vrx	VR7	6k	Axl
LK	AX6603-210B	LVR-IC	LDO, 2.1V±2%, 300mA, +CE	SOT-23-5	28vrx	VR7	6k	Axl
LK	RT9168-34CBR	LVR-IC	LDO, 3.4V±2%, 200mA, +CE	SOT-23-5	28vt	VR4	6g	Rct
LK0	XC9236C20DMR	DC-DC-IC	PWM/PFM, st-dwn, 2.0V±2%, 600mA, 3MHz, Vin>2V, LSST, CL	SOT-25	28dc4	DC1	6g	Tor
LK1	XC9236C21DMR	DC-DC-IC	PWM/PFM, st-dwn, 2.1V±2%, 600mA, 3MHz, Vin>2V, LSST, CL	SOT-25	28dc4	DC1	6g	Tor
LK2	XC9236C22DMR	DC-DC-IC	PWM/PFM, st-dwn, 2.2V±2%, 600mA, 3MHz, Vin>2V, LSST, CL	SOT-25	28dc4	DC1	6g	Tor
LK26	MIC5203-2.6BM5	LVR-IC	LDO, 2.6V±1%, 80mA, +CE	SOT-23-5	28cx	VR4	6g	Mcr
LK28	MIC5203-2.8BM5	LVR-IC	LDO, 2.8V±1%, 80mA, +CE	SOT-23-5	28cx	VR4	6g	Mcr
LK3	XC9236C23DMR	DC-DC-IC	PWM/PFM, st-dwn, 2.3V±2%, 600mA, 3MHz, Vin>2V, LSST, CL	SOT-25	28dc4	DC1	6g	Tor
LK30	MIC5203-3.0BM5	LVR-IC	LDO, 3V±1%, 80mA, +CE	SOT-23-5	28cx	VR4	6g	Mcr
LK33	MIC5203-3.3BM5	LVR-IC	LDO, 3.3V±1%, 80mA, +CE	SOT-23-5	28cx	VR4	6g	Mcr
LK36	MIC5203-3.6BM5	LVR-IC	LDO, 3.6V±1%, 80mA, +CE	SOT-23-5	28cx	VR4	6g	Mcr
LK38	MIC5203-3.8BM5	LVR-IC	LDO, 3.8V±1%, 80mA, +CE	SOT-23-5	28cx	VR4	6g	Mcr
LK4	XC9236C24DMR	DC-DC-IC	PWM/PFM, st-dwn, 2.4V±2%, 600mA, 3MHz, Vin>2V, LSST, CL	SOT-25	28dc4	DC1	6g	Tor
LK40	MIC5203-4.0BM5	LVR-IC	LDO, 4V±1%, 80mA, +CE	SOT-23-5	28cx	VR4	6g	Mcr
LK45	MIC5203-4.5BM5	LVR-IC	LDO, 4.5V±1%, 80mA, +CE	SOT-23-5	28cx	VR4	6g	Mcr
LK47	MIC5203-4.7BM5	LVR-IC	LDO, 4.7V±1%, 80mA, +CE	SOT-23-5	28cx	VR4	6g	Mcr
LK5	XC9236C25DMR	DC-DC-IC	PWM/PFM, st-dwn, 2.5V±2%, 600mA, 3MHz, Vin>2V, LSST, CL	SOT-25	28dc4	DC1	6g	Tor
LK50	MIC5203-5.0BM5	LVR-IC	LDO, 5V±1%, 80mA, +CE	SOT-23-5	28cx	VR4	6g	Mcr
LK6	XC9236C26DMR	DC-DC-IC	PWM/PFM, st-dwn, 2.6V±2%, 600mA, 3MHz, Vin>2V, LSST, CL	SOT-25	28dc4	DC1	6g	Tor
LK7	XC9236C27DMR	DC-DC-IC	PWM/PFM, st-dwn, 2.7V±2%, 600mA, 3MHz, Vin>2V, LSST, CL	SOT-25	28dc4	DC1	6g	Tor
LK8	XC6219D09AMR	LVR-IC	LDO, 0.95V±2%, 150mA, -CE	SOT-25	28cx	VR4	6g	Tor
LK8	XC9236C28DMR	DC-DC-IC	PWM/PFM, st-dwn, 2.8V±2%, 600mA, 3MHz, Vin>2V, LSST, CL	SOT-25	28dc4	DC1	6g	Tor
LK9	XC6219D10AMR	LVR-IC	LDO, 1.05V±2%, 150mA, -CE	SOT-25	28cx	VR4	6g	Tor
LK9	XC9236C29DMR	DC-DC-IC	PWM/PFM, st-dwn, 2.9V±2%, 600mA, 3MHz, Vin>2V, LSST, CL	SOT-25	28dc4	DC1	6g	Tor
LKA	XC6219D11AMR	LVR-IC	LDO, 1.15V±2%, 150mA, -CE	SOT-25	28cx	VR4	6g	Tor
LKA	XC9236C2ADMR	DC-DC-IC	PWM/PFM, st-dwn, 2.05V±2%, 600mA, 3MHz, Vin>2V, LSST, CL	SOT-25	28dc4	DC1	6g	Tor
LKAB	LP5951MF-1.5	LVR-IC	LDO, 1.5V±2%, 150mA, +CE	SOT-23-5	28cx	VR4	6a	Nsc
LKB	XC6219D12AMR	LVR-IC	LDO, 1.25V±2%, 150mA, -CE	SOT-25	28cx	VR4	6g	Tor
LKB	XC9236C2BDMR	DC-DC-IC	PWM/PFM, st-dwn, 2.15V±2%, 600mA, 3MHz, Vin>2V, LSST, CL	SOT-25	28dc4	DC1	6g	Tor
LKBB	LP5951MF-1.8	LVR-IC	LDO, 1.8V±2%, 150mA, +CE	SOT-23-5	28cx	VR4	6a	Nsc
LKC	XC6219D13AMR	LVR-IC	LDO, 1.35V±2%, 150mA, -CE	SOT-25	28cx	VR4	6g	Tor
LKC	XC9236C2CDMR	DC-DC-IC	PWM/PFM, st-dwn, 2.25V±2%, 600mA, 3MHz, Vin>2V, LSST, CL	SOT-25	28dc4	DC1	6g	Tor
LKCB	LP5951MF-2.0	LVR-IC	LDO, 2.0V±2%, 150mA, +CE	SOT-23-5	28cx	VR4	6a	Nsc
LKD	XC6219D14AMR	LVR-IC	LDO, 1.45V±2%, 150mA, -CE	SOT-25	28cx	VR4	6g	Tor
LKD	XC9236C2DDMR	DC-DC-IC	PWM/PFM, st-dwn, 2.35V±2%, 600mA, 3MHz, Vin>2V, LSST, CL	SOT-25	28dc4	DC1	6g	Tor
LKE	XC6219D15AMR	LVR-IC	LDO, 1.55V±2%, 150mA, -CE	SOT-25	28cx	VR4	6g	Tor
LKE	XC9236C2EDMR	DC-DC-IC	PWM/PFM, st-dwn, 2.45V±2%, 600mA, 3MHz, Vin>2V, LSST, CL	SOT-25	28dc4	DC1	6g	Tor
LKEB	LP5951MF-2.5	LVR-IC	LDO, 2.5V±2%, 150mA, +CE	SOT-23-5	28cx	VR4	6a	Nsc
LKF	XC6219D16AMR	LVR-IC	LDO, 1.65V±2%, 150mA, -CE	SOT-25	28cx	VR4	6g	Tor
LKF	XC9236C2FDMR	DC-DC-IC	PWM/PFM, st-dwn, 2.55V±2%, 600mA, 3MHz, Vin>2V, LSST, CL	SOT-25	28dc4	DC1	6g	Tor
LKFB	LP5951MF-2.8	LVR-IC	LDO, 2.8V±2%, 150mA, +CE	SOT-23-5	28cx	VR4	6a	Nsc
LKGB	LP5951MF-3.0	LVR-IC	LDO, 3.0V±2%, 150mA, +CE	SOT-23-5	28cx	VR4	6a	Nsc
LKH	XC6219D17AMR	LVR-IC	LDO, 1.75V±2%, 150mA, -CE	SOT-25	28cx	VR4	6g	Tor
LKH	XC9236C2HDMR	DC-DC-IC	PWM/PFM, st-dwn, 2.65V±2%, 600mA, 3MHz, Vin>2V, LSST, CL	SOT-25	28dc4	DC1	6g	Tor
LKHB	LP5951MF-3.3	LVR-IC	LDO, 3.3V±2%, 150mA, +CE	SOT-23-5	28cx	VR4	6a	Nsc
LKK	XC6219D18AMR	LVR-IC	LDO, 1.85V±2%, 240mA, -CE	SOT-25	28cx	VR4	6g	Tor
LKK	XC9236C2KDMR	DC-DC-IC	PWM/PFM, st-dwn, 2.75V±2%, 600mA, 3MHz, Vin>2V, LSST, CL	SOT-25	28dc4	DC1	6g	Tor
LKL	XC6219D19AMR	LVR-IC	LDO, 1.95V±2%, 240mA, -CE	SOT-25	28cx	VR4	6g	Tor
LKL	XC9236C2LDMR	DC-DC-IC	PWM/PFM, st-dwn, 2.85V±2%, 600mA, 3MHz, Vin>2V, LSST, CL	SOT-25	28dc4	DC1	6g	Tor
LKM	XC6219D20AMR	LVR-IC	LDO, 2.05V±2%, 240mA, -CE	SOT-25	28cx	VR4	6g	Tor
LKM	XC9236C2MDMR	DC-DC-IC	PWM/PFM, st-dwn, 2.95V±2%, 600mA, 3MHz, Vin>2V, LSST, CL	SOT-25	28dc4	DC1	6g	Tor
LKN	XC6219D21AMR	LVR-IC	LDO, 2.15V±2%, 240mA, -CE	SOT-25	28cx	VR4	6g	Tor
LKP	XC6219D22AMR	LVR-IC	LDO, 2.25V±2%, 240mA, -CE	SOT-25	28cx	VR4	6g	Tor
LKR	XC6219D23AMR	LVR-IC	LDO, 2.35V±2%, 240mA, -CE	SOT-25	28cx	VR4	6g	Tor
LKRB	LP5951MF-1.3	LVR-IC	LDO, 1.3V±2%, 150mA, +CE	SOT-23-5	28cx	VR4	6a	Nsc
LKS	XC6219D24AMR	LVR-IC	LDO, 2.45V±2%, 240mA, -CE	SOT-25	28cx	VR4	6g	Tor
LKT	XC6219D25AMR	LVR-IC	LDO, 2.55V±2%, 240mA, -CE	SOT-25	28cx	VR4	6g	Tor
LKTA	LP2985AIM5-5.7	LVR-IC	ULDO, 5.7V±1%, 150mA, +CE	SOT-23-5	28vrx	VR7	6g	Nsc
LKTB	LP2985IM5-5.7	LVR-IC	ULDO, 5.7V±2.5%, 150mA, +CE	SOT-23-5	28vrx	VR7	6g	Nsc
LKU	XC6219D26AMR	LVR-IC	LDO, 2.65V±2%, 240mA, -CE	SOT-25	28cx	VR4	6g	Tor
LKV	XC6219D27AMR	LVR-IC	LDO, 2.75V±2%, 240mA, -CE	SOT-25	28cx	VR4	6g	Tor
LKX	XC6219D28AMR	LVR-IC	LDO, 2.85V±2%, 240mA, -CE	SOT-25	28cx	VR4	6g	Tor
LKY	XC6219D29AMR	LVR-IC	LDO, 2.95V±2%, 240mA, -CE	SOT-25	28cx	VR4	6g	Tor
LKZ	XC6219D30AMR	LVR-IC	LDO, 3.05V±2%, 240mA, -CE	SOT-25	28cx	VR4	6g	Tor



SMD code	Type	Function	Short description	Case	Pinout	Sch.	St.	Mnf.
LL	2SC4207-BL	Si-npn	Dual, AF, 60V, 150mA, 300mW, B=350..700, >80MHz	SOT-25	28/T11	-	6a	Tos
LL	R1122N201A	LVR-IC	LDO, LN, -CE, 2V±2%, 150mA	SOT-23-5	28vt	VR4	6g	Ric
LL	RT9168-35CBR	LVR-IC	LDO, 3.5V±2%, 200mA, +CE	SOT-23-5	28vt	VR4	6g	Rct
LL0	XC6219A31AMR	LVR-IC	LDO, 3.15V±2%, 240mA, +CE, PDR	SOT-25	28cx	VR4	6g	Tor
LL0	XC9236C30DMR	DC-DC-IC	PWM/PPM, st-dwn, 3.0V±2%, 600mA, 3MHz, Vin>2V, LSST, CL	SOT-25	28dc4	DC1	6g	Tor
LL1	XC6219A32AMR	LVR-IC	LDO, 3.25V±2%, 240mA, +CE, PDR	SOT-25	28cx	VR4	6g	Tor
LL1	XC9236C31DMR	DC-DC-IC	PWM/PPM, st-dwn, 3.1V±2%, 600mA, 3MHz, Vin>2V, LSST, CL	SOT-25	28dc4	DC1	6g	Tor
LL2	XC6219A33AMR	LVR-IC	LDO, 3.35V±2%, 240mA, +CE, PDR	SOT-25	28cx	VR4	6g	Tor
LL2	XC9236C32DMR	DC-DC-IC	PWM/PPM, st-dwn, 3.2V±2%, 600mA, 3MHz, Vin>2V, LSST, CL	SOT-25	28dc4	DC1	6g	Tor
LL3	XC6219A34AMR	LVR-IC	LDO, 3.45V±2%, 240mA, +CE, PDR	SOT-25	28cx	VR4	6g	Tor
LL3	XC9236C33DMR	DC-DC-IC	PWM/PPM, st-dwn, 3.3V±2%, 600mA, 3MHz, Vin>2V, LSST, CL	SOT-25	28dc4	DC1	6g	Tor
LL30	MIC5270-3.0BM5	LVR-IC	LDO, -3V±2%, 100mA	SOT-23-5	28sa	VR2	6g	Mcr
LL4	XC6219A35AMR	LVR-IC	LDO, 3.55V±2%, 240mA, +CE, PDR	SOT-25	28cx	VR4	6g	Tor
LL4	XC9236C34DMR	DC-DC-IC	PWM/PPM, st-dwn, 3.4V±2%, 600mA, 3MHz, Vin>2V, LSST, CL	SOT-25	28dc4	DC1	6g	Tor
LL41	MIC5270-4.1BM5	LVR-IC	LDO, -4.1V±2%, 100mA	SOT-23-5	28sa	VR2	6g	Mcr
LL5	XC6219A36AMR	LVR-IC	LDO, 3.65V±2%, 240mA, +CE, PDR	SOT-25	28cx	VR4	6g	Tor
LL5	XC9236C35DMR	DC-DC-IC	PWM/PPM, st-dwn, 3.5V±2%, 600mA, 3MHz, Vin>2V, LSST, CL	SOT-25	28dc4	DC1	6g	Tor
LL50	MIC5270-5.0BM5	LVR-IC	LDO, -5V±2%, 100mA	SOT-23-5	28sa	VR2	6g	Mcr
LL6	XC6219A37AMR	LVR-IC	LDO, 3.75V±2%, 240mA, +CE, PDR	SOT-25	28cx	VR4	6g	Tor
LL6	XC9236C36DMR	DC-DC-IC	PWM/PPM, st-dwn, 3.6V±2%, 600mA, 3MHz, Vin>2V, LSST, CL	SOT-25	28dc4	DC1	6g	Tor
LL7	XC6219A38AMR	LVR-IC	LDO, 3.85V±2%, 240mA, +CE, PDR	SOT-25	28cx	VR4	6g	Tor
LL7	XC9236C37DMR	DC-DC-IC	PWM/PPM, st-dwn, 3.7V±2%, 600mA, 3MHz, Vin>2V, LSST, CL	SOT-25	28dc4	DC1	6g	Tor
LL8	XC6219A39AMR	LVR-IC	LDO, 3.95V±2%, 240mA, +CE, PDR	SOT-25	28cx	VR4	6g	Tor
LL8	XC9236C38DMR	DC-DC-IC	PWM/PPM, st-dwn, 3.8V±2%, 600mA, 3MHz, Vin>2V, LSST, CL	SOT-25	28dc4	DC1	6g	Tor
LL9	XC6219A40AMR	LVR-IC	LDO, 4.05V±2%, 240mA, +CE, PDR	SOT-25	28cx	VR4	6g	Tor
LL9	XC9236C39DMR	DC-DC-IC	PWM/PPM, st-dwn, 3.9V±2%, 600mA, 3MHz, Vin>2V, LSST, CL	SOT-25	28dc4	DC1	6g	Tor
LLA	XC6219A41AMR	LVR-IC	LDO, 4.15V±2%, 240mA, +CE, PDR	SOT-25	28cx	VR4	6g	Tor
LLA	XC9236C3ADMR	DC-DC-IC	PWM/PPM, st-dwn, 3.05V±2%, 600mA, 3MHz, Vin>2V, LSST, CL	SOT-25	28dc4	DC1	6g	Tor
LLAA	MIC5270-BM5	LVR-IC	LDO, Negative, Adjustable, 100mA	SOT-23-5	28sa	VR3	6g	Mcr
LLB	XC6219A42AMR	LVR-IC	LDO, 4.25V±2%, 240mA, +CE, PDR	SOT-25	28cx	VR4	6g	Tor
LLB	XC9236C3BDMR	DC-DC-IC	PWM/PPM, st-dwn, 3.15V±2%, 600mA, 3MHz, Vin>2V, LSST, CL	SOT-25	28dc4	DC1	6g	Tor
LLC	XC6219A43AMR	LVR-IC	LDO, 4.35V±2%, 240mA, +CE, PDR	SOT-25	28cx	VR4	6g	Tor
LLC	XC9236C3CDMR	DC-DC-IC	PWM/PPM, st-dwn, 3.25V±2%, 600mA, 3MHz, Vin>2V, LSST, CL	SOT-25	28dc4	DC1	6g	Tor
LLD	XC6219A44AMR	LVR-IC	LDO, 4.45V±2%, 240mA, +CE, PDR	SOT-25	28cx	VR4	6g	Tor
LLD	XC9236C3DDMR	DC-DC-IC	PWM/PPM, st-dwn, 3.35V±2%, 600mA, 3MHz, Vin>2V, LSST, CL	SOT-25	28dc4	DC1	6g	Tor
LLE	XC6219A45AMR	LVR-IC	LDO, 4.55V±2%, 240mA, +CE, PDR	SOT-25	28cx	VR4	6g	Tor
LLE	XC9236C3EDMR	DC-DC-IC	PWM/PPM, st-dwn, 3.45V±2%, 600mA, 3MHz, Vin>2V, LSST, CL	SOT-25	28dc4	DC1	6g	Tor
LLF	XC6219A46AMR	LVR-IC	LDO, 4.65V±2%, 240mA, +CE, PDR	SOT-25	28cx	VR4	6g	Tor
LLF	XC9236C3FDMR	DC-DC-IC	PWM/PPM, st-dwn, 3.55V±2%, 600mA, 3MHz, Vin>2V, LSST, CL	SOT-25	28dc4	DC1	6g	Tor
LLH	XC6219A47AMR	LVR-IC	LDO, 4.75V±2%, 240mA, +CE, PDR	SOT-25	28cx	VR4	6g	Tor
LLH	XC9236C3HDMR	DC-DC-IC	PWM/PPM, st-dwn, 3.65V±2%, 600mA, 3MHz, Vin>2V, LSST, CL	SOT-25	28dc4	DC1	6g	Tor
LLK	XC6219A48AMR	LVR-IC	LDO, 4.85V±2%, 240mA, +CE, PDR	SOT-25	28cx	VR4	6g	Tor
LLK	XC9236C3KDMR	DC-DC-IC	PWM/PPM, st-dwn, 3.75V±2%, 600mA, 3MHz, Vin>2V, LSST, CL	SOT-25	28dc4	DC1	6g	Tor
LLL	XC6219A49AMR	LVR-IC	LDO, 4.95V±2%, 240mA, +CE, PDR	SOT-25	28cx	VR4	6g	Tor
LLL	XC9236C3LDMR	DC-DC-IC	PWM/PPM, st-dwn, 3.85V±2%, 600mA, 3MHz, Vin>2V, LSST, CL	SOT-25	28dc4	DC1	6g	Tor
LLM	XC9236C3MDMR	DC-DC-IC	PWM/PPM, st-dwn, 3.95V±2%, 600mA, 3MHz, Vin>2V, LSST, CL	SOT-25	28dc4	DC1	6g	Tor
Lm	AX6603-410B	LVR-IC	LDO, 4.1V±3%, 300mA, +CE	SOT-23-5	28vrx	VR7	6k	Axl
Lm	AX6603-220B	LVR-IC	LDO, 2.2V±2%, 300mA, +CE	SOT-23-5	28vrx	VR7	6k	Axl
Lm	IDT74LVC1125ADY	CMOS-Logic	Bus buffer gate with 3-state output	S05-1	28/Log14	-	6g	ldt
Lm	R1122N211A	LVR-IC	LDO, LN, -CE, 2.1V±2%, 150mA	SOT-23-5	28vt	VR4	6g	Ric
Lm	RT9168-36CBR	LVR-IC	LDO, 3.6V±2%, 200mA, +CE	SOT-23-5	28vt	VR4	6g	Rct
LM0	XC6219B31AMR	LVR-IC	LDO, 3.15V±2%, 240mA, +CE	SOT-25	28cx	VR4	6g	Tor
LM0	XC9236C40DMR	DC-DC-IC	PWM/PPM, st-dwn, 4.0V±2%, 600mA, 3MHz, Vin>2V, LSST, CL	SOT-25	28dc4	DC1	6g	Tor
LM1	XC6219B32AMR	LVR-IC	LDO, 3.25V±2%, 240mA, +CE	SOT-25	28cx	VR4	6g	Tor
LM2	XC6219B33AMR	LVR-IC	LDO, 3.35V±2%, 240mA, +CE	SOT-25	28cx	VR4	6g	Tor
LM2H	MIC5231-2.75BM5	LVR-IC	LDO, 2.75V±2%, 100mA, +CE	SOT-23-5	28vr3	VR4	6g	Mcr
LM3	XC6219B34AMR	LVR-IC	LDO, 3.45V±2%, 240mA, +CE	SOT-25	28cx	VR4	6g	Tor
LM30	MIC5231-3.0BM5	LVR-IC	LDO, 3.0V±2%, 100mA, +CE	SOT-23-5	28vr3	VR4	6g	Mcr
LM33	MIC5231-3.3BM5	LVR-IC	LDO, 3.3V±2%, 100mA, +CE	SOT-23-5	28vr3	VR4	6g	Mcr
LM4	XC6219B35AMR	LVR-IC	LDO, 3.55V±2%, 240mA, +CE	SOT-25	28cx	VR4	6g	Tor
LM5	XC6219B36AMR	LVR-IC	LDO, 3.65V±2%, 240mA, +CE	SOT-25	28cx	VR4	6g	Tor
LM50	MIC5231-5.0BM5	LVR-IC	LDO, 5.0V±2%, 100mA, +CE	SOT-23-5	28vr3	VR4	6g	Mcr
LM6	XC6219B37AMR	LVR-IC	LDO, 3.75V±2%, 240mA, +CE	SOT-25	28cx	VR4	6g	Tor
LM7	XC6219B38AMR	LVR-IC	LDO, 3.85V±2%, 240mA, +CE	SOT-25	28cx	VR4	6g	Tor
LM8	XC6219B39AMR	LVR-IC	LDO, 3.95V±2%, 240mA, +CE	SOT-25	28cx	VR4	6g	Tor
LM9	XC6219B40AMR	LVR-IC	LDO, 4.05V±2%, 240mA, +CE	SOT-25	28cx	VR4	6g	Tor
LMA	XC6219B41AMR	LVR-IC	LDO, 4.15V±2%, 240mA, +CE	SOT-25	28cx	VR4	6g	Tor
LMB	XC6219B42AMR	LVR-IC	LDO, 4.25V±2%, 240mA, +CE	SOT-25	28cx	VR4	6g	Tor
LMC	XC6219B43AMR	LVR-IC	LDO, 4.35V±2%, 240mA, +CE	SOT-25	28cx	VR4	6g	Tor
LMD	XC6219B44AMR	LVR-IC	LDO, 4.45V±2%, 240mA, +CE	SOT-25	28cx	VR4	6g	Tor



SMD code	Type	Function	Short description	Case	Pinout	Sch.	St.	Mnf.
LME	XC6219B45AMR	LVR-IC	LDO, 4.55V±2%, 240mA, +CE	SOT-25	28cx	VR4	6g	Tor
LMF	XC6219B46AMR	LVR-IC	LDO, 4.65V±2%, 240mA, +CE	SOT-25	28cx	VR4	6g	Tor
LMH	XC6219B47AMR	LVR-IC	LDO, 4.75V±2%, 240mA, +CE	SOT-25	28cx	VR4	6g	Tor
LMK	XC6219B48AMR	LVR-IC	LDO, 4.85V±2%, 240mA, +CE	SOT-25	28cx	VR4	6g	Tor
LML	XC6219B49AMR	LVR-IC	LDO, 4.95V±2%, 240mA, +CE	SOT-25	28cx	VR4	6g	Tor
Ln	AX6603-420B	LVR-IC	LDO, 4.2V±3%, 300mA, +CE	SOT-23-5	28vrx	VR7	6k	Axl
LN	AX6603-230B	LVR-IC	LDO, 2.3V±2%, 300mA, +CE	SOT-23-5	28vrx	VR7	6k	Axl
LN	IDT74LVC1G126ADY	CMOS-Logic	Bus buffer gate with 3-state output	SO5-1	28/Log13	-	6g	ldt
LN	R1122N221A	LVR-IC	LDO, LN, -CE, 2.2V±2%, 150mA	SOT-23-5	28vt	VR4	6g	Ric
LN	RT9168-37CBR	LVR-IC	LDO, 3.7V±2%, 200mA, +CE	SOT-23-5	28vt	VR4	6g	Rct
LN0	XC6219C31AMR	LVR-IC	LDO, 3.15V±2%, 240mA, -CE, PDR	SOT-25	28cx	VR4	6g	Tor
LN1	XC6219C32AMR	LVR-IC	LDO, 3.25V±2%, 240mA, -CE, PDR	SOT-25	28cx	VR4	6g	Tor
LN2	XC6219C33AMR	LVR-IC	LDO, 3.35V±2%, 240mA, -CE, PDR	SOT-25	28cx	VR4	6g	Tor
LN3	XC6219C34AMR	LVR-IC	LDO, 3.45V±2%, 240mA, -CE, PDR	SOT-25	28cx	VR4	6g	Tor
LN4	XC6219C35AMR	LVR-IC	LDO, 3.55V±2%, 240mA, -CE, PDR	SOT-25	28cx	VR4	6g	Tor
LN5	XC6219C36AMR	LVR-IC	LDO, 3.65V±2%, 240mA, -CE, PDR	SOT-25	28cx	VR4	6g	Tor
LN6	XC6219C37AMR	LVR-IC	LDO, 3.75V±2%, 240mA, -CE, PDR	SOT-25	28cx	VR4	6g	Tor
LN7	XC6219C38AMR	LVR-IC	LDO, 3.85V±2%, 240mA, -CE, PDR	SOT-25	28cx	VR4	6g	Tor
LN8	XC6219C39AMR	LVR-IC	LDO, 3.95V±2%, 240mA, -CE, PDR	SOT-25	28cx	VR4	6g	Tor
LN9	XC6219C40AMR	LVR-IC	LDO, 4.05V±2%, 240mA, -CE, PDR	SOT-25	28cx	VR4	6g	Tor
LNA	XC6219C41AMR	LVR-IC	LDO, 4.15V±2%, 240mA, -CE, PDR	SOT-25	28cx	VR4	6g	Tor
LNB	XC6219C42AMR	LVR-IC	LDO, 4.25V±2%, 240mA, -CE, PDR	SOT-25	28cx	VR4	6g	Tor
LNC	XC6219C43AMR	LVR-IC	LDO, 4.35V±2%, 240mA, -CE, PDR	SOT-25	28cx	VR4	6g	Tor
LND	XC6219C44AMR	LVR-IC	LDO, 4.45V±2%, 240mA, -CE, PDR	SOT-25	28cx	VR4	6g	Tor
LNE	XC6219C45AMR	LVR-IC	LDO, 4.55V±2%, 240mA, -CE, PDR	SOT-25	28cx	VR4	6g	Tor
LNF	XC6219C46AMR	LVR-IC	LDO, 4.65V±2%, 240mA, -CE, PDR	SOT-25	28cx	VR4	6g	Tor
LNH	XC6219C47AMR	LVR-IC	LDO, 4.75V±2%, 240mA, -CE, PDR	SOT-25	28cx	VR4	6g	Tor
LNK	XC6219C48AMR	LVR-IC	LDO, 4.85V±2%, 240mA, -CE, PDR	SOT-25	28cx	VR4	6g	Tor
LNL	XC6219C49AMR	LVR-IC	LDO, 4.95V±2%, 240mA, -CE, PDR	SOT-25	28cx	VR4	6g	Tor
LP	AX6603-240B	LVR-IC	LDO, 2.4V±2%, 300mA, +CE	SOT-23-5	28vrx	VR7	6k	Axl
LP	R1122N231A	LVR-IC	LDO, LN, -CE, 2.3V±2%, 150mA	SOT-23-5	28vt	VR4	6g	Ric
LP0	XC6219D31AMR	LVR-IC	LDO, 3.15V±2%, 240mA, -CE	SOT-25	28cx	VR4	6g	Tor
LP1	XC6219D32AMR	LVR-IC	LDO, 3.25V±2%, 240mA, -CE	SOT-25	28cx	VR4	6g	Tor
LP2	XC6219D33AMR	LVR-IC	LDO, 3.35V±2%, 240mA, -CE	SOT-25	28cx	VR4	6g	Tor
LP3	XC6219D34AMR	LVR-IC	LDO, 3.45V±2%, 240mA, -CE	SOT-25	28cx	VR4	6g	Tor
LP4	XC6219D35AMR	LVR-IC	LDO, 3.55V±2%, 240mA, -CE	SOT-25	28cx	VR4	6g	Tor
LP5	XC6219D36AMR	LVR-IC	LDO, 3.65V±2%, 240mA, -CE	SOT-25	28cx	VR4	6g	Tor
LP6	XC6219D37AMR	LVR-IC	LDO, 3.75V±2%, 240mA, -CE	SOT-25	28cx	VR4	6g	Tor
LP7	XC6219D38AMR	LVR-IC	LDO, 3.85V±2%, 240mA, -CE	SOT-25	28cx	VR4	6g	Tor
LP8	XC6219D39AMR	LVR-IC	LDO, 3.95V±2%, 240mA, -CE	SOT-25	28cx	VR4	6g	Tor
LP9	XC6219D40AMR	LVR-IC	LDO, 4.05V±2%, 240mA, -CE	SOT-25	28cx	VR4	6g	Tor
LPA	XC6219D41AMR	LVR-IC	LDO, 4.15V±2%, 240mA, -CE	SOT-25	28cx	VR4	6g	Tor
LPB	XC6219D42AMR	LVR-IC	LDO, 4.25V±2%, 240mA, -CE	SOT-25	28cx	VR4	6g	Tor
LPC	XC6219D43AMR	LVR-IC	LDO, 4.35V±2%, 240mA, -CE	SOT-25	28cx	VR4	6g	Tor
LPD	XC6219D44AMR	LVR-IC	LDO, 4.45V±2%, 240mA, -CE	SOT-25	28cx	VR4	6g	Tor
LPE	XC6219D45AMR	LVR-IC	LDO, 4.55V±2%, 240mA, -CE	SOT-25	28cx	VR4	6g	Tor
LPF	XC6219D46AMR	LVR-IC	LDO, 4.65V±2%, 240mA, -CE	SOT-25	28cx	VR4	6g	Tor
LPH	XC6219D47AMR	LVR-IC	LDO, 4.75V±2%, 240mA, -CE	SOT-25	28cx	VR4	6g	Tor
LPK	XC6219D48AMR	LVR-IC	LDO, 4.85V±2%, 240mA, -CE	SOT-25	28cx	VR4	6g	Tor
LPL	XC6219D49AMR	LVR-IC	LDO, 4.95V±2%, 240mA, -CE	SOT-25	28cx	VR4	6g	Tor
Lq	AX6603-430B	LVR-IC	LDO, 4.3V±3%, 300mA, +CE	SOT-23-5	28vrx	VR7	6k	Axl
LQ	AX6603-250B	LVR-IC	LDO, 2.5V±2%, 300mA, +CE	SOT-23-5	28vrx	VR7	6k	Axl
LQ	R1122N241A	LVR-IC	LDO, LN, -CE, 2.4V±2%, 150mA	SOT-23-5	28vt	VR4	6g	Ric
Lr	AX6603-440B	LVR-IC	LDO, 4.4V±3%, 300mA, +CE	SOT-23-5	28vrx	VR7	6k	Axl
LR	AX6603-260B	LVR-IC	LDO, 2.6V±2%, 300mA, +CE	SOT-23-5	28vrx	VR7	6k	Axl
LR	IDT74LVC1G79ADY	CMOS-Logic	Positive edge-triggered D-type flip-flop	SO5-1	28/Log20	-	6g	ldt
LR	R1122N251A	LVR-IC	LDO, LN, -CE, 2.5V±2%, 150mA	SOT-23-5	28vt	VR4	6g	Ric
Ls	AX6603-450B	LVR-IC	LDO, 4.5V±3%, 300mA, +CE	SOT-23-5	28vrx	VR7	6k	Axl
LS	AX6603-270B	LVR-IC	LDO, 2.7V±2%, 300mA, +CE	SOT-23-5	28vrx	VR7	6k	Axl
LS	R1122N261A	LVR-IC	LDO, LN, -CE, 2.6V±2%, 150mA	SOT-23-5	28vt	VR4	6g	Ric
LS20	MIC5245-2.0BM5	LVR-IC	LDO, 2V±2%, 150mA, +CE	SOT-23-5	28vrx	VR7	6g	Mcr
LS21	MIC5245-2.1BM5	LVR-IC	LDO, 2.1V±2%, 150mA, +CE	SOT-23-5	28vrx	VR7	6g	Mcr
LS22	MIC5245-2.2BM5	LVR-IC	LDO, 2.2V±2%, 150mA, +CE	SOT-23-5	28vrx	VR7	6g	Mcr
LS23	MIC5245-2.3BM5	LVR-IC	LDO, 2.3V±2%, 150mA, +CE	SOT-23-5	28vrx	VR7	6g	Mcr
LS25	MIC5245-2.5BM5	LVR-IC	LDO, 2.5V±2%, 150mA, +CE	SOT-23-5	28vrx	VR7	6g	Mcr
LS26	MIC5245-2.6BM5	LVR-IC	LDO, 2.6V±2%, 150mA, +CE	SOT-23-5	28vrx	VR7	6g	Mcr
LS27	MIC5245-2.7BM5	LVR-IC	LDO, 2.7V±2%, 150mA, +CE	SOT-23-5	28vrx	VR7	6g	Mcr
LS28	MIC5245-2.8BM5	LVR-IC	LDO, 2.8V±2%, 150mA, +CE	SOT-23-5	28vrx	VR7	6g	Mcr
LS2J	MIC5245-2.85BM5	LVR-IC	LDO, 2.85V±2%, 150mA, +CE	SOT-23-5	28vrx	VR7	6g	Mcr
LS30	MIC5245-3.0BM5	LVR-IC	LDO, 3V±2%, 150mA, +CE	SOT-23-5	28vrx	VR7	6g	Mcr



SMD code	Type	Function	Short description	Case	Pinout	Sch.	St.	Mnf.
LS31	MIC5245-3.1BM5	LVR-IC	LDO, 3.1V±2%, 150mA, +CE	SOT-23-5	28vrx	VR7	6g	Mcr
LS32	MIC5245-3.2BM5	LVR-IC	LDO, 3.2V±2%, 150mA, +CE	SOT-23-5	28vrx	VR7	6g	Mcr
LS33	MIC5245-3.3BM5	LVR-IC	LDO, 3.3V±2%, 150mA, +CE	SOT-23-5	28vrx	VR7	6g	Mcr
LS35	MIC5245-3.5BM5	LVR-IC	LDO, 3.5V±2%, 150mA, +CE	SOT-23-5	28vrx	VR7	6g	Mcr
LS50	MIC5245-5.0BM5	LVR-IC	LDO, 5V±2%, 150mA, +CE	SOT-23-5	28vrx	VR7	6g	Mcr
LST	NCP500SN25T1	LVR-IC	LDO, LN, +CE, 2.5V±2.5%, 150mA	SOT-353	30cxc	VR4	6b	Ons
Lt	AX6603-460B	LVR-IC	LDO, 4.6V±3%, 300mA, +CE	SOT-23-5	28vrx	VR7	6k	Axl
LT	AX6603-280B	LVR-IC	LDO, 2.8V±2%, 300mA, +CE	SOT-23-5	28vrx	VR7	6k	Axl
LT	IDT74LVC1G06ADY	CMOS-Logic	Inverter (ODO)	S05-1	28/Log19	-	6g	ldt
LT	R1122N271A	LVR-IC	LDO, LN, -CE, 2.7V±2%, 150mA	SOT-23-5	28vt	VR4	6g	Ric
LT-	RT9168-42PBR	LVR-IC	LDO, 4.2V±2%, 200mA, +CE	SOT-23-5	28vt	VR4	6g	Rct
LT15	MIC5246-1.5BM5	LVR-IC	LDO, 1.5V±2%, 150mA, +CE, Error	SOT-23-5	28w	VR8	6g	Mcr
LT21	MIC5246-2.1BM5	LVR-IC	LDO, 2.1V±2%, 150mA, +CE, Error	SOT-23-5	28w	VR8	6g	Mcr
LT25	MIC5246-2.5BM5	LVR-IC	LDO, 2.5V±2%, 150mA, +CE, Error	SOT-23-5	28w	VR8	6g	Mcr
LT26	MIC5246-2.6BM5	LVR-IC	LDO, 2.6V±2%, 150mA, +CE, Error	SOT-23-5	28w	VR8	6g	Mcr
LT27	MIC5246-2.7BM5	LVR-IC	LDO, 2.7V±2%, 150mA, +CE, Error	SOT-23-5	28w	VR8	6g	Mcr
LT28	MIC5246-2.8BM5	LVR-IC	LDO, 2.8V±2%, 150mA, +CE, Error	SOT-23-5	28w	VR8	6g	Mcr
LT2J	MIC5246-2.85BM5	LVR-IC	LDO, 2.85V±2%, 150mA, +CE, Error	SOT-23-5	28w	VR8	6g	Mcr
LT30	MIC5246-3.0BM5	LVR-IC	LDO, 3V±2%, 150mA, +CE, Error	SOT-23-5	28w	VR8	6g	Mcr
LT31	MIC5246-3.1BM5	LVR-IC	LDO, 3.1V±2%, 150mA, +CE, Error	SOT-23-5	28w	VR8	6g	Mcr
LT33	MIC5246-3.3BM5	LVR-IC	LDO, 3.3V±2%, 150mA, +CE, Error	SOT-23-5	28w	VR8	6g	Mcr
LTGC	LT1761ESS-BYP	LVR-IC	LDO, Lo-Power, Adjustable 1.22..20V±2%, 100mA	SOT-23-5	28wd	-	6a	Ltc
LTGD	LT1761ESS-2.5	LVR-IC	LDO, Lo-Power, +CE, 2.5V±2%, 100mA	SOT-23-5	28vrx	VR7	6a	Ltc
LTGE	LT1761ESS-3	LVR-IC	LDO, Lo-Power, +CE, 3V±2%, 100mA	SOT-23-5	28vrx	VR7	6a	Ltc
LTGF	LT1761ESS-3.3	LVR-IC	LDO, Lo-Power, +CE, 3.3V±2%, 100mA	SOT-23-5	28vrx	VR7	6a	Ltc
LTGG	LT1761ESS-5	LVR-IC	LDO, Lo-Power, +CE, 5V±2%, 100mA	SOT-23-5	28vrx	VR7	6a	Ltc
LTGH	LT1761ESS-SD	LVR-IC	LDO, Lo-Power, +CE, Adjustable 1.22..20V±2%, 100mA	SOT-23-5	28sg	VR16	6a	Ltc
LTJE	LT1761ESS-2	LVR-IC	LDO, Lo-Power, +CE, 2V±2%, 100mA	SOT-23-5	28vrx	VR7	6a	Ltc
LTJM	LT1761ESS-1.8	LVR-IC	LDO, Lo-Power, +CE, 1.8V±2%, 100mA	SOT-23-5	28vrx	VR7	6a	Ltc
LTKB	LT1761ESS-2.8	LVR-IC	LDO, Lo-Power, +CE, 2.8V±2%, 100mA	SOT-23-5	28vrx	VR7	6a	Ltc
LTMT	LT1761ESS-1.5	LVR-IC	LDO, Lo-Power, +CE, 1.5V±2%, 100mA	SOT-23-5	28vrx	VR7	6a	Ltc
Lu	AX6603-470B	LVR-IC	LDO, 4.7V±3%, 300mA, +CE	SOT-23-5	28vrx	VR7	6k	Axl
LU	AX6603-285B	LVR-IC	LDO, 2.85V±2%, 300mA, +CE	SOT-23-5	28vrx	VR7	6k	Axl
LU	R1122N281A	LVR-IC	LDO, LN, -CE, 2.8V±2%, 150mA	SOT-23-5	28vt	VR4	6g	Ric
LU15	MIC5247-1.5BM5	LVR-IC	LDO, 1.5V±1%, 150mA, +CE	SOT-23-5	28vrx	VR7	6g	Mcr
LU16	MIC5247-1.6BM5	LVR-IC	LDO, 1.6V±1%, 150mA, +CE	SOT-23-5	28vrx	VR7	6g	Mcr
LU18	MIC5247-1.8BM5	LVR-IC	LDO, 1.8V±1%, 150mA, +CE	SOT-23-5	28vrx	VR7	6g	Mcr
LU1J	MIC5247-1.85BM5	LVR-IC	LDO, 1.85V±1%, 150mA, +CE	SOT-23-5	28vrx	VR7	6g	Mcr
LU20	MIC5247-2.0BM5	LVR-IC	LDO, 2V±1%, 150mA, +CE	SOT-23-5	28vrx	VR7	6g	Mcr
LU21	MIC5247-2.1BM5	LVR-IC	LDO, 2.1V±1%, 150mA, +CE	SOT-23-5	28vrx	VR7	6g	Mcr
LU22	MIC5247-2.2BM5	LVR-IC	LDO, 2.2V±1%, 150mA, +CE	SOT-23-5	28vrx	VR7	6g	Mcr
LU24	MIC5247-2.4BM5	LVR-IC	LDO, 2.4V±1%, 150mA, +CE	SOT-23-5	28vrx	VR7	6g	Mcr
Lv	AX6603-475B	LVR-IC	LDO, 4.75V±3%, 300mA, +CE	SOT-23-5	28vrx	VR7	6k	Axl
LV	1SX265	PIN-diode	Dual, VHF/UHF, 50V, 50mA, 100mW, 0.23pF, 2.5Ω(100MHz)	CP5	28bg	-	6a	San
LV	AX6603-290B	LVR-IC	LDO, 2.9V±2%, 300mA, +CE	SOT-23-5	28vrx	VR7	6k	Axl
LV	IDT74LVC1G07ADY	CMOS-Logic	Noninverting buffer/driver (ODO)	S05-1	28/Log8	-	6g	ldt
LV	R1122N291A	LVR-IC	LDO, LN, -CE, 2.9V±2%, 150mA	SOT-23-5	28vt	VR4	6g	Ric
LV12	MIC5248-1.2BM5	LVR-IC	LDO, 1.2V±1%, 150mA, +CE, Error	SOT-23-5	28w	VR8	6g	Mcr
LV8	XC6219A092MR	LVR-IC	LDO, 0.9V±2%, 150mA, +CE, PDR	SOT-25	28cx	VR4	6g	Tor
LV9	XC6219A102MR	LVR-IC	LDO, 1V±2%, 150mA, +CE, PDR	SOT-25	28cx	VR4	6g	Tor
LVA	XC6219A112MR	LVR-IC	LDO, 1.1V±2%, 150mA, +CE, PDR	SOT-25	28cx	VR4	6g	Tor
LVB	XC6219A122MR	LVR-IC	LDO, 1.2V±2%, 150mA, +CE, PDR	SOT-25	28cx	VR4	6g	Tor
LVC	XC6219A132MR	LVR-IC	LDO, 1.3V±2%, 150mA, +CE, PDR	SOT-25	28cx	VR4	6g	Tor
LVD	XC6219A142MR	LVR-IC	LDO, 1.4V±2%, 150mA, +CE, PDR	SOT-25	28cx	VR4	6g	Tor
LVE	XC6219A152MR	LVR-IC	LDO, 1.5V±2%, 150mA, +CE, PDR	SOT-25	28cx	VR4	6g	Tor
LVF	XC6219A162MR	LVR-IC	LDO, 1.6V±2%, 150mA, +CE, PDR	SOT-25	28cx	VR4	6g	Tor
L VH	XC6219A172MR	LVR-IC	LDO, 1.7V±2%, 150mA, +CE, PDR	SOT-25	28cx	VR4	6g	Tor
LVK	XC6219A182MR	LVR-IC	LDO, 1.8V±2%, 240mA, +CE, PDR	SOT-25	28cx	VR4	6g	Tor
LVL	XC6219A192MR	LVR-IC	LDO, 1.9V±2%, 240mA, +CE, PDR	SOT-25	28cx	VR4	6g	Tor
LVM	XC6219A202MR	LVR-IC	LDO, 2V±2%, 240mA, +CE, PDR	SOT-25	28cx	VR4	6g	Tor
LVN	XC6219A212MR	LVR-IC	LDO, 2.1V±2%, 240mA, +CE, PDR	SOT-25	28cx	VR4	6g	Tor
LVP	XC6219A222MR	LVR-IC	LDO, 2.2V±2%, 240mA, +CE, PDR	SOT-25	28cx	VR4	6g	Tor
LVR	XC6219A232MR	LVR-IC	LDO, 2.3V±2%, 240mA, +CE, PDR	SOT-25	28cx	VR4	6g	Tor
LVS	XC6219A242MR	LVR-IC	LDO, 2.4V±2%, 240mA, +CE, PDR	SOT-25	28cx	VR4	6g	Tor
LVT	XC6219A252MR	LVR-IC	LDO, 2.5V±2%, 240mA, +CE, PDR	SOT-25	28cx	VR4	6g	Tor
L VU	XC6219A262MR	LVR-IC	LDO, 2.6V±2%, 240mA, +CE, PDR	SOT-25	28cx	VR4	6g	Tor
L VV	XC6219A272MR	LVR-IC	LDO, 2.7V±2%, 240mA, +CE, PDR	SOT-25	28cx	VR4	6g	Tor
L V X	XC6219A282MR	LVR-IC	LDO, 2.8V±2%, 240mA, +CE, PDR	SOT-25	28cx	VR4	6g	Tor
L V Y	XC6219A292MR	LVR-IC	LDO, 2.9V±2%, 240mA, +CE, PDR	SOT-25	28cx	VR4	6g	Tor
L V Z	XC6219A302MR	LVR-IC	LDO, 3V±2%, 240mA, +CE, PDR	SOT-25	28cx	VR4	6g	Tor



SMD code	Type	Function	Short description	Case	Pinout	Sch.	St.	Mnf.
LW	AX6603-480B	LVR-IC	LDO, 4.8V±3%, 300mA, +CE	SOT-23-5	28vrx	VR7	6k	Axl
LW	AX6603-300B	LVR-IC	LDO, 3.0V±2%, 300mA, -CE	SOT-23-5	28vrx	VR7	6k	Axl
LW25	MIC5255-2.5BM5	LVR-IC	LDO, 2.5V±1%, 150mA, +CE	SOT-23-5	28vrx	VR7	6g	Mcr
LW26	MIC5255-2.6BM5	LVR-IC	LDO, 2.6V±1%, 150mA, +CE	SOT-23-5	28vrx	VR7	6g	Mcr
LW27	MIC5255-2.7BM5	LVR-IC	LDO, 2.7V±1%, 150mA, +CE	SOT-23-5	28vrx	VR7	6g	Mcr
LW28	MIC5255-2.8BM5	LVR-IC	LDO, 2.8V±1%, 150mA, +CE	SOT-23-5	28vrx	VR7	6g	Mcr
LW29	MIC5255-2.9BM5	LVR-IC	LDO, 2.9V±1%, 150mA, +CE	SOT-23-5	28vrx	VR7	6g	Mcr
LW2H	MIC5255-2.75BM5	LVR-IC	LDO, 2.75V±1%, 150mA, +CE	SOT-23-5	28vrx	VR7	6g	Mcr
LW2J	MIC5255-2.85BM5	LVR-IC	LDO, 2.85V±1%, 150mA, +CE	SOT-23-5	28vrx	VR7	6g	Mcr
LW30	MIC5255-3.0BM5	LVR-IC	LDO, 3V±1%, 150mA, +CE	SOT-23-5	28vrx	VR7	6g	Mcr
LW31	MIC5255-3.1BM5	LVR-IC	LDO, 3.1V±1%, 150mA, +CE	SOT-23-5	28vrx	VR7	6g	Mcr
LW32	MIC5255-3.2BM5	LVR-IC	LDO, 3.2V±1%, 150mA, +CE	SOT-23-5	28vrx	VR7	6g	Mcr
LW33	MIC5255-3.3BM5	LVR-IC	LDO, 3.3V±1%, 150mA, +CE	SOT-23-5	28vrx	VR7	6g	Mcr
Lx	AX6603-490B	LVR-IC	LDO, 4.9V±3%, 300mA, +CE	SOT-23-5	28vrx	VR7	6k	Axl
LX	AX6603-310B	LVR-IC	LDO, 3.1V±2%, 300mA, +CE	SOT-23-5	28vrx	VR7	6k	Axl
LX26	MIC5256-2.6BM5	LVR-IC	LDO, 2.6V±1%, 150mA, +CE, -Error	SOT-23-5	28w	VR17	6g	Mcr
LX27	MIC5256-2.7BM5	LVR-IC	LDO, 2.7V±1%, 150mA, +CE, -Error	SOT-23-5	28w	VR17	6g	Mcr
LX28	MIC5256-2.8BM5	LVR-IC	LDO, 2.8V±1%, 150mA, +CE, -Error	SOT-23-5	28w	VR17	6g	Mcr
LX29	MIC5256-2.9BM5	LVR-IC	LDO, 2.9V±1%, 150mA, +CE, -Error	SOT-23-5	28w	VR17	6g	Mcr
LX2J	MIC5256-2.85BM5	LVR-IC	LDO, 2.85V±1%, 150mA, +CE, -Error	SOT-23-5	28w	VR17	6g	Mcr
LX30	MIC5256-3.0BM5	LVR-IC	LDO, 3V±1%, 150mA, +CE, -Error	SOT-23-5	28w	VR17	6g	Mcr
LX31	MIC5256-3.1BM5	LVR-IC	LDO, 3.1V±1%, 150mA, +CE, -Error	SOT-23-5	28w	VR17	6g	Mcr
LX33	MIC5256-3.3BM5	LVR-IC	LDO, 3.3V±1%, 150mA, +CE, -Error	SOT-23-5	28w	VR17	6g	Mcr
LX8	XC6219B092MR	LVR-IC	LDO, 0.9V±2%, 150mA, +CE	SOT-25	28cx	VR4	6g	Tor
LX9	XC6219B102MR	LVR-IC	LDO, 1V±2%, 150mA, +CE	SOT-25	28cx	VR4	6g	Tor
LXA	XC6219B112MR	LVR-IC	LDO, 1.1V±2%, 150mA, +CE	SOT-25	28cx	VR4	6g	Tor
LXB	XC6219B122MR	LVR-IC	LDO, 1.2V±2%, 150mA, +CE	SOT-25	28cx	VR4	6g	Tor
LXC	XC6219B132MR	LVR-IC	LDO, 1.3V±2%, 150mA, +CE	SOT-25	28cx	VR4	6g	Tor
LXD	XC6219B142MR	LVR-IC	LDO, 1.4V±2%, 150mA, +CE	SOT-25	28cx	VR4	6g	Tor
LXE	XC6219B152MR	LVR-IC	LDO, 1.5V±2%, 150mA, +CE	SOT-25	28cx	VR4	6g	Tor
LXF	XC6219B162MR	LVR-IC	LDO, 1.6V±2%, 150mA, +CE	SOT-25	28cx	VR4	6g	Tor
LXH	XC6219B172MR	LVR-IC	LDO, 1.7V±2%, 150mA, +CE	SOT-25	28cx	VR4	6g	Tor
LXK	XC6219B182MR	LVR-IC	LDO, 1.8V±2%, 240mA, +CE	SOT-25	28cx	VR4	6g	Tor
LXL	XC6219B192MR	LVR-IC	LDO, 1.9V±2%, 240mA, +CE	SOT-25	28cx	VR4	6g	Tor
LXM	XC6219B202MR	LVR-IC	LDO, 2V±2%, 240mA, +CE	SOT-25	28cx	VR4	6g	Tor
LXN	XC6219B212MR	LVR-IC	LDO, 2.1V±2%, 240mA, +CE	SOT-25	28cx	VR4	6g	Tor
LXP	XC6219B222MR	LVR-IC	LDO, 2.2V±2%, 240mA, +CE	SOT-25	28cx	VR4	6g	Tor
LXR	XC6219B232MR	LVR-IC	LDO, 2.3V±2%, 240mA, +CE	SOT-25	28cx	VR4	6g	Tor
LXS	XC6219B242MR	LVR-IC	LDO, 2.4V±2%, 240mA, +CE	SOT-25	28cx	VR4	6g	Tor
LXT	XC6219B252MR	LVR-IC	LDO, 2.5V±2%, 240mA, +CE	SOT-25	28cx	VR4	6g	Tor
LXU	XC6219B262MR	LVR-IC	LDO, 2.6V±2%, 240mA, +CE	SOT-25	28cx	VR4	6g	Tor
LXV	XC6219B272MR	LVR-IC	LDO, 2.7V±2%, 240mA, +CE	SOT-25	28cx	VR4	6g	Tor
LXX	XC6219B282MR	LVR-IC	LDO, 2.8V±2%, 240mA, +CE	SOT-25	28cx	VR4	6g	Tor
LXY	XC6219B292MR	LVR-IC	LDO, 2.9V±2%, 240mA, +CE	SOT-25	28cx	VR4	6g	Tor
LXZ	XC6219B302MR	LVR-IC	LDO, 3V±2%, 240mA, +CE	SOT-25	28cx	VR4	6g	Tor
Ly	AX6603-500B	LVR-IC	LDO, 5.0V±3%, 300mA, +CE	SOT-23-5	28vrx	VR7	6k	Axl
LY	2SC4207-Y	Si-npn	Dual, AF, 60V, 150mA, 300mW, B=120..240, >80MHz	SOT-25	28/T11	-	6a	Tos
LY	2SC4944-Y	Si-npn	Dual, AF, 60V, 150mA, 200mW, B=120..240, >80MHz	SOT-25	28/T11	-	6a	Tos
LY	AX6603-315B	LVR-IC	LDO, 3.15V±3%, 300mA, +CE	SOT-23-5	28vrx	VR7	6k	Axl
LY	IDT74LVC1G13ZADY	CMOS-Logic	2-input NAND Schmitt-trigger	SO5-1	28/Log12	-	6g	Idt
LY8	XC6219C092MR	LVR-IC	LDO, 0.9V±2%, 150mA, -CE, PDR	SOT-25	28cx	VR4	6g	Tor
LY9	XC6219C102MR	LVR-IC	LDO, 1V±2%, 150mA, -CE, PDR	SOT-25	28cx	VR4	6g	Tor
LYA	XC6219C112MR	LVR-IC	LDO, 1.1V±2%, 150mA, -CE, PDR	SOT-25	28cx	VR4	6g	Tor
LYB	XC6219C122MR	LVR-IC	LDO, 1.2V±2%, 150mA, -CE, PDR	SOT-25	28cx	VR4	6g	Tor
LYC	XC6219C132MR	LVR-IC	LDO, 1.3V±2%, 150mA, -CE, PDR	SOT-25	28cx	VR4	6g	Tor
LYD	XC6219C142MR	LVR-IC	LDO, 1.4V±2%, 150mA, -CE, PDR	SOT-25	28cx	VR4	6g	Tor
LYE	XC6219C152MR	LVR-IC	LDO, 1.5V±2%, 150mA, -CE, PDR	SOT-25	28cx	VR4	6g	Tor
LYF	XC6219C162MR	LVR-IC	LDO, 1.6V±2%, 150mA, -CE, PDR	SOT-25	28cx	VR4	6g	Tor
LYH	XC6219C172MR	LVR-IC	LDO, 1.7V±2%, 150mA, -CE, PDR	SOT-25	28cx	VR4	6g	Tor
LYK	XC6219C182MR	LVR-IC	LDO, 1.8V±2%, 240mA, -CE, PDR	SOT-25	28cx	VR4	6g	Tor
LYL	XC6219C192MR	LVR-IC	LDO, 1.9V±2%, 240mA, -CE, PDR	SOT-25	28cx	VR4	6g	Tor
LYM	XC6219C202MR	LVR-IC	LDO, 2V±2%, 240mA, -CE, PDR	SOT-25	28cx	VR4	6g	Tor
LYN	XC6219C212MR	LVR-IC	LDO, 2.1V±2%, 240mA, -CE, PDR	SOT-25	28cx	VR4	6g	Tor
LYP	XC6219C222MR	LVR-IC	LDO, 2.2V±2%, 240mA, -CE, PDR	SOT-25	28cx	VR4	6g	Tor
LYR	XC6219C232MR	LVR-IC	LDO, 2.3V±2%, 240mA, -CE, PDR	SOT-25	28cx	VR4	6g	Tor
LYS	XC6219C242MR	LVR-IC	LDO, 2.4V±2%, 240mA, -CE, PDR	SOT-25	28cx	VR4	6g	Tor
LYT	XC6219C252MR	LVR-IC	LDO, 2.5V±2%, 240mA, -CE, PDR	SOT-25	28cx	VR4	6g	Tor
LYU	XC6219C262MR	LVR-IC	LDO, 2.6V±2%, 240mA, -CE, PDR	SOT-25	28cx	VR4	6g	Tor
LYV	XC6219C272MR	LVR-IC	LDO, 2.7V±2%, 240mA, -CE, PDR	SOT-25	28cx	VR4	6g	Tor
LYX	XC6219C282MR	LVR-IC	LDO, 2.8V±2%, 240mA, -CE, PDR	SOT-25	28cx	VR4	6g	Tor



SMD code	Type	Function	Short description	Case	Pinout	Sch.	St.Mnf.
LYY	XC6219C292MR	LVR-IC	LDO, 2.9V±2%, 240mA, -CE, PDR	SOT-25	28cx	VR4	6g Tor
LYZ	XC6219C302MR	LVR-IC	LDO, 3V±2%, 240mA, -CE, PDR	SOT-25	28cx	VR4	6g Tor
LZ	AX6603-320B	LVR-IC	LDO, 3.2V±2%, 300mA, +CE	SOT-23-5	28vrx	VR7	6k Axl
LZ8	XC6219D092MR	LVR-IC	LDO, 0.9V±2%, 150mA, -CE	SOT-25	28cx	VR4	6g Tor
LZ9	XC6219D102MR	LVR-IC	LDO, 1V±2%, 150mA, -CE	SOT-25	28cx	VR4	6g Tor
LZA	XC6219D112MR	LVR-IC	LDO, 1.1V±2%, 150mA, -CE	SOT-25	28cx	VR4	6g Tor
LZB	XC6219D122MR	LVR-IC	LDO, 1.2V±2%, 150mA, -CE	SOT-25	28cx	VR4	6g Tor
LZC	XC6219D132MR	LVR-IC	LDO, 1.3V±2%, 150mA, -CE	SOT-25	28cx	VR4	6g Tor
LZD	XC6219D142MR	LVR-IC	LDO, 1.4V±2%, 150mA, -CE	SOT-25	28cx	VR4	6g Tor
LZE	XC6219D152MR	LVR-IC	LDO, 1.5V±2%, 150mA, -CE	SOT-25	28cx	VR4	6g Tor
LZF	XC6219D162MR	LVR-IC	LDO, 1.6V±2%, 150mA, -CE	SOT-25	28cx	VR4	6g Tor
LZH	XC6219D172MR	LVR-IC	LDO, 1.7V±2%, 150mA, -CE	SOT-25	28cx	VR4	6g Tor
LZK	XC6219D182MR	LVR-IC	LDO, 1.8V±2%, 240mA, -CE	SOT-25	28cx	VR4	6g Tor
LZL	XC6219D192MR	LVR-IC	LDO, 1.9V±2%, 240mA, -CE	SOT-25	28cx	VR4	6g Tor
LZM	XC6219D202MR	LVR-IC	LDO, 2V±2%, 240mA, -CE	SOT-25	28cx	VR4	6g Tor
LZN	XC6219D212MR	LVR-IC	LDO, 2.1V±2%, 240mA, -CE	SOT-25	28cx	VR4	6g Tor
LZP	XC6219D222MR	LVR-IC	LDO, 2.2V±2%, 240mA, -CE	SOT-25	28cx	VR4	6g Tor
LZR	XC6219D232MR	LVR-IC	LDO, 2.3V±2%, 240mA, -CE	SOT-25	28cx	VR4	6g Tor
LZS	XC6219D242MR	LVR-IC	LDO, 2.4V±2%, 240mA, -CE	SOT-25	28cx	VR4	6g Tor
LZT	XC6219D252MR	LVR-IC	LDO, 2.5V±2%, 240mA, -CE	SOT-25	28cx	VR4	6g Tor
LZU	XC6219D262MR	LVR-IC	LDO, 2.6V±2%, 240mA, -CE	SOT-25	28cx	VR4	6g Tor
LZV	XC6219D272MR	LVR-IC	LDO, 2.7V±2%, 240mA, -CE	SOT-25	28cx	VR4	6g Tor
LZX	XC6219D282MR	LVR-IC	LDO, 2.8V±2%, 240mA, -CE	SOT-25	28cx	VR4	6g Tor
LZY	XC6219D292MR	LVR-IC	LDO, 2.9V±2%, 240mA, -CE	SOT-25	28cx	VR4	6g Tor
LZZ	XC6219D302MR	LVR-IC	LDO, 3V±2%, 240mA, -CE	SOT-25	28cx	VR4	6g Tor
M0	R1121N301A	LVR-IC	LDO, LN, -CE, 3V±2%, 150mA	SOT-23-5	28vt	VR4	6g Ric
M0	RN5RG50AA	LVR-IC	Ext. transistor, 5V±2.5% 1A*	SOT-23-5	28vw	VR6	6g Ric
M0	RT9168A-15CBR	LVR-IC	LDO, 1.5V±2%, 500mA, +CE	SOT-23-5	28vt	VR4	6g Rct
M0	RN5RY401A	DC/DC-IC	VFM step-up, 4V±2.5%, 150mW, <180kHz	SOT-23-5	28vd	DC5	6g Ric
M001	R3134Q10EC	Vdet-IC	1.0V±1.8%, -Reset PPO, -MR	SC-88A	28z8	VD5	6m Ric
M002	R3134Q11EC	Vdet-IC	1.1V±1.8%, -Reset PPO, -MR	SC-88A	28z8	VD5	6m Ric
M003	R3134Q12EC	Vdet-IC	1.2V±1.8%, -Reset PPO, -MR	SC-88A	28z8	VD5	6m Ric
M004	R3134Q13EC	Vdet-IC	1.3V±1.8%, -Reset PPO, -MR	SC-88A	28z8	VD5	6m Ric
M005	R3134Q14EC	Vdet-IC	1.4V±1.8%, -Reset PPO, -MR	SC-88A	28z8	VD5	6m Ric
M006	R3134Q15EC	Vdet-IC	1.5V±1.8%, -Reset PPO, -MR	SC-88A	28z8	VD5	6m Ric
M007	R3134Q16EC	Vdet-IC	1.6V±1.8%, -Reset PPO, -MR	SC-88A	28z8	VD5	6m Ric
M008	R3134Q17EC	Vdet-IC	1.7V±1.8%, -Reset PPO, -MR	SC-88A	28z8	VD5	6m Ric
M009	R3134Q18EC	Vdet-IC	1.8V±1.8%, -Reset PPO, -MR	SC-88A	28z8	VD5	6m Ric
M010	R3134Q19EC	Vdet-IC	1.9V±1.8%, -Reset PPO, -MR	SC-88A	28z8	VD5	6m Ric
M011	R3134Q20EC	Vdet-IC	2.0V±1.8%, -Reset PPO, -MR	SC-88A	28z8	VD5	6m Ric
M012	R3134Q21EC	Vdet-IC	2.1V±1.8%, -Reset PPO, -MR	SC-88A	28z8	VD5	6m Ric
M013	R3134Q22EC	Vdet-IC	2.2V±1.8%, -Reset PPO, -MR	SC-88A	28z8	VD5	6m Ric
M014	R3134Q23EC	Vdet-IC	2.3V±1.8%, -Reset PPO, -MR	SC-88A	28z8	VD5	6m Ric
M015	R3134Q24EC	Vdet-IC	2.4V±1.8%, -Reset PPO, -MR	SC-88A	28z8	VD5	6m Ric
M016	R3134Q25EC	Vdet-IC	2.5V±1.8%, -Reset PPO, -MR	SC-88A	28z8	VD5	6m Ric
M017	R3134Q26EC	Vdet-IC	2.6V±1.8%, -Reset PPO, -MR	SC-88A	28z8	VD5	6m Ric
M018	R3134Q27EC	Vdet-IC	2.7V±1.8%, -Reset PPO, -MR	SC-88A	28z8	VD5	6m Ric
M019	R3134Q28EC	Vdet-IC	2.8V±1.8%, -Reset PPO, -MR	SC-88A	28z8	VD5	6m Ric
M020	R3134Q29EC	Vdet-IC	2.9V±1.8%, -Reset PPO, -MR	SC-88A	28z8	VD5	6m Ric
M021	R3134Q30EC	Vdet-IC	3.0V±1.8%, -Reset PPO, -MR	SC-88A	28z8	VD5	6m Ric
M022	R3134Q31EC	Vdet-IC	3.1V±1.8%, -Reset PPO, -MR	SC-88A	28z8	VD5	6m Ric
M023	R3134Q32EC	Vdet-IC	3.2V±1.8%, -Reset PPO, -MR	SC-88A	28z8	VD5	6m Ric
M024	R3134Q33EC	Vdet-IC	3.3V±1.8%, -Reset PPO, -MR	SC-88A	28z8	VD5	6m Ric
M025	R3134Q34EC	Vdet-IC	3.4V±1.8%, -Reset PPO, -MR	SC-88A	28z8	VD5	6m Ric
M026	R3134Q35EC	Vdet-IC	3.5V±1.8%, -Reset PPO, -MR	SC-88A	28z8	VD5	6m Ric
M027	R3134Q36EC	Vdet-IC	3.6V±1.8%, -Reset PPO, -MR	SC-88A	28z8	VD5	6m Ric
M028	R3134Q37EC	Vdet-IC	3.7V±1.8%, -Reset PPO, -MR	SC-88A	28z8	VD5	6m Ric
M029	R3134Q38EC	Vdet-IC	3.8V±1.8%, -Reset PPO, -MR	SC-88A	28z8	VD5	6m Ric
M030	R3134Q39EC	Vdet-IC	3.9V±1.8%, -Reset PPO, -MR	SC-88A	28z8	VD5	6m Ric
M031	R3134Q40EC	Vdet-IC	4.0V±1.8%, -Reset PPO, -MR	SC-88A	28z8	VD5	6m Ric
M032	R3134Q41EC	Vdet-IC	4.1V±1.8%, -Reset PPO, -MR	SC-88A	28z8	VD5	6m Ric
M033	R3134Q42EC	Vdet-IC	4.2V±1.8%, -Reset PPO, -MR	SC-88A	28z8	VD5	6m Ric
M034	R3134Q43EC	Vdet-IC	4.3V±1.8%, -Reset PPO, -MR	SC-88A	28z8	VD5	6m Ric
M035	R3134Q44EC	Vdet-IC	4.4V±1.8%, -Reset PPO, -MR	SC-88A	28z8	VD5	6m Ric
M036	R3134Q45EC	Vdet-IC	4.5V±1.8%, -Reset PPO, -MR	SC-88A	28z8	VD5	6m Ric
M037	R3134Q46EC	Vdet-IC	4.6V±1.8%, -Reset PPO, -MR	SC-88A	28z8	VD5	6m Ric
M038	R3134Q47EC	Vdet-IC	4.7V±1.8%, -Reset PPO, -MR	SC-88A	28z8	VD5	6m Ric
M039	R3134Q48EC	Vdet-IC	4.8V±1.8%, -Reset PPO, -MR	SC-88A	28z8	VD5	6m Ric
M040	R3134Q49EC	Vdet-IC	4.9V±1.8%, -Reset PPO, -MR	SC-88A	28z8	VD5	6m Ric
M041	R3134Q50EC	Vdet-IC	5.0V±1.8%, -Reset PPO, -MR	SC-88A	28z8	VD5	6m Ric



SMD code	Type	Function	Short description	Case	Pinout	Sch.	St.Mnf.
M042	R3134Q23EC2	Vdet-IC	2.32V±1.8%, -Reset PPO, -MR	SC-88A	28z8	VD5	6m Ric
M043	R3134Q26EC3	Vdet-IC	2.63V±1.8%, -Reset PPO, -MR	SC-88A	28z8	VD5	6m Ric
M044	R3134Q29EC3	Vdet-IC	2.93V±1.8%, -Reset PPO, -MR	SC-88A	28z8	VD5	6m Ric
M045	R3134Q30EC8	Vdet-IC	3.08V±1.8%, -Reset PPO, -MR	SC-88A	28z8	VD5	6m Ric
M046	R3134Q43EC8	Vdet-IC	4.38V±1.8%, -Reset PPO, -MR	SC-88A	28z8	VD5	6m Ric
M047	R3134Q46EC3	Vdet-IC	4.63V±1.8%, -Reset PPO, -MR	SC-88A	28z8	VD5	6m Ric
MOA	R3117N071A	Vdet-IC	0.7V±15mV, -Reset ODO, Sense	SOT-23-5	28rr	VD11	6g Ric
MOA	XC6108N20AMR	Vdet-IC	2.0V±2%, Hysteresis, -Reset ODO	SOT-25	28rm	VD14	6g Tor
MOA	XC6118C10AMR-G	Vdet-IC	1.0V±30mV, ±Reset PPO, Sense, hysteresis 5%, Cd	SOT-25	28mg	VD15	6g Tor
MOB	R3117N081A	Vdet-IC	0.8V±15mV, -Reset ODO, Sense	SOT-23-5	28rr	VD11	6g Ric
MOB	XC6108N20BMR	Vdet-IC	2.0V±2%, -Reset ODO	SOT-25	28rm	VD14	6g Tor
MOB	XC6118C10BMR-G	Vdet-IC	1.0V±30mV, ±Reset PPO, Sense, hysteresis <1%, Cd	SOT-25	28mg	VD15	6g Tor
MOC	R3117N091A	Vdet-IC	0.9V±15mV, -Reset ODO, Sense	SOT-23-5	28rr	VD11	6g Ric
MOC	XC6108N20CMR	Vdet-IC	2.0V±2%, Hysteresis, -Reset ODO	SOT-25	28rk	VD14	6g Tor
MOC	XC6118C10CMR-G	Vdet-IC	1.0V±30mV, ±Reset PPO, Sense, hysteresis 5%	SOT-25	28mf	VD12	6g Tor
MOD	R3117N101A	Vdet-IC	1.0V±15mV, -Reset ODO, Sense	SOT-23-5	28rr	VD11	6g Ric
MOD	XC6108N20DMR	Vdet-IC	2.0V±2%, -Reset ODO	SOT-25	28rk	VD14	6g Tor
MOD	XC6118C10DMR-G	Vdet-IC	1.0V±30mV, ±Reset PPO, Sense, hysteresis <1%	SOT-25	28mf	VD12	6g Tor
MOE	R3117N111A	Vdet-IC	1.1V±15mV, -Reset ODO, Sense	SOT-23-5	28rr	VD11	6g Ric
MOF	R3117N121A	Vdet-IC	1.2V±15mV, -Reset ODO, Sense	SOT-23-5	28rr	VD11	6g Ric
MOG	R3117N131A	Vdet-IC	1.3V±15mV, -Reset ODO, Sense	SOT-23-5	28rr	VD11	6g Ric
MOH	R3117N141A	Vdet-IC	1.4V±15mV, -Reset ODO, Sense	SOT-23-5	28rr	VD11	6g Ric
MOJ	R3117N151A	Vdet-IC	1.5V±15mV, -Reset ODO, Sense	SOT-23-5	28rr	VD11	6g Ric
MOK	R3117N161A	Vdet-IC	1.6V±1%, -Reset ODO, Sense	SOT-23-5	28rr	VD11	6g Ric
MOL	R3117N171A	Vdet-IC	1.7V±1%, -Reset ODO, Sense	SOT-23-5	28rr	VD11	6g Ric
MOM	R3117N181A	Vdet-IC	1.8V±1%, -Reset ODO, Sense	SOT-23-5	28rr	VD11	6g Ric
MON	R3117N191A	Vdet-IC	1.9V±1%, -Reset ODO, Sense	SOT-23-5	28rr	VD11	6g Ric
MOP	R3117N201A	Vdet-IC	2.0V±1%, -Reset ODO, Sense	SOT-23-5	28rr	VD11	6g Ric
MOQ	R3117N211A	Vdet-IC	2.1V±1%, -Reset ODO, Sense	SOT-23-5	28rr	VD11	6g Ric
MOR	R3117N221A	Vdet-IC	2.2V±1%, -Reset ODO, Sense	SOT-23-5	28rr	VD11	6g Ric
MOS	R3117N231A	Vdet-IC	2.3V±1%, -Reset ODO, Sense	SOT-23-5	28rr	VD11	6g Ric
MOT	R3117N241A	Vdet-IC	2.4V±1%, -Reset ODO, Sense	SOT-23-5	28rr	VD11	6g Ric
MOU	R3117N251A	Vdet-IC	2.5V±1%, -Reset ODO, Sense	SOT-23-5	28rr	VD11	6g Ric
MOV	R3117N261A	Vdet-IC	2.6V±1%, -Reset ODO, Sense	SOT-23-5	28rr	VD11	6g Ric
MOW	R3117N271A	Vdet-IC	2.7V±1%, -Reset ODO, Sense	SOT-23-5	28rr	VD11	6g Ric
MOX	R3117N281A	Vdet-IC	2.8V±1%, -Reset ODO, Sense	SOT-23-5	28rr	VD11	6g Ric
MOY	R3117N291A	Vdet-IC	2.9V±1%, -Reset ODO, Sense	SOT-23-5	28rr	VD11	6g Ric
MOZ	R3117N301A	Vdet-IC	3.0V±1%, -Reset ODO, Sense	SOT-23-5	28rr	VD11	6g Ric
M1	R1121N311A	LVR-IC	LDO, LN, -CE, 3.1V±2%, 150mA	SOT-23-5	28vt	VR4	6g Ric
M1	RT5RGS1AA	LVR-IC	Ext. transistor, 5.1V±2.5% 1A*	SOT-23-5	28vw	VR6	6g Ric
M1	RT9168A-16CBR	LVR-IC	LDO, 1.6V±2%, 500mA, +CE	SOT-23-5	28vt	VR4	6g Rct
M1	RN5RY411A	DC/DC-IC	VFM step-up, 4.1V±2.5%, 150mW, <180kHz	SOT-23-5	28vd	DC5	6g Ric
M10	R1224N102M	DC/DC-IC	PWM step-down, 1V, 180kHz	SOT-23-5	28ud	DC7	6g Ric
M12	R1224N122M	DC/DC-IC	PWM step-down, 1.2V, 180kHz	SOT-23-5	28ud	DC7	6g Ric
M13	88N13-AF5	Vdet-IC	1.3V±2%, -Reset ODO	SOT-23-5	28vdo	VD1	6a Utc
M13G	88N13G-AF5	Vdet-IC	1.3V±2%, -Reset ODO, halogen free	SOT-23-5	28vdo	VD1	6a Utc
M13L	88N13L-AF5	Vdet-IC	1.3V±2%, -Reset ODO, lead free	SOT-23-5	28vdo	VD1	6a Utc
M14	88N14-AF5	Vdet-IC	1.4V±2%, -Reset ODO	SOT-23-5	28vdo	VD1	6a Utc
M14G	88N14G-AF5	Vdet-IC	1.4V±2%, -Reset ODO, halogen free	SOT-23-5	28vdo	VD1	6a Utc
M14L	88N14L-AF5	Vdet-IC	1.4V±2%, -Reset ODO, lead free	SOT-23-5	28vdo	VD1	6a Utc
M15	88N15-AF5	Vdet-IC	1.5V±2%, -Reset ODO	SOT-23-5	28vdo	VD1	6a Utc
M15	R1224N152M	DC/DC-IC	PWM step-down, 1.5V, 180kHz	SOT-23-5	28ud	DC7	6g Ric
M15	XC6366C152MR	DC/DC-IC	PWM/PFM st-down, 180kHz, 1.5V±2.5%, 1A, +CE, soft start	SOT-25	28zm	DC7	6g Tor
M15	XC6368C152MR	DC/DC-IC	PWM/PFM step-up, 1.5V±2.5%, 200mA, 180kHz, +CE, soft start	SOT-25	28sh	DC11	6g Tor
M15G	88N15G-AF5	Vdet-IC	1.5V±2%, -Reset ODO, halogen free	SOT-23-5	28vdo	VD1	6a Utc
M15L	88N15L-AF5	Vdet-IC	1.5V±2%, -Reset ODO, lead free	SOT-23-5	28vdo	VD1	6a Utc
M16	88N16-AF5	Vdet-IC	1.6V±2%, -Reset ODO	SOT-23-5	28vdo	VD1	6a Utc
M16	XC6366C162MR	DC/DC-IC	PWM/PFM st-down, 180kHz, 1.6V±2.5%, 1A, +CE, soft start	SOT-25	28zm	DC7	6g Tor
M16	XC6368C162MR	DC/DC-IC	PWM/PFM step-up, 1.6V±2.5%, 200mA, 180kHz, +CE, soft start	SOT-25	28sh	DC11	6g Tor
M16G	88N16G-AF5	Vdet-IC	1.6V±2%, -Reset ODO, halogen free	SOT-23-5	28vdo	VD1	6a Utc
M16L	88N16L-AF5	Vdet-IC	1.6V±2%, -Reset ODO, lead free	SOT-23-5	28vdo	VD1	6a Utc
M17	88N17-AF5	Vdet-IC	1.7V±2%, -Reset ODO	SOT-23-5	28vdo	VD1	6a Utc
M17	XC6366C172MR	DC/DC-IC	PWM/PFM st-down, 180kHz, 1.7V±2.5%, 1A, +CE, soft start	SOT-25	28zm	DC7	6g Tor
M17	XC6368C172MR	DC/DC-IC	PWM/PFM step-up, 1.7V±2.5%, 200mA, 180kHz, +CE, soft start	SOT-25	28sh	DC11	6g Tor
M17G	88N17G-AF5	Vdet-IC	1.7V±2%, -Reset ODO, halogen free	SOT-23-5	28vdo	VD1	6a Utc
M17L	88N17L-AF5	Vdet-IC	1.7V±2%, -Reset ODO, lead free	SOT-23-5	28vdo	VD1	6a Utc
M18	88N18-AF5	Vdet-IC	1.8V±2%, -Reset ODO	SOT-23-5	28vdo	VD1	6a Utc
M18	R1224N182M	DC/DC-IC	PWM step-down, 1.8V, 180kHz	SOT-23-5	28ud	DC7	6g Ric
M18	XC6366C182MR	DC/DC-IC	PWM/PFM st-down, 180kHz, 1.8V±2.5%, 1A, +CE, soft start	SOT-25	28zm	DC7	6g Tor
M18	XC6368C182MR	DC/DC-IC	PWM/PFM step-up, 1.8V±2.5%, 200mA, 180kHz, +CE, soft start	SOT-25	28sh	DC11	6g Tor



SMD code	Type	Function	Short description	Case	Pinout	Sch.	St.	Mnf.
M18G	88N18G-AF5	Vdet-IC	1.8V±2%, -Reset ODO, halogen free	SOT-23-5	28vdo	VD1	6a	Utc
M18L	88N18L-AF5	Vdet-IC	1.8V±2%, -Reset ODO, lead free	SOT-23-5	28vdo	VD1	6a	Utc
M19	88N19-AF5	Vdet-IC	1.9V±2%, -Reset ODO	SOT-23-5	28vdo	VD1	6a	Utc
M19	XC6366C192MR	DC/DC-IC	PWM/PFM st-down, 180kHz, 1.9V±2.5%, 1A, +CE, soft start	SOT-25	28zm	DC7	6g	Tor
M19	XC6368C192MR	DC/DC-IC	PWM/PFM step-up, 1.9V±2.5%, 200mA, 180kHz, +CE, soft start	SOT-25	28sh	DC11	6g	Tor
M19G	88N19G-AF5	Vdet-IC	1.9V±2%, -Reset ODO, halogen free	SOT-23-5	28vdo	VD1	6a	Utc
M19L	88N19L-AF5	Vdet-IC	1.9V±2%, -Reset ODO, lead free	SOT-23-5	28vdo	VD1	6a	Utc
M1A	R3117N071C	Vdet-IC	0.7V±15mV, -Reset PPO, Sense	SOT-23-5	28rr	VD12	6g	Ric
M1A	XC6108N21AMR	Vdet-IC	2.1V±2%, Hysteresis, -Reset ODO	SOT-25	28rm	VD14	6g	Tor
M1A	XC6118C11AMR-G	Vdet-IC	1.1V±30mV, ±Reset PPO, Sense, hysteresis 5%, Cd	SOT-25	28mg	VD15	6g	Tor
M1A	TC105103ECT	DC/DC-IC	PWM/PFM step-down, 300kHz, 1.0V±1%, 1A, +CE	SOT-23-5	28zm	DC7	6g	Mcc
M1B	R3117N081C	Vdet-IC	0.8V±15mV, -Reset PPO, Sense	SOT-23-5	28rr	VD12	6g	Ric
M1B	XC6108N21BMR	Vdet-IC	2.1V±2%, -Reset ODO	SOT-25	28rm	VD14	6g	Tor
M1B	XC6118C11BMR-G	Vdet-IC	1.1V±30mV, ±Reset PPO, Sense, hysteresis <1%, Cd	SOT-25	28mg	VD15	6g	Tor
M1B	TC105113ECT	DC/DC-IC	PWM/PFM step-down, 300kHz, 1.1V±1%, 1A, +CE	SOT-23-5	28zm	DC7	6g	Mcc
M1C	R3117N091C	Vdet-IC	0.9V±15mV, -Reset PPO, Sense	SOT-23-5	28rr	VD12	6g	Ric
M1C	XC6108N21CMR	Vdet-IC	2.1V±2%, Hysteresis, -Reset ODO	SOT-25	28rk	VD14	6g	Tor
M1C	XC6118C11CMR-G	Vdet-IC	1.1V±30mV, ±Reset PPO, Sense, hysteresis 5%	SOT-25	28mf	VD12	6g	Tor
M1C	TC105123ECT	DC/DC-IC	PWM/PFM step-down, 300kHz, 1.2V±1%, 1A, +CE	SOT-23-5	28zm	DC7	6g	Mcc
M1D	R3117N101C	Vdet-IC	1.0V±15mV, -Reset PPO, Sense	SOT-23-5	28rr	VD12	6g	Ric
M1D	XC6108N21DMR	Vdet-IC	2.1V±2%, -Reset ODO	SOT-25	28rk	VD14	6g	Tor
M1D	XC6118C11DMR-G	Vdet-IC	1.1V±30mV, ±Reset PPO, Sense, hysteresis <1%	SOT-25	28mf	VD12	6g	Tor
M1D	TC105133ECT	DC/DC-IC	PWM/PFM step-down, 300kHz, 1.3V±1%, 1A, +CE	SOT-23-5	28zm	DC7	6g	Mcc
M1E	R3117N111C	Vdet-IC	1.1V±15mV, -Reset PPO, Sense	SOT-23-5	28rr	VD12	6g	Ric
M1E	TC105143ECT	DC/DC-IC	PWM/PFM step-down, 300kHz, 1.4V±1%, 1A, +CE	SOT-23-5	28zm	DC7	6g	Mcc
M1F	R3117N121C	Vdet-IC	1.2V±15mV, -Reset PPO, Sense	SOT-23-5	28rr	VD12	6g	Ric
M1F	TC105153ECT	DC/DC-IC	PWM/PFM step-down, 300kHz, 1.5V±1%, 1A, +CE	SOT-23-5	28zm	DC7	6g	Mcc
M1F	XC6366C153MR	DC/DC-IC	PWM/PFM st-down, 300kHz, 1.5V±2.5%, 1A, +CE, soft start	SOT-25	28zm	DC7	6g	Tor
M1F	XC6368C153MR	DC/DC-IC	PWM/PFM step-up, 1.5V±2.5%, 200mA, 300kHz, +CE, soft start	SOT-25	28sh	DC11	6g	Tor
M1G	R3117N131C	Vdet-IC	1.3V±15mV, -Reset PPO, Sense	SOT-23-5	28rr	VD12	6g	Ric
M1H	R3117N141C	Vdet-IC	1.4V±15mV, -Reset PPO, Sense	SOT-23-5	28rr	VD12	6g	Ric
M1H	TC105163ECT	DC/DC-IC	PWM/PFM step-down, 300kHz, 1.6V±1%, 1A, +CE	SOT-23-5	28zm	DC7	6g	Mcc
M1H	XC6366C163MR	DC/DC-IC	PWM/PFM st-down, 300kHz, 1.6V±2.5%, 1A, +CE, soft start	SOT-25	28zm	DC7	6g	Tor
M1H	XC6368C163MR	DC/DC-IC	PWM/PFM step-up, 1.6V±2.5%, 200mA, 300kHz, +CE, soft start	SOT-25	28sh	DC11	6g	Tor
M1J	R3117N151C	Vdet-IC	1.5V±15mV, -Reset PPO, Sense	SOT-23-5	28rr	VD12	6g	Ric
M1K	R3117N161C	Vdet-IC	1.6V±1%, -Reset PPO, Sense	SOT-23-5	28rr	VD12	6g	Ric
M1K	TC105173ECT	DC/DC-IC	PWM/PFM step-down, 300kHz, 1.7V±1%, 1A, +CE	SOT-23-5	28zm	DC7	6g	Mcc
M1K	XC6366C173MR	DC/DC-IC	PWM/PFM st-down, 300kHz, 1.7V±2.5%, 1A, +CE, soft start	SOT-25	28zm	DC7	6g	Tor
M1K	XC6368C173MR	DC/DC-IC	PWM/PFM step-up, 1.7V±2.5%, 200mA, 300kHz, +CE, soft start	SOT-25	28sh	DC11	6g	Tor
M1L	R3117N171C	Vdet-IC	1.7V±1%, -Reset PPO, Sense	SOT-23-5	28rr	VD12	6g	Ric
M1L	TC105183ECT	DC/DC-IC	PWM/PFM step-down, 300kHz, 1.8V±1%, 1A, +CE	SOT-23-5	28zm	DC7	6g	Mcc
M1L	XC6366C183MR	DC/DC-IC	PWM/PFM st-down, 300kHz, 1.8V±2.5%, 1A, +CE, soft start	SOT-25	28zm	DC7	6g	Tor
M1L	XC6368C183MR	DC/DC-IC	PWM/PFM step-up, 1.8V±2.5%, 200mA, 300kHz, +CE, soft start	SOT-25	28sh	DC11	6g	Tor
M1M	R3117N181C	Vdet-IC	1.8V±1%, -Reset PPO, Sense	SOT-23-5	28rr	VD12	6g	Ric
M1M	TC105193ECT	DC/DC-IC	PWM/PFM step-down, 300kHz, 1.9V±1%, 1A, +CE	SOT-23-5	28zm	DC7	6g	Mcc
M1M	XC6366C193MR	DC/DC-IC	PWM/PFM st-down, 300kHz, 1.9V±2.5%, 1A, +CE, soft start	SOT-25	28zm	DC7	6g	Tor
M1M	XC6368C193MR	DC/DC-IC	PWM/PFM step-up, 1.9V±2.5%, 200mA, 300kHz, +CE, soft start	SOT-25	28sh	DC11	6g	Tor
M1N	R3117N191C	Vdet-IC	1.9V±1%, -Reset PPO, Sense	SOT-23-5	28rr	VD12	6g	Ric
M1P	R3117N201C	Vdet-IC	2.0V±1%, -Reset PPO, Sense	SOT-23-5	28rr	VD12	6g	Ric
M1Q	R3117N211C	Vdet-IC	2.1V±1%, -Reset PPO, Sense	SOT-23-5	28rr	VD12	6g	Ric
M1R	R3117N221C	Vdet-IC	2.2V±1%, -Reset PPO, Sense	SOT-23-5	28rr	VD12	6g	Ric
M1S	R3117N231C	Vdet-IC	2.3V±1%, -Reset PPO, Sense	SOT-23-5	28rr	VD12	6g	Ric
M1T	R3117N241C	Vdet-IC	2.4V±1%, -Reset PPO, Sense	SOT-23-5	28rr	VD12	6g	Ric
M1U	R3117N251C	Vdet-IC	2.5V±1%, -Reset PPO, Sense	SOT-23-5	28rr	VD12	6g	Ric
M1V	R3117N261C	Vdet-IC	2.6V±1%, -Reset PPO, Sense	SOT-23-5	28rr	VD12	6g	Ric
M1W	R3117N271C	Vdet-IC	2.7V±1%, -Reset PPO, Sense	SOT-23-5	28rr	VD12	6g	Ric
M1X	R3117N281C	Vdet-IC	2.8V±1%, -Reset PPO, Sense	SOT-23-5	28rr	VD12	6g	Ric
M1Y	R3117N291C	Vdet-IC	2.9V±1%, -Reset PPO, Sense	SOT-23-5	28rr	VD12	6g	Ric
M1Z	R3117N301C	Vdet-IC	3.0V±1%, -Reset PPO, Sense	SOT-23-5	28rr	VD12	6g	Ric
M2	R1121N321A	LVR-IC	LDO, LN, -CE, 3.2V±2%, 150mA	SOT-23-5	28vt	VR4	6g	Ric
M2	RN5RG52AA	LVR-IC	Ext. transistor, 5.2V±2.5% 1A*	SOT-23-5	28vw	VR6	6g	Ric
M2	RT9168A-17CBR	LVR-IC	LDO, 1.7V±2%, 500mA, +CE	SOT-23-5	28vt	VR4	6g	Rct
M2	RN5RY421A	DC/DC-IC	VFM step-up, 4.2V±2.5%, 150mW, <180kHz	SOT-23-5	28vd	DC5	6g	Utc
M20	88N20-AF5	Vdet-IC	2.0V±2%, -Reset ODO	SOT-23-5	28vdo	VD1	6a	Utc
M20	XC6366C202MR	DC/DC-IC	PWM/PFM st-down, 180kHz, 2.0V±2.5%, 1A, +CE, soft start	SOT-25	28zm	DC7	6g	Tor
M20	XC6368C202MR	DC/DC-IC	PWM/PFM step-up, 2.0V±2.5%, 200mA, 180kHz, +CE, soft start	SOT-25	28sh	DC11	6g	Tor
M20G	88N20G-AF5	Vdet-IC	2.0V±2%, -Reset ODO, halogen free	SOT-23-5	28vdo	VD1	6a	Utc
M20L	88N20L-AF5	Vdet-IC	2.0V±2%, -Reset ODO, lead free	SOT-23-5	28vdo	VD1	6a	Utc
M21	88N21-AF5	Vdet-IC	2.1V±2%, -Reset ODO	SOT-23-5	28vdo	VD1	6a	Utc
M21	XC6366C212MR	DC/DC-IC	PWM/PFM st-down, 180kHz, 2.1V±2.5%, 1A, +CE, soft start	SOT-25	28zm	DC7	6g	Tor



SMD code	Type	Function	Short description	Case	Pinout	Sch.	St.	Mnf.
M21	XC6368C212MR	DC/DC-IC	PWM/PFM step-up, 2.1V±2.5%, 200mA, 180kHz, +CE, soft start	SOT-25	28sh	DC11	6g	Utc
M21G	88N21G-AF5	Vdet-IC	2.1V±2%, -Reset ODO, halogen free	SOT-23-5	28vdo	VD1	6a	Utc
M21L	88N21L-AF5	Vdet-IC	2.1V±2%, -Reset ODO, lead free	SOT-23-5	28vdo	VD1	6a	Utc
M22	88N22-AF5	Vdet-IC	2.2V±2%, -Reset ODO	SOT-23-5	28vdo	VD1	6a	Utc
M22	XC6366C222MR	DC/DC-IC	PWM/PFM st-down, 180kHz, 2.2V±2.5%, 1A, +CE, soft start	SOT-25	28zm	DC7	6g	Tor
M22	XC6368C222MR	DC/DC-IC	PWM/PFM step-up, 2.2V±2.5%, 200mA, 180kHz, +CE, soft start	SOT-25	28sh	DC11	6g	Tor
M22G	88N22G-AF5	Vdet-IC	2.2V±2%, -Reset ODO, halogen free	SOT-23-5	28vdo	VD1	6a	Utc
M22L	88N22L-AF5	Vdet-IC	2.2V±2%, -Reset ODO, lead free	SOT-23-5	28vdo	VD1	6a	Utc
M23	88N23-AF5	Vdet-IC	2.3V±2%, -Reset ODO	SOT-23-5	28vdo	VD1	6a	Utc
M23	XC6366C232MR	DC/DC-IC	PWM/PFM st-down, 180kHz, 2.3V±2.5%, 1A, +CE, soft start	SOT-25	28zm	DC7	6g	Tor
M23	XC6368C232MR	DC/DC-IC	PWM/PFM step-up, 2.3V±2.5%, 200mA, 180kHz, +CE, soft start	SOT-25	28sh	DC11	6g	Tor
M23G	88N23G-AF5	Vdet-IC	2.3V±2%, -Reset ODO, halogen free	SOT-23-5	28vdo	VD1	6a	Utc
M23L	88N23L-AF5	Vdet-IC	2.3V±2%, -Reset ODO, lead free	SOT-23-5	28vdo	VD1	6a	Utc
M24	88N24-AF5	Vdet-IC	2.4V±2%, -Reset ODO	SOT-23-5	28vdo	VD1	6a	Utc
M24	XC6366C242MR	DC/DC-IC	PWM/PFM st-down, 180kHz, 2.4V±2.5%, 1A, +CE, soft start	SOT-25	28zm	DC7	6g	Tor
M24	XC6368C242MR	DC/DC-IC	PWM/PFM step-up, 2.4V±2.5%, 200mA, 180kHz, +CE, soft start	SOT-25	28sh	DC11	6g	Tor
M24G	88N24G-AF5	Vdet-IC	2.4V±2%, -Reset ODO, halogen free	SOT-23-5	28vdo	VD1	6a	Utc
M24L	88N24L-AF5	Vdet-IC	2.4V±2%, -Reset ODO, lead free	SOT-23-5	28vdo	VD1	6a	Utc
M25	88N25-AF5	Vdet-IC	2.5V±2%, -Reset ODO	SOT-23-5	28vdo	VD1	6a	Utc
M25	R1224N252M	DC/DC-IC	PWM step-down, 2.5V, 180kHz	SOT-23-5	28ud	DC7	6g	Ric
M25	XC6366C252MR	DC/DC-IC	PWM/PFM st-down, 180kHz, 2.5V±2.5%, 1A, +CE, soft start	SOT-25	28zm	DC7	6g	Tor
M25	XC6368C252MR	DC/DC-IC	PWM/PFM step-up, 2.5V±2.5%, 200mA, 180kHz, +CE, soft start	SOT-25	28sh	DC11	6g	Tor
M25G	88N25G-AF5	Vdet-IC	2.5V±2%, -Reset ODO, halogen free	SOT-23-5	28vdo	VD1	6a	Utc
M25L	88N25L-AF5	Vdet-IC	2.5V±2%, -Reset ODO, lead free	SOT-23-5	28vdo	VD1	6a	Utc
M26	88N26-AF5	Vdet-IC	2.6V±2%, -Reset ODO	SOT-23-5	28vdo	VD1	6a	Utc
M26	XC6366C262MR	DC/DC-IC	PWM/PFM st-down, 180kHz, 2.6V±2.5%, 1A, +CE, soft start	SOT-25	28zm	DC7	6g	Tor
M26	XC6368C262MR	DC/DC-IC	PWM/PFM step-up, 2.6V±2.5%, 200mA, 180kHz, +CE, soft start	SOT-25	28sh	DC11	6g	Tor
M26G	88N26G-AF5	Vdet-IC	2.6V±2%, -Reset ODO, halogen free	SOT-23-5	28vdo	VD1	6a	Utc
M26L	88N26L-AF5	Vdet-IC	2.6V±2%, -Reset ODO, lead free	SOT-23-5	28vdo	VD1	6a	Utc
M27	88N27-AF5	Vdet-IC	2.7V±2%, -Reset ODO	SOT-23-5	28vdo	VD1	6a	Utc
M27	XC6366C272MR	DC/DC-IC	PWM/PFM st-down, 180kHz, 2.7V±2.5%, 1A, +CE, soft start	SOT-25	28zm	DC7	6g	Tor
M27	XC6368C272MR	DC/DC-IC	PWM/PFM step-up, 2.7V±2.5%, 200mA, 180kHz, +CE, soft start	SOT-25	28sh	DC11	6g	Tor
M27G	88N27G-AF5	Vdet-IC	2.7V±2%, -Reset ODO, halogen free	SOT-23-5	28vdo	VD1	6a	Utc
M27L	88N27L-AF5	Vdet-IC	2.7V±2%, -Reset ODO, lead free	SOT-23-5	28vdo	VD1	6a	Utc
M28	88N28-AF5	Vdet-IC	2.8V±2%, -Reset ODO	SOT-23-5	28vdo	VD1	6a	Utc
M28	XC6366C282MR	DC/DC-IC	PWM/PFM st-down, 180kHz, 2.8V±2.5%, 1A, +CE, soft start	SOT-25	28zm	DC7	6g	Tor
M28	XC6368C282MR	DC/DC-IC	PWM/PFM step-up, 2.8V±2.5%, 200mA, 180kHz, +CE, soft start	SOT-25	28sh	DC11	6g	Tor
M28G	88N28G-AF5	Vdet-IC	2.8V±2%, -Reset ODO, halogen free	SOT-23-5	28vdo	VD1	6a	Utc
M28L	88N28L-AF5	Vdet-IC	2.8V±2%, -Reset ODO, lead free	SOT-23-5	28vdo	VD1	6a	Utc
M29	88N29-AF5	Vdet-IC	2.9V±2%, -Reset ODO	SOT-23-5	28vdo	VD1	6a	Utc
M29	XC6366C292MR	DC/DC-IC	PWM/PFM st-down, 180kHz, 2.9V±2.5%, 1A, +CE, soft start	SOT-25	28zm	DC7	6g	Tor
M29	XC6368C292MR	DC/DC-IC	PWM/PFM step-up, 2.9V±2.5%, 200mA, 180kHz, +CE, soft start	SOT-25	28sh	DC11	6g	Tor
M29G	88N29G-AF5	Vdet-IC	2.9V±2%, -Reset ODO, halogen free	SOT-23-5	28vdo	VD1	6a	Utc
M29L	88N29L-AF5	Vdet-IC	2.9V±2%, -Reset ODO, lead free	SOT-23-5	28vdo	VD1	6a	Utc
M2A	XC6108N22AMR	Vdet-IC	2.2V±2%, Hysteresis, -Reset ODO	SOT-25	28rm	VD14	6g	Tor
M2A	XC6118C12AMR-G	Vdet-IC	1.2V±30mV, ±Reset PPO, Sense, hysteresis 5%, Cd	SOT-25	28mg	VD15	6g	Tor
M2A	TC105203ECT	DC/DC-IC	PWM/PFM step-down, 300kHz, 2.0V±1%, 1A, +CE	SOT-23-5	28zm	DC7	6g	Mcc
M2A	XC6366C203MR	DC/DC-IC	PWM/PFM st-down, 300kHz, 2.0V±2.5%, 1A, +CE, soft start	SOT-25	28zm	DC7	6g	Tor
M2A	XC6368C203MR	DC/DC-IC	PWM/PFM step-up, 2.0V±2.5%, 200mA, 300kHz, +CE, soft start	SOT-25	28sh	DC11	6g	Tor
M2B	XC6108N22BMR	Vdet-IC	2.2V±2%, -Reset ODO	SOT-25	28rm	VD14	6g	Tor
M2B	XC6118C12BMR-G	Vdet-IC	1.2V±30mV, ±Reset PPO, Sense, hysteresis <1%, Cd	SOT-25	28mg	VD15	6g	Tor
M2B	TC105213ECT	DC/DC-IC	PWM/PFM step-down, 300kHz, 2.1V±1%, 1A, +CE	SOT-23-5	28zm	DC7	6g	Mcc
M2B	XC6366C213MR	DC/DC-IC	PWM/PFM st-down, 300kHz, 2.1V±2.5%, 1A, +CE, soft start	SOT-25	28zm	DC7	6g	Tor
M2B	XC6368C213MR	DC/DC-IC	PWM/PFM step-up, 2.1V±2.5%, 200mA, 300kHz, +CE, soft start	SOT-25	28sh	DC11	6g	Tor
M2C	XC6108N22CMR	Vdet-IC	2.2V±2%, Hysteresis, -Reset ODO	SOT-25	28rk	VD14	6g	Tor
M2C	XC6118C12CMR-G	Vdet-IC	1.2V±30mV, ±Reset PPO, Sense, hysteresis 5%	SOT-25	28mf	VD12	6g	Tor
M2C	TC105223ECT	DC/DC-IC	PWM/PFM step-down, 300kHz, 2.2V±1%, 1A, +CE	SOT-23-5	28zm	DC7	6g	Mcc
M2C	XC6366C223MR	DC/DC-IC	PWM/PFM st-down, 300kHz, 2.2V±2.5%, 1A, +CE, soft start	SOT-25	28zm	DC7	6g	Tor
M2C	XC6368C223MR	DC/DC-IC	PWM/PFM step-up, 2.2V±2.5%, 200mA, 300kHz, +CE, soft start	SOT-25	28sh	DC11	6g	Tor
M2D	XC6108N22DMR	Vdet-IC	2.2V±2%, -Reset ODO	SOT-25	28rk	VD14	6g	Tor
M2D	XC6118C12DMR-G	Vdet-IC	1.2V±30mV, ±Reset PPO, Sense, hysteresis <1%	SOT-25	28mf	VD12	6g	Tor
M2D	TC105233ECT	DC/DC-IC	PWM/PFM step-down, 300kHz, 2.3V±1%, 1A, +CE	SOT-23-5	28zm	DC7	6g	Mcc
M2D	XC6366C233MR	DC/DC-IC	PWM/PFM st-down, 300kHz, 2.3V±2.5%, 1A, +CE, soft start	SOT-25	28zm	DC7	6g	Tor
M2D	XC6368C233MR	DC/DC-IC	PWM/PFM step-up, 2.3V±2.5%, 200mA, 300kHz, +CE, soft start	SOT-25	28sh	DC11	6g	Tor
M2E	TC105243ECT	DC/DC-IC	PWM/PFM step-down, 300kHz, 2.4V±1%, 1A, +CE	SOT-23-5	28zm	DC7	6g	Mcc
M2E	XC6366C243MR	DC/DC-IC	PWM/PFM st-down, 300kHz, 2.4V±2.5%, 1A, +CE, soft start	SOT-25	28zm	DC7	6g	Tor
M2E	XC6368C243MR	DC/DC-IC	PWM/PFM step-up, 2.4V±2.5%, 200mA, 300kHz, +CE, soft start	SOT-25	28sh	DC11	6g	Tor
M2F	TC105253ECT	DC/DC-IC	PWM/PFM step-down, 300kHz, 2.5V±1%, 1A, +CE	SOT-23-5	28zm	DC7	6g	Mcc
M2F	XC6366C253MR	DC/DC-IC	PWM/PFM st-down, 300kHz, 2.5V±2.5%, 1A, +CE, soft start	SOT-25	28zm	DC7	6g	Tor
M2F	XC6368C253MR	DC/DC-IC	PWM/PFM step-up, 2.5V±2.5%, 200mA, 300kHz, +CE, soft start	SOT-25	28sh	DC11	6g	Tor



SMD code	Type	Function	Short description	Case	Pinout	Sch.	St.	Mnf.
M2H	TC105263ECT	DC/DC-IC	PWM/PFM step-down, 300kHz, 2.6V±1%, 1A, +CE	SOT-23-5	28zm	DC7	6g	Mcc
M2H	X06366C263MR	DC/DC-IC	PWM/PFM st-down, 300kHz, 2.6V±2.5%, 1A, +CE, soft start	SOT-25	28zm	DC7	6g	Tor
M2H	X06368C263MR	DC/DC-IC	PWM/PFM step-up, 2.6V±2.5%, 200mA, 300kHz, +CE, soft start	SOT-25	28sh	DC11	6g	Tor
M2K	TC105273ECT	DC/DC-IC	PWM/PFM step-down, 300kHz, 2.7V±1%, 1A, +CE	SOT-23-5	28zm	DC7	6g	Mcc
M2K	X06366C273MR	DC/DC-IC	PWM/PFM st-down, 300kHz, 2.7V±2.5%, 1A, +CE, soft start	SOT-25	28zm	DC7	6g	Tor
M2K	X06368C273MR	DC/DC-IC	PWM/PFM step-up, 2.7V±2.5%, 200mA, 300kHz, +CE, soft start	SOT-25	28sh	DC11	6g	Tor
M2L	TC105283ECT	DC/DC-IC	PWM/PFM step-down, 300kHz, 2.8V±1%, 1A, +CE	SOT-23-5	28zm	DC7	6g	Mcc
M2L	X06366C283MR	DC/DC-IC	PWM/PFM st-down, 300kHz, 2.8V±2.5%, 1A, +CE, soft start	SOT-25	28zm	DC7	6g	Tor
M2L	X06368C283MR	DC/DC-IC	PWM/PFM step-up, 2.8V±2.5%, 200mA, 300kHz, +CE, soft start	SOT-25	28sh	DC11	6g	Tor
M2M	TC105293ECT	DC/DC-IC	PWM/PFM step-down, 300kHz, 2.9V±1%, 1A, +CE	SOT-23-5	28zm	DC7	6g	Mcc
M2M	X06366C293MR	DC/DC-IC	PWM/PFM st-down, 300kHz, 2.9V±2.5%, 1A, +CE, soft start	SOT-25	28zm	DC7	6g	Tor
M2M	X06368C293MR	DC/DC-IC	PWM/PFM step-up, 2.9V±2.5%, 200mA, 300kHz, +CE, soft start	SOT-25	28sh	DC11	6g	Tor
M3	NX3L1T384GW	CMOS-Logic	Single-pole single-throw analog switch	SOT-353-1	28/Log86	-	6a	Phi
M3	R112N1331A	LVR-IC	LDO, LN, -CE, 3.3V±2%, 150mA	SOT-23-5	28vt	VR4	6g	Ric
M3	RN5RG53AA	LVR-IC	Ext. transistor, 5.3V±2.5% 1A*	SOT-23-5	28wv	VR6	6g	Ric
M3	RT9168A-18CBR	LVR-IC	LDO, 1.8V±2%, 500mA, +CE	SOT-23-5	28vt	VR4	6g	Rct
M3	RN5RY431A	DC/DC-IC	VFM step-up, 4.3V±2.5%, 150mW, <180kHz	SOT-23-5	28vd	DC5	6g	Ric
M30	88N30-AF5	Vdet-IC	3.0V±2%, -Reset ODO	SOT-23-5	28vdo	VD1	6a	Utc
M30	R1224N302M	DC/DC-IC	PWM step-down, 3V, 180kHz	SOT-23-5	28uid	DC7	6g	Ric
M30	X06366C302MR	DC/DC-IC	PWM/PFM st-down, 180kHz, 3.0V±2.5%, 1A, +CE, soft start	SOT-25	28zm	DC7	6g	Tor
M30	X06368C302MR	DC/DC-IC	PWM/PFM step-up, 3.0V±2.5%, 200mA, 180kHz, +CE, soft start	SOT-25	28sh	DC11	6g	Tor
M30G	88N30G-AF5	Vdet-IC	3.0V±2%, -Reset ODO, halogen free	SOT-23-5	28vdo	VD1	6a	Utc
M30L	88N30L-AF5	Vdet-IC	3.0V±2%, -Reset ODO, lead free	SOT-23-5	28vdo	VD1	6a	Utc
M31	88N31-AF5	Vdet-IC	3.1V±2%, -Reset ODO	SOT-23-5	28vdo	VD1	6a	Utc
M31	X06366C312MR	DC/DC-IC	PWM/PFM st-down, 180kHz, 3.1V±2.5%, 1A, +CE, soft start	SOT-25	28zm	DC7	6g	Tor
M31	X06368C312MR	DC/DC-IC	PWM/PFM step-up, 3.1V±2.5%, 200mA, 180kHz, +CE, soft start	SOT-25	28sh	DC11	6g	Tor
M31G	88N31G-AF5	Vdet-IC	3.1V±2%, -Reset ODO, halogen free	SOT-23-5	28vdo	VD1	6a	Utc
M31L	88N31L-AF5	Vdet-IC	3.1V±2%, -Reset ODO, lead free	SOT-23-5	28vdo	VD1	6a	Utc
M32	88N32-AF5	Vdet-IC	3.2V±2%, -Reset ODO	SOT-23-5	28vdo	VD1	6a	Utc
M32	X06366C322MR	DC/DC-IC	PWM/PFM st-down, 180kHz, 3.2V±2.5%, 1A, +CE, soft start	SOT-25	28zm	DC7	6g	Tor
M32	X06368C322MR	DC/DC-IC	PWM/PFM step-up, 3.2V±2.5%, 200mA, 180kHz, +CE, soft start	SOT-25	28sh	DC11	6g	Tor
M32G	88N32G-AF5	Vdet-IC	3.2V±2%, -Reset ODO, halogen free	SOT-23-5	28vdo	VD1	6a	Utc
M32L	88N32L-AF5	Vdet-IC	3.2V±2%, -Reset ODO, lead free	SOT-23-5	28vdo	VD1	6a	Utc
M33	88N33-AF5	Vdet-IC	3.3V±2%, -Reset ODO	SOT-23-5	28vdo	VD1	6a	Utc
M33	R1224N332M	DC/DC-IC	PWM step-down, 3.3V, 180kHz	SOT-23-5	28uid	DC7	6g	Ric
M33	X06366C332MR	DC/DC-IC	PWM/PFM st-down, 180kHz, 3.3V±2.5%, 1A, +CE, soft start	SOT-25	28zm	DC7	6g	Tor
M33	X06368C332MR	DC/DC-IC	PWM/PFM step-up, 3.3V±2.5%, 200mA, 180kHz, +CE, soft start	SOT-25	28sh	DC11	6g	Tor
M33G	88N33G-AF5	Vdet-IC	3.3V±2%, -Reset ODO, halogen free	SOT-23-5	28vdo	VD1	6a	Utc
M33L	88N33L-AF5	Vdet-IC	3.3V±2%, -Reset ODO, lead free	SOT-23-5	28vdo	VD1	6a	Utc
M34	88N34-AF5	Vdet-IC	3.4V±2%, -Reset ODO	SOT-23-5	28vdo	VD1	6a	Utc
M34	X06366C342MR	DC/DC-IC	PWM/PFM st-down, 180kHz, 3.4V±2.5%, 1A, +CE, soft start	SOT-25	28zm	DC7	6g	Tor
M34	X06368C342MR	DC/DC-IC	PWM/PFM step-up, 3.4V±2.5%, 200mA, 180kHz, +CE, soft start	SOT-25	28sh	DC11	6g	Tor
M34G	88N34G-AF5	Vdet-IC	3.4V±2%, -Reset ODO, halogen free	SOT-23-5	28vdo	VD1	6a	Utc
M34L	88N34L-AF5	Vdet-IC	3.4V±2%, -Reset ODO, lead free	SOT-23-5	28vdo	VD1	6a	Utc
M35	88N35-AF5	Vdet-IC	3.5V±2%, -Reset ODO	SOT-23-5	28vdo	VD1	6a	Utc
M35	X06366C352MR	DC/DC-IC	PWM/PFM st-down, 180kHz, 3.5V±2.5%, 1A, +CE, soft start	SOT-25	28zm	DC7	6g	Tor
M35	X06368C352MR	DC/DC-IC	PWM/PFM step-up, 3.5V±2.5%, 200mA, 180kHz, +CE, soft start	SOT-25	28sh	DC11	6g	Tor
M35G	88N35G-AF5	Vdet-IC	3.5V±2%, -Reset ODO, halogen free	SOT-23-5	28vdo	VD1	6a	Utc
M35L	88N35L-AF5	Vdet-IC	3.5V±2%, -Reset ODO, lead free	SOT-23-5	28vdo	VD1	6a	Utc
M36	88N36-AF5	Vdet-IC	3.6V±2%, -Reset ODO	SOT-23-5	28vdo	VD1	6a	Utc
M36	X06366C362MR	DC/DC-IC	PWM/PFM st-down, 180kHz, 3.6V±2.5%, 1A, +CE, soft start	SOT-25	28zm	DC7	6g	Tor
M36	X06368C362MR	DC/DC-IC	PWM/PFM step-up, 3.6V±2.5%, 200mA, 180kHz, +CE, soft start	SOT-25	28sh	DC11	6g	Tor
M36G	88N36G-AF5	Vdet-IC	3.6V±2%, -Reset ODO, halogen free	SOT-23-5	28vdo	VD1	6a	Utc
M36L	88N36L-AF5	Vdet-IC	3.6V±2%, -Reset ODO, lead free	SOT-23-5	28vdo	VD1	6a	Utc
M37	88N37-AF5	Vdet-IC	3.7V±2%, -Reset ODO	SOT-23-5	28vdo	VD1	6a	Utc
M37	X06366C372MR	DC/DC-IC	PWM/PFM st-down, 180kHz, 3.7V±2.5%, 1A, +CE, soft start	SOT-25	28zm	DC7	6g	Tor
M37	X06368C372MR	DC/DC-IC	PWM/PFM step-up, 3.7V±2.5%, 200mA, 180kHz, +CE, soft start	SOT-25	28sh	DC11	6g	Tor
M37G	88N37G-AF5	Vdet-IC	3.7V±2%, -Reset ODO, halogen free	SOT-23-5	28vdo	VD1	6a	Utc
M37L	88N37L-AF5	Vdet-IC	3.7V±2%, -Reset ODO, lead free	SOT-23-5	28vdo	VD1	6a	Utc
M38	88N38-AF5	Vdet-IC	3.8V±2%, -Reset ODO	SOT-23-5	28vdo	VD1	6a	Utc
M38	X06366C382MR	DC/DC-IC	PWM/PFM st-down, 180kHz, 3.8V±2.5%, 1A, +CE, soft start	SOT-25	28zm	DC7	6g	Tor
M38	X06368C382MR	DC/DC-IC	PWM/PFM step-up, 3.8V±2.5%, 200mA, 180kHz, +CE, soft start	SOT-25	28sh	DC11	6g	Tor
M38G	88N38G-AF5	Vdet-IC	3.8V±2%, -Reset ODO, halogen free	SOT-23-5	28vdo	VD1	6a	Utc
M38L	88N38L-AF5	Vdet-IC	3.8V±2%, -Reset ODO, lead free	SOT-23-5	28vdo	VD1	6a	Utc
M39	88N39-AF5	Vdet-IC	3.9V±2%, -Reset ODO	SOT-23-5	28vdo	VD1	6a	Utc
M39	X06366C392MR	DC/DC-IC	PWM/PFM st-down, 180kHz, 3.9V±2.5%, 1A, +CE, soft start	SOT-25	28zm	DC7	6g	Tor
M39	X06368C392MR	DC/DC-IC	PWM/PFM step-up, 3.9V±2.5%, 200mA, 180kHz, +CE, soft start	SOT-25	28sh	DC11	6g	Tor
M39G	88N39G-AF5	Vdet-IC	3.9V±2%, -Reset ODO, halogen free	SOT-23-5	28vdo	VD1	6a	Utc
M39L	88N39L-AF5	Vdet-IC	3.9V±2%, -Reset ODO, lead free	SOT-23-5	28vdo	VD1	6a	Utc
M3A	X06108N23AMR	Vdet-IC	2.3V±2%, Hysteresis, -Reset ODO	SOT-25	28rm	VD14	6g	Tor



SMD code	Type	Function	Short description	Case	Pinout	Sch.	St.	Mnf.
M3A	XC6118C13AMR-G	Vdet-IC	1.3V±30mV, ±Reset PPO, Sense, hysteresis 5%, Cd	SOT-25	28mg	VD15	6g	Tor
M3A	TC105303ECT	DC/DC-IC	PWM/PFM step-down, 300kHz, 3.0V±1%, 1A, +CE	SOT-23-5	28zm	DC7	6g	Mcc
M3A	XC6366C303MR	DC/DC-IC	PWM/PFM st-down, 300kHz, 3.0V±2.5%, 1A, +CE, soft start	SOT-25	28zm	DC7	6g	Tor
M3A	XC6368C303MR	DC/DC-IC	PWM/PFM step-up, 3.0V±2.5%, 200mA, 300kHz, +CE, soft start	SOT-25	28sh	DC11	6g	Tor
M3B	XC6108N23BMR	Vdet-IC	2.3V±2%, -Reset ODO	SOT-25	28rm	VD14	6g	Tor
M3B	XC6118C13BMR-G	Vdet-IC	1.3V±30mV, ±Reset PPO, Sense, hysteresis <1%, Cd	SOT-25	28mg	VD15	6g	Tor
M3B	TC105313ECT	DC/DC-IC	PWM/PFM step-down, 300kHz, 3.1V±1%, 1A, +CE	SOT-23-5	28zm	DC7	6g	Mcc
M3B	XC6366C313MR	DC/DC-IC	PWM/PFM st-down, 300kHz, 3.1V±2.5%, 1A, +CE, soft start	SOT-25	28zm	DC7	6g	Tor
M3B	XC6368C313MR	DC/DC-IC	PWM/PFM step-up, 3.1V±2.5%, 200mA, 300kHz, +CE, soft start	SOT-25	28sh	DC11	6g	Tor
M3C	XC6108N23CMR	Vdet-IC	2.3V±2%, Hysteresis, -Reset ODO	SOT-25	28rk	VD14	6g	Tor
M3C	XC6118C13CMR-G	Vdet-IC	1.3V±30mV, ±Reset PPO, Sense, hysteresis 5%	SOT-25	28mf	VD12	6g	Tor
M3C	TC105323ECT	DC/DC-IC	PWM/PFM step-down, 300kHz, 3.2V±1%, 1A, +CE	SOT-23-5	28zm	DC7	6g	Mcc
M3C	XC6366C323MR	DC/DC-IC	PWM/PFM st-down, 300kHz, 3.2V±2.5%, 1A, +CE, soft start	SOT-25	28zm	DC7	6g	Tor
M3C	XC6368C323MR	DC/DC-IC	PWM/PFM step-up, 3.2V±2.5%, 200mA, 300kHz, +CE, soft start	SOT-25	28sh	DC11	6g	Tor
M3D	XC6108N23DMR	Vdet-IC	2.3V±2%, -Reset ODO	SOT-25	28rk	VD14	6g	Tor
M3D	XC6118C13DMR-G	Vdet-IC	1.3V±30mV, ±Reset PPO, Sense, hysteresis <1%	SOT-25	28mf	VD12	6g	Tor
M3D	TC105333ECT	DC/DC-IC	PWM/PFM step-down, 300kHz, 3.3V±1%, 1A, +CE	SOT-23-5	28zm	DC7	6g	Mcc
M3D	XC6366C333MR	DC/DC-IC	PWM/PFM st-down, 300kHz, 3.3V±2.5%, 1A, +CE, soft start	SOT-25	28zm	DC7	6g	Tor
M3D	XC6368C333MR	DC/DC-IC	PWM/PFM step-up, 3.3V±2.5%, 200mA, 300kHz, +CE, soft start	SOT-25	28sh	DC11	6g	Tor
M3E	TC105343ECT	DC/DC-IC	PWM/PFM step-down, 300kHz, 3.4V±1%, 1A, +CE	SOT-23-5	28zm	DC7	6g	Mcc
M3E	XC6366C343MR	DC/DC-IC	PWM/PFM st-down, 300kHz, 3.4V±2.5%, 1A, +CE, soft start	SOT-25	28zm	DC7	6g	Tor
M3F	TC105353ECT	DC/DC-IC	PWM/PFM step-down, 300kHz, 3.5V±1%, 1A, +CE	SOT-23-5	28zm	DC7	6g	Mcc
M3F	XC6366C353MR	DC/DC-IC	PWM/PFM st-down, 300kHz, 3.5V±2.5%, 1A, +CE, soft start	SOT-25	28zm	DC7	6g	Tor
M3F	XC6368C353MR	DC/DC-IC	PWM/PFM step-up, 3.5V±2.5%, 200mA, 300kHz, +CE, soft start	SOT-25	28sh	DC11	6g	Tor
M3H	TC105363ECT	DC/DC-IC	PWM/PFM step-down, 300kHz, 3.6V±1%, 1A, +CE	SOT-23-5	28zm	DC7	6g	Mcc
M3H	XC6366C363MR	DC/DC-IC	PWM/PFM st-down, 300kHz, 3.6V±2.5%, 1A, +CE, soft start	SOT-25	28zm	DC7	6g	Tor
M3H	XC6368C363MR	DC/DC-IC	PWM/PFM step-up, 3.6V±2.5%, 200mA, 300kHz, +CE, soft start	SOT-25	28sh	DC11	6g	Tor
M3K	TC105373ECT	DC/DC-IC	PWM/PFM step-down, 300kHz, 3.7V±1%, 1A, +CE	SOT-23-5	28zm	DC7	6g	Mcc
M3K	XC6366C373MR	DC/DC-IC	PWM/PFM st-down, 300kHz, 3.7V±2.5%, 1A, +CE, soft start	SOT-25	28zm	DC7	6g	Tor
M3K	XC6368C373MR	DC/DC-IC	PWM/PFM step-up, 3.7V±2.5%, 200mA, 300kHz, +CE, soft start	SOT-25	28sh	DC11	6g	Tor
M3L	TC105383ECT	DC/DC-IC	PWM/PFM step-down, 300kHz, 3.8V±1%, 1A, +CE	SOT-23-5	28zm	DC7	6g	Mcc
M3L	XC6366C383MR	DC/DC-IC	PWM/PFM st-down, 300kHz, 3.8V±2.5%, 1A, +CE, soft start	SOT-25	28zm	DC7	6g	Tor
M3L	XC6368C383MR	DC/DC-IC	PWM/PFM step-up, 3.8V±2.5%, 200mA, 300kHz, +CE, soft start	SOT-25	28sh	DC11	6g	Tor
M3M	TC105393ECT	DC/DC-IC	PWM/PFM step-down, 300kHz, 3.9V±1%, 1A, +CE	SOT-23-5	28zm	DC7	6g	Mcc
M3M	XC6366C393MR	DC/DC-IC	PWM/PFM st-down, 300kHz, 3.9V±2.5%, 1A, +CE, soft start	SOT-25	28zm	DC7	6g	Tor
M3M	XC6368C393MR	DC/DC-IC	PWM/PFM step-up, 3.9V±2.5%, 200mA, 300kHz, +CE, soft start	SOT-25	28sh	DC11	6g	Tor
M4	R112N13A1A	LVR-IC	LDO, LN, -CE, 3.4V±2%, 150mA	SOT-23-5	28vt	VR4	6g	Ric
M4	RN5RG54AA	LVR-IC	Ext. transistor, 5.4V±2.5% 1A*	SOT-23-5	28vw	VR6	6g	Ric
M4	RT9168A-19CBR	LVR-IC	LDO, 1.9V±2%, 500mA, +CE	SOT-23-5	28vt	VR4	6g	Rct
M4	RN5RY441A	DC/DC-IC	VFM step-up, 4.4V±2.5%, 150mW, <180kHz	SOT-23-5	28vd	DC5	6g	Ric
M40	88N40-AF5	Vdet-IC	4.0V±2%, -Reset ODO	SOT-23-5	28vdo	VD1	6a	Utc
M40	XC6366C402MR	DC/DC-IC	PWM/PFM st-down, 180kHz, 4.0V±2.5%, 1A, +CE, soft start	SOT-25	28zm	DC7	6g	Tor
M40	XC6368C402MR	DC/DC-IC	PWM/PFM step-up, 4.0V±2.5%, 200mA, 180kHz, +CE, soft start	SOT-25	28sh	DC11	6g	Tor
M40G	88N40G-AF5	Vdet-IC	4.0V±2%, -Reset ODO, halogen free	SOT-23-5	28vdo	VD1	6a	Utc
M40L	88N40L-AF5	Vdet-IC	4.0V±2%, -Reset ODO, lead free	SOT-23-5	28vdo	VD1	6a	Utc
M41	88N41-AF5	Vdet-IC	4.1V±2%, -Reset ODO	SOT-23-5	28vdo	VD1	6a	Utc
M41	XC6366C412MR	DC/DC-IC	PWM/PFM st-down, 180kHz, 4.1V±2.5%, 1A, +CE, soft start	SOT-25	28zm	DC7	6g	Tor
M41	XC6368C412MR	DC/DC-IC	PWM/PFM step-up, 4.1V±2.5%, 200mA, 180kHz, +CE, soft start	SOT-25	28sh	DC11	6g	Tor
M41G	88N41G-AF5	Vdet-IC	4.1V±2%, -Reset ODO, halogen free	SOT-23-5	28vdo	VD1	6a	Utc
M41L	88N41L-AF5	Vdet-IC	4.1V±2%, -Reset ODO, lead free	SOT-23-5	28vdo	VD1	6a	Utc
M42	88N42-AF5	Vdet-IC	4.2V±2%, -Reset ODO	SOT-23-5	28vdo	VD1	6a	Utc
M42	XC6366C422MR	DC/DC-IC	PWM/PFM st-down, 180kHz, 4.2V±2.5%, 1A, +CE, soft start	SOT-25	28zm	DC7	6g	Tor
M42	XC6368C422MR	DC/DC-IC	PWM/PFM step-up, 4.2V±2.5%, 200mA, 180kHz, +CE, soft start	SOT-25	28sh	DC11	6g	Tor
M42G	88N42G-AF5	Vdet-IC	4.2V±2%, -Reset ODO, halogen free	SOT-23-5	28vdo	VD1	6a	Utc
M42L	88N42L-AF5	Vdet-IC	4.2V±2%, -Reset ODO, lead free	SOT-23-5	28vdo	VD1	6a	Utc
M43	88N43-AF5	Vdet-IC	4.3V±2%, -Reset ODO	SOT-23-5	28vdo	VD1	6a	Utc
M43	XC6366C432MR	DC/DC-IC	PWM/PFM st-down, 180kHz, 4.3V±2.5%, 1A, +CE, soft start	SOT-25	28zm	DC7	6g	Tor
M43	XC6368C432MR	DC/DC-IC	PWM/PFM step-up, 4.3V±2.5%, 200mA, 180kHz, +CE, soft start	SOT-25	28sh	DC11	6g	Tor
M43G	88N43G-AF5	Vdet-IC	4.3V±2%, -Reset ODO, halogen free	SOT-23-5	28vdo	VD1	6a	Utc
M43L	88N43L-AF5	Vdet-IC	4.3V±2%, -Reset ODO, lead free	SOT-23-5	28vdo	VD1	6a	Utc
M44	88N44-AF5	Vdet-IC	4.4V±2%, -Reset ODO	SOT-23-5	28vdo	VD1	6a	Utc
M44	XC6366C442MR	DC/DC-IC	PWM/PFM st-down, 180kHz, 4.4V±2.5%, 1A, +CE, soft start	SOT-25	28zm	DC7	6g	Tor
M44	XC6368C442MR	DC/DC-IC	PWM/PFM step-up, 4.4V±2.5%, 200mA, 180kHz, +CE, soft start	SOT-25	28sh	DC11	6g	Tor
M44G	88N44G-AF5	Vdet-IC	4.4V±2%, -Reset ODO, halogen free	SOT-23-5	28vdo	VD1	6a	Utc
M44L	88N44L-AF5	Vdet-IC	4.4V±2%, -Reset ODO, lead free	SOT-23-5	28vdo	VD1	6a	Utc
M45	88N45-AF5	Vdet-IC	4.5V±2%, -Reset ODO	SOT-23-5	28vdo	VD1	6a	Utc
M45	XC6366C452MR	DC/DC-IC	PWM/PFM st-down, 180kHz, 4.5V±2.5%, 1A, +CE, soft start	SOT-25	28zm	DC7	6g	Tor
M45	XC6368C452MR	DC/DC-IC	PWM/PFM step-up, 4.5V±2.5%, 200mA, 180kHz, +CE, soft start	SOT-25	28sh	DC11	6g	Tor
M45G	88N45G-AF5	Vdet-IC	4.5V±2%, -Reset ODO, halogen free	SOT-23-5	28vdo	VD1	6a	Utc
M45L	88N45L-AF5	Vdet-IC	4.5V±2%, -Reset ODO, lead free	SOT-23-5	28vdo	VD1	6a	Utc



SMD code	Type	Function	Short description	Case	Pinout	Sch.	St.	Mnf.
M46	88N46-AF5	Vdet-IC	4.6V±2%, -Reset ODO	SOT-23-5	28vdo	VD1	6a	Utc
M46	XC6366C462MR	DC/DC-IC	PWM/PFM st-down, 180kHz, 4.6V±2.5%, 1A, +CE, soft start	SOT-25	28zm	DC7	6g	Tor
M46	XC6368C462MR	DC/DC-IC	PWM/PFM step-up, 4.6V±2.5%, 200mA, 180kHz, +CE, soft start	SOT-25	28sh	DC11	6g	Tor
M46G	88N46G-AF5	Vdet-IC	4.6V±2%, -Reset ODO, halogen free	SOT-23-5	28vdo	VD1	6a	Utc
M46L	88N46L-AF5	Vdet-IC	4.6V±2%, -Reset ODO, lead free	SOT-23-5	28vdo	VD1	6a	Utc
M47	88N47-AF5	Vdet-IC	4.7V±2%, -Reset ODO	SOT-23-5	28vdo	VD1	6a	Utc
M47	XC6366C472MR	DC/DC-IC	PWM/PFM st-down, 180kHz, 4.7V±2.5%, 1A, +CE, soft start	SOT-25	28zm	DC7	6g	Tor
M47	XC6368C472MR	DC/DC-IC	PWM/PFM step-up, 4.7V±2.5%, 200mA, 180kHz, +CE, soft start	SOT-25	28sh	DC11	6g	Tor
M47G	88N47G-AF5	Vdet-IC	4.7V±2%, -Reset ODO, halogen free	SOT-23-5	28vdo	VD1	6a	Utc
M47L	88N47L-AF5	Vdet-IC	4.7V±2%, -Reset ODO, lead free	SOT-23-5	28vdo	VD1	6a	Utc
M48	88N48-AF5	Vdet-IC	4.8V±2%, -Reset ODO	SOT-23-5	28vdo	VD1	6a	Utc
M48	XC6366C482MR	DC/DC-IC	PWM/PFM st-down, 180kHz, 4.8V±2.5%, 1A, +CE, soft start	SOT-25	28zm	DC7	6g	Tor
M48	XC6368C482MR	DC/DC-IC	PWM/PFM step-up, 4.8V±2.5%, 200mA, 180kHz, +CE, soft start	SOT-25	28sh	DC11	6g	Tor
M48G	88N48G-AF5	Vdet-IC	4.8V±2%, -Reset ODO, halogen free	SOT-23-5	28vdo	VD1	6a	Utc
M48L	88N48L-AF5	Vdet-IC	4.8V±2%, -Reset ODO, lead free	SOT-23-5	28vdo	VD1	6a	Utc
M49	88N49-AF5	Vdet-IC	4.9V±2%, -Reset ODO	SOT-23-5	28vdo	VD1	6a	Utc
M49	XC6366C492MR	DC/DC-IC	PWM/PFM st-down, 180kHz, 4.9V±2.5%, 1A, +CE, soft start	SOT-25	28zm	DC7	6g	Tor
M49	XC6368C492MR	DC/DC-IC	PWM/PFM step-up, 4.9V±2.5%, 200mA, 180kHz, +CE, soft start	SOT-25	28sh	DC11	6g	Tor
M49G	88N49G-AF5	Vdet-IC	4.9V±2%, -Reset ODO, halogen free	SOT-23-5	28vdo	VD1	6a	Utc
M49L	88N49L-AF5	Vdet-IC	4.9V±2%, -Reset ODO, lead free	SOT-23-5	28vdo	VD1	6a	Utc
M4A	XC6108N24AMR	Vdet-IC	2.4V±2%, Hysteresis, -Reset ODO	SOT-25	28rm	VD14	6g	Tor
M4A	XC6118C14AMR-G	Vdet-IC	1.4V±30mV, ±Reset PPO, Sense, hysteresis 5%, Cd	SOT-25	28mg	VD15	6g	Tor
M4A	TC105403ECT	DC/DC-IC	PWM/PFM step-down, 300kHz, 4.0V±1%, 1A, +CE	SOT-23-5	28zm	DC7	6g	Mcc
M4A	XC6366C403MR	DC/DC-IC	PWM/PFM st-down, 300kHz, 4.0V±2.5%, 1A, +CE, soft start	SOT-25	28zm	DC7	6g	Tor
M4A	XC6368C403MR	DC/DC-IC	PWM/PFM step-up, 4.0V±2.5%, 200mA, 300kHz, +CE, soft start	SOT-25	28sh	DC11	6g	Tor
M4B	XC6108N24BMR	Vdet-IC	2.4V±2%, -Reset ODO	SOT-25	28rm	VD14	6g	Tor
M4B	XC6118C14BMR-G	Vdet-IC	1.4V±30mV, ±Reset PPO, Sense, hysteresis <1%, Cd	SOT-25	28mg	VD15	6g	Tor
M4B	TC105413ECT	DC/DC-IC	PWM/PFM step-down, 300kHz, 4.1V±1%, 1A, +CE	SOT-23-5	28zm	DC7	6g	Mcc
M4B	XC6366C413MR	DC/DC-IC	PWM/PFM st-down, 300kHz, 4.1V±2.5%, 1A, +CE, soft start	SOT-25	28zm	DC7	6g	Tor
M4B	XC6368C413MR	DC/DC-IC	PWM/PFM step-up, 4.1V±2.5%, 200mA, 300kHz, +CE, soft start	SOT-25	28sh	DC11	6g	Tor
M4C	XC6108N24CMR	Vdet-IC	2.4V±2%, Hysteresis, -Reset ODO	SOT-25	28rk	VD14	6g	Tor
M4C	XC6118C14CMR-G	Vdet-IC	1.4V±30mV, ±Reset PPO, Sense, hysteresis 5%	SOT-25	28mf	VD12	6g	Tor
M4C	TC105423ECT	DC/DC-IC	PWM/PFM step-down, 300kHz, 4.2V±1%, 1A, +CE	SOT-23-5	28zm	DC7	6g	Mcc
M4C	XC6366C423MR	DC/DC-IC	PWM/PFM st-down, 300kHz, 4.2V±2.5%, 1A, +CE, soft start	SOT-25	28zm	DC7	6g	Tor
M4C	XC6368C423MR	DC/DC-IC	PWM/PFM step-up, 4.2V±2.5%, 200mA, 300kHz, +CE, soft start	SOT-25	28sh	DC11	6g	Tor
M4D	XC6108N24DMR	Vdet-IC	2.4V±2%, -Reset ODO	SOT-25	28rk	VD14	6g	Tor
M4D	XC6118C14DMR-G	Vdet-IC	1.4V±30mV, ±Reset PPO, Sense, hysteresis <1%	SOT-25	28mf	VD12	6g	Tor
M4D	TC105433ECT	DC/DC-IC	PWM/PFM step-down, 300kHz, 4.3V±1%, 1A, +CE	SOT-23-5	28zm	DC7	6g	Mcc
M4D	XC6366C433MR	DC/DC-IC	PWM/PFM st-down, 300kHz, 4.3V±2.5%, 1A, +CE, soft start	SOT-25	28zm	DC7	6g	Tor
M4D	XC6368C433MR	DC/DC-IC	PWM/PFM step-up, 4.3V±2.5%, 200mA, 300kHz, +CE, soft start	SOT-25	28sh	DC11	6g	Tor
M4E	TC105443ECT	DC/DC-IC	PWM/PFM step-down, 300kHz, 4.4V±1%, 1A, +CE	SOT-23-5	28zm	DC7	6g	Mcc
M4E	XC6366C443MR	DC/DC-IC	PWM/PFM st-down, 300kHz, 4.4V±2.5%, 1A, +CE, soft start	SOT-25	28zm	DC7	6g	Tor
M4E	XC6368C443MR	DC/DC-IC	PWM/PFM step-up, 4.4V±2.5%, 200mA, 300kHz, +CE, soft start	SOT-25	28sh	DC11	6g	Tor
M4F	TC105453ECT	DC/DC-IC	PWM/PFM step-down, 300kHz, 4.5V±1%, 1A, +CE	SOT-23-5	28zm	DC7	6g	Mcc
M4F	XC6366C453MR	DC/DC-IC	PWM/PFM st-down, 300kHz, 4.5V±2.5%, 1A, +CE, soft start	SOT-25	28zm	DC7	6g	Tor
M4F	XC6368C453MR	DC/DC-IC	PWM/PFM step-up, 4.5V±2.5%, 200mA, 300kHz, +CE, soft start	SOT-25	28sh	DC11	6g	Tor
M4H	TC105463ECT	DC/DC-IC	PWM/PFM step-down, 300kHz, 4.6V±1%, 1A, +CE	SOT-23-5	28zm	DC7	6g	Mcc
M4H	XC6366C463MR	DC/DC-IC	PWM/PFM st-down, 300kHz, 4.6V±2.5%, 1A, +CE, soft start	SOT-25	28zm	DC7	6g	Tor
M4H	XC6368C463MR	DC/DC-IC	PWM/PFM step-up, 4.6V±2.5%, 200mA, 300kHz, +CE, soft start	SOT-25	28sh	DC11	6g	Tor
M4K	TC105473ECT	DC/DC-IC	PWM/PFM step-down, 300kHz, 4.7V±1%, 1A, +CE	SOT-23-5	28zm	DC7	6g	Mcc
M4K	XC6366C473MR	DC/DC-IC	PWM/PFM st-down, 300kHz, 4.7V±2.5%, 1A, +CE, soft start	SOT-25	28zm	DC7	6g	Tor
M4K	XC6368C473MR	DC/DC-IC	PWM/PFM step-up, 4.7V±2.5%, 200mA, 300kHz, +CE, soft start	SOT-25	28sh	DC11	6g	Tor
M4L	TC105483ECT	DC/DC-IC	PWM/PFM step-down, 300kHz, 4.8V±1%, 1A, +CE	SOT-23-5	28zm	DC7	6g	Mcc
M4L	XC6366C483MR	DC/DC-IC	PWM/PFM st-down, 300kHz, 4.8V±2.5%, 1A, +CE, soft start	SOT-25	28zm	DC7	6g	Tor
M4L	XC6368C483MR	DC/DC-IC	PWM/PFM step-up, 4.8V±2.5%, 200mA, 300kHz, +CE, soft start	SOT-25	28sh	DC11	6g	Tor
M4M	TC105493ECT	DC/DC-IC	PWM/PFM step-down, 300kHz, 4.9V±1%, 1A, +CE	SOT-23-5	28zm	DC7	6g	Mcc
M4M	XC6366C493MR	DC/DC-IC	PWM/PFM st-down, 300kHz, 4.9V±2.5%, 1A, +CE, soft start	SOT-25	28zm	DC7	6g	Tor
M4M	XC6368C493MR	DC/DC-IC	PWM/PFM step-up, 4.9V±2.5%, 200mA, 300kHz, +CE, soft start	SOT-25	28sh	DC11	6g	Tor
M5	R1121N351A	LVR-IC	LDO, LN, -CE, 3.5V±2%, 150mA	SOT-23-5	28vt	VR4	6g	Ric
M5	RN5RG55AA	LVR-IC	Ext, transistor, 5.5V±2.5% 1A*	SOT-23-5	28vv	VR6	6g	Ric
M5	RT9168A-20CBR	LVR-IC	LDO, 2.0V±2%, 500mA, +CE	SOT-23-5	28vt	VR4	6g	Rct
M5	RN5RY451A	DC/DC-IC	VFM step-up, 4.5V±2.5%, 150mW, <180kHz	SOT-23-5	28vd	DC5	6g	Ric
M50	88N50-AF5	Vdet-IC	5.0V±2%, -Reset ODO	SOT-23-5	28vdo	VD1	6a	Utc
M50	R1224N502M	DC/DC-IC	PWM step-down, 5V, 180kHz	SOT-23-5	28ud	DC7	6g	Ric
M50	XC6366C502MR	DC/DC-IC	PWM/PFM st-down, 180kHz, 5.0V±2.5%, 1A, +CE, soft start	SOT-25	28zm	DC7	6g	Tor
M50	XC6368C502MR	DC/DC-IC	PWM/PFM step-up, 5.0V±2.5%, 200mA, 180kHz, +CE, soft start	SOT-25	28sh	DC11	6g	Tor
M50G	88N50G-AF5	Vdet-IC	5.0V±2%, -Reset ODO, halogen free	SOT-23-5	28vdo	VD1	6a	Utc
M50L	88N50L-AF5	Vdet-IC	5.0V±2%, -Reset ODO, lead free	SOT-23-5	28vdo	VD1	6a	Utc
M51	88N51-AF5	Vdet-IC	5.1V±2%, -Reset ODO	SOT-23-5	28vdo	VD1	6a	Utc
M51	XC6366C512MR	DC/DC-IC	PWM/PFM st-down, 180kHz, 5.1V±2.5%, 1A, +CE, soft start	SOT-25	28zm	DC7	6g	Tor



SMD code	Type	Function	Short description	Case	Pinout	Sch.	St.	Mnf.
M51	XC6368C512MR	DC/DC-IC	PWM/PFM step-up, 5.1V±2.5%, 200mA, 180kHz, +CE, soft start	SOT-25	28sh	DC11	6g	Tor
M512	AMS5312	LVR-IC	LDO, 1.2V±2%, 500mA	SOT-23-5	28sz	VR1	6a	Ams
M513	AMS5313	LVR-IC	LDO, 1.3V±2%, 500mA	SOT-23-5	28sz	VR1	6a	Ams
M514	AMS5314	LVR-IC	LDO, 1.4V±2%, 500mA	SOT-23-5	28sz	VR1	6a	Ams
M515	AMS5315	LVR-IC	LDO, 1.5V±2%, 500mA	SOT-23-5	28sz	VR1	6a	Ams
M516	AMS5316	LVR-IC	LDO, 1.6V±2%, 500mA	SOT-23-5	28sz	VR1	6a	Ams
M517	AMS5317	LVR-IC	LDO, 1.7V±2%, 500mA	SOT-23-5	28sz	VR1	6a	Ams
M518	AMS5318	LVR-IC	LDO, 1.8V±2%, 500mA	SOT-23-5	28sz	VR1	6a	Ams
M519	AMS5319	LVR-IC	LDO, 1.9V±2%, 500mA	SOT-23-5	28sz	VR1	6a	Ams
M51G	88N51G-AF5	Vdet-IC	5.1V±2%, -Reset ODO, halogen free	SOT-23-5	28vdo	VD1	6a	Utc
M51L	88N51L-AF5	Vdet-IC	5.1V±2%, -Reset ODO, lead free	SOT-23-5	28vdo	VD1	6a	Utc
M52	88N52-AF5	Vdet-IC	5.2V±2%, -Reset ODO	SOT-23-5	28vdo	VD1	6a	Utc
M52	XC6366C522MR	DC/DC-IC	PWM/PFM st-down, 180kHz, 5.2V±2.5%, 1A, +CE, soft start	SOT-25	28zm	DC7	6g	Tor
M52	XC6368C522MR	DC/DC-IC	PWM/PFM step-up, 5.2V±2.5%, 200mA, 180kHz, +CE, soft start	SOT-25	28sh	DC11	6g	Tor
M520	AMS5320	LVR-IC	LDO, 2.0V±2%, 500mA	SOT-23-5	28sz	VR1	6a	Ams
M521	AMS5321	LVR-IC	LDO, 2.1V±2%, 500mA	SOT-23-5	28sz	VR1	6a	Ams
M522	AMS5322	LVR-IC	LDO, 2.2V±2%, 500mA	SOT-23-5	28sz	VR1	6a	Ams
M523	AMS5323	LVR-IC	LDO, 2.3V±2%, 500mA	SOT-23-5	28sz	VR1	6a	Ams
M524	AMS5324	LVR-IC	LDO, 2.4V±2%, 500mA	SOT-23-5	28sz	VR1	6a	Ams
M525	AMS5325	LVR-IC	LDO, 2.5V±2%, 500mA	SOT-23-5	28sz	VR1	6a	Ams
M526	AMS5326	LVR-IC	LDO, 2.6V±2%, 500mA	SOT-23-5	28sz	VR1	6a	Ams
M527	AMS5327	LVR-IC	LDO, 2.7V±2%, 500mA	SOT-23-5	28sz	VR1	6a	Ams
M528	AMS5328	LVR-IC	LDO, 2.8V±2%, 500mA	SOT-23-5	28sz	VR1	6a	Ams
M529	AMS5329	LVR-IC	LDO, 2.9V±2%, 500mA	SOT-23-5	28sz	VR1	6a	Ams
M52G	88N52G-AF5	Vdet-IC	5.2V±2%, -Reset ODO, halogen free	SOT-23-5	28vdo	VD1	6a	Utc
M52L	88N52L-AF5	Vdet-IC	5.2V±2%, -Reset ODO, lead free	SOT-23-5	28vdo	VD1	6a	Utc
M53	88N53-AF5	Vdet-IC	5.3V±2%, -Reset ODO	SOT-23-5	28vdo	VD1	6a	Utc
M53	XC6366C532MR	DC/DC-IC	PWM/PFM st-down, 180kHz, 5.3V±2.5%, 1A, +CE, soft start	SOT-25	28zm	DC7	6g	Tor
M53	XC6368C532MR	DC/DC-IC	PWM/PFM step-up, 5.3V±2.5%, 200mA, 180kHz, +CE, soft start	SOT-25	28sh	DC11	6g	Tor
M530	AMS5330	LVR-IC	LDO, 3.0V±2%, 500mA	SOT-23-5	28sz	VR1	6a	Ams
M531	AMS5331	LVR-IC	LDO, 3.1V±2%, 500mA	SOT-23-5	28sz	VR1	6a	Ams
M532	AMS5332	LVR-IC	LDO, 3.2V±2%, 500mA	SOT-23-5	28sz	VR1	6a	Ams
M533	AMS5333	LVR-IC	LDO, 3.3V±2%, 500mA	SOT-23-5	28sz	VR1	6a	Ams
M534	AMS5334	LVR-IC	LDO, 3.4V±2%, 500mA	SOT-23-5	28sz	VR1	6a	Ams
M535	AMS5335	LVR-IC	LDO, 3.5V±2%, 500mA	SOT-23-5	28sz	VR1	6a	Ams
M536	AMS5336	LVR-IC	LDO, 3.6V±2%, 500mA	SOT-23-5	28sz	VR1	6a	Ams
M537	AMS5337	LVR-IC	LDO, 3.7V±2%, 500mA	SOT-23-5	28sz	VR1	6a	Ams
M538	AMS5338	LVR-IC	LDO, 3.8V±2%, 500mA	SOT-23-5	28sz	VR1	6a	Ams
M539	AMS5339	LVR-IC	LDO, 3.9V±2%, 500mA	SOT-23-5	28sz	VR1	6a	Ams
M53G	88N53G-AF5	Vdet-IC	5.3V±2%, -Reset ODO, halogen free	SOT-23-5	28vdo	VD1	6a	Utc
M53L	88N53L-AF5	Vdet-IC	5.3V±2%, -Reset ODO, lead free	SOT-23-5	28vdo	VD1	6a	Utc
M54	88N54-AF5	Vdet-IC	5.4V±2%, -Reset ODO	SOT-23-5	28vdo	VD1	6a	Utc
M54	XC6366C542MR	DC/DC-IC	PWM/PFM st-down, 180kHz, 5.4V±2.5%, 1A, +CE, soft start	SOT-25	28zm	DC7	6g	Tor
M54	XC6368C542MR	DC/DC-IC	PWM/PFM step-up, 5.4V±2.5%, 200mA, 180kHz, +CE, soft start	SOT-25	28sh	DC11	6g	Tor
M540	AMS5340	LVR-IC	LDO, 4.0V±2%, 500mA	SOT-23-5	28sz	VR1	6a	Ams
M541	AMS5341	LVR-IC	LDO, 4.1V±2%, 500mA	SOT-23-5	28sz	VR1	6a	Ams
M542	AMS5342	LVR-IC	LDO, 4.2V±2%, 500mA	SOT-23-5	28sz	VR1	6a	Ams
M543	AMS5343	LVR-IC	LDO, 4.3V±2%, 500mA	SOT-23-5	28sz	VR1	6a	Ams
M544	AMS5344	LVR-IC	LDO, 4.4V±2%, 500mA	SOT-23-5	28sz	VR1	6a	Ams
M545	AMS5345	LVR-IC	LDO, 4.5V±2%, 500mA	SOT-23-5	28sz	VR1	6a	Ams
M546	AMS5346	LVR-IC	LDO, 4.6V±2%, 500mA	SOT-23-5	28sz	VR1	6a	Ams
M547	AMS5347	LVR-IC	LDO, 4.7V±2%, 500mA	SOT-23-5	28sz	VR1	6a	Ams
M548	AMS5348	LVR-IC	LDO, 4.8V±2%, 500mA	SOT-23-5	28sz	VR1	6a	Ams
M549	AMS5349	LVR-IC	LDO, 4.9V±2%, 500mA	SOT-23-5	28sz	VR1	6a	Ams
M54G	88N54G-AF5	Vdet-IC	5.4V±2%, -Reset ODO, halogen free	SOT-23-5	28vdo	VD1	6a	Utc
M54L	88N54L-AF5	Vdet-IC	5.4V±2%, -Reset ODO, lead free	SOT-23-5	28vdo	VD1	6a	Utc
M55	88N55-AF5	Vdet-IC	5.5V±2%, -Reset ODO	SOT-23-5	28vdo	VD1	6a	Utc
M55	R1224N552M	DC/DC-IC	PWM step-down, 5.5V, 180kHz	SOT-23-5	28ud	DC7	6g	Ric
M55	XC6366C552MR	DC/DC-IC	PWM/PFM st-down, 180kHz, 5.5V±2.5%, 1A, +CE, soft start	SOT-25	28zm	DC7	6g	Tor
M55	XC6368C552MR	DC/DC-IC	PWM/PFM step-up, 5.5V±2.5%, 200mA, 180kHz, +CE, soft start	SOT-25	28sh	DC11	6g	Tor
M550	AMS5350	LVR-IC	LDO, 5.0V±2%, 500mA	SOT-23-5	28sz	VR1	6a	Ams
M551	AMS5351	LVR-IC	LDO, 5.1V±2%, 500mA	SOT-23-5	28sz	VR1	6a	Ams
M552	AMS5352	LVR-IC	LDO, 5.2V±2%, 500mA	SOT-23-5	28sz	VR1	6a	Ams
M553	AMS5353	LVR-IC	LDO, 5.3V±2%, 500mA	SOT-23-5	28sz	VR1	6a	Ams
M554	AMS5354	LVR-IC	LDO, 5.4V±2%, 500mA	SOT-23-5	28sz	VR1	6a	Ams
M555	AMS5355	LVR-IC	LDO, 5.5V±2%, 500mA	SOT-23-5	28sz	VR1	6a	Ams
M556	AMS5356	LVR-IC	LDO, 5.6V±2%, 500mA	SOT-23-5	28sz	VR1	6a	Ams
M557	AMS5357	LVR-IC	LDO, 5.7V±2%, 500mA	SOT-23-5	28sz	VR1	6a	Ams
M558	AMS5358	LVR-IC	LDO, 5.8V±2%, 500mA	SOT-23-5	28sz	VR1	6a	Ams
M559	AMS5359	LVR-IC	LDO, 5.9V±2%, 500mA	SOT-23-5	28sz	VR1	6a	Ams



SMD code	Type	Function	Short description	Case	Pinout	Sch.	St.	Mnf.
M55G	88N55G-AF5	Vdet-IC	5.5V±2%, -Reset ODO, halogen free	SOT-23-5	28vdo	VD1	6a	Utc
M55L	88N55L-AF5	Vdet-IC	5.5V±2%, -Reset ODO, lead free	SOT-23-5	28vdo	VD1	6a	Utc
M56	88N56-AF5	Vdet-IC	5.6V±2%, -Reset ODO	SOT-23-5	28vdo	VD1	6a	Utc
M56	XC6366C562MR	DC/DC-IC	PWM/PFM st-down, 180kHz, 5.6V±2.5%, 1A, +CE, soft start	SOT-25	28zm	DC7	6g	Tor
M56	XC6368C562MR	DC/DC-IC	PWM/PFM step-up, 5.6V±2.5%, 200mA, 180kHz, +CE, soft start	SOT-25	28sh	DC11	6g	Tor
M560	AMS5360	LVR-IC	LDO, 6.0V±2%, 500mA	SOT-23-5	28sz	VR1	6a	Ams
M561	AMS5361	LVR-IC	LDO, 6.1V±2%, 500mA	SOT-23-5	28sz	VR1	6a	Ams
M562	AMS5362	LVR-IC	LDO, 6.2V±2%, 500mA	SOT-23-5	28sz	VR1	6a	Ams
M563	AMS5363	LVR-IC	LDO, 6.3V±2%, 500mA	SOT-23-5	28sz	VR1	6a	Ams
M564	AMS5364	LVR-IC	LDO, 6.4V±2%, 500mA	SOT-23-5	28sz	VR1	6a	Ams
M565	AMS5368	LVR-IC	LDO, 6.5V±2%, 500mA	SOT-23-5	28sz	VR1	6a	Ams
M566	AMS5366	LVR-IC	LDO, 6.6V±2%, 500mA	SOT-23-5	28sz	VR1	6a	Ams
M567	AMS5367	LVR-IC	LDO, 6.7V±2%, 500mA	SOT-23-5	28sz	VR1	6a	Ams
M568	AMS5368	LVR-IC	LDO, 6.8V±2%, 500mA	SOT-23-5	28sz	VR1	6a	Ams
M569	AMS5369	LVR-IC	LDO, 6.9V±2%, 500mA	SOT-23-5	28sz	VR1	6a	Ams
M56G	88N56G-AF5	Vdet-IC	5.6V±2%, -Reset ODO, halogen free	SOT-23-5	28vdo	VD1	6a	Utc
M56L	88N56L-AF5	Vdet-IC	5.6V±2%, -Reset ODO, lead free	SOT-23-5	28vdo	VD1	6a	Utc
M57	88N57-AF5	Vdet-IC	5.7V±2%, -Reset ODO	SOT-23-5	28vdo	VD1	6a	Utc
M57	XC6366C572MR	DC/DC-IC	PWM/PFM st-down, 180kHz, 5.7V±2.5%, 1A, +CE, soft start	SOT-25	28zm	DC7	6g	Tor
M57	XC6368C572MR	DC/DC-IC	PWM/PFM step-up, 5.7V±2.5%, 200mA, 180kHz, +CE, soft start	SOT-25	28sh	DC11	6g	Tor
M570	AMS5370	LVR-IC	LDO, 7.0V±2%, 500mA	SOT-23-5	28sz	VR1	6a	Ams
M57G	88N57G-AF5	Vdet-IC	5.7V±2%, -Reset ODO, halogen free	SOT-23-5	28vdo	VD1	6a	Utc
M57L	88N57L-AF5	Vdet-IC	5.7V±2%, -Reset ODO, lead free	SOT-23-5	28vdo	VD1	6a	Utc
M58	88N58-AF5	Vdet-IC	5.8V±2%, -Reset ODO	SOT-23-5	28vdo	VD1	6a	Utc
M58	XC6366C582MR	DC/DC-IC	PWM/PFM st-down, 180kHz, 5.8V±2.5%, 1A, +CE, soft start	SOT-25	28zm	DC7	6g	Tor
M58	XC6368C582MR	DC/DC-IC	PWM/PFM step-up, 5.8V±2.5%, 200mA, 180kHz, +CE, soft start	SOT-25	28sh	DC11	6g	Tor
M58G	88N58G-AF5	Vdet-IC	5.8V±2%, -Reset ODO, halogen free	SOT-23-5	28vdo	VD1	6a	Utc
M58L	88N58L-AF5	Vdet-IC	5.8V±2%, -Reset ODO, lead free	SOT-23-5	28vdo	VD1	6a	Utc
M59	88N59-AF5	Vdet-IC	5.9V±2%, -Reset ODO	SOT-23-5	28vdo	VD1	6a	Utc
M59	XC6366C592MR	DC/DC-IC	PWM/PFM st-down, 180kHz, 5.9V±2.5%, 1A, +CE, soft start	SOT-25	28zm	DC7	6g	Tor
M59	XC6368C592MR	DC/DC-IC	PWM/PFM step-up, 5.9V±2.5%, 200mA, 180kHz, +CE, soft start	SOT-25	28sh	DC11	6g	Tor
M59G	88N59G-AF5	Vdet-IC	5.9V±2%, -Reset ODO, halogen free	SOT-23-5	28vdo	VD1	6a	Utc
M59L	88N59L-AF5	Vdet-IC	5.9V±2%, -Reset ODO, lead free	SOT-23-5	28vdo	VD1	6a	Utc
M5A	XC6108N25AMR	Vdet-IC	2.5V±2%, Hysteresis, -Reset ODO	SOT-25	28rm	VD14	6g	Tor
M5A	XC6118C15AMR-G	Vdet-IC	1.5V±30mV, ±Reset PPO, Sense, hysteresis 5%, Cd	SOT-25	28mg	VD15	6g	Tor
M5A	TC105503ECT	DC/DC-IC	PWM/PFM step-down, 300kHz, 5.0V±1%, 1A, +CE	SOT-23-5	28zm	DC7	6g	Mcc
M5A	XC6366C503MR	DC/DC-IC	PWM/PFM st-down, 300kHz, 5.0V±2.5%, 1A, +CE, soft start	SOT-25	28zm	DC7	6g	Tor
M5A	XC6368C503MR	DC/DC-IC	PWM/PFM step-up, 5.0V±2.5%, 200mA, 300kHz, +CE, soft start	SOT-25	28sh	DC11	6g	Tor
M5B	XC6108N25BMR	Vdet-IC	2.5V±2%, -Reset ODO	SOT-25	28rm	VD14	6g	Tor
M5B	XC6118C15BMR-G	Vdet-IC	1.5V±30mV, ±Reset PPO, Sense, hysteresis <1%, Cd	SOT-25	28mg	VD15	6g	Tor
M5B	TC105513ECT	DC/DC-IC	PWM/PFM step-down, 300kHz, 5.1V±1%, 1A, +CE	SOT-23-5	28zm	DC7	6g	Mcc
M5B	XC6366C513MR	DC/DC-IC	PWM/PFM st-down, 300kHz, 5.1V±2.5%, 1A, +CE, soft start	SOT-25	28zm	DC7	6g	Tor
M5B	XC6368C513MR	DC/DC-IC	PWM/PFM step-up, 5.1V±2.5%, 200mA, 300kHz, +CE, soft start	SOT-25	28sh	DC11	6g	Tor
M5C	XC6108N25CMR	Vdet-IC	2.5V±2%, Hysteresis, -Reset ODO	SOT-25	28rk	VD14	6g	Tor
M5C	XC6118C15CMR-G	Vdet-IC	1.5V±30mV, ±Reset PPO, Sense, hysteresis 5%	SOT-25	28mf	VD12	6g	Tor
M5C	TC105523ECT	DC/DC-IC	PWM/PFM step-down, 300kHz, 5.2V±1%, 1A, +CE	SOT-23-5	28zm	DC7	6g	Mcc
M5C	XC6366C523MR	DC/DC-IC	PWM/PFM st-down, 300kHz, 5.2V±2.5%, 1A, +CE, soft start	SOT-25	28zm	DC7	6g	Tor
M5C	XC6368C523MR	DC/DC-IC	PWM/PFM step-up, 5.2V±2.5%, 200mA, 300kHz, +CE, soft start	SOT-25	28sh	DC11	6g	Tor
M5D	XC6108N25DMR	Vdet-IC	2.5V±2%, -Reset ODO	SOT-25	28rk	VD14	6g	Tor
M5D	XC6118C15DMR-G	Vdet-IC	1.5V±30mV, ±Reset PPO, Sense, hysteresis <1%	SOT-25	28mf	VD12	6g	Tor
M5D	TC105533ECT	DC/DC-IC	PWM/PFM step-down, 300kHz, 5.3V±1%, 1A, +CE	SOT-23-5	28zm	DC7	6g	Mcc
M5D	XC6366C533MR	DC/DC-IC	PWM/PFM st-down, 300kHz, 5.3V±2.5%, 1A, +CE, soft start	SOT-25	28zm	DC7	6g	Tor
M5D	XC6368C533MR	DC/DC-IC	PWM/PFM step-up, 5.3V±2.5%, 200mA, 300kHz, +CE, soft start	SOT-25	28sh	DC11	6g	Tor
M5E	TC105543ECT	DC/DC-IC	PWM/PFM step-down, 300kHz, 5.4V±1%, 1A, +CE	SOT-23-5	28zm	DC7	6g	Mcc
M5E	XC6366C543MR	DC/DC-IC	PWM/PFM st-down, 300kHz, 5.4V±2.5%, 1A, +CE, soft start	SOT-25	28zm	DC7	6g	Tor
M5E	XC6368C543MR	DC/DC-IC	PWM/PFM step-up, 5.4V±2.5%, 200mA, 300kHz, +CE, soft start	SOT-25	28sh	DC11	6g	Tor
M5F	TC105553ECT	DC/DC-IC	PWM/PFM step-down, 300kHz, 5.5V±1%, 1A, +CE	SOT-23-5	28zm	DC7	6g	Mcc
M5F	XC6366C553MR	DC/DC-IC	PWM/PFM st-down, 300kHz, 5.5V±2.5%, 1A, +CE, soft start	SOT-25	28zm	DC7	6g	Tor
M5F	XC6368C553MR	DC/DC-IC	PWM/PFM step-up, 5.5V±2.5%, 200mA, 300kHz, +CE, soft start	SOT-25	28sh	DC11	6g	Tor
M5H	TC105563ECT	DC/DC-IC	PWM/PFM step-down, 300kHz, 5.6V±1%, 1A, +CE	SOT-23-5	28zm	DC7	6g	Mcc
M5H	XC6366C563MR	DC/DC-IC	PWM/PFM st-down, 300kHz, 5.6V±2.5%, 1A, +CE, soft start	SOT-25	28zm	DC7	6g	Tor
M5H	XC6368C563MR	DC/DC-IC	PWM/PFM step-up, 5.6V±2.5%, 200mA, 300kHz, +CE, soft start	SOT-25	28sh	DC11	6g	Tor
M5K	TC105573ECT	DC/DC-IC	PWM/PFM step-down, 300kHz, 5.7V±1%, 1A, +CE	SOT-23-5	28zm	DC7	6g	Mcc
M5K	XC6366C573MR	DC/DC-IC	PWM/PFM st-down, 300kHz, 5.7V±2.5%, 1A, +CE, soft start	SOT-25	28zm	DC7	6g	Tor
M5K	XC6368C573MR	DC/DC-IC	PWM/PFM step-up, 5.7V±2.5%, 200mA, 300kHz, +CE, soft start	SOT-25	28sh	DC11	6g	Tor
M5L	TC105583ECT	DC/DC-IC	PWM/PFM step-down, 300kHz, 5.8V±1%, 1A, +CE	SOT-23-5	28zm	DC7	6g	Mcc
M5L	XC6366C583MR	DC/DC-IC	PWM/PFM st-down, 300kHz, 5.8V±2.5%, 1A, +CE, soft start	SOT-25	28zm	DC7	6g	Tor
M5L	XC6368C583MR	DC/DC-IC	PWM/PFM step-up, 5.8V±2.5%, 200mA, 300kHz, +CE, soft start	SOT-25	28sh	DC11	6g	Tor
M5M	TC105593ECT	DC/DC-IC	PWM/PFM step-down, 300kHz, 5.9V±1%, 1A, +CE	SOT-23-5	28zm	DC7	6g	Mcc
M5M	XC6366C593MR	DC/DC-IC	PWM/PFM st-down, 300kHz, 5.9V±2.5%, 1A, +CE, soft start	SOT-25	28zm	DC7	6g	Tor



SMD code	Type	Function	Short description	Case	Pinout	Sch.	St.	Mnf.
M5M	XC6368C593MR	DC/DC-IC	PWM/PFM step-up, 5.9V±2.5%, 200mA, 300kHz, +CE, soft start	SOT-25	28sh	DC11	6g	Tor
M6	R1121N361A	LVR-IC	LDO, LN, -CE, 3.6V±2%, 150mA	SOT-23-5	28vt	VR4	6g	Ric
M6	RN5RG56AA	LVR-IC	Ext. transistor, 5.6V±2.5% 1A*	SOT-23-5	28vw	VR6	6g	Ric
M6	RT9168A-21CBR	LVR-IC	LDO, 2.1V±2%, 500mA, +CE	SOT-23-5	28vt	VR4	6g	Ric
M6	RN5RY461A	DC/DC-IC	VFM step-up, 4.6V±2.5%, 150mW, <180kHz	SOT-23-5	28vd	DC5	6g	Rct
M60	88N60-AF5	Vdet-IC	6.0V±2%, -Reset ODO	SOT-23-5	28vdo	VD1	6a	Ultc
M60	R1224N602M	DC/DC-IC	PWM step-down, 6V, 180kHz	SOT-23-5	28ud	DC7	6g	Ric
M60	XC6366C602MR	DC/DC-IC	PWM/PFM st-down, 180kHz, 6.0V±2.5%, 1A, +CE, soft start	SOT-25	28zm	DC7	6g	Tor
M60	XC6368C602MR	DC/DC-IC	PWM/PFM step-up, 6.0V±2.5%, 200mA, 180kHz, +CE, soft start	SOT-25	28sh	DC11	6g	Tor
M60G	88N60G-AF5	Vdet-IC	6.0V±2%, -Reset ODO, halogen free	SOT-23-5	28vdo	VD1	6a	Ultc
M60L	88N60L-AF5	Vdet-IC	6.0V±2%, -Reset ODO, lead free	SOT-23-5	28vdo	VD1	6a	Ultc
M61	XC6368C612MR	DC/DC-IC	PWM/PFM step-up, 6.1V±2.5%, 200mA, 180kHz, +CE, soft start	SOT-25	28sh	DC11	6g	Tor
M62	XC6368C622MR	DC/DC-IC	PWM/PFM step-up, 6.2V±2.5%, 200mA, 180kHz, +CE, soft start	SOT-25	28sh	DC11	6g	Tor
M63	XC6368C632MR	DC/DC-IC	PWM/PFM step-up, 6.3V±2.5%, 200mA, 180kHz, +CE, soft start	SOT-25	28sh	DC11	6g	Tor
M64	XC6368C642MR	DC/DC-IC	PWM/PFM step-up, 6.4V±2.5%, 200mA, 180kHz, +CE, soft start	SOT-25	28sh	DC11	6g	Tor
M65	XC6368C652MR	DC/DC-IC	PWM/PFM step-up, 6.5V±2.5%, 200mA, 180kHz, +CE, soft start	SOT-25	28sh	DC11	6g	Tor
M6A	XC6108N26AMR	Vdet-IC	2.6V±2%, Hysteresis, -Reset ODO	SOT-25	28rm	VD14	6g	Tor
M6A	XC6118C16AMR-G	Vdet-IC	1.6V±2%, ±Reset PPO, Sense, hysteresis 5%, Cd	SOT-25	28mg	VD15	6g	Tor
M6A	TC105603ECT	DC/DC-IC	PWM/PFM step-down, 300kHz, 6.0V±1%, 1A, +CE	SOT-23-5	28zm	DC7	6g	Mcc
M6A	XC6366C603MR	DC/DC-IC	PWM/PFM st-down, 300kHz, 6.0V±2.5%, 1A, +CE, soft start	SOT-25	28zm	DC7	6g	Tor
M6A	XC6368C603MR	DC/DC-IC	PWM/PFM step-up, 6.0V±2.5%, 200mA, 300kHz, +CE, soft start	SOT-25	28sh	DC11	6g	Tor
M6B	XC6108N26BMR	Vdet-IC	2.6V±2%, -Reset ODO	SOT-25	28rm	VD14	6g	Tor
M6B	XC6118C16BMR-G	Vdet-IC	1.6V±2%, ±Reset PPO, Sense, hysteresis <1%, Cd	SOT-25	28mg	VD15	6g	Tor
M6B	XC6368C613MR	DC/DC-IC	PWM/PFM step-up, 6.1V±2.5%, 200mA, 300kHz, +CE, soft start	SOT-25	28sh	DC11	6g	Tor
M6C	XC6108N26CMR	Vdet-IC	2.6V±2%, Hysteresis, -Reset ODO	SOT-25	28rk	VD14	6g	Tor
M6C	XC6118C16CMR-G	Vdet-IC	1.6V±2%, ±Reset PPO, Sense, hysteresis 5%	SOT-25	28mf	VD12	6g	Tor
M6C	XC6368C623MR	DC/DC-IC	PWM/PFM step-up, 6.2V±2.5%, 200mA, 300kHz, +CE, soft start	SOT-25	28sh	DC11	6g	Tor
M6D	XC6108N26DMR	Vdet-IC	2.6V±2%, -Reset ODO	SOT-25	28rk	VD14	6g	Tor
M6D	XC6118C16DMR-G	Vdet-IC	1.6V±2%, ±Reset PPO, Sense, hysteresis <1%	SOT-25	28mf	VD12	6g	Tor
M6D	XC6368C633MR	DC/DC-IC	PWM/PFM step-up, 6.3V±2.5%, 200mA, 300kHz, +CE, soft start	SOT-25	28sh	DC11	6g	Tor
M6E	XC6368C643MR	DC/DC-IC	PWM/PFM step-up, 6.4V±2.5%, 200mA, 300kHz, +CE, soft start	SOT-25	28sh	DC11	6g	Tor
M6F	XC6368C653MR	DC/DC-IC	PWM/PFM step-up, 6.5V±2.5%, 200mA, 300kHz, +CE, soft start	SOT-25	28sh	DC11	6g	Tor
M7	R1121N371A	LVR-IC	LDO, LN, -CE, 3.7V±2%, 150mA	SOT-23-5	28vt	VR4	6g	Ric
M7	RN5RG57AA	LVR-IC	Ext. transistor, 5.7V±2.5% 1A*	SOT-23-5	28vw	VR6	6g	Ric
M7	RT9168A-22CBR	LVR-IC	LDO, 2.2V±2%, 500mA, +CE	SOT-23-5	28vt	VR4	6g	Rct
M7	RN5RY471A	DC/DC-IC	VFM step-up, 4.7V±2.5%, 150mW, <180kHz	SOT-23-5	28vd	DC5	6g	Ric
M7A	XC6108N27AMR	Vdet-IC	2.7V±2%, Hysteresis, -Reset ODO	SOT-25	28rm	VD14	6g	Tor
M7A	XC6118C17AMR-G	Vdet-IC	1.7V±2%, ±Reset PPO, Sense, hysteresis 5%, Cd	SOT-25	28mg	VD15	6g	Tor
M7B	XC6108N27BMR	Vdet-IC	2.7V±2%, -Reset ODO	SOT-25	28rm	VD14	6g	Tor
M7B	XC6118C17BMR-G	Vdet-IC	1.7V±2%, ±Reset PPO, Sense, hysteresis <1%, Cd	SOT-25	28mg	VD15	6g	Tor
M7C	XC6108N27CMR	Vdet-IC	2.7V±2%, Hysteresis, -Reset ODO	SOT-25	28rk	VD14	6g	Tor
M7C	XC6118C17CMR-G	Vdet-IC	1.7V±2%, ±Reset PPO, Sense, hysteresis 5%	SOT-25	28mf	VD12	6g	Tor
M7D	XC6108N27DMR	Vdet-IC	2.7V±2%, -Reset ODO	SOT-25	28rk	VD14	6g	Tor
M7D	XC6118C17DMR-G	Vdet-IC	1.7V±2%, ±Reset PPO, Sense, hysteresis <1%	SOT-25	28mf	VD12	6g	Tor
M8	R1121N381A	LVR-IC	LDO, LN, -CE, 3.8V±2%, 150mA	SOT-23-5	28vt	VR4	6g	Ric
M8	RN5RG58AA	LVR-IC	Ext. transistor, 5.8V±2.5% 1A*	SOT-23-5	28vw	VR6	6g	Ric
M8	RT9168A-23CBR	LVR-IC	LDO, 2.3V±2%, 500mA, +CE	SOT-23-5	28vt	VR4	6g	Rct
M8	RN5RY481A	DC/DC-IC	VFM step-up, 4.8V±2.5%, 150mW, <180kHz	SOT-23-5	28vd	DC5	6g	Ric
M8A	XC6108N28AMR	Vdet-IC	2.8V±2%, Hysteresis, -Reset ODO	SOT-25	28rm	VD14	6g	Tor
M8A	XC6118C18AMR-G	Vdet-IC	1.8V±2%, ±Reset PPO, Sense, hysteresis 5%, Cd	SOT-25	28mg	VD15	6g	Tor
M8B	XC6108N28BMR	Vdet-IC	2.8V±2%, -Reset ODO	SOT-25	28rm	VD14	6g	Tor
M8B	XC6118C18BMR-G	Vdet-IC	1.8V±2%, ±Reset PPO, Sense, hysteresis <1%, Cd	SOT-25	28mg	VD15	6g	Tor
M8C	XC6108N28CMR	Vdet-IC	2.8V±2%, Hysteresis, -Reset ODO	SOT-25	28rk	VD14	6g	Tor
M8C	XC6118C18CMR-G	Vdet-IC	1.8V±2%, ±Reset PPO, Sense, hysteresis 5%	SOT-25	28mf	VD12	6g	Tor
M8D	XC6108N28DMR	Vdet-IC	2.8V±2%, -Reset ODO	SOT-25	28rk	VD14	6g	Tor
M8D	XC6118C18DMR-G	Vdet-IC	1.8V±2%, ±Reset PPO, Sense, hysteresis <1%	SOT-25	28mf	VD12	6g	Tor
M9	R1121N391A	LVR-IC	LDO, LN, -CE, 3.9V±2%, 150mA	SOT-23-5	28vt	VR4	6g	Ric
M9	RN5RG59AA	LVR-IC	Ext. transistor, 5.9V±2.5% 1A*	SOT-23-5	28vw	VR6	6g	Ric
M9	RT9168A-24CBR	LVR-IC	LDO, 2.4V±2%, 500mA, +CE	SOT-23-5	28vt	VR4	6g	Rct
M9	RN5RY491A	DC/DC-IC	VFM step-up, 4.9V±2.5%, 150mW, <180kHz	SOT-23-5	28vd	DC5	6g	Ric
M9A	XC6108N29AMR	Vdet-IC	2.9V±2%, Hysteresis, -Reset ODO	SOT-25	28rm	VD14	6g	Tor
M9A	XC6118C19AMR-G	Vdet-IC	1.9V±2%, ±Reset PPO, Sense, hysteresis 5%, Cd	SOT-25	28mg	VD15	6g	Tor
M9B	XC6108N29BMR	Vdet-IC	2.9V±2%, -Reset ODO	SOT-25	28rm	VD14	6g	Tor
M9B	XC6118C19BMR-G	Vdet-IC	1.9V±2%, ±Reset PPO, Sense, hysteresis <1%, Cd	SOT-25	28mg	VD15	6g	Tor
M9C	XC6108N29CMR	Vdet-IC	2.9V±2%, Hysteresis, -Reset ODO	SOT-25	28rk	VD14	6g	Tor
M9C	XC6118C19CMR-G	Vdet-IC	1.9V±2%, ±Reset PPO, Sense, hysteresis 5%	SOT-25	28mf	VD12	6g	Tor
M9D	XC6108N29DMR	Vdet-IC	2.9V±2%, -Reset ODO	SOT-25	28rk	VD14	6g	Tor
M9D	XC6118C19DMR-G	Vdet-IC	1.9V±2%, ±Reset PPO, Sense, hysteresis <1%	SOT-25	28mf	VD12	6g	Tor
MA	RT9168A-25CBR	LVR-IC	LDO, 2.5V±2%, 500mA, +CE	SOT-23-5	28vt	VR4	6g	Rct
MA8	XC9237C08CMR	DC-DC-IC	PWM-PWM/PFM, st-down, 0.8V±2%, 600mA, 1.2MHz, Vin>2V, LSST, CL	SOT-25	28dc4	DC1	6g	Tor



SMD code	Type	Function	Short description	Case	Pinout	Sch.	St.	Mnf.
MDA	XC6368C305MR	DC/DC-IC	PWM/PFM step-up, 3.0V±2.5%, 200mA, 500kHz, +CE, soft start	SOT-25	28sh	DC11	6g	Tor
MDB	XC9237C3BCMR	DC-DC-IC	PWM-PWM/PFM, st-dwn, 3.15V±2%, 600mA, 1.2MHz, Vin>2V, LSST, CL	SOT-25	28dc4	DC1	6g	Tor
MDB	XC6366C315MR	DC/DC-IC	PWM/PFM st-down, 500kHz, 3.1V±2.5%, 1A, +CE, soft start	SOT-25	28zm	DC7	6g	Tor
MDB	XC6368C315MR	DC/DC-IC	PWM/PFM step-up, 3.1V±2.5%, 200mA, 500kHz, +CE, soft start	SOT-25	28sh	DC11	6g	Tor
MDC	XC9237C3CCMR	DC-DC-IC	PWM-PWM/PFM, st-dwn, 3.25V±2%, 600mA, 1.2MHz, Vin>2V, LSST, CL	SOT-25	28dc4	DC1	6g	Tor
MDC	XC6366C325MR	DC/DC-IC	PWM/PFM st-down, 500kHz, 3.2V±2.5%, 1A, +CE, soft start	SOT-25	28zm	DC7	6g	Tor
MDC	XC6368C325MR	DC/DC-IC	PWM/PFM step-up, 3.2V±2.5%, 200mA, 500kHz, +CE, soft start	SOT-25	28sh	DC11	6g	Tor
MDD	XC9237C3DCMR	DC-DC-IC	PWM-PWM/PFM, st-dwn, 3.35V±2%, 600mA, 1.2MHz, Vin>2V, LSST, CL	SOT-25	28dc4	DC1	6g	Tor
MDD	XC6366C335MR	DC/DC-IC	PWM/PFM st-down, 500kHz, 3.3V±2.5%, 1A, +CE, soft start	SOT-25	28zm	DC7	6g	Tor
MDD	XC6368C335MR	DC/DC-IC	PWM/PFM step-up, 3.3V±2.5%, 200mA, 500kHz, +CE, soft start	SOT-25	28sh	DC11	6g	Tor
MDE	XC9237C3ECMR	DC-DC-IC	PWM-PWM/PFM, st-dwn, 3.45V±2%, 600mA, 1.2MHz, Vin>2V, LSST, CL	SOT-25	28dc4	DC1	6g	Tor
MDE	XC6366C345MR	DC/DC-IC	PWM/PFM st-down, 500kHz, 3.4V±2.5%, 1A, +CE, soft start	SOT-25	28zm	DC7	6g	Tor
MDE	XC6368C345MR	DC/DC-IC	PWM/PFM step-up, 3.4V±2.5%, 200mA, 500kHz, +CE, soft start	SOT-25	28sh	DC11	6g	Tor
MDF	XC9237C3FCMR	DC-DC-IC	PWM-PWM/PFM, st-dwn, 3.55V±2%, 600mA, 1.2MHz, Vin>2V, LSST, CL	SOT-25	28dc4	DC1	6g	Tor
MDF	XC6366C355MR	DC/DC-IC	PWM/PFM st-down, 500kHz, 3.5V±2.5%, 1A, +CE, soft start	SOT-25	28zm	DC7	6g	Tor
MDF	XC6368C355MR	DC/DC-IC	PWM/PFM step-up, 3.5V±2.5%, 200mA, 500kHz, +CE, soft start	SOT-25	28sh	DC11	6g	Tor
MDH	XC9237C3HCMR	DC-DC-IC	PWM-PWM/PFM, st-dwn, 3.65V±2%, 600mA, 1.2MHz, Vin>2V, LSST, CL	SOT-25	28dc4	DC1	6g	Tor
MDH	XC6366C365MR	DC/DC-IC	PWM/PFM st-down, 500kHz, 3.6V±2.5%, 1A, +CE, soft start	SOT-25	28zm	DC7	6g	Tor
MDH	XC6368C365MR	DC/DC-IC	PWM/PFM step-up, 3.6V±2.5%, 200mA, 500kHz, +CE, soft start	SOT-25	28sh	DC11	6g	Tor
MDK	XC9237C3KCMR	DC-DC-IC	PWM-PWM/PFM, st-dwn, 3.75V±2%, 600mA, 1.2MHz, Vin>2V, LSST, CL	SOT-25	28dc4	DC1	6g	Tor
MDK	XC6366C375MR	DC/DC-IC	PWM/PFM st-down, 500kHz, 3.7V±2.5%, 1A, +CE, soft start	SOT-25	28zm	DC7	6g	Tor
MDK	XC6368C375MR	DC/DC-IC	PWM/PFM step-up, 3.7V±2.5%, 200mA, 500kHz, +CE, soft start	SOT-25	28sh	DC11	6g	Tor
MDL	XC9237C3LCMR	DC-DC-IC	PWM-PWM/PFM, st-dwn, 3.85V±2%, 600mA, 1.2MHz, Vin>2V, LSST, CL	SOT-25	28dc4	DC1	6g	Tor
MDL	XC6366C385MR	DC/DC-IC	PWM/PFM st-down, 500kHz, 3.8V±2.5%, 1A, +CE, soft start	SOT-25	28zm	DC7	6g	Tor
MDL	XC6368C385MR	DC/DC-IC	PWM/PFM step-up, 3.8V±2.5%, 200mA, 500kHz, +CE, soft start	SOT-25	28sh	DC11	6g	Tor
MDM	XC9237C3MCMR	DC-DC-IC	PWM-PWM/PFM, st-dwn, 3.95V±2%, 600mA, 1.2MHz, Vin>2V, LSST, CL	SOT-25	28dc4	DC1	6g	Tor
MDM	XC6366C395MR	DC/DC-IC	PWM/PFM st-down, 500kHz, 3.9V±2.5%, 1A, +CE, soft start	SOT-25	28zm	DC7	6g	Tor
MDM	XC6368C395MR	DC/DC-IC	PWM/PFM step-up, 3.9V±2.5%, 200mA, 500kHz, +CE, soft start	SOT-25	28sh	DC11	6g	Tor
ME	BD5224FVE	Vdet-IC	2.4V, +Reset ODO	VSOFF-5	30ua	VD6	6c	Rhm
ME	BD5224G	Vdet-IC	2.4V, +Reset ODO	SSOP-5	28vdo	VD1	6c	Rhm
ME	RT9168A-29CBR	LVR-IC	LDO, 2.9V±2%, 500mA, +CE	SOT-23-5	28vt	VR4	6g	Rct
ME0	XC9237C40CMR	DC-DC-IC	PWM-PWM/PFM, st-dwn, 4.0V±2%, 600mA, 1.2MHz, Vin>2V, LSST, CL	SOT-25	28dc4	DC1	6g	Tor
ME0	XC6366C401MR	DC/DC-IC	PWM/PFM st-down, 100kHz, 4.0V±2.5%, 1A, +CE, soft start	SOT-25	28zm	DC7	6g	Tor
ME0	XC6368C401MR	DC/DC-IC	PWM/PFM step-up, 4.0V±2.5%, 200mA, 100kHz, +CE, soft start	SOT-25	28sh	DC11	6g	Tor
ME1	XC6366C411MR	DC/DC-IC	PWM/PFM st-down, 100kHz, 4.1V±2.5%, 1A, +CE, soft start	SOT-25	28zm	DC7	6g	Tor
ME1	XC6368C411MR	DC/DC-IC	PWM/PFM step-up, 4.1V±2.5%, 200mA, 100kHz, +CE, soft start	SOT-25	28sh	DC11	6g	Tor
ME2	XC6366C421MR	DC/DC-IC	PWM/PFM st-down, 100kHz, 4.2V±2.5%, 1A, +CE, soft start	SOT-25	28zm	DC7	6g	Tor
ME2	XC6368C421MR	DC/DC-IC	PWM/PFM step-up, 4.2V±2.5%, 200mA, 100kHz, +CE, soft start	SOT-25	28sh	DC11	6g	Tor
ME3	XC6366C431MR	DC/DC-IC	PWM/PFM st-down, 100kHz, 4.3V±2.5%, 1A, +CE, soft start	SOT-25	28zm	DC7	6g	Tor
ME3	XC6368C431MR	DC/DC-IC	PWM/PFM step-up, 4.3V±2.5%, 200mA, 100kHz, +CE, soft start	SOT-25	28sh	DC11	6g	Tor
ME4	XC6366C441MR	DC/DC-IC	PWM/PFM st-down, 100kHz, 4.4V±2.5%, 1A, +CE, soft start	SOT-25	28zm	DC7	6g	Tor
ME4	XC6368C441MR	DC/DC-IC	PWM/PFM step-up, 4.4V±2.5%, 200mA, 100kHz, +CE, soft start	SOT-25	28sh	DC11	6g	Tor
ME5	XC6366C451MR	DC/DC-IC	PWM/PFM st-down, 100kHz, 4.5V±2.5%, 1A, +CE, soft start	SOT-25	28zm	DC7	6g	Tor
ME5	XC6368C451MR	DC/DC-IC	PWM/PFM step-up, 4.5V±2.5%, 200mA, 100kHz, +CE, soft start	SOT-25	28sh	DC11	6g	Tor
ME6	XC6366C461MR	DC/DC-IC	PWM/PFM st-down, 100kHz, 4.6V±2.5%, 1A, +CE, soft start	SOT-25	28zm	DC7	6g	Tor
ME6	XC6368C461MR	DC/DC-IC	PWM/PFM step-up, 4.6V±2.5%, 200mA, 100kHz, +CE, soft start	SOT-25	28sh	DC11	6g	Tor
ME7	XC6366C471MR	DC/DC-IC	PWM/PFM st-down, 100kHz, 4.7V±2.5%, 1A, +CE, soft start	SOT-25	28zm	DC7	6g	Tor
ME7	XC6368C471MR	DC/DC-IC	PWM/PFM step-up, 4.7V±2.5%, 200mA, 100kHz, +CE, soft start	SOT-25	28sh	DC11	6g	Tor
ME8	XC6366C481MR	DC/DC-IC	PWM/PFM st-down, 100kHz, 4.8V±2.5%, 1A, +CE, soft start	SOT-25	28zm	DC7	6g	Tor
ME8	XC6368C481MR	DC/DC-IC	PWM/PFM step-up, 4.8V±2.5%, 200mA, 100kHz, +CE, soft start	SOT-25	28sh	DC11	6g	Tor
ME9	XC6366C491MR	DC/DC-IC	PWM/PFM st-down, 100kHz, 4.9V±2.5%, 1A, +CE, soft start	SOT-25	28zm	DC7	6g	Tor
ME9	XC6368C491MR	DC/DC-IC	PWM/PFM step-up, 4.9V±2.5%, 200mA, 100kHz, +CE, soft start	SOT-25	28sh	DC11	6g	Tor
MEA	XC6366C405MR	DC/DC-IC	PWM/PFM st-down, 500kHz, 4.0V±2.5%, 1A, +CE, soft start	SOT-25	28zm	DC7	6g	Tor
MEA	XC6368C405MR	DC/DC-IC	PWM/PFM step-up, 4.0V±2.5%, 200mA, 500kHz, +CE, soft start	SOT-25	28sh	DC11	6g	Tor
MEB	XC6366C415MR	DC/DC-IC	PWM/PFM st-down, 500kHz, 4.1V±2.5%, 1A, +CE, soft start	SOT-25	28zm	DC7	6g	Tor
MEB	XC6368C415MR	DC/DC-IC	PWM/PFM step-up, 4.1V±2.5%, 200mA, 500kHz, +CE, soft start	SOT-25	28sh	DC11	6g	Tor
MEC	XC6366C425MR	DC/DC-IC	PWM/PFM st-down, 500kHz, 4.2V±2.5%, 1A, +CE, soft start	SOT-25	28zm	DC7	6g	Tor
MEC	XC6368C425MR	DC/DC-IC	PWM/PFM step-up, 4.2V±2.5%, 200mA, 500kHz, +CE, soft start	SOT-25	28sh	DC11	6g	Tor
MED	XC6366C435MR	DC/DC-IC	PWM/PFM st-down, 500kHz, 4.3V±2.5%, 1A, +CE, soft start	SOT-25	28zm	DC7	6g	Tor
MED	XC6368C435MR	DC/DC-IC	PWM/PFM step-up, 4.3V±2.5%, 200mA, 500kHz, +CE, soft start	SOT-25	28sh	DC11	6g	Tor
MEE	XC6366C445MR	DC/DC-IC	PWM/PFM st-down, 500kHz, 4.4V±2.5%, 1A, +CE, soft start	SOT-25	28zm	DC7	6g	Tor
MEE	XC6368C445MR	DC/DC-IC	PWM/PFM step-up, 4.4V±2.5%, 200mA, 500kHz, +CE, soft start	SOT-25	28sh	DC11	6g	Tor
MEF	XC6366C455MR	DC/DC-IC	PWM/PFM st-down, 500kHz, 4.5V±2.5%, 1A, +CE, soft start	SOT-25	28zm	DC7	6g	Tor
MEF	XC6368C455MR	DC/DC-IC	PWM/PFM step-up, 4.5V±2.5%, 200mA, 500kHz, +CE, soft start	SOT-25	28sh	DC11	6g	Tor
MEH	XC6366C465MR	DC/DC-IC	PWM/PFM st-down, 500kHz, 4.6V±2.5%, 1A, +CE, soft start	SOT-25	28zm	DC7	6g	Tor
MEH	XC6368C465MR	DC/DC-IC	PWM/PFM step-up, 4.6V±2.5%, 200mA, 500kHz, +CE, soft start	SOT-25	28sh	DC11	6g	Tor
MEK	XC6366C475MR	DC/DC-IC	PWM/PFM st-down, 500kHz, 4.7V±2.5%, 1A, +CE, soft start	SOT-25	28zm	DC7	6g	Tor
MEK	XC6368C475MR	DC/DC-IC	PWM/PFM step-up, 4.7V±2.5%, 200mA, 500kHz, +CE, soft start	SOT-25	28sh	DC11	6g	Tor
MEL	XC6366C485MR	DC/DC-IC	PWM/PFM st-down, 500kHz, 4.8V±2.5%, 1A, +CE, soft start	SOT-25	28zm	DC7	6g	Tor
MEL	XC6368C485MR	DC/DC-IC	PWM/PFM step-up, 4.8V±2.5%, 200mA, 500kHz, +CE, soft start	SOT-25	28sh	DC11	6g	Tor



SMD code	Type	Function	Short description	Case	Pinout	Sch.	St.	Mnf.
MEM	XC6366C495MR	DC/DC-IC	PWM/PFM st-down, 500kHz, 4.9V±2.5%, 1A, +CE, soft start	SOT-25	28zm	DC7	6g	Tor
MEM	XC6368C495MR	DC/DC-IC	PWM/PFM step-up, 4.9V±2.5%, 200mA, 500kHz, +CE, soft start	SOT-25	28sh	DC11	6g	Tor
MF	BD5225FVE	Vdet-IC	2.5V, +Reset ODO	VSOFF-5	30ua	VD6	6c	Rhm
MF	BD5225G	Vdet-IC	2.5V, +Reset ODO	SSOP-5	28vdo	VD1	6c	Rhm
MF	RT9168A-30CBR	LVR-IC	LDO, 3.0V±2%, 500mA, +CE	SOT-23-5	28vt	VR4	6g	Rct
MF0	XC6366C501MR	DC/DC-IC	PWM/PFM st-down, 100kHz, 5.0V±2.5%, 1A, +CE, soft start	SOT-25	28zm	DC7	6g	Tor
MF0	XC6368C501MR	DC/DC-IC	PWM/PFM step-up, 5.0V±2.5%, 200mA, 100kHz, +CE, soft start	SOT-25	28sh	DC11	6g	Tor
MF1	XC6366C511MR	DC/DC-IC	PWM/PFM st-down, 100kHz, 5.1V±2.5%, 1A, +CE, soft start	SOT-25	28zm	DC7	6g	Tor
MF1	XC6368C511MR	DC/DC-IC	PWM/PFM step-up, 5.1V±2.5%, 200mA, 100kHz, +CE, soft start	SOT-25	28sh	DC11	6g	Tor
MF2	XC6366C521MR	DC/DC-IC	PWM/PFM st-down, 100kHz, 5.2V±2.5%, 1A, +CE, soft start	SOT-25	28zm	DC7	6g	Tor
MF2	XC6368C521MR	DC/DC-IC	PWM/PFM step-up, 5.2V±2.5%, 200mA, 100kHz, +CE, soft start	SOT-25	28sh	DC11	6g	Tor
MF3	XC6366C531MR	DC/DC-IC	PWM/PFM st-down, 100kHz, 5.3V±2.5%, 1A, +CE, soft start	SOT-25	28zm	DC7	6g	Tor
MF3	XC6368C531MR	DC/DC-IC	PWM/PFM step-up, 5.3V±2.5%, 200mA, 100kHz, +CE, soft start	SOT-25	28sh	DC11	6g	Tor
MF4	XC6366C541MR	DC/DC-IC	PWM/PFM st-down, 100kHz, 5.4V±2.5%, 1A, +CE, soft start	SOT-25	28zm	DC7	6g	Tor
MF4	XC6368C541MR	DC/DC-IC	PWM/PFM step-up, 5.4V±2.5%, 200mA, 100kHz, +CE, soft start	SOT-25	28sh	DC11	6g	Tor
MF5	XC6366C551MR	DC/DC-IC	PWM/PFM st-down, 100kHz, 5.5V±2.5%, 1A, +CE, soft start	SOT-25	28zm	DC7	6g	Tor
MF5	XC6368C551MR	DC/DC-IC	PWM/PFM step-up, 5.5V±2.5%, 200mA, 100kHz, +CE, soft start	SOT-25	28sh	DC11	6g	Tor
MF6	XC6366C561MR	DC/DC-IC	PWM/PFM st-down, 100kHz, 5.6V±2.5%, 1A, +CE, soft start	SOT-25	28zm	DC7	6g	Tor
MF6	XC6368C561MR	DC/DC-IC	PWM/PFM step-up, 5.6V±2.5%, 200mA, 100kHz, +CE, soft start	SOT-25	28sh	DC11	6g	Tor
MF7	XC6366C571MR	DC/DC-IC	PWM/PFM st-down, 100kHz, 5.7V±2.5%, 1A, +CE, soft start	SOT-25	28zm	DC7	6g	Tor
MF7	XC6368C571MR	DC/DC-IC	PWM/PFM step-up, 5.7V±2.5%, 200mA, 100kHz, +CE, soft start	SOT-25	28sh	DC11	6g	Tor
MF8	XC9237C08DMR	DC-DC-IC	PWM-PWM/PFM, st-dwn, 0.8V±2%, 600mA, 3MHz, Vin>2V, LSST, CL	SOT-25	28dc4	DC1	6g	Tor
MF8	XC6366C581MR	DC/DC-IC	PWM/PFM st-down, 100kHz, 5.8V±2.5%, 1A, +CE, soft start	SOT-25	28zm	DC7	6g	Tor
MF8	XC6368C581MR	DC/DC-IC	PWM/PFM step-up, 5.8V±2.5%, 200mA, 100kHz, +CE, soft start	SOT-25	28sh	DC11	6g	Tor
MF9	XC9237C09DMR	DC-DC-IC	PWM-PWM/PFM, st-dwn, 0.9V±2%, 600mA, 3MHz, Vin>2V, LSST, CL	SOT-25	28dc4	DC1	6g	Tor
MF9	XC6366C591MR	DC/DC-IC	PWM/PFM st-down, 100kHz, 5.9V±2.5%, 1A, +CE, soft start	SOT-25	28zm	DC7	6g	Tor
MF9	XC6368C591MR	DC/DC-IC	PWM/PFM step-up, 5.9V±2.5%, 200mA, 100kHz, +CE, soft start	SOT-25	28sh	DC11	6g	Tor
MFA	XC6366C505MR	DC/DC-IC	PWM/PFM st-down, 500kHz, 5.0V±2.5%, 1A, +CE, soft start	SOT-25	28zm	DC7	6g	Tor
MFA	XC6368C505MR	DC/DC-IC	PWM/PFM step-up, 5.0V±2.5%, 200mA, 500kHz, +CE, soft start	SOT-25	28sh	DC11	6g	Tor
MFb	XC6366C515MR	DC/DC-IC	PWM/PFM st-down, 500kHz, 5.1V±2.5%, 1A, +CE, soft start	SOT-25	28zm	DC7	6g	Tor
MFb	XC6368C515MR	DC/DC-IC	PWM/PFM step-up, 5.1V±2.5%, 200mA, 500kHz, +CE, soft start	SOT-25	28sh	DC11	6g	Tor
MFC	XC6366C525MR	DC/DC-IC	PWM/PFM st-down, 500kHz, 5.2V±2.5%, 1A, +CE, soft start	SOT-25	28zm	DC7	6g	Tor
MFC	XC6368C525MR	DC/DC-IC	PWM/PFM step-up, 5.2V±2.5%, 200mA, 500kHz, +CE, soft start	SOT-25	28sh	DC11	6g	Tor
MFD	XC6366C535MR	DC/DC-IC	PWM/PFM st-down, 500kHz, 5.3V±2.5%, 1A, +CE, soft start	SOT-25	28zm	DC7	6g	Tor
MFD	XC6368C535MR	DC/DC-IC	PWM/PFM step-up, 5.3V±2.5%, 200mA, 500kHz, +CE, soft start	SOT-25	28sh	DC11	6g	Tor
MFE	XC6366C545MR	DC/DC-IC	PWM/PFM st-down, 500kHz, 5.4V±2.5%, 1A, +CE, soft start	SOT-25	28zm	DC7	6g	Tor
MFE	XC6368C545MR	DC/DC-IC	PWM/PFM step-up, 5.4V±2.5%, 200mA, 500kHz, +CE, soft start	SOT-25	28sh	DC11	6g	Tor
MFf	XC6366C555MR	DC/DC-IC	PWM/PFM st-down, 500kHz, 5.5V±2.5%, 1A, +CE, soft start	SOT-25	28zm	DC7	6g	Tor
MFf	XC6368C555MR	DC/DC-IC	PWM/PFM step-up, 5.5V±2.5%, 200mA, 500kHz, +CE, soft start	SOT-25	28sh	DC11	6g	Tor
MFH	XC6366C565MR	DC/DC-IC	PWM/PFM st-down, 500kHz, 5.6V±2.5%, 1A, +CE, soft start	SOT-25	28zm	DC7	6g	Tor
MFH	XC6368C565MR	DC/DC-IC	PWM/PFM step-up, 5.6V±2.5%, 200mA, 500kHz, +CE, soft start	SOT-25	28sh	DC11	6g	Tor
MEK	XC6366C575MR	DC/DC-IC	PWM/PFM st-down, 500kHz, 5.7V±2.5%, 1A, +CE, soft start	SOT-25	28zm	DC7	6g	Tor
MEK	XC6368C575MR	DC/DC-IC	PWM/PFM step-up, 5.7V±2.5%, 200mA, 500kHz, +CE, soft start	SOT-25	28sh	DC11	6g	Tor
MFL	XC9237C0LDMR	DC-DC-IC	PWM-PWM/PFM, st-dwn, 0.85V±2%, 600mA, 3MHz, Vin>2V, LSST, CL	SOT-25	28dc4	DC1	6g	Tor
MFL	XC6366C585MR	DC/DC-IC	PWM/PFM st-down, 500kHz, 5.8V±2.5%, 1A, +CE, soft start	SOT-25	28zm	DC7	6g	Tor
MFL	XC6368C585MR	DC/DC-IC	PWM/PFM step-up, 5.8V±2.5%, 200mA, 500kHz, +CE, soft start	SOT-25	28sh	DC11	6g	Tor
MFm	XC9237C0MDMR	DC-DC-IC	PWM-PWM/PFM, st-dwn, 0.95V±2%, 600mA, 3MHz, Vin>2V, LSST, CL	SOT-25	28dc4	DC1	6g	Tor
MFm	XC6366C595MR	DC/DC-IC	PWM/PFM st-down, 500kHz, 5.9V±2.5%, 1A, +CE, soft start	SOT-25	28zm	DC7	6g	Tor
MFm	XC6368C595MR	DC/DC-IC	PWM/PFM step-up, 5.9V±2.5%, 200mA, 500kHz, +CE, soft start	SOT-25	28sh	DC11	6g	Tor
MG	BD5226FVE	Vdet-IC	2.6V, +Reset ODO	VSOFF-5	30ua	VD6	6c	Rhm
MG	BD5226G	Vdet-IC	2.6V, +Reset ODO	SSOP-5	28vdo	VD1	6c	Rhm
MG	RT9168A-31CBR	LVR-IC	LDO, 3.1V±2%, 500mA, +CE	SOT-23-5	28vt	VR4	6g	Rct
MH	BD5227FVE	Vdet-IC	2.7V, +Reset ODO	VSOFF-5	30ua	VD6	6c	Rhm
MH	BD5227G	Vdet-IC	2.7V, +Reset ODO	SSOP-5	28vdo	VD1	6c	Rhm
MH	RT9168A-32CBR	LVR-IC	LDO, 3.2V±2%, 500mA, +CE	SOT-23-5	28vt	VR4	6g	Rct
MH0	XC9237C10DMR	DC-DC-IC	PWM-PWM/PFM, st-dwn, 1.0V±2%, 600mA, 3MHz, Vin>2V, LSST, CL	SOT-25	28dc4	DC1	6g	Tor
MH0	XC6366C601MR	DC/DC-IC	PWM/PFM st-down, 100kHz, 6.0V±2.5%, 1A, +CE, soft start	SOT-25	28zm	DC7	6g	Tor
MH0	XC6368C601MR	DC/DC-IC	PWM/PFM step-up, 6.0V±2.5%, 200mA, 100kHz, +CE, soft start	SOT-25	28sh	DC11	6g	Tor
MH1	XC9237C11DMR	DC-DC-IC	PWM-PWM/PFM, st-dwn, 1.1V±2%, 600mA, 3MHz, Vin>2V, LSST, CL	SOT-25	28dc4	DC1	6g	Tor
MH1	XC6366C611MR	DC/DC-IC	PWM/PFM st-down, 6.1V±2.5%, 200mA, 100kHz, +CE, soft start	SOT-25	28zm	DC7	6g	Tor
MH2	XC9237C12DMR	DC-DC-IC	PWM-PWM/PFM, st-dwn, 1.2V±2%, 600mA, 3MHz, Vin>2V, LSST, CL	SOT-25	28dc4	DC1	6g	Tor
MH2	XC6366C621MR	DC/DC-IC	PWM/PFM step-up, 6.2V±2.5%, 200mA, 100kHz, +CE, soft start	SOT-25	28sh	DC11	6g	Tor
MH3	XC9237C13DMR	DC-DC-IC	PWM-PWM/PFM, st-dwn, 1.3V±2%, 600mA, 3MHz, Vin>2V, LSST, CL	SOT-25	28dc4	DC1	6g	Tor
MH3	XC6366C631MR	DC/DC-IC	PWM/PFM step-up, 6.3V±2.5%, 200mA, 100kHz, +CE, soft start	SOT-25	28sh	DC11	6g	Tor
MH4	XC9237C14DMR	DC-DC-IC	PWM-PWM/PFM, st-dwn, 1.4V±2%, 600mA, 3MHz, Vin>2V, LSST, CL	SOT-25	28dc4	DC1	6g	Tor
MH4	XC6366C641MR	DC/DC-IC	PWM/PFM step-up, 6.4V±2.5%, 200mA, 100kHz, +CE, soft start	SOT-25	28sh	DC11	6g	Tor
MH5	XC9237C15DMR	DC-DC-IC	PWM-PWM/PFM, st-dwn, 1.5V±2%, 600mA, 3MHz, Vin>2V, LSST, CL	SOT-25	28dc4	DC1	6g	Tor
MH5	XC6366C651MR	DC/DC-IC	PWM/PFM step-up, 6.5V±2.5%, 200mA, 100kHz, +CE, soft start	SOT-25	28sh	DC11	6g	Tor
MH6	XC9237C16DMR	DC-DC-IC	PWM-PWM/PFM, st-dwn, 1.6V±2%, 600mA, 3MHz, Vin>2V, LSST, CL	SOT-25	28dc4	DC1	6g	Tor
MH7	XC9237C17DMR	DC-DC-IC	PWM-PWM/PFM, st-dwn, 1.7V±2%, 600mA, 3MHz, Vin>2V, LSST, CL	SOT-25	28dc4	DC1	6g	Tor



SMD code	Type	Function	Short description	Case	Pinout	Sch.	St.	Mnf.
MH8	XC9237C18DMR	DC-DC-IC	PWM-PWM/PFM, st-dwn, 1.8V±2%, 600mA, 3MHz, Vin>2V, LSST, CL	SOT-25	28dc4	DC1	6g	Tor
MH9	XC9237C19DMR	DC-DC-IC	PWM-PWM/PFM, st-dwn, 1.9V±2%, 600mA, 3MHz, Vin>2V, LSST, CL	SOT-25	28dc4	DC1	6g	Tor
MHA	XC9237C1ADMR	DC-DC-IC	PWM-PWM/PFM, st-dwn, 1.05V±2%, 600mA, 3MHz, Vin>2V, LSST, CL	SOT-25	28dc4	DC1	6g	Tor
MHA	XC6368C605MR	DC/DC-IC	PWM/PFM st-dwn, 500kHz, 6.0V±2.5%, 1A, +CE, soft start	SOT-25	28zm	DC7	6g	Tor
MHA	XC6368C605MR	DC/DC-IC	PWM/PFM step-up, 6.0V±2.5%, 200mA, 500kHz, +CE, soft start	SOT-25	28sh	DC11	6g	Tor
MHB	XC9237C18DMR	DC-DC-IC	PWM/PFM, st-dwn, 1.15V±2%, 600mA, 3MHz, Vin>2V, LSST, CL	SOT-25	28dc4	DC1	6g	Tor
MHB	XC6368C615MR	DC/DC-IC	PWM/PFM step-up, 6.1V±2.5%, 200mA, 500kHz, +CE, soft start	SOT-25	28sh	DC11	6g	Tor
MHC	XC9237C1CDMR	DC-DC-IC	PWM-PWM/PFM, st-dwn, 1.25V±2%, 600mA, 3MHz, Vin>2V, LSST, CL	SOT-25	28dc4	DC1	6g	Tor
MHC	XC6368C625MR	DC/DC-IC	PWM/PFM step-up, 6.2V±2.5%, 200mA, 500kHz, +CE, soft start	SOT-25	28sh	DC11	6g	Tor
MHD	XC9237C1DDMR	DC-DC-IC	PWM-PWM/PFM, st-dwn, 1.35V±2%, 600mA, 3MHz, Vin>2V, LSST, CL	SOT-25	28dc4	DC1	6g	Tor
MHD	XC6368C635MR	DC/DC-IC	PWM/PFM step-up, 6.3V±2.5%, 200mA, 500kHz, +CE, soft start	SOT-25	28sh	DC11	6g	Tor
MHE	XC9237C1EDMR	DC-DC-IC	PWM-PWM/PFM, st-dwn, 1.45V±2%, 600mA, 3MHz, Vin>2V, LSST, CL	SOT-25	28dc4	DC1	6g	Tor
MHE	XC6368C645MR	DC/DC-IC	PWM/PFM step-up, 6.4V±2.5%, 200mA, 500kHz, +CE, soft start	SOT-25	28sh	DC11	6g	Tor
MHF	XC9237C1FDMR	DC-DC-IC	PWM-PWM/PFM, st-dwn, 1.55V±2%, 600mA, 3MHz, Vin>2V, LSST, CL	SOT-25	28dc4	DC1	6g	Tor
MHF	XC6368C655MR	DC/DC-IC	PWM/PFM step-up, 6.5V±2.5%, 200mA, 500kHz, +CE, soft start	SOT-25	28sh	DC11	6g	Tor
MHH	XC9237C1HDMR	DC-DC-IC	PWM-PWM/PFM, st-dwn, 1.65V±2%, 600mA, 3MHz, Vin>2V, LSST, CL	SOT-25	28dc4	DC1	6g	Tor
MHK	XC9237C1KDMR	DC-DC-IC	PWM-PWM/PFM, st-dwn, 1.75V±2%, 600mA, 3MHz, Vin>2V, LSST, CL	SOT-25	28dc4	DC1	6g	Tor
MHL	XC9237C1LDMR	DC-DC-IC	PWM-PWM/PFM, st-dwn, 1.85V±2%, 600mA, 3MHz, Vin>2V, LSST, CL	SOT-25	28dc4	DC1	6g	Tor
MHM	XC9237C1MDMR	DC-DC-IC	PWM-PWM/PFM, st-dwn, 1.95V±2%, 600mA, 3MHz, Vin>2V, LSST, CL	SOT-25	28dc4	DC1	6g	Tor
MJ	BD5228FVE	Vdet-IC	2.8V, +Reset ODO	VSOFF-5	30ua	VD6	6c	Rhm
MJ	BD5228G	Vdet-IC	2.8V, +Reset ODO	SSOP-5	28vdo	VD1	6c	Rhm
MJ	RT9168A-33CBR	LVR-IC	LDO, 3.3V±2%, 500mA, +CE	SOT-23-5	28vt	VR4	6g	Rct
MJ	RT9168A-33PBR	LVR-IC	LDO, 3.3V±2%, 500mA, +CE	SOT-23-5	28vt	VR4	6g	Rct
MK	BD5229FVE	Vdet-IC	2.9V, +Reset ODO	VSOFF-5	30ua	VD6	6c	Rhm
MK	BD5229G	Vdet-IC	2.9V, +Reset ODO	SSOP-5	28vdo	VD1	6c	Rhm
MK	RT9168A-34CBR	LVR-IC	LDO, 3.4V±2%, 500mA, +CE	SOT-23-5	28vt	VR4	6g	Rct
MK0	XC9237C20DMR	DC-DC-IC	PWM-PWM/PFM, st-dwn, 2.0V±2%, 600mA, 3MHz, Vin>2V, LSST, CL	SOT-25	28dc4	DC1	6g	Tor
MK1	XC9237C21DMR	DC-DC-IC	PWM-PWM/PFM, st-dwn, 2.1V±2%, 600mA, 3MHz, Vin>2V, LSST, CL	SOT-25	28dc4	DC1	6g	Tor
MK2	XC9237C22DMR	DC-DC-IC	PWM-PWM/PFM, st-dwn, 2.2V±2%, 600mA, 3MHz, Vin>2V, LSST, CL	SOT-25	28dc4	DC1	6g	Tor
MK3	XC9237C23DMR	DC-DC-IC	PWM-PWM/PFM, st-dwn, 2.3V±2%, 600mA, 3MHz, Vin>2V, LSST, CL	SOT-25	28dc4	DC1	6g	Tor
MK4	XC9237C24DMR	DC-DC-IC	PWM-PWM/PFM, st-dwn, 2.4V±2%, 600mA, 3MHz, Vin>2V, LSST, CL	SOT-25	28dc4	DC1	6g	Tor
MK5	XC9237C25DMR	DC-DC-IC	PWM-PWM/PFM, st-dwn, 2.5V±2%, 600mA, 3MHz, Vin>2V, LSST, CL	SOT-25	28dc4	DC1	6g	Tor
MK6	XC9237C26DMR	DC-DC-IC	PWM-PWM/PFM, st-dwn, 2.6V±2%, 600mA, 3MHz, Vin>2V, LSST, CL	SOT-25	28dc4	DC1	6g	Tor
MK7	XC9237C27DMR	DC-DC-IC	PWM-PWM/PFM, st-dwn, 2.7V±2%, 600mA, 3MHz, Vin>2V, LSST, CL	SOT-25	28dc4	DC1	6g	Tor
MK8	XC9237C28DMR	DC-DC-IC	PWM-PWM/PFM, st-dwn, 2.8V±2%, 600mA, 3MHz, Vin>2V, LSST, CL	SOT-25	28dc4	DC1	6g	Tor
MK9	XC9237C29DMR	DC-DC-IC	PWM-PWM/PFM, st-dwn, 2.9V±2%, 600mA, 3MHz, Vin>2V, LSST, CL	SOT-25	28dc4	DC1	6g	Tor
MKA	XC9237C2ADMR	DC-DC-IC	PWM-PWM/PFM, st-dwn, 2.05V±2%, 600mA, 3MHz, Vin>2V, LSST, CL	SOT-25	28dc4	DC1	6g	Tor
MKB	XC9237C2BDMR	DC-DC-IC	PWM-PWM/PFM, st-dwn, 2.15V±2%, 600mA, 3MHz, Vin>2V, LSST, CL	SOT-25	28dc4	DC1	6g	Tor
MKC	XC9237C2CDMR	DC-DC-IC	PWM-PWM/PFM, st-dwn, 2.25V±2%, 600mA, 3MHz, Vin>2V, LSST, CL	SOT-25	28dc4	DC1	6g	Tor
MKD	XC9237C2DDMR	DC-DC-IC	PWM-PWM/PFM, st-dwn, 2.35V±2%, 600mA, 3MHz, Vin>2V, LSST, CL	SOT-25	28dc4	DC1	6g	Tor
MKE	XC9237C2EDMR	DC-DC-IC	PWM-PWM/PFM, st-dwn, 2.45V±2%, 600mA, 3MHz, Vin>2V, LSST, CL	SOT-25	28dc4	DC1	6g	Tor
MKF	XC9237C2FDMR	DC-DC-IC	PWM-PWM/PFM, st-dwn, 2.55V±2%, 600mA, 3MHz, Vin>2V, LSST, CL	SOT-25	28dc4	DC1	6g	Tor
MKH	XC9237C2HDMR	DC-DC-IC	PWM-PWM/PFM, st-dwn, 2.65V±2%, 600mA, 3MHz, Vin>2V, LSST, CL	SOT-25	28dc4	DC1	6g	Tor
MKK	XC9237C2KDMR	DC-DC-IC	PWM-PWM/PFM, st-dwn, 2.75V±2%, 600mA, 3MHz, Vin>2V, LSST, CL	SOT-25	28dc4	DC1	6g	Tor
MKL	XC9237C2LDMR	DC-DC-IC	PWM-PWM/PFM, st-dwn, 2.85V±2%, 600mA, 3MHz, Vin>2V, LSST, CL	SOT-25	28dc4	DC1	6g	Tor
MKM	XC9237C2MDMR	DC-DC-IC	PWM-PWM/PFM, st-dwn, 2.95V±2%, 600mA, 3MHz, Vin>2V, LSST, CL	SOT-25	28dc4	DC1	6g	Tor
ML	BD5230FVE	Vdet-IC	3V, +Reset ODO	VSOFF-5	30ua	VD6	6c	Rhm
ML	BD5230G	Vdet-IC	3V, +Reset ODO	SSOP-5	28vdo	VD1	6c	Rhm
ML	NX3L1G384GW	CMOS-Logic	Single-pole single-throw analog switch	SOT-353-1	28/Log86	-	6a	Phi
ML	R1122N301A	LVR-IC	LDO, LN, -CE, 3V±2%, 150mA	SOT-23-5	28vt	VR4	6g	Ric
ML	RT9168A-35CBR	LVR-IC	LDO, 3.5V±2%, 500mA, +CE	SOT-23-5	28vt	VR4	6g	Rct
ML0	XC9237C30DMR	DC-DC-IC	PWM-PWM/PFM, st-dwn, 3.0V±2%, 600mA, 3MHz, Vin>2V, LSST, CL	SOT-25	28dc4	DC1	6g	Tor
ML1	XC9237C31DMR	DC-DC-IC	PWM-PWM/PFM, st-dwn, 3.1V±2%, 600mA, 3MHz, Vin>2V, LSST, CL	SOT-25	28dc4	DC1	6g	Tor
ML2	XC9237C32DMR	DC-DC-IC	PWM-PWM/PFM, st-dwn, 3.2V±2%, 600mA, 3MHz, Vin>2V, LSST, CL	SOT-25	28dc4	DC1	6g	Tor
ML3	XC9237C33DMR	DC-DC-IC	PWM-PWM/PFM, st-dwn, 3.3V±2%, 600mA, 3MHz, Vin>2V, LSST, CL	SOT-25	28dc4	DC1	6g	Tor
ML4	XC9237C34DMR	DC-DC-IC	PWM-PWM/PFM, st-dwn, 3.4V±2%, 600mA, 3MHz, Vin>2V, LSST, CL	SOT-25	28dc4	DC1	6g	Tor
ML5	XC9237C35DMR	DC-DC-IC	PWM-PWM/PFM, st-dwn, 3.5V±2%, 600mA, 3MHz, Vin>2V, LSST, CL	SOT-25	28dc4	DC1	6g	Tor
ML6	XC9237C36DMR	DC-DC-IC	PWM-PWM/PFM, st-dwn, 3.6V±2%, 600mA, 3MHz, Vin>2V, LSST, CL	SOT-25	28dc4	DC1	6g	Tor
ML7	XC9237C37DMR	DC-DC-IC	PWM-PWM/PFM, st-dwn, 3.7V±2%, 600mA, 3MHz, Vin>2V, LSST, CL	SOT-25	28dc4	DC1	6g	Tor
ML8	XC9237C38DMR	DC-DC-IC	PWM-PWM/PFM, st-dwn, 3.8V±2%, 600mA, 3MHz, Vin>2V, LSST, CL	SOT-25	28dc4	DC1	6g	Tor
ML9	XC9237C39DMR	DC-DC-IC	PWM-PWM/PFM, st-dwn, 3.9V±2%, 600mA, 3MHz, Vin>2V, LSST, CL	SOT-25	28dc4	DC1	6g	Tor
MLA	XC9237C3ADM	DC-DC-IC	PWM-PWM/PFM, st-dwn, 3.05V±2%, 600mA, 3MHz, Vin>2V, LSST, CL	SOT-25	28dc4	DC1	6g	Tor
MLB	XC9237C3BDMR	DC-DC-IC	PWM-PWM/PFM, st-dwn, 3.15V±2%, 600mA, 3MHz, Vin>2V, LSST, CL	SOT-25	28dc4	DC1	6g	Tor
MLC	XC9237C3CDMR	DC-DC-IC	PWM-PWM/PFM, st-dwn, 3.25V±2%, 600mA, 3MHz, Vin>2V, LSST, CL	SOT-25	28dc4	DC1	6g	Tor
MLD	XC9237C3DDMR	DC-DC-IC	PWM-PWM/PFM, st-dwn, 3.35V±2%, 600mA, 3MHz, Vin>2V, LSST, CL	SOT-25	28dc4	DC1	6g	Tor
MLE	XC9237C3EDMR	DC-DC-IC	PWM-PWM/PFM, st-dwn, 3.45V±2%, 600mA, 3MHz, Vin>2V, LSST, CL	SOT-25	28dc4	DC1	6g	Tor
MLF	XC9237C3FDMR	DC-DC-IC	PWM-PWM/PFM, st-dwn, 3.55V±2%, 600mA, 3MHz, Vin>2V, LSST, CL	SOT-25	28dc4	DC1	6g	Tor
MLH	XC9237C3HDMR	DC-DC-IC	PWM-PWM/PFM, st-dwn, 3.65V±2%, 600mA, 3MHz, Vin>2V, LSST, CL	SOT-25	28dc4	DC1	6g	Tor
MLK	XC9237C3KDMR	DC-DC-IC	PWM-PWM/PFM, st-dwn, 3.75V±2%, 600mA, 3MHz, Vin>2V, LSST, CL	SOT-25	28dc4	DC1	6g	Tor
MLL	XC9237C3LDMR	DC-DC-IC	PWM-PWM/PFM, st-dwn, 3.85V±2%, 600mA, 3MHz, Vin>2V, LSST, CL	SOT-25	28dc4	DC1	6g	Tor



SMD code	Type	Function	Short description	Case	Pinout	Sch.	St.	Mnf.
MLM	XC9237C3MDMR	DC-DC-IC	PWM-PWM/PFM, st-dwn, 3.95V±2%, 600mA, 3MHz, Vin>2V, LSST, CL	SOT-25	28dc4	DC1	6g	Tor
MM	BD5231FVE	Vdet-IC	3.1V, +Reset ODO	VSOFF-5	30ua	VD6	6c	Rhm
MM	BD5231G	Vdet-IC	3.1V, +Reset ODO	SSOP-5	28vdo	VD1	6c	Rhm
MM	R1122N311A	LVR-IC	LDO, LN, -CE, 3.1V±2%, 150mA	SOT-23-5	28vt	VR4	6g	Ric
MM	RT9168A-36CBR	LVR-IC	LDO, 3.6V±2%, 500mA, +CE	SOT-23-5	28vt	VR4	6g	Rct
MMO	XC9237C40DMR	DC-DC-IC	PWM-PWM/PFM, st-dwn, 4.0V±2%, 600mA, 3MHz, Vin>2V, LSST, CL	SOT-25	28dc4	DC1	6g	Tor
MN	BD5232FVE	Vdet-IC	3.2V, +Reset ODO	VSOFF-5	30ua	VD6	6c	Rhm
MN	BD5232G	Vdet-IC	3.2V, +Reset ODO	SSOP-5	28vdo	VD1	6c	Rhm
MN	R1122N321A	LVR-IC	LDO, LN, -CE, 3.2V±2%, 150mA	SOT-23-5	28vt	VR4	6g	Ric
MN	RT9168A-37CBR	LVR-IC	LDO, 3.7V±2%, 500mA, +CE	SOT-23-5	28vt	VR4	6g	Rct
mP	PT7M7823KTA	Vdet-IC	2.25V±1.5%, -Reset PPO, -MR, WD	SOT-23-5	28cp	VD17	6k	Pti
mP	PT7M7823KTAE	Vdet-IC	2.25V±1.5%, -Reset PPO, -MR, WD, Lead free	SOT-23-5	28cp	VD17	6k	Pti
MP	BD5233FVE	Vdet-IC	3.3V, +Reset ODO	VSOFF-5	30ua	VD6	6c	Rhm
MP	BD5233G	Vdet-IC	3.3V, +Reset ODO	SSOP-5	28vdo	VD1	6c	Rhm
MP	R1122N331A	LVR-IC	LDO, LN, -CE, 3.3V±2%, 150mA	SOT-23-5	28vt	VR4	6g	Ric
mQ	PT7M7824KTA	Vdet-IC	2.25V±1.5%, ±Reset PPO, WD	SOT-23-5	28xg	VD19	6k	Pti
mQ	PT7M7824KTAE	Vdet-IC	2.25V±1.5%, ±Reset PPO, WD, Lead free	SOT-23-5	28xg	VD19	6k	Pti
MQ	BD5234FVE	Vdet-IC	3.4V, +Reset ODO	VSOFF-5	30ua	VD6	6c	Rhm
MQ	BD5234G	Vdet-IC	3.4V, +Reset ODO	SSOP-5	28vdo	VD1	6c	Rhm
MQ	R1122N341A	LVR-IC	LDO, LN, -CE, 3.4V±2%, 150mA	SOT-23-5	28vt	VR4	6g	Ric
MQB	KRC681T	Si-npn-Digi	Dual, Sw, AF-mute, 50V, 300mA, 900mW, R1=2.2k	TSV	28/TD6	-	6l	Kec
MR	BD5235FVE	Vdet-IC	3.5V, +Reset ODO	VSOFF-5	30ua	VD6	6c	Rhm
MR	BD5235G	Vdet-IC	3.5V, +Reset ODO	SSOP-5	28vdo	VD1	6c	Rhm
MR	R1122N351A	LVR-IC	LDO, LN, -CE, 3.5V±2%, 150mA	SOT-23-5	28vt	VR4	6g	Ric
MRB	KRC682T	Si-npn-Digi	Dual, Sw, AF-mute, 50V, 300mA, 900mW, R1=4.7k	TSV	28/TD6	-	6l	Kec
MS	BD5236FVE	Vdet-IC	3.6V, +Reset ODO	VSOFF-5	30ua	VD6	6c	Rhm
MS	BD5236G	Vdet-IC	3.6V, +Reset ODO	SSOP-5	28vdo	VD1	6c	Rhm
MS	R1122N361A	LVR-IC	LDO, LN, -CE, 3.6V±2%, 150mA	SOT-23-5	28vt	VR4	6g	Ric
MSB	KRC683T	Si-npn-Digi	Dual, Sw, AF-mute, 50V, 300mA, 900mW, R1=5.6k	TSV	28/TD6	-	6l	Kec
M3E	XC6368C343MR	DC/DC-IC	PWM/PFM step-up, 3.4V±2.5%, 200mA, 300kHz, +CE, soft start	SOT-25	28sh	DC11	6g	Tor
MT	BD5237FVE	Vdet-IC	3.7V, +Reset ODO	VSOFF-5	30ua	VD6	6c	Rhm
MT	BD5237G	Vdet-IC	3.7V, +Reset ODO	SSOP-5	28vdo	VD1	6c	Rhm
MT	R1122N371A	LVR-IC	LDO, LN, -CE, 3.7V±2%, 150mA	SOT-23-5	28vt	VR4	6g	Ric
MTB	KRC684T	Si-npn-Digi	Dual, Sw, AF-mute, 50V, 300mA, 900mW, R1=6.8k	TSV	28/TD6	-	6l	Kec
MU	BD5238FVE	Vdet-IC	3.8V, +Reset ODO	VSOFF-5	30ua	VD6	6c	Rhm
MU	BD5238G	Vdet-IC	3.8V, +Reset ODO	SSOP-5	28vdo	VD1	6c	Rhm
MU	PT7M7018CLTA	Vdet-IC	1.8V±1.5%, -Reset PPO	SOT-23-5	28vdr	VD7	6k	Pti
MU	R1122N381A	LVR-IC	LDO, LN, -CE, 3.8V±2%, 150mA	SOT-23-5	28vt	VR4	6g	Ric
MU	PT7M7018CLTAE	Vdet-IC	1.8V±1.5%, -Reset PPO, Lead free	SOT-23-5	28vdr	VD7	6k	Pti
MUB	KRC685T	Si-npn-Digi	Dual, Sw, AF-mute, 50V, 300mA, 900mW, R1=10k	TSV	28/TD6	-	6l	Kec
MV	BD5239FVE	Vdet-IC	3.9V, +Reset ODO	VSOFF-5	30ua	VD6	6c	Rhm
MV	BD5239G	Vdet-IC	3.9V, +Reset ODO	SSOP-5	28vdo	VD1	6c	Rhm
MV	PT7M7018CHTA	Vdet-IC	1.8V±1.5%, +Reset PPO	SOT-23-5	28vdr	VD7	6k	Pti
MV	R1122N391A	LVR-IC	LDO, LN, -CE, 3.9V±2%, 150mA	SOT-23-5	28vt	VR4	6g	Ric
MV	PT7M7018CHTAE	Vdet-IC	1.8V±1.5%, +Reset PPO, Lead free	SOT-23-5	28vdr	VD7	6k	Pti
MVB	KRC686T	Si-npn-Digi	Dual, Sw, AF-mute, 50V, 300mA, 900mW, R1=22k	TSV	28/TD6	-	6l	Kec
MW	PT7M7018NLTA	Vdet-IC	1.8V±1.5%, -Reset ODO	SOT-23-5	28vdr	VD6	6k	Pti
MW	PT7M7018NLTAE	Vdet-IC	1.8V±1.5%, -Reset ODO, Lead free	SOT-23-5	28vdr	VD6	6k	Pti
MX	PT7M7019CLTA	Vdet-IC	1.9V±1.5%, -Reset PPO	SOT-23-5	28vdr	VD7	6k	Pti
MX	PT7M7019CLTAE	Vdet-IC	1.9V±1.5%, -Reset PPO, Lead free	SOT-23-5	28vdr	VD7	6k	Pti
MY	PT7M7019CHTA	Vdet-IC	1.9V±1.5%, +Reset PPO	SOT-23-5	28vdr	VD7	6k	Pti
MY	PT7M7019CHTAE	Vdet-IC	1.9V±1.5%, +Reset PPO, Lead free	SOT-23-5	28vdr	VD7	6k	Pti
MZ	PT7M7019NLTA	Vdet-IC	1.9V±1.5%, -Reset ODO	SOT-23-5	28vdr	VD6	6k	Pti
MZ	PT7M7019NLTAE	Vdet-IC	1.9V±1.5%, -Reset ODO, Lead free	SOT-23-5	28vdr	VD6	6k	Pti
NO	AP139-15TW	LVR-IC	LDO, LN, +CE, 1.5V±2%, 300mA	TSOT-23-5L	28vrx	VR7	6a	Ana
NO	AP139-15W	LVR-IC	LDO, LN, +CE, 1.5V±2%, 300mA	SOT-23-5L	28vrx	VR7	6k	Ana
NO	R1121N401A	LVR-IC	LDO, LN, -CE, 4V±2%, 150mA	SOT-23-5	28vt	VR4	6g	Ric
NO	RN5RG60AA	LVR-IC	Ext. transistor, 6V±2.5% 1A*	SOT-23-5	28vww	VR6	6g	Ric
NO	TC1185-4.0VRX	LVR-IC	LDO, 4V±2%, 150mA, +CE	SOT-23-5	28vrx	VR7	6g	Mcc
N0	RN5RY501A	DC/DC-IC	VFM step-up, 5V±2.5%, 150mW, <180kHz	SOT-23-5	28vdx	DC5	6g	Ric
N010	RP107Q102B	LVR-IC	LDO, 1.0V±1%, 200mA, +CE	SC-88A	28xm	VR4	6m	Ric
N011	RP107Q112B	LVR-IC	LDO, 1.1V±1%, 200mA, +CE	SC-88A	28xm	VR4	6m	Ric
N012	RP107Q122B	LVR-IC	LDO, 1.2V±1%, 200mA, +CE	SC-88A	28xm	VR4	6m	Ric
N013	RP107Q132B	LVR-IC	LDO, 1.3V±1%, 200mA, +CE	SC-88A	28xm	VR4	6m	Ric
N014	RP107Q142B	LVR-IC	LDO, 1.4V±1%, 200mA, +CE	SC-88A	28xm	VR4	6m	Ric
N015	RP107Q152B	LVR-IC	LDO, 1.5V±1%, 200mA, +CE	SC-88A	28xm	VR4	6m	Ric
N016	RP107Q162B	LVR-IC	LDO, 1.6V±1%, 200mA, +CE	SC-88A	28xm	VR4	6m	Ric
N017	RP107Q172B	LVR-IC	LDO, 1.7V±1%, 200mA, +CE	SC-88A	28xm	VR4	6m	Ric
N018	RP107Q182B	LVR-IC	LDO, 1.8V±1%, 200mA, +CE	SC-88A	28xm	VR4	6m	Ric
N019	RP107Q192B	LVR-IC	LDO, 1.9V±1%, 200mA, +CE	SC-88A	28xm	VR4	6m	Ric



SMD code	Type	Function	Short description	Case	Pinout	Sch.	St.	Mnf.
N020	RP107Q202B	LVR-IC	LDO, 2.0V±1%, 200mA, +CE	SC-88A	28xm	VR4	6m	Ric
N021	RP107Q212B	LVR-IC	LDO, 2.1V±1%, 200mA, +CE	SC-88A	28xm	VR4	6m	Ric
N022	RP107Q222B	LVR-IC	LDO, 2.2V±1%, 200mA, +CE	SC-88A	28xm	VR4	6m	Ric
N023	RP107Q232B	LVR-IC	LDO, 2.3V±1%, 200mA, +CE	SC-88A	28xm	VR4	6m	Ric
N024	RP107Q242B	LVR-IC	LDO, 2.4V±1%, 200mA, +CE	SC-88A	28xm	VR4	6m	Ric
N025	RP107Q252B	LVR-IC	LDO, 2.5V±1%, 200mA, +CE	SC-88A	28xm	VR4	6m	Ric
N026	RP107Q262B	LVR-IC	LDO, 2.6V±1%, 200mA, +CE	SC-88A	28xm	VR4	6m	Ric
N027	RP107Q272B	LVR-IC	LDO, 2.7V±1%, 200mA, +CE	SC-88A	28xm	VR4	6m	Ric
N028	RP107Q282B	LVR-IC	LDO, 2.8V±1%, 200mA, +CE	SC-88A	28xm	VR4	6m	Ric
N029	RP107Q292B	LVR-IC	LDO, 2.9V±1%, 200mA, +CE	SC-88A	28xm	VR4	6m	Ric
N030	RP107Q302B	LVR-IC	LDO, 3.0V±1%, 200mA, +CE	SC-88A	28xm	VR4	6m	Ric
N031	RP107Q312B	LVR-IC	LDO, 3.1V±1%, 200mA, +CE	SC-88A	28xm	VR4	6m	Ric
N032	RP107Q322B	LVR-IC	LDO, 3.2V±1%, 200mA, +CE	SC-88A	28xm	VR4	6m	Ric
N033	RP107Q332B	LVR-IC	LDO, 3.3V±1%, 200mA, +CE	SC-88A	28xm	VR4	6m	Ric
N034	RP107Q342B	LVR-IC	LDO, 3.4V±1%, 200mA, +CE	SC-88A	28xm	VR4	6m	Ric
N035	RP107Q352B	LVR-IC	LDO, 3.5V±1%, 200mA, +CE	SC-88A	28xm	VR4	6m	Ric
N036	RP107Q362B	LVR-IC	LDO, 3.6V±1%, 200mA, +CE	SC-88A	28xm	VR4	6m	Ric
N037	RP107Q372B	LVR-IC	LDO, 3.7V±1%, 200mA, +CE	SC-88A	28xm	VR4	6m	Ric
N038	RP107Q382B	LVR-IC	LDO, 3.8V±1%, 200mA, +CE	SC-88A	28xm	VR4	6m	Ric
N039	RP107Q392B	LVR-IC	LDO, 3.9V±1%, 200mA, +CE	SC-88A	28xm	VR4	6m	Ric
N040	RP107Q402B	LVR-IC	LDO, 4.0V±1%, 200mA, +CE	SC-88A	28xm	VR4	6m	Ric
N041	RP107Q412B	LVR-IC	LDO, 4.1V±1%, 200mA, +CE	SC-88A	28xm	VR4	6m	Ric
N042	RP107Q422B	LVR-IC	LDO, 4.2V±1%, 200mA, +CE	SC-88A	28xm	VR4	6m	Ric
N043	RP107Q122B5	LVR-IC	LDO, 1.25V±1%, 200mA, +CE	SC-88A	28xm	VR4	6m	Ric
N044	RP107Q182B5	LVR-IC	LDO, 1.85V±1%, 200mA, +CE	SC-88A	28xm	VR4	6m	Ric
N045	RP107Q282B5	LVR-IC	LDO, 2.85V±1%, 200mA, +CE	SC-88A	28xm	VR4	6m	Ric
N09	82N09-AF5-B	Vdet-IC	0.9V±2% -Reset ODO	SOT-23-5	28vda	VD6	6a	Utc
N09G	82N09G-AF5-B	Vdet-IC	0.9V±2% -Reset ODO, halogen free	SOT-23-5	28vda	VD6	6a	Utc
N09L	82N09L-AF5-B	Vdet-IC	0.9V±2% -Reset ODO, lead free	SOT-23-5	28vda	VD6	6a	Utc
N0A	R3117N311A	Vdet-IC	3.1V±1%, -Reset ODO, Sense	SOT-23-5	28rr	VD11	6g	Ric
N0A	XC6108N30AMR	Vdet-IC	3.0V±2%, Hysteresis, -Reset ODO	SOT-25	28rm	VD14	6g	Tor
N0A	XC6118C20AMR-G	Vdet-IC	2.0V±2%, ±Reset PPO, Sense, hysteresis 5%, Cd	SOT-25	28mg	VD15	6g	Tor
N0B	R3117N321A	Vdet-IC	3.2V±1%, -Reset ODO, Sense	SOT-23-5	28rr	VD11	6g	Ric
N0B	XC6108N30BMR	Vdet-IC	3.0V±2%, -Reset ODO	SOT-25	28rm	VD14	6g	Tor
N0B	XC6118C20BMR-G	Vdet-IC	2.0V±2%, ±Reset PPO, Sense, hysteresis <1%, Cd	SOT-25	28mg	VD15	6g	Tor
N0C	R3117N331A	Vdet-IC	3.3V±1%, -Reset ODO, Sense	SOT-23-5	28rr	VD11	6g	Ric
N0C	XC6108N30CMR	Vdet-IC	3.0V±2%, Hysteresis, -Reset ODO	SOT-25	28rk	VD14	6g	Tor
N0C	XC6118C20CMR-G	Vdet-IC	2.0V±2%, ±Reset PPO, Sense, hysteresis 5%	SOT-25	28mf	VD12	6g	Tor
N0D	R3117N341A	Vdet-IC	3.4V±1%, -Reset ODO, Sense	SOT-23-5	28rr	VD11	6g	Ric
N0D	XC6108N30DMR	Vdet-IC	3.0V±2%, -Reset ODO	SOT-25	28rk	VD14	6g	Tor
N0D	XC6118C20DMR-G	Vdet-IC	2.0V±2%, ±Reset PPO, Sense, hysteresis <1%	SOT-25	28mf	VD12	6g	Tor
N0E	R3117N351A	Vdet-IC	3.5V±1%, -Reset ODO, Sense	SOT-23-5	28rr	VD11	6g	Ric
N0F	R3117N361A	Vdet-IC	3.6V±1%, -Reset ODO, Sense	SOT-23-5	28rr	VD11	6g	Ric
N0G	R3117N371A	Vdet-IC	3.7V±1%, -Reset ODO, Sense	SOT-23-5	28rr	VD11	6g	Ric
N0H	R3117N381A	Vdet-IC	3.8V±1%, -Reset ODO, Sense	SOT-23-5	28rr	VD11	6g	Ric
N0J	R3117N391A	Vdet-IC	3.9V±1%, -Reset ODO, Sense	SOT-23-5	28rr	VD11	6g	Ric
N0K	R3117N401A	Vdet-IC	4.0V±1%, -Reset ODO, Sense	SOT-23-5	28rr	VD11	6g	Ric
N0L	R3117N411A	Vdet-IC	4.1V±1%, -Reset ODO, Sense	SOT-23-5	28rr	VD11	6g	Ric
N0M	R3117N421A	Vdet-IC	4.2V±1%, -Reset ODO, Sense	SOT-23-5	28rr	VD11	6g	Ric
N0N	R3117N431A	Vdet-IC	4.3V±1%, -Reset ODO, Sense	SOT-23-5	28rr	VD11	6g	Ric
N0P	R3117N441A	Vdet-IC	4.4V±1%, -Reset ODO, Sense	SOT-23-5	28rr	VD11	6g	Ric
N0Q	R3117N451A	Vdet-IC	4.5V±1%, -Reset ODO, Sense	SOT-23-5	28rr	VD11	6g	Ric
N0R	R3117N461A	Vdet-IC	4.6V±1%, -Reset ODO, Sense	SOT-23-5	28rr	VD11	6g	Ric
N0S	R3117N471A	Vdet-IC	4.7V±1%, -Reset ODO, Sense	SOT-23-5	28rr	VD11	6g	Ric
N0T	R3117N481A	Vdet-IC	4.8V±1%, -Reset ODO, Sense	SOT-23-5	28rr	VD11	6g	Ric
N0U	R3117N491A	Vdet-IC	4.9V±1%, -Reset ODO, Sense	SOT-23-5	28rr	VD11	6g	Ric
N0V	R3117N501A	Vdet-IC	5.0V±1%, -Reset ODO, Sense	SOT-23-5	28rr	VD11	6g	Ric
N1	AP139-18TW	LVR-IC	LDO, LN, +CE, 1.8V±2%, 300mA	TSOT-23-5L	28vrx	VR7	6a	Ana
N1	AP139-18W	LVR-IC	LDO, LN, +CE, 1.8V±2%, 300mA	SOT-23-5L	28vrx	VR7	6k	Ana
N1	R1121N411A	LVR-IC	LDO, LN, -CE, 4.1V±2%, 150mA	SOT-23-5	28vt	VR4	6g	Ric
N1	TC1185-2.5VRX	LVR-IC	LDO, 2.5V±2%, 150mA, +CE	SOT-23-5	28vrx	VR7	6g	Mcc
N1	RN5RY511A	DC/DC-IC	VFM step-up, 5.1V±2.5%, 150mW, <180kHz	SOT-23-5	28vd	DC5	6g	Ric
N10	82N10-AF5-B	Vdet-IC	1.0V±2% -Reset ODO	SOT-23-5	28vda	VD6	6a	Utc
N10G	82N10G-AF5-B	Vdet-IC	1.0V±2% -Reset ODO, halogen free	SOT-23-5	28vda	VD6	6a	Utc
N10L	82N10L-AF5-B	Vdet-IC	1.0V±2% -Reset ODO, lead free	SOT-23-5	28vda	VD6	6a	Utc
N11	82N11-AF5-B	Vdet-IC	1.1V±2% -Reset ODO	SOT-23-5	28vda	VD6	6a	Utc
N110	XC6366D101MR	DC/DC-IC	PWM/PFM st-down, 100kHz, Adj. 1.5..6V±2.5%, 1A, +CE, soft start	SOT-25	28zn	DC18	6g	Tor
N11G	82N11G-AF5-B	Vdet-IC	1.1V±2% -Reset ODO, halogen free	SOT-23-5	28vda	VD6	6a	Utc
N11L	82N11L-AF5-B	Vdet-IC	1.1V±2% -Reset ODO, lead free	SOT-23-5	28vda	VD6	6a	Utc
N12	82N12-AF5-B	Vdet-IC	1.2V±2% -Reset ODO	SOT-23-5	28vda	VD6	6a	Utc



SMD code	Type	Function	Short description	Case	Pinout	Sch.	St.	Mnf.
N12G	82N12G-AF5-B	Vdet-IC	1.2V±2% -Reset ODO, halogen free	SOT-23-5	28vda	VD6	6a	Utc
N12L	82N12L-AF5-B	Vdet-IC	1.2V±2% -Reset ODO, lead free	SOT-23-5	28vda	VD6	6a	Utc
N13	82N13-AF5-B	Vdet-IC	1.3V±2% -Reset ODO	SOT-23-5	28vda	VD6	6a	Utc
N13G	82N13G-AF5-B	Vdet-IC	1.3V±2% -Reset ODO, halogen free	SOT-23-5	28vda	VD6	6a	Utc
N13L	82N13L-AF5-B	Vdet-IC	1.3V±2% -Reset ODO, lead free	SOT-23-5	28vda	VD6	6a	Utc
N14	82N14-AF5-B	Vdet-IC	1.4V±2% -Reset ODO	SOT-23-5	28vda	VD6	6a	Utc
N14G	82N14G-AF5-B	Vdet-IC	1.4V±2% -Reset ODO, halogen free	SOT-23-5	28vda	VD6	6a	Utc
N14L	82N14L-AF5-B	Vdet-IC	1.4V±2% -Reset ODO, lead free	SOT-23-5	28vda	VD6	6a	Utc
N15	82N15-AF5-B	Vdet-IC	1.5V±2% -Reset ODO	SOT-23-5	28vda	VD6	6a	Utc
N15G	82N15G-AF5-B	Vdet-IC	1.5V±2% -Reset ODO, halogen free	SOT-23-5	28vda	VD6	6a	Utc
N15L	82N15L-AF5-B	Vdet-IC	1.5V±2% -Reset ODO, lead free	SOT-23-5	28vda	VD6	6a	Utc
N16	82N16-AF5-B	Vdet-IC	1.6V±2% -Reset ODO	SOT-23-5	28vda	VD6	6a	Utc
N16G	82N16G-AF5-B	Vdet-IC	1.6V±2% -Reset ODO, halogen free	SOT-23-5	28vda	VD6	6a	Utc
N16L	82N16L-AF5-B	Vdet-IC	1.6V±2% -Reset ODO, lead free	SOT-23-5	28vda	VD6	6a	Utc
N17	82N17-AF5-B	Vdet-IC	1.7V±2% -Reset ODO	SOT-23-5	28vda	VD6	6a	Utc
N17G	82N17G-AF5-B	Vdet-IC	1.7V±2% -Reset ODO, halogen free	SOT-23-5	28vda	VD6	6a	Utc
N17L	82N17L-AF5-B	Vdet-IC	1.7V±2% -Reset ODO, lead free	SOT-23-5	28vda	VD6	6a	Utc
N18	82N18-AF5-B	Vdet-IC	1.8V±2% -Reset ODO	SOT-23-5	28vda	VD6	6a	Utc
N18G	82N18G-AF5-B	Vdet-IC	1.8V±2% -Reset ODO, halogen free	SOT-23-5	28vda	VD6	6a	Utc
N18L	82N18L-AF5-B	Vdet-IC	1.8V±2% -Reset ODO, lead free	SOT-23-5	28vda	VD6	6a	Utc
N19	82N19-AF5-B	Vdet-IC	1.9V±2% -Reset ODO	SOT-23-5	28vda	VD6	6a	Utc
N19G	82N19G-AF5-B	Vdet-IC	1.9V±2% -Reset ODO, halogen free	SOT-23-5	28vda	VD6	6a	Utc
N19L	82N19L-AF5-B	Vdet-IC	1.9V±2% -Reset ODO, lead free	SOT-23-5	28vda	VD6	6a	Utc
N1A	R3117N311C	Vdet-IC	3.1V±1%, -Reset PPO, Sense	SOT-23-5	28rr	VD12	6g	Ric
N1A	XC6108N31AMR	Vdet-IC	3.1V±2%, Hysteresis, -Reset ODO	SOT-25	28rm	VD14	6g	Tor
N1A	XC6118C21AMR-G	Vdet-IC	2.1V±2%, ±Reset PPO, Sense, hysteresis 5%, Cd	SOT-25	28mg	VD15	6g	Tor
N1B	R3117N321C	Vdet-IC	3.2V±1%, -Reset PPO, Sense	SOT-23-5	28rr	VD12	6g	Ric
N1B	XC6108N31BMR	Vdet-IC	3.1V±2%, -Reset ODO	SOT-25	28rm	VD14	6g	Tor
N1B	XC6118C21BMR-G	Vdet-IC	2.1V±2%, ±Reset PPO, Sense, hysteresis <1%, Cd	SOT-25	28mg	VD15	6g	Tor
N1C	R3117N331C	Vdet-IC	3.3V±1%, -Reset PPO, Sense	SOT-23-5	28rr	VD12	6g	Ric
N1C	XC6108N31CMR	Vdet-IC	3.1V±2%, Hysteresis, -Reset ODO	SOT-25	28rk	VD14	6g	Tor
N1C	XC6118C21CMR-G	Vdet-IC	2.1V±2%, ±Reset PPO, Sense, hysteresis 5%	SOT-25	28mf	VD12	6g	Tor
N1D	R3117N341C	Vdet-IC	3.4V±1%, -Reset PPO, Sense	SOT-23-5	28rr	VD12	6g	Ric
N1D	XC6108N31DMR	Vdet-IC	3.1V±2%, -Reset ODO	SOT-25	28rk	VD14	6g	Tor
N1D	XC6118C21DMR-G	Vdet-IC	2.1V±2%, ±Reset PPO, Sense, hysteresis <1%	SOT-25	28mf	VD12	6g	Tor
N1E	R3117N351C	Vdet-IC	3.5V±1%, -Reset PPO, Sense	SOT-23-5	28rr	VD12	6g	Ric
N1F	R3117N361C	Vdet-IC	3.6V±1%, -Reset PPO, Sense	SOT-23-5	28rr	VD12	6g	Ric
N1G	R3117N371C	Vdet-IC	3.7V±1%, -Reset PPO, Sense	SOT-23-5	28rr	VD12	6g	Ric
N1H	R3117N381C	Vdet-IC	3.8V±1%, -Reset PPO, Sense	SOT-23-5	28rr	VD12	6g	Ric
N1J	R3117N391C	Vdet-IC	3.9V±1%, -Reset PPO, Sense	SOT-23-5	28rr	VD12	6g	Ric
N1K	R3117N401C	Vdet-IC	4.0V±1%, -Reset PPO, Sense	SOT-23-5	28rr	VD12	6g	Ric
N1L	R3117N411C	Vdet-IC	4.1V±1%, -Reset PPO, Sense	SOT-23-5	28rr	VD12	6g	Ric
N1M	R3117N421C	Vdet-IC	4.2V±1%, -Reset PPO, Sense	SOT-23-5	28rr	VD12	6g	Ric
N1N	R3117N431C	Vdet-IC	4.3V±1%, -Reset PPO, Sense	SOT-23-5	28rr	VD12	6g	Ric
N1P	R3117N441C	Vdet-IC	4.4V±1%, -Reset PPO, Sense	SOT-23-5	28rr	VD12	6g	Ric
N1Q	R3117N451C	Vdet-IC	4.5V±1%, -Reset PPO, Sense	SOT-23-5	28rr	VD12	6g	Ric
N1R	R3117N461C	Vdet-IC	4.6V±1%, -Reset PPO, Sense	SOT-23-5	28rr	VD12	6g	Ric
N1S	R3117N471C	Vdet-IC	4.7V±1%, -Reset PPO, Sense	SOT-23-5	28rr	VD12	6g	Ric
N1T	R3117N481C	Vdet-IC	4.8V±1%, -Reset PPO, Sense	SOT-23-5	28rr	VD12	6g	Ric
N1U	R3117N491C	Vdet-IC	4.9V±1%, -Reset PPO, Sense	SOT-23-5	28rr	VD12	6g	Ric
N1V	R3117N501C	Vdet-IC	5.0V±1%, -Reset PPO, Sense	SOT-23-5	28rr	VD12	6m	Ric
N2	AP139-20TW	LVR-IC	LDO, LN, +CE, 2.0V±2%, 300mA	TSOT-23-5L	28vrx	VR7	6a	Ana
N2	AP139-20W	LVR-IC	LDO, LN, +CE, 2.0V±2%, 300mA	TSOT-23-5L	28vrx	VR7	6k	Ana
N2	KRC666E	Si-npn-Digi	Dual, Sw, 50V, 100mA, 200mW, R1/R2=1k/10k	TESV	30/TD6	-	6l	Kec
N2	KRC666U	Si-npn-Digi	Dual, Sw, 50V, 100mA, 200mW, R1/R2=1k/10k	USV	28/TD9	-	6l	Kec
N2	R1121N421A	LVR-IC	LDO, LN, -CE, 4.2V±2%, 150mA	SOT-23-5	28vt	VR4	6g	Ric
N2	TC1185-2.7VRX	LVR-IC	LDO, 2.7V±2%, 150mA, +CE	SOT-23-5	28vrx	VR7	6g	Mcc
N̄2	RN5RY521A	DC/DC-IC	VFM step-up, 5.2V±2.5%, 150mW, <180kHz	SOT-23-5	28vd	DC5	6g	Ric
N20	82N20-AF5-B	Vdet-IC	2.0V±2% -Reset ODO	SOT-23-5	28vda	VD6	6a	Utc
N20G	82N20G-AF5-B	Vdet-IC	2.0V±2% -Reset ODO, halogen free	SOT-23-5	28vda	VD6	6a	Utc
N20L	82N20L-AF5-B	Vdet-IC	2.0V±2% -Reset ODO, lead free	SOT-23-5	28vda	VD6	6a	Utc
N21	82N21-AF5-B	Vdet-IC	2.1V±2% -Reset ODO	SOT-23-5	28vda	VD6	6a	Utc
N210	XC6366D102MR	DC/DC-IC	PWM/PPM st-down, 180kHz, Adj. 1.5..6V±2.5%, 1A, +CE, soft start	SOT-25	28zn	DC18	6g	Tor
N21G	82N21G-AF5-B	Vdet-IC	2.1V±2% -Reset ODO, halogen free	SOT-23-5	28vda	VD6	6a	Utc
N21L	82N21L-AF5-B	Vdet-IC	2.1V±2% -Reset ODO, lead free	SOT-23-5	28vda	VD6	6a	Utc
N22	82N22-AF5-B	Vdet-IC	2.2V±2% -Reset ODO	SOT-23-5	28vda	VD6	6a	Utc
N22G	82N22G-AF5-B	Vdet-IC	2.2V±2% -Reset ODO, halogen free	SOT-23-5	28vda	VD6	6a	Utc
N22L	82N22L-AF5-B	Vdet-IC	2.2V±2% -Reset ODO, lead free	SOT-23-5	28vda	VD6	6a	Utc
N23	82N23-AF5-B	Vdet-IC	2.3V±2% -Reset ODO	SOT-23-5	28vda	VD6	6a	Utc
N23G	82N23G-AF5-B	Vdet-IC	2.3V±2% -Reset ODO, halogen free	SOT-23-5	28vda	VD6	6a	Utc



SMD code	Type	Function	Short description	Case	Pinout	Sch.	St.	Mnf.
N23L	82N23L-AF5-B	Vdet-IC	2.3V±2% -Reset ODO, lead free	SOT-23-5	28vda	VD6	6a	Utc
N24	82N24-AF5-B	Vdet-IC	2.4V±2% -Reset ODO	SOT-23-5	28vda	VD6	6a	Utc
N24G	82N24G-AF5-B	Vdet-IC	2.4V±2% -Reset ODO, halogen free	SOT-23-5	28vda	VD6	6a	Utc
N24L	82N24L-AF5-B	Vdet-IC	2.4V±2% -Reset ODO, lead free	SOT-23-5	28vda	VD6	6a	Utc
N25	82N25-AF5-B	Vdet-IC	2.5V±2% -Reset ODO	SOT-23-5	28vda	VD6	6a	Utc
N25G	82N25G-AF5-B	Vdet-IC	2.5V±2% -Reset ODO, halogen free	SOT-23-5	28vda	VD6	6a	Utc
N25L	82N25L-AF5-B	Vdet-IC	2.5V±2% -Reset ODO, lead free	SOT-23-5	28vda	VD6	6a	Utc
N26	82N26-AF5-B	Vdet-IC	2.6V±2% -Reset ODO	SOT-23-5	28vda	VD6	6a	Utc
N26G	82N26G-AF5-B	Vdet-IC	2.6V±2% -Reset ODO, halogen free	SOT-23-5	28vda	VD6	6a	Utc
N26L	82N26L-AF5-B	Vdet-IC	2.6V±2% -Reset ODO, lead free	SOT-23-5	28vda	VD6	6a	Utc
N27	82N27-AF5-B	Vdet-IC	2.7V±2% -Reset ODO	SOT-23-5	28vda	VD6	6a	Utc
N27G	82N27G-AF5-B	Vdet-IC	2.7V±2% -Reset ODO, halogen free	SOT-23-5	28vda	VD6	6a	Utc
N27L	82N27L-AF5-B	Vdet-IC	2.7V±2% -Reset ODO, lead free	SOT-23-5	28vda	VD6	6a	Utc
N28	82N28-AF5-B	Vdet-IC	2.8V±2% -Reset ODO	SOT-23-5	28vda	VD6	6a	Utc
N28G	82N28G-AF5-B	Vdet-IC	2.8V±2% -Reset ODO, halogen free	SOT-23-5	28vda	VD6	6a	Utc
N28L	82N28L-AF5-B	Vdet-IC	2.8V±2% -Reset ODO, lead free	SOT-23-5	28vda	VD6	6a	Utc
N29	82N29-AF5-B	Vdet-IC	2.9V±2% -Reset ODO	SOT-23-5	28vda	VD6	6a	Utc
N29G	82N29G-AF5-B	Vdet-IC	2.9V±2% -Reset ODO, halogen free	SOT-23-5	28vda	VD6	6a	Utc
N29L	82N29L-AF5-B	Vdet-IC	2.9V±2% -Reset ODO, lead free	SOT-23-5	28vda	VD6	6a	Utc
N2A	S-1121B15MC	LVR-IC	LDO, 1.5V±1.0%, 150mA, +CE	SOT-23-5	28vt	VR4	6a	Sii
N2A	S-1121B15PN	LVR-IC	LDO, 1.5V±1.0%, 150mA, +CE	SOM-5	30vr4	VR4	6a	Sii
N2A	XC6108N32AMR	Vdet-IC	3.2V±2%, Hysteresis, -Reset ODO	SOT-25	28rm	VD14	6g	Tor
N2A	XC6118C22AMR-G	Vdet-IC	2.2V±2%, ±Reset PPO, Sense, hysteresis 5%, Cd	SOT-25	28mg	VD15	6g	Tor
N2B	S-1121B16MC	LVR-IC	LDO, 1.6V±1.0%, 150mA, +CE	SOT-23-5	28vt	VR4	6a	Sii
N2B	S-1121B16PN	LVR-IC	LDO, 1.6V±1.0%, 150mA, +CE	SOM-5	30vr4	VR4	6a	Sii
N2B	XC6108N32BMR	Vdet-IC	3.2V±2%, -Reset ODO	SOT-25	28rm	VD14	6g	Tor
N2B	XC6118C22BMR-G	Vdet-IC	2.2V±2%, ±Reset PPO, Sense, hysteresis <1%, Cd	SOT-25	28mg	VD15	6g	Tor
N2C	S-1121B17MC	LVR-IC	LDO, 1.7V±1.0%, 150mA, +CE	SOT-23-5	28vt	VR4	6a	Sii
N2C	S-1121B17PN	LVR-IC	LDO, 1.7V±1.0%, 150mA, +CE	SOM-5	30vr4	VR4	6a	Sii
N2C	XC6108N32CMR	Vdet-IC	3.2V±2%, Hysteresis, -Reset ODO	SOT-25	28rk	VD14	6g	Tor
N2C	XC6118C22CMR-G	Vdet-IC	2.2V±2%, ±Reset PPO, Sense, hysteresis 5%	SOT-25	28mf	VD12	6g	Tor
N2D	S-1121B18MC	LVR-IC	LDO, 1.8V±1.0%, 150mA, +CE	SOT-23-5	28vt	VR4	6a	Sii
N2D	S-1121B18PN	LVR-IC	LDO, 1.8V±1.0%, 150mA, +CE	SOM-5	30vr4	VR4	6a	Sii
N2D	XC6108N32DMR	Vdet-IC	3.2V±2%, -Reset ODO	SOT-25	28rk	VD14	6g	Tor
N2D	XC6118C22DMR-G	Vdet-IC	2.2V±2%, ±Reset PPO, Sense, hysteresis <1%	SOT-25	28mf	VD12	6g	Tor
N2E	S-1121B19MC	LVR-IC	LDO, 1.9V±1.0%, 150mA, +CE	SOT-23-5	28vt	VR4	6a	Sii
N2E	S-1121B19PN	LVR-IC	LDO, 1.9V±1.0%, 150mA, +CE	SOM-5	30vr4	VR4	6a	Sii
N2F	S-1121B20MC	LVR-IC	LDO, 2.0V±1.0%, 150mA, +CE	SOT-23-5	28vt	VR4	6a	Sii
N2F	S-1121B20PN	LVR-IC	LDO, 2.0V±1.0%, 150mA, +CE	SOM-5	30vr4	VR4	6a	Sii
N2G	S-1121B21MC	LVR-IC	LDO, 2.1V±1.0%, 150mA, +CE	SOT-23-5	28vt	VR4	6a	Sii
N2G	S-1121B21PN	LVR-IC	LDO, 2.1V±1.0%, 150mA, +CE	SOM-5	30vr4	VR4	6a	Sii
N2H	S-1121B22MC	LVR-IC	LDO, 2.2V±1.0%, 150mA, +CE	SOT-23-5	28vt	VR4	6a	Sii
N2H	S-1121B22PN	LVR-IC	LDO, 2.2V±1.0%, 150mA, +CE	SOM-5	30vr4	VR4	6a	Sii
N2I	S-1121B23MC	LVR-IC	LDO, 2.3V±1.0%, 150mA, +CE	SOT-23-5	28vt	VR4	6a	Sii
N2I	S-1121B23PN	LVR-IC	LDO, 2.3V±1.0%, 150mA, +CE	SOM-5	30vr4	VR4	6a	Sii
N2J	S-1121B24MC	LVR-IC	LDO, 2.4V±1.0%, 150mA, +CE	SOT-23-5	28vt	VR4	6a	Sii
N2J	S-1121B24PN	LVR-IC	LDO, 2.4V±1.0%, 150mA, +CE	SOM-5	30vr4	VR4	6a	Sii
N2K	S-1121B25MC	LVR-IC	LDO, 2.5V±1.0%, 150mA, +CE	SOT-23-5	28vt	VR4	6a	Sii
N2K	S-1121B25PN	LVR-IC	LDO, 2.5V±1.0%, 150mA, +CE	SOM-5	30vr4	VR4	6a	Sii
N2L	S-1121B26MC	LVR-IC	LDO, 2.6V±1.0%, 150mA, +CE	SOT-23-5	28vt	VR4	6a	Sii
N2L	S-1121B26PN	LVR-IC	LDO, 2.6V±1.0%, 150mA, +CE	SOM-5	30vr4	VR4	6a	Sii
N2M	S-1121B27MC	LVR-IC	LDO, 2.7V±1.0%, 150mA, +CE	SOT-23-5	28vt	VR4	6a	Sii
N2M	S-1121B27PN	LVR-IC	LDO, 2.7V±1.0%, 150mA, +CE	SOM-5	30vr4	VR4	6a	Sii
N2N	S-1121B28MC	LVR-IC	LDO, 2.8V±1.0%, 150mA, +CE	SOT-23-5	28vt	VR4	6a	Sii
N2N	S-1121B28PN	LVR-IC	LDO, 2.8V±1.0%, 150mA, +CE	SOM-5	30vr4	VR4	6a	Sii
N2O	S-1121B29MC	LVR-IC	LDO, 2.9V±1.0%, 150mA, +CE	SOT-23-5	28vt	VR4	6a	Sii
N2O	S-1121B29PN	LVR-IC	LDO, 2.9V±1.0%, 150mA, +CE	SOM-5	30vr4	VR4	6a	Sii
N2P	S-1121B30MC	LVR-IC	LDO, 3.0V±1.0%, 150mA, +CE	SOT-23-5	28vt	VR4	6a	Sii
N2P	S-1121B30PN	LVR-IC	LDO, 3.0V±1.0%, 150mA, +CE	SOM-5	30vr4	VR4	6a	Sii
N2Q	S-1121B31MC	LVR-IC	LDO, 3.1V±1.0%, 150mA, +CE	SOT-23-5	28vt	VR4	6a	Sii
N2Q	S-1121B31PN	LVR-IC	LDO, 3.1V±1.0%, 150mA, +CE	SOM-5	30vr4	VR4	6a	Sii
N2R	S-1121B32MC	LVR-IC	LDO, 3.2V±1.0%, 150mA, +CE	SOT-23-5	28vt	VR4	6a	Sii
N2R	S-1121B32PN	LVR-IC	LDO, 3.2V±1.0%, 150mA, +CE	SOM-5	30vr4	VR4	6a	Sii
N2S	S-1121B33MC	LVR-IC	LDO, 3.3V±1.0%, 150mA, +CE	SOT-23-5	28vt	VR4	6a	Sii
N2S	S-1121B33PN	LVR-IC	LDO, 3.3V±1.0%, 150mA, +CE	SOM-5	30vr4	VR4	6a	Sii
N2T	S-1121B34MC	LVR-IC	LDO, 3.4V±1.0%, 150mA, +CE	SOT-23-5	28vt	VR4	6a	Sii
N2T	S-1121B34PN	LVR-IC	LDO, 3.4V±1.0%, 150mA, +CE	SOM-5	30vr4	VR4	6a	Sii
N2U	S-1121B35MC	LVR-IC	LDO, 3.5V±1.0%, 150mA, +CE	SOT-23-5	28vt	VR4	6a	Sii
N2U	S-1121B35PN	LVR-IC	LDO, 3.5V±1.0%, 150mA, +CE	SOM-5	30vr4	VR4	6a	Sii
N2V	S-1121B36MC	LVR-IC	LDO, 3.6V±1.0%, 150mA, +CE	SOT-23-5	28vt	VR4	6a	Sii



SMD code	Type	Function	Short description	Case	Pinout	Sch.	St.	Mnf.
N2V	S-1121B36PN	LVR-IC	LDO, 3.6V±1.0%, 150mA, +CE	SON-5	30vr4	VR4	6a	Sii
N2W	S-1121B37MC	LVR-IC	LDO, 3.7V±1.0%, 150mA, +CE	SOT-23-5	28vt	VR4	6a	Sii
N2X	S-1121B37PN	LVR-IC	LDO, 3.7V±1.0%, 150mA, +CE	SON-5	30vr4	VR4	6a	Sii
N2X	S-1121B38MC	LVR-IC	LDO, 3.8V±1.0%, 150mA, +CE	SOT-23-5	28vt	VR4	6a	Sii
N2X	S-1121B38PN	LVR-IC	LDO, 3.8V±1.0%, 150mA, +CE	SON-5	30vr4	VR4	6a	Sii
N2Y	S-1121B39MC	LVR-IC	LDO, 3.9V±1.0%, 150mA, +CE	SOT-23-5	28vt	VR4	6a	Sii
N2Y	S-1121B39PN	LVR-IC	LDO, 3.9V±1.0%, 150mA, +CE	SON-5	30vr4	VR4	6a	Sii
N2Z	S-1121B40MC	LVR-IC	LDO, 4.0V±1.0%, 150mA, +CE	SOT-23-5	28vt	VR4	6a	Sii
N2Z	S-1121B40PN	LVR-IC	LDO, 4.0V±1.0%, 150mA, +CE	SON-5	30vr4	VR4	6a	Sii
N3	AP139-25TW	LVR-IC	LDO, LN, +CE, 2.5V±2%, 300mA	TSOT-23-5L	28vrx	VR7	6a	Ana
N3	AP139-25W	LVR-IC	LDO, LN, +CE, 2.5V±2%, 300mA	SOT-23-5L	28vrx	VR7	6k	Ana
N3	R1121N431A	LVR-IC	LDO, LN, -CE, 4.3V±2%, 150mA	SOT-23-5	28vt	VR4	6g	Ric
N3	TC1185-3.0VRX	LVR-IC	LDO, 3V±2%, 150mA, +CE	SOT-23-5	28vrx	VR7	6g	Mcc
N3	RN5RY531A	DC/DC-IC	VFM step-up, 5.3V±2.5%, 150mW, <180kHz	SOT-23-5	28vd	DC5	6g	Ric
N30	82N30-AF5-B	Vdet-IC	3.0V±2% -Reset ODO	SOT-23-5	28vda	VD6	6a	Utc
N30G	82N30G-AF5-B	Vdet-IC	3.0V±2% -Reset ODO, halogen free	SOT-23-5	28vda	VD6	6a	Utc
N30L	82N30L-AF5-B	Vdet-IC	3.0V±2% -Reset ODO, lead free	SOT-23-5	28vda	VD6	6a	Utc
N31	82N31-AF5-B	Vdet-IC	3.1V±2% -Reset ODO	SOT-23-5	28vda	VD6	6a	Utc
N310	XC6366D103MR	DC/DC-IC	PWM/PPM st-down, 300kHz, Adj. 1.5..6V±2.5%, 1A, +CE, soft start	SOT-25	28zn	DC18	6g	Tor
N31G	82N31G-AF5-B	Vdet-IC	3.1V±2% -Reset ODO, halogen free	SOT-23-5	28vda	VD6	6a	Utc
N31L	82N31L-AF5-B	Vdet-IC	3.1V±2% -Reset ODO, lead free	SOT-23-5	28vda	VD6	6a	Utc
N32	82N32-AF5-B	Vdet-IC	3.2V±2% -Reset ODO	SOT-23-5	28vda	VD6	6a	Utc
N32G	82N32G-AF5-B	Vdet-IC	3.2V±2% -Reset ODO, halogen free	SOT-23-5	28vda	VD6	6a	Utc
N32L	82N32L-AF5-B	Vdet-IC	3.2V±2% -Reset ODO, lead free	SOT-23-5	28vda	VD6	6a	Utc
N33	82N33-AF5-B	Vdet-IC	3.3V±2% -Reset ODO	SOT-23-5	28vda	VD6	6a	Utc
N33G	82N33G-AF5-B	Vdet-IC	3.3V±2% -Reset ODO, halogen free	SOT-23-5	28vda	VD6	6a	Utc
N33L	82N33L-AF5-B	Vdet-IC	3.3V±2% -Reset ODO, lead free	SOT-23-5	28vda	VD6	6a	Utc
N34	82N34-AF5-B	Vdet-IC	3.4V±2% -Reset ODO	SOT-23-5	28vda	VD6	6a	Utc
N34G	82N34G-AF5-B	Vdet-IC	3.4V±2% -Reset ODO, halogen free	SOT-23-5	28vda	VD6	6a	Utc
N34L	82N34L-AF5-B	Vdet-IC	3.4V±2% -Reset ODO, lead free	SOT-23-5	28vda	VD6	6a	Utc
N35	82N35-AF5-B	Vdet-IC	3.5V±2% -Reset ODO	SOT-23-5	28vda	VD6	6a	Utc
N35G	82N35G-AF5-B	Vdet-IC	3.5V±2% -Reset ODO, halogen free	SOT-23-5	28vda	VD6	6a	Utc
N35L	82N35L-AF5-B	Vdet-IC	3.5V±2% -Reset ODO, lead free	SOT-23-5	28vda	VD6	6a	Utc
N36	82N36-AF5-B	Vdet-IC	3.6V±2% -Reset ODO	SOT-23-5	28vda	VD6	6a	Utc
N36G	82N36G-AF5-B	Vdet-IC	3.6V±2% -Reset ODO, halogen free	SOT-23-5	28vda	VD6	6a	Utc
N36L	82N36L-AF5-B	Vdet-IC	3.6V±2% -Reset ODO, lead free	SOT-23-5	28vda	VD6	6a	Utc
N37	82N37-AF5-B	Vdet-IC	3.7V±2% -Reset ODO	SOT-23-5	28vda	VD6	6a	Utc
N37G	82N37G-AF5-B	Vdet-IC	3.7V±2% -Reset ODO, halogen free	SOT-23-5	28vda	VD6	6a	Utc
N37L	82N37L-AF5-B	Vdet-IC	3.7V±2% -Reset ODO, lead free	SOT-23-5	28vda	VD6	6a	Utc
N38	82N38-AF5-B	Vdet-IC	3.8V±2% -Reset ODO	SOT-23-5	28vda	VD6	6a	Utc
N38G	82N38G-AF5-B	Vdet-IC	3.8V±2% -Reset ODO, halogen free	SOT-23-5	28vda	VD6	6a	Utc
N38L	82N38L-AF5-B	Vdet-IC	3.8V±2% -Reset ODO, lead free	SOT-23-5	28vda	VD6	6a	Utc
N39	82N39-AF5-B	Vdet-IC	3.9V±2% -Reset ODO	SOT-23-5	28vda	VD6	6a	Utc
N39G	82N39G-AF5-B	Vdet-IC	3.9V±2% -Reset ODO, halogen free	SOT-23-5	28vda	VD6	6a	Utc
N39L	82N39L-AF5-B	Vdet-IC	3.9V±2% -Reset ODO, lead free	SOT-23-5	28vda	VD6	6a	Utc
N3A	S-1121B41MC	LVR-IC	LDO, 4.1V±1.0%, 150mA, +CE	SOT-23-5	28vt	VR4	6a	Sii
N3A	S-1121B41PN	LVR-IC	LDO, 4.1V±1.0%, 150mA, +CE	SON-5	30vr4	VR4	6a	Sii
N3A	XC6108N33AMR	Vdet-IC	3.3V±2%, Hysteresis, -Reset ODO	SOT-25	28rm	VD14	6g	Tor
N3A	XC6118C23AMR-G	Vdet-IC	2.3V±2%, ±Reset PPO, Sense, hysteresis 5%, Cd	SOT-25	28mg	VD15	6g	Tor
N3B	S-1121B42MC	LVR-IC	LDO, 4.2V±1.0%, 150mA, +CE	SOT-23-5	28vt	VR4	6a	Sii
N3B	S-1121B42PN	LVR-IC	LDO, 4.2V±1.0%, 150mA, +CE	SON-5	30vr4	VR4	6a	Sii
N3B	XC6108N33BMR	Vdet-IC	3.3V±2%, -Reset ODO	SOT-25	28rm	VD14	6g	Tor
N3B	XC6118C23BMR-G	Vdet-IC	2.3V±2%, ±Reset PPO, Sense, hysteresis <1%, Cd	SOT-25	28mg	VD15	6g	Tor
N3C	S-1121B43MC	LVR-IC	LDO, 4.3V±1.0%, 150mA, +CE	SOT-23-5	28vt	VR4	6a	Sii
N3C	S-1121B43PN	LVR-IC	LDO, 4.3V±1.0%, 150mA, +CE	SON-5	30vr4	VR4	6a	Sii
N3C	XC6108N33CMR	Vdet-IC	3.3V±2%, Hysteresis, -Reset ODO	SOT-25	28rk	VD14	6g	Tor
N3C	XC6118C23CMR-G	Vdet-IC	2.3V±2%, ±Reset PPO, Sense, hysteresis 5%	SOT-25	28mf	VD12	6g	Tor
N3D	S-1121B44MC	LVR-IC	LDO, 4.4V±1.0%, 150mA, +CE	SOT-23-5	28vt	VR4	6a	Sii
N3D	S-1121B44PN	LVR-IC	LDO, 4.4V±1.0%, 150mA, +CE	SON-5	30vr4	VR4	6a	Sii
N3D	XC6108N33DMR	Vdet-IC	3.3V±2%, -Reset ODO	SOT-25	28rk	VD14	6g	Tor
N3D	XC6118C23DMR-G	Vdet-IC	2.3V±2%, ±Reset PPO, Sense, hysteresis <1%	SOT-25	28mf	VD12	6g	Tor
N3E	S-1121B45MC	LVR-IC	LDO, 4.5V±1.0%, 150mA, +CE	SOT-23-5	28vt	VR4	6a	Sii
N3E	S-1121B45PN	LVR-IC	LDO, 4.5V±1.0%, 150mA, +CE	SON-5	30vr4	VR4	6a	Sii
N3F	S-1121B46MC	LVR-IC	LDO, 4.6V±1.0%, 150mA, +CE	SOT-23-5	28vt	VR4	6a	Sii
N3F	S-1121B46PN	LVR-IC	LDO, 4.6V±1.0%, 150mA, +CE	SON-5	30vr4	VR4	6a	Sii
N3G	S-1121B47MC	LVR-IC	LDO, 4.7V±1.0%, 150mA, +CE	SOT-23-5	28vt	VR4	6a	Sii
N3G	S-1121B47PN	LVR-IC	LDO, 4.7V±1.0%, 150mA, +CE	SON-5	30vr4	VR4	6a	Sii
N3H	S-1121B48MC	LVR-IC	LDO, 4.8V±1.0%, 150mA, +CE	SOT-23-5	28vt	VR4	6a	Sii
N3H	S-1121B48PN	LVR-IC	LDO, 4.8V±1.0%, 150mA, +CE	SON-5	30vr4	VR4	6a	Sii
N3I	S-1121B49MC	LVR-IC	LDO, 4.9V±1.0%, 150mA, +CE	SOT-23-5	28vt	VR4	6a	Sii



SMD code	Type	Function	Short description	Case	Pinout	Sch.	St.	Mnf.
N3I	S-1121B49PN	LVR-IC	LDO, 4.9V±1.0%, 150mA, +CE	SOM-5	30vr4	VR4	6a	Sii
N3J	S-1121B50MC	LVR-IC	LDO, 5.0V±1.0%, 150mA, +CE	SOT-23-5	28vt	VR4	6a	Sii
N3J	S-1121B50PN	LVR-IC	LDO, 5.0V±1.0%, 150mA, +CE	SOM-5	30vr4	VR4	6a	Sii
N3K	S-1121B51MC	LVR-IC	LDO, 5.1V±1.0%, 150mA, +CE	SOT-23-5	28vt	VR4	6a	Sii
N3K	S-1121B51PN	LVR-IC	LDO, 5.1V±1.0%, 150mA, +CE	SOM-5	30vr4	VR4	6a	Sii
N3L	S-1121B52MC	LVR-IC	LDO, 5.2V±1.0%, 150mA, +CE	SOT-23-5	28vt	VR4	6a	Sii
N3L	S-1121B52PN	LVR-IC	LDO, 5.2V±1.0%, 150mA, +CE	SOM-5	30vr4	VR4	6a	Sii
N3M	S-1121B53MC	LVR-IC	LDO, 5.3V±1.0%, 150mA, +CE	SOT-23-5	28vt	VR4	6a	Sii
N3M	S-1121B53PN	LVR-IC	LDO, 5.3V±1.0%, 150mA, +CE	SOM-5	30vr4	VR4	6a	Sii
N3N	S-1121B54MC	LVR-IC	LDO, 5.4V±1.0%, 150mA, +CE	SOT-23-5	28vt	VR4	6a	Sii
N3N	S-1121B54PN	LVR-IC	LDO, 5.4V±1.0%, 150mA, +CE	SOM-5	30vr4	VR4	6a	Sii
N3O	S-1121B55MC	LVR-IC	LDO, 5.5V±1.0%, 150mA, +CE	SOT-23-5	28vt	VR4	6a	Sii
N3O	S-1121B55PN	LVR-IC	LDO, 5.5V±1.0%, 150mA, +CE	SOM-5	30vr4	VR4	6a	Sii
N3P	S-1121B4HMC	LVR-IC	LDO, 4.75V±1.0%, 150mA, +CE	SOT-23-5	28vt	VR4	6a	Sii
N4	AP139-28TW	LVR-IC	LDO, LN, +CE, 2.8V±2%, 300mA	TSOT-23-5L	28vrx	VR7	6a	Ana
N4	AP139-28W	LVR-IC	LDO, LN, +CE, 2.8V±2%, 300mA	SOT-23-5L	28vrx	VR7	6k	Ana
N4	KRC667E	Si-npn-Digi	Dual, Sw, 50V, 100mA, 200mW, R1/R2=2.2k/2.2k	TESV	30/TD6	-	6l	Kec
N4	KRC667U	Si-npn-Digi	Dual, Sw, 50V, 100mA, 200mW, R1/R2=2.2k/2.2k	USV	28/TD9	-	6l	Kec
N4	R1121N441A	LVR-IC	LDO, LN, -CE, 4.4V±2%, 150mA	SOT-23-5	28vt	VR4	6g	Ric
N4	RN5RY541A	DC/DC-IC	VFM step-up, 5.4V±2.5%, 150mW, <180kHz	SOT-23-5	28vd	DC5	6g	Ric
N40	82N40-AF5-B	Vdet-IC	4.0V±2% -Reset ODO	SOT-23-5	28vda	VD6	6a	Utc
N409	MIC5238-0.9BD5	LVR-IC	LDO, 0.9V±2%, 150mA, +CE	TSOT-23-5	28ze	VR11	6g	Mcr
N40G	82N40G-AF5-B	Vdet-IC	4.0V±2% -Reset ODO, halogen free	SOT-23-5	28vda	VD6	6a	Utc
N40L	82N40L-AF5-B	Vdet-IC	4.0V±2% -Reset ODO, lead free	SOT-23-5	28vda	VD6	6a	Utc
N41	82N41-AF5-B	Vdet-IC	4.1V±2% -Reset ODO	SOT-23-5	28vda	VD6	6a	Utc
N410	MIC5238-1.0BD5	LVR-IC	LDO, 1.0V±2%, 150mA, +CE	TSOT-23-5	28ze	VR11	6g	Mcr
N410	XC6366D104MR	DC/DC-IC	PWM/PFM st-down, 500kHz, Adj. 1.5..6V±2.5%, 1A, +CE, soft start	SOT-25	28zn	DC18	6g	Tor
N411	MIC5238-1.1BD5	LVR-IC	LDO, 1.1V±2%, 150mA, +CE	TSOT-23-5	28ze	VR11	6g	Mcr
N412	MIC5238-1.2BD5	LVR-IC	LDO, 1.2V±2%, 150mA, +CE	TSOT-23-5	28ze	VR11	6g	Mcr
N413	MIC5238-1.3BD5	LVR-IC	LDO, 1.3V±2%, 150mA, +CE	TSOT-23-5	28ze	VR11	6g	Mcr
N41G	82N41G-AF5-B	Vdet-IC	4.1V±2% -Reset ODO, halogen free	SOT-23-5	28vda	VD6	6a	Utc
N41L	82N41L-AF5-B	Vdet-IC	4.1V±2% -Reset ODO, lead free	SOT-23-5	28vda	VD6	6a	Utc
N42	82N42-AF5-B	Vdet-IC	4.2V±2% -Reset ODO	SOT-23-5	28vda	VD6	6a	Utc
N42G	82N42G-AF5-B	Vdet-IC	4.2V±2% -Reset ODO, halogen free	SOT-23-5	28vda	VD6	6a	Utc
N42L	82N42L-AF5-B	Vdet-IC	4.2V±2% -Reset ODO, lead free	SOT-23-5	28vda	VD6	6a	Utc
N43	82N43-AF5-B	Vdet-IC	4.3V±2% -Reset ODO	SOT-23-5	28vda	VD6	6a	Utc
N43G	82N43G-AF5-B	Vdet-IC	4.3V±2% -Reset ODO, halogen free	SOT-23-5	28vda	VD6	6a	Utc
N43L	82N43L-AF5-B	Vdet-IC	4.3V±2% -Reset ODO, lead free	SOT-23-5	28vda	VD6	6a	Utc
N44	82N44-AF5-B	Vdet-IC	4.4V±2% -Reset ODO	SOT-23-5	28vda	VD6	6a	Utc
N44G	82N44G-AF5-B	Vdet-IC	4.4V±2% -Reset ODO, halogen free	SOT-23-5	28vda	VD6	6a	Utc
N44L	82N44L-AF5-B	Vdet-IC	4.4V±2% -Reset ODO, lead free	SOT-23-5	28vda	VD6	6a	Utc
N45	82N45-AF5-B	Vdet-IC	4.5V±2% -Reset ODO	SOT-23-5	28vda	VD6	6a	Utc
N45G	82N45G-AF5-B	Vdet-IC	4.5V±2% -Reset ODO, halogen free	SOT-23-5	28vda	VD6	6a	Utc
N45L	82N45L-AF5-B	Vdet-IC	4.5V±2% -Reset ODO, lead free	SOT-23-5	28vda	VD6	6a	Utc
N46	82N46-AF5-B	Vdet-IC	4.6V±2% -Reset ODO	SOT-23-5	28vda	VD6	6a	Utc
N46G	82N46G-AF5-B	Vdet-IC	4.6V±2% -Reset ODO, halogen free	SOT-23-5	28vda	VD6	6a	Utc
N46L	82N46L-AF5-B	Vdet-IC	4.6V±2% -Reset ODO, lead free	SOT-23-5	28vda	VD6	6a	Utc
N47	82N47-AF5-B	Vdet-IC	4.7V±2% -Reset ODO	SOT-23-5	28vda	VD6	6a	Utc
N47G	82N47G-AF5-B	Vdet-IC	4.7V±2% -Reset ODO, halogen free	SOT-23-5	28vda	VD6	6a	Utc
N47L	82N47L-AF5-B	Vdet-IC	4.7V±2% -Reset ODO, lead free	SOT-23-5	28vda	VD6	6a	Utc
N48	82N48-AF5-B	Vdet-IC	4.8V±2% -Reset ODO	SOT-23-5	28vda	VD6	6a	Utc
N48G	82N48G-AF5-B	Vdet-IC	4.8V±2% -Reset ODO, halogen free	SOT-23-5	28vda	VD6	6a	Utc
N48L	82N48L-AF5-B	Vdet-IC	4.8V±2% -Reset ODO, lead free	SOT-23-5	28vda	VD6	6a	Utc
N49	82N49-AF5-B	Vdet-IC	4.9V±2% -Reset ODO	SOT-23-5	28vda	VD6	6a	Utc
N49G	82N49G-AF5-B	Vdet-IC	4.9V±2% -Reset ODO, halogen free	SOT-23-5	28vda	VD6	6a	Utc
N49L	82N49L-AF5-B	Vdet-IC	4.9V±2% -Reset ODO, lead free	SOT-23-5	28vda	VD6	6a	Utc
N4A	XC6108N34AMR	Vdet-IC	3.4V±2%, Hysteresis, -Reset ODO	SOT-25	28rm	VD14	6g	Tor
N4A	XC6118C24AMR-G	Vdet-IC	2.4V±2%, ±Reset PPO, Sense, hysteresis 5%, Cd	SOT-25	28mg	VD15	6g	Tor
N4B	XC6108N34BMR	Vdet-IC	3.4V±2%, -Reset ODO	SOT-25	28rm	VD14	6g	Tor
N4B	XC6118C24BMR-G	Vdet-IC	2.4V±2%, ±Reset PPO, Sense, hysteresis <1%, Cd	SOT-25	28mg	VD15	6g	Tor
N4C	XC6108N34CMR	Vdet-IC	3.4V±2%, Hysteresis, -Reset ODO	SOT-25	28rk	VD14	6g	Tor
N4C	XC6118C24CMR-G	Vdet-IC	2.4V±2%, ±Reset PPO, Sense, hysteresis 5%	SOT-25	28mf	VD12	6g	Tor
N4D	XC6108N34DMR	Vdet-IC	3.4V±2%, -Reset ODO	SOT-25	28rk	VD14	6g	Tor
N4D	XC6118C24DMR-G	Vdet-IC	2.4V±2%, ±Reset PPO, Sense, hysteresis <1%	SOT-25	28mf	VD12	6g	Tor
N5	AP139-30TW	LVR-IC	LDO, LN, +CE, 3.0V±2%, 300mA	TSOT-23-5L	28vrx	VR7	6a	Ana
N5	AP139-30W	LVR-IC	LDO, LN, +CE, 3.0V±2%, 300mA	SOT-23-5L	28vrx	VR7	6k	Ana
N5	KRC668E	Si-npn-Digi	Dual, Sw, 50V, 100mA, 200mW, R1/R2=2.2k/10k	TESV	30/TD6	-	6l	Kec
N5	KRC668U	Si-npn-Digi	Dual, Sw, 50V, 100mA, 200mW, R1/R2=2.2k/10k	USV	28/TD9	-	6l	Kec
N5	R1121N451A	LVR-IC	LDO, LN, -CE, 4.5V±2%, 150mA	SOT-23-5	28vt	VR4	6g	Ric
N5	TC1185-3.3VRX	LVR-IC	LDO, 3.3V±2%, 150mA, +CE	SOT-23-5	28vrx	VR7	6g	Mcc



SMD code	Type	Function	Short description	Case	Pinout	Sch.	St.	Mnf.
N5	RN5RY551A	DC/DC-IC	VFM step-up, 5.5V±2.5%, 150mW, <180kHz	SOT-23-5	28vd	DC5	6g	Ric
N50	82N50-AF5-B	Vdet-IC	5.0V±2% -Reset ODO	SOT-23-5	28vda	VD6	6a	Utc
N50G	82N50G-AF5-B	Vdet-IC	5.0V±2% -Reset ODO, halogen free	SOT-23-5	28vda	VD6	6a	Utc
N50L	82N50L-AF5-B	Vdet-IC	5.0V±2% -Reset ODO, lead free	SOT-23-5	28vda	VD6	6a	Utc
N51	82N51-AF5-B	Vdet-IC	5.1V±2% -Reset ODO	SOT-23-5	28vda	VD6	6a	Utc
N51G	82N51G-AF5-B	Vdet-IC	5.1V±2% -Reset ODO, halogen free	SOT-23-5	28vda	VD6	6a	Utc
N51L	82N51L-AF5-B	Vdet-IC	5.1V±2% -Reset ODO, lead free	SOT-23-5	28vda	VD6	6a	Utc
N52	82N52-AF5-B	Vdet-IC	5.2V±2% -Reset ODO	SOT-23-5	28vda	VD6	6a	Utc
N52G	82N52G-AF5-B	Vdet-IC	5.2V±2% -Reset ODO, halogen free	SOT-23-5	28vda	VD6	6a	Utc
N52L	82N52L-AF5-B	Vdet-IC	5.2V±2% -Reset ODO, lead free	SOT-23-5	28vda	VD6	6a	Utc
N53	82N53-AF5-B	Vdet-IC	5.3V±2% -Reset ODO	SOT-23-5	28vda	VD6	6a	Utc
N53G	82N53G-AF5-B	Vdet-IC	5.3V±2% -Reset ODO, halogen free	SOT-23-5	28vda	VD6	6a	Utc
N53L	82N53L-AF5-B	Vdet-IC	5.3V±2% -Reset ODO, lead free	SOT-23-5	28vda	VD6	6a	Utc
N54	82N54-AF5-B	Vdet-IC	5.4V±2% -Reset ODO	SOT-23-5	28vda	VD6	6a	Utc
N54G	82N54G-AF5-B	Vdet-IC	5.4V±2% -Reset ODO, halogen free	SOT-23-5	28vda	VD6	6a	Utc
N54L	82N54L-AF5-B	Vdet-IC	5.4V±2% -Reset ODO, lead free	SOT-23-5	28vda	VD6	6a	Utc
N55	82N55-AF5-B	Vdet-IC	5.5V±2% -Reset ODO	SOT-23-5	28vda	VD6	6a	Utc
N55G	82N55G-AF5-B	Vdet-IC	5.5V±2% -Reset ODO, halogen free	SOT-23-5	28vda	VD6	6a	Utc
N55L	82N55L-AF5-B	Vdet-IC	5.5V±2% -Reset ODO, lead free	SOT-23-5	28vda	VD6	6a	Utc
N56	82N56-AF5-B	Vdet-IC	5.6V±2% -Reset ODO	SOT-23-5	28vda	VD6	6a	Utc
N56G	82N56G-AF5-B	Vdet-IC	5.6V±2% -Reset ODO, halogen free	SOT-23-5	28vda	VD6	6a	Utc
N56L	82N56L-AF5-B	Vdet-IC	5.6V±2% -Reset ODO, lead free	SOT-23-5	28vda	VD6	6a	Utc
N57	82N57-AF5-B	Vdet-IC	5.7V±2% -Reset ODO	SOT-23-5	28vda	VD6	6a	Utc
N57G	82N57G-AF5-B	Vdet-IC	5.7V±2% -Reset ODO, halogen free	SOT-23-5	28vda	VD6	6a	Utc
N57L	82N57L-AF5-B	Vdet-IC	5.7V±2% -Reset ODO, lead free	SOT-23-5	28vda	VD6	6a	Utc
N58	82N58-AF5-B	Vdet-IC	5.8V±2% -Reset ODO	SOT-23-5	28vda	VD6	6a	Utc
N58G	82N58G-AF5-B	Vdet-IC	5.8V±2% -Reset ODO, halogen free	SOT-23-5	28vda	VD6	6a	Utc
N58L	82N58L-AF5-B	Vdet-IC	5.8V±2% -Reset ODO, lead free	SOT-23-5	28vda	VD6	6a	Utc
N59	82N59-AF5-B	Vdet-IC	5.9V±2% -Reset ODO	SOT-23-5	28vda	VD6	6a	Utc
N59G	82N59G-AF5-B	Vdet-IC	5.9V±2% -Reset ODO, halogen free	SOT-23-5	28vda	VD6	6a	Utc
N59L	82N59L-AF5-B	Vdet-IC	5.9V±2% -Reset ODO, lead free	SOT-23-5	28vda	VD6	6a	Utc
N5A	XC6108N35AMR	Vdet-IC	3.5V±2%, Hysteresis, -Reset ODO	SOT-25	28rm	VD14	6g	Tor
N5A	XC6118C25AMR-G	Vdet-IC	2.5V±2%, ±Reset PPO, Sense, hysteresis 5%, Cd	SOT-25	28mg	VD15	6g	Tor
N5B	XC6108N35BMR	Vdet-IC	3.5V±2%, -Reset ODO	SOT-25	28rm	VD14	6g	Tor
N5B	XC6118C25BMR-G	Vdet-IC	2.5V±2%, ±Reset PPO, Sense, hysteresis <1%, Cd	SOT-25	28mg	VD15	6g	Tor
N5C	XC6108N35CMR	Vdet-IC	3.5V±2%, Hysteresis, -Reset ODO	SOT-25	28rk	VD14	6g	Tor
N5C	XC6118C25CMR-G	Vdet-IC	2.5V±2%, ±Reset PPO, Sense, hysteresis 5%	SOT-25	28mf	VD12	6g	Tor
N5D	XC6108N35DMR	Vdet-IC	3.5V±2%, -Reset ODO	SOT-25	28rk	VD14	6g	Tor
N5D	XC6118C25DMR-G	Vdet-IC	2.5V±2%, ±Reset PPO, Sense, hysteresis <1%	SOT-25	28mf	VD12	6g	Tor
N6	AP139-33TW	LVR-IC	LDO, LN, +CE, 3.3V±2%, 300mA	TSOT-23-5L	28vrx	VR7	6a	Ana
N6	AP139-33W	LVR-IC	LDO, LN, +CE, 3.3V±2%, 300mA	SOT-23-5L	28vrx	VR7	6k	Ana
N6	KRC669E	Si-npn-Digi	Dual, Sw, 50V, 100mA, 200mW, R1/R2=4.7k/10k	TESV	30/TD6	-	6l	Kec
N6	KRC669U	Si-npn-Digi	Dual, Sw, 50V, 100mA, 200mW, R1/R2=4.7k/10k	USV	28/TD9	-	6l	Kec
N6	R1121N461A	LVR-IC	LDO, LN, -CE, 4.6V±2%, 150mA	SOT-23-5	28vt	VR4	6g	Ric
N6	RN5RY561A	DC/DC-IC	VFM step-up, 5.6V±2.5%, 150mW, <180kHz	SOT-23-5	28vd	DC5	6g	Ric
N60	82N60-AF5-B	Vdet-IC	6.0V±2% -Reset ODO	SOT-23-5	28vda	VD6	6a	Utc
N60G	82N60G-AF5-B	Vdet-IC	6.0V±2% -Reset ODO, halogen free	SOT-23-5	28vda	VD6	6a	Utc
N60L	82N60L-AF5-B	Vdet-IC	6.0V±2% -Reset ODO, lead free	SOT-23-5	28vda	VD6	6a	Utc
N6A	S-1165B15MC	LVR-IC	LDO, 1.5V±1.0%, 200mA, +CE	SOT-23-5	28cx	VR4	6g	Sii
N6A	XC6108N36AMR	Vdet-IC	3.6V±2%, Hysteresis, -Reset ODO	SOT-25	28rm	VD14	6g	Tor
N6A	XC6118C26AMR-G	Vdet-IC	2.6V±2%, ±Reset PPO, Sense, hysteresis 5%, Cd	SOT-25	28mg	VD15	6g	Tor
N6B	S-1165B16MC	LVR-IC	LDO, 1.6V±1.0%, 200mA, +CE	SOT-23-5	28cx	VR4	6g	Sii
N6B	XC6108N36BMR	Vdet-IC	3.6V±2%, -Reset ODO	SOT-25	28rm	VD14	6g	Tor
N6B	XC6118C26BMR-G	Vdet-IC	2.6V±2%, ±Reset PPO, Sense, hysteresis <1%, Cd	SOT-25	28mg	VD15	6g	Tor
N6C	S-1165B17MC	LVR-IC	LDO, 1.7V±1.0%, 200mA, +CE	SOT-23-5	28cx	VR4	6g	Sii
N6C	XC6108N36CMR	Vdet-IC	3.6V±2%, Hysteresis, -Reset ODO	SOT-25	28rk	VD14	6g	Tor
N6C	XC6118C26CMR-G	Vdet-IC	2.6V±2%, ±Reset PPO, Sense, hysteresis 5%	SOT-25	28mf	VD12	6g	Tor
N6D	S-1165B18MC	LVR-IC	LDO, 1.8V±1.0%, 200mA, +CE	SOT-23-5	28cx	VR4	6g	Sii
N6D	XC6108N36DMR	Vdet-IC	3.6V±2%, -Reset ODO	SOT-25	28rk	VD14	6g	Tor
N6D	XC6118C26DMR-G	Vdet-IC	2.6V±2%, ±Reset PPO, Sense, hysteresis <1%	SOT-25	28mf	VD12	6g	Tor
N6E	S-1165B19MC	LVR-IC	LDO, 1.9V±1.0%, 200mA, +CE	SOT-23-5	28cx	VR4	6g	Sii
N6F	S-1165B20MC	LVR-IC	LDO, 2.0V±1.0%, 200mA, +CE	SOT-23-5	28cx	VR4	6g	Sii
N6G	S-1165B21MC	LVR-IC	LDO, 2.1V±1.0%, 200mA, +CE	SOT-23-5	28cx	VR4	6g	Sii
N6H	S-1165B22MC	LVR-IC	LDO, 2.2V±1.0%, 200mA, +CE	SOT-23-5	28cx	VR4	6g	Sii
N6I	S-1165B23MC	LVR-IC	LDO, 2.3V±1.0%, 200mA, +CE	SOT-23-5	28cx	VR4	6g	Sii
N6J	S-1165B24MC	LVR-IC	LDO, 2.4V±1.0%, 200mA, +CE	SOT-23-5	28cx	VR4	6g	Sii
N6K	S-1165B25MC	LVR-IC	LDO, 2.5V±1.0%, 200mA, +CE	SOT-23-5	28cx	VR4	6g	Sii
N6L	S-1165B26MC	LVR-IC	LDO, 2.6V±1.0%, 200mA, +CE	SOT-23-5	28cx	VR4	6g	Sii
N6M	S-1165B27MC	LVR-IC	LDO, 2.7V±1.0%, 200mA, +CE	SOT-23-5	28cx	VR4	6g	Sii
N6N	S-1165B28MC	LVR-IC	LDO, 2.8V±1.0%, 200mA, +CE	SOT-23-5	28cx	VR4	6g	Sii



SMD code	Type	Function	Short description	Case	Pinout	Sch.	St.Mnf.
N6O	S-1165B29MC	LVR-IC	LDO, 2.9V±1.0%, 200mA, +CE	SOT-23-5	28cx	VR4	6g Sii
N6P	S-1165B30MC	LVR-IC	LDO, 3.0V±1.0%, 200mA, +CE	SOT-23-5	28cx	VR4	6g Sii
N6Q	S-1165B31MC	LVR-IC	LDO, 3.1V±1.0%, 200mA, +CE	SOT-23-5	28cx	VR4	6g Sii
N6R	S-1165B32MC	LVR-IC	LDO, 3.2V±1.0%, 200mA, +CE	SOT-23-5	28cx	VR4	6g Sii
N6S	S-1165B33MC	LVR-IC	LDO, 3.3V±1.0%, 200mA, +CE	SOT-23-5	28cx	VR4	6g Sii
N6T	S-1165B34MC	LVR-IC	LDO, 3.4V±1.0%, 200mA, +CE	SOT-23-5	28cx	VR4	6g Sii
N6U	S-1165B35MC	LVR-IC	LDO, 3.5V±1.0%, 200mA, +CE	SOT-23-5	28cx	VR4	6g Sii
N6V	S-1165B36MC	LVR-IC	LDO, 3.3V±1.0%, 200mA, +CE	SOT-23-5	28cx	VR4	6g Sii
N6W	S-1165B37MC	LVR-IC	LDO, 3.7V±1.0%, 200mA, +CE	SOT-23-5	28cx	VR4	6g Sii
N6X	S-1165B38MC	LVR-IC	LDO, 3.8V±1.0%, 200mA, +CE	SOT-23-5	28cx	VR4	6g Sii
N6Y	S-1165B39MC	LVR-IC	LDO, 3.9V±1.0%, 200mA, +CE	SOT-23-5	28cx	VR4	6g Sii
N6Z	S-1165B40MC	LVR-IC	LDO, 4.0V±1.0%, 200mA, +CE	SOT-23-5	28cx	VR4	6g Sii
N7	AP139-35TW	LVR-IC	LDO, LN, +CE, 3.5V±2%, 300mA	TSOT-23-5L	28vrx	VR7	6a Ana
N7	AP139-35W	LVR-IC	LDO, LN, +CE, 3.5V±2%, 300mA	SOT-23-5L	28vrx	VR7	6k Ana
N7	KRC670E	Si-npn-Digi	Dual, Sw, 50V, 100mA, 200mW, R1/R2=10k/4.7k	TESV	30/TD6	-	6l Kec
N7	KRC670U	Si-npn-Digi	Dual, Sw, 50V, 100mA, 200mW, R1/R2=10k/4.7k	USV	28/TD9	-	6l Kec
N7	R1121N471A	LVR-IC	LDO, LN, -CE, 4.7V±2%, 150mA	SOT-23-5	28vt	VR4	6g Ric
N7	TC1185-5.0VRX	LVR-IC	LDO, 5V±2%, 150mA, +CE	SOT-23-5	28vrx	VR7	6g Mcc
N7	RN5RY571A	DC/DC-IC	VFM step-up, 5.7V±2.5%, 150mW, <180kHz	SOT-23-5	28vd	DC5	6g Ric
N7A	S-1165B41MC	LVR-IC	LDO, 4.1V±1.0%, 200mA, +CE	SOT-23-5	28cx	VR4	6g Sii
N7A	XC6108N37AMR	Vdet-IC	3.7V±2%, Hysteresis, -Reset ODO	SOT-25	28rm	VD14	6g Tor
N7A	XC6118C27AMR-G	Vdet-IC	2.7V±2%, ±Reset PPO, Sense, hysteresis 5%, Cd	SOT-25	28mg	VD15	6g Tor
N7B	S-1165B42MC	LVR-IC	LDO, 4.2V±1.0%, 200mA, +CE	SOT-23-5	28cx	VR4	6g Sii
N7B	XC6108N37BMR	Vdet-IC	3.7V±2%, -Reset ODO	SOT-25	28rm	VD14	6g Tor
N7B	XC6118C27BMR-G	Vdet-IC	2.7V±2%, ±Reset PPO, Sense, hysteresis <1%, Cd	SOT-25	28mg	VD15	6g Tor
N7C	S-1165B43MC	LVR-IC	LDO, 4.3V±1.0%, 200mA, +CE	SOT-23-5	28cx	VR4	6g Sii
N7C	XC6108N37CMR	Vdet-IC	3.7V±2%, Hysteresis, -Reset ODO	SOT-25	28rk	VD14	6g Tor
N7C	XC6118C27CMR-G	Vdet-IC	2.7V±2%, ±Reset PPO, Sense, hysteresis 5%	SOT-25	28mf	VD12	6g Tor
N7D	S-1165B44MC	LVR-IC	LDO, 4.4V±1.0%, 200mA, +CE	SOT-23-5	28cx	VR4	6g Sii
N7D	XC6108N37DMR	Vdet-IC	3.7V±2%, -Reset ODO	SOT-25	28rk	VD14	6g Tor
N7D	XC6118C27DMR-G	Vdet-IC	2.7V±2%, ±Reset PPO, Sense, hysteresis <1%	SOT-25	28mf	VD12	6g Tor
N7E	S-1165B45MC	LVR-IC	LDO, 4.5V±1.0%, 200mA, +CE	SOT-23-5	28cx	VR4	6g Sii
N7F	S-1165B46MC	LVR-IC	LDO, 4.6V±1.0%, 200mA, +CE	SOT-23-5	28cx	VR4	6g Sii
N7G	S-1165B47MC	LVR-IC	LDO, 4.7V±1.0%, 200mA, +CE	SOT-23-5	28cx	VR4	6g Sii
N7H	S-1165B48MC	LVR-IC	LDO, 4.8V±1.0%, 200mA, +CE	SOT-23-5	28cx	VR4	6g Sii
N7I	S-1165B49MC	LVR-IC	LDO, 4.9V±1.0%, 200mA, +CE	SOT-23-5	28cx	VR4	6g Sii
N7J	S-1165B50MC	LVR-IC	LDO, 5.0V±1.0%, 200mA, +CE	SOT-23-5	28cx	VR4	6g Sii
N7K	S-1165B51MC	LVR-IC	LDO, 5.1V±1.0%, 200mA, +CE	SOT-23-5	28cx	VR4	6g Sii
N7L	S-1165B52MC	LVR-IC	LDO, 5.2V±1.0%, 200mA, +CE	SOT-23-5	28cx	VR4	6g Sii
N7M	S-1165B53MC	LVR-IC	LDO, 5.3V±1.0%, 200mA, +CE	SOT-23-5	28cx	VR4	6g Sii
N7N	S-1165B54MC	LVR-IC	LDO, 5.4V±1.0%, 200mA, +CE	SOT-23-5	28cx	VR4	6g Sii
N7O	S-1165B55MC	LVR-IC	LDO, 5.5V±1.0%, 200mA, +CE	SOT-23-5	28cx	VR4	6g Sii
N8	KRC671E	Si-npn-Digi	Dual, Sw, 50V, 100mA, 200mW, R1/R2=47k/10k	TESV	30/TD6	-	6l Kec
N8	KRC671U	Si-npn-Digi	Dual, Sw, 50V, 100mA, 200mW, R1/R2=47k/10k	USV	28/TD9	-	6l Kec
N8	R1121N481A	LVR-IC	LDO, LN, -CE, 4.8V±2%, 150mA	SOT-23-5	28vt	VR4	6g Ric
N8	TC1185-2.85VRX	LVR-IC	LDO, 2.85V±2%, 150mA, +CE	SOT-23-5	28vrx	VR7	6g Mcc
N8	RN5RY581A	DC/DC-IC	VFM step-up, 5.8V±2.5%, 150mW, <180kHz	SOT-23-5	28vd	DC5	6g Ric
N815	MIC5305-1.5BD5	LVR-IC	LDO, LN, +CE, 1.5V±1%, 150mA	TSOT-23-5	28vrx	VR7	6g Mcr
N818	MIC5305-1.8BD5	LVR-IC	LDO, LN, +CE, 1.8V±1%, 150mA	TSOT-23-5	28vrx	VR7	6g Mcr
N825	MIC5305-2.5BD5	LVR-IC	LDO, LN, +CE, 2.5V±1%, 150mA	TSOT-23-5	28vrx	VR7	6g Mcr
N829	MIC5305-2.9BD5	LVR-IC	LDO, LN, +CE, 2.9V±1%, 150mA	TSOT-23-5	28vrx	VR7	6g Mcr
N82J	MIC5305-2.85BD5	LVR-IC	LDO, LN, +CE, 2.85V±1%, 150mA	TSOT-23-5	28vrx	VR7	6g Mcr
N830	MIC5305-3.0BD5	LVR-IC	LDO, LN, +CE, 3V±1%, 150mA	TSOT-23-5	28vrx	VR7	6g Mcr
N8A	XC6108N38AMR	Vdet-IC	3.8V±2%, Hysteresis, -Reset ODO	SOT-25	28rm	VD14	6g Tor
N8A	XC6118C28AMR-G	Vdet-IC	2.8V±2%, ±Reset PPO, Sense, hysteresis 5%, Cd	SOT-25	28mg	VD15	6g Tor
N8B	XC6108N38BMR	Vdet-IC	3.8V±2%, -Reset ODO	SOT-25	28rm	VD14	6g Tor
N8B	XC6118C28BMR-G	Vdet-IC	2.8V±2%, ±Reset PPO, Sense, hysteresis <1%, Cd	SOT-25	28mg	VD15	6g Tor
N8C	XC6108N38CMR	Vdet-IC	3.8V±2%, Hysteresis, -Reset ODO	SOT-25	28rk	VD14	6g Tor
N8C	XC6118C28CMR-G	Vdet-IC	2.8V±2%, ±Reset PPO, Sense, hysteresis 5%	SOT-25	28mf	VD12	6g Tor
N8D	XC6108N38DMR	Vdet-IC	3.8V±2%, -Reset ODO	SOT-25	28rk	VD14	6g Tor
N8D	XC6118C28DMR-G	Vdet-IC	2.8V±2%, ±Reset PPO, Sense, hysteresis <1%	SOT-25	28mf	VD12	6g Tor
N9	KRC672E	Si-npn-Digi	Dual, Sw, 50V, 100mA, 200mW, R1/R2=100k/100k	TESV	30/TD6	-	6l Kec
N9	KRC672U	Si-npn-Digi	Dual, Sw, 50V, 100mA, 200mW, R1/R2=100k/100k	USV	28/TD9	-	6l Kec
N9	R1121N491A	LVR-IC	LDO, LN, -CE, 4.9V±2%, 150mA	SOT-23-5	28vt	VR4	6g Ric
N9	TC1185-3.6VRX	LVR-IC	LDO, 3.6V±2%, 150mA, +CE	SOT-23-5	28vrx	VR7	6g Mcc
N9	RN5RY591A	DC/DC-IC	VFM step-up, 5.9V±2.5%, 150mW, <180kHz	SOT-23-5	28vd	DC5	6g Ric
N9A	XC6108N39AMR	Vdet-IC	3.9V±2%, Hysteresis, -Reset ODO	SOT-25	28rm	VD14	6g Tor
N9A	XC6118C29AMR-G	Vdet-IC	2.9V±2%, ±Reset PPO, Sense, hysteresis 5%, Cd	SOT-25	28mg	VD15	6g Tor
N9B	XC6108N39BMR	Vdet-IC	3.9V±2%, -Reset ODO	SOT-25	28rm	VD14	6g Tor
N9B	XC6118C29BMR-G	Vdet-IC	2.9V±2%, ±Reset PPO, Sense, hysteresis <1%, Cd	SOT-25	28mg	VD15	6g Tor



SMD code	Type	Function	Short description	Case	Pinout	Sch.	St.	Mnf.
N9C	XC6108N39CMR	Vdet-IC	3.9V±2%, Hysteresis, -Reset ODO	SOT-25	28rk	VD14	6g	Tor
N9C	XC6118C29CMR-G	Vdet-IC	2.9V±2%, ±Reset PPO, Sense, hysteresis 5%	SOT-25	28mf	VD12	6g	Tor
N9D	XC6108N39DMR	Vdet-IC	3.9V±2%, -Reset ODO	SOT-25	28rk	VD14	6g	Tor
N9D	XC6118C29DMR-G	Vdet-IC	2.9V±2%, ±Reset PPO, Sense, hysteresis <1%	SOT-25	28mf	VD12	6g	Tor
NA	KRC641T	Si-npn-Digi	Dual, Sw, 50V, 800mA, 900mW, R1/R2=1k/1k	TSV	28/TD6	-	6l	Kec
NA	KRC651E	Si-npn-Digi	Dual, Sw, 50V, 100mA, 200mW, R1/R2=4.7k/4.7k	TESV	30/TD6	-	6l	Kec
NA	KRC651U	Si-npn-Digi	Dual, Sw, 50V, 100mA, 200mW, R1/R2=4.7k/4.7k	USV	28/TD6	-	6l	Kec
NA	PT7M7020CLTA	Vdet-IC	2.0V±1.5%, -Reset PPO	SOT-23-5	28vdr	VD7	6k	Pti
ÑA	PT7M7020CLTAE	Vdet-IC	2.0V±1.5%, -Reset PPO, Lead free	SOT-23-5	28vdr	VD7	6k	Pti
NAA	RP109N081B	LVR-IC	LDO, 0.8V±1%, 150mA, +CE	SOT-23-5	28cx	VR4	6g	Ric
NAB	RP109N091B	LVR-IC	LDO, 0.9V±1%, 150mA, +CE	SOT-23-5	28cx	VR4	6g	Ric
NAC	RP109N101B	LVR-IC	LDO, 1.0V±1%, 150mA, +CE	SOT-23-5	28cx	VR4	6g	Ric
NAD	RP109N111B	LVR-IC	LDO, 1.1V±1%, 150mA, +CE	SOT-23-5	28cx	VR4	6g	Ric
NAE	RP109N121B	LVR-IC	LDO, 1.2V±1%, 150mA, +CE	SOT-23-5	28cx	VR4	6g	Ric
NAF	RP109N131B	LVR-IC	LDO, 1.3V±1%, 150mA, +CE	SOT-23-5	28cx	VR4	6g	Ric
NAG	RP109N141B	LVR-IC	LDO, 1.4V±1%, 150mA, +CE	SOT-23-5	28cx	VR4	6g	Ric
NAH	RP109N151B	LVR-IC	LDO, 1.5V±1%, 150mA, +CE	SOT-23-5	28cx	VR4	6g	Ric
NAJ	RP109N161B	LVR-IC	LDO, 1.6V±1%, 150mA, +CE	SOT-23-5	28cx	VR4	6g	Ric
NAK	RP109N171B	LVR-IC	LDO, 1.7V±1%, 150mA, +CE	SOT-23-5	28cx	VR4	6g	Ric
NAL	RP109N181B	LVR-IC	LDO, 1.8V±1%, 150mA, +CE	SOT-23-5	28cx	VR4	6g	Ric
NAM	RP109N191B	LVR-IC	LDO, 1.9V±1%, 150mA, +CE	SOT-23-5	28cx	VR4	6g	Ric
NAN	RP109N201B	LVR-IC	LDO, 2.0V±1%, 150mA, +CE	SOT-23-5	28cx	VR4	6g	Ric
NAP	RP109N211B	LVR-IC	LDO, 2.1V±1%, 150mA, +CE	SOT-23-5	28cx	VR4	6g	Ric
NAQ	RP109N221B	LVR-IC	LDO, 2.2V±1%, 150mA, +CE	SOT-23-5	28cx	VR4	6g	Ric
NAR	RP109N231B	LVR-IC	LDO, 2.3V±1%, 150mA, +CE	SOT-23-5	28cx	VR4	6g	Ric
NAS	RP109N241B	LVR-IC	LDO, 2.4V±1%, 150mA, +CE	SOT-23-5	28cx	VR4	6g	Ric
NAT	RP109N251B	LVR-IC	LDO, 2.5V±1%, 150mA, +CE	SOT-23-5	28cx	VR4	6g	Ric
NAU	RP109N261B	LVR-IC	LDO, 2.6V±1%, 150mA, +CE	SOT-23-5	28cx	VR4	6g	Ric
NAV	RP109N271B	LVR-IC	LDO, 2.7V±1%, 150mA, +CE	SOT-23-5	28cx	VR4	6g	Ric
NAW	RP109N281B	LVR-IC	LDO, 2.8V±1%, 150mA, +CE	SOT-23-5	28cx	VR4	6g	Ric
NAX	RP109N291B	LVR-IC	LDO, 2.9V±1%, 150mA, +CE	SOT-23-5	28cx	VR4	6g	Ric
NAY	RP109N301B	LVR-IC	LDO, 3.0V±1%, 150mA, +CE	SOT-23-5	28cx	VR4	6g	Ric
NAZ	RP109N311B	LVR-IC	LDO, 3.1V±1%, 150mA, +CE	SOT-23-5	28cx	VR4	6g	Ric
NB	KRC642T	Si-npn-Digi	Dual, Sw, 50V, 800mA, 900mW, R1/R2=2.2k/2.2k	TSV	28/TD6	-	6l	Kec
NB	KRC652E	Si-npn-Digi	Dual, Sw, 50V, 100mA, 200mW, R1/R2=10k/10k	TESV	30/TD6	-	6l	Kec
NB	KRC652U	Si-npn-Digi	Dual, Sw, 50V, 100mA, 200mW, R1/R2=10k/10k	USV	28/TD9	-	6l	Kec
NB	PT7M7020CHTA	Vdet-IC	2.0V±1.5%, +Reset PPO	SOT-23-5	28vdr	VD7	6k	Pti
NB	TC1014-2.6VFX	LVR-IC	LDO, 2.6V±2%, 50mA, +CE	SOT-23-5	28vrx	VR7	6g	Mcc
ÑB	PT7M7020CHTAE	Vdet-IC	2.0V±1.5%, +Reset PPO, Lead free	SOT-23-5	28vdr	VD7	6k	Pti
NBA	RP109N081D	LVR-IC	LDO, 0.8V±1%, 150mA, +CE, CL	SOT-23-5	28cx	VR4	6g	Ric
NBB	RP109N091D	LVR-IC	LDO, 0.9V±1%, 150mA, +CE, CL	SOT-23-5	28cx	VR4	6g	Ric
NBC	RP109N101D	LVR-IC	LDO, 1.0V±1%, 150mA, +CE, CL	SOT-23-5	28cx	VR4	6g	Ric
NBD	RP109N111D	LVR-IC	LDO, 1.1V±1%, 150mA, +CE, CL	SOT-23-5	28cx	VR4	6g	Ric
NBE	RP109N121D	LVR-IC	LDO, 1.2V±1%, 150mA, +CE, CL	SOT-23-5	28cx	VR4	6g	Ric
NBF	RP109N131D	LVR-IC	LDO, 1.3V±1%, 150mA, +CE, CL	SOT-23-5	28cx	VR4	6g	Ric
NBG	RP109N141D	LVR-IC	LDO, 1.4V±1%, 150mA, +CE, CL	SOT-23-5	28cx	VR4	6g	Ric
NBH	RP109N151D	LVR-IC	LDO, 1.5V±1%, 150mA, +CE, CL	SOT-23-5	28cx	VR4	6g	Ric
NBJ	RP109N161D	LVR-IC	LDO, 1.6V±1%, 150mA, +CE, CL	SOT-23-5	28cx	VR4	6g	Ric
NBK	RP109N171D	LVR-IC	LDO, 1.7V±1%, 150mA, +CE, CL	SOT-23-5	28cx	VR4	6g	Ric
NBL	RP109N181D	LVR-IC	LDO, 1.8V±1%, 150mA, +CE, CL	SOT-23-5	28cx	VR4	6g	Ric
NBM	RP109N191D	LVR-IC	LDO, 1.9V±1%, 150mA, +CE, CL	SOT-23-5	28cx	VR4	6g	Ric
NBN	RP109N201D	LVR-IC	LDO, 2.0V±1%, 150mA, +CE, CL	SOT-23-5	28cx	VR4	6g	Ric
NBP	RP109N211D	LVR-IC	LDO, 2.1V±1%, 150mA, +CE, CL	SOT-23-5	28cx	VR4	6g	Ric
NBQ	RP109N221D	LVR-IC	LDO, 2.2V±1%, 150mA, +CE, CL	SOT-23-5	28cx	VR4	6g	Ric
NBR	RP109N231D	LVR-IC	LDO, 2.3V±1%, 150mA, +CE, CL	SOT-23-5	28cx	VR4	6g	Ric
NBS	RP109N241D	LVR-IC	LDO, 2.4V±1%, 150mA, +CE, CL	SOT-23-5	28cx	VR4	6g	Ric
NBT	RP109N251D	LVR-IC	LDO, 2.5V±1%, 150mA, +CE, CL	SOT-23-5	28cx	VR4	6g	Ric
NBU	RP109N261D	LVR-IC	LDO, 2.6V±1%, 150mA, +CE, CL	SOT-23-5	28cx	VR4	6g	Ric
NBV	RP109N271D	LVR-IC	LDO, 2.7V±1%, 150mA, +CE, CL	SOT-23-5	28cx	VR4	6g	Ric
NBW	RP109N281D	LVR-IC	LDO, 2.8V±1%, 150mA, +CE, CL	SOT-23-5	28cx	VR4	6g	Ric
NBX	RP109N291D	LVR-IC	LDO, 2.9V±1%, 150mA, +CE, CL	SOT-23-5	28cx	VR4	6g	Ric
NBY	RP109N301D	LVR-IC	LDO, 3.0V±1%, 150mA, +CE, CL	SOT-23-5	28cx	VR4	6g	Ric
NBZ	RP109N311D	LVR-IC	LDO, 3.1V±1%, 150mA, +CE, CL	SOT-23-5	28cx	VR4	6g	Ric
NC	KRC643T	Si-npn-Digi	Dual, Sw, 50V, 800mA, 900mW, R1/R2=4.7k/4.7k	TSV	28/TD6	-	6l	Kec
NC	KRC653E	Si-npn-Digi	Dual, Sw, 50V, 100mA, 200mW, R1/R2=22k/22k	TESV	30/TD6	-	6l	Kec
NC	KRC653U	Si-npn-Digi	Dual, Sw, 50V, 100mA, 200mW, R1/R2=22k/22k	USV	28/TD9	-	6l	Kec
NC	PT7M7020NLTA	Vdet-IC	2.0V±1.5%, -Reset ODO	SOT-23-5	28vdr	VD6	6k	Pti
ÑC	PT7M7020NLTAE	Vdet-IC	2.0V±1.5%, -Reset ODO, Lead free	SOT-23-5	28vdr	VD6	6k	Pti
NC8	XC6222A081MR-G	LVR-IC	LDO, 0.8V±20mV, 700mA, +CE	SOT-25	28cx	VR4	6g	Tor
NC9	XC6222A091MR-G	LVR-IC	LDO, 0.9V±20mV, 700mA, +CE	SOT-25	28cx	VR4	6g	Tor



SMD code	Type	Function	Short description	Case	Pinout	Sch.	St.	Mnf.
NCA	XC6222A101MR-G	LVR-IC	LDO, 1.0V±20mV, 700mA, +CE	SOT-25	28cx	VR4	6g	Tor
NCB	XC6222A111MR-G	LVR-IC	LDO, 1.1V±20mV, 700mA, +CE	SOT-25	28cx	VR4	6g	Tor
NCC	XC6222A121MR-G	LVR-IC	LDO, 1.2V±20mV, 700mA, +CE	SOT-25	28cx	VR4	6g	Tor
NCD	XC6222A131MR-G	LVR-IC	LDO, 1.3V±20mV, 700mA, +CE	SOT-25	28cx	VR4	6g	Tor
NCE	XC6222A141MR-G	LVR-IC	LDO, 1.4V±20mV, 700mA, +CE	SOT-25	28cx	VR4	6g	Tor
NCF	XC6222A151MR-G	LVR-IC	LDO, 1.5V±20mV, 700mA, +CE	SOT-25	28cx	VR4	6g	Tor
NCH	XC6222A161MR-G	LVR-IC	LDO, 1.6V±20mV, 700mA, +CE	SOT-25	28cx	VR4	6g	Tor
NCK	XC6222A171MR-G	LVR-IC	LDO, 1.7V±20mV, 700mA, +CE	SOT-25	28cx	VR4	6g	Tor
NCL	XC6222A181MR-G	LVR-IC	LDO, 1.8V±20mV, 700mA, +CE	SOT-25	28cx	VR4	6g	Tor
NCM	XC6222A191MR-G	LVR-IC	LDO, 1.9V±20mV, 700mA, +CE	SOT-25	28cx	VR4	6g	Tor
NCN	XC6222A201MR-G	LVR-IC	LDO, 2.0V±20mV, 700mA, +CE	SOT-25	28cx	VR4	6g	Tor
NCP	XC6222A211MR-G	LVR-IC	LDO, 2.1V±1%, 700mA, +CE	SOT-25	28cx	VR4	6g	Tor
NCR	XC6222A221MR-G	LVR-IC	LDO, 2.2V±1%, 700mA, +CE	SOT-25	28cx	VR4	6g	Tor
NCS	XC6222A231MR-G	LVR-IC	LDO, 2.3V±1%, 700mA, +CE	SOT-25	28cx	VR4	6g	Tor
NCT	XC6222A241MR-G	LVR-IC	LDO, 2.4V±1%, 700mA, +CE	SOT-25	28cx	VR4	6g	Tor
NCU	XC6222A251MR-G	LVR-IC	LDO, 2.5V±1%, 700mA, +CE	SOT-25	28cx	VR4	6g	Tor
NCV	XC6222A261MR-G	LVR-IC	LDO, 2.6V±1%, 700mA, +CE	SOT-25	28cx	VR4	6g	Tor
NCX	XC6222A271MR-G	LVR-IC	LDO, 2.7V±1%, 700mA, +CE	SOT-25	28cx	VR4	6g	Tor
NCY	XC6222A281MR-G	LVR-IC	LDO, 2.8V±1%, 700mA, +CE	SOT-25	28cx	VR4	6g	Tor
NCZ	XC6222A291MR-G	LVR-IC	LDO, 2.9V±1%, 700mA, +CE	SOT-25	28cx	VR4	6g	Tor
ND	KRC644T	Si-npn-Digi	Dual, Sw, 50V, 800mA, 900mW, R1/R2=10k/10k	TSV	28/TD6	-	6l	Kec
ND	KRC654E	Si-npn-Digi	Dual, Sw, 50V, 100mA, 200mW, R1/R2=47k/47k	TESV	30/TD6	-	6l	Kec
ND	KRC654U	Si-npn-Digi	Dual, Sw, 50V, 100mA, 200mW, R1/R2=47k/47k	USV	28/TD9	-	6l	Kec
ND	PT7M7021CLTA	Vdet-IC	2.1V±1.5%, -Reset PPO	SOT-23-5	28vdr	VD7	6k	Pti
ND	PT7M7021CLTAE	Vdet-IC	2.1V±1.5%, -Reset PPO, Lead free	SOT-23-5	28vdr	VD7	6k	Pti
ND8	XC6222A08BMR-G	LVR-IC	LDO, 0.85V±20mV, 700mA, +CE	SOT-25	28cx	VR4	6g	Tor
ND9	XC6222A09BMR-G	LVR-IC	LDO, 0.95V±20mV, 700mA, +CE	SOT-25	28cx	VR4	6g	Tor
NDA	XC6222A10BMR-G	LVR-IC	LDO, 1.05V±20mV, 700mA, +CE	SOT-25	28cx	VR4	6g	Tor
NDB	XC6222A11BMR-G	LVR-IC	LDO, 1.15V±20mV, 700mA, +CE	SOT-25	28cx	VR4	6g	Tor
NDC	XC6222A12BMR-G	LVR-IC	LDO, 1.25V±20mV, 700mA, +CE	SOT-25	28cx	VR4	6g	Tor
NDD	XC6222A13BMR-G	LVR-IC	LDO, 1.35V±20mV, 700mA, +CE	SOT-25	28cx	VR4	6g	Tor
NDE	XC6222A14BMR-G	LVR-IC	LDO, 1.45V±20mV, 700mA, +CE	SOT-25	28cx	VR4	6g	Tor
NDF	XC6222A15BMR-G	LVR-IC	LDO, 1.55V±20mV, 700mA, +CE	SOT-25	28cx	VR4	6g	Tor
NDH	XC6222A16BMR-G	LVR-IC	LDO, 1.65V±20mV, 700mA, +CE	SOT-25	28cx	VR4	6g	Tor
NDK	XC6222A17BMR-G	LVR-IC	LDO, 1.75V±20mV, 700mA, +CE	SOT-25	28cx	VR4	6g	Tor
NDL	XC6222A18BMR-G	LVR-IC	LDO, 1.85V±20mV, 700mA, +CE	SOT-25	28cx	VR4	6g	Tor
NDM	XC6222A19BMR-G	LVR-IC	LDO, 1.95V±20mV, 700mA, +CE	SOT-25	28cx	VR4	6g	Tor
NDN	XC6222A20BMR-G	LVR-IC	LDO, 2.05V±1%, 700mA, +CE	SOT-25	28cx	VR4	6g	Tor
NDP	XC6222A21BMR-G	LVR-IC	LDO, 2.15V±1%, 700mA, +CE	SOT-25	28cx	VR4	6g	Tor
NDR	XC6222A22BMR-G	LVR-IC	LDO, 2.25V±1%, 700mA, +CE	SOT-25	28cx	VR4	6g	Tor
NDS	XC6222A23BMR-G	LVR-IC	LDO, 2.35V±1%, 700mA, +CE	SOT-25	28cx	VR4	6g	Tor
NDT	XC6222A24BMR-G	LVR-IC	LDO, 2.45V±1%, 700mA, +CE	SOT-25	28cx	VR4	6g	Tor
NDU	XC6222A25BMR-G	LVR-IC	LDO, 2.55V±1%, 700mA, +CE	SOT-25	28cx	VR4	6g	Tor
NDV	XC6222A26BMR-G	LVR-IC	LDO, 2.65V±1%, 700mA, +CE	SOT-25	28cx	VR4	6g	Tor
NDX	XC6222A27BMR-G	LVR-IC	LDO, 2.75V±1%, 700mA, +CE	SOT-25	28cx	VR4	6g	Tor
NDY	XC6222A28BMR-G	LVR-IC	LDO, 2.85V±1%, 700mA, +CE	SOT-25	28cx	VR4	6g	Tor
NDZ	XC6222A29BMR-G	LVR-IC	LDO, 2.95V±1%, 700mA, +CE	SOT-25	28cx	VR4	6g	Tor
NE	KRC645T	Si-npn-Digi	Dual, Sw, 50V, 800mA, 900mW, R1/R2=1k/10k	TSV	28/TD6	-	6l	Kec
NE	KRC655E	Si-npn-Digi	Dual, Sw, 50V, 100mA, 200mW, R1/R2=2.2k/47k	TESV	30/TD6	-	6l	Kec
NE	KRC655U	Si-npn-Digi	Dual, Sw, 50V, 100mA, 200mW, R1/R2=2.2k/47k	USV	28/TD9	-	6l	Kec
NE	PT7M7021CHTA	Vdet-IC	2.1V±1.5%, +Reset PPO	SOT-23-5	28vdr	VD7	6k	Pti
NE	RT2N08M	Si-npn-Digi	Dual, Sw, 50V, 100mA, 150mW, 200MHz, R1/R2=2.2k/10k	SOT-23-5	28/TD6	-	6a	Mit
NE	PT7M7021CHTAE	Vdet-IC	2.1V±1.5%, +Reset PPO, Lead free	SOT-23-5	28vdr	VD7	6k	Pti
NE0	XC6222A301MR-G	LVR-IC	LDO, 3.0V±1%, 700mA, +CE	SOT-25	28cx	VR4	6g	Tor
NE1	XC6222A311MR-G	LVR-IC	LDO, 3.1V±1%, 700mA, +CE	SOT-25	28cx	VR4	6g	Tor
NE18	MIC5207-1.8BD5	LVR-IC	LDO, LN, +CE, 1.8V	TSOT-23-5	28vrx	VR7	6g	Mcr
NE2	XC6222A321MR-G	LVR-IC	LDO, 3.2V±1%, 700mA, +CE	SOT-25	28cx	VR4	6g	Tor
NE3	XC6222A331MR-G	LVR-IC	LDO, 3.3V±1%, 700mA, +CE	SOT-25	28cx	VR4	6g	Tor
NE4	XC6222A341MR-G	LVR-IC	LDO, 3.4V±1%, 700mA, +CE	SOT-25	28cx	VR4	6g	Tor
NE5	XC6222A351MR-G	LVR-IC	LDO, 3.5V±1%, 700mA, +CE	SOT-25	28cx	VR4	6g	Tor
NE6	XC6222A361MR-G	LVR-IC	LDO, 3.6V±1%, 700mA, +CE	SOT-25	28cx	VR4	6g	Tor
NE7	XC6222A371MR-G	LVR-IC	LDO, 3.7V±1%, 700mA, +CE	SOT-25	28cx	VR4	6g	Tor
NE8	XC6222A381MR-G	LVR-IC	LDO, 3.8V±1%, 700mA, +CE	SOT-25	28cx	VR4	6g	Tor
NE9	XC6222A391MR-G	LVR-IC	LDO, 3.9V±1%, 700mA, +CE	SOT-25	28cx	VR4	6g	Tor
NEA	XC6222A401MR-G	LVR-IC	LDO, 4.0V±1%, 700mA, +CE	SOT-25	28cx	VR4	6g	Tor
NEB	XC6222A411MR-G	LVR-IC	LDO, 4.1V±1%, 700mA, +CE	SOT-25	28cx	VR4	6g	Tor
NEC	XC6222A421MR-G	LVR-IC	LDO, 4.2V±1%, 700mA, +CE	SOT-25	28cx	VR4	6g	Tor
NED	XC6222A431MR-G	LVR-IC	LDO, 4.3V±1%, 700mA, +CE	SOT-25	28cx	VR4	6g	Tor
NEE	XC6222A441MR-G	LVR-IC	LDO, 4.4V±1%, 700mA, +CE	SOT-25	28cx	VR4	6g	Tor
NEF	XC6222A451MR-G	LVR-IC	LDO, 4.5V±1%, 700mA, +CE	SOT-25	28cx	VR4	6g	Tor



SMD code	Type	Function	Short description	Case	Pinout	Sch.	St.	Mnf.
NEH	XC6222A461MR-G	LVR-IC	LDO, 4.6V±1%, 700mA, +CE	SOT-25	28cx	VR4	6g	Tor
NEK	XC6222A471MR-G	LVR-IC	LDO, 4.7V±1%, 700mA, +CE	SOT-25	28cx	VR4	6g	Tor
NEL	XC6222A481MR-G	LVR-IC	LDO, 4.8V±1%, 700mA, +CE	SOT-25	28cx	VR4	6g	Tor
NEM	XC6222A491MR-G	LVR-IC	LDO, 4.9V±1%, 700mA, +CE	SOT-25	28cx	VR4	6g	Tor
NEO	XC6222A501MR-G	LVR-IC	LDO, 5.0V±1%, 700mA, +CE	SOT-25	28cx	VR4	6g	Tor
NF	KRC646T	Si-npn-Digi	Dual, Sw, 50V, 800mA, 200mW, R1/R2=2.2k/10k	TSV	28/TD6	-	6l	Kec
NF	KRC656E	Si-npn-Digi	Dual, Sw, 50V, 100mA, 200mW, R1/R2=4.7k/47k	TESV	30/TD6	-	6l	Kec
NF	KRC656U	Si-npn-Digi	Dual, Sw, 50V, 100mA, 200mW, R1/R2=4.7k/47k	USV	28/TD9	-	6l	Kec
NF	PT7M7021NLTA	Vdet-IC	2.1V±1.5%, -Reset ODO	SOT-23-5	28vdr	VD6	6k	Pti
NF	PT7M7021NLTAE	Vdet-IC	2.1V±1.5%, -Reset ODO, Lead free	SOT-23-5	28vdr	VD6	6k	Pti
NFO	XC6222A30BMR-G	LVR-IC	LDO, 3.05V±1%, 700mA, +CE	SOT-25	28cx	VR4	6g	Tor
NF1	XC6222A31BMR-G	LVR-IC	LDO, 3.15V±1%, 700mA, +CE	SOT-25	28cx	VR4	6g	Tor
NF2	XC6222A32BMR-G	LVR-IC	LDO, 3.25V±1%, 700mA, +CE	SOT-25	28cx	VR4	6g	Tor
NF3	XC6222A33BMR-G	LVR-IC	LDO, 3.35V±1%, 700mA, +CE	SOT-25	28cx	VR4	6g	Tor
NF4	XC6222A34BMR-G	LVR-IC	LDO, 3.45V±1%, 700mA, +CE	SOT-25	28cx	VR4	6g	Tor
NF5	XC6222A35BMR-G	LVR-IC	LDO, 3.55V±1%, 700mA, +CE	SOT-25	28cx	VR4	6g	Tor
NF6	XC6222A36BMR-G	LVR-IC	LDO, 3.65V±1%, 700mA, +CE	SOT-25	28cx	VR4	6g	Tor
NF7	XC6222A37BMR-G	LVR-IC	LDO, 3.75V±1%, 700mA, +CE	SOT-25	28cx	VR4	6g	Tor
NF8	XC6222A38BMR-G	LVR-IC	LDO, 3.85V±1%, 700mA, +CE	SOT-25	28cx	VR4	6g	Tor
NF9	XC6222A39BMR-G	LVR-IC	LDO, 3.95V±1%, 700mA, +CE	SOT-25	28cx	VR4	6g	Tor
NFA	XC6222A40BMR-G	LVR-IC	LDO, 4.05V±1%, 700mA, +CE	SOT-25	28cx	VR4	6g	Tor
NFB	XC6222A41BMR-G	LVR-IC	LDO, 4.15V±1%, 700mA, +CE	SOT-25	28cx	VR4	6g	Tor
NFC	XC6222A42BMR-G	LVR-IC	LDO, 4.25V±1%, 700mA, +CE	SOT-25	28cx	VR4	6g	Tor
NFD	XC6222A43BMR-G	LVR-IC	LDO, 4.35V±1%, 700mA, +CE	SOT-25	28cx	VR4	6g	Tor
NFE	XC6222A44BMR-G	LVR-IC	LDO, 4.45V±1%, 700mA, +CE	SOT-25	28cx	VR4	6g	Tor
NFF	XC6222A45BMR-G	LVR-IC	LDO, 4.55V±1%, 700mA, +CE	SOT-25	28cx	VR4	6g	Tor
NFH	XC6222A46BMR-G	LVR-IC	LDO, 4.65V±1%, 700mA, +CE	SOT-25	28cx	VR4	6g	Tor
NFK	XC6222A47BMR-G	LVR-IC	LDO, 4.75V±1%, 700mA, +CE	SOT-25	28cx	VR4	6g	Tor
NFL	XC6222A48BMR-G	LVR-IC	LDO, 4.85V±1%, 700mA, +CE	SOT-25	28cx	VR4	6g	Tor
NFM	XC6222A49BMR-G	LVR-IC	LDO, 4.95V±1%, 700mA, +CE	SOT-25	28cx	VR4	6g	Tor
NG	PT7M7022CLTA	Vdet-IC	2.2V±1.5%, -Reset PPO	SOT-23-5	28vdr	VD7	6k	Pti
NG	PT7M7022CLTAE	Vdet-IC	2.2V±1.5%, -Reset PPO, Lead free	SOT-23-5	28vdr	VD7	6k	Pti
NH	KRC657E	Si-npn-Digi	Dual, Sw, 50V, 100mA, 200mW, R1/R2=10k/47k	TESV	30/TD6	-	6l	Kec
NH	KRC657U	Si-npn-Digi	Dual, Sw, 50V, 100mA, 200mW, R1/R2=10k/47k	USV	28/TD9	-	6l	Kec
NH	PT7M7022CHTA	Vdet-IC	2.2V±1.5%, +Reset PPO	SOT-23-5	28vdr	VD7	6k	Pti
NH	PT7M7022CHTAE	Vdet-IC	2.2V±1.5%, +Reset PPO, Lead free	SOT-23-5	28vdr	VD7	6k	Pti
NH8	XC6222B081MR-G	LVR-IC	LDO, 0.8V±20mV, 700mA, +CE, CL	SOT-25	28cx	VR4	6g	Tor
NH9	XC6222B091MR-G	LVR-IC	LDO, 0.9V±20mV, 700mA, +CE, CL	SOT-25	28cx	VR4	6g	Tor
NHA	XC6222B101MR-G	LVR-IC	LDO, 1.0V±20mV, 700mA, +CE, CL	SOT-25	28cx	VR4	6g	Tor
NHB	XC6222B111MR-G	LVR-IC	LDO, 1.1V±20mV, 700mA, +CE, CL	SOT-25	28cx	VR4	6g	Tor
NHC	XC6222B121MR-G	LVR-IC	LDO, 1.2V±20mV, 700mA, +CE, CL	SOT-25	28cx	VR4	6g	Tor
NHD	XC6222B131MR-G	LVR-IC	LDO, 1.3V±20mV, 700mA, +CE, CL	SOT-25	28cx	VR4	6g	Tor
NHE	XC6222B141MR-G	LVR-IC	LDO, 1.4V±20mV, 700mA, +CE, CL	SOT-25	28cx	VR4	6g	Tor
NHF	XC6222B151MR-G	LVR-IC	LDO, 1.5V±20mV, 700mA, +CE, CL	SOT-25	28cx	VR4	6g	Tor
NHH	XC6222B161MR-G	LVR-IC	LDO, 1.6V±20mV, 700mA, +CE, CL	SOT-25	28cx	VR4	6g	Tor
NHK	XC6222B171MR-G	LVR-IC	LDO, 1.7V±20mV, 700mA, +CE, CL	SOT-25	28cx	VR4	6g	Tor
NHL	XC6222B181MR-G	LVR-IC	LDO, 1.8V±20mV, 700mA, +CE, CL	SOT-25	28cx	VR4	6g	Tor
NHM	XC6222B191MR-G	LVR-IC	LDO, 1.9V±20mV, 700mA, +CE, CL	SOT-25	28cx	VR4	6g	Tor
NHN	XC6222B201MR-G	LVR-IC	LDO, 2.0V±20mV, 700mA, +CE, CL	SOT-25	28cx	VR4	6g	Tor
NHP	XC6222B211MR-G	LVR-IC	LDO, 2.1V±1%, 700mA, +CE, CL	SOT-25	28cx	VR4	6g	Tor
NHR	XC6222B221MR-G	LVR-IC	LDO, 2.2V±1%, 700mA, +CE, CL	SOT-25	28cx	VR4	6g	Tor
NHS	XC6222B231MR-G	LVR-IC	LDO, 2.3V±1%, 700mA, +CE, CL	SOT-25	28cx	VR4	6g	Tor
NHT	XC6222B241MR-G	LVR-IC	LDO, 2.4V±1%, 700mA, +CE, CL	SOT-25	28cx	VR4	6g	Tor
NHU	XC6222B251MR-G	LVR-IC	LDO, 2.5V±1%, 700mA, +CE, CL	SOT-25	28cx	VR4	6g	Tor
NHV	XC6222B261MR-G	LVR-IC	LDO, 2.6V±1%, 700mA, +CE, CL	SOT-25	28cx	VR4	6g	Tor
NHX	XC6222B271MR-G	LVR-IC	LDO, 2.7V±1%, 700mA, +CE, CL	SOT-25	28cx	VR4	6g	Tor
NHY	XC6222B281MR-G	LVR-IC	LDO, 2.8V±1%, 700mA, +CE, CL	SOT-25	28cx	VR4	6g	Tor
NHZ	XC6222B291MR-G	LVR-IC	LDO, 2.9V±1%, 700mA, +CE, CL	SOT-25	28cx	VR4	6g	Tor
NI	KRC658E	Si-npn-Digi	Dual, Sw, 50V, 100mA, 200mW, R1/R2=22k/47k	TESV	30/TD6	-	6l	Kec
NI	KRC658U	Si-npn-Digi	Dual, Sw, 50V, 100mA, 200mW, R1/R2=22k/47k	USV	28/TD9	-	6l	Kec
NI	PT7M7022NLTA	Vdet-IC	2.2V±1.5%, -Reset ODO	SOT-23-5	28vdr	VD6	6k	Pti
NI	PT7M7022NLTAE	Vdet-IC	2.2V±1.5%, -Reset ODO, Lead free	SOT-23-5	28vdr	VD6	6k	Pti
NJ	KRC659E	Si-npn-Digi	Dual, Sw, 50V, 100mA, 200mW, R1/R2=47k/22k	TESV	30/TD6	-	6l	Kec
NJ	KRC659U	Si-npn-Digi	Dual, Sw, 50V, 100mA, 200mW, R1/R2=47k/22k	USV	28/TD9	-	6l	Kec
NJ	PT7M7023CLTA	Vdet-IC	2.3V±1.5%, -Reset PPO	SOT-23-5	28vdr	VD7	6k	Pti
NJ	PT7M7023CLTAE	Vdet-IC	2.3V±1.5%, -Reset PPO, Lead free	SOT-23-5	28vdr	VD7	6k	Pti
NK	KRC660E	Si-npn-Digi	Dual, Sw, 50V, 100mA, 200mW, R1=4.7k	TESV	30/TD6	-	6l	Kec
NK	KRC660U	Si-npn-Digi	Dual, Sw, 50V, 100mA, 200mW, R1=4.7k	USV	28/TD9	-	6l	Kec
NK	PT7M7023CHTA	Vdet-IC	2.3V±1.5%, +Reset PPO	SOT-23-5	28vdr	VD7	6k	Pti
NK	PT7M7023CHTAE	Vdet-IC	2.3V±1.5%, +Reset PPO, Lead free	SOT-23-5	28vdr	VD7	6k	Pti



SMD code	Type	Function	Short description	Case	Pinout	Sch.	St.	Mnf.
NK8	XC6222B08BMR-G	LVR-IC	LDO, 0.85V±20mV, 700mA, +CE, CL	SOT-25	28cx	VR4	6g	Tor
NK9	XC6222B09BMR-G	LVR-IC	LDO, 0.95V±20mV, 700mA, +CE, CL	SOT-25	28cx	VR4	6g	Tor
NKA	XC6222B10BMR-G	LVR-IC	LDO, 1.05V±20mV, 700mA, +CE, CL	SOT-25	28cx	VR4	6g	Tor
NKB	XC6222B11BMR-G	LVR-IC	LDO, 1.15V±20mV, 700mA, +CE, CL	SOT-25	28cx	VR4	6g	Tor
NKC	XC6222B12BMR-G	LVR-IC	LDO, 1.25V±20mV, 700mA, +CE, CL	SOT-25	28cx	VR4	6g	Tor
NKD	XC6222B13BMR-G	LVR-IC	LDO, 1.35V±20mV, 700mA, +CE, CL	SOT-25	28cx	VR4	6g	Tor
NKE	XC6222B14BMR-G	LVR-IC	LDO, 1.45V±20mV, 700mA, +CE, CL	SOT-25	28cx	VR4	6g	Tor
NKF	XC6222B15BMR-G	LVR-IC	LDO, 1.55V±20mV, 700mA, +CE, CL	SOT-25	28cx	VR4	6g	Tor
NKH	XC6222B16BMR-G	LVR-IC	LDO, 1.65V±20mV, 700mA, +CE, CL	SOT-25	28cx	VR4	6g	Tor
NKK	XC6222B17BMR-G	LVR-IC	LDO, 1.75V±20mV, 700mA, +CE, CL	SOT-25	28cx	VR4	6g	Tor
NKL	XC6222B18BMR-G	LVR-IC	LDO, 1.85V±20mV, 700mA, +CE, CL	SOT-25	28cx	VR4	6g	Tor
NKM	XC6222B19BMR-G	LVR-IC	LDO, 1.95V±20mV, 700mA, +CE, CL	SOT-25	28cx	VR4	6g	Tor
NKN	XC6222B20BMR-G	LVR-IC	LDO, 2.05V±1%, 700mA, +CE, CL	SOT-25	28cx	VR4	6g	Tor
NKP	XC6222B21BMR-G	LVR-IC	LDO, 2.15V±1%, 700mA, +CE, CL	SOT-25	28cx	VR4	6g	Tor
NKR	XC6222B22BMR-G	LVR-IC	LDO, 2.25V±1%, 700mA, +CE, CL	SOT-25	28cx	VR4	6g	Tor
NKS	XC6222B23BMR-G	LVR-IC	LDO, 2.35V±1%, 700mA, +CE, CL	SOT-25	28cx	VR4	6g	Tor
NKT	XC6222B24BMR-G	LVR-IC	LDO, 2.45V±1%, 700mA, +CE, CL	SOT-25	28cx	VR4	6g	Tor
NKU	XC6222B25BMR-G	LVR-IC	LDO, 2.55V±1%, 700mA, +CE, CL	SOT-25	28cx	VR4	6g	Tor
NKV	XC6222B26BMR-G	LVR-IC	LDO, 2.65V±1%, 700mA, +CE, CL	SOT-25	28cx	VR4	6g	Tor
NKX	XC6222B27BMR-G	LVR-IC	LDO, 2.75V±1%, 700mA, +CE, CL	SOT-25	28cx	VR4	6g	Tor
NKY	XC6222B28BMR-G	LVR-IC	LDO, 2.85V±1%, 700mA, +CE, CL	SOT-25	28cx	VR4	6g	Tor
NKZ	XC6222B29BMR-G	LVR-IC	LDO, 2.95V±1%, 700mA, +CE, CL	SOT-25	28cx	VR4	6g	Tor
NL	PT7M7023NLT	Vdet-IC	2.3V±1.5%, -Reset ODO	SOT-23-5	28vdr	VD6	6k	Pti
NL	R1122N401A	LVR-IC	LDO, LN, -CE, 4V±2%, 150mA	SOT-23-5	28vt	VR4	6g	Ric
NL	PT7M7023NLTAE	Vdet-IC	2.3V±1.5%, -Reset ODO, Lead free	SOT-23-5	28vdr	VD6	6k	Pti
NL0	XC6222B301MR-G	LVR-IC	LDO, 3.0V±1%, 700mA, +CE, CL	SOT-25	28cx	VR4	6g	Tor
NL1	XC6222B311MR-G	LVR-IC	LDO, 3.1V±1%, 700mA, +CE, CL	SOT-25	28cx	VR4	6g	Tor
NL2	XC6222B321MR-G	LVR-IC	LDO, 3.2V±1%, 700mA, +CE, CL	SOT-25	28cx	VR4	6g	Tor
NL3	XC6222B331MR-G	LVR-IC	LDO, 3.3V±1%, 700mA, +CE, CL	SOT-25	28cx	VR4	6g	Tor
NL4	XC6222B341MR-G	LVR-IC	LDO, 3.4V±1%, 700mA, +CE, CL	SOT-25	28cx	VR4	6g	Tor
NL5	XC6222B351MR-G	LVR-IC	LDO, 3.5V±1%, 700mA, +CE, CL	SOT-25	28cx	VR4	6g	Tor
NL6	XC6222B361MR-G	LVR-IC	LDO, 3.6V±1%, 700mA, +CE, CL	SOT-25	28cx	VR4	6g	Tor
NL7	XC6222B371MR-G	LVR-IC	LDO, 3.7V±1%, 700mA, +CE, CL	SOT-25	28cx	VR4	6g	Tor
NL8	XC6222B381MR-G	LVR-IC	LDO, 3.8V±1%, 700mA, +CE, CL	SOT-25	28cx	VR4	6g	Tor
NL9	XC6222B391MR-G	LVR-IC	LDO, 3.9V±1%, 700mA, +CE, CL	SOT-25	28cx	VR4	6g	Tor
NLA	XC6222B401MR-G	LVR-IC	LDO, 4.0V±1%, 700mA, +CE, CL	SOT-25	28cx	VR4	6g	Tor
NLB	XC6222B411MR-G	LVR-IC	LDO, 4.1V±1%, 700mA, +CE, CL	SOT-25	28cx	VR4	6g	Tor
NLC	XC6222B421MR-G	LVR-IC	LDO, 4.2V±1%, 700mA, +CE, CL	SOT-25	28cx	VR4	6g	Tor
NLD	XC6222B431MR-G	LVR-IC	LDO, 4.3V±1%, 700mA, +CE, CL	SOT-25	28cx	VR4	6g	Tor
NLE	XC6222B441MR-G	LVR-IC	LDO, 4.4V±1%, 700mA, +CE, CL	SOT-25	28cx	VR4	6g	Tor
NLF	XC6222B451MR-G	LVR-IC	LDO, 4.5V±1%, 700mA, +CE, CL	SOT-25	28cx	VR4	6g	Tor
NLH	XC6222B461MR-G	LVR-IC	LDO, 4.6V±1%, 700mA, +CE, CL	SOT-25	28cx	VR4	6g	Tor
NLK	XC6222B471MR-G	LVR-IC	LDO, 4.7V±1%, 700mA, +CE, CL	SOT-25	28cx	VR4	6g	Tor
NLL	XC6222B481MR-G	LVR-IC	LDO, 4.8V±1%, 700mA, +CE, CL	SOT-25	28cx	VR4	6g	Tor
NLM	XC6222B491MR-G	LVR-IC	LDO, 4.9V±1%, 700mA, +CE, CL	SOT-25	28cx	VR4	6g	Tor
NLN	XC6222B501MR-G	LVR-IC	LDO, 5.0V±1%, 700mA, +CE, CL	SOT-25	28cx	VR4	6g	Tor
NM	KRC661E	Si-npn-Digi	Dual, Sw, 50V, 100mA, 200mW, R1=10k	TESV	30/TD6	-	6l	Kec
NM	KRC661U	Si-npn-Digi	Dual, Sw, 50V, 100mA, 200mW, R1=10k	USV	28/TD9	-	6l	Kec
NM	PT7M7024CLTA	Vdet-IC	2.4V±1.5%, -Reset PPO	SOT-23-5	28vdr	VD7	6k	Pti
NM	R1122N411A	LVR-IC	LDO, LN, -CE, 4.1V±2%, 150mA	SOT-23-5	28vt	VR4	6g	Ric
NM	PT7M7024CLTAE	Vdet-IC	2.4V±1.5%, -Reset PPO, Lead free	SOT-23-5	28vdr	VD7	6k	Pti
NM0	XC6222B30BMR-G	LVR-IC	LDO, 3.05V±1%, 700mA, +CE, CL	SOT-25	28cx	VR4	6g	Tor
NM1	XC6222B31BMR-G	LVR-IC	LDO, 3.15V±1%, 700mA, +CE, CL	SOT-25	28cx	VR4	6g	Tor
NM2	XC6222B32BMR-G	LVR-IC	LDO, 3.25V±1%, 700mA, +CE, CL	SOT-25	28cx	VR4	6g	Tor
NM3	XC6222B33BMR-G	LVR-IC	LDO, 3.35V±1%, 700mA, +CE, CL	SOT-25	28cx	VR4	6g	Tor
NM4	XC6222B34BMR-G	LVR-IC	LDO, 3.45V±1%, 700mA, +CE, CL	SOT-25	28cx	VR4	6g	Tor
NM5	XC6222B35BMR-G	LVR-IC	LDO, 3.55V±1%, 700mA, +CE, CL	SOT-25	28cx	VR4	6g	Tor
NM6	XC6222B36BMR-G	LVR-IC	LDO, 3.65V±1%, 700mA, +CE, CL	SOT-25	28cx	VR4	6g	Tor
NM7	XC6222B37BMR-G	LVR-IC	LDO, 3.75V±1%, 700mA, +CE, CL	SOT-25	28cx	VR4	6g	Tor
NM8	XC6222B38BMR-G	LVR-IC	LDO, 3.85V±1%, 700mA, +CE, CL	SOT-25	28cx	VR4	6g	Tor
NM9	XC6222B39BMR-G	LVR-IC	LDO, 3.95V±1%, 700mA, +CE, CL	SOT-25	28cx	VR4	6g	Tor
NMA	XC6222B40BMR-G	LVR-IC	LDO, 4.05V±1%, 700mA, +CE, CL	SOT-25	28cx	VR4	6g	Tor
NMB	XC6222B41BMR-G	LVR-IC	LDO, 4.15V±1%, 700mA, +CE, CL	SOT-25	28cx	VR4	6g	Tor
NMC	XC6222B42BMR-G	LVR-IC	LDO, 4.25V±1%, 700mA, +CE, CL	SOT-25	28cx	VR4	6g	Tor
NMD	XC6222B43BMR-G	LVR-IC	LDO, 4.35V±1%, 700mA, +CE, CL	SOT-25	28cx	VR4	6g	Tor
NME	XC6222B44BMR-G	LVR-IC	LDO, 4.45V±1%, 700mA, +CE, CL	SOT-25	28cx	VR4	6g	Tor
NMF	XC6222B45BMR-G	LVR-IC	LDO, 4.55V±1%, 700mA, +CE, CL	SOT-25	28cx	VR4	6g	Tor
NMH	XC6222B46BMR-G	LVR-IC	LDO, 4.65V±1%, 700mA, +CE, CL	SOT-25	28cx	VR4	6g	Tor
NMK	XC6222B47BMR-G	LVR-IC	LDO, 4.75V±1%, 700mA, +CE, CL	SOT-25	28cx	VR4	6g	Tor
NML	XC6222B48BMR-G	LVR-IC	LDO, 4.85V±1%, 700mA, +CE, CL	SOT-25	28cx	VR4	6g	Tor



SMD code	Type	Function	Short description	Case	Pinout	Sch.	St.	Mnf.
NMM	XC6222B49BMR-G	LVR-IC	LDO, 4.95V±1%, 700mA, +CE, CL	SOT-25	28cx	VR4	6g	Tor
NN	KRC662E	Si-npn-Digi	Dual, Sw, 50V, 100mA, 200mW, R1=100k	TESV	30/TD6	-	6l	Kec
NN	KRC662U	Si-npn-Digi	Dual, Sw, 50V, 100mA, 200mW, R1=100k	USV	28/TD9	-	6l	Kec
NN	PT7M7024CHTA	Vdet-IC	2.4V±1.5%, +Reset PPO	SOT-23-5	28vdr	VD7	6k	Pti
NN	R1122N421A	LVR-IC	LDO, LN, -CE, 4.2V±2%, 150mA	SOT-23-5	28vt	VR4	6g	Ric
ÑN	PT7M7024CHTAE	Vdet-IC	2.4V±1.5%, +Reset PPO, Lead free	SOT-23-5	28vdr	VD7	6k	Pti
NN8	XC6222C081MR-G	LVR-IC	LDO, 0.8V±20mV, 700mA, +CE, PDR	SOT-25	28cx	VR4	6g	Tor
NN9	XC6222C091MR-G	LVR-IC	LDO, 0.9V±20mV, 700mA, +CE, PDR	SOT-25	28cx	VR4	6g	Tor
NNA	XC6222C101MR-G	LVR-IC	LDO, 1.0V±20mV, 700mA, +CE, PDR	SOT-25	28cx	VR4	6g	Tor
NNB	XC6222C111MR-G	LVR-IC	LDO, 1.1V±20mV, 700mA, +CE, PDR	SOT-25	28cx	VR4	6g	Tor
NNC	XC6222C121MR-G	LVR-IC	LDO, 1.2V±20mV, 700mA, +CE, PDR	SOT-25	28cx	VR4	6g	Tor
NND	XC6222C131MR-G	LVR-IC	LDO, 1.3V±20mV, 700mA, +CE, PDR	SOT-25	28cx	VR4	6g	Tor
NNE	XC6222C141MR-G	LVR-IC	LDO, 1.4V±20mV, 700mA, +CE, PDR	SOT-25	28cx	VR4	6g	Tor
NNF	XC6222C151MR-G	LVR-IC	LDO, 1.5V±20mV, 700mA, +CE, PDR	SOT-25	28cx	VR4	6g	Tor
NNH	XC6222C161MR-G	LVR-IC	LDO, 1.6V±20mV, 700mA, +CE, PDR	SOT-25	28cx	VR4	6g	Tor
NNK	XC6222C171MR-G	LVR-IC	LDO, 1.7V±20mV, 700mA, +CE, PDR	SOT-25	28cx	VR4	6g	Tor
NNL	XC6222C181MR-G	LVR-IC	LDO, 1.8V±20mV, 700mA, +CE, PDR	SOT-25	28cx	VR4	6g	Tor
NNM	XC6222C191MR-G	LVR-IC	LDO, 1.9V±20mV, 700mA, +CE, PDR	SOT-25	28cx	VR4	6g	Tor
NNN	XC6222C201MR-G	LVR-IC	LDO, 2.0V±20mV, 700mA, +CE, PDR	SOT-25	28cx	VR4	6g	Tor
NNP	XC6222C211MR-G	LVR-IC	LDO, 2.1V±1%, 700mA, +CE, PDR	SOT-25	28cx	VR4	6g	Tor
NNR	XC6222C221MR-G	LVR-IC	LDO, 2.2V±1%, 700mA, +CE, PDR	SOT-25	28cx	VR4	6g	Tor
NNS	XC6222C231MR-G	LVR-IC	LDO, 2.3V±1%, 700mA, +CE, PDR	SOT-25	28cx	VR4	6g	Tor
NNT	XC6222C241MR-G	LVR-IC	LDO, 2.4V±1%, 700mA, +CE, PDR	SOT-25	28cx	VR4	6g	Tor
NNU	XC6222C251MR-G	LVR-IC	LDO, 2.5V±1%, 700mA, +CE, PDR	SOT-25	28cx	VR4	6g	Tor
NNV	XC6222C261MR-G	LVR-IC	LDO, 2.6V±1%, 700mA, +CE, PDR	SOT-25	28cx	VR4	6g	Tor
NNX	XC6222C271MR-G	LVR-IC	LDO, 2.7V±1%, 700mA, +CE, PDR	SOT-25	28cx	VR4	6g	Tor
NNY	XC6222C281MR-G	LVR-IC	LDO, 2.8V±1%, 700mA, +CE, PDR	SOT-25	28cx	VR4	6g	Tor
NNZ	XC6222C291MR-G	LVR-IC	LDO, 2.9V±1%, 700mA, +CE, PDR	SOT-25	28cx	VR4	6g	Tor
NO	KRC663E	Si-npn-Digi	Dual, Sw, 50V, 100mA, 200mW, R1=22k	TESV	30/TD6	-	6l	Kec
NO	KRC663U	Si-npn-Digi	Dual, Sw, 50V, 100mA, 200mW, R1=22k	USV	28/TD9	-	6l	Kec
NO	PT7M7024NLTA	Vdet-IC	2.4V±1.5%, -Reset ODO	SOT-23-5	28vdr	VD6	6k	Pti
ÑO	PT7M7024NLTAE	Vdet-IC	2.4V±1.5%, -Reset ODO, Lead free	SOT-23-5	28vdr	VD6	6k	Pti
NP	KRC664E	Si-npn-Digi	Dual, Sw, 50V, 100mA, 200mW, R1=47k	TESV	30/TD6	-	6l	Kec
NP	KRC664U	Si-npn-Digi	Dual, Sw, 50V, 100mA, 200mW, R1=47k	USV	28/TD9	-	6l	Kec
NP	PT7M7025CLTA	Vdet-IC	2.5V±1.5%, -Reset PPO	SOT-23-5	28vdr	VD7	6k	Pti
NP	R1122N431A	LVR-IC	LDO, LN, -CE, 4.3V±2%, 150mA	SOT-23-5	28vt	VR4	6g	Ric
ÑP	PT7M7025CLTAE	Vdet-IC	2.5V±1.5%, -Reset PPO, Lead free	SOT-23-5	28vdr	VD7	6k	Pti
NP8	XC6222C08BMR-G	LVR-IC	LDO, 0.85V±20mV, 700mA, +CE, PDR	SOT-25	28cx	VR4	6g	Tor
NP9	XC6222C09BMR-G	LVR-IC	LDO, 0.95V±20mV, 700mA, +CE, PDR	SOT-25	28cx	VR4	6g	Tor
NPA	XC6222C10BMR-G	LVR-IC	LDO, 1.05V±20mV, 700mA, +CE, PDR	SOT-25	28cx	VR4	6g	Tor
NPB	XC6222C11BMR-G	LVR-IC	LDO, 1.15V±20mV, 700mA, +CE, PDR	SOT-25	28cx	VR4	6g	Tor
NPC	XC6222C12BMR-G	LVR-IC	LDO, 1.25V±20mV, 700mA, +CE, PDR	SOT-25	28cx	VR4	6g	Tor
NPD	XC6222C13BMR-G	LVR-IC	LDO, 1.35V±20mV, 700mA, +CE, PDR	SOT-25	28cx	VR4	6g	Tor
NPE	XC6222C14BMR-G	LVR-IC	LDO, 1.45V±20mV, 700mA, +CE, PDR	SOT-25	28cx	VR4	6g	Tor
NPF	XC6222C15BMR-G	LVR-IC	LDO, 1.55V±20mV, 700mA, +CE, PDR	SOT-25	28cx	VR4	6g	Tor
NPH	XC6222C16BMR-G	LVR-IC	LDO, 1.65V±20mV, 700mA, +CE, PDR	SOT-25	28cx	VR4	6g	Tor
NPK	XC6222C17BMR-G	LVR-IC	LDO, 1.75V±20mV, 700mA, +CE, PDR	SOT-25	28cx	VR4	6g	Tor
NPL	XC6222C18BMR-G	LVR-IC	LDO, 1.85V±20mV, 700mA, +CE, PDR	SOT-25	28cx	VR4	6g	Tor
NPM	XC6222C19BMR-G	LVR-IC	LDO, 1.95V±20mV, 700mA, +CE, PDR	SOT-25	28cx	VR4	6g	Tor
NPN	XC6222C20BMR-G	LVR-IC	LDO, 2.05V±1%, 700mA, +CE, PDR	SOT-25	28cx	VR4	6g	Tor
NPP	XC6222C21BMR-G	LVR-IC	LDO, 2.15V±1%, 700mA, +CE, PDR	SOT-25	28cx	VR4	6g	Tor
NPR	XC6222C22BMR-G	LVR-IC	LDO, 2.25V±1%, 700mA, +CE, PDR	SOT-25	28cx	VR4	6g	Tor
NPS	XC6222C23BMR-G	LVR-IC	LDO, 2.35V±1%, 700mA, +CE, PDR	SOT-25	28cx	VR4	6g	Tor
NPT	XC6222C24BMR-G	LVR-IC	LDO, 2.45V±1%, 700mA, +CE, PDR	SOT-25	28cx	VR4	6g	Tor
NPU	XC6222C25BMR-G	LVR-IC	LDO, 2.55V±1%, 700mA, +CE, PDR	SOT-25	28cx	VR4	6g	Tor
NPV	XC6222C26BMR-G	LVR-IC	LDO, 2.65V±1%, 700mA, +CE, PDR	SOT-25	28cx	VR4	6g	Tor
NPX	XC6222C27BMR-G	LVR-IC	LDO, 2.75V±1%, 700mA, +CE, PDR	SOT-25	28cx	VR4	6g	Tor
NPY	XC6222C28BMR-G	LVR-IC	LDO, 2.85V±1%, 700mA, +CE, PDR	SOT-25	28cx	VR4	6g	Tor
NPZ	XC6222C29BMR-G	LVR-IC	LDO, 2.95V±1%, 700mA, +CE, PDR	SOT-25	28cx	VR4	6g	Tor
NQ	PT7M7025CHTA	Vdet-IC	2.5V±1.5%, +Reset PPO	SOT-23-5	28vdr	VD7	6k	Pti
NQ	R1122N441A	LVR-IC	LDO, LN, -CE, 4.4V±2%, 150mA	SOT-23-5	28vt	VR4	6g	Ric
ÑQ	PT7M7025CHTAE	Vdet-IC	2.5V±1.5%, +Reset PPO, Lead free	SOT-23-5	28vdr	VD7	6k	Pti
NR	PT7M7025NLTA	Vdet-IC	2.5V±1.5%, -Reset ODO	SOT-23-5	28vdr	VD6	6k	Pti
NR	R1122N451A	LVR-IC	LDO, LN, -CE, 4.5V±2%, 150mA	SOT-23-5	28vt	VR4	6g	Ric
ÑR	PT7M7025NLTAE	Vdet-IC	2.5V±1.5%, -Reset ODO, Lead free	SOT-23-5	28vdr	VD6	6k	Pti
NR0	XC6222C301MR-G	LVR-IC	LDO, 3.0V±1%, 700mA, +CE, PDR	SOT-25	28cx	VR4	6g	Tor
NR1	XC6222C311MR-G	LVR-IC	LDO, 3.1V±1%, 700mA, +CE, PDR	SOT-25	28cx	VR4	6g	Tor
NR2	XC6222C321MR-G	LVR-IC	LDO, 3.2V±1%, 700mA, +CE, PDR	SOT-25	28cx	VR4	6g	Tor
NR3	XC6222C331MR-G	LVR-IC	LDO, 3.3V±1%, 700mA, +CE, PDR	SOT-25	28cx	VR4	6g	Tor
NR4	XC6222C341MR-G	LVR-IC	LDO, 3.4V±1%, 700mA, +CE, PDR	SOT-25	28cx	VR4	6g	Tor



SMD code	Type	Function	Short description	Case	Pinout	Sch.	St.	Mnf.
NR5	XC6222C351MR-G	LVR-IC	LDO, 3.5V±1%, 700mA, +CE, PDR	SOT-25	28cx	VR4	6g	Tor
NR6	XC6222C361MR-G	LVR-IC	LDO, 3.6V±1%, 700mA, +CE, PDR	SOT-25	28cx	VR4	6g	Tor
NR7	XC6222C371MR-G	LVR-IC	LDO, 3.7V±1%, 700mA, +CE, PDR	SOT-25	28cx	VR4	6g	Tor
NR8	XC6222C381MR-G	LVR-IC	LDO, 3.8V±1%, 700mA, +CE, PDR	SOT-25	28cx	VR4	6g	Tor
NR9	XC6222C391MR-G	LVR-IC	LDO, 3.9V±1%, 700mA, +CE, PDR	SOT-25	28cx	VR4	6g	Tor
NRA	XC6222C401MR-G	LVR-IC	LDO, 4.0V±1%, 700mA, +CE, PDR	SOT-25	28cx	VR4	6g	Tor
NRB	XC6222C411MR-G	LVR-IC	LDO, 4.1V±1%, 700mA, +CE, PDR	SOT-25	28cx	VR4	6g	Tor
NRC	XC6222C421MR-G	LVR-IC	LDO, 4.2V±1%, 700mA, +CE, PDR	SOT-25	28cx	VR4	6g	Tor
NRD	XC6222C431MR-G	LVR-IC	LDO, 4.3V±1%, 700mA, +CE, PDR	SOT-25	28cx	VR4	6g	Tor
NRE	XC6222C441MR-G	LVR-IC	LDO, 4.4V±1%, 700mA, +CE, PDR	SOT-25	28cx	VR4	6g	Tor
NRF	XC6222C451MR-G	LVR-IC	LDO, 4.5V±1%, 700mA, +CE, PDR	SOT-25	28cx	VR4	6g	Tor
NRH	XC6222C461MR-G	LVR-IC	LDO, 4.6V±1%, 700mA, +CE, PDR	SOT-25	28cx	VR4	6g	Tor
NRK	XC6222C471MR-G	LVR-IC	LDO, 4.7V±1%, 700mA, +CE, PDR	SOT-25	28cx	VR4	6g	Tor
NRL	XC6222C481MR-G	LVR-IC	LDO, 4.8V±1%, 700mA, +CE, PDR	SOT-25	28cx	VR4	6g	Tor
NRM	XC6222C491MR-G	LVR-IC	LDO, 4.9V±1%, 700mA, +CE, PDR	SOT-25	28cx	VR4	6g	Tor
NRN	XC6222C501MR-G	LVR-IC	LDO, 5.0V±1%, 700mA, +CE, PDR	SOT-25	28cx	VR4	6g	Tor
NS	PT7M7026CLTA	Vdet-IC	2.6V±1.5%, -Reset PPO	SOT-23-5	28vdr	VD7	6k	Pti
NS	R1122N461A	LVR-IC	LDO, LN, -CE, 4.6V±2%, 150mA	SOT-23-5	28vt	VR4	6g	Ric
ÑS	PT7M7026CLTAE	Vdet-IC	2.6V±1.5%, -Reset PPO, Lead free	SOT-23-5	28vdr	VD7	6k	Pti
NS0	XC6222C30BMR-G	LVR-IC	LDO, 3.05V±1%, 700mA, +CE, PDR	SOT-25	28cx	VR4	6g	Tor
NS1	XC6222C31BMR-G	LVR-IC	LDO, 3.15V±1%, 700mA, +CE, PDR	SOT-25	28cx	VR4	6g	Tor
NS2	XC6222C32BMR-G	LVR-IC	LDO, 3.25V±1%, 700mA, +CE, PDR	SOT-25	28cx	VR4	6g	Tor
NS3	XC6222C33BMR-G	LVR-IC	LDO, 3.35V±1%, 700mA, +CE, PDR	SOT-25	28cx	VR4	6g	Tor
NS4	XC6222C34BMR-G	LVR-IC	LDO, 3.45V±1%, 700mA, +CE, PDR	SOT-25	28cx	VR4	6g	Tor
NS5	XC6222C35BMR-G	LVR-IC	LDO, 3.55V±1%, 700mA, +CE, PDR	SOT-25	28cx	VR4	6g	Tor
NS6	XC6222C36BMR-G	LVR-IC	LDO, 3.65V±1%, 700mA, +CE, PDR	SOT-25	28cx	VR4	6g	Tor
NS7	XC6222C37BMR-G	LVR-IC	LDO, 3.75V±1%, 700mA, +CE, PDR	SOT-25	28cx	VR4	6g	Tor
NS8	XC6222C38BMR-G	LVR-IC	LDO, 3.85V±1%, 700mA, +CE, PDR	SOT-25	28cx	VR4	6g	Tor
NS9	XC6222C39BMR-G	LVR-IC	LDO, 3.95V±1%, 700mA, +CE, PDR	SOT-25	28cx	VR4	6g	Tor
NSA	XC6222C40BMR-G	LVR-IC	LDO, 4.05V±1%, 700mA, +CE, PDR	SOT-25	28cx	VR4	6g	Tor
NSB	XC6222C41BMR-G	LVR-IC	LDO, 4.15V±1%, 700mA, +CE, PDR	SOT-25	28cx	VR4	6g	Tor
NSC	XC6222C42BMR-G	LVR-IC	LDO, 4.25V±1%, 700mA, +CE, PDR	SOT-25	28cx	VR4	6g	Tor
NSD	XC6222C43BMR-G	LVR-IC	LDO, 4.35V±1%, 700mA, +CE, PDR	SOT-25	28cx	VR4	6g	Tor
NSE	XC6222C44BMR-G	LVR-IC	LDO, 4.45V±1%, 700mA, +CE, PDR	SOT-25	28cx	VR4	6g	Tor
NSF	XC6222C45BMR-G	LVR-IC	LDO, 4.55V±1%, 700mA, +CE, PDR	SOT-25	28cx	VR4	6g	Tor
NSH	XC6222C46BMR-G	LVR-IC	LDO, 4.65V±1%, 700mA, +CE, PDR	SOT-25	28cx	VR4	6g	Tor
NSK	XC6222C47BMR-G	LVR-IC	LDO, 4.75V±1%, 700mA, +CE, PDR	SOT-25	28cx	VR4	6g	Tor
NSL	XC6222C48BMR-G	LVR-IC	LDO, 4.85V±1%, 700mA, +CE, PDR	SOT-25	28cx	VR4	6g	Tor
NSM	XC6222C49BMR-G	LVR-IC	LDO, 4.95V±1%, 700mA, +CE, PDR	SOT-25	28cx	VR4	6g	Tor
NT	PT7M7026CHTA	Vdet-IC	2.6V±1.5%, +Reset PPO	SOT-23-5	28vdr	VD7	6k	Pti
NT	R1122N471A	LVR-IC	LDO, LN, -CE, 4.7V±2%, 150mA	SOT-23-5	28vt	VR4	6g	Ric
NT	TC1185-2.6VRX	LVR-IC	LDO, 2.6V±2%, 150mA, +CE	SOT-23-5	28vrx	VR7	6g	Mcc
ÑT	PT7M7026CHTAE	Vdet-IC	2.6V±1.5%, +Reset PPO, Lead free	SOT-23-5	28vdr	VD7	6k	Pti
NT8	XC6222D081MR-G	LVR-IC	LDO, 0.8V±20mV, 700mA, +CE, PDR, CL	SOT-25	28cx	VR4	6g	Tor
NT9	XC6222D091MR-G	LVR-IC	LDO, 0.9V±20mV, 700mA, +CE, CL, PDR	SOT-25	28cx	VR4	6g	Tor
NTA	XC6222D101MR-G	LVR-IC	LDO, 1.0V±20mV, 700mA, +CE, PDR, CL	SOT-25	28cx	VR4	6g	Tor
NTB	XC6222D111MR-G	LVR-IC	LDO, 1.1V±20mV, 700mA, +CE, CL, PDR	SOT-25	28cx	VR4	6g	Tor
NTC	XC6222D121MR-G	LVR-IC	LDO, 1.2V±20mV, 700mA, +CE, CL, PDR	SOT-25	28cx	VR4	6g	Tor
NTD	XC6222D131MR-G	LVR-IC	LDO, 1.3V±20mV, 700mA, +CE, CL, PDR	SOT-25	28cx	VR4	6g	Tor
NTE	XC6222D141MR-G	LVR-IC	LDO, 1.4V±20mV, 700mA, +CE, CL, PDR	SOT-25	28cx	VR4	6g	Tor
NTF	XC6222D151MR-G	LVR-IC	LDO, 1.5V±20mV, 700mA, +CE, CL, PDR	SOT-25	28cx	VR4	6g	Tor
NTH	XC6222D161MR-G	LVR-IC	LDO, 1.6V±20mV, 700mA, +CE, CL, PDR	SOT-25	28cx	VR4	6g	Tor
NTK	XC6222D171MR-G	LVR-IC	LDO, 1.7V±20mV, 700mA, +CE, CL, PDR	SOT-25	28cx	VR4	6g	Tor
NTL	XC6222D181MR-G	LVR-IC	LDO, 1.8V±20mV, 700mA, +CE, CL, PDR	SOT-25	28cx	VR4	6g	Tor
NTM	XC6222D191MR-G	LVR-IC	LDO, 1.9V±20mV, 700mA, +CE, CL, PDR	SOT-25	28cx	VR4	6g	Tor
NTN	XC6222D201MR-G	LVR-IC	LDO, 2.0V±20mV, 700mA, +CE, CL, PDR	SOT-25	28cx	VR4	6g	Tor
NTP	XC6222D211MR-G	LVR-IC	LDO, 2.1V±1%, 700mA, +CE, CL, PDR	SOT-25	28cx	VR4	6g	Tor
NTR	XC6222D221MR-G	LVR-IC	LDO, 2.2V±1%, 700mA, +CE, CL, PDR	SOT-25	28cx	VR4	6g	Tor
NTS	XC6222D231MR-G	LVR-IC	LDO, 2.3V±1%, 700mA, +CE, CL, PDR	SOT-25	28cx	VR4	6g	Tor
NTT	XC6222D241MR-G	LVR-IC	LDO, 2.4V±1%, 700mA, +CE, CL, PDR	SOT-25	28cx	VR4	6g	Tor
NTU	XC6222D251MR-G	LVR-IC	LDO, 2.5V±1%, 700mA, +CE, CL, PDR	SOT-25	28cx	VR4	6g	Tor
NTV	XC6222D261MR-G	LVR-IC	LDO, 2.6V±1%, 700mA, +CE, CL, PDR	SOT-25	28cx	VR4	6g	Tor
NTX	XC6222D271MR-G	LVR-IC	LDO, 2.7V±1%, 700mA, +CE, CL, PDR	SOT-25	28cx	VR4	6g	Tor
NTY	XC6222D281MR-G	LVR-IC	LDO, 2.8V±1%, 700mA, +CE, CL, PDR	SOT-25	28cx	VR4	6g	Tor
NTZ	XC6222D291MR-G	LVR-IC	LDO, 2.9V±1%, 700mA, +CE, CL, PDR	SOT-25	28cx	VR4	6g	Tor
NU	PT7M7026NLTA	Vdet-IC	2.6V±1.5%, -Reset ODO	SOT-23-5	28vdr	VD6	6k	Pti
NU	R1122N481A	LVR-IC	LDO, LN, -CE, 4.8V±2%, 150mA	SOT-23-5	28vt	VR4	6g	Ric
ÑU	PT7M7026NLTAE	Vdet-IC	2.6V±1.5%, -Reset ODO, Lead free	SOT-23-5	28vdr	VD6	6k	Pti
NU18	MIC5247-1.8BD5	LVR-IC	LDO, 1.8V±1%, 150mA, +CE	SOT-23-5	28vrx	VR7	6g	Mcr
NU20	MIC5247-2.0BD5	LVR-IC	LDO, 2V±1%, 150mA, +CE	TSOT-23-5	28vrx	VR7	6g	Mcr



SMD code	Type	Function	Short description	Case	Pinout	Sch.	St.	Mnf.
NU8	XC6222D08BMR-G	LVR-IC	LDO, 0.85V±20mV, 700mA, +CE, PDR, CL	SOT-25	28cx	VR4	6g	Tor
NU9	XC6222D09BMR-G	LVR-IC	LDO, 0.95V±20mV, 700mA, +CE, PDR, CL	SOT-25	28cx	VR4	6g	Tor
NUA	XC6222D10BMR-G	LVR-IC	LDO, 1.05V±20mV, 700mA, +CE, PDR, CL	SOT-25	28cx	VR4	6g	Tor
NUB	XC6222D11BMR-G	LVR-IC	LDO, 1.15V±20mV, 700mA, +CE, PDR, CL	SOT-25	28cx	VR4	6g	Tor
NUC	XC6222D12BMR-G	LVR-IC	LDO, 1.25V±20mV, 700mA, +CE, CL, PDR	SOT-25	28cx	VR4	6g	Tor
NUD	XC6222D13BMR-G	LVR-IC	LDO, 1.35V±20mV, 700mA, +CE, CL, PDR	SOT-25	28cx	VR4	6g	Tor
NUE	XC6222D14BMR-G	LVR-IC	LDO, 1.45V±20mV, 700mA, +CE, CL, PDR	SOT-25	28cx	VR4	6g	Tor
NUF	XC6222D15BMR-G	LVR-IC	LDO, 1.55V±20mV, 700mA, +CE, CL, PDR	SOT-25	28cx	VR4	6g	Tor
NUH	XC6222D16BMR-G	LVR-IC	LDO, 1.65V±20mV, 700mA, +CE, CL, PDR	SOT-25	28cx	VR4	6g	Tor
NUK	XC6222D17BMR-G	LVR-IC	LDO, 1.75V±20mV, 700mA, +CE, CL, PDR	SOT-25	28cx	VR4	6g	Tor
NULL	XC6222D18BMR-G	LVR-IC	LDO, 1.85V±20mV, 700mA, +CE, CL, PDR	SOT-25	28cx	VR4	6g	Tor
NUM	XC6222D19BMR-G	LVR-IC	LDO, 1.95V±20mV, 700mA, +CE, CL, PDR	SOT-25	28cx	VR4	6g	Tor
NUN	XC6222D20BMR-G	LVR-IC	LDO, 2.05V±1%, 700mA, +CE, CL, PDR	SOT-25	28cx	VR4	6g	Tor
NUP	XC6222D21BMR-G	LVR-IC	LDO, 2.15V±1%, 700mA, +CE, CL, PDR	SOT-25	28cx	VR4	6g	Tor
NUR	XC6222D22BMR-G	LVR-IC	LDO, 2.25V±1%, 700mA, +CE, CL, PDR	SOT-25	28cx	VR4	6g	Tor
NUS	XC6222D23BMR-G	LVR-IC	LDO, 2.35V±1%, 700mA, +CE, CL, PDR	SOT-25	28cx	VR4	6g	Tor
NUT	XC6222D24BMR-G	LVR-IC	LDO, 2.45V±1%, 700mA, +CE, CL, PDR	SOT-25	28cx	VR4	6g	Tor
NUU	XC6222D25BMR-G	LVR-IC	LDO, 2.55V±1%, 700mA, +CE, CL, PDR	SOT-25	28cx	VR4	6g	Tor
NUV	XC6222D26BMR-G	LVR-IC	LDO, 2.65V±1%, 700mA, +CE, CL, PDR	SOT-25	28cx	VR4	6g	Tor
NUX	XC6222D27BMR-G	LVR-IC	LDO, 2.75V±1%, 700mA, +CE, CL, PDR	SOT-25	28cx	VR4	6g	Tor
NUY	XC6222D28BMR-G	LVR-IC	LDO, 2.85V±1%, 700mA, +CE, CL, PDR	SOT-25	28cx	VR4	6g	Tor
NUZ	XC6222D29BMR-G	LVR-IC	LDO, 2.95V±1%, 700mA, +CE, CL, PDR	SOT-25	28cx	VR4	6g	Tor
NV	PT7M7027CLTA	Vdet-IC	2.7V±1.5%, -Reset PPO	SOT-23-5	28vdr	VD7	6k	Pti
NV	R1122N491A	LVR-IC	LDO, LN, -CE, 4.9V±2%, 150mA	SOT-23-5	28vt	VR4	6g	Ric
NV̄	PT7M7027CLTAE	Vdet-IC	2.7V±1.5%, -Reset PPO, Lead free	SOT-23-5	28vdr	VD7	6k	Pti
NV0	XC6222D301MR-G	LVR-IC	LDO, 3.0V±1%, 700mA, +CE, CL, PDR	SOT-25	28cx	VR4	6g	Tor
NV1	XC6222D311MR-G	LVR-IC	LDO, 3.1V±1%, 700mA, +CE, CL, PDR	SOT-25	28cx	VR4	6g	Tor
NV2	XC6222D321MR-G	LVR-IC	LDO, 3.2V±1%, 700mA, +CE, CL, PDR	SOT-25	28cx	VR4	6g	Tor
NV3	XC6222D331MR-G	LVR-IC	LDO, 3.3V±1%, 700mA, +CE, CL, PDR	SOT-25	28cx	VR4	6g	Tor
NV4	XC6222D341MR-G	LVR-IC	LDO, 3.4V±1%, 700mA, +CE, CL, PDR	SOT-25	28cx	VR4	6g	Tor
NV5	XC6222D351MR-G	LVR-IC	LDO, 3.5V±1%, 700mA, +CE, CL, PDR	SOT-25	28cx	VR4	6g	Tor
NV6	XC6222D361MR-G	LVR-IC	LDO, 3.6V±1%, 700mA, +CE, CL, PDR	SOT-25	28cx	VR4	6g	Tor
NV7	XC6222D371MR-G	LVR-IC	LDO, 3.7V±1%, 700mA, +CE, CL, PDR	SOT-25	28cx	VR4	6g	Tor
NV8	XC6222D381MR-G	LVR-IC	LDO, 3.8V±1%, 700mA, +CE, CL, PDR	SOT-25	28cx	VR4	6g	Tor
NV9	XC6222D391MR-G	LVR-IC	LDO, 3.9V±1%, 700mA, +CE, CL, PDR	SOT-25	28cx	VR4	6g	Tor
NVA	XC6222D401MR-G	LVR-IC	LDO, 4.0V±1%, 700mA, +CE, CL, PDR	SOT-25	28cx	VR4	6g	Tor
NVB	XC6222D411MR-G	LVR-IC	LDO, 4.1V±1%, 700mA, +CE, CL, PDR	SOT-25	28cx	VR4	6g	Tor
NVC	XC6222D421MR-G	LVR-IC	LDO, 4.2V±1%, 700mA, +CE, CL, PDR	SOT-25	28cx	VR4	6g	Tor
NVD	XC6222D431MR-G	LVR-IC	LDO, 4.3V±1%, 700mA, +CE, CL, PDR	SOT-25	28cx	VR4	6g	Tor
NVE	XC6222D441MR-G	LVR-IC	LDO, 4.4V±1%, 700mA, +CE, CL, PDR	SOT-25	28cx	VR4	6g	Tor
NVF	XC6222D451MR-G	LVR-IC	LDO, 4.5V±1%, 700mA, +CE, CL, PDR	SOT-25	28cx	VR4	6g	Tor
NVH	XC6222D461MR-G	LVR-IC	LDO, 4.6V±1%, 700mA, +CE, CL, PDR	SOT-25	28cx	VR4	6g	Tor
NVK	XC6222D471MR-G	LVR-IC	LDO, 4.7V±1%, 700mA, +CE, CL, PDR	SOT-25	28cx	VR4	6g	Tor
NVL	XC6222D481MR-G	LVR-IC	LDO, 4.8V±1%, 700mA, +CE, CL, PDR	SOT-25	28cx	VR4	6g	Tor
NVM	XC6222D491MR-G	LVR-IC	LDO, 4.9V±1%, 700mA, +CE, CL, PDR	SOT-25	28cx	VR4	6g	Tor
NVN	XC6222D501MR-G	LVR-IC	LDO, 5.0V±1%, 700mA, +CE, CL, PDR	SOT-25	28cx	VR4	6g	Tor
NV	PT7M7027CHTA	Vdet-IC	2.7V±1.5%, +Reset PPO	SOT-23-5	28vdr	VD7	6k	Pti
NV̄	PT7M7027CHTAE	Vdet-IC	2.7V±1.5%, +Reset PPO, Lead free	SOT-23-5	28vdr	VD7	6k	Pti
NW25	MIC5255-2.5BD5	LVR-IC	LDO, 2.5V±1%, 150mA, +CE	SOT-23-5	28vrx	VR7	6g	Mcr
NW26	MIC5255-2.6BD5	LVR-IC	LDO, 2.6V±1%, 150mA, +CE	TSOT-23-5	28vrx	VR7	6g	Mcr
NW27	MIC5255-2.7BD5	LVR-IC	LDO, 2.7V±1%, 150mA, +CE	SOT-23-5	28vrx	VR7	6g	Mcr
NW28	MIC5255-2.8BD5	LVR-IC	LDO, 2.8V±1%, 150mA, +CE	SOT-23-5	28vrx	VR7	6g	Mcr
NW29	MIC5255-2.9BD5	LVR-IC	LDO, 2.9V±1%, 150mA, +CE	SOT-23-5	28vrx	VR7	6g	Mcr
NW2J	MIC5255-2.85BD5	LVR-IC	LDO, 2.85V±1%, 150mA, +CE	SOT-23-5	28vrx	VR7	6g	Mcr
NW30	MIC5255-3.0BD5	LVR-IC	LDO, 3V±1%, 150mA, +CE	SOT-23-5	28vrx	VR7	6g	Mcr
NW33	MIC5255-3.3BD5	LVR-IC	LDO, 3.3V±1%, 150mA, +CE	SOT-23-5	28vrx	VR7	6g	Mcr
NX	PT7M7027NLTA	Vdet-IC	2.7V±1.5%, -Reset ODO	SOT-23-5	28vdr	VD6	6k	Pti
NX̄	PT7M7027NLTAE	Vdet-IC	2.7V±1.5%, -Reset ODO, Lead free	SOT-23-5	28vdr	VD6	6k	Pti
NX0	XC6222D30BMR-G	LVR-IC	LDO, 3.05V±1%, 700mA, +CE, CL, PDR	SOT-25	28cx	VR4	6g	Tor
NX1	XC6222D31BMR-G	LVR-IC	LDO, 3.15V±1%, 700mA, +CE, CL, PDR	SOT-25	28cx	VR4	6g	Tor
NX2	XC6222D32BMR-G	LVR-IC	LDO, 3.25V±1%, 700mA, +CE, CL, PDR	SOT-25	28cx	VR4	6g	Tor
NX2J	MIC5256-2.85BD5	LVR-IC	LDO, 2.85V±1%, 150mA, +CE, -Error	SOT-23-5	28w	VR17	6g	Mcr
NX3	XC6222D33BMR-G	LVR-IC	LDO, 3.35V±1%, 700mA, +CE, CL, PDR	SOT-25	28cx	VR4	6g	Tor
NX4	XC6222D34BMR-G	LVR-IC	LDO, 3.45V±1%, 700mA, +CE, CL, PDR	SOT-25	28cx	VR4	6g	Tor
NX5	XC6222D35BMR-G	LVR-IC	LDO, 3.55V±1%, 700mA, +CE, CL, PDR	SOT-25	28cx	VR4	6g	Tor
NX6	XC6222D36BMR-G	LVR-IC	LDO, 3.65V±1%, 700mA, +CE, CL, PDR	SOT-25	28cx	VR4	6g	Tor
NX7	XC6222D37BMR-G	LVR-IC	LDO, 3.75V±1%, 700mA, +CE, CL, PDR	SOT-25	28cx	VR4	6g	Tor
NX8	XC6222D38BMR-G	LVR-IC	LDO, 3.85V±1%, 700mA, +CE, CL, PDR	SOT-25	28cx	VR4	6g	Tor
NX9	XC6222D39BMR-G	LVR-IC	LDO, 3.95V±1%, 700mA, +CE, CL, PDR	SOT-25	28cx	VR4	6g	Tor
NXA	XC6222D40BMR-G	LVR-IC	LDO, 4.05V±1%, 700mA, +CE, CL, PDR	SOT-25	28cx	VR4	6g	Tor



SMD code	Type	Function	Short description	Case	Pinout	Sch.	St.	Mnf.
NXB	XC6222D41BMR-G	LVR-IC	LDO, 4.15V±1%, 700mA, +CE, CL, PDR	SOT-25	28cx	VR4	6g	Tor
NXC	XC6222D42BMR-G	LVR-IC	LDO, 4.25V±1%, 700mA, +CE, CL, PDR	SOT-25	28cx	VR4	6g	Tor
NXD	XC6222D43BMR-G	LVR-IC	LDO, 4.35V±1%, 700mA, +CE, CL, PDR	SOT-25	28cx	VR4	6g	Tor
NXE	XC6222D44BMR-G	LVR-IC	LDO, 4.45V±1%, 700mA, +CE, CL, PDR	SOT-25	28cx	VR4	6g	Tor
NXF	XC6222D45BMR-G	LVR-IC	LDO, 4.55V±1%, 700mA, +CE, CL, PDR	SOT-25	28cx	VR4	6g	Tor
NXH	XC6222D46BMR-G	LVR-IC	LDO, 4.65V±1%, 700mA, +CE, CL, PDR	SOT-25	28cx	VR4	6g	Tor
NXK	XC6222D47BMR-G	LVR-IC	LDO, 4.75V±1%, 700mA, +CE, CL, PDR	SOT-25	28cx	VR4	6g	Tor
NXL	XC6222D48BMR-G	LVR-IC	LDO, 4.85V±1%, 700mA, +CE, CL, PDR	SOT-25	28cx	VR4	6g	Tor
NXM	XC6222D49BMR-G	LVR-IC	LDO, 4.95V±1%, 700mA, +CE, CL, PDR	SOT-25	28cx	VR4	6g	Tor
NY	PT7M7028CLTA	Vdet-IC	2.8V±1.5%, -Reset PPO	SOT-23-5	28vdr	VD7	6k	Pti
NY	TC1185-1.8VRX	LVR-IC	LDO, 1.8V±2%, 150mA, +CE	SOT-23-5	28vrx	VR7	6g	Mcc
ÑY	PT7M7028CLTAE	Vdet-IC	2.8V±1.5%, -Reset PPO, Lead free	SOT-23-5	28vrx	VD7	6k	Pti
NYA	S-1111B15MC	LVR-IC	LDO, 1.5V±1.0%, 150mA, +CE	SOT-23-5	28cx	VR4	6a	Sii
NYA	S-1111B15PN	LVR-IC	LDO, 1.5V±1.0%, 150mA, +CE	SOM-5	30v3r	VR4	6a	Sii
NYB	S-1111B16MC	LVR-IC	LDO, 1.6V±1.0%, 150mA, +CE	SOT-23-5	28cx	VR4	6a	Sii
NYB	S-1111B16PN	LVR-IC	LDO, 1.6V±1.0%, 150mA, +CE	SOM-5	30v3r	VR4	6a	Sii
NYC	S-1111B17MC	LVR-IC	LDO, 1.7V±1.0%, 150mA, +CE	SOT-23-5	28cx	VR4	6a	Sii
NYC	S-1111B17PN	LVR-IC	LDO, 1.7V±1.0%, 150mA, +CE	SOM-5	30v3r	VR4	6a	Sii
NYD	S-1111B18MC	LVR-IC	LDO, 1.8V±1.0%, 150mA, +CE	SOT-23-5	28cx	VR4	6a	Sii
NYD	S-1111B18PN	LVR-IC	LDO, 1.8V±1.0%, 150mA, +CE	SOM-5	30v3r	VR4	6a	Sii
NYE	S-1111B19MC	LVR-IC	LDO, 1.9V±1.0%, 150mA, +CE	SOT-23-5	28cx	VR4	6a	Sii
NYE	S-1111B19PN	LVR-IC	LDO, 1.9V±1.0%, 150mA, +CE	SOM-5	30v3r	VR4	6a	Sii
NYF	S-1111B20MC	LVR-IC	LDO, 2.0V±1.0%, 150mA, +CE	SOT-23-5	28cx	VR4	6a	Sii
NYF	S-1111B20PN	LVR-IC	LDO, 2.0V±1.0%, 150mA, +CE	SOM-5	30v3r	VR4	6a	Sii
NYG	S-1111B21MC	LVR-IC	LDO, 2.1V±1.0%, 150mA, +CE	SOT-23-5	28cx	VR4	6a	Sii
NYG	S-1111B21PN	LVR-IC	LDO, 2.1V±1.0%, 150mA, +CE	SOM-5	30v3r	VR4	6a	Sii
NYH	S-1111B22MC	LVR-IC	LDO, 2.2V±1.0%, 150mA, +CE	SOT-23-5	28cx	VR4	6a	Sii
NYH	S-1111B22PN	LVR-IC	LDO, 2.2V±1.0%, 150mA, +CE	SOM-5	30v3r	VR4	6a	Sii
NYI	S-1111B23MC	LVR-IC	LDO, 2.3V±1.0%, 150mA, +CE	SOT-23-5	28cx	VR4	6a	Sii
NYI	S-1111B23PN	LVR-IC	LDO, 2.3V±1.0%, 150mA, +CE	SOM-5	30v3r	VR4	6a	Sii
NYJ	S-1111B24MC	LVR-IC	LDO, 2.4V±1.0%, 150mA, +CE	SOT-23-5	28cx	VR4	6a	Sii
NYJ	S-1111B24PN	LVR-IC	LDO, 2.4V±1.0%, 150mA, +CE	SOM-5	30v3r	VR4	6a	Sii
NYK	S-1111B25MC	LVR-IC	LDO, 2.5V±1.0%, 150mA, +CE	SOT-23-5	28cx	VR4	6a	Sii
NYK	S-1111B25PN	LVR-IC	LDO, 2.5V±1.0%, 150mA, +CE	SOM-5	30v3r	VR4	6a	Sii
NYL	S-1111B26MC	LVR-IC	LDO, 2.6V±1.0%, 150mA, +CE	SOT-23-5	28cx	VR4	6a	Sii
NYL	S-1111B26PN	LVR-IC	LDO, 2.6V±1.0%, 150mA, +CE	SOM-5	30v3r	VR4	6a	Sii
NYM	S-1111B27MC	LVR-IC	LDO, 2.7V±1.0%, 150mA, +CE	SOT-23-5	28cx	VR4	6a	Sii
NYM	S-1111B27PN	LVR-IC	LDO, 2.7V±1.0%, 150mA, +CE	SOM-5	30v3r	VR4	6a	Sii
NYN	S-1111B28MC	LVR-IC	LDO, 2.8V±1.0%, 150mA, +CE	SOT-23-5	28cx	VR4	6a	Sii
NYN	S-1111B28PN	LVR-IC	LDO, 2.8V±1.0%, 150mA, +CE	SOM-5	30v3r	VR4	6a	Sii
NYO	S-1111B29MC	LVR-IC	LDO, 2.9V±1.0%, 150mA, +CE	SOT-23-5	28cx	VR4	6a	Sii
NYO	S-1111B29PN	LVR-IC	LDO, 2.9V±1.0%, 150mA, +CE	SOM-5	30v3r	VR4	6a	Sii
NYP	S-1111B30MC	LVR-IC	LDO, 3.0V±1.0%, 150mA, +CE	SOT-23-5	28cx	VR4	6a	Sii
NYP	S-1111B30PN	LVR-IC	LDO, 3.0V±1.0%, 150mA, +CE	SOM-5	30v3r	VR4	6a	Sii
NYQ	S-1111B31MC	LVR-IC	LDO, 3.1V±1.0%, 150mA, +CE	SOT-23-5	28cx	VR4	6a	Sii
NYQ	S-1111B31PN	LVR-IC	LDO, 3.1V±1.0%, 150mA, +CE	SOM-5	30v3r	VR4	6a	Sii
NYR	S-1111B32MC	LVR-IC	LDO, 3.2V±1.0%, 150mA, +CE	SOT-23-5	28cx	VR4	6a	Sii
NYR	S-1111B32PN	LVR-IC	LDO, 3.2V±1.0%, 150mA, +CE	SOM-5	30v3r	VR4	6a	Sii
NYS	S-1111B33MC	LVR-IC	LDO, 3.3V±1.0%, 150mA, +CE	SOT-23-5	28cx	VR4	6a	Sii
NYS	S-1111B33PN	LVR-IC	LDO, 3.3V±1.0%, 150mA, +CE	SOM-5	30v3r	VR4	6a	Sii
NYT	S-1111B34MC	LVR-IC	LDO, 3.4V±1.0%, 150mA, +CE	SOT-23-5	28cx	VR4	6a	Sii
NYT	S-1111B34PN	LVR-IC	LDO, 3.4V±1.0%, 150mA, +CE	SOM-5	30v3r	VR4	6a	Sii
NYU	S-1111B35MC	LVR-IC	LDO, 3.5V±1.0%, 150mA, +CE	SOT-23-5	28cx	VR4	6a	Sii
NYU	S-1111B35PN	LVR-IC	LDO, 3.5V±1.0%, 150mA, +CE	SOM-5	30v3r	VR4	6a	Sii
NYV	S-1111B36MC	LVR-IC	LDO, 3.6V±1.0%, 150mA, +CE	SOT-23-5	28cx	VR4	6a	Sii
NYV	S-1111B36PN	LVR-IC	LDO, 3.6V±1.0%, 150mA, +CE	SOM-5	30v3r	VR4	6a	Sii
NYW	S-1111B37MC	LVR-IC	LDO, 3.7V±1.0%, 150mA, +CE	SOT-23-5	28cx	VR4	6a	Sii
NYW	S-1111B37PN	LVR-IC	LDO, 3.7V±1.0%, 150mA, +CE	SOM-5	30v3r	VR4	6a	Sii
NYX	S-1111B38MC	LVR-IC	LDO, 3.8V±1.0%, 150mA, +CE	SOT-23-5	28cx	VR4	6a	Sii
NYX	S-1111B38PN	LVR-IC	LDO, 3.8V±1.0%, 150mA, +CE	SOM-5	30v3r	VR4	6a	Sii
NY Y	S-1111B39MC	LVR-IC	LDO, 3.9V±1.0%, 150mA, +CE	SOT-23-5	28cx	VR4	6a	Sii
NY Y	S-1111B39PN	LVR-IC	LDO, 3.9V±1.0%, 150mA, +CE	SOM-5	30v3r	VR4	6a	Sii
NYZ	S-1111B40MC	LVR-IC	LDO, 4.0V±1.0%, 150mA, +CE	SOT-23-5	28cx	VR4	6a	Sii
NYZ	S-1111B40PN	LVR-IC	LDO, 4.0V±1.0%, 150mA, +CE	SOM-5	30v3r	VR4	6a	Sii
NZ	PT7M7028CHTA	Vdet-IC	2.8V±1.5%, +Reset PPO	SOT-23-5	28vdr	VD7	6k	Pti
NZ	TC1185-2.8VRX	LVR-IC	LDO, 2.8V±2%, 150mA, +CE	SOT-23-5	28vrx	VR7	6g	Mcc
ÑZ	PT7M7028CHTAE	Vdet-IC	2.8V±1.5%, +Reset PPO, Lead free	SOT-23-5	28vdr	VD7	6k	Pti
NZA	S-1111B41MC	LVR-IC	LDO, 4.1V±1.0%, 150mA, +CE	SOT-23-5	28cx	VR4	6a	Sii
NZA	S-1111B41PN	LVR-IC	LDO, 4.1V±1.0%, 150mA, +CE	SOM-5	30v3r	VR4	6a	Sii
NZB	S-1111B42MC	LVR-IC	LDO, 4.2V±1.0%, 150mA, +CE	SOT-23-5	28cx	VR4	6a	Sii



SMD code	Type	Function	Short description	Case	Pinout	Sch.	St.	Mnf.
NZB	S-1111B42PN	LVR-IC	LDO, 4.2V±1.0%, 150mA, +CE	SON-5	30vr3	VR4	6a	Sii
NZC	S-1111B43MC	LVR-IC	LDO, 4.3V±1.0%, 150mA, +CE	SOT-23-5	28cx	VR4	6a	Sii
NZC	S-1111B43PN	LVR-IC	LDO, 4.3V±1.0%, 150mA, +CE	SON-5	30vr3	VR4	6a	Sii
NZD	S-1111B44MC	LVR-IC	LDO, 4.4V±1.0%, 150mA, +CE	SOT-23-5	28cx	VR4	6a	Sii
NZD	S-1111B44PN	LVR-IC	LDO, 4.4V±1.0%, 150mA, +CE	SON-5	30vr3	VR4	6a	Sii
NZE	S-1111B45MC	LVR-IC	LDO, 4.5V±1.0%, 150mA, +CE	SOT-23-5	28cx	VR4	6a	Sii
NZE	S-1111B45PN	LVR-IC	LDO, 4.5V±1.0%, 150mA, +CE	SON-5	30vr3	VR4	6a	Sii
NZF	S-1111B46MC	LVR-IC	LDO, 4.6V±1.0%, 150mA, +CE	SOT-23-5	28cx	VR4	6a	Sii
NZF	S-1111B46PN	LVR-IC	LDO, 4.6V±1.0%, 150mA, +CE	SON-5	30vr3	VR4	6a	Sii
NZG	S-1111B47MC	LVR-IC	LDO, 4.7V±1.0%, 150mA, +CE	SOT-23-5	28cx	VR4	6a	Sii
NZG	S-1111B47PN	LVR-IC	LDO, 4.7V±1.0%, 150mA, +CE	SON-5	30vr3	VR4	6a	Sii
NZH	S-1111B48MC	LVR-IC	LDO, 4.8V±1.0%, 150mA, +CE	SOT-23-5	28cx	VR4	6a	Sii
NZH	S-1111B48PN	LVR-IC	LDO, 4.8V±1.0%, 150mA, +CE	SON-5	30vr3	VR4	6a	Sii
NZI	S-1111B49MC	LVR-IC	LDO, 4.9V±1.0%, 150mA, +CE	SOT-23-5	28cx	VR4	6a	Sii
NZI	S-1111B49PN	LVR-IC	LDO, 4.9V±1.0%, 150mA, +CE	SON-5	30vr3	VR4	6a	Sii
NZJ	S-1111B50MC	LVR-IC	LDO, 5.0V±1.0%, 150mA, +CE	SOT-23-5	28cx	VR4	6a	Sii
NZJ	S-1111B50PN	LVR-IC	LDO, 5.0V±1.0%, 150mA, +CE	SON-5	30vr3	VR4	6a	Sii
NZK	S-1111B51MC	LVR-IC	LDO, 5.1V±1.0%, 150mA, +CE	SOT-23-5	28cx	VR4	6a	Sii
NZK	S-1111B51PN	LVR-IC	LDO, 5.1V±1.0%, 150mA, +CE	SON-5	30vr3	VR4	6a	Sii
NZL	S-1111B52MC	LVR-IC	LDO, 5.2V±1.0%, 150mA, +CE	SOT-23-5	28cx	VR4	6a	Sii
NZL	S-1111B52PN	LVR-IC	LDO, 5.2V±1.0%, 150mA, +CE	SON-5	30vr3	VR4	6a	Sii
NZM	S-1111B53MC	LVR-IC	LDO, 5.3V±1.0%, 150mA, +CE	SOT-23-5	28cx	VR4	6a	Sii
NZM	S-1111B53PN	LVR-IC	LDO, 5.3V±1.0%, 150mA, +CE	SON-5	30vr3	VR4	6a	Sii
NZN	S-1111B54MC	LVR-IC	LDO, 5.4V±1.0%, 150mA, +CE	SOT-23-5	28cx	VR4	6a	Sii
NZN	S-1111B54PN	LVR-IC	LDO, 5.4V±1.0%, 150mA, +CE	SON-5	30vr3	VR4	6a	Sii
NZO	S-1111B55MC	LVR-IC	LDO, 5.5V±1.0%, 150mA, +CE	SOT-23-5	28cx	VR4	6a	Sii
NZO	S-1111B55PN	LVR-IC	LDO, 5.5V±1.0%, 150mA, +CE	SON-5	30vr3	VR4	6a	Sii
OA	PT7M7028NLTAE	Vdet-IC	2.8V±1.5%, -Reset ODO	SOT-23-5	28vdr	VD6	6k	Pti
ŌA	PT7M7028NLTAE	Vdet-IC	2.8V±1.5%, -Reset ODO, Lead free	SOT-23-5	28vdr	VD6	6k	Pti
OB	PT7M7029CLTA	Vdet-IC	2.9V±1.5%, -Reset PPO	SOT-23-5	28vdr	VD7	6k	Pti
ŌB	PT7M7029CLTAE	Vdet-IC	2.9V±1.5%, -Reset PPO, Lead free	SOT-23-5	28vdr	VD7	6k	Pti
OC	PT7M7029CHTA	Vdet-IC	2.9V±1.5%, +Reset PPO	SOT-23-5	28vdr	VD7	6k	Pti
ŌC	PT7M7029CHTAE	Vdet-IC	2.9V±1.5%, +Reset PPO, Lead free	SOT-23-5	28vdr	VD7	6k	Pti
OD	PT7M7029NLTA	Vdet-IC	2.9V±1.5%, -Reset ODO	SOT-23-5	28vdr	VD6	6k	Pti
ŌD	PT7M7029NLTAE	Vdet-IC	2.9V±1.5%, -Reset ODO, Lead free	SOT-23-5	28vdr	VD6	6k	Pti
OE	PT7M7030CLTA	Vdet-IC	3.0V±1.5%, -Reset PPO	SOT-23-5	28vdr	VD7	6k	Pti
ŌE	PT7M7030CLTAE	Vdet-IC	3.0V±1.5%, -Reset PPO, Lead free	SOT-23-5	28vdr	VD7	6k	Pti
OF	PT7M7030CHTA	Vdet-IC	3.0V±1.5%, +Reset PPO	SOT-23-5	28vdr	VD7	6k	Pti
ŌF	PT7M7030CHTAE	Vdet-IC	3.0V±1.5%, +Reset PPO, Lead free	SOT-23-5	28vdr	VD7	6k	Pti
OG	PT7M7030NLTA	Vdet-IC	3.0V±1.5%, -Reset ODO	SOT-23-5	28vdr	VD6	6k	Pti
ŌG	PT7M7030NLTAE	Vdet-IC	3.0V±1.5%, -Reset ODO, Lead free	SOT-23-5	28vdr	VD6	6k	Pti
OGA	S-T111B15MC-OGATFG	LVR-IC	LDO, 1.5V±1%, 150mA, +CE	SOT-23-5	28vc	VR4	6r	Sii
OGB	S-T111B16MC-OGBTFG	LVR-IC	LDO, 1.6V±1%, 150mA, +CE	SOT-23-5	28vc	VR4	6r	Sii
OGC	S-T111B17MC-OGCTFG	LVR-IC	LDO, 1.7V±1%, 150mA, +CE	SOT-23-5	28vc	VR4	6r	Sii
OGD	S-T111B18MC-OGDTFG	LVR-IC	LDO, 1.8V±1%, 150mA, +CE	SOT-23-5	28vc	VR4	6r	Sii
OGE	S-T111B19MC-OGETFG	LVR-IC	LDO, 1.9V±1%, 150mA, +CE	SOT-23-5	28vc	VR4	6r	Sii
OGF	S-T111B20MC-OGFTFG	LVR-IC	LDO, 2.0V±1%, 150mA, +CE	SOT-23-5	28vc	VR4	6r	Sii
OGG	S-T111B21MC-OGGTFG	LVR-IC	LDO, 2.1V±1%, 150mA, +CE	SOT-23-5	28vc	VR4	6r	Sii
OGH	S-T111B22MC-OGHTFG	LVR-IC	LDO, 2.2V±1%, 150mA, +CE	SOT-23-5	28vc	VR4	6r	Sii
OGI	S-T111B23MC-OGITFG	LVR-IC	LDO, 2.3V±1%, 150mA, +CE	SOT-23-5	28vc	VR4	6r	Sii
OGJ	S-T111B24MC-OGJTFG	LVR-IC	LDO, 2.4V±1%, 150mA, +CE	SOT-23-5	28vc	VR4	6r	Sii
OGK	S-T111B25MC-OGKTFG	LVR-IC	LDO, 2.5V±1%, 150mA, +CE	SOT-23-5	28vc	VR4	6r	Sii
OGL	S-T111B26MC-OGLTFG	LVR-IC	LDO, 2.6V±1%, 150mA, +CE	SOT-23-5	28vc	VR4	6r	Sii
OGM	S-T111B27MC-OGMTFG	LVR-IC	LDO, 2.7V±1%, 150mA, +CE	SOT-23-5	28vc	VR4	6r	Sii
OGN	S-T111B28MC-OGNTFG	LVR-IC	LDO, 2.8V±1%, 150mA, +CE	SOT-23-5	28vc	VR4	6r	Sii
OGO	S-T111B29MC-OGOTFG	LVR-IC	LDO, 2.9V±1%, 150mA, +CE	SOT-23-5	28vc	VR4	6r	Sii
OGP	S-T111B30MC-OGPTFG	LVR-IC	LDO, 3.0V±1%, 150mA, +CE	SOT-23-5	28vc	VR4	6r	Sii
OGQ	S-T111B31MC-OGQTFG	LVR-IC	LDO, 3.1V±1%, 150mA, +CE	SOT-23-5	28vc	VR4	6r	Sii
OGR	S-T111B32MC-OGRTFG	LVR-IC	LDO, 3.2V±1%, 150mA, +CE	SOT-23-5	28vc	VR4	6r	Sii
OGS	S-T111B33MC-OGSTFG	LVR-IC	LDO, 3.3V±1%, 150mA, +CE	SOT-23-5	28vc	VR4	6r	Sii
OGT	S-T111B34MC-OGTTFG	LVR-IC	LDO, 3.4V±1%, 150mA, +CE	SOT-23-5	28vc	VR4	6r	Sii
OGU	S-T111B35MC-OGUTFG	LVR-IC	LDO, 3.5V±1%, 150mA, +CE	SOT-23-5	28vc	VR4	6r	Sii
OGV	S-T111B36MC-OGVTFG	LVR-IC	LDO, 3.6V±1%, 150mA, +CE	SOT-23-5	28vc	VR4	6r	Sii
OGW	S-T111B37MC-OGWTFG	LVR-IC	LDO, 3.7V±1%, 150mA, +CE	SOT-23-5	28vc	VR4	6r	Sii
OGX	S-T111B38MC-OGXTFG	LVR-IC	LDO, 3.8V±1%, 150mA, +CE	SOT-23-5	28vc	VR4	6r	Sii
OGY	S-T111B39MC-OGYTFG	LVR-IC	LDO, 3.9V±1%, 150mA, +CE	SOT-23-5	28vc	VR4	6r	Sii
OGZ	S-T111B40MC-OGZTFG	LVR-IC	LDO, 4.0V±1%, 150mA, +CE	SOT-23-5	28vc	VR4	6r	Sii
OH	PT7M7031CLTA	Vdet-IC	3.1V±1.5%, -Reset PPO	SOT-23-5	28vdr	VD7	6k	Pti
ŌH	PT7M7031CLTAE	Vdet-IC	3.1V±1.5%, -Reset PPO, Lead free	SOT-23-5	28vdr	VD7	6k	Pti
OHA	S-T111B41MC-OHATFG	LVR-IC	LDO, 4.1V±1%, 150mA, +CE	SOT-23-5	28vc	VR4	6r	Sii



SMD code	Type	Function	Short description	Case	Pinout	Sch.	St.	Mnf.
OHB	S-T111B42MC-OHBTFG	LVR-IC	LDO, 4.2V±1%, 150mA, +CE	SOT-23-5	28vc	VR4	6r	Sii
OHC	S-T111B43MC-OHCTFG	LVR-IC	LDO, 4.3V±1%, 150mA, +CE	SOT-23-5	28vc	VR4	6r	Sii
OHD	S-T111B44MC-OHDTFG	LVR-IC	LDO, 4.4V±1%, 150mA, +CE	SOT-23-5	28vc	VR4	6r	Sii
OHE	S-T111B45MC-OHETFG	LVR-IC	LDO, 4.5V±1%, 150mA, +CE	SOT-23-5	28vc	VR4	6r	Sii
OHF	S-T111B46MC-OHFTFG	LVR-IC	LDO, 4.6V±1%, 150mA, +CE	SOT-23-5	28vc	VR4	6r	Sii
OHG	S-T111B47MC-OHGTFG	LVR-IC	LDO, 4.7V±1%, 150mA, +CE	SOT-23-5	28vc	VR4	6r	Sii
OHH	S-T111B48MC-OHHTFG	LVR-IC	LDO, 4.8V±1%, 150mA, +CE	SOT-23-5	28vc	VR4	6r	Sii
OHI	S-T111B49MC-OHITFG	LVR-IC	LDO, 4.9V±1%, 150mA, +CE	SOT-23-5	28vc	VR4	6r	Sii
OHJ	S-T111B50MC-OHJTFG	LVR-IC	LDO, 5.0V±1%, 150mA, +CE	SOT-23-5	28vc	VR4	6r	Sii
OHK	S-T111B51MC-OHKTFG	LVR-IC	LDO, 5.1V±1%, 150mA, +CE	SOT-23-5	28vc	VR4	6r	Sii
OHL	S-T111B52MC-OHLTFG	LVR-IC	LDO, 5.2V±1%, 150mA, +CE	SOT-23-5	28vc	VR4	6r	Sii
OHM	S-T111B53MC-OHMTFG	LVR-IC	LDO, 5.3V±1%, 150mA, +CE	SOT-23-5	28vc	VR4	6r	Sii
OHN	S-T111B54MC-OHNTFG	LVR-IC	LDO, 5.4V±1%, 150mA, +CE	SOT-23-5	28vc	VR4	6r	Sii
OH0	S-T111B55MC-OHOTFG	LVR-IC	LDO, 5.5V±1%, 150mA, +CE	SOT-23-5	28vc	VR4	6r	Sii
OI	PT7M7031CHTA	Vdet-IC	3.1V±1.5%, +Reset PPO	SOT-23-5	28vdr	VD7	6k	Pti
OĪ	PT7M7031CHTAE	Vdet-IC	3.1V±1.5%, +Reset PPO, Lead free	SOT-23-5	28vdr	VD7	6k	Pti
OJ	PT7M7031NLTA	Vdet-IC	3.1V±1.5%, -Reset ODO	SOT-23-5	28vdr	VD6	6k	Pti
OĪ	PT7M7031NLTAE	Vdet-IC	3.1V±1.5%, -Reset ODO, Lead free	SOT-23-5	28vdr	VD6	6k	Pti
OK	PT7M7032CLTA	Vdet-IC	3.2V±1.5%, -Reset PPO	SOT-23-5	28vdr	VD7	6k	Pti
ÖK	PT7M7032CLTAE	Vdet-IC	3.2V±1.5%, -Reset PPO, Lead free	SOT-23-5	28vdr	VD7	6k	Pti
OL	PT7M7032CHTA	Vdet-IC	3.2V±1.5%, +Reset PPO	SOT-23-5	28vdr	VD7	6k	Pti
ÖL	PT7M7032CHTAE	Vdet-IC	3.2V±1.5%, +Reset PPO, Lead free	SOT-23-5	28vdr	VD7	6k	Pti
OM	PT7M7032NLTA	Vdet-IC	3.2V±1.5%, -Reset ODO	SOT-23-5	28vdr	VD6	6k	Pti
ÖM	PT7M7032NLTAE	Vdet-IC	3.2V±1.5%, -Reset ODO, Lead free	SOT-23-5	28vdr	VD6	6k	Pti
ON	PT7M7033CLTA	Vdet-IC	3.3V±1.5%, -Reset PPO	SOT-23-5	28vdr	VD7	6k	Pti
ÖN	PT7M7033CLTAE	Vdet-IC	3.3V±1.5%, -Reset PPO, Lead free	SOT-23-5	28vdr	VD7	6k	Pti
OO	PT7M7033CHTA	Vdet-IC	3.3V±1.5%, +Reset PPO	SOT-23-5	28vdr	VD7	6k	Pti
ÖO	PT7M7033CHTAE	Vdet-IC	3.3V±1.5%, +Reset PPO, Lead free	SOT-23-5	28vdr	VD7	6k	Pti
OP	PT7M7033NLTA	Vdet-IC	3.3V±1.5%, -Reset ODO	SOT-23-5	28vdr	VD6	6k	Pti
ÖP	PT7M7033NLTAE	Vdet-IC	3.3V±1.5%, -Reset ODO, Lead free	SOT-23-5	28vdr	VD6	6k	Pti
OQ	PT7M7034CLTA	Vdet-IC	3.4V±1.5%, -Reset PPO	SOT-23-5	28vdr	VD7	6k	Pti
ÖQ	PT7M7034CLTAE	Vdet-IC	3.4V±1.5%, -Reset PPO, Lead free	SOT-23-5	28vdr	VD7	6k	Pti
OR	PT7M7034CHTA	Vdet-IC	3.4V±1.5%, +Reset PPO	SOT-23-5	28vdr	VD7	6k	Pti
ÖR	PT7M7034CHTAE	Vdet-IC	3.4V±1.5%, +Reset PPO, Lead free	SOT-23-5	28vdr	VD7	6k	Pti
OS	PT7M7034NLTA	Vdet-IC	3.4V±1.5%, -Reset ODO	SOT-23-5	28vdr	VD6	6k	Pti
ÖS	PT7M7034NLTAE	Vdet-IC	3.4V±1.5%, -Reset ODO, Lead free	SOT-23-5	28vdr	VD6	6k	Pti
OT	PT7M7035CLTA	Vdet-IC	3.5V±1.5%, -Reset PPO	SOT-23-5	28vdr	VD7	6k	Pti
ÖT	PT7M7035CLTAE	Vdet-IC	3.5V±1.5%, -Reset PPO, Lead free	SOT-23-5	28vdr	VD7	6k	Pti
OU	PT7M7035CHTA	Vdet-IC	3.5V±1.5%, +Reset PPO	SOT-23-5	28vdr	VD7	6k	Pti
ÖU	PT7M7035CHTAE	Vdet-IC	3.5V±1.5%, +Reset PPO, Lead free	SOT-23-5	28vdr	VD7	6k	Pti
OV	PT7M7035NLTA	Vdet-IC	3.5V±1.5%, -Reset ODO	SOT-23-5	28vdr	VD6	6k	Pti
ÖV	PT7M7035NLTAE	Vdet-IC	3.5V±1.5%, -Reset ODO, Lead free	SOT-23-5	28vdr	VD6	6k	Pti
OW	PT7M7036CLTA	Vdet-IC	3.6V±1.5%, -Reset PPO	SOT-23-5	28vdr	VD7	6k	Pti
ÖW	PT7M7036CLTAE	Vdet-IC	3.6V±1.5%, -Reset PPO, Lead free	SOT-23-5	28vdr	VD7	6k	Pti
OX	PT7M7036CHTA	Vdet-IC	3.6V±1.5%, +Reset PPO	SOT-23-5	28vdr	VD7	6k	Pti
ÖX	PT7M7036CHTAE	Vdet-IC	3.6V±1.5%, +Reset PPO, Lead free	SOT-23-5	28vdr	VD7	6k	Pti
OY	PT7M7036NLTA	Vdet-IC	3.6V±1.5%, -Reset ODO	SOT-23-5	28vdr	VD6	6k	Pti
ÖY	PT7M7036NLTAE	Vdet-IC	3.6V±1.5%, -Reset ODO, Lead free	SOT-23-5	28vdr	VD6	6k	Pti
OZ	PT7M7037CLTA	Vdet-IC	3.7V±1.5%, -Reset PPO	SOT-23-5	28vdr	VD7	6k	Pti
ÖZ	PT7M7037CLTAE	Vdet-IC	3.7V±1.5%, -Reset PPO, Lead free	SOT-23-5	28vdr	VD7	6k	Pti
P0	R1121N501A	LVR-IC	LDO, LN, -CE, 5V±2%, 150mA	SOT-23-5	28vtt	VR4	6g	Ric
P0	TC1186-4.0VCT713	LVR-IC	LDO, 4.0V±3%, 150mA, +CE, -Error	SOT-23-5	28w	VR8	6g	Mcc
P0	RN5RY601A	DC/DC-IC	VFM step-up, 6V±2.5%, 150mW, <180kHz	SOT-23-5	28vd	DC5	6g	Ric
P00	R1161N281A5	LVR-IC	LDO, 2.85V±2%, 350mA, -CE, AE(Mode)	SOT-23-5	28x9	VR10	6g	Ric
P010	RP107Q102D	LVR-IC	LDO, 1.0V±1%, 200mA, +CE, CL	SC-88A	28xm	VR4	6m	Ric
P011	RP107Q112D	LVR-IC	LDO, 1.1V±1%, 200mA, +CE, CL	SC-88A	28xm	VR4	6m	Ric
P012	RP107Q122D	LVR-IC	LDO, 1.2V±1%, 200mA, +CE, CL	SC-88A	28xm	VR4	6m	Ric
P013	RP107Q132D	LVR-IC	LDO, 1.3V±1%, 200mA, +CE, CL	SC-88A	28xm	VR4	6m	Ric
P014	RP107Q142D	LVR-IC	LDO, 1.4V±1%, 200mA, +CE, CL	SC-88A	28xm	VR4	6m	Ric
P015	RP107Q152D	LVR-IC	LDO, 1.5V±1%, 200mA, +CE, CL	SC-88A	28xm	VR4	6m	Ric
P016	RP107Q162D	LVR-IC	LDO, 1.6V±1%, 200mA, +CE, CL	SC-88A	28xm	VR4	6m	Ric
P017	RP107Q172D	LVR-IC	LDO, 1.7V±1%, 200mA, +CE, CL	SC-88A	28xm	VR4	6m	Ric
P018	RP107Q182D	LVR-IC	LDO, 1.8V±1%, 200mA, +CE, CL	SC-88A	28xm	VR4	6m	Ric
P019	RP107Q192D	LVR-IC	LDO, 1.9V±1%, 200mA, +CE, CL	SC-88A	28xm	VR4	6m	Ric
P020	RP107Q202D	LVR-IC	LDO, 2.0V±1%, 200mA, +CE, CL	SC-88A	28xm	VR4	6m	Ric
P021	RP107Q212D	LVR-IC	LDO, 2.1V±1%, 200mA, +CE, CL	SC-88A	28xm	VR4	6m	Ric
P022	RP107Q222D	LVR-IC	LDO, 2.2V±1%, 200mA, +CE, CL	SC-88A	28xm	VR4	6m	Ric
P023	RP107Q232D	LVR-IC	LDO, 2.3V±1%, 200mA, +CE, CL	SC-88A	28xm	VR4	6m	Ric
P024	RP107Q242D	LVR-IC	LDO, 2.4V±1%, 200mA, +CE, CL	SC-88A	28xm	VR4	6m	Ric
P025	RP107Q252D	LVR-IC	LDO, 2.5V±1%, 200mA, +CE, CL	SC-88A	28xm	VR4	6m	Ric



SMD code	Type	Function	Short description	Case	Pinout	Sch.	St.	Mnf.
P026	RP107Q262D	LVR-IC	LDO, 2.6V±1%, 200mA, +CE, CL	SC-88A	28xm	VR4	6m	Ric
P027	RP107Q272D	LVR-IC	LDO, 2.7V±1%, 200mA, +CE, CL	SC-88A	28xm	VR4	6m	Ric
P028	RP107Q282D	LVR-IC	LDO, 2.8V±1%, 200mA, +CE, CL	SC-88A	28xm	VR4	6m	Ric
P029	RP107Q292D	LVR-IC	LDO, 2.9V±1%, 200mA, +CE, CL	SC-88A	28xm	VR4	6m	Ric
P030	RP107Q302D	LVR-IC	LDO, 3.0V±1%, 200mA, +CE, CL	SC-88A	28xm	VR4	6m	Ric
P031	RP107Q312D	LVR-IC	LDO, 3.1V±1%, 200mA, +CE, CL	SC-88A	28xm	VR4	6m	Ric
P032	RP107Q322D	LVR-IC	LDO, 3.2V±1%, 200mA, +CE, CL	SC-88A	28xm	VR4	6m	Ric
P033	RP107Q332D	LVR-IC	LDO, 3.3V±1%, 200mA, +CE, CL	SC-88A	28xm	VR4	6m	Ric
P034	RP107Q342D	LVR-IC	LDO, 3.4V±1%, 200mA, +CE, CL	SC-88A	28xm	VR4	6m	Ric
P035	RP107Q352D	LVR-IC	LDO, 3.5V±1%, 200mA, +CE, CL	SC-88A	28xm	VR4	6m	Ric
P036	RP107Q362D	LVR-IC	LDO, 3.6V±1%, 200mA, +CE, CL	SC-88A	28xm	VR4	6m	Ric
P037	RP107Q372D	LVR-IC	LDO, 3.7V±1%, 200mA, +CE, CL	SC-88A	28xm	VR4	6m	Ric
P038	RP107Q382D	LVR-IC	LDO, 3.8V±1%, 200mA, +CE, CL	SC-88A	28xm	VR4	6m	Ric
P039	RP107Q392D	LVR-IC	LDO, 3.9V±1%, 200mA, +CE, CL	SC-88A	28xm	VR4	6m	Ric
P040	RP107Q402D	LVR-IC	LDO, 4.0V±1%, 200mA, +CE, CL	SC-88A	28xm	VR4	6m	Ric
P041	RP107Q412D	LVR-IC	LDO, 4.1V±1%, 200mA, +CE, CL	SC-88A	28xm	VR4	6m	Ric
P042	RP107Q422D	LVR-IC	LDO, 4.2V±1%, 200mA, +CE, CL	SC-88A	28xm	VR4	6m	Ric
P043	RP107Q122D5	LVR-IC	LDO, 1.25V±1%, 200mA, +CE, CL	SC-88A	28xm	VR4	6m	Ric
P044	RP107Q182D5	LVR-IC	LDO, 1.85V±1%, 200mA, +CE, CL	SC-88A	28xm	VR4	6m	Ric
P045	RP107Q282D5	LVR-IC	LDO, 2.85V±1%, 200mA, +CE, CL	SC-88A	28xm	VR4	6m	Ric
P08	R1161N081A	LVR-IC	LDO, 0.8V±2%, 350mA, -CE, AE(Mode)	SOT-23-5	28x9	VR10	6g	Ric
P09	NCP585LSN09T1	LVR-IC	LDO, 0.9V±2%, 350mA, -CE, CL, AE(Mode)	SOT-23-5	28x9	VR10	6g	Ons
P09	R1161N091A	LVR-IC	LDO, 0.9V±2%, 350mA, -CE, AE(Mode)	SOT-23-5	28x9	VR10	6g	Ric
P0A	RP200N081B	LVR-IC	LDO, 0.8V±1.0%, 300mA, +CE, AE(mode)	SOT-23-5	28x9	VR10	6g	Ric
P0A	XC6108N40AMR	Vdet-IC	4.0V±2%, Hysteresis, -Reset ODO	SOT-25	28rm	VD14	6g	Tor
P0A	XC6118C30AMR-G	Vdet-IC	3.0V±2%, ±Reset PPO, Sense, hysteresis 5%, Cd	SOT-25	28mg	VD15	6g	Tor
P0B	RP200N091B	LVR-IC	LDO, 0.9V±1.0%, 300mA, +CE, AE(mode)	SOT-23-5	28x9	VR10	6g	Ric
P0B	XC6108N40BMR	Vdet-IC	4.0V±2%, -Reset ODO	SOT-25	28rm	VD14	6g	Tor
P0B	XC6118C30BMR-G	Vdet-IC	3.0V±2%, ±Reset PPO, Sense, hysteresis <1%, Cd	SOT-25	28mg	VD15	6g	Tor
P0C	RP200N101B	LVR-IC	LDO, 1V±1.0%, 300mA, +CE, AE(mode)	SOT-23-5	28x9	VR10	6g	Ric
P0C	XC6108N40CMR	Vdet-IC	4.0V±2%, Hysteresis, -Reset ODO	SOT-25	28rk	VD14	6g	Tor
P0C	XC6118C30CMR-G	Vdet-IC	3.0V±2%, ±Reset PPO, Sense, hysteresis 5%	SOT-25	28mf	VD12	6g	Tor
P0D	RP200N111B	LVR-IC	LDO, 1.1V±1.0%, 300mA, +CE, AE(mode)	SOT-23-5	28x9	VR10	6g	Ric
P0D	XC6108N40DMR	Vdet-IC	4.0V±2%, -Reset ODO	SOT-25	28rk	VD14	6g	Tor
P0D	XC6118C30DMR-G	Vdet-IC	3.0V±2%, ±Reset PPO, Sense, hysteresis <1%	SOT-25	28mf	VD12	6g	Tor
P0E	RP200N121B	LVR-IC	LDO, 1.2V±1.0%, 300mA, +CE, AE(mode)	SOT-23-5	28x9	VR10	6g	Ric
P0F	RP200N131B	LVR-IC	LDO, 1.3V±1.0%, 300mA, +CE, AE(mode)	SOT-23-5	28x9	VR10	6g	Ric
P0G	RP200N141B	LVR-IC	LDO, 1.4V±1.0%, 300mA, +CE, AE(mode)	SOT-23-5	28x9	VR10	6g	Ric
P0H	RP200N151B	LVR-IC	LDO, 1.5V±1.0%, 300mA, +CE, AE(mode)	SOT-23-5	28x9	VR10	6g	Ric
P0J	RP200N161B	LVR-IC	LDO, 1.6V±1.0%, 300mA, +CE, AE(mode)	SOT-23-5	28x9	VR10	6g	Ric
P0K	RP200N171B	LVR-IC	LDO, 1.7V±1.0%, 300mA, +CE, AE(mode)	SOT-23-5	28x9	VR10	6g	Ric
P0L	RP200N181B	LVR-IC	LDO, 1.8V±1.0%, 300mA, +CE, AE(mode)	SOT-23-5	28x9	VR10	6g	Ric
P0M	RP200N191B	LVR-IC	LDO, 1.9V±1.0%, 300mA, +CE, AE(mode)	SOT-23-5	28x9	VR10	6g	Ric
P0N	RP200N201B	LVR-IC	LDO, 2V±1.0%, 300mA, +CE, AE(mode)	SOT-23-5	28x9	VR10	6g	Ric
P0P	RP200N211B	LVR-IC	LDO, 2.1V±1.0%, 300mA, +CE, AE(mode)	SOT-23-5	28x9	VR10	6g	Ric
P0Q	RP200N221B	LVR-IC	LDO, 2.2V±1.0%, 300mA, +CE, AE(mode)	SOT-23-5	28x9	VR10	6g	Ric
P0R	RP200N231B	LVR-IC	LDO, 2.3V±1.0%, 300mA, +CE, AE(mode)	SOT-23-5	28x9	VR10	6g	Ric
P0S	RP200N241B	LVR-IC	LDO, 2.4V±1.0%, 300mA, +CE, AE(mode)	SOT-23-5	28x9	VR10	6g	Ric
P0T	RP200N251B	LVR-IC	LDO, 2.5V±1.0%, 300mA, +CE, AE(mode)	SOT-23-5	28x9	VR10	6g	Ric
P0U	RP200N261B	LVR-IC	LDO, 2.6V±1.0%, 300mA, +CE, AE(mode)	SOT-23-5	28x9	VR10	6g	Ric
P0V	RP200N271B	LVR-IC	LDO, 2.7V±1.0%, 300mA, +CE, AE(mode)	SOT-23-5	28x9	VR10	6g	Ric
P0W	RP200N281B	LVR-IC	LDO, 2.8V±1.0%, 300mA, +CE, AE(mode)	SOT-23-5	28x9	VR10	6g	Ric
P0X	RP200N291B	LVR-IC	LDO, 2.9V±1.0%, 300mA, +CE, AE(mode)	SOT-23-5	28x9	VR10	6g	Ric
P0Y	RP200N301B	LVR-IC	LDO, 3V±1.0%, 300mA, +CE, AE(mode)	SOT-23-5	28x9	VR10	6g	Ric
P0Z	RP200N311B	LVR-IC	LDO, 3.1V±1.0%, 300mA, +CE, AE(mode)	SOT-23-5	28x9	VR10	6g	Ric
P1	TC1186-2.5VCT713	LVR-IC	LDO, 2.5V±3%, 150mA, +CE, -Error	SOT-23-5	28w	VR8	6g	Mcc
P10	R1161N101A	LVR-IC	LDO, 1V±2%, 350mA, -CE, AE(Mode)	SOT-23-5	28x9	VR10	6g	Ric
P10A	ML6204A192M	LVR-IC	LDO, 1.9V±3%, 150mA, +CE, CL	SOT-23-5	28cx	VR4	6a	Mlc
P10B	ML6204B192M	LVR-IC	LDO, 1.9V±3%, 150mA, +CE	SOT-23-5	28cx	VR4	6a	Mlc
P10C	ML6204C192M	LVR-IC	LDO, 1.9V±3%, 150mA, -CE, CL	SOT-23-5	28cx	VR4	6a	Mlc
P10D	ML6204D192M	LVR-IC	LDO, 1.9V±3%, 150mA, -CE	SOT-23-5	28cx	VR4	6a	Mlc
P11	R1161N111A	LVR-IC	LDO, 1.1V±2%, 350mA, -CE, AE(Mode)	SOT-23-5	28x9	VR10	6g	Ric
P12	NCP585LSN12T1	LVR-IC	LDO, 1.2V±2%, 350mA, -CE, CL, AE(Mode)	SOT-23-5	28x9	VR10	6g	Ons
P12	R1161N121A	LVR-IC	LDO, 1.2V±2%, 350mA, -CE, AE(Mode)	SOT-23-5	28x9	VR10	6g	Ric
P13	R1161N131A	LVR-IC	LDO, 1.3V±2%, 350mA, -CE, AE(Mode)	SOT-23-5	28x9	VR10	6g	Ric
P14	R1161N141A	LVR-IC	LDO, 1.4V±2%, 350mA, -CE, AE(Mode)	SOT-23-5	28x9	VR10	6g	Ric
P15	R1161N151A	LVR-IC	LDO, 1.5V±2%, 350mA, -CE, AE(Mode)	SOT-23-5	28x9	VR10	6g	Ric
P15	XC6368E152MR	DC/DC-IC	PWM/PPM step-up, 1.5V±2.5%, 200mA, 180kHz, +CE	SOT-25	28sd	DC10	6g	Tor
P15A	CM7R151A-15B-T	LVR-IC	LDO, 1.5V±3%, 150mA, +CE, PDR	SOT-23-5	28cx	VR4	6a	Can
P15A	ML6204A152M	LVR-IC	LDO, 1.5V±3%, 150mA, +CE, CL	SOT-23-5	28cx	VR4	6a	Mlc



SMD code	Type	Function	Short description	Case	Pinout	Sch.	St.	Mnf.
P15B	CM7R151B-15B-T	LVR-IC	LDO, 1.5V±3%, 150mA, +CE	SOT-23-5	28cx	VR4	6a	Can
P15B	ML6204B152M	LVR-IC	LDO, 1.5V±3%, 150mA, +CE	SOT-23-5	28cx	VR4	6a	Mlc
P15C	CM7R151C-15B-T	LVR-IC	LDO, 1.5V±3%, 150mA, -CE, PDR	SOT-23-5	28cx	VR4	6a	Can
P15C	ML6204C152M	LVR-IC	LDO, 1.5V±3%, 150mA, -CE, CL	SOT-23-5	28cx	VR4	6a	Mlc
P15D	CM7R151D-15B-T	LVR-IC	LDO, 1.5V±3%, 150mA, -CE	SOT-23-5	28cx	VR4	6a	Can
P15D	ML6204D152M	LVR-IC	LDO, 1.5V±3%, 150mA, -CE	SOT-23-5	28cx	VR4	6a	Mlc
P16	R116N161A	LVR-IC	LDO, 1.6V±2%, 350mA, -CE, AE(Mode)	SOT-23-5	28x9	VR10	6g	Ric
P16	XC6368E162MR	DC/DC-IC	PWM/PFM step-up, 1.6V±2.5%, 200mA, 180kHz, +CE	SOT-25	28sd	DC10	6g	Tor
P16A	CM7R151A-16B-T	LVR-IC	LDO, 1.6V±3%, 150mA, -CE, PDR	SOT-23-5	28cx	VR4	6a	Can
P16A	ML6204A162M	LVR-IC	LDO, 1.6V±3%, 150mA, +CE, CL	SOT-23-5	28cx	VR4	6a	Mlc
P16B	CM7R151B-16B-T	LVR-IC	LDO, 1.6V±3%, 150mA, +CE	SOT-23-5	28cx	VR4	6a	Can
P16B	ML6204B162M	LVR-IC	LDO, 1.6V±3%, 150mA, +CE	SOT-23-5	28cx	VR4	6a	Mlc
P16C	CM7R151C-16B-T	LVR-IC	LDO, 1.6V±3%, 150mA, -CE, PDR	SOT-23-5	28cx	VR4	6a	Can
P16C	ML6204C162M	LVR-IC	LDO, 1.6V±3%, 150mA, -CE, CL	SOT-23-5	28cx	VR4	6a	Mlc
P16D	CM7R151D-16B-T	LVR-IC	LDO, 1.6V±3%, 150mA, -CE	SOT-23-5	28cx	VR4	6a	Can
P16D	ML6204D162M	LVR-IC	LDO, 1.6V±3%, 150mA, -CE	SOT-23-5	28cx	VR4	6a	Mlc
P17	R116N171A	LVR-IC	LDO, 1.7V±2%, 350mA, -CE, AE(Mode)	SOT-23-5	28x9	VR10	6g	Ric
P17	XC6368E172MR	DC/DC-IC	PWM/PFM step-up, 1.7V±2.5%, 200mA, 180kHz, +CE	SOT-25	28sd	DC10	6g	Tor
P17A	CM7R151A-17B-T	LVR-IC	LDO, 1.7V±3%, 150mA, -CE, PDR	SOT-23-5	28cx	VR4	6a	Can
P17A	ML6204A172M	LVR-IC	LDO, 1.7V±3%, 150mA, +CE, CL	SOT-23-5	28cx	VR4	6a	Mlc
P17B	CM7R151B-17B-T	LVR-IC	LDO, 1.7V±3%, 150mA, +CE	SOT-23-5	28cx	VR4	6a	Can
P17B	ML6204B172M	LVR-IC	LDO, 1.7V±3%, 150mA, +CE	SOT-23-5	28cx	VR4	6a	Mlc
P17C	CM7R151C-17B-T	LVR-IC	LDO, 1.7V±3%, 150mA, -CE, PDR	SOT-23-5	28cx	VR4	6a	Can
P17C	ML6204C172M	LVR-IC	LDO, 1.7V±3%, 150mA, -CE, CL	SOT-23-5	28cx	VR4	6a	Mlc
P17D	CM7R151D-17B-T	LVR-IC	LDO, 1.7V±3%, 150mA, -CE	SOT-23-5	28cx	VR4	6a	Can
P17D	ML6204D172M	LVR-IC	LDO, 1.7V±3%, 150mA, -CE	SOT-23-5	28cx	VR4	6a	Mlc
P18	NCP585LSN18T1	LVR-IC	LDO, 1.8V±2%, 350mA, -CE, CL, AE(Mode)	SOT-23-5	28x9	VR10	6g	Ons
P18	R116N181A	LVR-IC	LDO, 1.8V±2%, 350mA, -CE, AE(Mode)	SOT-23-5	28x9	VR10	6g	Ric
P18	XC6368E182MR	DC/DC-IC	PWM/PFM step-up, 1.8V±2.5%, 200mA, 180kHz, +CE	SOT-25	28sd	DC10	6g	Tor
P18A	CM7R151A-18B-T	LVR-IC	LDO, 1.8V±3%, 150mA, +CE, PDR	SOT-23-5	28cx	VR4	6a	Can
P18B	CM7R151B-18B-T	LVR-IC	LDO, 1.8V±3%, 150mA, +CE	SOT-23-5	28cx	VR4	6a	Can
P18C	CM7R151C-18B-T	LVR-IC	LDO, 1.8V±3%, 150mA, -CE, PDR	SOT-23-5	28cx	VR4	6a	Can
P18D	CM7R151D-18B-T	LVR-IC	LDO, 1.8V±3%, 150mA, -CE	SOT-23-5	28cx	VR4	6a	Can
P19	NC7SP19P6	CMOS-Logic	1-of-2 decoder/demultiplexer	SC-70-5	28/Log47	-	6a	F
P19	R116N191A	LVR-IC	LDO, 1.9V±2%, 350mA, -CE, AE(Mode)	SOT-23-5	28x9	VR10	6g	Ric
P19	XC6368E192MR	DC/DC-IC	PWM/PFM step-up, 1.9V±2.5%, 200mA, 180kHz, +CE	SOT-25	28sd	DC10	6g	Tor
P19A	CM7R151A-19B-T	LVR-IC	LDO, 1.9V±3%, 150mA, +CE, PDR	SOT-23-5	28cx	VR4	6a	Can
P19A	ML6204A182M	LVR-IC	LDO, 1.8V±3%, 150mA, +CE, CL	SOT-23-5	28cx	VR4	6a	Mlc
P19B	CM7R151B-19B-T	LVR-IC	LDO, 1.9V±3%, 150mA, +CE	SOT-23-5	28cx	VR4	6a	Can
P19B	ML6204B182M	LVR-IC	LDO, 1.8V±3%, 150mA, +CE	SOT-23-5	28cx	VR4	6a	Mlc
P19C	CM7R151C-19B-T	LVR-IC	LDO, 1.9V±3%, 150mA, -CE, PDR	SOT-23-5	28cx	VR4	6a	Can
P19C	ML6204C182M	LVR-IC	LDO, 1.8V±3%, 150mA, -CE, CL	SOT-23-5	28cx	VR4	6a	Mlc
P19D	CM7R151D-19B-T	LVR-IC	LDO, 1.9V±3%, 150mA, -CE	SOT-23-5	28cx	VR4	6a	Can
P19D	ML6204D182M	LVR-IC	LDO, 1.8V±3%, 150mA, -CE	SOT-23-5	28cx	VR4	6a	Mlc
P1A	RP200N081D	LVR-IC	LDO, 0.8V±1.0%, 300mA, +CE, CL, AE(mode)	SOT-23-5	28x9	VR10	6g	Ric
P1A	XC6108N41AMR	Vdet-IC	4.1V±2%, Hysteresis, -Reset ODO	SOT-25	28rm	VD14	6g	Tor
P1A	XC6118C31AMR-G	Vdet-IC	3.1V±2%, ±Reset PPO, Sense, hysteresis 5%, Cd	SOT-25	28mg	VD15	6g	Tor
P1B	RP200N091D	LVR-IC	LDO, 0.9V±1.0%, 300mA, +CE, CL, AE(mode)	SOT-23-5	28x9	VR10	6g	Ric
P1B	XC6108N41BMR	Vdet-IC	4.1V±2%, -Reset ODO	SOT-25	28rm	VD14	6g	Tor
P1B	XC6118C31BMR-G	Vdet-IC	3.1V±2%, ±Reset PPO, Sense, hysteresis <1%, Cd	SOT-25	28mg	VD15	6g	Tor
P1C	RP200N101D	LVR-IC	LDO, 1V±1.0%, 300mA, +CE, CL, AE(mode)	SOT-23-5	28x9	VR10	6g	Ric
P1C	XC6108N41CMR	Vdet-IC	4.1V±2%, Hysteresis, -Reset ODO	SOT-25	28rk	VD14	6g	Tor
P1C	XC6118C31CMR-G	Vdet-IC	3.1V±2%, ±Reset PPO, Sense, hysteresis 5%	SOT-25	28mf	VD12	6g	Tor
P1D	RP200N111D	LVR-IC	LDO, 1.1V±1.0%, 300mA, +CE, CL, AE(mode)	SOT-23-5	28x9	VR10	6g	Ric
P1D	XC6108N41DMR	Vdet-IC	4.1V±2%, -Reset ODO	SOT-25	28rk	VD14	6g	Tor
P1D	XC6118C31DMR-G	Vdet-IC	3.1V±2%, ±Reset PPO, Sense, hysteresis <1%	SOT-25	28mf	VD12	6g	Tor
P1E	RP200N121D	LVR-IC	LDO, 1.2V±1.0%, 300mA, +CE, CL, AE(mode)	SOT-23-5	28x9	VR10	6g	Ric
P1F	RP200N131D	LVR-IC	LDO, 1.3V±1.0%, 300mA, +CE, CL, AE(mode)	SOT-23-5	28x9	VR10	6g	Ric
P1F	XC6368E153MR	DC/DC-IC	PWM/PFM step-up, 1.5V±2.5%, 200mA, 300kHz, +CE	SOT-25	28sd	DC10	6g	Tor
P1FA	CM7R151A-15A-T	LVR-IC	LDO, 1.55V±3%, 150mA, +CE, PDR	SOT-23-5	28cx	VR4	6a	Can
P1FA	ML6204A15AM	LVR-IC	LDO, 1.55V±3%, 150mA, +CE, CL	SOT-23-5	28cx	VR4	6a	Mlc
P1FB	CM7R151B-15A-T	LVR-IC	LDO, 1.55V±3%, 150mA, +CE	SOT-23-5	28cx	VR4	6a	Can
P1FB	ML6204B15AM	LVR-IC	LDO, 1.55V±3%, 150mA, +CE	SOT-23-5	28cx	VR4	6a	Mlc
P1FC	CM7R151C-15A-T	LVR-IC	LDO, 1.55V±3%, 150mA, -CE, PDR	SOT-23-5	28cx	VR4	6a	Can
P1FC	ML6204C15AM	LVR-IC	LDO, 1.55V±3%, 150mA, -CE, CL	SOT-23-5	28cx	VR4	6a	Mlc
P1FD	CM7R151D-15A-T	LVR-IC	LDO, 1.55V±3%, 150mA, -CE	SOT-23-5	28cx	VR4	6a	Can
P1FD	ML6204D15AM	LVR-IC	LDO, 1.55V±3%, 150mA, -CE	SOT-23-5	28cx	VR4	6a	Mlc
P1G	RP200N141D	LVR-IC	LDO, 1.4V±1.0%, 300mA, +CE, CL, AE(mode)	SOT-23-5	28x9	VR10	6g	Ric
P1GA	CM7R151A-16A-T	LVR-IC	LDO, 1.65V±3%, 150mA, +CE, PDR	SOT-23-5	28cx	VR4	6a	Can
P1GA	ML6204A16AM	LVR-IC	LDO, 1.65V±3%, 150mA, +CE, CL	SOT-23-5	28cx	VR4	6a	Mlc



SMD code	Type	Function	Short description	Case	Pinout	Sch.	St.	Mnf.
P1GB	CM7R151B-16A-T	LVR-IC	LDO, 1.65V±3%, 150mA, +CE	SOT-23-5	28cx	VR4	6a	Can
P1GB	ML6204B16AM	LVR-IC	LDO, 1.65V±3%, 150mA, +CE	SOT-23-5	28cx	VR4	6a	Mlc
P1GC	CM7R151C-16A-T	LVR-IC	LDO, 1.65V±3%, 150mA, -CE, PDR	SOT-23-5	28cx	VR4	6a	Can
P1GC	ML6204C16AM	LVR-IC	LDO, 1.65V±3%, 150mA, -CE, CL	SOT-23-5	28cx	VR4	6a	Mlc
P1GD	CM7R151D-16A-T	LVR-IC	LDO, 1.65V±3%, 150mA, -CE	SOT-23-5	28cx	VR4	6a	Can
P1GD	ML6204D16AM	LVR-IC	LDO, 1.65V±3%, 150mA, -CE	SOT-23-5	28cx	VR4	6a	Mlc
P1H	RP200N151D	LVR-IC	LDO, 1.5V±1.0%, 300mA, +CE, CL, AE(mode)	SOT-23-5	28x9	VR10	6g	Ric
P1H	XC6368E163MR	DC/DC-IC	PWM/PFM step-up, 1.6V±2.5%, 200mA, 300kHz, +CE	SOT-25	28sd	DC10	6g	Tor
P1HA	CM7R151A-17A-T	LVR-IC	LDO, 1.75V±3%, 150mA, +CE, PDR	SOT-23-5	28cx	VR4	6a	Can
P1HA	ML6204A17AM	LVR-IC	LDO, 1.75V±3%, 150mA, +CE, CL	SOT-23-5	28cx	VR4	6a	Mlc
P1HB	CM7R151B-17A-T	LVR-IC	LDO, 1.75V±3%, 150mA, +CE	SOT-23-5	28cx	VR4	6a	Can
P1HB	ML6204B17AM	LVR-IC	LDO, 1.75V±3%, 150mA, +CE	SOT-23-5	28cx	VR4	6a	Mlc
P1HC	CM7R151C-17A-T	LVR-IC	LDO, 1.75V±3%, 150mA, -CE, PDR	SOT-23-5	28cx	VR4	6a	Can
P1HC	ML6204C17AM	LVR-IC	LDO, 1.75V±3%, 150mA, -CE, CL	SOT-23-5	28cx	VR4	6a	Mlc
P1HD	CM7R151D-17A-T	LVR-IC	LDO, 1.75V±3%, 150mA, -CE	SOT-23-5	28cx	VR4	6a	Can
P1HD	ML6204D17AM	LVR-IC	LDO, 1.75V±3%, 150mA, -CE	SOT-23-5	28cx	VR4	6a	Mlc
P1IA	CM7R151A-18A-T	LVR-IC	LDO, 1.85V±3%, 150mA, +CE, PDR	SOT-23-5	28cx	VR4	6a	Can
P1IA	ML6204A18AM	LVR-IC	LDO, 1.85V±3%, 150mA, +CE, CL	SOT-23-5	28cx	VR4	6a	Mlc
P1IB	CM7R151B-18A-T	LVR-IC	LDO, 1.85V±3%, 150mA, +CE	SOT-23-5	28cx	VR4	6a	Can
P1IB	ML6204B18AM	LVR-IC	LDO, 1.85V±3%, 150mA, +CE	SOT-23-5	28cx	VR4	6a	Mlc
P1IC	CM7R151C-18A-T	LVR-IC	LDO, 1.85V±3%, 150mA, -CE, PDR	SOT-23-5	28cx	VR4	6a	Can
P1IC	ML6204C18AM	LVR-IC	LDO, 1.85V±3%, 150mA, -CE, CL	SOT-23-5	28cx	VR4	6a	Mlc
P1ID	CM7R151D-18A-T	LVR-IC	LDO, 1.85V±3%, 150mA, -CE	SOT-23-5	28cx	VR4	6a	Can
P1ID	ML6204D18AM	LVR-IC	LDO, 1.85V±3%, 150mA, -CE	SOT-23-5	28cx	VR4	6a	Mlc
P1J	RP200N161D	LVR-IC	LDO, 1.6V±1.0%, 300mA, +CE, CL, AE(mode)	SOT-23-5	28x9	VR10	6g	Ric
P1JA	CM7R151A-19A-T	LVR-IC	LDO, 1.95V±3%, 150mA, +CE, PDR	SOT-23-5	28cx	VR4	6a	Can
P1JA	ML6204A19AM	LVR-IC	LDO, 1.95V±3%, 150mA, +CE, CL	SOT-23-5	28cx	VR4	6a	Mlc
P1JB	CM7R151B-19A-T	LVR-IC	LDO, 1.95V±3%, 150mA, +CE	SOT-23-5	28cx	VR4	6a	Can
P1JB	ML6204B19AM	LVR-IC	LDO, 1.95V±3%, 150mA, +CE	SOT-23-5	28cx	VR4	6a	Mlc
P1JC	CM7R151C-19A-T	LVR-IC	LDO, 1.95V±3%, 150mA, -CE, PDR	SOT-23-5	28cx	VR4	6a	Can
P1JC	ML6204C19AM	LVR-IC	LDO, 1.95V±3%, 150mA, -CE, CL	SOT-23-5	28cx	VR4	6a	Mlc
P1JD	CM7R151D-19A-T	LVR-IC	LDO, 1.95V±3%, 150mA, -CE	SOT-23-5	28cx	VR4	6a	Can
P1JD	ML6204D19AM	LVR-IC	LDO, 1.95V±3%, 150mA, -CE	SOT-23-5	28cx	VR4	6a	Mlc
P1K	RP200N171D	LVR-IC	LDO, 1.7V±1.0%, 300mA, +CE, CL, AE(mode)	SOT-23-5	28x9	VR10	6g	Ric
P1K	XC6368E173MR	DC/DC-IC	PWM/PFM step-up, 1.7V±2.5%, 200mA, 300kHz, +CE	SOT-25	28sd	DC10	6g	Tor
P1L	RP200N181D	LVR-IC	LDO, 1.8V±1.0%, 300mA, +CE, CL, AE(mode)	SOT-23-5	28x9	VR10	6g	Ric
P1L	XC6368E183MR	DC/DC-IC	PWM/PFM step-up, 1.8V±2.5%, 200mA, 300kHz, +CE	SOT-25	28sd	DC10	6g	Tor
P1M	RP200N191D	LVR-IC	LDO, 1.9V±1.0%, 300mA, +CE, CL, AE(mode)	SOT-23-5	28x9	VR10	6g	Ric
P1M	XC6368E193MR	DC/DC-IC	PWM/PFM step-up, 1.9V±2.5%, 200mA, 300kHz, +CE	SOT-25	28sd	DC10	6g	Tor
P1N	RP200N201D	LVR-IC	LDO, 2V±1.0%, 300mA, +CE, CL, AE(mode)	SOT-23-5	28x9	VR10	6g	Ric
P1P	RP200N211D	LVR-IC	LDO, 2.1V±1.0%, 300mA, +CE, CL, AE(mode)	SOT-23-5	28x9	VR10	6g	Ric
P1Q	RP200N221D	LVR-IC	LDO, 2.2V±1.0%, 300mA, +CE, CL, AE(mode)	SOT-23-5	28x9	VR10	6g	Ric
P1R	RP200N231D	LVR-IC	LDO, 2.3V±1.0%, 300mA, +CE, CL, AE(mode)	SOT-23-5	28x9	VR10	6g	Ric
P1S	RP200N241D	LVR-IC	LDO, 2.4V±1.0%, 300mA, +CE, CL, AE(mode)	SOT-23-5	28x9	VR10	6g	Ric
P1T	RP200N251D	LVR-IC	LDO, 2.5V±1.0%, 300mA, +CE, CL, AE(mode)	SOT-23-5	28x9	VR10	6g	Ric
P1U	RP200N261D	LVR-IC	LDO, 2.6V±1.0%, 300mA, +CE, CL, AE(mode)	SOT-23-5	28x9	VR10	6g	Ric
P1V	RP200N271D	LVR-IC	LDO, 2.7V±1.0%, 300mA, +CE, CL, AE(mode)	SOT-23-5	28x9	VR10	6g	Ric
P1W	RP200N281D	LVR-IC	LDO, 2.8V±1.0%, 300mA, +CE, CL, AE(mode)	SOT-23-5	28x9	VR10	6g	Ric
P1X	RP200N291D	LVR-IC	LDO, 2.9V±1.0%, 300mA, +CE, CL, AE(mode)	SOT-23-5	28x9	VR10	6g	Ric
P1Y	RP200N301D	LVR-IC	LDO, 3V±1.0%, 300mA, +CE, CL, AE(mode)	SOT-23-5	28x9	VR10	6g	Ric
P1Z	RP200N311D	LVR-IC	LDO, 3.1V±1.0%, 300mA, +CE, CL, AE(mode)	SOT-23-5	28x9	VR10	6g	Ric
p2	74AUP1G240GW	CMOS-Logic	Bus buffer inverted with 3-state output	SOT-353-1	28/Log22	-	6a	Phi
P2	KRA566E	Si-pnp-Digi	Dual, Sw, 50V, 100mA, 200mW, R1/R2=1k/10k	TESV	30/TD9	-	6l	KeC
P2	KRA566U	Si-pnp-Digi	Dual, Sw, 50V, 100mA, 200mW, R1/R2=1k/10k	USV	28/TD9	-	6l	KeC
P2	TC1186-2.7VCT713	LVR-IC	LDO, 2.7V±3%, 150mA, +CE, -Error	SOT-23-5	28w	VR8	6g	Mcc
P20	R1161N201A	LVR-IC	LDO, 2V±2%, 350mA, -CE, AE(mode)	SOT-23-5	28x9	VR10	6g	Ric
P20	XC6368E202MR	DC/DC-IC	PWM/PFM step-up, 2.0V±2.5%, 200mA, 180kHz, +CE	SOT-25	28sd	DC10	6g	Tor
P20A	CM7R151A-20B-T	LVR-IC	LDO, 2.0V±2%, 150mA, +CE, PDR	SOT-23-5	28cx	VR4	6a	Can
P20A	ML6204A202M	LVR-IC	LDO, 2.0V±2%, 150mA, +CE, CL	SOT-23-5	28cx	VR4	6a	Mlc
P20B	CM7R151B-20B-T	LVR-IC	LDO, 2.0V±2%, 150mA, +CE	SOT-23-5	28cx	VR4	6a	Can
P20B	ML6204B202M	LVR-IC	LDO, 2.0V±2%, 150mA, +CE	SOT-23-5	28cx	VR4	6a	Mlc
P20C	CM7R151C-20B-T	LVR-IC	LDO, 2.0V±2%, 150mA, -CE, PDR	SOT-23-5	28cx	VR4	6a	Can
P20C	ML6204C202M	LVR-IC	LDO, 2.0V±2%, 150mA, -CE, CL	SOT-23-5	28cx	VR4	6a	Mlc
P20D	CM7R151D-20B-T	LVR-IC	LDO, 2.0V±2%, 150mA, -CE	SOT-23-5	28cx	VR4	6a	Can
P20D	ML6204D202M	LVR-IC	LDO, 2.0V±2%, 150mA, -CE	SOT-23-5	28cx	VR4	6a	Mlc
P21	R1161N211A	LVR-IC	LDO, 2.1V±2%, 350mA, -CE, AE(mode)	SOT-23-5	28x9	VR10	6g	Ric
P21	XC6368E212MR	DC/DC-IC	PWM/PFM step-up, 2.1V±2.5%, 200mA, 180kHz, +CE	SOT-25	28sd	DC10	6g	Tor
P21A	CM7R151A-21B-T	LVR-IC	LDO, 2.1V±2%, 150mA, +CE, PDR	SOT-23-5	28cx	VR4	6a	Can
P21A	ML6204A212M	LVR-IC	LDO, 2.1V±2%, 150mA, +CE, CL	SOT-23-5	28cx	VR4	6a	Mlc
P21B	CM7R151B-21B-T	LVR-IC	LDO, 2.1V±2%, 150mA, +CE	SOT-23-5	28cx	VR4	6a	Can



SMD code	Type	Function	Short description	Case	Pinout	Sch.	St.	Mnf.
P21B	ML6204B212M	LVR-IC	LDO, 2.1V±2%, 150mA, +CE	SOT-23-5	28cx	VR4	6a	Mlc
P21C	CM7R151C-21B-T	LVR-IC	LDO, 2.1V±2%, 150mA, -CE, PDR	SOT-23-5	28cx	VR4	6a	Can
P21C	ML6204C212M	LVR-IC	LDO, 2.1V±2%, 150mA, -CE, CL	SOT-23-5	28cx	VR4	6a	Mlc
P21D	CM7R151D-21B-T	LVR-IC	LDO, 2.1V±2%, 150mA, -CE	SOT-23-5	28cx	VR4	6a	Can
P21D	ML6204D212M	LVR-IC	LDO, 2.1V±2%, 150mA, -CE	SOT-23-5	28cx	VR4	6a	Mlc
P22	R1161N221A	LVR-IC	LDO, 2.2V±2%, 350mA, -CE, AE(Mode)	SOT-23-5	28x9	VR10	6g	Ric
P22	XC6368E222MR	DC/DC-IC	PWM/PFM step-up, 2.2V±2.5%, 200mA, 180kHz, +CE	SOT-25	28sd	DC10	6g	Tor
P22A	CM7R151A-22B-T	LVR-IC	LDO, 2.2V±2%, 150mA, +CE, PDR	SOT-23-5	28cx	VR4	6a	Can
P22A	ML6204A222M	LVR-IC	LDO, 2.2V±2%, 150mA, +CE, CL	SOT-23-5	28cx	VR4	6a	Mlc
P22B	CM7R151B-22B-T	LVR-IC	LDO, 2.2V±2%, 150mA, +CE	SOT-23-5	28cx	VR4	6a	Can
P22B	ML6204B222M	LVR-IC	LDO, 2.2V±2%, 150mA, +CE	SOT-23-5	28cx	VR4	6a	Mlc
P22C	CM7R151C-22B-T	LVR-IC	LDO, 2.2V±2%, 150mA, -CE, PDR	SOT-23-5	28cx	VR4	6a	Can
P22C	ML6204C222M	LVR-IC	LDO, 2.2V±2%, 150mA, -CE, CL	SOT-23-5	28cx	VR4	6a	Mlc
P22D	CM7R151D-22B-T	LVR-IC	LDO, 2.2V±2%, 150mA, -CE	SOT-23-5	28cx	VR4	6a	Can
P22D	ML6204D222M	LVR-IC	LDO, 2.2V±2%, 150mA, -CE	SOT-23-5	28cx	VR4	6a	Mlc
P23	R1161N231A	LVR-IC	LDO, 2.3V±2%, 350mA, -CE, AE(Mode)	SOT-23-5	28x9	VR10	6g	Ric
P23	XC6368E232MR	DC/DC-IC	PWM/PFM step-up, 2.3V±2.5%, 200mA, 180kHz, +CE	SOT-25	28sd	DC10	6g	Tor
P23A	CM7R151A-23B-T	LVR-IC	LDO, 2.3V±2%, 150mA, +CE, PDR	SOT-23-5	28cx	VR4	6a	Can
P23A	ML6204A232M	LVR-IC	LDO, 2.3V±2%, 150mA, +CE, CL	SOT-23-5	28cx	VR4	6a	Mlc
P23B	CM7R151B-23B-T	LVR-IC	LDO, 2.3V±2%, 150mA, +CE	SOT-23-5	28cx	VR4	6a	Can
P23B	ML6204B232M	LVR-IC	LDO, 2.3V±2%, 150mA, +CE	SOT-23-5	28cx	VR4	6a	Mlc
P23C	CM7R151C-23B-T	LVR-IC	LDO, 2.3V±2%, 150mA, -CE, PDR	SOT-23-5	28cx	VR4	6a	Can
P23C	ML6204C232M	LVR-IC	LDO, 2.3V±2%, 150mA, -CE, CL	SOT-23-5	28cx	VR4	6a	Mlc
P23D	CM7R151D-23B-T	LVR-IC	LDO, 2.3V±2%, 150mA, -CE	SOT-23-5	28cx	VR4	6a	Can
P23D	ML6204D232M	LVR-IC	LDO, 2.3V±2%, 150mA, -CE	SOT-23-5	28cx	VR4	6a	Mlc
P24	R1161N241A	LVR-IC	LDO, 2.4V±2%, 350mA, -CE, AE(Mode)	SOT-23-5	28x9	VR10	6g	Ric
P24	XC6368E242MR	DC/DC-IC	PWM/PFM step-up, 2.4V±2.5%, 200mA, 180kHz, +CE	SOT-25	28sd	DC10	6g	Tor
P24A	CM7R151A-24B-T	LVR-IC	LDO, 2.4V±2%, 150mA, +CE, PDR	SOT-23-5	28cx	VR4	6a	Can
P24A	ML6204A242M	LVR-IC	LDO, 2.4V±2%, 150mA, +CE, CL	SOT-23-5	28cx	VR4	6a	Mlc
P24B	CM7R151B-24B-T	LVR-IC	LDO, 2.4V±2%, 150mA, +CE	SOT-23-5	28cx	VR4	6a	Can
P24B	ML6204B242M	LVR-IC	LDO, 2.4V±2%, 150mA, +CE	SOT-23-5	28cx	VR4	6a	Mlc
P24C	CM7R151C-24B-T	LVR-IC	LDO, 2.4V±2%, 150mA, -CE, PDR	SOT-23-5	28cx	VR4	6a	Can
P24C	ML6204C242M	LVR-IC	LDO, 2.4V±2%, 150mA, -CE, CL	SOT-23-5	28cx	VR4	6a	Mlc
P24D	CM7R151D-24B-T	LVR-IC	LDO, 2.4V±2%, 150mA, -CE	SOT-23-5	28cx	VR4	6a	Can
P24D	ML6204D242M	LVR-IC	LDO, 2.4V±2%, 150mA, -CE	SOT-23-5	28cx	VR4	6a	Mlc
P25	R1161N251A	LVR-IC	LDO, 2.5V±2%, 350mA, -CE, AE(Mode)	SOT-23-5	28x9	VR10	6g	Ric
P25	XC6368E252MR	DC/DC-IC	PWM/PFM step-up, 2.5V±2.5%, 200mA, 180kHz, +CE	SOT-25	28sd	DC10	6g	Tor
P25A	CM7R151A-25B-T	LVR-IC	LDO, 2.5V±2%, 150mA, +CE, PDR	SOT-23-5	28cx	VR4	6a	Can
P25A	ML6204A252M	LVR-IC	LDO, 2.5V±2%, 150mA, +CE, CL	SOT-23-5	28cx	VR4	6a	Mlc
P25B	CM7R151B-25B-T	LVR-IC	LDO, 2.5V±2%, 150mA, +CE	SOT-23-5	28cx	VR4	6a	Can
P25B	ML6204B252M	LVR-IC	LDO, 2.5V±2%, 150mA, +CE	SOT-23-5	28cx	VR4	6a	Mlc
P25C	CM7R151C-25B-T	LVR-IC	LDO, 2.5V±2%, 150mA, -CE, PDR	SOT-23-5	28cx	VR4	6a	Can
P25C	ML6204C252M	LVR-IC	LDO, 2.5V±2%, 150mA, -CE, CL	SOT-23-5	28cx	VR4	6a	Mlc
P25D	CM7R151D-25B-T	LVR-IC	LDO, 2.5V±2%, 150mA, -CE	SOT-23-5	28cx	VR4	6a	Can
P25D	ML6204D252M	LVR-IC	LDO, 2.5V±2%, 150mA, -CE	SOT-23-5	28cx	VR4	6a	Mlc
P26	R1161N261A	LVR-IC	LDO, 2.6V±2%, 350mA, -CE, AE(Mode)	SOT-23-5	28x9	VR10	6g	Ric
P26	XC6368E262MR	DC/DC-IC	PWM/PFM step-up, 2.6V±2.5%, 200mA, 180kHz, +CE	SOT-25	28sd	DC10	6g	Tor
P26A	CM7R151A-26B-T	LVR-IC	LDO, 2.6V±2%, 150mA, +CE, PDR	SOT-23-5	28cx	VR4	6a	Can
P26A	ML6204A262M	LVR-IC	LDO, 2.6V±2%, 150mA, +CE, CL	SOT-23-5	28cx	VR4	6a	Mlc
P26B	CM7R151B-26B-T	LVR-IC	LDO, 2.6V±2%, 150mA, +CE	SOT-23-5	28cx	VR4	6a	Can
P26B	ML6204B262M	LVR-IC	LDO, 2.6V±2%, 150mA, +CE	SOT-23-5	28cx	VR4	6a	Mlc
P26C	CM7R151C-26B-T	LVR-IC	LDO, 2.6V±2%, 150mA, -CE, PDR	SOT-23-5	28cx	VR4	6a	Can
P26C	ML6204C262M	LVR-IC	LDO, 2.6V±2%, 150mA, -CE, CL	SOT-23-5	28cx	VR4	6a	Mlc
P26D	CM7R151D-26B-T	LVR-IC	LDO, 2.6V±2%, 150mA, -CE	SOT-23-5	28cx	VR4	6a	Can
P26D	ML6204D262M	LVR-IC	LDO, 2.6V±2%, 150mA, -CE	SOT-23-5	28cx	VR4	6a	Mlc
P27	R1161N271A	LVR-IC	LDO, 2.7V±2%, 350mA, -CE, AE(Mode)	SOT-23-5	28x9	VR10	6g	Ric
P27	XC6368E272MR	DC/DC-IC	PWM/PFM step-up, 2.7V±2.5%, 200mA, 180kHz, +CE	SOT-25	28sd	DC10	6g	Tor
P27A	CM7R151A-27B-T	LVR-IC	LDO, 2.7V±2%, 150mA, +CE, PDR	SOT-23-5	28cx	VR4	6a	Can
P27A	ML6204A272M	LVR-IC	LDO, 2.7V±2%, 150mA, +CE, CL	SOT-23-5	28cx	VR4	6a	Mlc
P27B	CM7R151B-27B-T	LVR-IC	LDO, 2.7V±2%, 150mA, +CE	SOT-23-5	28cx	VR4	6a	Can
P27B	ML6204B272M	LVR-IC	LDO, 2.7V±2%, 150mA, +CE	SOT-23-5	28cx	VR4	6a	Mlc
P27C	CM7R151C-27B-T	LVR-IC	LDO, 2.7V±2%, 150mA, -CE, PDR	SOT-23-5	28cx	VR4	6a	Can
P27C	ML6204C272M	LVR-IC	LDO, 2.7V±2%, 150mA, -CE, CL	SOT-23-5	28cx	VR4	6a	Mlc
P27D	CM7R151D-27B-T	LVR-IC	LDO, 2.7V±2%, 150mA, -CE	SOT-23-5	28cx	VR4	6a	Can
P27D	ML6204D272M	LVR-IC	LDO, 2.7V±2%, 150mA, -CE	SOT-23-5	28cx	VR4	6a	Mlc
P28	NCP4561SNT1-28	LVR-IC	LDO, ULN, +CE, 2.8V±1.5%, 80mA	SOT-23-5	28vc	VR4	6b	Ons
P28	R1161N281A	LVR-IC	LDO, 2.8V±2%, 350mA, -CE, AE(Mode)	SOT-23-5	28x9	VR10	6g	Ric
P28	XC6368E282MR	DC/DC-IC	PWM/PFM step-up, 2.8V±2.5%, 200mA, 180kHz, +CE	SOT-25	28sd	DC10	6g	Tor
P28A	CM7R151A-28B-T	LVR-IC	LDO, 2.8V±2%, 150mA, +CE, PDR	SOT-23-5	28cx	VR4	6a	Can
P28A	ML6204A282M	LVR-IC	LDO, 2.8V±2%, 150mA, +CE, CL	SOT-23-5	28cx	VR4	6a	Mlc



SMD code	Type	Function	Short description	Case	Pinout	Sch.	St.	Mnf.
P28B	CM7R151B-28B-T	LVR-IC	LDO, 2.8V±2%, 150mA, +CE	SOT-23-5	28cx	VR4	6a	Can
P28B	ML6204B282M	LVR-IC	LDO, 2.8V±2%, 150mA, +CE	SOT-23-5	28cx	VR4	6a	Mlc
P28C	CM7R151C-28B-T	LVR-IC	LDO, 2.8V±2%, 150mA, -CE, PDR	SOT-23-5	28cx	VR4	6a	Can
P28C	ML6204C282M	LVR-IC	LDO, 2.8V±2%, 150mA, -CE, CL	SOT-23-5	28cx	VR4	6a	Mlc
P28D	CM7R151D-28B-T	LVR-IC	LDO, 2.8V±2%, 150mA, -CE	SOT-23-5	28cx	VR4	6a	Can
P28D	ML6204D282M	LVR-IC	LDO, 2.8V±2%, 150mA, -CE	SOT-23-5	28cx	VR4	6a	Mlc
P29	R1161N291A	LVR-IC	LDO, 2.9V±2%, 350mA, -CE, AE(Mode)	SOT-23-5	28x9	VR10	6g	Ric
P29	XC6368E292MR	DC/DC-IC	PWM/PFM step-up, 2.9V±2.5%, 200mA, 180kHz, +CE	SOT-25	28sd	DC10	6g	Tor
P29A	CM7R151A-29B-T	LVR-IC	LDO, 2.9V±2%, 150mA, +CE, PDR	SOT-23-5	28cx	VR4	6a	Can
P29A	ML6204A292M	LVR-IC	LDO, 2.9V±2%, 150mA, +CE, CL	SOT-23-5	28cx	VR4	6a	Mlc
P29B	CM7R151B-29B-T	LVR-IC	LDO, 2.9V±2%, 150mA, +CE	SOT-23-5	28cx	VR4	6a	Can
P29B	ML6204B292M	LVR-IC	LDO, 2.9V±2%, 150mA, +CE	SOT-23-5	28cx	VR4	6a	Mlc
P29C	CM7R151C-29B-T	LVR-IC	LDO, 2.9V±2%, 150mA, -CE, PDR	SOT-23-5	28cx	VR4	6a	Can
P29C	ML6204C292M	LVR-IC	LDO, 2.9V±2%, 150mA, -CE, CL	SOT-23-5	28cx	VR4	6a	Mlc
P29D	CM7R151D-29B-T	LVR-IC	LDO, 2.9V±2%, 150mA, -CE	SOT-23-5	28cx	VR4	6a	Can
P29D	ML6204D292M	LVR-IC	LDO, 2.9V±2%, 150mA, -CE	SOT-23-5	28cx	VR4	6a	Mlc
P2A	S-1167A15-M5T1G	LVR-IC	LDO, 1.5V±1.0%, 150mA, -CE	SOT-23-5	28cx	VR4	6g	Sii
P2A	XC6108N42AMR	Vdet-IC	4.2V±2%, Hysteresis, -Reset ODO	SOT-25	28rm	VD14	6g	Tor
P2A	XC6118C32AMR-G	Vdet-IC	3.2V±2%, ±Reset PPO, Sense, hysteresis 5%, Cd	SOT-25	28mg	VD15	6g	Tor
P2A	XC6368E203MR	DC/DC-IC	PWM/PFM step-up, 2.0V±2.5%, 200mA, 300kHz, +CE	SOT-25	28sd	DC10	6g	Tor
P2AA	CM7R151A-20A-T	LVR-IC	LDO, 2.05V±2%, 150mA, +CE, PDR	SOT-23-5	28cx	VR4	6a	Can
P2AA	ML6204A20AM	LVR-IC	LDO, 2.05V±2%, 150mA, +CE, CL	SOT-23-5	28cx	VR4	6a	Mlc
P2AB	CM7R151B-20A-T	LVR-IC	LDO, 2.05V±2%, 150mA, +CE	SOT-23-5	28cx	VR4	6a	Can
P2AB	ML6204B20AM	LVR-IC	LDO, 2.05V±2%, 150mA, +CE	SOT-23-5	28cx	VR4	6a	Mlc
P2AC	CM7R151C-20A-T	LVR-IC	LDO, 2.05V±2%, 150mA, -CE, PDR	SOT-23-5	28cx	VR4	6a	Can
P2AC	ML6204C20AM	LVR-IC	LDO, 2.05V±2%, 150mA, -CE, CL	SOT-23-5	28cx	VR4	6a	Mlc
P2AD	CM7R151D-20A-T	LVR-IC	LDO, 2.05V±2%, 150mA, -CE	SOT-23-5	28cx	VR4	6a	Can
P2AD	ML6204D20AM	LVR-IC	LDO, 2.05V±2%, 150mA, -CE	SOT-23-5	28cx	VR4	6a	Mlc
P2B	XC6108N42BMR	Vdet-IC	4.2V±2%, -Reset ODO	SOT-25	28rm	VD14	6g	Tor
P2B	XC6118C32BMR-G	Vdet-IC	3.2V±2%, ±Reset PPO, Sense, hysteresis <1%, Cd	SOT-25	28mg	VD15	6g	Tor
P2B	XC6368E213MR	DC/DC-IC	PWM/PFM step-up, 2.1V±2.5%, 200mA, 300kHz, +CE	SOT-25	28sd	DC10	6g	Tor
P2BA	CM7R151A-21A-T	LVR-IC	LDO, 2.15V±2%, 150mA, +CE, PDR	SOT-23-5	28cx	VR4	6a	Can
P2BA	ML6204A21AM	LVR-IC	LDO, 2.15V±2%, 150mA, +CE, CL	SOT-23-5	28cx	VR4	6a	Mlc
P2BB	CM7R151B-21A-T	LVR-IC	LDO, 2.15V±2%, 150mA, +CE	SOT-23-5	28cx	VR4	6a	Can
P2BB	ML6204B21AM	LVR-IC	LDO, 2.15V±2%, 150mA, +CE	SOT-23-5	28cx	VR4	6a	Mlc
P2BC	CM7R151C-21A-T	LVR-IC	LDO, 2.15V±2%, 150mA, -CE, PDR	SOT-23-5	28cx	VR4	6a	Can
P2BC	ML6204C21AM	LVR-IC	LDO, 2.15V±2%, 150mA, -CE, CL	SOT-23-5	28cx	VR4	6a	Mlc
P2BD	CM7R151D-21A-T	LVR-IC	LDO, 2.15V±2%, 150mA, -CE	SOT-23-5	28cx	VR4	6a	Can
P2BD	ML6204D21AM	LVR-IC	LDO, 2.15V±2%, 150mA, -CE	SOT-23-5	28cx	VR4	6a	Mlc
P2C	XC6108N42CMR	Vdet-IC	4.2V±2%, Hysteresis, -Reset ODO	SOT-25	28rk	VD14	6g	Tor
P2C	XC6118C32CMR-G	Vdet-IC	3.2V±2%, ±Reset PPO, Sense, hysteresis 5%	SOT-25	28mf	VD12	6g	Tor
P2C	XC6368E223MR	DC/DC-IC	PWM/PFM step-up, 2.2V±2.5%, 200mA, 300kHz, +CE	SOT-25	28sd	DC10	6g	Tor
P2CA	CM7R151A-22A-T	LVR-IC	LDO, 2.25V±2%, 150mA, +CE, PDR	SOT-23-5	28cx	VR4	6a	Can
P2CA	ML6204A22AM	LVR-IC	LDO, 2.25V±2%, 150mA, +CE, CL	SOT-23-5	28cx	VR4	6a	Mlc
P2CB	CM7R151B-22A-T	LVR-IC	LDO, 2.25V±2%, 150mA, +CE	SOT-23-5	28cx	VR4	6a	Can
P2CB	ML6204B22AM	LVR-IC	LDO, 2.25V±2%, 150mA, +CE	SOT-23-5	28cx	VR4	6a	Mlc
P2CC	CM7R151C-22A-T	LVR-IC	LDO, 2.25V±2%, 150mA, -CE, PDR	SOT-23-5	28cx	VR4	6a	Can
P2CC	ML6204C22AM	LVR-IC	LDO, 2.25V±2%, 150mA, -CE, CL	SOT-23-5	28cx	VR4	6a	Mlc
P2CD	CM7R151D-22A-T	LVR-IC	LDO, 2.25V±2%, 150mA, -CE	SOT-23-5	28cx	VR4	6a	Can
P2CD	ML6204D22AM	LVR-IC	LDO, 2.25V±2%, 150mA, -CE	SOT-23-5	28cx	VR4	6a	Mlc
P2D	XC6108N42DMR	Vdet-IC	4.2V±2%, -Reset ODO	SOT-25	28rk	VD14	6g	Tor
P2D	XC6118C32DMR-G	Vdet-IC	3.2V±2%, ±Reset PPO, Sense, hysteresis <1%	SOT-25	28mf	VD12	6g	Tor
P2D	XC6368E233MR	DC/DC-IC	PWM/PFM step-up, 2.3V±2.5%, 200mA, 300kHz, +CE	SOT-25	28sd	DC10	6g	Tor
P2DA	CM7R151A-23A-T	LVR-IC	LDO, 2.35V±2%, 150mA, +CE, PDR	SOT-23-5	28cx	VR4	6a	Can
P2DA	ML6204A23AM	LVR-IC	LDO, 2.35V±2%, 150mA, +CE, CL	SOT-23-5	28cx	VR4	6a	Mlc
P2DB	CM7R151B-23A-T	LVR-IC	LDO, 2.35V±2%, 150mA, +CE	SOT-23-5	28cx	VR4	6a	Can
P2DB	ML6204B23AM	LVR-IC	LDO, 2.35V±2%, 150mA, +CE	SOT-23-5	28cx	VR4	6a	Mlc
P2DC	CM7R151C-23A-T	LVR-IC	LDO, 2.35V±2%, 150mA, -CE, PDR	SOT-23-5	28cx	VR4	6a	Can
P2DC	ML6204C23AM	LVR-IC	LDO, 2.35V±2%, 150mA, -CE, CL	SOT-23-5	28cx	VR4	6a	Mlc
P2DD	CM7R151D-23A-T	LVR-IC	LDO, 2.35V±2%, 150mA, -CE	SOT-23-5	28cx	VR4	6a	Can
P2DD	ML6204D23AM	LVR-IC	LDO, 2.35V±2%, 150mA, -CE	SOT-23-5	28cx	VR4	6a	Mlc
P2E	S-1167A19-M5T1G	LVR-IC	LDO, 1.9V±1.0%, 150mA, -CE	SOT-23-5	28cx	VR4	6g	Sii
P2E	XC6368E243MR	DC/DC-IC	PWM/PFM step-up, 2.4V±2.5%, 200mA, 300kHz, +CE	SOT-25	28sd	DC10	6g	Tor
P2EA	CM7R151A-24A-T	LVR-IC	LDO, 2.45V±2%, 150mA, +CE, PDR	SOT-23-5	28cx	VR4	6a	Can
P2EA	ML6204A24AM	LVR-IC	LDO, 2.45V±2%, 150mA, +CE, CL	SOT-23-5	28cx	VR4	6a	Mlc
P2EB	CM7R151B-24A-T	LVR-IC	LDO, 2.45V±2%, 150mA, +CE	SOT-23-5	28cx	VR4	6a	Can
P2EB	ML6204B24AM	LVR-IC	LDO, 2.45V±2%, 150mA, +CE	SOT-23-5	28cx	VR4	6a	Mlc
P2EC	CM7R151C-24A-T	LVR-IC	LDO, 2.45V±2%, 150mA, -CE, PDR	SOT-23-5	28cx	VR4	6a	Can
P2EC	ML6204C24AM	LVR-IC	LDO, 2.45V±2%, 150mA, -CE, CL	SOT-23-5	28cx	VR4	6a	Mlc
P2ED	CM7R151D-24A-T	LVR-IC	LDO, 2.45V±2%, 150mA, -CE	SOT-23-5	28cx	VR4	6a	Can



SMD code	Type	Function	Short description	Case	Pinout	Sch.	St.	Mnf.
P2ED	ML6204D24AM	LVR-IC	LDO, 2.45V±2%, 150mA, -CE	SOT-23-5	28cx	VR4	6a	Mlc
P2F	XC6368E253MR	DC/DC-IC	PWM/PPM step-up, 2.5V±2.5%, 200mA, 300kHz, +CE	SOT-25	28sd	DC10	6g	Tor
P2FA	CM7R151A-25A-T	LVR-IC	LDO, 2.55V±2%, 150mA, +CE, PDR	SOT-23-5	28cx	VR4	6a	Can
P2FA	ML6204A25AM	LVR-IC	LDO, 2.55V±2%, 150mA, +CE, CL	SOT-23-5	28cx	VR4	6a	Mlc
P2FB	CM7R151B-25A-T	LVR-IC	LDO, 2.55V±2%, 150mA, +CE	SOT-23-5	28cx	VR4	6a	Can
P2FB	ML6204B25AM	LVR-IC	LDO, 2.55V±2%, 150mA, +CE	SOT-23-5	28cx	VR4	6a	Mlc
P2FC	CM7R151C-25A-T	LVR-IC	LDO, 2.55V±2%, 150mA, -CE, PDR	SOT-23-5	28cx	VR4	6a	Can
P2FC	ML6204C25AM	LVR-IC	LDO, 2.55V±2%, 150mA, -CE, CL	SOT-23-5	28cx	VR4	6a	Mlc
P2FD	CM7R151D-25A-T	LVR-IC	LDO, 2.55V±2%, 150mA, -CE	SOT-23-5	28cx	VR4	6a	Can
P2FD	ML6204D25AM	LVR-IC	LDO, 2.55V±2%, 150mA, -CE	SOT-23-5	28cx	VR4	6a	Mlc
P2GA	CM7R151A-26A-T	LVR-IC	LDO, 2.65V±2%, 150mA, +CE, PDR	SOT-23-5	28cx	VR4	6a	Can
P2GA	ML6204A26AM	LVR-IC	LDO, 2.65V±2%, 150mA, +CE, CL	SOT-23-5	28cx	VR4	6a	Mlc
P2GB	CM7R151B-26A-T	LVR-IC	LDO, 2.65V±2%, 150mA, +CE	SOT-23-5	28cx	VR4	6a	Can
P2GB	ML6204B26AM	LVR-IC	LDO, 2.65V±2%, 150mA, +CE	SOT-23-5	28cx	VR4	6a	Mlc
P2GC	CM7R151C-26A-T	LVR-IC	LDO, 2.65V±2%, 150mA, -CE, PDR	SOT-23-5	28cx	VR4	6a	Can
P2GC	ML6204C26AM	LVR-IC	LDO, 2.65V±2%, 150mA, -CE, CL	SOT-23-5	28cx	VR4	6a	Mlc
P2GD	CM7R151D-26A-T	LVR-IC	LDO, 2.65V±2%, 150mA, -CE	SOT-23-5	28cx	VR4	6a	Can
P2GD	ML6204D26AM	LVR-IC	LDO, 2.65V±2%, 150mA, -CE	SOT-23-5	28cx	VR4	6a	Mlc
P2H	XC6368E263MR	DC/DC-IC	PWM/PPM step-up, 2.6V±2.5%, 200mA, 300kHz, +CE	SOT-25	28sd	DC10	6g	Tor
P2HA	CM7R151A-27A-T	LVR-IC	LDO, 2.75V±2%, 150mA, +CE, PDR	SOT-23-5	28cx	VR4	6a	Can
P2HA	ML6204A27AM	LVR-IC	LDO, 2.75V±2%, 150mA, +CE, CL	SOT-23-5	28cx	VR4	6a	Mlc
P2HB	CM7R151B-27A-T	LVR-IC	LDO, 2.75V±2%, 150mA, +CE	SOT-23-5	28cx	VR4	6a	Can
P2HB	ML6204B27AM	LVR-IC	LDO, 2.75V±2%, 150mA, +CE	SOT-23-5	28cx	VR4	6a	Mlc
P2HC	CM7R151C-27A-T	LVR-IC	LDO, 2.75V±2%, 150mA, -CE, PDR	SOT-23-5	28cx	VR4	6a	Can
P2HC	ML6204C27AM	LVR-IC	LDO, 2.75V±2%, 150mA, -CE, CL	SOT-23-5	28cx	VR4	6a	Mlc
P2HD	CM7R151D-27A-T	LVR-IC	LDO, 2.75V±2%, 150mA, -CE	SOT-23-5	28cx	VR4	6a	Can
P2HD	ML6204D27AM	LVR-IC	LDO, 2.75V±2%, 150mA, -CE	SOT-23-5	28cx	VR4	6a	Mlc
P2IA	CM7R151A-28A-T	LVR-IC	LDO, 2.85V±2%, 150mA, +CE, PDR	SOT-23-5	28cx	VR4	6a	Can
P2IA	ML6204A28AM	LVR-IC	LDO, 2.85V±2%, 150mA, +CE, CL	SOT-23-5	28cx	VR4	6a	Mlc
P2IB	CM7R151B-28A-T	LVR-IC	LDO, 2.85V±2%, 150mA, +CE	SOT-23-5	28cx	VR4	6a	Can
P2IB	ML6204B28AM	LVR-IC	LDO, 2.85V±2%, 150mA, +CE	SOT-23-5	28cx	VR4	6a	Mlc
P2IC	CM7R151C-28A-T	LVR-IC	LDO, 2.85V±2%, 150mA, -CE, PDR	SOT-23-5	28cx	VR4	6a	Can
P2IC	ML6204C28AM	LVR-IC	LDO, 2.85V±2%, 150mA, -CE, CL	SOT-23-5	28cx	VR4	6a	Mlc
P2ID	CM7R151D-28A-T	LVR-IC	LDO, 2.85V±2%, 150mA, -CE	SOT-23-5	28cx	VR4	6a	Can
P2ID	ML6204D28AM	LVR-IC	LDO, 2.85V±2%, 150mA, -CE	SOT-23-5	28cx	VR4	6a	Mlc
P2JA	CM7R151A-29A-T	LVR-IC	LDO, 2.95V±2%, 150mA, +CE, PDR	SOT-23-5	28cx	VR4	6a	Can
P2JA	ML6204A29AM	LVR-IC	LDO, 2.95V±2%, 150mA, +CE, CL	SOT-23-5	28cx	VR4	6a	Mlc
P2JB	CM7R151B-29A-T	LVR-IC	LDO, 2.95V±2%, 150mA, +CE	SOT-23-5	28cx	VR4	6a	Can
P2JB	ML6204B29AM	LVR-IC	LDO, 2.95V±2%, 150mA, +CE	SOT-23-5	28cx	VR4	6a	Mlc
P2JC	CM7R151C-29A-T	LVR-IC	LDO, 2.95V±2%, 150mA, -CE, PDR	SOT-23-5	28cx	VR4	6a	Can
P2JC	ML6204C29AM	LVR-IC	LDO, 2.95V±2%, 150mA, -CE, CL	SOT-23-5	28cx	VR4	6a	Mlc
P2JD	CM7R151D-29A-T	LVR-IC	LDO, 2.95V±2%, 150mA, -CE	SOT-23-5	28cx	VR4	6a	Can
P2JD	ML6204D29AM	LVR-IC	LDO, 2.95V±2%, 150mA, -CE	SOT-23-5	28cx	VR4	6a	Mlc
P2K	XC6368E273MR	DC/DC-IC	PWM/PPM step-up, 2.7V±2.5%, 200mA, 300kHz, +CE	SOT-25	28sd	DC10	6g	Tor
P2L	XC6368E283MR	DC/DC-IC	PWM/PPM step-up, 2.8V±2.5%, 200mA, 300kHz, +CE	SOT-25	28sd	DC10	6g	Tor
P2M	XC6368E293MR	DC/DC-IC	PWM/PPM step-up, 2.9V±2.5%, 200mA, 300kHz, +CE	SOT-25	28sd	DC10	6g	Tor
P2P	S-1167A30-M5T1G	LVR-IC	LDO, 3.0V±1.0%, 150mA, -CE	SOT-23-5	28cx	VR4	6g	Sii
P2S	S-1167A33-M5T1G	LVR-IC	LDO, 3.3V±1.0%, 150mA, -CE	SOT-23-5	28cx	VR4	6g	Sii
P3	TC1186-3.0VCT713	LVR-IC	LDO, 3.0V±3%, 150mA, +CE, -Error	SOT-23-5	28w	VR8	6g	Mcc
P30	R1161N301A	LVR-IC	LDO, 3V±2%, 350mA, -CE, AE(Mode)	SOT-23-5	28x9	VR10	6g	Ric
P30	XC6368E302MR	DC/DC-IC	PWM/PPM step-up, 3.0V±2.5%, 200mA, 180kHz, +CE	SOT-25	28sd	DC10	6g	Tor
P30A	CM7R151A-30B-T	LVR-IC	LDO, 3.0V±2%, 150mA, +CE, PDR	SOT-23-5	28cx	VR4	6a	Can
P30A	ML6204A302M	LVR-IC	LDO, 3.0V±2%, 150mA, +CE, CL	SOT-23-5	28cx	VR4	6a	Mlc
P30B	CM7R151B-30B-T	LVR-IC	LDO, 3.0V±2%, 150mA, +CE	SOT-23-5	28cx	VR4	6a	Can
P30B	ML6204B302M	LVR-IC	LDO, 3.0V±2%, 150mA, +CE	SOT-23-5	28cx	VR4	6a	Mlc
P30C	CM7R151C-30B-T	LVR-IC	LDO, 3.0V±2%, 150mA, -CE, PDR	SOT-23-5	28cx	VR4	6a	Can
P30C	ML6204C302M	LVR-IC	LDO, 3.0V±2%, 150mA, -CE, CL	SOT-23-5	28cx	VR4	6a	Mlc
P30D	CM7R151D-30B-T	LVR-IC	LDO, 3.0V±2%, 150mA, -CE	SOT-23-5	28cx	VR4	6a	Can
P30D	ML6204D302M	LVR-IC	LDO, 3.0V±2%, 150mA, -CE	SOT-23-5	28cx	VR4	6a	Mlc
P31	R1161N311A	LVR-IC	LDO, 3.1V±2%, 350mA, -CE, AE(Mode)	SOT-23-5	28x9	VR10	6g	Ric
P31	XC6368E312MR	DC/DC-IC	PWM/PPM step-up, 3.1V±2.5%, 200mA, 180kHz, +CE	SOT-25	28sd	DC10	6g	Tor
P31A	CM7R151A-31B-T	LVR-IC	LDO, 3.1V±2%, 150mA, +CE, PDR	SOT-23-5	28cx	VR4	6a	Can
P31A	ML6204A312M	LVR-IC	LDO, 3.1V±2%, 150mA, +CE, CL	SOT-23-5	28cx	VR4	6a	Mlc
P31A	ML6204B312M	LVR-IC	LDO, 3.1V±2%, 150mA, +CE	SOT-23-5	28cx	VR4	6a	Mlc
P31B	CM7R151B-31B-T	LVR-IC	LDO, 3.1V±2%, 150mA, +CE	SOT-23-5	28cx	VR4	6a	Can
P31C	CM7R151C-31B-T	LVR-IC	LDO, 3.1V±2%, 150mA, -CE, PDR	SOT-23-5	28cx	VR4	6a	Can
P31C	ML6204C312M	LVR-IC	LDO, 3.1V±2%, 150mA, -CE, CL	SOT-23-5	28cx	VR4	6a	Mlc
P31D	CM7R151D-31B-T	LVR-IC	LDO, 3.1V±2%, 150mA, -CE	SOT-23-5	28cx	VR4	6a	Can
P31D	ML6204D312M	LVR-IC	LDO, 3.1V±2%, 150mA, -CE	SOT-23-5	28cx	VR4	6a	Mlc
P32	NC7SP32P5	CMOS-Logic	2-input OR gate	SC-70-5	28/Log4	-	6a	F



SMD code	Type	Function	Short description	Case	Pinout	Sch.	St.	Mnf.
P32	R1161N321A	LVR-IC	LDO, 3.2V±2%, 350mA, -CE, AE(Mode)	SOT-23-5	28x9	VR10	6g	Ric
P32	XC6368E322MR	DC/DC-IC	PWM/PFM step-up, 3.2V±2.5%, 200mA, 180kHz, +CE	SOT-25	28sd	DC10	6g	Tor
P32A	CM7R151A-32B-T	LVR-IC	LDO, 3.2V±2%, 150mA, +CE, PDR	SOT-23-5	28cx	VR4	6a	Can
P32A	ML6204A322M	LVR-IC	LDO, 3.2V±2%, 150mA, +CE, CL	SOT-23-5	28cx	VR4	6a	Mlc
P32B	CM7R151B-32B-T	LVR-IC	LDO, 3.2V±2%, 150mA, +CE	SOT-23-5	28cx	VR4	6a	Can
P32B	ML6204B322M	LVR-IC	LDO, 3.2V±2%, 150mA, +CE	SOT-23-5	28cx	VR4	6a	Mlc
P32C	CM7R151C-32B-T	LVR-IC	LDO, 3.2V±2%, 150mA, -CE, PDR	SOT-23-5	28cx	VR4	6a	Can
P32C	ML6204C322M	LVR-IC	LDO, 3.2V±2%, 150mA, -CE, CL	SOT-23-5	28cx	VR4	6a	Mlc
P32D	CM7R151D-32B-T	LVR-IC	LDO, 3.2V±2%, 150mA, -CE	SOT-23-5	28cx	VR4	6a	Can
P32D	ML6204D322M	LVR-IC	LDO, 3.2V±2%, 150mA, -CE	SOT-23-5	28cx	VR4	6a	Mlc
P33	R1161N331A	LVR-IC	LDO, 3.3V±2%, 350mA, -CE, AE(Mode)	SOT-23-5	28x9	VR10	6g	Ric
P33	XC6368E332MR	DC/DC-IC	PWM/PFM step-up, 3.3V±2.5%, 200mA, 180kHz, +CE	SOT-25	28sd	DC10	6g	Tor
P33A	CM7R151A-33B-T	LVR-IC	LDO, 3.3V±2%, 150mA, +CE, PDR	SOT-23-5	28cx	VR4	6a	Can
P33A	ML6204A332M	LVR-IC	LDO, 3.3V±2%, 150mA, +CE, CL	SOT-23-5	28cx	VR4	6a	Mlc
P33B	CM7R151B-33B-T	LVR-IC	LDO, 3.3V±2%, 150mA, +CE	SOT-23-5	28cx	VR4	6a	Can
P33B	ML6204B332M	LVR-IC	LDO, 3.3V±2%, 150mA, +CE	SOT-23-5	28cx	VR4	6a	Mlc
P33C	CM7R151C-33B-T	LVR-IC	LDO, 3.3V±2%, 150mA, -CE, PDR	SOT-23-5	28cx	VR4	6a	Can
P33C	ML6204C332M	LVR-IC	LDO, 3.3V±2%, 150mA, -CE, CL	SOT-23-5	28cx	VR4	6a	Mlc
P33D	CM7R151D-33B-T	LVR-IC	LDO, 3.3V±2%, 150mA, -CE	SOT-23-5	28cx	VR4	6a	Can
P33D	ML6204D332M	LVR-IC	LDO, 3.3V±2%, 150mA, -CE	SOT-23-5	28cx	VR4	6a	Mlc
P34	XC6368E342MR	DC/DC-IC	PWM/PFM step-up, 3.4V±2.5%, 200mA, 180kHz, +CE	SOT-25	28sd	DC10	6g	Tor
P34A	CM7R151A-34B-T	LVR-IC	LDO, 3.4V±2%, 150mA, +CE, PDR	SOT-23-5	28cx	VR4	6a	Can
P34A	ML6204A342M	LVR-IC	LDO, 3.4V±2%, 150mA, +CE, CL	SOT-23-5	28cx	VR4	6a	Mlc
P34B	CM7R151B-34B-T	LVR-IC	LDO, 3.4V±2%, 150mA, +CE	SOT-23-5	28cx	VR4	6a	Can
P34B	ML6204B342M	LVR-IC	LDO, 3.4V±2%, 150mA, +CE	SOT-23-5	28cx	VR4	6a	Mlc
P34C	CM7R151C-34B-T	LVR-IC	LDO, 3.4V±2%, 150mA, -CE, PDR	SOT-23-5	28cx	VR4	6a	Can
P34C	ML6204C342M	LVR-IC	LDO, 3.4V±2%, 150mA, -CE, CL	SOT-23-5	28cx	VR4	6a	Mlc
P34D	CM7R151D-34B-T	LVR-IC	LDO, 3.4V±2%, 150mA, -CE	SOT-23-5	28cx	VR4	6a	Can
P34D	ML6204D342M	LVR-IC	LDO, 3.4V±2%, 150mA, -CE	SOT-23-5	28cx	VR4	6a	Mlc
P35	XC6368E352MR	DC/DC-IC	PWM/PFM step-up, 3.5V±2.5%, 200mA, 180kHz, +CE	SOT-25	28sd	DC10	6g	Tor
P35A	CM7R151A-35B-T	LVR-IC	LDO, 3.5V±2%, 150mA, +CE, PDR	SOT-23-5	28cx	VR4	6a	Can
P35A	ML6204A352M	LVR-IC	LDO, 3.5V±2%, 150mA, +CE, CL	SOT-23-5	28cx	VR4	6a	Mlc
P35B	CM7R151B-35B-T	LVR-IC	LDO, 3.5V±2%, 150mA, +CE	SOT-23-5	28cx	VR4	6a	Can
P35B	ML6204B352M	LVR-IC	LDO, 3.5V±2%, 150mA, +CE	SOT-23-5	28cx	VR4	6a	Mlc
P35C	CM7R151C-35B-T	LVR-IC	LDO, 3.5V±2%, 150mA, -CE, PDR	SOT-23-5	28cx	VR4	6a	Can
P35C	ML6204C352M	LVR-IC	LDO, 3.5V±2%, 150mA, -CE, CL	SOT-23-5	28cx	VR4	6a	Mlc
P35D	CM7R151D-35B-T	LVR-IC	LDO, 3.5V±2%, 150mA, -CE	SOT-23-5	28cx	VR4	6a	Can
P35D	ML6204D352M	LVR-IC	LDO, 3.5V±2%, 150mA, -CE	SOT-23-5	28cx	VR4	6a	Mlc
P36	XC6368E362MR	DC/DC-IC	PWM/PFM step-up, 3.6V±2.5%, 200mA, 180kHz, +CE	SOT-25	28sd	DC10	6g	Tor
P36A	CM7R151A-36B-T	LVR-IC	LDO, 3.6V±2%, 150mA, +CE, PDR	SOT-23-5	28cx	VR4	6a	Can
P36A	ML6204A362M	LVR-IC	LDO, 3.6V±2%, 150mA, +CE, CL	SOT-23-5	28cx	VR4	6a	Mlc
P36B	CM7R151B-36B-T	LVR-IC	LDO, 3.6V±2%, 150mA, +CE	SOT-23-5	28cx	VR4	6a	Can
P36B	ML6204B362M	LVR-IC	LDO, 3.6V±2%, 150mA, +CE	SOT-23-5	28cx	VR4	6a	Mlc
P36C	CM7R151C-36B-T	LVR-IC	LDO, 3.6V±2%, 150mA, -CE, PDR	SOT-23-5	28cx	VR4	6a	Can
P36C	ML6204C362M	LVR-IC	LDO, 3.6V±2%, 150mA, -CE, CL	SOT-23-5	28cx	VR4	6a	Mlc
P36D	CM7R151D-36B-T	LVR-IC	LDO, 3.6V±2%, 150mA, -CE	SOT-23-5	28cx	VR4	6a	Can
P36D	ML6204D362M	LVR-IC	LDO, 3.6V±2%, 150mA, -CE	SOT-23-5	28cx	VR4	6a	Mlc
P37	XC6368E372MR	DC/DC-IC	PWM/PFM step-up, 3.7V±2.5%, 200mA, 180kHz, +CE	SOT-25	28sd	DC10	6g	Tor
P37A	CM7R151A-37B-T	LVR-IC	LDO, 3.7V±2%, 150mA, +CE, PDRV	SOT-23-5	28cx	VR4	6a	Can
P37A	ML6204A372M	LVR-IC	LDO, 3.7V±2%, 150mA, +CE, CL	SOT-23-5	28cx	VR4	6a	Mlc
P37B	CM7R151B-37B-T	LVR-IC	LDO, 3.7V±2%, 150mA, +CEV	SOT-23-5	28cx	VR4	6a	Can
P37B	ML6204B372M	LVR-IC	LDO, 3.7V±2%, 150mA, +CE	SOT-23-5	28cx	VR4	6a	Mlc
P37C	CM7R151C-37B-T	LVR-IC	LDO, 3.7V±2%, 150mA, -CE, PDRV	SOT-23-5	28cx	VR4	6a	Can
P37C	ML6204C372M	LVR-IC	LDO, 3.7V±2%, 150mA, -CE, CL	SOT-23-5	28cx	VR4	6a	Mlc
P37D	CM7R151D-37B-T	LVR-IC	LDO, 3.7V±2%, 150mA, -CEV	SOT-23-5	28cx	VR4	6a	Can
P37D	ML6204D372M	LVR-IC	LDO, 3.7V±2%, 150mA, -CE	SOT-23-5	28cx	VR4	6a	Mlc
P38	NC7SP38P5	CMOS-Logic	2-input NAND gate (ODO)	SC-70-5	28/Log17	-	6a	F
P38	XC6368E382MR	DC/DC-IC	PWM/PFM step-up, 3.8V±2.5%, 200mA, 180kHz, +CE	SOT-25	28sd	DC10	6g	Tor
P38A	CM7R151A-38B-T	LVR-IC	LDO, 3.8V±2%, 150mA, +CE, PDR	SOT-23-5	28cx	VR4	6a	Can
P38A	ML6204A382M	LVR-IC	LDO, 3.8V±2%, 150mA, +CE, CL	SOT-23-5	28cx	VR4	6a	Mlc
P38B	CM7R151B-38B-T	LVR-IC	LDO, 3.8V±2%, 150mA, +CE	SOT-23-5	28cx	VR4	6a	Can
P38B	ML6204B382M	LVR-IC	LDO, 3.8V±2%, 150mA, +CE	SOT-23-5	28cx	VR4	6a	Mlc
P38C	CM7R151C-38B-T	LVR-IC	LDO, 3.8V±2%, 150mA, -CE, PDR	SOT-23-5	28cx	VR4	6a	Can
P38C	ML6204C382M	LVR-IC	LDO, 3.8V±2%, 150mA, -CE, CL	SOT-23-5	28cx	VR4	6a	Mlc
P38D	CM7R151D-38B-T	LVR-IC	LDO, 3.8V±2%, 150mA, -CE	SOT-23-5	28cx	VR4	6a	Can
P38D	ML6204D382M	LVR-IC	LDO, 3.8V±2%, 150mA, -CE	SOT-23-5	28cx	VR4	6a	Mlc
P39	XC6368E392MR	DC/DC-IC	PWM/PFM step-up, 3.9V±2.5%, 200mA, 180kHz, +CE	SOT-25	28sd	DC10	6g	Tor
P39A	CM7R151A-39B-T	LVR-IC	LDO, 3.9V±2%, 150mA, +CE, PDR	SOT-23-5	28cx	VR4	6a	Can
P39A	ML6204A392M	LVR-IC	LDO, 3.9V±2%, 150mA, +CE, CL	SOT-23-5	28cx	VR4	6a	Mlc
P39B	CM7R151B-39B-T	LVR-IC	LDO, 3.9V±2%, 150mA, +CE	SOT-23-5	28cx	VR4	6a	Can



SMD code	Type	Function	Short description	Case	Pinout	Sch.	St.	Mnf.
P39B	ML6204B392M	LVR-IC	LDO, 3.9V±2%, 150mA, +CE	SOT-23-5	28cx	VR4	6a	Mlc
P39C	CM7R151C-39B-T	LVR-IC	LDO, 3.9V±2%, 150mA, -CE, PDR	SOT-23-5	28cx	VR4	6a	Can
P39C	ML6204C392M	LVR-IC	LDO, 3.9V±2%, 150mA, -CE, CL	SOT-23-5	28cx	VR4	6a	Mlc
P39D	CM7R151D-39B-T	LVR-IC	LDO, 3.9V±2%, 150mA, -CE	SOT-23-5	28cx	VR4	6a	Can
P39D	ML6204D392M	LVR-IC	LDO, 3.9V±2%, 150mA, -CE	SOT-23-5	28cx	VR4	6a	Mlc
P3A	XC6108N43AMR	Vdet-IC	4.3V±2%, Hysteresis, -Reset ODO	SOT-25	28rm	VD14	6g	Tor
P3A	XC6118C33AMR-G	Vdet-IC	3.3V±2%, ±Reset PPO, Sense, hysteresis 5%, Cd	SOT-25	28mg	VD15	6g	Tor
P3A	XC6368E303MR	DC/DC-IC	PWM/PFM step-up, 3.0V±2.5%, 200mA, 300kHz, +CE	SOT-25	28sd	DC10	6g	Tor
P3AA	CM7R151A-30A-T	LVR-IC	LDO, 3.05V±2%, 150mA, +CE, PDR	SOT-23-5	28cx	VR4	6a	Can
P3AA	ML6204A30AM	LVR-IC	LDO, 3.05V±2%, 150mA, +CE, CL	SOT-23-5	28cx	VR4	6a	Mlc
P3AB	CM7R151B-30A-T	LVR-IC	LDO, 3.05V±2%, 150mA, +CE	SOT-23-5	28cx	VR4	6a	Can
P3AB	ML6204B30AM	LVR-IC	LDO, 3.05V±2%, 150mA, +CE	SOT-23-5	28cx	VR4	6a	Mlc
P3AC	CM7R151C-30A-T	LVR-IC	LDO, 3.05V±2%, 150mA, -CE, PDR	SOT-23-5	28cx	VR4	6a	Can
P3AC	ML6204C30AM	LVR-IC	LDO, 3.05V±2%, 150mA, -CE, CL	SOT-23-5	28cx	VR4	6a	Mlc
P3AD	CM7R151D-30A-T	LVR-IC	LDO, 3.05V±2%, 150mA, -CE	SOT-23-5	28cx	VR4	6a	Can
P3AD	ML6204D30AM	LVR-IC	LDO, 3.05V±2%, 150mA, -CE	SOT-23-5	28cx	VR4	6a	Mlc
P3B	XC6108N43BMR	Vdet-IC	4.3V±2%, -Reset ODO	SOT-25	28rm	VD14	6g	Tor
P3B	XC6118C33BMR-G	Vdet-IC	3.3V±2%, ±Reset PPO, Sense, hysteresis <1%, Cd	SOT-25	28mg	VD15	6g	Tor
P3B	XC6368E313MR	DC/DC-IC	PWM/PFM step-up, 3.1V±2.5%, 200mA, 300kHz, +CE	SOT-25	28sd	DC10	6g	Tor
P3BA	CM7R151A-31A-T	LVR-IC	LDO, 3.15V±2%, 150mA, +CE, PDR	SOT-23-5	28cx	VR4	6a	Can
P3BA	ML6204A31AM	LVR-IC	LDO, 3.15V±2%, 150mA, +CE, CL	SOT-23-5	28cx	VR4	6a	Mlc
P3BB	CM7R151B-31A-T	LVR-IC	LDO, 3.15V±2%, 150mA, +CE	SOT-23-5	28cx	VR4	6a	Can
P3BB	ML6204B31AM	LVR-IC	LDO, 3.15V±2%, 150mA, +CE	SOT-23-5	28cx	VR4	6a	Mlc
P3BC	CM7R151C-31A-T	LVR-IC	LDO, 3.15V±2%, 150mA, -CE, PDR	SOT-23-5	28cx	VR4	6a	Can
P3BC	ML6204C31AM	LVR-IC	LDO, 3.15V±2%, 150mA, -CE, CL	SOT-23-5	28cx	VR4	6a	Mlc
P3BD	CM7R151D-31A-T	LVR-IC	LDO, 3.15V±2%, 150mA, -CE	SOT-23-5	28cx	VR4	6a	Can
P3BD	ML6204D31AM	LVR-IC	LDO, 3.15V±2%, 150mA, -CE	SOT-23-5	28cx	VR4	6a	Mlc
P3C	XC6108N43CMR	Vdet-IC	4.3V±2%, Hysteresis, -Reset ODO	SOT-25	28rk	VD14	6g	Tor
P3C	XC6118C33CMR-G	Vdet-IC	3.3V±2%, ±Reset PPO, Sense, hysteresis 5%	SOT-25	28mf	VD12	6g	Tor
P3C	XC6368E323MR	DC/DC-IC	PWM/PFM step-up, 3.2V±2.5%, 200mA, 300kHz, +CE	SOT-25	28sd	DC10	6g	Tor
P3CA	CM7R151A-32A-T	LVR-IC	LDO, 3.25V±2%, 150mA, +CE, PDR	SOT-23-5	28cx	VR4	6a	Can
P3CA	ML6204A32AM	LVR-IC	LDO, 3.25V±2%, 150mA, +CE, CL	SOT-23-5	28cx	VR4	6a	Mlc
P3CB	CM7R151B-32A-T	LVR-IC	LDO, 3.25V±2%, 150mA, +CE	SOT-23-5	28cx	VR4	6a	Can
P3CB	ML6204B32AM	LVR-IC	LDO, 3.25V±2%, 150mA, +CE	SOT-23-5	28cx	VR4	6a	Mlc
P3CC	CM7R151C-32A-T	LVR-IC	LDO, 3.25V±2%, 150mA, -CE, PDR	SOT-23-5	28cx	VR4	6a	Can
P3CC	ML6204C32AM	LVR-IC	LDO, 3.25V±2%, 150mA, -CE, CL	SOT-23-5	28cx	VR4	6a	Mlc
P3CD	CM7R151D-32A-T	LVR-IC	LDO, 3.25V±2%, 150mA, -CE	SOT-23-5	28cx	VR4	6a	Can
P3CD	ML6204D32AM	LVR-IC	LDO, 3.25V±2%, 150mA, -CE	SOT-23-5	28cx	VR4	6a	Mlc
P3D	XC6108N43DMR	Vdet-IC	4.3V±2%, -Reset ODO	SOT-25	28rk	VD14	6g	Tor
P3D	XC6118C33DMR-G	Vdet-IC	3.3V±2%, ±Reset PPO, Sense, hysteresis <1%	SOT-25	28mf	VD12	6g	Tor
P3D	XC6368E333MR	DC/DC-IC	PWM/PFM step-up, 3.3V±2.5%, 200mA, 300kHz, +CE	SOT-25	28sd	DC10	6g	Tor
P3DA	CM7R151A-33A-T	LVR-IC	LDO, 3.35V±2%, 150mA, +CE, PDR	SOT-23-5	28cx	VR4	6a	Can
P3DA	ML6204A33AM	LVR-IC	LDO, 3.35V±2%, 150mA, +CE, CL	SOT-23-5	28cx	VR4	6a	Mlc
P3DB	CM7R151B-33A-T	LVR-IC	LDO, 3.35V±2%, 150mA, +CE	SOT-23-5	28cx	VR4	6a	Can
P3DB	ML6204B33AM	LVR-IC	LDO, 3.35V±2%, 150mA, +CE	SOT-23-5	28cx	VR4	6a	Mlc
P3DC	CM7R151C-33A-T	LVR-IC	LDO, 3.35V±2%, 150mA, -CE, PDR	SOT-23-5	28cx	VR4	6a	Can
P3DC	ML6204C33AM	LVR-IC	LDO, 3.35V±2%, 150mA, -CE, CL	SOT-23-5	28cx	VR4	6a	Mlc
P3DD	CM7R151D-33A-T	LVR-IC	LDO, 3.35V±2%, 150mA, -CE	SOT-23-5	28cx	VR4	6a	Can
P3DD	ML6204D33AM	LVR-IC	LDO, 3.35V±2%, 150mA, -CE	SOT-23-5	28cx	VR4	6a	Mlc
P3E	XC6368E343MR	DC/DC-IC	PWM/PFM step-up, 3.4V±2.5%, 200mA, 300kHz, +CE	SOT-25	28sd	DC10	6g	Tor
P3EA	CM7R151A-34A-T	LVR-IC	LDO, 3.45V±2%, 150mA, +CE, PDR	SOT-23-5	28cx	VR4	6a	Can
P3EA	ML6204A34AM	LVR-IC	LDO, 3.45V±2%, 150mA, +CE, CL	SOT-23-5	28cx	VR4	6a	Mlc
P3EB	CM7R151B-34A-T	LVR-IC	LDO, 3.45V±2%, 150mA, +CE	SOT-23-5	28cx	VR4	6a	Can
P3EB	ML6204B34AM	LVR-IC	LDO, 3.45V±2%, 150mA, +CE	SOT-23-5	28cx	VR4	6a	Mlc
P3EC	CM7R151C-34A-T	LVR-IC	LDO, 3.45V±2%, 150mA, -CE, PDR	SOT-23-5	28cx	VR4	6a	Can
P3EC	ML6204C34AM	LVR-IC	LDO, 3.45V±2%, 150mA, -CE, CL	SOT-23-5	28cx	VR4	6a	Mlc
P3ED	CM7R151D-34A-T	LVR-IC	LDO, 3.45V±2%, 150mA, -CE	SOT-23-5	28cx	VR4	6a	Can
P3ED	ML6204D34AM	LVR-IC	LDO, 3.45V±2%, 150mA, -CE	SOT-23-5	28cx	VR4	6a	Mlc
P3F	XC6368E353MR	DC/DC-IC	PWM/PFM step-up, 3.5V±2.5%, 200mA, 300kHz, +CE	SOT-25	28sd	DC10	6g	Tor
P3FA	CM7R151A-35A-T	LVR-IC	LDO, 3.55V±2%, 150mA, +CE, PDR	SOT-23-5	28cx	VR4	6a	Can
P3FA	ML6204A35AM	LVR-IC	LDO, 3.55V±2%, 150mA, +CE, CL	SOT-23-5	28cx	VR4	6a	Mlc
P3FB	CM7R151B-35A-T	LVR-IC	LDO, 3.55V±2%, 150mA, +CE	SOT-23-5	28cx	VR4	6a	Can
P3FB	ML6204B35AM	LVR-IC	LDO, 3.55V±2%, 150mA, +CE	SOT-23-5	28cx	VR4	6a	Mlc
P3FC	CM7R151C-35A-T	LVR-IC	LDO, 3.55V±2%, 150mA, -CE, PDR	SOT-23-5	28cx	VR4	6a	Can
P3FC	ML6204C35AM	LVR-IC	LDO, 3.55V±2%, 150mA, -CE, CL	SOT-23-5	28cx	VR4	6a	Mlc
P3FD	CM7R151D-35A-T	LVR-IC	LDO, 3.55V±2%, 150mA, -CE	SOT-23-5	28cx	VR4	6a	Can
P3FD	ML6204D35AM	LVR-IC	LDO, 3.55V±2%, 150mA, -CE	SOT-23-5	28cx	VR4	6a	Mlc
P3GA	CM7R151A-36A-T	LVR-IC	LDO, 3.65V±2%, 150mA, +CE, PDR	SOT-23-5	28cx	VR4	6a	Can
P3GA	ML6204A36AM	LVR-IC	LDO, 3.65V±2%, 150mA, +CE, CL	SOT-23-5	28cx	VR4	6a	Mlc
P3GB	CM7R151B-36A-T	LVR-IC	LDO, 3.65V±2%, 150mA, +CE	SOT-23-5	28cx	VR4	6a	Can



SMD code	Type	Function	Short description	Case	Pinout	Sch.	St.	Mnf.
P3GB	ML6204B36AM	LVR-IC	LDO, 3.65V±2%, 150mA, +CE	SOT-23-5	28cx	VR4	6a	Mlc
P3GC	CM7R151C-36A-T	LVR-IC	LDO, 3.65V±2%, 150mA, -CE, PDR	SOT-23-5	28cx	VR4	6a	Can
P3GC	ML6204C36AM	LVR-IC	LDO, 3.65V±2%, 150mA, -CE, CL	SOT-23-5	28cx	VR4	6a	Mlc
P3GD	CM7R151D-36A-T	LVR-IC	LDO, 3.65V±2%, 150mA, -CE	SOT-23-5	28cx	VR4	6a	Can
P3GD	ML6204D36AM	LVR-IC	LDO, 3.65V±2%, 150mA, -CE	SOT-23-5	28cx	VR4	6a	Can
P3H	XC6368E363MR	DC/DC-IC	PWM/PPM step-up, 3.6V±2.5%, 200mA, 300kHz, +CE	SOT-25	28sd	DC10	6g	Tor
P3HA	CM7R151A-37A-T	LVR-IC	LDO, 3.75V±2%, 150mA, +CE, PDR	SOT-23-5	28cx	VR4	6a	Can
P3HA	ML6204A37AM	LVR-IC	LDO, 3.75V±2%, 150mA, +CE, CL	SOT-23-5	28cx	VR4	6a	Mlc
P3HB	CM7R151B-37A-T	LVR-IC	LDO, 3.75V±2%, 150mA, +CE	SOT-23-5	28cx	VR4	6a	Can
P3HB	ML6204B37AM	LVR-IC	LDO, 3.75V±2%, 150mA, +CE	SOT-23-5	28cx	VR4	6a	Mlc
P3HC	CM7R151C-37A-T	LVR-IC	LDO, 3.75V±2%, 150mA, -CE, PDR	SOT-23-5	28cx	VR4	6a	Can
P3HC	ML6204C37AM	LVR-IC	LDO, 3.75V±2%, 150mA, -CE, CL	SOT-23-5	28cx	VR4	6a	Mlc
P3HD	CM7R151D-37A-T	LVR-IC	LDO, 3.75V±2%, 150mA, -CE	SOT-23-5	28cx	VR4	6a	Can
P3HD	ML6204D37AM	LVR-IC	LDO, 3.75V±2%, 150mA, -CE	SOT-23-5	28cx	VR4	6a	Mlc
P3IA	CM7R151A-38A-T	LVR-IC	LDO, 3.85V±2%, 150mA, +CE, PDR	SOT-23-5	28cx	VR4	6a	Can
P3IA	ML6204A38AM	LVR-IC	LDO, 3.85V±2%, 150mA, +CE, CL	SOT-23-5	28cx	VR4	6a	Mlc
P3IB	CM7R151B-38A-T	LVR-IC	LDO, 3.85V±2%, 150mA, +CE	SOT-23-5	28cx	VR4	6a	Can
P3IB	ML6204B38AM	LVR-IC	LDO, 3.85V±2%, 150mA, +CE	SOT-23-5	28cx	VR4	6a	Mlc
P3IC	CM7R151C-38A-T	LVR-IC	LDO, 3.85V±2%, 150mA, -CE, PDR	SOT-23-5	28cx	VR4	6a	Can
P3IC	ML6204C38AM	LVR-IC	LDO, 3.85V±2%, 150mA, -CE, CL	SOT-23-5	28cx	VR4	6a	Mlc
P3ID	CM7R151D-38A-T	LVR-IC	LDO, 3.85V±2%, 150mA, -CE	SOT-23-5	28cx	VR4	6a	Can
P3ID	ML6204D38AM	LVR-IC	LDO, 3.85V±2%, 150mA, -CE	SOT-23-5	28cx	VR4	6a	Mlc
P3J	S-1167A50-M5T1G	LVR-IC	LDO, 5.0V±1.0%, 150mA, -CE	SOT-23-5	28cx	VR4	6g	Sii
P3JA	CM7R151A-39A-T	LVR-IC	LDO, 3.95V±2%, 150mA, +CE, PDR	SOT-23-5	28cx	VR4	6a	Can
P3JA	ML6204A39AM	LVR-IC	LDO, 3.95V±2%, 150mA, +CE, CL	SOT-23-5	28cx	VR4	6a	Mlc
P3JB	CM7R151B-39A-T	LVR-IC	LDO, 3.95V±2%, 150mA, +CE	SOT-23-5	28cx	VR4	6a	Can
P3JB	ML6204B39AM	LVR-IC	LDO, 3.95V±2%, 150mA, +CE	SOT-23-5	28cx	VR4	6a	Mlc
P3JC	CM7R151C-39A-T	LVR-IC	LDO, 3.95V±2%, 150mA, -CE, PDR	SOT-23-5	28cx	VR4	6a	Can
P3JC	ML6204C39AM	LVR-IC	LDO, 3.95V±2%, 150mA, -CE, CL	SOT-23-5	28cx	VR4	6a	Mlc
P3JD	CM7R151D-39A-T	LVR-IC	LDO, 3.95V±2%, 150mA, -CE	SOT-23-5	28cx	VR4	6a	Can
P3JD	ML6204D39AM	LVR-IC	LDO, 3.95V±2%, 150mA, -CE	SOT-23-5	28cx	VR4	6a	Mlc
P3K	XC6368E373MR	DC/DC-IC	PWM/PPM step-up, 3.7V±2.5%, 200mA, 300kHz, +CE	SOT-25	28sd	DC10	6g	Tor
P3L	XC6368E383MR	DC/DC-IC	PWM/PPM step-up, 3.8V±2.5%, 200mA, 300kHz, +CE	SOT-25	28sd	DC10	6g	Tor
P3M	XC6368E393MR	DC/DC-IC	PWM/PPM step-up, 3.9V±2.5%, 200mA, 300kHz, +CE	SOT-25	28sd	DC10	6g	Tor
P3P	S-1167A1J-M5T1G	LVR-IC	LDO, 1.85V±1.0%, 150mA, -CE	SOT-23-5	28cx	VR4	6g	Sii
P4	KRA567E	Si-pnp-Digi	Dual, Sw, 50V, 100mA, 200mW, R1/R2=2.2k/2.2k	TESV	30/TD9	-	6l	Kec
P4	KRA567U	Si-pnp-Digi	Dual, Sw, 50V, 100mA, 200mW, R1/R2=2.2k/2.2k	USV	28/TD9	-	6l	Kec
P4	KTA501F-Y	Si-pnp	Dual GP, 50V, 150mA, 100mW, B=120..240, 80MHz	TFSV	30/T12	-	6l	Kec
P40	XC6368E402MR	DC/DC-IC	PWM/PPM step-up, 4.0V±2.5%, 200mA, 180kHz, +CE	SOT-25	28sd	DC10	6g	Tor
P40A	CM7R151A-40B-T	LVR-IC	LDO, 4.0V±2%, 150mA, +CE, PDR	SOT-23-5	28cx	VR4	6a	Can
P40A	ML6204A402M	LVR-IC	LDO, 4.0V±2%, 150mA, +CE, CL	SOT-23-5	28cx	VR4	6a	Mlc
P40B	CM7R151B-40B-T	LVR-IC	LDO, 4.0V±2%, 150mA, +CE	SOT-23-5	28cx	VR4	6a	Can
P40B	ML6204B402M	LVR-IC	LDO, 4.0V±2%, 150mA, +CE	SOT-23-5	28cx	VR4	6a	Mlc
P40C	CM7R151C-40B-T	LVR-IC	LDO, 4.0V±2%, 150mA, -CE, PDR	SOT-23-5	28cx	VR4	6a	Can
P40C	ML6204C402M	LVR-IC	LDO, 4.0V±2%, 150mA, -CE, CL	SOT-23-5	28cx	VR4	6a	Mlc
P40D	CM7R151D-40B-T	LVR-IC	LDO, 4.0V±2%, 150mA, -CE	SOT-23-5	28cx	VR4	6a	Can
P40D	ML6204D402M	LVR-IC	LDO, 4.0V±2%, 150mA, -CE	SOT-23-5	28cx	VR4	6a	Mlc
P41	XC6368E412MR	DC/DC-IC	PWM/PPM step-up, 4.1V±2.5%, 200mA, 180kHz, +CE	SOT-25	28sd	DC10	6g	Tor
P41A	CM7R151A-41B-T	LVR-IC	LDO, 4.1V±2%, 150mA, +CE, PDR	SOT-23-5	28cx	VR4	6a	Can
P41A	ML6204A412M	LVR-IC	LDO, 4.1V±2%, 150mA, +CE, CL	SOT-23-5	28cx	VR4	6a	Mlc
P41B	CM7R151B-41B-T	LVR-IC	LDO, 4.1V±2%, 150mA, +CE	SOT-23-5	28cx	VR4	6a	Can
P41B	ML6204B412M	LVR-IC	LDO, 4.1V±2%, 150mA, +CE	SOT-23-5	28cx	VR4	6a	Mlc
P41C	CM7R151C-41B-T	LVR-IC	LDO, 4.1V±2%, 150mA, -CE, PDR	SOT-23-5	28cx	VR4	6a	Can
P41C	ML6204C412M	LVR-IC	LDO, 4.1V±2%, 150mA, -CE, CL	SOT-23-5	28cx	VR4	6a	Mlc
P41D	CM7R151D-41B-T	LVR-IC	LDO, 4.1V±2%, 150mA, -CE	SOT-23-5	28cx	VR4	6a	Can
P41D	ML6204D412M	LVR-IC	LDO, 4.1V±2%, 150mA, -CE	SOT-23-5	28cx	VR4	6a	Mlc
P42	XC6368E422MR	DC/DC-IC	PWM/PPM step-up, 4.2V±2.5%, 200mA, 180kHz, +CE	SOT-25	28sd	DC10	6g	Tor
P42A	CM7R151A-42B-T	LVR-IC	LDO, 4.2V±2%, 150mA, +CE, PDR	SOT-23-5	28cx	VR4	6a	Can
P42A	ML6204A422M	LVR-IC	LDO, 4.2V±2%, 150mA, +CE, CL	SOT-23-5	28cx	VR4	6a	Mlc
P42B	CM7R151B-42B-T	LVR-IC	LDO, 4.2V±2%, 150mA, +CE	SOT-23-5	28cx	VR4	6a	Can
P42B	ML6204B422M	LVR-IC	LDO, 4.2V±2%, 150mA, +CE	SOT-23-5	28cx	VR4	6a	Mlc
P42C	CM7R151C-42B-T	LVR-IC	LDO, 4.2V±2%, 150mA, -CE, PDR	SOT-23-5	28cx	VR4	6a	Can
P42C	ML6204C422M	LVR-IC	LDO, 4.2V±2%, 150mA, -CE, CL	SOT-23-5	28cx	VR4	6a	Mlc
P42D	CM7R151D-42B-T	LVR-IC	LDO, 4.2V±2%, 150mA, -CE	SOT-23-5	28cx	VR4	6a	Can
P42D	ML6204D422M	LVR-IC	LDO, 4.2V±2%, 150mA, -CE	SOT-23-5	28cx	VR4	6a	Mlc
P43	XC6368E432MR	DC/DC-IC	PWM/PPM step-up, 4.3V±2.5%, 200mA, 180kHz, +CE	SOT-25	28sd	DC10	6g	Tor
P43A	CM7R151A-43B-T	LVR-IC	LDO, 4.3V±2%, 150mA, +CE, PDR	SOT-23-5	28cx	VR4	6a	Can
P43A	ML6204A432M	LVR-IC	LDO, 4.3V±2%, 150mA, +CE, CL	SOT-23-5	28cx	VR4	6a	Mlc
P43B	CM7R151B-43B-T	LVR-IC	LDO, 4.3V±2%, 150mA, +CE	SOT-23-5	28cx	VR4	6a	Can
P43B	ML6204B432M	LVR-IC	LDO, 4.3V±2%, 150mA, +CE	SOT-23-5	28cx	VR4	6a	Mlc



SMD code	Type	Function	Short description	Case	Pinout	Sch.	St.	Mnf.
P43C	CM7R151C-43B-T	LVR-IC	LDO, 4.3V±2%, 150mA, -CE, PDR	SOT-23-5	28cx	VR4	6a	Can
P43C	ML6204C432M	LVR-IC	LDO, 4.3V±2%, 150mA, -CE, CL	SOT-23-5	28cx	VR4	6a	Mlc
P43D	CM7R151D-43B-T	LVR-IC	LDO, 4.3V±2%, 150mA, -CE	SOT-23-5	28cx	VR4	6a	Can
P43D	ML6204D432M	LVR-IC	LDO, 4.3V±2%, 150mA, -CE	SOT-23-5	28cx	VR4	6a	Mlc
P44	XC6368E442MR	DC/DC-IC	PWM/PFM step-up, 4.4V±2.5%, 200mA, 180kHz, +CE	SOT-25	28sd	DC10	6g	Tor
P44A	CM7R151A-44B-T	LVR-IC	LDO, 4.4V±2%, 150mA, +CE, PDR	SOT-23-5	28cx	VR4	6a	Can
P44A	ML6204A442M	LVR-IC	LDO, 4.4V±2%, 150mA, +CE, CL	SOT-23-5	28cx	VR4	6a	Mlc
P44B	CM7R151B-44B-T	LVR-IC	LDO, 4.4V±2%, 150mA, +CE	SOT-23-5	28cx	VR4	6a	Can
P44B	ML6204B442M	LVR-IC	LDO, 4.4V±2%, 150mA, +CE	SOT-23-5	28cx	VR4	6a	Mlc
P44C	CM7R151C-44B-T	LVR-IC	LDO, 4.4V±2%, 150mA, -CE, PDR	SOT-23-5	28cx	VR4	6a	Can
P44C	ML6204C442M	LVR-IC	LDO, 4.4V±2%, 150mA, -CE, CL	SOT-23-5	28cx	VR4	6a	Mlc
P44D	CM7R151D-44B-T	LVR-IC	LDO, 4.4V±2%, 150mA, -CE	SOT-23-5	28cx	VR4	6a	Can
P44D	ML6204D442M	LVR-IC	LDO, 4.4V±2%, 150mA, -CE	SOT-23-5	28cx	VR4	6a	Mlc
P45	XC6368E452MR	DC/DC-IC	PWM/PFM step-up, 4.5V±2.5%, 200mA, 180kHz, +CE	SOT-25	28sd	DC10	6g	Tor
P45A	CM7R151A-45B-T	LVR-IC	LDO, 4.5V±2%, 150mA, +CE, PDR	SOT-23-5	28cx	VR4	6a	Can
P45A	ML6204A452M	LVR-IC	LDO, 4.5V±2%, 150mA, +CE, CL	SOT-23-5	28cx	VR4	6a	Mlc
P45B	CM7R151B-45B-T	LVR-IC	LDO, 4.5V±2%, 150mA, +CE	SOT-23-5	28cx	VR4	6a	Can
P45B	ML6204B452M	LVR-IC	LDO, 4.5V±2%, 150mA, +CE	SOT-23-5	28cx	VR4	6a	Mlc
P45C	CM7R151C-45B-T	LVR-IC	LDO, 4.5V±2%, 150mA, -CE, PDR	SOT-23-5	28cx	VR4	6a	Can
P45C	ML6204C452M	LVR-IC	LDO, 4.5V±2%, 150mA, -CE, CL	SOT-23-5	28cx	VR4	6a	Mlc
P45D	CM7R151D-45B-T	LVR-IC	LDO, 4.5V±2%, 150mA, -CE	SOT-23-5	28cx	VR4	6a	Can
P45D	ML6204D452M	LVR-IC	LDO, 4.5V±2%, 150mA, -CE	SOT-23-5	28cx	VR4	6a	Mlc
P46	XC6368E462MR	DC/DC-IC	PWM/PFM step-up, 4.6V±2.5%, 200mA, 180kHz, +CE	SOT-25	28sd	DC10	6g	Tor
P46A	CM7R151A-46B-T	LVR-IC	LDO, 4.6V±2%, 150mA, +CE, PDR	SOT-23-5	28cx	VR4	6a	Can
P46A	ML6204A462M	LVR-IC	LDO, 4.6V±2%, 150mA, +CE, CL	SOT-23-5	28cx	VR4	6a	Mlc
P46B	CM7R151B-46B-T	LVR-IC	LDO, 4.6V±2%, 150mA, +CE	SOT-23-5	28cx	VR4	6a	Can
P46B	ML6204B462M	LVR-IC	LDO, 4.6V±2%, 150mA, +CE	SOT-23-5	28cx	VR4	6a	Mlc
P46C	CM7R151C-46B-T	LVR-IC	LDO, 4.6V±2%, 150mA, -CE, PDR	SOT-23-5	28cx	VR4	6a	Can
P46C	ML6204C462M	LVR-IC	LDO, 4.6V±2%, 150mA, -CE, CL	SOT-23-5	28cx	VR4	6a	Mlc
P46D	CM7R151D-46B-T	LVR-IC	LDO, 4.6V±2%, 150mA, -CE	SOT-23-5	28cx	VR4	6a	Can
P46D	ML6204D462M	LVR-IC	LDO, 4.6V±2%, 150mA, -CE	SOT-23-5	28cx	VR4	6a	Mlc
P47	XC6368E472MR	DC/DC-IC	PWM/PFM step-up, 4.7V±2.5%, 200mA, 180kHz, +CE	SOT-25	28sd	DC10	6g	Tor
P47A	CM7R151A-47B-T	LVR-IC	LDO, 4.7V±2%, 150mA, +CE, PDR	SOT-23-5	28cx	VR4	6a	Can
P47A	ML6204A472M	LVR-IC	LDO, 4.7V±2%, 150mA, +CE, CL	SOT-23-5	28cx	VR4	6a	Mlc
P47B	CM7R151B-47B-T	LVR-IC	LDO, 4.7V±2%, 150mA, +CE	SOT-23-5	28cx	VR4	6a	Can
P47B	ML6204B472M	LVR-IC	LDO, 4.7V±2%, 150mA, +CE	SOT-23-5	28cx	VR4	6a	Mlc
P47C	CM7R151C-47B-T	LVR-IC	LDO, 4.7V±2%, 150mA, -CE, PDR	SOT-23-5	28cx	VR4	6a	Can
P47C	ML6204C472M	LVR-IC	LDO, 4.7V±2%, 150mA, -CE, CL	SOT-23-5	28cx	VR4	6a	Mlc
P47D	CM7R151D-47B-T	LVR-IC	LDO, 4.7V±2%, 150mA, -CE	SOT-23-5	28cx	VR4	6a	Can
P47D	ML6204D472M	LVR-IC	LDO, 4.7V±2%, 150mA, -CE	SOT-23-5	28cx	VR4	6a	Mlc
P48	XC6368E482MR	DC/DC-IC	PWM/PFM step-up, 4.8V±2.5%, 200mA, 180kHz, +CE	SOT-25	28sd	DC10	6g	Tor
P48A	CM7R151A-48B-T	LVR-IC	LDO, 4.8V±2%, 150mA, +CE, PDR	SOT-23-5	28cx	VR4	6a	Can
P48A	ML6204A482M	LVR-IC	LDO, 4.8V±2%, 150mA, +CE, CL	SOT-23-5	28cx	VR4	6a	Mlc
P48B	CM7R151B-48B-T	LVR-IC	LDO, 4.8V±2%, 150mA, +CE	SOT-23-5	28cx	VR4	6a	Can
P48B	ML6204B482M	LVR-IC	LDO, 4.8V±2%, 150mA, +CE	SOT-23-5	28cx	VR4	6a	Mlc
P48C	CM7R151C-48B-T	LVR-IC	LDO, 4.8V±2%, 150mA, -CE, PDR	SOT-23-5	28cx	VR4	6a	Can
P48C	ML6204C482M	LVR-IC	LDO, 4.8V±2%, 150mA, -CE, CL	SOT-23-5	28cx	VR4	6a	Mlc
P48D	CM7R151D-48B-T	LVR-IC	LDO, 4.8V±2%, 150mA, -CE	SOT-23-5	28cx	VR4	6a	Can
P48D	ML6204D482M	LVR-IC	LDO, 4.8V±2%, 150mA, -CE	SOT-23-5	28cx	VR4	6a	Mlc
P49	XC6368E492MR	DC/DC-IC	PWM/PFM step-up, 4.9V±2.5%, 200mA, 180kHz, +CE	SOT-25	28sd	DC10	6g	Tor
P49A	CM7R151A-49B-T	LVR-IC	LDO, 4.9V±2%, 150mA, +CE, PDR	SOT-23-5	28cx	VR4	6a	Can
P49A	ML6204A492M	LVR-IC	LDO, 4.9V±2%, 150mA, +CE, CL	SOT-23-5	28cx	VR4	6a	Mlc
P49B	CM7R151B-49B-T	LVR-IC	LDO, 4.9V±2%, 150mA, +CE	SOT-23-5	28cx	VR4	6a	Can
P49B	ML6204B492M	LVR-IC	LDO, 4.9V±2%, 150mA, +CE	SOT-23-5	28cx	VR4	6a	Mlc
P49C	CM7R151C-49B-T	LVR-IC	LDO, 4.9V±2%, 150mA, -CE, PDR	SOT-23-5	28cx	VR4	6a	Can
P49C	ML6204C492M	LVR-IC	LDO, 4.9V±2%, 150mA, -CE, CL	SOT-23-5	28cx	VR4	6a	Mlc
P49D	CM7R151D-49B-T	LVR-IC	LDO, 4.9V±2%, 150mA, -CE	SOT-23-5	28cx	VR4	6a	Can
P49D	ML6204D492M	LVR-IC	LDO, 4.9V±2%, 150mA, -CE	SOT-23-5	28cx	VR4	6a	Mlc
P4A	S-1167B15-M5T1G	LVR-IC	LDO, 1.5V±1.0%, 150mA, +CE	SOT-23-5	28cx	VR4	6g	Sii
P4A	XC6108N44AMR	Vdet-IC	4.4V±2%, Hysteresis, -Reset ODO	SOT-25	28rm	VD14	6g	Tor
P4A	XC6118C34AMR-G	Vdet-IC	3.4V±2%, ±Reset PPO, Sense, hysteresis 5%, Cd	SOT-25	28mg	VD15	6g	Tor
P4A	XC6368E403MR	DC/DC-IC	PWM/PFM step-up, 4.0V±2.5%, 200mA, 300kHz, +CE	SOT-25	28sd	DC10	6g	Tor
P4AA	CM7R151A-40A-T	LVR-IC	LDO, 4.05V±2%, 150mA, +CE, PDR	SOT-23-5	28cx	VR4	6a	Can
P4AA	ML6204A40AM	LVR-IC	LDO, 4.05V±2%, 150mA, +CE, CL	SOT-23-5	28cx	VR4	6a	Mlc
P4AB	CM7R151B-40A-T	LVR-IC	LDO, 4.05V±2%, 150mA, +CE	SOT-23-5	28cx	VR4	6a	Can
P4AB	ML6204B40AM	LVR-IC	LDO, 4.05V±2%, 150mA, +CE	SOT-23-5	28cx	VR4	6a	Mlc
P4AC	CM7R151C-40A-T	LVR-IC	LDO, 4.05V±2%, 150mA, -CE, PDR	SOT-23-5	28cx	VR4	6a	Can
P4AC	ML6204C40AM	LVR-IC	LDO, 4.05V±2%, 150mA, -CE, CL	SOT-23-5	28cx	VR4	6a	Mlc
P4AD	CM7R151D-40A-T	LVR-IC	LDO, 4.05V±2%, 150mA, -CE	SOT-23-5	28cx	VR4	6a	Can
P4AD	ML6204D40AM	LVR-IC	LDO, 4.05V±2%, 150mA, -CE	SOT-23-5	28cx	VR4	6a	Mlc



SMD code	Type	Function	Short description	Case	Pinout	Sch.	St.	Mnf.
P4B	S-1167B16-M5T1G	LVR-IC	LDO, 1.6V±1.0%, 150mA, +CE	SOT-23-5	28cx	VR4	6g	Sii
P4B	XC6108N44BMR	Vdet-IC	4.4V±2%, -Reset ODO	SOT-25	28rm	VD14	6g	Tor
P4B	XC6118C34BMR-G	Vdet-IC	3.4V±2%, ±Reset PPO, Sense, hysteresis <1%, Cd	SOT-25	28mg	VD15	6g	Tor
P4B	XC6368E413MR	DC/DC-IC	PWM/PFM step-up, 4.1V±2.5%, 200mA, 300kHz, +CE	SOT-25	28sd	DC10	6g	Tor
P4BA	CM7R151A-41A-T	LVR-IC	LDO, 4.15V±2%, 150mA, +CE, PDR	SOT-23-5	28cx	VR4	6a	Can
P4BA	ML6204A41AM	LVR-IC	LDO, 4.15V±2%, 150mA, +CE, CL	SOT-23-5	28cx	VR4	6a	Mlc
P4BB	CM7R151B-41A-T	LVR-IC	LDO, 4.15V±2%, 150mA, +CE	SOT-23-5	28cx	VR4	6a	Can
P4BB	ML6204B41AM	LVR-IC	LDO, 4.15V±2%, 150mA, +CE	SOT-23-5	28cx	VR4	6a	Mlc
P4BC	CM7R151C-41A-T	LVR-IC	LDO, 4.15V±2%, 150mA, -CE, PDR	SOT-23-5	28cx	VR4	6a	Can
P4BC	ML6204C41AM	LVR-IC	LDO, 4.15V±2%, 150mA, -CE, CL	SOT-23-5	28cx	VR4	6a	Mlc
P4BD	CM7R151D-41A-T	LVR-IC	LDO, 4.15V±2%, 150mA, -CE	SOT-23-5	28cx	VR4	6a	Can
P4BD	ML6204D41AM	LVR-IC	LDO, 4.15V±2%, 150mA, -CE	SOT-23-5	28cx	VR4	6a	Mlc
P4C	S-1167B17-M5T1G	LVR-IC	LDO, 1.7V±1.0%, 150mA, +CE	SOT-23-5	28cx	VR4	6g	Sii
P4C	XC6108N44CMR	Vdet-IC	4.4V±2%, Hysteresis, -Reset ODO	SOT-25	28rk	VD14	6g	Tor
P4C	XC6118C34CMR-G	Vdet-IC	3.4V±2%, ±Reset PPO, Sense, hysteresis 5%	SOT-25	28mf	VD12	6g	Tor
P4C	XC6368E423MR	DC/DC-IC	PWM/PFM step-up, 4.2V±2.5%, 200mA, 300kHz, +CE	SOT-25	28sd	DC10	6g	Tor
P4CA	CM7R151A-42A-T	LVR-IC	LDO, 4.25V±2%, 150mA, +CE, PDR	SOT-23-5	28cx	VR4	6a	Can
P4CA	ML6204A42AM	LVR-IC	LDO, 4.25V±2%, 150mA, +CE, CL	SOT-23-5	28cx	VR4	6a	Mlc
P4CB	CM7R151B-42A-T	LVR-IC	LDO, 4.25V±2%, 150mA, +CE	SOT-23-5	28cx	VR4	6a	Can
P4CB	ML6204B42AM	LVR-IC	LDO, 4.25V±2%, 150mA, +CE	SOT-23-5	28cx	VR4	6a	Mlc
P4CC	CM7R151C-42A-T	LVR-IC	LDO, 4.25V±2%, 150mA, -CE, PDR	SOT-23-5	28cx	VR4	6a	Can
P4CC	ML6204C42AM	LVR-IC	LDO, 4.25V±2%, 150mA, -CE, CL	SOT-23-5	28cx	VR4	6a	Mlc
P4CD	CM7R151D-42A-T	LVR-IC	LDO, 4.25V±2%, 150mA, -CE	SOT-23-5	28cx	VR4	6a	Can
P4CD	ML6204D42AM	LVR-IC	LDO, 4.25V±2%, 150mA, -CE	SOT-23-5	28cx	VR4	6a	Mlc
P4D	S-1167B18-M5T1G	LVR-IC	LDO, 1.8V±1.0%, 150mA, +CE	SOT-23-5	28cx	VR4	6g	Sii
P4D	XC6108N44DMR	Vdet-IC	4.4V±2%, -Reset ODO	SOT-25	28rk	VD14	6g	Tor
P4D	XC6118C34DMR-G	Vdet-IC	3.4V±2%, ±Reset PPO, Sense, hysteresis <1%	SOT-25	28mf	VD12	6g	Tor
P4D	XC6368E433MR	DC/DC-IC	PWM/PFM step-up, 4.3V±2.5%, 200mA, 300kHz, +CE	SOT-25	28sd	DC10	6g	Tor
P4DA	CM7R151A-43A-T	LVR-IC	LDO, 4.35V±2%, 150mA, +CE, PDR	SOT-23-5	28cx	VR4	6a	Can
P4DA	ML6204A43AM	LVR-IC	LDO, 4.35V±2%, 150mA, +CE, CL	SOT-23-5	28cx	VR4	6a	Mlc
P4DB	CM7R151B-43A-T	LVR-IC	LDO, 4.35V±2%, 150mA, +CE	SOT-23-5	28cx	VR4	6a	Can
P4DB	ML6204B43AM	LVR-IC	LDO, 4.35V±2%, 150mA, +CE	SOT-23-5	28cx	VR4	6a	Mlc
P4DC	CM7R151C-43A-T	LVR-IC	LDO, 4.35V±2%, 150mA, -CE, PDR	SOT-23-5	28cx	VR4	6a	Can
P4DC	ML6204C43AM	LVR-IC	LDO, 4.35V±2%, 150mA, -CE, CL	SOT-23-5	28cx	VR4	6a	Mlc
P4DD	CM7R151D-43A-T	LVR-IC	LDO, 4.35V±2%, 150mA, -CE	SOT-23-5	28cx	VR4	6a	Can
P4DD	ML6204D43AM	LVR-IC	LDO, 4.35V±2%, 150mA, -CE	SOT-23-5	28cx	VR4	6a	Mlc
P4E	S-1167B19-M5T1G	LVR-IC	LDO, 1.9V±1.0%, 150mA, +CE	SOT-23-5	28cx	VR4	6g	Sii
P4E	XC6368E443MR	DC/DC-IC	PWM/PFM step-up, 4.4V±2.5%, 200mA, 300kHz, +CE	SOT-25	28sd	DC10	6g	Tor
P4EA	CM7R151A-44A-T	LVR-IC	LDO, 4.45V±2%, 150mA, +CE, PDR	SOT-23-5	28cx	VR4	6a	Can
P4EA	ML6204A44AM	LVR-IC	LDO, 4.45V±2%, 150mA, +CE, CL	SOT-23-5	28cx	VR4	6a	Mlc
P4EB	CM7R151B-44A-T	LVR-IC	LDO, 4.45V±2%, 150mA, +CE	SOT-23-5	28cx	VR4	6a	Can
P4EB	ML6204B44AM	LVR-IC	LDO, 4.45V±2%, 150mA, +CE	SOT-23-5	28cx	VR4	6a	Mlc
P4EC	CM7R151C-44A-T	LVR-IC	LDO, 4.45V±2%, 150mA, -CE, PDR	SOT-23-5	28cx	VR4	6a	Can
P4EC	ML6204C44AM	LVR-IC	LDO, 4.45V±2%, 150mA, -CE, CL	SOT-23-5	28cx	VR4	6a	Mlc
P4ED	CM7R151D-44A-T	LVR-IC	LDO, 4.45V±2%, 150mA, -CE	SOT-23-5	28cx	VR4	6a	Can
P4ED	ML6204D44AM	LVR-IC	LDO, 4.45V±2%, 150mA, -CE	SOT-23-5	28cx	VR4	6a	Mlc
P4F	S-1167B20-M5T1G	LVR-IC	LDO, 2.0V±1.0%, 150mA, +CE	SOT-23-5	28cx	VR4	6g	Sii
P4F	XC6368E453MR	DC/DC-IC	PWM/PFM step-up, 4.5V±2.5%, 200mA, 300kHz, +CE	SOT-25	28sd	DC10	6g	Tor
P4FA	CM7R151A-45A-T	LVR-IC	LDO, 4.55V±2%, 150mA, +CE, PDR	SOT-23-5	28cx	VR4	6a	Can
P4FA	ML6204A45AM	LVR-IC	LDO, 4.55V±2%, 150mA, +CE, CL	SOT-23-5	28cx	VR4	6a	Mlc
P4FB	CM7R151B-45A-T	LVR-IC	LDO, 4.55V±2%, 150mA, +CE	SOT-23-5	28cx	VR4	6a	Can
P4FB	ML6204B45AM	LVR-IC	LDO, 4.55V±2%, 150mA, +CE	SOT-23-5	28cx	VR4	6a	Mlc
P4FC	CM7R151C-45A-T	LVR-IC	LDO, 4.55V±2%, 150mA, -CE, PDR	SOT-23-5	28cx	VR4	6a	Can
P4FC	ML6204C45AM	LVR-IC	LDO, 4.55V±2%, 150mA, -CE, CL	SOT-23-5	28cx	VR4	6a	Mlc
P4FD	CM7R151D-45A-T	LVR-IC	LDO, 4.55V±2%, 150mA, -CE	SOT-23-5	28cx	VR4	6a	Can
P4FD	ML6204D45AM	LVR-IC	LDO, 4.55V±2%, 150mA, -CE	SOT-23-5	28cx	VR4	6a	Mlc
P4G	S-1167B21-M5T1G	LVR-IC	LDO, 2.1V±1.0%, 150mA, +CE	SOT-23-5	28cx	VR4	6g	Sii
P4GA	CM7R151A-46A-T	LVR-IC	LDO, 4.65V±2%, 150mA, +CE, PDR	SOT-23-5	28cx	VR4	6a	Can
P4GA	ML6204A46AM	LVR-IC	LDO, 4.65V±2%, 150mA, +CE, CL	SOT-23-5	28cx	VR4	6a	Mlc
P4GB	CM7R151B-46A-T	LVR-IC	LDO, 4.65V±2%, 150mA, +CE	SOT-23-5	28cx	VR4	6a	Can
P4GB	ML6204B46AM	LVR-IC	LDO, 4.65V±2%, 150mA, +CE	SOT-23-5	28cx	VR4	6a	Mlc
P4GC	CM7R151C-46A-T	LVR-IC	LDO, 4.65V±2%, 150mA, -CE, PDR	SOT-23-5	28cx	VR4	6a	Can
P4GC	ML6204C46AM	LVR-IC	LDO, 4.65V±2%, 150mA, -CE, CL	SOT-23-5	28cx	VR4	6a	Mlc
P4GD	CM7R151D-46A-T	LVR-IC	LDO, 4.65V±2%, 150mA, -CE	SOT-23-5	28cx	VR4	6a	Can
P4GD	ML6204D46AM	LVR-IC	LDO, 4.65V±2%, 150mA, -CE	SOT-23-5	28cx	VR4	6a	Mlc
P4H	S-1167B22-M5T1G	LVR-IC	LDO, 2.2V±1.0%, 150mA, +CE	SOT-23-5	28cx	VR4	6g	Sii
P4H	XC6368E463MR	DC/DC-IC	PWM/PFM step-up, 4.6V±2.5%, 200mA, 300kHz, +CE	SOT-25	28sd	DC10	6g	Tor
P4HA	CM7R151A-47A-T	LVR-IC	LDO, 4.75V±2%, 150mA, +CE, PDR	SOT-23-5	28cx	VR4	6a	Can
P4HA	ML6204A47AM	LVR-IC	LDO, 4.75V±2%, 150mA, +CE, CL	SOT-23-5	28cx	VR4	6a	Mlc
P4HB	CM7R151B-47A-T	LVR-IC	LDO, 4.75V±2%, 150mA, +CE	SOT-23-5	28cx	VR4	6a	Can



SMD code	Type	Function	Short description	Case	Pinout	Sch.	St.	Mnf.
P4HB	ML6204B47AM	LVR-IC	LDO, 4.75V±2%, 150mA, +CE	SOT-23-5	28cx	VR4	6a	Mlc
P4HC	CM7R151C-47A-T	LVR-IC	LDO, 4.75V±2%, 150mA, -CE, PDR	SOT-23-5	28cx	VR4	6a	Can
P4HC	ML6204C47AM	LVR-IC	LDO, 4.75V±2%, 150mA, -CE, CL	SOT-23-5	28cx	VR4	6a	Mlc
P4HD	CM7R151D-47A-T	LVR-IC	LDO, 4.75V±2%, 150mA, -CE	SOT-23-5	28cx	VR4	6a	Can
P4HD	ML6204D47AM	LVR-IC	LDO, 4.75V±2%, 150mA, -CE	SOT-23-5	28cx	VR4	6a	Mlc
P4I	S-1167B23-M5T1G	LVR-IC	LDO, 2.3V±1.0%, 150mA, +CE	SOT-23-5	28cx	VR4	6g	Sii
P4IA	CM7R151A-48A-T	LVR-IC	LDO, 4.85V±2%, 150mA, +CE, PDR	SOT-23-5	28cx	VR4	6a	Can
P4IA	ML6204A48AM	LVR-IC	LDO, 4.85V±2%, 150mA, +CE, CL	SOT-23-5	28cx	VR4	6a	Mlc
P4IB	CM7R151B-48A-T	LVR-IC	LDO, 4.85V±2%, 150mA, +CE	SOT-23-5	28cx	VR4	6a	Can
P4IB	ML6204B48AM	LVR-IC	LDO, 4.85V±2%, 150mA, +CE	SOT-23-5	28cx	VR4	6a	Mlc
P4IC	CM7R151C-48A-T	LVR-IC	LDO, 4.85V±2%, 150mA, -CE, PDR	SOT-23-5	28cx	VR4	6a	Can
P4IC	ML6204C48AM	LVR-IC	LDO, 4.85V±2%, 150mA, -CE, CL	SOT-23-5	28cx	VR4	6a	Mlc
P4ID	CM7R151D-48A-T	LVR-IC	LDO, 4.85V±2%, 150mA, -CE	SOT-23-5	28cx	VR4	6a	Can
P4ID	ML6204D48AM	LVR-IC	LDO, 4.85V±2%, 150mA, -CE	SOT-23-5	28cx	VR4	6a	Mlc
P4J	S-1167B24-M5T1G	LVR-IC	LDO, 2.4V±1.0%, 150mA, +CE	SOT-23-5	28cx	VR4	6g	Sii
P4JA	CM7R151A-49A-T	LVR-IC	LDO, 4.95V±2%, 150mA, +CE, PDR	SOT-23-5	28cx	VR4	6a	Can
P4JA	ML6204A49AM	LVR-IC	LDO, 4.95V±2%, 150mA, +CE, CL	SOT-23-5	28cx	VR4	6a	Mlc
P4JB	CM7R151B-49A-T	LVR-IC	LDO, 4.95V±2%, 150mA, +CE	SOT-23-5	28cx	VR4	6a	Can
P4JB	ML6204B49AM	LVR-IC	LDO, 4.95V±2%, 150mA, +CE	SOT-23-5	28cx	VR4	6a	Mlc
P4JC	CM7R151C-49A-T	LVR-IC	LDO, 4.95V±2%, 150mA, -CE, PDR	SOT-23-5	28cx	VR4	6a	Can
P4JC	ML6204C49AM	LVR-IC	LDO, 4.95V±2%, 150mA, -CE, CL	SOT-23-5	28cx	VR4	6a	Mlc
P4JD	CM7R151D-49A-T	LVR-IC	LDO, 4.95V±2%, 150mA, -CE	SOT-23-5	28cx	VR4	6a	Can
P4JD	ML6204D49AM	LVR-IC	LDO, 4.95V±2%, 150mA, -CE	SOT-23-5	28cx	VR4	6a	Mlc
P4K	S-1167B25-M5T1G	LVR-IC	LDO, 2.5V±1.0%, 150mA, +CE	SOT-23-5	28cx	VR4	6g	Sii
P4K	XC6368E473MR	DC/DC-IC	PWM/PFM step-up, 4.7V±2.5%, 200mA, 300kHz, +CE	SOT-25	28sd	DC10	6g	Tor
P4L	S-1167B26-M5T1G	LVR-IC	LDO, 2.6V±1.0%, 150mA, +CE	SOT-23-5	28cx	VR4	6g	Sii
P4L	XC6368E483MR	DC/DC-IC	PWM/PFM step-up, 4.8V±2.5%, 200mA, 300kHz, +CE	SOT-25	28sd	DC10	6g	Tor
P4M	S-1167B27-M5T1G	LVR-IC	LDO, 2.7V±1.0%, 150mA, +CE	SOT-23-5	28cx	VR4	6g	Sii
P4M	XC6368E493MR	DC/DC-IC	PWM/PFM step-up, 4.9V±2.5%, 200mA, 300kHz, +CE	SOT-25	28sd	DC10	6g	Tor
P4N	S-1167B28-M5T1G	LVR-IC	LDO, 2.8V±1.0%, 150mA, +CE	SOT-23-5	28cx	VR4	6g	Sii
P4O	S-1167B29-M5T1G	LVR-IC	LDO, 2.9V±1.0%, 150mA, +CE	SOT-23-5	28cx	VR4	6g	Sii
P4P	S-1167B30-M5T1G	LVR-IC	LDO, 3.0V±1.0%, 150mA, +CE	SOT-23-5	28cx	VR4	6g	Sii
P4Q	S-1167B31-M5T1G	LVR-IC	LDO, 3.1V±1.0%, 150mA, +CE	SOT-23-5	28cx	VR4	6g	Sii
P4R	S-1167B32-M5T1G	LVR-IC	LDO, 3.2V±1.0%, 150mA, +CE	SOT-23-5	28cx	VR4	6g	Sii
P4S	S-1167B33-M5T1G	LVR-IC	LDO, 3.3V±1.0%, 150mA, +CE	SOT-23-5	28cx	VR4	6g	Sii
P4T	S-1167B34-M5T1G	LVR-IC	LDO, 3.4V±1.0%, 150mA, +CE	SOT-23-5	28cx	VR4	6g	Sii
P4U	S-1167B35-M5T1G	LVR-IC	LDO, 3.5V±1.0%, 150mA, +CE	SOT-23-5	28cx	VR4	6g	Sii
P4V	S-1167B36-M5T1G	LVR-IC	LDO, 3.6V±1.0%, 150mA, +CE	SOT-23-5	28cx	VR4	6g	Sii
P4W	S-1167B37-M5T1G	LVR-IC	LDO, 3.7V±1.0%, 150mA, +CE	SOT-23-5	28cx	VR4	6g	Sii
P4X	S-1167B38-M5T1G	LVR-IC	LDO, 3.8V±1.0%, 150mA, +CE	SOT-23-5	28cx	VR4	6g	Sii
P4Y	S-1167B39-M5T1G	LVR-IC	LDO, 3.9V±1.0%, 150mA, +CE	SOT-23-5	28cx	VR4	6g	Sii
P4Z	S-1167B40-M5T1G	LVR-IC	LDO, 4.0V±1.0%, 150mA, +CE	SOT-23-5	28cx	VR4	6g	Sii
P5	KRA568E	Si-pnp-Digi	Dual, Sw, 50V, 100mA, 200mW, R1/R2=2.2k/10k	TESV	30/TD9	-	6l	Kec
P5	KRA568U	Si-pnp-Digi	Dual, Sw, 50V, 100mA, 200mW, R1/R2=2.2k/10k	USV	28/TD9	-	6l	Kec
P5	TC1186-3.3VCT713	LVR-IC	LDO, 3.3V±3%, 150mA, -CE, -Error	SOT-23-5	28w	VR8	6g	Mcc
P50	XC6368E502MR	DC/DC-IC	PWM/PFM step-up, 5.0V±2.5%, 200mA, 180kHz, +CE	SOT-25	28sd	DC10	6g	Tor
P50A	CM7R151A-50B-T	LVR-IC	LDO, 5.0V±2%, 150mA, +CE, PDR	SOT-23-5	28cx	VR4	6a	Can
P50A	ML6204A502M	LVR-IC	LDO, 5.0V±2%, 150mA, +CE, CL	SOT-23-5	28cx	VR4	6a	Mlc
P50B	CM7R151B-50B-T	LVR-IC	LDO, 5.0V±2%, 150mA, +CE	SOT-23-5	28cx	VR4	6a	Can
P50B	ML6204B502M	LVR-IC	LDO, 5.0V±2%, 150mA, +CE	SOT-23-5	28cx	VR4	6a	Mlc
P50C	CM7R151C-50B-T	LVR-IC	LDO, 5.0V±2%, 150mA, -CE, PDR	SOT-23-5	28cx	VR4	6a	Can
P50C	ML6204C502M	LVR-IC	LDO, 5.0V±2%, 150mA, -CE, CL	SOT-23-5	28cx	VR4	6a	Mlc
P50D	CM7R151D-50B-T	LVR-IC	LDO, 5.0V±2%, 150mA, -CE	SOT-23-5	28cx	VR4	6a	Can
P50D	ML6204D502M	LVR-IC	LDO, 5.0V±2%, 150mA, -CE	SOT-23-5	28cx	VR4	6a	Mlc
P51	XC6368E512MR	DC/DC-IC	PWM/PFM step-up, 5.1V±2.5%, 200mA, 180kHz, +CE	SOT-25	28sd	DC10	6g	Tor
P51A	CM7R151A-51B-T	LVR-IC	LDO, 5.1V±2%, 150mA, +CE, PDR	SOT-23-5	28cx	VR4	6a	Can
P51A	ML6204A512M	LVR-IC	LDO, 5.1V±2%, 150mA, +CE, CL	SOT-23-5	28cx	VR4	6a	Mlc
P51B	CM7R151B-51B-T	LVR-IC	LDO, 5.1V±2%, 150mA, +CE	SOT-23-5	28cx	VR4	6a	Can
P51B	ML6204B512M	LVR-IC	LDO, 5.1V±2%, 150mA, +CE	SOT-23-5	28cx	VR4	6a	Mlc
P51C	CM7R151C-51B-T	LVR-IC	LDO, 5.1V±2%, 150mA, -CE, PDR	SOT-23-5	28cx	VR4	6a	Can
P51C	ML6204C512M	LVR-IC	LDO, 5.1V±2%, 150mA, -CE, CL	SOT-23-5	28cx	VR4	6a	Mlc
P51D	CM7R151D-51B-T	LVR-IC	LDO, 5.1V±2%, 150mA, -CE	SOT-23-5	28cx	VR4	6a	Can
P51D	ML6204D512M	LVR-IC	LDO, 5.1V±2%, 150mA, -CE	SOT-23-5	28cx	VR4	6a	Mlc
P52	XC6368E522MR	DC/DC-IC	PWM/PFM step-up, 5.2V±2.5%, 200mA, 180kHz, +CE	SOT-25	28sd	DC10	6g	Tor
P52A	CM7R151A-52B-T	LVR-IC	LDO, 5.2V±2%, 150mA, +CE, PDR	SOT-23-5	28cx	VR4	6a	Can
P52A	ML6204A522M	LVR-IC	LDO, 5.2V±2%, 150mA, +CE, CL	SOT-23-5	28cx	VR4	6a	Mlc
P52B	CM7R151B-52B-T	LVR-IC	LDO, 5.2V±2%, 150mA, +CE	SOT-23-5	28cx	VR4	6a	Can
P52B	ML6204B522M	LVR-IC	LDO, 5.2V±2%, 150mA, +CE	SOT-23-5	28cx	VR4	6a	Mlc
P52C	CM7R151C-52B-T	LVR-IC	LDO, 5.2V±2%, 150mA, -CE, PDR	SOT-23-5	28cx	VR4	6a	Can
P52C	ML6204C522M	LVR-IC	LDO, 5.2V±2%, 150mA, -CE, CL	SOT-23-5	28cx	VR4	6a	Mlc



SMD code	Type	Function	Short description	Case	Pinout	Sch.	St.	Mnf.
P52D	CM7R151D-52B-T	LVR-IC	LDO, 5.2V±2%, 150mA, -CE	SOT-23-5	28cx	VR4	6a	Can
P52D	ML6204D522M	LVR-IC	LDO, 5.2V±2%, 150mA, -CE	SOT-23-5	28cx	VR4	6a	Mlc
P53	XC6368E532MR	DC/DC-IC	PWM/PFM step-up, 5.3V±2.5%, 200mA, 180kHz, +CE	SOT-25	28sd	DC10	6g	Tor
P53A	CM7R151A-53B-T	LVR-IC	LDO, 5.3V±2%, 150mA, +CE, PDR	SOT-23-5	28cx	VR4	6a	Can
P53A	ML6204A532M	LVR-IC	LDO, 5.3V±2%, 150mA, +CE, CL	SOT-23-5	28cx	VR4	6a	Mlc
P53B	CM7R151B-53B-T	LVR-IC	LDO, 5.3V±2%, 150mA, +CE	SOT-23-5	28cx	VR4	6a	Can
P53B	ML6204B532M	LVR-IC	LDO, 5.3V±2%, 150mA, +CE	SOT-23-5	28cx	VR4	6a	Mlc
P53C	CM7R151C-53B-T	LVR-IC	LDO, 5.3V±2%, 150mA, -CE, PDR	SOT-23-5	28cx	VR4	6a	Can
P53C	ML6204C532M	LVR-IC	LDO, 5.3V±2%, 150mA, -CE, CL	SOT-23-5	28cx	VR4	6a	Mlc
P53D	CM7R151D-53B-T	LVR-IC	LDO, 5.3V±2%, 150mA, -CE	SOT-23-5	28cx	VR4	6a	Can
P53D	ML6204D532M	LVR-IC	LDO, 5.3V±2%, 150mA, -CE	SOT-23-5	28cx	VR4	6a	Mlc
P54	XC6368E542MR	DC/DC-IC	PWM/PFM step-up, 5.4V±2.5%, 200mA, 180kHz, +CE	SOT-25	28sd	DC10	6g	Tor
P54A	CM7R151A-54B-T	LVR-IC	LDO, 5.4V±2%, 150mA, +CE, PDR	SOT-23-5	28cx	VR4	6a	Can
P54A	ML6204A542M	LVR-IC	LDO, 5.4V±2%, 150mA, +CE, CL	SOT-23-5	28cx	VR4	6a	Mlc
P54B	CM7R151B-54B-T	LVR-IC	LDO, 5.4V±2%, 150mA, +CE	SOT-23-5	28cx	VR4	6a	Can
P54B	ML6204B542M	LVR-IC	LDO, 5.4V±2%, 150mA, +CE	SOT-23-5	28cx	VR4	6a	Mlc
P54C	CM7R151C-54B-T	LVR-IC	LDO, 5.4V±2%, 150mA, -CE, PDR	SOT-23-5	28cx	VR4	6a	Can
P54C	ML6204C542M	LVR-IC	LDO, 5.4V±2%, 150mA, -CE, CL	SOT-23-5	28cx	VR4	6a	Mlc
P54D	CM7R151D-54B-T	LVR-IC	LDO, 5.4V±2%, 150mA, -CE	SOT-23-5	28cx	VR4	6a	Can
P54D	ML6204D542M	LVR-IC	LDO, 5.4V±2%, 150mA, -CE	SOT-23-5	28cx	VR4	6a	Mlc
P55	XC6368E552MR	DC/DC-IC	PWM/PFM step-up, 5.5V±2.5%, 200mA, 180kHz, +CE	SOT-25	28sd	DC10	6g	Tor
P55A	CM7R151A-55B-T	LVR-IC	LDO, 5.5V±2%, 150mA, +CE, PDR	SOT-23-5	28cx	VR4	6a	Can
P55A	ML6204A552M	LVR-IC	LDO, 5.5V±2%, 150mA, +CE, CL	SOT-23-5	28cx	VR4	6a	Mlc
P55B	CM7R151B-55B-T	LVR-IC	LDO, 5.5V±2%, 150mA, +CE	SOT-23-5	28cx	VR4	6a	Can
P55B	ML6204B552M	LVR-IC	LDO, 5.5V±2%, 150mA, +CE	SOT-23-5	28cx	VR4	6a	Mlc
P55C	CM7R151C-55B-T	LVR-IC	LDO, 5.5V±2%, 150mA, -CE, PDR	SOT-23-5	28cx	VR4	6a	Can
P55C	ML6204C552M	LVR-IC	LDO, 5.5V±2%, 150mA, -CE, CL	SOT-23-5	28cx	VR4	6a	Mlc
P55D	CM7R151D-55B-T	LVR-IC	LDO, 5.5V±2%, 150mA, -CE	SOT-23-5	28cx	VR4	6a	Can
P55D	ML6204D552M	LVR-IC	LDO, 5.5V±2%, 150mA, -CE	SOT-23-5	28cx	VR4	6a	Mlc
P56	XC6368E562MR	DC/DC-IC	PWM/PFM step-up, 5.6V±2.5%, 200mA, 180kHz, +CE	SOT-25	28sd	DC10	6g	Tor
P56A	CM7R151A-56B-T	LVR-IC	LDO, 5.6V±2%, 150mA, +CE, PDR	SOT-23-5	28cx	VR4	6a	Can
P56A	ML6204A562M	LVR-IC	LDO, 5.6V±2%, 150mA, +CE, CL	SOT-23-5	28cx	VR4	6a	Mlc
P56B	CM7R151B-56B-T	LVR-IC	LDO, 5.6V±2%, 150mA, +CE	SOT-23-5	28cx	VR4	6a	Can
P56B	ML6204B562M	LVR-IC	LDO, 5.6V±2%, 150mA, +CE	SOT-23-5	28cx	VR4	6a	Mlc
P56C	CM7R151C-56B-T	LVR-IC	LDO, 5.6V±2%, 150mA, -CE, PDR	SOT-23-5	28cx	VR4	6a	Can
P56C	ML6204C562M	LVR-IC	LDO, 5.6V±2%, 150mA, -CE, CL	SOT-23-5	28cx	VR4	6a	Mlc
P56D	CM7R151D-56B-T	LVR-IC	LDO, 5.6V±2%, 150mA, -CE	SOT-23-5	28cx	VR4	6a	Can
P56D	ML6204D562M	LVR-IC	LDO, 5.6V±2%, 150mA, -CE	SOT-23-5	28cx	VR4	6a	Mlc
P57	XC6368E572MR	DC/DC-IC	PWM/PFM step-up, 5.7V±2.5%, 200mA, 180kHz, +CE	SOT-25	28sd	DC10	6g	Tor
P57A	CM7R151A-57B-T	LVR-IC	LDO, 5.7V±2%, 150mA, +CE, PDR	SOT-23-5	28cx	VR4	6a	Can
P57A	ML6204A572M	LVR-IC	LDO, 5.7V±2%, 150mA, +CE, CL	SOT-23-5	28cx	VR4	6a	Mlc
P57B	CM7R151B-57B-T	LVR-IC	LDO, 5.7V±2%, 150mA, +CE	SOT-23-5	28cx	VR4	6a	Can
P57B	ML6204B572M	LVR-IC	LDO, 5.7V±2%, 150mA, +CE	SOT-23-5	28cx	VR4	6a	Mlc
P57C	CM7R151C-57B-T	LVR-IC	LDO, 5.7V±2%, 150mA, -CE, PDR	SOT-23-5	28cx	VR4	6a	Can
P57C	ML6204C572M	LVR-IC	LDO, 5.7V±2%, 150mA, -CE, CL	SOT-23-5	28cx	VR4	6a	Mlc
P57D	CM7R151D-57B-T	LVR-IC	LDO, 5.7V±2%, 150mA, -CE	SOT-23-5	28cx	VR4	6a	Can
P57D	ML6204D572M	LVR-IC	LDO, 5.7V±2%, 150mA, -CE	SOT-23-5	28cx	VR4	6a	Mlc
P58	XC6368E582MR	DC/DC-IC	PWM/PFM step-up, 5.8V±2.5%, 200mA, 180kHz, +CE	SOT-25	28sd	DC10	6g	Tor
P58A	CM7R151A-58B-T	LVR-IC	LDO, 5.8V±2%, 150mA, +CE, PDR	SOT-23-5	28cx	VR4	6a	Can
P58A	ML6204A582M	LVR-IC	LDO, 5.8V±2%, 150mA, +CE, CL	SOT-23-5	28cx	VR4	6a	Mlc
P58B	CM7R151B-58B-T	LVR-IC	LDO, 5.8V±2%, 150mA, +CE	SOT-23-5	28cx	VR4	6a	Can
P58B	ML6204B582M	LVR-IC	LDO, 5.8V±2%, 150mA, +CE	SOT-23-5	28cx	VR4	6a	Mlc
P58C	CM7R151C-58B-T	LVR-IC	LDO, 5.8V±2%, 150mA, -CE, PDR	SOT-23-5	28cx	VR4	6a	Can
P58C	ML6204C582M	LVR-IC	LDO, 5.8V±2%, 150mA, -CE, CL	SOT-23-5	28cx	VR4	6a	Mlc
P58D	CM7R151D-58B-T	LVR-IC	LDO, 5.8V±2%, 150mA, -CE	SOT-23-5	28cx	VR4	6a	Can
P58D	ML6204D582M	LVR-IC	LDO, 5.8V±2%, 150mA, -CE	SOT-23-5	28cx	VR4	6a	Mlc
P59	XC6368E592MR	DC/DC-IC	PWM/PFM step-up, 5.9V±2.5%, 200mA, 180kHz, +CE	SOT-25	28sd	DC10	6g	Tor
P59A	CM7R151A-59B-T	LVR-IC	LDO, 5.9V±2%, 150mA, +CE, PDR	SOT-23-5	28cx	VR4	6a	Can
P59A	ML6204A592M	LVR-IC	LDO, 5.9V±2%, 150mA, +CE, CL	SOT-23-5	28cx	VR4	6a	Mlc
P59B	CM7R151B-59B-T	LVR-IC	LDO, 5.9V±2%, 150mA, +CE	SOT-23-5	28cx	VR4	6a	Can
P59B	ML6204B592M	LVR-IC	LDO, 5.9V±2%, 150mA, +CE	SOT-23-5	28cx	VR4	6a	Mlc
P59C	CM7R151C-59B-T	LVR-IC	LDO, 5.9V±2%, 150mA, -CE, PDR	SOT-23-5	28cx	VR4	6a	Can
P59C	ML6204C592M	LVR-IC	LDO, 5.9V±2%, 150mA, -CE, CL	SOT-23-5	28cx	VR4	6a	Mlc
P59D	CM7R151D-59B-T	LVR-IC	LDO, 5.9V±2%, 150mA, -CE	SOT-23-5	28cx	VR4	6a	Can
P59D	ML6204D592M	LVR-IC	LDO, 5.9V±2%, 150mA, -CE	SOT-23-5	28cx	VR4	6a	Mlc
P5A	S-1167B41-M15T1G	LVR-IC	LDO, 4.1V±1.0%, 150mA, +CE	SOT-23-5	28cx	VR4	6g	Sii
P5A	XC6108N45AMR	Vdet-IC	4.5V±2%, Hysteresis, -Reset ODO	SOT-25	28rm	VD14	6g	Tor
P5A	XC6118C35AMR-G	Vdet-IC	3.5V±2%, ±Reset PPO, Sense, hysteresis 5%, Cd	SOT-25	28mg	VD15	6g	Tor
P5A	XC6368E503MR	DC/DC-IC	PWM/PFM step-up, 5.0V±2.5%, 200mA, 300kHz, +CE	SOT-25	28sd	DC10	6g	Tor
P5AA	CM7R151A-50A-T	LVR-IC	LDO, 5.05V±2%, 150mA, +CE, PDR	SOT-23-5	28cx	VR4	6a	Can



SMD code	Type	Function	Short description	Case	Pinout	Sch.	St.	Mnf.
P5AA	ML6204A50AM	LVR-IC	LDO, 5.05V±2%, 150mA, +CE, CL	SOT-23-5	28cx	VR4	6a	Mlc
P5AB	CM7R151B-50A-T	LVR-IC	LDO, 5.05V±2%, 150mA, +CE	SOT-23-5	28cx	VR4	6a	Can
P5AB	ML6204B50AM	LVR-IC	LDO, 5.05V±2%, 150mA, +CE	SOT-23-5	28cx	VR4	6a	Mlc
P5AC	CM7R151C-50A-T	LVR-IC	LDO, 5.05V±2%, 150mA, -CE, PDR	SOT-23-5	28cx	VR4	6a	Can
P5AC	ML6204C50AM	LVR-IC	LDO, 5.05V±2%, 150mA, -CE, CL	SOT-23-5	28cx	VR4	6a	Mlc
P5AD	CM7R151D-50A-T	LVR-IC	LDO, 5.05V±2%, 150mA, -CE	SOT-23-5	28cx	VR4	6a	Can
P5AD	ML6204D50AM	LVR-IC	LDO, 5.05V±2%, 150mA, -CE	SOT-23-5	28cx	VR4	6a	Mlc
P5B	S-1167B42-M5T1G	LVR-IC	LDO, 4.2V±1.0%, 150mA, +CE	SOT-23-5	28cx	VR4	6g	Sii
P5B	XC6108N45BMR	Vdet-IC	4.5V±2%, -Reset ODO	SOT-25	28rm	VD14	6g	Tor
P5B	XC6118C35BMR-G	Vdet-IC	3.5V±2%, ±Reset PPO, Sense, hysteresis <1%, Cd	SOT-25	28mg	VD15	6g	Tor
P5B	XC6368E513MR	DC/DC-IC	PWM/PPFM step-up, 5.1V±2.5%, 200mA, 300kHz, +CE	SOT-25	28sd	DC10	6g	Tor
P5BA	CM7R151A-51A-T	LVR-IC	LDO, 5.15V±2%, 150mA, +CE, PDR	SOT-23-5	28cx	VR4	6a	Can
P5BA	ML6204A51AM	LVR-IC	LDO, 5.15V±2%, 150mA, +CE, CL	SOT-23-5	28cx	VR4	6a	Mlc
P5BB	CM7R151B-51A-T	LVR-IC	LDO, 5.15V±2%, 150mA, +CE	SOT-23-5	28cx	VR4	6a	Can
P5BB	ML6204B51AM	LVR-IC	LDO, 5.15V±2%, 150mA, +CE	SOT-23-5	28cx	VR4	6a	Mlc
P5BC	CM7R151C-51A-T	LVR-IC	LDO, 5.15V±2%, 150mA, -CE, PDR	SOT-23-5	28cx	VR4	6a	Can
P5BC	ML6204C51AM	LVR-IC	LDO, 5.15V±2%, 150mA, -CE, CL	SOT-23-5	28cx	VR4	6a	Mlc
P5BD	CM7R151D-51A-T	LVR-IC	LDO, 5.15V±2%, 150mA, -CE	SOT-23-5	28cx	VR4	6a	Can
P5BD	ML6204D51AM	LVR-IC	LDO, 5.15V±2%, 150mA, -CE	SOT-23-5	28cx	VR4	6a	Mlc
P5C	S-1167B43-M5T1G	LVR-IC	LDO, 4.3V±1.0%, 150mA, +CE	SOT-23-5	28cx	VR4	6g	Sii
P5C	XC6108N45CMR	Vdet-IC	4.5V±2%, Hysteresis, -Reset ODO	SOT-25	28rk	VD14	6g	Tor
P5C	XC6118C35CMR-G	Vdet-IC	3.5V±2%, ±Reset PPO, Sense, hysteresis 5%	SOT-25	28mf	VD12	6g	Tor
P5C	XC6368E523MR	DC/DC-IC	PWM/PPFM step-up, 5.2V±2.5%, 200mA, 300kHz, +CE	SOT-25	28sd	DC10	6g	Tor
P5CA	CM7R151A-52A-T	LVR-IC	LDO, 5.25V±2%, 150mA, +CE, PDR	SOT-23-5	28cx	VR4	6a	Can
P5CA	ML6204A52AM	LVR-IC	LDO, 5.25V±2%, 150mA, +CE, CL	SOT-23-5	28cx	VR4	6a	Mlc
P5CB	CM7R151B-52A-T	LVR-IC	LDO, 5.25V±2%, 150mA, +CE	SOT-23-5	28cx	VR4	6a	Can
P5CB	ML6204B52AM	LVR-IC	LDO, 5.25V±2%, 150mA, +CE	SOT-23-5	28cx	VR4	6a	Mlc
P5CC	CM7R151C-52A-T	LVR-IC	LDO, 5.25V±2%, 150mA, -CE, PDR	SOT-23-5	28cx	VR4	6a	Can
P5CC	ML6204C52AM	LVR-IC	LDO, 5.25V±2%, 150mA, -CE, CL	SOT-23-5	28cx	VR4	6a	Mlc
P5CD	CM7R151D-52A-T	LVR-IC	LDO, 5.25V±2%, 150mA, -CE	SOT-23-5	28cx	VR4	6a	Can
P5CD	ML6204D52AM	LVR-IC	LDO, 5.25V±2%, 150mA, -CE	SOT-23-5	28cx	VR4	6a	Mlc
P5D	S-1167B44-M5T1G	LVR-IC	LDO, 4.4V±1.0%, 150mA, +CE	SOT-23-5	28cx	VR4	6g	Sii
P5D	XC6108N45DMR	Vdet-IC	4.5V±2%, -Reset ODO	SOT-25	28rk	VD14	6g	Tor
P5D	XC6118C35DMR-G	Vdet-IC	3.5V±2%, ±Reset PPO, Sense, hysteresis <1%	SOT-25	28mf	VD12	6g	Tor
P5D	XC6368E533MR	DC/DC-IC	PWM/PPFM step-up, 5.3V±2.5%, 200mA, 300kHz, +CE	SOT-25	28sd	DC10	6g	Tor
P5DA	CM7R151A-53A-T	LVR-IC	LDO, 5.35V±2%, 150mA, +CE, PDR	SOT-23-5	28cx	VR4	6a	Can
P5DA	ML6204A53AM	LVR-IC	LDO, 5.35V±2%, 150mA, +CE, CL	SOT-23-5	28cx	VR4	6a	Mlc
P5DB	CM7R151B-53A-T	LVR-IC	LDO, 5.35V±2%, 150mA, +CE	SOT-23-5	28cx	VR4	6a	Can
P5DB	ML6204B53AM	LVR-IC	LDO, 5.35V±2%, 150mA, +CE	SOT-23-5	28cx	VR4	6a	Mlc
P5DC	CM7R151C-53A-T	LVR-IC	LDO, 5.35V±2%, 150mA, -CE, PDR	SOT-23-5	28cx	VR4	6a	Can
P5DC	ML6204C53AM	LVR-IC	LDO, 5.35V±2%, 150mA, -CE, CL	SOT-23-5	28cx	VR4	6a	Mlc
P5DD	CM7R151D-53A-T	LVR-IC	LDO, 5.35V±2%, 150mA, -CE	SOT-23-5	28cx	VR4	6a	Can
P5DD	ML6204D53AM	LVR-IC	LDO, 5.35V±2%, 150mA, -CE	SOT-23-5	28cx	VR4	6a	Mlc
P5E	S-1167B45-M5T1G	LVR-IC	LDO, 4.5V±1.0%, 150mA, +CE	SOT-23-5	28cx	VR4	6g	Sii
P5E	XC6368E543MR	DC/DC-IC	PWM/PPFM step-up, 5.4V±2.5%, 200mA, 300kHz, +CE	SOT-25	28sd	DC10	6g	Tor
P5EA	CM7R151A-54A-T	LVR-IC	LDO, 5.45V±2%, 150mA, +CE, PDR	SOT-23-5	28cx	VR4	6a	Can
P5EA	ML6204A54AM	LVR-IC	LDO, 5.45V±2%, 150mA, +CE, CL	SOT-23-5	28cx	VR4	6a	Mlc
P5EB	CM7R151B-54A-T	LVR-IC	LDO, 5.45V±2%, 150mA, +CE	SOT-23-5	28cx	VR4	6a	Can
P5EB	ML6204B54AM	LVR-IC	LDO, 5.45V±2%, 150mA, +CE	SOT-23-5	28cx	VR4	6a	Mlc
P5EC	CM7R151C-54A-T	LVR-IC	LDO, 5.45V±2%, 150mA, -CE, PDR	SOT-23-5	28cx	VR4	6a	Can
P5EC	ML6204C54AM	LVR-IC	LDO, 5.45V±2%, 150mA, -CE, CL	SOT-23-5	28cx	VR4	6a	Mlc
P5ED	CM7R151D-54A-T	LVR-IC	LDO, 5.45V±2%, 150mA, -CE	SOT-23-5	28cx	VR4	6a	Can
P5ED	ML6204D54AM	LVR-IC	LDO, 5.45V±2%, 150mA, -CE	SOT-23-5	28cx	VR4	6a	Mlc
P5F	S-1167B46-M5T1G	LVR-IC	LDO, 4.6V±1.0%, 150mA, +CE	SOT-23-5	28cx	VR4	6g	Sii
P5F	XC6368E553MR	DC/DC-IC	PWM/PPFM step-up, 5.5V±2.5%, 200mA, 300kHz, +CE	SOT-25	28sd	DC10	6g	Tor
P5FA	CM7R151A-55A-T	LVR-IC	LDO, 5.55V±2%, 150mA, +CE, PDR	SOT-23-5	28cx	VR4	6a	Can
P5FA	ML6204A55AM	LVR-IC	LDO, 5.55V±2%, 150mA, +CE, CL	SOT-23-5	28cx	VR4	6a	Mlc
P5FB	CM7R151B-55A-T	LVR-IC	LDO, 5.55V±2%, 150mA, +CE	SOT-23-5	28cx	VR4	6a	Can
P5FB	ML6204B55AM	LVR-IC	LDO, 5.55V±2%, 150mA, +CE	SOT-23-5	28cx	VR4	6a	Mlc
P5FC	CM7R151C-55A-T	LVR-IC	LDO, 5.55V±2%, 150mA, -CE, PDR	SOT-23-5	28cx	VR4	6a	Can
P5FC	ML6204C55AM	LVR-IC	LDO, 5.55V±2%, 150mA, -CE, CL	SOT-23-5	28cx	VR4	6a	Mlc
P5FD	CM7R151D-55A-T	LVR-IC	LDO, 5.55V±2%, 150mA, -CE	SOT-23-5	28cx	VR4	6a	Can
P5FD	ML6204D55AM	LVR-IC	LDO, 5.55V±2%, 150mA, -CE	SOT-23-5	28cx	VR4	6a	Mlc
P5G	S-1167B47-M5T1G	LVR-IC	LDO, 4.7V±1.0%, 150mA, +CE	SOT-23-5	28cx	VR4	6g	Sii
P5GA	CM7R151A-56A-T	LVR-IC	LDO, 5.65V±2%, 150mA, +CE, PDR	SOT-23-5	28cx	VR4	6a	Can
P5GA	ML6204A56AM	LVR-IC	LDO, 5.65V±2%, 150mA, +CE, CL	SOT-23-5	28cx	VR4	6a	Mlc
P5GB	CM7R151B-56A-T	LVR-IC	LDO, 5.65V±2%, 150mA, +CE	SOT-23-5	28cx	VR4	6a	Can
P5GB	ML6204B56AM	LVR-IC	LDO, 5.65V±2%, 150mA, +CE	SOT-23-5	28cx	VR4	6a	Mlc
P5GC	CM7R151C-56A-T	LVR-IC	LDO, 5.65V±2%, 150mA, -CE, PDR	SOT-23-5	28cx	VR4	6a	Can
P5GC	ML6204C56AM	LVR-IC	LDO, 5.65V±2%, 150mA, -CE, CL	SOT-23-5	28cx	VR4	6a	Mlc



SMD code	Type	Function	Short description	Case	Pinout	Sch.	St.	Mnf.
P5GD	CM7R151D-56A-T	LVR-IC	LDO, 5.65V±2%, 150mA, -CE	SOT-23-5	28cx	VR4	6a	Can
P5GD	ML6204D56AM	LVR-IC	LDO, 5.65V±2%, 150mA, -CE	SOT-23-5	28cx	VR4	6a	Mlc
P5H	S-1167B48-M5T1G	LVR-IC	LDO, 4.8V±1.0%, 150mA, +CE	SOT-23-5	28cx	VR4	6g	Sii
P5H	XC6368E563MR	DC/DC-IC	PWM/PFM step-up, 5.6V±2.5%, 200mA, 300kHz, +CE	SOT-25	28sd	DC10	6g	Tor
P5HA	CM7R151A-57A-T	LVR-IC	LDO, 5.75V±2%, 150mA, +CE, PDR	SOT-23-5	28cx	VR4	6a	Can
P5HA	ML6204A57AM	LVR-IC	LDO, 5.75V±2%, 150mA, +CE, CL	SOT-23-5	28cx	VR4	6a	Mlc
P5HB	CM7R151B-57A-T	LVR-IC	LDO, 5.75V±2%, 150mA, +CE	SOT-23-5	28cx	VR4	6a	Can
P5HB	ML6204B57AM	LVR-IC	LDO, 5.75V±2%, 150mA, +CE	SOT-23-5	28cx	VR4	6a	Mlc
P5HC	CM7R151C-57A-T	LVR-IC	LDO, 5.75V±2%, 150mA, -CE, PDR	SOT-23-5	28cx	VR4	6a	Can
P5HC	ML6204C57AM	LVR-IC	LDO, 5.75V±2%, 150mA, -CE, CL	SOT-23-5	28cx	VR4	6a	Mlc
P5HD	CM7R151D-57A-T	LVR-IC	LDO, 5.75V±2%, 150mA, -CE	SOT-23-5	28cx	VR4	6a	Can
P5HD	ML6204D57AM	LVR-IC	LDO, 5.75V±2%, 150mA, -CE	SOT-23-5	28cx	VR4	6a	Mlc
P5I	S-1167B49-M5T1G	LVR-IC	LDO, 4.9V±1.0%, 150mA, +CE	SOT-23-5	28cx	VR4	6g	Sii
P5IA	CM7R151A-58A-T	LVR-IC	LDO, 5.85V±2%, 150mA, +CE, PDR	SOT-23-5	28cx	VR4	6a	Can
P5IA	ML6204A58AM	LVR-IC	LDO, 5.85V±2%, 150mA, +CE, CL	SOT-23-5	28cx	VR4	6a	Mlc
P5IB	CM7R151B-58A-T	LVR-IC	LDO, 5.85V±2%, 150mA, +CE	SOT-23-5	28cx	VR4	6a	Can
P5IB	ML6204B58AM	LVR-IC	LDO, 5.85V±2%, 150mA, +CE	SOT-23-5	28cx	VR4	6a	Mlc
P5IC	CM7R151C-58A-T	LVR-IC	LDO, 5.85V±2%, 150mA, -CE, PDR	SOT-23-5	28cx	VR4	6a	Can
P5IC	ML6204C58AM	LVR-IC	LDO, 5.85V±2%, 150mA, -CE, CL	SOT-23-5	28cx	VR4	6a	Mlc
P5ID	CM7R151D-58A-T	LVR-IC	LDO, 5.85V±2%, 150mA, -CE	SOT-23-5	28cx	VR4	6a	Can
P5ID	ML6204D58AM	LVR-IC	LDO, 5.85V±2%, 150mA, -CE	SOT-23-5	28cx	VR4	6a	Mlc
P5J	S-1167B50-M5T1G	LVR-IC	LDO, 5.0V±1.0%, 150mA, +CE	SOT-23-5	28cx	VR4	6g	Sii
P5JA	CM7R151A-59A-T	LVR-IC	LDO, 5.95V±2%, 150mA, +CE, PDR	SOT-23-5	28cx	VR4	6a	Can
P5JA	ML6204A59AM	LVR-IC	LDO, 5.95V±2%, 150mA, +CE, CL	SOT-23-5	28cx	VR4	6a	Mlc
P5JB	CM7R151B-59A-T	LVR-IC	LDO, 5.95V±2%, 150mA, +CE	SOT-23-5	28cx	VR4	6a	Can
P5JB	ML6204B59AM	LVR-IC	LDO, 5.95V±2%, 150mA, +CE	SOT-23-5	28cx	VR4	6a	Mlc
P5JC	CM7R151C-59A-T	LVR-IC	LDO, 5.95V±2%, 150mA, -CE, PDR	SOT-23-5	28cx	VR4	6a	Can
P5JC	ML6204C59AM	LVR-IC	LDO, 5.95V±2%, 150mA, -CE, CL	SOT-23-5	28cx	VR4	6a	Mlc
P5JD	CM7R151D-59A-T	LVR-IC	LDO, 5.95V±2%, 150mA, -CE	SOT-23-5	28cx	VR4	6a	Can
P5JD	ML6204D59AM	LVR-IC	LDO, 5.95V±2%, 150mA, -CE	SOT-23-5	28cx	VR4	6a	Mlc
P5K	S-1167B51-M5T1G	LVR-IC	LDO, 5.1V±1.0%, 150mA, +CE	SOT-23-5	28cx	VR4	6g	Sii
P5K	XC6368E573MR	DC/DC-IC	PWM/PFM step-up, 5.7V±2.5%, 200mA, 300kHz, +CE	SOT-25	28sd	DC10	6g	Tor
P5L	S-1167B52-M5T1G	LVR-IC	LDO, 5.2V±1.0%, 150mA, +CE	SOT-23-5	28cx	VR4	6g	Sii
P5L	XC6368E583MR	DC/DC-IC	PWM/PFM step-up, 5.8V±2.5%, 200mA, 300kHz, +CE	SOT-25	28sd	DC10	6g	Tor
P5M	S-1167B53-M5T1G	LVR-IC	LDO, 5.3V±1.0%, 150mA, +CE	SOT-23-5	28cx	VR4	6g	Sii
P5M	XC6368E593MR	DC/DC-IC	PWM/PFM step-up, 5.9V±2.5%, 200mA, 300kHz, +CE	SOT-25	28sd	DC10	6g	Tor
P5N	S-1167B54-M5T1G	LVR-IC	LDO, 5.4V±1.0%, 150mA, +CE	SOT-23-5	28cx	VR4	6g	Sii
P5O	S-1167B55-M5T1G	LVR-IC	LDO, 5.5V±1.0%, 150mA, +CE	SOT-23-5	28cx	VR4	6g	Sii
P6	KRA569E	Si-pnp-Digi	Dual, Sw, 50V, 100mA, 200mW, R1/R2=4.7k/10k	TESV	30/TD9	-	6l	Kec
P6	KRA569U	Si-pnp-Digi	Dual, Sw, 50V, 100mA, 200mW, R1/R2=4.7k/10k	USV	28/TD9	-	6l	Kec
P6	KA501F-GR	Si-pnp	Dual GP, 50V, 150mA, 100mW, B=200..400, 80MHz	TFSV	30/T12	-	6l	Kec
P60	XC6368E602MR	DC/DC-IC	PWM/PFM step-up, 6.0V±2.5%, 200mA, 180kHz, +CE	SOT-25	28sd	DC10	6g	Tor
P60A	CM7R151A-60B-T	LVR-IC	LDO, 6.0V±2%, 150mA, +CE, PDR	SOT-23-5	28cx	VR4	6a	Can
P60A	ML6204A602M	LVR-IC	LDO, 6.0V±2%, 150mA, +CE, CL	SOT-23-5	28cx	VR4	6a	Mlc
P60B	CM7R151B-60B-T	LVR-IC	LDO, 6.0V±2%, 150mA, +CE	SOT-23-5	28cx	VR4	6a	Can
P60B	ML6204B602M	LVR-IC	LDO, 6.0V±2%, 150mA, +CE	SOT-23-5	28cx	VR4	6a	Mlc
P60C	CM7R151C-60B-T	LVR-IC	LDO, 6.0V±2%, 150mA, -CE, PDR	SOT-23-5	28cx	VR4	6a	Can
P60C	ML6204C602M	LVR-IC	LDO, 6.0V±2%, 150mA, -CE, CL	SOT-23-5	28cx	VR4	6a	Mlc
P60D	CM7R151D-60B-T	LVR-IC	LDO, 6.0V±2%, 150mA, -CE	SOT-23-5	28cx	VR4	6a	Can
P60D	ML6204D602M	LVR-IC	LDO, 6.0V±2%, 150mA, -CE	SOT-23-5	28cx	VR4	6a	Mlc
P61	XC6368E612MR	DC/DC-IC	PWM/PFM step-up, 6.1V±2.5%, 200mA, 180kHz, +CE	SOT-25	28sd	DC10	6g	Tor
P62	XC6368E622MR	DC/DC-IC	PWM/PFM step-up, 6.2V±2.5%, 200mA, 180kHz, +CE	SOT-25	28sd	DC10	6g	Tor
P63	S-1701B3328-M5T1	LVRV/det-IC	LDO, 3.3V±1%, 400mA, Vdet=2.8V, -Reset ODO, +CE	SOT-23-5	28hg	VR15	6a	Sii
P63	XC6368E632MR	DC/DC-IC	PWM/PFM step-up, 6.3V±2.5%, 200mA, 180kHz, +CE	SOT-25	28sd	DC10	6g	Tor
P64	S-1701B5040-M5T1	LVRV/det-IC	LDO, 5V±1%, 400mA, Vdet=4V, -Reset ODO, +CE	SOT-23-5	28hg	VR15	6a	Sii
P64	XC6368E642MR	DC/DC-IC	PWM/PFM step-up, 6.4V±2.5%, 200mA, 180kHz, +CE	SOT-25	28sd	DC10	6g	Tor
P65	S-1701B5041-M5T1	LVRV/det-IC	LDO, 5V±1%, 400mA, Vdet=4.1V, -Reset ODO, +CE	SOT-23-5	28hg	VR15	6a	Sii
P65	XC6368E652MR	DC/DC-IC	PWM/PFM step-up, 6.5V±2.5%, 200mA, 180kHz, +CE	SOT-25	28sd	DC10	6g	Tor
P66	S-1701B5042-M5T1	LVRV/det-IC	LDO, 5V±1%, 400mA, Vdet=4.2V, -Reset ODO, +CE	SOT-23-5	28hg	VR15	6a	Sii
P67	S-1701B5043-M5T1	LVRV/det-IC	LDO, 5V±1%, 400mA, Vdet=4.3V, -Reset ODO, +CE	SOT-23-5	28hg	VR15	6a	Sii
P6A	S-1701A1815-M5T1	LVRV/det-IC	LDO, 1.8V±1%, 400mA, Vdet=1.5V, -Reset ODO, +CE	SOT-23-5	28hg	VR15	6a	Sii
P6A	XC6108N46AMR	Vdet-IC	4.6V±2%, Hysteresis, -Reset ODO	SOT-25	28rm	VD14	6g	Tor
P6A	XC6118C36AMR-G	Vdet-IC	3.6V±2%, ±Reset PPO, Sense, hysteresis 5%, Cd	SOT-25	28mg	VD15	6g	Tor
P6A	XC6368E603MR	DC/DC-IC	PWM/PFM step-up, 6.0V±2.5%, 200mA, 300kHz, +CE	SOT-25	28sd	DC10	6g	Tor
P6B	S-1701A2520-M5T1	LVRV/det-IC	LDO, 2.5V±1%, 400mA, Vdet=2V, -Reset ODO, +CE	SOT-23-5	28hg	VR15	6a	Sii
P6B	XC6108N46BMR	Vdet-IC	4.6V±2%, -Reset ODO	SOT-25	28rm	VD14	6g	Tor
P6B	XC6118C36BMR-G	Vdet-IC	3.6V±2%, ±Reset PPO, Sense, hysteresis <1%, Cd	SOT-25	28mg	VD15	6g	Tor
P6B	XC6368E613MR	DC/DC-IC	PWM/PFM step-up, 6.1V±2.5%, 200mA, 300kHz, +CE	SOT-25	28sd	DC10	6g	Tor
P6C	S-1701A2521-M5T1	LVRV/det-IC	LDO, 2.5V±1%, 400mA, Vdet=2.1V, -Reset ODO, +CE	SOT-23-5	28hg	VR15	6a	Sii
P6C	XC6108N46CMR	Vdet-IC	4.6V±2%, Hysteresis, -Reset ODO	SOT-25	28rk	VD14	6g	Tor



SMD code	Type	Function	Short description	Case	Pinout	Sch.	St.	Mnf.
P6C	XC6118C36CMR-G	Vdet-IC	3.6V±2%, ±Reset PPO, Sense, hysteresis 5%	SOT-25	28mf	VD12	6g	Tor
P6C	XC6368E623MR	DC/DC-IC	PWM/PPM step-up, 6.2V±2.5%, 200mA, 300kHz, +CE	SOT-25	28sd	DC10	6g	Tor
P6D	S-1701A2522-M5T1	LVR/Vdet-IC	LDO, 2.5V±1%, 400mA, Vdet=2.2V, -Reset ODO, +CE	SOT-23-5	28hg	VR15	6a	Sii
P6D	XC6108N46DMR	Vdet-IC	4.6V±2%, -Reset ODO	SOT-25	28rk	VD14	6g	Tor
P6D	XC6118C36DMR-G	Vdet-IC	3.6V±2%, ±Reset PPO, Sense, hysteresis <1%	SOT-25	28mf	VD12	6g	Tor
P6D	XC6368E633MR	DC/DC-IC	PWM/PPM step-up, 6.3V±2.5%, 200mA, 300kHz, +CE	SOT-25	28sd	DC10	6g	Tor
P6E	S-1701A3024-M5T1	LVR/Vdet-IC	LDO, 3V±1%, 400mA, Vdet=2.4V, -Reset ODO, +CE	SOT-23-5	28hg	VR15	6a	Sii
P6E	XC6368E643MR	DC/DC-IC	PWM/PPM step-up, 6.4V±2.5%, 200mA, 300kHz, +CE	SOT-25	28sd	DC10	6g	Tor
P6F	S-1701A3025-M5T1	LVR/Vdet-IC	LDO, 3V±1%, 400mA, Vdet=2.5V, -Reset ODO, +CE	SOT-23-5	28hg	VR15	6a	Sii
P6F	XC6368E653MR	DC/DC-IC	PWM/PPM step-up, 6.5V±2.5%, 200mA, 300kHz, +CE	SOT-25	28sd	DC10	6g	Tor
P6G	S-1701A3026-M5T1	LVR/Vdet-IC	LDO, 3V±1%, 400mA, Vdet=2.6V, -Reset ODO, +CE	SOT-23-5	28hg	VR15	6a	Sii
P6H	S-1701A3326-M5T1	LVR/Vdet-IC	LDO, 3.3V±1%, 400mA, Vdet=2.6V, -Reset ODO, +CE	SOT-23-5	28hg	VR15	6a	Sii
P6I	S-1701A3327-M5T1	LVR/Vdet-IC	LDO, 3.3V±1%, 400mA, Vdet=2.7V, -Reset ODO, +CE	SOT-23-5	28hg	VR15	6a	Sii
P6J	S-1701A3328-M5T1	LVR/Vdet-IC	LDO, 3.3V±1%, 400mA, Vdet=2.8V, -Reset ODO, +CE	SOT-23-5	28hg	VR15	6a	Sii
P6K	S-1701A3430-M5T1	LVR/Vdet-IC	LDO, 3.4V±1%, 400mA, Vdet=3V, -Reset ODO, +CE	SOT-23-5	28hg	VR15	6a	Sii
P6L	S-1701A5040-M5T1	LVR/Vdet-IC	LDO, 5V±1%, 400mA, Vdet=4V, -Reset ODO, +CE	SOT-23-5	28hg	VR15	6a	Sii
P6M	S-1701A5041-M5T1	LVR/Vdet-IC	LDO, 5V±1%, 400mA, Vdet=4.1V, -Reset ODO, +CE	SOT-23-5	28hg	VR15	6a	Sii
P6N	S-1701A5042-M5T1	LVR/Vdet-IC	LDO, 5V±1%, 400mA, Vdet=4.2V, -Reset ODO, +CE	SOT-23-5	28hg	VR15	6a	Sii
P6O	S-1701A5043-M5T1	LVR/Vdet-IC	LDO, 5V±1%, 400mA, Vdet=4.3V, -Reset ODO, +CE	SOT-23-5	28hg	VR15	6a	Sii
P6R	S-1701B1815-M5T1	LVR/Vdet-IC	LDO, 1.8V±1%, 400mA, Vdet=1.5V, -Reset ODO, +CE	SOT-23-5	28hg	VR15	6a	Sii
P6S	S-1701B2520-M5T1	LVR/Vdet-IC	LDO, 2.5V±1%, 400mA, Vdet=2V, -Reset ODO, +CE	SOT-23-5	28hg	VR15	6a	Sii
P6T	S-1701B2521-M5T1	LVR/Vdet-IC	LDO, 2.5V±1%, 400mA, Vdet=2.1V, -Reset ODO, +CE	SOT-23-5	28hg	VR15	6a	Sii
P6U	S-1701B2522-M5T1	LVR/Vdet-IC	LDO, 2.5V±1%, 400mA, Vdet=2.2V, -Reset ODO, +CE	SOT-23-5	28hg	VR15	6a	Sii
P6V	S-1701B3024-M5T1	LVR/Vdet-IC	LDO, 3V±1%, 400mA, Vdet=2.4V, -Reset ODO, +CE	SOT-23-5	28hg	VR15	6a	Sii
P6W	S-1701B3025-M5T1	LVR/Vdet-IC	LDO, 3V±1%, 400mA, Vdet=2.5V, -Reset ODO, +CE	SOT-23-5	28hg	VR15	6a	Sii
P6X	S-1701B3026-M5T1	LVR/Vdet-IC	LDO, 3V±1%, 400mA, Vdet=2.6V, -Reset ODO, +CE	SOT-23-5	28hg	VR15	6a	Sii
P6Y	S-1701B3326-M5T1	LVR/Vdet-IC	LDO, 3.3V±1%, 400mA, Vdet=2.6V, -Reset ODO, +CE	SOT-23-5	28hg	VR15	6a	Sii
P6Z	S-1701B3327-M5T1	LVR/Vdet-IC	LDO, 3.3V±1%, 400mA, Vdet=2.7V, -Reset ODO, +CE	SOT-23-5	28hg	VR15	6a	Sii
P7	KRA570E	Si-pnp-Digi	Dual, Sw, 50V, 100mA, 200mW, R1/R2=10k/4.7k	TESV	30/TD9	-	6l	Kec
P7	KRA570U	Si-pnp-Digi	Dual, Sw, 50V, 100mA, 200mW, R1/R2=10k/4.7k	USV	28/TD9	-	6l	Kec
P7	TC1186-5.0VCT713	LVR-IC	LDO, 5.0V±3%, 150mA, +CE, -Error	SOT-23-5	28w	VR8	6g	Mcc
P73	S-1701W2522-M5T1	LVR/Vdet-IC	LDO, 2.5V±1%, 400mA, Vdet=2.2V, -Reset ODO	SOT-23-5	28hj	VR13	6a	Sii
P74	S-1701W3024-M5T1	LVR/Vdet-IC	LDO, 3V±1%, 400mA, Vdet=2.4V, -Reset ODO	SOT-23-5	28hj	VR13	6a	Sii
P75	S-1701W3025-M5T1	LVR/Vdet-IC	LDO, 3V±1%, 400mA, Vdet=2.5V, -Reset ODO	SOT-23-5	28hj	VR13	6a	Sii
P76	S-1701W3026-M5T1	LVR/Vdet-IC	LDO, 3V±1%, 400mA, Vdet=2.6V, -Reset ODO	SOT-23-5	28hj	VR13	6a	Sii
P77	S-1701W3326-M5T1	LVR/Vdet-IC	LDO, 3.3V±1%, 400mA, Vdet=2.6V, -Reset ODO	SOT-23-5	28hj	VR13	6a	Sii
P78	S-1701W3327-M5T1	LVR/Vdet-IC	LDO, 3.3V±1%, 400mA, Vdet=2.7V, -Reset ODO	SOT-23-5	28hj	VR13	6a	Sii
p79	74AUP1G79GV	CMOS-Logic	Positive edge-triggered D-type flip-flop	SOT753	28/Log20	-	6a	Phi
P79	S-1701W3328-M5T1	LVR/Vdet-IC	LDO, 3.3V±1%, 400mA, Vdet=2.8V, -Reset ODO	SOT-23-5	28hj	VR13	6a	Sii
P7A	XC6108N47AMR	Vdet-IC	4.7V±2%, Hysteresis, -Reset ODO	SOT-25	28rm	VD14	6g	Tor
P7A	XC6118C37AMR-G	Vdet-IC	3.7V±2%, ±Reset PPO, Sense, hysteresis 5%, Cd	SOT-25	28mg	VD15	6g	Tor
P7B	XC6108N47BMR	Vdet-IC	4.7V±2%, -Reset ODO	SOT-25	28rm	VD14	6g	Tor
P7B	XC6118C37BMR-G	Vdet-IC	3.7V±2%, ±Reset PPO, Sense, hysteresis <1%, Cd	SOT-25	28mg	VD15	6g	Tor
P7C	XC6108N47CMR	Vdet-IC	4.7V±2%, Hysteresis, -Reset ODO	SOT-25	28rk	VD14	6g	Tor
P7C	XC6118C37CMR-G	Vdet-IC	3.7V±2%, ±Reset PPO, Sense, hysteresis 5%	SOT-25	28mf	VD12	6g	Tor
P7D	XC6108N47DMR	Vdet-IC	4.7V±2%, -Reset ODO	SOT-25	28rk	VD14	6g	Tor
P7D	XC6118C37DMR-G	Vdet-IC	3.7V±2%, ±Reset PPO, Sense, hysteresis <1%	SOT-25	28mf	VD12	6g	Tor
P7E	S-1701V1815-M5T1	LVR/Vdet-IC	LDO, 1.8V±1%, 400mA, Vdet=1.5V, -Reset ODO	SOT-23-5	28hj	VR13	6a	Sii
P7F	S-1701V2520-M5T1	LVR/Vdet-IC	LDO, 2.5V±1%, 400mA, Vdet=2V, -Reset ODO	SOT-23-5	28hj	VR13	6a	Sii
P7G	S-1701V2521-M5T1	LVR/Vdet-IC	LDO, 2.5V±1%, 400mA, Vdet=2.1V, -Reset ODO	SOT-23-5	28hj	VR13	6a	Sii
P7H	S-1701V2522-M5T1	LVR/Vdet-IC	LDO, 2.5V±1%, 400mA, Vdet=2.2V, -Reset ODO	SOT-23-5	28hj	VR13	6a	Sii
P7I	S-1701V3024-M5T1	LVR/Vdet-IC	LDO, 3V±1%, 400mA, Vdet=2.4V, -Reset ODO	SOT-23-5	28hj	VR13	6a	Sii
P7J	S-1701V3025-M5T1	LVR/Vdet-IC	LDO, 3V±1%, 400mA, Vdet=2.5V, -Reset ODO	SOT-23-5	28hj	VR13	6a	Sii
P7K	S-1701V3026-M5T1	LVR/Vdet-IC	LDO, 3V±1%, 400mA, Vdet=2.6V, -Reset ODO	SOT-23-5	28hj	VR13	6a	Sii
P7L	S-1701V3326-M5T1	LVR/Vdet-IC	LDO, 3.3V±1%, 400mA, Vdet=2.6V, -Reset ODO	SOT-23-5	28hj	VR13	6a	Sii
P7M	S-1701V3327-M5T1	LVR/Vdet-IC	LDO, 3.3V±1%, 400mA, Vdet=2.7V, -Reset ODO	SOT-23-5	28hj	VR13	6a	Sii
P7N	S-1701V3328-M5T1	LVR/Vdet-IC	LDO, 3.3V±1%, 400mA, Vdet=2.8V, -Reset ODO	SOT-23-5	28hj	VR13	6a	Sii
P7O	S-1701V5040-M5T1	LVR/Vdet-IC	LDO, 5V±1%, 400mA, Vdet=4V, -Reset ODO	SOT-23-5	28hj	VR13	6a	Sii
P7P	S-1701V5041-M5T1	LVR/Vdet-IC	LDO, 5V±1%, 400mA, Vdet=4.1V, -Reset ODO	SOT-23-5	28hj	VR13	6a	Sii
P7Q	S-1701V5042-M5T1	LVR/Vdet-IC	LDO, 5V±1%, 400mA, Vdet=4.2V, -Reset ODO	SOT-23-5	28hj	VR13	6a	Sii
P7R	S-1701V5043-M5T1	LVR/Vdet-IC	LDO, 5V±1%, 400mA, Vdet=4.3V, -Reset ODO	SOT-23-5	28hj	VR13	6a	Sii
P7S	S-1701V3430-M5T1	LVR/Vdet-IC	LDO, 3.4V±1%, 400mA, Vdet=3V, -Reset ODO	SOT-23-5	28hj	VR13	6a	Sii
P7X	S-1701W1815-M5T1	LVR/Vdet-IC	LDO, 1.8V±1%, 400mA, Vdet=1.5V, -Reset ODO	SOT-23-5	28hj	VR13	6a	Sii
P7Y	S-1701W2520-M5T1	LVR/Vdet-IC	LDO, 2.5V±1%, 400mA, Vdet=2V, -Reset ODO	SOT-23-5	28hj	VR13	6a	Sii
P7Z	S-1701W2521-M5T1	LVR/Vdet-IC	LDO, 2.5V±1%, 400mA, Vdet=2.1V, -Reset ODO	SOT-23-5	28hj	VR13	6a	Sii
P8	KRA571E	Si-pnp-Digi	Dual, Sw, 50V, 100mA, 200mW, R1/R2=47k/10k	TESV	30/TD9	-	6l	Kec
P8	KRA571U	Si-pnp-Digi	Dual, Sw, 50V, 100mA, 200mW, R1/R2=47k/10k	USV	28/TD9	-	6l	Kec
P8	TC1186-2.85VCT713	LVR-IC	LDO, 2.85V±3%, 150mA, +CE, -Error	SOT-23-5	28w	VR8	6g	Mcc
P86	NC75P86P5	CMOS-Logic	2-input EXCLUSIVE-OR gate	SC-70-5	28/Log5	-	6a	F
P8A	S-1701W5040-M5T1	LVR/Vdet-IC	LDO, 5V±1%, 400mA, Vdet=4V, -Reset ODO	SOT-23-5	28hj	VR13	6a	Sii



SMD code	Type	Function	Short description	Case	Pinout	Sch.	St.	Mnf.
P8A	XC6108N48AMR	Vdet-IC	4.8V±2%, Hysteresis, -Reset ODO	SOT-25	28rm	VD14	6g	Tor
P8A	XC6118C38AMR-G	Vdet-IC	3.8V±2%, ±Reset PPO, Sense, hysteresis 5%, Cd	SOT-25	28mg	VD15	6g	Tor
P8B	S-1701W5041-M5T1	LVR/Vdet-IC	LDO, 5V±1%, 400mA, Vdet=4.1V, -Reset ODO	SOT-23-5	28hj	VR13	6a	Sii
P8B	XC6108N48BMR	Vdet-IC	4.8V±2%, -Reset ODO	SOT-25	28rm	VD14	6g	Tor
P8B	XC6118C38BMR-G	Vdet-IC	3.8V±2%, ±Reset PPO, Sense, hysteresis <1%, Cd	SOT-25	28mg	VD15	6g	Tor
P8C	S-1701W5042-M5T1	LVR/Vdet-IC	LDO, 5V±1%, 400mA, Vdet=4.2V, -Reset ODO	SOT-23-5	28hj	VR13	6a	Sii
P8C	XC6108N48CMR	Vdet-IC	4.8V±2%, Hysteresis, -Reset ODO	SOT-25	28rk	VD14	6g	Tor
P8C	XC6118C38CMR-G	Vdet-IC	3.8V±2%, ±Reset PPO, Sense, hysteresis 5%	SOT-25	28mf	VD12	6g	Tor
P8D	S-1701W5043-M5T1	LVR/Vdet-IC	LDO, 5V±1%, 400mA, Vdet=4.3V, -Reset ODO	SOT-23-5	28hj	VR13	6a	Sii
P8D	XC6108N48DMR	Vdet-IC	4.8V±2%, -Reset ODO	SOT-25	28rk	VD14	6g	Tor
P8D	XC6118C38DMR-G	Vdet-IC	3.8V±2%, ±Reset PPO, Sense, hysteresis <1%	SOT-25	28mf	VD12	6g	Tor
P8E	S-1701W3430-M5T1	LVR/Vdet-IC	LDO, 3.4V±1%, 400mA, Vdet=3V, -Reset ODO	SOT-23-5	28hj	VR13	6a	Sii
P8J	S-1701X3228-M5T1	LVR/Vdet-IC	LDO, 3.2V±1%, 400mA, Vdet=2.8V, -Reset ODO	SOT-23-5	28hj	VR13	6a	Sii
P8O	S-1701Y3228-M5T1	LVR/Vdet-IC	LDO, 3.2V±1%, 400mA, Vdet=2.8V, -Reset ODO	SOT-23-5	28hj	VR13	6a	Sii
P8T	S-1701Z3228-M5T1	LVR/Vdet-IC	LDO, 3.2V±1%, 400mA, Vdet=2.8V, -Reset ODO	SOT-23-5	28hj	VR13	6a	Sii
P8Y	S-1701B3430-M5T1	LVR/Vdet-IC	LDO, 3.4V±1%, 400mA, Vdet=3V, -Reset ODO, +CE	SOT-23-5	28hg	VR15	6a	Sii
p9	74AUP1G09GW	CMOS-Logic	2-input AND gate (ODO)	SOT353-1	28LLog9	-	6a	Phi
P9	KRA572E	Si-pnp-Digi	Dual, Sw, 50V, 100mA, 200mW, R1/R2=100k/100k	TESV	30/DT9	-	6l	Kec
P9	KRA572U	Si-pnp-Digi	Dual, Sw, 50V, 100mA, 200mW, R1/R2=100k/100k	USV	28/TD9	-	6l	Kec
P9	TC1186-3.6VCT713	LVR-IC	LDO, 3.6V±3%, 150mA, +CE, -Error	SOT-23-5	28w	VR8	6g	Mcc
P9A	S-1701C1815-M5T1	LVR/Vdet-IC	LDO, 1.8V±1%, 400mA, Vdet=1.5V, -Reset ODO, +CE	SOT-23-5	28hg	VR15	6a	Sii
P9A	XC6108N49AMR	Vdet-IC	4.9V±2%, Hysteresis, -Reset ODO	SOT-25	28rm	VD14	6g	Tor
P9A	XC6118C39AMR-G	Vdet-IC	3.9V±2%, ±Reset PPO, Sense, hysteresis 5%, Cd	SOT-25	28mg	VD15	6g	Tor
P9B	S-1701C2520-M5T1	LVR/Vdet-IC	LDO, 2.5V±1%, 400mA, Vdet=2V, -Reset ODO, +CE	SOT-23-5	28hg	VR15	6a	Sii
P9B	XC6108N49BMR	Vdet-IC	4.9V±2%, -Reset ODO	SOT-25	28rm	VD14	6g	Tor
P9B	XC6118C39BMR-G	Vdet-IC	3.9V±2%, ±Reset PPO, Sense, hysteresis <1%, Cd	SOT-25	28mg	VD15	6g	Tor
P9C	S-1701C2521-M5T1	LVR/Vdet-IC	LDO, 2.5V±1%, 400mA, Vdet=2.1V, -Reset ODO, +CE	SOT-23-5	28hg	VR15	6a	Sii
P9C	XC6108N49CMR	Vdet-IC	4.9V±2%, Hysteresis, -Reset ODO	SOT-25	28rk	VD14	6g	Tor
P9C	XC6118C39CMR-G	Vdet-IC	3.9V±2%, ±Reset PPO, Sense, hysteresis 5%	SOT-25	28mf	VD12	6g	Tor
P9D	S-1701C2522-M5T1	LVR/Vdet-IC	LDO, 2.5V±1%, 400mA, Vdet=2.2V, -Reset ODO, +CE	SOT-23-5	28hg	VR15	6a	Sii
P9D	XC6108N49DMR	Vdet-IC	4.9V±2%, -Reset ODO	SOT-25	28rk	VD14	6g	Tor
P9D	XC6118C39DMR-G	Vdet-IC	3.9V±2%, ±Reset PPO, Sense, hysteresis <1%	SOT-25	28mf	VD12	6g	Tor
P9E	S-1701C3024-M5T1	LVR/Vdet-IC	LDO, 3V±1%, 400mA, Vdet=2.4V, -Reset ODO, +CE	SOT-23-5	28hg	VR15	6a	Sii
P9F	S-1701C3025-M5T1	LVR/Vdet-IC	LDO, 3V±1%, 400mA, Vdet=2.5V, -Reset ODO, +CE	SOT-23-5	28hg	VR15	6a	Sii
P9G	S-1701C3026-M5T1	LVR/Vdet-IC	LDO, 3V±1%, 400mA, Vdet=2.6V, -Reset ODO, +CE	SOT-23-5	28hg	VR15	6a	Sii
P9H	S-1701C3326-M5T1	LVR/Vdet-IC	LDO, 3.3V±1%, 400mA, Vdet=2.6V, -Reset ODO, +CE	SOT-23-5	28hg	VR15	6a	Sii
P9I	S-1701C3327-M5T1	LVR/Vdet-IC	LDO, 3.3V±1%, 400mA, Vdet=2.7V, -Reset ODO, +CE	SOT-23-5	28hg	VR15	6a	Sii
P9J	S-1701C3328-M5T1	LVR/Vdet-IC	LDO, 3.3V±1%, 400mA, Vdet=2.8V, -Reset ODO, +CE	SOT-23-5	28hg	VR15	6a	Sii
P9K	S-1701C3430-M5T1	LVR/Vdet-IC	LDO, 3.4V±1%, 400mA, Vdet=3V, -Reset ODO, +CE	SOT-23-5	28hg	VR15	6a	Sii
P9L	S-1701C5040-M5T1	LVR/Vdet-IC	LDO, 5V±1%, 400mA, Vdet=4V, -Reset ODO, +CE	SOT-23-5	28hg	VR15	6a	Sii
P9M	S-1701C5041-M5T1	LVR/Vdet-IC	LDO, 5V±1%, 400mA, Vdet=4.1V, -Reset ODO, +CE	SOT-23-5	28hg	VR15	6a	Sii
P9N	S-1701C5042-M5T1	LVR/Vdet-IC	LDO, 5V±1%, 400mA, Vdet=4.2V, -Reset ODO, +CE	SOT-23-5	28hg	VR15	6a	Sii
P9O	S-1701C5043-M5T1	LVR/Vdet-IC	LDO, 5V±1%, 400mA, Vdet=4.3V, -Reset ODO, +CE	SOT-23-5	28hg	VR15	6a	Sii
pA	74AUP1G00GW	CMOS-Logic	2-input NAND gate	SOT-353-1	28LLog1	-	6a	Phi
pA	EUP7917N	LVR-IC	LDO, Adjustable 1.2V..4.8V, 300mA, +CE	SC-70-5	28sg	VR5	6k	Eut
pA	EUP7917V	LVR-IC	LDO, Adjustable 1.2V..4.8V, 300mA, +CE	SOT-23-5	28sg	VR5	6k	Eut
PA	BD5240FVE	Vdet-IC	4V, +Reset ODO	VSOFF-5	30ua	VD6	6c	Rhm
PA	BD5240G	Vdet-IC	4V, +Reset ODO	SSOP-5	28vdo	VD1	6c	Rhm
PA	BH15PB1WHFV	LVR-IC	LDO, 1.5V, 150mA, +CE	HVSOF5	30vrv	VR10	6e	Rhm
PA	KRA521T	Si-pnp-Digi	Dual, Sw, 50V, 800mA, 900mW, R1/R2=1k/1k	TSV	28/DT9	-	6l	Kec
PA	KRA551E	Si-pnp-Digi	Dual, Sw, 50V, 100mA, 200mW, R1/R2=4.7k/4.7k	TESV	30/DT9	-	6l	Kec
PA	KRA551U	Si-npn-Digi	Dual, Sw, 50V, 100mA, 200mW, R1/R2=4.7k/4.7k	USV	28/DT9	-	6l	Kec
PA	PT7M7037CHTA	Vdet-IC	3.7V±1.5%, +Reset PPO	SOT-23-5	28vdr	VD7	6k	Pti
PA	PT7M7037CHTAE	Vdet-IC	3.7V±1.5%, +Reset PPO, Lead free	SOT-23-5	28vdr	VD7	6k	Pti
PAA	RP109N321B	LVR-IC	LDO, 3.2V±1%, 150mA, +CE	SOT-23-5	28cx	VR4	6g	Ric
PAB	RP109N331B	LVR-IC	LDO, 3.3V±1%, 150mA, +CE	SOT-23-5	28cx	VR4	6g	Ric
PAC	RP109N341B	LVR-IC	LDO, 3.4V±1%, 150mA, +CE	SOT-23-5	28cx	VR4	6g	Ric
PAD	RP109N351B	LVR-IC	LDO, 3.5V±1%, 150mA, +CE	SOT-23-5	28cx	VR4	6g	Ric
PAE	RP109N361B	LVR-IC	LDO, 3.6V±1%, 150mA, +CE	SOT-23-5	28cx	VR4	6g	Ric
PAF	RP109N121B5	LVR-IC	LDO, 1.25V±1%, 150mA, +CE	SOT-23-5	28cx	VR4	6g	Ric
PAG	RP109N181B5	LVR-IC	LDO, 1.85V±1%, 150mA, +CE	SOT-23-5	28cx	VR4	6g	Ric
PAH	RP109N281B5	LVR-IC	LDO, 2.85V±1%, 150mA, +CE	SOT-23-5	28cx	VR4	6g	Ric
PAJ	RP109N341B5	LVR-IC	LDO, 3.45V±1%, 150mA, +CE	SOT-23-5	28cx	VR4	6g	Ric
pB	74AUP1G02GW	CMOS-Logic	2-input NOR gate	SOT-353-1	28LLog2	-	6a	Phi
pB	EUP7917-25N	LVR-IC	LDO, 2.5V±3%, 300mA, +CE	SC-70-5	28vrx	VR7	6k	Eut
pB	EUP7917-25V	LVR-IC	LDO, 2.5V±3%, 300mA, +CE	SOT-23-5	28vrx	VR7	6k	Eut
PB	BD5241FVE	Vdet-IC	4.1V, +Reset ODO	VSOFF-5	30vru	VD6	6c	Rhm
PB	BD5241G	Vdet-IC	4.1V, +Reset ODO	SSOP-5	28vdo	VD1	6c	Rhm
PB	BH18RB1WGUT	LVR-IC	LDO, 1.8V, 150mA, +CE	HVSOF5	30vrv	VR10	6e	Rhm
PB	KRA522T	Si-pnp-Digi	Dual, Sw, 50V, 800mA, 900mW, R1/R2=2.2k/2.2k	TSV	28/DT9	-	6l	Kec



SMD code	Type	Function	Short description	Case	Pinout	Sch.	St.	Mnf.
PB	KRA552E	Si-nnp-Digi	Dual, Sw, 50V, 100mA, 200mW, R1/R2=10k/10k	TESV	30/TD9	-	6I	Kec
PB	KRA552U	Si-nnp-Digi	Dual, Sw, 50V, 100mA, 200mW, R1/R2=10k/10k	USV	28/TD9	-	6I	Kec
PB	PT7M7037NLTAE	Vdet-IC	3.7V±1.5%, -Reset ODO	SOT-23-5	28vdr	VD6	6k	Pti
PB	PT7M7037NLTAE	Vdet-IC	3.7V±1.5%, -Reset ODO, Lead free	SOT-23-5	28vdr	VD6	6k	Pti
PB5	XC6368E151MR	DC/DC-IC	PWM/PFM step-up, 1.5V±2.5%, 200mA, 100kHz, +CE	SOT-25	28sd	DC10	6g	Tor
PB6	XC6368E161MR	DC/DC-IC	PWM/PFM step-up, 1.6V±2.5%, 200mA, 100kHz, +CE	SOT-25	28sd	DC10	6g	Tor
PB7	XC6368E171MR	DC/DC-IC	PWM/PFM step-up, 1.7V±2.5%, 200mA, 100kHz, +CE	SOT-25	28sd	DC10	6g	Tor
PB8	XC6368E181MR	DC/DC-IC	PWM/PFM step-up, 1.8V±2.5%, 200mA, 100kHz, +CE	SOT-25	28sd	DC10	6g	Tor
PB9	XC6368E191MR	DC/DC-IC	PWM/PFM step-up, 1.9V±2.5%, 200mA, 100kHz, +CE	SOT-25	28sd	DC10	6g	Tor
PBA	RP109N321D	LVR-IC	LDO, 3.2V±1%, 150mA, +CE, CL	SOT-23-5	28cx	VR4	6g	Ric
PBB	RP109N331D	LVR-IC	LDO, 3.3V±1%, 150mA, +CE, CL	SOT-23-5	28cx	VR4	6g	Ric
PBC	RP109N341D	LVR-IC	LDO, 3.4V±1%, 150mA, +CE, CL	SOT-23-5	28cx	VR4	6g	Ric
PBD	RP109N351D	LVR-IC	LDO, 3.5V±1%, 150mA, +CE, CL	SOT-23-5	28cx	VR4	6g	Ric
PBE	RP109N361D	LVR-IC	LDO, 3.6V±1%, 150mA, +CE, CL	SOT-23-5	28cx	VR4	6g	Ric
PBF	RP109N121D5	LVR-IC	LDO, 1.25V±1%, 150mA, +CE, CL	SOT-23-5	28cx	VR4	6g	Ric
PBF	XC6368E155MR	DC/DC-IC	PWM/PFM step-up, 1.5V±2.5%, 200mA, 500kHz, +CE	SOT-25	28sd	DC10	6g	Tor
PBG	RP109N181D5	LVR-IC	LDO, 1.85V±1%, 150mA, +CE, CL	SOT-23-5	28cx	VR4	6g	Ric
PBH	RP109N281D5	LVR-IC	LDO, 2.85V±1%, 150mA, +CE, CL	SOT-23-5	28cx	VR4	6g	Ric
PBH	XC6368E165MR	DC/DC-IC	PWM/PFM step-up, 1.6V±2.5%, 200mA, 500kHz, +CE	SOT-25	28sd	DC10	6g	Tor
PBJ	RP109N341D5	LVR-IC	LDO, 3.45V±1%, 150mA, +CE, CL	SOT-23-5	28cx	VR4	6g	Ric
PBK	XC6368E175MR	DC/DC-IC	PWM/PFM step-up, 1.7V±2.5%, 200mA, 500kHz, +CE	SOT-25	28sd	DC10	6g	Tor
PBL	XC6368E185MR	DC/DC-IC	PWM/PFM step-up, 1.8V±2.5%, 200mA, 500kHz, +CE	SOT-25	28sd	DC10	6g	Tor
PBM	XC6368E195MR	DC/DC-IC	PWM/PFM step-up, 1.9V±2.5%, 200mA, 500kHz, +CE	SOT-25	28sd	DC10	6g	Tor
PBNI	TPS3123J12D	Vdet-IC	1.08V±1%, -Reset PPO, -MR, Strobe	SOT-23-5	28cp	VD17	6k	Ti
PBOI	TPS3123G15D	Vdet-IC	1.4V±1%, -Reset PPO, -MR, Strobe	SOT-23-5	28cp	VD17	6k	Ti
PBPI	TPS3123J18D	Vdet-IC	1.62V±1%, -Reset PPO, -MR, Strobe	SOT-23-5	28cp	VD17	6k	Ti
PBQI	TPS3124J12D	Vdet-IC	1.08V, ±Reset PPO	SOT-23-5	28xq	-	6k	Ti
PBRI	TPS3124G15D	Vdet-IC	1.4V, ±Reset PPO	SOT-23-5	28xq	-	6k	Ti
PBSI	TPS3124J18D	Vdet-IC	1.62V, ±Reset PPO	SOT-23-5	28xq	-	6k	Ti
PBTI	TPS3125J12D	Vdet-IC	1.08V, -MR, ±Reset PPO	SOT-23-5	28xf	VD21	6k	Ti
PBUI	TPS3125G15D	Vdet-IC	1.4V, -MR, ±Reset PPO	SOT-23-5	28xf	VD21	6k	Ti
PBVI	TPS3125J18D	Vdet-IC	1.62V, -MR, ±Reset PPO	SOT-23-5	28xf	VD21	6k	Ti
PBXI	TPS3125L30D	Vdet-IC	2.64V, -MR, ±Reset PPO	SOT-23-5	28xf	VD21	6k	Ti
pC	74AUP1G04GW	CMOS-Logic	Inverter	SOT-353-1	28/Log6	-	6a	Phi
pC	EUP7917-15N	LVR-IC	LDO, 1.5V±3%, 300mA, +CE	SC-70-5	28vrx	VR7	6k	Eut
pC	EUP7917-15V	LVR-IC	LDO, 1.5V±3%, 300mA, +CE	SOT-23-5	28vrx	VR7	6k	Eut
PC	BD5242FVE	Vdet-IC	4.2V, +Reset ODO	VSOFF-5	30ua	VD6	6c	Rhm
PC	BD5242G	Vdet-IC	4.2V, +Reset ODO	SSOP-5	28vdo	VD1	6c	Rhm
PC	BH25RB1WGUT	LVR-IC	LDO, 2.5V, 150mA, +CE	HVSOF5	30vrv	VR10	6e	Rhm
PC	KRA552T	Si-nnp-Digi	Dual, Sw, 50V, 800mA, 900mW, R1/R2=4.7k/4.7k	TSV	28/TD9	-	6I	Kec
PC	KRA553E	Si-nnp-Digi	Dual, Sw, 50V, 100mA, 200mW, R1/R2=22k/22k	TESV	30/TD9	-	6I	Kec
PC	KRA553U	Si-nnp-Digi	Dual, Sw, 50V, 100mA, 200mW, R1/R2=22k/22k	USV	28/TD9	-	6I	Kec
PC	PT7M7038CLTA	Vdet-IC	3.8V±1.5%, -Reset PPO	SOT-23-5	28vdr	VD7	6k	Pti
PC	PT7M7038CLTAE	Vdet-IC	3.8V±1.5%, -Reset PPO, Lead free	SOT-23-5	28vdr	VD7	6k	Pti
PC0	XC6368E201MR	DC/DC-IC	PWM/PFM step-up, 2.0V±2.5%, 200mA, 100kHz, +CE	SOT-25	28sd	DC10	6g	Tor
PC1	XC6368E211MR	DC/DC-IC	PWM/PFM step-up, 2.1V±2.5%, 200mA, 100kHz, +CE	SOT-25	28sd	DC10	6g	Tor
PC2	XC6368E221MR	DC/DC-IC	PWM/PFM step-up, 2.2V±2.5%, 200mA, 100kHz, +CE	SOT-25	28sd	DC10	6g	Tor
PC3	XC6368E231MR	DC/DC-IC	PWM/PFM step-up, 2.3V±2.5%, 200mA, 100kHz, +CE	SOT-25	28sd	DC10	6g	Tor
PC4	XC6368E241MR	DC/DC-IC	PWM/PFM step-up, 2.4V±2.5%, 200mA, 100kHz, +CE	SOT-25	28sd	DC10	6g	Tor
PC5	XC6368E251MR	DC/DC-IC	PWM/PFM step-up, 2.5V±2.5%, 200mA, 100kHz, +CE	SOT-25	28sd	DC10	6g	Tor
PC6	XC6368E261MR	DC/DC-IC	PWM/PFM step-up, 2.6V±2.5%, 200mA, 100kHz, +CE	SOT-25	28sd	DC10	6g	Tor
PC7	XC6368E271MR	DC/DC-IC	PWM/PFM step-up, 2.7V±2.5%, 200mA, 100kHz, +CE	SOT-25	28sd	DC10	6g	Tor
PC8	XC6368E281MR	DC/DC-IC	PWM/PFM step-up, 2.8V±2.5%, 200mA, 100kHz, +CE	SOT-25	28sd	DC10	6g	Tor
PC9	XC6368E291MR	DC/DC-IC	PWM/PFM step-up, 2.9V±2.5%, 200mA, 100kHz, +CE	SOT-25	28sd	DC10	6g	Tor
PCA	XC6368E205MR	DC/DC-IC	PWM/PFM step-up, 2.0V±2.5%, 200mA, 500kHz, +CE	SOT-25	28sd	DC10	6g	Tor
PCB	XC6368E215MR	DC/DC-IC	PWM/PFM step-up, 2.1V±2.5%, 200mA, 500kHz, +CE	SOT-25	28sd	DC10	6g	Tor
CCC	XC6368E225MR	DC/DC-IC	PWM/PFM step-up, 2.2V±2.5%, 200mA, 500kHz, +CE	SOT-25	28sd	DC10	6g	Tor
PCD	XC6368E235MR	DC/DC-IC	PWM/PFM step-up, 2.3V±2.5%, 200mA, 500kHz, +CE	SOT-25	28sd	DC10	6g	Tor
PCE	XC6368E245MR	DC/DC-IC	PWM/PFM step-up, 2.4V±2.5%, 200mA, 500kHz, +CE	SOT-25	28sd	DC10	6g	Tor
PCF	XC6368E255MR	DC/DC-IC	PWM/PFM step-up, 2.5V±2.5%, 200mA, 500kHz, +CE	SOT-25	28sd	DC10	6g	Tor
PCH	XC6368E265MR	DC/DC-IC	PWM/PFM step-up, 2.6V±2.5%, 200mA, 500kHz, +CE	SOT-25	28sd	DC10	6g	Tor
PCK	XC6368E275MR	DC/DC-IC	PWM/PFM step-up, 2.7V±2.5%, 200mA, 500kHz, +CE	SOT-25	28sd	DC10	6g	Tor
PCL	XC6368E285MR	DC/DC-IC	PWM/PFM step-up, 2.8V±2.5%, 200mA, 500kHz, +CE	SOT-25	28sd	DC10	6g	Tor
PCM	XC6368E295MR	DC/DC-IC	PWM/PFM step-up, 2.9V±2.5%, 200mA, 500kHz, +CE	SOT-25	28sd	DC10	6g	Tor
pD	74AUP1GU04GW	CMOS-Logic	Inverter	SOT-353-1	28/Log6	-	6a	Phi
pD	EUP7917-18N	LVR-IC	LDO, 1.8V±3%, 300mA, +CE	SC-70-5	28vrx	VR7	6k	Eut
pD	EUP7917-18V	LVR-IC	LDO, 1.8V±3%, 300mA, +CE	SOT-23-5	28vrx	VR7	6k	Eut
PD	BD5243FVE	Vdet-IC	4.3V, +Reset ODO	VSOFF-5	30ua	VD6	6c	Rhm
PD	BD5243G	Vdet-IC	4.3V, +Reset ODO	SSOP-5	28vdo	VD1	6c	Rhm
PD	BH28RB1WGUT	LVR-IC	LDO, 2.8V, 150mA, +CE	HVSOF5	30vrv	VR10	6e	Rhm



SMD code	Type	Function	Short description	Case	Pinout	Sch.	St.	Mnf.
PD	KRA524T	Si-pnp-Digi	Dual, Sw, 50V, 800mA, 900mW, R1/R2=10k/10k	TSV	28/TD9	-	6I	Kec
PD	KRA554E	Si-pnp-Digi	Dual, Sw, 50V, 100mA, 200mW, R1/R2=47k/47k	TESV	30/TD9	-	6I	Kec
PD	KRA554U	Si-pnp-Digi	Dual, Sw, 50V, 100mA, 200mW, R1/R2=47k/47k	USV	28/TD9	-	6I	Kec
PD	PT7M7038CHTA	Vdet-IC	3.8V±1.5%, +Reset PPO	SOT-23-5	28vdr	VD7	6k	Pti
PD	PT7M7038CHTAE	Vdet-IC	3.8V±1.5%, +Reset PPO, Lead free	SOT-23-5	28vdr	VD7	6k	Pti
PD0	XC6368E301MR	DC/DC-IC	PWM/PFM step-up, 3.0V±2.5%, 200mA, 100kHz, +CE	SOT-25	28sd	DC10	6g	Tor
PD1	XC6368E311MR	DC/DC-IC	PWM/PFM step-up, 3.1V±2.5%, 200mA, 100kHz, +CE	SOT-25	28sd	DC10	6g	Tor
PD2	XC6368E321MR	DC/DC-IC	PWM/PFM step-up, 3.2V±2.5%, 200mA, 100kHz, +CE	SOT-25	28sd	DC10	6g	Tor
PD3	XC6368E331MR	DC/DC-IC	PWM/PFM step-up, 3.3V±2.5%, 200mA, 100kHz, +CE	SOT-25	28sd	DC10	6g	Tor
PD4	XC6368E341MR	DC/DC-IC	PWM/PFM step-up, 3.4V±2.5%, 200mA, 100kHz, +CE	SOT-25	28sd	DC10	6g	Tor
PD5	XC6368E351MR	DC/DC-IC	PWM/PFM step-up, 3.5V±2.5%, 200mA, 100kHz, +CE	SOT-25	28sd	DC10	6g	Tor
PD6	XC6368E361MR	DC/DC-IC	PWM/PFM step-up, 3.6V±2.5%, 200mA, 100kHz, +CE	SOT-25	28sd	DC10	6g	Tor
PD7	XC6368E371MR	DC/DC-IC	PWM/PFM step-up, 3.7V±2.5%, 200mA, 100kHz, +CE	SOT-25	28sd	DC10	6g	Tor
PD8	XC6368E381MR	DC/DC-IC	PWM/PFM step-up, 3.8V±2.5%, 200mA, 100kHz, +CE	SOT-25	28sd	DC10	6g	Tor
PD9	XC6368E391MR	DC/DC-IC	PWM/PFM step-up, 3.9V±2.5%, 200mA, 100kHz, +CE	SOT-25	28sd	DC10	6g	Tor
PDA	XC6368E305MR	DC/DC-IC	PWM/PFM step-up, 3.0V±2.5%, 200mA, 500kHz, +CE	SOT-25	28sd	DC10	6g	Tor
PDB	XC6368E315MR	DC/DC-IC	PWM/PFM step-up, 3.1V±2.5%, 200mA, 500kHz, +CE	SOT-25	28sd	DC10	6g	Tor
PDC	XC6368E325MR	DC/DC-IC	PWM/PFM step-up, 3.2V±2.5%, 200mA, 500kHz, +CE	SOT-25	28sd	DC10	6g	Tor
PDD	XC6368E335MR	DC/DC-IC	PWM/PFM step-up, 3.3V±2.5%, 200mA, 500kHz, +CE	SOT-25	28sd	DC10	6g	Tor
PDE	XC6368E345MR	DC/DC-IC	PWM/PFM step-up, 3.4V±2.5%, 200mA, 500kHz, +CE	SOT-25	28sd	DC10	6g	Tor
PDF	XC6368E355MR	DC/DC-IC	PWM/PFM step-up, 3.5V±2.5%, 200mA, 500kHz, +CE	SOT-25	28sd	DC10	6g	Tor
PDH	XC6368E365MR	DC/DC-IC	PWM/PFM step-up, 3.6V±2.5%, 200mA, 500kHz, +CE	SOT-25	28sd	DC10	6g	Tor
PDK	XC6368E375MR	DC/DC-IC	PWM/PFM step-up, 3.7V±2.5%, 200mA, 500kHz, +CE	SOT-25	28sd	DC10	6g	Tor
PL	XC6368E385MR	DC/DC-IC	PWM/PFM step-up, 3.8V±2.5%, 200mA, 500kHz, +CE	SOT-25	28sd	DC10	6g	Tor
PLM	XC6368E395MR	DC/DC-IC	PWM/PFM step-up, 3.9V±2.5%, 200mA, 500kHz, +CE	SOT-25	28sd	DC10	6g	Tor
pE	74AUP1G08GW	CMOS-Logic	2-input AND gate	SOT-353-1	28/Log3	-	6a	Phi
pE	EUP7917-28N	LVR-IC	LDO, 2.8V±3%, 300mA, +CE	SC-70-5	28vrx	VR7	6k	Eut
pE	EUP7917-28V	LVR-IC	LDO, 2.8V±3%, 300mA, +CE	SOT-23-5	28vrx	VR7	6k	Eut
PE	BD5244FVE	Vdet-IC	4.4V, +Reset ODO	VSOFF-5	30ua	VD6	6c	Rhm
PE	BD5244G	Vdet-IC	4.4V, +Reset ODO	SSOP-5	28vdo	VD1	6c	Rhm
PE	BH29RB1WGUT	LVR-IC	LDO, 2.9V, 150mA, +CE	HVSOF5	30vrv	VR10	6e	Rhm
PE	KRA525T	Si-pnp-Digi	Dual, Sw, 50V, 800mA, 900mW, R1/R2=1k/10k	TSV	28/TD9	-	6I	Kec
PE	KRA555E	Si-pnp-Digi	Dual, Sw, 50V, 100mA, 200mW, R1/R2=2.2k/4.7k	TESV	30/TD9	-	6I	Kec
PE	KRA555U	Si-pnp-Digi	Dual, Sw, 50V, 100mA, 200mW, R1/R2=2.2k/4.7k	USV	28/TD9	-	6I	Kec
PE	PT7M7038NLTA	Vdet-IC	3.8V±1.5%, -Reset ODO	SOT-23-5	28vdr	VD6	6k	Pti
PE	PT7M7038NLTAE	Vdet-IC	3.8V±1.5%, -Reset ODO, Lead free	SOT-23-5	28vdr	VD6	6k	Pti
PE0	XC6368E401MR	DC/DC-IC	PWM/PFM step-up, 4.0V±2.5%, 200mA, 100kHz, +CE	SOT-25	28sd	DC10	6g	Tor
PE1	XC6368E411MR	DC/DC-IC	PWM/PFM step-up, 4.1V±2.5%, 200mA, 100kHz, +CE	SOT-25	28sd	DC10	6g	Tor
PE2	XC6368E421MR	DC/DC-IC	PWM/PFM step-up, 4.2V±2.5%, 200mA, 100kHz, +CE	SOT-25	28sd	DC10	6g	Tor
PE3	XC6368E431MR	DC/DC-IC	PWM/PFM step-up, 4.3V±2.5%, 200mA, 100kHz, +CE	SOT-25	28sd	DC10	6g	Tor
PE4	XC6368E441MR	DC/DC-IC	PWM/PFM step-up, 4.4V±2.5%, 200mA, 100kHz, +CE	SOT-25	28sd	DC10	6g	Tor
PE5	XC6368E451MR	DC/DC-IC	PWM/PFM step-up, 4.5V±2.5%, 200mA, 100kHz, +CE	SOT-25	28sd	DC10	6g	Tor
PE6	XC6368E461MR	DC/DC-IC	PWM/PFM step-up, 4.6V±2.5%, 200mA, 100kHz, +CE	SOT-25	28sd	DC10	6g	Tor
PE7	XC6368E471MR	DC/DC-IC	PWM/PFM step-up, 4.7V±2.5%, 200mA, 100kHz, +CE	SOT-25	28sd	DC10	6g	Tor
PE8	XC6368E481MR	DC/DC-IC	PWM/PFM step-up, 4.8V±2.5%, 200mA, 100kHz, +CE	SOT-25	28sd	DC10	6g	Tor
PE9	XC6368E491MR	DC/DC-IC	PWM/PFM step-up, 4.9V±2.5%, 200mA, 100kHz, +CE	SOT-25	28sd	DC10	6g	Tor
PEA	XC6368E405MR	DC/DC-IC	PWM/PFM step-up, 4.0V±2.5%, 200mA, 500kHz, +CE	SOT-25	28sd	DC10	6g	Tor
PEB	XC6368E415MR	DC/DC-IC	PWM/PFM step-up, 4.1V±2.5%, 200mA, 500kHz, +CE	SOT-25	28sd	DC10	6g	Tor
PEC	XC6368E425MR	DC/DC-IC	PWM/PFM step-up, 4.2V±2.5%, 200mA, 500kHz, +CE	SOT-25	28sd	DC10	6g	Tor
PED	XC6368E435MR	DC/DC-IC	PWM/PFM step-up, 4.3V±2.5%, 200mA, 500kHz, +CE	SOT-25	28sd	DC10	6g	Tor
PEE	XC6368E445MR	DC/DC-IC	PWM/PFM step-up, 4.4V±2.5%, 200mA, 500kHz, +CE	SOT-25	28sd	DC10	6g	Tor
PEF	XC6368E455MR	DC/DC-IC	PWM/PFM step-up, 4.5V±2.5%, 200mA, 500kHz, +CE	SOT-25	28sd	DC10	6g	Tor
PEH	XC6368E465MR	DC/DC-IC	PWM/PFM step-up, 4.6V±2.5%, 200mA, 500kHz, +CE	SOT-25	28sd	DC10	6g	Tor
PEK	XC6368E475MR	DC/DC-IC	PWM/PFM step-up, 4.7V±2.5%, 200mA, 500kHz, +CE	SOT-25	28sd	DC10	6g	Tor
PEL	XC6368E485MR	DC/DC-IC	PWM/PFM step-up, 4.8V±2.5%, 200mA, 500kHz, +CE	SOT-25	28sd	DC10	6g	Tor
PEM	XC6368E495MR	DC/DC-IC	PWM/PFM step-up, 4.9V±2.5%, 200mA, 500kHz, +CE	SOT-25	28sd	DC10	6g	Tor
pF	74AUP1G14GW	CMOS-Logic	Inverting Schmitt-trigger	SOT-353-1	28/Log7	-	6a	Phi
pF	EUP7917-285N	LVR-IC	LDO, 2.85V±3%, 300mA, +CE	SC-70-5	28vrx	VR7	6k	Eut
pF	EUP7917-285V	LVR-IC	LDO, 2.85V±3%, 300mA, +CE	SOT-23-5	28vrx	VR7	6k	Eut
PF	BD5245FVE	Vdet-IC	4.5V, +Reset ODO	VSOFF-5	30ua	VD6	6c	Rhm
PF	BD5245G	Vdet-IC	4.5V, +Reset ODO	SSOP-5	28vdo	VD1	6c	Rhm
PF	BH30RB1WGUT	LVR-IC	LDO, 3.0V, 150mA, +CE	HVSOF5	30vrv	VR10	6e	Rhm
PF	KRA526T	Si-pnp-Digi	Dual, Sw, 50V, 800mA, 900mW, R1/R2=2.2k/10k	TSV	28/TD9	-	6I	Kec
PF	KRA556E	Si-pnp-Digi	Dual, Sw, 50V, 100mA, 200mW, R1/R2=4.7k/4.7k	TESV	30/TD9	-	6I	Kec
PF	KRA556U	Si-pnp-Digi	Dual, Sw, 50V, 100mA, 200mW, R1/R2=4.7k/4.7k	USV	28/TD9	-	6I	Kec
PF	PT7M7039CLTA	Vdet-IC	3.9V±1.5%, -Reset PPO	SOT-23-5	28vdr	VD7	6k	Pti
PF	PT7M7039CLTAE	Vdet-IC	3.9V±1.5%, -Reset PPO, Lead free	SOT-23-5	28vdr	VD7	6k	Pti
PF0	XC6368E501MR	DC/DC-IC	PWM/PFM step-up, 5.0V±2.5%, 200mA, 100kHz, +CE	SOT-25	28sd	DC10	6g	Tor
PF1	XC6368E511MR	DC/DC-IC	PWM/PFM step-up, 5.1V±2.5%, 200mA, 100kHz, +CE	SOT-25	28sd	DC10	6g	Tor
PF2	XC6368E521MR	DC/DC-IC	PWM/PFM step-up, 5.2V±2.5%, 200mA, 100kHz, +CE	SOT-25	28sd	DC10	6g	Tor



SMD code	Type	Function	Short description	Case	Pinout	Sch.	St.	Mnf.
PF3	XC6368E531MR	DC/DC-IC	PWM/PFM step-up, 5.3V±2.5%, 200mA, 100kHz, +CE	SOT-25	28sd	DC10	6g	Tor
PF4	XC6368E541MR	DC/DC-IC	PWM/PFM step-up, 5.4V±2.5%, 200mA, 100kHz, +CE	SOT-25	28sd	DC10	6g	Tor
PF5	XC6368E551MR	DC/DC-IC	PWM/PFM step-up, 5.5V±2.5%, 200mA, 100kHz, +CE	SOT-25	28sd	DC10	6g	Tor
PF6	XC6368E561MR	DC/DC-IC	PWM/PFM step-up, 5.6V±2.5%, 200mA, 100kHz, +CE	SOT-25	28sd	DC10	6g	Tor
PF7	XC6368E571MR	DC/DC-IC	PWM/PFM step-up, 5.7V±2.5%, 200mA, 100kHz, +CE	SOT-25	28sd	DC10	6g	Tor
PF8	XC6368E581MR	DC/DC-IC	PWM/PFM step-up, 5.8V±2.5%, 200mA, 100kHz, +CE	SOT-25	28sd	DC10	6g	Tor
PF9	XC6368E591MR	DC/DC-IC	PWM/PFM step-up, 5.9V±2.5%, 200mA, 100kHz, +CE	SOT-25	28sd	DC10	6g	Tor
PFA	XC6368E505MR	DC/DC-IC	PWM/PFM step-up, 5.0V±2.5%, 200mA, 500kHz, +CE	SOT-25	28sd	DC10	6g	Tor
PFB	XC6368E515MR	DC/DC-IC	PWM/PFM step-up, 5.1V±2.5%, 200mA, 500kHz, +CE	SOT-25	28sd	DC10	6g	Tor
PFC	XC6368E525MR	DC/DC-IC	PWM/PFM step-up, 5.2V±2.5%, 200mA, 500kHz, +CE	SOT-25	28sd	DC10	6g	Tor
PFD	XC6368E535MR	DC/DC-IC	PWM/PFM step-up, 5.3V±2.5%, 200mA, 500kHz, +CE	SOT-25	28sd	DC10	6g	Tor
PFE	XC6368E545MR	DC/DC-IC	PWM/PFM step-up, 5.4V±2.5%, 200mA, 500kHz, +CE	SOT-25	28sd	DC10	6g	Tor
PFF	XC6368E555MR	DC/DC-IC	PWM/PFM step-up, 5.5V±2.5%, 200mA, 500kHz, +CE	SOT-25	28sd	DC10	6g	Tor
PFH	XC6368E565MR	DC/DC-IC	PWM/PFM step-up, 5.6V±2.5%, 200mA, 500kHz, +CE	SOT-25	28sd	DC10	6g	Tor
PFK	XC6368E575MR	DC/DC-IC	PWM/PFM step-up, 5.7V±2.5%, 200mA, 500kHz, +CE	SOT-25	28sd	DC10	6g	Tor
PFL	XC6368E585MR	DC/DC-IC	PWM/PFM step-up, 5.8V±2.5%, 200mA, 500kHz, +CE	SOT-25	28sd	DC10	6g	Tor
PFM	XC6368E595MR	DC/DC-IC	PWM/PFM step-up, 5.9V±2.5%, 200mA, 500kHz, +CE	SOT-25	28sd	DC10	6g	Tor
PFOI	TPS3126E12D	Vdet-IC	1.14V, -MR, ±Reset ODO	SOT-23-5	28xf	-	6k	Ti
PFPI	TPS3126E15D	Vdet-IC	1.43V, -MR, ±Reset ODO	SOT-23-5	28xf	-	6k	Ti
PFQI	TPS3126E18D	Vdet-IC	1.71V, -MR, ±Reset ODO	SOT-23-5	28xf	-	6k	Ti
PFRI	TPS3128E12D	Vdet-IC	1.14V±1%, -Reset ODO, -MR, Strobe	SOT-23-5	28cp	VD16	6k	Ti
PFSI	TPS3128E15D	Vdet-IC	1.43V±1%, -Reset ODO, -MR, Strobe	SOT-23-5	28cp	VD16	6k	Ti
PFTI	TPS3128E18D	Vdet-IC	1.71V±1%, -Reset ODO, -MR, Strobe	SOT-23-5	28cp	VD16	6k	Ti
PFUI	TPS76201DB	LVR-IC	LDO, Adjustable 0.7..5.5V, 150mA, +CE	SOT-23-5	28sg	VR16	6b	Ti
pG	74AUP1G32GW	CMOS-Logic	2-input OR gate	SOT-353-1	28LLog4	-	6a	Phi
pG	EUP7917-30N	LVR-IC	LDO, 3.0V±3%, 300mA, +CE	SC-70-5	28vrx	VR7	6k	Eut
pG	EUP7917-30V	LVR-IC	LDO, 3.0V±3%, 300mA, +CE	SOT-23-5	28vrx	VR7	6k	Eut
PG	BD5246FVE	Vdet-IC	4.6V, +Reset ODO	VSO5F-5	30ua	VD6	6c	Rhm
PG	BD5246G	Vdet-IC	4.6V, +Reset ODO	SSOP-5	28vdo	VD1	6c	Rhm
PG	BH31RB1WGUT	LVR-IC	LDO, 3.1V, 150mA, +CE	HVSOF5	30vrv	VR10	6e	Rhm
PG	PT7M7039CHTA	Vdet-IC	3.9V±1.5%, +Reset PPO	SOT-23-5	28vdr	VD7	6k	Pti
PG	PT7M7039CHTAE	Vdet-IC	3.9V±1.5%, +Reset PPO, Lead free	SOT-23-5	28vdr	VD7	6k	Pti
pH	74AUP1G86GW	CMOS-Logic	2-input EXCLUSIVE-OR gate	SOT-353-1	28LLog5	-	6a	Phi
pH	EUP7917-33N	LVR-IC	LDO, 3.3V±3%, 300mA, +CE	SC-70-5	28vrx	VR7	6k	Eut
pH	EUP7917-33V	LVR-IC	LDO, 3.3V±3%, 300mA, +CE	SOT-23-5	28vrx	VR7	6k	Eut
PH	BD5247FVE	Vdet-IC	4.7V, +Reset ODO	VSO5F-5	30ua	VD6	6c	Rhm
PH	BD5247G	Vdet-IC	4.7V, +Reset ODO	SSOP-5	28vdo	VD1	6c	Rhm
PH	BH33RB1WGUT	LVR-IC	LDO, 3.3V, 150mA, +CE	HVSOF5	30vrv	VR10	6e	Rhm
PH	KRA557E	Si-pnp-Digi	Dual, Sw, 50V, 100mA, 200mW, R1/R2=10k/47k	TESV	30/TD9	-	6l	Kec
PH	KRA557U	Si-pnp-Digi	Dual, Sw, 50V, 100mA, 200mW, R1/R2=10k/47k	USV	28/TD9	-	6l	Kec
PH	PT7M7039NLTA	Vdet-IC	3.9V±1.5%, -Reset ODO	SOT-23-5	28vdr	VD6	6k	Pti
PH	PT7M7039NLTAE	Vdet-IC	3.9V±1.5%, -Reset ODO, Lead free	SOT-23-5	28vdr	VD6	6k	Pti
PH0	XC6368E601MR	DC/DC-IC	PWM/PFM step-up, 6.0V±2.5%, 200mA, 100kHz, +CE	SOT-25	28sd	DC10	6g	Tor
PH1	XC6368E611MR	DC/DC-IC	PWM/PFM step-up, 6.1V±2.5%, 200mA, 100kHz, +CE	SOT-25	28sd	DC10	6g	Tor
PH2	XC6368E621MR	DC/DC-IC	PWM/PFM step-up, 6.2V±2.5%, 200mA, 100kHz, +CE	SOT-25	28sd	DC10	6g	Tor
PH3	XC6368E631MR	DC/DC-IC	PWM/PFM step-up, 6.3V±2.5%, 200mA, 100kHz, +CE	SOT-25	28sd	DC10	6g	Tor
PH4	XC6368E641MR	DC/DC-IC	PWM/PFM step-up, 6.4V±2.5%, 200mA, 100kHz, +CE	SOT-25	28sd	DC10	6g	Tor
PH5	XC6368E651MR	DC/DC-IC	PWM/PFM step-up, 6.5V±2.5%, 200mA, 100kHz, +CE	SOT-25	28sd	DC10	6g	Tor
PHA	XC6368E605MR	DC/DC-IC	PWM/PFM step-up, 6.0V±2.5%, 200mA, 500kHz, +CE	SOT-25	28sd	DC10	6g	Tor
PHB	XC6368E615MR	DC/DC-IC	PWM/PFM step-up, 6.1V±2.5%, 200mA, 500kHz, +CE	SOT-25	28sd	DC10	6g	Tor
PHC	XC6368E625MR	DC/DC-IC	PWM/PFM step-up, 6.2V±2.5%, 200mA, 500kHz, +CE	SOT-25	28sd	DC10	6g	Tor
PHD	XC6368E635MR	DC/DC-IC	PWM/PFM step-up, 6.3V±2.5%, 200mA, 500kHz, +CE	SOT-25	28sd	DC10	6g	Tor
PHE	XC6368E645MR	DC/DC-IC	PWM/PFM step-up, 6.4V±2.5%, 200mA, 500kHz, +CE	SOT-25	28sd	DC10	6g	Tor
PHF	XC6368E655MR	DC/DC-IC	PWM/PFM step-up, 6.5V±2.5%, 200mA, 500kHz, +CE	SOT-25	28sd	DC10	6g	Tor
PI	KRA558E	Si-pnp-Digi	Dual, Sw, 50V, 100mA, 200mW, R1/R2=22k/47k	TESV	30/TD9	-	6l	Kec
PI	KRA558U	Si-pnp-Digi	Dual, Sw, 50V, 100mA, 200mW, R1/R2=22k/47k	USV	28/TD9	-	6l	Kec
PI	PT7M7040CLTA	Vdet-IC	4.0V±1.5%, -Reset PPO	SOT-23-5	28vdr	VD7	6k	Pti
PI	PT7M7040CLTAE	Vdet-IC	4.0V±1.5%, -Reset PPO, Lead free	SOT-23-5	28vdr	VD7	6k	Pti
pJ	74AUP1G17GW	CMOS-Logic	Schmitt-trigger	SOT-353-1	28LLog11	-	6a	Phi
PJ	BD5248FVE	Vdet-IC	4.8V, +Reset ODO	VSO5F-5	30ua	VD6	6c	Rhm
PJ	BD5248G	Vdet-IC	4.8V, +Reset ODO	SSOP-5	28vdo	VD1	6c	Rhm
PJ	BH13RB1WGUT	LVR-IC	LDO, 1.3V, 150mA, +CE	HVSOF5	30vrv	VR10	6e	Rhm
PJ	KRA559E	Si-pnp-Digi	Dual, Sw, 50V, 100mA, 200mW, R1/R2=47k/22k	TESV	30/TD9	-	6l	Kec
PJ	KRA559U	Si-pnp-Digi	Dual, Sw, 50V, 100mA, 200mW, R1/R2=47k/22k	USV	28/TD9	-	6l	Kec
PJ	PT7M7040CHTA	Vdet-IC	4.0V±1.5%, +Reset PPO	SOT-23-5	28vdr	VD7	6k	Pti
PJ	PT7M7040CHTAE	Vdet-IC	4.0V±1.5%, +Reset PPO, Lead free	SOT-23-5	28vdr	VD7	6k	Pti
pK	EUP7917-48N	LVR-IC	LDO, 4.8V±3%, 300mA, +CE	SC-70-5	28vrx	VR7	6k	Eut
pK	EUP7917-48V	LVR-IC	LDO, 4.8V±3%, 300mA, +CE	SOT-23-5	28vrx	VR7	6k	Eut
PK	BD5249FVE	Vdet-IC	4.9V, +Reset ODO	VSO5F-5	30ua	VD6	6c	Rhm
PK	BD5249G	Vdet-IC	4.9V, +Reset ODO	SSOP-5	28vdo	VD1	6c	Rhm



SMD code	Type	Function	Short description	Case	Pinout	Sch.	St.	Mnf.
PK	KRA560E	Si-pnp-Digi	Dual, Sw, 50V, 100mA, 200mW, R1=4.7k	TESV	30/TD9	-	6l	Kec
PK	KRA560U	Si-pnp-Digi	Dual, Sw, 50V, 100mA, 200mW, R1=4.7k	USV	28/TD9	-	6l	Kec
PK	PT7M7040NLTA	Vdet-IC	4.0V±1.5%, -Reset ODO	SOT-23-5	28vdr	VD6	6k	Pti
PK	PT7M7040NLTAE	Vdet-IC	4.0V±1.5%, -Reset ODO, Lead free	SOT-23-5	28vdr	VD6	6k	Pti
PK2	S-1000C41-M5T1	Vdet-IC	4.1V, -Reset PPO	SOT-23-5	28vdm	VD7	6a	Sii
PK3	S-1000C42-M5T1	Vdet-IC	4.2V, -Reset PPO	SOT-23-5	28vdm	VD7	6a	Sii
PK4	S-1000C43-M5T1	Vdet-IC	4.3V, -Reset PPO	SOT-23-5	28vdm	VD7	6a	Sii
PK5	S-1000C44-M5T1	Vdet-IC	4.4V, -Reset PPO	SOT-23-5	28vdm	VD7	6a	Sii
PK6	S-1000C45-M5T1	Vdet-IC	4.5V, -Reset PPO	SOT-23-5	28vdm	VD7	6a	Sii
PK7	S-1000C46-M5T1	Vdet-IC	4.6V, -Reset PPO	SOT-23-5	28vdm	VD7	6a	Sii
PKA	S-1000C15-M5T1	Vdet-IC	1.5V, -Reset PPO	SOT-23-5	28vdm	VD7	6a	Sii
PKB	S-1000C16-M5T1	Vdet-IC	1.6V, -Reset PPO	SOT-23-5	28vdm	VD7	6a	Sii
PKC	S-1000C17-M5T1	Vdet-IC	1.7V, -Reset PPO	SOT-23-5	28vdm	VD7	6a	Sii
PKD	S-1000C18-M5T1	Vdet-IC	1.8V, -Reset PPO	SOT-23-5	28vdm	VD7	6a	Sii
PKE	S-1000C19-M5T1	Vdet-IC	1.9V, -Reset PPO	SOT-23-5	28vdm	VD7	6a	Sii
PKF	S-1000C20-M5T1	Vdet-IC	2.0V, -Reset PPO	SOT-23-5	28vdm	VD7	6a	Sii
PKG	S-1000C21-M5T1	Vdet-IC	2.1V, -Reset PPO	SOT-23-5	28vdm	VD7	6a	Sii
PKH	S-1000C22-M5T1	Vdet-IC	2.2V, -Reset PPO	SOT-23-5	28vdm	VD7	6a	Sii
PKI	S-1000C23-M5T1	Vdet-IC	2.3V, -Reset PPO	SOT-23-5	28vdm	VD7	6a	Sii
PKJ	S-1000C24-M5T1	Vdet-IC	2.4V, -Reset PPO	SOT-23-5	28vdm	VD7	6a	Sii
PKK	S-1000C25-M5T1	Vdet-IC	2.5V, -Reset PPO	SOT-23-5	28vdm	VD7	6a	Sii
PKL	S-1000C26-M5T1	Vdet-IC	2.6V, -Reset PPO	SOT-23-5	28vdm	VD7	6a	Sii
PKM	S-1000C27-M5T1	Vdet-IC	2.7V, -Reset PPO	SOT-23-5	28vdm	VD7	6a	Sii
PKN	S-1000C28-M5T1	Vdet-IC	2.8V, -Reset PPO	SOT-23-5	28vdm	VD7	6a	Sii
PKO	S-1000C29-M5T1	Vdet-IC	2.9V, -Reset PPO	SOT-23-5	28vdm	VD7	6a	Sii
PKP	S-1000C30-M5T1	Vdet-IC	3.0V, -Reset PPO	SOT-23-5	28vdm	VD7	6a	Sii
PKQ	S-1000C31-M5T1	Vdet-IC	3.1V, -Reset PPO	SOT-23-5	28vdm	VD7	6a	Sii
PKR	S-1000C32-M5T1	Vdet-IC	3.2V, -Reset PPO	SOT-23-5	28vdm	VD7	6a	Sii
PKS	S-1000C33-M5T1	Vdet-IC	3.3V, -Reset PPO	SOT-23-5	28vdm	VD7	6a	Sii
PKT	S-1000C34-M5T1	Vdet-IC	3.4V, -Reset PPO	SOT-23-5	28vdm	VD7	6a	Sii
PKU	S-1000C35-M5T1	Vdet-IC	3.5V, -Reset PPO	SOT-23-5	28vdm	VD7	6a	Sii
PKV	S-1000C36-M5T1	Vdet-IC	3.6V, -Reset PPO	SOT-23-5	28vdm	VD7	6a	Sii
PKW	S-1000C37-M5T1	Vdet-IC	3.7V, -Reset PPO	SOT-23-5	28vdm	VD7	6a	Sii
PKX	S-1000C38-M5T1	Vdet-IC	3.8V, -Reset PPO	SOT-23-5	28vdm	VD7	6a	Sii
PKY	S-1000C39-M5T1	Vdet-IC	3.9V, -Reset PPO	SOT-23-5	28vdm	VD7	6a	Sii
PKZ	S-1000C40-M5T1	Vdet-IC	4.0V, -Reset PPO	SOT-23-5	28vdm	VD7	6a	Sii
PL	BD5250FVE	Vdet-IC	5V, +Reset ODO	VSOF-5	30ua	VD6	6c	Rhm
PL	BD5250G	Vdet-IC	5V, +Reset ODO	SSOP-5	28vdo	VD1	6c	Rhm
PL	PT7M7041CLTA	Vdet-IC	4.1V±1.5%, -Reset PPO	SOT-23-5	28vdr	VD7	6k	Pti
PL	R1122N501A	LVR-IC	LDO, LN, -CE, 5V±2%, 150mA	SOT-23-5	28vt	VR4	6g	Pti
PL	PT7M7041CLTAE	Vdet-IC	4.1V±1.5%, -Reset PPO, Lead free	SOT-23-5	28vdr	VD7	6k	Pti
PL2	S-1000N41-M5T1	Vdet-IC	4.1V, -Reset ODO	SOT-23-5	28vdm	VD6	6a	Sii
PL3	S-1000N42-M5T1	Vdet-IC	4.2V, -Reset ODO	SOT-23-5	28vdm	VD6	6a	Sii
PL4	S-1000N43-M5T1	Vdet-IC	4.3V, -Reset ODO	SOT-23-5	28vdm	VD6	6a	Sii
PL5	S-1000N44-M5T1	Vdet-IC	4.4V, -Reset ODO	SOT-23-5	28vdm	VD6	6a	Sii
PL6	S-1000N45-M5T1	Vdet-IC	4.5V, -Reset ODO	SOT-23-5	28vdm	VD6	6a	Sii
PL7	S-1000N46-M5T1	Vdet-IC	4.6V, -Reset ODO	SOT-23-5	28vdm	VD6	6a	Sii
PLA	S-1000N15-M5T1	Vdet-IC	1.5V, -Reset ODO	SOT-23-5	28vdm	VD6	6a	Sii
PLB	S-1000N16-M5T1	Vdet-IC	1.6V, -Reset ODO	SOT-23-5	28vdm	VD6	6a	Sii
PLC	S-1000N17-M5T1	Vdet-IC	1.7V, -Reset ODO	SOT-23-5	28vdm	VD6	6a	Sii
PLD	S-1000N18-M5T1	Vdet-IC	1.8V, -Reset ODO	SOT-23-5	28vdm	VD6	6a	Sii
PLE	S-1000N19-M5T1	Vdet-IC	1.9V, -Reset ODO	SOT-23-5	28vdm	VD6	6a	Sii
PLF	S-1000N20-M5T1	Vdet-IC	2.0V, -Reset ODO	SOT-23-5	28vdm	VD6	6a	Sii
PLG	S-1000N21-M5T1	Vdet-IC	2.1V, -Reset ODO	SOT-23-5	28vdm	VD6	6a	Sii
PLH	S-1000N22-M5T1	Vdet-IC	2.2V, -Reset ODO	SOT-23-5	28vdm	VD6	6a	Sii
PLI	S-1000N23-M5T1	Vdet-IC	2.3V, -Reset ODO	SOT-23-5	28vdm	VD6	6a	Sii
PLJ	S-1000N24-M5T1	Vdet-IC	2.4V, -Reset ODO	SOT-23-5	28vdm	VD6	6a	Sii
PLK	S-1000N25-M5T1	Vdet-IC	2.5V, -Reset ODO	SOT-23-5	28vdm	VD6	6a	Sii
PLL	S-1000N26-M5T1	Vdet-IC	2.6V, -Reset ODO	SOT-23-5	28vdm	VD6	6a	Sii
PLM	S-1000N27-M5T1	Vdet-IC	2.7V, -Reset ODO	SOT-23-5	28vdm	VD6	6a	Sii
PLN	S-1000N28-M5T1	Vdet-IC	2.8V, -Reset ODO	SOT-23-5	28vdm	VD6	6a	Sii
PLO	S-1000N29-M5T1	Vdet-IC	2.9V, -Reset ODO	SOT-23-5	28vdm	VD6	6a	Sii
PLP	S-1000N30-M5T1	Vdet-IC	3.0V, -Reset ODO	SOT-23-5	28vdm	VD6	6a	Sii
PLQ	S-1000N31-M5T1	Vdet-IC	3.1V, -Reset ODO	SOT-23-5	28vdm	VD6	6a	Sii
PLR	S-1000N32-M5T1	Vdet-IC	3.2V, -Reset ODO	SOT-23-5	28vdm	VD6	6a	Sii
PLS	S-1000N33-M5T1	Vdet-IC	3.3V, -Reset ODO	SOT-23-5	28vdm	VD6	6a	Sii
PLT	S-1000N34-M5T1	Vdet-IC	3.4V, -Reset ODO	SOT-23-5	28vdm	VD6	6a	Sii
PLU	S-1000N35-M5T1	Vdet-IC	3.5V, -Reset ODO	SOT-23-5	28vdm	VD6	6a	Sii
PLV	S-1000N36-M5T1	Vdet-IC	3.6V, -Reset ODO	SOT-23-5	28vdm	VD6	6a	Sii
PLW	S-1000N37-M5T1	Vdet-IC	3.7V, -Reset ODO	SOT-23-5	28vdm	VD6	6a	Sii



SMD code	Type	Function	Short description	Case	Pinout	Sch.	St.	Mnf.
PLX	S-1000N38-M5T1	Vdet-IC	3.8V, -Reset ODO	SOT-23-5	28vdm	VD6	6a	Sii
PLY	S-1000N39-M5T1	Vdet-IC	3.9V, -Reset ODO	SOT-23-5	28vdm	VD6	6a	Sii
PLZ	S-1000N40-M5T1	Vdet-IC	4.0V, -Reset ODO	SOT-23-5	28vdm	VD6	6a	Sii
pM	74AUP1G125GW	CMOS-Logic	Bus buffer gate with 3-state output	SOT-353-1	28/Log14	-	6a	Phi
PM	BD5251FVE	Vdet-IC	5.1V, +Reset ODO	VSOFF-5	30ua	VD6	6c	Rhm
PM	BD5251G	Vdet-IC	5.1V, +Reset ODO	SSOP-5	28vdo	VD1	6c	Rhm
PM	KRA561E	Si-pnp-Digi	Dual, Sw, 50V, 100mA, 200mW, R1=10k	TESV	30/TD9	-	6l	Kec
PM	KRA561U	Si-pnp-Digi	Dual, Sw, 50V, 100mA, 200mW, R1=10k	USV	28/TD9	-	6l	Kec
PM	PT7M7041CHTA	Vdet-IC	4.1V±1.5%, +Reset PPO	SOT-23-5	28vdr	VD7	6k	Pti
PM	PT7M7041CHTAE	Vdet-IC	4.1V±1.5%, +Reset PPO, Lead free	SOT-23-5	28vdr	VD7	6k	Pti
pN	74AUP1G126GW	CMOS-Logic	Bus buffer gate with 3-state output	SOT-353-1	28/Log13	-	6a	Phi
PN	BD5252FVE	Vdet-IC	5.2V, +Reset ODO	VSOFF-5	30ua	VD6	6c	Rhm
PN	BD5252G	Vdet-IC	5.2V, +Reset ODO	SSOP-5	28vdo	VD1	6c	Rhm
PN	KRA562E	Si-pnp-Digi	Dual, Sw, 50V, 100mA, 200mW, R1=100k	TESV	30/TD9	-	6l	Kec
PN	KRA562U	Si-pnp-Digi	Dual, Sw, 50V, 100mA, 200mW, R1=100k	USV	28/TD9	-	6l	Kec
PN	PT7M7041NLTA	Vdet-IC	4.1V±1.5%, -Reset ODO	SOT-23-5	28vdr	VD6	6k	Pti
PN	PT7M7041NLTAE	Vdet-IC	4.1V±1.5%, -Reset ODO, Lead free	SOT-23-5	28vdr	VD6	6k	Pti
PO	KRA563E	Si-pnp-Digi	Dual, Sw, 50V, 100mA, 200mW, R1=22k	TESV	30/TD9	-	6l	Kec
PO	KRA563U	Si-pnp-Digi	Dual, Sw, 50V, 100mA, 200mW, R1=22k	USV	28/TD9	-	6l	Kec
PO	PT7M7042CLTA	Vdet-IC	4.2V±1.5%, -Reset PPO	SOT-23-5	28vdr	VD7	6k	Pti
PO	PT7M7042CLTAE	Vdet-IC	4.2V±1.5%, -Reset PPO, Lead free	SOT-23-5	28vdr	VD7	6k	Pti
POA	S-1200B15-M5T1G	LVR-IC	LDO, 1.5V±1.0%, 150mA, +CE	SOT-23-5	28cx	VR4	6g	Sii
POB	S-1200B16-M5T1G	LVR-IC	LDO, 1.6V±1.0%, 150mA, +CE	SOT-23-5	28cx	VR4	6g	Sii
POC	S-1200B17-M5T1G	LVR-IC	LDO, 1.7V±1.0%, 150mA, +CE	SOT-23-5	28cx	VR4	6g	Sii
POD	S-1200B18-M5T1G	LVR-IC	LDO, 1.8V±1.0%, 150mA, +CE	SOT-23-5	28cx	VR4	6g	Sii
POE	S-1200B19-M5T1G	LVR-IC	LDO, 1.9V±1.0%, 150mA, +CE	SOT-23-5	28cx	VR4	6g	Sii
POF	S-1200B20-M5T1G	LVR-IC	LDO, 2.0V±1.0%, 150mA, +CE	SOT-23-5	28cx	VR4	6g	Sii
POG	S-1200B21-M5T1G	LVR-IC	LDO, 2.1V±1.0%, 150mA, +CE	SOT-23-5	28cx	VR4	6g	Sii
POH	S-1200B22-M5T1G	LVR-IC	LDO, 2.2V±1.0%, 150mA, +CE	SOT-23-5	28cx	VR4	6g	Sii
POI	S-1200B23-M5T1G	LVR-IC	LDO, 2.3V±1.0%, 150mA, +CE	SOT-23-5	28cx	VR4	6g	Sii
POJ	S-1200B24-M5T1G	LVR-IC	LDO, 2.4V±1.0%, 150mA, +CE	SOT-23-5	28cx	VR4	6g	Sii
POK	S-1200B25-M5T1G	LVR-IC	LDO, 2.5V±1.0%, 150mA, +CE	SOT-23-5	28cx	VR4	6g	Sii
POL	S-1200B26-M5T1G	LVR-IC	LDO, 2.6V±1.0%, 150mA, +CE	SOT-23-5	28cx	VR4	6g	Sii
POM	S-1200B27-M5T1G	LVR-IC	LDO, 2.7V±1.0%, 150mA, +CE	SOT-23-5	28cx	VR4	6g	Sii
PON	S-1200B28-M5T1G	LVR-IC	LDO, 2.8V±1.0%, 150mA, +CE	SOT-23-5	28cx	VR4	6g	Sii
POO	S-1200B29-M5T1G	LVR-IC	LDO, 2.9V±1.0%, 150mA, +CE	SOT-23-5	28cx	VR4	6g	Sii
POP	S-1200B30-M5T1G	LVR-IC	LDO, 3.0V±1.0%, 150mA, +CE	SOT-23-5	28cx	VR4	6g	Sii
POQ	S-1200B31-M5T1G	LVR-IC	LDO, 3.1V±1.0%, 150mA, +CE	SOT-23-5	28cx	VR4	6g	Sii
POR	S-1200B32-M5T1G	LVR-IC	LDO, 3.2V±1.0%, 150mA, +CE	SOT-23-5	28cx	VR4	6g	Sii
POS	S-1200B33-M5T1G	LVR-IC	LDO, 3.3V±1.0%, 150mA, +CE	SOT-23-5	28cx	VR4	6g	Sii
POT	S-1200B34-M5T1G	LVR-IC	LDO, 3.4V±1.0%, 150mA, +CE	SOT-23-5	28cx	VR4	6g	Sii
POU	S-1200B35-M5T1G	LVR-IC	LDO, 3.5V±1.0%, 150mA, +CE	SOT-23-5	28cx	VR4	6g	Sii
POV	S-1200B36-M5T1G	LVR-IC	LDO, 3.6V±1.0%, 150mA, +CE	SOT-23-5	28cx	VR4	6g	Sii
POW	S-1200B37-M5T1G	LVR-IC	LDO, 3.7V±1.0%, 150mA, +CE	SOT-23-5	28cx	VR4	6g	Sii
POX	S-1200B38-M5T1G	LVR-IC	LDO, 3.8V±1.0%, 150mA, +CE	SOT-23-5	28cx	VR4	6g	Sii
POY	S-1200B39-M5T1G	LVR-IC	LDO, 3.9V±1.0%, 150mA, +CE	SOT-23-5	28cx	VR4	6g	Sii
POZ	S-1200B40-M5T1G	LVR-IC	LDO, 4.0V±1.0%, 150mA, +CE	SOT-23-5	28cx	VR4	6g	Sii
pP	74AUP1G79GW	CMOS-Logic	Positive edge-triggered D-type flip-flop	SOT-353-1	28/Log20	-	6a	Phi
PP	BD5253FVE	Vdet-IC	5.3V, +Reset ODO	VSOFF-5	30ua	VD6	6c	Rhm
PP	BD5253G	Vdet-IC	5.3V, +Reset ODO	SSOP-5	28vdo	VD1	6c	Rhm
PP	KRA564E	Si-pnp-Digi	Dual, Sw, 50V, 100mA, 200mW, R1=47k	TESV	30/TD9	-	6l	Kec
PP	KRA564U	Si-pnp-Digi	Dual, Sw, 50V, 100mA, 200mW, R1=47k	USV	28/TD9	-	6l	Kec
PP	PT7M7042CHTA	Vdet-IC	4.2V±1.5%, +Reset PPO	SOT-23-5	28vdr	VD7	6k	Pti
PP	PT7M7042CHTAE	Vdet-IC	4.2V±1.5%, +Reset PPO, Lead free	SOT-23-5	28vdr	VD7	6k	Pti
PPA	S-1200B41-M5T1G	LVR-IC	LDO, 4.1V±1.0%, 150mA, +CE	SOT-23-5	28cx	VR4	6g	Sii
PPB	S-1200B42-M5T1G	LVR-IC	LDO, 4.2V±1.0%, 150mA, +CE	SOT-23-5	28cx	VR4	6g	Sii
PPC	S-1200B43-M5T1G	LVR-IC	LDO, 4.3V±1.0%, 150mA, +CE	SOT-23-5	28cx	VR4	6g	Sii
PPD	S-1200B44-M5T1G	LVR-IC	LDO, 4.4V±1.0%, 150mA, +CE	SOT-23-5	28cx	VR4	6g	Sii
PPE	S-1200B45-M5T1G	LVR-IC	LDO, 4.5V±1.0%, 150mA, +CE	SOT-23-5	28cx	VR4	6g	Sii
PPF	S-1200B46-M5T1G	LVR-IC	LDO, 4.6V±1.0%, 150mA, +CE	SOT-23-5	28cx	VR4	6g	Sii
PPG	S-1200B47-M5T1G	LVR-IC	LDO, 4.7V±1.0%, 150mA, +CE	SOT-23-5	28cx	VR4	6g	Sii
PPH	S-1200B48-M5T1G	LVR-IC	LDO, 4.8V±1.0%, 150mA, +CE	SOT-23-5	28cx	VR4	6g	Sii
PPI	S-1200B49-M5T1G	LVR-IC	LDO, 4.9V±1.0%, 150mA, +CE	SOT-23-5	28cx	VR4	6g	Sii
PPJ	S-1200B50-M5T1G	LVR-IC	LDO, 5.0V±1.0%, 150mA, +CE	SOT-23-5	28cx	VR4	6g	Sii
PPK	S-1200B51-M5T1G	LVR-IC	LDO, 5.1V±1.0%, 150mA, +CE	SOT-23-5	28cx	VR4	6g	Sii
PLL	S-1200B52-M5T1G	LVR-IC	LDO, 5.2V±1.0%, 150mA, +CE	SOT-23-5	28cx	VR4	6g	Sii
PPM	S-1200B53-M5T1G	LVR-IC	LDO, 5.3V±1.0%, 150mA, +CE	SOT-23-5	28cx	VR4	6g	Sii
PPN	S-1200B54-M5T1G	LVR-IC	LDO, 5.4V±1.0%, 150mA, +CE	SOT-23-5	28cx	VR4	6g	Sii
PPO	S-1200B55-M5T1G	LVR-IC	LDO, 5.5V±1.0%, 150mA, +CE	SOT-23-5	28cx	VR4	6g	Sii
pQ	74AUP1T34GW	CMOS-Logic	Dual supply translating buffer	SOT-353-1	28/Log78	-	6a	Phi



SMD code	Type	Function	Short description	Case	Pinout	Sch.	St.	Mnf.
PQ	BD5254FVE	Vdet-IC	5.4V, +Reset ODO	VSOFF-5	30ua	VD6	6c	Rhm
PQ	BD5254G	Vdet-IC	5.4V, +Reset ODO	SSOP-5	28vdo	VD1	6c	Rhm
PQ	PT7M7042NLTA	Vdet-IC	4.2V±1.5%, -Reset ODO	SOT-23-5	28vdr	VD6	6k	Pti
P̄Q	PT7M7042NLTAE	Vdet-IC	4.2V±1.5%, -Reset ODO, Lead free	SOT-23-5	28vdr	VD6	6k	Pti
pR	74AUP1G06GW	CMOS-Logic	Inverter (ODO)	SOT-353-1	28/Log19	-	6a	Pti
pR	EUP7917-35N	LVR-IC	LDO, 3.5V±3%, 300mA, +CE	SC-70-5	28vrx	VR7	6k	Eut
pR	EUP7917-35V	LVR-IC	LDO, 3.5V±3%, 300mA, +CE	SOT-23-5	28vrx	VR7	6k	Eut
PR	BD5255FVE	Vdet-IC	5.5V, +Reset ODO	VSOFF-5	30ua	VD6	6c	Rhm
PR	BD5255G	Vdet-IC	5.5V, +Reset ODO	SSOP-5	28vdo	VD1	6c	Rhm
PR	PT7M7043CLTA	Vdet-IC	4.3V±1.5%, -Reset PPO	SOT-23-5	28vdr	VD7	6k	Pti
P̄R	PT7M7043CLTAE	Vdet-IC	4.3V±1.5%, -Reset PPO, Lead free	SOT-23-5	28vdr	VD7	6k	Pti
PS	BD5256FVE	Vdet-IC	5.6V, +Reset ODO	VSOFF-5	30ua	VD6	6c	Rhm
PS	BD5256G	Vdet-IC	5.6V, +Reset ODO	SSOP-5	28vdo	VD1	6c	Rhm
PS	PT7M7043CHTA	Vdet-IC	4.3V±1.5%, +Reset PPO	SOT-23-5	28vdr	VD7	6k	Pti
P̄S	PT7M7043CHTAE	Vdet-IC	4.3V±1.5%, +Reset PPO, Lead free	SOT-23-5	28vdr	VD7	6k	Pti
pT	EUP7917-12N	LVR-IC	LDO, 1.2V±3%, 300mA, +CE	SC-70-5	28vrx	VR7	6k	Eut
pT	EUP7917-12V	LVR-IC	LDO, 1.2V±3%, 300mA, +CE	SOT-23-5	28vrx	VR7	6k	Eut
PT	BD5257FVE	Vdet-IC	5.7V, +Reset ODO	VSOFF-5	30ua	VD6	6c	Rhm
PT	BD5257G	Vdet-IC	5.7V, +Reset ODO	SSOP-5	28vdo	VD1	6c	Rhm
PT	PT7M7043NLTA	Vdet-IC	4.3V±1.5%, -Reset ODO	SOT-23-5	28vdr	VD6	6k	Pti
P̄T	PT7M7043NLTAE	Vdet-IC	4.3V±1.5%, -Reset ODO, Lead free	SOT-23-5	28vdr	VD6	6k	Pti
pJ	EUP7917-185N	LVR-IC	LDO, 1.85V±3%, 300mA, +CE	SC-70-5	28vrx	VR7	6k	Eut
pJ	EUP7917-185V	LVR-IC	LDO, 1.85V±3%, 300mA, +CE	SOT-23-5	28vrx	VR7	6k	Eut
PU	BD5258FVE	Vdet-IC	5.8V, +Reset ODO	VSOFF-5	30ua	VD6	6c	Rhm
PU	BD5258G	Vdet-IC	5.8V, +Reset ODO	SSOP-5	28vdo	VD1	6c	Rhm
PU	PT7M7044CLTA	Vdet-IC	4.4V±1.5%, -Reset PPO	SOT-23-5	28vdr	VD7	6k	Pti
P̄U	PT7M7044CLTAE	Vdet-IC	4.4V±1.5%, -Reset PPO, Lead free	SOT-23-5	28vdr	VD7	6k	Pti
PV	BD5259FVE	Vdet-IC	5.9V, +Reset ODO	VSOFF-5	30ua	VD6	6c	Rhm
PV	BD5259G	Vdet-IC	5.9V, +Reset ODO	SSOP-5	28vdo	VD1	6c	Rhm
PV	PT7M7044CHTA	Vdet-IC	4.4V±1.5%, +Reset PPO	SOT-23-5	28vdr	VD7	6k	Pti
P̄V	PT7M7044CHTAE	Vdet-IC	4.4V±1.5%, +Reset PPO, Lead free	SOT-23-5	28vdr	VD7	6k	Pti
PV3	S-1701E3326-M5T1	LVR/Vdet-IC	LDO, 3.3V±1%, 400mA, Vdet=2.6V, -Reset ODO, +CE	SOT-23-5	28hg	VR15	6a	Sii
PV4	S-1701E3327-M5T1	LVR/Vdet-IC	LDO, 3.3V±1%, 400mA, Vdet=2.7V, -Reset ODO, +CE	SOT-23-5	28hg	VR15	6a	Sii
PV5	S-1701E3328-M5T1	LVR/Vdet-IC	LDO, 3.3V±1%, 400mA, Vdet=2.8V, -Reset ODO, +CE	SOT-23-5	28hg	VR15	6a	Sii
PV6	S-1701E5040-M5T1	LVR/Vdet-IC	LDO, 5V±1%, 400mA, Vdet=4V, -Reset ODO, +CE	SOT-23-5	28hg	VR15	6a	Sii
PV7	S-1701E5041-M5T1	LVR/Vdet-IC	LDO, 5V±1%, 400mA, Vdet=4.1V, -Reset ODO, +CE	SOT-23-5	28hg	VR15	6a	Sii
PV8	S-1701E5042-M5T1	LVR/Vdet-IC	LDO, 5V±1%, 400mA, Vdet=4.2V, -Reset ODO, +CE	SOT-23-5	28hg	VR15	6a	Sii
PV9	S-1701E5043-M5T1	LVR/Vdet-IC	LDO, 5V±1%, 400mA, Vdet=4.3V, -Reset ODO, +CE	SOT-23-5	28hg	VR15	6a	Sii
PVA	S-1701D1815-M5T1	LVR/Vdet-IC	LDO, 1.8V±1%, 400mA, Vdet=1.5V, -Reset ODO, +CE	SOT-23-5	28hg	VR15	6a	Sii
PVB	S-1701D2520-M5T1	LVR/Vdet-IC	LDO, 2.5V±1%, 400mA, Vdet=2V, -Reset ODO, +CE	SOT-23-5	28hg	VR15	6a	Sii
PVC	S-1701D2521-M5T1	LVR/Vdet-IC	LDO, 2.5V±1%, 400mA, Vdet=2.1V, -Reset ODO, +CE	SOT-23-5	28hg	VR15	6a	Sii
PVD	S-1701D2522-M5T1	LVR/Vdet-IC	LDO, 2.5V±1%, 400mA, Vdet=2.2V, -Reset ODO, +CE	SOT-23-5	28hg	VR15	6a	Sii
PVE	S-1701D3024-M5T1	LVR/Vdet-IC	LDO, 3V±1%, 400mA, Vdet=2.4V, -Reset ODO, +CE	SOT-23-5	28hg	VR15	6a	Sii
PVF	S-1701D3025-M5T1	LVR/Vdet-IC	LDO, 3V±1%, 400mA, Vdet=2.5V, -Reset ODO, +CE	SOT-23-5	28hg	VR15	6a	Sii
PVG	S-1701D3026-M5T1	LVR/Vdet-IC	LDO, 3V±1%, 400mA, Vdet=2.6V, -Reset ODO, +CE	SOT-23-5	28hg	VR15	6a	Sii
PVH	S-1701D3326-M5T1	LVR/Vdet-IC	LDO, 3.3V±1%, 400mA, Vdet=2.6V, -Reset ODO, +CE	SOT-23-5	28hg	VR15	6a	Sii
PVI	S-1701D3327-M5T1	LVR/Vdet-IC	LDO, 3.3V±1%, 400mA, Vdet=2.7V, -Reset ODO, +CE	SOT-23-5	28hg	VR15	6a	Sii
PVJ	S-1701D3328-M5T1	LVR/Vdet-IC	LDO, 3.3V±1%, 400mA, Vdet=2.8V, -Reset ODO, +CE	SOT-23-5	28hg	VR15	6a	Sii
PVK	S-1701D5040-M5T1	LVR/Vdet-IC	LDO, 5V±1%, 400mA, Vdet=4V, -Reset ODO, +CE	SOT-23-5	28hg	VR15	6a	Sii
PVL	S-1701D5041-M5T1	LVR/Vdet-IC	LDO, 5V±1%, 400mA, Vdet=4.1V, -Reset ODO, +CE	SOT-23-5	28hg	VR15	6a	Sii
PVM	S-1701D5042-M5T1	LVR/Vdet-IC	LDO, 5V±1%, 400mA, Vdet=4.2V, -Reset ODO, +CE	SOT-23-5	28hg	VR15	6a	Sii
PVN	S-1701D5043-M5T1	LVR/Vdet-IC	LDO, 5V±1%, 400mA, Vdet=4.3V, -Reset ODO, +CE	SOT-23-5	28hg	VR15	6a	Sii
PVO	S-1701D3430-M5T1	LVR/Vdet-IC	LDO, 3.4V±1%, 400mA, Vdet=3V, -Reset ODO, +CE	SOT-23-5	28hg	VR15	6a	Sii
PVT	S-1701E1815-M5T1	LVR/Vdet-IC	LDO, 1.8V±1%, 400mA, Vdet=1.5V, -Reset ODO, +CE	SOT-23-5	28hg	VR15	6a	Sii
PVU	S-1701E2520-M5T1	LVR/Vdet-IC	LDO, 2.5V±1%, 400mA, Vdet=2V, -Reset ODO, +CE	SOT-23-5	28hg	VR15	6a	Sii
PVV	S-1701E2521-M5T1	LVR/Vdet-IC	LDO, 2.5V±1%, 400mA, Vdet=2.1V, -Reset ODO, +CE	SOT-23-5	28hg	VR15	6a	Sii
PVW	S-1701E2522-M5T1	LVR/Vdet-IC	LDO, 2.5V±1%, 400mA, Vdet=2.2V, -Reset ODO, +CE	SOT-23-5	28hg	VR15	6a	Sii
PVX	S-1701E3024-M5T1	LVR/Vdet-IC	LDO, 3V±1%, 400mA, Vdet=2.4V, -Reset ODO, +CE	SOT-23-5	28hg	VR15	6a	Sii
PVY	S-1701E3025-M5T1	LVR/Vdet-IC	LDO, 3V±1%, 400mA, Vdet=2.5V, -Reset ODO, +CE	SOT-23-5	28hg	VR15	6a	Sii
PVZ	S-1701E3026-M5T1	LVR/Vdet-IC	LDO, 3V±1%, 400mA, Vdet=2.6V, -Reset ODO, +CE	SOT-23-5	28hg	VR15	6a	Sii
pW	EUP7917-29N	LVR-IC	LDO, 2.9V±3%, 300mA, +CE	SC-70-5	28vrx	VR7	6k	Eut
pW	EUP7917-29V	LVR-IC	LDO, 2.9V±3%, 300mA, +CE	SOT-23-5	28vrx	VR7	6k	Eut
PW	BD5260FVE	Vdet-IC	6V, +Reset ODO	VSOFF-5	30ua	VD6	6c	Rhm
PW	BD5260G	Vdet-IC	6V, +Reset ODO	SSOP-5	28vdo	VD1	6c	Rhm
P̄W	PT7M7044NLTA	Vdet-IC	4.4V±1.5%, -Reset ODO	SOT-23-5	28vdr	VD6	6k	Pti
PW	PT7M7044NLTAE	Vdet-IC	4.4V±1.5%, -Reset ODO, Lead free	SOT-23-5	28vdr	VD6	6k	Pti
PW3	S-1701N2515-M5T1	LVR/Vdet-IC	LDO, 2.5V±1%, 400mA, Vdet=1.5V, -Reset ODO	SOT-23-5	28hh	VR14	6a	Sii
PW4	S-1701N2715-M5T1	LVR/Vdet-IC	LDO, 2.7V±1%, 400mA, Vdet=1.5V, -Reset ODO	SOT-23-5	28hh	VR14	6a	Sii
PW5	S-1701N3015-M5T1	LVR/Vdet-IC	LDO, 3V±1%, 400mA, Vdet=1.5V, -Reset ODO	SOT-23-5	28hh	VR14	6a	Sii
PW6	S-1701N3315-M5T1	LVR/Vdet-IC	LDO, 3.3V±1%, 400mA, Vdet=1.5V, -Reset ODO	SOT-23-5	28hh	VR14	6a	Sii



SMD code	Type	Function	Short description	Case	Pinout	Sch.	St.	Mnf.
PW7	S-1701N5015-M5T1	LVR/Vdet-IC	LDO, 5V±1%, 400mA, Vdet=1.5V, -Reset ODO	SOT-23-5	28hh	VR14	6a	Sii
PWA	S-1701E3430-M5T1	LVR/Vdet-IC	LDO, 3.4V±1%, 400mA, Vdet=3V, -Reset ODO, +CE	SOT-23-5	28hg	VR15	6a	Sii
PWF	S-1701F1815-M5T1	LVR/Vdet-IC	LDO, 1.8V±1%, 400mA, Vdet=1.5V, -Reset ODO, +CE	SOT-23-5	28hg	VR15	6a	Sii
PWG	S-1701F2520-M5T1	LVR/Vdet-IC	LDO, 2.5V±1%, 400mA, Vdet=2V, -Reset ODO, +CE	SOT-23-5	28hg	VR15	6a	Sii
PWH	S-1701F2521-M5T1	LVR/Vdet-IC	LDO, 2.5V±1%, 400mA, Vdet=2.1V, -Reset ODO, +CE	SOT-23-5	28hg	VR15	6a	Sii
PWI	S-1701F2522-M5T1	LVR/Vdet-IC	LDO, 2.5V±1%, 400mA, Vdet=2.2V, -Reset ODO, +CE	SOT-23-5	28hg	VR15	6a	Sii
PWJ	S-1701F3024-M5T1	LVR/Vdet-IC	LDO, 3V±1%, 400mA, Vdet=2.4V, -Reset ODO, +CE	SOT-23-5	28hg	VR15	6a	Sii
PWK	S-1701F3025-M5T1	LVR/Vdet-IC	LDO, 3V±1%, 400mA, Vdet=2.5V, -Reset ODO, +CE	SOT-23-5	28hg	VR15	6a	Sii
PWL	S-1701F3026-M5T1	LVR/Vdet-IC	LDO, 3V±1%, 400mA, Vdet=2.6V, -Reset ODO, +CE	SOT-23-5	28hg	VR15	6a	Sii
PWM	S-1701F3326-M5T1	LVR/Vdet-IC	LDO, 3.3V±1%, 400mA, Vdet=2.6V, -Reset ODO, +CE	SOT-23-5	28hg	VR15	6a	Sii
PWN	S-1701F3327-M5T1	LVR/Vdet-IC	LDO, 3.3V±1%, 400mA, Vdet=2.7V, -Reset ODO, +CE	SOT-23-5	28hg	VR15	6a	Sii
PWO	S-1701F3328-M5T1	LVR/Vdet-IC	LDO, 3.3V±1%, 400mA, Vdet=2.8V, -Reset ODO, +CE	SOT-23-5	28hg	VR15	6a	Sii
PWP	S-1701F5040-M5T1	LVR/Vdet-IC	LDO, 5V±1%, 400mA, Vdet=4V, -Reset ODO, +CE	SOT-23-5	28hg	VR15	6a	Sii
PWQ	S-1701F5041-M5T1	LVR/Vdet-IC	LDO, 5V±1%, 400mA, Vdet=4.1V, -Reset ODO, +CE	SOT-23-5	28hg	VR15	6a	Sii
PWR	S-1701F5042-M5T1	LVR/Vdet-IC	LDO, 5V±1%, 400mA, Vdet=4.2V, -Reset ODO, +CE	SOT-23-5	28hg	VR15	6a	Sii
PWS	S-1701F5043-M5T1	LVR/Vdet-IC	LDO, 5V±1%, 400mA, Vdet=4.3V, -Reset ODO, +CE	SOT-23-5	28hg	VR15	6a	Sii
PWT	S-1701F3430-M5T1	LVR/Vdet-IC	LDO, 3.4V±1%, 400mA, Vdet=3V, -Reset ODO, +CE	SOT-23-5	28hg	VR15	6a	Sii
PWY	S-1701N1515-M5T1	LVR/Vdet-IC	LDO, 1.5V±1%, 400mA, Vdet=1.5V, -Reset ODO	SOT-23-5	28hh	VR14	6a	Sii
PWZ	S-1701N1815-M5T1	LVR/Vdet-IC	LDO, 1.8V±1%, 400mA, Vdet=1.5V, -Reset ODO	SOT-23-5	28hh	VR14	6a	Sii
pX	EUP7917-13N	LVR-IC	LDO, 1.3V±3%, 300mA, -CE	SC-70-5	28vrx	VR7	6k	Eut
pX	EUP7917-13V	LVR-IC	LDO, 1.3V±3%, 300mA, +CE	SOT-23-5	28vrx	VR7	6k	Eut
PX	PT7M7045CLTA	Vdet-IC	4.5V±1.5%, -Reset PPO	SOT-23-5	28vdr	VD7	6k	Pti
PX	PT7M7045CLTAE	Vdet-IC	4.5V±1.5%, -Reset PPO, Lead free	SOT-23-5	28vdr	VD7	6k	Pti
PX3	S-1701Q1815-M5T1	LVR/Vdet-IC	LDO, 1.8V±1%, 400mA, Vdet=1.5V, -Reset ODO	SOT-23-5	28hh	VR14	6a	Sii
PX4	S-1701Q2515-M5T1	LVR/Vdet-IC	LDO, 2.5V±1%, 400mA, Vdet=1.5V, -Reset ODO	SOT-23-5	28hh	VR14	6a	Sii
PX5	S-1701Q2715-M5T1	LVR/Vdet-IC	LDO, 2.74V±1%, 400mA, Vdet=1.5V, -Reset ODO	SOT-23-5	28hh	VR14	6a	Sii
PX6	S-1701Q3015-M5T1	LVR/Vdet-IC	LDO, 3V±1%, 400mA, Vdet=1.5V, -Reset ODO	SOT-23-5	28hh	VR14	6a	Sii
PX7	S-1701Q3315-M5T1	LVR/Vdet-IC	LDO, 3.3V±1%, 400mA, Vdet=1.5V, -Reset ODO	SOT-23-5	28hh	VR14	6a	Sii
PX8	S-1701Q5015-M5T1	LVR/Vdet-IC	LDO, 5V±1%, 400mA, Vdet=1.5V, -Reset ODO	SOT-23-5	28hh	VR14	6a	Sii
PXI	S-1701P1515-M5T1	LVR/Vdet-IC	LDO, 1.5V±1%, 400mA, Vdet=1.5V, -Reset ODO	SOT-23-5	28hh	VR14	6a	Sii
PXJ	S-1701P1815-M5T1	LVR/Vdet-IC	LDO, 1.8V±1%, 400mA, Vdet=1.5V, -Reset ODO	SOT-23-5	28hh	VR14	6a	Sii
PXK	S-1701P2515-M5T1	LVR/Vdet-IC	LDO, 2.5V±1%, 400mA, Vdet=1.5V, -Reset ODO	SOT-23-5	28hh	VR14	6a	Sii
PXL	S-1701P2715-M5T1	LVR/Vdet-IC	LDO, 2.74V±1%, 400mA, Vdet=1.5V, -Reset ODO	SOT-23-5	28hh	VR14	6a	Sii
PXM	S-1701P3015-M5T1	LVR/Vdet-IC	LDO, 3V±1%, 400mA, Vdet=1.5V, -Reset ODO	SOT-23-5	28hh	VR14	6a	Sii
PXN	S-1701P3315-M5T1	LVR/Vdet-IC	LDO, 3.3V±1%, 400mA, Vdet=1.5V, -Reset ODO	SOT-23-5	28hh	VR14	6a	Sii
PXO	S-1701P5015-M5T1	LVR/Vdet-IC	LDO, 5V±1%, 400mA, Vdet=1.5V, -Reset ODO	SOT-23-5	28hh	VR14	6a	Sii
PXZ	S-1701Q1515-M5T1	LVR/Vdet-IC	LDO, 1.5V±1%, 400mA, Vdet=1.5V, -Reset ODO	SOT-23-5	28hh	VR14	6a	Sii
PY	PT7M7045CHTA	Vdet-IC	4.5V±1.5%, +Reset PPO	SOT-23-5	28vdr	VD7	6k	Pti
PY	TC1186-1.8VCT713	LVR-IC	LDO, 1.8V±3%, 150mA, +CE, -Error	SOT-23-5	28w	VR8	6g	Mcc
PY	PT7M7045CHTAE	Vdet-IC	4.5V±1.5%, +Reset PPO, Lead free	SOT-23-5	28vdr	VD7	6k	Pti
PYE	S-1701R1515-M5T1	LVR/Vdet-IC	LDO, 1.5V±1%, 400mA, Vdet=1.5V, -Reset ODO	SOT-23-5	28hh	VR14	6a	Sii
PYF	S-1701R1815-M5T1	LVR/Vdet-IC	LDO, 1.8V±1%, 400mA, Vdet=1.5V, -Reset ODO	SOT-23-5	28hh	VR14	6a	Sii
PYG	S-1701R2515-M5T1	LVR/Vdet-IC	LDO, 2.5V±1%, 400mA, Vdet=1.5V, -Reset ODO	SOT-23-5	28hh	VR14	6a	Sii
PYH	S-1701R2715-M5T1	LVR/Vdet-IC	LDO, 2.74V±1%, 400mA, Vdet=1.5V, -Reset ODO	SOT-23-5	28hh	VR14	6a	Sii
PYI	S-1701R3015-M5T1	LVR/Vdet-IC	LDO, 3V±1%, 400mA, Vdet=1.5V, -Reset ODO	SOT-23-5	28hh	VR14	6a	Sii
PYJ	S-1701R3315-M5T1	LVR/Vdet-IC	LDO, 3.3V±1%, 400mA, Vdet=1.5V, -Reset ODO	SOT-23-5	28hh	VR14	6a	Sii
PYK	S-1701R5015-M5T1	LVR/Vdet-IC	LDO, 5V±1%, 400mA, Vdet=1.5V, -Reset ODO	SOT-23-5	28hh	VR14	6a	Sii
PYQ	S-1701S1515-M5T1	LVR/Vdet-IC	LDO, 1.5V±1%, 400mA, Vdet=1.5V, -Reset ODO	SOT-23-5	28hh	VR14	6a	Sii
PYR	S-1701S1815-M5T1	LVR/Vdet-IC	LDO, 1.8V±1%, 400mA, Vdet=1.5V, -Reset ODO	SOT-23-5	28hh	VR14	6a	Sii
PYS	S-1701S2515-M5T1	LVR/Vdet-IC	LDO, 2.5V±1%, 400mA, Vdet=1.5V, -Reset ODO	SOT-23-5	28hh	VR14	6a	Sii
PYT	S-1701S2715-M5T1	LVR/Vdet-IC	LDO, 2.74V±1%, 400mA, Vdet=1.5V, -Reset ODO	SOT-23-5	28hh	VR14	6a	Sii
PYU	S-1701S3015-M5T1	LVR/Vdet-IC	LDO, 3V±1%, 400mA, Vdet=1.5V, -Reset ODO	SOT-23-5	28hh	VR14	6a	Sii
PYV	S-1701S3315-M5T1	LVR/Vdet-IC	LDO, 3.3V±1%, 400mA, Vdet=1.5V, -Reset ODO	SOT-23-5	28hh	VR14	6a	Sii
PYW	S-1701S5015-M5T1	LVR/Vdet-IC	LDO, 5V±1%, 400mA, Vdet=1.5V, -Reset ODO	SOT-23-5	28hh	VR14	6a	Sii
PZ	PT7M7045NLTA	Vdet-IC	4.5V±1.5%, -Reset ODO	SOT-23-5	28vdr	VD6	6k	Pti
PZ	TC1186-2.8VCT713	LVR-IC	LDO, 2.8V±3%, 150mA, +CE, -Error	SOT-23-5	28w	VR8	6g	Mcc
PZ	PT7M7045NLTAE	Vdet-IC	4.5V±1.5%, -Reset ODO, Lead free	SOT-23-5	28vdr	VD6	6k	Pti
PZ3	S-1701U3328-M5T1	LVR/Vdet-IC	LDO, 3.3V±1%, 400mA, Vdet=2.8V, -Reset ODO	SOT-23-5	28hj	VR13	6a	Sii
PZ4	S-1701U5040-M5T1	LVR/Vdet-IC	LDO, 5V±1%, 400mA, Vdet=4V, -Reset ODO	SOT-23-5	28hj	VR13	6a	Sii
PZ5	S-1701U5041-M5T1	LVR/Vdet-IC	LDO, 5V±1%, 400mA, Vdet=4.1V, -Reset ODO	SOT-23-5	28hj	VR13	6a	Sii
PZ6	S-1701U5042-M5T1	LVR/Vdet-IC	LDO, 5V±1%, 400mA, Vdet=4.2V, -Reset ODO	SOT-23-5	28hj	VR13	6a	Sii
PZ7	S-1701U5043-M5T1	LVR/Vdet-IC	LDO, 5V±1%, 400mA, Vdet=4.3V, -Reset ODO	SOT-23-5	28hj	VR13	6a	Sii
PZ8	S-1701U3430-M5T1	LVR/Vdet-IC	LDO, 3.4V±1%, 400mA, Vdet=3V, -Reset ODO	SOT-23-5	28hj	VR13	6a	Sii
PZA	S-1701T1515-M5T1	LVR/Vdet-IC	LDO, 1.5V±1%, 400mA, Vdet=1.5V, -Reset ODO	SOT-23-5	28hh	VR14	6a	Sii
PZB	S-1701T1815-M5T1	LVR/Vdet-IC	LDO, 1.8V±1%, 400mA, Vdet=1.5V, -Reset ODO	SOT-23-5	28hh	VR14	6a	Sii
PZC	S-1701T2515-M5T1	LVR/Vdet-IC	LDO, 2.5V±1%, 400mA, Vdet=1.5V, -Reset ODO	SOT-23-5	28hh	VR14	6a	Sii
PZD	S-1701T2715-M5T1	LVR/Vdet-IC	LDO, 2.7V±1%, 400mA, Vdet=1.5V, -Reset ODO	SOT-23-5	28hh	VR14	6a	Sii
PZE	S-1701T3015-M5T1	LVR/Vdet-IC	LDO, 3V±1%, 400mA, Vdet=1.5V, -Reset ODO	SOT-23-5	28hh	VR14	6a	Sii
PZF	S-1701T3315-M5T1	LVR/Vdet-IC	LDO, 3.3V±1%, 400mA, Vdet=1.5V, -Reset ODO	SOT-23-5	28hh	VR14	6a	Sii
PZG	S-1701T5015-M5T1	LVR/Vdet-IC	LDO, 5V±1%, 400mA, Vdet=1.5V, -Reset ODO	SOT-23-5	28hh	VR14	6a	Sii



SMD code	Type	Function	Short description	Case	Pinout	Sch.	St.	Mnf.
PZR	S-1701U1815-M5T1	LVR/Vdet-IC	LDO, 1.8V±1%, 400mA, Vdet=1.5V, -Reset ODO	SOT-23-5	28hj	VR13	6a	Sii
PZS	S-1701U2520-M5T1	LVR/Vdet-IC	LDO, 2.5V±1%, 400mA, Vdet=2V, -Reset ODO	SOT-23-5	28hj	VR13	6a	Sii
PZT	S-1701U2521-M5T1	LVR/Vdet-IC	LDO, 2.5V±1%, 400mA, Vdet=2.1V, -Reset ODO	SOT-23-5	28hj	VR13	6a	Sii
PZU	S-1701U2522-M5T1	LVR/Vdet-IC	LDO, 2.5V±1%, 400mA, Vdet=2.2V, -Reset ODO	SOT-23-5	28hj	VR13	6a	Sii
PZV	S-1701U3024-M5T1	LVR/Vdet-IC	LDO, 3V±1%, 400mA, Vdet=2.4V, -Reset ODO	SOT-23-5	28hj	VR13	6a	Sii
PZW	S-1701U3025-M5T1	LVR/Vdet-IC	LDO, 3V±1%, 400mA, Vdet=2.5V, -Reset ODO	SOT-23-5	28hj	VR13	6a	Sii
PZX	S-1701U3026-M5T1	LVR/Vdet-IC	LDO, 3V±1%, 400mA, Vdet=2.6V, -Reset ODO	SOT-23-5	28hj	VR13	6a	Sii
PZY	S-1701U3326-M5T1	LVR/Vdet-IC	LDO, 3.3V±1%, 400mA, Vdet=2.6V, -Reset ODO	SOT-23-5	28hj	VR13	6a	Sii
PZZ	S-1701U3327-M5T1	LVR/Vdet-IC	LDO, 3.3V±1%, 400mA, Vdet=2.7V, -Reset ODO	SOT-23-5	28hj	VR13	6a	Sii
Q00	R1161N281B5	LVR-IC	LDO, 2.85V±2%, 350mA, +CE, AE(Mode)	SOT-23-5	28x9	VR10	6g	Ric
Q001	RP106Q072B	LVR-IC	LDO, 0.7V±0.8%, 400mA, +CE	SC-88A	28xm	VR4	6m	Ric
Q002	RP106Q082B	LVR-IC	LDO, 0.8V±0.8%, 400mA, +CE	SC-88A	28xm	VR4	6m	Ric
Q003	RP106Q092B	LVR-IC	LDO, 0.9V±0.8%, 400mA, +CE	SC-88A	28xm	VR4	6m	Ric
Q004	RP106Q102B	LVR-IC	LDO, 1.0V±0.8%, 400mA, +CE	SC-88A	28xm	VR4	6m	Ric
Q005	RP106Q112B	LVR-IC	LDO, 1.1V±0.8%, 400mA, +CE	SC-88A	28xm	VR4	6m	Ric
Q006	RP106Q122B	LVR-IC	LDO, 1.2V±0.8%, 400mA, +CE	SC-88A	28xm	VR4	6m	Ric
Q007	RP106Q132B	LVR-IC	LDO, 1.3V±0.8%, 400mA, +CE	SC-88A	28xm	VR4	6m	Ric
Q008	RP106Q142B	LVR-IC	LDO, 1.4V±0.8%, 400mA, +CE	SC-88A	28xm	VR4	6m	Ric
Q009	RP106Q152B	LVR-IC	LDO, 1.5V±0.8%, 400mA, +CE	SC-88A	28xm	VR4	6m	Ric
Q010	RP106Q162B	LVR-IC	LDO, 1.6V±0.8%, 400mA, +CE	SC-88A	28xm	VR4	6m	Ric
Q011	RP106Q172B	LVR-IC	LDO, 1.7V±0.8%, 400mA, +CE	SC-88A	28xm	VR4	6m	Ric
Q012	RP106Q182B	LVR-IC	LDO, 1.8V±0.8%, 400mA, +CE	SC-88A	28xm	VR4	6m	Ric
Q013	RP106Q102B5	LVR-IC	LDO, 1.05V±0.8%, 400mA, +CE	SC-88A	28xm	VR4	6m	Ric
Q014	RP106Q122B5	LVR-IC	LDO, 1.25V±0.8%, 400mA, +CE	SC-88A	28xm	VR4	6m	Ric
Q015	RP106Q182B5	LVR-IC	LDO, 1.85V±0.8%, 400mA, +CE	SC-88A	28xm	VR4	6m	Ric
Q016	RP106Q112B5	LVR-IC	LDO, 1.15V±0.8%, 400mA, +CE	SC-88A	28xm	VR4	6m	Ric
Q08	R1161N081B	LVR-IC	LDO, 0.8V±2%, 350mA, +CE, AE(Mode)	SOT-23-5	28x9	VR10	6g	Ric
Q09	NCP585HSN09T1	LVR-IC	LDO, 0.9V±2%, 350mA, +CE, CL, AE(Mode)	SOT-23-5	28x9	VR10	6g	Ons
Q09	R1161N091B	LVR-IC	LDO, 0.9V±2%, 350mA, +CE, AE(Mode)	SOT-23-5	28x9	VR10	6g	Ric
Q0A	RP200N321B	LVR-IC	LDO, 3.2V±1.0%, 300mA, +CE, AE(mode)	SOT-23-5	28x9	VR10	6g	Ric
Q0B	RP200N331B	LVR-IC	LDO, 3.3V±1.0%, 300mA, +CE, AE(mode)	SOT-23-5	28x9	VR10	6g	Ric
Q0C	RP200N341B	LVR-IC	LDO, 3.4V±1.0%, 300mA, +CE, AE(mode)	SOT-23-5	28x9	VR10	6g	Ric
Q0D	RP200N351B	LVR-IC	LDO, 3.5V±1.0%, 300mA, +CE, AE(mode)	SOT-23-5	28x9	VR10	6g	Ric
Q0E	RP200N361B	LVR-IC	LDO, 3.6V±1.0%, 300mA, +CE, AE(mode)	SOT-23-5	28x9	VR10	6g	Ric
Q0F	RP200N371B	LVR-IC	LDO, 3.7V±1.0%, 300mA, +CE, AE(mode)	SOT-23-5	28x9	VR10	6g	Ric
Q0G	RP200N381B	LVR-IC	LDO, 3.8V±1.0%, 300mA, +CE, AE(mode)	SOT-23-5	28x9	VR10	6g	Ric
Q0H	RP200N391B	LVR-IC	LDO, 3.9V±1.0%, 300mA, +CE, AE(mode)	SOT-23-5	28x9	VR10	6g	Ric
Q0J	RP200N401B	LVR-IC	LDO, 4V±1.0%, 300mA, +CE, AE(mode)	SOT-23-5	28x9	VR10	6g	Ric
Q10	NCP585HSN10T1	LVR-IC	LDO, 1.0V±2%, 350mA, +CE, CL, AE(Mode)	SOT-23-5	28x9	VR10	6g	Ons
Q10	R1161N101B	LVR-IC	LDO, 1V±2%, 350mA, +CE, AE(Mode)	SOT-23-5	28x9	VR10	6g	Ric
Q11	R1161N111B	LVR-IC	LDO, 1.1V±2%, 350mA, +CE, AE(Mode)	SOT-23-5	28x9	VR10	6g	Ric
Q12	NCP585HSN12T1	LVR-IC	LDO, 1.2V±2%, 350mA, +CE, CL, AE(Mode)	SOT-23-5	28x9	VR10	6g	Ons
Q12	R1161N121B	LVR-IC	LDO, 1.2V±2%, 350mA, +CE, AE(Mode)	SOT-23-5	28x9	VR10	6g	Ric
Q13	R1161N131B	LVR-IC	LDO, 1.3V±2%, 350mA, +CE, AE(Mode)	SOT-23-5	28x9	VR10	6g	Ric
Q14	R1161N141B	LVR-IC	LDO, 1.4V±2%, 350mA, +CE, AE(Mode)	SOT-23-5	28x9	VR10	6g	Ric
Q15	R1161N151B	LVR-IC	LDO, 1.5V±2%, 350mA, +CE, AE(Mode)	SOT-23-5	28x9	VR10	6g	Ric
Q16	R1161N161B	LVR-IC	LDO, 1.6V±2%, 350mA, +CE, AE(Mode)	SOT-23-5	28x9	VR10	6g	Ric
Q17	R1161N171B	LVR-IC	LDO, 1.7V±2%, 350mA, +CE, AE(Mode)	SOT-23-5	28x9	VR10	6g	Ric
Q18	NCP585HSN18T1	LVR-IC	LDO, 1.8V±2%, 350mA, +CE, CL, AE(Mode)	SOT-23-5	28x9	VR10	6g	Ons
Q18	R1161N181B	LVR-IC	LDO, 1.8V±2%, 350mA, +CE, AE(Mode)	SOT-23-5	28x9	VR10	6g	Ric
Q19	R1161N191B	LVR-IC	LDO, 1.9V±2%, 350mA, +CE, AE(Mode)	SOT-23-5	28x9	VR10	6g	Ric
Q1A	RP200N321D	LVR-IC	LDO, 3.2V±1.0%, 300mA, +CE, CL, AE(mode)	SOT-23-5	28x9	VR10	6g	Ric
Q1B	RP200N331D	LVR-IC	LDO, 3.3V±1.0%, 300mA, +CE, CL, AE(mode)	SOT-23-5	28x9	VR10	6g	Ric
Q1C	RP200N341D	LVR-IC	LDO, 3.4V±1.0%, 300mA, +CE, CL, AE(mode)	SOT-23-5	28x9	VR10	6g	Ric
Q1D	RP200N351D	LVR-IC	LDO, 3.5V±1.0%, 300mA, +CE, CL, AE(mode)	SOT-23-5	28x9	VR10	6g	Ric
Q1E	RP200N361D	LVR-IC	LDO, 3.6V±1.0%, 300mA, +CE, CL, AE(mode)	SOT-23-5	28x9	VR10	6g	Ric
Q1F	RP200N371D	LVR-IC	LDO, 3.7V±1.0%, 300mA, +CE, CL, AE(mode)	SOT-23-5	28x9	VR10	6g	Ric
Q1G	RP200N381D	LVR-IC	LDO, 3.8V±1.0%, 300mA, +CE, CL, AE(mode)	SOT-23-5	28x9	VR10	6g	Ric
Q1H	RP200N391D	LVR-IC	LDO, 3.9V±1.0%, 300mA, +CE, CL, AE(mode)	SOT-23-5	28x9	VR10	6g	Ric
Q1J	RP200N401D	LVR-IC	LDO, 4V±1.0%, 300mA, +CE, CL, AE(mode)	SOT-23-5	28x9	VR10	6g	Ric
Q20	R1161N201B	LVR-IC	LDO, 2V±2%, 350mA, +CE, AE(Mode)	SOT-23-5	28x9	VR10	6g	Ric
Q21	R1161N211B	LVR-IC	LDO, 2.1V±2%, 350mA, +CE, AE(Mode)	SOT-23-5	28x9	VR10	6g	Ric
Q22	R1161N221B	LVR-IC	LDO, 2.2V±2%, 350mA, +CE, AE(Mode)	SOT-23-5	28x9	VR10	6g	Ric
Q23	R1161N231B	LVR-IC	LDO, 2.3V±2%, 350mA, +CE, AE(Mode)	SOT-23-5	28x9	VR10	6g	Ric
Q24	R1161N241B	LVR-IC	LDO, 2.4V±2%, 350mA, +CE, AE(Mode)	SOT-23-5	28x9	VR10	6g	Ric
Q25	R1161N251B	LVR-IC	LDO, 2.5V±2%, 350mA, +CE, AE(Mode)	SOT-23-5	28x9	VR10	6g	Ric
Q26	R1161N261B	LVR-IC	LDO, 2.6V±2%, 350mA, +CE, AE(Mode)	SOT-23-5	28x9	VR10	6g	Ric
Q27	R1161N271B	LVR-IC	LDO, 2.7V±2%, 350mA, +CE, AE(Mode)	SOT-23-5	28x9	VR10	6g	Ric
Q28	R1161N281B	LVR-IC	LDO, 2.8V±2%, 350mA, +CE, AE(Mode)	SOT-23-5	28x9	VR10	6g	Ric
Q29	R1161N291B	LVR-IC	LDO, 2.9V±2%, 350mA, +CE, AE(Mode)	SOT-23-5	28x9	VR10	6g	Ric



SMD code	Type	Function	Short description	Case	Pinout	Sch.	St.	Mnf.
Q30	NCP585HSN30T1	LVR-IC	LDO, 3.0V±2%, 350mA, +CE, CL, AE(Mode)	SOT-23-5	28x9	VR10	6g	Ons
Q30	R1161N301B	LVR-IC	LDO, 3V±2%, 350mA, +CE, AE(Mode)	SOT-23-5	28x9	VR10	6g	Ric
Q31	R1161N311B	LVR-IC	LDO, 3.1V±2%, 350mA, +CE, AE(Mode)	SOT-23-5	28x9	VR10	6g	Ric
Q32	R1161N321B	LVR-IC	LDO, 3.2V±2%, 350mA, +CE, AE(Mode)	SOT-23-5	28x9	VR10	6g	Ric
Q33	R1161N331B	LVR-IC	LDO, 3.3V±2%, 350mA, +CE, AE(Mode)	SOT-23-5	28x9	VR10	6g	Ric
Q4	KTC601F-Y	Si-npn	Dual GP, 50V, 150mA, 100mW, B=120..240, 80MHz	TFSV	30/T11	-	6l	Kec
Q5	R1121N151A	LVR-IC	LDO, LN, -CE, 1.5V±2%, 150mA	SOT-23-5	28vt	VR4	6g	Ric
Q6	KTC601F-GR	Si-npn	Dual GP, 50V, 150mA, 100mW, B=200..400, 80MHz	TFSV	30/T11	-	6l	Kec
Q6	R1121N161A	LVR-IC	LDO, LN, -CE, 1.6V±2%, 150mA	SOT-23-5	28vt	VR4	6g	Ric
Q7	R1121N171A	LVR-IC	LDO, LN, -CE, 1.7V±2%, 150mA	SOT-23-5	28vt	VR4	6g	Ric
Q8	R1121N181A	LVR-IC	LDO, LN, -CE, 1.8V±2%, 150mA	SOT-23-5	28vt	VR4	6g	Ric
Q9	R1121N191A	LVR-IC	LDO, LN, -CE, 1.9V±2%, 150mA	SOT-23-5	28vt	VR4	6g	Ric
QA	PT7M7046CLTA	Vdet-IC	4.6V±1.5%, -Reset PPO	SOT-23-5	28vdr	VD7	6k	Pti
QA	PT7M7046CLTAE	Vdet-IC	4.6V±1.5%, -Reset PPO, Lead free	SOT-23-5	28vdr	VD7	6k	Pti
QAA	RP114N081B	LVR-IC	LDO, 0.8V±1%, 300mA, +CE	SOT-23-5	28cx	VR4	6g	Ric
QAB	RP114N091B	LVR-IC	LDO, 0.9V±1%, 300mA, +CE	SOT-23-5	28cx	VR4	6g	Ric
QAC	RP114N101B	LVR-IC	LDO, 1.0V±1%, 300mA, +CE	SOT-23-5	28cx	VR4	6g	Ric
QAD	RP114N111B	LVR-IC	LDO, 1.1V±1%, 300mA, +CE	SOT-23-5	28cx	VR4	6g	Ric
QAE	RP114N121B	LVR-IC	LDO, 1.2V±1%, 300mA, +CE	SOT-23-5	28cx	VR4	6g	Ric
QAF	RP114N131B	LVR-IC	LDO, 1.3V±1%, 300mA, +CE	SOT-23-5	28cx	VR4	6g	Ric
QAG	RP114N141B	LVR-IC	LDO, 1.4V±1%, 300mA, +CE	SOT-23-5	28cx	VR4	6g	Ric
QAH	RP114N151B	LVR-IC	LDO, 1.5V±1%, 300mA, +CE	SOT-23-5	28cx	VR4	6g	Ric
QAJ	RP114N161B	LVR-IC	LDO, 1.6V±1%, 300mA, +CE	SOT-23-5	28cx	VR4	6g	Ric
QAK	RP114N171B	LVR-IC	LDO, 1.7V±1%, 300mA, +CE	SOT-23-5	28cx	VR4	6g	Ric
QAL	RP114N181B	LVR-IC	LDO, 1.8V±1%, 300mA, +CE	SOT-23-5	28cx	VR4	6g	Ric
QAM	RP114N191B	LVR-IC	LDO, 1.9V±1%, 300mA, +CE	SOT-23-5	28cx	VR4	6g	Ric
QAN	RP114N201B	LVR-IC	LDO, 2.0V±1%, 300mA, +CE	SOT-23-5	28cx	VR4	6g	Ric
QAP	RP114N211B	LVR-IC	LDO, 2.1V±1%, 300mA, +CE	SOT-23-5	28cx	VR4	6g	Ric
QAQ	RP114N221B	LVR-IC	LDO, 2.2V±1%, 300mA, +CE	SOT-23-5	28cx	VR4	6g	Ric
QAR	RP114N231B	LVR-IC	LDO, 2.3V±1%, 300mA, +CE	SOT-23-5	28cx	VR4	6g	Ric
QAS	RP114N241B	LVR-IC	LDO, 2.4V±1%, 300mA, +CE	SOT-23-5	28cx	VR4	6g	Ric
QAT	RP114N251B	LVR-IC	LDO, 2.5V±1%, 300mA, +CE	SOT-23-5	28cx	VR4	6g	Ric
QAU	RP114N261B	LVR-IC	LDO, 2.6V±1%, 300mA, +CE	SOT-23-5	28cx	VR4	6g	Ric
QAV	RP114N271B	LVR-IC	LDO, 2.7V±1%, 300mA, +CE	SOT-23-5	28cx	VR4	6g	Ric
QAW	RP114N281B	LVR-IC	LDO, 2.8V±1%, 300mA, +CE	SOT-23-5	28cx	VR4	6g	Ric
QAX	RP114N291B	LVR-IC	LDO, 2.9V±1%, 300mA, +CE	SOT-23-5	28cx	VR4	6g	Ric
QAY	RP114N301B	LVR-IC	LDO, 3.0V±1%, 300mA, +CE	SOT-23-5	28cx	VR4	6g	Ric
QAZ	RP114N311B	LVR-IC	LDO, 3.1V±1%, 300mA, +CE	SOT-23-5	28cx	VR4	6g	Ric
QB	PT7M7046CHTA	Vdet-IC	4.6V±1.5%, +Reset PPO	SOT-23-5	28vdr	VD7	6k	Pti
QB	PT7M7046CHTAE	Vdet-IC	4.6V±1.5%, +Reset PPO, Lead free	SOT-23-5	28vdr	VD7	6k	Pti
QBA	RP114N081D	LVR-IC	LDO, 0.8V±1%, 300mA, +CE, CL	SOT-23-5	28cx	VR4	6g	Ric
QBB	RP114N091D	LVR-IC	LDO, 0.9V±1%, 300mA, +CE, CL	SOT-23-5	28cx	VR4	6g	Ric
QBC	RP114N101D	LVR-IC	LDO, 1.0V±1%, 300mA, +CE, CL	SOT-23-5	28cx	VR4	6g	Ric
QBD	RP114N111D	LVR-IC	LDO, 1.1V±1%, 300mA, +CE, CL	SOT-23-5	28cx	VR4	6g	Ric
QBE	RP114N121D	LVR-IC	LDO, 1.2V±1%, 300mA, +CE, CL	SOT-23-5	28cx	VR4	6g	Ric
QBF	RP114N131D	LVR-IC	LDO, 1.3V±1%, 300mA, +CE, CL	SOT-23-5	28cx	VR4	6g	Ric
QBG	RP114N141D	LVR-IC	LDO, 1.4V±1%, 300mA, +CE, CL	SOT-23-5	28cx	VR4	6g	Ric
QBH	RP114N151D	LVR-IC	LDO, 1.5V±1%, 300mA, +CE, CL	SOT-23-5	28cx	VR4	6g	Ric
QBJ	RP114N161D	LVR-IC	LDO, 1.6V±1%, 300mA, +CE, CL	SOT-23-5	28cx	VR4	6g	Ric
QBL	RP114N171D	LVR-IC	LDO, 1.7V±1%, 300mA, +CE, CL	SOT-23-5	28cx	VR4	6g	Ric
QBK	RP114N181D	LVR-IC	LDO, 1.8V±1%, 300mA, +CE, CL	SOT-23-5	28cx	VR4	6g	Ric
QBM	RP114N191D	LVR-IC	LDO, 1.9V±1%, 300mA, +CE, CL	SOT-23-5	28cx	VR4	6g	Ric
QBN	RP114N201D	LVR-IC	LDO, 2.0V±1%, 300mA, +CE, CL	SOT-23-5	28cx	VR4	6g	Ric
QBP	RP114N211D	LVR-IC	LDO, 2.1V±1%, 300mA, +CE, CL	SOT-23-5	28cx	VR4	6g	Ric
QBQ	RP114N221D	LVR-IC	LDO, 2.2V±1%, 300mA, +CE, CL	SOT-23-5	28cx	VR4	6g	Ric
QBR	RP114N231D	LVR-IC	LDO, 2.3V±1%, 300mA, +CE, CL	SOT-23-5	28cx	VR4	6g	Ric
QBS	RP114N241D	LVR-IC	LDO, 2.4V±1%, 300mA, +CE, CL	SOT-23-5	28cx	VR4	6g	Ric
QBT	RP114N251D	LVR-IC	LDO, 2.5V±1%, 300mA, +CE, CL	SOT-23-5	28cx	VR4	6g	Ric
QBU	RP114N261D	LVR-IC	LDO, 2.6V±1%, 300mA, +CE, CL	SOT-23-5	28cx	VR4	6g	Ric
QBV	RP114N271D	LVR-IC	LDO, 2.7V±1%, 300mA, +CE, CL	SOT-23-5	28cx	VR4	6g	Ric
QBW	RP114N281D	LVR-IC	LDO, 2.8V±1%, 300mA, +CE, CL	SOT-23-5	28cx	VR4	6g	Ric
QBX	RP114N291D	LVR-IC	LDO, 2.9V±1%, 300mA, +CE, CL	SOT-23-5	28cx	VR4	6g	Ric
QBY	RP114N301D	LVR-IC	LDO, 3.0V±1%, 300mA, +CE, CL	SOT-23-5	28cx	VR4	6g	Ric
QBZ	RP114N311D	LVR-IC	LDO, 3.1V±1%, 300mA, +CE, CL	SOT-23-5	28cx	VR4	6g	Ric
QC	PT7M7046NLTA	Vdet-IC	4.6V±1.5%, -Reset ODO	SOT-23-5	28vdr	VD6	6k	Pti
QC	PT7M7046NLTAE	Vdet-IC	4.6V±1.5%, -Reset ODO, Lead free	SOT-23-5	28vdr	VD6	6k	Pti
QD	BD5323FVE	Vdet-IC	2.3V, +Reset PPO	VSOFF-5	30ua	VD7	6c	Rhm
QD	BD5323G	Vdet-IC	2.3V, +Reset PPO	SSOP-5	28vdo	VD3	6c	Rhm
QD	PT7M7047CLTA	Vdet-IC	4.7V±1.5%, -Reset PPO	SOT-23-5	28vdr	VD7	6k	Pti
QD	PT7M7047CLTAE	Vdet-IC	4.7V±1.5%, -Reset PPO, Lead free	SOT-23-5	28vdr	VD7	6k	Pti



SMD code	Type	Function	Short description	Case	Pinout	Sch.	St.	Mnf.
QE	BD5324FVE	Vdet-IC	2.4V, +Reset PPO	VSOFF-5	30ua	VD7	6c	Rhm
QE	BD5324G	Vdet-IC	2.4V, +Reset PPO	SSOP-5	28vdo	VD3	6c	Rhm
QE	PT7M7047CHTA	Vdet-IC	4.7V±1.5%, +Reset PPO	SOT-23-5	28vdr	VD7	6k	Pti
QE	PT7M7047CHTAE	Vdet-IC	4.7V±1.5%, +Reset PPO, Lead free	SOT-23-5	28vdr	VD7	6k	Pti
QF	BD5325FVE	Vdet-IC	2.5V, +Reset PPO	VSOFF-5	30ua	VD7	6c	Rhm
QF	BD5325G	Vdet-IC	2.5V, +Reset PPO	SSOP-5	28vdo	VD3	6c	Rhm
QF	PT7M7047NLTA	Vdet-IC	4.7V±1.5%, -Reset ODO	SOT-23-5	28vdr	VD6	6k	Pti
QF	PT7M7047NLTAE	Vdet-IC	4.7V±1.5%, -Reset ODO, Lead free	SOT-23-5	28vdr	VD6	6k	Pti
QG	BD5326FVE	Vdet-IC	2.6V, +Reset PPO	VSOFF-5	30ua	VD7	6c	Rhm
QG	BD5326G	Vdet-IC	2.6V, +Reset PPO	SSOP-5	28vdo	VD3	6c	Rhm
QG	PT7M7048CLTA	Vdet-IC	4.8V±1.5%, -Reset PPO	SOT-23-5	28vdr	VD7	6k	Pti
QG	PT7M7048CLTAE	Vdet-IC	4.8V±1.5%, -Reset PPO, Lead free	SOT-23-5	28vdr	VD7	6k	Pti
QH	BD5327FVE	Vdet-IC	2.7V, +Reset PPO	VSOFF-5	30ua	VD7	6c	Rhm
QH	BD5327G	Vdet-IC	2.7V, +Reset PPO	SSOP-5	28vdo	VD3	6c	Rhm
QH	PT7M7048CHTA	Vdet-IC	4.8V±1.5%, +Reset PPO	SOT-23-5	28vdr	VD7	6k	Pti
QH	PT7M7048CHTAE	Vdet-IC	4.8V±1.5%, +Reset PPO, Lead free	SOT-23-5	28vdr	VD7	6k	Pti
QI	PT7M7048NLTA	Vdet-IC	4.8V±1.5%, -Reset ODO	SOT-23-5	28vdr	VD6	6k	Pti
QI	PT7M7048NLTAE	Vdet-IC	4.8V±1.5%, -Reset ODO, Lead free	SOT-23-5	28vdr	VD6	6k	Pti
QJ	BD5328FVE	Vdet-IC	2.8V, +Reset PPO	VSOFF-5	30ua	VD7	6c	Rhm
QJ	BD5328G	Vdet-IC	2.8V, +Reset PPO	SSOP-5	28vdo	VD3	6c	Rhm
QJ	PT7M7049CLTA	Vdet-IC	4.9V±1.5%, -Reset PPO	SOT-23-5	28vdr	VD7	6k	Pti
QJ	PT7M7049CLTAE	Vdet-IC	4.9V±1.5%, -Reset PPO, Lead free	SOT-23-5	28vdr	VD7	6k	Pti
QK	BD5329FVE	Vdet-IC	2.9V, +Reset PPO	VSOFF-5	30ua	VD7	6c	Rhm
QK	BD5329G	Vdet-IC	2.9V, +Reset PPO	SSOP-5	28vdo	VD3	6c	Rhm
QK	PT7M7049CHTA	Vdet-IC	4.9V±1.5%, +Reset PPO	SOT-23-5	28vdr	VD7	6k	Pti
QK	PT7M7049CHTAE	Vdet-IC	4.9V±1.5%, +Reset PPO, Lead free	SOT-23-5	28vdr	VD7	6k	Pti
QL	BD5330FVE	Vdet-IC	3V, +Reset PPO	VSOFF-5	30ua	VD7	6c	Rhm
QL	BD5330G	Vdet-IC	3V, +Reset PPO	SSOP-5	28vdo	VD3	6c	Rhm
QL	PT7M7049NLTA	Vdet-IC	4.9V±1.5%, -Reset ODO	SOT-23-5	28vdr	VD6	6k	Pti
QL	PT7M7049NLTAE	Vdet-IC	4.9V±1.5%, -Reset ODO, Lead free	SOT-23-5	28vdr	VD6	6k	Pti
QLA	S-1132B15-M5T1G	LVR-IC	LDO, 1.5V±1.0%, 300mA, +CE	SOT-23-5	28cx	VR4	6g	Sii
QLB	S-1132B16-M5T1G	LVR-IC	LDO, 1.6V±1.0%, 300mA, +CE	SOT-23-5	28cx	VR4	6g	Sii
QLC	S-1132B17-M5T1G	LVR-IC	LDO, 1.7V±1.0%, 300mA, +CE	SOT-23-5	28cx	VR4	6g	Sii
QLD	S-1132B18-M5T1G	LVR-IC	LDO, 1.8V±1.0%, 300mA, +CE	SOT-23-5	28cx	VR4	6g	Sii
QLE	S-1132B19-M5T1G	LVR-IC	LDO, 1.9V±1.0%, 300mA, +CE	SOT-23-5	28cx	VR4	6g	Sii
QLF	S-1132B20-M5T1G	LVR-IC	LDO, 2.0V±1.0%, 300mA, +CE	SOT-23-5	28cx	VR4	6g	Sii
QLG	S-1132B21-M5T1G	LVR-IC	LDO, 2.1V±1.0%, 300mA, +CE	SOT-23-5	28cx	VR4	6g	Sii
QLH	S-1132B22-M5T1G	LVR-IC	LDO, 2.2V±1.0%, 300mA, +CE	SOT-23-5	28cx	VR4	6g	Sii
QLI	S-1132B23-M5T1G	LVR-IC	LDO, 2.3V±1.0%, 300mA, +CE	SOT-23-5	28cx	VR4	6g	Sii
QLJ	S-1132B24-M5T1G	LVR-IC	LDO, 2.4V±1.0%, 300mA, +CE	SOT-23-5	28cx	VR4	6g	Sii
QLK	S-1132B25-M5T1G	LVR-IC	LDO, 2.5V±1.0%, 300mA, +CE	SOT-23-5	28cx	VR4	6g	Sii
QLL	S-1132B26-M5T1G	LVR-IC	LDO, 2.6V±1.0%, 300mA, +CE	SOT-23-5	28cx	VR4	6g	Sii
QLM	S-1132B27-M5T1G	LVR-IC	LDO, 2.7V±1.0%, 300mA, +CE	SOT-23-5	28cx	VR4	6g	Sii
QLN	S-1132B28-M5T1G	LVR-IC	LDO, 2.8V±1.0%, 300mA, +CE	SOT-23-5	28cx	VR4	6g	Sii
QLO	S-1132B29-M5T1G	LVR-IC	LDO, 2.9V±1.0%, 300mA, +CE	SOT-23-5	28cx	VR4	6g	Sii
QLP	S-1132B30-M5T1G	LVR-IC	LDO, 3.0V±1.0%, 300mA, +CE	SOT-23-5	28cx	VR4	6g	Sii
QLQ	S-1132B31-M5T1G	LVR-IC	LDO, 3.1V±1.0%, 300mA, +CE	SOT-23-5	28cx	VR4	6g	Sii
QLR	S-1132B32-M5T1G	LVR-IC	LDO, 3.2V±1.0%, 300mA, +CE	SOT-23-5	28cx	VR4	6g	Sii
QLS	S-1132B33-M5T1G	LVR-IC	LDO, 3.3V±1.0%, 300mA, +CE	SOT-23-5	28cx	VR4	6g	Sii
QLT	S-1132B34-M5T1G	LVR-IC	LDO, 3.4V±1.0%, 300mA, +CE	SOT-23-5	28cx	VR4	6g	Sii
QLU	S-1132B35-M5T1G	LVR-IC	LDO, 3.5V±1.0%, 300mA, +CE	SOT-23-5	28cx	VR4	6g	Sii
QLV	S-1132B36-M5T1G	LVR-IC	LDO, 3.6V±1.0%, 300mA, +CE	SOT-23-5	28cx	VR4	6g	Sii
QLW	S-1132B37-M5T1G	LVR-IC	LDO, 3.7V±1.0%, 300mA, +CE	SOT-23-5	28cx	VR4	6g	Sii
QLX	S-1132B38-M5T1G	LVR-IC	LDO, 3.8V±1.0%, 300mA, +CE	SOT-23-5	28cx	VR4	6g	Sii
QLY	S-1132B39-M5T1G	LVR-IC	LDO, 3.9V±1.0%, 300mA, +CE	SOT-23-5	28cx	VR4	6g	Sii
QLZ	S-1132B40-M5T1G	LVR-IC	LDO, 4.0V±1.0%, 300mA, +CE	SOT-23-5	28cx	VR4	6g	Sii
QM	BD5331FVE	Vdet-IC	3.1V, +Reset PPO	VSOFF-5	30ua	VD7	6c	Rhm
QM	BD5331G	Vdet-IC	3.1V, +Reset PPO	SSOP-5	28vdo	VD3	6c	Rhm
QM	PT7M7050CLTA	Vdet-IC	5.0V±1.5%, -Reset PPO	SOT-23-5	28vdr	VD7	6k	Pti
QM	PT7M7050CLTAE	Vdet-IC	5.0V±1.5%, -Reset PPO, Lead free	SOT-23-5	28vdr	VD7	6k	Pti
QMA	S-1132B41-M5T1G	LVR-IC	LDO, 4.1V±1.0%, 300mA, +CE	SOT-23-5	28cx	VR4	6g	Sii
QMB	S-1132B42-M5T1G	LVR-IC	LDO, 4.2V±1.0%, 300mA, +CE	SOT-23-5	28cx	VR4	6g	Sii
QMC	S-1132B43-M5T1G	LVR-IC	LDO, 4.3V±1.0%, 300mA, +CE	SOT-23-5	28cx	VR4	6g	Sii
QMD	S-1132B44-M5T1G	LVR-IC	LDO, 4.4V±1.0%, 300mA, +CE	SOT-23-5	28cx	VR4	6g	Sii
QME	S-1132B45-M5T1G	LVR-IC	LDO, 4.5V±1.0%, 300mA, +CE	SOT-23-5	28cx	VR4	6g	Sii
QMF	S-1132B46-M5T1G	LVR-IC	LDO, 4.6V±1.0%, 300mA, +CE	SOT-23-5	28cx	VR4	6g	Sii
QMG	S-1132B47-M5T1G	LVR-IC	LDO, 4.7V±1.0%, 300mA, +CE	SOT-23-5	28cx	VR4	6g	Sii
QMH	S-1132B48-M5T1G	LVR-IC	LDO, 4.8V±1.0%, 300mA, +CE	SOT-23-5	28cx	VR4	6g	Sii
QMI	S-1132B49-M5T1G	LVR-IC	LDO, 4.9V±1.0%, 300mA, +CE	SOT-23-5	28cx	VR4	6g	Sii
QMJ	S-1132B50-M5T1G	LVR-IC	LDO, 5.0V±1.0%, 300mA, +CE	SOT-23-5	28cx	VR4	6g	Sii



SMD code	Type	Function	Short description	Case	Pinout	Sch.	St.	Mnf.
QMK	S-1132B51-M5T1G	LVR-IC	LDO, 5.1V±1.0%, 300mA, +CE	SOT-23-5	28cx	VR4	6g	Sii
QML	S-1132B52-M5T1G	LVR-IC	LDO, 5.2V±1.0%, 300mA, +CE	SOT-23-5	28cx	VR4	6g	Sii
QMM	S-1132B53-M5T1G	LVR-IC	LDO, 5.3V±1.0%, 300mA, +CE	SOT-23-5	28cx	VR4	6g	Sii
QMN	S-1132B54-M5T1G	LVR-IC	LDO, 5.4V±1.0%, 300mA, +CE	SOT-23-5	28cx	VR4	6g	Sii
QMO	S-1132B55-M5T1G	LVR-IC	LDO, 5.5V±1.0%, 300mA, +CE	SOT-23-5	28cx	VR4	6g	Sii
QN	BD5332FVE	Vdet-IC	3.2V, +Reset PPO	VSOFF-5	30ua	VD7	6c	Rhm
QN	BD5332G	Vdet-IC	3.2V, +Reset PPO	SSOP-5	28vdo	VD3	6c	Rhm
QN	PT7M7050CHTA	Vdet-IC	5.0V±1.5%, +Reset PPO	SOT-23-5	28vdr	VD7	6k	Pti
QN	PT7M7050CHTAE	Vdet-IC	5.0V±1.5%, +Reset PPO, Lead free	SOT-23-5	28vdr	VD7	6k	Pti
QO	PT7M7050NLTA	Vdet-IC	5.0V±1.5%, -Reset ODO	SOT-23-5	28vdr	VD6	6k	Pti
QO	PT7M7050NLTAE	Vdet-IC	5.0V±1.5%, -Reset ODO, Lead free	SOT-23-5	28vdr	VD6	6k	Pti
QP	BD5333FVE	Vdet-IC	3.3V, +Reset PPO	VSOFF-5	30ua	VD7	6c	Rhm
QP	BD5333G	Vdet-IC	3.3V, +Reset PPO	SSOP-5	28vdo	VD3	6c	Rhm
QQ	BD5334FVE	Vdet-IC	3.4V, +Reset PPO	VSOFF-5	30ua	VD7	6c	Rhm
QQ	BD5334G	Vdet-IC	3.4V, +Reset PPO	SSOP-5	28vdo	VD3	6c	Rhm
QR	BD5335FVE	Vdet-IC	3.5V, +Reset PPO	VSOFF-5	30ua	VD7	6c	Rhm
QR	BD5335G	Vdet-IC	3.5V, +Reset PPO	SSOP-5	28vdo	VD3	6c	Rhm
QR	R1122N151A	LVR-IC	LDO, LN, -CE, 1.5V±2%, 150mA	SOT-23-5	28vt	VR4	6g	Ric
QS	BD5336FVE	Vdet-IC	3.6V, +Reset PPO	VSOFF-5	30ua	VD7	6c	Rhm
QS	BD5336G	Vdet-IC	3.6V, +Reset PPO	SSOP-5	28vdo	VD3	6c	Rhm
QS	R1122N161A	LVR-IC	LDO, LN, -CE, 1.6V±2%, 150mA	SOT-23-5	28vt	VR4	6g	Ric
QT	BD5337FVE	Vdet-IC	3.7V, +Reset PPO	VSOFF-5	30ua	VD7	6c	Rhm
QT	BD5337G	Vdet-IC	3.7V, +Reset PPO	SSOP-5	28vdo	VD3	6c	Rhm
QT	R1122N171A	LVR-IC	LDO, LN, -CE, 1.7V±2%, 150mA	SOT-23-5	28vt	VR4	6g	Ric
QU	BD5338FVE	Vdet-IC	3.8V, +Reset PPO	VSOFF-5	30ua	VD7	6c	Rhm
QU	BD5338G	Vdet-IC	3.8V, +Reset PPO	SSOP-5	28vdo	VD3	6c	Rhm
QU	R1122N181A	LVR-IC	LDO, LN, -CE, 1.8V±2%, 150mA	SOT-23-5	28vt	VR4	6g	Ric
QV	BD5339FVE	Vdet-IC	3.9V, +Reset PPO	VSOFF-5	30ua	VD7	6c	Rhm
QV	BD5339G	Vdet-IC	3.9V, +Reset PPO	SSOP-5	28vdo	VD3	6c	Rhm
QV	R1122N191A	LVR-IC	LDO, LN, -CE, 1.9V±2%, 150mA	SOT-23-5	28vt	VR4	6g	Ric
R0	R1121N201B	LVR-IC	LDO, LN, +CE, 2V±2%, 150mA	SOT-23-5	28vt	VR4	6g	Ric
R00	R1161N281D5	LVR-IC	LDO, 2.85V±2%, 350mA, +CE, CL, AE(Mode)	SOT-23-5	28x9	VR10	6g	Ric
R001	RP106Q072D	LVR-IC	LDO, 0.7V±0.8%, 400mA, +CE, CL	SC-88A	28xm	VR4	6m	Ric
R002	RP106Q082D	LVR-IC	LDO, 0.8V±0.8%, 400mA, +CE, CL	SC-88A	28xm	VR4	6m	Ric
R003	RP106Q092D	LVR-IC	LDO, 0.9V±0.8%, 400mA, +CE, CL	SC-88A	28xm	VR4	6m	Ric
R004	RP106Q102D	LVR-IC	LDO, 1.0V±0.8%, 400mA, +CE, CL	SC-88A	28xm	VR4	6m	Ric
R005	RP106Q112D	LVR-IC	LDO, 1.1V±0.8%, 400mA, +CE, CL	SC-88A	28xm	VR4	6m	Ric
R006	RP106Q122D	LVR-IC	LDO, 1.2V±0.8%, 400mA, +CE, CL	SC-88A	28xm	VR4	6m	Ric
R007	RP106Q132D	LVR-IC	LDO, 1.3V±0.8%, 400mA, +CE, CL	SC-88A	28xm	VR4	6m	Ric
R008	RP106Q142D	LVR-IC	LDO, 1.4V±0.8%, 400mA, +CE, CL	SC-88A	28xm	VR4	6m	Ric
R009	RP106Q152D	LVR-IC	LDO, 1.5V±0.8%, 400mA, +CE, CL	SC-88A	28xm	VR4	6m	Ric
R01	NCP585DSN125T	LVR-IC	LDO, 1.25V±2%, 350mA, +CE, CL, AE(Mode)	SOT-23-5	28x9	VR10	6g	Ons
R010	RP106Q162D	LVR-IC	LDO, 1.6V±0.8%, 400mA, +CE, CL	SC-88A	28xm	VR4	6m	Ric
R011	RP106Q172D	LVR-IC	LDO, 1.7V±0.8%, 400mA, +CE, CL	SC-88A	28xm	VR4	6m	Ric
R012	RP106Q182D	LVR-IC	LDO, 1.8V±0.8%, 400mA, +CE, CL	SC-88A	28xm	VR4	6m	Ric
R013	RP106Q102D5	LVR-IC	LDO, 1.05V±0.8%, 400mA, +CE, CL	SC-88A	28xm	VR4	6m	Ric
R014	RP106Q122D5	LVR-IC	LDO, 1.25V±0.8%, 400mA, +CE, CL	SC-88A	28xm	VR4	6m	Ric
R015	RP106Q182D5	LVR-IC	LDO, 1.85V±0.8%, 400mA, +CE, CL	SC-88A	28xm	VR4	6m	Ric
R016	RP106Q112D5	LVR-IC	LDO, 1.15V±0.8%, 400mA, +CE, CL	SC-88A	28xm	VR4	6m	Ric
R08	R1161N081D	LVR-IC	LDO, 0.8V±2%, 350mA, +CE, CL, AE(Mode)	SOT-23-5	28x9	VR10	6g	Ric
R09	NCP585DSN09T1	LVR-IC	LDO, 0.9V±2%, 350mA, +CE, CL, AE(Mode)	SOT-23-5	28x9	VR10	6g	Ons
R09	R1161N091D	LVR-IC	LDO, 0.9V±2%, 350mA, +CE, CL, AE(Mode)	SOT-23-5	28x9	VR10	6g	Ric
R0A	RP105N061B	LVR-IC	LDO, 0.6V±15mV, 400mA, +CE	SOT-23-5	28ze	VR11	6g	Ric
R0A	XC6108N50AMR	Vdet-IC	5.0V±2%, Hysteresis, -Reset ODO	SOT-25	28rm	VD14	6g	Tor
R0A	XC6118C40AMR-G	Vdet-IC	4.0V±2%, ±Reset PPO, Sense, hysteresis 5%, Cd	SOT-25	28mg	VD15	6g	Tor
R0B	RP105N071B	LVR-IC	LDO, 0.7V±15mV, 400mA, +CE	SOT-23-5	28ze	VR11	6g	Ric
R0B	XC6108N50BMR	Vdet-IC	5.0V±2%, -Reset ODO	SOT-25	28rm	VD14	6g	Tor
R0B	XC6118C40BMR-G	Vdet-IC	4.0V±2%, ±Reset PPO, Sense, hysteresis <1%, Cd	SOT-25	28mg	VD15	6g	Tor
R0C	RP105N081B	LVR-IC	LDO, 0.8V±15mV, 400mA, +CE	SOT-23-5	28ze	VR11	6g	Ric
R0C	XC6108N50CMR	Vdet-IC	5.0V±2%, Hysteresis, -Reset ODO	SOT-25	28rk	VD14	6g	Tor
R0C	XC6118C40CMR-G	Vdet-IC	4.0V±2%, ±Reset PPO, Sense, hysteresis 5%	SOT-25	28mf	VD12	6g	Tor
R0D	RP105N091B	LVR-IC	LDO, 0.9V±15mV, 400mA, +CE	SOT-23-5	28ze	VR11	6g	Ric
R0D	XC6108N50DMR	Vdet-IC	5.0±2%, -Reset ODO	SOT-25	28rk	VD14	6g	Tor
R0D	XC6118C40DMR-G	Vdet-IC	4.0V±2%, ±Reset PPO, Sense, hysteresis <1%	SOT-25	28mf	VD12	6g	Tor
R0E	RP105N101B	LVR-IC	LDO, 1.0V±15mV, 400mA, +CE	SOT-23-5	28ze	VR11	6g	Ric
R0F	RP105N121B	LVR-IC	LDO, 1.2V±15mV, 400mA, +CE	SOT-23-5	28ze	VR11	6g	Ric
R0G	RP105N131B	LVR-IC	LDO, 1.3V±15mV, 400mA, +CE	SOT-23-5	28ze	VR11	6g	Ric
R0H	RP105N141B	LVR-IC	LDO, 1.4V±15mV, 400mA, +CE	SOT-23-5	28ze	VR11	6g	Ric
R0J	RP105N151B	LVR-IC	LDO, 1.5V±15mV, 400mA, +CE	SOT-23-5	28ze	VR11	6g	Ric
R0K	RP105N111B	LVR-IC	LDO, 1.1V±15mV, 400mA, +CE	SOT-23-5	28ze	VR11	6g	Ric



SMD code	Type	Function	Short description	Case	Pinout	Sch.	St.	Mnf.
R1	R1121N211B	LVR-IC	LDO, LN, +CE, 2.1V±2%, 150mA	SOT-23-5	28vt	VR4	6g	Ric
R1	TC7S200AFE	CMOS-Logic	2-input NAND gate	SOM-5	30/Log1	-	6a	Tos
R10	R1161N101D	LVR-IC	LDO, 1V±2%, 350mA, +CE, CL, AE(Mode)	SOT-23-5	28x9	VR10	6g	Ric
R11	R1161N111D	LVR-IC	LDO, 1.1V±2%, 350mA, +CE, CL, AE(Mode)	SOT-23-5	28x9	VR10	6g	Ric
R12	NCP585DSN12T1	LVR-IC	LDO, 1.2V±2%, 350mA, +CE, CL, AE(Mode)	SOT-23-5	28x9	VR10	6g	Ons
R12	R1161N121D	LVR-IC	LDO, 1.2V±2%, 350mA, +CE, CL, AE(Mode)	SOT-23-5	28x9	VR10	6g	Ric
R13	R1161N131D	LVR-IC	LDO, 1.3V±2%, 350mA, +CE, CL, AE(Mode)	SOT-23-5	28x9	VR10	6g	Ric
R14	R1161N141D	LVR-IC	LDO, 1.4V±2%, 350mA, +CE, CL, AE(Mode)	SOT-23-5	28x9	VR10	6g	Ric
R15	NCP585DSN15T1	LVR-IC	LDO, 1.5V±2%, 350mA, +CE, CL, AE(Mode)	SOT-23-5	28x9	VR10	6g	Ons
R15	R1161N151D	LVR-IC	LDO, 1.5V±2%, 350mA, +CE, CL, AE(Mode)	SOT-23-5	28x9	VR10	6g	Ric
R15	TK11115CS	LVR-IC	LDO, 1.5V±2%, 200mA, -CE	SOT-23-5	28un	VR7	6k	Tok
R15	XC6368F152MR	DC/DC-IC	PWM/PFM step-up, 1.5V±2.5%, 200mA, 180kHz, +CE, soft start	SOT-25	28sd	DC10	6g	Tor
R15A	CM7R153A-15B-T	LVR-IC	LDO, 1.5V±3%, 150mA, +CE, PDR	SOT-23-5	28vt	VR4	6a	Can
R15B	CM7R153B-15B-T	LVR-IC	LDO, 1.5V±3%, 150mA, +CE	SOT-23-5	28vt	VR4	6a	Can
R15C	CM7R153C-15B-T	LVR-IC	LDO, 1.5V±3%, 150mA, -CE, PDR	SOT-23-5	28vt	VR4	6a	Can
R15D	CM7R153D-15B-T	LVR-IC	LDO, 1.5V±3%, 150mA, -CE	SOT-23-5	28vt	VR4	6a	Can
R16	R1161N161D	LVR-IC	LDO, 1.6V±2%, 350mA, +CE, CL, AE(Mode)	SOT-23-5	28x9	VR10	6g	Ric
R16	TK11116CS	LVR-IC	LDO, 1.6V±1.5%, 200mA, -CE	SOT-23-5	28un	VR7	6k	Tok
R16	XC6368F162MR	DC/DC-IC	PWM/PFM step-up, 1.6V±2.5%, 200mA, 180kHz, +CE, soft start	SOT-25	28sd	DC10	6g	Tor
R16A	CM7R153A-16B-T	LVR-IC	LDO, 1.6V±3%, 150mA, +CE, PDR	SOT-23-5	28vt	VR4	6a	Can
R16B	CM7R153B-16B-T	LVR-IC	LDO, 1.6V±3%, 150mA, +CE	SOT-23-5	28vt	VR4	6a	Can
R16C	CM7R153C-16B-T	LVR-IC	LDO, 1.6V±3%, 150mA, -CE, PDR	SOT-23-5	28vt	VR4	6a	Can
R16D	CM7R153D-16B-T	LVR-IC	LDO, 1.6V±3%, 150mA, -CE	SOT-23-5	28vt	VR4	6a	Can
R17	R1161N171D	LVR-IC	LDO, 1.7V±2%, 350mA, +CE, CL, AE(Mode)	SOT-23-5	28x9	VR10	6g	Ric
R17	TK11117CS	LVR-IC	LDO, 1.7V±1.5%, 200mA, -CE	SOT-23-5	28un	VR7	6k	Tok
R17	XC6368F172MR	DC/DC-IC	PWM/PFM step-up, 1.7V±2.5%, 200mA, 180kHz, +CE, soft start	SOT-25	28sd	DC10	6g	Tor
R17A	CM7R153A-17B-T	LVR-IC	LDO, 1.7V±3%, 150mA, +CE, PDR	SOT-23-5	28vt	VR4	6a	Can
R17B	CM7R153B-17B-T	LVR-IC	LDO, 1.7V±3%, 150mA, +CE	SOT-23-5	28vt	VR4	6a	Can
R17C	CM7R153C-17B-T	LVR-IC	LDO, 1.7V±3%, 150mA, -CE, PDR	SOT-23-5	28vt	VR4	6a	Can
R17D	CM7R153D-17B-T	LVR-IC	LDO, 1.7V±3%, 150mA, -CE	SOT-23-5	28vt	VR4	6a	Can
R18	NCP585DSN18T1	LVR-IC	LDO, 1.8V±2%, 350mA, +CE, CL, AE(Mode)	SOT-23-5	28x9	VR10	6g	Ons
R18	R1161N181D	LVR-IC	LDO, 1.8V±2%, 350mA, +CE, CL, AE(Mode)	SOT-23-5	28x9	VR10	6g	Ric
R18	TK11118CS	LVR-IC	LDO, 1.8V±1.5%, 200mA, -CE	SOT-23-5	28un	VR7	6k	Tok
R18	XC6368F182MR	DC/DC-IC	PWM/PFM step-up, 1.8V±2.5%, 200mA, 180kHz, +CE, soft start	SOT-25	28sd	DC10	6g	Tor
R18A	CM7R153A-18B-T	LVR-IC	LDO, 1.8V±3%, 150mA, +CE, PDR	SOT-23-5	28vt	VR4	6a	Can
R18B	CM7R153B-18B-T	LVR-IC	LDO, 1.8V±3%, 150mA, +CE	SOT-23-5	28vt	VR4	6a	Can
R18C	CM7R153C-18B-T	LVR-IC	LDO, 1.8V±3%, 150mA, -CE, PDR	SOT-23-5	28vt	VR4	6a	Can
R18D	CM7R153D-18B-T	LVR-IC	LDO, 1.8V±3%, 150mA, -CE	SOT-23-5	28vt	VR4	6a	Can
R19	R1161N191D	LVR-IC	LDO, 1.9V±2%, 350mA, +CE, CL, AE(Mode)	SOT-23-5	28x9	VR10	6g	Ric
R19	TK11119CS	LVR-IC	LDO, 1.9V±1.5%, 200mA, -CE	SOT-23-5	28un	VR7	6k	Tok
R19	XC6368F192MR	DC/DC-IC	PWM/PFM step-up, 1.9V±2.5%, 200mA, 180kHz, +CE, soft start	SOT-25	28sd	DC10	6g	Tor
R19A	CM7R153A-19B-T	LVR-IC	LDO, 1.9V±3%, 150mA, +CE, PDR	SOT-23-5	28vt	VR4	6a	Can
R19B	CM7R153B-19B-T	LVR-IC	LDO, 1.9V±3%, 150mA, +CE	SOT-23-5	28vt	VR4	6a	Can
R19C	CM7R153C-19B-T	LVR-IC	LDO, 1.9V±3%, 150mA, -CE, PDR	SOT-23-5	28vt	VR4	6a	Can
R19D	CM7R153D-19B-T	LVR-IC	LDO, 1.9V±3%, 150mA, -CE	SOT-23-5	28vt	VR4	6a	Can
R1A	RP105N061D	LVR-IC	LDO, 0.6V±15mV, 400mA, +CE, CL	SOT-23-5	28ze	VR11	6g	Ric
R1A	XC6118C41AMR-G	Vdet-IC	4.1V±2%, ±Reset PPO, Sense, hysteresis 5%, Cd	SOT-25	28mg	VD15	6g	Tor
R1B	RP105N071D	LVR-IC	LDO, 0.7V±15mV, 400mA, +CE, CL	SOT-23-5	28ze	VR11	6g	Ric
R1B	XC6118C41BMR-G	Vdet-IC	4.1V±2%, ±Reset PPO, Sense, hysteresis <1%, Cd	SOT-25	28mg	VD15	6g	Tor
R1C	RP105N081D	LVR-IC	LDO, 0.8V±15mV, 400mA, +CE, CL	SOT-23-5	28ze	VR11	6g	Ric
R1C	XC6118C41CMR-G	Vdet-IC	4.1V±2%, ±Reset PPO, Sense, hysteresis 5%	SOT-25	28mf	VD12	6g	Tor
R1D	RP105N091D	LVR-IC	LDO, 0.9V±15mV, 400mA, +CE, CL	SOT-23-5	28ze	VR11	6g	Ric
R1D	XC6118C41DMR-G	Vdet-IC	4.1V±2%, ±Reset PPO, Sense, hysteresis <1%	SOT-25	28mf	VD12	6g	Tor
R1E	RP105N101D	LVR-IC	LDO, 1.0V±15mV, 400mA, +CE, CL	SOT-23-5	28ze	VR11	6g	Ric
R1F	RP105N121D	LVR-IC	LDO, 1.2V±15mV, 400mA, +CE, CL	SOT-23-5	28ze	VR11	6g	Ric
R1F	XC6368F153MR	DC/DC-IC	PWM/PFM step-up, 1.5V±2.5%, 200mA, 300kHz, +CE, soft start	SOT-25	28sd	DC10	6g	Tor
R1FA	CM7R153A-15A-T	LVR-IC	LDO, 1.55V±3%, 150mA, +CE, PDR	SOT-23-5	28vt	VR4	6a	Can
R1FB	CM7R153B-15A-T	LVR-IC	LDO, 1.55V±3%, 150mA, +CE	SOT-23-5	28vt	VR4	6a	Can
R1FC	CM7R153C-15A-T	LVR-IC	LDO, 1.55V±3%, 150mA, -CE, PDR	SOT-23-5	28vt	VR4	6a	Can
R1FD	CM7R153D-15A-T	LVR-IC	LDO, 1.55V±3%, 150mA, -CE	SOT-23-5	28vt	VR4	6a	Can
R1G	RP105N131D	LVR-IC	LDO, 1.3V±15mV, 400mA, +CE, CL	SOT-23-5	28ze	VR11	6g	Ric
R1GA	CM7R153A-16A-T	LVR-IC	LDO, 1.65V±3%, 150mA, +CE, PDR	SOT-23-5	28vt	VR4	6a	Can
R1GB	CM7R153B-16A-T	LVR-IC	LDO, 1.65V±3%, 150mA, +CE	SOT-23-5	28vt	VR4	6a	Can
R1GC	CM7R153C-16A-T	LVR-IC	LDO, 1.65V±3%, 150mA, -CE, PDR	SOT-23-5	28vt	VR4	6a	Can
R1GD	CM7R153D-16A-T	LVR-IC	LDO, 1.65V±3%, 150mA, -CE	SOT-23-5	28vt	VR4	6a	Can
R1H	RP105N141D	LVR-IC	LDO, 1.4V±15mV, 400mA, +CE, CL	SOT-23-5	28ze	VR11	6g	Ric
R1H	XC6368F163MR	DC/DC-IC	PWM/PFM step-up, 1.6V±2.5%, 200mA, 300kHz, +CE, soft start	SOT-25	28sd	DC10	6g	Tor
R1HA	CM7R153A-17A-T	LVR-IC	LDO, 1.75V±3%, 150mA, +CE, PDR	SOT-23-5	28vt	VR4	6a	Can
R1HB	CM7R153B-17A-T	LVR-IC	LDO, 1.75V±3%, 150mA, +CE	SOT-23-5	28vt	VR4	6a	Can
R1HC	CM7R153C-17A-T	LVR-IC	LDO, 1.75V±3%, 150mA, -CE, PDR	SOT-23-5	28vt	VR4	6a	Can



SMD code	Type	Function	Short description	Case	Pinout	Sch.	St.	Mnf.
R1HD	CM7R153D-17A-T	LVR-IC	LDO, 1.75V±3%, 150mA, -CE	SOT-23-5	28vt	VR4	6a	Can
R1IA	CM7R153A-18A-T	LVR-IC	LDO, 1.85V±3%, 150mA, +CE, PDR	SOT-23-5	28vt	VR4	6a	Can
R1IB	CM7R153B-18A-T	LVR-IC	LDO, 1.85V±3%, 150mA, +CE	SOT-23-5	28vt	VR4	6a	Can
R1IC	CM7R153C-18A-T	LVR-IC	LDO, 1.85V±3%, 150mA, -CE, PDR	SOT-23-5	28vt	VR4	6a	Can
R1ID	CM7R153D-18A-T	LVR-IC	LDO, 1.85V±3%, 150mA, -CE	SOT-23-5	28vt	VR4	6a	Can
R1J	RP105N151D	LVR-IC	LDO, 1.5V±15mV, 400mA, +CE, CL	SOT-23-5	28ze	VR11	6g	Ric
R1JA	CM7R153A-19A-T	LVR-IC	LDO, 1.95V±3%, 150mA, +CE, PDR	SOT-23-5	28vt	VR4	6a	Can
R1JB	CM7R153B-19A-T	LVR-IC	LDO, 1.95V±3%, 150mA, +CE	SOT-23-5	28vt	VR4	6a	Can
R1JC	CM7R153C-19A-T	LVR-IC	LDO, 1.95V±3%, 150mA, -CE, PDR	SOT-23-5	28vt	VR4	6a	Can
R1JD	CM7R153D-19A-T	LVR-IC	LDO, 1.95V±3%, 150mA, -CE	SOT-23-5	28vt	VR4	6a	Can
R1K	RP105N111D	LVR-IC	LDO, 1.1V±15mV, 400mA, +CE, CL	SOT-23-5	28ze	VR11	6g	Ric
R1K	XC6368F173MR	DC/DC-IC	PWM/PFM step-up, 1.7V±2.5%, 200mA, 300kHz, +CE, soft start	SOT-25	28sd	DC10	6g	Tor
R1L	XC6368F183MR	DC/DC-IC	PWM/PFM step-up, 1.8V±2.5%, 200mA, 300kHz, +CE, soft start	SOT-25	28sd	DC10	6g	Tor
R1M	XC6368F193MR	DC/DC-IC	PWM/PFM step-up, 1.9V±2.5%, 200mA, 300kHz, +CE, soft start	SOT-25	28sd	DC10	6g	Tor
R2	R112N221B	LVR-IC	LDO, LN, +CE, 2.2V±2%, 150mA	SOT-23-5	28vt	VR4	6g	Ric
R2	TC7SZ08AFE	CMOS-Logic	2-input AND gate	SON-5	30/Log3	-	6a	Tos
R20	R116N201D	LVR-IC	LDO, 2V±2%, 350mA, +CE, CL, AE(Mode)	SOT-23-5	28x9	VR10	6g	Ric
R20	TK11120CS	LVR-IC	LDO, 2V±1.5%, 200mA, -CE	SOT-23-5	28un	VR7	6k	Tok
R20	XC6368F202MR	DC/DC-IC	PWM/PFM step-up, 2.0V±2.5%, 200mA, 180kHz, +CE, soft start	SOT-25	28sd	DC10	6g	Tor
R20A	CM7R153A-20B-T	LVR-IC	LDO, 2.0V±2%, 150mA, +CE, PDR	SOT-23-5	28vt	VR4	6a	Can
R20B	CM7R153B-20B-T	LVR-IC	LDO, 2.0V±2%, 150mA, +CE	SOT-23-5	28vt	VR4	6a	Can
R20C	CM7R153C-20B-T	LVR-IC	LDO, 2.0V±2%, 150mA, -CE, PDR	SOT-23-5	28vt	VR4	6a	Can
R20D	CM7R153D-20B-T	LVR-IC	LDO, 2.0V±2%, 150mA, -CE	SOT-23-5	28vt	VR4	6a	Can
R21	R116N211D	LVR-IC	LDO, 2.1V±2%, 350mA, +CE, CL, AE(Mode)	SOT-23-5	28x9	VR10	6g	Ric
R21	TK11121CS	LVR-IC	LDO, 2.1V±1.5%, 200mA, -CE	SOT-23-5	28un	VR7	6k	Tok
R21	XC6368F212MR	DC/DC-IC	PWM/PFM step-up, 2.1V±2.5%, 200mA, 180kHz, +CE, soft start	SOT-25	28sd	DC10	6g	Tor
R21A	CM7R153A-21B-T	LVR-IC	LDO, 2.1V±2%, 150mA, +CE, PDR	SOT-23-5	28vt	VR4	6a	Can
R21B	CM7R153B-21B-T	LVR-IC	LDO, 2.1V±2%, 150mA, +CE	SOT-23-5	28vt	VR4	6a	Can
R21C	CM7R153C-21B-T	LVR-IC	LDO, 2.1V±2%, 150mA, -CE, PDR	SOT-23-5	28vt	VR4	6a	Can
R21D	CM7R153D-21B-T	LVR-IC	LDO, 2.1V±2%, 150mA, -CE	SOT-23-5	28vt	VR4	6a	Can
R22	R116N221D	LVR-IC	LDO, 2.2V±2%, 350mA, +CE, CL, AE(Mode)	SOT-23-5	28x9	VR10	6g	Ric
R22	TK11122CS	LVR-IC	LDO, 2.2V±1.5%, 200mA, -CE	SOT-23-5	28un	VR7	6k	Tok
R22	XC6368F222MR	DC/DC-IC	PWM/PFM step-up, 2.2V±2.5%, 200mA, 180kHz, +CE, soft start	SOT-25	28sd	DC10	6g	Tor
R22A	CM7R153A-22B-T	LVR-IC	LDO, 2.2V±2%, 150mA, +CE, PDR	SOT-23-5	28vt	VR4	6a	Can
R22B	CM7R153B-22B-T	LVR-IC	LDO, 2.2V±2%, 150mA, +CE	SOT-23-5	28vt	VR4	6a	Can
R22C	CM7R153C-22B-T	LVR-IC	LDO, 2.2V±2%, 150mA, -CE, PDR	SOT-23-5	28vt	VR4	6a	Can
R22D	CM7R153D-22B-T	LVR-IC	LDO, 2.2V±2%, 150mA, -CE	SOT-23-5	28vt	VR4	6a	Can
R23	R116N231D	LVR-IC	LDO, 2.3V±2%, 350mA, +CE, CL, AE(Mode)	SOT-23-5	28x9	VR10	6g	Ric
R23	TK11123CS	LVR-IC	LDO, 2.3V±1.5%, 200mA, -CE	SOT-23-5	28un	VR7	6k	Tok
R23	XC6368F232MR	DC/DC-IC	PWM/PFM step-up, 2.3V±2.5%, 200mA, 180kHz, +CE, soft start	SOT-25	28sd	DC10	6g	Tor
R23A	CM7R153A-23B-T	LVR-IC	LDO, 2.3V±2%, 150mA, +CE, PDR	SOT-23-5	28vt	VR4	6a	Can
R23B	CM7R153B-23B-T	LVR-IC	LDO, 2.3V±2%, 150mA, +CE	SOT-23-5	28vt	VR4	6a	Can
R23C	CM7R153C-23B-T	LVR-IC	LDO, 2.3V±2%, 150mA, -CE, PDR	SOT-23-5	28vt	VR4	6a	Can
R23D	CM7R153D-23B-T	LVR-IC	LDO, 2.3V±2%, 150mA, -CE	SOT-23-5	28vt	VR4	6a	Can
R24	R116N241D	LVR-IC	LDO, 2.4V±2%, 350mA, +CE, CL, AE(Mode)	SOT-23-5	28x9	VR10	6g	Ric
R24	TK11124CS	LVR-IC	LDO, 2.4V±1.5%, 200mA, -CE	SOT-23-5	28un	VR7	6k	Tok
R24	XC6368F242MR	DC/DC-IC	PWM/PFM step-up, 2.4V±2.5%, 200mA, 180kHz, +CE, soft start	SOT-25	28sd	DC10	6g	Tor
R24A	CM7R153A-24B-T	LVR-IC	LDO, 2.4V±2%, 150mA, +CE, PDR	SOT-23-5	28vt	VR4	6a	Can
R24B	CM7R153B-24B-T	LVR-IC	LDO, 2.4V±2%, 150mA, +CE	SOT-23-5	28vt	VR4	6a	Can
R24C	CM7R153C-24B-T	LVR-IC	LDO, 2.4V±2%, 150mA, -CE, PDR	SOT-23-5	28vt	VR4	6a	Can
R24D	CM7R153D-24B-T	LVR-IC	LDO, 2.4V±2%, 150mA, -CE	SOT-23-5	28vt	VR4	6a	Can
R25	NCP585DSN25T1	LVR-IC	LDO, 2.5V±2%, 350mA, +CE, CL, AE(Mode)	SOT-23-5	28x9	VR10	6g	Ons
R25	R116N251D	LVR-IC	LDO, 2.5V±2%, 350mA, +CE, CL, AE(Mode)	SOT-23-5	28x9	VR10	6g	Ric
R25	TK11125CS	LVR-IC	LDO, 2.5V±1.5%, 200mA, -CE	SOT-23-5	28un	VR7	6k	Tok
R25	XC6368F252MR	DC/DC-IC	PWM/PFM step-up, 2.5V±2.5%, 200mA, 180kHz, +CE, soft start	SOT-25	28sd	DC10	6g	Tor
R25A	CM7R153A-25B-T	LVR-IC	LDO, 2.5V±2%, 150mA, +CE, PDR	SOT-23-5	28vt	VR4	6a	Can
R25B	CM7R153B-25B-T	LVR-IC	LDO, 2.5V±2%, 150mA, +CE	SOT-23-5	28vt	VR4	6a	Can
R25C	CM7R153C-25B-T	LVR-IC	LDO, 2.5V±2%, 150mA, -CE, PDR	SOT-23-5	28vt	VR4	6a	Can
R25D	CM7R153D-25B-T	LVR-IC	LDO, 2.5V±2%, 150mA, -CE	SOT-23-5	28vt	VR4	6a	Can
R26	R116N261D	LVR-IC	LDO, 2.6V±2%, 350mA, +CE, CL, AE(Mode)	SOT-23-5	28x9	VR10	6g	Ric
R26	TK11126CS	LVR-IC	LDO, 2.6V±1.5%, 200mA, -CE	SOT-23-5	28un	VR7	6k	Tok
R26	XC6368F262MR	DC/DC-IC	PWM/PFM step-up, 2.6V±2.5%, 200mA, 180kHz, +CE, soft start	SOT-25	28sd	DC10	6g	Tor
R26A	CM7R153A-26B-T	LVR-IC	LDO, 2.6V±2%, 150mA, +CE, PDR	SOT-23-5	28vt	VR4	6a	Can
R26B	CM7R153B-26B-T	LVR-IC	LDO, 2.6V±2%, 150mA, +CE	SOT-23-5	28vt	VR4	6a	Can
R26C	CM7R153C-26B-T	LVR-IC	LDO, 2.6V±2%, 150mA, -CE, PDR	SOT-23-5	28vt	VR4	6a	Can
R26D	CM7R153D-26B-T	LVR-IC	LDO, 2.6V±2%, 150mA, -CE	SOT-23-5	28vt	VR4	6a	Can
R27	R116N271D	LVR-IC	LDO, 2.7V±2%, 350mA, +CE, CL, AE(Mode)	SOT-23-5	28x9	VR10	6g	Ric
R27	TK11127CS	LVR-IC	LDO, 2.7V±1.5%, 200mA, -CE	SOT-23-5	28un	VR7	6k	Tok
R27	XC6368F272MR	DC/DC-IC	PWM/PFM step-up, 2.7V±2.5%, 200mA, 180kHz, +CE, soft start	SOT-25	28sd	DC10	6g	Tor
R27A	CM7R153A-27B-T	LVR-IC	LDO, 2.7V±2%, 150mA, +CE, PDR	SOT-23-5	28vt	VR4	6a	Can



SMD code	Type	Function	Short description	Case	Pinout	Sch.	St.	Mnf.
R27B	CM7R153B-27B-T	LVR-IC	LDO, 2.7V±2%, 150mA, +CE	SOT-23-5	28vt	VR4	6a	Can
R27C	CM7R153C-27B-T	LVR-IC	LDO, 2.7V±2%, 150mA, -CE, PDR	SOT-23-5	28vt	VR4	6a	Can
R27D	CM7R153D-27B-T	LVR-IC	LDO, 2.7V±2%, 150mA, -CE	SOT-23-5	28vt	VR4	6a	Can
R28	NCPS85DSN28T1	LVR-IC	LDO, 2.8V±2%, 350mA, +CE, CL, AE(Mode)	SOT-23-5	28x9	VR10	6g	Ons
R28	R1161N281D	LVR-IC	LDO, 2.8V±2%, 350mA, +CE, CL, AE(Mode)	SOT-23-5	28x9	VR10	6g	Ric
R28	TK11128CS	LVR-IC	LDO, 2.8V±1.5%, 200mA, -CE	SOT-23-5	28un	VR7	6k	Tok
R28	XC6368F282MR	DC/DC-IC	PWM/PFM step-up, 2.8V±2.5%, 200mA, 180kHz, +CE, soft start	SOT-25	28sd	DC10	6g	Tor
R28A	CM7R153A-28B-T	LVR-IC	LDO, 2.8V±2%, 150mA, +CE, PDR	SOT-23-5	28vt	VR4	6a	Can
R28B	CM7R153B-28B-T	LVR-IC	LDO, 2.8V±2%, 150mA, +CE	SOT-23-5	28vt	VR4	6a	Can
R28C	CM7R153C-28B-T	LVR-IC	LDO, 2.8V±2%, 150mA, -CE, PDR	SOT-23-5	28vt	VR4	6a	Can
R28D	CM7R153D-28B-T	LVR-IC	LDO, 2.8V±2%, 150mA, -CE	SOT-23-5	28vt	VR4	6a	Can
R29	R1161N291D	LVR-IC	LDO, 2.9V±2%, 350mA, +CE, CL, AE(Mode)	SOT-23-5	28x9	VR10	6g	Ric
R29	TK11129CS	LVR-IC	LDO, 2.9V±1.5%, 200mA, -CE	SOT-23-5	28un	VR7	6k	Tok
R29	XC6368F292MR	DC/DC-IC	PWM/PFM step-up, 2.9V±2.5%, 200mA, 180kHz, +CE, soft start	SOT-25	28sd	DC10	6g	Tor
R29A	CM7R153A-29B-T	LVR-IC	LDO, 2.9V±2%, 150mA, +CE, PDR	SOT-23-5	28vt	VR4	6a	Can
R29B	CM7R153B-29B-T	LVR-IC	LDO, 2.9V±2%, 150mA, +CE	SOT-23-5	28vt	VR4	6a	Can
R29C	CM7R153C-29B-T	LVR-IC	LDO, 2.9V±2%, 150mA, -CE, PDR	SOT-23-5	28vt	VR4	6a	Can
R29D	CM7R153D-29B-T	LVR-IC	LDO, 2.9V±2%, 150mA, -CE	SOT-23-5	28vt	VR4	6a	Can
R2A	XC6118C42AMR-G	Vdet-IC	4.2V±2%, ±Reset PPO, Sense, hysteresis 5%, Cd	SOT-25	28mg	VD15	6g	Tor
R2A	XC6368F203MR	DC/DC-IC	PWM/PFM step-up, 2.0V±2.5%, 200mA, 300kHz, +CE, soft start	SOT-25	28sd	DC10	6g	Tor
R2AA	CM7R153A-20A-T	LVR-IC	LDO, 2.05V±2%, 150mA, +CE, PDR	SOT-23-5	28vt	VR4	6a	Can
R2AB	CM7R153B-20A-T	LVR-IC	LDO, 2.05V±2%, 150mA, +CE	SOT-23-5	28vt	VR4	6a	Can
R2AC	CM7R153C-20A-T	LVR-IC	LDO, 2.05V±2%, 150mA, -CE, PDR	SOT-23-5	28vt	VR4	6a	Can
R2AD	CM7R153D-20A-T	LVR-IC	LDO, 2.05V±2%, 150mA, -CE	SOT-23-5	28vt	VR4	6a	Can
R2B	LM4040BIM7-2.5	Vref-IC	Precision, Shunt, 2.50V, 0.2%	SC-70-5	28dq	RF1	6a	Nsc
R2B	XC6118C42BMR-G	Vdet-IC	4.2V±2%, ±Reset PPO, Sense, hysteresis <1%, Cd	SOT-25	28mg	VD15	6g	Tor
R2B	XC6368F213MR	DC/DC-IC	PWM/PFM step-up, 2.1V±2.5%, 200mA, 300kHz, +CE, soft start	SOT-25	28sd	DC10	6g	Tor
R2BA	CM7R153A-21A-T	LVR-IC	LDO, 2.15V±2%, 150mA, +CE, PDR	SOT-23-5	28vt	VR4	6a	Can
R2BB	CM7R153B-21A-T	LVR-IC	LDO, 2.15V±2%, 150mA, +CE	SOT-23-5	28vt	VR4	6a	Can
R2BC	CM7R153C-21A-T	LVR-IC	LDO, 2.15V±2%, 150mA, -CE, PDR	SOT-23-5	28vt	VR4	6a	Can
R2BD	CM7R153D-21A-T	LVR-IC	LDO, 2.15V±2%, 150mA, -CE	SOT-23-5	28vt	VR4	6a	Can
R2C	LM4040CIM7-2.5	Vref-IC	Precision, Shunt, 2.50V, 0.5%	SC-70-5	28dq	RF1	6a	Nsc
R2C	XC6118C42CMR-G	Vdet-IC	4.2V±2%, ±Reset PPO, Sense, hysteresis 5%	SOT-25	28mf	VD12	6g	Tor
R2C	XC6368F223MR	DC/DC-IC	PWM/PFM step-up, 2.2V±2.5%, 200mA, 300kHz, +CE, soft start	SOT-25	28sd	DC10	6g	Tor
R2CA	CM7R153A-22A-T	LVR-IC	LDO, 2.25V±2%, 150mA, +CE, PDR	SOT-23-5	28vt	VR4	6a	Can
R2CB	CM7R153B-22A-T	LVR-IC	LDO, 2.25V±2%, 150mA, +CE	SOT-23-5	28vt	VR4	6a	Can
R2CC	CM7R153C-22A-T	LVR-IC	LDO, 2.25V±2%, 150mA, -CE, PDR	SOT-23-5	28vt	VR4	6a	Can
R2CD	CM7R153D-22A-T	LVR-IC	LDO, 2.25V±2%, 150mA, -CE	SOT-23-5	28vt	VR4	6a	Can
R2D	LM4040DIM7-2.5	Vref-IC	Precision, Shunt, 2.50V, 1%	SC-70-5	28dq	RF1	6a	Nsc
R2D	XC6118C42DMR-G	Vdet-IC	4.2V±2%, ±Reset PPO, Sense, hysteresis <1%	SOT-25	28mf	VD12	6g	Tor
R2D	XC6368F233MR	DC/DC-IC	PWM/PFM step-up, 2.3V±2.5%, 200mA, 300kHz, +CE, soft start	SOT-25	28sd	DC10	6g	Tor
R2DA	CM7R153A-23A-T	LVR-IC	LDO, 2.35V±2%, 150mA, +CE, PDR	SOT-23-5	28vt	VR4	6a	Can
R2DB	CM7R153B-23A-T	LVR-IC	LDO, 2.35V±2%, 150mA, +CE	SOT-23-5	28vt	VR4	6a	Can
R2DC	CM7R153C-23A-T	LVR-IC	LDO, 2.35V±2%, 150mA, -CE, PDR	SOT-23-5	28vt	VR4	6a	Can
R2DD	CM7R153D-23A-T	LVR-IC	LDO, 2.35V±2%, 150mA, -CE	SOT-23-5	28vt	VR4	6a	Can
R2E	LM4040EIM7-2.5	Vref-IC	Precision, Shunt, 2.50V, 2%	SC-70-5	28dq	RF1	6a	Nsc
R2E	XC6368F243MR	DC/DC-IC	PWM/PFM step-up, 2.4V±2.5%, 200mA, 300kHz, +CE, soft start	SOT-25	28sd	DC10	6g	Tor
R2EA	CM7R153A-24A-T	LVR-IC	LDO, 2.45V±2%, 150mA, +CE, PDR	SOT-23-5	28vt	VR4	6a	Can
R2EB	CM7R153B-24A-T	LVR-IC	LDO, 2.45V±2%, 150mA, +CE	SOT-23-5	28vt	VR4	6a	Can
R2EC	CM7R153C-24A-T	LVR-IC	LDO, 2.45V±2%, 150mA, -CE, PDR	SOT-23-5	28vt	VR4	6a	Can
R2ED	CM7R153D-24A-T	LVR-IC	LDO, 2.45V±2%, 150mA, -CE	SOT-23-5	28vt	VR4	6a	Can
R2F	XC6368F253MR	DC/DC-IC	PWM/PFM step-up, 2.5V±2.5%, 200mA, 300kHz, +CE, soft start	SOT-25	28sd	DC10	6g	Tor
R2FA	CM7R153A-25A-T	LVR-IC	LDO, 2.55V±2%, 150mA, +CE, PDR	SOT-23-5	28vt	VR4	6a	Can
R2FB	CM7R153B-25A-T	LVR-IC	LDO, 2.55V±2%, 150mA, +CE	SOT-23-5	28vt	VR4	6a	Can
R2FC	CM7R153C-25A-T	LVR-IC	LDO, 2.55V±2%, 150mA, -CE, PDR	SOT-23-5	28vt	VR4	6a	Can
R2FD	CM7R153D-25A-T	LVR-IC	LDO, 2.55V±2%, 150mA, -CE	SOT-23-5	28vt	VR4	6a	Can
R2GA	CM7R153A-26A-T	LVR-IC	LDO, 2.65V±2%, 150mA, +CE, PDR	SOT-23-5	28vt	VR4	6a	Can
R2GB	CM7R153B-26A-T	LVR-IC	LDO, 2.65V±2%, 150mA, +CE	SOT-23-5	28vt	VR4	6a	Can
R2GC	CM7R153C-26A-T	LVR-IC	LDO, 2.65V±2%, 150mA, -CE, PDR	SOT-23-5	28vt	VR4	6a	Can
R2GD	CM7R153D-26A-T	LVR-IC	LDO, 2.65V±2%, 150mA, -CE	SOT-23-5	28vt	VR4	6a	Can
R2H	XC6368F263MR	DC/DC-IC	PWM/PFM step-up, 2.6V±2.5%, 200mA, 300kHz, +CE, soft start	SOT-25	28sd	DC10	6g	Tor
R2HA	CM7R153A-27A-T	LVR-IC	LDO, 2.75V±2%, 150mA, +CE, PDR	SOT-23-5	28vt	VR4	6a	Can
R2HB	CM7R153B-27A-T	LVR-IC	LDO, 2.75V±2%, 150mA, +CE	SOT-23-5	28vt	VR4	6a	Can
R2HC	CM7R153C-27A-T	LVR-IC	LDO, 2.75V±2%, 150mA, -CE, PDR	SOT-23-5	28vt	VR4	6a	Can
R2HD	CM7R153D-27A-T	LVR-IC	LDO, 2.75V±2%, 150mA, -CE	SOT-23-5	28vt	VR4	6a	Can
R2IA	CM7R153A-28A-T	LVR-IC	LDO, 2.85V±2%, 150mA, +CE, PDR	SOT-23-5	28vt	VR4	6a	Can
R2IB	CM7R153B-28A-T	LVR-IC	LDO, 2.85V±2%, 150mA, +CE	SOT-23-5	28vt	VR4	6a	Can
R2IC	CM7R153C-28A-T	LVR-IC	LDO, 2.85V±2%, 150mA, -CE, PDR	SOT-23-5	28vt	VR4	6a	Can
R2ID	CM7R153D-28A-T	LVR-IC	LDO, 2.85V±2%, 150mA, -CE	SOT-23-5	28vt	VR4	6a	Can
R2JA	CM7R153A-29A-T	LVR-IC	LDO, 2.95V±2%, 150mA, +CE, PDR	SOT-23-5	28vt	VR4	6a	Can



SMD code	Type	Function	Short description	Case	Pinout	Sch.	St.	Mnf.
R2JB	CM7R153B-29A-T	LVR-IC	LDO, 2.95V±2%, 150mA, +CE	SOT-23-5	28vt	VR4	6a	Can
R2JC	CM7R153C-29A-T	LVR-IC	LDO, 2.95V±2%, 150mA, -CE, PDR	SOT-23-5	28vt	VR4	6a	Can
R2JD	CM7R153D-29A-T	LVR-IC	LDO, 2.95V±2%, 150mA, -CE	SOT-23-5	28vt	VR4	6a	Can
R2K	XC6368F273MR	DC/DC-IC	PWM/PFM step-up, 2.7V±2.5%, 200mA, 300kHz, +CE, soft start	SOT-25	28sd	DC10	6g	Tor
R2L	XC6368F283MR	DC/DC-IC	PWM/PFM step-up, 2.8V±2.5%, 200mA, 300kHz, +CE, soft start	SOT-25	28sd	DC10	6g	Tor
R2M	XC6368F293MR	DC/DC-IC	PWM/PFM step-up, 2.9V±2.5%, 200mA, 300kHz, +CE, soft start	SOT-25	28sd	DC10	6g	Tor
R3	R1121N231B	LVR-IC	LDO, LN, +CE, 2.3V±2%, 150mA	SOT-23-5	28vt	VR4	6g	Ric
R3	TC7S202AFE	CMOS-Logic	2-input NOR gate	SOM-5	30/Log2	-	6a	Tos
R30	NCP585DSN30T1	LVR-IC	LDO, 3.0V±2%, 350mA, +CE, CL, AE(Mode)	SOT-23-5	28x9	VR10	6g	Ons
R30	R1161N301D	LVR-IC	LDO, 3V±2%, 350mA, +CE, CL, AE(Mode)	SOT-23-5	28x9	VR10	6g	Ric
R30	TK11130CS	LVR-IC	LDO, 3V±1.5%, 200mA, -CE	SOT-23-5	28un	VR7	6k	Tok
R30	XC6368F302MR	DC/DC-IC	PWM/PFM step-up, 3.0V±2.5%, 200mA, 180kHz, +CE, soft start	SOT-25	28sd	DC10	6g	Tor
R30A	CM7R153A-30B-T	LVR-IC	LDO, 3.0V±2%, 150mA, +CE, PDR	SOT-23-5	28vt	VR4	6a	Can
R30B	CM7R153B-30B-T	LVR-IC	LDO, 3.0V±2%, 150mA, +CE	SOT-23-5	28vt	VR4	6a	Can
R30C	CM7R153C-30B-T	LVR-IC	LDO, 3.0V±2%, 150mA, -CE, PDR	SOT-23-5	28vt	VR4	6a	Can
R30D	CM7R153D-30B-T	LVR-IC	LDO, 3.0V±2%, 150mA, -CE	SOT-23-5	28vt	VR4	6a	Can
R31	R1161N311D	LVR-IC	LDO, 3.1V±2%, 350mA, +CE, CL, AE(Mode)	SOT-23-5	28x9	VR10	6g	Ric
R31	TK11131CS	LVR-IC	LDO, 3.1V±1.5%, 200mA, -CE	SOT-23-5	28un	VR7	6k	Tok
R31	XC6368F312MR	DC/DC-IC	PWM/PFM step-up, 3.1V±2.5%, 200mA, 180kHz, +CE, soft start	SOT-25	28sd	DC10	6g	Tor
R31A	CM7R153A-31B-T	LVR-IC	LDO, 3.1V±2%, 150mA, +CE, PDR	SOT-23-5	28vt	VR4	6a	Can
R31B	CM7R153B-31B-T	LVR-IC	LDO, 3.1V±2%, 150mA, +CE	SOT-23-5	28vt	VR4	6a	Can
R31C	CM7R153C-31B-T	LVR-IC	LDO, 3.1V±2%, 150mA, -CE, PDR	SOT-23-5	28vt	VR4	6a	Can
R31D	CM7R153D-31B-T	LVR-IC	LDO, 3.1V±2%, 150mA, -CE	SOT-23-5	28vt	VR4	6a	Can
R32	R1161N321D	LVR-IC	LDO, 3.2V±2%, 350mA, +CE, CL, AE(Mode)	SOT-23-5	28x9	VR10	6g	Ric
R32	TK11132CS	LVR-IC	LDO, 3.2V±1.5%, 200mA, -CE	SOT-23-5	28un	VR7	6k	Tok
R32	XC6368F322MR	DC/DC-IC	PWM/PFM step-up, 3.2V±2.5%, 200mA, 180kHz, +CE, soft start	SOT-25	28sd	DC10	6g	Tor
R32A	CM7R153A-32B-T	LVR-IC	LDO, 3.2V±2%, 150mA, +CE, PDR	SOT-23-5	28vt	VR4	6a	Can
R32B	CM7R153B-32B-T	LVR-IC	LDO, 3.2V±2%, 150mA, +CE	SOT-23-5	28vt	VR4	6a	Can
R32C	CM7R153C-32B-T	LVR-IC	LDO, 3.2V±2%, 150mA, -CE, PDR	SOT-23-5	28vt	VR4	6a	Can
R32D	CM7R153D-32B-T	LVR-IC	LDO, 3.2V±2%, 150mA, -CE	SOT-23-5	28vt	VR4	6a	Can
R33	NCP585DSN33T1	LVR-IC	LDO, 3.3V±2%, 350mA, +CE, CL, AE(Mode)	SOT-23-5	28x9	VR10	6g	Ons
R33	R1161N331D	LVR-IC	LDO, 3.3V±2%, 350mA, +CE, CL, AE(Mode)	SOT-23-5	28x9	VR10	6g	Ric
R33	TK11133CS	LVR-IC	LDO, 3.3V±1.5%, 200mA, -CE	SOT-23-5	28un	VR7	6k	Tok
R33	XC6368F332MR	DC/DC-IC	PWM/PFM step-up, 3.3V±2.5%, 200mA, 180kHz, +CE, soft start	SOT-25	28sd	DC10	6g	Tor
R33A	CM7R153A-33B-T	LVR-IC	LDO, 3.3V±2%, 150mA, +CE, PDR	SOT-23-5	28vt	VR4	6a	Can
R33B	CM7R153B-33B-T	LVR-IC	LDO, 3.3V±2%, 150mA, +CE	SOT-23-5	28vt	VR4	6a	Can
R33C	CM7R153C-33B-T	LVR-IC	LDO, 3.3V±2%, 150mA, -CE, PDR	SOT-23-5	28vt	VR4	6a	Can
R33D	CM7R153D-33B-T	LVR-IC	LDO, 3.3V±2%, 150mA, -CE	SOT-23-5	28vt	VR4	6a	Can
R34	TK11134CS	LVR-IC	LDO, 3.4V±1.5%, 200mA, -CE	SOT-23-5	28un	VR7	6k	Tok
R34	XC6368F342MR	DC/DC-IC	PWM/PFM step-up, 3.4V±2.5%, 200mA, 180kHz, +CE, soft start	SOT-25	28sd	DC10	6g	Tor
R34A	CM7R153A-34B-T	LVR-IC	LDO, 3.4V±2%, 150mA, +CE, PDR	SOT-23-5	28vt	VR4	6a	Can
R34B	CM7R153B-34B-T	LVR-IC	LDO, 3.4V±2%, 150mA, +CE	SOT-23-5	28vt	VR4	6a	Can
R34C	CM7R153C-34B-T	LVR-IC	LDO, 3.4V±2%, 150mA, -CE, PDR	SOT-23-5	28vt	VR4	6a	Can
R34D	CM7R153D-34B-T	LVR-IC	LDO, 3.4V±2%, 150mA, -CE	SOT-23-5	28vt	VR4	6a	Can
R35	TK11135CS	LVR-IC	LDO, 3.5V±1.5%, 200mA, -CE	SOT-23-5	28un	VR7	6k	Tok
R35	XC6368F352MR	DC/DC-IC	PWM/PFM step-up, 3.5V±2.5%, 200mA, 180kHz, +CE, soft start	SOT-25	28sd	DC10	6g	Tor
R35A	CM7R153A-35B-T	LVR-IC	LDO, 3.5V±2%, 150mA, +CE, PDR	SOT-23-5	28vt	VR4	6a	Can
R35B	CM7R153B-35B-T	LVR-IC	LDO, 3.5V±2%, 150mA, +CE	SOT-23-5	28vt	VR4	6a	Can
R35C	CM7R153C-35B-T	LVR-IC	LDO, 3.5V±2%, 150mA, -CE, PDR	SOT-23-5	28vt	VR4	6a	Can
R35D	CM7R153D-35B-T	LVR-IC	LDO, 3.5V±2%, 150mA, -CE	SOT-23-5	28vt	VR4	6a	Can
R36	TK11136CS	LVR-IC	LDO, 3.6V±1.5%, 200mA, -CE	SOT-23-5	28un	VR7	6k	Tok
R36	XC6368F362MR	DC/DC-IC	PWM/PFM step-up, 3.6V±2.5%, 200mA, 180kHz, +CE, soft start	SOT-25	28sd	DC10	6g	Tor
R36A	CM7R153A-36B-T	LVR-IC	LDO, 3.6V±2%, 150mA, +CE, PDR	SOT-23-5	28vt	VR4	6a	Can
R36B	CM7R153B-36B-T	LVR-IC	LDO, 3.6V±2%, 150mA, +CE	SOT-23-5	28vt	VR4	6a	Can
R36C	CM7R153C-36B-T	LVR-IC	LDO, 3.6V±2%, 150mA, -CE, PDR	SOT-23-5	28vt	VR4	6a	Can
R36D	CM7R153D-36B-T	LVR-IC	LDO, 3.6V±2%, 150mA, -CE	SOT-23-5	28vt	VR4	6a	Can
R37	TK11137CS	LVR-IC	LDO, 3.7V±1.5%, 200mA, -CE	SOT-23-5	28un	VR7	6k	Tok
R37	XC6368F372MR	DC/DC-IC	PWM/PFM step-up, 3.7V±2.5%, 200mA, 180kHz, +CE, soft start	SOT-25	28sd	DC10	6g	Tor
R37A	CM7R153A-37B-T	LVR-IC	LDO, 3.7V±2%, 150mA, +CE, PDRV	SOT-23-5	28vt	VR4	6a	Can
R37B	CM7R153B-37B-T	LVR-IC	LDO, 3.7V±2%, 150mA, +CEV	SOT-23-5	28vt	VR4	6a	Can
R37C	CM7R153C-37B-T	LVR-IC	LDO, 3.7V±2%, 150mA, -CE, PDRV	SOT-23-5	28vt	VR4	6a	Can
R37D	CM7R153D-37B-T	LVR-IC	LDO, 3.7V±2%, 150mA, -CEV	SOT-23-5	28vt	VR4	6a	Can
R38	TK11138CS	LVR-IC	LDO, 3.8V±1.5%, 200mA, -CE	SOT-23-5	28un	VR7	6k	Tok
R38	XC6368F382MR	DC/DC-IC	PWM/PFM step-up, 3.8V±2.5%, 200mA, 180kHz, +CE, soft start	SOT-25	28sd	DC10	6g	Tor
R38A	CM7R153A-38B-T	LVR-IC	LDO, 3.8V±2%, 150mA, +CE, PDR	SOT-23-5	28vt	VR4	6a	Can
R38B	CM7R153B-38B-T	LVR-IC	LDO, 3.8V±2%, 150mA, +CE	SOT-23-5	28vt	VR4	6a	Can
R38C	CM7R153C-38B-T	LVR-IC	LDO, 3.8V±2%, 150mA, -CE, PDR	SOT-23-5	28vt	VR4	6a	Can
R38D	CM7R153D-38B-T	LVR-IC	LDO, 3.8V±2%, 150mA, -CE	SOT-23-5	28vt	VR4	6a	Can
R39	TK11139CS	LVR-IC	LDO, 3.9V±1.5%, 200mA, -CE	SOT-23-5	28un	VR7	6k	Tok
R39	XC6368F392MR	DC/DC-IC	PWM/PFM step-up, 3.9V±2.5%, 200mA, 180kHz, +CE, soft start	SOT-25	28sd	DC10	6g	Tor



SMD code	Type	Function	Short description	Case	Pinout	Sch.	St.	Mnf.
R39A	CM7R153A-39B-T	LVR-IC	LDO, 3.9V±2%, 150mA, +CE, PDR	SOT-23-5	28vt	VR4	6a	Can
R39B	CM7R153B-39B-T	LVR-IC	LDO, 3.9V±2%, 150mA, +CE	SOT-23-5	28vt	VR4	6a	Can
R39C	CM7R153C-39B-T	LVR-IC	LDO, 3.9V±2%, 150mA, -CE, PDR	SOT-23-5	28vt	VR4	6a	Can
R39D	CM7R153D-39B-T	LVR-IC	LDO, 3.9V±2%, 150mA, -CE	SOT-23-5	28vt	VR4	6a	Can
R3A	XC6118C43AMR-G	Vdet-IC	4.3V±2%, ±Reset PPO, Sense, hysteresis 5%, Cd	SOT-25	28mg	VD15	6g	Tor
R3A	XC6368F303MR	DC/DC-IC	PWM/PFM step-up, 3.0V±2.5%, 200mA, 300kHz, +CE, soft start	SOT-25	28sd	DC10	6g	Tor
R3AA	CM7R153A-30A-T	LVR-IC	LDO, 3.05V±2%, 150mA, +CE, PDR	SOT-23-5	28vt	VR4	6a	Can
R3AB	CM7R153B-30A-T	LVR-IC	LDO, 3.05V±2%, 150mA, +CE	SOT-23-5	28vt	VR4	6a	Can
R3AC	CM7R153C-30A-T	LVR-IC	LDO, 3.05V±2%, 150mA, -CE, PDR	SOT-23-5	28vt	VR4	6a	Can
R3AD	CM7R153D-30A-T	LVR-IC	LDO, 3.05V±2%, 150mA, -CE	SOT-23-5	28vt	VR4	6a	Can
R3B	XC6118C43BMR-G	Vdet-IC	4.3V±2%, ±Reset PPO, Sense, hysteresis <1%, Cd	SOT-25	28mg	VD15	6g	Tor
R3B	XC6368F313MR	DC/DC-IC	PWM/PFM step-up, 3.1V±2.5%, 200mA, 300kHz, +CE, soft start	SOT-25	28sd	DC10	6g	Tor
R3BA	CM7R153A-31A-T	LVR-IC	LDO, 3.15V±2%, 150mA, +CE, PDR	SOT-23-5	28vt	VR4	6a	Can
R3BB	CM7R153B-31A-T	LVR-IC	LDO, 3.15V±2%, 150mA, +CE	SOT-23-5	28vt	VR4	6a	Can
R3BC	CM7R153C-31A-T	LVR-IC	LDO, 3.15V±2%, 150mA, -CE, PDR	SOT-23-5	28vt	VR4	6a	Can
R3BD	CM7R153D-31A-T	LVR-IC	LDO, 3.15V±2%, 150mA, -CE	SOT-23-5	28vt	VR4	6a	Can
R3C	XC6118C43CMR-G	Vdet-IC	4.3V±2%, ±Reset PPO, Sense, hysteresis 5%	SOT-25	28mf	VD12	6g	Tor
R3C	XC6368F323MR	DC/DC-IC	PWM/PFM step-up, 3.2V±2.5%, 200mA, 300kHz, +CE, soft start	SOT-25	28sd	DC10	6g	Tor
R3CA	CM7R153A-32A-T	LVR-IC	LDO, 3.25V±2%, 150mA, +CE, PDR	SOT-23-5	28vt	VR4	6a	Can
R3CB	CM7R153B-32A-T	LVR-IC	LDO, 3.25V±2%, 150mA, +CE	SOT-23-5	28vt	VR4	6a	Can
R3CC	CM7R153C-32A-T	LVR-IC	LDO, 3.25V±2%, 150mA, -CE, PDR	SOT-23-5	28vt	VR4	6a	Can
R3CD	CM7R153D-32A-T	LVR-IC	LDO, 3.25V±2%, 150mA, -CE	SOT-23-5	28vt	VR4	6a	Can
R3D	XC6118C43DMR-G	Vdet-IC	4.3V±2%, ±Reset PPO, Sense, hysteresis <1%	SOT-25	28mf	VD12	6g	Tor
R3D	XC6368F333MR	DC/DC-IC	PWM/PFM step-up, 3.3V±2.5%, 200mA, 300kHz, +CE, soft start	SOT-25	28sd	DC10	6g	Tor
R3DA	CM7R153A-33A-T	LVR-IC	LDO, 3.35V±2%, 150mA, +CE, PDR	SOT-23-5	28vt	VR4	6a	Can
R3DB	CM7R153B-33A-T	LVR-IC	LDO, 3.35V±2%, 150mA, +CE	SOT-23-5	28vt	VR4	6a	Can
R3DC	CM7R153C-33A-T	LVR-IC	LDO, 3.35V±2%, 150mA, -CE, PDR	SOT-23-5	28vt	VR4	6a	Can
R3DD	CM7R153D-33A-T	LVR-IC	LDO, 3.35V±2%, 150mA, -CE	SOT-23-5	28vt	VR4	6a	Can
R3E	XC6368F343MR	DC/DC-IC	PWM/PFM step-up, 3.4V±2.5%, 200mA, 300kHz, +CE, soft start	SOT-25	28sd	DC10	6g	Tor
R3EA	CM7R153A-34A-T	LVR-IC	LDO, 3.45V±2%, 150mA, +CE, PDR	SOT-23-5	28vt	VR4	6a	Can
R3EB	CM7R153B-34A-T	LVR-IC	LDO, 3.45V±2%, 150mA, +CE	SOT-23-5	28vt	VR4	6a	Can
R3EC	CM7R153C-34A-T	LVR-IC	LDO, 3.45V±2%, 150mA, -CE, PDR	SOT-23-5	28vt	VR4	6a	Can
R3ED	CM7R153D-34A-T	LVR-IC	LDO, 3.45V±2%, 150mA, -CE	SOT-23-5	28vt	VR4	6a	Can
R3F	XC6368F353MR	DC/DC-IC	PWM/PFM step-up, 3.5V±2.5%, 200mA, 300kHz, +CE, soft start	SOT-25	28sd	DC10	6g	Tor
R3FA	CM7R153A-35A-T	LVR-IC	LDO, 3.55V±2%, 150mA, +CE, PDR	SOT-23-5	28vt	VR4	6a	Can
R3FB	CM7R153B-35A-T	LVR-IC	LDO, 3.55V±2%, 150mA, +CE	SOT-23-5	28vt	VR4	6a	Can
R3FC	CM7R153C-35A-T	LVR-IC	LDO, 3.55V±2%, 150mA, -CE, PDR	SOT-23-5	28vt	VR4	6a	Can
R3FD	CM7R153D-35A-T	LVR-IC	LDO, 3.55V±2%, 150mA, -CE	SOT-23-5	28vt	VR4	6a	Can
R3GA	CM7R153A-36A-T	LVR-IC	LDO, 3.65V±2%, 150mA, +CE, PDR	SOT-23-5	28vt	VR4	6a	Can
R3GB	CM7R153B-36A-T	LVR-IC	LDO, 3.65V±2%, 150mA, +CE	SOT-23-5	28vt	VR4	6a	Can
R3GC	CM7R153C-36A-T	LVR-IC	LDO, 3.65V±2%, 150mA, -CE, PDR	SOT-23-5	28vt	VR4	6a	Can
R3GD	CM7R153D-36A-T	LVR-IC	LDO, 3.65V±2%, 150mA, -CE	SOT-23-5	28vt	VR4	6a	Can
R3H	XC6368F363MR	DC/DC-IC	PWM/PFM step-up, 3.6V±2.5%, 200mA, 300kHz, +CE, soft start	SOT-25	28sd	DC10	6g	Tor
R3HA	CM7R153A-37A-T	LVR-IC	LDO, 3.75V±2%, 150mA, +CE, PDR	SOT-23-5	28vt	VR4	6a	Can
R3HB	CM7R153B-37A-T	LVR-IC	LDO, 3.75V±2%, 150mA, +CE	SOT-23-5	28vt	VR4	6a	Can
R3HC	CM7R153C-37A-T	LVR-IC	LDO, 3.75V±2%, 150mA, -CE, PDR	SOT-23-5	28vt	VR4	6a	Can
R3HD	CM7R153D-37A-T	LVR-IC	LDO, 3.75V±2%, 150mA, -CE	SOT-23-5	28vt	VR4	6a	Can
R3IA	CM7R153A-38A-T	LVR-IC	LDO, 3.85V±2%, 150mA, +CE, PDR	SOT-23-5	28vt	VR4	6a	Can
R3IB	CM7R153B-38A-T	LVR-IC	LDO, 3.85V±2%, 150mA, +CE	SOT-23-5	28vt	VR4	6a	Can
R3IC	CM7R153C-38A-T	LVR-IC	LDO, 3.85V±2%, 150mA, -CE, PDR	SOT-23-5	28vt	VR4	6a	Can
R3ID	CM7R153D-38A-T	LVR-IC	LDO, 3.85V±2%, 150mA, -CE	SOT-23-5	28vt	VR4	6a	Can
R3JA	CM7R153A-39A-T	LVR-IC	LDO, 3.95V±2%, 150mA, +CE, PDR	SOT-23-5	28vt	VR4	6a	Can
R3JB	CM7R153B-39A-T	LVR-IC	LDO, 3.95V±2%, 150mA, +CE	SOT-23-5	28vt	VR4	6a	Can
R3JC	CM7R153C-39A-T	LVR-IC	LDO, 3.95V±2%, 150mA, -CE, PDR	SOT-23-5	28vt	VR4	6a	Can
R3JD	CM7R153D-39A-T	LVR-IC	LDO, 3.95V±2%, 150mA, -CE	SOT-23-5	28vt	VR4	6a	Can
R3K	XC6368F373MR	DC/DC-IC	PWM/PFM step-up, 3.7V±2.5%, 200mA, 300kHz, +CE, soft start	SOT-25	28sd	DC10	6g	Tor
R3L	XC6368F383MR	DC/DC-IC	PWM/PFM step-up, 3.8V±2.5%, 200mA, 300kHz, +CE, soft start	SOT-25	28sd	DC10	6g	Tor
R3M	XC6368F393MR	DC/DC-IC	PWM/PFM step-up, 3.9V±2.5%, 200mA, 300kHz, +CE, soft start	SOT-25	28sd	DC10	6g	Tor
R4	R1121N241B	LVR-IC	LDO, LN, +CE, 2.4V±2%, 150mA	SOT-23-5	28vt	VR4	6g	Ric
R4	TC7SZ32AFE	CMOS-Logic	2-input OR gate	SOM-5	30/Log4	-	6a	Tos
R40	TK11140CS	LVR-IC	LDO, 4V±1.5%, 200mA, -CE	SOT-23-5	28un	VR7	6k	Tok
R40	XC6368F402MR	DC/DC-IC	PWM/PFM step-up, 4.0V±2.5%, 200mA, 180kHz, +CE, soft start	SOT-25	28sd	DC10	6g	Tor
R40A	CM7R153A-40B-T	LVR-IC	LDO, 4.0V±2%, 150mA, +CE, PDR	SOT-23-5	28vt	VR4	6a	Can
R40B	CM7R153B-40B-T	LVR-IC	LDO, 4.0V±2%, 150mA, +CE	SOT-23-5	28vt	VR4	6a	Can
R40C	CM7R153C-40B-T	LVR-IC	LDO, 4.0V±2%, 150mA, -CE, PDR	SOT-23-5	28vt	VR4	6a	Can
R40D	CM7R153D-40B-T	LVR-IC	LDO, 4.0V±2%, 150mA, -CE	SOT-23-5	28vt	VR4	6a	Can
R41	TK11141CS	LVR-IC	LDO, 4.1V±1.5%, 200mA, -CE	SOT-23-5	28un	VR7	6k	Tok
R41	XC6368F412MR	DC/DC-IC	PWM/PFM step-up, 4.1V±2.5%, 200mA, 180kHz, +CE, soft start	SOT-25	28sd	DC10	6g	Tor
R41A	CM7R153A-41B-T	LVR-IC	LDO, 4.1V±2%, 150mA, +CE, PDR	SOT-23-5	28vt	VR4	6a	Can
R41B	CM7R153B-41B-T	LVR-IC	LDO, 4.1V±2%, 150mA, +CE	SOT-23-5	28vt	VR4	6a	Can



SMD code	Type	Function	Short description	Case	Pinout	Sch.	St.	Mnf.
R41C	CM7R153C-41B-T	LVR-IC	LDO, 4.1V±2%, 150mA, -CE, PDR	SOT-23-5	28vt	VR4	6a	Can
R41D	CM7R153D-41B-T	LVR-IC	LDO, 4.1V±2%, 150mA, -CE	SOT-23-5	28vt	VR4	6a	Can
R42	TK11142CS	LVR-IC	LDO, 4.2V±1.5%, 200mA, -CE	SOT-23-5	28un	VR7	6k	Tok
R42	XC6368F422MR	DC/DC-IC	PWM/PFM step-up, 4.2V±2.5%, 200mA, 180kHz, +CE, soft start	SOT-25	28sd	DC10	6g	Tor
R42A	CM7R153A-42B-T	LVR-IC	LDO, 4.2V±2%, 150mA, +CE, PDR	SOT-23-5	28vt	VR4	6a	Can
R42B	CM7R153B-42B-T	LVR-IC	LDO, 4.2V±2%, 150mA, -CE	SOT-23-5	28vt	VR4	6a	Can
R42C	CM7R153C-42B-T	LVR-IC	LDO, 4.2V±2%, 150mA, -CE, PDR	SOT-23-5	28vt	VR4	6a	Can
R42D	CM7R153D-42B-T	LVR-IC	LDO, 4.2V±2%, 150mA, -CE	SOT-23-5	28vt	VR4	6a	Can
R43	TK11143CS	LVR-IC	LDO, 4.3V±1.5%, 200mA, -CE	SOT-23-5	28un	VR7	6k	Tok
R43	XC6368F432MR	DC/DC-IC	PWM/PFM step-up, 4.3V±2.5%, 200mA, 180kHz, +CE, soft start	SOT-25	28sd	DC10	6g	Tor
R43A	CM7R153A-43B-T	LVR-IC	LDO, 4.3V±2%, 150mA, +CE, PDR	SOT-23-5	28vt	VR4	6a	Can
R43B	CM7R153B-43B-T	LVR-IC	LDO, 4.3V±2%, 150mA, -CE	SOT-23-5	28vt	VR4	6a	Can
R43C	CM7R153C-43B-T	LVR-IC	LDO, 4.3V±2%, 150mA, -CE, PDR	SOT-23-5	28vt	VR4	6a	Can
R43D	CM7R153D-43B-T	LVR-IC	LDO, 4.3V±2%, 150mA, -CE	SOT-23-5	28vt	VR4	6a	Can
R44	TK11144CS	LVR-IC	LDO, 4.4V±1.5%, 200mA, -CE	SOT-23-5	28un	VR7	6k	Tok
R44	XC6368F442MR	DC/DC-IC	PWM/PFM step-up, 4.4V±2.5%, 200mA, 180kHz, +CE, soft start	SOT-25	28sd	DC10	6g	Tor
R44A	CM7R153A-44B-T	LVR-IC	LDO, 4.4V±2%, 150mA, +CE, PDR	SOT-23-5	28vt	VR4	6a	Can
R44B	CM7R153B-44B-T	LVR-IC	LDO, 4.4V±2%, 150mA, +CE	SOT-23-5	28vt	VR4	6a	Can
R44C	CM7R153C-44B-T	LVR-IC	LDO, 4.4V±2%, 150mA, -CE, PDR	SOT-23-5	28vt	VR4	6a	Can
R44D	CM7R153D-44B-T	LVR-IC	LDO, 4.4V±2%, 150mA, -CE	SOT-23-5	28vt	VR4	6a	Can
R45	TK11145CS	LVR-IC	LDO, 4.5V±1.5%, 200mA, -CE	SOT-23-5	28un	VR7	6k	Tok
R45	XC6368F452MR	DC/DC-IC	PWM/PFM step-up, 4.5V±2.5%, 200mA, 180kHz, +CE, soft start	SOT-25	28sd	DC10	6g	Tor
R45A	CM7R153A-45B-T	LVR-IC	LDO, 4.5V±2%, 150mA, +CE, PDR	SOT-23-5	28vt	VR4	6a	Can
R45B	CM7R153B-45B-T	LVR-IC	LDO, 4.5V±2%, 150mA, +CE	SOT-23-5	28vt	VR4	6a	Can
R45C	CM7R153C-45B-T	LVR-IC	LDO, 4.5V±2%, 150mA, -CE, PDR	SOT-23-5	28vt	VR4	6a	Can
R45D	CM7R153D-45B-T	LVR-IC	LDO, 4.5V±2%, 150mA, -CE	SOT-23-5	28vt	VR4	6a	Can
R46	TK11146CS	LVR-IC	LDO, 4.6V±1.5%, 200mA, -CE	SOT-23-5	28un	VR7	6k	Tok
R46	XC6368F462MR	DC/DC-IC	PWM/PFM step-up, 4.6V±2.5%, 200mA, 180kHz, +CE, soft start	SOT-25	28sd	DC10	6g	Tor
R46A	CM7R153A-46B-T	LVR-IC	LDO, 4.6V±2%, 150mA, +CE, PDR	SOT-23-5	28vt	VR4	6a	Can
R46B	CM7R153B-46B-T	LVR-IC	LDO, 4.6V±2%, 150mA, +CE	SOT-23-5	28vt	VR4	6a	Can
R46C	CM7R153C-46B-T	LVR-IC	LDO, 4.6V±2%, 150mA, -CE, PDR	SOT-23-5	28vt	VR4	6a	Can
R46D	CM7R153D-46B-T	LVR-IC	LDO, 4.6V±2%, 150mA, -CE	SOT-23-5	28vt	VR4	6a	Can
R47	TK11147CS	LVR-IC	LDO, 4.7V±1.5%, 200mA, -CE	SOT-23-5	28un	VR7	6k	Tok
R47	XC6368F472MR	DC/DC-IC	PWM/PFM step-up, 4.7V±2.5%, 200mA, 180kHz, +CE, soft start	SOT-25	28sd	DC10	6g	Tor
R47A	CM7R153A-47B-T	LVR-IC	LDO, 4.7V±2%, 150mA, +CE, PDR	SOT-23-5	28vt	VR4	6a	Can
R47B	CM7R153B-47B-T	LVR-IC	LDO, 4.7V±2%, 150mA, +CE	SOT-23-5	28vt	VR4	6a	Can
R47C	CM7R153C-47B-T	LVR-IC	LDO, 4.7V±2%, 150mA, -CE, PDR	SOT-23-5	28vt	VR4	6a	Can
R47D	CM7R153D-47B-T	LVR-IC	LDO, 4.7V±2%, 150mA, -CE	SOT-23-5	28vt	VR4	6a	Can
R48	TK11148CS	LVR-IC	LDO, 4.8V±1.5%, 200mA, -CE	SOT-23-5	28un	VR7	6k	Tok
R48	XC6368F482MR	DC/DC-IC	PWM/PFM step-up, 4.8V±2.5%, 200mA, 180kHz, +CE, soft start	SOT-25	28sd	DC10	6g	Tor
R48A	CM7R153A-48B-T	LVR-IC	LDO, 4.8V±2%, 150mA, +CE, PDR	SOT-23-5	28vt	VR4	6a	Can
R48B	CM7R153B-48B-T	LVR-IC	LDO, 4.8V±2%, 150mA, +CE	SOT-23-5	28vt	VR4	6a	Can
R48C	CM7R153C-48B-T	LVR-IC	LDO, 4.8V±2%, 150mA, -CE, PDR	SOT-23-5	28vt	VR4	6a	Can
R48D	CM7R153D-48B-T	LVR-IC	LDO, 4.8V±2%, 150mA, -CE	SOT-23-5	28vt	VR4	6a	Can
R49	TK11149CS	LVR-IC	LDO, 4.9V±1.5%, 200mA, -CE	SOT-23-5	28un	VR7	6k	Tok
R49	XC6368F492MR	DC/DC-IC	PWM/PFM step-up, 4.9V±2.5%, 200mA, 180kHz, +CE, soft start	SOT-25	28sd	DC10	6g	Tor
R49A	CM7R153A-49B-T	LVR-IC	LDO, 4.9V±2%, 150mA, +CE, PDR	SOT-23-5	28vt	VR4	6a	Can
R49B	CM7R153B-49B-T	LVR-IC	LDO, 4.9V±2%, 150mA, +CE	SOT-23-5	28vt	VR4	6a	Can
R49C	CM7R153C-49B-T	LVR-IC	LDO, 4.9V±2%, 150mA, -CE, PDR	SOT-23-5	28vt	VR4	6a	Can
R49D	CM7R153D-49B-T	LVR-IC	LDO, 4.9V±2%, 150mA, -CE	SOT-23-5	28vt	VR4	6a	Can
R4A	XC6118C44AMR-G	Vdet-IC	4.4V±2%, ±Reset PPO, Sense, hysteresis 5%, Cd	SOT-25	28mg	VD15	6g	Tor
R4A	XC6368F403MR	DC/DC-IC	PWM/PFM step-up, 4.0V±2.5%, 200mA, 300kHz, +CE, soft start	SOT-25	28sd	DC10	6g	Tor
R4AA	CM7R153A-40A-T	LVR-IC	LDO, 4.05V±2%, 150mA, +CE, PDR	SOT-23-5	28vt	VR4	6a	Can
R4AB	CM7R153B-40A-T	LVR-IC	LDO, 4.05V±2%, 150mA, +CE	SOT-23-5	28vt	VR4	6a	Can
R4AC	CM7R153C-40A-T	LVR-IC	LDO, 4.05V±2%, 150mA, -CE, PDR	SOT-23-5	28vt	VR4	6a	Can
R4AD	CM7R153D-40A-T	LVR-IC	LDO, 4.05V±2%, 150mA, -CE	SOT-23-5	28vt	VR4	6a	Can
R4B	LM4040BIM7-4.1	Vref-IC	Precision, Shunt, 4.10V, 0.2%	SC-70-5	28dq	RF1	6a	Nsc
R4B	XC6118C44BMR-G	Vdet-IC	4.4V±2%, ±Reset PPO, Sense, hysteresis <1%, Cd	SOT-25	28mg	VD15	6g	Tor
R4B	XC6368F413MR	DC/DC-IC	PWM/PFM step-up, 4.1V±2.5%, 200mA, 300kHz, +CE, soft start	SOT-25	28sd	DC10	6g	Tor
R4BA	CM7R153A-41A-T	LVR-IC	LDO, 4.15V±2%, 150mA, +CE, PDR	SOT-23-5	28vt	VR4	6a	Can
R4BB	CM7R153B-41A-T	LVR-IC	LDO, 4.15V±2%, 150mA, +CE	SOT-23-5	28vt	VR4	6a	Can
R4BC	CM7R153C-41A-T	LVR-IC	LDO, 4.15V±2%, 150mA, -CE, PDR	SOT-23-5	28vt	VR4	6a	Can
R4BD	CM7R153D-41A-T	LVR-IC	LDO, 4.15V±2%, 150mA, -CE	SOT-23-5	28vt	VR4	6a	Can
R4C	LM4040CIM7-4.1	Vref-IC	Precision, Shunt, 4.10V, 0.5%	SC-70-5	28dq	RF1	6a	Nsc
R4C	XC6118C44CMR-G	Vdet-IC	4.4V±2%, ±Reset PPO, Sense, hysteresis 5%	SOT-25	28mf	VD12	6g	Tor
R4C	XC6368F423MR	DC/DC-IC	PWM/PFM step-up, 4.2V±2.5%, 200mA, 300kHz, +CE, soft start	SOT-25	28sd	DC10	6g	Tor
R4CA	CM7R153A-42A-T	LVR-IC	LDO, 4.25V±2%, 150mA, +CE, PDR	SOT-23-5	28vt	VR4	6a	Can
R4CB	CM7R153B-42A-T	LVR-IC	LDO, 4.25V±2%, 150mA, +CE	SOT-23-5	28vt	VR4	6a	Can
R4CC	CM7R153C-42A-T	LVR-IC	LDO, 4.25V±2%, 150mA, -CE, PDR	SOT-23-5	28vt	VR4	6a	Can
R4CD	CM7R153D-42A-T	LVR-IC	LDO, 4.25V±2%, 150mA, -CE	SOT-23-5	28vt	VR4	6a	Can



SMD code	Type	Function	Short description	Case	Pinout	Sch.	St.	Mnf.
R4D	LM4040DIM7-4.1	Vref-IC	Precision, Shunt, 4.10V, 1%	SC-70-5	28dq	RF1	6a	Nsc
R4D	XC6118C44DMR-G	Vdet-IC	4.4V±2%, ±Reset PPO, Sense, hysteresis <1%	SOT-25	28mf	VD12	6g	Tor
R4D	XC6368F433MR	DC/DC-IC	PWM/PFM step-up, 4.3V±2.5%, 200mA, 300kHz, +CE, soft start	SOT-25	28sd	DC10	6g	Tor
R4DA	CM7R153A-43A-T	LVR-IC	LDO, 4.35V±2%, 150mA, +CE, PDR	SOT-23-5	28vt	VR4	6a	Can
R4DB	CM7R153B-43A-T	LVR-IC	LDO, 4.35V±2%, 150mA, +CE	SOT-23-5	28vt	VR4	6a	Can
R4DC	CM7R153C-43A-T	LVR-IC	LDO, 4.35V±2%, 150mA, -CE, PDR	SOT-23-5	28vt	VR4	6a	Can
R4DD	CM7R153D-43A-T	LVR-IC	LDO, 4.35V±2%, 150mA, -CE	SOT-23-5	28vt	VR4	6a	Can
R4E	XC6368F443MR	DC/DC-IC	PWM/PFM step-up, 4.4V±2.5%, 200mA, 300kHz, +CE, soft start	SOT-25	28sd	DC10	6g	Tor
R4EA	CM7R153A-44A-T	LVR-IC	LDO, 4.45V±2%, 150mA, +CE, PDR	SOT-23-5	28vt	VR4	6a	Can
R4EB	CM7R153B-44A-T	LVR-IC	LDO, 4.45V±2%, 150mA, +CE	SOT-23-5	28vt	VR4	6a	Can
R4EC	CM7R153C-44A-T	LVR-IC	LDO, 4.45V±2%, 150mA, -CE, PDR	SOT-23-5	28vt	VR4	6a	Can
R4ED	CM7R153D-44A-T	LVR-IC	LDO, 4.45V±2%, 150mA, -CE	SOT-23-5	28vt	VR4	6a	Can
R4F	XC6368F453MR	DC/DC-IC	PWM/PFM step-up, 4.5V±2.5%, 200mA, 300kHz, +CE, soft start	SOT-25	28sd	DC10	6g	Tor
R4FA	CM7R153A-45A-T	LVR-IC	LDO, 4.55V±2%, 150mA, +CE, PDR	SOT-23-5	28vt	VR4	6a	Can
R4FB	CM7R153B-45A-T	LVR-IC	LDO, 4.55V±2%, 150mA, +CE	SOT-23-5	28vt	VR4	6a	Can
R4FC	CM7R153C-45A-T	LVR-IC	LDO, 4.55V±2%, 150mA, -CE, PDR	SOT-23-5	28vt	VR4	6a	Can
R4FD	CM7R153D-45A-T	LVR-IC	LDO, 4.55V±2%, 150mA, -CE	SOT-23-5	28vt	VR4	6a	Can
R4GA	CM7R153A-46A-T	LVR-IC	LDO, 4.65V±2%, 150mA, +CE, PDR	SOT-23-5	28vt	VR4	6a	Can
R4GB	CM7R153B-46A-T	LVR-IC	LDO, 4.65V±2%, 150mA, +CE	SOT-23-5	28vt	VR4	6a	Can
R4GC	CM7R153C-46A-T	LVR-IC	LDO, 4.65V±2%, 150mA, -CE, PDR	SOT-23-5	28vt	VR4	6a	Can
R4GD	CM7R153D-46A-T	LVR-IC	LDO, 4.65V±2%, 150mA, -CE	SOT-23-5	28vt	VR4	6a	Can
R4H	XC6368F463MR	DC/DC-IC	PWM/PFM step-up, 4.6V±2.5%, 200mA, 300kHz, +CE, soft start	SOT-25	28sd	DC10	6g	Tor
R4HA	CM7R153A-47A-T	LVR-IC	LDO, 4.75V±2%, 150mA, +CE, PDR	SOT-23-5	28vt	VR4	6a	Can
R4HB	CM7R153B-47A-T	LVR-IC	LDO, 4.75V±2%, 150mA, +CE	SOT-23-5	28vt	VR4	6a	Can
R4HC	CM7R153C-47A-T	LVR-IC	LDO, 4.75V±2%, 150mA, -CE, PDR	SOT-23-5	28vt	VR4	6a	Can
R4HD	CM7R153D-47A-T	LVR-IC	LDO, 4.75V±2%, 150mA, -CE	SOT-23-5	28vt	VR4	6a	Can
R4IA	CM7R153A-48A-T	LVR-IC	LDO, 4.85V±2%, 150mA, +CE, PDR	SOT-23-5	28vt	VR4	6a	Can
R4IB	CM7R153B-48A-T	LVR-IC	LDO, 4.85V±2%, 150mA, +CE	SOT-23-5	28vt	VR4	6a	Can
R4IC	CM7R153C-48A-T	LVR-IC	LDO, 4.85V±2%, 150mA, -CE, PDR	SOT-23-5	28vt	VR4	6a	Can
R4ID	CM7R153D-48A-T	LVR-IC	LDO, 4.85V±2%, 150mA, -CE	SOT-23-5	28vt	VR4	6a	Can
R4JA	CM7R153A-49A-T	LVR-IC	LDO, 4.95V±2%, 150mA, +CE, PDR	SOT-23-5	28vt	VR4	6a	Can
R4JB	CM7R153B-49A-T	LVR-IC	LDO, 4.95V±2%, 150mA, +CE	SOT-23-5	28vt	VR4	6a	Can
R4JC	CM7R153C-49A-T	LVR-IC	LDO, 4.95V±2%, 150mA, -CE, PDR	SOT-23-5	28vt	VR4	6a	Can
R4JD	CM7R153D-49A-T	LVR-IC	LDO, 4.95V±2%, 150mA, -CE	SOT-23-5	28vt	VR4	6a	Can
R4K	XC6368F473MR	DC/DC-IC	PWM/PFM step-up, 4.7V±2.5%, 200mA, 300kHz, +CE, soft start	SOT-25	28sd	DC10	6g	Tor
R4L	XC6368F483MR	DC/DC-IC	PWM/PFM step-up, 4.8V±2.5%, 200mA, 300kHz, +CE, soft start	SOT-25	28sd	DC10	6g	Tor
R4M	XC6368F493MR	DC/DC-IC	PWM/PFM step-up, 4.9V±2.5%, 200mA, 300kHz, +CE, soft start	SOT-25	28sd	DC10	6g	Tor
R5	R112N1251B	LVR-IC	LDO, LN, +CE, 2.5V±2%, 150mA	SOT-23-5	28vt	VR4	6g	Ric
R5	TC7SZ04AFE	CMOS-Logic	Inverter	SON-5	30/Log6	-	6a	Tos
R50	TK11150CS	LVR-IC	LDO, 5V±1.5%, 200mA, -CE	SOT-23-5	28un	VR7	6k	Tok
R50	XC6368F502MR	DC/DC-IC	PWM/PFM step-up, 5.0V±2.5%, 200mA, 180kHz, +CE, soft start	SOT-25	28sd	DC10	6g	Tor
R50A	CM7R153A-50B-T	LVR-IC	LDO, 5.0V±2%, 150mA, +CE, PDR	SOT-23-5	28vt	VR4	6a	Can
R50B	CM7R153B-50B-T	LVR-IC	LDO, 5.0V±2%, 150mA, +CE	SOT-23-5	28vt	VR4	6a	Can
R50C	CM7R153C-50B-T	LVR-IC	LDO, 5.0V±2%, 150mA, -CE, PDR	SOT-23-5	28vt	VR4	6a	Can
R50D	CM7R153D-50B-T	LVR-IC	LDO, 5.0V±2%, 150mA, -CE	SOT-23-5	28vt	VR4	6a	Can
R51	XC6368F512MR	DC/DC-IC	PWM/PFM step-up, 5.1V±2.5%, 200mA, 180kHz, +CE, soft start	SOT-25	28sd	DC10	6g	Tor
R51A	CM7R153A-51B-T	LVR-IC	LDO, 5.1V±2%, 150mA, +CE, PDR	SOT-23-5	28vt	VR4	6a	Can
R51B	CM7R153B-51B-T	LVR-IC	LDO, 5.1V±2%, 150mA, +CE	SOT-23-5	28vt	VR4	6a	Can
R51C	CM7R153C-51B-T	LVR-IC	LDO, 5.1V±2%, 150mA, -CE, PDR	SOT-23-5	28vt	VR4	6a	Can
R51D	CM7R153D-51B-T	LVR-IC	LDO, 5.1V±2%, 150mA, -CE	SOT-23-5	28vt	VR4	6a	Can
R52	XC6368F522MR	DC/DC-IC	PWM/PFM step-up, 5.2V±2.5%, 200mA, 180kHz, +CE, soft start	SOT-25	28sd	DC10	6g	Tor
R52A	CM7R153A-52B-T	LVR-IC	LDO, 5.2V±2%, 150mA, +CE, PDR	SOT-23-5	28vt	VR4	6a	Can
R52B	CM7R153B-52B-T	LVR-IC	LDO, 5.2V±2%, 150mA, +CE	SOT-23-5	28vt	VR4	6a	Can
R52C	CM7R153C-52B-T	LVR-IC	LDO, 5.2V±2%, 150mA, -CE, PDR	SOT-23-5	28vt	VR4	6a	Can
R52D	CM7R153D-52B-T	LVR-IC	LDO, 5.2V±2%, 150mA, -CE	SOT-23-5	28vt	VR4	6a	Can
R53	XC6368F532MR	DC/DC-IC	PWM/PFM step-up, 5.3V±2.5%, 200mA, 180kHz, +CE, soft start	SOT-25	28sd	DC10	6g	Tor
R53A	CM7R153A-53B-T	LVR-IC	LDO, 5.3V±2%, 150mA, +CE, PDR	SOT-23-5	28vt	VR4	6a	Can
R53B	CM7R153B-53B-T	LVR-IC	LDO, 5.3V±2%, 150mA, +CE	SOT-23-5	28vt	VR4	6a	Can
R53C	CM7R153C-53B-T	LVR-IC	LDO, 5.3V±2%, 150mA, -CE, PDR	SOT-23-5	28vt	VR4	6a	Can
R53D	CM7R153D-53B-T	LVR-IC	LDO, 5.3V±2%, 150mA, -CE	SOT-23-5	28vt	VR4	6a	Can
R54	XC6368F542MR	DC/DC-IC	PWM/PFM step-up, 5.4V±2.5%, 200mA, 180kHz, +CE, soft start	SOT-25	28sd	DC10	6g	Tor
R54A	CM7R153A-54B-T	LVR-IC	LDO, 5.4V±2%, 150mA, +CE, PDR	SOT-23-5	28vt	VR4	6a	Can
R54B	CM7R153B-54B-T	LVR-IC	LDO, 5.4V±2%, 150mA, +CE	SOT-23-5	28vt	VR4	6a	Can
R54C	CM7R153C-54B-T	LVR-IC	LDO, 5.4V±2%, 150mA, -CE, PDR	SOT-23-5	28vt	VR4	6a	Can
R54D	CM7R153D-54B-T	LVR-IC	LDO, 5.4V±2%, 150mA, -CE	SOT-23-5	28vt	VR4	6a	Can
R55	XC6368F552MR	DC/DC-IC	PWM/PFM step-up, 5.5V±2.5%, 200mA, 180kHz, +CE, soft start	SOT-25	28sd	DC10	6g	Tor
R55A	CM7R153A-55B-T	LVR-IC	LDO, 5.5V±2%, 150mA, +CE, PDR	SOT-23-5	28vt	VR4	6a	Can
R55B	CM7R153B-55B-T	LVR-IC	LDO, 5.5V±2%, 150mA, +CE	SOT-23-5	28vt	VR4	6a	Can
R55C	CM7R153C-55B-T	LVR-IC	LDO, 5.5V±2%, 150mA, -CE, PDR	SOT-23-5	28vt	VR4	6a	Can
R55D	CM7R153D-55B-T	LVR-IC	LDO, 5.5V±2%, 150mA, -CE	SOT-23-5	28vt	VR4	6a	Can



SMD code	Type	Function	Short description	Case	Pinout	Sch.	St.	Mnf.
R56	XC6368F562MR	DC/DC-IC	PWM/PFM step-up, 5.6V±2.5%, 200mA, 180kHz, +CE, soft start	SOT-25	28sd	DC10	6g	Tor
R56A	CM7R153A-56B-T	LVR-IC	LDO, 5.6V±2%, 150mA, +CE, PDR	SOT-23-5	28vt	VR4	6a	Can
R56B	CM7R153B-56B-T	LVR-IC	LDO, 5.6V±2%, 150mA, +CE	SOT-23-5	28vt	VR4	6a	Can
R56C	CM7R153C-56B-T	LVR-IC	LDO, 5.6V±2%, 150mA, -CE, PDR	SOT-23-5	28vt	VR4	6a	Can
R56D	CM7R153D-56B-T	LVR-IC	LDO, 5.6V±2%, 150mA, -CE	SOT-23-5	28vt	VR4	6a	Can
R57	XC6368F572MR	DC/DC-IC	PWM/PFM step-up, 5.7V±2.5%, 200mA, 180kHz, +CE, soft start	SOT-25	28sd	DC10	6g	Tor
R57A	CM7R153A-57B-T	LVR-IC	LDO, 5.7V±2%, 150mA, +CE, PDR	SOT-23-5	28vt	VR4	6a	Can
R57B	CM7R153B-57B-T	LVR-IC	LDO, 5.7V±2%, 150mA, +CE	SOT-23-5	28vt	VR4	6a	Can
R57C	CM7R153C-57B-T	LVR-IC	LDO, 5.7V±2%, 150mA, -CE, PDR	SOT-23-5	28vt	VR4	6a	Can
R57D	CM7R153D-57B-T	LVR-IC	LDO, 5.7V±2%, 150mA, -CE	SOT-23-5	28vt	VR4	6a	Can
R58	XC6368F582MR	DC/DC-IC	PWM/PFM step-up, 5.8V±2.5%, 200mA, 180kHz, +CE, soft start	SOT-25	28sd	DC10	6g	Tor
R58A	CM7R153A-58B-T	LVR-IC	LDO, 5.8V±2%, 150mA, +CE, PDR	SOT-23-5	28vt	VR4	6a	Can
R58B	CM7R153B-58B-T	LVR-IC	LDO, 5.8V±2%, 150mA, +CE	SOT-23-5	28vt	VR4	6a	Can
R58C	CM7R153C-58B-T	LVR-IC	LDO, 5.8V±2%, 150mA, -CE, PDR	SOT-23-5	28vt	VR4	6a	Can
R58D	CM7R153D-58B-T	LVR-IC	LDO, 5.8V±2%, 150mA, -CE	SOT-23-5	28vt	VR4	6a	Can
R59	XC6368F592MR	DC/DC-IC	PWM/PFM step-up, 5.9V±2.5%, 200mA, 180kHz, +CE, soft start	SOT-25	28sd	DC10	6g	Tor
R59A	CM7R153A-59B-T	LVR-IC	LDO, 5.9V±2%, 150mA, +CE, PDR	SOT-23-5	28vt	VR4	6a	Can
R59B	CM7R153B-59B-T	LVR-IC	LDO, 5.9V±2%, 150mA, +CE	SOT-23-5	28vt	VR4	6a	Can
R59C	CM7R153C-59B-T	LVR-IC	LDO, 5.9V±2%, 150mA, -CE, PDR	SOT-23-5	28vt	VR4	6a	Can
R59D	CM7R153D-59B-T	LVR-IC	LDO, 5.9V±2%, 150mA, -CE	SOT-23-5	28vt	VR4	6a	Can
R5A	XC6118C45AMR-G	Vdet-IC	4.5V±2%, ±Reset PPO, Sense, hysteresis 5%, Cd	SOT-25	28mg	VD15	6g	Tor
R5A	XC6368F503MR	DC/DC-IC	PWM/PFM step-up, 5.0V±2.5%, 200mA, 300kHz, +CE, soft start	SOT-25	28sd	DC10	6g	Tor
R5AA	CM7R153A-50A-T	LVR-IC	LDO, 5.05V±2%, 150mA, +CE, PDR	SOT-23-5	28vt	VR4	6a	Can
R5AB	CM7R153B-50A-T	LVR-IC	LDO, 5.05V±2%, 150mA, +CE	SOT-23-5	28vt	VR4	6a	Can
R5AC	CM7R153C-50A-T	LVR-IC	LDO, 5.05V±2%, 150mA, -CE, PDR	SOT-23-5	28vt	VR4	6a	Can
R5AD	CM7R153D-50A-T	LVR-IC	LDO, 5.05V±2%, 150mA, -CE	SOT-23-5	28vt	VR4	6a	Can
R5B	LM4040BIM7-5.0	Vref-IC	Precision, Shunt, 5.0V, 0.2%	SC-70-5	28dq	RF1	6a	Nsc
R5B	XC6118C45BMR-G	Vdet-IC	4.5V±2%, ±Reset PPO, Sense, hysteresis <1%, Cd	SOT-25	28mg	VD15	6g	Tor
R5B	XC6368F513MR	DC/DC-IC	PWM/PFM step-up, 5.1V±2.5%, 200mA, 300kHz, +CE, soft start	SOT-25	28sd	DC10	6g	Tor
R5BA	CM7R153A-51A-T	LVR-IC	LDO, 5.15V±2%, 150mA, +CE, PDR	SOT-23-5	28vt	VR4	6a	Can
R5BB	CM7R153B-51A-T	LVR-IC	LDO, 5.15V±2%, 150mA, +CE	SOT-23-5	28vt	VR4	6a	Can
R5BC	CM7R153C-51A-T	LVR-IC	LDO, 5.15V±2%, 150mA, -CE, PDR	SOT-23-5	28vt	VR4	6a	Can
R5BD	CM7R153D-51A-T	LVR-IC	LDO, 5.15V±2%, 150mA, -CE	SOT-23-5	28vt	VR4	6a	Can
R5C	LM4040CIM7-5.0	Vref-IC	Precision, Shunt, 5.00V, 0.5%	SC-70-5	28dq	RF1	6a	Nsc
R5C	XC6118C45CMR-G	Vdet-IC	4.5V±2%, ±Reset PPO, Sense, hysteresis 5%	SOT-25	28mf	VD12	6g	Tor
R5C	XC6368F523MR	DC/DC-IC	PWM/PFM step-up, 5.2V±2.5%, 200mA, 300kHz, +CE, soft start	SOT-25	28sd	DC10	6g	Tor
R5CA	CM7R153A-52A-T	LVR-IC	LDO, 5.25V±2%, 150mA, +CE, PDR	SOT-23-5	28vt	VR4	6a	Can
R5CB	CM7R153B-52A-T	LVR-IC	LDO, 5.25V±2%, 150mA, +CE	SOT-23-5	28vt	VR4	6a	Can
R5CC	CM7R153C-52A-T	LVR-IC	LDO, 5.25V±2%, 150mA, -CE, PDR	SOT-23-5	28vt	VR4	6a	Can
R5CD	CM7R153D-52A-T	LVR-IC	LDO, 5.25V±2%, 150mA, -CE	SOT-23-5	28vt	VR4	6a	Can
R5D	LM4040DIM7-5.0	Vref-IC	Precision, Shunt, 5.0V, 1%	SC-70-5	28dq	RF1	6a	Nsc
R5D	XC6118C45DMR-G	Vdet-IC	4.5V±2%, ±Reset PPO, Sense, hysteresis <1%	SOT-25	28mf	VD12	6g	Tor
R5D	XC6368F533MR	DC/DC-IC	PWM/PFM step-up, 5.3V±2.5%, 200mA, 300kHz, +CE, soft start	SOT-25	28sd	DC10	6g	Tor
R5DA	CM7R153A-53A-T	LVR-IC	LDO, 5.35V±2%, 150mA, +CE, PDR	SOT-23-5	28vt	VR4	6a	Can
R5DB	CM7R153B-53A-T	LVR-IC	LDO, 5.35V±2%, 150mA, +CE	SOT-23-5	28vt	VR4	6a	Can
R5DC	CM7R153C-53A-T	LVR-IC	LDO, 5.35V±2%, 150mA, -CE, PDR	SOT-23-5	28vt	VR4	6a	Can
R5DD	CM7R153D-53A-T	LVR-IC	LDO, 5.35V±2%, 150mA, -CE	SOT-23-5	28vt	VR4	6a	Can
R5E	XC6368F543MR	DC/DC-IC	PWM/PFM step-up, 5.4V±2.5%, 200mA, 300kHz, +CE, soft start	SOT-25	28sd	DC10	6g	Tor
R5EA	CM7R153A-54A-T	LVR-IC	LDO, 5.45V±2%, 150mA, +CE, PDR	SOT-23-5	28vt	VR4	6a	Can
R5EB	CM7R153B-54A-T	LVR-IC	LDO, 5.45V±2%, 150mA, +CE	SOT-23-5	28vt	VR4	6a	Can
R5EC	CM7R153C-54A-T	LVR-IC	LDO, 5.45V±2%, 150mA, -CE, PDR	SOT-23-5	28vt	VR4	6a	Can
R5ED	CM7R153D-54A-T	LVR-IC	LDO, 5.45V±2%, 150mA, -CE	SOT-23-5	28vt	VR4	6a	Can
R5F	XC6368F553MR	DC/DC-IC	PWM/PFM step-up, 5.5V±2.5%, 200mA, 300kHz, +CE, soft start	SOT-25	28sd	DC10	6g	Tor
R5FA	CM7R153A-55A-T	LVR-IC	LDO, 5.55V±2%, 150mA, +CE, PDR	SOT-23-5	28vt	VR4	6a	Can
R5FB	CM7R153B-55A-T	LVR-IC	LDO, 5.55V±2%, 150mA, +CE	SOT-23-5	28vt	VR4	6a	Can
R5FC	CM7R153C-55A-T	LVR-IC	LDO, 5.55V±2%, 150mA, -CE, PDR	SOT-23-5	28vt	VR4	6a	Can
R5FD	CM7R153D-55A-T	LVR-IC	LDO, 5.55V±2%, 150mA, -CE	SOT-23-5	28vt	VR4	6a	Can
R5GA	CM7R153A-56A-T	LVR-IC	LDO, 5.65V±2%, 150mA, +CE, PDR	SOT-23-5	28vt	VR4	6a	Can
R5GB	CM7R153B-56A-T	LVR-IC	LDO, 5.65V±2%, 150mA, +CE	SOT-23-5	28vt	VR4	6a	Can
R5GC	CM7R153C-56A-T	LVR-IC	LDO, 5.65V±2%, 150mA, -CE, PDR	SOT-23-5	28vt	VR4	6a	Can
R5GD	CM7R153D-56A-T	LVR-IC	LDO, 5.65V±2%, 150mA, -CE	SOT-23-5	28vt	VR4	6a	Can
R5H	XC6368F563MR	DC/DC-IC	PWM/PFM step-up, 5.6V±2.5%, 200mA, 300kHz, +CE, soft start	SOT-25	28sd	DC10	6g	Tor
R5HA	CM7R153A-57A-T	LVR-IC	LDO, 5.75V±2%, 150mA, +CE, PDR	SOT-23-5	28vt	VR4	6a	Can
R5HB	CM7R153B-57A-T	LVR-IC	LDO, 5.75V±2%, 150mA, +CE	SOT-23-5	28vt	VR4	6a	Can
R5HC	CM7R153C-57A-T	LVR-IC	LDO, 5.75V±2%, 150mA, -CE, PDR	SOT-23-5	28vt	VR4	6a	Can
R5HD	CM7R153D-57A-T	LVR-IC	LDO, 5.75V±2%, 150mA, -CE	SOT-23-5	28vt	VR4	6a	Can
R5IA	CM7R153A-58A-T	LVR-IC	LDO, 5.85V±2%, 150mA, +CE, PDR	SOT-23-5	28vt	VR4	6a	Can
R5IB	CM7R153B-58A-T	LVR-IC	LDO, 5.85V±2%, 150mA, +CE	SOT-23-5	28vt	VR4	6a	Can
R5IC	CM7R153C-58A-T	LVR-IC	LDO, 5.85V±2%, 150mA, -CE, PDR	SOT-23-5	28vt	VR4	6a	Can
R5ID	CM7R153D-58A-T	LVR-IC	LDO, 5.85V±2%, 150mA, -CE	SOT-23-5	28vt	VR4	6a	Can



SMD code	Type	Function	Short description	Case	Pinout	Sch.	St.	Mnf.
R5JA	CM7R153A-59A-T	LVR-IC	LDO, 5.95V±2%, 150mA, +CE, PDR	SOT-23-5	28vt	VR4	6a	Can
R5JB	CM7R153B-59A-T	LVR-IC	LDO, 5.95V±2%, 150mA, +CE	SOT-23-5	28vt	VR4	6a	Can
R5JC	CM7R153C-59A-T	LVR-IC	LDO, 5.95V±2%, 150mA, -CE, PDR	SOT-23-5	28vt	VR4	6a	Can
R5JD	CM7R153D-59A-T	LVR-IC	LDO, 5.95V±2%, 150mA, -CE	SOT-23-5	28vt	VR4	6a	Can
R5K	XC6368F573MR	DC/DC-IC	PWM/PFM step-up, 5.7V±2.5%, 200mA, 300kHz, +CE, soft start	SOT-25	28sd	DC10	6g	Tor
R5L	XC6368F583MR	DC/DC-IC	PWM/PFM step-up, 5.8V±2.5%, 200mA, 300kHz, +CE, soft start	SOT-25	28sd	DC10	6g	Tor
R5M	XC6368F593MR	DC/DC-IC	PWM/PFM step-up, 5.9V±2.5%, 200mA, 300kHz, +CE, soft start	SOT-25	28sd	DC10	6g	Tor
R6	R1121N261B	LVR-IC	LDO, LN, +CE, 2.6V±2%, 150mA	SOT-23-5	28vt	VR4	6g	Ric
R6	TC7SZU04AFE	CMOS-Logic	Inverter	SOM-5	30Log6	-	6a	Tos
R60	XC6368F602MR	DC/DC-IC	PWM/PFM step-up, 6.0V±2.5%, 200mA, 180kHz, +CE, soft start	SOT-25	28sd	DC10	6g	Tor
R60A	CM7R153A-60B-T	LVR-IC	LDO, 6.0V±2%, 150mA, +CE, PDR	SOT-23-5	28vt	VR4	6a	Can
R60B	CM7R153B-60B-T	LVR-IC	LDO, 6.0V±2%, 150mA, +CE	SOT-23-5	28vt	VR4	6a	Can
R60C	CM7R153C-60B-T	LVR-IC	LDO, 6.0V±2%, 150mA, -CE, PDR	SOT-23-5	28vt	VR4	6a	Can
R60D	CM7R153D-60B-T	LVR-IC	LDO, 6.0V±2%, 150mA, -CE	SOT-23-5	28vt	VR4	6a	Can
R61	XC6368F612MR	DC/DC-IC	PWM/PFM step-up, 6.1V±2.5%, 200mA, 180kHz, +CE, soft start	SOT-25	28sd	DC10	6g	Tor
R62	XC6368F622MR	DC/DC-IC	PWM/PFM step-up, 6.2V±2.5%, 200mA, 180kHz, +CE, soft start	SOT-25	28sd	DC10	6g	Tor
R63	XC6368F632MR	DC/DC-IC	PWM/PFM step-up, 6.3V±2.5%, 200mA, 180kHz, +CE, soft start	SOT-25	28sd	DC10	6g	Tor
R64	XC6368F642MR	DC/DC-IC	PWM/PFM step-up, 6.4V±2.5%, 200mA, 180kHz, +CE, soft start	SOT-25	28sd	DC10	6g	Tor
R65	XC6368F652MR	DC/DC-IC	PWM/PFM step-up, 6.5V±2.5%, 200mA, 180kHz, +CE, soft start	SOT-25	28sd	DC10	6g	Tor
R6A	XC6118C46AMR-G	Vdet-IC	4.6V±2%, ±Reset PPO, Sense, hysteresis 5%, Cd	SOT-25	28mg	VD15	6g	Tor
R6A	XC6368F603MR	DC/DC-IC	PWM/PFM step-up, 6.0V±2.5%, 200mA, 300kHz, +CE, soft start	SOT-25	28sd	DC10	6g	Tor
R6B	XC6118C46BMR-G	Vdet-IC	4.6V±2%, ±Reset PPO, Sense, hysteresis <1%, Cd	SOT-25	28mg	VD15	6g	Tor
R6B	XC6368F613MR	DC/DC-IC	PWM/PFM step-up, 6.1V±2.5%, 200mA, 300kHz, +CE, soft start	SOT-25	28sd	DC10	6g	Tor
R6C	XC6118C46CMR-G	Vdet-IC	4.6V±2%, ±Reset PPO, Sense, hysteresis 5%	SOT-25	28mf	VD12	6g	Tor
R6C	XC6368F623MR	DC/DC-IC	PWM/PFM step-up, 6.2V±2.5%, 200mA, 300kHz, +CE, soft start	SOT-25	28sd	DC10	6g	Tor
R6D	XC6118C46DMR-G	Vdet-IC	4.6V±2%, ±Reset PPO, Sense, hysteresis <1%	SOT-25	28mf	VD12	6g	Tor
R6D	XC6368F633MR	DC/DC-IC	PWM/PFM step-up, 6.3V±2.5%, 200mA, 300kHz, +CE, soft start	SOT-25	28sd	DC10	6g	Tor
R6E	XC6368F643MR	DC/DC-IC	PWM/PFM step-up, 6.4V±2.5%, 200mA, 300kHz, +CE, soft start	SOT-25	28sd	DC10	6g	Tor
R6F	XC6368F653MR	DC/DC-IC	PWM/PFM step-up, 6.5V±2.5%, 200mA, 300kHz, +CE, soft start	SOT-25	28sd	DC10	6g	Tor
R7	R1121N271B	LVR-IC	LDO, LN, +CE, 2.7V±2%, 150mA	SOT-23-5	28vt	VR4	6g	Ric
R7A	XC6118C47AMR-G	Vdet-IC	4.7V±2%, ±Reset PPO, Sense, hysteresis 5%, Cd	SOT-25	28mg	VD15	6g	Tor
R7B	XC6118C47BMR-G	Vdet-IC	4.7V±2%, ±Reset PPO, Sense, hysteresis <1%, Cd	SOT-25	28mg	VD15	6g	Tor
R7C	XC6118C47CMR-G	Vdet-IC	4.7V±2%, ±Reset PPO, Sense, hysteresis 5%	SOT-25	28mf	VD12	6g	Tor
R7D	XC6118C47DMR-G	Vdet-IC	4.7V±2%, ±Reset PPO, Sense, hysteresis <1%	SOT-25	28mf	VD12	6g	Tor
R8	R1121N281B	LVR-IC	LDO, LN, +CE, 2.8V±2%, 150mA	SOT-23-5	28vt	VR4	6g	Ric
R8A	XC6118C48AMR-G	Vdet-IC	4.8V±2%, ±Reset PPO, Sense, hysteresis 5%, Cd	SOT-25	28mg	VD15	6g	Tor
R8B	XC6118C48BMR-G	Vdet-IC	4.8V±2%, ±Reset PPO, Sense, hysteresis <1%, Cd	SOT-25	28mg	VD15	6g	Tor
R8C	XC6118C48CMR-G	Vdet-IC	4.8V±2%, ±Reset PPO, Sense, hysteresis 5%	SOT-25	28mf	VD12	6g	Tor
R8D	XC6118C48DMR-G	Vdet-IC	4.8V±2%, ±Reset PPO, Sense, hysteresis <1%	SOT-25	28mf	VD12	6g	Tor
R9	R1121N291B	LVR-IC	LDO, LN, +CE, 2.9V±2%, 150mA	SOT-23-5	28vt	VR4	6g	Ric
R9A	XC6118C49AMR-G	Vdet-IC	4.9V±2%, ±Reset PPO, Sense, hysteresis 5%, Cd	SOT-25	28mg	VD15	6g	Tor
R9B	XC6118C49BMR-G	Vdet-IC	4.9V±2%, ±Reset PPO, Sense, hysteresis <1%, Cd	SOT-25	28mg	VD15	6g	Tor
R9C	XC6118C49CMR-G	Vdet-IC	4.9V±2%, ±Reset PPO, Sense, hysteresis 5%	SOT-25	28mf	VD12	6g	Tor
R9D	XC6118C49DMR-G	Vdet-IC	4.9V±2%, ±Reset PPO, Sense, hysteresis <1%	SOT-25	28mf	VD12	6g	Tor
RA	BD5340FVE	Vdet-IC	4V, +Reset PPO	VSOFF-5	30ua	VD7	6c	Rhm
RA	BD5340G	Vdet-IC	4V, +Reset PPO	SSOP-5	28vdo	VD3	6c	Rhm
RAA	RP114N321B	LVR-IC	LDO, 3.2V±1%, 300mA, +CE	SOT-23-5	28cx	VR4	6g	Ric
RAA	TLV431ASN	Vref-IC	Programmable 1.24...1.6V±1%	TSOP-5	28rc	RF1	6b	Ons
RAB	NCP100SN	Vref-IC	Programmable 0.9...6V±1.7%	TSOP-5	28rf	RF2	6b	Ons
RAB	RP114N331B	LVR-IC	LDO, 3.3V±1%, 300mA, +CE	SOT-23-5	28cx	VR4	6g	Ric
RAC	RP114N341B	LVR-IC	LDO, 3.4V±1%, 300mA, +CE	SOT-23-5	28cx	VR4	6g	Ric
RAD	RP114N351B	LVR-IC	LDO, 3.5V±1%, 300mA, +CE	SOT-23-5	28cx	VR4	6g	Ric
RAE	RP114N361B	LVR-IC	LDO, 3.6V±1%, 300mA, +CE	SOT-23-5	28cx	VR4	6g	Ric
RAF	RP114N121B5	LVR-IC	LDO, 1.25V±1%, 300mA, +CE	SOT-23-5	28cx	VR4	6g	Ric
RAG	RP114N181B5	LVR-IC	LDO, 1.85V±1%, 300mA, +CE	SOT-23-5	28cx	VR4	6g	Ric
RAH	RP114N281B5	LVR-IC	LDO, 2.85V±1%, 300mA, +CE	SOT-23-5	28cx	VR4	6g	Ric
RAJ	RP114N341B5	LVR-IC	LDO, 3.45V±1%, 300mA, +CE	SOT-23-5	28cx	VR4	6g	Ric
RB	BD5341FVE	Vdet-IC	4.1V, +Reset PPO	VSOFF-5	30ua	VD7	6c	Rhm
RB	BD5341G	Vdet-IC	4.1V, +Reset PPO	SSOP-5	28vdo	VD3	6c	Rhm
RB5	XC6368F151MR	DC/DC-IC	PWM/PFM step-up, 1.5V±2.5%, 200mA, 100kHz, +CE, soft start	SOT-25	28sd	DC10	6g	Tor
RB6	XC6368F161MR	DC/DC-IC	PWM/PFM step-up, 1.6V±2.5%, 200mA, 100kHz, +CE, soft start	SOT-25	28sd	DC10	6g	Tor
RB7	XC6368F171MR	DC/DC-IC	PWM/PFM step-up, 1.7V±2.5%, 200mA, 100kHz, +CE, soft start	SOT-25	28sd	DC10	6g	Tor
RB8	XC6368F181MR	DC/DC-IC	PWM/PFM step-up, 1.8V±2.5%, 200mA, 100kHz, +CE, soft start	SOT-25	28sd	DC10	6g	Tor
RB9	XC6368F191MR	DC/DC-IC	PWM/PFM step-up, 1.9V±2.5%, 200mA, 100kHz, +CE, soft start	SOT-25	28sd	DC10	6g	Tor
RBA	RP114N321D	LVR-IC	LDO, 3.2V±1%, 300mA, +CE, CL	SOT-23-5	28cx	VR4	6g	Ric
RBB	RP114N331D	LVR-IC	LDO, 3.3V±1%, 300mA, +CE, CL	SOT-23-5	28cx	VR4	6g	Ric
RBBC	RP114N341D	LVR-IC	LDO, 3.4V±1%, 300mA, +CE, CL	SOT-23-5	28cx	VR4	6g	Ric
RBD	RP114N351D	LVR-IC	LDO, 3.5V±1%, 300mA, +CE, CL	SOT-23-5	28cx	VR4	6g	Ric
RBE	RP114N361D	LVR-IC	LDO, 3.6V±1%, 300mA, +CE, CL	SOT-23-5	28cx	VR4	6g	Ric
RBFB	RP114N121D5	LVR-IC	LDO, 1.25V±1%, 300mA, +CE, CL	SOT-23-5	28cx	VR4	6g	Ric



SMD code	Type	Function	Short description	Case	Pinout	Sch.	St.	Mnf.
REH	XC6368F465MR	DC/DC-IC	PWM/PFM step-up, 4.6V±2.5%, 200mA, 500kHz, +CE, soft start	SOT-25	28sd	DC10	6g	Tor
REK	XC6368F475MR	DC/DC-IC	PWM/PFM step-up, 4.7V±2.5%, 200mA, 500kHz, +CE, soft start	SOT-25	28sd	DC10	6g	Tor
REL	XC6368F485MR	DC/DC-IC	PWM/PFM step-up, 4.8V±2.5%, 200mA, 500kHz, +CE, soft start	SOT-25	28sd	DC10	6g	Tor
REM	XC6368F495MR	DC/DC-IC	PWM/PFM step-up, 4.9V±2.5%, 200mA, 500kHz, +CE, soft start	SOT-25	28sd	DC10	6g	Tor
RF	BD5345FVE	Vdet-IC	4.5V, +Reset PPO	VSOFF-5	30ua	VD7	6c	Rhm
RF	BD5345G	Vdet-IC	4.5V, +Reset PPO	SSOP-5	28vdo	VD3	6c	Rhm
RF0	XC6368F501MR	DC/DC-IC	PWM/PFM step-up, 5.0V±2.5%, 200mA, 100kHz, +CE, soft start	SOT-25	28sd	DC10	6g	Tor
RF1	XC6368F511MR	DC/DC-IC	PWM/PFM step-up, 5.1V±2.5%, 200mA, 100kHz, +CE, soft start	SOT-25	28sd	DC10	6g	Tor
RF2	XC6368F521MR	DC/DC-IC	PWM/PFM step-up, 5.2V±2.5%, 200mA, 100kHz, +CE, soft start	SOT-25	28sd	DC10	6g	Tor
RF3	XC6368F531MR	DC/DC-IC	PWM/PFM step-up, 5.3V±2.5%, 200mA, 100kHz, +CE, soft start	SOT-25	28sd	DC10	6g	Tor
RF4	XC6368F541MR	DC/DC-IC	PWM/PFM step-up, 5.4V±2.5%, 200mA, 100kHz, +CE, soft start	SOT-25	28sd	DC10	6g	Tor
RF5	XC6368F551MR	DC/DC-IC	PWM/PFM step-up, 5.5V±2.5%, 200mA, 100kHz, +CE, soft start	SOT-25	28sd	DC10	6g	Tor
RF6	XC6368F561MR	DC/DC-IC	PWM/PFM step-up, 5.6V±2.5%, 200mA, 100kHz, +CE, soft start	SOT-25	28sd	DC10	6g	Tor
RF7	XC6368F571MR	DC/DC-IC	PWM/PFM step-up, 5.7V±2.5%, 200mA, 100kHz, +CE, soft start	SOT-25	28sd	DC10	6g	Tor
RF8	XC6368F581MR	DC/DC-IC	PWM/PFM step-up, 5.8V±2.5%, 200mA, 100kHz, +CE, soft start	SOT-25	28sd	DC10	6g	Tor
RF9	XC6368F591MR	DC/DC-IC	PWM/PFM step-up, 5.9V±2.5%, 200mA, 100kHz, +CE, soft start	SOT-25	28sd	DC10	6g	Tor
RFA	XC6368F505MR	DC/DC-IC	PWM/PFM step-up, 5.0V±2.5%, 200mA, 500kHz, +CE, soft start	SOT-25	28sd	DC10	6g	Tor
RFB	XC6368F515MR	DC/DC-IC	PWM/PFM step-up, 5.1V±2.5%, 200mA, 500kHz, +CE, soft start	SOT-25	28sd	DC10	6g	Tor
RFC	XC6368F525MR	DC/DC-IC	PWM/PFM step-up, 5.2V±2.5%, 200mA, 500kHz, +CE, soft start	SOT-25	28sd	DC10	6g	Tor
RFD	XC6368F535MR	DC/DC-IC	PWM/PFM step-up, 5.3V±2.5%, 200mA, 500kHz, +CE, soft start	SOT-25	28sd	DC10	6g	Tor
RFE	XC6368F545MR	DC/DC-IC	PWM/PFM step-up, 5.4V±2.5%, 200mA, 500kHz, +CE, soft start	SOT-25	28sd	DC10	6g	Tor
RFE	XC6368F555MR	DC/DC-IC	PWM/PFM step-up, 5.5V±2.5%, 200mA, 500kHz, +CE, soft start	SOT-25	28sd	DC10	6g	Tor
RFH	XC6368F565MR	DC/DC-IC	PWM/PFM step-up, 5.6V±2.5%, 200mA, 500kHz, +CE, soft start	SOT-25	28sd	DC10	6g	Tor
RFK	XC6368F575MR	DC/DC-IC	PWM/PFM step-up, 5.7V±2.5%, 200mA, 500kHz, +CE, soft start	SOT-25	28sd	DC10	6g	Tor
RFI	XC6368F585MR	DC/DC-IC	PWM/PFM step-up, 5.8V±2.5%, 200mA, 500kHz, +CE, soft start	SOT-25	28sd	DC10	6g	Tor
RFM	XC6368F595MR	DC/DC-IC	PWM/PFM step-up, 5.9V±2.5%, 200mA, 500kHz, +CE, soft start	SOT-25	28sd	DC10	6g	Tor
RG	BD5346FVE	Vdet-IC	4.6V, +Reset PPO	VSOFF-5	30ua	VD7	6c	Rhm
RG	BD5346G	Vdet-IC	4.6V, +Reset PPO	SSOP-5	28vdo	VD3	6c	Rhm
RH	BD5347FVE	Vdet-IC	4.7V, +Reset PPO	VSOFF-5	30ua	VD7	6c	Rhm
RH	BD5347G	Vdet-IC	4.7V, +Reset PPO	SSOP-5	28vdo	VD3	6c	Rhm
RH0	XC6368F601MR	DC/DC-IC	PWM/PFM step-up, 6.0V±2.5%, 200mA, 100kHz, +CE, soft start	SOT-25	28sd	DC10	6g	Tor
RH1	XC6368F611MR	DC/DC-IC	PWM/PFM step-up, 6.1V±2.5%, 200mA, 100kHz, +CE, soft start	SOT-25	28sd	DC10	6g	Tor
RH2	XC6368F621MR	DC/DC-IC	PWM/PFM step-up, 6.2V±2.5%, 200mA, 100kHz, +CE, soft start	SOT-25	28sd	DC10	6g	Tor
RH3	XC6368F631MR	DC/DC-IC	PWM/PFM step-up, 6.3V±2.5%, 200mA, 100kHz, +CE, soft start	SOT-25	28sd	DC10	6g	Tor
RH4	XC6368F641MR	DC/DC-IC	PWM/PFM step-up, 6.4V±2.5%, 200mA, 100kHz, +CE, soft start	SOT-25	28sd	DC10	6g	Tor
RH5	XC6368F651MR	DC/DC-IC	PWM/PFM step-up, 6.5V±2.5%, 200mA, 100kHz, +CE, soft start	SOT-25	28sd	DC10	6g	Tor
RHA	XC6368F605MR	DC/DC-IC	PWM/PFM step-up, 6.0V±2.5%, 200mA, 500kHz, +CE, soft start	SOT-25	28sd	DC10	6g	Tor
RHB	XC6368F615MR	DC/DC-IC	PWM/PFM step-up, 6.1V±2.5%, 200mA, 500kHz, +CE, soft start	SOT-25	28sd	DC10	6g	Tor
RHC	XC6368F625MR	DC/DC-IC	PWM/PFM step-up, 6.2V±2.5%, 200mA, 500kHz, +CE, soft start	SOT-25	28sd	DC10	6g	Tor
RHD	XC6368F635MR	DC/DC-IC	PWM/PFM step-up, 6.3V±2.5%, 200mA, 500kHz, +CE, soft start	SOT-25	28sd	DC10	6g	Tor
RHE	XC6368F645MR	DC/DC-IC	PWM/PFM step-up, 6.4V±2.5%, 200mA, 500kHz, +CE, soft start	SOT-25	28sd	DC10	6g	Tor
RHF	XC6368F655MR	DC/DC-IC	PWM/PFM step-up, 6.5V±2.5%, 200mA, 500kHz, +CE, soft start	SOT-25	28sd	DC10	6g	Tor
RJ	BD5348FVE	Vdet-IC	4.8V, +Reset PPO	VSOFF-5	30ua	VD7	6c	Rhm
RJ	BD5348G	Vdet-IC	4.8V, +Reset PPO	SSOP-5	28vdo	VD3	6c	Rhm
RJB	LM4040BIM7-2.0	Vref-IC	Precision, Shunt, 2.048V, 0.2%	SC-70-5	28dq	RF1	6a	Nsc
RJC	LM4040CIM7-2.0	Vref-IC	Precision, Shunt, 2.048V, 0.5%	SC-70-5	28dq	RF1	6a	Nsc
RJD	LM4040DIM7-2.0	Vref-IC	Precision, Shunt, 2.048V, 1%	SC-70-5	28dq	RF1	6a	Nsc
RJE	LM4040EIM7-2.0	Vref-IC	Precision, Shunt, 2.048V, 2%	SC-70-5	28dq	RF1	6a	Nsc
RK	BD5349FVE	Vdet-IC	4.9V, +Reset PPO	VSOFF-5	30ua	VD7	6c	Rhm
RK	BD5349G	Vdet-IC	4.9V, +Reset PPO	SSOP-5	28vdo	VD3	6c	Rhm
RKB	LM4040BIM7-3.0	Vref-IC	Precision, Shunt, 3.0V, 0.2%	SC-70-5	28dq	RF1	6a	Nsc
RKC	LM4040CIM7-3.0	Vref-IC	Precision, Shunt, 3.00V, 0.5%	SC-70-5	28dq	RF1	6a	Nsc
RKD	LM4040DIM7-3.0	Vref-IC	Precision, Shunt, 3.0V, 1%	SC-70-5	28dq	RF1	6a	Nsc
RKE	LM4040EIM7-3.0	Vref-IC	Precision, Shunt, 3.00V, 2%	SC-70-5	28dq	RF1	6a	Nsc
RL	BD5350FVE	Vdet-IC	5V, +Reset PPO	VSOFF-5	30ua	VD7	6c	Rhm
RL	BD5350G	Vdet-IC	5V, +Reset PPO	SSOP-5	28vdo	VD3	6c	Rhm
RL	R1122N201B	LVR-IC	LDO, LN, +CE, 2V±2%, 150mA	SOT-23-5	28vt	VR4	6g	Ric
RM	BD5351FVE	Vdet-IC	5.1V, +Reset PPO	VSOFF-5	30ua	VD7	6c	Rhm
RM	BD5351G	Vdet-IC	5.1V, +Reset PPO	SSOP-5	28vdo	VD3	6c	Rhm
RM	R1122N211B	LVR-IC	LDO, LN, +CE, 2.1V±2%, 150mA	SOT-23-5	28vt	VR4	6g	Ric
RN	BD5352FVE	Vdet-IC	5.2V, +Reset PPO	VSOFF-5	30ua	VD7	6c	Rhm
RN	BD5352G	Vdet-IC	5.2V, +Reset PPO	SSOP-5	28vdo	VD3	6c	Rhm
RN	R1122N221B	LVR-IC	LDO, LN, +CE, 2.2V±2%, 150mA	SOT-23-5	28vt	VR4	6g	Ric
RP	BD5353FVE	Vdet-IC	5.3V, +Reset PPO	VSOFF-5	30ua	VD7	6c	Rhm
RP	BD5353G	Vdet-IC	5.3V, +Reset PPO	SSOP-5	28vdo	VD3	6c	Rhm
RP	R1122N231B	LVR-IC	LDO, LN, +CE, 2.3V±2%, 150mA	SOT-23-5	28vt	VR4	6g	Ric
RQ	BD5354FVE	Vdet-IC	5.4V, +Reset PPO	VSOFF-5	30ua	VD7	6c	Rhm
RQ	BD5354G	Vdet-IC	5.4V, +Reset PPO	SSOP-5	28vdo	VD3	6c	Rhm
RQ	R1122N241B	LVR-IC	LDO, LN, +CE, 2.4V±2%, 150mA	SOT-23-5	28vt	VR4	6g	Ric
RR	BD5355FVE	Vdet-IC	5.5V, +Reset PPO	VSOFF-5	30ua	VD7	6c	Rhm



SMD code	Type	Function	Short description	Case	Pinout	Sch.	St.	Mnf.
RR	BD5355G	Vdet-IC	5.5V, +Reset PPO	SSOP-5	28vdo	VD3	6c	Rhm
RR	R1122N251B	LVR-IC	LDO, LN, +CE, 2.5V±2%, 150mA	SOT-23-5	28vt	VR4	6g	Ric
RS	BD5356FVE	Vdet-IC	5.6V, +Reset PPO	VSOFF-5	30ua	VD7	6c	Rhm
RS	BD5356G	Vdet-IC	5.6V, +Reset PPO	SSOP-5	28vdo	VD3	6c	Rhm
RS	R1122N261B	LVR-IC	LDO, LN, +CE, 2.6V±2%, 150mA	SOT-23-5	28vt	VR4	6g	Ric
RT	BD5357FVE	Vdet-IC	5.7V, +Reset PPO	VSOFF-5	30ua	VD7	6c	Rhm
RT	BD5357G	Vdet-IC	5.7V, +Reset PPO	SSOP-5	28vdo	VD3	6c	Rhm
RT	R1122N271B	LVR-IC	LDO, LN, +CE, 2.7V±2%, 150mA	SOT-23-5	28vt	VR4	6g	Ric
RU	BD5358FVE	Vdet-IC	5.8V, +Reset PPO	VSOFF-5	30ua	VD7	6c	Rhm
RU	BD5358G	Vdet-IC	5.8V, +Reset PPO	SSOP-5	28vdo	VD3	6c	Rhm
RU	R1122N281B	LVR-IC	LDO, LN, +CE, 2.8V±2%, 150mA	SOT-23-5	28vt	VR4	6g	Ric
RUM	NGP300LSN25T1	Vdet-IC	2.5V±1.5%, -Reset PPO	TSOP-5	28vdm	VD7	6k	Ons
RV	BD5359FVE	Vdet-IC	5.9V, +Reset PPO	VSOFF-5	30ua	VD7	6c	Rhm
RV	BD5359G	Vdet-IC	5.9V, +Reset PPO	SSOP-5	28vdo	VD3	6c	Rhm
RV	R1122N291B	LVR-IC	LDO, LN, +CE, 2.9V±2%, 150mA	SOT-23-5	28vt	VR4	6g	Ric
RW	BD5360FVE	Vdet-IC	6V, +Reset PPO	VSOFF-5	30ua	VD7	6c	Rhm
RW	BD5360G	Vdet-IC	6V, +Reset PPO	SSOP-5	28vdo	VD3	6c	Rhm
RZ5A	S-8211CAS-M5T1G	BM-IC	1-cell Li-Ion overcharge prot, Ucu=4.280V, Tcy=1.2s	SOT-23-5	28bm2	VBM1	6g	Ric
RZA	S-8211CAA-M5T1G	BM-IC	1-cell Li-Ion overcharge prot, Ucu=4.275V, Tcy=1.2s	SOT-23-5	28bm2	VBM1	6g	Ric
RZB	S-8211CAB-M5T1G	BM-IC	1-cell Li-Ion overcharge prot, Ucu=4.325V, Tcy=1.2s	SOT-23-5	28bm2	VBM1	6g	Ric
RZD	S-8211CAD-M5T1G	BM-IC	1-cell Li-Ion overcharge prot, Ucu=4.350V, Tcy=143ms	SOT-23-5	28bm2	VBM1	6g	Ric
RZE	S-8211CAE-M5T1G	BM-IC	1-cell Li-Ion overcharge prot, Ucu=4.280V, Tcy=1.2s	SOT-23-5	28bm2	VBM1	6g	Ric
RZF	S-8211CAF-M5T1G	BM-IC	1-cell Li-Ion overcharge prot, Ucu=4.275V, Tcy=1.2s	SOT-23-5	28bm2	VBM1	6g	Ric
RZH	S-8211CAH-M5T1G	BM-IC	1-cell Li-Ion overcharge prot, Ucu=4.280V, Tcy=1.2s	SOT-23-5	28bm2	VBM1	6g	Ric
RZI	S-8211CAI-M5T1G	BM-IC	1-cell Li-Ion overcharge prot, Ucu=4.280V, Tcy=1.2s	SOT-23-5	28bm2	VBM1	6g	Ric
RZJ	S-8211CAJ-M5T1G	BM-IC	1-cell Li-Ion overcharge prot, Ucu=4.280V, Tcy=1.2s	SOT-23-5	28bm2	VBM1	6g	Ric
RZK	S-8211CAK-M5T1G	BM-IC	1-cell Li-Ion overcharge prot, Ucu=4.280V, Tcy=1.2s	SOT-23-5	28bm2	VBM1	6g	Ric
RZL	S-8211CAL-M5T1G	BM-IC	1-cell Li-Ion overcharge prot, Ucu=4.280V, Tcy=1.2s	SOT-23-5	28bm2	VBM1	6g	Ric
RZM	S-8211CAM-M5T1G	BM-IC	1-cell Li-Ion overcharge prot, Ucu=4.280V, Tcy=1.2s	SOT-23-5	28bm2	VBM1	6g	Ric
RZN	S-8211CAN-M5T1G	BM-IC	1-cell Li-Ion overcharge prot, Ucu=4.20V, Tcy=1.2s	SOT-23-5	28bm2	VBM1	6g	Ric
RZO	S-8211CAO-M5T1G	BM-IC	1-cell Li-Ion overcharge prot, Ucu=4.275V, Tcy=1.2s	SOT-23-5	28bm2	VBM1	6g	Ric
RZP	S-8211CAP-M5T1G	BM-IC	1-cell Li-Ion overcharge prot, Ucu=4.275V, Tcy=1.2s	SOT-23-5	28bm2	VBM1	6g	Ric
RZQ	S-8211CAQ-M5T1G	BM-IC	1-cell Li-Ion overcharge prot, Ucu=4.275V, Tcy=1.2s	SOT-23-5	28bm2	VBM1	6g	Ric
RZR	S-8211CAR-M5T1G	BM-IC	1-cell Li-Ion overcharge prot, Ucu=4.275V, Tcy=1.2s	SOT-23-5	28bm2	VBM1	6g	Ric
RZT	S-8211CAT-M5T1G	BM-IC	1-cell Li-Ion overcharge prot, Ucu=4.275V, Tcy=1.2s	SOT-23-5	28bm2	VBM1	6g	Ric
RZU	S-8211CAU-M5T1G	BM-IC	1-cell Li-Ion overcharge prot, Ucu=4.280V, Tcy=1.2s	SOT-23-5	28bm2	VBM1	6g	Ric
RZV	S-8211CAV-M5T1G	BM-IC	1-cell Li-Ion overcharge prot, Ucu=4.325V, Tcy=1.2s	SOT-23-5	28bm2	VBM1	6g	Ric
RZY	S-8211CAY-M5T1G	BM-IC	1-cell Li-Ion overcharge prot, Ucu=4.280V, Tcy=1.2s	SOT-23-5	28bm2	VBM1	6g	Ric
RZZ	S-8211CAZ-M5T1G	BM-IC	1-cell Li-Ion overcharge prot, Ucu=4.280V, Tcy=	SOT-23-5	28bm2	VBM1	6g	Ric
S0	R1121N301B	LVR-IC	LDO, LN, +CE, 3V±2%, 150mA	SOT-23-5	28vt	VR4	6g	F
S00	NG7500P5	CMOS-Logic	2-input NAND gate	SC-70-5	28VLog1	-	6a	F
S001	RP201Q282B5	LVR-IC	LDO, 2.85V±1%, 150mA, +CE, ECO	SC-88A	28xx	VR12	6m	Ric
S008	RP201Q082B	LVR-IC	LDO, 0.8V±1%, 150mA, +CE, ECO	SC-88A	28xx	VR12	6m	Ric
S009	RP201Q092B	LVR-IC	LDO, 0.9V±1%, 150mA, +CE, ECO	SC-88A	28xx	VR12	6m	Ric
S010	RP201Q102B	LVR-IC	LDO, 1.0V±1%, 150mA, +CE, ECO	SC-88A	28xx	VR12	6m	Ric
S011	RP201Q112B	LVR-IC	LDO, 1.1V±1%, 150mA, +CE, ECO	SC-88A	28xx	VR12	6m	Ric
S012	RP201Q122B	LVR-IC	LDO, 1.2V±1%, 150mA, +CE, ECO	SC-88A	28xx	VR12	6m	Ric
S013	RP201Q132B	LVR-IC	LDO, 1.3V±1%, 150mA, +CE, ECO	SC-88A	28xx	VR12	6m	Ric
S014	RP201Q142B	LVR-IC	LDO, 1.4V±1%, 150mA, +CE, ECO	SC-88A	28xx	VR12	6m	Ric
S015	RP201Q152B	LVR-IC	LDO, 1.5V±1%, 150mA, +CE, ECO	SC-88A	28xx	VR12	6m	Ric
S016	RP201Q162B	LVR-IC	LDO, 1.6V±1%, 150mA, +CE, ECO	SC-88A	28xx	VR12	6m	Ric
S017	RP201Q172B	LVR-IC	LDO, 1.7V±1%, 150mA, +CE, ECO	SC-88A	28xx	VR12	6m	Ric
S018	RP201Q182B	LVR-IC	LDO, 1.8V±1%, 150mA, +CE, ECO	SC-88A	28xx	VR12	6m	Ric
S019	RP201Q192B	LVR-IC	LDO, 1.9V±1%, 150mA, +CE, ECO	SC-88A	28xx	VR12	6m	Ric
S02	NG7502P5	CMOS-Logic	2-input NOR gate	SC-70-5	28VLog2	-	6a	F
S020	RP201Q202B	LVR-IC	LDO, 2.0V±1%, 150mA, +CE, ECO	SC-88A	28xx	VR12	6m	Ric
S021	RP201Q212B	LVR-IC	LDO, 2.1V±1%, 150mA, +CE, ECO	SC-88A	28xx	VR12	6m	Ric
S022	RP201Q222B	LVR-IC	LDO, 2.2V±1%, 150mA, +CE, ECO	SC-88A	28xx	VR12	6m	Ric
S023	RP201Q232B	LVR-IC	LDO, 2.3V±1%, 150mA, +CE, ECO	SC-88A	28xx	VR12	6m	Ric
S024	RP201Q242B	LVR-IC	LDO, 2.4V±1%, 150mA, +CE, ECO	SC-88A	28xx	VR12	6m	Ric
S025	RP201Q252B	LVR-IC	LDO, 2.5V±1%, 150mA, +CE, ECO	SC-88A	28xx	VR12	6m	Ric
S026	RP201Q262B	LVR-IC	LDO, 2.6V±1%, 150mA, +CE, ECO	SC-88A	28xx	VR12	6m	Ric
S027	RP201Q272B	LVR-IC	LDO, 2.7V±1%, 150mA, +CE, ECO	SC-88A	28xx	VR12	6m	Ric
S028	RP201Q282B	LVR-IC	LDO, 2.8V±1%, 150mA, +CE, ECO	SC-88A	28xx	VR12	6m	Ric
S029	RP201Q292B	LVR-IC	LDO, 2.9V±1%, 150mA, +CE, ECO	SC-88A	28xx	VR12	6m	Ric
S030	RP201Q302B	LVR-IC	LDO, 3.0V±1%, 150mA, +CE, ECO	SC-88A	28xx	VR12	6m	Ric
S031	RP201Q312B	LVR-IC	LDO, 3.1V±1%, 150mA, +CE, ECO	SC-88A	28xx	VR12	6m	Ric
S032	RP201Q322B	LVR-IC	LDO, 3.2V±1%, 150mA, +CE, ECO	SC-88A	28xx	VR12	6m	Ric
S033	RP201Q332B	LVR-IC	LDO, 3.3V±1%, 150mA, +CE, ECO	SC-88A	28xx	VR12	6m	Ric
S034	RP201Q342B	LVR-IC	LDO, 3.4V±1%, 150mA, +CE, ECO	SC-88A	28xx	VR12	6m	Ric



SMD code	Type	Function	Short description	Case	Pinout	Sch.	St.	Mnf.
S035	RP201Q352B	LVR-IC	LDO, 3.5V±1%, 150mA, +CE, ECO	SC-88A	28xx	VR12	6m	Ric
S036	RP201Q362B	LVR-IC	LDO, 3.6V±1%, 150mA, +CE, ECO	SC-88A	28xx	VR12	6m	Ric
S037	RP201Q372B	LVR-IC	LDO, 3.7V±1%, 150mA, +CE, ECO	SC-88A	28xx	VR12	6m	Ric
S038	RP201Q382B	LVR-IC	LDO, 3.8V±1%, 150mA, +CE, ECO	SC-88A	28xx	VR12	6m	Ric
S039	RP201Q392B	LVR-IC	LDO, 3.9V±1%, 150mA, +CE, ECO	SC-88A	28xx	VR12	6m	Ric
S04	NC7504P5	CMOS-Logic	Inverter	SC-70-5	28/Log6	-	6a	F
S040	RP201Q402B	LVR-IC	LDO, 4.0V±1%, 150mA, +CE, ECO	SC-88A	28xx	VR12	6m	Ric
S08	NC7508P5	CMOS-Logic	2-input AND gate	SC-70-5	28/Log3	-	6a	F
S0A	R3134N10EA	Vdet-IC	1.0V±1.8%, -Reset ODO, -MR	SOT-23-5	28z7	VD4	6g	Ric
S0A	XC6118C50AMR-G	Vdet-IC	5.0V±2%, ±Reset PPO, Sense, hysteresis 5%, Cd	SOT-25	28mg	VD15	6g	Tor
S0B	R3134N11EA	Vdet-IC	1.1V±1.8%, -Reset ODO, -MR	SOT-23-5	28z7	VD4	6g	Ric
S0B	XC6118C50BMR-G	Vdet-IC	5.0V±2%, ±Reset PPO, Sense, hysteresis <1%, Cd	SOT-25	28mg	VD15	6g	Tor
S0C	R3134N12EA	Vdet-IC	1.2V±1.8%, -Reset ODO, -MR	SOT-23-5	28z7	VD4	6g	Ric
S0C	XC6118C50CMR-G	Vdet-IC	5.0V±2%, ±Reset PPO, Sense, hysteresis 5%	SOT-25	28mf	VD12	6g	Tor
S0D	R3134N13EA	Vdet-IC	1.3V±1.8%, -Reset ODO, -MR	SOT-23-5	28z7	VD4	6g	Ric
S0D	XC6118C50DMR-G	Vdet-IC	5.0V±2%, ±Reset PPO, Sense, hysteresis <1%	SOT-25	28mf	VD12	6g	Tor
S0E	R3134N14EA	Vdet-IC	1.4V±1.8%, -Reset ODO, -MR	SOT-23-5	28z7	VD4	6g	Ric
S0F	R3134N15EA	Vdet-IC	1.5V±1.8%, -Reset ODO, -MR	SOT-23-5	28z7	VD4	6g	Ric
S0G	R3134N16EA	Vdet-IC	1.6V±1.8%, -Reset ODO, -MR	SOT-23-5	28z7	VD4	6g	Ric
S0H	R3134N17EA	Vdet-IC	1.7V±1.8%, -Reset ODO, -MR	SOT-23-5	28z7	VD4	6g	Ric
S0J	R3134N18EA	Vdet-IC	1.8V±1.8%, -Reset ODO, -MR	SOT-23-5	28z7	VD4	6g	Ric
S0K	R3134N19EA	Vdet-IC	1.9V±1.8%, -Reset ODO, -MR	SOT-23-5	28z7	VD4	6g	Ric
S0L	R3134N20EA	Vdet-IC	2.0V±1.8%, -Reset ODO, -MR	SOT-23-5	28z7	VD4	6g	Ric
S0M	R3134N21EA	Vdet-IC	2.1V±1.8%, -Reset ODO, -MR	SOT-23-5	28z7	VD4	6g	Ric
S0N	R3134N22EA	Vdet-IC	2.2V±1.8%, -Reset ODO, -MR	SOT-23-5	28z7	VD4	6g	Ric
S0P	R3134N23EA	Vdet-IC	2.3V±1.8%, -Reset ODO, -MR	SOT-23-5	28z7	VD4	6g	Ric
S0R	R3134N24EA	Vdet-IC	2.4V±1.8%, -Reset ODO, -MR	SOT-23-5	28z7	VD4	6g	Ric
S0S	R3134N25EA	Vdet-IC	2.5V±1.8%, -Reset ODO, -MR	SOT-23-5	28z7	VD4	6g	Ric
S0T	R3134N26EA	Vdet-IC	2.6V±1.8%, -Reset ODO, -MR	SOT-23-5	28z7	VD4	6g	Ric
S0U	R3134N27EA	Vdet-IC	2.7V±1.8%, -Reset ODO, -MR	SOT-23-5	28z7	VD4	6g	Ric
S0V	R3134N28EA	Vdet-IC	2.8V±1.8%, -Reset ODO, -MR	SOT-23-5	28z7	VD4	6g	Ric
S0W	R3134N29EA	Vdet-IC	2.9V±1.8%, -Reset ODO, -MR	SOT-23-5	28z7	VD4	6g	Ric
S0X	R3134N30EA	Vdet-IC	3.0V±1.8%, -Reset ODO, -MR	SOT-23-5	28z7	VD4	6g	Ric
S0Y	R3134N31EA	Vdet-IC	3.1V±1.8%, -Reset ODO, -MR	SOT-23-5	28z7	VD4	6g	Ric
S0Z	R3134N32EA	Vdet-IC	3.2V±1.8%, -Reset ODO, -MR	SOT-23-5	28z7	VD4	6g	Ric
S1	R1121N311B	LVR-IC	LDO, LN, +CE, 3.1V±2%, 150mA	SOT-23-5	28vt	VR4	6g	Ric
S14	NC7514P5	CMOS-Logic	Inverting Schmitt-trigger	SC-70-5	28/Log7	-	6a	F
S15	R1162N151B	LVR-IC	LDO, 1.5V±2%, 150mA, +CE, AE(Mode)	SOT-23-5	28x9	VR10	6g	Ric
S16	R1162N161B	LVR-IC	LDO, 1.6V±2%, 150mA, +CE, AE(Mode)	SOT-23-5	28x9	VR10	6g	Ric
S17	R1162N171B	LVR-IC	LDO, 1.7V±2%, 150mA, +CE, AE(Mode)	SOT-23-5	28x9	VR10	6g	Ric
S18	R1162N181B	LVR-IC	LDO, 1.8V±2%, 150mA, +CE, AE(Mode)	SOT-23-5	28x9	VR10	6g	Ric
S19	R1162N191B	LVR-IC	LDO, 1.9V±2%, 150mA, +CE, AE(Mode)	SOT-23-5	28x9	VR10	6g	Ric
S1A	R3134N10EC	Vdet-IC	1.0V±1.8%, -Reset PPO, -MR	SOT-23-5	28z7	VD5	6g	Ric
S1B	R3134N11EC	Vdet-IC	1.1V±1.8%, -Reset PPO, -MR	SOT-23-5	28z7	VD5	6g	Ric
S1C	R3134N12EC	Vdet-IC	1.2V±1.8%, -Reset PPO, -MR	SOT-23-5	28z7	VD5	6g	Ric
S1D	R3134N13EC	Vdet-IC	1.3V±1.8%, -Reset PPO, -MR	SOT-23-5	28z7	VD5	6g	Ric
S1E	R3134N14EC	Vdet-IC	1.4V±1.8%, -Reset PPO, -MR	SOT-23-5	28z7	VD5	6g	Ric
S1F	R3134N15EC	Vdet-IC	1.5V±1.8%, -Reset PPO, -MR	SOT-23-5	28z7	VD5	6g	Ric
S1G	R3134N16EC	Vdet-IC	1.6V±1.8%, -Reset PPO, -MR	SOT-23-5	28z7	VD5	6g	Ric
S1H	R3134N17EC	Vdet-IC	1.7V±1.8%, -Reset PPO, -MR	SOT-23-5	28z7	VD5	6g	Ric
S1J	R3134N18EC	Vdet-IC	1.8V±1.8%, -Reset PPO, -MR	SOT-23-5	28z7	VD5	6g	Ric
S1K	R3134N19EC	Vdet-IC	1.9V±1.8%, -Reset PPO, -MR	SOT-23-5	28z7	VD5	6g	Ric
S1L	R3134N20EC	Vdet-IC	2.0V±1.8%, -Reset PPO, -MR	SOT-23-5	28z7	VD5	6g	Ric
S1M	R3134N21EC	Vdet-IC	2.1V±1.8%, -Reset PPO, -MR	SOT-23-5	28z7	VD5	6g	Ric
S1N	R3134N22EC	Vdet-IC	2.2V±1.8%, -Reset PPO, -MR	SOT-23-5	28z7	VD5	6g	Ric
S1P	R3134N23EC	Vdet-IC	2.3V±1.8%, -Reset PPO, -MR	SOT-23-5	28z7	VD5	6g	Ric
S1R	R3134N24EC	Vdet-IC	2.4V±1.8%, -Reset PPO, -MR	SOT-23-5	28z7	VD5	6g	Ric
S1S	R3134N25EC	Vdet-IC	2.5V±1.8%, -Reset PPO, -MR	SOT-23-5	28z7	VD5	6g	Ric
S1T	R3134N26EC	Vdet-IC	2.6V±1.8%, -Reset PPO, -MR	SOT-23-5	28z7	VD5	6g	Ric
S1U	R3134N27EC	Vdet-IC	2.7V±1.8%, -Reset PPO, -MR	SOT-23-5	28z7	VD5	6g	Ric
S1V	R3134N28EC	Vdet-IC	2.8V±1.8%, -Reset PPO, -MR	SOT-23-5	28z7	VD5	6g	Ric
S1W	R3134N29EC	Vdet-IC	2.9V±1.8%, -Reset PPO, -MR	SOT-23-5	28z7	VD5	6g	Ric
S1X	R3134N30EC	Vdet-IC	3.0V±1.8%, -Reset PPO, -MR	SOT-23-5	28z7	VD5	6g	Ric
S1Y	R3134N31EC	Vdet-IC	3.1V±1.8%, -Reset PPO, -MR	SOT-23-5	28z7	VD5	6g	Ric
S1Z	R3134N32EC	Vdet-IC	3.2V±1.8%, -Reset PPO, -MR	SOT-23-5	28z7	VD5	6g	Ric
S2	R1121N321B	LVR-IC	LDO, LN, +CE, 3.2V±2%, 150mA	SOT-23-5	28vt	VR4	6g	Ric
S20	R1162N201B	LVR-IC	LDO, 2V±2%, 150mA, +CE, AE(Mode)	SOT-23-5	28x9	VR10	6g	Ric
S21	R1162N211B	LVR-IC	LDO, 2.1V±2%, 150mA, +CE, AE(Mode)	SOT-23-5	28x9	VR10	6g	Ric
S22	R1162N221B	LVR-IC	LDO, 2.2V±2%, 150mA, +CE, AE(Mode)	SOT-23-5	28x9	VR10	6g	Ric
S23	R1162N231B	LVR-IC	LDO, 2.3V±2%, 150mA, +CE, AE(Mode)	SOT-23-5	28x9	VR10	6g	Ric



SMD code	Type	Function	Short description	Case	Pinout	Sch.	St.	Mnf.
S24	R1162N241B	LVR-IC	LDO, 2.4V±2%, 150mA, +CE, AE(Mode)	SOT-23-5	28x9	VR10	6g	Ric
S25	R1162N251B	LVR-IC	LDO, 2.5V±2%, 150mA, +CE, AE(Mode)	SOT-23-5	28x9	VR10	6g	Ric
S26	R1162N261B	LVR-IC	LDO, 2.6V±2%, 150mA, +CE, AE(Mode)	SOT-23-5	28x9	VR10	6g	Ric
S27	R1162N271B	LVR-IC	LDO, 2.7V±2%, 150mA, +CE, AE(Mode)	SOT-23-5	28x9	VR10	6g	Ric
S28	R1162N281B	LVR-IC	LDO, 2.8V±2%, 150mA, +CE, AE(Mode)	SOT-23-5	28x9	VR10	6g	Ric
S29	R1162N291B	LVR-IC	LDO, 2.9V±2%, 150mA, +CE, AE(Mode)	SOT-23-5	28x9	VR10	6g	Ric
S3	FMS3	Si-pnp	Dual, GP, 120V, 50mA, 140MHz	SOT-23-5	28/T12	-	6a	Rhm
S3	R1121N331B	LVR-IC	LDO, LN, +CE, 3.3V±2%, 150mA	SOT-23-5	28vt	VR4	6g	Ric
S30	R1162N301B	LVR-IC	LDO, 3V±2%, 150mA, +CE, AE(Mode)	SOT-23-5	28x9	VR10	6g	Ric
S31	R1162N311B	LVR-IC	LDO, 3.1V±2%, 150mA, +CE, AE(Mode)	SOT-23-5	28x9	VR10	6g	Ric
S32	NC7532P5	CMOS-Logic	2-input OR gate	SC-70-5	28/Log4	-	6a	F
S32	R1162N321B	LVR-IC	LDO, 3.2V±2%, 150mA, +CE, AE(Mode)	SOT-23-5	28x9	VR10	6g	Ric
S33	R1162N331B	LVR-IC	LDO, 3.3V±2%, 150mA, +CE, AE(Mode)	SOT-23-5	28x9	VR10	6g	Ric
S34	R1162N341B	LVR-IC	LDO, 3.4V±2%, 150mA, +CE, AE(Mode)	SOT-23-5	28x9	VR10	6g	Ric
S35	R1162N351B	LVR-IC	LDO, 3.5V±2%, 150mA, +CE, AE(Mode)	SOT-23-5	28x9	VR10	6g	Ric
S36	R1162N361B	LVR-IC	LDO, 3.6V±2%, 150mA, +CE, AE(Mode)	SOT-23-5	28x9	VR10	6g	Ric
S37	R1162N371B	LVR-IC	LDO, 3.7V±2%, 150mA, +CE, AE(Mode)	SOT-23-5	28x9	VR10	6g	Ric
S38	R1162N381B	LVR-IC	LDO, 3.8V±2%, 150mA, +CE, AE(Mode)	SOT-23-5	28x9	VR10	6g	Ric
S39	R1162N391B	LVR-IC	LDO, 3.9V±2%, 150mA, +CE, AE(Mode)	SOT-23-5	28x9	VR10	6g	Ric
S4	FMS4	Si-pnp	Dual, GP, 120V, 50mA, 140MHz	SOT-23-5	28ty	-	6a	Rhm
S4	KTA501E-Y	Si-pnp	Dual GP, 50V, 150mA, 100mW, B=120...240, 80MHz	TESV	30/T12	-	6l	Kec
S4	KTA501U-Y	Si-pnp	Dual GP, 50V, 150mA, 100mW, B=120...240, 80MHz	USV	28/T12	-	6l	Kec
S4	R1121N341B	LVR-IC	LDO, LN, +CE, 3.4V±2%, 150mA	SOT-23-5	28vt	VR4	6g	Ric
S40	R1162N401B	LVR-IC	LDO, 4V±2%, 150mA, +CE, AE(Mode)	SOT-23-5	28x9	VR10	6g	Ric
S41	R1162N181B5	LVR-IC	LDO, 1.85V±2%, 150mA, +CE, AE(Mode)	SOT-23-5	28x9	VR10	6g	Ric
S42	R1162N281B5	LVR-IC	LDO, 2.85V±2%, 150mA, +CE, AE(Mode)	SOT-23-5	28x9	VR10	6g	Ric
S5	R1121N351B	LVR-IC	LDO, LN, +CE, 3.5V±2%, 150mA	SOT-23-5	28vt	VR4	6g	Ric
S6	KTA501E-GR	Si-pnp	Dual GP, 50V, 150mA, 100mW, B=200...400, 80MHz	TESV	30/T12	-	6l	Kec
S6	KTA501U-GR	Si-pnp	Dual GP, 50V, 150mA, 100mW, B=200...400, 80MHz	USV	28/T12	-	6l	Kec
S6	R1121N361B	LVR-IC	LDO, LN, +CE, 3.6V±2%, 150mA	SOT-23-5	28vt	VR4	6g	Ric
S7	R1121N371B	LVR-IC	LDO, LN, +CE, 3.7V±2%, 150mA	SOT-23-5	28vt	VR4	6g	Ric
S8	R1121N381B	LVR-IC	LDO, LN, +CE, 3.8V±2%, 150mA	SOT-23-5	28vt	VR4	6g	Ric
S86	NC7586P5	CMOS-Logic	2-input EXCLUSIVE-OR gate	SC-70-5	28/Log5	-	6a	F
S9	R1121N391B	LVR-IC	LDO, LN, +CE, 3.9V±2%, 150mA	SOT-23-5	28vt	VR4	6g	Ric
SAA	R3118N061A	Vdet-IC	0.6V±22.5mV, -Reset ODO, Sense	SOT-23-5	28z4	VD14	6g	Ric
SAB	R3118N071A	Vdet-IC	0.7V±22.5mV, -Reset ODO, Sense	SOT-23-5	28z4	VD14	6g	Ric
SAC	NCP302LSN47T1	Vdet-IC	4.7V±1.5%, -Reset PPO	TSOP-5	28vdo	VD3	6k	Ons
SAC	R3118N081A	Vdet-IC	0.8V±22.5mV, -Reset ODO, Sense	SOT-23-5	28z4	VD14	6g	Ric
SAD	R3118N091A	Vdet-IC	0.9V±22.5mV, -Reset ODO, Sense	SOT-23-5	28z4	VD14	6g	Ric
SAE	R3118N101A	Vdet-IC	1.0V±22.5mV, -Reset ODO, Sense	SOT-23-5	28z4	VD14	6g	Ric
SAF	NCP302LSN43T1	Vdet-IC	4.3V±1.5%, -Reset PPO	TSOP-5	28vdo	VD3	6k	Ons
SAF	R3118N111A	Vdet-IC	1.1V±22.5mV, -Reset ODO, Sense	SOT-23-5	28z4	VD14	6g	Ric
SAG	R3118N121A	Vdet-IC	1.2V±22.5mV, -Reset ODO, Sense	SOT-23-5	28z4	VD14	6g	Ric
SAH	R3118N131A	Vdet-IC	1.3V±22.5mV, -Reset ODO, Sense	SOT-23-5	28z4	VD14	6g	Ric
SAI	NCP302LSN40T1	Vdet-IC	4.0V±1.5%, -Reset PPO	TSOP-5	28vdo	VD3	6k	Ons
SAJ	R3118N141A	Vdet-IC	1.4V±22.5mV, -Reset ODO, Sense	SOT-23-5	28z4	VD14	6g	Ric
SAK	NCP302LSN38T1	Vdet-IC	3.8V±1.5%, -Reset PPO	TSOP-5	28vdo	VD3	6k	Ons
SAK	R3118N151A	Vdet-IC	1.5V±22.5mV, -Reset ODO, Sense	SOT-23-5	28z4	VD14	6g	Ric
SAL	NCP302LSN45T1	Vdet-IC	4.5V±1.5%, -Reset PPO	TSOP-5	28vdo	VD3	6k	Ons
SAL	R3118N161A	Vdet-IC	1.6V±1.5%, -Reset ODO, Sense	SOT-23-5	28z4	VD14	6g	Ric
SAM	R3118N171A	Vdet-IC	1.7V±1.5%, -Reset ODO, Sense	SOT-23-5	28z4	VD14	6g	Ric
SAN	R3118N181A	Vdet-IC	1.8V±1.5%, -Reset ODO, Sense	SOT-23-5	28z4	VD14	6g	Ric
SAP	R3118N191A	Vdet-IC	1.9V±1.5%, -Reset ODO, Sense	SOT-23-5	28z4	VD14	6g	Ric
SAQ	NCP302LSN33T1	Vdet-IC	3.3V±1.5%, -Reset PPO	TSOP-5	28vdo	VD3	6k	Ons
SAQ	R3118N201A	Vdet-IC	2.0V±1.5%, -Reset ODO, Sense	SOT-23-5	28z4	VD14	6g	Ric
SAR	R3118N211A	Vdet-IC	2.1V±1.5%, -Reset ODO, Sense	SOT-23-5	28z4	VD14	6g	Ric
SAS	R3118N221A	Vdet-IC	2.2V±1.5%, -Reset ODO, Sense	SOT-23-5	28z4	VD14	6g	Ric
SAT	NCP302LSN30T1	Vdet-IC	3.0V±1.5%, -Reset PPO	TSOP-5	28vdo	VD3	6k	Ons
SAT	R3118N231A	Vdet-IC	2.3V±1.5%, -Reset ODO, Sense	SOT-23-5	28z4	VD14	6g	Ric
SAU	R3118N241A	Vdet-IC	2.4V±1.5%, -Reset ODO, Sense	SOT-23-5	28z4	VD14	6g	Ric
SAV	R3118N251A	Vdet-IC	2.5V±1.5%, -Reset ODO, Sense	SOT-23-5	28z4	VD14	6g	Ric
SAW	NCP302LSN27T1	Vdet-IC	2.7V±1.5%, -Reset PPO	TSOP-5	28vdo	VD3	6k	Ons
SAW	R3118N261A	Vdet-IC	2.6V±1.5%, -Reset ODO, Sense	SOT-23-5	28z4	VD14	6g	Ric
SAX	R3118N271A	Vdet-IC	2.7V±1.5%, -Reset ODO, Sense	SOT-23-5	28z4	VD14	6g	Ric
SAY	R3118N281A	Vdet-IC	2.8V±1.5%, -Reset ODO, Sense	SOT-23-5	28z4	VD14	6g	Ric
SAZ	R3118N291A	Vdet-IC	2.9V±1.5%, -Reset ODO, Sense	SOT-23-5	28z4	VD14	6g	Ric
SBA	R3118N061C	Vdet-IC	0.6V±22.5mV, -Reset PPO, Sense	SOT-23-5	28z4	VD15	6g	Ric
SBB	R3118N071C	Vdet-IC	0.7V±22.5mV, -Reset PPO, Sense	SOT-23-5	28z4	VD15	6g	Ric
SBC	R3118N081C	Vdet-IC	0.8V±22.5mV, -Reset PPO, Sense	SOT-23-5	28z4	VD15	6g	Ric
SBD	NCP302LSN20T1	Vdet-IC	2.0V±1.5%, -Reset PPO	TSOP-5	28vdo	VD3	6k	Ons



SMD code	Type	Function	Short description	Case	Pinout	Sch.	St.	Mnf.
SBD	R3118N091C	Vdet-IC	0.9V±22.5mV, -Reset PPO, Sense	SOT-23-5	28z4	VD15	6g	Ric
SBE	R3118N101C	Vdet-IC	1.0V±22.5mV, -Reset PPO, Sense	SOT-23-5	28z4	VD15	6g	Ric
SBF	NCP302LSN18T1	Vdet-IC	1.8V±1.5%, -Reset PPO	TSOP-5	28vdo	VD3	6k	Ons
SBF	R3118N111C	Vdet-IC	1.1V±22.5mV, -Reset PPO, Sense	SOT-23-5	28z4	VD15	6g	Ric
SBG	R3118N121C	Vdet-IC	1.2V±22.5mV, -Reset PPO, Sense	SOT-23-5	28z4	VD15	6g	Ric
SBH	R3118N131C	Vdet-IC	1.3V±22.5mV, -Reset PPO, Sense	SOT-23-5	28z4	VD15	6g	Ric
SBI	NCP302LSN15T1	Vdet-IC	1.5V±1.5%, -Reset PPO	TSOP-5	28vdo	VD3	6k	Ons
SBJ	R3118N141C	Vdet-IC	1.4V±22.5mV, -Reset PPO, Sense	SOT-23-5	28z4	VD15	6g	Ric
SBK	R3118N151C	Vdet-IC	1.5V±22.5mV, -Reset PPO, Sense	SOT-23-5	28z4	VD15	6g	Ric
SBL	R3118N161C	Vdet-IC	1.6V±1.5%, -Reset PPO, Sense	SOT-23-5	28z4	VD15	6g	Ric
SBM	R3118N171C	Vdet-IC	1.7V±1.5%, -Reset PPO, Sense	SOT-23-5	28z4	VD15	6g	Ric
SBN	R3118N181C	Vdet-IC	1.8V±1.5%, -Reset PPO, Sense	SOT-23-5	28z4	VD15	6g	Ric
SBO	NCP302LSN09T1	Vdet-IC	0.9V±1.5%, -Reset PPO	TSOP-5	28vdo	VD3	6k	Ons
SBP	NCP303LSN49T1	Vdet-IC	4.9V±1.5%, -Reset ODO	TSOP-5	28vdo	VD1	6k	Ons
SBP	R3118N191C	Vdet-IC	1.9V±1.5%, -Reset PPO, Sense	SOT-23-5	28z4	VD15	6g	Ric
SBQ	R3118N201C	Vdet-IC	2.0V±1.5%, -Reset PPO, Sense	SOT-23-5	28z4	VD15	6g	Ric
SBR	NCP303LSN47T1	Vdet-IC	4.7V±1.5%, -Reset ODO	TSOP-5	28vdo	VD1	6k	Ons
SBR	R3118N211C	Vdet-IC	2.1V±1.5%, -Reset PPO, Sense	SOT-23-5	28z4	VD15	6g	Ric
SBS	NCP303LSN46T1	Vdet-IC	4.6V±1.5%, -Reset ODO	TSOP-5	28vdo	VD1	6k	Ons
SBS	R3118N221C	Vdet-IC	2.2V±1.5%, -Reset PPO, Sense	SOT-23-5	28z4	VD15	6g	Ric
SBT	NCP303LSN45T1	Vdet-IC	4.5V±1.5%, -Reset ODO	TSOP-5	28vdo	VD1	6k	Ons
SBT	R3118N231C	Vdet-IC	2.3V±1.5%, -Reset PPO, Sense	SOT-23-5	28z4	VD15	6g	Ric
SBU	NCP303LSN44T1	Vdet-IC	4.4V±1.5%, -Reset ODO	TSOP-5	28vdo	VD1	6k	Ons
SBU	R3118N241C	Vdet-IC	2.4V±1.5%, -Reset PPO, Sense	SOT-23-5	28z4	VD15	6g	Ric
SBV	NCV303LSN43T1	Vdet-IC	4.3V±1.5%, -Reset ODO	TSOP-5	28vdo	VD1	6k	Ons
SBV	R3118N251C	Vdet-IC	2.5V±1.5%, -Reset PPO, Sense	SOT-23-5	28z4	VD15	6g	Ric
SBW	NCP303LSN42T1	Vdet-IC	4.2V±1.5%, -Reset ODO	TSOP-5	28vdo	VD1	6k	Ons
SBW	R3118N261C	Vdet-IC	2.6V±1.5%, -Reset PPO, Sense	SOT-23-5	28z4	VD15	6g	Ric
SBX	R3118N271C	Vdet-IC	2.7V±1.5%, -Reset PPO, Sense	SOT-23-5	28z4	VD15	6g	Ric
SBY	NCP303LSN40T1	Vdet-IC	4.0V±1.5%, -Reset ODO	TSOP-5	28vdo	VD1	6k	Ons
SBY	R3118N281C	Vdet-IC	2.8V±1.5%, -Reset PPO, Sense	SOT-23-5	28z4	VD15	6g	Ric
SBZ	R3118N291C	Vdet-IC	2.9V±1.5%, -Reset PPO, Sense	SOT-23-5	28z4	VD15	6g	Ric
SC	TC75S51F	Op-IC	CMOS, Vcc=±0.75...±3.5V, Icc0=60µA	SOT-25	28opf	OP1	6a	Tos
SC	TC75S51FE	Op-IC	CMOS, Vcc=±0.75...±3.5V, Icc0=60µA	ESV	30opf	OP1	6a	Tos
SC	TC75S51FU	Op-IC	CMOS, Vcc=±0.75...±3.5V, Icc0=60µA	SOT-353	30opf	OP1	6a	Tos
SCA	NCP303LSN38T1	Vdet-IC	3.8V±1.5%, -Reset ODO	TSOP-5	28vdo	VD1	6k	Ons
SCD	NCP303LSN36T1	Vdet-IC	3.6V±1.5%, -Reset ODO	TSOP-5	28vdo	VD1	6k	Ons
SCDB	LP3990MFX-1.2	LVR-IC	1.2V±1.5%, 150mA, +CE	SOT-23-5	28cx	VR4	6g	Nsc
SCEB	LP3990MFX-1.5	LVR-IC	1.5V±1.5%, 150mA, +CE	SOT-23-5	28cx	VR4	6g	Nsc
SCF	NCP303LSN34T1	Vdet-IC	3.4V±1.5%, -Reset ODO	TSOP-5	28vdo	VD1	6k	Ons
SCFB	LP3990MFX-1.8	LVR-IC	1.8V±1.5%, 150mA, +CE	SOT-23-5	28cx	VR4	6g	Nsc
SCG	NCP303LSN33T1	Vdet-IC	3.3V±1.5%, -Reset ODO	TSOP-5	28vdo	VD1	6k	Ons
SCH	NCP303LSN32T1	Vdet-IC	3.2V±1.5%, -Reset ODO	TSOP-5	28vdo	VD1	6k	Ons
SCI	NCP303LSN31T1	Vdet-IC	3.1V±1.5%, -Reset ODO	TSOP-5	28vdo	VD1	6k	Ons
SCJ	NCP303LSN30T1	Vdet-IC	3.0V±1.5%, -Reset ODO	TSOP-5	28vdo	VD1	6k	Ons
SCJB	LP3990MFX-2.5	LVR-IC	2.5V±1.5%, 150mA, +CE	SOT-23-5	28cx	VR4	6g	Nsc
SCK	NCP303LSN29T1	Vdet-IC	2.9V±1.5%, -Reset ODO	TSOP-5	28vdo	VD1	6k	Ons
SCKB	LP3990MFX-2.8	LVR-IC	2.8V±1.5%, 150mA, +CE	SOT-23-5	28cx	VR4	6g	Nsc
SCL	NCP303LSN28T1	Vdet-IC	2.8V±1.5%, -Reset ODO	TSOP-5	28vdo	VD1	6k	Ons
SCLB	LP3990MFX-3.3	LVR-IC	3.3V±1.5%, 150mA, +CE	SOT-23-5	28cx	VR4	6g	Nsc
SCM	NCP303LSN27T1	Vdet-IC	2.7V±1.5%, -Reset ODO	TSOP-5	28vdo	VD1	6k	Ons
SCN	NCP303LSN26T1	Vdet-IC	2.6V±1.5%, -Reset ODO	TSOP-5	28vdo	VD1	6k	Ons
SCO	NCP303LSN25T1	Vdet-IC	2.5V±1.5%, -Reset ODO	TSOP-5	28vdo	VD1	6k	Ons
SCP	NCP303LSN24T1	Vdet-IC	2.4V±1.5%, -Reset ODO	TSOP-5	28vdo	VD1	6k	Ons
SCQ	NCP303LSN23T1	Vdet-IC	2.3V±1.5%, -Reset ODO	TSOP-5	28vdo	VD1	6k	Ons
SCR	NCP303LSN22T1	Vdet-IC	2.2V±1.5%, -Reset ODO	TSOP-5	28vdo	VD1	6k	Ons
SCT	NCP303LSN20T1	Vdet-IC	2.0V±1.5%, -Reset ODO	TSOP-5	28vdo	VD1	6k	Ons
SCV	NCP303LSN18T1	Vdet-IC	1.8V±1.5%, -Reset ODO	TSOP-5	28vdo	VD1	6k	Ons
SCW	NCP303LSN17T1	Vdet-IC	1.7V±1.5%, -Reset ODO	TSOP-5	28vdo	VD1	6k	Ons
SCX	NCP303LSN16T1	Vdet-IC	1.6V±1.5%, -Reset ODO	TSOP-5	28vdo	VD1	6k	Ons
SCY	NCP303LSN15T1	Vdet-IC	1.5V±1.5%, -Reset ODO	TSOP-5	28vdo	VD1	6k	Ons
SCZ	NCP303LSN14T1	Vdet-IC	1.4V±1.5%, -Reset ODO	TSOP-5	28vdo	VD1	6k	Ons
SDA	NCP303LSN13T1	Vdet-IC	1.3V±1.5%, -Reset ODO	TSOP-5	28vdo	VD1	6k	Ons
SDB	NCV303LSN12T1	Vdet-IC	1.2V±1.5%, -Reset ODO	TSOP-5	28vdo	VD1	6k	Ons
SDC	NCP303LSN11T1	Vdet-IC	1.1V±1.5%, -Reset ODO	TSOP-5	28vdo	VD1	6k	Ons
SDD	NCP303LSN10T1	Vdet-IC	1.0V±1.5%, -Reset ODO	TSOP-5	28vdo	VD1	6k	Ons
SDE	NCP303LSN09T1	Vdet-IC	0.9V±1.5%, -Reset ODO	TSOP-5	28vdo	VD1	6k	Ons
SDG	NCP302HSN45T1	Vdet-IC	4.5V±1.5%, +Reset PPO	TSOP-5	28vdo	VD3	6k	Ons
SDI	NCP302HSN30T1	Vdet-IC	3.0V±1.5%, +Reset PPO	TSOP-5	28vdo	VD3	6k	Ons
SDK	NCP302HSN27T1	Vdet-IC	2.7V±1.5%, +Reset PPO	TSOP-5	28vdo	VD3	6k	Ons



SMD code	Type	Function	Short description	Case	Pinout	Sch.	St.	Mnf.
SDO	NCP302HSN09T1	Vdet-IC	0.9V±1.5%, +Reset PPO	TSOP-5	28vdo	VD3	6k	Ons
SDP	NCP300HSN47T1	Vdet-IC	4.7V±1.5%, +Reset PPO	TSOP-5	28vdm	VD7	6k	Ons
SDQ	NCP300HSN45T1	Vdet-IC	4.5V±1.5%, +Reset PPO	TSOP-5	28vdm	VD7	6k	Ons
SDS	NCP300HSN30T1	Vdet-IC	3.0V±1.5%, +Reset PPO	TSOP-5	28vdm	VD7	6k	Ons
SDU	NCP300HSN27T1	Vdet-IC	2.7V±1.5%, +Reset PPO	TSOP-5	28vdm	VD7	6k	Ons
SDY	NCP300HSN09T1	Vdet-IC	0.9V±1.5%, +Reset PPO	TSOP-5	28vdm	VD7	6k	Ons
SDZ	NCP300LSN47T1	Vdet-IC	4.7V±1.5%, -Reset PPO	TSOP-5	28vdm	VD7	6k	Ons
SE	TC75S54F	Op-IC	CMOS, V _{cc} =±0.9...±3.5V, I _{cc0} =100µA	SOT-25	280pf	OP1	6a	Tos
SE	TC75S54FE	Op-IC	CMOS, V _{cc} =±0.9...±3.5V, I _{cc0} =100µA	ESV	300pf	OP1	6a	Tos
SE	TC75S54FU	Op-IC	CMOS, V _{cc} =±0.9...±3.5V, I _{cc0} =100µA	SOT-353	300pf	OP1	6a	Tos
SE2	S-1135A34-M5T1S	LVR-IC	LDO, 3.4V±1.0%, 300mA, +CE, CL, PDR	SOT-23-5	28cx	VR4	6g	Sii
SE3	S-1135A35-M5T1S	LVR-IC	LDO, 3.5V±1.0%, 300mA, +CE, CL, PDR	SOT-23-5	28cx	VR4	6g	Sii
SEA	NCP300LSN45T1	Vdet-IC	4.5V±1.5%, -Reset PPO	TSOP-5	28vdm	VD7	6k	Ons
SEA	S-1135A10-M5T1S	LVR-IC	LDO, 1.0V±15mV, 300mA, +CE, PDR, CL	SOT-23-5	28cx	VR4	6g	Sii
SEB	S-1135A11-M5T1S	LVR-IC	LDO, 1.1V±15mV, 300mA, +CE, PDR, CL	SOT-23-5	28cx	VR4	6g	Sii
SEC	NCP300LSN30T1	Vdet-IC	3.0V±1.5%, -Reset PPO	TSOP-5	28vdm	VD7	6k	Ons
SEC	S-1135A12-M5T1S	LVR-IC	LDO, 1.2V±15mV, 300mA, +CE, CL, PDR	SOT-23-5	28cx	VR4	6g	Sii
SED	NCP300LSN28T1	Vdet-IC	2.8V±1.5%, -Reset PPO	TSOP-5	28vdm	VD7	6k	Ons
SED	S-1135A13-M5T1S	LVR-IC	LDO, 1.3V±15mV, 300mA, +CE, CL, PDR	SOT-23-5	28cx	VR4	6g	Sii
SEE	NCP300LSN27T1	Vdet-IC	2.7V±1.5%, -Reset PPO	TSOP-5	28vdm	VD7	6k	Ons
SEE	S-1135A14-M5T1S	LVR-IC	LDO, 1.4V±15mV, 300mA, +CE, CL, PDR	SOT-23-5	28cx	VR4	6g	Sii
SEF	S-1135A15-M5T1S	LVR-IC	LDO, 1.5V±1.0%, 300mA, +CE, CL, PDR	SOT-23-5	28cx	VR4	6g	Sii
SEG	S-1135A16-M5T1S	LVR-IC	LDO, 1.6V±1.0%, 300mA, +CE, CL, PDR	SOT-23-5	28cx	VR4	6g	Sii
SEH	S-1135A17-M5T1S	LVR-IC	LDO, 1.7V±1.0%, 300mA, +CE, CL, PDR	SOT-23-5	28cx	VR4	6g	Sii
SEI	S-1135A18-M5T1S	LVR-IC	LDO, 1.8V±1.0%, 300mA, +CE, CL, PDR	SOT-23-5	28cx	VR4	6g	Sii
SEJ	NCP300LSN09T1	Vdet-IC	0.9V±1.5%, -Reset PPO	TSOP-5	28vdm	VD7	6k	Ons
SEK	S-1135A1J-M5T1S	LVR-IC	LDO, 1.85V±1.0%, 300mA, +CE, CL, PDR	SOT-23-5	28cx	VR4	6g	Sii
SEK	S-1135A19-M5T1S	LVR-IC	LDO, 1.9V±1.0%, 300mA, +CE, CL, PDR	SOT-23-5	28cx	VR4	6g	Sii
SEL	NCP301HSN45T1	Vdet-IC	4.5V±1.5%, +Reset ODO	TSOP-5	28vdm	VD6	6k	Ons
SEL	S-1135A20-M5T1S	LVR-IC	LDO, 2.0V±1.0%, 300mA, +CE, CL, PDR	SOT-23-5	28cx	VR4	6g	Sii
SEM	S-1135A21-M5T1S	LVR-IC	LDO, 2.1V±1.0%, 300mA, +CE, CL, PDR	SOT-23-5	28cx	VR4	6g	Sii
SEN	NCP301HSN30T1	Vdet-IC	3.0V±1.5%, +Reset ODO	TSOP-5	28vdm	VD6	6k	Ons
SEN	S-1135A22-M5T1S	LVR-IC	LDO, 2.2V±1.0%, 300mA, +CE, CL, PDR	SOT-23-5	28cx	VR4	6g	Sii
SEP	S-1135A23-M5T1S	LVR-IC	LDO, 2.3V±1.0%, 300mA, +CE, CL, PDR	SOT-23-5	28cx	VR4	6g	Sii
SEP	NCP301HSN27T1	Vdet-IC	2.7V±1.5%, +Reset ODO	TSOP-5	28vdm	VD6	6k	Ons
SEP	S-1135A24-M5T1S	LVR-IC	LDO, 2.4V±1.0%, 300mA, +CE, CL, PDR	SOT-23-5	28cx	VR4	6g	Sii
SEQ	S-1135A25-M5T1S	LVR-IC	LDO, 2.5V±1.0%, 300mA, +CE, CL, PDR	SOT-23-5	28cx	VR4	6g	Sii
SER	S-1135A26-M5T1S	LVR-IC	LDO, 2.6V±1.0%, 300mA, +CE, CL, PDR	SOT-23-5	28cx	VR4	6g	Sii
SES	S-1135A27-M5T1S	LVR-IC	LDO, 2.7V±1.0%, 300mA, +CE, CL, PDR	SOT-23-5	28cx	VR4	6g	Sii
SET	NCP301HSN09T1	Vdet-IC	0.9V±1.5%, +Reset ODO	TSOP-5	28vdm	VD6	6k	Ons
SET	S-1135A28-M5T1S	LVR-IC	LDO, 2.8V±1.0%, 300mA, +CE, CL, PDR	SOT-23-5	28cx	VR4	6g	Sii
SEU	NCP301LSN47T1	Vdet-IC	4.7V±1.5%, -Reset ODO	TSOP-5	28vdm	VD6	6k	Ons
SEU	S-1135A2J-M5T1S	LVR-IC	LDO, 2.85V±1.0%, 300mA, +CE, CL, PDR	SOT-23-5	28cx	VR4	6g	Sii
SEV	NCP301LSN45T1	Vdet-IC	4.5V±1.5%, -Reset ODO	TSOP-5	28vdm	VD6	6k	Ons
SEV	S-1135A29-M5T1S	LVR-IC	LDO, 2.9V±1.0%, 300mA, +CE, CL, PDR	SOT-23-5	28cx	VR4	6g	Sii
SEW	NCP301LSN31T1	Vdet-IC	3.1V±1.5%, -Reset ODO	TSOP-5	28vdm	VD6	6k	Ons
SEW	S-1135A30-M5T1S	LVR-IC	LDO, 3.0V±1.0%, 300mA, +CE, CL, PDR	SOT-23-5	28cx	VR4	6g	Sii
SEX	S-1135A31-M5T1S	LVR-IC	LDO, 3.1V±1.0%, 300mA, +CE, CL, PDR	SOT-23-5	28cx	VR4	6g	Sii
SEY	NCP301LSN30T1	Vdet-IC	3.0V±1.5%, -Reset ODO	TSOP-5	28vdm	VD6	6k	Ons
SEY	S-1135A32-M5T1S	LVR-IC	LDO, 3.2V±1.0%, 300mA, +CE, CL, PDR	SOT-23-5	28cx	VR4	6g	Sii
SEZ	NCP301LSN28T1	Vdet-IC	2.8V±1.5%, -Reset ODO	TSOP-5	28vdm	VD6	6k	Ons
SEZ	S-1135A33-M5T1S	LVR-IC	LDO, 3.3V±1.0%, 300mA, +CE, CL, PDR	SOT-23-5	28cx	VR4	6g	Sii
sf	PT7M7811JTA	Vdet-IC	4.0V±1.5%, -Reset PPO, -MR	SOT-23-5	28vd2	VD5	6k	Pti
sf	PT7M7811JTAE	Vdet-IC	4.0V±1.5%, -Reset PPO, -MR, Lead free	SOT-23-5	28vd2	VD5	6k	Pti
SF	TC75S55F	Op-IC	CMOS, V _{cc} =±0.9...±3.5V, I _{cc0} =10µA	SOT-25	280pf	OP1	6a	Tos
SF	TC75S55FE	Op-IC	CMOS, V _{cc} =±0.9...±3.5V, I _{cc0} =10µA	ESV	300pf	OP1	6a	Tos
SF	TC75S55FU	Op-IC	CMOS, V _{cc} =±0.9...±3.5V, I _{cc0} =10µA	SOT-353	300pf	OP1	6a	Tos
SFA	NCP301LSN27T1	Vdet-IC	2.7V±1.5%, -Reset ODO	TSOP-5	28vdm	VD6	6k	Ons
SFD	NCP301LSN20T1	Vdet-IC	2.0V±1.5%, -Reset ODO	TSOP-5	28vdm	VD6	6k	Ons
SFF	NCP301LSN09T1	Vdet-IC	0.9V±1.5%, -Reset ODO	TSOP-5	28vdm	VD6	6k	Ons
SFH	NCP302HSN18T1	Vdet-IC	1.8V±1.5%, +Reset PPO	TSOP-5	28vdo	VD3	6k	Ons
SFJ	NCP300HSN18T1	Vdet-IC	1.8V±1.5%, +Reset PPO	TSOP-5	28vdm	VD7	6k	Ons
SFK	NCP300LSN18T1	Vdet-IC	1.8V±1.5%, -Reset PPO	TSOP-5	28vdm	VD7	6k	Ons
SFM	NCP301HSN18T1	Vdet-IC	1.8V±1.5%, +Reset ODO	TSOP-5	28vdm	VD6	6k	Ons
SFN	NCP301LSN18T1	Vdet-IC	1.8V±1.5%, -Reset ODO	TSOP-5	28vdm	VD6	6k	Ons
sg	PT7M7812JTA	Vdet-IC	4.0V±1.5%, +Reset PPO, -MR	SOT-23-5	28vd2	VD5	6k	Pti
sg	PT7M7812JTAE	Vdet-IC	4.0V±1.5%, +Reset PPO, -MR, Lead free	SOT-23-5	28vd2	VD5	6k	Pti
SG	2SA1618-GR	Si-pnp	Dual, 50V, 150mA, 300mW, B=200...400, >80MHz	SOT-25	28/T12	-	6a	Tos
SG	2SA1873-GR	Si-pnp	Dual, AF-Amp, 50V, 150mA, 200mW, B=200...400	SOT-25	28/T12	-	6a	Tos
SG2	S-1135B34-M5T1S	LVR-IC	LDO, 3.4V±1.0%, 300mA, +CE, CL	SOT-23-5	28cx	VR4	6g	Sii



SMD code	Type	Function	Short description	Case	Pinout	Sch.	St.	Mnf.
SG3	S-1135B35-M5T1S	LVR-IC	LDO, 3.5V±1.0%, 300mA, +CE, CL	SOT-23-5	28cx	VR4	6g	Sii
SGA	S-1135B10-M5T1S	LVR-IC	LDO, 1.0V±15mV, 300mA, +CE, CL	SOT-23-5	28cx	VR4	6g	Sii
SGAA	MIC2287BD5	LDR-IC	1.2MHz PWM Boost Converter	SOT-23-5	28sq	LD3	6g	Mcr
SGAA	MIC2287YD5	LDR-IC	1.2MHz PWM Boost Converter	SOT-23-5	28sq	LD3	6g	Mcr
SGB	S-1135B11-M5T1S	LVR-IC	LDO, 1.1V±15mV, 300mA, +CE, CL	SOT-23-5	28cx	VR4	6g	Sii
SGC	S-1135B12-M5T1S	LVR-IC	LDO, 1.2V±15mV, 300mA, +CE, CL	SOT-23-5	28cx	VR4	6g	Sii
SGD	S-1135B13-M5T1S	LVR-IC	LDO, 1.3V±15mV, 300mA, +CE, CL	SOT-23-5	28cx	VR4	6g	Sii
SGE	S-1135B14-M5T1S	LVR-IC	LDO, 1.4V±15mV, 300mA, +CE, CL	SOT-23-5	28cx	VR4	6g	Sii
SGF	S-1135B15-M5T1S	LVR-IC	LDO, 1.5V±1.0%, 300mA, +CE, CL	SOT-23-5	28cx	VR4	6g	Sii
SGG	S-1135B16-M5T1S	LVR-IC	LDO, 1.6V±1.0%, 300mA, +CE, CL	SOT-23-5	28cx	VR4	6g	Sii
SGH	S-1135B17-M5T1S	LVR-IC	LDO, 1.7V±1.0%, 300mA, +CE, CL	SOT-23-5	28cx	VR4	6g	Sii
SGI	S-1135B18-M5T1S	LVR-IC	LDO, 1.8V±1.0%, 300mA, +CE, CL	SOT-23-5	28cx	VR4	6g	Sii
SGJ	S-1135B1J-M5T1S	LVR-IC	LDO, 1.85V±1.0%, 300mA, +CE, CL	SOT-23-5	28cx	VR4	6g	Sii
SGK	S-1135B19-M5T1S	LVR-IC	LDO, 1.9V±1.0%, 300mA, +CE, CL	SOT-23-5	28cx	VR4	6g	Sii
SGL	S-1135B20-M5T1S	LVR-IC	LDO, 2.0V±1.0%, 300mA, +CE, CL	SOT-23-5	28cx	VR4	6g	Sii
SGM	S-1135B21-M5T1S	LVR-IC	LDO, 2.1V±1.0%, 300mA, +CE, CL	SOT-23-5	28cx	VR4	6g	Sii
SGN	S-1135B22-M5T1S	LVR-IC	LDO, 2.2V±1.0%, 300mA, +CE, CL	SOT-23-5	28cx	VR4	6g	Sii
SGO	S-1135B23-M5T1S	LVR-IC	LDO, 2.3V±1.0%, 300mA, +CE, CL	SOT-23-5	28cx	VR4	6g	Sii
SGP	S-1135B24-M5T1S	LVR-IC	LDO, 2.4V±1.0%, 300mA, +CE, CL	SOT-23-5	28cx	VR4	6g	Sii
SGQ	S-1135B25-M5T1S	LVR-IC	LDO, 2.5V±1.0%, 300mA, +CE, CL	SOT-23-5	28cx	VR4	6g	Sii
SGR	S-1135B26-M5T1S	LVR-IC	LDO, 2.6V±1.0%, 300mA, +CE, CL	SOT-23-5	28cx	VR4	6g	Sii
SGS	S-1135B27-M5T1S	LVR-IC	LDO, 2.7V±1.0%, 300mA, +CE, CL	SOT-23-5	28cx	VR4	6g	Sii
SGT	S-1135B28-M5T1S	LVR-IC	LDO, 2.8V±1.0%, 300mA, +CE, CL	SOT-23-5	28cx	VR4	6g	Sii
SGU	S-1135B2J-M5T1S	LVR-IC	LDO, 2.85V±1.0%, 300mA, +CE, CL	SOT-23-5	28cx	VR4	6g	Sii
SGV	S-1135B29-M5T1S	LVR-IC	LDO, 2.9V±1.0%, 300mA, +CE, CL	SOT-23-5	28cx	VR4	6g	Sii
SGW	S-1135B30-M5T1S	LVR-IC	LDO, 3.0V±1.0%, 300mA, +CE, CL	SOT-23-5	28cx	VR4	6g	Sii
SGX	S-1135B31-M5T1S	LVR-IC	LDO, 3.1V±1.0%, 300mA, +CE, CL	SOT-23-5	28cx	VR4	6g	Sii
SGY	S-1135B32-M5T1S	LVR-IC	LDO, 3.2V±1.0%, 300mA, +CE, CL	SOT-23-5	28cx	VR4	6g	Sii
SGZ	S-1135B33-M5T1S	LVR-IC	LDO, 3.3V±1.0%, 300mA, +CE, CL	SOT-23-5	28cx	VR4	6g	Sii
sh	PT7M7823JTA	Vdet-IC	4.0V±1.5%, -Reset PPO, -MR, WD	SOT-23-5	28cp	VD17	6k	Pti
sh	PT7M7823JTAE	Vdet-IC	4.0V±1.5%, -Reset PPO, -MR, WD, Lead free	SOT-23-5	28cp	VD17	6k	Pti
SH	TC75S60F	Op-IC	CMOS, V _{cc} =±0.9...±3.5V, I _{cc0} =10μA	SOT-25	28opf	OP1	6a	Tos
SH	TC75S60FU	Op-IC	CMOS, V _{cc} =±0.9...±3.5V, I _{cc0} =10μA	SOT-353	30opf	OP1	6a	Tos
SHAA	MIC2288BD5	LDR-IC	1.2MHz PWM Boost converter, 1A	SOT-23-5	28sq	LD3	6g	Mcr
SHAA	MIC2288YD5	LDR-IC	1.2MHz PWM Boost converter, 1A	SOT-23-5	28sq	LD3	6g	Mcr
SHE	NCP300LSN20T1	Vdet-IC	2.0V±1.5%, -Reset PPO	TSOP-5	28vdm	VD7	6k	Ons
si	PT7M7824JTA	Vdet-IC	4.0V±1.5%, ±Reset PPO, WD	SOT-23-5	28gx	VD19	6k	Pti
si	PT7M7824JTAE	Vdet-IC	4.0V±1.5%, ±Reset PPO, WD, Lead free	SOT-23-5	28gx	VD19	6k	Pti
SIM	NCV300LSN20T1	Vdet-IC	2.0V±1.5%, -Reset PPO	TSOP-5	28vdm	VD7	6k	Ons
SIW	NCV300LSN27T1	Vdet-IC	2.7V±1.5%, -Reset PPO	TSOP-5	28vdm	VD7	6k	Ons
sj	PT7M7825JTA	Vdet-IC	4.0V±1.5%, ±Reset PPO, -MR	SOT-23-5	28xf	VD21	6k	Pti
sj	PT7M7825JTAE	Vdet-IC	4.0V±1.5%, ±Reset PPO, -MR, Lead free	SOT-23-5	28xf	VD21	6k	Pti
SJH	NCP302HSN40T1	Vdet-IC	4.0V±1.5%, +Reset PPO	TSOP-5	28vdo	VD3	6k	Ons
SKJ	NCP300LSN46T1	Vdet-IC	4.6V±1.5%, -Reset PPO	TSOP-5	28vdm	VD7	6k	Ons
SKK	NCP300LSN44T1	Vdet-IC	4.4V±1.5%, -Reset PPO	TSOP-5	28vdm	VD7	6k	Ons
SKS	NCV300LSN36T1	Vdet-IC	3.6V±1.5%, -Reset PPO	TSOP-5	28vdm	VD7	6k	Ons
SKU	NCP300LSN34T1	Vdet-IC	3.4V±1.5%, -Reset PPO	TSOP-5	28vdm	VD7	6k	Ons
SKV	NCP300LSN33T1	Vdet-IC	3.3V±1.5%, -Reset PPO	TSOP-5	28vdm	VD7	6k	Ons
SL	R1122N301B	LVR-IC	LDO, LN, +CE, 3V±2%, 150mA	SOT-23-5	28vt	VR4	6g	Ric
SM	R1122N311B	LVR-IC	LDO, LN, +CE, 3.1V±2%, 150mA	SOT-23-5	28vt	VR4	6g	Ric
SMD	NCP301HSN22T1	Vdet-IC	2.2V±1.5%, +Reset ODO	TSOP-5	28vdm	VD6	6k	Ons
SMP	NCP301LSN46T1	Vdet-IC	4.6V±1.5%, -Reset ODO	TSOP-5	28vdm	VD6	6k	Ons
SMS	NCP301LSN42T1	Vdet-IC	4.2V±1.5%, -Reset ODO	TSOP-5	28vdm	VD6	6k	Ons
SMU	NCP301LSN40T1	Vdet-IC	4.0V±1.5%, -Reset ODO	TSOP-5	28vdm	VD6	6k	Ons
SMY	NCP301LSN36T1	Vdet-IC	3.6V±1.5%, -Reset ODO	TSOP-5	28vdm	VD6	6k	Ons
SN	R1122N321B	LVR-IC	LDO, LN, +CE, 3.2V±2%, 150mA	SOT-23-5	28vt	VR4	6g	Ric
SNA	NCP301LSN34T1	Vdet-IC	3.4V±1.5%, -Reset ODO	TSOP-5	28vdm	VD6	6k	Ons
SNB	NCP301LSN33T1	Vdet-IC	3.3V±1.5%, -Reset ODO	TSOP-5	28vdm	VD6	6k	Ons
SNC	NCP301LSN32T1	Vdet-IC	3.2V±1.5%, -Reset ODO	TSOP-5	28vdm	VD6	6k	Ons
SNE	NCP301LSN26T1	Vdet-IC	2.6V±1.5%, -Reset ODO	TSOP-5	28vdm	VD6	6k	Ons
SNF	NCP301LSN25T1	Vdet-IC	2.5V±1.5%, -Reset ODO	TSOP-5	28vdm	VD6	6k	Ons
SNG	NCP301LSN22T1	Vdet-IC	2.2V±1.5%, -Reset ODO	TSOP-5	28vdm	VD6	6k	Ons
SNJ	NCP301LSN16T1	Vdet-IC	1.6V±1.5%, -Reset ODO	TSOP-5	28vdm	VD6	6k	Ons
SNN	NCP301LSN12T1	Vdet-IC	1.2V±1.5%, -Reset ODO	TSOP-5	28vdm	VD6	6k	Ons
SP	KIC7S00FU	CMOS-Logic	2-input NAND gate	SOT-353	28/Log1	-	6a	Kec
SP	R1122N331B	LVR-IC	LDO, LN, +CE, 3.3V±2%, 150mA	SOT-23-5	28vt	VR4	6g	Ric
SQ	KIC7S02FU	CMOS-Logic	2-input NOR gate	SOT-353	28/Log2	-	6a	Kec
SQ	R1122N341B	LVR-IC	LDO, LN, +CE, 3.4V±2%, 150mA	SOT-23-5	28vt	VR4	6g	Ric
SQV	NCV300LSN30T1	Vdet-IC	3.0V±1.5%, -Reset PPO	TSOP-5	28vdm	VD7	6k	Ons
SR	KIC7S04FU	CMOS-Logic	Inverter	SOT-353	28/Log6	-	6a	Kec



SMD code	Type	Function	Short description	Case	Pinout	Sch.	St.	Mnf.
SR	R1122N351B	LVR-IC	LDO, LN, +CE, 3.5V±2%, 150mA	SOT-23-5	28vt	VR4	6g	Ric
SRA	NCP300LSN185T	Vdet-IC	1.85V±1.5%, -Reset PPO	TSOP-5	28vdm	VD7	6k	Ons
SRK	NCV301LSN12T1	Vdet-IC	1.2V±1.5%, -Reset ODO	TSOP-5	28vdm	VD6	6k	Ons
SRL	NCV301LSN16T1	Vdet-IC	1.6V±1.5%, -Reset ODO	TSOP-5	28vdm	VD6	6k	Ons
SRM	NCV301LSN20T1	Vdet-IC	2.0V±1.5%, -Reset ODO	TSOP-5	28vdm	VD6	6k	Ons
SRN	NCV301LSN25T1	Vdet-IC	2.5V±1.5%, -Reset ODO	TSOP-5	28vdm	VD6	6k	Ons
SRO	NCV301LSN28T1	Vdet-IC	2.8V±1.5%, -Reset ODO	TSOP-5	28vdm	VD6	6k	Ons
SRP	NCV301LSN40T1	Vdet-IC	4.0V±1.5%, -Reset ODO	TSOP-5	28vdm	VD6	6k	Ons
SRQ	NCV301LSN45T1	Vdet-IC	4.5V±1.5%, -Reset ODO	TSOP-5	28vdm	VD6	6k	Ons
SRS	NCV303LSN13T1	Vdet-IC	1.3V±1.5%, -Reset ODO	TSOP-5	28vdo	VD1	6k	Ons
SRT	NCV303LSN14T1	Vdet-IC	1.4V±1.5%, -Reset ODO	TSOP-5	28vdo	VD1	6k	Ons
SRU	NCV303LSN15T1	Vdet-IC	1.5V±1.5%, -Reset ODO	TSOP-5	28vdo	VD1	6k	Ons
SRV	NCV303LSN16T1	Vdet-IC	1.6V±1.5%, -Reset ODO	TSOP-5	28vdo	VD1	6k	Ons
SRW	NCV303LSN20T1	Vdet-IC	2.0V±1.5%, -Reset ODO	TSOP-5	28vdo	VD1	6k	Ons
SRX	NCV303LSN23T1	Vdet-IC	2.3V±1.5%, -Reset ODO	TSOP-5	28vdo	VD1	6k	Ons
SS	KIC7SU04FU	CMOS-Logic	Inverter	SOT-353	28/Log6	-	6a	Kec
SS	R1122N361B	LVR-IC	LDO, LN, +CE, 3.6V±2%, 150mA	SOT-23-5	28vt	VR4	6g	Ric
SSA	NCV303LSN30T1	Vdet-IC	3.0V±1.5%, -Reset ODO	TSOP-5	28vdo	VD1	6k	Ons
SSC	NCV303LSN36T1	Vdet-IC	3.6V±1.5%, -Reset ODO	TSOP-5	28vdo	VD1	6k	Ons
SSE	NCV303LSN42T1	Vdet-IC	4.2V±1.5%, -Reset ODO	TSOP-5	28vdo	VD1	6k	Ons
SSF	NCV303LSN44T1	Vdet-IC	4.4V±1.5%, -Reset ODO	TSOP-5	28vdo	VD1	6k	Ons
SSG	NCV303LSN45T1	Vdet-IC	4.5V±1.5%, -Reset ODO	TSOP-5	28vdo	VD1	6k	Ons
SSH	NCV303LSN46T1	Vdet-IC	4.6V±1.5%, -Reset ODO	TSOP-5	28vdo	VD1	6k	Ons
SSI	NCV303LSN49T1	Vdet-IC	4.9V±1.5%, -Reset ODO	TSOP-5	28vdo	VD1	6k	Ons
SSJ	NCV301LSN47T1	Vdet-IC	4.7V±1.5%, -Reset ODO	TSOP-5	28vdm	VD6	6k	Ons
SSK	NCV303LSN29T1	Vdet-IC	2.6V±1.5%, -Reset ODO	TSOP-5	28vdo	VD1	6k	Ons
SSL	NCV300LSN28T1	Vdet-IC	2.8V±1.5%, -Reset PPO	TSOP-5	28vdm	VD7	6k	Ons
SSM	NCV303LSN10T1	Vdet-IC	1.0V±1.5%, -Reset ODO	TSOP-5	28vdo	VD1	6k	Ons
ST	KIC7S08FU	CMOS-Logic	2-input AND gate	SOT-353	28/Log3	-	6a	Kec
ST	R1122N371B	LVR-IC	LDO, LN, +CE, 3.7V±2%, 150mA	SOT-23-5	28vt	VR4	6g	Ric
SU	KIC7S14FU	CMOS-Logic	Inverting Schmitt-trigger	SOT-353	28/Log7	-	6a	Kec
SU	R1122N381B	LVR-IC	LDO, LN, +CE, 3.8V±2%, 150mA	SOT-23-5	28vt	VR4	6g	Ric
SU4	NC7SU04P5	CMOS-Logic	Inverter	SC-70-5	28/Log6	-	6a	F
SUA	NCV301LSN22T1	Vdet-IC	2.2V±1.5%, -Reset ODO	TSOP-5	28vdm	VD6	6k	Ons
SUD	NCV301HSN27T1	Vdet-IC	2.7V±1.5%, -Reset ODO	TSOP-5	28vdm	VD6	6k	Ons
SV	KIC7S32FU	CMOS-Logic	2-input OR gate	SOT-353	28/Log4	-	6a	Kec
SV	R1122N391B	LVR-IC	LDO, LN, +CE, 3.9V±2%, 150mA	SOT-23-5	28vt	VR4	6g	Ric
SW	KIC7S66FU	CMOS-Logic	Bilateral analogic switch	SOT-353	28/Log16	-	6a	Kec
SX	KIC7S86FU	CMOS-Logic	2-input EXCLUSIVE-OR gate	SOT-353	28/Log5	-	6a	Kec
SY	2SA1618-Y	Si-pnp	Dual, 50V, 150mA, 300mW, B=120..240, >80MHz	SOT-25	28/T12	-	6a	Tos
SY	2SA1873-Y	Si-pnp	Dual, AF-Amp, 50V, 150mA, 200mW, B=120..240	SOT-25	28/T12	-	6a	Tos
T0	BD45485G	Vdet-IC	4.8V, -Reset ODO, 500ms	SSOP-5	28vdp	VD6	6c	Rhm
T0	R1121N401B	LVR-IC	LDO, LN, +CE, 4V±2%, 150mA	SOT-23-5	28vt	VR4	6g	Ric
T00	74HCT1G00GV	CMOS-Logic	2-input NAND gate	SOT7753	28/Log1	-	6a	Phi
T00	NC75T00P5	CMOS-Logic	2-input NAND gate	SC-70-5	28/Log1	-	6a	F
T00	U74AHCT1G00-AF5	CMOS-Logic	2-input NAND gate	SOT-23-5	28/Log1	-	6a	Ulc
T00	U74AHCT1G00-AL5	CMOS-Logic	2-input NAND gate	SOT-353	28/Log1	-	6a	Ulc
T001	RP201Q282D5	LVR-IC	LDO, 2.85V±1%, 150mA, +CE, auto disc, ECO	SC-88A	28xx	VR12	6m	Ric
T008	RP201Q082D	LVR-IC	LDO, 0.8V±1%, 150mA, +CE, auto disc, ECO	SC-88A	28xx	VR12	6m	Ric
T009	RP201Q092D	LVR-IC	LDO, 0.9V±1%, 150mA, +CE, auto disc, ECO	SC-88A	28xx	VR12	6m	Ric
T00L	U74AHCT1G00L-AF5	CMOS-Logic	2-input NAND gate	SOT-23-5	28/Log1	-	6a	Ulc
T00L	U74AHCT1G00L-AL5	CMOS-Logic	2-input NAND gate	SOT-353	28/Log1	-	6a	Ulc
T010	RP201Q102D	LVR-IC	LDO, 1.0V±1%, 150mA, +CE, auto disc, ECO	SC-88A	28xx	VR12	6m	Ric
T011	RP201Q112D	LVR-IC	LDO, 1.1V±1%, 150mA, +CE, auto disc, ECO	SC-88A	28xx	VR12	6m	Ric
T012	RP201Q122D	LVR-IC	LDO, 1.2V±1%, 150mA, +CE, auto disc, ECO	SC-88A	28xx	VR12	6m	Ric
T013	RP201Q132D	LVR-IC	LDO, 1.3V±1%, 150mA, +CE, auto disc, ECO	SC-88A	28xx	VR12	6m	Ric
T014	RP201Q142D	LVR-IC	LDO, 1.4V±1%, 150mA, +CE, auto disc, ECO	SC-88A	28xx	VR12	6m	Ric
T015	RP201Q152D	LVR-IC	LDO, 1.5V±1%, 150mA, +CE, auto disc, ECO	SC-88A	28xx	VR12	6m	Ric
T016	RP201Q162D	LVR-IC	LDO, 1.6V±1%, 150mA, +CE, auto disc, ECO	SC-88A	28xx	VR12	6m	Ric
T017	RP201Q172D	LVR-IC	LDO, 1.7V±1%, 150mA, +CE, auto disc, ECO	SC-88A	28xx	VR12	6m	Ric
T018	RP201Q182D	LVR-IC	LDO, 1.8V±1%, 150mA, +CE, auto disc, ECO	SC-88A	28xx	VR12	6m	Ric
T019	RP201Q192D	LVR-IC	LDO, 1.9V±1%, 150mA, +CE, auto disc, ECO	SC-88A	28xx	VR12	6m	Ric
T02	74HCT1G02GV	CMOS-Logic	2-input NOR gate	SOT7753	28/Log2	-	6a	Phi
T02	NC75T02P5	CMOS-Logic	2-input NOR gate	SC-70-5	28/Log2	-	6a	F
T02	U74AHCT1G02-AF5	CMOS-Logic	2-input NOR gate	SOT-23-5	28/Log2	-	6a	Ulc
T02	U74AHCT1G02-AL5	CMOS-Logic	2-input NOR gate	SOT-353	28/Log2	-	6a	Ulc
T020	RP201Q202D	LVR-IC	LDO, 2.0V±1%, 150mA, +CE, auto disc, ECO	SC-88A	28xx	VR12	6m	Ric
T021	RP201Q212D	LVR-IC	LDO, 2.1V±1%, 150mA, +CE, auto disc, ECO	SC-88A	28xx	VR12	6m	Ric
T022	RP201Q222D	LVR-IC	LDO, 2.2V±1%, 150mA, +CE, auto disc, ECO	SC-88A	28xx	VR12	6m	Ric
T023	RP201Q232D	LVR-IC	LDO, 2.3V±1%, 150mA, +CE, auto disc, ECO	SC-88A	28xx	VR12	6m	Ric



SMD code	Type	Function	Short description	Case	Pinout	Sch.	St.	Mnf.
T024	RP201Q242D	LVR-IC	LDO, 2.4V±1%, 150mA, +CE, auto disc, ECO	SC-88A	28xx	VR12	6m	Ric
T025	RP201Q252D	LVR-IC	LDO, 2.5V±1%, 150mA, +CE, auto disc, ECO	SC-88A	28xx	VR12	6m	Ric
T026	RP201Q262D	LVR-IC	LDO, 2.6V±1%, 150mA, +CE, auto disc, ECO	SC-88A	28xx	VR12	6m	Ric
T027	RP201Q272D	LVR-IC	LDO, 2.7V±1%, 150mA, +CE, auto disc, ECO	SC-88A	28xx	VR12	6m	Ric
T028	RP201Q282D	LVR-IC	LDO, 2.8V±1%, 150mA, +CE, auto disc, ECO	SC-88A	28xx	VR12	6m	Ric
T029	RP201Q292D	LVR-IC	LDO, 2.9V±1%, 150mA, +CE, auto disc, ECO	SC-88A	28xx	VR12	6m	Ric
T02L	U74AHC1TG02L-AF5	CMOS-Logic	2-input NOR gate	SOT-23-5	28/Log2	-	6a	Ult
T02L	U74AHC1TG02L-AL5	CMOS-Logic	2-input NOR gate	SOT-353	28/Log2	-	6a	Ult
T02L	U74AHC1TG02L-AF5	CMOS-Logic	2-input NOR gate	SOT-23-5	28/Log2	-	6a	Ult
T02L	U74AHC1TG02L-AL5	CMOS-Logic	2-input NOR gate	SOT-353	28/Log2	-	6a	Ult
T030	RP201Q302D	LVR-IC	LDO, 3.0V±1%, 150mA, +CE, auto disc, ECO	SC-88A	28xx	VR12	6m	Ric
T031	RP201Q312D	LVR-IC	LDO, 3.1V±1%, 150mA, +CE, auto disc, ECO	SC-88A	28xx	VR12	6m	Ric
T032	RP201Q322D	LVR-IC	LDO, 3.2V±1%, 150mA, +CE, auto disc, ECO	SC-88A	28xx	VR12	6m	Ric
T033	RP201Q332D	LVR-IC	LDO, 3.3V±1%, 150mA, +CE, auto disc, ECO	SC-88A	28xx	VR12	6m	Ric
T034	RP201Q342D	LVR-IC	LDO, 3.4V±1%, 150mA, +CE, auto disc, ECO	SC-88A	28xx	VR12	6m	Ric
T035	RP201Q352D	LVR-IC	LDO, 3.5V±1%, 150mA, +CE, auto disc, ECO	SC-88A	28xx	VR12	6m	Ric
T036	RP201Q362D	LVR-IC	LDO, 3.6V±1%, 150mA, +CE, auto disc, ECO	SC-88A	28xx	VR12	6m	Ric
T037	RP201Q372D	LVR-IC	LDO, 3.7V±1%, 150mA, +CE, auto disc, ECO	SC-88A	28xx	VR12	6m	Ric
T038	RP201Q382D	LVR-IC	LDO, 3.8V±1%, 150mA, +CE, auto disc, ECO	SC-88A	28xx	VR12	6m	Ric
T039	RP201Q392D	LVR-IC	LDO, 3.9V±1%, 150mA, +CE, auto disc, ECO	SC-88A	28xx	VR12	6m	Ric
T04	74HCT1G04GV	CMOS-Logic	Inverter	SOT753	28/Log6	-	6a	Phi
T04	NC7ST04P5	CMOS-Logic	Inverter	SC-70-5	28/Log6	-	6a	F
T04	U74AHC1TG04-AF5	CMOS-Logic	Inverter	SOT-23-5	28/Log6	-	6a	Ult
T04	U74AHC1TG04-AL5	CMOS-Logic	Inverter	SOT-353	28/Log6	-	6a	Ult
T040	RP201Q402D	LVR-IC	LDO, 4.0V±1%, 150mA, +CE, auto disc, ECO	SC-88A	28xx	VR12	6m	Ric
T08	74HCT1G08GV	CMOS-Logic	2-input AND gate	SOT753	28/Log3	-	6a	Phi
T08	NC7ST08P5	CMOS-Logic	2-input AND gate	SC-70-5	28/Log3	-	6a	F
T08	U74AHC1TG08-AF5	CMOS-Logic	2-input AND gate	SOT-23-5	28/Log3	-	6a	Ult
T08	U74AHC1TG08-AL5	CMOS-Logic	2-input AND gate	SOT-353	28/Log3	-	6a	Ult
T08L	U74AHC1TG08L-AF5	CMOS-Logic	2-input AND gate	SOT-23-5	28/Log3	-	6a	Ult
T08L	U74AHC1TG08L-AL5	CMOS-Logic	2-input AND gate	SOT-353	28/Log3	-	6a	Ult
T08L	U74AHC1TG08L-AF5	CMOS-Logic	2-input AND gate	SOT-23-5	28/Log3	-	6a	Ult
T08L	U74AHC1TG08L-AL5	CMOS-Logic	2-input AND gate	SOT-353	28/Log3	-	6a	Ult
T09	XC9225A096M	DC/DC-IC	PWM step-down, 600kHz, 0.9V±1%, 600mA, +CE	SOT-25	28dc4	DC1	6g	Tor
T09	XC9225B096M	DC/DC-IC	PWM step-down, 600kHz, 0.9V±1%, 600mA, -CE	SOT-25	28dc4	DC1	6g	Tor
T09	XC9225C096M	DC/DC-IC	PWM step-down, 600kHz, 0.9V±1%, 600mA, +CE, PDR	SOT-25	28dc4	DC1	6g	Tor
T09	XC9225D096M	DC/DC-IC	PWM step-down, 600kHz, 0.9V±1%, 600mA, -CE, PDR	SOT-25	28dc4	DC1	6g	Tor
T0A	R3134N33EA	Vdet-IC	3.3V±1.8%, -Reset ODO, -MR	SOT-23-5	28z7	VD4	6g	Ric
T0B	R3134N34EA	Vdet-IC	3.4V±1.8%, -Reset ODO, -MR	SOT-23-5	28z7	VD4	6g	Ric
T0C	R3134N35EA	Vdet-IC	3.5V±1.8%, -Reset ODO, -MR	SOT-23-5	28z7	VD4	6g	Ric
T0D	R3134N36EA	Vdet-IC	3.6V±1.8%, -Reset ODO, -MR	SOT-23-5	28z7	VD4	6g	Ric
T0E	R3134N37EA	Vdet-IC	3.7V±1.8%, -Reset ODO, -MR	SOT-23-5	28z7	VD4	6g	Ric
T0F	R3134N38EA	Vdet-IC	3.8V±1.8%, -Reset ODO, -MR	SOT-23-5	28z7	VD4	6g	Ric
T0G	R3134N39EA	Vdet-IC	3.9V±1.8%, -Reset ODO, -MR	SOT-23-5	28z7	VD4	6g	Ric
T0H	R3134N40EA	Vdet-IC	4.0V±1.8%, -Reset ODO, -MR	SOT-23-5	28z7	VD4	6g	Ric
T0J	R3134N41EA	Vdet-IC	4.1V±1.8%, -Reset ODO, -MR	SOT-23-5	28z7	VD4	6g	Ric
T0K	R3134N42EA	Vdet-IC	4.2V±1.8%, -Reset ODO, -MR	SOT-23-5	28z7	VD4	6g	Ric
T0L	R3134N43EA	Vdet-IC	4.3V±1.8%, -Reset ODO, -MR	SOT-23-5	28z7	VD4	6g	Ric
T0M	R3134N44EA	Vdet-IC	4.4V±1.8%, -Reset ODO, -MR	SOT-23-5	28z7	VD4	6g	Ric
T0M	XC9225A09CM	DC/DC-IC	PWM step-down, 1.2MHz, 0.9V±1%, 600mA, +CE	SOT-25	28dc4	DC1	6g	Tor
T0M	XC9225B09CM	DC/DC-IC	PWM step-down, 1.2MHz, 0.9V±1%, 600mA, -CE	SOT-25	28dc4	DC1	6g	Tor
T0M	XC9225C09CM	DC/DC-IC	PWM step-down, 1.2MHz, 0.9V±1%, 600mA, +CE, PDR	SOT-25	28dc4	DC1	6g	Tor
T0M	XC9225D09CM	DC/DC-IC	PWM step-down, 1.2MHz, 0.9V±1%, 600mA, -CE, PDR	SOT-25	28dc4	DC1	6g	Tor
T0N	R3134N45EA	Vdet-IC	4.5V±1.8%, -Reset ODO, -MR	SOT-23-5	28z7	VD4	6g	Ric
T0P	R3134N46EA	Vdet-IC	4.6V±1.8%, -Reset ODO, -MR	SOT-23-5	28z7	VD4	6g	Ric
T0R	R3134N47EA	Vdet-IC	4.7V±1.8%, -Reset ODO, -MR	SOT-23-5	28z7	VD4	6g	Ric
T0S	R3134N48EA	Vdet-IC	4.8V±1.8%, -Reset ODO, -MR	SOT-23-5	28z7	VD4	6g	Ric
T0T	R3134N49EA	Vdet-IC	4.9V±1.8%, -Reset ODO, -MR	SOT-23-5	28z7	VD4	6g	Ric
T0U	R3134N50EA	Vdet-IC	5.0V±1.8%, -Reset ODO, -MR	SOT-23-5	28z7	VD4	6g	Ric
T0V	R3134N23EA2	Vdet-IC	2.32V±1.8%, -Reset ODO, -MR	SOT-23-5	28z7	VD4	6g	Ric
T0W	R3134N26EA3	Vdet-IC	2.63V±1.8%, -Reset ODO, -MR	SOT-23-5	28z7	VD4	6g	Ric
T0X	R3134N29EA3	Vdet-IC	2.93V±1.8%, -Reset ODO, -MR	SOT-23-5	28z7	VD4	6g	Ric
T0Y	R3134N30EA8	Vdet-IC	3.08V±1.8%, -Reset ODO, -MR	SOT-23-5	28z7	VD4	6g	Ric
T0Z	R3134N43EA8	Vdet-IC	4.38V±1.8%, -Reset ODO, -MR	SOT-23-5	28z7	VD4	6g	Ric
T1	BD45475G	Vdet-IC	4.7V, -Reset ODO, 500ms	SSOP-5	28vdp	VD6	6c	Rhm
T1	HD74LV1GT00ACM	CMOS-Logic	2-input NAND gate	CMCPAK-5	28/Log1	-	6a	Ren
T1	HD74LV1GT00AVS	CMOS-Logic	2-input NAND gate	VSON-5	30/Log1	-	6a	Ren
T1	R1121N411B	LVR-IC	LDO, LN, +CE, 4.1V±2%, 150mA	SOT-23-5	28vt	VR4	6g	Ric
T10	MIC1555BM5	LIN-IC	RC Timer/Oscillator, 2.7..18V, 0.05%/°C	SOT-23-5	28la	AD2	6g	Mcr
T10	XC9225A106M	DC/DC-IC	PWM step-down, 600kHz, 1.0V±1%, 600mA, +CE	SOT-25	28dc4	DC1	6g	Tor



SMD code	Type	Function	Short description	Case	Pinout	Sch.	St.	Mnf.
U70	XC9225B106M	DC/DC-IC	PWM step-down, 600kHz, 1.0V±1%, 600mA, -CE	SOT-25	28dc4	DC1	6g	Tor
T10	XC9225C106M	DC/DC-IC	PWM step-down, 600kHz, 1.0V±1%, 600mA, +CE, PDR	SOT-25	28dc4	DC1	6g	Tor
T10	XC9225D106M	DC/DC-IC	PWM step-down, 600kHz, 1.0V±1%, 600mA, -CE, PDR	SOT-25	28dc4	DC1	6g	Tor
T11	MIC1557BM5	LIN-IC	RC Oscillator, 2.7...18V, 0.05%/°C	SOT-23-5	28lb	AD1	6g	Mcr
U11	XC9225A116M	DC/DC-IC	PWM step-down, 600kHz, 1.1V±1%, 600mA, +CE	SOT-25	28dc4	DC1	6g	Tor
U11	XC9225B116M	DC/DC-IC	PWM step-down, 600kHz, 1.1V±1%, 600mA, -CE	SOT-25	28dc4	DC1	6g	Tor
T11	XC9225C116M	DC/DC-IC	PWM step-down, 600kHz, 1.1V±1%, 600mA, +CE, PDR	SOT-25	28dc4	DC1	6g	Tor
T11	XC9225D116M	DC/DC-IC	PWM step-down, 600kHz, 1.1V±1%, 600mA, -CE, PDR	SOT-25	28dc4	DC1	6g	Tor
U12	XC9225A126M	DC/DC-IC	PWM step-down, 600kHz, 1.2V±1%, 600mA, +CE	SOT-25	28dc4	DC1	6g	Tor
U12	XC9225B126M	DC/DC-IC	PWM step-down, 600kHz, 1.2V±1%, 600mA, -CE	SOT-25	28dc4	DC1	6g	Tor
T12	XC9225C126M	DC/DC-IC	PWM step-down, 600kHz, 1.2V±1%, 600mA, +CE, PDR	SOT-25	28dc4	DC1	6g	Tor
T12	XC9225D126M	DC/DC-IC	PWM step-down, 600kHz, 1.2V±1%, 600mA, -CE, PDR	SOT-25	28dc4	DC1	6g	Tor
U13	XC9225A136M	DC/DC-IC	PWM step-down, 600kHz, 1.3V±1%, 600mA, +CE	SOT-25	28dc4	DC1	6g	Tor
U13	XC9225B136M	DC/DC-IC	PWM step-down, 600kHz, 1.3V±1%, 600mA, -CE	SOT-25	28dc4	DC1	6g	Tor
T13	XC9225C136M	DC/DC-IC	PWM step-down, 600kHz, 1.3V±1%, 600mA, +CE, PDR	SOT-25	28dc4	DC1	6g	Tor
T13	XC9225D136M	DC/DC-IC	PWM step-down, 600kHz, 1.3V±1%, 600mA, -CE, PDR	SOT-25	28dc4	DC1	6g	Tor
T14	74HCT1G14GV	CMOS-Logic	Inverting Schmitt-trigger	SOT753	28/Log7	-	6a	Phi
T14	NC7ST14P5	CMOS-Logic	Inverting Schmitt-trigger	SC-70-5	28/Log7	-	6a	F
U14	XC9225A146M	DC/DC-IC	PWM step-down, 600kHz, 1.4V±1%, 600mA, +CE	SOT-25	28dc4	DC1	6g	Tor
U14	XC9225B146M	DC/DC-IC	PWM step-down, 600kHz, 1.4V±1%, 600mA, -CE	SOT-25	28dc4	DC1	6g	Tor
T14	XC9225C146M	DC/DC-IC	PWM step-down, 600kHz, 1.4V±1%, 600mA, +CE, PDR	SOT-25	28dc4	DC1	6g	Tor
T14	XC9225D146M	DC/DC-IC	PWM step-down, 600kHz, 1.4V±1%, 600mA, -CE, PDR	SOT-25	28dc4	DC1	6g	Tor
T15	R1162N151D	LVR-IC	LDO, 1.5V±2%, 350mA, +CE, CL, AE(Mode)	SOT-23-5	28x9	VR10	6g	Ric
U15	XC9225A156M	DC/DC-IC	PWM step-down, 600kHz, 1.5V±1%, 600mA, +CE	SOT-25	28dc4	DC1	6g	Tor
U15	XC9225B156M	DC/DC-IC	PWM step-down, 600kHz, 1.5V±1%, 600mA, -CE	SOT-25	28dc4	DC1	6g	Tor
T15	XC9225C156M	DC/DC-IC	PWM step-down, 600kHz, 1.5V±1%, 600mA, +CE, PDR	SOT-25	28dc4	DC1	6g	Tor
T15	XC9225D156M	DC/DC-IC	PWM step-down, 600kHz, 1.5V±1%, 600mA, -CE, PDR	SOT-25	28dc4	DC1	6g	Tor
T16	R1162N161D	LVR-IC	LDO, 1.6V±2%, 350mA, +CE, CL, AE(Mode)	SOT-23-5	28x9	VR10	6g	Ric
U16	XC9225A166M	DC/DC-IC	PWM step-down, 600kHz, 1.6V±1%, 600mA, +CE	SOT-25	28dc4	DC1	6g	Tor
U16	XC9225B166M	DC/DC-IC	PWM step-down, 600kHz, 1.6V±1%, 600mA, -CE	SOT-25	28dc4	DC1	6g	Tor
T16	XC9225C166M	DC/DC-IC	PWM step-down, 600kHz, 1.6V±1%, 600mA, +CE, PDR	SOT-25	28dc4	DC1	6g	Tor
T16	XC9225D166M	DC/DC-IC	PWM step-down, 600kHz, 1.6V±1%, 600mA, -CE, PDR	SOT-25	28dc4	DC1	6g	Tor
T17	R1162N171D	LVR-IC	LDO, 1.7V±2%, 350mA, +CE, CL, AE(Mode)	SOT-23-5	28x9	VR10	6g	Ric
U17	XC9225A176M	DC/DC-IC	PWM step-down, 600kHz, 1.7V±1%, 600mA, +CE	SOT-25	28dc4	DC1	6g	Tor
U17	XC9225B176M	DC/DC-IC	PWM step-down, 600kHz, 1.7V±1%, 600mA, -CE	SOT-25	28dc4	DC1	6g	Tor
T17	XC9225C176M	DC/DC-IC	PWM step-down, 600kHz, 1.7V±1%, 600mA, +CE, PDR	SOT-25	28dc4	DC1	6g	Tor
T17	XC9225D176M	DC/DC-IC	PWM step-down, 600kHz, 1.7V±1%, 600mA, -CE, PDR	SOT-25	28dc4	DC1	6g	Tor
U18	R1162N181D	LVR-IC	LDO, 1.8V±2%, 350mA, +CE, CL, AE(Mode)	SOT-23-5	28x9	VR10	6g	Ric
U18	XC9225A186M	DC/DC-IC	PWM step-down, 600kHz, 1.8V±1%, 600mA, +CE	SOT-25	28dc4	DC1	6g	Tor
T18	XC9225B186M	DC/DC-IC	PWM step-down, 600kHz, 1.8V±1%, 600mA, -CE	SOT-25	28dc4	DC1	6g	Tor
T18	XC9225C186M	DC/DC-IC	PWM step-down, 600kHz, 1.8V±1%, 600mA, +CE, PDR	SOT-25	28dc4	DC1	6g	Tor
T18	XC9225D186M	DC/DC-IC	PWM step-down, 600kHz, 1.8V±1%, 600mA, -CE, PDR	SOT-25	28dc4	DC1	6g	Tor
T19	R1162N191D	LVR-IC	LDO, 1.9V±2%, 350mA, +CE, CL, AE(Mode)	SOT-23-5	28x9	VR10	6g	Ric
U19	XC9225A196M	DC/DC-IC	PWM step-down, 600kHz, 1.9V±1%, 600mA, +CE	SOT-25	28dc4	DC1	6g	Tor
U19	XC9225B196M	DC/DC-IC	PWM step-down, 600kHz, 1.9V±1%, 600mA, -CE	SOT-25	28dc4	DC1	6g	Tor
T19	XC9225C196M	DC/DC-IC	PWM step-down, 600kHz, 1.9V±1%, 600mA, +CE, PDR	SOT-25	28dc4	DC1	6g	Tor
T19	XC9225D196M	DC/DC-IC	PWM step-down, 600kHz, 1.9V±1%, 600mA, -CE, PDR	SOT-25	28dc4	DC1	6g	Tor
T1A	R3134N33EC	Vdet-IC	3.3V±1.8%, -Reset PPO, -MR	SOT-23-5	28z7	V05	6g	Ric
U1A	XC9225A10CM	DC/DC-IC	PWM step-down, 1.2MHz, 1.0V±1%, 600mA, +CE	SOT-25	28dc4	DC1	6g	Tor
U1A	XC9225B10CM	DC/DC-IC	PWM step-down, 1.2MHz, 1.0V±1%, 600mA, -CE	SOT-25	28dc4	DC1	6g	Tor
T1A	XC9225C10CM	DC/DC-IC	PWM step-down, 1.2MHz, 1.0V±1%, 600mA, +CE, PDR	SOT-25	28dc4	DC1	6g	Tor
T1A	XC9225D10CM	DC/DC-IC	PWM step-down, 1.2MHz, 1.0V±1%, 600mA, -CE, PDR	SOT-25	28dc4	DC1	6g	Tor
T1B	R3134N34EC	Vdet-IC	3.4V±1.8%, -Reset PPO, -MR	SOT-23-5	28z7	V05	6g	Ric
U1B	XC9225A11CM	DC/DC-IC	PWM step-down, 1.2MHz, 1.1V±1%, 600mA, +CE	SOT-25	28dc4	DC1	6g	Tor
U1B	XC9225B11CM	DC/DC-IC	PWM step-down, 1.2MHz, 1.1V±1%, 600mA, -CE	SOT-25	28dc4	DC1	6g	Tor
T1B	XC9225C11CM	DC/DC-IC	PWM step-down, 1.2MHz, 1.1V±1%, 600mA, +CE, PDR	SOT-25	28dc4	DC1	6g	Tor
T1B	XC9225D11CM	DC/DC-IC	PWM step-down, 1.2MHz, 1.1V±1%, 600mA, -CE, PDR	SOT-25	28dc4	DC1	6g	Tor
T1C	R3134N35EC	Vdet-IC	3.5V±1.8%, -Reset PPO, -MR	SOT-23-5	28z7	V05	6g	Ric
U1C	XC9225A12CM	DC/DC-IC	PWM step-down, 1.2MHz, 1.2V±1%, 600mA, +CE	SOT-25	28dc4	DC1	6g	Tor
U1C	XC9225B12CM	DC/DC-IC	PWM step-down, 1.2MHz, 1.2V±1%, 600mA, -CE	SOT-25	28dc4	DC1	6g	Tor
T1C	XC9225C12CM	DC/DC-IC	PWM step-down, 1.2MHz, 1.2V±1%, 600mA, +CE, PDR	SOT-25	28dc4	DC1	6g	Tor
T1C	XC9225D12CM	DC/DC-IC	PWM step-down, 1.2MHz, 1.2V±1%, 600mA, -CE, PDR	SOT-25	28dc4	DC1	6g	Tor
T1D	R3134N36EC	Vdet-IC	3.6V±1.8%, -Reset PPO, -MR	SOT-23-5	28z7	V05	6g	Ric
U1D	XC9225A13CM	DC/DC-IC	PWM step-down, 1.2MHz, 1.3V±1%, 600mA, +CE	SOT-25	28dc4	DC1	6g	Tor
U1D	XC9225B13CM	DC/DC-IC	PWM step-down, 1.2MHz, 1.3V±1%, 600mA, -CE	SOT-25	28dc4	DC1	6g	Tor
T1D	XC9225C13CM	DC/DC-IC	PWM step-down, 1.2MHz, 1.3V±1%, 600mA, +CE, PDR	SOT-25	28dc4	DC1	6g	Tor
T1D	XC9225D13CM	DC/DC-IC	PWM step-down, 1.2MHz, 1.3V±1%, 600mA, -CE, PDR	SOT-25	28dc4	DC1	6g	Tor
T1E	R3134N37EC	Vdet-IC	3.7V±1.8%, -Reset PPO, -MR	SOT-23-5	28z7	V05	6g	Ric
U1E	XC9225A14CM	DC/DC-IC	PWM step-down, 1.2MHz, 1.4V±1%, 600mA, +CE	SOT-25	28dc4	DC1	6g	Tor
U1E	XC9225B14CM	DC/DC-IC	PWM step-down, 1.2MHz, 1.4V±1%, 600mA, -CE	SOT-25	28dc4	DC1	6g	Tor



SMD code	Type	Function	Short description	Case	Pinout	Sch.	St.	Mnf.
T1E	XC9225C14CM	DC/DC-IC	PWM step-down, 1.2MHz, 1.4V±1%, 600mA, +CE, PDR	SOT-25	28dc4	DC1	6g	Tor
T1E	XC9225D14CM	DC/DC-IC	PWM step-down, 1.2MHz, 1.4V±1%, 600mA, -CE, PDR	SOT-25	28dc4	DC1	6g	Tor
T1F	R3134N38EC	Vdet-IC	3.8V±1.8%, -Reset PPO, -MR	SOT-23-5	28z7	VD5	6g	Ric
T1F	XC9225A15CM	DC/DC-IC	PWM step-down, 1.2MHz, 1.5V±1%, 600mA, +CE	SOT-25	28dc4	DC1	6g	Tor
T1F	XC9225B15CM	DC/DC-IC	PWM step-down, 1.2MHz, 1.5V±1%, 600mA, -CE	SOT-25	28dc4	DC1	6g	Tor
T1F	XC9225C15CM	DC/DC-IC	PWM step-down, 1.2MHz, 1.5V±1%, 600mA, +CE, PDR	SOT-25	28dc4	DC1	6g	Tor
T1F	XC9225D15CM	DC/DC-IC	PWM step-down, 1.2MHz, 1.5V±1%, 600mA, -CE, PDR	SOT-25	28dc4	DC1	6g	Tor
T1G	R3134N39EC	Vdet-IC	3.9V±1.8%, -Reset PPO, -MR	SOT-23-5	28z7	VD5	6g	Ric
T1H	R3134N40EC	Vdet-IC	4.0V±1.8%, -Reset PPO, -MR	SOT-23-5	28z7	VD5	6g	Ric
T1H	XC9225A16CM	DC/DC-IC	PWM step-down, 1.2MHz, 1.6V±1%, 600mA, +CE	SOT-25	28dc4	DC1	6g	Tor
T1H	XC9225B16CM	DC/DC-IC	PWM step-down, 1.2MHz, 1.6V±1%, 600mA, -CE	SOT-25	28dc4	DC1	6g	Tor
T1H	XC9225C16CM	DC/DC-IC	PWM step-down, 1.2MHz, 1.6V±1%, 600mA, +CE, PDR	SOT-25	28dc4	DC1	6g	Tor
T1H	XC9225D16CM	DC/DC-IC	PWM step-down, 1.2MHz, 1.6V±1%, 600mA, -CE, PDR	SOT-25	28dc4	DC1	6g	Tor
T1J	R3134N41EC	Vdet-IC	4.1V±1.8%, -Reset PPO, -MR	SOT-23-5	28z7	VD5	6g	Ric
T1K	R3134N42EC	Vdet-IC	4.2V±1.8%, -Reset PPO, -MR	SOT-23-5	28z7	VD5	6g	Ric
T1K	XC9225A17CM	DC/DC-IC	PWM step-down, 1.2MHz, 1.7V±1%, 600mA, +CE	SOT-25	28dc4	DC1	6g	Tor
T1K	XC9225B17CM	DC/DC-IC	PWM step-down, 1.2MHz, 1.7V±1%, 600mA, -CE	SOT-25	28dc4	DC1	6g	Tor
T1K	XC9225C17CM	DC/DC-IC	PWM step-down, 1.2MHz, 1.7V±1%, 600mA, +CE, PDR	SOT-25	28dc4	DC1	6g	Tor
T1K	XC9225D17CM	DC/DC-IC	PWM step-down, 1.2MHz, 1.7V±1%, 600mA, -CE, PDR	SOT-25	28dc4	DC1	6g	Tor
T1L	R3134N43EC	Vdet-IC	4.3V±1.8%, -Reset PPO, -MR	SOT-23-5	28z7	VD5	6g	Ric
T1L	XC9225A18CM	DC/DC-IC	PWM step-down, 1.2MHz, 1.8V±1%, 600mA, +CE	SOT-25	28dc4	DC1	6g	Tor
T1L	XC9225B18CM	DC/DC-IC	PWM step-down, 1.2MHz, 1.8V±1%, 600mA, -CE	SOT-25	28dc4	DC1	6g	Tor
T1L	XC9225C18CM	DC/DC-IC	PWM step-down, 1.2MHz, 1.8V±1%, 600mA, +CE, PDR	SOT-25	28dc4	DC1	6g	Tor
T1L	XC9225D18CM	DC/DC-IC	PWM step-down, 1.2MHz, 1.8V±1%, 600mA, -CE, PDR	SOT-25	28dc4	DC1	6g	Tor
T1M	R3134N44EC	Vdet-IC	4.4V±1.8%, -Reset PPO, -MR	SOT-23-5	28z7	VD5	6g	Ric
T1M	XC9225A19CM	DC/DC-IC	PWM step-down, 1.2MHz, 1.9V±1%, 600mA, +CE	SOT-25	28dc4	DC1	6g	Tor
T1M	XC9225B19CM	DC/DC-IC	PWM step-down, 1.2MHz, 1.9V±1%, 600mA, -CE	SOT-25	28dc4	DC1	6g	Tor
T1M	XC9225C19CM	DC/DC-IC	PWM step-down, 1.2MHz, 1.9V±1%, 600mA, +CE, PDR	SOT-25	28dc4	DC1	6g	Tor
T1M	XC9225D19CM	DC/DC-IC	PWM step-down, 1.2MHz, 1.9V±1%, 600mA, -CE, PDR	SOT-25	28dc4	DC1	6g	Tor
T1N	R3134N45EC	Vdet-IC	4.5V±1.8%, -Reset PPO, -MR	SOT-23-5	28z7	VD5	6g	Ric
T1N	XC74UL00AAN	CMOS-Logic	2-input NAND gate	SOT-25	28/Log1	-	6a	Tor
T1P	R3134N46EC	Vdet-IC	4.6V±1.8%, -Reset PPO, -MR	SOT-23-5	28z7	VD5	6g	Ric
T1R	R3134N47EC	Vdet-IC	4.7V±1.8%, -Reset PPO, -MR	SOT-23-5	28z7	VD5	6g	Ric
T1S	R3134N48EC	Vdet-IC	4.8V±1.8%, -Reset PPO, -MR	SOT-23-5	28z7	VD5	6g	Ric
T1T	R3134N49EC	Vdet-IC	4.9V±1.8%, -Reset PPO, -MR	SOT-23-5	28z7	VD5	6g	Ric
T1U	R3134N50EC	Vdet-IC	5.0V±1.8%, -Reset PPO, -MR	SOT-23-5	28z7	VD5	6g	Ric
T1V	R3134N23EC2	Vdet-IC	2.32V±1.8%, -Reset PPO, -MR	SOT-23-5	28z7	VD5	6g	Ric
T1W	R3134N26EC3	Vdet-IC	2.63V±1.8%, -Reset PPO, -MR	SOT-23-5	28z7	VD5	6g	Ric
T1X	R3134N29EC3	Vdet-IC	2.93V±1.8%, -Reset PPO, -MR	SOT-23-5	28z7	VD5	6g	Ric
T1Y	R3134N30EC8	Vdet-IC	3.08V±1.8%, -Reset PPO, -MR	SOT-23-5	28z7	VD5	6g	Ric
T1Z	R3134N43EC8	Vdet-IC	4.38V±1.8%, -Reset PPO, -MR	SOT-23-5	28z7	VD5	6g	Ric
T2	BD45465G	Vdet-IC	4.6V, -Reset ODO, 500ms	SSOP-5	28vdp	VD6	6c	Rhm
T2	HD74LV1GT08ACM	CMOS-Logic	2-input AND gate	CMPAK-5	28/Log3	-	6a	Ren
T2	HD74LV1GT08AVS	CMOS-Logic	2-input AND gate	VSON-5	30/Log3	-	6a	Ren
T20	R1121N421B	LVR-IC	LDO, LN, +CE, 4.2V±2%, 150mA	SOT-23-5	28vl	VR4	6g	Ric
T20	R1162N201D	LVR-IC	LDO, 2V±2%, 350mA, +CE, CL, AE(Mode)	SOT-23-5	28x9	VR10	6g	Ric
T20	XC31BPN20AM	Tdet-IC	Sensor (-30..+80°C); t=25°C- Vout=2V±3%	SOT-25	28xa	-	6g	Tor
T20	XC9225A206M	DC/DC-IC	PWM step-down, 600kHz, 2.0V±1%, 600mA, +CE	SOT-25	28dc4	DC1	6g	Tor
T20	XC9225B206M	DC/DC-IC	PWM step-down, 600kHz, 2.0V±1%, 600mA, -CE	SOT-25	28dc4	DC1	6g	Tor
T20	XC9225C206M	DC/DC-IC	PWM step-down, 600kHz, 2.0V±1%, 600mA, +CE, PDR	SOT-25	28dc4	DC1	6g	Tor
T20	XC9225D206M	DC/DC-IC	PWM step-down, 600kHz, 2.0V±1%, 600mA, -CE, PDR	SOT-25	28dc4	DC1	6g	Tor
T21	R1162N211D	LVR-IC	LDO, 2.1V±2%, 350mA, +CE, CL, AE(Mode)	SOT-23-5	28x9	VR10	6g	Ric
T21	XC31BPN21AM	Tdet-IC	Sensor (-30..+80°C); t=25°C- Vout=2.1V±3%	SOT-25	28xa	-	6g	Tor
T21	XC9225A216M	DC/DC-IC	PWM step-down, 600kHz, 2.1V±1%, 600mA, +CE	SOT-25	28dc4	DC1	6g	Tor
T21	XC9225B216M	DC/DC-IC	PWM step-down, 600kHz, 2.1V±1%, 600mA, -CE	SOT-25	28dc4	DC1	6g	Tor
T21	XC9225C216M	DC/DC-IC	PWM step-down, 600kHz, 2.1V±1%, 600mA, +CE, PDR	SOT-25	28dc4	DC1	6g	Tor
T21	XC9225D216M	DC/DC-IC	PWM step-down, 600kHz, 2.1V±1%, 600mA, -CE, PDR	SOT-25	28dc4	DC1	6g	Tor
T22	R1162N221D	LVR-IC	LDO, 2.2V±2%, 350mA, +CE, CL, AE(Mode)	SOT-23-5	28x9	VR10	6g	Ric
T22	XC31BPN22AM	Tdet-IC	Sensor (-30..+80°C); t=25°C- Vout=2.2V±3%	SOT-25	28xa	-	6g	Tor
T22	XC9225A226M	DC/DC-IC	PWM step-down, 600kHz, 2.2V±1%, 600mA, +CE	SOT-25	28dc4	DC1	6g	Tor
T22	XC9225B226M	DC/DC-IC	PWM step-down, 600kHz, 2.2V±1%, 600mA, -CE	SOT-25	28dc4	DC1	6g	Tor
T22	XC9225C226M	DC/DC-IC	PWM step-down, 600kHz, 2.2V±1%, 600mA, +CE, PDR	SOT-25	28dc4	DC1	6g	Tor
T22	XC9225D226M	DC/DC-IC	PWM step-down, 600kHz, 2.2V±1%, 600mA, -CE, PDR	SOT-25	28dc4	DC1	6g	Tor
T23	R1162N231D	LVR-IC	LDO, 2.3V±2%, 350mA, +CE, CL, AE(Mode)	SOT-23-5	28x9	VR10	6g	Ric
T23	XC31BPN23AM	Tdet-IC	Sensor (-30..+80°C); t=25°C- Vout=2.3V±3%	SOT-25	28xa	-	6g	Tor
T23	XC9225A236M	DC/DC-IC	PWM step-down, 600kHz, 2.3V±1%, 600mA, +CE	SOT-25	28dc4	DC1	6g	Tor
T23	XC9225B236M	DC/DC-IC	PWM step-down, 600kHz, 2.3V±1%, 600mA, -CE	SOT-25	28dc4	DC1	6g	Tor
T23	XC9225C236M	DC/DC-IC	PWM step-down, 600kHz, 2.3V±1%, 600mA, +CE, PDR	SOT-25	28dc4	DC1	6g	Tor
T23	XC9225D236M	DC/DC-IC	PWM step-down, 600kHz, 2.3V±1%, 600mA, -CE, PDR	SOT-25	28dc4	DC1	6g	Tor
T24	R1162N241D	LVR-IC	LDO, 2.4V±2%, 350mA, +CE, CL, AE(Mode)	SOT-23-5	28x9	VR10	6g	Ric



SMD code	Type	Function	Short description	Case	Pinout	Sch.	St.	Mnf.
T24	XC31BPN24AM	Tdet-IC	Sensor (-30..+80°C); t=25°C Vout=2.4V±3%	SOT-25	28xa	-	6g	Tor
T24	XC9225A246M	DC/DC-IC	PWM step-down, 600kHz, 2.4V±1%, 600mA, +CE	SOT-25	28dc4	DC1	6g	Tor
T24	XC9225B246M	DC/DC-IC	PWM step-down, 600kHz, 2.4V±1%, 600mA, -CE	SOT-25	28dc4	DC1	6g	Tor
T24	XC9225C246M	DC/DC-IC	PWM step-down, 600kHz, 2.4V±1%, 600mA, +CE, PDR	SOT-25	28dc4	DC1	6g	Tor
T24	XC9225D246M	DC/DC-IC	PWM step-down, 600kHz, 2.4V±1%, 600mA, -CE, PDR	SOT-25	28dc4	DC1	6g	Tor
T25	74HCT1G125GV	CMOS-Logic	Bus buffer gate with 3-state output	SOT753	28/Log14	-	6a	Phi
T25	R1162N251D	LVR-IC	LDO, 2.5V±2%, 350mA, +CE, CL, AE(Mode)	SOT-23-5	28x9	VR10	6g	Ric
T25	XC31BPN25AM	Tdet-IC	Sensor (-30..+80°C); t=25°C Vout=2.5V±3%	SOT-25	28xa	-	6g	Tor
T25	XC9225A256M	DC/DC-IC	PWM step-down, 600kHz, 2.5V±1%, 600mA, +CE	SOT-25	28dc4	DC1	6g	Tor
T25	XC9225B256M	DC/DC-IC	PWM step-down, 600kHz, 2.5V±1%, 600mA, -CE	SOT-25	28dc4	DC1	6g	Tor
T25	XC9225C256M	DC/DC-IC	PWM step-down, 600kHz, 2.5V±1%, 600mA, +CE, PDR	SOT-25	28dc4	DC1	6g	Tor
T25	XC9225D256M	DC/DC-IC	PWM step-down, 600kHz, 2.5V±1%, 600mA, -CE, PDR	SOT-25	28dc4	DC1	6g	Tor
T26	74HCT1G126GV	CMOS-Logic	Bus buffer gate with 3-state output	SOT753	28/Log13	-	6a	Phi
T26	R1162N261D	LVR-IC	LDO, 2.6V±2%, 350mA, +CE, CL, AE(Mode)	SOT-23-5	28x9	VR10	6g	Ric
T26	XC31BPN26AM	Tdet-IC	Sensor (-30..+80°C); t=25°C Vout=2.6V±3%	SOT-25	28xa	-	6g	Tor
T26	XC9225A266M	DC/DC-IC	PWM step-down, 600kHz, 2.6V±1%, 600mA, +CE	SOT-25	28dc4	DC1	6g	Tor
T26	XC9225B266M	DC/DC-IC	PWM step-down, 600kHz, 2.6V±1%, 600mA, -CE	SOT-25	28dc4	DC1	6g	Tor
T26	XC9225C266M	DC/DC-IC	PWM step-down, 600kHz, 2.6V±1%, 600mA, +CE, PDR	SOT-25	28dc4	DC1	6g	Tor
T26	XC9225D266M	DC/DC-IC	PWM step-down, 600kHz, 2.6V±1%, 600mA, -CE, PDR	SOT-25	28dc4	DC1	6g	Tor
T27	R1162N271D	LVR-IC	LDO, 2.7V±2%, 350mA, +CE, CL, AE(Mode)	SOT-23-5	28x9	VR10	6g	Ric
T27	XC31BPN27AM	Tdet-IC	Sensor (-30..+80°C); t=25°C Vout=2.7V±3%	SOT-25	28xa	-	6g	Tor
T27	XC9225A276M	DC/DC-IC	PWM step-down, 600kHz, 2.7V±1%, 600mA, +CE	SOT-25	28dc4	DC1	6g	Tor
T27	XC9225B276M	DC/DC-IC	PWM step-down, 600kHz, 2.7V±1%, 600mA, -CE	SOT-25	28dc4	DC1	6g	Tor
T27	XC9225C276M	DC/DC-IC	PWM step-down, 600kHz, 2.7V±1%, 600mA, +CE, PDR	SOT-25	28dc4	DC1	6g	Tor
T27	XC9225D276M	DC/DC-IC	PWM step-down, 600kHz, 2.7V±1%, 600mA, -CE, PDR	SOT-25	28dc4	DC1	6g	Tor
T28	R1162N281D	LVR-IC	LDO, 2.8V±2%, 350mA, +CE, CL, AE(Mode)	SOT-23-5	28x9	VR10	6g	Ric
T28	XC31BPN28AM	Tdet-IC	Sensor (-30..+80°C); t=25°C Vout=2.8V±3%	SOT-25	28xa	-	6g	Tor
T28	XC9225A286M	DC/DC-IC	PWM step-down, 600kHz, 2.8V±1%, 600mA, +CE	SOT-25	28dc4	DC1	6g	Tor
T28	XC9225B286M	DC/DC-IC	PWM step-down, 600kHz, 2.8V±1%, 600mA, -CE	SOT-25	28dc4	DC1	6g	Tor
T28	XC9225C286M	DC/DC-IC	PWM step-down, 600kHz, 2.8V±1%, 600mA, +CE, PDR	SOT-25	28dc4	DC1	6g	Tor
T28	XC9225D286M	DC/DC-IC	PWM step-down, 600kHz, 2.8V±1%, 600mA, -CE, PDR	SOT-25	28dc4	DC1	6g	Tor
T29	R1162N291D	LVR-IC	LDO, 2.9V±2%, 350mA, +CE, CL, AE(Mode)	SOT-23-5	28x9	VR10	6g	Ric
T29	XC31BPN29AM	Tdet-IC	Sensor (-30..+80°C); t=25°C Vout=2.9V±3%	SOT-25	28xa	-	6g	Tor
T29	XC9225A296M	DC/DC-IC	PWM step-down, 600kHz, 2.9V±1%, 600mA, +CE	SOT-25	28dc4	DC1	6g	Tor
T29	XC9225B296M	DC/DC-IC	PWM step-down, 600kHz, 2.9V±1%, 600mA, -CE	SOT-25	28dc4	DC1	6g	Tor
T29	XC9225C296M	DC/DC-IC	PWM step-down, 600kHz, 2.9V±1%, 600mA, +CE, PDR	SOT-25	28dc4	DC1	6g	Tor
T29	XC9225D296M	DC/DC-IC	PWM step-down, 600kHz, 2.9V±1%, 600mA, -CE, PDR	SOT-25	28dc4	DC1	6g	Tor
T2A	XC9225A20CM	DC/DC-IC	PWM step-down, 1.2MHz, 2.0V±1%, 600mA, +CE	SOT-25	28dc4	DC1	6g	Tor
T2A	XC9225B20CM	DC/DC-IC	PWM step-down, 1.2MHz, 2.0V±1%, 600mA, -CE	SOT-25	28dc4	DC1	6g	Tor
T2A	XC9225C20CM	DC/DC-IC	PWM step-down, 1.2MHz, 2.0V±1%, 600mA, +CE, PDR	SOT-25	28dc4	DC1	6g	Tor
T2A	XC9225D20CM	DC/DC-IC	PWM step-down, 1.2MHz, 2.0V±1%, 600mA, -CE, PDR	SOT-25	28dc4	DC1	6g	Tor
T2B	XC9225A21CM	DC/DC-IC	PWM step-down, 1.2MHz, 2.1V±1%, 600mA, +CE	SOT-25	28dc4	DC1	6g	Tor
T2B	XC9225B21CM	DC/DC-IC	PWM step-down, 1.2MHz, 2.1V±1%, 600mA, -CE	SOT-25	28dc4	DC1	6g	Tor
T2B	XC9225C21CM	DC/DC-IC	PWM step-down, 1.2MHz, 2.1V±1%, 600mA, +CE, PDR	SOT-25	28dc4	DC1	6g	Tor
T2B	XC9225D21CM	DC/DC-IC	PWM step-down, 1.2MHz, 2.1V±1%, 600mA, -CE, PDR	SOT-25	28dc4	DC1	6g	Tor
T2C	XC9225A22CM	DC/DC-IC	PWM step-down, 1.2MHz, 2.2V±1%, 600mA, +CE	SOT-25	28dc4	DC1	6g	Tor
T2C	XC9225B22CM	DC/DC-IC	PWM step-down, 1.2MHz, 2.2V±1%, 600mA, -CE	SOT-25	28dc4	DC1	6g	Tor
T2C	XC9225C22CM	DC/DC-IC	PWM step-down, 1.2MHz, 2.2V±1%, 600mA, +CE, PDR	SOT-25	28dc4	DC1	6g	Tor
T2C	XC9225D22CM	DC/DC-IC	PWM step-down, 1.2MHz, 2.2V±1%, 600mA, -CE, PDR	SOT-25	28dc4	DC1	6g	Tor
T2D	XC9225A23CM	DC/DC-IC	PWM step-down, 1.2MHz, 2.3V±1%, 600mA, +CE	SOT-25	28dc4	DC1	6g	Tor
T2D	XC9225B23CM	DC/DC-IC	PWM step-down, 1.2MHz, 2.3V±1%, 600mA, -CE	SOT-25	28dc4	DC1	6g	Tor
T2D	XC9225C23CM	DC/DC-IC	PWM step-down, 1.2MHz, 2.3V±1%, 600mA, +CE, PDR	SOT-25	28dc4	DC1	6g	Tor
T2D	XC9225D23CM	DC/DC-IC	PWM step-down, 1.2MHz, 2.3V±1%, 600mA, -CE, PDR	SOT-25	28dc4	DC1	6g	Tor
T2E	XC9225A24CM	DC/DC-IC	PWM step-down, 1.2MHz, 2.4V±1%, 600mA, +CE	SOT-25	28dc4	DC1	6g	Tor
T2E	XC9225B24CM	DC/DC-IC	PWM step-down, 1.2MHz, 2.4V±1%, 600mA, -CE	SOT-25	28dc4	DC1	6g	Tor
T2E	XC9225C24CM	DC/DC-IC	PWM step-down, 1.2MHz, 2.4V±1%, 600mA, +CE, PDR	SOT-25	28dc4	DC1	6g	Tor
T2E	XC9225D24CM	DC/DC-IC	PWM step-down, 1.2MHz, 2.4V±1%, 600mA, -CE, PDR	SOT-25	28dc4	DC1	6g	Tor
T2F	XC9225A25CM	DC/DC-IC	PWM step-down, 1.2MHz, 2.5V±1%, 600mA, +CE	SOT-25	28dc4	DC1	6g	Tor
T2F	XC9225B25CM	DC/DC-IC	PWM step-down, 1.2MHz, 2.5V±1%, 600mA, -CE	SOT-25	28dc4	DC1	6g	Tor
T2F	XC9225C25CM	DC/DC-IC	PWM step-down, 1.2MHz, 2.5V±1%, 600mA, +CE, PDR	SOT-25	28dc4	DC1	6g	Tor
T2F	XC9225D25CM	DC/DC-IC	PWM step-down, 1.2MHz, 2.5V±1%, 600mA, -CE, PDR	SOT-25	28dc4	DC1	6g	Tor
T2H	XC9225A26CM	DC/DC-IC	PWM step-down, 1.2MHz, 2.6V±1%, 600mA, +CE	SOT-25	28dc4	DC1	6g	Tor
T2H	XC9225B26CM	DC/DC-IC	PWM step-down, 1.2MHz, 2.6V±1%, 600mA, -CE	SOT-25	28dc4	DC1	6g	Tor
T2H	XC9225C26CM	DC/DC-IC	PWM step-down, 1.2MHz, 2.6V±1%, 600mA, +CE, PDR	SOT-25	28dc4	DC1	6g	Tor
T2H	XC9225D26CM	DC/DC-IC	PWM step-down, 1.2MHz, 2.6V±1%, 600mA, -CE, PDR	SOT-25	28dc4	DC1	6g	Tor
T2K	XC9225A27CM	DC/DC-IC	PWM step-down, 1.2MHz, 2.7V±1%, 600mA, +CE	SOT-25	28dc4	DC1	6g	Tor
T2K	XC9225B27CM	DC/DC-IC	PWM step-down, 1.2MHz, 2.7V±1%, 600mA, -CE	SOT-25	28dc4	DC1	6g	Tor
T2K	XC9225C27CM	DC/DC-IC	PWM step-down, 1.2MHz, 2.7V±1%, 600mA, +CE, PDR	SOT-25	28dc4	DC1	6g	Tor
T2K	XC9225D27CM	DC/DC-IC	PWM step-down, 1.2MHz, 2.7V±1%, 600mA, -CE, PDR	SOT-25	28dc4	DC1	6g	Tor
T2L	XC9225A28CM	DC/DC-IC	PWM step-down, 1.2MHz, 2.8V±1%, 600mA, +CE	SOT-25	28dc4	DC1	6g	Tor



SMD code	Type	Function	Short description	Case	Pinout	Sch.	St.	Mnf.
T1ZL	XC9225B28CM	DC/DC-IC	PWM step-down, 1.2MHz, 2.8V±1%, 600mA, -CE	SOT-25	28dc4	DC1	6g	Tor
T2L	XC9225C28CM	DC/DC-IC	PWM step-down, 1.2MHz, 2.8V±1%, 600mA, +CE, PDR	SOT-25	28dc4	DC1	6g	Tor
T2L	XC9225D28CM	DC/DC-IC	PWM step-down, 1.2MHz, 2.8V±1%, 600mA, -CE, PDR	SOT-25	28dc4	DC1	6g	Tor
T2ZM	XC9225A29CM	DC/DC-IC	PWM step-down, 1.2MHz, 2.9V±1%, 600mA, +CE	SOT-25	28dc4	DC1	6g	Tor
T2ZM	XC9225B29CM	DC/DC-IC	PWM step-down, 1.2MHz, 2.9V±1%, 600mA, -CE	SOT-25	28dc4	DC1	6g	Tor
T2ZM	XC9225C29CM	DC/DC-IC	PWM step-down, 1.2MHz, 2.9V±1%, 600mA, +CE, PDR	SOT-25	28dc4	DC1	6g	Tor
T2ZM	XC9225D29CM	DC/DC-IC	PWM step-down, 1.2MHz, 2.9V±1%, 600mA, -CE, PDR	SOT-25	28dc4	DC1	6g	Tor
T2N	XC74UL08AAN	CMOS-Logic	2-input AND gate	SOT-25	28/Log3	-	6a	Tor
T3	BD45455G	Vdet-IC	4.5V, -Reset ODO, 500ms	SSOP-5	28dp	VD6	6c	Rhm
T3	HD74LV1GT02ACM	CMOS-Logic	2-input NOR gate	CMPAK-5	28/Log2	-	6a	Ren
T3	HD74LV1GT02AVS	CMOS-Logic	2-input NOR gate	VSON-5	30/Log2	-	6a	Ren
T3	R1121N431B	LVR-IC	LDO, LN, +CE, 4.3V±2%, 150mA	SOT-23-5	28v	VR4	6g	Ric
T30	R1162N301D	LVR-IC	LDO, 3V±2%, 350mA, +CE, CL, AE(Mode)	SOT-23-5	28x9	VR10	6g	Ric
T30	XC31BPN30AM	Tdet-IC	Sensor (-30...+80°C); t=25°C Vout=3V±3%	SOT-25	28xa	-	6g	Tor
T30	XC9225A306M	DC/DC-IC	PWM step-down, 600kHz, 3.0V±1%, 600mA, +CE	SOT-25	28dc4	DC1	6g	Tor
T30	XC9225B306M	DC/DC-IC	PWM step-down, 600kHz, 3.0V±1%, 600mA, -CE	SOT-25	28dc4	DC1	6g	Tor
T30	XC9225C306M	DC/DC-IC	PWM step-down, 600kHz, 3.0V±1%, 600mA, +CE, PDR	SOT-25	28dc4	DC1	6g	Tor
T30	XC9225D306M	DC/DC-IC	PWM step-down, 600kHz, 3.0V±1%, 600mA, -CE, PDR	SOT-25	28dc4	DC1	6g	Tor
T30	XC9225E306M	DC/DC-IC	PWM step-down, 600kHz, 3.0V±1%, 900mA, +CE	SOT-25	28dc4	DC1	6g	Tor
T30	XC9225F306M	DC/DC-IC	PWM step-down, 600kHz, 3.0V±1%, 900mA, -CE	SOT-25	28dc4	DC1	6g	Tor
T30	XC9225G306M	DC/DC-IC	PWM step-down, 600kHz, 3.0V±1%, 900mA, +CE, PDR	SOT-25	28dc4	DC1	6g	Tor
T30	XC9225H306M	DC/DC-IC	PWM step-down, 600kHz, 3.0V±1%, 900mA, -CE, PDR	SOT-25	28dc4	DC1	6g	Tor
T31	R1162N311D	LVR-IC	LDO, 3.1V±2%, 350mA, +CE, CL, AE(Mode)	SOT-23-5	28x9	VR10	6g	Ric
T31	XC31BPN31AM	Tdet-IC	Sensor (-30...+80°C); t=25°C Vout=3.1V±3%	SOT-25	28xa	-	6g	Tor
T31	XC9225A316M	DC/DC-IC	PWM step-down, 600kHz, 3.1V±1%, 600mA, +CE	SOT-25	28dc4	DC1	6g	Tor
T31	XC9225B316M	DC/DC-IC	PWM step-down, 600kHz, 3.1V±1%, 600mA, -CE	SOT-25	28dc4	DC1	6g	Tor
T31	XC9225C316M	DC/DC-IC	PWM step-down, 600kHz, 3.1V±1%, 600mA, +CE, PDR	SOT-25	28dc4	DC1	6g	Tor
T31	XC9225D316M	DC/DC-IC	PWM step-down, 600kHz, 3.1V±1%, 600mA, -CE, PDR	SOT-25	28dc4	DC1	6g	Tor
T31	XC9225E316M	DC/DC-IC	PWM step-down, 600kHz, 3.1V±1%, 900mA, +CE	SOT-25	28dc4	DC1	6g	Tor
T31	XC9225F316M	DC/DC-IC	PWM step-down, 600kHz, 3.1V±1%, 900mA, -CE	SOT-25	28dc4	DC1	6g	Tor
T31	XC9225G316M	DC/DC-IC	PWM step-down, 600kHz, 3.1V±1%, 900mA, +CE, PDR	SOT-25	28dc4	DC1	6g	Tor
T31	XC9225H316M	DC/DC-IC	PWM step-down, 600kHz, 3.1V±1%, 900mA, -CE, PDR	SOT-25	28dc4	DC1	6g	Tor
T32	74HCT1G32GV	CMOS-Logic	2-input OR gate	SOT753	28/Log4	-	6a	Phi
T32	NC7ST32P5	CMOS-Logic	2-input OR gate	SC-70-5	28/Log4	-	6a	F
T32	R1162N321D	LVR-IC	LDO, 3.2V±2%, 350mA, +CE, CL, AE(Mode)	SOT-23-5	28x9	VR10	6g	Ric
T32	U74AHCT1G32-AF5	CMOS-Logic	2-input OR gate	SOT-23-5	28/Log4	-	6a	Utc
T32	U74AHCT1G32-AL5	CMOS-Logic	2-input OR gate	SOT-353	28/Log4	-	6a	Utc
T32	XC31BPN32AM	Tdet-IC	Sensor (-30...+80°C); t=25°C Vout=3.1V±3%	SOT-25	28xa	-	6g	Tor
T32	XC9225A326M	DC/DC-IC	PWM step-down, 600kHz, 3.2V±1%, 600mA, +CE	SOT-25	28dc4	DC1	6g	Tor
T32	XC9225B326M	DC/DC-IC	PWM step-down, 600kHz, 3.2V±1%, 600mA, -CE	SOT-25	28dc4	DC1	6g	Tor
T32	XC9225C326M	DC/DC-IC	PWM step-down, 600kHz, 3.2V±1%, 600mA, +CE, PDR	SOT-25	28dc4	DC1	6g	Tor
T32	XC9225D326M	DC/DC-IC	PWM step-down, 600kHz, 3.2V±1%, 600mA, -CE, PDR	SOT-25	28dc4	DC1	6g	Tor
T32	XC9225E326M	DC/DC-IC	PWM step-down, 600kHz, 3.2V±1%, 900mA, +CE	SOT-25	28dc4	DC1	6g	Tor
T32	XC9225F326M	DC/DC-IC	PWM step-down, 600kHz, 3.2V±1%, 900mA, -CE	SOT-25	28dc4	DC1	6g	Tor
T32	XC9225G326M	DC/DC-IC	PWM step-down, 600kHz, 3.2V±1%, 900mA, +CE, PDR	SOT-25	28dc4	DC1	6g	Tor
T32	XC9225H326M	DC/DC-IC	PWM step-down, 600kHz, 3.2V±1%, 900mA, -CE, PDR	SOT-25	28dc4	DC1	6g	Tor
T32L	U74AHCT1G32L-AF5	CMOS-Logic	2-input OR gate	SOT-23-5	28/Log4	-	6a	Utc
T32L	U74AHCT1G32L-AL5	CMOS-Logic	2-input OR gate	SOT-353	28/Log4	-	6a	Utc
T32L	U74AHCT1G32G-AF5	CMOS-Logic	2-input OR gate	SOT-23-5	28/Log4	-	6a	Utc
T32L	U74AHCT1G32G-AL5	CMOS-Logic	2-input OR gate	SOT-353	28/Log4	-	6a	Utc
T33	R1162N331D	LVR-IC	LDO, 3.3V±2%, 350mA, +CE, CL, AE(Mode)	SOT-23-5	28x9	VR10	6g	Ric
T33	XC31BPN33AM	Tdet-IC	Sensor (-30...+80°C); t=25°C Vout=3.3V±3%	SOT-25	28xa	-	6g	Tor
T33	XC9225A336M	DC/DC-IC	PWM step-down, 600kHz, 3.3V±1%, 600mA, +CE	SOT-25	28dc4	DC1	6g	Tor
T33	XC9225B336M	DC/DC-IC	PWM step-down, 600kHz, 3.3V±1%, 600mA, -CE	SOT-25	28dc4	DC1	6g	Tor
T33	XC9225C336M	DC/DC-IC	PWM step-down, 600kHz, 3.3V±1%, 600mA, +CE, PDR	SOT-25	28dc4	DC1	6g	Tor
T33	XC9225D336M	DC/DC-IC	PWM step-down, 600kHz, 3.3V±1%, 600mA, -CE, PDR	SOT-25	28dc4	DC1	6g	Tor
T33	XC9225E336M	DC/DC-IC	PWM step-down, 600kHz, 3.3V±1%, 900mA, +CE	SOT-25	28dc4	DC1	6g	Tor
T33	XC9225F336M	DC/DC-IC	PWM step-down, 600kHz, 3.3V±1%, 900mA, -CE	SOT-25	28dc4	DC1	6g	Tor
T33	XC9225G336M	DC/DC-IC	PWM step-down, 600kHz, 3.3V±1%, 900mA, +CE, PDR	SOT-25	28dc4	DC1	6g	Tor
T33	XC9225H336M	DC/DC-IC	PWM step-down, 600kHz, 3.3V±1%, 900mA, -CE, PDR	SOT-25	28dc4	DC1	6g	Tor
T34	R1162N341D	LVR-IC	LDO, 3.4V±2%, 350mA, +CE, CL, AE(Mode)	SOT-23-5	28x9	VR10	6g	Ric
T34	XC31BPN34AM	Tdet-IC	Sensor (-30...+80°C); t=25°C Vout=3.4V±3%	SOT-25	28xa	-	6g	Tor
T34	XC9225A346M	DC/DC-IC	PWM step-down, 600kHz, 3.4V±1%, 600mA, +CE	SOT-25	28dc4	DC1	6g	Tor
T34	XC9225B346M	DC/DC-IC	PWM step-down, 600kHz, 3.4V±1%, 600mA, -CE	SOT-25	28dc4	DC1	6g	Tor
T34	XC9225C346M	DC/DC-IC	PWM step-down, 600kHz, 3.4V±1%, 600mA, +CE, PDR	SOT-25	28dc4	DC1	6g	Tor
T34	XC9225D346M	DC/DC-IC	PWM step-down, 600kHz, 3.4V±1%, 600mA, -CE, PDR	SOT-25	28dc4	DC1	6g	Tor
T34	XC9225E346M	DC/DC-IC	PWM step-down, 600kHz, 3.4V±1%, 900mA, +CE	SOT-25	28dc4	DC1	6g	Tor
T34	XC9225F346M	DC/DC-IC	PWM step-down, 600kHz, 3.4V±1%, 900mA, -CE	SOT-25	28dc4	DC1	6g	Tor
T34	XC9225G346M	DC/DC-IC	PWM step-down, 600kHz, 3.4V±1%, 900mA, +CE, PDR	SOT-25	28dc4	DC1	6g	Tor
T34	XC9225H346M	DC/DC-IC	PWM step-down, 600kHz, 3.4V±1%, 900mA, -CE, PDR	SOT-25	28dc4	DC1	6g	Tor



SMD code	Type	Function	Short description	Case	Pinout	Sch.	St.	Mnf.
T3C	XC9225E32CM	DC/DC-IC	PWM step-down, 1.2MHz, 3.2V±1%, 900mA, +CE	SOT-25	28dc4	DC1	6g	Tor
T3C	XC9225F32CM	DC/DC-IC	PWM step-down, 1.2MHz, 3.2V±1%, 900mA, -CE	SOT-25	28dc4	DC1	6g	Tor
T3C	XC9225G32CM	DC/DC-IC	PWM step-down, 1.2MHz, 3.2V±1%, 900mA, +CE, PDR	SOT-25	28dc4	DC1	6g	Tor
T3C	XC9225H32CM	DC/DC-IC	PWM step-down, 1.2MHz, 3.2V±1%, 900mA, -CE, PDR	SOT-25	28dc4	DC1	6g	Tor
T3D	XC9225A33CM	DC/DC-IC	PWM step-down, 1.2MHz, 3.3V±1%, 600mA, +CE	SOT-25	28dc4	DC1	6g	Tor
T3D	XC9225B33CM	DC/DC-IC	PWM step-down, 1.2MHz, 3.3V±1%, 600mA, -CE	SOT-25	28dc4	DC1	6g	Tor
T3D	XC9225C33CM	DC/DC-IC	PWM step-down, 1.2MHz, 3.3V±1%, 600mA, +CE, PDR	SOT-25	28dc4	DC1	6g	Tor
T3D	XC9225D33CM	DC/DC-IC	PWM step-down, 1.2MHz, 3.3V±1%, 600mA, -CE, PDR	SOT-25	28dc4	DC1	6g	Tor
T3D	XC9225E33CM	DC/DC-IC	PWM step-down, 1.2MHz, 3.3V±1%, 900mA, +CE	SOT-25	28dc4	DC1	6g	Tor
T3D	XC9225F33CM	DC/DC-IC	PWM step-down, 1.2MHz, 3.3V±1%, 900mA, -CE	SOT-25	28dc4	DC1	6g	Tor
T3D	XC9225G33CM	DC/DC-IC	PWM step-down, 1.2MHz, 3.3V±1%, 900mA, +CE, PDR	SOT-25	28dc4	DC1	6g	Tor
T3D	XC9225H33CM	DC/DC-IC	PWM step-down, 1.2MHz, 3.3V±1%, 900mA, -CE, PDR	SOT-25	28dc4	DC1	6g	Tor
T3E	XC9225A34CM	DC/DC-IC	PWM step-down, 1.2MHz, 3.4V±1%, 600mA, +CE	SOT-25	28dc4	DC1	6g	Tor
T3E	XC9225B34CM	DC/DC-IC	PWM step-down, 1.2MHz, 3.4V±1%, 600mA, -CE	SOT-25	28dc4	DC1	6g	Tor
T3E	XC9225C34CM	DC/DC-IC	PWM step-down, 1.2MHz, 3.4V±1%, 600mA, +CE, PDR	SOT-25	28dc4	DC1	6g	Tor
T3E	XC9225D34CM	DC/DC-IC	PWM step-down, 1.2MHz, 3.4V±1%, 600mA, -CE, PDR	SOT-25	28dc4	DC1	6g	Tor
T3E	XC9225E34CM	DC/DC-IC	PWM step-down, 1.2MHz, 3.4V±1%, 900mA, +CE	SOT-25	28dc4	DC1	6g	Tor
T3E	XC9225F34CM	DC/DC-IC	PWM step-down, 1.2MHz, 3.4V±1%, 900mA, -CE	SOT-25	28dc4	DC1	6g	Tor
T3E	XC9225G34CM	DC/DC-IC	PWM step-down, 1.2MHz, 3.4V±1%, 900mA, +CE, PDR	SOT-25	28dc4	DC1	6g	Tor
T3E	XC9225H34CM	DC/DC-IC	PWM step-down, 1.2MHz, 3.4V±1%, 900mA, -CE, PDR	SOT-25	28dc4	DC1	6g	Tor
T3F	XC9225A35CM	DC/DC-IC	PWM step-down, 1.2MHz, 3.5V±1%, 600mA, +CE	SOT-25	28dc4	DC1	6g	Tor
T3F	XC9225B35CM	DC/DC-IC	PWM step-down, 1.2MHz, 3.5V±1%, 600mA, -CE	SOT-25	28dc4	DC1	6g	Tor
T3F	XC9225C35CM	DC/DC-IC	PWM step-down, 1.2MHz, 3.5V±1%, 600mA, +CE, PDR	SOT-25	28dc4	DC1	6g	Tor
T3F	XC9225D35CM	DC/DC-IC	PWM step-down, 1.2MHz, 3.5V±1%, 600mA, -CE, PDR	SOT-25	28dc4	DC1	6g	Tor
T3F	XC9225E35CM	DC/DC-IC	PWM step-down, 1.2MHz, 3.5V±1%, 900mA, +CE	SOT-25	28dc4	DC1	6g	Tor
T3F	XC9225F35CM	DC/DC-IC	PWM step-down, 1.2MHz, 3.5V±1%, 900mA, -CE	SOT-25	28dc4	DC1	6g	Tor
T3F	XC9225G35CM	DC/DC-IC	PWM step-down, 1.2MHz, 3.5V±1%, 900mA, +CE, PDR	SOT-25	28dc4	DC1	6g	Tor
T3F	XC9225H35CM	DC/DC-IC	PWM step-down, 1.2MHz, 3.5V±1%, 900mA, -CE, PDR	SOT-25	28dc4	DC1	6g	Tor
T3H	XC9225A36CM	DC/DC-IC	PWM step-down, 1.2MHz, 3.6V±1%, 600mA, +CE	SOT-25	28dc4	DC1	6g	Tor
T3H	XC9225B36CM	DC/DC-IC	PWM step-down, 1.2MHz, 3.6V±1%, 600mA, -CE	SOT-25	28dc4	DC1	6g	Tor
T3H	XC9225C36CM	DC/DC-IC	PWM step-down, 1.2MHz, 3.6V±1%, 600mA, +CE, PDR	SOT-25	28dc4	DC1	6g	Tor
T3H	XC9225D36CM	DC/DC-IC	PWM step-down, 1.2MHz, 3.6V±1%, 600mA, -CE, PDR	SOT-25	28dc4	DC1	6g	Tor
T3H	XC9225E36CM	DC/DC-IC	PWM step-down, 1.2MHz, 3.6V±1%, 900mA, +CE	SOT-25	28dc4	DC1	6g	Tor
T3H	XC9225F36CM	DC/DC-IC	PWM step-down, 1.2MHz, 3.6V±1%, 900mA, -CE	SOT-25	28dc4	DC1	6g	Tor
T3H	XC9225G36CM	DC/DC-IC	PWM step-down, 1.2MHz, 3.6V±1%, 900mA, +CE, PDR	SOT-25	28dc4	DC1	6g	Tor
T3H	XC9225H36CM	DC/DC-IC	PWM step-down, 1.2MHz, 3.6V±1%, 900mA, -CE, PDR	SOT-25	28dc4	DC1	6g	Tor
T3K	XC9225A37CM	DC/DC-IC	PWM step-down, 1.2MHz, 3.7V±1%, 600mA, +CE	SOT-25	28dc4	DC1	6g	Tor
T3K	XC9225B37CM	DC/DC-IC	PWM step-down, 1.2MHz, 3.7V±1%, 600mA, -CE	SOT-25	28dc4	DC1	6g	Tor
T3K	XC9225C37CM	DC/DC-IC	PWM step-down, 1.2MHz, 3.7V±1%, 600mA, +CE, PDR	SOT-25	28dc4	DC1	6g	Tor
T3K	XC9225D37CM	DC/DC-IC	PWM step-down, 1.2MHz, 3.7V±1%, 600mA, -CE, PDR	SOT-25	28dc4	DC1	6g	Tor
T3K	XC9225E37CM	DC/DC-IC	PWM step-down, 1.2MHz, 3.7V±1%, 900mA, +CE	SOT-25	28dc4	DC1	6g	Tor
T3K	XC9225F37CM	DC/DC-IC	PWM step-down, 1.2MHz, 3.7V±1%, 900mA, -CE	SOT-25	28dc4	DC1	6g	Tor
T3K	XC9225G37CM	DC/DC-IC	PWM step-down, 1.2MHz, 3.7V±1%, 900mA, +CE, PDR	SOT-25	28dc4	DC1	6g	Tor
T3K	XC9225H37CM	DC/DC-IC	PWM step-down, 1.2MHz, 3.7V±1%, 900mA, -CE, PDR	SOT-25	28dc4	DC1	6g	Tor
T3L	XC9225A38CM	DC/DC-IC	PWM step-down, 1.2MHz, 3.8V±1%, 600mA, +CE	SOT-25	28dc4	DC1	6g	Tor
T3L	XC9225B38CM	DC/DC-IC	PWM step-down, 1.2MHz, 3.8V±1%, 600mA, -CE	SOT-25	28dc4	DC1	6g	Tor
T3L	XC9225C38CM	DC/DC-IC	PWM step-down, 1.2MHz, 3.8V±1%, 600mA, +CE, PDR	SOT-25	28dc4	DC1	6g	Tor
T3L	XC9225D38CM	DC/DC-IC	PWM step-down, 1.2MHz, 3.8V±1%, 600mA, -CE, PDR	SOT-25	28dc4	DC1	6g	Tor
T3L	XC9225E38CM	DC/DC-IC	PWM step-down, 1.2MHz, 3.8V±1%, 900mA, +CE	SOT-25	28dc4	DC1	6g	Tor
T3L	XC9225F38CM	DC/DC-IC	PWM step-down, 1.2MHz, 3.8V±1%, 900mA, -CE	SOT-25	28dc4	DC1	6g	Tor
T3L	XC9225G38CM	DC/DC-IC	PWM step-down, 1.2MHz, 3.8V±1%, 900mA, +CE, PDR	SOT-25	28dc4	DC1	6g	Tor
T3L	XC9225H38CM	DC/DC-IC	PWM step-down, 1.2MHz, 3.8V±1%, 900mA, -CE, PDR	SOT-25	28dc4	DC1	6g	Tor
T3M	XC9225A39CM	DC/DC-IC	PWM step-down, 1.2MHz, 3.9V±1%, 600mA, +CE	SOT-25	28dc4	DC1	6g	Tor
T3M	XC9225B39CM	DC/DC-IC	PWM step-down, 1.2MHz, 3.9V±1%, 600mA, -CE	SOT-25	28dc4	DC1	6g	Tor
T3M	XC9225C39CM	DC/DC-IC	PWM step-down, 1.2MHz, 3.9V±1%, 600mA, +CE, PDR	SOT-25	28dc4	DC1	6g	Tor
T3M	XC9225D39CM	DC/DC-IC	PWM step-down, 1.2MHz, 3.9V±1%, 600mA, -CE, PDR	SOT-25	28dc4	DC1	6g	Tor
T3M	XC9225E39CM	DC/DC-IC	PWM step-down, 1.2MHz, 3.9V±1%, 900mA, +CE	SOT-25	28dc4	DC1	6g	Tor
T3M	XC9225F39CM	DC/DC-IC	PWM step-down, 1.2MHz, 3.9V±1%, 900mA, -CE	SOT-25	28dc4	DC1	6g	Tor
T3M	XC9225G39CM	DC/DC-IC	PWM step-down, 1.2MHz, 3.9V±1%, 900mA, +CE, PDR	SOT-25	28dc4	DC1	6g	Tor
T3M	XC9225H39CM	DC/DC-IC	PWM step-down, 1.2MHz, 3.9V±1%, 900mA, -CE, PDR	SOT-25	28dc4	DC1	6g	Tor
T3N	XC74UL02AAN	CMOS-Logic	2-input NOR gate	SOT-25	28LLog2	-	6a	Tor
T4	BD45445G	Vdet-IC	4.4V, -Reset ODO, 500ms	SSOP-5	28vdp	VD6	6c	Rhm
T4	HD74LV1GT32ACM	CMOS-Logic	2-input OR gate	CMCPAK-5	28LLog4	-	6a	Ren
T4	HD74LV1GT32AVS	CMOS-Logic	2-input OR gate	VSON-5	30LLog4	-	6a	Ben
T4	R1121N441B	LVR-IC	LDO, LN, +CE, 4.4V±2%, 150mA	SOT-23-5	28vt	VR4	6g	Ric
T40	R1162N401D	LVR-IC	LDO, 4V±2%, 350mA, +CE, Cl, AE(Mode)	SOT-23-5	28x9	VR10	6g	Ric
T40	XC31BPN40AM	Tdet-IC	Sensor (-30, +80°C); t=25°C; Vout=4V±3%	SOT-25	28xa	-	6g	Tor
T40	XC9225A406M	DC/DC-IC	PWM step-down, 600kHz, 4.0V±1%, 600mA, +CE	SOT-25	28dc4	DC1	6g	Tor
T40	XC9225B406M	DC/DC-IC	PWM step-down, 600kHz, 4.0V±1%, 600mA, -CE	SOT-25	28dc4	DC1	6g	Tor
T40	XC9225C406M	DC/DC-IC	PWM step-down, 600kHz, 4.0V±1%, 600mA, +CE, PDR	SOT-25	28dc4	DC1	6g	Tor



SMD code	Type	Function	Short description	Case	Pinout	Sch.	St.	Mnf.
T40	XC9225D406M	DC/DC-IC	PWM step-down, 600kHz, 4.0V±1%, 600mA, -CE, PDR	SOT-25	28dc4	DC1	6g	Tor
T40	XC9225E406M	DC/DC-IC	PWM step-down, 600kHz, 4.0V±1%, 900mA, +CE	SOT-25	28dc4	DC1	6g	Tor
T40	XC9225F406M	DC/DC-IC	PWM step-down, 600kHz, 4.0V±1%, 900mA, -CE	SOT-25	28dc4	DC1	6g	Tor
T40	XC9225G406M	DC/DC-IC	PWM step-down, 600kHz, 4.0V±1%, 900mA, +CE, PDR	SOT-25	28dc4	DC1	6g	Tor
T40	XC9225H406M	DC/DC-IC	PWM step-down, 600kHz, 4.0V±1%, 900mA, -CE, PDR	SOT-25	28dc4	DC1	6g	Tor
T41	R1162N181D5	LVR-IC	LDO, 1.85V±2%, 350mA, +CE, CL, AE(Mode)	SOT-23-5	28x9	VR10	6g	Ric
T41	XC31BPN41AM	Tdet-IC	Sensor (-30..+80°C); t=25°C- Vout=4.1V±3%	SOT-25	28xa	-	6g	Tor
T42	R1162N281D5	LVR-IC	LDO, 2.85V±2%, 350mA, +CE, CL, AE(Mode)	SOT-23-5	28x9	VR10	6g	Ric
T42	XC31BPN42AM	Tdet-IC	Sensor (-30..+80°C); t=25°C- Vout=4.2V±3%	SOT-25	28xa	-	6g	Tor
T43	XC31BPN43AM	Tdet-IC	Sensor (-30..+80°C); t=25°C- Vout=4.3V±3%	SOT-25	28xa	-	6g	Tor
T44	XC31BPN44AM	Tdet-IC	Sensor (-30..+80°C); t=25°C- Vout=4.4V±3%	SOT-25	28xa	-	6g	Tor
T45	XC31BPN45AM	Tdet-IC	Sensor (-30..+80°C); t=25°C- Vout=4.5V±3%	SOT-25	28xa	-	6g	Tor
T46	XC31BPN46AM	Tdet-IC	Sensor (-30..+80°C); t=25°C- Vout=4.6V±3%	SOT-25	28xa	-	6g	Tor
T47	XC31BPN47AM	Tdet-IC	Sensor (-30..+80°C); t=25°C- Vout=4.7V±3%	SOT-25	28xa	-	6g	Tor
T48	XC31BPN48AM	Tdet-IC	Sensor (-30..+80°C); t=25°C- Vout=4.8V±3%	SOT-25	28xa	-	6g	Tor
T49	XC31BPN49AM	Tdet-IC	Sensor (-30..+80°C); t=25°C- Vout=4.9V±3%	SOT-25	28xa	-	6g	Tor
T4A	XC9225A40CM	DC/DC-IC	PWM step-down, 1.2MHz, 4.0V±1%, 600mA, +CE	SOT-25	28dc4	DC1	6g	Tor
T4A	XC9225B40CM	DC/DC-IC	PWM step-down, 1.2MHz, 4.0V±1%, 600mA, -CE	SOT-25	28dc4	DC1	6g	Tor
T4A	XC9225C40CM	DC/DC-IC	PWM step-down, 1.2MHz, 4.0V±1%, 600mA, +CE, PDR	SOT-25	28dc4	DC1	6g	Tor
T4A	XC9225D40CM	DC/DC-IC	PWM step-down, 1.2MHz, 4.0V±1%, 600mA, -CE, PDR	SOT-25	28dc4	DC1	6g	Tor
T4A	XC9225E40CM	DC/DC-IC	PWM step-down, 1.2MHz, 4.0V±1%, 900mA, +CE	SOT-25	28dc4	DC1	6g	Tor
T4A	XC9225F40CM	DC/DC-IC	PWM step-down, 1.2MHz, 4.0V±1%, 900mA, -CE	SOT-25	28dc4	DC1	6g	Tor
T4A	XC9225G40CM	DC/DC-IC	PWM step-down, 1.2MHz, 4.0V±1%, 900mA, +CE, PDR	SOT-25	28dc4	DC1	6g	Tor
T4A	XC9225H40CM	DC/DC-IC	PWM step-down, 1.2MHz, 4.0V±1%, 900mA, -CE, PDR	SOT-25	28dc4	DC1	6g	Tor
T4N	XC74UL32AAN	CMOS-Logic	2-input OR gate	SOT-25	28/Log4	-	6a	Tor
T5	BD45435G	Vdet-IC	4.3V, -Reset ODO, 500ms	SSOP-5	28vdp	VD6	6c	Rhm
T5	HD74LV1GT04ACM	CMOS-Logic	Inverter	CMCPAK-5	28/Log6	-	6a	Ren
T5	HD74LV1GT04AVS	CMOS-Logic	Inverter	VSON-5	30/Log6	-	6a	Ren
T5	R1121N451B	LVR-IC	LDO, LN, +CE, 4.5V±2%, 150mA	SOT-23-5	28vt	VR4	6g	Ric
T50	XC31BPN50AM	Tdet-IC	Sensor (-30..+80°C); t=25°C- Vout=5V±3%	SOT-25	28xa	-	6g	Tor
T51	XC31BPN51AM	Tdet-IC	Sensor (-30..+80°C); t=25°C- Vout=5.1V±3%	SOT-25	28xa	-	6g	Tor
T52	XC31BPN52AM	Tdet-IC	Sensor (-30..+80°C); t=25°C- Vout=5.2V±3%	SOT-25	28xa	-	6g	Tor
T53	XC31BPN53AM	Tdet-IC	Sensor (-30..+80°C); t=25°C- Vout=5.3V±3%	SOT-25	28xa	-	6g	Tor
T54	XC31BPN54AM	Tdet-IC	Sensor (-30..+80°C); t=25°C- Vout=5.4V±3%	SOT-25	28xa	-	6g	Tor
T55	XC31BPN55AM	Tdet-IC	Sensor (-30..+80°C); t=25°C- Vout=5.5V±3%	SOT-25	28xa	-	6g	Tor
T56	XC31BPN56AM	Tdet-IC	Sensor (-30..+80°C); t=25°C- Vout=5.6V±3%	SOT-25	28xa	-	6g	Tor
T57	XC31BPN57AM	Tdet-IC	Sensor (-30..+80°C); t=25°C- Vout=5.7V±3%	SOT-25	28xa	-	6g	Tor
T58	XC31BPN58AM	Tdet-IC	Sensor (-30..+80°C); t=25°C- Vout=5.8V±3%	SOT-25	28xa	-	6g	Tor
T59	XC31BPN59AM	Tdet-IC	Sensor (-30..+80°C); t=25°C- Vout=5.9V±3%	SOT-25	28xa	-	6g	Tor
T5N	XC74UL04AAN	CMOS-Logic	Inverter	SOT-25	28/Log6	-	6a	Tor
T5N	XC74ULU04AAN	CMOS-Logic	Inverter	SOT-25	28/Log6	-	6a	Tor
T6	BD45425G	Vdet-IC	4.2V, -Reset ODO, 500ms	SSOP-5	28vdp	VD6	6c	Rhm
T6	R1121N461B	LVR-IC	LDO, LN, +CE, 4.6V±2%, 150mA	SOT-23-5	28vt	VR4	6g	Ric
T60	XC31BPN60AM	Tdet-IC	Sensor (-30..+80°C); t=25°C- Vout=6V±3%	SOT-25	28xa	-	6g	Tor
T66	74HCT1G66GV	CMOS-Logic	Bilateral analogic switch	SOT753	28/Log16	-	6a	Phi
T66	U74AHCT1G66-AF5	CMOS-Logic	Bilateral analogic switch	SOT-23-5	28/Log16	-	6a	Utc
T66	U74AHCT1G66-AL5	CMOS-Logic	Bilateral analogic switch	SOT-353	28/Log16	-	6a	Utc
T66L	U74AHCT1G66L-AF5	CMOS-Logic	Bilateral analogic switch	SOT-23-5	28/Log16	-	6a	Utc
T66L	U74AHCT1G66L-AL5	CMOS-Logic	Bilateral analogic switch	SOT-353	28/Log16	-	6a	Utc
T6A	S-1009C08I-M5T1U	Vdet-IC	0.8V±12mV, -Reset PPO	SOT-23-5	28vdo	VD3	6g	Sii
T6B	S-1009C09I-M5T1U	Vdet-IC	0.9V±12mV, -Reset PPO	SOT-23-5	28vdo	VD3	6g	Sii
T6C	S-1009C10I-M5T1U	Vdet-IC	1.0V±12mV, -Reset PPO	SOT-23-5	28vdo	VD3	6g	Sii
T6D	S-1009C11I-M5T1U	Vdet-IC	1.1V±12mV, -Reset PPO	SOT-23-5	28vdo	VD3	6g	Sii
T6E	S-1009C12I-M5T1U	Vdet-IC	1.2V±12mV, -Reset PPO	SOT-23-5	28vdo	VD3	6g	Sii
T6F	S-1009C13I-M5T1U	Vdet-IC	1.3V±12mV, -Reset PPO	SOT-23-5	28vdo	VD3	6g	Sii
T6G	S-1009C14I-M5T1U	Vdet-IC	1.4V±12mV, -Reset PPO	SOT-23-5	28vdo	VD3	6g	Sii
T6H	S-1009C15I-M5T1U	Vdet-IC	1.5V±12mV, -Reset PPO	SOT-23-5	28vdo	VD3	6g	Sii
T6I	S-1009C16I-M5T1U	Vdet-IC	1.6V±12mV, -Reset PPO	SOT-23-5	28vdo	VD3	6g	Sii
T6J	S-1009C17I-M5T1U	Vdet-IC	1.7V±12mV, -Reset PPO	SOT-23-5	28vdo	VD3	6g	Sii
T6K	S-1009C18I-M5T1U	Vdet-IC	1.8V±12mV, -Reset PPO	SOT-23-5	28vdo	VD3	6g	Sii
T6L	S-1009C19I-M5T1U	Vdet-IC	1.9V±12mV, -Reset PPO	SOT-23-5	28vdo	VD3	6g	Sii
T6M	S-1009C20I-M5T1U	Vdet-IC	2.0V±12mV, -Reset PPO	SOT-23-5	28vdo	VD3	6g	Sii
T6N	S-1009C21I-M5T1U	Vdet-IC	2.1V±12mV, -Reset PPO	SOT-23-5	28vdo	VD3	6g	Sii
T6N	XC74ULU04AN	CMOS-Logic	Inverter	SOT-25	28/Log6	-	6a	Tor
T6O	S-1009C22I-M5T1U	Vdet-IC	2.2V±12mV, -Reset PPO	SOT-23-5	28vdo	VD3	6g	Sii
T6P	S-1009C23I-M5T1U	Vdet-IC	2.3V±12mV, -Reset PPO	SOT-23-5	28vdo	VD3	6g	Sii
T6Q	S-1009C24I-M5T1U	Vdet-IC	2.4V±0.5%, -Reset PPO	SOT-23-5	28vdo	VD3	6g	Sii
T6R	S-1009C25I-M5T1U	Vdet-IC	2.5V±0.5%, -Reset PPO	SOT-23-5	28vdo	VD3	6g	Sii
T6S	S-1009C26I-M5T1U	Vdet-IC	2.6V±0.5%, -Reset PPO	SOT-23-5	28vdo	VD3	6g	Sii
T6T	S-1009C27I-M5T1U	Vdet-IC	2.7V±0.5%, -Reset PPO	SOT-23-5	28vdo	VD3	6g	Sii



SMD code	Type	Function	Short description	Case	Pinout	Sch.	St.	Mnf.
T6U	S-1009C28I-M5T1U	Vdet-IC	2.8V±0.5%, -Reset PPO	SOT-23-5	28vdo	VD3	6g	Sii
T6V	S-1009C29I-M5T1U	Vdet-IC	2.9V±0.5%, -Reset PPO	SOT-23-5	28vdo	VD3	6g	Sii
T6W	S-1009C30I-M5T1U	Vdet-IC	3.0V±0.5%, -Reset PPO	SOT-23-5	28vdo	VD3	6g	Sii
T6X	S-1009C31I-M5T1U	Vdet-IC	3.1V±0.5%, -Reset PPO	SOT-23-5	28vdo	VD3	6g	Sii
T6Y	S-1009C32I-M5T1U	Vdet-IC	3.2V±0.5%, -Reset PPO	SOT-23-5	28vdo	VD3	6g	Sii
T6Z	S-1009C33I-M5T1U	Vdet-IC	3.3V±0.5%, -Reset PPO	SOT-23-5	28vdo	VD3	6g	Sii
T7	BD45415G	Vdet-IC	4.1V, -Reset ODO, 500ms	SSOP-5	28vdp	VD6	6c	Rhm
T7	R1121N471B	LVR-IC	LDO, LN, +CE, 4.7V±2%, 150mA	SOT-23-5	28vt	VR4	6g	Ric
T7A	S-1009C34I-M5T1U	Vdet-IC	3.4V±0.5%, -Reset PPO	SOT-23-5	28vdo	VD3	6g	Sii
T7B	S-1009C35I-M5T1U	Vdet-IC	3.5V±0.5%, -Reset PPO	SOT-23-5	28vdo	VD3	6g	Sii
T7C	S-1009C36I-M5T1U	Vdet-IC	3.6V±0.5%, -Reset PPO	SOT-23-5	28vdo	VD3	6g	Sii
T7D	S-1009C37I-M5T1U	Vdet-IC	3.7V±0.5%, -Reset PPO	SOT-23-5	28vdo	VD3	6g	Sii
T7E	S-1009C38I-M5T1U	Vdet-IC	3.8V±0.5%, -Reset PPO	SOT-23-5	28vdo	VD3	6g	Sii
T7F	S-1009C39I-M5T1U	Vdet-IC	3.9V±0.5%, -Reset PPO	SOT-23-5	28vdo	VD3	6g	Sii
T7G	S-1009C40I-M5T1U	Vdet-IC	4.0V±0.5%, -Reset PPO	SOT-23-5	28vdo	VD3	6g	Sii
T7H	S-1009C41I-M5T1U	Vdet-IC	4.1V±0.5%, -Reset PPO	SOT-23-5	28vdo	VD3	6g	Sii
T7I	S-1009C42I-M5T1U	Vdet-IC	4.2V±0.5%, -Reset PPO	SOT-23-5	28vdo	VD3	6g	Sii
T7J	S-1009C43I-M5T1U	Vdet-IC	4.3V±0.5%, -Reset PPO	SOT-23-5	28vdo	VD3	6g	Sii
T7K	S-1009C44I-M5T1U	Vdet-IC	4.4V±0.5%, -Reset PPO	SOT-23-5	28vdo	VD3	6g	Sii
T7L	S-1009C45I-M5T1U	Vdet-IC	4.5V±0.5%, -Reset PPO	SOT-23-5	28vdo	VD3	6g	Sii
T7M	S-1009C46I-M5T1U	Vdet-IC	4.6V±0.5%, -Reset PPO	SOT-23-5	28vdo	VD3	6g	Sii
T8	BD45405G	Vdet-IC	4V, -Reset ODO, 500ms	SSOP-5	28vdp	VD6	6c	Rhm
T8	HD74LV1GT86ACM	CMOS-Logic	2-input EXCLUSIVE-OR gate	CMPAK-5	28/Log5	-	6a	Ren
T8	HD74LV1GT86AVS	CMOS-Logic	2-input EXCLUSIVE-OR gate	VSON-5	30/Log5	-	6a	Ren
T8	R1121N481B	LVR-IC	LDO, LN, +CE, 4.8V±2%, 150mA	SOT-23-5	28vt	VR4	6g	Ric
T86	74HCT1G86GV	CMOS-Logic	2-input EXCLUSIVE-OR gate	SOT753	28/Log5	-	6a	Phi
T86	NC75T86P5	CMOS-Logic	2-input EXCLUSIVE-OR gate	SC-70-5	28/Log5	-	6a	F
T86	U74AHCT1G86-AF5	CMOS-Logic	2-input EXCLUSIVE-OR gate	SOT-23-5	28/Log5	-	6a	Utc
T86	U74AHCT1G86-AL5	CMOS-Logic	2-input EXCLUSIVE-OR gate	SOT-353	28/Log5	-	6a	Utc
T86L	U74AHCT1G86L-AF5	CMOS-Logic	2-input EXCLUSIVE-OR gate	SOT-23-5	28/Log5	-	6a	Utc
T86L	U74AHCT1G86L-AL5	CMOS-Logic	2-input EXCLUSIVE-OR gate	SOT-353	28/Log5	-	6a	Utc
T8A	S-1009N08I-M5T1U	Vdet-IC	0.8V±12mV, -Reset ODO	SOT-23-5	28vdo	VD1	6g	Sii
T8A	XC6118N08AMR-G	Vdet-IC	0.8V±30mV, ±Reset ODO, Sense, hysteresis 5%, Cd	SOT-25	28mg	VD14	6g	Tor
T8B	S-1009N09I-M5T1U	Vdet-IC	0.9V±12mV, -Reset ODO	SOT-23-5	28vdo	VD1	6g	Sii
T8B	XC6118N08BMR-G	Vdet-IC	0.8V±30mV, ±Reset ODO, Sense, hysteresis <1%, Cd	SOT-25	28mg	VD14	6g	Tor
T8C	S-1009N10I-M5T1U	Vdet-IC	1.0V±12mV, -Reset ODO	SOT-23-5	28vdo	VD1	6g	Sii
T8C	XC6118N08CMR-G	Vdet-IC	0.8V±30mV, ±Reset ODO, Sense, hysteresis 5%	SOT-25	28mf	VD11	6g	Tor
T8D	S-1009N11I-M5T1U	Vdet-IC	1.1V±12mV, -Reset ODO	SOT-23-5	28vdo	VD1	6g	Sii
T8D	XC6118N08DMR-G	Vdet-IC	0.8V±30mV, ±Reset ODO, Sense, hysteresis <1%	SOT-25	28mf	VD11	6g	Tor
T8E	S-1009N12I-M5T1U	Vdet-IC	1.2V±12mV, -Reset ODO	SOT-23-5	28vdo	VD1	6g	Sii
T8F	S-1009N13I-M5T1U	Vdet-IC	1.3V±12mV, -Reset ODO	SOT-23-5	28vdo	VD1	6g	Sii
T8G	S-1009N14I-M5T1U	Vdet-IC	1.4V±12mV, -Reset ODO	SOT-23-5	28vdo	VD1	6g	Sii
T8H	S-1009N15I-M5T1U	Vdet-IC	1.5V±12mV, -Reset ODO	SOT-23-5	28vdo	VD1	6g	Sii
T8I	S-1009N16I-M5T1U	Vdet-IC	1.6V±12mV, -Reset ODO	SOT-23-5	28vdo	VD1	6g	Sii
T8J	S-1009N17I-M5T1U	Vdet-IC	1.7V±12mV, -Reset ODO	SOT-23-5	28vdo	VD1	6g	Sii
T8K	S-1009N18I-M5T1U	Vdet-IC	1.8V±12mV, -Reset ODO	SOT-23-5	28vdo	VD1	6g	Sii
T8L	S-1009N19I-M5T1U	Vdet-IC	1.9V±12mV, -Reset ODO	SOT-23-5	28vdo	VD1	6g	Sii
T8M	S-1009N20I-M5T1U	Vdet-IC	2.0V±12mV, -Reset ODO	SOT-23-5	28vdo	VD1	6g	Sii
T8N	S-1009N21I-M5T1U	Vdet-IC	2.1V±12mV, -Reset ODO	SOT-23-5	28vdo	VD1	6g	Sii
T8N	XC74UL86AAN	CMOS-Logic	2-input EXCLUSIVE-OR gate	SOT-25	28/Log5	-	6a	Tor
T8O	S-1009N22I-M5T1U	Vdet-IC	2.2V±12mV, -Reset ODO	SOT-23-5	28vdo	VD1	6g	Sii
T8P	S-1009N23I-M5T1U	Vdet-IC	2.3V±12mV, -Reset ODO	SOT-23-5	28vdo	VD1	6g	Sii
T8Q	S-1009N24I-M5T1U	Vdet-IC	2.4V±0.5%, -Reset ODO	SOT-23-5	28vdo	VD1	6g	Sii
T8R	S-1009N25I-M5T1U	Vdet-IC	2.5V±0.5%, -Reset ODO	SOT-23-5	28vdo	VD1	6g	Sii
T8S	S-1009N26I-M5T1U	Vdet-IC	2.6V±0.5%, -Reset ODO	SOT-23-5	28vdo	VD1	6g	Sii
T8T	S-1009N27I-M5T1U	Vdet-IC	2.7V±0.5%, -Reset ODO	SOT-23-5	28vdo	VD1	6g	Sii
T8U	S-1009N28I-M5T1U	Vdet-IC	2.8V±0.5%, -Reset ODO	SOT-23-5	28vdo	VD1	6g	Sii
T8V	S-1009N29I-M5T1U	Vdet-IC	2.9V±0.5%, -Reset ODO	SOT-23-5	28vdo	VD1	6g	Sii
T8W	S-1009N30I-M5T1U	Vdet-IC	3.0V±0.5%, -Reset ODO	SOT-23-5	28vdo	VD1	6g	Sii
T8X	S-1009N31I-M5T1U	Vdet-IC	3.1V±0.5%, -Reset ODO	SOT-23-5	28vdo	VD1	6g	Sii
T8Y	S-1009N32I-M5T1U	Vdet-IC	3.2V±0.5%, -Reset ODO	SOT-23-5	28vdo	VD1	6g	Sii
T8Z	S-1009N33I-M5T1U	Vdet-IC	3.3V±0.5%, -Reset ODO	SOT-23-5	28vdo	VD1	6g	Sii
T9	BD45395G	Vdet-IC	3.9V, -Reset ODO, 500ms	SSOP-5	28vdp	VD6	6c	Rhm
T9	HD74LV1GT66ACM	CMOS-Logic	Bilateral analogic switch	CMPAK-5	28/Log16	-	6a	Ren
T9	HD74LV1GT66AVS	CMOS-Logic	Bilateral analogic switch	VSON-5	30/Log16	-	6a	Ren
T9	R1121N491B	LVR-IC	LDO, LN, +CE, 4.9V±2%, 150mA	SOT-23-5	28vt	VR4	6g	Ric
T9A	S-1009N34I-M5T1U	Vdet-IC	3.4V±0.5%, -Reset ODO	SOT-23-5	28vdo	VD1	6g	Sii
T9A	XC6118N09AMR-G	Vdet-IC	0.9V±30mV, ±Reset ODO, Sense, hysteresis 5%, Cd	SOT-25	28mg	VD14	6g	Tor
T9B	S-1009N35I-M5T1U	Vdet-IC	3.5V±0.5%, -Reset ODO	SOT-23-5	28vdo	VD1	6g	Sii
T9B	XC6118N09BMR-G	Vdet-IC	0.9V±30mV, ±Reset ODO, Sense, hysteresis <1%, Cd	SOT-25	28mg	VD14	6g	Tor



SMD code	Type	Function	Short description	Case	Pinout	Sch.	St.	Mnf.
T9C	S-1009N361-M5T1U	Vdet-IC	3.6V±0.5%, -Reset ODO	SOT-23-5	28vdo	VD1	6g	Sii
T9C	XC6118N09CMR-G	Vdet-IC	0.9V±30mV, ±Reset ODO, Sense, hysteresis 5%	SOT-25	28mf	VD11	6g	Tor
T9D	S-1009N371-M5T1U	Vdet-IC	3.7V±0.5%, -Reset ODO	SOT-23-5	28vdo	VD1	6g	Sii
T9D	XC6118N09DMR-G	Vdet-IC	0.9V±30mV, ±Reset ODO, Sense, hysteresis <1%	SOT-25	28mf	VD11	6g	Tor
T9E	S-1009N381-M5T1U	Vdet-IC	3.8V±0.5%, -Reset ODO	SOT-23-5	28vdo	VD1	6g	Sii
T9F	S-1009N391-M5T1U	Vdet-IC	3.9V±0.5%, -Reset ODO	SOT-23-5	28vdo	VD1	6g	Sii
T9G	S-1009N401-M5T1U	Vdet-IC	4.0V±0.5%, -Reset ODO	SOT-23-5	28vdo	VD1	6g	Sii
T9H	S-1009N411-M5T1U	Vdet-IC	4.1V±0.5%, -Reset ODO	SOT-23-5	28vdo	VD1	6g	Sii
T9I	S-1009N421-M5T1U	Vdet-IC	4.2V±0.5%, -Reset ODO	SOT-23-5	28vdo	VD1	6g	Sii
T9J	S-1009N431-M5T1U	Vdet-IC	4.3V±0.5%, -Reset ODO	SOT-23-5	28vdo	VD1	6g	Sii
T9K	S-1009N441-M5T1U	Vdet-IC	4.4V±0.5%, -Reset ODO	SOT-23-5	28vdo	VD1	6g	Sii
T9L	S-1009N451-M5T1U	Vdet-IC	4.5V±0.5%, -Reset ODO	SOT-23-5	28vdo	VD1	6g	Sii
T9M	S-1009N461-M5T1U	Vdet-IC	4.6V±0.5%, -Reset ODO	SOT-23-5	28vdo	VD1	6g	Sii
T9N	XC74UL4066M	CMOS-Logic	Bilateral analogic switch	SOT-25	28/Log16	-	6a	Tor
TA	74HCT1G00GW	CMOS-Logic	2-input NAND gate	SOT-353	28/Log1	-	6a	Phi
TA	BD45385G	Vdet-IC	3.8V, -Reset ODO, 500ms	SSOP-5	28vdp	VD6	6c	Rhm
TA	HD74LV1GT14ACM	CMOS-Logic	Inverting Schmitt-trigger	CMPAK-5	28/Log7	-	6a	Ren
TA	HD74LV1GT14AVS	CMOS-Logic	Inverting Schmitt-trigger	VSON-5	30/Log7	-	6a	Ren
TA	KIC75Z00FU	CMOS-Logic	2-input NAND gate	SOT-353	28/Log1	-	6a	Kec
TA9	XC9225A0M6M	DC/DC-IC	PWM step-down, 600kHz, 0.95V±1%, 600mA, +CE	SOT-25	28dc4	DC1	6g	Tor
TA9	XC9225B0M6M	DC/DC-IC	PWM step-down, 600kHz, 0.95V±1%, 600mA, -CE	SOT-25	28dc4	DC1	6g	Tor
TA9	XC9225C0M6M	DC/DC-IC	PWM step-down, 600kHz, 0.95V±1%, 600mA, +CE, PDR	SOT-25	28dc4	DC1	6g	Tor
TA9	XC9225D0M6M	DC/DC-IC	PWM step-down, 600kHz, 0.95V±1%, 600mA, -CE, PDR	SOT-25	28dc4	DC1	6g	Tor
TAA	NCV303LSN28T1	Vdet-IC	2.8V±1.5%, -Reset ODO	TSOP-5	28vdo	VD1	6k	Ons
TAA	R3118N301A	Vdet-IC	3.0V±1.5%, -Reset ODO, Sense	SOT-23-5	28z4	VD14	6g	Ric
TAB	R3118N311A	Vdet-IC	3.1V±1.5%, -Reset ODO, Sense	SOT-23-5	28z4	VD14	6g	Ric
TAC	R3118N321A	Vdet-IC	3.2V±1.5%, -Reset ODO, Sense	SOT-23-5	28z4	VD14	6g	Ric
TAD	R3118N331A	Vdet-IC	3.3V±1.5%, -Reset ODO, Sense	SOT-23-5	28z4	VD14	6g	Ric
TAE	R3118N341A	Vdet-IC	3.4V±1.5%, -Reset ODO, Sense	SOT-23-5	28z4	VD14	6g	Ric
TAF	R3118N351A	Vdet-IC	3.5V±1.5%, -Reset ODO, Sense	SOT-23-5	28z4	VD14	6g	Ric
TAG	R3118N361A	Vdet-IC	3.6V±1.5%, -Reset ODO, Sense	SOT-23-5	28z4	VD14	6g	Ric
TAH	R3118N371A	Vdet-IC	3.7V±1.5%, -Reset ODO, Sense	SOT-23-5	28z4	VD14	6g	Ric
TAJ	R3118N381A	Vdet-IC	3.8V±1.5%, -Reset ODO, Sense	SOT-23-5	28z4	VD14	6g	Ric
TAK	R3118N391A	Vdet-IC	3.9V±1.5%, -Reset ODO, Sense	SOT-23-5	28z4	VD14	6g	Ric
TAL	R3118N401A	Vdet-IC	4.0V±1.5%, -Reset ODO, Sense	SOT-23-5	28z4	VD14	6g	Ric
TAM	R3118N411A	Vdet-IC	4.1V±1.5%, -Reset ODO, Sense	SOT-23-5	28z4	VD14	6g	Ric
TAAM	XC9225A0MCM	DC/DC-IC	PWM step-down, 1.2MHz, 0.95V±1%, 600mA, +CE	SOT-25	28dc4	DC1	6g	Tor
TAAM	XC9225B0MCM	DC/DC-IC	PWM step-down, 1.2MHz, 0.95V±1%, 600mA, -CE	SOT-25	28dc4	DC1	6g	Tor
TAAM	XC9225C0MCM	DC/DC-IC	PWM step-down, 1.2MHz, 0.95V±1%, 600mA, +CE, PDR	SOT-25	28dc4	DC1	6g	Tor
TAAM	XC9225D0MCM	DC/DC-IC	PWM step-down, 1.2MHz, 0.95V±1%, 600mA, -CE, PDR	SOT-25	28dc4	DC1	6g	Tor
TAN	NCP301LSN24T1	Vdet-IC	2.4V±1.5%, -Reset ODO	TSOP-5	28vdm	VD6	6k	Ons
TAN	R3118N421A	Vdet-IC	4.2V±1.5%, -Reset ODO, Sense	SOT-23-5	28z4	VD14	6g	Ric
TAN	XC74UL14AAN	CMOS-Logic	Inverting Schmitt-trigger	SOT-25	28/Log7	-	6a	Tor
TAP	R3118N431A	Vdet-IC	4.3V±1.5%, -Reset ODO, Sense	SOT-23-5	28z4	VD14	6g	Ric
TAQ	R3118N441A	Vdet-IC	4.4V±1.5%, -Reset ODO, Sense	SOT-23-5	28z4	VD14	6g	Ric
TAR	R3118N451A	Vdet-IC	4.5V±1.5%, -Reset ODO, Sense	SOT-23-5	28z4	VD14	6g	Ric
TAS	R3118N461A	Vdet-IC	4.6V±1.5%, -Reset ODO, Sense	SOT-23-5	28z4	VD14	6g	Ric
TAT	R3118N471A	Vdet-IC	4.7V±1.5%, -Reset ODO, Sense	SOT-23-5	28z4	VD14	6g	Ric
TAU	R3118N481A	Vdet-IC	4.8V±1.5%, -Reset ODO, Sense	SOT-23-5	28z4	VD14	6g	Ric
TAV	R3118N491A	Vdet-IC	4.9V±1.5%, -Reset ODO, Sense	SOT-23-5	28z4	VD14	6g	Ric
TAW	R3118N501A	Vdet-IC	5.0V±1.5%, -Reset ODO, Sense	SOT-23-5	28z4	VD14	6g	Ric
TB	74HCT1G02GW	CMOS-Logic	2-input NOR gate	SOT-353	28/Log2	-	6a	Phi
TB	BD45375G	Vdet-IC	3.7V, -Reset ODO, 500ms	SSOP-5	28vdp	VD6	6c	Rhm
TB	HD74LV1GT125ACM	CMOS-Logic	Bus buffer gate with 3-state output	CMPAK-5	28/Log14	-	6a	Ren
TB	HD74LV1GT125AVS	CMOS-Logic	Bus buffer gate with 3-state output	VSON-5	30/Log14	-	6a	Ren
TB	KIC75Z02FU	CMOS-Logic	2-input NOR gate	SOT-353	28/Log2	-	6a	Kec
TB0	XC9225A1A6M	DC/DC-IC	PWM step-down, 600kHz, 1.05V±1%, 600mA, +CE	SOT-25	28dc4	DC1	6g	Tor
TB0	XC9225B1A6M	DC/DC-IC	PWM step-down, 600kHz, 1.05V±1%, 600mA, -CE	SOT-25	28dc4	DC1	6g	Tor
TB0	XC9225C1A6M	DC/DC-IC	PWM step-down, 600kHz, 1.05V±1%, 600mA, +CE, PDR	SOT-25	28dc4	DC1	6g	Tor
TB0	XC9225D1A6M	DC/DC-IC	PWM step-down, 600kHz, 1.05V±1%, 600mA, -CE, PDR	SOT-25	28dc4	DC1	6g	Tor
TB1	XC9225A1B6M	DC/DC-IC	PWM step-down, 600kHz, 1.15V±1%, 600mA, +CE	SOT-25	28dc4	DC1	6g	Tor
TB1	XC9225B1B6M	DC/DC-IC	PWM step-down, 600kHz, 1.15V±1%, 600mA, -CE, PDR	SOT-25	28dc4	DC1	6g	Tor
TB2	XC9225A1C6M	DC/DC-IC	PWM step-down, 600kHz, 1.25V±1%, 600mA, +CE	SOT-25	28dc4	DC1	6g	Tor
TB2	XC9225B1C6M	DC/DC-IC	PWM step-down, 600kHz, 1.25V±1%, 600mA, -CE	SOT-25	28dc4	DC1	6g	Tor
TB2	XC9225C1C6M	DC/DC-IC	PWM step-down, 600kHz, 1.25V±1%, 600mA, +CE, PDR	SOT-25	28dc4	DC1	6g	Tor
TB2	XC9225D1C6M	DC/DC-IC	PWM step-down, 600kHz, 1.25V±1%, 600mA, -CE, PDR	SOT-25	28dc4	DC1	6g	Tor
TB3	XC9225A1D6M	DC/DC-IC	PWM step-down, 600kHz, 1.35V±1%, 600mA, +CE	SOT-25	28dc4	DC1	6g	Tor
TB3	XC9225B1D6M	DC/DC-IC	PWM step-down, 600kHz, 1.35V±1%, 600mA, -CE	SOT-25	28dc4	DC1	6g	Tor



SMD code	Type	Function	Short description	Case	Pinout	Sch.	St.	Mnf.
TBL	XC9225B1LCM	DC/DC-IC	PWM step-down, 1.2MHz, 1.85V±1%, 600mA, -CE	SOT-25	28dc4	DC1	6g	Tor
TBL	XC9225C1LCM	DC/DC-IC	PWM step-down, 1.2MHz, 1.85V±1%, 600mA, +CE, PDR	SOT-25	28dc4	DC1	6g	Tor
TBL	XC9225D1LCM	DC/DC-IC	PWM step-down, 1.2MHz, 1.85V±1%, 600mA, -CE, PDR	SOT-25	28dc4	DC1	6g	Tor
TBM	R3118N411C	Vdet-IC	4.1V±1.5%, -Reset PPO, Sense	SOT-23-5	28z4	VD15	6g	Ric
TBM	XC9225A1MCM	DC/DC-IC	PWM step-down, 1.2MHz, 1.95V±1%, 600mA, +CE	SOT-25	28dc4	DC1	6g	Tor
TBM	XC9225B1MCM	DC/DC-IC	PWM step-down, 1.2MHz, 1.95V±1%, 600mA, -CE	SOT-25	28dc4	DC1	6g	Tor
TBM	XC9225C1MCM	DC/DC-IC	PWM step-down, 1.2MHz, 1.95V±1%, 600mA, +CE, PDR	SOT-25	28dc4	DC1	6g	Tor
TBM	XC9225D1MCM	DC/DC-IC	PWM step-down, 1.2MHz, 1.95V±1%, 600mA, -CE, PDR	SOT-25	28dc4	DC1	6g	Tor
TBN	R3118N421C	Vdet-IC	4.2V±1.5%, -Reset PPO, Sense	SOT-23-5	28z4	VD15	6g	Ric
TBP	R3118N431C	Vdet-IC	4.3V±1.5%, -Reset PPO, Sense	SOT-23-5	28z4	VD15	6g	Ric
TBQ	R3118N441C	Vdet-IC	4.4V±1.5%, -Reset PPO, Sense	SOT-23-5	28z4	VD15	6g	Ric
TBR	R3118N451C	Vdet-IC	4.5V±1.5%, -Reset PPO, Sense	SOT-23-5	28z4	VD15	6g	Ric
TBS	R3118N461C	Vdet-IC	4.6V±1.5%, -Reset PPO, Sense	SOT-23-5	28z4	VD15	6g	Ric
TBT	R3118N471C	Vdet-IC	4.7V±1.5%, -Reset PPO, Sense	SOT-23-5	28z4	VD15	6g	Ric
TBU	R3118N481C	Vdet-IC	4.8V±1.5%, -Reset PPO, Sense	SOT-23-5	28z4	VD15	6g	Ric
TBV	R3118N491C	Vdet-IC	4.9V±1.5%, -Reset PPO, Sense	SOT-23-5	28z4	VD15	6g	Ric
TBW	R3118N501C	Vdet-IC	5.0V±1.5%, -Reset PPO, Sense	SOT-23-5	28z4	VD15	6g	Ric
TC	74HCT1G04GW	CMOS-Logic	Inverter	SOT-353	28/Log6	-	6a	Phi
TC	BD45365G	Vdet-IC	3.6V, -Reset ODO, 500ms	SSOP-5	28vdp	VD6	6c	Rhm
TC	HD74LV1GT126ACM	CMOS-Logic	Bus buffer gate with 3-state output	CMPAK-5	28/Log13	-	6a	Ren
TC	HD74LV1GT126AVS	CMOS-Logic	Bus buffer gate with 3-state output	VSON-5	30/Log13	-	6a	Ren
TC	KIC7SZ04FU	CMOS-Logic	Inverter	SOT-353	28/Log6	-	6a	Kec
TC0	XC9225A2A6M	DC/DC-IC	PWM step-down, 600kHz, 2.05V±1%, 600mA, +CE	SOT-25	28dc4	DC1	6g	Tor
TC0	XC9225B2A6M	DC/DC-IC	PWM step-down, 600kHz, 2.05V±1%, 600mA, -CE	SOT-25	28dc4	DC1	6g	Tor
TC0	XC9225C2A6M	DC/DC-IC	PWM step-down, 600kHz, 2.05V±1%, 600mA, +CE, PDR	SOT-25	28dc4	DC1	6g	Tor
TC0	XC9225D2A6M	DC/DC-IC	PWM step-down, 600kHz, 2.05V±1%, 600mA, -CE, PDR	SOT-25	28dc4	DC1	6g	Tor
TC1	XC9225A2B6M	DC/DC-IC	PWM step-down, 600kHz, 2.15V±1%, 600mA, +CE	SOT-25	28dc4	DC1	6g	Tor
TC1	XC9225B2B6M	DC/DC-IC	PWM step-down, 600kHz, 2.15V±1%, 600mA, -CE	SOT-25	28dc4	DC1	6g	Tor
TC1	XC9225C2B6M	DC/DC-IC	PWM step-down, 600kHz, 2.15V±1%, 600mA, +CE, PDR	SOT-25	28dc4	DC1	6g	Tor
TC1	XC9225D2B6M	DC/DC-IC	PWM step-down, 600kHz, 2.15V±1%, 600mA, -CE, PDR	SOT-25	28dc4	DC1	6g	Tor
TC2	XC9225A2C6M	DC/DC-IC	PWM step-down, 600kHz, 2.25V±1%, 600mA, +CE	SOT-25	28dc4	DC1	6g	Tor
TC2	XC9225B2C6M	DC/DC-IC	PWM step-down, 600kHz, 2.25V±1%, 600mA, -CE	SOT-25	28dc4	DC1	6g	Tor
TC2	XC9225C2C6M	DC/DC-IC	PWM step-down, 600kHz, 2.25V±1%, 600mA, +CE, PDR	SOT-25	28dc4	DC1	6g	Tor
TC2	XC9225D2C6M	DC/DC-IC	PWM step-down, 600kHz, 2.25V±1%, 600mA, -CE, PDR	SOT-25	28dc4	DC1	6g	Tor
TC3	XC9225A2D6M	DC/DC-IC	PWM step-down, 600kHz, 2.35V±1%, 600mA, +CE	SOT-25	28dc4	DC1	6g	Tor
TC3	XC9225B2D6M	DC/DC-IC	PWM step-down, 600kHz, 2.35V±1%, 600mA, -CE	SOT-25	28dc4	DC1	6g	Tor
TC3	XC9225C2D6M	DC/DC-IC	PWM step-down, 600kHz, 2.35V±1%, 600mA, +CE, PDR	SOT-25	28dc4	DC1	6g	Tor
TC3	XC9225D2D6M	DC/DC-IC	PWM step-down, 600kHz, 2.35V±1%, 600mA, -CE, PDR	SOT-25	28dc4	DC1	6g	Tor
TC4	XC9225A2E6M	DC/DC-IC	PWM step-down, 600kHz, 2.45V±1%, 600mA, +CE	SOT-25	28dc4	DC1	6g	Tor
TC4	XC9225B2E6M	DC/DC-IC	PWM step-down, 600kHz, 2.45V±1%, 600mA, -CE	SOT-25	28dc4	DC1	6g	Tor
TC4	XC9225C2E6M	DC/DC-IC	PWM step-down, 600kHz, 2.45V±1%, 600mA, +CE, PDR	SOT-25	28dc4	DC1	6g	Tor
TC4	XC9225D2E6M	DC/DC-IC	PWM step-down, 600kHz, 2.45V±1%, 600mA, -CE, PDR	SOT-25	28dc4	DC1	6g	Tor
TC5	XC9225A2F6M	DC/DC-IC	PWM step-down, 600kHz, 2.55V±1%, 600mA, +CE	SOT-25	28dc4	DC1	6g	Tor
TC5	XC9225B2F6M	DC/DC-IC	PWM step-down, 600kHz, 2.55V±1%, 600mA, -CE	SOT-25	28dc4	DC1	6g	Tor
TC5	XC9225C2F6M	DC/DC-IC	PWM step-down, 600kHz, 2.55V±1%, 600mA, +CE, PDR	SOT-25	28dc4	DC1	6g	Tor
TC5	XC9225D2F6M	DC/DC-IC	PWM step-down, 600kHz, 2.55V±1%, 600mA, -CE, PDR	SOT-25	28dc4	DC1	6g	Tor
TC6	XC9225A2H6M	DC/DC-IC	PWM step-down, 600kHz, 2.65V±1%, 600mA, +CE	SOT-25	28dc4	DC1	6g	Tor
TC6	XC9225B2H6M	DC/DC-IC	PWM step-down, 600kHz, 2.65V±1%, 600mA, -CE	SOT-25	28dc4	DC1	6g	Tor
TC6	XC9225C2H6M	DC/DC-IC	PWM step-down, 600kHz, 2.65V±1%, 600mA, +CE, PDR	SOT-25	28dc4	DC1	6g	Tor
TC6	XC9225D2H6M	DC/DC-IC	PWM step-down, 600kHz, 2.65V±1%, 600mA, -CE, PDR	SOT-25	28dc4	DC1	6g	Tor
TC7	XC9225A2K6M	DC/DC-IC	PWM step-down, 600kHz, 2.75V±1%, 600mA, +CE	SOT-25	28dc4	DC1	6g	Tor
TC7	XC9225B2K6M	DC/DC-IC	PWM step-down, 600kHz, 2.75V±1%, 600mA, -CE	SOT-25	28dc4	DC1	6g	Tor
TC7	XC9225C2K6M	DC/DC-IC	PWM step-down, 600kHz, 2.75V±1%, 600mA, +CE, PDR	SOT-25	28dc4	DC1	6g	Tor
TC7	XC9225D2K6M	DC/DC-IC	PWM step-down, 600kHz, 2.75V±1%, 600mA, -CE, PDR	SOT-25	28dc4	DC1	6g	Tor
TC8	XC9225A2L6M	DC/DC-IC	PWM step-down, 600kHz, 2.85V±1%, 600mA, +CE	SOT-25	28dc4	DC1	6g	Tor
TC8	XC9225B2L6M	DC/DC-IC	PWM step-down, 600kHz, 2.85V±1%, 600mA, -CE	SOT-25	28dc4	DC1	6g	Tor
TC8	XC9225C2L6M	DC/DC-IC	PWM step-down, 600kHz, 2.85V±1%, 600mA, +CE, PDR	SOT-25	28dc4	DC1	6g	Tor
TC8	XC9225D2L6M	DC/DC-IC	PWM step-down, 600kHz, 2.85V±1%, 600mA, -CE, PDR	SOT-25	28dc4	DC1	6g	Tor
TC9	XC9225A2M6M	DC/DC-IC	PWM step-down, 600kHz, 2.95V±1%, 600mA, +CE	SOT-25	28dc4	DC1	6g	Tor
TC9	XC9225B2M6M	DC/DC-IC	PWM step-down, 600kHz, 2.95V±1%, 600mA, -CE	SOT-25	28dc4	DC1	6g	Tor
TC9	XC9225C2M6M	DC/DC-IC	PWM step-down, 600kHz, 2.95V±1%, 600mA, +CE, PDR	SOT-25	28dc4	DC1	6g	Tor
TC9	XC9225D2M6M	DC/DC-IC	PWM step-down, 600kHz, 2.95V±1%, 600mA, -CE, PDR	SOT-25	28dc4	DC1	6g	Tor
TCa	XC9225A2ACM	DC/DC-IC	PWM step-down, 1.2MHz, 2.05V±1%, 600mA, +CE	SOT-25	28dc4	DC1	6g	Tor
TCa	XC9225B2ACM	DC/DC-IC	PWM step-down, 1.2MHz, 2.05V±1%, 600mA, -CE	SOT-25	28dc4	DC1	6g	Tor
TCa	XC9225C2ACM	DC/DC-IC	PWM step-down, 1.2MHz, 2.05V±1%, 600mA, +CE, PDR	SOT-25	28dc4	DC1	6g	Tor
TCa	XC9225D2ACM	DC/DC-IC	PWM step-down, 1.2MHz, 2.05V±1%, 600mA, -CE, PDR	SOT-25	28dc4	DC1	6g	Tor
TCb	XC9225A2BCM	DC/DC-IC	PWM step-down, 1.2MHz, 2.15V±1%, 600mA, +CE	SOT-25	28dc4	DC1	6g	Tor
TCb	XC9225B2BCM	DC/DC-IC	PWM step-down, 1.2MHz, 2.15V±1%, 600mA, -CE	SOT-25	28dc4	DC1	6g	Tor
TCb	XC9225C2BCM	DC/DC-IC	PWM step-down, 1.2MHz, 2.15V±1%, 600mA, +CE, PDR	SOT-25	28dc4	DC1	6g	Tor
TCb	XC9225D2BCM	DC/DC-IC	PWM step-down, 1.2MHz, 2.15V±1%, 600mA, -CE, PDR	SOT-25	28dc4	DC1	6g	Tor



SMD code	Type	Function	Short description	Case	Pinout	Sch.	St.	Mnf.
TDD	XC9225B3DCM	DC/DC-IC	PWM step-down, 1.2MHz, 3.35V±1%, 600mA, -CE	SOT-25	28dc4	DC1	6g	Tor
TDD	XC9225C3DCM	DC/DC-IC	PWM step-down, 1.2MHz, 3.35V±1%, 600mA, +CE, PDR	SOT-25	28dc4	DC1	6g	Tor
TDD	XC9225D3DCM	DC/DC-IC	PWM step-down, 1.2MHz, 3.35V±1%, 600mA, -CE, PDR	SOT-25	28dc4	DC1	6g	Tor
TDD	XC9225E3DCM	DC/DC-IC	PWM step-down, 1.2MHz, 3.35V±1%, 900mA, +CE	SOT-25	28dc4	DC1	6g	Tor
TDD	XC9225F3DCM	DC/DC-IC	PWM step-down, 1.2MHz, 3.35V±1%, 900mA, -CE	SOT-25	28dc4	DC1	6g	Tor
TDD	XC9225G3DCM	DC/DC-IC	PWM step-down, 1.2MHz, 3.35V±1%, 900mA, +CE, PDR	SOT-25	28dc4	DC1	6g	Tor
TDD	XC9225H3DCM	DC/DC-IC	PWM step-down, 1.2MHz, 3.35V±1%, 900mA, -CE, PDR	SOT-25	28dc4	DC1	6g	Tor
TDE	XC9225A3ECM	DC/DC-IC	PWM step-down, 1.2MHz, 3.45V±1%, 600mA, +CE	SOT-25	28dc4	DC1	6g	Tor
TDE	XC9225B3ECM	DC/DC-IC	PWM step-down, 1.2MHz, 3.45V±1%, 600mA, -CE	SOT-25	28dc4	DC1	6g	Tor
TDE	XC9225C3ECM	DC/DC-IC	PWM step-down, 1.2MHz, 3.45V±1%, 600mA, +CE, PDR	SOT-25	28dc4	DC1	6g	Tor
TDE	XC9225D3ECM	DC/DC-IC	PWM step-down, 1.2MHz, 3.45V±1%, 600mA, -CE, PDR	SOT-25	28dc4	DC1	6g	Tor
TDE	XC9225E3ECM	DC/DC-IC	PWM step-down, 1.2MHz, 3.45V±1%, 900mA, +CE	SOT-25	28dc4	DC1	6g	Tor
TDE	XC9225F3ECM	DC/DC-IC	PWM step-down, 1.2MHz, 3.45V±1%, 900mA, -CE	SOT-25	28dc4	DC1	6g	Tor
TDE	XC9225G3ECM	DC/DC-IC	PWM step-down, 1.2MHz, 3.45V±1%, 900mA, +CE, PDR	SOT-25	28dc4	DC1	6g	Tor
TDE	XC9225H3ECM	DC/DC-IC	PWM step-down, 1.2MHz, 3.45V±1%, 900mA, -CE, PDR	SOT-25	28dc4	DC1	6g	Tor
TDF	XC9225A3FCM	DC/DC-IC	PWM step-down, 1.2MHz, 3.55V±1%, 600mA, +CE	SOT-25	28dc4	DC1	6g	Tor
TDF	XC9225B3FCM	DC/DC-IC	PWM step-down, 1.2MHz, 3.55V±1%, 600mA, -CE	SOT-25	28dc4	DC1	6g	Tor
TDF	XC9225C3FCM	DC/DC-IC	PWM step-down, 1.2MHz, 3.55V±1%, 600mA, +CE, PDR	SOT-25	28dc4	DC1	6g	Tor
TDF	XC9225D3FCM	DC/DC-IC	PWM step-down, 1.2MHz, 3.55V±1%, 600mA, -CE, PDR	SOT-25	28dc4	DC1	6g	Tor
TDF	XC9225E3FCM	DC/DC-IC	PWM step-down, 1.2MHz, 3.55V±1%, 900mA, +CE	SOT-25	28dc4	DC1	6g	Tor
TDF	XC9225F3FCM	DC/DC-IC	PWM step-down, 1.2MHz, 3.55V±1%, 900mA, -CE	SOT-25	28dc4	DC1	6g	Tor
TDF	XC9225G3FCM	DC/DC-IC	PWM step-down, 1.2MHz, 3.55V±1%, 900mA, +CE, PDR	SOT-25	28dc4	DC1	6g	Tor
TDF	XC9225H3FCM	DC/DC-IC	PWM step-down, 1.2MHz, 3.55V±1%, 900mA, -CE, PDR	SOT-25	28dc4	DC1	6g	Tor
TDH	XC9225A3HCM	DC/DC-IC	PWM step-down, 1.2MHz, 3.65V±1%, 600mA, +CE	SOT-25	28dc4	DC1	6g	Tor
TDH	XC9225B3HCM	DC/DC-IC	PWM step-down, 1.2MHz, 3.65V±1%, 600mA, -CE	SOT-25	28dc4	DC1	6g	Tor
TDH	XC9225C3HCM	DC/DC-IC	PWM step-down, 1.2MHz, 3.65V±1%, 600mA, +CE, PDR	SOT-25	28dc4	DC1	6g	Tor
TDH	XC9225D3HCM	DC/DC-IC	PWM step-down, 1.2MHz, 3.65V±1%, 600mA, -CE, PDR	SOT-25	28dc4	DC1	6g	Tor
TDH	XC9225E3HCM	DC/DC-IC	PWM step-down, 1.2MHz, 3.65V±1%, 900mA, +CE	SOT-25	28dc4	DC1	6g	Tor
TDH	XC9225F3HCM	DC/DC-IC	PWM step-down, 1.2MHz, 3.65V±1%, 900mA, -CE	SOT-25	28dc4	DC1	6g	Tor
TDH	XC9225G3HCM	DC/DC-IC	PWM step-down, 1.2MHz, 3.65V±1%, 900mA, +CE, PDR	SOT-25	28dc4	DC1	6g	Tor
TDH	XC9225H3HCM	DC/DC-IC	PWM step-down, 1.2MHz, 3.65V±1%, 900mA, -CE, PDR	SOT-25	28dc4	DC1	6g	Tor
TDK	XC9225A3KCM	DC/DC-IC	PWM step-down, 1.2MHz, 3.75V±1%, 600mA, +CE	SOT-25	28dc4	DC1	6g	Tor
TDK	XC9225B3KCM	DC/DC-IC	PWM step-down, 1.2MHz, 3.75V±1%, 600mA, -CE	SOT-25	28dc4	DC1	6g	Tor
TDK	XC9225C3KCM	DC/DC-IC	PWM step-down, 1.2MHz, 3.75V±1%, 600mA, +CE, PDR	SOT-25	28dc4	DC1	6g	Tor
TDK	XC9225D3KCM	DC/DC-IC	PWM step-down, 1.2MHz, 3.75V±1%, 600mA, -CE, PDR	SOT-25	28dc4	DC1	6g	Tor
TDK	XC9225E3KCM	DC/DC-IC	PWM step-down, 1.2MHz, 3.75V±1%, 900mA, +CE	SOT-25	28dc4	DC1	6g	Tor
TDK	XC9225F3KCM	DC/DC-IC	PWM step-down, 1.2MHz, 3.75V±1%, 900mA, -CE	SOT-25	28dc4	DC1	6g	Tor
TDK	XC9225G3KCM	DC/DC-IC	PWM step-down, 1.2MHz, 3.75V±1%, 900mA, +CE, PDR	SOT-25	28dc4	DC1	6g	Tor
TDK	XC9225H3KCM	DC/DC-IC	PWM step-down, 1.2MHz, 3.75V±1%, 900mA, -CE, PDR	SOT-25	28dc4	DC1	6g	Tor
TDL	XC9225A3LCM	DC/DC-IC	PWM step-down, 1.2MHz, 3.85V±1%, 600mA, +CE	SOT-25	28dc4	DC1	6g	Tor
TDL	XC9225B3LCM	DC/DC-IC	PWM step-down, 1.2MHz, 3.85V±1%, 600mA, -CE	SOT-25	28dc4	DC1	6g	Tor
TDL	XC9225C3LCM	DC/DC-IC	PWM step-down, 1.2MHz, 3.85V±1%, 600mA, +CE, PDR	SOT-25	28dc4	DC1	6g	Tor
TDL	XC9225D3LCM	DC/DC-IC	PWM step-down, 1.2MHz, 3.85V±1%, 600mA, -CE, PDR	SOT-25	28dc4	DC1	6g	Tor
TDL	XC9225E3LCM	DC/DC-IC	PWM step-down, 1.2MHz, 3.85V±1%, 900mA, +CE	SOT-25	28dc4	DC1	6g	Tor
TDL	XC9225F3LCM	DC/DC-IC	PWM step-down, 1.2MHz, 3.85V±1%, 900mA, -CE	SOT-25	28dc4	DC1	6g	Tor
TDL	XC9225G3LCM	DC/DC-IC	PWM step-down, 1.2MHz, 3.85V±1%, 900mA, +CE, PDR	SOT-25	28dc4	DC1	6g	Tor
TDL	XC9225H3LCM	DC/DC-IC	PWM step-down, 1.2MHz, 3.85V±1%, 900mA, -CE, PDR	SOT-25	28dc4	DC1	6g	Tor
TDM	XC9225A3MCM	DC/DC-IC	PWM step-down, 1.2MHz, 3.95V±1%, 600mA, +CE	SOT-25	28dc4	DC1	6g	Tor
TDM	XC9225B3MCM	DC/DC-IC	PWM step-down, 1.2MHz, 3.95V±1%, 600mA, -CE	SOT-25	28dc4	DC1	6g	Tor
TDM	XC9225C3MCM	DC/DC-IC	PWM step-down, 1.2MHz, 3.95V±1%, 600mA, +CE, PDR	SOT-25	28dc4	DC1	6g	Tor
TDM	XC9225D3MCM	DC/DC-IC	PWM step-down, 1.2MHz, 3.95V±1%, 600mA, -CE, PDR	SOT-25	28dc4	DC1	6g	Tor
TDM	XC9225E3MCM	DC/DC-IC	PWM step-down, 1.2MHz, 3.95V±1%, 900mA, +CE	SOT-25	28dc4	DC1	6g	Tor
TDM	XC9225F3MCM	DC/DC-IC	PWM step-down, 1.2MHz, 3.95V±1%, 900mA, -CE	SOT-25	28dc4	DC1	6g	Tor
TDM	XC9225G3MCM	DC/DC-IC	PWM step-down, 1.2MHz, 3.95V±1%, 900mA, +CE, PDR	SOT-25	28dc4	DC1	6g	Tor
TDM	XC9225H3MCM	DC/DC-IC	PWM step-down, 1.2MHz, 3.95V±1%, 900mA, -CE, PDR	SOT-25	28dc4	DC1	6g	Tor
TE	74HCT1G08GW	CMOS-Logic	2-input AND gate	SOT-353	28/Log3	-	6a	Phi
TE	BD45345G	Vdet-IC	3.4V, -Reset ODO, 500ms	SSOP-5	28vdp	VD6	6c	Rhm
TE	KIC7S208FU	CMOS-Logic	2-input AND gate	SOT-353	28/Log3	-	6a	Kec
TF	74HCT1G14GW	CMOS-Logic	Inverting Schmitt-trigger	SOT-353	28/Log7	-	6a	Phi
TF	BD45335G	Vdet-IC	3.3V, -Reset ODO, 500ms	SSOP-5	28vdp	VD6	6c	Rhm
TF	KIC7S214FU	CMOS-Logic	Inverting Schmitt-trigger	SOT-353	28/Log7	-	6a	Kec
TF6	U74HC1G66L-AF5	CMOS-Logic	Bilateral analogic switch	SOT-23-5	28/Log16	-	6a	Ulc
TF6L	U74HC1G66L-AF5	CMOS-Logic	Bilateral analogic switch	SOT-23-5	28/Log16	-	6a	Ulc
TF6L	U74HC1G66G-AF5	CMOS-Logic	Bilateral analogic switch	SOT-23-5	28/Log16	-	6a	Ulc
TG	74HCT1G32GW	CMOS-Logic	2-input OR gate	SOT-353	28/Log4	-	6a	Phi
TG	BD45325G	Vdet-IC	3.2V, -Reset ODO, 500ms	SSOP-5	28vdp	VD6	6c	Rhm
TG	KIC7S232FU	CMOS-Logic	2-input OR gate	SOT-353	28/Log4	-	6a	Kec
TH	74HCT1G86GW	CMOS-Logic	2-input EXCLUSIVE-OR gate	SOT-353	28/Log5	-	6a	Phi
TH	BD45315G	Vdet-IC	3.1V, -Reset ODO, 500ms	SSOP-5	28vdp	VD6	6c	Rhm
TH	KIC7S266FU	CMOS-Logic	Bilateral analogic switch	SOT-353	28/Log16	-	6a	Kec



SMD code	Type	Function	Short description	Case	Pinout	Sch.	St.	Mnf.
TJ	BD45305G	Vdet-IC	3V, -Reset ODO, 500ms	SSOP-5	28vdp	VD6	6c	Rhm
TJ	KIC7SZ86FU	CMOS-Logic	2-input EXCLUSIVE-OR gate	SOT-353	28/Log5	-	6a	Kec
TK	BD45295G	Vdet-IC	2.9V, -Reset ODO, 500ms	SSOP-5	28vdp	VD6	6c	Rhm
TK	KIC7SZ125FU	CMOS-Logic	Bus buffer gate with 3-state output	SOT-353	28/Log14	-	6a	Kec
TL	74HCT1G66GW	CMOS-Logic	Bilateral analogic switch	SOT-353	28/Log16	-	6a	Phi
TL	BD45285G	Vdet-IC	2.8V, -Reset ODO, 500ms	SSOP-5	28vdp	VD6	6c	Rhm
TL	KIC7SZ126FU	CMOS-Logic	Bus buffer gate with 3-state output	SOT-353	28/Log13	-	6a	Kec
TL	R1122N401B	LVR-IC	LDO, LN, +CE, 4V±2%, 150mA	SOT-23-5	28vt	VR4	6g	Ric
TM	74HCT1G125GW	CMOS-Logic	Bus buffer gate with 3-state output	SOT-353	28/Log14	-	6a	Phi
TM	BD45275G	Vdet-IC	2.7V, -Reset ODO, 500ms	SSOP-5	28vdp	VD6	6c	Rhm
TM	R1122N411B	LVR-IC	LDO, LN, +CE, 4.1V±2%, 150mA	SOT-23-5	28vt	VR4	6g	Ric
TN	74HCT1G126GW	CMOS-Logic	Bus buffer gate with 3-state output	SOT-353	28/Log13	-	6a	Phi
TN	BD45265G	Vdet-IC	2.6V, -Reset ODO, 500ms	SSOP-5	28vdp	VD6	6c	Rhm
TN	KIC7SZ38FU	CMOS-Logic	2-input NAND gate (ODO)	SOT-353	28/Log17	-	6a	Kec
TN	KIC7SZU04FU	CMOS-Logic	Inverter	SOT-353	28/Log6	-	6a	Kec
TN	R1122N421B	LVR-IC	LDO, LN, +CE, 4.2V±2%, 150mA	SOT-23-5	28vt	VR4	6g	Ric
TP	BD45255G	Vdet-IC	2.5V, -Reset ODO, 500ms	SSOP-5	28vdp	VD6	6c	Rhm
TP	R1122N431B	LVR-IC	LDO, LN, +CE, 4.3V±2%, 150mA	SOT-23-5	28vt	VR4	6g	Ric
TP10A	ML6209A192M	LVR-IC	LDO, 1.9V±3%, 150mA, +CE, CL	SOT-23-5	28cx	VR4	6a	Mlc
TP10B	ML6209B192M	LVR-IC	LDO, 1.9V±3%, 150mA, +CE	SOT-23-5	28cx	VR4	6a	Mlc
TP10C	ML6209C192M	LVR-IC	LDO, 1.9V±3%, 150mA, -CE, CL	SOT-23-5	28cx	VR4	6a	Mlc
TP10D	ML6209D192M	LVR-IC	LDO, 1.9V±3%, 150mA, -CE	SOT-23-5	28cx	VR4	6a	Mlc
TP15A	ML6209A152M	LVR-IC	LDO, 1.5V±3%, 150mA, +CE, CL	SOT-23-5	28cx	VR4	6a	Mlc
TP15B	ML6209B152M	LVR-IC	LDO, 1.5V±3%, 150mA, +CE	SOT-23-5	28cx	VR4	6a	Mlc
TP15C	ML6209C152M	LVR-IC	LDO, 1.5V±3%, 150mA, -CE, CL	SOT-23-5	28cx	VR4	6a	Mlc
TP15D	ML6209D152M	LVR-IC	LDO, 1.5V±3%, 150mA, -CE	SOT-23-5	28cx	VR4	6a	Mlc
TP16A	ML6209A162M	LVR-IC	LDO, 1.6V±3%, 150mA, +CE, CL	SOT-23-5	28cx	VR4	6a	Mlc
TP16B	ML6209B162M	LVR-IC	LDO, 1.6V±3%, 150mA, +CE	SOT-23-5	28cx	VR4	6a	Mlc
TP16C	ML6209C162M	LVR-IC	LDO, 1.6V±3%, 150mA, -CE, CL	SOT-23-5	28cx	VR4	6a	Mlc
TP16D	ML6209D162M	LVR-IC	LDO, 1.6V±3%, 150mA, -CE	SOT-23-5	28cx	VR4	6a	Mlc
TP17A	ML6209A172M	LVR-IC	LDO, 1.7V±3%, 150mA, +CE, CL	SOT-23-5	28cx	VR4	6a	Mlc
TP17B	ML6209B172M	LVR-IC	LDO, 1.7V±3%, 150mA, +CE	SOT-23-5	28cx	VR4	6a	Mlc
TP17C	ML6209C172M	LVR-IC	LDO, 1.7V±3%, 150mA, -CE, CL	SOT-23-5	28cx	VR4	6a	Mlc
TP17D	ML6209D172M	LVR-IC	LDO, 1.7V±3%, 150mA, -CE	SOT-23-5	28cx	VR4	6a	Mlc
TP19A	ML6209A182M	LVR-IC	LDO, 1.8V±3%, 150mA, +CE, CL	SOT-23-5	28cx	VR4	6a	Mlc
TP19B	ML6209B182M	LVR-IC	LDO, 1.8V±3%, 150mA, +CE	SOT-23-5	28cx	VR4	6a	Mlc
TP19C	ML6209C182M	LVR-IC	LDO, 1.8V±3%, 150mA, -CE, CL	SOT-23-5	28cx	VR4	6a	Mlc
TP19D	ML6209D182M	LVR-IC	LDO, 1.8V±3%, 150mA, -CE	SOT-23-5	28cx	VR4	6a	Mlc
TP1FA	ML6209A15AM	LVR-IC	LDO, 1.55V±3%, 150mA, +CE, CL	SOT-23-5	28cx	VR4	6a	Mlc
TP1FB	ML6209B15AM	LVR-IC	LDO, 1.55V±3%, 150mA, +CE	SOT-23-5	28cx	VR4	6a	Mlc
TP1FC	ML6209C15AM	LVR-IC	LDO, 1.55V±3%, 150mA, -CE, CL	SOT-23-5	28cx	VR4	6a	Mlc
TP1FD	ML6209D15AM	LVR-IC	LDO, 1.55V±3%, 150mA, -CE	SOT-23-5	28cx	VR4	6a	Mlc
TP1GA	ML6209A16AM	LVR-IC	LDO, 1.65V±3%, 150mA, +CE, CL	SOT-23-5	28cx	VR4	6a	Mlc
TP1GB	ML6209B16AM	LVR-IC	LDO, 1.65V±3%, 150mA, +CE	SOT-23-5	28cx	VR4	6a	Mlc
TP1GC	ML6209C16AM	LVR-IC	LDO, 1.65V±3%, 150mA, -CE, CL	SOT-23-5	28cx	VR4	6a	Mlc
TP1GD	ML6209D16AM	LVR-IC	LDO, 1.65V±3%, 150mA, -CE	SOT-23-5	28cx	VR4	6a	Mlc
TP1HA	ML6209A17AM	LVR-IC	LDO, 1.75V±3%, 150mA, +CE, CL	SOT-23-5	28cx	VR4	6a	Mlc
TP1HB	ML6209B17AM	LVR-IC	LDO, 1.75V±3%, 150mA, +CE	SOT-23-5	28cx	VR4	6a	Mlc
TP1HC	ML6209C17AM	LVR-IC	LDO, 1.75V±3%, 150mA, -CE, CL	SOT-23-5	28cx	VR4	6a	Mlc
TP1HD	ML6209D17AM	LVR-IC	LDO, 1.75V±3%, 150mA, -CE	SOT-23-5	28cx	VR4	6a	Mlc
TP1IA	ML6209A18AM	LVR-IC	LDO, 1.85V±3%, 150mA, +CE, CL	SOT-23-5	28cx	VR4	6a	Mlc
TP1IB	ML6209B18AM	LVR-IC	LDO, 1.85V±3%, 150mA, +CE	SOT-23-5	28cx	VR4	6a	Mlc
TP1IC	ML6209C18AM	LVR-IC	LDO, 1.85V±3%, 150mA, -CE, CL	SOT-23-5	28cx	VR4	6a	Mlc
TP1ID	ML6209D18AM	LVR-IC	LDO, 1.85V±3%, 150mA, -CE	SOT-23-5	28cx	VR4	6a	Mlc
TP1JA	ML6209A19AM	LVR-IC	LDO, 1.95V±3%, 150mA, +CE, CL	SOT-23-5	28cx	VR4	6a	Mlc
TP1JB	ML6209B19AM	LVR-IC	LDO, 1.95V±3%, 150mA, +CE	SOT-23-5	28cx	VR4	6a	Mlc
TP1JC	ML6209C19AM	LVR-IC	LDO, 1.95V±3%, 150mA, -CE, CL	SOT-23-5	28cx	VR4	6a	Mlc
TP1JD	ML6209D19AM	LVR-IC	LDO, 1.95V±3%, 150mA, -CE	SOT-23-5	28cx	VR4	6a	Mlc
TP20A	ML6209A202M	LVR-IC	LDO, 2.0V±2%, 150mA, +CE, CL	SOT-23-5	28cx	VR4	6a	Mlc
TP20B	ML6209B202M	LVR-IC	LDO, 2.0V±2%, 150mA, +CE	SOT-23-5	28cx	VR4	6a	Mlc
TP20C	ML6209C202M	LVR-IC	LDO, 2.0V±2%, 150mA, -CE, CL	SOT-23-5	28cx	VR4	6a	Mlc
TP20D	ML6209D202M	LVR-IC	LDO, 2.0V±2%, 150mA, -CE	SOT-23-5	28cx	VR4	6a	Mlc
TP21A	ML6209A212M	LVR-IC	LDO, 2.1V±2%, 150mA, +CE, CL	SOT-23-5	28cx	VR4	6a	Mlc
TP21B	ML6209B212M	LVR-IC	LDO, 2.1V±2%, 150mA, +CE	SOT-23-5	28cx	VR4	6a	Mlc
TP21C	ML6209C212M	LVR-IC	LDO, 2.1V±2%, 150mA, -CE, CL	SOT-23-5	28cx	VR4	6a	Mlc
TP21D	ML6209D212M	LVR-IC	LDO, 2.1V±2%, 150mA, -CE	SOT-23-5	28cx	VR4	6a	Mlc
TP22A	ML6209A222M	LVR-IC	LDO, 2.2V±2%, 150mA, +CE, CL	SOT-23-5	28cx	VR4	6a	Mlc
TP22B	ML6209B222M	LVR-IC	LDO, 2.2V±2%, 150mA, +CE	SOT-23-5	28cx	VR4	6a	Mlc
TP22C	ML6209C222M	LVR-IC	LDO, 2.2V±2%, 150mA, -CE, CL	SOT-23-5	28cx	VR4	6a	Mlc
TP22D	ML6209D222M	LVR-IC	LDO, 2.2V±2%, 150mA, -CE	SOT-23-5	28cx	VR4	6a	Mlc



SMD code	Type	Function	Short description	Case	Pinout	Sch.	St.	Mnf.
TP5DA	ML6209A53AM	LVR-IC	LDO, 5.35V±2%, 150mA, +CE, CL	SOT-23-5	28cx	VR4	6a	Mlc
TP5DB	ML6209B53AM	LVR-IC	LDO, 5.35V±2%, 150mA, +CE	SOT-23-5	28cx	VR4	6a	Mlc
TP5DC	ML6209C53AM	LVR-IC	LDO, 5.35V±2%, 150mA, -CE, CL	SOT-23-5	28cx	VR4	6a	Mlc
TP5DD	ML6209D53AM	LVR-IC	LDO, 5.35V±2%, 150mA, -CE	SOT-23-5	28cx	VR4	6a	Mlc
TP5EA	ML6209A54AM	LVR-IC	LDO, 5.45V±2%, 150mA, +CE, CL	SOT-23-5	28cx	VR4	6a	Mlc
TP5EB	ML6209B54AM	LVR-IC	LDO, 5.45V±2%, 150mA, +CE	SOT-23-5	28cx	VR4	6a	Mlc
TP5EC	ML6209C54AM	LVR-IC	LDO, 5.45V±2%, 150mA, -CE, CL	SOT-23-5	28cx	VR4	6a	Mlc
TP5ED	ML6209D54AM	LVR-IC	LDO, 5.45V±2%, 150mA, -CE	SOT-23-5	28cx	VR4	6a	Mlc
TP5FA	ML6209A55AM	LVR-IC	LDO, 5.55V±2%, 150mA, +CE, CL	SOT-23-5	28cx	VR4	6a	Mlc
TP5FB	ML6209B55AM	LVR-IC	LDO, 5.55V±2%, 150mA, +CE	SOT-23-5	28cx	VR4	6a	Mlc
TP5FC	ML6209C55AM	LVR-IC	LDO, 5.55V±2%, 150mA, -CE, CL	SOT-23-5	28cx	VR4	6a	Mlc
TP5FD	ML6209D55AM	LVR-IC	LDO, 5.55V±2%, 150mA, -CE	SOT-23-5	28cx	VR4	6a	Mlc
TP5GA	ML6209A56AM	LVR-IC	LDO, 5.65V±2%, 150mA, +CE, CL	SOT-23-5	28cx	VR4	6a	Mlc
TP5GB	ML6209B56AM	LVR-IC	LDO, 5.65V±2%, 150mA, +CE	SOT-23-5	28cx	VR4	6a	Mlc
TP5GC	ML6209C56AM	LVR-IC	LDO, 5.65V±2%, 150mA, -CE, CL	SOT-23-5	28cx	VR4	6a	Mlc
TP5GD	ML6209D56AM	LVR-IC	LDO, 5.65V±2%, 150mA, -CE	SOT-23-5	28cx	VR4	6a	Mlc
TP5HA	ML6209A57AM	LVR-IC	LDO, 5.75V±2%, 150mA, +CE, CL	SOT-23-5	28cx	VR4	6a	Mlc
TP5HB	ML6209B57AM	LVR-IC	LDO, 5.75V±2%, 150mA, +CE	SOT-23-5	28cx	VR4	6a	Mlc
TP5HC	ML6209C57AM	LVR-IC	LDO, 5.75V±2%, 150mA, -CE, CL	SOT-23-5	28cx	VR4	6a	Mlc
TP5HD	ML6209D57AM	LVR-IC	LDO, 5.75V±2%, 150mA, -CE	SOT-23-5	28cx	VR4	6a	Mlc
TP5IA	ML6209A58AM	LVR-IC	LDO, 5.85V±2%, 150mA, +CE, CL	SOT-23-5	28cx	VR4	6a	Mlc
TP5IB	ML6209B58AM	LVR-IC	LDO, 5.85V±2%, 150mA, +CE	SOT-23-5	28cx	VR4	6a	Mlc
TP5IC	ML6209C58AM	LVR-IC	LDO, 5.85V±2%, 150mA, -CE, CL	SOT-23-5	28cx	VR4	6a	Mlc
TP5ID	ML6209D58AM	LVR-IC	LDO, 5.85V±2%, 150mA, -CE	SOT-23-5	28cx	VR4	6a	Mlc
TP5JA	ML6209A59AM	LVR-IC	LDO, 5.95V±2%, 150mA, +CE, CL	SOT-23-5	28cx	VR4	6a	Mlc
TP5JB	ML6209B59AM	LVR-IC	LDO, 5.95V±2%, 150mA, +CE	SOT-23-5	28cx	VR4	6a	Mlc
TP5JC	ML6209C59AM	LVR-IC	LDO, 5.95V±2%, 150mA, -CE, CL	SOT-23-5	28cx	VR4	6a	Mlc
TP5JD	ML6209D59AM	LVR-IC	LDO, 5.95V±2%, 150mA, -CE	SOT-23-5	28cx	VR4	6a	Mlc
TP60A	ML6209A602M	LVR-IC	LDO, 6.0V±2%, 150mA, +CE, CL	SOT-23-5	28cx	VR4	6a	Mlc
TP60B	ML6209B602M	LVR-IC	LDO, 6.0V±2%, 150mA, +CE	SOT-23-5	28cx	VR4	6a	Mlc
TP60C	ML6209C602M	LVR-IC	LDO, 6.0V±2%, 150mA, -CE, CL	SOT-23-5	28cx	VR4	6a	Mlc
TP60D	ML6209D602M	LVR-IC	LDO, 6.0V±2%, 150mA, -CE	SOT-23-5	28cx	VR4	6a	Mlc
TQ	BD45245G	Vdet-IC	2.4V, -Reset ODO, 500ms	SSOP-5	28vdp	VD6	6c	Rhm
TQ	R1122N441B	LVR-IC	LDO, LN, +CE, 4.4V±2%, 150mA	SOT-23-5	28vt	VR4	6g	Ric
TR	BD45235G	Vdet-IC	2.3V, -Reset ODO, 500ms	SSOP-5	28vdp	VD6	6c	Rhm
TR	R1122N451B	LVR-IC	LDO, LN, +CE, 4.5V±2%, 150mA	SOT-23-5	28vt	VR4	6g	Ric
TS	BD45481G	Vdet-IC	4.8V, -Reset ODO, 100ms	SSOP-5	28vdp	VD6	6c	Rhm
TS	R1122N461B	LVR-IC	LDO, LN, +CE, 4.6V±2%, 150mA	SOT-23-5	28vt	VR4	6g	Ric
TT	BD45471G	Vdet-IC	4.7V, -Reset ODO, 100ms	SSOP-5	28vdp	VD6	6c	Rhm
TT	R1122N471B	LVR-IC	LDO, LN, +CE, 4.7V±2%, 150mA	SOT-23-5	28vt	VR4	6g	Ric
TU	BD45461G	Vdet-IC	4.6V, -Reset ODO, 100ms	SSOP-5	28vdp	VD6	6c	Rhm
TU	R1122N481B	LVR-IC	LDO, LN, +CE, 4.8V±2%, 150mA	SOT-23-5	28vt	VR4	6g	Ric
TV	BD45451G	Vdet-IC	4.5V, -Reset ODO, 100ms	SSOP-5	28vdp	VD6	6c	Rhm
TV	R1122N491B	LVR-IC	LDO, LN, +CE, 4.9V±2%, 150mA	SOT-23-5	28vt	VR4	6g	Ric
TVA	S-11L10B08-M5T1U	LVR-IC	LDO, 0.8V±15mV, 150mA, +CE, PDR	SOT-23-5	28cx	VR4	6g	Sii
TVB	S-11L10B09-M5T1U	LVR-IC	LDO, 0.9V±15mV, 150mA, +CE, PDR	SOT-23-5	28cx	VR4	6g	Sii
TVC	S-11L10B10-M5T1U	LVR-IC	LDO, 1.0V±15mV, 150mA, +CE, PDR	SOT-23-5	28cx	VR4	6g	Sii
TVD	S-11L10B11-M5T1U	LVR-IC	LDO, 1.1V±15mV, 150mA, +CE, PDR	SOT-23-5	28cx	VR4	6g	Sii
TVE	S-11L10B12-M5T1U	LVR-IC	LDO, 1.2V±15mV, 150mA, +CE, PDR	SOT-23-5	28cx	VR4	6g	Sii
TVF	S-11L10B13-M5T1U	LVR-IC	LDO, 1.3V±15mV, 150mA, +CE, PDR	SOT-23-5	28cx	VR4	6g	Sii
TVG	S-11L10B14-M5T1U	LVR-IC	LDO, 1.4V±15mV, 150mA, +CE, PDR	SOT-23-5	28cx	VR4	6g	Sii
TVH	S-11L10B15-M5T1U	LVR-IC	LDO, 1.5V±1.0%, 150mA, +CE, PDR	SOT-23-5	28cx	VR4	6g	Sii
TVI	S-11L10B16-M5T1U	LVR-IC	LDO, 1.6V±1.0%, 150mA, +CE, PDR	SOT-23-5	28cx	VR4	6g	Sii
TVJ	S-11L10B17-M5T1U	LVR-IC	LDO, 1.7V±1.0%, 150mA, +CE, PDR	SOT-23-5	28cx	VR4	6g	Sii
TVK	S-11L10B18-M5T1U	LVR-IC	LDO, 1.8V±1.0%, 150mA, +CE, PDR	SOT-23-5	28cx	VR4	6g	Sii
TVL	S-11L10B19-M5T1U	LVR-IC	LDO, 1.9V±1.0%, 150mA, +CE, PDR	SOT-23-5	28cx	VR4	6g	Sii
TVM	S-11L10B20-M5T1U	LVR-IC	LDO, 2.0V±1.0%, 150mA, +CE, PDR	SOT-23-5	28cx	VR4	6g	Sii
TVN	S-11L10B21-M5T1U	LVR-IC	LDO, 2.1V±1.0%, 150mA, +CE, PDR	SOT-23-5	28cx	VR4	6g	Sii
TVO	S-11L10B22-M5T1U	LVR-IC	LDO, 2.2V±1.0%, 150mA, +CE, PDR	SOT-23-5	28cx	VR4	6g	Sii
TVP	S-11L10B23-M5T1U	LVR-IC	LDO, 2.3V±1.0%, 150mA, +CE, PDR	SOT-23-5	28cx	VR4	6g	Sii
TVQ	S-11L10B24-M5T1U	LVR-IC	LDO, 2.4V±1.0%, 150mA, +CE, PDR	SOT-23-5	28cx	VR4	6g	Sii
TVR	S-11L10B25-M5T1U	LVR-IC	LDO, 2.5V±1.0%, 150mA, +CE, PDR	SOT-23-5	28cx	VR4	6g	Sii
TVS	S-11L10B26-M5T1U	LVR-IC	LDO, 2.6V±1.0%, 150mA, +CE, PDR	SOT-23-5	28cx	VR4	6g	Sii
TVT	S-11L10B27-M5T1U	LVR-IC	LDO, 2.7V±1.0%, 150mA, +CE, PDR	SOT-23-5	28cx	VR4	6g	Sii
TVU	S-11L10B28-M5T1U	LVR-IC	LDO, 2.8V±1.0%, 150mA, +CE, PDR	SOT-23-5	28cx	VR4	6g	Sii
TVV	S-11L10B29-M5T1U	LVR-IC	LDO, 2.9V±1.0%, 150mA, +CE, PDR	SOT-23-5	28cx	VR4	6g	Sii
TVW	S-11L10B30-M5T1U	LVR-IC	LDO, 3.0V±1.0%, 150mA, +CE, PDR	SOT-23-5	28cx	VR4	6g	Sii
TVX	S-11L10B31-M5T1U	LVR-IC	LDO, 3.1V±1.0%, 150mA, +CE, PDR	SOT-23-5	28cx	VR4	6g	Sii
TVY	S-11L10B32-M5T1U	LVR-IC	LDO, 3.2V±1.0%, 150mA, +CE, PDR	SOT-23-5	28cx	VR4	6g	Sii
TVZ	S-11L10B33-M5T1U	LVR-IC	LDO, 3.3V±1.0%, 150mA, +CE, PDR	SOT-23-5	28cx	VR4	6g	Sii



SMD code	Type	Function	Short description	Case	Pinout	Sch.	St.	Mnf.
TW	BD45441G	Vdet-IC	4.4V, -Reset ODO, 100ms	SSOP-5	28vdp	VD6	6c	Rhm
TX	BD45431G	Vdet-IC	4.3V, -Reset ODO, 100ms	SSOP-5	28vdp	VD6	6c	Rhm
TXA	S-11L10D08-M5T1U	LVR-IC	LDO, 0.8V±15mV, 150mA, +CE	SOT-23-5	28cx	VR4	6g	Sii
TXB	S-11L10D09-M5T1U	LVR-IC	LDO, 0.9V±15mV, 150mA, +CE	SOT-23-5	28cx	VR4	6g	Sii
TXC	S-11L10D10-M5T1U	LVR-IC	LDO, 1.0V±15mV, 150mA, +CE	SOT-23-5	28cx	VR4	6g	Sii
TXD	S-11L10D11-M5T1U	LVR-IC	LDO, 1.1V±15mV, 150mA, +CE	SOT-23-5	28cx	VR4	6g	Sii
TXE	S-11L10D12-M5T1U	LVR-IC	LDO, 1.2V±15mV, 150mA, +CE	SOT-23-5	28cx	VR4	6g	Sii
TXF	S-11L10D13-M5T1U	LVR-IC	LDO, 1.3V±15mV, 150mA, +CE	SOT-23-5	28cx	VR4	6g	Sii
TXG	S-11L10D14-M5T1U	LVR-IC	LDO, 1.4V±15mV, 150mA, +CE	SOT-23-5	28cx	VR4	6g	Sii
TXH	S-11L10D15-M5T1U	LVR-IC	LDO, 1.5V±1.0%, 150mA, +CE	SOT-23-5	28cx	VR4	6g	Sii
TXI	S-11L10D16-M5T1U	LVR-IC	LDO, 1.6V±1.0%, 150mA, +CE	SOT-23-5	28cx	VR4	6g	Sii
TXJ	S-11L10D17-M5T1U	LVR-IC	LDO, 1.7V±1.0%, 150mA, +CE	SOT-23-5	28cx	VR4	6g	Sii
TXK	S-11L10D18-M5T1U	LVR-IC	LDO, 1.8V±1.0%, 150mA, +CE	SOT-23-5	28cx	VR4	6g	Sii
TXL	S-11L10D19-M5T1U	LVR-IC	LDO, 1.9V±1.0%, 150mA, +CE	SOT-23-5	28cx	VR4	6g	Sii
TXM	S-11L10D20-M5T1U	LVR-IC	LDO, 2.0V±1.0%, 150mA, +CE	SOT-23-5	28cx	VR4	6g	Sii
TXN	S-11L10D21-M5T1U	LVR-IC	LDO, 2.1V±1.0%, 150mA, +CE	SOT-23-5	28cx	VR4	6g	Sii
TXO	S-11L10D22-M5T1U	LVR-IC	LDO, 2.2V±1.0%, 150mA, +CE	SOT-23-5	28cx	VR4	6g	Sii
TXP	S-11L10D23-M5T1U	LVR-IC	LDO, 2.3V±1.0%, 150mA, +CE	SOT-23-5	28cx	VR4	6g	Sii
TXQ	S-11L10D24-M5T1U	LVR-IC	LDO, 2.4V±1.0%, 150mA, +CE	SOT-23-5	28cx	VR4	6g	Sii
TXR	S-11L10D25-M5T1U	LVR-IC	LDO, 2.5V±1.0%, 150mA, +CE	SOT-23-5	28cx	VR4	6g	Sii
TXS	S-11L10D26-M5T1U	LVR-IC	LDO, 2.6V±1.0%, 150mA, +CE	SOT-23-5	28cx	VR4	6g	Sii
TXT	S-11L10D27-M5T1U	LVR-IC	LDO, 2.7V±1.0%, 150mA, +CE	SOT-23-5	28cx	VR4	6g	Sii
TXU	S-11L10D28-M5T1U	LVR-IC	LDO, 2.8V±1.0%, 150mA, +CE	SOT-23-5	28cx	VR4	6g	Sii
TXV	S-11L10D29-M5T1U	LVR-IC	LDO, 2.9V±1.0%, 150mA, +CE	SOT-23-5	28cx	VR4	6g	Sii
TXW	S-11L10D30-M5T1U	LVR-IC	LDO, 3.0V±1.0%, 150mA, +CE	SOT-23-5	28cx	VR4	6g	Sii
TXX	S-11L10D31-M5T1U	LVR-IC	LDO, 3.1V±1.0%, 150mA, +CE	SOT-23-5	28cx	VR4	6g	Sii
TXY	S-11L10D32-M5T1U	LVR-IC	LDO, 3.2V±1.0%, 150mA, +CE	SOT-23-5	28cx	VR4	6g	Sii
TXZ	S-11L10D33-M5T1U	LVR-IC	LDO, 3.3V±1.0%, 150mA, +CE	SOT-23-5	28cx	VR4	6g	Sii
TY	BD45421G	Vdet-IC	4.2V, -Reset ODO, 100ms	SSOP-5	28vdp	VD6	6c	Rhm
TZ	BD45411G	Vdet-IC	4.1V, -Reset ODO, 100ms	SSOP-5	28vdp	VD6	6c	Rhm
U0	BD45401G	Vdet-IC	4V, -Reset ODO, 100ms	SSOP-5	28vdp	VD6	6c	Rhm
U0	R1121N501B	LVR-IC	LDO, LN, +CE, 5V±2%, 150mA	SOT-23-5	28vit	VR4	6g	Ric
U0	TC74A0-5.0VCT	Tdet-IC	Sensor (-40...+125±3°C), Vcc=5V, I2C-bus	SOT-23-5	28hd	-	6g	Mcc
U00_	SN74AUC1G00DBV	CMOS-Logic	2-input NAND gate	SOT-23-5	28/Log1	-	6a	Ti
U001	R3111Q222A5	Vdet-IC	2.25V±2%, -Reset PPO	SC-88A	28ru	VD7	6m	Ric
U009	R3111Q092A	Vdet-IC	0.9V±2%, -Reset PPO	SC-88A	28ru	VD7	6m	Ric
U010	R3111Q102A	Vdet-IC	1.0V±2%, -Reset PPO	SC-88A	28ru	VD7	6m	Ric
U011	R3111Q112A	Vdet-IC	1.1V±2%, -Reset PPO	SC-88A	28ru	VD7	6m	Ric
U012	R3111Q122A	Vdet-IC	1.2V±2%, -Reset PPO	SC-88A	28ru	VD7	6m	Ric
U013	R3111Q132A	Vdet-IC	1.3V±2%, -Reset PPO	SC-88A	28ru	VD7	6m	Ric
U014	R3111Q142A	Vdet-IC	1.4V±2%, -Reset PPO	SC-88A	28ru	VD7	6m	Ric
U015	R3111Q152A	Vdet-IC	1.5V±2%, -Reset PPO	SC-88A	28ru	VD7	6m	Ric
U016	R3111Q162A	Vdet-IC	1.6V±2%, -Reset PPO	SC-88A	28ru	VD7	6m	Ric
U017	R3111Q172A	Vdet-IC	1.7V±2%, -Reset PPO	SC-88A	28ru	VD7	6m	Ric
U018	R3111Q182A	Vdet-IC	1.8V±2%, -Reset PPO	SC-88A	28ru	VD7	6m	Ric
U019	R3111Q192A	Vdet-IC	1.9V±2%, -Reset PPO	SC-88A	28ru	VD7	6m	Ric
U020	R3111Q202A	Vdet-IC	2.0V±2%, -Reset PPO	SC-88A	28ru	VD7	6m	Ric
U021	R3111Q212A	Vdet-IC	2.1V±2%, -Reset PPO	SC-88A	28ru	VD7	6m	Ric
U022	R3111Q222A	Vdet-IC	2.2V±2%, -Reset PPO	SC-88A	28ru	VD7	6m	Ric
U023	R3111Q232A	Vdet-IC	2.3V±2%, -Reset PPO	SC-88A	28ru	VD7	6m	Ric
U024	R3111Q242A	Vdet-IC	2.4V±2%, -Reset PPO	SC-88A	28ru	VD7	6m	Ric
U025	R3111Q252A	Vdet-IC	2.5V±2%, -Reset PPO	SC-88A	28ru	VD7	6m	Ric
U026	R3111Q262A	Vdet-IC	2.6V±2%, -Reset PPO	SC-88A	28ru	VD7	6m	Ric
U027	R3111Q272A	Vdet-IC	2.7V±2%, -Reset PPO	SC-88A	28ru	VD7	6m	Ric
U028	R3111Q282A	Vdet-IC	2.8V±2%, -Reset PPO	SC-88A	28ru	VD7	6m	Ric
U029	R3111Q292A	Vdet-IC	2.9V±2%, -Reset PPO	SC-88A	28ru	VD7	6m	Ric
U030	R3111Q302A	Vdet-IC	3.0V±2%, -Reset PPO	SC-88A	28ru	VD7	6m	Ric
U031	R3111Q312A	Vdet-IC	3.1V±2%, -Reset PPO	SC-88A	28ru	VD7	6m	Ric
U032	R3111Q322A	Vdet-IC	3.2V±2%, -Reset PPO	SC-88A	28ru	VD7	6m	Ric
U033	R3111Q332A	Vdet-IC	3.3V±2%, -Reset PPO	SC-88A	28ru	VD7	6m	Ric
U034	R3111Q342A	Vdet-IC	3.4V±2%, -Reset PPO	SC-88A	28ru	VD7	6m	Ric
U035	R3111Q352A	Vdet-IC	3.5V±2%, -Reset PPO	SC-88A	28ru	VD7	6m	Ric
U036	R3111Q362A	Vdet-IC	3.6V±2%, -Reset PPO	SC-88A	28ru	VD7	6m	Ric
U037	R3111Q372A	Vdet-IC	3.7V±2%, -Reset PPO	SC-88A	28ru	VD7	6m	Ric
U038	R3111Q382A	Vdet-IC	3.8V±2%, -Reset PPO	SC-88A	28ru	VD7	6m	Ric
U039	R3111Q392A	Vdet-IC	3.9V±2%, -Reset PPO	SC-88A	28ru	VD7	6m	Ric
U040	R3111Q402A	Vdet-IC	4.0V±2%, -Reset PPO	SC-88A	28ru	VD7	6m	Ric
U041	R3111Q412A	Vdet-IC	4.1V±2%, -Reset PPO	SC-88A	28ru	VD7	6m	Ric
U042	R3111Q422A	Vdet-IC	4.2V±2%, -Reset PPO	SC-88A	28ru	VD7	6m	Ric
U043	R3111Q432A	Vdet-IC	4.3V±2%, -Reset PPO	SC-88A	28ru	VD7	6m	Ric



SMD code	Type	Function	Short description	Case	Pinout	Sch.	St.	Mnf.
U044	R3111Q442A	Vdet-IC	4.4V±2%, -Reset PPO	SC-88A	28ru	VD7	6m	Ric
U045	R3111Q452A	Vdet-IC	4.5V±2%, -Reset PPO	SC-88A	28ru	VD7	6m	Ric
U046	R3111Q462A	Vdet-IC	4.6V±2%, -Reset PPO	SC-88A	28ru	VD7	6m	Ric
U047	R3111Q472A	Vdet-IC	4.7V±2%, -Reset PPO	SC-88A	28ru	VD7	6m	Ric
U048	R3111Q482A	Vdet-IC	4.8V±2%, -Reset PPO	SC-88A	28ru	VD7	6m	Ric
U049	R3111Q492A	Vdet-IC	4.9V±2%, -Reset PPO	SC-88A	28ru	VD7	6m	Ric
U050	R3111Q502A	Vdet-IC	5.0V±2%, -Reset PPO	SC-88A	28ru	VD7	6m	Ric
U051	R3111Q512A	Vdet-IC	5.1V±2%, -Reset PPO	SC-88A	28ru	VD7	6m	Ric
U052	R3111Q522A	Vdet-IC	5.2V±2%, -Reset PPO	SC-88A	28ru	VD7	6m	Ric
U053	R3111Q532A	Vdet-IC	5.3V±2%, -Reset PPO	SC-88A	28ru	VD7	6m	Ric
U054	R3111Q542A	Vdet-IC	5.4V±2%, -Reset PPO	SC-88A	28ru	VD7	6m	Ric
U055	R3111Q552A	Vdet-IC	5.5V±2%, -Reset PPO	SC-88A	28ru	VD7	6m	Ric
U056	R3111Q562A	Vdet-IC	5.6V±2%, -Reset PPO	SC-88A	28ru	VD7	6m	Ric
U057	R3111Q572A	Vdet-IC	5.7V±2%, -Reset PPO	SC-88A	28ru	VD7	6m	Ric
U058	R3111Q582A	Vdet-IC	5.8V±2%, -Reset PPO	SC-88A	28ru	VD7	6m	Ric
U059	R3111Q592A	Vdet-IC	5.9V±2%, -Reset PPO	SC-88A	28ru	VD7	6m	Ric
U060	R3111Q602A	Vdet-IC	6.0V±2%, -Reset PPO	SC-88A	28ru	VD7	6m	Ric
U09	XC9226A096M	DC/DC-IC	PWM/PFM step-down, 600kHz, 0.9V±1%, 600mA, +CE	SOT-25	28dc4	DC1	6g	Tor
U09	XC9226B096M	DC/DC-IC	PWM/PFM step-down, 600kHz, 0.9V±1%, 600mA, -CE	SOT-25	28dc4	DC1	6g	Tor
U09	XC9226C096M	DC/DC-IC	PWM/PFM step-down, 600kHz, 0.9V±1%, 600mA, +CE, PDR	SOT-25	28dc4	DC1	6g	Tor
U09	XC9226D096M	DC/DC-IC	PWM/PFM step-down, 600kHz, 0.9V±1%, 600mA, -CE, PDR	SOT-25	28dc4	DC1	6g	Tor
U0A	R3134N46EA3	Vdet-IC	4.63V±1.8%, -Reset ODO, -MR	SOT-23-5	28z7	VD4	6g	Ric
U0A	XC6118N10AMR-G	Vdet-IC	1.0V±30mV, ±Reset ODO, Sense, hysteresis 5%, Cd	SOT-25	28mg	VD14	6g	Tor
U0B	XC6118N10BMR-G	Vdet-IC	1.0V±30mV, ±Reset ODO, Sense, hysteresis <1%, Cd	SOT-25	28mg	VD14	6g	Tor
U0C	XC6118N10CMR-G	Vdet-IC	1.0V±30mV, ±Reset ODO, Sense, hysteresis 5%	SOT-25	28mf	VD11	6g	Tor
U0D	XC6118N10DMR-G	Vdet-IC	1.0V±30mV, ±Reset ODO, Sense, hysteresis <1%	SOT-25	28mf	VD11	6g	Tor
U0M	XC9226A09CM	DC/DC-IC	PWM/PFM step-down, 1.2MHz, 0.9V±1%, 600mA, +CE	SOT-25	28dc4	DC1	6g	Tor
U0M	XC9226B09CM	DC/DC-IC	PWM/PFM step-down, 1.2MHz, 0.9V±1%, 600mA, -CE	SOT-25	28dc4	DC1	6g	Tor
U0M	XC9226C09CM	DC/DC-IC	PWM/PFM step-down, 1.2MHz, 0.9V±1%, 600mA, +CE, PDR	SOT-25	28dc4	DC1	6g	Tor
U0M	XC9226D09CM	DC/DC-IC	PWM/PFM step-down, 1.2MHz, 0.9V±1%, 600mA, -CE, PDR	SOT-25	28dc4	DC1	6g	Tor
U1	BD45391G	Vdet-IC	3.9V, -Reset ODO, 100ms	SSOP-5	28vdp	VD6	6c	Rhm
U1	TC74A1-5.0VCT	Tdet-IC	Sensor (-40...+125±3°C), Vcc=5V, I2C-bus	SOT-23-5	28hd	-	6g	Mcc
U10	XC9226A106M	DC/DC-IC	PWM/PFM step-down, 600kHz, 1.0V±1%, 600mA, +CE	SOT-25	28dc4	DC1	6g	Tor
U10	XC9226B106M	DC/DC-IC	PWM/PFM step-down, 600kHz, 1.0V±1%, 600mA, -CE	SOT-25	28dc4	DC1	6g	Tor
U10	XC9226C106M	DC/DC-IC	PWM/PFM step-down, 600kHz, 1.0V±1%, 600mA, +CE, PDR	SOT-25	28dc4	DC1	6g	Tor
U10	XC9226D106M	DC/DC-IC	PWM/PFM step-down, 600kHz, 1.0V±1%, 600mA, -CE, PDR	SOT-25	28dc4	DC1	6g	Tor
U11	XC9226A116M	DC/DC-IC	PWM/PFM step-down, 600kHz, 1.1V±1%, 600mA, +CE	SOT-25	28dc4	DC1	6g	Tor
U11	XC9226B116M	DC/DC-IC	PWM/PFM step-down, 600kHz, 1.1V±1%, 600mA, -CE	SOT-25	28dc4	DC1	6g	Tor
U11	XC9226C116M	DC/DC-IC	PWM/PFM step-down, 600kHz, 1.1V±1%, 600mA, +CE, PDR	SOT-25	28dc4	DC1	6g	Tor
U11	XC9226D116M	DC/DC-IC	PWM/PFM step-down, 600kHz, 1.1V±1%, 600mA, -CE, PDR	SOT-25	28dc4	DC1	6g	Tor
U12	XC9226A126M	DC/DC-IC	PWM/PFM step-down, 600kHz, 1.2V±1%, 600mA, +CE	SOT-25	28dc4	DC1	6g	Tor
U12	XC9226B126M	DC/DC-IC	PWM/PFM step-down, 600kHz, 1.2V±1%, 600mA, -CE	SOT-25	28dc4	DC1	6g	Tor
U12	XC9226C126M	DC/DC-IC	PWM/PFM step-down, 600kHz, 1.2V±1%, 600mA, +CE, PDR	SOT-25	28dc4	DC1	6g	Tor
U12	XC9226D126M	DC/DC-IC	PWM/PFM step-down, 600kHz, 1.2V±1%, 600mA, -CE, PDR	SOT-25	28dc4	DC1	6g	Tor
U13	XC9226A136M	DC/DC-IC	PWM/PFM step-down, 600kHz, 1.3V±1%, 600mA, +CE	SOT-25	28dc4	DC1	6g	Tor
U13	XC9226B136M	DC/DC-IC	PWM/PFM step-down, 600kHz, 1.3V±1%, 600mA, -CE	SOT-25	28dc4	DC1	6g	Tor
U13	XC9226C136M	DC/DC-IC	PWM/PFM step-down, 600kHz, 1.3V±1%, 600mA, +CE, PDR	SOT-25	28dc4	DC1	6g	Tor
U13	XC9226D136M	DC/DC-IC	PWM/PFM step-down, 600kHz, 1.3V±1%, 600mA, -CE, PDR	SOT-25	28dc4	DC1	6g	Tor
U14	XC9226A146M	DC/DC-IC	PWM/PFM step-down, 600kHz, 1.4V±1%, 600mA, +CE	SOT-25	28dc4	DC1	6g	Tor
U14	XC9226B146M	DC/DC-IC	PWM/PFM step-down, 600kHz, 1.4V±1%, 600mA, -CE	SOT-25	28dc4	DC1	6g	Tor
U14	XC9226C146M	DC/DC-IC	PWM/PFM step-down, 600kHz, 1.4V±1%, 600mA, +CE, PDR	SOT-25	28dc4	DC1	6g	Tor
U14	XC9226D146M	DC/DC-IC	PWM/PFM step-down, 600kHz, 1.4V±1%, 600mA, -CE, PDR	SOT-25	28dc4	DC1	6g	Tor
U14	SN74AUC1G14DBV	CMOS-Logic	Inverting Schmitt-trigger	SOT-23-5	28fLog7	-	6a	Ti
U15	XC9226A156M	DC/DC-IC	PWM/PFM step-down, 600kHz, 1.5V±1%, 600mA, +CE	SOT-25	28dc4	DC1	6g	Tor
U15	XC9226B156M	DC/DC-IC	PWM/PFM step-down, 600kHz, 1.5V±1%, 600mA, -CE	SOT-25	28dc4	DC1	6g	Tor
U15	XC9226C156M	DC/DC-IC	PWM/PFM step-down, 600kHz, 1.5V±1%, 600mA, +CE, PDR	SOT-25	28dc4	DC1	6g	Tor
U15	XC9226D156M	DC/DC-IC	PWM/PFM step-down, 600kHz, 1.5V±1%, 600mA, -CE, PDR	SOT-25	28dc4	DC1	6g	Tor
U16	XC9226A166M	DC/DC-IC	PWM/PFM step-down, 600kHz, 1.6V±1%, 600mA, +CE	SOT-25	28dc4	DC1	6g	Tor
U16	XC9226B166M	DC/DC-IC	PWM/PFM step-down, 600kHz, 1.6V±1%, 600mA, -CE	SOT-25	28dc4	DC1	6g	Tor
U16	XC9226C166M	DC/DC-IC	PWM/PFM step-down, 600kHz, 1.6V±1%, 600mA, +CE, PDR	SOT-25	28dc4	DC1	6g	Tor
U16	XC9226D166M	DC/DC-IC	PWM/PFM step-down, 600kHz, 1.6V±1%, 600mA, -CE, PDR	SOT-25	28dc4	DC1	6g	Tor
U17	XC9226A176M	DC/DC-IC	PWM/PFM step-down, 600kHz, 1.7V±1%, 600mA, +CE	SOT-25	28dc4	DC1	6g	Tor
U17	XC9226B176M	DC/DC-IC	PWM/PFM step-down, 600kHz, 1.7V±1%, 600mA, -CE	SOT-25	28dc4	DC1	6g	Tor
U17	XC9226C176M	DC/DC-IC	PWM/PFM step-down, 600kHz, 1.7V±1%, 600mA, +CE, PDR	SOT-25	28dc4	DC1	6g	Tor
U17	XC9226D176M	DC/DC-IC	PWM/PFM step-down, 600kHz, 1.7V±1%, 600mA, -CE, PDR	SOT-25	28dc4	DC1	6g	Tor
U17	SN74AUC1G17DBV	CMOS-Logic	Schmitt-trigger	SOT-23-5	28fLog11	-	6a	Ti
U18	XC9226A186M	DC/DC-IC	PWM/PFM step-down, 600kHz, 1.8V±1%, 600mA, +CE	SOT-25	28dc4	DC1	6g	Tor
U18	XC9226B186M	DC/DC-IC	PWM/PFM step-down, 600kHz, 1.8V±1%, 600mA, -CE	SOT-25	28dc4	DC1	6g	Tor
U18	XC9226C186M	DC/DC-IC	PWM/PFM step-down, 600kHz, 1.8V±1%, 600mA, +CE, PDR	SOT-25	28dc4	DC1	6g	Tor
U18	XC9226D186M	DC/DC-IC	PWM/PFM step-down, 600kHz, 1.8V±1%, 600mA, -CE, PDR	SOT-25	28dc4	DC1	6g	Tor



SMD code	Type	Function	Short description	Case	Pinout	Sch.	St.	Mnf.
U19	XC9226A196M	DC/DC-IC	PWM/PFM step-down, 600kHz, 1.9V±1%, 600mA, +CE	SOT-25	28dc4	DC1	6g	Tor
U19	XC9226B196M	DC/DC-IC	PWM/PFM step-down, 600kHz, 1.9V±1%, 600mA, -CE	SOT-25	28dc4	DC1	6g	Tor
U19	XC9226C196M	DC/DC-IC	PWM/PFM step-down, 600kHz, 1.9V±1%, 600mA, +CE, PDR	SOT-25	28dc4	DC1	6g	Tor
U19	XC9226D196M	DC/DC-IC	PWM/PFM step-down, 600kHz, 1.9V±1%, 600mA, -CE, PDR	SOT-25	28dc4	DC1	6g	Tor
U1A	R3134N46EC3	Vdet-IC	4.63V±1.8%, -Reset PPO, -MR	SOT-23-5	28z7	VD5	6g	Ric
U1A	XC6118N11AMR-G	Vdet-IC	1.1V±30mV, ±Reset ODO, Sense, hysteresis 5%, Cd	SOT-25	28mg	VD14	6g	Tor
U1A	XC9226A10CM	DC/DC-IC	PWM/PFM step-down, 1.2MHz, 1.0V±1%, 600mA, +CE	SOT-25	28dc4	DC1	6g	Tor
U1A	XC9226B10CM	DC/DC-IC	PWM/PFM step-down, 1.2MHz, 1.0V±1%, 600mA, -CE	SOT-25	28dc4	DC1	6g	Tor
U1A	XC9226C10CM	DC/DC-IC	PWM/PFM step-down, 1.2MHz, 1.0V±1%, 600mA, +CE, PDR	SOT-25	28dc4	DC1	6g	Tor
U1A	XC9226D10CM	DC/DC-IC	PWM/PFM step-down, 1.2MHz, 1.0V±1%, 600mA, -CE, PDR	SOT-25	28dc4	DC1	6g	Tor
U1B	XC6118N11BMR-G	Vdet-IC	1.1V±30mV, ±Reset ODO, Sense, hysteresis <1%, Cd	SOT-25	28mg	VD14	6g	Tor
U1B	XC9226A11CM	DC/DC-IC	PWM/PFM step-down, 1.2MHz, 1.1V±1%, 600mA, +CE	SOT-25	28dc4	DC1	6g	Tor
U1B	XC9226B11CM	DC/DC-IC	PWM/PFM step-down, 1.2MHz, 1.1V±1%, 600mA, -CE	SOT-25	28dc4	DC1	6g	Tor
U1B	XC9226C11CM	DC/DC-IC	PWM/PFM step-down, 1.2MHz, 1.1V±1%, 600mA, +CE, PDR	SOT-25	28dc4	DC1	6g	Tor
U1B	XC9226D11CM	DC/DC-IC	PWM/PFM step-down, 1.2MHz, 1.1V±1%, 600mA, -CE, PDR	SOT-25	28dc4	DC1	6g	Tor
U1C	XC6118N11CMR-G	Vdet-IC	1.1V±30mV, ±Reset ODO, Sense, hysteresis 5%	SOT-25	28mf	VD11	6g	Tor
U1C	XC9226A12CM	DC/DC-IC	PWM/PFM step-down, 1.2MHz, 1.2V±1%, 600mA, +CE	SOT-25	28dc4	DC1	6g	Tor
U1C	XC9226B12CM	DC/DC-IC	PWM/PFM step-down, 1.2MHz, 1.2V±1%, 600mA, -CE	SOT-25	28dc4	DC1	6g	Tor
U1C	XC9226C12CM	DC/DC-IC	PWM/PFM step-down, 1.2MHz, 1.2V±1%, 600mA, +CE, PDR	SOT-25	28dc4	DC1	6g	Tor
U1C	XC9226D12CM	DC/DC-IC	PWM/PFM step-down, 1.2MHz, 1.2V±1%, 600mA, -CE, PDR	SOT-25	28dc4	DC1	6g	Tor
U1D	XC6118N11DMR-G	Vdet-IC	1.1V±30mV, ±Reset ODO, Sense, hysteresis <1%	SOT-25	28mf	VD11	6g	Tor
U1D	XC9226A13CM	DC/DC-IC	PWM/PFM step-down, 1.2MHz, 1.3V±1%, 600mA, +CE	SOT-25	28dc4	DC1	6g	Tor
U1D	XC9226B13CM	DC/DC-IC	PWM/PFM step-down, 1.2MHz, 1.3V±1%, 600mA, -CE	SOT-25	28dc4	DC1	6g	Tor
U1D	XC9226C13CM	DC/DC-IC	PWM/PFM step-down, 1.2MHz, 1.3V±1%, 600mA, +CE, PDR	SOT-25	28dc4	DC1	6g	Tor
U1D	XC9226D13CM	DC/DC-IC	PWM/PFM step-down, 1.2MHz, 1.3V±1%, 600mA, -CE, PDR	SOT-25	28dc4	DC1	6g	Tor
U1E	XC9226A14CM	DC/DC-IC	PWM/PFM step-down, 1.2MHz, 1.4V±1%, 600mA, +CE	SOT-25	28dc4	DC1	6g	Tor
U1E	XC9226B14CM	DC/DC-IC	PWM/PFM step-down, 1.2MHz, 1.4V±1%, 600mA, -CE	SOT-25	28dc4	DC1	6g	Tor
U1E	XC9226C14CM	DC/DC-IC	PWM/PFM step-down, 1.2MHz, 1.4V±1%, 600mA, +CE, PDR	SOT-25	28dc4	DC1	6g	Tor
U1E	XC9226D14CM	DC/DC-IC	PWM/PFM step-down, 1.2MHz, 1.4V±1%, 600mA, -CE, PDR	SOT-25	28dc4	DC1	6g	Tor
U1F	XC9226A15CM	DC/DC-IC	PWM/PFM step-down, 1.2MHz, 1.5V±1%, 600mA, +CE	SOT-25	28dc4	DC1	6g	Tor
U1F	XC9226B15CM	DC/DC-IC	PWM/PFM step-down, 1.2MHz, 1.5V±1%, 600mA, -CE	SOT-25	28dc4	DC1	6g	Tor
U1F	XC9226C15CM	DC/DC-IC	PWM/PFM step-down, 1.2MHz, 1.5V±1%, 600mA, +CE, PDR	SOT-25	28dc4	DC1	6g	Tor
U1F	XC9226D15CM	DC/DC-IC	PWM/PFM step-down, 1.2MHz, 1.5V±1%, 600mA, -CE, PDR	SOT-25	28dc4	DC1	6g	Tor
U1H	XC9226A16CM	DC/DC-IC	PWM/PFM step-down, 1.2MHz, 1.6V±1%, 600mA, +CE	SOT-25	28dc4	DC1	6g	Tor
U1H	XC9226B16CM	DC/DC-IC	PWM/PFM step-down, 1.2MHz, 1.6V±1%, 600mA, -CE	SOT-25	28dc4	DC1	6g	Tor
U1H	XC9226C16CM	DC/DC-IC	PWM/PFM step-down, 1.2MHz, 1.6V±1%, 600mA, +CE, PDR	SOT-25	28dc4	DC1	6g	Tor
U1H	XC9226D16CM	DC/DC-IC	PWM/PFM step-down, 1.2MHz, 1.6V±1%, 600mA, -CE, PDR	SOT-25	28dc4	DC1	6g	Tor
U1K	XC9226A17CM	DC/DC-IC	PWM/PFM step-down, 1.2MHz, 1.7V±1%, 600mA, +CE	SOT-25	28dc4	DC1	6g	Tor
U1K	XC9226B17CM	DC/DC-IC	PWM/PFM step-down, 1.2MHz, 1.7V±1%, 600mA, -CE	SOT-25	28dc4	DC1	6g	Tor
U1K	XC9226C17CM	DC/DC-IC	PWM/PFM step-down, 1.2MHz, 1.7V±1%, 600mA, +CE, PDR	SOT-25	28dc4	DC1	6g	Tor
U1K	XC9226D17CM	DC/DC-IC	PWM/PFM step-down, 1.2MHz, 1.7V±1%, 600mA, -CE, PDR	SOT-25	28dc4	DC1	6g	Tor
U1L	XC9226A18CM	DC/DC-IC	PWM/PFM step-down, 1.2MHz, 1.8V±1%, 600mA, +CE	SOT-25	28dc4	DC1	6g	Tor
U1L	XC9226B18CM	DC/DC-IC	PWM/PFM step-down, 1.2MHz, 1.8V±1%, 600mA, -CE	SOT-25	28dc4	DC1	6g	Tor
U1L	XC9226C18CM	DC/DC-IC	PWM/PFM step-down, 1.2MHz, 1.8V±1%, 600mA, +CE, PDR	SOT-25	28dc4	DC1	6g	Tor
U1L	XC9226D18CM	DC/DC-IC	PWM/PFM step-down, 1.2MHz, 1.8V±1%, 600mA, -CE, PDR	SOT-25	28dc4	DC1	6g	Tor
U1M	XC9226A19CM	DC/DC-IC	PWM/PFM step-down, 1.2MHz, 1.9V±1%, 600mA, +CE	SOT-25	28dc4	DC1	6g	Tor
U1M	XC9226B19CM	DC/DC-IC	PWM/PFM step-down, 1.2MHz, 1.9V±1%, 600mA, -CE	SOT-25	28dc4	DC1	6g	Tor
U1M	XC9226C19CM	DC/DC-IC	PWM/PFM step-down, 1.2MHz, 1.9V±1%, 600mA, +CE, PDR	SOT-25	28dc4	DC1	6g	Tor
U1M	XC9226D19CM	DC/DC-IC	PWM/PFM step-down, 1.2MHz, 1.9V±1%, 600mA, -CE, PDR	SOT-25	28dc4	DC1	6g	Tor
U2	AX6608-12B	LVR-IC	LDO, 1.2V±3%, 300mA, +CE	SOT-23-5	28vrx	VR7	6k	Axl
U2	BD45381G	Vdet-IC	3.8V, -Reset ODO, 100ms	SSOP-5	28vdp	VD6	6c	Rhm
U2	TC74A2-5.0VCT	Tdet-IC	Sensor (-40..+125±3°C), Vcc=5V, I2C-bus	SOT-23-5	28hd	-	6g	Mcc
U20	XC9226A206M	DC/DC-IC	PWM/PFM step-down, 600kHz, 2.0V±1%, 600mA, +CE	SOT-25	28dc4	DC1	6g	Tor
U20	XC9226B206M	DC/DC-IC	PWM/PFM step-down, 600kHz, 2.0V±1%, 600mA, -CE	SOT-25	28dc4	DC1	6g	Tor
U20	XC9226C206M	DC/DC-IC	PWM/PFM step-down, 600kHz, 2.0V±1%, 600mA, +CE, PDR	SOT-25	28dc4	DC1	6g	Tor
U20	XC9226D206M	DC/DC-IC	PWM/PFM step-down, 600kHz, 2.0V±1%, 600mA, -CE, PDR	SOT-25	28dc4	DC1	6g	Tor
U21	XC9226A216M	DC/DC-IC	PWM/PFM step-down, 600kHz, 2.1V±1%, 600mA, +CE	SOT-25	28dc4	DC1	6g	Tor
U21	XC9226B216M	DC/DC-IC	PWM/PFM step-down, 600kHz, 2.1V±1%, 600mA, -CE	SOT-25	28dc4	DC1	6g	Tor
U21	XC9226C216M	DC/DC-IC	PWM/PFM step-down, 600kHz, 2.1V±1%, 600mA, +CE, PDR	SOT-25	28dc4	DC1	6g	Tor
U21	XC9226D216M	DC/DC-IC	PWM/PFM step-down, 600kHz, 2.1V±1%, 600mA, -CE, PDR	SOT-25	28dc4	DC1	6g	Tor
U22	XC9226A226M	DC/DC-IC	PWM/PFM step-down, 600kHz, 2.2V±1%, 600mA, +CE	SOT-25	28dc4	DC1	6g	Tor
U22	XC9226B226M	DC/DC-IC	PWM/PFM step-down, 600kHz, 2.2V±1%, 600mA, -CE	SOT-25	28dc4	DC1	6g	Tor
U22	XC9226C226M	DC/DC-IC	PWM/PFM step-down, 600kHz, 2.2V±1%, 600mA, +CE, PDR	SOT-25	28dc4	DC1	6g	Tor
U22	XC9226D226M	DC/DC-IC	PWM/PFM step-down, 600kHz, 2.2V±1%, 600mA, -CE, PDR	SOT-25	28dc4	DC1	6g	Tor
U23	XC9226A236M	DC/DC-IC	PWM/PFM step-down, 600kHz, 2.3V±1%, 600mA, +CE	SOT-25	28dc4	DC1	6g	Tor
U23	XC9226B236M	DC/DC-IC	PWM/PFM step-down, 600kHz, 2.3V±1%, 600mA, -CE	SOT-25	28dc4	DC1	6g	Tor
U23	XC9226C236M	DC/DC-IC	PWM/PFM step-down, 600kHz, 2.3V±1%, 600mA, +CE, PDR	SOT-25	28dc4	DC1	6g	Tor
U23	XC9226D236M	DC/DC-IC	PWM/PFM step-down, 600kHz, 2.3V±1%, 600mA, -CE, PDR	SOT-25	28dc4	DC1	6g	Tor
U24	XC9226A246M	DC/DC-IC	PWM/PFM step-down, 600kHz, 2.4V±1%, 600mA, +CE	SOT-25	28dc4	DC1	6g	Tor
U24	XC9226B246M	DC/DC-IC	PWM/PFM step-down, 600kHz, 2.4V±1%, 600mA, -CE	SOT-25	28dc4	DC1	6g	Tor



SMD code	Type	Function	Short description	Case	Pinout	Sch.	St.	Mnf.
U24	XC9226C246M	DC/DC-IC	PWM/PFM step-down, 600kHz, 2.4V±1%, 600mA, +CE, PDR	SOT-25	28dc4	DC1	6g	Tor
U24	XC9226D246M	DC/DC-IC	PWM/PFM step-down, 600kHz, 2.4V±1%, 600mA, -CE, PDR	SOT-25	28dc4	DC1	6g	Tor
U25	XC9226A256M	DC/DC-IC	PWM/PFM step-down, 600kHz, 2.5V±1%, 600mA, +CE	SOT-25	28dc4	DC1	6g	Tor
U25	XC9226B256M	DC/DC-IC	PWM/PFM step-down, 600kHz, 2.5V±1%, 600mA, -CE	SOT-25	28dc4	DC1	6g	Tor
U25	XC9226C256M	DC/DC-IC	PWM/PFM step-down, 600kHz, 2.5V±1%, 600mA, +CE, PDR	SOT-25	28dc4	DC1	6g	Tor
U25	XC9226D256M	DC/DC-IC	PWM/PFM step-down, 600kHz, 2.5V±1%, 600mA, -CE, PDR	SOT-25	28dc4	DC1	6g	Tor
U25	SN74AUC1G125DBV	CMOS-Logic	Bus buffer gate with 3-state output	SOT-23-5	28Lsg14	-	6a	Ti
U26	XC9226A266M	DC/DC-IC	PWM/PFM step-down, 600kHz, 2.6V±1%, 600mA, +CE	SOT-25	28dc4	DC1	6g	Tor
U26	XC9226B266M	DC/DC-IC	PWM/PFM step-down, 600kHz, 2.6V±1%, 600mA, -CE	SOT-25	28dc4	DC1	6g	Tor
U26	XC9226C266M	DC/DC-IC	PWM/PFM step-down, 600kHz, 2.6V±1%, 600mA, +CE, PDR	SOT-25	28dc4	DC1	6g	Tor
U26	XC9226D266M	DC/DC-IC	PWM/PFM step-down, 600kHz, 2.6V±1%, 600mA, -CE, PDR	SOT-25	28dc4	DC1	6g	Tor
U26	SN74AUC1G126DBV	CMOS-Logic	Bus buffer gate with 3-state output	SOT-23-5	28Lsg13	-	6a	Ti
U27	XC9226A276M	DC/DC-IC	PWM/PFM step-down, 600kHz, 2.7V±1%, 600mA, +CE	SOT-25	28dc4	DC1	6g	Tor
U27	XC9226B276M	DC/DC-IC	PWM/PFM step-down, 600kHz, 2.7V±1%, 600mA, -CE	SOT-25	28dc4	DC1	6g	Tor
U27	XC9226C276M	DC/DC-IC	PWM/PFM step-down, 600kHz, 2.7V±1%, 600mA, +CE, PDR	SOT-25	28dc4	DC1	6g	Tor
U27	XC9226D276M	DC/DC-IC	PWM/PFM step-down, 600kHz, 2.7V±1%, 600mA, -CE, PDR	SOT-25	28dc4	DC1	6g	Tor
U28	XC9226A286M	DC/DC-IC	PWM/PFM step-down, 600kHz, 2.8V±1%, 600mA, +CE	SOT-25	28dc4	DC1	6g	Tor
U28	XC9226B286M	DC/DC-IC	PWM/PFM step-down, 600kHz, 2.8V±1%, 600mA, -CE	SOT-25	28dc4	DC1	6g	Tor
U28	XC9226C286M	DC/DC-IC	PWM/PFM step-down, 600kHz, 2.8V±1%, 600mA, +CE, PDR	SOT-25	28dc4	DC1	6g	Tor
U28	XC9226D286M	DC/DC-IC	PWM/PFM step-down, 600kHz, 2.8V±1%, 600mA, -CE, PDR	SOT-25	28dc4	DC1	6g	Tor
U29	XC9226A296M	DC/DC-IC	PWM/PFM step-down, 600kHz, 2.9V±1%, 600mA, +CE	SOT-25	28dc4	DC1	6g	Tor
U29	XC9226B296M	DC/DC-IC	PWM/PFM step-down, 600kHz, 2.9V±1%, 600mA, -CE	SOT-25	28dc4	DC1	6g	Tor
U29	XC9226C296M	DC/DC-IC	PWM/PFM step-down, 600kHz, 2.9V±1%, 600mA, +CE, PDR	SOT-25	28dc4	DC1	6g	Tor
U29	XC9226D296M	DC/DC-IC	PWM/PFM step-down, 600kHz, 2.9V±1%, 600mA, -CE, PDR	SOT-25	28dc4	DC1	6g	Tor
U2A	XC6118M12AMR-G	Vdet-IC	1.2V±30mV, ±Reset ODO, Sense, hysteresis 5%, Cd	SOT-25	28mg	VD14	6g	Tor
U2A	XC9226A20CM	DC/DC-IC	PWM/PFM step-down, 1.2MHz, 2.0V±1%, 600mA, +CE	SOT-25	28dc4	DC1	6g	Tor
U2A	XC9226B20CM	DC/DC-IC	PWM/PFM step-down, 1.2MHz, 2.0V±1%, 600mA, -CE	SOT-25	28dc4	DC1	6g	Tor
U2A	XC9226C20CM	DC/DC-IC	PWM/PFM step-down, 1.2MHz, 2.0V±1%, 600mA, +CE, PDR	SOT-25	28dc4	DC1	6g	Tor
U2A	XC9226D20CM	DC/DC-IC	PWM/PFM step-down, 1.2MHz, 2.0V±1%, 600mA, -CE, PDR	SOT-25	28dc4	DC1	6g	Tor
U2B	XC6118M12BMR-G	Vdet-IC	1.2V±30mV, ±Reset ODO, Sense, hysteresis <1%, Cd	SOT-25	28mg	VD14	6g	Tor
U2B	XC9226A21CM	DC/DC-IC	PWM/PFM step-down, 1.2MHz, 2.1V±1%, 600mA, +CE	SOT-25	28dc4	DC1	6g	Tor
U2B	XC9226B21CM	DC/DC-IC	PWM/PFM step-down, 1.2MHz, 2.1V±1%, 600mA, -CE	SOT-25	28dc4	DC1	6g	Tor
U2B	XC9226C21CM	DC/DC-IC	PWM/PFM step-down, 1.2MHz, 2.1V±1%, 600mA, +CE, PDR	SOT-25	28dc4	DC1	6g	Tor
U2B	XC9226D21CM	DC/DC-IC	PWM/PFM step-down, 1.2MHz, 2.1V±1%, 600mA, -CE, PDR	SOT-25	28dc4	DC1	6g	Tor
U2C	XC6118M12CMR-G	Vdet-IC	1.2V±30mV, ±Reset ODO, Sense, hysteresis 5%	SOT-25	28mf	VD11	6g	Tor
U2C	XC9226A22CM	DC/DC-IC	PWM/PFM step-down, 1.2MHz, 2.2V±1%, 600mA, +CE	SOT-25	28dc4	DC1	6g	Tor
U2C	XC9226B22CM	DC/DC-IC	PWM/PFM step-down, 1.2MHz, 2.2V±1%, 600mA, -CE	SOT-25	28dc4	DC1	6g	Tor
U2C	XC9226C22CM	DC/DC-IC	PWM/PFM step-down, 1.2MHz, 2.2V±1%, 600mA, +CE, PDR	SOT-25	28dc4	DC1	6g	Tor
U2C	XC9226D22CM	DC/DC-IC	PWM/PFM step-down, 1.2MHz, 2.2V±1%, 600mA, -CE, PDR	SOT-25	28dc4	DC1	6g	Tor
U2D	XC6118M12DMR-G	Vdet-IC	1.2V±30mV, ±Reset ODO, Sense, hysteresis <1%	SOT-25	28mf	VD11	6g	Tor
U2D	XC9226A23CM	DC/DC-IC	PWM/PFM step-down, 1.2MHz, 2.3V±1%, 600mA, +CE	SOT-25	28dc4	DC1	6g	Tor
U2D	XC9226B23CM	DC/DC-IC	PWM/PFM step-down, 1.2MHz, 2.3V±1%, 600mA, -CE	SOT-25	28dc4	DC1	6g	Tor
U2D	XC9226C23CM	DC/DC-IC	PWM/PFM step-down, 1.2MHz, 2.3V±1%, 600mA, +CE, PDR	SOT-25	28dc4	DC1	6g	Tor
U2D	XC9226D23CM	DC/DC-IC	PWM/PFM step-down, 1.2MHz, 2.3V±1%, 600mA, -CE, PDR	SOT-25	28dc4	DC1	6g	Tor
U2E	XC9226A24CM	DC/DC-IC	PWM/PFM step-down, 1.2MHz, 2.4V±1%, 600mA, +CE	SOT-25	28dc4	DC1	6g	Tor
U2E	XC9226B24CM	DC/DC-IC	PWM/PFM step-down, 1.2MHz, 2.4V±1%, 600mA, -CE	SOT-25	28dc4	DC1	6g	Tor
U2E	XC9226C24CM	DC/DC-IC	PWM/PFM step-down, 1.2MHz, 2.4V±1%, 600mA, +CE, PDR	SOT-25	28dc4	DC1	6g	Tor
U2E	XC9226D24CM	DC/DC-IC	PWM/PFM step-down, 1.2MHz, 2.4V±1%, 600mA, -CE, PDR	SOT-25	28dc4	DC1	6g	Tor
U2F	XC9226A25CM	DC/DC-IC	PWM/PFM step-down, 1.2MHz, 2.5V±1%, 600mA, +CE	SOT-25	28dc4	DC1	6g	Tor
U2F	XC9226B25CM	DC/DC-IC	PWM/PFM step-down, 1.2MHz, 2.5V±1%, 600mA, -CE	SOT-25	28dc4	DC1	6g	Tor
U2F	XC9226C25CM	DC/DC-IC	PWM/PFM step-down, 1.2MHz, 2.5V±1%, 600mA, +CE, PDR	SOT-25	28dc4	DC1	6g	Tor
U2F	XC9226D25CM	DC/DC-IC	PWM/PFM step-down, 1.2MHz, 2.5V±1%, 600mA, -CE, PDR	SOT-25	28dc4	DC1	6g	Tor
U2H	XC9226A26CM	DC/DC-IC	PWM/PFM step-down, 1.2MHz, 2.6V±1%, 600mA, +CE	SOT-25	28dc4	DC1	6g	Tor
U2H	XC9226B26CM	DC/DC-IC	PWM/PFM step-down, 1.2MHz, 2.6V±1%, 600mA, -CE	SOT-25	28dc4	DC1	6g	Tor
U2H	XC9226C26CM	DC/DC-IC	PWM/PFM step-down, 1.2MHz, 2.6V±1%, 600mA, +CE, PDR	SOT-25	28dc4	DC1	6g	Tor
U2H	XC9226D26CM	DC/DC-IC	PWM/PFM step-down, 1.2MHz, 2.6V±1%, 600mA, -CE, PDR	SOT-25	28dc4	DC1	6g	Tor
U2K	XC9226A27CM	DC/DC-IC	PWM/PFM step-down, 1.2MHz, 2.7V±1%, 600mA, +CE	SOT-25	28dc4	DC1	6g	Tor
U2K	XC9226B27CM	DC/DC-IC	PWM/PFM step-down, 1.2MHz, 2.7V±1%, 600mA, -CE	SOT-25	28dc4	DC1	6g	Tor
U2K	XC9226C27CM	DC/DC-IC	PWM/PFM step-down, 1.2MHz, 2.7V±1%, 600mA, +CE, PDR	SOT-25	28dc4	DC1	6g	Tor
U2K	XC9226D27CM	DC/DC-IC	PWM/PFM step-down, 1.2MHz, 2.7V±1%, 600mA, -CE, PDR	SOT-25	28dc4	DC1	6g	Tor
U2L	XC9226A28CM	DC/DC-IC	PWM/PFM step-down, 1.2MHz, 2.8V±1%, 600mA, +CE	SOT-25	28dc4	DC1	6g	Tor
U2L	XC9226B28CM	DC/DC-IC	PWM/PFM step-down, 1.2MHz, 2.8V±1%, 600mA, -CE	SOT-25	28dc4	DC1	6g	Tor
U2L	XC9226C28CM	DC/DC-IC	PWM/PFM step-down, 1.2MHz, 2.8V±1%, 600mA, +CE, PDR	SOT-25	28dc4	DC1	6g	Tor
U2L	XC9226D28CM	DC/DC-IC	PWM/PFM step-down, 1.2MHz, 2.8V±1%, 600mA, -CE, PDR	SOT-25	28dc4	DC1	6g	Tor
U2M	XC9226A29CM	DC/DC-IC	PWM/PFM step-down, 1.2MHz, 2.9V±1%, 600mA, +CE	SOT-25	28dc4	DC1	6g	Tor
U2M	XC9226B29CM	DC/DC-IC	PWM/PFM step-down, 1.2MHz, 2.9V±1%, 600mA, -CE	SOT-25	28dc4	DC1	6g	Tor
U2M	XC9226C29CM	DC/DC-IC	PWM/PFM step-down, 1.2MHz, 2.9V±1%, 600mA, +CE, PDR	SOT-25	28dc4	DC1	6g	Tor
U2M	XC9226D29CM	DC/DC-IC	PWM/PFM step-down, 1.2MHz, 2.9V±1%, 600mA, -CE, PDR	SOT-25	28dc4	DC1	6g	Tor
U3	BD45371G	Vdet-IC	3.7V, -Reset ODO, 100ms	SSOP-5	28vdp	VD6	6c	Rhm
U3	TC74A3-5.0VCT	Tdet-IC	Sensor (-40...+125±3°C), Vcc=5V, I2C-bus	SOT-23-5	28hd	-	6g	Mcc



SMD code	Type	Function	Short description	Case	Pinout	Sch.	St.	Mnf.
<u>U3H</u>	XC9226H36CM	DC/DC-IC	PWM/PFM step-down, 1.2MHz, 3.6V±1%, 900mA, -CE, PDR	SOT-25	28dc4	DC1	6g	Tor
<u>U3K</u>	XC9226A37CM	DC/DC-IC	PWM/PFM step-down, 1.2MHz, 3.7V±1%, 600mA, +CE	SOT-25	28dc4	DC1	6g	Tor
<u>U3K</u>	XC9226B37CM	DC/DC-IC	PWM/PFM step-down, 1.2MHz, 3.7V±1%, 600mA, -CE	SOT-25	28dc4	DC1	6g	Tor
<u>U3K</u>	XC9226C37CM	DC/DC-IC	PWM/PFM step-down, 1.2MHz, 3.7V±1%, 600mA, +CE, PDR	SOT-25	28dc4	DC1	6g	Tor
<u>U3K</u>	XC9226D37CM	DC/DC-IC	PWM/PFM step-down, 1.2MHz, 3.7V±1%, 600mA, -CE, PDR	SOT-25	28dc4	DC1	6g	Tor
<u>U3K</u>	XC9226E37CM	DC/DC-IC	PWM/PFM step-down, 1.2MHz, 3.7V±1%, 900mA, +CE	SOT-25	28dc4	DC1	6g	Tor
<u>U3K</u>	XC9226F37CM	DC/DC-IC	PWM/PFM step-down, 1.2MHz, 3.7V±1%, 900mA, -CE	SOT-25	28dc4	DC1	6g	Tor
<u>U3K</u>	XC9226G37CM	DC/DC-IC	PWM/PFM step-down, 1.2MHz, 3.7V±1%, 900mA, +CE, PDR	SOT-25	28dc4	DC1	6g	Tor
<u>U3K</u>	XC9226H37CM	DC/DC-IC	PWM/PFM step-down, 1.2MHz, 3.7V±1%, 900mA, -CE, PDR	SOT-25	28dc4	DC1	6g	Tor
<u>U3L</u>	XC9226A38CM	DC/DC-IC	PWM/PFM step-down, 1.2MHz, 3.8V±1%, 600mA, +CE	SOT-25	28dc4	DC1	6g	Tor
<u>U3L</u>	XC9226B38CM	DC/DC-IC	PWM/PFM step-down, 1.2MHz, 3.8V±1%, 600mA, -CE	SOT-25	28dc4	DC1	6g	Tor
<u>U3L</u>	XC9226C38CM	DC/DC-IC	PWM/PFM step-down, 1.2MHz, 3.8V±1%, 600mA, +CE, PDR	SOT-25	28dc4	DC1	6g	Tor
<u>U3L</u>	XC9226D38CM	DC/DC-IC	PWM/PFM step-down, 1.2MHz, 3.8V±1%, 600mA, -CE, PDR	SOT-25	28dc4	DC1	6g	Tor
<u>U3L</u>	XC9226E38CM	DC/DC-IC	PWM/PFM step-down, 1.2MHz, 3.8V±1%, 900mA, +CE	SOT-25	28dc4	DC1	6g	Tor
<u>U3L</u>	XC9226F38CM	DC/DC-IC	PWM/PFM step-down, 1.2MHz, 3.8V±1%, 900mA, -CE	SOT-25	28dc4	DC1	6g	Tor
<u>U3L</u>	XC9226G38CM	DC/DC-IC	PWM/PFM step-down, 1.2MHz, 3.8V±1%, 900mA, +CE, PDR	SOT-25	28dc4	DC1	6g	Tor
<u>U3L</u>	XC9226H38CM	DC/DC-IC	PWM/PFM step-down, 1.2MHz, 3.8V±1%, 900mA, -CE, PDR	SOT-25	28dc4	DC1	6g	Tor
<u>U3M</u>	XC9226A39CM	DC/DC-IC	PWM/PFM step-down, 1.2MHz, 3.9V±1%, 600mA, +CE	SOT-25	28dc4	DC1	6g	Tor
<u>U3M</u>	XC9226B39CM	DC/DC-IC	PWM/PFM step-down, 1.2MHz, 3.9V±1%, 600mA, -CE	SOT-25	28dc4	DC1	6g	Tor
<u>U3M</u>	XC9226C39CM	DC/DC-IC	PWM/PFM step-down, 1.2MHz, 3.9V±1%, 600mA, +CE, PDR	SOT-25	28dc4	DC1	6g	Tor
<u>U3M</u>	XC9226D39CM	DC/DC-IC	PWM/PFM step-down, 1.2MHz, 3.9V±1%, 600mA, -CE, PDR	SOT-25	28dc4	DC1	6g	Tor
<u>U3M</u>	XC9226E39CM	DC/DC-IC	PWM/PFM step-down, 1.2MHz, 3.9V±1%, 900mA, +CE	SOT-25	28dc4	DC1	6g	Tor
<u>U3M</u>	XC9226F39CM	DC/DC-IC	PWM/PFM step-down, 1.2MHz, 3.9V±1%, 900mA, -CE	SOT-25	28dc4	DC1	6g	Tor
<u>U3M</u>	XC9226G39CM	DC/DC-IC	PWM/PFM step-down, 1.2MHz, 3.9V±1%, 900mA, +CE, PDR	SOT-25	28dc4	DC1	6g	Tor
<u>U3M</u>	XC9226H39CM	DC/DC-IC	PWM/PFM step-down, 1.2MHz, 3.9V±1%, 900mA, -CE, PDR	SOT-25	28dc4	DC1	6g	Tor
<u>U4</u>	BD45361G	Vdet-IC	3.6V, -Reset ODO, 100ms	SSOP-5	28vdp	VD6	6c	Rhm
<u>U4</u>	TC74A4-5.0VCT	Tdet-IC	Sensor (-40..+125±3°C), Vcc=5V, I2C-bus	SOT-23-5	28hd	-	6g	Mcc
<u>U40</u>	XC9226A406M	DC/DC-IC	PWM/PFM step-down, 600kHz, 4.0V±1%, 600mA, +CE	SOT-25	28dc4	DC1	6g	Tor
<u>U40</u>	XC9226B406M	DC/DC-IC	PWM/PFM step-down, 600kHz, 4.0V±1%, 600mA, -CE	SOT-25	28dc4	DC1	6g	Tor
<u>U40</u>	XC9226C406M	DC/DC-IC	PWM/PFM step-down, 600kHz, 4.0V±1%, 600mA, +CE, PDR	SOT-25	28dc4	DC1	6g	Tor
<u>U40</u>	XC9226D406M	DC/DC-IC	PWM/PFM step-down, 600kHz, 4.0V±1%, 600mA, -CE, PDR	SOT-25	28dc4	DC1	6g	Tor
<u>U40</u>	XC9226E406M	DC/DC-IC	PWM/PFM step-down, 600kHz, 4.0V±1%, 900mA, +CE	SOT-25	28dc4	DC1	6g	Tor
<u>U40</u>	XC9226F406M	DC/DC-IC	PWM/PFM step-down, 600kHz, 4.0V±1%, 900mA, -CE	SOT-25	28dc4	DC1	6g	Tor
<u>U40</u>	XC9226G406M	DC/DC-IC	PWM/PFM step-down, 600kHz, 4.0V±1%, 900mA, +CE, PDR	SOT-25	28dc4	DC1	6g	Tor
<u>U40</u>	XC9226H406M	DC/DC-IC	PWM/PFM step-down, 600kHz, 4.0V±1%, 900mA, -CE, PDR	SOT-25	28dc4	DC1	6g	Tor
<u>U40</u>	SN74AUC1G240DBV	CMOS-Logic	Bus buffer inverted with 3-state output	SOT-23-5	28/Log22	-	6a	Ti
<u>U4A</u>	XC6118N14AMR-G	Vdet-IC	1.4V±30mV, ±Reset ODO, Sense, hysteresis 5%, Cd	SOT-25	28mg	VD14	6g	Tor
<u>U4A</u>	XC9226A40CM	DC/DC-IC	PWM/PFM step-down, 1.2MHz, 4.0V±1%, 600mA, +CE	SOT-25	28dc4	DC1	6g	Tor
<u>U4A</u>	XC9226B40CM	DC/DC-IC	PWM/PFM step-down, 1.2MHz, 4.0V±1%, 600mA, -CE	SOT-25	28dc4	DC1	6g	Tor
<u>U4A</u>	XC9226C40CM	DC/DC-IC	PWM/PFM step-down, 1.2MHz, 4.0V±1%, 600mA, +CE, PDR	SOT-25	28dc4	DC1	6g	Tor
<u>U4A</u>	XC9226D40CM	DC/DC-IC	PWM/PFM step-down, 1.2MHz, 4.0V±1%, 600mA, -CE, PDR	SOT-25	28dc4	DC1	6g	Tor
<u>U4A</u>	XC9226E40CM	DC/DC-IC	PWM/PFM step-down, 1.2MHz, 4.0V±1%, 900mA, +CE	SOT-25	28dc4	DC1	6g	Tor
<u>U4A</u>	XC9226F40CM	DC/DC-IC	PWM/PFM step-down, 1.2MHz, 4.0V±1%, 900mA, -CE	SOT-25	28dc4	DC1	6g	Tor
<u>U4A</u>	XC9226G40CM	DC/DC-IC	PWM/PFM step-down, 1.2MHz, 4.0V±1%, 900mA, +CE, PDR	SOT-25	28dc4	DC1	6g	Tor
<u>U4A</u>	XC9226H40CM	DC/DC-IC	PWM/PFM step-down, 1.2MHz, 4.0V±1%, 900mA, -CE, PDR	SOT-25	28dc4	DC1	6g	Tor
<u>U4B</u>	XC6118N14BMR-G	Vdet-IC	1.4V±30mV, ±Reset ODO, Sense, hysteresis <1%, Cd	SOT-25	28mg	VD14	6g	Tor
<u>U4C</u>	XC6118N14CMR-G	Vdet-IC	1.4V±30mV, ±Reset ODO, Sense, hysteresis 5%	SOT-25	28mf	VD11	6g	Tor
<u>U4D</u>	XC6118N14DMR-G	Vdet-IC	1.4V±30mV, ±Reset ODO, Sense, hysteresis <1%	SOT-25	28mf	VD11	6g	Tor
<u>U5</u>	AX6608-15B	LVR-IC	LDO, 1.5V±3%, 300mA, +CE	SOT-23-5	28vrx	VR7	6k	Axl
<u>U5</u>	BD45351G	Vdet-IC	3.5V, -Reset ODO, 100ms	SSOP-5	28vdp	VD6	6c	Rhm
<u>U5</u>	TC74A5-5.0VCT	Tdet-IC	Sensor (-40..+125±3°C), Vcc=5V, I2C-bus	SOT-23-5	28hd	-	6g	Mcc
<u>U5A</u>	XC6118N15AMR-G	Vdet-IC	1.5V±30mV, ±Reset ODO, Sense, hysteresis 5%, Cd	SOT-25	28mg	VD14	6g	Tor
<u>U5B</u>	XC6118N15BMR-G	Vdet-IC	1.5V±30mV, ±Reset ODO, Sense, hysteresis <1%, Cd	SOT-25	28mg	VD14	6g	Tor
<u>U5C</u>	XC6118N15CMR-G	Vdet-IC	1.5V±30mV, ±Reset ODO, Sense, hysteresis 5%	SOT-25	28mf	VD11	6g	Tor
<u>U5D</u>	XC6118N15DMR-G	Vdet-IC	1.5V±30mV, ±Reset ODO, Sense, hysteresis <1%	SOT-25	28mf	VD11	6g	Tor
<u>U6</u>	BD45341G	Vdet-IC	3.4V, -Reset ODO, 100ms	SSOP-5	28vdp	VD6	6c	Rhm
<u>U6</u>	TC74A6-5.0VCT	Tdet-IC	Sensor (-40..+125±3°C), Vcc=5V, I2C-bus	SOT-23-5	28hd	-	6g	Mcc
<u>U6A</u>	XC6118N16AMR-G	Vdet-IC	1.6V±2%, ±Reset ODO, Sense, hysteresis 5%, Cd	SOT-25	28mg	VD14	6g	Tor
<u>U6B</u>	XC6118N16BMR-G	Vdet-IC	1.6V±2%, ±Reset ODO, Sense, hysteresis <1%, Cd	SOT-25	28mg	VD14	6g	Tor
<u>U6C</u>	XC6118N16CMR-G	Vdet-IC	1.6V±2%, ±Reset ODO, Sense, hysteresis 5%	SOT-25	28mf	VD11	6g	Tor
<u>U6D</u>	XC6118N16DMR-G	Vdet-IC	1.6V±2%, ±Reset ODO, Sense, hysteresis <1%	SOT-25	28mf	VD11	6g	Tor
<u>U7</u>	BD45331G	Vdet-IC	3.3V, -Reset ODO, 100ms	SSOP-5	28vdp	VD6	6c	Rhm
<u>U7</u>	TC74A7-5.0VCT	Tdet-IC	Sensor (-40..+125±3°C), Vcc=5V, I2C-bus	SOT-23-5	28hd	-	6g	Mcc
<u>U7_</u>	SN74AUC1G17DCK	CMOS-Logic	Schmitt-trigger	SC-70-5	28/Log11	-	6a	Ti
<u>U7_</u>	SN74AUC1G17DRL	CMOS-Logic	Schmitt-trigger	SOT-553	30/Log11	-	6a	Ti
<u>U7A</u>	XC6118N17AMR-G	Vdet-IC	1.7V±2%, ±Reset ODO, Sense, hysteresis 5%, Cd	SOT-25	28mg	VD14	6g	Tor
<u>U7B</u>	XC6118N17BMR-G	Vdet-IC	1.7V±2%, ±Reset ODO, Sense, hysteresis <1%, Cd	SOT-25	28mg	VD14	6g	Tor
<u>U7C</u>	XC6118N17CMR-G	Vdet-IC	1.7V±2%, ±Reset ODO, Sense, hysteresis 5%	SOT-25	28mf	VD11	6g	Tor
<u>U7D</u>	XC6118N17DMR-G	Vdet-IC	1.7V±2%, ±Reset ODO, Sense, hysteresis <1%	SOT-25	28mf	VD11	6g	Tor
<u>U8</u>	BD45321G	Vdet-IC	3.2V, -Reset ODO, 100ms	SSOP-5	28vdp	VD6	6c	Rhm



SMD code	Type	Function	Short description	Case	Pinout	Sch.	St.	Mnf.
UBA	XC6118N18AMR-G	Vdet-IC	1.8V±2%, ±Reset ODO, Sense, hysteresis 5%, Cd	SOT-25	28mg	VD14	6g	Tor
UBB	XC6118N18BMR-G	Vdet-IC	1.8V±2%, ±Reset ODO, Sense, hysteresis <1%, Cd	SOT-25	28mg	VD14	6g	Tor
UBC	XC6118N18CMR-G	Vdet-IC	1.8V±2%, ±Reset ODO, Sense, hysteresis 5%	SOT-25	28mf	VD11	6g	Tor
UBD	XC6118N18DMR-G	Vdet-IC	1.8V±2%, ±Reset ODO, Sense, hysteresis <1%	SOT-25	28mf	VD11	6g	Tor
U9	BD45311G	Vdet-IC	3.1V, -Reset ODO, 100ms	SSOP-5	28vdp	VD6	6c	Rhm
UBA	XC6118N19AMR-G	Vdet-IC	1.9V±2%, ±Reset ODO, Sense, hysteresis 5%, Cd	SOT-25	28mg	VD14	6g	Tor
UBB	XC6118N19BMR-G	Vdet-IC	1.9V±2%, ±Reset ODO, Sense, hysteresis <1%, Cd	SOT-25	28mg	VD14	6g	Tor
UBC	XC6118N19CMR-G	Vdet-IC	1.9V±2%, ±Reset ODO, Sense, hysteresis 5%	SOT-25	28mf	VD11	6g	Tor
UBD	XC6118N19DMR-G	Vdet-IC	1.9V±2%, ±Reset ODO, Sense, hysteresis <1%	SOT-25	28mf	VD11	6g	Tor
Ua	AX6608-19A	LVR-IC	LDO, 1.9V±3%, 300mA, +CE	SC-70-5L	28vrx	VR7	6k	Axl
Ua	AX6608-19B	LVR-IC	LDO, 1.9V±3%, 300mA, +CE	SOT-23-5	28vrx	VR7	6k	Axl
UA	AX6608-18B	LVR-IC	LDO, 1.8V±3%, 300mA, +CE	SOT-23-5	28vrx	VR7	6k	Axl
UA	BD45301G	Vdet-IC	3V, -Reset ODO, 100ms	SSOP-5	28vdp	VD6	6c	Rhm
UA_	SN74AUC1G00DCK	CMOS-Logic	2-input NAND gate	SC-70-5	28NLog1	-	6a	Ti
UA_	SN74AUC1G00DRL	CMOS-Logic	2-input NAND gate	SOT-553	30NLog1	-	6a	Ti
UA9	XC9226A0M6M	DC/DC-IC	PWM/PFM step-down, 600kHz, 0.95V±1%, 600mA, +CE	SOT-25	28dc4	DC1	6g	Tor
UA9	XC9226B0M6M	DC/DC-IC	PWM/PFM step-down, 600kHz, 0.95V±1%, 600mA, -CE	SOT-25	28dc4	DC1	6g	Tor
UA9	XC9226C0M6M	DC/DC-IC	PWM/PFM step-down, 600kHz, 0.95V±1%, 600mA, +CE, PDR	SOT-25	28dc4	DC1	6g	Tor
UA9	XC9226D0M6M	DC/DC-IC	PWM/PFM step-down, 600kHz, 0.95V±1%, 600mA, -CE, PDR	SOT-25	28dc4	DC1	6g	Tor
AAA	RP503N081A	DC/DC-IC	PWM/VFM st-down, 0.8V±18mV, 600mA, +CE	SOT-23-5	28gq	DC20	6g	Ric
UAB	RP503N091A	DC/DC-IC	PWM/VFM st-down, 0.9V±18mV, 600mA, +CE	SOT-23-5	28gq	DC20	6g	Ric
UAC	RP503N101A	DC/DC-IC	PWM/VFM st-down, 1.0V±18mV, 600mA, +CE	SOT-23-5	28gq	DC20	6g	Ric
UAD	RP503N111A	DC/DC-IC	PWM/VFM st-down, 1.1V±18mV, 600mA, +CE	SOT-23-5	28gq	DC20	6g	Ric
UAE	RP503N121A	DC/DC-IC	PWM/VFM st-down, 1.2V±1.5%, 600mA, +CE	SOT-23-5	28gq	DC20	6g	Ric
UAF	RP503N121A5	DC/DC-IC	PWM/VFM st-down, 1.25V±1.5%, 600mA, +CE	SOT-23-5	28gq	DC20	6g	Ric
UAG	RP503N131A	DC/DC-IC	PWM/VFM st-down, 1.3V±1.5%, 600mA, +CE	SOT-23-5	28gq	DC20	6g	Ric
UAH	RP503N141A	DC/DC-IC	PWM/VFM st-down, 1.4V±1.5%, 600mA, +CE	SOT-23-5	28gq	DC20	6g	Ric
UAJ	RP503N151A	DC/DC-IC	PWM/VFM st-down, 1.5V±1.5%, 600mA, +CE	SOT-23-5	28gq	DC20	6g	Ric
UAK	RP503N161A	DC/DC-IC	PWM/VFM st-down, 1.6V±1.5%, 600mA, +CE	SOT-23-5	28gq	DC20	6g	Ric
UAL	RP503N171A	DC/DC-IC	PWM/VFM st-down, 1.7V±1.5%, 600mA, +CE	SOT-23-5	28gq	DC20	6g	Ric
UAM	RP503N181A	DC/DC-IC	PWM/VFM st-down, 1.8V±1.5%, 600mA, +CE	SOT-23-5	28gq	DC20	6g	Ric
UAM	XC9226A0MCM	DC/DC-IC	PWM/PFM step-down, 1.2MHz, 0.95V±1%, 600mA, +CE	SOT-25	28dc4	DC1	6g	Tor
UAM	XC9226B0MCM	DC/DC-IC	PWM/PFM step-down, 1.2MHz, 0.95V±1%, 600mA, -CE	SOT-25	28dc4	DC1	6g	Tor
UAM	XC9226C0MCM	DC/DC-IC	PWM/PFM step-down, 1.2MHz, 0.95V±1%, 600mA, +CE, PDR	SOT-25	28dc4	DC1	6g	Tor
UAM	XC9226D0MCM	DC/DC-IC	PWM/PFM step-down, 1.2MHz, 0.95V±1%, 600mA, -CE, PDR	SOT-25	28dc4	DC1	6g	Tor
UAN	RP503N191A	DC/DC-IC	PWM/VFM st-down, 1.9V±1.5%, 600mA, +CE	SOT-23-5	28gq	DC20	6g	Ric
UAP	RP503N201A	DC/DC-IC	PWM/VFM st-down, 2.0V±1.5%, 600mA, +CE	SOT-23-5	28gq	DC20	6g	Ric
UAQ	RP503N211A	DC/DC-IC	PWM/VFM st-down, 2.1V±1.5%, 600mA, +CE	SOT-23-5	28gq	DC20	6g	Ric
UAR	RP503N221A	DC/DC-IC	PWM/VFM st-down, 2.2V±1.5%, 600mA, +CE	SOT-23-5	28gq	DC20	6g	Ric
UAS	RP503N231A	DC/DC-IC	PWM/VFM st-down, 2.3V±1.5%, 600mA, +CE	SOT-23-5	28gq	DC20	6g	Ric
UAT	RP503N241A	DC/DC-IC	PWM/VFM st-down, 2.4V±1.5%, 600mA, +CE	SOT-23-5	28gq	DC20	6g	Ric
UAU	RP503N251A	DC/DC-IC	PWM/VFM st-down, 2.5V±1.5%, 600mA, +CE	SOT-23-5	28gq	DC20	6g	Ric
Ub	AX6608-21A	LVR-IC	LDO, 2.1V±3%, 300mA, +CE	SC-70-5L	28vrx	VR7	6k	Axl
UB	AX6608-12A	LVR-IC	LDO, 1.2V±3%, 300mA, +CE	SC-70-5L	28vrx	VR7	6k	Axl
UB	AX6608-21B	LVR-IC	LDO, 2.1V±3%, 300mA, +CE	SOT-23-5	28vrx	VR7	6k	Axl
UB	BD45291G	Vdet-IC	2.9V, -Reset ODO, 100ms	SSOP-5	28vdp	VD6	6c	Rhm
UB0	XC9226A1A6M	DC/DC-IC	PWM/PFM step-down, 600kHz, 1.05V±1%, 600mA, +CE	SOT-25	28dc4	DC1	6g	Tor
UB0	XC9226B1A6M	DC/DC-IC	PWM/PFM step-down, 600kHz, 1.05V±1%, 600mA, -CE	SOT-25	28dc4	DC1	6g	Tor
UB0	XC9226C1A6M	DC/DC-IC	PWM/PFM step-down, 600kHz, 1.05V±1%, 600mA, +CE, PDR	SOT-25	28dc4	DC1	6g	Tor
UB0	XC9226D1A6M	DC/DC-IC	PWM/PFM step-down, 600kHz, 1.05V±1%, 600mA, -CE, PDR	SOT-25	28dc4	DC1	6g	Tor
UB1	XC9226A1B6M	DC/DC-IC	PWM/PFM step-down, 600kHz, 1.15V±1%, 600mA, +CE	SOT-25	28dc4	DC1	6g	Tor
UB1	XC9226B1B6M	DC/DC-IC	PWM/PFM step-down, 600kHz, 1.15V±1%, 600mA, -CE	SOT-25	28dc4	DC1	6g	Tor
UB1	XC9226C1B6M	DC/DC-IC	PWM/PFM step-down, 600kHz, 1.15V±1%, 600mA, +CE, PDR	SOT-25	28dc4	DC1	6g	Tor
UB1	XC9226D1B6M	DC/DC-IC	PWM/PFM step-down, 600kHz, 1.15V±1%, 600mA, -CE, PDR	SOT-25	28dc4	DC1	6g	Tor
UB2	XC9226A1C6M	DC/DC-IC	PWM/PFM step-down, 600kHz, 1.25V±1%, 600mA, +CE	SOT-25	28dc4	DC1	6g	Tor
UB2	XC9226B1C6M	DC/DC-IC	PWM/PFM step-down, 600kHz, 1.25V±1%, 600mA, -CE	SOT-25	28dc4	DC1	6g	Tor
UB2	XC9226C1C6M	DC/DC-IC	PWM/PFM step-down, 600kHz, 1.25V±1%, 600mA, +CE, PDR	SOT-25	28dc4	DC1	6g	Tor
UB2	XC9226D1C6M	DC/DC-IC	PWM/PFM step-down, 600kHz, 1.25V±1%, 600mA, -CE, PDR	SOT-25	28dc4	DC1	6g	Tor
UB3	XC9226A1D6M	DC/DC-IC	PWM/PFM step-down, 600kHz, 1.35V±1%, 600mA, +CE	SOT-25	28dc4	DC1	6g	Tor
UB3	XC9226B1D6M	DC/DC-IC	PWM/PFM step-down, 600kHz, 1.35V±1%, 600mA, -CE	SOT-25	28dc4	DC1	6g	Tor
UB3	XC9226C1D6M	DC/DC-IC	PWM/PFM step-down, 600kHz, 1.35V±1%, 600mA, +CE, PDR	SOT-25	28dc4	DC1	6g	Tor
UB3	XC9226D1D6M	DC/DC-IC	PWM/PFM step-down, 600kHz, 1.35V±1%, 600mA, -CE, PDR	SOT-25	28dc4	DC1	6g	Tor
UB4	XC9226A1E6M	DC/DC-IC	PWM/PFM step-down, 600kHz, 1.45V±1%, 600mA, +CE	SOT-25	28dc4	DC1	6g	Tor
UB4	XC9226B1E6M	DC/DC-IC	PWM/PFM step-down, 600kHz, 1.45V±1%, 600mA, -CE	SOT-25	28dc4	DC1	6g	Tor
UB4	XC9226C1E6M	DC/DC-IC	PWM/PFM step-down, 600kHz, 1.45V±1%, 600mA, +CE, PDR	SOT-25	28dc4	DC1	6g	Tor
UB4	XC9226D1E6M	DC/DC-IC	PWM/PFM step-down, 600kHz, 1.45V±1%, 600mA, -CE, PDR	SOT-25	28dc4	DC1	6g	Tor
UB5	XC9226A1F6M	DC/DC-IC	PWM/PFM step-down, 600kHz, 1.55V±1%, 600mA, +CE	SOT-25	28dc4	DC1	6g	Tor
UB5	XC9226B1F6M	DC/DC-IC	PWM/PFM step-down, 600kHz, 1.55V±1%, 600mA, -CE	SOT-25	28dc4	DC1	6g	Tor
UB5	XC9226C1F6M	DC/DC-IC	PWM/PFM step-down, 600kHz, 1.55V±1%, 600mA, +CE, PDR	SOT-25	28dc4	DC1	6g	Tor
UB5	XC9226D1F6M	DC/DC-IC	PWM/PFM step-down, 600kHz, 1.55V±1%, 600mA, -CE, PDR	SOT-25	28dc4	DC1	6g	Tor



SMD code	Type	Function	Short description	Case	Pinout	Sch.	St.	Mnf.
UDF	XC9226H3ECM	DC/DC-IC	PWM/PFM step-down, 1.2MHz, 3.45V±1%, 900mA, -CE, PDR	SOT-25	28dc4	DC1	6g	Tor
UDF	XC9226A3FCM	DC/DC-IC	PWM/PFM step-down, 1.2MHz, 3.55V±1%, 600mA, +CE	SOT-25	28dc4	DC1	6g	Tor
UDF	XC9226B3FCM	DC/DC-IC	PWM/PFM step-down, 1.2MHz, 3.55V±1%, 600mA, -CE	SOT-25	28dc4	DC1	6g	Tor
UDF	XC9226C3FCM	DC/DC-IC	PWM/PFM step-down, 1.2MHz, 3.55V±1%, 600mA, +CE, PDR	SOT-25	28dc4	DC1	6g	Tor
UDF	XC9226D3FCM	DC/DC-IC	PWM/PFM step-down, 1.2MHz, 3.55V±1%, 600mA, -CE, PDR	SOT-25	28dc4	DC1	6g	Tor
UDF	XC9226E3FCM	DC/DC-IC	PWM/PFM step-down, 1.2MHz, 3.55V±1%, 900mA, -CE, PDR	SOT-25	28dc4	DC1	6g	Tor
UDF	XC9226F3FCM	DC/DC-IC	PWM/PFM step-down, 1.2MHz, 3.55V±1%, 900mA, -CE	SOT-25	28dc4	DC1	6g	Tor
UDF	XC9226G3FCM	DC/DC-IC	PWM/PFM step-down, 1.2MHz, 3.55V±1%, 900mA, +CE, PDR	SOT-25	28dc4	DC1	6g	Tor
UDF	XC9226H3FCM	DC/DC-IC	PWM/PFM step-down, 1.2MHz, 3.55V±1%, 900mA, -CE, PDR	SOT-25	28dc4	DC1	6g	Tor
UDH	XC9226A3HCM	DC/DC-IC	PWM/PFM step-down, 1.2MHz, 3.65V±1%, 600mA, +CE	SOT-25	28dc4	DC1	6g	Tor
UDH	XC9226B3HCM	DC/DC-IC	PWM/PFM step-down, 1.2MHz, 3.65V±1%, 600mA, -CE	SOT-25	28dc4	DC1	6g	Tor
UDH	XC9226C3HCM	DC/DC-IC	PWM/PFM step-down, 1.2MHz, 3.65V±1%, 600mA, +CE, PDR	SOT-25	28dc4	DC1	6g	Tor
UDH	XC9226D3HCM	DC/DC-IC	PWM/PFM step-down, 1.2MHz, 3.65V±1%, 600mA, -CE, PDR	SOT-25	28dc4	DC1	6g	Tor
UDH	XC9226E3HCM	DC/DC-IC	PWM/PFM step-down, 1.2MHz, 3.65V±1%, 900mA, +CE	SOT-25	28dc4	DC1	6g	Tor
UDH	XC9226F3HCM	DC/DC-IC	PWM/PFM step-down, 1.2MHz, 3.65V±1%, 900mA, -CE	SOT-25	28dc4	DC1	6g	Tor
UDH	XC9226G3HCM	DC/DC-IC	PWM/PFM step-down, 1.2MHz, 3.65V±1%, 900mA, +CE, PDR	SOT-25	28dc4	DC1	6g	Tor
UDH	XC9226H3HCM	DC/DC-IC	PWM/PFM step-down, 1.2MHz, 3.65V±1%, 900mA, -CE, PDR	SOT-25	28dc4	DC1	6g	Tor
UDK	XC9226A3KCM	DC/DC-IC	PWM/PFM step-down, 1.2MHz, 3.75V±1%, 600mA, +CE	SOT-25	28dc4	DC1	6g	Tor
UDK	XC9226B3KCM	DC/DC-IC	PWM/PFM step-down, 1.2MHz, 3.75V±1%, 600mA, -CE	SOT-25	28dc4	DC1	6g	Tor
UDK	XC9226C3KCM	DC/DC-IC	PWM/PFM step-down, 1.2MHz, 3.75V±1%, 600mA, +CE, PDR	SOT-25	28dc4	DC1	6g	Tor
UDK	XC9226D3KCM	DC/DC-IC	PWM/PFM step-down, 1.2MHz, 3.75V±1%, 600mA, -CE, PDR	SOT-25	28dc4	DC1	6g	Tor
UDK	XC9226E3KCM	DC/DC-IC	PWM/PFM step-down, 1.2MHz, 3.75V±1%, 900mA, +CE	SOT-25	28dc4	DC1	6g	Tor
UDK	XC9226F3KCM	DC/DC-IC	PWM/PFM step-down, 1.2MHz, 3.75V±1%, 900mA, -CE	SOT-25	28dc4	DC1	6g	Tor
UDK	XC9226G3KCM	DC/DC-IC	PWM/PFM step-down, 1.2MHz, 3.75V±1%, 900mA, +CE, PDR	SOT-25	28dc4	DC1	6g	Tor
UDK	XC9226H3KCM	DC/DC-IC	PWM/PFM step-down, 1.2MHz, 3.75V±1%, 900mA, -CE, PDR	SOT-25	28dc4	DC1	6g	Tor
UDL	MIC2753-LBM5	Vdet-IC	4.63V, MR, +Reset ODO	SOT-23-5	28eg	-	6g	Mcr
UDL	XC9226A3LCM	DC/DC-IC	PWM/PFM step-down, 1.2MHz, 3.85V±1%, 600mA, +CE	SOT-25	28dc4	DC1	6g	Tor
UDL	XC9226B3LCM	DC/DC-IC	PWM/PFM step-down, 1.2MHz, 3.85V±1%, 600mA, -CE	SOT-25	28dc4	DC1	6g	Tor
UDL	XC9226C3LCM	DC/DC-IC	PWM/PFM step-down, 1.2MHz, 3.85V±1%, 600mA, +CE, PDR	SOT-25	28dc4	DC1	6g	Tor
UDL	XC9226D3LCM	DC/DC-IC	PWM/PFM step-down, 1.2MHz, 3.85V±1%, 600mA, -CE, PDR	SOT-25	28dc4	DC1	6g	Tor
UDL	XC9226E3LCM	DC/DC-IC	PWM/PFM step-down, 1.2MHz, 3.85V±1%, 900mA, +CE	SOT-25	28dc4	DC1	6g	Tor
UDL	XC9226F3LCM	DC/DC-IC	PWM/PFM step-down, 1.2MHz, 3.85V±1%, 900mA, -CE	SOT-25	28dc4	DC1	6g	Tor
UDL	XC9226G3LCM	DC/DC-IC	PWM/PFM step-down, 1.2MHz, 3.85V±1%, 900mA, +CE, PDR	SOT-25	28dc4	DC1	6g	Tor
UDL	XC9226H3LCM	DC/DC-IC	PWM/PFM step-down, 1.2MHz, 3.85V±1%, 900mA, -CE, PDR	SOT-25	28dc4	DC1	6g	Tor
UDM	MIC2753-MBM5	Vdet-IC	4.38V, MR, +Reset ODO	SOT-23-5	28eg	-	6g	Mcr
UDM	XC9226A3MCM	DC/DC-IC	PWM/PFM step-down, 1.2MHz, 3.95V±1%, 600mA, +CE	SOT-25	28dc4	DC1	6g	Tor
UDM	XC9226B3MCM	DC/DC-IC	PWM/PFM step-down, 1.2MHz, 3.95V±1%, 600mA, -CE	SOT-25	28dc4	DC1	6g	Tor
UDM	XC9226C3MCM	DC/DC-IC	PWM/PFM step-down, 1.2MHz, 3.95V±1%, 600mA, +CE, PDR	SOT-25	28dc4	DC1	6g	Tor
UDM	XC9226D3MCM	DC/DC-IC	PWM/PFM step-down, 1.2MHz, 3.95V±1%, 600mA, -CE, PDR	SOT-25	28dc4	DC1	6g	Tor
UDM	XC9226E3MCM	DC/DC-IC	PWM/PFM step-down, 1.2MHz, 3.95V±1%, 900mA, +CE	SOT-25	28dc4	DC1	6g	Tor
UDM	XC9226F3MCM	DC/DC-IC	PWM/PFM step-down, 1.2MHz, 3.95V±1%, 900mA, -CE	SOT-25	28dc4	DC1	6g	Tor
UDM	XC9226G3MCM	DC/DC-IC	PWM/PFM step-down, 1.2MHz, 3.95V±1%, 900mA, +CE, PDR	SOT-25	28dc4	DC1	6g	Tor
UDM	XC9226H3MCM	DC/DC-IC	PWM/PFM step-down, 1.2MHz, 3.95V±1%, 900mA, -CE, PDR	SOT-25	28dc4	DC1	6g	Tor
UDR	MIC2753-RBM5	Vdet-IC	2.63V, MR, +Reset ODO	SOT-23-5	28eg	-	6g	Mcr
UDS	MIC2753-SBM5	Vdet-IC	2.93V, MR, +Reset ODO	SOT-23-5	28eg	-	6g	Mcr
UDT	MIC2753-TBM5	Vdet-IC	3.08V, MR, +Reset ODO	SOT-23-5	28eg	-	6g	Mcr
Ue	AX6608-20A	LVR-IC	LDO, 2.0V±3%, 300mA, +CE	SC-70-5L	28vrx	VR7	6k	Axl
Ue	AX6608-20B	LVR-IC	LDO, 2.0V±3%, 300mA, +CE	SOT-23-5	28vrx	VR7	6k	Axl
UE	AX6608-28B	LVR-IC	LDO, 2.8V±3%, 300mA, +CE	SOT-23-5	28vrx	VR7	6k	Axl
UE	BD45261G	Vdet-IC	2.6V, -Reset ODO, 100ms	SSOP-5	28vdp	VD6	6c	Rhm
UEL	MIC2754-LBM5	Vdet-IC	4.63V, MR, -Reset ODO	SOT-23-5	28eh	-	6g	Mcr
UEM	MIC2754-MBM5	Vdet-IC	4.38V, MR, -Reset ODO	SOT-23-5	28eh	-	6g	Mcr
UER	MIC2754-RBM5	Vdet-IC	2.63V, MR, -Reset ODO	SOT-23-5	28eh	-	6g	Mcr
UES	MIC2754-SBM5	Vdet-IC	2.93V, MR, -Reset ODO	SOT-23-5	28eh	-	6g	Mcr
UET	MIC2754-TBM5	Vdet-IC	3.08V, MR, -Reset ODO	SOT-23-5	28eh	-	6g	Mcr
Uf	AX6608-26A	LVR-IC	LDO, 2.6V±3%, 300mA, +CE	SC-70-5L	28vrx	VR7	6k	Axl
Uf	AX6608-26B	LVR-IC	LDO, 2.6V±3%, 300mA, +CE	SOT-23-5	28vrx	VR7	6k	Axl
UF	AX6608-25A	LVR-IC	LDO, 2.5V±3%, 300mA, +CE	SC-70-5L	28vrx	VR7	6k	Axl
UF	AX6608-25B	LVR-IC	LDO, 2.5V±3%, 300mA, +CE	SOT-23-5	28vrx	VR7	6k	Axl
UF	BD45251G	Vdet-IC	2.5V, -Reset ODO, 100ms	SSOP-5	28vdp	VD6	6c	Rhm
UF_	SN74AUC1G14DCK	CMOS-Logic	Inverting Schmitt-trigger	SC-70-5	28Log7	-	6a	Ti
UG	AX6608-28A	LVR-IC	LDO, 2.8V±3%, 300mA, +CE	SC-70-5L	28vrx	VR7	6k	Axl
UG	BD45241G	Vdet-IC	2.4V, -Reset ODO, 100ms	SSOP-5	28vdp	VD6	6c	Rhm
UG_	SN74AUC1G31DRL	CMOS-Logic	2-input OR gate	SOT-553	30Log4	-	6a	Ti
UG_	SN74AUC1G32DCK	CMOS-Logic	2-input OR gate	SC-70-5	28Log4	-	6a	Ti
UG17	MIC2777N-17BM5	Vdet-IC	Vcc/Vin, 1.8V±5%, ±Reset PPO	SOT-23-5	28xn	-	6g	Mcr
UG22	MIC2777N-22BM5	Vdet-IC	Vcc/Vin, 2.4V±5%, ±Reset PPO	SOT-23-5	28xn	-	6g	Mcr
UG23	MIC2777N-23BM5	Vdet-IC	Vcc/Vin, 2.5V±5%, ±Reset PPO	SOT-23-5	28xn	-	6g	Mcr
UG25	MIC2777N-25BM5	Vdet-IC	Vcc/Vin, 2.7V±5%, ±Reset PPO	SOT-23-5	28xn	-	6g	Mcr
UG26	MIC2777N-26BM5	Vdet-IC	Vcc/Vin, 2.85V±5%, ±Reset PPO	SOT-23-5	28xn	-	6g	Mcr



SMD code	Type	Function	Short description	Case	Pinout	Sch.	St.	Mnf.
UG28	MIC2777N-28BM5	Vdet-IC	Vcc&Vin, 3V±5%, ±Reset PPO	SOT-23-5	28xn	-	6g	Mcr
UG29	MIC2777N-29BM5	Vdet-IC	Vcc&Vin, 3.3V±10%, ±Reset PPO	SOT-23-5	28xn	-	6g	Mcr
UG31	MIC2777N-31BM5	Vdet-IC	Vcc&Vin, 3.3V±5%, ±Reset PPO	SOT-23-5	28xn	-	6g	Mcr
UG44	MIC2777N-44BM5	Vdet-IC	Vcc&Vin, 5V±10%, ±Reset PPO	SOT-23-5	28xn	-	6g	Mcr
UG46	MIC2777N-46BM5	Vdet-IC	Vcc&Vin, 5V±5%, ±Reset PPO	SOT-23-5	28xn	-	6g	Mcr
Uh	AX6608-29A	LVR-IC	LDO, 2.9V±3%, 300mA, +CE	SC-70-5L	28vrx	VR7	6k	Axl
Uh	AX6608-29B	LVR-IC	LDO, 2.9V±3%, 300mA, +CE	SOT-23-5	28vrx	VR7	6k	Axl
UH	AX6608-30A	LVR-IC	LDO, 3.0V±3%, 300mA, +CE	SC-70-5L	28vrx	VR7	6k	Axl
UH	AX6608-30B	LVR-IC	LDO, 3.0V±3%, 300mA, +CE	SOT-23-5	28vrx	VR7	6k	Axl
UH	BD45231G	Vdet-IC	2.3V, -Reset ODO, 100ms	SSOP-5	28vdp	VD6	6c	Rhm
UH17	MIC2777H-17BM5	Vdet-IC	Vcc&Vin, 1.8V±5%, ±Reset PPO	SOT-23-5	28xn	-	6g	Mcr
UH22	MIC2777H-22BM5	Vdet-IC	Vcc&Vin, 2.4V±5%, ±Reset PPO	SOT-23-5	28xn	-	6g	Mcr
UH23	MIC2777H-23BM5	Vdet-IC	Vcc&Vin, 2.5V±5%, ±Reset PPO	SOT-23-5	28xn	-	6g	Mcr
UH25	MIC2777H-25BM5	Vdet-IC	Vcc&Vin, 2.7V±5%, ±Reset PPO	SOT-23-5	28xn	-	6g	Mcr
UH26	MIC2777H-26BM5	Vdet-IC	Vcc&Vin, 2.85V±5%, ±Reset PPO	SOT-23-5	28xn	-	6g	Mcr
UH28	MIC2777H-28BM5	Vdet-IC	Vcc&Vin, 3.3V±10%, ±Reset PPO	SOT-23-5	28xn	-	6g	Mcr
UH29	MIC2777H-29BM5	Vdet-IC	Vcc&Vin, 3.3V±10%, ±Reset PPO	SOT-23-5	28xn	-	6g	Mcr
UH31	MIC2777H-31BM5	Vdet-IC	Vcc&Vin, 3.3V±5%, ±Reset PPO	SOT-23-5	28xn	-	6g	Mcr
UH44	MIC2777H-44BM5	Vdet-IC	Vcc&Vin, 5V±10%, ±Reset PPO	SOT-23-5	28xn	-	6g	Mcr
UH46	MIC2777H-46BM5	Vdet-IC	Vcc&Vin, 5V±5%, ±Reset PPO	SOT-23-5	28xn	-	6g	Mcr
Ui	AX6608-33A	LVR-IC	LDO, 3.3V±3%, 300mA, +CE	SC-70-5L	28vrx	VR7	6k	Axl
Ui	AX6608-33B	LVR-IC	LDO, 3.3V±3%, 300mA, +CE	SOT-23-5	28vrx	VR7	6k	Axl
Ui17	MIC2777L-17BM5	Vdet-IC	Vcc&Vin, 1.8V±5%, ±Reset PPO	SOT-23-5	28xn	-	6g	Mcr
Ui22	MIC2777L-22BM5	Vdet-IC	Vcc&Vin, 2.4V±5%, ±Reset PPO	SOT-23-5	28xn	-	6g	Mcr
Ui23	MIC2777L-23BM5	Vdet-IC	Vcc&Vin, 2.5V±5%, ±Reset PPO	SOT-23-5	28xn	-	6g	Mcr
Ui25	MIC2777L-25BM5	Vdet-IC	Vcc&Vin, 2.7V±5%, ±Reset PPO	SOT-23-5	28xn	-	6g	Mcr
Ui26	MIC2777L-26BM5	Vdet-IC	Vcc&Vin, 2.85V±5%, ±Reset PPO	SOT-23-5	28xn	-	6g	Mcr
Ui28	MIC2777L-28BM5	Vdet-IC	Vcc&Vin, 3V±5%, ±Reset PPO	SOT-23-5	28xn	-	6g	Mcr
Ui29	MIC2777L-29BM5	Vdet-IC	Vcc&Vin, 3.3V±10%, ±Reset PPO	SOT-23-5	28xn	-	6g	Mcr
Ui31	MIC2777L-31BM5	Vdet-IC	Vcc&Vin, 3.3V±5%, ±Reset PPO	SOT-23-5	28xn	-	6g	Mcr
Ui44	MIC2777L-44BM5	Vdet-IC	Vcc&Vin, 5V±10%, ±Reset PPO	SOT-23-5	28xn	-	6g	Mcr
Ui46	MIC2777L-46BM5	Vdet-IC	Vcc&Vin, 5V±5%, ±Reset PPO	SOT-23-5	28xn	-	6g	Mcr
Uj	BD45482G	Vdet-IC	4.8V, -Reset ODO, 200ms	SSOP-5	28vdp	VD6	6c	Rhm
Uj17	MIC2775-17BM5	Vdet-IC	1.69V, -MR, ±Reset PPO	SOT-23-5	28xf	VD21	6g	Mcr
Uj22	MIC2775-22BM5	Vdet-IC	2.25V, -MR, ±Reset PPO	SOT-23-5	28xf	VD21	6g	Mcr
Uj23	MIC2775-23BM5	Vdet-IC	2.34V, -MR, ±Reset PPO	SOT-23-5	28xf	VD21	6g	Mcr
Uj25	MIC2775-25BM5	Vdet-IC	2.53V, -MR, ±Reset PPO	SOT-23-5	28xf	VD21	6g	Mcr
Uj26	MIC2775-26BM5	Vdet-IC	2.67V, -MR, ±Reset PPO	SOT-23-5	28xf	VD21	6g	Mcr
Uj28	MIC2775-28BM5	Vdet-IC	2.81V, -MR, ±Reset PPO	SOT-23-5	28xf	VD21	6g	Mcr
Uj29	MIC2775-29BM5	Vdet-IC	2.93V, -MR, ±Reset PPO	SOT-23-5	28xf	VD21	6g	Mcr
Uj31	MIC2775-31BM5	Vdet-IC	3.09V, -MR, ±Reset PPO	SOT-23-5	28xf	VD21	6g	Mcr
Uj44	MIC2775-44BM5	Vdet-IC	4.43V, -MR, ±Reset PPO	SOT-23-5	28xf	VD21	6g	Mcr
Uj46	MIC2775-46BM5	Vdet-IC	4.68V, -MR, ±Reset PPO	SOT-23-5	28xf	VD21	6g	Mcr
Uk	BD45472G	Vdet-IC	4.7V, -Reset ODO, 200ms	SSOP-5	28vdp	VD6	6c	Rhm
UK_	SN74AUC1G240DCK	CMOS-Logic	Bus buffer inverted with 3-state output	SC-70-5	28fLog22	-	6a	Ti
UKAA	MIC2776N-BM5	Vdet-IC	Adjustable, -MR, -Reset ODO	SOT-23-5	28ek	-	6g	Mcr
UL	R1122N501B	LVR-IC	LDO, LN, +CE, 5V±2%, 150mA	SOT-23-5	28vt	VR4	6g	Ric
UL5	U74AHCT1G125-AF5	CMOS-Logic	Bus buffer gate with 3-state output	SOT-23-5	28fLog14	-	6a	Utc
UL5	U74AHCT1G125-AL5	CMOS-Logic	Bus buffer gate with 3-state output	SOT-353	28fLog14	-	6a	Utc
UL5L	U74AHCT1G125G-AF5	CMOS-Logic	Bus buffer gate with 3-state output	SOT-23-5	28fLog14	-	6a	Utc
UL5L	U74AHCT1G125G-AL5	CMOS-Logic	Bus buffer gate with 3-state output	SOT-353	28fLog14	-	6a	Utc
UL5L	U74AHCT1G125L-AF5	CMOS-Logic	Bus buffer gate with 3-state output	SOT-23-5	28fLog14	-	6a	Utc
UL5L	U74AHCT1G125L-AL5	CMOS-Logic	Bus buffer gate with 3-state output	SOT-353	28fLog14	-	6a	Utc
UL6	U74AHCT1G126-AF5	CMOS-Logic	Bus buffer gate with 3-state output	SOT-23-5	28fLog13	-	6a	Utc
UL6	U74AHCT1G126-AL5	CMOS-Logic	Bus buffer gate with 3-state output	SOT-353	28fLog13	-	6a	Utc
UL6L	U74AHCT1G126G-AF5	CMOS-Logic	Bus buffer gate with 3-state output	SOT-23-5	28fLog13	-	6a	Utc
UL6L	U74AHCT1G126G-AL5	CMOS-Logic	Bus buffer gate with 3-state output	SOT-353	28fLog13	-	6a	Utc
UL6L	U74AHCT1G126L-AF5	CMOS-Logic	Bus buffer gate with 3-state output	SOT-23-5	28fLog13	-	6a	Utc
UL6L	U74AHCT1G126L-AL5	CMOS-Logic	Bus buffer gate with 3-state output	SOT-353	28fLog13	-	6a	Utc
ULAA	MIC2776H-BM5	Vdet-IC	Adjustable, -MR, +Reset PPO	SOT-23-5	28ek	-	6g	Mcr
UM	BD45452G	Vdet-IC	4.5V, -Reset ODO, 200ms	SSOP-5	28vdp	VD6	6c	Rhm
UM_	SN74AUC1G125DCK	CMOS-Logic	Bus buffer gate with 3-state output	SC-70-5	28fLog14	-	6a	Ti
UMAA	MIC2776L-BM5	Vdet-IC	Adjustable, -MR, -Reset PPO	SOT-23-5	28ek	-	6g	Mcr
UN	BD45442G	Vdet-IC	4.4V, -Reset ODO, 200ms	SSOP-5	28vdp	VD6	6c	Rhm
UN_	SN74AUC1G126DCK	CMOS-Logic	Bus buffer gate with 3-state output	SC-70-5	28fLog13	-	6a	Ti
UN17	MIC2777-17BM5	Vdet-IC	Vcc&Vin, 1.8V±5%, ±Reset PPO	SOT-23-5	28xn	-	6g	Mcr
UN22	MIC2777-22BM5	Vdet-IC	Vcc&Vin, 2.4V±5%, ±Reset PPO	SOT-23-5	28xn	-	6g	Mcr
UN23	MIC2777-23BM5	Vdet-IC	Vcc&Vin, 2.5V±5%, ±Reset PPO	SOT-23-5	28xn	-	6g	Mcr
UN25	MIC2777-25BM5	Vdet-IC	Vcc&Vin, 2.85V±5%, ±Reset PPO	SOT-23-5	28xn	-	6g	Mcr
UN26	MIC2777-26BM5	Vdet-IC	Vcc&Vin, 2.7V±5%, ±Reset PPO	SOT-23-5	28xn	-	6g	Mcr



SMD code	Type	Function	Short description	Case	Pinout	Sch.	St.	Mnf.
UN28	MIC2777-28BM5	Vdet-IC	Vcc&Vin, 3V±5%, ±Reset PPO	SOT-23-5	28xn	-	6g	Mcr
UN29	MIC2777-29BM5	Vdet-IC	Vcc&Vin, 3.3V±10%, ±Reset PPO	SOT-23-5	28xn	-	6g	Mcr
UN31	MIC2777-31BM5	Vdet-IC	Vcc&Vin, 3.3V±5%, ±Reset PPO	SOT-23-5	28xn	-	6g	Mcr
UN44	MIC2777-44BM5	Vdet-IC	Vcc&Vin, 5V±10%, ±Reset PPO	SOT-23-5	28xn	-	6g	Mcr
UN46	MIC2777-46BM5	Vdet-IC	Vcc&Vin, 5V±5%, ±Reset PPO	SOT-23-5	28xn	-	6g	Mcr
UO	AX6608-22A	LVR-IC	LDO, 2.2V±3%, 300mA, +CE	SC-70-5L	28vrx	VR7	6k	Axl
UP	BD45432G	Vdet-IC	4.3V, -Reset ODO, 200ms	SSOP-5	28vdp	VD6	6c	Rhm
UQ	BD45422G	Vdet-IC	4.2V, -Reset ODO, 200ms	SSOP-5	28vdp	VD6	6c	Rhm
UR	BD45412G	Vdet-IC	4.1V, -Reset ODO, 200ms	SSOP-5	28vdp	VD6	6c	Rhm
US	AX6608-16A	LVR-IC	LDO, 1.6V±3%, 300mA, +CE	SC-70-5L	28vrx	VR7	6k	Axl
US	AX6608-16B	LVR-IC	LDO, 1.6V±3%, 300mA, +CE	SOT-23-5	28vrx	VR7	6k	Axl
US	BD45402G	Vdet-IC	4V, -Reset ODO, 200ms	SSOP-5	28vdp	VD6	6c	Rhm
UT	AX6608-24A	LVR-IC	LDO, 2.4V±3%, 300mA, +CE	SC-70-5L	28vrx	VR7	6k	Axl
UT	AX6608-24B	LVR-IC	LDO, 2.4V±3%, 300mA, +CE	SOT-23-5	28vrx	VR7	6k	Axl
UT	BD45392G	Vdet-IC	3.9V, -Reset ODO, 200ms	SSOP-5	28vdp	VD6	6c	Rhm
UU	AX6608-32A	LVR-IC	LDO, 3.2V±3%, 300mA, +CE	SC-70-5L	28vrx	VR7	6k	Axl
UU	AX6608-32B	LVR-IC	LDO, 3.2V±3%, 300mA, +CE	SOT-23-5	28vrx	VR7	6k	Axl
UU	BD45382G	Vdet-IC	3.8V, -Reset ODO, 200ms	SSOP-5	28vdp	VD6	6c	Rhm
Uv	AX6608-23A	LVR-IC	LDO, 2.3V±3%, 300mA, +CE	SC-70-5L	28vrx	VR7	6k	Axl
Uv	AX6608-23B	LVR-IC	LDO, 2.3V±3%, 300mA, +CE	SOT-23-5	28vrx	VR7	6k	Axl
Uv	BD45372G	Vdet-IC	3.7V, -Reset ODO, 200ms	SSOP-5	28vdp	VD6	6c	Rhm
Uw	AX6608-27A	LVR-IC	LDO, 2.7V±3%, 300mA, +CE	SC-70-5L	28vrx	VR7	6k	Axl
UW	BD45362G	Vdet-IC	3.6V, -Reset ODO, 200ms	SSOP-5	28vdp	VD6	6c	Rhm
Ux	AX6608-31A	LVR-IC	LDO, 3.1V±3%, 300mA, +CE	SC-70-5L	28vrx	VR7	6k	Axl
Ux	AX6608-31B	LVR-IC	LDO, 3.1V±3%, 300mA, +CE	SOT-23-5	28vrx	VR7	6k	Axl
UX	AX6608-17A	LVR-IC	LDO, 1.7V±3%, 300mA, +CE	SC-70-5L	28vrx	VR7	6k	Axl
UX	AX6608-17B	LVR-IC	LDO, 1.7V±3%, 300mA, +CE	SOT-23-5	28vrx	VR7	6k	Axl
UX	BD45352G	Vdet-IC	3.5V, -Reset ODO, 200ms	SSOP-5	28vdp	VD6	6c	Rhm
UY	BD45342G	Vdet-IC	3.4V, -Reset ODO, 200ms	SSOP-5	28vdp	VD6	6c	Rhm
UZ	BD45332G	Vdet-IC	3.3V, -Reset ODO, 200ms	SSOP-5	28vdp	VD6	6c	Rhm
V0	MC74VHC1G01DF	CMOS-Logic	2-input NAND gate (ODO)	SOT-353	28/Log17	-	6b	Ons
V0	MC74VHC1G01DT	CMOS-Logic	2-input NAND gate (ODO)	SOT-23-5	28/Log17	-	6b	Ons
V0	TC74A0-3.3VCT	Tdet-IC	Sensor (-40...+125±3°C), Vcc=3.3V, I2C-bus	SOT-23-5	28hd	-	6g	Mcc
V00	74LVC1G00GV	CMOS-Logic	2-input NAND gate	SOT753	28/Log1	-	6a	Phi
V009	R3111Q092C	Vdet-IC	0.9V±2%, -Reset ODO	SC-88A	28ru	VD6	6m	Ric
V010	R3111Q102C	Vdet-IC	1.0V±2%, -Reset ODO	SC-88A	28ru	VD6	6m	Ric
V011	R3111Q112C	Vdet-IC	1.1V±2%, -Reset ODO	SC-88A	28ru	VD6	6m	Ric
V012	R3111Q122C	Vdet-IC	1.2V±2%, -Reset ODO	SC-88A	28ru	VD6	6m	Ric
V013	R3111Q132C	Vdet-IC	1.3V±2%, -Reset ODO	SC-88A	28ru	VD6	6m	Ric
V014	R3111Q142C	Vdet-IC	1.4V±2%, -Reset ODO	SC-88A	28ru	VD6	6m	Ric
V015	R3111Q152C	Vdet-IC	1.5V±2%, -Reset ODO	SC-88A	28ru	VD6	6m	Ric
V016	R3111Q162C	Vdet-IC	1.6V±2%, -Reset ODO	SC-88A	28ru	VD6	6m	Ric
V017	R3111Q172C	Vdet-IC	1.7V±2%, -Reset ODO	SC-88A	28ru	VD6	6m	Ric
V018	R3111Q182C	Vdet-IC	1.8V±2%, -Reset ODO	SC-88A	28ru	VD6	6m	Ric
V019	R3111Q192C	Vdet-IC	1.9V±2%, -Reset ODO	SC-88A	28ru	VD6	6m	Ric
V02	74LVC1G02GV	CMOS-Logic	2-input NOR gate	SOT753	28/Log2	-	6a	Phi
V020	R3111Q202C	Vdet-IC	2.0V±2%, -Reset ODO	SC-88A	28ru	VD6	6m	Ric
V021	R3111Q212C	Vdet-IC	2.1V±2%, -Reset ODO	SC-88A	28ru	VD6	6m	Ric
V022	R3111Q222C	Vdet-IC	2.2V±2%, -Reset ODO	SC-88A	28ru	VD6	6m	Ric
V023	R3111Q232C	Vdet-IC	2.3V±2%, -Reset ODO	SC-88A	28ru	VD6	6m	Ric
V024	R3111Q242C	Vdet-IC	2.4V±2%, -Reset ODO	SC-88A	28ru	VD6	6m	Ric
V025	R3111Q252C	Vdet-IC	2.5V±2%, -Reset ODO	SC-88A	28ru	VD6	6m	Ric
V026	R3111Q262C	Vdet-IC	2.6V±2%, -Reset ODO	SC-88A	28ru	VD6	6m	Ric
V027	R3111Q272C	Vdet-IC	2.7V±2%, -Reset ODO	SC-88A	28ru	VD6	6m	Ric
V028	R3111Q282C	Vdet-IC	2.8V±2%, -Reset ODO	SC-88A	28ru	VD6	6m	Ric
V029	R3111Q292C	Vdet-IC	2.9V±2%, -Reset ODO	SC-88A	28ru	VD6	6m	Ric
V030	R3111Q302C	Vdet-IC	3.0V±2%, -Reset ODO	SC-88A	28ru	VD6	6m	Ric
V031	R3111Q312C	Vdet-IC	3.1V±2%, -Reset ODO	SC-88A	28ru	VD6	6m	Ric
V032	R3111Q322C	Vdet-IC	3.2V±2%, -Reset ODO	SC-88A	28ru	VD6	6m	Ric
V033	R3111Q332C	Vdet-IC	3.3V±2%, -Reset ODO	SC-88A	28ru	VD6	6m	Ric
V034	R3111Q342C	Vdet-IC	3.4V±2%, -Reset ODO	SC-88A	28ru	VD6	6m	Ric
V035	R3111Q352C	Vdet-IC	3.5V±2%, -Reset ODO	SC-88A	28ru	VD6	6m	Ric
V036	R3111Q362C	Vdet-IC	3.6V±2%, -Reset ODO	SC-88A	28ru	VD6	6m	Ric
V037	R3111Q372C	Vdet-IC	3.7V±2%, -Reset ODO	SC-88A	28ru	VD6	6m	Ric
V038	R3111Q382C	Vdet-IC	3.8V±2%, -Reset ODO	SC-88A	28ru	VD6	6m	Ric
V039	R3111Q392C	Vdet-IC	3.9V±2%, -Reset ODO	SC-88A	28ru	VD6	6m	Ric
V04	74LVC1G04GV	CMOS-Logic	Inverter	SOT753	28/Log6	-	6a	Phi
V040	R3111Q402C	Vdet-IC	4.0V±2%, -Reset ODO	SC-88A	28ru	VD6	6m	Ric
V041	R3111Q412C	Vdet-IC	4.1V±2%, -Reset ODO	SC-88A	28ru	VD6	6m	Ric
V042	R3111Q422C	Vdet-IC	4.2V±2%, -Reset ODO	SC-88A	28ru	VD6	6m	Ric



SMD code	Type	Function	Short description	Case	Pinout	Sch.	St.	Mnf.
V043	R3111Q432C	Vdet-IC	4.3V±2%, -Reset ODO	SC-88A	28ru	VD6	6m	Ric
V044	R3111Q442C	Vdet-IC	4.4V±2%, -Reset ODO	SC-88A	28ru	VD6	6m	Ric
V045	R3111Q452C	Vdet-IC	4.5V±2%, -Reset ODO	SC-88A	28ru	VD6	6m	Ric
V046	R3111Q462C	Vdet-IC	4.6V±2%, -Reset ODO	SC-88A	28ru	VD6	6m	Ric
V047	R3111Q472C	Vdet-IC	4.7V±2%, -Reset ODO	SC-88A	28ru	VD6	6m	Ric
V048	R3111Q482C	Vdet-IC	4.8V±2%, -Reset ODO	SC-88A	28ru	VD6	6m	Ric
V049	R3111Q492C	Vdet-IC	4.9V±2%, -Reset ODO	SC-88A	28ru	VD6	6m	Ric
V050	R3111Q502C	Vdet-IC	5.0V±2%, -Reset ODO	SC-88A	28ru	VD6	6m	Ric
V051	R3111Q512C	Vdet-IC	5.1V±2%, -Reset ODO	SC-88A	28ru	VD6	6m	Ric
V052	R3111Q522C	Vdet-IC	5.2V±2%, -Reset ODO	SC-88A	28ru	VD6	6m	Ric
V053	R3111Q532C	Vdet-IC	5.3V±2%, -Reset ODO	SC-88A	28ru	VD6	6m	Ric
V054	R3111Q542C	Vdet-IC	5.4V±2%, -Reset ODO	SC-88A	28ru	VD6	6m	Ric
V055	R3111Q552C	Vdet-IC	5.5V±2%, -Reset ODO	SC-88A	28ru	VD6	6m	Ric
V056	R3111Q562C	Vdet-IC	5.6V±2%, -Reset ODO	SC-88A	28ru	VD6	6m	Ric
V057	R3111Q572C	Vdet-IC	5.7V±2%, -Reset ODO	SC-88A	28ru	VD6	6m	Ric
V058	R3111Q582C	Vdet-IC	5.8V±2%, -Reset ODO	SC-88A	28ru	VD6	6m	Ric
V059	R3111Q592C	Vdet-IC	5.9V±2%, -Reset ODO	SC-88A	28ru	VD6	6m	Ric
V06	74LVC1G06GV	CMOS-Logic	Inverter (ODO)	SOT753	28/Log19	-	6a	Phi
V060	R3111Q602C	Vdet-IC	6.0V±2%, -Reset ODO	SC-88A	28ru	VD6	6m	Ric
V07	74LVC1G07GV	CMOS-Logic	Noninverting buffer/driver (ODO)	SOT753	28/Log8	-	6a	Phi
V08	74LVC1G08GV	CMOS-Logic	2-input AND gate	SOT753	28/Log3	-	6a	Phi
V09	XC9227A096M	DC/DC-IC	PWM-PWM/PFM st-dwn, 600kHz, 0.9V±1%, 600mA, +CE	SOT-25	28dc4	DC1	6g	Tor
V09	XC9227B096M	DC/DC-IC	PWM-PWM/PFM st-dwn, 600kHz, 0.9V±1%, 600mA, -CE	SOT-25	28dc4	DC1	6g	Tor
V09	XC9227C096M	DC/DC-IC	PWM-PWM/PFM st-dwn, 600kHz, 0.9V±1%, 600mA, +CE, PDR	SOT-25	28dc4	DC1	6g	Tor
V09	XC9227D096M	DC/DC-IC	PWM-PWM/PFM st-dwn, 600kHz, 0.9V±1%, 600mA, -CE, PDR	SOT-25	28dc4	DC1	6g	Tor
V0A	R3119N023A	Vdet-IC	2.3V±1.5%, -Reset ODO	SOT-23-5	28z1	VD1	6g	Ric
V0A	XC6118N20AMR-G	Vdet-IC	2.0V±2%, ±Reset ODO, Sense, hysteresis 5%, Cd	SOT-25	28mg	VD14	6g	Tor
V0B	R3119N024A	Vdet-IC	2.4V±1.5%, -Reset ODO	SOT-23-5	28z1	VD1	6g	Ric
V0B	XC6118N20BMR-G	Vdet-IC	2.0V±2%, ±Reset ODO, Sense, hysteresis <1%, Cd	SOT-25	28mg	VD14	6g	Tor
V0C	R3119N025A	Vdet-IC	2.5V±1.5%, -Reset ODO	SOT-23-5	28z1	VD1	6g	Ric
V0C	XC6118N20CMR-G	Vdet-IC	2.0V±2%, ±Reset ODO, Sense, hysteresis 5%	SOT-25	28mf	VD11	6g	Tor
V0D	R3119N026A	Vdet-IC	2.6V±1.5%, -Reset ODO	SOT-23-5	28z1	VD1	6g	Ric
V0D	XC6118N20DMR-G	Vdet-IC	2.0V±2%, ±Reset ODO, Sense, hysteresis <1%	SOT-25	28mf	VD11	6g	Tor
V0E	R3119N027A	Vdet-IC	2.7V±1.5%, -Reset ODO	SOT-23-5	28z1	VD1	6g	Ric
V0F	R3119N028A	Vdet-IC	2.8V±1.5%, -Reset ODO	SOT-23-5	28z1	VD1	6g	Ric
V0G	R3119N029A	Vdet-IC	2.9V±1.5%, -Reset ODO	SOT-23-5	28z1	VD1	6g	Ric
V0H	R3119N030A	Vdet-IC	3.0V±1.5%, -Reset ODO	SOT-23-5	28z1	VD1	6g	Ric
V0J	R3119N031A	Vdet-IC	3.1V±1.5%, -Reset ODO	SOT-23-5	28z1	VD1	6g	Ric
V0K	R3119N032A	Vdet-IC	3.2V±1.5%, -Reset ODO	SOT-23-5	28z1	VD1	6g	Ric
V0L	R3119N033A	Vdet-IC	3.3V±1.5%, -Reset ODO	SOT-23-5	28z1	VD1	6g	Ric
V0M	R3119N034A	Vdet-IC	3.4V±1.5%, -Reset ODO	SOT-23-5	28z1	VD1	6g	Ric
V0M	XC9227A09CM	DC/DC-IC	PWM-PWM/PFM st-dwn, 1.2MHz, 0.9V±1%, 600mA, +CE	SOT-25	28dc4	DC1	6g	Tor
V0M	XC9227B09CM	DC/DC-IC	PWM-PWM/PFM st-dwn, 1.2MHz, 0.9V±1%, 600mA, -CE	SOT-25	28dc4	DC1	6g	Tor
V0M	XC9227C09CM	DC/DC-IC	PWM-PWM/PFM st-dwn, 1.2MHz, 0.9V±1%, 600mA, +CE, PDR	SOT-25	28dc4	DC1	6g	Tor
V0M	XC9227D09CM	DC/DC-IC	PWM-PWM/PFM st-dwn, 1.2MHz, 0.9V±1%, 600mA, -CE, PDR	SOT-25	28dc4	DC1	6g	Tor
V0N	R3119N035A	Vdet-IC	3.5V±1.5%, -Reset ODO	SOT-23-5	28z1	VD1	6g	Ric
V0P	R3119N036A	Vdet-IC	3.6V±1.5%, -Reset ODO	SOT-23-5	28z1	VD1	6g	Ric
V0R	R3119N037A	Vdet-IC	3.7V±1.5%, -Reset ODO	SOT-23-5	28z1	VD1	6g	Ric
V0S	R3119N038A	Vdet-IC	3.8V±1.5%, -Reset ODO	SOT-23-5	28z1	VD1	6g	Ric
V0T	R3119N039A	Vdet-IC	3.9V±1.5%, -Reset ODO	SOT-23-5	28z1	VD1	6g	Ric
V0U	R3119N040A	Vdet-IC	4.0V±1.5%, -Reset ODO	SOT-23-5	28z1	VD1	6g	Ric
V0V	R3119N041A	Vdet-IC	4.1V±1.5%, -Reset ODO	SOT-23-5	28z1	VD1	6g	Ric
V0W	R3119N042A	Vdet-IC	4.2V±1.5%, -Reset ODO	SOT-23-5	28z1	VD1	6g	Ric
V0X	R3119N043A	Vdet-IC	4.3V±1.5%, -Reset ODO	SOT-23-5	28z1	VD1	6g	Ric
V0Y	R3119N044A	Vdet-IC	4.4V±1.5%, -Reset ODO	SOT-23-5	28z1	VD1	6g	Ric
V0Z	R3119N045A	Vdet-IC	4.5V±1.5%, -Reset ODO	SOT-23-5	28z1	VD1	6g	Ric
V1	BD45312G	Vdet-IC	3.1V, -Reset ODO, 200ms	SSOP-5	28vdp	VD6	6c	Rhm
V1	MC74VHC1G00DF	CMOS-Logic	2-input NAND gate	SOT-353	28/Log1	-	6b	Ons
V1	MC74VHC1G00DT	CMOS-Logic	2-input NAND gate	SOT-23-5	28/Log1	-	6b	Ons
V1	NL17SZ16DF	CMOS-Logic	Noninverting buffer	SC-70-5	28/Log10	-	6b	Ons
V1	NL17SZ17DF	CMOS-Logic	Schmitt-trigger	SC-70-5	28/Log11	-	6b	Ons
V1	TC74A1-3.3VCT	Tdet-IC	Sensor (-40...+125±3°C), Vcc=3.3V, I2C-bus	SOT-23-5	28hd	-	6g	Mcc
V1	TC7SA00F	CMOS-Logic	2-input NAND gate	SSOP-5	28/Log1	-	6a	Tos
V1	TC7SA00FU	CMOS-Logic	2-input NAND gate	SC-70-5	28/Log1	-	6a	Tos
V10	XC9227A106M	DC/DC-IC	PWM-PWM/PFM st-dwn, 600kHz, 1.0V±1%, 600mA, +CE	SOT-25	28dc4	DC1	6g	Tor
V10	XC9227B106M	DC/DC-IC	PWM-PWM/PFM st-dwn, 600kHz, 1.0V±1%, 600mA, -CE	SOT-25	28dc4	DC1	6g	Tor
V10	XC9227C106M	DC/DC-IC	PWM-PWM/PFM st-dwn, 600kHz, 1.0V±1%, 600mA, +CE, PDR	SOT-25	28dc4	DC1	6g	Tor
V10	XC9227D106M	DC/DC-IC	PWM-PWM/PFM st-dwn, 600kHz, 1.0V±1%, 600mA, -CE, PDR	SOT-25	28dc4	DC1	6g	Tor
V11	XC9227A116M	DC/DC-IC	PWM-PWM/PFM st-dwn, 600kHz, 1.1V±1%, 600mA, +CE	SOT-25	28dc4	DC1	6g	Tor
V11	XC9227B116M	DC/DC-IC	PWM-PWM/PFM st-dwn, 600kHz, 1.1V±1%, 600mA, -CE	SOT-25	28dc4	DC1	6g	Tor



SMD code	Type	Function	Short description	Case	Pinout	Sch.	St.	Mnf.
V11	XC9227C116M	DC/DC-IC	PWM-PWM/PFM st-dwn, 600kHz, 1.1V±1%, 600mA, +CE, PDR	SOT-25	28dc4	DC1	6g	Tor
V11	XC9227D116M	DC/DC-IC	PWM-PWM/PFM st-dwn, 600kHz, 1.1V±1%, 600mA, -CE, PDR	SOT-25	28dc4	DC1	6g	Tor
V11A	ML6201P113M	LVR-IC	1.1V±3%, 250mA	SOT-23-5	28ym	VR1	6a	Mlc
V12	XC9227A126M	DC/DC-IC	PWM-PWM/PFM st-dwn, 600kHz, 1.2V±1%, 600mA, +CE	SOT-25	28dc4	DC1	6g	Tor
V12	XC9227B126M	DC/DC-IC	PWM-PWM/PFM st-dwn, 600kHz, 1.2V±1%, 600mA, -CE	SOT-25	28dc4	DC1	6g	Tor
V12	XC9227C126M	DC/DC-IC	PWM-PWM/PFM st-dwn, 600kHz, 1.2V±1%, 600mA, +CE, PDR	SOT-25	28dc4	DC1	6g	Tor
V12	XC9227D126M	DC/DC-IC	PWM-PWM/PFM st-dwn, 600kHz, 1.2V±1%, 600mA, -CE, PDR	SOT-25	28dc4	DC1	6g	Tor
V12A	ML6201P123M	LVR-IC	1.2V±3%, 250mA	SOT-23-5	28ym	VR1	6a	Mlc
V13	XC9227A136M	DC/DC-IC	PWM-PWM/PFM st-dwn, 600kHz, 1.3V±1%, 600mA, +CE	SOT-25	28dc4	DC1	6g	Tor
V13	XC9227B136M	DC/DC-IC	PWM-PWM/PFM st-dwn, 600kHz, 1.3V±1%, 600mA, -CE	SOT-25	28dc4	DC1	6g	Tor
V13	XC9227C136M	DC/DC-IC	PWM-PWM/PFM st-dwn, 600kHz, 1.3V±1%, 600mA, +CE, PDR	SOT-25	28dc4	DC1	6g	Tor
V13	XC9227D136M	DC/DC-IC	PWM-PWM/PFM st-dwn, 600kHz, 1.3V±1%, 600mA, -CE, PDR	SOT-25	28dc4	DC1	6g	Tor
V13A	ML6201P133M	LVR-IC	1.3V±3%, 250mA	SOT-23-5	28ym	VR1	6a	Mlc
V14	74LVC1G14GV	CMOS-Logic	Inverting Schmitt-trigger	SOT753	28/Log7	-	6a	Phi
V14	XC9227A146M	DC/DC-IC	PWM-PWM/PFM st-dwn, 600kHz, 1.4V±1%, 600mA, +CE	SOT-25	28dc4	DC1	6g	Tor
V14	XC9227B146M	DC/DC-IC	PWM-PWM/PFM st-dwn, 600kHz, 1.4V±1%, 600mA, -CE	SOT-25	28dc4	DC1	6g	Tor
V14	XC9227C146M	DC/DC-IC	PWM-PWM/PFM st-dwn, 600kHz, 1.4V±1%, 600mA, +CE, PDR	SOT-25	28dc4	DC1	6g	Tor
V14	XC9227D146M	DC/DC-IC	PWM-PWM/PFM st-dwn, 600kHz, 1.4V±1%, 600mA, -CE, PDR	SOT-25	28dc4	DC1	6g	Tor
V14A	ML6201P143M	LVR-IC	1.4V±3%, 250mA	SOT-23-5	28ym	VR1	6a	Mlc
V15	R1163N151B	LVR-IC	LDO, 1.5V±1.5%, 150mA, +CE, AE(Mode)	SOT-23-5	28x9	VR10	6g	Ric
V15	XC9110C151MR	DC/DC-IC	PFM step-up, 100kHz, 1.5V±2.5%, 400mA, +CE	SOT-25	28sc	DC3	6g	Tor
V15	XC9227A156M	DC/DC-IC	PWM-PWM/PFM st-dwn, 600kHz, 1.5V±1%, 600mA, +CE	SOT-25	28dc4	DC1	6g	Tor
V15	XC9227B156M	DC/DC-IC	PWM-PWM/PFM st-dwn, 600kHz, 1.5V±1%, 600mA, -CE	SOT-25	28dc4	DC1	6g	Tor
V15	XC9227C156M	DC/DC-IC	PWM-PWM/PFM st-dwn, 600kHz, 1.5V±1%, 600mA, +CE, PDR	SOT-25	28dc4	DC1	6g	Tor
V15	XC9227D156M	DC/DC-IC	PWM-PWM/PFM st-dwn, 600kHz, 1.5V±1%, 600mA, -CE, PDR	SOT-25	28dc4	DC1	6g	Tor
V15A	ML6201P153M	LVR-IC	1.5V±3%, 250mA	SOT-23-5	28ym	VR1	6a	Mlc
V16	R1163N161B	LVR-IC	LDO, 1.6V±1.5%, 150mA, +CE, AE(Mode)	SOT-23-5	28x9	VR10	6g	Ric
V16	XC9110C161MR	DC/DC-IC	PFM step-up, 100kHz, 1.6V±2.5%, 400mA, +CE	SOT-25	28sc	DC3	6g	Tor
V16	XC9227A166M	DC/DC-IC	PWM-PWM/PFM st-dwn, 600kHz, 1.6V±1%, 600mA, +CE	SOT-25	28dc4	DC1	6g	Tor
V16	XC9227B166M	DC/DC-IC	PWM-PWM/PFM st-dwn, 600kHz, 1.6V±1%, 600mA, -CE	SOT-25	28dc4	DC1	6g	Tor
V16	XC9227C166M	DC/DC-IC	PWM-PWM/PFM st-dwn, 600kHz, 1.6V±1%, 600mA, +CE, PDR	SOT-25	28dc4	DC1	6g	Tor
V16	XC9227D166M	DC/DC-IC	PWM-PWM/PFM st-dwn, 600kHz, 1.6V±1%, 600mA, -CE, PDR	SOT-25	28dc4	DC1	6g	Tor
V16A	ML6201P163M	LVR-IC	1.6V±3%, 250mA	SOT-23-5	28ym	VR1	6a	Mlc
V16C	SS6680C-16CV	Vdet-IC	1.6V±2.5%, +Reset PPO	SOT-23-5	28y4	VD7	6a	Ssc
V16N	SS6680N-16CV	Vdet-IC	1.6V±2.5%, +Reset ODO	SOT-23-5	28y4	VD6	6a	Ssc
V16P	SS6680P-16CV	Vdet-IC	1.6V±2.5%, -Reset ODO	SOT-23-5	28y4	VD6	6a	Ssc
V17	74LVC1G17GV	CMOS-Logic	Schmitt-trigger	SOT753	28/Log11	-	6a	Phi
V17	R1163N171B	LVR-IC	LDO, 1.7V±1.5%, 150mA, +CE, AE(Mode)	SOT-23-5	28x9	VR10	6g	Ric
V17	XC9110C171MR	DC/DC-IC	PFM step-up, 100kHz, 1.7V±2.5%, 400mA, +CE	SOT-25	28sc	DC3	6g	Tor
V17	XC9227A176M	DC/DC-IC	PWM-PWM/PFM st-dwn, 600kHz, 1.7V±1%, 600mA, +CE	SOT-25	28dc4	DC1	6g	Tor
V17	XC9227B176M	DC/DC-IC	PWM-PWM/PFM st-dwn, 600kHz, 1.7V±1%, 600mA, -CE	SOT-25	28dc4	DC1	6g	Tor
V17	XC9227C176M	DC/DC-IC	PWM-PWM/PFM st-dwn, 600kHz, 1.7V±1%, 600mA, +CE, PDR	SOT-25	28dc4	DC1	6g	Tor
V17	XC9227D176M	DC/DC-IC	PWM-PWM/PFM st-dwn, 600kHz, 1.7V±1%, 600mA, -CE, PDR	SOT-25	28dc4	DC1	6g	Tor
V17A	ML6201P173M	LVR-IC	1.7V±3%, 250mA	SOT-23-5	28ym	VR1	6a	Mlc
V17C	SS6680C-17CV	Vdet-IC	1.7V±2.5%, +Reset PPO	SOT-23-5	28y4	VD7	6a	Ssc
V17N	SS6680N-17CV	Vdet-IC	1.7V±2.5%, +Reset ODO	SOT-23-5	28y4	VD6	6a	Ssc
V17P	SS6680P-17CV	Vdet-IC	1.7V±2.5%, -Reset ODO	SOT-23-5	28y4	VD6	6a	Ssc
V18	R1163N181B	LVR-IC	LDO, 1.8V±1.5%, 150mA, +CE, AE(Mode)	SOT-23-5	28x9	VR10	6g	Ric
V18	XC9110C181MR	DC/DC-IC	PFM step-up, 100kHz, 1.8V±2.5%, 400mA, +CE	SOT-25	28sc	DC3	6g	Tor
V18	XC9227A186M	DC/DC-IC	PWM-PWM/PFM st-dwn, 600kHz, 1.8V±1%, 600mA, +CE	SOT-25	28dc4	DC1	6g	Tor
V18	XC9227B186M	DC/DC-IC	PWM-PWM/PFM st-dwn, 600kHz, 1.8V±1%, 600mA, -CE	SOT-25	28dc4	DC1	6g	Tor
V18	XC9227C186M	DC/DC-IC	PWM-PWM/PFM st-dwn, 600kHz, 1.8V±1%, 600mA, +CE, PDR	SOT-25	28dc4	DC1	6g	Tor
V18	XC9227D186M	DC/DC-IC	PWM-PWM/PFM st-dwn, 600kHz, 1.8V±1%, 600mA, -CE, PDR	SOT-25	28dc4	DC1	6g	Tor
V18A	ML6201P183M	LVR-IC	1.8V±3%, 250mA	SOT-23-5	28ym	VR1	6a	Mlc
V18C	SS6680C-18CV	Vdet-IC	1.8V±2.5%, +Reset PPO	SOT-23-5	28y4	VD7	6a	Ssc
V18N	SS6680N-18CV	Vdet-IC	1.8V±2.5%, +Reset ODO	SOT-23-5	28y4	VD6	6a	Ssc
V18P	SS6680P-18CV	Vdet-IC	1.8V±2.5%, -Reset ODO	SOT-23-5	28y4	VD6	6a	Ssc
V19	R1163N191B	LVR-IC	LDO, 1.9V±1.5%, 150mA, +CE, AE(Mode)	SOT-23-5	28x9	VR10	6g	Ric
V19	XC9110C191MR	DC/DC-IC	PFM step-up, 100kHz, 1.9V±2.5%, 400mA, +CE	SOT-25	28sc	DC3	6g	Tor
V19	XC9227A196M	DC/DC-IC	PWM-PWM/PFM st-dwn, 600kHz, 1.9V±1%, 600mA, +CE	SOT-25	28dc4	DC1	6g	Tor
V19	XC9227B196M	DC/DC-IC	PWM-PWM/PFM st-dwn, 600kHz, 1.9V±1%, 600mA, -CE	SOT-25	28dc4	DC1	6g	Tor
V19	XC9227C196M	DC/DC-IC	PWM-PWM/PFM st-dwn, 600kHz, 1.9V±1%, 600mA, +CE, PDR	SOT-25	28dc4	DC1	6g	Tor
V19	XC9227D196M	DC/DC-IC	PWM-PWM/PFM st-dwn, 600kHz, 1.9V±1%, 600mA, -CE, PDR	SOT-25	28dc4	DC1	6g	Tor
V19A	ML6201P193M	LVR-IC	1.9V±3%, 250mA	SOT-23-5	28ym	VR1	6a	Mlc
V19C	SS6680C-19CV	Vdet-IC	1.9V±2.5%, +Reset PPO	SOT-23-5	28y4	VD7	6a	Ssc
V19N	SS6680N-19CV	Vdet-IC	1.9V±2.5%, +Reset ODO	SOT-23-5	28y4	VD6	6a	Ssc
V19P	SS6680P-19CV	Vdet-IC	1.9V±2.5%, -Reset ODO	SOT-23-5	28y4	VD6	6a	Ssc
V1A	R3119N023E	Vdet-IC	2.3V±1.5%, ±Reset ODO, Sense	SOT-23-5	28z2	VD11	6g	Ric
V1A	XC6118N21AMR-G	Vdet-IC	2.1V±2%, ±Reset ODO, Sense, hysteresis 5%, Cd	SOT-25	28mg	VD14	6g	Tor
V1A	XC9227A10CM	DC/DC-IC	PWM-PWM/PFM st-dwn, 1.2MHz, 1.0V±1%, 600mA, +CE	SOT-25	28dc4	DC1	6g	Tor



SMD code	Type	Function	Short description	Case	Pinout	Sch.	St.	Mnf.
V7A	XC9227B10CM	DC/DC-IC	PWM-PWM/PFM st-dwn, 1.2MHz, 1.0V±1%, 600mA, -CE	SOT-25	28dc4	DC1	6g	Tor
V7A	XC9227C10CM	DC/DC-IC	PWM-PWM/PFM st-dwn, 1.2MHz, 1.0V±1%, 600mA, +CE, PDR	SOT-25	28dc4	DC1	6g	Tor
V7A	XC9227D10CM	DC/DC-IC	PWM-PWM/PFM st-dwn, 1.2MHz, 1.0V±1%, 600mA, -CE, PDR	SOT-25	28dc4	DC1	6g	Tor
V7B	R3119N024E	Vdet-IC	2.4V±1.5%, ±Reset ODO, Sense	SOT-23-5	28z2	VD11	6g	Ric
V7B	XC6118N21BMR-G	Vdet-IC	2.1V±2%, ±Reset ODO, Sense, hysteresis <1%, Cd	SOT-25	28mg	VD14	6g	Tor
V7B	XC9227A11CM	DC/DC-IC	PWM-PWM/PFM st-dwn, 1.2MHz, 1.1V±1%, 600mA, +CE	SOT-25	28dc4	DC1	6g	Tor
V7B	XC9227B11CM	DC/DC-IC	PWM-PWM/PFM st-dwn, 1.2MHz, 1.1V±1%, 600mA, -CE	SOT-25	28dc4	DC1	6g	Tor
V7B	XC9227C11CM	DC/DC-IC	PWM-PWM/PFM st-dwn, 1.2MHz, 1.1V±1%, 600mA, +CE, PDR	SOT-25	28dc4	DC1	6g	Tor
V7B	XC9227D11CM	DC/DC-IC	PWM-PWM/PFM st-dwn, 1.2MHz, 1.1V±1%, 600mA, -CE, PDR	SOT-25	28dc4	DC1	6g	Tor
V7C	R3119N025E	Vdet-IC	2.5V±1.5%, ±Reset ODO, Sense	SOT-23-5	28z2	VD11	6g	Ric
V7C	XC6118N21CMR-G	Vdet-IC	2.1V±2%, ±Reset ODO, Sense, hysteresis 5%	SOT-25	28mf	VD11	6g	Tor
V7C	XC9227A12CM	DC/DC-IC	PWM-PWM/PFM st-dwn, 1.2MHz, 1.2V±1%, 600mA, +CE	SOT-25	28dc4	DC1	6g	Tor
V7C	XC9227B12CM	DC/DC-IC	PWM-PWM/PFM st-dwn, 1.2MHz, 1.2V±1%, 600mA, -CE	SOT-25	28dc4	DC1	6g	Tor
V7C	XC9227C12CM	DC/DC-IC	PWM-PWM/PFM st-dwn, 1.2MHz, 1.2V±1%, 600mA, +CE, PDR	SOT-25	28dc4	DC1	6g	Tor
V7C	XC9227D12CM	DC/DC-IC	PWM-PWM/PFM st-dwn, 1.2MHz, 1.2V±1%, 600mA, -CE, PDR	SOT-25	28dc4	DC1	6g	Tor
V7D	R3119N026E	Vdet-IC	2.6V±1.5%, ±Reset ODO, Sense	SOT-23-5	28z2	VD11	6g	Ric
V7D	XC6118N21DMR-G	Vdet-IC	2.1V±2%, ±Reset ODO, Sense, hysteresis <1%	SOT-25	28mf	VD11	6g	Tor
V7D	XC9227A13CM	DC/DC-IC	PWM-PWM/PFM st-dwn, 1.2MHz, 1.3V±1%, 600mA, +CE	SOT-25	28dc4	DC1	6g	Tor
V7D	XC9227B13CM	DC/DC-IC	PWM-PWM/PFM st-dwn, 1.2MHz, 1.3V±1%, 600mA, -CE	SOT-25	28dc4	DC1	6g	Tor
V7D	XC9227C13CM	DC/DC-IC	PWM-PWM/PFM st-dwn, 1.2MHz, 1.3V±1%, 600mA, +CE, PDR	SOT-25	28dc4	DC1	6g	Tor
V7D	XC9227D13CM	DC/DC-IC	PWM-PWM/PFM st-dwn, 1.2MHz, 1.3V±1%, 600mA, -CE, PDR	SOT-25	28dc4	DC1	6g	Tor
V7E	R3119N027E	Vdet-IC	2.7V±1.5%, ±Reset ODO, Sense	SOT-23-5	28z2	VD11	6g	Ric
V7E	XC9227A14CM	DC/DC-IC	PWM-PWM/PFM st-dwn, 1.2MHz, 1.4V±1%, 600mA, +CE	SOT-25	28dc4	DC1	6g	Tor
V7E	XC9227B14CM	DC/DC-IC	PWM-PWM/PFM st-dwn, 1.2MHz, 1.4V±1%, 600mA, -CE	SOT-25	28dc4	DC1	6g	Tor
V7E	XC9227C14CM	DC/DC-IC	PWM-PWM/PFM st-dwn, 1.2MHz, 1.4V±1%, 600mA, +CE, PDR	SOT-25	28dc4	DC1	6g	Tor
V7E	XC9227D14CM	DC/DC-IC	PWM-PWM/PFM st-dwn, 1.2MHz, 1.4V±1%, 600mA, -CE, PDR	SOT-25	28dc4	DC1	6g	Tor
V7F	R3119N028E	Vdet-IC	2.8V±1.5%, ±Reset ODO, Sense	SOT-23-5	28z2	VD11	6g	Ric
V7F	XC9227A15CM	DC/DC-IC	PWM-PWM/PFM st-dwn, 1.2MHz, 1.5V±1%, 600mA, +CE	SOT-25	28dc4	DC1	6g	Tor
V7F	XC9227B15CM	DC/DC-IC	PWM-PWM/PFM st-dwn, 1.2MHz, 1.5V±1%, 600mA, -CE	SOT-25	28dc4	DC1	6g	Tor
V7F	XC9227C15CM	DC/DC-IC	PWM-PWM/PFM st-dwn, 1.2MHz, 1.5V±1%, 600mA, +CE, PDR	SOT-25	28dc4	DC1	6g	Tor
V7F	XC9227D15CM	DC/DC-IC	PWM-PWM/PFM st-dwn, 1.2MHz, 1.5V±1%, 600mA, -CE, PDR	SOT-25	28dc4	DC1	6g	Tor
V7G	R3119N029E	Vdet-IC	2.9V±1.5%, ±Reset ODO, Sense	SOT-23-5	28z2	VD11	6g	Ric
V7H	R3119N030E	Vdet-IC	3.0V±1.5%, ±Reset ODO, Sense	SOT-23-5	28z2	VD11	6g	Ric
V7H	XC9227A16CM	DC/DC-IC	PWM-PWM/PFM st-dwn, 1.2MHz, 1.6V±1%, 600mA, +CE	SOT-25	28dc4	DC1	6g	Tor
V7H	XC9227B16CM	DC/DC-IC	PWM-PWM/PFM st-dwn, 1.2MHz, 1.6V±1%, 600mA, -CE	SOT-25	28dc4	DC1	6g	Tor
V7H	XC9227C16CM	DC/DC-IC	PWM-PWM/PFM st-dwn, 1.2MHz, 1.6V±1%, 600mA, +CE, PDR	SOT-25	28dc4	DC1	6g	Tor
V7H	XC9227D16CM	DC/DC-IC	PWM-PWM/PFM st-dwn, 1.2MHz, 1.6V±1%, 600mA, -CE, PDR	SOT-25	28dc4	DC1	6g	Tor
V7J	R3119N031E	Vdet-IC	3.1V±1.5%, ±Reset ODO, Sense	SOT-23-5	28z2	VD11	6g	Ric
V7K	R3119N032E	Vdet-IC	3.2V±1.5%, ±Reset ODO, Sense	SOT-23-5	28z2	VD11	6g	Ric
V7K	XC9227A17CM	DC/DC-IC	PWM-PWM/PFM st-dwn, 1.2MHz, 1.7V±1%, 600mA, +CE	SOT-25	28dc4	DC1	6g	Tor
V7K	XC9227B17CM	DC/DC-IC	PWM-PWM/PFM st-dwn, 1.2MHz, 1.7V±1%, 600mA, -CE	SOT-25	28dc4	DC1	6g	Tor
V7K	XC9227C17CM	DC/DC-IC	PWM-PWM/PFM st-dwn, 1.2MHz, 1.7V±1%, 600mA, +CE, PDR	SOT-25	28dc4	DC1	6g	Tor
V7K	XC9227D17CM	DC/DC-IC	PWM-PWM/PFM st-dwn, 1.2MHz, 1.7V±1%, 600mA, -CE, PDR	SOT-25	28dc4	DC1	6g	Tor
V7L	R3119N033E	Vdet-IC	3.3V±1.5%, ±Reset ODO, Sense	SOT-23-5	28z2	VD11	6g	Ric
V7L	XC9227A18CM	DC/DC-IC	PWM-PWM/PFM st-dwn, 1.2MHz, 1.8V±1%, 600mA, +CE	SOT-25	28dc4	DC1	6g	Tor
V7L	XC9227B18CM	DC/DC-IC	PWM-PWM/PFM st-dwn, 1.2MHz, 1.8V±1%, 600mA, -CE	SOT-25	28dc4	DC1	6g	Tor
V7L	XC9227C18CM	DC/DC-IC	PWM-PWM/PFM st-dwn, 1.2MHz, 1.8V±1%, 600mA, +CE, PDR	SOT-25	28dc4	DC1	6g	Tor
V7L	XC9227D18CM	DC/DC-IC	PWM-PWM/PFM st-dwn, 1.2MHz, 1.8V±1%, 600mA, -CE, PDR	SOT-25	28dc4	DC1	6g	Tor
V7M	R3119N034E	Vdet-IC	3.4V±1.5%, ±Reset ODO, Sense	SOT-23-5	28z2	VD11	6g	Ric
V7M	XC9227A19CM	DC/DC-IC	PWM-PWM/PFM st-dwn, 1.2MHz, 1.9V±1%, 600mA, +CE	SOT-25	28dc4	DC1	6g	Tor
V7M	XC9227B19CM	DC/DC-IC	PWM-PWM/PFM st-dwn, 1.2MHz, 1.9V±1%, 600mA, -CE	SOT-25	28dc4	DC1	6g	Tor
V7M	XC9227C19CM	DC/DC-IC	PWM-PWM/PFM st-dwn, 1.2MHz, 1.9V±1%, 600mA, +CE, PDR	SOT-25	28dc4	DC1	6g	Tor
V7M	XC9227D19CM	DC/DC-IC	PWM-PWM/PFM st-dwn, 1.2MHz, 1.9V±1%, 600mA, -CE, PDR	SOT-25	28dc4	DC1	6g	Tor
V7N	R3119N035E	Vdet-IC	3.5V±1.5%, ±Reset ODO, Sense	SOT-23-5	28z2	VD11	6g	Ric
V7P	R3119N036E	Vdet-IC	3.6V±1.5%, ±Reset ODO, Sense	SOT-23-5	28z2	VD11	6g	Ric
V7R	R3119N037E	Vdet-IC	3.7V±1.5%, ±Reset ODO, Sense	SOT-23-5	28z2	VD11	6g	Ric
V7S	R3119N038E	Vdet-IC	3.8V±1.5%, ±Reset ODO, Sense	SOT-23-5	28z2	VD11	6g	Ric
V7T	R3119N039E	Vdet-IC	3.9V±1.5%, ±Reset ODO, Sense	SOT-23-5	28z2	VD11	6g	Ric
V7U	R3119N040E	Vdet-IC	4.0V±1.5%, ±Reset ODO, Sense	SOT-23-5	28z2	VD11	6g	Ric
V7V	R3119N041E	Vdet-IC	4.1V±1.5%, ±Reset ODO, Sense	SOT-23-5	28z2	VD11	6g	Ric
V7W	R3119N042E	Vdet-IC	4.2V±1.5%, ±Reset ODO, Sense	SOT-23-5	28z2	VD11	6g	Ric
V7X	R3119N043E	Vdet-IC	4.3V±1.5%, ±Reset ODO, Sense	SOT-23-5	28z2	VD11	6g	Ric
V7Y	R3119N044E	Vdet-IC	4.4V±1.5%, ±Reset ODO, Sense	SOT-23-5	28z2	VD11	6g	Ric
V7Z	R3119N045E	Vdet-IC	4.5V±1.5%, ±Reset ODO, Sense	SOT-23-5	28z2	VD11	6g	Ric
V2	BD45302G	Vdet-IC	3V, -Reset ODO, 200ms	SSOP-5	28vdp	VD6	6c	Rhm
V2	MC74VHC1G08DF	CMOS-Logic	2-input AND gate	SC-70-5	28LLog3	-	6b	Ons
V2	MC74VHC1G08DT	CMOS-Logic	2-input AND gate	SOT-23-5	28LLog3	-	6b	Ons
V2	TC74A2-3.3VCT	Tdet-IC	Sensor (-40...+125±3°C), Vcc=3.3V, I2C-bus	SOT-23-5	28hd	-	6g	Mcc
V2	TC7SA08F	CMOS-Logic	2-input AND gate	SSOP-5	28LLog3	-	6a	Tos
V2	TC7SA08FU	CMOS-Logic	2-input AND gate	SC-70-5	28LLog3	-	6a	Tos



SMD code	Type	Function	Short description	Case	Pinout	Sch.	St.	Mnf.
V20	R1163N201B	LVR-IC	LDO, 2V±1.5%, 150mA, +CE, AE(Mode)	SOT-23-5	28x9	VR10	6g	Ric
V20	XC9110C201MR	DC/DC-IC	PFM step-up, 100kHz, 2.0V±2.5%, 400mA, +CE	SOT-25	28sc	DC3	6g	Tor
V20	XC9227A206M	DC/DC-IC	PWM-PWM/PFM st-dwn, 600kHz, 2.0V±1%, 600mA, +CE	SOT-25	28dc4	DC1	6g	Tor
V20	XC9227B206M	DC/DC-IC	PWM-PWM/PFM st-dwn, 600kHz, 2.0V±1%, 600mA, -CE	SOT-25	28dc4	DC1	6g	Tor
V20	XC9227C206M	DC/DC-IC	PWM-PWM/PFM st-dwn, 600kHz, 2.0V±1%, 600mA, +CE, PDR	SOT-25	28dc4	DC1	6g	Tor
V20	XC9227D206M	DC/DC-IC	PWM-PWM/PFM st-dwn, 600kHz, 2.0V±1%, 600mA, -CE, PDR	SOT-25	28dc4	DC1	6g	Tor
V20A	ML6201P202M	LVR-IC	2.0V±2%, 250mA	SOT-23-5	28ym	VR1	6a	Mlc
V20C	SS6680C-20CV	Vdet-IC	2.0V±2.5%, +Reset PPO	SOT-23-5	28y4	VD7	6a	Ssc
V20N	SS6680N-20CV	Vdet-IC	2.0V±2.5%, +Reset ODO	SOT-23-5	28y4	VD6	6a	Ssc
V20P	SS6680P-20CV	Vdet-IC	2.0V±2.5%, -Reset ODO	SOT-23-5	28y4	VD6	6a	Ssc
V21	R1163N211B	LVR-IC	LDO, 2.1V±1.5%, 150mA, +CE, AE(Mode)	SOT-23-5	28x9	VR10	6g	Ric
V21	XC9110C211MR	DC/DC-IC	PFM step-up, 100kHz, 2.1V±2.5%, 400mA, +CE	SOT-25	28sc	DC3	6g	Tor
V21	XC9227A216M	DC/DC-IC	PWM-PWM/PFM st-dwn, 600kHz, 2.1V±1%, 600mA, +CE	SOT-25	28dc4	DC1	6g	Tor
V21	XC9227B216M	DC/DC-IC	PWM-PWM/PFM st-dwn, 600kHz, 2.1V±1%, 600mA, -CE	SOT-25	28dc4	DC1	6g	Tor
V21	XC9227C216M	DC/DC-IC	PWM-PWM/PFM st-dwn, 600kHz, 2.1V±1%, 600mA, +CE, PDR	SOT-25	28dc4	DC1	6g	Tor
V21	XC9227D216M	DC/DC-IC	PWM-PWM/PFM st-dwn, 600kHz, 2.1V±1%, 600mA, -CE, PDR	SOT-25	28dc4	DC1	6g	Tor
V21A	ML6201P212M	LVR-IC	2.1V±2%, 250mA	SOT-23-5	28ym	VR1	6a	Mlc
V21C	SS6680C-21CV	Vdet-IC	2.1V±2.5%, +Reset PPO	SOT-23-5	28y4	VD7	6a	Ssc
V21N	SS6680N-21CV	Vdet-IC	2.1V±2.5%, +Reset ODO	SOT-23-5	28y4	VD6	6a	Ssc
V21P	SS6680P-21CV	Vdet-IC	2.1V±2.5%, -Reset ODO	SOT-23-5	28y4	VD6	6a	Ssc
V22	R1163N221B	LVR-IC	LDO, 2.2V±1.5%, 150mA, +CE, AE(Mode)	SOT-23-5	28x9	VR10	6g	Ric
V22	XC9110C221MR	DC/DC-IC	PFM step-up, 100kHz, 2.2V±2.5%, 400mA, +CE	SOT-25	28sc	DC3	6g	Tor
V22	XC9227A226M	DC/DC-IC	PWM-PWM/PFM st-dwn, 600kHz, 2.2V±1%, 600mA, +CE	SOT-25	28dc4	DC1	6g	Tor
V22	XC9227B226M	DC/DC-IC	PWM-PWM/PFM st-dwn, 600kHz, 2.2V±1%, 600mA, -CE	SOT-25	28dc4	DC1	6g	Tor
V22	XC9227C226M	DC/DC-IC	PWM-PWM/PFM st-dwn, 600kHz, 2.2V±1%, 600mA, +CE, PDR	SOT-25	28dc4	DC1	6g	Tor
V22	XC9227D226M	DC/DC-IC	PWM-PWM/PFM st-dwn, 600kHz, 2.2V±1%, 600mA, -CE, PDR	SOT-25	28dc4	DC1	6g	Tor
V22A	ML6201P222M	LVR-IC	2.2V±2%, 250mA	SOT-23-5	28ym	VR1	6a	Mlc
V22C	SS6680C-22CV	Vdet-IC	2.2V±2.5%, +Reset PPO	SOT-23-5	28y4	VD7	6a	Ssc
V22N	SS6680N-22CV	Vdet-IC	2.2V±2.5%, +Reset ODO	SOT-23-5	28y4	VD6	6a	Ssc
V22P	SS6680P-22CV	Vdet-IC	2.2V±2.5%, -Reset ODO	SOT-23-5	28y4	VD6	6a	Ssc
V23	R1163N231B	LVR-IC	LDO, 2.3V±1.5%, 150mA, +CE, AE(Mode)	SOT-23-5	28x9	VR10	6g	Ric
V23	XC9110C231MR	DC/DC-IC	PFM step-up, 100kHz, 2.3V±2.5%, 400mA, +CE	SOT-25	28sc	DC3	6g	Tor
V23	XC9227A236M	DC/DC-IC	PWM-PWM/PFM st-dwn, 600kHz, 2.3V±1%, 600mA, +CE	SOT-25	28dc4	DC1	6g	Tor
V23	XC9227B236M	DC/DC-IC	PWM-PWM/PFM st-dwn, 600kHz, 2.3V±1%, 600mA, -CE	SOT-25	28dc4	DC1	6g	Tor
V23	XC9227C236M	DC/DC-IC	PWM-PWM/PFM st-dwn, 600kHz, 2.3V±1%, 600mA, +CE, PDR	SOT-25	28dc4	DC1	6g	Tor
V23	XC9227D236M	DC/DC-IC	PWM-PWM/PFM st-dwn, 600kHz, 2.3V±1%, 600mA, -CE, PDR	SOT-25	28dc4	DC1	6g	Tor
V23A	ML6201P232M	LVR-IC	2.3V±2%, 250mA	SOT-23-5	28ym	VR1	6a	Mlc
V23C	SS6680C-23CV	Vdet-IC	2.3V±2.5%, +Reset PPO	SOT-23-5	28y4	VD7	6a	Ssc
V23N	SS6680N-23CV	Vdet-IC	2.3V±2.5%, +Reset ODO	SOT-23-5	28y4	VD6	6a	Ssc
V23P	SS6680P-23CV	Vdet-IC	2.3V±2.5%, -Reset ODO	SOT-23-5	28y4	VD6	6a	Ssc
V24	R1163N241B	LVR-IC	LDO, 2.4V±1.5%, 150mA, +CE, AE(Mode)	SOT-23-5	28x9	VR10	6g	Ric
V24	XC9110C241MR	DC/DC-IC	PFM step-up, 100kHz, 2.4V±2.5%, 400mA, +CE	SOT-25	28sc	DC3	6g	Tor
V24	XC9227A246M	DC/DC-IC	PWM-PWM/PFM st-dwn, 600kHz, 2.4V±1%, 600mA, +CE	SOT-25	28dc4	DC1	6g	Tor
V24	XC9227B246M	DC/DC-IC	PWM-PWM/PFM st-dwn, 600kHz, 2.4V±1%, 600mA, -CE	SOT-25	28dc4	DC1	6g	Tor
V24	XC9227C246M	DC/DC-IC	PWM-PWM/PFM st-dwn, 600kHz, 2.4V±1%, 600mA, +CE, PDR	SOT-25	28dc4	DC1	6g	Tor
V24	XC9227D246M	DC/DC-IC	PWM-PWM/PFM st-dwn, 600kHz, 2.4V±1%, 600mA, -CE, PDR	SOT-25	28dc4	DC1	6g	Tor
V24A	ML6201P242M	LVR-IC	2.4V±2%, 250mA	SOT-23-5	28ym	VR1	6a	Mlc
V24C	SS6680C-24CV	Vdet-IC	2.4V±2.5%, +Reset PPO	SOT-23-5	28y4	VD7	6a	Ssc
V24N	SS6680N-24CV	Vdet-IC	2.4V±2.5%, +Reset ODO	SOT-23-5	28y4	VD6	6a	Ssc
V24P	SS6680P-24CV	Vdet-IC	2.4V±2.5%, -Reset ODO	SOT-23-5	28y4	VD6	6a	Ssc
V25	74LVC1G125GV	CMOS-Logic	Bus buffer gate with 3-state output	SOT753	28/Log14	-	6a	Phi
V25	R1163N251B	LVR-IC	LDO, 2.5V±1.5%, 150mA, +CE, AE(Mode)	SOT-23-5	28x9	VR10	6g	Ric
V25	XC9110C251MR	DC/DC-IC	PFM step-up, 100kHz, 2.5V±2.5%, 400mA, +CE	SOT-25	28sc	DC3	6g	Tor
V25	XC9227A256M	DC/DC-IC	PWM-PWM/PFM st-dwn, 600kHz, 2.5V±1%, 600mA, +CE	SOT-25	28dc4	DC1	6g	Tor
V25	XC9227B256M	DC/DC-IC	PWM-PWM/PFM st-dwn, 600kHz, 2.5V±1%, 600mA, -CE	SOT-25	28dc4	DC1	6g	Tor
V25	XC9227C256M	DC/DC-IC	PWM-PWM/PFM st-dwn, 600kHz, 2.5V±1%, 600mA, +CE, PDR	SOT-25	28dc4	DC1	6g	Tor
V25	XC9227D256M	DC/DC-IC	PWM-PWM/PFM st-dwn, 600kHz, 2.5V±1%, 600mA, -CE, PDR	SOT-25	28dc4	DC1	6g	Tor
V25	SN74CBTLV1G125DBV	CMOS-Logic	Single high-speed line switch	SOT-23-5	28/Log14	-	6a	Ti
V25A	ML6201P252M	LVR-IC	2.5V±2%, 250mA	SOT-23-5	28ym	VR1	6a	Mlc
V25C	SS6680C-25CV	Vdet-IC	2.5V±2.5%, +Reset PPO	SOT-23-5	28y4	VD7	6a	Ssc
V25N	SS6680N-25CV	Vdet-IC	2.5V±2.5%, +Reset ODO	SOT-23-5	28y4	VD6	6a	Ssc
V25P	SS6680P-25CV	Vdet-IC	2.5V±2.5%, -Reset ODO	SOT-23-5	28y4	VD6	6a	Ssc
V26	74LVC1G126GV	CMOS-Logic	Bus buffer gate with 3-state output	SOT753	28/Log13	-	6a	Phi
V26	R1163N261B	LVR-IC	LDO, 2.6V±1.5%, 150mA, +CE, AE(Mode)	SOT-23-5	28x9	VR10	6g	Ric
V26	XC9110C261MR	DC/DC-IC	PFM step-up, 100kHz, 2.6V±2.5%, 400mA, +CE	SOT-25	28sc	DC3	6g	Tor
V26	XC9227A266M	DC/DC-IC	PWM-PWM/PFM st-dwn, 600kHz, 2.6V±1%, 600mA, +CE	SOT-25	28dc4	DC1	6g	Tor
V26	XC9227B266M	DC/DC-IC	PWM-PWM/PFM st-dwn, 600kHz, 2.6V±1%, 600mA, -CE	SOT-25	28dc4	DC1	6g	Tor
V26	XC9227C266M	DC/DC-IC	PWM-PWM/PFM st-dwn, 600kHz, 2.6V±1%, 600mA, +CE, PDR	SOT-25	28dc4	DC1	6g	Tor
V26	XC9227D266M	DC/DC-IC	PWM-PWM/PFM st-dwn, 600kHz, 2.6V±1%, 600mA, -CE, PDR	SOT-25	28dc4	DC1	6g	Tor
V26A	ML6201P262M	LVR-IC	2.6V±2%, 250mA	SOT-23-5	28ym	VR1	6a	Mlc



SMD code	Type	Function	Short description	Case	Pinout	Sch.	St.	Mnf.
V26C	SS6680C-26CV	Vdet-IC	2.6V±2.5%, +Reset PPO	SOT-23-5	28y4	VD7	6a	Ssc
V26N	SS6680N-26CV	Vdet-IC	2.6V±2.5%, +Reset ODO	SOT-23-5	28y4	VD6	6a	Ssc
V26P	SS6680P-26CV	Vdet-IC	2.6V±2.5%, -Reset ODO	SOT-23-5	28y4	VD6	6a	Ssc
V27	R1163N271B	LVR-IC	LDO, 2.7V±1.5%, 150mA, +CE, AE(Mode)	SOT-23-5	28x9	VR10	6g	Ric
V27	XC9110C271MR	DC/DC-IC	PFM step-up, 100kHz, 2.7V±2.5%, 400mA, +CE	SOT-25	28sc	DC3	6g	Tor
V27	XC9227A276M	DC/DC-IC	PWM-PWM/PFM st-dwn, 600kHz, 2.7V±1%, 600mA, +CE	SOT-25	28dc4	DC1	6g	Tor
V27	XC9227B276M	DC/DC-IC	PWM-PWM/PFM st-dwn, 600kHz, 2.7V±1%, 600mA, -CE	SOT-25	28dc4	DC1	6g	Tor
V27	XC9227C276M	DC/DC-IC	PWM-PWM/PFM st-dwn, 600kHz, 2.7V±1%, 600mA, +CE, PDR	SOT-25	28dc4	DC1	6g	Tor
V27	XC9227D276M	DC/DC-IC	PWM-PWM/PFM st-dwn, 600kHz, 2.7V±1%, 600mA, -CE, PDR	SOT-25	28dc4	DC1	6g	Tor
V27A	ML6201P272M	LVR-IC	2.7V±2%, 250mA	SOT-23-5	28ym	VR1	6a	Mlc
V27C	SS6680C-27CV	Vdet-IC	2.7V±2.5%, +Reset PPO	SOT-23-5	28y4	VD7	6a	Ssc
V27N	SS6680N-27CV	Vdet-IC	2.7V±2.5%, +Reset ODO	SOT-23-5	28y4	VD6	6a	Ssc
V27P	SS6680P-27CV	Vdet-IC	2.7V±2.5%, -Reset ODO	SOT-23-5	28y4	VD6	6a	Ssc
V28	R1163N281B	LVR-IC	LDO, 2.8V±1.5%, 150mA, +CE, AE(Mode)	SOT-23-5	28x9	VR10	6g	Ric
V28	XC9110C281MR	DC/DC-IC	PFM step-up, 100kHz, 2.8V±2.5%, 400mA, +CE	SOT-25	28sc	DC3	6g	Tor
V28	XC9227A286M	DC/DC-IC	PWM-PWM/PFM st-dwn, 600kHz, 2.8V±1%, 600mA, +CE	SOT-25	28dc4	DC1	6g	Tor
V28	XC9227B286M	DC/DC-IC	PWM-PWM/PFM st-dwn, 600kHz, 2.8V±1%, 600mA, -CE	SOT-25	28dc4	DC1	6g	Tor
V28	XC9227C286M	DC/DC-IC	PWM-PWM/PFM st-dwn, 600kHz, 2.8V±1%, 600mA, +CE, PDR	SOT-25	28dc4	DC1	6g	Tor
V28	XC9227D286M	DC/DC-IC	PWM-PWM/PFM st-dwn, 600kHz, 2.8V±1%, 600mA, -CE, PDR	SOT-25	28dc4	DC1	6g	Tor
V28A	ML6201P282M	LVR-IC	2.8V±2%, 250mA	SOT-23-5	28ym	VR1	6a	Mlc
V28C	SS6680C-28CV	Vdet-IC	2.8V±2.5%, +Reset PPO	SOT-23-5	28y4	VD7	6a	Ssc
V28N	SS6680N-28CV	Vdet-IC	2.8V±2.5%, +Reset ODO	SOT-23-5	28y4	VD6	6a	Ssc
V28P	SS6680P-28CV	Vdet-IC	2.8V±2.5%, -Reset ODO	SOT-23-5	28y4	VD6	6a	Ssc
V29	R1163N291B	LVR-IC	LDO, 2.9V±1.5%, 150mA, +CE, AE(Mode)	SOT-23-5	28x9	VR10	6g	Ric
V29	XC9110C291MR	DC/DC-IC	PFM step-up, 100kHz, 2.9V±2.5%, 400mA, +CE	SOT-25	28sc	DC3	6g	Tor
V29	XC9227A296M	DC/DC-IC	PWM-PWM/PFM st-dwn, 600kHz, 2.9V±1%, 600mA, +CE	SOT-25	28dc4	DC1	6g	Tor
V29	XC9227B296M	DC/DC-IC	PWM-PWM/PFM st-dwn, 600kHz, 2.9V±1%, 600mA, -CE	SOT-25	28dc4	DC1	6g	Tor
V29	XC9227C296M	DC/DC-IC	PWM-PWM/PFM st-dwn, 600kHz, 2.9V±1%, 600mA, +CE, PDR	SOT-25	28dc4	DC1	6g	Tor
V29	XC9227D296M	DC/DC-IC	PWM-PWM/PFM st-dwn, 600kHz, 2.9V±1%, 600mA, -CE, PDR	SOT-25	28dc4	DC1	6g	Tor
V29A	ML6201P292M	LVR-IC	2.9V±2%, 250mA	SOT-23-5	28ym	VR1	6a	Mlc
V29C	SS6680C-29CV	Vdet-IC	2.9V±2.5%, +Reset PPO	SOT-23-5	28y4	VD7	6a	Ssc
V29N	SS6680N-29CV	Vdet-IC	2.9V±2.5%, +Reset ODO	SOT-23-5	28y4	VD6	6a	Ssc
V29P	SS6680P-29CV	Vdet-IC	2.9V±2.5%, -Reset ODO	SOT-23-5	28y4	VD6	6a	Ssc
V2A	XC6118N22AMR-G	Vdet-IC	2.2V±2%, ±Reset ODO, Sense, hysteresis 5%, Cd	SOT-25	28mg	VD14	6g	Tor
V2A	XC9227A20CM	DC/DC-IC	PWM-PWM/PFM st-dwn, 1.2MHz, 2.0V±1%, 600mA, +CE	SOT-25	28dc4	DC1	6g	Tor
V2A	XC9227B20CM	DC/DC-IC	PWM-PWM/PFM st-dwn, 1.2MHz, 2.0V±1%, 600mA, -CE	SOT-25	28dc4	DC1	6g	Tor
V2A	XC9227C20CM	DC/DC-IC	PWM-PWM/PFM st-dwn, 1.2MHz, 2.0V±1%, 600mA, +CE, PDR	SOT-25	28dc4	DC1	6g	Tor
V2A	XC9227D20CM	DC/DC-IC	PWM-PWM/PFM st-dwn, 1.2MHz, 2.0V±1%, 600mA, -CE, PDR	SOT-25	28dc4	DC1	6g	Tor
V2B	XC6118N22BMR-G	Vdet-IC	2.2V±2%, ±Reset ODO, Sense, hysteresis <1%, Cd	SOT-25	28mg	VD14	6g	Tor
V2B	XC9227A21CM	DC/DC-IC	PWM-PWM/PFM st-dwn, 1.2MHz, 2.1V±1%, 600mA, +CE	SOT-25	28dc4	DC1	6g	Tor
V2B	XC9227B21CM	DC/DC-IC	PWM-PWM/PFM st-dwn, 1.2MHz, 2.1V±1%, 600mA, -CE	SOT-25	28dc4	DC1	6g	Tor
V2B	XC9227C21CM	DC/DC-IC	PWM-PWM/PFM st-dwn, 1.2MHz, 2.1V±1%, 600mA, +CE, PDR	SOT-25	28dc4	DC1	6g	Tor
V2B	XC9227D21CM	DC/DC-IC	PWM-PWM/PFM st-dwn, 1.2MHz, 2.1V±1%, 600mA, -CE, PDR	SOT-25	28dc4	DC1	6g	Tor
V2C	XC6118N22CMR-G	Vdet-IC	2.2V±2%, ±Reset ODO, Sense, hysteresis 5%	SOT-25	28mf	VD11	6g	Tor
V2C	XC9227A22CM	DC/DC-IC	PWM-PWM/PFM st-dwn, 1.2MHz, 2.2V±1%, 600mA, +CE	SOT-25	28dc4	DC1	6g	Tor
V2C	XC9227B22CM	DC/DC-IC	PWM-PWM/PFM st-dwn, 1.2MHz, 2.2V±1%, 600mA, -CE	SOT-25	28dc4	DC1	6g	Tor
V2C	XC9227C22CM	DC/DC-IC	PWM-PWM/PFM st-dwn, 1.2MHz, 2.2V±1%, 600mA, +CE, PDR	SOT-25	28dc4	DC1	6g	Tor
V2C	XC9227D22CM	DC/DC-IC	PWM-PWM/PFM st-dwn, 1.2MHz, 2.2V±1%, 600mA, -CE, PDR	SOT-25	28dc4	DC1	6g	Tor
V2D	XC6118N22DMR-G	Vdet-IC	2.2V±2%, ±Reset ODO, Sense, hysteresis <1%	SOT-25	28mf	VD11	6g	Tor
V2D	XC9227A23CM	DC/DC-IC	PWM-PWM/PFM st-dwn, 1.2MHz, 2.3V±1%, 600mA, +CE	SOT-25	28dc4	DC1	6g	Tor
V2D	XC9227B23CM	DC/DC-IC	PWM-PWM/PFM st-dwn, 1.2MHz, 2.3V±1%, 600mA, -CE	SOT-25	28dc4	DC1	6g	Tor
V2D	XC9227C23CM	DC/DC-IC	PWM-PWM/PFM st-dwn, 1.2MHz, 2.3V±1%, 600mA, +CE, PDR	SOT-25	28dc4	DC1	6g	Tor
V2D	XC9227D23CM	DC/DC-IC	PWM-PWM/PFM st-dwn, 1.2MHz, 2.3V±1%, 600mA, -CE, PDR	SOT-25	28dc4	DC1	6g	Tor
V2E	XC9227A24CM	DC/DC-IC	PWM-PWM/PFM st-dwn, 1.2MHz, 2.4V±1%, 600mA, +CE	SOT-25	28dc4	DC1	6g	Tor
V2E	XC9227B24CM	DC/DC-IC	PWM-PWM/PFM st-dwn, 1.2MHz, 2.4V±1%, 600mA, -CE	SOT-25	28dc4	DC1	6g	Tor
V2E	XC9227C24CM	DC/DC-IC	PWM-PWM/PFM st-dwn, 1.2MHz, 2.4V±1%, 600mA, +CE, PDR	SOT-25	28dc4	DC1	6g	Tor
V2E	XC9227D24CM	DC/DC-IC	PWM-PWM/PFM st-dwn, 1.2MHz, 2.4V±1%, 600mA, -CE, PDR	SOT-25	28dc4	DC1	6g	Tor
V2F	XC9227A25CM	DC/DC-IC	PWM-PWM/PFM st-dwn, 1.2MHz, 2.5V±1%, 600mA, +CE	SOT-25	28dc4	DC1	6g	Tor
V2F	XC9227B25CM	DC/DC-IC	PWM-PWM/PFM st-dwn, 1.2MHz, 2.5V±1%, 600mA, -CE	SOT-25	28dc4	DC1	6g	Tor
V2F	XC9227C25CM	DC/DC-IC	PWM-PWM/PFM st-dwn, 1.2MHz, 2.5V±1%, 600mA, +CE, PDR	SOT-25	28dc4	DC1	6g	Tor
V2F	XC9227D25CM	DC/DC-IC	PWM-PWM/PFM st-dwn, 1.2MHz, 2.5V±1%, 600mA, -CE, PDR	SOT-25	28dc4	DC1	6g	Tor
V2H	XC9227A26CM	DC/DC-IC	PWM-PWM/PFM st-dwn, 1.2MHz, 2.6V±1%, 600mA, +CE	SOT-25	28dc4	DC1	6g	Tor
V2H	XC9227B26CM	DC/DC-IC	PWM-PWM/PFM st-dwn, 1.2MHz, 2.6V±1%, 600mA, -CE	SOT-25	28dc4	DC1	6g	Tor
V2H	XC9227C26CM	DC/DC-IC	PWM-PWM/PFM st-dwn, 1.2MHz, 2.6V±1%, 600mA, +CE, PDR	SOT-25	28dc4	DC1	6g	Tor
V2H	XC9227D26CM	DC/DC-IC	PWM-PWM/PFM st-dwn, 1.2MHz, 2.6V±1%, 600mA, -CE, PDR	SOT-25	28dc4	DC1	6g	Tor
V2K	XC9227A27CM	DC/DC-IC	PWM-PWM/PFM st-dwn, 1.2MHz, 2.7V±1%, 600mA, +CE	SOT-25	28dc4	DC1	6g	Tor
V2K	XC9227B27CM	DC/DC-IC	PWM-PWM/PFM st-dwn, 1.2MHz, 2.7V±1%, 600mA, -CE	SOT-25	28dc4	DC1	6g	Tor
V2K	XC9227C27CM	DC/DC-IC	PWM-PWM/PFM st-dwn, 1.2MHz, 2.7V±1%, 600mA, +CE, PDR	SOT-25	28dc4	DC1	6g	Tor
V2K	XC9227D27CM	DC/DC-IC	PWM-PWM/PFM st-dwn, 1.2MHz, 2.7V±1%, 600mA, -CE, PDR	SOT-25	28dc4	DC1	6g	Tor
V2L	XC9227A28CM	DC/DC-IC	PWM-PWM/PFM st-dwn, 1.2MHz, 2.8V±1%, 600mA, +CE	SOT-25	28dc4	DC1	6g	Tor



SMD code	Type	Function	Short description	Case	Pinout	Sch.	St.	Mnf.
V2L	XC9227B28CM	DC/DC-IC	PWM-PWM/PFM st-dwn, 1.2MHz, 2.8V±1%, 600mA, -CE	SOT-25	28dc4	DC1	6g	Tor
V2L	XC9227C28CM	DC/DC-IC	PWM-PWM/PFM st-dwn, 1.2MHz, 2.8V±1%, 600mA, +CE, PDR	SOT-25	28dc4	DC1	6g	Tor
V2L	XC9227D28CM	DC/DC-IC	PWM-PWM/PFM st-dwn, 1.2MHz, 2.8V±1%, 600mA, -CE, PDR	SOT-25	28dc4	DC1	6g	Tor
V2M	XC9227A29CM	DC/DC-IC	PWM-PWM/PFM st-dwn, 1.2MHz, 2.9V±1%, 600mA, +CE	SOT-25	28dc4	DC1	6g	Tor
V2M	XC9227B29CM	DC/DC-IC	PWM-PWM/PFM st-dwn, 1.2MHz, 2.9V±1%, 600mA, -CE	SOT-25	28dc4	DC1	6g	Tor
V2M	XC9227C29CM	DC/DC-IC	PWM-PWM/PFM st-dwn, 1.2MHz, 2.9V±1%, 600mA, +CE, PDR	SOT-25	28dc4	DC1	6g	Tor
V2M	XC9227D29CM	DC/DC-IC	PWM-PWM/PFM st-dwn, 1.2MHz, 2.9V±1%, 600mA, -CE, PDR	SOT-25	28dc4	DC1	6g	Tor
V3	BD45292G	Vdet-IC	2.9V, -Reset ODO, 200ms	SSOP-5	28vdp	VD6	6c	Rhm
V3	MC74VHC1G02DF	CMOS-Logic	2-input NOR gate	SOT-353	28/Log2	-	6b	Ons
V3	MC74VHC1G02DT	CMOS-Logic	2-input NOR gate	SOT-23-5	28/Log2	-	6b	Ons
V3	RT9167A-2HCB	LVR-IC	LDO, 2.85V±2%, 600mA, +CE	SOT-23-5	28vrx	VR7	6g	Rct
V3	TC74A3-3.3VCT	Tdet-IC	Sensor (-40, +125±3°C), Vcc=3.3V, I2C-bus	SOT-23-5	28hd	-	6g	Mcc
V3-	RT9167A-2HPB	LVR-IC	LDO, 2.85V±2%, 600mA, +CE	SOT-23-5	28vrx	VR7	6g	Rct
V30	R1163N301B	LVR-IC	LDO, 3V±1.5%, 150mA, +CE, AE(Mode)	SOT-23-5	28x9	VR10	6g	Ric
V30	XC9110C301MR	DC/DC-IC	PFM step-up, 100kHz, 3.0V±2.5%, 400mA, +CE	SOT-25	28sc	DC3	6g	Tor
V30	XC9227A306M	DC/DC-IC	PWM-PWM/PFM st-dwn, 600kHz, 3.0V±1%, 600mA, +CE	SOT-25	28dc4	DC1	6g	Tor
V30	XC9227B306M	DC/DC-IC	PWM-PWM/PFM st-dwn, 600kHz, 3.0V±1%, 600mA, -CE	SOT-25	28dc4	DC1	6g	Tor
V30	XC9227C306M	DC/DC-IC	PWM-PWM/PFM st-dwn, 600kHz, 3.0V±1%, 600mA, +CE, PDR	SOT-25	28dc4	DC1	6g	Tor
V30	XC9227D306M	DC/DC-IC	PWM-PWM/PFM st-dwn, 600kHz, 3.0V±1%, 900mA, +CE	SOT-25	28dc4	DC1	6g	Tor
V30	XC9227E306M	DC/DC-IC	PWM-PWM/PFM st-dwn, 600kHz, 3.0V±1%, 900mA, -CE	SOT-25	28dc4	DC1	6g	Tor
V30	XC9227F306M	DC/DC-IC	PWM-PWM/PFM st-dwn, 600kHz, 3.0V±1%, 900mA, -CE, PDR	SOT-25	28dc4	DC1	6g	Tor
V30	XC9227G306M	DC/DC-IC	PWM-PWM/PFM st-dwn, 600kHz, 3.0V±1%, 900mA, +CE, PDR	SOT-25	28dc4	DC1	6g	Tor
V30	XC9227H306M	DC/DC-IC	PWM-PWM/PFM st-dwn, 600kHz, 3.0V±1%, 900mA, -CE, PDR	SOT-25	28dc4	DC1	6g	Tor
V30A	ML6201P302M	LVR-IC	3.0V±2%, 250mA	SOT-23-5	28ym	VR1	6a	Mlc
V30C	SS6680C-30CV	Vdet-IC	3.0V±2.5%, +Reset PPO	SOT-23-5	28y4	VD7	6a	Ssc
V30N	SS6680N-30CV	Vdet-IC	3.0V±2.5%, +Reset ODO	SOT-23-5	28y4	VD6	6a	Ssc
V30P	SS6680P-30CV	Vdet-IC	3.0V±2.5%, -Reset ODO	SOT-23-5	28y4	VD6	6a	Ssc
V31	R1163N311B	LVR-IC	LDO, 3.1V±1.5%, 150mA, +CE, AE(Mode)	SOT-23-5	28x9	VR10	6g	Ric
V31	XC9110C311MR	DC/DC-IC	PFM step-up, 100kHz, 3.1V±2.5%, 400mA, +CE	SOT-25	28sc	DC3	6g	Tor
V31	XC9227A316M	DC/DC-IC	PWM-PWM/PFM st-dwn, 600kHz, 3.1V±1%, 600mA, +CE	SOT-25	28dc4	DC1	6g	Tor
V31	XC9227B316M	DC/DC-IC	PWM-PWM/PFM st-dwn, 600kHz, 3.1V±1%, 600mA, -CE	SOT-25	28dc4	DC1	6g	Tor
V31	XC9227C316M	DC/DC-IC	PWM-PWM/PFM st-dwn, 600kHz, 3.1V±1%, 600mA, +CE, PDR	SOT-25	28dc4	DC1	6g	Tor
V31	XC9227D316M	DC/DC-IC	PWM-PWM/PFM st-dwn, 600kHz, 3.1V±1%, 600mA, -CE, PDR	SOT-25	28dc4	DC1	6g	Tor
V31	XC9227E316M	DC/DC-IC	PWM-PWM/PFM st-dwn, 600kHz, 3.1V±1%, 900mA, +CE	SOT-25	28dc4	DC1	6g	Tor
V31	XC9227F316M	DC/DC-IC	PWM-PWM/PFM st-dwn, 600kHz, 3.1V±1%, 900mA, -CE	SOT-25	28dc4	DC1	6g	Tor
V31	XC9227G316M	DC/DC-IC	PWM-PWM/PFM st-dwn, 600kHz, 3.1V±1%, 900mA, +CE, PDR	SOT-25	28dc4	DC1	6g	Tor
V31	XC9227H316M	DC/DC-IC	PWM-PWM/PFM st-dwn, 600kHz, 3.1V±1%, 900mA, -CE, PDR	SOT-25	28dc4	DC1	6g	Tor
V31A	ML6201P312M	LVR-IC	3.1V±2%, 250mA	SOT-23-5	28ym	VR1	6a	Mlc
V31C	SS6680C-31CV	Vdet-IC	3.1V±2.5%, +Reset PPO	SOT-23-5	28y4	VD7	6a	Ssc
V31N	SS6680N-31CV	Vdet-IC	3.1V±2.5%, +Reset ODO	SOT-23-5	28y4	VD6	6a	Ssc
V31P	SS6680P-31CV	Vdet-IC	3.1V±2.5%, -Reset ODO	SOT-23-5	28y4	VD6	6a	Ssc
V32	74LVC1G32GV	CMOS-Logic	2-input OR gate	SOT753	28/Log4	-	6a	Phi
V32	NC75V32P5	CMOS-Logic	2-input OR gate	SC-70-5	28/Log4	-	6a	F
V32	R1163N321B	LVR-IC	LDO, 3.2V±1.5%, 150mA, +CE, AE(Mode)	SOT-23-5	28x9	VR10	6g	Ric
V32	XC9110C321MR	DC/DC-IC	PFM step-up, 100kHz, 3.2V±2.5%, 400mA, +CE	SOT-25	28sc	DC3	6g	Tor
V32	XC9227A326M	DC/DC-IC	PWM-PWM/PFM st-dwn, 600kHz, 3.2V±1%, 600mA, +CE	SOT-25	28dc4	DC1	6g	Tor
V32	XC9227B326M	DC/DC-IC	PWM-PWM/PFM st-dwn, 600kHz, 3.2V±1%, 600mA, -CE	SOT-25	28dc4	DC1	6g	Tor
V32	XC9227C326M	DC/DC-IC	PWM-PWM/PFM st-dwn, 600kHz, 3.2V±1%, 600mA, +CE, PDR	SOT-25	28dc4	DC1	6g	Tor
V32	XC9227D326M	DC/DC-IC	PWM-PWM/PFM st-dwn, 600kHz, 3.2V±1%, 600mA, -CE, PDR	SOT-25	28dc4	DC1	6g	Tor
V32	XC9227E326M	DC/DC-IC	PWM-PWM/PFM st-dwn, 600kHz, 3.2V±1%, 900mA, +CE	SOT-25	28dc4	DC1	6g	Tor
V32	XC9227F326M	DC/DC-IC	PWM-PWM/PFM st-dwn, 600kHz, 3.2V±1%, 900mA, -CE	SOT-25	28dc4	DC1	6g	Tor
V32	XC9227G326M	DC/DC-IC	PWM-PWM/PFM st-dwn, 600kHz, 3.2V±1%, 900mA, +CE, PDR	SOT-25	28dc4	DC1	6g	Tor
V32	XC9227H326M	DC/DC-IC	PWM-PWM/PFM st-dwn, 600kHz, 3.2V±1%, 900mA, -CE, PDR	SOT-25	28dc4	DC1	6g	Tor
V32A	ML6201P322M	LVR-IC	3.2V±2%, 250mA	SOT-23-5	28ym	VR1	6a	Mlc
V32C	SS6680C-32CV	Vdet-IC	3.2V±2.5%, +Reset PPO	SOT-23-5	28y4	VD7	6a	Ssc
V32N	SS6680N-32CV	Vdet-IC	3.2V±2.5%, +Reset ODO	SOT-23-5	28y4	VD6	6a	Ssc
V32P	SS6680P-32CV	Vdet-IC	3.2V±2.5%, -Reset ODO	SOT-23-5	28y4	VD6	6a	Ssc
V33	R1163N331B	LVR-IC	LDO, 3.3V±1.5%, 150mA, +CE, AE(Mode)	SOT-23-5	28x9	VR10	6g	Ric
V33	XC9110C331MR	DC/DC-IC	PFM step-up, 100kHz, 3.3V±2.5%, 400mA, +CE	SOT-25	28sc	DC3	6g	Tor
V33	XC9227A336M	DC/DC-IC	PWM-PWM/PFM st-dwn, 600kHz, 3.3V±1%, 600mA, +CE	SOT-25	28dc4	DC1	6g	Tor
V33	XC9227B336M	DC/DC-IC	PWM-PWM/PFM st-dwn, 600kHz, 3.3V±1%, 600mA, -CE	SOT-25	28dc4	DC1	6g	Tor
V33	XC9227C336M	DC/DC-IC	PWM-PWM/PFM st-dwn, 600kHz, 3.3V±1%, 600mA, +CE, PDR	SOT-25	28dc4	DC1	6g	Tor
V33	XC9227D336M	DC/DC-IC	PWM-PWM/PFM st-dwn, 600kHz, 3.3V±1%, 600mA, -CE, PDR	SOT-25	28dc4	DC1	6g	Tor
V33	XC9227E336M	DC/DC-IC	PWM-PWM/PFM st-dwn, 600kHz, 3.3V±1%, 900mA, +CE	SOT-25	28dc4	DC1	6g	Tor
V33	XC9227F336M	DC/DC-IC	PWM-PWM/PFM st-dwn, 600kHz, 3.3V±1%, 900mA, -CE	SOT-25	28dc4	DC1	6g	Tor
V33	XC9227G336M	DC/DC-IC	PWM-PWM/PFM st-dwn, 600kHz, 3.3V±1%, 900mA, +CE, PDR	SOT-25	28dc4	DC1	6g	Tor
V33	XC9227H336M	DC/DC-IC	PWM-PWM/PFM st-dwn, 600kHz, 3.3V±1%, 900mA, -CE, PDR	SOT-25	28dc4	DC1	6g	Tor
V33A	ML6201P332M	LVR-IC	3.3V±2%, 250mA	SOT-23-5	28ym	VR1	6a	Mlc
V33C	SS6680C-33CV	Vdet-IC	3.3V±2.5%, +Reset PPO	SOT-23-5	28y4	VD7	6a	Ssc
V33N	SS6680N-33CV	Vdet-IC	3.3V±2.5%, +Reset ODO	SOT-23-5	28y4	VD6	6a	Ssc



SMD code	Type	Function	Short description	Case	Pinout	Sch.	St.	Mnf.
V33P	SS6680P-33CV	Vdet-IC	3.3V±2.5%, -Reset ODO	SOT-23-5	28y4	VD6	6a	Ssc
V34	R1163N341B	LVR-IC	LDO, 3.4V±1.5%, 150mA, +CE, AE(Mode)	SOT-23-5	28x9	VR10	6g	Ric
V34	XC9110C341MR	DC/DC-IC	PFM step-up, 100kHz, 3.4V±2.5%, 400mA, +CE	SOT-25	28sc	DC3	6g	Tor
V34	XC9227A346M	DC/DC-IC	PWM-PWM/PFM st-dwn, 600kHz, 3.4V±1%, 600mA, +CE	SOT-25	28dc4	DC1	6g	Tor
V34	XC9227B346M	DC/DC-IC	PWM-PWM/PFM st-dwn, 600kHz, 3.4V±1%, 600mA, -CE	SOT-25	28dc4	DC1	6g	Tor
V34	XC9227C346M	DC/DC-IC	PWM-PWM/PFM st-dwn, 600kHz, 3.4V±1%, 600mA, +CE, PDR	SOT-25	28dc4	DC1	6g	Tor
V34	XC9227D346M	DC/DC-IC	PWM-PWM/PFM st-dwn, 600kHz, 3.4V±1%, 600mA, -CE, PDR	SOT-25	28dc4	DC1	6g	Tor
V34	XC9227E346M	DC/DC-IC	PWM-PWM/PFM st-dwn, 600kHz, 3.4V±1%, 900mA, +CE	SOT-25	28dc4	DC1	6g	Tor
V34	XC9227F346M	DC/DC-IC	PWM-PWM/PFM st-dwn, 600kHz, 3.4V±1%, 900mA, -CE	SOT-25	28dc4	DC1	6g	Tor
V34	XC9227G346M	DC/DC-IC	PWM-PWM/PFM st-dwn, 600kHz, 3.4V±1%, 900mA, +CE, PDR	SOT-25	28dc4	DC1	6g	Tor
V34	XC9227H346M	DC/DC-IC	PWM-PWM/PFM st-dwn, 600kHz, 3.4V±1%, 900mA, -CE, PDR	SOT-25	28dc4	DC1	6g	Tor
V34A	ML6201P342M	LVR-IC	3.4V±2%, 250mA	SOT-23-5	28ym	VR1	6a	Mlc
V34C	SS6680C-34CV	Vdet-IC	3.4V±2.5%, +Reset PPO	SOT-23-5	28y4	VD7	6a	Ssc
V34N	SS6680N-34CV	Vdet-IC	3.4V±2.5%, +Reset ODO	SOT-23-5	28y4	VD6	6a	Ssc
V34P	SS6680P-34CV	Vdet-IC	3.4V±2.5%, -Reset ODO	SOT-23-5	28y4	VD6	6a	Ssc
V35	R1163N351B	LVR-IC	LDO, 3.5V±1.5%, 150mA, +CE, AE(Mode)	SOT-23-5	28x9	VR10	6g	Ric
V35	XC9110C351MR	DC/DC-IC	PFM step-up, 100kHz, 3.5V±2.5%, 400mA, +CE	SOT-25	28sc	DC3	6g	Tor
V35	XC9227A356M	DC/DC-IC	PWM-PWM/PFM st-dwn, 600kHz, 3.5V±1%, 600mA, +CE	SOT-25	28dc4	DC1	6g	Tor
V35	XC9227B356M	DC/DC-IC	PWM-PWM/PFM st-dwn, 600kHz, 3.5V±1%, 600mA, -CE	SOT-25	28dc4	DC1	6g	Tor
V35	XC9227C356M	DC/DC-IC	PWM-PWM/PFM st-dwn, 600kHz, 3.5V±1%, 600mA, +CE, PDR	SOT-25	28dc4	DC1	6g	Tor
V35	XC9227D356M	DC/DC-IC	PWM-PWM/PFM st-dwn, 600kHz, 3.5V±1%, 600mA, -CE, PDR	SOT-25	28dc4	DC1	6g	Tor
V35	XC9227E356M	DC/DC-IC	PWM-PWM/PFM st-dwn, 600kHz, 3.5V±1%, 900mA, +CE	SOT-25	28dc4	DC1	6g	Tor
V35	XC9227F356M	DC/DC-IC	PWM-PWM/PFM st-dwn, 600kHz, 3.5V±1%, 900mA, -CE	SOT-25	28dc4	DC1	6g	Tor
V35	XC9227G356M	DC/DC-IC	PWM-PWM/PFM st-dwn, 600kHz, 3.5V±1%, 900mA, +CE, PDR	SOT-25	28dc4	DC1	6g	Tor
V35	XC9227H356M	DC/DC-IC	PWM-PWM/PFM st-dwn, 600kHz, 3.5V±1%, 900mA, -CE, PDR	SOT-25	28dc4	DC1	6g	Tor
V35A	ML6201P352M	LVR-IC	3.5V±2%, 250mA	SOT-23-5	28ym	VR1	6a	Mlc
V35C	SS6680C-35CV	Vdet-IC	3.5V±2.5%, +Reset PPO	SOT-23-5	28y4	VD7	6a	Ssc
V35N	SS6680N-35CV	Vdet-IC	3.5V±2.5%, +Reset ODO	SOT-23-5	28y4	VD6	6a	Ssc
V35P	SS6680P-35CV	Vdet-IC	3.5V±2.5%, -Reset ODO	SOT-23-5	28y4	VD6	6a	Ssc
V36	R1163N361B	LVR-IC	LDO, 3.6V±1.5%, 150mA, +CE, AE(Mode)	SOT-23-5	28x9	VR10	6g	Ric
V36	XC9110C361MR	DC/DC-IC	PFM step-up, 100kHz, 3.6V±2.5%, 400mA, +CE	SOT-25	28sc	DC3	6g	Tor
V36	XC9227A366M	DC/DC-IC	PWM-PWM/PFM st-dwn, 600kHz, 3.6V±1%, 600mA, +CE	SOT-25	28dc4	DC1	6g	Tor
V36	XC9227B366M	DC/DC-IC	PWM-PWM/PFM st-dwn, 600kHz, 3.6V±1%, 600mA, -CE	SOT-25	28dc4	DC1	6g	Tor
V36	XC9227C366M	DC/DC-IC	PWM-PWM/PFM st-dwn, 600kHz, 3.6V±1%, 600mA, +CE, PDR	SOT-25	28dc4	DC1	6g	Tor
V36	XC9227D366M	DC/DC-IC	PWM-PWM/PFM st-dwn, 600kHz, 3.6V±1%, 600mA, -CE, PDR	SOT-25	28dc4	DC1	6g	Tor
V36	XC9227E366M	DC/DC-IC	PWM-PWM/PFM st-dwn, 600kHz, 3.6V±1%, 900mA, +CE	SOT-25	28dc4	DC1	6g	Tor
V36	XC9227F366M	DC/DC-IC	PWM-PWM/PFM st-dwn, 600kHz, 3.6V±1%, 900mA, -CE	SOT-25	28dc4	DC1	6g	Tor
V36	XC9227G366M	DC/DC-IC	PWM-PWM/PFM st-dwn, 600kHz, 3.6V±1%, 900mA, +CE, PDR	SOT-25	28dc4	DC1	6g	Tor
V36	XC9227H366M	DC/DC-IC	PWM-PWM/PFM st-dwn, 600kHz, 3.6V±1%, 900mA, -CE, PDR	SOT-25	28dc4	DC1	6g	Tor
V36A	ML6201P362M	LVR-IC	3.6V±2%, 250mA	SOT-23-5	28ym	VR1	6a	Mlc
V36C	SS6680C-36CV	Vdet-IC	3.6V±2.5%, +Reset PPO	SOT-23-5	28y4	VD7	6a	Ssc
V36N	SS6680N-36CV	Vdet-IC	3.6V±2.5%, +Reset ODO	SOT-23-5	28y4	VD6	6a	Ssc
V36P	SS6680P-36CV	Vdet-IC	3.6V±2.5%, -Reset ODO	SOT-23-5	28y4	VD6	6a	Ssc
V37	R1163N371B	LVR-IC	LDO, 3.7V±1.5%, 150mA, +CE, AE(Mode)	SOT-23-5	28x9	VR10	6g	Ric
V37	XC9110C371MR	DC/DC-IC	PFM step-up, 100kHz, 3.7V±2.5%, 400mA, +CE	SOT-25	28sc	DC3	6g	Tor
V37	XC9227A376M	DC/DC-IC	PWM-PWM/PFM st-dwn, 600kHz, 3.7V±1%, 600mA, +CE	SOT-25	28dc4	DC1	6g	Tor
V37	XC9227B376M	DC/DC-IC	PWM-PWM/PFM st-dwn, 600kHz, 3.7V±1%, 600mA, -CE	SOT-25	28dc4	DC1	6g	Tor
V37	XC9227C376M	DC/DC-IC	PWM-PWM/PFM st-dwn, 600kHz, 3.7V±1%, 600mA, +CE, PDR	SOT-25	28dc4	DC1	6g	Tor
V37	XC9227D376M	DC/DC-IC	PWM-PWM/PFM st-dwn, 600kHz, 3.7V±1%, 600mA, -CE, PDR	SOT-25	28dc4	DC1	6g	Tor
V37	XC9227E376M	DC/DC-IC	PWM-PWM/PFM st-dwn, 600kHz, 3.7V±1%, 900mA, +CE	SOT-25	28dc4	DC1	6g	Tor
V37	XC9227F376M	DC/DC-IC	PWM-PWM/PFM st-dwn, 600kHz, 3.7V±1%, 900mA, -CE	SOT-25	28dc4	DC1	6g	Tor
V37	XC9227G376M	DC/DC-IC	PWM-PWM/PFM st-dwn, 600kHz, 3.7V±1%, 900mA, +CE, PDR	SOT-25	28dc4	DC1	6g	Tor
V37	XC9227H376M	DC/DC-IC	PWM-PWM/PFM st-dwn, 600kHz, 3.7V±1%, 900mA, -CE, PDR	SOT-25	28dc4	DC1	6g	Tor
V37A	ML6201P372M	LVR-IC	3.7V±2%, 250mA	SOT-23-5	28ym	VR1	6a	Mlc
V37C	SS6680C-37CV	Vdet-IC	3.7V±2.5%, +Reset PPO	SOT-23-5	28y4	VD7	6a	Ssc
V37N	SS6680N-37CV	Vdet-IC	3.7V±2.5%, +Reset ODO	SOT-23-5	28y4	VD6	6a	Ssc
V37P	SS6680P-37CV	Vdet-IC	3.7V±2.5%, -Reset ODO	SOT-23-5	28y4	VD6	6a	Ssc
V38	R1163N381B	LVR-IC	LDO, 3.8V±1.5%, 150mA, +CE, AE(Mode)	SOT-23-5	28x9	VR10	6g	Ric
V38	XC9110C381MR	DC/DC-IC	PFM step-up, 100kHz, 3.8V±2.5%, 400mA, +CE	SOT-25	28sc	DC3	6g	Tor
V38	XC9227A386M	DC/DC-IC	PWM-PWM/PFM st-dwn, 600kHz, 3.8V±1%, 600mA, +CE	SOT-25	28dc4	DC1	6g	Tor
V38	XC9227B386M	DC/DC-IC	PWM-PWM/PFM st-dwn, 600kHz, 3.8V±1%, 600mA, -CE	SOT-25	28dc4	DC1	6g	Tor
V38	XC9227C386M	DC/DC-IC	PWM-PWM/PFM st-dwn, 600kHz, 3.8V±1%, 600mA, +CE, PDR	SOT-25	28dc4	DC1	6g	Tor
V38	XC9227D386M	DC/DC-IC	PWM-PWM/PFM st-dwn, 600kHz, 3.8V±1%, 600mA, -CE, PDR	SOT-25	28dc4	DC1	6g	Tor
V38	XC9227E386M	DC/DC-IC	PWM-PWM/PFM st-dwn, 600kHz, 3.8V±1%, 900mA, +CE	SOT-25	28dc4	DC1	6g	Tor
V38	XC9227F386M	DC/DC-IC	PWM-PWM/PFM st-dwn, 600kHz, 3.8V±1%, 900mA, -CE	SOT-25	28dc4	DC1	6g	Tor
V38	XC9227G386M	DC/DC-IC	PWM-PWM/PFM st-dwn, 600kHz, 3.8V±1%, 900mA, +CE, PDR	SOT-25	28dc4	DC1	6g	Tor
V38	XC9227H386M	DC/DC-IC	PWM-PWM/PFM st-dwn, 600kHz, 3.8V±1%, 900mA, -CE, PDR	SOT-25	28dc4	DC1	6g	Tor
V38A	ML6201P382M	LVR-IC	3.8V±2%, 250mA	SOT-23-5	28ym	VR1	6a	Mlc
V38C	SS6680C-38CV	Vdet-IC	3.8V±2.5%, +Reset PPO	SOT-23-5	28y4	VD7	6a	Ssc
V38N	SS6680N-38CV	Vdet-IC	3.8V±2.5%, +Reset ODO	SOT-23-5	28y4	VD6	6a	Ssc



SMD code	Type	Function	Short description	Case	Pinout	Sch.	St.	Mnf.
V38P	SS6680P-38CV	Vdet-IC	3.8V±2.5%, -Reset ODO	SOT-23-5	28y4	VD6	6a	Ssc
V39	R1163N391B	LVR-IC	LDO, 3.9V±1.5%, 150mA, +CE, AE(Mode)	SOT-23-5	28x9	VR10	6g	Ric
V39	XC9110C391MR	DC/DC-IC	PFM step-up, 100kHz, 3.9V±2.5%, 400mA, +CE	SOT-25	28sc	DC3	6g	Tor
V39	XC9227A396M	DC/DC-IC	PWM-PWM/PFM st-dwn, 600kHz, 3.9V±1%, 600mA, +CE	SOT-25	28dc4	DC1	6g	Tor
V39	XC9227B396M	DC/DC-IC	PWM-PWM/PFM st-dwn, 600kHz, 3.9V±1%, 600mA, -CE	SOT-25	28dc4	DC1	6g	Tor
V39	XC9227C396M	DC/DC-IC	PWM-PWM/PFM st-dwn, 600kHz, 3.9V±1%, 600mA, +CE, PDR	SOT-25	28dc4	DC1	6g	Tor
V39	XC9227D396M	DC/DC-IC	PWM-PWM/PFM st-dwn, 600kHz, 3.9V±1%, 600mA, -CE, PDR	SOT-25	28dc4	DC1	6g	Tor
V39	XC9227E396M	DC/DC-IC	PWM-PWM/PFM st-dwn, 600kHz, 3.9V±1%, 900mA, +CE	SOT-25	28dc4	DC1	6g	Tor
V39	XC9227F396M	DC/DC-IC	PWM-PWM/PFM st-dwn, 600kHz, 3.9V±1%, 900mA, -CE	SOT-25	28dc4	DC1	6g	Tor
V39	XC9227G396M	DC/DC-IC	PWM-PWM/PFM st-dwn, 600kHz, 3.9V±1%, 900mA, +CE, PDR	SOT-25	28dc4	DC1	6g	Tor
V39	XC9227H396M	DC/DC-IC	PWM-PWM/PFM st-dwn, 600kHz, 3.9V±1%, 900mA, -CE, PDR	SOT-25	28dc4	DC1	6g	Tor
V39A	ML6201P392M	LVR-IC	3.9V±2.5%, 250mA	SOT-23-5	28ym	VR1	6a	Mlc
V39C	SS6680C-39CV	Vdet-IC	3.9V±2.5%, +Reset PPO	SOT-23-5	28y4	VD7	6a	Ssc
V39N	SS6680N-39CV	Vdet-IC	3.9V±2.5%, +Reset ODO	SOT-23-5	28y4	VD6	6a	Ssc
V39P	SS6680P-39CV	Vdet-IC	3.9V±2.5%, -Reset ODO	SOT-23-5	28y4	VD6	6a	Ssc
V3A	XC6118N23AMR-G	Vdet-IC	2.3V±2%, ±Reset ODO, Sense, hysteresis 5%, Cd	SOT-25	28mg	VD14	6g	Tor
V3A	XC9227A30CM	DC/DC-IC	PWM-PWM/PFM st-dwn, 1.2MHz, 3.0V±1%, 600mA, +CE	SOT-25	28dc4	DC1	6g	Tor
V3A	XC9227B30CM	DC/DC-IC	PWM-PWM/PFM st-dwn, 1.2MHz, 3.0V±1%, 600mA, -CE	SOT-25	28dc4	DC1	6g	Tor
V3A	XC9227C30CM	DC/DC-IC	PWM-PWM/PFM st-dwn, 1.2MHz, 3.0V±1%, 600mA, +CE, PDR	SOT-25	28dc4	DC1	6g	Tor
V3A	XC9227D30CM	DC/DC-IC	PWM-PWM/PFM st-dwn, 1.2MHz, 3.0V±1%, 600mA, -CE, PDR	SOT-25	28dc4	DC1	6g	Tor
V3A	XC9227E30CM	DC/DC-IC	PWM-PWM/PFM st-dwn, 1.2MHz, 3.0V±1%, 900mA, +CE	SOT-25	28dc4	DC1	6g	Tor
V3A	XC9227F30CM	DC/DC-IC	PWM-PWM/PFM st-dwn, 1.2MHz, 3.0V±1%, 900mA, -CE	SOT-25	28dc4	DC1	6g	Tor
V3A	XC9227G30CM	DC/DC-IC	PWM-PWM/PFM st-dwn, 1.2MHz, 3.0V±1%, 900mA, +CE, PDR	SOT-25	28dc4	DC1	6g	Tor
V3A	XC9227H30CM	DC/DC-IC	PWM-PWM/PFM st-dwn, 1.2MHz, 3.0V±1%, 900mA, -CE, PDR	SOT-25	28dc4	DC1	6g	Tor
V3B	XC6118N23BMR-G	Vdet-IC	2.3V±2%, ±Reset ODO, Sense, hysteresis <1%, Cd	SOT-25	28mg	VD14	6g	Tor
V3B	XC9227A31CM	DC/DC-IC	PWM-PWM/PFM st-dwn, 1.2MHz, 3.1V±1%, 600mA, +CE	SOT-25	28dc4	DC1	6g	Tor
V3B	XC9227B31CM	DC/DC-IC	PWM-PWM/PFM st-dwn, 1.2MHz, 3.1V±1%, 600mA, -CE	SOT-25	28dc4	DC1	6g	Tor
V3B	XC9227C31CM	DC/DC-IC	PWM-PWM/PFM st-dwn, 1.2MHz, 3.1V±1%, 600mA, +CE, PDR	SOT-25	28dc4	DC1	6g	Tor
V3B	XC9227D31CM	DC/DC-IC	PWM-PWM/PFM st-dwn, 1.2MHz, 3.1V±1%, 600mA, -CE, PDR	SOT-25	28dc4	DC1	6g	Tor
V3B	XC9227E31CM	DC/DC-IC	PWM-PWM/PFM st-dwn, 1.2MHz, 3.1V±1%, 900mA, +CE	SOT-25	28dc4	DC1	6g	Tor
V3B	XC9227F31CM	DC/DC-IC	PWM-PWM/PFM st-dwn, 1.2MHz, 3.1V±1%, 900mA, -CE	SOT-25	28dc4	DC1	6g	Tor
V3B	XC9227G31CM	DC/DC-IC	PWM-PWM/PFM st-dwn, 1.2MHz, 3.1V±1%, 900mA, +CE, PDR	SOT-25	28dc4	DC1	6g	Tor
V3B	XC9227H31CM	DC/DC-IC	PWM-PWM/PFM st-dwn, 1.2MHz, 3.1V±1%, 900mA, -CE, PDR	SOT-25	28dc4	DC1	6g	Tor
V3C	XC6118N23CMR-G	Vdet-IC	2.3V±2%, ±Reset ODO, Sense, hysteresis 5%	SOT-25	28mf	VD11	6g	Tor
V3C	XC9227A32CM	DC/DC-IC	PWM-PWM/PFM st-dwn, 1.2MHz, 3.2V±1%, 600mA, +CE	SOT-25	28dc4	DC1	6g	Tor
V3C	XC9227B32CM	DC/DC-IC	PWM-PWM/PFM st-dwn, 1.2MHz, 3.2V±1%, 600mA, -CE	SOT-25	28dc4	DC1	6g	Tor
V3C	XC9227C32CM	DC/DC-IC	PWM-PWM/PFM st-dwn, 1.2MHz, 3.2V±1%, 600mA, +CE, PDR	SOT-25	28dc4	DC1	6g	Tor
V3C	XC9227D32CM	DC/DC-IC	PWM-PWM/PFM st-dwn, 1.2MHz, 3.2V±1%, 600mA, -CE, PDR	SOT-25	28dc4	DC1	6g	Tor
V3C	XC9227E32CM	DC/DC-IC	PWM-PWM/PFM st-dwn, 1.2MHz, 3.2V±1%, 900mA, +CE	SOT-25	28dc4	DC1	6g	Tor
V3C	XC9227F32CM	DC/DC-IC	PWM-PWM/PFM st-dwn, 1.2MHz, 3.2V±1%, 900mA, -CE	SOT-25	28dc4	DC1	6g	Tor
V3C	XC9227G32CM	DC/DC-IC	PWM-PWM/PFM st-dwn, 1.2MHz, 3.2V±1%, 900mA, +CE, PDR	SOT-25	28dc4	DC1	6g	Tor
V3C	XC9227H32CM	DC/DC-IC	PWM-PWM/PFM st-dwn, 1.2MHz, 3.2V±1%, 900mA, -CE, PDR	SOT-25	28dc4	DC1	6g	Tor
V3D	XC6118N23DMR-G	Vdet-IC	2.3V±2%, ±Reset ODO, Sense, hysteresis <1%	SOT-25	28mf	VD11	6g	Tor
V3D	XC9227A33CM	DC/DC-IC	PWM-PWM/PFM st-dwn, 1.2MHz, 3.3V±1%, 600mA, +CE	SOT-25	28dc4	DC1	6g	Tor
V3D	XC9227B33CM	DC/DC-IC	PWM-PWM/PFM st-dwn, 1.2MHz, 3.3V±1%, 600mA, -CE	SOT-25	28dc4	DC1	6g	Tor
V3D	XC9227C33CM	DC/DC-IC	PWM-PWM/PFM st-dwn, 1.2MHz, 3.3V±1%, 600mA, +CE, PDR	SOT-25	28dc4	DC1	6g	Tor
V3D	XC9227D33CM	DC/DC-IC	PWM-PWM/PFM st-dwn, 1.2MHz, 3.3V±1%, 600mA, -CE, PDR	SOT-25	28dc4	DC1	6g	Tor
V3D	XC9227E33CM	DC/DC-IC	PWM-PWM/PFM st-dwn, 1.2MHz, 3.3V±1%, 900mA, +CE	SOT-25	28dc4	DC1	6g	Tor
V3D	XC9227F33CM	DC/DC-IC	PWM-PWM/PFM st-dwn, 1.2MHz, 3.3V±1%, 900mA, -CE	SOT-25	28dc4	DC1	6g	Tor
V3D	XC9227G33CM	DC/DC-IC	PWM-PWM/PFM st-dwn, 1.2MHz, 3.3V±1%, 900mA, +CE, PDR	SOT-25	28dc4	DC1	6g	Tor
V3D	XC9227H33CM	DC/DC-IC	PWM-PWM/PFM st-dwn, 1.2MHz, 3.3V±1%, 900mA, -CE, PDR	SOT-25	28dc4	DC1	6g	Tor
V3E	XC9227A34CM	DC/DC-IC	PWM-PWM/PFM st-dwn, 1.2MHz, 3.4V±1%, 600mA, +CE	SOT-25	28dc4	DC1	6g	Tor
V3E	XC9227B34CM	DC/DC-IC	PWM-PWM/PFM st-dwn, 1.2MHz, 3.4V±1%, 600mA, -CE	SOT-25	28dc4	DC1	6g	Tor
V3E	XC9227C34CM	DC/DC-IC	PWM-PWM/PFM st-dwn, 1.2MHz, 3.4V±1%, 600mA, +CE, PDR	SOT-25	28dc4	DC1	6g	Tor
V3E	XC9227D34CM	DC/DC-IC	PWM-PWM/PFM st-dwn, 1.2MHz, 3.4V±1%, 600mA, -CE, PDR	SOT-25	28dc4	DC1	6g	Tor
V3E	XC9227E34CM	DC/DC-IC	PWM-PWM/PFM st-dwn, 1.2MHz, 3.4V±1%, 900mA, +CE	SOT-25	28dc4	DC1	6g	Tor
V3E	XC9227F34CM	DC/DC-IC	PWM-PWM/PFM st-dwn, 1.2MHz, 3.4V±1%, 900mA, -CE	SOT-25	28dc4	DC1	6g	Tor
V3E	XC9227G34CM	DC/DC-IC	PWM-PWM/PFM st-dwn, 1.2MHz, 3.4V±1%, 900mA, +CE, PDR	SOT-25	28dc4	DC1	6g	Tor
V3E	XC9227H34CM	DC/DC-IC	PWM-PWM/PFM st-dwn, 1.2MHz, 3.4V±1%, 900mA, -CE, PDR	SOT-25	28dc4	DC1	6g	Tor
V3F	XC9227A35CM	DC/DC-IC	PWM-PWM/PFM st-dwn, 1.2MHz, 3.5V±1%, 600mA, +CE	SOT-25	28dc4	DC1	6g	Tor
V3F	XC9227B35CM	DC/DC-IC	PWM-PWM/PFM st-dwn, 1.2MHz, 3.5V±1%, 600mA, -CE	SOT-25	28dc4	DC1	6g	Tor
V3F	XC9227C35CM	DC/DC-IC	PWM-PWM/PFM st-dwn, 1.2MHz, 3.5V±1%, 600mA, +CE, PDR	SOT-25	28dc4	DC1	6g	Tor
V3F	XC9227D35CM	DC/DC-IC	PWM-PWM/PFM st-dwn, 1.2MHz, 3.5V±1%, 600mA, -CE, PDR	SOT-25	28dc4	DC1	6g	Tor
V3F	XC9227E35CM	DC/DC-IC	PWM-PWM/PFM st-dwn, 1.2MHz, 3.5V±1%, 900mA, +CE	SOT-25	28dc4	DC1	6g	Tor
V3F	XC9227F35CM	DC/DC-IC	PWM-PWM/PFM st-dwn, 1.2MHz, 3.5V±1%, 900mA, -CE	SOT-25	28dc4	DC1	6g	Tor
V3F	XC9227G35CM	DC/DC-IC	PWM-PWM/PFM st-dwn, 1.2MHz, 3.5V±1%, 900mA, +CE, PDR	SOT-25	28dc4	DC1	6g	Tor
V3F	XC9227H35CM	DC/DC-IC	PWM-PWM/PFM st-dwn, 1.2MHz, 3.5V±1%, 900mA, -CE, PDR	SOT-25	28dc4	DC1	6g	Tor
V3H	XC9227A36CM	DC/DC-IC	PWM-PWM/PFM st-dwn, 1.2MHz, 3.6V±1%, 600mA, +CE	SOT-25	28dc4	DC1	6g	Tor
V3H	XC9227B36CM	DC/DC-IC	PWM-PWM/PFM st-dwn, 1.2MHz, 3.6V±1%, 600mA, -CE	SOT-25	28dc4	DC1	6g	Tor
V3H	XC9227C36CM	DC/DC-IC	PWM-PWM/PFM st-dwn, 1.2MHz, 3.6V±1%, 600mA, +CE, PDR	SOT-25	28dc4	DC1	6g	Tor



SMD code	Type	Function	Short description	Case	Pinout	Sch.	St.	Mnf.
V3H	XC9227D36CM	DC/DC-IC	PWM-PWM/PFM st-dwn, 1.2MHz, 3.6V±1%, 600mA, -CE, PDR	SOT-25	28dc4	DC1	6g	Tor
V3H	XC9227E36CM	DC/DC-IC	PWM-PWM/PFM st-dwn, 1.2MHz, 3.6V±1%, 900mA, +CE	SOT-25	28dc4	DC1	6g	Tor
V3H	XC9227F36CM	DC/DC-IC	PWM-PWM/PFM st-dwn, 1.2MHz, 3.6V±1%, 900mA, -CE	SOT-25	28dc4	DC1	6g	Tor
V3H	XC9227G36CM	DC/DC-IC	PWM-PWM/PFM st-dwn, 1.2MHz, 3.6V±1%, 900mA, +CE, PDR	SOT-25	28dc4	DC1	6g	Tor
V3H	XC9227H36CM	DC/DC-IC	PWM-PWM/PFM st-dwn, 1.2MHz, 3.6V±1%, 900mA, -CE, PDR	SOT-25	28dc4	DC1	6g	Tor
V3K	XC9227A37CM	DC/DC-IC	PWM-PWM/PFM st-dwn, 1.2MHz, 3.7V±1%, 600mA, +CE	SOT-25	28dc4	DC1	6g	Tor
V3K	XC9227B37CM	DC/DC-IC	PWM-PWM/PFM st-dwn, 1.2MHz, 3.7V±1%, 600mA, -CE	SOT-25	28dc4	DC1	6g	Tor
V3K	XC9227C37CM	DC/DC-IC	PWM-PWM/PFM st-dwn, 1.2MHz, 3.7V±1%, 600mA, +CE, PDR	SOT-25	28dc4	DC1	6g	Tor
V3K	XC9227D37CM	DC/DC-IC	PWM-PWM/PFM st-dwn, 1.2MHz, 3.7V±1%, 600mA, -CE, PDR	SOT-25	28dc4	DC1	6g	Tor
V3K	XC9227E37CM	DC/DC-IC	PWM-PWM/PFM st-dwn, 1.2MHz, 3.7V±1%, 900mA, +CE	SOT-25	28dc4	DC1	6g	Tor
V3K	XC9227F37CM	DC/DC-IC	PWM-PWM/PFM st-dwn, 1.2MHz, 3.7V±1%, 900mA, -CE	SOT-25	28dc4	DC1	6g	Tor
V3K	XC9227G37CM	DC/DC-IC	PWM-PWM/PFM st-dwn, 1.2MHz, 3.7V±1%, 900mA, +CE, PDR	SOT-25	28dc4	DC1	6g	Tor
V3K	XC9227H37CM	DC/DC-IC	PWM-PWM/PFM st-dwn, 1.2MHz, 3.7V±1%, 900mA, -CE, PDR	SOT-25	28dc4	DC1	6g	Tor
V3L	XC9227A38CM	DC/DC-IC	PWM-PWM/PFM st-dwn, 1.2MHz, 3.8V±1%, 600mA, +CE	SOT-25	28dc4	DC1	6g	Tor
V3L	XC9227B38CM	DC/DC-IC	PWM-PWM/PFM st-dwn, 1.2MHz, 3.8V±1%, 600mA, -CE	SOT-25	28dc4	DC1	6g	Tor
V3L	XC9227C38CM	DC/DC-IC	PWM-PWM/PFM st-dwn, 1.2MHz, 3.8V±1%, 600mA, +CE, PDR	SOT-25	28dc4	DC1	6g	Tor
V3L	XC9227D38CM	DC/DC-IC	PWM-PWM/PFM st-dwn, 1.2MHz, 3.8V±1%, 600mA, -CE, PDR	SOT-25	28dc4	DC1	6g	Tor
V3L	XC9227E38CM	DC/DC-IC	PWM-PWM/PFM st-dwn, 1.2MHz, 3.8V±1%, 900mA, +CE	SOT-25	28dc4	DC1	6g	Tor
V3L	XC9227F38CM	DC/DC-IC	PWM-PWM/PFM st-dwn, 1.2MHz, 3.8V±1%, 900mA, -CE	SOT-25	28dc4	DC1	6g	Tor
V3L	XC9227G38CM	DC/DC-IC	PWM-PWM/PFM st-dwn, 1.2MHz, 3.8V±1%, 900mA, +CE, PDR	SOT-25	28dc4	DC1	6g	Tor
V3L	XC9227H38CM	DC/DC-IC	PWM-PWM/PFM st-dwn, 1.2MHz, 3.8V±1%, 900mA, -CE, PDR	SOT-25	28dc4	DC1	6g	Tor
V3M	XC9227A39CM	DC/DC-IC	PWM-PWM/PFM st-dwn, 1.2MHz, 3.9V±1%, 600mA, +CE	SOT-25	28dc4	DC1	6g	Tor
V3M	XC9227B39CM	DC/DC-IC	PWM-PWM/PFM st-dwn, 1.2MHz, 3.9V±1%, 600mA, -CE	SOT-25	28dc4	DC1	6g	Tor
V3M	XC9227C39CM	DC/DC-IC	PWM-PWM/PFM st-dwn, 1.2MHz, 3.9V±1%, 600mA, +CE, PDR	SOT-25	28dc4	DC1	6g	Tor
V3M	XC9227D39CM	DC/DC-IC	PWM-PWM/PFM st-dwn, 1.2MHz, 3.9V±1%, 600mA, -CE, PDR	SOT-25	28dc4	DC1	6g	Tor
V3M	XC9227E39CM	DC/DC-IC	PWM-PWM/PFM st-dwn, 1.2MHz, 3.9V±1%, 900mA, +CE	SOT-25	28dc4	DC1	6g	Tor
V3M	XC9227F39CM	DC/DC-IC	PWM-PWM/PFM st-dwn, 1.2MHz, 3.9V±1%, 900mA, -CE	SOT-25	28dc4	DC1	6g	Tor
V3M	XC9227G39CM	DC/DC-IC	PWM-PWM/PFM st-dwn, 1.2MHz, 3.9V±1%, 900mA, +CE, PDR	SOT-25	28dc4	DC1	6g	Tor
V3M	XC9227H39CM	DC/DC-IC	PWM-PWM/PFM st-dwn, 1.2MHz, 3.9V±1%, 900mA, -CE, PDR	SOT-25	28dc4	DC1	6g	Tor
V4	BD45282G	Vdet-IC	2.8V, -Reset ODO, 200ms	SSOP-5	28vdp	VD6	6c	Rhm
V4	MC74VHC1G32DF	CMOS-Logic	2-input OR gate	SOT-353	28/Log4	-	6b	Ons
V4	MC74VHC1G32DT	CMOS-Logic	2-input OR gate	SOT-23-5	28/Log4	-	6b	Ons
V4	TC74AA-3.3VCT	Tdet-IC	Sensor (-40...+125±3°C), Vcc=3.3V, I2C-bus	SOT-23-5	28hd	-	6g	Mcc
V40	R1163N401B	LVR-IC	LDO, 4V±1.5%, 150mA, +CE, AE(Mode)	SOT-23-5	28x9	VR10	6g	Ric
V40	XC9110C401MR	DC/DC-IC	PFM step-up, 100kHz, 4.0V±2.5%, 400mA, +CE	SOT-25	28sc	DC3	6g	Tor
V40	XC9227A406M	DC/DC-IC	PWM-PWM/PFM st-dwn, 600kHz, 4.0V±1%, 600mA, +CE	SOT-25	28dc4	DC1	6g	Tor
V40	XC9227B406M	DC/DC-IC	PWM-PWM/PFM st-dwn, 600kHz, 4.0V±1%, 600mA, -CE	SOT-25	28dc4	DC1	6g	Tor
V40	XC9227C406M	DC/DC-IC	PWM-PWM/PFM st-dwn, 600kHz, 4.0V±1%, 600mA, +CE, PDR	SOT-25	28dc4	DC1	6g	Tor
V40	XC9227D406M	DC/DC-IC	PWM-PWM/PFM st-dwn, 600kHz, 4.0V±1%, 600mA, -CE, PDR	SOT-25	28dc4	DC1	6g	Tor
V40	XC9227E406M	DC/DC-IC	PWM-PWM/PFM st-dwn, 600kHz, 4.0V±1%, 900mA, +CE	SOT-25	28dc4	DC1	6g	Tor
V40	XC9227F406M	DC/DC-IC	PWM-PWM/PFM st-dwn, 600kHz, 4.0V±1%, 900mA, -CE	SOT-25	28dc4	DC1	6g	Tor
V40	XC9227G406M	DC/DC-IC	PWM-PWM/PFM st-dwn, 600kHz, 4.0V±1%, 900mA, +CE, PDR	SOT-25	28dc4	DC1	6g	Tor
V40	XC9227H406M	DC/DC-IC	PWM-PWM/PFM st-dwn, 600kHz, 4.0V±1%, 900mA, -CE, PDR	SOT-25	28dc4	DC1	6g	Tor
V40A	ML6201P402M	LVR-IC	4.0V±2%, 250mA	SOT-23-5	28ym	VR1	6a	Mlc
V40C	SS6680C-40CV	Vdet-IC	4.0V±2.5%, +Reset PPO	SOT-23-5	28y4	VD7	6a	Ssc
V40N	SS6680N-40CV	Vdet-IC	4.0V±2.5%, +Reset ODO	SOT-23-5	28y4	VD6	6a	Ssc
V40P	SS6680P-40CV	Vdet-IC	4.0V±2.5%, -Reset ODO	SOT-23-5	28y4	VD6	6a	Ssc
V41	R1163N181B5	LVR-IC	LDO, 1.85V±1.5%, 150mA, +CE, AE(Mode)	SOT-23-5	28x9	VR10	6g	Ric
V41	XC9110C411MR	DC/DC-IC	PFM step-up, 100kHz, 4.1V±2.5%, 400mA, +CE	SOT-25	28sc	DC3	6g	Tor
V41A	ML6201P412M	LVR-IC	4.1V±2%, 250mA	SOT-23-5	28ym	VR1	6a	Mlc
V41C	SS6680C-41CV	Vdet-IC	4.1V±2.5%, +Reset PPO	SOT-23-5	28y4	VD7	6a	Ssc
V41N	SS6680N-41CV	Vdet-IC	4.1V±2.5%, +Reset ODO	SOT-23-5	28y4	VD6	6a	Ssc
V41P	SS6680P-41CV	Vdet-IC	4.1V±2.5%, -Reset ODO	SOT-23-5	28y4	VD6	6a	Ssc
V42	R1163N281B5	LVR-IC	LDO, 2.85V±1.5%, 150mA, +CE, AE(Mode)	SOT-23-5	28x9	VR10	6g	Ric
V42	XC9110C421MR	DC/DC-IC	PFM step-up, 100kHz, 4.2V±2.5%, 400mA, +CE	SOT-25	28sc	DC3	6g	Tor
V42A	ML6201P422M	LVR-IC	4.2V±2%, 250mA	SOT-23-5	28ym	VR1	6a	Mlc
V42C	SS6680C-42CV	Vdet-IC	4.2V±2.5%, +Reset PPO	SOT-23-5	28y4	VD7	6a	Ssc
V42N	SS6680N-42CV	Vdet-IC	4.2V±2.5%, +Reset ODO	SOT-23-5	28y4	VD6	6a	Ssc
V42P	SS6680P-42CV	Vdet-IC	4.2V±2.5%, -Reset ODO	SOT-23-5	28y4	VD6	6a	Ssc
V43	XC9110C431MR	DC/DC-IC	PFM step-up, 100kHz, 4.3V±2.5%, 400mA, +CE	SOT-25	28sc	DC3	6g	Tor
V43A	ML6201P432M	LVR-IC	4.3V±2%, 250mA	SOT-23-5	28ym	VR1	6a	Mlc
V43C	SS6680C-43CV	Vdet-IC	4.3V±2.5%, +Reset PPO	SOT-23-5	28y4	VD7	6a	Ssc
V43N	SS6680N-43CV	Vdet-IC	4.3V±2.5%, +Reset ODO	SOT-23-5	28y4	VD6	6a	Ssc
V43P	SS6680P-43CV	Vdet-IC	4.3V±2.5%, -Reset ODO	SOT-23-5	28y4	VD6	6a	Ssc
V44	XC9110C441MR	DC/DC-IC	PFM step-up, 100kHz, 4.4V±2.5%, 400mA, +CE	SOT-25	28sc	DC3	6g	Tor
V44A	ML6201P442M	LVR-IC	4.4V±2%, 250mA	SOT-23-5	28ym	VR1	6a	Mlc
V44C	SS6680C-44CV	Vdet-IC	4.4V±2.5%, +Reset PPO	SOT-23-5	28y4	VD7	6a	Ssc
V44N	SS6680N-44CV	Vdet-IC	4.4V±2.5%, +Reset ODO	SOT-23-5	28y4	VD6	6a	Ssc
V44P	SS6680P-44CV	Vdet-IC	4.4V±2.5%, -Reset ODO	SOT-23-5	28y4	VD6	6a	Ssc
V45	XC9110C451MR	DC/DC-IC	PFM step-up, 100kHz, 4.5V±2.5%, 400mA, +CE	SOT-25	28sc	DC3	6g	Tor



SMD code	Type	Function	Short description	Case	Pinout	Sch.	St.	Mnf.
V45A	ML6201P452M	LVR-IC	4.5V±2%, 250mA	SOT-23-5	28ym	VR1	6a	Mlc
V45C	SS6680C-45CV	Vdet-IC	4.5V±2.5%, +Reset PPO	SOT-23-5	28y4	VD7	6a	Ssc
V45N	SS6680N-45CV	Vdet-IC	4.5V±2.5%, +Reset ODO	SOT-23-5	28y4	VD6	6a	Ssc
V45P	SS6680P-45CV	Vdet-IC	4.5V±2.5%, -Reset ODO	SOT-23-5	28y4	VD6	6a	Ssc
V46	XC9110C461MR	DC/DC-IC	PFM step-up, 100kHz, 4.6V±2.5%, 400mA, +CE	SOT-25	28sc	DC3	6g	Tor
V46A	ML6201P462M	LVR-IC	4.6V±2%, 250mA	SOT-23-5	28ym	VR1	6a	Mlc
V46C	SS6680C-46CV	Vdet-IC	4.6V±2.5%, +Reset PPO	SOT-23-5	28y4	VD7	6a	Ssc
V46N	SS6680N-46CV	Vdet-IC	4.6V±2.5%, +Reset ODO	SOT-23-5	28y4	VD6	6a	Ssc
V46P	SS6680P-46CV	Vdet-IC	4.6V±2.5%, -Reset ODO	SOT-23-5	28y4	VD6	6a	Ssc
V47	XC9110C471MR	DC/DC-IC	PFM step-up, 100kHz, 4.7V±2.5%, 400mA, +CE	SOT-25	28sc	DC3	6g	Tor
V47A	ML6201P472M	LVR-IC	4.7V±2%, 250mA	SOT-23-5	28ym	VR1	6a	Mlc
V47C	SS6680C-47CV	Vdet-IC	4.7V±2.5%, +Reset PPO	SOT-23-5	28y4	VD7	6a	Ssc
V47N	SS6680N-47CV	Vdet-IC	4.7V±2.5%, +Reset ODO	SOT-23-5	28y4	VD6	6a	Ssc
V47P	SS6680P-47CV	Vdet-IC	4.7V±2.5%, -Reset ODO	SOT-23-5	28y4	VD6	6a	Ssc
V48	XC9110C481MR	DC/DC-IC	PFM step-up, 100kHz, 4.8V±2.5%, 400mA, +CE	SOT-25	28sc	DC3	6g	Tor
V48A	ML6201P482M	LVR-IC	4.8V±2%, 250mA	SOT-23-5	28ym	VR1	6a	Mlc
V48C	SS6680C-48CV	Vdet-IC	4.8V±2.5%, +Reset PPO	SOT-23-5	28y4	VD7	6a	Ssc
V48N	SS6680N-48CV	Vdet-IC	4.8V±2.5%, +Reset ODO	SOT-23-5	28y4	VD6	6a	Ssc
V48P	SS6680P-48CV	Vdet-IC	4.8V±2.5%, -Reset ODO	SOT-23-5	28y4	VD6	6a	Ssc
V49	XC9110C491MR	DC/DC-IC	PFM step-up, 100kHz, 4.9V±2.5%, 400mA, +CE	SOT-25	28sc	DC3	6g	Tor
V49A	ML6201P492M	LVR-IC	4.9V±2%, 250mA	SOT-23-5	28ym	VR1	6a	Mlc
V49C	SS6680C-49CV	Vdet-IC	4.9V±2.5%, +Reset PPO	SOT-23-5	28y4	VD7	6a	Ssc
V49N	SS6680N-49CV	Vdet-IC	4.9V±2.5%, +Reset ODO	SOT-23-5	28y4	VD6	6a	Ssc
V49P	SS6680P-49CV	Vdet-IC	4.9V±2.5%, -Reset ODO	SOT-23-5	28y4	VD6	6a	Ssc
V4A	XC6118N24AMR-G	Vdet-IC	2.4V±2%, ±Reset ODO, Sense, hysteresis 5%, Cd	SOT-25	28mg	VD14	6g	Tor
V4A	XC9227A40CM	DC/DC-IC	PWM-PWM/PFM st-dwn, 1.2MHz, 4.0V±1%, 600mA, +CE	SOT-25	28dc4	DC1	6g	Tor
V4A	XC9227B40CM	DC/DC-IC	PWM-PWM/PFM st-dwn, 1.2MHz, 4.0V±1%, 600mA, -CE	SOT-25	28dc4	DC1	6g	Tor
V4A	XC9227C40CM	DC/DC-IC	PWM-PWM/PFM st-dwn, 1.2MHz, 4.0V±1%, 600mA, +CE, PDR	SOT-25	28dc4	DC1	6g	Tor
V4A	XC9227D40CM	DC/DC-IC	PWM-PWM/PFM st-dwn, 1.2MHz, 4.0V±1%, 600mA, -CE, PDR	SOT-25	28dc4	DC1	6g	Tor
V4A	XC9227E40CM	DC/DC-IC	PWM-PWM/PFM st-dwn, 1.2MHz, 4.0V±1%, 900mA, +CE	SOT-25	28dc4	DC1	6g	Tor
V4A	XC9227F40CM	DC/DC-IC	PWM-PWM/PFM st-dwn, 1.2MHz, 4.0V±1%, 900mA, -CE	SOT-25	28dc4	DC1	6g	Tor
V4A	XC9227G40CM	DC/DC-IC	PWM-PWM/PFM st-dwn, 1.2MHz, 4.0V±1%, 900mA, +CE, PDR	SOT-25	28dc4	DC1	6g	Tor
V4A	XC9227H40CM	DC/DC-IC	PWM-PWM/PFM st-dwn, 1.2MHz, 4.0V±1%, 900mA, -CE, PDR	SOT-25	28dc4	DC1	6g	Tor
V4B	XC6118N24BMR-G	Vdet-IC	2.4V±2%, ±Reset ODO, Sense, hysteresis <1%, Cd	SOT-25	28mg	VD14	6g	Tor
V4C	XC6118N24CMR-G	Vdet-IC	2.4V±2%, ±Reset ODO, Sense, hysteresis 5%	SOT-25	28mf	VD11	6g	Tor
V4D	XC6118N24DMR-G	Vdet-IC	2.4V±2%, ±Reset ODO, Sense, hysteresis <1%	SOT-25	28mf	VD11	6g	Tor
V5	BD45272G	Vdet-IC	2.7V, -Reset ODO, 200ms	SSOP-5	28vdp	VD6	6c	Rhm
V5	MC74VHC1G04DF	CMOS-Logic	Inverter	SC-70-5	28LLog6	-	6b	Ons
V5	MC74VHC1G04DT	CMOS-Logic	Inverter	SOT-23-5	28LLog6	-	6b	Ons
V5	R112N151B	LVR-IC	LDO, LN, +CE, 1.5V±2%, 150mA	SOT-23-5	28vt	VR4	6g	Ric
V5	TC74A5-3.3VCT	Tdet-IC	Sensor (-40...+125±3°C), Vcc=3.3V, I2C-bus	SOT-23-5	28hd	-	6g	Mcc
V5-	RT9167-2HPB	LVR-IC	LDO, 2.85V±2%, 300mA, +CE	SOT-23-5	28vrx	VR7	6g	Rct
V50	XC9110C501MR	DC/DC-IC	PFM step-up, 100kHz, 5.0V±2.5%, 400mA, +CE	SOT-25	28sc	DC3	6g	Tor
V50A	ML6201P502M	LVR-IC	5.0V±2%, 250mA	SOT-23-5	28ym	VR1	6a	Mlc
V50C	SS6680C-50CV	Vdet-IC	5.0V±2.5%, +Reset PPO	SOT-23-5	28y4	VD7	6a	Ssc
V50N	SS6680N-50CV	Vdet-IC	5.0V±2.5%, +Reset ODO	SOT-23-5	28y4	VD6	6a	Ssc
V50P	SS6680P-50CV	Vdet-IC	5.0V±2.5%, -Reset ODO	SOT-23-5	28y4	VD6	6a	Ssc
V51	XC9110C511MR	DC/DC-IC	PFM step-up, 100kHz, 5.1V±2.5%, 400mA, +CE	SOT-25	28sc	DC3	6g	Tor
V51A	ML6201P512M	LVR-IC	5.1V±2%, 250mA	SOT-23-5	28ym	VR1	6a	Mlc
V51C	SS6680C-51CV	Vdet-IC	5.1V±2.5%, +Reset PPO	SOT-23-5	28y4	VD7	6a	Ssc
V51N	SS6680N-51CV	Vdet-IC	5.1V±2.5%, +Reset ODO	SOT-23-5	28y4	VD6	6a	Ssc
V51P	SS6680P-51CV	Vdet-IC	5.1V±2.5%, -Reset ODO	SOT-23-5	28y4	VD6	6a	Ssc
V52	XC9110C521MR	DC/DC-IC	PFM step-up, 100kHz, 5.2V±2.5%, 400mA, +CE	SOT-25	28sc	DC3	6g	Tor
V52A	ML6201P522M	LVR-IC	5.2V±2%, 250mA	SOT-23-5	28ym	VR1	6a	Mlc
V52C	SS6680C-52CV	Vdet-IC	5.2V±2.5%, +Reset PPO	SOT-23-5	28y4	VD7	6a	Ssc
V52N	SS6680N-52CV	Vdet-IC	5.2V±2.5%, +Reset ODO	SOT-23-5	28y4	VD6	6a	Ssc
V52P	SS6680P-52CV	Vdet-IC	5.2V±2.5%, -Reset ODO	SOT-23-5	28y4	VD6	6a	Ssc
V53	XC9110C531MR	DC/DC-IC	PFM step-up, 100kHz, 5.3V±2.5%, 400mA, +CE	SOT-25	28sc	DC3	6g	Tor
V53A	ML6201P532M	LVR-IC	5.3V±2%, 250mA	SOT-23-5	28ym	VR1	6a	Mlc
V53C	SS6680C-53CV	Vdet-IC	5.3V±2.5%, +Reset PPO	SOT-23-5	28y4	VD7	6a	Ssc
V53N	SS6680N-53CV	Vdet-IC	5.3V±2.5%, +Reset ODO	SOT-23-5	28y4	VD6	6a	Ssc
V53P	SS6680P-53CV	Vdet-IC	5.3V±2.5%, -Reset ODO	SOT-23-5	28y4	VD6	6a	Ssc
V54	XC9110C541MR	DC/DC-IC	PFM step-up, 100kHz, 5.4V±2.5%, 400mA, +CE	SOT-25	28sc	DC3	6g	Tor
V54A	ML6201P542M	LVR-IC	5.4V±2%, 250mA	SOT-23-5	28ym	VR1	6a	Mlc
V54C	SS6680C-54CV	Vdet-IC	5.4V±2.5%, +Reset PPO	SOT-23-5	28y4	VD7	6a	Ssc
V54N	SS6680N-54CV	Vdet-IC	5.4V±2.5%, +Reset ODO	SOT-23-5	28y4	VD6	6a	Ssc
V54P	SS6680P-54CV	Vdet-IC	5.4V±2.5%, -Reset ODO	SOT-23-5	28y4	VD6	6a	Ssc
V55	XC9110C551MR	DC/DC-IC	PFM step-up, 100kHz, 5.5V±2.5%, 400mA, +CE	SOT-25	28sc	DC3	6g	Tor
V55A	ML6201P552M	LVR-IC	5.5V±2%, 250mA	SOT-23-5	28ym	VR1	6a	Mlc
V55C	SS6680C-55CV	Vdet-IC	5.5V±2.5%, +Reset PPO	SOT-23-5	28y4	VD7	6a	Ssc



SMD code	Type	Function	Short description	Case	Pinout	Sch.	St.	Mnf.
V55N	SS6680N-55CV	Vdet-IC	5.5V±2.5%, +Reset ODO	SOT-23-5	28y4	VD6	6a	Ssc
V55P	SS6680P-55CV	Vdet-IC	5.5V±2.5%, -Reset ODO	SOT-23-5	28y4	VD6	6a	Ssc
V56	XC9110C561MR	DC/DC-IC	PFM step-up, 100kHz, 5.6V±2.5%, 400mA, +CE	SOT-25	28sc	DC3	6g	Tor
V56A	ML6201P562M	LVR-IC	5.6V±2%, 250mA	SOT-23-5	28ym	VR1	6a	Mlc
V56C	SS6680C-56CV	Vdet-IC	5.6V±2.5%, +Reset PPO	SOT-23-5	28y4	VD7	6a	Ssc
V56N	SS6680N-56CV	Vdet-IC	5.6V±2.5%, +Reset ODO	SOT-23-5	28y4	VD6	6a	Ssc
V56P	SS6680P-56CV	Vdet-IC	5.6V±2.5%, -Reset ODO	SOT-23-5	28y4	VD6	6a	Ssc
V57	XC9110C571MR	DC/DC-IC	PFM step-up, 100kHz, 5.7V±2.5%, 400mA, +CE	SOT-25	28sc	DC3	6g	Tor
V57A	ML6201P572M	LVR-IC	5.7V±2%, 250mA	SOT-23-5	28ym	VR1	6a	Mlc
V57C	SS6680C-57CV	Vdet-IC	5.7V±2.5%, +Reset PPO	SOT-23-5	28y4	VD7	6a	Ssc
V57N	SS6680N-57CV	Vdet-IC	5.7V±2.5%, +Reset ODO	SOT-23-5	28y4	VD6	6a	Ssc
V57P	SS6680P-57CV	Vdet-IC	5.7V±2.5%, -Reset ODO	SOT-23-5	28y4	VD6	6a	Ssc
V58	XC9110C581MR	DC/DC-IC	PFM step-up, 100kHz, 5.8V±2.5%, 400mA, +CE	SOT-25	28sc	DC3	6g	Tor
V58A	ML6201P582M	LVR-IC	5.8V±2%, 250mA	SOT-23-5	28ym	VR1	6a	Mlc
V58C	SS6680C-58CV	Vdet-IC	5.8V±2.5%, +Reset PPO	SOT-23-5	28y4	VD7	6a	Ssc
V58N	SS6680N-58CV	Vdet-IC	5.8V±2.5%, +Reset ODO	SOT-23-5	28y4	VD6	6a	Ssc
V58P	SS6680P-58CV	Vdet-IC	5.8V±2.5%, -Reset ODO	SOT-23-5	28y4	VD6	6a	Ssc
V59	XC9110C591MR	DC/DC-IC	PFM step-up, 100kHz, 5.9V±2.5%, 400mA, +CE	SOT-25	28sc	DC3	6g	Tor
V59A	ML6201P592M	LVR-IC	5.9V±2%, 250mA	SOT-23-5	28ym	VR1	6a	Mlc
V59C	SS6680C-59CV	Vdet-IC	5.9V±2.5%, +Reset PPO	SOT-23-5	28y4	VD7	6a	Ssc
V59N	SS6680N-59CV	Vdet-IC	5.9V±2.5%, +Reset ODO	SOT-23-5	28y4	VD6	6a	Ssc
V59P	SS6680P-59CV	Vdet-IC	5.9V±2.5%, -Reset ODO	SOT-23-5	28y4	VD6	6a	Ssc
V5A	XC6118N25AMR-G	Vdet-IC	2.5V±2%, ±Reset ODO, Sense, hysteresis 5%, Cd	SOT-25	28mg	VD14	6g	Tor
V5B	XC6118N25BMR-G	Vdet-IC	2.5V±2%, ±Reset ODO, Sense, hysteresis <1%, Cd	SOT-25	28mg	VD14	6g	Tor
V5C	XC6118N25CMR-G	Vdet-IC	2.5V±2%, ±Reset ODO, Sense, hysteresis 5%	SOT-25	28mf	VD11	6g	Tor
V5D	XC6118N25DMR-G	Vdet-IC	2.5V±2%, ±Reset ODO, Sense, hysteresis <1%	SOT-25	28mf	VD11	6g	Tor
V6	BD45262G	Vdet-IC	2.6V, -Reset ODO, 200ms	SSOP-5	28vdp	VD6	6c	Rhm
V6	R1121N161B	LVR-IC	LDO, LN, +CE, 1.6V±2%, 150mA	SOT-23-5	28vt	VR4	6g	Ric
V6	TC74A6-3.3VCT	Tdet-IC	Sensor (-40...+125±3°C), Vcc=3.3V, I2C-bus	SOT-23-5	28hd	-	6g	Mcc
V60	XC9110C601MR	DC/DC-IC	PFM step-up, 100kHz, 6.0V±2.5%, 400mA, +CE	SOT-25	28sc	DC3	6g	Tor
V60A	ML6201P602M	LVR-IC	6.0V±2%, 250mA	SOT-23-5	28ym	VR1	6a	Mlc
V60C	SS6680C-60CV	Vdet-IC	6.0V±2.5%, +Reset PPO	SOT-23-5	28y4	VD7	6a	Ssc
V60N	SS6680N-60CV	Vdet-IC	6.0V±2.5%, +Reset ODO	SOT-23-5	28y4	VD6	6a	Ssc
V60P	SS6680P-60CV	Vdet-IC	6.0V±2.5%, -Reset ODO	SOT-23-5	28y4	VD6	6a	Ssc
V61	XC9110C611MR	DC/DC-IC	PFM step-up, 100kHz, 6.1V±2.5%, 400mA, +CE	SOT-25	28sc	DC3	6g	Tor
V62	XC9110C621MR	DC/DC-IC	PFM step-up, 100kHz, 6.2V±2.5%, 400mA, +CE	SOT-25	28sc	DC3	6g	Tor
V63	XC9110C631MR	DC/DC-IC	PFM step-up, 100kHz, 6.3V±2.5%, 400mA, +CE	SOT-25	28sc	DC3	6g	Tor
V64	XC9110C641MR	DC/DC-IC	PFM step-up, 100kHz, 6.4V±2.5%, 400mA, +CE	SOT-25	28sc	DC3	6g	Tor
V65	XC9110C651MR	DC/DC-IC	PFM step-up, 100kHz, 6.5V±2.5%, 400mA, +CE	SOT-25	28sc	DC3	6g	Tor
V66	74LVC1G66GV	CMOS-Logic	Bilateral analogic switch	SOT753	28/Log16	-	6a	Phi
V66	XC9110C661MR	DC/DC-IC	PFM step-up, 100kHz, 6.6V±2.5%, 400mA, +CE	SOT-25	28sc	DC3	6g	Tor
V67	XC9110C671MR	DC/DC-IC	PFM step-up, 100kHz, 6.7V±2.5%, 400mA, +CE	SOT-25	28sc	DC3	6g	Tor
V68	XC9110C681MR	DC/DC-IC	PFM step-up, 100kHz, 6.8V±2.5%, 400mA, +CE	SOT-25	28sc	DC3	6g	Tor
V69	XC9110C691MR	DC/DC-IC	PFM step-up, 100kHz, 6.9V±2.5%, 400mA, +CE	SOT-25	28sc	DC3	6g	Tor
V6A	XC6118N26AMR-G	Vdet-IC	2.6V±2%, ±Reset ODO, Sense, hysteresis 5%, Cd	SOT-25	28mg	VD14	6g	Tor
V6B	XC6118N26BMR-G	Vdet-IC	2.6V±2%, ±Reset ODO, Sense, hysteresis <1%, Cd	SOT-25	28mg	VD14	6g	Tor
V6C	XC6118N26CMR-G	Vdet-IC	2.6V±2%, ±Reset ODO, Sense, hysteresis 5%	SOT-25	28mf	VD11	6g	Tor
V6D	XC6118N26DMR-G	Vdet-IC	2.6V±2%, ±Reset ODO, Sense, hysteresis <1%	SOT-25	28mf	VD11	6g	Tor
V7	BD45262G	Vdet-IC	2.5V, -Reset ODO, 200ms	SSOP-5	28vdp	VD6	6c	Rhm
V7	MC74VHC1G07DF	CMOS-Logic	Noninverting buffer/driver (ODO)	SC-70-5	28/Log8	-	6b	Ons
V7	MC74VHC1G07DT	CMOS-Logic	Noninverting buffer/driver (ODO)	SOT-23-5	28/Log8	-	6b	Ons
V7	R1121N171B	LVR-IC	LDO, LN, +CE, 1.7V±2%, 150mA	SOT-23-5	28vt	VR4	6g	Ric
V7	TC74A7-3.3VCT	Tdet-IC	Sensor (-40...+125±3°C), Vcc=3.3V, I2C-bus	SOT-23-5	28hd	-	6g	Mcc
V70	XC9110C701MR	DC/DC-IC	PFM step-up, 100kHz, 7.0V±2.5%, 400mA, +CE	SOT-25	28sc	DC3	6g	Tor
V79	74LVC1G79GV	CMOS-Logic	Positive edge-triggered D-type flip-flop	SOT753	28/Log20	-	6a	Phi
V7A	XC6118N27AMR-G	Vdet-IC	2.7V±2%, ±Reset ODO, Sense, hysteresis 5%, Cd	SOT-25	28mg	VD14	6g	Tor
V7B	XC6118N27BMR-G	Vdet-IC	2.7V±2%, ±Reset ODO, Sense, hysteresis <1%, Cd	SOT-25	28mg	VD14	6g	Tor
V7C	XC6118N27CMR-G	Vdet-IC	2.7V±2%, ±Reset ODO, Sense, hysteresis 5%	SOT-25	28mf	VD11	6g	Tor
V7D	XC6118N27DMR-G	Vdet-IC	2.7V±2%, ±Reset ODO, Sense, hysteresis <1%	SOT-25	28mf	VD11	6g	Tor
V8	BD45242G	Vdet-IC	2.4V, -Reset ODO, 200ms	SSOP-5	28vdp	VD6	6c	Rhm
V8	MC74VHC1G86DF	CMOS-Logic	2-input EXCLUSIVE-OR gate	SOT-353	28/Log5	-	6b	Ons
V8	MC74VHC1G86DT	CMOS-Logic	2-input EXCLUSIVE-OR gate	SOT-23-5	28/Log5	-	6b	Ons
V8	R1121N181B	LVR-IC	LDO, LN, +CE, 1.8V±2%, 150mA	SOT-23-5	28vt	VR4	6g	Ric
V80	74LVC1G80GV	CMOS-Logic	Positive edge-triggered D-type flip-flop	SOT753	28/Log21	-	6a	Phi
V86	74LVC1G86GV	CMOS-Logic	2-input EXCLUSIVE-OR gate	SOT753	28/Log5	-	6a	Phi
V8A	XC6118N28AMR-G	Vdet-IC	2.8V±2%, ±Reset ODO, Sense, hysteresis 5%, Cd	SOT-25	28mg	VD14	6g	Tor
V8B	XC6118N28BMR-G	Vdet-IC	2.8V±2%, ±Reset ODO, Sense, hysteresis <1%, Cd	SOT-25	28mg	VD14	6g	Tor
V8C	XC6118N28CMR-G	Vdet-IC	2.8V±2%, ±Reset ODO, Sense, hysteresis 5%	SOT-25	28mf	VD11	6g	Tor
V8D	XC6118N28DMR-G	Vdet-IC	2.8V±2%, ±Reset ODO, Sense, hysteresis <1%	SOT-25	28mf	VD11	6g	Tor
V9	BD45232G	Vdet-IC	2.3V, -Reset ODO, 200ms	SSOP-5	28vdp	VD6	6c	Rhm



SMD

SMD code	Type	Function	Short description	Case	Pinout	Sch.	St.	Mnf.
V9	MC74HVC1G66DF	CMOS-Logic	Bilateral analogic switch	SC-70-5	28/Log16	-	6b	Ons
V9	MC74HVC1G66DT	CMOS-Logic	Bilateral analogic switch	SOT-23-5	28/Log16	-	6b	Ons
V9	MC74HVC1G66DF	CMOS-Logic	Bilateral analogic switch	SOT-353	28/Log16	-	6b	Ons
V9	MC74HVC1G66DT	CMOS-Logic	Bilateral analogic switch	SOT-23-5	28/Log16	-	6b	Ons
V9	R1121N191B	LVR-IC	LDO, LN, +CE, 1.9V±2%, 150mA	SOT-23-5	28vt	VR4	6g	Ric
V9A	XC6118N29AMR-G	Vdet-IC	2.9V±2%, ±Reset ODO, Sense, hysteresis 5%, Cd	SOT-25	28mg	VD14	6g	Tor
V9B	XC6118N29BMR-G	Vdet-IC	2.9V±2%, ±Reset ODO, Sense, hysteresis <1%, Cd	SOT-25	28mg	VD14	6g	Tor
V9C	XC6118N29CMR-G	Vdet-IC	2.9V±2%, ±Reset ODO, Sense, hysteresis 5%	SOT-25	28mf	VD11	6g	Tor
V9D	XC6118N29DMR-G	Vdet-IC	2.9V±2%, ±Reset ODO, Sense, hysteresis <1%	SOT-25	28mf	VD11	6g	Tor
VA	74LVC1G00GW	CMOS-Logic	2-input NAND gate	SOT-353-1	28/Log1	-	6a	Phi
VA	BD46485G	Vdet-IC	4.8V, -Reset PPO, 500ms	SSOP-5	28vdp	VD7	6c	Rhm
VA	MC74VHC1G14DF	CMOS-Logic	Inverting Schmitt-trigger	SC-70-5	28/Log7	-	6b	Ons
VA	MC74VHC1G14DT	CMOS-Logic	Inverting Schmitt-trigger	SOT-23-5	28/Log7	-	6b	Ons
VA2	S-1135C34-M5T1S	LVR-IC	LDO, 3.4V±1.0%, 300mA, +CE, PDR	SOT-23-5	28cx	VR4	6g	Sii
VA3	S-1135C35-M5T1S	LVR-IC	LDO, 3.5V±1.0%, 300mA, +CE, PDR	SOT-23-5	28cx	VR4	6g	Sii
VAA9	XC9227A0M6M	DC/DC-IC	PWM-PWM/PFM st-dwn, 600kHz, 0.95V±1%, 600mA, +CE	SOT-25	28dc4	DC1	6g	Tor
VAA9	XC9227B0M6M	DC/DC-IC	PWM-PWM/PFM st-dwn, 600kHz, 0.95V±1%, 600mA, -CE	SOT-25	28dc4	DC1	6g	Tor
VAA9	XC9227C0M6M	DC/DC-IC	PWM-PWM/PFM st-dwn, 600kHz, 0.95V±1%, 600mA, +CE, PDR	SOT-25	28dc4	DC1	6g	Tor
VAA9	XC9227D0M6M	DC/DC-IC	PWM-PWM/PFM st-dwn, 600kHz, 0.95V±1%, 600mA, -CE, PDR	SOT-25	28dc4	DC1	6g	Tor
VAA	S-1135C10-M5T1S	LVR-IC	LDO, 1.0V±15mV, 300mA, +CE, PDR	SOT-23-5	28cx	VR4	6g	Sii
VAB	S-1135C11-M5T1S	LVR-IC	LDO, 1.1V±15mV, 300mA, +CE, PDR	SOT-23-5	28cx	VR4	6g	Sii
VAC	S-1135C12-M5T1S	LVR-IC	LDO, 1.2V±15mV, 300mA, +CE, PDR	SOT-23-5	28cx	VR4	6g	Sii
VAD	S-1135C13-M5T1S	LVR-IC	LDO, 1.3V±15mV, 300mA, +CE, PDR	SOT-23-5	28cx	VR4	6g	Sii
VAE	S-1135C14-M5T1S	LVR-IC	LDO, 1.4V±15mV, 300mA, +CE, PDR	SOT-23-5	28cx	VR4	6g	Sii
VAF	S-1135C15-M5T1S	LVR-IC	LDO, 1.5V±1.0%, 300mA, +CE, PDR	SOT-23-5	28cx	VR4	6g	Sii
VAG	S-1135C16-M5T1S	LVR-IC	LDO, 1.6V±1.0%, 300mA, +CE, PDR	SOT-23-5	28cx	VR4	6g	Sii
VAH	S-1135C17-M5T1S	LVR-IC	LDO, 1.7V±1.0%, 300mA, +CE, PDR	SOT-23-5	28cx	VR4	6g	Sii
VAI	S-1135C18-M5T1S	LVR-IC	LDO, 1.8V±1.0%, 300mA, +CE, PDR	SOT-23-5	28cx	VR4	6g	Sii
VAJ	S-1135C1J-M5T1S	LVR-IC	LDO, 1.85V±1.0%, 300mA, +CE, PDR	SOT-23-5	28cx	VR4	6g	Sii
VAK	S-1135C19-M5T1S	LVR-IC	LDO, 1.9V±1.0%, 300mA, +CE, PDR	SOT-23-5	28cx	VR4	6g	Sii
VAL	S-1135C20-M5T1S	LVR-IC	LDO, 2.0V±1.0%, 300mA, +CE, PDR	SOT-23-5	28cx	VR4	6g	Sii
VAM	S-1135C21-M5T1S	LVR-IC	LDO, 2.1V±1.0%, 300mA, +CE, PDR	SOT-23-5	28cx	VR4	6g	Sii
VAM	XC9227A0MCM	DC/DC-IC	PWM-PWM/PFM st-dwn, 1.2MHz, 0.95V±1%, 600mA, +CE	SOT-25	28dc4	DC1	6g	Tor
VAM	XC9227B0MCM	DC/DC-IC	PWM-PWM/PFM st-dwn, 1.2MHz, 0.95V±1%, 600mA, -CE	SOT-25	28dc4	DC1	6g	Tor
VAM	XC9227C0MCM	DC/DC-IC	PWM-PWM/PFM st-dwn, 1.2MHz, 0.95V±1%, 600mA, +CE, PDR	SOT-25	28dc4	DC1	6g	Tor
VAM	XC9227D0MCM	DC/DC-IC	PWM-PWM/PFM st-dwn, 1.2MHz, 0.95V±1%, 600mA, -CE, PDR	SOT-25	28dc4	DC1	6g	Tor
VAN	S-1135C22-M5T1S	LVR-IC	LDO, 2.2V±1.0%, 300mA, +CE, PDR	SOT-23-5	28cx	VR4	6g	Sii
VAO	S-1135C23-M5T1S	LVR-IC	LDO, 2.3V±1.0%, 300mA, +CE, PDR	SOT-23-5	28cx	VR4	6g	Sii
VAP	S-1135C24-M5T1S	LVR-IC	LDO, 2.4V±1.0%, 300mA, +CE, PDR	SOT-23-5	28cx	VR4	6g	Sii
VAQ	S-1135C25-M5T1S	LVR-IC	LDO, 2.5V±1.0%, 300mA, +CE, PDR	SOT-23-5	28cx	VR4	6g	Sii
VAR	S-1135C26-M5T1S	LVR-IC	LDO, 2.6V±1.0%, 300mA, +CE, PDR	SOT-23-5	28cx	VR4	6g	Sii
VAS	S-1135C27-M5T1S	LVR-IC	LDO, 2.7V±1.0%, 300mA, +CE, PDR	SOT-23-5	28cx	VR4	6g	Sii
VAT	S-1135C28-M5T1S	LVR-IC	LDO, 2.8V±1.0%, 300mA, +CE, PDR	SOT-23-5	28cx	VR4	6g	Sii
VAU	S-1135C2J-M5T1S	LVR-IC	LDO, 2.85V±1.0%, 300mA, +CE, PDR	SOT-23-5	28cx	VR4	6g	Sii
VAV	S-1135C29-M5T1S	LVR-IC	LDO, 2.9V±1.0%, 300mA, +CE, PDR	SOT-23-5	28cx	VR4	6g	Sii
VAW	S-1135C30-M5T1S	LVR-IC	LDO, 3.0V±1.0%, 300mA, +CE, PDR	SOT-23-5	28cx	VR4	6g	Sii
VAX	S-1135C31-M5T1S	LVR-IC	LDO, 3.1V±1.0%, 300mA, +CE, PDR	SOT-23-5	28cx	VR4	6g	Sii
VAY	S-1135C32-M5T1S	LVR-IC	LDO, 3.2V±1.0%, 300mA, +CE, PDR	SOT-23-5	28cx	VR4	6g	Sii
VAZ	S-1135C33-M5T1S	LVR-IC	LDO, 3.3V±1.0%, 300mA, +CE, PDR	SOT-23-5	28cx	VR4	6g	Sii
VB	74LVC1G02GW	CMOS-Logic	2-input NOR gate	SOT-353-1	28/Log2	-	6a	Phi
VB	BD46475G	Vdet-IC	4.7V, -Reset PPO, 500ms	SSOP-5	28vdp	VD7	6c	Rhm
VB0	XC9227A1A6M	DC/DC-IC	PWM-PWM/PFM st-dwn, 600kHz, 1.05V±1%, 600mA, +CE	SOT-25	28dc4	DC1	6g	Tor
VB0	XC9227B1A6M	DC/DC-IC	PWM-PWM/PFM st-dwn, 600kHz, 1.05V±1%, 600mA, -CE	SOT-25	28dc4	DC1	6g	Tor
VB0	XC9227C1A6M	DC/DC-IC	PWM-PWM/PFM st-dwn, 600kHz, 1.05V±1%, 600mA, +CE, PDR	SOT-25	28dc4	DC1	6g	Tor
VB0	XC9227D1A6M	DC/DC-IC	PWM-PWM/PFM st-dwn, 600kHz, 1.05V±1%, 600mA, -CE, PDR	SOT-25	28dc4	DC1	6g	Tor
VB1	XC9227A1B6M	DC/DC-IC	PWM-PWM/PFM st-dwn, 600kHz, 1.15V±1%, 600mA, +CE	SOT-25	28dc4	DC1	6g	Tor
VB1	XC9227B1B6M	DC/DC-IC	PWM-PWM/PFM st-dwn, 600kHz, 1.15V±1%, 600mA, -CE	SOT-25	28dc4	DC1	6g	Tor
VB1	XC9227C1B6M	DC/DC-IC	PWM-PWM/PFM st-dwn, 600kHz, 1.15V±1%, 600mA, +CE, PDR	SOT-25	28dc4	DC1	6g	Tor
VB1	XC9227D1B6M	DC/DC-IC	PWM-PWM/PFM st-dwn, 600kHz, 1.15V±1%, 600mA, -CE, PDR	SOT-25	28dc4	DC1	6g	Tor
VB2	S-1135D34-M5T1S	LVR-IC	LDO, 3.4V±1.0%, 300mA, +CE	SOT-23-5	28cx	VR4	6g	Sii
VB2	XC9227A1C6M	DC/DC-IC	PWM-PWM/PFM st-dwn, 600kHz, 1.25V±1%, 600mA, +CE	SOT-25	28dc4	DC1	6g	Tor
VB2	XC9227B1C6M	DC/DC-IC	PWM-PWM/PFM st-dwn, 600kHz, 1.25V±1%, 600mA, -CE	SOT-25	28dc4	DC1	6g	Tor
VB2	XC9227C1C6M	DC/DC-IC	PWM-PWM/PFM st-dwn, 600kHz, 1.25V±1%, 600mA, +CE, PDR	SOT-25	28dc4	DC1	6g	Tor
VB2	XC9227D1C6M	DC/DC-IC	PWM-PWM/PFM st-dwn, 600kHz, 1.25V±1%, 600mA, -CE, PDR	SOT-25	28dc4	DC1	6g	Tor
VB3	S-1135D35-M5T1S	LVR-IC	LDO, 3.5V±1.0%, 300mA, +CE	SOT-23-5	28cx	VR4	6g	Sii
VB3	XC9227A1D6M	DC/DC-IC	PWM-PWM/PFM st-dwn, 600kHz, 1.35V±1%, 600mA, +CE	SOT-25	28dc4	DC1	6g	Tor
VB3	XC9227B1D6M	DC/DC-IC	PWM-PWM/PFM st-dwn, 600kHz, 1.35V±1%, 600mA, -CE	SOT-25	28dc4	DC1	6g	Tor
VB3	XC9227C1D6M	DC/DC-IC	PWM-PWM/PFM st-dwn, 600kHz, 1.35V±1%, 600mA, +CE, PDR	SOT-25	28dc4	DC1	6g	Tor
VB3	XC9227D1D6M	DC/DC-IC	PWM-PWM/PFM st-dwn, 600kHz, 1.35V±1%, 600mA, -CE, PDR	SOT-25	28dc4	DC1	6g	Tor
VB4	XC9227A1E6M	DC/DC-IC	PWM-PWM/PFM st-dwn, 600kHz, 1.45V±1%, 600mA, +CE	SOT-25	28dc4	DC1	6g	Tor



SMD code	Type	Function	Short description	Case	Pinout	Sch.	St.	Mnf.
VBL	XC9227D1LCM	DC/DC-IC	PWM-PWM/PFM st-dwn, 1.2MHz, 1.85V±1%, 600mA, -CE, PDR	SOT-25	28dc4	DC1	6g	Tor
VBM	S-1135D21-M5T1S	LVR-IC	LDO, 2.1V±1.0%, 300mA, +CE	SOT-23-5	28cx	VR4	6g	Sii
VBM	XC9227A1MCM	DC/DC-IC	PWM-PWM/PFM st-dwn, 1.2MHz, 1.95V±1%, 600mA, +CE	SOT-25	28dc4	DC1	6g	Tor
VBM	XC9227B1MCM	DC/DC-IC	PWM-PWM/PFM st-dwn, 1.2MHz, 1.95V±1%, 600mA, -CE	SOT-25	28dc4	DC1	6g	Tor
VBM	XC9227C1MCM	DC/DC-IC	PWM-PWM/PFM st-dwn, 1.2MHz, 1.95V±1%, 600mA, +CE, PDR	SOT-25	28dc4	DC1	6g	Tor
VBM	XC9227D1MCM	DC/DC-IC	PWM-PWM/PFM st-dwn, 1.2MHz, 1.95V±1%, 600mA, -CE, PDR	SOT-25	28dc4	DC1	6g	Tor
VBN	S-1135D22-M5T1S	LVR-IC	LDO, 2.2V±1.0%, 300mA, +CE	SOT-23-5	28cx	VR4	6g	Sii
VBO	S-1135D23-M5T1S	LVR-IC	LDO, 2.3V±1.0%, 300mA, +CE	SOT-23-5	28cx	VR4	6g	Sii
VBP	S-1135D24-M5T1S	LVR-IC	LDO, 2.4V±1.0%, 300mA, +CE	SOT-23-5	28cx	VR4	6g	Sii
VBQ	S-1135D25-M5T1S	LVR-IC	LDO, 2.5V±1.0%, 300mA, +CE	SOT-23-5	28cx	VR4	6g	Sii
VBR	S-1135D26-M5T1S	LVR-IC	LDO, 2.6V±1.0%, 300mA, +CE	SOT-23-5	28cx	VR4	6g	Sii
VBS	S-1135D27-M5T1S	LVR-IC	LDO, 2.7V±1.0%, 300mA, +CE	SOT-23-5	28cx	VR4	6g	Sii
VBT	S-1135D28-M5T1S	LVR-IC	LDO, 2.8V±1.0%, 300mA, +CE	SOT-23-5	28cx	VR4	6g	Sii
VBU	S-1135D2J-M5T1S	LVR-IC	LDO, 2.85V±1.0%, 300mA, +CE	SOT-23-5	28cx	VR4	6g	Sii
VBV	S-1135D29-M5T1S	LVR-IC	LDO, 2.9V±1.0%, 300mA, +CE	SOT-23-5	28cx	VR4	6g	Sii
VBW	S-1135D30-M5T1S	LVR-IC	LDO, 3.0V±1.0%, 300mA, +CE	SOT-23-5	28cx	VR4	6g	Sii
VBX	S-1135D31-M5T1S	LVR-IC	LDO, 3.1V±1.0%, 300mA, +CE	SOT-23-5	28cx	VR4	6g	Sii
VBY	S-1135D32-M5T1S	LVR-IC	LDO, 3.2V±1.0%, 300mA, +CE	SOT-23-5	28cx	VR4	6g	Sii
VBZ	S-1135D33-M5T1S	LVR-IC	LDO, 3.3V±1.0%, 300mA, +CE	SOT-23-5	28cx	VR4	6g	Sii
VC	74LVC1G04GW	CMOS-Logic	Inverter	SOT-353-1	28/Log6	-	6a	Phi
VC	BD46465G	Vdet-IC	4.6V, -Reset PPO, 500ms	SSOP-5	28vdp	VD7	6c	Rhm
VC	MC74VHC1GT14DF	CMOS-Logic	Inverting Schmitt-trigger	SC-70-5	28/Log7	-	6b	Ons
VC	MC74VHC1GT14DT	CMOS-Logic	Inverting Schmitt-trigger	SOT-23-5	28/Log7	-	6b	Ons
VC-	RT9193-1HPB	LVR-IC	LDO, 1.85V±1%, 300mA, +CE	SOT-23-5	28vrx	VR7	6g	Rct
Vc0	XC9227A2A6M	DC/DC-IC	PWM-PWM/PFM st-dwn, 600kHz, 2.05V±1%, 600mA, +CE	SOT-25	28dc4	DC1	6g	Tor
Vc0	XC9227B2A6M	DC/DC-IC	PWM-PWM/PFM st-dwn, 600kHz, 2.05V±1%, 600mA, -CE	SOT-25	28dc4	DC1	6g	Tor
Vc0	XC9227C2A6M	DC/DC-IC	PWM-PWM/PFM st-dwn, 600kHz, 2.05V±1%, 600mA, +CE, PDR	SOT-25	28dc4	DC1	6g	Tor
Vc0	XC9227D2A6M	DC/DC-IC	PWM-PWM/PFM st-dwn, 600kHz, 2.05V±1%, 600mA, -CE, PDR	SOT-25	28dc4	DC1	6g	Tor
Vc1	XC9227A2B6M	DC/DC-IC	PWM-PWM/PFM st-dwn, 600kHz, 2.15V±1%, 600mA, +CE	SOT-25	28dc4	DC1	6g	Tor
Vc1	XC9227B2B6M	DC/DC-IC	PWM-PWM/PFM st-dwn, 600kHz, 2.15V±1%, 600mA, -CE	SOT-25	28dc4	DC1	6g	Tor
Vc1	XC9227C2B6M	DC/DC-IC	PWM-PWM/PFM st-dwn, 600kHz, 2.15V±1%, 600mA, +CE, PDR	SOT-25	28dc4	DC1	6g	Tor
Vc1	XC9227D2B6M	DC/DC-IC	PWM-PWM/PFM st-dwn, 600kHz, 2.15V±1%, 600mA, -CE, PDR	SOT-25	28dc4	DC1	6g	Tor
Vc2	XC9227A2C6M	DC/DC-IC	PWM-PWM/PFM st-dwn, 600kHz, 2.25V±1%, 600mA, +CE	SOT-25	28dc4	DC1	6g	Tor
Vc2	XC9227B2C6M	DC/DC-IC	PWM-PWM/PFM st-dwn, 600kHz, 2.25V±1%, 600mA, -CE	SOT-25	28dc4	DC1	6g	Tor
Vc2	XC9227C2C6M	DC/DC-IC	PWM-PWM/PFM st-dwn, 600kHz, 2.25V±1%, 600mA, +CE, PDR	SOT-25	28dc4	DC1	6g	Tor
Vc2	XC9227D2C6M	DC/DC-IC	PWM-PWM/PFM st-dwn, 600kHz, 2.25V±1%, 600mA, -CE, PDR	SOT-25	28dc4	DC1	6g	Tor
Vc3	XC9227A2D6M	DC/DC-IC	PWM-PWM/PFM st-dwn, 600kHz, 2.35V±1%, 600mA, +CE	SOT-25	28dc4	DC1	6g	Tor
Vc3	XC9227B2D6M	DC/DC-IC	PWM-PWM/PFM st-dwn, 600kHz, 2.35V±1%, 600mA, -CE	SOT-25	28dc4	DC1	6g	Tor
Vc3	XC9227C2D6M	DC/DC-IC	PWM-PWM/PFM st-dwn, 600kHz, 2.35V±1%, 600mA, +CE, PDR	SOT-25	28dc4	DC1	6g	Tor
Vc3	XC9227D2D6M	DC/DC-IC	PWM-PWM/PFM st-dwn, 600kHz, 2.35V±1%, 600mA, -CE, PDR	SOT-25	28dc4	DC1	6g	Tor
Vc4	XC9227A2E6M	DC/DC-IC	PWM-PWM/PFM st-dwn, 600kHz, 2.45V±1%, 600mA, +CE	SOT-25	28dc4	DC1	6g	Tor
Vc4	XC9227B2E6M	DC/DC-IC	PWM-PWM/PFM st-dwn, 600kHz, 2.45V±1%, 600mA, -CE	SOT-25	28dc4	DC1	6g	Tor
Vc4	XC9227C2E6M	DC/DC-IC	PWM-PWM/PFM st-dwn, 600kHz, 2.45V±1%, 600mA, +CE, PDR	SOT-25	28dc4	DC1	6g	Tor
Vc4	XC9227D2E6M	DC/DC-IC	PWM-PWM/PFM st-dwn, 600kHz, 2.45V±1%, 600mA, -CE, PDR	SOT-25	28dc4	DC1	6g	Tor
Vc5	XC9227A2F6M	DC/DC-IC	PWM-PWM/PFM st-dwn, 600kHz, 2.55V±1%, 600mA, +CE	SOT-25	28dc4	DC1	6g	Tor
Vc5	XC9227B2F6M	DC/DC-IC	PWM-PWM/PFM st-dwn, 600kHz, 2.55V±1%, 600mA, -CE	SOT-25	28dc4	DC1	6g	Tor
Vc5	XC9227C2F6M	DC/DC-IC	PWM-PWM/PFM st-dwn, 600kHz, 2.55V±1%, 600mA, +CE, PDR	SOT-25	28dc4	DC1	6g	Tor
Vc5	XC9227D2F6M	DC/DC-IC	PWM-PWM/PFM st-dwn, 600kHz, 2.55V±1%, 600mA, -CE, PDR	SOT-25	28dc4	DC1	6g	Tor
Vc6	XC9227A2H6M	DC/DC-IC	PWM-PWM/PFM st-dwn, 600kHz, 2.65V±1%, 600mA, +CE	SOT-25	28dc4	DC1	6g	Tor
Vc6	XC9227B2H6M	DC/DC-IC	PWM-PWM/PFM st-dwn, 600kHz, 2.65V±1%, 600mA, -CE	SOT-25	28dc4	DC1	6g	Tor
Vc6	XC9227C2H6M	DC/DC-IC	PWM-PWM/PFM st-dwn, 600kHz, 2.65V±1%, 600mA, +CE, PDR	SOT-25	28dc4	DC1	6g	Tor
Vc6	XC9227D2H6M	DC/DC-IC	PWM-PWM/PFM st-dwn, 600kHz, 2.65V±1%, 600mA, -CE, PDR	SOT-25	28dc4	DC1	6g	Tor
Vc7	XC9227A2J6M	DC/DC-IC	PWM-PWM/PFM st-dwn, 600kHz, 2.75V±1%, 600mA, +CE	SOT-25	28dc4	DC1	6g	Tor
Vc7	XC9227B2J6M	DC/DC-IC	PWM-PWM/PFM st-dwn, 600kHz, 2.75V±1%, 600mA, -CE	SOT-25	28dc4	DC1	6g	Tor
Vc7	XC9227C2J6M	DC/DC-IC	PWM-PWM/PFM st-dwn, 600kHz, 2.75V±1%, 600mA, +CE, PDR	SOT-25	28dc4	DC1	6g	Tor
Vc7	XC9227D2J6M	DC/DC-IC	PWM-PWM/PFM st-dwn, 600kHz, 2.75V±1%, 600mA, -CE, PDR	SOT-25	28dc4	DC1	6g	Tor
Vc8	XC9227A2L6M	DC/DC-IC	PWM-PWM/PFM st-dwn, 600kHz, 2.85V±1%, 600mA, +CE	SOT-25	28dc4	DC1	6g	Tor
Vc8	XC9227B2L6M	DC/DC-IC	PWM-PWM/PFM st-dwn, 600kHz, 2.85V±1%, 600mA, -CE	SOT-25	28dc4	DC1	6g	Tor
Vc8	XC9227C2L6M	DC/DC-IC	PWM-PWM/PFM st-dwn, 600kHz, 2.85V±1%, 600mA, +CE, PDR	SOT-25	28dc4	DC1	6g	Tor
Vc8	XC9227D2L6M	DC/DC-IC	PWM-PWM/PFM st-dwn, 600kHz, 2.85V±1%, 600mA, -CE, PDR	SOT-25	28dc4	DC1	6g	Tor
Vc9	XC9227A2M6M	DC/DC-IC	PWM-PWM/PFM st-dwn, 600kHz, 2.95V±1%, 600mA, +CE	SOT-25	28dc4	DC1	6g	Tor
Vc9	XC9227B2M6M	DC/DC-IC	PWM-PWM/PFM st-dwn, 600kHz, 2.95V±1%, 600mA, -CE	SOT-25	28dc4	DC1	6g	Tor
Vc9	XC9227C2M6M	DC/DC-IC	PWM-PWM/PFM st-dwn, 600kHz, 2.95V±1%, 600mA, +CE, PDR	SOT-25	28dc4	DC1	6g	Tor
Vc9	XC9227D2M6M	DC/DC-IC	PWM-PWM/PFM st-dwn, 600kHz, 2.95V±1%, 600mA, -CE, PDR	SOT-25	28dc4	DC1	6g	Tor
VcA	XC9227A2ACM	DC/DC-IC	PWM-PWM/PFM st-dwn, 1.2MHz, 2.05V±1%, 600mA, +CE	SOT-25	28dc4	DC1	6g	Tor
VcA	XC9227B2ACM	DC/DC-IC	PWM-PWM/PFM st-dwn, 1.2MHz, 2.05V±1%, 600mA, -CE	SOT-25	28dc4	DC1	6g	Tor
VcA	XC9227C2ACM	DC/DC-IC	PWM-PWM/PFM st-dwn, 1.2MHz, 2.05V±1%, 600mA, +CE, PDR	SOT-25	28dc4	DC1	6g	Tor
VcA	XC9227D2ACM	DC/DC-IC	PWM-PWM/PFM st-dwn, 1.2MHz, 2.05V±1%, 600mA, -CE, PDR	SOT-25	28dc4	DC1	6g	Tor
VcB	XC9227A2BCM	DC/DC-IC	PWM-PWM/PFM st-dwn, 1.2MHz, 2.15V±1%, 600mA, +CE	SOT-25	28dc4	DC1	6g	Tor
VcB	XC9227B2BCM	DC/DC-IC	PWM-PWM/PFM st-dwn, 1.2MHz, 2.15V±1%, 600mA, -CE	SOT-25	28dc4	DC1	6g	Tor



SMD code	Type	Function	Short description	Case	Pinout	Sch.	St.	Mnf.
VCB	XC9227C2BCM	DC/DC-IC	PWM-PWM/PFM st-dwn, 1.2MHz, 2.15V±1%, 600mA, +CE, PDR	SOT-25	28dc4	DC1	6g	Tor
VCB	XC9227D2BCM	DC/DC-IC	PWM-PWM/PFM st-dwn, 1.2MHz, 2.15V±1%, 600mA, -CE, PDR	SOT-25	28dc4	DC1	6g	Tor
VCC	XC9227A2CCM	DC/DC-IC	PWM-PWM/PFM st-dwn, 1.2MHz, 2.25V±1%, 600mA, +CE	SOT-25	28dc4	DC1	6g	Tor
VCC	XC9227B2CCM	DC/DC-IC	PWM-PWM/PFM st-dwn, 1.2MHz, 2.25V±1%, 600mA, -CE	SOT-25	28dc4	DC1	6g	Tor
VCC	XC9227C2CCM	DC/DC-IC	PWM-PWM/PFM st-dwn, 1.2MHz, 2.25V±1%, 600mA, +CE, PDR	SOT-25	28dc4	DC1	6g	Tor
VCC	XC9227D2CCM	DC/DC-IC	PWM-PWM/PFM st-dwn, 1.2MHz, 2.25V±1%, 600mA, -CE, PDR	SOT-25	28dc4	DC1	6g	Tor
VCD	XC9227A2DCM	DC/DC-IC	PWM-PWM/PFM st-dwn, 1.2MHz, 2.35V±1%, 600mA, +CE	SOT-25	28dc4	DC1	6g	Tor
VCD	XC9227B2DCM	DC/DC-IC	PWM-PWM/PFM st-dwn, 1.2MHz, 2.35V±1%, 600mA, -CE	SOT-25	28dc4	DC1	6g	Tor
VCD	XC9227C2DCM	DC/DC-IC	PWM-PWM/PFM st-dwn, 1.2MHz, 2.35V±1%, 600mA, +CE, PDR	SOT-25	28dc4	DC1	6g	Tor
VCD	XC9227D2DCM	DC/DC-IC	PWM-PWM/PFM st-dwn, 1.2MHz, 2.35V±1%, 600mA, -CE, PDR	SOT-25	28dc4	DC1	6g	Tor
VCE	XC9227A2ECM	DC/DC-IC	PWM-PWM/PFM st-dwn, 1.2MHz, 2.45V±1%, 600mA, +CE	SOT-25	28dc4	DC1	6g	Tor
VCE	XC9227B2ECM	DC/DC-IC	PWM-PWM/PFM st-dwn, 1.2MHz, 2.45V±1%, 600mA, -CE	SOT-25	28dc4	DC1	6g	Tor
VCE	XC9227C2ECM	DC/DC-IC	PWM-PWM/PFM st-dwn, 1.2MHz, 2.45V±1%, 600mA, +CE, PDR	SOT-25	28dc4	DC1	6g	Tor
VCE	XC9227D2ECM	DC/DC-IC	PWM-PWM/PFM st-dwn, 1.2MHz, 2.45V±1%, 600mA, -CE, PDR	SOT-25	28dc4	DC1	6g	Tor
VCF	XC9227A2FCM	DC/DC-IC	PWM-PWM/PFM st-dwn, 1.2MHz, 2.55V±1%, 600mA, +CE	SOT-25	28dc4	DC1	6g	Tor
VCF	XC9227B2FCM	DC/DC-IC	PWM-PWM/PFM st-dwn, 1.2MHz, 2.55V±1%, 600mA, -CE	SOT-25	28dc4	DC1	6g	Tor
VCF	XC9227C2FCM	DC/DC-IC	PWM-PWM/PFM st-dwn, 1.2MHz, 2.55V±1%, 600mA, +CE, PDR	SOT-25	28dc4	DC1	6g	Tor
VCF	XC9227D2FCM	DC/DC-IC	PWM-PWM/PFM st-dwn, 1.2MHz, 2.55V±1%, 600mA, -CE, PDR	SOT-25	28dc4	DC1	6g	Tor
VCH	XC9227A2HCM	DC/DC-IC	PWM-PWM/PFM st-dwn, 1.2MHz, 2.65V±1%, 600mA, +CE	SOT-25	28dc4	DC1	6g	Tor
VCH	XC9227B2HCM	DC/DC-IC	PWM-PWM/PFM st-dwn, 1.2MHz, 2.65V±1%, 600mA, -CE	SOT-25	28dc4	DC1	6g	Tor
VCH	XC9227C2HCM	DC/DC-IC	PWM-PWM/PFM st-dwn, 1.2MHz, 2.65V±1%, 600mA, +CE, PDR	SOT-25	28dc4	DC1	6g	Tor
VCH	XC9227D2HCM	DC/DC-IC	PWM-PWM/PFM st-dwn, 1.2MHz, 2.65V±1%, 600mA, -CE, PDR	SOT-25	28dc4	DC1	6g	Tor
VCK	XC9227A2KCM	DC/DC-IC	PWM-PWM/PFM st-dwn, 1.2MHz, 2.75V±1%, 600mA, +CE	SOT-25	28dc4	DC1	6g	Tor
VCK	XC9227B2KCM	DC/DC-IC	PWM-PWM/PFM st-dwn, 1.2MHz, 2.75V±1%, 600mA, -CE	SOT-25	28dc4	DC1	6g	Tor
VCK	XC9227C2KCM	DC/DC-IC	PWM-PWM/PFM st-dwn, 1.2MHz, 2.75V±1%, 600mA, +CE, PDR	SOT-25	28dc4	DC1	6g	Tor
VCK	XC9227D2KCM	DC/DC-IC	PWM-PWM/PFM st-dwn, 1.2MHz, 2.75V±1%, 600mA, -CE, PDR	SOT-25	28dc4	DC1	6g	Tor
VCL	XC9227A2LCM	DC/DC-IC	PWM-PWM/PFM st-dwn, 1.2MHz, 2.85V±1%, 600mA, +CE	SOT-25	28dc4	DC1	6g	Tor
VCL	XC9227B2LCM	DC/DC-IC	PWM-PWM/PFM st-dwn, 1.2MHz, 2.85V±1%, 600mA, -CE	SOT-25	28dc4	DC1	6g	Tor
VCL	XC9227C2LCM	DC/DC-IC	PWM-PWM/PFM st-dwn, 1.2MHz, 2.85V±1%, 600mA, +CE, PDR	SOT-25	28dc4	DC1	6g	Tor
VCL	XC9227D2LCM	DC/DC-IC	PWM-PWM/PFM st-dwn, 1.2MHz, 2.85V±1%, 600mA, -CE, PDR	SOT-25	28dc4	DC1	6g	Tor
VCM	XC9227A2MCM	DC/DC-IC	PWM-PWM/PFM st-dwn, 1.2MHz, 2.95V±1%, 600mA, +CE	SOT-25	28dc4	DC1	6g	Tor
VCM	XC9227B2MCM	DC/DC-IC	PWM-PWM/PFM st-dwn, 1.2MHz, 2.95V±1%, 600mA, -CE	SOT-25	28dc4	DC1	6g	Tor
VCM	XC9227C2MCM	DC/DC-IC	PWM-PWM/PFM st-dwn, 1.2MHz, 2.95V±1%, 600mA, +CE, PDR	SOT-25	28dc4	DC1	6g	Tor
VCM	XC9227D2MCM	DC/DC-IC	PWM-PWM/PFM st-dwn, 1.2MHz, 2.95V±1%, 600mA, -CE, PDR	SOT-25	28dc4	DC1	6g	Tor
VD	74LVC1GU04GW	CMOS-Logic	Inverter	SOT-353-1	28/Log6	-	6a	Phi
VD	BD4645G	Vdet-IC	4.5V, -Reset PPO, 500ms	SSOP-5	28vdg	VD7	6c	Rhm
VD	MC74VHC1G132DF	CMOS-Logic	2-input NAND Schmitt-trigger	SOT-353	28/Log12	-	6b	Onts
VD-	RT9193-35PB	LVR-IC	LDO, 3.5V±1%, 300mA, +CE	SOT-23-5	28vrx	VR7	6g	Rct
VD0	XC9227A3A6M	DC/DC-IC	PWM-PWM/PFM st-dwn, 600kHz, 3.05V±1%, 600mA, +CE	SOT-25	28dc4	DC1	6g	Tor
VD0	XC9227B3A6M	DC/DC-IC	PWM-PWM/PFM st-dwn, 600kHz, 3.05V±1%, 600mA, -CE	SOT-25	28dc4	DC1	6g	Tor
VD0	XC9227C3A6M	DC/DC-IC	PWM-PWM/PFM st-dwn, 600kHz, 3.05V±1%, 600mA, +CE, PDR	SOT-25	28dc4	DC1	6g	Tor
VD0	XC9227D3A6M	DC/DC-IC	PWM-PWM/PFM st-dwn, 600kHz, 3.05V±1%, 600mA, -CE, PDR	SOT-25	28dc4	DC1	6g	Tor
VD0	XC9227E3A6M	DC/DC-IC	PWM-PWM/PFM st-dwn, 600kHz, 3.05V±1%, 900mA, +CE	SOT-25	28dc4	DC1	6g	Tor
VD0	XC9227F3A6M	DC/DC-IC	PWM-PWM/PFM st-dwn, 600kHz, 3.05V±1%, 900mA, -CE	SOT-25	28dc4	DC1	6g	Tor
VD0	XC9227G3A6M	DC/DC-IC	PWM-PWM/PFM st-dwn, 600kHz, 3.05V±1%, 900mA, +CE, PDR	SOT-25	28dc4	DC1	6g	Tor
VD0	XC9227H3A6M	DC/DC-IC	PWM-PWM/PFM st-dwn, 600kHz, 3.05V±1%, 900mA, -CE, PDR	SOT-25	28dc4	DC1	6g	Tor
VD1	XC9227A3B6M	DC/DC-IC	PWM-PWM/PFM st-dwn, 600kHz, 3.15V±1%, 600mA, +CE	SOT-25	28dc4	DC1	6g	Tor
VD1	XC9227B3B6M	DC/DC-IC	PWM-PWM/PFM st-dwn, 600kHz, 3.15V±1%, 600mA, -CE	SOT-25	28dc4	DC1	6g	Tor
VD1	XC9227C3B6M	DC/DC-IC	PWM-PWM/PFM st-dwn, 600kHz, 3.15V±1%, 600mA, +CE, PDR	SOT-25	28dc4	DC1	6g	Tor
VD1	XC9227D3B6M	DC/DC-IC	PWM-PWM/PFM st-dwn, 600kHz, 3.15V±1%, 600mA, -CE, PDR	SOT-25	28dc4	DC1	6g	Tor
VD1	XC9227E3B6M	DC/DC-IC	PWM-PWM/PFM st-dwn, 600kHz, 3.15V±1%, 900mA, +CE	SOT-25	28dc4	DC1	6g	Tor
VD1	XC9227F3B6M	DC/DC-IC	PWM-PWM/PFM st-dwn, 600kHz, 3.15V±1%, 900mA, -CE	SOT-25	28dc4	DC1	6g	Tor
VD1	XC9227G3B6M	DC/DC-IC	PWM-PWM/PFM st-dwn, 600kHz, 3.15V±1%, 900mA, +CE, PDR	SOT-25	28dc4	DC1	6g	Tor
VD1	XC9227H3B6M	DC/DC-IC	PWM-PWM/PFM st-dwn, 600kHz, 3.15V±1%, 900mA, -CE, PDR	SOT-25	28dc4	DC1	6g	Tor
VD2	XC9227A3C6M	DC/DC-IC	PWM-PWM/PFM st-dwn, 600kHz, 3.25V±1%, 600mA, +CE	SOT-25	28dc4	DC1	6g	Tor
VD2	XC9227B3C6M	DC/DC-IC	PWM-PWM/PFM st-dwn, 600kHz, 3.25V±1%, 600mA, -CE	SOT-25	28dc4	DC1	6g	Tor
VD2	XC9227C3C6M	DC/DC-IC	PWM-PWM/PFM st-dwn, 600kHz, 3.25V±1%, 600mA, +CE, PDR	SOT-25	28dc4	DC1	6g	Tor
VD2	XC9227D3C6M	DC/DC-IC	PWM-PWM/PFM st-dwn, 600kHz, 3.25V±1%, 600mA, -CE, PDR	SOT-25	28dc4	DC1	6g	Tor
VD2	XC9227E3C6M	DC/DC-IC	PWM-PWM/PFM st-dwn, 600kHz, 3.25V±1%, 900mA, +CE	SOT-25	28dc4	DC1	6g	Tor
VD2	XC9227F3C6M	DC/DC-IC	PWM-PWM/PFM st-dwn, 600kHz, 3.25V±1%, 900mA, -CE	SOT-25	28dc4	DC1	6g	Tor
VD2	XC9227G3C6M	DC/DC-IC	PWM-PWM/PFM st-dwn, 600kHz, 3.25V±1%, 900mA, +CE, PDR	SOT-25	28dc4	DC1	6g	Tor
VD2	XC9227H3C6M	DC/DC-IC	PWM-PWM/PFM st-dwn, 600kHz, 3.25V±1%, 900mA, -CE, PDR	SOT-25	28dc4	DC1	6g	Tor
VD3	XC9227A3D6M	DC/DC-IC	PWM-PWM/PFM st-dwn, 600kHz, 3.35V±1%, 600mA, +CE	SOT-25	28dc4	DC1	6g	Tor
VD3	XC9227B3D6M	DC/DC-IC	PWM-PWM/PFM st-dwn, 600kHz, 3.35V±1%, 600mA, -CE	SOT-25	28dc4	DC1	6g	Tor
VD3	XC9227C3D6M	DC/DC-IC	PWM-PWM/PFM st-dwn, 600kHz, 3.35V±1%, 600mA, +CE, PDR	SOT-25	28dc4	DC1	6g	Tor
VD3	XC9227D3D6M	DC/DC-IC	PWM-PWM/PFM st-dwn, 600kHz, 3.35V±1%, 600mA, -CE, PDR	SOT-25	28dc4	DC1	6g	Tor
VD3	XC9227E3D6M	DC/DC-IC	PWM-PWM/PFM st-dwn, 600kHz, 3.35V±1%, 900mA, +CE	SOT-25	28dc4	DC1	6g	Tor
VD3	XC9227F3D6M	DC/DC-IC	PWM-PWM/PFM st-dwn, 600kHz, 3.35V±1%, 900mA, -CE	SOT-25	28dc4	DC1	6g	Tor
VD3	XC9227G3D6M	DC/DC-IC	PWM-PWM/PFM st-dwn, 600kHz, 3.35V±1%, 900mA, +CE, PDR	SOT-25	28dc4	DC1	6g	Tor
VD3	XC9227H3D6M	DC/DC-IC	PWM-PWM/PFM st-dwn, 600kHz, 3.35V±1%, 900mA, -CE, PDR	SOT-25	28dc4	DC1	6g	Tor



SMD code	Type	Function	Short description	Case	Pinout	Sch.	St.	Mnf.
VDC	XC9227G3CCM	DC/DC-IC	PWM-PWM/PFM st-dwn, 1.2MHz, 3.25V±1%, 900mA, +CE, PDR	SOT-25	28dc4	DC1	6g	Tor
VDC	XC9227H3CCM	DC/DC-IC	PWM-PWM/PFM st-dwn, 1.2MHz, 3.25V±1%, 900mA, -CE, PDR	SOT-25	28dc4	DC1	6g	Tor
VDD	XC9227A3DCM	DC/DC-IC	PWM-PWM/PFM st-dwn, 1.2MHz, 3.35V±1%, 600mA, +CE	SOT-25	28dc4	DC1	6g	Tor
VDD	XC9227B3DCM	DC/DC-IC	PWM-PWM/PFM st-dwn, 1.2MHz, 3.35V±1%, 600mA, -CE	SOT-25	28dc4	DC1	6g	Tor
VDD	XC9227C3DCM	DC/DC-IC	PWM-PWM/PFM st-dwn, 1.2MHz, 3.35V±1%, 600mA, +CE, PDR	SOT-25	28dc4	DC1	6g	Tor
VDD	XC9227D3DCM	DC/DC-IC	PWM-PWM/PFM st-dwn, 1.2MHz, 3.35V±1%, 600mA, -CE, PDR	SOT-25	28dc4	DC1	6g	Tor
VDD	XC9227E3DCM	DC/DC-IC	PWM-PWM/PFM st-dwn, 1.2MHz, 3.35V±1%, 900mA, +CE	SOT-25	28dc4	DC1	6g	Tor
VDD	XC9227F3DCM	DC/DC-IC	PWM-PWM/PFM st-dwn, 1.2MHz, 3.35V±1%, 900mA, -CE	SOT-25	28dc4	DC1	6g	Tor
VDD	XC9227G3DCM	DC/DC-IC	PWM-PWM/PFM st-dwn, 1.2MHz, 3.35V±1%, 900mA, +CE, PDR	SOT-25	28dc4	DC1	6g	Tor
VDD	XC9227H3DCM	DC/DC-IC	PWM-PWM/PFM st-dwn, 1.2MHz, 3.35V±1%, 900mA, -CE, PDR	SOT-25	28dc4	DC1	6g	Tor
VDE	XC9227A3ECM	DC/DC-IC	PWM-PWM/PFM st-dwn, 1.2MHz, 3.45V±1%, 600mA, +CE	SOT-25	28dc4	DC1	6g	Tor
VDE	XC9227B3ECM	DC/DC-IC	PWM-PWM/PFM st-dwn, 1.2MHz, 3.45V±1%, 600mA, -CE	SOT-25	28dc4	DC1	6g	Tor
VDE	XC9227C3ECM	DC/DC-IC	PWM-PWM/PFM st-dwn, 1.2MHz, 3.45V±1%, 600mA, +CE, PDR	SOT-25	28dc4	DC1	6g	Tor
VDE	XC9227D3ECM	DC/DC-IC	PWM-PWM/PFM st-dwn, 1.2MHz, 3.45V±1%, 600mA, -CE, PDR	SOT-25	28dc4	DC1	6g	Tor
VDE	XC9227E3ECM	DC/DC-IC	PWM-PWM/PFM st-dwn, 1.2MHz, 3.45V±1%, 900mA, +CE	SOT-25	28dc4	DC1	6g	Tor
VDE	XC9227F3ECM	DC/DC-IC	PWM-PWM/PFM st-dwn, 1.2MHz, 3.45V±1%, 900mA, -CE	SOT-25	28dc4	DC1	6g	Tor
VDE	XC9227G3ECM	DC/DC-IC	PWM-PWM/PFM st-dwn, 1.2MHz, 3.45V±1%, 900mA, +CE, PDR	SOT-25	28dc4	DC1	6g	Tor
VDE	XC9227H3ECM	DC/DC-IC	PWM-PWM/PFM st-dwn, 1.2MHz, 3.45V±1%, 900mA, -CE, PDR	SOT-25	28dc4	DC1	6g	Tor
VDF	XC9227A3FCM	DC/DC-IC	PWM-PWM/PFM st-dwn, 1.2MHz, 3.55V±1%, 600mA, +CE	SOT-25	28dc4	DC1	6g	Tor
VDF	XC9227B3FCM	DC/DC-IC	PWM-PWM/PFM st-dwn, 1.2MHz, 3.55V±1%, 600mA, -CE	SOT-25	28dc4	DC1	6g	Tor
VDF	XC9227C3FCM	DC/DC-IC	PWM-PWM/PFM st-dwn, 1.2MHz, 3.55V±1%, 600mA, +CE, PDR	SOT-25	28dc4	DC1	6g	Tor
VDF	XC9227D3FCM	DC/DC-IC	PWM-PWM/PFM st-dwn, 1.2MHz, 3.55V±1%, 600mA, -CE, PDR	SOT-25	28dc4	DC1	6g	Tor
VDF	XC9227E3FCM	DC/DC-IC	PWM-PWM/PFM st-dwn, 1.2MHz, 3.55V±1%, 900mA, +CE	SOT-25	28dc4	DC1	6g	Tor
VDF	XC9227F3FCM	DC/DC-IC	PWM-PWM/PFM st-dwn, 1.2MHz, 3.55V±1%, 900mA, -CE	SOT-25	28dc4	DC1	6g	Tor
VDF	XC9227G3FCM	DC/DC-IC	PWM-PWM/PFM st-dwn, 1.2MHz, 3.55V±1%, 900mA, +CE, PDR	SOT-25	28dc4	DC1	6g	Tor
VDF	XC9227H3FCM	DC/DC-IC	PWM-PWM/PFM st-dwn, 1.2MHz, 3.55V±1%, 900mA, -CE, PDR	SOT-25	28dc4	DC1	6g	Tor
VDH	XC9227A3HCM	DC/DC-IC	PWM-PWM/PFM st-dwn, 1.2MHz, 3.65V±1%, 600mA, +CE	SOT-25	28dc4	DC1	6g	Tor
VDH	XC9227B3HCM	DC/DC-IC	PWM-PWM/PFM st-dwn, 1.2MHz, 3.65V±1%, 600mA, -CE	SOT-25	28dc4	DC1	6g	Tor
VDH	XC9227C3HCM	DC/DC-IC	PWM-PWM/PFM st-dwn, 1.2MHz, 3.65V±1%, 600mA, +CE, PDR	SOT-25	28dc4	DC1	6g	Tor
VDH	XC9227D3HCM	DC/DC-IC	PWM-PWM/PFM st-dwn, 1.2MHz, 3.65V±1%, 600mA, -CE, PDR	SOT-25	28dc4	DC1	6g	Tor
VDH	XC9227E3HCM	DC/DC-IC	PWM-PWM/PFM st-dwn, 1.2MHz, 3.65V±1%, 900mA, +CE	SOT-25	28dc4	DC1	6g	Tor
VDH	XC9227F3HCM	DC/DC-IC	PWM-PWM/PFM st-dwn, 1.2MHz, 3.65V±1%, 900mA, -CE	SOT-25	28dc4	DC1	6g	Tor
VDH	XC9227G3HCM	DC/DC-IC	PWM-PWM/PFM st-dwn, 1.2MHz, 3.65V±1%, 900mA, +CE, PDR	SOT-25	28dc4	DC1	6g	Tor
VDH	XC9227H3HCM	DC/DC-IC	PWM-PWM/PFM st-dwn, 1.2MHz, 3.65V±1%, 900mA, -CE, PDR	SOT-25	28dc4	DC1	6g	Tor
VDK	XC9227A3KCM	DC/DC-IC	PWM-PWM/PFM st-dwn, 1.2MHz, 3.75V±1%, 600mA, +CE	SOT-25	28dc4	DC1	6g	Tor
VDK	XC9227B3KCM	DC/DC-IC	PWM-PWM/PFM st-dwn, 1.2MHz, 3.75V±1%, 600mA, -CE	SOT-25	28dc4	DC1	6g	Tor
VDK	XC9227C3KCM	DC/DC-IC	PWM-PWM/PFM st-dwn, 1.2MHz, 3.75V±1%, 600mA, +CE, PDR	SOT-25	28dc4	DC1	6g	Tor
VDK	XC9227D3KCM	DC/DC-IC	PWM-PWM/PFM st-dwn, 1.2MHz, 3.75V±1%, 600mA, -CE, PDR	SOT-25	28dc4	DC1	6g	Tor
VDK	XC9227E3KCM	DC/DC-IC	PWM-PWM/PFM st-dwn, 1.2MHz, 3.75V±1%, 900mA, +CE	SOT-25	28dc4	DC1	6g	Tor
VDK	XC9227F3KCM	DC/DC-IC	PWM-PWM/PFM st-dwn, 1.2MHz, 3.75V±1%, 900mA, -CE	SOT-25	28dc4	DC1	6g	Tor
VDK	XC9227G3KCM	DC/DC-IC	PWM-PWM/PFM st-dwn, 1.2MHz, 3.75V±1%, 900mA, +CE, PDR	SOT-25	28dc4	DC1	6g	Tor
VDK	XC9227H3KCM	DC/DC-IC	PWM-PWM/PFM st-dwn, 1.2MHz, 3.75V±1%, 900mA, -CE, PDR	SOT-25	28dc4	DC1	6g	Tor
VDL	XC9227A3LCM	DC/DC-IC	PWM-PWM/PFM st-dwn, 1.2MHz, 3.85V±1%, 600mA, +CE	SOT-25	28dc4	DC1	6g	Tor
VDL	XC9227B3LCM	DC/DC-IC	PWM-PWM/PFM st-dwn, 1.2MHz, 3.85V±1%, 600mA, -CE	SOT-25	28dc4	DC1	6g	Tor
VDL	XC9227C3LCM	DC/DC-IC	PWM-PWM/PFM st-dwn, 1.2MHz, 3.85V±1%, 600mA, +CE, PDR	SOT-25	28dc4	DC1	6g	Tor
VDL	XC9227D3LCM	DC/DC-IC	PWM-PWM/PFM st-dwn, 1.2MHz, 3.85V±1%, 600mA, -CE, PDR	SOT-25	28dc4	DC1	6g	Tor
VDL	XC9227E3LCM	DC/DC-IC	PWM-PWM/PFM st-dwn, 1.2MHz, 3.85V±1%, 900mA, +CE	SOT-25	28dc4	DC1	6g	Tor
VDL	XC9227F3LCM	DC/DC-IC	PWM-PWM/PFM st-dwn, 1.2MHz, 3.85V±1%, 900mA, -CE	SOT-25	28dc4	DC1	6g	Tor
VDL	XC9227G3LCM	DC/DC-IC	PWM-PWM/PFM st-dwn, 1.2MHz, 3.85V±1%, 900mA, +CE, PDR	SOT-25	28dc4	DC1	6g	Tor
VDL	XC9227H3LCM	DC/DC-IC	PWM-PWM/PFM st-dwn, 1.2MHz, 3.85V±1%, 900mA, -CE, PDR	SOT-25	28dc4	DC1	6g	Tor
VDM	XC9227A3MCM	DC/DC-IC	PWM-PWM/PFM st-dwn, 1.2MHz, 3.95V±1%, 600mA, +CE	SOT-25	28dc4	DC1	6g	Tor
VDM	XC9227B3MCM	DC/DC-IC	PWM-PWM/PFM st-dwn, 1.2MHz, 3.95V±1%, 600mA, -CE	SOT-25	28dc4	DC1	6g	Tor
VDM	XC9227C3MCM	DC/DC-IC	PWM-PWM/PFM st-dwn, 1.2MHz, 3.95V±1%, 600mA, +CE, PDR	SOT-25	28dc4	DC1	6g	Tor
VDM	XC9227D3MCM	DC/DC-IC	PWM-PWM/PFM st-dwn, 1.2MHz, 3.95V±1%, 600mA, -CE, PDR	SOT-25	28dc4	DC1	6g	Tor
VDM	XC9227E3MCM	DC/DC-IC	PWM-PWM/PFM st-dwn, 1.2MHz, 3.95V±1%, 900mA, +CE	SOT-25	28dc4	DC1	6g	Tor
VDM	XC9227F3MCM	DC/DC-IC	PWM-PWM/PFM st-dwn, 1.2MHz, 3.95V±1%, 900mA, -CE	SOT-25	28dc4	DC1	6g	Tor
VDM	XC9227G3MCM	DC/DC-IC	PWM-PWM/PFM st-dwn, 1.2MHz, 3.95V±1%, 900mA, +CE, PDR	SOT-25	28dc4	DC1	6g	Tor
VDM	XC9227H3MCM	DC/DC-IC	PWM-PWM/PFM st-dwn, 1.2MHz, 3.95V±1%, 900mA, -CE, PDR	SOT-25	28dc4	DC1	6g	Tor
VE	74LVC1G08GW	CMOS-Logic	2-input AND gate	SOT-353-1	28LLog3	-	6a	Phi
VE	BD46445G	Vdet-IC	4.4V, -Reset PPO, 500ms	SSOP-5	28vdp	V07	6c	Rhm
VE	MC74HVC1GT66DF	CMOS-Logic	Bilateral analogic switch	SC-70-5	28LLog16	-	6b	Ons
VE	MC74HVC1GT66DT	CMOS-Logic	Bilateral analogic switch	SOT-23-5	28LLog16	-	6b	Ons
VE	MC74HVC1GT66DF	CMOS-Logic	Bilateral analogic switch	SOT-353	28LLog16	-	6b	Ons
VE	MC74HVC1GT66DT	CMOS-Logic	Bilateral analogic switch	SOT-23-5	28LLog16	-	6b	Ons
VF	74LVC1G14GW	CMOS-Logic	Inverting Schmitt-trigger	SOT-353-1	28LLog7	-	6a	Phi
VF	BD46435G	Vdet-IC	4.3V, -Reset PPO, 500ms	SSOP-5	28vdp	V07	6c	Rhm
VF	MC74HVC1G05DF	CMOS-Logic	Inverter (ODO)	SOT-353	28LLog19	-	6b	Ons
VF	MC74HVC1G05DT	CMOS-Logic	Inverter (ODO)	SOT-23-5	28LLog19	-	6b	Ons
VG	74LVC1G32GW	CMOS-Logic	2-input OR gate	SOT-353-1	28LLog4	-	6a	Phi
VG	BD46425G	Vdet-IC	4.2V, -Reset PPO, 500ms	SSOP-5	28vdp	V07	6c	Rhm



SMD code	Type	Function	Short description	Case	Pinout	Sch.	St.	Mnf.
VH	74LVC1G86GW	CMOS-Logic	2-input EXCLUSIVE-OR gate	SOT-353-1	28/Log5	-	6a	Phi
VH	BD46415G	Vdet-IC	4.1V, -Reset PPO, 500ms	SSOP-5	28vdp	VD7	6c	Rhm
VH	MC74VHC1GT00DF	CMOS-Logic	2-input NAND gate	SOT-353	28/Log1	-	6b	Ons
VH	MC74VHC1GT00DT	CMOS-Logic	2-input NAND gate	SOT-23-5	28/Log1	-	6b	Ons
VH2	S-1137A34-M5T1S	LVR-IC	LDO, 3.4V±1.0%, 300mA, +CE, CL, PDR	SOT-23-5	28vrx	VR7	6g	Sii
VH3	S-1137A35-M5T1S	LVR-IC	LDO, 3.5V±1.0%, 300mA, +CE, CL, PDR	SOT-23-5	28vrx	VR7	6g	Sii
VHC	S-1137A12-M5T1S	LVR-IC	LDO, 1.2V±15mV, 300mA, +CE, CL, PDR	SOT-23-5	28vrx	VR7	6g	Sii
VHD	S-1137A13-M5T1S	LVR-IC	LDO, 1.3V±15mV, 300mA, +CE, CL, PDR	SOT-23-5	28vrx	VR7	6g	Sii
VHE	S-1137A14-M5T1S	LVR-IC	LDO, 1.4V±15mV, 300mA, +CE, CL, PDR	SOT-23-5	28vrx	VR7	6g	Sii
VHF	S-1137A15-M5T1S	LVR-IC	LDO, 1.5V±1.0%, 300mA, +CE, CL, PDR	SOT-23-5	28vrx	VR7	6g	Sii
VHG	S-1137A16-M5T1S	LVR-IC	LDO, 1.6V±1.0%, 300mA, +CE, CL, PDR	SOT-23-5	28vrx	VR7	6g	Sii
VHH	S-1137A17-M5T1S	LVR-IC	LDO, 1.7V±1.0%, 300mA, +CE, CL, PDR	SOT-23-5	28vrx	VR7	6g	Sii
VHI	S-1137A18-M5T1S	LVR-IC	LDO, 1.8V±1.0%, 300mA, +CE, CL, PDR	SOT-23-5	28vrx	VR7	6g	Sii
VHJ	S-1137A1J-M5T1S	LVR-IC	LDO, 1.85V±1.0%, 300mA, +CE, CL, PDR	SOT-23-5	28vrx	VR7	6g	Sii
VHK	S-1137A19-M5T1S	LVR-IC	LDO, 1.9V±1.0%, 300mA, +CE, CL, PDR	SOT-23-5	28vrx	VR7	6g	Sii
VHL	S-1137A20-M5T1S	LVR-IC	LDO, 2.0V±1.0%, 300mA, +CE, CL, PDR	SOT-23-5	28vrx	VR7	6g	Sii
VHM	S-1137A21-M5T1S	LVR-IC	LDO, 2.1V±1.0%, 300mA, +CE, CL, PDR	SOT-23-5	28vrx	VR7	6g	Sii
VHN	S-1137A22-M5T1S	LVR-IC	LDO, 2.2V±1.0%, 300mA, +CE, CL, PDR	SOT-23-5	28vrx	VR7	6g	Sii
VHO	S-1137A23-M5T1S	LVR-IC	LDO, 2.3V±1.0%, 300mA, +CE, CL, PDR	SOT-23-5	28vrx	VR7	6g	Sii
VHP	S-1137A24-M5T1S	LVR-IC	LDO, 2.4V±1.0%, 300mA, +CE, CL, PDR	SOT-23-5	28vrx	VR7	6g	Sii
VHQ	S-1137A25-M5T1S	LVR-IC	LDO, 2.5V±1.0%, 300mA, +CE, CL, PDR	SOT-23-5	28vrx	VR7	6g	Sii
VHR	S-1137A26-M5T1S	LVR-IC	LDO, 2.6V±1.0%, 300mA, +CE, CL, PDR	SOT-23-5	28vrx	VR7	6g	Sii
VHS	S-1137A27-M5T1S	LVR-IC	LDO, 2.7V±1.0%, 300mA, +CE, CL, PDR	SOT-23-5	28vrx	VR7	6g	Sii
VHT	S-1137A28-M5T1S	LVR-IC	LDO, 2.8V±1.0%, 300mA, +CE, CL, PDR	SOT-23-5	28vrx	VR7	6g	Sii
VHU	S-1137A2J-M5T1S	LVR-IC	LDO, 2.85V±1.0%, 300mA, +CE, CL, PDR	SOT-23-5	28vrx	VR7	6g	Sii
VHV	S-1137A29-M5T1S	LVR-IC	LDO, 2.9V±1.0%, 300mA, +CE, CL, PDR	SOT-23-5	28vrx	VR7	6g	Sii
VHW	S-1137A30-M5T1S	LVR-IC	LDO, 3.0V±1.0%, 300mA, +CE, CL, PDR	SOT-23-5	28vrx	VR7	6g	Sii
VHX	S-1137A31-M5T1S	LVR-IC	LDO, 3.1V±1.0%, 300mA, +CE, CL, PDR	SOT-23-5	28vrx	VR7	6g	Sii
VHY	S-1137A32-M5T1S	LVR-IC	LDO, 3.2V±1.0%, 300mA, +CE, CL, PDR	SOT-23-5	28vrx	VR7	6g	Sii
VHZ	S-1137A33-M5T1S	LVR-IC	LDO, 3.3V±1.0%, 300mA, +CE, CL, PDR	SOT-23-5	28vrx	VR7	6g	Sii
VI2	S-1137B34-M5T1S	LVR-IC	LDO, 3.4V±1.0%, 300mA, +CE, CL	SOT-23-5	28vrx	VR7	6g	Sii
VI3	S-1137B35-M5T1S	LVR-IC	LDO, 3.5V±1.0%, 300mA, +CE, CL	SOT-23-5	28vrx	VR7	6g	Sii
VIC	S-1137B12-M5T1S	LVR-IC	LDO, 1.2V±15mV, 300mA, +CE, CL	SOT-23-5	28vrx	VR7	6g	Sii
VID	S-1137B13-M5T1S	LVR-IC	LDO, 1.3V±15mV, 300mA, +CE, CL	SOT-23-5	28vrx	VR7	6g	Sii
VIE	S-1137B14-M5T1S	LVR-IC	LDO, 1.4V±15mV, 300mA, +CE, CL	SOT-23-5	28vrx	VR7	6g	Sii
VIF	S-1137B15-M5T1S	LVR-IC	LDO, 1.5V±1.0%, 300mA, +CE, CL	SOT-23-5	28vrx	VR7	6g	Sii
VIG	S-1137B16-M5T1S	LVR-IC	LDO, 1.6V±1.0%, 300mA, +CE, CL	SOT-23-5	28vrx	VR7	6g	Sii
VIH	S-1137B17-M5T1S	LVR-IC	LDO, 1.7V±1.0%, 300mA, +CE, CL	SOT-23-5	28vrx	VR7	6g	Sii
VII	S-1137B18-M5T1S	LVR-IC	LDO, 1.8V±1.0%, 300mA, +CE, CL	SOT-23-5	28vrx	VR7	6g	Sii
VIJ	S-1137B1J-M5T1S	LVR-IC	LDO, 1.85V±1.0%, 300mA, +CE, CL	SOT-23-5	28vrx	VR7	6g	Sii
VIK	S-1137B19-M5T1S	LVR-IC	LDO, 1.9V±1.0%, 300mA, +CE, CL	SOT-23-5	28vrx	VR7	6g	Sii
VIL	S-1137B20-M5T1S	LVR-IC	LDO, 2.0V±1.0%, 300mA, +CE, CL	SOT-23-5	28vrx	VR7	6g	Sii
VIM	S-1137B21-M5T1S	LVR-IC	LDO, 2.1V±1.0%, 300mA, +CE, CL	SOT-23-5	28vrx	VR7	6g	Sii
VIN	S-1137B22-M5T1S	LVR-IC	LDO, 2.2V±1.0%, 300mA, +CE, CL	SOT-23-5	28vrx	VR7	6g	Sii
VIO	S-1137B23-M5T1S	LVR-IC	LDO, 2.3V±1.0%, 300mA, +CE, CL	SOT-23-5	28vrx	VR7	6g	Sii
VIP	S-1137B24-M5T1S	LVR-IC	LDO, 2.4V±1.0%, 300mA, +CE, CL	SOT-23-5	28vrx	VR7	6g	Sii
VIQ	S-1137B25-M5T1S	LVR-IC	LDO, 2.5V±1.0%, 300mA, +CE, CL	SOT-23-5	28vrx	VR7	6g	Sii
VIR	S-1137B26-M5T1S	LVR-IC	LDO, 2.6V±1.0%, 300mA, +CE, CL	SOT-23-5	28vrx	VR7	6g	Sii
VIS	S-1137B27-M5T1S	LVR-IC	LDO, 2.7V±1.0%, 300mA, +CE, CL	SOT-23-5	28vrx	VR7	6g	Sii
VIT	S-1137B28-M5T1S	LVR-IC	LDO, 2.8V±1.0%, 300mA, +CE, CL	SOT-23-5	28vrx	VR7	6g	Sii
VIU	S-1137B2J-M5T1S	LVR-IC	LDO, 2.85V±1.0%, 300mA, +CE, CL	SOT-23-5	28vrx	VR7	6g	Sii
VIV	S-1137B29-M5T1S	LVR-IC	LDO, 2.9V±1.0%, 300mA, +CE, CL	SOT-23-5	28vrx	VR7	6g	Sii
VIW	S-1137B30-M5T1S	LVR-IC	LDO, 3.0V±1.0%, 300mA, +CE, CL	SOT-23-5	28vrx	VR7	6g	Sii
VIX	S-1137B31-M5T1S	LVR-IC	LDO, 3.1V±1.0%, 300mA, +CE, CL	SOT-23-5	28vrx	VR7	6g	Sii
VIY	S-1137B32-M5T1S	LVR-IC	LDO, 3.2V±1.0%, 300mA, +CE, CL	SOT-23-5	28vrx	VR7	6g	Sii
VIZ	S-1137B33-M5T1S	LVR-IC	LDO, 3.3V±1.0%, 300mA, +CE, CL	SOT-23-5	28vrx	VR7	6g	Sii
VJ	74LVC1G17GW	CMOS-Logic	Schmitt-trigger	SOT-353-1	28/Log11	-	6a	Phi
VJ	BD46405G	Vdet-IC	4V, -Reset PPO, 500ms	SSOP-5	28vdp	VD7	6c	Rhm
VJ	MC74VHC1GT02DF	CMOS-Logic	2-input NOR gate	SOT-353	28/Log2	-	6b	Ons
VJ	MC74VHC1GT02DT	CMOS-Logic	2-input NOR gate	SOT-23-5	28/Log2	-	6b	Ons
VJ-	RC79198-29PBR	LVR-IC	LDO, 2.9V±1%, 300mA, +CE	SOT-23-5	28xc	VR4	6a	Rct
VJ2	S-1137C34-M5T1S	LVR-IC	LDO, 3.4V±1.0%, 300mA, +CE, PDR	SOT-23-5	28vrx	VR7	6g	Sii
VJ3	S-1137C35-M5T1S	LVR-IC	LDO, 3.5V±1.0%, 300mA, +CE, PDR	SOT-23-5	28vrx	VR7	6g	Sii
VJC	S-1137C12-M5T1S	LVR-IC	LDO, 1.2V±15mV, 300mA, +CE, PDR	SOT-23-5	28vrx	VR7	6g	Sii
VJD	S-1137C13-M5T1S	LVR-IC	LDO, 1.3V±15mV, 300mA, +CE, PDR	SOT-23-5	28vrx	VR7	6g	Sii
VJE	S-1137C14-M5T1S	LVR-IC	LDO, 1.4V±15mV, 300mA, +CE, PDR	SOT-23-5	28vrx	VR7	6g	Sii
VJF	S-1137C15-M5T1S	LVR-IC	LDO, 1.5V±1.0%, 300mA, +CE, PDR	SOT-23-5	28vrx	VR7	6g	Sii
VJG	S-1137C16-M5T1S	LVR-IC	LDO, 1.6V±1.0%, 300mA, +CE, PDR	SOT-23-5	28vrx	VR7	6g	Sii
VJH	S-1137C17-M5T1S	LVR-IC	LDO, 1.7V±1.0%, 300mA, +CE, PDR	SOT-23-5	28vrx	VR7	6g	Sii
VJI	S-1137C18-M5T1S	LVR-IC	LDO, 1.8V±1.0%, 300mA, +CE, PDR	SOT-23-5	28vrx	VR7	6g	Sii



SMD code	Type	Function	Short description	Case	Pinout	Sch.	St.	Mnf.
VJJ	S-1137C1J-M5T1S	LVR-IC	LDO, 1.85V±1.0%, 300mA, +CE, PDR	SOT-23-5	28vrx	VR7	6g	Sii
VJK	S-1137C19-M5T1S	LVR-IC	LDO, 1.9V±1.0%, 300mA, +CE, PDR	SOT-23-5	28vrx	VR7	6g	Sii
VJL	S-1137C20-M5T1S	LVR-IC	LDO, 2.0V±1.0%, 300mA, +CE, PDR	SOT-23-5	28vrx	VR7	6g	Sii
VJM	S-1137C21-M5T1S	LVR-IC	LDO, 2.1V±1.0%, 300mA, +CE, PDR	SOT-23-5	28vrx	VR7	6g	Sii
VJN	S-1137C22-M5T1S	LVR-IC	LDO, 2.2V±1.0%, 300mA, +CE, PDR	SOT-23-5	28vrx	VR7	6g	Sii
VJO	S-1137C23-M5T1S	LVR-IC	LDO, 2.3V±1.0%, 300mA, +CE, PDR	SOT-23-5	28vrx	VR7	6g	Sii
VJP	S-1137C24-M5T1S	LVR-IC	LDO, 2.4V±1.0%, 300mA, +CE, PDR	SOT-23-5	28vrx	VR7	6g	Sii
VJQ	S-1137C25-M5T1S	LVR-IC	LDO, 2.5V±1.0%, 300mA, +CE, PDR	SOT-23-5	28vrx	VR7	6g	Sii
VJR	S-1137C26-M5T1S	LVR-IC	LDO, 2.6V±1.0%, 300mA, +CE, PDR	SOT-23-5	28vrx	VR7	6g	Sii
VJS	S-1137C27-M5T1S	LVR-IC	LDO, 2.7V±1.0%, 300mA, +CE, PDR	SOT-23-5	28vrx	VR7	6g	Sii
VJT	S-1137C28-M5T1S	LVR-IC	LDO, 2.8V±1.0%, 300mA, +CE, PDR	SOT-23-5	28vrx	VR7	6g	Sii
VJU	S-1137C2J-M5T1S	LVR-IC	LDO, 2.85V±1.0%, 300mA, +CE, PDR	SOT-23-5	28vrx	VR7	6g	Sii
VJV	S-1137C29-M5T1S	LVR-IC	LDO, 2.9V±1.0%, 300mA, +CE, PDR	SOT-23-5	28vrx	VR7	6g	Sii
VJW	S-1137C30-M5T1S	LVR-IC	LDO, 3.0V±1.0%, 300mA, +CE, PDR	SOT-23-5	28vrx	VR7	6g	Sii
VJX	S-1137C31-M5T1S	LVR-IC	LDO, 3.1V±1.0%, 300mA, +CE, PDR	SOT-23-5	28vrx	VR7	6g	Sii
VJY	S-1137C32-M5T1S	LVR-IC	LDO, 3.2V±1.0%, 300mA, +CE, PDR	SOT-23-5	28vrx	VR7	6g	Sii
VJZ	S-1137C33-M5T1S	LVR-IC	LDO, 3.3V±1.0%, 300mA, +CE, PDR	SOT-23-5	28vrx	VR7	6g	Sii
VK	BD46395G	Vdet-IC	3.9V, -Reset PPO, 500ms	SSOP-5	28vdp	VD7	6c	Rhm
VK	MC74VHC1GT04DF	CMOS-Logic	Inverter	SC-70-5	28/Log6	-	6b	Ons
VK	MC74VHC1GT04DT	CMOS-Logic	Inverter	SOT-23-5	28/Log6	-	6b	Ons
VK	MC74VHC1GU04DF	CMOS-Logic	Inverter	SOT-353	28/Log6	-	6b	Ons
VK	MC74VHC1GU04DT	CMOS-Logic	Inverter	SOT-23-5	28/Log6	-	6b	Ons
VK2	S-1137D34-M5T1S	LVR-IC	LDO, 3.4V±1.0%, 300mA, +CE, PDR	SOT-23-5	28vrx	VR7	6g	Sii
VK3	S-1137D35-M5T1S	LVR-IC	LDO, 3.5V±1.0%, 300mA, +CE, PDR	SOT-23-5	28vrx	VR7	6g	Sii
VKC	S-1137D12-M5T1S	LVR-IC	LDO, 1.2V±15mV, 300mA, +CE, PDR	SOT-23-5	28vrx	VR7	6g	Sii
VKD	S-1137D13-M5T1S	LVR-IC	LDO, 1.3V±15mV, 300mA, +CE, PDR	SOT-23-5	28vrx	VR7	6g	Sii
VKE	S-1137D14-M5T1S	LVR-IC	LDO, 1.4V±15mV, 300mA, +CE, PDR	SOT-23-5	28vrx	VR7	6g	Sii
VKF	S-1137D15-M5T1S	LVR-IC	LDO, 1.5V±1.0%, 300mA, +CE, PDR	SOT-23-5	28vrx	VR7	6g	Sii
VKG	S-1137D16-M5T1S	LVR-IC	LDO, 1.6V±1.0%, 300mA, +CE, PDR	SOT-23-5	28vrx	VR7	6g	Sii
VKH	S-1137D17-M5T1S	LVR-IC	LDO, 1.7V±1.0%, 300mA, +CE, PDR	SOT-23-5	28vrx	VR7	6g	Sii
VKI	S-1137D18-M5T1S	LVR-IC	LDO, 1.8V±1.0%, 300mA, +CE, PDR	SOT-23-5	28vrx	VR7	6g	Sii
VKJ	S-1137D1J-M5T1S	LVR-IC	LDO, 1.85V±1.0%, 300mA, +CE, PDR	SOT-23-5	28vrx	VR7	6g	Sii
VKK	S-1137D19-M5T1S	LVR-IC	LDO, 1.9V±1.0%, 300mA, +CE, PDR	SOT-23-5	28vrx	VR7	6g	Sii
VKL	S-1137D20-M5T1S	LVR-IC	LDO, 2.0V±1.0%, 300mA, +CE, PDR	SOT-23-5	28vrx	VR7	6g	Sii
VKM	S-1137D21-M5T1S	LVR-IC	LDO, 2.1V±1.0%, 300mA, +CE, PDR	SOT-23-5	28vrx	VR7	6g	Sii
VKN	S-1137D22-M5T1S	LVR-IC	LDO, 2.2V±1.0%, 300mA, +CE, PDR	SOT-23-5	28vrx	VR7	6g	Sii
VKO	S-1137D23-M5T1S	LVR-IC	LDO, 2.3V±1.0%, 300mA, +CE, PDR	SOT-23-5	28vrx	VR7	6g	Sii
VKP	S-1137D24-M5T1S	LVR-IC	LDO, 2.4V±1.0%, 300mA, +CE, PDR	SOT-23-5	28vrx	VR7	6g	Sii
VKQ	S-1137D25-M5T1S	LVR-IC	LDO, 2.5V±1.0%, 300mA, +CE, PDR	SOT-23-5	28vrx	VR7	6g	Sii
VKR	S-1137D26-M5T1S	LVR-IC	LDO, 2.6V±1.0%, 300mA, +CE, PDR	SOT-23-5	28vrx	VR7	6g	Sii
VKS	S-1137D27-M5T1S	LVR-IC	LDO, 2.7V±1.0%, 300mA, +CE, PDR	SOT-23-5	28vrx	VR7	6g	Sii
VKT	S-1137D28-M5T1S	LVR-IC	LDO, 2.8V±1.0%, 300mA, +CE, PDR	SOT-23-5	28vrx	VR7	6g	Sii
VKU	S-1137D2J-M5T1S	LVR-IC	LDO, 2.85V±1.0%, 300mA, +CE, PDR	SOT-23-5	28vrx	VR7	6g	Sii
VKV	S-1137D29-M5T1S	LVR-IC	LDO, 2.9V±1.0%, 300mA, +CE, PDR	SOT-23-5	28vrx	VR7	6g	Sii
VKW	S-1137D30-M5T1S	LVR-IC	LDO, 3.0V±1.0%, 300mA, +CE, PDR	SOT-23-5	28vrx	VR7	6g	Sii
VKX	S-1137D31-M5T1S	LVR-IC	LDO, 3.1V±1.0%, 300mA, +CE, PDR	SOT-23-5	28vrx	VR7	6g	Sii
VKY	S-1137D32-M5T1S	LVR-IC	LDO, 3.2V±1.0%, 300mA, +CE, PDR	SOT-23-5	28vrx	VR7	6g	Sii
VKZ	S-1137D33-M5T1S	LVR-IC	LDO, 3.3V±1.0%, 300mA, +CE, PDR	SOT-23-5	28vrx	VR7	6g	Sii
VL	74LVC1G66GW	CMOS-Logic	Bilateral analogic switch	SOT-353-1	28/Log16	-	6a	Phi
VL	BD46385G	Vdet-IC	3.8V, -Reset PPO, 500ms	SSOP-5	28vdp	VD7	6c	Rhm
VL	MC74VHC1GT50DF	CMOS-Logic	Noninverting buffer	SOT-353	28/Log10	-	6b	Ons
VL	MC74VHC1GT50DT	CMOS-Logic	Noninverting buffer	SOT-23-5	28/Log10	-	6b	Ons
VM	74LVC1G125GW	CMOS-Logic	Bus buffer gate with 3-state output	SOT-353-1	28/Log14	-	6a	Phi
VM	BD46375G	Vdet-IC	3.7V, -Reset PPO, 500ms	SSOP-5	28vdp	VD7	6c	Rhm
VM	MC74VHC1GT86DF	CMOS-Logic	2-input EXCLUSIVE-OR gate	SOT-353	28/Log5	-	6b	Ons
VM	MC74VHC1GT86DT	CMOS-Logic	2-input EXCLUSIVE-OR gate	SOT-23-5	28/Log5	-	6b	Ons
VM-	RT9818C-50PB	Vdet-IC	5.0V±1.5%, -ODO +Reset, Td=220ms	SOT-23-5	28vdm	VD6	6a	Rct
VM_	SN74CBTLV1G125DCK	CMOS-Logic	Single high-speed line switch	SC-70-5	28/Log14	-	6a	Ti
VN	74LVC1G126GW	CMOS-Logic	Bus buffer gate with 3-state output	SOT-353-1	28/Log13	-	6a	Phi
VN	BD46365G	Vdet-IC	3.6V, -Reset PPO, 500ms	SSOP-5	28vdp	VD7	6c	Rhm
VN	MC74VHC1GT32DF	CMOS-Logic	2-input OR gate	SOT-353	28/Log4	-	6b	Ons
VN	MC74VHC1GT32DT	CMOS-Logic	2-input OR gate	SOT-23-5	28/Log4	-	6b	Ons
VN-	RT9193-29PB	LVR-IC	LDO, 2.9V±1%, 300mA, +CE	SOT-23-5	28vrx	VR7	6g	Rct
VN=	RT9193-29GB	LVR-IC	LDO, 2.9V±1%, 300mA, +CE	SOT-23-5	28vrx	VR7	6g	Rct
VO	BD45322G	Vdet-IC	3.2V, -Reset ODO, 200ms	SSOP-5	28vdp	VD6	6c	Rhm
VO	MC74VHC1G125DF	CMOS-Logic	Bus buffer gate with 3-state output	SOT-353	28/Log14	-	6b	Ons
VO	MC74VHC1G125DT	CMOS-Logic	Bus buffer gate with 3-state output	SOT-23-5	28/Log14	-	6b	Ons
VP	74LVC1G79GW	CMOS-Logic	Positive edge-triggered D-type flip-flop	SOT-353-1	28/Log20	-	6a	Phi
VP	BD46355G	Vdet-IC	3.5V, -Reset PPO, 500ms	SSOP-5	28vdp	VD7	6c	Rhm
VP	MC74VHC1G03DF	CMOS-Logic	2-input NOR gate (ODO)	SOT-353	28/Log18	-	6b	Ons



SMD code	Type	Function	Short description	Case	Pinout	Sch.	St.	Mnf.
VP	MC74VHC1G03DT	CMOS-Logic	2-input NOR gate (ODO)	SOT-23-5	28/Log18	-	6b	Ons
VQ	BD46345G	Vdet-IC	3.5V, -Reset PPO, 500ms	SSOP-5	28vdp	VD7	6c	Rhm
VQ-	RT9193-20PB	LVR-IC	LDO, 2.0V±1%, 300mA, +CE	SOT-23-5	28vrx	VR7	6g	Rct
VR	74LVC1G06GW	CMOS-Logic	Inverter (ODO)	SOT-353-1	28/Log19	-	6a	Phi
VR	BD46335G	Vdet-IC	3.3V, -Reset PPO, 500ms	SSOP-5	28vdp	VD7	6c	Rhm
VR	KIC7SH04FU	CMOS-Logic	Inverter	SOT-353	28/Log6	-	6a	Kec
VR	MC74VHC1G50DF	CMOS-Logic	Noninverting buffer	SOT-353	28/Log10	-	6b	Ons
VR	MC74VHC1G50DT	CMOS-Logic	Noninverting buffer	SOT-23-5	28/Log10	-	6b	Ons
VR	R1122N151B	LVR-IC	LDO, LN, +CE, 1.5V±2%, 150mA	SOT-23-5	28vt	VR4	6g	Ric
VR-	RT9198-15PBR	LVR-IC	LDO, 1.5V±1%, 300mA, +CE	SOT-23-5	28cx	VR4	6a	Rct
VR=	RT9198-15GBR	LVR-IC	LDO, 1.5V±1%, 300mA, +CE	SOT-23-5	28cx	VR4	6a	Rct
VS	74LVC1G07GW	CMOS-Logic	Noninverting buffer/driver (ODO)	SOT-353-1	28/Log8	-	6a	Phi
VS	BD46325G	Vdet-IC	3.2V, -Reset PPO, 500ms	SSOP-5	28vdp	VD7	6c	Rhm
VS	R1122N161B	LVR-IC	LDO, LN, +CE, 1.6V±2%, 150mA	SOT-23-5	28vt	VR4	6g	Ric
VS-	RT9198-20PB	LVR-IC	LDO, 2.0V±1%, 300mA, +CE	SOT-23-5	28xm	VR4	6a	Rct
VT	74LVC1G80GW	CMOS-Logic	Positive edge-triggered D-type flip-flop	SOT-353-1	28/Log21	-	6a	Phi
VT	BD46315G	Vdet-IC	3.1V, -Reset PPO, 500ms	SSOP-5	28vdp	VD7	6c	Rhm
VT	KIC7SH08FU	CMOS-Logic	2-input AND gate	SOT-353	28/Log3	-	6a	Kec
VT	MC74VHC1GT08DF	CMOS-Logic	2-input AND gate	SC-70-5	28/Log3	-	6b	Ons
VT	MC74VHC1GT08DT	CMOS-Logic	2-input AND gate	SOT-23-5	28/Log3	-	6b	Ons
VT	R1122N171B	LVR-IC	LDO, LN, +CE, 1.7V±2%, 150mA	SOT-23-5	28vt	VR4	6g	Ric
VT-	RT9198-20PBR	LVR-IC	LDO, 2.0V±1%, 300mA, +CE	SOT-23-5	28cx	VR4	6a	Rct
VU	BD46305G	Vdet-IC	3V, -Reset PPO, 500ms	SSOP-5	28vdp	VD7	6c	Rhm
VU	R1122N181B	LVR-IC	LDO, LN, +CE, 1.8V±2%, 150mA	SOT-23-5	28vt	VR4	6g	Ric
VU-	RT9198-29PB	LVR-IC	LDO, 2.9V±1%, 300mA, +CE	SOT-23-5	28xm	VR4	6a	Rct
VU4	74LVC1GU04GV	CMOS-Logic	Inverter	SOT753	28/Log6	-	6a	Phi
VV	BD46295G	Vdet-IC	2.9V, -Reset PPO, 500ms	SSOP-5	28vdp	VD7	6c	Rhm
VV	R1122N191B	LVR-IC	LDO, LN, +CE, 1.9V±2%, 150mA	SOT-23-5	28vt	VR4	6g	Ric
VV-	RT9169-50PB	LVR-IC	LDO, 5.0V±2%, 100mA, -CE	SOT-23-5	28cx	VR4	6g	Rct
VW	BD46285G	Vdet-IC	2.8V, -Reset PPO, 500ms	SSOP-5	28vdp	VD7	6c	Rhm
VW-	RT9198-2HPB	LVR-IC	LDO, 2.85V±1%, 300mA, +CE	SOT-23-5	28xm	VR4	6a	Rct
VX	BD46275G	Vdet-IC	2.7V, -Reset PPO, 500ms	SSOP-5	28vdp	VD7	6c	Rhm
VX	MC74HVC1G09DF	CMOS-Logic	2-input AND gate (ODO)	SC-70-5	28/Log9	-	6b	Ons
VX	MC74HVC1G09DT	CMOS-Logic	2-input AND gate (ODO)	SOT-23-5	28/Log9	-	6b	Ons
VX-	RT9193-26PB	LVR-IC	LDO, 2.6V±1%, 300mA, +CE	SOT-23-5	28vrx	VR7	6g	Rct
VY	BD46265G	Vdet-IC	2.6V, -Reset PPO, 500ms	SSOP-5	28vdp	VD7	6c	Rhm
VY-	RT9198-34PB	LVR-IC	LDO, 3.4V±1%, 300mA, +CE	SOT-23-5	28xm	VR4	6a	Rct
VZ	BD46255G	Vdet-IC	2.5V, -Reset PPO, 500ms	SSOP-5	28vdp	VD7	6c	Rhm
VZ	MC74VHC1G135DF	CMOS-Logic	2-input NAND Schmitt-trigger (ODO)	SOT-353	28/Log15	-	6b	Ons
VZ	MC74VHC1G135DT	CMOS-Logic	2-input NAND Schmitt-trigger (ODO)	SOT-23-5	28/Log15	-	6b	Ons
VZ-	RT9198-34PBR	LVR-IC	LDO, 3.4V±1%, 300mA, +CE	SOT-23-5	28cx	VR4	6a	Rct
W0	BD46245G	Vdet-IC	2.4V, -Reset PPO, 500ms	SSOP-5	28vdp	VD7	6c	Rhm
W0	R1210N301D	DC/DC-IC	PWM step-up, 3V, 180kHz	SOT-23-5	28sc	DC3	6g	Ric
W0-	RT9169-12PB	LVR-IC	LDO, 1.2V±2%, 100mA, -CE	SOT-23-5	28cx	VR4	6g	Rct
W009	R3111Q092B	Vdet-IC	0.9V±2%, +Reset ODO	SC-88A	28ru	VD6	6m	Ric
W010	R3111Q102B	Vdet-IC	1.0V±2%, +Reset ODO	SC-88A	28ru	VD6	6m	Ric
W011	R3111Q112B	Vdet-IC	1.1V±2%, +Reset ODO	SC-88A	28ru	VD6	6m	Ric
W012	R3111Q122B	Vdet-IC	1.2V±2%, +Reset ODO	SC-88A	28ru	VD6	6m	Ric
W013	R3111Q132B	Vdet-IC	1.3V±2%, +Reset ODO	SC-88A	28ru	VD6	6m	Ric
W014	R3111Q142B	Vdet-IC	1.4V±2%, +Reset ODO	SC-88A	28ru	VD6	6m	Ric
W015	R3111Q152B	Vdet-IC	1.5V±2%, +Reset ODO	SC-88A	28ru	VD6	6m	Ric
W016	R3111Q162B	Vdet-IC	1.6V±2%, +Reset ODO	SC-88A	28ru	VD6	6m	Ric
W017	R3111Q172B	Vdet-IC	1.7V±2%, +Reset ODO	SC-88A	28ru	VD6	6m	Ric
W018	R3111Q182B	Vdet-IC	1.8V±2%, +Reset ODO	SC-88A	28ru	VD6	6m	Ric
W019	R3111Q192B	Vdet-IC	1.9V±2%, +Reset ODO	SC-88A	28ru	VD6	6m	Ric
W020	R3111Q202B	Vdet-IC	2.0V±2%, +Reset ODO	SC-88A	28ru	VD6	6m	Ric
W021	R3111Q212B	Vdet-IC	2.1V±2%, +Reset ODO	SC-88A	28ru	VD6	6m	Ric
W022	R3111Q222B	Vdet-IC	2.2V±2%, +Reset ODO	SC-88A	28ru	VD6	6m	Ric
W023	R3111Q232B	Vdet-IC	2.3V±2%, +Reset ODO	SC-88A	28ru	VD6	6m	Ric
W024	R3111Q242B	Vdet-IC	2.4V±2%, +Reset ODO	SC-88A	28ru	VD6	6m	Ric
W025	R3111Q252B	Vdet-IC	2.5V±2%, +Reset ODO	SC-88A	28ru	VD6	6m	Ric
W026	R3111Q262B	Vdet-IC	2.6V±2%, +Reset ODO	SC-88A	28ru	VD6	6m	Ric
W027	R3111Q272B	Vdet-IC	2.7V±2%, +Reset ODO	SC-88A	28ru	VD6	6m	Ric
W028	R3111Q282B	Vdet-IC	2.8V±2%, +Reset ODO	SC-88A	28ru	VD6	6m	Ric
W029	R3111Q292B	Vdet-IC	2.9V±2%, +Reset ODO	SC-88A	28ru	VD6	6m	Ric
W030	R3111Q302B	Vdet-IC	3.0V±2%, +Reset ODO	SC-88A	28ru	VD6	6m	Ric
W031	R3111Q312B	Vdet-IC	3.1V±2%, +Reset ODO	SC-88A	28ru	VD6	6m	Ric
W032	R3111Q322B	Vdet-IC	3.2V±2%, +Reset ODO	SC-88A	28ru	VD6	6m	Ric
W033	R3111Q332B	Vdet-IC	3.3V±2%, +Reset ODO	SC-88A	28ru	VD6	6m	Ric
W034	R3111Q342B	Vdet-IC	3.4V±2%, +Reset ODO	SC-88A	28ru	VD6	6m	Ric



SMD code	Type	Function	Short description	Case	Pinout	Sch.	St.	Mnf.
W035	R3111Q352B	Vdet-IC	3.5V±2%, +Reset ODO	SC-88A	28ru	VD6	6m	Ric
W036	R3111Q362B	Vdet-IC	3.6V±2%, +Reset ODO	SC-88A	28ru	VD6	6m	Ric
W037	R3111Q372B	Vdet-IC	3.7V±2%, +Reset ODO	SC-88A	28ru	VD6	6m	Ric
W038	R3111Q382B	Vdet-IC	3.8V±2%, +Reset ODO	SC-88A	28ru	VD6	6m	Ric
W039	R3111Q392B	Vdet-IC	3.9V±2%, +Reset ODO	SC-88A	28ru	VD6	6m	Ric
W040	R3111Q402B	Vdet-IC	4.0V±2%, +Reset ODO	SC-88A	28ru	VD6	6m	Ric
W041	R3111Q412B	Vdet-IC	4.1V±2%, +Reset ODO	SC-88A	28ru	VD6	6m	Ric
W042	R3111Q422B	Vdet-IC	4.2V±2%, +Reset ODO	SC-88A	28ru	VD6	6m	Ric
W043	R3111Q432B	Vdet-IC	4.3V±2%, +Reset ODO	SC-88A	28ru	VD6	6m	Ric
W044	R3111Q442B	Vdet-IC	4.4V±2%, +Reset ODO	SC-88A	28ru	VD6	6m	Ric
W045	R3111Q452B	Vdet-IC	4.5V±2%, +Reset ODO	SC-88A	28ru	VD6	6m	Ric
W046	R3111Q462B	Vdet-IC	4.6V±2%, +Reset ODO	SC-88A	28ru	VD6	6m	Ric
W047	R3111Q472B	Vdet-IC	4.7V±2%, +Reset ODO	SC-88A	28ru	VD6	6m	Ric
W048	R3111Q482B	Vdet-IC	4.8V±2%, +Reset ODO	SC-88A	28ru	VD6	6m	Ric
W049	R3111Q492B	Vdet-IC	4.9V±2%, +Reset ODO	SC-88A	28ru	VD6	6m	Ric
W050	R3111Q502B	Vdet-IC	5.0V±2%, +Reset ODO	SC-88A	28ru	VD6	6m	Ric
W051	R3111Q512B	Vdet-IC	5.1V±2%, +Reset ODO	SC-88A	28ru	VD6	6m	Ric
W052	R3111Q522B	Vdet-IC	5.2V±2%, +Reset ODO	SC-88A	28ru	VD6	6m	Ric
W053	R3111Q532B	Vdet-IC	5.3V±2%, +Reset ODO	SC-88A	28ru	VD6	6m	Ric
W054	R3111Q542B	Vdet-IC	5.4V±2%, +Reset ODO	SC-88A	28ru	VD6	6m	Ric
W055	R3111Q552B	Vdet-IC	5.5V±2%, +Reset ODO	SC-88A	28ru	VD6	6m	Ric
W056	R3111Q562B	Vdet-IC	5.6V±2%, +Reset ODO	SC-88A	28ru	VD6	6m	Ric
W057	R3111Q572B	Vdet-IC	5.7V±2%, +Reset ODO	SC-88A	28ru	VD6	6m	Ric
W058	R3111Q582B	Vdet-IC	5.8V±2%, +Reset ODO	SC-88A	28ru	VD6	6m	Ric
W059	R3111Q592B	Vdet-IC	5.9V±2%, +Reset ODO	SC-88A	28ru	VD6	6m	Ric
W060	R3111Q602B	Vdet-IC	6.0V±2%, +Reset ODO	SC-88A	28ru	VD6	6m	Ric
W0A	R3119N046A	Vdet-IC	4.6V±1.5%, -Reset ODO	SOT-23-5	28z1	VD1	6g	Ric
W0B	R3119N047A	Vdet-IC	4.7V±1.5%, -Reset ODO	SOT-23-5	28z1	VD1	6g	Ric
W0C	R3119N048A	Vdet-IC	4.8V±1.5%, -Reset ODO	SOT-23-5	28z1	VD1	6g	Ric
W0D	R3119N049A	Vdet-IC	4.9V±1.5%, -Reset ODO	SOT-23-5	28z1	VD1	6g	Ric
W0E	R3119N050A	Vdet-IC	5.0V±1.5%, -Reset ODO	SOT-23-5	28z1	VD1	6g	Ric
W0F	R3119N051A	Vdet-IC	5.1V±1.5%, -Reset ODO	SOT-23-5	28z1	VD1	6g	Ric
W0G	R3119N052A	Vdet-IC	5.2V±1.5%, -Reset ODO	SOT-23-5	28z1	VD1	6g	Ric
W0H	R3119N053A	Vdet-IC	5.3V±1.5%, -Reset ODO	SOT-23-5	28z1	VD1	6g	Ric
W0J	R3119N054A	Vdet-IC	5.4V±1.5%, -Reset ODO	SOT-23-5	28z1	VD1	6g	Ric
W0K	R3119N055A	Vdet-IC	5.5V±1.5%, -Reset ODO	SOT-23-5	28z1	VD1	6g	Ric
W0L	R3119N056A	Vdet-IC	5.6V±1.5%, -Reset ODO	SOT-23-5	28z1	VD1	6g	Ric
W0M	R3119N057A	Vdet-IC	5.7V±1.5%, -Reset ODO	SOT-23-5	28z1	VD1	6g	Ric
W0N	R3119N058A	Vdet-IC	5.8V±1.5%, -Reset ODO	SOT-23-5	28z1	VD1	6g	Ric
W0P	R3119N059A	Vdet-IC	5.9V±1.5%, -Reset ODO	SOT-23-5	28z1	VD1	6g	Ric
W0R	R3119N060A	Vdet-IC	6.0V±1.5%, -Reset ODO	SOT-23-5	28z1	VD1	6g	Ric
W0S	R3119N061A	Vdet-IC	6.1V±1.5%, -Reset ODO	SOT-23-5	28z1	VD1	6g	Ric
W0T	R3119N062A	Vdet-IC	6.2V±1.5%, -Reset ODO	SOT-23-5	28z1	VD1	6g	Ric
W0U	R3119N063A	Vdet-IC	6.3V±1.5%, -Reset ODO	SOT-23-5	28z1	VD1	6g	Ric
W0V	R3119N064A	Vdet-IC	6.4V±1.5%, -Reset ODO	SOT-23-5	28z1	VD1	6g	Ric
W0W	R3119N065A	Vdet-IC	6.5V±1.5%, -Reset ODO	SOT-23-5	28z1	VD1	6g	Ric
W0X	R3119N066A	Vdet-IC	6.6V±1.5%, -Reset ODO	SOT-23-5	28z1	VD1	6g	Ric
W0Y	R3119N067A	Vdet-IC	6.7V±1.5%, -Reset ODO	SOT-23-5	28z1	VD1	6g	Ric
W0Z	R3119N068A	Vdet-IC	6.8V±1.5%, -Reset ODO	SOT-23-5	28z1	VD1	6g	Ric
W1	BD46235G	Vdet-IC	2.3V, -Reset PPO, 500ms	SSOP-5	28vdp	VD7	6c	Rhm
W1	FMW1	Si-npn	Dual, GP, 60V, 150mA, 180MHz	SOT-23-5	28/T11	-	6a	Rhm
W1	MC74VHC1GT125DF	CMOS-Logic	Bus buffer gate with 3-state output	SOT-353	28/Log14	-	6b	Ons
W1	MC74VHC1GT125DT	CMOS-Logic	Bus buffer gate with 3-state output	SOT-23-5	28/Log14	-	6b	Ons
W1	R1210N311D	DC/DC-IC	PWM step-up, 3.1V, 180kHz	SOT-23-5	28sc	DC3	6g	Ric
W11	FMW11	Si-npn	Dual, HF, 30V, 50mA, >600MHz	SOT-23-5	28ty	-	6a	Rhm
W13	FMW13	Si-npn	Dual, HF, 30V, 50mA, >900MHz	SOT-23-5	28ty	-	6a	Rhm
W15	R1163N151D	LVR-IC	LDO, 1.5V±1.5%, 150mA, +CE, CL, AE(Mode)	SOT-23-5	28x9	VR10	6g	Ric
W16	R1163N161D	LVR-IC	LDO, 1.6V±1.5%, 150mA, +CE, CL, AE(Mode)	SOT-23-5	28x9	VR10	6g	Ric
W17	R1163N171D	LVR-IC	LDO, 1.7V±1.5%, 150mA, +CE, CL, AE(Mode)	SOT-23-5	28x9	VR10	6g	Ric
W18	R1163N181D	LVR-IC	LDO, 1.8V±1.5%, 150mA, +CE, CL, AE(Mode)	SOT-23-5	28x9	VR10	6g	Ric
W19	R1163N191D	LVR-IC	LDO, 1.9V±1.5%, 150mA, +CE, CL, AE(Mode)	SOT-23-5	28x9	VR10	6g	Ric
W1A	R3119N046E	Vdet-IC	4.6V±1.5%, ±Reset ODO, Sense	SOT-23-5	28z2	VD11	6g	Ric
W1B	R3119N047E	Vdet-IC	4.7V±1.5%, ±Reset ODO, Sense	SOT-23-5	28z2	VD11	6g	Ric
W1C	R3119N048E	Vdet-IC	4.8V±1.5%, ±Reset ODO, Sense	SOT-23-5	28z2	VD11	6g	Ric
W1D	R3119N049E	Vdet-IC	4.9V±1.5%, ±Reset ODO, Sense	SOT-23-5	28z2	VD11	6g	Ric
W1E	R3119N050E	Vdet-IC	5.0V±1.5%, ±Reset ODO, Sense	SOT-23-5	28z2	VD11	6g	Ric
W1F	R3119N051E	Vdet-IC	5.1V±1.5%, ±Reset ODO, Sense	SOT-23-5	28z2	VD11	6g	Ric
W1G	R3119N052E	Vdet-IC	5.2V±1.5%, ±Reset ODO, Sense	SOT-23-5	28z2	VD11	6g	Ric
W1H	R3119N053E	Vdet-IC	5.3V±1.5%, ±Reset ODO, Sense	SOT-23-5	28z2	VD11	6g	Ric
W1J	R3119N054E	Vdet-IC	5.4V±1.5%, ±Reset ODO, Sense	SOT-23-5	28z2	VD11	6g	Ric



SMD code	Type	Function	Short description	Case	Pinout	Sch.	St.	Mnf.
W1K	R3119N055E	Vdet-IC	5.5V±1.5%, ±Reset ODO, Sense	SOT-23-5	28z2	VD11	6g	Ric
W1L	R3119N056E	Vdet-IC	5.6V±1.5%, ±Reset ODO, Sense	SOT-23-5	28z2	VD11	6g	Ric
W1M	R3119N057E	Vdet-IC	5.7V±1.5%, ±Reset ODO, Sense	SOT-23-5	28z2	VD11	6g	Ric
W1N	R3119N058E	Vdet-IC	5.8V±1.5%, ±Reset ODO, Sense	SOT-23-5	28z2	VD11	6g	Ric
W1P	R3119N059E	Vdet-IC	5.9V±1.5%, ±Reset ODO, Sense	SOT-23-5	28z2	VD11	6g	Ric
W1R	R3119N060E	Vdet-IC	6.0V±1.5%, ±Reset ODO, Sense	SOT-23-5	28z2	VD11	6g	Ric
W1S	R3119N061E	Vdet-IC	6.1V±1.5%, ±Reset ODO, Sense	SOT-23-5	28z2	VD11	6g	Ric
W1T	R3119N062E	Vdet-IC	6.2V±1.5%, ±Reset ODO, Sense	SOT-23-5	28z2	VD11	6g	Ric
W1U	R3119N063E	Vdet-IC	6.3V±1.5%, ±Reset ODO, Sense	SOT-23-5	28z2	VD11	6g	Ric
W1V	R3119N064E	Vdet-IC	6.4V±1.5%, ±Reset ODO, Sense	SOT-23-5	28z2	VD11	6g	Ric
W1W	R3119N065E	Vdet-IC	6.5V±1.5%, ±Reset ODO, Sense	SOT-23-5	28z2	VD11	6g	Ric
W1X	R3119N066E	Vdet-IC	6.6V±1.5%, ±Reset ODO, Sense	SOT-23-5	28z2	VD11	6g	Ric
W1Y	R3119N067E	Vdet-IC	6.7V±1.5%, ±Reset ODO, Sense	SOT-23-5	28z2	VD11	6g	Ric
W1Z	R3119N068E	Vdet-IC	6.8V±1.5%, ±Reset ODO, Sense	SOT-23-5	28z2	VD11	6g	Ric
W2	BD46481G	Vdet-IC	4.8V, -Reset PPO, 100ms	SSOP-5	28vdp	VD7	6c	Rhm
W2	FMW2	Si-npn	Dual, GP, 60V, 150mA, 180MHz	SOT-23-5	28ty	-	6a	Rhm
W2	MC74VHC1G126DF	CMOS-Logic	Bus buffer gate with 3-state output	SOT-353	28/Log13	-	6b	Ons
W2	MC74VHC1G126DT	CMOS-Logic	Bus buffer gate with 3-state output	SOT-23-5	28/Log13	-	6b	Ons
W2	R1210N321D	DC/DC-IC	PWM step-up, 3.2V, 180kHz	SOT-23-5	28sc	DC3	6g	Ric
W2-	RT9818C-30PB	Vdet-IC	3.0V±1.5%, -ODO +Reset, Td=220ms	SOT-23-5	28vdm	VD6	6a	Rct
W20	R1163N201D	LVR-IC	LDO, 2V±1.5%, 150mA, +CE, CL, AE(Mode)	SOT-23-5	28x9	VR10	6g	Ric
W20	TK11120S	LVR-IC	LDO, 2V±1.5%, 200mA, -CE	SOT-23-5	28x9	VR7	6k	Tok
W21	R1163N211D	LVR-IC	LDO, 2.1V±1.5%, 150mA, +CE, CL, AE(Mode)	SOT-23-5	28x9	VR10	6g	Ric
W21	TK11121S	LVR-IC	LDO, 2.1V±1.5%, 200mA, -CE	SOT-23-5	28x9	VR7	6k	Tok
W22	R1163N221D	LVR-IC	LDO, 2.2V±1.5%, 150mA, +CE, CL, AE(Mode)	SOT-23-5	28x9	VR10	6g	Ric
W22	TK11122S	LVR-IC	LDO, 2.3V±1.5%, 200mA, -CE	SOT-23-5	28x9	VR7	6k	Tok
W23	R1163N231D	LVR-IC	LDO, 2.3V±1.5%, 150mA, +CE, CL, AE(Mode)	SOT-23-5	28x9	VR10	6g	Ric
W23	TK11123S	LVR-IC	LDO, 2.3V±1.5%, 200mA, -CE	SOT-23-5	28x9	VR7	6k	Tok
W24	R1163N241D	LVR-IC	LDO, 2.4V±1.5%, 150mA, +CE, CL, AE(Mode)	SOT-23-5	28x9	VR10	6g	Ric
W24	TK11124S	LVR-IC	LDO, 2.4V±1.5%, 200mA, -CE	SOT-23-5	28x9	VR7	6k	Tok
W25	R1163N251D	LVR-IC	LDO, 2.5V±1.5%, 150mA, +CE, CL, AE(Mode)	SOT-23-5	28x9	VR10	6g	Ric
W25	TK11125S	LVR-IC	LDO, 2.5V±1.5%, 200mA, -CE	SOT-23-5	28x9	VR7	6k	Tok
W26	R1163N261D	LVR-IC	LDO, 2.6V±1.5%, 150mA, +CE, CL, AE(Mode)	SOT-23-5	28x9	VR10	6g	Ric
W26	TK11126S	LVR-IC	LDO, 2.6V±1.5%, 200mA, -CE	SOT-23-5	28x9	VR7	6k	Tok
W27	R1163N271D	LVR-IC	LDO, 2.7V±1.5%, 150mA, +CE, CL, AE(Mode)	SOT-23-5	28x9	VR10	6g	Ric
W27	TK11127S	LVR-IC	LDO, 2.7V±1.5%, 200mA, -CE	SOT-23-5	28x9	VR7	6k	Tok
W28	R1163N281D	LVR-IC	LDO, 2.8V±1.5%, 150mA, +CE, CL, AE(Mode)	SOT-23-5	28x9	VR10	6g	Ric
W28	TK11128S	LVR-IC	LDO, 2.8V±1.5%, 200mA, -CE	SOT-23-5	28x9	VR7	6k	Tok
W29	R1163N291D	LVR-IC	LDO, 2.9V±1.5%, 150mA, +CE, CL, AE(Mode)	SOT-23-5	28x9	VR10	6g	Ric
W29	TK11129S	LVR-IC	LDO, 2.9V±1.5%, 200mA, -CE	SOT-23-5	28x9	VR7	6k	Tok
W3	BD46471G	Vdet-IC	4.7V, -Reset PPO, 100ms	SSOP-5	28vdp	VD7	6c	Rhm
W3	FMW3	Si-npn	Dual, GP, 120V, 50mA, 140MHz	SOT-23-5	28/T11	-	6a	Rhm
W3	MC74VHC1GT126DF	CMOS-Logic	Bus buffer gate with 3-state output	SOT-353	28/Log13	-	6b	Ons
W3	MC74VHC1GT126DT	CMOS-Logic	Bus buffer gate with 3-state output	SOT-23-5	28/Log13	-	6b	Ons
W3	R1210N331D	DC/DC-IC	PWM step-up, 3.3V, 180kHz	SOT-23-5	28sc	DC3	6g	Ric
W3-	RT9198-24PBR	LVR-IC	LDO, 2.4V±1%, 300mA, +CE	SOT-23-5	28cx	VR4	6a	Rct
W30	R1163N301D	LVR-IC	LDO, 3V±1.5%, 150mA, +CE, CL, AE(Mode)	SOT-23-5	28x9	VR10	6g	Ric
W30	TK11130S	LVR-IC	LDO, 3V±1.5%, 200mA, -CE	SOT-23-5	28x9	VR7	6k	Tok
W31	R1163N311D	LVR-IC	LDO, 3.1V±1.5%, 150mA, +CE, CL, AE(Mode)	SOT-23-5	28x9	VR10	6g	Ric
W31	TK11131S	LVR-IC	LDO, 3.1V±1.5%, 200mA, -CE	SOT-23-5	28x9	VR7	6k	Tok
W32	R1163N321D	LVR-IC	LDO, 3.2V±1.5%, 150mA, +CE, CL, AE(Mode)	SOT-23-5	28x9	VR10	6g	Ric
W32	TK11132S	LVR-IC	LDO, 3.2V±1.5%, 200mA, -CE	SOT-23-5	28x9	VR7	6k	Tok
W33	R1163N331D	LVR-IC	LDO, 3.3V±1.5%, 150mA, +CE, CL, AE(Mode)	SOT-23-5	28x9	VR10	6g	Ric
W33	TK11133S	LVR-IC	LDO, 3.3V±1.5%, 200mA, -CE	SOT-23-5	28x9	VR7	6k	Tok
W34	R1163N341D	LVR-IC	LDO, 3.4V±1.5%, 150mA, +CE, CL, AE(Mode)	SOT-23-5	28x9	VR10	6g	Ric
W34	TK11134S	LVR-IC	LDO, 3.4V±1.5%, 200mA, -CE	SOT-23-5	28x9	VR7	6k	Tok
W35	R1163N351D	LVR-IC	LDO, 3.5V±1.5%, 150mA, +CE, CL, AE(Mode)	SOT-23-5	28x9	VR10	6g	Ric
W35	TK11135S	LVR-IC	LDO, 3.5V±1.5%, 200mA, -CE	SOT-23-5	28x9	VR7	6k	Tok
W36	R1163N361D	LVR-IC	LDO, 3.6V±1.5%, 150mA, +CE, CL, AE(Mode)	SOT-23-5	28x9	VR10	6g	Ric
W36	TK11136S	LVR-IC	LDO, 3.6V±1.5%, 200mA, -CE	SOT-23-5	28x9	VR7	6k	Tok
W37	R1163N371D	LVR-IC	LDO, 3.7V±1.5%, 150mA, +CE, CL, AE(Mode)	SOT-23-5	28x9	VR10	6g	Ric
W37	TK11137S	LVR-IC	LDO, 3.7V±1.5%, 200mA, -CE	SOT-23-5	28x9	VR7	6k	Tok
W38	R1163N381D	LVR-IC	LDO, 3.8V±1.5%, 150mA, +CE, CL, AE(Mode)	SOT-23-5	28x9	VR10	6g	Ric
W38	TK11138S	LVR-IC	LDO, 3.8V±1.5%, 200mA, -CE	SOT-23-5	28x9	VR7	6k	Tok
W39	R1163N391D	LVR-IC	LDO, 3.9V±1.5%, 150mA, +CE, CL, AE(Mode)	SOT-23-5	28x9	VR10	6g	Ric
W39	TK11139S	LVR-IC	LDO, 3.9V±1.5%, 200mA, -CE	SOT-23-5	28x9	VR7	6k	Tok
W4	BD46461G	Vdet-IC	4.6V, -Reset PPO, 100ms	SSOP-5	28vdp	VD7	6c	Rhm
W4	FMW4	Si-npn	Dual, GP, 120V, 50mA, 140MHz	SOT-23-5	28ty	-	6a	Rhm
W4	R1210N341D	DC/DC-IC	PWM step-up, 3.4V, 180kHz	SOT-23-5	28sc	DC3	6g	Ric
W4-	RT9198-26PBR	LVR-IC	LDO, 2.6V±1%, 300mA, +CE	SOT-23-5	28cx	VR4	6a	Rct



SMD code	Type	Function	Short description	Case	Pinout	Sch.	St.	Mnf.
W40	R1163N401D	LVR-IC	LDO, 4V±1.5%, 150mA, +CE, CL, AE(Mode)	SOT-23-5	28x9	VR10	6g	Ric
W40	TK11140S	LVR-IC	LDO, 4V±1.5%, 200mA, -CE	SOT-23-5	28un	VR7	6k	Tok
W41	R1163N181D5	LVR-IC	LDO, 1.85V±1.5%, 150mA, +CE, CL, AE(Mode)	SOT-23-5	28x9	VR10	6g	Ric
W41	TK11141S	LVR-IC	LDO, 4.1V±1.5%, 200mA, -CE	SOT-23-5	28un	VR7	6k	Tok
W42	R1163N281D5	LVR-IC	LDO, 2.85V±1.5%, 150mA, +CE, CL, AE(Mode)	SOT-23-5	28x9	VR10	6g	Ric
W42	TK11142S	LVR-IC	LDO, 4.2V±1.5%, 200mA, -CE	SOT-23-5	28un	VR7	6k	Tok
W43	TK11143S	LVR-IC	LDO, 4.3V±1.5%, 200mA, -CE	SOT-23-5	28un	VR7	6k	Tok
W44	TK11144S	LVR-IC	LDO, 4.4V±1.5%, 200mA, -CE	SOT-23-5	28un	VR7	6k	Tok
W45	TK11145S	LVR-IC	LDO, 4.5V±1.5%, 200mA, -CE	SOT-23-5	28un	VR7	6k	Tok
W46	TK11146S	LVR-IC	LDO, 4.6V±1.5%, 200mA, -CE	SOT-23-5	28un	VR7	6k	Tok
W47	TK11147S	LVR-IC	LDO, 4.7V±1.5%, 200mA, -CE	SOT-23-5	28un	VR7	6k	Tok
W48	TK11148S	LVR-IC	LDO, 4.8V±1.5%, 200mA, -CE	SOT-23-5	28un	VR7	6k	Tok
W49	TK11149S	LVR-IC	LDO, 4.9V±1.5%, 200mA, -CE	SOT-23-5	28un	VR7	6k	Tok
W5	BD46451G	Vdet-IC	4.5V, -Reset PPO, 100ms	SSOP-5	28vdp	VD7	6c	Rhm
W5	FMW5	Si-npn	Dual, GP, 50V, 100mA	SOT-23-5	28/T11	-	6a	Rhm
W5	R1210N351D	DC/DC-IC	PWM step-up, 3.5V, 180kHz	SOT-23-5	28sc	DC3	6g	Ric
W5-	RT9198-27PBR	LVR-IC	LDO, 2.7V±1%, 300mA, +CE	SOT-23-5	28cx	VR4	6a	Rct
W50	TK11150S	LVR-IC	LDO, 5V±1.5%, 200mA, -CE	SOT-23-5	28un	VR7	6k	Tok
W6	BD46441G	Vdet-IC	4.4V, -Reset PPO, 100ms	SSOP-5	28vdp	VD7	6c	Rhm
W6	FMW6	Si-npn	Dual, HF, 30V, 50mA, 300mV, B=27..270, 1.5GHz	SC-74A	28/T18	-	5b	Rhm
W6	R1210N361D	DC/DC-IC	PWM step-up, 3.6V, 180kHz	SOT-23-5	28sc	DC3	6g	Ric
W6	UMW6N	Si-npn	Dual, HF, 30V, 50mA, 150mV, B=27..270, 1.5GHz	SC-88A	28/T18	-	5b	Rhm
W6-	RT9198-1HPBR	LVR-IC	LDO, 1.85V±1%, 300mA, +CE	SOT-23-5	28cx	VR4	6a	Rct
W7	BD46431G	Vdet-IC	4.3V, -Reset PPO, 100ms	SSOP-5	28vdp	VD7	6c	Rhm
W7	R1210N371D	DC/DC-IC	PWM step-up, 3.7V, 180kHz	SOT-23-5	28sc	DC3	6g	Ric
W8	BD46421G	Vdet-IC	4.2V, -Reset PPO, 100ms	SSOP-5	28vdp	VD7	6c	Rhm
W8	FMW8	Si-npn	Dual, HF, 20V, 50mA, >1400MHz	SOT-23-5	28/T11	-	6a	Rhm
W8	R1210N381D	DC/DC-IC	PWM step-up, 3.8V, 180kHz	SOT-23-5	28sc	DC3	6g	Ric
W9	BD46411G	Vdet-IC	4.1V, -Reset PPO, 100ms	SSOP-5	28vdp	VD7	6c	Rhm
W9	FMW9	Si-npn	Dual, HF, 20V, 50mA, >1400MHz	SOT-23-5	28ty	-	6a	Rhm
W9	R1210N391D	DC/DC-IC	PWM step-up, 3.9V, 180kHz	SOT-23-5	28sc	DC3	6g	Ric
W9-	RT9193-17PB	LVR-IC	LDO, 1.7V±1%, 300mA, +CE	SOT-23-5	28vrx	VR7	6g	Rct
WA	BD46401G	Vdet-IC	4V, -Reset PPO, 100ms	SSOP-5	28vdp	VD7	6c	Rhm
WA	R1210N401D	DC/DC-IC	PWM step-up, 4V, 180kHz	SOT-23-5	28sc	DC3	6g	Ric
WA	RN5RK301A	DC/DC-IC	VFM step-up, Vout=3V±1.5%	SOT-23-5	28sc	DC3	6g	Ric
WA-	RT9818A-22PB	Vdet-IC	2.2V±1.5%, -ODO +Reset	SOT-23-5	28vdm	VD6	6a	Rct
WAA	R3117N073A	Vdet-IC	0.7V±15mV, -Reset ODO, Sense	SOT-23-5	28rr	VD11	6g	Ric
WAB	R3117N083A	Vdet-IC	0.8V±15mV, -Reset ODO, Sense	SOT-23-5	28rr	VD11	6g	Ric
WAC	R3117N093A	Vdet-IC	0.9V±15mV, -Reset ODO, Sense	SOT-23-5	28rr	VD11	6g	Ric
WAD	R3117N103A	Vdet-IC	1.0V±15mV, -Reset ODO, Sense	SOT-23-5	28rr	VD11	6g	Ric
WAE	R3117N113A	Vdet-IC	1.1V±15mV, -Reset ODO, Sense	SOT-23-5	28rr	VD11	6g	Ric
WAF	R3117N123A	Vdet-IC	1.2V±15mV, -Reset ODO, Sense	SOT-23-5	28rr	VD11	6g	Ric
WAG	R3117N133A	Vdet-IC	1.3V±15mV, -Reset ODO, Sense	SOT-23-5	28rr	VD11	6g	Ric
WAH	R3117N143A	Vdet-IC	1.4V±15mV, -Reset ODO, Sense	SOT-23-5	28rr	VD11	6g	Ric
WAJ	R3117N153A	Vdet-IC	1.5V±15mV, -Reset ODO, Sense	SOT-23-5	28rr	VD11	6g	Ric
WAK	R3117N163A	Vdet-IC	1.6V±1%, -Reset ODO, Sense	SOT-23-5	28rr	VD11	6g	Ric
WAL	R3117N173A	Vdet-IC	1.7V±1%, -Reset ODO, Sense	SOT-23-5	28rr	VD11	6g	Ric
WAM	R3117N183A	Vdet-IC	1.8V±1%, -Reset ODO, Sense	SOT-23-5	28rr	VD11	6g	Ric
WAN	R3117N193A	Vdet-IC	1.9V±1%, -Reset ODO, Sense	SOT-23-5	28rr	VD11	6g	Ric
WAP	R3117N203A	Vdet-IC	2.0V±1%, -Reset ODO, Sense	SOT-23-5	28rr	VD11	6g	Ric
WAQ	R3117N213A	Vdet-IC	2.1V±1%, -Reset ODO, Sense	SOT-23-5	28rr	VD11	6g	Ric
WAR	R3117N223A	Vdet-IC	2.2V±1%, -Reset ODO, Sense	SOT-23-5	28rr	VD11	6g	Ric
WAS	R3117N233A	Vdet-IC	2.3V±1%, -Reset ODO, Sense	SOT-23-5	28rr	VD11	6g	Ric
WAT	R3117N243A	Vdet-IC	2.4V±1%, -Reset ODO, Sense	SOT-23-5	28rr	VD11	6g	Ric
WAU	R3117N253A	Vdet-IC	2.5V±1%, -Reset ODO, Sense	SOT-23-5	28rr	VD11	6g	Ric
WAV	R3117N263A	Vdet-IC	2.6V±1%, -Reset ODO, Sense	SOT-23-5	28rr	VD11	6g	Ric
WAW	R3117N273A	Vdet-IC	2.7V±1%, -Reset ODO, Sense	SOT-23-5	28rr	VD11	6g	Ric
WAX	R3117N283A	Vdet-IC	2.8V±1%, -Reset ODO, Sense	SOT-23-5	28rr	VD11	6g	Ric
WAY	R3117N293A	Vdet-IC	2.9V±1%, -Reset ODO, Sense	SOT-23-5	28rr	VD11	6g	Ric
WAZ	R3117N303A	Vdet-IC	3.0V±1%, -Reset ODO, Sense	SOT-23-5	28rr	VD11	6g	Ric
WB	BD46391G	Vdet-IC	3.9V, -Reset PPO, 100ms	SSOP-5	28vdp	VD7	6c	Rhm
WB	R1210N411D	DC/DC-IC	PWM step-up, 4.1V, 180kHz	SOT-23-5	28sc	DC3	6g	Ric
WB	RN5RK241A	DC/DC-IC	VFM step-up, Vout=2.4V±1.5%	SOT-23-5	28sc	DC3	6g	Ric
WB-	RT9818A-26PB	Vdet-IC	2.6V±1.5%, -ODO +Reset	SOT-23-5	28vdm	VD6	6a	Rct
WB=	RT9818A-26GB	Vdet-IC	2.6V±1.5%, -ODO +Reset	SOT-23-5	28vdm	VD6	6a	Rct
WBA	R3117N073C	Vdet-IC	0.7V±15mV, -Reset PPO, Sense	SOT-23-5	28rr	VD12	6g	Ric
WBB	R3117N083C	Vdet-IC	0.8V±15mV, -Reset PPO, Sense	SOT-23-5	28rr	VD12	6g	Ric
WBC	R3117N093C	Vdet-IC	0.9V±15mV, -Reset PPO, Sense	SOT-23-5	28rr	VD12	6g	Ric
WBD	R3117N103C	Vdet-IC	1.0V±15mV, -Reset PPO, Sense	SOT-23-5	28rr	VD12	6g	Ric
WBE	R3117N113C	Vdet-IC	1.1V±15mV, -Reset PPO, Sense	SOT-23-5	28rr	VD12	6g	Ric



SMD code	Type	Function	Short description	Case	Pinout	Sch.	St.	Mnf.
WBF	R3117N123C	Vdet-IC	1.2V±15mV, -Reset PPO, Sense	SOT-23-5	28rr	VD12	6g	Ric
WBG	R3117N133C	Vdet-IC	1.3V±15mV, -Reset PPO, Sense	SOT-23-5	28rr	VD12	6g	Ric
WBH	R3117N143C	Vdet-IC	1.4V±15mV, -Reset PPO, Sense	SOT-23-5	28rr	VD12	6g	Ric
WBJ	R3117N153C	Vdet-IC	1.5V±15mV, -Reset PPO, Sense	SOT-23-5	28rr	VD12	6g	Ric
WBK	R3117N163C	Vdet-IC	1.6V±1%, -Reset PPO, Sense	SOT-23-5	28rr	VD12	6g	Ric
WBL	R3117N173C	Vdet-IC	1.7V±1%, -Reset PPO, Sense	SOT-23-5	28rr	VD12	6g	Ric
WBM	R3117N183C	Vdet-IC	1.8V±1%, -Reset PPO, Sense	SOT-23-5	28rr	VD12	6g	Ric
WBN	R3117N193C	Vdet-IC	1.9V±1%, -Reset PPO, Sense	SOT-23-5	28rr	VD12	6g	Ric
WBP	R3117N203C	Vdet-IC	2.0V±1%, -Reset PPO, Sense	SOT-23-5	28rr	VD12	6g	Ric
WBQ	R3117N213C	Vdet-IC	2.1V±1%, -Reset PPO, Sense	SOT-23-5	28rr	VD12	6g	Ric
WBR	R3117N223C	Vdet-IC	2.2V±1%, -Reset PPO, Sense	SOT-23-5	28rr	VD12	6g	Ric
WBS	R3117N233C	Vdet-IC	2.3V±1%, -Reset PPO, Sense	SOT-23-5	28rr	VD12	6g	Ric
WBT	R3117N243C	Vdet-IC	2.4V±1%, -Reset PPO, Sense	SOT-23-5	28rr	VD12	6g	Ric
WBU	R3117N253C	Vdet-IC	2.5V±1%, -Reset PPO, Sense	SOT-23-5	28rr	VD12	6g	Ric
WBV	R3117N263C	Vdet-IC	2.6V±1%, -Reset PPO, Sense	SOT-23-5	28rr	VD12	6g	Ric
WBW	R3117N273C	Vdet-IC	2.7V±1%, -Reset PPO, Sense	SOT-23-5	28rr	VD12	6g	Ric
WBX	R3117N283C	Vdet-IC	2.8V±1%, -Reset PPO, Sense	SOT-23-5	28rr	VD12	6g	Ric
WBY	R3117N293C	Vdet-IC	2.9V±1%, -Reset PPO, Sense	SOT-23-5	28rr	VD12	6g	Ric
WBZ	R3117N303C	Vdet-IC	3.0V±1%, -Reset PPO, Sense	SOT-23-5	28rr	VD12	6g	Ric
WC	BD46381G	Vdet-IC	3.8V, -Reset PPO, 100ms	SSOP-5	28vdp	VD7	6c	Rhm
WC	R1210N421D	DC/DC-IC	PWM step-up, 4.2V, 180kHz	SOT-23-5	28sc	DC3	6g	Ric
WC	RN5RK501A	DC/DC-IC	VFM step-up, Vout=5V±1.5%	SOT-23-5	28sc	DC3	6g	Ric
WD	BD46371G	Vdet-IC	3.7V, -Reset PPO, 100ms	SSOP-5	28vdp	VD7	6c	Rhm
WD	R1210N431D	DC/DC-IC	PWM step-up, 4.3V, 180kHz	SOT-23-5	28sc	DC3	6g	Ric
WD	RN5RK201A	DC/DC-IC	VFM step-up, Vout=2V±1.5%	SOT-23-5	28sc	DC3	6g	Ric
WD-	RT9818C-27PB	Vdet-IC	2.7V±1.5%, -ODO +Reset, Td=220ms	SOT-23-5	28vdm	VD6	6a	Rct
WD=	RT9818C-27GB	Vdet-IC	2.7V±1.5%, -ODO +Reset, Td=220ms	SOT-23-5	28vdm	VD6	6a	Rct
WE	BD46361G	Vdet-IC	3.6V, -Reset PPO, 100ms	SSOP-5	28vdp	VD7	6c	Rhm
WE	R1210N441D	DC/DC-IC	PWM step-up, 4.4V, 180kHz	SOT-23-5	28sc	DC3	6g	Ric
WE	RN5RK251A	DC/DC-IC	VFM step-up, Vout=2.5V±1.5%	SOT-23-5	28sc	DC3	6g	Ric
WE-	RT9013-12PB	LVR-IC	LDO, 1.2V±2%, 500mA, +CE	SOT-23-5	28cx	VR4	6g	Rct
WF	BD46351G	Vdet-IC	3.5V, -Reset PPO, 100ms	SSOP-5	28vdp	VD7	6c	Rhm
WF	R1210N451D	DC/DC-IC	PWM step-up, 4.5V, 180kHz	SOT-23-5	28sc	DC3	6g	Ric
WF	RN5RK331A	DC/DC-IC	VFM step-up, Vout=3.3V±1.5%	SOT-23-5	28sc	DC3	6g	Ric
WF-	RT9013-1BPB	LVR-IC	LDO, 1.25V±2%, 500mA, +CE	SOT-23-5	28cx	VR4	6g	Rct
WG	BD46341G	Vdet-IC	3.4V, -Reset PPO, 100ms	SSOP-5	28vdp	VD7	6c	Rhm
WG	R1210N461D	DC/DC-IC	PWM step-up, 4.6V, 180kHz	SOT-23-5	28sc	DC3	6g	Ric
WG	RN5RK551A	DC/DC-IC	VFM step-up, Vout=5.5V±1.5%	SOT-23-5	28sc	DC3	6g	Ric
WG-	RT9013-15PB	LVR-IC	LDO, 1.5V±2%, 500mA, +CE	SOT-23-5	28cx	VR4	6g	Rct
WG=	RT9013-15GB	LVR-IC	LDO, 1.5V±2%, 500mA, +CE	SOT-23-5	28cx	VR4	6g	Rct
WH	BD46331G	Vdet-IC	3.3V, -Reset PPO, 100ms	SSOP-5	28vdp	VD7	6c	Rhm
WH	R1210N471D	DC/DC-IC	PWM step-up, 4.7V, 180kHz	SOT-23-5	28sc	DC3	6g	Ric
WH	RN5RK221A	DC/DC-IC	VFM step-up, Vout=2.2V±1.5%	SOT-23-5	28sc	DC3	6g	Ric
WH-	RT9013-25PB	LVR-IC	LDO, 2.5V±2%, 500mA, +CE	SOT-23-5	28cx	VR4	6g	Rct
WJ	BD46321G	Vdet-IC	3.2V, -Reset PPO, 100ms	SSOP-5	28vdp	VD7	6c	Rhm
WJ	R1210N481D	DC/DC-IC	PWM step-up, 4.8V, 180kHz	SOT-23-5	28sc	DC3	6g	Ric
WJ	RN5RK271A	DC/DC-IC	VFM step-up, Vout=2.7V±1.5%	SOT-23-5	28sc	DC3	6g	Ric
WJ-	RT9013-33PB	LVR-IC	LDO, 3.3V±2%, 500mA, +CE	SOT-23-5	28cx	VR4	6g	Rct
WJ=	RT9013-33GB	LVR-IC	LDO, 3.3V±2%, 500mA, +CE	SOT-23-5	28cx	VR4	6g	Rct
WK	BD46311G	Vdet-IC	3.1V, -Reset PPO, 100ms	SSOP-5	28vdp	VD7	6c	Rhm
WK	R1210N491D	DC/DC-IC	PWM step-up, 4.9V, 180kHz	SOT-23-5	28sc	DC3	6g	Ric
WK	RN5RK361A	DC/DC-IC	VFM step-up, Vout=3.6V±1.5%	SOT-23-5	28sc	DC3	6g	Ric
WL	BD46301G	Vdet-IC	3V, -Reset PPO, 100ms	SSOP-5	28vdp	VD7	6c	Rhm
WL	RN5RK261A	DC/DC-IC	VFM step-up, Vout=2.6V±1.5%	SOT-23-5	28sc	DC3	6g	Ric
WM	BD46291G	Vdet-IC	2.9V, -Reset PPO, 100ms	SSOP-5	28vdp	VD7	6c	Rhm
WM	R1210N511D	DC/DC-IC	PWM step-up, 5.1V, 180kHz	SOT-23-5	28sc	DC3	6g	Ric
WM	RN5RK281A	DC/DC-IC	VFM step-up, Vout=2.8V±1.5%	SOT-23-5	28sc	DC3	6g	Ric
WM-	RT9198-1HPB	LDO	LDO, 1.85V±1%, 300mA, +CE	SOT-23-5	28xm	VR4	6a	Rct
WN	BD46281G	Vdet-IC	2.8V, -Reset PPO, 100ms	SSOP-5	28vdp	VD7	6c	Rhm
WN	R1210N521D	DC/DC-IC	PWM step-up, 5.2V, 180kHz	SOT-23-5	28sc	DC3	6g	Ric
WN	RN5RK321A	DC/DC-IC	VFM step-up, Vout=3.2V±1.5%	SOT-23-5	28sc	DC3	6g	Ric
WN-	RT9818A-33PB	Vdet-IC	3.3V±1.5%, -ODO +Reset	SOT-23-5	28vdm	VD6	6a	Rct
WP	R1210N531D	DC/DC-IC	PWM step-up, 5.3V, 180kHz	SOT-23-5	28sc	DC3	6g	Ric
WP	RN5RK371A	DC/DC-IC	VFM step-up, Vout=3.7V±1.5%	SOT-23-5	28sc	DC3	6g	Ric
WP-	RT9818A-23PB	Vdet-IC	2.3V±1.5%, -ODO +Reset	SOT-23-5	28vdm	VD6	6a	Rct
WQ	BD46261G	Vdet-IC	2.6V, -Reset PPO, 100ms	SSOP-5	28vdp	VD7	6c	Rhm
WQ	R1210N541D	DC/DC-IC	PWM step-up, 5.4V, 180kHz	SOT-23-5	28sc	DC3	6g	Ric
WQ	RN5RK391A	DC/DC-IC	VFM step-up, Vout=3.9V±1.5%	SOT-23-5	28sc	DC3	6g	Ric
WQ-	RT9818A-25PB	Vdet-IC	2.5V±1.5%, -ODO +Reset	SOT-23-5	28vdm	VD6	6a	Rct
WR	BD46251G	Vdet-IC	2.5V, -Reset PPO, 100ms	SSOP-5	28vdp	VD7	6c	Rhm



SMD code	Type	Function	Short description	Case	Pinout	Sch.	St.	Mnf.
WR	R1210N551D	DC/DC-IC	PWM step-up, 5.5V, 180kHz	SOT-23-5	28sc	DC3	6g	Ric
WR-	RT9818A-27PB	Vdet-IC	2.7V±1.5%, -ODO +Reset	SOT-23-5	28vdm	VD6	6a	Rct
WS	BD46241G	Vdet-IC	2.4V, -Reset PPO, 100ms	SSOP-5	28vdp	VD7	6c	Rhm
WS	R1210N561D	DC/DC-IC	PWM step-up, 5.6V, 180kHz	SOT-23-5	28sc	DC3	6g	Ric
WT	BD46231G	Vdet-IC	2.3V, -Reset PPO, 100ms	SSOP-5	28vdp	VD7	6c	Rhm
WT	R1210N571D	DC/DC-IC	PWM step-up, 5.7V, 180kHz	SOT-23-5	28sc	DC3	6g	Ric
WU	BD46482G	Vdet-IC	4.8V, -Reset PPO, 200ms	SSOP-5	28vdp	VD7	6c	Rhm
WU	R1210N581D	DC/DC-IC	PWM step-up, 5.8V, 180kHz	SOT-23-5	28sc	DC3	6g	Ric
WV	BD46472G	Vdet-IC	4.7V, -Reset PPO, 200ms	SSOP-5	28vdp	VD7	6c	Rhm
WV	R1210N591D	DC/DC-IC	PWM step-up, 5.9V, 180kHz	SOT-23-5	28sc	DC3	6g	Ric
WW	BD46462G	Vdet-IC	4.6V, -Reset PPO, 200ms	SSOP-5	28vdp	VD7	6c	Rhm
WW-	RT9013-30PB	LVR-IC	LDO, 3.0V±2%, 500mA, +CE	SOT-23-5	28cx	VR4	6g	Rct
WX	BD46452G	Vdet-IC	4.5V, -Reset PPO, 200ms	SSOP-5	28vdp	VD7	6c	Rhm
WX-	RT9013-31PB	LVR-IC	LDO, 3.1V±2%, 500mA, +CE	SOT-23-5	28cx	VR4	6g	Rct
WX=	RT9013-31GB	LVR-IC	LDO, 3.1V±2%, 500mA, +CE	SOT-23-5	28cx	VR4	6g	Rct
WY	BD46442G	Vdet-IC	4.4V, -Reset PPO, 200ms	SSOP-5	28vdp	VD7	6c	Rhm
WY-	RT9818A-37PB	Vdet-IC	3.7V±1.5%, -ODO +Reset	SOT-23-5	28vdm	VD6	6a	Rct
WY=	RT9818A-37GB	Vdet-IC	3.7V±1.5%, -ODO +Reset	SOT-23-5	28vdm	VD6	6a	Rct
WZ	BD46432G	Vdet-IC	4.3V, -Reset PPO, 200ms	SSOP-5	28vdp	VD7	6c	Rhm
X0	BD46422G	Vdet-IC	4.2V, -Reset PPO, 200ms	SSOP-5	28vdp	VD7	6c	Rhm
X0-	RT9198T-18PBR	LVR-IC	LDO, 1.5V±1%, 300mA, +CE	SOT-23-5	28xm	VR4	6a	Rct
X00	R1131N181A5	LVR-IC	LDO, 1.85V±2%, 300mA, +CE	SOT-23-5	28cx	VR4	6g	Rct
X009	R3112Q092A	Vdet-IC	0.91V±2%, -Reset PPO	SC-88A	28rv	VD3	6m	Ric
X01	R1131N281A5	LVR-IC	LDO, 2.85V±2%, 300mA, +CE	SOT-23-5	28cx	VR4	6g	Rct
X010	R3112Q102A	Vdet-IC	1.0V±2%, -Reset PPO	SC-88A	28rv	VD3	6m	Ric
X011	R3112Q112A	Vdet-IC	1.1V±2%, -Reset PPO	SC-88A	28rv	VD3	6m	Ric
X012	R3112Q122A	Vdet-IC	1.2V±2%, -Reset PPO	SC-88A	28rv	VD3	6m	Ric
X013	R3112Q132A	Vdet-IC	1.3V±2%, -Reset PPO	SC-88A	28rv	VD3	6m	Ric
X014	R3112Q142A	Vdet-IC	1.4V±2%, -Reset PPO	SC-88A	28rv	VD3	6m	Ric
X015	R3112Q152A	Vdet-IC	1.5V±2%, -Reset PPO	SC-88A	28rv	VD3	6m	Ric
X016	R3112Q162A	Vdet-IC	1.6V±2%, -Reset PPO	SC-88A	28rv	VD3	6m	Ric
X017	R3112Q172A	Vdet-IC	1.7V±2%, -Reset PPO	SC-88A	28rv	VD3	6m	Ric
X018	R3112Q182A	Vdet-IC	1.8V±2%, -Reset PPO	SC-88A	28rv	VD3	6m	Ric
X019	R3112Q192A	Vdet-IC	1.9V±2%, -Reset PPO	SC-88A	28rv	VD3	6m	Ric
X02	R1131N121A5	LVR-IC	LDO, 1.25V±2%, 300mA, +CE	SOT-23-5	28cx	VR4	6g	Rct
X020	R3112Q202A	Vdet-IC	2.0V±2%, -Reset PPO	SC-88A	28rv	VD3	6m	Ric
X021	R3112Q212A	Vdet-IC	2.1V±2%, -Reset PPO	SC-88A	28rv	VD3	6m	Ric
X022	R3112Q222A	Vdet-IC	2.2V±2%, -Reset PPO	SC-88A	28rv	VD3	6m	Ric
X023	R3112Q232A	Vdet-IC	2.3V±2%, -Reset PPO	SC-88A	28rv	VD3	6m	Ric
X024	R3112Q242A	Vdet-IC	2.4V±2%, -Reset PPO	SC-88A	28rv	VD3	6m	Ric
X025	R3112Q252A	Vdet-IC	2.5V±2%, -Reset PPO	SC-88A	28rv	VD3	6m	Ric
X026	R3112Q262A	Vdet-IC	2.6V±2%, -Reset PPO	SC-88A	28rv	VD3	6m	Ric
X027	R3112Q272A	Vdet-IC	2.7V±2%, -Reset PPO	SC-88A	28rv	VD3	6m	Ric
X028	R3112Q282A	Vdet-IC	2.8V±2%, -Reset PPO	SC-88A	28rv	VD3	6m	Ric
X029	R3112Q292A	Vdet-IC	2.9V±2%, -Reset PPO	SC-88A	28rv	VD3	6m	Ric
X030	R3112Q302A	Vdet-IC	3V±2%, -Reset PPO	SC-88A	28rv	VD3	6m	Ric
X031	R3112Q312A	Vdet-IC	3.1V±2%, -Reset PPO	SC-88A	28rv	VD3	6m	Ric
X032	R3112Q322A	Vdet-IC	3.2V±2%, -Reset PPO	SC-88A	28rv	VD3	6m	Ric
X033	R3112Q332A	Vdet-IC	3.3V±2%, -Reset PPO	SC-88A	28rv	VD3	6m	Ric
X034	R3112Q342A	Vdet-IC	3.4V±2%, -Reset PPO	SC-88A	28rv	VD3	6m	Ric
X035	R3112Q352A	Vdet-IC	3.5V±2%, -Reset PPO	SC-88A	28rv	VD3	6m	Ric
X036	R3112Q362A	Vdet-IC	3.6V±2%, -Reset PPO	SC-88A	28rv	VD3	6m	Ric
X037	R3112Q372A	Vdet-IC	3.7V±2%, -Reset PPO	SC-88A	28rv	VD3	6m	Ric
X038	R3112Q382A	Vdet-IC	3.8V±2%, -Reset PPO	SC-88A	28rv	VD3	6m	Ric
X039	R3112Q392A	Vdet-IC	3.9V±2%, -Reset PPO	SC-88A	28rv	VD3	6m	Ric
X040	R3112Q402A	Vdet-IC	4V±2%, -Reset PPO	SC-88A	28rv	VD3	6m	Ric
X041	R3112Q412A	Vdet-IC	4.1V±2%, -Reset PPO	SC-88A	28rv	VD3	6m	Ric
X042	R3112Q422A	Vdet-IC	4.2V±2%, -Reset PPO	SC-88A	28rv	VD3	6m	Ric
X043	R3112Q432A	Vdet-IC	4.3V±2%, -Reset PPO	SC-88A	28rv	VD3	6m	Ric
X044	R3112Q442A	Vdet-IC	4.4V±2%, -Reset PPO	SC-88A	28rv	VD3	6m	Ric
X045	R3112Q452A	Vdet-IC	4.5V±2%, -Reset PPO	SC-88A	28rv	VD3	6m	Ric
X046	R3112Q462A	Vdet-IC	4.6V±2%, -Reset PPO	SC-88A	28rv	VD3	6m	Ric
X047	R3112Q472A	Vdet-IC	4.7V±2%, -Reset PPO	SC-88A	28rv	VD3	6m	Ric
X048	R3112Q482A	Vdet-IC	4.8V±2%, -Reset PPO	SC-88A	28rv	VD3	6m	Ric
X049	R3112Q492A	Vdet-IC	4.9V±2%, -Reset PPO	SC-88A	28rv	VD3	6m	Ric
X050	R3112Q502A	Vdet-IC	5V±2%, -Reset PPO	SC-88A	28rv	VD3	6m	Ric
X08	R1131N081A	LVR-IC	LDO, 0.8V±2%, 300mA, +CE	SOT-23-5	28cx	VR4	6g	Rct
X09	R1131N091A	LVR-IC	LDO, 0.9V±2%, 300mA, +CE	SOT-23-5	28cx	VR4	6g	Rct
X0A	R3119N069A	Vdet-IC	6.9V±1.5%, -Reset ODO	SOT-23-5	28z1	VD1	6g	Ric
X0A	XC6118N30AMR-G	Vdet-IC	3.0V±2%, ±Reset ODO, Sense, hysteresis 5%, Cd	SOT-25	28mg	VD14	6g	Tor



SMD code	Type	Function	Short description	Case	Pinout	Sch.	St.	Mnf.
X0B	R3119N070A	Vdet-IC	7.0V±1.5%, -Reset ODO	SOT-23-5	28z1	VD1	6g	Ric
X0B	XC6118N30BMR-G	Vdet-IC	3.0V±2%, ±Reset ODO, Sense, hysteresis <1%, Cd	SOT-25	28mg	VD14	6g	Tor
X0C	R3119N071A	Vdet-IC	7.1V±1.5%, -Reset ODO	SOT-23-5	28z1	VD1	6g	Ric
X0C	XC6118N30CMR-G	Vdet-IC	3.0V±2%, ±Reset ODO, Sense, hysteresis 5%	SOT-25	28mf	VD11	6g	Tor
X0D	R3119N072A	Vdet-IC	7.2V±1.5%, -Reset ODO	SOT-23-5	28z1	VD1	6g	Ric
X0D	XC6118N30DMR-G	Vdet-IC	3.0V±2%, ±Reset ODO, Sense, hysteresis <1%	SOT-25	28mf	VD11	6g	Tor
X0E	R3119N073A	Vdet-IC	7.3V±1.5%, -Reset ODO	SOT-23-5	28z1	VD1	6g	Ric
X0F	R3119N074A	Vdet-IC	7.4V±1.5%, -Reset ODO	SOT-23-5	28z1	VD1	6g	Ric
X0G	R3119N075A	Vdet-IC	7.5V±1.5%, -Reset ODO	SOT-23-5	28z1	VD1	6g	Ric
X0H	R3119N076A	Vdet-IC	7.6V±1.5%, -Reset ODO	SOT-23-5	28z1	VD1	6g	Ric
X0J	R3119N077A	Vdet-IC	7.7V±1.5%, -Reset ODO	SOT-23-5	28z1	VD1	6g	Ric
X0K	R3119N078A	Vdet-IC	7.8V±1.5%, -Reset ODO	SOT-23-5	28z1	VD1	6g	Ric
X0L	R3119N079A	Vdet-IC	7.9V±1.5%, -Reset ODO	SOT-23-5	28z1	VD1	6g	Ric
X0M	R3119N080A	Vdet-IC	8.0V±1.5%, -Reset ODO	SOT-23-5	28z1	VD1	6g	Ric
X0N	R3119N081A	Vdet-IC	8.1V±1.5%, -Reset ODO	SOT-23-5	28z1	VD1	6g	Ric
X0P	R3119N082A	Vdet-IC	8.2V±1.5%, -Reset ODO	SOT-23-5	28z1	VD1	6g	Ric
X0R	R3119N083A	Vdet-IC	8.3V±1.5%, -Reset ODO	SOT-23-5	28z1	VD1	6g	Ric
X0S	R3119N084A	Vdet-IC	8.4V±1.5%, -Reset ODO	SOT-23-5	28z1	VD1	6g	Ric
X0T	R3119N085A	Vdet-IC	8.5V±1.5%, -Reset ODO	SOT-23-5	28z1	VD1	6g	Ric
X0U	R3119N086A	Vdet-IC	8.6V±1.5%, -Reset ODO	SOT-23-5	28z1	VD1	6g	Ric
X0V	R3119N087A	Vdet-IC	8.7V±1.5%, -Reset ODO	SOT-23-5	28z1	VD1	6g	Ric
X0W	R3119N088A	Vdet-IC	8.8V±1.5%, -Reset ODO	SOT-23-5	28z1	VD1	6g	Ric
X0X	R3119N089A	Vdet-IC	8.9V±1.5%, -Reset ODO	SOT-23-5	28z1	VD1	6g	Ric
X0Y	R3119N090A	Vdet-IC	9.0V±1.5%, -Reset ODO	SOT-23-5	28z1	VD1	6g	Ric
X0Z	R3119N091A	Vdet-IC	9.1V±1.5%, -Reset ODO	SOT-23-5	28z1	VD1	6g	Ric
X1	BD46412G	Vdet-IC	4.1V, -Reset PPO, 200ms	SSOP-5	28vdp	VD7	6c	Rhm
X1-	RT9198T-25PB	LVR-IC	LDO, 2.5V±1%, 300mA, +CE	SOT-23-5	28xm	VR4	6a	Rct
X10	R1131N101A	LVR-IC	LDO, 1V±2%, 300mA, +CE	SOT-23-5	28bc	VR4	6g	Ric
X11	R1131N111A	LVR-IC	LDO, 1.1V±2%, 300mA, +CE	SOT-23-5	28cx	VR4	6g	Ric
X12	R1131N121A	LVR-IC	LDO, 1.2V±2%, 300mA, +CE	SOT-23-5	28cx	VR4	6g	Ric
X13	R1131N131A	LVR-IC	LDO, 1.3V±2%, 300mA, +CE	SOT-23-5	28cx	VR4	6g	Ric
X14	R1131N141A	LVR-IC	LDO, 1.4V±2%, 300mA, +CE	SOT-23-5	28cx	VR4	6g	Ric
X15	R1131N151A	LVR-IC	LDO, 1.5V±2%, 300mA, +CE	SOT-23-5	28cx	VR4	6g	Ric
X15	XC9110D151MR	DC/DC-IC	PFM step-up, 100kHz, 1.5V±2.5%, 400mA, +CE	SOT-25	28sd	DC6	6g	Tor
X16	R1131N161A	LVR-IC	LDO, 1.6V±2%, 300mA, +CE	SOT-23-5	28cx	VR4	6g	Ric
X16	XC9110D161MR	DC/DC-IC	PFM step-up, 100kHz, 1.6V±2.5%, 400mA, +CE	SOT-25	28sd	DC6	6g	Tor
X17	R1131N171A	LVR-IC	LDO, 1.7V±2%, 300mA, +CE	SOT-23-5	28cx	VR4	6g	Ric
X17	XC9110D171MR	DC/DC-IC	PFM step-up, 100kHz, 1.7V±2.5%, 400mA, +CE	SOT-25	28sd	DC6	6g	Tor
X18	R1131N181A	LVR-IC	LDO, 1.8V±2%, 300mA, +CE	SOT-23-5	28cx	VR4	6g	Ric
X18	XC9110D181MR	DC/DC-IC	PFM step-up, 100kHz, 1.8V±2.5%, 400mA, +CE	SOT-25	28sd	DC6	6g	Tor
X19	R1131N191A	LVR-IC	LDO, 1.9V±2%, 300mA, +CE	SOT-23-5	28cx	VR4	6g	Ric
X19	XC9110D191MR	DC/DC-IC	PFM step-up, 100kHz, 1.9V±2.5%, 400mA, +CE	SOT-25	28sd	DC6	6g	Tor
X1A	R3119N069E	Vdet-IC	6.9V±1.5%, ±Reset ODO, Sense	SOT-23-5	28z2	VD11	6g	Ric
X1A	XC6118N31AMR-G	Vdet-IC	3.1V±2%, ±Reset ODO, Sense, hysteresis 5%, Cd	SOT-25	28mg	VD14	6g	Tor
X1B	R3119N070E	Vdet-IC	7.0V±1.5%, ±Reset ODO, Sense	SOT-23-5	28z2	VD11	6g	Ric
X1B	XC6118N31BMR-G	Vdet-IC	3.1V±2%, ±Reset ODO, Sense, hysteresis <1%, Cd	SOT-25	28mg	VD14	6g	Tor
X1C	R3119N071E	Vdet-IC	7.1V±1.5%, ±Reset ODO, Sense	SOT-23-5	28z2	VD11	6g	Ric
X1C	XC6118N31CMR-G	Vdet-IC	3.1V±2%, ±Reset ODO, Sense, hysteresis 5%	SOT-25	28mf	VD11	6g	Tor
X1D	R3119N072E	Vdet-IC	7.2V±1.5%, ±Reset ODO, Sense	SOT-23-5	28z2	VD11	6g	Ric
X1D	XC6118N31DMR-G	Vdet-IC	3.1V±2%, ±Reset ODO, Sense, hysteresis <1%	SOT-25	28mf	VD11	6g	Tor
X1E	R3119N073E	Vdet-IC	7.3V±1.5%, ±Reset ODO, Sense	SOT-23-5	28z2	VD11	6g	Ric
X1F	R3119N074E	Vdet-IC	7.4V±1.5%, ±Reset ODO, Sense	SOT-23-5	28z2	VD11	6g	Ric
X1G	R3119N075E	Vdet-IC	7.5V±1.5%, ±Reset ODO, Sense	SOT-23-5	28z2	VD11	6g	Ric
X1H	R3119N076E	Vdet-IC	7.6V±1.5%, ±Reset ODO, Sense	SOT-23-5	28z2	VD11	6g	Ric
X1J	R3119N077E	Vdet-IC	7.7V±1.5%, ±Reset ODO, Sense	SOT-23-5	28z2	VD11	6g	Ric
X1K	R3119N078E	Vdet-IC	7.8V±1.5%, ±Reset ODO, Sense	SOT-23-5	28z2	VD11	6g	Ric
X1L	R3119N079E	Vdet-IC	7.9V±1.5%, ±Reset ODO, Sense	SOT-23-5	28z2	VD11	6g	Ric
X1M	R3119N080E	Vdet-IC	8.0V±1.5%, ±Reset ODO, Sense	SOT-23-5	28z2	VD11	6g	Ric
X1N	R3119N081E	Vdet-IC	8.1V±1.5%, ±Reset ODO, Sense	SOT-23-5	28z2	VD11	6g	Ric
X1P	R3119N082E	Vdet-IC	8.2V±1.5%, ±Reset ODO, Sense	SOT-23-5	28z2	VD11	6g	Ric
X1R	R3119N083E	Vdet-IC	8.3V±1.5%, ±Reset ODO, Sense	SOT-23-5	28z2	VD11	6g	Ric
X1S	R3119N084E	Vdet-IC	8.4V±1.5%, ±Reset ODO, Sense	SOT-23-5	28z2	VD11	6g	Ric
X1T	R3119N085E	Vdet-IC	8.5V±1.5%, ±Reset ODO, Sense	SOT-23-5	28z2	VD11	6g	Ric
X1U	R3119N086E	Vdet-IC	8.6V±1.5%, ±Reset ODO, Sense	SOT-23-5	28z2	VD11	6g	Ric
X1V	R3119N087E	Vdet-IC	8.7V±1.5%, ±Reset ODO, Sense	SOT-23-5	28z2	VD11	6g	Ric
X1W	R3119N088E	Vdet-IC	8.8V±1.5%, ±Reset ODO, Sense	SOT-23-5	28z2	VD11	6g	Ric
X1X	R3119N089E	Vdet-IC	8.9V±1.5%, ±Reset ODO, Sense	SOT-23-5	28z2	VD11	6g	Ric
X1Y	R3119N090E	Vdet-IC	9.0V±1.5%, ±Reset ODO, Sense	SOT-23-5	28z2	VD11	6g	Ric
X1Z	R3119N091E	Vdet-IC	9.1V±1.5%, ±Reset ODO, Sense	SOT-23-5	28z2	VD11	6g	Ric
X2	BD46402G	Vdet-IC	4V, -Reset PPO, 200ms	SSOP-5	28vdp	VD7	6c	Rhm



SMD code	Type	Function	Short description	Case	Pinout	Sch.	St.	Mnf.
X2	R1210N222C	DC/DC-IC	PWM step-up, 2.1V, 100kHz, +CE, ext, transistor	SOT-23-5	28sd	DC6	6g	Ric
X20	R1131N201A	LVR-IC	LDO, 2V±2%, 300mA, +CE	SOT-23-5	28cx	VR4	6g	Ric
X20	XC9110D201MR	DC/DC-IC	PFM step-up, 100kHz, 2.0V±2.5%, 400mA, +CE	SOT-25	28sd	DC6	6g	Tor
X21	R1131N211A	LVR-IC	LDO, 2.1V±2%, 300mA, +CE	SOT-23-5	28cx	VR4	6g	Ric
X21	XC9110D211MR	DC/DC-IC	PFM step-up, 100kHz, 2.1V±2.5%, 400mA, +CE	SOT-25	28sd	DC6	6g	Tor
X22	R1131N221A	LVR-IC	LDO, 2.2V±2%, 300mA, +CE	SOT-23-5	28cx	VR4	6g	Ric
X22	XC9110D221MR	DC/DC-IC	PFM step-up, 100kHz, 2.2V±2.5%, 400mA, +CE	SOT-25	28sd	DC6	6g	Tor
X23	R1131N231A	LVR-IC	LDO, 2.3V±2%, 300mA, +CE	SOT-23-5	28cx	VR4	6g	Ric
X23	XC9110D231MR	DC/DC-IC	PFM step-up, 100kHz, 2.3V±2.5%, 400mA, +CE	SOT-25	28sd	DC6	6g	Tor
X24	R1131N241A	LVR-IC	LDO, 2.4V±2%, 300mA, +CE	SOT-23-5	28cx	VR4	6g	Ric
X24	XC9110D241MR	DC/DC-IC	PFM step-up, 100kHz, 2.4V±2.5%, 400mA, +CE	SOT-25	28sd	DC6	6g	Tor
X25	R1131N251A	LVR-IC	LDO, 2.5V±2%, 300mA, +CE	SOT-23-5	28cx	VR4	6g	Ric
X25	XC9110D251MR	DC/DC-IC	PFM step-up, 100kHz, 2.5V±2.5%, 400mA, +CE	SOT-25	28sd	DC6	6g	Tor
X26	R1131N261A	LVR-IC	LDO, 2.6V±2%, 300mA, +CE	SOT-23-5	28cx	VR4	6g	Ric
X26	XC9110D261MR	DC/DC-IC	PFM step-up, 100kHz, 2.6V±2.5%, 400mA, +CE	SOT-25	28sd	DC6	6g	Tor
X27	R1131N271A	LVR-IC	LDO, 2.7V±2%, 300mA, +CE	SOT-23-5	28cx	VR4	6g	Ric
X27	XC9110D271MR	DC/DC-IC	PFM step-up, 100kHz, 2.7V±2.5%, 400mA, +CE	SOT-25	28sd	DC6	6g	Tor
X28	R1131N281A	LVR-IC	LDO, 2.8V±2%, 300mA, +CE	SOT-23-5	28cx	VR4	6g	Ric
X28	XC9110D281MR	DC/DC-IC	PFM step-up, 100kHz, 2.8V±2.5%, 400mA, +CE	SOT-25	28sd	DC6	6g	Tor
X29	R1131N291A	LVR-IC	LDO, 2.9V±2%, 300mA, +CE	SOT-23-5	28cx	VR4	6g	Ric
X29	XC9110D291MR	DC/DC-IC	PFM step-up, 100kHz, 2.9V±2.5%, 400mA, +CE	SOT-25	28sd	DC6	6g	Tor
X2A	XC6118N32AMR-G	Vdet-IC	3.2V±2%, ±Reset ODO, Sense, hysteresis 5%, Cd	SOT-25	28mg	VD14	6g	Tor
X2B	XC6118N32BMR-G	Vdet-IC	3.2V±2%, ±Reset ODO, Sense, hysteresis <1%, Cd	SOT-25	28mg	VD14	6g	Tor
X2C	XC6118N32CMR-G	Vdet-IC	3.2V±2%, ±Reset ODO, Sense, hysteresis 5%	SOT-25	28mf	VD11	6g	Tor
X2D	XC6118N32DMR-G	Vdet-IC	3.2V±2%, ±Reset ODO, Sense, hysteresis <1%	SOT-25	28mf	VD11	6g	Tor
X3	BD46392G	Vdet-IC	3.9V, -Reset PPO, 200ms	SSOP-5	28vdp	VD7	6c	Rhm
X3	R1210N232C	DC/DC-IC	PWM step-up, 2.3V, 100kHz, +CE, ext, transistor	SOT-23-5	28sd	DC6	6g	Ric
X30	R1131N301A	LVR-IC	LDO, 3V±2%, 300mA, +CE	SOT-23-5	28cx	VR4	6g	Ric
X30	XC9110D301MR	DC/DC-IC	PFM step-up, 100kHz, 3.0V±2.5%, 400mA, +CE	SOT-25	28sd	DC6	6g	Tor
X31	R1131N311A	LVR-IC	LDO, 3.1V±2%, 300mA, +CE	SOT-23-5	28cx	VR4	6g	Ric
X31	XC9110D311MR	DC/DC-IC	PFM step-up, 100kHz, 3.1V±2.5%, 400mA, +CE	SOT-25	28sd	DC6	6g	Tor
X32	R1131N321A	LVR-IC	LDO, 3.2V±2%, 300mA, +CE	SOT-23-5	28cx	VR4	6g	Ric
X32	XC9110D321MR	DC/DC-IC	PFM step-up, 100kHz, 3.2V±2.5%, 400mA, +CE	SOT-25	28sd	DC6	6g	Tor
X33	R1131N331A	LVR-IC	LDO, 3.3V±2%, 300mA, +CE	SOT-23-5	28cx	VR4	6g	Ric
X33	XC9110D331MR	DC/DC-IC	PFM step-up, 100kHz, 3.3V±2.5%, 400mA, +CE	SOT-25	28sd	DC6	6g	Tor
X34	XC9110D341MR	DC/DC-IC	PFM step-up, 100kHz, 3.4V±2.5%, 400mA, +CE	SOT-25	28sd	DC6	6g	Tor
X35	XC9110D351MR	DC/DC-IC	PFM step-up, 100kHz, 3.5V±2.5%, 400mA, +CE	SOT-25	28sd	DC6	6g	Tor
X36	XC9110D361MR	DC/DC-IC	PFM step-up, 100kHz, 3.6V±2.5%, 400mA, +CE	SOT-25	28sd	DC6	6g	Tor
X37	XC9110D371MR	DC/DC-IC	PFM step-up, 100kHz, 3.7V±2.5%, 400mA, +CE	SOT-25	28sd	DC6	6g	Tor
X38	XC9110D381MR	DC/DC-IC	PFM step-up, 100kHz, 3.8V±2.5%, 400mA, +CE	SOT-25	28sd	DC6	6g	Tor
X39	XC9110D391MR	DC/DC-IC	PFM step-up, 100kHz, 3.9V±2.5%, 400mA, +CE	SOT-25	28sd	DC6	6g	Tor
X3A	XC6118N33AMR-G	Vdet-IC	3.3V±2%, ±Reset ODO, Sense, hysteresis 5%, Cd	SOT-25	28mg	VD14	6g	Tor
X3B	XC6118N33BMR-G	Vdet-IC	3.3V±2%, ±Reset ODO, Sense, hysteresis <1%, Cd	SOT-25	28mg	VD14	6g	Tor
X3C	XC6118N33CMR-G	Vdet-IC	3.3V±2%, ±Reset ODO, Sense, hysteresis 5%	SOT-25	28mf	VD11	6g	Tor
X3D	XC6118N33DMR-G	Vdet-IC	3.3V±2%, ±Reset ODO, Sense, hysteresis <1%	SOT-25	28mf	VD11	6g	Tor
X4	BD46382G	Vdet-IC	3.8V, -Reset PPO, 200ms	SSOP-5	28vdp	VD7	6c	Rhm
X4	R1210N242C	DC/DC-IC	PWM step-up, 2.4V, 100kHz, +CE, ext, transistor	SOT-23-5	28sd	DC6	6g	Ric
X40	R1172N181A5	LVR-IC	LDO, 1.85V±2%, 1A, -CE	SOT-23-5	28vrd	VR4	6g	Ric
X40	XC9110D401MR	DC/DC-IC	PFM step-up, 100kHz, 4.0V±2.5%, 400mA, +CE	SOT-25	28sd	DC6	6g	Tor
X41	R1172N281A5	LVR-IC	LDO, 2.85V±2%, 1A, -CE	SOT-23-5	28vrd	VR4	6g	Ric
X41	XC9110D411MR	DC/DC-IC	PFM step-up, 100kHz, 4.1V±2.5%, 400mA, +CE	SOT-25	28sd	DC6	6g	Tor
X42	XC9110D421MR	DC/DC-IC	PFM step-up, 100kHz, 4.2V±2.5%, 400mA, +CE	SOT-25	28sd	DC6	6g	Tor
X43	XC9110D431MR	DC/DC-IC	PFM step-up, 100kHz, 4.3V±2.5%, 400mA, +CE	SOT-25	28sd	DC6	6g	Tor
X44	XC9110D441MR	DC/DC-IC	PFM step-up, 100kHz, 4.4V±2.5%, 400mA, +CE	SOT-25	28sd	DC6	6g	Tor
X45	XC9110D451MR	DC/DC-IC	PFM step-up, 100kHz, 4.5V±2.5%, 400mA, +CE	SOT-25	28sd	DC6	6g	Tor
X46	XC9110D461MR	DC/DC-IC	PFM step-up, 100kHz, 4.6V±2.5%, 400mA, +CE	SOT-25	28sd	DC6	6g	Tor
X47	XC9110D471MR	DC/DC-IC	PFM step-up, 100kHz, 4.7V±2.5%, 400mA, +CE	SOT-25	28sd	DC6	6g	Tor
X48	R1172N081A	LVR-IC	LDO, 0.8V±2%, 1A, -CE	SOT-23-5	28vrd	VR4	6g	Ric
X48	XC9110D481MR	DC/DC-IC	PFM step-up, 100kHz, 4.8V±2.5%, 400mA, +CE	SOT-25	28sd	DC6	6g	Tor
X49	R1172N091A	LVR-IC	LDO, 0.9V±2%, 1A, -CE	SOT-23-5	28vrd	VR4	6g	Ric
X49	XC9110D491MR	DC/DC-IC	PFM step-up, 100kHz, 4.9V±2.5%, 400mA, +CE	SOT-25	28sd	DC6	6g	Tor
X4A	XC6118N34AMR-G	Vdet-IC	3.4V±2%, ±Reset ODO, Sense, hysteresis 5%, Cd	SOT-25	28mg	VD14	6g	Tor
X4B	XC6118N34BMR-G	Vdet-IC	3.4V±2%, ±Reset ODO, Sense, hysteresis <1%, Cd	SOT-25	28mg	VD14	6g	Tor
X4C	XC6118N34CMR-G	Vdet-IC	3.4V±2%, ±Reset ODO, Sense, hysteresis 5%	SOT-25	28mf	VD11	6g	Tor
X4D	XC6118N34DMR-G	Vdet-IC	3.4V±2%, ±Reset ODO, Sense, hysteresis <1%	SOT-25	28mf	VD11	6g	Tor
X5	BD46372G	Vdet-IC	3.7V, -Reset PPO, 200ms	SSOP-5	28vdp	VD7	6c	Rhm
X5	R1210N252C	DC/DC-IC	PWM step-up, 2.5V, 100kHz, +CE, ext, transistor	SOT-23-5	28sd	DC6	6g	Ric
X50	R1172N101A	LVR-IC	LDO, 1V±2%, 1A, -CE	SOT-23-5	28vrd	VR4	6g	Ric
X50	XC9110D501MR	DC/DC-IC	PFM step-up, 100kHz, 5.0V±2.5%, 400mA, +CE	SOT-25	28sd	DC6	6g	Tor
X51	R1172N111A	LVR-IC	LDO, 1.1V±2%, 1A, -CE	SOT-23-5	28vrd	VR4	6g	Ric



SMD code	Type	Function	Short description	Case	Pinout	Sch.	St.	Mnf.
X51	XC9110D511MR	DC/DC-IC	PFM step-up, 100kHz, 5.1V±2.5%, 400mA, +CE	SOT-25	28sd	DC6	6g	Tor
X52	R1172N121A	LVR-IC	LDO, 1.2V±2%, 1A, -CE	SOT-23-5	28vrd	VR4	6g	Ric
X52	XC9110D521MR	DC/DC-IC	PFM step-up, 100kHz, 5.2V±2.5%, 400mA, +CE	SOT-25	28sd	DC6	6g	Tor
X53	R1172N131A	LVR-IC	LDO, 1.3V±2%, 1A, -CE	SOT-23-5	28vrd	VR4	6g	Ric
X53	XC9110D531MR	DC/DC-IC	PFM step-up, 100kHz, 5.3V±2.5%, 400mA, +CE	SOT-25	28sd	DC6	6g	Tor
X54	R1172N141A	LVR-IC	LDO, 1.4V±2%, 1A, -CE	SOT-23-5	28vrd	VR4	6g	Ric
X54	XC9110D541MR	DC/DC-IC	PFM step-up, 100kHz, 5.4V±2.5%, 400mA, +CE	SOT-25	28sd	DC6	6g	Tor
X55	R1172N151A	LVR-IC	LDO, 1.5V±2%, 1A, -CE	SOT-23-5	28vrd	VR4	6g	Ric
X55	XC9110D551MR	DC/DC-IC	PFM step-up, 100kHz, 5.5V±2.5%, 400mA, +CE	SOT-25	28sd	DC6	6g	Tor
X56	R1172N161A	LVR-IC	LDO, 1.6V±2%, 1A, -CE	SOT-23-5	28vrd	VR4	6g	Ric
X56	XC9110D561MR	DC/DC-IC	PFM step-up, 100kHz, 5.6V±2.5%, 400mA, +CE	SOT-25	28sd	DC6	6g	Tor
X57	R1172N171A	LVR-IC	LDO, 1.7V±2%, 1A, -CE	SOT-23-5	28vrd	VR4	6g	Ric
X57	XC9110D571MR	DC/DC-IC	PFM step-up, 100kHz, 5.7V±2.5%, 400mA, +CE	SOT-25	28sd	DC6	6g	Tor
X58	R1172N181A	LVR-IC	LDO, 1.8V±2%, 1A, -CE	SOT-23-5	28vrd	VR4	6g	Ric
X58	XC9110D581MR	DC/DC-IC	PFM step-up, 100kHz, 5.8V±2.5%, 400mA, +CE	SOT-25	28sd	DC6	6g	Tor
X59	R1172N191A	LVR-IC	LDO, 1.9V±2%, 1A, -CE	SOT-23-5	28vrd	VR4	6g	Ric
X59	XC9110D591MR	DC/DC-IC	PFM step-up, 100kHz, 5.9V±2.5%, 400mA, +CE	SOT-25	28sd	DC6	6g	Tor
X5A	XC6118N35AMR-G	Vdet-IC	3.5V±2%, ±Reset ODO, Sense, hysteresis 5%, Cd	SOT-25	28mg	VD14	6g	Tor
X5B	XC6118N35BMR-G	Vdet-IC	3.5V±2%, ±Reset ODO, Sense, hysteresis <1%, Cd	SOT-25	28mg	VD14	6g	Tor
X5C	XC6118N35CMR-G	Vdet-IC	3.5V±2%, ±Reset ODO, Sense, hysteresis 5%	SOT-25	28mf	VD11	6g	Tor
X5D	XC6118N35DMR-G	Vdet-IC	3.5V±2%, ±Reset ODO, Sense, hysteresis <1%	SOT-25	28mf	VD11	6g	Tor
X6	BD46362G	Vdet-IC	3.6V, -Reset PPO, 200ms	SSOP-5	28vdp	VD7	6c	Rhm
X6	R1210N262C	DC/DC-IC	PWM step-up, 2.6V, 100kHz, +CE, ext, transistor	SOT-23-5	28sd	DC6	6g	Ric
X60	R1172N201A	LVR-IC	LDO, 2V±2%, 1A, -CE	SOT-23-5	28vrd	VR4	6g	Ric
X60	XC9110D601MR	DC/DC-IC	PFM step-up, 100kHz, 6.0V±2.5%, 400mA, +CE	SOT-25	28sd	DC6	6g	Tor
X61	R1172N211A	LVR-IC	LDO, 2.1V±2%, 1A, -CE	SOT-23-5	28vrd	VR4	6g	Ric
X61	XC9110D611MR	DC/DC-IC	PFM step-up, 100kHz, 6.1V±2.5%, 400mA, +CE	SOT-25	28sd	DC6	6g	Tor
X62	R1172N221A	LVR-IC	LDO, 2.2V±2%, 1A, -CE	SOT-23-5	28vrd	VR4	6g	Ric
X62	XC9110D621MR	DC/DC-IC	PFM step-up, 100kHz, 6.2V±2.5%, 400mA, +CE	SOT-25	28sd	DC6	6g	Tor
X63	R1172N231A	LVR-IC	LDO, 2.3V±2%, 1A, -CE	SOT-23-5	28vrd	VR4	6g	Ric
X63	XC9110D631MR	DC/DC-IC	PFM step-up, 100kHz, 6.3V±2.5%, 400mA, +CE	SOT-25	28sd	DC6	6g	Tor
X64	R1172N241A	LVR-IC	LDO, 2.4V±2%, 1A, -CE	SOT-23-5	28vrd	VR4	6g	Ric
X64	XC9110D641MR	DC/DC-IC	PFM step-up, 100kHz, 6.4V±2.5%, 400mA, +CE	SOT-25	28sd	DC6	6g	Tor
X65	R1172N251A	LVR-IC	LDO, 2.5V±2%, 1A, -CE	SOT-23-5	28vrd	VR4	6g	Ric
X65	XC9110D651MR	DC/DC-IC	PFM step-up, 100kHz, 6.5V±2.5%, 400mA, +CE	SOT-25	28sd	DC6	6g	Tor
X66	R1172N261A	LVR-IC	LDO, 2.6V±2%, 1A, -CE	SOT-23-5	28vrd	VR4	6g	Ric
X66	XC9110D661MR	DC/DC-IC	PFM step-up, 100kHz, 6.6V±2.5%, 400mA, +CE	SOT-25	28sd	DC6	6g	Tor
X67	R1172N271A	LVR-IC	LDO, 2.7V±2%, 1A, -CE	SOT-23-5	28vrd	VR4	6g	Ric
X67	XC9110D671MR	DC/DC-IC	PFM step-up, 100kHz, 6.7V±2.5%, 400mA, +CE	SOT-25	28sd	DC6	6g	Tor
X68	R1172N281A	LVR-IC	LDO, 2.8V±2%, 1A, -CE	SOT-23-5	28vrd	VR4	6g	Ric
X68	XC9110D681MR	DC/DC-IC	PFM step-up, 100kHz, 6.8V±2.5%, 400mA, +CE	SOT-25	28sd	DC6	6g	Tor
X69	R1172N291A	LVR-IC	LDO, 2.9V±2%, 1A, -CE	SOT-23-5	28vrd	VR4	6g	Ric
X69	XC9110D691MR	DC/DC-IC	PFM step-up, 100kHz, 6.9V±2.5%, 400mA, +CE	SOT-25	28sd	DC6	6g	Tor
X6A	XC6118N36AMR-G	Vdet-IC	3.6V±2%, ±Reset ODO, Sense, hysteresis 5%, Cd	SOT-25	28mg	VD14	6g	Tor
X6B	XC6118N36BMR-G	Vdet-IC	3.6V±2%, ±Reset ODO, Sense, hysteresis <1%, Cd	SOT-25	28mg	VD14	6g	Tor
X6C	XC6118N36CMR-G	Vdet-IC	3.6V±2%, ±Reset ODO, Sense, hysteresis 5%	SOT-25	28mf	VD11	6g	Tor
X6D	XC6118N36DMR-G	Vdet-IC	3.6V±2%, ±Reset ODO, Sense, hysteresis <1%	SOT-25	28mf	VD11	6g	Tor
X7	BD46352G	Vdet-IC	3.5V, -Reset PPO, 200ms	SSOP-5	28vdp	VD7	6c	Rhm
X7	R1210N272C	DC/DC-IC	PWM step-up, 2.7V, 100kHz, +CE, ext, transistor	SOT-23-5	28sd	DC6	6g	Ric
X70	R1172N301A	LVR-IC	LDO, 3V±2%, 1A, -CE	SOT-23-5	28vrd	VR4	6g	Ric
X70	XC9110D701MR	DC/DC-IC	PFM step-up, 100kHz, 7.0V±2.5%, 400mA, +CE	SOT-25	28sd	DC6	6g	Tor
X71	R1172N311A	LVR-IC	LDO, 3.1V±2%, 1A, -CE	SOT-23-5	28vrd	VR4	6g	Ric
X72	R1172N321A	LVR-IC	LDO, 3.2V±2%, 1A, -CE	SOT-23-5	28vrd	VR4	6g	Ric
X73	R1172N331A	LVR-IC	LDO, 3.3V±2%, 1A, -CE	SOT-23-5	28vrd	VR4	6g	Ric
X74	R1172N341A	LVR-IC	LDO, 3.4V±2%, 1A, -CE, -CE	SOT-23-5	28vrd	VR4	6g	Ric
X75	R1172N351A	LVR-IC	LDO, 3.5V±2%, 1A, -CE	SOT-23-5	28vrd	VR4	6g	Ric
X76	R1172N361A	LVR-IC	LDO, 3.6V±2%, 1A, -CE	SOT-23-5	28vrd	VR4	6g	Ric
X77	R1172N371A	LVR-IC	LDO, 3.7V±2%, 1A, -CE	SOT-23-5	28vrd	VR4	6g	Ric
X78	R1172N381A	LVR-IC	LDO, 3.8V±2%, 1A, -CE	SOT-23-5	28vrd	VR4	6g	Ric
X79	R1172N391A	LVR-IC	LDO, 3.9V±2%, 1A, -CE	SOT-23-5	28vrd	VR4	6g	Ric
X7A	XC6118N37AMR-G	Vdet-IC	3.7V±2%, ±Reset ODO, Sense, hysteresis 5%, Cd	SOT-25	28mg	VD14	6g	Tor
X7B	XC6118N37BMR-G	Vdet-IC	3.7V±2%, ±Reset ODO, Sense, hysteresis <1%, Cd	SOT-25	28mg	VD14	6g	Tor
X7C	XC6118N37CMR-G	Vdet-IC	3.7V±2%, ±Reset ODO, Sense, hysteresis 5%	SOT-25	28mf	VD11	6g	Tor
X7D	XC6118N37DMR-G	Vdet-IC	3.7V±2%, ±Reset ODO, Sense, hysteresis <1%	SOT-25	28mf	VD11	6g	Tor
X8	BD46342G	Vdet-IC	3.4V, -Reset PPO, 200ms	SSOP-5	28vdp	VD7	6c	Rhm
X8	R1210N282C	DC/DC-IC	PWM step-up, 2.8V, 100kHz, +CE, ext, transistor	SOT-23-5	28sd	DC6	6g	Ric
X8-	RT9193-24PB	LVR-IC	LDO, 2.4V±1%, 300mA, +CE	SOT-23-5	28vrx	VR7	6g	Rct
X80	R1172N401A	LVR-IC	LDO, 4V±2%, 1A, -CE	SOT-23-5	28vrd	VR4	6g	Ric
X81	R1172N411A	LVR-IC	LDO, 4.1V±2%, 1A, -CE	SOT-23-5	28vrd	VR4	6g	Ric
X82	R1172N421A	LVR-IC	LDO, 4.2V±2%, 1A, -CE	SOT-23-5	28vrd	VR4	6g	Ric



SMD code	Type	Function	Short description	Case	Pinout	Sch.	St.	Mnf.
X83	R1172N431A	LVR-IC	LDO, 4.3V±2%, 1A, -CE	SOT-23-5	28vrd	VR4	6g	Ric
X84	R1172N441A	LVR-IC	LDO, 4.4V±2%, 1A, -CE	SOT-23-5	28vrd	VR4	6g	Ric
X85	R1172N451A	LVR-IC	LDO, 4.5V±2%, 1A, -CE	SOT-23-5	28vrd	VR4	6g	Ric
X86	R1172N461A	LVR-IC	LDO, 4.6V±2%, 1A, -CE	SOT-23-5	28vrd	VR4	6g	Ric
X87	R1172N471A	LVR-IC	LDO, 4.7V±2%, 1A, -CE	SOT-23-5	28vrd	VR4	6g	Ric
X88	R1172N481A	LVR-IC	LDO, 4.8V±2%, 1A, -CE	SOT-23-5	28vrd	VR4	6g	Ric
X89	R1172N491A	LVR-IC	LDO, 4.9V±2%, 1A, -CE	SOT-23-5	28vrd	VR4	6g	Ric
X8A	XC6118N38AMR-G	Vdet-IC	3.8V±2%, ±Reset ODO, Sense, hysteresis 5%, Cd	SOT-25	28mg	VD14	6g	Tor
X8B	XC6118N38BMR-G	Vdet-IC	3.8V±2%, ±Reset ODO, Sense, hysteresis <1%, Cd	SOT-25	28mg	VD14	6g	Tor
X8C	XC6118N38CMR-G	Vdet-IC	3.8V±2%, ±Reset ODO, Sense, hysteresis 5%	SOT-25	28mf	VD11	6g	Tor
X8D	XC6118N38DMR-G	Vdet-IC	3.8V±2%, ±Reset ODO, Sense, hysteresis <1%	SOT-25	28mf	VD11	6g	Tor
X9	BD46332G	Vdet-IC	3.3V, -Reset PPO, 200ms	SSOP-5	28vdp	VD7	6c	Rhm
X9	R1210N292C	DC/DC-IC	PWM step-up, 2.9V, 100kHz, +CE, ext, transistor	SOT-23-5	28sd	DC6	6g	Ric
X9-	RT9169-16PB	LVR-IC	LDO, 1.6V±2%, 100mA, -CE	SOT-23-5	28cx	VR4	6g	Rct
X90	R1172N501A	LVR-IC	LDO, 5V±2%, 1A, -CE	SOT-23-5	28vrd	VR4	6g	Ric
X9A	XC6118N39AMR-G	Vdet-IC	3.9V±2%, ±Reset ODO, Sense, hysteresis 5%, Cd	SOT-25	28mg	VD14	6g	Tor
X9B	XC6118N39BMR-G	Vdet-IC	3.9V±2%, ±Reset ODO, Sense, hysteresis <1%, Cd	SOT-25	28mg	VD14	6g	Tor
X9C	XC6118N39CMR-G	Vdet-IC	3.9V±2%, ±Reset ODO, Sense, hysteresis 5%	SOT-25	28mf	VD11	6g	Tor
X9D	XC6118N39DMR-G	Vdet-IC	3.9V±2%, ±Reset ODO, Sense, hysteresis <1%	SOT-25	28mf	VD11	6g	Tor
XA	BD46322G	Vdet-IC	3.2V, -Reset PPO, 200ms	SSOP-5	28vdp	VD7	6c	Rhm
XA	R1210N302C	DC/DC-IC	PWM step-up, 3V, 100kHz, +CE, ext, transistor	SOT-23-5	28sd	DC6	6g	Ric
XA	RN1501	Si-npn-Digi	Dual, Sw, 50V, 100mA, 300mW, 250MHz, R1/R2=4k7/4k7	SMV	30/TD6	-	6a	Tos
XA	RN1701	Si-npn-Digi	Dual, Sw, 50V, 100mA, 300mW, 250MHz, R1/R2=4k7/4k7	SOT-353	30/TD6	-	6a	Tos
XA	RN1701JE	Si-npn-Digi	Dual, Sw, 50V, 100mA, 100mW, 250MHz, R1/R2=4k7/4k7	ESV	30/TD6	-	6a	Tos
XA	RN5RK271B	DC/DC-IC	VFM step-up, Vout=2.7V±1.5%	SOT-23-5	28sc	DC3	6g	Ric
XAA	R3117N313A	Vdet-IC	3.1V±1%, -Reset ODO, Sense	SOT-23-5	28rr	VD11	6g	Ric
XAB	R3117N323A	Vdet-IC	3.2V±1%, -Reset ODO, Sense	SOT-23-5	28rr	VD11	6g	Ric
XAC	R3117N333A	Vdet-IC	3.3V±1%, -Reset ODO, Sense	SOT-23-5	28rr	VD11	6g	Ric
XAD	R3117N343A	Vdet-IC	3.4V±1%, -Reset ODO, Sense	SOT-23-5	28rr	VD11	6g	Ric
XAE	R3117N353A	Vdet-IC	3.5V±1%, -Reset ODO, Sense	SOT-23-5	28rr	VD11	6g	Ric
XAF	R3117N363A	Vdet-IC	3.6V±1%, -Reset ODO, Sense	SOT-23-5	28rr	VD11	6g	Ric
XAG	R3117N373A	Vdet-IC	3.7V±1%, -Reset ODO, Sense	SOT-23-5	28rr	VD11	6g	Ric
XAH	R3117N383A	Vdet-IC	3.8V±1%, -Reset ODO, Sense	SOT-23-5	28rr	VD11	6g	Ric
XAJ	R3117N393A	Vdet-IC	3.9V±1%, -Reset ODO, Sense	SOT-23-5	28rr	VD11	6g	Ric
XAK	R3117N403A	Vdet-IC	4.0V±1%, -Reset ODO, Sense	SOT-23-5	28rr	VD11	6g	Ric
XAL	R3117N413A	Vdet-IC	4.1V±1%, -Reset ODO, Sense	SOT-23-5	28rr	VD11	6g	Ric
XAM	R3117N423A	Vdet-IC	4.2V±1%, -Reset ODO, Sense	SOT-23-5	28rr	VD11	6g	Ric
XAN	R3117N433A	Vdet-IC	4.3V±1%, -Reset ODO, Sense	SOT-23-5	28rr	VD11	6g	Ric
XAP	R3117N443A	Vdet-IC	4.4V±1%, -Reset ODO, Sense	SOT-23-5	28rr	VD11	6g	Ric
XAQ	R3117N453A	Vdet-IC	4.5V±1%, -Reset ODO, Sense	SOT-23-5	28rr	VD11	6g	Ric
XAR	R3117N463A	Vdet-IC	4.6V±1%, -Reset ODO, Sense	SOT-23-5	28rr	VD11	6g	Ric
XAS	R3117N473A	Vdet-IC	4.7V±1%, -Reset ODO, Sense	SOT-23-5	28rr	VD11	6g	Ric
XAT	R3117N483A	Vdet-IC	4.8V±1%, -Reset ODO, Sense	SOT-23-5	28rr	VD11	6g	Ric
XAU	R3117N493A	Vdet-IC	4.9V±1%, -Reset ODO, Sense	SOT-23-5	28rr	VD11	6g	Ric
XAV	R3117N503A	Vdet-IC	5.0V±1%, -Reset ODO, Sense	SOT-23-5	28rr	VD11	6g	Ric
XB	4A002MH5	CMOS-Logic	2-input NOR gate	MCPH5	28Log2	-	6a	San
XB	BD46312G	Vdet-IC	3.1V, -Reset PPO, 200ms	SSOP-5	28vdp	VD7	6c	Rhm
XB	R1210N312C	DC/DC-IC	PWM step-up, 3.1V, 100kHz, +CE, ext, transistor	SOT-23-5	28sd	DC6	6g	Ric
XB	RN1502	Si-npn-Digi	Dual, Sw, 50V, 100mA, 300mW, 250MHz, R1/R2=20k/10k	SMV	30/TD6	-	6a	Tos
XB	RN1702	Si-npn-Digi	Dual, Sw, 50V, 100mA, 300mW, 250MHz, R1/R2=20k/10k	SOT-353	30/TD6	-	6a	Tos
XB	RN1702JE	Si-npn-Digi	Dual, Sw, 50V, 100mA, 100mW, 250MHz, R1/R2=20k/10k	ESV	30/TD6	-	6a	Tos
XB	RN5RK201B	DC/DC-IC	VFM step-up, Vout=2V±1.5%	SOT-23-5	28sc	DC3	6g	Ric
XB-	RT9013-18PB	LVR-IC	LDO, 1.8V±2%, 500mA, +CE	SOT-23-5	28cx	VR4	6g	Rct
XBA	R3117N313C	Vdet-IC	3.1V±1%, -Reset PPO, Sense	SOT-23-5	28rr	VD12	6g	Ric
XBB	R3117N323C	Vdet-IC	3.2V±1%, -Reset PPO, Sense	SOT-23-5	28rr	VD12	6g	Ric
XBC	R3117N333C	Vdet-IC	3.3V±1%, -Reset PPO, Sense	SOT-23-5	28rr	VD12	6g	Ric
XBD	R3117N343C	Vdet-IC	3.4V±1%, -Reset PPO, Sense	SOT-23-5	28rr	VD12	6g	Ric
XBE	R3117N353C	Vdet-IC	3.5V±1%, -Reset PPO, Sense	SOT-23-5	28rr	VD12	6g	Ric
XBF	R3117N363C	Vdet-IC	3.6V±1%, -Reset PPO, Sense	SOT-23-5	28rr	VD12	6g	Ric
XBG	R3117N373C	Vdet-IC	3.7V±1%, -Reset PPO, Sense	SOT-23-5	28rr	VD12	6g	Ric
XBH	R3117N383C	Vdet-IC	3.8V±1%, -Reset PPO, Sense	SOT-23-5	28rr	VD12	6g	Ric
XBJ	R3117N393C	Vdet-IC	3.9V±1%, -Reset PPO, Sense	SOT-23-5	28rr	VD12	6g	Ric
XBK	R3117N403C	Vdet-IC	4.0V±1%, -Reset PPO, Sense	SOT-23-5	28rr	VD12	6g	Ric
XBL	R3117N413C	Vdet-IC	4.1V±1%, -Reset PPO, Sense	SOT-23-5	28rr	VD12	6g	Ric
XBM	R3117N423C	Vdet-IC	4.2V±1%, -Reset PPO, Sense	SOT-23-5	28rr	VD12	6g	Ric
XBN	R3117N433C	Vdet-IC	4.3V±1%, -Reset PPO, Sense	SOT-23-5	28rr	VD12	6g	Ric
XBP	R3117N443C	Vdet-IC	4.4V±1%, -Reset PPO, Sense	SOT-23-5	28rr	VD12	6g	Ric
XBQ	R3117N453C	Vdet-IC	4.5V±1%, -Reset PPO, Sense	SOT-23-5	28rr	VD12	6g	Ric
XBR	R3117N463C	Vdet-IC	4.6V±1%, -Reset PPO, Sense	SOT-23-5	28rr	VD12	6g	Ric
XBS	R3117N473C	Vdet-IC	4.7V±1%, -Reset PPO, Sense	SOT-23-5	28rr	VD12	6g	Ric



SMD code	Type	Function	Short description	Case	Pinout	Sch.	St.	Mnf.
XBT	R3117N483C	Vdet-IC	4.8V±1%, -Reset PPO, Sense	SOT-23-5	28rr	VD12	6g	Ric
XBU	R3117N493C	Vdet-IC	4.9V±1%, -Reset PPO, Sense	SOT-23-5	28rr	VD12	6g	Ric
XBV	R3117N503C	Vdet-IC	5.0V±1%, -Reset PPO, Sense	SOT-23-5	28rr	VD12	6g	Ric
XC	4A004MH5	CMOS-Logic	Inverter	MCPH5	28/Log6	-	6a	San
XC	BD46302G	Vdet-IC	3V, -Reset PPO, 200ms	SSOP-5	28vdp	VD7	6c	Rhm
XC	R1210N322C	DC/DC-IC	PWM step-up, 3.2V, 100kHz, +CE, ext, transistor	SOT-23-5	28sd	DC6	6g	Ric
XC	RN1503	Si-npn-Digi	Dual, Sw, 50V, 100mA, 300mW, 250MHz, R1/R2=22k/22k	SMV	30/TD6	-	6a	Tos
XC	RN1703	Si-npn-Digi	Dual, Sw, 50V, 100mA, 300mW, 250MHz, R1/R2=22k/22k	SOT-353	30/TD6	-	6a	Tos
XC	RN1703JE	Si-npn-Digi	Dual, Sw, 50V, 100mA, 100mW, 250MHz, R1/R2=22k/22k	ESV	30/TD6	-	6a	Tos
XC	RN5RK221B	DC/DC-IC	VFM step-up, Vout=2.2V±1.5%	SOT-23-5	28sc	DC3	6g	Ric
XC-	RT9013-1HPB	LVR-IC	LDO, 1.85V±2%, 500mA, +CE	SOT-23-5	28cx	VR4	6g	Rct
XCAT	YB1210ST25R120	LVR-IC	LDO, ULN, 1.2V±2%, 300mA, +CE	SOT-25	28cx	VR7	6a	Ybn
XCBT	YB1210ST25R130	LVR-IC	LDO, ULN, 1.3V±2%, 300mA, +CE	SOT-25	28cx	VR7	6a	Ybn
XCBT	YB1210ST25R140	LVR-IC	LDO, ULN, 1.4V±2%, 300mA, +CE	SOT-25	28cx	VR7	6a	Ybn
XCDT	YB1210ST25R150	LVR-IC	LDO, ULN, 1.5V±2%, 300mA, +CE	SOT-25	28cx	VR7	6a	Ybn
XCET	YB1210ST25R160	LVR-IC	LDO, ULN, 1.6V±2%, 300mA, +CE	SOT-25	28cx	VR7	6a	Ybn
XCGT	YB1210ST25R170	LVR-IC	LDO, ULN, 1.7V±2%, 300mA, +CE	SOT-25	28cx	VR7	6a	Ybn
XCGT	YB1210ST25R180	LVR-IC	LDO, ULN, 1.8V±2%, 300mA, +CE	SOT-25	28cx	VR7	6a	Ybn
XCHT	YB1210ST25R190	LVR-IC	LDO, ULN, 1.9V±2%, 300mA, +CE	SOT-25	28cx	VR7	6a	Ybn
XGJT	YB1210ST25R200	LVR-IC	LDO, ULN, 2.0V±2%, 300mA, +CE	SOT-25	28cx	VR7	6a	Ybn
XGJT	YB1210ST25R210	LVR-IC	LDO, ULN, 2.1V±2%, 300mA, +CE	SOT-25	28cx	VR7	6a	Ybn
XCKT	YB1210ST25R220	LVR-IC	LDO, ULN, 2.2V±2%, 300mA, +CE	SOT-25	28cx	VR7	6a	Ybn
XCLT	YB1210ST25R230	LVR-IC	LDO, ULN, 2.3V±2%, 300mA, +CE	SOT-25	28cx	VR7	6a	Ybn
XGMT	YB1210ST25R240	LVR-IC	LDO, ULN, 2.4V±2%, 300mA, +CE	SOT-25	28cx	VR7	6a	Ybn
XCNT	YB1210ST25R250	LVR-IC	LDO, ULN, 2.5V±2%, 300mA, +CE	SOT-25	28cx	VR7	6a	Ybn
XCOT	YB1210ST25R260	LVR-IC	LDO, ULN, 2.6V±2%, 300mA, +CE	SOT-25	28cx	VR7	6a	Ybn
XCPY	YB1210ST25R270	LVR-IC	LDO, ULN, 2.7V±2%, 300mA, +CE	SOT-25	28cx	VR7	6a	Ybn
XQPT	YB1210ST25R280	LVR-IC	LDO, ULN, 2.8V±2%, 300mA, +CE	SOT-25	28cx	VR7	6a	Ybn
XCRT	YB1210ST25R290	LVR-IC	LDO, ULN, 2.9V±2%, 300mA, +CE	SOT-25	28cx	VR7	6a	Ybn
XGST	YB1210ST25R300	LVR-IC	LDO, ULN, 3.0V±2%, 300mA, +CE	SOT-25	28cx	VR7	6a	Ybn
XCTT	YB1210ST25R310	LVR-IC	LDO, ULN, 3.1V±2%, 300mA, +CE	SOT-25	28cx	VR7	6a	Ybn
XCUY	YB1210ST25R320	LVR-IC	LDO, ULN, 3.2V±2%, 300mA, +CE	SOT-25	28cx	VR7	6a	Ybn
XCVY	YB1210ST25R330	LVR-IC	LDO, ULN, 3.3V±2%, 300mA, +CE	SOT-25	28cx	VR7	6a	Ybn
XGWT	YB1210ST25R340	LVR-IC	LDO, ULN, 3.4V±2%, 300mA, +CE	SOT-25	28cx	VR7	6a	Ybn
XCXT	YB1210ST25R350	LVR-IC	LDO, ULN, 3.5V±2%, 300mA, +CE	SOT-25	28cx	VR7	6a	Ybn
XCYT	YB1210ST25R360	LVR-IC	LDO, ULN, 3.6V±2%, 300mA, +CE	SOT-25	28cx	VR7	6a	Ybn
XD	4A000MH5	CMOS-Logic	2-input NAND gate	MCPH5	28/Log1	-	6a	San
XD	BD46292G	Vdet-IC	2.9V, -Reset PPO, 200ms	SSOP-5	28vdp	VD7	6c	Rhm
XD	R1210N332C	DC/DC-IC	PWM step-up, 3.3V, 100kHz, +CE, ext, transistor	SOT-23-5	28sd	DC6	6g	Ric
XD	RN1504	Si-npn-Digi	Dual, Sw, 50V, 100mA, 300mW, 250MHz, R1/R2=47k/47k	SMV	30/TD6	-	6a	Tos
XD	RN1704	Si-npn-Digi	Dual, Sw, 50V, 100mA, 300mW, 250MHz, R1/R2=47k/47k	SOT-353	30/TD6	-	6a	Tos
XD	RN1704JE	Si-npn-Digi	Dual, Sw, 50V, 100mA, 100mW, 250MHz, R1/R2=47k/47k	ESV	30/TD6	-	6a	Tos
XD	RN5RK251B	DC/DC-IC	VFM step-up, Vout=2.5V±1.5%	SOT-23-5	28sc	DC3	6g	Ric
XD-	RT9013-28PB	LVR-IC	LDO, 2.8V±2%, 500mA, +CE	SOT-23-5	28cx	VR4	6g	Rct
XE	4A032MH5	CMOS-Logic	2-input OR gate	MCPH5	28/Log4	-	6a	San
XE	BD46282G	Vdet-IC	2.8V, -Reset PPO, 200ms	SSOP-5	28vdp	VD7	6c	Rhm
XE	R1210N342C	DC/DC-IC	PWM step-up, 3.4V, 100kHz, +CE, ext, transistor	SOT-23-5	28sd	DC6	6g	Ric
XE	RN1505	Si-npn-Digi	Dual, Sw, 50V, 100mA, 300mW, 250MHz, R1/R2=2k2/47k	SMV	30/TD6	-	6a	Tos
XE	RN1705	Si-npn-Digi	Dual, Sw, 50V, 100mA, 300mW, 250MHz, R1/R2=2k2/47k	SOT-353	30/TD6	-	6a	Tos
XE	RN1705JE	Si-npn-Digi	Dual, Sw, 50V, 100mA, 100mW, 250MHz, R1/R2=2k2/47k	ESV	30/TD6	-	6a	Tos
XE	RN5RK301B	DC/DC-IC	VFM step-up, Vout=3V±1.5%	SOT-23-5	28sc	DC3	6g	Ric
XE-	RT9013-2HPB	LVR-IC	LDO, 2.85V±2%, 500mA, +CE	SOT-23-5	28cx	VR4	6g	Rct
XEAT	YB1230ST25X180	LVR-IC	LDO, 1.8V±2%, 600mA, +CE	SOT-25	28cx	VR7	6a	Ybn
XEBT	YB1230ST25X190	LVR-IC	LDO, 1.9V±2%, 600mA, +CE	SOT-25	28cx	VR7	6a	Ybn
XECT	YB1230ST25X200	LVR-IC	LDO, 2.0V±2%, 600mA, +CE	SOT-25	28cx	VR7	6a	Ybn
XEDT	YB1230ST25X210	LVR-IC	LDO, 2.1V±2%, 600mA, +CE	SOT-25	28cx	VR7	6a	Ybn
XEET	YB1230ST25X220	LVR-IC	LDO, 2.2V±2%, 600mA, +CE	SOT-25	28cx	VR7	6a	Ybn
XEFT	YB1230ST25X230	LVR-IC	LDO, 2.3V±2%, 600mA, +CE	SOT-25	28cx	VR7	6a	Ybn
XEGT	YB1230ST25X240	LVR-IC	LDO, 2.4V±2%, 600mA, +CE	SOT-25	28cx	VR7	6a	Ybn
XEHT	YB1230ST25X250	LVR-IC	LDO, 2.5V±2%, 600mA, +CE	SOT-25	28cx	VR7	6a	Ybn
XEIT	YB1230ST25X260	LVR-IC	LDO, 2.6V±2%, 600mA, +CE	SOT-25	28cx	VR7	6a	Ybn
XEJT	YB1230ST25X270	LVR-IC	LDO, 2.7V±2%, 600mA, +CE	SOT-25	28cx	VR7	6a	Ybn
XEKT	YB1230ST25X280	LVR-IC	LDO, 2.8V±2%, 600mA, +CE	SOT-25	28cx	VR7	6a	Ybn
XELT	YB1230ST25X290	LVR-IC	LDO, 2.9V±2%, 600mA, +CE	SOT-25	28cx	VR7	6a	Ybn
XEMT	YB1230ST25X300	LVR-IC	LDO, 3.0V±2%, 600mA, +CE	SOT-25	28cx	VR7	6a	Ybn
XENT	YB1230ST25X310	LVR-IC	LDO, 3.1V±2%, 600mA, +CE	SOT-25	28cx	VR7	6a	Ybn
XF	4A034MH5	CMOS-Logic	Noninverting buffer	MCPH5	28/Log10	-	6a	San
XF	BD46272G	Vdet-IC	2.7V, -Reset PPO, 200ms	SSOP-5	28vdp	VD7	6c	Rhm
XF	R1210N352C	DC/DC-IC	PWM step-up, 3.5V, 100kHz, +CE, ext, transistor	SOT-23-5	28sd	DC6	6g	Ric
XF	RN1506	Si-npn-Digi	Dual, Sw, 50V, 100mA, 300mW, 250MHz, R1/R2=4k7/47k	SMV	30/TD6	-	6a	Tos



SMD code	Type	Function	Short description	Case	Pinout	Sch.	St.	Mnf.
XF	RN1706	Si-npn-Digi	Dual, Sw, 50V, 100mA, 300mW, 250MHz, R1/R2=4k7/47k	SOT-353	30/TD6	-	6a	Tos
XF	RN1706JE	Si-npn-Digi	Dual, Sw, 50V, 100mA, 300mW, 250MHz, R1/R2=4k7/47k	ESV	30/TD6	-	6a	Tos
XF	RN5RK331B	DC/DC-IC	VFM step-up, Vout=3.3V±1.5%	SOT-23-5	28sc	DC3	6g	Ric
XF-	RT9818C-25PB	Vdet-IC	2.5V±1.5%, -ODO +Reset, Td=220ms	SOT-23-5	28vdm	VD6	6a	Rct
XF=	RT9818C-25GB	Vdet-IC	2.5V±1.5%, -ODO +Reset, Td=220ms	SOT-23-5	28vdm	VD6	6a	Rct
XG	4AM01MH5	CMOS-Logic	Inverter with high side switch (ODO)	MCPH5	28/Log19	-	6a	San
XG	BD46262G	Vdet-IC	2.6V, -Reset PPO, 200ms	SSOP-5	28vdp	VD7	6c	Rhm
XG	R1210N362C	DC/DC-IC	PWM step-up, 3.6V, 100kHz, +CE, ext, transistor	SOT-23-5	28sd	DC6	6g	Ric
XG	RN5RK361B	DC/DC-IC	VFM step-up, Vout=3.6V±1.5%	SOT-23-5	28sc	DC3	6g	Ric
XG-	RT9818C-28PB	Vdet-IC	2.8V±1.5%, -ODO +Reset, Td=220ms	SOT-23-5	28vdm	VD6	6a	Rct
XH	4AM02MH5	CMOS-Logic	Noninverting buffer with high side switch (ODO)	MCPH5	28/Log8	-	6a	San
XH	BD46252G	Vdet-IC	2.5V, -Reset PPO, 200ms	SSOP-5	28vdp	VD7	6c	Rhm
XH	R1210N372C	DC/DC-IC	PWM step-up, 3.7V, 100kHz, +CE, ext, transistor	SOT-23-5	28sd	DC6	6g	Ric
XH	RN1507	Si-npn-Digi	Dual, Sw, 50V, 100mA, 300mW, 250MHz, R1/R2=10k/47k	SMV	30/TD6	-	6a	Tos
XH	RN1707	Si-npn-Digi	Dual, Sw, 50V, 100mA, 300mW, 250MHz, R1/R2=10k/47k	SOT-353	30/TD6	-	6a	Tos
XH	RN1707JE	Si-npn-Digi	Dual, Sw, 50V, 100mA, 300mW, 250MHz, R1/R2=10k/47k	ESV	30/TD6	-	6a	Tos
XH	RN5RK501B	DC/DC-IC	VFM step-up, Vout=5V±1.5%	SOT-23-5	28sc	DC3	6g	Ric
XH-	RT9013-27PB	LVR-IC	LDO, 2.7V±2%, 500mA, +CE	SOT-23-5	28cx	VR4	6g	Rct
XI	RN1508	Si-npn-Digi	Dual, Sw, 50V, 100mA, 300mW, 250MHz, R1/R2=22k/47k	SMV	30/TD6	-	6a	Tos
XI	RN1708	Si-npn-Digi	Dual, Sw, 50V, 100mA, 300mW, 250MHz, R1/R2=22k/47k	SOT-353	30/TD6	-	6a	Tos
XI	RN1708JE	Si-npn-Digi	Dual, Sw, 50V, 100mA, 300mW, 250MHz, R1/R2=22k/47k	ESV	30/TD6	-	6a	Tos
XJ	4AM03MH5	CMOS-Logic	Noninverting buffer (ODO)	MCPH5	28/Log8	-	6a	San
XJ	BD46242G	Vdet-IC	2.4V, -Reset PPO, 200ms	SSOP-5	28vdp	VD7	6c	Rhm
XJ	R1210N382C	DC/DC-IC	PWM step-up, 3.8V, 100kHz, +CE, ext, transistor	SOT-23-5	28sd	DC6	6g	Ric
XJ	RN1509	Si-npn-Digi	Dual, Sw, 50V, 100mA, 300mW, 250MHz, R1/R2=47k/22k	SMV	30/TD6	-	6a	Tos
XJ	RN1709	Si-npn-Digi	Dual, Sw, 50V, 100mA, 300mW, 250MHz, R1/R2=47k/22k	SOT-353	30/TD6	-	6a	Tos
XJ	RN1709JE	Si-npn-Digi	Dual, Sw, 50V, 100mA, 300mW, 250MHz, R1/R2=47k/22k	ESV	30/TD6	-	6a	Tos
XJ	RN5RK551B	DC/DC-IC	VFM step-up, Vout=5.5V±1.5%	SOT-23-5	28sc	DC3	6g	Ric
XJ-	RT9013-20PB	LVR-IC	LDO, 2.0V±2%, 500mA, +CE	SOT-23-5	28cx	VR4	6g	Rct
XJCT	YB1231ST25X320	LVR-IC	LDO, 3.2V±2%, 600mA, +CE	SOT-25	28cx	VR4	6a	Ybn
XJDT	YB1231ST25X330	LVR-IC	LDO, 3.3V±2%, 600mA, +CE	SOT-25	28cx	VR4	6a	Ybn
XJET	YB1231ST25X340	LVR-IC	LDO, 3.4V±2%, 600mA, +CE	SOT-25	28cx	VR4	6a	Ybn
XJFT	YB1231ST25X350	LVR-IC	LDO, 3.5V±2%, 600mA, +CE	SOT-25	28cx	VR4	6a	Ybn
XJGT	YB1231ST25X360	LVR-IC	LDO, 3.6V±2%, 600mA, +CE	SOT-25	28cx	VR4	6a	Ybn
XJHT	YB1231ST25X370	LVR-IC	LDO, 3.7V±2%, 600mA, +CE	SOT-25	28cx	VR4	6a	Ybn
XJIT	YB1231ST25X380	LVR-IC	LDO, 3.8V±2%, 600mA, +CE	SOT-25	28cx	VR4	6a	Ybn
XJJT	YB1231ST25X390	LVR-IC	LDO, 3.9V±2%, 600mA, +CE	SOT-25	28cx	VR4	6a	Ybn
XJKT	YB1231ST25X400	LVR-IC	LDO, 4.0V±2%, 600mA, +CE	SOT-25	28cx	VR4	6a	Ybn
XJLT	YB1231ST25X410	LVR-IC	LDO, 4.1V±2%, 600mA, +CE	SOT-25	28cx	VR4	6a	Ybn
XJMT	YB1231ST25X420	LVR-IC	LDO, 4.2V±2%, 600mA, +CE	SOT-25	28cx	VR4	6a	Ybn
XJNT	YB1231ST25X430	LVR-IC	LDO, 4.3V±2%, 600mA, +CE	SOT-25	28cx	VR4	6a	Ybn
XJOT	YB1231ST25X440	LVR-IC	LDO, 4.4V±2%, 600mA, +CE	SOT-25	28cx	VR4	6a	Ybn
XJPT	YB1231ST25X450	LVR-IC	LDO, 4.5V±2%, 600mA, +CE	SOT-25	28cx	VR4	6a	Ybn
XK	4AM04MH5	CMOS-Logic	Inverter (ODO)	MCPH5	28/Log19	-	6a	San
XK	BD46232G	Vdet-IC	2.3V, -Reset PPO, 200ms	SSOP-5	28vdp	VD7	6c	Rhm
XK	R1210N392C	DC/DC-IC	PWM step-up, 3.9V, 100kHz, +CE, ext, transistor	SOT-23-5	28sd	DC6	6g	Ric
XK	RN1510	Si-npn-Digi	Dual, Sw, 50V, 100mA, 300mW, 250MHz, R1=4k7	SMV	30/TD6	-	6a	Tos
XK	RN1710	Si-npn-Digi	Dual, Sw, 50V, 100mA, 300mW, 250MHz, R1=4k7	SOT-353	30/TD6	-	6a	Tos
XK	RN1710JE	Si-npn-Digi	Dual, Sw, 50V, 100mA, 300mW, 250MHz, R1=4k7	ESV	30/TD6	-	6a	Tos
XK	RN5RK391B	DC/DC-IC	VFM step-up, Vout=3.9V±1.5%	SOT-23-5	28sc	DC3	6g	Ric
XL	R1210N402C	DC/DC-IC	PWM step-up, 4V, 100kHz, +CE, ext, transistor	SOT-23-5	28sd	DC6	6g	Ric
XM	R1210N412C	DC/DC-IC	PWM step-up, 4.1V, 100kHz, +CE, ext, transistor	SOT-23-5	28sd	DC6	6g	Ric
XM	RN1511	Si-npn-Digi	Dual, Sw, 50V, 100mA, 300mW, 250MHz, R1=10k	SMV	30/TD6	-	6a	Tos
XM	RN1711	Si-npn-Digi	Dual, Sw, 50V, 100mA, 300mW, 250MHz, R1=10k	SOT-353	30/TD6	-	6a	Tos
XM	RN1711JE	Si-npn-Digi	Dual, Sw, 50V, 100mA, 300mW, 250MHz, R1=10k	ESV	30/TD6	-	6a	Tos
XN	R1210N422C	DC/DC-IC	PWM step-up, 4.2V, 100kHz, +CE, ext, transistor	SOT-23-5	28sd	DC6	6g	Ric
XN	R1210N432C	DC/DC-IC	PWM step-up, 4.3V, 100kHz, +CE, ext, transistor	SOT-23-5	28sd	DC6	6g	Ric
XQ	R1210N442C	DC/DC-IC	PWM step-up, 4.4V, 100kHz, +CE, ext, transistor	SOT-23-5	28sd	DC6	6g	Ric
XQ=	RT9193-4GGB	LVR-IC	LDO, 4.0V±1%, 300mA, +CE	SOT-23-5	28vrx	VR7	6g	Rct
XR	R1210N452C	DC/DC-IC	PWM step-up, 4.5V, 100kHz, +CE, ext, transistor	SOT-23-5	28sd	DC6	6g	Ric
XS	4A008MH5	CMOS-Logic	2-input AND gate	MCPH5	28/Log3	-	6a	San
XS	R1210N462C	DC/DC-IC	PWM step-up, 4.6V, 100kHz, +CE, ext, transistor	SOT-23-5	28sd	DC6	6g	Ric
XT	R1210N472C	DC/DC-IC	PWM step-up, 4.7V, 100kHz, +CE, ext, transistor	SOT-23-5	28sd	DC6	6g	Ric
XU	R1210N482C	DC/DC-IC	PWM step-up, 4.8V, 100kHz, +CE, ext, transistor	SOT-23-5	28sd	DC6	6g	Ric
XV	R1210N492C	DC/DC-IC	PWM step-up, 4.9V, 100kHz, +CE, ext, transistor	SOT-23-5	28sd	DC6	6g	Ric
XW	R1210N501C	DC/DC-IC	PWM step-up, 5V, 100kHz, +CE, ext, transistor	SOT-23-5	28sd	DC6	6g	Ric
Y*P*	BD46271G	Vdet-IC	2.7V, -Reset PPO, 100ms	SSOP-5	28vdp	VD7	6c	Rhm
Y0	R1210N502C	DC/DC-IC	PWM step-up, 5V, 100kHz, +CE, ext, transistor	SOT-23-5	28sd	DC6	6g	Ric
Y00	R1131N181B5	LVR-IC	LDO, 1.85V±2%, 300mA, -CE	SOT-23-5	28cx	VR4	6g	Ric
Y009	R3112Q092C	Vdet-IC	0.91V±2%, -Reset ODO	SC-88A	28nv	VD1	6m	Ric



SMD code	Type	Function	Short description	Case	Pinout	Sch.	St.Mnf.
Y01	R1131N281B5	LVR-IC	LDO, 2.85V±2%, 300mA, -CE	SOT-23-5	28cx	VR4	6g Ric
Y010	R3112Q102C	Vdet-IC	1.0V±2%, -Reset ODO	SC-88A	28rv	VD1	6m Ric
Y011	R3112Q112C	Vdet-IC	1.1V±2%, -Reset ODO	SC-88A	28rv	VD1	6m Ric
Y012	R3112Q122C	Vdet-IC	1.2V±2%, -Reset ODO	SC-88A	28rv	VD1	6m Ric
Y013	R3112Q132C	Vdet-IC	1.3V±2%, -Reset ODO	SC-88A	28rv	VD1	6m Ric
Y014	R3112Q142C	Vdet-IC	1.4V±2%, -Reset ODO	SC-88A	28rv	VD1	6m Ric
Y015	R3112Q152C	Vdet-IC	1.5V±2%, -Reset ODO	SC-88A	28rv	VD1	6m Ric
Y016	R3112Q162C	Vdet-IC	1.6V±2%, -Reset ODO	SC-88A	28rv	VD1	6m Ric
Y017	R3112Q172C	Vdet-IC	1.7V±2%, -Reset ODO	SC-88A	28rv	VD1	6m Ric
Y018	R3112Q182C	Vdet-IC	1.8V±2%, -Reset ODO	SC-88A	28rv	VD1	6m Ric
Y019	R3112Q192C	Vdet-IC	1.9V±2%, -Reset ODO	SC-88A	28rv	VD1	6m Ric
Y02	R1131N121B5	LVR-IC	LDO, 1.25V±2%, 300mA, -CE	SOT-23-5	28cx	VR4	6g Ric
Y020	R3112Q202C	Vdet-IC	2.0V±2%, -Reset ODO	SC-88A	28rv	VD1	6m Ric
Y021	R3112Q212C	Vdet-IC	2.1V±2%, -Reset ODO	SC-88A	28rv	VD1	6m Ric
Y022	R3112Q222C	Vdet-IC	2.2V±2%, -Reset ODO	SC-88A	28rv	VD1	6m Ric
Y023	R3112Q232C	Vdet-IC	2.3V±2%, -Reset ODO	SC-88A	28rv	VD1	6m Ric
Y024	R3112Q242C	Vdet-IC	2.4V±2%, -Reset ODO	SC-88A	28rv	VD1	6m Ric
Y025	R3112Q252C	Vdet-IC	2.5V±2%, -Reset ODO	SC-88A	28rv	VD1	6m Ric
Y026	R3112Q262C	Vdet-IC	2.6V±2%, -Reset ODO	SC-88A	28rv	VD1	6m Ric
Y027	R3112Q272C	Vdet-IC	2.7V±2%, -Reset ODO	SC-88A	28rv	VD1	6m Ric
Y028	R3112Q282C	Vdet-IC	2.8V±2%, -Reset ODO	SC-88A	28rv	VD1	6m Ric
Y029	R3112Q292C	Vdet-IC	2.9V±2%, -Reset ODO	SC-88A	28rv	VD1	6m Ric
Y030	R3112Q302C	Vdet-IC	3V±2%, -Reset ODO	SC-88A	28rv	VD1	6m Ric
Y031	R3112Q312C	Vdet-IC	3.1V±2%, -Reset ODO	SC-88A	28rv	VD1	6m Ric
Y032	R3112Q322C	Vdet-IC	3.2V±2%, -Reset ODO	SC-88A	28rv	VD1	6m Ric
Y033	R3112Q332C	Vdet-IC	3.3V±2%, -Reset ODO	SC-88A	28rv	VD1	6m Ric
Y034	R3112Q342C	Vdet-IC	3.4V±2%, -Reset ODO	SC-88A	28rv	VD1	6m Ric
Y035	R3112Q352C	Vdet-IC	3.5V±2%, -Reset ODO	SC-88A	28rv	VD1	6m Ric
Y036	R3112Q362C	Vdet-IC	3.6V±2%, -Reset ODO	SC-88A	28rv	VD1	6m Ric
Y037	R3112Q372C	Vdet-IC	3.7V±2%, -Reset ODO	SC-88A	28rv	VD1	6m Ric
Y038	R3112Q382C	Vdet-IC	3.8V±2%, -Reset ODO	SC-88A	28rv	VD1	6m Ric
Y039	R3112Q392C	Vdet-IC	3.9V±2%, -Reset ODO	SC-88A	28rv	VD1	6m Ric
Y040	R3112Q402C	Vdet-IC	4V±2%, -Reset ODO	SC-88A	28rv	VD1	6m Ric
Y041	R3112Q412C	Vdet-IC	4.1V±2%, -Reset ODO	SC-88A	28rv	VD1	6m Ric
Y042	R3112Q422C	Vdet-IC	4.2V±2%, -Reset ODO	SC-88A	28rv	VD1	6m Ric
Y043	R3112Q432C	Vdet-IC	4.3V±2%, -Reset ODO	SC-88A	28rv	VD1	6m Ric
Y044	R3112Q442C	Vdet-IC	4.4V±2%, -Reset ODO	SC-88A	28rv	VD1	6m Ric
Y045	R3112Q452C	Vdet-IC	4.5V±2%, -Reset ODO	SC-88A	28rv	VD1	6m Ric
Y046	R3112Q462C	Vdet-IC	4.6V±2%, -Reset ODO	SC-88A	28rv	VD1	6m Ric
Y047	R3112Q472C	Vdet-IC	4.7V±2%, -Reset ODO	SC-88A	28rv	VD1	6m Ric
Y048	R3112Q482C	Vdet-IC	4.8V±2%, -Reset ODO	SC-88A	28rv	VD1	6m Ric
Y049	R3112Q492C	Vdet-IC	4.9V±2%, -Reset ODO	SC-88A	28rv	VD1	6m Ric
Y050	R3112Q502C	Vdet-IC	5V±2%, -Reset ODO	SC-88A	28rv	VD1	6m Ric
Y08	R1131N081B	LVR-IC	LDO, 0.8V±2%, 300mA, -CE	SOT-23-5	28cx	VR4	6g Ric
Y09	R1131N091B	LVR-IC	LDO, 0.9V±2%, 300mA, -CE	SOT-23-5	28cx	VR4	6g Ric
Y0A	R3119N092A	Vdet-IC	9.2V±1.5%, -Reset ODO	SOT-23-5	28z1	VD1	6g Ric
Y0A	XC6118N40AMR-G	Vdet-IC	4.0V±2%, ±Reset ODO, Sense, hysteresis 5%, Cd	SOT-25	28mg	VD14	6g Tor
Y0B	R3119N093A	Vdet-IC	9.3V±1.5%, -Reset ODO	SOT-23-5	28z1	VD1	6g Ric
Y0B	XC6118N40BMR-G	Vdet-IC	4.0V±2%, ±Reset ODO, Sense, hysteresis <1%, Cd	SOT-25	28mg	VD14	6g Tor
Y0C	R3119N094A	Vdet-IC	9.4V±1.5%, -Reset ODO	SOT-23-5	28z1	VD1	6g Ric
Y0C	XC6118N40CMR-G	Vdet-IC	4.0V±2%, ±Reset ODO, Sense, hysteresis 5%	SOT-25	28mf	VD11	6g Tor
Y0D	R3119N095A	Vdet-IC	9.5V±1.5%, -Reset ODO	SOT-23-5	28z1	VD1	6g Ric
Y0D	XC6118N40DMR-G	Vdet-IC	4.0V±2%, ±Reset ODO, Sense, hysteresis <1%	SOT-25	28mf	VD11	6g Tor
Y0E	R3119N096A	Vdet-IC	9.6V±1.5%, -Reset ODO	SOT-23-5	28z1	VD1	6g Ric
Y0F	R3119N097A	Vdet-IC	9.7V±1.5%, -Reset ODO	SOT-23-5	28z1	VD1	6g Ric
Y0G	R3119N098A	Vdet-IC	9.8V±1.5%, -Reset ODO	SOT-23-5	28z1	VD1	6g Ric
Y0H	R3119N099A	Vdet-IC	9.9V±1.5%, -Reset ODO	SOT-23-5	28z1	VD1	6g Ric
Y0J	R3119N100A	Vdet-IC	10.0V±1.5%, -Reset ODO	SOT-23-5	28z1	VD1	6g Ric
Y0K	R3119N101A	Vdet-IC	10.1V±1.5%, -Reset ODO	SOT-23-5	28z1	VD1	6g Ric
Y0L	R3119N102A	Vdet-IC	10.2V±1.5%, -Reset ODO	SOT-23-5	28z1	VD1	6g Ric
Y0M	R3119N103A	Vdet-IC	10.3V±1.5%, -Reset ODO	SOT-23-5	28z1	VD1	6g Ric
Y0N	R3119N104A	Vdet-IC	10.4V±1.5%, -Reset ODO	SOT-23-5	28z1	VD1	6g Ric
Y0P	R3119N105A	Vdet-IC	10.5V±1.5%, -Reset ODO	SOT-23-5	28z1	VD1	6g Ric
Y0R	R3119N106A	Vdet-IC	10.6V±1.5%, -Reset ODO	SOT-23-5	28z1	VD1	6g Ric
Y0S	R3119N107A	Vdet-IC	10.7V±1.5%, -Reset ODO	SOT-23-5	28z1	VD1	6g Ric
Y0T	R3119N108A	Vdet-IC	10.8V±1.5%, -Reset ODO	SOT-23-5	28z1	VD1	6g Ric
Y0U	R3119N109A	Vdet-IC	10.9V±1.5%, -Reset ODO	SOT-23-5	28z1	VD1	6g Ric
Y0V	R3119N110A	Vdet-IC	11.0V±1.5%, -Reset ODO	SOT-23-5	28z1	VD1	6g Ric
Y0W	R3119N111A	Vdet-IC	11.1V±1.5%, -Reset ODO	SOT-23-5	28z1	VD1	6g Ric
Y0X	R3119N112A	Vdet-IC	11.2V±1.5%, -Reset ODO	SOT-23-5	28z1	VD1	6g Ric



SMD code	Type	Function	Short description	Case	Pinout	Sch.	St.	Mnf.
Y0Y	R3119N113A	Vdet-IC	11.3V±1.5%, -Reset ODO	SOT-23-5	28z1	VD1	6g	Ric
Y0Z	R3119N114A	Vdet-IC	11.4V±1.5%, -Reset ODO	SOT-23-5	28z1	VD1	6g	Ric
Y1	R1210N512C	DC/DC-IC	PWM step-up, 5.1V, 100kHz, +CE, ext, transistor	SOT-23-5	28sd	DC6	6g	Ric
Y10	R1131N101B	LVR-IC	LDO, 1V±2%, 300mA, -CE	SOT-23-5	28cx	VR4	6g	Ric
Y11	R1131N111B	LVR-IC	LDO, 1.1V±2%, 300mA, -CE	SOT-23-5	28cx	VR4	6g	Ric
Y12	R1131N121B	LVR-IC	LDO, 1.2V±2%, 300mA, -CE	SOT-23-5	28cx	VR4	6g	Ric
Y13	R1131N131B	LVR-IC	LDO, 1.3V±2%, 300mA, -CE	SOT-23-5	28cx	VR4	6g	Ric
Y14	R1131N141B	LVR-IC	LDO, 1.4V±2%, 300mA, -CE	SOT-23-5	28cx	VR4	6g	Ric
Y15	R1131N151B	LVR-IC	LDO, 1.5V±2%, 300mA, -CE	SOT-23-5	28cx	VR4	6g	Ric
Y15	XC9110E151MR	DC/DC-IC	PFM step-up, 100kHz, 1.5V±2.5%, 400mA	SOT-25	28sx	DC4	6g	Tor
Y16	R1131N161B	LVR-IC	LDO, 1.6V±2%, 300mA, -CE	SOT-23-5	28cx	VR4	6g	Ric
Y16	XC9110E161MR	DC/DC-IC	PFM step-up, 100kHz, 1.6V±2.5%, 400mA	SOT-25	28cx	DC4	6g	Tor
Y17	R1131N171B	LVR-IC	LDO, 1.7V±2%, 300mA, -CE	SOT-23-5	28cx	VR4	6g	Ric
Y17	XC9110E171MR	DC/DC-IC	PFM step-up, 100kHz, 1.7V±2.5%, 400mA	SOT-25	28sx	DC4	6g	Tor
Y18	R1131N181B	LVR-IC	LDO, 1.8V±2%, 300mA, -CE	SOT-23-5	28cx	VR4	6g	Ric
Y18	XC9110E181MR	DC/DC-IC	PFM step-up, 100kHz, 1.8V±2.5%, 400mA	SOT-25	28sx	DC4	6g	Tor
Y19	R1131N191B	LVR-IC	LDO, 1.9V±2%, 300mA, -CE	SOT-23-5	28cx	VR4	6g	Ric
Y19	XC9110E191MR	DC/DC-IC	PFM step-up, 100kHz, 1.9V±2.5%, 400mA	SOT-25	28sx	DC4	6g	Tor
Y1A	R3119N092E	Vdet-IC	9.2V±1.5%, ±Reset ODO, Sense	SOT-23-5	28z2	VD11	6g	Ric
Y1A	XC6118N41AMR-G	Vdet-IC	4.1V±2%, ±Reset ODO, Sense, hysteresis 5%, Cd	SOT-25	28mg	VD14	6g	Tor
Y1B	R3119N093E	Vdet-IC	9.3V±1.5%, ±Reset ODO, Sense	SOT-23-5	28z2	VD11	6g	Ric
Y1B	XC6118N41BMR-G	Vdet-IC	4.1V±2%, ±Reset ODO, Sense, hysteresis <1%, Cd	SOT-25	28mg	VD14	6g	Tor
Y1C	R3119N094E	Vdet-IC	9.4V±1.5%, ±Reset ODO, Sense	SOT-23-5	28z2	VD11	6g	Ric
Y1C	XC6118N41CMR-G	Vdet-IC	4.1V±2%, ±Reset ODO, Sense, hysteresis 5%	SOT-25	28mf	VD11	6g	Tor
Y1D	R3119N095E	Vdet-IC	9.5V±1.5%, ±Reset ODO, Sense	SOT-23-5	28z2	VD11	6g	Ric
Y1D	XC6118N41DMR-G	Vdet-IC	4.1V±2%, ±Reset ODO, Sense, hysteresis <1%	SOT-25	28mf	VD11	6g	Tor
Y1E	R3119N096E	Vdet-IC	9.6V±1.5%, ±Reset ODO, Sense	SOT-23-5	28z2	VD11	6g	Ric
Y1F	R3119N097E	Vdet-IC	9.7V±1.5%, ±Reset ODO, Sense	SOT-23-5	28z2	VD11	6g	Ric
Y1G	R3119N098E	Vdet-IC	9.8V±1.5%, ±Reset ODO, Sense	SOT-23-5	28z2	VD11	6g	Ric
Y1H	R3119N099E	Vdet-IC	9.9V±1.5%, ±Reset ODO, Sense	SOT-23-5	28z2	VD11	6g	Ric
Y1J	R3119N100E	Vdet-IC	10.0V±1.5%, ±Reset ODO, Sense	SOT-23-5	28z2	VD11	6g	Ric
Y1K	R3119N101E	Vdet-IC	10.1V±1.5%, ±Reset ODO, Sense	SOT-23-5	28z2	VD11	6g	Ric
Y1L	R3119N102E	Vdet-IC	10.2V±1.5%, ±Reset ODO, Sense	SOT-23-5	28z2	VD11	6g	Ric
Y1M	R3119N103E	Vdet-IC	10.3V±1.5%, ±Reset ODO, Sense	SOT-23-5	28z2	VD11	6g	Ric
Y1N	R3119N104E	Vdet-IC	10.4V±1.5%, ±Reset ODO, Sense	SOT-23-5	28z2	VD11	6g	Ric
Y1P	R3119N105E	Vdet-IC	10.5V±1.5%, ±Reset ODO, Sense	SOT-23-5	28z2	VD11	6g	Ric
Y1R	R3119N106E	Vdet-IC	10.6V±1.5%, ±Reset ODO, Sense	SOT-23-5	28z2	VD11	6g	Ric
Y1S	R3119N107E	Vdet-IC	10.7V±1.5%, ±Reset ODO, Sense	SOT-23-5	28z2	VD11	6g	Ric
Y1T	R3119N108E	Vdet-IC	10.8V±1.5%, ±Reset ODO, Sense	SOT-23-5	28z2	VD11	6g	Ric
Y1U	R3119N109E	Vdet-IC	10.9V±1.5%, ±Reset ODO, Sense	SOT-23-5	28z2	VD11	6g	Ric
Y1V	R3119N110E	Vdet-IC	11.0V±1.5%, ±Reset ODO, Sense	SOT-23-5	28z2	VD11	6g	Ric
Y1W	R3119N111E	Vdet-IC	11.1V±1.5%, ±Reset ODO, Sense	SOT-23-5	28z2	VD11	6g	Ric
Y1X	R3119N112E	Vdet-IC	11.2V±1.5%, ±Reset ODO, Sense	SOT-23-5	28z2	VD11	6g	Ric
Y1Y	R3119N113E	Vdet-IC	11.3V±1.5%, ±Reset ODO, Sense	SOT-23-5	28z2	VD11	6g	Ric
Y1Z	R3119N114E	Vdet-IC	11.4V±1.5%, ±Reset ODO, Sense	SOT-23-5	28z2	VD11	6g	Ric
Y2	R1210N522C	DC/DC-IC	PWM step-up, 5.2V, 100kHz, +CE, ext, transistor	SOT-23-5	28sd	DC6	6g	Ric
Y20	R1131N201B	LVR-IC	LDO, 2V±2%, 300mA, -CE	SOT-23-5	28cx	VR4	6g	Ric
Y20	XC9110E201MR	DC/DC-IC	PFM step-up, 100kHz, 2.0V±2.5%, 400mA	SOT-25	28sx	DC4	6g	Tor
Y21	R1131N211B	LVR-IC	LDO, 2.1V±2%, 300mA, -CE	SOT-23-5	28cx	VR4	6g	Ric
Y21	XC9110E211MR	DC/DC-IC	PFM step-up, 100kHz, 2.1V±2.5%, 400mA	SOT-25	28sx	DC4	6g	Tor
Y22	R1131N221B	LVR-IC	LDO, 2.2V±2%, 300mA, -CE	SOT-23-5	28cx	VR4	6g	Ric
Y22	XC9110E221MR	DC/DC-IC	PFM step-up, 100kHz, 2.2V±2.5%, 400mA	SOT-25	28sx	DC4	6g	Tor
Y23	R1131N231B	LVR-IC	LDO, 2.3V±2%, 300mA, -CE	SOT-23-5	28cx	VR4	6g	Ric
Y23	XC9110E231MR	DC/DC-IC	PFM step-up, 100kHz, 2.3V±2.5%, 400mA	SOT-25	28sx	DC4	6g	Tor
Y24	R1131N241B	LVR-IC	LDO, 2.4V±2%, 300mA, -CE	SOT-23-5	28cx	VR4	6g	Ric
Y24	XC9110E241MR	DC/DC-IC	PFM step-up, 100kHz, 2.4V±2.5%, 400mA	SOT-25	28sx	DC4	6g	Tor
Y25	R1131N251B	LVR-IC	LDO, 2.5V±2%, 300mA, -CE	SOT-23-5	28cx	VR4	6g	Ric
Y25	XC9110E251MR	DC/DC-IC	PFM step-up, 100kHz, 2.5V±2.5%, 400mA	SOT-25	28sx	DC4	6g	Tor
Y26	R1131N261B	LVR-IC	LDO, 2.6V±2%, 300mA, -CE	SOT-23-5	28cx	VR4	6g	Ric
Y26	XC9110E261MR	DC/DC-IC	PFM step-up, 100kHz, 2.6V±2.5%, 400mA	SOT-25	28sx	DC4	6g	Tor
Y27	R1131N271B	LVR-IC	LDO, 2.7V±2%, 300mA, -CE	SOT-23-5	28cx	VR4	6g	Ric
Y27	XC9110E271MR	DC/DC-IC	PFM step-up, 100kHz, 2.7V±2.5%, 400mA	SOT-25	28sx	DC4	6g	Tor
Y28	R1131N281B	LVR-IC	LDO, 2.8V±2%, 300mA, -CE	SOT-23-5	28cx	VR4	6g	Ric
Y28	XC9110E281MR	DC/DC-IC	PFM step-up, 100kHz, 2.8V±2.5%, 400mA	SOT-25	28sx	DC4	6g	Tor
Y29	R1131N291B	LVR-IC	LDO, 2.9V±2%, 300mA, -CE	SOT-23-5	28cx	VR4	6g	Ric
Y29	XC9110E291MR	DC/DC-IC	PFM step-up, 100kHz, 2.9V±2.5%, 400mA	SOT-25	28sx	DC4	6g	Tor
Y2A	XC6118N42AMR-G	Vdet-IC	4.2V±2%, ±Reset ODO, Sense, hysteresis 5%, Cd	SOT-25	28mg	VD14	6g	Tor
Y2B	XC6118N42BMR-G	Vdet-IC	4.2V±2%, ±Reset ODO, Sense, hysteresis <1%, Cd	SOT-25	28mg	VD14	6g	Tor
Y2C	XC6118N42CMR-G	Vdet-IC	4.2V±2%, ±Reset ODO, Sense, hysteresis 5%	SOT-25	28mf	VD11	6g	Tor
Y2D	XC6118N42DMR-G	Vdet-IC	4.2V±2%, ±Reset ODO, Sense, hysteresis <1%	SOT-25	28mf	VD11	6g	Tor



SMD code	Type	Function	Short description	Case	Pinout	Sch.	St.	Mnf.
Y3	R1210N532C	DC/DC-IC	PWM step-up, 5.3V, 100kHz, +CE, ext, transistor	SOT-23-5	28sd	DC6	6g	Ric
Y3-	RT9198-4GPBG	LVR-IC	LDO, 4.75V±1%, 300mA, +CE	SOT-23-5	28xm	VR4	6a	Rct
Y3=	RT9198-4GGBG	LVR-IC	LDO, 4.75V±1%, 300mA, +CE	SOT-23-5	28xm	VR4	6a	Rct
Y30	R1131N301B	LVR-IC	LDO, 3V±2%, 300mA, -CE	SOT-23-5	28cx	VR4	6g	Ric
Y30	XC9110E301MR	DC/DC-IC	PFM step-up, 100kHz, 3.0V±2.5%, 400mA	SOT-25	28sx	DC4	6g	Tor
Y31	R1131N311B	LVR-IC	LDO, 3.1V±2%, 300mA, -CE	SOT-23-5	28cx	VR4	6g	Ric
Y31	XC9110E311MR	DC/DC-IC	PFM step-up, 100kHz, 3.1V±2.5%, 400mA	SOT-25	28sx	DC4	6g	Tor
Y32	R1131N321B	LVR-IC	LDO, 3.2V±2%, 300mA, -CE	SOT-23-5	28cx	VR4	6g	Ric
Y32	XC9110E321MR	DC/DC-IC	PFM step-up, 100kHz, 3.2V±2.5%, 400mA	SOT-25	28sx	DC4	6g	Tor
Y33	R1131N331B	LVR-IC	LDO, 3.3V±2%, 300mA, -CE	SOT-23-5	28cx	VR4	6g	Ric
Y33	XC9110E331MR	DC/DC-IC	PFM step-up, 100kHz, 3.3V±2.5%, 400mA	SOT-25	28sx	DC4	6g	Tor
Y34	XC9110E341MR	DC/DC-IC	PFM step-up, 100kHz, 3.4V±2.5%, 400mA	SOT-25	28sx	DC4	6g	Tor
Y35	XC9110E351MR	DC/DC-IC	PFM step-up, 100kHz, 3.5V±2.5%, 400mA	SOT-25	28sx	DC4	6g	Tor
Y36	XC9110E361MR	DC/DC-IC	PFM step-up, 100kHz, 3.6V±2.5%, 400mA	SOT-25	28sx	DC4	6g	Tor
Y37	XC9110E371MR	DC/DC-IC	PFM step-up, 100kHz, 3.7V±2.5%, 400mA	SOT-25	28sx	DC4	6g	Tor
Y38	XC9110E381MR	DC/DC-IC	PFM step-up, 100kHz, 3.8V±2.5%, 400mA	SOT-25	28sx	DC4	6g	Tor
Y39	XC9110E391MR	DC/DC-IC	PFM step-up, 100kHz, 3.9V±2.5%, 400mA	SOT-25	28sx	DC4	6g	Tor
Y3A	XC6118N43AMR-G	Vdet-IC	4.3V±2%, ±Reset ODO, Sense, hysteresis 5%, Cd	SOT-25	28mg	VD14	6g	Tor
Y3B	XC6118N43BMR-G	Vdet-IC	4.3V±2%, ±Reset ODO, Sense, hysteresis <1%, Cd	SOT-25	28mg	VD14	6g	Tor
Y3C	XC6118N43CMR-G	Vdet-IC	4.3V±2%, ±Reset ODO, Sense, hysteresis 5%	SOT-25	28mf	VD11	6g	Tor
Y3D	XC6118N43DMR-G	Vdet-IC	4.3V±2%, ±Reset ODO, Sense, hysteresis <1%	SOT-25	28mf	VD11	6g	Tor
Y4	R1210N542C	DC/DC-IC	PWM step-up, 5.4V, 100kHz, +CE, ext, transistor	SOT-23-5	28sd	DC6	6g	Ric
Y4-	RT9198-33PBG	LVR-IC	LDO, 3.3V±1%, 300mA, +CE	SOT-23-5	28xm	VR4	6a	Rct
Y4=	RT9198-33GBG	LVR-IC	LDO, 3.3V±1%, 300mA, +CE	SOT-23-5	28xm	VR4	6a	Rct
Y40	R1172N181B5	LVR-IC	LDO, 1.85V±2%, 1A, +CE	SOT-23-5	28vrd	VR4	6g	Ric
Y40	XC9110E401MR	DC/DC-IC	PFM step-up, 100kHz, 4.0V±2.5%, 400mA	SOT-25	28sx	DC4	6g	Tor
Y41	R1172N281B5	LVR-IC	LDO, 2.85V±2%, 1A, +CE	SOT-23-5	28vrd	VR4	6g	Ric
Y41	XC9110E411MR	DC/DC-IC	PFM step-up, 100kHz, 4.1V±2.5%, 400mA	SOT-25	28sx	DC4	6g	Tor
Y42	XC9110E421MR	DC/DC-IC	PFM step-up, 100kHz, 4.2V±2.5%, 400mA	SOT-25	28sx	DC4	6g	Tor
Y43	XC9110E431MR	DC/DC-IC	PFM step-up, 100kHz, 4.3V±2.5%, 400mA	SOT-25	28sx	DC4	6g	Tor
Y44	XC9110E441MR	DC/DC-IC	PFM step-up, 100kHz, 4.4V±2.5%, 400mA	SOT-25	28sx	DC4	6g	Tor
Y45	XC9110E451MR	DC/DC-IC	PFM step-up, 100kHz, 4.5V±2.5%, 400mA	SOT-25	28sx	DC4	6g	Tor
Y46	XC9110E461MR	DC/DC-IC	PFM step-up, 100kHz, 4.6V±2.5%, 400mA	SOT-25	28sx	DC4	6g	Tor
Y47	XC9110E471MR	DC/DC-IC	PFM step-up, 100kHz, 4.7V±2.5%, 400mA	SOT-25	28sx	DC4	6g	Tor
Y48	R1172N081B	LVR-IC	LDO, 0.8V±2%, 1A, +CE	SOT-23-5	28vrd	VR4	6g	Ric
Y48	XC9110E481MR	DC/DC-IC	PFM step-up, 100kHz, 4.8V±2.5%, 400mA	SOT-25	28sx	DC4	6g	Tor
Y49	R1172N091B	LVR-IC	LDO, 0.9V±2%, 1A, +CE	SOT-23-5	28vrd	VR4	6g	Ric
Y49	XC9110E491MR	DC/DC-IC	PFM step-up, 100kHz, 4.9V±2.5%, 400mA	SOT-25	28sx	DC4	6g	Tor
Y4A	XC6118N44AMR-G	Vdet-IC	4.4V±2%, ±Reset ODO, Sense, hysteresis 5%, Cd	SOT-25	28mg	VD14	6g	Tor
Y4B	XC6118N44BMR-G	Vdet-IC	4.4V±2%, ±Reset ODO, Sense, hysteresis <1%, Cd	SOT-25	28mg	VD14	6g	Tor
Y4C	XC6118N44CMR-G	Vdet-IC	4.4V±2%, ±Reset ODO, Sense, hysteresis 5%	SOT-25	28mf	VD11	6g	Tor
Y4D	XC6118N44DMR-G	Vdet-IC	4.4V±2%, ±Reset ODO, Sense, hysteresis <1%	SOT-25	28mf	VD11	6g	Tor
Y5	FMY5	Si-np	Dual, GP, 120V, 50mA, 140MHz	SOT-23-5	28td	-	6a	Rhm
Y5	R1210N552C	DC/DC-IC	PWM step-up, 5.5V, 100kHz, +CE, ext, transistor	SOT-23-5	28sd	DC6	6g	Ric
Y50	R1172N101B	LVR-IC	LDO, 1V±2%, 1A, +CE	SOT-23-5	28vrd	VR4	6g	Ric
Y50	XC9110E501MR	DC/DC-IC	PFM step-up, 100kHz, 5.0V±2.5%, 400mA	SOT-25	28sx	DC4	6g	Tor
Y51	R1172N111B	LVR-IC	LDO, 1.1V±2%, 1A, +CE	SOT-23-5	28vrd	VR4	6g	Ric
Y51	XC9110E511MR	DC/DC-IC	PFM step-up, 100kHz, 5.1V±2.5%, 400mA	SOT-25	28sx	DC4	6g	Tor
Y52	R1172N121B	LVR-IC	LDO, 1.2V±2%, 1A, +CE	SOT-23-5	28vrd	VR4	6g	Ric
Y52	XC9110E521MR	DC/DC-IC	PFM step-up, 100kHz, 5.2V±2.5%, 400mA	SOT-25	28sx	DC4	6g	Tor
Y53	R1172N131B	LVR-IC	LDO, 1.3V±2%, 1A, +CE	SOT-23-5	28vrd	VR4	6g	Ric
Y53	XC9110E531MR	DC/DC-IC	PFM step-up, 100kHz, 5.3V±2.5%, 400mA	SOT-25	28sx	DC4	6g	Tor
Y54	R1172N141B	LVR-IC	LDO, 1.4V±2%, 1A, +CE	SOT-23-5	28vrd	VR4	6g	Ric
Y54	XC9110E541MR	DC/DC-IC	PFM step-up, 100kHz, 5.4V±2.5%, 400mA	SOT-25	28sx	DC4	6g	Tor
Y55	R1172N151B	LVR-IC	LDO, 1.5V±2%, 1A, +CE	SOT-23-5	28vrd	VR4	6g	Ric
Y55	XC9110E551MR	DC/DC-IC	PFM step-up, 100kHz, 5.5V±2.5%, 400mA	SOT-25	28sx	DC4	6g	Tor
Y56	R1172N161B	LVR-IC	LDO, 1.6V±2%, 1A, +CE	SOT-23-5	28vrd	VR4	6g	Ric
Y56	XC9110E561MR	DC/DC-IC	PFM step-up, 100kHz, 5.6V±2.5%, 400mA	SOT-25	28sx	DC4	6g	Tor
Y57	R1172N171B	LVR-IC	LDO, 1.7V±2%, 1A, +CE	SOT-23-5	28vrd	VR4	6g	Ric
Y57	XC9110E571MR	DC/DC-IC	PFM step-up, 100kHz, 5.7V±2.5%, 400mA	SOT-25	28sx	DC4	6g	Tor
Y58	R1172N181B	LVR-IC	LDO, 1.8V±2%, 1A, +CE	SOT-23-5	28vrd	VR4	6g	Ric
Y58	XC9110E581MR	DC/DC-IC	PFM step-up, 100kHz, 5.8V±2.5%, 400mA	SOT-25	28sx	DC4	6g	Tor
Y59	R1172N191B	LVR-IC	LDO, 1.9V±2%, 1A, +CE	SOT-23-5	28vrd	VR4	6g	Ric
Y59	XC9110E591MR	DC/DC-IC	PFM step-up, 100kHz, 5.9V±2.5%, 400mA	SOT-25	28sx	DC4	6g	Tor
Y5A	XC6118N45AMR-G	Vdet-IC	4.5V±2%, ±Reset ODO, Sense, hysteresis 5%, Cd	SOT-25	28mg	VD14	6g	Tor
Y5B	XC6118N45BMR-G	Vdet-IC	4.5V±2%, ±Reset ODO, Sense, hysteresis <1%, Cd	SOT-25	28mg	VD14	6g	Tor
Y5C	XC6118N45CMR-G	Vdet-IC	4.5V±2%, ±Reset ODO, Sense, hysteresis 5%	SOT-25	28mf	VD11	6g	Tor
Y5D	XC6118N45DMR-G	Vdet-IC	4.5V±2%, ±Reset ODO, Sense, hysteresis <1%	SOT-25	28mf	VD11	6g	Tor
Y6	FMY6	Si-np	Dual, GP, 40V, 500mA, 200 (250)MHz	SOT-23-5	28td	-	6a	Rhm
Y6	R1210N562C	DC/DC-IC	PWM step-up, 5.6V, 100kHz, +CE, ext, transistor	SOT-23-5	28sd	DC6	6g	Ric



SMD code	Type	Function	Short description	Case	Pinout	Sch.	St.	Mnf.
Y60	R1172N201B	LVR-IC	LDO, 2V±2%, 1A, +CE	SOT-23-5	28vrd	VR4	6g	Ric
Y60	XC9110E601MR	DC/DC-IC	PFM step-up, 100kHz, 6.0V±2.5%, 400mA	SOT-25	28sx	DC4	6g	Tor
Y61	R1172N211B	LVR-IC	LDO, 2.1V±2%, 1A, +CE	SOT-23-5	28vrd	VR4	6g	Ric
Y61	XC9110E611MR	DC/DC-IC	PFM step-up, 100kHz, 6.1V±2.5%, 400mA	SOT-25	28sx	DC4	6g	Tor
Y62	R1172N221B	LVR-IC	LDO, 2.2V±2%, 1A, +CE	SOT-23-5	28vrd	VR4	6g	Ric
Y62	XC9110E621MR	DC/DC-IC	PFM step-up, 100kHz, 6.2V±2.5%, 400mA	SOT-25	28sx	DC4	6g	Tor
Y63	R1172N231B	LVR-IC	LDO, 2.3V±2%, 1A, +CE	SOT-23-5	28vrd	VR4	6g	Ric
Y63	XC9110E631MR	DC/DC-IC	PFM step-up, 100kHz, 6.3V±2.5%, 400mA	SOT-25	28sx	DC4	6g	Tor
Y64	R1172N241B	LVR-IC	LDO, 2.4V±2%, 1A, +CE	SOT-23-5	28vrd	VR4	6g	Ric
Y64	XC9110E641MR	DC/DC-IC	PFM step-up, 100kHz, 6.4V±2.5%, 400mA	SOT-25	28sx	DC4	6g	Tor
Y65	R1172N251B	LVR-IC	LDO, 2.5V±2%, 1A, +CE	SOT-23-5	28vrd	VR4	6g	Ric
Y65	XC9110E651MR	DC/DC-IC	PFM step-up, 100kHz, 6.5V±2.5%, 400mA	SOT-25	28sx	DC4	6g	Tor
Y66	R1172N261B	LVR-IC	LDO, 2.6V±2%, 1A, +CE	SOT-23-5	28vrd	VR4	6g	Ric
Y66	XC9110E661MR	DC/DC-IC	PFM step-up, 100kHz, 6.6V±2.5%, 400mA	SOT-25	28sx	DC4	6g	Tor
Y67	R1172N271B	LVR-IC	LDO, 2.7V±2%, 1A, +CE	SOT-23-5	28vrd	VR4	6g	Ric
Y67	XC9110E671MR	DC/DC-IC	PFM step-up, 100kHz, 6.7V±2.5%, 400mA	SOT-25	28sx	DC4	6g	Tor
Y68	R1172N281B	LVR-IC	LDO, 2.8V±2%, 1A, +CE	SOT-23-5	28vrd	VR4	6g	Ric
Y68	XC9110E681MR	DC/DC-IC	PFM step-up, 100kHz, 6.8V±2.5%, 400mA	SOT-25	28sx	DC4	6g	Tor
Y69	R1172N291B	LVR-IC	LDO, 2.9V±2%, 1A, +CE	SOT-23-5	28vrd	VR4	6g	Ric
Y69	XC9110E691MR	DC/DC-IC	PFM step-up, 100kHz, 6.9V±2.5%, 400mA	SOT-25	28sx	DC4	6g	Tor
Y6A	XC6118N46AMR-G	Vdet-IC	4.6V±2%, ±Reset ODO, Sense, hysteresis 5%, Cd	SOT-25	28mg	VD14	6g	Tor
Y6B	XC6118N46BMR-G	Vdet-IC	4.6V±2%, ±Reset ODO, Sense, hysteresis <1%, Cd	SOT-25	28mg	VD14	6g	Tor
Y6C	XC6118N46CMR-G	Vdet-IC	4.6V±2%, ±Reset ODO, Sense, hysteresis 5%	SOT-25	28mf	VD11	6g	Tor
Y6D	XC6118N46DMR-G	Vdet-IC	4.6V±2%, ±Reset ODO, Sense, hysteresis <1%	SOT-25	28mf	VD11	6g	Tor
Y7	R1210N572C	DC/DC-IC	PWM step-up, 5.7V, 100kHz, +CE, ext, transistor	SOT-23-5	28sd	DC6	6g	Ric
Y7-	RT9198-35PBR	LVR-IC	LDO, 3.5V±1%, 300mA, +CE	SOT-23-5	28cx	VR4	6a	Rct
Y70	R1172N301B	LVR-IC	LDO, 3V±2%, 1A, +CE	SOT-23-5	28vrd	VR4	6g	Ric
Y70	XC9110E701MR	DC/DC-IC	PFM step-up, 100kHz, 7.0V±2.5%, 400mA	SOT-25	28sx	DC4	6g	Tor
Y71	R1172N311B	LVR-IC	LDO, 3.1V±2%, 1A, +CE	SOT-23-5	28vrd	VR4	6g	Ric
Y72	R1172N321B	LVR-IC	LDO, 3.2V±2%, 1A, +CE	SOT-23-5	28vrd	VR4	6g	Ric
Y73	R1172N331B	LVR-IC	LDO, 3.3V±2%, 1A, +CE	SOT-23-5	28vrd	VR4	6g	Ric
Y74	R1172N341B	LVR-IC	LDO, 3.4V±2%, 1A, +CE	SOT-23-5	28vrd	VR4	6g	Ric
Y75	R1172N351B	LVR-IC	LDO, 3.5V±2%, 1A, +CE	SOT-23-5	28vrd	VR4	6g	Ric
Y76	R1172N361B	LVR-IC	LDO, 3.6V±2%, 1A, +CE	SOT-23-5	28vrd	VR4	6g	Ric
Y77	R1172N371B	LVR-IC	LDO, 3.7V±2%, 1A, +CE	SOT-23-5	28vrd	VR4	6g	Ric
Y78	R1172N381B	LVR-IC	LDO, 3.8V±2%, 1A, +CE	SOT-23-5	28vrd	VR4	6g	Ric
Y79	R1172N391B	LVR-IC	LDO, 3.9V±2%, 1A, +CE	SOT-23-5	28vrd	VR4	6g	Ric
Y7A	XC6118N47AMR-G	Vdet-IC	4.7V±2%, ±Reset ODO, Sense, hysteresis 5%, Cd	SOT-25	28mg	VD14	6g	Tor
Y7B	XC6118N47BMR-G	Vdet-IC	4.7V±2%, ±Reset ODO, Sense, hysteresis <1%, Cd	SOT-25	28mg	VD14	6g	Tor
Y7C	XC6118N47CMR-G	Vdet-IC	4.7V±2%, ±Reset ODO, Sense, hysteresis 5%	SOT-25	28mf	VD11	6g	Tor
Y7D	XC6118N47DMR-G	Vdet-IC	4.7V±2%, ±Reset ODO, Sense, hysteresis <1%	SOT-25	28mf	VD11	6g	Tor
Y8	R1210N582C	DC/DC-IC	PWM step-up, 5.8V, 100kHz, +CE, ext, transistor	SOT-23-5	28sd	DC6	6g	Ric
Y8-	RT9198-39PBG	LVR-IC	LDO, 3.9V±1%, 300mA, +CE	SOT-23-5	28xm	VR4	6a	Rct
Y80	R1172N401B	LVR-IC	LDO, 4V±2%, 1A, +CE	SOT-23-5	28vrd	VR4	6g	Ric
Y81	R1172N411B	LVR-IC	LDO, 4.1V±2%, 1A, +CE	SOT-23-5	28vrd	VR4	6g	Ric
Y82	R1172N421B	LVR-IC	LDO, 4.2V±2%, 1A, +CE	SOT-23-5	28vrd	VR4	6g	Ric
Y83	R1172N431B	LVR-IC	LDO, 4.3V±2%, 1A, +CE	SOT-23-5	28vrd	VR4	6g	Ric
Y84	R1172N441B	LVR-IC	LDO, 4.4V±2%, 1A, +CE	SOT-23-5	28vrd	VR4	6g	Ric
Y85	R1172N451B	LVR-IC	LDO, 4.5V±2%, 1A, +CE	SOT-23-5	28vrd	VR4	6g	Ric
Y86	R1172N461B	LVR-IC	LDO, 4.6V±2%, 1A, +CE	SOT-23-5	28vrd	VR4	6g	Ric
Y87	R1172N471B	LVR-IC	LDO, 4.7V±2%, 1A, +CE	SOT-23-5	28vrd	VR4	6g	Ric
Y88	R1172N481B	LVR-IC	LDO, 4.8V±2%, 1A, +CE	SOT-23-5	28vrd	VR4	6g	Ric
Y89	R1172N491B	LVR-IC	LDO, 4.9V±2%, 1A, +CE	SOT-23-5	28vrd	VR4	6g	Ric
Y8A	XC6118N48AMR-G	Vdet-IC	4.8V±2%, ±Reset ODO, Sense, hysteresis 5%, Cd	SOT-25	28mg	VD14	6g	Tor
Y8B	XC6118N48BMR-G	Vdet-IC	4.8V±2%, ±Reset ODO, Sense, hysteresis <1%, Cd	SOT-25	28mg	VD14	6g	Tor
Y8C	XC6118N48CMR-G	Vdet-IC	4.8V±2%, ±Reset ODO, Sense, hysteresis 5%	SOT-25	28mf	VD11	6g	Tor
Y8D	XC6118N48DMR-G	Vdet-IC	4.8V±2%, ±Reset ODO, Sense, hysteresis <1%	SOT-25	28mf	VD11	6g	Tor
Y9	R1210N592C	DC/DC-IC	PWM step-up, 5.9V, 100kHz, +CE, ext, transistor	SOT-23-5	28sd	DC6	6g	Ric
Y90	R1172N501B	LVR-IC	LDO, 5V±2%, 1A, +CE	SOT-23-5	28vrd	VR4	6g	Ric
Y9A	XC6118N49AMR-G	Vdet-IC	4.9V±2%, ±Reset ODO, Sense, hysteresis 5%, Cd	SOT-25	28mg	VD14	6g	Tor
Y9B	XC6118N49BMR-G	Vdet-IC	4.9V±2%, ±Reset ODO, Sense, hysteresis <1%, Cd	SOT-25	28mg	VD14	6g	Tor
Y9C	XC6118N49CMR-G	Vdet-IC	4.9V±2%, ±Reset ODO, Sense, hysteresis 5%	SOT-25	28mf	VD11	6g	Tor
Y9D	XC6118N49DMR-G	Vdet-IC	4.9V±2%, ±Reset ODO, Sense, hysteresis <1%	SOT-25	28mf	VD11	6g	Tor
YA	BU4209FWE	Vdet-IC	0.9V, +Reset ODO	VSOF-5	30kva	VD1	6c	Rhm
YA	BU4209G	Vdet-IC	0.9V, +Reset ODO	SSOP-5	28vdo	VD1	6c	Rhm
YA	RN2501	Si-pnp-Digi	Dual, Sw, 50V, 100mA, 300mW, R1/R2=4.7k/4.7k	SMV	30/TD9	-	6a	Tos
YA	RN2701	Si-pnp-Digi	Dual, Sw, 50V, 100mA, 200mW, R1/R2=4.7k/4.7k	SOT-353	30/TD9	-	6a	Tos
YA	RN2701JE	Si-pnp-Digi	Dual, Sw, 50V, 100mA, 100mW, R1/R2=4.7k/4.7k	SOT-553	30/TD9	-	6a	Tos
YA	RN5RK202A	DC/DC-IC	VFM step-up, Vout=2V±1.5%	SOT-23-5	28sc	DC3	6g	Ric
YB	74LVC1G38GV	CMOS-Logic	2-input NAND gate (ODO)	SOT753	28Log17	-	6a	Phi



SMD code	Type	Function	Short description	Case	Pinout	Sch.	St.	Mnf.
YB	74LVC1G38GW	CMOS-Logic	2-input NAND gate (ODO)	SOT-353-1	28/Log17	-	6a	Phi
YB	BU4210FWE	Vdet-IC	1.0V, +Reset ODO	VSOFF-5	30vka	VD1	6c	Rhm
YB	BU4210G	Vdet-IC	1.0V, +Reset ODO	SSOP-5	28vdo	VD1	6c	Rhm
YB	RN2502	Si-pnp-Digi	Dual, Sw, 50V, 100mA, 300mW, R1/R2=10k/10k	SMV	30/TD9	-	6a	Tos
YB	RN2702	Si-pnp-Digi	Dual, Sw, 50V, 100mA, 200mW, R1/R2=10k/10k	SOT-353	30/TD9	-	6a	Tos
YB	RN2702JE	Si-pnp-Digi	Dual, Sw, 50V, 100mA, 100mW, R1/R2=10k/10k	SOT-553	30/TD9	-	6a	Tos
YB	RN5RK252A	DC/DC-IC	VFM step-up, Vout=2.5V±1.5%	SOT-23-5	28sc	DC3	6g	Ric
YC	BU4211FWE	Vdet-IC	1.1V, +Reset ODO	VSOFF-5	30vka	VD1	6c	Rhm
YC	BU4211G	Vdet-IC	1.1V, +Reset ODO	SSOP-5	28vdo	VD1	6c	Rhm
YC	R1210N222D	DC/DC-IC	PWM step-up, 2.1V, 180kHz, +CE, ext, transistor	SOT-23-5	28sd	DC6	6g	Ric
YC	RN2503	Si-pnp-Digi	Dual, Sw, 50V, 100mA, 300mW, R1/R2=22k/22k	SMV	30/TD9	-	6a	Tos
YC	RN2703	Si-pnp-Digi	Dual, Sw, 50V, 100mA, 200mW, R1/R2=22k/22k	SOT-353	30/TD9	-	6a	Tos
YC	RN2703JE	Si-pnp-Digi	Dual, Sw, 50V, 100mA, 100mW, R1/R2=22k/22k	SOT-553	30/TD9	-	6a	Tos
YC	RN5RK272A	DC/DC-IC	VFM step-up, Vout=2.7V±1.5%	SOT-23-5	28sc	DC3	6g	Ric
YD	BU4212FWE	Vdet-IC	1.2V, +Reset ODO	VSOFF-5	30vka	VD1	6c	Rhm
YD	BU4212G	Vdet-IC	1.2V, +Reset ODO	SSOP-5	28vdo	VD1	6c	Rhm
YD	R1210N232D	DC/DC-IC	PWM step-up, 2.3V, 180kHz, +CE, ext, transistor	SOT-23-5	28sd	DC6	6g	Ric
YD	RN2504	Si-pnp-Digi	Dual, Sw, 50V, 100mA, 300mW, R1/R2=47k/47k	SMV	30/TD9	-	6a	Tos
YD	RN2704	Si-pnp-Digi	Dual, Sw, 50V, 100mA, 200mW, R1/R2=47k/47k	SOT-353	30/TD9	-	6a	Tos
YD	RN2704JE	Si-pnp-Digi	Dual, Sw, 50V, 100mA, 100mW, R1/R2=47k/47k	SOT-553	30/TD9	-	6a	Tos
YD	RN5RK302A	DC/DC-IC	VFM step-up, Vout=3V±1.5%	SOT-23-5	28sc	DC3	6g	Ric
YDAT	YB1253ST25X120	LVR-IC	LDO, 1.2V±2%, 300mA, +CE	SOT-25	28cx	VR7	6a	Ybn
YDBT	YB1253ST25X130	LVR-IC	LDO, 1.3V±2%, 300mA, +CE	SOT-25	28cx	VR7	6a	Ybn
YDCT	YB1253ST25X140	LVR-IC	LDO, 1.4V±2%, 300mA, +CE	SOT-25	28cx	VR7	6a	Ybn
YDDT	YB1253ST25X150	LVR-IC	LDO, 1.5V±2%, 300mA, +CE	SOT-25	28cx	VR7	6a	Ybn
YDET	YB1253ST25X160	LVR-IC	LDO, 1.6V±2%, 300mA, +CE	SOT-25	28cx	VR7	6a	Ybn
YDFT	YB1253ST25X170	LVR-IC	LDO, 1.7V±2%, 300mA, +CE	SOT-25	28cx	VR7	6a	Ybn
YDGT	YB1253ST25X180	LVR-IC	LDO, 1.8V±2%, 300mA, +CE	SOT-25	28cx	VR7	6a	Ybn
YDHT	YB1253ST25X190	LVR-IC	LDO, 1.9V±2%, 300mA, +CE	SOT-25	28cx	VR7	6a	Ybn
YDIT	YB1253ST25X200	LVR-IC	LDO, 2.0V±2%, 300mA, +CE	SOT-25	28cx	VR7	6a	Ybn
YDJT	YB1253ST25X210	LVR-IC	LDO, 2.1V±2%, 300mA, +CE	SOT-25	28cx	VR7	6a	Ybn
YDKT	YB1253ST25X220	LVR-IC	LDO, 2.2V±2%, 300mA, +CE	SOT-25	28cx	VR7	6a	Ybn
YDLT	YB1253ST25X230	LVR-IC	LDO, 2.3V±2%, 300mA, +CE	SOT-25	28cx	VR7	6a	Ybn
YDMT	YB1253ST25X240	LVR-IC	LDO, 2.4V±2%, 300mA, +CE	SOT-25	28cx	VR7	6a	Ybn
YDNT	YB1253ST25X250	LVR-IC	LDO, 2.5V±2%, 300mA, +CE	SOT-25	28cx	VR7	6a	Ybn
YDOT	YB1253ST25X260	LVR-IC	LDO, 2.6V±2%, 300mA, +CE	SOT-25	28cx	VR7	6a	Ybn
YDPT	YB1253ST25X270	LVR-IC	LDO, 2.7V±2%, 300mA, +CE	SOT-25	28cx	VR7	6a	Ybn
YDQT	YB1253ST25X280	LVR-IC	LDO, 2.8V±2%, 300mA, +CE	SOT-25	28cx	VR7	6a	Ybn
YDRT	YB1253ST25X290	LVR-IC	LDO, 2.9V±2%, 300mA, +CE	SOT-25	28cx	VR7	6a	Ybn
YDST	YB1253ST25X300	LVR-IC	LDO, 3.0V±2%, 300mA, +CE	SOT-25	28cx	VR7	6a	Ybn
YDTT	YB1253ST25X310	LVR-IC	LDO, 3.1V±2%, 300mA, +CE	SOT-25	28cx	VR7	6a	Ybn
YDUT	YB1253ST25X320	LVR-IC	LDO, 3.2V±2%, 300mA, +CE	SOT-25	28cx	VR7	6a	Ybn
YDVT	YB1253ST25X330	LVR-IC	LDO, 3.3V±2%, 300mA, +CE	SOT-25	28cx	VR7	6a	Ybn
YDWT	YB1253ST25X340	LVR-IC	LDO, 3.4V±2%, 300mA, +CE	SOT-25	28cx	VR7	6a	Ybn
YDXT	YB1253ST25X350	LVR-IC	LDO, 3.5V±2%, 300mA, +CE	SOT-25	28cx	VR7	6a	Ybn
YDYT	YB1253ST25X360	LVR-IC	LDO, 3.6V±2%, 300mA, +CE	SOT-25	28cx	VR7	6a	Ybn
YE	BU4213FWE	Vdet-IC	1.3V, +Reset ODO	VSOFF-5	30vka	VD1	6c	Rhm
YE	BU4213G	Vdet-IC	1.3V, +Reset ODO	SSOP-5	28vdo	VD1	6c	Rhm
YE	R1210N242D	DC/DC-IC	PWM step-up, 2.4V, 180kHz, +CE, ext, transistor	SOT-23-5	28sd	DC6	6g	Ric
YE	RN2505	Si-pnp-Digi	Dual, Sw, 50V, 100mA, 300mW, R1/R2=2.2k/47k	SMV	30/TD9	-	6a	Tos
YE	RN2705	Si-pnp-Digi	Dual, Sw, 50V, 100mA, 200mW, R1/R2=2.2k/47k	SOT-353	30/TD9	-	6a	Tos
YE	RN2705JE	Si-pnp-Digi	Dual, Sw, 50V, 100mA, 100mW, R1/R2=2.2k/47k	SOT-553	30/TD9	-	6a	Tos
YE	RN5RK332A	DC/DC-IC	VFM step-up, Vout=3.3V±1.5%	SOT-23-5	28sc	DC3	6g	Ric
YF	BU4214FWE	Vdet-IC	1.4V, +Reset ODO	VSOFF-5	30vka	VD1	6c	Rhm
YF	BU4214G	Vdet-IC	1.4V, +Reset ODO	SSOP-5	28vdo	VD1	6c	Rhm
YF	R1210N252D	DC/DC-IC	PWM step-up, 2.5V, 180kHz, +CE, ext, transistor	SOT-23-5	28sd	DC6	6g	Ric
YF	RN2506	Si-pnp-Digi	Dual, Sw, 50V, 100mA, 300mW, R1/R2=4.7k/47k	SMV	30/TD9	-	6a	Tos
YF	RN2706	Si-pnp-Digi	Dual, Sw, 50V, 100mA, 200mW, R1/R2=4.7k/47k	SOT-353	30/TD9	-	6a	Tos
YF	RN2706JE	Si-pnp-Digi	Dual, Sw, 50V, 100mA, 100mW, R1/R2=4.7k/47k	SOT-553	30/TD9	-	6a	Tos
YF	RN5RK502A	DC/DC-IC	VFM step-up, Vout=5V±1.5%	SOT-23-5	28sc	DC3	6g	Ric
YG	BU4215FWE	Vdet-IC	1.5V, +Reset ODO	VSOFF-5	30vka	VD1	6c	Rhm
YG	BU4215G	Vdet-IC	1.5V, +Reset ODO	SSOP-5	28vdo	VD1	6c	Rhm
YG	R1210N262D	DC/DC-IC	PWM step-up, 2.6V, 180kHz, +CE, ext, transistor	SOT-23-5	28sd	DC6	6g	Ric
YG	RN5RK552A	DC/DC-IC	VFM step-up, Vout=5.5V±1.5%	SOT-23-5	28sc	DC3	6g	Ric
YH	BU4216FWE	Vdet-IC	1.6V, +Reset ODO	VSOFF-5	30vka	VD1	6c	Rhm
YH	BU4216G	Vdet-IC	1.6V, +Reset ODO	SSOP-5	28vdo	VD1	6c	Rhm
YH	R1210N272D	DC/DC-IC	PWM step-up, 2.7V, 180kHz, +CE, ext, transistor	SOT-23-5	28sd	DC6	6g	Ric
YH	RN2507	Si-pnp-Digi	Dual, Sw, 50V, 100mA, 300mW, R1/R2=10k/47k	SMV	30/TD9	-	6a	Tos
YH	RN2707	Si-pnp-Digi	Dual, Sw, 50V, 100mA, 200mW, R1/R2=10k/47k	SOT-353	30/TD9	-	6a	Tos
YH	RN2707JE	Si-pnp-Digi	Dual, Sw, 50V, 100mA, 100mW, R1/R2=10k/47k	SOT-553	30/TD9	-	6a	Tos



SMD code	Type	Function	Short description	Case	Pinout	Sch.	St.	Mnf.
YH	RN5RK522A	DC/DC-IC	VFM step-up, Vout=5.2V±1.5%	SOT-23-5	28sc	DC3	6g	Ric
YH-	RT9198-19PBR	LVR-IC	LDO, 1.9V±1%, 300mA, +CE	SOT-23-5	28cx	VR4	6a	Rct
YI	RN2508	Si-pnp-Digi	Dual, Sw, 50V, 100mA, 300mW, R1/R2=22k/47k	SMV	30/TD9	-	6a	Tos
YI	RN2708	Si-pnp-Digi	Dual, Sw, 50V, 100mA, 200mW, R1/R2=22k/47k	SOT-353	30/TD9	-	6a	Tos
YI	RN2708JE	Si-pnp-Digi	Dual, Sw, 50V, 100mA, 100mW, R1/R2=22k/47k	SOT-553	30/TD9	-	6a	Tos
YJ	BU4217FWE	Vdet-IC	1.7V, +Reset ODO	VSOFF-5	30vka	VD1	6c	Rhm
YJ	BU4217G	Vdet-IC	1.7V, +Reset ODO	SSOP-5	28vdo	VD1	6c	Rhm
YJ	R1210N282D	DC/DC-IC	PWM step-up, 2.8V, 180kHz, +CE, ext, transistor	SOT-23-5	28sd	DC6	6g	Ric
YJ	RN2509	Si-pnp-Digi	Dual, Sw, 50V, 100mA, 300mW, R1/R2=47k/22k	SMV	30/TD9	-	6a	Tos
YJ	RN2709	Si-pnp-Digi	Dual, Sw, 50V, 100mA, 200mW, R1/R2=47k/22k	SOT-353	30/TD9	-	6a	Tos
YJ	RN2709JE	Si-pnp-Digi	Dual, Sw, 50V, 100mA, 100mW, R1/R2=47k/22k	SOT-553	30/TD9	-	6a	Tos
YJ	RN5RK222A	DC/DC-IC	VFM step-up, Vout=2.2V±1.5%	SOT-23-5	28sc	DC3	6g	Ric
YJ-	RT9818A-20PB	Vdet-IC	2.0V±1.5%, -ODO +Reset	SOT-23-5	28vdm	VD6	6a	Rct
YJ12	SGM2019-1.2YC5G	LVR-IC	LDO, 1.2V±2%, 500mA, +CE	SC-70-5	28vrx	VR7	6a	Sgm
YJ12	SGM2019-1.2YN5G	LVR-IC	LDO, 1.2V±2%, 500mA, +CE	SOT-23-5	28vrx	VR7	6a	Sgm
YJ13	SGM2019-1.3YC5G	LVR-IC	LDO, 1.3V±2%, 500mA, +CE	SC-70-5	28vrx	VR7	6a	Sgm
YJ13	SGM2019-1.3YN5G	LVR-IC	LDO, 1.3V±2%, 500mA, +CE	SOT-23-5	28vrx	VR7	6a	Sgm
YJ15	SGM2019-1.5YC5G	LVR-IC	LDO, 1.5V±2%, 500mA, +CE	SC-70-5	28vrx	VR7	6a	Sgm
YJ15	SGM2019-1.5YN5G	LVR-IC	LDO, 1.5V±2%, 500mA, +CE	SOT-23-5	28vrx	VR7	6a	Sgm
YJ18	SGM2019-1.8YC5G	LVR-IC	LDO, 1.8V±2%, 500mA, +CE	SC-70-5	28vrx	VR7	6a	Sgm
YJ18	SGM2019-1.8YN5G	LVR-IC	LDO, 1.8V±2%, 500mA, +CE	SOT-23-5	28vrx	VR7	6a	Sgm
YJ21	SGM2019-2.1YC5G	LVR-IC	LDO, 2.1V±2%, 500mA, +CE	SC-70-5	28vrx	VR7	6a	Sgm
YJ21	SGM2019-2.1YN5G	LVR-IC	LDO, 2.1V±2%, 500mA, +CE	SOT-23-5	28vrx	VR7	6a	Sgm
YJ25	SGM2019-2.5YC5G	LVR-IC	LDO, 2.5V±2%, 500mA, +CE	SC-70-5	28vrx	VR7	6a	Sgm
YJ25	SGM2019-2.5YN5G	LVR-IC	LDO, 2.5V±2%, 500mA, +CE	SOT-23-5	28vrx	VR7	6a	Sgm
YJ27	SGM2019-2.7YC5G	LVR-IC	LDO, 2.7V±2%, 500mA, +CE	SC-70-5	28vrx	VR7	6a	Sgm
YJ27	SGM2019-2.7YN5G	LVR-IC	LDO, 2.7V±2%, 500mA, +CE	SOT-23-5	28vrx	VR7	6a	Sgm
YJ28	SGM2019-2.8YC5G	LVR-IC	LDO, 2.8V±2%, 500mA, +CE	SC-70-5	28vrx	VR7	6a	Sgm
YJ28	SGM2019-2.8YN5G	LVR-IC	LDO, 2.8V±2%, 500mA, +CE	SOT-23-5	28vrx	VR7	6a	Sgm
YJ29	SGM2019-2.9YC5G	LVR-IC	LDO, 2.9V±2%, 500mA, +CE	SC-70-5	28vrx	VR7	6a	Sgm
YJ29	SGM2019-2.9YN5G	LVR-IC	LDO, 2.9V±2%, 500mA, +CE	SOT-23-5	28vrx	VR7	6a	Sgm
YJ2J	SGM2019-2.85YC5G	LVR-IC	LDO, 2.85V±2%, 500mA, +CE	SC-70-5	28vrx	VR7	6a	Sgm
YJ2J	SGM2019-2.85YN5G	LVR-IC	LDO, 2.85V±2%, 500mA, +CE	SOT-23-5	28vrx	VR7	6a	Sgm
YJ30	SGM2019-3.0YC5G	LVR-IC	LDO, 3.0V±2%, 500mA, +CE	SC-70-5	28vrx	VR7	6a	Sgm
YJ30	SGM2019-3.0YN5G	LVR-IC	LDO, 3.0V±2%, 500mA, +CE	SOT-23-5	28vrx	VR7	6a	Sgm
YJ31	SGM2019-3.1YC5G	LVR-IC	LDO, 3.1V±2%, 500mA, +CE	SC-70-5	28vrx	VR7	6a	Sgm
YJ31	SGM2019-3.1YN5G	LVR-IC	LDO, 3.1V±2%, 500mA, +CE	SOT-23-5	28vrx	VR7	6a	Sgm
YJ32	SGM2019-3.2YC5G	LVR-IC	LDO, 3.2V±2%, 500mA, +CE	SC-70-5	28vrx	VR7	6a	Sgm
YJ32	SGM2019-3.2YN5G	LVR-IC	LDO, 3.2V±2%, 500mA, +CE	SOT-23-5	28vrx	VR7	6a	Sgm
YJ33	SGM2019-3.3YC5G	LVR-IC	LDO, 3.3V±2%, 500mA, +CE	SC-70-5	28vrx	VR7	6a	Sgm
YJ33	SGM2019-3.3YN5G	LVR-IC	LDO, 3.3V±2%, 500mA, +CE	SOT-23-5	28vrx	VR7	6a	Sgm
YJ36	SGM2019-3.6YC5G	LVR-IC	LDO, 3.6V±2%, 500mA, +CE	SC-70-5	28vrx	VR7	6a	Sgm
YJ36	SGM2019-3.6YN5G	LVR-IC	LDO, 3.6V±2%, 500mA, +CE	SOT-23-5	28vrx	VR7	6a	Sgm
YJ42	SGM2019-4.2YC5G	LVR-IC	LDO, 4.2V±2%, 500mA, +CE	SC-70-5	28vrx	VR7	6a	Sgm
YJ42	SGM2019-4.2YN5G	LVR-IC	LDO, 4.2V±2%, 500mA, +CE	SOT-23-5	28vrx	VR7	6a	Sgm
YJ50	SGM2019-5.0YC5G	LVR-IC	LDO, 5.0V±2%, 500mA, +CE	SC-70-5	28vrx	VR7	6a	Sgm
YJ50	SGM2019-5.0YN5G	LVR-IC	LDO, 5.0V±2%, 500mA, +CE	SOT-23-5	28vrx	VR7	6a	Sgm
YJAA	SGM2019-ADJYC5G	LVR-IC	LDO, Adjustable 1.2..5.0V, 500mA, +CE	SC-70-5	28sg	VR16	6a	Sgm
YJAA	SGM2019-ADJYN5G	LVR-IC	LDO, Adjustable 1.2..5.0V, 500mA, +CE	SOT-23-5	28sg	VR16	6a	Sgm
YK	BU4218FWE	Vdet-IC	1.8V, +Reset ODO	VSOFF-5	30vka	VD1	6c	Rhm
YK	BU4218G	Vdet-IC	1.8V, +Reset ODO	SSOP-5	28vdo	VD1	6c	Rhm
YK	R1210N292D	DC/DC-IC	PWM step-up, 2.9V, 180kHz, +CE, ext, transistor	SOT-23-5	28sd	DC6	6g	Ric
YK	RN2510	Si-pnp-Digi	Dual, Sw, 50V, 100mA, 300mW, R1/R2=4.7k/0k	SMV	30/TD9	-	6a	Tos
YK	RN2710	Si-pnp-Digi	Dual, Sw, 50V, 100mA, 200mW, R1/R2=4.7k/0k	SOT-353	30/TD9	-	6a	Tos
YK	RN2710JE	Si-pnp-Digi	Dual, Sw, 50V, 100mA, 100mW, R1/R2=4.7k/0k	SOT-553	30/TD9	-	6a	Tos
YK	RN5RK452A	DC/DC-IC	VFM step-up, Vout=4.5V±1.5%	SOT-23-5	28sc	DC3	6g	Ric
YK-	RT9818C-20PB	Vdet-IC	2.0V±1.5%, -ODO +Reset, Td=220ms	SOT-23-5	28vdm	VD6	6a	Rct
YL	74LVC1G384GV	CMOS-Logic	Bilateral analogic switch	SOT753	28/Log16	-	6a	Phi
YL	74LVC1G384GW	CMOS-Logic	Bilateral analogic switch	SOT-353-1	28/Log16	-	6a	Phi
YL	BD45462G	Vdet-IC	4.6V, -Reset ODO, 200ms	SSOP-5	28vdp	VD6	6c	Rhm
YL	BU4219FWE	Vdet-IC	1.9V, +Reset ODO	VSOFF-5	30vka	VD1	6c	Rhm
YL	BU4219G	Vdet-IC	1.9V, +Reset ODO	SSOP-5	28vdo	VD1	6c	Rhm
YL	R1210N302D	DC/DC-IC	PWM step-up, 3V, 180kHz, +CE, ext, transistor	SOT-23-5	28sd	DC6	6g	Ric
YL-	RT9818A-36PB	Vdet-IC	3.6V±1.5%, -ODO +Reset	SOT-23-5	28vdm	VD6	6a	Rct
YM	BU4220FWE	Vdet-IC	2.0V, +Reset ODO	VSOFF-5	30vka	VD1	6c	Rhm
YM	BU4220G	Vdet-IC	2.0V, +Reset ODO	SSOP-5	28vdo	VD1	6c	Rhm
YM	R1210N312D	DC/DC-IC	PWM step-up, 3.1V, 180kHz, +CE, ext, transistor	SOT-23-5	28sd	DC6	6g	Ric
YM	RN2511	Si-pnp-Digi	Dual, Sw, 50V, 100mA, 300mW, R1/R2=10k/0k	SMV	30/TD9	-	6a	Tos
YM	RN2711	Si-pnp-Digi	Dual, Sw, 50V, 100mA, 200mW, R1/R2=10k/0k	SOT-353	30/TD9	-	6a	Tos
YM	RN2711JE	Si-pnp-Digi	Dual, Sw, 50V, 100mA, 100mW, R1/R2=10k/0k	SOT-553	30/TD9	-	6a	Tos
YM-	RT9818A-39PB	Vdet-IC	3.9V±1.5%, -ODO +Reset	SOT-23-5	28vdm	VD6	6a	Rct



SMD code	Type	Function	Short description	Case	Pinout	Sch.	St.	Mnf.
YN	74LVC1G34GV	CMOS-Logic	Noninverting buffer	SOT753	28/Log10	-	6a	Phi
YN	74LVC1G34GW	CMOS-Logic	Noninverting buffer	SOT-353-1	28/Log10	-	6a	Phi
YN	BU4221FWE	Vdet-IC	2.1V, +Reset ODO	VSOFF-5	30vka	VD1	6c	Rhm
YN	BU4221G	Vdet-IC	2.1V, +Reset ODO	SSOP-5	28vdo	VD1	6c	Rhm
YN	R1210N322D	DC/DC-IC	PWM step-up, 3.2V, 180kHz, +CE, ext, transistor	SOT-23-5	28sd	DC6	6g	Ric
YP	BU4222FWE	Vdet-IC	2.2V, +Reset ODO	VSOFF-5	30vka	VD1	6c	Rhm
YP	BU4222G	Vdet-IC	2.2V, +Reset ODO	SSOP-5	28vdo	VD1	6c	Rhm
YP	R1210N332D	DC/DC-IC	PWM step-up, 3.3V, 180kHz, +CE, ext, transistor	SOT-23-5	28sd	DC6	6g	Ric
YQ	BU4223FWE	Vdet-IC	2.3V, +Reset ODO	VSOFF-5	30vka	VD1	6c	Rhm
YQ	BU4223G	Vdet-IC	2.3V, +Reset ODO	SSOP-5	28vdo	VD1	6c	Rhm
YQ	R1210N342D	DC/DC-IC	PWM step-up, 3.4V, 180kHz, +CE, ext, transistor	SOT-23-5	28sd	DC6	6g	Ric
YR	BU4224FWE	Vdet-IC	2.4V, +Reset ODO	VSOFF-5	30vka	VD1	6c	Rhm
YR	BU4224G	Vdet-IC	2.4V, +Reset ODO	SSOP-5	28vdo	VD1	6c	Rhm
YR	R1210N352D	DC/DC-IC	PWM step-up, 3.5V, 180kHz, +CE, ext, transistor	SOT-23-5	28sd	DC6	6g	Ric
YS	BU4225FWE	Vdet-IC	2.5V, +Reset ODO	VSOFF-5	30vka	VD1	6c	Rhm
YS	BU4225G	Vdet-IC	2.5V, +Reset ODO	SSOP-5	28vdo	VD1	6c	Rhm
YS	R1210N362D	DC/DC-IC	PWM step-up, 3.6V, 180kHz, +CE, ext, transistor	SOT-23-5	28sd	DC6	6g	Ric
YT	BU4226FWE	Vdet-IC	2.6V, +Reset ODO	VSOFF-5	30vka	VD1	6c	Rhm
YT	BU4226G	Vdet-IC	2.6V, +Reset ODO	SSOP-5	28vdo	VD1	6c	Rhm
YT	R1210N372D	DC/DC-IC	PWM step-up, 3.7V, 180kHz, +CE, ext, transistor	SOT-23-5	28sd	DC6	6g	Ric
YU	BU4227FWE	Vdet-IC	2.7V, +Reset ODO	VSOFF-5	30vka	VD1	6c	Rhm
YU	BU4227G	Vdet-IC	2.7V, +Reset ODO	SSOP-5	28vdo	VD1	6c	Rhm
YU	R1210N382D	DC/DC-IC	PWM step-up, 3.8V, 180kHz, +CE, ext, transistor	SOT-23-5	28sd	DC6	6g	Ric
YU-	RT9013-32PB	LVR-IC	LDO, 3.2V±2%, 500mA, +CE	SOT-23-5	28cx	VR4	6g	Rct
YV	BU4228FWE	Vdet-IC	2.8V, +Reset ODO	VSOFF-5	30vka	VD1	6c	Rhm
YV	BU4228G	Vdet-IC	2.8V, +Reset ODO	SSOP-5	28vdo	VD1	6c	Rhm
YV	R1210N392D	DC/DC-IC	PWM step-up, 3.9V, 180kHz, +CE, ext, transistor	SOT-23-5	28sd	DC6	6g	Ric
YW	BU4229FWE	Vdet-IC	2.9V, +Reset ODO	VSOFF-5	30vka	VD1	6c	Rhm
YW	BU4229G	Vdet-IC	2.9V, +Reset ODO	SSOP-5	28vdo	VD1	6c	Rhm
YW	R1210N601D	DC/DC-IC	PWM step-up, 6V, 180kHz	SOT-23-5	28sc	DC3	6g	Ric
YW-	RT9198-18PBG	LVR-IC	LDO, 1.8V±1%, 300mA, +CE	SOT-23-5	28xm	VR4	6a	Rct
YW=	RT9198-18GBG	LVR-IC	LDO, 1.8V±1%, 300mA, +CE	SOT-23-5	28cx	VR4	6a	Rct
YX	BU4230FWE	Vdet-IC	3V, +Reset ODO	VSOFF-5	30vka	VD1	6c	Rhm
YX	BU4230G	Vdet-IC	3V, +Reset ODO	SSOP-5	28vdo	VD1	6c	Rhm
YY	BU4231FWE	Vdet-IC	3.1V, +Reset ODO	VSOFF-5	30vka	VD1	6c	Rhm
YY	BU4231G	Vdet-IC	3.1V, +Reset ODO	SSOP-5	28vdo	VD1	6c	Rhm
YZ	BU4232FWE	Vdet-IC	3.2V, +Reset ODO	VSOFF-5	30vka	VD1	6c	Rhm
YZ	BU4232G	Vdet-IC	3.2V, +Reset ODO	SSOP-5	28vdo	VD1	6c	Rhm
Z0	R1210N402D	DC/DC-IC	PWM step-up, 4V, 180kHz, +CE, ext, transistor	SOT-23-5	28sd	DC6	6g	Ric
Z00	NC75Z00P5	CMOS-Logic	2-input NAND gate	SC-70-5	28/Log1	-	6a	F
Z00	R1131N181D5	LVR-IC	LDO, 1.85V±2%, 300mA, +CE, CL	SOT-23-5	28cx	VR4	6g	Ric
Z01	R1131N281D5	LVR-IC	LDO, 2.85V±2%, 300mA, +CE, CL	SOT-23-5	28cx	VR4	6g	Ric
Z02	NC75Z02P5	CMOS-Logic	2-input NOR gate	SC-70-5	28/Log2	-	6a	F
Z02	R1131N121D5	LVR-IC	LDO, 1.25V±2%, 300mA, +CE, CL	SOT-23-5	28cx	VR4	6g	Ric
Z08	NC75Z08P5	CMOS-Logic	2-input AND gate	SC-70-5	28/Log3	-	6a	F
Z08	R1131N081D	LVR-IC	LDO, 0.8V±2%, 300mA, +CE, CL	SOT-23-5	28cx	VR4	6g	Ric
Z09	R1131N091D	LVR-IC	LDO, 0.9V±2%, 300mA, +CE, CL	SOT-23-5	28cx	VR4	6g	Ric
Z0A	R3119N115A	Vdet-IC	11.5V±1.5%, -Reset ODO	SOT-23-5	28z1	VD1	6g	Ric
Z0A	XC6118N50AMR-G	Vdet-IC	5.0V±2%, ±Reset ODO, Sense, hysteresis 5%, Cd	SOT-25	28mg	VD14	6g	Tor
Z0B	R3119N116A	Vdet-IC	11.6V±1.5%, -Reset ODO	SOT-23-5	28z1	VD1	6g	Ric
Z0B	XC6118N50BMR-G	Vdet-IC	5.0V±2%, ±Reset ODO, Sense, hysteresis <1%, Cd	SOT-25	28mg	VD14	6g	Tor
Z0C	R3119N117A	Vdet-IC	11.7V±1.5%, -Reset ODO	SOT-23-5	28z1	VD1	6g	Ric
Z0C	XC6118N50CMR-G	Vdet-IC	5.0V±2%, ±Reset ODO, Sense, hysteresis 5%	SOT-25	28mf	VD11	6g	Tor
Z0D	R3119N118A	Vdet-IC	11.8V±1.5%, -Reset ODO	SOT-23-5	28z1	VD1	6g	Ric
Z0D	XC6118N50DMR-G	Vdet-IC	5.0V±2%, ±Reset ODO, Sense, hysteresis <1%	SOT-25	28mf	VD11	6g	Tor
Z0E	R3119N119A	Vdet-IC	11.9V±1.5%, -Reset ODO	SOT-23-5	28z1	VD1	6g	Ric
Z0F	R3119N120A	Vdet-IC	12.0V±1.5%, -Reset ODO	SOT-23-5	28z1	VD1	6g	Ric
Z1	BZA856A	TVS	Quad, 5.6V, 3.75A, 25W(1ms)	SOT-353	30bc	-	6a	Phi
Z1	BZA956A	TVS	Quad, 5.6V, 3.75A, 25W(1ms)	SOT-665	30bc	-	6a	Phi
Z1	R1210N412D	DC/DC-IC	PWM step-up, 4.1V, 180kHz, +CE, ext, transistor	SOT-23-5	28sd	DC6	6g	Ric
Z10	R1131N101D	LVR-IC	LDO, 1V±2%, 300mA, +CE, CL	SOT-23-5	28cx	VR4	6g	Ric
Z11	R1131N111D	LVR-IC	LDO, 1.1V±2%, 300mA, +CE, CL	SOT-23-5	28cx	VR4	6g	Ric
Z12	R1131N121D	LVR-IC	LDO, 1.2V±2%, 300mA, +CE, CL	SOT-23-5	28cx	VR4	6g	Ric
Z13	R1131N131D	LVR-IC	LDO, 1.3V±2%, 300mA, +CE, CL	SOT-23-5	28cx	VR4	6g	Ric
Z14	R1131N141D	LVR-IC	LDO, 1.4V±2%, 300mA, +CE, CL	SOT-23-5	28cx	VR4	6g	Ric
Z15	R1131N151D	LVR-IC	LDO, 1.5V±2%, 300mA, +CE, CL	SOT-23-5	28cx	VR4	6g	Ric
Z15	XC9110F151MR	DC/DC-IC	PFM step-up, 100kHz, 1.5V±2.5%, 400mA	SOT-25	28sy	DC13	6g	Tor
Z16	R1131N161D	LVR-IC	LDO, 1.6V±2%, 300mA, +CE, CL	SOT-23-5	28cx	VR4	6g	Ric
Z16	XC9110F161MR	DC/DC-IC	PFM step-up, 100kHz, 1.6V±2.5%, 400mA	SOT-25	28sy	DC13	6g	Tor
Z17	R1131N171D	LVR-IC	LDO, 1.7V±2%, 300mA, +CE, CL	SOT-23-5	28cx	VR4	6g	Ric
Z17	XC9110F171MR	DC/DC-IC	PFM step-up, 100kHz, 1.7V±2.5%, 400mA	SOT-25	28sy	DC13	6g	Tor



SMD code	Type	Function	Short description	Case	Pinout	Sch.	St.	Mnf.
Z18	R1131N181D	LVR-IC	LDO, 1.8V±2%, 300mA, +CE, CL	SOT-23-5	28cx	VR4	6g	Ric
Z18	XC9110F181MR	DC/DC-IC	PFM step-up, 100kHz, 1.8V±2.5%, 400mA	SOT-25	28sy	DC13	6g	Tor
Z19	R1131N191D	LVR-IC	LDO, 1.9V±2%, 300mA, +CE, CL	SOT-23-5	28cx	VR4	6g	Ric
Z19	XC9110F191MR	DC/DC-IC	PFM step-up, 100kHz, 1.9V±2.5%, 400mA	SOT-25	28sy	DC13	6g	Tor
Z1A	R3119N115E	Vdet-IC	11.5V±1.5%, ±Reset ODO, Sense	SOT-23-5	282z	VD11	6g	Ric
Z1B	R3119N116E	Vdet-IC	11.6V±1.5%, ±Reset ODO, Sense	SOT-23-5	282z	VD11	6g	Ric
Z1C	R3119N117E	Vdet-IC	11.7V±1.5%, ±Reset ODO, Sense	SOT-23-5	282z	VD11	6g	Ric
Z1D	R3119N118E	Vdet-IC	11.8V±1.5%, ±Reset ODO, Sense	SOT-23-5	282z	VD11	6g	Ric
Z1E	R3119N119E	Vdet-IC	11.9V±1.5%, ±Reset ODO, Sense	SOT-23-5	282z	VD11	6g	Ric
Z1F	R3119N120E	Vdet-IC	12.0V±1.5%, ±Reset ODO, Sense	SOT-23-5	282z	VD11	6g	Ric
Z2	BZA862A	TVS	Quad, 6.2V, 3.75A, 25W(1ms)	SOT-353	30bc	-	6a	Phi
Z2	BZA962A	TVS	Quad, 6.2V, 3.75A, 25W(1ms)	SOT-665	30bc	-	6a	Phi
Z2	R1210N422D	DC/DC-IC	PWM step-up, 4.2V, 180kHz, +CE, ext, transistor	SOT-23-5	28sd	DC6	6g	Ric
Z20	R1131N201D	LVR-IC	LDO, 2V±2%, 300mA, +CE, CL	SOT-23-5	28cx	VR4	6g	Ric
Z20	XC9110F201MR	DC/DC-IC	PFM step-up, 100kHz, 2.0V±2.5%, 400mA	SOT-25	28sy	DC13	6g	Tor
Z21	R1131N211D	LVR-IC	LDO, 2.1V±2%, 300mA, +CE, CL	SOT-23-5	28cx	VR4	6g	Ric
Z21	XC9110F211MR	DC/DC-IC	PFM step-up, 100kHz, 2.1V±2.5%, 400mA	SOT-25	28sy	DC13	6g	Tor
Z22	R1131N221D	LVR-IC	LDO, 2.2V±2%, 300mA, +CE, CL	SOT-23-5	28cx	VR4	6g	Ric
Z22	XC9110F221MR	DC/DC-IC	PFM step-up, 100kHz, 2.2V±2.5%, 400mA	SOT-25	28sy	DC13	6g	Tor
Z23	R1131N231D	LVR-IC	LDO, 2.3V±2%, 300mA, +CE, CL	SOT-23-5	28cx	VR4	6g	Ric
Z23	XC9110F231MR	DC/DC-IC	PFM step-up, 100kHz, 2.3V±2.5%, 400mA	SOT-25	28sy	DC13	6g	Tor
Z24	R1131N241D	LVR-IC	LDO, 2.4V±2%, 300mA, +CE, CL	SOT-23-5	28cx	VR4	6g	Ric
Z24	XC9110F241MR	DC/DC-IC	PFM step-up, 100kHz, 2.4V±2.5%, 400mA	SOT-25	28sy	DC13	6g	Tor
Z25	R1131N251D	LVR-IC	LDO, 2.5V±2%, 300mA, +CE, CL	SOT-23-5	28cx	VR4	6g	Ric
Z25	XC9110F251MR	DC/DC-IC	PFM step-up, 100kHz, 2.5V±2.5%, 400mA	SOT-25	28sy	DC13	6g	Tor
Z26	R1131N261D	LVR-IC	LDO, 2.6V±2%, 300mA, +CE, CL	SOT-23-5	28cx	VR4	6g	Ric
Z26	XC9110F261MR	DC/DC-IC	PFM step-up, 100kHz, 2.6V±2.5%, 400mA	SOT-25	28sy	DC13	6g	Tor
Z27	R1131N271D	LVR-IC	LDO, 2.7V±2%, 300mA, +CE, CL	SOT-23-5	28cx	VR4	6g	Ric
Z27	XC9110F271MR	DC/DC-IC	PFM step-up, 100kHz, 2.7V±2.5%, 400mA	SOT-25	28sy	DC13	6g	Tor
Z28	R1131N281D	LVR-IC	LDO, 2.8V±2%, 300mA, +CE, CL	SOT-23-5	28cx	VR4	6g	Ric
Z28	XC9110F281MR	DC/DC-IC	PFM step-up, 100kHz, 2.8V±2.5%, 400mA	SOT-25	28sy	DC13	6g	Tor
Z29	R1131N291D	LVR-IC	LDO, 2.9V±2%, 300mA, +CE, CL	SOT-23-5	28cx	VR4	6g	Ric
Z29	XC9110F291MR	DC/DC-IC	PFM step-up, 100kHz, 2.9V±2.5%, 400mA	SOT-25	28sy	DC13	6g	Tor
Z3	BZA868A	TVS	Quad, 6.8V, 3.75A, 25W(1ms)	SOT-353	30bc	-	6a	Phi
Z3	BZA968A	TVS	Quad, 6.8V, 3.75A, 25W(1ms)	SOT-665	30bc	-	6a	Phi
Z3	R1210N432D	DC/DC-IC	PWM step-up, 4.3V, 180kHz, +CE, ext, transistor	SOT-23-5	28sd	DC6	6g	Ric
Z30	R1131N301D	LVR-IC	LDO, 3V±2%, 300mA, +CE, CL	SOT-23-5	28cx	VR4	6g	Ric
Z30	XC9110F301MR	DC/DC-IC	PFM step-up, 100kHz, 3.0V±2.5%, 400mA	SOT-25	28sy	DC13	6g	Tor
Z31	R1131N311D	LVR-IC	LDO, 3.1V±2%, 300mA, +CE, CL	SOT-23-5	28cx	VR4	6g	Ric
Z31	XC9110F311MR	DC/DC-IC	PFM step-up, 100kHz, 3.1V±2.5%, 400mA	SOT-25	28sy	DC13	6g	Tor
Z32	R1131N321D	LVR-IC	LDO, 3.2V±2%, 300mA, +CE, CL	SOT-23-5	28cx	VR4	6g	Ric
Z32	XC9110F321MR	DC/DC-IC	PFM step-up, 100kHz, 3.2V±2.5%, 400mA	SOT-25	28sy	DC13	6g	Tor
Z33	R1131N331D	LVR-IC	LDO, 3.3V±2%, 300mA, +CE, CL	SOT-23-5	28cx	VR4	6g	Ric
Z33	XC9110F331MR	DC/DC-IC	PFM step-up, 100kHz, 3.3V±2.5%, 400mA	SOT-25	28sy	DC13	6g	Tor
Z34	XC9110F341MR	DC/DC-IC	PFM step-up, 100kHz, 3.4V±2.5%, 400mA	SOT-25	28sy	DC13	6g	Tor
Z35	XC9110F351MR	DC/DC-IC	PFM step-up, 100kHz, 3.5V±2.5%, 400mA	SOT-25	28sy	DC13	6g	Tor
Z36	XC9110F361MR	DC/DC-IC	PFM step-up, 100kHz, 3.6V±2.5%, 400mA	SOT-25	28sy	DC13	6g	Tor
Z37	XC9110F371MR	DC/DC-IC	PFM step-up, 100kHz, 3.7V±2.5%, 400mA	SOT-25	28sy	DC13	6g	Tor
Z38	XC9110F381MR	DC/DC-IC	PFM step-up, 100kHz, 3.8V±2.5%, 400mA	SOT-25	28sy	DC13	6g	Tor
Z39	XC9110F391MR	DC/DC-IC	PFM step-up, 100kHz, 3.9V±2.5%, 400mA	SOT-25	28sy	DC13	6g	Tor
Z4	BZA820A	TVS	Quad, 20V, 3.75A, 17W(1ms)	SOT-353	30bc	-	6a	Phi
Z4	R1210N442D	DC/DC-IC	PWM step-up, 4.4V, 180kHz, +CE, ext, transistor	SOT-23-5	28sd	DC6	6g	Ric
Z4	RT9808-23CB	Vdet-IC	2.3V±2%, -ODO +Reset	SOT-23-5	28vdm	VD6	6a	Rct
Z4	RT9808-23PB	Vdet-IC	2.3V±2%, -ODO +Reset	SOT-23-5	28vdm	VD6	6a	Rct
Z40	R1172N181D5	LVR-IC	LDO, 1.85V±2%, 1A, +CE, CL	SOT-23-5	28vrd	VR4	6g	Ric
Z40	XC9110F401MR	DC/DC-IC	PFM step-up, 100kHz, 4.0V±2.5%, 400mA	SOT-25	28sy	DC13	6g	Tor
Z41	R1172N281D5	LVR-IC	LDO, 2.85V±2%, 1A, +CE, CL	SOT-23-5	28vrd	VR4	6g	Ric
Z41	XC9110F411MR	DC/DC-IC	PFM step-up, 100kHz, 4.1V±2.5%, 400mA	SOT-25	28sy	DC13	6g	Tor
Z42	XC9110F421MR	DC/DC-IC	PFM step-up, 100kHz, 4.2V±2.5%, 400mA	SOT-25	28sy	DC13	6g	Tor
Z43	XC9110F431MR	DC/DC-IC	PFM step-up, 100kHz, 4.3V±2.5%, 400mA	SOT-25	28sy	DC13	6g	Tor
Z44	XC9110F441MR	DC/DC-IC	PFM step-up, 100kHz, 4.4V±2.5%, 400mA	SOT-25	28sy	DC13	6g	Tor
Z45	XC9110F451MR	DC/DC-IC	PFM step-up, 100kHz, 4.5V±2.5%, 400mA	SOT-25	28sy	DC13	6g	Tor
Z46	XC9110F461MR	DC/DC-IC	PFM step-up, 100kHz, 4.6V±2.5%, 400mA	SOT-25	28sy	DC13	6g	Tor
Z47	XC9110F471MR	DC/DC-IC	PFM step-up, 100kHz, 4.7V±2.5%, 400mA	SOT-25	28sy	DC13	6g	Tor
Z48	R1172N081D	LVR-IC	LDO, 0.8V±2%, 1A, +CE, CL	SOT-23-5	28vrd	VR4	6g	Ric
Z48	XC9110F481MR	DC/DC-IC	PFM step-up, 100kHz, 4.8V±2.5%, 400mA	SOT-25	28sy	DC13	6g	Tor
Z49	R1172N091D	LVR-IC	LDO, 0.9V±2%, 1A, +CE, CL	SOT-23-5	28vrd	VR4	6g	Ric
Z49	XC9110F491MR	DC/DC-IC	PFM step-up, 100kHz, 4.9V±2.5%, 400mA	SOT-25	28sy	DC13	6g	Tor
Z5	R1210N452D	DC/DC-IC	PWM step-up, 4.5V, 180kHz, +CE, ext, transistor	SOT-23-5	28sd	DC6	6g	Ric
Z50	R1172N101D	LVR-IC	LDO, 1V±2%, 1A, +CE, CL	SOT-23-5	28vrd	VR4	6g	Ric
Z50	XC9110F501MR	DC/DC-IC	PFM step-up, 100kHz, 5.0V±2.5%, 400mA	SOT-25	28sy	DC13	6g	Tor



SMD code	Type	Function	Short description	Case	Pinout	Sch.	St.	Mnf.
Z51	R1172N111D	LVR-IC	LDO, 1.1V±2%, 1A, +CE, CL	SOT-23-5	28vrd	VR4	6g	Ric
Z51	XC9110F511MR	DC/DC-IC	PFM step-up, 100kHz, 5.1V±2.5%, 400mA	SOT-25	28sy	DC13	6g	Tor
Z52	R1172N121D	LVR-IC	LDO, 1.2V±2%, 1A, +CE, CL	SOT-23-5	28vrd	VR4	6g	Ric
Z52	XC9110F521MR	DC/DC-IC	PFM step-up, 100kHz, 5.2V±2.5%, 400mA	SOT-25	28sy	DC13	6g	Tor
Z53	R1172N131D	LVR-IC	LDO, 1.3V±2%, 1A, +CE, CL	SOT-23-5	28vrd	VR4	6g	Ric
Z53	XC9110F531MR	DC/DC-IC	PFM step-up, 100kHz, 5.3V±2.5%, 400mA	SOT-25	28sy	DC13	6g	Tor
Z54	R1172N141D	LVR-IC	LDO, 1.4V±2%, 1A, +CE, CL	SOT-23-5	28vrd	VR4	6g	Ric
Z54	XC9110F541MR	DC/DC-IC	PFM step-up, 100kHz, 5.4V±2.5%, 400mA	SOT-25	28sy	DC13	6g	Tor
Z55	R1172N151D	LVR-IC	LDO, 1.5V±2%, 1A, +CE, CL	SOT-23-5	28vrd	VR4	6g	Ric
Z55	XC9110F551MR	DC/DC-IC	PFM step-up, 100kHz, 5.5V±2.5%, 400mA	SOT-25	28sy	DC13	6g	Tor
Z56	R1172N161D	LVR-IC	LDO, 1.6V±2%, 1A, +CE, CL	SOT-23-5	28vrd	VR4	6g	Ric
Z56	XC9110F561MR	DC/DC-IC	PFM step-up, 100kHz, 5.6V±2.5%, 400mA	SOT-25	28sy	DC13	6g	Tor
Z57	R1172N171D	LVR-IC	LDO, 1.7V±2%, 1A, +CE, CL	SOT-23-5	28vrd	VR4	6g	Ric
Z57	XC9110F571MR	DC/DC-IC	PFM step-up, 100kHz, 5.7V±2.5%, 400mA	SOT-25	28sy	DC13	6g	Tor
Z58	R1172N181D	LVR-IC	LDO, 1.8V±2%, 1A, +CE, CL	SOT-23-5	28vrd	VR4	6g	Ric
Z58	XC9110F581MR	DC/DC-IC	PFM step-up, 100kHz, 5.8V±2.5%, 400mA	SOT-25	28sy	DC13	6g	Tor
Z59	R1172N191D	LVR-IC	LDO, 1.9V±2%, 1A, +CE, CL	SOT-23-5	28vrd	VR4	6g	Ric
Z59	XC9110F591MR	DC/DC-IC	PFM step-up, 100kHz, 5.9V±2.5%, 400mA	SOT-25	28sy	DC13	6g	Tor
Z6	R1210N462D	DC/DC-IC	PWM step-up, 4.6V, 180kHz, +CE, ext, transistor	SOT-23-5	28sd	DC6	6g	Ric
Z60	R1172N201D	LVR-IC	LDO, 2V±2%, 1A, +CE, CL	SOT-23-5	28vrd	VR4	6g	Ric
Z60	XC9110F601MR	DC/DC-IC	PFM step-up, 100kHz, 6.0V±2.5%, 400mA	SOT-25	28sy	DC13	6g	Tor
Z61	R1172N211D	LVR-IC	LDO, 2.1V±2%, 1A, +CE, CL	SOT-23-5	28vrd	VR4	6g	Ric
Z61	XC9110F611MR	DC/DC-IC	PFM step-up, 100kHz, 6.1V±2.5%, 400mA	SOT-25	28sy	DC13	6g	Tor
Z62	R1172N221D	LVR-IC	LDO, 2.2V±2%, 1A, +CE, CL	SOT-23-5	28vrd	VR4	6g	Ric
Z62	XC9110F621MR	DC/DC-IC	PFM step-up, 100kHz, 6.2V±2.5%, 400mA	SOT-25	28sy	DC13	6g	Tor
Z63	R1172N231D	LVR-IC	LDO, 2.3V±2%, 1A, +CE, CL	SOT-23-5	28vrd	VR4	6g	Ric
Z63	XC9110F631MR	DC/DC-IC	PFM step-up, 100kHz, 6.3V±2.5%, 400mA	SOT-25	28sy	DC13	6g	Tor
Z64	R1172N241D	LVR-IC	LDO, 2.4V±2%, 1A, +CE, CL	SOT-23-5	28vrd	VR4	6g	Ric
Z64	XC9110F641MR	DC/DC-IC	PFM step-up, 100kHz, 6.4V±2.5%, 400mA	SOT-25	28sy	DC13	6g	Tor
Z65	R1172N251D	LVR-IC	LDO, 2.5V±2%, 1A, +CE, CL	SOT-23-5	28vrd	VR4	6g	Ric
Z65	XC9110F651MR	DC/DC-IC	PFM step-up, 100kHz, 6.5V±2.5%, 400mA	SOT-25	28sy	DC13	6g	Tor
Z66	R1172N261D	LVR-IC	LDO, 2.6V±2%, 1A, +CE, CL	SOT-23-5	28vrd	VR4	6g	Ric
Z66	XC9110F661MR	DC/DC-IC	PFM step-up, 100kHz, 6.6V±2.5%, 400mA	SOT-25	28sy	DC13	6g	Tor
Z67	R1172N271D	LVR-IC	LDO, 2.7V±2%, 1A, +CE, CL	SOT-23-5	28vrd	VR4	6g	Ric
Z67	XC9110F671MR	DC/DC-IC	PFM step-up, 100kHz, 6.7V±2.5%, 400mA	SOT-25	28sy	DC13	6g	Tor
Z68	R1172N281D	LVR-IC	LDO, 2.8V±2%, 1A, +CE, CL	SOT-23-5	28vrd	VR4	6g	Ric
Z68	XC9110F681MR	DC/DC-IC	PFM step-up, 100kHz, 6.8V±2.5%, 400mA	SOT-25	28sy	DC13	6g	Tor
Z69	R1172N291D	LVR-IC	LDO, 2.9V±2%, 1A, +CE, CL	SOT-23-5	28vrd	VR4	6g	Ric
Z69	XC9110F691MR	DC/DC-IC	PFM step-up, 100kHz, 6.9V±2.5%, 400mA	SOT-25	28sy	DC13	6g	Tor
Z7	R1210N472D	DC/DC-IC	PWM step-up, 4.7V, 180kHz, +CE, ext, transistor	SOT-23-5	28sd	DC6	6g	Ric
Z7	RT9808-27CB	Vdet-IC	2.7V±2%, -ODO +Reset	SOT-23-5	28vdm	VD6	6a	Rct
Z7-	RT9808-27PB	Vdet-IC	2.7V±2%, -ODO +Reset	SOT-23-5	28vdm	VD6	6a	Rct
Z70	R1172N301D	LVR-IC	LDO, 3V±2%, 1A, +CE, CL	SOT-23-5	28vrd	VR4	6g	Ric
Z70	XC9110F701MR	DC/DC-IC	PFM step-up, 100kHz, 7.0V±2.5%, 400mA	SOT-25	28sy	DC13	6g	Tor
Z71	R1172N311D	LVR-IC	LDO, 3.1V±2%, 1A, +CE, CL	SOT-23-5	28vrd	VR4	6g	Ric
Z72	R1172N321D	LVR-IC	LDO, 3.2V±2%, 1A, +CE, CL	SOT-23-5	28vrd	VR4	6g	Ric
Z73	R1172N331D	LVR-IC	LDO, 3.3V±2%, 1A, +CE, CL	SOT-23-5	28vrd	VR4	6g	Ric
Z74	R1172N341D	LVR-IC	LDO, 3.4V±2%, 1A, +CE, CL	SOT-23-5	28vrd	VR4	6g	Ric
Z75	R1172N351D	LVR-IC	LDO, 3.5V±2%, 1A, +CE, CL	SOT-23-5	28vrd	VR4	6g	Ric
Z76	R1172N361D	LVR-IC	LDO, 3.6V±2%, 1A, +CE, CL	SOT-23-5	28vrd	VR4	6g	Ric
Z77	R1172N371D	LVR-IC	LDO, 3.7V±2%, 1A, +CE, CL	SOT-23-5	28vrd	VR4	6g	Ric
Z78	R1172N381D	LVR-IC	LDO, 3.8V±2%, 1A, +CE, CL	SOT-23-5	28vrd	VR4	6g	Ric
Z79	R1172N391D	LVR-IC	LDO, 3.9V±2%, 1A, +CE, CL	SOT-23-5	28vrd	VR4	6g	Ric
Z8	R1210N482D	DC/DC-IC	PWM step-up, 4.8V, 180kHz, +CE, ext, transistor	SOT-23-5	28sd	DC6	6g	Ric
Z8	RT9808-50CB	Vdet-IC	5.0V±2%, -ODO +Reset	SOT-23-5	28vdm	VD6	6a	Rct
Z80	R1172N401D	LVR-IC	LDO, 4V±2%, 1A, +CE, CL	SOT-23-5	28vrd	VR4	6g	Ric
Z81	R1172N411D	LVR-IC	LDO, 4.1V±2%, 1A, +CE, CL	SOT-23-5	28vrd	VR4	6g	Ric
Z82	R1172N421D	LVR-IC	LDO, 4.2V±2%, 1A, +CE, CL	SOT-23-5	28vrd	VR4	6g	Ric
Z83	R1172N431D	LVR-IC	LDO, 4.3V±2%, 1A, +CE, CL	SOT-23-5	28vrd	VR4	6g	Ric
Z84	R1172N441D	LVR-IC	LDO, 4.4V±2%, 1A, +CE, CL	SOT-23-5	28vrd	VR4	6g	Ric
Z85	R1172N451D	LVR-IC	LDO, 4.5V±2%, 1A, +CE, CL	SOT-23-5	28vrd	VR4	6g	Ric
Z86	R1172N461D	LVR-IC	LDO, 4.6V±2%, 1A, +CE, CL	SOT-23-5	28vrd	VR4	6g	Ric
Z87	R1172N471D	LVR-IC	LDO, 4.7V±2%, 1A, +CE, CL	SOT-23-5	28vrd	VR4	6g	Ric
Z88	R1172N481D	LVR-IC	LDO, 4.8V±2%, 1A, +CE, CL	SOT-23-5	28vrd	VR4	6g	Ric
Z89	R1172N491D	LVR-IC	LDO, 4.9V±2%, 1A, +CE, CL	SOT-23-5	28vrd	VR4	6g	Ric
Z9	R1210N492D	DC/DC-IC	PWM step-up, 4.9V, 180kHz, +CE, ext, transistor	SOT-23-5	28sd	DC6	6g	Ric
Z9	RT9808-30CB	Vdet-IC	3.0V±2%, -ODO +Reset	SOT-23-5	28vdm	VD6	6a	Rct
Z90	R1172N501D	LVR-IC	LDO, 5V±2%, 1A, +CE, CL	SOT-23-5	28vrd	VR4	6g	Ric
ZA	BU4233FWE	Vdet-IC	3.3V, +Reset ODO	VSOFF-5	30vka	VD1	6c	Rhm
ZA	BU4233G	Vdet-IC	3.3V, +Reset ODO	SSOP-5	28vdo	VD1	6c	Rhm
ZA	R1210N502D	DC/DC-IC	PWM step-up, 5V, 180kHz, +CE, ext, transistor	SOT-23-5	28sd	DC6	6g	Ric



SMD code	Type	Function	Short description	Case	Pinout	Sch.	St.	Mnf.
ZB	BU4234FWE	Vdet-IC	3.4V, +Reset ODO	VSOFF-5	30vka	VD1	6c	Rhm
ZB	BU4234G	Vdet-IC	3.4V, +Reset ODO	SSOP-5	28vdo	VD1	6c	Rhm
ZB	R1210N512D	DC/DC-IC	PWM step-up, 5.1V, 180kHz, +CE, ext, transistor	SOT-23-5	28sd	DC6	6g	Ric
ZB	RT9808-25CB	Vdet-IC	2.5V±2%, -ODO +Reset	SOT-23-5	28vdm	VD6	6a	Rct
ZC	BU4235FWE	Vdet-IC	3.5V, +Reset ODO	VSOFF-5	30vka	VD1	6c	Rhm
ZC	BU4235G	Vdet-IC	3.5V, +Reset ODO	SSOP-5	28vdo	VD1	6c	Rhm
ZC	R1210N522D	DC/DC-IC	PWM step-up, 5.2V, 180kHz, +CE, ext, transistor	SOT-23-5	28sd	DC6	6g	Ric
ZC-	RT9808-15PB	Vdet-IC	1.5V±2%, -ODO +Reset	SOT-23-5	28vdm	VD6	6a	Rct
ZD	BU4236FWE	Vdet-IC	3.6V, +Reset ODO	VSOFF-5	30vka	VD1	6c	Rhm
ZD	BU4236G	Vdet-IC	3.6V, +Reset ODO	SSOP-5	28vdo	VD1	6c	Rhm
ZD	R1210N532D	DC/DC-IC	PWM step-up, 5.3V, 180kHz, +CE, ext, transistor	SOT-23-5	28sd	DC6	6g	Ric
ZD-	RT9013-29PB	LVR-IC	LDO, 2.9V±2%, 500mA, +CE	SOT-23-5	28cx	VR4	6g	Rct
ZE	BU4237FWE	Vdet-IC	3.7V, +Reset ODO	VSOFF-5	30vka	VD1	6c	Rhm
ZE	BU4237G	Vdet-IC	3.7V, +Reset ODO	SSOP-5	28vdo	VD1	6c	Rhm
ZE	R1210N542D	DC/DC-IC	PWM step-up, 5.4V, 180kHz, +CE, ext, transistor	SOT-23-5	28sd	DC6	6g	Ric
ZF	BU4238FWE	Vdet-IC	3.8V, +Reset ODO	VSOFF-5	30vka	VD1	6c	Rhm
ZF	BU4238G	Vdet-IC	3.8V, +Reset ODO	SSOP-5	28vdo	VD1	6c	Rhm
ZF	R1210N552D	DC/DC-IC	PWM step-up, 5.5V, 180kHz, +CE, ext, transistor	SOT-23-5	28sd	DC6	6g	Ric
ZG	BU4239FWE	Vdet-IC	3.9V, +Reset ODO	VSOFF-5	30vka	VD1	6c	Rhm
ZG	BU4239G	Vdet-IC	3.9V, +Reset ODO	SSOP-5	28vdo	VD1	6c	Rhm
ZG	R1210N562D	DC/DC-IC	PWM step-up, 5.6V, 180kHz, +CE, ext, transistor	SOT-23-5	28sd	DC6	6g	Ric
ZG-	RT9193-50PB	LVR-IC	LDO, 5.0V±1%, 300mA, +CE	SOT-23-5	28vrx	VR7	6g	Rct
ZH	BU4240FWE	Vdet-IC	4V, +Reset ODO	VSOFF-5	30vka	VD1	6c	Rhm
ZH	BU4240G	Vdet-IC	4V, +Reset ODO	SSOP-5	28vdo	VD1	6c	Rhm
ZH	R1210N572D	DC/DC-IC	PWM step-up, 5.7V, 180kHz, +CE, ext, transistor	SOT-23-5	28sd	DC6	6g	Ric
ZH-	RT9198-35PB	LVR-IC	LDO, 3.5V±1%, 300mA, +CE	SOT-23-5	28xm	VR4	6a	Rct
ZJ	BU4241FWE	Vdet-IC	4.1V, +Reset ODO	VSOFF-5	30vka	VD1	6c	Rhm
ZJ	BU4241G	Vdet-IC	4.1V, +Reset ODO	SSOP-5	28vdo	VD1	6c	Rhm
ZJ	R1210N582D	DC/DC-IC	PWM step-up, 5.8V, 180kHz, +CE, ext, transistor	SOT-23-5	28sd	DC6	6g	Ric
ZJ-	RT9198-4GPB	LVR-IC	LDO, 4.75V±1%, 300mA, +CE	SOT-23-5	28xm	VR4	6a	Rct
ZK	BU4242FWE	Vdet-IC	4.2V, +Reset ODO	VSOFF-5	30vka	VD1	6c	Rhm
ZK	BU4242G	Vdet-IC	4.2V, +Reset ODO	SSOP-5	28vdo	VD1	6c	Rhm
ZK	R1210N592D	DC/DC-IC	PWM step-up, 5.9V, 180kHz, +CE, ext, transistor	SOT-23-5	28sd	DC6	6g	Ric
ZK-	RT9198-50PB	LVR-IC	LDO, 5.0V±1%, 300mA, +CE	SOT-23-5	28xm	VR4	6a	Rct
ZL	BU4243FWE	Vdet-IC	4.3V, +Reset ODO	VSOFF-5	30vka	VD1	6c	Rhm
ZL	BU4243G	Vdet-IC	4.3V, +Reset ODO	SSOP-5	28vdo	VD1	6c	Rhm
ZL	R1210N602D	DC/DC-IC	PWM step-up, 6V, 180kHz, +CE, ext, transistor	SOT-23-5	28sd	DC6	6g	Ric
ZL-	RT9818C-33PB	Vdet-IC	3.3V±1.5%, -ODO +Reset, Td=220ms	SOT-23-5	28vdm	VD6	6a	Rct
ZM	BU4244FWE	Vdet-IC	4.4V, +Reset ODO	VSOFF-5	30vka	VD1	6c	Rhm
ZM	BU4244G	Vdet-IC	4.4V, +Reset ODO	SSOP-5	28vdo	VD1	6c	Rhm
ZM-	RT9169H-15PB	LVR-IC	LDO, 5.0V±2%, 100mA, +CE	SOT-23-5	28cx	VR4	6g	Rct
ZN	BU4245FWE	Vdet-IC	4.5V, +Reset ODO	VSOFF-5	30vka	VD1	6c	Rhm
ZN	BU4245G	Vdet-IC	4.5V, +Reset ODO	SSOP-5	28vdo	VD1	6c	Rhm
ZP	BU4246FWE	Vdet-IC	4.6V, +Reset ODO	VSOFF-5	30vka	VD1	6c	Rhm
ZP	BU4246G	Vdet-IC	4.6V, +Reset ODO	SSOP-5	28vdo	VD1	6c	Rhm
ZQ	BU4247FWE	Vdet-IC	4.7V, +Reset ODO	VSOFF-5	30vka	VD1	6c	Rhm
ZQ	BU4247G	Vdet-IC	4.7V, +Reset ODO	SSOP-5	28vdo	VD1	6c	Rhm
ZR	BU4248FWE	Vdet-IC	4.8V, +Reset ODO	VSOFF-5	30vka	VD1	6c	Rhm
ZR	BU4248G	Vdet-IC	4.8V, +Reset ODO	SSOP-5	28vdo	VD1	6c	Rhm
ZS	BU4309FWE	Vdet-IC	0.9V, +Reset PPO	VSOFF-5	30vka	VD3	6c	Rhm
ZS	BU4309G	Vdet-IC	0.9V, +Reset PPO	SSOP-5	28vdo	VD3	6c	Rhm
ZS-	RT9818A-24PB	Vdet-IC	2.4V±1.5%, -ODO +Reset	SOT-23-5	28vdm	VD6	6a	Rct
ZT	BU4310FWE	Vdet-IC	1.0V, +Reset PPO	VSOFF-5	30vka	VD3	6c	Rhm
ZT	BU4310G	Vdet-IC	1.0V, +Reset PPO	SSOP-5	28vdo	VD3	6c	Rhm
ZU	BU4311FWE	Vdet-IC	1.1V, +Reset PPO	VSOFF-5	30vka	VD3	6c	Rhm
ZU	BU4311G	Vdet-IC	1.1V, +Reset PPO	SSOP-5	28vdo	VD3	6c	Rhm
ZU-	RT9013-13PB	LVR-IC	LDO, 1.3V±2%, 500mA, +CE	SOT-23-5	28cx	VR4	6g	Rct
ZV	BU4312FWE	Vdet-IC	1.2V, +Reset PPO	VSOFF-5	30vka	VD3	6c	Rhm
ZV	BU4312G	Vdet-IC	1.2V, +Reset PPO	SSOP-5	28vdo	VD3	6c	Rhm
ZW	BU4313FWE	Vdet-IC	1.3V, +Reset PPO	VSOFF-5	30vka	VD3	6c	Rhm
ZW	BU4313G	Vdet-IC	1.3V, +Reset PPO	SSOP-5	28vdo	VD3	6c	Rhm
ZW	R1210N602C	DC/DC-IC	PWM step-up, 6V, 100kHz, +CE, ext, transistor	SOT-23-5	28sd	DC6	6g	Ric
ZX	BU4314FWE	Vdet-IC	1.4V, +Reset PPO	VSOFF-5	30vka	VD3	6c	Rhm
ZX	BU4314G	Vdet-IC	1.4V, +Reset PPO	SSOP-5	28vdo	VD3	6c	Rhm
ZX-	RT9193-16PB	LVR-IC	LDO, 1.6V±1%, 300mA, +CE	SOT-23-5	28vrx	VR7	6g	Rct
ZX=	RT9193-16GB	LVR-IC	LDO, 1.6V±1%, 300mA, +CE	SOT-23-5	28vrx	VR7	6g	Rct
ZY	BU4315FWE	Vdet-IC	1.5V, +Reset PPO	VSOFF-5	30vka	VD3	6c	Rhm
ZY	BU4315G	Vdet-IC	1.5V, +Reset PPO	SSOP-5	28vdo	VD3	6c	Rhm
ZY-	RT9013-16PB	LVR-IC	LDO, 1.6V±2%, 500mA, +CE	SOT-23-5	28cx	VR4	6g	Rct
ZZ	BU4316FWE	Vdet-IC	1.6V, +Reset PPO	VSOFF-5	30vka	VD3	6c	Rhm
ZZ	BU4316G	Vdet-IC	1.6V, +Reset PPO	SSOP-5	28vdo	VD3	6c	Rhm



SECTION 8
SOT-89-5 CASE SMD SEMICONDUCTOR COMPONENTS

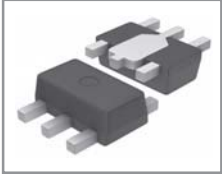

SMD code	Type	Function	Short description	Case	Pinout Sch.	St.	Mnf.
00E	XC6505A151PR	LVR-IC	LDO, 1.5V±20mV, 200mA, +CE	SOT-89-5	32um VR4	6n	Tor
00F	XC6505A161PR	LVR-IC	LDO, 1.6V±20mV, 200mA, +CE	SOT-89-5	32um VR4	6n	Tor
00H	XC6505A171PR	LVR-IC	LDO, 1.7V±20mV, 200mA, +CE	SOT-89-5	32um VR4	6n	Tor
00K	XC6505A181PR	LVR-IC	LDO, 1.8V±20mV, 200mA, +CE	SOT-89-5	32um VR4	6n	Tor
00L	XC6505A191PR	LVR-IC	LDO, 1.9V±20mV, 200mA, +CE	SOT-89-5	32um VR4	6n	Tor
00M	XC6505A201PR	LVR-IC	LDO, 2.0V±1%, 200mA, +CE	SOT-89-5	32um VR4	6n	Tor
00N	XC6505A211PR	LVR-IC	LDO, 2.1V±1%, 200mA, +CE	SOT-89-5	32um VR4	6n	Tor
00P	XC6505A221PR	LVR-IC	LDO, 2.2V±1%, 200mA, +CE	SOT-89-5	32um VR4	6n	Tor
00R	XC6505A231PR	LVR-IC	LDO, 2.3V±1%, 200mA, +CE	SOT-89-5	32um VR4	6n	Tor
00S	XC6505A241PR	LVR-IC	LDO, 2.4V±1%, 200mA, +CE	SOT-89-5	32um VR4	6n	Tor
00T	XC6505A251PR	LVR-IC	LDO, 2.5V±1%, 200mA, +CE	SOT-89-5	32um VR4	6n	Tor
00U	XC6505A261PR	LVR-IC	LDO, 2.6V±1%, 200mA, +CE	SOT-89-5	32um VR4	6n	Tor
00V	XC6505A271PR	LVR-IC	LDO, 2.7V±1%, 200mA, +CE	SOT-89-5	32um VR4	6n	Tor
00X	XC6505A281PR	LVR-IC	LDO, 2.8V±1%, 200mA, +CE	SOT-89-5	32um VR4	6n	Tor
00Y	XC6505A291PR	LVR-IC	LDO, 2.9V±1%, 200mA, +CE	SOT-89-5	32um VR4	6n	Tor
00Z	XC6505A301PR	LVR-IC	LDO, 3.0V±1%, 200mA, +CE	SOT-89-5	32um VR4	6n	Tor
010	XC6505A311PR	LVR-IC	LDO, 3.1V±1%, 200mA, +CE	SOT-89-5	32um VR4	6n	Tor
011	XC6505A321PR	LVR-IC	LDO, 3.2V±1%, 200mA, +CE	SOT-89-5	32um VR4	6n	Tor
012	XC6505A331PR	LVR-IC	LDO, 3.3V±1%, 200mA, +CE	SOT-89-5	32um VR4	6n	Tor
013	XC6505A341PR	LVR-IC	LDO, 3.4V±1%, 200mA, +CE	SOT-89-5	32um VR4	6n	Tor
014	XC6505A351PR	LVR-IC	LDO, 3.5V±1%, 200mA, +CE	SOT-89-5	32um VR4	6n	Tor
015	XC6505A361PR	LVR-IC	LDO, 3.6V±1%, 200mA, +CE	SOT-89-5	32um VR4	6n	Tor
016	XC6505A371PR	LVR-IC	LDO, 3.7V±1%, 200mA, +CE	SOT-89-5	32um VR4	6n	Tor
017	XC6505A381PR	LVR-IC	LDO, 3.8V±1%, 200mA, +CE	SOT-89-5	32um VR4	6n	Tor
018	XC6505A391PR	LVR-IC	LDO, 3.9V±1%, 200mA, +CE	SOT-89-5	32um VR4	6n	Tor
019	XC6505A401PR	LVR-IC	LDO, 4.0V±1%, 200mA, +CE	SOT-89-5	32um VR4	6n	Tor
01A	XC6505A411PR	LVR-IC	LDO, 4.1V±1%, 200mA, +CE	SOT-89-5	32um VR4	6n	Tor
01B	XC6505A421PR	LVR-IC	LDO, 4.2V±1%, 200mA, +CE	SOT-89-5	32um VR4	6n	Tor
01C	XC6505A431PR	LVR-IC	LDO, 4.3V±1%, 200mA, +CE	SOT-89-5	32um VR4	6n	Tor
01D	XC6505A441PR	LVR-IC	LDO, 4.4V±1%, 200mA, +CE	SOT-89-5	32um VR4	6n	Tor
01E	XC6505A451PR	LVR-IC	LDO, 4.5V±1%, 200mA, +CE	SOT-89-5	32um VR4	6n	Tor
01F	XC6505A461PR	LVR-IC	LDO, 4.6V±1%, 200mA, +CE	SOT-89-5	32um VR4	6n	Tor
01H	XC6505A471PR	LVR-IC	LDO, 4.7V±1%, 200mA, +CE	SOT-89-5	32um VR4	6n	Tor
01K	XC6505A481PR	LVR-IC	LDO, 4.8V±1%, 200mA, +CE	SOT-89-5	32um VR4	6n	Tor
01L	XC6505A491PR	LVR-IC	LDO, 4.9V±1%, 200mA, +CE	SOT-89-5	32um VR4	6n	Tor
01M	XC6505A501PR	LVR-IC	LDO, 5.0V±1%, 200mA, +CE	SOT-89-5	32um VR4	6n	Tor
020	ELM85103A	LVR-IC	LDO, 1.0V±2%, 800mA, +CE	SOT-89-5	32vrt VR4	6h	Elm
020	XC6505A611PR	LVR-IC	LDO, 6.1V±1%, 200mA, +CE	SOT-89-5	32um VR4	6n	Tor
021	XC6505A621PR	LVR-IC	LDO, 6.2V±1%, 200mA, +CE	SOT-89-5	32um VR4	6n	Tor
022	XC6505A631PR	LVR-IC	LDO, 6.3V±1%, 200mA, +CE	SOT-89-5	32um VR4	6n	Tor
023	XC6505A641PR	LVR-IC	LDO, 6.4V±1%, 200mA, +CE	SOT-89-5	32um VR4	6n	Tor
024	XC6505A651PR	LVR-IC	LDO, 6.5V±1%, 200mA, +CE	SOT-89-5	32um VR4	6n	Tor
025	XC6505A661PR	LVR-IC	LDO, 6.6V±1%, 200mA, +CE	SOT-89-5	32um VR4	6n	Tor
026	XC6505A671PR	LVR-IC	LDO, 6.7V±1%, 200mA, +CE	SOT-89-5	32um VR4	6n	Tor
027	XC6505A681PR	LVR-IC	LDO, 6.8V±1%, 200mA, +CE	SOT-89-5	32um VR4	6n	Tor
028	ELM85083A	LVR-IC	LDO, 0.8V±2%, 800mA, +CE	SOT-89-5	32vrt VR4	6h	Elm
028	XC6505A691PR	LVR-IC	LDO, 6.9V±1%, 200mA, +CE	SOT-89-5	32um VR4	6n	Tor
029	ELM85093A	LVR-IC	LDO, 0.9±2%, 800mA, +CE	SOT-89-5	32vrt VR4	6h	Elm
029	XC6505A701PR	LVR-IC	LDO, 7.0V±1%, 200mA, +CE	SOT-89-5	32um VR4	6n	Tor
02A	ELM85113A	LVR-IC	LDO, 1.1±2%, 800mA, +CE	SOT-89-5	32vrt VR4	6h	Elm
02B	ELM85123A	LVR-IC	LDO, 1.2±2%, 800mA, +CE	SOT-89-5	32vrt VR4	6h	Elm
02C	ELM85133A	LVR-IC	LDO, 1.3±2%, 800mA, +CE	SOT-89-5	32vrt VR4	6h	Elm
02D	ELM85143A	LVR-IC	LDO, 1.4±2%, 800mA, +CE	SOT-89-5	32vrt VR4	6h	Elm
02E	ELM85153A	LVR-IC	LDO, 1.5±2%, 800mA, +CE	SOT-89-5	32vrt VR4	6h	Elm
02F	ELM85163A	LVR-IC	LDO, 1.6±2%, 800mA, +CE	SOT-89-5	32vrt VR4	6h	Elm
02G	ELM85173A	LVR-IC	LDO, 1.7±2%, 800mA, +CE	SOT-89-5	32vrt VR4	6h	Elm
02H	ELM85183A	LVR-IC	LDO, 1.8±2%, 800mA, +CE	SOT-89-5	32vrt VR4	6h	Elm
02J	ELM85193A	LVR-IC	LDO, 1.9±2%, 800mA, +CE	SOT-89-5	32vrt VR4	6h	Elm
02K	ELM85203A	LVR-IC	LDO, 2.0±2%, 800mA, +CE	SOT-89-5	32vrt VR4	6h	Elm
02L	ELM85213A	LVR-IC	LDO, 2.1±2%, 800mA, +CE	SOT-89-5	32vrt VR4	6h	Elm
02M	ELM85223A	LVR-IC	LDO, 2.2±2%, 800mA, +CE	SOT-89-5	32vrt VR4	6h	Elm
02N	ELM85233A	LVR-IC	LDO, 2.3±2%, 800mA, +CE	SOT-89-5	32vrt VR4	6h	Elm
02N	XC6505A511PR	LVR-IC	LDO, 5.1V±1%, 200mA, +CE	SOT-89-5	32um VR4	6n	Tor
02P	ELM85243A	LVR-IC	LDO, 2.4±2%, 800mA, +CE	SOT-89-5	32vrt VR4	6h	Elm
02P	XC6505A521PR	LVR-IC	LDO, 5.2V±1%, 200mA, +CE	SOT-89-5	32um VR4	6n	Tor
02Q	ELM85253A	LVR-IC	LDO, 2.5±2%, 800mA, +CE	SOT-89-5	32vrt VR4	6h	Elm
02R	ELM85263A	LVR-IC	LDO, 2.6±2%, 800mA, +CE	SOT-89-5	32vrt VR4	6h	Elm
02R	XC6505A531PR	LVR-IC	LDO, 5.3V±1%, 200mA, +CE	SOT-89-5	32um VR4	6n	Tor
02S	ELM85273A	LVR-IC	LDO, 2.7±2%, 800mA, +CE	SOT-89-5	32vrt VR4	6h	Elm
02S	XC6505A541PR	LVR-IC	LDO, 5.4V±1%, 200mA, +CE	SOT-89-5	32um VR4	6n	Tor



SMD code	Type	Function	Short description	Case	Pinout Sch.	St.	Mnf.
02T	ELM85283A	LVR-IC	LDO, 2.8±2%, 800mA, +CE	SOT-89-5	32vrt VR4	6h	Elm
02T	XC6505A551PR	LVR-IC	LDO, 5.5V±1%, 200mA, +CE	SOT-89-5	32um VR4	6n	Tor
02U	ELM85293A	LVR-IC	LDO, 2.9±2%, 800mA, +CE	SOT-89-5	32vrt VR4	6h	Elm
02U	XC6505A561PR	LVR-IC	LDO, 5.6V±1%, 200mA, +CE	SOT-89-5	32um VR4	6n	Tor
02V	ELM85303A	LVR-IC	LDO, 3.0±2%, 800mA, +CE	SOT-89-5	32vrt VR4	6h	Elm
02V	XC6505A571PR	LVR-IC	LDO, 5.7V±1%, 200mA, +CE	SOT-89-5	32um VR4	6n	Tor
02X	XC6505A581PR	LVR-IC	LDO, 5.8V±1%, 200mA, +CE	SOT-89-5	32um VR4	6n	Tor
02Y	XC6505A591PR	LVR-IC	LDO, 5.9V±1%, 200mA, +CE	SOT-89-5	32um VR4	6n	Tor
02Z	XC6505A601PR	LVR-IC	LDO, 6.0V±1%, 200mA, +CE	SOT-89-5	32um VR4	6n	Tor
030	ELM85403A	LVR-IC	LDO, 4.0±2%, 800mA, +CE	SOT-89-5	32vrt VR4	6h	Elm
031	ELM85313A	LVR-IC	LDO, 3.1±2%, 800mA, +CE	SOT-89-5	32vrt VR4	6h	Elm
032	ELM85323A	LVR-IC	LDO, 3.2±2%, 800mA, +CE	SOT-89-5	32vrt VR4	6h	Elm
033	ELM85333A	LVR-IC	LDO, 3.3±2%, 800mA, +CE	SOT-89-5	32vrt VR4	6h	Elm
034	ELM85343A	LVR-IC	LDO, 3.4±2%, 800mA, +CE	SOT-89-5	32vrt VR4	6h	Elm
035	ELM85353A	LVR-IC	LDO, 3.5±2%, 800mA, +CE	SOT-89-5	32vrt VR4	6h	Elm
036	ELM85363A	LVR-IC	LDO, 3.6±2%, 800mA, +CE	SOT-89-5	32vrt VR4	6h	Elm
037	ELM85373A	LVR-IC	LDO, 3.7±2%, 800mA, +CE	SOT-89-5	32vrt VR4	6h	Elm
038	ELM85383A	LVR-IC	LDO, 3.8±2%, 800mA, +CE	SOT-89-5	32vrt VR4	6h	Elm
039	ELM85393A	LVR-IC	LDO, 3.9±2%, 800mA, +CE	SOT-89-5	32vrt VR4	6h	Elm
03A	ELM85413A	LVR-IC	LDO, 4.1±2%, 800mA, +CE	SOT-89-5	32vrt VR4	6h	Elm
03A	XC6505A711PR	LVR-IC	LDO, 7.1V±1%, 200mA, +CE	SOT-89-5	32um VR4	6n	Tor
03B	ELM85423A	LVR-IC	LDO, 4.2±2%, 800mA, +CE	SOT-89-5	32vrt VR4	6h	Elm
03B	XC6505A721PR	LVR-IC	LDO, 7.2V±1%, 200mA, +CE	SOT-89-5	32um VR4	6n	Tor
03C	ELM85433A	LVR-IC	LDO, 4.3±2%, 800mA, +CE	SOT-89-5	32vrt VR4	6h	Elm
03C	XC6505A731PR	LVR-IC	LDO, 7.3V±1%, 200mA, +CE	SOT-89-5	32um VR4	6n	Tor
03D	ELM85443A	LVR-IC	LDO, 4.4±2%, 800mA, +CE	SOT-89-5	32vrt VR4	6h	Elm
03D	XC6505A741PR	LVR-IC	LDO, 7.4V±1%, 200mA, +CE	SOT-89-5	32um VR4	6n	Tor
03E	ELM85453A	LVR-IC	LDO, 4.5±2%, 800mA, +CE	SOT-89-5	32vrt VR4	6h	Elm
03E	XC6505A751PR	LVR-IC	LDO, 7.5V±1%, 200mA, +CE	SOT-89-5	32um VR4	6n	Tor
03F	ELM85463A	LVR-IC	LDO, 4.6±2%, 800mA, +CE	SOT-89-5	32vrt VR4	6h	Elm
03F	XC6505A761PR	LVR-IC	LDO, 7.6V±1%, 200mA, +CE	SOT-89-5	32um VR4	6n	Tor
03G	ELM85473A	LVR-IC	LDO, 4.7±2%, 800mA, +CE	SOT-89-5	32vrt VR4	6h	Elm
03H	ELM85483A	LVR-IC	LDO, 4.8±2%, 800mA, +CE	SOT-89-5	32vrt VR4	6h	Elm
03H	XC6505A771PR	LVR-IC	LDO, 7.7V±1%, 200mA, +CE	SOT-89-5	32um VR4	6n	Tor
03J	ELM85493A	LVR-IC	LDO, 4.9±2%, 800mA, +CE	SOT-89-5	32vrt VR4	6h	Elm
03K	ELM85503A	LVR-IC	LDO, 5.0±2%, 800mA, +CE	SOT-89-5	32vrt VR4	6h	Elm
03K	XC6505A781PR	LVR-IC	LDO, 7.8V±1%, 200mA, +CE	SOT-89-5	32um VR4	6n	Tor
03L	XC6505A791PR	LVR-IC	LDO, 7.9V±1%, 200mA, +CE	SOT-89-5	32um VR4	6n	Tor
03M	XC6505A801PR	LVR-IC	LDO, 8.0V±1%, 200mA, +CE	SOT-89-5	32um VR4	6n	Tor
04E	XC6505C151PR	LVR-IC	LDO, 1.5V±20mV, 200mA, +CE, CL	SOT-89-5	32um VR4	6n	Tor
04F	XC6505C161PR	LVR-IC	LDO, 1.6V±20mV, 200mA, +CE, CL	SOT-89-5	32um VR4	6n	Tor
04H	XC6505C171PR	LVR-IC	LDO, 1.7V±20mV, 200mA, +CE, CL	SOT-89-5	32um VR4	6n	Tor
04K	XC6505C181PR	LVR-IC	LDO, 1.8V±20mV, 200mA, +CE, CL	SOT-89-5	32um VR4	6n	Tor
04L	XC6505C191PR	LVR-IC	LDO, 1.9V±20mV, 200mA, +CE, CL	SOT-89-5	32um VR4	6n	Tor
04M	XC6505C201PR	LVR-IC	LDO, 2.0V±1%, 200mA, +CE, CL	SOT-89-5	32um VR4	6n	Tor
04N	XC6505C211PR	LVR-IC	LDO, 2.1V±1%, 200mA, +CE, CL	SOT-89-5	32um VR4	6n	Tor
04P	XC6505C221PR	LVR-IC	LDO, 2.2V±1%, 200mA, +CE, CL	SOT-89-5	32um VR4	6n	Tor
04R	XC6505C231PR	LVR-IC	LDO, 2.3V±1%, 200mA, +CE, CL	SOT-89-5	32um VR4	6n	Tor
04S	XC6505C241PR	LVR-IC	LDO, 2.4V±1%, 200mA, +CE, CL	SOT-89-5	32um VR4	6n	Tor
04T	XC6505C251PR	LVR-IC	LDO, 2.5V±1%, 200mA, +CE, CL	SOT-89-5	32um VR4	6n	Tor
04U	XC6505C261PR	LVR-IC	LDO, 2.6V±1%, 200mA, +CE, CL	SOT-89-5	32um VR4	6n	Tor
04V	XC6505C271PR	LVR-IC	LDO, 2.7V±1%, 200mA, +CE, CL	SOT-89-5	32um VR4	6n	Tor
04X	XC6505C281PR	LVR-IC	LDO, 2.8V±1%, 200mA, +CE, CL	SOT-89-5	32um VR4	6n	Tor
04Y	XC6505C291PR	LVR-IC	LDO, 2.9V±1%, 200mA, +CE, CL	SOT-89-5	32um VR4	6n	Tor
04Z	XC6505C301PR	LVR-IC	LDO, 3.0V±1%, 200mA, +CE, CL	SOT-89-5	32um VR4	6n	Tor
050	XC6505C311PR	LVR-IC	LDO, 3.1V±1%, 200mA, +CE, CL	SOT-89-5	32um VR4	6n	Tor
051	XC6505C321PR	LVR-IC	LDO, 3.2V±1%, 200mA, +CE, CL	SOT-89-5	32um VR4	6n	Tor
052	XC6505C331PR	LVR-IC	LDO, 3.3V±1%, 200mA, +CE, CL	SOT-89-5	32um VR4	6n	Tor
053	XC6505C341PR	LVR-IC	LDO, 3.4V±1%, 200mA, +CE, CL	SOT-89-5	32um VR4	6n	Tor
054	XC6505C351PR	LVR-IC	LDO, 3.5V±1%, 200mA, +CE, CL	SOT-89-5	32um VR4	6n	Tor
055	XC6505C361PR	LVR-IC	LDO, 3.6V±1%, 200mA, +CE, CL	SOT-89-5	32um VR4	6n	Tor
056	XC6505C371PR	LVR-IC	LDO, 3.7V±1%, 200mA, +CE, CL	SOT-89-5	32um VR4	6n	Tor
057	XC6505C381PR	LVR-IC	LDO, 3.8V±1%, 200mA, +CE, CL	SOT-89-5	32um VR4	6n	Tor
058	XC6505C391PR	LVR-IC	LDO, 3.9V±1%, 200mA, +CE, CL	SOT-89-5	32um VR4	6n	Tor
059	XC6505C401PR	LVR-IC	LDO, 4.0V±1%, 200mA, +CE, CL	SOT-89-5	32um VR4	6n	Tor
05A	XC6505C411PR	LVR-IC	LDO, 4.1V±1%, 200mA, +CE, CL	SOT-89-5	32um VR4	6n	Tor
05B	XC6505C421PR	LVR-IC	LDO, 4.2V±1%, 200mA, +CE, CL	SOT-89-5	32um VR4	6n	Tor
05C	XC6505C431PR	LVR-IC	LDO, 4.3V±1%, 200mA, +CE, CL	SOT-89-5	32um VR4	6n	Tor
05D	XC6505C441PR	LVR-IC	LDO, 4.4V±1%, 200mA, +CE, CL	SOT-89-5	32um VR4	6n	Tor
05E	XC6505C451PR	LVR-IC	LDO, 4.5V±1%, 200mA, +CE, CL	SOT-89-5	32um VR4	6n	Tor



SMD code	Type	Function	Short description	Case	Pinout Sch.	St.	Mnf.
05F	XC6505C461PR	LVR-IC	LDO, 4.6V±1%, 200mA, +CE, CL	SOT-89-5	32um VR4	6n	Tor
05H	XC6505C471PR	LVR-IC	LDO, 4.7V±1%, 200mA, +CE, CL	SOT-89-5	32um VR4	6n	Tor
05K	XC6505C481PR	LVR-IC	LDO, 4.8V±1%, 200mA, +CE, CL	SOT-89-5	32um VR4	6n	Tor
05L	XC6505C491PR	LVR-IC	LDO, 4.9V±1%, 200mA, +CE, CL	SOT-89-5	32um VR4	6n	Tor
05M	XC6505C501PR	LVR-IC	LDO, 5.0V±1%, 200mA, +CE, CL	SOT-89-5	32um VR4	6n	Tor
060	XC6505C611PR	LVR-IC	LDO, 6.1V±1%, 200mA, +CE, CL	SOT-89-5	32um VR4	6n	Tor
061	XC6505C621PR	LVR-IC	LDO, 6.2V±1%, 200mA, +CE, CL	SOT-89-5	32um VR4	6n	Tor
062	XC6505C631PR	LVR-IC	LDO, 6.3V±1%, 200mA, +CE, CL	SOT-89-5	32um VR4	6n	Tor
063	XC6505C641PR	LVR-IC	LDO, 6.4V±1%, 200mA, +CE, CL	SOT-89-5	32um VR4	6n	Tor
064	XC6505C651PR	LVR-IC	LDO, 6.5V±1%, 200mA, +CE, CL	SOT-89-5	32um VR4	6n	Tor
065	XC6505C661PR	LVR-IC	LDO, 6.6V±1%, 200mA, +CE, CL	SOT-89-5	32um VR4	6n	Tor
066	XC6505C671PR	LVR-IC	LDO, 6.7V±1%, 200mA, +CE, CL	SOT-89-5	32um VR4	6n	Tor
067	XC6505C681PR	LVR-IC	LDO, 6.8V±1%, 200mA, +CE, CL	SOT-89-5	32um VR4	6n	Tor
068	XC6505C691PR	LVR-IC	LDO, 6.9V±1%, 200mA, +CE, CL	SOT-89-5	32um VR4	6n	Tor
069	XC6505C701PR	LVR-IC	LDO, 7.0V±1%, 200mA, +CE, CL	SOT-89-5	32um VR4	6n	Tor
06N	XC6505C511PR	LVR-IC	LDO, 5.1V±1%, 200mA, +CE, CL	SOT-89-5	32um VR4	6n	Tor
06P	XC6505C521PR	LVR-IC	LDO, 5.2V±1%, 200mA, +CE, CL	SOT-89-5	32um VR4	6n	Tor
06R	XC6505C531PR	LVR-IC	LDO, 5.3V±1%, 200mA, +CE, CL	SOT-89-5	32um VR4	6n	Tor
06S	XC6505C541PR	LVR-IC	LDO, 5.4V±1%, 200mA, +CE, CL	SOT-89-5	32um VR4	6n	Tor
06T	XC6505C551PR	LVR-IC	LDO, 5.5V±1%, 200mA, +CE, CL	SOT-89-5	32um VR4	6n	Tor
06U	XC6505C561PR	LVR-IC	LDO, 5.6V±1%, 200mA, +CE, CL	SOT-89-5	32um VR4	6n	Tor
06V	XC6505C571PR	LVR-IC	LDO, 5.7V±1%, 200mA, +CE, CL	SOT-89-5	32um VR4	6n	Tor
06X	XC6505C581PR	LVR-IC	LDO, 5.8V±1%, 200mA, +CE, CL	SOT-89-5	32um VR4	6n	Tor
06Y	XC6505C591PR	LVR-IC	LDO, 5.9V±1%, 200mA, +CE, CL	SOT-89-5	32um VR4	6n	Tor
06Z	XC6505C601PR	LVR-IC	LDO, 6.0V±1%, 200mA, +CE, CL	SOT-89-5	32um VR4	6n	Tor
07A	XC6505C711PR	LVR-IC	LDO, 7.1V±1%, 200mA, +CE, CL	SOT-89-5	32um VR4	6n	Tor
07B	XC6505C721PR	LVR-IC	LDO, 7.2V±1%, 200mA, +CE, CL	SOT-89-5	32um VR4	6n	Tor
07C	XC6505C731PR	LVR-IC	LDO, 7.3V±1%, 200mA, +CE, CL	SOT-89-5	32um VR4	6n	Tor
07D	XC6505C741PR	LVR-IC	LDO, 7.4V±1%, 200mA, +CE, CL	SOT-89-5	32um VR4	6n	Tor
07E	XC6505C751PR	LVR-IC	LDO, 7.5V±1%, 200mA, +CE, CL	SOT-89-5	32um VR4	6n	Tor
07F	XC6505C761PR	LVR-IC	LDO, 7.6V±1%, 200mA, +CE, CL	SOT-89-5	32um VR4	6n	Tor
07H	XC6505C771PR	LVR-IC	LDO, 7.7V±1%, 200mA, +CE, CL	SOT-89-5	32um VR4	6n	Tor
07K	XC6505C781PR	LVR-IC	LDO, 7.8V±1%, 200mA, +CE, CL	SOT-89-5	32um VR4	6n	Tor
07L	XC6505C791PR	LVR-IC	LDO, 7.9V±1%, 200mA, +CE, CL	SOT-89-5	32um VR4	6n	Tor
07M	XC6505C801PR	LVR-IC	LDO, 8.0V±1%, 200mA, +CE, CL	SOT-89-5	32um VR4	6n	Tor
0A0	XC6210A312PR	LVR-IC	LDO, 3.1V±2%, 700mA, +CE, PDR	SOT-89-5	32vy VR4	6h	Tor
0A1	XC6210A322PR	LVR-IC	LDO, 3.2V±2%, 700mA, +CE, PDR	SOT-89-5	32vy VR4	6h	Tor
0A2	XC6210A332PR	LVR-IC	LDO, 3.3V±2%, 700mA, +CE, PDR	SOT-89-5	32vy VR4	6h	Tor
0A3	XC6210A342PR	LVR-IC	LDO, 3.4V±2%, 700mA, +CE, PDR	SOT-89-5	32vy VR4	6h	Tor
0A4	XC6210A352PR	LVR-IC	LDO, 3.5V±2%, 700mA, +CE, PDR	SOT-89-5	32vy VR4	6h	Tor
0A5	XC6210A362PR	LVR-IC	LDO, 3.6V±2%, 700mA, +CE, PDR	SOT-89-5	32vy VR4	6h	Tor
0A6	XC6210A372PR	LVR-IC	LDO, 3.7V±2%, 700mA, +CE, PDR	SOT-89-5	32vy VR4	6h	Tor
0A7	XC6210A382PR	LVR-IC	LDO, 3.8V±2%, 700mA, +CE, PDR	SOT-89-5	32vy VR4	6h	Tor
0A8	XC6210A392PR	LVR-IC	LDO, 3.9V±2%, 700mA, +CE, PDR	SOT-89-5	32vy VR4	6h	Tor
0A9	XC6210A402PR	LVR-IC	LDO, 4V±2%, 700mA, +CE, PDR	SOT-89-5	32vy VR4	6h	Tor
0AA	XC6210A412PR	LVR-IC	LDO, 4.1V±2%, 700mA, +CE, PDR	SOT-89-5	32vy VR4	6h	Tor
0AB	XC6210A422PR	LVR-IC	LDO, 4.2V±2%, 700mA, +CE, PDR	SOT-89-5	32vy VR4	6h	Tor
0AC	XC6210A432PR	LVR-IC	LDO, 4.3V±2%, 700mA, +CE, PDR	SOT-89-5	32vy VR4	6h	Tor
0AD	XC6210A442PR	LVR-IC	LDO, 4.4V±2%, 700mA, +CE, PDR	SOT-89-5	32vy VR4	6h	Tor
0AE	XC6210A452PR	LVR-IC	LDO, 4.5V±2%, 700mA, +CE, PDR	SOT-89-5	32vy VR4	6h	Tor
0AF	XC6210A462PR	LVR-IC	LDO, 4.6V±2%, 700mA, +CE, PDR	SOT-89-5	32vy VR4	6h	Tor
0AH	XC6210A472PR	LVR-IC	LDO, 4.7V±2%, 700mA, +CE, PDR	SOT-89-5	32vy VR4	6h	Tor
0AK	XC6210A482PR	LVR-IC	LDO, 4.8V±2%, 700mA, +CE, PDR	SOT-89-5	32vy VR4	6h	Tor
0AL	XC6210A492PR	LVR-IC	LDO, 4.9V±2%, 700mA, +CE, PDR	SOT-89-5	32vy VR4	6h	Tor
0AM	XC6210A502PR	LVR-IC	LDO, 5V±2%, 700mA, +CE, PDR	SOT-89-5	32vy VR4	6h	Tor
0B0	XC6210B312PR	LVR-IC	LDO, 3.1V±2%, 700mA, +CE	SOT-89-5	32vy VR4	6h	Tor
0B1	XC6210B322PR	LVR-IC	LDO, 3.2V±2%, 700mA, +CE	SOT-89-5	32vy VR4	6h	Tor
0B2	XC6210B332PR	LVR-IC	LDO, 3.3V±2%, 700mA, +CE	SOT-89-5	32vy VR4	6h	Tor
0B3	XC6210B342PR	LVR-IC	LDO, 3.4V±2%, 700mA, +CE	SOT-89-5	32vy VR4	6h	Tor
0B4	XC6210B352PR	LVR-IC	LDO, 3.5V±2%, 700mA, +CE	SOT-89-5	32vy VR4	6h	Tor
0B5	XC6210B362PR	LVR-IC	LDO, 3.6V±2%, 700mA, +CE	SOT-89-5	32vy VR4	6h	Tor
0B6	XC6210B372PR	LVR-IC	LDO, 3.7V±2%, 700mA, +CE	SOT-89-5	32vy VR4	6h	Tor
0B7	XC6210B382PR	LVR-IC	LDO, 3.8V±2%, 700mA, +CE	SOT-89-5	32vy VR4	6h	Tor
0B8	XC6210B392PR	LVR-IC	LDO, 3.9V±2%, 700mA, +CE	SOT-89-5	32vy VR4	6h	Tor
0B9	XC6210B402PR	LVR-IC	LDO, 4V±2%, 700mA, +CE	SOT-89-5	32vy VR4	6h	Tor
0BA	XC6210B412PR	LVR-IC	LDO, 4.1V±2%, 700mA, +CE	SOT-89-5	32vy VR4	6h	Tor
0BB	XC6210B422PR	LVR-IC	LDO, 4.2V±2%, 700mA, +CE	SOT-89-5	32vy VR4	6h	Tor
0BC	XC6210B432PR	LVR-IC	LDO, 4.3V±2%, 700mA, +CE	SOT-89-5	32vy VR4	6h	Tor
0BD	XC6210B442PR	LVR-IC	LDO, 4.4V±2%, 700mA, +CE	SOT-89-5	32vy VR4	6h	Tor
0BE	XC6210B452PR	LVR-IC	LDO, 4.5V±2%, 700mA, +CE	SOT-89-5	32vy VR4	6h	Tor



SMD code	Type	Function	Short description	Case	Pinout Sch.	St.	Mnf.
0BF	XC6210B462PR	LVR-IC	LDO, 4.6V±2%, 700mA, +CE	SOT-89-5	32vy VR4	6h	Tor
0BH	XC6210B472PR	LVR-IC	LDO, 4.7V±2%, 700mA, +CE	SOT-89-5	32vy VR4	6h	Tor
0BK	XC6210B482PR	LVR-IC	LDO, 4.8V±2%, 700mA, +CE	SOT-89-5	32vy VR4	6h	Tor
0BL	XC6210B492PR	LVR-IC	LDO, 4.9V±2%, 700mA, +CE	SOT-89-5	32vy VR4	6h	Tor
0BM	XC6210B502PR	LVR-IC	LDO, 5V±2%, 700mA, +CE	SOT-89-5	32vy VR4	6h	Tor
0C0	XC6210C312PR	LVR-IC	LDO, 3.1V±2%, 700mA, -CE, PDR	SOT-89-5	32vy VR4	6h	Tor
0C1	XC6210C322PR	LVR-IC	LDO, 3.2V±2%, 700mA, -CE, PDR	SOT-89-5	32vy VR4	6h	Tor
0C2	XC6210C332PR	LVR-IC	LDO, 3.3V±2%, 700mA, -CE, PDR	SOT-89-5	32vy VR4	6h	Tor
0C3	XC6210C342PR	LVR-IC	LDO, 3.4V±2%, 700mA, -CE, PDR	SOT-89-5	32vy VR4	6h	Tor
0C4	XC6210C352PR	LVR-IC	LDO, 3.5V±2%, 700mA, -CE, PDR	SOT-89-5	32vy VR4	6h	Tor
0C5	XC6210C362PR	LVR-IC	LDO, 3.6V±2%, 700mA, -CE, PDR	SOT-89-5	32vy VR4	6h	Tor
0C6	XC6210C372PR	LVR-IC	LDO, 3.7V±2%, 700mA, -CE, PDR	SOT-89-5	32vy VR4	6h	Tor
0C7	XC6210C382PR	LVR-IC	LDO, 3.8V±2%, 700mA, -CE, PDR	SOT-89-5	32vy VR4	6h	Tor
0C8	XC6210C392PR	LVR-IC	LDO, 3.9V±2%, 700mA, -CE, PDR	SOT-89-5	32vy VR4	6h	Tor
0C9	XC6210C402PR	LVR-IC	LDO, 4V±2%, 700mA, -CE, PDR	SOT-89-5	32vy VR4	6h	Tor
0CA	XC6210C412PR	LVR-IC	LDO, 4.1V±2%, 700mA, -CE, PDR	SOT-89-5	32vy VR4	6h	Tor
0CB	XC6210C422PR	LVR-IC	LDO, 4.2V±2%, 700mA, -CE, PDR	SOT-89-5	32vy VR4	6h	Tor
0CC	XC6210C432PR	LVR-IC	LDO, 4.3V±2%, 700mA, -CE, PDR	SOT-89-5	32vy VR4	6h	Tor
0CD	XC6210C442PR	LVR-IC	LDO, 4.4V±2%, 700mA, -CE, PDR	SOT-89-5	32vy VR4	6h	Tor
0CE	XC6210C452PR	LVR-IC	LDO, 4.5V±2%, 700mA, -CE, PDR	SOT-89-5	32vy VR4	6h	Tor
0CF	XC6210C462PR	LVR-IC	LDO, 4.6V±2%, 700mA, -CE, PDR	SOT-89-5	32vy VR4	6h	Tor
0CH	XC6210C472PR	LVR-IC	LDO, 4.7V±2%, 700mA, -CE, PDR	SOT-89-5	32vy VR4	6h	Tor
0CK	XC6210C482PR	LVR-IC	LDO, 4.8V±2%, 700mA, -CE, PDR	SOT-89-5	32vy VR4	6h	Tor
0CL	XC6210C492PR	LVR-IC	LDO, 4.9V±2%, 700mA, -CE, PDR	SOT-89-5	32vy VR4	6h	Tor
0CM	XC6210C502PR	LVR-IC	LDO, 5V±2%, 700mA, -CE, PDR	SOT-89-5	32vy VR4	6h	Tor
0D0	XC6210D312PR	LVR-IC	LDO, 3.1V±2%, 700mA, -CE	SOT-89-5	32vy VR4	6h	Tor
0D1	XC6210D322PR	LVR-IC	LDO, 3.2V±2%, 700mA, -CE	SOT-89-5	32vy VR4	6h	Tor
0D2	XC6210D332PR	LVR-IC	LDO, 3.3V±2%, 700mA, -CE	SOT-89-5	32vy VR4	6h	Tor
0D3	XC6210D342PR	LVR-IC	LDO, 3.4V±2%, 700mA, -CE	SOT-89-5	32vy VR4	6h	Tor
0D4	XC6210D352PR	LVR-IC	LDO, 3.5V±2%, 700mA, -CE	SOT-89-5	32vy VR4	6h	Tor
0D5	XC6210D362PR	LVR-IC	LDO, 3.6V±2%, 700mA, -CE	SOT-89-5	32vy VR4	6h	Tor
0D6	XC6210D372PR	LVR-IC	LDO, 3.7V±2%, 700mA, -CE	SOT-89-5	32vy VR4	6h	Tor
0D7	XC6210D382PR	LVR-IC	LDO, 3.8V±2%, 700mA, -CE	SOT-89-5	32vy VR4	6h	Tor
0D8	XC6210D392PR	LVR-IC	LDO, 3.9V±2%, 700mA, -CE	SOT-89-5	32vy VR4	6h	Tor
0D9	XC6210D402PR	LVR-IC	LDO, 4V±2%, 700mA, -CE	SOT-89-5	32vy VR4	6h	Tor
0DA	XC6210D412PR	LVR-IC	LDO, 4.1V±2%, 700mA, -CE	SOT-89-5	32vy VR4	6h	Tor
0DB	XC6210D422PR	LVR-IC	LDO, 4.2V±2%, 700mA, -CE	SOT-89-5	32vy VR4	6h	Tor
0DC	XC6210D432PR	LVR-IC	LDO, 4.3V±2%, 700mA, -CE	SOT-89-5	32vy VR4	6h	Tor
0DD	XC6210D442PR	LVR-IC	LDO, 4.4V±2%, 700mA, -CE	SOT-89-5	32vy VR4	6h	Tor
0DE	XC6210D452PR	LVR-IC	LDO, 4.5V±2%, 700mA, -CE	SOT-89-5	32vy VR4	6h	Tor
0DF	XC6210D462PR	LVR-IC	LDO, 4.6V±2%, 700mA, -CE	SOT-89-5	32vy VR4	6h	Tor
0DH	XC6210D472PR	LVR-IC	LDO, 4.7V±2%, 700mA, -CE	SOT-89-5	32vy VR4	6h	Tor
0DK	XC6210D482PR	LVR-IC	LDO, 4.8V±2%, 700mA, -CE	SOT-89-5	32vy VR4	6h	Tor
0DL	XC6210D492PR	LVR-IC	LDO, 4.9V±2%, 700mA, -CE	SOT-89-5	32vy VR4	6h	Tor
0DM	XC6210D502PR	LVR-IC	LDO, 5V±2%, 700mA, -CE	SOT-89-5	32vy VR4	6h	Tor
0E8	XC6210A08APR	LVR-IC	LDO, 0.85V±2%, 700mA, +CE, PDR	SOT-89-5	32vy VR4	6h	Tor
0E9	XC6210A09APR	LVR-IC	LDO, 0.95V±2%, 700mA, +CE, PDR	SOT-89-5	32vy VR4	6h	Tor
0EA	XC6210A11APR	LVR-IC	LDO, 1.15V±2%, 700mA, +CE, PDR	SOT-89-5	32vy VR4	6h	Tor
0EB	XC6210A12APR	LVR-IC	LDO, 1.25V±2%, 700mA, +CE, PDR	SOT-89-5	32vy VR4	6h	Tor
0EC	XC6210A13APR	LVR-IC	LDO, 1.35V±2%, 700mA, +CE, PDR	SOT-89-5	32vy VR4	6h	Tor
0ED	XC6210A14APR	LVR-IC	LDO, 1.45V±2%, 700mA, +CE, PDR	SOT-89-5	32vy VR4	6h	Tor
0EE	XC6210A15APR	LVR-IC	LDO, 1.55V±2%, 700mA, +CE, PDR	SOT-89-5	32vy VR4	6h	Tor
0EF	XC6210A16APR	LVR-IC	LDO, 1.65V±2%, 700mA, +CE, PDR	SOT-89-5	32vy VR4	6h	Tor
0EH	XC6210A17APR	LVR-IC	LDO, 1.75V±2%, 700mA, +CE, PDR	SOT-89-5	32vy VR4	6h	Tor
0EK	XC6210A18APR	LVR-IC	LDO, 1.85V±2%, 700mA, +CE, PDR	SOT-89-5	32vy VR4	6h	Tor
0EL	XC6210A19APR	LVR-IC	LDO, 1.95V±2%, 700mA, +CE, PDR	SOT-89-5	32vy VR4	6h	Tor
0EM	XC6210A20APR	LVR-IC	LDO, 2.05V±2%, 700mA, +CE, PDR	SOT-89-5	32vy VR4	6h	Tor
0EN	XC6210A21APR	LVR-IC	LDO, 2.15V±2%, 700mA, +CE, PDR	SOT-89-5	32vy VR4	6h	Tor
0EP	XC6210A22APR	LVR-IC	LDO, 2.25V±2%, 700mA, +CE, PDR	SOT-89-5	32vy VR4	6h	Tor
0ER	XC6210A23APR	LVR-IC	LDO, 2.35V±2%, 700mA, +CE, PDR	SOT-89-5	32vy VR4	6h	Tor
0ES	XC6210A24APR	LVR-IC	LDO, 2.45V±2%, 700mA, +CE, PDR	SOT-89-5	32vy VR4	6h	Tor
0ET	XC6210A25APR	LVR-IC	LDO, 2.55V±2%, 700mA, +CE, PDR	SOT-89-5	32vy VR4	6h	Tor
0EU	XC6210A26APR	LVR-IC	LDO, 2.65V±2%, 700mA, +CE, PDR	SOT-89-5	32vy VR4	6h	Tor
0EV	XC6210A27APR	LVR-IC	LDO, 2.75V±2%, 700mA, +CE, PDR	SOT-89-5	32vy VR4	6h	Tor
0EX	XC6210A28APR	LVR-IC	LDO, 2.85V±2%, 700mA, +CE, PDR	SOT-89-5	32vy VR4	6h	Tor
0EY	XC6210A29APR	LVR-IC	LDO, 2.95V±2%, 700mA, +CE, PDR	SOT-89-5	32vy VR4	6h	Tor
0EZ	XC6210A30APR	LVR-IC	LDO, 3.05V±2%, 700mA, +CE, PDR	SOT-89-5	32vy VR4	6h	Tor
0F8	XC6210B08APR	LVR-IC	LDO, 0.85V±2%, 700mA, +CE	SOT-89-5	32vy VR4	6h	Tor
0F9	XC6210B09APR	LVR-IC	LDO, 0.95V±2%, 700mA, +CE	SOT-89-5	32vy VR4	6h	Tor
0FA	XC6210B11APR	LVR-IC	LDO, 1.15V±2%, 700mA, +CE	SOT-89-5	32vy VR4	6h	Tor



SMD code	Type	Function	Short description	Case	Pinout Sch.	St.	Mnf.
0FB	XC6210B12APR	LVR-IC	LDO, 1.25V±2%, 700mA, +CE	SOT-89-5	32vy VR4	6h	Tor
0FC	XC6210B13APR	LVR-IC	LDO, 1.35V±2%, 700mA, +CE	SOT-89-5	32vy VR4	6h	Tor
0FD	XC6210B14APR	LVR-IC	LDO, 1.45V±2%, 700mA, +CE	SOT-89-5	32vy VR4	6h	Tor
0FE	XC6210B15APR	LVR-IC	LDO, 1.55V±2%, 700mA, +CE	SOT-89-5	32vy VR4	6h	Tor
0FF	XC6210B16APR	LVR-IC	LDO, 1.65V±2%, 700mA, +CE	SOT-89-5	32vy VR4	6h	Tor
0FH	XC6210B17APR	LVR-IC	LDO, 1.75V±2%, 700mA, +CE	SOT-89-5	32vy VR4	6h	Tor
0FK	XC6210B18APR	LVR-IC	LDO, 1.85V±2%, 700mA, +CE	SOT-89-5	32vy VR4	6h	Tor
0FL	XC6210B19APR	LVR-IC	LDO, 1.95V±2%, 700mA, +CE	SOT-89-5	32vy VR4	6h	Tor
0FM	XC6210B20APR	LVR-IC	LDO, 2.05V±2%, 700mA, +CE	SOT-89-5	32vy VR4	6h	Tor
0FN	XC6210B21APR	LVR-IC	LDO, 2.15V±2%, 700mA, +CE	SOT-89-5	32vy VR4	6h	Tor
0FP	XC6210B22APR	LVR-IC	LDO, 2.25V±2%, 700mA, +CE	SOT-89-5	32vy VR4	6h	Tor
0FR	XC6210B23APR	LVR-IC	LDO, 2.35V±2%, 700mA, +CE	SOT-89-5	32vy VR4	6h	Tor
0FS	XC6210B24APR	LVR-IC	LDO, 2.45V±2%, 700mA, +CE	SOT-89-5	32vy VR4	6h	Tor
0FT	XC6210B25APR	LVR-IC	LDO, 2.55V±2%, 700mA, +CE	SOT-89-5	32vy VR4	6h	Tor
0FU	XC6210B26APR	LVR-IC	LDO, 2.65V±2%, 700mA, +CE	SOT-89-5	32vy VR4	6h	Tor
0FV	XC6210B27APR	LVR-IC	LDO, 2.75V±2%, 700mA, +CE	SOT-89-5	32vy VR4	6h	Tor
0FX	XC6210B28APR	LVR-IC	LDO, 2.85V±2%, 700mA, +CE	SOT-89-5	32vy VR4	6h	Tor
0FY	XC6210B29APR	LVR-IC	LDO, 2.95V±2%, 700mA, +CE	SOT-89-5	32vy VR4	6h	Tor
0FZ	XC6210B30APR	LVR-IC	LDO, 3.05V±2%, 700mA, +CE	SOT-89-5	32vy VR4	6h	Tor
0H8	XC6210C08APR	LVR-IC	LDO, 0.85V±2%, 700mA, -CE, PDR	SOT-89-5	32vy VR4	6h	Tor
0H9	XC6210C09APR	LVR-IC	LDO, 0.95V±2%, 700mA, -CE, PDR	SOT-89-5	32vy VR4	6h	Tor
0HA	XC6210C11APR	LVR-IC	LDO, 1.15V±2%, 700mA, -CE, PDR	SOT-89-5	32vy VR4	6h	Tor
0HB	XC6210C12APR	LVR-IC	LDO, 1.25V±2%, 700mA, -CE, PDR	SOT-89-5	32vy VR4	6h	Tor
0HC	XC6210C13APR	LVR-IC	LDO, 1.35V±2%, 700mA, -CE, PDR	SOT-89-5	32vy VR4	6h	Tor
0HD	XC6210C14APR	LVR-IC	LDO, 1.45V±2%, 700mA, -CE, PDR	SOT-89-5	32vy VR4	6h	Tor
0HE	XC6210C15APR	LVR-IC	LDO, 1.55V±2%, 700mA, -CE, PDR	SOT-89-5	32vy VR4	6h	Tor
0HF	XC6210C16APR	LVR-IC	LDO, 1.65V±2%, 700mA, -CE, PDR	SOT-89-5	32vy VR4	6h	Tor
0HH	XC6210C17APR	LVR-IC	LDO, 1.75V±2%, 700mA, -CE, PDR	SOT-89-5	32vy VR4	6h	Tor
0HK	XC6210C18APR	LVR-IC	LDO, 1.85V±2%, 700mA, -CE, PDR	SOT-89-5	32vy VR4	6h	Tor
0HL	XC6210C19APR	LVR-IC	LDO, 1.95V±2%, 700mA, -CE, PDR	SOT-89-5	32vy VR4	6h	Tor
0HM	XC6210C20APR	LVR-IC	LDO, 2.05V±2%, 700mA, -CE, PDR	SOT-89-5	32vy VR4	6h	Tor
0HN	XC6210C21APR	LVR-IC	LDO, 2.15V±2%, 700mA, -CE, PDR	SOT-89-5	32vy VR4	6h	Tor
0HP	XC6210C22APR	LVR-IC	LDO, 2.25V±2%, 700mA, -CE, PDR	SOT-89-5	32vy VR4	6h	Tor
0HR	XC6210C23APR	LVR-IC	LDO, 2.35V±2%, 700mA, -CE, PDR	SOT-89-5	32vy VR4	6h	Tor
0HS	XC6210C24APR	LVR-IC	LDO, 2.45V±2%, 700mA, -CE, PDR	SOT-89-5	32vy VR4	6h	Tor
0HT	XC6210C25APR	LVR-IC	LDO, 2.55V±2%, 700mA, -CE, PDR	SOT-89-5	32vy VR4	6h	Tor
0HU	XC6210C26APR	LVR-IC	LDO, 2.65V±2%, 700mA, -CE, PDR	SOT-89-5	32vy VR4	6h	Tor
0HV	XC6210C27APR	LVR-IC	LDO, 2.75V±2%, 700mA, -CE, PDR	SOT-89-5	32vy VR4	6h	Tor
0HX	XC6210C28APR	LVR-IC	LDO, 2.85V±2%, 700mA, -CE, PDR	SOT-89-5	32vy VR4	6h	Tor
0HY	XC6210C29APR	LVR-IC	LDO, 2.95V±2%, 700mA, -CE, PDR	SOT-89-5	32vy VR4	6h	Tor
0HZ	XC6210C30APR	LVR-IC	LDO, 3.05V±2%, 700mA, -CE, PDR	SOT-89-5	32vy VR4	6h	Tor
0K8	XC6210D08APR	LVR-IC	LDO, 0.85V±2%, 700mA, -CE	SOT-89-5	32vy VR4	6h	Tor
0K9	XC6210D09APR	LVR-IC	LDO, 0.95V±2%, 700mA, -CE	SOT-89-5	32vy VR4	6h	Tor
0KA	XC6210D11APR	LVR-IC	LDO, 1.15V±2%, 700mA, -CE	SOT-89-5	32vy VR4	6h	Tor
0KB	XC6210D12APR	LVR-IC	LDO, 1.25V±2%, 700mA, -CE	SOT-89-5	32vy VR4	6h	Tor
0KC	XC6210D13APR	LVR-IC	LDO, 1.35V±2%, 700mA, -CE	SOT-89-5	32vy VR4	6h	Tor
0KD	XC6210D14APR	LVR-IC	LDO, 1.45V±2%, 700mA, -CE	SOT-89-5	32vy VR4	6h	Tor
0KE	XC6210D15APR	LVR-IC	LDO, 1.55V±2%, 700mA, -CE	SOT-89-5	32vy VR4	6h	Tor
0KF	XC6210D16APR	LVR-IC	LDO, 1.65V±2%, 700mA, -CE	SOT-89-5	32vy VR4	6h	Tor
0KH	XC6210D17APR	LVR-IC	LDO, 1.75V±2%, 700mA, -CE	SOT-89-5	32vy VR4	6h	Tor
0KK	XC6210D18APR	LVR-IC	LDO, 1.85V±2%, 700mA, -CE	SOT-89-5	32vy VR4	6h	Tor
0KL	XC6210D19APR	LVR-IC	LDO, 1.95V±2%, 700mA, -CE	SOT-89-5	32vy VR4	6h	Tor
0KM	XC6210D20APR	LVR-IC	LDO, 2.05V±2%, 700mA, -CE	SOT-89-5	32vy VR4	6h	Tor
0KN	XC6210D21APR	LVR-IC	LDO, 2.15V±2%, 700mA, -CE	SOT-89-5	32vy VR4	6h	Tor
0KP	XC6210D22APR	LVR-IC	LDO, 2.25V±2%, 700mA, -CE	SOT-89-5	32vy VR4	6h	Tor
0KR	XC6210D23APR	LVR-IC	LDO, 2.35V±2%, 700mA, -CE	SOT-89-5	32vy VR4	6h	Tor
0KS	XC6210D24APR	LVR-IC	LDO, 2.45V±2%, 700mA, -CE	SOT-89-5	32vy VR4	6h	Tor
0KT	XC6210D25APR	LVR-IC	LDO, 2.55V±2%, 700mA, -CE	SOT-89-5	32vy VR4	6h	Tor
0KU	XC6210D26APR	LVR-IC	LDO, 2.65V±2%, 700mA, -CE	SOT-89-5	32vy VR4	6h	Tor
0KV	XC6210D27APR	LVR-IC	LDO, 2.75V±2%, 700mA, -CE	SOT-89-5	32vy VR4	6h	Tor
0KX	XC6210D28APR	LVR-IC	LDO, 2.85V±2%, 700mA, -CE	SOT-89-5	32vy VR4	6h	Tor
0KY	XC6210D29APR	LVR-IC	LDO, 2.95V±2%, 700mA, -CE	SOT-89-5	32vy VR4	6h	Tor
0KZ	XC6210D30APR	LVR-IC	LDO, 3.05V±2%, 700mA, -CE	SOT-89-5	32vy VR4	6h	Tor
0L0	XC6210A31APR	LVR-IC	LDO, 3.15V±2%, 700mA, +CE, PDR	SOT-89-5	32vy VR4	6h	Tor
0L1	XC6210A32APR	LVR-IC	LDO, 3.25V±2%, 700mA, +CE, PDR	SOT-89-5	32vy VR4	6h	Tor
0L2	XC6210A33APR	LVR-IC	LDO, 3.35V±2%, 700mA, +CE, PDR	SOT-89-5	32vy VR4	6h	Tor
0L3	XC6210A34APR	LVR-IC	LDO, 3.45V±2%, 700mA, +CE, PDR	SOT-89-5	32vy VR4	6h	Tor
0L4	XC6210A35APR	LVR-IC	LDO, 3.55V±2%, 700mA, +CE, PDR	SOT-89-5	32vy VR4	6h	Tor
0L5	XC6210A36APR	LVR-IC	LDO, 3.65V±2%, 700mA, +CE, PDR	SOT-89-5	32vy VR4	6h	Tor
0L6	XC6210A37APR	LVR-IC	LDO, 3.75V±2%, 700mA, +CE, PDR	SOT-89-5	32vy VR4	6h	Tor



SMD code	Type	Function	Short description	Case	Pinout Sch.	St.	Mnf.
0L7	XC6210A38APR	LVR-IC	LDO, 3.85V±2%, 700mA, +CE, PDR	SOT-89-5	32vy VR4	6h	Tor
0L8	XC6210A39APR	LVR-IC	LDO, 3.95V±2%, 700mA, +CE, PDR	SOT-89-5	32vy VR4	6h	Tor
0L9	XC6210A40APR	LVR-IC	LDO, 4.05V±2%, 700mA, +CE, PDR	SOT-89-5	32vy VR4	6h	Tor
0LA	XC6210A41APR	LVR-IC	LDO, 4.15V±2%, 700mA, +CE, PDR	SOT-89-5	32vy VR4	6h	Tor
0LB	XC6210A42APR	LVR-IC	LDO, 4.25V±2%, 700mA, +CE, PDR	SOT-89-5	32vy VR4	6h	Tor
0LC	XC6210A43APR	LVR-IC	LDO, 4.35V±2%, 700mA, +CE, PDR	SOT-89-5	32vy VR4	6h	Tor
0LD	XC6210A44APR	LVR-IC	LDO, 4.45V±2%, 700mA, +CE, PDR	SOT-89-5	32vy VR4	6h	Tor
0LE	XC6210A45APR	LVR-IC	LDO, 4.55V±2%, 700mA, +CE, PDR	SOT-89-5	32vy VR4	6h	Tor
0LF	XC6210A46APR	LVR-IC	LDO, 4.65V±2%, 700mA, +CE, PDR	SOT-89-5	32vy VR4	6h	Tor
0LH	XC6210A47APR	LVR-IC	LDO, 4.75V±2%, 700mA, +CE, PDR	SOT-89-5	32vy VR4	6h	Tor
0LK	XC6210A48APR	LVR-IC	LDO, 4.85V±2%, 700mA, +CE, PDR	SOT-89-5	32vy VR4	6h	Tor
0LL	XC6210A49APR	LVR-IC	LDO, 4.95V±2%, 700mA, +CE, PDR	SOT-89-5	32vy VR4	6h	Tor
0M0	XC6210B31APR	LVR-IC	LDO, 3.15V±2%, 700mA, +CE	SOT-89-5	32vy VR4	6h	Tor
0M1	XC6210B32APR	LVR-IC	LDO, 3.25V±2%, 700mA, +CE	SOT-89-5	32vy VR4	6h	Tor
0M2	XC6210B33APR	LVR-IC	LDO, 3.35V±2%, 700mA, +CE	SOT-89-5	32vy VR4	6h	Tor
0M3	XC6210B34APR	LVR-IC	LDO, 3.45V±2%, 700mA, +CE	SOT-89-5	32vy VR4	6h	Tor
0M4	XC6210B35APR	LVR-IC	LDO, 3.55V±2%, 700mA, +CE	SOT-89-5	32vy VR4	6h	Tor
0M5	XC6210B36APR	LVR-IC	LDO, 3.65V±2%, 700mA, +CE	SOT-89-5	32vy VR4	6h	Tor
0M6	XC6210B37APR	LVR-IC	LDO, 3.75V±2%, 700mA, +CE	SOT-89-5	32vy VR4	6h	Tor
0M7	XC6210B38APR	LVR-IC	LDO, 3.85V±2%, 700mA, +CE	SOT-89-5	32vy VR4	6h	Tor
0M8	XC6210B39APR	LVR-IC	LDO, 3.95V±2%, 700mA, +CE	SOT-89-5	32vy VR4	6h	Tor
0M9	XC6210B40APR	LVR-IC	LDO, 4.05V±2%, 700mA, +CE	SOT-89-5	32vy VR4	6h	Tor
0MA	XC6210B41APR	LVR-IC	LDO, 4.15V±2%, 700mA, +CE	SOT-89-5	32vy VR4	6h	Tor
0MB	XC6210B42APR	LVR-IC	LDO, 4.25V±2%, 700mA, +CE	SOT-89-5	32vy VR4	6h	Tor
0MC	XC6210B43APR	LVR-IC	LDO, 4.35V±2%, 700mA, +CE	SOT-89-5	32vy VR4	6h	Tor
0MD	XC6210B44APR	LVR-IC	LDO, 4.45V±2%, 700mA, +CE	SOT-89-5	32vy VR4	6h	Tor
0ME	XC6210B45APR	LVR-IC	LDO, 4.55V±2%, 700mA, +CE	SOT-89-5	32vy VR4	6h	Tor
0MF	XC6210B46APR	LVR-IC	LDO, 4.65V±2%, 700mA, +CE	SOT-89-5	32vy VR4	6h	Tor
0MH	XC6210B47APR	LVR-IC	LDO, 4.75V±2%, 700mA, +CE	SOT-89-5	32vy VR4	6h	Tor
0MK	XC6210B48APR	LVR-IC	LDO, 4.85V±2%, 700mA, +CE	SOT-89-5	32vy VR4	6h	Tor
0ML	XC6210B49APR	LVR-IC	LDO, 4.95V±2%, 700mA, +CE	SOT-89-5	32vy VR4	6h	Tor
0N0	XC6210C31APR	LVR-IC	LDO, 3.15V±2%, 700mA, -CE, PDR	SOT-89-5	32vy VR4	6h	Tor
0N1	XC6210C32APR	LVR-IC	LDO, 3.25V±2%, 700mA, -CE, PDR	SOT-89-5	32vy VR4	6h	Tor
0N2	XC6210C33APR	LVR-IC	LDO, 3.35V±2%, 700mA, -CE, PDR	SOT-89-5	32vy VR4	6h	Tor
0N3	XC6210C34APR	LVR-IC	LDO, 3.45V±2%, 700mA, -CE, PDR	SOT-89-5	32vy VR4	6h	Tor
0N4	XC6210C35APR	LVR-IC	LDO, 3.55V±2%, 700mA, -CE, PDR	SOT-89-5	32vy VR4	6h	Tor
0N5	XC6210C36APR	LVR-IC	LDO, 3.65V±2%, 700mA, -CE, PDR	SOT-89-5	32vy VR4	6h	Tor
0N6	XC6210C37APR	LVR-IC	LDO, 3.75V±2%, 700mA, -CE, PDR	SOT-89-5	32vy VR4	6h	Tor
0N7	XC6210C38APR	LVR-IC	LDO, 3.85V±2%, 700mA, -CE, PDR	SOT-89-5	32vy VR4	6h	Tor
0N8	XC6210C39APR	LVR-IC	LDO, 3.95V±2%, 700mA, -CE, PDR	SOT-89-5	32vy VR4	6h	Tor
0N9	XC6210C40APR	LVR-IC	LDO, 4.05V±2%, 700mA, -CE, PDR	SOT-89-5	32vy VR4	6h	Tor
0NA	XC6210C41APR	LVR-IC	LDO, 4.15V±2%, 700mA, -CE, PDR	SOT-89-5	32vy VR4	6h	Tor
0NB	XC6210C42APR	LVR-IC	LDO, 4.25V±2%, 700mA, -CE, PDR	SOT-89-5	32vy VR4	6h	Tor
0NC	XC6210C43APR	LVR-IC	LDO, 4.35V±2%, 700mA, -CE, PDR	SOT-89-5	32vy VR4	6h	Tor
0ND	XC6210C44APR	LVR-IC	LDO, 4.45V±2%, 700mA, -CE, PDR	SOT-89-5	32vy VR4	6h	Tor
0NE	XC6210C45APR	LVR-IC	LDO, 4.55V±2%, 700mA, -CE, PDR	SOT-89-5	32vy VR4	6h	Tor
0NF	XC6210C46APR	LVR-IC	LDO, 4.65V±2%, 700mA, -CE, PDR	SOT-89-5	32vy VR4	6h	Tor
0NH	XC6210C47APR	LVR-IC	LDO, 4.75V±2%, 700mA, -CE, PDR	SOT-89-5	32vy VR4	6h	Tor
0NK	XC6210C48APR	LVR-IC	LDO, 4.85V±2%, 700mA, -CE, PDR	SOT-89-5	32vy VR4	6h	Tor
0NL	XC6210C49APR	LVR-IC	LDO, 4.95V±2%, 700mA, -CE, PDR	SOT-89-5	32vy VR4	6h	Tor
0P0	XC6210D31APR	LVR-IC	LDO, 3.15V±2%, 700mA, -CE	SOT-89-5	32vy VR4	6h	Tor
0P1	XC6210D32APR	LVR-IC	LDO, 3.25V±2%, 700mA, -CE	SOT-89-5	32vy VR4	6h	Tor
0P2	XC6210D33APR	LVR-IC	LDO, 3.35V±2%, 700mA, -CE	SOT-89-5	32vy VR4	6h	Tor
0P3	XC6210D34APR	LVR-IC	LDO, 3.45V±2%, 700mA, -CE	SOT-89-5	32vy VR4	6h	Tor
0P4	XC6210D35APR	LVR-IC	LDO, 3.55V±2%, 700mA, -CE	SOT-89-5	32vy VR4	6h	Tor
0P5	XC6210D36APR	LVR-IC	LDO, 3.65V±2%, 700mA, -CE	SOT-89-5	32vy VR4	6h	Tor
0P6	XC6210D37APR	LVR-IC	LDO, 3.75V±2%, 700mA, -CE	SOT-89-5	32vy VR4	6h	Tor
0P7	XC6210D38APR	LVR-IC	LDO, 3.85V±2%, 700mA, -CE	SOT-89-5	32vy VR4	6h	Tor
0P8	XC6210D39APR	LVR-IC	LDO, 3.95V±2%, 700mA, -CE	SOT-89-5	32vy VR4	6h	Tor
0P9	XC6210D40APR	LVR-IC	LDO, 4.05V±2%, 700mA, -CE	SOT-89-5	32vy VR4	6h	Tor
0PA	XC6210D41APR	LVR-IC	LDO, 4.15V±2%, 700mA, -CE	SOT-89-5	32vy VR4	6h	Tor
0PB	XC6210D42APR	LVR-IC	LDO, 4.25V±2%, 700mA, -CE	SOT-89-5	32vy VR4	6h	Tor
0PC	XC6210D43APR	LVR-IC	LDO, 4.35V±2%, 700mA, -CE	SOT-89-5	32vy VR4	6h	Tor
0PD	XC6210D44APR	LVR-IC	LDO, 4.45V±2%, 700mA, -CE	SOT-89-5	32vy VR4	6h	Tor
0PE	XC6210D45APR	LVR-IC	LDO, 4.55V±2%, 700mA, -CE	SOT-89-5	32vy VR4	6h	Tor
0PF	XC6210D46APR	LVR-IC	LDO, 4.65V±2%, 700mA, -CE	SOT-89-5	32vy VR4	6h	Tor
0PH	XC6210D47APR	LVR-IC	LDO, 4.75V±2%, 700mA, -CE	SOT-89-5	32vy VR4	6h	Tor
0PK	XC6210D48APR	LVR-IC	LDO, 4.85V±2%, 700mA, -CE	SOT-89-5	32vy VR4	6h	Tor
0PL	XC6210D49APR	LVR-IC	LDO, 4.95V±2%, 700mA, -CE	SOT-89-5	32vy VR4	6h	Tor
0V7	XC6210A082PR	LVR-IC	LDO, 0.8V±2%, 700mA, +CE, PDR	SOT-89-5	32vy VR4	6h	Tor



SMD code	Type	Function	Short description	Case	Pinout Sch.	St.	Mnf.
0V8	XC6210A092PR	LVR-IC	LDO, 0.9V±2%, 700mA, +CE, PDR	SOT-89-5	32vy VR4	6h	Tor
0V9	XC6210A102PR	LVR-IC	LDO, 1V±2%, 700mA, +CE, PDR	SOT-89-5	32vy VR4	6h	Tor
0VA	XC6210A112PR	LVR-IC	LDO, 1.1V±2%, 700mA, +CE, PDR	SOT-89-5	32vy VR4	6h	Tor
0VB	XC6210A122PR	LVR-IC	LDO, 1.2V±2%, 700mA, +CE, PDR	SOT-89-5	32vy VR4	6h	Tor
0VC	XC6210A132PR	LVR-IC	LDO, 1.3V±2%, 700mA, +CE, PDR	SOT-89-5	32vy VR4	6h	Tor
0VD	XC6210A142PR	LVR-IC	LDO, 1.4V±2%, 700mA, +CE, PDR	SOT-89-5	32vy VR4	6h	Tor
0VE	XC6210A152PR	LVR-IC	LDO, 1.5V±2%, 700mA, +CE, PDR	SOT-89-5	32vy VR4	6h	Tor
0VF	XC6210A162PR	LVR-IC	LDO, 1.6V±2%, 700mA, +CE, PDR	SOT-89-5	32vy VR4	6h	Tor
0VH	XC6210A172PR	LVR-IC	LDO, 1.7V±2%, 700mA, +CE, PDR	SOT-89-5	32vy VR4	6h	Tor
0VK	XC6210A182PR	LVR-IC	LDO, 1.8V±2%, 700mA, +CE, PDR	SOT-89-5	32vy VR4	6h	Tor
0VL	XC6210A192PR	LVR-IC	LDO, 1.9V±2%, 700mA, +CE, PDR	SOT-89-5	32vy VR4	6h	Tor
0VM	XC6210A202PR	LVR-IC	LDO, 2V±2%, 700mA, +CE, PDR	SOT-89-5	32vy VR4	6h	Tor
0VN	XC6210A212PR	LVR-IC	LDO, 2.1V±2%, 700mA, +CE, PDR	SOT-89-5	32vy VR4	6h	Tor
0VP	XC6210A222PR	LVR-IC	LDO, 2.2V±2%, 700mA, +CE, PDR	SOT-89-5	32vy VR4	6h	Tor
0VR	XC6210A232PR	LVR-IC	LDO, 2.3V±2%, 700mA, +CE, PDR	SOT-89-5	32vy VR4	6h	Tor
0VS	XC6210A242PR	LVR-IC	LDO, 2.4V±2%, 700mA, +CE, PDR	SOT-89-5	32vy VR4	6h	Tor
0VT	XC6210A252PR	LVR-IC	LDO, 2.5V±2%, 700mA, +CE, PDR	SOT-89-5	32vy VR4	6h	Tor
0VU	XC6210A262PR	LVR-IC	LDO, 2.6V±2%, 700mA, +CE, PDR	SOT-89-5	32vy VR4	6h	Tor
0VV	XC6210A272PR	LVR-IC	LDO, 2.7V±2%, 700mA, +CE, PDR	SOT-89-5	32vy VR4	6h	Tor
0VX	XC6210A282PR	LVR-IC	LDO, 2.8V±2%, 700mA, +CE, PDR	SOT-89-5	32vy VR4	6h	Tor
0VY	XC6210A292PR	LVR-IC	LDO, 2.9V±2%, 700mA, +CE, PDR	SOT-89-5	32vy VR4	6h	Tor
0VZ	XC6210A302PR	LVR-IC	LDO, 3V±2%, 700mA, +CE, PDR	SOT-89-5	32vy VR4	6h	Tor
0X7	XC6210B082PR	LVR-IC	LDO, 0.8V±2%, 700mA, +CE	SOT-89-5	32vy VR4	6h	Tor
0X8	XC6210B092PR	LVR-IC	LDO, 0.9V±2%, 700mA, +CE	SOT-89-5	32vy VR4	6h	Tor
0X9	XC6210B102PR	LVR-IC	LDO, 1V±2%, 700mA, +CE	SOT-89-5	32vy VR4	6h	Tor
0XA	XC6210B112PR	LVR-IC	LDO, 1.1V±2%, 700mA, +CE	SOT-89-5	32vy VR4	6h	Tor
0XB	XC6210B122PR	LVR-IC	LDO, 1.2V±2%, 700mA, +CE	SOT-89-5	32vy VR4	6h	Tor
0XC	XC6210B132PR	LVR-IC	LDO, 1.3V±2%, 700mA, +CE	SOT-89-5	32vy VR4	6h	Tor
0XD	XC6210B142PR	LVR-IC	LDO, 1.4V±2%, 700mA, +CE	SOT-89-5	32vy VR4	6h	Tor
0XE	XC6210B152PR	LVR-IC	LDO, 1.5V±2%, 700mA, +CE	SOT-89-5	32vy VR4	6h	Tor
0XF	XC6210B162PR	LVR-IC	LDO, 1.6V±2%, 700mA, +CE	SOT-89-5	32vy VR4	6h	Tor
0XH	XC6210B172PR	LVR-IC	LDO, 1.7V±2%, 700mA, +CE	SOT-89-5	32vy VR4	6h	Tor
0XK	XC6210B182PR	LVR-IC	LDO, 1.8V±2%, 700mA, +CE	SOT-89-5	32vy VR4	6h	Tor
0XL	XC6210B192PR	LVR-IC	LDO, 1.9V±2%, 700mA, +CE	SOT-89-5	32vy VR4	6h	Tor
0XM	XC6210B202PR	LVR-IC	LDO, 2V±2%, 700mA, +CE	SOT-89-5	32vy VR4	6h	Tor
0XN	XC6210B212PR	LVR-IC	LDO, 2.1V±2%, 700mA, +CE	SOT-89-5	32vy VR4	6h	Tor
0XP	XC6210B222PR	LVR-IC	LDO, 2.2V±2%, 700mA, +CE	SOT-89-5	32vy VR4	6h	Tor
0XR	XC6210B232PR	LVR-IC	LDO, 2.3V±2%, 700mA, +CE	SOT-89-5	32vy VR4	6h	Tor
0XS	XC6210B242PR	LVR-IC	LDO, 2.4V±2%, 700mA, +CE	SOT-89-5	32vy VR4	6h	Tor
0XT	XC6210B252PR	LVR-IC	LDO, 2.5V±2%, 700mA, +CE	SOT-89-5	32vy VR4	6h	Tor
0XU	XC6210B262PR	LVR-IC	LDO, 2.6V±2%, 700mA, +CE	SOT-89-5	32vy VR4	6h	Tor
0XV	XC6210B272PR	LVR-IC	LDO, 2.7V±2%, 700mA, +CE	SOT-89-5	32vy VR4	6h	Tor
0XX	XC6210B282PR	LVR-IC	LDO, 2.8V±2%, 700mA, +CE	SOT-89-5	32vy VR4	6h	Tor
0XY	XC6210B292PR	LVR-IC	LDO, 2.9V±2%, 700mA, +CE	SOT-89-5	32vy VR4	6h	Tor
0XZ	XC6210B302PR	LVR-IC	LDO, 3V±2%, 700mA, +CE	SOT-89-5	32vy VR4	6h	Tor
0Y7	XC6210C082PR	LVR-IC	LDO, 0.8V±2%, 700mA, -CE, PDR	SOT-89-5	32vy VR4	6h	Tor
0Y8	XC6210C092PR	LVR-IC	LDO, 0.9V±2%, 700mA, -CE, PDR	SOT-89-5	32vy VR4	6h	Tor
0Y9	XC6210C102PR	LVR-IC	LDO, 1V±2%, 700mA, -CE, PDR	SOT-89-5	32vy VR4	6h	Tor
0YA	XC6210C112PR	LVR-IC	LDO, 1.1V±2%, 700mA, -CE, PDR	SOT-89-5	32vy VR4	6h	Tor
0YB	XC6210C122PR	LVR-IC	LDO, 1.2V±2%, 700mA, -CE, PDR	SOT-89-5	32vy VR4	6h	Tor
0YC	XC6210C132PR	LVR-IC	LDO, 1.3V±2%, 700mA, -CE, PDR	SOT-89-5	32vy VR4	6h	Tor
0YD	XC6210C142PR	LVR-IC	LDO, 1.4V±2%, 700mA, -CE, PDR	SOT-89-5	32vy VR4	6h	Tor
0YE	XC6210C152PR	LVR-IC	LDO, 1.5V±2%, 700mA, -CE, PDR	SOT-89-5	32vy VR4	6h	Tor
0YF	XC6210C162PR	LVR-IC	LDO, 1.6V±2%, 700mA, -CE, PDR	SOT-89-5	32vy VR4	6h	Tor
0YH	XC6210C172PR	LVR-IC	LDO, 1.7V±2%, 700mA, -CE, PDR	SOT-89-5	32vy VR4	6h	Tor
0YK	XC6210C182PR	LVR-IC	LDO, 1.8V±2%, 700mA, -CE, PDR	SOT-89-5	32vy VR4	6h	Tor
0YL	XC6210C192PR	LVR-IC	LDO, 1.9V±2%, 700mA, -CE, PDR	SOT-89-5	32vy VR4	6h	Tor
0YM	XC6210C202PR	LVR-IC	LDO, 2V±2%, 700mA, -CE, PDR	SOT-89-5	32vy VR4	6h	Tor
0YN	XC6210C212PR	LVR-IC	LDO, 2.1V±2%, 700mA, -CE, PDR	SOT-89-5	32vy VR4	6h	Tor
0YP	XC6210C222PR	LVR-IC	LDO, 2.2V±2%, 700mA, -CE, PDR	SOT-89-5	32vy VR4	6h	Tor
0YR	XC6210C232PR	LVR-IC	LDO, 2.3V±2%, 700mA, -CE, PDR	SOT-89-5	32vy VR4	6h	Tor
0YS	XC6210C242PR	LVR-IC	LDO, 2.4V±2%, 700mA, -CE, PDR	SOT-89-5	32vy VR4	6h	Tor
0YT	XC6210C252PR	LVR-IC	LDO, 2.5V±2%, 700mA, -CE, PDR	SOT-89-5	32vy VR4	6h	Tor
0YU	XC6210C262PR	LVR-IC	LDO, 2.6V±2%, 700mA, -CE, PDR	SOT-89-5	32vy VR4	6h	Tor
0YV	XC6210C272PR	LVR-IC	LDO, 2.7V±2%, 700mA, -CE, PDR	SOT-89-5	32vy VR4	6h	Tor
0YX	XC6210C282PR	LVR-IC	LDO, 2.8V±2%, 700mA, -CE, PDR	SOT-89-5	32vy VR4	6h	Tor
0YY	XC6210C292PR	LVR-IC	LDO, 2.9V±2%, 700mA, -CE, PDR	SOT-89-5	32vy VR4	6h	Tor
0YZ	XC6210C302PR	LVR-IC	LDO, 3V±2%, 700mA, -CE, PDR	SOT-89-5	32vy VR4	6h	Tor
0Z0	XC6210D102PR	LVR-IC	LDO, 1V±2%, 700mA, -CE	SOT-89-5	32vy VR4	6h	Tor
0Z7	XC6210D082PR	LVR-IC	LDO, 0.8V±2%, 700mA, -CE	SOT-89-5	32vy VR4	6h	Tor



SMD code	Type	Function	Short description	Case	Pinout	Sch.	St.	Mnf.
1C5	XC6503D171PR-G	LVR-IC	LDO, 1.7V±20mV, 500mA, +CE	SOT-89-5	32um	VR4	6n	Tor
1C5	XC6372C250P	DC/DC-IC	PWM/PFM step-up, 50kHz, +CE, 2.5V±2.5%, 100mA	SOT-89-5	32gb	DC3	6h	Tor
1C6	XC6503D181PR-G	LVR-IC	LDO, 1.8V±20mV, 500mA, +CE	SOT-89-5	32um	VR4	6n	Tor
1C6	XC6372C260P	DC/DC-IC	PWM/PFM step-up, 50kHz, +CE, 2.6V±2.5%, 100mA	SOT-89-5	32gb	DC3	6h	Tor
1C7	XC6503D191PR-G	LVR-IC	LDO, 1.9V±20mV, 500mA, +CE	SOT-89-5	32um	VR4	6n	Tor
1C7	XC6372C270P	DC/DC-IC	PWM/PFM step-up, 50kHz, +CE, 2.7V±2.5%, 100mA	SOT-89-5	32gb	DC3	6h	Tor
1C8	XC6503D201PR-G	LVR-IC	LDO, 2.0V±1%, 500mA, +CE	SOT-89-5	32um	VR4	6n	Tor
1C8	XC6372C280P	DC/DC-IC	PWM/PFM step-up, 50kHz, +CE, 2.8V±2.5%, 100mA	SOT-89-5	32gb	DC3	6h	Tor
1C9	XC6503D211PR-G	LVR-IC	LDO, 2.1V±1%, 500mA, +CE	SOT-89-5	32um	VR4	6n	Tor
1C9	XC6372C290P	DC/DC-IC	PWM/PFM step-up, 50kHz, +CE, 2.9V±2.5%, 100mA	SOT-89-5	32gb	DC3	6h	Tor
1CA	XC6503D221PR-G	LVR-IC	LDO, 2.2V±1%, 500mA, +CE	SOT-89-5	32um	VR4	6n	Tor
1CB	XC6503D231PR-G	LVR-IC	LDO, 2.3V±1%, 500mA, +CE	SOT-89-5	32um	VR4	6n	Tor
1CC	XC6503D241PR-G	LVR-IC	LDO, 2.4V±1%, 500mA, +CE	SOT-89-5	32um	VR4	6n	Tor
1CD	XC6503D251PR-G	LVR-IC	LDO, 2.5V±1%, 500mA, +CE	SOT-89-5	32um	VR4	6n	Tor
1CE	XC6503D261PR-G	LVR-IC	LDO, 2.6V±1%, 500mA, +CE	SOT-89-5	32um	VR4	6n	Tor
1CF	XC6503D271PR-G	LVR-IC	LDO, 2.7V±1%, 500mA, +CE	SOT-89-5	32um	VR4	6n	Tor
1CH	XC6503D281PR-G	LVR-IC	LDO, 2.8V±1%, 500mA, +CE	SOT-89-5	32um	VR4	6n	Tor
1CK	XC6503D291PR-G	LVR-IC	LDO, 2.9V±1%, 500mA, +CE	SOT-89-5	32um	VR4	6n	Tor
1CL	XC6503D301PR-G	LVR-IC	LDO, 3.0V±1%, 500mA, +CE	SOT-89-5	32um	VR4	6n	Tor
1CM	XC6503D311PR-G	LVR-IC	LDO, 3.1V±1%, 500mA, +CE	SOT-89-5	32um	VR4	6n	Tor
1CN	XC6503D321PR-G	LVR-IC	LDO, 3.2V±1%, 500mA, +CE	SOT-89-5	32um	VR4	6n	Tor
1CP	XC6503D331PR-G	LVR-IC	LDO, 3.3V±1%, 500mA, +CE	SOT-89-5	32um	VR4	6n	Tor
1CR	XC6503D341PR-G	LVR-IC	LDO, 3.4V±1%, 500mA, +CE	SOT-89-5	32um	VR4	6n	Tor
1CS	XC6503D351PR-G	LVR-IC	LDO, 3.5V±1%, 500mA, +CE	SOT-89-5	32um	VR4	6n	Tor
1CT	XC6503D361PR-G	LVR-IC	LDO, 3.6V±1%, 500mA, +CE	SOT-89-5	32um	VR4	6n	Tor
1CU	XC6503D371PR-G	LVR-IC	LDO, 3.7V±1%, 500mA, +CE	SOT-89-5	32um	VR4	6n	Tor
1CV	XC6503D381PR-G	LVR-IC	LDO, 3.8V±1%, 500mA, +CE	SOT-89-5	32um	VR4	6n	Tor
1CX	XC6503D391PR-G	LVR-IC	LDO, 3.9V±1%, 500mA, +CE	SOT-89-5	32um	VR4	6n	Tor
1CY	XC6503D401PR-G	LVR-IC	LDO, 4.0V±1%, 500mA, +CE	SOT-89-5	32um	VR4	6n	Tor
1CZ	XC6503D411PR-G	LVR-IC	LDO, 4.1V±1%, 500mA, +CE	SOT-89-5	32um	VR4	6n	Tor
1D0	XC6503D421PR-G	LVR-IC	LDO, 4.2V±1%, 500mA, +CE	SOT-89-5	32um	VR4	6n	Tor
1D0	XC6372C300P	DC/DC-IC	PWM/PFM step-up, 50kHz, +CE, 3.0V±2.5%, 100mA	SOT-89-5	32gb	DC3	6h	Tor
1D1	XC6503D431PR-G	LVR-IC	LDO, 4.3V±1%, 500mA, +CE	SOT-89-5	32um	VR4	6n	Tor
1D1	XC6372C310P	DC/DC-IC	PWM/PFM step-up, 50kHz, +CE, 3.1V±2.5%, 100mA	SOT-89-5	32gb	DC3	6h	Tor
1D2	XC6503D441PR-G	LVR-IC	LDO, 4.4V±1%, 500mA, +CE	SOT-89-5	32um	VR4	6n	Tor
1D2	XC6372C320P	DC/DC-IC	PWM/PFM step-up, 50kHz, +CE, 3.2V±2.5%, 100mA	SOT-89-5	32gb	DC3	6h	Tor
1D3	XC6503D451PR-G	LVR-IC	LDO, 4.5V±1%, 500mA, +CE	SOT-89-5	32um	VR4	6n	Tor
1D3	XC6372C330P	DC/DC-IC	PWM/PFM step-up, 50kHz, +CE, 3.3V±2.5%, 100mA	SOT-89-5	32gb	DC3	6h	Tor
1D4	XC6503D461PR-G	LVR-IC	LDO, 4.6V±1%, 500mA, +CE	SOT-89-5	32um	VR4	6n	Tor
1D4	XC6372C340P	DC/DC-IC	PWM/PFM step-up, 50kHz, +CE, 3.4V±2.5%, 100mA	SOT-89-5	32gb	DC3	6h	Tor
1D5	XC6503D471PR-G	LVR-IC	LDO, 4.7V±1%, 500mA, +CE	SOT-89-5	32um	VR4	6n	Tor
1D5	XC6372C350P	DC/DC-IC	PWM/PFM step-up, 50kHz, +CE, 3.5V±2.5%, 100mA	SOT-89-5	32gb	DC3	6h	Tor
1D6	XC6503D481PR-G	LVR-IC	LDO, 4.8V±1%, 500mA, +CE	SOT-89-5	32um	VR4	6n	Tor
1D6	XC6372C360P	DC/DC-IC	PWM/PFM step-up, 50kHz, +CE, 3.6V±2.5%, 100mA	SOT-89-5	32gb	DC3	6h	Tor
1D7	XC6503D491PR-G	LVR-IC	LDO, 4.9V±1%, 500mA, +CE	SOT-89-5	32um	VR4	6n	Tor
1D7	XC6372C370P	DC/DC-IC	PWM/PFM step-up, 50kHz, +CE, 3.7V±2.5%, 100mA	SOT-89-5	32gb	DC3	6h	Tor
1D8	XC6503D501PR-G	LVR-IC	LDO, 5.0V±1%, 500mA, +CE	SOT-89-5	32um	VR4	6n	Tor
1D8	XC6372C380P	DC/DC-IC	PWM/PFM step-up, 50kHz, +CE, 3.8V±2.5%, 100mA	SOT-89-5	32gb	DC3	6h	Tor
1D9	XC6372C390P	DC/DC-IC	PWM/PFM step-up, 50kHz, +CE, 3.9V±2.5%, 100mA	SOT-89-5	32gb	DC3	6h	Tor
1E0	XC6503D12APR-G	LVR-IC	LDO, 1.25V±20mV, 500mA, +CE	SOT-89-5	32um	VR4	6n	Tor
1E0	XC6372C400P	DC/DC-IC	PWM/PFM step-up, 50kHz, +CE, 4.0V±2.5%, 100mA	SOT-89-5	32gb	DC3	6h	Tor
1E1	XC6503D13APR-G	LVR-IC	LDO, 1.35V±20mV, 500mA, +CE	SOT-89-5	32um	VR4	6n	Tor
1E1	XC6372C410P	DC/DC-IC	PWM/PFM step-up, 50kHz, +CE, 4.1V±2.5%, 100mA	SOT-89-5	32gb	DC3	6h	Tor
1E2	XC6503D14APR-G	LVR-IC	LDO, 1.45V±20mV, 500mA, +CE	SOT-89-5	32um	VR4	6n	Tor
1E2	XC6372C420P	DC/DC-IC	PWM/PFM step-up, 50kHz, +CE, 4.2V±2.5%, 100mA	SOT-89-5	32gb	DC3	6h	Tor
1E3	XC6503D15APR-G	LVR-IC	LDO, 1.55V±20mV, 500mA, +CE	SOT-89-5	32um	VR4	6n	Tor
1E3	XC6372C430P	DC/DC-IC	PWM/PFM step-up, 50kHz, +CE, 4.3V±2.5%, 100mA	SOT-89-5	32gb	DC3	6h	Tor
1E4	XC6503D16APR-G	LVR-IC	LDO, 1.65V±20mV, 500mA, +CE	SOT-89-5	32um	VR4	6n	Tor
1E4	XC6372C440P	DC/DC-IC	PWM/PFM step-up, 50kHz, +CE, 4.4V±2.5%, 100mA	SOT-89-5	32gb	DC3	6h	Tor
1E5	XC6503D17APR-G	LVR-IC	LDO, 1.75V±20mV, 500mA, +CE	SOT-89-5	32um	VR4	6n	Tor
1E5	XC6372C450P	DC/DC-IC	PWM/PFM step-up, 50kHz, +CE, 4.5V±2.5%, 100mA	SOT-89-5	32gb	DC3	6h	Tor
1E6	XC6503D18APR-G	LVR-IC	LDO, 1.85V±20mV, 500mA, +CE	SOT-89-5	32um	VR4	6n	Tor
1E6	XC6372C460P	DC/DC-IC	PWM/PFM step-up, 50kHz, +CE, 4.6V±2.5%, 100mA	SOT-89-5	32gb	DC3	6h	Tor
1E7	XC6503D19APR-G	LVR-IC	LDO, 1.95V±20mV, 500mA, +CE	SOT-89-5	32um	VR4	6n	Tor
1E7	XC6372C470P	DC/DC-IC	PWM/PFM step-up, 50kHz, +CE, 4.7V±2.5%, 100mA	SOT-89-5	32gb	DC3	6h	Tor
1E8	XC6503D20APR-G	LVR-IC	LDO, 2.05V±1%, 500mA, +CE	SOT-89-5	32um	VR4	6n	Tor
1E8	XC6372C480P	DC/DC-IC	PWM/PFM step-up, 50kHz, +CE, 4.8V±2.5%, 100mA	SOT-89-5	32gb	DC3	6h	Tor
1E9	XC6503D21APR-G	LVR-IC	LDO, 2.15V±1%, 500mA, +CE	SOT-89-5	32um	VR4	6n	Tor
1E9	XC6372C490P	DC/DC-IC	PWM/PFM step-up, 50kHz, +CE, 4.9V±2.5%, 100mA	SOT-89-5	32gb	DC3	6h	Tor
1EA	XC6503D22APR-G	LVR-IC	LDO, 2.25V±1%, 500mA, +CE	SOT-89-5	32um	VR4	6n	Tor



SMD code	Type	Function	Short description	Case	Pinout Sch.	St.	Mnf.
1EB	XC6503D23APR-G	LVR-IC	LDO, 2.35V±1%, 500mA, +CE	SOT-89-5	32um VR4	6n	Tor
1EC	XC6503D24APR-G	LVR-IC	LDO, 2.45V±1%, 500mA, +CE	SOT-89-5	32um VR4	6n	Tor
1ED	XC6503D25APR-G	LVR-IC	LDO, 2.55V±1%, 500mA, +CE	SOT-89-5	32um VR4	6n	Tor
1EE	XC6503D26APR-G	LVR-IC	LDO, 2.65V±1%, 500mA, +CE	SOT-89-5	32um VR4	6n	Tor
1EF	XC6503D27APR-G	LVR-IC	LDO, 2.75V±1%, 500mA, +CE	SOT-89-5	32um VR4	6n	Tor
1EH	XC6503D28APR-G	LVR-IC	LDO, 2.85V±1%, 500mA, +CE	SOT-89-5	32um VR4	6n	Tor
1EK	XC6503D29APR-G	LVR-IC	LDO, 2.95V±1%, 500mA, +CE	SOT-89-5	32um VR4	6n	Tor
1EL	XC6503D30APR-G	LVR-IC	LDO, 3.05V±1%, 500mA, +CE	SOT-89-5	32um VR4	6n	Tor
1EM	XC6503D31APR-G	LVR-IC	LDO, 3.15V±1%, 500mA, +CE	SOT-89-5	32um VR4	6n	Tor
1EN	XC6503D32APR-G	LVR-IC	LDO, 3.25V±1%, 500mA, +CE	SOT-89-5	32um VR4	6n	Tor
1EP	XC6503D33APR-G	LVR-IC	LDO, 3.35V±1%, 500mA, +CE	SOT-89-5	32um VR4	6n	Tor
1ER	XC6503D34APR-G	LVR-IC	LDO, 3.45V±1%, 500mA, +CE	SOT-89-5	32um VR4	6n	Tor
1ES	XC6503D35APR-G	LVR-IC	LDO, 3.55V±1%, 500mA, +CE	SOT-89-5	32um VR4	6n	Tor
1ET	XC6503D36APR-G	LVR-IC	LDO, 3.65V±1%, 500mA, +CE	SOT-89-5	32um VR4	6n	Tor
1EU	XC6503D37APR-G	LVR-IC	LDO, 3.75V±1%, 500mA, +CE	SOT-89-5	32um VR4	6n	Tor
1EV	XC6503D38APR-G	LVR-IC	LDO, 3.85V±1%, 500mA, +CE	SOT-89-5	32um VR4	6n	Tor
1EX	XC6503D39APR-G	LVR-IC	LDO, 3.95V±1%, 500mA, +CE	SOT-89-5	32um VR4	6n	Tor
1EY	XC6503D40APR-G	LVR-IC	LDO, 4.05V±1%, 500mA, +CE	SOT-89-5	32um VR4	6n	Tor
1EZ	XC6503D41APR-G	LVR-IC	LDO, 4.15V±1%, 500mA, +CE	SOT-89-5	32um VR4	6n	Tor
1F0	XC6503D42APR-G	LVR-IC	LDO, 4.25V±1%, 500mA, +CE	SOT-89-5	32um VR4	6n	Tor
1F0	XC6372C500P	DC/DC-IC	PWM/PFM step-up, 50kHz, +CE, 5.0V±2.5%, 100mA	SOT-89-5	32gb DC3	6h	Tor
1F1	XC6503D43APR-G	LVR-IC	LDO, 4.35V±1%, 500mA, +CE	SOT-89-5	32um VR4	6n	Tor
1F1	XC6372C510P	DC/DC-IC	PWM/PFM step-up, 50kHz, +CE, 5.1V±2.5%, 100mA	SOT-89-5	32gb DC3	6h	Tor
1F2	XC6503D44APR-G	LVR-IC	LDO, 4.45V±1%, 500mA, +CE	SOT-89-5	32um VR4	6n	Tor
1F2	XC6372C520P	DC/DC-IC	PWM/PFM step-up, 50kHz, +CE, 5.2V±2.5%, 100mA	SOT-89-5	32gb DC3	6h	Tor
1F3	XC6503D45APR-G	LVR-IC	LDO, 4.55V±1%, 500mA, +CE	SOT-89-5	32um VR4	6n	Tor
1F3	XC6372C530P	DC/DC-IC	PWM/PFM step-up, 50kHz, +CE, 5.3V±2.5%, 100mA	SOT-89-5	32gb DC3	6h	Tor
1F4	XC6503D46APR-G	LVR-IC	LDO, 4.65V±1%, 500mA, +CE	SOT-89-5	32um VR4	6n	Tor
1F4	XC6372C540P	DC/DC-IC	PWM/PFM step-up, 50kHz, +CE, 5.4V±2.5%, 100mA	SOT-89-5	32gb DC3	6h	Tor
1F5	XC6503D47APR-G	LVR-IC	LDO, 4.75V±1%, 500mA, +CE	SOT-89-5	32um VR4	6n	Tor
1F5	XC6372C550P	DC/DC-IC	PWM/PFM step-up, 50kHz, +CE, 5.5V±2.5%, 100mA	SOT-89-5	32gb DC3	6h	Tor
1F6	XC6503D48APR-G	LVR-IC	LDO, 4.85V±1%, 500mA, +CE	SOT-89-5	32um VR4	6n	Tor
1F6	XC6372C560P	DC/DC-IC	PWM/PFM step-up, 50kHz, +CE, 5.6V±2.5%, 100mA	SOT-89-5	32gb DC3	6h	Tor
1F7	XC6503D49APR-G	LVR-IC	LDO, 4.95V±1%, 500mA, +CE	SOT-89-5	32um VR4	6n	Tor
1F7	XC6372C570P	DC/DC-IC	PWM/PFM step-up, 50kHz, +CE, 5.7V±2.5%, 100mA	SOT-89-5	32gb DC3	6h	Tor
1F8	XC6372C580P	DC/DC-IC	PWM/PFM step-up, 50kHz, +CE, 5.8V±2.5%, 100mA	SOT-89-5	32gb DC3	6h	Tor
1F9	XC6372C590P	DC/DC-IC	PWM/PFM step-up, 50kHz, +CE, 5.9V±2.5%, 100mA	SOT-89-5	32gb DC3	6h	Tor
1H0	XC6372C600P	DC/DC-IC	PWM/PFM step-up, 50kHz, +CE, 6.0V±2.5%, 100mA	SOT-89-5	32gb DC3	6h	Tor
1H1	XC6372C610P	DC/DC-IC	PWM/PFM step-up, 50kHz, +CE, 6.1V±2.5%, 100mA	SOT-89-5	32gb DC3	6h	Tor
1H2	XC6372C620P	DC/DC-IC	PWM/PFM step-up, 50kHz, +CE, 6.2V±2.5%, 100mA	SOT-89-5	32gb DC3	6h	Tor
1H3	XC6372C630P	DC/DC-IC	PWM/PFM step-up, 50kHz, +CE, 6.3V±2.5%, 100mA	SOT-89-5	32gb DC3	6h	Tor
1H4	XC6372C640P	DC/DC-IC	PWM/PFM step-up, 50kHz, +CE, 6.4V±2.5%, 100mA	SOT-89-5	32gb DC3	6h	Tor
1H5	XC6372C650P	DC/DC-IC	PWM/PFM step-up, 50kHz, +CE, 6.5V±2.5%, 100mA	SOT-89-5	32gb DC3	6h	Tor
1H6	XC6372C660P	DC/DC-IC	PWM/PFM step-up, 50kHz, +CE, 6.6V±2.5%, 100mA	SOT-89-5	32gb DC3	6h	Tor
1H7	XC6372C670P	DC/DC-IC	PWM/PFM step-up, 50kHz, +CE, 6.7V±2.5%, 100mA	SOT-89-5	32gb DC3	6h	Tor
1H8	XC6372C680P	DC/DC-IC	PWM/PFM step-up, 50kHz, +CE, 6.8V±2.5%, 100mA	SOT-89-5	32gb DC3	6h	Tor
1H9	XC6372C690P	DC/DC-IC	PWM/PFM step-up, 50kHz, +CE, 6.9V±2.5%, 100mA	SOT-89-5	32gb DC3	6h	Tor
1K0	XC6372C700P	DC/DC-IC	PWM/PFM step-up, 50kHz, +CE, 7.0V±2.5%, 100mA	SOT-89-5	32gb DC3	6h	Tor
20M	XC6216B202PR	LVR-IC	2.0V±2%, 150mA, +CE	SOT-89-5	32vrq VR4	6n	Tor
20M	XE6216B202PR	LVR-IC	2.0V±2%, 150mA, +CE	SOT-89-5	32vrq VR4	6p	Tor
20N	XC6216B212PR	LVR-IC	2.1V±2%, 150mA, +CE	SOT-89-5	32vrq VR4	6n	Tor
20N	XE6216B212PR	LVR-IC	2.1V±2%, 150mA, +CE	SOT-89-5	32vrq VR4	6p	Tor
20P	TK11220BU	LVR-IC	LDO, 2V±2%, 150mA, +CE	SOT-89-5	32vg R7	6i	Tok
20P	XC6216B222PR	LVR-IC	2.2V±2%, 150mA, +CE	SOT-89-5	32vrq VR4	6n	Tor
20P	XE6216B222PR	LVR-IC	2.2V±2%, 150mA, +CE	SOT-89-5	32vrq VR4	6p	Tor
20Q	TK11320BU	LVR-IC	LDO, 2V±2%, 150mA, -CE	SOT-89-5	32vg R7	6i	Tok
20R	XC6216B232PR	LVR-IC	2.3V±2%, 150mA, +CE	SOT-89-5	32vrq VR4	6n	Tor
20R	XE6216B232PR	LVR-IC	2.3V±2%, 150mA, +CE	SOT-89-5	32vrq VR4	6p	Tor
20S	XC6216B242PR	LVR-IC	2.4V±2%, 150mA, +CE	SOT-89-5	32vrq VR4	6n	Tor
20S	XE6216B242PR	LVR-IC	2.4V±2%, 150mA, +CE	SOT-89-5	32vrq VR4	6p	Tor
20T	XC6216B252PR	LVR-IC	2.5V±2%, 150mA, +CE	SOT-89-5	32vrq VR4	6n	Tor
20T	XE6216B252PR	LVR-IC	2.5V±2%, 150mA, +CE	SOT-89-5	32vrq VR4	6p	Tor
20U	XC6216B262PR	LVR-IC	2.6V±2%, 150mA, +CE	SOT-89-5	32vrq VR4	6n	Tor
20U	XE6216B262PR	LVR-IC	2.6V±2%, 150mA, +CE	SOT-89-5	32vrq VR4	6p	Tor
20V	XC6216B272PR	LVR-IC	2.7V±2%, 150mA, +CE	SOT-89-5	32vrq VR4	6n	Tor
20V	XE6216B272PR	LVR-IC	2.7V±2%, 150mA, +CE	SOT-89-5	32vrq VR4	6p	Tor
20X	XC6216B282PR	LVR-IC	2.8V±2%, 150mA, +CE	SOT-89-5	32vrq VR4	6n	Tor
20X	XE6216B282PR	LVR-IC	2.8V±2%, 150mA, +CE	SOT-89-5	32vrq VR4	6p	Tor
20Y	XC6216B292PR	LVR-IC	2.9V±2%, 150mA, +CE	SOT-89-5	32vrq VR4	6n	Tor
20Y	XE6216B292PR	LVR-IC	2.9V±2%, 150mA, +CE	SOT-89-5	32vrq VR4	6p	Tor



SMD code	Type	Function	Short description	Case	Pinout Sch.	St.	Mnf.
20Z	XC6216B302PR	LVR-IC	3.0V±2%, 150mA, +CE	SOT-89-5	32vrq VR4	6n	Tor
20Z	XE6216B302PR	LVR-IC	3.0V±2%, 150mA, +CE	SOT-89-5	32vrq VR4	6p	Tor
210	XC6216B312PR	LVR-IC	3.1V±2%, 150mA, +CE	SOT-89-5	32vrq VR4	6n	Tor
210	XE6216B312PR	LVR-IC	3.1V±2%, 150mA, +CE	SOT-89-5	32vrq VR4	6p	Tor
211	XC6216B322PR	LVR-IC	3.2V±2%, 150mA, +CE	SOT-89-5	32vrq VR4	6n	Tor
211	XE6216B322PR	LVR-IC	3.2V±2%, 150mA, +CE	SOT-89-5	32vrq VR4	6p	Tor
212	XC6216B332PR	LVR-IC	3.3V±2%, 150mA, +CE	SOT-89-5	32vrq VR4	6n	Tor
212	XE6216B332PR	LVR-IC	3.3V±2%, 150mA, +CE	SOT-89-5	32vrq VR4	6p	Tor
213	XC6216B342PR	LVR-IC	3.4V±2%, 150mA, +CE	SOT-89-5	32vrq VR4	6n	Tor
213	XE6216B342PR	LVR-IC	3.4V±2%, 150mA, +CE	SOT-89-5	32vrq VR4	6p	Tor
214	XC6216B352PR	LVR-IC	3.5V±2%, 150mA, +CE	SOT-89-5	32vrq VR4	6n	Tor
214	XE6216B352PR	LVR-IC	3.5V±2%, 150mA, +CE	SOT-89-5	32vrq VR4	6p	Tor
215	XC6216B362PR	LVR-IC	3.6V±2%, 150mA, +CE	SOT-89-5	32vrq VR4	6n	Tor
215	XE6216B362PR	LVR-IC	3.6V±2%, 150mA, +CE	SOT-89-5	32vrq VR4	6p	Tor
216	XC6216B372PR	LVR-IC	3.7V±2%, 150mA, +CE	SOT-89-5	32vrq VR4	6n	Tor
216	XE6216B372PR	LVR-IC	3.7V±2%, 150mA, +CE	SOT-89-5	32vrq VR4	6p	Tor
217	XC6216B382PR	LVR-IC	3.8V±2%, 150mA, +CE	SOT-89-5	32vrq VR4	6n	Tor
217	XE6216B382PR	LVR-IC	3.8V±2%, 150mA, +CE	SOT-89-5	32vrq VR4	6p	Tor
218	XC6216B392PR	LVR-IC	3.9V±2%, 150mA, +CE	SOT-89-5	32vrq VR4	6n	Tor
218	XE6216B392PR	LVR-IC	3.9V±2%, 150mA, +CE	SOT-89-5	32vrq VR4	6p	Tor
219	XC6216B402PR	LVR-IC	4.0V±2%, 150mA, +CE	SOT-89-5	32vrq VR4	6n	Tor
219	XE6216B402PR	LVR-IC	4.0V±2%, 150mA, +CE	SOT-89-5	32vrq VR4	6p	Tor
21A	XC6216B412PR	LVR-IC	4.1V±2%, 150mA, +CE	SOT-89-5	32vrq VR4	6n	Tor
21A	XE6216B412PR	LVR-IC	4.1V±2%, 150mA, +CE	SOT-89-5	32vrq VR4	6p	Tor
21B	XC6216B422PR	LVR-IC	4.2V±2%, 150mA, +CE	SOT-89-5	32vrq VR4	6n	Tor
21B	XE6216B422PR	LVR-IC	4.2V±2%, 150mA, +CE	SOT-89-5	32vrq VR4	6p	Tor
21C	XC6216B432PR	LVR-IC	4.3V±2%, 150mA, +CE	SOT-89-5	32vrq VR4	6n	Tor
21C	XE6216B432PR	LVR-IC	4.3V±2%, 150mA, +CE	SOT-89-5	32vrq VR4	6p	Tor
21D	XC6216B442PR	LVR-IC	4.4V±2%, 150mA, +CE	SOT-89-5	32vrq VR4	6n	Tor
21D	XE6216B442PR	LVR-IC	4.4V±2%, 150mA, +CE	SOT-89-5	32vrq VR4	6p	Tor
21E	XC6216B452PR	LVR-IC	4.5V±2%, 150mA, +CE	SOT-89-5	32vrq VR4	6n	Tor
21E	XE6216B452PR	LVR-IC	4.5V±2%, 150mA, +CE	SOT-89-5	32vrq VR4	6p	Tor
21F	XC6216B462PR	LVR-IC	4.6V±2%, 150mA, +CE	SOT-89-5	32vrq VR4	6n	Tor
21F	XE6216B462PR	LVR-IC	4.6V±2%, 150mA, +CE	SOT-89-5	32vrq VR4	6p	Tor
21H	XC6216B472PR	LVR-IC	4.7V±2%, 150mA, +CE	SOT-89-5	32vrq VR4	6n	Tor
21H	XE6216B472PR	LVR-IC	4.7V±2%, 150mA, +CE	SOT-89-5	32vrq VR4	6p	Tor
21K	XC6216B482PR	LVR-IC	4.8V±2%, 150mA, +CE	SOT-89-5	32vrq VR4	6n	Tor
21K	XE6216B482PR	LVR-IC	4.8V±2%, 150mA, +CE	SOT-89-5	32vrq VR4	6p	Tor
21L	XC6216B492PR	LVR-IC	4.9V±2%, 150mA, +CE	SOT-89-5	32vrq VR4	6n	Tor
21L	XE6216B492PR	LVR-IC	4.9V±2%, 150mA, +CE	SOT-89-5	32vrq VR4	6p	Tor
21M	XC6216B502PR	LVR-IC	5.0V±2%, 150mA, +CE	SOT-89-5	32vrq VR4	6n	Tor
21M	XE6216B502PR	LVR-IC	5.0V±2%, 150mA, +CE	SOT-89-5	32vrq VR4	6p	Tor
21N	XC6216B512PR	LVR-IC	5.1V±2%, 150mA, +CE	SOT-89-5	32vrq VR4	6n	Tor
21N	XE6216B512PR	LVR-IC	5.1V±2%, 150mA, +CE	SOT-89-5	32vrq VR4	6p	Tor
21P	TK11221BU	LVR-IC	LDO, 2.1V±2%, 150mA, +CE	SOT-89-5	32vg VR7	6i	Tok
21P	XC6216B522PR	LVR-IC	5.2V±2%, 150mA, +CE	SOT-89-5	32vrq VR4	6n	Tor
21P	XE6216B522PR	LVR-IC	5.2V±2%, 150mA, +CE	SOT-89-5	32vrq VR4	6p	Tor
21Q	TK11321BU	LVR-IC	LDO, 2.1V±2%, 150mA, -CE	SOT-89-5	32vg VR7	6i	Tok
21R	XC6216B532PR	LVR-IC	5.3V±2%, 150mA, +CE	SOT-89-5	32vrq VR4	6n	Tor
21R	XE6216B532PR	LVR-IC	5.3V±2%, 150mA, +CE	SOT-89-5	32vrq VR4	6p	Tor
21S	XC6216B542PR	LVR-IC	5.4V±2%, 150mA, +CE	SOT-89-5	32vrq VR4	6n	Tor
21S	XE6216B542PR	LVR-IC	5.4V±2%, 150mA, +CE	SOT-89-5	32vrq VR4	6p	Tor
21T	XC6216B552PR	LVR-IC	5.5V±2%, 150mA, +CE	SOT-89-5	32vrq VR4	6n	Tor
21T	XE6216B552PR	LVR-IC	5.5V±2%, 150mA, +CE	SOT-89-5	32vrq VR4	6p	Tor
21U	XC6216B562PR	LVR-IC	5.6V±2%, 150mA, +CE	SOT-89-5	32vrq VR4	6n	Tor
21U	XE6216B562PR	LVR-IC	5.6V±2%, 150mA, +CE	SOT-89-5	32vrq VR4	6p	Tor
21V	XC6216B572PR	LVR-IC	5.7V±2%, 150mA, +CE	SOT-89-5	32vrq VR4	6n	Tor
21V	XE6216B572PR	LVR-IC	5.7V±2%, 150mA, +CE	SOT-89-5	32vrq VR4	6p	Tor
21X	XC6216B582PR	LVR-IC	5.8V±2%, 150mA, +CE	SOT-89-5	32vrq VR4	6n	Tor
21X	XE6216B582PR	LVR-IC	5.8V±2%, 150mA, +CE	SOT-89-5	32vrq VR4	6p	Tor
21Y	XC6216B592PR	LVR-IC	5.9V±2%, 150mA, +CE	SOT-89-5	32vrq VR4	6n	Tor
21Y	XE6216B592PR	LVR-IC	5.9V±2%, 150mA, +CE	SOT-89-5	32vrq VR4	6p	Tor
21Z	XC6216B602PR	LVR-IC	6.0V±2%, 150mA, +CE	SOT-89-5	32vrq VR4	6n	Tor
21Z	XE6216B602PR	LVR-IC	6.0V±2%, 150mA, +CE	SOT-89-5	32vrq VR4	6p	Tor
220	XC6216B612PR	LVR-IC	6.1V±2%, 150mA, +CE	SOT-89-5	32vrq VR4	6n	Tor
220	XE6216B612PR	LVR-IC	6.1V±2%, 150mA, +CE	SOT-89-5	32vrq VR4	6p	Tor
221	XC6216B622PR	LVR-IC	6.2V±2%, 150mA, +CE	SOT-89-5	32vrq VR4	6n	Tor
221	XE6216B622PR	LVR-IC	6.2V±2%, 150mA, +CE	SOT-89-5	32vrq VR4	6p	Tor
222	XC6216B632PR	LVR-IC	6.3V±2%, 150mA, +CE	SOT-89-5	32vrq VR4	6n	Tor
222	XE6216B632PR	LVR-IC	6.3V±2%, 150mA, +CE	SOT-89-5	32vrq VR4	6p	Tor



SMD code	Type	Function	Short description	Case	Pinout Sch.	St.	Mnf.
223	XC6216B642PR	LVR-IC	6.4V±2%, 150mA, +CE	SOT-89-5	32vrq VR4	6n	Tor
223	XE6216B642PR	LVR-IC	6.4V±2%, 150mA, +CE	SOT-89-5	32vrq VR4	6p	Tor
224	XC6216B652PR	LVR-IC	6.5V±2%, 150mA, +CE	SOT-89-5	32vrq VR4	6p	Tor
224	XE6216B652PR	LVR-IC	6.5V±2%, 150mA, +CE	SOT-89-5	32vrq VR4	6p	Tor
225	XC6216B662PR	LVR-IC	6.6V±2%, 150mA, +CE	SOT-89-5	32vrq VR4	6n	Tor
225	XE6216B662PR	LVR-IC	6.6V±2%, 150mA, +CE	SOT-89-5	32vrq VR4	6p	Tor
226	XC6216B672PR	LVR-IC	6.7V±2%, 150mA, +CE	SOT-89-5	32vrq VR4	6n	Tor
226	XE6216B672PR	LVR-IC	6.7V±2%, 150mA, +CE	SOT-89-5	32vrq VR4	6p	Tor
227	XC6216B682PR	LVR-IC	6.8V±2%, 150mA, +CE	SOT-89-5	32vrq VR4	6n	Tor
227	XE6216B682PR	LVR-IC	6.8V±2%, 150mA, +CE	SOT-89-5	32vrq VR4	6p	Tor
228	XC6216B692PR	LVR-IC	6.9V±2%, 150mA, +CE	SOT-89-5	32vrq VR4	6n	Tor
228	XE6216B692PR	LVR-IC	6.9V±2%, 150mA, +CE	SOT-89-5	32vrq VR4	6p	Tor
229	XC6216B702PR	LVR-IC	7.0V±2%, 150mA, +CE	SOT-89-5	32vrq VR4	6n	Tor
229	XE6216B702PR	LVR-IC	7.0V±2%, 150mA, +CE	SOT-89-5	32vrq VR4	6p	Tor
22A	XC6216B712PR	LVR-IC	7.1V±2%, 150mA, +CE	SOT-89-5	32vrq VR4	6n	Tor
22A	XE6216B712PR	LVR-IC	7.1V±2%, 150mA, +CE	SOT-89-5	32vrq VR4	6p	Tor
22B	XC6216B722PR	LVR-IC	7.2V±2%, 150mA, +CE	SOT-89-5	32vrq VR4	6n	Tor
22B	XE6216B722PR	LVR-IC	7.2V±2%, 150mA, +CE	SOT-89-5	32vrq VR4	6p	Tor
22C	XC6216B732PR	LVR-IC	7.3V±2%, 150mA, +CE	SOT-89-5	32vrq VR4	6n	Tor
22C	XE6216B732PR	LVR-IC	7.3V±2%, 150mA, +CE	SOT-89-5	32vrq VR4	6p	Tor
22D	XC6216B742PR	LVR-IC	7.4V±2%, 150mA, +CE	SOT-89-5	32vrq VR4	6n	Tor
22D	XE6216B742PR	LVR-IC	7.4V±2%, 150mA, +CE	SOT-89-5	32vrq VR4	6p	Tor
22E	XC6216B752PR	LVR-IC	7.5V±2%, 150mA, +CE	SOT-89-5	32vrq VR4	6n	Tor
22E	XE6216B752PR	LVR-IC	7.5V±2%, 150mA, +CE	SOT-89-5	32vrq VR4	6p	Tor
22F	XC6216B762PR	LVR-IC	7.6V±2%, 150mA, +CE	SOT-89-5	32vrq VR4	6n	Tor
22F	XE6216B762PR	LVR-IC	7.6V±2%, 150mA, +CE	SOT-89-5	32vrq VR4	6p	Tor
22H	XC6216B772PR	LVR-IC	7.7V±2%, 150mA, +CE	SOT-89-5	32vrq VR4	6n	Tor
22H	XE6216B772PR	LVR-IC	7.7V±2%, 150mA, +CE	SOT-89-5	32vrq VR4	6p	Tor
22K	XC6216B782PR	LVR-IC	7.8V±2%, 150mA, +CE	SOT-89-5	32vrq VR4	6n	Tor
22K	XE6216B782PR	LVR-IC	7.8V±2%, 150mA, +CE	SOT-89-5	32vrq VR4	6p	Tor
22L	XC6216B792PR	LVR-IC	7.9V±2%, 150mA, +CE	SOT-89-5	32vrq VR4	6n	Tor
22L	XE6216B792PR	LVR-IC	7.9V±2%, 150mA, +CE	SOT-89-5	32vrq VR4	6p	Tor
22M	XC6216B802PR	LVR-IC	8.0V±2%, 150mA, +CE	SOT-89-5	32vrq VR4	6n	Tor
22M	XE6216B802PR	LVR-IC	8.0V±2%, 150mA, +CE	SOT-89-5	32vrq VR4	6p	Tor
22N	XC6216B812PR	LVR-IC	8.1V±2%, 150mA, +CE	SOT-89-5	32vrq VR4	6n	Tor
22N	XE6216B812PR	LVR-IC	8.1V±2%, 150mA, +CE	SOT-89-5	32vrq VR4	6p	Tor
22P	TK1122ZBU	LVR-IC	LDO, 2.2V±2%, 150mA, +CE	SOT-89-5	32vg VR7	6i	Tok
22P	XC6216B822PR	LVR-IC	8.2V±2%, 150mA, +CE	SOT-89-5	32vrq VR4	6n	Tor
22P	XE6216B822PR	LVR-IC	8.2V±2%, 150mA, +CE	SOT-89-5	32vrq VR4	6p	Tor
22Q	TK1132ZBU	LVR-IC	LDO, 2.2V±2%, 150mA, -CE	SOT-89-5	32vg VR7	6i	Tok
22R	XC6216B832PR	LVR-IC	8.3V±2%, 150mA, +CE	SOT-89-5	32vrq VR4	6n	Tor
22R	XE6216B832PR	LVR-IC	8.3V±2%, 150mA, +CE	SOT-89-5	32vrq VR4	6p	Tor
22S	XC6216B842PR	LVR-IC	8.4V±2%, 150mA, +CE	SOT-89-5	32vrq VR4	6n	Tor
22S	XE6216B842PR	LVR-IC	8.4V±2%, 150mA, +CE	SOT-89-5	32vrq VR4	6p	Tor
22T	XC6216B852PR	LVR-IC	8.5V±2%, 150mA, +CE	SOT-89-5	32vrq VR4	6n	Tor
22T	XE6216B852PR	LVR-IC	8.5V±2%, 150mA, +CE	SOT-89-5	32vrq VR4	6p	Tor
22U	XC6216B862PR	LVR-IC	8.6V±2%, 150mA, +CE	SOT-89-5	32vrq VR4	6n	Tor
22U	XE6216B862PR	LVR-IC	8.6V±2%, 150mA, +CE	SOT-89-5	32vrq VR4	6p	Tor
22V	XC6216B872PR	LVR-IC	8.7V±2%, 150mA, +CE	SOT-89-5	32vrq VR4	6n	Tor
22V	XE6216B872PR	LVR-IC	8.7V±2%, 150mA, +CE	SOT-89-5	32vrq VR4	6p	Tor
22X	XC6216B882PR	LVR-IC	8.8V±2%, 150mA, +CE	SOT-89-5	32vrq VR4	6n	Tor
22X	XE6216B882PR	LVR-IC	8.8V±2%, 150mA, +CE	SOT-89-5	32vrq VR4	6p	Tor
22Y	XC6216B892PR	LVR-IC	8.9V±2%, 150mA, +CE	SOT-89-5	32vrq VR4	6n	Tor
22Y	XE6216B892PR	LVR-IC	8.9V±2%, 150mA, +CE	SOT-89-5	32vrq VR4	6p	Tor
22Z	XC6216B902PR	LVR-IC	9.0V±2%, 150mA, +CE	SOT-89-5	32vrq VR4	6n	Tor
22Z	XE6216B902PR	LVR-IC	9.0V±2%, 150mA, +CE	SOT-89-5	32vrq VR4	6p	Tor
230	XC6216B912PR	LVR-IC	9.1V±2%, 150mA, +CE	SOT-89-5	32vrq VR4	6n	Tor
230	XE6216B912PR	LVR-IC	9.1V±2%, 150mA, +CE	SOT-89-5	32vrq VR4	6p	Tor
231	XC6216B922PR	LVR-IC	9.2V±2%, 150mA, +CE	SOT-89-5	32vrq VR4	6n	Tor
231	XE6216B922PR	LVR-IC	9.2V±2%, 150mA, +CE	SOT-89-5	32vrq VR4	6p	Tor
232	XC6216B932PR	LVR-IC	9.3V±2%, 150mA, +CE	SOT-89-5	32vrq VR4	6n	Tor
232	XE6216B932PR	LVR-IC	9.3V±2%, 150mA, +CE	SOT-89-5	32vrq VR4	6p	Tor
233	XC6216B942PR	LVR-IC	9.4V±2%, 150mA, +CE	SOT-89-5	32vrq VR4	6n	Tor
233	XE6216B942PR	LVR-IC	9.4V±2%, 150mA, +CE	SOT-89-5	32vrq VR4	6p	Tor
234	XC6216B952PR	LVR-IC	9.5V±2%, 150mA, +CE	SOT-89-5	32vrq VR4	6n	Tor
234	XE6216B952PR	LVR-IC	9.5V±2%, 150mA, +CE	SOT-89-5	32vrq VR4	6p	Tor
235	XC6216B962PR	LVR-IC	9.6V±2%, 150mA, +CE	SOT-89-5	32vrq VR4	6n	Tor
235	XE6216B962PR	LVR-IC	9.6V±2%, 150mA, +CE	SOT-89-5	32vrq VR4	6p	Tor
236	XC6216B972PR	LVR-IC	9.7V±2%, 150mA, +CE	SOT-89-5	32vrq VR4	6n	Tor
236	XE6216B972PR	LVR-IC	9.7V±2%, 150mA, +CE	SOT-89-5	32vrq VR4	6p	Tor



SMD code	Type	Function	Short description	Case	Pinout Sch.	St.	Mnf.
237	XC6216B982PR	LVR-IC	9.8V±2%, 150mA, +CE	SOT-89-5	32vrq VR4	6n	Tor
237	XE6216B982PR	LVR-IC	9.8V±2%, 150mA, +CE	SOT-89-5	32vrq VR4	6p	Tor
238	XC6216B992PR	LVR-IC	9.9V±2%, 150mA, +CE	SOT-89-5	32vrq VR4	6n	Tor
238	XE6216B992PR	LVR-IC	9.9V±2%, 150mA, +CE	SOT-89-5	32vrq VR4	6p	Tor
239	XC6216BA02PR	LVR-IC	10.0V±2%, 150mA, +CE	SOT-89-5	32vrq VR4	6n	Tor
239	XE6216BA02PR	LVR-IC	10.0V±2%, 150mA, +CE	SOT-89-5	32vrq VR4	6p	Tor
23A	XC6216BA12PR	LVR-IC	10.1V±2%, 150mA, +CE	SOT-89-5	32vrq VR4	6n	Tor
23A	XE6216BA12PR	LVR-IC	10.1V±2%, 150mA, +CE	SOT-89-5	32vrq VR4	6p	Tor
23B	XC6216BA22PR	LVR-IC	10.2V±2%, 150mA, +CE	SOT-89-5	32vrq VR4	6n	Tor
23B	XE6216BA22PR	LVR-IC	10.2V±2%, 150mA, +CE	SOT-89-5	32vrq VR4	6p	Tor
23C	XC6216BA32PR	LVR-IC	10.3V±2%, 150mA, +CE	SOT-89-5	32vrq VR4	6n	Tor
23C	XE6216BA32PR	LVR-IC	10.3V±2%, 150mA, +CE	SOT-89-5	32vrq VR4	6p	Tor
23D	XC6216BA42PR	LVR-IC	10.4V±2%, 150mA, +CE	SOT-89-5	32vrq VR4	6n	Tor
23D	XE6216BA42PR	LVR-IC	10.4V±2%, 150mA, +CE	SOT-89-5	32vrq VR4	6p	Tor
23E	XC6216BA52PR	LVR-IC	10.5V±2%, 150mA, +CE	SOT-89-5	32vrq VR4	6n	Tor
23E	XE6216BA52PR	LVR-IC	10.5V±2%, 150mA, +CE	SOT-89-5	32vrq VR4	6p	Tor
23F	XC6216BA62PR	LVR-IC	10.6V±2%, 150mA, +CE	SOT-89-5	32vrq VR4	6n	Tor
23F	XE6216BA62PR	LVR-IC	10.6V±2%, 150mA, +CE	SOT-89-5	32vrq VR4	6p	Tor
23H	XC6216BA72PR	LVR-IC	10.7V±2%, 150mA, +CE	SOT-89-5	32vrq VR4	6n	Tor
23H	XE6216BA72PR	LVR-IC	10.7V±2%, 150mA, +CE	SOT-89-5	32vrq VR4	6p	Tor
23K	XC6216BA82PR	LVR-IC	10.8V±2%, 150mA, +CE	SOT-89-5	32vrq VR4	6n	Tor
23K	XE6216BA82PR	LVR-IC	10.8V±2%, 150mA, +CE	SOT-89-5	32vrq VR4	6p	Tor
23L	XC6216BA92PR	LVR-IC	10.9V±2%, 150mA, +CE	SOT-89-5	32vrq VR4	6n	Tor
23L	XE6216BA92PR	LVR-IC	10.9V±2%, 150mA, +CE	SOT-89-5	32vrq VR4	6p	Tor
23M	XC6216BB02PR	LVR-IC	11.0V±2%, 150mA, +CE	SOT-89-5	32vrq VR4	6n	Tor
23M	XE6216BB02PR	LVR-IC	11.0V±2%, 150mA, +CE	SOT-89-5	32vrq VR4	6p	Tor
23N	XC6216BB12PR	LVR-IC	11.1V±2%, 150mA, +CE	SOT-89-5	32vrq VR4	6n	Tor
23N	XE6216BB12PR	LVR-IC	11.1V±2%, 150mA, +CE	SOT-89-5	32vrq VR4	6p	Tor
23P	TK11223BU	LVR-IC	LDO, 2.3V±2%, 150mA, +CE	SOT-89-5	32vg VR7	6i	Tok
23P	XC6216BB22PR	LVR-IC	11.2V±2%, 150mA, +CE	SOT-89-5	32vrq VR4	6n	Tor
23P	XE6216BB22PR	LVR-IC	11.2V±2%, 150mA, +CE	SOT-89-5	32vrq VR4	6p	Tor
23Q	TK11323BU	LVR-IC	LDO, 2.3V±2%, 150mA, -CE	SOT-89-5	32vg VR7	6i	Tok
23R	XC6216BB32PR	LVR-IC	11.3V±2%, 150mA, +CE	SOT-89-5	32vrq VR4	6n	Tor
23R	XE6216BB32PR	LVR-IC	11.3V±2%, 150mA, +CE	SOT-89-5	32vrq VR4	6p	Tor
23S	XC6216BB42PR	LVR-IC	11.4V±2%, 150mA, +CE	SOT-89-5	32vrq VR4	6n	Tor
23S	XE6216BB42PR	LVR-IC	11.4V±2%, 150mA, +CE	SOT-89-5	32vrq VR4	6p	Tor
23T	XC6216BB52PR	LVR-IC	11.5V±2%, 150mA, +CE	SOT-89-5	32vrq VR4	6n	Tor
23T	XE6216BB52PR	LVR-IC	11.5V±2%, 150mA, +CE	SOT-89-5	32vrq VR4	6p	Tor
23U	XC6216BB62PR	LVR-IC	11.6V±2%, 150mA, +CE	SOT-89-5	32vrq VR4	6n	Tor
23U	XE6216BB62PR	LVR-IC	11.6V±2%, 150mA, +CE	SOT-89-5	32vrq VR4	6p	Tor
23V	XC6216BB72PR	LVR-IC	11.7V±2%, 150mA, +CE	SOT-89-5	32vrq VR4	6n	Tor
23V	XE6216BB72PR	LVR-IC	11.7V±2%, 150mA, +CE	SOT-89-5	32vrq VR4	6p	Tor
23X	XC6216BB82PR	LVR-IC	11.8V±2%, 150mA, +CE	SOT-89-5	32vrq VR4	6n	Tor
23X	XE6216BB82PR	LVR-IC	11.8V±2%, 150mA, +CE	SOT-89-5	32vrq VR4	6p	Tor
23Y	XC6216BB92PR	LVR-IC	11.9V±2%, 150mA, +CE	SOT-89-5	32vrq VR4	6n	Tor
23Y	XE6216BB92PR	LVR-IC	11.9V±2%, 150mA, +CE	SOT-89-5	32vrq VR4	6p	Tor
23Z	XC6216BC02PR	LVR-IC	12.0V±2%, 150mA, +CE	SOT-89-5	32vrq VR4	6n	Tor
23Z	XE6216BC02PR	LVR-IC	12.0V±2%, 150mA, +CE	SOT-89-5	32vrq VR4	6p	Tor
24P	TK11224BU	LVR-IC	LDO, 2.4V±2%, 150mA, +CE	SOT-89-5	32vg VR7	6i	Tok
24Q	TK11324BU	LVR-IC	LDO, 2.4V±2%, 150mA, -CE	SOT-89-5	32vg VR7	6i	Tok
25P	TK11225BU	LVR-IC	LDO, 2.5V±2%, 150mA, +CE	SOT-89-5	32vg VR7	6i	Tok
25Q	TK11325BU	LVR-IC	LDO, 2.5V±2%, 150mA, -CE	SOT-89-5	32vg VR7	6i	Tok
26P	TK11226BU	LVR-IC	LDO, 2.6V±2%, 150mA, +CE	SOT-89-5	32vg VR7	6i	Tok
26Q	TK11326BU	LVR-IC	LDO, 2.6V±2%, 150mA, -CE	SOT-89-5	32vg VR7	6i	Tok
27P	TK11227BU	LVR-IC	LDO, 2.7V±2%, 150mA, +CE	SOT-89-5	32vg VR7	6i	Tok
27Q	TK11327BU	LVR-IC	LDO, 2.7V±2%, 150mA, -CE	SOT-89-5	32vg VR7	6i	Tok
28P	TK11228BU	LVR-IC	LDO, 2.8V±2%, 150mA, +CE	SOT-89-5	32vg VR7	6i	Tok
28Q	TK11328BU	LVR-IC	LDO, 2.8V±2%, 150mA, -CE	SOT-89-5	32vg VR7	6i	Tok
29P	TK11229BU	LVR-IC	LDO, 2.9V±2%, 150mA, +CE	SOT-89-5	32vg VR7	6i	Tok
29Q	TK11329BU	LVR-IC	LDO, 2.9V±2%, 150mA, -CE	SOT-89-5	32vg VR7	6i	Tok
30P	TK11230BU	LVR-IC	LDO, 3V±2%, 150mA, +CE	SOT-89-5	32vg VR7	6i	Tok
30Q	TK11330BU	LVR-IC	LDO, 3V±2%, 150mA, -CE	SOT-89-5	32vg VR7	6i	Tok
31P	TK11231BU	LVR-IC	LDO, 3.1V±2%, 150mA, +CE	SOT-89-5	32vg VR7	6i	Tok
31Q	TK11331BU	LVR-IC	LDO, 3.1V±2%, 150mA, -CE	SOT-89-5	32vg VR7	6i	Tok
320	XC6372E201P	DC/DC-IC	PWM/PFM step-up, 100kHz, int. Vdd, 2.0V±2.5%, 100mA	SOT-89-5	32gc DC4	6h	Tor
321	XC6372E211P	DC/DC-IC	PWM/PFM step-up, 100kHz, int. Vdd, 2.1V±2.5%, 100mA	SOT-89-5	32gc DC4	6h	Tor
322	XC6372E221P	DC/DC-IC	PWM/PFM step-up, 100kHz, int. Vdd, 2.2V±2.5%, 100mA	SOT-89-5	32gc DC4	6h	Tor
323	XC6372E231P	DC/DC-IC	PWM/PFM step-up, 100kHz, int. Vdd, 2.3V±2.5%, 100mA	SOT-89-5	32gc DC4	6h	Tor
324	XC6372E241P	DC/DC-IC	PWM/PFM step-up, 100kHz, int. Vdd, 2.4V±2.5%, 100mA	SOT-89-5	32gc DC4	6h	Tor
325	XC6372E251P	DC/DC-IC	PWM/PFM step-up, 100kHz, int. Vdd, 2.5V±2.5%, 100mA	SOT-89-5	32gc DC4	6h	Tor



SMD code	Type	Function	Short description	Case	Pinout Sch.	St.	Mnf.
35A	XC6372E502P	DC/DC-IC	PWM/PFM step-up, 180kHz, int. Vdd, 5.0V±2.5%, 100mA	SOT-89-5	32gc	DC4	6h Tok
35B	XC6372E512P	DC/DC-IC	PWM/PFM step-up, 180kHz, int. Vdd, 5.1V±2.5%, 100mA	SOT-89-5	32gc	DC4	6h Tok
35C	XC6372E522P	DC/DC-IC	PWM/PFM step-up, 180kHz, int. Vdd, 5.2V±2.5%, 100mA	SOT-89-5	32gc	DC4	6h Tok
35D	XC6372E532P	DC/DC-IC	PWM/PFM step-up, 180kHz, int. Vdd, 5.3V±2.5%, 100mA	SOT-89-5	32gc	DC4	6h Tok
35E	XC6372E542P	DC/DC-IC	PWM/PFM step-up, 180kHz, int. Vdd, 5.4V±2.5%, 100mA	SOT-89-5	32gc	DC4	6h Tok
35F	XC6372E552P	DC/DC-IC	PWM/PFM step-up, 180kHz, int. Vdd, 5.5V±2.5%, 100mA	SOT-89-5	32gc	DC4	6h Tok
35H	XC6372E562P	DC/DC-IC	PWM/PFM step-up, 180kHz, int. Vdd, 5.6V±2.5%, 100mA	SOT-89-5	32gc	DC4	6h Tok
35K	XC6372E572P	DC/DC-IC	PWM/PFM step-up, 180kHz, int. Vdd, 5.7V±2.5%, 100mA	SOT-89-5	32gc	DC4	6h Tok
35L	XC6372E582P	DC/DC-IC	PWM/PFM step-up, 180kHz, int. Vdd, 5.8V±2.5%, 100mA	SOT-89-5	32gc	DC4	6h Tok
35M	XC6372E592P	DC/DC-IC	PWM/PFM step-up, 180kHz, int. Vdd, 5.9V±2.5%, 100mA	SOT-89-5	32gc	DC4	6h Tok
35P	TK11235BU	LVR-IC	LDO, 3.5V±2%, 150mA, +CE	SOT-89-5	32vg	VR7	6i Tok
35Q	TK11335BU	LVR-IC	LDO, 3.5V±2%, 150mA, -CE	SOT-89-5	32vg	VR7	6i Tok
360	XC6372E601P	DC/DC-IC	PWM/PFM step-up, 100kHz, int. Vdd, 6.0V±2.5%, 100mA	SOT-89-5	32gc	DC4	6h Tok
361	XC6372E611P	DC/DC-IC	PWM/PFM step-up, 100kHz, int. Vdd, 6.1V±2.5%, 100mA	SOT-89-5	32gc	DC4	6h Tok
362	XC6372E621P	DC/DC-IC	PWM/PFM step-up, 100kHz, int. Vdd, 6.2V±2.5%, 100mA	SOT-89-5	32gc	DC4	6h Tok
363	XC6372E631P	DC/DC-IC	PWM/PFM step-up, 100kHz, int. Vdd, 6.3V±2.5%, 100mA	SOT-89-5	32gc	DC4	6h Tok
364	XC6372E641P	DC/DC-IC	PWM/PFM step-up, 100kHz, int. Vdd, 6.4V±2.5%, 100mA	SOT-89-5	32gc	DC4	6h Tok
365	XC6372E651P	DC/DC-IC	PWM/PFM step-up, 100kHz, int. Vdd, 6.5V±2.5%, 100mA	SOT-89-5	32gc	DC4	6h Tok
366	XC6372E661P	DC/DC-IC	PWM/PFM step-up, 100kHz, int. Vdd, 6.6V±2.5%, 100mA	SOT-89-5	32gc	DC4	6h Tok
367	XC6372E671P	DC/DC-IC	PWM/PFM step-up, 100kHz, int. Vdd, 6.7V±2.5%, 100mA	SOT-89-5	32gc	DC4	6h Tok
368	XC6372E681P	DC/DC-IC	PWM/PFM step-up, 100kHz, int. Vdd, 6.8V±2.5%, 100mA	SOT-89-5	32gc	DC4	6h Tok
369	XC6372E691P	DC/DC-IC	PWM/PFM step-up, 100kHz, int. Vdd, 6.9V±2.5%, 100mA	SOT-89-5	32gc	DC4	6h Tok
36A	XC6372E602P	DC/DC-IC	PWM/PFM step-up, 180kHz, int. Vdd, 6.0V±2.5%, 100mA	SOT-89-5	32gc	DC4	6h Tok
36B	XC6372E612P	DC/DC-IC	PWM/PFM step-up, 180kHz, int. Vdd, 6.1V±2.5%, 100mA	SOT-89-5	32gc	DC4	6h Tok
36C	XC6372E622P	DC/DC-IC	PWM/PFM step-up, 180kHz, int. Vdd, 6.2V±2.5%, 100mA	SOT-89-5	32gc	DC4	6h Tok
36D	XC6372E632P	DC/DC-IC	PWM/PFM step-up, 180kHz, int. Vdd, 6.3V±2.5%, 100mA	SOT-89-5	32gc	DC4	6h Tok
36E	XC6372E642P	DC/DC-IC	PWM/PFM step-up, 180kHz, int. Vdd, 6.4V±2.5%, 100mA	SOT-89-5	32gc	DC4	6h Tok
36F	XC6372E652P	DC/DC-IC	PWM/PFM step-up, 180kHz, int. Vdd, 6.5V±2.5%, 100mA	SOT-89-5	32gc	DC4	6h Tok
36H	XC6372E662P	DC/DC-IC	PWM/PFM step-up, 180kHz, int. Vdd, 6.6V±2.5%, 100mA	SOT-89-5	32gc	DC4	6h Tok
36K	XC6372E672P	DC/DC-IC	PWM/PFM step-up, 180kHz, int. Vdd, 6.7V±2.5%, 100mA	SOT-89-5	32gc	DC4	6h Tok
36L	XC6372E682P	DC/DC-IC	PWM/PFM step-up, 180kHz, int. Vdd, 6.8V±2.5%, 100mA	SOT-89-5	32gc	DC4	6h Tok
36M	XC6372E692P	DC/DC-IC	PWM/PFM step-up, 180kHz, int. Vdd, 6.9V±2.5%, 100mA	SOT-89-5	32gc	DC4	6h Tok
36P	TK11236BU	LVR-IC	LDO, 3.6V±2%, 150mA, +CE	SOT-89-5	32vg	VR7	6i Tok
36Q	TK11336BU	LVR-IC	LDO, 3.6V±2%, 150mA, -CE	SOT-89-5	32vg	VR7	6i Tok
370	XC6372E701P	DC/DC-IC	PWM/PFM step-up, 100kHz, int. Vdd, 7.0V±2.5%, 100mA	SOT-89-5	32gc	DC4	6h Tok
37A	XC6372E702P	DC/DC-IC	PWM/PFM step-up, 180kHz, int. Vdd, 7.0V±2.5%, 100mA	SOT-89-5	32gc	DC4	6h Tok
37P	TK11237BU	LVR-IC	LDO, 3.7V±2%, 150mA, +CE	SOT-89-5	32vg	VR7	6i Tok
37Q	TK11337BU	LVR-IC	LDO, 3.7V±2%, 150mA, -CE	SOT-89-5	32vg	VR7	6i Tok
38P	TK11238BU	LVR-IC	LDO, 3.8V±2%, 150mA, +CE	SOT-89-5	32vg	VR7	6i Tok
38Q	TK11338BU	LVR-IC	LDO, 3.8V±2%, 150mA, -CE	SOT-89-5	32vg	VR7	6i Tok
39P	TK11239BU	LVR-IC	LDO, 3.9V±2%, 150mA, +CE	SOT-89-5	32vg	VR7	6i Tok
39Q	TK11339BU	LVR-IC	LDO, 3.9V±2%, 150mA, -CE	SOT-89-5	32vg	VR7	6i Tok
3A8	XC6227A081PR	LVR-IC	LDO, 0.8V±20mV, 700mA, +CE	SOT-89-5	32vy	VR4	6n Tok
3A9	XC6227A091PR	LVR-IC	LDO, 0.9V±20mV, 700mA, +CE	SOT-89-5	32vy	VR4	6n Tok
3AA	XC6227A101PR	LVR-IC	LDO, 1.0V±20mV, 700mA, +CE	SOT-89-5	32vy	VR4	6n Tok
3AB	XC6227A111PR	LVR-IC	LDO, 1.1V±20mV, 700mA, +CE	SOT-89-5	32vy	VR4	6n Tok
3AC	XC6227A121PR	LVR-IC	LDO, 1.2V±20mV, 700mA, +CE	SOT-89-5	32vy	VR4	6n Tok
3AD	XC6227A131PR	LVR-IC	LDO, 1.3V±20mV, 700mA, +CE	SOT-89-5	32vy	VR4	6n Tok
3AE	XC6227A141PR	LVR-IC	LDO, 1.4V±20mV, 700mA, +CE	SOT-89-5	32vy	VR4	6n Tok
3AF	XC6227A151PR	LVR-IC	LDO, 1.5V±20mV, 700mA, +CE	SOT-89-5	32vy	VR4	6n Tok
3AH	XC6227A161PR	LVR-IC	LDO, 1.6V±20mV, 700mA, +CE	SOT-89-5	32vy	VR4	6n Tok
3AK	XC6227A171PR	LVR-IC	LDO, 1.7V±20mV, 700mA, +CE	SOT-89-5	32vy	VR4	6n Tok
3AL	XC6227A181PR	LVR-IC	LDO, 1.8V±20mV, 700mA, +CE	SOT-89-5	32vy	VR4	6n Tok
3AM	XC6227A191PR	LVR-IC	LDO, 1.9V±20mV, 700mA, +CE	SOT-89-5	32vy	VR4	6n Tok
3AN	XC6227A201PR	LVR-IC	LDO, 2.0V±20mV, 700mA, +CE	SOT-89-5	32vy	VR4	6n Tok
3AP	XC6227A211PR	LVR-IC	LDO, 2.1V±1%, 700mA, +CE	SOT-89-5	32vy	VR4	6n Tok
3AR	XC6227A221PR	LVR-IC	LDO, 2.2V±1%, 700mA, +CE	SOT-89-5	32vy	VR4	6n Tok
3AS	XC6227A231PR	LVR-IC	LDO, 2.3V±1%, 700mA, +CE	SOT-89-5	32vy	VR4	6n Tok
3AT	XC6227A241PR	LVR-IC	LDO, 2.4V±1%, 700mA, +CE	SOT-89-5	32vy	VR4	6n Tok
3AU	XC6227A251PR	LVR-IC	LDO, 2.5V±1%, 700mA, +CE	SOT-89-5	32vy	VR4	6n Tok
3AV	XC6227A261PR	LVR-IC	LDO, 2.6V±1%, 700mA, +CE	SOT-89-5	32vy	VR4	6n Tok
3AX	XC6227A271PR	LVR-IC	LDO, 2.7V±1%, 700mA, +CE	SOT-89-5	32vy	VR4	6n Tok
3AY	XC6227A281PR	LVR-IC	LDO, 2.8V±1%, 700mA, +CE	SOT-89-5	32vy	VR4	6n Tok
3AZ	XC6227A291PR	LVR-IC	LDO, 2.9V±1%, 700mA, +CE	SOT-89-5	32vy	VR4	6n Tok
3B8	XC6227A08BPR	LVR-IC	LDO, 0.85V±20mV, 700mA, +CE	SOT-89-5	32vy	VR4	6n Tok
3B9	XC6227A09BPR	LVR-IC	LDO, 1.95V±20mV, 700mA, +CE	SOT-89-5	32vy	VR4	6n Tok
3BA	XC6227A10BPR	LVR-IC	LDO, 1.05V±20mV, 700mA, +CE	SOT-89-5	32vy	VR4	6n Tok
3BB	XC6227A11BPR	LVR-IC	LDO, 1.15V±20mV, 700mA, +CE	SOT-89-5	32vy	VR4	6n Tok
3BC	XC6227A12BPR	LVR-IC	LDO, 1.25V±20mV, 700mA, +CE	SOT-89-5	32vy	VR4	6n Tok
3BD	XC6227A13BPR	LVR-IC	LDO, 1.35V±20mV, 700mA, +CE	SOT-89-5	32vy	VR4	6n Tok



SMD code	Type	Function	Short description	Case	Pinout Sch.	St.	Mnf.
3BE	XC6227A14BPR	LVR-IC	LDO, 1.45V±20mV, 700mA, +CE	SOT-89-5	32vy VR4	6n	Tor
3BF	XC6227A15BPR	LVR-IC	LDO, 1.55V±20mV, 700mA, +CE	SOT-89-5	32vy VR4	6n	Tor
3BH	XC6227A16BPR	LVR-IC	LDO, 1.65V±20mV, 700mA, +CE	SOT-89-5	32vy VR4	6n	Tor
3BK	XC6227A17BPR	LVR-IC	LDO, 1.75V±20mV, 700mA, +CE	SOT-89-5	32vy VR4	6n	Tor
3BL	XC6227A18BPR	LVR-IC	LDO, 1.85V±20mV, 700mA, +CE	SOT-89-5	32vy VR4	6n	Tor
3BM	XC6227A19BPR	LVR-IC	LDO, 1.95V±20mV, 700mA, +CE	SOT-89-5	32vy VR4	6n	Tor
3BN	XC6227A20BPR	LVR-IC	LDO, 2.05V±1%, 700mA, +CE	SOT-89-5	32vy VR4	6n	Tor
3BP	XC6227A21BPR	LVR-IC	LDO, 2.15V±1%, 700mA, +CE	SOT-89-5	32vy VR4	6n	Tor
3BR	XC6227A22BPR	LVR-IC	LDO, 2.25V±1%, 700mA, +CE	SOT-89-5	32vy VR4	6n	Tor
3BS	XC6227A23BPR	LVR-IC	LDO, 2.35V±1%, 700mA, +CE	SOT-89-5	32vy VR4	6n	Tor
3BT	XC6227A24BPR	LVR-IC	LDO, 2.45V±1%, 700mA, +CE	SOT-89-5	32vy VR4	6n	Tor
3BU	XC6227A25BPR	LVR-IC	LDO, 2.55V±1%, 700mA, +CE	SOT-89-5	32vy VR4	6n	Tor
3BV	XC6227A26BPR	LVR-IC	LDO, 2.65V±1%, 700mA, +CE	SOT-89-5	32vy VR4	6n	Tor
3BX	XC6227A27BPR	LVR-IC	LDO, 2.75V±1%, 700mA, +CE	SOT-89-5	32vy VR4	6n	Tor
3BY	XC6227A28BPR	LVR-IC	LDO, 2.85V±1%, 700mA, +CE	SOT-89-5	32vy VR4	6n	Tor
3BZ	XC6227A29BPR	LVR-IC	LDO, 2.95V±1%, 700mA, +CE	SOT-89-5	32vy VR4	6n	Tor
3C0	XC6227A301PR	LVR-IC	LDO, 3.0V±1%, 700mA, +CE	SOT-89-5	32vy VR4	6n	Tor
3C0	XC6372E200P	DC/DC-IC	PWM/PFM step-up, 50kHz, int. Vdd, 2.0V±2.5%, 100mA	SOT-89-5	32gc DC4	6h	Tor
3C1	XC6227A311PR	LVR-IC	LDO, 3.1V±1%, 700mA, +CE	SOT-89-5	32vy VR4	6n	Tor
3C1	XC6372E210P	DC/DC-IC	PWM/PFM step-up, 50kHz, int. Vdd, 2.1V±2.5%, 100mA	SOT-89-5	32gc DC4	6h	Tor
3C2	XC6227A321PR	LVR-IC	LDO, 3.2V±1%, 700mA, +CE	SOT-89-5	32vy VR4	6n	Tor
3C2	XC6372E220P	DC/DC-IC	PWM/PFM step-up, 50kHz, int. Vdd, 2.2V±2.5%, 100mA	SOT-89-5	32gc DC4	6h	Tor
3C3	XC6227A331PR	LVR-IC	LDO, 3.3V±1%, 700mA, +CE	SOT-89-5	32vy VR4	6n	Tor
3C3	XC6372E230P	DC/DC-IC	PWM/PFM step-up, 50kHz, int. Vdd, 2.3V±2.5%, 100mA	SOT-89-5	32gc DC4	6h	Tor
3C4	XC6227A341PR	LVR-IC	LDO, 3.4V±1%, 700mA, +CE	SOT-89-5	32vy VR4	6n	Tor
3C4	XC6372E240P	DC/DC-IC	PWM/PFM step-up, 50kHz, int. Vdd, 2.4V±2.5%, 100mA	SOT-89-5	32gc DC4	6h	Tor
3C5	XC6227A351PR	LVR-IC	LDO, 3.5V±1%, 700mA, +CE	SOT-89-5	32vy VR4	6n	Tor
3C5	XC6372E250P	DC/DC-IC	PWM/PFM step-up, 50kHz, int. Vdd, 2.5V±2.5%, 100mA	SOT-89-5	32gc DC4	6h	Tor
3C6	XC6227A361PR	LVR-IC	LDO, 3.6V±1%, 700mA, +CE	SOT-89-5	32vy VR4	6n	Tor
3C6	XC6372E260P	DC/DC-IC	PWM/PFM step-up, 50kHz, int. Vdd, 2.6V±2.5%, 100mA	SOT-89-5	32gc DC4	6h	Tor
3C7	XC6227A371PR	LVR-IC	LDO, 3.7V±1%, 700mA, +CE	SOT-89-5	32vy VR4	6n	Tor
3C7	XC6372E270P	DC/DC-IC	PWM/PFM step-up, 50kHz, int. Vdd, 2.7V±2.5%, 100mA	SOT-89-5	32gc DC4	6h	Tor
3C8	XC6227A381PR	LVR-IC	LDO, 3.8V±1%, 700mA, +CE	SOT-89-5	32vy VR4	6n	Tor
3C8	XC6372E280P	DC/DC-IC	PWM/PFM step-up, 50kHz, int. Vdd, 2.8V±2.5%, 100mA	SOT-89-5	32gc DC4	6h	Tor
3C9	XC6227A391PR	LVR-IC	LDO, 3.9V±1%, 700mA, +CE	SOT-89-5	32vy VR4	6n	Tor
3C9	XC6372E290P	DC/DC-IC	PWM/PFM step-up, 50kHz, int. Vdd, 2.9V±2.5%, 100mA	SOT-89-5	32gc DC4	6h	Tor
3CA	XC6227A401PR	LVR-IC	LDO, 4.0V±1%, 700mA, +CE	SOT-89-5	32vy VR4	6n	Tor
3CB	XC6227A411PR	LVR-IC	LDO, 4.1V±1%, 700mA, +CE	SOT-89-5	32vy VR4	6n	Tor
3CC	XC6227A421PR	LVR-IC	LDO, 4.2V±1%, 700mA, +CE	SOT-89-5	32vy VR4	6n	Tor
3CD	XC6227A431PR	LVR-IC	LDO, 4.3V±1%, 700mA, +CE	SOT-89-5	32vy VR4	6n	Tor
3CE	XC6227A441PR	LVR-IC	LDO, 4.4V±1%, 700mA, +CE	SOT-89-5	32vy VR4	6n	Tor
3CF	XC6227A451PR	LVR-IC	LDO, 4.5V±1%, 700mA, +CE	SOT-89-5	32vy VR4	6n	Tor
3CH	XC6227A461PR	LVR-IC	LDO, 4.6V±1%, 700mA, +CE	SOT-89-5	32vy VR4	6n	Tor
3CK	XC6227A471PR	LVR-IC	LDO, 4.7V±1%, 700mA, +CE	SOT-89-5	32vy VR4	6n	Tor
3CL	XC6227A481PR	LVR-IC	LDO, 4.8V±1%, 700mA, +CE	SOT-89-5	32vy VR4	6n	Tor
3CM	XC6227A491PR	LVR-IC	LDO, 4.9V±1%, 700mA, +CE	SOT-89-5	32vy VR4	6n	Tor
3CN	XC6227A501PR	LVR-IC	LDO, 5.0V±1%, 700mA, +CE	SOT-89-5	32vy VR4	6n	Tor
3D0	XC6227A30BPR	LVR-IC	LDO, 3.05V±1%, 700mA, +CE	SOT-89-5	32vy VR4	6n	Tor
3D0	XC6372E300P	DC/DC-IC	PWM/PFM step-up, 50kHz, int. Vdd, 3.0V±2.5%, 100mA	SOT-89-5	32gc DC4	6h	Tor
3D1	XC6227A31BPR	LVR-IC	LDO, 3.15V±1%, 700mA, +CE	SOT-89-5	32vy VR4	6n	Tor
3D1	XC6372E310P	DC/DC-IC	PWM/PFM step-up, 50kHz, int. Vdd, 3.1V±2.5%, 100mA	SOT-89-5	32gc DC4	6h	Tor
3D2	XC6227A32BPR	LVR-IC	LDO, 3.25V±1%, 700mA, +CE	SOT-89-5	32vy VR4	6n	Tor
3D2	XC6372E320P	DC/DC-IC	PWM/PFM step-up, 50kHz, int. Vdd, 3.2V±2.5%, 100mA	SOT-89-5	32gc DC4	6h	Tor
3D3	XC6227A33BPR	LVR-IC	LDO, 3.35V±1%, 700mA, +CE	SOT-89-5	32vy VR4	6n	Tor
3D3	XC6372E330P	DC/DC-IC	PWM/PFM step-up, 50kHz, int. Vdd, 3.3V±2.5%, 100mA	SOT-89-5	32gc DC4	6h	Tor
3D4	XC6227A34BPR	LVR-IC	LDO, 3.45V±1%, 700mA, +CE	SOT-89-5	32vy VR4	6n	Tor
3D4	XC6372E340P	DC/DC-IC	PWM/PFM step-up, 50kHz, int. Vdd, 3.4V±2.5%, 100mA	SOT-89-5	32gc DC4	6h	Tor
3D5	XC6227A35BPR	LVR-IC	LDO, 3.55V±1%, 700mA, +CE	SOT-89-5	32vy VR4	6n	Tor
3D5	XC6372E350P	DC/DC-IC	PWM/PFM step-up, 50kHz, int. Vdd, 3.5V±2.5%, 100mA	SOT-89-5	32gc DC4	6h	Tor
3D6	XC6227A36BPR	LVR-IC	LDO, 3.65V±1%, 700mA, +CE	SOT-89-5	32vy VR4	6n	Tor
3D6	XC6372E360P	DC/DC-IC	PWM/PFM step-up, 50kHz, int. Vdd, 3.6V±2.5%, 100mA	SOT-89-5	32gc DC4	6h	Tor
3D7	XC6227A37BPR	LVR-IC	LDO, 3.75V±1%, 700mA, +CE	SOT-89-5	32vy VR4	6n	Tor
3D7	XC6372E370P	DC/DC-IC	PWM/PFM step-up, 50kHz, int. Vdd, 3.7V±2.5%, 100mA	SOT-89-5	32gc DC4	6h	Tor
3D8	XC6227A38BPR	LVR-IC	LDO, 3.85V±1%, 700mA, +CE	SOT-89-5	32vy VR4	6n	Tor
3D8	XC6372E380P	DC/DC-IC	PWM/PFM step-up, 50kHz, int. Vdd, 3.8V±2.5%, 100mA	SOT-89-5	32gc DC4	6h	Tor
3D9	XC6227A39BPR	LVR-IC	LDO, 3.95V±1%, 700mA, +CE	SOT-89-5	32vy VR4	6n	Tor
3D9	XC6372E390P	DC/DC-IC	PWM/PFM step-up, 50kHz, int. Vdd, 3.9V±2.5%, 100mA	SOT-89-5	32gc DC4	6h	Tor
3DA	XC6227A40BPR	LVR-IC	LDO, 4.05V±1%, 700mA, +CE	SOT-89-5	32vy VR4	6n	Tor
3DB	XC6227A41BPR	LVR-IC	LDO, 4.15V±1%, 700mA, +CE	SOT-89-5	32vy VR4	6n	Tor
3DC	XC6227A42BPR	LVR-IC	LDO, 4.25V±1%, 700mA, +CE	SOT-89-5	32vy VR4	6n	Tor



SMD code	Type	Function	Short description	Case	Pinout Sch.	St.	Mnf.
3DD	XC6227A43BPR	LVR-IC	LDO, 4.35V±1%, 700mA, +CE	SOT-89-5	32vy VR4	6n	Tor
3DE	XC6227A44BPR	LVR-IC	LDO, 4.45V±1%, 700mA, +CE	SOT-89-5	32vy VR4	6n	Tor
3DF	XC6227A45BPR	LVR-IC	LDO, 4.55V±1%, 700mA, +CE	SOT-89-5	32vy VR4	6n	Tor
3DH	XC6227A46BPR	LVR-IC	LDO, 4.65V±1%, 700mA, +CE	SOT-89-5	32vy VR4	6n	Tor
3DK	XC6227A47BPR	LVR-IC	LDO, 4.75V±1%, 700mA, +CE	SOT-89-5	32vy VR4	6n	Tor
3DL	XC6227A48BPR	LVR-IC	LDO, 4.85V±1%, 700mA, +CE	SOT-89-5	32vy VR4	6n	Tor
3DM	XC6227A49BPR	LVR-IC	LDO, 4.95V±1%, 700mA, +CE	SOT-89-5	32vy VR4	6n	Tor
3E0	XC6372E400P	DC/DC-IC	PWM/PFM step-up, 50kHz, int. Vdd, 4.0V±2.5%, 100mA	SOT-89-5	32gc DC4	6h	Tor
3E1	XC6372E410P	DC/DC-IC	PWM/PFM step-up, 50kHz, int. Vdd, 4.1V±2.5%, 100mA	SOT-89-5	32gc DC4	6h	Tor
3E2	XC6372E420P	DC/DC-IC	PWM/PFM step-up, 50kHz, int. Vdd, 4.2V±2.5%, 100mA	SOT-89-5	32gc DC4	6h	Tor
3E3	XC6372E430P	DC/DC-IC	PWM/PFM step-up, 50kHz, int. Vdd, 4.3V±2.5%, 100mA	SOT-89-5	32gc DC4	6h	Tor
3E4	XC6372E440P	DC/DC-IC	PWM/PFM step-up, 50kHz, int. Vdd, 4.4V±2.5%, 100mA	SOT-89-5	32gc DC4	6h	Tor
3E5	XC6372E450P	DC/DC-IC	PWM/PFM step-up, 50kHz, int. Vdd, 4.5V±2.5%, 100mA	SOT-89-5	32gc DC4	6h	Tor
3E6	XC6372E460P	DC/DC-IC	PWM/PFM step-up, 50kHz, int. Vdd, 4.6V±2.5%, 100mA	SOT-89-5	32gc DC4	6h	Tor
3E7	XC6372E470P	DC/DC-IC	PWM/PFM step-up, 50kHz, int. Vdd, 4.7V±2.5%, 100mA	SOT-89-5	32gc DC4	6h	Tor
3E8	XC6227C081P	LVR-IC	LDO, 0.8V±20mV, 700mA, +CE, PDR	SOT-89-5	32vy VR4	6n	Tor
3E8	XC6372E480P	DC/DC-IC	PWM/PFM step-up, 50kHz, int. Vdd, 4.8V±2.5%, 100mA	SOT-89-5	32gc DC4	6h	Tor
3E9	XC6227C091P	LVR-IC	LDO, 0.9V±20mV, 700mA, +CE, PDR	SOT-89-5	32vy VR4	6n	Tor
3E9	XC6372E490P	DC/DC-IC	PWM/PFM step-up, 50kHz, int. Vdd, 4.9V±2.5%, 100mA	SOT-89-5	32gc DC4	6h	Tor
3EA	XC6227C101P	LVR-IC	LDO, 1.0V±20mV, 700mA, +CE, PDR	SOT-89-5	32vy VR4	6n	Tor
3EB	XC6227C111P	LVR-IC	LDO, 1.1V±20mV, 700mA, +CE, PDR	SOT-89-5	32vy VR4	6n	Tor
3EC	XC6227C121P	LVR-IC	LDO, 1.2V±20mV, 700mA, +CE, PDR	SOT-89-5	32vy VR4	6n	Tor
3ED	XC6227C131P	LVR-IC	LDO, 1.3V±20mV, 700mA, +CE, PDR	SOT-89-5	32vy VR4	6n	Tor
3EE	XC6227C141P	LVR-IC	LDO, 1.4V±20mV, 700mA, +CE, PDR	SOT-89-5	32vy VR4	6n	Tor
3EF	XC6227C151P	LVR-IC	LDO, 1.5V±20mV, 700mA, +CE, PDR	SOT-89-5	32vy VR4	6n	Tor
3EH	XC6227C161P	LVR-IC	LDO, 1.6V±20mV, 700mA, +CE, PDR	SOT-89-5	32vy VR4	6n	Tor
3EK	XC6227C171P	LVR-IC	LDO, 1.7V±20mV, 700mA, +CE, PDR	SOT-89-5	32vy VR4	6n	Tor
3EL	XC6227C181P	LVR-IC	LDO, 1.8V±20mV, 700mA, +CE, PDR	SOT-89-5	32vy VR4	6n	Tor
3EM	XC6227C191P	LVR-IC	LDO, 1.9V±20mV, 700mA, +CE, PDR	SOT-89-5	32vy VR4	6n	Tor
3EN	XC6227C201P	LVR-IC	LDO, 2.0V±20mV, 700mA, +CE, PDR	SOT-89-5	32vy VR4	6n	Tor
3EP	XC6227C211P	LVR-IC	LDO, 2.1V±1%, 700mA, +CE, PDR	SOT-89-5	32vy VR4	6n	Tor
3ER	XC6227C221P	LVR-IC	LDO, 2.2V±1%, 700mA, +CE, PDR	SOT-89-5	32vy VR4	6n	Tor
3ES	XC6227C231P	LVR-IC	LDO, 2.3V±1%, 700mA, +CE, PDR	SOT-89-5	32vy VR4	6n	Tor
3ET	XC6227C241P	LVR-IC	LDO, 2.4V±1%, 700mA, +CE, PDR	SOT-89-5	32vy VR4	6n	Tor
3EU	XC6227C251P	LVR-IC	LDO, 2.5V±1%, 700mA, +CE, PDR	SOT-89-5	32vy VR4	6n	Tor
3EV	XC6227C261P	LVR-IC	LDO, 2.6V±1%, 700mA, +CE, PDR	SOT-89-5	32vy VR4	6n	Tor
3EX	XC6227C271P	LVR-IC	LDO, 2.7V±1%, 700mA, +CE, PDR	SOT-89-5	32vy VR4	6n	Tor
3EY	XC6227C281P	LVR-IC	LDO, 2.8V±1%, 700mA, +CE, PDR	SOT-89-5	32vy VR4	6n	Tor
3EZ	XC6227C291P	LVR-IC	LDO, 2.9V±1%, 700mA, +CE, PDR	SOT-89-5	32vy VR4	6n	Tor
3F0	XC6372E500P	DC/DC-IC	PWM/PFM step-up, 50kHz, int. Vdd, 5.0V±2.5%, 100mA	SOT-89-5	32gc DC4	6h	Tor
3F1	XC6372E510P	DC/DC-IC	PWM/PFM step-up, 50kHz, int. Vdd, 5.1V±2.5%, 100mA	SOT-89-5	32gc DC4	6h	Tor
3F2	XC6372E520P	DC/DC-IC	PWM/PFM step-up, 50kHz, int. Vdd, 5.2V±2.5%, 100mA	SOT-89-5	32gc DC4	6h	Tor
3F3	XC6372E530P	DC/DC-IC	PWM/PFM step-up, 50kHz, int. Vdd, 5.3V±2.5%, 100mA	SOT-89-5	32gc DC4	6h	Tor
3F4	XC6372E540P	DC/DC-IC	PWM/PFM step-up, 50kHz, int. Vdd, 5.4V±2.5%, 100mA	SOT-89-5	32gc DC4	6h	Tor
3F5	XC6372E550P	DC/DC-IC	PWM/PFM step-up, 50kHz, int. Vdd, 5.5V±2.5%, 100mA	SOT-89-5	32gc DC4	6h	Tor
3F6	XC6372E560P	DC/DC-IC	PWM/PFM step-up, 50kHz, int. Vdd, 5.6V±2.5%, 100mA	SOT-89-5	32gc DC4	6h	Tor
3F7	XC6372E570P	DC/DC-IC	PWM/PFM step-up, 50kHz, int. Vdd, 5.7V±2.5%, 100mA	SOT-89-5	32gc DC4	6h	Tor
3F8	XC6227C08BPR	LVR-IC	LDO, 0.85V±20mV, 700mA, +CE, PDR	SOT-89-5	32vy VR4	6n	Tor
3F8	XC6372E580P	DC/DC-IC	PWM/PFM step-up, 50kHz, int. Vdd, 5.8V±2.5%, 100mA	SOT-89-5	32gc DC4	6h	Tor
3F9	XC6227C09BPR	LVR-IC	LDO, 1.95V±20mV, 700mA, +CE, PDR	SOT-89-5	32vy VR4	6n	Tor
3F9	XC6372E590P	DC/DC-IC	PWM/PFM step-up, 50kHz, int. Vdd, 5.9V±2.5%, 100mA	SOT-89-5	32gc DC4	6h	Tor
3FA	XC6227C10BPR	LVR-IC	LDO, 1.05V±20mV, 700mA, +CE, PDR	SOT-89-5	32vy VR4	6n	Tor
3FB	XC6227C11BPR	LVR-IC	LDO, 1.15V±20mV, 700mA, +CE, PDR	SOT-89-5	32vy VR4	6n	Tor
3FC	XC6227C12BPR	LVR-IC	LDO, 1.25V±20mV, 700mA, +CE, PDR	SOT-89-5	32vy VR4	6n	Tor
3FD	XC6227C13BPR	LVR-IC	LDO, 1.35V±20mV, 700mA, +CE, PDR	SOT-89-5	32vy VR4	6n	Tor
3FE	XC6227C14BPR	LVR-IC	LDO, 1.45V±20mV, 700mA, +CE, PDR	SOT-89-5	32vy VR4	6n	Tor
3FF	XC6227C15BPR	LVR-IC	LDO, 1.55V±20mV, 700mA, +CE, PDR	SOT-89-5	32vy VR4	6n	Tor
3FH	XC6227C16BPR	LVR-IC	LDO, 1.65V±20mV, 700mA, +CE, PDR	SOT-89-5	32vy VR4	6n	Tor
3FK	XC6227C17BPR	LVR-IC	LDO, 1.75V±20mV, 700mA, +CE, PDR	SOT-89-5	32vy VR4	6n	Tor
3FL	XC6227C18BPR	LVR-IC	LDO, 1.85V±20mV, 700mA, +CE, PDR	SOT-89-5	32vy VR4	6n	Tor
3FM	XC6227C19BPR	LVR-IC	LDO, 1.95V±20mV, 700mA, +CE, PDR	SOT-89-5	32vy VR4	6n	Tor
3FN	XC6227C20BPR	LVR-IC	LDO, 2.05V±1%, 700mA, +CE, PDR	SOT-89-5	32vy VR4	6n	Tor
3FP	XC6227C21BPR	LVR-IC	LDO, 2.15V±1%, 700mA, +CE, PDR	SOT-89-5	32vy VR4	6n	Tor
3FR	XC6227C22BPR	LVR-IC	LDO, 2.25V±1%, 700mA, +CE, PDR	SOT-89-5	32vy VR4	6n	Tor
3FS	XC6227C23BPR	LVR-IC	LDO, 2.35V±1%, 700mA, +CE, PDR	SOT-89-5	32vy VR4	6n	Tor
3FT	XC6227C24BPR	LVR-IC	LDO, 2.45V±1%, 700mA, +CE, PDR	SOT-89-5	32vy VR4	6n	Tor
3FU	XC6227C25BPR	LVR-IC	LDO, 2.55V±1%, 700mA, +CE, PDR	SOT-89-5	32vy VR4	6n	Tor
3FV	XC6227C26BPR	LVR-IC	LDO, 2.65V±1%, 700mA, +CE, PDR	SOT-89-5	32vy VR4	6n	Tor
3FX	XC6227C27BPR	LVR-IC	LDO, 2.75V±1%, 700mA, +CE, PDR	SOT-89-5	32vy VR4	6n	Tor
3FY	XC6227C28BPR	LVR-IC	LDO, 2.85V±1%, 700mA, +CE, PDR	SOT-89-5	32vy VR4	6n	Tor



SMD code	Type	Function	Short description	Case	Pinout Sch.	St.	Mnf.
3FZ	XC6227C29BPR	LVR-IC	LDO, 2.95V±1%, 700mA, +CE, PDR	SOT-89-5	32vy VR4	6n	Tor
3H0	XC6227C301PR	LVR-IC	LDO, 3.0V±1%, 700mA, +CE, PDR	SOT-89-5	32vy VR4	6n	Tor
3H0	XC6372E600P	DC/DC-IC	PWM/PFM step-up, 50kHz, int. Vdd, 6.0V±2.5%, 100mA	SOT-89-5	32gc DC4	6h	Tor
3H1	XC6227C311PR	LVR-IC	LDO, 3.1V±1%, 700mA, +CE, PDR	SOT-89-5	32vy VR4	6n	Tor
3H1	XC6372E610P	DC/DC-IC	PWM/PFM step-up, 50kHz, int. Vdd, 6.1V±2.5%, 100mA	SOT-89-5	32gc DC4	6h	Tor
3H2	XC6227C321PR	LVR-IC	LDO, 3.2V±1%, 700mA, +CE, PDR	SOT-89-5	32vy VR4	6n	Tor
3H2	XC6372E620P	DC/DC-IC	PWM/PFM step-up, 50kHz, int. Vdd, 6.2V±2.5%, 100mA	SOT-89-5	32gc DC4	6h	Tor
3H3	XC6227C331PR	LVR-IC	LDO, 3.3V±1%, 700mA, +CE, PDR	SOT-89-5	32vy VR4	6n	Tor
3H3	XC6372E630P	DC/DC-IC	PWM/PFM step-up, 50kHz, int. Vdd, 6.3V±2.5%, 100mA	SOT-89-5	32gc DC4	6h	Tor
3H4	XC6227C341PR	LVR-IC	LDO, 3.4V±1%, 700mA, +CE, PDR	SOT-89-5	32vy VR4	6n	Tor
3H4	XC6372E640P	DC/DC-IC	PWM/PFM step-up, 50kHz, int. Vdd, 6.4V±2.5%, 100mA	SOT-89-5	32gc DC4	6h	Tor
3H5	XC6227C351PR	LVR-IC	LDO, 3.5V±1%, 700mA, +CE, PDR	SOT-89-5	32vy VR4	6n	Tor
3H5	XC6372E650P	DC/DC-IC	PWM/PFM step-up, 50kHz, int. Vdd, 6.5V±2.5%, 100mA	SOT-89-5	32gc DC4	6h	Tor
3H6	XC6227C361PR	LVR-IC	LDO, 3.6V±1%, 700mA, +CE, PDR	SOT-89-5	32vy VR4	6n	Tor
3H6	XC6372E660P	DC/DC-IC	PWM/PFM step-up, 50kHz, int. Vdd, 6.6V±2.5%, 100mA	SOT-89-5	32gc DC4	6h	Tor
3H7	XC6227C371PR	LVR-IC	LDO, 3.7V±1%, 700mA, +CE, PDR	SOT-89-5	32vy VR4	6n	Tor
3H7	XC6372E670P	DC/DC-IC	PWM/PFM step-up, 50kHz, int. Vdd, 6.7V±2.5%, 100mA	SOT-89-5	32gc DC4	6h	Tor
3H8	XC6227C381PR	LVR-IC	LDO, 3.8V±1%, 700mA, +CE, PDR	SOT-89-5	32vy VR4	6n	Tor
3H8	XC6372E680P	DC/DC-IC	PWM/PFM step-up, 50kHz, int. Vdd, 6.8V±2.5%, 100mA	SOT-89-5	32gc DC4	6h	Tor
3H9	XC6227C391PR	LVR-IC	LDO, 3.9V±1%, 700mA, +CE, PDR	SOT-89-5	32vy VR4	6n	Tor
3H9	XC6372E690P	DC/DC-IC	PWM/PFM step-up, 50kHz, int. Vdd, 6.9V±2.5%, 100mA	SOT-89-5	32gc DC4	6h	Tor
3HA	XC6227C401PR	LVR-IC	LDO, 4.0V±1%, 700mA, +CE, PDR	SOT-89-5	32vy VR4	6n	Tor
3HB	XC6227C411PR	LVR-IC	LDO, 4.1V±1%, 700mA, +CE, PDR	SOT-89-5	32vy VR4	6n	Tor
3HC	XC6227C421PR	LVR-IC	LDO, 4.2V±1%, 700mA, +CE, PDR	SOT-89-5	32vy VR4	6n	Tor
3HD	XC6227C431PR	LVR-IC	LDO, 4.3V±1%, 700mA, +CE, PDR	SOT-89-5	32vy VR4	6n	Tor
3HE	XC6227C441PR	LVR-IC	LDO, 4.4V±1%, 700mA, +CE, PDR	SOT-89-5	32vy VR4	6n	Tor
3HF	XC6227C451PR	LVR-IC	LDO, 4.5V±1%, 700mA, +CE, PDR	SOT-89-5	32vy VR4	6n	Tor
3HH	XC6227C461PR	LVR-IC	LDO, 4.6V±1%, 700mA, +CE, PDR	SOT-89-5	32vy VR4	6n	Tor
3HK	XC6227C471PR	LVR-IC	LDO, 4.7V±1%, 700mA, +CE, PDR	SOT-89-5	32vy VR4	6n	Tor
3HL	XC6227C481PR	LVR-IC	LDO, 4.8V±1%, 700mA, +CE, PDR	SOT-89-5	32vy VR4	6n	Tor
3HM	XC6227C491PR	LVR-IC	LDO, 4.9V±1%, 700mA, +CE, PDR	SOT-89-5	32vy VR4	6n	Tor
3HN	XC6227C501PR	LVR-IC	LDO, 5.0V±1%, 700mA, +CE, PDR	SOT-89-5	32vy VR4	6n	Tor
3K0	XC6227C30BPR	LVR-IC	LDO, 3.05V±1%, 700mA, +CE, PDR	SOT-89-5	32vy VR4	6n	Tor
3K0	XC6372E700P	DC/DC-IC	PWM/PFM step-up, 50kHz, int. Vdd, 7.0V±2.5%, 100mA	SOT-89-5	32gc DC4	6h	Tor
3K1	XC6227C31BPR	LVR-IC	LDO, 3.15V±1%, 700mA, +CE, PDR	SOT-89-5	32vy VR4	6n	Tor
3K2	XC6227C32BPR	LVR-IC	LDO, 3.25V±1%, 700mA, +CE, PDR	SOT-89-5	32vy VR4	6n	Tor
3K3	XC6227C33BPR	LVR-IC	LDO, 3.35V±1%, 700mA, +CE, PDR	SOT-89-5	32vy VR4	6n	Tor
3K4	XC6227C34BPR	LVR-IC	LDO, 3.45V±1%, 700mA, +CE, PDR	SOT-89-5	32vy VR4	6n	Tor
3K5	XC6227C35BPR	LVR-IC	LDO, 3.55V±1%, 700mA, +CE, PDR	SOT-89-5	32vy VR4	6n	Tor
3K6	XC6227C36BPR	LVR-IC	LDO, 3.65V±1%, 700mA, +CE, PDR	SOT-89-5	32vy VR4	6n	Tor
3K7	XC6227C37BPR	LVR-IC	LDO, 3.75V±1%, 700mA, +CE, PDR	SOT-89-5	32vy VR4	6n	Tor
3K8	XC6227C38BPR	LVR-IC	LDO, 3.85V±1%, 700mA, +CE, PDR	SOT-89-5	32vy VR4	6n	Tor
3K9	XC6227C39BPR	LVR-IC	LDO, 3.95V±1%, 700mA, +CE, PDR	SOT-89-5	32vy VR4	6n	Tor
3KA	XC6227C40BPR	LVR-IC	LDO, 4.05V±1%, 700mA, +CE, PDR	SOT-89-5	32vy VR4	6n	Tor
3KB	XC6227C41BPR	LVR-IC	LDO, 4.15V±1%, 700mA, +CE, PDR	SOT-89-5	32vy VR4	6n	Tor
3KC	XC6227C42BPR	LVR-IC	LDO, 4.25V±1%, 700mA, +CE, PDR	SOT-89-5	32vy VR4	6n	Tor
3KD	XC6227C43BPR	LVR-IC	LDO, 4.35V±1%, 700mA, +CE, PDR	SOT-89-5	32vy VR4	6n	Tor
3KE	XC6227C44BPR	LVR-IC	LDO, 4.45V±1%, 700mA, +CE, PDR	SOT-89-5	32vy VR4	6n	Tor
3KF	XC6227C45BPR	LVR-IC	LDO, 4.55V±1%, 700mA, +CE, PDR	SOT-89-5	32vy VR4	6n	Tor
3KH	XC6227C46BPR	LVR-IC	LDO, 4.65V±1%, 700mA, +CE, PDR	SOT-89-5	32vy VR4	6n	Tor
3KK	XC6227C47BPR	LVR-IC	LDO, 4.75V±1%, 700mA, +CE, PDR	SOT-89-5	32vy VR4	6n	Tor
3KL	XC6227C48BPR	LVR-IC	LDO, 4.85V±1%, 700mA, +CE, PDR	SOT-89-5	32vy VR4	6n	Tor
3KM	XC6227C49BPR	LVR-IC	LDO, 4.95V±1%, 700mA, +CE, PDR	SOT-89-5	32vy VR4	6n	Tor
40P	TK11240BU	LVR-IC	LDO, 4V±2%, 150mA, +CE	SOT-89-5	32vg VR7	6i	Tok
40Q	TK11340BU	LVR-IC	LDO, 4V±2%, 150mA, -CE	SOT-89-5	32vg VR7	6i	Tok
41P	TK11241BU	LVR-IC	LDO, 4.1V±2%, 150mA, +CE	SOT-89-5	32vg VR7	6i	Tok
41Q	TK11341BU	LVR-IC	LDO, 4.1V±2%, 150mA, -CE	SOT-89-5	32vg VR7	6i	Tok
42P	TK11242BU	LVR-IC	LDO, 4.2V±2%, 150mA, +CE	SOT-89-5	32vg VR7	6i	Tok
42Q	TK11342BU	LVR-IC	LDO, 4.2V±2%, 150mA, -CE	SOT-89-5	32vg VR7	6i	Tok
43P	TK11243BU	LVR-IC	LDO, 4.3V±2%, 150mA, +CE	SOT-89-5	32vg VR7	6i	Tok
43Q	TK11343BU	LVR-IC	LDO, 4.3V±2%, 150mA, -CE	SOT-89-5	32vg VR7	6i	Tok
44P	TK11244BU	LVR-IC	LDO, 4.4V±2%, 150mA, +CE	SOT-89-5	32vg VR7	6i	Tok
44Q	TK11344BU	LVR-IC	LDO, 4.4V±2%, 150mA, -CE	SOT-89-5	32vg VR7	6i	Tok
45P	TK11245BU	LVR-IC	LDO, 4.5V±2%, 150mA, +CE	SOT-89-5	32vg VR7	6i	Tok
45Q	TK11345BU	LVR-IC	LDO, 4.5V±2%, 150mA, -CE	SOT-89-5	32vg VR7	6i	Tok
46P	TK11246BU	LVR-IC	LDO, 4.6V±2%, 150mA, +CE	SOT-89-5	32vg VR7	6i	Tok
46Q	TK11346BU	LVR-IC	LDO, 4.6V±2%, 150mA, -CE	SOT-89-5	32vg VR7	6i	Tok
47P	TK11247BU	LVR-IC	LDO, 4.7V±2%, 150mA, +CE	SOT-89-5	32vg VR7	6i	Tok
47Q	TK11347BU	LVR-IC	LDO, 4.7V±2%, 150mA, -CE	SOT-89-5	32vg VR7	6i	Tok
48P	TK11248BU	LVR-IC	LDO, 4.8V±2%, 150mA, +CE	SOT-89-5	32vg VR7	6i	Tok



SMD code	Type	Function	Short description	Case	Pinout Sch.	St.	Mnf.
48Q	TK11348BU	LVR-IC	LDO, 4.8V±2%, 150mA, -CE	SOT-89-5	32vg VR7	6i	Tok
49P	TK11249BU	LVR-IC	LDO, 4.9V±2%, 150mA, +CE	SOT-89-5	32vg VR7	6i	Tok
49Q	TK11349BU	LVR-IC	LDO, 4.9V±2%, 150mA, -CE	SOT-89-5	32vg VR7	6i	Tok
4A0	XC6204A312PR	LVR-IC	LDO, 3.1V±2%, 150mA, +CE, PDR	SOT-89-5	32um VR4	6h	Tor
4A1	XC6204A322PR	LVR-IC	LDO, 3.2V±2%, 150mA, +CE, PDR	SOT-89-5	32um VR4	6h	Tor
4A2	XC6204A332PR	LVR-IC	LDO, 3.3V±2%, 150mA, +CE, PDR	SOT-89-5	32um VR4	6h	Tor
4A3	XC6204A342PR	LVR-IC	LDO, 3.4V±2%, 150mA, +CE, PDR	SOT-89-5	32um VR4	6h	Tor
4A4	XC6204A352PR	LVR-IC	LDO, 3.5V±2%, 150mA, +CE, PDR	SOT-89-5	32um VR4	6h	Tor
4A5	XC6204A362PR	LVR-IC	LDO, 3.6V±2%, 150mA, +CE, PDR	SOT-89-5	32um VR4	6h	Tor
4A6	XC6204A372PR	LVR-IC	LDO, 3.7V±2%, 150mA, +CE, PDR	SOT-89-5	32um VR4	6h	Tor
4A7	XC6204A382PR	LVR-IC	LDO, 3.8V±2%, 150mA, +CE, PDR	SOT-89-5	32um VR4	6h	Tor
4A8	XC6204A392PR	LVR-IC	LDO, 3.9V±2%, 150mA, +CE, PDR	SOT-89-5	32um VR4	6h	Tor
4A9	XC6204A402PR	LVR-IC	LDO, 4V±2%, 150mA, +CE, PDR	SOT-89-5	32um VR4	6h	Tor
4AA	FT521AAb	LVR-IC	LDO, Dual out, V1/V2=1.2V/1.2V±2%, 250mA	SOT-89-5	32zw VR19	6s	Fmd
4AA	XC6204A412PR	LVR-IC	LDO, 4.1V±2%, 150mA, +CE, PDR	SOT-89-5	32um VR4	6h	Tor
4AB	FT521ABb	LVR-IC	LDO, Dual out, V1/V2=1.2V/1.3V±2%, 250mA	SOT-89-5	32zw VR19	6s	Fmd
4AB	XC6204A422PR	LVR-IC	LDO, 4.2V±2%, 150mA, +CE, PDR	SOT-89-5	32um VR4	6h	Tor
4AC	FT521ACb	LVR-IC	LDO, Dual out, V1/V2=1.2V/1.5V±2%, 250mA	SOT-89-5	32zw VR19	6s	Fmd
4AC	XC6204A432PR	LVR-IC	LDO, 4.3V±2%, 150mA, +CE, PDR	SOT-89-5	32um VR4	6h	Tor
4AD	FT521ADb	LVR-IC	LDO, Dual out, V1/V2=1.2V/1.8V±2%, 250mA	SOT-89-5	32zw VR19	6s	Fmd
4AD	XC6204A442PR	LVR-IC	LDO, 4.4V±2%, 150mA, +CE, PDR	SOT-89-5	32um VR4	6h	Tor
4AE	FT521AEb	LVR-IC	LDO, Dual out, V1/V2=1.2V/2.5V±2%, 250mA	SOT-89-5	32zw VR19	6s	Fmd
4AE	XC6204A452PR	LVR-IC	LDO, 4.5V±2%, 150mA, +CE, PDR	SOT-89-5	32um VR4	6h	Tor
4AF	FT521AFb	LVR-IC	LDO, Dual out, V1/V2=1.2V/2.7V±2%, 250mA	SOT-89-5	32zw VR19	6s	Fmd
4AF	XC6204A462PR	LVR-IC	LDO, 4.6V±2%, 150mA, +CE, PDR	SOT-89-5	32um VR4	6h	Tor
4AG	FT521AGb	LVR-IC	LDO, Dual out, V1/V2=1.2V/2.8V±2%, 250mA	SOT-89-5	32zw VR19	6s	Fmd
4AH	FT521AHb	LVR-IC	LDO, Dual out, V1/V2=1.2V/2.85V±2%, 250mA	SOT-89-5	32zw VR19	6s	Fmd
4AH	XC6204A472PR	LVR-IC	LDO, 4.7V±2%, 150mA, +CE, PDR	SOT-89-5	32um VR4	6h	Tor
4AI	FT521AIb	LVR-IC	LDO, Dual out, V1/V2=1.2V/3.0V±2%, 250mA	SOT-89-5	32zw VR19	6s	Fmd
4AJ	FT521AJb	LVR-IC	LDO, Dual out, V1/V2=1.2V/3.3V±2%, 250mA	SOT-89-5	32zw VR19	6s	Fmd
4AK	FT521AKb	LVR-IC	LDO, Dual out, V1/V2=1.2V/3.6V±2%, 250mA	SOT-89-5	32zw VR19	6s	Fmd
4AK	XC6204A482PR	LVR-IC	LDO, 4.8V±2%, 150mA, +CE, PDR	SOT-89-5	32um VR4	6h	Tor
4AL	XC6204A492PR	LVR-IC	LDO, 4.9V±2%, 150mA, +CE, PDR	SOT-89-5	32um VR4	6h	Tor
4AM	XC6204A502PR	LVR-IC	LDO, 5V±2%, 150mA, +CE, PDR	SOT-89-5	32um VR4	6h	Tor
4AN	XC6204A512PR	LVR-IC	LDO, 5.1V±2%, 150mA, +CE, PDR	SOT-89-5	32um VR4	6h	Tor
4AP	XC6204A522PR	LVR-IC	LDO, 5.2V±2%, 150mA, +CE, PDR	SOT-89-5	32um VR4	6h	Tor
4AR	XC6204A532PR	LVR-IC	LDO, 5.3V±2%, 150mA, +CE, PDR	SOT-89-5	32um VR4	6h	Tor
4AS	XC6204A542PR	LVR-IC	LDO, 5.4V±2%, 150mA, +CE, PDR	SOT-89-5	32um VR4	6h	Tor
4AT	XC6204A552PR	LVR-IC	LDO, 5.5V±2%, 150mA, +CE, PDR	SOT-89-5	32um VR4	6h	Tor
4AU	XC6204A562PR	LVR-IC	LDO, 5.6V±2%, 150mA, +CE, PDR	SOT-89-5	32um VR4	6h	Tor
4AV	XC6204A572PR	LVR-IC	LDO, 5.7V±2%, 150mA, +CE, PDR	SOT-89-5	32um VR4	6h	Tor
4AX	XC6204A582PR	LVR-IC	LDO, 5.8V±2%, 150mA, +CE, PDR	SOT-89-5	32um VR4	6h	Tor
4AY	XC6204A592PR	LVR-IC	LDO, 5.9V±2%, 150mA, +CE, PDR	SOT-89-5	32um VR4	6h	Tor
4AZ	XC6204A602PR	LVR-IC	LDO, 6V±2%, 150mA, +CE, PDR	SOT-89-5	32um VR4	6h	Tor
4B0	XC6204B312PR	LVR-IC	LDO, 3.1V±2%, 150mA, +CE	SOT-89-5	32um VR4	6h	Tor
4B1	XC6204B322PR	LVR-IC	LDO, 3.2V±2%, 150mA, +CE	SOT-89-5	32um VR4	6h	Tor
4B2	XC6204B332PR	LVR-IC	LDO, 3.3V±2%, 150mA, +CE	SOT-89-5	32um VR4	6h	Tor
4B3	XC6204B342PR	LVR-IC	LDO, 3.4V±2%, 150mA, +CE	SOT-89-5	32um VR4	6h	Tor
4B4	XC6204B352PR	LVR-IC	LDO, 3.5V±2%, 150mA, +CE	SOT-89-5	32um VR4	6h	Tor
4B5	XC6204B362PR	LVR-IC	LDO, 3.6V±2%, 150mA, +CE	SOT-89-5	32um VR4	6h	Tor
4B6	XC6204B372PR	LVR-IC	LDO, 3.7V±2%, 150mA, +CE	SOT-89-5	32um VR4	6h	Tor
4B7	XC6204B382PR	LVR-IC	LDO, 3.8V±2%, 150mA, +CE	SOT-89-5	32um VR4	6h	Tor
4B8	XC6204B392PR	LVR-IC	LDO, 3.9V±2%, 150mA, +CE	SOT-89-5	32um VR4	6h	Tor
4B9	XC6204B402PR	LVR-IC	LDO, 4V±2%, 150mA, +CE	SOT-89-5	32um VR4	6h	Tor
4BA	FT521BAb	LVR-IC	LDO, Dual out, V1/V2=1.3V/1.2V±2%, 250mA	SOT-89-5	32zw VR19	6s	Fmd
4BA	XC6204B412PR	LVR-IC	LDO, 4.1V±2%, 150mA, +CE	SOT-89-5	32um VR4	6h	Tor
4BB	FT521BBb	LVR-IC	LDO, Dual out, V1/V2=1.3V/1.3V±2%, 250mA	SOT-89-5	32zw VR19	6s	Fmd
4BB	XC6204B422PR	LVR-IC	LDO, 4.2V±2%, 150mA, +CE	SOT-89-5	32um VR4	6h	Tor
4BC	FT521BCb	LVR-IC	LDO, Dual out, V1/V2=1.3V/1.5V±2%, 250mA	SOT-89-5	32zw VR19	6s	Fmd
4BC	XC6204B432PR	LVR-IC	LDO, 4.3V±2%, 150mA, +CE	SOT-89-5	32um VR4	6h	Tor
4BD	FT521BDb	LVR-IC	LDO, Dual out, V1/V2=1.3V/1.8V±2%, 250mA	SOT-89-5	32zw VR19	6s	Fmd
4BD	XC6204B442PR	LVR-IC	LDO, 4.4V±2%, 150mA, +CE	SOT-89-5	32um VR4	6h	Tor
4BE	FT521BEb	LVR-IC	LDO, Dual out, V1/V2=1.3V/2.5V±2%, 250mA	SOT-89-5	32zw VR19	6s	Fmd
4BE	XC6204B452PR	LVR-IC	LDO, 4.5V±2%, 150mA, +CE	SOT-89-5	32um VR4	6h	Tor
4BF	FT521BFb	LVR-IC	LDO, Dual out, V1/V2=1.3V/2.7V±2%, 250mA	SOT-89-5	32zw VR19	6s	Fmd
4BF	XC6204B462PR	LVR-IC	LDO, 4.6V±2%, 150mA, +CE	SOT-89-5	32um VR4	6h	Tor
4BG	FT521BGb	LVR-IC	LDO, Dual out, V1/V2=1.3V/2.8V±2%, 250mA	SOT-89-5	32zw VR19	6s	Fmd
4BH	FT521BHb	LVR-IC	LDO, Dual out, V1/V2=1.3V/2.85V±2%, 250mA	SOT-89-5	32zw VR19	6s	Fmd
4BH	XC6204B472PR	LVR-IC	LDO, 4.7V±2%, 150mA, +CE	SOT-89-5	32um VR4	6h	Tor
4BI	FT521BIb	LVR-IC	LDO, Dual out, V1/V2=1.3V/3.0V±2%, 250mA	SOT-89-5	32zw VR19	6s	Fmd



SMD code	Type	Function	Short description	Case	Pinout	Sch.	St.	Mnf.
4BJ	FT521Bjb	LVR-IC	LDO, Dual out, V1/V2=1.3V/3.3V±2%, 250mA	SOT-89-5	32zw	VR19	6s	Fmd
4BK	FT521Bkb	LVR-IC	LDO, Dual out, V1/V2=1.3V/3.6V±2%, 250mA	SOT-89-5	32zw	VR19	6s	Fmd
4BK	XC6204B482PR	LVR-IC	LDO, 4.8V±2%, 150mA, +CE	SOT-89-5	32um	VR4	6h	Tor
4BL	XC6204B492PR	LVR-IC	LDO, 4.9V±2%, 150mA, +CE	SOT-89-5	32um	VR4	6h	Tor
4BM	XC6204B502PR	LVR-IC	LDO, 5V±2%, 150mA, +CE	SOT-89-5	32um	VR4	6h	Tor
4BN	XC6204B512PR	LVR-IC	LDO, 5.1V±2%, 150mA, +CE	SOT-89-5	32um	VR4	6h	Tor
4BP	XC6204B522PR	LVR-IC	LDO, 5.2V±2%, 150mA, +CE	SOT-89-5	32um	VR4	6h	Tor
4BR	XC6204B532PR	LVR-IC	LDO, 5.3V±2%, 150mA, +CE	SOT-89-5	32um	VR4	6h	Tor
4BS	XC6204B542PR	LVR-IC	LDO, 5.4V±2%, 150mA, +CE	SOT-89-5	32um	VR4	6h	Tor
4BT	XC6204B552PR	LVR-IC	LDO, 5.5V±2%, 150mA, +CE	SOT-89-5	32um	VR4	6h	Tor
4BU	XC6204B562PR	LVR-IC	LDO, 5.6V±2%, 150mA, +CE	SOT-89-5	32um	VR4	6h	Tor
4BV	XC6204B572PR	LVR-IC	LDO, 5.7V±2%, 150mA, +CE	SOT-89-5	32um	VR4	6h	Tor
4BX	XC6204B582PR	LVR-IC	LDO, 5.8V±2%, 150mA, +CE	SOT-89-5	32um	VR4	6h	Tor
4BY	XC6204B592PR	LVR-IC	LDO, 5.9V±2%, 150mA, +CE	SOT-89-5	32um	VR4	6h	Tor
4BZ	XC6204B602PR	LVR-IC	LDO, 6V±2%, 150mA, +CE	SOT-89-5	32um	VR4	6h	Tor
4C0	XC6204C312PR	LVR-IC	LDO, 3.1V±2%, 150mA, -CE, PDR	SOT-89-5	32um	VR4	6h	Tor
4C1	XC6204C322PR	LVR-IC	LDO, 3.2V±2%, 150mA, -CE, PDR	SOT-89-5	32um	VR4	6h	Tor
4C2	XC6204C332PR	LVR-IC	LDO, 3.3V±2%, 150mA, -CE, PDR	SOT-89-5	32um	VR4	6h	Tor
4C3	XC6204C342PR	LVR-IC	LDO, 3.4V±2%, 150mA, -CE, PDR	SOT-89-5	32um	VR4	6h	Tor
4C4	XC6204C352PR	LVR-IC	LDO, 3.5V±2%, 150mA, -CE, PDR	SOT-89-5	32um	VR4	6h	Tor
4C5	XC6204C362PR	LVR-IC	LDO, 3.6V±2%, 150mA, -CE, PDR	SOT-89-5	32um	VR4	6h	Tor
4C6	XC6204C372PR	LVR-IC	LDO, 3.7V±2%, 150mA, -CE, PDR	SOT-89-5	32um	VR4	6h	Tor
4C7	XC6204C382PR	LVR-IC	LDO, 3.8V±2%, 150mA, -CE, PDR	SOT-89-5	32um	VR4	6h	Tor
4C8	XC6204C392PR	LVR-IC	LDO, 3.9V±2%, 150mA, -CE, PDR	SOT-89-5	32um	VR4	6h	Tor
4C9	XC6204C402PR	LVR-IC	LDO, 4V±2%, 150mA, -CE, PDR	SOT-89-5	32um	VR4	6h	Tor
4CA	FT521CAb	LVR-IC	LDO, Dual out, V1/V2=1.5V/1.2V±2%, 250mA	SOT-89-5	32zw	VR19	6s	Fmd
4CA	XC6204C412PR	LVR-IC	LDO, 4.1V±2%, 150mA, -CE, PDR	SOT-89-5	32um	VR4	6h	Tor
4CB	FT521CBb	LVR-IC	LDO, Dual out, V1/V2=1.5V/1.3V±2%, 250mA	SOT-89-5	32zw	VR19	6s	Fmd
4CB	XC6204C422PR	LVR-IC	LDO, 4.2V±2%, 150mA, -CE, PDR	SOT-89-5	32um	VR4	6h	Tor
4CC	FT521CCb	LVR-IC	LDO, Dual out, V1/V2=1.5V/1.5V±2%, 250mA	SOT-89-5	32zw	VR19	6s	Fmd
4CC	XC6204C432PR	LVR-IC	LDO, 4.3V±2%, 150mA, -CE, PDR	SOT-89-5	32um	VR4	6h	Tor
4CD	FT521CDb	LVR-IC	LDO, Dual out, V1/V2=1.5V/1.8V±2%, 250mA	SOT-89-5	32zw	VR19	6s	Fmd
4CD	XC6204C442PR	LVR-IC	LDO, 4.4V±2%, 150mA, -CE, PDR	SOT-89-5	32um	VR4	6h	Tor
4CE	FT521CEb	LVR-IC	LDO, Dual out, V1/V2=1.5V/2.5V±2%, 250mA	SOT-89-5	32zw	VR19	6s	Fmd
4CE	XC6204C452PR	LVR-IC	LDO, 4.5V±2%, 150mA, -CE, PDR	SOT-89-5	32um	VR4	6h	Tor
4CF	FT521CFb	LVR-IC	LDO, Dual out, V1/V2=1.5V/2.7V±2%, 250mA	SOT-89-5	32zw	VR19	6s	Fmd
4CF	XC6204C462PR	LVR-IC	LDO, 4.6V±2%, 150mA, -CE, PDR	SOT-89-5	32um	VR4	6h	Tor
4CG	FT521CGb	LVR-IC	LDO, Dual out, V1/V2=1.5V/2.8V±2%, 250mA	SOT-89-5	32zw	VR19	6s	Fmd
4CH	FT521CHb	LVR-IC	LDO, Dual out, V1/V2=1.5V/2.85V±2%, 250mA	SOT-89-5	32zw	VR19	6s	Fmd
4CH	XC6204C472PR	LVR-IC	LDO, 4.7V±2%, 150mA, -CE, PDR	SOT-89-5	32um	VR4	6h	Tor
4CI	FT521Cib	LVR-IC	LDO, Dual out, V1/V2=1.5V/3.0V±2%, 250mA	SOT-89-5	32zw	VR19	6s	Fmd
4CJ	FT521Cjb	LVR-IC	LDO, Dual out, V1/V2=1.5V/3.3V±2%, 250mA	SOT-89-5	32zw	VR19	6s	Fmd
4CK	FT521CKb	LVR-IC	LDO, Dual out, V1/V2=1.5V/3.6V±2%, 250mA	SOT-89-5	32zw	VR19	6s	Fmd
4CK	XC6204C482PR	LVR-IC	LDO, 4.8V±2%, 150mA, -CE, PDR	SOT-89-5	32um	VR4	6h	Tor
4CL	XC6204C492PR	LVR-IC	LDO, 4.9V±2%, 150mA, -CE, PDR	SOT-89-5	32um	VR4	6h	Tor
4CM	XC6204C502PR	LVR-IC	LDO, 5V±2%, 150mA, -CE, PDR	SOT-89-5	32um	VR4	6h	Tor
4CN	XC6204C512PR	LVR-IC	LDO, 5.1V±2%, 150mA, -CE, PDR	SOT-89-5	32um	VR4	6h	Tor
4CP	XC6204C522PR	LVR-IC	LDO, 5.2V±2%, 150mA, -CE, PDR	SOT-89-5	32um	VR4	6h	Tor
4CR	XC6204C532PR	LVR-IC	LDO, 5.3V±2%, 150mA, -CE, PDR	SOT-89-5	32um	VR4	6h	Tor
4CS	XC6204C542PR	LVR-IC	LDO, 5.4V±2%, 150mA, -CE, PDR	SOT-89-5	32um	VR4	6h	Tor
4CT	XC6204C552PR	LVR-IC	LDO, 5.5V±2%, 150mA, -CE, PDR	SOT-89-5	32um	VR4	6h	Tor
4CU	XC6204C562PR	LVR-IC	LDO, 5.6V±2%, 150mA, -CE, PDR	SOT-89-5	32um	VR4	6h	Tor
4CV	XC6204C572PR	LVR-IC	LDO, 5.7V±2%, 150mA, -CE, PDR	SOT-89-5	32um	VR4	6h	Tor
4CX	XC6204C582PR	LVR-IC	LDO, 5.8V±2%, 150mA, -CE, PDR	SOT-89-5	32um	VR4	6h	Tor
4CY	XC6204C592PR	LVR-IC	LDO, 5.9V±2%, 150mA, -CE, PDR	SOT-89-5	32um	VR4	6h	Tor
4CZ	XC6204C602PR	LVR-IC	LDO, 6V±2%, 150mA, -CE, PDR	SOT-89-5	32um	VR4	6h	Tor
4D0	XC6204D312PR	LVR-IC	LDO, 3.1V±2%, 150mA, -CE	SOT-89-5	32um	VR4	6h	Tor
4D1	XC6204D322PR	LVR-IC	LDO, 3.2V±2%, 150mA, -CE	SOT-89-5	32um	VR4	6h	Tor
4D2	XC6204D332PR	LVR-IC	LDO, 3.3V±2%, 150mA, -CE	SOT-89-5	32um	VR4	6h	Tor
4D3	XC6204D342PR	LVR-IC	LDO, 3.4V±2%, 150mA, -CE	SOT-89-5	32um	VR4	6h	Tor
4D4	XC6204D352PR	LVR-IC	LDO, 3.5V±2%, 150mA, -CE	SOT-89-5	32um	VR4	6h	Tor
4D5	XC6204D362PR	LVR-IC	LDO, 3.6V±2%, 150mA, -CE	SOT-89-5	32um	VR4	6h	Tor
4D6	XC6204D372PR	LVR-IC	LDO, 3.7V±2%, 150mA, -CE	SOT-89-5	32um	VR4	6h	Tor
4D7	XC6204D382PR	LVR-IC	LDO, 3.8V±2%, 150mA, -CE	SOT-89-5	32um	VR4	6h	Tor
4D8	XC6204D392PR	LVR-IC	LDO, 3.9V±2%, 150mA, -CE	SOT-89-5	32um	VR4	6h	Tor
4D9	XC6204D402PR	LVR-IC	LDO, 4V±2%, 150mA, -CE	SOT-89-5	32um	VR4	6h	Tor
4DA	FT521DAb	LVR-IC	LDO, Dual out, V1/V2=1.8V/1.2V±2%, 250mA	SOT-89-5	32zw	VR19	6s	Fmd
4DA	XC6204D412PR	LVR-IC	LDO, 4.1V±2%, 150mA, -CE	SOT-89-5	32um	VR4	6h	Tor
4DB	FT521DBb	LVR-IC	LDO, Dual out, V1/V2=1.8V/1.3V±2%, 250mA	SOT-89-5	32zw	VR19	6s	Fmd
4DB	XC6204D422PR	LVR-IC	LDO, 4.2V±2%, 150mA, -CE	SOT-89-5	32um	VR4	6h	Tor



SMD code	Type	Function	Short description	Case	Pinout Sch.	St.	Mnf.
4DC	FT521DCb	LVR-IC	LDO, Dual out, V1/V2=1.8V/1.5V±2%, 250mA	SOT-89-5	32zw VR19	6s	Fmd
4DC	XC6204D432PR	LVR-IC	LDO, 4.3V±2%, 150mA, -CE	SOT-89-5	32um VR4	6h	Tor
4DD	FT521DDb	LVR-IC	LDO, Dual out, V1/V2=1.8V/1.8V±2%, 250mA	SOT-89-5	32zw VR19	6s	Fmd
4DD	XC6204D442PR	LVR-IC	LDO, 4.4V±2%, 150mA, -CE	SOT-89-5	32um VR4	6h	Tor
4DE	FT521DEb	LVR-IC	LDO, Dual out, V1/V2=1.8V/2.5V±2%, 250mA	SOT-89-5	32zw VR19	6s	Fmd
4DE	XC6204D452PR	LVR-IC	LDO, 4.5V±2%, 150mA, -CE	SOT-89-5	32um VR4	6h	Tor
4DF	FT521DFb	LVR-IC	LDO, Dual out, V1/V2=1.8V/2.7V±2%, 250mA	SOT-89-5	32zw VR19	6s	Fmd
4DF	XC6204D462PR	LVR-IC	LDO, 4.6V±2%, 150mA, -CE	SOT-89-5	32um VR4	6h	Tor
4DG	FT521DGb	LVR-IC	LDO, Dual out, V1/V2=1.8V/2.8V±2%, 250mA	SOT-89-5	32zw VR19	6s	Fmd
4DH	FT521DHb	LVR-IC	LDO, Dual out, V1/V2=1.8V/2.85V±2%, 250mA	SOT-89-5	32zw VR19	6s	Fmd
4DH	XC6204D472PR	LVR-IC	LDO, 4.7V±2%, 150mA, -CE	SOT-89-5	32um VR4	6h	Tor
4DI	FT521DIb	LVR-IC	LDO, Dual out, V1/V2=1.8V/3.0V±2%, 250mA	SOT-89-5	32zw VR19	6s	Fmd
4DJ	FT521DIb	LVR-IC	LDO, Dual out, V1/V2=1.8V/3.3V±2%, 250mA	SOT-89-5	32zw VR19	6s	Fmd
4DK	FT521DKb	LVR-IC	LDO, Dual out, V1/V2=1.8V/3.6V±2%, 250mA	SOT-89-5	32zw VR19	6s	Fmd
4DK	XC6204D482PR	LVR-IC	LDO, 4.8V±2%, 150mA, -CE	SOT-89-5	32um VR4	6h	Tor
4DL	XC6204D492PR	LVR-IC	LDO, 4.9V±2%, 150mA, -CE	SOT-89-5	32um VR4	6h	Tor
4DM	XC6204D502PR	LVR-IC	LDO, 5.0V±2%, 150mA, -CE	SOT-89-5	32um VR4	6h	Tor
4DN	XC6204D512PR	LVR-IC	LDO, 5.1V±2%, 150mA, -CE	SOT-89-5	32um VR4	6h	Tor
4DP	XC6204D522PR	LVR-IC	LDO, 5.2V±2%, 150mA, -CE	SOT-89-5	32um VR4	6h	Tor
4DR	XC6204D532PR	LVR-IC	LDO, 5.3V±2%, 150mA, -CE	SOT-89-5	32um VR4	6h	Tor
4DS	XC6204D542PR	LVR-IC	LDO, 5.4V±2%, 150mA, -CE	SOT-89-5	32um VR4	6h	Tor
4DT	XC6204D552PR	LVR-IC	LDO, 5.5V±2%, 150mA, -CE	SOT-89-5	32um VR4	6h	Tor
4DU	XC6204D562PR	LVR-IC	LDO, 5.6V±2%, 150mA, -CE	SOT-89-5	32um VR4	6h	Tor
4DV	XC6204D572PR	LVR-IC	LDO, 5.7V±2%, 150mA, -CE	SOT-89-5	32um VR4	6h	Tor
4DX	XC6204D582PR	LVR-IC	LDO, 5.8V±2%, 150mA, -CE	SOT-89-5	32um VR4	6h	Tor
4DY	XC6204D592PR	LVR-IC	LDO, 5.9V±2%, 150mA, -CE	SOT-89-5	32um VR4	6h	Tor
4DZ	XC6204D602PR	LVR-IC	LDO, 6.0V±2%, 150mA, -CE	SOT-89-5	32um VR4	6h	Tor
4EA	FT521EAb	LVR-IC	LDO, Dual out, V1/V2=2.5V/1.2V±2%, 250mA	SOT-89-5	32zw VR19	6s	Fmd
4EB	FT521EBb	LVR-IC	LDO, Dual out, V1/V2=2.5V/1.3V±2%, 250mA	SOT-89-5	32zw VR19	6s	Fmd
4EC	FT521ECb	LVR-IC	LDO, Dual out, V1/V2=2.5V/1.5V±2%, 250mA	SOT-89-5	32zw VR19	6s	Fmd
4ED	FT521EDb	LVR-IC	LDO, Dual out, V1/V2=2.5V/1.8V±2%, 250mA	SOT-89-5	32zw VR19	6s	Fmd
4EE	FT521EEb	LVR-IC	LDO, Dual out, V1/V2=2.5V/2.5V±2%, 250mA	SOT-89-5	32zw VR19	6s	Fmd
4EF	FT521EFb	LVR-IC	LDO, Dual out, V1/V2=2.5V/2.7V±2%, 250mA	SOT-89-5	32zw VR19	6s	Fmd
4EG	FT521EGb	LVR-IC	LDO, Dual out, V1/V2=2.5V/2.8V±2%, 250mA	SOT-89-5	32zw VR19	6s	Fmd
4EH	FT521EHb	LVR-IC	LDO, Dual out, V1/V2=2.5V/2.85V±2%, 250mA	SOT-89-5	32zw VR19	6s	Fmd
4EI	FT521Eib	LVR-IC	LDO, Dual out, V1/V2=2.5V/3.0V±2%, 250mA	SOT-89-5	32zw VR19	6s	Fmd
4EJ	FT521EJb	LVR-IC	LDO, Dual out, V1/V2=2.5V/3.3V±2%, 250mA	SOT-89-5	32zw VR19	6s	Fmd
4EK	FT521EKb	LVR-IC	LDO, Dual out, V1/V2=2.5V/3.6V±2%, 250mA	SOT-89-5	32zw VR19	6s	Fmd
4EK	XC6204A18APR	LVR-IC	LDO, 1.85V±2%, 150mA, +CE, PDR	SOT-89-5	32um VR4	6h	Tor
4EL	XC6204A19APR	LVR-IC	LDO, 1.95V±2%, 150mA, +CE, PDR	SOT-89-5	32um VR4	6h	Tor
4EM	XC6204A20APR	LVR-IC	LDO, 2.05V±2%, 150mA, +CE, PDR	SOT-89-5	32um VR4	6h	Tor
4EN	XC6204A21APR	LVR-IC	LDO, 2.15V±2%, 150mA, +CE, PDR	SOT-89-5	32um VR4	6h	Tor
4EP	XC6204A22APR	LVR-IC	LDO, 2.25V±2%, 150mA, +CE, PDR	SOT-89-5	32um VR4	6h	Tor
4ER	XC6204A23APR	LVR-IC	LDO, 2.35V±2%, 150mA, +CE, PDR	SOT-89-5	32um VR4	6h	Tor
4ES	XC6204A24APR	LVR-IC	LDO, 2.45V±2%, 150mA, +CE, PDR	SOT-89-5	32um VR4	6h	Tor
4ET	XC6204A25APR	LVR-IC	LDO, 2.55V±2%, 150mA, +CE, PDR	SOT-89-5	32um VR4	6h	Tor
4EU	XC6204A26APR	LVR-IC	LDO, 2.65V±2%, 150mA, +CE, PDR	SOT-89-5	32um VR4	6h	Tor
4EV	XC6204A27APR	LVR-IC	LDO, 2.75V±2%, 150mA, +CE, PDR	SOT-89-5	32um VR4	6h	Tor
4EX	XC6204A28APR	LVR-IC	LDO, 2.85V±2%, 150mA, +CE, PDR	SOT-89-5	32um VR4	6h	Tor
4EY	XC6204A29APR	LVR-IC	LDO, 2.95V±2%, 150mA, +CE, PDR	SOT-89-5	32um VR4	6h	Tor
4EZ	XC6204A30APR	LVR-IC	LDO, 3.05V±2%, 150mA, +CE, PDR	SOT-89-5	32um VR4	6h	Tor
4FA	FT521FAb	LVR-IC	LDO, Dual out, V1/V2=2.7V/1.2V±2%, 250mA	SOT-89-5	32zw VR19	6s	Fmd
4FB	FT521FBb	LVR-IC	LDO, Dual out, V1/V2=2.7V/1.3V±2%, 250mA	SOT-89-5	32zw VR19	6s	Fmd
4FC	FT521FCb	LVR-IC	LDO, Dual out, V1/V2=2.7V/1.5V±2%, 250mA	SOT-89-5	32zw VR19	6s	Fmd
4FD	FT521FDb	LVR-IC	LDO, Dual out, V1/V2=2.7V/1.8V±2%, 250mA	SOT-89-5	32zw VR19	6s	Fmd
4FE	FT521FEb	LVR-IC	LDO, Dual out, V1/V2=2.7V/2.5V±2%, 250mA	SOT-89-5	32zw VR19	6s	Fmd
4FF	FT521FFb	LVR-IC	LDO, Dual out, V1/V2=2.7V/2.7V±2%, 250mA	SOT-89-5	32zw VR19	6s	Fmd
4FG	FT521FGb	LVR-IC	LDO, Dual out, V1/V2=2.7V/2.8V±2%, 250mA	SOT-89-5	32zw VR19	6s	Fmd
4FH	FT521FHb	LVR-IC	LDO, Dual out, V1/V2=2.7V/2.85V±2%, 250mA	SOT-89-5	32zw VR19	6s	Fmd
4FI	FT521Fib	LVR-IC	LDO, Dual out, V1/V2=2.7V/3.0V±2%, 250mA	SOT-89-5	32zw VR19	6s	Fmd
4FJ	FT521FJb	LVR-IC	LDO, Dual out, V1/V2=2.7V/3.3V±2%, 250mA	SOT-89-5	32zw VR19	6s	Fmd
4FK	FT521FKb	LVR-IC	LDO, Dual out, V1/V2=2.7V/3.6V±2%, 250mA	SOT-89-5	32zw VR19	6s	Fmd
4FK	XC6204B18APR	LVR-IC	LDO, 1.85V±2%, 150mA, +CE	SOT-89-5	32um VR4	6h	Tor
4FL	XC6204B19APR	LVR-IC	LDO, 1.95V±2%, 150mA, +CE	SOT-89-5	32um VR4	6h	Tor
4FM	XC6204B20APR	LVR-IC	LDO, 2.05V±2%, 150mA, +CE	SOT-89-5	32um VR4	6h	Tor
4FN	XC6204B21APR	LVR-IC	LDO, 2.15V±2%, 150mA, +CE	SOT-89-5	32um VR4	6h	Tor
4FP	XC6204B22APR	LVR-IC	LDO, 2.25V±2%, 150mA, +CE	SOT-89-5	32um VR4	6h	Tor
4FR	XC6204B23APR	LVR-IC	LDO, 2.35V±2%, 150mA, +CE	SOT-89-5	32um VR4	6h	Tor
4FS	XC6204B24APR	LVR-IC	LDO, 2.45V±2%, 150mA, +CE	SOT-89-5	32um VR4	6h	Tor
4FT	XC6204B25APR	LVR-IC	LDO, 2.55V±2%, 150mA, +CE	SOT-89-5	32um VR4	6h	Tor



SMD code	Type	Function	Short description	Case	Pinout Sch.	St.	Mnf.
4FU	XC6204B26APR	LVR-IC	LDO, 2.65V±2%, 150mA, +CE	SOT-89-5	32um VR4	6h	Tor
4FV	XC6204B27APR	LVR-IC	LDO, 2.75V±2%, 150mA, +CE	SOT-89-5	32um VR4	6h	Tor
4FX	XC6204B28APR	LVR-IC	LDO, 2.85V±2%, 150mA, +CE	SOT-89-5	32um VR4	6h	Tor
4FY	XC6204B29APR	LVR-IC	LDO, 2.95V±2%, 150mA, +CE	SOT-89-5	32um VR4	6h	Tor
4FZ	XC6204B30APR	LVR-IC	LDO, 3.05V±2%, 150mA, +CE	SOT-89-5	32um VR4	6h	Tor
4GA	FT521GAb	LVR-IC	LDO, Dual out, V1/V2=2.8V/1.2V±2%, 250mA	SOT-89-5	32zw VR19	6s	Fmd
4GB	FT521GBb	LVR-IC	LDO, Dual out, V1/V2=2.8V/1.3V±2%, 250mA	SOT-89-5	32zw VR19	6s	Fmd
4GC	FT521GCb	LVR-IC	LDO, Dual out, V1/V2=2.8V/1.5V±2%, 250mA	SOT-89-5	32zw VR19	6s	Fmd
4GD	FT521GDb	LVR-IC	LDO, Dual out, V1/V2=2.8V/1.8V±2%, 250mA	SOT-89-5	32zw VR19	6s	Fmd
4GE	FT521GEb	LVR-IC	LDO, Dual out, V1/V2=2.8V/2.5V±2%, 250mA	SOT-89-5	32zw VR19	6s	Fmd
4GF	FT521GFb	LVR-IC	LDO, Dual out, V1/V2=2.8V/2.7V±2%, 250mA	SOT-89-5	32zw VR19	6s	Fmd
4GG	FT521GGb	LVR-IC	LDO, Dual out, V1/V2=2.8V/2.8V±2%, 250mA	SOT-89-5	32zw VR19	6s	Fmd
4GH	FT521GHb	LVR-IC	LDO, Dual out, V1/V2=2.8V/2.85V±2%, 250mA	SOT-89-5	32zw VR19	6s	Fmd
4GI	FT521Gib	LVR-IC	LDO, Dual out, V1/V2=2.8V/3.0V±2%, 250mA	SOT-89-5	32zw VR19	6s	Fmd
4GJ	FT521GJb	LVR-IC	LDO, Dual out, V1/V2=2.8V/3.3V±2%, 250mA	SOT-89-5	32zw VR19	6s	Fmd
4GK	FT521GKb	LVR-IC	LDO, Dual out, V1/V2=2.8V/3.6V±2%, 250mA	SOT-89-5	32zw VR19	6s	Fmd
4HA	FT521HAb	LVR-IC	LDO, Dual out, V1/V2=2.85V/1.2V±2%, 250mA	SOT-89-5	32zw VR19	6s	Fmd
4HB	FT521HBb	LVR-IC	LDO, Dual out, V1/V2=2.85V/1.3V±2%, 250mA	SOT-89-5	32zw VR19	6s	Fmd
4HC	FT521HCb	LVR-IC	LDO, Dual out, V1/V2=2.85V/1.5V±2%, 250mA	SOT-89-5	32zw VR19	6s	Fmd
4HD	FT521HDb	LVR-IC	LDO, Dual out, V1/V2=2.85V/1.8V±2%, 250mA	SOT-89-5	32zw VR19	6s	Fmd
4HE	FT521HEb	LVR-IC	LDO, Dual out, V1/V2=2.85V/2.5V±2%, 250mA	SOT-89-5	32zw VR19	6s	Fmd
4HF	FT521HFb	LVR-IC	LDO, Dual out, V1/V2=2.85V/2.7V±2%, 250mA	SOT-89-5	32zw VR19	6s	Fmd
4HG	FT521HGb	LVR-IC	LDO, Dual out, V1/V2=2.85V/2.8V±2%, 250mA	SOT-89-5	32zw VR19	6s	Fmd
4HH	FT521HHb	LVR-IC	LDO, Dual out, V1/V2=2.85V/2.85V±2%, 250mA	SOT-89-5	32zw VR19	6s	Fmd
4HI	FT521Hib	LVR-IC	LDO, Dual out, V1/V2=2.85V/3.0V±2%, 250mA	SOT-89-5	32zw VR19	6s	Fmd
4HJ	FT521HJb	LVR-IC	LDO, Dual out, V1/V2=2.85V/3.3V±2%, 250mA	SOT-89-5	32zw VR19	6s	Fmd
4HK	FT521HKb	LVR-IC	LDO, Dual out, V1/V2=2.85V/3.6V±2%, 250mA	SOT-89-5	32zw VR19	6s	Fmd
4HK	XC6204C18APR	LVR-IC	LDO, 1.85V±2%, 150mA, -CE, PDR	SOT-89-5	32um VR4	6h	Tor
4HL	XC6204C19APR	LVR-IC	LDO, 1.95V±2%, 150mA, -CE, PDR	SOT-89-5	32um VR4	6h	Tor
4HM	XC6204C20APR	LVR-IC	LDO, 2.05V±2%, 150mA, -CE, PDR	SOT-89-5	32um VR4	6h	Tor
4HN	XC6204C21APR	LVR-IC	LDO, 2.15V±2%, 150mA, -CE, PDR	SOT-89-5	32um VR4	6h	Tor
4HP	XC6204C22APR	LVR-IC	LDO, 2.25V±2%, 150mA, -CE, PDR	SOT-89-5	32um VR4	6h	Tor
4HR	XC6204C23APR	LVR-IC	LDO, 2.35V±2%, 150mA, -CE, PDR	SOT-89-5	32um VR4	6h	Tor
4HS	XC6204C24APR	LVR-IC	LDO, 2.45V±2%, 150mA, -CE, PDR	SOT-89-5	32um VR4	6h	Tor
4HT	XC6204C25APR	LVR-IC	LDO, 2.55V±2%, 150mA, -CE, PDR	SOT-89-5	32um VR4	6h	Tor
4HU	XC6204C26APR	LVR-IC	LDO, 2.65V±2%, 150mA, -CE, PDR	SOT-89-5	32um VR4	6h	Tor
4HV	XC6204C27APR	LVR-IC	LDO, 2.75V±2%, 150mA, -CE, PDR	SOT-89-5	32um VR4	6h	Tor
4HX	XC6204C28APR	LVR-IC	LDO, 2.85V±2%, 150mA, -CE, PDR	SOT-89-5	32um VR4	6h	Tor
4HY	XC6204C29APR	LVR-IC	LDO, 2.95V±2%, 150mA, -CE, PDR	SOT-89-5	32um VR4	6h	Tor
4HZ	XC6204C30APR	LVR-IC	LDO, 3.05V±2%, 150mA, -CE, PDR	SOT-89-5	32um VR4	6h	Tor
4IA	FT521IAb	LVR-IC	LDO, Dual out, V1/V2=3.0V/1.2V±2%, 250mA	SOT-89-5	32zw VR19	6s	Fmd
4IB	FT521IBb	LVR-IC	LDO, Dual out, V1/V2=3.0V/1.3V±2%, 250mA	SOT-89-5	32zw VR19	6s	Fmd
4IC	FT521ICb	LVR-IC	LDO, Dual out, V1/V2=3.0V/1.5V±2%, 250mA	SOT-89-5	32zw VR19	6s	Fmd
4ID	FT521IDb	LVR-IC	LDO, Dual out, V1/V2=3.0V/1.8V±2%, 250mA	SOT-89-5	32zw VR19	6s	Fmd
4IE	FT521IEb	LVR-IC	LDO, Dual out, V1/V2=3.0V/2.5V±2%, 250mA	SOT-89-5	32zw VR19	6s	Fmd
4IF	FT521IFb	LVR-IC	LDO, Dual out, V1/V2=3.0V/2.7V±2%, 250mA	SOT-89-5	32zw VR19	6s	Fmd
4IG	FT521IGb	LVR-IC	LDO, Dual out, V1/V2=3.0V/2.8V±2%, 250mA	SOT-89-5	32zw VR19	6s	Fmd
4IH	FT521IHb	LVR-IC	LDO, Dual out, V1/V2=3.0V/2.85V±2%, 250mA	SOT-89-5	32zw VR19	6s	Fmd
4II	FT521Iib	LVR-IC	LDO, Dual out, V1/V2=3.0V/3.0V±2%, 250mA	SOT-89-5	32zw VR19	6s	Fmd
4IJ	FT521IJb	LVR-IC	LDO, Dual out, V1/V2=3.0V/3.3V±2%, 250mA	SOT-89-5	32zw VR19	6s	Fmd
4IK	FT521IKb	LVR-IC	LDO, Dual out, V1/V2=3.0V/3.6V±2%, 250mA	SOT-89-5	32zw VR19	6s	Fmd
4JA	FT521JAb	LVR-IC	LDO, Dual out, V1/V2=3.3V/1.2V±2%, 250mA	SOT-89-5	32zw VR19	6s	Fmd
4JB	FT521JbB	LVR-IC	LDO, Dual out, V1/V2=3.3V/1.3V±2%, 250mA	SOT-89-5	32zw VR19	6s	Fmd
4JC	FT521JCb	LVR-IC	LDO, Dual out, V1/V2=3.3V/1.8V±2%, 250mA	SOT-89-5	32zw VR19	6s	Fmd
4JD	FT521JDb	LVR-IC	LDO, Dual out, V1/V2=3.3V/1.8V±2%, 250mA	SOT-89-5	32zw VR19	6s	Fmd
4JE	FT521JEb	LVR-IC	LDO, Dual out, V1/V2=3.3V/2.5V±2%, 250mA	SOT-89-5	32zw VR19	6s	Fmd
4JF	FT521JFb	LVR-IC	LDO, Dual out, V1/V2=3.3V/2.7V±2%, 250mA	SOT-89-5	32zw VR19	6s	Fmd
4JG	FT521JGb	LVR-IC	LDO, Dual out, V1/V2=3.3V/2.8V±2%, 250mA	SOT-89-5	32zw VR19	6s	Fmd
4JH	FT521JHb	LVR-IC	LDO, Dual out, V1/V2=3.3V/2.85V±2%, 250mA	SOT-89-5	32zw VR19	6s	Fmd
4JI	FT521Jib	LVR-IC	LDO, Dual out, V1/V2=3.3V/3.0V±2%, 250mA	SOT-89-5	32zw VR19	6s	Fmd
4JJ	FT521JjB	LVR-IC	LDO, Dual out, V1/V2=3.3V/3.3V±2%, 250mA	SOT-89-5	32zw VR19	6s	Fmd
4JK	FT521JkB	LVR-IC	LDO, Dual out, V1/V2=3.3V/3.6V±2%, 250mA	SOT-89-5	32zw VR19	6s	Fmd
4KA	FT521KAb	LVR-IC	LDO, Dual out, V1/V2=3.6V/1.2V±2%, 250mA	SOT-89-5	32zw VR19	6s	Fmd
4KB	FT521KbB	LVR-IC	LDO, Dual out, V1/V2=3.6V/1.3V±2%, 250mA	SOT-89-5	32zw VR19	6s	Fmd
4KC	FT521KCb	LVR-IC	LDO, Dual out, V1/V2=3.6V/1.5V±2%, 250mA	SOT-89-5	32zw VR19	6s	Fmd
4KD	FT521KDb	LVR-IC	LDO, Dual out, V1/V2=3.6V/1.8V±2%, 250mA	SOT-89-5	32zw VR19	6s	Fmd
4KE	FT521KEb	LVR-IC	LDO, Dual out, V1/V2=3.6V/2.5V±2%, 250mA	SOT-89-5	32zw VR19	6s	Fmd
4KF	FT521KFb	LVR-IC	LDO, Dual out, V1/V2=3.6V/2.7V±2%, 250mA	SOT-89-5	32zw VR19	6s	Fmd
4KG	FT521KGb	LVR-IC	LDO, Dual out, V1/V2=3.6V/2.8V±2%, 250mA	SOT-89-5	32zw VR19	6s	Fmd
4KH	FT521KHb	LVR-IC	LDO, Dual out, V1/V2=3.6V/2.85V±2%, 250mA	SOT-89-5	32zw VR19	6s	Fmd



SMD code	Type	Function	Short description	Case	Pinout	Sch.	St.	Mnf.
4KI	FT521K1b	LVR-IC	LDO, Dual out, V1/V2=3.6V/3.0V±2%, 250mA	SOT-89-5	32zw	VR19	6s	Fmd
4KJ	FT521K1b	LVR-IC	LDO, Dual out, V1/V2=3.6V/3.3V±2%, 250mA	SOT-89-5	32zw	VR19	6s	Fmd
4KK	FT521KKb	LVR-IC	LDO, Dual out, V1/V2=3.6V/3.6V±2%, 250mA	SOT-89-5	32zw	VR19	6s	Fmd
4KK	XC6204D18APR	LVR-IC	LDO, 1.85V±2%, 150mA, -CE	SOT-89-5	32um	VR4	6h	Tor
4KL	XC6204D19APR	LVR-IC	LDO, 1.95V±2%, 150mA, -CE	SOT-89-5	32um	VR4	6h	Tor
4KM	XC6204D20APR	LVR-IC	LDO, 2.05V±2%, 150mA, -CE	SOT-89-5	32um	VR4	6h	Tor
4KN	XC6204D21APR	LVR-IC	LDO, 2.15V±2%, 150mA, -CE	SOT-89-5	32um	VR4	6h	Tor
4KP	XC6204D22APR	LVR-IC	LDO, 2.25V±2%, 150mA, -CE	SOT-89-5	32um	VR4	6h	Tor
4KR	XC6204D23APR	LVR-IC	LDO, 2.35V±2%, 150mA, -CE	SOT-89-5	32um	VR4	6h	Tor
4KS	XC6204D24APR	LVR-IC	LDO, 2.45V±2%, 150mA, -CE	SOT-89-5	32um	VR4	6h	Tor
4KT	XC6204D25APR	LVR-IC	LDO, 2.55V±2%, 150mA, -CE	SOT-89-5	32um	VR4	6h	Tor
4KU	XC6204D26APR	LVR-IC	LDO, 2.65V±2%, 150mA, -CE	SOT-89-5	32um	VR4	6h	Tor
4KV	XC6204D27APR	LVR-IC	LDO, 2.75V±2%, 150mA, -CE	SOT-89-5	32um	VR4	6h	Tor
4KX	XC6204D28APR	LVR-IC	LDO, 2.85V±2%, 150mA, -CE	SOT-89-5	32um	VR4	6h	Tor
4KY	XC6204D29APR	LVR-IC	LDO, 2.95V±2%, 150mA, -CE	SOT-89-5	32um	VR4	6h	Tor
4KZ	XC6204D30APR	LVR-IC	LDO, 3.05V±2%, 150mA, -CE	SOT-89-5	32um	VR4	6h	Tor
4L0	XC6204A31APR	LVR-IC	LDO, 3.15V±2%, 150mA, +CE, PDR	SOT-89-5	32um	VR4	6h	Tor
4L1	XC6204A32APR	LVR-IC	LDO, 3.25V±2%, 150mA, +CE, PDR	SOT-89-5	32um	VR4	6h	Tor
4L2	XC6204A33APR	LVR-IC	LDO, 3.35V±2%, 150mA, +CE, PDR	SOT-89-5	32um	VR4	6h	Tor
4L3	XC6204A34APR	LVR-IC	LDO, 3.45V±2%, 150mA, +CE, PDR	SOT-89-5	32um	VR4	6h	Tor
4L4	XC6204A35APR	LVR-IC	LDO, 3.55V±2%, 150mA, +CE, PDR	SOT-89-5	32um	VR4	6h	Tor
4L5	XC6204A36APR	LVR-IC	LDO, 3.65V±2%, 150mA, +CE, PDR	SOT-89-5	32um	VR4	6h	Tor
4L6	XC6204A37APR	LVR-IC	LDO, 3.75V±2%, 150mA, +CE, PDR	SOT-89-5	32um	VR4	6h	Tor
4L7	XC6204A38APR	LVR-IC	LDO, 3.85V±2%, 150mA, +CE, PDR	SOT-89-5	32um	VR4	6h	Tor
4L8	XC6204A39APR	LVR-IC	LDO, 3.95V±2%, 150mA, +CE, PDR	SOT-89-5	32um	VR4	6h	Tor
4L9	XC6204A40APR	LVR-IC	LDO, 4.05V±2%, 150mA, +CE, PDR	SOT-89-5	32um	VR4	6h	Tor
4LA	XC6204A41APR	LVR-IC	LDO, 4.15V±2%, 150mA, +CE, PDR	SOT-89-5	32um	VR4	6h	Tor
4LB	XC6204A42APR	LVR-IC	LDO, 4.25V±2%, 150mA, +CE, PDR	SOT-89-5	32um	VR4	6h	Tor
4LC	XC6204A43APR	LVR-IC	LDO, 4.35V±2%, 150mA, +CE, PDR	SOT-89-5	32um	VR4	6h	Tor
4LD	XC6204A44APR	LVR-IC	LDO, 4.45V±2%, 150mA, +CE, PDR	SOT-89-5	32um	VR4	6h	Tor
4LE	XC6204A45APR	LVR-IC	LDO, 4.55V±2%, 150mA, +CE, PDR	SOT-89-5	32um	VR4	6h	Tor
4LF	XC6204A46APR	LVR-IC	LDO, 4.65V±2%, 150mA, +CE, PDR	SOT-89-5	32um	VR4	6h	Tor
4LH	XC6204A47APR	LVR-IC	LDO, 4.75V±2%, 150mA, +CE, PDR	SOT-89-5	32um	VR4	6h	Tor
4LK	XC6204A48APR	LVR-IC	LDO, 4.85V±2%, 150mA, +CE, PDR	SOT-89-5	32um	VR4	6h	Tor
4LL	XC6204A49APR	LVR-IC	LDO, 4.95V±2%, 150mA, +CE, PDR	SOT-89-5	32um	VR4	6h	Tor
4LM	XC6204A50APR	LVR-IC	LDO, 5.05V±2%, 150mA, +CE, PDR	SOT-89-5	32um	VR4	6h	Tor
4LN	XC6204A51APR	LVR-IC	LDO, 5.15V±2%, 150mA, +CE, PDR	SOT-89-5	32um	VR4	6h	Tor
4LP	XC6204A52APR	LVR-IC	LDO, 5.25V±2%, 150mA, +CE, PDR	SOT-89-5	32um	VR4	6h	Tor
4LR	XC6204A53APR	LVR-IC	LDO, 5.35V±2%, 150mA, +CE, PDR	SOT-89-5	32um	VR4	6h	Tor
4LS	XC6204A54APR	LVR-IC	LDO, 5.45V±2%, 150mA, +CE, PDR	SOT-89-5	32um	VR4	6h	Tor
4LT	XC6204A55APR	LVR-IC	LDO, 5.55V±2%, 150mA, +CE, PDR	SOT-89-5	32um	VR4	6h	Tor
4LU	XC6204A56APR	LVR-IC	LDO, 5.65V±2%, 150mA, +CE, PDR	SOT-89-5	32um	VR4	6h	Tor
4LV	XC6204A57APR	LVR-IC	LDO, 5.75V±2%, 150mA, +CE, PDR	SOT-89-5	32um	VR4	6h	Tor
4LX	XC6204A58APR	LVR-IC	LDO, 5.85V±2%, 150mA, +CE, PDR	SOT-89-5	32um	VR4	6h	Tor
4LY	XC6204A59APR	LVR-IC	LDO, 5.95V±2%, 150mA, +CE, PDR	SOT-89-5	32um	VR4	6h	Tor
4M0	XC6204B31APR	LVR-IC	LDO, 3.15V±2%, 150mA, +CE	SOT-89-5	32um	VR4	6h	Tor
4M1	XC6204B32APR	LVR-IC	LDO, 3.25V±2%, 150mA, +CE	SOT-89-5	32um	VR4	6h	Tor
4M2	XC6204B33APR	LVR-IC	LDO, 3.35V±2%, 150mA, +CE	SOT-89-5	32um	VR4	6h	Tor
4M3	XC6204B34APR	LVR-IC	LDO, 3.45V±2%, 150mA, +CE	SOT-89-5	32um	VR4	6h	Tor
4M4	XC6204B35APR	LVR-IC	LDO, 3.55V±2%, 150mA, +CE	SOT-89-5	32um	VR4	6h	Tor
4M5	XC6204B36APR	LVR-IC	LDO, 3.65V±2%, 150mA, +CE	SOT-89-5	32um	VR4	6h	Tor
4M6	XC6204B37APR	LVR-IC	LDO, 3.75V±2%, 150mA, +CE	SOT-89-5	32um	VR4	6h	Tor
4M7	XC6204B38APR	LVR-IC	LDO, 3.85V±2%, 150mA, +CE	SOT-89-5	32um	VR4	6h	Tor
4M8	XC6204B39APR	LVR-IC	LDO, 3.95V±2%, 150mA, +CE	SOT-89-5	32um	VR4	6h	Tor
4M9	XC6204B40APR	LVR-IC	LDO, 4.05V±2%, 150mA, +CE	SOT-89-5	32um	VR4	6h	Tor
4MA	XC6204B41APR	LVR-IC	LDO, 4.15V±2%, 150mA, +CE	SOT-89-5	32um	VR4	6h	Tor
4MB	XC6204B42APR	LVR-IC	LDO, 4.25V±2%, 150mA, +CE	SOT-89-5	32um	VR4	6h	Tor
4MC	XC6204B43APR	LVR-IC	LDO, 4.35V±2%, 150mA, +CE	SOT-89-5	32um	VR4	6h	Tor
4MD	XC6204B44APR	LVR-IC	LDO, 4.45V±2%, 150mA, +CE	SOT-89-5	32um	VR4	6h	Tor
4ME	XC6204B45APR	LVR-IC	LDO, 4.55V±2%, 150mA, +CE	SOT-89-5	32um	VR4	6h	Tor
4MF	XC6204B46APR	LVR-IC	LDO, 4.65V±2%, 150mA, +CE	SOT-89-5	32um	VR4	6h	Tor
4MH	XC6204B47APR	LVR-IC	LDO, 4.75V±2%, 150mA, +CE	SOT-89-5	32um	VR4	6h	Tor
4MK	XC6204B48APR	LVR-IC	LDO, 4.85V±2%, 150mA, +CE	SOT-89-5	32um	VR4	6h	Tor
4ML	XC6204B49APR	LVR-IC	LDO, 4.95V±2%, 150mA, +CE	SOT-89-5	32um	VR4	6h	Tor
4MM	XC6204B50APR	LVR-IC	LDO, 5.05V±2%, 150mA, +CE	SOT-89-5	32um	VR4	6h	Tor
4MN	XC6204B51APR	LVR-IC	LDO, 5.15V±2%, 150mA, +CE	SOT-89-5	32um	VR4	6h	Tor
4MP	XC6204B52APR	LVR-IC	LDO, 5.25V±2%, 150mA, +CE	SOT-89-5	32um	VR4	6h	Tor
4MR	XC6204B53APR	LVR-IC	LDO, 5.35V±2%, 150mA, +CE	SOT-89-5	32um	VR4	6h	Tor
4MS	XC6204B54APR	LVR-IC	LDO, 5.45V±2%, 150mA, +CE	SOT-89-5	32um	VR4	6h	Tor
4MT	XC6204B55APR	LVR-IC	LDO, 5.55V±2%, 150mA, +CE	SOT-89-5	32um	VR4	6h	Tor



SMD code	Type	Function	Short description	Case	Pinout Sch.	St.	Mnf.
4MU	XC6204B56APR	LVR-IC	LDO, 5.65V±2%, 150mA, +CE	SOT-89-5	32um VR4	6h	Tor
4MV	XC6204B57APR	LVR-IC	LDO, 5.75V±2%, 150mA, +CE	SOT-89-5	32um VR4	6h	Tor
4MX	XC6204B58APR	LVR-IC	LDO, 5.85V±2%, 150mA, +CE	SOT-89-5	32um VR4	6h	Tor
4MY	XC6204B59APR	LVR-IC	LDO, 5.95V±2%, 150mA, +CE	SOT-89-5	32um VR4	6h	Tor
4N0	XC6204C31APR	LVR-IC	LDO, 3.15V±2%, 150mA, -CE, PDR	SOT-89-5	32um VR4	6h	Tor
4N1	XC6204C32APR	LVR-IC	LDO, 3.25V±2%, 150mA, -CE, PDR	SOT-89-5	32um VR4	6h	Tor
4N2	XC6204C33APR	LVR-IC	LDO, 3.35V±2%, 150mA, -CE, PDR	SOT-89-5	32um VR4	6h	Tor
4N3	XC6204C34APR	LVR-IC	LDO, 3.45V±2%, 150mA, -CE, PDR	SOT-89-5	32um VR4	6h	Tor
4N4	XC6204C35APR	LVR-IC	LDO, 3.55V±2%, 150mA, -CE, PDR	SOT-89-5	32um VR4	6h	Tor
4N5	XC6204C36APR	LVR-IC	LDO, 3.65V±2%, 150mA, -CE, PDR	SOT-89-5	32um VR4	6h	Tor
4N6	XC6204C37APR	LVR-IC	LDO, 3.75V±2%, 150mA, -CE, PDR	SOT-89-5	32um VR4	6h	Tor
4N7	XC6204C38APR	LVR-IC	LDO, 3.85V±2%, 150mA, -CE, PDR	SOT-89-5	32um VR4	6h	Tor
4N8	XC6204C39APR	LVR-IC	LDO, 3.95V±2%, 150mA, -CE, PDR	SOT-89-5	32um VR4	6h	Tor
4N9	XC6204C40APR	LVR-IC	LDO, 4.05V±2%, 150mA, -CE, PDR	SOT-89-5	32um VR4	6h	Tor
4NA	XC6204C41APR	LVR-IC	LDO, 4.15V±2%, 150mA, -CE, PDR	SOT-89-5	32um VR4	6h	Tor
4NB	XC6204C42APR	LVR-IC	LDO, 4.25V±2%, 150mA, -CE, PDR	SOT-89-5	32um VR4	6h	Tor
4NC	XC6204C43APR	LVR-IC	LDO, 4.35V±2%, 150mA, -CE, PDR	SOT-89-5	32um VR4	6h	Tor
4ND	XC6204C44APR	LVR-IC	LDO, 4.45V±2%, 150mA, -CE, PDR	SOT-89-5	32um VR4	6h	Tor
4NE	XC6204C45APR	LVR-IC	LDO, 4.55V±2%, 150mA, -CE, PDR	SOT-89-5	32um VR4	6h	Tor
4NF	XC6204C46APR	LVR-IC	LDO, 4.65V±2%, 150mA, -CE, PDR	SOT-89-5	32um VR4	6h	Tor
4NH	XC6204C47APR	LVR-IC	LDO, 4.75V±2%, 150mA, -CE, PDR	SOT-89-5	32um VR4	6h	Tor
4NK	XC6204C48APR	LVR-IC	LDO, 4.85V±2%, 150mA, -CE, PDR	SOT-89-5	32um VR4	6h	Tor
4NL	XC6204C49APR	LVR-IC	LDO, 4.95V±2%, 150mA, -CE, PDR	SOT-89-5	32um VR4	6h	Tor
4NM	XC6204C50APR	LVR-IC	LDO, 5.05V±2%, 150mA, -CE, PDR	SOT-89-5	32um VR4	6h	Tor
4NN	XC6204C51APR	LVR-IC	LDO, 5.15V±2%, 150mA, -CE, PDR	SOT-89-5	32um VR4	6h	Tor
4NP	XC6204C52APR	LVR-IC	LDO, 5.25V±2%, 150mA, -CE, PDR	SOT-89-5	32um VR4	6h	Tor
4NR	XC6204C53APR	LVR-IC	LDO, 5.35V±2%, 150mA, -CE, PDR	SOT-89-5	32um VR4	6h	Tor
4NS	XC6204C54APR	LVR-IC	LDO, 5.45V±2%, 150mA, -CE, PDR	SOT-89-5	32um VR4	6h	Tor
4NT	XC6204C55APR	LVR-IC	LDO, 5.55V±2%, 150mA, -CE, PDR	SOT-89-5	32um VR4	6h	Tor
4NU	XC6204C56APR	LVR-IC	LDO, 5.65V±2%, 150mA, -CE, PDR	SOT-89-5	32um VR4	6h	Tor
4NV	XC6204C57APR	LVR-IC	LDO, 5.75V±2%, 150mA, -CE, PDR	SOT-89-5	32um VR4	6h	Tor
4NX	XC6204C58APR	LVR-IC	LDO, 5.85V±2%, 150mA, -CE, PDR	SOT-89-5	32um VR4	6h	Tor
4NY	XC6204C59APR	LVR-IC	LDO, 5.95V±2%, 150mA, -CE, PDR	SOT-89-5	32um VR4	6h	Tor
4P0	XC6204D31APR	LVR-IC	LDO, 3.15V±2%, 150mA, -CE	SOT-89-5	32um VR4	6h	Tor
4P1	XC6204D32APR	LVR-IC	LDO, 3.25V±2%, 150mA, -CE	SOT-89-5	32um VR4	6h	Tor
4P2	XC6204D33APR	LVR-IC	LDO, 3.35V±2%, 150mA, -CE	SOT-89-5	32um VR4	6h	Tor
4P3	XC6204D34APR	LVR-IC	LDO, 3.45V±2%, 150mA, -CE	SOT-89-5	32um VR4	6h	Tor
4P4	XC6204D35APR	LVR-IC	LDO, 3.55V±2%, 150mA, -CE	SOT-89-5	32um VR4	6h	Tor
4P5	XC6204D36APR	LVR-IC	LDO, 3.65V±2%, 150mA, -CE	SOT-89-5	32um VR4	6h	Tor
4P6	XC6204D37APR	LVR-IC	LDO, 3.75V±2%, 150mA, -CE	SOT-89-5	32um VR4	6h	Tor
4P7	XC6204D38APR	LVR-IC	LDO, 3.85V±2%, 150mA, -CE	SOT-89-5	32um VR4	6h	Tor
4P8	XC6204D39APR	LVR-IC	LDO, 3.95V±2%, 150mA, -CE	SOT-89-5	32um VR4	6h	Tor
4P9	XC6204D40APR	LVR-IC	LDO, 4.05V±2%, 150mA, -CE	SOT-89-5	32um VR4	6h	Tor
4PA	XC6204D41APR	LVR-IC	LDO, 4.15V±2%, 150mA, -CE	SOT-89-5	32um VR4	6h	Tor
4PB	XC6204D42APR	LVR-IC	LDO, 4.25V±2%, 150mA, -CE	SOT-89-5	32um VR4	6h	Tor
4PC	XC6204D43APR	LVR-IC	LDO, 4.35V±2%, 150mA, -CE	SOT-89-5	32um VR4	6h	Tor
4PD	XC6204D44APR	LVR-IC	LDO, 4.45V±2%, 150mA, -CE	SOT-89-5	32um VR4	6h	Tor
4PE	XC6204D45APR	LVR-IC	LDO, 4.55V±2%, 150mA, -CE	SOT-89-5	32um VR4	6h	Tor
4PF	XC6204D46APR	LVR-IC	LDO, 4.65V±2%, 150mA, -CE	SOT-89-5	32um VR4	6h	Tor
4PH	XC6204D47APR	LVR-IC	LDO, 4.75V±2%, 150mA, -CE	SOT-89-5	32um VR4	6h	Tor
4PK	XC6204D48APR	LVR-IC	LDO, 4.85V±2%, 150mA, -CE	SOT-89-5	32um VR4	6h	Tor
4PL	XC6204D49APR	LVR-IC	LDO, 4.95V±2%, 150mA, -CE	SOT-89-5	32um VR4	6h	Tor
4PM	XC6204D50APR	LVR-IC	LDO, 5.05V±2%, 150mA, -CE	SOT-89-5	32um VR4	6h	Tor
4PN	XC6204D51APR	LVR-IC	LDO, 5.15V±2%, 150mA, -CE	SOT-89-5	32um VR4	6h	Tor
4PP	XC6204D52APR	LVR-IC	LDO, 5.25V±2%, 150mA, -CE	SOT-89-5	32um VR4	6h	Tor
4PR	XC6204D53APR	LVR-IC	LDO, 5.35V±2%, 150mA, -CE	SOT-89-5	32um VR4	6h	Tor
4PS	XC6204D54APR	LVR-IC	LDO, 5.45V±2%, 150mA, -CE	SOT-89-5	32um VR4	6h	Tor
4PT	XC6204D55APR	LVR-IC	LDO, 5.55V±2%, 150mA, -CE	SOT-89-5	32um VR4	6h	Tor
4PU	XC6204D56APR	LVR-IC	LDO, 5.65V±2%, 150mA, -CE	SOT-89-5	32um VR4	6h	Tor
4PV	XC6204D57APR	LVR-IC	LDO, 5.75V±2%, 150mA, -CE	SOT-89-5	32um VR4	6h	Tor
4PX	XC6204D58APR	LVR-IC	LDO, 5.85V±2%, 150mA, -CE	SOT-89-5	32um VR4	6h	Tor
4PY	XC6204D59APR	LVR-IC	LDO, 5.95V±2%, 150mA, -CE	SOT-89-5	32um VR4	6h	Tor
4VK	XC6204A182PR	LVR-IC	LDO, 1.8V±2%, 150mA, +CE, PDR	SOT-89-5	32um VR4	6h	Tor
4VL	XC6204A192PR	LVR-IC	LDO, 1.9V±2%, 150mA, +CE, PDR	SOT-89-5	32um VR4	6h	Tor
4VM	XC6204A202PR	LVR-IC	LDO, 2V±2%, 150mA, +CE, PDR	SOT-89-5	32um VR4	6h	Tor
4VN	XC6204A212PR	LVR-IC	LDO, 2.1V±2%, 150mA, +CE, PDR	SOT-89-5	32um VR4	6h	Tor
4VP	XC6204A222PR	LVR-IC	LDO, 2.2V±2%, 150mA, +CE, PDR	SOT-89-5	32um VR4	6h	Tor
4VR	XC6204A232PR	LVR-IC	LDO, 2.3V±2%, 150mA, +CE, PDR	SOT-89-5	32um VR4	6h	Tor
4VS	XC6204A242PR	LVR-IC	LDO, 2.4V±2%, 150mA, +CE, PDR	SOT-89-5	32um VR4	6h	Tor
4VT	XC6204A252PR	LVR-IC	LDO, 2.5V±2%, 150mA, +CE, PDR	SOT-89-5	32um VR4	6h	Tor



SMD code	Type	Function	Short description	Case	Pinout Sch.	St.	Mnf.
4VU	XC6204A262PR	LVR-IC	LDO, 2.6V±2%, 150mA, +CE, PDR	SOT-89-5	32um VR4	6h	Tor
4VV	XC6204A272PR	LVR-IC	LDO, 2.7V±2%, 150mA, +CE, PDR	SOT-89-5	32um VR4	6h	Tor
4VX	XC6204A282PR	LVR-IC	LDO, 2.8V±2%, 150mA, +CE, PDR	SOT-89-5	32um VR4	6h	Tor
4VY	XC6204A292PR	LVR-IC	LDO, 2.9V±2%, 150mA, +CE, PDR	SOT-89-5	32um VR4	6h	Tor
4VZ	XC6204A302PR	LVR-IC	LDO, 3V±2%, 150mA, +CE, PDR	SOT-89-5	32um VR4	6h	Tor
4XK	XC6204B182PR	LVR-IC	LDO, 1.8V±2%, 150mA, +CE	SOT-89-5	32um VR4	6h	Tor
4XL	XC6204B192PR	LVR-IC	LDO, 1.9V±2%, 150mA, +CE	SOT-89-5	32um VR4	6h	Tor
4XM	XC6204B202PR	LVR-IC	LDO, 2V±2%, 150mA, +CE	SOT-89-5	32um VR4	6h	Tor
4XN	XC6204B212PR	LVR-IC	LDO, 2.1V±2%, 150mA, +CE	SOT-89-5	32um VR4	6h	Tor
4XP	XC6204B222PR	LVR-IC	LDO, 2.2V±2%, 150mA, +CE	SOT-89-5	32um VR4	6h	Tor
4XR	XC6204B232PR	LVR-IC	LDO, 2.3V±2%, 150mA, +CE	SOT-89-5	32um VR4	6h	Tor
4XS	XC6204B242PR	LVR-IC	LDO, 2.4V±2%, 150mA, +CE	SOT-89-5	32um VR4	6h	Tor
4XT	XC6204B252PR	LVR-IC	LDO, 2.5V±2%, 150mA, +CE	SOT-89-5	32um VR4	6h	Tor
4XU	XC6204B262PR	LVR-IC	LDO, 2.6V±2%, 150mA, +CE	SOT-89-5	32um VR4	6h	Tor
4XV	XC6204B272PR	LVR-IC	LDO, 2.7V±2%, 150mA, +CE	SOT-89-5	32um VR4	6h	Tor
4XX	XC6204B282PR	LVR-IC	LDO, 2.8V±2%, 150mA, +CE	SOT-89-5	32um VR4	6h	Tor
4XY	XC6204B292PR	LVR-IC	LDO, 2.9V±2%, 150mA, +CE	SOT-89-5	32um VR4	6h	Tor
4XZ	XC6204B302PR	LVR-IC	LDO, 3V±2%, 150mA, +CE	SOT-89-5	32um VR4	6h	Tor
4YK	XC6204C182PR	LVR-IC	LDO, 1.8V±2%, 150mA, -CE, PDR	SOT-89-5	32um VR4	6h	Tor
4YL	XC6204C192PR	LVR-IC	LDO, 1.9V±2%, 150mA, -CE, PDR	SOT-89-5	32um VR4	6h	Tor
4YM	XC6204C202PR	LVR-IC	LDO, 2V±2%, 150mA, -CE, PDR	SOT-89-5	32um VR4	6h	Tor
4YN	XC6204C212PR	LVR-IC	LDO, 2.1V±2%, 150mA, -CE, PDR	SOT-89-5	32um VR4	6h	Tor
4YP	XC6204C222PR	LVR-IC	LDO, 2.2V±2%, 150mA, -CE, PDR	SOT-89-5	32um VR4	6h	Tor
4YR	XC6204C232PR	LVR-IC	LDO, 2.3V±2%, 150mA, -CE, PDR	SOT-89-5	32um VR4	6h	Tor
4YS	XC6204C242PR	LVR-IC	LDO, 2.4V±2%, 150mA, -CE, PDR	SOT-89-5	32um VR4	6h	Tor
4YT	XC6204C252PR	LVR-IC	LDO, 2.5V±2%, 150mA, -CE, PDR	SOT-89-5	32um VR4	6h	Tor
4YU	XC6204C262PR	LVR-IC	LDO, 2.6V±2%, 150mA, -CE, PDR	SOT-89-5	32um VR4	6h	Tor
4YV	XC6204C272PR	LVR-IC	LDO, 2.7V±2%, 150mA, -CE, PDR	SOT-89-5	32um VR4	6h	Tor
4YX	XC6204C282PR	LVR-IC	LDO, 2.8V±2%, 150mA, -CE, PDR	SOT-89-5	32um VR4	6h	Tor
4YY	XC6204C292PR	LVR-IC	LDO, 2.9V±2%, 150mA, -CE, PDR	SOT-89-5	32um VR4	6h	Tor
4YZ	XC6204C302PR	LVR-IC	LDO, 3V±2%, 150mA, -CE, PDR	SOT-89-5	32um VR4	6h	Tor
4ZK	XC6204D182PR	LVR-IC	LDO, 1.8V±2%, 150mA, -CE	SOT-89-5	32um VR4	6h	Tor
4ZL	XC6204D192PR	LVR-IC	LDO, 1.9V±2%, 150mA, -CE	SOT-89-5	32um VR4	6h	Tor
4ZM	XC6204D202PR	LVR-IC	LDO, 2V±2%, 150mA, -CE	SOT-89-5	32um VR4	6h	Tor
4ZN	XC6204D212PR	LVR-IC	LDO, 2.1V±2%, 150mA, -CE	SOT-89-5	32um VR4	6h	Tor
4ZP	XC6204D222PR	LVR-IC	LDO, 2.2V±2%, 150mA, -CE	SOT-89-5	32um VR4	6h	Tor
4ZR	XC6204D232PR	LVR-IC	LDO, 2.3V±2%, 150mA, -CE	SOT-89-5	32um VR4	6h	Tor
4ZS	XC6204D242PR	LVR-IC	LDO, 2.4V±2%, 150mA, -CE	SOT-89-5	32um VR4	6h	Tor
4ZT	XC6204D252PR	LVR-IC	LDO, 2.5V±2%, 150mA, -CE	SOT-89-5	32um VR4	6h	Tor
4ZU	XC6204D262PR	LVR-IC	LDO, 2.6V±2%, 150mA, -CE	SOT-89-5	32um VR4	6h	Tor
4ZV	XC6204D272PR	LVR-IC	LDO, 2.7V±2%, 150mA, -CE	SOT-89-5	32um VR4	6h	Tor
4ZX	XC6204D282PR	LVR-IC	LDO, 2.8V±2%, 150mA, -CE	SOT-89-5	32um VR4	6h	Tor
4ZY	XC6204D292PR	LVR-IC	LDO, 2.9V±2%, 150mA, -CE	SOT-89-5	32um VR4	6h	Tor
4ZZ	XC6204D302PR	LVR-IC	LDO, 3V±2%, 150mA, -CE	SOT-89-5	32um VR4	6h	Tor
50P	TK11250BU	LVR-IC	LDO, 5V±2%, 150mA, +CE	SOT-89-5	32vg VR7	6i	Tok
50Q	TK11350BU	LVR-IC	LDO, 5V±2%, 150mA, -CE	SOT-89-5	32vg VR7	6i	Tok
55P	TK11255BU	LVR-IC	LDO, 5.5V±2%, 150mA, +CE	SOT-89-5	32vg VR7	6i	Tok
55Q	TK11355BU	LVR-IC	LDO, 5.5V±2%, 150mA, -CE	SOT-89-5	32vg VR7	6i	Tok
5E8	XC6205A09APR	LVR-IC	LDO, 0.95V±2%, 150mA, +CE, PDR	SOT-89-5	32um VR4	6h	Tor
5E9	XC6205A10APR	LVR-IC	LDO, 1.05V±2%, 150mA, +CE, PDR	SOT-89-5	32um VR4	6h	Tor
5EA	XC6205A11APR	LVR-IC	LDO, 1.15V±2%, 150mA, +CE, PDR	SOT-89-5	32um VR4	6h	Tor
5EB	XC6205A12APR	LVR-IC	LDO, 1.25V±2%, 150mA, +CE, PDR	SOT-89-5	32um VR4	6h	Tor
5EC	XC6205A13APR	LVR-IC	LDO, 1.35V±2%, 150mA, +CE, PDR	SOT-89-5	32um VR4	6h	Tor
5ED	XC6205A14APR	LVR-IC	LDO, 1.45V±2%, 150mA, +CE, PDR	SOT-89-5	32um VR4	6h	Tor
5EE	XC6205A15APR	LVR-IC	LDO, 1.55V±2%, 150mA, +CE, PDR	SOT-89-5	32um VR4	6h	Tor
5EF	XC6205A16APR	LVR-IC	LDO, 1.65V±2%, 150mA, +CE, PDR	SOT-89-5	32um VR4	6h	Tor
5EH	XC6205A17APR	LVR-IC	LDO, 1.75V±2%, 150mA, +CE, PDR	SOT-89-5	32um VR4	6h	Tor
5F8	XC6205B09APR	LVR-IC	LDO, 0.95V±2%, 150mA, +CE	SOT-89-5	32um VR4	6h	Tor
5F9	XC6205B10APR	LVR-IC	LDO, 1.05V±2%, 150mA, +CE	SOT-89-5	32um VR4	6h	Tor
5FA	XC6205B11APR	LVR-IC	LDO, 1.15V±2%, 150mA, +CE	SOT-89-5	32um VR4	6h	Tor
5FB	XC6205B12APR	LVR-IC	LDO, 1.25V±2%, 150mA, +CE	SOT-89-5	32um VR4	6h	Tor
5FC	XC6205B13APR	LVR-IC	LDO, 1.35V±2%, 150mA, +CE	SOT-89-5	32um VR4	6h	Tor
5FD	XC6205B14APR	LVR-IC	LDO, 1.45V±2%, 150mA, +CE	SOT-89-5	32um VR4	6h	Tor
5FE	XC6205B15APR	LVR-IC	LDO, 1.55V±2%, 150mA, +CE	SOT-89-5	32um VR4	6h	Tor
5FF	XC6205B16APR	LVR-IC	LDO, 1.65V±2%, 150mA, +CE	SOT-89-5	32um VR4	6h	Tor
5FH	XC6205B17APR	LVR-IC	LDO, 1.75V±2%, 150mA, +CE	SOT-89-5	32um VR4	6h	Tor
5H8	XC6205C09APR	LVR-IC	LDO, 0.95V±2%, 150mA, -CE, PDR	SOT-89-5	32um VR4	6h	Tor
5H9	XC6205C10APR	LVR-IC	LDO, 1.05V±2%, 150mA, -CE, PDR	SOT-89-5	32um VR4	6h	Tor
5HA	XC6205C11APR	LVR-IC	LDO, 1.15V±2%, 150mA, -CE, PDR	SOT-89-5	32um VR4	6h	Tor
5HB	XC6205C12APR	LVR-IC	LDO, 1.25V±2%, 150mA, -CE, PDR	SOT-89-5	32um VR4	6h	Tor



SMD code	Type	Function	Short description	Case	Pinout Sch.	St.	Mnf.
5HC	XC6205C13APR	LVR-IC	LDO, 1.35V±2%, 150mA, -CE, PDR	SOT-89-5	32um VR4	6h	Tor
5HD	XC6205C14APR	LVR-IC	LDO, 1.45V±2%, 150mA, -CE, PDR	SOT-89-5	32um VR4	6h	Tor
5HE	XC6205C15APR	LVR-IC	LDO, 1.55V±2%, 150mA, -CE, PDR	SOT-89-5	32um VR4	6h	Tor
5HF	XC6205C16APR	LVR-IC	LDO, 1.65V±2%, 150mA, -CE, PDR	SOT-89-5	32um VR4	6h	Tor
5HH	XC6205C17APR	LVR-IC	LDO, 1.75V±2%, 150mA, -CE, PDR	SOT-89-5	32um VR4	6h	Tor
5K8	XC6205D09APR	LVR-IC	LDO, 0.95V±2%, 150mA, -CE	SOT-89-5	32um VR4	6h	Tor
5K9	XC6205D10APR	LVR-IC	LDO, 1.05V±2%, 150mA, -CE	SOT-89-5	32um VR4	6h	Tor
5KA	XC6205D11APR	LVR-IC	LDO, 1.15V±2%, 150mA, -CE	SOT-89-5	32um VR4	6h	Tor
5KB	XC6205D12APR	LVR-IC	LDO, 1.25V±2%, 150mA, -CE	SOT-89-5	32um VR4	6h	Tor
5KC	XC6205D13APR	LVR-IC	LDO, 1.35V±2%, 150mA, -CE	SOT-89-5	32um VR4	6h	Tor
5KD	XC6205D14APR	LVR-IC	LDO, 1.45V±2%, 150mA, -CE	SOT-89-5	32um VR4	6h	Tor
5KE	XC6205D15APR	LVR-IC	LDO, 1.55V±2%, 150mA, -CE	SOT-89-5	32um VR4	6h	Tor
5KF	XC6205D16APR	LVR-IC	LDO, 1.65V±2%, 150mA, -CE	SOT-89-5	32um VR4	6h	Tor
5KH	XC6205D17APR	LVR-IC	LDO, 1.75V±2%, 150mA, -CE	SOT-89-5	32um VR4	6h	Tor
5V8	XC6205A092PR	LVR-IC	LDO, 0.9V±2%, 150mA, +CE, PDR	SOT-89-5	32um VR4	6h	Tor
5V9	XC6205A102PR	LVR-IC	LDO, 1V±2%, 150mA, +CE, PDR	SOT-89-5	32um VR4	6h	Tor
5VA	XC6205A112PR	LVR-IC	LDO, 1.1V±2%, 150mA, +CE, PDR	SOT-89-5	32um VR4	6h	Tor
5VB	XC6205A122PR	LVR-IC	LDO, 1.2V±2%, 150mA, +CE, PDR	SOT-89-5	32um VR4	6h	Tor
5VC	XC6205A132PR	LVR-IC	LDO, 1.3V±2%, 150mA, +CE, PDR	SOT-89-5	32um VR4	6h	Tor
5VD	XC6205A142PR	LVR-IC	LDO, 1.4V±2%, 150mA, +CE, PDR	SOT-89-5	32um VR4	6h	Tor
5VE	XC6205A152PR	LVR-IC	LDO, 1.5V±2%, 150mA, +CE, PDR	SOT-89-5	32um VR4	6h	Tor
5VF	XC6205A162PR	LVR-IC	LDO, 1.6V±2%, 150mA, +CE, PDR	SOT-89-5	32um VR4	6h	Tor
5VH	XC6205A172PR	LVR-IC	LDO, 1.7V±2%, 150mA, +CE, PDR	SOT-89-5	32um VR4	6h	Tor
5X8	XC6205B092PR	LVR-IC	LDO, 0.9V±2%, 150mA, +CE	SOT-89-5	32um VR4	6h	Tor
5X9	XC6205B102PR	LVR-IC	LDO, 1V±2%, 150mA, +CE	SOT-89-5	32um VR4	6h	Tor
5XA	XC6205B112PR	LVR-IC	LDO, 1.1V±2%, 150mA, +CE	SOT-89-5	32um VR4	6h	Tor
5XB	XC6205B122PR	LVR-IC	LDO, 1.2V±2%, 150mA, +CE	SOT-89-5	32um VR4	6h	Tor
5XC	XC6205B132PR	LVR-IC	LDO, 1.3V±2%, 150mA, +CE	SOT-89-5	32um VR4	6h	Tor
5XD	XC6205B142PR	LVR-IC	LDO, 1.4V±2%, 150mA, +CE	SOT-89-5	32um VR4	6h	Tor
5XE	XC6205B152PR	LVR-IC	LDO, 1.5V±2%, 150mA, +CE	SOT-89-5	32um VR4	6h	Tor
5XF	XC6205B162PR	LVR-IC	LDO, 1.6V±2%, 150mA, +CE	SOT-89-5	32um VR4	6h	Tor
5XH	XC6205B172PR	LVR-IC	LDO, 1.7V±2%, 150mA, +CE	SOT-89-5	32um VR4	6h	Tor
5Y8	XC6205C092PR	LVR-IC	LDO, 0.9V±2%, 150mA, -CE, PDR	SOT-89-5	32um VR4	6h	Tor
5Y9	XC6205C102PR	LVR-IC	LDO, 1V±2%, 150mA, -CE, PDR	SOT-89-5	32um VR4	6h	Tor
5YA	XC6205C112PR	LVR-IC	LDO, 1.1V±2%, 150mA, -CE, PDR	SOT-89-5	32um VR4	6h	Tor
5YB	XC6205C122PR	LVR-IC	LDO, 1.2V±2%, 150mA, -CE, PDR	SOT-89-5	32um VR4	6h	Tor
5YC	XC6205C132PR	LVR-IC	LDO, 1.3V±2%, 150mA, -CE, PDR	SOT-89-5	32um VR4	6h	Tor
5YD	XC6205C142PR	LVR-IC	LDO, 1.4V±2%, 150mA, -CE, PDR	SOT-89-5	32um VR4	6h	Tor
5YE	XC6205C152PR	LVR-IC	LDO, 1.5V±2%, 150mA, -CE, PDR	SOT-89-5	32um VR4	6h	Tor
5YF	XC6205C162PR	LVR-IC	LDO, 1.6V±2%, 150mA, -CE, PDR	SOT-89-5	32um VR4	6h	Tor
5YH	XC6205C172PR	LVR-IC	LDO, 1.7V±2%, 150mA, -CE, PDR	SOT-89-5	32um VR4	6h	Tor
5Z8	XC6205D092PR	LVR-IC	LDO, 0.9V±2%, 150mA, -CE	SOT-89-5	32um VR4	6h	Tor
5Z9	XC6205D102PR	LVR-IC	LDO, 1V±2%, 150mA, -CE	SOT-89-5	32um VR4	6h	Tor
5ZA	XC6205D112PR	LVR-IC	LDO, 1.1V±2%, 150mA, -CE	SOT-89-5	32um VR4	6h	Tor
5ZB	XC6205D122PR	LVR-IC	LDO, 1.2V±2%, 150mA, -CE	SOT-89-5	32um VR4	6h	Tor
5ZC	XC6205D132PR	LVR-IC	LDO, 1.3V±2%, 150mA, -CE	SOT-89-5	32um VR4	6h	Tor
5ZD	XC6205D142PR	LVR-IC	LDO, 1.4V±2%, 150mA, -CE	SOT-89-5	32um VR4	6h	Tor
5ZE	XC6205D152PR	LVR-IC	LDO, 1.5V±2%, 150mA, -CE	SOT-89-5	32um VR4	6h	Tor
5ZF	XC6205D162PR	LVR-IC	LDO, 1.6V±2%, 150mA, -CE	SOT-89-5	32um VR4	6h	Tor
5ZH	XC6205D172PR	LVR-IC	LDO, 1.7V±2%, 150mA, -CE	SOT-89-5	32um VR4	6h	Tor
60P	TK11260BU	LVR-IC	LDO, 6V±2%, 150mA, +CE	SOT-89-5	32vg VR7	6i	Tok
60Q	TK11360BU	LVR-IC	LDO, 6V±2%, 150mA, -CE	SOT-89-5	32vg VR7	6i	Tok
7A0	XC6207A312PR	LVR-IC	LDO, 3.1V±2%, 300mA, -CE, Shutdown	SOT-89-5	32cw VR4a	6h	Tor
7A1	XC6207A322PR	LVR-IC	LDO, 3.2V±2%, 300mA, -CE, Shutdown	SOT-89-5	32cw VR4a	6h	Tor
7A2	XC6207A332PR	LVR-IC	LDO, 3.3V±2%, 300mA, -CE, Shutdown	SOT-89-5	32cw VR4a	6h	Tor
7A3	XC6207A342PR	LVR-IC	LDO, 3.4V±2%, 300mA, -CE, Shutdown	SOT-89-5	32cw VR4a	6h	Tor
7A4	XC6207A352PR	LVR-IC	LDO, 3.5V±2%, 300mA, -CE, Shutdown	SOT-89-5	32cw VR4a	6h	Tor
7A5	XC6207A362PR	LVR-IC	LDO, 3.6V±2%, 300mA, -CE, Shutdown	SOT-89-5	32cw VR4a	6h	Tor
7A6	XC6207A372PR	LVR-IC	LDO, 3.7V±2%, 300mA, -CE, Shutdown	SOT-89-5	32cw VR4a	6h	Tor
7A7	XC6207A382PR	LVR-IC	LDO, 3.8V±2%, 300mA, -CE, Shutdown	SOT-89-5	32cw VR4a	6h	Tor
7A8	XC6207A392PR	LVR-IC	LDO, 3.9V±2%, 300mA, -CE, Shutdown	SOT-89-5	32cw VR4a	6h	Tor
7A9	XC6207A402PR	LVR-IC	LDO, 4V±2%, 300mA, -CE, Shutdown	SOT-89-5	32cw VR4a	6h	Tor
7AA	XC6602A051PR-G	LVR-IC	LDO, 0.5V±15mV, 1A, +CE, soft start	SOT-89-5	32zl VR11	6h	Tor
7AA	XC6207A412PR	LVR-IC	LDO, 4.1V±2%, 300mA, -CE, Shutdown	SOT-89-5	32cw VR4a	6h	Tor
7AB	XC6207A122PR	LVR-IC	LDO, 1.2V±2%, 300mA, -CE, Shutdown	SOT-89-5	32cw VR4a	6h	Tor
7AB	XC6602A061PR-G	LVR-IC	LDO, 0.6V±15mV, 1A, +CE, soft start	SOT-89-5	32zl VR11	6h	Tor
7AB	XC6207A422PR	LVR-IC	LDO, 4.2V±2%, 300mA, -CE, Shutdown	SOT-89-5	32cw VR4a	6h	Tor
7AC	XC6207A132PR	LVR-IC	LDO, 1.3V±2%, 300mA, -CE, Shutdown	SOT-89-5	32cw VR4a	6h	Tor
7AC	XC6602A071PR-G	LVR-IC	LDO, 0.7V±15mV, 1A, +CE, soft start	SOT-89-5	32zl VR11	6h	Tor
7AC	XC6207A432PR	LVR-IC	LDO, 4.3V±2%, 300mA, -CE, Shutdown	SOT-89-5	32cw VR4a	6h	Tor



SMD code	Type	Function	Short description	Case	Pinout Sch.	St.	Mnf.
7AD	XC6207A142PR	LVR-IC	LDO, 1.4V±2%, 300mA, -CE, Shutdown	SOT-89-5	32cw	VR4a	6h Tor
7AD	XC6602A081PR-G	LVR-IC	LDO, 0.8V±15mV, 1A, +CE, soft start	SOT-89-5	32zl	VR11	6n Tor
7AD	XC6207A442PR	LVR-IC	LDO, 4.4V±2%, 300mA, -CE, Shutdown	SOT-89-5	32cw	VR4a	6h Tor
7AE	XC6207A152PR	LVR-IC	LDO, 1.5V±2%, 300mA, -CE, Shutdown	SOT-89-5	32cw	VR4a	6h Tor
7AE	XC6602A091PR-G	LVR-IC	LDO, 0.9V±15mV, 1A, +CE, soft start	SOT-89-5	32zl	VR11	6n Tor
7AE	XC6207A452PR	LVR-IC	LDO, 4.5V±2%, 300mA, -CE, Shutdown	SOT-89-5	32cw	VR4a	6h Tor
7AF	XC6207A162PR	LVR-IC	LDO, 1.6V±2%, 300mA, -CE, Shutdown	SOT-89-5	32cw	VR4a	6h Tor
7AF	XC6602A101PR-G	LVR-IC	LDO, 1.0V±15mV, 1A, +CE, soft start	SOT-89-5	32zl	VR11	6n Tor
7AF	XC6207A462PR	LVR-IC	LDO, 4.6V±2%, 300mA, -CE, Shutdown	SOT-89-5	32cw	VR4a	6h Tor
7AH	XC6207A172PR	LVR-IC	LDO, 1.7V±2%, 300mA, -CE, Shutdown	SOT-89-5	32cw	VR4a	6h Tor
7AH	XC6602A111PR-G	LVR-IC	LDO, 1.1V±15mV, 1A, +CE, soft start	SOT-89-5	32zl	VR11	6n Tor
7AH	XC6207A472PR	LVR-IC	LDO, 4.7V±2%, 300mA, -CE, Shutdown	SOT-89-5	32cw	VR4a	6h Tor
7AK	XC6207A182PR	LVR-IC	LDO, 1.8V±2%, 300mA, -CE, Shutdown	SOT-89-5	32cw	VR4a	6h Tor
7AK	XC6602A121PR-G	LVR-IC	LDO, 1.2V±20mV, 1A, +CE, soft start	SOT-89-5	32zl	VR11	6n Tor
7AK	XC6207A482PR	LVR-IC	LDO, 4.8V±2%, 300mA, -CE, Shutdown	SOT-89-5	32cw	VR4a	6h Tor
7AL	XC6207A192PR	LVR-IC	LDO, 1.9V±2%, 300mA, -CE, Shutdown	SOT-89-5	32cw	VR4a	6h Tor
7AL	XC6602A131PR-G	LVR-IC	LDO, 1.3V±20mV, 1A, +CE, soft start	SOT-89-5	32zl	VR11	6n Tor
7AL	XC6207A492PR	LVR-IC	LDO, 4.9V±2%, 300mA, -CE, Shutdown	SOT-89-5	32cw	VR4a	6h Tor
7AM	XC6207A202PR	LVR-IC	LDO, 2V±2%, 300mA, -CE, Shutdown	SOT-89-5	32cw	VR4a	6h Tor
7AM	XC6602A141PR-G	LVR-IC	LDO, 1.4V±20mV, 1A, +CE, soft start	SOT-89-5	32zl	VR11	6n Tor
7AM	XC6207A502PR	LVR-IC	LDO, 5.0V±2%, 300mA, -CE, Shutdown	SOT-89-5	32cw	VR4a	6h Tor
7AN	XC6207A212PR	LVR-IC	LDO, 2.1V±2%, 300mA, -CE, Shutdown	SOT-89-5	32cw	VR4a	6h Tor
7AN	XC6602A151PR-G	LVR-IC	LDO, 1.5V±20mV, 1A, +CE, soft start	SOT-89-5	32zl	VR11	6n Tor
7AP	XC6207A222PR	LVR-IC	LDO, 2.2V±2%, 300mA, -CE, Shutdown	SOT-89-5	32cw	VR4a	6h Tor
7AP	XC6602A161PR-G	LVR-IC	LDO, 1.6V±20mV, 1A, +CE, soft start	SOT-89-5	32zl	VR11	6n Tor
7AR	XC6207A232PR	LVR-IC	LDO, 2.3V±2%, 300mA, -CE, Shutdown	SOT-89-5	32cw	VR4a	6h Tor
7AR	XC6602A171PR-G	LVR-IC	LDO, 1.7V±20mV, 1A, +CE, soft start	SOT-89-5	32zl	VR11	6n Tor
7AS	XC6207A242PR	LVR-IC	LDO, 2.4V±2%, 300mA, -CE, Shutdown	SOT-89-5	32cw	VR4a	6h Tor
7AS	XC6602A181PR-G	LVR-IC	LDO, 1.8V±20mV, 1A, +CE, soft start	SOT-89-5	32zl	VR11	6n Tor
7AT	XC6207A252PR	LVR-IC	LDO, 2.5V±2%, 300mA, -CE, Shutdown	SOT-89-5	32cw	VR4a	6h Tor
7AU	XC6207A262PR	LVR-IC	LDO, 2.6V±2%, 300mA, -CE, Shutdown	SOT-89-5	32cw	VR4a	6h Tor
7AV	XC6207A272PR	LVR-IC	LDO, 2.7V±2%, 300mA, -CE, Shutdown	SOT-89-5	32cw	VR4a	6h Tor
7AX	XC6207A282PR	LVR-IC	LDO, 2.8V±2%, 300mA, -CE, Shutdown	SOT-89-5	32cw	VR4a	6h Tor
7AY	XC6207A292PR	LVR-IC	LDO, 2.9V±2%, 300mA, -CE, Shutdown	SOT-89-5	32cw	VR4a	6h Tor
7AZ	XC6207A302PR	LVR-IC	LDO, 3V±2%, 300mA, -CE, Shutdown	SOT-89-5	32cw	VR4a	6h Tor
7B0	XC6207B312PR	LVR-IC	LDO, 3.1V±2%, 300mA, -CE, CL, Shutdown	SOT-89-5	32cw	VR4a	6h Tor
7B1	XC6207B322PR	LVR-IC	LDO, 3.2V±2%, 300mA, -CE, CL, Shutdown	SOT-89-5	32cw	VR4a	6h Tor
7B2	XC6207B332PR	LVR-IC	LDO, 3.3V±2%, 300mA, -CE, CL, Shutdown	SOT-89-5	32cw	VR4a	6h Tor
7B3	XC6207B342PR	LVR-IC	LDO, 3.4V±2%, 300mA, -CE, CL, Shutdown	SOT-89-5	32cw	VR4a	6h Tor
7B4	XC6207B352PR	LVR-IC	LDO, 3.5V±2%, 300mA, -CE, CL, Shutdown	SOT-89-5	32cw	VR4a	6h Tor
7B5	XC6207B362PR	LVR-IC	LDO, 3.6V±2%, 300mA, -CE, CL, Shutdown	SOT-89-5	32cw	VR4a	6h Tor
7B6	XC6207B372PR	LVR-IC	LDO, 3.7V±2%, 300mA, -CE, CL, Shutdown	SOT-89-5	32cw	VR4a	6h Tor
7B7	XC6207B382PR	LVR-IC	LDO, 3.8V±2%, 300mA, -CE, CL, Shutdown	SOT-89-5	32cw	VR4a	6h Tor
7B8	XC6207B392PR	LVR-IC	LDO, 3.9V±2%, 300mA, -CE, CL, Shutdown	SOT-89-5	32cw	VR4a	6h Tor
7B9	XC6207B402PR	LVR-IC	LDO, 4V±2%, 300mA, -CE, CL, Shutdown	SOT-89-5	32cw	VR4a	6h Tor
7BA	XC6602B051PR-G	LVR-IC	LDO, 0.5V±15mV, 1A, +CE	SOT-89-5	32zl	VR11	6n Tor
7BA	XC6207B412PR	LVR-IC	LDO, 4.1V±2%, 300mA, -CE, CL, Shutdown	SOT-89-5	32cw	VR4a	6h Tor
7BB	XC6207B122PR	LVR-IC	LDO, 1.2V±2%, 300mA, -CE, CL, Shutdown	SOT-89-5	32cw	VR4a	6h Tor
7BB	XC6602B061PR-G	LVR-IC	LDO, 0.6V±15mV, 1A, +CE	SOT-89-5	32zl	VR11	6n Tor
7BB	XC6207B422PR	LVR-IC	LDO, 4.2V±2%, 300mA, -CE, CL, Shutdown	SOT-89-5	32cw	VR4a	6h Tor
7BC	XC6207B132PR	LVR-IC	LDO, 1.3V±2%, 300mA, -CE, CL, Shutdown	SOT-89-5	32cw	VR4a	6h Tor
7BC	XC6602B071PR-G	LVR-IC	LDO, 0.7V±15mV, 1A, +CE	SOT-89-5	32zl	VR11	6n Tor
7BC	XC6207B432PR	LVR-IC	LDO, 4.3V±2%, 300mA, -CE, CL, Shutdown	SOT-89-5	32cw	VR4a	6h Tor
7BD	XC6207B142PR	LVR-IC	LDO, 1.4V±2%, 300mA, -CE, CL, Shutdown	SOT-89-5	32cw	VR4a	6h Tor
7BD	XC6602B081PR-G	LVR-IC	LDO, 0.8V±15mV, 1A, +CE	SOT-89-5	32zl	VR11	6n Tor
7BD	XC6207B442PR	LVR-IC	LDO, 4.4V±2%, 300mA, -CE, CL, Shutdown	SOT-89-5	32cw	VR4a	6h Tor
7BE	XC6207B152PR	LVR-IC	LDO, 1.5V±2%, 300mA, -CE, CL, Shutdown	SOT-89-5	32cw	VR4a	6h Tor
7BE	XC6602B091PR-G	LVR-IC	LDO, 0.9V±15mV, 1A, +CE	SOT-89-5	32zl	VR11	6n Tor
7BE	XC6207B452PR	LVR-IC	LDO, 4.5V±2%, 300mA, -CE, CL, Shutdown	SOT-89-5	32cw	VR4a	6h Tor
7BF	XC6207B162PR	LVR-IC	LDO, 1.6V±2%, 300mA, -CE, CL, Shutdown	SOT-89-5	32cw	VR4a	6h Tor
7BF	XC6602B101PR-G	LVR-IC	LDO, 1.0V±15mV, 1A, +CE	SOT-89-5	32zl	VR11	6n Tor
7BF	XC6207B462PR	LVR-IC	LDO, 4.6V±2%, 300mA, -CE, CL, Shutdown	SOT-89-5	32cw	VR4a	6h Tor
7BH	XC6207B172PR	LVR-IC	LDO, 1.7V±2%, 300mA, -CE, CL, Shutdown	SOT-89-5	32cw	VR4a	6h Tor
7BH	XC6602B111PR-G	LVR-IC	LDO, 1.1V±15mV, 1A, +CE	SOT-89-5	32zl	VR11	6n Tor
7BH	XC6207B472PR	LVR-IC	LDO, 4.7V±2%, 300mA, -CE, CL, Shutdown	SOT-89-5	32cw	VR4a	6h Tor
7BK	XC6207B182PR	LVR-IC	LDO, 1.8V±2%, 300mA, -CE, CL, Shutdown	SOT-89-5	32cw	VR4a	6h Tor
7BK	XC6602B121PR-G	LVR-IC	LDO, 1.2V±20mV, 1A, +CE	SOT-89-5	32zl	VR11	6n Tor
7BK	XC6207B482PR	LVR-IC	LDO, 4.8V±2%, 300mA, -CE, CL, Shutdown	SOT-89-5	32cw	VR4a	6h Tor
7BL	XC6207B192PR	LVR-IC	LDO, 1.9V±2%, 300mA, -CE, CL, Shutdown	SOT-89-5	32cw	VR4a	6h Tor
7BL	XC6602B131PR-G	LVR-IC	LDO, 1.3V±20mV, 1A, +CE	SOT-89-5	32zl	VR11	6n Tor



SMD code	Type	Function	Short description	Case	Pinout Sch.	St.	Mnf.
7BL	XC6207B492PR	LVR-IC	LDO, 4.9V±2%, 300mA, -CE, CL, Shutdown	SOT-89-5	32cw VR4a	6h	Tor
7BM	XC6207B202PR	LVR-IC	LDO, 2V±2%, 300mA, -CE, CL, Shutdown	SOT-89-5	32cw VR4a	6h	Tor
7BM	XC6602B141PR-G	LVR-IC	LDO, 1.4V±20mV, 1A, +CE	SOT-89-5	32zl VR11	6n	Tor
7BM	XC6207B502PR	LVR-IC	LDO, 5.0V±2%, 300mA, -CE, CL, Shutdown	SOT-89-5	32cw VR4a	6h	Tor
7BN	XC6207B212PR	LVR-IC	LDO, 2.1V±2%, 300mA, -CE, CL, Shutdown	SOT-89-5	32cw VR4a	6h	Tor
7BN	XC6602B151PR-G	LVR-IC	LDO, 1.5V±20mV, 1A, +CE	SOT-89-5	32zl VR11	6n	Tor
7BP	XC6207B222PR	LVR-IC	LDO, 2.2V±2%, 300mA, -CE, CL, Shutdown	SOT-89-5	32cw VR4a	6h	Tor
7BP	XC6602B161PR-G	LVR-IC	LDO, 1.6V±20mV, 1A, +CE	SOT-89-5	32zl VR11	6n	Tor
7BR	XC6207B232PR	LVR-IC	LDO, 2.3V±2%, 300mA, -CE, CL, Shutdown	SOT-89-5	32cw VR4a	6h	Tor
7BR	XC6602B171PR-G	LVR-IC	LDO, 1.7V±20mV, 1A, +CE	SOT-89-5	32zl VR11	6n	Tor
7BS	XC6207B242PR	LVR-IC	LDO, 2.4V±2%, 300mA, -CE, CL, Shutdown	SOT-89-5	32cw VR4a	6h	Tor
7BS	XC6602B181PR-G	LVR-IC	LDO, 1.8V±20mV, 1A, +CE	SOT-89-5	32zl VR11	6n	Tor
7BT	XC6207B252PR	LVR-IC	LDO, 2.5V±2%, 300mA, -CE, CL, Shutdown	SOT-89-5	32cw VR4a	6h	Tor
7BU	XC6207B262PR	LVR-IC	LDO, 2.6V±2%, 300mA, -CE, CL, Shutdown	SOT-89-5	32cw VR4a	6h	Tor
7BV	XC6207B272PR	LVR-IC	LDO, 2.7V±2%, 300mA, -CE, CL, Shutdown	SOT-89-5	32cw VR4a	6h	Tor
7BX	XC6207B282PR	LVR-IC	LDO, 2.8V±2%, 300mA, -CE, CL, Shutdown	SOT-89-5	32cw VR4a	6h	Tor
7BY	XC6207B292PR	LVR-IC	LDO, 2.9V±2%, 300mA, -CE, CL, Shutdown	SOT-89-5	32cw VR4a	6h	Tor
7BZ	XC6207B302PR	LVR-IC	LDO, 3V±2%, 300mA, -CE, CL, Shutdown	SOT-89-5	32cw VR4a	6h	Tor
7N0	XC6207A31APR	LVR-IC	LDO, 3.15V±2%, 300mA, -CE, Shutdown	SOT-89-5	32cw VR4a	6h	Tor
7N1	XC6207A32APR	LVR-IC	LDO, 3.25V±2%, 300mA, -CE, Shutdown	SOT-89-5	32cw VR4a	6h	Tor
7N2	XC6207A33APR	LVR-IC	LDO, 3.35V±2%, 300mA, -CE, Shutdown	SOT-89-5	32cw VR4a	6h	Tor
7N3	XC6207A34APR	LVR-IC	LDO, 3.45V±2%, 300mA, -CE, Shutdown	SOT-89-5	32cw VR4a	6h	Tor
7N4	XC6207A35APR	LVR-IC	LDO, 3.55V±2%, 300mA, -CE, Shutdown	SOT-89-5	32cw VR4a	6h	Tor
7N5	XC6207A36APR	LVR-IC	LDO, 3.65V±2%, 300mA, -CE, Shutdown	SOT-89-5	32cw VR4a	6h	Tor
7N6	XC6207A37APR	LVR-IC	LDO, 3.75V±2%, 300mA, -CE, Shutdown	SOT-89-5	32cw VR4a	6h	Tor
7N7	XC6207A38APR	LVR-IC	LDO, 3.85V±2%, 300mA, -CE, Shutdown	SOT-89-5	32cw VR4a	6h	Tor
7N8	XC6207A39APR	LVR-IC	LDO, 3.95V±2%, 300mA, -CE, Shutdown	SOT-89-5	32cw VR4a	6h	Tor
7N9	XC6207A40APR	LVR-IC	LDO, 4.05V±2%, 300mA, -CE, Shutdown	SOT-89-5	32cw VR4a	6h	Tor
7NA	XC6207A41APR	LVR-IC	LDO, 4.15V±2%, 300mA, -CE, Shutdown	SOT-89-5	32cw VR4a	6h	Tor
7NB	XC6207A42APR	LVR-IC	LDO, 4.25V±2%, 300mA, -CE, Shutdown	SOT-89-5	32cw VR4a	6h	Tor
7NC	XC6207A43APR	LVR-IC	LDO, 4.35V±2%, 300mA, -CE, Shutdown	SOT-89-5	32cw VR4a	6h	Tor
7NC	XC6207A43APR	LVR-IC	LDO, 4.35V±2%, 300mA, -CE, Shutdown	SOT-89-5	32cw VR4a	6h	Tor
7ND	XC6207A44A2PR	LVR-IC	LDO, 4.45V±2%, 300mA, -CE, Shutdown	SOT-89-5	32cw VR4a	6h	Tor
7NE	XC6207A45APR	LVR-IC	LDO, 4.55V±2%, 300mA, -CE, Shutdown	SOT-89-5	32cw VR4a	6h	Tor
7NE	XC6207A45APR	LVR-IC	LDO, 4.55V±2%, 300mA, -CE, Shutdown	SOT-89-5	32cw VR4a	6h	Tor
7NF	XC6207A46APR	LVR-IC	LDO, 4.65V±2%, 300mA, -CE, Shutdown	SOT-89-5	32cw VR4a	6h	Tor
7NE	XC6207A46APR	LVR-IC	LDO, 4.65V±2%, 300mA, -CE, Shutdown	SOT-89-5	32cw VR4a	6h	Tor
7NH	XC6207A47APR	LVR-IC	LDO, 4.75V±2%, 300mA, -CE, Shutdown	SOT-89-5	32cw VR4a	6h	Tor
7NH	XC6207A47APR	LVR-IC	LDO, 4.75V±2%, 300mA, -CE, Shutdown	SOT-89-5	32cw VR4a	6h	Tor
7NK	XC6207A48APR	LVR-IC	LDO, 4.85V±2%, 300mA, -CE, Shutdown	SOT-89-5	32cw VR4a	6h	Tor
7NK	XC6207A48APR	LVR-IC	LDO, 4.85V±2%, 300mA, -CE, Shutdown	SOT-89-5	32cw VR4a	6h	Tor
7NL	XC6207A49APR	LVR-IC	LDO, 4.95V±2%, 300mA, -CE, Shutdown	SOT-89-5	32cw VR4a	6h	Tor
7NL	XC6207A49APR	LVR-IC	LDO, 4.95V±2%, 300mA, -CE, Shutdown	SOT-89-5	32cw VR4a	6h	Tor
7NM	XC6207A20APR	LVR-IC	LDO, 2.05V±2%, 300mA, -CE, Shutdown	SOT-89-5	32cw VR4a	6h	Tor
7NN	XC6207A21APR	LVR-IC	LDO, 2.15V±2%, 300mA, -CE, Shutdown	SOT-89-5	32cw VR4a	6h	Tor
7NP	XC6207A22APR	LVR-IC	LDO, 2.25V±2%, 300mA, -CE, Shutdown	SOT-89-5	32cw VR4a	6h	Tor
7NR	XC6207A23APR	LVR-IC	LDO, 2.35V±2%, 300mA, -CE, Shutdown	SOT-89-5	32cw VR4a	6h	Tor
7NS	XC6207A24APR	LVR-IC	LDO, 2.45V±2%, 300mA, -CE, Shutdown	SOT-89-5	32cw VR4a	6h	Tor
7NT	XC6207A25APR	LVR-IC	LDO, 2.55V±2%, 300mA, -CE, Shutdown	SOT-89-5	32cw VR4a	6h	Tor
7NU	XC6207A26APR	LVR-IC	LDO, 2.65V±2%, 300mA, -CE, Shutdown	SOT-89-5	32cw VR4a	6h	Tor
7NV	XC6207A27APR	LVR-IC	LDO, 2.75V±2%, 300mA, -CE, Shutdown	SOT-89-5	32cw VR4a	6h	Tor
7NX	XC6207A28APR	LVR-IC	LDO, 2.85V±2%, 300mA, -CE, Shutdown	SOT-89-5	32cw VR4a	6h	Tor
7NY	XC6207A29APR	LVR-IC	LDO, 2.95V±2%, 300mA, -CE, Shutdown	SOT-89-5	32cw VR4a	6h	Tor
7NZ	XC6207A30APR	LVR-IC	LDO, 3.05V±2%, 300mA, -CE, Shutdown	SOT-89-5	32cw VR4a	6h	Tor
7P0	XC6207B31APR	LVR-IC	LDO, 3.15V±2%, 300mA, -CE, CL, Shutdown	SOT-89-5	32cw VR4a	6h	Tor
7P1	XC6207B32APR	LVR-IC	LDO, 3.25V±2%, 300mA, -CE, CL, Shutdown	SOT-89-5	32cw VR4a	6h	Tor
7P2	XC6207B33APR	LVR-IC	LDO, 3.35V±2%, 300mA, -CE, CL, Shutdown	SOT-89-5	32cw VR4a	6h	Tor
7P3	XC6207B34APR	LVR-IC	LDO, 3.45V±2%, 300mA, -CE, CL, Shutdown	SOT-89-5	32cw VR4a	6h	Tor
7P4	XC6207B35APR	LVR-IC	LDO, 3.55V±2%, 300mA, -CE, CL, Shutdown	SOT-89-5	32cw VR4a	6h	Tor
7P5	XC6207B36APR	LVR-IC	LDO, 3.65V±2%, 300mA, -CE, CL, Shutdown	SOT-89-5	32cw VR4a	6h	Tor
7P6	XC6207B37APR	LVR-IC	LDO, 3.75V±2%, 300mA, -CE, CL, Shutdown	SOT-89-5	32cw VR4a	6h	Tor
7P7	XC6207B38APR	LVR-IC	LDO, 3.85V±2%, 300mA, -CE, CL, Shutdown	SOT-89-5	32cw VR4a	6h	Tor
7P8	XC6207B39APR	LVR-IC	LDO, 3.95V±2%, 300mA, -CE, CL, Shutdown	SOT-89-5	32cw VR4a	6h	Tor
7P9	XC6207B40APR	LVR-IC	LDO, 4.05V±2%, 300mA, -CE, CL, Shutdown	SOT-89-5	32cw VR4a	6h	Tor
7PA	XC6207B41APR	LVR-IC	LDO, 4.15V±2%, 300mA, -CE, CL, Shutdown	SOT-89-5	32cw VR4a	6h	Tor
7PB	XC6207B12APR	LVR-IC	LDO, 1.25V±2%, 300mA, -CE, CL, Shutdown	SOT-89-5	32cw VR4a	6h	Tor
7PB	XC6207B42APR	LVR-IC	LDO, 4.25V±2%, 300mA, -CE, CL, Shutdown	SOT-89-5	32cw VR4a	6h	Tor
7PC	XC6207B13APR	LVR-IC	LDO, 1.35V±2%, 300mA, -CE, CL, Shutdown	SOT-89-5	32cw VR4a	6h	Tor



SMD code	Type	Function	Short description	Case	Pinout Sch.	St.	Mnf.
7PC	XC6207B43APR	LVR-IC	LDO, 4.35V±2%, 300mA, -CE, CL, Shutdown	SOT-89-5	32cw VR4a	6h	Tor
7PD	XC6207B14APR	LVR-IC	LDO, 1.45V±2%, 300mA, -CE, CL, Shutdown	SOT-89-5	32cw VR4a	6h	Tor
7PD	XC6207B44APR	LVR-IC	LDO, 4.45V±2%, 300mA, -CE, CL, Shutdown	SOT-89-5	32cw VR4a	6h	Tor
7PE	XC6207B15APR	LVR-IC	LDO, 1.55V±2%, 300mA, -CE, CL, Shutdown	SOT-89-5	32cw VR4a	6h	Tor
7PE	XC6207B45APR	LVR-IC	LDO, 4.55V±2%, 300mA, -CE, CL, Shutdown	SOT-89-5	32cw VR4a	6h	Tor
7PF	XC6207B16APR	LVR-IC	LDO, 1.65V±2%, 300mA, -CE, CL, Shutdown	SOT-89-5	32cw VR4a	6h	Tor
7PE	XC6207B46APR	LVR-IC	LDO, 4.65V±2%, 300mA, -CE, CL, Shutdown	SOT-89-5	32cw VR4a	6h	Tor
7PH	XC6207B17APR	LVR-IC	LDO, 1.75V±2%, 300mA, -CE, CL, Shutdown	SOT-89-5	32cw VR4a	6h	Tor
7PH	XC6207B47APR	LVR-IC	LDO, 4.75V±2%, 300mA, -CE, CL, Shutdown	SOT-89-5	32cw VR4a	6h	Tor
7PK	XC6207B18APR	LVR-IC	LDO, 1.85V±2%, 300mA, -CE, CL, Shutdown	SOT-89-5	32cw VR4a	6h	Tor
7PK	XC6207B48APR	LVR-IC	LDO, 4.85V±2%, 300mA, -CE, CL, Shutdown	SOT-89-5	32cw VR4a	6h	Tor
7PL	XC6207B19APR	LVR-IC	LDO, 1.95V±2%, 300mA, -CE, CL, Shutdown	SOT-89-5	32cw VR4a	6h	Tor
7PL	XC6207B49APR	LVR-IC	LDO, 4.95V±2%, 300mA, -CE, CL, Shutdown	SOT-89-5	32cw VR4a	6h	Tor
7PM	XC6207B20APR	LVR-IC	LDO, 2.05V±2%, 300mA, -CE, CL, Shutdown	SOT-89-5	32cw VR4a	6h	Tor
7PN	XC6207B21APR	LVR-IC	LDO, 2.15V±2%, 300mA, -CE, CL, Shutdown	SOT-89-5	32cw VR4a	6h	Tor
7PP	XC6207B22APR	LVR-IC	LDO, 2.25V±2%, 300mA, -CE, CL, Shutdown	SOT-89-5	32cw VR4a	6h	Tor
7PR	XC6207B23APR	LVR-IC	LDO, 2.35V±2%, 300mA, -CE, CL, Shutdown	SOT-89-5	32cw VR4a	6h	Tor
7PS	XC6207B24APR	LVR-IC	LDO, 2.45V±2%, 300mA, -CE, CL, Shutdown	SOT-89-5	32cw VR4a	6h	Tor
7PT	XC6207B25APR	LVR-IC	LDO, 2.55V±2%, 300mA, -CE, CL, Shutdown	SOT-89-5	32cw VR4a	6h	Tor
7PU	XC6207B26APR	LVR-IC	LDO, 2.65V±2%, 300mA, -CE, CL, Shutdown	SOT-89-5	32cw VR4a	6h	Tor
7PV	XC6207B27APR	LVR-IC	LDO, 2.75V±2%, 300mA, -CE, CL, Shutdown	SOT-89-5	32cw VR4a	6h	Tor
7PX	XC6207B28APR	LVR-IC	LDO, 2.85V±2%, 300mA, -CE, CL, Shutdown	SOT-89-5	32cw VR4a	6h	Tor
7PY	XC6207B29APR	LVR-IC	LDO, 2.95V±2%, 300mA, -CE, CL, Shutdown	SOT-89-5	32cw VR4a	6h	Tor
7PZ	XC6207B30APR	LVR-IC	LDO, 3.05V±2%, 300mA, -CE, CL, Shutdown	SOT-89-5	32cw VR4a	6h	Tor
80P	TK11280BU	LVR-IC	LDO, 8V±2%, 150mA, +CE	SOT-89-5	32vg VR7	6i	Tok
80Q	TK11380BU	LVR-IC	LDO, 8V±2%, 150mA, -CE	SOT-89-5	32vg VR7	6i	Tok
81K	XC6701B18PR	LVR-IC	1.8V±2%, 150mA, +CE	SOT-89-5	32vrq VR4	6n	Tor
81L	XC6701B19PR	LVR-IC	1.9V±2%, 150mA, +CE	SOT-89-5	32vrq VR4	6n	Tor
81M	XC6701B20PR	LVR-IC	2.0V±2%, 150mA, +CE	SOT-89-5	32vrq VR4	6n	Tor
81N	XC6701B21PR	LVR-IC	2.1V±2%, 150mA, +CE	SOT-89-5	32vrq VR4	6n	Tor
81P	XC6701B22PR	LVR-IC	2.2V±2%, 150mA, +CE	SOT-89-5	32vrq VR4	6n	Tor
81R	XC6701B23PR	LVR-IC	2.3V±2%, 150mA, +CE	SOT-89-5	32vrq VR4	6n	Tor
81S	XC6701B24PR	LVR-IC	2.4V±2%, 150mA, +CE	SOT-89-5	32vrq VR4	6n	Tor
81T	XC6701B25PR	LVR-IC	2.5V±2%, 150mA, +CE	SOT-89-5	32vrq VR4	6n	Tor
81U	XC6701B26PR	LVR-IC	2.6V±2%, 150mA, +CE	SOT-89-5	32vrq VR4	6n	Tor
81V	XC6701B27PR	LVR-IC	2.7V±2%, 150mA, +CE	SOT-89-5	32vrq VR4	6n	Tor
81X	XC6701B28PR	LVR-IC	2.8V±2%, 150mA, +CE	SOT-89-5	32vrq VR4	6n	Tor
81Y	XC6701B29PR	LVR-IC	2.9V±2%, 150mA, +CE	SOT-89-5	32vrq VR4	6n	Tor
81Z	XC6701B30PR	LVR-IC	3.0V±2%, 150mA, +CE	SOT-89-5	32vrq VR4	6n	Tor
820	XC6701B31PR	LVR-IC	3.1V±2%, 150mA, +CE	SOT-89-5	32vrq VR4	6n	Tor
821	XC6701B32PR	LVR-IC	3.2V±2%, 150mA, +CE	SOT-89-5	32vrq VR4	6n	Tor
822	XC6701B33PR	LVR-IC	3.3V±2%, 150mA, +CE	SOT-89-5	32vrq VR4	6n	Tor
823	XC6701B34PR	LVR-IC	3.4V±2%, 150mA, +CE	SOT-89-5	32vrq VR4	6n	Tor
824	XC6701B35PR	LVR-IC	3.5V±2%, 150mA, +CE	SOT-89-5	32vrq VR4	6n	Tor
825	XC6701B36PR	LVR-IC	3.6V±2%, 150mA, +CE	SOT-89-5	32vrq VR4	6n	Tor
826	XC6701B37PR	LVR-IC	3.7V±2%, 150mA, +CE	SOT-89-5	32vrq VR4	6n	Tor
827	XC6701B38PR	LVR-IC	3.8V±2%, 150mA, +CE	SOT-89-5	32vrq VR4	6n	Tor
828	XC6701B39PR	LVR-IC	3.9V±2%, 150mA, +CE	SOT-89-5	32vrq VR4	6n	Tor
829	XC6701B40PR	LVR-IC	4.0V±2%, 150mA, +CE	SOT-89-5	32vrq VR4	6n	Tor
82A	XC6701B41PR	LVR-IC	4.1V±2%, 150mA, +CE	SOT-89-5	32vrq VR4	6n	Tor
82B	XC6701B42PR	LVR-IC	4.2V±2%, 150mA, +CE	SOT-89-5	32vrq VR4	6n	Tor
82C	XC6701B43PR	LVR-IC	4.3V±2%, 150mA, +CE	SOT-89-5	32vrq VR4	6n	Tor
82D	XC6701B44PR	LVR-IC	4.4V±2%, 150mA, +CE	SOT-89-5	32vrq VR4	6n	Tor
82E	XC6701B45PR	LVR-IC	4.5V±2%, 150mA, +CE	SOT-89-5	32vrq VR4	6n	Tor
82F	XC6701B46PR	LVR-IC	4.6V±2%, 150mA, +CE	SOT-89-5	32vrq VR4	6n	Tor
82H	XC6701B47PR	LVR-IC	4.7V±2%, 150mA, +CE	SOT-89-5	32vrq VR4	6n	Tor
82K	XC6701B48PR	LVR-IC	4.8V±2%, 150mA, +CE	SOT-89-5	32vrq VR4	6n	Tor
82L	XC6701B49PR	LVR-IC	4.9V±2%, 150mA, +CE	SOT-89-5	32vrq VR4	6n	Tor
82M	XC6701B50PR	LVR-IC	5.0V±2%, 150mA, +CE	SOT-89-5	32vrq VR4	6n	Tor
82N	XC6701B51PR	LVR-IC	5.1V±2%, 150mA, +CE	SOT-89-5	32vrq VR4	6n	Tor
82P	XC6701B52PR	LVR-IC	5.2V±2%, 150mA, +CE	SOT-89-5	32vrq VR4	6n	Tor
82R	XC6701B53PR	LVR-IC	5.3V±2%, 150mA, +CE	SOT-89-5	32vrq VR4	6n	Tor
82S	XC6701B54PR	LVR-IC	5.4V±2%, 150mA, +CE	SOT-89-5	32vrq VR4	6n	Tor
82T	XC6701B55PR	LVR-IC	5.5V±2%, 150mA, +CE	SOT-89-5	32vrq VR4	6n	Tor
82U	XC6701B56PR	LVR-IC	5.6V±2%, 150mA, +CE	SOT-89-5	32vrq VR4	6n	Tor
82V	XC6701B57PR	LVR-IC	5.7V±2%, 150mA, +CE	SOT-89-5	32vrq VR4	6n	Tor
82X	XC6701B58PR	LVR-IC	5.8V±2%, 150mA, +CE	SOT-89-5	32vrq VR4	6n	Tor
82Y	XC6701B59PR	LVR-IC	5.9V±2%, 150mA, +CE	SOT-89-5	32vrq VR4	6n	Tor
82Z	XC6701B60PR	LVR-IC	6.0V±2%, 150mA, +CE	SOT-89-5	32vrq VR4	6n	Tor
830	XC6701B61PR	LVR-IC	6.1V±2%, 150mA, +CE	SOT-89-5	32vrq VR4	6n	Tor



SMD code	Type	Function	Short description	Case	Pinout Sch.	St.	Mnf.
831	XC6701B62PR	LVR-IC	6.2V±2%, 150mA, +CE	SOT-89-5	32vrq VR4	6n	Tor
832	XC6701B63PR	LVR-IC	6.3V±2%, 150mA, +CE	SOT-89-5	32vrq VR4	6n	Tor
833	XC6701B64PR	LVR-IC	6.4V±2%, 150mA, +CE	SOT-89-5	32vrq VR4	6n	Tor
834	XC6701B65PR	LVR-IC	6.5V±2%, 150mA, +CE	SOT-89-5	32vrq VR4	6n	Tor
835	XC6701B66PR	LVR-IC	6.6V±2%, 150mA, +CE	SOT-89-5	32vrq VR4	6n	Tor
836	XC6701B67PR	LVR-IC	6.7V±2%, 150mA, +CE	SOT-89-5	32vrq VR4	6n	Tor
837	XC6701B68PR	LVR-IC	6.8V±2%, 150mA, +CE	SOT-89-5	32vrq VR4	6n	Tor
838	XC6701B69PR	LVR-IC	6.9V±2%, 150mA, +CE	SOT-89-5	32vrq VR4	6n	Tor
839	XC6701B70PR	LVR-IC	7.0V±2%, 150mA, +CE	SOT-89-5	32vrq VR4	6n	Tor
83A	XC6701B71PR	LVR-IC	7.1V±2%, 150mA, +CE	SOT-89-5	32vrq VR4	6n	Tor
83B	XC6701B72PR	LVR-IC	7.2V±2%, 150mA, +CE	SOT-89-5	32vrq VR4	6n	Tor
83C	XC6701B73PR	LVR-IC	7.3V±2%, 150mA, +CE	SOT-89-5	32vrq VR4	6n	Tor
83D	XC6701B74PR	LVR-IC	7.4V±2%, 150mA, +CE	SOT-89-5	32vrq VR4	6n	Tor
83E	XC6701B75PR	LVR-IC	7.5V±2%, 150mA, +CE	SOT-89-5	32vrq VR4	6n	Tor
83F	XC6701B76PR	LVR-IC	7.6V±2%, 150mA, +CE	SOT-89-5	32vrq VR4	6n	Tor
83H	XC6701B77PR	LVR-IC	7.7V±2%, 150mA, +CE	SOT-89-5	32vrq VR4	6n	Tor
83K	XC6701B78PR	LVR-IC	7.8V±2%, 150mA, +CE	SOT-89-5	32vrq VR4	6n	Tor
83L	XC6701B79PR	LVR-IC	7.9V±2%, 150mA, +CE	SOT-89-5	32vrq VR4	6n	Tor
83M	XC6701B80PR	LVR-IC	8.0V±2%, 150mA, +CE	SOT-89-5	32vrq VR4	6n	Tor
83N	XC6701B81PR	LVR-IC	8.1V±2%, 150mA, +CE	SOT-89-5	32vrq VR4	6n	Tor
83P	XC6701B82PR	LVR-IC	8.2V±2%, 150mA, +CE	SOT-89-5	32vrq VR4	6n	Tor
83R	XC6701B83PR	LVR-IC	8.3V±2%, 150mA, +CE	SOT-89-5	32vrq VR4	6n	Tor
83S	XC6701B84PR	LVR-IC	8.4V±2%, 150mA, +CE	SOT-89-5	32vrq VR4	6n	Tor
83T	XC6701B85PR	LVR-IC	8.5V±2%, 150mA, +CE	SOT-89-5	32vrq VR4	6n	Tor
83U	XC6701B86PR	LVR-IC	8.6V±2%, 150mA, +CE	SOT-89-5	32vrq VR4	6n	Tor
83V	XC6701B87PR	LVR-IC	8.7V±2%, 150mA, +CE	SOT-89-5	32vrq VR4	6n	Tor
83X	XC6701B88PR	LVR-IC	8.8V±2%, 150mA, +CE	SOT-89-5	32vrq VR4	6n	Tor
83Y	XC6701B89PR	LVR-IC	8.9V±2%, 150mA, +CE	SOT-89-5	32vrq VR4	6n	Tor
83Z	XC6701B90PR	LVR-IC	9.0V±2%, 150mA, +CE	SOT-89-5	32vrq VR4	6n	Tor
840	XC6701B91PR	LVR-IC	9.1V±2%, 150mA, +CE	SOT-89-5	32vrq VR4	6n	Tor
841	XC6701B92PR	LVR-IC	9.2V±2%, 150mA, +CE	SOT-89-5	32vrq VR4	6n	Tor
842	XC6701B93PR	LVR-IC	9.3V±2%, 150mA, +CE	SOT-89-5	32vrq VR4	6n	Tor
843	XC6701B94PR	LVR-IC	9.4V±2%, 150mA, +CE	SOT-89-5	32vrq VR4	6n	Tor
844	XC6701B95PR	LVR-IC	9.5V±2%, 150mA, +CE	SOT-89-5	32vrq VR4	6n	Tor
845	XC6701B96PR	LVR-IC	9.6V±2%, 150mA, +CE	SOT-89-5	32vrq VR4	6n	Tor
846	XC6701B97PR	LVR-IC	9.7V±2%, 150mA, +CE	SOT-89-5	32vrq VR4	6n	Tor
847	XC6701B98PR	LVR-IC	9.8V±2%, 150mA, +CE	SOT-89-5	32vrq VR4	6n	Tor
848	XC6701B99PR	LVR-IC	9.9V±2%, 150mA, +CE	SOT-89-5	32vrq VR4	6n	Tor
849	XC6701BA0PR	LVR-IC	10.0V±2%, 150mA, +CE	SOT-89-5	32vrq VR4	6n	Tor
84A	XC6701BA1PR	LVR-IC	10.1V±2%, 150mA, +CE	SOT-89-5	32vrq VR4	6n	Tor
84B	XC6701BA2PR	LVR-IC	10.2V±2%, 150mA, +CE	SOT-89-5	32vrq VR4	6n	Tor
84C	XC6701BA3PR	LVR-IC	10.3V±2%, 150mA, +CE	SOT-89-5	32vrq VR4	6n	Tor
84D	XC6701BA4PR	LVR-IC	10.4V±2%, 150mA, +CE	SOT-89-5	32vrq VR4	6n	Tor
84E	XC6701BA5PR	LVR-IC	10.5V±2%, 150mA, +CE	SOT-89-5	32vrq VR4	6n	Tor
84F	XC6701BA6PR	LVR-IC	10.6V±2%, 150mA, +CE	SOT-89-5	32vrq VR4	6n	Tor
84H	XC6701BA7PR	LVR-IC	10.7V±2%, 150mA, +CE	SOT-89-5	32vrq VR4	6n	Tor
84K	XC6701BA8PR	LVR-IC	10.8V±2%, 150mA, +CE	SOT-89-5	32vrq VR4	6n	Tor
84L	XC6701BA9PR	LVR-IC	10.9V±2%, 150mA, +CE	SOT-89-5	32vrq VR4	6n	Tor
84M	XC6701BB0PR	LVR-IC	11.0V±2%, 150mA, +CE	SOT-89-5	32vrq VR4	6n	Tor
84N	XC6701BB1PR	LVR-IC	11.1V±2%, 150mA, +CE	SOT-89-5	32vrq VR4	6n	Tor
84P	XC6701BB2PR	LVR-IC	11.2V±2%, 150mA, +CE	SOT-89-5	32vrq VR4	6n	Tor
84R	XC6701BB3PR	LVR-IC	11.3V±2%, 150mA, +CE	SOT-89-5	32vrq VR4	6n	Tor
84S	XC6701BB4PR	LVR-IC	11.4V±2%, 150mA, +CE	SOT-89-5	32vrq VR4	6n	Tor
84T	XC6701BB5PR	LVR-IC	11.5V±2%, 150mA, +CE	SOT-89-5	32vrq VR4	6n	Tor
84U	XC6701BB6PR	LVR-IC	11.6V±2%, 150mA, +CE	SOT-89-5	32vrq VR4	6n	Tor
84V	XC6701BB7PR	LVR-IC	11.7V±2%, 150mA, +CE	SOT-89-5	32vrq VR4	6n	Tor
84X	XC6701BB8PR	LVR-IC	11.8V±2%, 150mA, +CE	SOT-89-5	32vrq VR4	6n	Tor
84Y	XC6701BB9PR	LVR-IC	11.9V±2%, 150mA, +CE	SOT-89-5	32vrq VR4	6n	Tor
84Z	XC6701BC0PR	LVR-IC	12.0V±2%, 150mA, +CE	SOT-89-5	32vrq VR4	6n	Tor
8A0	XC6701BC1PR	LVR-IC	12.1V±2%, 150mA, +CE	SOT-89-5	32vrq VR4	6n	Tor
8A1	XC6701BC2PR	LVR-IC	12.2V±2%, 150mA, +CE	SOT-89-5	32vrq VR4	6n	Tor
8A2	XC6701BC3PR	LVR-IC	12.3V±2%, 150mA, +CE	SOT-89-5	32vrq VR4	6n	Tor
8A3	XC6701BC4PR	LVR-IC	12.4V±2%, 150mA, +CE	SOT-89-5	32vrq VR4	6n	Tor
8A4	XC6701BC5PR	LVR-IC	12.5V±2%, 150mA, +CE	SOT-89-5	32vrq VR4	6n	Tor
8A5	XC6701BC6PR	LVR-IC	12.6V±2%, 150mA, +CE	SOT-89-5	32vrq VR4	6n	Tor
8A6	XC6701BC7PR	LVR-IC	12.7V±2%, 150mA, +CE	SOT-89-5	32vrq VR4	6n	Tor
8A7	XC6701BC8PR	LVR-IC	12.8V±2%, 150mA, +CE	SOT-89-5	32vrq VR4	6n	Tor
8A8	XC6701BC9PR	LVR-IC	12.9V±2%, 150mA, +CE	SOT-89-5	32vrq VR4	6n	Tor
8A9	XC6701BD0PR	LVR-IC	13.0V±2%, 150mA, +CE	SOT-89-5	32vrq VR4	6n	Tor
8AA	XC6701BD1PR	LVR-IC	13.1V±2%, 150mA, +CE	SOT-89-5	32vrq VR4	6n	Tor



SMD code	Type	Function	Short description	Case	Pinout Sch.	St.	Mnf.
8AB	XC6701BD2PR	LVR-IC	13.2V±2%, 150mA, +CE	SOT-89-5	32vrq VR4	6n	Tor
8AC	XC6701BD3PR	LVR-IC	13.3V±2%, 150mA, +CE	SOT-89-5	32vrq VR4	6n	Tor
8AD	XC6701BD4PR	LVR-IC	13.4V±2%, 150mA, +CE	SOT-89-5	32vrq VR4	6n	Tor
8AE	XC6701BD5PR	LVR-IC	13.5V±2%, 150mA, +CE	SOT-89-5	32vrq VR4	6n	Tor
8AF	XC6701BD6PR	LVR-IC	13.6V±2%, 150mA, +CE	SOT-89-5	32vrq VR4	6n	Tor
8AH	XC6701BD7PR	LVR-IC	13.7V±2%, 150mA, +CE	SOT-89-5	32vrq VR4	6n	Tor
8AK	XC6701BD8PR	LVR-IC	13.8V±2%, 150mA, +CE	SOT-89-5	32vrq VR4	6n	Tor
8AL	XC6701BD9PR	LVR-IC	13.9V±2%, 150mA, +CE	SOT-89-5	32vrq VR4	6n	Tor
8AM	XC6701BE0PR	LVR-IC	14.0V±2%, 150mA, +CE	SOT-89-5	32vrq VR4	6n	Tor
8AN	XC6701BE1PR	LVR-IC	14.1V±2%, 150mA, +CE	SOT-89-5	32vrq VR4	6n	Tor
8AP	XC6701BE2PR	LVR-IC	14.2V±2%, 150mA, +CE	SOT-89-5	32vrq VR4	6n	Tor
8AR	XC6701BE3PR	LVR-IC	14.3V±2%, 150mA, +CE	SOT-89-5	32vrq VR4	6n	Tor
8AS	XC6701BE4PR	LVR-IC	14.4V±2%, 150mA, +CE	SOT-89-5	32vrq VR4	6n	Tor
8AT	XC6701BE5PR	LVR-IC	14.5V±2%, 150mA, +CE	SOT-89-5	32vrq VR4	6n	Tor
8AU	XC6701BE6PR	LVR-IC	14.6V±2%, 150mA, +CE	SOT-89-5	32vrq VR4	6n	Tor
8AV	XC6701BE7PR	LVR-IC	14.7V±2%, 150mA, +CE	SOT-89-5	32vrq VR4	6n	Tor
8AX	XC6701BE8PR	LVR-IC	14.8V±2%, 150mA, +CE	SOT-89-5	32vrq VR4	6n	Tor
8AY	XC6701BE9PR	LVR-IC	14.9V±2%, 150mA, +CE	SOT-89-5	32vrq VR4	6n	Tor
8AZ	XC6701BF0PR	LVR-IC	15.0V±2%, 150mA, +CE	SOT-89-5	32vrq VR4	6n	Tor
8B0	XC6701BF1PR	LVR-IC	15.1V±2%, 150mA, +CE	SOT-89-5	32vrq VR4	6n	Tor
8B1	XC6701BF2PR	LVR-IC	15.2V±2%, 150mA, +CE	SOT-89-5	32vrq VR4	6n	Tor
8B2	XC6701BF3PR	LVR-IC	15.3V±2%, 150mA, +CE	SOT-89-5	32vrq VR4	6n	Tor
8B3	XC6701BF4PR	LVR-IC	15.4V±2%, 150mA, +CE	SOT-89-5	32vrq VR4	6n	Tor
8B4	XC6701BF5PR	LVR-IC	15.5V±2%, 150mA, +CE	SOT-89-5	32vrq VR4	6n	Tor
8B5	XC6701BF6PR	LVR-IC	15.6V±2%, 150mA, +CE	SOT-89-5	32vrq VR4	6n	Tor
8B6	XC6701BF7PR	LVR-IC	15.7V±2%, 150mA, +CE	SOT-89-5	32vrq VR4	6n	Tor
8B7	XC6701BF8PR	LVR-IC	15.8V±2%, 150mA, +CE	SOT-89-5	32vrq VR4	6n	Tor
8B8	XC6701BF9PR	LVR-IC	15.9V±2%, 150mA, +CE	SOT-89-5	32vrq VR4	6n	Tor
8B9	XC6701BG0PR	LVR-IC	16.0V±2%, 150mA, +CE	SOT-89-5	32vrq VR4	6n	Tor
8BA	XC6701BG1PR	LVR-IC	16.1V±2%, 150mA, +CE	SOT-89-5	32vrq VR4	6n	Tor
8BB	XC6701BG2PR	LVR-IC	16.2V±2%, 150mA, +CE	SOT-89-5	32vrq VR4	6n	Tor
8BC	XC6701BG3PR	LVR-IC	16.3V±2%, 150mA, +CE	SOT-89-5	32vrq VR4	6n	Tor
8BD	XC6701BG4PR	LVR-IC	16.4V±2%, 150mA, +CE	SOT-89-5	32vrq VR4	6n	Tor
8BE	XC6701BG5PR	LVR-IC	16.5V±2%, 150mA, +CE	SOT-89-5	32vrq VR4	6n	Tor
8BF	XC6701BG6PR	LVR-IC	16.6V±2%, 150mA, +CE	SOT-89-5	32vrq VR4	6n	Tor
8BH	XC6701BG7PR	LVR-IC	16.7V±2%, 150mA, +CE	SOT-89-5	32vrq VR4	6n	Tor
8BK	XC6701BG8PR	LVR-IC	16.8V±2%, 150mA, +CE	SOT-89-5	32vrq VR4	6n	Tor
8BL	XC6701BG9PR	LVR-IC	16.9V±2%, 150mA, +CE	SOT-89-5	32vrq VR4	6n	Tor
8BM	XC6701BH0PR	LVR-IC	17.0V±2%, 150mA, +CE	SOT-89-5	32vrq VR4	6n	Tor
8BN	XC6701BH1PR	LVR-IC	17.1V±2%, 150mA, +CE	SOT-89-5	32vrq VR4	6n	Tor
8BP	XC6701BH2PR	LVR-IC	17.2V±2%, 150mA, +CE	SOT-89-5	32vrq VR4	6n	Tor
8BR	XC6701BH3PR	LVR-IC	17.3V±2%, 150mA, +CE	SOT-89-5	32vrq VR4	6n	Tor
8BS	XC6701BH4PR	LVR-IC	17.4V±2%, 150mA, +CE	SOT-89-5	32vrq VR4	6n	Tor
8BT	XC6701BH5PR	LVR-IC	17.5V±2%, 150mA, +CE	SOT-89-5	32vrq VR4	6n	Tor
8BU	XC6701BH6PR	LVR-IC	17.6V±2%, 150mA, +CE	SOT-89-5	32vrq VR4	6n	Tor
8BV	XC6701BH7PR	LVR-IC	17.7V±2%, 150mA, +CE	SOT-89-5	32vrq VR4	6n	Tor
8BX	XC6701BH8PR	LVR-IC	17.8V±2%, 150mA, +CE	SOT-89-5	32vrq VR4	6n	Tor
8BY	XC6701BH9PR	LVR-IC	17.9V±2%, 150mA, +CE	SOT-89-5	32vrq VR4	6n	Tor
8BZ	XC6701BJ0PR	LVR-IC	18.0V±2%, 150mA, +CE	SOT-89-5	32vrq VR4	6n	Tor
902	XC6223G121PR-G	LVR-IC	LDO, 1.2V±20mV, 300mA, +CE, PDR, ICP	SOT-89-5	32um VR4	6n	Tor
903	XC6223G131PR-G	LVR-IC	LDO, 1.3V±20mV, 300mA, +CE, PDR, ICP	SOT-89-5	32um VR4	6n	Tor
904	XC6223G141PR-G	LVR-IC	LDO, 1.4V±20mV, 300mA, +CE, PDR, ICP	SOT-89-5	32um VR4	6n	Tor
905	XC6223G151PR-G	LVR-IC	LDO, 1.5V±20mV, 300mA, +CE, PDR, ICP	SOT-89-5	32um VR4	6n	Tor
906	XC6223G161PR-G	LVR-IC	LDO, 1.6V±20mV, 300mA, +CE, PDR, ICP	SOT-89-5	32um VR4	6n	Tor
907	XC6223G171PR-G	LVR-IC	LDO, 1.7V±20mV, 300mA, +CE, PDR, ICP	SOT-89-5	32um VR4	6n	Tor
908	XC6223G181PR-G	LVR-IC	LDO, 1.8V±20mV, 300mA, +CE, PDR, ICP	SOT-89-5	32um VR4	6n	Tor
909	XC6223G191PR-G	LVR-IC	LDO, 1.9V±20mV, 300mA, +CE, PDR, ICP	SOT-89-5	32um VR4	6n	Tor
90A	XC6223G201PR-G	LVR-IC	LDO, 2.0V±1%, 300mA, +CE, PDR, ICP	SOT-89-5	32um VR4	6n	Tor
90B	XC6223G211PR-G	LVR-IC	LDO, 2.1V±1%, 300mA, +CE, PDR, ICP	SOT-89-5	32um VR4	6n	Tor
90C	XC6223G221PR-G	LVR-IC	LDO, 2.2V±1%, 300mA, +CE, PDR, ICP	SOT-89-5	32um VR4	6n	Tor
90D	XC6223G231PR-G	LVR-IC	LDO, 2.3V±1%, 300mA, +CE, PDR, ICP	SOT-89-5	32um VR4	6n	Tor
90E	XC6223G241PR-G	LVR-IC	LDO, 2.4V±1%, 300mA, +CE, PDR, ICP	SOT-89-5	32um VR4	6n	Tor
90F	XC6223G251PR-G	LVR-IC	LDO, 2.5V±1%, 300mA, +CE, PDR, ICP	SOT-89-5	32um VR4	6n	Tor
90H	XC6223G261PR-G	LVR-IC	LDO, 2.6V±1%, 300mA, +CE, PDR, ICP	SOT-89-5	32um VR4	6n	Tor
90K	XC6223G271PR-G	LVR-IC	LDO, 2.7V±1%, 300mA, +CE, PDR, ICP	SOT-89-5	32um VR4	6n	Tor
90L	XC6223G281PR-G	LVR-IC	LDO, 2.8V±1%, 300mA, +CE, PDR, ICP	SOT-89-5	32um VR4	6n	Tor
90M	XC6223G291PR-G	LVR-IC	LDO, 2.9V±1%, 300mA, +CE, PDR, ICP	SOT-89-5	32um VR4	6n	Tor
90N	XC6223G301PR-G	LVR-IC	LDO, 3.0V±1%, 300mA, +CE, PDR, ICP	SOT-89-5	32um VR4	6n	Tor
90P	XC6223G311PR-G	LVR-IC	LDO, 3.1V±1%, 300mA, +CE, PDR, ICP	SOT-89-5	32um VR4	6n	Tor
90R	XC6223G321PR-G	LVR-IC	LDO, 3.2V±1%, 300mA, +CE, PDR, ICP	SOT-89-5	32um VR4	6n	Tor



SMD code	Type	Function	Short description	Case	Pinout Sch.	St.	Mnf.
957	XC6223H17BPR-G	LVR-IC	LDO, 1.75V±20mV, 300mA, +CE, CL, PDR, ICP	SOT-89-5	32um VR4	6n	Tor
958	XC6223H18BPR-G	LVR-IC	LDO, 1.85V±20mV, 300mA, +CE, CL, PDR, ICP	SOT-89-5	32um VR4	6n	Tor
959	XC6223H19BPR-G	LVR-IC	LDO, 1.95V±20mV, 300mA, +CE, CL, PDR, ICP	SOT-89-5	32um VR4	6n	Tor
95A	XC6223H20BPR-G	LVR-IC	LDO, 2.05V±1%, 300mA, +CE, CL, PDR, ICP	SOT-89-5	32um VR4	6n	Tor
95B	XC6223H21BPR-G	LVR-IC	LDO, 2.15V±1%, 300mA, +CE, CL, PDR, ICP	SOT-89-5	32um VR4	6n	Tor
95C	XC6223H22BPR-G	LVR-IC	LDO, 2.25V±1%, 300mA, +CE, CL, PDR, ICP	SOT-89-5	32um VR4	6n	Tor
95D	XC6223H23BPR-G	LVR-IC	LDO, 2.35V±1%, 300mA, +CE, CL, PDR, ICP	SOT-89-5	32um VR4	6n	Tor
95E	XC6223H24BPR-G	LVR-IC	LDO, 2.45V±1%, 300mA, +CE, CL, PDR, ICP	SOT-89-5	32um VR4	6n	Tor
95F	XC6223H25BPR-G	LVR-IC	LDO, 2.55V±1%, 300mA, +CE, CL, PDR, ICP	SOT-89-5	32um VR4	6n	Tor
95H	XC6223H26BPR-G	LVR-IC	LDO, 2.65V±1%, 300mA, +CE, CL, PDR, ICP	SOT-89-5	32um VR4	6n	Tor
95K	XC6223H27BPR-G	LVR-IC	LDO, 2.75V±1%, 300mA, +CE, CL, PDR, ICP	SOT-89-5	32um VR4	6n	Tor
95L	XC6223H28BPR-G	LVR-IC	LDO, 2.85V±1%, 300mA, +CE, CL, PDR, ICP	SOT-89-5	32um VR4	6n	Tor
95M	XC6223H29BPR-G	LVR-IC	LDO, 2.95V±1%, 300mA, +CE, CL, PDR, ICP	SOT-89-5	32um VR4	6n	Tor
95N	XC6223H30BPR-G	LVR-IC	LDO, 3.05V±1%, 300mA, +CE, CL, PDR, ICP	SOT-89-5	32um VR4	6n	Tor
95P	XC6223H31BPR-G	LVR-IC	LDO, 3.15V±1%, 300mA, +CE, CL, PDR, ICP	SOT-89-5	32um VR4	6n	Tor
95R	XC6223H32BPR-G	LVR-IC	LDO, 3.25V±1%, 300mA, +CE, CL, PDR, ICP	SOT-89-5	32um VR4	6n	Tor
95S	XC6223H33BPR-G	LVR-IC	LDO, 3.35V±1%, 300mA, +CE, CL, PDR, ICP	SOT-89-5	32um VR4	6n	Tor
95T	XC6223H34BPR-G	LVR-IC	LDO, 3.45V±1%, 300mA, +CE, CL, PDR, ICP	SOT-89-5	32um VR4	6n	Tor
95U	XC6223H35BPR-G	LVR-IC	LDO, 3.55V±1%, 300mA, +CE, CL, PDR, ICP	SOT-89-5	32um VR4	6n	Tor
95V	XC6223H36BPR-G	LVR-IC	LDO, 3.65V±1%, 300mA, +CE, CL, PDR, ICP	SOT-89-5	32um VR4	6n	Tor
95X	XC6223H37BPR-G	LVR-IC	LDO, 3.75V±1%, 300mA, +CE, CL, PDR, ICP	SOT-89-5	32um VR4	6n	Tor
95Y	XC6223H38BPR-G	LVR-IC	LDO, 3.85V±1%, 300mA, +CE, CL, PDR, ICP	SOT-89-5	32um VR4	6n	Tor
95Z	XC6223H39BPR-G	LVR-IC	LDO, 3.95V±1%, 300mA, +CE, CL, PDR, ICP	SOT-89-5	32um VR4	6n	Tor
9A0	XC6209A312PR	LVR-IC	LDO, 3.1V±2%, 150mA, +CE, PDR	SOT-89-5	32um VR4	6h	Tor
9A0	XC6601A071PR	LVR-IC	0.7V±20mV, 400mA, +CE, PDR, UVLO	SOT-89-5	32gk VR11	6n	Tor
9A0	XC6209E312PR	LVR-IC	LDO, 3.1V±2%, 300mA, +CE, PDR	SOT-89-5	32um VR4	6h	Tor
9A1	XC6209A322PR	LVR-IC	LDO, 3.2V±2%, 150mA, +CE, PDR	SOT-89-5	32um VR4	6h	Tor
9A1	XC6601A07BPR	LVR-IC	0.75V±20mV, 400mA, +CE, PDR, UVLO	SOT-89-5	32gk VR11	6n	Tor
9A1	XC6209E322PR	LVR-IC	LDO, 3.2V±2%, 300mA, +CE, PDR	SOT-89-5	32um VR4	6h	Tor
9A2	XC6209A332PR	LVR-IC	LDO, 3.3V±2%, 150mA, +CE, PDR	SOT-89-5	32um VR4	6h	Tor
9A2	XC6601A081PR	LVR-IC	0.8V±20mV, 400mA, +CE, PDR, UVLO	SOT-89-5	32gk VR11	6n	Tor
9A2	XC6209E332PR	LVR-IC	LDO, 3.3V±2%, 300mA, +CE, PDR	SOT-89-5	32um VR4	6h	Tor
9A3	XC6209A342PR	LVR-IC	LDO, 3.4V±2%, 150mA, +CE, PDR	SOT-89-5	32um VR4	6h	Tor
9A3	XC6601A08BPR	LVR-IC	0.85V±20mV, 400mA, +CE, PDR, UVLO	SOT-89-5	32gk VR11	6n	Tor
9A3	XC6209E342PR	LVR-IC	LDO, 3.4V±2%, 300mA, +CE, PDR	SOT-89-5	32um VR4	6h	Tor
9A4	XC6209A352PR	LVR-IC	LDO, 3.5V±2%, 150mA, +CE, PDR	SOT-89-5	32um VR4	6h	Tor
9A4	XC6601A091PR	LVR-IC	0.9V±20mV, 400mA, +CE, PDR, UVLO	SOT-89-5	32gk VR11	6n	Tor
9A4	XC6209E352PR	LVR-IC	LDO, 3.5V±2%, 300mA, +CE, PDR	SOT-89-5	32um VR4	6h	Tor
9A5	XC6209A362PR	LVR-IC	LDO, 3.6V±2%, 150mA, +CE, PDR	SOT-89-5	32um VR4	6h	Tor
9A5	XC6601A09BPR	LVR-IC	0.95V±20mV, 400mA, +CE, PDR, UVLO	SOT-89-5	32gk VR11	6n	Tor
9A5	XC6209E362PR	LVR-IC	LDO, 3.6V±2%, 300mA, +CE, PDR	SOT-89-5	32um VR4	6h	Tor
9A6	XC6209A372PR	LVR-IC	LDO, 3.7V±2%, 150mA, +CE, PDR	SOT-89-5	32um VR4	6h	Tor
9A6	XC6601A101PR	LVR-IC	1.0V±20mV, 400mA, +CE, PDR, UVLO	SOT-89-5	32gk VR11	6n	Tor
9A6	XC6209E372PR	LVR-IC	LDO, 3.7V±2%, 300mA, +CE, PDR	SOT-89-5	32um VR4	6h	Tor
9A7	XC6209A382PR	LVR-IC	LDO, 3.8V±2%, 150mA, +CE, PDR	SOT-89-5	32um VR4	6h	Tor
9A7	XC6601A10BPR	LVR-IC	1.05V±20mV, 400mA, +CE, PDR, UVLO	SOT-89-5	32gk VR11	6n	Tor
9A7	XC6209E382PR	LVR-IC	LDO, 3.8V±2%, 300mA, +CE, PDR	SOT-89-5	32um VR4	6h	Tor
9A8	XC6209A392PR	LVR-IC	LDO, 3.9V±2%, 150mA, +CE, PDR	SOT-89-5	32um VR4	6h	Tor
9A8	XC6601A111PR	LVR-IC	1.1V±20mV, 400mA, +CE, PDR, UVLO	SOT-89-5	32gk VR11	6n	Tor
9A8	XC6209E392PR	LVR-IC	LDO, 3.9V±2%, 300mA, +CE, PDR	SOT-89-5	32um VR4	6h	Tor
9A9	XC6209A402PR	LVR-IC	LDO, 4V±2%, 150mA, +CE, PDR	SOT-89-5	32um VR4	6h	Tor
9A9	XC6601A11BPR	LVR-IC	1.15V±20mV, 400mA, +CE, PDR, UVLO	SOT-89-5	32gk VR11	6n	Tor
9A9	XC6209E402PR	LVR-IC	LDO, 4V±2%, 300mA, +CE, PDR	SOT-89-5	32um VR4	6h	Tor
9AA	XC6209A412PR	LVR-IC	LDO, 4.1V±2%, 150mA, +CE, PDR	SOT-89-5	32um VR4	6h	Tor
9AA	XC6601A121PR	LVR-IC	1.2V±20mV, 400mA, +CE, PDR, UVLO	SOT-89-5	32gk VR11	6n	Tor
9AA	XC6209E412PR	LVR-IC	LDO, 4.1V±2%, 300mA, +CE, PDR	SOT-89-5	32um VR4	6h	Tor
9AB	XC6209A422PR	LVR-IC	LDO, 4.2V±2%, 150mA, +CE, PDR	SOT-89-5	32um VR4	6h	Tor
9AB	XC6601A12BPR	LVR-IC	1.25V±20mV, 400mA, +CE, PDR, UVLO	SOT-89-5	32gk VR11	6n	Tor
9AB	XC6209E422PR	LVR-IC	LDO, 4.2V±2%, 300mA, +CE, PDR	SOT-89-5	32um VR4	6h	Tor
9AC	XC6209A432PR	LVR-IC	LDO, 4.3V±2%, 150mA, +CE, PDR	SOT-89-5	32um VR4	6h	Tor
9AC	XC6601A131PR	LVR-IC	1.3V±20mV, 400mA, +CE, PDR, UVLO	SOT-89-5	32gk VR11	6n	Tor
9AC	XC6209E432PR	LVR-IC	LDO, 4.3V±2%, 300mA, +CE, PDR	SOT-89-5	32um VR4	6h	Tor
9AD	XC6209A442PR	LVR-IC	LDO, 4.4V±2%, 150mA, +CE, PDR	SOT-89-5	32um VR4	6h	Tor
9AD	XC6601A13BPR	LVR-IC	1.35V±20mV, 400mA, +CE, PDR, UVLO	SOT-89-5	32gk VR11	6n	Tor
9AD	XC6209E442PR	LVR-IC	LDO, 4.4V±2%, 300mA, +CE, PDR	SOT-89-5	32um VR4	6h	Tor
9AE	XC6209A452PR	LVR-IC	LDO, 4.5V±2%, 150mA, +CE, PDR	SOT-89-5	32um VR4	6h	Tor
9AE	XC6601A141PR	LVR-IC	1.4V±20mV, 400mA, +CE, PDR, UVLO	SOT-89-5	32gk VR11	6n	Tor
9AE	XC6209E452PR	LVR-IC	LDO, 4.5V±2%, 300mA, +CE, PDR	SOT-89-5	32um VR4	6h	Tor
9AF	XC6209A462PR	LVR-IC	LDO, 4.6V±2%, 150mA, +CE, PDR	SOT-89-5	32um VR4	6h	Tor
9AF	XC6601A14BPR	LVR-IC	1.45V±20mV, 400mA, +CE, PDR, UVLO	SOT-89-5	32gk VR11	6n	Tor



SMD code	Type	Function	Short description	Case	Pinout Sch.	St.	Mnf.
9AF	XC6209E462PR	LVR-IC	LDO, 4.6V±2%, 300mA, +CE, PDR	SOT-89-5	32um VR4	6h	Tor
9AH	XC6209A472PR	LVR-IC	LDO, 4.7V±2%, 150mA, +CE, PDR	SOT-89-5	32um VR4	6h	Tor
9AH	XC6601A151PR	LVR-IC	1.5V±20mV, 400mA, +CE, PDR, UVLO	SOT-89-5	32gk VR11	6n	Tor
9AH	XC6209E472PR	LVR-IC	LDO, 4.7V±2%, 300mA, +CE, PDR	SOT-89-5	32um VR4	6h	Tor
9AK	XC6209A482PR	LVR-IC	LDO, 4.8V±2%, 150mA, +CE, PDR	SOT-89-5	32um VR4	6h	Tor
9AK	XC6601A15BPR	LVR-IC	1.55V±20mV, 400mA, +CE, PDR, UVLO	SOT-89-5	32gk VR11	6n	Tor
9AK	XC6209E482PR	LVR-IC	LDO, 4.8V±2%, 300mA, +CE, PDR	SOT-89-5	32um VR4	6h	Tor
9AL	XC6209A492PR	LVR-IC	LDO, 4.9V±2%, 150mA, +CE, PDR	SOT-89-5	32um VR4	6h	Tor
9AL	XC6601A161PR	LVR-IC	1.6V±20mV, 400mA, +CE, PDR, UVLO	SOT-89-5	32gk VR11	6n	Tor
9AL	XC6209E492PR	LVR-IC	LDO, 4.9V±2%, 300mA, +CE, PDR	SOT-89-5	32um VR4	6h	Tor
9AM	XC6209A502PR	LVR-IC	LDO, 5V±2%, 150mA, +CE, PDR	SOT-89-5	32um VR4	6h	Tor
9AM	XC6601A16BPR	LVR-IC	1.65V±20mV, 400mA, +CE, PDR, UVLO	SOT-89-5	32gk VR11	6n	Tor
9AM	XC6209E502PR	LVR-IC	LDO, 5V±2%, 300mA, +CE, PDR	SOT-89-5	32um VR4	6h	Tor
9AN	XC6209A512PR	LVR-IC	LDO, 5.1V±2%, 150mA, +CE, PDR	SOT-89-5	32um VR4	6h	Tor
9AN	XC6601A171PR	LVR-IC	1.7V±20mV, 400mA, +CE, PDR, UVLO	SOT-89-5	32gk VR11	6n	Tor
9AN	XC6209E512PR	LVR-IC	LDO, 5.1V±2%, 300mA, +CE, PDR	SOT-89-5	32um VR4	6h	Tor
9AP	XC6209A522PR	LVR-IC	LDO, 5.2V±2%, 150mA, +CE, PDR	SOT-89-5	32um VR4	6h	Tor
9AP	XC6601A17BPR	LVR-IC	1.75V±20mV, 400mA, +CE, PDR, UVLO	SOT-89-5	32gk VR11	6n	Tor
9AP	XC6209E522PR	LVR-IC	LDO, 5.2V±2%, 300mA, +CE, PDR	SOT-89-5	32um VR4	6h	Tor
9AR	XC6209A532PR	LVR-IC	LDO, 5.3V±2%, 150mA, +CE, PDR	SOT-89-5	32um VR4	6h	Tor
9AR	XC6601A181PR	LVR-IC	1.8V±20mV, 400mA, +CE, PDR, UVLO	SOT-89-5	32gk VR11	6n	Tor
9AR	XC6209E532PR	LVR-IC	LDO, 5.3V±2%, 300mA, +CE, PDR	SOT-89-5	32um VR4	6h	Tor
9AS	XC6209A542PR	LVR-IC	LDO, 5.4V±2%, 150mA, +CE, PDR	SOT-89-5	32um VR4	6h	Tor
9AS	XC6209E542PR	LVR-IC	LDO, 5.4V±2%, 300mA, +CE, PDR	SOT-89-5	32um VR4	6h	Tor
9AT	XC6209A552PR	LVR-IC	LDO, 5.5V±2%, 150mA, +CE, PDR	SOT-89-5	32um VR4	6h	Tor
9AT	XC6209E552PR	LVR-IC	LDO, 5.5V±2%, 300mA, +CE, PDR	SOT-89-5	32um VR4	6h	Tor
9AU	XC6209A562PR	LVR-IC	LDO, 5.6V±2%, 150mA, +CE, PDR	SOT-89-5	32um VR4	6h	Tor
9AU	XC6209E562PR	LVR-IC	LDO, 5.6V±2%, 300mA, +CE, PDR	SOT-89-5	32um VR4	6h	Tor
9AV	XC6209A572PR	LVR-IC	LDO, 5.7V±2%, 150mA, +CE, PDR	SOT-89-5	32um VR4	6h	Tor
9AV	XC6209E572PR	LVR-IC	LDO, 5.7V±2%, 300mA, +CE, PDR	SOT-89-5	32um VR4	6h	Tor
9AX	XC6209A582PR	LVR-IC	LDO, 5.8V±2%, 150mA, +CE, PDR	SOT-89-5	32um VR4	6h	Tor
9AX	XC6209E582PR	LVR-IC	LDO, 5.8V±2%, 300mA, +CE, PDR	SOT-89-5	32um VR4	6h	Tor
9AY	XC6209A592PR	LVR-IC	LDO, 5.9V±2%, 150mA, +CE, PDR	SOT-89-5	32um VR4	6h	Tor
9AY	XC6209E592PR	LVR-IC	LDO, 5.9V±2%, 300mA, +CE, PDR	SOT-89-5	32um VR4	6h	Tor
9AZ	XC6209A602PR	LVR-IC	LDO, 6V±2%, 150mA, +CE, PDR	SOT-89-5	32um VR4	6h	Tor
9AZ	XC6209E602PR	LVR-IC	LDO, 6V±2%, 300mA, +CE, PDR	SOT-89-5	32um VR4	6h	Tor
9B0	XC6209B312PR	LVR-IC	LDO, 3.1V±2%, 150mA, +CE	SOT-89-5	32um VR4	6h	Tor
9B0	XC6601B071PR	LVR-IC	0.7V±20mV, 400mA, +CE, UVLO	SOT-89-5	32gk VR11	6n	Tor
9B0	XC6209F312PR	LVR-IC	LDO, 3.1V±2%, 300mA, +CE	SOT-89-5	32um VR4	6h	Tor
9B1	XC6209B322PR	LVR-IC	LDO, 3.2V±2%, 150mA, +CE	SOT-89-5	32um VR4	6h	Tor
9B1	XC6601B07BPR	LVR-IC	0.75V±20mV, 400mA, +CE, UVLO	SOT-89-5	32gk VR11	6n	Tor
9B1	XC6209F322PR	LVR-IC	LDO, 3.2V±2%, 300mA, +CE	SOT-89-5	32um VR4	6h	Tor
9B2	XC6209B332PR	LVR-IC	LDO, 3.3V±2%, 150mA, +CE	SOT-89-5	32um VR4	6h	Tor
9B2	XC6601B081PR	LVR-IC	0.8V±20mV, 400mA, +CE, UVLO	SOT-89-5	32gk VR11	6n	Tor
9B2	XC6209F332PR	LVR-IC	LDO, 3.3V±2%, 300mA, +CE	SOT-89-5	32um VR4	6h	Tor
9B3	XC6209B342PR	LVR-IC	LDO, 3.4V±2%, 150mA, +CE	SOT-89-5	32um VR4	6h	Tor
9B3	XC6601B08BPR	LVR-IC	0.85V±20mV, 400mA, +CE, UVLO	SOT-89-5	32gk VR11	6n	Tor
9B3	XC6209F342PR	LVR-IC	LDO, 3.4V±2%, 300mA, +CE	SOT-89-5	32um VR4	6h	Tor
9B4	XC6209B352PR	LVR-IC	LDO, 3.5V±2%, 150mA, +CE	SOT-89-5	32um VR4	6h	Tor
9B4	XC6601B091PR	LVR-IC	0.9V±20mV, 400mA, +CE, UVLO	SOT-89-5	32gk VR11	6n	Tor
9B4	XC6209F352PR	LVR-IC	LDO, 3.5V±2%, 300mA, +CE	SOT-89-5	32um VR4	6h	Tor
9B5	XC6209B362PR	LVR-IC	LDO, 3.6V±2%, 150mA, +CE	SOT-89-5	32um VR4	6h	Tor
9B5	XC6601B09BPR	LVR-IC	0.95V±20mV, 400mA, +CE, UVLO	SOT-89-5	32gk VR11	6n	Tor
9B5	XC6209F362PR	LVR-IC	LDO, 3.6V±2%, 300mA, +CE	SOT-89-5	32um VR4	6h	Tor
9B6	XC6209B372PR	LVR-IC	LDO, 3.7V±2%, 150mA, +CE	SOT-89-5	32um VR4	6h	Tor
9B6	XC6601B101PR	LVR-IC	1.0V±20mV, 400mA, +CE, UVLO	SOT-89-5	32gk VR11	6n	Tor
9B6	XC6209F372PR	LVR-IC	LDO, 3.7V±2%, 300mA, +CE	SOT-89-5	32um VR4	6h	Tor
9B7	XC6209B382PR	LVR-IC	LDO, 3.8V±2%, 150mA, +CE	SOT-89-5	32um VR4	6h	Tor
9B7	XC6601B10BPR	LVR-IC	1.05V±20mV, 400mA, +CE, UVLO	SOT-89-5	32gk VR11	6n	Tor
9B7	XC6209F382PR	LVR-IC	LDO, 3.8V±2%, 300mA, +CE	SOT-89-5	32um VR4	6h	Tor
9B8	XC6209B392PR	LVR-IC	LDO, 3.9V±2%, 150mA, +CE	SOT-89-5	32um VR4	6h	Tor
9B8	XC6601B111PR	LVR-IC	1.1V±20mV, 400mA, +CE, UVLO	SOT-89-5	32gk VR11	6n	Tor
9B8	XC6209F392PR	LVR-IC	LDO, 3.9V±2%, 300mA, +CE	SOT-89-5	32um VR4	6h	Tor
9B9	XC6209B402PR	LVR-IC	LDO, 4V±2%, 150mA, +CE	SOT-89-5	32um VR4	6h	Tor
9B9	XC6601B11BPR	LVR-IC	1.15V±20mV, 400mA, +CE, UVLO	SOT-89-5	32gk VR11	6n	Tor
9B9	XC6209F402PR	LVR-IC	LDO, 4V±2%, 300mA, +CE	SOT-89-5	32um VR4	6h	Tor
9BA	XC6209B412PR	LVR-IC	LDO, 4.1V±2%, 150mA, +CE	SOT-89-5	32um VR4	6h	Tor
9BA	XC6601B121PR	LVR-IC	1.2V±20mV, 400mA, +CE, UVLO	SOT-89-5	32gk VR11	6n	Tor
9BA	XC6209F412PR	LVR-IC	LDO, 4.1V±2%, 300mA, +CE	SOT-89-5	32um VR4	6h	Tor
9BB	XC6209B422PR	LVR-IC	LDO, 4.2V±2%, 150mA, +CE	SOT-89-5	32um VR4	6h	Tor



SMD code	Type	Function	Short description	Case	Pinout	Sch.	St.	Mnf.
9BB	XC6601B12BPR	LVR-IC	1.25V±20mV, 400mA, +CE, UVLO	SOT-89-5	32gk	VR11	6n	Tor
9BB	XC6209F422PR	LVR-IC	LDO, 4.2V±2%, 300mA, +CE	SOT-89-5	32um	VR4	6h	Tor
9BC	XC6209B432PR	LVR-IC	LDO, 4.3V±2%, 150mA, +CE	SOT-89-5	32um	VR4	6h	Tor
9BC	XC6601B131PR	LVR-IC	1.3V±20mV, 400mA, +CE, UVLO	SOT-89-5	32gk	VR11	6n	Tor
9BC	XC6209F432PR	LVR-IC	LDO, 4.3V±2%, 300mA, +CE	SOT-89-5	32um	VR4	6h	Tor
9BD	XC6209B442PR	LVR-IC	LDO, 4.4V±2%, 150mA, +CE	SOT-89-5	32um	VR4	6h	Tor
9BD	XC6601B13BPR	LVR-IC	1.35V±20mV, 400mA, +CE, UVLO	SOT-89-5	32gk	VR11	6n	Tor
9BD	XC6209F442PR	LVR-IC	LDO, 4.4V±2%, 300mA, +CE	SOT-89-5	32um	VR4	6h	Tor
9BE	XC6209B452PR	LVR-IC	LDO, 4.5V±2%, 150mA, +CE	SOT-89-5	32um	VR4	6h	Tor
9BE	XC6601B141PR	LVR-IC	1.4V±20mV, 400mA, +CE, UVLO	SOT-89-5	32gk	VR11	6n	Tor
9BE	XC6209F452PR	LVR-IC	LDO, 4.5V±2%, 300mA, +CE	SOT-89-5	32um	VR4	6h	Tor
9BF	XC6209B462PR	LVR-IC	LDO, 4.6V±2%, 150mA, +CE	SOT-89-5	32um	VR4	6h	Tor
9BF	XC6601B14BPR	LVR-IC	1.45V±20mV, 400mA, +CE, UVLO	SOT-89-5	32gk	VR11	6n	Tor
9BF	XC6209F462PR	LVR-IC	LDO, 4.6V±2%, 300mA, +CE	SOT-89-5	32um	VR4	6h	Tor
9BH	XC6209B472PR	LVR-IC	LDO, 4.7V±2%, 150mA, +CE	SOT-89-5	32um	VR4	6h	Tor
9BH	XC6601B151PR	LVR-IC	1.5V±20mV, 400mA, +CE, UVLO	SOT-89-5	32gk	VR11	6n	Tor
9BH	XC6209F472PR	LVR-IC	LDO, 4.7V±2%, 300mA, +CE	SOT-89-5	32um	VR4	6h	Tor
9BK	XC6209B482PR	LVR-IC	LDO, 4.8V±2%, 150mA, +CE	SOT-89-5	32um	VR4	6h	Tor
9BK	XC6601B15BPR	LVR-IC	1.55V±20mV, 400mA, +CE, UVLO	SOT-89-5	32gk	VR11	6n	Tor
9BK	XC6209F482PR	LVR-IC	LDO, 4.8V±2%, 300mA, +CE	SOT-89-5	32um	VR4	6h	Tor
9BL	XC6209B492PR	LVR-IC	LDO, 4.9V±2%, 150mA, +CE	SOT-89-5	32um	VR4	6h	Tor
9BL	XC6601B161PR	LVR-IC	1.6V±20mV, 400mA, +CE, UVLO	SOT-89-5	32gk	VR11	6n	Tor
9BL	XC6209F492PR	LVR-IC	LDO, 4.9V±2%, 300mA, +CE	SOT-89-5	32um	VR4	6h	Tor
9BM	XC6209B502PR	LVR-IC	LDO, 5V±2%, 150mA, +CE	SOT-89-5	32um	VR4	6h	Tor
9BM	XC6601B16BPR	LVR-IC	1.65V±20mV, 400mA, +CE, UVLO	SOT-89-5	32gk	VR11	6n	Tor
9BM	XC6209F502PR	LVR-IC	LDO, 5V±2%, 300mA, +CE	SOT-89-5	32um	VR4	6h	Tor
9BN	XC6209B512PR	LVR-IC	LDO, 5.1V±2%, 150mA, +CE	SOT-89-5	32um	VR4	6h	Tor
9BN	XC6601B171PR	LVR-IC	1.7V±20mV, 400mA, +CE, UVLO	SOT-89-5	32gk	VR11	6n	Tor
9BN	XC6209F512PR	LVR-IC	LDO, 5.1V±2%, 300mA, +CE	SOT-89-5	32um	VR4	6h	Tor
9BP	XC6209B522PR	LVR-IC	LDO, 5.2V±2%, 150mA, +CE	SOT-89-5	32um	VR4	6h	Tor
9BP	XC6601B17BPR	LVR-IC	1.75V±20mV, 400mA, +CE, UVLO	SOT-89-5	32gk	VR11	6n	Tor
9BP	XC6209F522PR	LVR-IC	LDO, 5.2V±2%, 300mA, +CE	SOT-89-5	32um	VR4	6h	Tor
9BR	XC6209B532PR	LVR-IC	LDO, 5.3V±2%, 150mA, +CE	SOT-89-5	32um	VR4	6h	Tor
9BR	XC6601B181PR	LVR-IC	1.8V±20mV, 400mA, +CE, UVLO	SOT-89-5	32gk	VR11	6n	Tor
9BR	XC6209F532PR	LVR-IC	LDO, 5.3V±2%, 300mA, +CE	SOT-89-5	32um	VR4	6h	Tor
9BS	XC6209B542PR	LVR-IC	LDO, 5.4V±2%, 150mA, +CE	SOT-89-5	32um	VR4	6h	Tor
9BS	XC6209F542PR	LVR-IC	LDO, 5.4V±2%, 300mA, +CE	SOT-89-5	32um	VR4	6h	Tor
9BT	XC6209B552PR	LVR-IC	LDO, 5.5V±2%, 150mA, +CE	SOT-89-5	32um	VR4	6h	Tor
9BT	XC6209F552PR	LVR-IC	LDO, 5.5V±2%, 300mA, +CE	SOT-89-5	32um	VR4	6h	Tor
9BU	XC6209B562PR	LVR-IC	LDO, 5.6V±2%, 150mA, +CE	SOT-89-5	32um	VR4	6h	Tor
9BU	XC6209F562PR	LVR-IC	LDO, 5.6V±2%, 300mA, +CE	SOT-89-5	32um	VR4	6h	Tor
9BV	XC6209B572PR	LVR-IC	LDO, 5.7V±2%, 150mA, +CE	SOT-89-5	32um	VR4	6h	Tor
9BV	XC6209F572PR	LVR-IC	LDO, 5.7V±2%, 300mA, +CE	SOT-89-5	32um	VR4	6h	Tor
9BX	XC6209B582PR	LVR-IC	LDO, 5.8V±2%, 150mA, +CE	SOT-89-5	32um	VR4	6h	Tor
9BX	XC6209F582PR	LVR-IC	LDO, 5.8V±2%, 300mA, +CE	SOT-89-5	32um	VR4	6h	Tor
9BY	XC6209B592PR	LVR-IC	LDO, 5.9V±2%, 150mA, +CE	SOT-89-5	32um	VR4	6h	Tor
9BY	XC6209F592PR	LVR-IC	LDO, 5.9V±2%, 300mA, +CE	SOT-89-5	32um	VR4	6h	Tor
9BZ	XC6209B602PR	LVR-IC	LDO, 6V±2%, 150mA, +CE	SOT-89-5	32um	VR4	6h	Tor
9BZ	XC6209F602PR	LVR-IC	LDO, 6V±2%, 300mA, +CE	SOT-89-5	32um	VR4	6h	Tor
9C0	XC6209C312PR	LVR-IC	LDO, 3.1V±2%, 150mA, -CE, PDR	SOT-89-5	32um	VR4	6h	Tor
9C0	XC6209G312PR	LVR-IC	LDO, 3.1V±2%, 300mA, -CE, PDR	SOT-89-5	32um	VR4	6h	Tor
9C1	XC6209C322PR	LVR-IC	LDO, 3.2V±2%, 150mA, -CE, PDR	SOT-89-5	32um	VR4	6h	Tor
9C1	XC6209G322PR	LVR-IC	LDO, 3.2V±2%, 300mA, -CE, PDR	SOT-89-5	32um	VR4	6h	Tor
9C2	XC6209C332PR	LVR-IC	LDO, 3.3V±2%, 150mA, -CE, PDR	SOT-89-5	32um	VR4	6h	Tor
9C2	XC6223A121PR-G	LVR-IC	LDO, 1.2V±20mV, 300mA, +CE	SOT-89-5	32um	VR4	6n	Tor
9C2	XC6209G332PR	LVR-IC	LDO, 3.3V±2%, 300mA, -CE, PDR	SOT-89-5	32um	VR4	6h	Tor
9C3	XC6209C342PR	LVR-IC	LDO, 3.4V±2%, 150mA, -CE, PDR	SOT-89-5	32um	VR4	6h	Tor
9C3	XC6223A131PR-G	LVR-IC	LDO, 1.3V±20mV, 300mA, +CE	SOT-89-5	32um	VR4	6n	Tor
9C3	XC6209G342PR	LVR-IC	LDO, 3.4V±2%, 300mA, -CE, PDR	SOT-89-5	32um	VR4	6h	Tor
9C4	XC6209C352PR	LVR-IC	LDO, 3.5V±2%, 150mA, -CE, PDR	SOT-89-5	32um	VR4	6h	Tor
9C4	XC6223A141PR-G	LVR-IC	LDO, 1.4V±20mV, 300mA, +CE	SOT-89-5	32um	VR4	6n	Tor
9C4	XC6209G352PR	LVR-IC	LDO, 3.5V±2%, 300mA, -CE, PDR	SOT-89-5	32um	VR4	6h	Tor
9C5	XC6209C362PR	LVR-IC	LDO, 3.6V±2%, 150mA, -CE, PDR	SOT-89-5	32um	VR4	6h	Tor
9C5	XC6223A151PR-G	LVR-IC	LDO, 1.5V±20mV, 300mA, +CE	SOT-89-5	32um	VR4	6n	Tor
9C5	XC6209G362PR	LVR-IC	LDO, 3.6V±2%, 300mA, -CE, PDR	SOT-89-5	32um	VR4	6h	Tor
9C6	XC6209C372PR	LVR-IC	LDO, 3.7V±2%, 150mA, -CE, PDR	SOT-89-5	32um	VR4	6h	Tor
9C6	XC6223A161PR-G	LVR-IC	LDO, 1.6V±20mV, 300mA, +CE	SOT-89-5	32um	VR4	6n	Tor
9C6	XC6209G372PR	LVR-IC	LDO, 3.7V±2%, 300mA, -CE, PDR	SOT-89-5	32um	VR4	6h	Tor
9C7	XC6209C382PR	LVR-IC	LDO, 3.8V±2%, 150mA, -CE, PDR	SOT-89-5	32um	VR4	6h	Tor
9C7	XC6223A171PR-G	LVR-IC	LDO, 1.7V±20mV, 300mA, +CE	SOT-89-5	32um	VR4	6n	Tor



SMD code	Type	Function	Short description	Case	Pinout Sch.	St.	Mnf.
9C7	XC6209G382PR	LVR-IC	LDO, 3.8V±2%, 300mA, -CE, PDR	SOT-89-5	32um VR4	6h	Tor
9C8	XC6209C392PR	LVR-IC	LDO, 3.9V±2%, 150mA, -CE, PDR	SOT-89-5	32um VR4	6h	Tor
9C8	XC6223A181PR-G	LVR-IC	LDO, 1.8V±20mV, 300mA, +CE	SOT-89-5	32um VR4	6h	Tor
9C8	XC6209G392PR	LVR-IC	LDO, 3.9V±2%, 300mA, -CE, PDR	SOT-89-5	32um VR4	6h	Tor
9C9	XC6209C402PR	LVR-IC	LDO, 4V±2%, 150mA, -CE, PDR	SOT-89-5	32um VR4	6h	Tor
9C9	XC6223A191PR-G	LVR-IC	LDO, 1.9V±20mV, 300mA, +CE	SOT-89-5	32um VR4	6h	Tor
9C9	XC6209G402PR	LVR-IC	LDO, 4V±2%, 300mA, -CE, PDR	SOT-89-5	32um VR4	6h	Tor
9CA	XC6209C412PR	LVR-IC	LDO, 4.1V±2%, 150mA, -CE, PDR	SOT-89-5	32um VR4	6h	Tor
9CA	XC6223A201PR-G	LVR-IC	LDO, 2.0V±1%, 300mA, +CE	SOT-89-5	32um VR4	6h	Tor
9CA	XC6209G412PR	LVR-IC	LDO, 4.1V±2%, 300mA, -CE, PDR	SOT-89-5	32um VR4	6h	Tor
9CB	XC6209C422PR	LVR-IC	LDO, 4.2V±2%, 150mA, -CE, PDR	SOT-89-5	32um VR4	6h	Tor
9CB	XC6223A211PR-G	LVR-IC	LDO, 2.1V±1%, 300mA, +CE	SOT-89-5	32um VR4	6h	Tor
9CB	XC6209G422PR	LVR-IC	LDO, 4.2V±2%, 300mA, -CE, PDR	SOT-89-5	32um VR4	6h	Tor
9CC	XC6209C432PR	LVR-IC	LDO, 4.3V±2%, 150mA, -CE, PDR	SOT-89-5	32um VR4	6h	Tor
9CC	XC6223A221PR-G	LVR-IC	LDO, 2.2V±1%, 300mA, +CE	SOT-89-5	32um VR4	6h	Tor
9CC	XC6209G432PR	LVR-IC	LDO, 4.3V±2%, 300mA, -CE, PDR	SOT-89-5	32um VR4	6h	Tor
9CD	XC6209C442PR	LVR-IC	LDO, 4.4V±2%, 150mA, -CE, PDR	SOT-89-5	32um VR4	6h	Tor
9CD	XC6223A231PR-G	LVR-IC	LDO, 2.3V±1%, 300mA, +CE	SOT-89-5	32um VR4	6h	Tor
9CD	XC6209G442PR	LVR-IC	LDO, 4.4V±2%, 300mA, -CE, PDR	SOT-89-5	32um VR4	6h	Tor
9CE	XC6209C452PR	LVR-IC	LDO, 4.5V±2%, 150mA, -CE, PDR	SOT-89-5	32um VR4	6h	Tor
9CE	XC6223A241PR-G	LVR-IC	LDO, 2.4V±1%, 300mA, +CE	SOT-89-5	32um VR4	6h	Tor
9CE	XC6209G452PR	LVR-IC	LDO, 4.5V±2%, 300mA, -CE, PDR	SOT-89-5	32um VR4	6h	Tor
9CF	XC6209C462PR	LVR-IC	LDO, 4.6V±2%, 150mA, -CE, PDR	SOT-89-5	32um VR4	6h	Tor
9CF	XC6223A251PR-G	LVR-IC	LDO, 2.5V±1%, 300mA, +CE	SOT-89-5	32um VR4	6h	Tor
9CF	XC6209G462PR	LVR-IC	LDO, 4.6V±2%, 300mA, -CE, PDR	SOT-89-5	32um VR4	6h	Tor
9CH	XC6209C472PR	LVR-IC	LDO, 4.7V±2%, 150mA, -CE, PDR	SOT-89-5	32um VR4	6h	Tor
9CH	XC6223A261PR-G	LVR-IC	LDO, 2.6V±1%, 300mA, +CE	SOT-89-5	32um VR4	6h	Tor
9CH	XC6209G472PR	LVR-IC	LDO, 4.7V±2%, 300mA, -CE, PDR	SOT-89-5	32um VR4	6h	Tor
9CK	XC6209C482PR	LVR-IC	LDO, 4.8V±2%, 150mA, -CE, PDR	SOT-89-5	32um VR4	6h	Tor
9CK	XC6223A271PR-G	LVR-IC	LDO, 2.7V±1%, 300mA, +CE	SOT-89-5	32um VR4	6h	Tor
9CK	XC6209G482PR	LVR-IC	LDO, 4.8V±2%, 300mA, -CE, PDR	SOT-89-5	32um VR4	6h	Tor
9CL	XC6209C492PR	LVR-IC	LDO, 4.9V±2%, 150mA, -CE, PDR	SOT-89-5	32um VR4	6h	Tor
9CL	XC6223A281PR-G	LVR-IC	LDO, 2.8V±1%, 300mA, +CE	SOT-89-5	32um VR4	6h	Tor
9CL	XC6209G492PR	LVR-IC	LDO, 4.9V±2%, 300mA, -CE, PDR	SOT-89-5	32um VR4	6h	Tor
9CM	XC6209C502PR	LVR-IC	LDO, 5V±2%, 150mA, -CE, PDR	SOT-89-5	32um VR4	6h	Tor
9CM	XC6223A291PR-G	LVR-IC	LDO, 2.9V±1%, 300mA, +CE	SOT-89-5	32um VR4	6h	Tor
9CM	XC6209G502PR	LVR-IC	LDO, 5V±2%, 300mA, -CE, PDR	SOT-89-5	32um VR4	6h	Tor
9CN	XC6209C512PR	LVR-IC	LDO, 5.1V±2%, 150mA, -CE, PDR	SOT-89-5	32um VR4	6h	Tor
9CN	XC6223A301PR-G	LVR-IC	LDO, 3.0V±1%, 300mA, +CE	SOT-89-5	32um VR4	6h	Tor
9CN	XC6209G512PR	LVR-IC	LDO, 5.1V±2%, 300mA, -CE, PDR	SOT-89-5	32um VR4	6h	Tor
9CP	XC6209C522PR	LVR-IC	LDO, 5.2V±2%, 150mA, -CE, PDR	SOT-89-5	32um VR4	6h	Tor
9CP	XC6223A311PR-G	LVR-IC	LDO, 3.1V±1%, 300mA, +CE	SOT-89-5	32um VR4	6h	Tor
9CP	XC6209G522PR	LVR-IC	LDO, 5.2V±2%, 300mA, -CE, PDR	SOT-89-5	32um VR4	6h	Tor
9CR	XC6209C532PR	LVR-IC	LDO, 5.3V±2%, 150mA, -CE, PDR	SOT-89-5	32um VR4	6h	Tor
9CR	XC6223A321PR-G	LVR-IC	LDO, 3.2V±1%, 300mA, +CE	SOT-89-5	32um VR4	6h	Tor
9CR	XC6209G532PR	LVR-IC	LDO, 5.3V±2%, 300mA, -CE, PDR	SOT-89-5	32um VR4	6h	Tor
9CS	XC6209C542PR	LVR-IC	LDO, 5.4V±2%, 150mA, -CE, PDR	SOT-89-5	32um VR4	6h	Tor
9CS	XC6223A331PR-G	LVR-IC	LDO, 3.3V±1%, 300mA, +CE	SOT-89-5	32um VR4	6h	Tor
9CS	XC6209G542PR	LVR-IC	LDO, 5.4V±2%, 300mA, -CE, PDR	SOT-89-5	32um VR4	6h	Tor
9CT	XC6209C552PR	LVR-IC	LDO, 5.5V±2%, 150mA, -CE, PDR	SOT-89-5	32um VR4	6h	Tor
9CT	XC6223A341PR-G	LVR-IC	LDO, 3.4V±1%, 300mA, +CE	SOT-89-5	32um VR4	6h	Tor
9CT	XC6209G552PR	LVR-IC	LDO, 5.5V±2%, 300mA, -CE, PDR	SOT-89-5	32um VR4	6h	Tor
9CU	XC6209C562PR	LVR-IC	LDO, 5.6V±2%, 150mA, -CE, PDR	SOT-89-5	32um VR4	6h	Tor
9CU	XC6223A351PR-G	LVR-IC	LDO, 3.5V±1%, 300mA, +CE	SOT-89-5	32um VR4	6h	Tor
9CU	XC6209G562PR	LVR-IC	LDO, 5.6V±2%, 300mA, -CE, PDR	SOT-89-5	32um VR4	6h	Tor
9CV	XC6209C572PR	LVR-IC	LDO, 5.7V±2%, 150mA, -CE, PDR	SOT-89-5	32um VR4	6h	Tor
9CV	XC6223A361PR-G	LVR-IC	LDO, 3.6V±1%, 300mA, +CE	SOT-89-5	32um VR4	6h	Tor
9CV	XC6209G572PR	LVR-IC	LDO, 5.7V±2%, 300mA, -CE, PDR	SOT-89-5	32um VR4	6h	Tor
9CX	XC6209C582PR	LVR-IC	LDO, 5.8V±2%, 150mA, -CE, PDR	SOT-89-5	32um VR4	6h	Tor
9CX	XC6223A371PR-G	LVR-IC	LDO, 3.7V±1%, 300mA, +CE	SOT-89-5	32um VR4	6h	Tor
9CX	XC6209G582PR	LVR-IC	LDO, 5.8V±2%, 300mA, -CE, PDR	SOT-89-5	32um VR4	6h	Tor
9CY	XC6209C592PR	LVR-IC	LDO, 5.9V±2%, 150mA, -CE, PDR	SOT-89-5	32um VR4	6h	Tor
9CY	XC6223A381PR-G	LVR-IC	LDO, 3.8V±1%, 300mA, +CE	SOT-89-5	32um VR4	6h	Tor
9CY	XC6209G592PR	LVR-IC	LDO, 5.9V±2%, 300mA, -CE, PDR	SOT-89-5	32um VR4	6h	Tor
9CZ	XC6209C602PR	LVR-IC	LDO, 6V±2%, 150mA, -CE, PDR	SOT-89-5	32um VR4	6h	Tor
9CZ	XC6223A391PR-G	LVR-IC	LDO, 3.9V±1%, 300mA, +CE	SOT-89-5	32um VR4	6h	Tor
9CZ	XC6209G602PR	LVR-IC	LDO, 6V±2%, 300mA, -CE, PDR	SOT-89-5	32um VR4	6h	Tor
9D0	XC6209D312PR	LVR-IC	LDO, 3.1V±2%, 150mA, -CE	SOT-89-5	32um VR4	6h	Tor
9D0	XC6223A401PR-G	LVR-IC	LDO, 4.0V±1%, 300mA, +CE	SOT-89-5	32um VR4	6h	Tor
9D0	XC6209H312PR	LVR-IC	LDO, 3.1V±2%, 300mA, -CE	SOT-89-5	32um VR4	6h	Tor



SMD code	Type	Function	Short description	Case	Pinout Sch.	St.	Mnf.
9D1	XC6209D322PR	LVR-IC	LDO, 3.2V±2%, 150mA, -CE	SOT-89-5	32um VR4	6h	Tor
9D1	XC6209H322PR	LVR-IC	LDO, 3.2V±2%, 300mA, -CE	SOT-89-5	32um VR4	6h	Tor
9D2	XC6209D332PR	LVR-IC	LDO, 3.3V±2%, 150mA, -CE	SOT-89-5	32um VR4	6h	Tor
9D2	XC6209H332PR	LVR-IC	LDO, 3.3V±2%, 300mA, -CE	SOT-89-5	32um VR4	6h	Tor
9D3	XC6209D342PR	LVR-IC	LDO, 3.4V±2%, 150mA, -CE	SOT-89-5	32um VR4	6h	Tor
9D3	XC6209H342PR	LVR-IC	LDO, 3.4V±2%, 300mA, -CE	SOT-89-5	32um VR4	6h	Tor
9D4	XC6209D352PR	LVR-IC	LDO, 3.5V±2%, 150mA, -CE	SOT-89-5	32um VR4	6h	Tor
9D4	XC6209H352PR	LVR-IC	LDO, 3.5V±2%, 300mA, -CE	SOT-89-5	32um VR4	6h	Tor
9D5	XC6209D362PR	LVR-IC	LDO, 3.6V±2%, 150mA, -CE	SOT-89-5	32um VR4	6h	Tor
9D5	XC6209H362PR	LVR-IC	LDO, 3.6V±2%, 300mA, -CE	SOT-89-5	32um VR4	6h	Tor
9D6	XC6209D372PR	LVR-IC	LDO, 3.7V±2%, 150mA, -CE	SOT-89-5	32um VR4	6h	Tor
9D6	XC6209H372PR	LVR-IC	LDO, 3.7V±2%, 300mA, -CE	SOT-89-5	32um VR4	6h	Tor
9D7	XC6209D382PR	LVR-IC	LDO, 3.8V±2%, 150mA, -CE	SOT-89-5	32um VR4	6h	Tor
9D7	XC6209H382PR	LVR-IC	LDO, 3.8V±2%, 300mA, -CE	SOT-89-5	32um VR4	6h	Tor
9D8	XC6209D392PR	LVR-IC	LDO, 3.9V±2%, 150mA, -CE	SOT-89-5	32um VR4	6h	Tor
9D8	XC6209H392PR	LVR-IC	LDO, 3.9V±2%, 300mA, -CE	SOT-89-5	32um VR4	6h	Tor
9D9	XC6209D402PR	LVR-IC	LDO, 4V±2%, 150mA, -CE	SOT-89-5	32um VR4	6h	Tor
9D9	XC6209H402PR	LVR-IC	LDO, 4V±2%, 300mA, -CE	SOT-89-5	32um VR4	6h	Tor
9DA	XC6209D412PR	LVR-IC	LDO, 4.1V±2%, 150mA, -CE	SOT-89-5	32um VR4	6h	Tor
9DA	XC6209H412PR	LVR-IC	LDO, 4.1V±2%, 300mA, -CE	SOT-89-5	32um VR4	6h	Tor
9DB	XC6209D422PR	LVR-IC	LDO, 4.2V±2%, 150mA, -CE	SOT-89-5	32um VR4	6h	Tor
9DB	XC6209H422PR	LVR-IC	LDO, 4.2V±2%, 300mA, -CE	SOT-89-5	32um VR4	6h	Tor
9DC	XC6209D432PR	LVR-IC	LDO, 4.3V±2%, 150mA, -CE	SOT-89-5	32um VR4	6h	Tor
9DC	XC6209H432PR	LVR-IC	LDO, 4.3V±2%, 300mA, -CE	SOT-89-5	32um VR4	6h	Tor
9DD	XC6209D442PR	LVR-IC	LDO, 4.4V±2%, 150mA, -CE	SOT-89-5	32um VR4	6h	Tor
9DD	XC6209H442PR	LVR-IC	LDO, 4.4V±2%, 300mA, -CE	SOT-89-5	32um VR4	6h	Tor
9DE	XC6209D452PR	LVR-IC	LDO, 4.5V±2%, 150mA, -CE	SOT-89-5	32um VR4	6h	Tor
9DE	XC6209H452PR	LVR-IC	LDO, 4.5V±2%, 300mA, -CE	SOT-89-5	32um VR4	6h	Tor
9DF	XC6209D462PR	LVR-IC	LDO, 4.6V±2%, 150mA, -CE	SOT-89-5	32um VR4	6h	Tor
9DF	XC6209H462PR	LVR-IC	LDO, 4.6V±2%, 300mA, -CE	SOT-89-5	32um VR4	6h	Tor
9DH	XC6209D472PR	LVR-IC	LDO, 4.7V±2%, 150mA, -CE	SOT-89-5	32um VR4	6h	Tor
9DH	XC6209H472PR	LVR-IC	LDO, 4.7V±2%, 300mA, -CE	SOT-89-5	32um VR4	6h	Tor
9DK	XC6209D482PR	LVR-IC	LDO, 4.8V±2%, 150mA, -CE	SOT-89-5	32um VR4	6h	Tor
9DK	XC6209H482PR	LVR-IC	LDO, 4.8V±2%, 300mA, -CE	SOT-89-5	32um VR4	6h	Tor
9DL	XC6209D492PR	LVR-IC	LDO, 4.9V±2%, 150mA, -CE	SOT-89-5	32um VR4	6h	Tor
9DL	XC6209H492PR	LVR-IC	LDO, 4.9V±2%, 300mA, -CE	SOT-89-5	32um VR4	6h	Tor
9DM	XC6209D502PR	LVR-IC	LDO, 5V±2%, 150mA, -CE	SOT-89-5	32um VR4	6h	Tor
9DM	XC6209H502PR	LVR-IC	LDO, 5V±2%, 300mA, -CE	SOT-89-5	32um VR4	6h	Tor
9DN	XC6209D512PR	LVR-IC	LDO, 5.1V±2%, 150mA, -CE	SOT-89-5	32um VR4	6h	Tor
9DN	XC6209H512PR	LVR-IC	LDO, 5.1V±2%, 300mA, -CE	SOT-89-5	32um VR4	6h	Tor
9DP	XC6209D522PR	LVR-IC	LDO, 5.2V±2%, 150mA, -CE	SOT-89-5	32um VR4	6h	Tor
9DP	XC6209H522PR	LVR-IC	LDO, 5.2V±2%, 300mA, -CE	SOT-89-5	32um VR4	6h	Tor
9DR	XC6209D532PR	LVR-IC	LDO, 5.3V±2%, 150mA, -CE	SOT-89-5	32um VR4	6h	Tor
9DR	XC6209H532PR	LVR-IC	LDO, 5.3V±2%, 300mA, -CE	SOT-89-5	32um VR4	6h	Tor
9DS	XC6209D542PR	LVR-IC	LDO, 5.4V±2%, 150mA, -CE	SOT-89-5	32um VR4	6h	Tor
9DS	XC6209H542PR	LVR-IC	LDO, 5.4V±2%, 300mA, -CE	SOT-89-5	32um VR4	6h	Tor
9DT	XC6209D552PR	LVR-IC	LDO, 5.5V±2%, 150mA, -CE	SOT-89-5	32um VR4	6h	Tor
9DT	XC6209H552PR	LVR-IC	LDO, 5.5V±2%, 300mA, -CE	SOT-89-5	32um VR4	6h	Tor
9DU	XC6209D562PR	LVR-IC	LDO, 5.6V±2%, 150mA, -CE	SOT-89-5	32um VR4	6h	Tor
9DU	XC6209H562PR	LVR-IC	LDO, 5.6V±2%, 300mA, -CE	SOT-89-5	32um VR4	6h	Tor
9DV	XC6209D572PR	LVR-IC	LDO, 5.7V±2%, 150mA, -CE	SOT-89-5	32um VR4	6h	Tor
9DV	XC6209H572PR	LVR-IC	LDO, 5.7V±2%, 300mA, -CE	SOT-89-5	32um VR4	6h	Tor
9DX	XC6209D582PR	LVR-IC	LDO, 5.8V±2%, 150mA, -CE	SOT-89-5	32um VR4	6h	Tor
9DX	XC6209H582PR	LVR-IC	LDO, 5.8V±2%, 300mA, -CE	SOT-89-5	32um VR4	6h	Tor
9DY	XC6209D592PR	LVR-IC	LDO, 5.9V±2%, 150mA, -CE	SOT-89-5	32um VR4	6h	Tor
9DY	XC6209H592PR	LVR-IC	LDO, 5.9V±2%, 300mA, -CE	SOT-89-5	32um VR4	6h	Tor
9DZ	XC6209D602PR	LVR-IC	LDO, 6V±2%, 150mA, -CE	SOT-89-5	32um VR4	6h	Tor
9DZ	XC6209H602PR	LVR-IC	LDO, 6V±2%, 300mA, -CE	SOT-89-5	32um VR4	6h	Tor
9E2	XC6223A12BPR-G	LVR-IC	LDO, 1.25V±20mV, 300mA, +CE	SOT-89-5	32um VR4	6n	Tor
9E3	XC6223A13BPR-G	LVR-IC	LDO, 1.35V±20mV, 300mA, +CE	SOT-89-5	32um VR4	6n	Tor
9E4	XC6223A14BPR-G	LVR-IC	LDO, 1.45V±20mV, 300mA, +CE	SOT-89-5	32um VR4	6n	Tor
9E5	XC6223A15BPR-G	LVR-IC	LDO, 1.55V±20mV, 300mA, +CE	SOT-89-5	32um VR4	6n	Tor
9E6	XC6223A16BPR-G	LVR-IC	LDO, 1.65V±20mV, 300mA, +CE	SOT-89-5	32um VR4	6n	Tor
9E7	XC6223A17BPR-G	LVR-IC	LDO, 1.75V±20mV, 300mA, +CE	SOT-89-5	32um VR4	6n	Tor
9E8	XC6209A09APR	LVR-IC	LDO, 0.95V±2%, 150mA, +CE, PDR	SOT-89-5	32um VR4	6h	Tor
9E8	XC6223A18BPR-G	LVR-IC	LDO, 1.85V±20mV, 300mA, +CE	SOT-89-5	32um VR4	6n	Tor
9E8	XC6209E09APR	LVR-IC	LDO, 0.95V±2%, 300mA, +CE, PDR	SOT-89-5	32um VR4	6h	Tor
9E9	XC6209A10APR	LVR-IC	LDO, 1.05V±2%, 150mA, +CE, PDR	SOT-89-5	32um VR4	6h	Tor
9E9	XC6223A19BPR-G	LVR-IC	LDO, 1.95V±20mV, 300mA, +CE	SOT-89-5	32um VR4	6n	Tor
9E9	XC6209E10APR	LVR-IC	LDO, 1.05V±2%, 300mA, +CE, PDR	SOT-89-5	32um VR4	6h	Tor



SMD code	Type	Function	Short description	Case	Pinout Sch.	St.	Mnf.
9EA	XC6209A11APR	LVR-IC	LDO, 1.15V±2%, 150mA, +CE, PDR	SOT-89-5	32um VR4	6h	Tor
9EA	XC6223A20BPR-G	LVR-IC	LDO, 2.05V±1%, 300mA, +CE	SOT-89-5	32um VR4	6n	Tor
9EA	XC6209E11APR	LVR-IC	LDO, 1.15V±2%, 300mA, +CE, PDR	SOT-89-5	32um VR4	6h	Tor
9EB	XC6209A12APR	LVR-IC	LDO, 1.25V±2%, 150mA, +CE, PDR	SOT-89-5	32um VR4	6h	Tor
9EB	XC6223A21BPR-G	LVR-IC	LDO, 2.15V±1%, 300mA, +CE	SOT-89-5	32um VR4	6n	Tor
9EB	XC6209E12APR	LVR-IC	LDO, 1.25V±2%, 300mA, +CE, PDR	SOT-89-5	32um VR4	6h	Tor
9EC	XC6209A13APR	LVR-IC	LDO, 1.35V±2%, 150mA, +CE, PDR	SOT-89-5	32um VR4	6h	Tor
9EC	XC6223A22BPR-G	LVR-IC	LDO, 2.25V±1%, 300mA, +CE	SOT-89-5	32um VR4	6n	Tor
9EC	XC6209E13APR	LVR-IC	LDO, 1.35V±2%, 300mA, +CE, PDR	SOT-89-5	32um VR4	6h	Tor
9ED	XC6209A14APR	LVR-IC	LDO, 1.45V±2%, 150mA, +CE, PDR	SOT-89-5	32um VR4	6h	Tor
9ED	XC6223A23BPR-G	LVR-IC	LDO, 2.35V±1%, 300mA, +CE	SOT-89-5	32um VR4	6n	Tor
9ED	XC6209E14APR	LVR-IC	LDO, 1.45V±2%, 300mA, +CE, PDR	SOT-89-5	32um VR4	6h	Tor
9EE	XC6209A15APR	LVR-IC	LDO, 1.55V±2%, 150mA, +CE, PDR	SOT-89-5	32um VR4	6h	Tor
9EE	XC6223A24BPR-G	LVR-IC	LDO, 2.45V±1%, 300mA, +CE	SOT-89-5	32um VR4	6n	Tor
9EE	XC6209E15APR	LVR-IC	LDO, 1.55V±2%, 300mA, +CE, PDR	SOT-89-5	32um VR4	6h	Tor
9EF	XC6209A16APR	LVR-IC	LDO, 1.65V±2%, 150mA, +CE, PDR	SOT-89-5	32um VR4	6h	Tor
9EF	XC6223A25BPR-G	LVR-IC	LDO, 2.55V±1%, 300mA, +CE	SOT-89-5	32um VR4	6n	Tor
9EF	XC6209E16APR	LVR-IC	LDO, 1.65V±2%, 300mA, +CE, PDR	SOT-89-5	32um VR4	6h	Tor
9EH	XC6209A17APR	LVR-IC	LDO, 1.75V±2%, 150mA, +CE, PDR	SOT-89-5	32um VR4	6h	Tor
9EH	XC6223A26BPR-G	LVR-IC	LDO, 2.65V±1%, 300mA, +CE	SOT-89-5	32um VR4	6n	Tor
9EH	XC6209E17APR	LVR-IC	LDO, 1.75V±2%, 300mA, +CE, PDR	SOT-89-5	32um VR4	6h	Tor
9EK	XC6209A18APR	LVR-IC	LDO, 1.85V±2%, 150mA, +CE, PDR	SOT-89-5	32um VR4	6h	Tor
9EK	XC6223A27BPR-G	LVR-IC	LDO, 2.75V±1%, 300mA, +CE	SOT-89-5	32um VR4	6n	Tor
9EK	XC6209E18APR	LVR-IC	LDO, 1.85V±2%, 300mA, +CE, PDR	SOT-89-5	32um VR4	6h	Tor
9EL	XC6209A19APR	LVR-IC	LDO, 1.95V±2%, 150mA, +CE, PDR	SOT-89-5	32um VR4	6h	Tor
9EL	XC6223A28BPR-G	LVR-IC	LDO, 2.85V±1%, 300mA, +CE	SOT-89-5	32um VR4	6n	Tor
9EL	XC6209E19APR	LVR-IC	LDO, 1.95V±2%, 300mA, +CE, PDR	SOT-89-5	32um VR4	6h	Tor
9EM	XC6209A20APR	LVR-IC	LDO, 2.05V±2%, 150mA, +CE, PDR	SOT-89-5	32um VR4	6h	Tor
9EM	XC6223A29BPR-G	LVR-IC	LDO, 2.95V±1%, 300mA, +CE	SOT-89-5	32um VR4	6n	Tor
9EM	XC6209E20APR	LVR-IC	LDO, 2.05V±2%, 300mA, +CE, PDR	SOT-89-5	32um VR4	6h	Tor
9EN	XC6209A21APR	LVR-IC	LDO, 2.15V±2%, 150mA, +CE, PDR	SOT-89-5	32um VR4	6h	Tor
9EN	XC6223A30BPR-G	LVR-IC	LDO, 3.05V±1%, 300mA, +CE	SOT-89-5	32um VR4	6n	Tor
9EN	XC6209E21APR	LVR-IC	LDO, 2.15V±2%, 300mA, +CE, PDR	SOT-89-5	32um VR4	6h	Tor
9EP	XC6209A22APR	LVR-IC	LDO, 2.25V±2%, 150mA, +CE, PDR	SOT-89-5	32um VR4	6h	Tor
9EP	XC6223A31BPR-G	LVR-IC	LDO, 3.15V±1%, 300mA, +CE	SOT-89-5	32um VR4	6n	Tor
9EP	XC6209E22APR	LVR-IC	LDO, 2.25V±2%, 300mA, +CE, PDR	SOT-89-5	32um VR4	6h	Tor
9ER	XC6209A23APR	LVR-IC	LDO, 2.35V±2%, 150mA, +CE, PDR	SOT-89-5	32um VR4	6h	Tor
9ER	XC6223A32BPR-G	LVR-IC	LDO, 3.25V±1%, 300mA, +CE	SOT-89-5	32um VR4	6n	Tor
9ER	XC6209E23APR	LVR-IC	LDO, 2.35V±2%, 300mA, +CE, PDR	SOT-89-5	32um VR4	6h	Tor
9ES	XC6209A24APR	LVR-IC	LDO, 2.45V±2%, 150mA, +CE, PDR	SOT-89-5	32um VR4	6h	Tor
9ES	XC6223A33BPR-G	LVR-IC	LDO, 3.35V±1%, 300mA, +CE	SOT-89-5	32um VR4	6n	Tor
9ES	XC6209E24APR	LVR-IC	LDO, 2.45V±2%, 300mA, +CE, PDR	SOT-89-5	32um VR4	6h	Tor
9ET	XC6209A25APR	LVR-IC	LDO, 2.55V±2%, 150mA, +CE, PDR	SOT-89-5	32um VR4	6h	Tor
9ET	XC6223A34BPR-G	LVR-IC	LDO, 3.45V±1%, 300mA, +CE	SOT-89-5	32um VR4	6n	Tor
9ET	XC6209E25APR	LVR-IC	LDO, 2.55V±2%, 300mA, +CE, PDR	SOT-89-5	32um VR4	6h	Tor
9EU	XC6209A26APR	LVR-IC	LDO, 2.65V±2%, 150mA, +CE, PDR	SOT-89-5	32um VR4	6h	Tor
9EU	XC6223A35BPR-G	LVR-IC	LDO, 3.55V±1%, 300mA, +CE	SOT-89-5	32um VR4	6n	Tor
9EU	XC6209E26APR	LVR-IC	LDO, 2.65V±2%, 300mA, +CE, PDR	SOT-89-5	32um VR4	6h	Tor
9EV	XC6209A27APR	LVR-IC	LDO, 2.75V±2%, 150mA, +CE, PDR	SOT-89-5	32um VR4	6h	Tor
9EV	XC6223A36BPR-G	LVR-IC	LDO, 3.65V±1%, 300mA, +CE	SOT-89-5	32um VR4	6n	Tor
9EV	XC6209E27APR	LVR-IC	LDO, 2.75V±2%, 300mA, +CE, PDR	SOT-89-5	32um VR4	6h	Tor
9EX	XC6209A28APR	LVR-IC	LDO, 2.85V±2%, 150mA, +CE, PDR	SOT-89-5	32um VR4	6h	Tor
9EX	XC6223A37BPR-G	LVR-IC	LDO, 3.75V±1%, 300mA, +CE	SOT-89-5	32um VR4	6n	Tor
9EX	XC6209E28APR	LVR-IC	LDO, 2.85V±2%, 300mA, +CE, PDR	SOT-89-5	32um VR4	6h	Tor
9EY	XC6209A29APR	LVR-IC	LDO, 2.95V±2%, 150mA, +CE, PDR	SOT-89-5	32um VR4	6h	Tor
9EY	XC6223A38BPR-G	LVR-IC	LDO, 3.85V±1%, 300mA, +CE	SOT-89-5	32um VR4	6n	Tor
9EY	XC6209E29APR	LVR-IC	LDO, 2.95V±2%, 300mA, +CE, PDR	SOT-89-5	32um VR4	6h	Tor
9EZ	XC6209A30APR	LVR-IC	LDO, 3.05V±2%, 150mA, +CE, PDR	SOT-89-5	32um VR4	6h	Tor
9EZ	XC6223A39BPR-G	LVR-IC	LDO, 3.95V±1%, 300mA, +CE	SOT-89-5	32um VR4	6n	Tor
9EZ	XC6209E30APR	LVR-IC	LDO, 3.05V±2%, 300mA, +CE, PDR	SOT-89-5	32um VR4	6h	Tor
9F2	XC6223B121PR-G	LVR-IC	LDO, 1.2V±20mV, 300mA, +CE, CL	SOT-89-5	32um VR4	6n	Tor
9F3	XC6223B131PR-G	LVR-IC	LDO, 1.3V±20mV, 300mA, +CE, CL	SOT-89-5	32um VR4	6n	Tor
9F4	XC6223B141PR-G	LVR-IC	LDO, 1.4V±20mV, 300mA, +CE, CL	SOT-89-5	32um VR4	6n	Tor
9F5	XC6223B151PR-G	LVR-IC	LDO, 1.5V±20mV, 300mA, +CE, CL	SOT-89-5	32um VR4	6n	Tor
9F6	XC6223B161PR-G	LVR-IC	LDO, 1.6V±20mV, 300mA, +CE, CL	SOT-89-5	32um VR4	6n	Tor
9F7	XC6223B171PR-G	LVR-IC	LDO, 1.7V±20mV, 300mA, +CE, CL	SOT-89-5	32um VR4	6n	Tor
9F8	XC6209B09APR	LVR-IC	LDO, 0.95V±2%, 150mA, +CE	SOT-89-5	32um VR4	6h	Tor
9F8	XC6223B181PR-G	LVR-IC	LDO, 1.8V±20mV, 300mA, +CE, CL	SOT-89-5	32um VR4	6n	Tor
9F8	XC6209F09APR	LVR-IC	LDO, 0.95V±2%, 300mA, +CE	SOT-89-5	32um VR4	6h	Tor
9F9	XC6209B10APR	LVR-IC	LDO, 1.05V±2%, 150mA, +CE	SOT-89-5	32um VR4	6h	Tor



SMD code	Type	Function	Short description	Case	Pinout	Sch.	St.	Mnf.
9F9	XC6223B191PR-G	LVR-IC	LDO, 1.9V±20mV, 300mA, +CE, CL	SOT-89-5	32um	VR4	6n	Tor
9E9	XC6209F10APR	LVR-IC	LDO, 1.05V±2%, 300mA, +CE	SOT-89-5	32um	VR4	6h	Tor
9FA	XC6209B11APR	LVR-IC	LDO, 1.15V±2%, 150mA, +CE	SOT-89-5	32um	VR4	6h	Tor
9FA	XC6223B201PR-G	LVR-IC	LDO, 2.0V±1%, 300mA, +CE, CL	SOT-89-5	32um	VR4	6n	Tor
9FA	XC6209F11APR	LVR-IC	LDO, 1.15V±2%, 300mA, +CE	SOT-89-5	32um	VR4	6h	Tor
9FB	XC6209B12APR	LVR-IC	LDO, 1.25V±2%, 150mA, +CE	SOT-89-5	32um	VR4	6h	Tor
9FB	XC6223B211PR-G	LVR-IC	LDO, 2.1V±1%, 300mA, +CE, CL	SOT-89-5	32um	VR4	6n	Tor
9FB	XC6209F12APR	LVR-IC	LDO, 1.25V±2%, 300mA, +CE	SOT-89-5	32um	VR4	6h	Tor
9FC	XC6209B13APR	LVR-IC	LDO, 1.35V±2%, 150mA, +CE	SOT-89-5	32um	VR4	6h	Tor
9FC	XC6223B221PR-G	LVR-IC	LDO, 2.2V±1%, 300mA, +CE, CL	SOT-89-5	32um	VR4	6n	Tor
9FC	XC6209F13APR	LVR-IC	LDO, 1.35V±2%, 300mA, +CE	SOT-89-5	32um	VR4	6h	Tor
9FD	XC6209B14APR	LVR-IC	LDO, 1.45V±2%, 150mA, +CE	SOT-89-5	32um	VR4	6h	Tor
9FD	XC6223B231PR-G	LVR-IC	LDO, 2.3V±1%, 300mA, +CE, CL	SOT-89-5	32um	VR4	6n	Tor
9FD	XC6209F14APR	LVR-IC	LDO, 1.45V±2%, 300mA, +CE	SOT-89-5	32um	VR4	6h	Tor
9FE	XC6209B15APR	LVR-IC	LDO, 1.55V±2%, 150mA, +CE	SOT-89-5	32um	VR4	6h	Tor
9FE	XC6223B241PR-G	LVR-IC	LDO, 2.4V±1%, 300mA, +CE, CL	SOT-89-5	32um	VR4	6n	Tor
9FE	XC6209F15APR	LVR-IC	LDO, 1.55V±2%, 300mA, +CE	SOT-89-5	32um	VR4	6h	Tor
9FF	XC6209B16APR	LVR-IC	LDO, 1.65V±2%, 150mA, +CE	SOT-89-5	32um	VR4	6h	Tor
9FF	XC6223B251PR-G	LVR-IC	LDO, 2.5V±1%, 300mA, +CE, CL	SOT-89-5	32um	VR4	6n	Tor
9FF	XC6209F16APR	LVR-IC	LDO, 1.65V±2%, 300mA, +CE	SOT-89-5	32um	VR4	6h	Tor
9FH	XC6209B17APR	LVR-IC	LDO, 1.75V±2%, 150mA, +CE	SOT-89-5	32um	VR4	6h	Tor
9FH	XC6223B261PR-G	LVR-IC	LDO, 2.6V±1%, 300mA, +CE, CL	SOT-89-5	32um	VR4	6n	Tor
9FH	XC6209F17APR	LVR-IC	LDO, 1.75V±2%, 300mA, +CE	SOT-89-5	32um	VR4	6h	Tor
9FK	XC6209B18APR	LVR-IC	LDO, 1.85V±2%, 150mA, +CE	SOT-89-5	32um	VR4	6h	Tor
9FK	XC6223B271PR-G	LVR-IC	LDO, 2.7V±1%, 300mA, +CE, CL	SOT-89-5	32um	VR4	6n	Tor
9FK	XC6209F18APR	LVR-IC	LDO, 1.85V±2%, 300mA, +CE	SOT-89-5	32um	VR4	6h	Tor
9FL	XC6209B19APR	LVR-IC	LDO, 1.95V±2%, 150mA, +CE	SOT-89-5	32um	VR4	6h	Tor
9FL	XC6223B281PR-G	LVR-IC	LDO, 2.8V±1%, 300mA, +CE, CL	SOT-89-5	32um	VR4	6n	Tor
9FL	XC6209F19APR	LVR-IC	LDO, 1.95V±2%, 300mA, +CE	SOT-89-5	32um	VR4	6h	Tor
9FM	XC6209B20APR	LVR-IC	LDO, 2.05V±2%, 150mA, +CE	SOT-89-5	32um	VR4	6h	Tor
9FM	XC6223B291PR-G	LVR-IC	LDO, 2.9V±1%, 300mA, +CE, CL	SOT-89-5	32um	VR4	6n	Tor
9FM	XC6209F20APR	LVR-IC	LDO, 2.05V±2%, 300mA, +CE	SOT-89-5	32um	VR4	6h	Tor
9FN	XC6209B21APR	LVR-IC	LDO, 2.15V±2%, 150mA, +CE	SOT-89-5	32um	VR4	6h	Tor
9FN	XC6223B301PR-G	LVR-IC	LDO, 3.0V±1%, 300mA, +CE, CL	SOT-89-5	32um	VR4	6n	Tor
9FN	XC6209F21APR	LVR-IC	LDO, 2.15V±2%, 300mA, +CE	SOT-89-5	32um	VR4	6h	Tor
9FP	XC6209B22APR	LVR-IC	LDO, 2.25V±2%, 150mA, +CE	SOT-89-5	32um	VR4	6h	Tor
9FP	XC6223B311PR-G	LVR-IC	LDO, 3.1V±1%, 300mA, +CE, CL	SOT-89-5	32um	VR4	6n	Tor
9FP	XC6209F22APR	LVR-IC	LDO, 2.25V±2%, 300mA, +CE	SOT-89-5	32um	VR4	6h	Tor
9FR	XC6209B23APR	LVR-IC	LDO, 2.35V±2%, 150mA, +CE	SOT-89-5	32um	VR4	6h	Tor
9FR	XC6223B321PR-G	LVR-IC	LDO, 3.2V±1%, 300mA, +CE, CL	SOT-89-5	32um	VR4	6n	Tor
9FR	XC6209F23APR	LVR-IC	LDO, 2.35V±2%, 300mA, +CE	SOT-89-5	32um	VR4	6h	Tor
9FS	XC6209B24APR	LVR-IC	LDO, 2.45V±2%, 150mA, +CE	SOT-89-5	32um	VR4	6h	Tor
9FS	XC6223B331PR-G	LVR-IC	LDO, 3.3V±1%, 300mA, +CE, CL	SOT-89-5	32um	VR4	6n	Tor
9FS	XC6209F24APR	LVR-IC	LDO, 2.45V±2%, 300mA, +CE	SOT-89-5	32um	VR4	6h	Tor
9FT	XC6209B25APR	LVR-IC	LDO, 2.55V±2%, 150mA, +CE	SOT-89-5	32um	VR4	6h	Tor
9FT	XC6223B341PR-G	LVR-IC	LDO, 3.4V±1%, 300mA, +CE, CL	SOT-89-5	32um	VR4	6n	Tor
9FT	XC6209F25APR	LVR-IC	LDO, 2.55V±2%, 300mA, +CE	SOT-89-5	32um	VR4	6h	Tor
9FU	XC6209B26APR	LVR-IC	LDO, 2.65V±2%, 150mA, +CE	SOT-89-5	32um	VR4	6h	Tor
9FU	XC6223B351PR-G	LVR-IC	LDO, 3.5V±1%, 300mA, +CE, CL	SOT-89-5	32um	VR4	6n	Tor
9FU	XC6209F26APR	LVR-IC	LDO, 2.65V±2%, 300mA, +CE	SOT-89-5	32um	VR4	6h	Tor
9FV	XC6209B27APR	LVR-IC	LDO, 2.75V±2%, 150mA, +CE	SOT-89-5	32um	VR4	6h	Tor
9FV	XC6223B361PR-G	LVR-IC	LDO, 3.6V±1%, 300mA, +CE, CL	SOT-89-5	32um	VR4	6n	Tor
9FV	XC6209F27APR	LVR-IC	LDO, 2.75V±2%, 300mA, +CE	SOT-89-5	32um	VR4	6h	Tor
9FX	XC6209B28APR	LVR-IC	LDO, 2.85V±2%, 150mA, +CE	SOT-89-5	32um	VR4	6h	Tor
9FX	XC6223B371PR-G	LVR-IC	LDO, 3.7V±1%, 300mA, +CE, CL	SOT-89-5	32um	VR4	6n	Tor
9FX	XC6209F28APR	LVR-IC	LDO, 2.85V±2%, 300mA, +CE	SOT-89-5	32um	VR4	6h	Tor
9FY	XC6209B29APR	LVR-IC	LDO, 2.95V±2%, 150mA, +CE	SOT-89-5	32um	VR4	6h	Tor
9FY	XC6223B381PR-G	LVR-IC	LDO, 3.8V±1%, 300mA, +CE, CL	SOT-89-5	32um	VR4	6n	Tor
9FY	XC6209F29APR	LVR-IC	LDO, 2.95V±2%, 300mA, +CE	SOT-89-5	32um	VR4	6h	Tor
9FZ	XC6209B30APR	LVR-IC	LDO, 3.05V±2%, 150mA, +CE	SOT-89-5	32um	VR4	6h	Tor
9FZ	XC6223B391PR-G	LVR-IC	LDO, 3.9V±1%, 300mA, +CE, CL	SOT-89-5	32um	VR4	6n	Tor
9FZ	XC6209F30APR	LVR-IC	LDO, 3.05V±2%, 300mA, +CE	SOT-89-5	32um	VR4	6h	Tor
9H0	XC6223B401PR-G	LVR-IC	LDO, 4.0V±1%, 300mA, +CE, CL	SOT-89-5	32um	VR4	6n	Tor
9H8	XC6209C09APR	LVR-IC	LDO, 0.95V±2%, 150mA, -CE, PDR	SOT-89-5	32um	VR4	6h	Tor
9H8	XC6209G09APR	LVR-IC	LDO, 0.95V±2%, 300mA, -CE, PDR	SOT-89-5	32um	VR4	6h	Tor
9H9	XC6209C10APR	LVR-IC	LDO, 1.05V±2%, 150mA, -CE, PDR	SOT-89-5	32um	VR4	6h	Tor
9H9	XC6209G10APR	LVR-IC	LDO, 1.05V±2%, 300mA, -CE, PDR	SOT-89-5	32um	VR4	6h	Tor
9HA	XC6209C11APR	LVR-IC	LDO, 1.15V±2%, 150mA, -CE, PDR	SOT-89-5	32um	VR4	6h	Tor
9HA	XC6209G11APR	LVR-IC	LDO, 1.15V±2%, 300mA, -CE, PDR	SOT-89-5	32um	VR4	6h	Tor
9HB	XC6209C12APR	LVR-IC	LDO, 1.25V±2%, 150mA, -CE, PDR	SOT-89-5	32um	VR4	6h	Tor



SMD code	Type	Function	Short description	Case	Pinout Sch.	St.	Mnf.
9HB	XC6209G12APR	LVR-IC	LDO, 1.25V±2%, 300mA, -CE, PDR	SOT-89-5	32um VR4	6h	Tor
9HC	XC6209C13APR	LVR-IC	LDO, 1.35V±2%, 150mA, -CE, PDR	SOT-89-5	32um VR4	6h	Tor
9HC	XC6209G13APR	LVR-IC	LDO, 1.35V±2%, 300mA, -CE, PDR	SOT-89-5	32um VR4	6h	Tor
9HD	XC6209C14APR	LVR-IC	LDO, 1.45V±2%, 150mA, -CE, PDR	SOT-89-5	32um VR4	6h	Tor
9HD	XC6209G14APR	LVR-IC	LDO, 1.45V±2%, 300mA, -CE, PDR	SOT-89-5	32um VR4	6h	Tor
9HE	XC6209C15APR	LVR-IC	LDO, 1.55V±2%, 150mA, -CE, PDR	SOT-89-5	32um VR4	6h	Tor
9HE	XC6209G15APR	LVR-IC	LDO, 1.55V±2%, 300mA, -CE, PDR	SOT-89-5	32um VR4	6h	Tor
9HF	XC6209C16APR	LVR-IC	LDO, 1.65V±2%, 150mA, -CE, PDR	SOT-89-5	32um VR4	6h	Tor
9HF	XC6209G16APR	LVR-IC	LDO, 1.65V±2%, 300mA, -CE, PDR	SOT-89-5	32um VR4	6h	Tor
9HH	XC6209C17APR	LVR-IC	LDO, 1.75V±2%, 150mA, -CE, PDR	SOT-89-5	32um VR4	6h	Tor
9HH	XC6209G17APR	LVR-IC	LDO, 1.75V±2%, 300mA, -CE, PDR	SOT-89-5	32um VR4	6h	Tor
9HK	XC6209C18APR	LVR-IC	LDO, 1.85V±2%, 150mA, -CE, PDR	SOT-89-5	32um VR4	6h	Tor
9HK	XC6209G18APR	LVR-IC	LDO, 1.85V±2%, 300mA, -CE, PDR	SOT-89-5	32um VR4	6h	Tor
9HL	XC6209C19APR	LVR-IC	LDO, 1.95V±2%, 150mA, -CE, PDR	SOT-89-5	32um VR4	6h	Tor
9HL	XC6209G19APR	LVR-IC	LDO, 1.95V±2%, 300mA, -CE, PDR	SOT-89-5	32um VR4	6h	Tor
9HM	XC6209C20APR	LVR-IC	LDO, 2.05V±2%, 150mA, -CE, PDR	SOT-89-5	32um VR4	6h	Tor
9HM	XC6209G20APR	LVR-IC	LDO, 2.05V±2%, 300mA, -CE, PDR	SOT-89-5	32um VR4	6h	Tor
9HN	XC6209C21APR	LVR-IC	LDO, 2.15V±2%, 150mA, -CE, PDR	SOT-89-5	32um VR4	6h	Tor
9HN	XC6209G21APR	LVR-IC	LDO, 2.15V±2%, 300mA, -CE, PDR	SOT-89-5	32um VR4	6h	Tor
9HP	XC6209C22APR	LVR-IC	LDO, 2.25V±2%, 150mA, -CE, PDR	SOT-89-5	32um VR4	6h	Tor
9HP	XC6209G22APR	LVR-IC	LDO, 2.25V±2%, 300mA, -CE, PDR	SOT-89-5	32um VR4	6h	Tor
9HR	XC6209C23APR	LVR-IC	LDO, 2.35V±2%, 150mA, -CE, PDR	SOT-89-5	32um VR4	6h	Tor
9HR	XC6209G23APR	LVR-IC	LDO, 2.35V±2%, 300mA, -CE, PDR	SOT-89-5	32um VR4	6h	Tor
9HS	XC6209C24APR	LVR-IC	LDO, 2.45V±2%, 150mA, -CE, PDR	SOT-89-5	32um VR4	6h	Tor
9HS	XC6209G24APR	LVR-IC	LDO, 2.45V±2%, 300mA, -CE, PDR	SOT-89-5	32um VR4	6h	Tor
9HT	XC6209C25APR	LVR-IC	LDO, 2.55V±2%, 150mA, -CE, PDR	SOT-89-5	32um VR4	6h	Tor
9HT	XC6209G25APR	LVR-IC	LDO, 2.55V±2%, 300mA, -CE, PDR	SOT-89-5	32um VR4	6h	Tor
9HU	XC6209C26APR	LVR-IC	LDO, 2.65V±2%, 150mA, -CE, PDR	SOT-89-5	32um VR4	6h	Tor
9HU	XC6209G26APR	LVR-IC	LDO, 2.65V±2%, 300mA, -CE, PDR	SOT-89-5	32um VR4	6h	Tor
9HV	XC6209C27APR	LVR-IC	LDO, 2.75V±2%, 150mA, -CE, PDR	SOT-89-5	32um VR4	6h	Tor
9HV	XC6209G27APR	LVR-IC	LDO, 2.75V±2%, 300mA, -CE, PDR	SOT-89-5	32um VR4	6h	Tor
9HX	XC6209C28APR	LVR-IC	LDO, 2.85V±2%, 150mA, -CE, PDR	SOT-89-5	32um VR4	6h	Tor
9HX	XC6209G28APR	LVR-IC	LDO, 2.85V±2%, 300mA, -CE, PDR	SOT-89-5	32um VR4	6h	Tor
9HY	XC6209C29APR	LVR-IC	LDO, 2.95V±2%, 150mA, -CE, PDR	SOT-89-5	32um VR4	6h	Tor
9HY	XC6209G29APR	LVR-IC	LDO, 2.95V±2%, 300mA, -CE, PDR	SOT-89-5	32um VR4	6h	Tor
9HZ	XC6209C30APR	LVR-IC	LDO, 3.05V±2%, 150mA, -CE, PDR	SOT-89-5	32um VR4	6h	Tor
9HZ	XC6209G30APR	LVR-IC	LDO, 3.05V±2%, 300mA, -CE, PDR	SOT-89-5	32um VR4	6h	Tor
9K2	XC6223B12BPR-G	LVR-IC	LDO, 1.25V±20mV, 300mA, +CE, CL	SOT-89-5	32um VR4	6h	Tor
9K3	XC6223B13BPR-G	LVR-IC	LDO, 1.35V±20mV, 300mA, +CE, CL	SOT-89-5	32um VR4	6h	Tor
9K4	XC6223B14BPR-G	LVR-IC	LDO, 1.45V±20mV, 300mA, +CE, CL	SOT-89-5	32um VR4	6h	Tor
9K5	XC6223B15BPR-G	LVR-IC	LDO, 1.55V±20mV, 300mA, +CE, CL	SOT-89-5	32um VR4	6h	Tor
9K6	XC6223B16BPR-G	LVR-IC	LDO, 1.65V±20mV, 300mA, +CE, CL	SOT-89-5	32um VR4	6h	Tor
9K7	XC6223B17BPR-G	LVR-IC	LDO, 1.75V±20mV, 300mA, +CE, CL	SOT-89-5	32um VR4	6h	Tor
9K8	XC6209D09APR	LVR-IC	LDO, 0.95V±2%, 150mA, -CE	SOT-89-5	32um VR4	6h	Tor
9K8	XC6223B18BPR-G	LVR-IC	LDO, 1.85V±20mV, 300mA, +CE, CL	SOT-89-5	32um VR4	6h	Tor
9K8	XC6209H09APR	LVR-IC	LDO, 0.95V±2%, 300mA, -CE	SOT-89-5	32um VR4	6h	Tor
9K9	XC6209D10APR	LVR-IC	LDO, 1.05V±2%, 150mA, -CE	SOT-89-5	32um VR4	6h	Tor
9K9	XC6223B19BPR-G	LVR-IC	LDO, 1.95V±20mV, 300mA, +CE, CL	SOT-89-5	32um VR4	6h	Tor
9K9	XC6209H10APR	LVR-IC	LDO, 1.05V±2%, 300mA, -CE	SOT-89-5	32um VR4	6h	Tor
9KA	XC6209D11APR	LVR-IC	LDO, 1.15V±2%, 150mA, -CE	SOT-89-5	32um VR4	6h	Tor
9KA	XC6223B20BPR-G	LVR-IC	LDO, 2.05V±1%, 300mA, +CE, CL	SOT-89-5	32um VR4	6h	Tor
9KA	XC6209H11APR	LVR-IC	LDO, 1.15V±2%, 300mA, -CE	SOT-89-5	32um VR4	6h	Tor
9KB	XC6209D12APR	LVR-IC	LDO, 1.25V±2%, 150mA, -CE	SOT-89-5	32um VR4	6h	Tor
9KB	XC6223B21BPR-G	LVR-IC	LDO, 2.15V±1%, 300mA, +CE, CL	SOT-89-5	32um VR4	6h	Tor
9KB	XC6209H12APR	LVR-IC	LDO, 1.25V±2%, 300mA, -CE	SOT-89-5	32um VR4	6h	Tor
9KC	XC6209D13APR	LVR-IC	LDO, 1.35V±2%, 150mA, -CE	SOT-89-5	32um VR4	6h	Tor
9KC	XC6223B22BPR-G	LVR-IC	LDO, 2.25V±1%, 300mA, +CE, CL	SOT-89-5	32um VR4	6h	Tor
9KC	XC6209H13APR	LVR-IC	LDO, 1.35V±2%, 300mA, -CE	SOT-89-5	32um VR4	6h	Tor
9KD	XC6209D14APR	LVR-IC	LDO, 1.45V±2%, 150mA, -CE	SOT-89-5	32um VR4	6h	Tor
9KD	XC6223B23BPR-G	LVR-IC	LDO, 2.35V±1%, 300mA, +CE, CL	SOT-89-5	32um VR4	6h	Tor
9KD	XC6209H14APR	LVR-IC	LDO, 1.45V±2%, 300mA, -CE	SOT-89-5	32um VR4	6h	Tor
9KE	XC6209D15APR	LVR-IC	LDO, 1.55V±2%, 150mA, -CE	SOT-89-5	32um VR4	6h	Tor
9KE	XC6223B24BPR-G	LVR-IC	LDO, 2.45V±1%, 300mA, +CE, CL	SOT-89-5	32um VR4	6h	Tor
9KE	XC6209H15APR	LVR-IC	LDO, 1.55V±2%, 300mA, -CE	SOT-89-5	32um VR4	6h	Tor
9KF	XC6209D16APR	LVR-IC	LDO, 1.65V±2%, 150mA, -CE	SOT-89-5	32um VR4	6h	Tor
9KF	XC6223B25BPR-G	LVR-IC	LDO, 2.55V±1%, 300mA, +CE, CL	SOT-89-5	32um VR4	6h	Tor
9KF	XC6209H16APR	LVR-IC	LDO, 1.65V±2%, 300mA, -CE	SOT-89-5	32um VR4	6h	Tor
9KH	XC6209D17APR	LVR-IC	LDO, 1.75V±2%, 150mA, -CE	SOT-89-5	32um VR4	6h	Tor
9KH	XC6223B26BPR-G	LVR-IC	LDO, 2.65V±1%, 300mA, +CE, CL	SOT-89-5	32um VR4	6h	Tor
9KH	XC6209H17APR	LVR-IC	LDO, 1.75V±2%, 300mA, -CE	SOT-89-5	32um VR4	6h	Tor



SMD code	Type	Function	Short description	Case	Pinout Sch.	St.	Mnf.
9KK	XC6209D18APR	LVR-IC	LDO, 1.85V±2%, 150mA, -CE	SOT-89-5	32um VR4	6h	Tor
9KK	XC6223B27BPR-G	LVR-IC	LDO, 2.75V±1%, 300mA, +CE, CL	SOT-89-5	32um VR4	6n	Tor
9KK	XC6209H18APR	LVR-IC	LDO, 1.85V±2%, 300mA, -CE	SOT-89-5	32um VR4	6h	Tor
9KL	XC6209D19APR	LVR-IC	LDO, 1.95V±2%, 150mA, -CE	SOT-89-5	32um VR4	6h	Tor
9KL	XC6223B28BPR-G	LVR-IC	LDO, 2.85V±1%, 300mA, +CE, CL	SOT-89-5	32um VR4	6n	Tor
9KL	XC6209H19APR	LVR-IC	LDO, 1.95V±2%, 300mA, -CE	SOT-89-5	32um VR4	6h	Tor
9KM	XC6209D20APR	LVR-IC	LDO, 2.05V±2%, 150mA, -CE	SOT-89-5	32um VR4	6h	Tor
9KM	XC6223B29BPR-G	LVR-IC	LDO, 2.95V±1%, 300mA, +CE, CL	SOT-89-5	32um VR4	6n	Tor
9KM	XC6209H20APR	LVR-IC	LDO, 2.05V±2%, 300mA, -CE	SOT-89-5	32um VR4	6h	Tor
9KN	XC6209D21APR	LVR-IC	LDO, 2.15V±2%, 150mA, -CE	SOT-89-5	32um VR4	6h	Tor
9KN	XC6223B30BPR-G	LVR-IC	LDO, 3.05V±1%, 300mA, +CE, CL	SOT-89-5	32um VR4	6n	Tor
9KN	XC6209H21APR	LVR-IC	LDO, 2.15V±2%, 300mA, -CE	SOT-89-5	32um VR4	6h	Tor
9KP	XC6209D22APR	LVR-IC	LDO, 2.25V±2%, 150mA, -CE	SOT-89-5	32um VR4	6h	Tor
9KP	XC6223B31BPR-G	LVR-IC	LDO, 3.15V±1%, 300mA, +CE, CL	SOT-89-5	32um VR4	6n	Tor
9KP	XC6209H22APR	LVR-IC	LDO, 2.25V±2%, 300mA, -CE	SOT-89-5	32um VR4	6h	Tor
9KR	XC6209D23APR	LVR-IC	LDO, 2.35V±2%, 150mA, -CE	SOT-89-5	32um VR4	6h	Tor
9KR	XC6223B32BPR-G	LVR-IC	LDO, 3.25V±1%, 300mA, +CE, CL	SOT-89-5	32um VR4	6n	Tor
9KR	XC6209H23APR	LVR-IC	LDO, 2.35V±2%, 300mA, -CE	SOT-89-5	32um VR4	6h	Tor
9KS	XC6209D24APR	LVR-IC	LDO, 2.45V±2%, 150mA, -CE	SOT-89-5	32um VR4	6h	Tor
9KS	XC6223B33BPR-G	LVR-IC	LDO, 3.35V±1%, 300mA, +CE, CL	SOT-89-5	32um VR4	6n	Tor
9KS	XC6209H24APR	LVR-IC	LDO, 2.45V±2%, 300mA, -CE	SOT-89-5	32um VR4	6h	Tor
9KT	XC6209D25APR	LVR-IC	LDO, 2.55V±2%, 150mA, -CE	SOT-89-5	32um VR4	6h	Tor
9KT	XC6223B34BPR-G	LVR-IC	LDO, 3.45V±1%, 300mA, +CE, CL	SOT-89-5	32um VR4	6n	Tor
9KT	XC6209H25APR	LVR-IC	LDO, 2.55V±2%, 300mA, -CE	SOT-89-5	32um VR4	6h	Tor
9KU	XC6209D26APR	LVR-IC	LDO, 2.65V±2%, 150mA, -CE	SOT-89-5	32um VR4	6h	Tor
9KU	XC6223B35BPR-G	LVR-IC	LDO, 3.55V±1%, 300mA, +CE, CL	SOT-89-5	32um VR4	6n	Tor
9KU	XC6209H26APR	LVR-IC	LDO, 2.65V±2%, 300mA, -CE	SOT-89-5	32um VR4	6h	Tor
9KV	XC6209D27APR	LVR-IC	LDO, 2.75V±2%, 150mA, -CE	SOT-89-5	32um VR4	6h	Tor
9KV	XC6223B36BPR-G	LVR-IC	LDO, 3.65V±1%, 300mA, +CE, CL	SOT-89-5	32um VR4	6n	Tor
9KV	XC6209H27APR	LVR-IC	LDO, 2.75V±2%, 300mA, -CE	SOT-89-5	32um VR4	6h	Tor
9KX	XC6209D28APR	LVR-IC	LDO, 2.85V±2%, 150mA, -CE	SOT-89-5	32um VR4	6h	Tor
9KX	XC6223B37BPR-G	LVR-IC	LDO, 3.75V±1%, 300mA, +CE, CL	SOT-89-5	32um VR4	6n	Tor
9KX	XC6209H28APR	LVR-IC	LDO, 2.85V±2%, 300mA, -CE	SOT-89-5	32um VR4	6h	Tor
9KY	XC6209D29APR	LVR-IC	LDO, 2.95V±2%, 150mA, -CE	SOT-89-5	32um VR4	6h	Tor
9KY	XC6223B38BPR-G	LVR-IC	LDO, 3.85V±1%, 300mA, +CE, CL	SOT-89-5	32um VR4	6n	Tor
9KY	XC6209H29APR	LVR-IC	LDO, 2.95V±2%, 300mA, -CE	SOT-89-5	32um VR4	6h	Tor
9KZ	XC6209D30APR	LVR-IC	LDO, 3.05V±2%, 150mA, -CE	SOT-89-5	32um VR4	6h	Tor
9KZ	XC6223B39BPR-G	LVR-IC	LDO, 3.95V±1%, 300mA, +CE, CL	SOT-89-5	32um VR4	6n	Tor
9KZ	XC6209H30APR	LVR-IC	LDO, 3.05V±2%, 300mA, -CE	SOT-89-5	32um VR4	6h	Tor
9L0	XC6209A31APR	LVR-IC	LDO, 3.15V±2%, 150mA, +CE, PDR	SOT-89-5	32um VR4	6h	Tor
9L0	XC6209E31APR	LVR-IC	LDO, 3.15V±2%, 300mA, +CE, PDR	SOT-89-5	32um VR4	6h	Tor
9L1	XC6209A32APR	LVR-IC	LDO, 3.25V±2%, 150mA, +CE, PDR	SOT-89-5	32um VR4	6h	Tor
9L1	XC6209E32APR	LVR-IC	LDO, 3.25V±2%, 300mA, +CE, PDR	SOT-89-5	32um VR4	6h	Tor
9L2	XC6209A33APR	LVR-IC	LDO, 3.35V±2%, 150mA, +CE, PDR	SOT-89-5	32um VR4	6h	Tor
9L2	XC6223C121PR-G	LVR-IC	LDO, 1.2V±20mV, 300mA, +CE, PDR	SOT-89-5	32um VR4	6n	Tor
9L2	XC6209E33APR	LVR-IC	LDO, 3.35V±2%, 300mA, +CE, PDR	SOT-89-5	32um VR4	6h	Tor
9L3	XC6209A34APR	LVR-IC	LDO, 3.45V±2%, 150mA, +CE, PDR	SOT-89-5	32um VR4	6h	Tor
9L3	XC6223C131PR-G	LVR-IC	LDO, 1.3V±20mV, 300mA, +CE, PDR	SOT-89-5	32um VR4	6n	Tor
9L3	XC6209E34APR	LVR-IC	LDO, 3.45V±2%, 300mA, +CE, PDR	SOT-89-5	32um VR4	6h	Tor
9L4	XC6209A35APR	LVR-IC	LDO, 3.55V±2%, 150mA, +CE, PDR	SOT-89-5	32um VR4	6h	Tor
9L4	XC6223C141PR-G	LVR-IC	LDO, 1.4V±20mV, 300mA, +CE, PDR	SOT-89-5	32um VR4	6n	Tor
9L4	XC6209E35APR	LVR-IC	LDO, 3.55V±2%, 300mA, +CE, PDR	SOT-89-5	32um VR4	6h	Tor
9L5	XC6209A36APR	LVR-IC	LDO, 3.65V±2%, 150mA, +CE, PDR	SOT-89-5	32um VR4	6h	Tor
9L5	XC6223C151PR-G	LVR-IC	LDO, 1.5V±20mV, 300mA, +CE, PDR	SOT-89-5	32um VR4	6n	Tor
9L5	XC6209E36APR	LVR-IC	LDO, 3.65V±2%, 300mA, +CE, PDR	SOT-89-5	32um VR4	6h	Tor
9L6	XC6209A37APR	LVR-IC	LDO, 3.75V±2%, 150mA, +CE, PDR	SOT-89-5	32um VR4	6h	Tor
9L6	XC6223C161PR-G	LVR-IC	LDO, 1.6V±20mV, 300mA, +CE, PDR	SOT-89-5	32um VR4	6n	Tor
9L6	XC6209E37APR	LVR-IC	LDO, 3.75V±2%, 300mA, +CE, PDR	SOT-89-5	32um VR4	6h	Tor
9L7	XC6209A38APR	LVR-IC	LDO, 3.85V±2%, 150mA, +CE, PDR	SOT-89-5	32um VR4	6h	Tor
9L7	XC6223C171PR-G	LVR-IC	LDO, 1.7V±20mV, 300mA, +CE, PDR	SOT-89-5	32um VR4	6n	Tor
9L7	XC6209E38APR	LVR-IC	LDO, 3.85V±2%, 300mA, +CE, PDR	SOT-89-5	32um VR4	6h	Tor
9L8	XC6209A39APR	LVR-IC	LDO, 3.95V±2%, 150mA, +CE, PDR	SOT-89-5	32um VR4	6h	Tor
9L8	XC6223C181PR-G	LVR-IC	LDO, 1.8V±20mV, 300mA, +CE, PDR	SOT-89-5	32um VR4	6n	Tor
9L8	XC6209E39APR	LVR-IC	LDO, 3.95V±2%, 300mA, +CE, PDR	SOT-89-5	32um VR4	6h	Tor
9L9	XC6209A40APR	LVR-IC	LDO, 4.05V±2%, 150mA, +CE, PDR	SOT-89-5	32um VR4	6h	Tor
9L9	XC6223C191PR-G	LVR-IC	LDO, 1.9V±20mV, 300mA, +CE, PDR	SOT-89-5	32um VR4	6n	Tor
9L9	XC6209E40APR	LVR-IC	LDO, 4.05V±2%, 300mA, +CE, PDR	SOT-89-5	32um VR4	6h	Tor
9LA	XC6209A41APR	LVR-IC	LDO, 4.15V±2%, 150mA, +CE, PDR	SOT-89-5	32um VR4	6h	Tor
9LA	XC6223C201PR-G	LVR-IC	LDO, 2.0V±1%, 300mA, +CE, PDR	SOT-89-5	32um VR4	6n	Tor
9LA	XC6209E41APR	LVR-IC	LDO, 4.15V±2%, 300mA, +CE, PDR	SOT-89-5	32um VR4	6h	Tor



SMD code	Type	Function	Short description	Case	Pinout Sch.	St.	Mnf.
9M7	XC6209B38APR	LVR-IC	LDO, 3.85V±2%, 150mA, +CE	SOT-89-5	32um VR4	6h	Tor
9M7	XC6209F38APR	LVR-IC	LDO, 3.85V±2%, 300mA, +CE	SOT-89-5	32um VR4	6h	Tor
9M8	XC6209B39APR	LVR-IC	LDO, 3.95V±2%, 150mA, +CE	SOT-89-5	32um VR4	6h	Tor
9M8	XC6209F39APR	LVR-IC	LDO, 3.95V±2%, 300mA, +CE	SOT-89-5	32um VR4	6h	Tor
9M9	XC6209B40APR	LVR-IC	LDO, 4.05V±2%, 150mA, +CE	SOT-89-5	32um VR4	6h	Tor
9M9	XC6209F40APR	LVR-IC	LDO, 4.05V±2%, 300mA, +CE	SOT-89-5	32um VR4	6h	Tor
9MA	XC6209B41APR	LVR-IC	LDO, 4.15V±2%, 150mA, +CE	SOT-89-5	32um VR4	6h	Tor
9MA	XC6209F41APR	LVR-IC	LDO, 4.15V±2%, 300mA, +CE	SOT-89-5	32um VR4	6h	Tor
9MB	XC6209B42APR	LVR-IC	LDO, 4.25V±2%, 150mA, +CE	SOT-89-5	32um VR4	6h	Tor
9MB	XC6209F42APR	LVR-IC	LDO, 4.25V±2%, 300mA, +CE	SOT-89-5	32um VR4	6h	Tor
9MC	XC6209B43APR	LVR-IC	LDO, 4.35V±2%, 150mA, +CE	SOT-89-5	32um VR4	6h	Tor
9MC	XC6209F43APR	LVR-IC	LDO, 4.35V±2%, 300mA, +CE	SOT-89-5	32um VR4	6h	Tor
9MD	XC6209B44APR	LVR-IC	LDO, 4.45V±2%, 150mA, +CE	SOT-89-5	32um VR4	6h	Tor
9MD	XC6209F44APR	LVR-IC	LDO, 4.45V±2%, 300mA, +CE	SOT-89-5	32um VR4	6h	Tor
9ME	XC6209B45APR	LVR-IC	LDO, 4.55V±2%, 150mA, +CE	SOT-89-5	32um VR4	6h	Tor
9ME	XC6209F45APR	LVR-IC	LDO, 4.55V±2%, 300mA, +CE	SOT-89-5	32um VR4	6h	Tor
9MF	XC6209B46APR	LVR-IC	LDO, 4.65V±2%, 150mA, +CE	SOT-89-5	32um VR4	6h	Tor
9MF	XC6209F46APR	LVR-IC	LDO, 4.65V±2%, 300mA, +CE	SOT-89-5	32um VR4	6h	Tor
9MH	XC6209B47APR	LVR-IC	LDO, 4.75V±2%, 150mA, +CE	SOT-89-5	32um VR4	6h	Tor
9MH	XC6209F47APR	LVR-IC	LDO, 4.75V±2%, 300mA, +CE	SOT-89-5	32um VR4	6h	Tor
9MK	XC6209B48APR	LVR-IC	LDO, 4.85V±2%, 150mA, +CE	SOT-89-5	32um VR4	6h	Tor
9MK	XC6209F48APR	LVR-IC	LDO, 4.85V±2%, 300mA, +CE	SOT-89-5	32um VR4	6h	Tor
9ML	XC6209B49APR	LVR-IC	LDO, 4.95V±2%, 150mA, +CE	SOT-89-5	32um VR4	6h	Tor
9ML	XC6209F49APR	LVR-IC	LDO, 4.95V±2%, 300mA, +CE	SOT-89-5	32um VR4	6h	Tor
9MM	XC6209B50APR	LVR-IC	LDO, 5.05V±2%, 150mA, +CE	SOT-89-5	32um VR4	6h	Tor
9MM	XC6209F50APR	LVR-IC	LDO, 5.05V±2%, 300mA, +CE	SOT-89-5	32um VR4	6h	Tor
9MN	XC6209B51APR	LVR-IC	LDO, 5.15V±2%, 150mA, +CE	SOT-89-5	32um VR4	6h	Tor
9MN	XC6209F51APR	LVR-IC	LDO, 5.15V±2%, 300mA, +CE	SOT-89-5	32um VR4	6h	Tor
9MP	XC6209B52APR	LVR-IC	LDO, 5.25V±2%, 150mA, +CE	SOT-89-5	32um VR4	6h	Tor
9MP	XC6209F52APR	LVR-IC	LDO, 5.25V±2%, 300mA, +CE	SOT-89-5	32um VR4	6h	Tor
9MR	XC6209B53APR	LVR-IC	LDO, 5.35V±2%, 150mA, +CE	SOT-89-5	32um VR4	6h	Tor
9MR	XC6209F53APR	LVR-IC	LDO, 5.35V±2%, 300mA, +CE	SOT-89-5	32um VR4	6h	Tor
9MS	XC6209B54APR	LVR-IC	LDO, 5.45V±2%, 150mA, +CE	SOT-89-5	32um VR4	6h	Tor
9MS	XC6209F54APR	LVR-IC	LDO, 5.45V±2%, 300mA, +CE	SOT-89-5	32um VR4	6h	Tor
9MT	XC6209B55APR	LVR-IC	LDO, 5.55V±2%, 150mA, +CE	SOT-89-5	32um VR4	6h	Tor
9MT	XC6209F55APR	LVR-IC	LDO, 5.55V±2%, 300mA, +CE	SOT-89-5	32um VR4	6h	Tor
9MU	XC6209B56APR	LVR-IC	LDO, 5.65V±2%, 150mA, +CE	SOT-89-5	32um VR4	6h	Tor
9MU	XC6209F56APR	LVR-IC	LDO, 5.65V±2%, 300mA, +CE	SOT-89-5	32um VR4	6h	Tor
9MV	XC6209B57APR	LVR-IC	LDO, 5.75V±2%, 150mA, +CE	SOT-89-5	32um VR4	6h	Tor
9MV	XC6209F57APR	LVR-IC	LDO, 5.75V±2%, 300mA, +CE	SOT-89-5	32um VR4	6h	Tor
9MX	XC6209B58APR	LVR-IC	LDO, 5.85V±2%, 150mA, +CE	SOT-89-5	32um VR4	6h	Tor
9MX	XC6209F58APR	LVR-IC	LDO, 5.85V±2%, 300mA, +CE	SOT-89-5	32um VR4	6h	Tor
9MY	XC6209B59APR	LVR-IC	LDO, 5.95V±2%, 150mA, +CE	SOT-89-5	32um VR4	6h	Tor
9MY	XC6209F59APR	LVR-IC	LDO, 5.95V±2%, 300mA, +CE	SOT-89-5	32um VR4	6h	Tor
9N0	XC6209C31APR	LVR-IC	LDO, 3.15V±2%, 150mA, -CE, PDR	SOT-89-5	32um VR4	6h	Tor
9N0	XC6209G31APR	LVR-IC	LDO, 3.15V±2%, 300mA, -CE, PDR	SOT-89-5	32um VR4	6h	Tor
9N1	XC6209C32APR	LVR-IC	LDO, 3.25V±2%, 150mA, -CE, PDR	SOT-89-5	32um VR4	6h	Tor
9N1	XC6209G32APR	LVR-IC	LDO, 3.25V±2%, 300mA, -CE, PDR	SOT-89-5	32um VR4	6h	Tor
9N2	XC6209C33APR	LVR-IC	LDO, 3.35V±2%, 150mA, -CE, PDR	SOT-89-5	32um VR4	6h	Tor
9N2	XC6223C12BPR-G	LVR-IC	LDO, 1.25V±20mV, 300mA, +CE, PDR	SOT-89-5	32um VR4	6n	Tor
9N2	XC6209G33APR	LVR-IC	LDO, 3.35V±2%, 300mA, -CE, PDR	SOT-89-5	32um VR4	6h	Tor
9N3	XC6209C34APR	LVR-IC	LDO, 3.45V±2%, 150mA, -CE, PDR	SOT-89-5	32um VR4	6h	Tor
9N3	XC6223C13BPR-G	LVR-IC	LDO, 1.35V±20mV, 300mA, +CE, PDR	SOT-89-5	32um VR4	6n	Tor
9N3	XC6209G34APR	LVR-IC	LDO, 3.45V±2%, 300mA, -CE, PDR	SOT-89-5	32um VR4	6h	Tor
9N4	XC6209C35APR	LVR-IC	LDO, 3.55V±2%, 150mA, -CE, PDR	SOT-89-5	32um VR4	6h	Tor
9N4	XC6223C14BPR-G	LVR-IC	LDO, 1.45V±20mV, 300mA, +CE, PDR	SOT-89-5	32um VR4	6n	Tor
9N4	XC6209G35APR	LVR-IC	LDO, 3.55V±2%, 300mA, -CE, PDR	SOT-89-5	32um VR4	6h	Tor
9N5	XC6209C36APR	LVR-IC	LDO, 3.65V±2%, 150mA, -CE, PDR	SOT-89-5	32um VR4	6h	Tor
9N5	XC6223C15BPR-G	LVR-IC	LDO, 1.55V±20mV, 300mA, +CE, PDR	SOT-89-5	32um VR4	6n	Tor
9N5	XC6209G36APR	LVR-IC	LDO, 3.65V±2%, 300mA, -CE, PDR	SOT-89-5	32um VR4	6h	Tor
9N6	XC6209C37APR	LVR-IC	LDO, 3.75V±2%, 150mA, -CE, PDR	SOT-89-5	32um VR4	6h	Tor
9N6	XC6223C16BPR-G	LVR-IC	LDO, 1.65V±20mV, 300mA, +CE, PDR	SOT-89-5	32um VR4	6n	Tor
9N6	XC6209G37APR	LVR-IC	LDO, 3.75V±2%, 300mA, -CE, PDR	SOT-89-5	32um VR4	6h	Tor
9N7	XC6209C38APR	LVR-IC	LDO, 3.85V±2%, 150mA, -CE, PDR	SOT-89-5	32um VR4	6h	Tor
9N7	XC6223C17BPR-G	LVR-IC	LDO, 1.75V±20mV, 300mA, +CE, PDR	SOT-89-5	32um VR4	6n	Tor
9N7	XC6209G38APR	LVR-IC	LDO, 3.85V±2%, 300mA, -CE, PDR	SOT-89-5	32um VR4	6h	Tor
9N8	XC6209C39APR	LVR-IC	LDO, 3.95V±2%, 150mA, -CE, PDR	SOT-89-5	32um VR4	6h	Tor
9N8	XC6223C18BPR-G	LVR-IC	LDO, 1.85V±20mV, 300mA, +CE, PDR	SOT-89-5	32um VR4	6n	Tor
9N8	XC6209G39APR	LVR-IC	LDO, 3.95V±2%, 300mA, -CE, PDR	SOT-89-5	32um VR4	6h	Tor
9N9	XC6209C40APR	LVR-IC	LDO, 4.05V±2%, 150mA, -CE, PDR	SOT-89-5	32um VR4	6h	Tor



SMD code	Type	Function	Short description	Case	Pinout Sch.	St.	Mnf.
9N9	XC6223C19BPR-G	LVR-IC	LDO, 1.95V±20mV, 300mA, +CE, PDR	SOT-89-5	32um VR4	6n	Tor
9N9	XC6209G40APR	LVR-IC	LDO, 4.05V±2%, 300mA, -CE, PDR	SOT-89-5	32um VR4	6h	Tor
9NA	XC6209C41APR	LVR-IC	LDO, 4.15V±2%, 150mA, -CE, PDR	SOT-89-5	32um VR4	6h	Tor
9NA	XC6223C20BPR-G	LVR-IC	LDO, 2.05V±1%, 300mA, +CE, PDR	SOT-89-5	32um VR4	6n	Tor
9NA	XC6209G41APR	LVR-IC	LDO, 4.15V±2%, 300mA, -CE, PDR	SOT-89-5	32um VR4	6h	Tor
9NB	XC6209C42APR	LVR-IC	LDO, 4.25V±2%, 150mA, -CE, PDR	SOT-89-5	32um VR4	6h	Tor
9NB	XC6223C21BPR-G	LVR-IC	LDO, 2.15V±1%, 300mA, +CE, PDR	SOT-89-5	32um VR4	6n	Tor
9NB	XC6209G42APR	LVR-IC	LDO, 4.25V±2%, 300mA, -CE, PDR	SOT-89-5	32um VR4	6h	Tor
9NC	XC6209C43APR	LVR-IC	LDO, 4.35V±2%, 150mA, -CE, PDR	SOT-89-5	32um VR4	6h	Tor
9NC	XC6223C22BPR-G	LVR-IC	LDO, 2.25V±1%, 300mA, +CE, PDR	SOT-89-5	32um VR4	6n	Tor
9NC	XC6209G43APR	LVR-IC	LDO, 4.35V±2%, 300mA, -CE, PDR	SOT-89-5	32um VR4	6h	Tor
9ND	XC6209C44APR	LVR-IC	LDO, 4.45V±2%, 150mA, -CE, PDR	SOT-89-5	32um VR4	6h	Tor
9ND	XC6223C23BPR-G	LVR-IC	LDO, 2.35V±1%, 300mA, +CE, PDR	SOT-89-5	32um VR4	6n	Tor
9ND	XC6209G44APR	LVR-IC	LDO, 4.45V±2%, 300mA, -CE, PDR	SOT-89-5	32um VR4	6h	Tor
9NE	XC6209C45APR	LVR-IC	LDO, 4.55V±2%, 150mA, -CE, PDR	SOT-89-5	32um VR4	6h	Tor
9NE	XC6223C24BPR-G	LVR-IC	LDO, 2.45V±1%, 300mA, +CE, PDR	SOT-89-5	32um VR4	6n	Tor
9NE	XC6209G45APR	LVR-IC	LDO, 4.55V±2%, 300mA, -CE, PDR	SOT-89-5	32um VR4	6h	Tor
9NF	XC6209C46APR	LVR-IC	LDO, 4.65V±2%, 150mA, -CE, PDR	SOT-89-5	32um VR4	6h	Tor
9NF	XC6223C25BPR-G	LVR-IC	LDO, 2.55V±1%, 300mA, +CE, PDR	SOT-89-5	32um VR4	6n	Tor
9NF	XC6209G46APR	LVR-IC	LDO, 4.65V±2%, 300mA, -CE, PDR	SOT-89-5	32um VR4	6h	Tor
9NH	XC6209C47APR	LVR-IC	LDO, 4.75V±2%, 150mA, -CE, PDR	SOT-89-5	32um VR4	6h	Tor
9NH	XC6223C26BPR-G	LVR-IC	LDO, 2.65V±1%, 300mA, +CE, PDR	SOT-89-5	32um VR4	6n	Tor
9NH	XC6209G47APR	LVR-IC	LDO, 4.75V±2%, 300mA, -CE, PDR	SOT-89-5	32um VR4	6h	Tor
9NK	XC6209C48APR	LVR-IC	LDO, 4.85V±2%, 150mA, -CE, PDR	SOT-89-5	32um VR4	6h	Tor
9NK	XC6223C27BPR-G	LVR-IC	LDO, 2.75V±1%, 300mA, +CE, PDR	SOT-89-5	32um VR4	6n	Tor
9NK	XC6209G48APR	LVR-IC	LDO, 4.85V±2%, 300mA, -CE, PDR	SOT-89-5	32um VR4	6h	Tor
9NL	XC6209C49APR	LVR-IC	LDO, 4.95V±2%, 150mA, -CE, PDR	SOT-89-5	32um VR4	6h	Tor
9NL	XC6223C28BPR-G	LVR-IC	LDO, 2.85V±1%, 300mA, +CE, PDR	SOT-89-5	32um VR4	6n	Tor
9NL	XC6209G49APR	LVR-IC	LDO, 4.95V±2%, 300mA, -CE, PDR	SOT-89-5	32um VR4	6h	Tor
9NM	XC6209C50APR	LVR-IC	LDO, 5.05V±2%, 150mA, -CE, PDR	SOT-89-5	32um VR4	6h	Tor
9NM	XC6223C29BPR-G	LVR-IC	LDO, 2.95V±1%, 300mA, +CE, PDR	SOT-89-5	32um VR4	6n	Tor
9NM	XC6209G50APR	LVR-IC	LDO, 5.05V±2%, 300mA, -CE, PDR	SOT-89-5	32um VR4	6h	Tor
9NN	XC6209C51APR	LVR-IC	LDO, 5.15V±2%, 150mA, -CE, PDR	SOT-89-5	32um VR4	6h	Tor
9NN	XC6223C30BPR-G	LVR-IC	LDO, 3.05V±1%, 300mA, +CE, PDR	SOT-89-5	32um VR4	6n	Tor
9NN	XC6209G51APR	LVR-IC	LDO, 5.15V±2%, 300mA, -CE, PDR	SOT-89-5	32um VR4	6h	Tor
9NP	XC6209C52APR	LVR-IC	LDO, 5.25V±2%, 150mA, -CE, PDR	SOT-89-5	32um VR4	6h	Tor
9NP	XC6223C31BPR-G	LVR-IC	LDO, 3.15V±1%, 300mA, +CE, PDR	SOT-89-5	32um VR4	6n	Tor
9NP	XC6209G52APR	LVR-IC	LDO, 5.25V±2%, 300mA, -CE, PDR	SOT-89-5	32um VR4	6h	Tor
9NR	XC6209C53APR	LVR-IC	LDO, 5.35V±2%, 150mA, -CE, PDR	SOT-89-5	32um VR4	6h	Tor
9NR	XC6223C32BPR-G	LVR-IC	LDO, 3.25V±1%, 300mA, +CE, PDR	SOT-89-5	32um VR4	6n	Tor
9NR	XC6209G53APR	LVR-IC	LDO, 5.35V±2%, 300mA, -CE, PDR	SOT-89-5	32um VR4	6h	Tor
9NS	XC6209C54APR	LVR-IC	LDO, 5.45V±2%, 150mA, -CE, PDR	SOT-89-5	32um VR4	6h	Tor
9NS	XC6223C33BPR-G	LVR-IC	LDO, 3.35V±1%, 300mA, +CE, PDR	SOT-89-5	32um VR4	6n	Tor
9NS	XC6209G54APR	LVR-IC	LDO, 5.45V±2%, 300mA, -CE, PDR	SOT-89-5	32um VR4	6h	Tor
9NT	XC6209C55APR	LVR-IC	LDO, 5.55V±2%, 150mA, -CE, PDR	SOT-89-5	32um VR4	6h	Tor
9NT	XC6223C34BPR-G	LVR-IC	LDO, 3.45V±1%, 300mA, +CE, PDR	SOT-89-5	32um VR4	6n	Tor
9NT	XC6209G55APR	LVR-IC	LDO, 5.55V±2%, 300mA, -CE, PDR	SOT-89-5	32um VR4	6h	Tor
9NU	XC6209C56APR	LVR-IC	LDO, 5.65V±2%, 150mA, -CE, PDR	SOT-89-5	32um VR4	6h	Tor
9NU	XC6223C35BPR-G	LVR-IC	LDO, 3.55V±1%, 300mA, +CE, PDR	SOT-89-5	32um VR4	6n	Tor
9NU	XC6209G56APR	LVR-IC	LDO, 5.65V±2%, 300mA, -CE, PDR	SOT-89-5	32um VR4	6h	Tor
9NV	XC6209C57APR	LVR-IC	LDO, 5.75V±2%, 150mA, -CE, PDR	SOT-89-5	32um VR4	6h	Tor
9NV	XC6223C36BPR-G	LVR-IC	LDO, 3.65V±1%, 300mA, +CE, PDR	SOT-89-5	32um VR4	6n	Tor
9NV	XC6209G57APR	LVR-IC	LDO, 5.75V±2%, 300mA, -CE, PDR	SOT-89-5	32um VR4	6h	Tor
9NX	XC6209C58APR	LVR-IC	LDO, 5.85V±2%, 150mA, -CE, PDR	SOT-89-5	32um VR4	6h	Tor
9NX	XC6223C37BPR-G	LVR-IC	LDO, 3.75V±1%, 300mA, +CE, PDR	SOT-89-5	32um VR4	6n	Tor
9NX	XC6209G58APR	LVR-IC	LDO, 5.85V±2%, 300mA, -CE, PDR	SOT-89-5	32um VR4	6h	Tor
9NY	XC6209C59APR	LVR-IC	LDO, 5.95V±2%, 150mA, -CE, PDR	SOT-89-5	32um VR4	6h	Tor
9NY	XC6223C38BPR-G	LVR-IC	LDO, 3.85V±1%, 300mA, +CE, PDR	SOT-89-5	32um VR4	6n	Tor
9NY	XC6209G59APR	LVR-IC	LDO, 5.95V±2%, 300mA, -CE, PDR	SOT-89-5	32um VR4	6h	Tor
9NZ	XC6223C39BPR-G	LVR-IC	LDO, 3.95V±1%, 300mA, +CE, PDR	SOT-89-5	32um VR4	6n	Tor
9P0	XC6209D31APR	LVR-IC	LDO, 3.15V±2%, 150mA, -CE	SOT-89-5	32um VR4	6h	Tor
9P0	XC6209H31APR	LVR-IC	LDO, 3.15V±2%, 300mA, -CE	SOT-89-5	32um VR4	6h	Tor
9P1	XC6209D32APR	LVR-IC	LDO, 3.25V±2%, 150mA, -CE	SOT-89-5	32um VR4	6h	Tor
9P1	XC6209H32APR	LVR-IC	LDO, 3.25V±2%, 300mA, -CE	SOT-89-5	32um VR4	6h	Tor
9P2	XC6209D33APR	LVR-IC	LDO, 3.35V±2%, 150mA, -CE	SOT-89-5	32um VR4	6h	Tor
9P2	XC6223D121PR-G	LVR-IC	LDO, 1.2V±20mV, 300mA, +CE, CL, PDR	SOT-89-5	32um VR4	6n	Tor
9P2	XC6209H33APR	LVR-IC	LDO, 3.35V±2%, 300mA, -CE	SOT-89-5	32um VR4	6h	Tor
9P3	XC6209D34APR	LVR-IC	LDO, 3.45V±2%, 150mA, -CE	SOT-89-5	32um VR4	6h	Tor
9P3	XC6223D131PR-G	LVR-IC	LDO, 1.3V±20mV, 300mA, +CE, CL, PDR	SOT-89-5	32um VR4	6n	Tor
9P3	XC6209H34APR	LVR-IC	LDO, 3.45V±2%, 300mA, -CE	SOT-89-5	32um VR4	6h	Tor



SMD code	Type	Function	Short description	Case	Pinout Sch.	St.	Mnf.
9P4	XC6209D35APR	LVR-IC	LDO, 3.55V±2%, 150mA, -CE	SOT-89-5	32um VR4	6h	Tor
9P4	XC6223D141PR-G	LVR-IC	LDO, 1.4V±20mV, 300mA, +CE, CL, PDR	SOT-89-5	32um VR4	6h	Tor
9P4	XC6209H35APR	LVR-IC	LDO, 3.55V±2%, 300mA, -CE	SOT-89-5	32um VR4	6h	Tor
9P5	XC6209D36APR	LVR-IC	LDO, 3.65V±2%, 150mA, -CE	SOT-89-5	32um VR4	6h	Tor
9P5	XC6223D151PR-G	LVR-IC	LDO, 1.5V±20mV, 300mA, +CE, CL, PDR	SOT-89-5	32um VR4	6h	Tor
9P5	XC6209H36APR	LVR-IC	LDO, 3.65V±2%, 300mA, -CE	SOT-89-5	32um VR4	6h	Tor
9P6	XC6209D37APR	LVR-IC	LDO, 3.75V±2%, 150mA, -CE	SOT-89-5	32um VR4	6h	Tor
9P6	XC6223D161PR-G	LVR-IC	LDO, 1.6V±20mV, 300mA, +CE, CL, PDR	SOT-89-5	32um VR4	6h	Tor
9P6	XC6209H37APR	LVR-IC	LDO, 3.75V±2%, 300mA, -CE	SOT-89-5	32um VR4	6h	Tor
9P7	XC6209D38APR	LVR-IC	LDO, 3.85V±2%, 150mA, -CE	SOT-89-5	32um VR4	6h	Tor
9P7	XC6223D171PR-G	LVR-IC	LDO, 1.7V±20mV, 300mA, +CE, CL, PDR	SOT-89-5	32um VR4	6h	Tor
9P7	XC6209H38APR	LVR-IC	LDO, 3.85V±2%, 300mA, -CE	SOT-89-5	32um VR4	6h	Tor
9P8	XC6209D39APR	LVR-IC	LDO, 3.95V±2%, 150mA, -CE	SOT-89-5	32um VR4	6h	Tor
9P8	XC6223D181PR-G	LVR-IC	LDO, 1.8V±20mV, 300mA, +CE, CL, PDR	SOT-89-5	32um VR4	6h	Tor
9P8	XC6209H39APR	LVR-IC	LDO, 3.95V±2%, 300mA, -CE	SOT-89-5	32um VR4	6h	Tor
9P9	XC6209D40APR	LVR-IC	LDO, 4.05V±2%, 150mA, -CE	SOT-89-5	32um VR4	6h	Tor
9P9	XC6223D191PR-G	LVR-IC	LDO, 1.9V±20mV, 300mA, +CE, CL, PDR	SOT-89-5	32um VR4	6h	Tor
9P9	XC6209H40APR	LVR-IC	LDO, 4.05V±2%, 300mA, -CE	SOT-89-5	32um VR4	6h	Tor
9PA	XC6209D41APR	LVR-IC	LDO, 4.15V±2%, 150mA, -CE	SOT-89-5	32um VR4	6h	Tor
9PA	XC6223D201PR-G	LVR-IC	LDO, 2.0V±1%, 300mA, +CE, CL, PDR	SOT-89-5	32um VR4	6h	Tor
9PA	XC6209H41APR	LVR-IC	LDO, 4.15V±2%, 300mA, -CE	SOT-89-5	32um VR4	6h	Tor
9PB	XC6209D42APR	LVR-IC	LDO, 4.25V±2%, 150mA, -CE	SOT-89-5	32um VR4	6h	Tor
9PB	XC6223D211PR-G	LVR-IC	LDO, 2.1V±1%, 300mA, +CE, CL, PDR	SOT-89-5	32um VR4	6h	Tor
9PB	XC6209H42APR	LVR-IC	LDO, 4.25V±2%, 300mA, -CE	SOT-89-5	32um VR4	6h	Tor
9PC	XC6209D43APR	LVR-IC	LDO, 4.35V±2%, 150mA, -CE	SOT-89-5	32um VR4	6h	Tor
9PC	XC6223D221PR-G	LVR-IC	LDO, 2.2V±1%, 300mA, +CE, CL, PDR	SOT-89-5	32um VR4	6h	Tor
9PC	XC6209H43APR	LVR-IC	LDO, 4.35V±2%, 300mA, -CE	SOT-89-5	32um VR4	6h	Tor
9PD	XC6209D44APR	LVR-IC	LDO, 4.45V±2%, 150mA, -CE	SOT-89-5	32um VR4	6h	Tor
9PD	XC6223D231PR-G	LVR-IC	LDO, 2.3V±1%, 300mA, +CE, CL, PDR	SOT-89-5	32um VR4	6h	Tor
9PD	XC6209H44APR	LVR-IC	LDO, 4.45V±2%, 300mA, -CE	SOT-89-5	32um VR4	6h	Tor
9PE	XC6209D45APR	LVR-IC	LDO, 4.55V±2%, 150mA, -CE	SOT-89-5	32um VR4	6h	Tor
9PE	XC6223D241PR-G	LVR-IC	LDO, 2.4V±1%, 300mA, +CE, CL, PDR	SOT-89-5	32um VR4	6h	Tor
9PE	XC6209H45APR	LVR-IC	LDO, 4.55V±2%, 300mA, -CE	SOT-89-5	32um VR4	6h	Tor
9PF	XC6209D46APR	LVR-IC	LDO, 4.65V±2%, 150mA, -CE	SOT-89-5	32um VR4	6h	Tor
9PF	XC6223D251PR-G	LVR-IC	LDO, 2.5V±1%, 300mA, +CE, CL, PDR	SOT-89-5	32um VR4	6h	Tor
9PF	XC6209H46APR	LVR-IC	LDO, 4.65V±2%, 300mA, -CE	SOT-89-5	32um VR4	6h	Tor
9PH	XC6209D47APR	LVR-IC	LDO, 4.75V±2%, 150mA, -CE	SOT-89-5	32um VR4	6h	Tor
9PH	XC6223D261PR-G	LVR-IC	LDO, 2.6V±1%, 300mA, +CE, CL, PDR	SOT-89-5	32um VR4	6h	Tor
9PH	XC6209H47APR	LVR-IC	LDO, 4.75V±2%, 300mA, -CE	SOT-89-5	32um VR4	6h	Tor
9PK	XC6209D48APR	LVR-IC	LDO, 4.85V±2%, 150mA, -CE	SOT-89-5	32um VR4	6h	Tor
9PK	XC6223D271PR-G	LVR-IC	LDO, 2.7V±1%, 300mA, +CE, CL, PDR	SOT-89-5	32um VR4	6h	Tor
9PK	XC6209H48APR	LVR-IC	LDO, 4.85V±2%, 300mA, -CE	SOT-89-5	32um VR4	6h	Tor
9PL	XC6209D49APR	LVR-IC	LDO, 4.95V±2%, 150mA, -CE	SOT-89-5	32um VR4	6h	Tor
9PL	XC6223D281PR-G	LVR-IC	LDO, 2.8V±1%, 300mA, +CE, CL, PDR	SOT-89-5	32um VR4	6h	Tor
9PL	XC6209H49APR	LVR-IC	LDO, 4.95V±2%, 300mA, -CE	SOT-89-5	32um VR4	6h	Tor
9PM	XC6209D50APR	LVR-IC	LDO, 5.05V±2%, 150mA, -CE	SOT-89-5	32um VR4	6h	Tor
9PM	XC6223D291PR-G	LVR-IC	LDO, 2.9V±1%, 300mA, +CE, CL, PDR	SOT-89-5	32um VR4	6h	Tor
9PM	XC6209H50APR	LVR-IC	LDO, 5.05V±2%, 300mA, -CE	SOT-89-5	32um VR4	6h	Tor
9PN	XC6209D51APR	LVR-IC	LDO, 5.15V±2%, 150mA, -CE	SOT-89-5	32um VR4	6h	Tor
9PN	XC6223D301PR-G	LVR-IC	LDO, 3.0V±1%, 300mA, +CE, CL, PDR	SOT-89-5	32um VR4	6h	Tor
9PN	XC6209H51APR	LVR-IC	LDO, 5.15V±2%, 300mA, -CE	SOT-89-5	32um VR4	6h	Tor
9PP	XC6209D52APR	LVR-IC	LDO, 5.25V±2%, 150mA, -CE	SOT-89-5	32um VR4	6h	Tor
9PP	XC6223D311PR-G	LVR-IC	LDO, 3.1V±1%, 300mA, +CE, CL, PDR	SOT-89-5	32um VR4	6h	Tor
9PP	XC6209H52APR	LVR-IC	LDO, 5.25V±2%, 300mA, -CE	SOT-89-5	32um VR4	6h	Tor
9PR	XC6209D53APR	LVR-IC	LDO, 5.35V±2%, 150mA, -CE	SOT-89-5	32um VR4	6h	Tor
9PR	XC6223D321PR-G	LVR-IC	LDO, 3.2V±1%, 300mA, +CE, CL, PDR	SOT-89-5	32um VR4	6h	Tor
9PR	XC6209H53APR	LVR-IC	LDO, 5.35V±2%, 300mA, -CE	SOT-89-5	32um VR4	6h	Tor
9PS	XC6209D54APR	LVR-IC	LDO, 5.45V±2%, 150mA, -CE	SOT-89-5	32um VR4	6h	Tor
9PS	XC6223D331PR-G	LVR-IC	LDO, 3.3V±1%, 300mA, +CE, CL, PDR	SOT-89-5	32um VR4	6h	Tor
9PS	XC6209H54APR	LVR-IC	LDO, 5.45V±2%, 300mA, -CE	SOT-89-5	32um VR4	6h	Tor
9PT	XC6209D55APR	LVR-IC	LDO, 5.55V±2%, 150mA, -CE	SOT-89-5	32um VR4	6h	Tor
9PT	XC6223D341PR-G	LVR-IC	LDO, 3.4V±1%, 300mA, +CE, CL, PDR	SOT-89-5	32um VR4	6h	Tor
9PT	XC6209H55APR	LVR-IC	LDO, 5.55V±2%, 300mA, -CE	SOT-89-5	32um VR4	6h	Tor
9PU	XC6209D56APR	LVR-IC	LDO, 5.65V±2%, 150mA, -CE	SOT-89-5	32um VR4	6h	Tor
9PU	XC6223D351PR-G	LVR-IC	LDO, 3.5V±1%, 300mA, +CE, CL, PDR	SOT-89-5	32um VR4	6h	Tor
9PU	XC6209H56APR	LVR-IC	LDO, 5.65V±2%, 300mA, -CE	SOT-89-5	32um VR4	6h	Tor
9PV	XC6209D57APR	LVR-IC	LDO, 5.75V±2%, 150mA, -CE	SOT-89-5	32um VR4	6h	Tor
9PV	XC6223D361PR-G	LVR-IC	LDO, 3.6V±1%, 300mA, +CE, CL, PDR	SOT-89-5	32um VR4	6h	Tor
9PV	XC6209H57APR	LVR-IC	LDO, 5.75V±2%, 300mA, -CE	SOT-89-5	32um VR4	6h	Tor
9PX	XC6209D58APR	LVR-IC	LDO, 5.85V±2%, 150mA, -CE	SOT-89-5	32um VR4	6h	Tor



SMD code	Type	Function	Short description	Case	Pinout Sch.	St.	Mnf.
9V8	XC6209A092PR	LVR-IC	LDO, 0.9V±2%, 150mA, +CE, PDR	SOT-89-5	32um VR4	6h	Tor
9V8	XC6223E18BPR-G	LVR-IC	LDO, 1.85V±20mV, 300mA, +CE, ICP	SOT-89-5	32um VR4	6h	Tor
9V8	XC6209E092PR	LVR-IC	LDO, 0.9V±2%, 300mA, +CE, PDR	SOT-89-5	32um VR4	6h	Tor
9V9	XC6209A102PR	LVR-IC	LDO, 1V±2%, 150mA, +CE, PDR	SOT-89-5	32um VR4	6h	Tor
9V9	XC6223E19BPR-G	LVR-IC	LDO, 1.95V±20mV, 300mA, +CE, ICP	SOT-89-5	32um VR4	6h	Tor
9V9	XC6209E102PR	LVR-IC	LDO, 1V±2%, 300mA, +CE, PDR	SOT-89-5	32um VR4	6h	Tor
9VA	XC6209A112PR	LVR-IC	LDO, 1.1V±2%, 150mA, +CE, PDR	SOT-89-5	32um VR4	6h	Tor
9VA	XC6223E20BPR-G	LVR-IC	LDO, 2.05V±1%, 300mA, +CE, ICP	SOT-89-5	32um VR4	6h	Tor
9VA	XC6209E112PR	LVR-IC	LDO, 1.1V±2%, 300mA, +CE, PDR	SOT-89-5	32um VR4	6h	Tor
9VB	XC6209A122PR	LVR-IC	LDO, 1.2V±2%, 150mA, +CE, PDR	SOT-89-5	32um VR4	6h	Tor
9VB	XC6223E21BPR-G	LVR-IC	LDO, 2.15V±1%, 300mA, +CE, ICP	SOT-89-5	32um VR4	6h	Tor
9VB	XC6209E122PR	LVR-IC	LDO, 1.2V±2%, 300mA, +CE, PDR	SOT-89-5	32um VR4	6h	Tor
9VC	XC6209A132PR	LVR-IC	LDO, 1.3V±2%, 150mA, +CE, PDR	SOT-89-5	32um VR4	6h	Tor
9VC	XC6223E22BPR-G	LVR-IC	LDO, 2.25V±1%, 300mA, +CE, ICP	SOT-89-5	32um VR4	6h	Tor
9VC	XC6209E132PR	LVR-IC	LDO, 1.3V±2%, 300mA, +CE, PDR	SOT-89-5	32um VR4	6h	Tor
9VD	XC6209A142PR	LVR-IC	LDO, 1.4V±2%, 150mA, +CE, PDR	SOT-89-5	32um VR4	6h	Tor
9VD	XC6223E23BPR-G	LVR-IC	LDO, 2.35V±1%, 300mA, +CE, ICP	SOT-89-5	32um VR4	6h	Tor
9VD	XC6209E142PR	LVR-IC	LDO, 1.4V±2%, 300mA, +CE, PDR	SOT-89-5	32um VR4	6h	Tor
9VE	XC6209A152PR	LVR-IC	LDO, 1.5V±2%, 150mA, +CE, PDR	SOT-89-5	32um VR4	6h	Tor
9VE	XC6223E24BPR-G	LVR-IC	LDO, 2.45V±1%, 300mA, +CE, ICP	SOT-89-5	32um VR4	6h	Tor
9VE	XC6209E152PR	LVR-IC	LDO, 1.5V±2%, 300mA, +CE, PDR	SOT-89-5	32um VR4	6h	Tor
9VF	XC6209A162PR	LVR-IC	LDO, 1.6V±2%, 150mA, +CE, PDR	SOT-89-5	32um VR4	6h	Tor
9VF	XC6223E25BPR-G	LVR-IC	LDO, 2.55V±1%, 300mA, +CE, ICP	SOT-89-5	32um VR4	6h	Tor
9VF	XC6209E162PR	LVR-IC	LDO, 1.6V±2%, 300mA, +CE, PDR	SOT-89-5	32um VR4	6h	Tor
9VH	XC6209A172PR	LVR-IC	LDO, 1.7V±2%, 150mA, +CE, PDR	SOT-89-5	32um VR4	6h	Tor
9VH	XC6223E26BPR-G	LVR-IC	LDO, 2.65V±1%, 300mA, +CE, ICP	SOT-89-5	32um VR4	6h	Tor
9VH	XC6209E172PR	LVR-IC	LDO, 1.7V±2%, 300mA, +CE, PDR	SOT-89-5	32um VR4	6h	Tor
9VK	XC6209A182PR	LVR-IC	LDO, 1.8V±2%, 150mA, +CE, PDR	SOT-89-5	32um VR4	6h	Tor
9VK	XC6223E27BPR-G	LVR-IC	LDO, 2.75V±1%, 300mA, +CE, ICP	SOT-89-5	32um VR4	6h	Tor
9VK	XC6209E182PR	LVR-IC	LDO, 1.8V±2%, 300mA, +CE, PDR	SOT-89-5	32um VR4	6h	Tor
9VL	XC6209A192PR	LVR-IC	LDO, 1.9V±2%, 150mA, +CE, PDR	SOT-89-5	32um VR4	6h	Tor
9VL	XC6223E28BPR-G	LVR-IC	LDO, 2.85V±1%, 300mA, +CE, ICP	SOT-89-5	32um VR4	6h	Tor
9VL	XC6209E192PR	LVR-IC	LDO, 1.9V±2%, 300mA, +CE, PDR	SOT-89-5	32um VR4	6h	Tor
9VM	XC6209A202PR	LVR-IC	LDO, 2V±2%, 150mA, +CE, PDR	SOT-89-5	32um VR4	6h	Tor
9VM	XC6223E29BPR-G	LVR-IC	LDO, 2.95V±1%, 300mA, +CE, ICP	SOT-89-5	32um VR4	6h	Tor
9VM	XC6209E202PR	LVR-IC	LDO, 2V±2%, 300mA, +CE, PDR	SOT-89-5	32um VR4	6h	Tor
9VN	XC6209A212PR	LVR-IC	LDO, 2.1V±2%, 150mA, +CE, PDR	SOT-89-5	32um VR4	6h	Tor
9VN	XC6223E30BPR-G	LVR-IC	LDO, 3.05V±1%, 300mA, +CE, ICP	SOT-89-5	32um VR4	6h	Tor
9VN	XC6209E212PR	LVR-IC	LDO, 2.1V±2%, 300mA, +CE, PDR	SOT-89-5	32um VR4	6h	Tor
9VP	XC6209A222PR	LVR-IC	LDO, 2.2V±2%, 150mA, +CE, PDR	SOT-89-5	32um VR4	6h	Tor
9VP	XC6223E31BPR-G	LVR-IC	LDO, 3.15V±1%, 300mA, +CE, ICP	SOT-89-5	32um VR4	6h	Tor
9VP	XC6209E222PR	LVR-IC	LDO, 2.2V±2%, 300mA, +CE, PDR	SOT-89-5	32um VR4	6h	Tor
9VR	XC6209A232PR	LVR-IC	LDO, 2.3V±2%, 150mA, +CE, PDR	SOT-89-5	32um VR4	6h	Tor
9VR	XC6223E32BPR-G	LVR-IC	LDO, 3.25V±1%, 300mA, +CE, ICP	SOT-89-5	32um VR4	6h	Tor
9VR	XC6209E232PR	LVR-IC	LDO, 2.3V±2%, 300mA, +CE, PDR	SOT-89-5	32um VR4	6h	Tor
9VS	XC6209A242PR	LVR-IC	LDO, 2.4V±2%, 150mA, +CE, PDR	SOT-89-5	32um VR4	6h	Tor
9VS	XC6223E33BPR-G	LVR-IC	LDO, 3.35V±1%, 300mA, +CE, ICP	SOT-89-5	32um VR4	6h	Tor
9VS	XC6209E242PR	LVR-IC	LDO, 2.4V±2%, 300mA, +CE, PDR	SOT-89-5	32um VR4	6h	Tor
9VT	XC6209A252PR	LVR-IC	LDO, 2.5V±2%, 150mA, +CE, PDR	SOT-89-5	32um VR4	6h	Tor
9VT	XC6223E34BPR-G	LVR-IC	LDO, 3.45V±1%, 300mA, +CE, ICP	SOT-89-5	32um VR4	6h	Tor
9VT	XC6209E252PR	LVR-IC	LDO, 2.5V±2%, 300mA, +CE, PDR	SOT-89-5	32um VR4	6h	Tor
9VU	XC6209A262PR	LVR-IC	LDO, 2.6V±2%, 150mA, +CE, PDR	SOT-89-5	32um VR4	6h	Tor
9VU	XC6223E35BPR-G	LVR-IC	LDO, 3.55V±1%, 300mA, +CE, ICP	SOT-89-5	32um VR4	6h	Tor
9VU	XC6209E262PR	LVR-IC	LDO, 2.6V±2%, 300mA, +CE, PDR	SOT-89-5	32um VR4	6h	Tor
9VV	XC6209A272PR	LVR-IC	LDO, 2.7V±2%, 150mA, +CE, PDR	SOT-89-5	32um VR4	6h	Tor
9VV	XC6223E36BPR-G	LVR-IC	LDO, 3.65V±1%, 300mA, +CE, ICP	SOT-89-5	32um VR4	6h	Tor
9VV	XC6209E272PR	LVR-IC	LDO, 2.7V±2%, 300mA, +CE, PDR	SOT-89-5	32um VR4	6h	Tor
9VX	XC6209A282PR	LVR-IC	LDO, 2.8V±2%, 150mA, +CE, PDR	SOT-89-5	32um VR4	6h	Tor
9VX	XC6223E37BPR-G	LVR-IC	LDO, 3.75V±1%, 300mA, +CE, ICP	SOT-89-5	32um VR4	6h	Tor
9VX	XC6209E282PR	LVR-IC	LDO, 2.8V±2%, 300mA, +CE, PDR	SOT-89-5	32um VR4	6h	Tor
9VY	XC6209A292PR	LVR-IC	LDO, 2.9V±2%, 150mA, +CE, PDR	SOT-89-5	32um VR4	6h	Tor
9VY	XC6223E38BPR-G	LVR-IC	LDO, 3.85V±1%, 300mA, +CE, ICP	SOT-89-5	32um VR4	6h	Tor
9VY	XC6209E292PR	LVR-IC	LDO, 2.9V±2%, 300mA, +CE, PDR	SOT-89-5	32um VR4	6h	Tor
9VZ	XC6209A302PR	LVR-IC	LDO, 3V±2%, 150mA, +CE, PDR	SOT-89-5	32um VR4	6h	Tor
9VZ	XC6223E39BPR-G	LVR-IC	LDO, 3.95V±1%, 300mA, +CE, ICP	SOT-89-5	32um VR4	6h	Tor
9VZ	XC6209E302PR	LVR-IC	LDO, 3V±2%, 300mA, +CE, PDR	SOT-89-5	32um VR4	6h	Tor
9X2	XC6223F121PR-G	LVR-IC	LDO, 1.2V±20mV, 300mA, +CE, CL, ICP	SOT-89-5	32um VR4	6h	Tor
9X3	XC6223F131PR-G	LVR-IC	LDO, 1.3V±20mV, 300mA, +CE, CL, ICP	SOT-89-5	32um VR4	6h	Tor
9X4	XC6223F141PR-G	LVR-IC	LDO, 1.4V±20mV, 300mA, +CE, CL, ICP	SOT-89-5	32um VR4	6h	Tor
9X5	XC6223F151PR-G	LVR-IC	LDO, 1.5V±20mV, 300mA, +CE, CL, ICP	SOT-89-5	32um VR4	6h	Tor



SMD code	Type	Function	Short description	Case	Pinout Sch.	St.	Mnf.
9X6	XC6223F161PR-G	LVR-IC	LDO, 1.6V±20mV, 300mA, +CE, CL, ICP	SOT-89-5	32um VR4	6n	Tor
9X7	XC6223F171PR-G	LVR-IC	LDO, 1.7V±20mV, 300mA, +CE, CL, ICP	SOT-89-5	32um VR4	6n	Tor
9X8	XC6209B092PR	LVR-IC	LDO, 0.9V±2%, 150mA, +CE	SOT-89-5	32um VR4	6h	Tor
9X8	XC6223F181PR-G	LVR-IC	LDO, 1.8V±20mV, 300mA, +CE, CL, ICP	SOT-89-5	32um VR4	6n	Tor
9X8	XC6209F092PR	LVR-IC	LDO, 0.9V±2%, 300mA, +CE	SOT-89-5	32um VR4	6h	Tor
9X9	XC6209B102PR	LVR-IC	LDO, 1V±2%, 150mA, +CE	SOT-89-5	32um VR4	6h	Tor
9X9	XC6223F191PR-G	LVR-IC	LDO, 1.9V±20mV, 300mA, +CE, CL, ICP	SOT-89-5	32um VR4	6n	Tor
9X9	XC6209F102PR	LVR-IC	LDO, 1V±2%, 300mA, +CE	SOT-89-5	32um VR4	6h	Tor
9XA	XC6209B112PR	LVR-IC	LDO, 1.1V±2%, 150mA, +CE	SOT-89-5	32um VR4	6h	Tor
9XA	XC6223F201PR-G	LVR-IC	LDO, 2.0V±1%, 300mA, +CE, CL, ICP	SOT-89-5	32um VR4	6n	Tor
9XA	XC6209F112PR	LVR-IC	LDO, 1.1V±2%, 300mA, +CE	SOT-89-5	32um VR4	6h	Tor
9XB	XC6209B122PR	LVR-IC	LDO, 1.2V±2%, 150mA, +CE	SOT-89-5	32um VR4	6h	Tor
9XB	XC6223F211PR-G	LVR-IC	LDO, 2.1V±1%, 300mA, +CE, CL, ICP	SOT-89-5	32um VR4	6n	Tor
9XB	XC6209F122PR	LVR-IC	LDO, 1.2V±2%, 300mA, +CE	SOT-89-5	32um VR4	6h	Tor
9XC	XC6209B132PR	LVR-IC	LDO, 1.3V±2%, 150mA, +CE	SOT-89-5	32um VR4	6h	Tor
9XC	XC6223F221PR-G	LVR-IC	LDO, 2.2V±1%, 300mA, +CE, CL, ICP	SOT-89-5	32um VR4	6n	Tor
9XC	XC6209F132PR	LVR-IC	LDO, 1.3V±2%, 300mA, +CE	SOT-89-5	32um VR4	6h	Tor
9XD	XC6209B142PR	LVR-IC	LDO, 1.4V±2%, 150mA, +CE	SOT-89-5	32um VR4	6h	Tor
9XD	XC6223F231PR-G	LVR-IC	LDO, 2.3V±1%, 300mA, +CE, CL, ICP	SOT-89-5	32um VR4	6n	Tor
9XD	XC6209F142PR	LVR-IC	LDO, 1.4V±2%, 300mA, +CE	SOT-89-5	32um VR4	6h	Tor
9XE	XC6209B152PR	LVR-IC	LDO, 1.5V±2%, 150mA, +CE	SOT-89-5	32um VR4	6h	Tor
9XE	XC6223F241PR-G	LVR-IC	LDO, 2.4V±1%, 300mA, +CE, CL, ICP	SOT-89-5	32um VR4	6n	Tor
9XE	XC6209F152PR	LVR-IC	LDO, 1.5V±2%, 300mA, +CE	SOT-89-5	32um VR4	6h	Tor
9XF	XC6209B162PR	LVR-IC	LDO, 1.6V±2%, 150mA, +CE	SOT-89-5	32um VR4	6h	Tor
9XF	XC6223F251PR-G	LVR-IC	LDO, 2.5V±1%, 300mA, +CE, CL, ICP	SOT-89-5	32um VR4	6n	Tor
9XF	XC6209F162PR	LVR-IC	LDO, 1.6V±2%, 300mA, +CE	SOT-89-5	32um VR4	6h	Tor
9XH	XC6209B172PR	LVR-IC	LDO, 1.7V±2%, 150mA, +CE	SOT-89-5	32um VR4	6h	Tor
9XH	XC6223F261PR-G	LVR-IC	LDO, 2.6V±1%, 300mA, +CE, CL, ICP	SOT-89-5	32um VR4	6n	Tor
9XH	XC6209F172PR	LVR-IC	LDO, 1.7V±2%, 300mA, +CE	SOT-89-5	32um VR4	6h	Tor
9XK	XC6209B182PR	LVR-IC	LDO, 1.8V±2%, 150mA, +CE	SOT-89-5	32um VR4	6h	Tor
9XK	XC6223F271PR-G	LVR-IC	LDO, 2.7V±1%, 300mA, +CE, CL, ICP	SOT-89-5	32um VR4	6n	Tor
9XK	XC6209F182PR	LVR-IC	LDO, 1.8V±2%, 300mA, +CE	SOT-89-5	32um VR4	6h	Tor
9XL	XC6209B192PR	LVR-IC	LDO, 1.9V±2%, 150mA, +CE	SOT-89-5	32um VR4	6h	Tor
9XL	XC6223F281PR-G	LVR-IC	LDO, 2.8V±1%, 300mA, +CE, CL, ICP	SOT-89-5	32um VR4	6n	Tor
9XL	XC6209F192PR	LVR-IC	LDO, 1.9V±2%, 300mA, +CE	SOT-89-5	32um VR4	6h	Tor
9XM	XC6209B202PR	LVR-IC	LDO, 2V±2%, 150mA, +CE	SOT-89-5	32um VR4	6h	Tor
9XM	XC6223F291PR-G	LVR-IC	LDO, 2.9V±1%, 300mA, +CE, CL, ICP	SOT-89-5	32um VR4	6n	Tor
9XM	XC6209F202PR	LVR-IC	LDO, 2V±2%, 300mA, +CE	SOT-89-5	32um VR4	6h	Tor
9XN	XC6209B212PR	LVR-IC	LDO, 2.1V±2%, 150mA, +CE	SOT-89-5	32um VR4	6h	Tor
9XN	XC6223F301PR-G	LVR-IC	LDO, 3.0V±1%, 300mA, +CE, CL, ICP	SOT-89-5	32um VR4	6n	Tor
9XN	XC6209F212PR	LVR-IC	LDO, 2.1V±2%, 300mA, +CE	SOT-89-5	32um VR4	6h	Tor
9XP	XC6209B222PR	LVR-IC	LDO, 2.2V±2%, 150mA, +CE	SOT-89-5	32um VR4	6h	Tor
9XP	XC6223F311PR-G	LVR-IC	LDO, 3.1V±1%, 300mA, +CE, CL, ICP	SOT-89-5	32um VR4	6n	Tor
9XP	XC6209F222PR	LVR-IC	LDO, 2.2V±2%, 300mA, +CE	SOT-89-5	32um VR4	6h	Tor
9XR	XC6209B232PR	LVR-IC	LDO, 2.3V±2%, 150mA, +CE	SOT-89-5	32um VR4	6h	Tor
9XR	XC6223F321PR-G	LVR-IC	LDO, 3.2V±1%, 300mA, +CE, CL, ICP	SOT-89-5	32um VR4	6n	Tor
9XR	XC6209F232PR	LVR-IC	LDO, 2.3V±2%, 300mA, +CE	SOT-89-5	32um VR4	6h	Tor
9XS	XC6209B242PR	LVR-IC	LDO, 2.4V±2%, 150mA, +CE	SOT-89-5	32um VR4	6h	Tor
9XS	XC6223F331PR-G	LVR-IC	LDO, 3.3V±1%, 300mA, +CE, CL, ICP	SOT-89-5	32um VR4	6n	Tor
9XS	XC6209F242PR	LVR-IC	LDO, 2.4V±2%, 300mA, +CE	SOT-89-5	32um VR4	6h	Tor
9XT	XC6209B252PR	LVR-IC	LDO, 2.5V±2%, 150mA, +CE	SOT-89-5	32um VR4	6h	Tor
9XT	XC6223F341PR-G	LVR-IC	LDO, 3.4V±1%, 300mA, +CE, CL, ICP	SOT-89-5	32um VR4	6n	Tor
9XT	XC6209F252PR	LVR-IC	LDO, 2.5V±2%, 300mA, +CE	SOT-89-5	32um VR4	6h	Tor
9XU	XC6209B262PR	LVR-IC	LDO, 2.6V±2%, 150mA, +CE	SOT-89-5	32um VR4	6h	Tor
9XU	XC6223F351PR-G	LVR-IC	LDO, 3.5V±1%, 300mA, +CE, CL, ICP	SOT-89-5	32um VR4	6n	Tor
9XU	XC6209F262PR	LVR-IC	LDO, 2.6V±2%, 300mA, +CE	SOT-89-5	32um VR4	6h	Tor
9XV	XC6209B272PR	LVR-IC	LDO, 2.7V±2%, 150mA, +CE	SOT-89-5	32um VR4	6h	Tor
9XV	XC6223F361PR-G	LVR-IC	LDO, 3.6V±1%, 300mA, +CE, CL, ICP	SOT-89-5	32um VR4	6n	Tor
9XV	XC6209F272PR	LVR-IC	LDO, 2.7V±2%, 300mA, +CE	SOT-89-5	32um VR4	6h	Tor
9XX	XC6209B282PR	LVR-IC	LDO, 2.8V±2%, 150mA, +CE	SOT-89-5	32um VR4	6h	Tor
9XX	XC6223F371PR-G	LVR-IC	LDO, 3.7V±1%, 300mA, +CE, CL, ICP	SOT-89-5	32um VR4	6n	Tor
9XX	XC6209F282PR	LVR-IC	LDO, 2.8V±2%, 300mA, +CE	SOT-89-5	32um VR4	6h	Tor
9XY	XC6209B292PR	LVR-IC	LDO, 2.9V±2%, 150mA, +CE	SOT-89-5	32um VR4	6h	Tor
9XY	XC6223F381PR-G	LVR-IC	LDO, 3.8V±1%, 300mA, +CE, CL, ICP	SOT-89-5	32um VR4	6n	Tor
9XY	XC6209F292PR	LVR-IC	LDO, 2.9V±2%, 300mA, +CE	SOT-89-5	32um VR4	6h	Tor
9XZ	XC6209B302PR	LVR-IC	LDO, 3V±2%, 150mA, +CE	SOT-89-5	32um VR4	6h	Tor
9XZ	XC6223F391PR-G	LVR-IC	LDO, 3.9V±1%, 300mA, +CE, CL, ICP	SOT-89-5	32um VR4	6n	Tor
9XZ	XC6209F302PR	LVR-IC	LDO, 3V±2%, 300mA, +CE	SOT-89-5	32um VR4	6h	Tor
9Y0	XC6223F401PR-G	LVR-IC	LDO, 4.0V±1%, 300mA, +CE, CL, ICP	SOT-89-5	32um VR4	6n	Tor
9Y8	XC6209C092PR	LVR-IC	LDO, 0.9V±2%, 150mA, -CE, PDR	SOT-89-5	32um VR4	6h	Tor



SMD code	Type	Function	Short description	Case	Pinout Sch.	St.	Mnf.
9Y8	XC6209G092PR	LVR-IC	LDO, 0.9V±2%, 300mA, -CE, PDR	SOT-89-5	32um VR4	6h	Tor
9Y9	XC6209C102PR	LVR-IC	LDO, 1V±2%, 150mA, -CE, PDR	SOT-89-5	32um VR4	6h	Tor
9Y9	XC6209G102PR	LVR-IC	LDO, 1V±2%, 300mA, -CE, PDR	SOT-89-5	32um VR4	6h	Tor
9YA	XC6209C112PR	LVR-IC	LDO, 1.1V±2%, 150mA, -CE, PDR	SOT-89-5	32um VR4	6h	Tor
9YA	XC6209G112PR	LVR-IC	LDO, 1.1V±2%, 300mA, -CE, PDR	SOT-89-5	32um VR4	6h	Tor
9YB	XC6209C122PR	LVR-IC	LDO, 1.2V±2%, 150mA, -CE, PDR	SOT-89-5	32um VR4	6h	Tor
9YB	XC6209G122PR	LVR-IC	LDO, 1.2V±2%, 300mA, -CE, PDR	SOT-89-5	32um VR4	6h	Tor
9YC	XC6209C132PR	LVR-IC	LDO, 1.3V±2%, 150mA, -CE, PDR	SOT-89-5	32um VR4	6h	Tor
9YC	XC6209G132PR	LVR-IC	LDO, 1.3V±2%, 300mA, -CE, PDR	SOT-89-5	32um VR4	6h	Tor
9YD	XC6209C142PR	LVR-IC	LDO, 1.4V±2%, 150mA, -CE, PDR	SOT-89-5	32um VR4	6h	Tor
9YD	XC6209G142PR	LVR-IC	LDO, 1.4V±2%, 300mA, -CE, PDR	SOT-89-5	32um VR4	6h	Tor
9YE	XC6209C152PR	LVR-IC	LDO, 1.5V±2%, 150mA, -CE, PDR	SOT-89-5	32um VR4	6h	Tor
9YE	XC6209G152PR	LVR-IC	LDO, 1.5V±2%, 300mA, -CE, PDR	SOT-89-5	32um VR4	6h	Tor
9YF	XC6209C162PR	LVR-IC	LDO, 1.6V±2%, 150mA, -CE, PDR	SOT-89-5	32um VR4	6h	Tor
9YF	XC6209G162PR	LVR-IC	LDO, 1.6V±2%, 300mA, -CE, PDR	SOT-89-5	32um VR4	6h	Tor
9YH	XC6209C172PR	LVR-IC	LDO, 1.7V±2%, 150mA, -CE, PDR	SOT-89-5	32um VR4	6h	Tor
9YH	XC6209G172PR	LVR-IC	LDO, 1.7V±2%, 300mA, -CE, PDR	SOT-89-5	32um VR4	6h	Tor
9YK	XC6209C182PR	LVR-IC	LDO, 1.8V±2%, 150mA, -CE, PDR	SOT-89-5	32um VR4	6h	Tor
9YK	XC6209G182PR	LVR-IC	LDO, 1.8V±2%, 300mA, -CE, PDR	SOT-89-5	32um VR4	6h	Tor
9YL	XC6209C192PR	LVR-IC	LDO, 1.9V±2%, 150mA, -CE, PDR	SOT-89-5	32um VR4	6h	Tor
9YL	XC6209G192PR	LVR-IC	LDO, 1.9V±2%, 300mA, -CE, PDR	SOT-89-5	32um VR4	6h	Tor
9YM	XC6209C202PR	LVR-IC	LDO, 2V±2%, 150mA, -CE, PDR	SOT-89-5	32um VR4	6h	Tor
9YM	XC6209G202PR	LVR-IC	LDO, 2V±2%, 300mA, -CE, PDR	SOT-89-5	32um VR4	6h	Tor
9YN	XC6209C212PR	LVR-IC	LDO, 2.1V±2%, 150mA, -CE, PDR	SOT-89-5	32um VR4	6h	Tor
9YN	XC6209G212PR	LVR-IC	LDO, 2.1V±2%, 300mA, -CE, PDR	SOT-89-5	32um VR4	6h	Tor
9YP	XC6209C222PR	LVR-IC	LDO, 2.2V±2%, 150mA, -CE, PDR	SOT-89-5	32um VR4	6h	Tor
9YP	XC6209G222PR	LVR-IC	LDO, 2.2V±2%, 300mA, -CE, PDR	SOT-89-5	32um VR4	6h	Tor
9YR	XC6209C232PR	LVR-IC	LDO, 2.3V±2%, 150mA, -CE, PDR	SOT-89-5	32um VR4	6h	Tor
9YR	XC6209G232PR	LVR-IC	LDO, 2.3V±2%, 300mA, -CE, PDR	SOT-89-5	32um VR4	6h	Tor
9YS	XC6209C242PR	LVR-IC	LDO, 2.4V±2%, 150mA, -CE, PDR	SOT-89-5	32um VR4	6h	Tor
9YS	XC6209G242PR	LVR-IC	LDO, 2.4V±2%, 300mA, -CE, PDR	SOT-89-5	32um VR4	6h	Tor
9YT	XC6209C252PR	LVR-IC	LDO, 2.5V±2%, 150mA, -CE, PDR	SOT-89-5	32um VR4	6h	Tor
9YT	XC6209G252PR	LVR-IC	LDO, 2.5V±2%, 300mA, -CE, PDR	SOT-89-5	32um VR4	6h	Tor
9YU	XC6209C262PR	LVR-IC	LDO, 2.6V±2%, 150mA, -CE, PDR	SOT-89-5	32um VR4	6h	Tor
9YU	XC6209G262PR	LVR-IC	LDO, 2.6V±2%, 300mA, -CE, PDR	SOT-89-5	32um VR4	6h	Tor
9YV	XC6209C272PR	LVR-IC	LDO, 2.7V±2%, 150mA, -CE, PDR	SOT-89-5	32um VR4	6h	Tor
9YV	XC6209G272PR	LVR-IC	LDO, 2.7V±2%, 300mA, -CE, PDR	SOT-89-5	32um VR4	6h	Tor
9YX	XC6209C282PR	LVR-IC	LDO, 2.8V±2%, 150mA, -CE, PDR	SOT-89-5	32um VR4	6h	Tor
9YX	XC6209G282PR	LVR-IC	LDO, 2.8V±2%, 300mA, -CE, PDR	SOT-89-5	32um VR4	6h	Tor
9YY	XC6209C292PR	LVR-IC	LDO, 2.9V±2%, 150mA, -CE, PDR	SOT-89-5	32um VR4	6h	Tor
9YY	XC6209G292PR	LVR-IC	LDO, 2.9V±2%, 300mA, -CE, PDR	SOT-89-5	32um VR4	6h	Tor
9YZ	XC6209C302PR	LVR-IC	LDO, 3V±2%, 150mA, -CE, PDR	SOT-89-5	32um VR4	6h	Tor
9YZ	XC6209G302PR	LVR-IC	LDO, 3V±2%, 300mA, -CE, PDR	SOT-89-5	32um VR4	6h	Tor
9Z2	XC6223F12BPR-G	LVR-IC	LDO, 1.25V±20mV, 300mA, +CE, CL, ICP	SOT-89-5	32um VR4	6h	Tor
9Z3	XC6223F13BPR-G	LVR-IC	LDO, 1.35V±20mV, 300mA, +CE, CL, ICP	SOT-89-5	32um VR4	6h	Tor
9Z4	XC6223F14BPR-G	LVR-IC	LDO, 1.45V±20mV, 300mA, +CE, CL, ICP	SOT-89-5	32um VR4	6h	Tor
9Z5	XC6223F15BPR-G	LVR-IC	LDO, 1.55V±20mV, 300mA, +CE, CL, ICP	SOT-89-5	32um VR4	6h	Tor
9Z6	XC6223F16BPR-G	LVR-IC	LDO, 1.65V±20mV, 300mA, +CE, CL, ICP	SOT-89-5	32um VR4	6h	Tor
9Z7	XC6223F17BPR-G	LVR-IC	LDO, 1.75V±20mV, 300mA, +CE, CL, ICP	SOT-89-5	32um VR4	6h	Tor
9Z8	XC6209D092PR	LVR-IC	LDO, 0.9V±2%, 150mA, -CE	SOT-89-5	32um VR4	6h	Tor
9Z8	XC6223F18BPR-G	LVR-IC	LDO, 1.85V±20mV, 300mA, +CE, CL, ICP	SOT-89-5	32um VR4	6h	Tor
9Z8	XC6209H092PR	LVR-IC	LDO, 0.9V±2%, 300mA, -CE	SOT-89-5	32um VR4	6h	Tor
9Z9	XC6209D102PR	LVR-IC	LDO, 1V±2%, 150mA, -CE	SOT-89-5	32um VR4	6h	Tor
9Z9	XC6223F19BPR-G	LVR-IC	LDO, 1.95V±20mV, 300mA, +CE, CL, ICP	SOT-89-5	32um VR4	6h	Tor
9Z9	XC6209H102PR	LVR-IC	LDO, 1V±2%, 300mA, -CE	SOT-89-5	32um VR4	6h	Tor
9ZA	XC6209D112PR	LVR-IC	LDO, 1.1V±2%, 150mA, -CE	SOT-89-5	32um VR4	6h	Tor
9ZA	XC6223F20BPR-G	LVR-IC	LDO, 2.05V±1%, 300mA, +CE, CL, ICP	SOT-89-5	32um VR4	6h	Tor
9ZA	XC6209H112PR	LVR-IC	LDO, 1.1V±2%, 300mA, -CE	SOT-89-5	32um VR4	6h	Tor
9ZB	XC6209D122PR	LVR-IC	LDO, 1.2V±2%, 150mA, -CE	SOT-89-5	32um VR4	6h	Tor
9ZB	XC6223F21BPR-G	LVR-IC	LDO, 2.15V±1%, 300mA, +CE, CL, ICP	SOT-89-5	32um VR4	6h	Tor
9ZB	XC6209H122PR	LVR-IC	LDO, 1.2V±2%, 300mA, -CE	SOT-89-5	32um VR4	6h	Tor
9ZC	XC6209D132PR	LVR-IC	LDO, 1.3V±2%, 150mA, -CE	SOT-89-5	32um VR4	6h	Tor
9ZC	XC6223F22BPR-G	LVR-IC	LDO, 2.25V±1%, 300mA, +CE, CL, ICP	SOT-89-5	32um VR4	6h	Tor
9ZC	XC6209H132PR	LVR-IC	LDO, 1.3V±2%, 300mA, -CE	SOT-89-5	32um VR4	6h	Tor
9ZD	XC6209D142PR	LVR-IC	LDO, 1.4V±2%, 150mA, -CE	SOT-89-5	32um VR4	6h	Tor
9ZD	XC6223F23BPR-G	LVR-IC	LDO, 2.35V±1%, 300mA, +CE, CL, ICP	SOT-89-5	32um VR4	6h	Tor
9ZD	XC6209H142PR	LVR-IC	LDO, 1.4V±2%, 300mA, -CE	SOT-89-5	32um VR4	6h	Tor
9ZE	XC6209D152PR	LVR-IC	LDO, 1.5V±2%, 150mA, -CE	SOT-89-5	32um VR4	6h	Tor
9ZE	XC6223F24BPR-G	LVR-IC	LDO, 2.45V±1%, 300mA, +CE, CL, ICP	SOT-89-5	32um VR4	6h	Tor
9ZE	XC6209H152PR	LVR-IC	LDO, 1.5V±2%, 300mA, -CE	SOT-89-5	32um VR4	6h	Tor



SMD code	Type	Function	Short description	Case	Pinout Sch.	St.	Mnf.
92F	XC6209D162PR	LVR-IC	LDO, 1.6V±2%, 150mA, -CE	SOT-89-5	32um VR4	6h	Tor
92F	XC6223F25BPR-G	LVR-IC	LDO, 2.55V±1%, 300mA, +CE, CL, ICP	SOT-89-5	32um VR4	6h	Tor
92F	XC6209H162PR	LVR-IC	LDO, 1.6V±2%, 300mA, -CE	SOT-89-5	32um VR4	6h	Tor
92H	XC6209D172PR	LVR-IC	LDO, 1.7V±2%, 150mA, -CE	SOT-89-5	32um VR4	6h	Tor
92H	XC6223F26BPR-G	LVR-IC	LDO, 2.65V±1%, 300mA, +CE, CL, ICP	SOT-89-5	32um VR4	6h	Tor
92H	XC6209H172PR	LVR-IC	LDO, 1.7V±2%, 300mA, -CE	SOT-89-5	32um VR4	6h	Tor
92K	XC6209D182PR	LVR-IC	LDO, 1.8V±2%, 150mA, -CE	SOT-89-5	32um VR4	6h	Tor
92K	XC6223F27BPR-G	LVR-IC	LDO, 2.75V±1%, 300mA, +CE, CL, ICP	SOT-89-5	32um VR4	6h	Tor
92K	XC6209H182PR	LVR-IC	LDO, 1.8V±2%, 300mA, -CE	SOT-89-5	32um VR4	6h	Tor
92L	XC6209D192PR	LVR-IC	LDO, 1.9V±2%, 150mA, -CE	SOT-89-5	32um VR4	6h	Tor
92L	XC6223F28BPR-G	LVR-IC	LDO, 2.85V±1%, 300mA, +CE, CL, ICP	SOT-89-5	32um VR4	6h	Tor
92L	XC6209H192PR	LVR-IC	LDO, 1.9V±2%, 300mA, -CE	SOT-89-5	32um VR4	6h	Tor
92M	XC6209D202PR	LVR-IC	LDO, 2V±2%, 150mA, -CE	SOT-89-5	32um VR4	6h	Tor
92M	XC6223F29BPR-G	LVR-IC	LDO, 2.95V±1%, 300mA, +CE, CL, ICP	SOT-89-5	32um VR4	6h	Tor
92M	XC6209H202PR	LVR-IC	LDO, 2V±2%, 300mA, -CE	SOT-89-5	32um VR4	6h	Tor
92N	XC6209D212PR	LVR-IC	LDO, 2.1V±2%, 150mA, -CE	SOT-89-5	32um VR4	6h	Tor
92N	XC6223F30BPR-G	LVR-IC	LDO, 3.05V±1%, 300mA, +CE, CL, ICP	SOT-89-5	32um VR4	6h	Tor
92N	XC6209H212PR	LVR-IC	LDO, 2.1V±2%, 300mA, -CE	SOT-89-5	32um VR4	6h	Tor
92P	XC6209D222PR	LVR-IC	LDO, 2.2V±2%, 150mA, -CE	SOT-89-5	32um VR4	6h	Tor
92P	XC6223F31BPR-G	LVR-IC	LDO, 3.15V±1%, 300mA, +CE, CL, ICP	SOT-89-5	32um VR4	6h	Tor
92P	XC6209H222PR	LVR-IC	LDO, 2.2V±2%, 300mA, -CE	SOT-89-5	32um VR4	6h	Tor
92R	XC6209D232PR	LVR-IC	LDO, 2.3V±2%, 150mA, -CE	SOT-89-5	32um VR4	6h	Tor
92R	XC6223F32BPR-G	LVR-IC	LDO, 3.25V±1%, 300mA, +CE, CL, ICP	SOT-89-5	32um VR4	6h	Tor
92R	XC6209H232PR	LVR-IC	LDO, 2.3V±2%, 300mA, -CE	SOT-89-5	32um VR4	6h	Tor
92S	XC6209D242PR	LVR-IC	LDO, 2.4V±2%, 150mA, -CE	SOT-89-5	32um VR4	6h	Tor
92S	XC6223F33BPR-G	LVR-IC	LDO, 3.35V±1%, 300mA, +CE, CL, ICP	SOT-89-5	32um VR4	6h	Tor
92S	XC6209H242PR	LVR-IC	LDO, 2.4V±2%, 300mA, -CE	SOT-89-5	32um VR4	6h	Tor
92T	XC6209D252PR	LVR-IC	LDO, 2.5V±2%, 150mA, -CE	SOT-89-5	32um VR4	6h	Tor
92T	XC6223F34BPR-G	LVR-IC	LDO, 3.45V±1%, 300mA, +CE, CL, ICP	SOT-89-5	32um VR4	6h	Tor
92T	XC6209H252PR	LVR-IC	LDO, 2.5V±2%, 300mA, -CE	SOT-89-5	32um VR4	6h	Tor
92U	XC6209D262PR	LVR-IC	LDO, 2.6V±2%, 150mA, -CE	SOT-89-5	32um VR4	6h	Tor
92U	XC6223F35BPR-G	LVR-IC	LDO, 3.55V±1%, 300mA, +CE, CL, ICP	SOT-89-5	32um VR4	6h	Tor
92U	XC6209H262PR	LVR-IC	LDO, 2.6V±2%, 300mA, -CE	SOT-89-5	32um VR4	6h	Tor
92V	XC6209D272PR	LVR-IC	LDO, 2.7V±2%, 150mA, -CE	SOT-89-5	32um VR4	6h	Tor
92V	XC6223F36BPR-G	LVR-IC	LDO, 3.65V±1%, 300mA, +CE, CL, ICP	SOT-89-5	32um VR4	6h	Tor
92V	XC6209H272PR	LVR-IC	LDO, 2.7V±2%, 300mA, -CE	SOT-89-5	32um VR4	6h	Tor
92X	XC6209D282PR	LVR-IC	LDO, 2.8V±2%, 150mA, -CE	SOT-89-5	32um VR4	6h	Tor
92X	XC6223F37BPR-G	LVR-IC	LDO, 3.75V±1%, 300mA, +CE, CL, ICP	SOT-89-5	32um VR4	6h	Tor
92X	XC6209H282PR	LVR-IC	LDO, 2.8V±2%, 300mA, -CE	SOT-89-5	32um VR4	6h	Tor
92Y	XC6209D292PR	LVR-IC	LDO, 2.9V±2%, 150mA, -CE	SOT-89-5	32um VR4	6h	Tor
92Y	XC6223F38BPR-G	LVR-IC	LDO, 3.85V±1%, 300mA, +CE, CL, ICP	SOT-89-5	32um VR4	6h	Tor
92Y	XC6209H292PR	LVR-IC	LDO, 2.9V±2%, 300mA, -CE	SOT-89-5	32um VR4	6h	Tor
92Z	XC6209D302PR	LVR-IC	LDO, 3V±2%, 150mA, -CE	SOT-89-5	32um VR4	6h	Tor
92Z	XC6223F39BPR-G	LVR-IC	LDO, 3.95V±1%, 300mA, +CE, CL, ICP	SOT-89-5	32um VR4	6h	Tor
92Z	XC6209H302PR	LVR-IC	LDO, 3V±2%, 300mA, -CE	SOT-89-5	32um VR4	6h	Tor
Ā20	XC6371C201P	DC/DC-IC	PWM step-up, 100kHz, +CE, 2.0V±2.5%, 100mA	SOT-89-5	32gb DC3	6h	Tor
Ā21	XC6371C211P	DC/DC-IC	PWM step-up, 100kHz, +CE, 2.1V±2.5%, 100mA	SOT-89-5	32gb DC3	6h	Tor
Ā22	XC6371C221P	DC/DC-IC	PWM step-up, 100kHz, +CE, 2.2V±2.5%, 100mA	SOT-89-5	32gb DC3	6h	Tor
Ā23	XC6371C231P	DC/DC-IC	PWM step-up, 100kHz, +CE, 2.3V±2.5%, 100mA	SOT-89-5	32gb DC3	6h	Tor
Ā24	XC6371C241P	DC/DC-IC	PWM step-up, 100kHz, +CE, 2.4V±2.5%, 100mA	SOT-89-5	32gb DC3	6h	Tor
Ā25	XC6371C251P	DC/DC-IC	PWM step-up, 100kHz, +CE, 2.5V±2.5%, 100mA	SOT-89-5	32gb DC3	6h	Tor
Ā26	XC6371C261P	DC/DC-IC	PWM step-up, 100kHz, +CE, 2.6V±2.5%, 100mA	SOT-89-5	32gb DC3	6h	Tor
Ā27	XC6371C271P	DC/DC-IC	PWM step-up, 100kHz, +CE, 2.7V±2.5%, 100mA	SOT-89-5	32gb DC3	6h	Tor
Ā28	XC6371C281P	DC/DC-IC	PWM step-up, 100kHz, +CE, 2.8V±2.5%, 100mA	SOT-89-5	32gb DC3	6h	Tor
Ā29	XC6371C291P	DC/DC-IC	PWM step-up, 100kHz, +CE, 2.9V±2.5%, 100mA	SOT-89-5	32gb DC3	6h	Tor
Ā2A	XC6371C202P	DC/DC-IC	PWM step-up, 180kHz, +CE, 2.0V±2.5%, 100mA	SOT-89-5	32gb DC3	6h	Tor
Ā2B	XC6371C212P	DC/DC-IC	PWM step-up, 180kHz, +CE, 2.1V±2.5%, 100mA	SOT-89-5	32gb DC3	6h	Tor
Ā2C	XC6371C222P	DC/DC-IC	PWM step-up, 180kHz, +CE, 2.2V±2.5%, 100mA	SOT-89-5	32gb DC3	6h	Tor
Ā2D	XC6371C232P	DC/DC-IC	PWM step-up, 180kHz, +CE, 2.3V±2.5%, 100mA	SOT-89-5	32gb DC3	6h	Tor
Ā2E	XC6371C242P	DC/DC-IC	PWM step-up, 180kHz, +CE, 2.4V±2.5%, 100mA	SOT-89-5	32gb DC3	6h	Tor
Ā2F	XC6371C252P	DC/DC-IC	PWM step-up, 180kHz, +CE, 2.5V±2.5%, 100mA	SOT-89-5	32gb DC3	6h	Tor
A2H	XC6371C262P	DC/DC-IC	PWM step-up, 180kHz, +CE, 2.6V±2.5%, 100mA	SOT-89-5	32gb DC3	6h	Tor
Ā2K	XC6371C272P	DC/DC-IC	PWM step-up, 180kHz, +CE, 2.7V±2.5%, 100mA	SOT-89-5	32gb DC3	6h	Tor
Ā2L	XC6371C282P	DC/DC-IC	PWM step-up, 180kHz, +CE, 2.8V±2.5%, 100mA	SOT-89-5	32gb DC3	6h	Tor
Ā2M	XC6371C292P	DC/DC-IC	PWM step-up, 180kHz, +CE, 2.9V±2.5%, 100mA	SOT-89-5	32gb DC3	6h	Tor
Ā30	XC6371C301P	DC/DC-IC	PWM step-up, 100kHz, +CE, 3.0V±2.5%, 100mA	SOT-89-5	32gb DC3	6h	Tor
Ā31	XC6371C311P	DC/DC-IC	PWM step-up, 100kHz, +CE, 3.1V±2.5%, 100mA	SOT-89-5	32gb DC3	6h	Tor
Ā32	XC6371C321P	DC/DC-IC	PWM step-up, 100kHz, +CE, 3.2V±2.5%, 100mA	SOT-89-5	32gb DC3	6h	Tor
Ā33	XC6371C331P	DC/DC-IC	PWM step-up, 100kHz, +CE, 3.3V±2.5%, 100mA	SOT-89-5	32gb DC3	6h	Tor
Ā34	XC6371C341P	DC/DC-IC	PWM step-up, 100kHz, +CE, 3.4V±2.5%, 100mA	SOT-89-5	32gb DC3	6h	Tor



SMD code	Type	Function	Short description	Case	Pinout Sch.	St.	Mnf.
ÅH4	XC6371C640P	DC/DC-IC	PWM step-up, 50kHz, +CE, 6.4V±2.5%, 100mA	SOT-89-5	32gb DC3	6h	Tor
ÅH4	XC6373C640P	DC/DC-IC	PWM step-up, 30kHz, +CE, 6.4V±2.5%, 100mA	SOT-89-5	32gb DC3	6h	Tor
ÅH5	XC6373C650P	DC/DC-IC	PWM step-up, 30kHz, +CE, 6.5V±2.5%, 100mA	SOT-89-5	32gb DC3	6h	Tor
ÅH5	XC6371C650P	DC/DC-IC	PWM step-up, 50kHz, +CE, 6.5V±2.5%, 100mA	SOT-89-5	32gb DC3	6h	Tor
ÅH5	XC6373C650P	DC/DC-IC	PWM step-up, 30kHz, +CE, 6.5V±2.5%, 100mA	SOT-89-5	32gb DC3	6h	Tor
ÅH6	XC6373C660P	DC/DC-IC	PWM step-up, 30kHz, +CE, 6.6V±2.5%, 100mA	SOT-89-5	32gb DC3	6h	Tor
ÅH6	XC6371C660P	DC/DC-IC	PWM step-up, 50kHz, +CE, 6.6V±2.5%, 100mA	SOT-89-5	32gb DC3	6h	Tor
ÅH6	XC6373C660P	DC/DC-IC	PWM step-up, 30kHz, +CE, 6.6V±2.5%, 100mA	SOT-89-5	32gb DC3	6h	Tor
ÅH7	XC6371C670P	DC/DC-IC	PWM step-up, 50kHz, +CE, 6.7V±2.5%, 100mA	SOT-89-5	32gb DC3	6h	Tor
ÅH7	XC6373C670P	DC/DC-IC	PWM step-up, 30kHz, +CE, 6.7V±2.5%, 100mA	SOT-89-5	32gb DC3	6h	Tor
ÅH8	XC6373C680P	DC/DC-IC	PWM step-up, 30kHz, +CE, 6.8V±2.5%, 100mA	SOT-89-5	32gb DC3	6h	Tor
ÅH8	XC6371C680P	DC/DC-IC	PWM step-up, 50kHz, +CE, 6.8V±2.5%, 100mA	SOT-89-5	32gb DC3	6h	Tor
ÅH8	XC6373C680P	DC/DC-IC	PWM step-up, 30kHz, +CE, 6.8V±2.5%, 100mA	SOT-89-5	32gb DC3	6h	Tor
ÅH9	XC6373C690P	DC/DC-IC	PWM step-up, 30kHz, +CE, 6.9V±2.5%, 100mA	SOT-89-5	32gb DC3	6h	Tor
ÅH9	XC6371C690P	DC/DC-IC	PWM step-up, 50kHz, +CE, 6.9V±2.5%, 100mA	SOT-89-5	32gb DC3	6h	Tor
ÅH9	XC6373C690P	DC/DC-IC	PWM step-up, 30kHz, +CE, 6.9V±2.5%, 100mA	SOT-89-5	32gb DC3	6h	Tor
AK0	XC6373C700P	DC/DC-IC	PWM step-up, 30kHz, +CE, 7.0V±2.5%, 100mA	SOT-89-5	32gb DC3	6h	Tor
ÅK0	XC6371C700P	DC/DC-IC	PWM step-up, 50kHz, +CE, 7.0V±2.5%, 100mA	SOT-89-5	32gb DC3	6h	Tor
AK0	XC6373C700P	DC/DC-IC	PWM step-up, 30kHz, +CE, 7.0V±2.5%, 100mA	SOT-89-5	32gb DC3	6h	Tor
BCK	S-814A20AUC	LVR-IC	LDO, 2.0V±2%, 150mA, +CE	SOT-89-5	32vr4 VR4	6n	Sii
BCL	S-814A21AUC	LVR-IC	LDO, 2.1V±2%, 150mA, +CE	SOT-89-5	32vr4 VR4	6n	Sii
BCM	S-814A22AUC	LVR-IC	LDO, 2.2V±2%, 150mA, +CE	SOT-89-5	32vr4 VR4	6n	Sii
BCN	S-814A23AUC	LVR-IC	LDO, 2.3V±2%, 150mA, +CE	SOT-89-5	32vr4 VR4	6n	Sii
BCO	S-814A24AUC	LVR-IC	LDO, 2.4V±2%, 150mA, +CE	SOT-89-5	32vr4 VR4	6n	Sii
BCP	S-814A25AUC	LVR-IC	LDO, 2.5V±2%, 150mA, +CE	SOT-89-5	32vr4 VR4	6n	Sii
BCQ	S-814A26AUC	LVR-IC	LDO, 2.6V±2%, 150mA, +CE	SOT-89-5	32vr4 VR4	6n	Sii
BCR	S-814A27AUC	LVR-IC	LDO, 2.7V±2%, 150mA, +CE	SOT-89-5	32vr4 VR4	6n	Sii
BCS	S-814A28AUC	LVR-IC	LDO, 2.8V±2%, 150mA, +CE	SOT-89-5	32vr4 VR4	6n	Sii
BCT	S-814A29AUC	LVR-IC	LDO, 2.9V±2%, 150mA, +CE	SOT-89-5	32vr4 VR4	6n	Sii
BCU	S-814A30AUC	LVR-IC	LDO, 3.0V±2%, 150mA, +CE	SOT-89-5	32vr4 VR4	6n	Sii
BCV	S-814A31AUC	LVR-IC	LDO, 3.1V±2%, 150mA, +CE	SOT-89-5	32vr4 VR4	6n	Sii
BCW	S-814A32AUC	LVR-IC	LDO, 3.2V±2%, 150mA, +CE	SOT-89-5	32vr4 VR4	6n	Sii
BCX	S-814A33AUC	LVR-IC	LDO, 3.3V±2%, 150mA, +CE	SOT-89-5	32vr4 VR4	6n	Sii
BCY	S-814A34AUC	LVR-IC	LDO, 3.4V±2%, 150mA, +CE	SOT-89-5	32vr4 VR4	6n	Sii
BCZ	S-814A35AUC	LVR-IC	LDO, 3.5V±2%, 150mA, +CE	SOT-89-5	32vr4 VR4	6n	Sii
BDA	S-814A36AUC	LVR-IC	LDO, 3.6V±2%, 150mA, +CE	SOT-89-5	32vr4 VR4	6n	Sii
BDB	S-814A37AUC	LVR-IC	LDO, 3.7V±2%, 150mA, +CE	SOT-89-5	32vr4 VR4	6n	Sii
BDC	S-814A38AUC	LVR-IC	LDO, 3.8V±2%, 150mA, +CE	SOT-89-5	32vr4 VR4	6n	Sii
BDD	S-814A39AUC	LVR-IC	LDO, 3.9V±2%, 150mA, +CE	SOT-89-5	32vr4 VR4	6n	Sii
BDE	S-814A40AUC	LVR-IC	LDO, 4.0V±2%, 150mA, +CE	SOT-89-5	32vr4 VR4	6n	Sii
BDF	S-814A41AUC	LVR-IC	LDO, 4.1V±2%, 150mA, +CE	SOT-89-5	32vr4 VR4	6n	Sii
BDG	S-814A42AUC	LVR-IC	LDO, 4.2V±2%, 150mA, +CE	SOT-89-5	32vr4 VR4	6n	Sii
BDH	S-814A43AUC	LVR-IC	LDO, 4.3V±2%, 150mA, +CE	SOT-89-5	32vr4 VR4	6n	Sii
BDI	S-814A44AUC	LVR-IC	LDO, 4.4V±2%, 150mA, +CE	SOT-89-5	32vr4 VR4	6n	Sii
BDJ	S-814A45AUC	LVR-IC	LDO, 4.5V±2%, 150mA, +CE	SOT-89-5	32vr4 VR4	6n	Sii
BDK	S-814A46AUC	LVR-IC	LDO, 4.6V±2%, 150mA, +CE	SOT-89-5	32vr4 VR4	6n	Sii
BDL	S-814A47AUC	LVR-IC	LDO, 4.7V±2%, 150mA, +CE	SOT-89-5	32vr4 VR4	6n	Sii
BDM	S-814A48AUC	LVR-IC	LDO, 4.8V±2%, 150mA, +CE	SOT-89-5	32vr4 VR4	6n	Sii
BDN	S-814A49AUC	LVR-IC	LDO, 4.9V±2%, 150mA, +CE	SOT-89-5	32vr4 VR4	6n	Sii
BDO	S-814A50AUC	LVR-IC	LDO, 5.0V±2%, 150mA, +CE	SOT-89-5	32vr4 VR4	6n	Sii
BDP	S-814A51AUC	LVR-IC	LDO, 5.1V±2%, 150mA, +CE	SOT-89-5	32vr4 VR4	6n	Sii
BDQ	S-814A52AUC	LVR-IC	LDO, 5.2V±2%, 150mA, +CE	SOT-89-5	32vr4 VR4	6n	Sii
BDR	S-814A53AUC	LVR-IC	LDO, 5.3V±2%, 150mA, +CE	SOT-89-5	32vr4 VR4	6n	Sii
BDS	S-814A54AUC	LVR-IC	LDO, 5.4V±2%, 150mA, +CE	SOT-89-5	32vr4 VR4	6n	Sii
BDT	S-814A55AUC	LVR-IC	LDO, 5.5V±2%, 150mA, +CE	SOT-89-5	32vr4 VR4	6n	Sii
BDU	S-814A56AUC	LVR-IC	LDO, 5.6V±2%, 150mA, +CE	SOT-89-5	32vr4 VR4	6n	Sii
BDV	S-814A57AUC	LVR-IC	LDO, 5.7V±2%, 150mA, +CE	SOT-89-5	32vr4 VR4	6n	Sii
BDW	S-814A58AUC	LVR-IC	LDO, 5.8V±2%, 150mA, +CE	SOT-89-5	32vr4 VR4	6n	Sii
BDX	S-814A59AUC	LVR-IC	LDO, 5.9V±2%, 150mA, +CE	SOT-89-5	32vr4 VR4	6n	Sii
BDY	S-814A60AUC	LVR-IC	LDO, 6.0V±2%, 150mA, +CE	SOT-89-5	32vr4 VR4	6n	Sii
BGA	S-818A20AUC	LVR-IC	LDO, 2.0V±2%, 200mA, +CE	SOT-89-5	32vr4 VR4	6n	Sii
BGB	S-818A21AUC	LVR-IC	LDO, 2.1V±2%, 200mA, +CE	SOT-89-5	32vr4 VR4	6n	Sii
BGC	S-818A22AUC	LVR-IC	LDO, 2.2V±2%, 200mA, +CE	SOT-89-5	32vr4 VR4	6n	Sii
BGD	S-818A23AUC	LVR-IC	LDO, 2.3V±2%, 200mA, +CE	SOT-89-5	32vr4 VR4	6n	Sii
BGE	S-818A24AUC	LVR-IC	LDO, 2.4V±2%, 200mA, +CE	SOT-89-5	32vr4 VR4	6n	Sii
BGF	S-818A25AUC	LVR-IC	LDO, 2.5V±2%, 200mA, +CE	SOT-89-5	32vr4 VR4	6n	Sii
BGG	S-818A26AUC	LVR-IC	LDO, 2.6V±2%, 200mA, +CE	SOT-89-5	32vr4 VR4	6n	Sii
BGH	S-818A27AUC	LVR-IC	LDO, 2.7V±2%, 200mA, +CE	SOT-89-5	32vr4 VR4	6n	Sii
BGI	S-818A28AUC	LVR-IC	LDO, 2.8V±2%, 200mA, +CE	SOT-89-5	32vr4 VR4	6n	Sii



SMD code	Type	Function	Short description	Case	Pinout	Sch.	St.	Mnf.
BGJ	S-818A29AUC	LVR-IC	LDO, 2.9V±2%, 200mA, +CE	SOT-89-5	32vr4	VR4	6n	Sii
BGK	S-818A30AUC	LVR-IC	LDO, 3.0V±2%, 200mA, +CE	SOT-89-5	32vr4	VR4	6n	Sii
BGL	S-818A31AUC	LVR-IC	LDO, 3.1V±2%, 200mA, +CE	SOT-89-5	32vr4	VR4	6n	Sii
BGM	S-818A32AUC	LVR-IC	LDO, 3.2V±2%, 200mA, +CE	SOT-89-5	32vr4	VR4	6n	Sii
BGN	S-818A33AUC	LVR-IC	LDO, 3.3V±2%, 200mA, +CE	SOT-89-5	32vr4	VR4	6n	Sii
BGO	S-818A34AUC	LVR-IC	LDO, 3.4V±2%, 200mA, +CE	SOT-89-5	32vr4	VR4	6n	Sii
BGP	S-818A35AUC	LVR-IC	LDO, 3.5V±2%, 200mA, +CE	SOT-89-5	32vr4	VR4	6n	Sii
BGQ	S-818A36AUC	LVR-IC	LDO, 3.6V±2%, 200mA, +CE	SOT-89-5	32vr4	VR4	6n	Sii
BGR	S-818A37AUC	LVR-IC	LDO, 3.7V±2%, 200mA, +CE	SOT-89-5	32vr4	VR4	6n	Sii
BGS	S-818A38AUC	LVR-IC	LDO, 3.8V±2%, 200mA, +CE	SOT-89-5	32vr4	VR4	6n	Sii
BGT	S-818A39AUC	LVR-IC	LDO, 3.9V±2%, 200mA, +CE	SOT-89-5	32vr4	VR4	6n	Sii
BGU	S-818A40AUC	LVR-IC	LDO, 4.0V±2%, 200mA, +CE	SOT-89-5	32vr4	VR4	6n	Sii
BGV	S-818A41AUC	LVR-IC	LDO, 4.1V±2%, 200mA, +CE	SOT-89-5	32vr4	VR4	6n	Sii
BGW	S-818A42AUC	LVR-IC	LDO, 4.2V±2%, 200mA, +CE	SOT-89-5	32vr4	VR4	6n	Sii
BGX	S-818A43AUC	LVR-IC	LDO, 4.3V±2%, 200mA, +CE	SOT-89-5	32vr4	VR4	6n	Sii
BGY	S-818A44AUC	LVR-IC	LDO, 4.4V±2%, 200mA, +CE	SOT-89-5	32vr4	VR4	6n	Sii
BGZ	S-818A45AUC	LVR-IC	LDO, 4.5V±2%, 200mA, +CE	SOT-89-5	32vr4	VR4	6n	Sii
BHA	S-818A46AUC	LVR-IC	LDO, 4.6V±2%, 200mA, +CE	SOT-89-5	32vr4	VR4	6n	Sii
BHB	S-818A47AUC	LVR-IC	LDO, 4.7V±2%, 200mA, +CE	SOT-89-5	32vr4	VR4	6n	Sii
BHC	S-818A48AUC	LVR-IC	LDO, 4.8V±2%, 200mA, +CE	SOT-89-5	32vr4	VR4	6n	Sii
BHD	S-818A49AUC	LVR-IC	LDO, 4.9V±2%, 200mA, +CE	SOT-89-5	32vr4	VR4	6n	Sii
BHE	S-818A50AUC	LVR-IC	LDO, 5.0V±2%, 200mA, +CE	SOT-89-5	32vr4	VR4	6n	Sii
BHF	S-818A51AUC	LVR-IC	LDO, 5.1V±2%, 200mA, +CE	SOT-89-5	32vr4	VR4	6n	Sii
BHG	S-818A52AUC	LVR-IC	LDO, 5.2V±2%, 200mA, +CE	SOT-89-5	32vr4	VR4	6n	Sii
BHH	S-818A53AUC	LVR-IC	LDO, 5.3V±2%, 200mA, +CE	SOT-89-5	32vr4	VR4	6n	Sii
BHI	S-818A54AUC	LVR-IC	LDO, 5.4V±2%, 200mA, +CE	SOT-89-5	32vr4	VR4	6n	Sii
BHJ	S-818A55AUC	LVR-IC	LDO, 5.5V±2%, 200mA, +CE	SOT-89-5	32vr4	VR4	6n	Sii
BHK	S-818A56AUC	LVR-IC	LDO, 5.6V±2%, 200mA, +CE	SOT-89-5	32vr4	VR4	6n	Sii
BHL	S-818A57AUC	LVR-IC	LDO, 5.7V±2%, 200mA, +CE	SOT-89-5	32vr4	VR4	6n	Sii
BHM	S-818A58AUC	LVR-IC	LDO, 5.8V±2%, 200mA, +CE	SOT-89-5	32vr4	VR4	6n	Sii
BHN	S-818A59AUC	LVR-IC	LDO, 5.9V±2%, 200mA, +CE	SOT-89-5	32vr4	VR4	6n	Sii
BHO	S-818A60AUC	LVR-IC	LDO, 6.0V±2%, 200mA, +CE	SOT-89-5	32vr4	VR4	6n	Sii
C01C	R1130H001C	LVR-IC	LDO, Adjustable 1.5..5V±2%, 300mA, -CE	SOT-89-5	32vrp	-	6h	Ric
C15A	R1130H151A	LVR-IC	LDO, 1.5V±2%, 300mA, -CE	SOT-89-5	32vz	VR4	6h	Ric
C15B	R1130H151B	LVR-IC	LDO, 1.5V±2%, 300mA, +CE	SOT-89-5	32vz	VR4	6h	Ric
C16A	R1130H161A	LVR-IC	LDO, 1.6V±2%, 300mA, -CE	SOT-89-5	32vz	VR4	6h	Ric
C16B	R1130H161B	LVR-IC	LDO, 1.6V±2%, 300mA, +CE	SOT-89-5	32vz	VR4	6h	Ric
C17A	R1130H171A	LVR-IC	LDO, 1.7V±2%, 300mA, -CE	SOT-89-5	32vz	VR4	6h	Ric
C17B	R1130H171B	LVR-IC	LDO, 1.7V±2%, 300mA, +CE	SOT-89-5	32vz	VR4	6h	Ric
C18A	R1130H181A	LVR-IC	LDO, 1.8V±2%, 300mA, -CE	SOT-89-5	32vz	VR4	6h	Ric
C18B	R1130H181B	LVR-IC	LDO, 1.8V±2%, 300mA, +CE	SOT-89-5	32vz	VR4	6h	Ric
C19A	R1130H191A	LVR-IC	LDO, 1.9V±2%, 300mA, -CE	SOT-89-5	32vz	VR4	6h	Ric
C19B	R1130H191B	LVR-IC	LDO, 1.9V±2%, 300mA, +CE	SOT-89-5	32vz	VR4	6h	Ric
C20A	R1130H201A	LVR-IC	LDO, 2.0V±2%, 300mA, -CE	SOT-89-5	32vz	VR4	6h	Ric
C20B	R1130H201B	LVR-IC	LDO, 2.0V±2%, 300mA, +CE	SOT-89-5	32vz	VR4	6h	Ric
C21A	R1130H211A	LVR-IC	LDO, 2.1V±2%, 300mA, -CE	SOT-89-5	32vz	VR4	6h	Ric
C21B	R1130H211B	LVR-IC	LDO, 2.1V±2%, 300mA, +CE	SOT-89-5	32vz	VR4	6h	Ric
C22A	R1130H221A	LVR-IC	LDO, 2.2V±2%, 300mA, -CE	SOT-89-5	32vz	VR4	6h	Ric
C22B	R1130H221B	LVR-IC	LDO, 2.2V±2%, 300mA, +CE	SOT-89-5	32vz	VR4	6h	Ric
C23A	R1130H231A	LVR-IC	LDO, 2.3V±2%, 300mA, -CE	SOT-89-5	32vz	VR4	6h	Ric
C23B	R1130H231B	LVR-IC	LDO, 2.3V±2%, 300mA, +CE	SOT-89-5	32vz	VR4	6h	Ric
C24A	R1130H241A	LVR-IC	LDO, 2.4V±2%, 300mA, -CE	SOT-89-5	32vz	VR4	6h	Ric
C24B	R1130H241B	LVR-IC	LDO, 2.4V±2%, 300mA, +CE	SOT-89-5	32vz	VR4	6h	Ric
C25A	R1130H251A	LVR-IC	LDO, 2.5V±2%, 300mA, -CE	SOT-89-5	32vz	VR4	6h	Ric
C25B	R1130H251B	LVR-IC	LDO, 2.5V±2%, 300mA, +CE	SOT-89-5	32vz	VR4	6h	Ric
C26A	R1130H261A	LVR-IC	LDO, 2.6V±2%, 300mA, -CE	SOT-89-5	32vz	VR4	6h	Ric
C26B	R1130H261B	LVR-IC	LDO, 2.6V±2%, 300mA, +CE	SOT-89-5	32vz	VR4	6h	Ric
C27A	R1130H271A	LVR-IC	LDO, 2.7V±2%, 300mA, -CE	SOT-89-5	32vz	VR4	6h	Ric
C27B	R1130H271B	LVR-IC	LDO, 2.7V±2%, 300mA, +CE	SOT-89-5	32vz	VR4	6h	Ric
C28A	R1130H281A	LVR-IC	LDO, 2.8V±2%, 300mA, -CE	SOT-89-5	32vz	VR4	6h	Ric
C28B	R1130H281B	LVR-IC	LDO, 2.8V±2%, 300mA, +CE	SOT-89-5	32vz	VR4	6h	Ric
C29A	R1130H291A	LVR-IC	LDO, 2.9V±2%, 300mA, -CE	SOT-89-5	32vz	VR4	6h	Ric
C29B	R1130H291B	LVR-IC	LDO, 2.9V±2%, 300mA, +CE	SOT-89-5	32vz	VR4	6h	Ric
C30A	R1130H301A	LVR-IC	LDO, 3.0V±2%, 300mA, -CE	SOT-89-5	32vz	VR4	6h	Ric
C30B	R1130H301B	LVR-IC	LDO, 3.0V±2%, 300mA, +CE	SOT-89-5	32vz	VR4	6h	Ric
C31A	R1130H311A	LVR-IC	LDO, 3.1V±2%, 300mA, -CE	SOT-89-5	32vz	VR4	6h	Ric
C31B	R1130H311B	LVR-IC	LDO, 3.1V±2%, 300mA, +CE	SOT-89-5	32vz	VR4	6h	Ric
C32A	R1130H321A	LVR-IC	LDO, 3.2V±2%, 300mA, -CE	SOT-89-5	32vz	VR4	6h	Ric
C32B	R1130H321B	LVR-IC	LDO, 3.2V±2%, 300mA, +CE	SOT-89-5	32vz	VR4	6h	Ric
C33A	R1130H331A	LVR-IC	LDO, 3.3V±2%, 300mA, -CE	SOT-89-5	32vz	VR4	6h	Ric



SMD code	Type	Function	Short description	Case	Pinout Sch.	St.	Mnf.
C33B	R1130H331B	LVR-IC	LDO, 3.3V±2%, 300mA, +CE	SOT-89-5	32vz	VR4	6h Ric
C34A	R1130H341A	LVR-IC	LDO, 3.4V±2%, 300mA, -CE	SOT-89-5	32vz	VR4	6h Ric
C34B	R1130H341B	LVR-IC	LDO, 3.4V±2%, 300mA, +CE	SOT-89-5	32vz	VR4	6h Ric
C35A	R1130H351A	LVR-IC	LDO, 3.5V±2%, 300mA, -CE	SOT-89-5	32vz	VR4	6h Ric
C35B	R1130H351B	LVR-IC	LDO, 3.5V±2%, 300mA, +CE	SOT-89-5	32vz	VR4	6h Ric
C36A	R1130H361A	LVR-IC	LDO, 3.6V±2%, 300mA, -CE	SOT-89-5	32vz	VR4	6h Ric
C36B	R1130H361B	LVR-IC	LDO, 3.6V±2%, 300mA, +CE	SOT-89-5	32vz	VR4	6h Ric
C37A	R1130H371A	LVR-IC	LDO, 3.7V±2%, 300mA, -CE	SOT-89-5	32vz	VR4	6h Ric
C37B	R1130H371B	LVR-IC	LDO, 3.7V±2%, 300mA, +CE	SOT-89-5	32vz	VR4	6h Ric
C38A	R1130H381A	LVR-IC	LDO, 3.8V±2%, 300mA, -CE	SOT-89-5	32vz	VR4	6h Ric
C38B	R1130H381B	LVR-IC	LDO, 3.8V±2%, 300mA, +CE	SOT-89-5	32vz	VR4	6h Ric
C39A	R1130H391A	LVR-IC	LDO, 3.9V±2%, 300mA, -CE	SOT-89-5	32vz	VR4	6h Ric
C39B	R1130H391B	LVR-IC	LDO, 3.9V±2%, 300mA, +CE	SOT-89-5	32vz	VR4	6h Ric
C40A	R1130H401A	LVR-IC	LDO, 4V±2%, 300mA, -CE	SOT-89-5	32vz	VR4	6h Ric
C40B	R1130H401B	LVR-IC	LDO, 4V±2%, 300mA, +CE	SOT-89-5	32vz	VR4	6h Ric
C41A	R1130H411A	LVR-IC	LDO, 4.1V±2%, 300mA, -CE	SOT-89-5	32vz	VR4	6h Ric
C41B	R1130H411B	LVR-IC	LDO, 4.1V±2%, 300mA, +CE	SOT-89-5	32vz	VR4	6h Ric
C42A	R1130H421A	LVR-IC	LDO, 4.2V±2%, 300mA, -CE	SOT-89-5	32vz	VR4	6h Ric
C42B	R1130H421B	LVR-IC	LDO, 4.2V±2%, 300mA, +CE	SOT-89-5	32vz	VR4	6h Ric
C43A	R1130H431A	LVR-IC	LDO, 4.3V±2%, 300mA, -CE	SOT-89-5	32vz	VR4	6h Ric
C43B	R1130H431B	LVR-IC	LDO, 4.3V±2%, 300mA, +CE	SOT-89-5	32vz	VR4	6h Ric
C44A	R1130H441A	LVR-IC	LDO, 4.4V±2%, 300mA, -CE	SOT-89-5	32vz	VR4	6h Ric
C44B	R1130H441B	LVR-IC	LDO, 4.4V±2%, 300mA, +CE	SOT-89-5	32vz	VR4	6h Ric
C45A	R1130H451A	LVR-IC	LDO, 4.5V±2%, 300mA, -CE	SOT-89-5	32vz	VR4	6h Ric
C45B	R1130H451B	LVR-IC	LDO, 4.5V±2%, 300mA, +CE	SOT-89-5	32vz	VR4	6h Ric
C46A	R1130H461A	LVR-IC	LDO, 4.6V±2%, 300mA, -CE	SOT-89-5	32vz	VR4	6h Ric
C46B	R1130H461B	LVR-IC	LDO, 4.6V±2%, 300mA, +CE	SOT-89-5	32vz	VR4	6h Ric
C47A	R1130H471A	LVR-IC	LDO, 4.7V±2%, 300mA, -CE	SOT-89-5	32vz	VR4	6h Ric
C47B	R1130H471B	LVR-IC	LDO, 4.7V±2%, 300mA, +CE	SOT-89-5	32vz	VR4	6h Ric
C48A	R1130H481A	LVR-IC	LDO, 4.8V±2%, 300mA, -CE	SOT-89-5	32vz	VR4	6h Ric
C48B	R1130H481B	LVR-IC	LDO, 4.8V±2%, 300mA, +CE	SOT-89-5	32vz	VR4	6h Ric
C49A	R1130H491A	LVR-IC	LDO, 4.9V±2%, 300mA, -CE	SOT-89-5	32vz	VR4	6h Ric
C49B	R1130H491B	LVR-IC	LDO, 4.9V±2%, 300mA, +CE	SOT-89-5	32vz	VR4	6h Ric
C4N	S-812C33BUC-C4NT2G	LVR-IC	3.3V±2%, 50mA, +CE	SOT-89-5	32tr	VR4	6s Ric
C50A	R1130H501A	LVR-IC	LDO, 5V±2%, 300mA, -CE	SOT-89-5	32vz	VR4	6h Ric
C50B	R1130H501B	LVR-IC	LDO, 5V±2%, 300mA, +CE	SOT-89-5	32vz	VR4	6h Ric
C5E	S-812C50BUC-C5ET2G	LVR-IC	5.0V±2%, 50mA, +CE	SOT-89-5	32tr	VR4	6s Sii
CB-	XC62GR2112P	LVR-IC	2.1V±2%, 150mA, +CE	SOT-89-5	32ex	VR4	6h Tor
CB-	XC62GP2112P	LVR-IC	2.1V±2%, 150mA, -CE	SOT-89-5	32ex	VR4	6h Tor
CB+	XC62GR2122P	LVR-IC	2.1V±2%, 150mA, +CE, HS response	SOT-89-5	32ex	VR4	6h Tor
CB+	XC62GP2122P	LVR-IC	2.1V±2%, 150mA, -CE, HS response	SOT-89-5	32ex	VR4	6h Tor
CC-	XC62GR2212P	LVR-IC	2.2V±2%, 150mA, +CE	SOT-89-5	32ex	VR4	6h Tor
CC-	XC62GP2212P	LVR-IC	2.2V±2%, 150mA, -CE	SOT-89-5	32ex	VR4	6h Tor
CC+	XC62GR2222P	LVR-IC	2.2V±2%, 150mA, +CE, HS response	SOT-89-5	32ex	VR4	6h Tor
CC+	XC62GP2222P	LVR-IC	2.2V±2%, 150mA, -CE, HS response	SOT-89-5	32ex	VR4	6h Tor
CD-	XC62GR2312P	LVR-IC	2.3V±2%, 150mA, +CE	SOT-89-5	32ex	VR4	6h Tor
CD-	XC62GP2312P	LVR-IC	2.3V±2%, 150mA, -CE	SOT-89-5	32ex	VR4	6h Tor
CD+	XC62GR2322P	LVR-IC	2.3V±2%, 150mA, +CE, HS response	SOT-89-5	32ex	VR4	6h Tor
CD+	XC62GP2322P	LVR-IC	2.3V±2%, 150mA, -CE, HS response	SOT-89-5	32ex	VR4	6h Tor
CE-	XC62GR2412P	LVR-IC	2.4V±2%, 150mA, +CE	SOT-89-5	32ex	VR4	6h Tor
CE-	XC62GP2412P	LVR-IC	2.4V±2%, 150mA, -CE	SOT-89-5	32ex	VR4	6h Tor
CE+	XC62GR2422P	LVR-IC	2.4V±2%, 150mA, +CE, HS response	SOT-89-5	32ex	VR4	6h Tor
CE+	XC62GP2422P	LVR-IC	2.4V±2%, 150mA, -CE, HS response	SOT-89-5	32ex	VR4	6h Tor
CF-	XC62GR2512P	LVR-IC	2.5V±2%, 150mA, +CE	SOT-89-5	32ex	VR4	6h Tor
CF-	XC62GP2512P	LVR-IC	2.5V±2%, 150mA, -CE	SOT-89-5	32ex	VR4	6h Tor
CF+	XC62GR2522P	LVR-IC	2.5V±2%, 150mA, +CE, HS response	SOT-89-5	32ex	VR4	6h Tor
CF+	XC62GP2522P	LVR-IC	2.5V±2%, 150mA, -CE, HS response	SOT-89-5	32ex	VR4	6h Tor
CH-	XC62GR2612P	LVR-IC	2.6V±2%, 150mA, +CE	SOT-89-5	32ex	VR4	6h Tor
CH-	XC62GP2612P	LVR-IC	2.6V±2%, 150mA, -CE	SOT-89-5	32ex	VR4	6h Tor
CH+	XC62GR2622P	LVR-IC	2.6V±2%, 150mA, +CE, HS response	SOT-89-5	32ex	VR4	6h Tor
CH+	XC62GP2622P	LVR-IC	2.6V±2%, 150mA, -CE, HS response	SOT-89-5	32ex	VR4	6h Tor
CK-	XC62GR2712P	LVR-IC	2.7V±2%, 150mA, +CE	SOT-89-5	32ex	VR4	6h Tor
CK-	XC62GP2712P	LVR-IC	2.7V±2%, 150mA, -CE	SOT-89-5	32ex	VR4	6h Tor
CK+	XC62GR2722P	LVR-IC	2.7V±2%, 150mA, +CE, HS response	SOT-89-5	32ex	VR4	6h Tor
CK+	XC62GP2722P	LVR-IC	2.7V±2%, 150mA, -CE, HS response	SOT-89-5	32ex	VR4	6h Tor
CL-	XC62GR2812P	LVR-IC	2.8V±2%, 150mA, +CE	SOT-89-5	32ex	VR4	6h Tor
CL-	XC62GP2812P	LVR-IC	2.8V±2%, 150mA, -CE	SOT-89-5	32ex	VR4	6h Tor
CL+	XC62GR2822P	LVR-IC	2.8V±2%, 150mA, +CE, HS response	SOT-89-5	32ex	VR4	6h Tor
CL+	XC62GP2822P	LVR-IC	2.8V±2%, 150mA, -CE, HS response	SOT-89-5	32ex	VR4	6h Tor
CM-	XC62GR2912P	LVR-IC	2.9V±2%, 150mA, +CE	SOT-89-5	32ex	VR4	6h Tor



SMD code	Type	Function	Short description	Case	Pinout	Sch.	St.	Mnf.
CM-	XC62GP2912P	LVR-IC	2.9V±2%, 150mA, -CE	SOT-89-5	32ex	VR4	6h	Tor
CM+	XC62GR2922P	LVR-IC	2.9V±2%, 150mA, +CE, HS response	SOT-89-5	32ex	VR4	6h	Tor
CM+	XC62GP2922P	LVR-IC	2.9V±2%, 150mA, -CE, HS response	SOT-89-5	32ex	VR4	6h	Tor
D0	AP131-41Y	LVR-IC	LDO, 4.1V±2%, 300mA, +CE	SOT-89-5L	32vrx	VR4	6j	Ana
D02A	R1150H002A	LVRVdet-IC	LDO, 3.3V±2%, 150mA, Vdet=2.5V, -Reset ODO	SOT-89-5	32ya	-	6h	Ric
D02B	R1150H002B	LVRVdet-IC	LDO, 3.3V±2%, 150mA, Vdet=2.5V, -Reset ODO	SOT-89-5	32yb	-	6h	Ric
D02D	R1150H002D	LVRVdet-IC	LDO, 3.3V±2%, 150mA, Vdet=2.5V, -Reset ODO	SOT-89-5	32yc	-	6h	Ric
D03A	R1150H003A	LVRVdet-IC	LDO, 5.0V±2%, 150mA, Vdet=4.3V, -Reset ODO	SOT-89-5	32ya	-	6h	Ric
D03B	R1150H003B	LVRVdet-IC	LDO, 5.0V±2%, 150mA, Vdet=4.3V, -Reset ODO	SOT-89-5	32yb	-	6h	Ric
D04B	R1150H004B	LVRVdet-IC	LDO, 2.5V±2%, 150mA, Vdet=2.3V, -Reset ODO	SOT-89-5	32yb	-	6h	Ric
D05B	R1150H005B	LVRVdet-IC	LDO, 3.3V±2%, 150mA, Vdet=2.9V, -Reset ODO	SOT-89-5	32yb	-	6h	Ric
D06A	R1150H006A	LVRVdet-IC	LDO, 5.0V±2%, 150mA, Vdet=4.5V, -Reset ODO	SOT-89-5	32ya	-	6h	Ric
D06B	R1150H006B	LVRVdet-IC	LDO, 5.0V±2%, 150mA, Vdet=4.5V, -Reset ODO	SOT-89-5	32yb	-	6h	Ric
D07C	R1150H007C	LVRVdet-IC	LDO, 3.5V±2%, 150mA, Vdet=3.1V, -Reset ODO	SOT-89-5	32yc	-	6h	Ric
D08C	R1150H008C	LVRVdet-IC	LDO, 3.3V±2%, 150mA, Vdet=4.2V, -Reset ODO	SOT-89-5	32yc	-	6h	Ric
D09C	R1150H009C	LVRVdet-IC	LDO, 5.0V±2%, 150mA, Vdet=4.1V, -Reset ODO	SOT-89-5	32yc	-	6h	Ric
D1	AP131-42Y	LVR-IC	LDO, 4.2V±2%, 300mA, +CE	SOT-89-5L	32vrx	VR4	6j	Ana
D10A	R1150H010A	LVRVdet-IC	LDO, 3.0V±2%, 150mA, Vdet=4.2V, -Reset ODO	SOT-89-5	32ya	-	6h	Ric
D11A	R1150H011A	LVRVdet-IC	LDO, 7.0V±2%, 150mA, Vdet=2.8V, -Reset ODO	SOT-89-5	32ya	-	6h	Ric
D12A	R1150H012A	LVRVdet-IC	LDO, 12.0V±2%, 150mA, Vdet=4.7V, -Reset ODO	SOT-89-5	32ya	-	6h	Ric
D13A	R1150H013A	LVRVdet-IC	LDO, 7.5V±2%, 150mA, Vdet=4.3V, -Reset ODO	SOT-89-5	32ya	-	6h	Ric
D14A	R1150H014A	LVRVdet-IC	LDO, 7.5V±2%, 150mA, Vdet=4.7V, -Reset ODO	SOT-89-5	32ya	-	6h	Ric
D15A	R1150H015A	LVRVdet-IC	LDO, 3.0V±2%, 150mA, Vdet=2.5V, -Reset ODO	SOT-89-5	32ya	-	6h	Ric
D16D	R1150H016D	LVRVdet-IC	LDO, 5.0V±2%, 150mA, Vdet=3.5V, -Reset ODO	SOT-89-5	32yc	-	6h	Ric
D17D	R1150H017D	LVRVdet-IC	LDO, 3.3V±2%, 150mA, Vdet=2.9V, -Reset ODO	SOT-89-5	32yc	-	6h	Ric
D18D	R1150H018D	LVRVdet-IC	LDO, 5.0V±2%, 150mA, Vdet=3.0V, -Reset ODO	SOT-89-5	32yc	-	6h	Ric
D19A	R1150H019A	LVRVdet-IC	LDO, 14.0V±2%, 150mA, Vdet=15.0V, -Reset ODO	SOT-89-5	32ya	-	6h	Ric
D2	AP131-43Y	LVR-IC	LDO, 4.3V±2%, 300mA, +CE	SOT-89-5L	32vrx	VR4	6j	Ana
D20C	R1150H020C	LVRVdet-IC	LDO, 5.0V±2%, 150mA, Vdet=4.2V, -Reset ODO	SOT-89-5	32yc	-	6h	Ric
D20D	R1150H020D	LVRVdet-IC	LDO, 5.0V±2%, 150mA, Vdet=4.2V, -Reset ODO	SOT-89-5	32yc	-	6h	Ric
D21A	R1150H021A	LVRVdet-IC	LDO, 3.6V±2%, 150mA, Vdet=4.3V, -Reset ODO	SOT-89-5	32ya	-	6h	Ric
D21B	R1150H021B	LVRVdet-IC	LDO, 3.6V±2%, 150mA, Vdet=4.3V, -Reset ODO	SOT-89-5	32yb	-	6h	Ric
D22D	R1150H022D	LVRVdet-IC	LDO, 3.3V±2%, 150mA, Vdet=2.8V, -Reset ODO	SOT-89-5	32yc	-	6h	Ric
D23A	R1150H023A	LVRVdet-IC	LDO, 12.0V±2%, 150mA, Vdet=4.2V, -Reset ODO	SOT-89-5	32ya	-	6h	Ric
D24B	R1150H024B	LVRVdet-IC	LDO, 3.3V±2%, 150mA, Vdet=3.6V, -Reset ODO	SOT-89-5	32yb	-	6h	Ric
D25B	R1150H025B	LVRVdet-IC	LDO, 4.0V±2%, 150mA, Vdet=5.0V, -Reset ODO	SOT-89-5	32yb	-	6h	Ric
D26D	R1150H026D	LVRVdet-IC	LDO, 3.3V±2%, 150mA, Vdet=2.3V, -Reset ODO	SOT-89-5	32yc	-	6h	Ric
D27A	R1150H027A	LVRVdet-IC	LDO, 3.6V±2%, 150mA, Vdet=9.0V, -Reset ODO	SOT-89-5	32ya	-	6h	Ric
D28D	R1150H028D	LVRVdet-IC	LDO, 5.0V±2%, 150mA, Vdet=2.1V, -Reset ODO	SOT-89-5	32yc	-	6h	Ric
D29A	R1150H029A	LVRVdet-IC	LDO, 3.6V±2%, 150mA, Vdet=7.8V, -Reset ODO	SOT-89-5	32ya	-	6h	Ric
D3	AP131-44Y	LVR-IC	LDO, 4.4V±2%, 300mA, +CE	SOT-89-5L	32vrx	VR4	6j	Ana
D30D	R1150H030D	LVRVdet-IC	LDO, 3.3V±2%, 150mA, Vdet=2.2V, -Reset ODO	SOT-89-5	32yc	-	6h	Ric
D31D	R1150H031D	LVRVdet-IC	LDO, 3.3V±2%, 150mA, Vdet=2.0V, -Reset ODO	SOT-89-5	32yc	-	6h	Ric
D32D	R1150H032D	LVRVdet-IC	LDO, 3.4V±2%, 150mA, Vdet=2.0V, -Reset ODO	SOT-89-5	32yc	-	6h	Ric
D33A	R1150H033A	LVRVdet-IC	LDO, 3.1V±2%, 150mA, Vdet=4.5V, -Reset ODO	SOT-89-5	32ya	-	6h	Ric
D34C	R1150H034C	LVRVdet-IC	LDO, 5.0V±2%, 150mA, Vdet=13.0V, -Reset ODO	SOT-89-5	32yc	-	6h	Ric
D35B	R1150H035B	LVRVdet-IC	LDO, 3.3V±2%, 150mA, Vdet=3.8V, -Reset ODO	SOT-89-5	32yb	-	6h	Ric
D36B	R1150H036B	LVRVdet-IC	LDO, 3.3V±2%, 150mA, Vdet=5.6V, -Reset ODO	SOT-89-5	32yb	-	6h	Ric
D37B	R1150H037B	LVRVdet-IC	LDO, 2.5V±2%, 150mA, Vdet=4.1V, -Reset ODO	SOT-89-5	32yb	-	6h	Ric
D38B	R1150H038B	LVRVdet-IC	LDO, 5.0V±2%, 150mA, Vdet=2.3V, -Reset ODO	SOT-89-5	32yb	-	6h	Ric
D39A	R1150H039A	LVRVdet-IC	LDO, 3.3V±2%, 150mA, Vdet=6.8V, -Reset ODO	SOT-89-5	32ya	-	6h	Ric
D4	AP131-45Y	LVR-IC	LDO, 4.5V±2%, 300mA, +CE	SOT-89-5L	32vrx	VR4	6j	Ana
D40A	R1150H040A	LVRVdet-IC	LDO, 3.3V±2%, 150mA, Vdet=5.0V, -Reset ODO	SOT-89-5	32ya	-	6h	Ric
D41C	R1150H041C	LVRVdet-IC	LDO, 7.0V±2%, 150mA, Vdet=7.5V, -Reset ODO	SOT-89-5	32yc	-	6h	Ric
D42A	R1150H042A	LVRVdet-IC	LDO, 5.6V±2%, 150mA, Vdet=4.5V, -Reset ODO	SOT-89-5	32ya	-	6h	Ric
D43A	R1150H043A	LVRVdet-IC	LDO, 9.0V±2%, 150mA, Vdet=9.9V, -Reset ODO	SOT-89-5	32ya	-	6h	Ric
D44A	R1150H044A	LVRVdet-IC	LDO, 8.0V±2%, 150mA, Vdet=8.9V, -Reset ODO	SOT-89-5	32ya	-	6h	Ric
D45A	R1150H045A	LVRVdet-IC	LDO, 5.0V±2%, 150mA, Vdet=5.6V, -Reset ODO	SOT-89-5	32yb	-	6h	Ric
D46A	R1150H046A	LVRVdet-IC	LDO, 5.6V±2%, 150mA, Vdet=3.0V, -Reset ODO	SOT-89-5	32ya	-	6h	Ric
D47A	R1150H047A	LVRVdet-IC	LDO, 12.0V±2%, 150mA, Vdet=5.0V, -Reset ODO	SOT-89-5	32ya	-	6h	Ric
D48A	R1150H048A	LVRVdet-IC	LDO, 5.0V±2%, 150mA, Vdet=7.5V, -Reset ODO	SOT-89-5	32ya	-	6h	Ric
D49A	R1150H049A	LVRVdet-IC	LDO, 2.85V±2%, 150mA, Vdet=4.5V, -Reset ODO	SOT-89-5	32ya	-	6h	Ric
D5	AP131-46Y	LVR-IC	LDO, 4.6V±2%, 300mA, +CE	SOT-89-5L	32vrx	VR4	6j	Ana
D50A	R1150H050A	LVRVdet-IC	LDO, 5.4V±2%, 150mA, Vdet=3.0V, -Reset ODO	SOT-89-5	32ya	-	6h	Ric
D6	AP131-47Y	LVR-IC	LDO, 4.7V±2%, 300mA, +CE	SOT-89-5L	32vrx	VR4	6j	Ana
D7	AP131-48Y	LVR-IC	LDO, 4.8V±2%, 300mA, +CE	SOT-89-5L	32vrx	VR4	6j	Ana
D8	AP131-49Y	LVR-IC	LDO, 4.9V±2%, 300mA, +CE	SOT-89-5L	32vrx	VR4	6j	Ana
D9	AP131-50Y	LVR-IC	LDO, 5V±2%, 300mA, +CE	SOT-89-5L	32vrx	VR4	6j	Ana
DA	AP131-15Y	LVR-IC	LDO, 1.5V±2%, 300mA, +CE	SOT-89-5L	32vrx	VR4	6j	Ana
DA-	XC62GR3012P	LVR-IC	3.0V±2%, 150mA, +CE	SOT-89-5	32ex	VR4	6h	Tor



SMD code	Type	Function	Short description	Case	Pinout Sch.	St.	Mnf.
DA-	XC62GP3012P	LVR-IC	3.0V±2%, 150mA, -CE	SOT-89-5	32ex VR4	6h	Tor
DA+	XC62GR3022P	LVR-IC	3.0V±2%, 150mA, +CE, HS response	SOT-89-5	32ex VR4	6h	Tor
DA+	XC62GP3022P	LVR-IC	3.0V±2%, 150mA, -CE, HS response	SOT-89-5	32ex VR4	6h	Tor
DB	AP131-16Y	LVR-IC	LDO, 1.6V±2%, 300mA, +CE	SOT-89-5L	32vrx VR4	6j	Ana
DB-	XC62GR3112P	LVR-IC	3.1V±2%, 150mA, +CE	SOT-89-5	32ex VR4	6h	Tor
DB-	XC62GP3112P	LVR-IC	3.1V±2%, 150mA, -CE	SOT-89-5	32ex VR4	6h	Tor
DB+	XC62GR3122P	LVR-IC	3.1V±2%, 150mA, +CE, HS response	SOT-89-5	32ex VR4	6h	Tor
DB+	XC62GP3122P	LVR-IC	3.1V±2%, 150mA, -CE, HS response	SOT-89-5	32ex VR4	6h	Tor
DC	AP131-17Y	LVR-IC	LDO, 1.7V±2%, 300mA, +CE	SOT-89-5L	32vrx VR4	6j	Ana
DC-	XC62GR3212P	LVR-IC	3.2V±2%, 150mA, +CE	SOT-89-5	32ex VR4	6h	Tor
DC-	XC62GP3212P	LVR-IC	3.2V±2%, 150mA, -CE	SOT-89-5	32ex VR4	6h	Tor
DC+	XC62GR3222P	LVR-IC	3.2V±2%, 150mA, +CE, HS response	SOT-89-5	32ex VR4	6h	Tor
DC+	XC62GP3222P	LVR-IC	3.2V±2%, 150mA, -CE, HS response	SOT-89-5	32ex VR4	6h	Tor
DD	AP131-18Y	LVR-IC	LDO, 1.8V±2%, 300mA, +CE	SOT-89-5L	32vrx VR4	6j	Ana
DD-	XC62GR3312P	LVR-IC	3.3V±2%, 150mA, +CE	SOT-89-5	32ex VR4	6h	Tor
DD-	XC62GP3312P	LVR-IC	3.3V±2%, 150mA, -CE	SOT-89-5	32ex VR4	6h	Tor
DD+	XC62GR3322P	LVR-IC	3.3V±2%, 150mA, +CE, HS response	SOT-89-5	32ex VR4	6h	Tor
DD+	XC62GP3322P	LVR-IC	3.3V±2%, 150mA, -CE, HS response	SOT-89-5	32ex VR4	6h	Tor
DE	AP131-19Y	LVR-IC	LDO, 1.9V±2%, 300mA, +CE	SOT-89-5L	32vrx VR4	6j	Ana
DE-	XC62GR3412P	LVR-IC	3.4V±2%, 150mA, +CE	SOT-89-5	32ex VR4	6h	Tor
DE-	XC62GP3412P	LVR-IC	3.4V±2%, 150mA, -CE	SOT-89-5	32ex VR4	6h	Tor
DE+	XC62GR3422P	LVR-IC	3.4V±2%, 150mA, +CE, HS response	SOT-89-5	32ex VR4	6h	Tor
DE+	XC62GP3422P	LVR-IC	3.4V±2%, 150mA, -CE, HS response	SOT-89-5	32ex VR4	6h	Tor
DF	AP131-20Y	LVR-IC	LDO, 2V±2%, 300mA, +CE	SOT-89-5L	32vrx VR4	6j	Ana
DF-	XC62GR3512P	LVR-IC	3.5V±2%, 150mA, +CE	SOT-89-5	32ex VR4	6h	Tor
DF-	XC62GP3512P	LVR-IC	3.5V±2%, 150mA, -CE	SOT-89-5	32ex VR4	6h	Tor
DF+	XC62GR3522P	LVR-IC	3.5V±2%, 150mA, +CE, HS response	SOT-89-5	32ex VR4	6h	Tor
DF+	XC62GP3522P	LVR-IC	3.5V±2%, 150mA, -CE, HS response	SOT-89-5	32ex VR4	6h	Tor
DG	AP131-21Y	LVR-IC	LDO, 2.1V±2%, 300mA, +CE	SOT-89-5L	32vrx VR4	6j	Ana
DH	AP131-22Y	LVR-IC	LDO, 2.2V±2%, 300mA, +CE	SOT-89-5L	32vrx VR4	6j	Ana
DH-	XC62GR3612P	LVR-IC	3.6V±2%, 150mA, +CE	SOT-89-5	32ex VR4	6h	Tor
DH-	XC62GP3612P	LVR-IC	3.6V±2%, 150mA, -CE	SOT-89-5	32ex VR4	6h	Tor
DH+	XC62GR3622P	LVR-IC	3.6V±2%, 150mA, +CE, HS response	SOT-89-5	32ex VR4	6h	Tor
DH+	XC62GP3622P	LVR-IC	3.6V±2%, 150mA, -CE, HS response	SOT-89-5	32ex VR4	6h	Tor
DI	AP131-23Y	LVR-IC	LDO, 2.3V±2%, 300mA, +CE	SOT-89-5L	32vrx VR4	6j	Ana
DJ	AP131-24Y	LVR-IC	LDO, 2.4V±2%, 300mA, +CE	SOT-89-5L	32vrx VR4	6j	Ana
DK	AP131-25Y	LVR-IC	LDO, 2.5V±2%, 300mA, +CE	SOT-89-5L	32vrx VR4	6j	Ana
DK-	XC62GR3712P	LVR-IC	3.7V±2%, 150mA, +CE	SOT-89-5	32ex VR4	6h	Tor
DK-	XC62GP3712P	LVR-IC	3.7V±2%, 150mA, -CE	SOT-89-5	32ex VR4	6h	Tor
DK+	XC62GR3722P	LVR-IC	3.7V±2%, 150mA, +CE, HS response	SOT-89-5	32ex VR4	6h	Tor
DK+	XC62GP3722P	LVR-IC	3.7V±2%, 150mA, -CE, HS response	SOT-89-5	32ex VR4	6h	Tor
DL	AP131-26Y	LVR-IC	LDO, 2.6V±2%, 300mA, +CE	SOT-89-5L	32vrx VR4	6j	Ana
DL-	XC62GR3812P	LVR-IC	3.8V±2%, 150mA, +CE	SOT-89-5	32ex VR4	6h	Tor
DL-	XC62GP3812P	LVR-IC	3.8V±2%, 150mA, -CE	SOT-89-5	32ex VR4	6h	Tor
DL+	XC62GR3822P	LVR-IC	3.8V±2%, 150mA, +CE, HS response	SOT-89-5	32ex VR4	6h	Tor
DL+	XC62GP3822P	LVR-IC	3.8V±2%, 150mA, -CE, HS response	SOT-89-5	32ex VR4	6h	Tor
DM	AP131-27Y	LVR-IC	LDO, 2.7V±2%, 300mA, +CE	SOT-89-5L	32vrx VR4	6j	Ana
DM-	XC62GR3912P	LVR-IC	3.9V±2%, 150mA, +CE	SOT-89-5	32ex VR4	6h	Tor
DM-	XC62GP3912P	LVR-IC	3.9V±2%, 150mA, -CE	SOT-89-5	32ex VR4	6h	Tor
DM+	XC62GR3922P	LVR-IC	3.9V±2%, 150mA, +CE, HS response	SOT-89-5	32ex VR4	6h	Tor
DM+	XC62GP3922P	LVR-IC	3.9V±2%, 150mA, -CE, HS response	SOT-89-5	32ex VR4	6h	Tor
DN	AP131-28Y	LVR-IC	LDO, 2.8V±2%, 300mA, +CE	SOT-89-5L	32vrx VR4	6j	Ana
DO	AP131-29Y	LVR-IC	LDO, 2.9V±2%, 300mA, +CE	SOT-89-5L	32vrx VR4	6j	Ana
DP	AP131-30Y	LVR-IC	LDO, 3V±2%, 300mA, +CE	SOT-89-5L	32vrx VR4	6j	Ana
DQ	AP131-31Y	LVR-IC	LDO, 3.1V±2%, 300mA, +CE	SOT-89-5L	32vrx VR4	6j	Ana
DR	AP131-32Y	LVR-IC	LDO, 3.2V±2%, 300mA, +CE	SOT-89-5L	32vrx VR4	6j	Ana
DS	AP131-33Y	LVR-IC	LDO, 3.3V±2%, 300mA, +CE	SOT-89-5L	32vrx VR4	6j	Ana
DT	AP131-34Y	LVR-IC	LDO, 3.4V±2%, 300mA, +CE	SOT-89-5L	32vrx VR4	6j	Ana
DU	AP131-35Y	LVR-IC	LDO, 3.5V±2%, 300mA, +CE	SOT-89-5L	32vrx VR4	6j	Ana
DV	AP131-36Y	LVR-IC	LDO, 3.6V±2%, 300mA, +CE	SOT-89-5L	32vrx VR4	6j	Ana
DW	AP131-37Y	LVR-IC	LDO, 3.7V±2%, 300mA, +CE	SOT-89-5L	32vrx VR4	6j	Ana
DX	AP131-38Y	LVR-IC	LDO, 3.8V±2%, 300mA, +CE	SOT-89-5L	32vrx VR4	6j	Ana
DY	AP131-39Y	LVR-IC	LDO, 3.9V±2%, 300mA, +CE	SOT-89-5L	32vrx VR4	6j	Ana
DZ	AP131-40Y	LVR-IC	LDO, 4V±2%, 300mA, +CE	SOT-89-5L	32vrx VR4	6j	Ana
E15A	R1170H151A	LVR-IC	LDO, 1.5V±2%, 800mA, -CE	SOT-89-5	32vy VR4	6h	Ric
E15B	R1170H151B	LVR-IC	LDO, 1.5V±2%, 800mA, +CE	SOT-89-5	32vy VR4	6h	Ric
E16A	R1170H161A	LVR-IC	LDO, 1.6V±2%, 800mA, -CE	SOT-89-5	32vy VR4	6h	Ric
E16B	R1170H161B	LVR-IC	LDO, 1.6V±2%, 800mA, +CE	SOT-89-5	32vy VR4	6h	Ric
E17A	R1170H171A	LVR-IC	LDO, 1.7V±2%, 800mA, -CE	SOT-89-5	32vy VR4	6h	Ric
E17B	R1170H171B	LVR-IC	LDO, 1.7V±2%, 800mA, +CE	SOT-89-5	32vy VR4	6h	Ric



SMD code	Type	Function	Short description	Case	Pinout Sch.	St.	Mnf.
E18A	R1170H181A	LVR-IC	LDO, 1.8V±2%, 800mA, -CE	SOT-89-5	32vy VR4	6h	Ric
E18B	R1170H181B	LVR-IC	LDO, 1.8V±2%, 800mA, +CE	SOT-89-5	32vy VR4	6h	Ric
E19A	R1170H191A	LVR-IC	LDO, 1.9V±2%, 800mA, -CE	SOT-89-5	32vy VR4	6h	Ric
E19B	R1170H191B	LVR-IC	LDO, 1.9V±2%, 800mA, +CE	SOT-89-5	32vy VR4	6h	Ric
E20A	R1170H201A	LVR-IC	LDO, 2V±2%, 800mA, -CE	SOT-89-5	32vy VR4	6h	Ric
E20B	R1170H201B	LVR-IC	LDO, 2V±2%, 800mA, +CE	SOT-89-5	32vy VR4	6h	Ric
E21A	R1170H211A	LVR-IC	LDO, 2.1V±2%, 800mA, -CE	SOT-89-5	32vy VR4	6h	Ric
E21B	R1170H211B	LVR-IC	LDO, 2.1V±2%, 800mA, +CE	SOT-89-5	32vy VR4	6h	Ric
E22A	R1170H221A	LVR-IC	LDO, 2.2V±2%, 800mA, -CE	SOT-89-5	32vy VR4	6h	Ric
E22B	R1170H221B	LVR-IC	LDO, 2.2V±2%, 800mA, +CE	SOT-89-5	32vy VR4	6h	Ric
E23A	R1170H231A	LVR-IC	LDO, 2.3V±2%, 800mA, -CE	SOT-89-5	32vy VR4	6h	Ric
E23B	R1170H231B	LVR-IC	LDO, 2.3V±2%, 800mA, +CE	SOT-89-5	32vy VR4	6h	Ric
E24A	R1170H241A	LVR-IC	LDO, 2.4V±2%, 800mA, -CE	SOT-89-5	32vy VR4	6h	Ric
E24B	R1170H241B	LVR-IC	LDO, 2.4V±2%, 800mA, +CE	SOT-89-5	32vy VR4	6h	Ric
E25A	R1170H251A	LVR-IC	LDO, 2.5V±2%, 800mA, -CE	SOT-89-5	32vy VR4	6h	Ric
E25B	R1170H251B	LVR-IC	LDO, 2.5V±2%, 800mA, +CE	SOT-89-5	32vy VR4	6h	Ric
E26A	R1170H261A	LVR-IC	LDO, 2.6V±2%, 800mA, -CE	SOT-89-5	32vy VR4	6h	Ric
E26B	R1170H261B	LVR-IC	LDO, 2.6V±2%, 800mA, +CE	SOT-89-5	32vy VR4	6h	Ric
E27A	R1170H271A	LVR-IC	LDO, 2.7V±2%, 800mA, -CE	SOT-89-5	32vy VR4	6h	Ric
E27B	R1170H271B	LVR-IC	LDO, 2.7V±2%, 800mA, +CE	SOT-89-5	32vy VR4	6h	Ric
E28A	R1170H281A	LVR-IC	LDO, 2.8V±2%, 800mA, -CE	SOT-89-5	32vy VR4	6h	Ric
E28B	R1170H281B	LVR-IC	LDO, 2.8V±2%, 800mA, +CE	SOT-89-5	32vy VR4	6h	Ric
E29A	R1170H291A	LVR-IC	LDO, 2.9V±2%, 800mA, -CE	SOT-89-5	32vy VR4	6h	Ric
E29B	R1170H291B	LVR-IC	LDO, 2.9V±2%, 800mA, +CE	SOT-89-5	32vy VR4	6h	Ric
E30A	R1170H301A	LVR-IC	LDO, 3V±2%, 800mA, -CE	SOT-89-5	32vy VR4	6h	Ric
E30B	R1170H301B	LVR-IC	LDO, 3V±2%, 800mA, +CE	SOT-89-5	32vy VR4	6h	Ric
E31A	R1170H311A	LVR-IC	LDO, 3.1V±2%, 800mA, -CE	SOT-89-5	32vy VR4	6h	Ric
E31B	R1170H311B	LVR-IC	LDO, 3.1V±2%, 800mA, +CE	SOT-89-5	32vy VR4	6h	Ric
E32A	R1170H321A	LVR-IC	LDO, 3.2V±2%, 800mA, -CE	SOT-89-5	32vy VR4	6h	Ric
E32B	R1170H321B	LVR-IC	LDO, 3.2V±2%, 800mA, +CE	SOT-89-5	32vy VR4	6h	Ric
E33A	R1170H331A	LVR-IC	LDO, 3.3V±2%, 800mA, -CE	SOT-89-5	32vy VR4	6h	Ric
E33B	R1170H331B	LVR-IC	LDO, 3.3V±2%, 800mA, +CE	SOT-89-5	32vy VR4	6h	Ric
E34A	R1170H341A	LVR-IC	LDO, 3.4V±2%, 800mA, -CE	SOT-89-5	32vy VR4	6h	Ric
E34B	R1170H341B	LVR-IC	LDO, 3.4V±2%, 800mA, +CE	SOT-89-5	32vy VR4	6h	Ric
E35A	R1170H351A	LVR-IC	LDO, 3.5V±2%, 800mA, -CE	SOT-89-5	32vy VR4	6h	Ric
E35B	R1170H351B	LVR-IC	LDO, 3.5V±2%, 800mA, +CE	SOT-89-5	32vy VR4	6h	Ric
E36A	R1170H361A	LVR-IC	LDO, 3.6V±2%, 800mA, -CE	SOT-89-5	32vy VR4	6h	Ric
E36B	R1170H361B	LVR-IC	LDO, 3.6V±2%, 800mA, +CE	SOT-89-5	32vy VR4	6h	Ric
E37A	R1170H371A	LVR-IC	LDO, 3.7V±2%, 800mA, -CE	SOT-89-5	32vy VR4	6h	Ric
E37B	R1170H371B	LVR-IC	LDO, 3.7V±2%, 800mA, +CE	SOT-89-5	32vy VR4	6h	Ric
E38A	R1170H381A	LVR-IC	LDO, 3.8V±2%, 800mA, -CE	SOT-89-5	32vy VR4	6h	Ric
E38B	R1170H381B	LVR-IC	LDO, 3.8V±2%, 800mA, +CE	SOT-89-5	32vy VR4	6h	Ric
E39A	R1170H391A	LVR-IC	LDO, 3.9V±2%, 800mA, -CE	SOT-89-5	32vy VR4	6h	Ric
E39B	R1170H391B	LVR-IC	LDO, 3.9V±2%, 800mA, +CE	SOT-89-5	32vy VR4	6h	Ric
E40A	R1170H401A	LVR-IC	LDO, 4V±2%, 800mA, -CE	SOT-89-5	32vy VR4	6h	Ric
E40B	R1170H401B	LVR-IC	LDO, 4V±2%, 800mA, +CE	SOT-89-5	32vy VR4	6h	Ric
E41A	R1170H411A	LVR-IC	LDO, 4.1V±2%, 800mA, -CE	SOT-89-5	32vy VR4	6h	Ric
E41B	R1170H411B	LVR-IC	LDO, 4.1V±2%, 800mA, +CE	SOT-89-5	32vy VR4	6h	Ric
E42A	R1170H421A	LVR-IC	LDO, 4.2V±2%, 800mA, -CE	SOT-89-5	32vy VR4	6h	Ric
E42B	R1170H421B	LVR-IC	LDO, 4.2V±2%, 800mA, +CE	SOT-89-5	32vy VR4	6h	Ric
E43A	R1170H431A	LVR-IC	LDO, 4.3V±2%, 800mA, -CE	SOT-89-5	32vy VR4	6h	Ric
E43B	R1170H431B	LVR-IC	LDO, 4.3V±2%, 800mA, +CE	SOT-89-5	32vy VR4	6h	Ric
E44A	R1170H441A	LVR-IC	LDO, 4.4V±2%, 800mA, -CE	SOT-89-5	32vy VR4	6h	Ric
E44B	R1170H441B	LVR-IC	LDO, 4.4V±2%, 800mA, +CE	SOT-89-5	32vy VR4	6h	Ric
E45A	R1170H451A	LVR-IC	LDO, 4.5V±2%, 800mA, -CE	SOT-89-5	32vy VR4	6h	Ric
E45B	R1170H451B	LVR-IC	LDO, 4.5V±2%, 800mA, +CE	SOT-89-5	32vy VR4	6h	Ric
E46A	R1170H461A	LVR-IC	LDO, 4.6V±2%, 800mA, -CE	SOT-89-5	32vy VR4	6h	Ric
E46B	R1170H461B	LVR-IC	LDO, 4.6V±2%, 800mA, +CE	SOT-89-5	32vy VR4	6h	Ric
E47A	R1170H471A	LVR-IC	LDO, 4.7V±2%, 800mA, -CE	SOT-89-5	32vy VR4	6h	Ric
E47B	R1170H471B	LVR-IC	LDO, 4.7V±2%, 800mA, +CE	SOT-89-5	32vy VR4	6h	Ric
E48A	R1170H481A	LVR-IC	LDO, 4.8V±2%, 800mA, -CE	SOT-89-5	32vy VR4	6h	Ric
E48B	R1170H481B	LVR-IC	LDO, 4.8V±2%, 800mA, +CE	SOT-89-5	32vy VR4	6h	Ric
E49A	R1170H491A	LVR-IC	LDO, 4.9V±2%, 800mA, -CE	SOT-89-5	32vy VR4	6h	Ric
E49B	R1170H491B	LVR-IC	LDO, 4.9V±2%, 800mA, +CE	SOT-89-5	32vy VR4	6h	Ric
E50A	R1170H501A	LVR-IC	LDO, 5V±2%, 800mA, -CE	SOT-89-5	32vy VR4	6h	Ric
E50B	R1170H501B	LVR-IC	LDO, 5V±2%, 800mA, +CE	SOT-89-5	32vy VR4	6h	Ric
EA-	XC62GR4012P	LVR-IC	4.0V±2%, 150mA, +CE	SOT-89-5	32ex VR4	6h	Tor
ĒA-	XC62GP4012P	LVR-IC	4.0V±2%, 150mA, -CE	SOT-89-5	32ex VR4	6h	Tor
EA+	XC62GR4022P	LVR-IC	4.0V±2%, 150mA, +CE, HS response	SOT-89-5	32ex VR4	6h	Tor
ĒA+	XC62GP4022P	LVR-IC	4.0V±2%, 150mA, -CE, HS response	SOT-89-5	32ex VR4	6h	Tor



SMD code	Type	Function	Short description	Case	Pinout Sch.	St.	Mnf.
EB-	XC62GR4112P	LVR-IC	4.1V±2%, 150mA, +CE	SOT-89-5	32ex VR4	6h	Tor
EB-	XC62GP4112P	LVR-IC	4.1V±2%, 150mA, -CE	SOT-89-5	32ex VR4	6h	Tor
EB+	XC62GR4122P	LVR-IC	4.1V±2%, 150mA, +CE, HS response	SOT-89-5	32ex VR4	6h	Tor
EB+	XC62GP4122P	LVR-IC	4.1V±2%, 150mA, -CE, HS response	SOT-89-5	32ex VR4	6h	Tor
EC-	XC62GR4212P	LVR-IC	4.2V±2%, 150mA, +CE	SOT-89-5	32ex VR4	6h	Tor
EC-	XC62GP4212P	LVR-IC	4.2V±2%, 150mA, -CE	SOT-89-5	32ex VR4	6h	Tor
EC+	XC62GR4222P	LVR-IC	4.2V±2%, 150mA, +CE, HS response	SOT-89-5	32ex VR4	6h	Tor
EC+	XC62GP4222P	LVR-IC	4.2V±2%, 150mA, -CE, HS response	SOT-89-5	32ex VR4	6h	Tor
ED-	XC62GR4312P	LVR-IC	4.3V±2%, 150mA, +CE	SOT-89-5	32ex VR4	6h	Tor
ED-	XC62GP4312P	LVR-IC	4.3V±2%, 150mA, -CE	SOT-89-5	32ex VR4	6h	Tor
ED+	XC62GR4322P	LVR-IC	4.3V±2%, 150mA, +CE, HS response	SOT-89-5	32ex VR4	6h	Tor
ED+	XC62GP4322P	LVR-IC	4.3V±2%, 150mA, -CE, HS response	SOT-89-5	32ex VR4	6h	Tor
EE-	XC62GR4412P	LVR-IC	4.4V±2%, 150mA, +CE	SOT-89-5	32ex VR4	6h	Tor
EE-	XC62GP4412P	LVR-IC	4.4V±2%, 150mA, -CE	SOT-89-5	32ex VR4	6h	Tor
EE+	XC62GR4422P	LVR-IC	4.4V±2%, 150mA, +CE, HS response	SOT-89-5	32ex VR4	6h	Tor
EE+	XC62GP4422P	LVR-IC	4.4V±2%, 150mA, -CE, HS response	SOT-89-5	32ex VR4	6h	Tor
EF-	XC62GR4512P	LVR-IC	4.5V±2%, 150mA, +CE	SOT-89-5	32ex VR4	6h	Tor
EF-	XC62GP4512P	LVR-IC	4.5V±2%, 150mA, -CE	SOT-89-5	32ex VR4	6h	Tor
EF+	XC62GR4522P	LVR-IC	4.5V±2%, 150mA, +CE, HS response	SOT-89-5	32ex VR4	6h	Tor
EF+	XC62GP4522P	LVR-IC	4.5V±2%, 150mA, -CE, HS response	SOT-89-5	32ex VR4	6h	Tor
EH-	XC62GR4612P	LVR-IC	4.6V±2%, 150mA, +CE	SOT-89-5	32ex VR4	6h	Tor
EH-	XC62GP4612P	LVR-IC	4.6V±2%, 150mA, -CE	SOT-89-5	32ex VR4	6h	Tor
EH+	XC62GR4622P	LVR-IC	4.6V±2%, 150mA, +CE, HS response	SOT-89-5	32ex VR4	6h	Tor
EH+	XC62GP4622P	LVR-IC	4.6V±2%, 150mA, -CE, HS response	SOT-89-5	32ex VR4	6h	Tor
EH13	AIC1731-13CX5	LVR-IC	LDO, 1.3V±2%, 300mA, +CE	SOT-89-5	32vrx VR7	6j	Aic
EH13G	AIC1731-13CX5G	LVR-IC	LDO, 1.3V±2%, 300mA, +CE	SOT-89-5	32vrx VR7	6j	Aic
EH13P	AIC1731-13CX5P	LVR-IC	LDO, 1.3V±2%, 300mA, +CE	SOT-89-5	32vrx VR7	6j	Aic
EH15	AIC1731-15CX5	LVR-IC	LDO, 1.5V±2%, 300mA, +CE	SOT-89-5	32vrx VR7	6j	Aic
EH15G	AIC1731-15CX5G	LVR-IC	LDO, 1.5V±2%, 300mA, +CE	SOT-89-5	32vrx VR7	6j	Aic
EH15P	AIC1731-15CX5P	LVR-IC	LDO, 1.5V±2%, 300mA, +CE	SOT-89-5	32vrx VR7	6j	Aic
EH18	AIC1731-18CX5	LVR-IC	LDO, 1.8V±2%, 300mA, +CE	SOT-89-5	32vrx VR7	6j	Aic
EH18G	AIC1731-18CX5G	LVR-IC	LDO, 1.8V±2%, 300mA, +CE	SOT-89-5	32vrx VR7	6j	Aic
EH18P	AIC1731-18CX5P	LVR-IC	LDO, 1.8V±2%, 300mA, +CE	SOT-89-5	32vrx VR7	6j	Aic
EH25	AIC1731-25CX5	LVR-IC	LDO, 2.5V±2%, 300mA, +CE	SOT-89-5	32vrx VR7	6j	Aic
EH25G	AIC1731-25CX5G	LVR-IC	LDO, 2.5V±2%, 300mA, +CE	SOT-89-5	32vrx VR7	6j	Aic
EH25P	AIC1731-25CX5P	LVR-IC	LDO, 2.5V±2%, 300mA, +CE	SOT-89-5	32vrx VR7	6j	Aic
EH28	AIC1731-28CX5	LVR-IC	LDO, 2.8V±2%, 300mA, +CE	SOT-89-5	32vrx VR7	6j	Aic
EH28G	AIC1731-28CX5G	LVR-IC	LDO, 2.8V±2%, 300mA, +CE	SOT-89-5	32vrx VR7	6j	Aic
EH28P	AIC1731-28CX5P	LVR-IC	LDO, 2.8V±2%, 300mA, +CE	SOT-89-5	32vrx VR7	6j	Aic
EH30	AIC1731-30CX5	LVR-IC	LDO, 3.0V±2%, 300mA, +CE	SOT-89-5	32vrx VR7	6j	Aic
EH30G	AIC1731-30CX5G	LVR-IC	LDO, 3.0V±2%, 300mA, +CE	SOT-89-5	32vrx VR7	6j	Aic
EH30P	AIC1731-30CX5P	LVR-IC	LDO, 3.0V±2%, 300mA, +CE	SOT-89-5	32vrx VR7	6j	Aic
EH33	AIC1731-33CX5	LVR-IC	LDO, 3.3V±2%, 300mA, +CE	SOT-89-5	32vrx VR7	6j	Aic
EH33G	AIC1731-33CX5G	LVR-IC	LDO, 3.3V±2%, 300mA, +CE	SOT-89-5	32vrx VR7	6j	Aic
EH33P	AIC1731-33CX5P	LVR-IC	LDO, 3.3V±2%, 300mA, +CE	SOT-89-5	32vrx VR7	6j	Aic
EI13	AIC1733-13CX5	LVR-IC	LDO, 1.3V±2%, 500mA, +CE	SOT-89-5	32vrx VR7	6j	Aic
EI13G	AIC1733-13CX5G	LVR-IC	LDO, 1.3V±2%, 500mA, +CE	SOT-89-5	32vrx VR7	6j	Aic
EI13P	AIC1733-13CX5P	LVR-IC	LDO, 1.3V±2%, 500mA, +CE	SOT-89-5	32vrx VR7	6j	Aic
EI15	AIC1733-15CX5	LVR-IC	LDO, 1.5V±2%, 500mA, +CE	SOT-89-5	32vrx VR7	6j	Aic
EI15G	AIC1733-15CX5G	LVR-IC	LDO, 1.5V±2%, 500mA, +CE	SOT-89-5	32vrx VR7	6j	Aic
EI15P	AIC1733-15CX5P	LVR-IC	LDO, 1.5V±2%, 500mA, +CE	SOT-89-5	32vrx VR7	6j	Aic
EI18	AIC1733-18CX5	LVR-IC	LDO, 1.8V±2%, 500mA, +CE	SOT-89-5	32vrx VR7	6j	Aic
EI18G	AIC1733-18CX5G	LVR-IC	LDO, 1.8V±2%, 500mA, +CE	SOT-89-5	32vrx VR7	6j	Aic
EI18P	AIC1733-18CX5P	LVR-IC	LDO, 1.8V±2%, 500mA, +CE	SOT-89-5	32vrx VR7	6j	Aic
EI25	AIC1733-25CX5	LVR-IC	LDO, 2.5V±2%, 500mA, +CE	SOT-89-5	32vrx VR7	6j	Aic
EI25G	AIC1733-25CX5G	LVR-IC	LDO, 2.5V±2%, 500mA, +CE	SOT-89-5	32vrx VR7	6j	Aic
EI25P	AIC1733-25CX5P	LVR-IC	LDO, 2.5V±2%, 500mA, +CE	SOT-89-5	32vrx VR7	6j	Aic
EI28	AIC1733-28CX5	LVR-IC	LDO, 2.8V±2%, 500mA, +CE	SOT-89-5	32vrx VR7	6j	Aic
EI28G	AIC1733-28CX5G	LVR-IC	LDO, 2.8V±2%, 500mA, +CE	SOT-89-5	32vrx VR7	6j	Aic
EI28P	AIC1733-28CX5P	LVR-IC	LDO, 2.8V±2%, 500mA, +CE	SOT-89-5	32vrx VR7	6j	Aic
EI30	AIC1733-30CX5	LVR-IC	LDO, 3.0V±2%, 500mA, +CE	SOT-89-5	32vrx VR7	6j	Aic
EI30G	AIC1733-30CX5G	LVR-IC	LDO, 3.0V±2%, 500mA, +CE	SOT-89-5	32vrx VR7	6j	Aic
EI30P	AIC1733-30CX5P	LVR-IC	LDO, 3.0V±2%, 500mA, +CE	SOT-89-5	32vrx VR7	6j	Aic
EI33	AIC1733-33CX5	LVR-IC	LDO, 3.3V±2%, 500mA, +CE	SOT-89-5	32vrx VR7	6j	Aic
EI33G	AIC1733-33CX5G	LVR-IC	LDO, 3.3V±2%, 500mA, +CE	SOT-89-5	32vrx VR7	6j	Aic
EI33P	AIC1733-33CX5P	LVR-IC	LDO, 3.3V±2%, 500mA, +CE	SOT-89-5	32vrx VR7	6j	Aic
EK-	XC62GR4712P	LVR-IC	4.7V±2%, 150mA, +CE	SOT-89-5	32ex VR4	6h	Tor
EK-	XC62GP4712P	LVR-IC	4.7V±2%, 150mA, -CE	SOT-89-5	32ex VR4	6h	Tor
EK+	XC62GR4722P	LVR-IC	4.7V±2%, 150mA, +CE, HS response	SOT-89-5	32ex VR4	6h	Tor
EK+	XC62GP4722P	LVR-IC	4.7V±2%, 150mA, -CE, HS response	SOT-89-5	32ex VR4	6h	Tor



SMD code	Type	Function	Short description	Case	Pinout Sch.	St.	Mnf.
EL-	XC62GR4812P	LVR-IC	4.8V±2%, 150mA, +CE	SOT-89-5	32ex VR4	6h	Tor
ĒL-	XC62GP4812P	LVR-IC	4.8V±2%, 150mA, -CE	SOT-89-5	32ex VR4	6h	Tor
EL+	XC62GR4822P	LVR-IC	4.8V±2%, 150mA, +CE, HS response	SOT-89-5	32ex VR4	6h	Tor
ĒL+	XC62GP4822P	LVR-IC	4.8V±2%, 150mA, -CE, HS response	SOT-89-5	32ex VR4	6h	Tor
EM-	XC62GR4912P	LVR-IC	4.9V±2%, 150mA, +CE	SOT-89-5	32ex VR4	6h	Tor
ĒM-	XC62GP4912P	LVR-IC	4.9V±2%, 150mA, -CE	SOT-89-5	32ex VR4	6h	Tor
EM+	XC62GR4922P	LVR-IC	4.9V±2%, 150mA, +CE, HS response	SOT-89-5	32ex VR4	6h	Tor
ĒM+	XC62GP4922P	LVR-IC	4.9V±2%, 150mA, -CE, HS response	SOT-89-5	32ex VR4	6h	Tor
ET	AP1602BY	DC/DC-IC	Step-up DC-DC converter for NiMH battery charge (3.3V)	SOT-89-5	32st -	6j	Ana
EZ	AP1602AY	DC/DC-IC	Step-up DC-DC converter for NiMH battery charge (3.3V)	SOT-89-5	32sr -	6j	Ana
FA	ELM99202B	LVR-IC	LDO, 2.0V±2%, 300mA, -CE	SOT-89-5	32vrt VR1	6n	Elm
FĀ-	XC62GR5012P	LVR-IC	5.0V±2%, 150mA, +CE	SOT-89-5	32ex VR4	6h	Tor
FA-	XC62GP5012P	LVR-IC	5.0V±2%, 150mA, -CE	SOT-89-5	32ex VR4	6h	Tor
FĀ+	XC62GR5022P	LVR-IC	5.0V±2%, 150mA, +CE, HS response	SOT-89-5	32ex VR4	6h	Tor
FA+	XC62GP5022P	LVR-IC	5.0V±2%, 150mA, -CE, HS response	SOT-89-5	32ex VR4	6h	Tor
FB	ELM99212B	LVR-IC	LDO, 2.1V±2%, 300mA, -CE	SOT-89-5	32vrt VR1	6n	Elm
FC	ELM99222B	LVR-IC	LDO, 2.2V±2%, 300mA, -CE	SOT-89-5	32vrt VR1	6n	Elm
FD	ELM99232B	LVR-IC	LDO, 2.3V±2%, 300mA, -CE	SOT-89-5	32vrt VR1	6n	Elm
FE	ELM99242B	LVR-IC	LDO, 2.4V±2%, 300mA, -CE	SOT-89-5	32vrt VR1	6n	Elm
FF	ELM99252B	LVR-IC	LDO, 2.5V±2%, 300mA, -CE	SOT-89-5	32vrt VR1	6n	Elm
FG	ELM99262B	LVR-IC	LDO, 2.6V±2%, 300mA, -CE	SOT-89-5	32vrt VR1	6n	Elm
FH	ELM99272B	LVR-IC	LDO, 2.7V±2%, 300mA, -CE	SOT-89-5	32vrt VR1	6n	Elm
FH1G	AIC1747-11GX5N	LVR-IC	LDO, 1.1V±2%, 300mA, +CE	SOT-89-5	32cx VR4	6j	Aic
FH1P	AIC1747-11PX5N	LVR-IC	LDO, 1.1V±2%, 300mA, +CE	SOT-89-5	32cx VR4	6j	Aic
FH2G	AIC1747-12GX5N	LVR-IC	LDO, 1.2V±2%, 300mA, +CE	SOT-89-5	32cx VR4	6j	Aic
FH2P	AIC1747-12PX5N	LVR-IC	LDO, 1.2V±2%, 300mA, +CE	SOT-89-5	32cx VR4	6j	Aic
FH3G	AIC1747-13GX5N	LVR-IC	LDO, 1.3V±2%, 300mA, +CE	SOT-89-5	32cx VR4	6j	Aic
FH3P	AIC1747-13PX5N	LVR-IC	LDO, 1.3V±2%, 300mA, +CE	SOT-89-5	32cx VR4	6j	Aic
FH5G	AIC1747-15GX5N	LVR-IC	LDO, 1.5V±2%, 300mA, +CE	SOT-89-5	32cx VR4	6j	Aic
FH5P	AIC1747-15PX5N	LVR-IC	LDO, 1.5V±2%, 300mA, +CE	SOT-89-5	32cx VR4	6j	Aic
FH8G	AIC1747-18GX5N	LVR-IC	LDO, 1.8V±2%, 300mA, +CE	SOT-89-5	32cx VR4	6j	Aic
FH8P	AIC1747-18PX5N	LVR-IC	LDO, 1.8V±2%, 300mA, +CE	SOT-89-5	32cx VR4	6j	Aic
FI20G	AIC1747-20GX5N	LVR-IC	LDO, 2.0V±2%, 300mA, +CE	SOT-89-5	32cx VR4	6j	Aic
FI20P	AIC1747-20PX5N	LVR-IC	LDO, 2.0V±2%, 300mA, +CE	SOT-89-5	32cx VR4	6j	Aic
FI25G	AIC1747-25GX5N	LVR-IC	LDO, 2.5V±2%, 300mA, +CE	SOT-89-5	32cx VR4	6j	Aic
FI25P	AIC1747-25PX5N	LVR-IC	LDO, 2.5V±2%, 300mA, +CE	SOT-89-5	32cx VR4	6j	Aic
FI27G	AIC1747-27GX5N	LVR-IC	LDO, 2.7V±2%, 300mA, +CE	SOT-89-5	32cx VR4	6j	Aic
FI27P	AIC1747-27PX5N	LVR-IC	LDO, 2.7V±2%, 300mA, +CE	SOT-89-5	32cx VR4	6j	Aic
FI2JG	AIC1747-285GX5N	LVR-IC	LDO, 2.85V±2%, 300mA, +CE	SOT-89-5	32cx VR4	6j	Aic
FI2JP	AIC1747-285PX5N	LVR-IC	LDO, 2.85V±2%, 300mA, +CE	SOT-89-5	32cx VR4	6j	Aic
FI30G	AIC1747-30GX5N	LVR-IC	LDO, 3.0V±2%, 300mA, +CE	SOT-89-5	32cx VR4	6j	Aic
FI30P	AIC1747-30PX5N	LVR-IC	LDO, 3.0V±2%, 300mA, +CE	SOT-89-5	32cx VR4	6j	Aic
FI33G	AIC1747-33GX5N	LVR-IC	LDO, 3.3V±2%, 300mA, +CE	SOT-89-5	32cx VR4	6j	Aic
FI33P	AIC1747-33PX5N	LVR-IC	LDO, 3.3V±2%, 300mA, +CE	SOT-89-5	32cx VR4	6j	Aic
FI35G	AIC1747-35GX5N	LVR-IC	LDO, 3.5V±2%, 300mA, +CE	SOT-89-5	32cx VR4	6j	Aic
FI35P	AIC1747-35PX5N	LVR-IC	LDO, 3.5V±2%, 300mA, +CE	SOT-89-5	32cx VR4	6j	Aic
FI37G	AIC1747-37GX5N	LVR-IC	LDO, 3.7V±2%, 300mA, +CE	SOT-89-5	32cx VR4	6j	Aic
FI37P	AIC1747-37PX5N	LVR-IC	LDO, 3.7V±2%, 300mA, +CE	SOT-89-5	32cx VR4	6j	Aic
FI38G	AIC1747-38GX5N	LVR-IC	LDO, 3.8V±2%, 300mA, +CE	SOT-89-5	32cx VR4	6j	Aic
FI38P	AIC1747-38PX5N	LVR-IC	LDO, 3.8V±2%, 300mA, +CE	SOT-89-5	32cx VR4	6j	Aic
FJ	ELM99282B	LVR-IC	LDO, 2.8V±2%, 300mA, -CE	SOT-89-5	32vrt VR1	6n	Elm
FK	ELM99292B	LVR-IC	LDO, 2.9V±2%, 300mA, -CE	SOT-89-5	32vrt VR1	6n	Elm
FR0	XC6901D091PR-G	LVR-IC	-0.9V±1.5%, 200mA, +CE, CL	SOT-89-5	32ex VR7	6n	Tor
FR1	XC6901D101PR-G	LVR-IC	-1.0V±1.5%, 200mA, +CE, CL	SOT-89-5	32ex VR7	6n	Tor
FR11G	AIC1746-11GX5N	LVR-IC	LDO, 1.1V±2%, 150mA, +CE	SOT-89-5	32cx VR4	6j	Aic
FR11P	AIC1746-11PX5N	LVR-IC	LDO, 1.1V±2%, 150mA, +CE	SOT-89-5	32cx VR4	6j	Aic
FR12G	AIC1746-12GX5N	LVR-IC	LDO, 1.2V±2%, 150mA, +CE	SOT-89-5	32cx VR4	6j	Aic
FR12P	AIC1746-12PX5N	LVR-IC	LDO, 1.2V±2%, 150mA, +CE	SOT-89-5	32cx VR4	6j	Aic
FR13G	AIC1746-13GX5N	LVR-IC	LDO, 1.3V±2%, 150mA, +CE	SOT-89-5	32cx VR4	6j	Aic
FR13P	AIC1746-13PX5N	LVR-IC	LDO, 1.3V±2%, 150mA, +CE	SOT-89-5	32cx VR4	6j	Aic
FR15G	AIC1746-15GX5N	LVR-IC	LDO, 1.5V±2%, 150mA, +CE	SOT-89-5	32cx VR4	6j	Aic
FR15P	AIC1746-15PX5N	LVR-IC	LDO, 1.5V±2%, 150mA, +CE	SOT-89-5	32cx VR4	6j	Aic
FR18G	AIC1746-18GX5N	LVR-IC	LDO, 1.8V±2%, 150mA, +CE	SOT-89-5	32cx VR4	6j	Aic
FR18P	AIC1746-18PX5N	LVR-IC	LDO, 1.8V±2%, 150mA, +CE	SOT-89-5	32cx VR4	6j	Aic
FR2	XC6901D111PR-G	LVR-IC	-1.1V±1.5%, 200mA, +CE, CL	SOT-89-5	32ex VR7	6n	Tor
FR20G	AIC1746-20GX5N	LVR-IC	LDO, 2.0V±2%, 150mA, +CE	SOT-89-5	32cx VR4	6j	Aic
FR20P	AIC1746-20PX5N	LVR-IC	LDO, 2.0V±2%, 150mA, +CE	SOT-89-5	32cx VR4	6j	Aic
FR25G	AIC1746-25GX5N	LVR-IC	LDO, 2.5V±2%, 150mA, +CE	SOT-89-5	32cx VR4	6j	Aic
FR25P	AIC1746-25PX5N	LVR-IC	LDO, 2.5V±2%, 150mA, +CE	SOT-89-5	32cx VR4	6j	Aic
FR27G	AIC1746-27GX5N	LVR-IC	LDO, 2.7V±2%, 150mA, +CE	SOT-89-5	32cx VR4	6j	Aic



SMD code	Type	Function	Short description	Case	Pinout	Sch.	St.	Mnf.
FR27P	AIC1746-27PX5N	LVR-IC	LDO, 2.7V±2%, 150mA, +CE	SOT-89-5	32cx	VR4	6j	Aic
FR2JG	AIC1746-285GX5N	LVR-IC	LDO, 2.85V±2%, 150mA, +CE	SOT-89-5	32cx	VR4	6j	Aic
FR2JP	AIC1746-285PX5N	LVR-IC	LDO, 2.85V±2%, 150mA, +CE	SOT-89-5	32cx	VR4	6j	Aic
FR3	XC6901D121PR-G	LVR-IC	-1.2V±1.5%, 200mA, +CE, CL	SOT-89-5	32ex	VR7	6n	Tor
FR30G	AIC1746-30GX5N	LVR-IC	LDO, 3.0V±2%, 150mA, +CE	SOT-89-5	32cx	VR4	6j	Aic
FR30P	AIC1746-30PX5N	LVR-IC	LDO, 3.0V±2%, 150mA, +CE	SOT-89-5	32cx	VR4	6j	Aic
FR33G	AIC1746-33GX5N	LVR-IC	LDO, 3.3V±2%, 150mA, +CE	SOT-89-5	32cx	VR4	6j	Aic
FR33P	AIC1746-33PX5N	LVR-IC	LDO, 3.3V±2%, 150mA, +CE	SOT-89-5	32cx	VR4	6j	Aic
FR35G	AIC1746-35GX5N	LVR-IC	LDO, 3.5V±2%, 150mA, +CE	SOT-89-5	32cx	VR4	6j	Aic
FR35P	AIC1746-35PX5N	LVR-IC	LDO, 3.5V±2%, 150mA, +CE	SOT-89-5	32cx	VR4	6j	Aic
FR37G	AIC1746-37GX5N	LVR-IC	LDO, 3.7V±2%, 150mA, +CE	SOT-89-5	32cx	VR4	6j	Aic
FR37P	AIC1746-37PX5N	LVR-IC	LDO, 3.7V±2%, 150mA, +CE	SOT-89-5	32cx	VR4	6j	Aic
FR38G	AIC1746-38GX5N	LVR-IC	LDO, 3.8V±2%, 150mA, +CE	SOT-89-5	32cx	VR4	6j	Aic
FR38P	AIC1746-38PX5N	LVR-IC	LDO, 3.8V±2%, 150mA, +CE	SOT-89-5	32cx	VR4	6j	Aic
FR4	XC6901D131PR-G	LVR-IC	-1.3V±1.5%, 200mA, +CE, CL	SOT-89-5	32ex	VR7	6n	Tor
FR5	XC6901D141PR-G	LVR-IC	-1.4V±1.5%, 200mA, +CE, CL	SOT-89-5	32ex	VR7	6n	Tor
FR6	XC6901D151PR-G	LVR-IC	-1.5V±1.5%, 200mA, +CE, CL	SOT-89-5	32ex	VR7	6n	Tor
FR7	XC6901D161PR-G	LVR-IC	-1.6V±1.5%, 200mA, +CE, CL	SOT-89-5	32ex	VR7	6n	Tor
FR8	XC6901D171PR-G	LVR-IC	-1.7V±1.5%, 200mA, +CE, CL	SOT-89-5	32ex	VR7	6n	Tor
FR9	XC6901D181PR-G	LVR-IC	-1.8V±1.5%, 200mA, +CE, CL	SOT-89-5	32ex	VR7	6n	Tor
FRA	XC6901D191PR-G	LVR-IC	-1.9V±1.5%, 200mA, +CE, CL	SOT-89-5	32ex	VR7	6n	Tor
FRB	XC6901D201PR-G	LVR-IC	-2.0V±1.5%, 200mA, +CE, CL	SOT-89-5	32ex	VR7	6n	Tor
FRC	XC6901D211PR-G	LVR-IC	-2.1V±1.5%, 200mA, +CE, CL	SOT-89-5	32ex	VR7	6n	Tor
FRD	XC6901D221PR-G	LVR-IC	-2.2V±1.5%, 200mA, +CE, CL	SOT-89-5	32ex	VR7	6n	Tor
FRE	XC6901D231PR-G	LVR-IC	-2.3V±1.5%, 200mA, +CE, CL	SOT-89-5	32ex	VR7	6n	Tor
FRF	XC6901D241PR-G	LVR-IC	-2.4V±1.5%, 200mA, +CE, CL	SOT-89-5	32ex	VR7	6n	Tor
FRH	XC6901D251PR-G	LVR-IC	-2.5V±1.5%, 200mA, +CE, CL	SOT-89-5	32ex	VR7	6n	Tor
FRJ	XC6901D261PR-G	LVR-IC	-2.6V±1.5%, 200mA, +CE, CL	SOT-89-5	32ex	VR7	6n	Tor
FRL	XC6901D271PR-G	LVR-IC	-2.7V±1.5%, 200mA, +CE, CL	SOT-89-5	32ex	VR7	6n	Tor
FRM	XC6901D281PR-G	LVR-IC	-2.8V±1.5%, 200mA, +CE, CL	SOT-89-5	32ex	VR7	6n	Tor
FRN	XC6901D291PR-G	LVR-IC	-2.9V±1.5%, 200mA, +CE, CL	SOT-89-5	32ex	VR7	6n	Tor
FRP	XC6901D301PR-G	LVR-IC	-3.0V±1.5%, 200mA, +CE, CL	SOT-89-5	32ex	VR7	6n	Tor
FRR	XC6901D311PR-G	LVR-IC	-3.1V±1.5%, 200mA, +CE, CL	SOT-89-5	32ex	VR7	6n	Tor
FRS	XC6901D321PR-G	LVR-IC	-3.2V±1.5%, 200mA, +CE, CL	SOT-89-5	32ex	VR7	6n	Tor
FRT	XC6901D331PR-G	LVR-IC	-3.3V±1.5%, 200mA, +CE, CL	SOT-89-5	32ex	VR7	6n	Tor
FRU	XC6901D341PR-G	LVR-IC	-3.4V±1.5%, 200mA, +CE, CL	SOT-89-5	32ex	VR7	6n	Tor
FRV	XC6901D351PR-G	LVR-IC	-3.5V±1.5%, 200mA, +CE, CL	SOT-89-5	32ex	VR7	6n	Tor
FRX	XC6901D361PR-G	LVR-IC	-3.6V±1.5%, 200mA, +CE, CL	SOT-89-5	32ex	VR7	6n	Tor
FRY	XC6901D371PR-G	LVR-IC	-3.7V±1.5%, 200mA, +CE, CL	SOT-89-5	32ex	VR7	6n	Tor
FRZ	XC6901D381PR-G	LVR-IC	-3.8V±1.5%, 200mA, +CE, CL	SOT-89-5	32ex	VR7	6n	Tor
F50	XC6901D391PR-G	LVR-IC	-3.9V±1.5%, 200mA, +CE, CL	SOT-89-5	32ex	VR7	6n	Tor
FS1	XC6901D401PR-G	LVR-IC	-4.0V±1.5%, 200mA, +CE, CL	SOT-89-5	32ex	VR7	6n	Tor
FS2	XC6901D411PR-G	LVR-IC	-4.1V±1.5%, 200mA, +CE, CL	SOT-89-5	32ex	VR7	6n	Tor
FS3	XC6901D421PR-G	LVR-IC	-4.2V±1.5%, 200mA, +CE, CL	SOT-89-5	32ex	VR7	6n	Tor
FS4	XC6901D431PR-G	LVR-IC	-4.3V±1.5%, 200mA, +CE, CL	SOT-89-5	32ex	VR7	6n	Tor
FS5	XC6901D441PR-G	LVR-IC	-4.4V±1.5%, 200mA, +CE, CL	SOT-89-5	32ex	VR7	6n	Tor
FS6	XC6901D451PR-G	LVR-IC	-4.5V±1.5%, 200mA, +CE, CL	SOT-89-5	32ex	VR7	6n	Tor
FS7	XC6901D461PR-G	LVR-IC	-4.6V±1.5%, 200mA, +CE, CL	SOT-89-5	32ex	VR7	6n	Tor
FS8	XC6901D471PR-G	LVR-IC	-4.7V±1.5%, 200mA, +CE, CL	SOT-89-5	32ex	VR7	6n	Tor
FS9	XC6901D481PR-G	LVR-IC	-4.8V±1.5%, 200mA, +CE, CL	SOT-89-5	32ex	VR7	6n	Tor
FSA	XC6901D491PR-G	LVR-IC	-4.9V±1.5%, 200mA, +CE, CL	SOT-89-5	32ex	VR7	6n	Tor
FSB	XC6901D501PR-G	LVR-IC	-5.0V±1.5%, 200mA, +CE, CL	SOT-89-5	32ex	VR7	6n	Tor
FSC	XC6901D511PR-G	LVR-IC	-5.1V±1.5%, 200mA, +CE, CL	SOT-89-5	32ex	VR7	6n	Tor
FSD	XC6901D521PR-G	LVR-IC	-5.2V±1.5%, 200mA, +CE, CL	SOT-89-5	32ex	VR7	6n	Tor
FSE	XC6901D531PR-G	LVR-IC	-5.3V±1.5%, 200mA, +CE, CL	SOT-89-5	32ex	VR7	6n	Tor
FSF	XC6901D541PR-G	LVR-IC	-5.4V±1.5%, 200mA, +CE, CL	SOT-89-5	32ex	VR7	6n	Tor
FSH	XC6901D551PR-G	LVR-IC	-5.5V±1.5%, 200mA, +CE, CL	SOT-89-5	32ex	VR7	6n	Tor
FSJ	XC6901D561PR-G	LVR-IC	-5.6V±1.5%, 200mA, +CE, CL	SOT-89-5	32ex	VR7	6n	Tor
FSL	XC6901D571PR-G	LVR-IC	-5.7V±1.5%, 200mA, +CE, CL	SOT-89-5	32ex	VR7	6n	Tor
FSM	XC6901D581PR-G	LVR-IC	-5.8V±1.5%, 200mA, +CE, CL	SOT-89-5	32ex	VR7	6n	Tor
FSN	XC6901D591PR-G	LVR-IC	-5.9V±1.5%, 200mA, +CE, CL	SOT-89-5	32ex	VR7	6n	Tor
FSP	XC6901D601PR-G	LVR-IC	-6.0V±1.5%, 200mA, +CE, CL	SOT-89-5	32ex	VR7	6n	Tor
FSR	XC6901D611PR-G	LVR-IC	-6.1V±1.5%, 200mA, +CE, CL	SOT-89-5	32ex	VR7	6n	Tor
FSS	XC6901D621PR-G	LVR-IC	-6.2V±1.5%, 200mA, +CE, CL	SOT-89-5	32ex	VR7	6n	Tor
FST	XC6901D631PR-G	LVR-IC	-6.3V±1.5%, 200mA, +CE, CL	SOT-89-5	32ex	VR7	6n	Tor
F5U	XC6901D641PR-G	LVR-IC	-6.4V±1.5%, 200mA, +CE, CL	SOT-89-5	32ex	VR7	6n	Tor
FSV	XC6901D651PR-G	LVR-IC	-6.5V±1.5%, 200mA, +CE, CL	SOT-89-5	32ex	VR7	6n	Tor
FSX	XC6901D661PR-G	LVR-IC	-6.6V±1.5%, 200mA, +CE, CL	SOT-89-5	32ex	VR7	6n	Tor
FSY	XC6901D671PR-G	LVR-IC	-6.7V±1.5%, 200mA, +CE, CL	SOT-89-5	32ex	VR7	6n	Tor
FSZ	XC6901D681PR-G	LVR-IC	-6.8V±1.5%, 200mA, +CE, CL	SOT-89-5	32ex	VR7	6n	Tor



SMD code	Type	Function	Short description	Case	Pinout Sch.	St.	Mnf.
FT0	XC6901D691PR-G	LVR-IC	-6.9V±1.5%, 200mA, +CE, CL	SOT-89-5	32ex VR7	6n	Tor
FT1	XC6901D701PR-G	LVR-IC	-7.0V±1.5%, 200mA, +CE, CL	SOT-89-5	32ex VR7	6n	Tor
FT2	XC6901D711PR-G	LVR-IC	-7.1V±1.5%, 200mA, +CE, CL	SOT-89-5	32ex VR7	6n	Tor
FT3	XC6901D721PR-G	LVR-IC	-7.2V±1.5%, 200mA, +CE, CL	SOT-89-5	32ex VR7	6n	Tor
FT4	XC6901D731PR-G	LVR-IC	-7.3V±1.5%, 200mA, +CE, CL	SOT-89-5	32ex VR7	6n	Tor
FT5	XC6901D741PR-G	LVR-IC	-7.4V±1.5%, 200mA, +CE, CL	SOT-89-5	32ex VR7	6n	Tor
FT6	XC6901D751PR-G	LVR-IC	-7.5V±1.5%, 200mA, +CE, CL	SOT-89-5	32ex VR7	6n	Tor
FT7	XC6901D761PR-G	LVR-IC	-7.6V±1.5%, 200mA, +CE, CL	SOT-89-5	32ex VR7	6n	Tor
FT8	XC6901D771PR-G	LVR-IC	-7.7V±1.5%, 200mA, +CE, CL	SOT-89-5	32ex VR7	6n	Tor
FT9	XC6901D781PR-G	LVR-IC	-7.8V±1.5%, 200mA, +CE, CL	SOT-89-5	32ex VR7	6n	Tor
FTA	XC6901D791PR-G	LVR-IC	-7.9V±1.5%, 200mA, +CE, CL	SOT-89-5	32ex VR7	6n	Tor
FTB	XC6901D801PR-G	LVR-IC	-8.0V±1.5%, 200mA, +CE, CL	SOT-89-5	32ex VR7	6n	Tor
FTC	XC6901D811PR-G	LVR-IC	-8.1V±1.5%, 200mA, +CE, CL	SOT-89-5	32ex VR7	6n	Tor
FTD	XC6901D821PR-G	LVR-IC	-8.2V±1.5%, 200mA, +CE, CL	SOT-89-5	32ex VR7	6n	Tor
FTE	XC6901D831PR-G	LVR-IC	-8.3V±1.5%, 200mA, +CE, CL	SOT-89-5	32ex VR7	6n	Tor
FTF	XC6901D841PR-G	LVR-IC	-8.4V±1.5%, 200mA, +CE, CL	SOT-89-5	32ex VR7	6n	Tor
FTH	XC6901D851PR-G	LVR-IC	-8.5V±1.5%, 200mA, +CE, CL	SOT-89-5	32ex VR7	6n	Tor
FTK	XC6901D861PR-G	LVR-IC	-8.6V±1.5%, 200mA, +CE, CL	SOT-89-5	32ex VR7	6n	Tor
FTL	XC6901D871PR-G	LVR-IC	-8.7V±1.5%, 200mA, +CE, CL	SOT-89-5	32ex VR7	6n	Tor
FTM	XC6901D881PR-G	LVR-IC	-8.8V±1.5%, 200mA, +CE, CL	SOT-89-5	32ex VR7	6n	Tor
FTN	XC6901D891PR-G	LVR-IC	-8.9V±1.5%, 200mA, +CE, CL	SOT-89-5	32ex VR7	6n	Tor
FTP	XC6901D901PR-G	LVR-IC	-9.0V±1.5%, 200mA, +CE, CL	SOT-89-5	32ex VR7	6n	Tor
FTR	XC6901D911PR-G	LVR-IC	-9.1V±1.5%, 200mA, +CE, CL	SOT-89-5	32ex VR7	6n	Tor
FTS	XC6901D921PR-G	LVR-IC	-9.2V±1.5%, 200mA, +CE, CL	SOT-89-5	32ex VR7	6n	Tor
FTT	XC6901D931PR-G	LVR-IC	-9.3V±1.5%, 200mA, +CE, CL	SOT-89-5	32ex VR7	6n	Tor
FTU	XC6901D941PR-G	LVR-IC	-9.4V±1.5%, 200mA, +CE, CL	SOT-89-5	32ex VR7	6n	Tor
FTV	XC6901D951PR-G	LVR-IC	-9.5V±1.5%, 200mA, +CE, CL	SOT-89-5	32ex VR7	6n	Tor
FTX	XC6901D961PR-G	LVR-IC	-9.6V±1.5%, 200mA, +CE, CL	SOT-89-5	32ex VR7	6n	Tor
FTY	XC6901D971PR-G	LVR-IC	-9.7V±1.5%, 200mA, +CE, CL	SOT-89-5	32ex VR7	6n	Tor
FTZ	XC6901D981PR-G	LVR-IC	-9.8V±1.5%, 200mA, +CE, CL	SOT-89-5	32ex VR7	6n	Tor
FU0	XC6901D991PR-G	LVR-IC	-9.9V±1.5%, 200mA, +CE, CL	SOT-89-5	32ex VR7	6n	Tor
FU1	XC6901DA01PR-G	LVR-IC	-10.0V±1.5%, 200mA, +CE, CL	SOT-89-5	32ex VR7	6n	Tor
FU2	XC6901DA11PR-G	LVR-IC	-10.1V±1.5%, 200mA, +CE, CL	SOT-89-5	32ex VR7	6n	Tor
FU3	XC6901DA21PR-G	LVR-IC	-10.2V±1.5%, 200mA, +CE, CL	SOT-89-5	32ex VR7	6n	Tor
FU4	XC6901DA31PR-G	LVR-IC	-10.3V±1.5%, 200mA, +CE, CL	SOT-89-5	32ex VR7	6n	Tor
FU5	XC6901DA41PR-G	LVR-IC	-10.4V±1.5%, 200mA, +CE, CL	SOT-89-5	32ex VR7	6n	Tor
FU6	XC6901DA51PR-G	LVR-IC	-10.5V±1.5%, 200mA, +CE, CL	SOT-89-5	32ex VR7	6n	Tor
FU7	XC6901DA61PR-G	LVR-IC	-10.6V±1.5%, 200mA, +CE, CL	SOT-89-5	32ex VR7	6n	Tor
FU8	XC6901DA71PR-G	LVR-IC	-10.7V±1.5%, 200mA, +CE, CL	SOT-89-5	32ex VR7	6n	Tor
FU9	XC6901DA81PR-G	LVR-IC	-10.8V±1.5%, 200mA, +CE, CL	SOT-89-5	32ex VR7	6n	Tor
FUA	XC6901DA91PR-G	LVR-IC	-10.9V±1.5%, 200mA, +CE, CL	SOT-89-5	32ex VR7	6n	Tor
FUB	XC6901DB01PR-G	LVR-IC	-11.0V±1.5%, 200mA, +CE, CL	SOT-89-5	32ex VR7	6n	Tor
FUC	XC6901DB11PR-G	LVR-IC	-11.1V±1.5%, 200mA, +CE, CL	SOT-89-5	32ex VR7	6n	Tor
FUD	XC6901DB21PR-G	LVR-IC	-11.2V±1.5%, 200mA, +CE, CL	SOT-89-5	32ex VR7	6n	Tor
FUE	XC6901DB31PR-G	LVR-IC	-11.3V±1.5%, 200mA, +CE, CL	SOT-89-5	32ex VR7	6n	Tor
FUF	XC6901DB41PR-G	LVR-IC	-11.4V±1.5%, 200mA, +CE, CL	SOT-89-5	32ex VR7	6n	Tor
FUH	XC6901DB51PR-G	LVR-IC	-11.5V±1.5%, 200mA, +CE, CL	SOT-89-5	32ex VR7	6n	Tor
FUK	XC6901DB61PR-G	LVR-IC	-11.6V±1.5%, 200mA, +CE, CL	SOT-89-5	32ex VR7	6n	Tor
FUL	XC6901DB71PR-G	LVR-IC	-11.7V±1.5%, 200mA, +CE, CL	SOT-89-5	32ex VR7	6n	Tor
FUM	XC6901DB81PR-G	LVR-IC	-11.8V±1.5%, 200mA, +CE, CL	SOT-89-5	32ex VR7	6n	Tor
FUN	XC6901DB91PR-G	LVR-IC	-11.9V±1.5%, 200mA, +CE, CL	SOT-89-5	32ex VR7	6n	Tor
FUP	XC6901DC01PR-G	LVR-IC	-12.0V±1.5%, 200mA, +CE, CL	SOT-89-5	32ex VR7	6n	Tor
G001	R1154H001C	LVR-IC	LDO, Adjustable, 150mA, +CE	SOT-89-5	32vrr VR16	6h	Ric
G025	R1154H025B	LVR-IC	LDO, 2.5V±2%, 150mA, +CE	SOT-89-5	32vrq VR4	6h	Ric
G026	R1154H026B	LVR-IC	LDO, 2.6V±2%, 150mA, +CE	SOT-89-5	32vrq VR4	6h	Ric
G027	R1154H027B	LVR-IC	LDO, 2.7V±2%, 150mA, +CE	SOT-89-5	32vrq VR4	6h	Ric
G028	R1154H028B	LVR-IC	LDO, 2.8V±2%, 150mA, +CE	SOT-89-5	32vrq VR4	6h	Ric
G029	R1154H029B	LVR-IC	LDO, 2.9V±2%, 150mA, +CE	SOT-89-5	32vrq VR4	6h	Ric
G030	R1154H030B	LVR-IC	LDO, 3.0V±2%, 150mA, +CE	SOT-89-5	32vrq VR4	6h	Ric
G031	R1154H031B	LVR-IC	LDO, 3.1V±2%, 150mA, +CE	SOT-89-5	32vrq VR4	6h	Ric
G032	R1154H032B	LVR-IC	LDO, 3.2V±2%, 150mA, +CE	SOT-89-5	32vrq VR4	6h	Ric
G033	R1154H033B	LVR-IC	LDO, 3.3V±2%, 150mA, +CE	SOT-89-5	32vrq VR4	6h	Ric
G034	R1154H034B	LVR-IC	LDO, 3.4V±2%, 150mA, +CE	SOT-89-5	32vrq VR4	6h	Ric
G035	R1154H035B	LVR-IC	LDO, 3.5V±2%, 150mA, +CE	SOT-89-5	32vrq VR4	6h	Ric
G036	R1154H036B	LVR-IC	LDO, 3.6V±2%, 150mA, +CE	SOT-89-5	32vrq VR4	6h	Ric
G037	R1154H037B	LVR-IC	LDO, 3.7V±2%, 150mA, +CE	SOT-89-5	32vrq VR4	6h	Ric
G038	R1154H038B	LVR-IC	LDO, 3.8V±2%, 150mA, +CE	SOT-89-5	32vrq VR4	6h	Ric
G039	R1154H039B	LVR-IC	LDO, 3.9V±2%, 150mA, +CE	SOT-89-5	32vrq VR4	6h	Ric
G040	R1154H040B	LVR-IC	LDO, 4.0V±2%, 150mA, +CE	SOT-89-5	32vrq VR4	6h	Ric
G041	R1154H041B	LVR-IC	LDO, 4.1V±2%, 150mA, +CE	SOT-89-5	32vrq VR4	6h	Ric



SMD code	Type	Function	Short description	Case	Pinout Sch.	St.	Mnf.
G112	R1154H112B	LVR-IC	LDO, 11.2V±2%, 150mA, +CE	SOT-89-5	32vrq VR4	6h	Ric
G113	R1154H113B	LVR-IC	LDO, 11.3V±2%, 150mA, +CE	SOT-89-5	32vrq VR4	6h	Ric
G114	R1154H114B	LVR-IC	LDO, 11.4V±2%, 150mA, +CE	SOT-89-5	32vrq VR4	6h	Ric
G115	R1154H115B	LVR-IC	LDO, 11.5V±2%, 150mA, +CE	SOT-89-5	32vrq VR4	6h	Ric
G116	R1154H116B	LVR-IC	LDO, 11.6V±2%, 150mA, +CE	SOT-89-5	32vrq VR4	6h	Ric
G117	R1154H117B	LVR-IC	LDO, 11.7V±2%, 150mA, +CE	SOT-89-5	32vrq VR4	6h	Ric
G118	R1154H118B	LVR-IC	LDO, 11.8V±2%, 150mA, +CE	SOT-89-5	32vrq VR4	6h	Ric
G119	R1154H119B	LVR-IC	LDO, 11.9V±2%, 150mA, +CE	SOT-89-5	32vrq VR4	6h	Ric
G120	R1154H120B	LVR-IC	LDO, 12V±2%, 150mA, +CE	SOT-89-5	32vrq VR4	6h	Ric
GA	ELM99302B	LVR-IC	LDO, 3.0V±2%, 300mA, -CE	SOT-89-5	32vrt VR1	6n	Elm
GB	ELM99312B	LVR-IC	LDO, 3.1V±2%, 300mA, -CE	SOT-89-5	32vrt VR1	6n	Elm
GB08G	AIC1748BH-08GX5	LVR-IC	LDO, 0.8V±2%, 600mA, +CE	SOT89-5	32vrnx VR7	6j	Aic
GB09G	AIC1748BH-09GX5	LVR-IC	LDO, 0.9V±2%, 600mA, +CE	SOT89-5	32vrnx VR7	6j	Aic
GB10G	AIC1748BH-10GX5	LVR-IC	LDO, 1.0V±2%, 600mA, +CE	SOT89-5	32vrnx VR7	6j	Aic
GB11G	AIC1748BH-11GX5	LVR-IC	LDO, 1.1V±2%, 600mA, +CE	SOT89-5	32vrnx VR7	6j	Aic
GB12G	AIC1748BH-12GX5	LVR-IC	LDO, 1.2V±2%, 600mA, +CE	SOT89-5	32vrnx VR7	6j	Aic
GB13G	AIC1748BH-13GX5	LVR-IC	LDO, 1.3V±2%, 600mA, +CE	SOT89-5	32vrnx VR7	6j	Aic
GB14G	AIC1748BH-14GX5	LVR-IC	LDO, 1.4V±2%, 600mA, +CE	SOT89-5	32vrnx VR7	6j	Aic
GB15G	AIC1748BH-15GX5	LVR-IC	LDO, 1.5V±2%, 600mA, +CE	SOT89-5	32vrnx VR7	6j	Aic
GB16G	AIC1748BH-16GX5	LVR-IC	LDO, 1.6V±2%, 600mA, +CE	SOT89-5	32vrnx VR7	6j	Aic
GB17G	AIC1748BH-17GX5	LVR-IC	LDO, 1.7V±2%, 600mA, +CE	SOT89-5	32vrnx VR7	6j	Aic
GB18G	AIC1748BH-18GX5	LVR-IC	LDO, 1.8V±2%, 600mA, +CE	SOT89-5	32vrnx VR7	6j	Aic
GB19G	AIC1748BH-19GX5	LVR-IC	LDO, 1.9V±2%, 600mA, +CE	SOT89-5	32vrnx VR7	6j	Aic
GB20G	AIC1748BH-20GX5	LVR-IC	LDO, 2.0V±2%, 600mA, +CE	SOT89-5	32vrnx VR7	6j	Aic
GB21G	AIC1748BH-21GX5	LVR-IC	LDO, 2.1V±2%, 600mA, +CE	SOT89-5	32vrnx VR7	6j	Aic
GB22G	AIC1748BH-22GX5	LVR-IC	LDO, 2.2V±2%, 600mA, +CE	SOT89-5	32vrnx VR7	6j	Aic
GB23G	AIC1748BH-23GX5	LVR-IC	LDO, 2.3V±2%, 600mA, +CE	SOT89-5	32vrnx VR7	6j	Aic
GB24G	AIC1748BH-24GX5	LVR-IC	LDO, 2.4V±2%, 600mA, +CE	SOT89-5	32vrnx VR7	6j	Aic
GB25G	AIC1748BH-25GX5	LVR-IC	LDO, 2.5V±2%, 600mA, +CE	SOT89-5	32vrnx VR7	6j	Aic
GB26G	AIC1748BH-26GX5	LVR-IC	LDO, 2.6V±2%, 600mA, +CE	SOT89-5	32vrnx VR7	6j	Aic
GB27G	AIC1748BH-27GX5	LVR-IC	LDO, 2.7V±2%, 600mA, +CE	SOT89-5	32vrnx VR7	6j	Aic
GB28G	AIC1748BH-28GX5	LVR-IC	LDO, 2.8V±2%, 600mA, +CE	SOT89-5	32vrnx VR7	6j	Aic
GB29G	AIC1748BH-29GX5	LVR-IC	LDO, 2.9V±2%, 600mA, +CE	SOT89-5	32vrnx VR7	6j	Aic
GB2JG	AIC1748BH-285GX5	LVR-IC	LDO, 2.85V±2%, 600mA, +CE	SOT89-5	32vrnx VR7	6j	Aic
GB30G	AIC1748BH-30GX5	LVR-IC	LDO, 3.0V±2%, 600mA, +CE	SOT89-5	32vrnx VR7	6j	Aic
GB31G	AIC1748BH-32GX5	LVR-IC	LDO, 3.1V±2%, 600mA, +CE	SOT89-5	32vrnx VR7	6j	Aic
GB32G	AIC1748BH-33GX5	LVR-IC	LDO, 3.2V±2%, 600mA, +CE	SOT89-5	32vrnx VR7	6j	Aic
GB33G	AIC1748BH-33GX5	LVR-IC	LDO, 3.3V±2%, 600mA, +CE	SOT89-5	32vrnx VR7	6j	Aic
GC	ELM99322B	LVR-IC	LDO, 3.2V±2%, 300mA, -CE	SOT-89-5	32vrt VR1	6n	Elm
GC08G	AIC1748BL-08GX5	LVR-IC	LDO, 0.8V±2%, 600mA, -CE	SOT89-5	32vrnx VR7	6j	Aic
GC09G	AIC1748BL-09GX5	LVR-IC	LDO, 0.9V±2%, 600mA, -CE	SOT89-5	32vrnx VR7	6j	Aic
GC10G	AIC1748BL-10GX5	LVR-IC	LDO, 1.0V±2%, 600mA, -CE	SOT89-5	32vrnx VR7	6j	Aic
GC11G	AIC1748BL-11GX5	LVR-IC	LDO, 1.1V±2%, 600mA, -CE	SOT89-5	32vrnx VR7	6j	Aic
GC12G	AIC1748BL-12GX5	LVR-IC	LDO, 1.2V±2%, 600mA, -CE	SOT89-5	32vrnx VR7	6j	Aic
GC13G	AIC1748BL-13GX5	LVR-IC	LDO, 1.3V±2%, 600mA, -CE	SOT89-5	32vrnx VR7	6j	Aic
GC14G	AIC1748BL-14GX5	LVR-IC	LDO, 1.4V±2%, 600mA, -CE	SOT89-5	32vrnx VR7	6j	Aic
GC15G	AIC1748BL-15GX5	LVR-IC	LDO, 1.5V±2%, 600mA, -CE	SOT89-5	32vrnx VR7	6j	Aic
GC16G	AIC1748BL-16GX5	LVR-IC	LDO, 1.6V±2%, 600mA, -CE	SOT89-5	32vrnx VR7	6j	Aic
GC17G	AIC1748BL-17GX5	LVR-IC	LDO, 1.7V±2%, 600mA, -CE	SOT89-5	32vrnx VR7	6j	Aic
GC18G	AIC1748BL-18GX5	LVR-IC	LDO, 1.8V±2%, 600mA, -CE	SOT89-5	32vrnx VR7	6j	Aic
GC19G	AIC1748BL-19GX5	LVR-IC	LDO, 1.9V±2%, 600mA, -CE	SOT89-5	32vrnx VR7	6j	Aic
GC20G	AIC1748BL-20GX5	LVR-IC	LDO, 2.0V±2%, 600mA, -CE	SOT89-5	32vrnx VR7	6j	Aic
GC21G	AIC1748BL-21GX5	LVR-IC	LDO, 2.1V±2%, 600mA, -CE	SOT89-5	32vrnx VR7	6j	Aic
GC22G	AIC1748BL-22GX5	LVR-IC	LDO, 2.2V±2%, 600mA, -CE	SOT89-5	32vrnx VR7	6j	Aic
GC23G	AIC1748BL-23GX5	LVR-IC	LDO, 2.3V±2%, 600mA, -CE	SOT89-5	32vrnx VR7	6j	Aic
GC24G	AIC1748BL-24GX5	LVR-IC	LDO, 2.4V±2%, 600mA, -CE	SOT89-5	32vrnx VR7	6j	Aic
GC25G	AIC1748BL-25GX5	LVR-IC	LDO, 2.5V±2%, 600mA, -CE	SOT89-5	32vrnx VR7	6j	Aic
GC26G	AIC1748BL-26GX5	LVR-IC	LDO, 2.6V±2%, 600mA, -CE	SOT89-5	32vrnx VR7	6j	Aic
GC27G	AIC1748BL-27GX5	LVR-IC	LDO, 2.7V±2%, 600mA, -CE	SOT89-5	32vrnx VR7	6j	Aic
GC28G	AIC1748BL-28GX5	LVR-IC	LDO, 2.8V±2%, 600mA, -CE	SOT89-5	32vrnx VR7	6j	Aic
GC29G	AIC1748BL-29GX5	LVR-IC	LDO, 2.9V±2%, 600mA, -CE	SOT89-5	32vrnx VR7	6j	Aic
GC2JG	AIC1748BL-285GX5	LVR-IC	LDO, 2.85V±2%, 600mA, -CE	SOT89-5	32vrnx VR7	6j	Aic
GC30G	AIC1748BL-30GX5	LVR-IC	LDO, 3.0V±2%, 600mA, -CE	SOT89-5	32vrnx VR7	6j	Aic
GC31G	AIC1748BL-32GX5	LVR-IC	LDO, 3.1V±2%, 600mA, -CE	SOT89-5	32vrnx VR7	6j	Aic
GC32G	AIC1748BL-33GX5	LVR-IC	LDO, 3.2V±2%, 600mA, -CE	SOT89-5	32vrnx VR7	6j	Aic
GC33G	AIC1748BL-33GX5	LVR-IC	LDO, 3.3V±2%, 600mA, -CE	SOT89-5	32vrnx VR7	6j	Aic
GD	ELM99332B	LVR-IC	LDO, 3.3V±2%, 300mA, -CE	SOT-89-5	32vrt VR1	6n	Elm
GE	ELM99342B	LVR-IC	LDO, 3.4V±2%, 300mA, -CE	SOT-89-5	32vrt VR1	6n	Elm
GF	ELM99352B	LVR-IC	LDO, 3.5V±2%, 300mA, -CE	SOT-89-5	32vrt VR1	6n	Elm
GG	ELM99362B	LVR-IC	LDO, 3.6V±2%, 300mA, -CE	SOT-89-5	32vrt VR1	6n	Elm



SMD code	Type	Function	Short description	Case	Pinout Sch.	St.	Mnf.
GH	ELM99372B	LVR-IC	LDO, 3.7V±2%, 300mA, -CE	SOT-89-5	32vrt	VR1	6n Elm
GIG	AIC1748AH-285GX5	LVR-IC	LDO, Adjustable 0.8..4.5V, 600mA, +CE	SOT89-5	32sg	VR5	6j Aic
GJ	ELM99382B	LVR-IC	LDO, 3.8V±2%, 300mA, -CE	SOT-89-5	32vrt	VR1	6n Elm
GJG	AIC1748AL-285GX5	LVR-IC	LDO, Adjustable 0.8..4.5V, 600mA, -CE	SOT89-5	32sg	VR5	6j Aic
GK	ELM99392B	LVR-IC	LDO, 3.9V±2%, 300mA, -CE	SOT-89-5	32vrt	VR1	6n Elm
H08	XC6220A081PR	LVR-IC	LDO, 0.8V±20mV, 1A, +CE	SOT-89-5	32vy	VR4	6n Tor
H09	XC6220A091PR	LVR-IC	LDO, 0.9V±20mV, 1A, +CE	SOT-89-5	32vy	VR4	6n Tor
H0A	XC6220A101PR	LVR-IC	LDO, 1V±20mV, 1A, +CE	SOT-89-5	32vy	VR4	6n Tor
H0B	XC6220A111PR	LVR-IC	LDO, 1.1V±20mV, 1A, +CE	SOT-89-5	32vy	VR4	6n Tor
H0C	XC6220A121PR	LVR-IC	LDO, 1.2V±20mV, 1A, +CE	SOT-89-5	32vy	VR4	6n Tor
H0D	XC6220A131PR	LVR-IC	LDO, 1.3V±20mV, 1A, +CE	SOT-89-5	32vy	VR4	6n Tor
H0E	XC6220A141PR	LVR-IC	LDO, 1.4V±20mV, 1A, +CE	SOT-89-5	32vy	VR4	6n Tor
H0F	XC6220A151PR	LVR-IC	LDO, 1.5V±20mV, 1A, +CE	SOT-89-5	32vy	VR4	6n Tor
H0H	XC6220A161PR	LVR-IC	LDO, 1.6V±20mV, 1A, +CE	SOT-89-5	32vy	VR4	6n Tor
H0K	XC6220A171PR	LVR-IC	LDO, 1.7V±20mV, 1A, +CE	SOT-89-5	32vy	VR4	6n Tor
H0L	XC6220A181PR	LVR-IC	LDO, 1.8V±20mV, 1A, +CE	SOT-89-5	32vy	VR4	6n Tor
H0M	XC6220A191PR	LVR-IC	LDO, 1.9V±20mV, 1A, +CE	SOT-89-5	32vy	VR4	6n Tor
H0N	XC6220A201PR	LVR-IC	LDO, 2V±1%, 1A, +CE	SOT-89-5	32vy	VR4	6n Tor
H0P	XC6220A211PR	LVR-IC	LDO, 2.1V±1%, 1A, +CE	SOT-89-5	32vy	VR4	6n Tor
H0R	XC6220A221PR	LVR-IC	LDO, 2.2V±1%, 1A, +CE	SOT-89-5	32vy	VR4	6n Tor
H0S	XC6220A231PR	LVR-IC	LDO, 2.3V±1%, 1A, +CE	SOT-89-5	32vy	VR4	6n Tor
H0T	XC6220A241PR	LVR-IC	LDO, 2.4V±1%, 1A, +CE	SOT-89-5	32vy	VR4	6n Tor
H0U	XC6220A251PR	LVR-IC	LDO, 2.5V±1%, 1A, +CE	SOT-89-5	32vy	VR4	6n Tor
H0V	XC6220A261PR	LVR-IC	LDO, 2.6V±1%, 1A, +CE	SOT-89-5	32vy	VR4	6n Tor
H0X	XC6220A271PR	LVR-IC	LDO, 2.7V±1%, 1A, +CE	SOT-89-5	32vy	VR4	6n Tor
H0Y	XC6220A281PR	LVR-IC	LDO, 2.8V±1%, 1A, +CE	SOT-89-5	32vy	VR4	6n Tor
H0Z	XC6220A291PR	LVR-IC	LDO, 2.9V±1%, 1A, +CE	SOT-89-5	32vy	VR4	6n Tor
H18	XC6220A08BPR	LVR-IC	LDO, 0.85V±20mV, 1A, +CE	SOT-89-5	32vy	VR4	6n Tor
H19	XC6220A09BPR	LVR-IC	LDO, 0.95V±20mV, 1A, +CE	SOT-89-5	32vy	VR4	6n Tor
H1A	XC6220A10BPR	LVR-IC	LDO, 1.05V±20mV, 1A, +CE	SOT-89-5	32vy	VR4	6n Tor
H1B	XC6220A11BPR	LVR-IC	LDO, 1.15V±20mV, 1A, +CE	SOT-89-5	32vy	VR4	6n Tor
H1C	XC6220A12BPR	LVR-IC	LDO, 1.25V±20mV, 1A, +CE	SOT-89-5	32vy	VR4	6n Tor
H1D	XC6220A13BPR	LVR-IC	LDO, 1.35V±20mV, 1A, +CE	SOT-89-5	32vy	VR4	6n Tor
H1E	XC6220A14BPR	LVR-IC	LDO, 1.45V±20mV, 1A, +CE	SOT-89-5	32vy	VR4	6n Tor
H1F	XC6220A15BPR	LVR-IC	LDO, 1.55V±20mV, 1A, +CE	SOT-89-5	32vy	VR4	6n Tor
H1H	XC6220A16BPR	LVR-IC	LDO, 1.65V±20mV, 1A, +CE	SOT-89-5	32vy	VR4	6n Tor
H1K	XC6220A17BPR	LVR-IC	LDO, 1.75V±20mV, 1A, +CE	SOT-89-5	32vy	VR4	6n Tor
H1L	XC6220A18BPR	LVR-IC	LDO, 1.85V±20mV, 1A, +CE	SOT-89-5	32vy	VR4	6n Tor
H1M	XC6220A19BPR	LVR-IC	LDO, 1.95V±20mV, 1A, +CE	SOT-89-5	32vy	VR4	6n Tor
H1N	XC6220A20BPR	LVR-IC	LDO, 2.05V±1%, 1A, +CE	SOT-89-5	32vy	VR4	6n Tor
H1P	XC6220A21BPR	LVR-IC	LDO, 2.15V±1%, 1A, +CE	SOT-89-5	32vy	VR4	6n Tor
H1R	XC6220A22BPR	LVR-IC	LDO, 2.25V±1%, 1A, +CE	SOT-89-5	32vy	VR4	6n Tor
H1S	XC6220A23BPR	LVR-IC	LDO, 2.35V±1%, 1A, +CE	SOT-89-5	32vy	VR4	6n Tor
H1T	XC6220A24BPR	LVR-IC	LDO, 2.45V±1%, 1A, +CE	SOT-89-5	32vy	VR4	6n Tor
H1U	XC6220A25BPR	LVR-IC	LDO, 2.55V±1%, 1A, +CE	SOT-89-5	32vy	VR4	6n Tor
H1V	XC6220A26BPR	LVR-IC	LDO, 2.65V±1%, 1A, +CE	SOT-89-5	32vy	VR4	6n Tor
H1X	XC6220A27BPR	LVR-IC	LDO, 2.75V±1%, 1A, +CE	SOT-89-5	32vy	VR4	6n Tor
H1Y	XC6220A28BPR	LVR-IC	LDO, 2.85V±1%, 1A, +CE	SOT-89-5	32vy	VR4	6n Tor
H1Z	XC6220A29BPR	LVR-IC	LDO, 2.95V±1%, 1A, +CE	SOT-89-5	32vy	VR4	6n Tor
H20	XC6220A301PR	LVR-IC	LDO, 3V±1%, 1A, +CE	SOT-89-5	32vy	VR4	6n Tor
H21	XC6220A311PR	LVR-IC	LDO, 3.1V±1%, 1A, +CE	SOT-89-5	32vy	VR4	6n Tor
H22	XC6220A321PR	LVR-IC	LDO, 3.2V±1%, 1A, +CE	SOT-89-5	32vy	VR4	6n Tor
H23	XC6220A331PR	LVR-IC	LDO, 3.3V±1%, 1A, +CE	SOT-89-5	32vy	VR4	6n Tor
H24	XC6220A341PR	LVR-IC	LDO, 3.4V±1%, 1A, +CE	SOT-89-5	32vy	VR4	6n Tor
H25	XC6220A351PR	LVR-IC	LDO, 3.5V±1%, 1A, +CE	SOT-89-5	32vy	VR4	6n Tor
H26	XC6220A361PR	LVR-IC	LDO, 3.6V±1%, 1A, +CE	SOT-89-5	32vy	VR4	6n Tor
H27	XC6220A371PR	LVR-IC	LDO, 3.7V±1%, 1A, +CE	SOT-89-5	32vy	VR4	6n Tor
H28	XC6220A381PR	LVR-IC	LDO, 3.8V±1%, 1A, +CE	SOT-89-5	32vy	VR4	6n Tor
H29	XC6220A391PR	LVR-IC	LDO, 3.9V±1%, 1A, +CE	SOT-89-5	32vy	VR4	6n Tor
H2A	XC6220A401PR	LVR-IC	LDO, 4V±1%, 1A, +CE	SOT-89-5	32vy	VR4	6n Tor
H2B	XC6220A411PR	LVR-IC	LDO, 4.1V±1%, 1A, +CE	SOT-89-5	32vy	VR4	6n Tor
H2C	XC6220A421PR	LVR-IC	LDO, 4.2V±1%, 1A, +CE	SOT-89-5	32vy	VR4	6n Tor
H2D	XC6220A431PR	LVR-IC	LDO, 4.3V±1%, 1A, +CE	SOT-89-5	32vy	VR4	6n Tor
H2E	XC6220A441PR	LVR-IC	LDO, 4.4V±1%, 1A, +CE	SOT-89-5	32vy	VR4	6n Tor
H2F	XC6220A451PR	LVR-IC	LDO, 4.5V±1%, 1A, +CE	SOT-89-5	32vy	VR4	6n Tor
H2H	XC6220A461PR	LVR-IC	LDO, 4.6V±1%, 1A, +CE	SOT-89-5	32vy	VR4	6n Tor
H2K	XC6220A471PR	LVR-IC	LDO, 4.7V±1%, 1A, +CE	SOT-89-5	32vy	VR4	6n Tor
H2L	XC6220A481PR	LVR-IC	LDO, 4.8V±1%, 1A, +CE	SOT-89-5	32vy	VR4	6n Tor
H2M	XC6220A491PR	LVR-IC	LDO, 4.9V±1%, 1A, +CE	SOT-89-5	32vy	VR4	6n Tor
H2N	XC6220A501PR	LVR-IC	LDO, 5V±1%, 1A, +CE	SOT-89-5	32vy	VR4	6n Tor



SMD code	Type	Function	Short description	Case	Pinout Sch.	St.	Mnf.
H30	XC6220A30BPR	LVR-IC	LDO, 3.05V±1%, 1A, +CE	SOT-89-5	32vy VR4	6n	Tor
H31	XC6220A31BPR	LVR-IC	LDO, 3.15V±1%, 1A, +CE	SOT-89-5	32vy VR4	6n	Tor
H32	XC6220A32BPR	LVR-IC	LDO, 3.25V±1%, 1A, +CE	SOT-89-5	32vy VR4	6n	Tor
H33	XC6220A33BPR	LVR-IC	LDO, 3.35V±1%, 1A, +CE	SOT-89-5	32vy VR4	6n	Tor
H34	XC6220A34BPR	LVR-IC	LDO, 3.45V±1%, 1A, +CE	SOT-89-5	32vy VR4	6n	Tor
H35	XC6220A35BPR	LVR-IC	LDO, 3.55V±1%, 1A, +CE	SOT-89-5	32vy VR4	6n	Tor
H36	XC6220A36BPR	LVR-IC	LDO, 3.65V±1%, 1A, +CE	SOT-89-5	32vy VR4	6n	Tor
H37	XC6220A37BPR	LVR-IC	LDO, 3.75V±1%, 1A, +CE	SOT-89-5	32vy VR4	6n	Tor
H38	XC6220A38BPR	LVR-IC	LDO, 3.85V±1%, 1A, +CE	SOT-89-5	32vy VR4	6n	Tor
H39	XC6220A39BPR	LVR-IC	LDO, 3.95V±1%, 1A, +CE	SOT-89-5	32vy VR4	6n	Tor
H3A	XC6220A40BPR	LVR-IC	LDO, 4.05V±1%, 1A, +CE	SOT-89-5	32vy VR4	6n	Tor
H3B	XC6220A41BPR	LVR-IC	LDO, 4.15V±1%, 1A, +CE	SOT-89-5	32vy VR4	6n	Tor
H3C	XC6220A42BPR	LVR-IC	LDO, 4.25V±1%, 1A, +CE	SOT-89-5	32vy VR4	6n	Tor
H3D	XC6220A43BPR	LVR-IC	LDO, 4.35V±1%, 1A, +CE	SOT-89-5	32vy VR4	6n	Tor
H3E	XC6220A44BPR	LVR-IC	LDO, 4.45V±1%, 1A, +CE	SOT-89-5	32vy VR4	6n	Tor
H3F	XC6220A45BPR	LVR-IC	LDO, 4.55V±1%, 1A, +CE	SOT-89-5	32vy VR4	6n	Tor
H3H	XC6220A46BPR	LVR-IC	LDO, 4.65V±1%, 1A, +CE	SOT-89-5	32vy VR4	6n	Tor
H3K	XC6220A47BPR	LVR-IC	LDO, 4.75V±1%, 1A, +CE	SOT-89-5	32vy VR4	6n	Tor
H3L	XC6220A48BPR	LVR-IC	LDO, 4.85V±1%, 1A, +CE	SOT-89-5	32vy VR4	6n	Tor
H3M	XC6220A49BPR	LVR-IC	LDO, 4.95V±1%, 1A, +CE	SOT-89-5	32vy VR4	6n	Tor
H48	XC6220B081PR	LVR-IC	LDO, 0.8V±20mV, 1A, +CE, CL	SOT-89-5	32vy VR4	6n	Tor
H49	XC6220B091PR	LVR-IC	LDO, 0.9V±20mV, 1A, +CE, CL	SOT-89-5	32vy VR4	6n	Tor
H4A	XC6220B101PR	LVR-IC	LDO, 1V±20mV, 1A, +CE, CL	SOT-89-5	32vy VR4	6n	Tor
H4B	XC6220B111PR	LVR-IC	LDO, 1.1V±20mV, 1A, +CE, CL	SOT-89-5	32vy VR4	6n	Tor
H4C	XC6220B121PR	LVR-IC	LDO, 1.2V±20mV, 1A, +CE, CL	SOT-89-5	32vy VR4	6n	Tor
H4D	XC6220B131PR	LVR-IC	LDO, 1.3V±20mV, 1A, +CE, CL	SOT-89-5	32vy VR4	6n	Tor
H4E	XC6220B141PR	LVR-IC	LDO, 1.4V±20mV, 1A, +CE, CL	SOT-89-5	32vy VR4	6n	Tor
H4F	XC6220B151PR	LVR-IC	LDO, 1.5V±20mV, 1A, +CE, CL	SOT-89-5	32vy VR4	6n	Tor
H4H	XC6220B161PR	LVR-IC	LDO, 1.6V±20mV, 1A, +CE, CL	SOT-89-5	32vy VR4	6n	Tor
H4K	XC6220B171PR	LVR-IC	LDO, 1.7V±20mV, 1A, +CE, CL	SOT-89-5	32vy VR4	6n	Tor
H4L	XC6220B181PR	LVR-IC	LDO, 1.8V±20mV, 1A, +CE, CL	SOT-89-5	32vy VR4	6n	Tor
H4M	XC6220B191PR	LVR-IC	LDO, 1.9V±20mV, 1A, +CE, CL	SOT-89-5	32vy VR4	6n	Tor
H4N	XC6220B201PR	LVR-IC	LDO, 2V±1%, 1A, +CE, CL	SOT-89-5	32vy VR4	6n	Tor
H4P	XC6220B211PR	LVR-IC	LDO, 2.1V±1%, 1A, +CE, CL	SOT-89-5	32vy VR4	6n	Tor
H4R	XC6220B221PR	LVR-IC	LDO, 2.2V±1%, 1A, +CE, CL	SOT-89-5	32vy VR4	6n	Tor
H4S	XC6220B231PR	LVR-IC	LDO, 2.3V±1%, 1A, +CE, CL	SOT-89-5	32vy VR4	6n	Tor
H4T	XC6220B241PR	LVR-IC	LDO, 2.4V±1%, 1A, +CE, CL	SOT-89-5	32vy VR4	6n	Tor
H4U	XC6220B251PR	LVR-IC	LDO, 2.5V±1%, 1A, +CE, CL	SOT-89-5	32vy VR4	6n	Tor
H4V	XC6220B261PR	LVR-IC	LDO, 2.6V±1%, 1A, +CE, CL	SOT-89-5	32vy VR4	6n	Tor
H4X	XC6220B271PR	LVR-IC	LDO, 2.7V±1%, 1A, +CE, CL	SOT-89-5	32vy VR4	6n	Tor
H4Y	XC6220B281PR	LVR-IC	LDO, 2.8V±1%, 1A, +CE, CL	SOT-89-5	32vy VR4	6n	Tor
H4Z	XC6220B291PR	LVR-IC	LDO, 2.9V±1%, 1A, +CE, CL	SOT-89-5	32vy VR4	6n	Tor
H58	XC6220B08BPR	LVR-IC	LDO, 0.85V±20mV, 1A, +CE, CL	SOT-89-5	32vy VR4	6n	Tor
H59	XC6220B09BPR	LVR-IC	LDO, 0.95V±20mV, 1A, +CE, CL	SOT-89-5	32vy VR4	6n	Tor
H5A	XC6220B10BPR	LVR-IC	LDO, 1.05V±20mV, 1A, +CE, CL	SOT-89-5	32vy VR4	6n	Tor
H5B	XC6220B11BPR	LVR-IC	LDO, 1.15V±20mV, 1A, +CE, CL	SOT-89-5	32vy VR4	6n	Tor
H5C	XC6220B12BPR	LVR-IC	LDO, 1.25V±20mV, 1A, +CE, CL	SOT-89-5	32vy VR4	6n	Tor
H5D	XC6220B13BPR	LVR-IC	LDO, 1.35V±20mV, 1A, +CE, CL	SOT-89-5	32vy VR4	6n	Tor
H5E	XC6220B14BPR	LVR-IC	LDO, 1.45V±20mV, 1A, +CE, CL	SOT-89-5	32vy VR4	6n	Tor
H5F	XC6220B15BPR	LVR-IC	LDO, 1.55V±20mV, 1A, +CE, CL	SOT-89-5	32vy VR4	6n	Tor
H5H	XC6220B16BPR	LVR-IC	LDO, 1.65V±20mV, 1A, +CE, CL	SOT-89-5	32vy VR4	6n	Tor
H5K	XC6220B17BPR	LVR-IC	LDO, 1.75V±20mV, 1A, +CE, CL	SOT-89-5	32vy VR4	6n	Tor
H5L	XC6220B18BPR	LVR-IC	LDO, 1.85V±20mV, 1A, +CE, CL	SOT-89-5	32vy VR4	6n	Tor
H5M	XC6220B19BPR	LVR-IC	LDO, 1.95V±20mV, 1A, +CE, CL	SOT-89-5	32vy VR4	6n	Tor
H5N	XC6220B20BPR	LVR-IC	LDO, 2.05V±1%, 1A, +CE, CL	SOT-89-5	32vy VR4	6n	Tor
H5P	XC6220B21BPR	LVR-IC	LDO, 2.15V±1%, 1A, +CE, CL	SOT-89-5	32vy VR4	6n	Tor
H5R	XC6220B22BPR	LVR-IC	LDO, 2.25V±1%, 1A, +CE, CL	SOT-89-5	32vy VR4	6n	Tor
H5S	XC6220B23BPR	LVR-IC	LDO, 2.35V±1%, 1A, +CE, CL	SOT-89-5	32vy VR4	6n	Tor
H5T	XC6220B24BPR	LVR-IC	LDO, 2.45V±1%, 1A, +CE, CL	SOT-89-5	32vy VR4	6n	Tor
H5U	XC6220B25BPR	LVR-IC	LDO, 2.55V±1%, 1A, +CE, CL	SOT-89-5	32vy VR4	6n	Tor
H5V	XC6220B26BPR	LVR-IC	LDO, 2.65V±1%, 1A, +CE, CL	SOT-89-5	32vy VR4	6n	Tor
H5X	XC6220B27BPR	LVR-IC	LDO, 2.75V±1%, 1A, +CE, CL	SOT-89-5	32vy VR4	6n	Tor
H5Y	XC6220B28BPR	LVR-IC	LDO, 2.85V±1%, 1A, +CE, CL	SOT-89-5	32vy VR4	6n	Tor
H5Z	XC6220B29BPR	LVR-IC	LDO, 2.95V±1%, 1A, +CE, CL	SOT-89-5	32vy VR4	6n	Tor
H60	XC6220B301PR	LVR-IC	LDO, 3V±1%, 1A, +CE, CL	SOT-89-5	32vy VR4	6n	Tor
H61	XC6220B311PR	LVR-IC	LDO, 3.1V±1%, 1A, +CE, CL	SOT-89-5	32vy VR4	6n	Tor
H62	XC6220B321PR	LVR-IC	LDO, 3.2V±1%, 1A, +CE, CL	SOT-89-5	32vy VR4	6n	Tor
H63	XC6220B331PR	LVR-IC	LDO, 3.3V±1%, 1A, +CE, CL	SOT-89-5	32vy VR4	6n	Tor
H64	XC6220B341PR	LVR-IC	LDO, 3.4V±1%, 1A, +CE, CL	SOT-89-5	32vy VR4	6n	Tor
H65	XC6220B351PR	LVR-IC	LDO, 3.5V±1%, 1A, +CE, CL	SOT-89-5	32vy VR4	6n	Tor



SMD code	Type	Function	Short description	Case	Pinout Sch.	St.	Mnf.
H66	XC6220B361PR	LVR-IC	LDO, 3.6V±1%, 1A, +CE, CL	SOT-89-5	32vy VR4	6n	Tor
H67	XC6220B371PR	LVR-IC	LDO, 3.7V±1%, 1A, +CE, CL	SOT-89-5	32vy VR4	6n	Tor
H68	XC6220B381PR	LVR-IC	LDO, 3.8V±1%, 1A, +CE, CL	SOT-89-5	32vy VR4	6n	Tor
H69	XC6220B391PR	LVR-IC	LDO, 3.9V±1%, 1A, +CE, CL	SOT-89-5	32vy VR4	6n	Tor
H6A	XC6220B401PR	LVR-IC	LDO, 4.0V±1%, 1A, +CE, CL	SOT-89-5	32vy VR4	6n	Tor
H6B	XC6220B411PR	LVR-IC	LDO, 4.1V±1%, 1A, +CE, CL	SOT-89-5	32vy VR4	6n	Tor
H6C	XC6220B421PR	LVR-IC	LDO, 4.2V±1%, 1A, +CE, CL	SOT-89-5	32vy VR4	6n	Tor
H6D	XC6220B431PR	LVR-IC	LDO, 4.3V±1%, 1A, +CE, CL	SOT-89-5	32vy VR4	6n	Tor
H6E	XC6220B441PR	LVR-IC	LDO, 4.4V±1%, 1A, +CE, CL	SOT-89-5	32vy VR4	6n	Tor
H6F	XC6220B451PR	LVR-IC	LDO, 4.5V±1%, 1A, +CE, CL	SOT-89-5	32vy VR4	6n	Tor
H6H	XC6220B461PR	LVR-IC	LDO, 4.6V±1%, 1A, +CE, CL	SOT-89-5	32vy VR4	6n	Tor
H6K	XC6220B471PR	LVR-IC	LDO, 4.7V±1%, 1A, +CE, CL	SOT-89-5	32vy VR4	6n	Tor
H6L	XC6220B481PR	LVR-IC	LDO, 4.8V±1%, 1A, +CE, CL	SOT-89-5	32vy VR4	6n	Tor
H6M	XC6220B491PR	LVR-IC	LDO, 4.9V±1%, 1A, +CE, CL	SOT-89-5	32vy VR4	6n	Tor
H6N	XC6220B501PR	LVR-IC	LDO, 5.0V±1%, 1A, +CE, CL	SOT-89-5	32vy VR4	6n	Tor
H70	XC6220B30BPR	LVR-IC	LDO, 3.05V±1%, 1A, +CE, CL	SOT-89-5	32vy VR4	6n	Tor
H71	XC6220B31BPR	LVR-IC	LDO, 3.15V±1%, 1A, +CE, CL	SOT-89-5	32vy VR4	6n	Tor
H72	XC6220B32BPR	LVR-IC	LDO, 3.25V±1%, 1A, +CE, CL	SOT-89-5	32vy VR4	6n	Tor
H73	XC6220B33BPR	LVR-IC	LDO, 3.35V±1%, 1A, +CE, CL	SOT-89-5	32vy VR4	6n	Tor
H74	XC6220B34BPR	LVR-IC	LDO, 3.45V±1%, 1A, +CE, CL	SOT-89-5	32vy VR4	6n	Tor
H75	XC6220B35BPR	LVR-IC	LDO, 3.55V±1%, 1A, +CE, CL	SOT-89-5	32vy VR4	6n	Tor
H76	XC6220B36BPR	LVR-IC	LDO, 3.65V±1%, 1A, +CE, CL	SOT-89-5	32vy VR4	6n	Tor
H77	XC6220B37BPR	LVR-IC	LDO, 3.75V±1%, 1A, +CE, CL	SOT-89-5	32vy VR4	6n	Tor
H78	XC6220B38BPR	LVR-IC	LDO, 3.85V±1%, 1A, +CE, CL	SOT-89-5	32vy VR4	6n	Tor
H79	XC6220B39BPR	LVR-IC	LDO, 3.95V±1%, 1A, +CE, CL	SOT-89-5	32vy VR4	6n	Tor
H7A	XC6220B40BPR	LVR-IC	LDO, 4.05V±1%, 1A, +CE, CL	SOT-89-5	32vy VR4	6n	Tor
H7B	XC6220B41BPR	LVR-IC	LDO, 4.15V±1%, 1A, +CE, CL	SOT-89-5	32vy VR4	6n	Tor
H7C	XC6220B42BPR	LVR-IC	LDO, 4.25V±1%, 1A, +CE, CL	SOT-89-5	32vy VR4	6n	Tor
H7D	XC6220B43BPR	LVR-IC	LDO, 4.35V±1%, 1A, +CE, CL	SOT-89-5	32vy VR4	6n	Tor
H7E	XC6220B44BPR	LVR-IC	LDO, 4.45V±1%, 1A, +CE, CL	SOT-89-5	32vy VR4	6n	Tor
H7F	XC6220B45BPR	LVR-IC	LDO, 4.55V±1%, 1A, +CE, CL	SOT-89-5	32vy VR4	6n	Tor
H7H	XC6220B46BPR	LVR-IC	LDO, 4.65V±1%, 1A, +CE, CL	SOT-89-5	32vy VR4	6n	Tor
H7K	XC6220B47BPR	LVR-IC	LDO, 4.75V±1%, 1A, +CE, CL	SOT-89-5	32vy VR4	6n	Tor
H7L	XC6220B48BPR	LVR-IC	LDO, 4.85V±1%, 1A, +CE, CL	SOT-89-5	32vy VR4	6n	Tor
H7M	XC6220B49BPR	LVR-IC	LDO, 4.95V±1%, 1A, +CE, CL	SOT-89-5	32vy VR4	6n	Tor
H88	XC6220C081PR	LVR-IC	LDO, 0.8V±20mV, 1A, +CE, PDR	SOT-89-5	32vy VR4	6n	Tor
H89	XC6220C091PR	LVR-IC	LDO, 0.9V±20mV, 1A, +CE, PDR	SOT-89-5	32vy VR4	6n	Tor
H8A	XC6220C101PR	LVR-IC	LDO, 1.0V±20mV, 1A, +CE, PDR	SOT-89-5	32vy VR4	6n	Tor
H8B	XC6220C111PR	LVR-IC	LDO, 1.1V±20mV, 1A, +CE, PDR	SOT-89-5	32vy VR4	6n	Tor
H8C	XC6220C121PR	LVR-IC	LDO, 1.2V±20mV, 1A, +CE, PDR	SOT-89-5	32vy VR4	6n	Tor
H8D	XC6220C131PR	LVR-IC	LDO, 1.3V±20mV, 1A, +CE, PDR	SOT-89-5	32vy VR4	6n	Tor
H8E	XC6220C141PR	LVR-IC	LDO, 1.4V±20mV, 1A, +CE, PDR	SOT-89-5	32vy VR4	6n	Tor
H8F	XC6220C151PR	LVR-IC	LDO, 1.5V±20mV, 1A, +CE, PDR	SOT-89-5	32vy VR4	6n	Tor
H8H	XC6220C161PR	LVR-IC	LDO, 1.6V±20mV, 1A, +CE, PDR	SOT-89-5	32vy VR4	6n	Tor
H8K	XC6220C171PR	LVR-IC	LDO, 1.7V±20mV, 1A, +CE, PDR	SOT-89-5	32vy VR4	6n	Tor
H8L	XC6220C181PR	LVR-IC	LDO, 1.8V±20mV, 1A, +CE, PDR	SOT-89-5	32vy VR4	6n	Tor
H8M	XC6220C191PR	LVR-IC	LDO, 1.9V±20mV, 1A, +CE, PDR	SOT-89-5	32vy VR4	6n	Tor
H8N	XC6220C201PR	LVR-IC	LDO, 2.0V±1%, 1A, +CE, PDR	SOT-89-5	32vy VR4	6n	Tor
H8P	XC6220C211PR	LVR-IC	LDO, 2.1V±1%, 1A, +CE, PDR	SOT-89-5	32vy VR4	6n	Tor
H8R	XC6220C221PR	LVR-IC	LDO, 2.2V±1%, 1A, +CE, PDR	SOT-89-5	32vy VR4	6n	Tor
H8S	XC6220C231PR	LVR-IC	LDO, 2.3V±1%, 1A, +CE, PDR	SOT-89-5	32vy VR4	6n	Tor
H8T	XC6220C241PR	LVR-IC	LDO, 2.4V±1%, 1A, +CE, PDR	SOT-89-5	32vy VR4	6n	Tor
H8U	XC6220C251PR	LVR-IC	LDO, 2.5V±1%, 1A, +CE, PDR	SOT-89-5	32vy VR4	6n	Tor
H8V	XC6220C261PR	LVR-IC	LDO, 2.6V±1%, 1A, +CE, PDR	SOT-89-5	32vy VR4	6n	Tor
H8X	XC6220C271PR	LVR-IC	LDO, 2.7V±1%, 1A, +CE, PDR	SOT-89-5	32vy VR4	6n	Tor
H8Y	XC6220C281PR	LVR-IC	LDO, 2.8V±1%, 1A, +CE, PDR	SOT-89-5	32vy VR4	6n	Tor
H8Z	XC6220C291PR	LVR-IC	LDO, 2.9V±1%, 1A, +CE, PDR	SOT-89-5	32vy VR4	6n	Tor
H98	XC6220C08BPR	LVR-IC	LDO, 0.85V±20mV, 1A, +CE, PDR	SOT-89-5	32vy VR4	6n	Tor
H99	XC6220C09BPR	LVR-IC	LDO, 0.95V±20mV, 1A, +CE, PDR	SOT-89-5	32vy VR4	6n	Tor
H9A	XC6220C10BPR	LVR-IC	LDO, 1.05V±20mV, 1A, +CE, PDR	SOT-89-5	32vy VR4	6n	Tor
H9B	XC6220C11BPR	LVR-IC	LDO, 1.15V±20mV, 1A, +CE, PDR	SOT-89-5	32vy VR4	6n	Tor
H9C	XC6220C12BPR	LVR-IC	LDO, 1.25V±20mV, 1A, +CE, PDR	SOT-89-5	32vy VR4	6n	Tor
H9D	XC6220C13BPR	LVR-IC	LDO, 1.35V±20mV, 1A, +CE, PDR	SOT-89-5	32vy VR4	6n	Tor
H9E	XC6220C14BPR	LVR-IC	LDO, 1.45V±20mV, 1A, +CE, PDR	SOT-89-5	32vy VR4	6n	Tor
H9F	XC6220C15BPR	LVR-IC	LDO, 1.55V±20mV, 1A, +CE, PDR	SOT-89-5	32vy VR4	6n	Tor
H9H	XC6220C16BPR	LVR-IC	LDO, 1.65V±20mV, 1A, +CE, PDR	SOT-89-5	32vy VR4	6n	Tor
H9K	XC6220C17BPR	LVR-IC	LDO, 1.75V±20mV, 1A, +CE, PDR	SOT-89-5	32vy VR4	6n	Tor
H9L	XC6220C18BPR	LVR-IC	LDO, 1.85V±20mV, 1A, +CE, PDR	SOT-89-5	32vy VR4	6n	Tor
H9M	XC6220C19BPR	LVR-IC	LDO, 1.95V±20mV, 1A, +CE, PDR	SOT-89-5	32vy VR4	6n	Tor
H9N	XC6220C20BPR	LVR-IC	LDO, 2.05V±1%, 1A, +CE, PDR	SOT-89-5	32vy VR4	6n	Tor



SMD code	Type	Function	Short description	Case	Pinout Sch.	St.	Mnf.
H9P	XC6220C21BPR	LVR-IC	LDO, 2.15V±1%, 1A, +CE, PDR	SOT-89-5	32vy VR4	6n	Tor
H9R	XC6220C22BPR	LVR-IC	LDO, 2.25V±1%, 1A, +CE, PDR	SOT-89-5	32vy VR4	6n	Tor
H9S	XC6220C23BPR	LVR-IC	LDO, 2.35V±1%, 1A, +CE, PDR	SOT-89-5	32vy VR4	6n	Tor
H9T	XC6220C24BPR	LVR-IC	LDO, 2.45V±1%, 1A, +CE, PDR	SOT-89-5	32vy VR4	6n	Tor
H9U	XC6220C25BPR	LVR-IC	LDO, 2.55V±1%, 1A, +CE, PDR	SOT-89-5	32vy VR4	6n	Tor
H9V	XC6220C26BPR	LVR-IC	LDO, 2.65V±1%, 1A, +CE, PDR	SOT-89-5	32vy VR4	6n	Tor
H9X	XC6220C27BPR	LVR-IC	LDO, 2.75V±1%, 1A, +CE, PDR	SOT-89-5	32vy VR4	6n	Tor
H9Y	XC6220C28BPR	LVR-IC	LDO, 2.85V±1%, 1A, +CE, PDR	SOT-89-5	32vy VR4	6n	Tor
H9Z	XC6220C29BPR	LVR-IC	LDO, 2.95V±1%, 1A, +CE, PDR	SOT-89-5	32vy VR4	6n	Tor
HA	ELM99402B	LVR-IC	LDO, 4.0V±2%, 300mA, -CE	SOT-89-5	32vrt VR1	6n	Elm
HA0	XC6220C301PR	LVR-IC	LDO, 3V±1%, 1A, +CE, PDR	SOT-89-5	32vy VR4	6n	Tor
HA1	XC6220C311PR	LVR-IC	LDO, 3.1V±1%, 1A, +CE, PDR	SOT-89-5	32vy VR4	6n	Tor
HA2	XC6220C321PR	LVR-IC	LDO, 3.2V±1%, 1A, +CE, PDR	SOT-89-5	32vy VR4	6n	Tor
HA3	XC6220C331PR	LVR-IC	LDO, 3.3V±1%, 1A, +CE, PDR	SOT-89-5	32vy VR4	6n	Tor
HA4	XC6220C341PR	LVR-IC	LDO, 3.4V±1%, 1A, +CE, PDR	SOT-89-5	32vy VR4	6n	Tor
HA5	XC6220C351PR	LVR-IC	LDO, 3.5V±1%, 1A, +CE, PDR	SOT-89-5	32vy VR4	6n	Tor
HA6	XC6220C361PR	LVR-IC	LDO, 3.6V±1%, 1A, +CE, PDR	SOT-89-5	32vy VR4	6n	Tor
HA7	XC6220C371PR	LVR-IC	LDO, 3.7V±1%, 1A, +CE, PDR	SOT-89-5	32vy VR4	6n	Tor
HA8	XC6220C381PR	LVR-IC	LDO, 3.8V±1%, 1A, +CE, PDR	SOT-89-5	32vy VR4	6n	Tor
HA9	XC6220C391PR	LVR-IC	LDO, 3.9V±1%, 1A, +CE, PDR	SOT-89-5	32vy VR4	6n	Tor
HAA	XC6220C401PR	LVR-IC	LDO, 4V±1%, 1A, +CE, PDR	SOT-89-5	32vy VR4	6n	Tor
HAB	XC6220C411PR	LVR-IC	LDO, 4.1V±1%, 1A, +CE, PDR	SOT-89-5	32vy VR4	6n	Tor
HAC	XC6220C421PR	LVR-IC	LDO, 4.2V±1%, 1A, +CE, PDR	SOT-89-5	32vy VR4	6n	Tor
HAD	XC6220C431PR	LVR-IC	LDO, 4.3V±1%, 1A, +CE, PDR	SOT-89-5	32vy VR4	6n	Tor
HAE	XC6220C441PR	LVR-IC	LDO, 4.4V±1%, 1A, +CE, PDR	SOT-89-5	32vy VR4	6n	Tor
HAF	XC6220C451PR	LVR-IC	LDO, 4.5V±1%, 1A, +CE, PDR	SOT-89-5	32vy VR4	6n	Tor
HAH	XC6220C461PR	LVR-IC	LDO, 4.6V±1%, 1A, +CE, PDR	SOT-89-5	32vy VR4	6n	Tor
HAK	XC6220C471PR	LVR-IC	LDO, 4.7V±1%, 1A, +CE, PDR	SOT-89-5	32vy VR4	6n	Tor
HAL	XC6220C481PR	LVR-IC	LDO, 4.8V±1%, 1A, +CE, PDR	SOT-89-5	32vy VR4	6n	Tor
HAM	XC6220C491PR	LVR-IC	LDO, 4.9V±1%, 1A, +CE, PDR	SOT-89-5	32vy VR4	6n	Tor
HAN	XC6220C501PR	LVR-IC	LDO, 5V±1%, 1A, +CE, PDR	SOT-89-5	32vy VR4	6n	Tor
HB	ELM99412B	LVR-IC	LDO, 4.1V±2%, 300mA, -CE	SOT-89-5	32vrt VR1	6n	Elm
HB0	XC6220C30BPR	LVR-IC	LDO, 3.05V±1%, 1A, +CE, PDR	SOT-89-5	32vy VR4	6n	Tor
HB1	XC6220C31BPR	LVR-IC	LDO, 3.15V±1%, 1A, +CE, PDR	SOT-89-5	32vy VR4	6n	Tor
HB2	XC6220C32BPR	LVR-IC	LDO, 3.25V±1%, 1A, +CE, PDR	SOT-89-5	32vy VR4	6n	Tor
HB3	XC6220C33BPR	LVR-IC	LDO, 3.35V±1%, 1A, +CE, PDR	SOT-89-5	32vy VR4	6n	Tor
HB4	XC6220C34BPR	LVR-IC	LDO, 3.45V±1%, 1A, +CE, PDR	SOT-89-5	32vy VR4	6n	Tor
HB5	XC6220C35BPR	LVR-IC	LDO, 3.55V±1%, 1A, +CE, PDR	SOT-89-5	32vy VR4	6n	Tor
HB6	XC6220C36BPR	LVR-IC	LDO, 3.65V±1%, 1A, +CE, PDR	SOT-89-5	32vy VR4	6n	Tor
HB7	XC6220C37BPR	LVR-IC	LDO, 3.75V±1%, 1A, +CE, PDR	SOT-89-5	32vy VR4	6n	Tor
HB8	XC6220C38BPR	LVR-IC	LDO, 3.85V±1%, 1A, +CE, PDR	SOT-89-5	32vy VR4	6n	Tor
HB9	XC6220C39BPR	LVR-IC	LDO, 3.95V±1%, 1A, +CE, PDR	SOT-89-5	32vy VR4	6n	Tor
HBA	XC6220C40BPR	LVR-IC	LDO, 4.05V±1%, 1A, +CE, PDR	SOT-89-5	32vy VR4	6n	Tor
HBB	XC6220C41BPR	LVR-IC	LDO, 4.15V±1%, 1A, +CE, PDR	SOT-89-5	32vy VR4	6n	Tor
HBC	XC6220C42BPR	LVR-IC	LDO, 4.25V±1%, 1A, +CE, PDR	SOT-89-5	32vy VR4	6n	Tor
HBD	XC6220C43BPR	LVR-IC	LDO, 4.35V±1%, 1A, +CE, PDR	SOT-89-5	32vy VR4	6n	Tor
HBE	XC6220C44BPR	LVR-IC	LDO, 4.45V±1%, 1A, +CE, PDR	SOT-89-5	32vy VR4	6n	Tor
HBF	XC6220C45BPR	LVR-IC	LDO, 4.55V±1%, 1A, +CE, PDR	SOT-89-5	32vy VR4	6n	Tor
HBH	XC6220C46BPR	LVR-IC	LDO, 4.65V±1%, 1A, +CE, PDR	SOT-89-5	32vy VR4	6n	Tor
HBK	XC6220C47BPR	LVR-IC	LDO, 4.75V±1%, 1A, +CE, PDR	SOT-89-5	32vy VR4	6n	Tor
HBL	XC6220C48BPR	LVR-IC	LDO, 4.85V±1%, 1A, +CE, PDR	SOT-89-5	32vy VR4	6n	Tor
HBM	XC6220C49BPR	LVR-IC	LDO, 4.95V±1%, 1A, +CE, PDR	SOT-89-5	32vy VR4	6n	Tor
HC	ELM99422B	LVR-IC	LDO, 4.2V±2%, 300mA, -CE	SOT-89-5	32vrt VR1	6n	Elm
HC8	XC6220D081PR	LVR-IC	LDO, 0.8V±20mV, 1A, +CE, CL, PDR	SOT-89-5	32vy VR4	6n	Tor
HC9	XC6220D091PR	LVR-IC	LDO, 0.9V±20mV, 1A, +CE, CL, PDR	SOT-89-5	32vy VR4	6n	Tor
HCA	XC6220D101PR	LVR-IC	LDO, 1V±20mV, 1A, +CE, CL, PDR	SOT-89-5	32vy VR4	6n	Tor
HCB	XC6220D111PR	LVR-IC	LDO, 1.1V±20mV, 1A, +CE, CL, PDR	SOT-89-5	32vy VR4	6n	Tor
HCC	XC6220D121PR	LVR-IC	LDO, 1.2V±20mV, 1A, +CE, CL, PDR	SOT-89-5	32vy VR4	6n	Tor
HCD	XC6220D131PR	LVR-IC	LDO, 1.3V±20mV, 1A, +CE, CL, PDR	SOT-89-5	32vy VR4	6n	Tor
HCE	XC6220D141PR	LVR-IC	LDO, 1.4V±20mV, 1A, +CE, CL, PDR	SOT-89-5	32vy VR4	6n	Tor
HCF	XC6220D151PR	LVR-IC	LDO, 1.5V±20mV, 1A, +CE, CL, PDR	SOT-89-5	32vy VR4	6n	Tor
HCH	XC6220D161PR	LVR-IC	LDO, 1.6V±20mV, 1A, +CE, CL, PDR	SOT-89-5	32vy VR4	6n	Tor
HCK	XC6220D171PR	LVR-IC	LDO, 1.7V±20mV, 1A, +CE, CL, PDR	SOT-89-5	32vy VR4	6n	Tor
HCL	XC6220D181PR	LVR-IC	LDO, 1.8V±20mV, 1A, +CE, CL, PDR	SOT-89-5	32vy VR4	6n	Tor
HCM	XC6220D191PR	LVR-IC	LDO, 1.9V±20mV, 1A, +CE, CL, PDR	SOT-89-5	32vy VR4	6n	Tor
HCN	XC6220D201PR	LVR-IC	LDO, 2V±1%, 1A, +CE, CL, PDR	SOT-89-5	32vy VR4	6n	Tor
HCP	XC6220D211PR	LVR-IC	LDO, 2.1V±1%, 1A, +CE, CL, PDR	SOT-89-5	32vy VR4	6n	Tor
HCR	XC6220D221PR	LVR-IC	LDO, 2.2V±1%, 1A, +CE, CL, PDR	SOT-89-5	32vy VR4	6n	Tor
HCS	XC6220D231PR	LVR-IC	LDO, 2.3V±1%, 1A, +CE, CL, PDR	SOT-89-5	32vy VR4	6n	Tor
HCT	XC6220D241PR	LVR-IC	LDO, 2.4V±1%, 1A, +CE, CL, PDR	SOT-89-5	32vy VR4	6n	Tor



SMD code	Type	Function	Short description	Case	Pinout Sch.	St.	Mnf.
HCU	XC6220D251PR	LVR-IC	LDO, 2.5V±1%, 1A, +CE, CL, PDR	SOT-89-5	32vy VR4	6n	Tor
HCV	XC6220D261PR	LVR-IC	LDO, 2.6V±1%, 1A, +CE, CL, PDR	SOT-89-5	32vy VR4	6n	Tor
HCX	XC6220D271PR	LVR-IC	LDO, 2.7V±1%, 1A, +CE, CL, PDR	SOT-89-5	32vy VR4	6n	Tor
HCY	XC6220D281PR	LVR-IC	LDO, 2.8V±1%, 1A, +CE, CL, PDR	SOT-89-5	32vy VR4	6n	Tor
HCZ	XC6220D291PR	LVR-IC	LDO, 2.9V±1%, 1A, +CE, CL, PDR	SOT-89-5	32vy VR4	6n	Tor
HD	ELM99432B	LVR-IC	LDO, 4.3V±2%, 300mA, -CE	SOT-89-5	32vrt VR1	6n	Elm
HD8	XC6220D08BPR	LVR-IC	LDO, 0.85V±20mV, 1A, +CE, CL, PDR	SOT-89-5	32vy VR4	6n	Tor
HD9	XC6220D09BPR	LVR-IC	LDO, 0.95V±20mV, 1A, +CE, CL, PDR	SOT-89-5	32vy VR4	6n	Tor
HDA	XC6220D10BPR	LVR-IC	LDO, 1.05V±20mV, 1A, +CE, CL, PDR	SOT-89-5	32vy VR4	6n	Tor
HDB	XC6220D11BPR	LVR-IC	LDO, 1.15V±20mV, 1A, +CE, CL, PDR	SOT-89-5	32vy VR4	6n	Tor
HDC	XC6220D12BPR	LVR-IC	LDO, 1.25V±20mV, 1A, +CE, CL, PDR	SOT-89-5	32vy VR4	6n	Tor
HDD	XC6220D13BPR	LVR-IC	LDO, 1.35V±20mV, 1A, +CE, CL, PDR	SOT-89-5	32vy VR4	6n	Tor
HDE	XC6220D14BPR	LVR-IC	LDO, 1.45V±20mV, 1A, +CE, CL, PDR	SOT-89-5	32vy VR4	6n	Tor
HDF	XC6220D15BPR	LVR-IC	LDO, 1.55V±20mV, 1A, +CE, CL, PDR	SOT-89-5	32vy VR4	6n	Tor
HDH	XC6220D16BPR	LVR-IC	LDO, 1.65V±20mV, 1A, +CE, CL, PDR	SOT-89-5	32vy VR4	6n	Tor
HDK	XC6220D17BPR	LVR-IC	LDO, 1.75V±20mV, 1A, +CE, CL, PDR	SOT-89-5	32vy VR4	6n	Tor
HDL	XC6220D18BPR	LVR-IC	LDO, 1.85V±20mV, 1A, +CE, CL, PDR	SOT-89-5	32vy VR4	6n	Tor
HDM	XC6220D19BPR	LVR-IC	LDO, 1.95V±20mV, 1A, +CE, CL, PDR	SOT-89-5	32vy VR4	6n	Tor
HDN	XC6220D20BPR	LVR-IC	LDO, 2.05V±1%, 1A, +CE, CL, PDR	SOT-89-5	32vy VR4	6n	Tor
HDP	XC6220D21BPR	LVR-IC	LDO, 2.15V±1%, 1A, +CE, CL, PDR	SOT-89-5	32vy VR4	6n	Tor
HDR	XC6220D22BPR	LVR-IC	LDO, 2.25V±1%, 1A, +CE, CL, PDR	SOT-89-5	32vy VR4	6n	Tor
HDS	XC6220D23BPR	LVR-IC	LDO, 2.35V±1%, 1A, +CE, CL, PDR	SOT-89-5	32vy VR4	6n	Tor
HDT	XC6220D24BPR	LVR-IC	LDO, 2.45V±1%, 1A, +CE, CL, PDR	SOT-89-5	32vy VR4	6n	Tor
HDU	XC6220D25BPR	LVR-IC	LDO, 2.55V±1%, 1A, +CE, CL, PDR	SOT-89-5	32vy VR4	6n	Tor
HDV	XC6220D26BPR	LVR-IC	LDO, 2.65V±1%, 1A, +CE, CL, PDR	SOT-89-5	32vy VR4	6n	Tor
HDX	XC6220D27BPR	LVR-IC	LDO, 2.75V±1%, 1A, +CE, CL, PDR	SOT-89-5	32vy VR4	6n	Tor
HDY	XC6220D28BPR	LVR-IC	LDO, 2.85V±1%, 1A, +CE, CL, PDR	SOT-89-5	32vy VR4	6n	Tor
HDZ	XC6220D29BPR	LVR-IC	LDO, 2.95V±1%, 1A, +CE, CL, PDR	SOT-89-5	32vy VR4	6n	Tor
HE	ELM99442B	LVR-IC	LDO, 4.4V±2%, 300mA, -CE	SOT-89-5	32vrt VR1	6n	Elm
HE0	XC6220D301PR	LVR-IC	LDO, 3V±1%, 1A, +CE, CL, PDR	SOT-89-5	32vy VR4	6n	Tor
HE1	XC6220D311PR	LVR-IC	LDO, 3.1V±1%, 1A, +CE, CL, PDR	SOT-89-5	32vy VR4	6n	Tor
HE2	XC6220D321PR	LVR-IC	LDO, 3.2V±1%, 1A, +CE, CL, PDR	SOT-89-5	32vy VR4	6n	Tor
HE3	XC6220D331PR	LVR-IC	LDO, 3.3V±1%, 1A, +CE, CL, PDR	SOT-89-5	32vy VR4	6n	Tor
HE4	XC6220D341PR	LVR-IC	LDO, 3.4V±1%, 1A, +CE, CL, PDR	SOT-89-5	32vy VR4	6n	Tor
HE5	XC6220D351PR	LVR-IC	LDO, 3.5V±1%, 1A, +CE, CL, PDR	SOT-89-5	32vy VR4	6n	Tor
HE6	XC6220D361PR	LVR-IC	LDO, 3.6V±1%, 1A, +CE, CL, PDR	SOT-89-5	32vy VR4	6n	Tor
HE7	XC6220D371PR	LVR-IC	LDO, 3.7V±1%, 1A, +CE, CL, PDR	SOT-89-5	32vy VR4	6n	Tor
HE8	XC6220D381PR	LVR-IC	LDO, 3.8V±1%, 1A, +CE, CL, PDR	SOT-89-5	32vy VR4	6n	Tor
HE9	XC6220D391PR	LVR-IC	LDO, 3.9V±1%, 1A, +CE, CL, PDR	SOT-89-5	32vy VR4	6n	Tor
HEA	XC6220D401PR	LVR-IC	LDO, 4V±1%, 1A, +CE, CL, PDR	SOT-89-5	32vy VR4	6n	Tor
HEB	XC6220D411PR	LVR-IC	LDO, 4.1V±1%, 1A, +CE, CL, PDR	SOT-89-5	32vy VR4	6n	Tor
HEC	XC6220D421PR	LVR-IC	LDO, 4.2V±1%, 1A, +CE, CL, PDR	SOT-89-5	32vy VR4	6n	Tor
HED	XC6220D431PR	LVR-IC	LDO, 4.3V±1%, 1A, +CE, CL, PDR	SOT-89-5	32vy VR4	6n	Tor
HEE	XC6220D441PR	LVR-IC	LDO, 4.4V±1%, 1A, +CE, CL, PDR	SOT-89-5	32vy VR4	6n	Tor
HEF	XC6220D451PR	LVR-IC	LDO, 4.5V±1%, 1A, +CE, CL, PDR	SOT-89-5	32vy VR4	6n	Tor
HEH	XC6220D461PR	LVR-IC	LDO, 4.6V±1%, 1A, +CE, CL, PDR	SOT-89-5	32vy VR4	6n	Tor
HEK	XC6220D471PR	LVR-IC	LDO, 4.7V±1%, 1A, +CE, CL, PDR	SOT-89-5	32vy VR4	6n	Tor
HEL	XC6220D481PR	LVR-IC	LDO, 4.8V±1%, 1A, +CE, CL, PDR	SOT-89-5	32vy VR4	6n	Tor
HEM	XC6220D491PR	LVR-IC	LDO, 4.9V±1%, 1A, +CE, CL, PDR	SOT-89-5	32vy VR4	6n	Tor
HEN	XC6220D501PR	LVR-IC	LDO, 5V±1%, 1A, +CE, CL, PDR	SOT-89-5	32vy VR4	6n	Tor
HF	ELM99452B	LVR-IC	LDO, 4.5V±2%, 300mA, -CE	SOT-89-5	32vrt VR1	6n	Elm
HF0	XC6220D30BPR	LVR-IC	LDO, 3.05V±1%, 1A, +CE, CL, PDR	SOT-89-5	32vy VR4	6n	Tor
HF1	XC6220D31BPR	LVR-IC	LDO, 3.15V±1%, 1A, +CE, CL, PDR	SOT-89-5	32vy VR4	6n	Tor
HF2	XC6220D32BPR	LVR-IC	LDO, 3.25V±1%, 1A, +CE, CL, PDR	SOT-89-5	32vy VR4	6n	Tor
HF3	XC6220D33BPR	LVR-IC	LDO, 3.35V±1%, 1A, +CE, CL, PDR	SOT-89-5	32vy VR4	6n	Tor
HF4	XC6220D34BPR	LVR-IC	LDO, 3.45V±1%, 1A, +CE, CL, PDR	SOT-89-5	32vy VR4	6n	Tor
HF5	XC6220D35BPR	LVR-IC	LDO, 3.55V±1%, 1A, +CE, CL, PDR	SOT-89-5	32vy VR4	6n	Tor
HF6	XC6220D36BPR	LVR-IC	LDO, 3.65V±1%, 1A, +CE, CL, PDR	SOT-89-5	32vy VR4	6n	Tor
HF7	XC6220D37BPR	LVR-IC	LDO, 3.75V±1%, 1A, +CE, CL, PDR	SOT-89-5	32vy VR4	6n	Tor
HF8	XC6220D38BPR	LVR-IC	LDO, 3.85V±1%, 1A, +CE, CL, PDR	SOT-89-5	32vy VR4	6n	Tor
HF9	XC6220D39BPR	LVR-IC	LDO, 3.95V±1%, 1A, +CE, CL, PDR	SOT-89-5	32vy VR4	6n	Tor
HFA	XC6220D40BPR	LVR-IC	LDO, 4.05V±1%, 1A, +CE, CL, PDR	SOT-89-5	32vy VR4	6n	Tor
HFB	XC6220D41BPR	LVR-IC	LDO, 4.15V±1%, 1A, +CE, CL, PDR	SOT-89-5	32vy VR4	6n	Tor
HFC	XC6220D42BPR	LVR-IC	LDO, 4.25V±1%, 1A, +CE, CL, PDR	SOT-89-5	32vy VR4	6n	Tor
HFD	XC6220D43BPR	LVR-IC	LDO, 4.35V±1%, 1A, +CE, CL, PDR	SOT-89-5	32vy VR4	6n	Tor
HFE	XC6220D44BPR	LVR-IC	LDO, 4.45V±1%, 1A, +CE, CL, PDR	SOT-89-5	32vy VR4	6n	Tor
HFF	XC6220D45BPR	LVR-IC	LDO, 4.55V±1%, 1A, +CE, CL, PDR	SOT-89-5	32vy VR4	6n	Tor
HFH	XC6220D46BPR	LVR-IC	LDO, 4.65V±1%, 1A, +CE, CL, PDR	SOT-89-5	32vy VR4	6n	Tor
HFK	XC6220D47BPR	LVR-IC	LDO, 4.75V±1%, 1A, +CE, CL, PDR	SOT-89-5	32vy VR4	6n	Tor
HFL	XC6220D48BPR	LVR-IC	LDO, 4.85V±1%, 1A, +CE, CL, PDR	SOT-89-5	32vy VR4	6n	Tor



SMD code	Type	Function	Short description	Case	Pinout	Sch.	St.	Mnf.
HFM	XC6220D49BPR	LVR-IC	LDO, 4.95V±1%, 1A, +CE, CL, PDR	SOT-89-5	32vy	VR4	6n	Tor
HG	ELM99462B	LVR-IC	LDO, 4.6V±2%, 300mA, -CE	SOT-89-5	32vrt	VR1	6n	Elm
HH	ELM99472B	LVR-IC	LDO, 4.7V±2%, 300mA, -CE	SOT-89-5	32vrt	VR1	6n	Elm
HJ	ELM99482B	LVR-IC	LDO, 4.8V±2%, 300mA, -CE	SOT-89-5	32vrt	VR1	6n	Elm
HK	ELM99492B	LVR-IC	LDO, 4.9V±2%, 300mA, -CE	SOT-89-5	32vrt	VR1	6n	Elm
J01A	R1172H181A5	LVR-IC	LDO, 1.85V±2%, 1A, -CE	SOT-89-5	32vy	VR4	6h	Ric
J01B	R1172H181B5	LVR-IC	LDO, 1.85V±2%, 1A, +CE	SOT-89-5	32vy	VR4	6h	Ric
J01D	R1172H181D5	LVR-IC	LDO, 1.85V±2%, 1A, +CE, CL	SOT-89-5	32vy	VR4	6h	Ric
J02A	R1172H281A5	LVR-IC	LDO, 2.85V±2%, 1A, -CE	SOT-89-5	32vy	VR4	6h	Ric
J02B	R1172H281B5	LVR-IC	LDO, 2.85V±2%, 1A, +CE	SOT-89-5	32vy	VR4	6h	Ric
J02D	R1172H281D5	LVR-IC	LDO, 2.85V±2%, 1A, +CE, CL	SOT-89-5	32vy	VR4	6h	Ric
J08A	R1172H081A	LVR-IC	LDO, 0.8V±2%, 1A, -CE	SOT-89-5	32vy	VR4	6h	Ric
J08B	R1172H081B	LVR-IC	LDO, 0.8V±2%, 1A, +CE	SOT-89-5	32vy	VR4	6h	Ric
J08D	R1172H081D	LVR-IC	LDO, 0.8V±2%, 1A, +CE, CL	SOT-89-5	32vy	VR4	6h	Ric
J09A	R1172H091A	LVR-IC	LDO, 0.9V±2%, 1A, -CE	SOT-89-5	32vy	VR4	6h	Ric
J09B	R1172H091B	LVR-IC	LDO, 0.9V±2%, 1A, +CE	SOT-89-5	32vy	VR4	6h	Ric
J09D	R1172H091D	LVR-IC	LDO, 0.9V±2%, 1A, +CE, CL	SOT-89-5	32vy	VR4	6h	Ric
J10A	R1172H101A	LVR-IC	LDO, 1V±2%, 1A, -CE	SOT-89-5	32vy	VR4	6h	Ric
J10B	R1172H101B	LVR-IC	LDO, 1V±2%, 1A, +CE	SOT-89-5	32vy	VR4	6h	Ric
J10D	R1172H101D	LVR-IC	LDO, 1V±2%, 1A, +CE, CL	SOT-89-5	32vy	VR4	6h	Ric
J11A	R1172H111A	LVR-IC	LDO, 1.1V±2%, 1A, -CE	SOT-89-5	32vy	VR4	6h	Ric
J11B	R1172H111B	LVR-IC	LDO, 1.1V±2%, 1A, +CE	SOT-89-5	32vy	VR4	6h	Ric
J11D	R1172H111D	LVR-IC	LDO, 1.1V±2%, 1A, +CE, CL	SOT-89-5	32vy	VR4	6h	Ric
J12A	R1172H121A	LVR-IC	LDO, 1.2V±2%, 1A, -CE	SOT-89-5	32vy	VR4	6h	Ric
J12B	R1172H121B	LVR-IC	LDO, 1.2V±2%, 1A, +CE	SOT-89-5	32vy	VR4	6h	Ric
J12D	R1172H121D	LVR-IC	LDO, 1.2V±2%, 1A, +CE, CL	SOT-89-5	32vy	VR4	6h	Ric
J13A	R1172H131A	LVR-IC	LDO, 1.3V±2%, 1A, -CE	SOT-89-5	32vy	VR4	6h	Ric
J13B	R1172H131B	LVR-IC	LDO, 1.3V±2%, 1A, +CE	SOT-89-5	32vy	VR4	6h	Ric
J13D	R1172H131D	LVR-IC	LDO, 1.3V±2%, 1A, +CE, CL	SOT-89-5	32vy	VR4	6h	Ric
J14A	R1172H141A	LVR-IC	LDO, 1.4V±2%, 1A, -CE	SOT-89-5	32vy	VR4	6h	Ric
J14B	R1172H141B	LVR-IC	LDO, 1.4V±2%, 1A, +CE	SOT-89-5	32vy	VR4	6h	Ric
J14D	R1172H141D	LVR-IC	LDO, 1.4V±2%, 1A, +CE, CL	SOT-89-5	32vy	VR4	6h	Ric
J15A	R1172H151A	LVR-IC	LDO, 1.5V±2%, 1A, -CE	SOT-89-5	32vy	VR4	6h	Ric
J15B	R1172H151B	LVR-IC	LDO, 1.5V±2%, 1A, +CE	SOT-89-5	32vy	VR4	6h	Ric
J15D	R1172H151D	LVR-IC	LDO, 1.5V±2%, 1A, +CE, CL	SOT-89-5	32vy	VR4	6h	Ric
J16A	R1172H161A	LVR-IC	LDO, 1.6V±2%, 1A, -CE	SOT-89-5	32vy	VR4	6h	Ric
J16B	R1172H161B	LVR-IC	LDO, 1.6V±2%, 1A, +CE	SOT-89-5	32vy	VR4	6h	Ric
J16D	R1172H161D	LVR-IC	LDO, 1.6V±2%, 1A, +CE, CL	SOT-89-5	32vy	VR4	6h	Ric
J17A	R1172H171A	LVR-IC	LDO, 1.7V±2%, 1A, -CE	SOT-89-5	32vy	VR4	6h	Ric
J17B	R1172H171B	LVR-IC	LDO, 1.7V±2%, 1A, +CE	SOT-89-5	32vy	VR4	6h	Ric
J17D	R1172H171D	LVR-IC	LDO, 1.7V±2%, 1A, +CE, CL	SOT-89-5	32vy	VR4	6h	Ric
J18A	R1172H181A	LVR-IC	LDO, 1.8V±2%, 1A, -CE	SOT-89-5	32vy	VR4	6h	Ric
J18B	R1172H181B	LVR-IC	LDO, 1.8V±2%, 1A, +CE	SOT-89-5	32vy	VR4	6h	Ric
J18D	R1172H181D	LVR-IC	LDO, 1.8V±2%, 1A, +CE, CL	SOT-89-5	32vy	VR4	6h	Ric
J19A	R1172H191A	LVR-IC	LDO, 1.9V±2%, 1A, -CE	SOT-89-5	32vy	VR4	6h	Ric
J19B	R1172H191B	LVR-IC	LDO, 1.9V±2%, 1A, +CE	SOT-89-5	32vy	VR4	6h	Ric
J19D	R1172H191D	LVR-IC	LDO, 1.9V±2%, 1A, +CE, CL	SOT-89-5	32vy	VR4	6h	Ric
J20A	R1172H201A	LVR-IC	LDO, 2V±2%, 1A, -CE	SOT-89-5	32vy	VR4	6h	Ric
J20B	R1172H201B	LVR-IC	LDO, 2V±2%, 1A, +CE	SOT-89-5	32vy	VR4	6h	Ric
J20D	R1172H201D	LVR-IC	LDO, 2V±2%, 1A, +CE, CL	SOT-89-5	32vy	VR4	6h	Ric
J21A	R1172H211A	LVR-IC	LDO, 2.1V±2%, 1A, -CE	SOT-89-5	32vy	VR4	6h	Ric
J21B	R1172H211B	LVR-IC	LDO, 2.1V±2%, 1A, +CE	SOT-89-5	32vy	VR4	6h	Ric
J21D	R1172H211D	LVR-IC	LDO, 2.1V±2%, 1A, +CE, CL	SOT-89-5	32vy	VR4	6h	Ric
J22A	R1172H221A	LVR-IC	LDO, 2.2V±2%, 1A, -CE	SOT-89-5	32vy	VR4	6h	Ric
J22B	R1172H221B	LVR-IC	LDO, 2.2V±2%, 1A, +CE	SOT-89-5	32vy	VR4	6h	Ric
J22D	R1172H221D	LVR-IC	LDO, 2.2V±2%, 1A, +CE, CL	SOT-89-5	32vy	VR4	6h	Ric
J23A	R1172H231A	LVR-IC	LDO, 2.3V±2%, 1A, -CE	SOT-89-5	32vy	VR4	6h	Ric
J23B	R1172H231B	LVR-IC	LDO, 2.3V±2%, 1A, +CE	SOT-89-5	32vy	VR4	6h	Ric
J23D	R1172H231D	LVR-IC	LDO, 2.3V±2%, 1A, +CE, CL	SOT-89-5	32vy	VR4	6h	Ric
J24A	R1172H241A	LVR-IC	LDO, 2.4V±2%, 1A, -CE	SOT-89-5	32vy	VR4	6h	Ric
J24B	R1172H241B	LVR-IC	LDO, 2.4V±2%, 1A, +CE	SOT-89-5	32vy	VR4	6h	Ric
J24D	R1172H241D	LVR-IC	LDO, 2.4V±2%, 1A, +CE, CL	SOT-89-5	32vy	VR4	6h	Ric
J25A	R1172H251A	LVR-IC	LDO, 2.5V±2%, 1A, -CE	SOT-89-5	32vy	VR4	6h	Ric
J25B	R1172H251B	LVR-IC	LDO, 2.5V±2%, 1A, +CE	SOT-89-5	32vy	VR4	6h	Ric
J25D	R1172H251D	LVR-IC	LDO, 2.5V±2%, 1A, +CE, CL	SOT-89-5	32vy	VR4	6h	Ric
J26A	R1172H261A	LVR-IC	LDO, 2.6V±2%, 1A, -CE	SOT-89-5	32vy	VR4	6h	Ric
J26B	R1172H261B	LVR-IC	LDO, 2.6V±2%, 1A, +CE	SOT-89-5	32vy	VR4	6h	Ric
J26D	R1172H261D	LVR-IC	LDO, 2.6V±2%, 1A, +CE, CL	SOT-89-5	32vy	VR4	6h	Ric
J27A	R1172H271A	LVR-IC	LDO, 2.7V±2%, 1A, -CE	SOT-89-5	32vy	VR4	6h	Ric
J27B	R1172H271B	LVR-IC	LDO, 2.7V±2%, 1A, +CE	SOT-89-5	32vy	VR4	6h	Ric



SMD code	Type	Function	Short description	Case	Pinout Sch.	St.	Mnf.
J27D	R1172H271D	LVR-IC	LDO, 2.7V±2%, 1A, +CE, CL	SOT-89-5	32vy VR4	6h	Ric
J28A	R1172H281A	LVR-IC	LDO, 2.8V±2%, 1A, -CE	SOT-89-5	32vy VR4	6h	Ric
J28B	R1172H281B	LVR-IC	LDO, 2.8V±2%, 1A, +CE	SOT-89-5	32vy VR4	6h	Ric
J28D	R1172H281D	LVR-IC	LDO, 2.8V±2%, 1A, +CE, CL	SOT-89-5	32vy VR4	6h	Ric
J29A	R1172H291A	LVR-IC	LDO, 2.9V±2%, 1A, -CE	SOT-89-5	32vy VR4	6h	Ric
J29B	R1172H291B	LVR-IC	LDO, 2.9V±2%, 1A, +CE	SOT-89-5	32vy VR4	6h	Ric
J29D	R1172H291D	LVR-IC	LDO, 2.9V±2%, 1A, +CE, CL	SOT-89-5	32vy VR4	6h	Ric
J30A	R1172H301A	LVR-IC	LDO, 3V±2%, 1A, -CE	SOT-89-5	32vy VR4	6h	Ric
J30B	R1172H301B	LVR-IC	LDO, 3V±2%, 1A, +CE	SOT-89-5	32vy VR4	6h	Ric
J30D	R1172H301D	LVR-IC	LDO, 3V±2%, 1A, +CE, CL	SOT-89-5	32vy VR4	6h	Ric
J31A	R1172H311A	LVR-IC	LDO, 3.1V±2%, 1A, -CE	SOT-89-5	32vy VR4	6h	Ric
J31B	R1172H311B	LVR-IC	LDO, 3.1V±2%, 1A, +CE	SOT-89-5	32vy VR4	6h	Ric
J31D	R1172H311D	LVR-IC	LDO, 3.1V±2%, 1A, +CE, CL	SOT-89-5	32vy VR4	6h	Ric
J32A	R1172H321A	LVR-IC	LDO, 3.2V±2%, 1A, -CE	SOT-89-5	32vy VR4	6h	Ric
J32B	R1172H321B	LVR-IC	LDO, 3.2V±2%, 1A, +CE	SOT-89-5	32vy VR4	6h	Ric
J32D	R1172H321D	LVR-IC	LDO, 3.2V±2%, 1A, +CE, CL	SOT-89-5	32vy VR4	6h	Ric
J33A	R1172H331A	LVR-IC	LDO, 3.3V±2%, 1A, -CE	SOT-89-5	32vy VR4	6h	Ric
J33B	R1172H331B	LVR-IC	LDO, 3.3V±2%, 1A, +CE	SOT-89-5	32vy VR4	6h	Ric
J33D	R1172H331D	LVR-IC	LDO, 3.3V±2%, 1A, +CE, CL	SOT-89-5	32vy VR4	6h	Ric
J34A	R1172H341A	LVR-IC	LDO, 3.4V±2%, 1A, -CE, -CE	SOT-89-5	32vy VR4	6h	Ric
J34B	R1172H341B	LVR-IC	LDO, 3.4V±2%, 1A, +CE	SOT-89-5	32vy VR4	6h	Ric
J34D	R1172H341D	LVR-IC	LDO, 3.4V±2%, 1A, +CE, CL	SOT-89-5	32vy VR4	6h	Ric
J35A	R1172H351A	LVR-IC	LDO, 3.5V±2%, 1A, -CE	SOT-89-5	32vy VR4	6h	Ric
J35B	R1172H351B	LVR-IC	LDO, 3.5V±2%, 1A, +CE	SOT-89-5	32vy VR4	6h	Ric
J35D	R1172H351D	LVR-IC	LDO, 3.5V±2%, 1A, +CE, CL	SOT-89-5	32vy VR4	6h	Ric
J36A	R1172H361A	LVR-IC	LDO, 3.6V±2%, 1A, -CE	SOT-89-5	32vy VR4	6h	Ric
J36B	R1172H361B	LVR-IC	LDO, 3.6V±2%, 1A, +CE	SOT-89-5	32vy VR4	6h	Ric
J36D	R1172H361D	LVR-IC	LDO, 3.6V±2%, 1A, +CE, CL	SOT-89-5	32vy VR4	6h	Ric
J37A	R1172H371A	LVR-IC	LDO, 3.7V±2%, 1A, -CE	SOT-89-5	32vy VR4	6h	Ric
J37B	R1172H371B	LVR-IC	LDO, 3.7V±2%, 1A, +CE	SOT-89-5	32vy VR4	6h	Ric
J37D	R1172H371D	LVR-IC	LDO, 3.7V±2%, 1A, +CE, CL	SOT-89-5	32vy VR4	6h	Ric
J38A	R1172H381A	LVR-IC	LDO, 3.8V±2%, 1A, -CE	SOT-89-5	32vy VR4	6h	Ric
J38B	R1172H381B	LVR-IC	LDO, 3.8V±2%, 1A, +CE	SOT-89-5	32vy VR4	6h	Ric
J38D	R1172H381D	LVR-IC	LDO, 3.8V±2%, 1A, +CE, CL	SOT-89-5	32vy VR4	6h	Ric
J39A	R1172H391A	LVR-IC	LDO, 3.9V±2%, 1A, -CE	SOT-89-5	32vy VR4	6h	Ric
J39B	R1172H391B	LVR-IC	LDO, 3.9V±2%, 1A, +CE	SOT-89-5	32vy VR4	6h	Ric
J39D	R1172H391D	LVR-IC	LDO, 3.9V±2%, 1A, +CE, CL	SOT-89-5	32vy VR4	6h	Ric
J40A	R1172H401A	LVR-IC	LDO, 4V±2%, 1A, -CE	SOT-89-5	32vy VR4	6h	Ric
J40B	R1172H401B	LVR-IC	LDO, 4V±2%, 1A, +CE	SOT-89-5	32vy VR4	6h	Ric
J40D	R1172H401D	LVR-IC	LDO, 4V±2%, 1A, +CE, CL	SOT-89-5	32vy VR4	6h	Ric
J41A	R1172H411A	LVR-IC	LDO, 4.1V±2%, 1A, -CE	SOT-89-5	32vy VR4	6h	Ric
J41B	R1172H411B	LVR-IC	LDO, 4.1V±2%, 1A, +CE	SOT-89-5	32vy VR4	6h	Ric
J41D	R1172H411D	LVR-IC	LDO, 4.1V±2%, 1A, +CE, CL	SOT-89-5	32vy VR4	6h	Ric
J42A	R1172H421A	LVR-IC	LDO, 4.2V±2%, 1A, -CE	SOT-89-5	32vy VR4	6h	Ric
J42B	R1172H421B	LVR-IC	LDO, 4.2V±2%, 1A, +CE	SOT-89-5	32vy VR4	6h	Ric
J42D	R1172H421D	LVR-IC	LDO, 4.2V±2%, 1A, +CE, CL	SOT-89-5	32vy VR4	6h	Ric
J43A	R1172H431A	LVR-IC	LDO, 4.3V±2%, 1A, -CE	SOT-89-5	32vy VR4	6h	Ric
J43B	R1172H431B	LVR-IC	LDO, 4.3V±2%, 1A, +CE	SOT-89-5	32vy VR4	6h	Ric
J43D	R1172H431D	LVR-IC	LDO, 4.3V±2%, 1A, +CE, CL	SOT-89-5	32vy VR4	6h	Ric
J44A	R1172H441A	LVR-IC	LDO, 4.4V±2%, 1A, -CE	SOT-89-5	32vy VR4	6h	Ric
J44B	R1172H441B	LVR-IC	LDO, 4.4V±2%, 1A, +CE	SOT-89-5	32vy VR4	6h	Ric
J44D	R1172H441D	LVR-IC	LDO, 4.4V±2%, 1A, +CE, CL	SOT-89-5	32vy VR4	6h	Ric
J45A	R1172H451A	LVR-IC	LDO, 4.5V±2%, 1A, -CE	SOT-89-5	32vy VR4	6h	Ric
J45B	R1172H451B	LVR-IC	LDO, 4.5V±2%, 1A, +CE	SOT-89-5	32vy VR4	6h	Ric
J45D	R1172H451D	LVR-IC	LDO, 4.5V±2%, 1A, +CE, CL	SOT-89-5	32vy VR4	6h	Ric
J46A	R1172H461A	LVR-IC	LDO, 4.6V±2%, 1A, -CE	SOT-89-5	32vy VR4	6h	Ric
J46B	R1172H461B	LVR-IC	LDO, 4.6V±2%, 1A, +CE	SOT-89-5	32vy VR4	6h	Ric
J46D	R1172H461D	LVR-IC	LDO, 4.6V±2%, 1A, +CE, CL	SOT-89-5	32vy VR4	6h	Ric
J47A	R1172H471A	LVR-IC	LDO, 4.7V±2%, 1A, -CE	SOT-89-5	32vy VR4	6h	Ric
J47B	R1172H471B	LVR-IC	LDO, 4.7V±2%, 1A, +CE	SOT-89-5	32vy VR4	6h	Ric
J47D	R1172H471D	LVR-IC	LDO, 4.7V±2%, 1A, +CE, CL	SOT-89-5	32vy VR4	6h	Ric
J48A	R1172H481A	LVR-IC	LDO, 4.8V±2%, 1A, -CE	SOT-89-5	32vy VR4	6h	Ric
J48B	R1172H481B	LVR-IC	LDO, 4.8V±2%, 1A, +CE	SOT-89-5	32vy VR4	6h	Ric
J48D	R1172H481D	LVR-IC	LDO, 4.8V±2%, 1A, +CE, CL	SOT-89-5	32vy VR4	6h	Ric
J49A	R1172H491A	LVR-IC	LDO, 4.9V±2%, 1A, -CE	SOT-89-5	32vy VR4	6h	Ric
J49B	R1172H491B	LVR-IC	LDO, 4.9V±2%, 1A, +CE	SOT-89-5	32vy VR4	6h	Ric
J49D	R1172H491D	LVR-IC	LDO, 4.9V±2%, 1A, +CE, CL	SOT-89-5	32vy VR4	6h	Ric
J50A	R1172H501A	LVR-IC	LDO, 5V±2%, 1A, -CE	SOT-89-5	32vy VR4	6h	Ric
J50B	R1172H501B	LVR-IC	LDO, 5V±2%, 1A, +CE	SOT-89-5	32vy VR4	6h	Ric
J50D	R1172H501D	LVR-IC	LDO, 5V±2%, 1A, +CE, CL	SOT-89-5	32vy VR4	6h	Ric



SMD code	Type	Function	Short description	Case	Pinout	Sch.	St.	Mnf.
JA	ELM99502B	LVR-IC	LDO, 5.0V±2%, 300mA, -CE	SOT-89-5	32vrt	VR1	6n	Elm
JB	ELM99512B	LVR-IC	LDO, 5.1V±2%, 300mA, -CE	SOT-89-5	32vrt	VR1	6n	Elm
JC	ELM99522B	LVR-IC	LDO, 5.2V±2%, 300mA, -CE	SOT-89-5	32vrt	VR1	6n	Elm
JD	ELM99532B	LVR-IC	LDO, 5.3V±2%, 300mA, -CE	SOT-89-5	32vrt	VR1	6n	Elm
JE	ELM99542B	LVR-IC	LDO, 5.4V±2%, 300mA, -CE	SOT-89-5	32vrt	VR1	6n	Elm
JF	AP1119-15	LVR-IC	LDO, 1.5V±2%, 500mA, -CE	SOT-89-5	32sb	VR4	6j	Ana
JF	ELM99552B	LVR-IC	LDO, 5.5V±2%, 300mA, -CE	SOT-89-5	32vrt	VR1	6n	Elm
JG	AP1119-18	LVR-IC	LDO, 1.8V±2%, 500mA, -CE	SOT-89-5	32sb	VR4	6j	Ana
JG	ELM99562B	LVR-IC	LDO, 5.6V±2%, 300mA, -CE	SOT-89-5	32vrt	VR1	6n	Elm
JH	AP1119-25	LVR-IC	LDO, 2.5V±2%, 500mA, -CE	SOT-89-5	32sb	VR4	6j	Ana
JH	ELM99572B	LVR-IC	LDO, 5.7V±2%, 300mA, -CE	SOT-89-5	32vrt	VR1	6n	Elm
JJ	AP1119-33	LVR-IC	LDO, 3.3V±2%, 500mA, -CE	SOT-89-5	32sb	VR4	6j	Ana
JJ	AP1119-50	LVR-IC	LDO, 5V±2%, 500mA, -CE	SOT-89-5	32sb	VR4	6j	Ana
JJ	ELM99582B	LVR-IC	LDO, 5.8V±2%, 300mA, -CE	SOT-89-5	32vrt	VR1	6n	Elm
JK	AP1119-90	LVR-IC	LDO, 9V±2%, 500mA, -CE	SOT-89-5	32sb	VR4	6j	Ana
JK	ELM99592B	LVR-IC	LDO, 5.9V±2%, 300mA, -CE	SOT-89-5	32vrt	VR1	6n	Elm
JL	AP1119-12	LVR-IC	LDO, 12V±2%, 500mA, -CE	SOT-89-5	32sb	VR4	6j	Ana
KA	ELM99602B	LVR-IC	LDO, 6.0V±2%, 300mA, -CE	SOT-89-5	32vrt	VR1	6n	Elm
L00B	R1173H001B	LVR-IC	LDO, Adjustable, 1A, +CE	SOT-89-5	32vri	VR5	6h	Ric
L00D	R1173H001D	LVR-IC	LDO, Adjustable, 1A, +CE, CL	SOT-89-5	32vri	VR5	6h	Ric
L01B	R1173H181B5	LVR-IC	LDO, 1.85V±2%, 1A, +CE	SOT-89-5	32um	VR4	6h	Ric
L01D	R1173H181D5	LVR-IC	LDO, 1.85V±2%, 1A, +CE, CL	SOT-89-5	32um	VR4	6h	Ric
L02B	R1173H281B5	LVR-IC	LDO, 2.85V±2%, 1A, +CE	SOT-89-5	32um	VR4	6h	Ric
L02D	R1173H281D5	LVR-IC	LDO, 2.85V±2%, 1A, +CE, CL	SOT-89-5	32um	VR4	6h	Ric
L08B	R1173H081B	LVR-IC	LDO, 0.8V±2%, 1A, +CE	SOT-89-5	32um	VR4	6h	Ric
L08D	R1173H081D	LVR-IC	LDO, 0.8V±2%, 1A, +CE, CL	SOT-89-5	32um	VR4	6h	Ric
L09B	R1173H091B	LVR-IC	LDO, 0.9V±2%, 1A, +CE	SOT-89-5	32um	VR4	6h	Ric
L09D	R1173H091D	LVR-IC	LDO, 0.9V±2%, 1A, +CE, CL	SOT-89-5	32um	VR4	6h	Ric
L10B	R1173H101B	LVR-IC	LDO, 1V±2%, 1A, +CE	SOT-89-5	32um	VR4	6h	Ric
L10D	R1173H101D	LVR-IC	LDO, 1V±2%, 1A, +CE, CL	SOT-89-5	32um	VR4	6h	Ric
L11B	R1173H111B	LVR-IC	LDO, 1.1V±2%, 1A, +CE	SOT-89-5	32um	VR4	6h	Ric
L11D	R1173H111D	LVR-IC	LDO, 1.1V±2%, 1A, +CE, CL	SOT-89-5	32um	VR4	6h	Ric
L12B	R1173H121B	LVR-IC	LDO, 1.2V±2%, 1A, +CE	SOT-89-5	32um	VR4	6h	Ric
L12D	R1173H121D	LVR-IC	LDO, 1.2V±2%, 1A, +CE, CL	SOT-89-5	32um	VR4	6h	Ric
L13B	R1173H131B	LVR-IC	LDO, 1.3V±2%, 1A, +CE	SOT-89-5	32um	VR4	6h	Ric
L13D	R1173H131D	LVR-IC	LDO, 1.3V±2%, 1A, +CE, CL	SOT-89-5	32um	VR4	6h	Ric
L14B	R1173H141B	LVR-IC	LDO, 1.4V±2%, 1A, +CE	SOT-89-5	32um	VR4	6h	Ric
L14D	R1173H141D	LVR-IC	LDO, 1.4V±2%, 1A, +CE, CL	SOT-89-5	32um	VR4	6h	Ric
L15B	R1173H151B	LVR-IC	LDO, 1.5V±2%, 1A, +CE	SOT-89-5	32um	VR4	6h	Ric
L15D	R1173H151D	LVR-IC	LDO, 1.5V±2%, 1A, +CE, CL	SOT-89-5	32um	VR4	6h	Ric
L16B	R1173H161B	LVR-IC	LDO, 1.6V±2%, 1A, +CE	SOT-89-5	32um	VR4	6h	Ric
L16D	R1173H161D	LVR-IC	LDO, 1.6V±2%, 1A, +CE, CL	SOT-89-5	32um	VR4	6h	Ric
L17B	R1173H171B	LVR-IC	LDO, 1.7V±2%, 1A, +CE	SOT-89-5	32um	VR4	6h	Ric
L17D	R1173H171D	LVR-IC	LDO, 1.7V±2%, 1A, +CE, CL	SOT-89-5	32um	VR4	6h	Ric
L18B	R1173H181B	LVR-IC	LDO, 1.8V±2%, 1A, +CE	SOT-89-5	32um	VR4	6h	Ric
L18D	R1173H181D	LVR-IC	LDO, 1.8V±2%, 1A, +CE, CL	SOT-89-5	32um	VR4	6h	Ric
L19B	R1173H191B	LVR-IC	LDO, 1.9V±2%, 1A, +CE	SOT-89-5	32um	VR4	6h	Ric
L19D	R1173H191D	LVR-IC	LDO, 1.9V±2%, 1A, +CE, CL	SOT-89-5	32um	VR4	6h	Ric
L20B	R1173H201B	LVR-IC	LDO, 2V±2%, 1A, +CE	SOT-89-5	32um	VR4	6h	Ric
L20D	R1173H201D	LVR-IC	LDO, 2V±2%, 1A, +CE, CL	SOT-89-5	32um	VR4	6h	Ric
L21B	R1173H211B	LVR-IC	LDO, 2.1V±2%, 1A, +CE	SOT-89-5	32um	VR4	6h	Ric
L21D	R1173H211D	LVR-IC	LDO, 2.1V±2%, 1A, +CE, CL	SOT-89-5	32um	VR4	6h	Ric
L22B	R1173H221B	LVR-IC	LDO, 2.2V±2%, 1A, +CE	SOT-89-5	32um	VR4	6h	Ric
L22D	R1173H221D	LVR-IC	LDO, 2.2V±2%, 1A, +CE, CL	SOT-89-5	32um	VR4	6h	Ric
L23B	R1173H231B	LVR-IC	LDO, 2.3V±2%, 1A, +CE	SOT-89-5	32um	VR4	6h	Ric
L23D	R1173H231D	LVR-IC	LDO, 2.3V±2%, 1A, +CE, CL	SOT-89-5	32um	VR4	6h	Ric
L24B	R1173H241B	LVR-IC	LDO, 2.4V±2%, 1A, +CE	SOT-89-5	32um	VR4	6h	Ric
L24D	R1173H241D	LVR-IC	LDO, 2.4V±2%, 1A, +CE, CL	SOT-89-5	32um	VR4	6h	Ric
L25B	R1173H251B	LVR-IC	LDO, 2.5V±2%, 1A, +CE	SOT-89-5	32um	VR4	6h	Ric
L25D	R1173H251D	LVR-IC	LDO, 2.5V±2%, 1A, +CE, CL	SOT-89-5	32um	VR4	6h	Ric
L26B	R1173H261B	LVR-IC	LDO, 2.6V±2%, 1A, +CE	SOT-89-5	32um	VR4	6h	Ric
L26D	R1173H261D	LVR-IC	LDO, 2.6V±2%, 1A, +CE, CL	SOT-89-5	32um	VR4	6h	Ric
L27B	R1173H271B	LVR-IC	LDO, 2.7V±2%, 1A, +CE	SOT-89-5	32um	VR4	6h	Ric
L27D	R1173H271D	LVR-IC	LDO, 2.7V±2%, 1A, +CE, CL	SOT-89-5	32um	VR4	6h	Ric
L28B	R1173H281B	LVR-IC	LDO, 2.8V±2%, 1A, +CE	SOT-89-5	32um	VR4	6h	Ric
L28D	R1173H281D	LVR-IC	LDO, 2.8V±2%, 1A, +CE, CL	SOT-89-5	32um	VR4	6h	Ric
L29B	R1173H291B	LVR-IC	LDO, 2.9V±2%, 1A, +CE	SOT-89-5	32um	VR4	6h	Ric
L29D	R1173H291D	LVR-IC	LDO, 2.9V±2%, 1A, +CE, CL	SOT-89-5	32um	VR4	6h	Ric
L30B	R1173H301B	LVR-IC	LDO, 3V±2%, 1A, +CE	SOT-89-5	32um	VR4	6h	Ric
L30D	R1173H301D	LVR-IC	LDO, 3V±2%, 1A, +CE, CL	SOT-89-5	32um	VR4	6h	Ric



SMD code	Type	Function	Short description	Case	Pinout Sch.	St.	Mnf.
L31B	R1173H311B	LVR-IC	LDO, 3.1V±2%, 1A, +CE	SOT-89-5	32um VR4	6h	Ric
L31D	R1173H311D	LVR-IC	LDO, 3.1V±2%, 1A, +CE, CL	SOT-89-5	32um VR4	6h	Ric
L32B	R1173H321B	LVR-IC	LDO, 3.2V±2%, 1A, +CE	SOT-89-5	32um VR4	6h	Ric
L32D	R1173H321D	LVR-IC	LDO, 3.2V±2%, 1A, +CE, CL	SOT-89-5	32um VR4	6h	Ric
L33B	R1173H331B	LVR-IC	LDO, 3.3V±2%, 1A, +CE	SOT-89-5	32um VR4	6h	Ric
L33D	R1173H331D	LVR-IC	LDO, 3.3V±2%, 1A, +CE, CL	SOT-89-5	32um VR4	6h	Ric
L34B	R1173H341B	LVR-IC	LDO, 3.4V±2%, 1A, +CE	SOT-89-5	32um VR4	6h	Ric
L34D	R1173H341D	LVR-IC	LDO, 3.4V±2%, 1A, +CE, CL	SOT-89-5	32um VR4	6h	Ric
L35B	R1173H351B	LVR-IC	LDO, 3.5V±2%, 1A, +CE	SOT-89-5	32um VR4	6h	Ric
L35D	R1173H351D	LVR-IC	LDO, 3.5V±2%, 1A, +CE, CL	SOT-89-5	32um VR4	6h	Ric
L36B	R1173H361B	LVR-IC	LDO, 3.6V±2%, 1A, +CE	SOT-89-5	32um VR4	6h	Ric
L36D	R1173H361D	LVR-IC	LDO, 3.6V±2%, 1A, +CE, CL	SOT-89-5	32um VR4	6h	Ric
L37B	R1173H371B	LVR-IC	LDO, 3.7V±2%, 1A, +CE	SOT-89-5	32um VR4	6h	Ric
L37D	R1173H371D	LVR-IC	LDO, 3.7V±2%, 1A, +CE, CL	SOT-89-5	32um VR4	6h	Ric
L38B	R1173H381B	LVR-IC	LDO, 3.8V±2%, 1A, +CE	SOT-89-5	32um VR4	6h	Ric
L38D	R1173H381D	LVR-IC	LDO, 3.8V±2%, 1A, +CE, CL	SOT-89-5	32um VR4	6h	Ric
L39B	R1173H391B	LVR-IC	LDO, 3.9V±2%, 1A, +CE	SOT-89-5	32um VR4	6h	Ric
L39D	R1173H391D	LVR-IC	LDO, 3.9V±2%, 1A, +CE, CL	SOT-89-5	32um VR4	6h	Ric
L40B	R1173H401B	LVR-IC	LDO, 4V±2%, 1A, +CE	SOT-89-5	32um VR4	6h	Ric
L40D	R1173H401D	LVR-IC	LDO, 4V±2%, 1A, +CE, CL	SOT-89-5	32um VR4	6h	Ric
L41B	R1173H411B	LVR-IC	LDO, 4.1V±2%, 1A, +CE	SOT-89-5	32um VR4	6h	Ric
L41D	R1173H411D	LVR-IC	LDO, 4.1V±2%, 1A, +CE, CL	SOT-89-5	32um VR4	6h	Ric
L42B	R1173H421B	LVR-IC	LDO, 4.2V±2%, 1A, +CE	SOT-89-5	32um VR4	6h	Ric
L42D	R1173H421D	LVR-IC	LDO, 4.2V±2%, 1A, +CE, CL	SOT-89-5	32um VR4	6h	Ric
L43B	R1173H431B	LVR-IC	LDO, 4.3V±2%, 1A, +CE	SOT-89-5	32um VR4	6h	Ric
L43D	R1173H431D	LVR-IC	LDO, 4.3V±2%, 1A, +CE, CL	SOT-89-5	32um VR4	6h	Ric
L44B	R1173H441B	LVR-IC	LDO, 4.4V±2%, 1A, +CE	SOT-89-5	32um VR4	6h	Ric
L44D	R1173H441D	LVR-IC	LDO, 4.4V±2%, 1A, +CE, CL	SOT-89-5	32um VR4	6h	Ric
L45B	R1173H451B	LVR-IC	LDO, 4.5V±2%, 1A, +CE	SOT-89-5	32um VR4	6h	Ric
L45D	R1173H451D	LVR-IC	LDO, 4.5V±2%, 1A, +CE, CL	SOT-89-5	32um VR4	6h	Ric
L46B	R1173H461B	LVR-IC	LDO, 4.6V±2%, 1A, +CE	SOT-89-5	32um VR4	6h	Ric
L46D	R1173H461D	LVR-IC	LDO, 4.6V±2%, 1A, +CE, CL	SOT-89-5	32um VR4	6h	Ric
L47B	R1173H471B	LVR-IC	LDO, 4.7V±2%, 1A, +CE	SOT-89-5	32um VR4	6h	Ric
L47D	R1173H471D	LVR-IC	LDO, 4.7V±2%, 1A, +CE, CL	SOT-89-5	32um VR4	6h	Ric
L48B	R1173H481B	LVR-IC	LDO, 4.8V±2%, 1A, +CE	SOT-89-5	32um VR4	6h	Ric
L48D	R1173H481D	LVR-IC	LDO, 4.8V±2%, 1A, +CE, CL	SOT-89-5	32um VR4	6h	Ric
L49B	R1173H491B	LVR-IC	LDO, 4.9V±2%, 1A, +CE	SOT-89-5	32um VR4	6h	Ric
L49D	R1173H491D	LVR-IC	LDO, 4.9V±2%, 1A, +CE, CL	SOT-89-5	32um VR4	6h	Ric
L50B	R1173H501B	LVR-IC	LDO, 5V±2%, 1A, +CE	SOT-89-5	32um VR4	6h	Ric
L50D	R1173H501D	LVR-IC	LDO, 5V±2%, 1A, +CE, CL	SOT-89-5	32um VR4	6h	Ric
LA	ELM9203B	LVR-IC	LDO, 2.0V±2%, 300mA, +CE	SOT-89-5	32vrt VR1	6n	Elm
LA0	XC6219A312PR	LVR-IC	LDO, 3.1V±2%, 240mA, +CE, PDR	SOT-89-5	32um VR4	6h	Tor
LA1	XC6219A322PR	LVR-IC	LDO, 3.2V±2%, 240mA, +CE, PDR	SOT-89-5	32um VR4	6h	Tor
LA2	XC6219A332PR	LVR-IC	LDO, 3.3V±2%, 240mA, +CE, PDR	SOT-89-5	32um VR4	6h	Tor
LA3	XC6219A342PR	LVR-IC	LDO, 3.4V±2%, 240mA, +CE, PDR	SOT-89-5	32um VR4	6h	Tor
LA4	XC6219A352PR	LVR-IC	LDO, 3.5V±2%, 240mA, +CE, PDR	SOT-89-5	32um VR4	6h	Tor
LA5	XC6219A362PR	LVR-IC	LDO, 3.6V±2%, 240mA, +CE, PDR	SOT-89-5	32um VR4	6h	Tor
LA6	XC6219A372PR	LVR-IC	LDO, 3.7V±2%, 240mA, +CE, PDR	SOT-89-5	32um VR4	6h	Tor
LA7	XC6219A382PR	LVR-IC	LDO, 3.8V±2%, 240mA, +CE, PDR	SOT-89-5	32um VR4	6h	Tor
LA8	XC6219A392PR	LVR-IC	LDO, 3.9V±2%, 240mA, +CE, PDR	SOT-89-5	32um VR4	6h	Tor
LA9	XC6219A402PR	LVR-IC	LDO, 4V±2%, 240mA, +CE, PDR	SOT-89-5	32um VR4	6h	Tor
LA0	XC6219A412PR	LVR-IC	LDO, 4.1V±2%, 240mA, +CE, PDR	SOT-89-5	32um VR4	6h	Tor
LAB	XC6219A422PR	LVR-IC	LDO, 4.2V±2%, 240mA, +CE, PDR	SOT-89-5	32um VR4	6h	Tor
LAC	XC6219A432PR	LVR-IC	LDO, 4.3V±2%, 240mA, +CE, PDR	SOT-89-5	32um VR4	6h	Tor
LAD	XC6219A442PR	LVR-IC	LDO, 4.4V±2%, 240mA, +CE, PDR	SOT-89-5	32um VR4	6h	Tor
LAE	XC6219A452PR	LVR-IC	LDO, 4.5V±2%, 240mA, +CE, PDR	SOT-89-5	32um VR4	6h	Tor
LA0	XC6219A462PR	LVR-IC	LDO, 4.6V±2%, 240mA, +CE, PDR	SOT-89-5	32um VR4	6h	Tor
LAH	XC6219A472PR	LVR-IC	LDO, 4.7V±2%, 240mA, +CE, PDR	SOT-89-5	32um VR4	6h	Tor
LAK	XC6219A482PR	LVR-IC	LDO, 4.8V±2%, 240mA, +CE, PDR	SOT-89-5	32um VR4	6h	Tor
LAL	XC6219A492PR	LVR-IC	LDO, 4.9V±2%, 240mA, +CE, PDR	SOT-89-5	32um VR4	6h	Tor
LAM	XC6219A502PR	LVR-IC	LDO, 5V±2%, 240mA, +CE, PDR	SOT-89-5	32um VR4	6h	Tor
LB	ELM9213B	LVR-IC	LDO, 2.1V±2%, 300mA, +CE	SOT-89-5	32vrt VR1	6n	Elm
LB0	XC6219B312PR	LVR-IC	LDO, 3.1V±2%, 240mA, +CE	SOT-89-5	32um VR4	6h	Tor
LB1	XC6219B322PR	LVR-IC	LDO, 3.2V±2%, 240mA, +CE	SOT-89-5	32um VR4	6h	Tor
LB2	XC6219B332PR	LVR-IC	LDO, 3.3V±2%, 240mA, +CE	SOT-89-5	32um VR4	6h	Tor
LB3	XC6219B342PR	LVR-IC	LDO, 3.4V±2%, 240mA, +CE	SOT-89-5	32um VR4	6h	Tor
LB4	XC6219B352PR	LVR-IC	LDO, 3.5V±2%, 240mA, +CE	SOT-89-5	32um VR4	6h	Tor
LB5	XC6219B362PR	LVR-IC	LDO, 3.6V±2%, 240mA, +CE	SOT-89-5	32um VR4	6h	Tor
LB6	XC6219B372PR	LVR-IC	LDO, 3.7V±2%, 240mA, +CE	SOT-89-5	32um VR4	6h	Tor
LB7	XC6219B382PR	LVR-IC	LDO, 3.8V±2%, 240mA, +CE	SOT-89-5	32um VR4	6h	Tor



SMD code	Type	Function	Short description	Case	Pinout Sch.	St.	Mnf.
LB8	XC6219B392PR	LVR-IC	LDO, 3.9V±2%, 240mA, +CE	SOT-89-5	32um VR4	6h	Tor
LB9	XC6219B402PR	LVR-IC	LDO, 4V±2%, 240mA, +CE	SOT-89-5	32um VR4	6h	Tor
LBA	XC6219B412PR	LVR-IC	LDO, 4.1V±2%, 240mA, +CE	SOT-89-5	32um VR4	6h	Tor
LBB	XC6219B422PR	LVR-IC	LDO, 4.2V±2%, 240mA, +CE	SOT-89-5	32um VR4	6h	Tor
LBC	XC6219B432PR	LVR-IC	LDO, 4.3V±2%, 240mA, +CE	SOT-89-5	32um VR4	6h	Tor
LBD	XC6219B442PR	LVR-IC	LDO, 4.4V±2%, 240mA, +CE	SOT-89-5	32um VR4	6h	Tor
LBE	XC6219B452PR	LVR-IC	LDO, 4.5V±2%, 240mA, +CE	SOT-89-5	32um VR4	6h	Tor
LBF	XC6219B462PR	LVR-IC	LDO, 4.6V±2%, 240mA, +CE	SOT-89-5	32um VR4	6h	Tor
LBH	XC6219B472PR	LVR-IC	LDO, 4.7V±2%, 240mA, +CE	SOT-89-5	32um VR4	6h	Tor
LBK	XC6219B482PR	LVR-IC	LDO, 4.8V±2%, 240mA, +CE	SOT-89-5	32um VR4	6h	Tor
LBL	XC6219B492PR	LVR-IC	LDO, 4.9V±2%, 240mA, +CE	SOT-89-5	32um VR4	6h	Tor
LBM	XC6219B502PR	LVR-IC	LDO, 5V±2%, 240mA, +CE	SOT-89-5	32um VR4	6h	Tor
LC	ELM99223B	LVR-IC	LDO, 2.2V±2%, 300mA, +CE	SOT-89-5	32vrt VR1	6n	Elm
LC0	XC6219C312PR	LVR-IC	LDO, 3.1V±2%, 240mA, -CE, PDR	SOT-89-5	32um VR4	6h	Tor
LC1	XC6219C322PR	LVR-IC	LDO, 3.2V±2%, 240mA, -CE, PDR	SOT-89-5	32um VR4	6h	Tor
LC2	XC6219C332PR	LVR-IC	LDO, 3.3V±2%, 240mA, -CE, PDR	SOT-89-5	32um VR4	6h	Tor
LC3	XC6219C342PR	LVR-IC	LDO, 3.4V±2%, 240mA, -CE, PDR	SOT-89-5	32um VR4	6h	Tor
LC4	XC6219C352PR	LVR-IC	LDO, 3.5V±2%, 240mA, -CE, PDR	SOT-89-5	32um VR4	6h	Tor
LC5	XC6219C362PR	LVR-IC	LDO, 3.6V±2%, 240mA, -CE, PDR	SOT-89-5	32um VR4	6h	Tor
LC6	XC6219C372PR	LVR-IC	LDO, 3.7V±2%, 240mA, -CE, PDR	SOT-89-5	32um VR4	6h	Tor
LC7	XC6219C382PR	LVR-IC	LDO, 3.8V±2%, 240mA, -CE, PDR	SOT-89-5	32um VR4	6h	Tor
LC8	XC6219C392PR	LVR-IC	LDO, 3.9V±2%, 240mA, -CE, PDR	SOT-89-5	32um VR4	6h	Tor
LC9	XC6219C402PR	LVR-IC	LDO, 4V±2%, 240mA, -CE, PDR	SOT-89-5	32um VR4	6h	Tor
LCA	XC6219C412PR	LVR-IC	LDO, 4.1V±2%, 240mA, -CE, PDR	SOT-89-5	32um VR4	6h	Tor
LCB	XC6219C422PR	LVR-IC	LDO, 4.2V±2%, 240mA, -CE, PDR	SOT-89-5	32um VR4	6h	Tor
LCC	XC6219C432PR	LVR-IC	LDO, 4.3V±2%, 240mA, -CE, PDR	SOT-89-5	32um VR4	6h	Tor
LCD	XC6219C442PR	LVR-IC	LDO, 4.4V±2%, 240mA, -CE, PDR	SOT-89-5	32um VR4	6h	Tor
LCE	XC6219C452PR	LVR-IC	LDO, 4.5V±2%, 240mA, -CE, PDR	SOT-89-5	32um VR4	6h	Tor
LCF	XC6219C462PR	LVR-IC	LDO, 4.6V±2%, 240mA, -CE, PDR	SOT-89-5	32um VR4	6h	Tor
LCH	XC6219C472PR	LVR-IC	LDO, 4.7V±2%, 240mA, -CE, PDR	SOT-89-5	32um VR4	6h	Tor
LCK	XC6219C482PR	LVR-IC	LDO, 4.8V±2%, 240mA, -CE, PDR	SOT-89-5	32um VR4	6h	Tor
LCL	XC6219C492PR	LVR-IC	LDO, 4.9V±2%, 240mA, -CE, PDR	SOT-89-5	32um VR4	6h	Tor
LCM	XC6219C502PR	LVR-IC	LDO, 5V±2%, 240mA, -CE, PDR	SOT-89-5	32um VR4	6h	Tor
LD	ELM99233B	LVR-IC	LDO, 2.3V±2%, 300mA, +CE	SOT-89-5	32vrt VR1	6n	Elm
LD0	XC6219D312PR	LVR-IC	LDO, 3.1V±2%, 240mA, -CE	SOT-89-5	32um VR4	6h	Tor
LD1	XC6219D322PR	LVR-IC	LDO, 3.2V±2%, 240mA, -CE	SOT-89-5	32um VR4	6h	Tor
LD2	XC6219D332PR	LVR-IC	LDO, 3.3V±2%, 240mA, -CE	SOT-89-5	32um VR4	6h	Tor
LD3	XC6219D342PR	LVR-IC	LDO, 3.4V±2%, 240mA, -CE	SOT-89-5	32um VR4	6h	Tor
LD4	XC6219D352PR	LVR-IC	LDO, 3.5V±2%, 240mA, -CE	SOT-89-5	32um VR4	6h	Tor
LD5	XC6219D362PR	LVR-IC	LDO, 3.6V±2%, 240mA, -CE	SOT-89-5	32um VR4	6h	Tor
LD6	XC6219D372PR	LVR-IC	LDO, 3.7V±2%, 240mA, -CE	SOT-89-5	32um VR4	6h	Tor
LD7	XC6219D382PR	LVR-IC	LDO, 3.8V±2%, 240mA, -CE	SOT-89-5	32um VR4	6h	Tor
LD8	XC6219D392PR	LVR-IC	LDO, 3.9V±2%, 240mA, -CE	SOT-89-5	32um VR4	6h	Tor
LD9	XC6219D402PR	LVR-IC	LDO, 4V±2%, 240mA, -CE	SOT-89-5	32um VR4	6h	Tor
LDA	XC6219D412PR	LVR-IC	LDO, 4.1V±2%, 240mA, -CE	SOT-89-5	32um VR4	6h	Tor
LDB	XC6219D422PR	LVR-IC	LDO, 4.2V±2%, 240mA, -CE	SOT-89-5	32um VR4	6h	Tor
LDC	XC6219D432PR	LVR-IC	LDO, 4.3V±2%, 240mA, -CE	SOT-89-5	32um VR4	6h	Tor
LDD	XC6219D442PR	LVR-IC	LDO, 4.4V±2%, 240mA, -CE	SOT-89-5	32um VR4	6h	Tor
LDE	XC6219D452PR	LVR-IC	LDO, 4.5V±2%, 240mA, -CE	SOT-89-5	32um VR4	6h	Tor
LDF	XC6219D462PR	LVR-IC	LDO, 4.6V±2%, 240mA, -CE	SOT-89-5	32um VR4	6h	Tor
LDH	XC6219D472PR	LVR-IC	LDO, 4.7V±2%, 240mA, -CE	SOT-89-5	32um VR4	6h	Tor
LDK	XC6219D482PR	LVR-IC	LDO, 4.8V±2%, 240mA, -CE	SOT-89-5	32um VR4	6h	Tor
LDL	XC6219D492PR	LVR-IC	LDO, 4.9V±2%, 240mA, -CE	SOT-89-5	32um VR4	6h	Tor
LDM	XC6219D502PR	LVR-IC	LDO, 5V±2%, 240mA, -CE	SOT-89-5	32um VR4	6h	Tor
LE	ELM99243B	LVR-IC	LDO, 2.4V±2%, 300mA, +CE	SOT-89-5	32vrt VR1	6n	Elm
LE8	XC6219A09APR	LVR-IC	LDO, 0.95V±2%, 150mA, +CE, PDR	SOT-89-5	32um VR4	6h	Tor
LE9	XC6219A10APR	LVR-IC	LDO, 1.05V±2%, 150mA, +CE, PDR	SOT-89-5	32um VR4	6h	Tor
LEA	XC6219A11APR	LVR-IC	LDO, 1.15V±2%, 150mA, +CE, PDR	SOT-89-5	32um VR4	6h	Tor
LEB	XC6219A12APR	LVR-IC	LDO, 1.25V±2%, 150mA, +CE, PDR	SOT-89-5	32um VR4	6h	Tor
LEC	XC6219A13APR	LVR-IC	LDO, 1.35V±2%, 150mA, +CE, PDR	SOT-89-5	32um VR4	6h	Tor
LED	XC6219A14APR	LVR-IC	LDO, 1.45V±2%, 150mA, +CE, PDR	SOT-89-5	32um VR4	6h	Tor
LEE	XC6219A15APR	LVR-IC	LDO, 1.55V±2%, 150mA, +CE, PDR	SOT-89-5	32um VR4	6h	Tor
LEF	XC6219A16APR	LVR-IC	LDO, 1.65V±2%, 150mA, +CE, PDR	SOT-89-5	32um VR4	6h	Tor
LEH	XC6219A17APR	LVR-IC	LDO, 1.75V±2%, 150mA, +CE, PDR	SOT-89-5	32um VR4	6h	Tor
LEK	XC6219A18APR	LVR-IC	LDO, 1.85V±2%, 240mA, +CE, PDR	SOT-89-5	32um VR4	6h	Tor
LEL	XC6219A19APR	LVR-IC	LDO, 1.95V±2%, 240mA, +CE, PDR	SOT-89-5	32um VR4	6h	Tor
LEM	XC6219A20APR	LVR-IC	LDO, 2.05V±2%, 240mA, +CE, PDR	SOT-89-5	32um VR4	6h	Tor
LEN	XC6219A21APR	LVR-IC	LDO, 2.15V±2%, 240mA, +CE, PDR	SOT-89-5	32um VR4	6h	Tor
LEP	XC6219A22APR	LVR-IC	LDO, 2.25V±2%, 240mA, +CE, PDR	SOT-89-5	32um VR4	6h	Tor
LER	XC6219A23APR	LVR-IC	LDO, 2.35V±2%, 240mA, +CE, PDR	SOT-89-5	32um VR4	6h	Tor



SMD code	Type	Function	Short description	Case	Pinout Sch.	St.	Mnf.
LES	XC6219A24APR	LVR-IC	LDO, 2.45V±2%, 240mA, +CE, PDR	SOT-89-5	32um VR4	6h	Tor
LET	XC6219A25APR	LVR-IC	LDO, 2.55V±2%, 240mA, +CE, PDR	SOT-89-5	32um VR4	6h	Tor
LEU	XC6219A26APR	LVR-IC	LDO, 2.65V±2%, 240mA, +CE, PDR	SOT-89-5	32um VR4	6h	Tor
LEV	XC6219A27APR	LVR-IC	LDO, 2.75V±2%, 240mA, +CE, PDR	SOT-89-5	32um VR4	6h	Tor
LEX	XC6219A28APR	LVR-IC	LDO, 2.85V±2%, 240mA, +CE, PDR	SOT-89-5	32um VR4	6h	Tor
LEY	XC6219A29APR	LVR-IC	LDO, 2.95V±2%, 240mA, +CE, PDR	SOT-89-5	32um VR4	6h	Tor
LEZ	XC6219A30APR	LVR-IC	LDO, 3.05V±2%, 240mA, +CE, PDR	SOT-89-5	32um VR4	6h	Tor
LF	ELM99253B	LVR-IC	LDO, 2.5V±2%, 300mA, +CE	SOT-89-5	32vrt VR1	6n	Elm
LF8	XC6219B09APR	LVR-IC	LDO, 0.95V±2%, 150mA, +CE	SOT-89-5	32um VR4	6h	Tor
LF9	XC6219B10APR	LVR-IC	LDO, 1.05V±2%, 150mA, +CE	SOT-89-5	32um VR4	6h	Tor
LFA	XC6219B11APR	LVR-IC	LDO, 1.15V±2%, 150mA, +CE	SOT-89-5	32um VR4	6h	Tor
LFB	XC6219B12APR	LVR-IC	LDO, 1.25V±2%, 150mA, +CE	SOT-89-5	32um VR4	6h	Tor
LFC	XC6219B13APR	LVR-IC	LDO, 1.35V±2%, 150mA, +CE	SOT-89-5	32um VR4	6h	Tor
LFD	XC6219B14APR	LVR-IC	LDO, 1.45V±2%, 150mA, +CE	SOT-89-5	32um VR4	6h	Tor
LFE	XC6219B15APR	LVR-IC	LDO, 1.55V±2%, 150mA, +CE	SOT-89-5	32um VR4	6h	Tor
FFF	XC6219B16APR	LVR-IC	LDO, 1.65V±2%, 150mA, +CE	SOT-89-5	32um VR4	6h	Tor
LFH	XC6219B17APR	LVR-IC	LDO, 1.75V±2%, 150mA, +CE	SOT-89-5	32um VR4	6h	Tor
LFK	XC6219B18APR	LVR-IC	LDO, 1.85V±2%, 240mA, +CE	SOT-89-5	32um VR4	6h	Tor
LFL	XC6219B19APR	LVR-IC	LDO, 1.95V±2%, 240mA, +CE	SOT-89-5	32um VR4	6h	Tor
LFM	XC6219B20APR	LVR-IC	LDO, 2.05V±2%, 240mA, +CE	SOT-89-5	32um VR4	6h	Tor
LFN	XC6219B21APR	LVR-IC	LDO, 2.15V±2%, 240mA, +CE	SOT-89-5	32um VR4	6h	Tor
LFP	XC6219B22APR	LVR-IC	LDO, 2.25V±2%, 240mA, +CE	SOT-89-5	32um VR4	6h	Tor
LFR	XC6219B23APR	LVR-IC	LDO, 2.35V±2%, 240mA, +CE	SOT-89-5	32um VR4	6h	Tor
LFS	XC6219B24APR	LVR-IC	LDO, 2.45V±2%, 240mA, +CE	SOT-89-5	32um VR4	6h	Tor
LFT	XC6219B25APR	LVR-IC	LDO, 2.55V±2%, 240mA, +CE	SOT-89-5	32um VR4	6h	Tor
LFU	XC6219B26APR	LVR-IC	LDO, 2.65V±2%, 240mA, +CE	SOT-89-5	32um VR4	6h	Tor
LFV	XC6219B27APR	LVR-IC	LDO, 2.75V±2%, 240mA, +CE	SOT-89-5	32um VR4	6h	Tor
LFX	XC6219B28APR	LVR-IC	LDO, 2.85V±2%, 240mA, +CE	SOT-89-5	32um VR4	6h	Tor
LFY	XC6219B29BPR	LVR-IC	LDO, 2.95V±1%, 240mA, +CE	SOT-89-5	32um VR4	6h	Tor
LFZ	XC6219B30APR	LVR-IC	LDO, 3.05V±2%, 240mA, +CE	SOT-89-5	32um VR4	6h	Tor
LG	ELM99263B	LVR-IC	LDO, 2.6V±2%, 300mA, +CE	SOT-89-5	32vrt VR1	6n	Elm
LH	ELM99273B	LVR-IC	LDO, 2.7V±2%, 300mA, +CE	SOT-89-5	32vrt VR1	6n	Elm
LH8	XC6219C09APR	LVR-IC	LDO, 0.95V±2%, 150mA, -CE, PDR	SOT-89-5	32um VR4	6h	Tor
LH9	XC6219C10APR	LVR-IC	LDO, 1.05V±2%, 150mA, -CE, PDR	SOT-89-5	32um VR4	6h	Tor
LHA	XC6219C11APR	LVR-IC	LDO, 1.15V±2%, 150mA, -CE, PDR	SOT-89-5	32um VR4	6h	Tor
LHB	XC6219C12APR	LVR-IC	LDO, 1.25V±2%, 150mA, -CE, PDR	SOT-89-5	32um VR4	6h	Tor
LHC	XC6219C13APR	LVR-IC	LDO, 1.35V±2%, 150mA, -CE, PDR	SOT-89-5	32um VR4	6h	Tor
LHD	XC6219C14APR	LVR-IC	LDO, 1.45V±2%, 150mA, -CE, PDR	SOT-89-5	32um VR4	6h	Tor
LHE	XC6219C15APR	LVR-IC	LDO, 1.55V±2%, 150mA, -CE, PDR	SOT-89-5	32um VR4	6h	Tor
LHF	XC6219C16APR	LVR-IC	LDO, 1.65V±2%, 150mA, -CE, PDR	SOT-89-5	32um VR4	6h	Tor
LHH	XC6219C17APR	LVR-IC	LDO, 1.75V±2%, 150mA, -CE, PDR	SOT-89-5	32um VR4	6h	Tor
LHK	XC6219C18APR	LVR-IC	LDO, 1.85V±2%, 240mA, -CE, PDR	SOT-89-5	32um VR4	6h	Tor
LHL	XC6219C19APR	LVR-IC	LDO, 1.95V±2%, 240mA, -CE, PDR	SOT-89-5	32um VR4	6h	Tor
LHM	XC6219C20APR	LVR-IC	LDO, 2.05V±2%, 240mA, -CE, PDR	SOT-89-5	32um VR4	6h	Tor
LHN	XC6219C21APR	LVR-IC	LDO, 2.15V±2%, 240mA, -CE, PDR	SOT-89-5	32um VR4	6h	Tor
LHP	XC6219C22APR	LVR-IC	LDO, 2.25V±2%, 240mA, -CE, PDR	SOT-89-5	32um VR4	6h	Tor
LHR	XC6219C23APR	LVR-IC	LDO, 2.35V±2%, 240mA, -CE, PDR	SOT-89-5	32um VR4	6h	Tor
LHS	XC6219C24APR	LVR-IC	LDO, 2.45V±2%, 240mA, -CE, PDR	SOT-89-5	32um VR4	6h	Tor
LHT	XC6219C25APR	LVR-IC	LDO, 2.55V±2%, 240mA, -CE, PDR	SOT-89-5	32um VR4	6h	Tor
LHU	XC6219C26APR	LVR-IC	LDO, 2.65V±2%, 240mA, -CE, PDR	SOT-89-5	32um VR4	6h	Tor
LHV	XC6219C27APR	LVR-IC	LDO, 2.75V±2%, 240mA, -CE, PDR	SOT-89-5	32um VR4	6h	Tor
LHX	XC6219C28APR	LVR-IC	LDO, 2.85V±2%, 240mA, -CE, PDR	SOT-89-5	32um VR4	6h	Tor
LHY	XC6219C29APR	LVR-IC	LDO, 2.95V±2%, 240mA, -CE, PDR	SOT-89-5	32um VR4	6h	Tor
LHZ	XC6219C30APR	LVR-IC	LDO, 3.05V±2%, 240mA, -CE, PDR	SOT-89-5	32um VR4	6h	Tor
LJ	ELM99283B	LVR-IC	LDO, 2.8V±2%, 300mA, +CE	SOT-89-5	32vrt VR1	6n	Elm
LK	ELM99293B	LVR-IC	LDO, 2.9V±2%, 300mA, +CE	SOT-89-5	32vrt VR1	6n	Elm
LK8	XC6219D09APR	LVR-IC	LDO, 0.95V±2%, 150mA, -CE	SOT-89-5	32um VR4	6h	Tor
LK9	XC6219D10APR	LVR-IC	LDO, 1.05V±2%, 150mA, -CE	SOT-89-5	32um VR4	6h	Tor
LKA	XC6219D11APR	LVR-IC	LDO, 1.15V±2%, 150mA, -CE	SOT-89-5	32um VR4	6h	Tor
LKB	XC6219D12APR	LVR-IC	LDO, 1.25V±2%, 150mA, -CE	SOT-89-5	32um VR4	6h	Tor
LKC	XC6219D13APR	LVR-IC	LDO, 1.35V±2%, 150mA, -CE	SOT-89-5	32um VR4	6h	Tor
LKD	XC6219D14APR	LVR-IC	LDO, 1.45V±2%, 150mA, -CE	SOT-89-5	32um VR4	6h	Tor
LKE	XC6219D15APR	LVR-IC	LDO, 1.55V±2%, 150mA, -CE	SOT-89-5	32um VR4	6h	Tor
LKF	XC6219D16APR	LVR-IC	LDO, 1.65V±2%, 150mA, -CE	SOT-89-5	32um VR4	6h	Tor
LKH	XC6219D17APR	LVR-IC	LDO, 1.75V±2%, 150mA, -CE	SOT-89-5	32um VR4	6h	Tor
LKL	XC6219D18APR	LVR-IC	LDO, 1.85V±2%, 240mA, -CE	SOT-89-5	32um VR4	6h	Tor
LKK	XC6219D19APR	LVR-IC	LDO, 1.95V±2%, 240mA, -CE	SOT-89-5	32um VR4	6h	Tor
LKM	XC6219D20APR	LVR-IC	LDO, 2.05V±2%, 240mA, -CE	SOT-89-5	32um VR4	6h	Tor
LKN	XC6219D21APR	LVR-IC	LDO, 2.15V±2%, 240mA, -CE	SOT-89-5	32um VR4	6h	Tor
LKP	XC6219D22APR	LVR-IC	LDO, 2.25V±2%, 240mA, -CE	SOT-89-5	32um VR4	6h	Tor



SMD code	Type	Function	Short description	Case	Pinout Sch.	St.	Mnf.
LKR	XC6219D23APR	LVR-IC	LDO, 2.35V±2%, 240mA, -CE	SOT-89-5	32um VR4	6h	Tor
LKS	XC6219D24APR	LVR-IC	LDO, 2.45V±2%, 240mA, -CE	SOT-89-5	32um VR4	6h	Tor
LKT	XC6219D25APR	LVR-IC	LDO, 2.55V±2%, 240mA, -CE	SOT-89-5	32um VR4	6h	Tor
LKU	XC6219D26APR	LVR-IC	LDO, 2.65V±2%, 240mA, -CE	SOT-89-5	32um VR4	6h	Tor
LKV	XC6219D27APR	LVR-IC	LDO, 2.75V±2%, 240mA, -CE	SOT-89-5	32um VR4	6h	Tor
LKX	XC6219D28APR	LVR-IC	LDO, 2.85V±2%, 240mA, -CE	SOT-89-5	32um VR4	6h	Tor
LKY	XC6219D29APR	LVR-IC	LDO, 2.95V±2%, 240mA, -CE	SOT-89-5	32um VR4	6h	Tor
LKZ	XC6219D30APR	LVR-IC	LDO, 3.05V±2%, 240mA, -CE	SOT-89-5	32um VR4	6h	Tor
LL0	XC6219A31APR	LVR-IC	LDO, 3.15V±2%, 240mA, +CE, PDR	SOT-89-5	32um VR4	6h	Tor
LL1	XC6219A32APR	LVR-IC	LDO, 3.25V±2%, 240mA, +CE, PDR	SOT-89-5	32um VR4	6h	Tor
LL2	XC6219A33APR	LVR-IC	LDO, 3.35V±2%, 240mA, +CE, PDR	SOT-89-5	32um VR4	6h	Tor
LL3	XC6219A34APR	LVR-IC	LDO, 3.45V±2%, 240mA, +CE, PDR	SOT-89-5	32um VR4	6h	Tor
LL4	XC6219A35APR	LVR-IC	LDO, 3.55V±2%, 240mA, +CE, PDR	SOT-89-5	32um VR4	6h	Tor
LL5	XC6219A36APR	LVR-IC	LDO, 3.65V±2%, 240mA, +CE, PDR	SOT-89-5	32um VR4	6h	Tor
LL6	XC6219A37APR	LVR-IC	LDO, 3.75V±2%, 240mA, +CE, PDR	SOT-89-5	32um VR4	6h	Tor
LL7	XC6219A38APR	LVR-IC	LDO, 3.85V±2%, 240mA, +CE, PDR	SOT-89-5	32um VR4	6h	Tor
LL8	XC6219A39APR	LVR-IC	LDO, 3.95V±2%, 240mA, +CE, PDR	SOT-89-5	32um VR4	6h	Tor
LL9	XC6219A40APR	LVR-IC	LDO, 4.05V±2%, 240mA, +CE, PDR	SOT-89-5	32um VR4	6h	Tor
LLA	XC6219A41APR	LVR-IC	LDO, 4.15V±2%, 240mA, +CE, PDR	SOT-89-5	32um VR4	6h	Tor
LLB	XC6219A42APR	LVR-IC	LDO, 4.25V±2%, 240mA, +CE, PDR	SOT-89-5	32um VR4	6h	Tor
LLC	XC6219A43APR	LVR-IC	LDO, 4.35V±2%, 240mA, +CE, PDR	SOT-89-5	32um VR4	6h	Tor
LLD	XC6219A44APR	LVR-IC	LDO, 4.45V±2%, 240mA, +CE, PDR	SOT-89-5	32um VR4	6h	Tor
LLE	XC6219A45APR	LVR-IC	LDO, 4.55V±2%, 240mA, +CE, PDR	SOT-89-5	32um VR4	6h	Tor
LLF	XC6219A46APR	LVR-IC	LDO, 4.65V±2%, 240mA, +CE, PDR	SOT-89-5	32um VR4	6h	Tor
LLH	XC6219A47APR	LVR-IC	LDO, 4.75V±2%, 240mA, +CE, PDR	SOT-89-5	32um VR4	6h	Tor
LLK	XC6219A48APR	LVR-IC	LDO, 4.85V±2%, 240mA, +CE, PDR	SOT-89-5	32um VR4	6h	Tor
LLL	XC6219A49APR	LVR-IC	LDO, 4.95V±2%, 240mA, +CE, PDR	SOT-89-5	32um VR4	6h	Tor
LM0	XC6219B31APR	LVR-IC	LDO, 3.15V±2%, 240mA, +CE	SOT-89-5	32um VR4	6h	Tor
LM1	XC6219B32APR	LVR-IC	LDO, 3.25V±2%, 240mA, +CE	SOT-89-5	32um VR4	6h	Tor
LM2	XC6219B33APR	LVR-IC	LDO, 3.35V±2%, 240mA, +CE	SOT-89-5	32um VR4	6h	Tor
LM3	XC6219B34APR	LVR-IC	LDO, 3.45V±2%, 240mA, +CE	SOT-89-5	32um VR4	6h	Tor
LM4	XC6219B35APR	LVR-IC	LDO, 3.55V±2%, 240mA, +CE	SOT-89-5	32um VR4	6h	Tor
LM5	XC6219B36APR	LVR-IC	LDO, 3.65V±2%, 240mA, +CE	SOT-89-5	32um VR4	6h	Tor
LM6	XC6219B37APR	LVR-IC	LDO, 3.75V±2%, 240mA, +CE	SOT-89-5	32um VR4	6h	Tor
LM7	XC6219B38APR	LVR-IC	LDO, 3.85V±2%, 240mA, +CE	SOT-89-5	32um VR4	6h	Tor
LM8	XC6219B39APR	LVR-IC	LDO, 3.95V±2%, 240mA, +CE	SOT-89-5	32um VR4	6h	Tor
LM9	XC6219B40APR	LVR-IC	LDO, 4.05V±2%, 240mA, +CE	SOT-89-5	32um VR4	6h	Tor
LMA	XC6219B41APR	LVR-IC	LDO, 4.15V±2%, 240mA, +CE	SOT-89-5	32um VR4	6h	Tor
LMB	XC6219B42APR	LVR-IC	LDO, 4.25V±2%, 240mA, +CE	SOT-89-5	32um VR4	6h	Tor
LMC	XC6219B43APR	LVR-IC	LDO, 4.35V±2%, 240mA, +CE	SOT-89-5	32um VR4	6h	Tor
LMD	XC6219B44APR	LVR-IC	LDO, 4.45V±2%, 240mA, +CE	SOT-89-5	32um VR4	6h	Tor
LME	XC6219B45APR	LVR-IC	LDO, 4.55V±2%, 240mA, +CE	SOT-89-5	32um VR4	6h	Tor
LMF	XC6219B46APR	LVR-IC	LDO, 4.65V±2%, 240mA, +CE	SOT-89-5	32um VR4	6h	Tor
LMH	XC6219B47APR	LVR-IC	LDO, 4.75V±2%, 240mA, +CE	SOT-89-5	32um VR4	6h	Tor
LMK	XC6219B48APR	LVR-IC	LDO, 4.85V±2%, 240mA, +CE	SOT-89-5	32um VR4	6h	Tor
LML	XC6219B49APR	LVR-IC	LDO, 4.95V±2%, 240mA, +CE	SOT-89-5	32um VR4	6h	Tor
LN0	XC6219C31APR	LVR-IC	LDO, 3.15V±2%, 240mA, -CE, PDR	SOT-89-5	32um VR4	6h	Tor
LN1	XC6219C32APR	LVR-IC	LDO, 3.25V±2%, 240mA, -CE, PDR	SOT-89-5	32um VR4	6h	Tor
LN2	XC6219C33APR	LVR-IC	LDO, 3.35V±2%, 240mA, -CE, PDR	SOT-89-5	32um VR4	6h	Tor
LN3	XC6219C34APR	LVR-IC	LDO, 3.45V±2%, 240mA, -CE, PDR	SOT-89-5	32um VR4	6h	Tor
LN4	XC6219C35APR	LVR-IC	LDO, 3.55V±2%, 240mA, -CE, PDR	SOT-89-5	32um VR4	6h	Tor
LN5	XC6219C36APR	LVR-IC	LDO, 3.65V±2%, 240mA, -CE, PDR	SOT-89-5	32um VR4	6h	Tor
LN6	XC6219C37APR	LVR-IC	LDO, 3.75V±2%, 240mA, -CE, PDR	SOT-89-5	32um VR4	6h	Tor
LN7	XC6219C38APR	LVR-IC	LDO, 3.85V±2%, 240mA, -CE, PDR	SOT-89-5	32um VR4	6h	Tor
LN8	XC6219C39APR	LVR-IC	LDO, 3.95V±2%, 240mA, -CE, PDR	SOT-89-5	32um VR4	6h	Tor
LN9	XC6219C40APR	LVR-IC	LDO, 4.05V±2%, 240mA, -CE, PDR	SOT-89-5	32um VR4	6h	Tor
LNA	XC6219C41APR	LVR-IC	LDO, 4.15V±2%, 240mA, -CE, PDR	SOT-89-5	32um VR4	6h	Tor
LNB	XC6219C42APR	LVR-IC	LDO, 4.25V±2%, 240mA, -CE, PDR	SOT-89-5	32um VR4	6h	Tor
LNC	XC6219C43APR	LVR-IC	LDO, 4.35V±2%, 240mA, -CE, PDR	SOT-89-5	32um VR4	6h	Tor
LND	XC6219C44APR	LVR-IC	LDO, 4.45V±2%, 240mA, -CE, PDR	SOT-89-5	32um VR4	6h	Tor
LNE	XC6219C45APR	LVR-IC	LDO, 4.55V±2%, 240mA, -CE, PDR	SOT-89-5	32um VR4	6h	Tor
LNF	XC6219C46APR	LVR-IC	LDO, 4.65V±2%, 240mA, -CE, PDR	SOT-89-5	32um VR4	6h	Tor
LNH	XC6219C47APR	LVR-IC	LDO, 4.75V±2%, 240mA, -CE, PDR	SOT-89-5	32um VR4	6h	Tor
LNK	XC6219C48APR	LVR-IC	LDO, 4.85V±2%, 240mA, -CE, PDR	SOT-89-5	32um VR4	6h	Tor
LNL	XC6219C49APR	LVR-IC	LDO, 4.95V±2%, 240mA, -CE, PDR	SOT-89-5	32um VR4	6h	Tor
LP0	XC6219D31APR	LVR-IC	LDO, 3.15V±2%, 240mA, -CE	SOT-89-5	32um VR4	6h	Tor
LP1	XC6219D32APR	LVR-IC	LDO, 3.25V±2%, 240mA, -CE	SOT-89-5	32um VR4	6h	Tor
LP2	XC6219D33APR	LVR-IC	LDO, 3.35V±2%, 240mA, -CE	SOT-89-5	32um VR4	6h	Tor
LP3	XC6219D34APR	LVR-IC	LDO, 3.45V±2%, 240mA, -CE	SOT-89-5	32um VR4	6h	Tor
LP4	XC6219D35APR	LVR-IC	LDO, 3.55V±2%, 240mA, -CE	SOT-89-5	32um VR4	6h	Tor



SMD code	Type	Function	Short description	Case	Pinout Sch.	St.	Mnf.
LP5	XC6219D36APR	LVR-IC	LDO, 3.65V±2%, 240mA, -CE	SOT-89-5	32um VR4	6h	Tor
LP6	XC6219D37APR	LVR-IC	LDO, 3.75V±2%, 240mA, -CE	SOT-89-5	32um VR4	6h	Tor
LP7	XC6219D38APR	LVR-IC	LDO, 3.85V±2%, 240mA, -CE	SOT-89-5	32um VR4	6h	Tor
LP8	XC6219D39APR	LVR-IC	LDO, 3.95V±2%, 240mA, -CE	SOT-89-5	32um VR4	6h	Tor
LP9	XC6219D40APR	LVR-IC	LDO, 4.05V±2%, 240mA, -CE	SOT-89-5	32um VR4	6h	Tor
LPA	XC6219D41APR	LVR-IC	LDO, 4.15V±2%, 240mA, -CE	SOT-89-5	32um VR4	6h	Tor
LPB	XC6219D42APR	LVR-IC	LDO, 4.25V±2%, 240mA, -CE	SOT-89-5	32um VR4	6h	Tor
LPC	XC6219D43APR	LVR-IC	LDO, 4.35V±2%, 240mA, -CE	SOT-89-5	32um VR4	6h	Tor
LPD	XC6219D44APR	LVR-IC	LDO, 4.45V±2%, 240mA, -CE	SOT-89-5	32um VR4	6h	Tor
LPE	XC6219D45APR	LVR-IC	LDO, 4.55V±2%, 240mA, -CE	SOT-89-5	32um VR4	6h	Tor
LPF	XC6219D46APR	LVR-IC	LDO, 4.65V±2%, 240mA, -CE	SOT-89-5	32um VR4	6h	Tor
LPH	XC6219D47APR	LVR-IC	LDO, 4.75V±2%, 240mA, -CE	SOT-89-5	32um VR4	6h	Tor
LPK	XC6219D48APR	LVR-IC	LDO, 4.85V±2%, 240mA, -CE	SOT-89-5	32um VR4	6h	Tor
LPL	XC6219D49APR	LVR-IC	LDO, 4.95V±2%, 240mA, -CE	SOT-89-5	32um VR4	6h	Tor
LV8	XC6219A092PR	LVR-IC	LDO, 0.9V±2%, 150mA, +CE, PDR	SOT-89-5	32um VR4	6h	Tor
LV9	XC6219A102PR	LVR-IC	LDO, 1V±2%, 150mA, +CE, PDR	SOT-89-5	32um VR4	6h	Tor
LVA	XC6219A112PR	LVR-IC	LDO, 1.1V±2%, 150mA, +CE, PDR	SOT-89-5	32um VR4	6h	Tor
LVB	XC6219A122PR	LVR-IC	LDO, 1.2V±2%, 150mA, +CE, PDR	SOT-89-5	32um VR4	6h	Tor
LVC	XC6219A132PR	LVR-IC	LDO, 1.3V±2%, 150mA, +CE, PDR	SOT-89-5	32um VR4	6h	Tor
LVD	XC6219A142PR	LVR-IC	LDO, 1.4V±2%, 150mA, +CE, PDR	SOT-89-5	32um VR4	6h	Tor
LVE	XC6219A152PR	LVR-IC	LDO, 1.5V±2%, 150mA, +CE, PDR	SOT-89-5	32um VR4	6h	Tor
LVF	XC6219A162PR	LVR-IC	LDO, 1.6V±2%, 150mA, +CE, PDR	SOT-89-5	32um VR4	6h	Tor
L VH	XC6219A172PR	LVR-IC	LDO, 1.7V±2%, 150mA, +CE, PDR	SOT-89-5	32um VR4	6h	Tor
LVI	XC6219A182PR	LVR-IC	LDO, 1.8V±2%, 240mA, +CE, PDR	SOT-89-5	32um VR4	6h	Tor
LVL	XC6219A192PR	LVR-IC	LDO, 1.9V±2%, 240mA, +CE, PDR	SOT-89-5	32um VR4	6h	Tor
LVM	XC6219A202PR	LVR-IC	LDO, 2V±2%, 240mA, +CE, PDR	SOT-89-5	32um VR4	6h	Tor
LVN	XC6219A212PR	LVR-IC	LDO, 2.1V±2%, 240mA, +CE, PDR	SOT-89-5	32um VR4	6h	Tor
LVP	XC6219A222PR	LVR-IC	LDO, 2.2V±2%, 240mA, +CE, PDR	SOT-89-5	32um VR4	6h	Tor
LVR	XC6219A232PR	LVR-IC	LDO, 2.3V±2%, 240mA, +CE, PDR	SOT-89-5	32um VR4	6h	Tor
LVS	XC6219A242PR	LVR-IC	LDO, 2.4V±2%, 240mA, +CE, PDR	SOT-89-5	32um VR4	6h	Tor
LVT	XC6219A252PR	LVR-IC	LDO, 2.5V±2%, 240mA, +CE, PDR	SOT-89-5	32um VR4	6h	Tor
L VU	XC6219A262PR	LVR-IC	LDO, 2.6V±2%, 240mA, +CE, PDR	SOT-89-5	32um VR4	6h	Tor
L VV	XC6219A272PR	LVR-IC	LDO, 2.7V±2%, 240mA, +CE, PDR	SOT-89-5	32um VR4	6h	Tor
L V X	XC6219A282PR	LVR-IC	LDO, 2.8V±2%, 240mA, +CE, PDR	SOT-89-5	32um VR4	6h	Tor
L V Y	XC6219A292PR	LVR-IC	LDO, 2.9V±2%, 240mA, +CE, PDR	SOT-89-5	32um VR4	6h	Tor
L V Z	XC6219A302PR	LVR-IC	LDO, 3V±2%, 240mA, +CE, PDR	SOT-89-5	32um VR4	6h	Tor
L X 8	XC6219B092PR	LVR-IC	LDO, 0.9V±2%, 150mA, +CE	SOT-89-5	32um VR4	6h	Tor
L X 9	XC6219B102PR	LVR-IC	LDO, 1V±2%, 150mA, +CE	SOT-89-5	32um VR4	6h	Tor
L X A	XC6219B112PR	LVR-IC	LDO, 1.1V±2%, 150mA, +CE	SOT-89-5	32um VR4	6h	Tor
L X B	XC6219B122PR	LVR-IC	LDO, 1.2V±2%, 150mA, +CE	SOT-89-5	32um VR4	6h	Tor
L X C	XC6219B132PR	LVR-IC	LDO, 1.3V±2%, 150mA, +CE	SOT-89-5	32um VR4	6h	Tor
L X D	XC6219B142PR	LVR-IC	LDO, 1.4V±2%, 150mA, +CE	SOT-89-5	32um VR4	6h	Tor
L X E	XC6219B152PR	LVR-IC	LDO, 1.5V±2%, 150mA, +CE	SOT-89-5	32um VR4	6h	Tor
L X F	XC6219B162PR	LVR-IC	LDO, 1.6V±2%, 150mA, +CE	SOT-89-5	32um VR4	6h	Tor
L X H	XC6219B172PR	LVR-IC	LDO, 1.7V±2%, 150mA, +CE	SOT-89-5	32um VR4	6h	Tor
L X K	XC6219B182PR	LVR-IC	LDO, 1.8V±2%, 240mA, +CE	SOT-89-5	32um VR4	6h	Tor
L X L	XC6219B192PR	LVR-IC	LDO, 1.9V±2%, 240mA, +CE	SOT-89-5	32um VR4	6h	Tor
L X M	XC6219B202PR	LVR-IC	LDO, 2V±2%, 240mA, +CE	SOT-89-5	32um VR4	6h	Tor
L X N	XC6219B212PR	LVR-IC	LDO, 2.1V±2%, 240mA, +CE	SOT-89-5	32um VR4	6h	Tor
L X P	XC6219B222PR	LVR-IC	LDO, 2.2V±2%, 240mA, +CE	SOT-89-5	32um VR4	6h	Tor
L X R	XC6219B232PR	LVR-IC	LDO, 2.3V±2%, 240mA, +CE	SOT-89-5	32um VR4	6h	Tor
L X S	XC6219B242PR	LVR-IC	LDO, 2.4V±2%, 240mA, +CE	SOT-89-5	32um VR4	6h	Tor
L X T	XC6219B252PR	LVR-IC	LDO, 2.5V±2%, 240mA, +CE	SOT-89-5	32um VR4	6h	Tor
L X U	XC6219B262PR	LVR-IC	LDO, 2.6V±2%, 240mA, +CE	SOT-89-5	32um VR4	6h	Tor
L X V	XC6219B272PR	LVR-IC	LDO, 2.7V±2%, 240mA, +CE	SOT-89-5	32um VR4	6h	Tor
L X X	XC6219B282PR	LVR-IC	LDO, 2.8V±2%, 240mA, +CE	SOT-89-5	32um VR4	6h	Tor
L X Y	XC6219B292PR	LVR-IC	LDO, 2.9V±2%, 240mA, +CE	SOT-89-5	32um VR4	6h	Tor
L X Z	XC6219B302PR	LVR-IC	LDO, 3V±2%, 240mA, +CE	SOT-89-5	32um VR4	6h	Tor
L Y 8	XC6219C092PR	LVR-IC	LDO, 0.9V±2%, 150mA, -CE, PDR	SOT-89-5	32um VR4	6h	Tor
L Y 9	XC6219C102PR	LVR-IC	LDO, 1V±2%, 150mA, -CE, PDR	SOT-89-5	32um VR4	6h	Tor
L Y A	XC6219C112PR	LVR-IC	LDO, 1.1V±2%, 150mA, -CE, PDR	SOT-89-5	32um VR4	6h	Tor
L Y B	XC6219C122PR	LVR-IC	LDO, 1.2V±2%, 150mA, -CE, PDR	SOT-89-5	32um VR4	6h	Tor
L Y C	XC6219C132PR	LVR-IC	LDO, 1.3V±2%, 150mA, -CE, PDR	SOT-89-5	32um VR4	6h	Tor
L Y D	XC6219C142PR	LVR-IC	LDO, 1.4V±2%, 150mA, -CE, PDR	SOT-89-5	32um VR4	6h	Tor
L Y E	XC6219C152PR	LVR-IC	LDO, 1.5V±2%, 150mA, -CE, PDR	SOT-89-5	32um VR4	6h	Tor
L Y F	XC6219C162PR	LVR-IC	LDO, 1.6V±2%, 150mA, -CE, PDR	SOT-89-5	32um VR4	6h	Tor
L Y H	XC6219C172PR	LVR-IC	LDO, 1.7V±2%, 150mA, -CE, PDR	SOT-89-5	32um VR4	6h	Tor
L Y K	XC6219C182PR	LVR-IC	LDO, 1.8V±2%, 240mA, -CE, PDR	SOT-89-5	32um VR4	6h	Tor
L Y L	XC6219C192PR	LVR-IC	LDO, 1.9V±2%, 240mA, -CE, PDR	SOT-89-5	32um VR4	6h	Tor
L Y M	XC6219C202PR	LVR-IC	LDO, 2V±2%, 240mA, -CE, PDR	SOT-89-5	32um VR4	6h	Tor



SMD code	Type	Function	Short description	Case	Pinout Sch.	St.	Mnf.
LYN	XC6219C212PR	LVR-IC	LDO, 2.1V±2%, 240mA, -CE, PDR	SOT-89-5	32um VR4	6h	Tor
LYP	XC6219C222PR	LVR-IC	LDO, 2.2V±2%, 240mA, -CE, PDR	SOT-89-5	32um VR4	6h	Tor
LYR	XC6219C232PR	LVR-IC	LDO, 2.3V±2%, 240mA, -CE, PDR	SOT-89-5	32um VR4	6h	Tor
LYS	XC6219C242PR	LVR-IC	LDO, 2.4V±2%, 240mA, -CE, PDR	SOT-89-5	32um VR4	6h	Tor
LYT	XC6219C252PR	LVR-IC	LDO, 2.5V±2%, 240mA, -CE, PDR	SOT-89-5	32um VR4	6h	Tor
LYU	XC6219C262PR	LVR-IC	LDO, 2.6V±2%, 240mA, -CE, PDR	SOT-89-5	32um VR4	6h	Tor
LYV	XC6219C272PR	LVR-IC	LDO, 2.7V±2%, 240mA, -CE, PDR	SOT-89-5	32um VR4	6h	Tor
LYX	XC6219C282PR	LVR-IC	LDO, 2.8V±2%, 240mA, -CE, PDR	SOT-89-5	32um VR4	6h	Tor
LYY	XC6219C292PR	LVR-IC	LDO, 2.9V±2%, 240mA, -CE, PDR	SOT-89-5	32um VR4	6h	Tor
LYZ	XC6219C302PR	LVR-IC	LDO, 3V±2%, 240mA, -CE, PDR	SOT-89-5	32um VR4	6h	Tor
LZ8	XC6219D092PR	LVR-IC	LDO, 0.9V±2%, 150mA, -CE	SOT-89-5	32um VR4	6h	Tor
LZ9	XC6219D102PR	LVR-IC	LDO, 1V±2%, 150mA, -CE	SOT-89-5	32um VR4	6h	Tor
LZA	XC6219D112PR	LVR-IC	LDO, 1.1V±2%, 150mA, -CE	SOT-89-5	32um VR4	6h	Tor
LZB	XC6219D122PR	LVR-IC	LDO, 1.2V±2%, 150mA, -CE	SOT-89-5	32um VR4	6h	Tor
LZC	XC6219D132PR	LVR-IC	LDO, 1.3V±2%, 150mA, -CE	SOT-89-5	32um VR4	6h	Tor
LZD	XC6219D142PR	LVR-IC	LDO, 1.4V±2%, 150mA, -CE	SOT-89-5	32um VR4	6h	Tor
LZE	XC6219D152PR	LVR-IC	LDO, 1.5V±2%, 150mA, -CE	SOT-89-5	32um VR4	6h	Tor
LZF	XC6219D162PR	LVR-IC	LDO, 1.6V±2%, 150mA, -CE	SOT-89-5	32um VR4	6h	Tor
LZH	XC6219D172PR	LVR-IC	LDO, 1.7V±2%, 150mA, -CE	SOT-89-5	32um VR4	6h	Tor
LZK	XC6219D182PR	LVR-IC	LDO, 1.8V±2%, 240mA, -CE	SOT-89-5	32um VR4	6h	Tor
LZL	XC6219D192PR	LVR-IC	LDO, 1.9V±2%, 240mA, -CE	SOT-89-5	32um VR4	6h	Tor
LZM	XC6219D202PR	LVR-IC	LDO, 2V±2%, 240mA, -CE	SOT-89-5	32um VR4	6h	Tor
LZN	XC6219D212PR	LVR-IC	LDO, 2.1V±2%, 240mA, -CE	SOT-89-5	32um VR4	6h	Tor
LZP	XC6219D222PR	LVR-IC	LDO, 2.2V±2%, 240mA, -CE	SOT-89-5	32um VR4	6h	Tor
LZR	XC6219D232PR	LVR-IC	LDO, 2.3V±2%, 240mA, -CE	SOT-89-5	32um VR4	6h	Tor
LZS	XC6219D242PR	LVR-IC	LDO, 2.4V±2%, 240mA, -CE	SOT-89-5	32um VR4	6h	Tor
LZT	XC6219D252PR	LVR-IC	LDO, 2.5V±2%, 240mA, -CE	SOT-89-5	32um VR4	6h	Tor
LZU	XC6219D262PR	LVR-IC	LDO, 2.6V±2%, 240mA, -CE	SOT-89-5	32um VR4	6h	Tor
LZV	XC6219D272PR	LVR-IC	LDO, 2.7V±2%, 240mA, -CE	SOT-89-5	32um VR4	6h	Tor
LZX	XC6219D282PR	LVR-IC	LDO, 2.8V±2%, 240mA, -CE	SOT-89-5	32um VR4	6h	Tor
LZY	XC6219D292PR	LVR-IC	LDO, 2.9V±2%, 240mA, -CE	SOT-89-5	32um VR4	6h	Tor
LZZ	XC6219D302PR	LVR-IC	LDO, 3V±2%, 240mA, -CE	SOT-89-5	32um VR4	6h	Tor
M020	R1514H020B	LVR-IC	2V±2%, 150mA, +CE	SOT-89-5	32wg VR4	6h	Ric
M021	R1514H021B	LVR-IC	2.1V±2%, 150mA, +CE	SOT-89-5	32wg VR4	6h	Ric
M022	R1514H022B	LVR-IC	2.2V±2%, 150mA, +CE	SOT-89-5	32wg VR4	6h	Ric
M023	R1514H023B	LVR-IC	2.3V±2%, 150mA, +CE	SOT-89-5	32wg VR4	6h	Ric
M024	R1514H024B	LVR-IC	2.4V±2%, 150mA, +CE	SOT-89-5	32wg VR4	6h	Ric
M025	R1514H025B	LVR-IC	2.5V±2%, 150mA, +CE	SOT-89-5	32wg VR4	6h	Ric
M026	R1514H026B	LVR-IC	2.6V±2%, 150mA, +CE	SOT-89-5	32wg VR4	6h	Ric
M027	R1514H027B	LVR-IC	2.7V±2%, 150mA, +CE	SOT-89-5	32wg VR4	6h	Ric
M028	R1514H028B	LVR-IC	2.8V±2%, 150mA, +CE	SOT-89-5	32wg VR4	6h	Ric
M029	R1514H029B	LVR-IC	2.9V±2%, 150mA, +CE	SOT-89-5	32wg VR4	6h	Ric
M030	R1514H030B	LVR-IC	3V±2%, 150mA, +CE	SOT-89-5	32wg VR4	6h	Ric
M031	R1514H031B	LVR-IC	3.1V±2%, 150mA, +CE	SOT-89-5	32wg VR4	6h	Ric
M032	R1514H032B	LVR-IC	3.2V±2%, 150mA, +CE	SOT-89-5	32wg VR4	6h	Ric
M033	R1514H033B	LVR-IC	3.3V±2%, 150mA, +CE	SOT-89-5	32wg VR4	6h	Ric
M034	R1514H034B	LVR-IC	3.4V±2%, 150mA, +CE	SOT-89-5	32wg VR4	6h	Ric
M035	R1514H035B	LVR-IC	3.5V±2%, 150mA, +CE	SOT-89-5	32wg VR4	6h	Ric
M036	R1514H036B	LVR-IC	3.6V±2%, 150mA, +CE	SOT-89-5	32wg VR4	6h	Ric
M037	R1514H037B	LVR-IC	3.7V±2%, 150mA, +CE	SOT-89-5	32wg VR4	6h	Ric
M038	R1514H038B	LVR-IC	3.8V±2%, 150mA, +CE	SOT-89-5	32wg VR4	6h	Ric
M039	R1514H039B	LVR-IC	3.8V±2%, 150mA, +CE	SOT-89-5	32wg VR4	6h	Ric
M040	R1514H040B	LVR-IC	4V±2%, 150mA, +CE	SOT-89-5	32wg VR4	6h	Ric
M041	R1514H041B	LVR-IC	4.1V±2%, 150mA, +CE	SOT-89-5	32wg VR4	6h	Ric
M042	R1514H042B	LVR-IC	4.2V±2%, 150mA, +CE	SOT-89-5	32wg VR4	6h	Ric
M043	R1514H043B	LVR-IC	4.3V±2%, 150mA, +CE	SOT-89-5	32wg VR4	6h	Ric
M044	R1514H044B	LVR-IC	4.4V±2%, 150mA, +CE	SOT-89-5	32wg VR4	6h	Ric
M045	R1514H045B	LVR-IC	4.5V±2%, 150mA, +CE	SOT-89-5	32wg VR4	6h	Ric
M046	R1514H046B	LVR-IC	4.6V±2%, 150mA, +CE	SOT-89-5	32wg VR4	6h	Ric
M047	R1514H047B	LVR-IC	4.7V±2%, 150mA, +CE	SOT-89-5	32wg VR4	6h	Ric
M048	R1514H048B	LVR-IC	4.8V±2%, 150mA, +CE	SOT-89-5	32wg VR4	6h	Ric
M049	R1514H049B	LVR-IC	4.9V±2%, 150mA, +CE	SOT-89-5	32wg VR4	6h	Ric
M050	R1514H050B	LVR-IC	5V±2%, 150mA, +CE	SOT-89-5	32wg VR4	6h	Ric
M051	R1514H051B	LVR-IC	5.1V±2%, 150mA, +CE	SOT-89-5	32wg VR4	6h	Ric
M052	R1514H052B	LVR-IC	5.2V±2%, 150mA, +CE	SOT-89-5	32wg VR4	6h	Ric
M053	R1514H053B	LVR-IC	5.3V±2%, 150mA, +CE	SOT-89-5	32wg VR4	6h	Ric
M054	R1514H054B	LVR-IC	5.4V±2%, 150mA, +CE	SOT-89-5	32wg VR4	6h	Ric
M055	R1514H055B	LVR-IC	5.5V±2%, 150mA, +CE	SOT-89-5	32wg VR4	6h	Ric
M056	R1514H056B	LVR-IC	5.6V±2%, 150mA, +CE	SOT-89-5	32wg VR4	6h	Ric
M057	R1514H057B	LVR-IC	5.7V±2%, 150mA, +CE	SOT-89-5	32wg VR4	6h	Ric



SMD code	Type	Function	Short description	Case	Pinout	Sch.	St.	Mnf.
M058	R1514H058B	LVR-IC	5.8V±2%, 150mA, +CE	SOT-89-5	32wg	VR4	6h	Ric
M059	R1514H059B	LVR-IC	5.9V±2%, 150mA, +CE	SOT-89-5	32wg	VR4	6h	Ric
M060	R1514H060B	LVR-IC	6V±2%, 150mA, +CE	SOT-89-5	32wg	VR4	6h	Ric
M061	R1514H061B	LVR-IC	6.1V±2%, 150mA, +CE	SOT-89-5	32wg	VR4	6h	Ric
M062	R1514H062B	LVR-IC	6.2V±2%, 150mA, +CE	SOT-89-5	32wg	VR4	6h	Ric
M063	R1514H063B	LVR-IC	6.3V±2%, 150mA, +CE	SOT-89-5	32wg	VR4	6h	Ric
M064	R1514H064B	LVR-IC	6.4V±2%, 150mA, +CE	SOT-89-5	32wg	VR4	6h	Ric
M065	R1514H065B	LVR-IC	6.5V±2%, 150mA, +CE	SOT-89-5	32wg	VR4	6h	Ric
M066	R1514H066B	LVR-IC	6.6V±2%, 150mA, +CE	SOT-89-5	32wg	VR4	6h	Ric
M067	R1514H067B	LVR-IC	6.7V±2%, 150mA, +CE	SOT-89-5	32wg	VR4	6h	Ric
M068	R1514H068B	LVR-IC	6.8V±2%, 150mA, +CE	SOT-89-5	32wg	VR4	6h	Ric
M069	R1514H069B	LVR-IC	6.9V±2%, 150mA, +CE	SOT-89-5	32wg	VR4	6h	Ric
M070	R1514H070B	LVR-IC	7V±2%, 150mA, +CE	SOT-89-5	32wg	VR4	6h	Ric
M071	R1514H071B	LVR-IC	7.1V±2%, 150mA, +CE	SOT-89-5	32wg	VR4	6h	Ric
M072	R1514H072B	LVR-IC	7.2V±2%, 150mA, +CE	SOT-89-5	32wg	VR4	6h	Ric
M073	R1514H073B	LVR-IC	7.3V±2%, 150mA, +CE	SOT-89-5	32wg	VR4	6h	Ric
M074	R1514H074B	LVR-IC	7.4V±2%, 150mA, +CE	SOT-89-5	32wg	VR4	6h	Ric
M075	R1514H075B	LVR-IC	7.5V±2%, 150mA, +CE	SOT-89-5	32wg	VR4	6h	Ric
M076	R1514H076B	LVR-IC	7.6V±2%, 150mA, +CE	SOT-89-5	32wg	VR4	6h	Ric
M077	R1514H077B	LVR-IC	7.7V±2%, 150mA, +CE	SOT-89-5	32wg	VR4	6h	Ric
M078	R1514H078B	LVR-IC	7.8V±2%, 150mA, +CE	SOT-89-5	32wg	VR4	6h	Ric
M079	R1514H079B	LVR-IC	7.9V±2%, 150mA, +CE	SOT-89-5	32wg	VR4	6h	Ric
M080	R1514H080B	LVR-IC	8V±2%, 150mA, +CE	SOT-89-5	32wg	VR4	6h	Ric
M081	R1514H081B	LVR-IC	8.1V±2%, 150mA, +CE	SOT-89-5	32wg	VR4	6h	Ric
M082	R1514H082B	LVR-IC	8.2V±2%, 150mA, +CE	SOT-89-5	32wg	VR4	6h	Ric
M083	R1514H083B	LVR-IC	8.3V±2%, 150mA, +CE	SOT-89-5	32wg	VR4	6h	Ric
M084	R1514H084B	LVR-IC	8.4V±2%, 150mA, +CE	SOT-89-5	32wg	VR4	6h	Ric
M085	R1514H085B	LVR-IC	8.5V±2%, 150mA, +CE	SOT-89-5	32wg	VR4	6h	Ric
M086	R1514H086B	LVR-IC	8.6V±2%, 150mA, +CE	SOT-89-5	32wg	VR4	6h	Ric
M087	R1514H087B	LVR-IC	8.7V±2%, 150mA, +CE	SOT-89-5	32wg	VR4	6h	Ric
M088	R1514H088B	LVR-IC	8.8V±2%, 150mA, +CE	SOT-89-5	32wg	VR4	6h	Ric
M089	R1514H089B	LVR-IC	8.9V±2%, 150mA, +CE	SOT-89-5	32wg	VR4	6h	Ric
M090	R1514H090B	LVR-IC	9V±2%, 150mA, +CE	SOT-89-5	32wg	VR4	6h	Ric
M091	R1514H091B	LVR-IC	9.1V±2%, 150mA, +CE	SOT-89-5	32wg	VR4	6h	Ric
M092	R1514H092B	LVR-IC	9.2V±2%, 150mA, +CE	SOT-89-5	32wg	VR4	6h	Ric
M093	R1514H093B	LVR-IC	9.3V±2%, 150mA, +CE	SOT-89-5	32wg	VR4	6h	Ric
M094	R1514H094B	LVR-IC	9.4V±2%, 150mA, +CE	SOT-89-5	32wg	VR4	6h	Ric
M095	R1514H095B	LVR-IC	9.5V±2%, 150mA, +CE	SOT-89-5	32wg	VR4	6h	Ric
M096	R1514H096B	LVR-IC	9.6V±2%, 150mA, +CE	SOT-89-5	32wg	VR4	6h	Ric
M097	R1514H097B	LVR-IC	9.7V±2%, 150mA, +CE	SOT-89-5	32wg	VR4	6h	Ric
M098	R1514H098B	LVR-IC	9.8V±2%, 150mA, +CE	SOT-89-5	32wg	VR4	6h	Ric
M099	R1514H099B	LVR-IC	9.9V±2%, 150mA, +CE	SOT-89-5	32wg	VR4	6h	Ric
M100	R1514H100B	LVR-IC	10V±2%, 150mA, +CE	SOT-89-5	32wg	VR4	6h	Ric
M101	R1514H101B	LVR-IC	10.1V±2%, 150mA, +CE	SOT-89-5	32wg	VR4	6h	Ric
M102	R1514H102B	LVR-IC	10.2V±2%, 150mA, +CE	SOT-89-5	32wg	VR4	6h	Ric
M103	R1514H103B	LVR-IC	10.3V±2%, 150mA, +CE	SOT-89-5	32wg	VR4	6h	Ric
M104	R1514H104B	LVR-IC	10.4V±2%, 150mA, +CE	SOT-89-5	32wg	VR4	6h	Ric
M105	R1514H105B	LVR-IC	10.5V±2%, 150mA, +CE	SOT-89-5	32wg	VR4	6h	Ric
M106	R1514H106B	LVR-IC	10.6V±2%, 150mA, +CE	SOT-89-5	32wg	VR4	6h	Ric
M107	R1514H107B	LVR-IC	10.7V±2%, 150mA, +CE	SOT-89-5	32wg	VR4	6h	Ric
M108	R1514H108B	LVR-IC	10.8V±2%, 150mA, +CE	SOT-89-5	32wg	VR4	6h	Ric
M109	R1514H109B	LVR-IC	10.9V±2%, 150mA, +CE	SOT-89-5	32wg	VR4	6h	Ric
M110	R1514H110B	LVR-IC	11V±2%, 150mA, +CE	SOT-89-5	32wg	VR4	6h	Ric
M111	R1514H111B	LVR-IC	11.1V±2%, 150mA, +CE	SOT-89-5	32wg	VR4	6h	Ric
M112	R1514H112B	LVR-IC	11.2V±2%, 150mA, +CE	SOT-89-5	32wg	VR4	6h	Ric
M113	R1514H113B	LVR-IC	11.3V±2%, 150mA, +CE	SOT-89-5	32wg	VR4	6h	Ric
M114	R1514H114B	LVR-IC	11.4V±2%, 150mA, +CE	SOT-89-5	32wg	VR4	6h	Ric
M115	R1514H115B	LVR-IC	11.5V±2%, 150mA, +CE	SOT-89-5	32wg	VR4	6h	Ric
M116	R1514H116B	LVR-IC	11.6V±2%, 150mA, +CE	SOT-89-5	32wg	VR4	6h	Ric
M117	R1514H117B	LVR-IC	11.7V±2%, 150mA, +CE	SOT-89-5	32wg	VR4	6h	Ric
M118	R1514H118B	LVR-IC	11.8V±2%, 150mA, +CE	SOT-89-5	32wg	VR4	6h	Ric
M119	R1514H119B	LVR-IC	11.9V±2%, 150mA, +CE	SOT-89-5	32wg	VR4	6h	Ric
M120	R1514H120B	LVR-IC	12V±2%, 150mA, +CE	SOT-89-5	32wg	VR4	6h	Ric
MA	ELM99303B	LVR-IC	LDO, 3.0V±2%, 300mA, +CE	SOT-89-5	32vrt	VR1	6n	Elm
MB	ELM99313B	LVR-IC	LDO, 3.1V±2%, 300mA, +CE	SOT-89-5	32vrt	VR1	6n	Elm
MC	ELM99323B	LVR-IC	LDO, 3.2V±2%, 300mA, +CE	SOT-89-5	32vrt	VR1	6n	Elm
MD	ELM99333B	LVR-IC	LDO, 3.3V±2%, 300mA, +CE	SOT-89-5	32vrt	VR1	6n	Elm
ME	ELM99343B	LVR-IC	LDO, 3.4V±2%, 300mA, +CE	SOT-89-5	32vrt	VR1	6n	Elm
MF	ELM99353B	LVR-IC	LDO, 3.5V±2%, 300mA, +CE	SOT-89-5	32vrt	VR1	6n	Elm
MG	ELM99363B	LVR-IC	LDO, 3.6V±2%, 300mA, +CE	SOT-89-5	32vrt	VR1	6n	Elm



SMD code	Type	Function	Short description	Case	Pinout Sch.	St.	Mnf.
N087	R1515H087B	LVR-IC	8.7V±2%, 50mA, +CE	SOT-89-5	32yp VR4	6h	Ric
N088	R1515H088B	LVR-IC	8.8V±2%, 50mA, +CE	SOT-89-5	32yp VR4	6h	Ric
N089	R1515H089B	LVR-IC	8.9V±2%, 50mA, +CE	SOT-89-5	32yp VR4	6h	Ric
N090	R1515H090B	LVR-IC	9V±2%, 50mA, +CE	SOT-89-5	32yp VR4	6h	Ric
N091	R1515H091B	LVR-IC	9.1V±2%, 50mA, +CE	SOT-89-5	32yp VR4	6h	Ric
N092	R1515H092B	LVR-IC	9.2V±2%, 50mA, +CE	SOT-89-5	32yp VR4	6h	Ric
N093	R1515H093B	LVR-IC	9.3V±2%, 50mA, +CE	SOT-89-5	32yp VR4	6h	Ric
N094	R1515H094B	LVR-IC	9.4V±2%, 50mA, +CE	SOT-89-5	32yp VR4	6h	Ric
N095	R1515H095B	LVR-IC	9.5V±2%, 50mA, +CE	SOT-89-5	32yp VR4	6h	Ric
N096	R1515H096B	LVR-IC	9.6V±2%, 50mA, +CE	SOT-89-5	32yp VR4	6h	Ric
N097	R1515H097B	LVR-IC	9.7V±2%, 50mA, +CE	SOT-89-5	32yp VR4	6h	Ric
N098	R1515H098B	LVR-IC	9.8V±2%, 50mA, +CE	SOT-89-5	32yp VR4	6h	Ric
N099	R1515H099B	LVR-IC	9.9V±2%, 50mA, +CE	SOT-89-5	32yp VR4	6h	Ric
N100	R1515H100B	LVR-IC	10V±2%, 50mA, +CE	SOT-89-5	32yp VR4	6h	Ric
N101	R1515H101B	LVR-IC	10.1V±2%, 50mA, +CE	SOT-89-5	32yp VR4	6h	Ric
N102	R1515H102B	LVR-IC	10.2V±2%, 50mA, +CE	SOT-89-5	32yp VR4	6h	Ric
N103	R1515H103B	LVR-IC	10.3V±2%, 50mA, +CE	SOT-89-5	32yp VR4	6h	Ric
N104	R1515H104B	LVR-IC	10.4V±2%, 50mA, +CE	SOT-89-5	32yp VR4	6h	Ric
N105	R1515H105B	LVR-IC	10.5V±2%, 50mA, +CE	SOT-89-5	32yp VR4	6h	Ric
N106	R1515H106B	LVR-IC	10.6V±2%, 50mA, +CE	SOT-89-5	32yp VR4	6h	Ric
N107	R1515H107B	LVR-IC	10.7V±2%, 50mA, +CE	SOT-89-5	32yp VR4	6h	Ric
N108	R1515H108B	LVR-IC	10.8V±2%, 50mA, +CE	SOT-89-5	32yp VR4	6h	Ric
N109	R1515H109B	LVR-IC	10.9V±2%, 50mA, +CE	SOT-89-5	32yp VR4	6h	Ric
N110	R1515H110B	LVR-IC	11V±2%, 50mA, +CE	SOT-89-5	32yp VR4	6h	Ric
N111	R1515H111B	LVR-IC	11.1V±2%, 50mA, +CE	SOT-89-5	32yp VR4	6h	Ric
N112	R1515H112B	LVR-IC	11.2V±2%, 50mA, +CE	SOT-89-5	32yp VR4	6h	Ric
N113	R1515H113B	LVR-IC	11.3V±2%, 50mA, +CE	SOT-89-5	32yp VR4	6h	Ric
N114	R1515H114B	LVR-IC	11.4V±2%, 50mA, +CE	SOT-89-5	32yp VR4	6h	Ric
N115	R1515H115B	LVR-IC	11.5V±2%, 50mA, +CE	SOT-89-5	32yp VR4	6h	Ric
N116	R1515H116B	LVR-IC	11.6V±2%, 50mA, +CE	SOT-89-5	32yp VR4	6h	Ric
N117	R1515H117B	LVR-IC	11.7V±2%, 50mA, +CE	SOT-89-5	32yp VR4	6h	Ric
N118	R1515H118B	LVR-IC	11.8V±2%, 50mA, +CE	SOT-89-5	32yp VR4	6h	Ric
N119	R1515H119B	LVR-IC	11.9V±2%, 50mA, +CE	SOT-89-5	32yp VR4	6h	Ric
N120	R1515H120B	LVR-IC	12V±2%, 50mA, +CE	SOT-89-5	32yp VR4	6h	Ric
N4A	S-1131B15UC	LVR-IC	LDO, 1.5V±1%, 300mA, +CE	SOT-89-5	32vm VR4	6j	Sii
N4B	S-1131B16UC	LVR-IC	LDO, 1.6V±1%, 300mA, +CE	SOT-89-5	32vm VR4	6j	Sii
N4C	S-1131B17UC	LVR-IC	LDO, 1.7V±1%, 300mA, +CE	SOT-89-5	32vm VR4	6j	Sii
N4D	S-1131B18UC	LVR-IC	LDO, 1.8V±1%, 300mA, +CE	SOT-89-5	32vm VR4	6j	Sii
N4E	S-1131B19UC	LVR-IC	LDO, 1.9V±1%, 300mA, +CE	SOT-89-5	32vm VR4	6j	Sii
N4F	S-1131B20UC	LVR-IC	LDO, 2.0V±1%, 300mA, +CE	SOT-89-5	32vm VR4	6j	Sii
N4G	S-1131B21UC	LVR-IC	LDO, 2.1V±1%, 300mA, +CE	SOT-89-5	32vm VR4	6j	Sii
N4H	S-1131B22UC	LVR-IC	LDO, 2.2V±1%, 300mA, +CE	SOT-89-5	32vm VR4	6j	Sii
N4I	S-1131B23UC	LVR-IC	LDO, 2.3V±1%, 300mA, +CE	SOT-89-5	32vm VR4	6j	Sii
N4J	S-1131B24UC	LVR-IC	LDO, 2.4V±1%, 300mA, +CE	SOT-89-5	32vm VR4	6j	Sii
N4K	S-1131B25UC	LVR-IC	LDO, 2.5V±1%, 300mA, +CE	SOT-89-5	32vm VR4	6j	Sii
N4L	S-1131B26UC	LVR-IC	LDO, 2.6V±1%, 300mA, +CE	SOT-89-5	32vm VR4	6j	Sii
N4M	S-1131B27UC	LVR-IC	LDO, 2.7V±1%, 300mA, +CE	SOT-89-5	32vm VR4	6j	Sii
N4N	S-1131B28UC	LVR-IC	LDO, 2.8V±1%, 300mA, +CE	SOT-89-5	32vm VR4	6j	Sii
N4O	S-1131B29UC	LVR-IC	LDO, 2.9V±1%, 300mA, +CE	SOT-89-5	32vm VR4	6j	Sii
N4P	S-1131B30UC	LVR-IC	LDO, 3.0V±1%, 300mA, +CE	SOT-89-5	32vm VR4	6j	Sii
N4Q	S-1131B31UC	LVR-IC	LDO, 3.1V±1%, 300mA, +CE	SOT-89-5	32vm VR4	6j	Sii
N4R	S-1131B32UC	LVR-IC	LDO, 3.2V±1%, 300mA, +CE	SOT-89-5	32vm VR4	6j	Sii
N4S	S-1131B33UC	LVR-IC	LDO, 3.3V±1%, 300mA, +CE	SOT-89-5	32vm VR4	6j	Sii
N4T	S-1131B34UC	LVR-IC	LDO, 3.4V±1%, 300mA, +CE	SOT-89-5	32vm VR4	6j	Sii
N4U	S-1131B35UC	LVR-IC	LDO, 3.5V±1%, 300mA, +CE	SOT-89-5	32vm VR4	6j	Sii
N4V	S-1131B36UC	LVR-IC	LDO, 3.6V±1%, 300mA, +CE	SOT-89-5	32vm VR4	6j	Sii
N4W	S-1131B37UC	LVR-IC	LDO, 3.7V±1%, 300mA, +CE	SOT-89-5	32vm VR4	6j	Sii
N4X	S-1131B38UC	LVR-IC	LDO, 3.8V±1%, 300mA, +CE	SOT-89-5	32vm VR4	6j	Sii
N4Y	S-1131B39UC	LVR-IC	LDO, 3.9V±1%, 300mA, +CE	SOT-89-5	32vm VR4	6j	Sii
N4Z	S-1131B40UC	LVR-IC	LDO, 4.0V±1%, 300mA, +CE	SOT-89-5	32vm VR4	6j	Sii
N5A	S-1131B41UC	LVR-IC	LDO, 4.1V±1%, 300mA, +CE	SOT-89-5	32vm VR4	6j	Sii
N5B	S-1131B42UC	LVR-IC	LDO, 4.2V±1%, 300mA, +CE	SOT-89-5	32vm VR4	6j	Sii
N5C	S-1131B43UC	LVR-IC	LDO, 4.3V±1%, 300mA, +CE	SOT-89-5	32vm VR4	6j	Sii
N5D	S-1131B44UC	LVR-IC	LDO, 4.4V±1%, 300mA, +CE	SOT-89-5	32vm VR4	6j	Sii
N5E	S-1131B45UC	LVR-IC	LDO, 4.5V±1%, 300mA, +CE	SOT-89-5	32vm VR4	6j	Sii
N5F	S-1131B46UC	LVR-IC	LDO, 4.6V±1%, 300mA, +CE	SOT-89-5	32vm VR4	6j	Sii
N5G	S-1131B47UC	LVR-IC	LDO, 4.7V±1%, 300mA, +CE	SOT-89-5	32vm VR4	6j	Sii
N5H	S-1131B48UC	LVR-IC	LDO, 4.8V±1%, 300mA, +CE	SOT-89-5	32vm VR4	6j	Sii
N5I	S-1131B49UC	LVR-IC	LDO, 4.9V±1%, 300mA, +CE	SOT-89-5	32vm VR4	6j	Sii
N5J	S-1131B50UC	LVR-IC	LDO, 5.0V±1%, 300mA, +CE	SOT-89-5	32vm VR4	6j	Sii



SMD code	Type	Function	Short description	Case	Pinout	Sch.	St.	Mnf.
N5K	S-1131B51UC	LVR-IC	LDO, 5.1V±1%, 300mA, +CE	SOT-89-5	32vm	VR4	6j	Sii
N5L	S-1131B52UC	LVR-IC	LDO, 5.2V±1%, 300mA, +CE	SOT-89-5	32vm	VR4	6j	Sii
N5M	S-1131B53UC	LVR-IC	LDO, 5.3V±1%, 300mA, +CE	SOT-89-5	32vm	VR4	6j	Sii
N5N	S-1131B54UC	LVR-IC	LDO, 5.4V±1%, 300mA, +CE	SOT-89-5	32vm	VR4	6j	Sii
N5O	S-1131B55UC	LVR-IC	LDO, 5.5V±1%, 300mA, +CE	SOT-89-5	32vm	VR4	6j	Sii
NA	ELM99403B	LVR-IC	LDO, 4.0V±2%, 300mA, +CE	SOT-89-5	32vrt	VR1	6n	Elm
NB	ELM99413B	LVR-IC	LDO, 4.1V±2%, 300mA, +CE	SOT-89-5	32vrt	VR1	6n	Elm
NC	ELM99423B	LVR-IC	LDO, 4.2V±2%, 300mA, +CE	SOT-89-5	32vrt	VR1	6n	Elm
NC8	XC6222A081PR-G	LVR-IC	LDO, 0.8V±20mV, 700mA, +CE	SOT-89-5	32vy	VR4	6n	Tor
NC9	XC6222A091PR-G	LVR-IC	LDO, 0.9V±20mV, 700mA, +CE	SOT-89-5	32vy	VR4	6n	Tor
NCA	XC6222A101PR-G	LVR-IC	LDO, 1.0V±20mV, 700mA, +CE	SOT-89-5	32vy	VR4	6n	Tor
NCB	XC6222A111PR-G	LVR-IC	LDO, 1.1V±20mV, 700mA, +CE	SOT-89-5	32vy	VR4	6n	Tor
NCC	XC6222A121PR-G	LVR-IC	LDO, 1.2V±20mV, 700mA, +CE	SOT-89-5	32vy	VR4	6n	Tor
NCD	XC6222A131PR-G	LVR-IC	LDO, 1.3V±20mV, 700mA, +CE	SOT-89-5	32vy	VR4	6n	Tor
NCE	XC6222A141PR-G	LVR-IC	LDO, 1.4V±20mV, 700mA, +CE	SOT-89-5	32vy	VR4	6n	Tor
NCF	XC6222A151PR-G	LVR-IC	LDO, 1.5V±20mV, 700mA, +CE	SOT-89-5	32vy	VR4	6n	Tor
NCH	XC6222A161PR-G	LVR-IC	LDO, 1.6V±20mV, 700mA, +CE	SOT-89-5	32vy	VR4	6n	Tor
NCK	XC6222A171PR-G	LVR-IC	LDO, 1.7V±20mV, 700mA, +CE	SOT-89-5	32vy	VR4	6n	Tor
NCL	XC6222A181PR-G	LVR-IC	LDO, 1.8V±20mV, 700mA, +CE	SOT-89-5	32vy	VR4	6n	Tor
NCM	XC6222A191PR-G	LVR-IC	LDO, 1.9V±20mV, 700mA, +CE	SOT-89-5	32vy	VR4	6n	Tor
NCN	XC6222A201PR-G	LVR-IC	LDO, 2.0V±20mV, 700mA, +CE	SOT-89-5	32vy	VR4	6n	Tor
NCP	XC6222A211PR-G	LVR-IC	LDO, 2.1V±1%, 700mA, +CE	SOT-89-5	32vy	VR4	6n	Tor
NCR	XC6222A221PR-G	LVR-IC	LDO, 2.2V±1%, 700mA, +CE	SOT-89-5	32vy	VR4	6n	Tor
NCS	XC6222A231PR-G	LVR-IC	LDO, 2.3V±1%, 700mA, +CE	SOT-89-5	32vy	VR4	6n	Tor
NCT	XC6222A241PR-G	LVR-IC	LDO, 2.4V±1%, 700mA, +CE	SOT-89-5	32vy	VR4	6n	Tor
NCU	XC6222A251PR-G	LVR-IC	LDO, 2.5V±1%, 700mA, +CE	SOT-89-5	32vy	VR4	6n	Tor
NCV	XC6222A261PR-G	LVR-IC	LDO, 2.6V±1%, 700mA, +CE	SOT-89-5	32vy	VR4	6n	Tor
NCX	XC6222A271PR-G	LVR-IC	LDO, 2.7V±1%, 700mA, +CE	SOT-89-5	32vy	VR4	6n	Tor
NCY	XC6222A281PR-G	LVR-IC	LDO, 2.8V±1%, 700mA, +CE	SOT-89-5	32vy	VR4	6n	Tor
NCZ	XC6222A291PR-G	LVR-IC	LDO, 2.9V±1%, 700mA, +CE	SOT-89-5	32vy	VR4	6n	Tor
ND	ELM99433B	LVR-IC	LDO, 4.3V±2%, 300mA, +CE	SOT-89-5	32vrt	VR1	6n	Elm
ND8	XC6222A08BPR-G	LVR-IC	LDO, 0.85V±20mV, 700mA, +CE	SOT-89-5	32vy	VR4	6n	Tor
ND9	XC6222A09BPR-G	LVR-IC	LDO, 0.95V±20mV, 700mA, +CE	SOT-89-5	32vy	VR4	6n	Tor
NDA	XC6222A10BPR-G	LVR-IC	LDO, 1.05V±20mV, 700mA, +CE	SOT-89-5	32vy	VR4	6n	Tor
NDB	XC6222A11BPR-G	LVR-IC	LDO, 1.15V±20mV, 700mA, +CE	SOT-89-5	32vy	VR4	6n	Tor
NDC	XC6222A12BPR-G	LVR-IC	LDO, 1.25V±20mV, 700mA, +CE	SOT-89-5	32vy	VR4	6n	Tor
NDD	XC6222A13BPR-G	LVR-IC	LDO, 1.35V±20mV, 700mA, +CE	SOT-89-5	32vy	VR4	6n	Tor
NDE	XC6222A14BPR-G	LVR-IC	LDO, 1.45V±20mV, 700mA, +CE	SOT-89-5	32vy	VR4	6n	Tor
NDF	XC6222A15BPR-G	LVR-IC	LDO, 1.55V±20mV, 700mA, +CE	SOT-89-5	32vy	VR4	6n	Tor
NDH	XC6222A16BPR-G	LVR-IC	LDO, 1.65V±20mV, 700mA, +CE	SOT-89-5	32vy	VR4	6n	Tor
NDK	XC6222A17BPR-G	LVR-IC	LDO, 1.75V±20mV, 700mA, +CE	SOT-89-5	32vy	VR4	6n	Tor
NDL	XC6222A18BPR-G	LVR-IC	LDO, 1.85V±20mV, 700mA, +CE	SOT-89-5	32vy	VR4	6n	Tor
NDM	XC6222A19BPR-G	LVR-IC	LDO, 1.95V±20mV, 700mA, +CE	SOT-89-5	32vy	VR4	6n	Tor
NDN	XC6222A20BPR-G	LVR-IC	LDO, 2.05V±1%, 700mA, +CE	SOT-89-5	32vy	VR4	6n	Tor
NDP	XC6222A21BPR-G	LVR-IC	LDO, 2.15V±1%, 700mA, +CE	SOT-89-5	32vy	VR4	6n	Tor
NDR	XC6222A22BPR-G	LVR-IC	LDO, 2.25V±1%, 700mA, +CE	SOT-89-5	32vy	VR4	6n	Tor
NDS	XC6222A23BPR-G	LVR-IC	LDO, 2.35V±1%, 700mA, +CE	SOT-89-5	32vy	VR4	6n	Tor
NDT	XC6222A24BPR-G	LVR-IC	LDO, 2.45V±1%, 700mA, +CE	SOT-89-5	32vy	VR4	6n	Tor
NDU	XC6222A25BPR-G	LVR-IC	LDO, 2.55V±1%, 700mA, +CE	SOT-89-5	32vy	VR4	6n	Tor
NDV	XC6222A26BPR-G	LVR-IC	LDO, 2.65V±1%, 700mA, +CE	SOT-89-5	32vy	VR4	6n	Tor
NDX	XC6222A27BPR-G	LVR-IC	LDO, 2.75V±1%, 700mA, +CE	SOT-89-5	32vy	VR4	6n	Tor
NDY	XC6222A28BPR-G	LVR-IC	LDO, 2.85V±1%, 700mA, +CE	SOT-89-5	32vy	VR4	6n	Tor
NDZ	XC6222A29BPR-G	LVR-IC	LDO, 2.95V±1%, 700mA, +CE	SOT-89-5	32vy	VR4	6n	Tor
NE	ELM99443B	LVR-IC	LDO, 4.4V±2%, 300mA, +CE	SOT-89-5	32vrt	VR1	6n	Elm
NE0	XC6222A301PR-G	LVR-IC	LDO, 3.0V±1%, 700mA, +CE	SOT-89-5	32vy	VR4	6n	Tor
NE1	XC6222A311PR-G	LVR-IC	LDO, 3.1V±1%, 700mA, +CE	SOT-89-5	32vy	VR4	6n	Tor
NE2	XC6222A321PR-G	LVR-IC	LDO, 3.2V±1%, 700mA, +CE	SOT-89-5	32vy	VR4	6n	Tor
NE3	XC6222A331PR-G	LVR-IC	LDO, 3.3V±1%, 700mA, +CE	SOT-89-5	32vy	VR4	6n	Tor
NE4	XC6222A341PR-G	LVR-IC	LDO, 3.4V±1%, 700mA, +CE	SOT-89-5	32vy	VR4	6n	Tor
NE5	XC6222A351PR-G	LVR-IC	LDO, 3.5V±1%, 700mA, +CE	SOT-89-5	32vy	VR4	6n	Tor
NE6	XC6222A361PR-G	LVR-IC	LDO, 3.6V±1%, 700mA, +CE	SOT-89-5	32vy	VR4	6n	Tor
NE7	XC6222A371PR-G	LVR-IC	LDO, 3.7V±1%, 700mA, +CE	SOT-89-5	32vy	VR4	6n	Tor
NE8	XC6222A381PR-G	LVR-IC	LDO, 3.8V±1%, 700mA, +CE	SOT-89-5	32vy	VR4	6n	Tor
NE9	XC6222A391PR-G	LVR-IC	LDO, 3.9V±1%, 700mA, +CE	SOT-89-5	32vy	VR4	6n	Tor
NEA	XC6222A401PR-G	LVR-IC	LDO, 4.0V±1%, 700mA, +CE	SOT-89-5	32vy	VR4	6n	Tor
NEB	XC6222A411PR-G	LVR-IC	LDO, 4.1V±1%, 700mA, +CE	SOT-89-5	32vy	VR4	6n	Tor
NEC	XC6222A421PR-G	LVR-IC	LDO, 4.2V±1%, 700mA, +CE	SOT-89-5	32vy	VR4	6n	Tor
NED	XC6222A431PR-G	LVR-IC	LDO, 4.3V±1%, 700mA, +CE	SOT-89-5	32vy	VR4	6n	Tor
NEE	XC6222A441PR-G	LVR-IC	LDO, 4.4V±1%, 700mA, +CE	SOT-89-5	32vy	VR4	6n	Tor
NEF	XC6222A451PR-G	LVR-IC	LDO, 4.5V±1%, 700mA, +CE	SOT-89-5	32vy	VR4	6n	Tor



SMD code	Type	Function	Short description	Case	Pinout Sch.	St.	Mnf.
NEH	XC6222A461PR-G	LVR-IC	LDO, 4.6V±1%, 700mA, +CE	SOT-89-5	32vy VR4	6n	Tor
NEK	XC6222A471PR-G	LVR-IC	LDO, 4.7V±1%, 700mA, +CE	SOT-89-5	32vy VR4	6n	Tor
NEL	XC6222A481PR-G	LVR-IC	LDO, 4.8V±1%, 700mA, +CE	SOT-89-5	32vy VR4	6n	Tor
NEM	XC6222A491PR-G	LVR-IC	LDO, 4.9V±1%, 700mA, +CE	SOT-89-5	32vy VR4	6n	Tor
NEN	XC6222A501PR-G	LVR-IC	LDO, 5.0V±1%, 700mA, +CE	SOT-89-5	32vy VR4	6n	Tor
NF	ELM99453B	LVR-IC	LDO, 4.5V±2%, 300mA, +CE	SOT-89-5	32vrt VR1	6n	Elm
NF0	XC6222A30BPR-G	LVR-IC	LDO, 3.05V±1%, 700mA, +CE	SOT-89-5	32vy VR4	6n	Tor
NF1	XC6222A31BPR-G	LVR-IC	LDO, 3.15V±1%, 700mA, +CE	SOT-89-5	32vy VR4	6n	Tor
NF2	XC6222A32BPR-G	LVR-IC	LDO, 3.25V±1%, 700mA, +CE	SOT-89-5	32vy VR4	6n	Tor
NF3	XC6222A33BPR-G	LVR-IC	LDO, 3.35V±1%, 700mA, +CE	SOT-89-5	32vy VR4	6n	Tor
NF4	XC6222A34BPR-G	LVR-IC	LDO, 3.45V±1%, 700mA, +CE	SOT-89-5	32vy VR4	6n	Tor
NF5	XC6222A35BPR-G	LVR-IC	LDO, 3.55V±1%, 700mA, +CE	SOT-89-5	32vy VR4	6n	Tor
NF6	XC6222A36BPR-G	LVR-IC	LDO, 3.65V±1%, 700mA, +CE	SOT-89-5	32vy VR4	6n	Tor
NF7	XC6222A37BPR-G	LVR-IC	LDO, 3.75V±1%, 700mA, +CE	SOT-89-5	32vy VR4	6n	Tor
NF8	XC6222A38BPR-G	LVR-IC	LDO, 3.85V±1%, 700mA, +CE	SOT-89-5	32vy VR4	6n	Tor
NF9	XC6222A39BPR-G	LVR-IC	LDO, 3.95V±1%, 700mA, +CE	SOT-89-5	32vy VR4	6n	Tor
NFA	XC6222A40BPR-G	LVR-IC	LDO, 4.05V±1%, 700mA, +CE	SOT-89-5	32vy VR4	6n	Tor
NFB	XC6222A41BPR-G	LVR-IC	LDO, 4.15V±1%, 700mA, +CE	SOT-89-5	32vy VR4	6n	Tor
NFC	XC6222A42BPR-G	LVR-IC	LDO, 4.25V±1%, 700mA, +CE	SOT-89-5	32vy VR4	6n	Tor
NFD	XC6222A43BPR-G	LVR-IC	LDO, 4.35V±1%, 700mA, +CE	SOT-89-5	32vy VR4	6n	Tor
NFE	XC6222A44BPR-G	LVR-IC	LDO, 4.45V±1%, 700mA, +CE	SOT-89-5	32vy VR4	6n	Tor
NFF	XC6222A45BPR-G	LVR-IC	LDO, 4.55V±1%, 700mA, +CE	SOT-89-5	32vy VR4	6n	Tor
NFH	XC6222A46BPR-G	LVR-IC	LDO, 4.65V±1%, 700mA, +CE	SOT-89-5	32vy VR4	6n	Tor
NFK	XC6222A47BPR-G	LVR-IC	LDO, 4.75V±1%, 700mA, +CE	SOT-89-5	32vy VR4	6n	Tor
NFL	XC6222A48BPR-G	LVR-IC	LDO, 4.85V±1%, 700mA, +CE	SOT-89-5	32vy VR4	6n	Tor
NFM	XC6222A49BPR-G	LVR-IC	LDO, 4.95V±1%, 700mA, +CE	SOT-89-5	32vy VR4	6n	Tor
NG	ELM99463B	LVR-IC	LDO, 4.6V±2%, 300mA, +CE	SOT-89-5	32vrt VR1	6n	Elm
NH	ELM99473B	LVR-IC	LDO, 4.7V±2%, 300mA, +CE	SOT-89-5	32vrt VR1	6n	Elm
NH8	XC6222B081PR-G	LVR-IC	LDO, 0.8V±20mV, 700mA, +CE, CL	SOT-89-5	32vy VR4	6n	Tor
NH9	XC6222B091PR-G	LVR-IC	LDO, 0.9V±20mV, 700mA, +CE, CL	SOT-89-5	32vy VR4	6n	Tor
NHA	XC6222B101PR-G	LVR-IC	LDO, 1.0V±20mV, 700mA, +CE, CL	SOT-89-5	32vy VR4	6n	Tor
NHB	XC6222B111PR-G	LVR-IC	LDO, 1.1V±20mV, 700mA, +CE, CL	SOT-89-5	32vy VR4	6n	Tor
NHC	XC6222B121PR-G	LVR-IC	LDO, 1.2V±20mV, 700mA, +CE, CL	SOT-89-5	32vy VR4	6n	Tor
NHD	XC6222B131PR-G	LVR-IC	LDO, 1.3V±20mV, 700mA, +CE, CL	SOT-89-5	32vy VR4	6n	Tor
NHE	XC6222B141PR-G	LVR-IC	LDO, 1.4V±20mV, 700mA, +CE, CL	SOT-89-5	32vy VR4	6n	Tor
NHF	XC6222B151PR-G	LVR-IC	LDO, 1.5V±20mV, 700mA, +CE, CL	SOT-89-5	32vy VR4	6n	Tor
NHH	XC6222B161PR-G	LVR-IC	LDO, 1.6V±20mV, 700mA, +CE, CL	SOT-89-5	32vy VR4	6n	Tor
NHK	XC6222B171PR-G	LVR-IC	LDO, 1.7V±20mV, 700mA, +CE, CL	SOT-89-5	32vy VR4	6n	Tor
NHL	XC6222B181PR-G	LVR-IC	LDO, 1.8V±20mV, 700mA, +CE, CL	SOT-89-5	32vy VR4	6n	Tor
NHM	XC6222B191PR-G	LVR-IC	LDO, 1.9V±20mV, 700mA, +CE, CL	SOT-89-5	32vy VR4	6n	Tor
NHN	XC6222B201PR-G	LVR-IC	LDO, 2.0V±20mV, 700mA, +CE, CL	SOT-89-5	32vy VR4	6n	Tor
NHP	XC6222B211PR-G	LVR-IC	LDO, 2.1V±1%, 700mA, +CE, CL	SOT-89-5	32vy VR4	6n	Tor
NHR	XC6222B221PR-G	LVR-IC	LDO, 2.2V±1%, 700mA, +CE, CL	SOT-89-5	32vy VR4	6n	Tor
NHS	XC6222B231PR-G	LVR-IC	LDO, 2.3V±1%, 700mA, +CE, CL	SOT-89-5	32vy VR4	6n	Tor
NHT	XC6222B241PR-G	LVR-IC	LDO, 2.4V±1%, 700mA, +CE, CL	SOT-89-5	32vy VR4	6n	Tor
NHU	XC6222B251PR-G	LVR-IC	LDO, 2.5V±1%, 700mA, +CE, CL	SOT-89-5	32vy VR4	6n	Tor
NHV	XC6222B261PR-G	LVR-IC	LDO, 2.6V±1%, 700mA, +CE, CL	SOT-89-5	32vy VR4	6n	Tor
NHX	XC6222B271PR-G	LVR-IC	LDO, 2.7V±1%, 700mA, +CE, CL	SOT-89-5	32vy VR4	6n	Tor
NHY	XC6222B281PR-G	LVR-IC	LDO, 2.8V±1%, 700mA, +CE, CL	SOT-89-5	32vy VR4	6n	Tor
NHZ	XC6222B291PR-G	LVR-IC	LDO, 2.9V±1%, 700mA, +CE, CL	SOT-89-5	32vy VR4	6n	Tor
NJ	ELM99483B	LVR-IC	LDO, 4.8V±2%, 300mA, +CE	SOT-89-5	32vrt VR1	6n	Elm
NK	ELM99493B	LVR-IC	LDO, 4.9V±2%, 300mA, +CE	SOT-89-5	32vrt VR1	6n	Elm
NK8	XC6222B08BPR-G	LVR-IC	LDO, 0.85V±20mV, 700mA, +CE, CL	SOT-89-5	32vy VR4	6n	Tor
NK9	XC6222B09BPR-G	LVR-IC	LDO, 0.95V±20mV, 700mA, +CE, CL	SOT-89-5	32vy VR4	6n	Tor
NKA	XC6222B10BPR-G	LVR-IC	LDO, 1.05V±20mV, 700mA, +CE, CL	SOT-89-5	32vy VR4	6n	Tor
NKB	XC6222B11BPR-G	LVR-IC	LDO, 1.15V±20mV, 700mA, +CE, CL	SOT-89-5	32vy VR4	6n	Tor
NKC	XC6222B12BPR-G	LVR-IC	LDO, 1.25V±20mV, 700mA, +CE, CL	SOT-89-5	32vy VR4	6n	Tor
NKD	XC6222B13BPR-G	LVR-IC	LDO, 1.35V±20mV, 700mA, +CE, CL	SOT-89-5	32vy VR4	6n	Tor
NKE	XC6222B14BPR-G	LVR-IC	LDO, 1.45V±20mV, 700mA, +CE, CL	SOT-89-5	32vy VR4	6n	Tor
NKF	XC6222B15BPR-G	LVR-IC	LDO, 1.55V±20mV, 700mA, +CE, CL	SOT-89-5	32vy VR4	6n	Tor
NKH	XC6222B16BPR-G	LVR-IC	LDO, 1.65V±20mV, 700mA, +CE, CL	SOT-89-5	32vy VR4	6n	Tor
NKK	XC6222B17BPR-G	LVR-IC	LDO, 1.75V±20mV, 700mA, +CE, CL	SOT-89-5	32vy VR4	6n	Tor
NKL	XC6222B18BPR-G	LVR-IC	LDO, 1.85V±20mV, 700mA, +CE, CL	SOT-89-5	32vy VR4	6n	Tor
NKM	XC6222B19BPR-G	LVR-IC	LDO, 1.95V±20mV, 700mA, +CE, CL	SOT-89-5	32vy VR4	6n	Tor
NKN	XC6222B20BPR-G	LVR-IC	LDO, 2.05V±1%, 700mA, +CE, CL	SOT-89-5	32vy VR4	6n	Tor
NKP	XC6222B21BPR-G	LVR-IC	LDO, 2.15V±1%, 700mA, +CE, CL	SOT-89-5	32vy VR4	6n	Tor
NKR	XC6222B22BPR-G	LVR-IC	LDO, 2.25V±1%, 700mA, +CE, CL	SOT-89-5	32vy VR4	6n	Tor
NKS	XC6222B23BPR-G	LVR-IC	LDO, 2.35V±1%, 700mA, +CE, CL	SOT-89-5	32vy VR4	6n	Tor
NKT	XC6222B24BPR-G	LVR-IC	LDO, 2.45V±1%, 700mA, +CE, CL	SOT-89-5	32vy VR4	6n	Tor
NKU	XC6222B25BPR-G	LVR-IC	LDO, 2.55V±1%, 700mA, +CE, CL	SOT-89-5	32vy VR4	6n	Tor



SMD code	Type	Function	Short description	Case	Pinout Sch.	St.	Mnf.
NXF	XC6222D45BPR-G	LVR-IC	LDO, 4.55V±1%, 700mA, +CE, CL, PDR	SOT-89-5	32vy VR4	6n	Tor
NXH	XC6222D46BPR-G	LVR-IC	LDO, 4.65V±1%, 700mA, +CE, CL, PDR	SOT-89-5	32vy VR4	6n	Tor
NXK	XC6222D47BPR-G	LVR-IC	LDO, 4.75V±1%, 700mA, +CE, CL, PDR	SOT-89-5	32vy VR4	6n	Tor
NXL	XC6222D48BPR-G	LVR-IC	LDO, 4.85V±1%, 700mA, +CE, CL, PDR	SOT-89-5	32vy VR4	6n	Tor
NXM	XC6222D49BPR-G	LVR-IC	LDO, 4.95V±1%, 700mA, +CE, CL, PDR	SOT-89-5	32vy VR4	6n	Tor
OTA	S-1170B15UC	LVR-IC	LDO, 1.5V±1.0%, 800mA, +CE	SOT-89-5	32vy VR4	6n	Sii
OTB	S-1170B16UC	LVR-IC	LDO, 1.6V±1.0%, 800mA, +CE	SOT-89-5	32vy VR4	6n	Sii
OTC	S-1170B17UC	LVR-IC	LDO, 1.7V±1.0%, 800mA, +CE	SOT-89-5	32vy VR4	6n	Sii
OTD	S-1170B18UC	LVR-IC	LDO, 1.8V±1.0%, 800mA, +CE	SOT-89-5	32vy VR4	6n	Sii
OTE	S-1170B19UC	LVR-IC	LDO, 1.9V±1.0%, 800mA, +CE	SOT-89-5	32vy VR4	6n	Sii
OTF	S-1170B20UC	LVR-IC	LDO, 2.0V±1.0%, 800mA, +CE	SOT-89-5	32vy VR4	6n	Sii
OTG	S-1170B21UC	LVR-IC	LDO, 2.1V±1.0%, 800mA, +CE	SOT-89-5	32vy VR4	6n	Sii
OTH	S-1170B22UC	LVR-IC	LDO, 2.2V±1.0%, 800mA, +CE	SOT-89-5	32vy VR4	6n	Sii
OTI	S-1170B23UC	LVR-IC	LDO, 2.3V±1.0%, 800mA, +CE	SOT-89-5	32vy VR4	6n	Sii
OTJ	S-1170B24UC	LVR-IC	LDO, 2.4V±1.0%, 800mA, +CE	SOT-89-5	32vy VR4	6n	Sii
OTK	S-1170B25UC	LVR-IC	LDO, 2.5V±1.0%, 800mA, +CE	SOT-89-5	32vy VR4	6n	Sii
OTL	S-1170B26UC	LVR-IC	LDO, 2.6V±1.0%, 800mA, +CE	SOT-89-5	32vy VR4	6n	Sii
OTM	S-1170B27UC	LVR-IC	LDO, 2.7V±1.0%, 800mA, +CE	SOT-89-5	32vy VR4	6n	Sii
OTN	S-1170B28UC	LVR-IC	LDO, 2.8V±1.0%, 800mA, +CE	SOT-89-5	32vy VR4	6n	Sii
OTO	S-1170B29UC	LVR-IC	LDO, 2.9V±1.0%, 800mA, +CE	SOT-89-5	32vy VR4	6n	Sii
OTP	S-1170B30UC	LVR-IC	LDO, 3.0V±1.0%, 800mA, +CE	SOT-89-5	32vy VR4	6n	Sii
OTQ	S-1170B31UC	LVR-IC	LDO, 3.1V±1.0%, 800mA, +CE	SOT-89-5	32vy VR4	6n	Sii
OTR	S-1170B32UC	LVR-IC	LDO, 3.2V±1.0%, 800mA, +CE	SOT-89-5	32vy VR4	6n	Sii
OTS	S-1170B33UC	LVR-IC	LDO, 3.3V±1.0%, 800mA, +CE	SOT-89-5	32vy VR4	6n	Sii
OTT	S-1170B34UC	LVR-IC	LDO, 3.4V±1.0%, 800mA, +CE	SOT-89-5	32vy VR4	6n	Sii
OTU	S-1170B35UC	LVR-IC	LDO, 3.5V±1.0%, 800mA, +CE	SOT-89-5	32vy VR4	6n	Sii
OTV	S-1170B36UC	LVR-IC	LDO, 3.6V±1.0%, 800mA, +CE	SOT-89-5	32vy VR4	6n	Sii
OTW	S-1170B37UC	LVR-IC	LDO, 3.7V±1.0%, 800mA, +CE	SOT-89-5	32vy VR4	6n	Sii
OTX	S-1170B38UC	LVR-IC	LDO, 3.8V±1.0%, 800mA, +CE	SOT-89-5	32vy VR4	6n	Sii
OTY	S-1170B39UC	LVR-IC	LDO, 3.9V±1.0%, 800mA, +CE	SOT-89-5	32vy VR4	6n	Sii
OTZ	S-1170B40UC	LVR-IC	LDO, 4.0V±1.0%, 800mA, +CE	SOT-89-5	32vy VR4	6n	Sii
OUA	S-1170B41UC	LVR-IC	LDO, 4.1V±1.0%, 800mA, +CE	SOT-89-5	32vy VR4	6n	Sii
OUB	S-1170B42UC	LVR-IC	LDO, 4.2V±1.0%, 800mA, +CE	SOT-89-5	32vy VR4	6n	Sii
OUC	S-1170B43UC	LVR-IC	LDO, 4.3V±1.0%, 800mA, +CE	SOT-89-5	32vy VR4	6n	Sii
OUD	S-1170B44UC	LVR-IC	LDO, 4.4V±1.0%, 800mA, +CE	SOT-89-5	32vy VR4	6n	Sii
OUE	S-1170B45UC	LVR-IC	LDO, 4.5V±1.0%, 800mA, +CE	SOT-89-5	32vy VR4	6n	Sii
OUF	S-1170B46UC	LVR-IC	LDO, 4.6V±1.0%, 800mA, +CE	SOT-89-5	32vy VR4	6n	Sii
OUG	S-1170B47UC	LVR-IC	LDO, 4.7V±1.0%, 800mA, +CE	SOT-89-5	32vy VR4	6n	Sii
OUH	S-1170B48UC	LVR-IC	LDO, 4.8V±1.0%, 800mA, +CE	SOT-89-5	32vy VR4	6n	Sii
OUI	S-1170B49UC	LVR-IC	LDO, 4.9V±1.0%, 800mA, +CE	SOT-89-5	32vy VR4	6n	Sii
OUI	S-1170B50UC	LVR-IC	LDO, 5.0V±1.0%, 800mA, +CE	SOT-89-5	32vy VR4	6n	Sii
OUI	S-1170B51UC	LVR-IC	LDO, 5.1V±1.0%, 800mA, +CE	SOT-89-5	32vy VR4	6n	Sii
OUL	S-1170B52UC	LVR-IC	LDO, 5.2V±1.0%, 800mA, +CE	SOT-89-5	32vy VR4	6n	Sii
OUM	S-1170B53UC	LVR-IC	LDO, 5.3V±1.0%, 800mA, +CE	SOT-89-5	32vy VR4	6n	Sii
OUN	S-1170B54UC	LVR-IC	LDO, 5.4V±1.0%, 800mA, +CE	SOT-89-5	32vy VR4	6n	Sii
OOU	S-1170B55UC	LVR-IC	LDO, 5.5V±1.0%, 800mA, +CE	SOT-89-5	32vy VR4	6n	Sii
P10A	ML6204A192P	LVR-IC	LDO, 1.9V±3%, 150mA, +CE, CL	SOT-89-5	32um VR4	6j	Mlc
P10B	ML6204B192P	LVR-IC	LDO, 1.9V±3%, 150mA, +CE	SOT-89-5	32um VR4	6j	Mlc
P10C	ML6204C192P	LVR-IC	LDO, 1.9V±3%, 150mA, -CE, CL	SOT-89-5	32um VR4	6j	Mlc
P10D	ML6204D192P	LVR-IC	LDO, 1.9V±3%, 150mA, -CE	SOT-89-5	32um VR4	6j	Mlc
P15A	CM7R151A-15B-P	LVR-IC	LDO, 1.5V±3%, 150mA, +CE, PDR	SOT-89-5	32um VR4	6j	Can
P15A	ML6204A152P	LVR-IC	LDO, 1.5V±3%, 150mA, +CE, CL	SOT-89-5	32um VR4	6j	Mlc
P15B	CM7R151B-15B-P	LVR-IC	LDO, 1.5V±3%, 150mA, +CE	SOT-89-5	32um VR4	6j	Can
P15B	ML6204B152P	LVR-IC	LDO, 1.5V±3%, 150mA, +CE	SOT-89-5	32um VR4	6j	Mlc
P15C	CM7R151C-15B-P	LVR-IC	LDO, 1.5V±3%, 150mA, -CE, PDR	SOT-89-5	32um VR4	6j	Can
P15C	ML6204C152P	LVR-IC	LDO, 1.5V±3%, 150mA, -CE, CL	SOT-89-5	32um VR4	6j	Mlc
P15D	CM7R151D-15B-P	LVR-IC	LDO, 1.5V±3%, 150mA, -CE	SOT-89-5	32um VR4	6j	Can
P15D	ML6204D152P	LVR-IC	LDO, 1.5V±3%, 150mA, -CE	SOT-89-5	32um VR4	6j	Mlc
P16A	CM7R151A-16B-P	LVR-IC	LDO, 1.6V±3%, 150mA, +CE, PDR	SOT-89-5	32um VR4	6j	Can
P16A	ML6204A162P	LVR-IC	LDO, 1.6V±3%, 150mA, +CE, CL	SOT-89-5	32um VR4	6j	Mlc
P16B	CM7R151B-16B-P	LVR-IC	LDO, 1.6V±3%, 150mA, +CE	SOT-89-5	32um VR4	6j	Can
P16B	ML6204B162P	LVR-IC	LDO, 1.6V±3%, 150mA, +CE	SOT-89-5	32um VR4	6j	Mlc
P16C	CM7R151C-16B-P	LVR-IC	LDO, 1.6V±3%, 150mA, -CE, PDR	SOT-89-5	32um VR4	6j	Can
P16C	ML6204C162P	LVR-IC	LDO, 1.6V±3%, 150mA, -CE, CL	SOT-89-5	32um VR4	6j	Mlc
P16D	CM7R151D-16B-P	LVR-IC	LDO, 1.6V±3%, 150mA, -CE	SOT-89-5	32um VR4	6j	Can
P16D	ML6204D162P	LVR-IC	LDO, 1.6V±3%, 150mA, -CE	SOT-89-5	32um VR4	6j	Mlc
P17A	CM7R151A-17B-P	LVR-IC	LDO, 1.7V±3%, 150mA, +CE, PDR	SOT-89-5	32um VR4	6j	Can
P17A	ML6204A172P	LVR-IC	LDO, 1.7V±3%, 150mA, +CE, CL	SOT-89-5	32um VR4	6j	Mlc
P17B	CM7R151B-17B-P	LVR-IC	LDO, 1.7V±3%, 150mA, +CE	SOT-89-5	32um VR4	6j	Can
P17B	ML6204B172P	LVR-IC	LDO, 1.7V±3%, 150mA, +CE	SOT-89-5	32um VR4	6j	Mlc



SMD code	Type	Function	Short description	Case	Pinout	Sch.	St.	Mnf.
P17C	CM7R151C-17B-P	LVR-IC	LDO, 1.7V±3%, 150mA, -CE, PDR	SOT-89-5	32um	VR4	6j	Can
P17C	ML6204C172P	LVR-IC	LDO, 1.7V±3%, 150mA, -CE, CL	SOT-89-5	32um	VR4	6j	Mlc
P17D	CM7R151D-17B-P	LVR-IC	LDO, 1.7V±3%, 150mA, -CE	SOT-89-5	32um	VR4	6j	Can
P17D	ML6204D172P	LVR-IC	LDO, 1.7V±3%, 150mA, -CE	SOT-89-5	32um	VR4	6j	Mlc
P18A	CM7R151A-18B-P	LVR-IC	LDO, 1.8V±3%, 150mA, +CE, PDR	SOT-89-5	32um	VR4	6j	Can
P18B	CM7R151B-18B-P	LVR-IC	LDO, 1.8V±3%, 150mA, +CE	SOT-89-5	32um	VR4	6j	Can
P18C	CM7R151C-18B-P	LVR-IC	LDO, 1.8V±3%, 150mA, -CE, PDR	SOT-89-5	32um	VR4	6j	Can
P18D	CM7R151D-18B-P	LVR-IC	LDO, 1.8V±3%, 150mA, -CE	SOT-89-5	32um	VR4	6j	Can
P19A	CM7R151A-19B-P	LVR-IC	LDO, 1.9V±3%, 150mA, +CE, PDR	SOT-89-5	32um	VR4	6j	Can
P19A	ML6204A182P	LVR-IC	LDO, 1.8V±3%, 150mA, +CE, CL	SOT-89-5	32um	VR4	6j	Mlc
P19B	CM7R151B-19B-P	LVR-IC	LDO, 1.9V±3%, 150mA, +CE	SOT-89-5	32um	VR4	6j	Can
P19B	ML6204B182P	LVR-IC	LDO, 1.8V±3%, 150mA, +CE	SOT-89-5	32um	VR4	6j	Mlc
P19C	CM7R151C-19B-P	LVR-IC	LDO, 1.9V±3%, 150mA, -CE, PDR	SOT-89-5	32um	VR4	6j	Can
P19C	ML6204C182P	LVR-IC	LDO, 1.8V±3%, 150mA, -CE, CL	SOT-89-5	32um	VR4	6j	Mlc
P19D	CM7R151D-19B-P	LVR-IC	LDO, 1.9V±3%, 150mA, -CE	SOT-89-5	32um	VR4	6j	Can
P19D	ML6204D182P	LVR-IC	LDO, 1.8V±3%, 150mA, -CE	SOT-89-5	32um	VR4	6j	Mlc
P1FA	CM7R151A-15A-P	LVR-IC	LDO, 1.55V±3%, 150mA, +CE, PDR	SOT-89-5	32um	VR4	6j	Can
P1FA	ML6204A15AP	LVR-IC	LDO, 1.55V±3%, 150mA, +CE, CL	SOT-89-5	32um	VR4	6j	Mlc
P1FB	CM7R151B-15A-P	LVR-IC	LDO, 1.55V±3%, 150mA, +CE	SOT-89-5	32um	VR4	6j	Can
P1FB	ML6204B15AP	LVR-IC	LDO, 1.55V±3%, 150mA, +CE	SOT-89-5	32um	VR4	6j	Mlc
P1FC	CM7R151C-15A-P	LVR-IC	LDO, 1.55V±3%, 150mA, -CE, PDR	SOT-89-5	32um	VR4	6j	Can
P1FC	ML6204C15AP	LVR-IC	LDO, 1.55V±3%, 150mA, -CE, CL	SOT-89-5	32um	VR4	6j	Mlc
P1FD	CM7R151D-15A-P	LVR-IC	LDO, 1.55V±3%, 150mA, -CE	SOT-89-5	32um	VR4	6j	Can
P1FD	ML6204D15AP	LVR-IC	LDO, 1.55V±3%, 150mA, -CE	SOT-89-5	32um	VR4	6j	Mlc
P1GA	CM7R151A-16A-P	LVR-IC	LDO, 1.65V±3%, 150mA, +CE, PDR	SOT-89-5	32um	VR4	6j	Can
P1GA	ML6204A16AP	LVR-IC	LDO, 1.65V±3%, 150mA, +CE, CL	SOT-89-5	32um	VR4	6j	Mlc
P1GB	CM7R151B-16A-P	LVR-IC	LDO, 1.65V±3%, 150mA, +CE	SOT-89-5	32um	VR4	6j	Can
P1GB	ML6204B16AP	LVR-IC	LDO, 1.65V±3%, 150mA, +CE	SOT-89-5	32um	VR4	6j	Mlc
P1GC	CM7R151C-16A-P	LVR-IC	LDO, 1.65V±3%, 150mA, -CE, PDR	SOT-89-5	32um	VR4	6j	Can
P1GC	ML6204C16AP	LVR-IC	LDO, 1.65V±3%, 150mA, -CE, CL	SOT-89-5	32um	VR4	6j	Mlc
P1GD	CM7R151D-16A-P	LVR-IC	LDO, 1.65V±3%, 150mA, -CE	SOT-89-5	32um	VR4	6j	Can
P1GD	ML6204D16AP	LVR-IC	LDO, 1.65V±3%, 150mA, -CE	SOT-89-5	32um	VR4	6j	Mlc
P1HA	CM7R151A-17A-P	LVR-IC	LDO, 1.75V±3%, 150mA, +CE, PDR	SOT-89-5	32um	VR4	6j	Can
P1HA	ML6204A17AP	LVR-IC	LDO, 1.75V±3%, 150mA, +CE, CL	SOT-89-5	32um	VR4	6j	Mlc
P1HB	CM7R151B-17A-P	LVR-IC	LDO, 1.75V±3%, 150mA, +CE	SOT-89-5	32um	VR4	6j	Can
P1HB	ML6204B17AP	LVR-IC	LDO, 1.75V±3%, 150mA, +CE	SOT-89-5	32um	VR4	6j	Mlc
P1HC	CM7R151C-17A-P	LVR-IC	LDO, 1.75V±3%, 150mA, -CE, PDR	SOT-89-5	32um	VR4	6j	Can
P1HC	ML6204C17AP	LVR-IC	LDO, 1.75V±3%, 150mA, -CE, CL	SOT-89-5	32um	VR4	6j	Mlc
P1HD	CM7R151D-17A-P	LVR-IC	LDO, 1.75V±3%, 150mA, -CE	SOT-89-5	32um	VR4	6j	Can
P1HD	ML6204D17AP	LVR-IC	LDO, 1.75V±3%, 150mA, -CE	SOT-89-5	32um	VR4	6j	Mlc
P1IA	CM7R151A-18A-P	LVR-IC	LDO, 1.85V±3%, 150mA, +CE, PDR	SOT-89-5	32um	VR4	6j	Can
P1IA	ML6204A18AP	LVR-IC	LDO, 1.85V±3%, 150mA, +CE, CL	SOT-89-5	32um	VR4	6j	Mlc
P1IB	CM7R151B-18A-P	LVR-IC	LDO, 1.85V±3%, 150mA, +CE	SOT-89-5	32um	VR4	6j	Can
P1IB	ML6204B18AP	LVR-IC	LDO, 1.85V±3%, 150mA, +CE	SOT-89-5	32um	VR4	6j	Mlc
P1IC	CM7R151C-18A-P	LVR-IC	LDO, 1.85V±3%, 150mA, -CE, PDR	SOT-89-5	32um	VR4	6j	Can
P1IC	ML6204C18AP	LVR-IC	LDO, 1.85V±3%, 150mA, -CE, CL	SOT-89-5	32um	VR4	6j	Mlc
P1ID	CM7R151D-18A-P	LVR-IC	LDO, 1.85V±3%, 150mA, -CE	SOT-89-5	32um	VR4	6j	Can
P1ID	ML6204D18AP	LVR-IC	LDO, 1.85V±3%, 150mA, -CE	SOT-89-5	32um	VR4	6j	Mlc
P1JA	CM7R151A-19A-P	LVR-IC	LDO, 1.95V±3%, 150mA, +CE, PDR	SOT-89-5	32um	VR4	6j	Can
P1JA	ML6204A19AP	LVR-IC	LDO, 1.95V±3%, 150mA, +CE, CL	SOT-89-5	32um	VR4	6j	Mlc
P1JB	CM7R151B-19A-P	LVR-IC	LDO, 1.95V±3%, 150mA, +CE	SOT-89-5	32um	VR4	6j	Can
P1JB	ML6204B19AP	LVR-IC	LDO, 1.95V±3%, 150mA, +CE	SOT-89-5	32um	VR4	6j	Mlc
P1JC	CM7R151C-19A-P	LVR-IC	LDO, 1.95V±3%, 150mA, -CE, PDR	SOT-89-5	32um	VR4	6j	Can
P1JC	ML6204C19AP	LVR-IC	LDO, 1.95V±3%, 150mA, -CE, CL	SOT-89-5	32um	VR4	6j	Mlc
P1JD	CM7R151D-19A-P	LVR-IC	LDO, 1.95V±3%, 150mA, -CE	SOT-89-5	32um	VR4	6j	Can
P1JD	ML6204D19AP	LVR-IC	LDO, 1.95V±3%, 150mA, -CE	SOT-89-5	32um	VR4	6j	Mlc
P20	TK11220AU	LVR-IC	LDO, 2V±2.4%, 150mA, +CE	SOT-89-5	32v±	VR7	6j	Tok
P20A	CM7R151A-20B-P	LVR-IC	LDO, 2.0V±2%, 150mA, +CE, PDR	SOT-89-5	32um	VR4	6j	Can
P20A	ML6204A202P	LVR-IC	LDO, 2.0V±2%, 150mA, +CE, CL	SOT-89-5	32um	VR4	6j	Mlc
P20B	CM7R151B-20B-P	LVR-IC	LDO, 2.0V±2%, 150mA, +CE	SOT-89-5	32um	VR4	6j	Can
P20B	ML6204B202P	LVR-IC	LDO, 2.0V±2%, 150mA, +CE	SOT-89-5	32um	VR4	6j	Mlc
P20C	CM7R151C-20B-P	LVR-IC	LDO, 2.0V±2%, 150mA, -CE, PDR	SOT-89-5	32um	VR4	6j	Can
P20C	ML6204C202P	LVR-IC	LDO, 2.0V±2%, 150mA, -CE, CL	SOT-89-5	32um	VR4	6j	Mlc
P20D	CM7R151D-20B-P	LVR-IC	LDO, 2.0V±2%, 150mA, -CE	SOT-89-5	32um	VR4	6j	Can
P20D	ML6204D202P	LVR-IC	LDO, 2.0V±2%, 150mA, -CE	SOT-89-5	32um	VR4	6j	Mlc
P21A	CM7R151A-21B-P	LVR-IC	LDO, 2.1V±2%, 150mA, +CE, PDR	SOT-89-5	32um	VR4	6j	Can
P21A	ML6204A212P	LVR-IC	LDO, 2.1V±2%, 150mA, +CE, CL	SOT-89-5	32um	VR4	6j	Mlc
P21B	CM7R151B-21B-P	LVR-IC	LDO, 2.1V±2%, 150mA, +CE	SOT-89-5	32um	VR4	6j	Can
P21B	ML6204B212P	LVR-IC	LDO, 2.1V±2%, 150mA, +CE	SOT-89-5	32um	VR4	6j	Mlc
P21C	CM7R151C-21B-P	LVR-IC	LDO, 2.1V±2%, 150mA, -CE, PDR	SOT-89-5	32um	VR4	6j	Can



SMD code	Type	Function	Short description	Case	Pinout	Sch.	St.	Mnf.
P21C	ML6204C212P	LVR-IC	LDO, 2.1V±2%, 150mA, -CE, CL	SOT-89-5	32um	VR4	6j	Mic
P21D	CM7R151D-21B-P	LVR-IC	LDO, 2.1V±2%, 150mA, -CE	SOT-89-5	32um	VR4	6j	Can
P21D	ML6204D212P	LVR-IC	LDO, 2.1V±2%, 150mA, -CE	SOT-89-5	32um	VR4	6j	Mic
P22	TK11222AU	LVR-IC	LDO, 2.2V±2.4%, 150mA, +CE	SOT-89-5	32vg	VR7	6i	Tok
P22A	CM7R151A-22B-P	LVR-IC	LDO, 2.2V±2%, 150mA, +CE, PDR	SOT-89-5	32um	VR4	6j	Can
P22A	ML6204A222P	LVR-IC	LDO, 2.2V±2%, 150mA, +CE, CL	SOT-89-5	32um	VR4	6j	Mic
P22B	CM7R151B-22B-P	LVR-IC	LDO, 2.2V±2%, 150mA, +CE	SOT-89-5	32um	VR4	6j	Can
P22B	ML6204B222P	LVR-IC	LDO, 2.2V±2%, 150mA, +CE	SOT-89-5	32um	VR4	6j	Mic
P22C	CM7R151C-22B-P	LVR-IC	LDO, 2.2V±2%, 150mA, -CE, PDR	SOT-89-5	32um	VR4	6j	Can
P22C	ML6204C222P	LVR-IC	LDO, 2.2V±2%, 150mA, -CE, CL	SOT-89-5	32um	VR4	6j	Mic
P22D	CM7R151D-22B-P	LVR-IC	LDO, 2.2V±2%, 150mA, -CE	SOT-89-5	32um	VR4	6j	Can
P22D	ML6204D222P	LVR-IC	LDO, 2.2V±2%, 150mA, -CE	SOT-89-5	32um	VR4	6j	Mic
P23A	CM7R151A-23B-P	LVR-IC	LDO, 2.3V±2%, 150mA, +CE, PDR	SOT-89-5	32um	VR4	6j	Can
P23A	ML6204A232P	LVR-IC	LDO, 2.3V±2%, 150mA, +CE, CL	SOT-89-5	32um	VR4	6j	Mic
P23B	CM7R151B-23B-P	LVR-IC	LDO, 2.3V±2%, 150mA, +CE	SOT-89-5	32um	VR4	6j	Can
P23B	ML6204B232P	LVR-IC	LDO, 2.3V±2%, 150mA, +CE	SOT-89-5	32um	VR4	6j	Mic
P23C	CM7R151C-23B-P	LVR-IC	LDO, 2.3V±2%, 150mA, -CE, PDR	SOT-89-5	32um	VR4	6j	Can
P23C	ML6204C232P	LVR-IC	LDO, 2.3V±2%, 150mA, -CE, CL	SOT-89-5	32um	VR4	6j	Mic
P23D	CM7R151D-23B-P	LVR-IC	LDO, 2.3V±2%, 150mA, -CE	SOT-89-5	32um	VR4	6j	Can
P23D	ML6204D232P	LVR-IC	LDO, 2.3V±2%, 150mA, -CE	SOT-89-5	32um	VR4	6j	Mic
P24A	CM7R151A-24B-P	LVR-IC	LDO, 2.4V±2%, 150mA, +CE, PDR	SOT-89-5	32um	VR4	6j	Can
P24A	ML6204A242P	LVR-IC	LDO, 2.4V±2%, 150mA, +CE, CL	SOT-89-5	32um	VR4	6j	Mic
P24B	CM7R151B-24B-P	LVR-IC	LDO, 2.4V±2%, 150mA, +CE	SOT-89-5	32um	VR4	6j	Can
P24B	ML6204B242P	LVR-IC	LDO, 2.4V±2%, 150mA, +CE	SOT-89-5	32um	VR4	6j	Mic
P24C	CM7R151C-24B-P	LVR-IC	LDO, 2.4V±2%, 150mA, -CE, PDR	SOT-89-5	32um	VR4	6j	Can
P24C	ML6204C242P	LVR-IC	LDO, 2.4V±2%, 150mA, -CE, CL	SOT-89-5	32um	VR4	6j	Mic
P24D	CM7R151D-24B-P	LVR-IC	LDO, 2.4V±2%, 150mA, -CE	SOT-89-5	32um	VR4	6j	Can
P24D	ML6204D242P	LVR-IC	LDO, 2.4V±2%, 150mA, -CE	SOT-89-5	32um	VR4	6j	Mic
P25	TK11225AU	LVR-IC	LDO, 2.5V±2.4%, 150mA, +CE	SOT-89-5	32vg	VR7	6i	Tok
P25A	CM7R151A-25B-P	LVR-IC	LDO, 2.5V±2%, 150mA, +CE, PDR	SOT-89-5	32um	VR4	6j	Can
P25A	ML6204A252P	LVR-IC	LDO, 2.5V±2%, 150mA, +CE, CL	SOT-89-5	32um	VR4	6j	Mic
P25B	CM7R151B-25B-P	LVR-IC	LDO, 2.5V±2%, 150mA, +CE	SOT-89-5	32um	VR4	6j	Can
P25B	ML6204B252P	LVR-IC	LDO, 2.5V±2%, 150mA, +CE	SOT-89-5	32um	VR4	6j	Mic
P25C	CM7R151C-25B-P	LVR-IC	LDO, 2.5V±2%, 150mA, -CE, PDR	SOT-89-5	32um	VR4	6j	Can
P25C	ML6204C252P	LVR-IC	LDO, 2.5V±2%, 150mA, -CE, CL	SOT-89-5	32um	VR4	6j	Mic
P25D	CM7R151D-25B-P	LVR-IC	LDO, 2.5V±2%, 150mA, -CE	SOT-89-5	32um	VR4	6j	Can
P25D	ML6204D252P	LVR-IC	LDO, 2.5V±2%, 150mA, -CE	SOT-89-5	32um	VR4	6j	Mic
P26A	CM7R151A-26B-P	LVR-IC	LDO, 2.6V±2%, 150mA, +CE, PDR	SOT-89-5	32um	VR4	6j	Can
P26A	ML6204A262P	LVR-IC	LDO, 2.6V±2%, 150mA, +CE, CL	SOT-89-5	32um	VR4	6j	Mic
P26B	CM7R151B-26B-P	LVR-IC	LDO, 2.6V±2%, 150mA, +CE	SOT-89-5	32um	VR4	6j	Can
P26B	ML6204B262P	LVR-IC	LDO, 2.6V±2%, 150mA, +CE	SOT-89-5	32um	VR4	6j	Mic
P26C	CM7R151C-26B-P	LVR-IC	LDO, 2.6V±2%, 150mA, -CE, PDR	SOT-89-5	32um	VR4	6j	Can
P26C	ML6204C262P	LVR-IC	LDO, 2.6V±2%, 150mA, -CE, CL	SOT-89-5	32um	VR4	6j	Mic
P26D	CM7R151D-26B-P	LVR-IC	LDO, 2.6V±2%, 150mA, -CE	SOT-89-5	32um	VR4	6j	Can
P26D	ML6204D262P	LVR-IC	LDO, 2.6V±2%, 150mA, -CE	SOT-89-5	32um	VR4	6j	Mic
P27A	CM7R151A-27B-P	LVR-IC	LDO, 2.7V±2%, 150mA, +CE, PDR	SOT-89-5	32um	VR4	6j	Can
P27A	ML6204A272P	LVR-IC	LDO, 2.7V±2%, 150mA, +CE, CL	SOT-89-5	32um	VR4	6j	Mic
P27B	CM7R151B-27B-P	LVR-IC	LDO, 2.7V±2%, 150mA, +CE	SOT-89-5	32um	VR4	6j	Can
P27B	ML6204B272P	LVR-IC	LDO, 2.7V±2%, 150mA, +CE	SOT-89-5	32um	VR4	6j	Mic
P27C	CM7R151C-27B-P	LVR-IC	LDO, 2.7V±2%, 150mA, -CE, PDR	SOT-89-5	32um	VR4	6j	Can
P27C	ML6204C272P	LVR-IC	LDO, 2.7V±2%, 150mA, -CE, CL	SOT-89-5	32um	VR4	6j	Mic
P27D	CM7R151D-27B-P	LVR-IC	LDO, 2.7V±2%, 150mA, -CE	SOT-89-5	32um	VR4	6j	Can
P27D	ML6204D272P	LVR-IC	LDO, 2.7V±2%, 150mA, -CE	SOT-89-5	32um	VR4	6j	Mic
P28	TK11228AU	LVR-IC	LDO, 2.8V±2.4%, 150mA, +CE	SOT-89-5	32vg	VR7	6i	Tok
P28A	CM7R151A-28B-P	LVR-IC	LDO, 2.8V±2%, 150mA, +CE, PDR	SOT-89-5	32um	VR4	6j	Can
P28A	ML6204A282P	LVR-IC	LDO, 2.8V±2%, 150mA, +CE, CL	SOT-89-5	32um	VR4	6j	Mic
P28B	CM7R151B-28B-P	LVR-IC	LDO, 2.8V±2%, 150mA, +CE	SOT-89-5	32um	VR4	6j	Can
P28B	ML6204B282P	LVR-IC	LDO, 2.8V±2%, 150mA, +CE	SOT-89-5	32um	VR4	6j	Mic
P28C	CM7R151C-28B-P	LVR-IC	LDO, 2.8V±2%, 150mA, -CE, PDR	SOT-89-5	32um	VR4	6j	Can
P28C	ML6204C282P	LVR-IC	LDO, 2.8V±2%, 150mA, -CE, CL	SOT-89-5	32um	VR4	6j	Mic
P28D	CM7R151D-28B-P	LVR-IC	LDO, 2.8V±2%, 150mA, -CE	SOT-89-5	32um	VR4	6j	Can
P28D	ML6204D282P	LVR-IC	LDO, 2.8V±2%, 150mA, -CE	SOT-89-5	32um	VR4	6j	Mic
P29A	CM7R151A-29B-P	LVR-IC	LDO, 2.9V±2%, 150mA, +CE, PDR	SOT-89-5	32um	VR4	6j	Can
P29A	ML6204A292P	LVR-IC	LDO, 2.9V±2%, 150mA, +CE, CL	SOT-89-5	32um	VR4	6j	Mic
P29B	CM7R151B-29B-P	LVR-IC	LDO, 2.9V±2%, 150mA, +CE	SOT-89-5	32um	VR4	6j	Can
P29B	ML6204B292P	LVR-IC	LDO, 2.9V±2%, 150mA, +CE	SOT-89-5	32um	VR4	6j	Mic
P29C	CM7R151C-29B-P	LVR-IC	LDO, 2.9V±2%, 150mA, -CE, PDR	SOT-89-5	32um	VR4	6j	Can
P29C	ML6204C292P	LVR-IC	LDO, 2.9V±2%, 150mA, -CE, CL	SOT-89-5	32um	VR4	6j	Mic
P29D	CM7R151D-29B-P	LVR-IC	LDO, 2.9V±2%, 150mA, -CE	SOT-89-5	32um	VR4	6j	Can
P29D	ML6204D292P	LVR-IC	LDO, 2.9V±2%, 150mA, -CE	SOT-89-5	32um	VR4	6j	Mic



SMD code	Type	Function	Short description	Case	Pinout Sch.	St.	Mnf.
P2AA	CM7R151A-20A-P	LVR-IC	LDO, 2.05V±2%, 150mA, +CE, PDR	SOT-89-5	32um VR4	6j	Can
P2AA	ML6204A20AP	LVR-IC	LDO, 2.05V±2%, 150mA, +CE, CL	SOT-89-5	32um VR4	6j	Mic
P2AB	CM7R151B-20A-P	LVR-IC	LDO, 2.05V±2%, 150mA, +CE	SOT-89-5	32um VR4	6j	Can
P2AB	ML6204B20AP	LVR-IC	LDO, 2.05V±2%, 150mA, +CE	SOT-89-5	32um VR4	6j	Mic
P2AC	CM7R151C-20A-P	LVR-IC	LDO, 2.05V±2%, 150mA, -CE, PDR	SOT-89-5	32um VR4	6j	Can
P2AC	ML6204C20AP	LVR-IC	LDO, 2.05V±2%, 150mA, -CE, CL	SOT-89-5	32um VR4	6j	Mic
P2AD	CM7R151D-20A-P	LVR-IC	LDO, 2.05V±2%, 150mA, -CE	SOT-89-5	32um VR4	6j	Can
P2AD	ML6204D20AP	LVR-IC	LDO, 2.05V±2%, 150mA, -CE	SOT-89-5	32um VR4	6j	Mic
P2BA	CM7R151A-21A-P	LVR-IC	LDO, 2.15V±2%, 150mA, +CE, PDR	SOT-89-5	32um VR4	6j	Can
P2BA	ML6204A21AP	LVR-IC	LDO, 2.15V±2%, 150mA, +CE, CL	SOT-89-5	32um VR4	6j	Mic
P2BB	CM7R151B-21A-P	LVR-IC	LDO, 2.15V±2%, 150mA, +CE	SOT-89-5	32um VR4	6j	Can
P2BB	ML6204B21AP	LVR-IC	LDO, 2.15V±2%, 150mA, +CE	SOT-89-5	32um VR4	6j	Mic
P2BC	CM7R151C-21A-P	LVR-IC	LDO, 2.15V±2%, 150mA, -CE, PDR	SOT-89-5	32um VR4	6j	Can
P2BC	ML6204C21AP	LVR-IC	LDO, 2.15V±2%, 150mA, -CE, CL	SOT-89-5	32um VR4	6j	Mic
P2BD	CM7R151D-21A-P	LVR-IC	LDO, 2.15V±2%, 150mA, -CE	SOT-89-5	32um VR4	6j	Can
P2BD	ML6204D21AP	LVR-IC	LDO, 2.15V±2%, 150mA, -CE	SOT-89-5	32um VR4	6j	Mic
P2CA	CM7R151A-22A-P	LVR-IC	LDO, 2.25V±2%, 150mA, +CE, PDR	SOT-89-5	32um VR4	6j	Can
P2CA	ML6204A22AP	LVR-IC	LDO, 2.25V±2%, 150mA, +CE, CL	SOT-89-5	32um VR4	6j	Mic
P2CB	CM7R151B-22A-P	LVR-IC	LDO, 2.25V±2%, 150mA, +CE	SOT-89-5	32um VR4	6j	Can
P2CB	ML6204B22AP	LVR-IC	LDO, 2.25V±2%, 150mA, +CE	SOT-89-5	32um VR4	6j	Mic
P2CC	CM7R151C-22A-P	LVR-IC	LDO, 2.25V±2%, 150mA, -CE, PDR	SOT-89-5	32um VR4	6j	Can
P2CC	ML6204C22AP	LVR-IC	LDO, 2.25V±2%, 150mA, -CE, CL	SOT-89-5	32um VR4	6j	Mic
P2CD	CM7R151D-22A-P	LVR-IC	LDO, 2.25V±2%, 150mA, -CE	SOT-89-5	32um VR4	6j	Can
P2CD	ML6204D22AP	LVR-IC	LDO, 2.25V±2%, 150mA, -CE	SOT-89-5	32um VR4	6j	Mic
P2DA	CM7R151A-23A-P	LVR-IC	LDO, 2.35V±2%, 150mA, +CE, PDR	SOT-89-5	32um VR4	6j	Can
P2DA	ML6204A23AP	LVR-IC	LDO, 2.35V±2%, 150mA, +CE, CL	SOT-89-5	32um VR4	6j	Mic
P2DB	CM7R151B-23A-P	LVR-IC	LDO, 2.35V±2%, 150mA, +CE	SOT-89-5	32um VR4	6j	Can
P2DB	ML6204B23AP	LVR-IC	LDO, 2.35V±2%, 150mA, +CE	SOT-89-5	32um VR4	6j	Mic
P2DC	CM7R151C-23A-P	LVR-IC	LDO, 2.35V±2%, 150mA, -CE, PDR	SOT-89-5	32um VR4	6j	Can
P2DC	ML6204C23AP	LVR-IC	LDO, 2.35V±2%, 150mA, -CE, CL	SOT-89-5	32um VR4	6j	Mic
P2DD	CM7R151D-23A-P	LVR-IC	LDO, 2.35V±2%, 150mA, -CE	SOT-89-5	32um VR4	6j	Can
P2DD	ML6204D23AP	LVR-IC	LDO, 2.35V±2%, 150mA, -CE	SOT-89-5	32um VR4	6j	Mic
P2EA	CM7R151A-24A-P	LVR-IC	LDO, 2.45V±2%, 150mA, +CE, PDR	SOT-89-5	32um VR4	6j	Can
P2EA	ML6204A24AP	LVR-IC	LDO, 2.45V±2%, 150mA, +CE, CL	SOT-89-5	32um VR4	6j	Mic
P2EB	CM7R151B-24A-P	LVR-IC	LDO, 2.45V±2%, 150mA, +CE	SOT-89-5	32um VR4	6j	Can
P2EB	ML6204B24AP	LVR-IC	LDO, 2.45V±2%, 150mA, +CE	SOT-89-5	32um VR4	6j	Mic
P2EC	CM7R151C-24A-P	LVR-IC	LDO, 2.45V±2%, 150mA, -CE, PDR	SOT-89-5	32um VR4	6j	Can
P2EC	ML6204C24AP	LVR-IC	LDO, 2.45V±2%, 150mA, -CE, CL	SOT-89-5	32um VR4	6j	Mic
P2ED	CM7R151D-24A-P	LVR-IC	LDO, 2.45V±2%, 150mA, -CE	SOT-89-5	32um VR4	6j	Can
P2ED	ML6204D24AP	LVR-IC	LDO, 2.45V±2%, 150mA, -CE	SOT-89-5	32um VR4	6j	Mic
P2FA	CM7R151A-25A-P	LVR-IC	LDO, 2.55V±2%, 150mA, +CE, PDR	SOT-89-5	32um VR4	6j	Can
P2FA	ML6204A25AP	LVR-IC	LDO, 2.55V±2%, 150mA, +CE, CL	SOT-89-5	32um VR4	6j	Mic
P2FB	CM7R151B-25A-P	LVR-IC	LDO, 2.55V±2%, 150mA, +CE	SOT-89-5	32um VR4	6j	Can
P2FB	ML6204B25AP	LVR-IC	LDO, 2.55V±2%, 150mA, +CE	SOT-89-5	32um VR4	6j	Mic
P2FC	CM7R151C-25A-P	LVR-IC	LDO, 2.55V±2%, 150mA, -CE, PDR	SOT-89-5	32um VR4	6j	Can
P2FC	ML6204C25AP	LVR-IC	LDO, 2.55V±2%, 150mA, -CE, CL	SOT-89-5	32um VR4	6j	Mic
P2FD	CM7R151D-25A-P	LVR-IC	LDO, 2.55V±2%, 150mA, -CE	SOT-89-5	32um VR4	6j	Can
P2FD	ML6204D25AP	LVR-IC	LDO, 2.55V±2%, 150mA, -CE	SOT-89-5	32um VR4	6j	Mic
P2GA	CM7R151A-26A-P	LVR-IC	LDO, 2.65V±2%, 150mA, +CE, PDR	SOT-89-5	32um VR4	6j	Can
P2GA	ML6204A26AP	LVR-IC	LDO, 2.65V±2%, 150mA, +CE, CL	SOT-89-5	32um VR4	6j	Mic
P2GB	CM7R151B-26A-P	LVR-IC	LDO, 2.65V±2%, 150mA, +CE	SOT-89-5	32um VR4	6j	Can
P2GB	ML6204B26AP	LVR-IC	LDO, 2.65V±2%, 150mA, +CE	SOT-89-5	32um VR4	6j	Mic
P2GC	CM7R151C-26A-P	LVR-IC	LDO, 2.65V±2%, 150mA, -CE, PDR	SOT-89-5	32um VR4	6j	Can
P2GC	ML6204C26AP	LVR-IC	LDO, 2.65V±2%, 150mA, -CE, CL	SOT-89-5	32um VR4	6j	Mic
P2GD	CM7R151D-26A-P	LVR-IC	LDO, 2.65V±2%, 150mA, -CE	SOT-89-5	32um VR4	6j	Can
P2GD	ML6204D26AP	LVR-IC	LDO, 2.65V±2%, 150mA, -CE	SOT-89-5	32um VR4	6j	Mic
P2HA	CM7R151A-27A-P	LVR-IC	LDO, 2.75V±2%, 150mA, +CE, PDR	SOT-89-5	32um VR4	6j	Can
P2HA	ML6204A27AP	LVR-IC	LDO, 2.75V±2%, 150mA, +CE, CL	SOT-89-5	32um VR4	6j	Mic
P2HB	CM7R151B-27A-P	LVR-IC	LDO, 2.75V±2%, 150mA, +CE	SOT-89-5	32um VR4	6j	Can
P2HB	ML6204B27AP	LVR-IC	LDO, 2.75V±2%, 150mA, +CE	SOT-89-5	32um VR4	6j	Mic
P2HC	CM7R151C-27A-P	LVR-IC	LDO, 2.75V±2%, 150mA, -CE, PDR	SOT-89-5	32um VR4	6j	Can
P2HC	ML6204C27AP	LVR-IC	LDO, 2.75V±2%, 150mA, -CE, CL	SOT-89-5	32um VR4	6j	Mic
P2HD	CM7R151D-27A-P	LVR-IC	LDO, 2.75V±2%, 150mA, -CE	SOT-89-5	32um VR4	6j	Can
P2HD	ML6204D27AP	LVR-IC	LDO, 2.75V±2%, 150mA, -CE	SOT-89-5	32um VR4	6j	Mic
P2IA	CM7R151A-28A-P	LVR-IC	LDO, 2.85V±2%, 150mA, +CE, PDR	SOT-89-5	32um VR4	6j	Can
P2IA	ML6204A28AP	LVR-IC	LDO, 2.85V±2%, 150mA, +CE, CL	SOT-89-5	32um VR4	6j	Mic
P2IB	CM7R151B-28A-P	LVR-IC	LDO, 2.85V±2%, 150mA, +CE	SOT-89-5	32um VR4	6j	Can
P2IB	ML6204B28AP	LVR-IC	LDO, 2.85V±2%, 150mA, +CE	SOT-89-5	32um VR4	6j	Mic
P2IC	CM7R151C-28A-P	LVR-IC	LDO, 2.85V±2%, 150mA, -CE, PDR	SOT-89-5	32um VR4	6j	Can
P2IC	ML6204C28AP	LVR-IC	LDO, 2.85V±2%, 150mA, -CE, CL	SOT-89-5	32um VR4	6j	Mic



SMD code	Type	Function	Short description	Case	Pinout Sch.	St.	Mnf.
P2ID	CM7R151D-28A-P	LVR-IC	LDO, 2.85V±2%, 150mA, -CE	SOT-89-5	32um VR4	6j	Can
P2ID	ML6204D28AP	LVR-IC	LDO, 2.85V±2%, 150mA, -CE	SOT-89-5	32um VR4	6j	Mic
P2JA	CM7R151A-29A-P	LVR-IC	LDO, 2.95V±2%, 150mA, +CE, PDR	SOT-89-5	32um VR4	6j	Can
P2JA	ML6204A29AP	LVR-IC	LDO, 2.95V±2%, 150mA, +CE, CL	SOT-89-5	32um VR4	6j	Mic
P2JB	CM7R151B-29A-P	LVR-IC	LDO, 2.95V±2%, 150mA, +CE	SOT-89-5	32um VR4	6j	Can
P2JB	ML6204B29AP	LVR-IC	LDO, 2.95V±2%, 150mA, +CE	SOT-89-5	32um VR4	6j	Mic
P2JC	CM7R151C-29A-P	LVR-IC	LDO, 2.95V±2%, 150mA, -CE, PDR	SOT-89-5	32um VR4	6j	Can
P2JC	ML6204C29AP	LVR-IC	LDO, 2.95V±2%, 150mA, -CE, CL	SOT-89-5	32um VR4	6j	Mic
P2JD	CM7R151D-29A-P	LVR-IC	LDO, 2.95V±2%, 150mA, -CE	SOT-89-5	32um VR4	6j	Can
P2JD	ML6204D29AP	LVR-IC	LDO, 2.95V±2%, 150mA, -CE	SOT-89-5	32um VR4	6j	Mic
P30	TK11230AU	LVR-IC	LDO, 3V±2.4%, 150mA, +CE	SOT-89-5	32vg VR7	6i	Tok
P30A	CM7R151A-30B-P	LVR-IC	LDO, 3.0V±2%, 150mA, +CE, PDR	SOT-89-5	32um VR4	6j	Can
P30A	ML6204A302P	LVR-IC	LDO, 3.0V±2%, 150mA, +CE, CL	SOT-89-5	32um VR4	6j	Mic
P30B	CM7R151B-30B-P	LVR-IC	LDO, 3.0V±2%, 150mA, +CE	SOT-89-5	32um VR4	6j	Can
P30B	ML6204B302P	LVR-IC	LDO, 3.0V±2%, 150mA, +CE	SOT-89-5	32um VR4	6j	Mic
P30C	CM7R151C-30B-P	LVR-IC	LDO, 3.0V±2%, 150mA, -CE, PDR	SOT-89-5	32um VR4	6j	Can
P30C	ML6204C302P	LVR-IC	LDO, 3.0V±2%, 150mA, -CE, CL	SOT-89-5	32um VR4	6j	Mic
P30D	CM7R151D-30B-P	LVR-IC	LDO, 3.0V±2%, 150mA, -CE	SOT-89-5	32um VR4	6j	Can
P30D	ML6204D302P	LVR-IC	LDO, 3.0V±2%, 150mA, -CE	SOT-89-5	32um VR4	6j	Mic
P31	TK11231AU	LVR-IC	LDO, 3.1V±2.4%, 150mA, +CE	SOT-89-5	32vg VR7	6i	Tok
P3101C	PAM3101ECB150	LVR-IC	LDO, 1.5V±2%, 300mA, +CE	SOT-89-5	32vr4 VR4	6q	Pam
P3101E	PAM3101ECB180	LVR-IC	LDO, 1.8V±2%, 300mA, +CE	SOT-89-5	32vr4 VR4	6q	Pam
P3101G	PAM3101ECB250	LVR-IC	LDO, 2.5V±2%, 300mA, +CE	SOT-89-5	32vr4 VR4	6q	Pam
P3101H	PAM3101ECB280	LVR-IC	LDO, 2.8V±2%, 300mA, +CE	SOT-89-5	32vr4 VR4	6q	Pam
P3101I	PAM3101ECB285	LVR-IC	LDO, 2.85V±2%, 300mA, +CE	SOT-89-5	32vr4 VR4	6q	Pam
P3101J	PAM3101ECB300	LVR-IC	LDO, 3.0V±2%, 300mA, +CE	SOT-89-5	32vr4 VR4	6q	Pam
P3101K	PAM3101ECB330	LVR-IC	LDO, 3.3V±2%, 300mA, +CE	SOT-89-5	32vr4 VR4	6q	Pam
P3101M	PAM3101ECB400	LVR-IC	LDO, 4.0V±2%, 300mA, +CE	SOT-89-5	32vr4 VR4	6q	Pam
P3101O	PAM3101ECB380	LVR-IC	LDO, 3.8V±2%, 300mA, +CE	SOT-89-5	32vr4 VR4	6q	Pam
P3101P	PAM3101ECB310	LVR-IC	LDO, 3.1V±2%, 300mA, +CE	SOT-89-5	32vr4 VR4	6q	Pam
P3101Q	PAM3101ECB290	LVR-IC	LDO, 2.9V±2%, 300mA, +CE	SOT-89-5	32vr4 VR4	6q	Pam
P3101T	PAM3101ECB475	LVR-IC	LDO, 4.75V±2%, 300mA, +CE	SOT-89-5	32vr4 VR4	6q	Pam
P31A	CM7R151A-31B-P	LVR-IC	LDO, 3.1V±2%, 150mA, +CE, PDR	SOT-89-5	32um VR4	6j	Can
P31A	ML6204A312P	LVR-IC	LDO, 3.1V±2%, 150mA, +CE, CL	SOT-89-5	32um VR4	6j	Mic
P31A	ML6204B312P	LVR-IC	LDO, 3.1V±2%, 150mA, +CE	SOT-89-5	32um VR4	6j	Mic
P31B	CM7R151B-31B-P	LVR-IC	LDO, 3.1V±2%, 150mA, +CE	SOT-89-5	32um VR4	6j	Can
P31C	CM7R151C-31B-P	LVR-IC	LDO, 3.1V±2%, 150mA, -CE, PDR	SOT-89-5	32um VR4	6j	Can
P31C	ML6204C312P	LVR-IC	LDO, 3.1V±2%, 150mA, -CE, CL	SOT-89-5	32um VR4	6j	Mic
P31D	CM7R151D-31B-P	LVR-IC	LDO, 3.1V±2%, 150mA, -CE	SOT-89-5	32um VR4	6j	Can
P31D	ML6204D312P	LVR-IC	LDO, 3.1V±2%, 150mA, -CE	SOT-89-5	32um VR4	6j	Mic
P32A	CM7R151A-32B-P	LVR-IC	LDO, 3.2V±2%, 150mA, +CE, PDR	SOT-89-5	32um VR4	6j	Can
P32A	ML6204A322P	LVR-IC	LDO, 3.2V±2%, 150mA, +CE, CL	SOT-89-5	32um VR4	6j	Mic
P32B	CM7R151B-32B-P	LVR-IC	LDO, 3.2V±2%, 150mA, +CE	SOT-89-5	32um VR4	6j	Can
P32B	ML6204B322P	LVR-IC	LDO, 3.2V±2%, 150mA, +CE	SOT-89-5	32um VR4	6j	Mic
P32C	CM7R151C-32B-P	LVR-IC	LDO, 3.2V±2%, 150mA, -CE, PDR	SOT-89-5	32um VR4	6j	Can
P32C	ML6204C322P	LVR-IC	LDO, 3.2V±2%, 150mA, -CE, CL	SOT-89-5	32um VR4	6j	Mic
P32D	CM7R151D-32B-P	LVR-IC	LDO, 3.2V±2%, 150mA, -CE	SOT-89-5	32um VR4	6j	Can
P32D	ML6204D322P	LVR-IC	LDO, 3.2V±2%, 150mA, -CE	SOT-89-5	32um VR4	6j	Mic
P33	TK11233AU	LVR-IC	LDO, 3.3V±2.4%, 150mA, +CE	SOT-89-5	32vg VR7	6i	Tok
P33A	CM7R151A-33B-P	LVR-IC	LDO, 3.3V±2%, 150mA, +CE, PDR	SOT-89-5	32um VR4	6j	Can
P33A	ML6204A332P	LVR-IC	LDO, 3.3V±2%, 150mA, +CE, CL	SOT-89-5	32um VR4	6j	Mic
P33B	CM7R151B-33B-P	LVR-IC	LDO, 3.3V±2%, 150mA, +CE	SOT-89-5	32um VR4	6j	Can
P33B	ML6204B332P	LVR-IC	LDO, 3.3V±2%, 150mA, +CE	SOT-89-5	32um VR4	6j	Mic
P33C	CM7R151C-33B-P	LVR-IC	LDO, 3.3V±2%, 150mA, -CE, PDR	SOT-89-5	32um VR4	6j	Can
P33C	ML6204C332P	LVR-IC	LDO, 3.3V±2%, 150mA, -CE, CL	SOT-89-5	32um VR4	6j	Mic
P33D	CM7R151D-33B-P	LVR-IC	LDO, 3.3V±2%, 150mA, -CE	SOT-89-5	32um VR4	6j	Can
P33D	ML6204D332P	LVR-IC	LDO, 3.3V±2%, 150mA, -CE	SOT-89-5	32um VR4	6j	Mic
P34A	CM7R151A-34B-P	LVR-IC	LDO, 3.4V±2%, 150mA, +CE, PDR	SOT-89-5	32um VR4	6j	Can
P34A	ML6204A342P	LVR-IC	LDO, 3.4V±2%, 150mA, +CE, CL	SOT-89-5	32um VR4	6j	Mic
P34B	CM7R151B-34B-P	LVR-IC	LDO, 3.4V±2%, 150mA, +CE	SOT-89-5	32um VR4	6j	Can
P34B	ML6204B342P	LVR-IC	LDO, 3.4V±2%, 150mA, +CE	SOT-89-5	32um VR4	6j	Mic
P34C	CM7R151C-34B-P	LVR-IC	LDO, 3.4V±2%, 150mA, -CE, PDR	SOT-89-5	32um VR4	6j	Can
P34C	ML6204C342P	LVR-IC	LDO, 3.4V±2%, 150mA, -CE, CL	SOT-89-5	32um VR4	6j	Mic
P34D	CM7R151D-34B-P	LVR-IC	LDO, 3.4V±2%, 150mA, -CE	SOT-89-5	32um VR4	6j	Can
P34D	ML6204D342P	LVR-IC	LDO, 3.4V±2%, 150mA, -CE	SOT-89-5	32um VR4	6j	Mic
P35	TK11235AU	LVR-IC	LDO, 3.5V±2.4%, 150mA, +CE	SOT-89-5	32vg VR7	6i	Tok
P35A	CM7R151A-35B-P	LVR-IC	LDO, 3.5V±2%, 150mA, +CE, PDR	SOT-89-5	32um VR4	6j	Can
P35A	ML6204A352P	LVR-IC	LDO, 3.5V±2%, 150mA, +CE, CL	SOT-89-5	32um VR4	6j	Mic
P35B	CM7R151B-35B-P	LVR-IC	LDO, 3.5V±2%, 150mA, +CE	SOT-89-5	32um VR4	6j	Can
P35B	ML6204B352P	LVR-IC	LDO, 3.5V±2%, 150mA, +CE	SOT-89-5	32um VR4	6j	Mic



SMD code	Type	Function	Short description	Case	Pinout Sch.	St.	Mnf.
P35C	CM7R151C-35B-P	LVR-IC	LDO, 3.5V±2%, 150mA, -CE, PDR	SOT-89-5	32um VR4	6j	Can
P35C	ML6204C352P	LVR-IC	LDO, 3.5V±2%, 150mA, -CE, CL	SOT-89-5	32um VR4	6j	Mic
P35D	CM7R151D-35B-P	LVR-IC	LDO, 3.5V±2%, 150mA, -CE	SOT-89-5	32um VR4	6j	Can
P35D	ML6204D352P	LVR-IC	LDO, 3.5V±2%, 150mA, -CE	SOT-89-5	32um VR4	6j	Mic
P36	TK11236AU	LVR-IC	LDO, 3.6V±2.4%, 150mA, +CE	SOT-89-5	32vg VR7	6i	Tok
P36A	CM7R151A-36B-P	LVR-IC	LDO, 3.6V±2%, 150mA, +CE, PDR	SOT-89-5	32um VR4	6j	Can
P36A	ML6204A362P	LVR-IC	LDO, 3.6V±2%, 150mA, +CE, CL	SOT-89-5	32um VR4	6j	Mic
P36B	CM7R151B-36B-P	LVR-IC	LDO, 3.6V±2%, 150mA, +CE	SOT-89-5	32um VR4	6j	Can
P36B	ML6204B362P	LVR-IC	LDO, 3.6V±2%, 150mA, +CE	SOT-89-5	32um VR4	6j	Mic
P36C	CM7R151C-36B-P	LVR-IC	LDO, 3.6V±2%, 150mA, -CE, PDR	SOT-89-5	32um VR4	6j	Can
P36C	ML6204C362P	LVR-IC	LDO, 3.6V±2%, 150mA, -CE, CL	SOT-89-5	32um VR4	6j	Mic
P36D	CM7R151D-36B-P	LVR-IC	LDO, 3.6V±2%, 150mA, -CE	SOT-89-5	32um VR4	6j	Can
P36D	ML6204D362P	LVR-IC	LDO, 3.6V±2%, 150mA, -CE	SOT-89-5	32um VR4	6j	Mic
P37A	CM7R151A-37B-P	LVR-IC	LDO, 3.7V±2%, 150mA, +CE, PDRV	SOT-89-5	32um VR4	6j	Can
P37A	ML6204A372P	LVR-IC	LDO, 3.7V±2%, 150mA, +CE, CL	SOT-89-5	32um VR4	6j	Mic
P37B	CM7R151B-37B-P	LVR-IC	LDO, 3.7V±2%, 150mA, +CEV	SOT-89-5	32um VR4	6j	Can
P37B	ML6204B372P	LVR-IC	LDO, 3.7V±2%, 150mA, +CE	SOT-89-5	32um VR4	6j	Mic
P37C	CM7R151C-37B-P	LVR-IC	LDO, 3.7V±2%, 150mA, -CE, PDRV	SOT-89-5	32um VR4	6j	Can
P37C	ML6204C372P	LVR-IC	LDO, 3.7V±2%, 150mA, -CE, CL	SOT-89-5	32um VR4	6j	Mic
P37D	CM7R151D-37B-P	LVR-IC	LDO, 3.7V±2%, 150mA, -CEV	SOT-89-5	32um VR4	6j	Can
P37D	ML6204D372P	LVR-IC	LDO, 3.7V±2%, 150mA, -CE	SOT-89-5	32um VR4	6j	Mic
P38	TK11238AU	LVR-IC	LDO, 3.8V±2.4%, 150mA, +CE	SOT-89-5	32vg VR7	6i	Tok
P38A	CM7R151A-38B-P	LVR-IC	LDO, 3.8V±2%, 150mA, +CE, PDR	SOT-89-5	32um VR4	6j	Can
P38A	ML6204A382P	LVR-IC	LDO, 3.8V±2%, 150mA, +CE, CL	SOT-89-5	32um VR4	6j	Mic
P38B	CM7R151B-38B-P	LVR-IC	LDO, 3.8V±2%, 150mA, +CE	SOT-89-5	32um VR4	6j	Can
P38B	ML6204B382P	LVR-IC	LDO, 3.8V±2%, 150mA, +CE	SOT-89-5	32um VR4	6j	Mic
P38C	CM7R151C-38B-P	LVR-IC	LDO, 3.8V±2%, 150mA, -CE, PDR	SOT-89-5	32um VR4	6j	Can
P38C	ML6204C382P	LVR-IC	LDO, 3.8V±2%, 150mA, -CE, CL	SOT-89-5	32um VR4	6j	Mic
P38D	CM7R151D-38B-P	LVR-IC	LDO, 3.8V±2%, 150mA, -CE	SOT-89-5	32um VR4	6j	Can
P38D	ML6204D382P	LVR-IC	LDO, 3.8V±2%, 150mA, -CE	SOT-89-5	32um VR4	6j	Mic
P39A	CM7R151A-39B-P	LVR-IC	LDO, 3.9V±2%, 150mA, +CE, PDR	SOT-89-5	32um VR4	6j	Can
P39A	ML6204A392P	LVR-IC	LDO, 3.9V±2%, 150mA, +CE, CL	SOT-89-5	32um VR4	6j	Mic
P39B	CM7R151B-39B-P	LVR-IC	LDO, 3.9V±2%, 150mA, +CE	SOT-89-5	32um VR4	6j	Can
P39B	ML6204B392P	LVR-IC	LDO, 3.9V±2%, 150mA, +CE	SOT-89-5	32um VR4	6j	Mic
P39C	CM7R151C-39B-P	LVR-IC	LDO, 3.9V±2%, 150mA, -CE, PDR	SOT-89-5	32um VR4	6j	Can
P39C	ML6204C392P	LVR-IC	LDO, 3.9V±2%, 150mA, -CE, CL	SOT-89-5	32um VR4	6j	Mic
P39D	CM7R151D-39B-P	LVR-IC	LDO, 3.9V±2%, 150mA, -CE	SOT-89-5	32um VR4	6j	Can
P39D	ML6204D392P	LVR-IC	LDO, 3.9V±2%, 150mA, -CE	SOT-89-5	32um VR4	6j	Mic
P3AA	CM7R151A-30A-P	LVR-IC	LDO, 3.05V±2%, 150mA, +CE, PDR	SOT-89-5	32um VR4	6j	Can
P3AA	ML6204A30AP	LVR-IC	LDO, 3.05V±2%, 150mA, +CE, CL	SOT-89-5	32um VR4	6j	Mic
P3AB	CM7R151B-30A-P	LVR-IC	LDO, 3.05V±2%, 150mA, +CE	SOT-89-5	32um VR4	6j	Can
P3AB	ML6204B30AP	LVR-IC	LDO, 3.05V±2%, 150mA, +CE	SOT-89-5	32um VR4	6j	Mic
P3AC	CM7R151C-30A-P	LVR-IC	LDO, 3.05V±2%, 150mA, -CE, PDR	SOT-89-5	32um VR4	6j	Can
P3AC	ML6204C30AP	LVR-IC	LDO, 3.05V±2%, 150mA, -CE, CL	SOT-89-5	32um VR4	6j	Mic
P3AD	CM7R151D-30A-P	LVR-IC	LDO, 3.05V±2%, 150mA, -CE	SOT-89-5	32um VR4	6j	Can
P3AD	ML6204D30AP	LVR-IC	LDO, 3.05V±2%, 150mA, -CE	SOT-89-5	32um VR4	6j	Mic
P3BA	CM7R151A-31A-P	LVR-IC	LDO, 3.15V±2%, 150mA, +CE, PDR	SOT-89-5	32um VR4	6j	Can
P3BA	ML6204A31AP	LVR-IC	LDO, 3.15V±2%, 150mA, +CE, CL	SOT-89-5	32um VR4	6j	Mic
P3BB	CM7R151B-31A-P	LVR-IC	LDO, 3.15V±2%, 150mA, +CE	SOT-89-5	32um VR4	6j	Can
P3BB	ML6204B31AP	LVR-IC	LDO, 3.15V±2%, 150mA, +CE	SOT-89-5	32um VR4	6j	Mic
P3BC	CM7R151C-31A-P	LVR-IC	LDO, 3.15V±2%, 150mA, -CE, PDR	SOT-89-5	32um VR4	6j	Can
P3BC	ML6204C31AP	LVR-IC	LDO, 3.15V±2%, 150mA, -CE, CL	SOT-89-5	32um VR4	6j	Mic
P3BD	CM7R151D-31A-P	LVR-IC	LDO, 3.15V±2%, 150mA, -CE	SOT-89-5	32um VR4	6j	Can
P3BD	ML6204D31AP	LVR-IC	LDO, 3.15V±2%, 150mA, -CE	SOT-89-5	32um VR4	6j	Mic
P3CA	CM7R151A-32A-P	LVR-IC	LDO, 3.25V±2%, 150mA, +CE, PDR	SOT-89-5	32um VR4	6j	Can
P3CA	ML6204A32AP	LVR-IC	LDO, 3.25V±2%, 150mA, +CE, CL	SOT-89-5	32um VR4	6j	Mic
P3CB	CM7R151B-32A-P	LVR-IC	LDO, 3.25V±2%, 150mA, +CE	SOT-89-5	32um VR4	6j	Can
P3CB	ML6204B32AP	LVR-IC	LDO, 3.25V±2%, 150mA, +CE	SOT-89-5	32um VR4	6j	Mic
P3CC	CM7R151C-32A-P	LVR-IC	LDO, 3.25V±2%, 150mA, -CE, PDR	SOT-89-5	32um VR4	6j	Can
P3CC	ML6204C32AP	LVR-IC	LDO, 3.25V±2%, 150mA, -CE, CL	SOT-89-5	32um VR4	6j	Mic
P3CD	CM7R151D-32A-P	LVR-IC	LDO, 3.25V±2%, 150mA, -CE	SOT-89-5	32um VR4	6j	Can
P3CD	ML6204D32AP	LVR-IC	LDO, 3.25V±2%, 150mA, -CE	SOT-89-5	32um VR4	6j	Mic
P3DA	CM7R151A-33A-P	LVR-IC	LDO, 3.35V±2%, 150mA, +CE, PDR	SOT-89-5	32um VR4	6j	Can
P3DA	ML6204A33AP	LVR-IC	LDO, 3.35V±2%, 150mA, +CE, CL	SOT-89-5	32um VR4	6j	Mic
P3DB	CM7R151B-33A-P	LVR-IC	LDO, 3.35V±2%, 150mA, +CE	SOT-89-5	32um VR4	6j	Can
P3DB	ML6204B33AP	LVR-IC	LDO, 3.35V±2%, 150mA, +CE	SOT-89-5	32um VR4	6j	Mic
P3DC	CM7R151C-33A-P	LVR-IC	LDO, 3.35V±2%, 150mA, -CE, PDR	SOT-89-5	32um VR4	6j	Can
P3DC	ML6204C33AP	LVR-IC	LDO, 3.35V±2%, 150mA, -CE, CL	SOT-89-5	32um VR4	6j	Mic
P3DD	CM7R151D-33A-P	LVR-IC	LDO, 3.35V±2%, 150mA, -CE	SOT-89-5	32um VR4	6j	Can
P3DD	ML6204D33AP	LVR-IC	LDO, 3.35V±2%, 150mA, -CE	SOT-89-5	32um VR4	6j	Mic



SMD code	Type	Function	Short description	Case	Pinout Sch.	St.	Mnf.
P3EA	CM7R151A-34A-P	LVR-IC	LDO, 3.45V±2%, 150mA, +CE, PDR	SOT-89-5	32um VR4	6j	Can
P3EA	ML6204A34AP	LVR-IC	LDO, 3.45V±2%, 150mA, +CE, CL	SOT-89-5	32um VR4	6j	Mic
P3EB	CM7R151B-34A-P	LVR-IC	LDO, 3.45V±2%, 150mA, +CE	SOT-89-5	32um VR4	6j	Can
P3EB	ML6204B34AP	LVR-IC	LDO, 3.45V±2%, 150mA, +CE	SOT-89-5	32um VR4	6j	Mic
P3EC	CM7R151C-34A-P	LVR-IC	LDO, 3.45V±2%, 150mA, -CE, PDR	SOT-89-5	32um VR4	6j	Can
P3EC	ML6204C34AP	LVR-IC	LDO, 3.45V±2%, 150mA, -CE, CL	SOT-89-5	32um VR4	6j	Mic
P3ED	CM7R151D-34A-P	LVR-IC	LDO, 3.45V±2%, 150mA, -CE	SOT-89-5	32um VR4	6j	Can
P3ED	ML6204D34AP	LVR-IC	LDO, 3.45V±2%, 150mA, -CE	SOT-89-5	32um VR4	6j	Mic
P3FA	CM7R151A-35A-P	LVR-IC	LDO, 3.55V±2%, 150mA, +CE, PDR	SOT-89-5	32um VR4	6j	Can
P3FA	ML6204A35AP	LVR-IC	LDO, 3.55V±2%, 150mA, +CE, CL	SOT-89-5	32um VR4	6j	Mic
P3FB	CM7R151B-35A-P	LVR-IC	LDO, 3.55V±2%, 150mA, +CE	SOT-89-5	32um VR4	6j	Can
P3FB	ML6204B35AP	LVR-IC	LDO, 3.55V±2%, 150mA, +CE	SOT-89-5	32um VR4	6j	Mic
P3FC	CM7R151C-35A-P	LVR-IC	LDO, 3.55V±2%, 150mA, -CE, PDR	SOT-89-5	32um VR4	6j	Can
P3FC	ML6204C35AP	LVR-IC	LDO, 3.55V±2%, 150mA, -CE, CL	SOT-89-5	32um VR4	6j	Mic
P3FD	CM7R151D-35A-P	LVR-IC	LDO, 3.55V±2%, 150mA, -CE	SOT-89-5	32um VR4	6j	Can
P3FD	ML6204D35AP	LVR-IC	LDO, 3.55V±2%, 150mA, -CE	SOT-89-5	32um VR4	6j	Mic
P3GA	CM7R151A-36A-P	LVR-IC	LDO, 3.65V±2%, 150mA, +CE, PDR	SOT-89-5	32um VR4	6j	Can
P3GA	ML6204A36AP	LVR-IC	LDO, 3.65V±2%, 150mA, +CE, CL	SOT-89-5	32um VR4	6j	Mic
P3GB	CM7R151B-36A-P	LVR-IC	LDO, 3.65V±2%, 150mA, +CE	SOT-89-5	32um VR4	6j	Can
P3GB	ML6204B36AP	LVR-IC	LDO, 3.65V±2%, 150mA, +CE	SOT-89-5	32um VR4	6j	Mic
P3GC	CM7R151C-36A-P	LVR-IC	LDO, 3.65V±2%, 150mA, -CE, PDR	SOT-89-5	32um VR4	6j	Can
P3GC	ML6204C36AP	LVR-IC	LDO, 3.65V±2%, 150mA, -CE, CL	SOT-89-5	32um VR4	6j	Mic
P3GD	CM7R151D-36A-P	LVR-IC	LDO, 3.65V±2%, 150mA, -CE	SOT-89-5	32um VR4	6j	Can
P3GD	ML6204D36AP	LVR-IC	LDO, 3.65V±2%, 150mA, -CE	SOT-89-5	32um VR4	6j	Mic
P3HA	CM7R151A-37A-P	LVR-IC	LDO, 3.75V±2%, 150mA, +CE, PDR	SOT-89-5	32um VR4	6j	Can
P3HA	ML6204A37AP	LVR-IC	LDO, 3.75V±2%, 150mA, +CE, CL	SOT-89-5	32um VR4	6j	Mic
P3HB	CM7R151B-37A-P	LVR-IC	LDO, 3.75V±2%, 150mA, +CE	SOT-89-5	32um VR4	6j	Can
P3HB	ML6204B37AP	LVR-IC	LDO, 3.75V±2%, 150mA, +CE	SOT-89-5	32um VR4	6j	Mic
P3HC	CM7R151C-37A-P	LVR-IC	LDO, 3.75V±2%, 150mA, -CE, PDR	SOT-89-5	32um VR4	6j	Can
P3HC	ML6204C37AP	LVR-IC	LDO, 3.75V±2%, 150mA, -CE, CL	SOT-89-5	32um VR4	6j	Mic
P3HD	CM7R151D-37A-P	LVR-IC	LDO, 3.75V±2%, 150mA, -CE	SOT-89-5	32um VR4	6j	Can
P3HD	ML6204D37AP	LVR-IC	LDO, 3.75V±2%, 150mA, -CE	SOT-89-5	32um VR4	6j	Mic
P3IA	CM7R151A-38A-P	LVR-IC	LDO, 3.85V±2%, 150mA, +CE, PDR	SOT-89-5	32um VR4	6j	Can
P3IA	ML6204A38AP	LVR-IC	LDO, 3.85V±2%, 150mA, +CE, CL	SOT-89-5	32um VR4	6j	Mic
P3IB	CM7R151B-38A-P	LVR-IC	LDO, 3.85V±2%, 150mA, +CE	SOT-89-5	32um VR4	6j	Can
P3IB	ML6204B38AP	LVR-IC	LDO, 3.85V±2%, 150mA, +CE	SOT-89-5	32um VR4	6j	Mic
P3IC	CM7R151C-38A-P	LVR-IC	LDO, 3.85V±2%, 150mA, -CE, PDR	SOT-89-5	32um VR4	6j	Can
P3IC	ML6204C38AP	LVR-IC	LDO, 3.85V±2%, 150mA, -CE, CL	SOT-89-5	32um VR4	6j	Mic
P3ID	CM7R151D-38A-P	LVR-IC	LDO, 3.85V±2%, 150mA, -CE	SOT-89-5	32um VR4	6j	Can
P3ID	ML6204D38AP	LVR-IC	LDO, 3.85V±2%, 150mA, -CE	SOT-89-5	32um VR4	6j	Mic
P3JA	CM7R151A-39A-P	LVR-IC	LDO, 3.95V±2%, 150mA, +CE, PDR	SOT-89-5	32um VR4	6j	Can
P3JA	ML6204A39AP	LVR-IC	LDO, 3.95V±2%, 150mA, +CE, CL	SOT-89-5	32um VR4	6j	Mic
P3JB	CM7R151B-39A-P	LVR-IC	LDO, 3.95V±2%, 150mA, +CE	SOT-89-5	32um VR4	6j	Can
P3JB	ML6204B39AP	LVR-IC	LDO, 3.95V±2%, 150mA, +CE	SOT-89-5	32um VR4	6j	Mic
P3JC	CM7R151C-39A-P	LVR-IC	LDO, 3.95V±2%, 150mA, -CE, PDR	SOT-89-5	32um VR4	6j	Can
P3JC	ML6204C39AP	LVR-IC	LDO, 3.95V±2%, 150mA, -CE, CL	SOT-89-5	32um VR4	6j	Mic
P3JD	CM7R151D-39A-P	LVR-IC	LDO, 3.95V±2%, 150mA, -CE	SOT-89-5	32um VR4	6j	Can
P3JD	ML6204D39AP	LVR-IC	LDO, 3.95V±2%, 150mA, -CE	SOT-89-5	32um VR4	6j	Mic
P40	TK11240AU	LVR-IC	LDO, 4V±2.4%, 150mA, +CE	SOT-89-5	32vg VR7	6i	Tok
P40A	CM7R151A-40B-P	LVR-IC	LDO, 4.0V±2%, 150mA, +CE, PDR	SOT-89-5	32um VR4	6j	Can
P40A	ML6204A402P	LVR-IC	LDO, 4.0V±2%, 150mA, +CE, CL	SOT-89-5	32um VR4	6j	Mic
P40B	CM7R151B-40B-P	LVR-IC	LDO, 4.0V±2%, 150mA, +CE	SOT-89-5	32um VR4	6j	Can
P40B	ML6204B402P	LVR-IC	LDO, 4.0V±2%, 150mA, +CE	SOT-89-5	32um VR4	6j	Mic
P40C	CM7R151C-40B-P	LVR-IC	LDO, 4.0V±2%, 150mA, -CE, PDR	SOT-89-5	32um VR4	6j	Can
P40C	ML6204C402P	LVR-IC	LDO, 4.0V±2%, 150mA, -CE, CL	SOT-89-5	32um VR4	6j	Mic
P40D	CM7R151D-40B-P	LVR-IC	LDO, 4.0V±2%, 150mA, -CE	SOT-89-5	32um VR4	6j	Can
P40D	ML6204D402P	LVR-IC	LDO, 4.0V±2%, 150mA, -CE	SOT-89-5	32um VR4	6j	Mic
P41A	CM7R151A-41B-P	LVR-IC	LDO, 4.1V±2%, 150mA, +CE, PDR	SOT-89-5	32um VR4	6j	Can
P41A	ML6204A412P	LVR-IC	LDO, 4.1V±2%, 150mA, +CE, CL	SOT-89-5	32um VR4	6j	Mic
P41B	CM7R151B-41B-P	LVR-IC	LDO, 4.1V±2%, 150mA, +CE	SOT-89-5	32um VR4	6j	Can
P41B	ML6204B412P	LVR-IC	LDO, 4.1V±2%, 150mA, +CE	SOT-89-5	32um VR4	6j	Mic
P41C	CM7R151C-41B-P	LVR-IC	LDO, 4.1V±2%, 150mA, -CE, PDR	SOT-89-5	32um VR4	6j	Can
P41C	ML6204C412P	LVR-IC	LDO, 4.1V±2%, 150mA, -CE, CL	SOT-89-5	32um VR4	6j	Mic
P41D	CM7R151D-41B-P	LVR-IC	LDO, 4.1V±2%, 150mA, -CE	SOT-89-5	32um VR4	6j	Can
P41D	ML6204D412P	LVR-IC	LDO, 4.1V±2%, 150mA, -CE	SOT-89-5	32um VR4	6j	Mic
P42A	CM7R151A-42B-P	LVR-IC	LDO, 4.2V±2%, 150mA, +CE, PDR	SOT-89-5	32um VR4	6j	Can
P42A	ML6204A422P	LVR-IC	LDO, 4.2V±2%, 150mA, +CE, CL	SOT-89-5	32um VR4	6j	Mic
P42B	CM7R151B-42B-P	LVR-IC	LDO, 4.2V±2%, 150mA, +CE	SOT-89-5	32um VR4	6j	Can
P42B	ML6204B422P	LVR-IC	LDO, 4.2V±2%, 150mA, +CE	SOT-89-5	32um VR4	6j	Mic
P42C	CM7R151C-42B-P	LVR-IC	LDO, 4.2V±2%, 150mA, -CE, PDR	SOT-89-5	32um VR4	6j	Can



SMD code	Type	Function	Short description	Case	Pinout Sch.	St.	Mnf.
P42C	ML6204C422P	LVR-IC	LDO, 4.2V±2%, 150mA, -CE, CL	SOT-89-5	32um VR4	6j	Mic
P42D	CM7R151D-42B-P	LVR-IC	LDO, 4.2V±2%, 150mA, -CE	SOT-89-5	32um VR4	6j	Can
P42D	ML6204D422P	LVR-IC	LDO, 4.2V±2%, 150mA, -CE	SOT-89-5	32um VR4	6j	Mic
P43A	CM7R151A-43B-P	LVR-IC	LDO, 4.3V±2%, 150mA, +CE, PDR	SOT-89-5	32um VR4	6j	Can
P43A	ML6204A432P	LVR-IC	LDO, 4.3V±2%, 150mA, +CE, CL	SOT-89-5	32um VR4	6j	Mic
P43B	CM7R151B-43B-P	LVR-IC	LDO, 4.3V±2%, 150mA, +CE	SOT-89-5	32um VR4	6j	Can
P43B	ML6204B432P	LVR-IC	LDO, 4.3V±2%, 150mA, +CE	SOT-89-5	32um VR4	6j	Mic
P43C	CM7R151C-43B-P	LVR-IC	LDO, 4.3V±2%, 150mA, -CE, PDR	SOT-89-5	32um VR4	6j	Can
P43C	ML6204C432P	LVR-IC	LDO, 4.3V±2%, 150mA, -CE, CL	SOT-89-5	32um VR4	6j	Mic
P43D	CM7R151D-43B-P	LVR-IC	LDO, 4.3V±2%, 150mA, -CE	SOT-89-5	32um VR4	6j	Can
P43D	ML6204D432P	LVR-IC	LDO, 4.3V±2%, 150mA, -CE	SOT-89-5	32um VR4	6j	Mic
P44A	CM7R151A-44B-P	LVR-IC	LDO, 4.4V±2%, 150mA, +CE, PDR	SOT-89-5	32um VR4	6j	Can
P44A	ML6204A442P	LVR-IC	LDO, 4.4V±2%, 150mA, +CE, CL	SOT-89-5	32um VR4	6j	Mic
P44B	CM7R151B-44B-P	LVR-IC	LDO, 4.4V±2%, 150mA, +CE	SOT-89-5	32um VR4	6j	Can
P44B	ML6204B442P	LVR-IC	LDO, 4.4V±2%, 150mA, +CE	SOT-89-5	32um VR4	6j	Mic
P44C	CM7R151C-44B-P	LVR-IC	LDO, 4.4V±2%, 150mA, -CE, PDR	SOT-89-5	32um VR4	6j	Can
P44C	ML6204C442P	LVR-IC	LDO, 4.4V±2%, 150mA, -CE, CL	SOT-89-5	32um VR4	6j	Mic
P44D	CM7R151D-44B-P	LVR-IC	LDO, 4.4V±2%, 150mA, -CE	SOT-89-5	32um VR4	6j	Can
P44D	ML6204D442P	LVR-IC	LDO, 4.4V±2%, 150mA, -CE	SOT-89-5	32um VR4	6j	Mic
P45	TK11245AU	LVR-IC	LDO, 4.5V±2.4%, 150mA, +CE	SOT-89-5	32vg VR7	6i	Tok
P45A	CM7R151A-45B-P	LVR-IC	LDO, 4.5V±2%, 150mA, +CE, PDR	SOT-89-5	32um VR4	6j	Can
P45A	ML6204A452P	LVR-IC	LDO, 4.5V±2%, 150mA, +CE, CL	SOT-89-5	32um VR4	6j	Mic
P45B	CM7R151B-45B-P	LVR-IC	LDO, 4.5V±2%, 150mA, +CE	SOT-89-5	32um VR4	6j	Can
P45B	ML6204B452P	LVR-IC	LDO, 4.5V±2%, 150mA, +CE	SOT-89-5	32um VR4	6j	Mic
P45C	CM7R151C-45B-P	LVR-IC	LDO, 4.5V±2%, 150mA, -CE, PDR	SOT-89-5	32um VR4	6j	Can
P45C	ML6204C452P	LVR-IC	LDO, 4.5V±2%, 150mA, -CE, CL	SOT-89-5	32um VR4	6j	Mic
P45D	CM7R151D-45B-P	LVR-IC	LDO, 4.5V±2%, 150mA, -CE	SOT-89-5	32um VR4	6j	Can
P45D	ML6204D452P	LVR-IC	LDO, 4.5V±2%, 150mA, -CE	SOT-89-5	32um VR4	6j	Mic
P46A	CM7R151A-46B-P	LVR-IC	LDO, 4.6V±2%, 150mA, +CE, PDR	SOT-89-5	32um VR4	6j	Can
P46A	ML6204A462P	LVR-IC	LDO, 4.6V±2%, 150mA, +CE, CL	SOT-89-5	32um VR4	6j	Mic
P46B	CM7R151B-46B-P	LVR-IC	LDO, 4.6V±2%, 150mA, +CE	SOT-89-5	32um VR4	6j	Can
P46B	ML6204B462P	LVR-IC	LDO, 4.6V±2%, 150mA, +CE	SOT-89-5	32um VR4	6j	Mic
P46C	CM7R151C-46B-P	LVR-IC	LDO, 4.6V±2%, 150mA, -CE, PDR	SOT-89-5	32um VR4	6j	Can
P46C	ML6204C462P	LVR-IC	LDO, 4.6V±2%, 150mA, -CE, CL	SOT-89-5	32um VR4	6j	Mic
P46D	CM7R151D-46B-P	LVR-IC	LDO, 4.6V±2%, 150mA, -CE	SOT-89-5	32um VR4	6j	Can
P46D	ML6204D462P	LVR-IC	LDO, 4.6V±2%, 150mA, -CE	SOT-89-5	32um VR4	6j	Mic
P47A	CM7R151A-47B-P	LVR-IC	LDO, 4.7V±2%, 150mA, +CE, PDR	SOT-89-5	32um VR4	6j	Can
P47A	ML6204A472P	LVR-IC	LDO, 4.7V±2%, 150mA, +CE, CL	SOT-89-5	32um VR4	6j	Mic
P47B	CM7R151B-47B-P	LVR-IC	LDO, 4.7V±2%, 150mA, +CE	SOT-89-5	32um VR4	6j	Can
P47B	ML6204B472P	LVR-IC	LDO, 4.7V±2%, 150mA, +CE	SOT-89-5	32um VR4	6j	Mic
P47C	CM7R151C-47B-P	LVR-IC	LDO, 4.7V±2%, 150mA, -CE, PDR	SOT-89-5	32um VR4	6j	Can
P47C	ML6204C472P	LVR-IC	LDO, 4.7V±2%, 150mA, -CE, CL	SOT-89-5	32um VR4	6j	Mic
P47D	CM7R151D-47B-P	LVR-IC	LDO, 4.7V±2%, 150mA, -CE	SOT-89-5	32um VR4	6j	Can
P47D	ML6204D472P	LVR-IC	LDO, 4.7V±2%, 150mA, -CE	SOT-89-5	32um VR4	6j	Mic
P48	TK11248AU	LVR-IC	LDO, 4.8V±2.4%, 150mA, +CE	SOT-89-5	32vg VR7	6i	Tok
P48A	CM7R151A-48B-P	LVR-IC	LDO, 4.8V±2%, 150mA, +CE, PDR	SOT-89-5	32um VR4	6j	Can
P48A	ML6204A482P	LVR-IC	LDO, 4.8V±2%, 150mA, +CE, CL	SOT-89-5	32um VR4	6j	Mic
P48B	CM7R151B-48B-P	LVR-IC	LDO, 4.8V±2%, 150mA, +CE	SOT-89-5	32um VR4	6j	Can
P48B	ML6204B482P	LVR-IC	LDO, 4.8V±2%, 150mA, +CE	SOT-89-5	32um VR4	6j	Mic
P48C	CM7R151C-48B-P	LVR-IC	LDO, 4.8V±2%, 150mA, -CE, PDR	SOT-89-5	32um VR4	6j	Can
P48C	ML6204C482P	LVR-IC	LDO, 4.8V±2%, 150mA, -CE, CL	SOT-89-5	32um VR4	6j	Mic
P48D	CM7R151D-48B-P	LVR-IC	LDO, 4.8V±2%, 150mA, -CE	SOT-89-5	32um VR4	6j	Can
P48D	ML6204D482P	LVR-IC	LDO, 4.8V±2%, 150mA, -CE	SOT-89-5	32um VR4	6j	Mic
P49	TK11249AU	LVR-IC	LDO, 4.9V±2.4%, 150mA, +CE	SOT-89-5	32vg VR7	6i	Tok
P49A	CM7R151A-49B-P	LVR-IC	LDO, 4.9V±2%, 150mA, +CE, PDR	SOT-89-5	32um VR4	6j	Can
P49A	ML6204A492P	LVR-IC	LDO, 4.9V±2%, 150mA, +CE, CL	SOT-89-5	32um VR4	6j	Mic
P49B	CM7R151B-49B-P	LVR-IC	LDO, 4.9V±2%, 150mA, +CE	SOT-89-5	32um VR4	6j	Can
P49B	ML6204B492P	LVR-IC	LDO, 4.9V±2%, 150mA, +CE	SOT-89-5	32um VR4	6j	Mic
P49C	CM7R151C-49B-P	LVR-IC	LDO, 4.9V±2%, 150mA, -CE, PDR	SOT-89-5	32um VR4	6j	Can
P49C	ML6204C492P	LVR-IC	LDO, 4.9V±2%, 150mA, -CE, CL	SOT-89-5	32um VR4	6j	Mic
P49D	CM7R151D-49B-P	LVR-IC	LDO, 4.9V±2%, 150mA, -CE	SOT-89-5	32um VR4	6j	Can
P49D	ML6204D492P	LVR-IC	LDO, 4.9V±2%, 150mA, -CE	SOT-89-5	32um VR4	6j	Mic
P4AA	CM7R151A-40A-P	LVR-IC	LDO, 4.05V±2%, 150mA, +CE, PDR	SOT-89-5	32um VR4	6j	Can
P4AA	ML6204A40AP	LVR-IC	LDO, 4.05V±2%, 150mA, +CE, CL	SOT-89-5	32um VR4	6j	Mic
P4AB	CM7R151B-40A-P	LVR-IC	LDO, 4.05V±2%, 150mA, +CE	SOT-89-5	32um VR4	6j	Can
P4AB	ML6204B40AP	LVR-IC	LDO, 4.05V±2%, 150mA, +CE	SOT-89-5	32um VR4	6j	Mic
P4AC	CM7R151C-40A-P	LVR-IC	LDO, 4.05V±2%, 150mA, -CE, PDR	SOT-89-5	32um VR4	6j	Can
P4AC	ML6204C40AP	LVR-IC	LDO, 4.05V±2%, 150mA, -CE, CL	SOT-89-5	32um VR4	6j	Mic
P4AD	CM7R151D-40A-P	LVR-IC	LDO, 4.05V±2%, 150mA, -CE	SOT-89-5	32um VR4	6j	Can
P4AD	ML6204D40AP	LVR-IC	LDO, 4.05V±2%, 150mA, -CE	SOT-89-5	32um VR4	6j	Mic



SMD code	Type	Function	Short description	Case	Pinout	Sch.	St.	Mnf.
P4JD	CM7R151D-49A-P	LVR-IC	LDO, 4.95V±2%, 150mA, -CE	SOT-89-5	32um	VR4	6j	Can
P4JD	ML6204D49AP	LVR-IC	LDO, 4.95V±2%, 150mA, -CE	SOT-89-5	32um	VR4	6j	Mic
P50	TK11250AU	LVR-IC	LDO, 5V±2.4%, 150mA, +CE	SOT-89-5	32vg	VR7	6i	Tok
P50A	CM7R151A-50B-P	LVR-IC	LDO, 5.0V±2%, 150mA, +CE, PDR	SOT-89-5	32um	VR4	6j	Can
P50A	ML6204A502P	LVR-IC	LDO, 5.0V±2%, 150mA, +CE, CL	SOT-89-5	32um	VR4	6j	Mic
P50B	CM7R151B-50B-P	LVR-IC	LDO, 5.0V±2%, 150mA, +CE	SOT-89-5	32um	VR4	6j	Can
P50B	ML6204B502P	LVR-IC	LDO, 5.0V±2%, 150mA, +CE	SOT-89-5	32um	VR4	6j	Mic
P50C	CM7R151C-50B-P	LVR-IC	LDO, 5.0V±2%, 150mA, -CE, PDR	SOT-89-5	32um	VR4	6j	Can
P50C	ML6204C502P	LVR-IC	LDO, 5.0V±2%, 150mA, -CE, CL	SOT-89-5	32um	VR4	6j	Mic
P50D	CM7R151D-50B-P	LVR-IC	LDO, 5.0V±2%, 150mA, -CE	SOT-89-5	32um	VR4	6j	Can
P50D	ML6204D502P	LVR-IC	LDO, 5.0V±2%, 150mA, -CE	SOT-89-5	32um	VR4	6j	Mic
P51A	CM7R151A-51B-P	LVR-IC	LDO, 5.1V±2%, 150mA, +CE, PDR	SOT-89-5	32um	VR4	6j	Can
P51A	ML6204A512P	LVR-IC	LDO, 5.1V±2%, 150mA, +CE, CL	SOT-89-5	32um	VR4	6j	Mic
P51B	CM7R151B-51B-P	LVR-IC	LDO, 5.1V±2%, 150mA, +CE	SOT-89-5	32um	VR4	6j	Can
P51B	ML6204B512P	LVR-IC	LDO, 5.1V±2%, 150mA, +CE	SOT-89-5	32um	VR4	6j	Mic
P51C	CM7R151C-51B-P	LVR-IC	LDO, 5.1V±2%, 150mA, -CE, PDR	SOT-89-5	32um	VR4	6j	Can
P51C	ML6204C512P	LVR-IC	LDO, 5.1V±2%, 150mA, -CE, CL	SOT-89-5	32um	VR4	6j	Mic
P51D	CM7R151D-51B-P	LVR-IC	LDO, 5.1V±2%, 150mA, -CE	SOT-89-5	32um	VR4	6j	Can
P51D	ML6204D512P	LVR-IC	LDO, 5.1V±2%, 150mA, -CE	SOT-89-5	32um	VR4	6j	Mic
P52A	CM7R151A-52B-P	LVR-IC	LDO, 5.2V±2%, 150mA, +CE, PDR	SOT-89-5	32um	VR4	6j	Can
P52A	ML6204A522P	LVR-IC	LDO, 5.2V±2%, 150mA, +CE, CL	SOT-89-5	32um	VR4	6j	Mic
P52B	CM7R151B-52B-P	LVR-IC	LDO, 5.2V±2%, 150mA, +CE	SOT-89-5	32um	VR4	6j	Can
P52B	ML6204B522P	LVR-IC	LDO, 5.2V±2%, 150mA, +CE	SOT-89-5	32um	VR4	6j	Mic
P52C	CM7R151C-52B-P	LVR-IC	LDO, 5.2V±2%, 150mA, -CE, PDR	SOT-89-5	32um	VR4	6j	Can
P52C	ML6204C522P	LVR-IC	LDO, 5.2V±2%, 150mA, -CE, CL	SOT-89-5	32um	VR4	6j	Mic
P52D	CM7R151D-52B-P	LVR-IC	LDO, 5.2V±2%, 150mA, -CE	SOT-89-5	32um	VR4	6j	Can
P52D	ML6204D522P	LVR-IC	LDO, 5.2V±2%, 150mA, -CE	SOT-89-5	32um	VR4	6j	Mic
P53A	CM7R151A-53B-P	LVR-IC	LDO, 5.3V±2%, 150mA, +CE, PDR	SOT-89-5	32um	VR4	6j	Can
P53A	ML6204A532P	LVR-IC	LDO, 5.3V±2%, 150mA, +CE, CL	SOT-89-5	32um	VR4	6j	Mic
P53B	CM7R151B-53B-P	LVR-IC	LDO, 5.3V±2%, 150mA, +CE	SOT-89-5	32um	VR4	6j	Can
P53B	ML6204B532P	LVR-IC	LDO, 5.3V±2%, 150mA, +CE	SOT-89-5	32um	VR4	6j	Mic
P53C	CM7R151C-53B-P	LVR-IC	LDO, 5.3V±2%, 150mA, -CE, PDR	SOT-89-5	32um	VR4	6j	Can
P53C	ML6204C532P	LVR-IC	LDO, 5.3V±2%, 150mA, -CE, CL	SOT-89-5	32um	VR4	6j	Mic
P53D	CM7R151D-53B-P	LVR-IC	LDO, 5.3V±2%, 150mA, -CE	SOT-89-5	32um	VR4	6j	Can
P53D	ML6204D532P	LVR-IC	LDO, 5.3V±2%, 150mA, -CE	SOT-89-5	32um	VR4	6j	Mic
P54A	CM7R151A-54B-P	LVR-IC	LDO, 5.4V±2%, 150mA, +CE, PDR	SOT-89-5	32um	VR4	6j	Can
P54A	ML6204A542P	LVR-IC	LDO, 5.4V±2%, 150mA, +CE, CL	SOT-89-5	32um	VR4	6j	Mic
P54B	CM7R151B-54B-P	LVR-IC	LDO, 5.4V±2%, 150mA, +CE	SOT-89-5	32um	VR4	6j	Can
P54B	ML6204B542P	LVR-IC	LDO, 5.4V±2%, 150mA, +CE	SOT-89-5	32um	VR4	6j	Mic
P54C	CM7R151C-54B-P	LVR-IC	LDO, 5.4V±2%, 150mA, -CE, PDR	SOT-89-5	32um	VR4	6j	Can
P54C	ML6204C542P	LVR-IC	LDO, 5.4V±2%, 150mA, -CE, CL	SOT-89-5	32um	VR4	6j	Mic
P54D	CM7R151D-54B-P	LVR-IC	LDO, 5.4V±2%, 150mA, -CE	SOT-89-5	32um	VR4	6j	Can
P54D	ML6204D542P	LVR-IC	LDO, 5.4V±2%, 150mA, -CE	SOT-89-5	32um	VR4	6j	Mic
P55A	CM7R151A-55B-P	LVR-IC	LDO, 5.5V±2%, 150mA, +CE, PDR	SOT-89-5	32um	VR4	6j	Can
P55A	ML6204A552P	LVR-IC	LDO, 5.5V±2%, 150mA, +CE, CL	SOT-89-5	32um	VR4	6j	Mic
P55B	CM7R151B-55B-P	LVR-IC	LDO, 5.5V±2%, 150mA, +CE	SOT-89-5	32um	VR4	6j	Can
P55B	ML6204B552P	LVR-IC	LDO, 5.5V±2%, 150mA, +CE	SOT-89-5	32um	VR4	6j	Mic
P55C	CM7R151C-55B-P	LVR-IC	LDO, 5.5V±2%, 150mA, -CE, PDR	SOT-89-5	32um	VR4	6j	Can
P55C	ML6204C552P	LVR-IC	LDO, 5.5V±2%, 150mA, -CE, CL	SOT-89-5	32um	VR4	6j	Mic
P55D	CM7R151D-55B-P	LVR-IC	LDO, 5.5V±2%, 150mA, -CE	SOT-89-5	32um	VR4	6j	Can
P55D	ML6204D552P	LVR-IC	LDO, 5.5V±2%, 150mA, -CE	SOT-89-5	32um	VR4	6j	Mic
P56A	CM7R151A-56B-P	LVR-IC	LDO, 5.6V±2%, 150mA, +CE, PDR	SOT-89-5	32um	VR4	6j	Can
P56A	ML6204A562P	LVR-IC	LDO, 5.6V±2%, 150mA, +CE, CL	SOT-89-5	32um	VR4	6j	Mic
P56B	CM7R151B-56B-P	LVR-IC	LDO, 5.6V±2%, 150mA, +CE	SOT-89-5	32um	VR4	6j	Can
P56B	ML6204B562P	LVR-IC	LDO, 5.6V±2%, 150mA, +CE	SOT-89-5	32um	VR4	6j	Mic
P56C	CM7R151C-56B-P	LVR-IC	LDO, 5.6V±2%, 150mA, -CE, PDR	SOT-89-5	32um	VR4	6j	Can
P56C	ML6204C562P	LVR-IC	LDO, 5.6V±2%, 150mA, -CE, CL	SOT-89-5	32um	VR4	6j	Mic
P56D	CM7R151D-56B-P	LVR-IC	LDO, 5.6V±2%, 150mA, -CE	SOT-89-5	32um	VR4	6j	Can
P56D	ML6204D562P	LVR-IC	LDO, 5.6V±2%, 150mA, -CE	SOT-89-5	32um	VR4	6j	Mic
P57A	CM7R151A-57B-P	LVR-IC	LDO, 5.7V±2%, 150mA, +CE, PDR	SOT-89-5	32um	VR4	6j	Can
P57A	ML6204A572P	LVR-IC	LDO, 5.7V±2%, 150mA, +CE, CL	SOT-89-5	32um	VR4	6j	Mic
P57B	CM7R151B-57B-P	LVR-IC	LDO, 5.7V±2%, 150mA, +CE	SOT-89-5	32um	VR4	6j	Can
P57B	ML6204B572P	LVR-IC	LDO, 5.7V±2%, 150mA, +CE	SOT-89-5	32um	VR4	6j	Mic
P57C	CM7R151C-57B-P	LVR-IC	LDO, 5.7V±2%, 150mA, -CE, PDR	SOT-89-5	32um	VR4	6j	Can
P57C	ML6204C572P	LVR-IC	LDO, 5.7V±2%, 150mA, -CE, CL	SOT-89-5	32um	VR4	6j	Mic
P57D	CM7R151D-57B-P	LVR-IC	LDO, 5.7V±2%, 150mA, -CE	SOT-89-5	32um	VR4	6j	Can
P57D	ML6204D572P	LVR-IC	LDO, 5.7V±2%, 150mA, -CE	SOT-89-5	32um	VR4	6j	Mic
P58A	CM7R151A-58B-P	LVR-IC	LDO, 5.8V±2%, 150mA, +CE, PDR	SOT-89-5	32um	VR4	6j	Can
P58A	ML6204A582P	LVR-IC	LDO, 5.8V±2%, 150mA, +CE, CL	SOT-89-5	32um	VR4	6j	Mic
P58B	CM7R151B-58B-P	LVR-IC	LDO, 5.8V±2%, 150mA, +CE	SOT-89-5	32um	VR4	6j	Can



SMD code	Type	Function	Short description	Case	Pinout Sch.	St.	Mnf.
P58B	ML6204B582P	LVR-IC	LDO, 5.8V±2%, 150mA, +CE	SOT-89-5	32um VR4	6j	Mic
P58C	CM7R151C-58B-P	LVR-IC	LDO, 5.8V±2%, 150mA, -CE, PDR	SOT-89-5	32um VR4	6j	Can
P58C	ML6204C582P	LVR-IC	LDO, 5.8V±2%, 150mA, -CE, CL	SOT-89-5	32um VR4	6j	Mic
P58D	CM7R151D-58B-P	LVR-IC	LDO, 5.8V±2%, 150mA, -CE	SOT-89-5	32um VR4	6j	Can
P58D	ML6204D582P	LVR-IC	LDO, 5.8V±2%, 150mA, -CE	SOT-89-5	32um VR4	6j	Mic
P59A	CM7R151A-59B-P	LVR-IC	LDO, 5.9V±2%, 150mA, +CE, PDR	SOT-89-5	32um VR4	6j	Can
P59A	ML6204A592P	LVR-IC	LDO, 5.9V±2%, 150mA, +CE, CL	SOT-89-5	32um VR4	6j	Mic
P59B	CM7R151B-59B-P	LVR-IC	LDO, 5.9V±2%, 150mA, +CE	SOT-89-5	32um VR4	6j	Can
P59B	ML6204B592P	LVR-IC	LDO, 5.9V±2%, 150mA, +CE	SOT-89-5	32um VR4	6j	Mic
P59C	CM7R151C-59B-P	LVR-IC	LDO, 5.9V±2%, 150mA, -CE, PDR	SOT-89-5	32um VR4	6j	Can
P59C	ML6204C592P	LVR-IC	LDO, 5.9V±2%, 150mA, -CE, CL	SOT-89-5	32um VR4	6j	Mic
P59D	CM7R151D-59B-P	LVR-IC	LDO, 5.9V±2%, 150mA, -CE	SOT-89-5	32um VR4	6j	Can
P59D	ML6204D592P	LVR-IC	LDO, 5.9V±2%, 150mA, -CE	SOT-89-5	32um VR4	6j	Mic
P5AA	CM7R151A-50A-P	LVR-IC	LDO, 5.05V±2%, 150mA, +CE, PDR	SOT-89-5	32um VR4	6j	Can
P5AA	ML6204A50AP	LVR-IC	LDO, 5.05V±2%, 150mA, +CE, CL	SOT-89-5	32um VR4	6j	Mic
P5AB	CM7R151B-50A-P	LVR-IC	LDO, 5.05V±2%, 150mA, +CE	SOT-89-5	32um VR4	6j	Can
P5AB	ML6204B50AP	LVR-IC	LDO, 5.05V±2%, 150mA, +CE	SOT-89-5	32um VR4	6j	Mic
P5AC	CM7R151C-50A-P	LVR-IC	LDO, 5.05V±2%, 150mA, -CE, PDR	SOT-89-5	32um VR4	6j	Can
P5AC	ML6204C50AP	LVR-IC	LDO, 5.05V±2%, 150mA, -CE, CL	SOT-89-5	32um VR4	6j	Mic
P5AD	CM7R151D-50A-P	LVR-IC	LDO, 5.05V±2%, 150mA, -CE	SOT-89-5	32um VR4	6j	Can
P5AD	ML6204D50AP	LVR-IC	LDO, 5.05V±2%, 150mA, -CE	SOT-89-5	32um VR4	6j	Mic
P5BA	CM7R151A-51A-P	LVR-IC	LDO, 5.15V±2%, 150mA, +CE, PDR	SOT-89-5	32um VR4	6j	Can
P5BA	ML6204A51AP	LVR-IC	LDO, 5.15V±2%, 150mA, +CE, CL	SOT-89-5	32um VR4	6j	Mic
P5BB	CM7R151B-51A-P	LVR-IC	LDO, 5.15V±2%, 150mA, +CE	SOT-89-5	32um VR4	6j	Can
P5BB	ML6204B51AP	LVR-IC	LDO, 5.15V±2%, 150mA, +CE	SOT-89-5	32um VR4	6j	Mic
P5BC	CM7R151C-51A-P	LVR-IC	LDO, 5.15V±2%, 150mA, -CE, PDR	SOT-89-5	32um VR4	6j	Can
P5BC	ML6204C51AP	LVR-IC	LDO, 5.15V±2%, 150mA, -CE, CL	SOT-89-5	32um VR4	6j	Mic
P5BD	CM7R151D-51A-P	LVR-IC	LDO, 5.15V±2%, 150mA, -CE	SOT-89-5	32um VR4	6j	Can
P5BD	ML6204D51AP	LVR-IC	LDO, 5.15V±2%, 150mA, -CE	SOT-89-5	32um VR4	6j	Mic
P5CA	CM7R151A-52A-P	LVR-IC	LDO, 5.25V±2%, 150mA, +CE, PDR	SOT-89-5	32um VR4	6j	Can
P5CA	ML6204A52AP	LVR-IC	LDO, 5.25V±2%, 150mA, +CE, CL	SOT-89-5	32um VR4	6j	Mic
P5CB	CM7R151B-52A-P	LVR-IC	LDO, 5.25V±2%, 150mA, +CE	SOT-89-5	32um VR4	6j	Can
P5CB	ML6204B52AP	LVR-IC	LDO, 5.25V±2%, 150mA, +CE	SOT-89-5	32um VR4	6j	Mic
P5CC	CM7R151C-52A-P	LVR-IC	LDO, 5.25V±2%, 150mA, -CE, PDR	SOT-89-5	32um VR4	6j	Can
P5CC	ML6204C52AP	LVR-IC	LDO, 5.25V±2%, 150mA, -CE, CL	SOT-89-5	32um VR4	6j	Mic
P5CD	CM7R151D-52A-P	LVR-IC	LDO, 5.25V±2%, 150mA, -CE	SOT-89-5	32um VR4	6j	Can
P5CD	ML6204D52AP	LVR-IC	LDO, 5.25V±2%, 150mA, -CE	SOT-89-5	32um VR4	6j	Mic
P5DA	CM7R151A-53A-P	LVR-IC	LDO, 5.35V±2%, 150mA, +CE, PDR	SOT-89-5	32um VR4	6j	Can
P5DA	ML6204A53AP	LVR-IC	LDO, 5.35V±2%, 150mA, +CE, CL	SOT-89-5	32um VR4	6j	Mic
P5DB	CM7R151B-53A-P	LVR-IC	LDO, 5.35V±2%, 150mA, +CE	SOT-89-5	32um VR4	6j	Can
P5DB	ML6204B53AP	LVR-IC	LDO, 5.35V±2%, 150mA, +CE	SOT-89-5	32um VR4	6j	Mic
P5DC	CM7R151C-53A-P	LVR-IC	LDO, 5.35V±2%, 150mA, -CE, PDR	SOT-89-5	32um VR4	6j	Can
P5DC	ML6204C53AP	LVR-IC	LDO, 5.35V±2%, 150mA, -CE, CL	SOT-89-5	32um VR4	6j	Mic
P5DD	CM7R151D-53A-P	LVR-IC	LDO, 5.35V±2%, 150mA, -CE	SOT-89-5	32um VR4	6j	Can
P5DD	ML6204D53AP	LVR-IC	LDO, 5.35V±2%, 150mA, -CE	SOT-89-5	32um VR4	6j	Mic
P5EA	CM7R151A-54A-P	LVR-IC	LDO, 5.45V±2%, 150mA, +CE, PDR	SOT-89-5	32um VR4	6j	Can
P5EA	ML6204A54AP	LVR-IC	LDO, 5.45V±2%, 150mA, +CE, CL	SOT-89-5	32um VR4	6j	Mic
P5EB	CM7R151B-54A-P	LVR-IC	LDO, 5.45V±2%, 150mA, +CE	SOT-89-5	32um VR4	6j	Can
P5EB	ML6204B54AP	LVR-IC	LDO, 5.45V±2%, 150mA, +CE	SOT-89-5	32um VR4	6j	Mic
P5EC	CM7R151C-54A-P	LVR-IC	LDO, 5.45V±2%, 150mA, -CE, PDR	SOT-89-5	32um VR4	6j	Can
P5EC	ML6204C54AP	LVR-IC	LDO, 5.45V±2%, 150mA, -CE, CL	SOT-89-5	32um VR4	6j	Mic
P5ED	CM7R151D-54A-P	LVR-IC	LDO, 5.45V±2%, 150mA, -CE	SOT-89-5	32um VR4	6j	Can
P5ED	ML6204D54AP	LVR-IC	LDO, 5.45V±2%, 150mA, -CE	SOT-89-5	32um VR4	6j	Mic
P5FA	CM7R151A-55A-P	LVR-IC	LDO, 5.55V±2%, 150mA, +CE, PDR	SOT-89-5	32um VR4	6j	Can
P5FA	ML6204A55AP	LVR-IC	LDO, 5.55V±2%, 150mA, +CE, CL	SOT-89-5	32um VR4	6j	Mic
P5FB	CM7R151B-55A-P	LVR-IC	LDO, 5.55V±2%, 150mA, +CE	SOT-89-5	32um VR4	6j	Can
P5FB	ML6204B55AP	LVR-IC	LDO, 5.55V±2%, 150mA, +CE	SOT-89-5	32um VR4	6j	Mic
P5FC	CM7R151C-55A-P	LVR-IC	LDO, 5.55V±2%, 150mA, -CE, PDR	SOT-89-5	32um VR4	6j	Can
P5FC	ML6204C55AP	LVR-IC	LDO, 5.55V±2%, 150mA, -CE, CL	SOT-89-5	32um VR4	6j	Mic
P5FD	CM7R151D-55A-P	LVR-IC	LDO, 5.55V±2%, 150mA, -CE	SOT-89-5	32um VR4	6j	Can
P5FD	ML6204D55AP	LVR-IC	LDO, 5.55V±2%, 150mA, -CE	SOT-89-5	32um VR4	6j	Mic
P5GA	CM7R151A-56A-P	LVR-IC	LDO, 5.65V±2%, 150mA, +CE, PDR	SOT-89-5	32um VR4	6j	Can
P5GA	ML6204A56AP	LVR-IC	LDO, 5.65V±2%, 150mA, +CE, CL	SOT-89-5	32um VR4	6j	Mic
P5GB	CM7R151B-56A-P	LVR-IC	LDO, 5.65V±2%, 150mA, +CE	SOT-89-5	32um VR4	6j	Can
P5GB	ML6204B56AP	LVR-IC	LDO, 5.65V±2%, 150mA, +CE	SOT-89-5	32um VR4	6j	Mic
P5GC	CM7R151C-56A-P	LVR-IC	LDO, 5.65V±2%, 150mA, -CE, PDR	SOT-89-5	32um VR4	6j	Can
P5GC	ML6204C56AP	LVR-IC	LDO, 5.65V±2%, 150mA, -CE, CL	SOT-89-5	32um VR4	6j	Mic
P5GD	CM7R151D-56A-P	LVR-IC	LDO, 5.65V±2%, 150mA, -CE	SOT-89-5	32um VR4	6j	Can
P5GD	ML6204D56AP	LVR-IC	LDO, 5.65V±2%, 150mA, -CE	SOT-89-5	32um VR4	6j	Mic
P5HA	CM7R151A-57A-P	LVR-IC	LDO, 5.75V±2%, 150mA, +CE, PDR	SOT-89-5	32um VR4	6j	Can



SMD code	Type	Function	Short description	Case	Pinout Sch.	St.	Mnf.
P5HA	ML6204A57AP	LVR-IC	LDO, 5.75V±2%, 150mA, +CE, CL	SOT-89-5	32um VR4	6j	Mc
P5HB	CM7R151B-57A-P	LVR-IC	LDO, 5.75V±2%, 150mA, +CE	SOT-89-5	32um VR4	6j	Can
P5HB	ML6204B57AP	LVR-IC	LDO, 5.75V±2%, 150mA, +CE	SOT-89-5	32um VR4	6j	Mc
P5HC	CM7R151C-57A-P	LVR-IC	LDO, 5.75V±2%, 150mA, -CE, PDR	SOT-89-5	32um VR4	6j	Can
P5HC	ML6204C57AP	LVR-IC	LDO, 5.75V±2%, 150mA, -CE, CL	SOT-89-5	32um VR4	6j	Mc
P5HD	CM7R151D-57A-P	LVR-IC	LDO, 5.75V±2%, 150mA, -CE, CL	SOT-89-5	32um VR4	6j	Can
P5HD	ML6204D57AP	LVR-IC	LDO, 5.75V±2%, 150mA, -CE	SOT-89-5	32um VR4	6j	Mc
P5IA	CM7R151A-58A-P	LVR-IC	LDO, 5.85V±2%, 150mA, +CE, PDR	SOT-89-5	32um VR4	6j	Can
P5IA	ML6204A58AP	LVR-IC	LDO, 5.85V±2%, 150mA, +CE, CL	SOT-89-5	32um VR4	6j	Mc
P5IB	CM7R151B-58A-P	LVR-IC	LDO, 5.85V±2%, 150mA, +CE	SOT-89-5	32um VR4	6j	Can
P5IB	ML6204B58AP	LVR-IC	LDO, 5.85V±2%, 150mA, +CE	SOT-89-5	32um VR4	6j	Mc
P5IC	CM7R151C-58A-P	LVR-IC	LDO, 5.85V±2%, 150mA, -CE, PDR	SOT-89-5	32um VR4	6j	Can
P5IC	ML6204C58AP	LVR-IC	LDO, 5.85V±2%, 150mA, -CE, CL	SOT-89-5	32um VR4	6j	Mc
P5ID	CM7R151D-58A-P	LVR-IC	LDO, 5.85V±2%, 150mA, -CE	SOT-89-5	32um VR4	6j	Can
P5ID	ML6204D58AP	LVR-IC	LDO, 5.85V±2%, 150mA, -CE	SOT-89-5	32um VR4	6j	Mc
P5JA	CM7R151A-59A-P	LVR-IC	LDO, 5.95V±2%, 150mA, +CE, PDR	SOT-89-5	32um VR4	6j	Can
P5JA	ML6204A59AP	LVR-IC	LDO, 5.95V±2%, 150mA, +CE, CL	SOT-89-5	32um VR4	6j	Mc
P5JB	CM7R151B-59A-P	LVR-IC	LDO, 5.95V±2%, 150mA, +CE	SOT-89-5	32um VR4	6j	Can
P5JB	ML6204B59AP	LVR-IC	LDO, 5.95V±2%, 150mA, +CE	SOT-89-5	32um VR4	6j	Mc
P5JC	CM7R151C-59A-P	LVR-IC	LDO, 5.95V±2%, 150mA, -CE, PDR	SOT-89-5	32um VR4	6j	Can
P5JC	ML6204C59AP	LVR-IC	LDO, 5.95V±2%, 150mA, -CE, CL	SOT-89-5	32um VR4	6j	Mc
P5JD	CM7R151D-59A-P	LVR-IC	LDO, 5.95V±2%, 150mA, -CE	SOT-89-5	32um VR4	6j	Can
P5JD	ML6204D59AP	LVR-IC	LDO, 5.95V±2%, 150mA, -CE	SOT-89-5	32um VR4	6j	Mc
P60A	CM7R151A-60B-P	LVR-IC	LDO, 6.0V±2%, 150mA, +CE, PDR	SOT-89-5	32um VR4	6j	Can
P60A	ML6204A602P	LVR-IC	LDO, 6.0V±2%, 150mA, +CE, CL	SOT-89-5	32um VR4	6j	Mc
P60B	CM7R151B-60B-P	LVR-IC	LDO, 6.0V±2%, 150mA, +CE	SOT-89-5	32um VR4	6j	Can
P60B	ML6204B602P	LVR-IC	LDO, 6.0V±2%, 150mA, +CE	SOT-89-5	32um VR4	6j	Mc
P60C	CM7R151C-60B-P	LVR-IC	LDO, 6.0V±2%, 150mA, -CE, PDR	SOT-89-5	32um VR4	6j	Can
P60C	ML6204C602P	LVR-IC	LDO, 6.0V±2%, 150mA, -CE, CL	SOT-89-5	32um VR4	6j	Mc
P60D	CM7R151D-60B-P	LVR-IC	LDO, 6.0V±2%, 150mA, -CE	SOT-89-5	32um VR4	6j	Can
P60D	ML6204D602P	LVR-IC	LDO, 6.0V±2%, 150mA, -CE	SOT-89-5	32um VR4	6j	Mc
P63	S-1701B3328-U5T1	LVR/Vdet-IC	LDO, 3.3V±1%, 400mA, Vdet=2.8V, -Reset ODO, +CE	SOT-89-5	32hk VR15	6j	Sii
P64	S-1701B5040-U5T1	LVR/Vdet-IC	LDO, 5V±1%, 400mA, Vdet=4V, -Reset ODO, +CE	SOT-89-5	32hk VR15	6j	Sii
P65	S-1701B5041-U5T1	LVR/Vdet-IC	LDO, 5V±1%, 400mA, Vdet=4.1V, -Reset ODO, +CE	SOT-89-5	32hk VR15	6j	Sii
P66	S-1701B5042-U5T1	LVR/Vdet-IC	LDO, 5V±1%, 400mA, Vdet=4.2V, -Reset ODO, +CE	SOT-89-5	32hk VR15	6j	Sii
P67	S-1701B5043-U5T1	LVR/Vdet-IC	LDO, 5V±1%, 400mA, Vdet=4.3V, -Reset ODO, +CE	SOT-89-5	32hk VR15	6j	Sii
P6A	S-1701A1815-U5T1	LVR/Vdet-IC	LDO, 1.8V±1%, 400mA, Vdet=1.5V, -Reset ODO, +CE	SOT-89-5	32hk VR15	6j	Sii
P6B	S-1701A2520-U5T1	LVR/Vdet-IC	LDO, 2.5V±1%, 400mA, Vdet=2V, -Reset ODO, +CE	SOT-89-5	32hk VR15	6j	Sii
P6C	S-1701A2521-U5T1	LVR/Vdet-IC	LDO, 2.5V±1%, 400mA, Vdet=2.1V, -Reset ODO, +CE	SOT-89-5	32hk VR15	6j	Sii
P6D	S-1701A2522-U5T1	LVR/Vdet-IC	LDO, 2.5V±1%, 400mA, Vdet=2.2V, -Reset ODO, +CE	SOT-89-5	32hk VR15	6j	Sii
P6E	S-1701A3024-U5T1	LVR/Vdet-IC	LDO, 3V±1%, 400mA, Vdet=2.4V, -Reset ODO, +CE	SOT-89-5	32hk VR15	6j	Sii
P6F	S-1701A3025-U5T1	LVR/Vdet-IC	LDO, 3V±1%, 400mA, Vdet=2.5V, -Reset ODO, +CE	SOT-89-5	32hk VR15	6j	Sii
P6G	S-1701A3026-U5T1	LVR/Vdet-IC	LDO, 3V±1%, 400mA, Vdet=2.6V, -Reset ODO, +CE	SOT-89-5	32hk VR15	6j	Sii
P6H	S-1701A3326-U5T1	LVR/Vdet-IC	LDO, 3.3V±1%, 400mA, Vdet=2.6V, -Reset ODO, +CE	SOT-89-5	32hk VR15	6j	Sii
P6I	S-1701A3327-U5T1	LVR/Vdet-IC	LDO, 3.3V±1%, 400mA, Vdet=2.7V, -Reset ODO, +CE	SOT-89-5	32hk VR15	6j	Sii
P6J	S-1701A3328-U5T1	LVR/Vdet-IC	LDO, 3.3V±1%, 400mA, Vdet=2.8V, -Reset ODO, +CE	SOT-89-5	32hk VR15	6j	Sii
P6K	S-1701A3430-U5T1	LVR/Vdet-IC	LDO, 3.4V±1%, 400mA, Vdet=3V, -Reset ODO, +CE	SOT-89-5	32hk VR15	6j	Sii
P6L	S-1701A5040-U5T1	LVR/Vdet-IC	LDO, 5V±1%, 400mA, Vdet=4V, -Reset ODO, +CE	SOT-89-5	32hk VR15	6j	Sii
P6M	S-1701A5041-U5T1	LVR/Vdet-IC	LDO, 5V±1%, 400mA, Vdet=4.1V, -Reset ODO, +CE	SOT-89-5	32hk VR15	6j	Sii
P6N	S-1701A5042-U5T1	LVR/Vdet-IC	LDO, 5V±1%, 400mA, Vdet=4.2V, -Reset ODO, +CE	SOT-89-5	32hk VR15	6j	Sii
P6O	S-1701A5043-U5T1	LVR/Vdet-IC	LDO, 5V±1%, 400mA, Vdet=4.3V, -Reset ODO, +CE	SOT-89-5	32hk VR15	6j	Sii
P6R	S-1701B1815-U5T1	LVR/Vdet-IC	LDO, 1.8V±1%, 400mA, Vdet=1.5V, -Reset ODO, +CE	SOT-89-5	32hk VR15	6j	Sii
P6S	S-1701B2520-U5T1	LVR/Vdet-IC	LDO, 2.5V±1%, 400mA, Vdet=2V, -Reset ODO, +CE	SOT-89-5	32hk VR15	6j	Sii
P6T	S-1701B2521-U5T1	LVR/Vdet-IC	LDO, 2.5V±1%, 400mA, Vdet=2.1V, -Reset ODO, +CE	SOT-89-5	32hk VR15	6j	Sii
P6U	S-1701B2522-U5T1	LVR/Vdet-IC	LDO, 2.5V±1%, 400mA, Vdet=2.2V, -Reset ODO, +CE	SOT-89-5	32hk VR15	6j	Sii
P6V	S-1701B3024-U5T1	LVR/Vdet-IC	LDO, 3V±1%, 400mA, Vdet=2.4V, -Reset ODO, +CE	SOT-89-5	32hk VR15	6j	Sii
P6W	S-1701B3025-U5T1	LVR/Vdet-IC	LDO, 3V±1%, 400mA, Vdet=2.5V, -Reset ODO, +CE	SOT-89-5	32hk VR15	6j	Sii
P6X	S-1701B3026-U5T1	LVR/Vdet-IC	LDO, 3V±1%, 400mA, Vdet=2.6V, -Reset ODO, +CE	SOT-89-5	32hk VR15	6j	Sii
P6Y	S-1701B3326-U5T1	LVR/Vdet-IC	LDO, 3.3V±1%, 400mA, Vdet=2.6V, -Reset ODO, +CE	SOT-89-5	32hk VR15	6j	Sii
P6Z	S-1701B3327-U5T1	LVR/Vdet-IC	LDO, 3.3V±1%, 400mA, Vdet=2.7V, -Reset ODO, +CE	SOT-89-5	32hk VR15	6j	Sii
P73	S-1701W2522-U5T1	LVR/Vdet-IC	LDO, 2.5V±1%, 400mA, Vdet=2.2V, -Reset ODO	SOT-89-5	32hm VR13	6j	Sii
P74	S-1701W3024-U5T1	LVR/Vdet-IC	LDO, 3V±1%, 400mA, Vdet=2.4V, -Reset ODO	SOT-89-5	32hm VR13	6j	Sii
P75	S-1701W3025-U5T1	LVR/Vdet-IC	LDO, 3V±1%, 400mA, Vdet=2.5V, -Reset ODO	SOT-89-5	32hm VR13	6j	Sii
P76	S-1701W3026-U5T1	LVR/Vdet-IC	LDO, 3V±1%, 400mA, Vdet=2.6V, -Reset ODO	SOT-89-5	32hm VR13	6j	Sii
P77	S-1701W3326-U5T1	LVR/Vdet-IC	LDO, 3.3V±1%, 400mA, Vdet=2.6V, -Reset ODO	SOT-89-5	32hm VR13	6j	Sii
P78	S-1701W3327-U5T1	LVR/Vdet-IC	LDO, 3.3V±1%, 400mA, Vdet=2.7V, -Reset ODO	SOT-89-5	32hm VR13	6j	Sii
P79	S-1701W3328-U5T1	LVR/Vdet-IC	LDO, 3.3V±1%, 400mA, Vdet=2.8V, -Reset ODO	SOT-89-5	32hm VR13	6j	Sii
P7E	S-1701V1815-U5T1	LVR/Vdet-IC	LDO, 1.8V±1%, 400mA, Vdet=1.5V, -Reset ODO	SOT-89-5	32hm VR13	6j	Sii
P7F	S-1701V2520-U5T1	LVR/Vdet-IC	LDO, 2.5V±1%, 400mA, Vdet=2V, -Reset ODO	SOT-89-5	32hm VR13	6j	Sii
P7G	S-1701V2521-U5T1	LVR/Vdet-IC	LDO, 2.5V±1%, 400mA, Vdet=2.1V, -Reset ODO	SOT-89-5	32hm VR13	6j	Sii



SMD code	Type	Function	Short description	Case	Pinout	Sch.	St.	Mnf.
PZF	S-1701T3315-U5T1	LVR/Vdet-IC	LDO, 3.3V±1%, 400mA, Vdet=1.5V, -Reset ODO	SOT-89-5	32hl	VR14	6j	Sii
PZG	S-1701T5015-U5T1	LVR/Vdet-IC	LDO, 5V±1%, 400mA, Vdet=1.5V, -Reset ODO	SOT-89-5	32hl	VR14	6j	Sii
PZR	S-1701U1815-U5T1	LVR/Vdet-IC	LDO, 1.8V±1%, 400mA, Vdet=1.5V, -Reset ODO	SOT-89-5	32hm	VR13	6j	Sii
PZS	S-1701U2520-U5T1	LVR/Vdet-IC	LDO, 2.5V±1%, 400mA, Vdet=2V, -Reset ODO	SOT-89-5	32hm	VR13	6j	Sii
PZT	S-1701U2521-U5T1	LVR/Vdet-IC	LDO, 2.5V±1%, 400mA, Vdet=2.1V, -Reset ODO	SOT-89-5	32hm	VR13	6j	Sii
PZU	S-1701U2522-U5T1	LVR/Vdet-IC	LDO, 2.5V±1%, 400mA, Vdet=2.2V, -Reset ODO	SOT-89-5	32hm	VR13	6j	Sii
PZV	S-1701U3024-U5T1	LVR/Vdet-IC	LDO, 3V±1%, 400mA, Vdet=2.4V, -Reset ODO	SOT-89-5	32hm	VR13	6j	Sii
PZW	S-1701U3025-U5T1	LVR/Vdet-IC	LDO, 3V±1%, 400mA, Vdet=2.5V, -Reset ODO	SOT-89-5	32hm	VR13	6j	Sii
PZX	S-1701U3026-U5T1	LVR/Vdet-IC	LDO, 3V±1%, 400mA, Vdet=2.6V, -Reset ODO	SOT-89-5	32hm	VR13	6j	Sii
PZY	S-1701U3326-U5T1	LVR/Vdet-IC	LDO, 3.3V±1%, 400mA, Vdet=2.6V, -Reset ODO	SOT-89-5	32hm	VR13	6j	Sii
PZZ	S-1701U3327-U5T1	LVR/Vdet-IC	LDO, 3.3V±1%, 400mA, Vdet=2.7V, -Reset ODO	SOT-89-5	32hm	VR13	6j	Sii
Q30	TK11330U	LVR-IC	LDO, 3V±5%, 170mA, -CE	SOT-89-5	32vg	VR7	6i	Tok
Q33	TK11333U	LVR-IC	LDO, 3.3V±5%, 170mA, -CE	SOT-89-5	32vg	VR7	6i	Tok
Q40	TK11340U	LVR-IC	LDO, 4V±5%, 170mA, -CE	SOT-89-5	32vg	VR7	6i	Tok
Q45	TK11345U	LVR-IC	LDO, 4.5V±5%, 170mA, -CE	SOT-89-5	32vg	VR7	6i	Tok
Q48	TK11348U	LVR-IC	LDO, 4.8V±5%, 170mA, -CE	SOT-89-5	32vg	VR7	6i	Tok
Q50	TK11350U	LVR-IC	LDO, 5V±5%, 170mA, -CE	SOT-89-5	32vg	VR7	6i	Tok
Q8B	S-1133B12-U5T1G	LVR-IC	LDO, 1.2V±15mV, 300mA, +CE	SOT-89-5	32um	VR4	6n	Sii
Q8C	S-1133B13-U5T1G	LVR-IC	LDO, 1.3V±15mV, 300mA, +CE	SOT-89-5	32um	VR4	6n	Sii
Q8D	S-1133B14-U5T1G	LVR-IC	LDO, 1.4V±15mV, 300mA, +CE	SOT-89-5	32um	VR4	6n	Sii
Q8E	S-1133B15-U5T1G	LVR-IC	LDO, 1.5V±1.0%, 300mA, +CE	SOT-89-5	32um	VR4	6n	Sii
Q8F	S-1133B16-U5T1G	LVR-IC	LDO, 1.6V±1.0%, 300mA, +CE	SOT-89-5	32um	VR4	6n	Sii
Q8G	S-1133B17-U5T1G	LVR-IC	LDO, 1.7V±1.0%, 300mA, +CE	SOT-89-5	32um	VR4	6n	Sii
Q8H	S-1133B18-U5T1G	LVR-IC	LDO, 1.8V±1.0%, 300mA, +CE	SOT-89-5	32um	VR4	6n	Sii
Q8I	S-1133B19-U5T1G	LVR-IC	LDO, 1.9V±1.0%, 300mA, +CE	SOT-89-5	32um	VR4	6n	Sii
Q8J	S-1133B20-U5T1G	LVR-IC	LDO, 2.0V±1.0%, 300mA, +CE	SOT-89-5	32um	VR4	6n	Sii
Q8K	S-1133B21-U5T1G	LVR-IC	LDO, 2.1V±1.0%, 300mA, +CE	SOT-89-5	32um	VR4	6n	Sii
Q8L	S-1133B22-U5T1G	LVR-IC	LDO, 2.2V±1.0%, 300mA, +CE	SOT-89-5	32um	VR4	6n	Sii
Q8M	S-1133B23-U5T1G	LVR-IC	LDO, 2.3V±1.0%, 300mA, +CE	SOT-89-5	32um	VR4	6n	Sii
Q8N	S-1133B24-U5T1G	LVR-IC	LDO, 2.4V±1.0%, 300mA, +CE	SOT-89-5	32um	VR4	6n	Sii
Q8O	S-1133B25-U5T1G	LVR-IC	LDO, 2.5V±1.0%, 300mA, +CE	SOT-89-5	32um	VR4	6n	Sii
Q8P	S-1133B26-U5T1G	LVR-IC	LDO, 2.6V±1.0%, 300mA, +CE	SOT-89-5	32um	VR4	6n	Sii
Q8Q	S-1133B27-U5T1G	LVR-IC	LDO, 2.7V±1.0%, 300mA, +CE	SOT-89-5	32um	VR4	6n	Sii
Q8R	S-1133B28-U5T1G	LVR-IC	LDO, 2.8V±1.0%, 300mA, +CE	SOT-89-5	32um	VR4	6n	Sii
Q8S	S-1133B29-U5T1G	LVR-IC	LDO, 2.9V±1.0%, 300mA, +CE	SOT-89-5	32um	VR4	6n	Sii
Q8T	S-1133B30-U5T1G	LVR-IC	LDO, 3.0V±1.0%, 300mA, +CE	SOT-89-5	32um	VR4	6n	Sii
Q8U	S-1133B31-U5T1G	LVR-IC	LDO, 3.1V±1.0%, 300mA, +CE	SOT-89-5	32um	VR4	6n	Sii
Q8V	S-1133B32-U5T1G	LVR-IC	LDO, 3.2V±1.0%, 300mA, +CE	SOT-89-5	32um	VR4	6n	Sii
Q8W	S-1133B33-U5T1G	LVR-IC	LDO, 3.3V±1.0%, 300mA, +CE	SOT-89-5	32um	VR4	6n	Sii
Q8X	S-1133B34-U5T1G	LVR-IC	LDO, 3.4V±1.0%, 300mA, +CE	SOT-89-5	32um	VR4	6n	Sii
Q8Y	S-1133B35-U5T1G	LVR-IC	LDO, 3.5V±1.0%, 300mA, +CE	SOT-89-5	32um	VR4	6n	Sii
Q8Z	S-1133B36-U5T1G	LVR-IC	LDO, 3.6V±1.0%, 300mA, +CE	SOT-89-5	32um	VR4	6n	Sii
Q9A	S-1133B37-U5T1G	LVR-IC	LDO, 3.7V±1.0%, 300mA, +CE	SOT-89-5	32um	VR4	6n	Sii
Q9B	S-1133B38-U5T1G	LVR-IC	LDO, 3.8V±1.0%, 300mA, +CE	SOT-89-5	32um	VR4	6n	Sii
Q9C	S-1133B39-U5T1G	LVR-IC	LDO, 3.9V±1.0%, 300mA, +CE	SOT-89-5	32um	VR4	6n	Sii
Q9D	S-1133B40-U5T1G	LVR-IC	LDO, 4.0V±1.0%, 300mA, +CE	SOT-89-5	32um	VR4	6n	Sii
Q9E	S-1133B41-U5T1G	LVR-IC	LDO, 4.1V±1.0%, 300mA, +CE	SOT-89-5	32um	VR4	6n	Sii
Q9F	S-1133B42-U5T1G	LVR-IC	LDO, 4.2V±1.0%, 300mA, +CE	SOT-89-5	32um	VR4	6n	Sii
Q9G	S-1133B43-U5T1G	LVR-IC	LDO, 4.3V±1.0%, 300mA, +CE	SOT-89-5	32um	VR4	6n	Sii
Q9H	S-1133B44-U5T1G	LVR-IC	LDO, 4.4V±1.0%, 300mA, +CE	SOT-89-5	32um	VR4	6n	Sii
Q9I	S-1133B45-U5T1G	LVR-IC	LDO, 4.5V±1.0%, 300mA, +CE	SOT-89-5	32um	VR4	6n	Sii
Q9J	S-1133B46-U5T1G	LVR-IC	LDO, 4.6V±1.0%, 300mA, +CE	SOT-89-5	32um	VR4	6n	Sii
Q9K	S-1133B47-U5T1G	LVR-IC	LDO, 4.7V±1.0%, 300mA, +CE	SOT-89-5	32um	VR4	6n	Sii
Q9L	S-1133B48-U5T1G	LVR-IC	LDO, 4.8V±1.0%, 300mA, +CE	SOT-89-5	32um	VR4	6n	Sii
Q9M	S-1133B49-U5T1G	LVR-IC	LDO, 4.9V±1.0%, 300mA, +CE	SOT-89-5	32um	VR4	6n	Sii
Q9N	S-1133B50-U5T1G	LVR-IC	LDO, 5.0V±1.0%, 300mA, +CE	SOT-89-5	32um	VR4	6n	Sii
Q9O	S-1133B51-U5T1G	LVR-IC	LDO, 5.1V±1.0%, 300mA, +CE	SOT-89-5	32um	VR4	6n	Sii
Q9P	S-1133B52-U5T1G	LVR-IC	LDO, 5.2V±1.0%, 300mA, +CE	SOT-89-5	32um	VR4	6n	Sii
Q9Q	S-1133B53-U5T1G	LVR-IC	LDO, 5.3V±1.0%, 300mA, +CE	SOT-89-5	32um	VR4	6n	Sii
Q9R	S-1133B54-U5T1G	LVR-IC	LDO, 5.4V±1.0%, 300mA, +CE	SOT-89-5	32um	VR4	6n	Sii
Q9S	S-1133B55-U5T1G	LVR-IC	LDO, 5.5V±1.0%, 300mA, +CE	SOT-89-5	32um	VR4	6n	Sii
Q9T	S-1133B56-U5T1G	LVR-IC	LDO, 5.6V±1.0%, 300mA, +CE	SOT-89-5	32um	VR4	6n	Sii
Q9U	S-1133B57-U5T1G	LVR-IC	LDO, 5.7V±1.0%, 300mA, +CE	SOT-89-5	32um	VR4	6n	Sii
Q9V	S-1133B58-U5T1G	LVR-IC	LDO, 5.8V±1.0%, 300mA, +CE	SOT-89-5	32um	VR4	6n	Sii
Q9W	S-1133B59-U5T1G	LVR-IC	LDO, 5.9V±1.0%, 300mA, +CE	SOT-89-5	32um	VR4	6n	Sii
Q9X	S-1133B60-U5T1G	LVR-IC	LDO, 6.0V±1.0%, 300mA, +CE	SOT-89-5	32um	VR4	6n	Sii
QA	ELM99603B	LVR-IC	LDO, 6.0V±2%, 300mA, +CE	SOT-89-5	32vrt	VR1	6n	Elm
QLA	S-1132B15-U5T1G	LVR-IC	LDO, 1.5V±1.0%, 300mA, +CE	SOT-89-5	32vr4	VR4	6n	Sii
QLB	S-1132B16-U5T1G	LVR-IC	LDO, 1.6V±1.0%, 300mA, +CE	SOT-89-5	32vr4	VR4	6n	Sii
QLC	S-1132B17-U5T1G	LVR-IC	LDO, 1.7V±1.0%, 300mA, +CE	SOT-89-5	32vr4	VR4	6n	Sii



SMD code	Type	Function	Short description	Case	Pinout Sch.	St.	Mnf.
QLD	S-1132B18-U5T1G	LVR-IC	LDO, 1.8V±1.0%, 300mA, +CE	SOT-89-5	32vr4 VR4	6n	Sii
QLE	S-1132B19-U5T1G	LVR-IC	LDO, 1.9V±1.0%, 300mA, +CE	SOT-89-5	32vr4 VR4	6n	Sii
QLF	S-1132B20-U5T1G	LVR-IC	LDO, 2.0V±1.0%, 300mA, +CE	SOT-89-5	32vr4 VR4	6n	Sii
QLG	S-1132B21-U5T1G	LVR-IC	LDO, 2.1V±1.0%, 300mA, +CE	SOT-89-5	32vr4 VR4	6n	Sii
QLH	S-1132B22-U5T1G	LVR-IC	LDO, 2.2V±1.0%, 300mA, +CE	SOT-89-5	32vr4 VR4	6n	Sii
QLI	S-1132B23-U5T1G	LVR-IC	LDO, 2.3V±1.0%, 300mA, +CE	SOT-89-5	32vr4 VR4	6n	Sii
QLJ	S-1132B24-U5T1G	LVR-IC	LDO, 2.4V±1.0%, 300mA, +CE	SOT-89-5	32vr4 VR4	6n	Sii
QLK	S-1132B25-U5T1G	LVR-IC	LDO, 2.5V±1.0%, 300mA, +CE	SOT-89-5	32vr4 VR4	6n	Sii
QLL	S-1132B26-U5T1G	LVR-IC	LDO, 2.6V±1.0%, 300mA, +CE	SOT-89-5	32vr4 VR4	6n	Sii
QLM	S-1132B27-U5T1G	LVR-IC	LDO, 2.7V±1.0%, 300mA, +CE	SOT-89-5	32vr4 VR4	6n	Sii
QLN	S-1132B28-U5T1G	LVR-IC	LDO, 2.8V±1.0%, 300mA, +CE	SOT-89-5	32vr4 VR4	6n	Sii
QLO	S-1132B29-U5T1G	LVR-IC	LDO, 2.9V±1.0%, 300mA, +CE	SOT-89-5	32vr4 VR4	6n	Sii
QLP	S-1132B30-U5T1G	LVR-IC	LDO, 3.0V±1.0%, 300mA, +CE	SOT-89-5	32vr4 VR4	6n	Sii
QLQ	S-1132B31-U5T1G	LVR-IC	LDO, 3.1V±1.0%, 300mA, +CE	SOT-89-5	32vr4 VR4	6n	Sii
QLR	S-1132B32-U5T1G	LVR-IC	LDO, 3.2V±1.0%, 300mA, +CE	SOT-89-5	32vr4 VR4	6n	Sii
QLS	S-1132B33-U5T1G	LVR-IC	LDO, 3.3V±1.0%, 300mA, +CE	SOT-89-5	32vr4 VR4	6n	Sii
QLT	S-1132B34-U5T1G	LVR-IC	LDO, 3.4V±1.0%, 300mA, +CE	SOT-89-5	32vr4 VR4	6n	Sii
QLU	S-1132B35-U5T1G	LVR-IC	LDO, 3.5V±1.0%, 300mA, +CE	SOT-89-5	32vr4 VR4	6n	Sii
QLV	S-1132B36-U5T1G	LVR-IC	LDO, 3.6V±1.0%, 300mA, +CE	SOT-89-5	32vr4 VR4	6n	Sii
QLW	S-1132B37-U5T1G	LVR-IC	LDO, 3.7V±1.0%, 300mA, +CE	SOT-89-5	32vr4 VR4	6n	Sii
QLX	S-1132B38-U5T1G	LVR-IC	LDO, 3.8V±1.0%, 300mA, +CE	SOT-89-5	32vr4 VR4	6n	Sii
QLY	S-1132B39-U5T1G	LVR-IC	LDO, 3.9V±1.0%, 300mA, +CE	SOT-89-5	32vr4 VR4	6n	Sii
QLZ	S-1132B40-U5T1G	LVR-IC	LDO, 4.0V±1.0%, 300mA, +CE	SOT-89-5	32vr4 VR4	6n	Sii
QMA	S-1132B41-U5T1G	LVR-IC	LDO, 4.1V±1.0%, 300mA, +CE	SOT-89-5	32vr4 VR4	6n	Sii
QMB	S-1132B42-U5T1G	LVR-IC	LDO, 4.2V±1.0%, 300mA, +CE	SOT-89-5	32vr4 VR4	6n	Sii
QMC	S-1132B43-U5T1G	LVR-IC	LDO, 4.3V±1.0%, 300mA, +CE	SOT-89-5	32vr4 VR4	6n	Sii
QMD	S-1132B44-U5T1G	LVR-IC	LDO, 4.4V±1.0%, 300mA, +CE	SOT-89-5	32vr4 VR4	6n	Sii
QME	S-1132B45-U5T1G	LVR-IC	LDO, 4.5V±1.0%, 300mA, +CE	SOT-89-5	32vr4 VR4	6n	Sii
QMF	S-1132B46-U5T1G	LVR-IC	LDO, 4.6V±1.0%, 300mA, +CE	SOT-89-5	32vr4 VR4	6n	Sii
QMG	S-1132B47-U5T1G	LVR-IC	LDO, 4.7V±1.0%, 300mA, +CE	SOT-89-5	32vr4 VR4	6n	Sii
QMH	S-1132B48-U5T1G	LVR-IC	LDO, 4.8V±1.0%, 300mA, +CE	SOT-89-5	32vr4 VR4	6n	Sii
QMI	S-1132B49-U5T1G	LVR-IC	LDO, 4.9V±1.0%, 300mA, +CE	SOT-89-5	32vr4 VR4	6n	Sii
QMJ	S-1132B50-U5T1G	LVR-IC	LDO, 5.0V±1.0%, 300mA, +CE	SOT-89-5	32vr4 VR4	6n	Sii
QMK	S-1132B51-U5T1G	LVR-IC	LDO, 5.1V±1.0%, 300mA, +CE	SOT-89-5	32vr4 VR4	6n	Sii
QML	S-1132B52-U5T1G	LVR-IC	LDO, 5.2V±1.0%, 300mA, +CE	SOT-89-5	32vr4 VR4	6n	Sii
QMM	S-1132B53-U5T1G	LVR-IC	LDO, 5.3V±1.0%, 300mA, +CE	SOT-89-5	32vr4 VR4	6n	Sii
QMN	S-1132B54-U5T1G	LVR-IC	LDO, 5.4V±1.0%, 300mA, +CE	SOT-89-5	32vr4 VR4	6n	Sii
QMO	S-1132B55-U5T1G	LVR-IC	LDO, 5.5V±1.0%, 300mA, +CE	SOT-89-5	32vr4 VR4	6n	Sii
R01A	R5510H001A	LVR/Vdet-IC	LDO, 2.5V±2%, 300mA/VDet, -Reset ODO	SOT-89-5	32sk VR15	6h	Ric
R02A	R5510H002A	LVR/Vdet-IC	LDO, 2.6V±2%, 300mA/VDet, -Reset ODO	SOT-89-5	32sk VR15	6h	Ric
R02H	R5510H002H	LVR/Vdet-IC	LDO, 2.6V±2%, 300mA/VDet, -Reset ODO	SOT-89-5	32sm VR15	6h	Ric
R02K	R5510H002K	LVR/Vdet-IC	LDO, 2.6V±2%, 300mA/VDet, -Reset ODO	SOT-89-5	32sm VR15	6h	Ric
R030	R1500H030B	LVR-IC	LDO, 3.0V±2%, 500mA, +CE	SOT-89-5	33x2 VR4	6h	Ric
R031	R1500H031B	LVR-IC	LDO, 3.1V±2%, 500mA, +CE	SOT-89-5	33x2 VR4	6h	Ric
R032	R1500H032B	LVR-IC	LDO, 3.2V±2%, 500mA, +CE	SOT-89-5	33x2 VR4	6h	Ric
R033	R1500H033B	LVR-IC	LDO, 3.3V±2%, 500mA, +CE	SOT-89-5	33x2 VR4	6h	Ric
R034	R1500H034B	LVR-IC	LDO, 3.4V±2%, 500mA, +CE	SOT-89-5	33x2 VR4	6h	Ric
R035	R1500H035B	LVR-IC	LDO, 3.5V±2%, 500mA, +CE	SOT-89-5	33x2 VR4	6h	Ric
R036	R1500H036B	LVR-IC	LDO, 3.6V±2%, 500mA, +CE	SOT-89-5	33x2 VR4	6h	Ric
R037	R1500H037B	LVR-IC	LDO, 3.7V±2%, 500mA, +CE	SOT-89-5	33x2 VR4	6h	Ric
R038	R1500H038B	LVR-IC	LDO, 3.8V±2%, 500mA, +CE	SOT-89-5	33x2 VR4	6h	Ric
R039	R1500H039B	LVR-IC	LDO, 3.9V±2%, 500mA, +CE	SOT-89-5	33x2 VR4	6h	Ric
R03A	R5510H003A	LVR/Vdet-IC	LDO, 2.7V±2%, 300mA/VDet, -Reset ODO	SOT-89-5	32sk VR15	6h	Ric
R03B	R5510H003B	LVR/Vdet-IC	LDO, 2.7V±2%, 300mA/VDet, -Reset ODO	SOT-89-5	32sk VR15	6h	Ric
R03C	R5510H003C	LVR/Vdet-IC	LDO, 2.7V±2%, 300mA/VDet, -Reset ODO	SOT-89-5	32sk VR15	6h	Ric
R03F	R5510H003F	LVR/Vdet-IC	LDO, 2.7V±2%, 300mA/VDet, -Reset ODO	SOT-89-5	32sk VR15	6h	Ric
R03L	R5510H003L	LVR/Vdet-IC	LDO, 2.7V±2%, 300mA/VDet, -Reset ODO	SOT-89-5	32sk VR15	6h	Ric
R040	R1500H040B	LVR-IC	LDO, 4.0V±2%, 500mA, +CE	SOT-89-5	33x2 VR4	6h	Ric
R041	R1500H041B	LVR-IC	LDO, 4.1V±2%, 500mA, +CE	SOT-89-5	33x2 VR4	6h	Ric
R042	R1500H042B	LVR-IC	LDO, 4.2V±2%, 500mA, +CE	SOT-89-5	33x2 VR4	6h	Ric
R043	R1500H043B	LVR-IC	LDO, 4.3V±2%, 500mA, +CE	SOT-89-5	33x2 VR4	6h	Ric
R044	R1500H044B	LVR-IC	LDO, 4.4V±2%, 500mA, +CE	SOT-89-5	33x2 VR4	6h	Ric
R045	R1500H045B	LVR-IC	LDO, 4.5V±2%, 500mA, +CE	SOT-89-5	33x2 VR4	6h	Ric
R046	R1500H046B	LVR-IC	LDO, 4.6V±2%, 500mA, +CE	SOT-89-5	33x2 VR4	6h	Ric
R047	R1500H047B	LVR-IC	LDO, 4.7V±2%, 500mA, +CE	SOT-89-5	33x2 VR4	6h	Ric
R048	R1500H048B	LVR-IC	LDO, 4.8V±2%, 500mA, +CE	SOT-89-5	33x2 VR4	6h	Ric
R049	R1500H049B	LVR-IC	LDO, 4.9V±2%, 500mA, +CE	SOT-89-5	33x2 VR4	6h	Ric
R04B	R5510H004B	LVR/Vdet-IC	LDO, 2.8V±2%, 300mA/VDet, -Reset ODO	SOT-89-5	32sk VR15	6h	Ric
R04J	R5510H004J	LVR/Vdet-IC	LDO, 2.8V±2%, 300mA/VDet, -Reset ODO	SOT-89-5	32sm VR15	6h	Ric
R050	R1500H050B	LVR-IC	LDO, 5.0V±2%, 500mA, +CE	SOT-89-5	33x2 VR4	6h	Ric



SMD code	Type	Function	Short description	Case	Pinout Sch.	St.	Mnf.
R110	R1500H110B	LVR-IC	LDO, 11.0V±2%, 500mA, +CE	SOT-89-5	33x2	VR4	6h Ric
R111	R1500H111B	LVR-IC	LDO, 11.1V±2%, 500mA, +CE	SOT-89-5	33x2	VR4	6h Ric
R112	R1500H112B	LVR-IC	LDO, 11.2V±2%, 500mA, +CE	SOT-89-5	33x2	VR4	6h Ric
R113	R1500H113B	LVR-IC	LDO, 11.3V±2%, 500mA, +CE	SOT-89-5	33x2	VR4	6h Ric
R114	R1500H114B	LVR-IC	LDO, 11.4V±2%, 500mA, +CE	SOT-89-5	33x2	VR4	6h Ric
R115	R1500H115B	LVR-IC	LDO, 11.5V±2%, 500mA, +CE	SOT-89-5	33x2	VR4	6h Ric
R116	R1500H116B	LVR-IC	LDO, 11.6V±2%, 500mA, +CE	SOT-89-5	33x2	VR4	6h Ric
R117	R1500H117B	LVR-IC	LDO, 11.7V±2%, 500mA, +CE	SOT-89-5	33x2	VR4	6h Ric
R118	R1500H118B	LVR-IC	LDO, 11.8V±2%, 500mA, +CE	SOT-89-5	33x2	VR4	6h Ric
R119	R1500H119B	LVR-IC	LDO, 11.9V±2%, 500mA, +CE	SOT-89-5	33x2	VR4	6h Ric
R11A	R5510H011A	LVR/Vdet-IC	LDO, 3.5V±2%, 300mA/VDet, -Reset ODO	SOT-89-5	32sk	VR15	6h Ric
R11C	R5510H011C	LVR/Vdet-IC	LDO, 3.5V±2%, 300mA/VDet, -Reset ODO	SOT-89-5	32sk	VR15	6h Ric
R11N	R5510H011N	LVR/Vdet-IC	LDO, 3.5V±2%, 300mA/VDet, -Reset ODO	SOT-89-5	32sk	VR15	6h Ric
R120	R1500H120B	LVR-IC	LDO, 12.0V±2%, 500mA, +CE	SOT-89-5	33x2	VR4	6h Ric
R12D	R5510H012D	LVR/Vdet-IC	LDO, 3.6V±2%, 300mA/VDet, -Reset ODO	SOT-89-5	32sn	VR15	6h Ric
R13D	R5510H013D	LVR/Vdet-IC	LDO, 3.7V±2%, 300mA/VDet, -Reset ODO	SOT-89-5	32sn	VR15	6h Ric
R14H	R5510H014H	LVR/Vdet-IC	LDO, 3.8V±2%, 300mA/VDet, -Reset ODO	SOT-89-5	32sm	VR15	6h Ric
R14J	R5510H014J	LVR/Vdet-IC	LDO, 3.8V±2%, 300mA/VDet, -Reset ODO	SOT-89-5	32sm	VR15	6h Ric
R14K	R5510H014K	LVR/Vdet-IC	LDO, 3.8V±2%, 300mA/VDet, -Reset ODO	SOT-89-5	32sm	VR15	6h Ric
R15	TK11215UM	LVR-IC	LDO, 1.5V±5%, 170mA, +CE	SOT-89-5	32vg	VR7	6i Tok
R15H	R5510H015H	LVR/Vdet-IC	LDO, 3.9V±2%, 300mA/VDet, -Reset ODO	SOT-89-5	32sm	VR15	6h Ric
R15J	R5510H015J	LVR/Vdet-IC	LDO, 3.9V±2%, 300mA/VDet, -Reset ODO	SOT-89-5	32sm	VR15	6h Ric
R15K	R5510H015K	LVR/Vdet-IC	LDO, 3.9V±2%, 300mA/VDet, -Reset ODO	SOT-89-5	32sm	VR15	6h Ric
R16	TK11216UM	LVR-IC	LDO, 1.6V±5%, 170mA, +CE	SOT-89-5	32vg	VR7	6i Tok
R16H	R5510H016H	LVR/Vdet-IC	LDO, 4V±2%, 300mA/VDet, -Reset ODO	SOT-89-5	32sm	VR15	6h Ric
R16J	R5510H016J	LVR/Vdet-IC	LDO, 4V±2%, 300mA/VDet, -Reset ODO	SOT-89-5	32sm	VR15	6h Ric
R16K	R5510H016K	LVR/Vdet-IC	LDO, 4V±2%, 300mA/VDet, -Reset ODO	SOT-89-5	32sm	VR15	6h Ric
R17	TK11217UM	LVR-IC	LDO, 1.7V±5%, 170mA, +CE	SOT-89-5	32vg	VR7	6i Tok
R17H	R5510H017H	LVR/Vdet-IC	LDO, 4.1V±2%, 300mA/VDet, -Reset ODO	SOT-89-5	32sm	VR15	6h Ric
R17J	R5510H017J	LVR/Vdet-IC	LDO, 4.1V±2%, 300mA/VDet, -Reset ODO	SOT-89-5	32sm	VR15	6h Ric
R17K	R5510H017K	LVR/Vdet-IC	LDO, 4.1V±2%, 300mA/VDet, -Reset ODO	SOT-89-5	32sm	VR15	6h Ric
R18	TK11218UM	LVR-IC	LDO, 1.8V±5%, 170mA, +CE	SOT-89-5	32vg	VR7	6i Tok
R18D	R5510H018D	LVR/Vdet-IC	LDO, 4.2V±2%, 300mA/VDet, -Reset ODO	SOT-89-5	32sn	VR15	6h Ric
R19	TK11219UM	LVR-IC	LDO, 1.9V±5%, 170mA, +CE	SOT-89-5	32vg	VR7	6i Tok
R19C	R5510H019C	LVR/Vdet-IC	LDO, 4.3V±2%, 300mA/VDet, -Reset ODO	SOT-89-5	32sk	VR15	6h Ric
R20	TK11220UM	LVR-IC	LDO, 2V±5%, 170mA, +CE	SOT-89-5	32vg	VR7	6i Tok
R20C	R5510H020C	LVR/Vdet-IC	LDO, 4.4V±2%, 300mA/VDet, -Reset ODO	SOT-89-5	32sk	VR15	6h Ric
R21	TK11221UM	LVR-IC	LDO, 2.1V±5%, 170mA, +CE	SOT-89-5	32vg	VR7	6i Tok
R21M	R5510H021M	LVR/Vdet-IC	LDO, 4.5V±2%, 300mA/VDet, -Reset ODO	SOT-89-5	32sk	VR15	6h Ric
R22	TK11222UM	LVR-IC	LDO, 2.2V±5%, 170mA, +CE	SOT-89-5	32vg	VR7	6i Tok
R22J	R5510H022J	LVR/Vdet-IC	LDO, 4.6V±2%, 300mA/VDet, -Reset ODO	SOT-89-5	32sm	VR15	6h Ric
R22L	R5510H022L	LVR/Vdet-IC	LDO, 4.6V±2%, 300mA/VDet, -Reset ODO	SOT-89-5	32sk	VR15	6h Ric
R23	TK11223UM	LVR-IC	LDO, 2.3V±5%, 170mA, +CE	SOT-89-5	32vg	VR7	6i Tok
R23L	R5510H023L	LVR/Vdet-IC	LDO, 4.7V±2%, 300mA/VDet, -Reset ODO	SOT-89-5	32sk	VR15	6h Ric
R24	TK11224UM	LVR-IC	LDO, 2.4V±5%, 170mA, +CE	SOT-89-5	32vg	VR7	6i Tok
R24D	R5510H024D	LVR/Vdet-IC	LDO, 4.8V±2%, 300mA/VDet, -Reset ODO	SOT-89-5	32sn	VR15	6h Ric
R25	TK11225UM	LVR-IC	LDO, 2.5V±5%, 170mA, +CE	SOT-89-5	32vg	VR7	6i Tok
R25K	R5510H025K	LVR/Vdet-IC	LDO, 4.9V±2%, 300mA/VDet, -Reset ODO	SOT-89-5	32sm	VR15	6h Ric
R26	TK11226UM	LVR-IC	LDO, 2.6V±5%, 170mA, +CE	SOT-89-5	32vg	VR7	6i Tok
R26N	R5510H026N	LVR/Vdet-IC	LDO, 5V±2%, 300mA/VDet, -Reset ODO	SOT-89-5	32sk	VR15	6h Ric
R27	TK11227UM	LVR-IC	LDO, 2.7V±5%, 170mA, +CE	SOT-89-5	32vg	VR7	6i Tok
R27N	R5510H027N	LVR/Vdet-IC	LDO, 5.1V±2%, 300mA/VDet, -Reset ODO	SOT-89-5	32sk	VR15	6h Ric
R28	TK11228UM	LVR-IC	LDO, 2.8V±2.4%, 150mA, +CE	SOT-89-5	32vg	VR7	6i Tok
R29	TK11229UM	LVR-IC	LDO, 2.9V±5%, 170mA, +CE	SOT-89-5	32vg	VR7	6i Tok
R30	TK11230UM	LVR-IC	LDO, 3V±5%, 170mA, +CE	SOT-89-5	32vg	VR7	6i Tok
R31	TK11231UM	LVR-IC	LDO, 3.1V±5%, 170mA, +CE	SOT-89-5	32vg	VR7	6i Tok
R32	TK11232UM	LVR-IC	LDO, 3.2V±5%, 170mA, +CE	SOT-89-5	32vg	VR7	6i Tok
R33	TK11233UM	LVR-IC	LDO, 3.3V±5%, 170mA, +CE	SOT-89-5	32vg	VR7	6i Tok
R34	TK11234UM	LVR-IC	LDO, 3.4V±5%, 170mA, +CE	SOT-89-5	32vg	VR7	6i Tok
R35	TK11235UM	LVR-IC	LDO, 3.5V±5%, 170mA, +CE	SOT-89-5	32vg	VR7	6i Tok
R36	TK11236UM	LVR-IC	LDO, 3.6V±5%, 170mA, +CE	SOT-89-5	32vg	VR7	6i Tok
R37	TK11237UM	LVR-IC	LDO, 3.7V±5%, 170mA, +CE	SOT-89-5	32vg	VR7	6i Tok
R38	TK11238UM	LVR-IC	LDO, 3.8V±5%, 170mA, +CE	SOT-89-5	32vg	VR7	6i Tok
R39	TK11239UM	LVR-IC	LDO, 3.9V±5%, 170mA, +CE	SOT-89-5	32vg	VR7	6i Tok
R40	TK11240UM	LVR-IC	LDO, 4V±5%, 170mA, +CE	SOT-89-5	32vg	VR7	6i Tok
R41	TK11241UM	LVR-IC	LDO, 4.1V±5%, 170mA, +CE	SOT-89-5	32vg	VR7	6i Tok
R42	TK11242UM	LVR-IC	LDO, 4.2V±5%, 170mA, +CE	SOT-89-5	32vg	VR7	6i Tok
R43	TK11243UM	LVR-IC	LDO, 4.3V±5%, 170mA, +CE	SOT-89-5	32vg	VR7	6i Tok
R44	TK11244UM	LVR-IC	LDO, 4.4V±5%, 170mA, +CE	SOT-89-5	32vg	VR7	6i Tok
R45	TK11245UM	LVR-IC	LDO, 4.5V±5%, 170mA, +CE	SOT-89-5	32vg	VR7	6i Tok



SMD code	Type	Function	Short description	Case	Pinout Sch.	St.	Mnf.
SGV	S-1135B29-U5T1G	LVR-IC	LDO, 2.9V±1.0%, 300mA, +CE, CL	SOT-89-5	32vr4 VR4	6n	Sii
SGW	S-1135B30-U5T1G	LVR-IC	LDO, 3.0V±1.0%, 300mA, +CE, CL	SOT-89-5	32vr4 VR4	6n	Sii
SGX	S-1135B31-U5T1G	LVR-IC	LDO, 3.1V±1.0%, 300mA, +CE, CL	SOT-89-5	32vr4 VR4	6n	Sii
SGY	S-1135B32-U5T1G	LVR-IC	LDO, 3.2V±1.0%, 300mA, +CE, CL	SOT-89-5	32vr4 VR4	6n	Sii
SGZ	S-1135B33-U5T1G	LVR-IC	LDO, 3.3V±1.0%, 300mA, +CE, CL	SOT-89-5	32vr4 VR4	6n	Sii
SH	ELM99172B	LVR-IC	LDO, 1.7V±2%, 300mA, -CE	SOT-89-5	32vrt VR1	6n	Elm
SH0	XC6373E600P	DC/DC-IC	PWM step-up, 30kHz, int. Vdd, 6.0V±2.5%, 100mA	SOT-89-5	32gc DC4	6h	Tor
SH0	XC6371E600P	DC/DC-IC	PWM step-up, 50kHz, int. Vdd, 6.0V±2.5%, 100mA	SOT-89-5	32gc DC4	6h	Tor
SH0	XC6373E600P	DC/DC-IC	PWM step-up, 30kHz, int. Vdd, 6.0V±2.5%, 100mA	SOT-89-5	32gc DC4	6h	Tor
SH1	XC6373E610P	DC/DC-IC	PWM step-up, 30kHz, int. Vdd, 6.1V±2.5%, 100mA	SOT-89-5	32gc DC4	6h	Tor
SH1	XC6371E610P	DC/DC-IC	PWM step-up, 50kHz, int. Vdd, 6.1V±2.5%, 100mA	SOT-89-5	32gc DC4	6h	Tor
SH1	XC6373E610P	DC/DC-IC	PWM step-up, 30kHz, int. Vdd, 6.1V±2.5%, 100mA	SOT-89-5	32gc DC4	6h	Tor
SH2	XC6373E620P	DC/DC-IC	PWM step-up, 30kHz, int. Vdd, 6.2V±2.5%, 100mA	SOT-89-5	32gc DC4	6h	Tor
SH2	XC6371E620P	DC/DC-IC	PWM step-up, 50kHz, int. Vdd, 6.2V±2.5%, 100mA	SOT-89-5	32gc DC4	6h	Tor
SH2	XC6373E620P	DC/DC-IC	PWM step-up, 30kHz, int. Vdd, 6.2V±2.5%, 100mA	SOT-89-5	32gc DC4	6h	Tor
SH3	XC6373E630P	DC/DC-IC	PWM step-up, 30kHz, int. Vdd, 6.3V±2.5%, 100mA	SOT-89-5	32gc DC4	6h	Tor
SH3	XC6371E630P	DC/DC-IC	PWM step-up, 50kHz, int. Vdd, 6.3V±2.5%, 100mA	SOT-89-5	32gc DC4	6h	Tor
SH3	XC6373E630P	DC/DC-IC	PWM step-up, 30kHz, int. Vdd, 6.3V±2.5%, 100mA	SOT-89-5	32gc DC4	6h	Tor
SH4	XC6373E640P	DC/DC-IC	PWM step-up, 30kHz, int. Vdd, 6.4V±2.5%, 100mA	SOT-89-5	32gc DC4	6h	Tor
SH4	XC6371E640P	DC/DC-IC	PWM step-up, 50kHz, int. Vdd, 6.4V±2.5%, 100mA	SOT-89-5	32gc DC4	6h	Tor
SH4	XC6373E640P	DC/DC-IC	PWM step-up, 30kHz, int. Vdd, 6.4V±2.5%, 100mA	SOT-89-5	32gc DC4	6h	Tor
SH5	XC6373E650P	DC/DC-IC	PWM step-up, 30kHz, int. Vdd, 6.5V±2.5%, 100mA	SOT-89-5	32gc DC4	6h	Tor
SH5	XC6371E650P	DC/DC-IC	PWM step-up, 50kHz, int. Vdd, 6.5V±2.5%, 100mA	SOT-89-5	32gc DC4	6h	Tor
SH5	XC6373E650P	DC/DC-IC	PWM step-up, 30kHz, int. Vdd, 6.5V±2.5%, 100mA	SOT-89-5	32gc DC4	6h	Tor
SH6	XC6373E660P	DC/DC-IC	PWM step-up, 30kHz, int. Vdd, 6.6V±2.5%, 100mA	SOT-89-5	32gc DC4	6h	Tor
SH6	XC6371E660P	DC/DC-IC	PWM step-up, 50kHz, int. Vdd, 6.6V±2.5%, 100mA	SOT-89-5	32gc DC4	6h	Tor
SH6	XC6373E660P	DC/DC-IC	PWM step-up, 30kHz, int. Vdd, 6.6V±2.5%, 100mA	SOT-89-5	32gc DC4	6h	Tor
SH7	XC6373E670P	DC/DC-IC	PWM step-up, 30kHz, int. Vdd, 6.7V±2.5%, 100mA	SOT-89-5	32gc DC4	6h	Tor
SH7	XC6371E670P	DC/DC-IC	PWM step-up, 50kHz, int. Vdd, 6.7V±2.5%, 100mA	SOT-89-5	32gc DC4	6h	Tor
SH7	XC6373E670P	DC/DC-IC	PWM step-up, 30kHz, int. Vdd, 6.7V±2.5%, 100mA	SOT-89-5	32gc DC4	6h	Tor
SH8	XC6373E680P	DC/DC-IC	PWM step-up, 30kHz, int. Vdd, 6.8V±2.5%, 100mA	SOT-89-5	32gc DC4	6h	Tor
SH8	XC6371E680P	DC/DC-IC	PWM step-up, 50kHz, int. Vdd, 6.8V±2.5%, 100mA	SOT-89-5	32gc DC4	6h	Tor
SH8	XC6373E680P	DC/DC-IC	PWM step-up, 30kHz, int. Vdd, 6.8V±2.5%, 100mA	SOT-89-5	32gc DC4	6h	Tor
SH9	XC6373E690P	DC/DC-IC	PWM step-up, 30kHz, int. Vdd, 6.9V±2.5%, 100mA	SOT-89-5	32gc DC4	6h	Tor
SH9	XC6371E690P	DC/DC-IC	PWM step-up, 50kHz, int. Vdd, 6.9V±2.5%, 100mA	SOT-89-5	32gc DC4	6h	Tor
SH9	XC6373E690P	DC/DC-IC	PWM step-up, 30kHz, int. Vdd, 6.9V±2.5%, 100mA	SOT-89-5	32gc DC4	6h	Tor
SJ	ELM99182B	LVR-IC	LDO, 1.8V±2%, 300mA, -CE	SOT-89-5	32vrt VR1	6n	Elm
SK	ELM99192B	LVR-IC	LDO, 1.9V±2%, 300mA, -CE	SOT-89-5	32vrt VR1	6n	Elm
SK0	XC6373E700P	DC/DC-IC	PWM step-up, 30kHz, int. Vdd, 7.0V±2.5%, 100mA	SOT-89-5	32gc DC4	6h	Tor
SK0	XC6371E700P	DC/DC-IC	PWM step-up, 50kHz, int. Vdd, 7.0V±2.5%, 100mA	SOT-89-5	32gc DC4	6h	Tor
SK0	XC6373E700P	DC/DC-IC	PWM step-up, 30kHz, int. Vdd, 7.0V±2.5%, 100mA	SOT-89-5	32gc DC4	6h	Tor
SOA	S-1172B10-U5T1G	LVR-IC	LDO, 1.0V±15mV, 1A, +CE	SOT-89-5	32vy VR4	6n	Sii
SOB	S-1172B11-U5T1G	LVR-IC	LDO, 1.1V±15mV, 1A, +CE	SOT-89-5	32vy VR4	6n	Sii
SOC	S-1172B12-U5T1G	LVR-IC	LDO, 1.2V±15mV, 1A, +CE	SOT-89-5	32vy VR4	6n	Sii
SOD	S-1172B13-U5T1G	LVR-IC	LDO, 1.3V±15mV, 1A, +CE	SOT-89-5	32vy VR4	6n	Sii
SOE	S-1172B14-U5T1G	LVR-IC	LDO, 1.4V±15mV, 1A, +CE	SOT-89-5	32vy VR4	6n	Sii
SOF	S-1172B15-U5T1G	LVR-IC	LDO, 1.5V±1.0%, 1A, +CE	SOT-89-5	32vy VR4	6n	Sii
SOG	S-1172B16-U5T1G	LVR-IC	LDO, 1.6V±1.0%, 1A, +CE	SOT-89-5	32vy VR4	6n	Sii
SOH	S-1172B17-U5T1G	LVR-IC	LDO, 1.7V±1.0%, 1A, +CE	SOT-89-5	32vy VR4	6n	Sii
SOI	S-1172B18-U5T1G	LVR-IC	LDO, 1.8V±1.0%, 1A, +CE	SOT-89-5	32vy VR4	6n	Sii
SOJ	S-1172B1J-U5T1G	LVR-IC	LDO, 1.85V±1.0%, 1A, +CE	SOT-89-5	32vy VR4	6n	Sii
SOK	S-1172B19-U5T1G	LVR-IC	LDO, 1.9V±1.0%, 1A, +CE	SOT-89-5	32vy VR4	6n	Sii
SOL	S-1172B20-U5T1G	LVR-IC	LDO, 2.0V±1.0%, 1A, +CE	SOT-89-5	32vy VR4	6n	Sii
SOM	S-1172B21-U5T1G	LVR-IC	LDO, 2.1V±1.0%, 1A, +CE	SOT-89-5	32vy VR4	6n	Sii
SON	S-1172B22-U5T1G	LVR-IC	LDO, 2.2V±1.0%, 1A, +CE	SOT-89-5	32vy VR4	6n	Sii
SOO	S-1172B23-U5T1G	LVR-IC	LDO, 2.3V±1.0%, 1A, +CE	SOT-89-5	32vy VR4	6n	Sii
SOP	S-1172B24-U5T1G	LVR-IC	LDO, 2.4V±1.0%, 1A, +CE	SOT-89-5	32vy VR4	6n	Sii
SOQ	S-1172B25-U5T1G	LVR-IC	LDO, 2.5V±1.0%, 1A, +CE	SOT-89-5	32vy VR4	6n	Sii
SOR	S-1172B26-U5T1G	LVR-IC	LDO, 2.6V±1.0%, 1A, +CE	SOT-89-5	32vy VR4	6n	Sii
SOS	S-1172B27-U5T1G	LVR-IC	LDO, 2.7V±1.0%, 1A, +CE	SOT-89-5	32vy VR4	6n	Sii
SOT	S-1172B28-U5T1G	LVR-IC	LDO, 2.8V±1.0%, 1A, +CE	SOT-89-5	32vy VR4	6n	Sii
SOU	S-1172B2J-U5T1G	LVR-IC	LDO, 2.85V±1.0%, 1A, +CE	SOT-89-5	32vy VR4	6n	Sii
SOV	S-1172B29-U5T1G	LVR-IC	LDO, 2.9V±1.0%, 1A, +CE	SOT-89-5	32vy VR4	6n	Sii
SOW	S-1172B30-U5T1G	LVR-IC	LDO, 3.0V±1.0%, 1A, +CE	SOT-89-5	32vy VR4	6n	Sii
SOX	S-1172B31-U5T1G	LVR-IC	LDO, 3.1V±1.0%, 1A, +CE	SOT-89-5	32vy VR4	6n	Sii
SOY	S-1172B32-U5T1G	LVR-IC	LDO, 3.2V±1.0%, 1A, +CE	SOT-89-5	32vy VR4	6n	Sii
SOZ	S-1172B33-U5T1G	LVR-IC	LDO, 3.3V±1.0%, 1A, +CE	SOT-89-5	32vy VR4	6n	Sii
SPA	S-1172B34-U5T1G	LVR-IC	LDO, 3.4V±1.0%, 1A, +CE	SOT-89-5	32vy VR4	6n	Sii
SPB	S-1172B35-U5T1G	LVR-IC	LDO, 3.5V±1.0%, 1A, +CE	SOT-89-5	32vy VR4	6n	Sii
SPC	S-1172B36-U5T1G	LVR-IC	LDO, 3.6V±1.0%, 1A, +CE	SOT-89-5	32vy VR4	6n	Sii



SMD code	Type	Function	Short description	Case	Pinout Sch.	St.	Mnf.
SPD	S-1172B37-U5T1G	LVR-IC	LDO, 3.7V±1.0%, 1A, +CE	SOT-89-5	32vy VR4	6n	Sii
SPE	S-1172B38-U5T1G	LVR-IC	LDO, 3.8V±1.0%, 1A, +CE	SOT-89-5	32vy VR4	6n	Sii
SPF	S-1172B39-U5T1G	LVR-IC	LDO, 3.9V±1.0%, 1A, +CE	SOT-89-5	32vy VR4	6n	Sii
SPG	S-1172B40-U5T1G	LVR-IC	LDO, 4.0V±1.0%, 1A, +CE	SOT-89-5	32vy VR4	6n	Sii
SPH	S-1172B41-U5T1G	LVR-IC	LDO, 4.1V±1.0%, 1A, +CE	SOT-89-5	32vy VR4	6n	Sii
SPI	S-1172B42-U5T1G	LVR-IC	LDO, 4.2V±1.0%, 1A, +CE	SOT-89-5	32vy VR4	6n	Sii
SPJ	S-1172B43-U5T1G	LVR-IC	LDO, 4.3V±1.0%, 1A, +CE	SOT-89-5	32vy VR4	6n	Sii
SPK	S-1172B44-U5T1G	LVR-IC	LDO, 4.4V±1.0%, 1A, +CE	SOT-89-5	32vy VR4	6n	Sii
SPL	S-1172B45-U5T1G	LVR-IC	LDO, 4.5V±1.0%, 1A, +CE	SOT-89-5	32vy VR4	6n	Sii
SPM	S-1172B46-U5T1G	LVR-IC	LDO, 4.6V±1.0%, 1A, +CE	SOT-89-5	32vy VR4	6n	Sii
SPN	S-1172B47-U5T1G	LVR-IC	LDO, 4.7V±1.0%, 1A, +CE	SOT-89-5	32vy VR4	6n	Sii
SPO	S-1172B48-U5T1G	LVR-IC	LDO, 4.8V±1.0%, 1A, +CE	SOT-89-5	32vy VR4	6n	Sii
SPP	S-1172B49-U5T1G	LVR-IC	LDO, 4.9V±1.0%, 1A, +CE	SOT-89-5	32vy VR4	6n	Sii
SPQ	S-1172B50-U5T1G	LVR-IC	LDO, 5.0V±1.0%, 1A, +CE	SOT-89-5	32vy VR4	6n	Sii
SPS	S-1172B1C-U5T1G	LVR-IC	LDO, 1.25V±15mV, 1A, +CE	SOT-89-5	32vy VR4	6n	Sii
TF	ELM99153B	LVR-IC	LDO, 1.5V±2%, 300mA, +CE	SOT-89-5	32vrt VR1	6n	Elm
TG	ELM99163B	LVR-IC	LDO, 1.6V±2%, 300mA, +CE	SOT-89-5	32vrt VR1	6n	Elm
TH	ELM99173B	LVR-IC	LDO, 1.7V±2%, 300mA, +CE	SOT-89-5	32vrt VR1	6n	Elm
TJ	ELM99183B	LVR-IC	LDO, 1.8V±2%, 300mA, +CE	SOT-89-5	32vrt VR1	6n	Elm
TK	ELM99193B	LVR-IC	LDO, 1.9V±2%, 300mA, +CE	SOT-89-5	32vrt VR1	6n	Elm
TP10A	ML6209A192P	LVR-IC	LDO, 1.9V±3%, 150mA, +CE, CL	SOT-89-5	32um VR4	6j	Mlc
TP10B	ML6209B192P	LVR-IC	LDO, 1.9V±3%, 150mA, +CE	SOT-89-5	32um VR4	6j	Mlc
TP10C	ML6209C192P	LVR-IC	LDO, 1.9V±3%, 150mA, -CE, CL	SOT-89-5	32um VR4	6j	Mlc
TP10D	ML6209D192P	LVR-IC	LDO, 1.9V±3%, 150mA, -CE	SOT-89-5	32um VR4	6j	Mlc
TP15A	ML6209A152P	LVR-IC	LDO, 1.5V±3%, 150mA, +CE, CL	SOT-89-5	32um VR4	6j	Mlc
TP15B	ML6209B152P	LVR-IC	LDO, 1.5V±3%, 150mA, +CE	SOT-89-5	32um VR4	6j	Mlc
TP15C	ML6209C152P	LVR-IC	LDO, 1.5V±3%, 150mA, -CE, CL	SOT-89-5	32um VR4	6j	Mlc
TP15D	ML6209D152P	LVR-IC	LDO, 1.5V±3%, 150mA, -CE	SOT-89-5	32um VR4	6j	Mlc
TP16A	ML6209A162P	LVR-IC	LDO, 1.6V±3%, 150mA, +CE, CL	SOT-89-5	32um VR4	6j	Mlc
TP16B	ML6209B162P	LVR-IC	LDO, 1.6V±3%, 150mA, +CE	SOT-89-5	32um VR4	6j	Mlc
TP16C	ML6209C162P	LVR-IC	LDO, 1.6V±3%, 150mA, -CE, CL	SOT-89-5	32um VR4	6j	Mlc
TP16D	ML6209D162P	LVR-IC	LDO, 1.6V±3%, 150mA, -CE	SOT-89-5	32um VR4	6j	Mlc
TP17A	ML6209A172P	LVR-IC	LDO, 1.7V±3%, 150mA, +CE, CL	SOT-89-5	32um VR4	6j	Mlc
TP17B	ML6209B172P	LVR-IC	LDO, 1.7V±3%, 150mA, +CE	SOT-89-5	32um VR4	6j	Mlc
TP17C	ML6209C172P	LVR-IC	LDO, 1.7V±3%, 150mA, -CE, CL	SOT-89-5	32um VR4	6j	Mlc
TP17D	ML6209D172P	LVR-IC	LDO, 1.7V±3%, 150mA, -CE	SOT-89-5	32um VR4	6j	Mlc
TP19A	ML6209A182P	LVR-IC	LDO, 1.8V±3%, 150mA, +CE, CL	SOT-89-5	32um VR4	6j	Mlc
TP19B	ML6209B182P	LVR-IC	LDO, 1.8V±3%, 150mA, +CE	SOT-89-5	32um VR4	6j	Mlc
TP19C	ML6209C182P	LVR-IC	LDO, 1.8V±3%, 150mA, -CE, CL	SOT-89-5	32um VR4	6j	Mlc
TP19D	ML6209D182P	LVR-IC	LDO, 1.8V±3%, 150mA, -CE	SOT-89-5	32um VR4	6j	Mlc
TP1FA	ML6209A15AP	LVR-IC	LDO, 1.55V±3%, 150mA, +CE, CL	SOT-89-5	32um VR4	6j	Mlc
TP1FB	ML6209B15AP	LVR-IC	LDO, 1.55V±3%, 150mA, +CE	SOT-89-5	32um VR4	6j	Mlc
TP1FC	ML6209C15AP	LVR-IC	LDO, 1.55V±3%, 150mA, -CE, CL	SOT-89-5	32um VR4	6j	Mlc
TP1FD	ML6209D15AP	LVR-IC	LDO, 1.55V±3%, 150mA, -CE	SOT-89-5	32um VR4	6j	Mlc
TP1GA	ML6209A16AP	LVR-IC	LDO, 1.65V±3%, 150mA, +CE, CL	SOT-89-5	32um VR4	6j	Mlc
TP1GB	ML6209B16AP	LVR-IC	LDO, 1.65V±3%, 150mA, +CE	SOT-89-5	32um VR4	6j	Mlc
TP1GC	ML6209C16AP	LVR-IC	LDO, 1.65V±3%, 150mA, -CE, CL	SOT-89-5	32um VR4	6j	Mlc
TP1GD	ML6209D16AP	LVR-IC	LDO, 1.65V±3%, 150mA, -CE	SOT-89-5	32um VR4	6j	Mlc
TP1HA	ML6209A17AP	LVR-IC	LDO, 1.75V±3%, 150mA, +CE, CL	SOT-89-5	32um VR4	6j	Mlc
TP1HB	ML6209B17AP	LVR-IC	LDO, 1.75V±3%, 150mA, +CE	SOT-89-5	32um VR4	6j	Mlc
TP1HC	ML6209C17AP	LVR-IC	LDO, 1.75V±3%, 150mA, -CE, CL	SOT-89-5	32um VR4	6j	Mlc
TP1HD	ML6209D17AP	LVR-IC	LDO, 1.75V±3%, 150mA, -CE	SOT-89-5	32um VR4	6j	Mlc
TP1IA	ML6209A18AP	LVR-IC	LDO, 1.85V±3%, 150mA, +CE, CL	SOT-89-5	32um VR4	6j	Mlc
TP1IB	ML6209B18AP	LVR-IC	LDO, 1.85V±3%, 150mA, +CE	SOT-89-5	32um VR4	6j	Mlc
TP1IC	ML6209C18AP	LVR-IC	LDO, 1.85V±3%, 150mA, -CE, CL	SOT-89-5	32um VR4	6j	Mlc
TP1ID	ML6209D18AP	LVR-IC	LDO, 1.85V±3%, 150mA, -CE	SOT-89-5	32um VR4	6j	Mlc
TP1JA	ML6209A19AP	LVR-IC	LDO, 1.95V±3%, 150mA, +CE, CL	SOT-89-5	32um VR4	6j	Mlc
TP1JB	ML6209B19AP	LVR-IC	LDO, 1.95V±3%, 150mA, +CE	SOT-89-5	32um VR4	6j	Mlc
TP1JC	ML6209C19AP	LVR-IC	LDO, 1.95V±3%, 150mA, -CE, CL	SOT-89-5	32um VR4	6j	Mlc
TP1JD	ML6209D19AP	LVR-IC	LDO, 1.95V±3%, 150mA, -CE	SOT-89-5	32um VR4	6j	Mlc
TP20A	ML6209A202P	LVR-IC	LDO, 2.0V±2%, 150mA, +CE, CL	SOT-89-5	32um VR4	6j	Mlc
TP20B	ML6209B202P	LVR-IC	LDO, 2.0V±2%, 150mA, +CE	SOT-89-5	32um VR4	6j	Mlc
TP20C	ML6209C202P	LVR-IC	LDO, 2.0V±2%, 150mA, -CE, CL	SOT-89-5	32um VR4	6j	Mlc
TP20D	ML6209D202P	LVR-IC	LDO, 2.0V±2%, 150mA, -CE	SOT-89-5	32um VR4	6j	Mlc
TP21A	ML6209A212P	LVR-IC	LDO, 2.1V±2%, 150mA, +CE, CL	SOT-89-5	32um VR4	6j	Mlc
TP21B	ML6209B212P	LVR-IC	LDO, 2.1V±2%, 150mA, +CE	SOT-89-5	32um VR4	6j	Mlc
TP21C	ML6209C212P	LVR-IC	LDO, 2.1V±2%, 150mA, -CE, CL	SOT-89-5	32um VR4	6j	Mlc
TP21D	ML6209D212P	LVR-IC	LDO, 2.1V±2%, 150mA, -CE	SOT-89-5	32um VR4	6j	Mlc
TP22A	ML6209A222P	LVR-IC	LDO, 2.2V±2%, 150mA, +CE, CL	SOT-89-5	32um VR4	6j	Mlc
TP22B	ML6209B222P	LVR-IC	LDO, 2.2V±2%, 150mA, +CE	SOT-89-5	32um VR4	6j	Mlc



SMD code	Type	Function	Short description	Case	Pinout Sch.	St.	Mnf.
TP5CC	ML6209C52AP	LVR-IC	LDO, 5.25V±2%, 150mA, -CE, CL	SOT-89-5	32um VR4	6j	Mic
TP5CD	ML6209D52AP	LVR-IC	LDO, 5.25V±2%, 150mA, -CE	SOT-89-5	32um VR4	6j	Mic
TP5DA	ML6209A53AP	LVR-IC	LDO, 5.35V±2%, 150mA, +CE, CL	SOT-89-5	32um VR4	6j	Mic
TP5DB	ML6209B53AP	LVR-IC	LDO, 5.35V±2%, 150mA, +CE	SOT-89-5	32um VR4	6j	Mic
TP5DC	ML6209C53AP	LVR-IC	LDO, 5.35V±2%, 150mA, -CE, CL	SOT-89-5	32um VR4	6j	Mic
TP5DD	ML6209D53AP	LVR-IC	LDO, 5.35V±2%, 150mA, -CE	SOT-89-5	32um VR4	6j	Mic
TP5EA	ML6209A54AP	LVR-IC	LDO, 5.45V±2%, 150mA, +CE, CL	SOT-89-5	32um VR4	6j	Mic
TP5EB	ML6209B54AP	LVR-IC	LDO, 5.45V±2%, 150mA, +CE	SOT-89-5	32um VR4	6j	Mic
TP5EC	ML6209C54AP	LVR-IC	LDO, 5.45V±2%, 150mA, -CE, CL	SOT-89-5	32um VR4	6j	Mic
TP5ED	ML6209D54AP	LVR-IC	LDO, 5.45V±2%, 150mA, -CE	SOT-89-5	32um VR4	6j	Mic
TP5FA	ML6209A55AP	LVR-IC	LDO, 5.55V±2%, 150mA, +CE, CL	SOT-89-5	32um VR4	6j	Mic
TP5FB	ML6209B55AP	LVR-IC	LDO, 5.55V±2%, 150mA, +CE	SOT-89-5	32um VR4	6j	Mic
TP5FC	ML6209C55AP	LVR-IC	LDO, 5.55V±2%, 150mA, -CE, CL	SOT-89-5	32um VR4	6j	Mic
TP5FD	ML6209D55AP	LVR-IC	LDO, 5.55V±2%, 150mA, -CE	SOT-89-5	32um VR4	6j	Mic
TP5GA	ML6209A56AP	LVR-IC	LDO, 5.65V±2%, 150mA, +CE, CL	SOT-89-5	32um VR4	6j	Mic
TP5GB	ML6209B56AP	LVR-IC	LDO, 5.65V±2%, 150mA, +CE	SOT-89-5	32um VR4	6j	Mic
TP5GC	ML6209C56AP	LVR-IC	LDO, 5.65V±2%, 150mA, -CE, CL	SOT-89-5	32um VR4	6j	Mic
TP5GD	ML6209D56AP	LVR-IC	LDO, 5.65V±2%, 150mA, -CE	SOT-89-5	32um VR4	6j	Mic
TP5HA	ML6209A57AP	LVR-IC	LDO, 5.75V±2%, 150mA, +CE, CL	SOT-89-5	32um VR4	6j	Mic
TP5HB	ML6209B57AP	LVR-IC	LDO, 5.75V±2%, 150mA, +CE	SOT-89-5	32um VR4	6j	Mic
TP5HC	ML6209C57AP	LVR-IC	LDO, 5.75V±2%, 150mA, -CE, CL	SOT-89-5	32um VR4	6j	Mic
TP5HD	ML6209D57AP	LVR-IC	LDO, 5.75V±2%, 150mA, -CE	SOT-89-5	32um VR4	6j	Mic
TP5IA	ML6209A58AP	LVR-IC	LDO, 5.85V±2%, 150mA, +CE, CL	SOT-89-5	32um VR4	6j	Mic
TP5IB	ML6209B58AP	LVR-IC	LDO, 5.85V±2%, 150mA, +CE	SOT-89-5	32um VR4	6j	Mic
TP5IC	ML6209C58AP	LVR-IC	LDO, 5.85V±2%, 150mA, -CE, CL	SOT-89-5	32um VR4	6j	Mic
TP5ID	ML6209D58AP	LVR-IC	LDO, 5.85V±2%, 150mA, -CE	SOT-89-5	32um VR4	6j	Mic
TP5JA	ML6209A59AP	LVR-IC	LDO, 5.95V±2%, 150mA, +CE, CL	SOT-89-5	32um VR4	6j	Mic
TP5JB	ML6209B59AP	LVR-IC	LDO, 5.95V±2%, 150mA, +CE	SOT-89-5	32um VR4	6j	Mic
TP5JC	ML6209C59AP	LVR-IC	LDO, 5.95V±2%, 150mA, -CE, CL	SOT-89-5	32um VR4	6j	Mic
TP5JD	ML6209D59AP	LVR-IC	LDO, 5.95V±2%, 150mA, -CE	SOT-89-5	32um VR4	6j	Mic
TP60A	ML6209A602P	LVR-IC	LDO, 6.0V±2%, 150mA, +CE, CL	SOT-89-5	32um VR4	6j	Mic
TP60B	ML6209B602P	LVR-IC	LDO, 6.0V±2%, 150mA, +CE	SOT-89-5	32um VR4	6j	Mic
TP60C	ML6209C602P	LVR-IC	LDO, 6.0V±2%, 150mA, -CE, CL	SOT-89-5	32um VR4	6j	Mic
TP60D	ML6209D602P	LVR-IC	LDO, 6.0V±2%, 150mA, -CE	SOT-89-5	32um VR4	6j	Mic
U01B	RP131H121B5	LVR-IC	LDO, 1.25V±1%, 1A, +CE	SOT-89-5	32xa VR4	6h	Ric
U01D	RP131H121D5	LVR-IC	LDO, 1.25V±1%, 1A, +CE, CL	SOT-89-5	32xa VR4	6h	Ric
U02B	RP131H181B5	LVR-IC	LDO, 1.85V±1%, 1A, +CE	SOT-89-5	32xa VR4	6h	Ric
U02D	RP131H181D5	LVR-IC	LDO, 1.85V±1%, 1A, +CE, CL	SOT-89-5	32xa VR4	6h	Ric
U03B	RP131H281B5	LVR-IC	LDO, 2.85V±1%, 1A, +CE	SOT-89-5	32xa VR4	6h	Ric
U03D	RP131H281D5	LVR-IC	LDO, 2.85V±1%, 1A, +CE, CL	SOT-89-5	32xa VR4	6h	Ric
U04B	RP131H101B5	LVR-IC	LDO, 1.05V±1%, 1A, +CE	SOT-89-5	32xa VR4	6h	Ric
U04D	RP131H101D5	LVR-IC	LDO, 1.05V±1%, 1A, +CE, CL	SOT-89-5	32xa VR4	6h	Ric
U08B	RP131H081B	LVR-IC	LDO, 0.8V±1%, 1A, +CE	SOT-89-5	32xa VR4	6h	Ric
U08D	RP131H081D	LVR-IC	LDO, 0.8V±1%, 1A, +CE, CL	SOT-89-5	32xa VR4	6h	Ric
U09B	RP131H091B	LVR-IC	LDO, 0.9V±1%, 1A, +CE	SOT-89-5	32xa VR4	6h	Ric
U09D	RP131H091D	LVR-IC	LDO, 0.9V±1%, 1A, +CE, CL	SOT-89-5	32xa VR4	6h	Ric
U10B	RP131H101B	LVR-IC	LDO, 1.1V±1%, 1A, +CE	SOT-89-5	32xa VR4	6h	Ric
U10D	RP131H101D	LVR-IC	LDO, 1.1V±1%, 1A, +CE, CL	SOT-89-5	32xa VR4	6h	Ric
U11B	RP131H111B	LVR-IC	LDO, 1.1V±1%, 1A	SOT-89-5	32xa VR4	6h	Ric
U11D	RP131H111D	LVR-IC	LDO, 1.1V±1%, 1A, +CE, CL	SOT-89-5	32xa VR4	6h	Ric
U12B	RP131H121B	LVR-IC	LDO, 1.2V±1%, 1A, +CE	SOT-89-5	32xa VR4	6h	Ric
U12D	RP131H121D	LVR-IC	LDO, 1.2V±1%, 1A, +CE, CL	SOT-89-5	32xa VR4	6h	Ric
U13B	RP131H131B	LVR-IC	LDO, 1.3V±1%, 1A, +CE	SOT-89-5	32xa VR4	6h	Ric
U13D	RP131H131D	LVR-IC	LDO, 1.3V±1%, 1A, +CE, CL	SOT-89-5	32xa VR4	6h	Ric
U14B	RP131H141B	LVR-IC	LDO, 1.4V±1%, 1A, +CE	SOT-89-5	32xa VR4	6h	Ric
U14D	RP131H141D	LVR-IC	LDO, 1.4V±1%, 1A, +CE, CL	SOT-89-5	32xa VR4	6h	Ric
U15B	RP131H151B	LVR-IC	LDO, 1.5V±1%, 1A, +CE	SOT-89-5	32xa VR4	6h	Ric
U15D	RP131H151D	LVR-IC	LDO, 1.5V±1%, 1A, +CE, CL	SOT-89-5	32xa VR4	6h	Ric
U16B	RP131H161B	LVR-IC	LDO, 1.6V±1%, 1A, +CE	SOT-89-5	32xa VR4	6h	Ric
U16D	RP131H161D	LVR-IC	LDO, 1.6V±1%, 1A, +CE, CL	SOT-89-5	32xa VR4	6h	Ric
U17B	RP131H171B	LVR-IC	LDO, 1.7V±1%, 1A, +CE	SOT-89-5	32xa VR4	6h	Ric
U17D	RP131H171D	LVR-IC	LDO, 1.7V±1%, 1A, +CE, CL	SOT-89-5	32xa VR4	6h	Ric
U18B	RP131H181B	LVR-IC	LDO, 1.8V±1%, 1A, +CE	SOT-89-5	32xa VR4	6h	Ric
U18D	RP131H181D	LVR-IC	LDO, 1.8V±1%, 1A, +CE, CL	SOT-89-5	32xa VR4	6h	Ric
U19B	RP131H191B	LVR-IC	LDO, 1.9V±1%, 1A, +CE	SOT-89-5	32xa VR4	6h	Ric
U19D	RP131H191D	LVR-IC	LDO, 1.9V±1%, 1A, +CE, CL	SOT-89-5	32xa VR4	6h	Ric
U20B	RP131H201B	LVR-IC	LDO, 2V±1%, 1A, +CE	SOT-89-5	32xa VR4	6h	Ric
U20D	RP131H201D	LVR-IC	LDO, 2V±1%, 1A, +CE, CL	SOT-89-5	32xa VR4	6h	Ric
U21B	RP131H211B	LVR-IC	LDO, 2.1V±1%, 1A, +CE	SOT-89-5	32xa VR4	6h	Ric
U21D	RP131H211D	LVR-IC	LDO, 2.1V±1%, 1A, +CE, CL	SOT-89-5	32xa VR4	6h	Ric



SMD code	Type	Function	Short description	Case	Pinout Sch.	St.	Mnf.
U22B	RP131H221B	LVR-IC	LDO, 2.2V±1%, 1A, +CE	SOT-89-5	32xa	VR4	6h Ric
U22D	RP131H221D	LVR-IC	LDO, 2.2V±1%, 1A, +CE, CL	SOT-89-5	32xa	VR4	6h Ric
U23B	RP131H231B	LVR-IC	LDO, 2.3V±1%, 1A, +CE	SOT-89-5	32xa	VR4	6h Ric
U23D	RP131H231D	LVR-IC	LDO, 2.3V±1%, 1A, +CE, CL	SOT-89-5	32xa	VR4	6h Ric
U24B	RP131H241B	LVR-IC	LDO, 2.4V±1%, 1A, +CE	SOT-89-5	32xa	VR4	6h Ric
U24D	RP131H241D	LVR-IC	LDO, 2.4V±1%, 1A, +CE, CL	SOT-89-5	32xa	VR4	6h Ric
U25B	RP131H251B	LVR-IC	LDO, 2.5V±1%, 1A, +CE	SOT-89-5	32xa	VR4	6h Ric
U25D	RP131H251D	LVR-IC	LDO, 2.5V±1%, 1A, +CE, CL	SOT-89-5	32xa	VR4	6h Ric
U26B	RP131H261B	LVR-IC	LDO, 2.6V±1%, 1A, +CE	SOT-89-5	32xa	VR4	6h Ric
U26D	RP131H261D	LVR-IC	LDO, 2.6V±1%, 1A, +CE, CL	SOT-89-5	32xa	VR4	6h Ric
U27B	RP131H271B	LVR-IC	LDO, 2.7V±1%, 1A, +CE	SOT-89-5	32xa	VR4	6h Ric
U27D	RP131H271D	LVR-IC	LDO, 2.7V±1%, 1A, +CE, CL	SOT-89-5	32xa	VR4	6h Ric
U28B	RP131H281B	LVR-IC	LDO, 2.8V±1%, 1A, +CE	SOT-89-5	32xa	VR4	6h Ric
U28D	RP131H281D	LVR-IC	LDO, 2.8V±1%, 1A, +CE, CL	SOT-89-5	32xa	VR4	6h Ric
U29B	RP131H291B	LVR-IC	LDO, 2.9V±1%, 1A, +CE	SOT-89-5	32xa	VR4	6h Ric
U29D	RP131H291D	LVR-IC	LDO, 2.9V±1%, 1A, +CE, CL	SOT-89-5	32xa	VR4	6h Ric
U30B	RP131H301B	LVR-IC	LDO, 3V±1%, 1A, +CE	SOT-89-5	32xa	VR4	6h Ric
U30D	RP131H301D	LVR-IC	LDO, 3V±1%, 1A, +CE, CL	SOT-89-5	32xa	VR4	6h Ric
U31B	RP131H311B	LVR-IC	LDO, 3.1V±1%, 1A, +CE	SOT-89-5	32xa	VR4	6h Ric
U31D	RP131H311D	LVR-IC	LDO, 3.1V±1%, 1A, +CE, CL	SOT-89-5	32xa	VR4	6h Ric
U32B	RP131H321B	LVR-IC	LDO, 3.2V±1%, 1A, +CE	SOT-89-5	32xa	VR4	6h Ric
U32D	RP131H321D	LVR-IC	LDO, 3.2V±1%, 1A, +CE, CL	SOT-89-5	32xa	VR4	6h Ric
U33B	RP131H331B	LVR-IC	LDO, 3.3V±1%, 1A, +CE	SOT-89-5	32xa	VR4	6h Ric
U33D	RP131H331D	LVR-IC	LDO, 3.3V±1%, 1A, +CE, CL	SOT-89-5	32xa	VR4	6h Ric
U34B	RP131H341B	LVR-IC	LDO, 3.4V±1%, 1A, +CE	SOT-89-5	32xa	VR4	6h Ric
U34D	RP131H341D	LVR-IC	LDO, 3.4V±1%, 1A, +CE, CL	SOT-89-5	32xa	VR4	6h Ric
U35B	RP131H351B	LVR-IC	LDO, 3.5V±1%, 1A, +CE	SOT-89-5	32xa	VR4	6h Ric
U35D	RP131H351D	LVR-IC	LDO, 3.5V±1%, 1A, +CE, CL	SOT-89-5	32xa	VR4	6h Ric
U36B	RP131H361B	LVR-IC	LDO, 3.6V±1%, 1A, +CE	SOT-89-5	32xa	VR4	6h Ric
U36D	RP131H361D	LVR-IC	LDO, 3.6V±1%, 1A, +CE, CL	SOT-89-5	32xa	VR4	6h Ric
U37B	RP131H371B	LVR-IC	LDO, 3.7V±1%, 1A, +CE	SOT-89-5	32xa	VR4	6h Ric
U37D	RP131H371D	LVR-IC	LDO, 3.7V±1%, 1A, +CE, CL	SOT-89-5	32xa	VR4	6h Ric
U38B	RP131H381B	LVR-IC	LDO, 3.8V±1%, 1A, +CE	SOT-89-5	32xa	VR4	6h Ric
U38D	RP131H381D	LVR-IC	LDO, 3.8V±1%, 1A, +CE, CL	SOT-89-5	32xa	VR4	6h Ric
U39B	RP131H391B	LVR-IC	LDO, 3.9V±1%, 1A, +CE	SOT-89-5	32xa	VR4	6h Ric
U39D	RP131H391D	LVR-IC	LDO, 3.9V±1%, 1A, +CE, CL	SOT-89-5	32xa	VR4	6h Ric
U40B	RP131H401B	LVR-IC	LDO, 4V±1%, 1A, +CE	SOT-89-5	32xa	VR4	6h Ric
U40D	RP131H401D	LVR-IC	LDO, 4V±1%, 1A, +CE, CL	SOT-89-5	32xa	VR4	6h Ric
U41B	RP131H411B	LVR-IC	LDO, 4.1V±1%, 1A, +CE	SOT-89-5	32xa	VR4	6h Ric
U41D	RP131H411D	LVR-IC	LDO, 4.1V±1%, 1A, +CE, CL	SOT-89-5	32xa	VR4	6h Ric
U42B	RP131H421B	LVR-IC	LDO, 4.2V±1%, 1A, +CE	SOT-89-5	32xa	VR4	6h Ric
U42D	RP131H421D	LVR-IC	LDO, 4.2V±1%, 1A, +CE, CL	SOT-89-5	32xa	VR4	6h Ric
U43B	RP131H431B	LVR-IC	LDO, 4.3V±1%, 1A, +CE	SOT-89-5	32xa	VR4	6h Ric
U43D	RP131H431D	LVR-IC	LDO, 4.3V±1%, 1A, +CE, CL	SOT-89-5	32xa	VR4	6h Ric
U44B	RP131H441B	LVR-IC	LDO, 4.4V±1%, 1A, +CE	SOT-89-5	32xa	VR4	6h Ric
U44D	RP131H441D	LVR-IC	LDO, 4.4V±1%, 1A, +CE, CL	SOT-89-5	32xa	VR4	6h Ric
U45B	RP131H451B	LVR-IC	LDO, 4.5V±1%, 1A, +CE	SOT-89-5	32xa	VR4	6h Ric
U45D	RP131H451D	LVR-IC	LDO, 4.5V±1%, 1A, +CE, CL	SOT-89-5	32xa	VR4	6h Ric
U46B	RP131H461B	LVR-IC	LDO, 4.6V±1%, 1A, +CE	SOT-89-5	32xa	VR4	6h Ric
U46D	RP131H461D	LVR-IC	LDO, 4.6V±1%, 1A, +CE, CL	SOT-89-5	32xa	VR4	6h Ric
U47B	RP131H471B	LVR-IC	LDO, 4.7V±1%, 1A, +CE	SOT-89-5	32xa	VR4	6h Ric
U47D	RP131H471D	LVR-IC	LDO, 4.7V±1%, 1A, +CE, CL	SOT-89-5	32xa	VR4	6h Ric
U48B	RP131H481B	LVR-IC	LDO, 4.8V±1%, 1A, +CE	SOT-89-5	32xa	VR4	6h Ric
U48D	RP131H481D	LVR-IC	LDO, 4.8V±1%, 1A, +CE, CL	SOT-89-5	32xa	VR4	6h Ric
U49B	RP131H491B	LVR-IC	LDO, 4.9V±1%, 1A, +CE	SOT-89-5	32xa	VR4	6h Ric
U49D	RP131H491D	LVR-IC	LDO, 4.9V±1%, 1A, +CE, CL	SOT-89-5	32xa	VR4	6h Ric
U50B	RP131H501B	LVR-IC	LDO, 5V±1%, 1A, +CE	SOT-89-5	32xa	VR4	6h Ric
U50D	RP131H501D	LVR-IC	LDO, 5V±1%, 1A, +CE, CL	SOT-89-5	32xa	VR4	6h Ric
VA2	S-1135C34-U5T1G	LVR-IC	LDO, 3.4V±1.0%, 300mA, +CE	SOT-89-5	32vr4	VR4	6n Sii
VA3	S-1135C35-U5T1G	LVR-IC	LDO, 3.5V±1.0%, 300mA, +CE	SOT-89-5	32vr4	VR4	6n Sii
VAA	S-1135C10-U5T1G	LVR-IC	LDO, 1.0V±15mV, 300mA, +CE	SOT-89-5	32vr4	VR4	6n Sii
VAB	S-1135C11-U5T1G	LVR-IC	LDO, 1.1V±15mV, 300mA, +CE	SOT-89-5	32vr4	VR4	6n Sii
VAC	S-1135C12-U5T1G	LVR-IC	LDO, 1.2V±15mV, 300mA, +CE	SOT-89-5	32vr4	VR4	6n Sii
VAD	S-1135C13-U5T1G	LVR-IC	LDO, 1.3V±15mV, 300mA, +CE	SOT-89-5	32vr4	VR4	6n Sii
VAE	S-1135C14-U5T1G	LVR-IC	LDO, 1.4V±15mV, 300mA, +CE	SOT-89-5	32vr4	VR4	6n Sii
VAF	S-1135C15-U5T1G	LVR-IC	LDO, 1.5V±1.0%, 300mA, +CE	SOT-89-5	32vr4	VR4	6n Sii
VAG	S-1135C16-U5T1G	LVR-IC	LDO, 1.6V±1.0%, 300mA, +CE	SOT-89-5	32vr4	VR4	6n Sii
VAH	S-1135C17-U5T1G	LVR-IC	LDO, 1.7V±1.0%, 300mA, +CE	SOT-89-5	32vr4	VR4	6n Sii
VAI	S-1135C18-U5T1G	LVR-IC	LDO, 1.8V±1.0%, 300mA, +CE	SOT-89-5	32vr4	VR4	6n Sii
VAJ	S-1135C1J-U5T1G	LVR-IC	LDO, 1.85V±1.0%, 300mA, +CE	SOT-89-5	32vr4	VR4	6n Sii



SMD code	Type	Function	Short description	Case	Pinout Sch.	St.	Mnf.
VKS	S-1137D27-U5T1G	LVR-IC	LDO, 2.7V±1.0%	SOT-89-5	32es VR7	6n	Sii
VKT	S-1137D28-U5T1G	LVR-IC	LDO, 2.8V±1.0%	SOT-89-5	32es VR7	6n	Sii
VKU	S-1137D2J-U5T1G	LVR-IC	LDO, 2.85V±1.0%	SOT-89-5	32es VR7	6n	Sii
VKV	S-1137D29-U5T1G	LVR-IC	LDO, 2.9V±1.0%	SOT-89-5	32es VR7	6n	Sii
VKW	S-1137D30-U5T1G	LVR-IC	LDO, 3.0V±1.0%	SOT-89-5	32es VR7	6n	Sii
VKX	S-1137D31-U5T1G	LVR-IC	LDO, 3.1V±1.0%	SOT-89-5	32es VR7	6n	Sii
VKY	S-1137D32-U5T1G	LVR-IC	LDO, 3.2V±1.0%	SOT-89-5	32es VR7	6n	Sii
VKZ	S-1137D33-U5T1G	LVR-IC	LDO, 3.3V±1.0%	SOT-89-5	32es VR7	6n	Sii
W020	R1190H020B	LVR-IC	2.0V±1.5%, 1A, +CE	SOT-89-5	32zt VR7	6h	Ric
W021	R1190H021B	LVR-IC	2.1V±1.5%, 1A, +CE	SOT-89-5	32zt VR7	6h	Ric
W022	R1190H022B	LVR-IC	2.2V±1.5%, 1A, +CE	SOT-89-5	32zt VR7	6h	Ric
W023	R1190H023B	LVR-IC	2.3V±1.5%, 1A, +CE	SOT-89-5	32zt VR7	6h	Ric
W024	R1190H024B	LVR-IC	2.4V±1.5%, 1A, +CE	SOT-89-5	32zt VR7	6h	Ric
W025	R1190H025B	LVR-IC	2.5V±1.5%, 1A, +CE	SOT-89-5	32zt VR7	6h	Ric
W026	R1190H026B	LVR-IC	2.6V±1.5%, 1A, +CE	SOT-89-5	32zt VR7	6h	Ric
W027	R1190H027B	LVR-IC	2.7V±1.5%, 1A, +CE	SOT-89-5	32zt VR7	6h	Ric
W028	R1190H028B	LVR-IC	2.8V±1.5%, 1A, +CE	SOT-89-5	32zt VR7	6h	Ric
W029	R1190H029B	LVR-IC	2.9V±1.5%, 1A, +CE	SOT-89-5	32zt VR7	6h	Ric
W030	R1190H030B	LVR-IC	3.0V±1.5%, 1A, +CE	SOT-89-5	32zt VR7	6h	Ric
W031	R1190H031B	LVR-IC	3.1V±1.5%, 1A, +CE	SOT-89-5	32zt VR7	6h	Ric
W032	R1190H032B	LVR-IC	3.2V±1.5%, 1A, +CE	SOT-89-5	32zt VR7	6h	Ric
W033	R1190H033B	LVR-IC	3.3V±1.5%, 1A, +CE	SOT-89-5	32zt VR7	6h	Ric
W034	R1190H034B	LVR-IC	3.4V±1.5%, 1A, +CE	SOT-89-5	32zt VR7	6h	Ric
W035	R1190H035B	LVR-IC	3.5V±1.5%, 1A, +CE	SOT-89-5	32zt VR7	6h	Ric
W036	R1190H036B	LVR-IC	3.6V±1.5%, 1A, +CE	SOT-89-5	32zt VR7	6h	Ric
W037	R1190H037B	LVR-IC	3.7V±1.5%, 1A, +CE	SOT-89-5	32zt VR7	6h	Ric
W038	R1190H038B	LVR-IC	3.8V±1.5%, 1A, +CE	SOT-89-5	32zt VR7	6h	Ric
W039	R1190H039B	LVR-IC	3.9V±1.5%, 1A, +CE	SOT-89-5	32zt VR7	6h	Ric
W040	R1190H040B	LVR-IC	4.0V±1.5%, 1A, +CE	SOT-89-5	32zt VR7	6h	Ric
W041	R1190H041B	LVR-IC	4.1V±1.5%, 1A, +CE	SOT-89-5	32zt VR7	6h	Ric
W042	R1190H042B	LVR-IC	4.2V±1.5%, 1A, +CE	SOT-89-5	32zt VR7	6h	Ric
W043	R1190H043B	LVR-IC	4.3V±1.5%, 1A, +CE	SOT-89-5	32zt VR7	6h	Ric
W044	R1190H044B	LVR-IC	4.4V±1.5%, 1A, +CE	SOT-89-5	32zt VR7	6h	Ric
W045	R1190H045B	LVR-IC	4.5V±1.5%, 1A, +CE	SOT-89-5	32zt VR7	6h	Ric
W046	R1190H046B	LVR-IC	4.6V±1.5%, 1A, +CE	SOT-89-5	32zt VR7	6h	Ric
W047	R1190H047B	LVR-IC	4.7V±1.5%, 1A, +CE	SOT-89-5	32zt VR7	6h	Ric
W048	R1190H048B	LVR-IC	4.8V±1.5%, 1A, +CE	SOT-89-5	32zt VR7	6h	Ric
W049	R1190H049B	LVR-IC	4.9V±1.5%, 1A, +CE	SOT-89-5	32zt VR7	6h	Ric
W050	R1190H050B	LVR-IC	5.0V±1.5%, 1A, +CE	SOT-89-5	32zt VR7	6h	Ric
W051	R1190H051B	LVR-IC	5.1V±1.5%, 1A, +CE	SOT-89-5	32zt VR7	6h	Ric
W052	R1190H052B	LVR-IC	5.2V±1.5%, 1A, +CE	SOT-89-5	32zt VR7	6h	Ric
W053	R1190H053B	LVR-IC	5.3V±1.5%, 1A, +CE	SOT-89-5	32zt VR7	6h	Ric
W054	R1190H054B	LVR-IC	5.4V±1.5%, 1A, +CE	SOT-89-5	32zt VR7	6h	Ric
W055	R1190H055B	LVR-IC	5.5V±1.5%, 1A, +CE	SOT-89-5	32zt VR7	6h	Ric
W056	R1190H056B	LVR-IC	5.6V±1.5%, 1A, +CE	SOT-89-5	32zt VR7	6h	Ric
W057	R1190H057B	LVR-IC	5.7V±1.5%, 1A, +CE	SOT-89-5	32zt VR7	6h	Ric
W058	R1190H058B	LVR-IC	5.8V±1.5%, 1A, +CE	SOT-89-5	32zt VR7	6h	Ric
W059	R1190H059B	LVR-IC	5.9V±1.5%, 1A, +CE	SOT-89-5	32zt VR7	6h	Ric
W060	R1190H060B	LVR-IC	6.0V±1.5%, 1A, +CE	SOT-89-5	32zt VR7	6h	Ric
W061	R1190H061B	LVR-IC	6.1V±1.5%, 1A, +CE	SOT-89-5	32zt VR7	6h	Ric
W062	R1190H062B	LVR-IC	6.2V±1.5%, 1A, +CE	SOT-89-5	32zt VR7	6h	Ric
W063	R1190H063B	LVR-IC	6.3V±1.5%, 1A, +CE	SOT-89-5	32zt VR7	6h	Ric
W064	R1190H064B	LVR-IC	6.4V±1.5%, 1A, +CE	SOT-89-5	32zt VR7	6h	Ric
W065	R1190H065B	LVR-IC	6.5V±1.5%, 1A, +CE	SOT-89-5	32zt VR7	6h	Ric
W066	R1190H066B	LVR-IC	6.6V±1.5%, 1A, +CE	SOT-89-5	32zt VR7	6h	Ric
W067	R1190H067B	LVR-IC	6.7V±1.5%, 1A, +CE	SOT-89-5	32zt VR7	6h	Ric
W068	R1190H068B	LVR-IC	6.8V±1.5%, 1A, +CE	SOT-89-5	32zt VR7	6h	Ric
W069	R1190H069B	LVR-IC	6.9V±1.5%, 1A, +CE	SOT-89-5	32zt VR7	6h	Ric
W070	R1190H070B	LVR-IC	7.0V±1.5%, 1A, +CE	SOT-89-5	32zt VR7	6h	Ric
W071	R1190H071B	LVR-IC	7.1V±1.5%, 1A, +CE	SOT-89-5	32zt VR7	6h	Ric
W072	R1190H072B	LVR-IC	7.2V±1.5%, 1A, +CE	SOT-89-5	32zt VR7	6h	Ric
W073	R1190H073B	LVR-IC	7.3V±1.5%, 1A, +CE	SOT-89-5	32zt VR7	6h	Ric
W074	R1190H074B	LVR-IC	7.4V±1.5%, 1A, +CE	SOT-89-5	32zt VR7	6h	Ric
W075	R1190H075B	LVR-IC	7.5V±1.5%, 1A, +CE	SOT-89-5	32zt VR7	6h	Ric
W076	R1190H076B	LVR-IC	7.6V±1.5%, 1A, +CE	SOT-89-5	32zt VR7	6h	Ric
W077	R1190H077B	LVR-IC	7.7V±1.5%, 1A, +CE	SOT-89-5	32zt VR7	6h	Ric
W078	R1190H078B	LVR-IC	7.8V±1.5%, 1A, +CE	SOT-89-5	32zt VR7	6h	Ric
W079	R1190H079B	LVR-IC	7.9V±1.5%, 1A, +CE	SOT-89-5	32zt VR7	6h	Ric
W080	R1190H080B	LVR-IC	8.0V±1.5%, 1A, +CE	SOT-89-5	32zt VR7	6h	Ric
W081	R1190H081B	LVR-IC	8.1V±1.5%, 1A, +CE	SOT-89-5	32zt VR7	6h	Ric



SECTION 9
6 and more pin CASES SMD SEMICONDUCTOR COMPONENTS

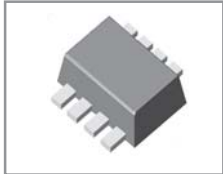
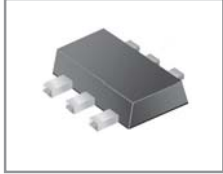

SMD code	Type	Function	Short description	Case	Pinout	Sch.	St.	Mnf.
+AAAA	MAX9718AEUB+	LIN-IC	AF PA, BTL, 2.7..5.5V 1.4W(5V/4Ω), select shutdown	SOP-10	60	AFP19	8d	Max
+AAAB	MAX9718BEUB+	LIN-IC	AF PA, BTL, 2.7..5.5V, 1.4W(5V/4Ω), select shutdown	SOP-10	60	AFP20	8d	Max
+AAAC	MAX9718CEUB+	LIN-IC	AF PA, BTL, 2.7..5.5V, 1.4W(5V/4Ω), select shutdown	SOP-10	60	AFP20	8d	Max
+AAAD	MAX9718DEUB+	LIN-IC	AF PA, BTL, 2.7..5.5V, 1.4W(5V/4Ω), select shutdown	SOP-10	60	AFP20	8d	Max
+AAAJ	MAX9718EEUB+	LIN-IC	AF PA, BTL, 2.7..5.5V, 1.4W(5V/4Ω), select shutdown	SOP-10	60	AFP20	8d	Max
+AAAK	MAX9718FEUB+	LIN-IC	AF PA, BTL, 2.7..5.5V, 1.4W(5V/4Ω), select shutdown	SOP-10	60	AFP20	8d	Max
+AAAL	MAX9718GEUB+	LIN-IC	AF PA, BTL, 2.7..5.5V, 1.4W(5V/4Ω), select shutdown	SOP-10	60	AFP20	8d	Max
+AAAM	MAX9718HEUB+	LIN-IC	AF PA, BTL, 2.7..5.5V, 1.4W(5V/4Ω), select shutdown	SOP-10	60	AFP20	8d	Max
+ACLX	MAX16052AUT+T	Vdet-IC	Adjustable sequencing/supervisory, 2.25..16V, ODO	SOT-23-6	33	-	7b	Max
+ACLX	MAX16053AUT+T	Vdet-IC	Adjustable sequencing/supervisory, 2.25..16V, PPO	SOT-23-6	33	-	7b	Max
00	KIC7W00FK	CMOS-Logic	Dual 2-input NAND gates	US8	47/Log50	-	8c	Kec
00	XC74WL00AASR	CMOS-Logic	Dual 2-input NAND gates	MOSOP-8B	47/Log50	-	8d	Tor
005	FAN7005MU	LIN-IC	AF PA, 2.7..5.5V, 2x300mW(5V/8Ω), shutdown	SSOP-8	47	AFP17	-	F
00B	U74HC2G02-SM1	CMOS-Logic	Dual 2-input NOR gates	MSOP-8	47/Log53	-	8d	Utc
00BL	U74HC2G02L-SM1	CMOS-Logic	Dual 2-input NOR gates	MSOP-8	47/Log53	-	8d	Utc
00W	U74HC2G00-SM1	CMOS-Logic	Dual 2-input NAND gates	MSOP-8	47/Log50	-	8d	Utc
00WL	U74HC2G00L-SM1	CMOS-Logic	Dual 2-input NAND gates	MSOP-8	47/Log50	-	8d	Utc
011	EC49222-1-B3	LVR-IC	LDO, Dual out, Vout1/Vout2=3.0V/3.3V±2%, 250mA, +CE	SOT-23-6L	33x5	VR19	7d	Ecm
011	GS6202RQR	LVR-IC	LDO, Dual out, Vout1/Vout2=3.0V/3.3V±2%, 250mA, +CE	SOT-23-6L	33x5	VR19	7b	Glo
012	EC49222-2-B3	LVR-IC	LDO, Dual out, Vout1/Vout2=1.8V/3.0V±2%, 250mA, +CE	SOT-23-6L	33x5	VR19	7d	Ecm
012	GS6202RFQ	LVR-IC	LDO, Dual out, Vout1/Vout2=1.8V/3.0V±2%, 250mA, +CE	SOT-23-6L	33x5	VR19	7b	Glo
013	EC49222-3-B3	LVR-IC	LDO, Dual out, Vout1/Vout2=3.0V/3.0V±2%, 250mA, +CE	SOT-23-6L	33x5	VR19	7d	Ecm
013	GS6202RQOF	LVR-IC	LDO, Dual out, Vout1/Vout2=3.0V/3.0V±2%, 250mA, +CE	SOT-23-6L	33x5	VR19	7b	Glo
014	EC49222-4-B3	LVR-IC	LDO, Dual out, Vout1/Vout2=1.3V/2.8V±2%, 250mA, +CE	SOT-23-6L	33x5	VR19	7d	Ecm
01A	EC49222-A-B3	LVR-IC	LDO, Dual out, Vout1/Vout2=3.3V/3.3V±2%, 250mA, +CE	SOT-23-6L	33x5	VR19	7d	Ecm
01A	GS6202RRRF	LVR-IC	LDO, Dual out, Vout1/Vout2=3.3V/3.3V±2%, 250mA, +CE	SOT-23-6L	33x5	VR19	7b	Glo
01B	EC49222-B-B3	LVR-IC	LDO, Dual out, Vout1/Vout2=2.8V/3.3V±2%, 250mA, +CE	SOT-23-6L	33x5	VR19	7d	Ecm
01B	GS6202RJRF	LVR-IC	LDO, Dual out, Vout1/Vout2=2.8V/3.3V±2%, 250mA, +CE	SOT-23-6L	33x5	VR19	7b	Glo
01C	EC49222-C-B3	LVR-IC	LDO, Dual out, Vout1/Vout2=2.5V/3.3V±2%, 250mA, +CE	SOT-23-6L	33x5	VR19	7d	Ecm
01C	GS6202RRHF	LVR-IC	LDO, Dual out, Vout1/Vout2=2.5V/3.3V±2%, 250mA, +CE	SOT-23-6L	33x5	VR19	7b	Glo
01C25A	XC9101C25ASR	DC-DC-IC	PWM, step-up, 2.5V±2.5%, 1.5A	SOP-8	47xd	DC17	8g	Tor
01C26A	XC9101C26ASR	DC-DC-IC	PWM, step-up, 2.6V±2.5%, 1.5A	SOP-8	47xd	DC17	8g	Tor
01C27A	XC9101C27ASR	DC-DC-IC	PWM, step-up, 2.7V±2.5%, 1.5A	SOP-8	47xd	DC17	8g	Tor
01C28A	XC9101C28ASR	DC-DC-IC	PWM, step-up, 2.8V±2.5%, 1.5A	SOP-8	47xd	DC17	8g	Tor
01C29A	XC9101C29ASR	DC-DC-IC	PWM, step-up, 2.9V±2.5%, 1.5A	SOP-8	47xd	DC17	8g	Tor
01C30A	XC9101C30ASR	DC-DC-IC	PWM, step-up, 3.0V±2.5%, 1.5A	SOP-8	47xd	DC17	8g	Tor
01C31A	XC9101C31ASR	DC-DC-IC	PWM, step-up, 3.1V±2.5%, 1.5A	SOP-8	47xd	DC17	8g	Tor
01C32A	XC9101C32ASR	DC-DC-IC	PWM, step-up, 3.2V±2.5%, 1.5A	SOP-8	47xd	DC17	8g	Tor
01C33A	XC9101C33ASR	DC-DC-IC	PWM, step-up, 3.3V±2.5%, 1.5A	SOP-8	47xd	DC17	8g	Tor
01C34A	XC9101C34ASR	DC-DC-IC	PWM, step-up, 3.4V±2.5%, 1.5A	SOP-8	47xd	DC17	8g	Tor
01C35A	XC9101C35ASR	DC-DC-IC	PWM, step-up, 3.5V±2.5%, 1.5A	SOP-8	47xd	DC17	8g	Tor
01C36A	XC9101C36ASR	DC-DC-IC	PWM, step-up, 3.6V±2.5%, 1.5A	SOP-8	47xd	DC17	8g	Tor
01C37A	XC9101C37ASR	DC-DC-IC	PWM, step-up, 3.7V±2.5%, 1.5A	SOP-8	47xd	DC17	8g	Tor
01C38A	XC9101C38ASR	DC-DC-IC	PWM, step-up, 3.8V±2.5%, 1.5A	SOP-8	47xd	DC17	8g	Tor
01C39A	XC9101C39ASR	DC-DC-IC	PWM, step-up, 3.9V±2.5%, 1.5A	SOP-8	47xd	DC17	8g	Tor
01C40A	XC9101C40ASR	DC-DC-IC	PWM, step-up, 4.0V±2.5%, 1.5A	SOP-8	47xd	DC17	8g	Tor
01C41A	XC9101C41ASR	DC-DC-IC	PWM, step-up, 4.1V±2.5%, 1.5A	SOP-8	47xd	DC17	8g	Tor
01C42A	XC9101C42ASR	DC-DC-IC	PWM, step-up, 4.2V±2.5%, 1.5A	SOP-8	47xd	DC17	8g	Tor
01C43A	XC9101C43ASR	DC-DC-IC	PWM, step-up, 4.3V±2.5%, 1.5A	SOP-8	47xd	DC17	8g	Tor
01C44A	XC9101C44ASR	DC-DC-IC	PWM, step-up, 4.4V±2.5%, 1.5A	SOP-8	47xd	DC17	8g	Tor
01C45A	XC9101C45ASR	DC-DC-IC	PWM, step-up, 4.5V±2.5%, 1.5A	SOP-8	47xd	DC17	8g	Tor
01C46A	XC9101C46ASR	DC-DC-IC	PWM, step-up, 4.6V±2.5%, 1.5A	SOP-8	47xd	DC17	8g	Tor
01C47A	XC9101C47ASR	DC-DC-IC	PWM, step-up, 4.7V±2.5%, 1.5A	SOP-8	47xd	DC17	8g	Tor
01C48A	XC9101C48ASR	DC-DC-IC	PWM, step-up, 4.8V±2.5%, 1.5A	SOP-8	47xd	DC17	8g	Tor
01C49A	XC9101C49ASR	DC-DC-IC	PWM, step-up, 4.9V±2.5%, 1.5A	SOP-8	47xd	DC17	8g	Tor
01C50A	XC9101C50ASR	DC-DC-IC	PWM, step-up, 5.0V±2.5%, 1.5A	SOP-8	47xd	DC17	8g	Tor
01C51A	XC9101C51ASR	DC-DC-IC	PWM, step-up, 5.1V±2.5%, 1.5A	SOP-8	47xd	DC17	8g	Tor
01C52A	XC9101C52ASR	DC-DC-IC	PWM, step-up, 5.2V±2.5%, 1.5A	SOP-8	47xd	DC17	8g	Tor
01C53A	XC9101C53ASR	DC-DC-IC	PWM, step-up, 5.3V±2.5%, 1.5A	SOP-8	47xd	DC17	8g	Tor
01C54A	XC9101C54ASR	DC-DC-IC	PWM, step-up, 5.4V±2.5%, 1.5A	SOP-8	47xd	DC17	8g	Tor
01C55A	XC9101C55ASR	DC-DC-IC	PWM, step-up, 5.5V±2.5%, 1.5A	SOP-8	47xd	DC17	8g	Tor
01C56A	XC9101C56ASR	DC-DC-IC	PWM, step-up, 5.6V±2.5%, 1.5A	SOP-8	47xd	DC17	8g	Tor
01C57A	XC9101C57ASR	DC-DC-IC	PWM, step-up, 5.7V±2.5%, 1.5A	SOP-8	47xd	DC17	8g	Tor
01C58A	XC9101C58ASR	DC-DC-IC	PWM, step-up, 5.8V±2.5%, 1.5A	SOP-8	47xd	DC17	8g	Tor
01C59A	XC9101C59ASR	DC-DC-IC	PWM, step-up, 5.9V±2.5%, 1.5A	SOP-8	47xd	DC17	8g	Tor
01C60A	XC9101C60ASR	DC-DC-IC	PWM, step-up, 6.0V±2.5%, 1.5A	SOP-8	47xd	DC17	8g	Tor
01C61A	XC9101C61ASR	DC-DC-IC	PWM, step-up, 6.1V±2.5%, 1.5A	SOP-8	47xd	DC17	8g	Tor
01C62A	XC9101C62ASR	DC-DC-IC	PWM, step-up, 6.2V±2.5%, 1.5A	SOP-8	47xd	DC17	8g	Tor
01C63A	XC9101C63ASR	DC-DC-IC	PWM, step-up, 6.3V±2.5%, 1.5A	SOP-8	47xd	DC17	8g	Tor
01C64A	XC9101C64ASR	DC-DC-IC	PWM, step-up, 6.4V±2.5%, 1.5A	SOP-8	47xd	DC17	8g	Tor



SMD code	Type	Function	Short description	Case	Pinout	Sch.	St.	Mnf.
01CD5A	XC9101CD5ASR	DC-DC-IC	PWM, step-up, 13.5V±2.5%, 1.5A	SOP-8	47xd	DC17	8g	Tor
01CD6A	XC9101CD6ASR	DC-DC-IC	PWM, step-up, 13.6V±2.5%, 1.5A	SOP-8	47xd	DC17	8g	Tor
01CD7A	XC9101CD7ASR	DC-DC-IC	PWM, step-up, 13.7V±2.5%, 1.5A	SOP-8	47xd	DC17	8g	Tor
01CD8A	XC9101CD8ASR	DC-DC-IC	PWM, step-up, 13.8V±2.5%, 1.5A	SOP-8	47xd	DC17	8g	Tor
01CD9A	XC9101CD9ASR	DC-DC-IC	PWM, step-up, 13.9V±2.5%, 1.5A	SOP-8	47xd	DC17	8g	Tor
01CE0A	XC9101CE0ASR	DC-DC-IC	PWM, step-up, 14.0V±2.5%, 1.5A	SOP-8	47xd	DC17	8g	Tor
01CE1A	XC9101CE1ASR	DC-DC-IC	PWM, step-up, 14.1V±2.5%, 1.5A	SOP-8	47xd	DC17	8g	Tor
01CE2A	XC9101CE2ASR	DC-DC-IC	PWM, step-up, 14.2V±2.5%, 1.5A	SOP-8	47xd	DC17	8g	Tor
01CE3A	XC9101CE3ASR	DC-DC-IC	PWM, step-up, 14.3V±2.5%, 1.5A	SOP-8	47xd	DC17	8g	Tor
01CE4A	XC9101CE4ASR	DC-DC-IC	PWM, step-up, 14.4V±2.5%, 1.5A	SOP-8	47xd	DC17	8g	Tor
01CE5A	XC9101CE5ASR	DC-DC-IC	PWM, step-up, 14.5V±2.5%, 1.5A	SOP-8	47xd	DC17	8g	Tor
01CE6A	XC9101CE6ASR	DC-DC-IC	PWM, step-up, 14.6V±2.5%, 1.5A	SOP-8	47xd	DC17	8g	Tor
01CE7A	XC9101CE7ASR	DC-DC-IC	PWM, step-up, 14.7V±2.5%, 1.5A	SOP-8	47xd	DC17	8g	Tor
01CE8A	XC9101CE8ASR	DC-DC-IC	PWM, step-up, 14.8V±2.5%, 1.5A	SOP-8	47xd	DC17	8g	Tor
01CE9A	XC9101CE9ASR	DC-DC-IC	PWM, step-up, 14.9V±2.5%, 1.5A	SOP-8	47xd	DC17	8g	Tor
01CF0A	XC9101CF0ASR	DC-DC-IC	PWM, step-up, 15.0V±2.5%, 1.5A	SOP-8	47xd	DC17	8g	Tor
01CF1A	XC9101CF1ASR	DC-DC-IC	PWM, step-up, 15.1V±2.5%, 1.5A	SOP-8	47xd	DC17	8g	Tor
01CF2A	XC9101CF2ASR	DC-DC-IC	PWM, step-up, 15.2V±2.5%, 1.5A	SOP-8	47xd	DC17	8g	Tor
01CF3A	XC9101CF3ASR	DC-DC-IC	PWM, step-up, 15.3V±2.5%, 1.5A	SOP-8	47xd	DC17	8g	Tor
01CF4A	XC9101CF4ASR	DC-DC-IC	PWM, step-up, 15.4V±2.5%, 1.5A	SOP-8	47xd	DC17	8g	Tor
01CF5A	XC9101CF5ASR	DC-DC-IC	PWM, step-up, 15.5V±2.5%, 1.5A	SOP-8	47xd	DC17	8g	Tor
01CF6A	XC9101CF6ASR	DC-DC-IC	PWM, step-up, 15.6V±2.5%, 1.5A	SOP-8	47xd	DC17	8g	Tor
01CF7A	XC9101CF7ASR	DC-DC-IC	PWM, step-up, 15.7V±2.5%, 1.5A	SOP-8	47xd	DC17	8g	Tor
01CF8A	XC9101CF8ASR	DC-DC-IC	PWM, step-up, 15.8V±2.5%, 1.5A	SOP-8	47xd	DC17	8g	Tor
01CF9A	XC9101CF9ASR	DC-DC-IC	PWM, step-up, 15.9V±2.5%, 1.5A	SOP-8	47xd	DC17	8g	Tor
01CH0A	XC9101CHOASR	DC-DC-IC	PWM, step-up, 16.0V±2.5%, 1.5A	SOP-8	47xd	DC17	8g	Tor
01D	EC49222-D-B3	LVR-IC	LDO, Dual out, Vout1/Vout2=1.8V/3.3V±2%, 250mA, +CE	SOT-23-6L	33x5	VR19	7d	Ecm
01D	GS6202RFRF	LVR-IC	LDO, Dual out, Vout1/Vout2=1.8V/3.3V±2%, 250mA, +CE	SOT-23-6L	33x5	VR19	7b	Glo
01E	EC49222-E-B3	LVR-IC	LDO, Dual out, Vout1/Vout2=1.5V/3.3V±2%, 250mA, +CE	SOT-23-6L	33x5	VR19	7d	Ecm
01E	GS6202RGRF	LVR-IC	LDO, Dual out, Vout1/Vout2=1.5V/3.3V±2%, 250mA, +CE	SOT-23-6L	33x5	VR19	7b	Glo
01F	EC49222-F-B3	LVR-IC	LDO, Dual out, Vout1/Vout2=1.2V/3.3V±2%, 250mA, +CE	SOT-23-6L	33x5	VR19	7d	Ecm
01F	GS6202RDRF	LVR-IC	LDO, Dual out, Vout1/Vout2=1.2V/3.3V±2%, 250mA, +CE	SOT-23-6L	33x5	VR19	7b	Glo
01G	EC49222-G-B3	LVR-IC	LDO, Dual out, Vout1/Vout2=2.8V/2.8V±2%, 250mA, +CE	SOT-23-6L	33x5	VR19	7d	Ecm
01G	GS6202RJF	LVR-IC	LDO, Dual out, Vout1/Vout2=2.8V/2.8V±2%, 250mA, +CE	SOT-23-6L	33x5	VR19	7b	Glo
01H	EC49222-H-B3	LVR-IC	LDO, Dual out, Vout1/Vout2=2.5V/2.8V±2%, 250mA, +CE	SOT-23-6L	33x5	VR19	7d	Ecm
01H	GS6202RHJF	LVR-IC	LDO, Dual out, Vout1/Vout2=2.5V/2.8V±2%, 250mA, +CE	SOT-23-6L	33x5	VR19	7b	Glo
01J	EC49222-J-B3	LVR-IC	LDO, Dual out, Vout1/Vout2=1.8V/2.8V±2%, 250mA, +CE	SOT-23-6L	33x5	VR19	7d	Ecm
01J	GS6202RFJF	LVR-IC	LDO, Dual out, Vout1/Vout2=1.8V/2.8V±2%, 250mA, +CE	SOT-23-6L	33x5	VR19	7b	Glo
01K	EC49222-K-B3	LVR-IC	LDO, Dual out, Vout1/Vout2=1.5V/2.8V±2%, 250mA, +CE	SOT-23-6L	33x5	VR19	7d	Ecm
01K	GS6202RGJF	LVR-IC	LDO, Dual out, Vout1/Vout2=1.5V/2.8V±2%, 250mA, +CE	SOT-23-6L	33x5	VR19	7b	Glo
01L	EC49222-L-B3	LVR-IC	LDO, Dual out, Vout1/Vout2=1.2V/2.8V±2%, 250mA, +CE	SOT-23-6L	33x5	VR19	7d	Ecm
01L	GS6202RDJF	LVR-IC	LDO, Dual out, Vout1/Vout2=1.2V/2.8V±2%, 250mA, +CE	SOT-23-6L	33x5	VR19	7b	Glo
01M	EC49222-M-B3	LVR-IC	LDO, Dual out, Vout1/Vout2=2.5V/2.5V±2%, 250mA, +CE	SOT-23-6L	33x5	VR19	7d	Ecm
01M	GS6202RHFF	LVR-IC	LDO, Dual out, Vout1/Vout2=2.5V/2.5V±2%, 250mA, +CE	SOT-23-6L	33x5	VR19	7b	Glo
01N	EC49222-N-B3	LVR-IC	LDO, Dual out, Vout1/Vout2=1.8V/1.5V±2%, 250mA, +CE	SOT-23-6L	33x5	VR19	7d	Ecm
01N	GS6202RFHF	LVR-IC	LDO, Dual out, Vout1/Vout2=1.8V/1.5V±2%, 250mA, +CE	SOT-23-6L	33x5	VR19	7b	Glo
01P	EC49222-P-B3	LVR-IC	LDO, Dual out, Vout1/Vout2=1.5V/2.5V±2%, 250mA, +CE	SOT-23-6L	33x5	VR19	7d	Ecm
01P	GS6202RGHF	LVR-IC	LDO, Dual out, Vout1/Vout2=1.5V/2.5V±2%, 250mA, +CE	SOT-23-6L	33x5	VR19	7b	Glo
01Q	EC49222-Q-B3	LVR-IC	LDO, Dual out, Vout1/Vout2=1.2V/2.5V±2%, 250mA, +CE	SOT-23-6L	33x5	VR19	7d	Ecm
01Q	GS6202RDHF	LVR-IC	LDO, Dual out, Vout1/Vout2=1.2V/2.5V±2%, 250mA, +CE	SOT-23-6L	33x5	VR19	7b	Glo
01R	EC49222-R-B3	LVR-IC	LDO, Dual out, Vout1/Vout2=1.8V/1.8V±2%, 250mA, +CE	SOT-23-6L	33x5	VR19	7d	Ecm
01R	GS6202RFFF	LVR-IC	LDO, Dual out, Vout1/Vout2=1.8V/1.8V±2%, 250mA, +CE	SOT-23-6L	33x5	VR19	7b	Glo
01S	EC49222-S-B3	LVR-IC	LDO, Dual out, Vout1/Vout2=1.5V/1.8V±2%, 250mA, +CE	SOT-23-6L	33x5	VR19	7d	Ecm
01S	GS6202RGFF	LVR-IC	LDO, Dual out, Vout1/Vout2=1.5V/1.8V±2%, 250mA, +CE	SOT-23-6L	33x5	VR19	7b	Glo
01T	EC49222-T-B3	LVR-IC	LDO, Dual out, Vout1/Vout2=1.2V/1.8V±2%, 250mA, +CE	SOT-23-6L	33x5	VR19	7d	Ecm
01T	GS6202RDF	LVR-IC	LDO, Dual out, Vout1/Vout2=1.2V/1.8V±2%, 250mA, +CE	SOT-23-6L	33x5	VR19	7b	Glo
01U	EC49222-U-B3	LVR-IC	LDO, Dual out, Vout1/Vout2=1.5V/1.5V±2%, 250mA, +CE	SOT-23-6L	33x5	VR19	7d	Ecm
01U	GS6202RGGF	LVR-IC	LDO, Dual out, Vout1/Vout2=1.5V/1.5V±2%, 250mA, +CE	SOT-23-6L	33x5	VR19	7b	Glo
01V	EC49222-V-B3	LVR-IC	LDO, Dual out, Vout1/Vout2=1.2V/1.5V±2%, 250mA, +CE	SOT-23-6L	33x5	VR19	7d	Ecm
01V	GS6202RDGF	LVR-IC	LDO, Dual out, Vout1/Vout2=1.2V/1.5V±2%, 250mA, +CE	SOT-23-6L	33x5	VR19	7b	Glo
01W	EC49222-W-B3	LVR-IC	LDO, Dual out, Vout1/Vout2=2.85V/2.85V±2%, 250mA, +CE	SOT-23-6L	33x5	VR19	7d	Ecm
01W	GS6202R11F	LVR-IC	LDO, Dual out, Vout1/Vout2=2.85V/2.85V±2%, 250mA, +CE	SOT-23-6L	33x5	VR19	7b	Glo
024	FAN7024MU	LIN-IC	AF PA, BTL, 2.3..5.5V, 675mW(5V/8Q), shutdown	SSOP-8	47	AFP12	-	F
03B	U74HC2G32-SM1	CMOS-Logic	Dual 2-input OR gates	MSOP-8	47L og52	-	8d	Utc
03BL	U74HC2G32L-SM1	CMOS-Logic	Dual 2-input OR gates	MSOP-8	47L og52	-	8d	Utc
04	K1C7W04FK	CMOS-Logic	Triple inverters	US8	47L og56	-	8c	Kec
04	XC74WL04AASR	CMOS-Logic	Triple inverters	MSOP-8B	47L og56	-	8d	Tor
05	R1163D151E	LVR-IC	LDO, 1.5V±1.5%, 150mA, +CE, AE(mode)	SON-6	34vrc	VR10	7g	Ric
05	XC74WL02AASR	CMOS-Logic	Dual 2-input NOR gates	MSOP-8B	47L og53	-	8d	Tor
05J0	SMS05	TVS	Quad, 5V, 24A, 350W(1ms)	SOT-23-6L	33xd	-	7b	Smt



SMD code	Type	Function	Short description	Case	Pinout	Sch.	St.	Mnf.
06	R1163D161E	LVR-IC	LDO, 1.6V±1.5%, 150mA, +CE, AE(mode)	SON-6	34vrc	VR10	7g	Ric
07	R1163D171E	LVR-IC	LDO, 1.7V±1.5%, 150mA, +CE, AE(mode)	SON-6	34vrc	VR10	7g	Ric
08	KIC7W08FK	CMOS-Logic	Dual 2-input AND gates	US8	47Log51	-	8c	Kec
08	R1163D181E	LVR-IC	LDO, 1.8V±1.5%, 150mA, +CE, AE(mode)	SON-6	34vrc	VR10	7g	Ric
08	XC74WL08AASR	CMOS-Logic	Dual 2-input AND gates	MSOP-8B	47Log51	-	8d	Tor
09	R1163D191E	LVR-IC	LDO, 1.9V±1.5%, 150mA, +CE, AE(mode)	SON-6	34vrc	VR10	7g	Ric
0A	MUN5111DW	Si-pnp-Digi	Dual, Sw, 2x50V, 100mA, 400mW, R1/R2=10/10k	SOT-363	33TD4	-	7b	Mot
0A	R1161D281A5	LVR-IC	LDO, 2.85V±2%, 350mA, -CE, AE(mode)	SON-6	34vrc	VR10	7g	Ric
0A	R5326N001B	LVR-IC	LDO, Dual out, Vout1/Vout2=2.2V/2V±1%, 150mA, +CE, CL	SOT-23-6	33rg	VR19	7d	Ric
0B	MUN5112DW	Si-pnp-Digi	Dual, Sw, 2x50V, 100mA, 400mW, R1/R2=22/22k	SOT-363	33TD4	-	7b	Mot
0B	R1161D101A	LVR-IC	LDO, 1V±2%, 350mA, -CE, AE(mode)	SON-6	34vrc	VR10	7g	Ric
0B	R5326N002B	LVR-IC	LDO, Dual out, Vout1/Vout2=2.8V/3V±1%, 150mA, +CE, CL	SOT-23-6	33rg	VR19	7d	Ric
0C	MUN5113DW	Si-pnp-Digi	Dual, Sw, 2x50V, 100mA, 400mW, R1/R2=47k/47k	SOT-363	33TD4	-	7b	Mot
0C	R1161D201A	LVR-IC	LDO, 2V±2%, 350mA, -CE, AE(mode)	SON-6	34vrc	VR10	7g	Ric
0C	R5326N003B	LVR-IC	LDO, Dual out, Vout1/Vout2=1.8V/3V±1%, 150mA, +CE, CL	SOT-23-6	33rg	VR19	7d	Ric
0D	MUN5114DW	Si-pnp-Digi	Dual, Sw, 2x50V, 100mA, 400mW, R1/R2=10/47k	SOT-363	33TD4	-	7b	Mot
0D	R1161D301A	LVR-IC	LDO, 3V±2%, 350mA, -CE, AE(mode)	SON-6	34vrc	VR10	7g	Ric
0D	R5326N004B	LVR-IC	LDO, Dual out, Vout1/Vout2=2.5V/3V±1%, 150mA, +CE, CL	SOT-23-6	33rg	VR19	7d	Ric
0E	MUN5115DW	Si-pnp-Digi	Dual, Sw, 2x50V, 100mA, 400mW, R1=10k	SOT-363	33TD4	-	7b	Mot
0E	R5326N005B	LVR-IC	LDO, Dual out, Vout1/Vout2=1.8V/2.5V±1%, 150mA, +CE, CL	SOT-23-6	33rg	VR19	7d	Ric
0F	MUN5116DW	Si-pnp-Digi	Dual, Sw, 2x50V, 100mA, 400mW, R1=4k7	SOT-363	33TD4	-	7b	Mot
0F	R1161D101B	LVR-IC	LDO, 1V±2%, 350mA, +CE, AE(mode)	SON-6	34vrc	VR10	7g	Ric
0F	R5326N006B	LVR-IC	LDO, Dual out, Vout1/Vout2=1.8V/3.3V±1%, 150mA, +CE, CL	SOT-23-6	33rg	VR19	7d	Ric
0G	MUN5130DW	Si-pnp-Digi	Dual, Sw, 2x50V, 100mA, 400mW, R1/R2=1k/1k0	SOT-363	33TD4	-	7b	Mot
0G	R1161D201B	LVR-IC	LDO, 2V±2%, 350mA, +CE, AE(mode)	SON-6	34vrc	VR10	7g	Ric
0G	R5326N007B	LVR-IC	LDO, Dual out, Vout1/Vout2=2.5V/2.8V±1%, 150mA, +CE, CL	SOT-23-6	33rg	VR19	7d	Ric
0H	MUN5131DW	Si-pnp-Digi	Dual, Sw, 2x50V, 100mA, 400mW, R1/R2=2k/2k2	SOT-363	33TD4	-	7b	Mot
0H	R1161D301B	LVR-IC	LDO, 3V±2%, 350mA, +CE, AE(mode)	SON-6	34vrc	VR10	7g	Ric
0H	R5326N008B	LVR-IC	LDO, Dual out, Vout1/Vout2=1.2V/1.2V±1%, 150mA, +CE, CL	SOT-23-6	33rg	VR19	7d	Ric
0J	MUN5132DW	Si-pnp-Digi	Dual, Sw, 2x50V, 100mA, 400mW, R1/R2=4k/4k7	SOT-363	33TD4	-	7b	Mot
0J	R1161D101D	LVR-IC	LDO, 1V±2%, 350mA, +CE, CL, AE(mode)	SON-6	34vrc	VR10	7g	Ric
0J	R5326N009B	LVR-IC	LDO, Dual out, Vout1/Vout2=1.1V/1.6V±1%, 150mA, +CE, CL	SOT-23-6	33rg	VR19	7d	Ric
0K	MUN5133DW	Si-pnp-Digi	Dual, Sw, 2x50V, 100mA, 400mW, R1/R2=4k7/47k	SOT-363	33TD4	-	7b	Mot
0K	R5326N010B	LVR-IC	LDO, Dual out, Vout1/Vout2=1.5V/2.8V±1%, 150mA, +CE, CL	SOT-23-6	33rg	VR19	7d	Ric
0L	MUN5134DW	Si-pnp-Digi	Dual, Sw, 2x50V, 100mA, 400mW, R1/R2=22k/47k	SOT-363	33TD4	-	7b	Mot
0L	R1161D201D	LVR-IC	LDO, 2V±2%, 350mA, +CE, CL, AE(mode)	SON-6	34vrc	VR10	7g	Ric
0L	R5326N011B	LVR-IC	LDO, Dual out, Vout1/Vout2=3V/3V±1%, 150mA, +CE, CL	SOT-23-6	33rg	VR19	7d	Ric
0M	R1161D301D	LVR-IC	LDO, 3V±2%, 350mA, +CE, CL, AE(mode)	SON-6	34vrc	VR10	7g	Ric
0M	R5326N012B	LVR-IC	LDO, Dual out, Vout1/Vout2=3.1V/3.1V±1%, 150mA, +CE, CL	SOT-23-6	33rg	VR19	7d	Ric
0N	MUN5136DW	Si-pnp-Digi	Dual, Sw, 2x50V, 100mA, 400mW, R1/R2=100k/100k	SOT-363	33TD4	-	7b	Mot
0N	R5326N013B	LVR-IC	LDO, Dual out, Vout1/Vout2=2.7V/1.8V±1%, 150mA, +CE, CL	SOT-23-6	33rg	VR19	7d	Ric
0P	MUN5137DW	Si-pnp-Digi	Dual, Sw, 2x50V, 100mA, 400mW, R1/R2=47k/22k	SOT-363	33TD4	-	7b	Mot
0P	R5326N014B	LVR-IC	LDO, Dual out, Vout1/Vout2=1.8V/2.6V±1%, 150mA, +CE, CL	SOT-23-6	33rg	VR19	7d	Ric
0Q	R5326N015B	LVR-IC	LDO, Dual out, Vout1/Vout2=3.3V/3.3V±1%, 150mA, +CE, CL	SOT-23-6	33rg	VR19	7d	Ric
0R	R5326N016B	LVR-IC	LDO, Dual out, Vout1/Vout2=2.85V/2.85V±1%, 150mA, +CE, CL	SOT-23-6	33rg	VR19	7d	Ric
0S	R5326N017B	LVR-IC	LDO, Dual out, Vout1/Vout2=1.1V/1.1V±1%, 150mA, +CE, CL	SOT-23-6	33rg	VR19	7d	Ric
0T	R5326N018B	LVR-IC	LDO, Dual out, Vout1/Vout2=1.2V/1.2V±1%, 150mA, +CE, CL	SOT-23-6	33rg	VR19	7d	Ric
0U	R5326N019B	LVR-IC	LDO, Dual out, Vout1/Vout2=1.2V/2.9V±1%, 150mA, +CE, CL	SOT-23-6	33rg	VR19	7d	Ric
0V	R5326N020B	LVR-IC	LDO, Dual out, Vout1/Vout2=2.8V/3.0V±1%, 150mA, +CE, CL	SOT-23-6	33rg	VR19	7d	Ric
0W	R5326N021B	LVR-IC	LDO, Dual out, Vout1/Vout2=1.5V/2.8V±1%, 150mA, +CE, CL	SOT-23-6	33rg	VR19	7d	Ric
0X	R5326N022B	LVR-IC	LDO, Dual out, Vout1/Vout2=1.8V/2.9V±1%, 150mA, +CE, CL	SOT-23-6	33rg	VR19	7d	Ric
0Y	R5326N023B	LVR-IC	LDO, Dual out, Vout1/Vout2=4.2V/3.1V±1%, 150mA, +CE, CL	SOT-23-6	33rg	VR19	7d	Ric
0Z	R5326N024B	LVR-IC	LDO, Dual out, Vout1/Vout2=1.5V/3.0V±1%, 150mA, +CE, CL	SOT-23-6	33rg	VR19	7d	Ric
10	R1163D201E	LVR-IC	LDO, 2V±1.5%, 150mA, +CE, AE(mode)	SON-6	34vrc	VR10	7g	Ric
10.	MA3A100	Z-diode	Triple, 9.4..10.6V, 70mA, Zzt=80, 100mW,	SOP-6	33bb	-	7b	Pan
101	XC6415AA01MR	LVR-IC	LDO, Dual out, Vout1/Vout2=1.80/2.80V±1%, 200mA, +CE	SOT-26	33x5	VR19	7d	Tor
102	XC6415AA02MR	LVR-IC	LDO, Dual out, Vout1/Vout2=1.20/2.90V±1%, 200mA, +CE	SOT-26	33x5	VR19	7d	Tor
103	XC6415AA03MR	LVR-IC	LDO, Dual out, Vout1/Vout2=1.80/1.80V±1%, 200mA, +CE	SOT-26	33x5	VR19	7d	Tor
104	XC6415AA04MR	LVR-IC	LDO, Dual out, Vout1/Vout2=1.50/2.70V±1%, 200mA, +CE	SOT-26	33x5	VR19	7d	Tor
105	FC105	Si-pnp-Digi	Dual, Sw, 50V, 100mA, 200mW, 200MHz, R1/R2=47k/47k	SOT-363	33TD4	-	7b	San
105	XC6415AA05MR	LVR-IC	LDO, Dual out, Vout1/Vout2=2.85/2.85V±1%, 200mA, +CE	SOT-26	33x5	VR19	7d	Tor
106	FC106	Si-pnp-Digi	Dual, Sw, 50V, 100mA, 200mW, 200MHz, R1/R2=47k/47k	SOT-363	33TD3	-	7b	San
106	XC6415AA06MR	LVR-IC	LDO, Dual out, Vout1/Vout2=1.80/3.30V±1%, 200mA, +CE	SOT-26	33x5	VR19	7d	Tor
107	XC6415AA07MR	LVR-IC	LDO, Dual out, Vout1/Vout2=1.80/3.00V±1%, 200mA, +CE	SOT-26	33x5	VR19	7d	Tor
108	XC6415AA08MR	LVR-IC	LDO, Dual out, Vout1/Vout2=2.80/1.80V±1%, 200mA, +CE	SOT-26	33x5	VR19	7d	Tor
109	XC6415AA09MR	LVR-IC	LDO, Dual out, Vout1/Vout2=1.20/1.20V±1%, 200mA, +CE	SOT-26	33x5	VR19	7d	Tor
10N02Z	NM5F10N02Z	n-MOSFET-e*	V-MOS, LogL, 20V, 7A, 2.5W, <16mQ(5A), 65/325ns	SOP-8	47fs	-	8d	Ons
11	MUN5311DW	Si-n/p-Digi	Dual, Sw, 50V, 100mA, 200mW, R1/R2=10/10k	SOT-363	33TD2	-	7b	Mot
11	R1163D211E	LVR-IC	LDO, 2.1V±1.5%, 150mA, +CE, AE(mode)	SON-6	34vrc	VR10	7g	Ric
110	XC6415AA10MR	LVR-IC	LDO, Dual out, Vout1/Vout2=1.10/1.30V±1%, 200mA, +CE	SOT-26	33x5	VR19	7d	Tor



SMD code	Type	Function	Short description	Case	Pinout	Sch.	St.	Mnf.
111	XC6415AA11MR	LVR-IC	LDO, Dual out, Vout1/Vout2=1.30/1.50V±1%, 200mA, +CE	SOT-26	33x5	VR19	7d	Tor
112	XC6415AA12MR	LVR-IC	LDO, Dual out, Vout1/Vout2=2.80/2.80V±1%, 200mA, +CE	SOT-26	33x5	VR19	7d	Tor
113	XC6415AA13MR	LVR-IC	LDO, Dual out, Vout1/Vout2=2.50/3.30V±1%, 200mA, +CE	SOT-26	33x5	VR19	7d	Tor
114	XC6415AA14MR	LVR-IC	LDO, Dual out, Vout1/Vout2=3.00/3.30V±1%, 200mA, +CE	SOT-26	33x5	VR19	7d	Tor
115	XC6415AA15MR	LVR-IC	LDO, Dual out, Vout1/Vout2=1.20/1.80V±1%, 200mA, +CE	SOT-26	33x5	VR19	7d	Tor
116	XC6415AA16MR	LVR-IC	LDO, Dual out, Vout1/Vout2=2.80/3.30V±1%, 200mA, +CE	SOT-26	33x5	VR19	7d	Tor
1166	LT1166CS8	LIN-IC	Dual AF voltage amplifier (60W AF PA driver)	SOP-8	47	-	8d	Ltc
117	XC6415AA17MR	LVR-IC	LDO, Dual out, Vout1/Vout2=3.30/3.30V±1%, 200mA, +CE	SOT-26	33x5	VR19	7d	Tor
118	XC6415AA18MR	LVR-IC	LDO, Dual out, Vout1/Vout2=3.10/3.10V±1%, 200mA, +CE	SOT-26	33x5	VR19	7d	Tor
119	XC6415AA19MR	LVR-IC	LDO, Dual out, Vout1/Vout2=2.80/1.50V±1%, 200mA, +CE	SOT-26	33x5	VR19	7d	Tor
12	MUN5312DW	Si-n/p-Digi	Dual, Sw, 50V, 100mA, 200mW, R1/R2=22/22k	SOT-363	33/TD2	-	7b	Mot
12	R1163D221E	LVR-IC	LDO, 2.2V±1.5%, 150mA, +CE, AE(mode)	SON-6	34vrc	VR10	7g	Ric
12Z1	SMS12	TVS	Quad, 12V, 15A, 350W(1ms)	SOT-23-6L	33dx	-	7b	Smt
120	XC6415AA20MR	LVR-IC	LDO, Dual out, Vout1/Vout2=1.30/2.80V±1%, 200mA, +CE	SOT-26	33x5	VR19	7d	Tor
121	XC6415AA21MR	LVR-IC	LDO, Dual out, Vout1/Vout2=1.50/2.80V±1%, 200mA, +CE	SOT-26	33x5	VR19	7d	Tor
122	XC6415AA22MR	LVR-IC	LDO, Dual out, Vout1/Vout2=1.80/3.00V±1%, 200mA, +CE	SOT-26	33x5	VR19	7d	Tor
123	XC6415AA23MR	LVR-IC	LDO, Dual out, Vout1/Vout2=1.85/2.80V±1%, 200mA, +CE	SOT-26	33x5	VR19	7d	Tor
124	XC6415AA24MR	LVR-IC	LDO, Dual out, Vout1/Vout2=1.85/3.30V±1%, 200mA, +CE	SOT-26	33x5	VR19	7d	Tor
125	KIC7W125FK	CMOS-Logic	Dual bus buffer with 3-state output	US8	47/Log54	-	8c	Kec
125	XC6415AA25MR	LVR-IC	LDO, Dual out, Vout1/Vout2=2.60/2.80V±1%, 200mA, +CE	SOT-26	33x5	VR19	7d	Tor
125	KIC74WL125AASR	CMOS-Logic	Dual bus buffer with 3-state output	MSOP-8B	47/Log54	-	8d	Tor
126	KIC7W126FK	CMOS-Logic	Dual bus buffer with 3-state output	US8	47/Log55	-	8c	Kec
126	XC6415AA26MR	LVR-IC	LDO, Dual out, Vout1/Vout2=1.50/1.50V±1%, 200mA, +CE	SOT-26	33x5	VR19	7d	Tor
126	KIC74WL126AASR	CMOS-Logic	Dual bus buffer with 3-state output	MSOP-8B	47/Log55	-	8d	Tor
127	XC6415AA27MR	LVR-IC	LDO, Dual out, Vout1/Vout2=2.00/3.00V±1%, 200mA, +CE	SOT-26	33x5	VR19	7d	Tor
128	XC6415AA28MR	LVR-IC	LDO, Dual out, Vout1/Vout2=3.30/1.80V±1%, 200mA, +CE	SOT-26	33x5	VR19	7d	Tor
129	XC6415AA29MR	LVR-IC	LDO, Dual out, Vout1/Vout2=3.30/1.75V±1%, 200mA, +CE	SOT-26	33x5	VR19	7d	Tor
12A	MMQA12V	TVS	Quad, 12V, 24W(1ms)	SC-74	33dx	-	7b	Ons
13	BC847BVN	Si-n/p	Dual, GP, 50V, 100mA, 200mW, B=200..450, >100MHz	SOT-666	35/T9	-	7b	Phi
13	MUN5313DW	Si-n/p-Digi	Dual, Sw, 50V, 100mA, 200mW, R1/R2=47k/47k	SOT-363	33/TD2	-	7b	Mot
13	R1163D231E	LVR-IC	LDO, 2.3V±1.5%, 150mA, +CE, AE(mode)	SON-6	34vrc	VR10	7g	Ric
130	XC6415AA30MR	LVR-IC	LDO, Dual out, Vout1/Vout2=2.10/4.10V±1%, 200mA, +CE	SOT-26	33x5	VR19	7d	Tor
131	XC6415AA31MR	LVR-IC	LDO, Dual out, Vout1/Vout2=1.20/2.80V±1%, 200mA, +CE	SOT-26	33x5	VR19	7d	Tor
132	XC6415AA32MR	LVR-IC	LDO, Dual out, Vout1/Vout2=1.50/1.80V±1%, 200mA, +CE	SOT-26	33x5	VR19	7d	Tor
133	XC6415AA33MR	LVR-IC	LDO, Dual out, Vout1/Vout2=1.50/3.00V±1%, 200mA, +CE	SOT-26	33x5	VR19	7d	Tor
134	XC6415AA34MR	LVR-IC	LDO, Dual out, Vout1/Vout2=1.50/3.30V±1%, 200mA, +CE	SOT-26	33x5	VR19	7d	Tor
135	XC6415AA35MR	LVR-IC	LDO, Dual out, Vout1/Vout2=1.50/2.60V±1%, 200mA, +CE	SOT-26	33x5	VR19	7d	Tor
136	XC6415AA36MR	LVR-IC	LDO, Dual out, Vout1/Vout2=2.00/2.50V±1%, 200mA, +CE	SOT-26	33x5	VR19	7d	Tor
137	XC6415AA37MR	LVR-IC	LDO, Dual out, Vout1/Vout2=3.30/4.50V±1%, 200mA, +CE	SOT-26	33x5	VR19	7d	Tor
138	XC6415AA38MR	LVR-IC	LDO, Dual out, Vout1/Vout2=2.50/2.50V±1%, 200mA, +CE	SOT-26	33x5	VR19	7d	Tor
139	XC6415AA39MR	LVR-IC	LDO, Dual out, Vout1/Vout2=1.80/2.50V±1%, 200mA, +CE	SOT-26	33x5	VR19	7d	Tor
13A	MMQA13V1	TVS	Quad, 13V, 24W(1ms)	SC-74	33dx	-	7b	Ons
13A	TK74013L	LVR-IC	LDO, Dual out, Vout1/Vout2=1.3V/1.3V±2%, 300mA, +CE	SOT-23L-8	47uh	VR22	8d	Tok
13F	BC847BPDW	Si-n/p	Dual, GP, 50V, 100mA, 250mW, B=200..450, >100MHz	SOT-363	33/T9	-	7b	Ons
13G	BC847CPDW	Si-n/p	Dual, GP, 50V, 100mA, 250mW, B=420..800, >100MHz	SOT-363	33/T9	-	7b	Ons
13K	BC848BPDW	Si-n/p	Dual, GP, 30V, 100mA, 250mW, B=200..450, >100MHz	SOT-363	33/T9	-	7b	Ons
13L	BC848CPDW	Si-n/p	Dual, GP, 30V, 100mA, 250mW, B=420..800, >100MHz	SOT-363	33/T9	-	7b	Ons
13P	TK11213BM	LVR-IC	LDO, 1.3V±2%, 150mA, +CE	SOT-23L-6	33vf	VR7	7b	Tok
13t	BC847BPN	Si-n/p	Dual, GP, 50V, 100mA, 200mW, B=200..450, >100MHz	SOT-363	33/T9	-	7b	Phi
14	KIC7W14FK	CMOS-Logic	Triple Schmitt-trigger inverters	US8	47/Log57	-	8c	Kec
14	MUN5314DW	Si-n/p-Digi	Dual, Sw, 50V, 100mA, 200mW, R1/R2=10/47k	SOT-363	33/TD2	-	7b	Mot
14	R1163D241E	LVR-IC	LDO, 2.4V±1.5%, 150mA, +CE, AE(mode)	SON-6	34vrc	VR10	7g	Ric
14	XC74WL14AASR	CMOS-Logic	Triple Schmitt-trigger inverters	MSOP-8B	47/Log57	-	8d	Tor
140	XC6415AA40MR	LVR-IC	LDO, Dual out, Vout1/Vout2=1.20/2.50V±1%, 200mA, +CE	SOT-26	33x5	VR19	7d	Tor
141	XC6415AA41MR	LVR-IC	LDO, Dual out, Vout1/Vout2=2.80/3.00V±1%, 200mA, +CE	SOT-26	33x5	VR19	7d	Tor
142	XC6415AA42MR	LVR-IC	LDO, Dual out, Vout1/Vout2=2.90/1.80V±1%, 200mA, +CE	SOT-26	33x5	VR19	7d	Tor
143	XC6415AA43MR	LVR-IC	LDO, Dual out, Vout1/Vout2=3.00/1.80V±1%, 200mA, +CE	SOT-26	33x5	VR19	7d	Tor
144	XC6415AA44MR	LVR-IC	LDO, Dual out, Vout1/Vout2=2.50/1.80V±1%, 200mA, +CE	SOT-26	33x5	VR19	7d	Tor
145	XC6415AA45MR	LVR-IC	LDO, Dual out, Vout1/Vout2=1.80/2.85V±1%, 200mA, +CE	SOT-26	33x5	VR19	7d	Tor
146	XC6415AA46MR	LVR-IC	LDO, Dual out, Vout1/Vout2=1.50/1.20V±1%, 200mA, +CE	SOT-26	33x5	VR19	7d	Tor
1460A1	LT1460ACS8-10	VrefIC	µPower, Precision, Series, 10V, 0.075%	S8	47af	VR1	8d	Ltc
1460A2	LT1460ACS8-2.5	VrefIC	µPower, Precision, Series, 2.5V, 0.075%	S8	47af	VR1	8d	Ltc
1460A5	LT1460ACS8-5	VrefIC	µPower, Precision, Series, 5.0V, 0.075%	S8	47af	VR1	8d	Ltc
1460D1	LT1460DCS8-10	VrefIC	µPower, Precision, Series, 10V, 0.075%	S8	47af	VR1	8d	Ltc
1460D2	LT1460DCS8-2.5	VrefIC	µPower, Precision, Series, 2.5V, 0.075%	S8	47af	VR1	8d	Ltc
1460D5	LT1460DCS8-5	VrefIC	µPower, Precision, Series, 5.0V, 0.075%	S8	47af	VR1	8d	Ltc
147	XC6415AA47MR	LVR-IC	LDO, Dual out, Vout1/Vout2=2.85/1.50V±1%, 200mA, +CE	SOT-26	33x5	VR19	7d	Tor
148	XC6415AA48MR	LVR-IC	LDO, Dual out, Vout1/Vout2=3.20/3.20V±1%, 200mA, +CE	SOT-26	33x5	VR19	7d	Tor
149	XC6415AA49MR	LVR-IC	LDO, Dual out, Vout1/Vout2=1.20/3.00V±1%, 200mA, +CE	SOT-26	33x5	VR19	7d	Tor
14A	TK74014L	LVR-IC	LDO, Dual out, Vout1/Vout2=1.4V/1.4V±2%, 300mA, +CE	SOT-23L-8	47uh	VR22	8d	Tok



SMD code	Type	Function	Short description	Case	Pinout	Sch.	St.	Mnf.
14P	TK11214BM	LVR-IC	LDO, 1.4V±2%, 150mA, +CE	SOT-23L-6	33vf	VR7	7b	Tok
15	MUN5315DW	Si-n/p-Digi	Dual, Sw, 50V, 100mA, 200mW, R1=10k	SOT-363	33/TTD2	-	7b	Mot
15	R1163D251E	LVR-IC	LDO, 2.5V±1.5%, 150mA, +CE, AE(mode)	SON-6	34vrc	VR10	7g	Ric
15F ↓	SMS15	TVS	Quad, 15V, 12A, 350W(1ms)	SOT-23-6L	33dx	-	7b	Smt
150	XC6415AA50MR	LVR-IC	LDO, Dual out, Vout1/Vout2=2.60/2.85V±1%, 200mA, +CE	SOT-26	33x5	VR19	7d	Tor
151	XC6415AA51MR	LVR-IC	LDO, Dual out, Vout1/Vout2=1.5V/1.7V±0.5%, 200mA, +CE	SOT-26	33x5	VR19	7d	Tor
1515G	LR31515BG-AG6	LVR-IC	LDO, Dual out, Vout1/Vout2=1.5V/1.5V±0.5%, 150mA, +CE	SOP-6	33x5	VR19	7b	Utc
1516G	LR31516BG-AG6	LVR-IC	LDO, Dual out, Vout1/Vout2=1.5V/1.6V±0.5%, 150mA, +CE	SOP-6	33x5	VR19	7b	Utc
1517G	LR31517BG-AG6	LVR-IC	LDO, Dual out, Vout1/Vout2=1.5V/1.7V±0.5%, 150mA, +CE	SOP-6	33x5	VR19	7b	Utc
1518G	LR31518BG-AG6	LVR-IC	LDO, Dual out, Vout1/Vout2=1.5V/1.8V±0.5%, 150mA, +CE	SOP-6	33x5	VR19	7b	Utc
1519G	LR31519BG-AG6	LVR-IC	LDO, Dual out, Vout1/Vout2=1.5V/1.9V±0.5%, 150mA, +CE	SOP-6	33x5	VR19	7b	Utc
152	XC6415AA52MR	LVR-IC	LDO, Dual out, Vout1/Vout2=5.0V/3.6V±1%, 200mA, +CE	SOT-26	33x5	VR19	7d	Tor
1520G	LR31520BG-AG6	LVR-IC	LDO, Dual out, Vout1/Vout2=1.5V/2.0V±0.5%, 150mA, +CE	SOP-6	33x5	VR19	7b	Utc
1521G	LR31521BG-AG6	LVR-IC	LDO, Dual out, Vout1/Vout2=1.5V/2.1V±0.5%, 150mA, +CE	SOP-6	33x5	VR19	7b	Utc
1522G	LR31522BG-AG6	LVR-IC	LDO, Dual out, Vout1/Vout2=1.5V/2.2V±0.5%, 150mA, +CE	SOP-6	33x5	VR19	7b	Utc
1523G	LR31523BG-AG6	LVR-IC	LDO, Dual out, Vout1/Vout2=1.5V/2.3V±0.5%, 150mA, +CE	SOP-6	33x5	VR19	7b	Utc
1524G	LR31524BG-AG6	LVR-IC	LDO, Dual out, Vout1/Vout2=1.5V/2.4V±0.5%, 150mA, +CE	SOP-6	33x5	VR19	7b	Utc
1525G	LR31525BG-AG6	LVR-IC	LDO, Dual out, Vout1/Vout2=1.5V/2.5V±0.5%, 150mA, +CE	SOP-6	33x5	VR19	7b	Utc
1526G	LR31526BG-AG6	LVR-IC	LDO, Dual out, Vout1/Vout2=1.5V/2.6V±0.5%, 150mA, +CE	SOP-6	33x5	VR19	7b	Utc
1527G	LR31527BG-AG6	LVR-IC	LDO, Dual out, Vout1/Vout2=1.5V/2.7V±0.5%, 150mA, +CE	SOP-6	33x5	VR19	7b	Utc
1528G	LR31528BG-AG6	LVR-IC	LDO, Dual out, Vout1/Vout2=1.5V/2.8V±0.5%, 150mA, +CE	SOP-6	33x5	VR19	7b	Utc
1529G	LR31529BG-AG6	LVR-IC	LDO, Dual out, Vout1/Vout2=1.5V/2.9V±0.5%, 150mA, +CE	SOP-6	33x5	VR19	7b	Utc
153	XC6415AA53MR	LVR-IC	LDO, Dual out, Vout1/Vout2=1.80/1.20V±1%, 200mA, +CE	SOT-26	33x5	VR19	7d	Tor
1530G	LR31530BG-AG6	LVR-IC	LDO, Dual out, Vout1/Vout2=1.5V/3.0V±0.5%, 150mA, +CE	SOP-6	33x5	VR19	7b	Utc
1531G	LR31531BG-AG6	LVR-IC	LDO, Dual out, Vout1/Vout2=1.5V/3.1V±0.5%, 150mA, +CE	SOP-6	33x5	VR19	7b	Utc
1532G	LR31532BG-AG6	LVR-IC	LDO, Dual out, Vout1/Vout2=1.5V/3.2V±0.5%, 150mA, +CE	SOP-6	33x5	VR19	7b	Utc
1533G	LR31533BG-AG6	LVR-IC	LDO, Dual out, Vout1/Vout2=1.5V/3.3V±0.5%, 150mA, +CE	SOP-6	33x5	VR19	7b	Utc
154	XC6415AA54MR	LVR-IC	LDO, Dual out, Vout1/Vout2=2.60/3.00V±1%, 200mA, +CE	SOT-26	33x5	VR19	7d	Tor
155	XC6415AA55MR	LVR-IC	LDO, Dual out, Vout1/Vout2=2.60/3.20V±1%, 200mA, +CE	SOT-26	33x5	VR19	7d	Tor
156	XC6415AA56MR	LVR-IC	LDO, Dual out, Vout1/Vout2=1.80/2.60V±1%, 200mA, +CE	SOT-26	33x5	VR19	7d	Tor
157	XC6415AA57MR	LVR-IC	LDO, Dual out, Vout1/Vout2=2.60/3.30V±1%, 200mA, +CE	SOT-26	33x5	VR19	7d	Tor
158	XC6415AA58MR	LVR-IC	LDO, Dual out, Vout1/Vout2=2.50/3.90V±1%, 200mA, +CE	SOT-26	33x5	VR19	7d	Tor
159	XC6415AA59MR	LVR-IC	LDO, Dual out, Vout1/Vout2=1.80/2.70V±1%, 200mA, +CE	SOT-26	33x5	VR19	7d	Tor
15A	MMQA15V	TVS	Quad, 15V, 24W(1ms)	SC-74	33dx	-	7b	Ons
15A	TK74015L	LVR-IC	LDO, Dual out, Vout1/Vout2=1.5V/1.5V±2%, 300mA, +CE	SOT-23L-8	47uh	VR22	8d	Tok
15P	TK11215BM	LVR-IC	LDO, 1.5V±2%, 150mA, +CE	SOT-23L-6	33vf	VR7	7b	Tok
16	MUN5316DW	Si-n/p-Digi	Dual, Sw, 50V, 100mA, 200mW, R1=4k7	SOT-363	33/TTD2	-	7b	Mot
16	R1163D261E	LVR-IC	LDO, 2.6V±1.5%, 150mA, +CE, AE(mode)	SON-6	34vrc	VR10	7g	Ric
160	XC6415AA60MR	LVR-IC	LDO, Dual out, Vout1/Vout2=1.00/2.80V±1%, 200mA, +CE	SOT-26	33x5	VR19	7d	Tor
161	XC6415AA61MR	LVR-IC	LDO, Dual out, Vout1/Vout2=3.00/1.50V±1%, 200mA, +CE	SOT-26	33x5	VR19	7d	Tor
1615G	LR31615BG-AG6	LVR-IC	LDO, Dual out, Vout1/Vout2=1.6V/1.5V±0.5%, 150mA, +CE	SOP-6	33x5	VR19	7b	Utc
1616G	LR31616BG-AG6	LVR-IC	LDO, Dual out, Vout1/Vout2=1.6V/1.6V±0.5%, 150mA, +CE	SOP-6	33x5	VR19	7b	Utc
1617G	LR31617BG-AG6	LVR-IC	LDO, Dual out, Vout1/Vout2=1.6V/1.7V±0.5%, 150mA, +CE	SOP-6	33x5	VR19	7b	Utc
1618G	LR31618BG-AG6	LVR-IC	LDO, Dual out, Vout1/Vout2=1.6V/1.8V±0.5%, 150mA, +CE	SOP-6	33x5	VR19	7b	Utc
1619G	LR31619BG-AG6	LVR-IC	LDO, Dual out, Vout1/Vout2=1.6V/1.9V±0.5%, 150mA, +CE	SOP-6	33x5	VR19	7b	Utc
162	XC6415AA62MR	LVR-IC	LDO, Dual out, Vout1/Vout2=2.70/1.80V±1%, 200mA, +CE	SOT-26	33x5	VR19	7d	Tor
1620G	LR31620BG-AG6	LVR-IC	LDO, Dual out, Vout1/Vout2=1.6V/2.0V±0.5%, 150mA, +CE	SOP-6	33x5	VR19	7b	Utc
1621G	LR31621BG-AG6	LVR-IC	LDO, Dual out, Vout1/Vout2=1.6V/2.1V±0.5%, 150mA, +CE	SOP-6	33x5	VR19	7b	Utc
1622G	LR31622BG-AG6	LVR-IC	LDO, Dual out, Vout1/Vout2=1.6V/2.2V±0.5%, 150mA, +CE	SOP-6	33x5	VR19	7b	Utc
1623G	LR31623BG-AG6	LVR-IC	LDO, Dual out, Vout1/Vout2=1.6V/2.3V±0.5%, 150mA, +CE	SOP-6	33x5	VR19	7b	Utc
1624G	LR31624BG-AG6	LVR-IC	LDO, Dual out, Vout1/Vout2=1.6V/2.4V±0.5%, 150mA, +CE	SOP-6	33x5	VR19	7b	Utc
1625G	LR31625BG-AG6	LVR-IC	LDO, Dual out, Vout1/Vout2=1.6V/2.5V±0.5%, 150mA, +CE	SOP-6	33x5	VR19	7b	Utc
1626G	LR31626BG-AG6	LVR-IC	LDO, Dual out, Vout1/Vout2=1.6V/2.6V±0.5%, 150mA, +CE	SOP-6	33x5	VR19	7b	Utc
1627G	LR31627BG-AG6	LVR-IC	LDO, Dual out, Vout1/Vout2=1.6V/2.7V±0.5%, 150mA, +CE	SOP-6	33x5	VR19	7b	Utc
1628G	LR31628BG-AG6	LVR-IC	LDO, Dual out, Vout1/Vout2=1.6V/2.8V±0.5%, 150mA, +CE	SOP-6	33x5	VR19	7b	Utc
1629G	LR31629BG-AG6	LVR-IC	LDO, Dual out, Vout1/Vout2=1.6V/2.9V±0.5%, 150mA, +CE	SOP-6	33x5	VR19	7b	Utc
163	XC6415AA63MR	LVR-IC	LDO, Dual out, Vout1/Vout2=2.80/2.70V±1%, 200mA, +CE	SOT-26	33x5	VR19	7d	Tor
1630G	LR31630BG-AG6	LVR-IC	LDO, Dual out, Vout1/Vout2=1.6V/3.0V±0.5%, 150mA, +CE	SOP-6	33x5	VR19	7b	Utc
1631G	LR31631BG-AG6	LVR-IC	LDO, Dual out, Vout1/Vout2=1.6V/3.1V±0.5%, 150mA, +CE	SOP-6	33x5	VR19	7b	Utc
1632G	LR31632BG-AG6	LVR-IC	LDO, Dual out, Vout1/Vout2=1.6V/3.2V±0.5%, 150mA, +CE	SOP-6	33x5	VR19	7b	Utc
1633G	LR31633BG-AG6	LVR-IC	LDO, Dual out, Vout1/Vout2=1.6V/3.3V±0.5%, 150mA, +CE	SOP-6	33x5	VR19	7b	Utc
164	XC6415AA64MR	LVR-IC	LDO, Dual out, Vout1/Vout2=2.80/3.10V±1%, 200mA, +CE	SOT-26	33x5	VR19	7d	Tor
1648	AIC1648CG	LDR-IC	1.2 MHz PWM White LED driver, OVP 4.2V	SOT-23-6	33sv	LD2	7b	Aic
1648P	AIC1648PG	LDR-IC	1.2 MHz PWM White LED driver, OVP 4.2V	SOT-23-6	33sv	LD2	7b	Aic
165	XC6415AA65MR	LVR-IC	LDO, Dual out, Vout1/Vout2=2.85/3.30V±1%, 200mA, +CE	SOT-26	33x5	VR19	7d	Tor
166	XC6415AA66MR	LVR-IC	LDO, Dual out, Vout1/Vout2=1.20/3.30V±1%, 200mA, +CE	SOT-26	33x5	VR19	7d	Tor
167	XC6415AA67MR	LVR-IC	LDO, Dual out, Vout1/Vout2=2.80/2.50V±1%, 200mA, +CE	SOT-26	33x5	VR19	7d	Tor
168	XC6415AA68MR	LVR-IC	LDO, Dual out, Vout1/Vout2=2.85/1.20V±1%, 200mA, +CE	SOT-26	33x5	VR19	7d	Tor
169	XC6415AA69MR	LVR-IC	LDO, Dual out, Vout1/Vout2=2.75/2.75V±1%, 200mA, +CE	SOT-26	33x5	VR19	7d	Tor
16A	TK74016L	LVR-IC	LDO, Dual out, Vout1/Vout2=1.6V/1.6V±2%, 300mA, +CE	SOT-23L-8	47uh	VR22	8d	Tok



SMD code	Type	Function	Short description	Case	Pinout	Sch.	St.	Mnf.
16P	TK11216BM	LVR-IC	LDO, 1.6V±2%, 150mA, +CE	SOT-23L-6	33vf	VR7	7b	Tok
16T	TW64148T-16WS	Si-diode	Triple, Sw, 100V, 150mA, Vf<1.25V(150mA), <4pF	SOT-363	33bb	-	7b	Tfr
17	R1163D271E	LVR-IC	LDO, 2.7V±1.5%, 150mA, +CE, AE(mode)	SON-6	34vrc	VR10	7g	Ric
170	XC6415AA70MR	LVR-IC	LDO, Dual out, Vout1/Vout2=3.00/2.90V±1%, 200mA, +CE	SOT-26	33x5	VR19	7d	Tor
171	XC6415AA71MR	LVR-IC	LDO, Dual out, Vout1/Vout2=3.00/2.95V±1%, 200mA, +CE	SOT-26	33x5	VR19	7d	Tor
1715G	LR31715BG-AG6	LVR-IC	LDO, Dual out, Vout1/Vout2=1.7V/1.5V±0.5%, 150mA, +CE	SOP-6	33x5	VR19	7b	Utc
1716G	LR31716BG-AG6	LVR-IC	LDO, Dual out, Vout1/Vout2=1.7V/1.6V±0.5%, 150mA, +CE	SOP-6	33x5	VR19	7b	Utc
1717G	LR31717BG-AG6	LVR-IC	LDO, Dual out, Vout1/Vout2=1.7V/1.7V±0.5%, 150mA, +CE	SOP-6	33x5	VR19	7b	Utc
1718G	LR31718BG-AG6	LVR-IC	LDO, Dual out, Vout1/Vout2=1.7V/1.8V±0.5%, 150mA, +CE	SOP-6	33x5	VR19	7b	Utc
1719G	LR31719BG-AG6	LVR-IC	LDO, Dual out, Vout1/Vout2=1.7V/1.9V±0.5%, 150mA, +CE	SOP-6	33x5	VR19	7b	Utc
172	XC6415AA72MR	LVR-IC	LDO, Dual out, Vout1/Vout2=3.00/3.05V±1%, 200mA, +CE	SOT-26	33x5	VR19	7d	Tor
1720G	LR31720BG-AG6	LVR-IC	LDO, Dual out, Vout1/Vout2=1.7V/2.0V±0.5%, 150mA, +CE	SOP-6	33x5	VR19	7b	Utc
1721G	LR31721BG-AG6	LVR-IC	LDO, Dual out, Vout1/Vout2=1.7V/2.1V±0.5%, 150mA, +CE	SOP-6	33x5	VR19	7b	Utc
1722G	LR31722BG-AG6	LVR-IC	LDO, Dual out, Vout1/Vout2=1.7V/2.2V±0.5%, 150mA, +CE	SOP-6	33x5	VR19	7b	Utc
1723G	LR31723BG-AG6	LVR-IC	LDO, Dual out, Vout1/Vout2=1.7V/2.3V±0.5%, 150mA, +CE	SOP-6	33x5	VR19	7b	Utc
1724G	LR31724BG-AG6	LVR-IC	LDO, Dual out, Vout1/Vout2=1.7V/2.4V±0.5%, 150mA, +CE	SOP-6	33x5	VR19	7b	Utc
1725G	LR31725BG-AG6	LVR-IC	LDO, Dual out, Vout1/Vout2=1.7V/2.5V±0.5%, 150mA, +CE	SOP-6	33x5	VR19	7b	Utc
1726G	LR31726BG-AG6	LVR-IC	LDO, Dual out, Vout1/Vout2=1.7V/2.6V±0.5%, 150mA, +CE	SOP-6	33x5	VR19	7b	Utc
1727G	LR31727BG-AG6	LVR-IC	LDO, Dual out, Vout1/Vout2=1.7V/2.7V±0.5%, 150mA, +CE	SOP-6	33x5	VR19	7b	Utc
1728G	LR31728BG-AG6	LVR-IC	LDO, Dual out, Vout1/Vout2=1.7V/2.8V±0.5%, 150mA, +CE	SOP-6	33x5	VR19	7b	Utc
1729G	LR31729BG-AG6	LVR-IC	LDO, Dual out, Vout1/Vout2=1.7V/2.9V±0.5%, 150mA, +CE	SOP-6	33x5	VR19	7b	Utc
173	XC6415AA73MR	LVR-IC	LDO, Dual out, Vout1/Vout2=3.10/2.90V±1%, 200mA, +CE	SOT-26	33x5	VR19	7d	Tor
1730G	LR31730BG-AG6	LVR-IC	LDO, Dual out, Vout1/Vout2=1.7V/3.0V±0.5%, 150mA, +CE	SOP-6	33x5	VR19	7b	Utc
1731G	LR31731BG-AG6	LVR-IC	LDO, Dual out, Vout1/Vout2=1.7V/3.1V±0.5%, 150mA, +CE	SOP-6	33x5	VR19	7b	Utc
1732G	LR31732BG-AG6	LVR-IC	LDO, Dual out, Vout1/Vout2=1.7V/3.2V±0.5%, 150mA, +CE	SOP-6	33x5	VR19	7b	Utc
1733G	LR31733BG-AG6	LVR-IC	LDO, Dual out, Vout1/Vout2=1.7V/3.3V±0.5%, 150mA, +CE	SOP-6	33x5	VR19	7b	Utc
174	XC6415AA74MR	LVR-IC	LDO, Dual out, Vout1/Vout2=3.10/2.95V±1%, 200mA, +CE	SOT-26	33x5	VR19	7d	Tor
175	XC6415AA75MR	LVR-IC	LDO, Dual out, Vout1/Vout2=3.10/3.00V±1%, 200mA, +CE	SOT-26	33x5	VR19	7d	Tor
176	XC6415AA76MR	LVR-IC	LDO, Dual out, Vout1/Vout2=3.10/3.05V±1%, 200mA, +CE	SOT-26	33x5	VR19	7d	Tor
177	XC6415AA77MR	LVR-IC	LDO, Dual out, Vout1/Vout2=3.00/3.10V±1%, 200mA, +CE	SOT-26	33x5	VR19	7d	Tor
178	XC6415AA78MR	LVR-IC	LDO, Dual out, Vout1/Vout2=1.20/2.60V±1%, 200mA, +CE	SOT-26	33x5	VR19	7d	Tor
179	XC6415AA79MR	LVR-IC	LDO, Dual out, Vout1/Vout2=1.20/2.5V±1%, 200mA, +CE	SOT-26	33x5	VR19	7d	Tor
17A	TK74017L	LVR-IC	LDO, Dual out, Vout1/Vout2=1.7V/1.7V±2%, 300mA, +CE	SOT-23L-8	47uh	VR22	8d	Tok
17P	TK11217BM	LVR-IC	LDO, 1.7V±2%, 150mA, +CE	SOT-23L-6	33vf	VR7	7b	Tok
18	R1163D281E	LVR-IC	LDO, 2.8V±1.5%, 150mA, +CE, AE(mode)	SON-6	34vrc	VR10	7g	Ric
180	XC6415AA80MR	LVR-IC	LDO, Dual out, Vout1/Vout2=1.10/1.50V±1%, 200mA, +CE	SOT-26	33x5	VR19	7d	Tor
181	XC6415AA81MR	LVR-IC	LDO, Dual out, Vout1/Vout2=2.00/3.30V±1%, 200mA, +CE	SOT-26	33x5	VR19	7d	Tor
1815G	LR31815BG-AG6	LVR-IC	LDO, Dual out, Vout1/Vout2=1.8V/1.5V±0.5%, 150mA, +CE	SOP-6	33x5	VR19	7b	Utc
1816G	LR31816BG-AG6	LVR-IC	LDO, Dual out, Vout1/Vout2=1.8V/1.6V±0.5%, 150mA, +CE	SOP-6	33x5	VR19	7b	Utc
1817G	LR31817BG-AG6	LVR-IC	LDO, Dual out, Vout1/Vout2=1.8V/1.7V±0.5%, 150mA, +CE	SOP-6	33x5	VR19	7b	Utc
1818G	LR31818BG-AG6	LVR-IC	LDO, Dual out, Vout1/Vout2=1.8V/1.8V±0.5%, 150mA, +CE	SOP-6	33x5	VR19	7b	Utc
1819G	LR31819BG-AG6	LVR-IC	LDO, Dual out, Vout1/Vout2=1.8V/1.9V±0.5%, 150mA, +CE	SOP-6	33x5	VR19	7b	Utc
182	XC6415AA82MR	LVR-IC	LDO, Dual out, Vout1/Vout2=3.30/2.00V±1%, 200mA, +CE	SOT-26	33x5	VR19	7d	Tor
1820G	LR31820BG-AG6	LVR-IC	LDO, Dual out, Vout1/Vout2=1.8V/2.0V±0.5%, 150mA, +CE	SOP-6	33x5	VR19	7b	Utc
1821G	LR31821BG-AG6	LVR-IC	LDO, Dual out, Vout1/Vout2=1.8V/2.1V±0.5%, 150mA, +CE	SOP-6	33x5	VR19	7b	Utc
1822G	LR31822BG-AG6	LVR-IC	LDO, Dual out, Vout1/Vout2=1.8V/2.2V±0.5%, 150mA, +CE	SOP-6	33x5	VR19	7b	Utc
1823G	LR31823BG-AG6	LVR-IC	LDO, Dual out, Vout1/Vout2=1.8V/2.3V±0.5%, 150mA, +CE	SOP-6	33x5	VR19	7b	Utc
1824G	LR31824BG-AG6	LVR-IC	LDO, Dual out, Vout1/Vout2=1.8V/2.4V±0.5%, 150mA, +CE	SOP-6	33x5	VR19	7b	Utc
1825G	LR31825BG-AG6	LVR-IC	LDO, Dual out, Vout1/Vout2=1.8V/2.5V±0.5%, 150mA, +CE	SOP-6	33x5	VR19	7b	Utc
1826G	LR31826BG-AG6	LVR-IC	LDO, Dual out, Vout1/Vout2=1.8V/2.6V±0.5%, 150mA, +CE	SOP-6	33x5	VR19	7b	Utc
1827G	LR31827BG-AG6	LVR-IC	LDO, Dual out, Vout1/Vout2=1.8V/2.7V±0.5%, 150mA, +CE	SOP-6	33x5	VR19	7b	Utc
1828G	LR31828BG-AG6	LVR-IC	LDO, Dual out, Vout1/Vout2=1.8V/2.8V±0.5%, 150mA, +CE	SOP-6	33x5	VR19	7b	Utc
1829G	LR31829BG-AG6	LVR-IC	LDO, Dual out, Vout1/Vout2=1.8V/2.9V±0.5%, 150mA, +CE	SOP-6	33x5	VR19	7b	Utc
183	XC6415AA83MR	LVR-IC	LDO, Dual out, Vout1/Vout2=2.80/1.20V±1%, 200mA, +CE	SOT-26	33x5	VR19	7d	Tor
1830G	LR31830BG-AG6	LVR-IC	LDO, Dual out, Vout1/Vout2=1.8V/3.0V±0.5%, 150mA, +CE	SOP-6	33x5	VR19	7b	Utc
1831G	LR31831BG-AG6	LVR-IC	LDO, Dual out, Vout1/Vout2=1.8V/3.1V±0.5%, 150mA, +CE	SOP-6	33x5	VR19	7b	Utc
1832G	LR31832BG-AG6	LVR-IC	LDO, Dual out, Vout1/Vout2=1.8V/3.2V±0.5%, 150mA, +CE	SOP-6	33x5	VR19	7b	Utc
1833G	LR31833BG-AG6	LVR-IC	LDO, Dual out, Vout1/Vout2=1.8V/3.3V±0.5%, 150mA, +CE	SOP-6	33x5	VR19	7b	Utc
184	XC6415AA84MR	LVR-IC	LDO, Dual out, Vout1/Vout2=1.00/3.30V±1%, 200mA, +CE	SOT-26	33x5	VR19	7d	Tor
185	XC6415AA85MR	LVR-IC	LDO, Dual out, Vout1/Vout2=2.70/2.70V±1%, 200mA, +CE	SOT-26	33x5	VR19	7d	Tor
186	XC6415AA86MR	LVR-IC	LDO, Dual out, Vout1/Vout2=2.70/3.30V±1%, 200mA, +CE	SOT-26	33x5	VR19	7d	Tor
187	XC6415AA87MR	LVR-IC	LDO, Dual out, Vout1/Vout2=2.90/2.90V±1%, 200mA, +CE	SOT-26	33x5	VR19	7d	Tor
188	XC6415AA88MR	LVR-IC	LDO, Dual out, Vout1/Vout2=2.50/2.80V±1%, 200mA, +CE	SOT-26	33x5	VR19	7d	Tor
189	XC6415AA89MR	LVR-IC	LDO, Dual out, Vout1/Vout2=2.50/3.00V±1%, 200mA, +CE	SOT-26	33x5	VR19	7d	Tor
18A	MMQA18V	TVS	Quad, 18V, 24W(1ms)	SC-74	33dx	-	7b	Ons
18A	TK74018L	LVR-IC	LDO, Dual out, Vout1/Vout2=1.8V/1.8V±2%, 300mA, +CE	SOT-23L-8	47uh	VR22	8d	Tok
18P	TK11218BM	LVR-IC	LDO, 1.8V±2%, 150mA, +CE	SOT-23L-6	33vf	VR7	7b	Tok
19	R1163D291E	LVR-IC	LDO, 2.9V±1.5%, 150mA, +CE, AE(mode)	SON-6	34vrc	VR10	7g	Ric
190	XC6415AA90MR	LVR-IC	LDO, Dual out, Vout1/Vout2=4.5V/4.5V±1%, 200mA, +CE	SOT-26	33x5	VR19	7d	Tor
191	XC6415AA91MR	LVR-IC	LDO, Dual out, Vout1/Vout2=3.3V/5.0V±1%, 200mA, +CE	SOT-26	33x5	VR19	7d	Tor



SMD code	Type	Function	Short description	Case	Pinout	Sch.	St.	Mnf.
1915G	LR31915BG-AG6	LVR-IC	LDO, Dual out, Vout1/Vout2=1.9V/1.5V±0.5%, 150mA, +CE	SOP-6	33x5	VR19	7b	Utc
1916G	LR31916BG-AG6	LVR-IC	LDO, Dual out, Vout1/Vout2=1.9V/1.6V±0.5%, 150mA, +CE	SOP-6	33x5	VR19	7b	Utc
1917G	LR31917BG-AG6	LVR-IC	LDO, Dual out, Vout1/Vout2=1.9V/1.7V±0.5%, 150mA, +CE	SOP-6	33x5	VR19	7b	Utc
1918G	LR31918BG-AG6	LVR-IC	LDO, Dual out, Vout1/Vout2=1.9V/1.8V±0.5%, 150mA, +CE	SOP-6	33x5	VR19	7b	Utc
1919G	LR31919BG-AG6	LVR-IC	LDO, Dual out, Vout1/Vout2=1.9V/1.9V±0.5%, 150mA, +CE	SOP-6	33x5	VR19	7b	Utc
192	XC6415AA92MR	LVR-IC	LDO, Dual out, Vout1/Vout2=3.00/5.00V±1%, 200mA, +CE	SOT-26	33x5	VR19	7d	Tor
1920G	LR31920BG-AG6	LVR-IC	LDO, Dual out, Vout1/Vout2=1.9V/2.0V±0.5%, 150mA, +CE	SOP-6	33x5	VR19	7b	Utc
1921G	LR31921BG-AG6	LVR-IC	LDO, Dual out, Vout1/Vout2=1.9V/2.1V±0.5%, 150mA, +CE	SOP-6	33x5	VR19	7b	Utc
1922G	LR31922BG-AG6	LVR-IC	LDO, Dual out, Vout1/Vout2=1.9V/2.2V±0.5%, 150mA, +CE	SOP-6	33x5	VR19	7b	Utc
1923G	LR31923BG-AG6	LVR-IC	LDO, Dual out, Vout1/Vout2=1.9V/2.3V±0.5%, 150mA, +CE	SOP-6	33x5	VR19	7b	Utc
1924G	LR31924BG-AG6	LVR-IC	LDO, Dual out, Vout1/Vout2=1.9V/2.4V±0.5%, 150mA, +CE	SOP-6	33x5	VR19	7b	Utc
1925G	LR31925BG-AG6	LVR-IC	LDO, Dual out, Vout1/Vout2=1.9V/2.5V±0.5%, 150mA, +CE	SOP-6	33x5	VR19	7b	Utc
1926G	LR31926BG-AG6	LVR-IC	LDO, Dual out, Vout1/Vout2=1.9V/2.6V±0.5%, 150mA, +CE	SOP-6	33x5	VR19	7b	Utc
1927G	LR31927BG-AG6	LVR-IC	LDO, Dual out, Vout1/Vout2=1.9V/2.7V±0.5%, 150mA, +CE	SOP-6	33x5	VR19	7b	Utc
1928G	LR31928BG-AG6	LVR-IC	LDO, Dual out, Vout1/Vout2=1.9V/2.8V±0.5%, 150mA, +CE	SOP-6	33x5	VR19	7b	Utc
1929G	LR31929BG-AG6	LVR-IC	LDO, Dual out, Vout1/Vout2=1.9V/2.9V±0.5%, 150mA, +CE	SOP-6	33x5	VR19	7b	Utc
193	XC6415AA93MR	LVR-IC	LDO, Dual out, Vout1/Vout2=1.80/2.90V±1%, 200mA, +CE	SOT-26	33x5	VR19	7d	Tor
1930G	LR31930BG-AG6	LVR-IC	LDO, Dual out, Vout1/Vout2=1.9V/3.0V±0.5%, 150mA, +CE	SOP-6	33x5	VR19	7b	Utc
1931G	LR31931BG-AG6	LVR-IC	LDO, Dual out, Vout1/Vout2=1.9V/3.1V±0.5%, 150mA, +CE	SOP-6	33x5	VR19	7b	Utc
1932G	LR31932BG-AG6	LVR-IC	LDO, Dual out, Vout1/Vout2=1.9V/3.2V±0.5%, 150mA, +CE	SOP-6	33x5	VR19	7b	Utc
1933G	LR31933BG-AG6	LVR-IC	LDO, Dual out, Vout1/Vout2=1.9V/3.3V±0.5%, 150mA, +CE	SOP-6	33x5	VR19	7b	Utc
194	XC6415AA94MR	LVR-IC	LDO, Dual out, Vout1/Vout2=1.10/1.80V±1%, 200mA, +CE	SOT-26	33x5	VR19	7d	Tor
195	XC6415AA95MR	LVR-IC	LDO, Dual out, Vout1/Vout2=1.20/1.30V±1%, 200mA, +CE	SOT-26	33x5	VR19	7d	Tor
196	XC6415AA96MR	LVR-IC	LDO, Dual out, Vout1/Vout2=1.00/1.20V±1%, 200mA, +CE	SOT-26	33x5	VR19	7d	Tor
197	XC6415AA97MR	LVR-IC	LDO, Dual out, Vout1/Vout2=1.50/2.50V±1%, 200mA, +CE	SOT-26	33x5	VR19	7d	Tor
198	XC6415AA98MR	LVR-IC	LDO, Dual out, Vout1/Vout2=1.20/0.90V±1%, 200mA, +CE	SOT-26	33x5	VR19	7d	Tor
199	XC6415AA99MR	LVR-IC	LDO, Dual out, Vout1/Vout2=3.15/3.15V±1%, 200mA, +CE	SOT-26	33x5	VR19	7d	Tor
19A	TK74019L	LVR-IC	LDO, Dual out, Vout1/Vout2=1.9V/1.9V±2%, 300mA, +CE	SOT-23L-8	47uh	VR22	8d	Tok
19P	TK11219BM	LVR-IC	LDO, 1.9V±2%, 150mA, +CE	SOT-23L-6	33vf	VR7	7b	Tok
1A	R1161D121A5	LVR-IC	LDO, 1.25V±2%, 350mA, -CE, AE(mode)	SOM-6	34wrc	VR10	7g	Ric
1A	R5326N001A	LVR-IC	LDO, Dual out, Vout1/Vout2=2V/2V±1%, 150mA, +CE	SOT-23-6	33rg	VR19	7d	Ric
1A0	XC6415AAA0MR	LVR-IC	LDO, Dual out, Vout1/Vout2=3.10/1.80V±1%, 200mA, +CE	SOT-26	33x5	VR19	7d	Tor
1A1	XC6415AAA1MR	LVR-IC	LDO, Dual out, Vout1/Vout2=1.80/2.00V±1%, 200mA, +CE	SOT-26	33x5	VR19	7d	Tor
1A2	XC6415AAA2MR	LVR-IC	LDO, Dual out, Vout1/Vout2=1.50/1.30V±1%, 200mA, +CE	SOT-26	33x5	VR19	7d	Tor
1A3	XC6415AAA3MR	LVR-IC	LDO, Dual out, Vout1/Vout2=2.85/2.60V±1%, 200mA, +CE	SOT-26	33x5	VR19	7d	Tor
1A4	XC6415AAA4MR	LVR-IC	LDO, Dual out, Vout1/Vout2=1.25/2.50V±1%, 200mA, +CE	SOT-26	33x5	VR19	7d	Tor
1A5	XC6415AAA5MR	LVR-IC	LDO, Dual out, Vout1/Vout2=1.85/1.20V±1%, 200mA, +CE	SOT-26	33x5	VR19	7d	Tor
1A6	XC6415AAA6MR	LVR-IC	LDO, Dual out, Vout1/Vout2=3.30/2.50V±1%, 200mA, +CE	SOT-26	33x5	VR19	7d	Tor
1A7	XC6415AAA7MR	LVR-IC	LDO, Dual out, Vout1/Vout2=1.80/1.95V±1%, 200mA, +CE	SOT-26	33x5	VR19	7d	Tor
1A8	XC6415AAA8MR	LVR-IC	LDO, Dual out, Vout1/Vout2=2.85/3.00V±1%, 200mA, +CE	SOT-26	33x5	VR19	7d	Tor
1A8T	CMKZ5250B	Z-diode	Triple, 19.0..21.0V, Izt=6.2mA, Zzt=25Q, 200mW	SOT-363	33dd	-	7b	Gen
1A9	XC6415AAA9MR	LVR-IC	LDO, Dual out, Vout1/Vout2=1.55/2.80V±1%, 200mA, +CE	SOT-26	33x5	VR19	7d	Tor
1B	BC846BDW1	Si-npn	Dual, GP, 80V, 100mA, 200mW, B=200..450, >100MHz	SOT-363	33/T8	-	7b	Ons
1B	R1161D111A	LVR-IC	LDO, 1.1V±2%, 350mA, -CE, AE(mode)	SOM-6	34wrc	VR10	7g	Ric
1B	R5326N002A	LVR-IC	LDO, Dual out, Vout1/Vout2=2.8V/2.8V±1%, 150mA, +CE	SOT-23-6	33rg	VR19	7d	Ric
1B0	XC6415AAB0MR	LVR-IC	LDO, Dual out, Vout1/Vout2=1.90/1.90V±1%, 200mA, +CE	SOT-26	33x5	VR19	7d	Tor
1B1	XC6415AAB1MR	LVR-IC	LDO, Dual out, Vout1/Vout2=2.50/2.85V±1%, 200mA, +CE	SOT-26	33x5	VR19	7d	Tor
1B2	XC6415AAB2MR	LVR-IC	LDO, Dual out, Vout1/Vout2=3.00/1.00V±1%, 200mA, +CE	SOT-26	33x5	VR19	7d	Tor
1B3	XC6415AAB3MR	LVR-IC	LDO, Dual out, Vout1/Vout2=1.30/1.80V±1%, 200mA, +CE	SOT-26	33x5	VR19	7d	Tor
1B4	XC6415AAB4MR	LVR-IC	LDO, Dual out, Vout1/Vout2=2.70/3.00V±1%, 200mA, +CE	SOT-26	33x5	VR19	7d	Tor
1B5	XC6415AAB5MR	LVR-IC	LDO, Dual out, Vout1/Vout2=2.80/1.90V±1%, 200mA, +CE	SOT-26	33x5	VR19	7d	Tor
1B6	XC6415AAB6MR	LVR-IC	LDO, Dual out, Vout1/Vout2=2.50/0.90V±1%, 200mA, +CE	SOT-26	33x5	VR19	7d	Tor
1B7	XC6415AAB7MR	LVR-IC	LDO, Dual out, Vout1/Vout2=3.15/2.85V±1%, 200mA, +CE	SOT-26	33x5	VR19	7d	Tor
1B8	XC6415AAB8MR	LVR-IC	LDO, Dual out, Vout1/Vout2=2.60/1.30V±1%, 200mA, +CE	SOT-26	33x5	VR19	7d	Tor
1B8T	CMKZ5251B	Z-diode	Triple, 20.90..23.10V, Izt=5.6mA, Zzt=29Q, 200mW	SOT-363	33dd	-	7b	Gen
1B9	XC6415AAB9MR	LVR-IC	LDO, Dual out, Vout1/Vout2=3.00/2.50V±1%, 200mA, +CE	SOT-26	33x5	VR19	7d	Tor
1Bs	BC817UPN	Si-n/p	Dual, AF-Drv, 50V, 500mA, 330mW, B=100..600, >200MHz	SOT457	33/T9	-	7b	Sie
1C	R1161D211A	LVR-IC	LDO, 2.1V±2%, 350mA, -CE, AE(mode)	SOM-6	34wrc	VR10	7g	Ric
1C	R5326N003A	LVR-IC	LDO, Dual out, Vout1/Vout2=1.8V/3V±1%, 150mA, +CE	SOT-23-6	33rg	VR19	7d	Ric
1C0	XC6415AAC0MR	LVR-IC	LDO, Dual out, Vout1/Vout2=3.30/1.10V±1%, 200mA, +CE	SOT-26	33x5	VR19	7d	Tor
1C1	XC6415AAC1MR	LVR-IC	LDO, Dual out, Vout1/Vout2=3.30/2.50V±1%, 200mA, +CE	SOT-26	33x5	VR19	7d	Tor
1C12A	XC9201C12AKR	DC-DC-IC	PWM, step-up, 1.2V±2.5%, 3A	MSOP-8A	55xd	DC17	8f	Tor
1C13A	XC9201C13AKR	DC-DC-IC	PWM, step-up, 1.3V±2.5%, 3A	MSOP-8A	55xd	DC17	8f	Tor
1C14A	XC9201C14AKR	DC-DC-IC	PWM, step-up, 1.4V±2.5%, 3A	MSOP-8A	55xd	DC17	8f	Tor
1C15A	XC9201C15AKR	DC-DC-IC	PWM, step-up, 1.5V±2.5%, 3A	MSOP-8A	55xd	DC17	8f	Tor
1C16A	XC9201C16AKR	DC-DC-IC	PWM, step-up, 1.6V±2.5%, 3A	MSOP-8A	55xd	DC17	8f	Tor
1C17A	XC9201C17AKR	DC-DC-IC	PWM, step-up, 1.7V±2.5%, 3A	MSOP-8A	55xd	DC17	8f	Tor
1C18A	XC9201C18AKR	DC-DC-IC	PWM, step-up, 1.8V±2.5%, 3A	MSOP-8A	55xd	DC17	8f	Tor
1C19A	XC9201C19AKR	DC-DC-IC	PWM, step-up, 1.9V±2.5%, 3A	MSOP-8A	55xd	DC17	8f	Tor
1C2	XC6415AAC2MR	LVR-IC	LDO, Dual out, Vout1/Vout2=1.85/2.85V±1%, 200mA, +CE	SOT-26	33x5	VR19	7d	Tor



SMD code	Type	Function	Short description	Case	Pinout	Sch.	St.	Mnf.
1C84A	XC9201C84AKR	DC-DC-IC	PWM, step-up, 8.4V±2.5%, 3A	MSOP-8A	55xd	DC17	8f	Tor
1C85A	XC9201C85AKR	DC-DC-IC	PWM, step-up, 8.5V±2.5%, 3A	MSOP-8A	55xd	DC17	8f	Tor
1C86A	XC9201C86AKR	DC-DC-IC	PWM, step-up, 8.6V±2.5%, 3A	MSOP-8A	55xd	DC17	8f	Tor
1C87A	XC9201C87AKR	DC-DC-IC	PWM, step-up, 8.7V±2.5%, 3A	MSOP-8A	55xd	DC17	8f	Tor
1C88A	XC9201C88AKR	DC-DC-IC	PWM, step-up, 8.8V±2.5%, 3A	MSOP-8A	55xd	DC17	8f	Tor
1C89A	XC9201C89AKR	DC-DC-IC	PWM, step-up, 8.9V±2.5%, 3A	MSOP-8A	55xd	DC17	8f	Tor
1C8T	CMKZ5252B	Z-diode	Triple, 22.80..25.20V, Izt=5.2mA, Zzt=33Ω, 200mW	SOT-363	33dd	-	7b	Cen
1C9	XC6415AAC9MR	LVR-IC	LDO, Dual out, Vout1/Vout2=1.50/2.40V±1%, 200mA, +CE	SOT-26	33x5	VR19	7d	Tor
1C90A	XC9201C90AKR	DC-DC-IC	PWM, step-up, 9.0V±2.5%, 3A	MSOP-8A	55xd	DC17	8f	Tor
1C91A	XC9201C91AKR	DC-DC-IC	PWM, step-up, 9.1V±2.5%, 3A	MSOP-8A	55xd	DC17	8f	Tor
1C92A	XC9201C92AKR	DC-DC-IC	PWM, step-up, 9.2V±2.5%, 3A	MSOP-8A	55xd	DC17	8f	Tor
1C93A	XC9201C93AKR	DC-DC-IC	PWM, step-up, 9.3V±2.5%, 3A	MSOP-8A	55xd	DC17	8f	Tor
1C94A	XC9201C94AKR	DC-DC-IC	PWM, step-up, 9.4V±2.5%, 3A	MSOP-8A	55xd	DC17	8f	Tor
1C95A	XC9201C95AKR	DC-DC-IC	PWM, step-up, 9.5V±2.5%, 3A	MSOP-8A	55xd	DC17	8f	Tor
1C96A	XC9201C96AKR	DC-DC-IC	PWM, step-up, 9.6V±2.5%, 3A	MSOP-8A	55xd	DC17	8f	Tor
1C97A	XC9201C97AKR	DC-DC-IC	PWM, step-up, 9.7V±2.5%, 3A	MSOP-8A	55xd	DC17	8f	Tor
1C98A	XC9201C98AKR	DC-DC-IC	PWM, step-up, 9.8V±2.5%, 3A	MSOP-8A	55xd	DC17	8f	Tor
1C99A	XC9201C99AKR	DC-DC-IC	PWM, step-up, 9.9V±2.5%, 3A	MSOP-8A	55xd	DC17	8f	Tor
1CA0A	XC9201CA0AKR	DC-DC-IC	PWM, step-up, 10.0V±2.5%, 3A	MSOP-8A	55xd	DC17	8f	Tor
1CA1A	XC9201CA1AKR	DC-DC-IC	PWM, step-up, 10.1V±2.5%, 3A	MSOP-8A	55xd	DC17	8f	Tor
1CA2A	XC9201CA2AKR	DC-DC-IC	PWM, step-up, 10.2V±2.5%, 3A	MSOP-8A	55xd	DC17	8f	Tor
1CA3A	XC9201CA3AKR	DC-DC-IC	PWM, step-up, 10.3V±2.5%, 3A	MSOP-8A	55xd	DC17	8f	Tor
1CA4A	XC9201CA4AKR	DC-DC-IC	PWM, step-up, 10.4V±2.5%, 3A	MSOP-8A	55xd	DC17	8f	Tor
1CA5A	XC9201CA5AKR	DC-DC-IC	PWM, step-up, 10.5V±2.5%, 3A	MSOP-8A	55xd	DC17	8f	Tor
1CA6A	XC9201CA6AKR	DC-DC-IC	PWM, step-up, 10.6V±2.5%, 3A	MSOP-8A	55xd	DC17	8f	Tor
1CA7A	XC9201CA7AKR	DC-DC-IC	PWM, step-up, 10.7V±2.5%, 3A	MSOP-8A	55xd	DC17	8f	Tor
1CA8A	XC9201CA8AKR	DC-DC-IC	PWM, step-up, 10.8V±2.5%, 3A	MSOP-8A	55xd	DC17	8f	Tor
1CA9A	XC9201CA9AKR	DC-DC-IC	PWM, step-up, 10.9V±2.5%, 3A	MSOP-8A	55xd	DC17	8f	Tor
1CB0A	XC9201CB0AKR	DC-DC-IC	PWM, step-up, 11.0V±2.5%, 3A	MSOP-8A	55xd	DC17	8f	Tor
1CB1A	XC9201CB1AKR	DC-DC-IC	PWM, step-up, 11.1V±2.5%, 3A	MSOP-8A	55xd	DC17	8f	Tor
1CB2A	XC9201CB2AKR	DC-DC-IC	PWM, step-up, 11.2V±2.5%, 3A	MSOP-8A	55xd	DC17	8f	Tor
1CB3A	XC9201CB3AKR	DC-DC-IC	PWM, step-up, 11.3V±2.5%, 3A	MSOP-8A	55xd	DC17	8f	Tor
1CB4A	XC9201CB4AKR	DC-DC-IC	PWM, step-up, 11.4V±2.5%, 3A	MSOP-8A	55xd	DC17	8f	Tor
1CB5A	XC9201CB5AKR	DC-DC-IC	PWM, step-up, 11.5V±2.5%, 3A	MSOP-8A	55xd	DC17	8f	Tor
1CB6A	XC9201CB6AKR	DC-DC-IC	PWM, step-up, 11.6V±2.5%, 3A	MSOP-8A	55xd	DC17	8f	Tor
1CB7A	XC9201CB7AKR	DC-DC-IC	PWM, step-up, 11.7V±2.5%, 3A	MSOP-8A	55xd	DC17	8f	Tor
1CB8A	XC9201CB8AKR	DC-DC-IC	PWM, step-up, 11.8V±2.5%, 3A	MSOP-8A	55xd	DC17	8f	Tor
1CB9A	XC9201CB9AKR	DC-DC-IC	PWM, step-up, 11.9V±2.5%, 3A	MSOP-8A	55xd	DC17	8f	Tor
1CC0A	XC9201CC0AKR	DC-DC-IC	PWM, step-up, 12.0V±2.5%, 3A	MSOP-8A	55xd	DC17	8f	Tor
1CC1A	XC9201CC1AKR	DC-DC-IC	PWM, step-up, 12.1V±2.5%, 3A	MSOP-8A	55xd	DC17	8f	Tor
1CC2A	XC9201CC2AKR	DC-DC-IC	PWM, step-up, 12.2V±2.5%, 3A	MSOP-8A	55xd	DC17	8f	Tor
1CC3A	XC9201CC3AKR	DC-DC-IC	PWM, step-up, 12.3V±2.5%, 3A	MSOP-8A	55xd	DC17	8f	Tor
1CC4A	XC9201CC4AKR	DC-DC-IC	PWM, step-up, 12.4V±2.5%, 3A	MSOP-8A	55xd	DC17	8f	Tor
1CC5A	XC9201CC5AKR	DC-DC-IC	PWM, step-up, 12.5V±2.5%, 3A	MSOP-8A	55xd	DC17	8f	Tor
1CC6A	XC9201CC6AKR	DC-DC-IC	PWM, step-up, 12.6V±2.5%, 3A	MSOP-8A	55xd	DC17	8f	Tor
1CC7A	XC9201CC7AKR	DC-DC-IC	PWM, step-up, 12.7V±2.5%, 3A	MSOP-8A	55xd	DC17	8f	Tor
1CC8A	XC9201CC8AKR	DC-DC-IC	PWM, step-up, 12.8V±2.5%, 3A	MSOP-8A	55xd	DC17	8f	Tor
1CC9A	XC9201CC9AKR	DC-DC-IC	PWM, step-up, 12.9V±2.5%, 3A	MSOP-8A	55xd	DC17	8f	Tor
1CD0A	XC9201CD0AKR	DC-DC-IC	PWM, step-up, 13.0V±2.5%, 3A	MSOP-8A	55xd	DC17	8f	Tor
1CD1A	XC9201CD1AKR	DC-DC-IC	PWM, step-up, 13.1V±2.5%, 3A	MSOP-8A	55xd	DC17	8f	Tor
1CD2A	XC9201CD2AKR	DC-DC-IC	PWM, step-up, 13.2V±2.5%, 3A	MSOP-8A	55xd	DC17	8f	Tor
1CD3A	XC9201CD3AKR	DC-DC-IC	PWM, step-up, 13.3V±2.5%, 3A	MSOP-8A	55xd	DC17	8f	Tor
1CD4A	XC9201CD4AKR	DC-DC-IC	PWM, step-up, 13.4V±2.5%, 3A	MSOP-8A	55xd	DC17	8f	Tor
1CD5A	XC9201CD5AKR	DC-DC-IC	PWM, step-up, 13.5V±2.5%, 3A	MSOP-8A	55xd	DC17	8f	Tor
1CD6A	XC9201CD6AKR	DC-DC-IC	PWM, step-up, 13.6V±2.5%, 3A	MSOP-8A	55xd	DC17	8f	Tor
1CD7A	XC9201CD7AKR	DC-DC-IC	PWM, step-up, 13.7V±2.5%, 3A	MSOP-8A	55xd	DC17	8f	Tor
1CD8A	XC9201CD8AKR	DC-DC-IC	PWM, step-up, 13.8V±2.5%, 3A	MSOP-8A	55xd	DC17	8f	Tor
1CD9A	XC9201CD9AKR	DC-DC-IC	PWM, step-up, 13.9V±2.5%, 3A	MSOP-8A	55xd	DC17	8f	Tor
1CE0A	XC9201CE0AKR	DC-DC-IC	PWM, step-up, 14.0V±2.5%, 3A	MSOP-8A	55xd	DC17	8f	Tor
1CE1A	XC9201CE1AKR	DC-DC-IC	PWM, step-up, 14.1V±2.5%, 3A	MSOP-8A	55xd	DC17	8f	Tor
1CE2A	XC9201CE2AKR	DC-DC-IC	PWM, step-up, 14.2V±2.5%, 3A	MSOP-8A	55xd	DC17	8f	Tor
1CE3A	XC9201CE3AKR	DC-DC-IC	PWM, step-up, 14.3V±2.5%, 3A	MSOP-8A	55xd	DC17	8f	Tor
1CE4A	XC9201CE4AKR	DC-DC-IC	PWM, step-up, 14.4V±2.5%, 3A	MSOP-8A	55xd	DC17	8f	Tor
1CE5A	XC9201CE5AKR	DC-DC-IC	PWM, step-up, 14.5V±2.5%, 3A	MSOP-8A	55xd	DC17	8f	Tor
1CE6A	XC9201CE6AKR	DC-DC-IC	PWM, step-up, 14.6V±2.5%, 3A	MSOP-8A	55xd	DC17	8f	Tor
1CE7A	XC9201CE7AKR	DC-DC-IC	PWM, step-up, 14.7V±2.5%, 3A	MSOP-8A	55xd	DC17	8f	Tor
1CE8A	XC9201CE8AKR	DC-DC-IC	PWM, step-up, 14.8V±2.5%, 3A	MSOP-8A	55xd	DC17	8f	Tor
1CE9A	XC9201CE9AKR	DC-DC-IC	PWM, step-up, 14.9V±2.5%, 3A	MSOP-8A	55xd	DC17	8f	Tor
1CF0A	XC9201CF0AKR	DC-DC-IC	PWM, step-up, 15.0V±2.5%, 3A	MSOP-8A	55xd	DC17	8f	Tor
1CF1A	XC9201CF1AKR	DC-DC-IC	PWM, step-up, 15.1V±2.5%, 3A	MSOP-8A	55xd	DC17	8f	Tor



SMD code	Type	Function	Short description	Case	Pinout	Sch.	St.	Mnf.
1CF2A	XC9201CF2AKR	DC-DC-IC	PWM, step-up, 15.2V±2.5%, 3A	MSOP-8A	55xd	DC17	8f	Tor
1CF3A	XC9201CF3AKR	DC-DC-IC	PWM, step-up, 15.3V±2.5%, 3A	MSOP-8A	55xd	DC17	8f	Tor
1CF4A	XC9201CF4AKR	DC-DC-IC	PWM, step-up, 15.4V±2.5%, 3A	MSOP-8A	55xd	DC17	8f	Tor
1CF5A	XC9201CF5AKR	DC-DC-IC	PWM, step-up, 15.5V±2.5%, 3A	MSOP-8A	55xd	DC17	8f	Tor
1CF6A	XC9201CF6AKR	DC-DC-IC	PWM, step-up, 15.6V±2.5%, 3A	MSOP-8A	55xd	DC17	8f	Tor
1CF7A	XC9201CF7AKR	DC-DC-IC	PWM, step-up, 15.7V±2.5%, 3A	MSOP-8A	55xd	DC17	8f	Tor
1CF8A	XC9201CF8AKR	DC-DC-IC	PWM, step-up, 15.8V±2.5%, 3A	MSOP-8A	55xd	DC17	8f	Tor
1CF9A	XC9201CF9AKR	DC-DC-IC	PWM, step-up, 15.9V±2.5%, 3A	MSOP-8A	55xd	DC17	8f	Tor
1CHOA	XC9201CHOAKR	DC-DC-IC	PWM, step-up, 16.0V±2.5%, 3A	MSOP-8A	55xd	DC17	8f	Tor
1Cs	BC847S	Si-npn	Dual, GP, 50V, 100mA, 200mW, B>100, >100MHz	SOT-363	33/T8	-	7b	Sie
1D	R1161D311A	LVR-IC	LDO, 3.1V±2%, 350mA, -CE, AE(mode)	SON-6	34vrc	VR10	7g	Ric
1D	R5326N004A	LVR-IC	LDO, Dual out, Vout1/Vout2=2.5V/3V±1%, 150mA, +CE	SOT-23-6	33rg	VR19	7d	Ric
1D0	XC6415AAD0MR	LVR-IC	LDO, Dual out, Vout1/Vout2=3.30/3.60V±1%, 200mA, +CE	SOT-26	33x5	VR19	7d	Tor
1D1	XC6415AAD1MR	LVR-IC	LDO, Dual out, Vout1/Vout2=1.00/2.85V±1%, 200mA, +CE	SOT-26	33x5	VR19	7d	Tor
1D2	XC6415AAD2MR	LVR-IC	LDO, Dual out, Vout1/Vout2=1.80/1.85V±1%, 200mA, +CE	SOT-26	33x5	VR19	7d	Tor
1D3	XC6415AAD3MR	LVR-IC	LDO, Dual out, Vout1/Vout2=3.6V/1.5V±1%, 200mA, +CE	SOT-26	33x5	VR19	7d	Tor
1D4	XC6415AAD4MR	LVR-IC	LDO, Dual out, Vout1/Vout2=3.00/2.80V±1%, 200mA, +CE	SOT-26	33x5	VR19	7d	Tor
1D5	XC6415AAD5MR	LVR-IC	LDO, Dual out, Vout1/Vout2=4.5V/2.6V±1%, 200mA, +CE	SOT-26	33x5	VR19	7d	Tor
1D6	XC6415AAD6MR	LVR-IC	LDO, Dual out, Vout1/Vout2=2.00/1.80V±1%, 200mA, +CE	SOT-26	33x5	VR19	7d	Tor
1D7	XC6415AAD7MR	LVR-IC	LDO, Dual out, Vout1/Vout2=3.30/3.10V±1%, 200mA, +CE	SOT-26	33x5	VR19	7d	Tor
1D8	XC6415AAD8MR	LVR-IC	LDO, Dual out, Vout1/Vout2=3.20/3.10V±1%, 200mA, +CE	SOT-26	33x5	VR19	7d	Tor
1D8T	CMKZ5253B	Z-diode	Triple, 23.75..26.25V, lzt=5mA, Zzt=35Ω, 200mW	SOT-363	33dd	-	7b	Cen
1D9	XC6415AAD9MR	LVR-IC	LDO, Dual out, Vout1/Vout2=3.4V/3.1V±1%, 200mA, +CE	SOT-26	33x5	VR19	7d	Tor
1Ds	BC846S	Si-npn	Dual, GP, 80V, 100mA, 200mW, B>200, >100MHz	SOT-363	33/T8	-	7b	Sie
1Ds	BC846U	Si-npn	Dual, AF, 80V, 100mA, 250mW, B=110..450, >100MHz	SC-74	33/T8	-	7a	Sie
1E	R1161D121B5	LVR-IC	LDO, 1.25V±2%, 350mA, +CE, AE(mode)	SON-6	34vrc	VR10	7g	Ric
1E	R5326N005A	LVR-IC	LDO, Dual out, Vout1/Vout2=1.8V/2.5V±1%, 150mA, +CE	SOT-23-6	33rg	VR19	7d	Ric
1E0	XC6415AAE0MR	LVR-IC	LDO, Dual out, Vout1/Vout2=3.10/2.80V±1%, 200mA, +CE	SOT-26	33x5	VR19	7d	Tor
1E1	XC6415AAE1MR	LVR-IC	LDO, Dual out, Vout1/Vout2=2.50/3.10V±1%, 200mA, +CE	SOT-26	33x5	VR19	7d	Tor
1E2	XC6415AAE2MR	LVR-IC	LDO, Dual out, Vout1/Vout2=3.4V/3.4V±1%, 200mA, +CE	SOT-26	33x5	VR19	7d	Tor
1E8T	CMKZ5254B	Z-diode	Triple, 25.65..28.35V, lzt=4.6mA, Zzt=41Ω, 200mW	SOT-363	33dd	-	7b	Cen
1F	BC847BDW1	Si-npn	Dual, GP, 50V, 100mA, 200mW, B=200..450, >100MHz	SOT-363	33/T8	-	7b	Ons
1F	BC847BV	Si-npn	Dual, GP, 50V, 100mA, 200mW, B=200..450, >100MHz	SOT-666	35/T8	-	7b	Phi
1F	R1161D111B	LVR-IC	LDO, 1.1V±2%, 350mA, +CE, AE(mode)	SON-6	34vrc	VR10	7g	Ric
1F	R5326N006A	LVR-IC	LDO, Dual out, Vout1/Vout2=1.8V/3.3V±1%, 150mA, +CE	SOT-23-6	33rg	VR19	7d	Ric
1F8T	CMKZ5255B	Z-diode	Triple, 26.60..29.40V, lzt=4.5mA, Zzt=44Ω, 200mW	SOT-363	33dd	-	7b	Cen
1Ft	BC847BS	Si-npn	Dual, GP, 50V, 100mA, 200mW, B=200..450, >100MHz	SOT-363	33/T8	-	7b	Phi
1G	BC847CDW1	Si-npn	Dual, GP, 50V, 100mA, 200mW, B=420..800, >100MHz	SOT-363	33/T8	-	7b	Ons
1G	R1161D211B	LVR-IC	LDO, 2.1V±2%, 350mA, +CE, AE(mode)	SON-6	34vrc	VR10	7g	Ric
1G	R5326N007A	LVR-IC	LDO, Dual out, Vout1/Vout2=2.5V/2.8V±1%, 150mA, +CE	SOT-23-6	33rg	VR19	7d	Ric
1G8T	CMKZ5256B	Z-diode	Triple, 28.50..31.60V, lzt=4.2mA, Zzt=49Ω, 200mW	SOT-363	33dd	-	7b	Cen
1H	R1161D311B	LVR-IC	LDO, 3.1V±2%, 350mA, +CE, AE(mode)	SON-6	34vrc	VR10	7g	Ric
1H	R5326N008A	LVR-IC	LDO, Dual out, Vout1/Vout2=1.2V/1.2V±1%, 150mA, +CE	SOT-23-6	33rg	VR19	7d	Ric
1H8T	CMKZ5257B	Z-diode	Triple, 31.35..34.65V, lzt=3.8mA, Zzt=58Ω, 200mW	SOT-363	33dd	-	7b	Cen
1J	R1161D121D5	LVR-IC	LDO, 1.25V±2%, 350mA, +CE, CL, AE(mode)	SON-6	34vrc	VR10	7g	Ric
1J	R5326N009A	LVR-IC	LDO, Dual out, Vout1/Vout2=1.5V/1.6V±1%, 150mA, +CE	SOT-23-6	33rg	VR19	7d	Ric
1J8T	CMKZ5258B	Z-diode	Triple, 34.20..37.80V, lzt=3.4mA, Zzt=70Ω, 200mW	SOT-363	33dd	-	7b	Cen
1K	BC848BDW1	Si-npn	Dual, GP, 30V, 100mA, 200mW, B=200..450, >100MHz	SOT-363	33/T8	-	7b	Ons
1K	R1161D111D	LVR-IC	LDO, 1.1V±2%, 350mA, +CE, CL, AE(mode)	SON-6	34vrc	VR10	7g	Ric
1K	R5326N010A	LVR-IC	LDO, Dual out, Vout1/Vout2=1.5V/2.8V±1%, 150mA, +CE	SOT-23-6	33rg	VR19	7d	Ric
1K8T	CMKZ5259B	Z-diode	Triple, 37.05..40.95V, lzt=3.2mA, Zzt=80Ω, 200mW	SOT-363	33dd	-	7b	Cen
1L	BC848CDW1	Si-npn	Dual, GP, 30V, 100mA, 200mW, B=420..800, >100MHz	SOT-363	33/T8	-	7b	Ons
1L	R1161D211D	LVR-IC	LDO, 2.1V±2%, 350mA, +CE, CL, AE(mode)	SON-6	34vrc	VR10	7g	Ric
1L	R5326N011A	LVR-IC	LDO, Dual out, Vout1/Vout2=3V/3V±1%, 150mA, +CE	SOT-23-6	33rg	VR19	7d	Ric
1L8T	CMKZ5260B	Z-diode	Triple, 40.85..45.15V, lzt=3.0mA, Zzt=93Ω, 200mW	SOT-363	33dd	-	7b	Cen
1M	R1161D311D	LVR-IC	LDO, 3.1V±2%, 350mA, +CE, CL, AE(mode)	SON-6	34vrc	VR10	7g	Ric
1M	R5326N012A	LVR-IC	LDO, Dual out, Vout1/Vout2=3.1V/3.1V±1%, 150mA, +CE	SOT-23-6	33rg	VR19	7d	Ric
1M8T	CMKZ5261B	Z-diode	Triple, 44.65..49.35V, lzt=2.7mA, Zzt=105Ω, 200mW	SOT-363	33dd	-	7b	Cen
1N	R5326N013A	LVR-IC	LDO, Dual out, Vout1/Vout2=2.7V/1.8V±1%, 150mA, +CE	SOT-23-6	33rg	VR19	7d	Ric
1Os	BC846PN	Si-n/p	Dual, GP, 80V, 100mA, 200mW, B=200..450, >100MHz	SOT-363	33/T9	-	7b	Sie
1P	R5326N014A	LVR-IC	LDO, Dual out, Vout1/Vout2=1.8V/2.6V±1%, 150mA, +CE	SOT-23-6	33rg	VR19	7d	Ric
1Ps	BC847PN	Si-n/p	Dual, AF, 50V, 100mA, 250mW, B=110..800, >100MHz	SOT-363	33/T9	-	7b	Sie
1Q	R5326N015A	LVR-IC	LDO, Dual out, Vout1/Vout2=3.3V/3.3V±1%, 150mA, +CE	SOT-23-6	33rg	VR19	7d	Ric
1R	R5326N016A	LVR-IC	LDO, Dual out, Vout1/Vout2=2.85V/2.85V±1%, 150mA, +CE	SOT-23-6	33rg	VR19	7d	Ric
1S	R5326N017A	LVR-IC	LDO, Dual out, Vout1/Vout2=1.1V/1.1V±1%, 150mA, +CE	SOT-23-6	33rg	VR19	7d	Ric
1T	R5326N018A	LVR-IC	LDO, Dual out, Vout1/Vout2=1.2V/1.2V±1%, 150mA, +CE	SOT-23-6	33rg	VR19	7d	Ric
1U	R5326N019A	LVR-IC	LDO, Dual out, Vout1/Vout2=1.2V/2.9V±1%, 150mA, +CE	SOT-23-6	33rg	VR19	7d	Ric
1V	BAT54VPT	Si-diode	Dual, SBD, 30V, 200mA, Vf<1V(100mA), 5ns	SOT-563	35dw	-	7b	Chm
1V	R5326N020A	LVR-IC	LDO, Dual out, Vout1/Vout2=2.8V/3.0V±1%, 150mA, +CE	SOT-23-6	33rg	VR19	7d	Ric
1W	R5326N021A	LVR-IC	LDO, Dual out, Vout1/Vout2=1.5V/2.8V±1%, 150mA, +CE	SOT-23-6	33rg	VR19	7d	Ric



SMD code	Type	Function	Short description	Case	Pinout	Sch.	St.	Mnf.
1X	R5326N022A	LVR-IC	LDO, Dual out, Vout1/Vout2=1.8V/2.9V±1%, 150mA, +CE	SOT-23-6	33rg	VR19	7d	Ric
1Y	R5326N023A	LVR-IC	LDO, Dual out, Vout1/Vout2=4.2V/3.1V±1%, 150mA, +CE	SOT-23-6	33rg	VR19	7d	Ric
1Z	R5326N024A	LVR-IC	LDO, Dual out, Vout1/Vout2=1.5V/3.0V±1%, 150mA, +CE	SOT-23-6	33rg	VR19	7d	Ric
20	R1163D301E	LVR-IC	LDO, 3V±1.5%, 150mA, +CE, AE(mode)	SOM-6	34vrc	VR10	7g	Ric
2000D1	TPA2000D1PW	LIN-IC	AF PA, BTL, class-D, 2.7..5.5V, 2W(5W/4Q)	SOP-16	60	-	-	Ti
2000D2	TPA2000D2PWP	LIN-IC	AF PA, BTL, class-D, 2.5..5.5V, 2x2W(5V/3Q), shutdown	SSOP-24	60	-	-	Ti
2001D1	TPA2001D1PW	LIN-IC	AF PA, BTL, class-D, 2.7..5.5V, 1W(5W/8Q)	SOP-16	60	-	-	Ti
201	XC6420AB01MR-G	LVR-IC	LDO, Dual out, Vout1/Vout2=1.20V/1.20V±2%, 150mA, +CE	SOT-26	33x5	VR19	7d	Tor
2015G	LR32015BG-AG6	LVR-IC	LDO, Dual out, Vout1/Vout2=2.0V/1.5V±0.5%, 150mA, +CE	SOP-6	33x5	VR19	7b	Utc
2016G	LR32016BG-AG6	LVR-IC	LDO, Dual out, Vout1/Vout2=2.0V/1.6V±0.5%, 150mA, +CE	SOP-6	33x5	VR19	7b	Utc
2017G	LR32017BG-AG6	LVR-IC	LDO, Dual out, Vout1/Vout2=2.0V/1.7V±0.5%, 150mA, +CE	SOP-6	33x5	VR19	7b	Utc
2018G	LR32018BG-AG6	LVR-IC	LDO, Dual out, Vout1/Vout2=2.0V/1.8V±0.5%, 150mA, +CE	SOP-6	33x5	VR19	7b	Utc
2019G	LR32019BG-AG6	LVR-IC	LDO, Dual out, Vout1/Vout2=2.0V/1.9V±0.5%, 150mA, +CE	SOP-6	33x5	VR19	7b	Utc
202	XC6420AB02MR-G	LVR-IC	LDO, Dual out, Vout1/Vout2=1.20V/1.50V±2%, 150mA, +CE	SOT-26	33x5	VR19	7d	Tor
2020G	LR32020BG-AG6	LVR-IC	LDO, Dual out, Vout1/Vout2=2.0V/2.0V±0.5%, 150mA, +CE	SOP-6	33x5	VR19	7b	Utc
2021G	LR32021BG-AG6	LVR-IC	LDO, Dual out, Vout1/Vout2=2.0V/2.1V±0.5%, 150mA, +CE	SOP-6	33x5	VR19	7b	Utc
2022A	SGM2022-AYN6	LVR-IC	LDO, Dual out, Vout1/Vout2=2.8V/2.8V±2%, 250mA, +CE	SOT-23-6	33zc	VR19	7b	Sgm
2022AA	SGM2022-AYN6	LVR-IC	LDO, Dual out, Vout1/Vout2=1.2V/1.8V±2%, 250mA, +CE	SOT-23-6	33zc	VR19	7b	Sgm
2022C	SGM2022-CYN6	LVR-IC	LDO, Dual out, Vout1/Vout2=2.8V/3.0V±2%, 250mA, +CE	SOT-23-6	33zc	VR19	7b	Sgm
2022D	SGM2022-DYN6	LVR-IC	LDO, Dual out, Vout1/Vout2=2.8V/2.5V±2%, 250mA, +CE	SOT-23-6	33zc	VR19	7b	Sgm
2022E	SGM2022-EYN6	LVR-IC	LDO, Dual out, Vout1/Vout2=2.8V/1.8V±2%, 250mA, +CE	SOT-23-6	33zc	VR19	7b	Sgm
2022G	LR32022BG-AG6	LVR-IC	LDO, Dual out, Vout1/Vout2=2.0V/2.0V±0.5%, 150mA, +CE	SOP-6	33x5	VR19	7b	Utc
2022H	SGM2022-GYN6	LVR-IC	LDO, Dual out, Vout1/Vout2=2.5V/1.8V±2%, 250mA, +CE	SOT-23-6	33zc	VR19	7b	Sgm
2022H	SGM2022-HYN6	LVR-IC	LDO, Dual out, Vout1/Vout2=3.3V/2.5V±2%, 250mA, +CE	SOT-23-6	33zc	VR19	7b	Sgm
2022I	SGM2022-YN6	LVR-IC	LDO, Dual out, Vout1/Vout2=3.3V/1.8V±2%, 250mA, +CE	SOT-23-6	33zc	VR19	7b	Sgm
2022K	SGM2022-KYN6	LVR-IC	LDO, Dual out, Vout1/Vout2=3.0V/1.8V±2%, 250mA, +CE	SOT-23-6	33zc	VR19	7b	Sgm
2022M	SGM2022-MYN6	LVR-IC	LDO, Dual out, Vout1/Vout2=2.8V/1.2V±2%, 250mA, +CE	SOT-23-6	33zc	VR19	7b	Sgm
2022N	SGM2022-NNY6	LVR-IC	LDO, Dual out, Vout1/Vout2=2.8V/1.3V±2%, 250mA, +CE	SOT-23-6	33zc	VR19	7b	Sgm
2022O	SGM2022-OYN6	LVR-IC	LDO, Dual out, Vout1/Vout2=2.8V/1.5V±2%, 250mA, +CE	SOT-23-6	33zc	VR19	7b	Sgm
2022P	SGM2022-PYN6	LVR-IC	LDO, Dual out, Vout1/Vout2=1.5V/2.8V±2%, 250mA, +CE	SOT-23-6	33zc	VR19	7b	Sgm
2022Q	SGM2022-QYN6	LVR-IC	LDO, Dual out, Vout1/Vout2=2.5V/1.5V±2%, 250mA, +CE	SOT-23-6	33zc	VR19	7b	Sgm
2022R	SGM2022-RYN6	LVR-IC	LDO, Dual out, Vout1/Vout2=2.5V/2.8V±2%, 250mA, +CE	SOT-23-6	33zc	VR19	7b	Sgm
2022S	SGM2022-SYN6	LVR-IC	LDO, Dual out, Vout1/Vout2=1.3V/2.8V±2%, 250mA, +CE	SOT-23-6	33zc	VR19	7b	Sgm
2022T	SGM2022-TYN6	LVR-IC	LDO, Dual out, Vout1/Vout2=1.5V/3.3V±2%, 250mA, +CE	SOT-23-6	33zc	VR19	7b	Sgm
2022U	SGM2022-UYN6	LVR-IC	LDO, Dual out, Vout1/Vout2=3.0V/2.0V±2%, 250mA, +CE	SOT-23-6	33zc	VR19	7b	Sgm
2022V	SGM2022-VYN6	LVR-IC	LDO, Dual out, Vout1/Vout2=1.8V/3.3V±2%, 250mA, +CE	SOT-23-6	33zc	VR19	7b	Sgm
2022W	SGM2022-WYN6	LVR-IC	LDO, Dual out, Vout1/Vout2=1.2V/2.8V±2%, 250mA, +CE	SOT-23-6	33zc	VR19	7b	Sgm
2022X	SGM2022-XYN6	LVR-IC	LDO, Dual out, Vout1/Vout2=3.3V/2.8V±2%, 250mA, +CE	SOT-23-6	33zc	VR19	7b	Sgm
2022Y	SGM2022-YYN6	LVR-IC	LDO, Dual out, Vout1/Vout2=1.8V/2.8V±2%, 250mA, +CE	SOT-23-6	33zc	VR19	7b	Sgm
2022Z	SGM2022-ZYN6	LVR-IC	LDO, Dual out, Vout1/Vout2=1.8V/1.8V±2%, 250mA, +CE	SOT-23-6	33zc	VR19	7b	Sgm
2023G	LR32023BG-AG6	LVR-IC	LDO, Dual out, Vout1/Vout2=2.0V/2.3V±0.5%, 150mA, +CE	SOP-6	33x5	VR19	7b	Utc
2024G	LR32024BG-AG6	LVR-IC	LDO, Dual out, Vout1/Vout2=2.0V/2.4V±0.5%, 150mA, +CE	SOP-6	33x5	VR19	7b	Utc
2025G	LR32025BG-AG6	LVR-IC	LDO, Dual out, Vout1/Vout2=2.0V/2.5V±0.5%, 150mA, +CE	SOP-6	33x5	VR19	7b	Utc
2026G	LR32026BG-AG6	LVR-IC	LDO, Dual out, Vout1/Vout2=2.0V/2.6V±0.5%, 150mA, +CE	SOP-6	33x5	VR19	7b	Utc
2027G	LR32027BG-AG6	LVR-IC	LDO, Dual out, Vout1/Vout2=2.0V/2.7V±0.5%, 150mA, +CE	SOP-6	33x5	VR19	7b	Utc
2028G	LR32028BG-AG6	LVR-IC	LDO, Dual out, Vout1/Vout2=2.0V/2.8V±0.5%, 150mA, +CE	SOP-6	33x5	VR19	7b	Utc
2029G	LR32029BG-AG6	LVR-IC	LDO, Dual out, Vout1/Vout2=2.0V/2.9V±0.5%, 150mA, +CE	SOP-6	33x5	VR19	7b	Utc
203	XC6420AB03MR-G	LVR-IC	LDO, Dual out, Vout1/Vout2=1.20V/2.50V±2%, 150mA, +CE	SOT-26	33x5	VR19	7d	Tor
2030G	LR32030BG-AG6	LVR-IC	LDO, Dual out, Vout1/Vout2=2.0V/3.0V±0.5%, 150mA, +CE	SOP-6	33x5	VR19	7b	Utc
2031G	LR32031BG-AG6	LVR-IC	LDO, Dual out, Vout1/Vout2=2.0V/3.1V±0.5%, 150mA, +CE	SOP-6	33x5	VR19	7b	Utc
2032G	LR32032BG-AG6	LVR-IC	LDO, Dual out, Vout1/Vout2=2.0V/3.2V±0.5%, 150mA, +CE	SOP-6	33x5	VR19	7b	Utc
2033G	LR32033BG-AG6	LVR-IC	LDO, Dual out, Vout1/Vout2=2.0V/3.3V±0.5%, 150mA, +CE	SOP-6	33x5	VR19	7b	Utc
204	XC6420AB04MR-G	LVR-IC	LDO, Dual out, Vout1/Vout2=1.20V/2.85V±2%, 150mA, +CE	SOT-26	33x5	VR19	7d	Tor
205	XC6420AB05MR-G	LVR-IC	LDO, Dual out, Vout1/Vout2=1.20V/3.0V±2%, 150mA, +CE	SOT-26	33x5	VR19	7d	Tor
206	XC6420AB06MR-G	LVR-IC	LDO, Dual out, Vout1/Vout2=1.20V/3.30V±2%, 150mA, +CE	SOT-26	33x5	VR19	7d	Tor
207	XC6420AB07MR-G	LVR-IC	LDO, Dual out, Vout1/Vout2=1.50V/1.50V±2%, 150mA, +CE	SOT-26	33x5	VR19	7d	Tor
208	XC6420AB08MR-G	LVR-IC	LDO, Dual out, Vout1/Vout2=1.50V/1.80V±2%, 150mA, +CE	SOT-26	33x5	VR19	7d	Tor
209	XC6420AB09MR-G	LVR-IC	LDO, Dual out, Vout1/Vout2=1.50V/2.50V±2%, 150mA, +CE	SOT-26	33x5	VR19	7d	Tor
20A	MMQA20V	TVS	Quad, 20V, 24W(1ms)	SC-74	33dx	-	7b	Ons
20A	TK74020L	LVR-IC	LDO, Dual out, Vout1/Vout2=2V/2V±2%, 300mA, +CE	SOT-23L-8	47uh	VR22	8d	Tok
20P	TK11220BM	LVR-IC	LDO, 2V±2%, 150mA, +CE	SOT-23L-6	33vf	VR7	7b	Tok
20Q	TK11320BM	LVR-IC	LDO, 2V±2%, 150mA, -CE	SOT-23L-6	33vf	VR7	7b	Tok
20R	TK11320CM	LVR-IC	LDO, 2V±5%, 170mA, -CE	SOT-23L-6	33vf	VR7	7b	Tok
21	R1163D311E	LVR-IC	LDO, 3.1V±1.5%, 150mA, +CE, AE(mode)	SOM-6	34vrc	VR10	7g	Ric
21	VNA-21	MMIC	RF amplifier, 0.5..2.5GHz, 13.1dB (50Q)	SOT-363	33ac	A2	7b	Mc
210	XC6420AB10MR-G	LVR-IC	LDO, Dual out, Vout1/Vout2=1.50V/2.85V±2%, 150mA, +CE	SOT-26	33x5	VR19	7d	Tor
211	XC6420AB11MR-G	LVR-IC	LDO, Dual out, Vout1/Vout2=1.50V/3.00V±2%, 150mA, +CE	SOT-26	33x5	VR19	7d	Tor
2115G	LR32115BG-AG6	LVR-IC	LDO, Dual out, Vout1/Vout2=2.1V/1.5V±0.5%, 150mA, +CE	SOP-6	33x5	VR19	7b	Utc
2116G	LR32116BG-AG6	LVR-IC	LDO, Dual out, Vout1/Vout2=2.1V/1.6V±0.5%, 150mA, +CE	SOP-6	33x5	VR19	7b	Utc
2117G	LR32117BG-AG6	LVR-IC	LDO, Dual out, Vout1/Vout2=2.1V/1.7V±0.5%, 150mA, +CE	SOP-6	33x5	VR19	7b	Utc



SMD code	Type	Function	Short description	Case	Pinout	Sch.	St.	Mnf.
2118G	LR32118BG-AG6	LVR-IC	LDO, Dual out, Vout1/Vout2=2.1V/1.8V±0.5%, 150mA, +CE	SOP-6	33x5	VR19	7b	Utc
2119G	LR32119BG-AG6	LVR-IC	LDO, Dual out, Vout1/Vout2=2.1V/1.9V±0.5%, 150mA, +CE	SOP-6	33x5	VR19	7b	Utc
212	XC6420AB12MR-G	LVR-IC	LDO, Dual out, Vout1/Vout2=1.50/3.30V±2%, 150mA, +CE	SOT-26	33x5	VR19	7d	Tor
2120G	LR32110BG-AG6	LVR-IC	LDO, Dual out, Vout1/Vout2=2.1V/2.0V±0.5%, 150mA, +CE	SOP-6	33x5	VR19	7b	Utc
2121G	LR32121BG-AG6	LVR-IC	LDO, Dual out, Vout1/Vout2=2.1V/2.1V±0.5%, 150mA, +CE	SOP-6	33x5	VR19	7b	Utc
2122G	LR32122BG-AG6	LVR-IC	LDO, Dual out, Vout1/Vout2=2.1V/2.2V±0.5%, 150mA, +CE	SOP-6	33x5	VR19	7b	Utc
2123G	LR32123BG-AG6	LVR-IC	LDO, Dual out, Vout1/Vout2=2.1V/2.3V±0.5%, 150mA, +CE	SOP-6	33x5	VR19	7b	Utc
2124G	LR32124BG-AG6	LVR-IC	LDO, Dual out, Vout1/Vout2=2.1V/2.4V±0.5%, 150mA, +CE	SOP-6	33x5	VR19	7b	Utc
2125G	LR32125BG-AG6	LVR-IC	LDO, Dual out, Vout1/Vout2=2.1V/2.5V±0.5%, 150mA, +CE	SOP-6	33x5	VR19	7b	Utc
2126G	LR32126BG-AG6	LVR-IC	LDO, Dual out, Vout1/Vout2=2.1V/2.6V±0.5%, 150mA, +CE	SOP-6	33x5	VR19	7b	Utc
2127G	LR32127BG-AG6	LVR-IC	LDO, Dual out, Vout1/Vout2=2.1V/2.7V±0.5%, 150mA, +CE	SOP-6	33x5	VR19	7b	Utc
2128G	LR32128BG-AG6	LVR-IC	LDO, Dual out, Vout1/Vout2=2.1V/2.8V±0.5%, 150mA, +CE	SOP-6	33x5	VR19	7b	Utc
2129G	LR32129BG-AG6	LVR-IC	LDO, Dual out, Vout1/Vout2=2.1V/2.9V±0.5%, 150mA, +CE	SOP-6	33x5	VR19	7b	Utc
213	XC6420AB13MR-G	LVR-IC	LDO, Dual out, Vout1/Vout2=1.8V/1.8V±2%, 150mA, +CE	SOT-26	33x5	VR19	7d	Tor
2130G	LR32130BG-AG6	LVR-IC	LDO, Dual out, Vout1/Vout2=2.1V/2.0V±0.5%, 150mA, +CE	SOP-6	33x5	VR19	7b	Utc
2131G	LR32131BG-AG6	LVR-IC	LDO, Dual out, Vout1/Vout2=2.1V/3.1V±0.5%, 150mA, +CE	SOP-6	33x5	VR19	7b	Utc
2132G	LR32132BG-AG6	LVR-IC	LDO, Dual out, Vout1/Vout2=2.1V/3.2V±0.5%, 150mA, +CE	SOP-6	33x5	VR19	7b	Utc
2133G	LR32133BG-AG6	LVR-IC	LDO, Dual out, Vout1/Vout2=2.1V/3.3V±0.5%, 150mA, +CE	SOP-6	33x5	VR19	7b	Utc
214	XC6420AB14MR-G	LVR-IC	LDO, Dual out, Vout1/Vout2=1.8V/2.5V±2%, 150mA, +CE	SOT-26	33x5	VR19	7d	Tor
215	XC6420AB15MR-G	LVR-IC	LDO, Dual out, Vout1/Vout2=2.85/2.85V±2%, 150mA, +CE	SOT-26	33x5	VR19	7d	Tor
216	XC6420AB16MR-G	LVR-IC	LDO, Dual out, Vout1/Vout2=1.8V/2.85V±2%, 150mA, +CE	SOT-26	33x5	VR19	7d	Tor
217	XC6420AB17MR-G	LVR-IC	LDO, Dual out, Vout1/Vout2=1.8V/3.0V±2%, 150mA, +CE	SOT-26	33x5	VR19	7d	Tor
218	XC6420AB18MR-G	LVR-IC	LDO, Dual out, Vout1/Vout2=3.0/1.8V±2%, 150mA, +CE	SOT-26	33x5	VR19	7d	Tor
219	XC6420AB19MR-G	LVR-IC	LDO, Dual out, Vout1/Vout2=1.8V/3.3V±2%, 150mA, +CE	SOT-26	33x5	VR19	7d	Tor
21A	MMQA21V	TVS	Quad, 21V, 24W(1ms)	SC-74	33xdx	-	7b	Ons
21A	TK74021L	LVR-IC	LDO, Dual out, Vout1/Vout2=2.1V/2.1V±2%, 300mA, +CE	SOT-23L-8	47uh	VR22	8d	Tok
21P	TK11221BM	LVR-IC	LDO, 2.1V±2%, 150mA, +CE	SOT-23L-6	33vf	VR7	7b	Tok
21Q	TK11321BM	LVR-IC	LDO, 2.1V±2%, 150mA, -CE	SOT-23L-6	33vf	VR7	7b	Tok
21R	TK11321CM	LVR-IC	LDO, 2.1V±5%, 170mA, -CE	SOT-23L-6	33vf	VR7	7b	Tok
22	R1163D321E	LVR-IC	LDO, 3.2V±1.5%, 150mA, +CE, AE(mode)	SON-6	34wrc	VR10	7g	Ric
22	VNA-22	MMIC	RF amplifier, 0.5..2.5GHz, 12.2dB (50Ω)	SOT-363	33cac	A2	7b	Mc
220	XC6420AB20MR-G	LVR-IC	LDO, Dual out, Vout1/Vout2=2.50/2.50V±2%, 150mA, +CE	SOT-26	33x5	VR19	7d	Tor
221	XC6420AB21MR-G	LVR-IC	LDO, Dual out, Vout1/Vout2=2.50/2.80V±2%, 150mA, +CE	SOT-26	33x5	VR19	7d	Tor
2215G	LR32215BG-AG6	LVR-IC	LDO, Dual out, Vout1/Vout2=2.2V/1.5V±0.5%, 150mA, +CE	SOP-6	33x5	VR19	7b	Utc
2216G	LR32216BG-AG6	LVR-IC	LDO, Dual out, Vout1/Vout2=2.2V/1.6V±0.5%, 150mA, +CE	SOP-6	33x5	VR19	7b	Utc
2217G	LR32217BG-AG6	LVR-IC	LDO, Dual out, Vout1/Vout2=2.2V/1.7V±0.5%, 150mA, +CE	SOP-6	33x5	VR19	7b	Utc
2218G	LR32218BG-AG6	LVR-IC	LDO, Dual out, Vout1/Vout2=2.2V/1.8V±0.5%, 150mA, +CE	SOP-6	33x5	VR19	7b	Utc
2219G	LR32219BG-AG6	LVR-IC	LDO, Dual out, Vout1/Vout2=2.2V/1.9V±0.5%, 150mA, +CE	SOP-6	33x5	VR19	7b	Utc
222	XC6420AB22MR-G	LVR-IC	LDO, Dual out, Vout1/Vout2=2.50/2.85V±2%, 150mA, +CE	SOT-26	33x5	VR19	7d	Tor
2220G	LR32220BG-AG6	LVR-IC	LDO, Dual out, Vout1/Vout2=2.2V/2.0V±0.5%, 150mA, +CE	SOP-6	33x5	VR19	7b	Utc
2221G	LR32221BG-AG6	LVR-IC	LDO, Dual out, Vout1/Vout2=2.2V/2.1V±0.5%, 150mA, +CE	SOP-6	33x5	VR19	7b	Utc
2222G	LR32222BG-AG6	LVR-IC	LDO, Dual out, Vout1/Vout2=2.2V/2.2V±0.5%, 150mA, +CE	SOP-6	33x5	VR19	7b	Utc
2223G	LR32223BG-AG6	LVR-IC	LDO, Dual out, Vout1/Vout2=2.2V/2.3V±0.5%, 150mA, +CE	SOP-6	33x5	VR19	7b	Utc
2224G	LR32224BG-AG6	LVR-IC	LDO, Dual out, Vout1/Vout2=2.2V/2.4V±0.5%, 150mA, +CE	SOP-6	33x5	VR19	7b	Utc
2225G	LR32225BG-AG6	LVR-IC	LDO, Dual out, Vout1/Vout2=2.2V/2.5V±0.5%, 150mA, +CE	SOP-6	33x5	VR19	7b	Utc
2226G	LR32226BG-AG6	LVR-IC	LDO, Dual out, Vout1/Vout2=2.2V/2.6V±0.5%, 150mA, +CE	SOP-6	33x5	VR19	7b	Utc
2227G	LR32227BG-AG6	LVR-IC	LDO, Dual out, Vout1/Vout2=2.2V/2.7V±0.5%, 150mA, +CE	SOP-6	33x5	VR19	7b	Utc
2228G	LR32228BG-AG6	LVR-IC	LDO, Dual out, Vout1/Vout2=2.2V/2.8V±0.5%, 150mA, +CE	SOP-6	33x5	VR19	7b	Utc
2229G	LR32229BG-AG6	LVR-IC	LDO, Dual out, Vout1/Vout2=2.2V/2.9V±0.5%, 150mA, +CE	SOP-6	33x5	VR19	7b	Utc
223	XC6420AB23MR-G	LVR-IC	LDO, Dual out, Vout1/Vout2=3.30/1.50V±2%, 150mA, +CE	SOT-26	33x5	VR19	7d	Tor
2230G	LR32230BG-AG6	LVR-IC	LDO, Dual out, Vout1/Vout2=2.2V/3.0V±0.5%, 150mA, +CE	SOP-6	33x5	VR19	7b	Utc
2231G	LR32231BG-AG6	LVR-IC	LDO, Dual out, Vout1/Vout2=2.2V/3.1V±0.5%, 150mA, +CE	SOP-6	33x5	VR19	7b	Utc
2232G	LR32232BG-AG6	LVR-IC	LDO, Dual out, Vout1/Vout2=2.2V/3.2V±0.5%, 150mA, +CE	SOP-6	33x5	VR19	7b	Utc
2233G	LR32233BG-AG6	LVR-IC	LDO, Dual out, Vout1/Vout2=2.2V/3.3V±0.5%, 150mA, +CE	SOP-6	33x5	VR19	7b	Utc
224	XC6420AB24MR-G	LVR-IC	LDO, Dual out, Vout1/Vout2=2.50/3.00V±2%, 150mA, +CE	SOT-26	33x5	VR19	7d	Tor
225	XC6420AB25MR-G	LVR-IC	LDO, Dual out, Vout1/Vout2=2.50/3.30V±2%, 150mA, +CE	SOT-26	33x5	VR19	7d	Tor
226	XC6420AB26MR-G	LVR-IC	LDO, Dual out, Vout1/Vout2=2.85/3.00V±2%, 150mA, +CE	SOT-26	33x5	VR19	7d	Tor
227	XC6420AB27MR-G	LVR-IC	LDO, Dual out, Vout1/Vout2=2.85/3.30V±2%, 150mA, +CE	SOT-26	33x5	VR19	7d	Tor
228	XC6420AB28MR-G	LVR-IC	LDO, Dual out, Vout1/Vout2=3.0/3.0V±2%, 150mA, +CE	SOT-26	33x5	VR19	7d	Tor
229	XC6420AB29MR-G	LVR-IC	LDO, Dual out, Vout1/Vout2=1.20/1.80V±2%, 150mA, +CE	SOT-26	33x5	VR19	7d	Tor
22A	MMQA22V	TVS	Quad, 22V, 24W(1ms)	SC-74	33dx	-	7b	Ons
22A	TK74022L	LVR-IC	LDO, Dual out, Vout1/Vout2=2.2V/2.2V±2%, 300mA, +CE	SOT-23L-8	47uh	VR22	8d	Tok
22P	TK11222BM	LVR-IC	LDO, 2.2V±2%, 150mA, +CE	SOT-23L-6	33vf	VR7	7b	Tok
22Q	TK11322BM	LVR-IC	LDO, 2.2V±2%, 150mA, -CE	SOT-23L-6	33vf	VR7	7b	Tok
22R	TK11322CM	LVR-IC	LDO, 2.2V±5%, 170mA, -CE	SOT-23L-6	33vf	VR7	7b	Tok
23	R1163D331E	LVR-IC	LDO, 3.3V±1.5%, 150mA, +CE, AE(mode)	SON-6	34wrc	VR10	7g	Ric
23	VNA-23	MMIC	RF amplifier, 0.5..2.5GHz, 14.6dB (50Ω)	SOT-363	33cac	A2	7b	Mc
230	XC6420AB30MR-G	LVR-IC	LDO, Dual out, Vout1/Vout2=1.30/2.80V±2%, 150mA, +CE	SOT-26	33x5	VR19	7d	Tor
231	XC6420AB31MR-G	LVR-IC	LDO, Dual out, Vout1/Vout2=1.50/2.80V±2%, 150mA, +CE	SOT-26	33x5	VR19	7d	Tor
2315G	LR32315BG-AG6	LVR-IC	LDO, Dual out, Vout1/Vout2=2.3V/1.5V±0.5%, 150mA, +CE	SOP-6	33x5	VR19	7b	Utc



SMD code	Type	Function	Short description	Case	Pinout	Sch.	St.	Mnf.
2316G	LR32316BG-AG6	LVR-IC	LDO, Dual out, Vout1/Vout2=2.3V/1.6V±0.5%, 150mA, +CE	SOP-6	33x5	VR19	7b	Utc
2317G	LR32317BG-AG6	LVR-IC	LDO, Dual out, Vout1/Vout2=2.3V/1.7V±0.5%, 150mA, +CE	SOP-6	33x5	VR19	7b	Utc
2318G	LR32318BG-AG6	LVR-IC	LDO, Dual out, Vout1/Vout2=2.3V/1.8V±0.5%, 150mA, +CE	SOP-6	33x5	VR19	7b	Utc
2319G	LR32319BG-AG6	LVR-IC	LDO, Dual out, Vout1/Vout2=2.3V/1.9V±0.5%, 150mA, +CE	SOP-6	33x5	VR19	7b	Utc
232	XC6420AB32MR-G	LVR-IC	LDO, Dual out, Vout1/Vout2=1.8V/2.8V±2%, 150mA, +CE	SOT-26	33x5	VR19	7d	Tor
2320G	LR32320BG-AG6	LVR-IC	LDO, Dual out, Vout1/Vout2=2.3V/2.3V±0.5%, 150mA, +CE	SOP-6	33x5	VR19	7b	Utc
2321G	LR32321BG-AG6	LVR-IC	LDO, Dual out, Vout1/Vout2=2.3V/2.1V±0.5%, 150mA, +CE	SOP-6	33x5	VR19	7b	Utc
2322G	LR32322BG-AG6	LVR-IC	LDO, Dual out, Vout1/Vout2=2.3V/2.2V±0.5%, 150mA, +CE	SOP-6	33x5	VR19	7b	Utc
2323G	LR32323BG-AG6	LVR-IC	LDO, Dual out, Vout1/Vout2=2.3V/2.3V±0.5%, 150mA, +CE	SOP-6	33x5	VR19	7b	Utc
2324G	LR32324BG-AG6	LVR-IC	LDO, Dual out, Vout1/Vout2=2.3V/2.4V±0.5%, 150mA, +CE	SOP-6	33x5	VR19	7b	Utc
2325G	LR32325BG-AG6	LVR-IC	LDO, Dual out, Vout1/Vout2=2.3V/2.5V±0.5%, 150mA, +CE	SOP-6	33x5	VR19	7b	Utc
2326G	LR32326BG-AG6	LVR-IC	LDO, Dual out, Vout1/Vout2=2.3V/2.6V±0.5%, 150mA, +CE	SOP-6	33x5	VR19	7b	Utc
2327G	LR32327BG-AG6	LVR-IC	LDO, Dual out, Vout1/Vout2=2.3V/2.7V±0.5%, 150mA, +CE	SOP-6	33x5	VR19	7b	Utc
2328G	LR32328BG-AG6	LVR-IC	LDO, Dual out, Vout1/Vout2=2.3V/2.8V±0.5%, 150mA, +CE	SOP-6	33x5	VR19	7b	Utc
2329G	LR32329BG-AG6	LVR-IC	LDO, Dual out, Vout1/Vout2=2.3V/2.9V±0.5%, 150mA, +CE	SOP-6	33x5	VR19	7b	Utc
233	XC6420AB33MR-G	LVR-IC	LDO, Dual out, Vout1/Vout2=2.80/2.80V±2%, 150mA, +CE	SOT-26	33x5	VR19	7d	Tor
2330G	LR32330BG-AG6	LVR-IC	LDO, Dual out, Vout1/Vout2=2.3V/3.0V±0.5%, 150mA, +CE	SOP-6	33x5	VR19	7b	Utc
2331G	LR32331BG-AG6	LVR-IC	LDO, Dual out, Vout1/Vout2=2.3V/3.1V±0.5%, 150mA, +CE	SOP-6	33x5	VR19	7b	Utc
2332G	LR32332BG-AG6	LVR-IC	LDO, Dual out, Vout1/Vout2=2.3V/3.2V±0.5%, 150mA, +CE	SOP-6	33x5	VR19	7b	Utc
2333G	LR32333BG-AG6	LVR-IC	LDO, Dual out, Vout1/Vout2=2.3V/3.3V±0.5%, 150mA, +CE	SOP-6	33x5	VR19	7b	Utc
2338	KBA2338B-MSOP	LIN-IC	AF PA, BTL, class-D, 2.5..5.5V, 3W(5V/4Q), shutdown	SSOP-8	47	AFP24	-	Ktc
234	XC6420AB34MR-G	LVR-IC	LDO, Dual out, Vout1/Vout2=2.80/3.00V±2%, 150mA, +CE	SOT-26	33x5	VR19	7d	Tor
235	XC6420AB35MR-G	LVR-IC	LDO, Dual out, Vout1/Vout2=2.80/3.30V±2%, 150mA, +CE	SOT-26	33x5	VR19	7d	Tor
236	XC6420AB36MR-G	LVR-IC	LDO, Dual out, Vout1/Vout2=1.20/3.60V±2%, 150mA, +CE	SOT-26	33x5	VR19	7d	Tor
237	XC6420AB37MR-G	LVR-IC	LDO, Dual out, Vout1/Vout2=3.60/1.20V±2%, 150mA, +CE	SOT-26	33x5	VR19	7d	Tor
238	XC6420AB38MR-G	LVR-IC	LDO, Dual out, Vout1/Vout2=1.20/2.80V±2%, 150mA, +CE	SOT-26	33x5	VR19	7d	Tor
239	XC6420AB39MR-G	LVR-IC	LDO, Dual out, Vout1/Vout2=3.30/2.00V±2%, 150mA, +CE	SOT-26	33x5	VR19	7d	Tor
23A	TK74023L	LVR-IC	LDO, Dual out, Vout1/Vout2=2.3V/2.3V±2%, 300mA, +CE	SOT-23L-8	47uh	VR22	8d	Tok
23P	TK11223BM	LVR-IC	LDO, 2.3V±2%, 150mA, +CE	SOT-23L-6	33vf	VR7	7b	Tok
23Q	TK11323BM	LVR-IC	LDO, 2.3V 2.5%, 150mA, -CE	SOT-23L-6	33vf	VR7	7b	Tok
24	μPA831TC	Si-npn	Dual, VHF/UHF, LN, 2V, 65mA, 90mW, B=70..140, 4.5GHz	SMM-6	35/T3	-	7b	Nec
24	TR1163D341E	LVR-IC	LDO, 3.4V±1.5%, 150mA, +CE, AE(mode)	SON-6	34wrc	VR10	7g	Ric
24P Z	SMS24	TVS	Quad, 24V, 8A, 350W(1ms)	SOT-23-6L	33xdx	-	7b	Smt
240	XC6420AB40MR-G	LVR-IC	LDO, Dual out, Vout1/Vout2=3.0/3.30V±2%, 150mA, +CE	SOT-26	33x5	VR19	7d	Tor
240	XC74WL240AASR	CMOS-Logic	Dual bus buffer inverted with 3-state output	MSOP-8B	47L,og67	-	8d	Tor
241	KIC7W241FK	CMOS-Logic	Dual bus buffer non-inverted with 3-state output	USB	47L,og60	-	8c	Kec
241	XC6420AB41MR-G	LVR-IC	LDO, Dual out, Vout1/Vout2=3.30/3.30V±2%, 150mA, +CE	SOT-26	33x5	VR19	7d	Tor
241	XC74WL241AASR	CMOS-Logic	Dual bus buffer non-inverted with 3-state output	MSOP-8B	47L,og60	-	8d	Tor
2415G	LR32415BG-AG6	LVR-IC	LDO, Dual out, Vout1/Vout2=2.4V/1.5V±0.5%, 150mA, +CE	SOP-6	33x5	VR19	7b	Utc
2416G	LR32416BG-AG6	LVR-IC	LDO, Dual out, Vout1/Vout2=2.4V/1.6V±0.5%, 150mA, +CE	SOP-6	33x5	VR19	7b	Utc
2417G	LR32417BG-AG6	LVR-IC	LDO, Dual out, Vout1/Vout2=2.4V/1.7V±0.5%, 150mA, +CE	SOP-6	33x5	VR19	7b	Utc
2418G	LR32418BG-AG6	LVR-IC	LDO, Dual out, Vout1/Vout2=2.4V/1.8V±0.5%, 150mA, +CE	SOP-6	33x5	VR19	7b	Utc
2419G	LR32419BG-AG6	LVR-IC	LDO, Dual out, Vout1/Vout2=2.4V/1.9V±0.5%, 150mA, +CE	SOP-6	33x5	VR19	7b	Utc
242	XC6420AB42MR-G	LVR-IC	LDO, Dual out, Vout1/Vout2=1.30/1.50V±2%, 150mA, +CE	SOT-26	33x5	VR19	7d	Tor
2420G	LR32420BG-AG6	LVR-IC	LDO, Dual out, Vout1/Vout2=2.4V/2.0V±0.5%, 150mA, +CE	SOP-6	33x5	VR19	7b	Utc
2421G	LR32421BG-AG6	LVR-IC	LDO, Dual out, Vout1/Vout2=2.4V/2.1V±0.5%, 150mA, +CE	SOP-6	33x5	VR19	7b	Utc
2422G	LR32422BG-AG6	LVR-IC	LDO, Dual out, Vout1/Vout2=2.4V/2.2V±0.5%, 150mA, +CE	SOP-6	33x5	VR19	7b	Utc
2423G	LR32423BG-AG6	LVR-IC	LDO, Dual out, Vout1/Vout2=2.4V/2.3V±0.5%, 150mA, +CE	SOP-6	33x5	VR19	7b	Utc
2424G	LR32424BG-AG6	LVR-IC	LDO, Dual out, Vout1/Vout2=2.4V/2.4V±0.5%, 150mA, +CE	SOP-6	33x5	VR19	7b	Utc
2425G	LR32425BG-AG6	LVR-IC	LDO, Dual out, Vout1/Vout2=2.4V/2.5V±0.5%, 150mA, +CE	SOP-6	33x5	VR19	7b	Utc
2426G	LR32426BG-AG6	LVR-IC	LDO, Dual out, Vout1/Vout2=2.4V/2.6V±0.5%, 150mA, +CE	SOP-6	33x5	VR19	7b	Utc
2427G	LR32427BG-AG6	LVR-IC	LDO, Dual out, Vout1/Vout2=2.4V/2.7V±0.5%, 150mA, +CE	SOP-6	33x5	VR19	7b	Utc
2428G	LR32428BG-AG6	LVR-IC	LDO, Dual out, Vout1/Vout2=2.4V/2.8V±0.5%, 150mA, +CE	SOP-6	33x5	VR19	7b	Utc
2429G	LR32429BG-AG6	LVR-IC	LDO, Dual out, Vout1/Vout2=2.4V/2.9V±0.5%, 150mA, +CE	SOP-6	33x5	VR19	7b	Utc
243	XC6420AB43MR-G	LVR-IC	LDO, Dual out, Vout1/Vout2=2.60/2.80V±2%, 150mA, +CE	SOT-26	33x5	VR19	7d	Tor
2430G	LR32430BG-AG6	LVR-IC	LDO, Dual out, Vout1/Vout2=2.4V/3.0V±0.5%, 150mA, +CE	SOP-6	33x5	VR19	7b	Utc
2431G	LR32431BG-AG6	LVR-IC	LDO, Dual out, Vout1/Vout2=2.4V/3.1V±0.5%, 150mA, +CE	SOP-6	33x5	VR19	7b	Utc
2432G	LR32432BG-AG6	LVR-IC	LDO, Dual out, Vout1/Vout2=2.4V/3.2V±0.5%, 150mA, +CE	SOP-6	33x5	VR19	7b	Utc
2433G	LR32433BG-AG6	LVR-IC	LDO, Dual out, Vout1/Vout2=2.4V/3.3V±0.5%, 150mA, +CE	SOP-6	33x5	VR19	7b	Utc
244	XC6420AB44MR-G	LVR-IC	LDO, Dual out, Vout1/Vout2=3.10/3.30V±2%, 150mA, +CE	SOT-26	33x5	VR19	7d	Tor
245	XC6420AB45MR-G	LVR-IC	LDO, Dual out, Vout1/Vout2=1.50/2.60V±2%, 150mA, +CE	SOT-26	33x5	VR19	7d	Tor
246	XC6420AB46MR-G	LVR-IC	LDO, Dual out, Vout1/Vout2=2.60/3.30V±2%, 150mA, +CE	SOT-26	33x5	VR19	7d	Tor
247	XC6420AB47MR-G	LVR-IC	LDO, Dual out, Vout1/Vout2=3.40/3.40V±2%, 150mA, +CE	SOT-26	33x5	VR19	7d	Tor
248	XC6420AB48MR-G	LVR-IC	LDO, Dual out, Vout1/Vout2=2.85/2.60V±2%, 150mA, +CE	SOT-26	33x5	VR19	7d	Tor
249	XC6420AB49MR-G	LVR-IC	LDO, Dual out, Vout1/Vout2=3.30/1.80V±2%, 150mA, +CE	SOT-26	33x5	VR19	7d	Tor
24A	MMQA24V	TVS	Quad, 24V, 24W(1ms)	SC-74	33dx	-	7b	Ons
24A	TK74024L	LVR-IC	LDO, Dual out, Vout1/Vout2=2.4V/2.4V±2%, 300mA, +CE	SOT-23L-8	47uh	VR22	8d	Tok
24P	TK11224BM	LVR-IC	LDO, 2.4V±2%, 150mA, +CE	SOT-23L-6	33vf	VR7	7b	Tok
24Q	TK11324BM	LVR-IC	LDO, 2.4V±2%, 150mA, -CE	SOT-23L-6	33vf	VR7	7b	Tok
24R	μPA810T-FB	Si-npn	Dual, VHF/UHF, 20V, 100mA, 4.5GHz, B=40..80	SOT-363	33tf	-	7b	Nec



SMD code	Type	Function	Short description	Case	Pinout	Sch.	St.	Mnf.
25	R1163D351E	LVR-IC	LDO, 3.5V±1.5%, 150mA, +CE, AE(mode)	SON-6	34vrc	VR10	7g	Ric
25	VNA-25	MMIC	RF amplifier, 0.5..2.5GHz, 16dB (50Ω)	SOT-363	33cac	A2	7b	Mc
250	XC6420AB50MR-G	LVR-IC	LDO, Dual out, Vout1/Vout2=1.8V/1.2V±2%, 150mA, +CE	SOT-26	33x5	VR19	7d	Tor
251	XC6420AB51MR-G	LVR-IC	LDO, Dual out, Vout1/Vout2=2.10/3.10V±2%, 150mA, +CE	SOT-26	33x5	VR19	7d	Tor
2515G	LR32515BG-AG6	LVR-IC	LDO, Dual out, Vout1/Vout2=2.5V/1.5V±0.5%, 150mA, +CE	SOP-6	33x5	VR19	7b	Utc
2516G	LR32516BG-AG6	LVR-IC	LDO, Dual out, Vout1/Vout2=2.5V/1.6V±0.5%, 150mA, +CE	SOP-6	33x5	VR19	7b	Utc
2517G	LR32517BG-AG6	LVR-IC	LDO, Dual out, Vout1/Vout2=2.5V/1.7V±0.5%, 150mA, +CE	SOP-6	33x5	VR19	7b	Utc
2518G	LR32518BG-AG6	LVR-IC	LDO, Dual out, Vout1/Vout2=2.5V/1.8V±0.5%, 150mA, +CE	SOP-6	33x5	VR19	7b	Utc
2519G	LR32519BG-AG6	LVR-IC	LDO, Dual out, Vout1/Vout2=2.5V/1.9V±0.5%, 150mA, +CE	SOP-6	33x5	VR19	7b	Utc
252	XC6420AB52MR-G	LVR-IC	LDO, Dual out, Vout1/Vout2=1.50/3.10V±2%, 150mA, +CE	SOT-26	33x5	VR19	7d	Tor
2520G	LR32520BG-AG6	LVR-IC	LDO, Dual out, Vout1/Vout2=2.5V/2.0V±0.5%, 150mA, +CE	SOP-6	33x5	VR19	7b	Utc
2521G	LR32521BG-AG6	LVR-IC	LDO, Dual out, Vout1/Vout2=2.5V/2.1V±0.5%, 150mA, +CE	SOP-6	33x5	VR19	7b	Utc
2522G	LR32522BG-AG6	LVR-IC	LDO, Dual out, Vout1/Vout2=2.5V/2.2V±0.5%, 150mA, +CE	SOP-6	33x5	VR19	7b	Utc
2523G	LR32523BG-AG6	LVR-IC	LDO, Dual out, Vout1/Vout2=2.5V/2.3V±0.5%, 150mA, +CE	SOP-6	33x5	VR19	7b	Utc
2524G	LR32524BG-AG6	LVR-IC	LDO, Dual out, Vout1/Vout2=2.5V/2.4V±0.5%, 150mA, +CE	SOP-6	33x5	VR19	7b	Utc
2525G	LR32525BG-AG6	LVR-IC	LDO, Dual out, Vout1/Vout2=2.5V/2.5V±0.5%, 150mA, +CE	SOP-6	33x5	VR19	7b	Utc
2526G	LR32526BG-AG6	LVR-IC	LDO, Dual out, Vout1/Vout2=2.5V/2.6V±0.5%, 150mA, +CE	SOP-6	33x5	VR19	7b	Utc
2527G	LR32527BG-AG6	LVR-IC	LDO, Dual out, Vout1/Vout2=2.5V/2.7V±0.5%, 150mA, +CE	SOP-6	33x5	VR19	7b	Utc
2528G	LR32528BG-AG6	LVR-IC	LDO, Dual out, Vout1/Vout2=2.5V/2.8V±0.5%, 150mA, +CE	SOP-6	33x5	VR19	7b	Utc
2529G	LR32529BG-AG6	LVR-IC	LDO, Dual out, Vout1/Vout2=2.5V/2.9V±0.5%, 150mA, +CE	SOP-6	33x5	VR19	7b	Utc
253	XC6420AB53MR-G	LVR-IC	LDO, Dual out, Vout1/Vout2=3.30/2.80V±2%, 150mA, +CE	SOT-26	33x5	VR19	7d	Tor
2530G	LR32530BG-AG6	LVR-IC	LDO, Dual out, Vout1/Vout2=2.5V/3.0V±0.5%, 150mA, +CE	SOP-6	33x5	VR19	7b	Utc
2531G	LR32531BG-AG6	LVR-IC	LDO, Dual out, Vout1/Vout2=2.5V/3.1V±0.5%, 150mA, +CE	SOP-6	33x5	VR19	7b	Utc
2532G	LR32532BG-AG6	LVR-IC	LDO, Dual out, Vout1/Vout2=2.5V/3.2V±0.5%, 150mA, +CE	SOP-6	33x5	VR19	7b	Utc
2533G	LR32533BG-AG6	LVR-IC	LDO, Dual out, Vout1/Vout2=2.5V/3.3V±0.5%, 150mA, +CE	SOP-6	33x5	VR19	7b	Utc
254	XC6420AB54MR-G	LVR-IC	LDO, Dual out, Vout1/Vout2=3.0/2.8V±2%, 150mA, +CE	SOT-26	33x5	VR19	7d	Tor
255	XC6420AB55MR-G	LVR-IC	LDO, Dual out, Vout1/Vout2=3.30/3.00V±2%, 150mA, +CE	SOT-26	33x5	VR19	7d	Tor
257	XC74WL157AASR	CMOS-Logic	2-input multiplexer	MSOP-8B	47L0q66	-	8d	Tor
25A	TK74025L	LVR-IC	LDO, Dual out, Vout1/Vout2=2.5V/2.5V±2%, 300mA, +CE	SOT-23L-8	47uh	VR22	8d	Tok
25P	TK11225BM	LVR-IC	LDO, 2.5V±2%, 150mA, +CE	SOT-23L-6	33vfv	VR7	7b	Tok
25Q	TK11325BM	LVR-IC	LDO, 2.5V±2%, 150mA, -CE	SOT-23L-6	33vfv	VR7	7b	Tok
25R	μPA810T-GB	Si-npn	Dual, VHF/UHF, 20V, 100mA, 4.5GHz, B=70..140	SOT-363	33if	-	7b	Nec
25R	TK11325CM	LVR-IC	LDO, 2.5V±5%, 170mA, -CE	SOT-23L-6	33vfv	VR7	7b	Tok
26	R1163D361E	LVR-IC	LDO, 3.6V±1.5%, 150mA, +CE, AE(mode)	SON-6	34vrc	VR10	7g	Ric
2615G	LR32615BG-AG6	LVR-IC	LDO, Dual out, Vout1/Vout2=2.6V/1.5V±0.5%, 150mA, +CE	SOP-6	33x5	VR19	7b	Utc
2616G	LR32616BG-AG6	LVR-IC	LDO, Dual out, Vout1/Vout2=2.6V/1.6V±0.5%, 150mA, +CE	SOP-6	33x5	VR19	7b	Utc
2617G	LR32617BG-AG6	LVR-IC	LDO, Dual out, Vout1/Vout2=2.6V/1.7V±0.5%, 150mA, +CE	SOP-6	33x5	VR19	7b	Utc
2618G	LR32618BG-AG6	LVR-IC	LDO, Dual out, Vout1/Vout2=2.6V/1.8V±0.5%, 150mA, +CE	SOP-6	33x5	VR19	7b	Utc
2619G	LR32619BG-AG6	LVR-IC	LDO, Dual out, Vout1/Vout2=2.6V/1.9V±0.5%, 150mA, +CE	SOP-6	33x5	VR19	7b	Utc
2620G	LR32620BG-AG6	LVR-IC	LDO, Dual out, Vout1/Vout2=2.6V/2.0V±0.5%, 150mA, +CE	SOP-6	33x5	VR19	7b	Utc
2621G	LR32621BG-AG6	LVR-IC	LDO, Dual out, Vout1/Vout2=2.6V/2.1V±0.5%, 150mA, +CE	SOP-6	33x5	VR19	7b	Utc
2622G	LR32622BG-AG6	LVR-IC	LDO, Dual out, Vout1/Vout2=2.6V/2.2V±0.5%, 150mA, +CE	SOP-6	33x5	VR19	7b	Utc
2623G	LR32623BG-AG6	LVR-IC	LDO, Dual out, Vout1/Vout2=2.6V/2.3V±0.5%, 150mA, +CE	SOP-6	33x5	VR19	7b	Utc
2624G	LR32624BG-AG6	LVR-IC	LDO, Dual out, Vout1/Vout2=2.6V/2.4V±0.5%, 150mA, +CE	SOP-6	33x5	VR19	7b	Utc
2625G	LR32625BG-AG6	LVR-IC	LDO, Dual out, Vout1/Vout2=2.6V/2.5V±0.5%, 150mA, +CE	SOP-6	33x5	VR19	7b	Utc
2626G	LR32626BG-AG6	LVR-IC	LDO, Dual out, Vout1/Vout2=2.6V/2.6V±0.5%, 150mA, +CE	SOP-6	33x5	VR19	7b	Utc
2627G	LR32627BG-AG6	LVR-IC	LDO, Dual out, Vout1/Vout2=2.6V/2.7V±0.5%, 150mA, +CE	SOP-6	33x5	VR19	7b	Utc
2628G	LR32628BG-AG6	LVR-IC	LDO, Dual out, Vout1/Vout2=2.6V/2.8V±0.5%, 150mA, +CE	SOP-6	33x5	VR19	7b	Utc
2629G	LR32629BG-AG6	LVR-IC	LDO, Dual out, Vout1/Vout2=2.6V/2.9V±0.5%, 150mA, +CE	SOP-6	33x5	VR19	7b	Utc
2630G	LR32630BG-AG6	LVR-IC	LDO, Dual out, Vout1/Vout2=2.6V/3.0V±0.5%, 150mA, +CE	SOP-6	33x5	VR19	7b	Utc
2631G	LR32631BG-AG6	LVR-IC	LDO, Dual out, Vout1/Vout2=2.6V/3.1V±0.5%, 150mA, +CE	SOP-6	33x5	VR19	7b	Utc
2632G	LR32632BG-AG6	LVR-IC	LDO, Dual out, Vout1/Vout2=2.6V/3.2V±0.5%, 150mA, +CE	SOP-6	33x5	VR19	7b	Utc
2633G	LR32633BG-AG6	LVR-IC	LDO, Dual out, Vout1/Vout2=2.6V/3.3V±0.5%, 150mA, +CE	SOP-6	33x5	VR19	7b	Utc
26A	TK74026L	LVR-IC	LDO, Dual out, Vout1/Vout2=2.6V/2.6V±2%, 300mA, +CE	SOT-23L-8	47uh	VR22	8d	Tok
26P	TK11226BM	LVR-IC	LDO, 2.6V±2%, 150mA, +CE	SOT-23L-6	33vfv	VR7	7b	Tok
26Q	TK11326BM	LVR-IC	LDO, 2.6V±2%, 150mA, -CE	SOT-23L-6	33vfv	VR7	7b	Tok
26R	TK11326CM	LVR-IC	LDO, 2.6V±5%, 170mA, -CE	SOT-23L-6	33vfv	VR7	7b	Tok
27	R1163D371E	LVR-IC	LDO, 3.7V±1.5%, 150mA, +CE, AE(mode)	SON-6	34vrc	VR10	7g	Ric
2715G	LR32715BG-AG6	LVR-IC	LDO, Dual out, Vout1/Vout2=2.7V/1.5V±0.5%, 150mA, +CE	SOP-6	33x5	VR19	7b	Utc
2716G	LR32716BG-AG6	LVR-IC	LDO, Dual out, Vout1/Vout2=2.7V/1.6V±0.5%, 150mA, +CE	SOP-6	33x5	VR19	7b	Utc
2717G	LR32717BG-AG6	LVR-IC	LDO, Dual out, Vout1/Vout2=2.7V/1.7V±0.5%, 150mA, +CE	SOP-6	33x5	VR19	7b	Utc
2718G	LR32718BG-AG6	LVR-IC	LDO, Dual out, Vout1/Vout2=2.7V/1.8V±0.5%, 150mA, +CE	SOP-6	33x5	VR19	7b	Utc
2719G	LR32719BG-AG6	LVR-IC	LDO, Dual out, Vout1/Vout2=2.7V/1.9V±0.5%, 150mA, +CE	SOP-6	33x5	VR19	7b	Utc
2720G	LR32720BG-AG6	LVR-IC	LDO, Dual out, Vout1/Vout2=2.7V/2.0V±0.5%, 150mA, +CE	SOP-6	33x5	VR19	7b	Utc
2721G	LR32721BG-AG6	LVR-IC	LDO, Dual out, Vout1/Vout2=2.7V/2.1V±0.5%, 150mA, +CE	SOP-6	33x5	VR19	7b	Utc
2722G	LR32722BG-AG6	LVR-IC	LDO, Dual out, Vout1/Vout2=2.7V/2.2V±0.5%, 150mA, +CE	SOP-6	33x5	VR19	7b	Utc
2723G	LR32723BG-AG6	LVR-IC	LDO, Dual out, Vout1/Vout2=2.7V/2.3V±0.5%, 150mA, +CE	SOP-6	33x5	VR19	7b	Utc
2724G	LR32724BG-AG6	LVR-IC	LDO, Dual out, Vout1/Vout2=2.7V/2.4V±0.5%, 150mA, +CE	SOP-6	33x5	VR19	7b	Utc
2725G	LR32725BG-AG6	LVR-IC	LDO, Dual out, Vout1/Vout2=2.7V/2.5V±0.5%, 150mA, +CE	SOP-6	33x5	VR19	7b	Utc
2726G	LR32726BG-AG6	LVR-IC	LDO, Dual out, Vout1/Vout2=2.7V/2.6V±0.5%, 150mA, +CE	SOP-6	33x5	VR19	7b	Utc



SMD code	Type	Function	Short description	Case	Pinout	Sch.	St.	Mnf.
2727G	LR32727BG-AG6	LVR-IC	LDO, Dual out, Vout1/Vout2=2.7V/2.7V±0.5%, 150mA, +CE	SOP-6	33x5	VR19	7b	Utc
2728G	LR32728BG-AG6	LVR-IC	LDO, Dual out, Vout1/Vout2=2.7V/2.8V±0.5%, 150mA, +CE	SOP-6	33x5	VR19	7b	Utc
2729G	LR32729BG-AG6	LVR-IC	LDO, Dual out, Vout1/Vout2=2.7V/2.9V±0.5%, 150mA, +CE	SOP-6	33x5	VR19	7b	Utc
2730G	LR32730BG-AG6	LVR-IC	LDO, Dual out, Vout1/Vout2=2.7V/3.0V±0.5%, 150mA, +CE	SOP-6	33x5	VR19	7b	Utc
2731G	LR32731BG-AG6	LVR-IC	LDO, Dual out, Vout1/Vout2=2.7V/3.1V±0.5%, 150mA, +CE	SOP-6	33x5	VR19	7b	Utc
2732G	LR32732BG-AG6	LVR-IC	LDO, Dual out, Vout1/Vout2=2.7V/3.2V±0.5%, 150mA, +CE	SOP-6	33x5	VR19	7b	Utc
2733G	LR32733BG-AG6	LVR-IC	LDO, Dual out, Vout1/Vout2=2.7V/3.3V±0.5%, 150mA, +CE	SOP-6	33x5	VR19	7b	Utc
27A	MMQA27V	TVS	Quad, 27V, 24W(1ms)	SC-74	33dx	-	7b	Ons
27A	TK74027L	LVR-IC	LDO, Dual out, Vout1/Vout2=2.7V/2.7V±2%, 300mA, +CE	SOT-23L-8	47uh	VR22	8d	Tok
27P	TK11227BM	LVR-IC	LDO, 2.7V±2%, 150mA, +CE	SOT-23L-6	33vf	VR7	7b	Tok
27Q	TK11327BM	LVR-IC	LDO, 2.7V±2%, 150mA, -CE	SOT-23L-6	33vf	VR7	7b	Tok
27R	TK11327CM	LVR-IC	LDO, 2.7V±5%, 170mA, -CE	SOT-23L-6	33vf	VR7	7b	Tok
28	R1163D381E	LVR-IC	LDO, 3.8V±1.5%, 150mA, +CE, AE(mode)	SON-6	34vrc	VR10	7g	Ric
28	VNA-28	MMIC	RF amplifier, 0.5..2.5GHz, 18.3db (50Ω)	SOT-363	33ac	A2	7b	Mic
2811A	BMS446EFV	LIN-IC	AF PA, BTL, class-D, 10..26V, 2x20W(20V/4Ω), shutdown	HTSSOP-54	60	-	8c	Rhm
2811A	NCP2811ADT	LIN-IC	AF PA, 2.2..5.5V, 2x27mW(5V/32Ω), shutdown	TSSOP-14	60	-	-	Ons
2811B	NCP2811BDT	LIN-IC	AF PA, 2.2..5.5V, 2x27mW(5V/32Ω), shutdown	TSSOP-14	60	-	-	Ons
2815G	LR32815BG-AG6	LVR-IC	LDO, Dual out, Vout1/Vout2=2.8V/1.5V±0.5%, 150mA, +CE	SOP-6	33x5	VR19	7b	Utc
2816G	LR32816BG-AG6	LVR-IC	LDO, Dual out, Vout1/Vout2=2.8V/1.6V±0.5%, 150mA, +CE	SOP-6	33x5	VR19	7b	Utc
2817G	LR32817BG-AG6	LVR-IC	LDO, Dual out, Vout1/Vout2=2.8V/1.7V±0.5%, 150mA, +CE	SOP-6	33x5	VR19	7b	Utc
2818G	LR32818BG-AG6	LVR-IC	LDO, Dual out, Vout1/Vout2=2.8V/1.8V±0.5%, 150mA, +CE	SOP-6	33x5	VR19	7b	Utc
2819G	LR32819BG-AG6	LVR-IC	LDO, Dual out, Vout1/Vout2=2.8V/1.9V±0.5%, 150mA, +CE	SOP-6	33x5	VR19	7b	Utc
2820G	LR32820BG-AG6	LVR-IC	LDO, Dual out, Vout1/Vout2=2.8V/2.0V±0.5%, 150mA, +CE	SOP-6	33x5	VR19	7b	Utc
2821G	LR32821BG-AG6	LVR-IC	LDO, Dual out, Vout1/Vout2=2.8V/2.1V±0.5%, 150mA, +CE	SOP-6	33x5	VR19	7b	Utc
2822G	LR32822BG-AG6	LVR-IC	LDO, Dual out, Vout1/Vout2=2.8V/2.2V±0.5%, 150mA, +CE	SOP-6	33x5	VR19	7b	Utc
2823G	LR32823BG-AG6	LVR-IC	LDO, Dual out, Vout1/Vout2=2.8V/2.3V±0.5%, 150mA, +CE	SOP-6	33x5	VR19	7b	Utc
2824G	LR32824BG-AG6	LVR-IC	LDO, Dual out, Vout1/Vout2=2.8V/2.4V±0.5%, 150mA, +CE	SOP-6	33x5	VR19	7b	Utc
2825G	LR32825BG-AG6	LVR-IC	LDO, Dual out, Vout1/Vout2=2.8V/2.5V±0.5%, 150mA, +CE	SOP-6	33x5	VR19	7b	Utc
2826G	LR32826BG-AG6	LVR-IC	LDO, Dual out, Vout1/Vout2=2.8V/2.6V±0.5%, 150mA, +CE	SOP-6	33x5	VR19	7b	Utc
2827G	LR32827BG-AG6	LVR-IC	LDO, Dual out, Vout1/Vout2=2.8V/2.7V±0.5%, 150mA, +CE	SOP-6	33x5	VR19	7b	Utc
2828G	LR32828BG-AG6	LVR-IC	LDO, Dual out, Vout1/Vout2=2.8V/2.8V±0.5%, 150mA, +CE	SOP-6	33x5	VR19	7b	Utc
2829G	LR32829BG-AG6	LVR-IC	LDO, Dual out, Vout1/Vout2=2.8V/2.9V±0.5%, 150mA, +CE	SOP-6	33x5	VR19	7b	Utc
2830G	LR32830BG-AG6	LVR-IC	LDO, Dual out, Vout1/Vout2=2.8V/3.0V±0.5%, 150mA, +CE	SOP-6	33x5	VR19	7b	Utc
2831G	LR32831BG-AG6	LVR-IC	LDO, Dual out, Vout1/Vout2=2.8V/3.1V±0.5%, 150mA, +CE	SOP-6	33x5	VR19	7b	Utc
2832G	LR32832BG-AG6	LVR-IC	LDO, Dual out, Vout1/Vout2=2.8V/3.2V±0.5%, 150mA, +CE	SOP-6	33x5	VR19	7b	Utc
2833G	LR32833BG-AG6	LVR-IC	LDO, Dual out, Vout1/Vout2=2.8V/3.3V±0.5%, 150mA, +CE	SOP-6	33x5	VR19	7b	Utc
28A	TK74028L	LVR-IC	LDO, Dual out, Vout1/Vout2=2.8V/2.8V±2%, 300mA, +CE	SOT-23L-8	47uh	VR22	8d	Tok
28P	TK11228BM	LVR-IC	LDO, 2.8V±2%, 150mA, +CE	SOT-23L-6	33vf	VR7	7b	Tok
28Q	TK11328BM	LVR-IC	LDO, 2.8V±2%, 150mA, -CE	SOT-23L-6	33vf	VR7	7b	Tok
28R	TK11328CM	LVR-IC	LDO, 2.8V±5%, 170mA, -CE	SOT-23L-6	33vf	VR7	7b	Tok
29	R1163D391E	LVR-IC	LDO, 3.9V±1.5%, 150mA, +CE, AE(mode)	SON-6	34vrc	VR10	7g	Ric
2915G	LR32915BG-AG6	LVR-IC	LDO, Dual out, Vout1/Vout2=2.9V/1.5V±0.5%, 150mA, +CE	SOP-6	33x5	VR19	7b	Utc
2916G	LR32916BG-AG6	LVR-IC	LDO, Dual out, Vout1/Vout2=2.9V/1.6V±0.5%, 150mA, +CE	SOP-6	33x5	VR19	7b	Utc
2917G	LR32917BG-AG6	LVR-IC	LDO, Dual out, Vout1/Vout2=2.9V/1.7V±0.5%, 150mA, +CE	SOP-6	33x5	VR19	7b	Utc
2918G	LR32918BG-AG6	LVR-IC	LDO, Dual out, Vout1/Vout2=2.9V/1.8V±0.5%, 150mA, +CE	SOP-6	33x5	VR19	7b	Utc
2919G	LR32919BG-AG6	LVR-IC	LDO, Dual out, Vout1/Vout2=2.9V/1.9V±0.5%, 150mA, +CE	SOP-6	33x5	VR19	7b	Utc
2920G	LR32920BG-AG6	LVR-IC	LDO, Dual out, Vout1/Vout2=2.9V/2.0V±0.5%, 150mA, +CE	SOP-6	33x5	VR19	7b	Utc
2921G	LR32921BG-AG6	LVR-IC	LDO, Dual out, Vout1/Vout2=2.9V/2.1V±0.5%, 150mA, +CE	SOP-6	33x5	VR19	7b	Utc
2922G	LR32922BG-AG6	LVR-IC	LDO, Dual out, Vout1/Vout2=2.9V/2.2V±0.5%, 150mA, +CE	SOP-6	33x5	VR19	7b	Utc
2923G	LR32923BG-AG6	LVR-IC	LDO, Dual out, Vout1/Vout2=2.9V/2.3V±0.5%, 150mA, +CE	SOP-6	33x5	VR19	7b	Utc
2924G	LR32924BG-AG6	LVR-IC	LDO, Dual out, Vout1/Vout2=2.9V/2.4V±0.5%, 150mA, +CE	SOP-6	33x5	VR19	7b	Utc
2925G	LR32925BG-AG6	LVR-IC	LDO, Dual out, Vout1/Vout2=2.9V/2.5V±0.5%, 150mA, +CE	SOP-6	33x5	VR19	7b	Utc
2926G	LR32926BG-AG6	LVR-IC	LDO, Dual out, Vout1/Vout2=2.9V/2.6V±0.5%, 150mA, +CE	SOP-6	33x5	VR19	7b	Utc
2927G	LR32927BG-AG6	LVR-IC	LDO, Dual out, Vout1/Vout2=2.9V/2.7V±0.5%, 150mA, +CE	SOP-6	33x5	VR19	7b	Utc
2928G	LR32928BG-AG6	LVR-IC	LDO, Dual out, Vout1/Vout2=2.9V/2.8V±0.5%, 150mA, +CE	SOP-6	33x5	VR19	7b	Utc
2929G	LR32929BG-AG6	LVR-IC	LDO, Dual out, Vout1/Vout2=2.9V/2.9V±0.5%, 150mA, +CE	SOP-6	33x5	VR19	7b	Utc
2930G	LR32930BG-AG6	LVR-IC	LDO, Dual out, Vout1/Vout2=2.9V/3.0V±0.5%, 150mA, +CE	SOP-6	33x5	VR19	7b	Utc
2931G	LR32931BG-AG6	LVR-IC	LDO, Dual out, Vout1/Vout2=2.9V/3.1V±0.5%, 150mA, +CE	SOP-6	33x5	VR19	7b	Utc
2932G	LR32932BG-AG6	LVR-IC	LDO, Dual out, Vout1/Vout2=2.9V/3.2V±0.5%, 150mA, +CE	SOP-6	33x5	VR19	7b	Utc
2933G	LR32933BG-AG6	LVR-IC	LDO, Dual out, Vout1/Vout2=2.9V/3.3V±0.5%, 150mA, +CE	SOP-6	33x5	VR19	7b	Utc
29A	TK74029L	LVR-IC	LDO, Dual out, Vout1/Vout2=2.9V/2.9V±2%, 300mA, +CE	SOT-23L-8	47uh	VR22	8d	Tok
29P	TK11229BM	LVR-IC	LDO, 2.9V±2%, 150mA, +CE	SOT-23L-6	33vf	VR7	7b	Tok
29Q	TK11329BM	LVR-IC	LDO, 2.9V±2%, 150mA, -CE	SOT-23L-6	33vf	VR7	7b	Tok
29R	TK11329CM	LVR-IC	LDO, 2.9V±5%, 170mA, -CE	SOT-23L-6	33vf	VR7	7b	Tok
2A	R1161D181A5	LVR-IC	LDO, 1.85V±2%, 350mA, -CE, AE(mode)	SON-6	34vrc	VR10	7g	Ric
2B	R1161D121A	LVR-IC	LDO, 1.2V±2%, 350mA, -CE, AE(mode)	SON-6	34vrc	VR10	7g	Ric
2C	µPA843TC	Si-npn	Dual, VHF/UHF, 15(9)V, 35(100)MA, B=60..120, 13.5GHz	SMM-6	35T/3	-	7b	Nec
2C	R1161D221A	LVR-IC	LDO, 2.2V±2%, 350mA, -CE, AE(mode)	SON-6	34vrc	VR10	7g	Ric
2D	R1161D321A	LVR-IC	LDO, 3.2V±2%, 350mA, -CE, AE(mode)	SON-6	34vrc	VR10	7g	Ric
2E	R1161D181B5	LVR-IC	LDO, 1.85V±2%, 350mA, +CE, AE(mode)	SON-6	34vrc	VR10	7g	Ric



SMD code	Type	Function	Short description	Case	Pinout	Sch.	St.	Mnf.
2F	R1161D121B	LVR-IC	LDO, 1.2V±2%, 350mA, +CE, AE(mode)	SON-6	34vrc	VR10	7g	Ric
2G	R1161D221B	LVR-IC	LDO, 2.2V±2%, 350mA, +CE, AE(mode)	SON-6	34vrc	VR10	7g	Ric
2H	R1161D321B	LVR-IC	LDO, 3.2V±2%, 350mA, +CE, AE(mode)	SON-6	34vrc	VR10	7g	Ric
2J	R1161D181D5	LVR-IC	LDO, 1.85V±2%, 350mA, +CE, CL, AE(mode)	SON-6	34vrc	VR10	7g	Ric
2K	DDZX22DT5	Z-diode	Triple, 22V±2.5%, 200mW	SOT-363	33dd	-	7k	Di
2K	R1161D121D	LVR-IC	LDO, 1.2V±2%, 350mA, +CE, CL, AE(mode)	SON-6	34vrc	VR10	7g	Ric
2L	BAT754L	Si-diode	Triple, Schottky, Sw, U-Fst, 30V, 0.2A, Vf<0.6V(0.1A), <0.3ns	SOT-23-6	33dd	-	7b	Phi
2L	R1161D221D	LVR-IC	LDO, 2.2V±2%, 350mA, +CE, CL, AE(mode)	SON-6	34vrc	VR10	7g	Ric
2M	DDZX27DT5	Z-diode	Triple, 27V±2.5%, 200mW	SOT-363	33dd	-	7k	Di
2M	R1161D321D	LVR-IC	LDO, 3.2V±2%, 350mA, +CE, CL, AE(mode)	SON-6	34vrc	VR10	7g	Ric
2N	DDZX30D5	Z-diode	Triple, 30V±2.5%, 200mW	SOT-363	33dd	-	7k	Di
2N02	ZXM62N02E6	n-MOSFET-e	Dual, V-MOS, LogL, 20V, 1.7A, <0.1Q	SOT-363	33fc	-	7b	Zx
2N03	ZXM62N03E6	n-MOSFET-e	Dual, V-MOS, LogL, 30V, 1.7A, <0.15Q	SOT-363	33fc	-	7b	Zx
2P02	ZXM62P02E6	n-MOSFET-e	Dual, V-MOS, LogL, 20V, 2.3A, <0.2Q	SOT-363	33fc	-	7b	Zx
2P03	ZXM62P03E6	n-MOSFET-e	Dual, V-MOS, LogL, 30V, 2.6A, <0.23Q	SOT-363	33fc	-	7b	Zx
2V	BAS40VPT	Si-diode	Dual, SBD, 40V, 200mA, Vf<1V(40mA), 5ns	SOT-563	35dw	-	7b	Chm
30	MUN5330DW	Si-n/p-Digi	Dual, Sw, 50V, 100mA, 200mW, R1/R2=1k/1k0	SOT-363	33/TD2	-	7b	Mot
30	R1163D401E	LVR-IC	LDO, 4V±1.5%, 150mA, +CE, AE(mode)	SON-6	34vrc	VR10	7g	Ric
301	TPA301D	LIN-IC	AF PA, BTL, 2.5..5.5V, 350mW(5V/8Q), shutdown	SOP-8	47	AFP11	-	Ti
3015G	LR33015BG-AG6	LVR-IC	LDO, Dual out, Vout1/Vout2=3.0V/1.5V±0.5%, 150mA, +CE	SOP-6	33x5	VR19	7b	Utc
3016G	LR33016BG-AG6	LVR-IC	LDO, Dual out, Vout1/Vout2=3.0V/1.6V±0.5%, 150mA, +CE	SOP-6	33x5	VR19	7b	Utc
3017G	LR33017BG-AG6	LVR-IC	LDO, Dual out, Vout1/Vout2=3.0V/1.7V±0.5%, 150mA, +CE	SOP-6	33x5	VR19	7b	Utc
3018G	LR33018BG-AG6	LVR-IC	LDO, Dual out, Vout1/Vout2=3.0V/1.8V±0.5%, 150mA, +CE	SOP-6	33x5	VR19	7b	Utc
3019G	LR33019BG-AG6	LVR-IC	LDO, Dual out, Vout1/Vout2=3.0V/1.9V±0.5%, 150mA, +CE	SOP-6	33x5	VR19	7b	Utc
3020G	LR33020BG-AG6	LVR-IC	LDO, Dual out, Vout1/Vout2=3.0V/2.0V±0.5%, 150mA, +CE	SOP-6	33x5	VR19	7b	Utc
3021G	LR33021BG-AG6	LVR-IC	LDO, Dual out, Vout1/Vout2=3.0V/2.1V±0.5%, 150mA, +CE	SOP-6	33x5	VR19	7b	Utc
3022G	LR33022BG-AG6	LVR-IC	LDO, Dual out, Vout1/Vout2=3.0V/2.2V±0.5%, 150mA, +CE	SOP-6	33x5	VR19	7b	Utc
3023G	LR33023BG-AG6	LVR-IC	LDO, Dual out, Vout1/Vout2=3.0V/2.3V±0.5%, 150mA, +CE	SOP-6	33x5	VR19	7b	Utc
3024G	LR33024BG-AG6	LVR-IC	LDO, Dual out, Vout1/Vout2=3.0V/2.4V±0.5%, 150mA, +CE	SOP-6	33x5	VR19	7b	Utc
3025G	LR33025BG-AG6	LVR-IC	LDO, Dual out, Vout1/Vout2=3.0V/2.5V±0.5%, 150mA, +CE	SOP-6	33x5	VR19	7b	Utc
3026G	LR33026BG-AG6	LVR-IC	LDO, Dual out, Vout1/Vout2=3.0V/2.6V±0.5%, 150mA, +CE	SOP-6	33x5	VR19	7b	Utc
3027G	LR33027BG-AG6	LVR-IC	LDO, Dual out, Vout1/Vout2=3.0V/2.7V±0.5%, 150mA, +CE	SOP-6	33x5	VR19	7b	Utc
3028G	LR33028BG-AG6	LVR-IC	LDO, Dual out, Vout1/Vout2=3.0V/2.8V±0.5%, 150mA, +CE	SOP-6	33x5	VR19	7b	Utc
3029G	LR33029BG-AG6	LVR-IC	LDO, Dual out, Vout1/Vout2=3.0V/2.9V±0.5%, 150mA, +CE	SOP-6	33x5	VR19	7b	Utc
3030G	LR33030BG-AG6	LVR-IC	LDO, Dual out, Vout1/Vout2=3.0V/3.0V±0.5%, 150mA, +CE	SOP-6	33x5	VR19	7b	Utc
3031G	LR33031BG-AG6	LVR-IC	LDO, Dual out, Vout1/Vout2=3.0V/3.1V±0.5%, 150mA, +CE	SOP-6	33x5	VR19	7b	Utc
3032G	LR33032BG-AG6	LVR-IC	LDO, Dual out, Vout1/Vout2=3.0V/3.2V±0.5%, 150mA, +CE	SOP-6	33x5	VR19	7b	Utc
3033G	LR33033BG-AG6	LVR-IC	LDO, Dual out, Vout1/Vout2=3.0V/3.3V±0.5%, 150mA, +CE	SOP-6	33x5	VR19	7b	Utc
30A	MMQA30V	TVS	Quad, 30V, 24W(1ms)	SC-74	33dx	-	7b	Ons
30A	TK74030L	LVR-IC	LDO, Dual out, Vout1/Vout2=3V/3V±2%, 300mA, +CE	SOT-23L-8	47uh	VR22	8d	Tok
30P	TK11230BM	LVR-IC	LDO, 3V±2%, 150mA, +CE	SOT-23L-6	33vf	VR7	7b	Tok
30Q	TK11330BM	LVR-IC	LDO, 3V±2%, 150mA, -CE	SOT-23L-6	33vf	VR7	7b	Tok
30R	TK11330CM	LVR-IC	LDO, 3V±5%, 170mA, -CE	SOT-23L-6	33vf	VR7	7b	Tok
31	MUN5331DW	Si-n/p-Digi	Dual, Sw, 50V, 100mA, 200mW, R1/R2=2k2/2k2	SOT-363	33/TD2	-	7b	Mot
31	R1163D181E5	LVR-IC	LDO, 1.85V±1.5%, 150mA, +CE, AE(mode)	SON-6	34vrc	VR10	7g	Ric
311	TPA311D	LIN-IC	AF PA, BTL, 2.5..5.5V, 250mW(5V/8Q), shutdown	SOP-8	47	AFP23	-	Ti
3115G	LR33115BG-AG6	LVR-IC	LDO, Dual out, Vout1/Vout2=3.1V/1.5V±0.5%, 150mA, +CE	SOP-6	33x5	VR19	7b	Utc
3116G	LR33116BG-AG6	LVR-IC	LDO, Dual out, Vout1/Vout2=3.1V/1.6V±0.5%, 150mA, +CE	SOP-6	33x5	VR19	7b	Utc
3117G	LR33117BG-AG6	LVR-IC	LDO, Dual out, Vout1/Vout2=3.1V/1.7V±0.5%, 150mA, +CE	SOP-6	33x5	VR19	7b	Utc
3118G	LR33118BG-AG6	LVR-IC	LDO, Dual out, Vout1/Vout2=3.1V/1.8V±0.5%, 150mA, +CE	SOP-6	33x5	VR19	7b	Utc
3119G	LR33119BG-AG6	LVR-IC	LDO, Dual out, Vout1/Vout2=3.1V/1.9V±0.5%, 150mA, +CE	SOP-6	33x5	VR19	7b	Utc
3120G	LR33120BG-AG6	LVR-IC	LDO, Dual out, Vout1/Vout2=3.1V/2.0V±0.5%, 150mA, +CE	SOP-6	33x5	VR19	7b	Utc
3121G	LR33121BG-AG6	LVR-IC	LDO, Dual out, Vout1/Vout2=3.1V/2.1V±0.5%, 150mA, +CE	SOP-6	33x5	VR19	7b	Utc
3122G	LR33122BG-AG6	LVR-IC	LDO, Dual out, Vout1/Vout2=3.1V/2.2V±0.5%, 150mA, +CE	SOP-6	33x5	VR19	7b	Utc
3123G	LR33123BG-AG6	LVR-IC	LDO, Dual out, Vout1/Vout2=3.1V/2.3V±0.5%, 150mA, +CE	SOP-6	33x5	VR19	7b	Utc
3124G	LR33124BG-AG6	LVR-IC	LDO, Dual out, Vout1/Vout2=3.1V/2.4V±0.5%, 150mA, +CE	SOP-6	33x5	VR19	7b	Utc
3125G	LR33125BG-AG6	LVR-IC	LDO, Dual out, Vout1/Vout2=3.1V/2.5V±0.5%, 150mA, +CE	SOP-6	33x5	VR19	7b	Utc
3126G	LR33126BG-AG6	LVR-IC	LDO, Dual out, Vout1/Vout2=3.1V/2.6V±0.5%, 150mA, +CE	SOP-6	33x5	VR19	7b	Utc
3127G	LR33127BG-AG6	LVR-IC	LDO, Dual out, Vout1/Vout2=3.1V/2.7V±0.5%, 150mA, +CE	SOP-6	33x5	VR19	7b	Utc
3128G	LR33128BG-AG6	LVR-IC	LDO, Dual out, Vout1/Vout2=3.1V/2.8V±0.5%, 150mA, +CE	SOP-6	33x5	VR19	7b	Utc
3129G	LR33129BG-AG6	LVR-IC	LDO, Dual out, Vout1/Vout2=3.1V/2.9V±0.5%, 150mA, +CE	SOP-6	33x5	VR19	7b	Utc
3130G	LR33130BG-AG6	LVR-IC	LDO, Dual out, Vout1/Vout2=3.1V/3.0V±0.5%, 150mA, +CE	SOP-6	33x5	VR19	7b	Utc
3131G	LR33131BG-AG6	LVR-IC	LDO, Dual out, Vout1/Vout2=3.1V/3.1V±0.5%, 150mA, +CE	SOP-6	33x5	VR19	7b	Utc
3132G	LR33132BG-AG6	LVR-IC	LDO, Dual out, Vout1/Vout2=3.1V/3.2V±0.5%, 150mA, +CE	SOP-6	33x5	VR19	7b	Utc
3133G	LR33133BG-AG6	LVR-IC	LDO, Dual out, Vout1/Vout2=3.1V/3.3V±0.5%, 150mA, +CE	SOP-6	33x5	VR19	7b	Utc
31A	TK74031L	LVR-IC	LDO, Dual out, Vout1/Vout2=3.1V/3.1V±2%, 300mA, +CE	SOT-23L-8	47uh	VR22	8d	Tok
31P	TK11231BM	LVR-IC	LDO, 3.1V±2%, 150mA, +CE	SOT-23L-6	33vf	VR7	7b	Tok
31Q	TK11331BM	LVR-IC	LDO, 3.1V±2%, 150mA, -CE	SOT-23L-6	33vf	VR7	7b	Tok
31R	TK11331CM	LVR-IC	LDO, 3.1V±5%, 170mA, -CE	SOT-23L-6	33vf	VR7	7b	Tok
32	KIC7W32FK	CMOS-Logic	Dual 2-input OR gates	US8	47L.og52	-	8c	Kec



SMD code	Type	Function	Short description	Case	Pinout	Sch.	St.	Mnf.
32	MUN5332DW	Si-n/p-Digi	Dual, Sw, 50V, 100mA, 200mW, R1/R2=4k/4k7	SOT-363	33/TD2	-	7b	Mot
32	R1163D281E5	LVR-IC	LDO, 2.85V±1.5%, 150mA, +CE, AE(mode)	SOM-6	34wrc	VR10	7g	Ric
32	XC74WL32AASR	CMOS-Logic	Dual 2-input OR gates	MSOP-8B	47/Log52	-	8d	Tor
3215G	LR33215BG-AG6	LVR-IC	LDO, Dual out, Vout1/Vout2=3.2V/1.5V±0.5%, 150mA, +CE	SOP-6	33x5	VR19	7b	Utc
3216G	LR33216BG-AG6	LVR-IC	LDO, Dual out, Vout1/Vout2=3.2V/1.6V±0.5%, 150mA, +CE	SOP-6	33x5	VR19	7b	Utc
3217G	LR33217BG-AG6	LVR-IC	LDO, Dual out, Vout1/Vout2=3.2V/1.7V±0.5%, 150mA, +CE	SOP-6	33x5	VR19	7b	Utc
3218G	LR33218BG-AG6	LVR-IC	LDO, Dual out, Vout1/Vout2=3.2V/1.8V±0.5%, 150mA, +CE	SOP-6	33x5	VR19	7b	Utc
3219G	LR33219BG-AG6	LVR-IC	LDO, Dual out, Vout1/Vout2=3.2V/1.9V±0.5%, 150mA, +CE	SOP-6	33x5	VR19	7b	Utc
3220G	LR33220BG-AG6	LVR-IC	LDO, Dual out, Vout1/Vout2=3.2V/2.0V±0.5%, 150mA, +CE	SOP-6	33x5	VR19	7b	Utc
3221G	LR33221BG-AG6	LVR-IC	LDO, Dual out, Vout1/Vout2=3.2V/2.1V±0.5%, 150mA, +CE	SOP-6	33x5	VR19	7b	Utc
3222G	LR33222BG-AG6	LVR-IC	LDO, Dual out, Vout1/Vout2=3.2V/2.2V±0.5%, 150mA, +CE	SOP-6	33x5	VR19	7b	Utc
3223G	LR33223BG-AG6	LVR-IC	LDO, Dual out, Vout1/Vout2=3.2V/2.3V±0.5%, 150mA, +CE	SOP-6	33x5	VR19	7b	Utc
3224G	LR33224BG-AG6	LVR-IC	LDO, Dual out, Vout1/Vout2=3.2V/2.4V±0.5%, 150mA, +CE	SOP-6	33x5	VR19	7b	Utc
3225G	LR33225BG-AG6	LVR-IC	LDO, Dual out, Vout1/Vout2=3.2V/2.5V±0.5%, 150mA, +CE	SOP-6	33x5	VR19	7b	Utc
3226G	LR33226BG-AG6	LVR-IC	LDO, Dual out, Vout1/Vout2=3.2V/2.6V±0.5%, 150mA, +CE	SOP-6	33x5	VR19	7b	Utc
3227G	LR33227BG-AG6	LVR-IC	LDO, Dual out, Vout1/Vout2=3.2V/2.7V±0.5%, 150mA, +CE	SOP-6	33x5	VR19	7b	Utc
3228G	LR33228BG-AG6	LVR-IC	LDO, Dual out, Vout1/Vout2=3.2V/2.8V±0.5%, 150mA, +CE	SOP-6	33x5	VR19	7b	Utc
3229G	LR33229BG-AG6	LVR-IC	LDO, Dual out, Vout1/Vout2=3.2V/2.9V±0.5%, 150mA, +CE	SOP-6	33x5	VR19	7b	Utc
3230G	LR33230BG-AG6	LVR-IC	LDO, Dual out, Vout1/Vout2=3.2V/3.0V±0.5%, 150mA, +CE	SOP-6	33x5	VR19	7b	Utc
3231G	LR33231BG-AG6	LVR-IC	LDO, Dual out, Vout1/Vout2=3.2V/3.1V±0.5%, 150mA, +CE	SOP-6	33x5	VR19	7b	Utc
3232G	LR33232BG-AG6	LVR-IC	LDO, Dual out, Vout1/Vout2=3.2V/3.2V±0.5%, 150mA, +CE	SOP-6	33x5	VR19	7b	Utc
3233G	LR33233BG-AG6	LVR-IC	LDO, Dual out, Vout1/Vout2=3.2V/3.3V±0.5%, 150mA, +CE	SOP-6	33x5	VR19	7b	Utc
32A	TK74032L	LVR-IC	LDO, Dual out, Vout1/Vout2=3.2V/3.2V±2%, 300mA, +CE	SOT-23L-8	47uh	VR22	8d	Tok
32P	TK11232BM	LVR-IC	LDO, 3.2V±2%, 150mA, +CE	SOT-23L-6	33vf	VR7	7b	Tok
32Q	TK11332BM	LVR-IC	LDO, 3.2V±2%, 150mA, -CE	SOT-23L-6	33vf	VR7	7b	Tok
32R	TK11332CM	LVR-IC	LDO, 3.2V±5%, 170mA, -CE	SOT-23L-6	33vf	VR7	7b	Tok
33	MUN5333DW	Si-n/p-Digi	Dual, Sw, 50V, 100mA, 200mW, R1/R2=4k7/47k	SOT-363	33/TD2	-	7b	Mot
3315G	LR33315BG-AG6	LVR-IC	LDO, Dual out, Vout1/Vout2=3.3V/1.5V±0.5%, 150mA, +CE	SOP-6	33x5	VR19	7b	Utc
3316G	LR33316BG-AG6	LVR-IC	LDO, Dual out, Vout1/Vout2=3.3V/1.6V±0.5%, 150mA, +CE	SOP-6	33x5	VR19	7b	Utc
3317G	LR33317BG-AG6	LVR-IC	LDO, Dual out, Vout1/Vout2=3.3V/1.7V±0.5%, 150mA, +CE	SOP-6	33x5	VR19	7b	Utc
3318G	LR33318BG-AG6	LVR-IC	LDO, Dual out, Vout1/Vout2=3.3V/1.8V±0.5%, 150mA, +CE	SOP-6	33x5	VR19	7b	Utc
3319G	LR33319BG-AG6	LVR-IC	LDO, Dual out, Vout1/Vout2=3.3V/1.9V±0.5%, 150mA, +CE	SOP-6	33x5	VR19	7b	Utc
3320G	LR33320BG-AG6	LVR-IC	LDO, Dual out, Vout1/Vout2=3.3V/2.0V±0.5%, 150mA, +CE	SOP-6	33x5	VR19	7b	Utc
3321G	LR33321BG-AG6	LVR-IC	LDO, Dual out, Vout1/Vout2=3.3V/2.1V±0.5%, 150mA, +CE	SOP-6	33x5	VR19	7b	Utc
3322G	LR33322BG-AG6	LVR-IC	LDO, Dual out, Vout1/Vout2=3.3V/2.2V±0.5%, 150mA, +CE	SOP-6	33x5	VR19	7b	Utc
3323G	LR33323BG-AG6	LVR-IC	LDO, Dual out, Vout1/Vout2=3.3V/2.3V±0.5%, 150mA, +CE	SOP-6	33x5	VR19	7b	Utc
3324G	LR33324BG-AG6	LVR-IC	LDO, Dual out, Vout1/Vout2=3.3V/2.4V±0.5%, 150mA, +CE	SOP-6	33x5	VR19	7b	Utc
3325G	LR33325BG-AG6	LVR-IC	LDO, Dual out, Vout1/Vout2=3.3V/2.5V±0.5%, 150mA, +CE	SOP-6	33x5	VR19	7b	Utc
3326G	LR33326BG-AG6	LVR-IC	LDO, Dual out, Vout1/Vout2=3.3V/2.6V±0.5%, 150mA, +CE	SOP-6	33x5	VR19	7b	Utc
3327G	LR33327BG-AG6	LVR-IC	LDO, Dual out, Vout1/Vout2=3.3V/2.7V±0.5%, 150mA, +CE	SOP-6	33x5	VR19	7b	Utc
3328G	LR33328BG-AG6	LVR-IC	LDO, Dual out, Vout1/Vout2=3.3V/2.8V±0.5%, 150mA, +CE	SOP-6	33x5	VR19	7b	Utc
3329G	LR33329BG-AG6	LVR-IC	LDO, Dual out, Vout1/Vout2=3.3V/2.9V±0.5%, 150mA, +CE	SOP-6	33x5	VR19	7b	Utc
3330G	LR33330BG-AG6	LVR-IC	LDO, Dual out, Vout1/Vout2=3.3V/3.0V±0.5%, 150mA, +CE	SOP-6	33x5	VR19	7b	Utc
3331G	LR33331BG-AG6	LVR-IC	LDO, Dual out, Vout1/Vout2=3.3V/3.1V±0.5%, 150mA, +CE	SOP-6	33x5	VR19	7b	Utc
3332G	LR33332BG-AG6	LVR-IC	LDO, Dual out, Vout1/Vout2=3.3V/3.2V±0.5%, 150mA, +CE	SOP-6	33x5	VR19	7b	Utc
3333G	LR33333BG-AG6	LVR-IC	LDO, Dual out, Vout1/Vout2=3.3V/3.3V±0.5%, 150mA, +CE	SOP-6	33x5	VR19	7b	Utc
33A	MMQA33V	TVS	Quad, 33V, 24W(1ms)	SC-74	33dx	-	7b	Ons
33A	TK74033L	LVR-IC	LDO, Dual out, Vout1/Vout2=3.3V/3.3V±2%, 300mA, +CE	SOT-23L-8	47uh	VR22	8d	Tok
33P	TK11233BM	LVR-IC	LDO, 3.3V±2%, 150mA, +CE	SOT-23L-6	33vf	VR7	7b	Tok
33Q	TK11333BM	LVR-IC	LDO, 3.3V±2%, 150mA, -CE	SOT-23L-6	33vf	VR7	7b	Tok
33R	TK11333CM	LVR-IC	LDO, 3.3V±5%, 170mA, -CE	SOT-23L-6	33vf	VR7	7b	Tok
34	MUN5334DW	Si-n/p-Digi	Dual, Sw, 50V, 100mA, 200mW, R1/R2=22k/47k	SOT-363	33/TD2	-	7b	Mot
34119	SGCS34119	LIN-IC	AF PA, 2.16V, 250mW(5V/32Q), shutdown	SOP-8	47	AFP37	8d	Sec
34A	TK74034L	LVR-IC	LDO, Dual out, Vout1/Vout2=3.4V/3.4V±2%, 300mA, +CE	SOT-23L-8	47uh	VR22	8d	Tok
34P	TK11234BM	LVR-IC	LDO, 3.4V±2%, 150mA, +CE	SOT-23L-6	33vf	VR7	7b	Tok
34Q	TK11334BM	LVR-IC	LDO, 3.4V±2%, 150mA, -CE	SOT-23L-6	33vf	VR7	7b	Tok
34R	μPA812T-FB	Si-npn	Dual, VHF/UHF, 20V, 30mA, 120mW, 5.5GHz, B=40..80	SOT-363	33/T1	-	7b	Nec
35	MUN5335DW	Si-n/p-Digi	Dual, Sw, 50V, 100mA, 200mW, R1/R2=2.2k/47k	SOT-363	33/TD2	-	7b	Mot
3541	BH3541F	LIN-IC	AF PA, 2.8..6.5V, 2x62mW(5V/16Q), mute	SOP-8	47	AFP2	8a	Rhm
3544	BH3544F	LIN-IC	AF PA, 2.8..6.5V, 2x62mW(5V/16Q), mute	SOP-8	47	AFP2	8a	Rhm
3547	BH3547F	LIN-IC	AF PA, 4.5..6.5V, 2x77mW(5V/16Q), mute	SOP-8	47	AFP2	8a	Rhm
3548	BH3548F	LIN-IC	AF PA, 4.5..5V, 2x62mW(5V/16Q), mute	SOP-8	47	AFP2	8a	Rhm
35A	TK74035L	LVR-IC	LDO, Dual out, Vout1/Vout2=3.5V/3.5V±2%, 300mA, +CE	SOT-23L-8	47uh	VR22	8d	Tok
35P	TK11235BM	LVR-IC	LDO, 3.5V±2%, 150mA, +CE	SOT-23L-6	33vf	VR7	7b	Tok
35Q	TK11335BM	LVR-IC	LDO, 3.5V±2%, 150mA, -CE	SOT-23L-6	33vf	VR7	7b	Tok
35R	μPA812T-GB	Si-npn	Dual, VHF/UHF, 20V, 30mA, 120mW, 5.5GHz, B=70..140	SOT-363	33/T1	-	7b	Nec
35R	TK11335CM	LVR-IC	LDO, 3.5V±5%, 170mA, -CE	SOT-23L-6	33vf	VR7	7b	Tok
36A	TK74036L	LVR-IC	LDO, Dual out, Vout1/Vout2=3.6V/3.6V±2%, 300mA, +CE	SOT-23L-8	47uh	VR22	8d	Tok
36P	TK11236BM	LVR-IC	LDO, 3.6V±2%, 150mA, +CE	SOT-23L-6	33vf	VR7	7b	Tok
36Q	TK11336BM	LVR-IC	LDO, 3.6V±2%, 150mA, -CE	SOT-23L-6	33vf	VR7	7b	Tok



SMD code	Type	Function	Short description	Case	Pinout	Sch.	St.	Mnf.
37	μPA835TC	Si-npn	Dual, VHF/UHF, 9(20)V, 30(100)mA, B=75..150, 12GHz	SMM-6	35/T3	-	7b	Nec
37A	TK74037L	LVR-IC	LDO, Dual out, Vout1/Vout2=3.7V/3.7V±2%, 300mA, +CE	SOT-23L-8	47uh	VR22	8d	Tok
37P	TK11237BM	LVR-IC	LDO, 3.7V±2%, 150mA, +CE	SOT-23L-6	33vf	VR7	7b	Tok
37Q	TK11337BM	LVR-IC	LDO, 3.7V±2%, 150mA, -CE	SOT-23L-6	33vf	VR7	7b	Tok
38A	TK74038L	LVR-IC	LDO, Dual out, Vout1/Vout2=3.8V/3.8V±2%, 300mA, +CE	SOT-23L-8	47uh	VR22	8d	Tok
38P	TK11238BM	LVR-IC	LDO, 3.8V±2%, 150mA, +CE	SOT-23L-6	33vf	VR7	7b	Tok
38Q	TK11338BM	LVR-IC	LDO, 3.8V±2%, 150mA, -CE	SOT-23L-6	33vf	VR7	7b	Tok
38R	TK11338CM	LVR-IC	LDO, 3.8V±5%, 170mA, -CE	SOT-23L-6	33vf	VR7	7b	Tok
39A	TK74039L	LVR-IC	LDO, Dual out, Vout1/Vout2=3.9V/3.9V±2%, 300mA, +CE	SOT-23L-8	47uh	VR22	8d	Tok
39P	TK11239BM	LVR-IC	LDO, 3.9V±2%, 150mA, +CE	SOT-23L-6	33vf	VR7	7b	Tok
39Q	TK11339BM	LVR-IC	LDO, 3.9V±2%, 150mA, -CE	SOT-23L-6	33vf	VR7	7b	Tok
3B	BC856BDW	Si-pnp	Dual, GP, 80V, 100mA, 250mW, B=220..475, >100MHz	SOT-363	33/T10	-	7c	Ons
3B	R1161D131A	LVR-IC	LDO, 1.3V±2%, 350mA, -CE, AE(mode)	SON-6	34vrc	VR10	7g	Ric
3C	R1161D231A	LVR-IC	LDO, 2.3V±2%, 350mA, -CE, AE(mode)	SON-6	34vrc	VR10	7g	Ric
3Cs	BC857S	Si-pnp	Dual, AF, 50V, 100mA, 310mW, B=90..270, >100MHz	SOT-363	33/T10	-	7l	Inf
3D	R1161D331A	LVR-IC	LDO, 3.3V±2%, 350mA, -CE, AE(mode)	SON-6	34vrc	VR10	7g	Ric
3Ds	BC856S	Si-pnp	Dual, AF, 80V, 100mA, 310mW, B=90..270, >100MHz	SOT-363	33/T10	-	7b	Sie
3F	BC857BDW	Si-pnp	Dual, GP, 50V, 100mA, 250mW, B=220..475, >100MHz	SOT-363	33/T10	-	7b	Ons
3F	BC857BV	Si-pnp	Dual, AF, 50V, 100mA, 310mW, B=90..270, >100MHz	SOT-666	35/T10	-	7b	Phi
3F	R1161D131B	LVR-IC	LDO, 1.3V±2%, 350mA, +CE, AE(mode)	SON-6	34vrc	VR10	7g	Ric
3Ft	BC857BS	Si-pnp	Dual, AF, 50V, 100mA, 310mW, B=90..270, >100MHz	SOT-363	33/T10	-	7b	Phi
3G	BC857CDW	Si-pnp	Dual, GP, 50V, 100mA, 250mW, B=420..800, >100MHz	SOT-363	33/T10	-	7c	Ons
3G	R1161D231B	LVR-IC	LDO, 2.3V±2%, 350mA, +CE, AE(mode)	SON-6	34vrc	VR10	7g	Ric
3G04	U74HCT3G04-P08	CMOS-Logic	Triple inverters	TSSOP-8	47Llog56	-	8d	Utc
3G04	U74HCT3G04-SM1	CMOS-Logic	Triple inverters	MSOP-8	47Llog56	-	8d	Utc
3G04L	U74HCT3G04L-P08	CMOS-Logic	Triple inverters	TSSOP-8	47Llog56	-	8d	Utc
3G04L	U74HCT3G04L-SM1	CMOS-Logic	Triple inverters	MSOP-8	47Llog56	-	8d	Utc
3G34	U74HCT3G34-P08	CMOS-Logic	Triple non-inverter buffers	TSSOP-8	47Llog69	-	8d	Utc
3G34	U74HCT3G34-SM1	CMOS-Logic	Triple non-inverter buffers	MSOP-8	47Llog69	-	8d	Utc
3G34L	U74HCT3G34L-P08	CMOS-Logic	Triple non-inverter buffers	TSSOP-8	47Llog69	-	8d	Utc
3G34L	U74HCT3G34L-SM1	CMOS-Logic	Triple non-inverter buffers	MSOP-8	47Llog69	-	8d	Utc
3H	R1161D331B	LVR-IC	LDO, 3.3V±2%, 350mA, +CE, AE(mode)	SON-6	34vrc	VR10	7g	Ric
3K	BC858BDW	Si-pnp	Dual, GP, 30V, 100mA, 250mW, B=220..475, >100MHz	SOT-363	33/T10	-	7c	Ons
3K	R1161D131D	LVR-IC	LDO, 1.3V±2%, 350mA, +CE, CL, AE(mode)	SON-6	34vrc	VR10	7g	Ric
3L	BC858CDW	Si-pnp	Dual, GP, 30V, 100mA, 250mW, B=420..800, >100MHz	SOT-363	33/T10	-	7c	Ons
3L	R1161D231D	LVR-IC	LDO, 2.3V±2%, 350mA, +CE, CL, AE(mode)	SON-6	34vrc	VR10	7g	Ric
3M	R1161D331D	LVR-IC	LDO, 3.3V±2%, 350mA, +CE, CL, AE(mode)	SON-6	34vrc	VR10	7g	Ric
4	ECC001F-G	MMIC	Buff/amp, DC, 6GHz, 22dB (1GHz, 50dB)	SOT-363	33a1	A1	7j	Wjz
400	TK15400M	LIN-IC	5V, 75Ω, 6dB, triple video line driver, stand-by	SOP-12	60	-	8c	Tok
401	TK15401M	LIN-IC	5V, 75Ω, 6dB, triple video line driver, stand-by	SOP-12	60	-	8c	Tok
402	TK15402M	LIN-IC	5V, 75Ω, 6dB, triple video line driver, stand-by	SOP-12	60	-	8c	Tok
403	KAB3403T	LDR-IC	1.1 MHz White LED step-up DC/DC converter, OVP 21V	TS6	33le	LD2	7k	Kec
403	TK15403M	LIN-IC	5V, 75Ω, 6dB, dual video line driver, stand-by	SOP-8	47	-	8d	Tok
404	TK15404M	LIN-IC	5V, 75Ω, 6dB, video line driver, stand-by	SOP-6	33	-	7b	Tok
405	KAB3405T	LDR-IC	1 MHz White LED step-up DC/DC converter, OVP 38V	TS6	33lf	LD2	7k	Kec
405	TK15405M	LIN-IC	5V, 75Ω, 6dB, video line driver, stand-by	SOP-6	33	-	7b	Tok
406	TK15406M	LIN-IC	5V, 75Ω, 6dB, video line driver, stand-by	SOP-6	33	-	7b	Tok
407	TK15407M	LIN-IC	5V, 75Ω, 6dB, dual video line driver, stand-by	SOP-8	47	-	8d	Tok
408	TK15408M	LIN-IC	5V, 75Ω, 6dB, dual video line driver, stand-by	SOP-8	47	-	8d	Tok
409	TK15409M	LIN-IC	5V, 75Ω, 6dB, dual video line driver, stand-by	SOP-8	47	-	8d	Tok
40A	TK74040L	LVR-IC	LDO, Dual out, Vout1/Vout2=4V/4V±2%, 300mA, +CE	SOT-23L-8	47uh	VR22	8d	Tok
40P	TK11240BM	LVR-IC	LDO, 4V±2%, 150mA, +CE	SOT-23L-6	33vf	VR7	7b	Tok
40Q	TK11340BM	LVR-IC	LDO, 4V±2%, 150mA, -CE	SOT-23L-6	33vf	VR7	7b	Tok
40R	TK11340CM	LVR-IC	LDO, 4V±5%, 170mA, -CE	SOT-23L-6	33vf	VR7	7b	Tok
410	TK15410M	LIN-IC	5V, 75Ω, 6dB, video line driver, logic control	SOP-8	47	-	8d	Tok
411	TK15411M	LIN-IC	5V, 75Ω, 6dB, video line driver, logic control	SOP-8	47	-	8d	Tok
412	TK15412M	LIN-IC	5V, 75Ω, 6dB, video line driver, stand-by	SOP-8	47	-	8d	Tok
413	TK15413M	LIN-IC	5V, 75Ω, 6dB, video line driver, stand-by	SOP-8	47	-	8d	Tok
414	TK15414M	LIN-IC	5V, 75Ω, 6dB, dual video line driver, stand-by	SOP-8	47	-	8d	Tok
415	TK15415M	LIN-IC	5V, 75Ω, 6dB, dual video line driver, stand-by	SOP-8	47	-	8d	Tok
418	TK65418M	DC/DC-IC	PCA, st-dwn, 1.8V±3%, 100mA, Vbat monitor	SOT-23L-6	33	-	7b	Tok
419	TK65419M	DC/DC-IC	PCA, st-dwn, 1.9V±3%, 100mA, Vbat monitor	SOT-23L-6	33	-	7b	Tok
41A	TK74041L	LVR-IC	LDO, Dual out, Vout1/Vout2=4.1V/4.1V±2%, 300mA, +CE	SOT-23L-8	47uh	VR22	8d	Tok
41P	TK11241BM	LVR-IC	LDO, 4.1V±2%, 150mA, +CE	SOT-23L-6	33vf	VR7	7b	Tok
41Q	TK11341BM	LVR-IC	LDO, 4.1V±2%, 150mA, -CE	SOT-23L-6	33vf	VR7	7b	Tok
420	TK15420M	LIN-IC	5V, 75Ω, 6dB, dual video line driver	SOP-8	47	-	8d	Tok
420	TK65420M	DC/DC-IC	PCA, st-dwn, 2.0V±3%, 100mA, Vbat monitor	SOT-23L-6	33	-	7b	Tok
4201A	SN4201M	LIN-IC	AF PA, BTL, 2.5..5.5V, 1.4W(5V/4Ω), shutdown	MSOP-8	55	AFP22	-	Se
421	TK15421M	LIN-IC	5V, 75Ω, 6dB, dual video line driver	SOP-8	47	-	8d	Tok
421	TK65421M	DC/DC-IC	PCA, st-dwn, 2.1V±3%, 100mA, Vbat monitor	SOT-23L-6	33	-	7b	Tok



SMD code	Type	Function	Short description	Case	Pinout	Sch.	St.	Mnf.
422	TK65422M	DC/DC-IC	PCA, st-dwn, 2.2V±3%, 100mA, Vbat monitor	SOT-23L-6	33	-	7b	Tok
423	TK65423M	DC/DC-IC	PCA, st-dwn, 2.3V±3%, 100mA, Vbat monitor	SOT-23L-6	33	-	7b	Tok
424	TK65424M	DC/DC-IC	PCA, st-dwn, 2.4V±3%, 100mA, Vbat monitor	SOT-23L-6	33	-	7b	Tok
425	TK65425M	DC/DC-IC	PCA, st-dwn, 2.5V±3%, 100mA, Vbat monitor	SOT-23L-6	33	-	7b	Tok
426	TK65426M	DC/DC-IC	PCA, st-dwn, 2.6V±3%, 100mA, Vbat monitor	SOT-23L-6	33	-	7b	Tok
427	TK65427M	DC/DC-IC	PCA, st-dwn, 2.7V±3%, 100mA, Vbat monitor	SOT-23L-6	33	-	7b	Tok
428	TK65428M	DC/DC-IC	PCA, st-dwn, 2.8V±3%, 100mA, Vbat monitor	SOT-23L-6	33	-	7b	Tok
42A	TK74042L	LVR-IC	LDO, Dual out, Vout1/Vout2=4.2V/4.2V±2%, 300mA, +CE	SOT-23L-8	47uh	VR22	8d	Tok
42P	TK11242BM	LVR-IC	LDO, 4.2V±2%, 150mA, +CE	SOT-23L-6	33vf	VR7	7b	Tok
42Q	TK11342BM	LVR-IC	LDO, 4.2V±2%, 150mA, -CE	SOT-23L-6	33vf	VR7	7b	Tok
430	TK65430M	DC/DC-IC	PCA, st-dwn, 3.0V±3%, 100mA, Vbat monitor	SOT-23L-6	33	-	7b	Tok
431	TK65431M	DC/DC-IC	PCA, st-dwn, 3.1V±3%, 100mA, Vbat monitor	SOT-23L-6	33	-	7b	Tok
431ACM	LM431ACM	Vref-IC	Adjust Precision Shunt, 2.44, 2.55V, 2%, 0..+70°	SOP-8	47	-	8d	Nsc
431AIM	LM431AIM	Vref-IC	Adjust Precision Shunt, 2.44, 2.55V, 2%, -40..+85°	SOP-8	47	-	8d	Nsc
431BCM	LM431BCM	Vref-IC	Adjust Precision Shunt, 2.44, 2.55V, 1%, 0..+70°	SOP-8	47	-	8d	Nsc
431BIM	LM431BIM	Vref-IC	Adjust Precision Shunt, 2.44, 2.55V, 1%, -40..+85°	SOP-8	47	-	8d	Nsc
431CCM	LM431CCM	Vref-IC	Adjust Precision Shunt, 2.44, 2.55V, 0.5%, 0..+70°	SOP-8	47	-	8d	Nsc
431CIM	LM431CIM	Vref-IC	Adjust Precision Shunt, 2.44, 2.55V, 0.5%, -40..+85°	SOP-8	47	-	8d	Nsc
432	TK65432M	DC/DC-IC	PCA, st-dwn, 3.2V±3%, 100mA, Vbat monitor	SOT-23L-6	33	-	7b	Tok
433	TK65433M	DC/DC-IC	PCA, st-dwn, 3.3V±3%, 100mA, Vbat monitor	SOT-23L-6	33	-	7b	Tok
43A	TK74043L	LVR-IC	LDO, Dual out, Vout1/Vout2=4.3V/4.3V±2%, 300mA, +CE	SOT-23L-8	47uh	VR22	8d	Tok
43P	TK11243BM	LVR-IC	LDO, 4.3V±2%, 150mA, +CE	SOT-23L-6	33vf	VR7	7b	Tok
43Q	TK11343BM	LVR-IC	LDO, 4.3V±2%, 150mA, -CE	SOT-23L-6	33vf	VR7	7b	Tok
44A	TK74044L	LVR-IC	LDO, Dual out, Vout1/Vout2=4.4V/4.4V±2%, 300mA, +CE	SOT-23L-8	47uh	VR22	8d	Tok
44P	TK11244BM	LVR-IC	LDO, 4.4V±2%, 150mA, +CE	SOT-23L-6	33vf	VR7	7b	Tok
44Q	TK11344BM	LVR-IC	LDO, 4.4V±2%, 150mA, -CE	SOT-23L-6	33vf	VR7	7b	Tok
44R	µPA811T-FB	Si-npn	Dual, VHF/UHF, 20V, 35mA, 8.5GHz, B=40..80	SOT-363	33if	-	7b	Nec
453	XC74WL4053SR	CMOS-Logic	2-channel analog multiplexer/demultiplexer	MSOP-8B	47L0q658	-	8d	Tor
45A	TK74045L	LVR-IC	LDO, Dual out, Vout1/Vout2=4.5V/4.5V±2%, 300mA, +CE	SOT-23L-8	47uh	VR22	8d	Tok
45P	TK11245BM	LVR-IC	LDO, 4.5V±2%, 150mA, +CE	SOT-23L-6	33vf	VR7	7b	Tok
45Q	TK11345BM	LVR-IC	LDO, 4.5V±2%, 150mA, -CE	SOT-23L-6	33vf	VR7	7b	Tok
45R	µPA811T-GB	Si-npn	Dual, VHF/UHF, 20V, 35mA, 8.5GHz, B=70..140	SOT-363	33if	-	7b	Nec
45R	TK11345CM	LVR-IC	LDO, 4.5V, 5%, 150mA, -CE	SOT-23L-6	33vf	VR7	7b	Tok
46	MBT3946DW	Si-n/p	Dual, GP, 60V, 200mA, 150mW, B=100..300, >300MHz	SOT-363	33/T9	-	7b	Ons
460BI1	LT1460BIS8-10	Vref-IC	µPower, Precision, Series, 10V, 0.075%	S8	47af	VR1	8d	Ltc
460BI2	LT1460BIS8-2.5	Vref-IC	µPower, Precision, Series, 2.5V, 0.075%	S8	47af	VR1	8d	Ltc
460BI5	LT1460BIS8-5	Vref-IC	µPower, Precision, Series, 5.0V, 0.075%	S8	47af	VR1	8d	Ltc
460EI1	LT1460EIS8-10	Vref-IC	µPower, Precision, Series, 10V, 0.075%	S8	47af	VR1	8d	Ltc
460EI2	LT1460EIS8-2.5	Vref-IC	µPower, Precision, Series, 2.5V, 0.075%	S8	47af	VR1	8d	Ltc
460EI5	LT1460EIS8-5	Vref-IC	µPower, Precision, Series, 5.0V, 0.075%	S8	47af	VR1	8d	Ltc
468	XC74WL4066SR	CMOS-Logic	2-channel analog switch	MSOP-8B	47L0q68	-	8d	Tor
46A	TK74046L	LVR-IC	LDO, Dual out, Vout1/Vout2=4.6V/4.6V±2%, 300mA, +CE	SOT-23L-8	47uh	VR22	8d	Tok
46P	TK11246BM	LVR-IC	LDO, 4.6V±2%, 150mA, +CE	SOT-23L-6	33vf	VR7	7b	Tok
46Q	TK11346BM	LVR-IC	LDO, 4.6V±2%, 150mA, -CE	SOT-23L-6	33vf	VR7	7b	Tok
47A	TK74047L	LVR-IC	LDO, Dual out, Vout1/Vout2=4.7V/4.7V±2%, 300mA, +CE	SOT-23L-8	47uh	VR22	8d	Tok
47P	TK11247BM	LVR-IC	LDO, 4.7V±2%, 150mA, +CE	SOT-23L-6	33vf	VR7	7b	Tok
47Q	TK11347BM	LVR-IC	LDO, 4.7V±2%, 150mA, -CE	SOT-23L-6	33vf	VR7	7b	Tok
47R	TK11347CM	LVR-IC	LDO, 4.7V±5%, 170mA, -CE	SOT-23L-6	33vf	VR7	7b	Tok
482I	TS482ID	LIN-IC	AF PA, 2.5.5V, 2x100mW(5V/16Q)	SOP-8	47	AFP6	-	Ste
482I	TS482IST	LIN-IC	AF PA, 2.5.5V, 2x100mW(5V/16Q)	SSOP-8	47	AFP6	-	Ste
487I	TS4871IST	LIN-IC	AF PA, BTL, 2.5.5.5V, 1W(5V/8Q), shutdown	SSOP-8	47	AFP11	-	Ste
487I1	TS4871IDT	LIN-IC	AF PA, BTL, 2.5.5.5V, 1W(5V/8Q), shutdown	SOP-8	47	AFP11	-	Ste
4890	MC4890S	LIN-IC	AF PA, BTL, 2.5.5.5V, 1.5W(5V/8Q), shutdown	MSOP-8	55	AFP12	-	Mep
4890	TS4890IDT	LIN-IC	AF PA, BTL, 2.5.5.5V, 1W(5V/8Q), shutdown	SOP-8	47	AFP12	-	Ste
4890I	TS4890IST	LIN-IC	AF PA, BTL, 2.5.5.5V, 1W(5V/8Q), shutdown	SSOP-8	47	AFP12	-	Ste
4890M	SH4890M	LIN-IC	AF PA, BTL, 2.2.5.5V, 1W(5V/8Q), shutdown	SOP-8	47	AFP12	-	Sit
48A	TK74048L	LVR-IC	LDO, Dual out, Vout1/Vout2=4.8V/4.8V±2%, 300mA, +CE	SOT-23L-8	47uh	VR22	8d	Tok
48P	TK11248BM	LVR-IC	LDO, 4.8V±2%, 150mA, +CE	SOT-23L-6	33vf	VR7	7b	Tok
48Q	TK11348BM	LVR-IC	LDO, 4.8V±2%, 150mA, -CE	SOT-23L-6	33vf	VR7	7b	Tok
48R	TK11348CM	LVR-IC	LDO, 4.8V±5%, 170mA, -CE	SOT-23L-6	33vf	VR7	7b	Tok
4910B	SN4910M	LIN-IC	AF PA, BTL, 2.2.5.5V, 2x35mW(5V/32Q), shutdown	MSOP-8	55	AFP29	-	Se
4913	LM4913MH	LIN-IC	AF PA, BTL, 3.5.5V, 2W(3V/4Q), shutdown	SOP-10	60	AFP42	-	Nsc
4914	LM4914MH	LIN-IC	AF PA, BTL, 2.5.5.5V, 1W(5V/8Q), shutdown	SSOP-10	60	-	-	Nsc
49A	TK74049L	LVR-IC	LDO, Dual out, Vout1/Vout2=4.9V/4.9V±2%, 300mA, +CE	SOT-23L-8	47uh	VR22	8d	Tok
49P	TK11249BM	LVR-IC	LDO, 4.9V±2%, 150mA, +CE	SOT-23L-6	33vf	VR7	7b	Tok
49Q	TK11349BM	LVR-IC	LDO, 4.9V±2%, 150mA, -CE	SOT-23L-6	33vf	VR7	7b	Tok
4A	FT521AAa	LVR-IC	LDO, Dual out, Vout1/Vout2=1.2V/1.2V±2%, 250mA, +CE	SOT-23-6	33x5	VR19	7d	Fmd
4AB	FT521ABa	LVR-IC	LDO, Dual out, Vout1/Vout2=1.2V/1.3V±2%, 250mA, +CE	SOT-23-6	33x5	VR19	7d	Fmd
4AC	FT521ACa	LVR-IC	LDO, Dual out, Vout1/Vout2=1.2V/1.5V±2%, 250mA, +CE	SOT-23-6	33x5	VR19	7d	Fmd
4AD	FT521ADa	LVR-IC	LDO, Dual out, Vout1/Vout2=1.2V/1.8V±2%, 250mA, +CE	SOT-23-6	33x5	VR19	7d	Fmd



SMD code	Type	Function	Short description	Case	Pinout	Sch.	St.	Mnf.
4AE	FT521AEa	LVR-IC	LDO, Dual out, Vout1/Vout2=1.2V/2.5V±2%, 250mA, +CE	SOT-23-6	33x5	VR19	7d	Fmd
4AF	FT521AFa	LVR-IC	LDO, Dual out, Vout1/Vout2=1.2V/2.7V±2%, 250mA, +CE	SOT-23-6	33x5	VR19	7d	Fmd
4AG	FT521AGa	LVR-IC	LDO, Dual out, Vout1/Vout2=1.2V/2.8V±2%, 250mA, +CE	SOT-23-6	33x5	VR19	7d	Fmd
4AH	FT521AHa	LVR-IC	LDO, Dual out, Vout1/Vout2=1.2V/2.85V±2%, 250mA, +CE	SOT-23-6	33x5	VR19	7d	Fmd
4AI	FT521AIa	LVR-IC	LDO, Dual out, Vout1/Vout2=1.2V/3.0V±2%, 250mA, +CE	SOT-23-6	33x5	VR19	7d	Fmd
4AJ	FT521AJa	LVR-IC	LDO, Dual out, Vout1/Vout2=1.2V/3.3V±2%, 250mA, +CE	SOT-23-6	33x5	VR19	7d	Fmd
4AK	FT521AKa	LVR-IC	LDO, Dual out, Vout1/Vout2=1.2V/3.6V±2%, 250mA, +CE	SOT-23-6	33x5	VR19	7d	Fmd
4B	R1161D141A	LVR-IC	LDO, 1.4V±2%, 350mA, -CE, AE(mode)	SOM-6	34vrc	VR10	7g	Ric
4BA	FT521BAa	LVR-IC	LDO, Dual out, Vout1/Vout2=1.3V/1.2V±2%, 250mA, +CE	SOT-23-6	33x5	VR19	7d	Fmd
4BB	FT521BBa	LVR-IC	LDO, Dual out, Vout1/Vout2=1.3V/1.3V±2%, 250mA, +CE	SOT-23-6	33x5	VR19	7d	Fmd
4BC	FT521BCa	LVR-IC	LDO, Dual out, Vout1/Vout2=1.3V/1.5V±2%, 250mA, +CE	SOT-23-6	33x5	VR19	7d	Fmd
4BD	FT521BDa	LVR-IC	LDO, Dual out, Vout1/Vout2=1.3V/1.8V±2%, 250mA, +CE	SOT-23-6	33x5	VR19	7d	Fmd
4BE	FT521BEa	LVR-IC	LDO, Dual out, Vout1/Vout2=1.3V/2.5V±2%, 250mA, +CE	SOT-23-6	33x5	VR19	7d	Fmd
4BF	FT521BFa	LVR-IC	LDO, Dual out, Vout1/Vout2=1.3V/2.7V±2%, 250mA, +CE	SOT-23-6	33x5	VR19	7d	Fmd
4BG	FT521BGa	LVR-IC	LDO, Dual out, Vout1/Vout2=1.3V/2.8V±2%, 250mA, +CE	SOT-23-6	33x5	VR19	7d	Fmd
4BH	FT521BHa	LVR-IC	LDO, Dual out, Vout1/Vout2=1.3V/2.85V±2%, 250mA, +CE	SOT-23-6	33x5	VR19	7d	Fmd
4BI	FT521BIa	LVR-IC	LDO, Dual out, Vout1/Vout2=1.3V/3.0V±2%, 250mA, +CE	SOT-23-6	33x5	VR19	7d	Fmd
4BJ	FT521BJa	LVR-IC	LDO, Dual out, Vout1/Vout2=1.3V/3.3V±2%, 250mA, +CE	SOT-23-6	33x5	VR19	7d	Fmd
4BK	FT521BKa	LVR-IC	LDO, Dual out, Vout1/Vout2=1.3V/3.6V±2%, 250mA, +CE	SOT-23-6	33x5	VR19	7d	Fmd
4C	R1161D241A	LVR-IC	LDO, 2.4V±2%, 350mA, -CE, AE(mode)	SOM-6	34vrc	VR10	7g	Ric
4C25A	XC9101C25AKR	DC-DC-IC	PWM, step-up, 2.5V±2.5%, 1.5A	MSOP-8A	55xd	DC17	8f	Tor
4C26A	XC9101C26AKR	DC-DC-IC	PWM, step-up, 2.6V±2.5%, 1.5A	MSOP-8A	55xd	DC17	8f	Tor
4C27A	XC9101C27AKR	DC-DC-IC	PWM, step-up, 2.7V±2.5%, 1.5A	MSOP-8A	55xd	DC17	8f	Tor
4C28A	XC9101C28AKR	DC-DC-IC	PWM, step-up, 2.8V±2.5%, 1.5A	MSOP-8A	55xd	DC17	8f	Tor
4C29A	XC9101C29AKR	DC-DC-IC	PWM, step-up, 2.9V±2.5%, 1.5A	MSOP-8A	55xd	DC17	8f	Tor
4C30A	XC9101C30AKR	DC-DC-IC	PWM, step-up, 3.0V±2.5%, 1.5A	MSOP-8A	55xd	DC17	8f	Tor
4C31A	XC9101C31AKR	DC-DC-IC	PWM, step-up, 3.1V±2.5%, 1.5A	MSOP-8A	55xd	DC17	8f	Tor
4C32A	XC9101C32AKR	DC-DC-IC	PWM, step-up, 3.2V±2.5%, 1.5A	MSOP-8A	55xd	DC17	8f	Tor
4C33A	XC9101C33AKR	DC-DC-IC	PWM, step-up, 3.3V±2.5%, 1.5A	MSOP-8A	55xd	DC17	8f	Tor
4C34A	XC9101C34AKR	DC-DC-IC	PWM, step-up, 3.4V±2.5%, 1.5A	MSOP-8A	55xd	DC17	8f	Tor
4C35A	XC9101C35AKR	DC-DC-IC	PWM, step-up, 3.5V±2.5%, 1.5A	MSOP-8A	55xd	DC17	8f	Tor
4C36A	XC9101C36AKR	DC-DC-IC	PWM, step-up, 3.6V±2.5%, 1.5A	MSOP-8A	55xd	DC17	8f	Tor
4C37A	XC9101C37AKR	DC-DC-IC	PWM, step-up, 3.7V±2.5%, 1.5A	MSOP-8A	55xd	DC17	8f	Tor
4C38A	XC9101C38AKR	DC-DC-IC	PWM, step-up, 3.8V±2.5%, 1.5A	MSOP-8A	55xd	DC17	8f	Tor
4C39A	XC9101C39AKR	DC-DC-IC	PWM, step-up, 3.9V±2.5%, 1.5A	MSOP-8A	55xd	DC17	8f	Tor
4C40A	XC9101C40AKR	DC-DC-IC	PWM, step-up, 4.0V±2.5%, 1.5A	MSOP-8A	55xd	DC17	8f	Tor
4C41A	XC9101C41AKR	DC-DC-IC	PWM, step-up, 4.1V±2.5%, 1.5A	MSOP-8A	55xd	DC17	8f	Tor
4C42A	XC9101C42AKR	DC-DC-IC	PWM, step-up, 4.2V±2.5%, 1.5A	MSOP-8A	55xd	DC17	8f	Tor
4C43A	XC9101C43AKR	DC-DC-IC	PWM, step-up, 4.3V±2.5%, 1.5A	MSOP-8A	55xd	DC17	8f	Tor
4C44A	XC9101C44AKR	DC-DC-IC	PWM, step-up, 4.4V±2.5%, 1.5A	MSOP-8A	55xd	DC17	8f	Tor
4C45A	XC9101C45AKR	DC-DC-IC	PWM, step-up, 4.5V±2.5%, 1.5A	MSOP-8A	55xd	DC17	8f	Tor
4C46A	XC9101C46AKR	DC-DC-IC	PWM, step-up, 4.6V±2.5%, 1.5A	MSOP-8A	55xd	DC17	8f	Tor
4C47A	XC9101C47AKR	DC-DC-IC	PWM, step-up, 4.7V±2.5%, 1.5A	MSOP-8A	55xd	DC17	8f	Tor
4C48A	XC9101C48AKR	DC-DC-IC	PWM, step-up, 4.8V±2.5%, 1.5A	MSOP-8A	55xd	DC17	8f	Tor
4C49A	XC9101C49AKR	DC-DC-IC	PWM, step-up, 4.9V±2.5%, 1.5A	MSOP-8A	55xd	DC17	8f	Tor
4C50A	XC9101C50AKR	DC-DC-IC	PWM, step-up, 5.0V±2.5%, 1.5A	MSOP-8A	55xd	DC17	8f	Tor
4C51A	XC9101C51AKR	DC-DC-IC	PWM, step-up, 5.1V±2.5%, 1.5A	MSOP-8A	55xd	DC17	8f	Tor
4C52A	XC9101C52AKR	DC-DC-IC	PWM, step-up, 5.2V±2.5%, 1.5A	MSOP-8A	55xd	DC17	8f	Tor
4C53A	XC9101C53AKR	DC-DC-IC	PWM, step-up, 5.3V±2.5%, 1.5A	MSOP-8A	55xd	DC17	8f	Tor
4C54A	XC9101C54AKR	DC-DC-IC	PWM, step-up, 5.4V±2.5%, 1.5A	MSOP-8A	55xd	DC17	8f	Tor
4C55A	XC9101C55AKR	DC-DC-IC	PWM, step-up, 5.5V±2.5%, 1.5A	MSOP-8A	55xd	DC17	8f	Tor
4C56A	XC9101C56AKR	DC-DC-IC	PWM, step-up, 5.6V±2.5%, 1.5A	MSOP-8A	55xd	DC17	8f	Tor
4C57A	XC9101C57AKR	DC-DC-IC	PWM, step-up, 5.7V±2.5%, 1.5A	MSOP-8A	55xd	DC17	8f	Tor
4C58A	XC9101C58AKR	DC-DC-IC	PWM, step-up, 5.8V±2.5%, 1.5A	MSOP-8A	55xd	DC17	8f	Tor
4C59A	XC9101C59AKR	DC-DC-IC	PWM, step-up, 5.9V±2.5%, 1.5A	MSOP-8A	55xd	DC17	8f	Tor
4C60A	XC9101C60AKR	DC-DC-IC	PWM, step-up, 6.0V±2.5%, 1.5A	MSOP-8A	55xd	DC17	8f	Tor
4C61A	XC9101C61AKR	DC-DC-IC	PWM, step-up, 6.1V±2.5%, 1.5A	MSOP-8A	55xd	DC17	8f	Tor
4C62A	XC9101C62AKR	DC-DC-IC	PWM, step-up, 6.2V±2.5%, 1.5A	MSOP-8A	55xd	DC17	8f	Tor
4C63A	XC9101C63AKR	DC-DC-IC	PWM, step-up, 6.3V±2.5%, 1.5A	MSOP-8A	55xd	DC17	8f	Tor
4C64A	XC9101C64AKR	DC-DC-IC	PWM, step-up, 6.4V±2.5%, 1.5A	MSOP-8A	55xd	DC17	8f	Tor
4C65A	XC9101C65AKR	DC-DC-IC	PWM, step-up, 6.5V±2.5%, 1.5A	MSOP-8A	55xd	DC17	8f	Tor
4C66A	XC9101C66AKR	DC-DC-IC	PWM, step-up, 6.6V±2.5%, 1.5A	MSOP-8A	55xd	DC17	8f	Tor
4C67A	XC9101C67AKR	DC-DC-IC	PWM, step-up, 6.7V±2.5%, 1.5A	MSOP-8A	55xd	DC17	8f	Tor
4C68A	XC9101C68AKR	DC-DC-IC	PWM, step-up, 6.8V±2.5%, 1.5A	MSOP-8A	55xd	DC17	8f	Tor
4C69A	XC9101C69AKR	DC-DC-IC	PWM, step-up, 6.9V±2.5%, 1.5A	MSOP-8A	55xd	DC17	8f	Tor
4C70A	XC9101C70AKR	DC-DC-IC	PWM, step-up, 7.0V±2.5%, 1.5A	MSOP-8A	55xd	DC17	8f	Tor
4C71A	XC9101C71AKR	DC-DC-IC	PWM, step-up, 7.1V±2.5%, 1.5A	MSOP-8A	55xd	DC17	8f	Tor
4C72A	XC9101C72AKR	DC-DC-IC	PWM, step-up, 7.2V±2.5%, 1.5A	MSOP-8A	55xd	DC17	8f	Tor
4C73A	XC9101C73AKR	DC-DC-IC	PWM, step-up, 7.3V±2.5%, 1.5A	MSOP-8A	55xd	DC17	8f	Tor
4C74A	XC9101C74AKR	DC-DC-IC	PWM, step-up, 7.4V±2.5%, 1.5A	MSOP-8A	55xd	DC17	8f	Tor



SMD code	Type	Function	Short description	Case	Pinout	Sch.	St.	Mnf.
4C75A	XC9101C75AKR	DC-DC-IC	PWM, step-up, 7.5V±2.5%, 1.5A	MSOP-8A	55xd	DC17	8f	Tor
4C76A	XC9101C76AKR	DC-DC-IC	PWM, step-up, 7.6V±2.5%, 1.5A	MSOP-8A	55xd	DC17	8f	Tor
4C77A	XC9101C77AKR	DC-DC-IC	PWM, step-up, 7.7V±2.5%, 1.5A	MSOP-8A	55xd	DC17	8f	Tor
4C78A	XC9101C78AKR	DC-DC-IC	PWM, step-up, 7.8V±2.5%, 1.5A	MSOP-8A	55xd	DC17	8f	Tor
4C79A	XC9101C79AKR	DC-DC-IC	PWM, step-up, 7.9V±2.5%, 1.5A	MSOP-8A	55xd	DC17	8f	Tor
4C80A	XC9101C80AKR	DC-DC-IC	PWM, step-up, 8.0V±2.5%, 1.5A	MSOP-8A	55xd	DC17	8f	Tor
4C81A	XC9101C81AKR	DC-DC-IC	PWM, step-up, 8.1V±2.5%, 1.5A	MSOP-8A	55xd	DC17	8f	Tor
4C82A	XC9101C82AKR	DC-DC-IC	PWM, step-up, 8.2V±2.5%, 1.5A	MSOP-8A	55xd	DC17	8f	Tor
4C83A	XC9101C83AKR	DC-DC-IC	PWM, step-up, 8.3V±2.5%, 1.5A	MSOP-8A	55xd	DC17	8f	Tor
4C84A	XC9101C84AKR	DC-DC-IC	PWM, step-up, 8.4V±2.5%, 1.5A	MSOP-8A	55xd	DC17	8f	Tor
4C85A	XC9101C85AKR	DC-DC-IC	PWM, step-up, 8.5V±2.5%, 1.5A	MSOP-8A	55xd	DC17	8f	Tor
4C86A	XC9101C86AKR	DC-DC-IC	PWM, step-up, 8.6V±2.5%, 1.5A	MSOP-8A	55xd	DC17	8f	Tor
4C87A	XC9101C87AKR	DC-DC-IC	PWM, step-up, 8.7V±2.5%, 1.5A	MSOP-8A	55xd	DC17	8f	Tor
4C88A	XC9101C88AKR	DC-DC-IC	PWM, step-up, 8.8V±2.5%, 1.5A	MSOP-8A	55xd	DC17	8f	Tor
4C89A	XC9101C89AKR	DC-DC-IC	PWM, step-up, 8.9V±2.5%, 1.5A	MSOP-8A	55xd	DC17	8f	Tor
4C90A	XC9101C90AKR	DC-DC-IC	PWM, step-up, 9.0V±2.5%, 1.5A	MSOP-8A	55xd	DC17	8f	Tor
4C91A	XC9101C91AKR	DC-DC-IC	PWM, step-up, 9.1V±2.5%, 1.5A	MSOP-8A	55xd	DC17	8f	Tor
4C92A	XC9101C92AKR	DC-DC-IC	PWM, step-up, 9.2V±2.5%, 1.5A	MSOP-8A	55xd	DC17	8f	Tor
4C93A	XC9101C93AKR	DC-DC-IC	PWM, step-up, 9.3V±2.5%, 1.5A	MSOP-8A	55xd	DC17	8f	Tor
4C94A	XC9101C94AKR	DC-DC-IC	PWM, step-up, 9.4V±2.5%, 1.5A	MSOP-8A	55xd	DC17	8f	Tor
4C95A	XC9101C95AKR	DC-DC-IC	PWM, step-up, 9.5V±2.5%, 1.5A	MSOP-8A	55xd	DC17	8f	Tor
4C96A	XC9101C96AKR	DC-DC-IC	PWM, step-up, 9.6V±2.5%, 1.5A	MSOP-8A	55xd	DC17	8f	Tor
4C97A	XC9101C97AKR	DC-DC-IC	PWM, step-up, 9.7V±2.5%, 1.5A	MSOP-8A	55xd	DC17	8f	Tor
4C98A	XC9101C98AKR	DC-DC-IC	PWM, step-up, 9.8V±2.5%, 1.5A	MSOP-8A	55xd	DC17	8f	Tor
4C99A	XC9101C99AKR	DC-DC-IC	PWM, step-up, 9.9V±2.5%, 1.5A	MSOP-8A	55xd	DC17	8f	Tor
4CA	FT521Ca	LVR-IC	LDO, Dual out, Vout1/Vout2=1.5V/1.2V±2%, 250mA, +CE	SOT-23-6	33x5	VR19	7d	Fmd
4CA0A	XC9101CA0AKR	DC-DC-IC	PWM, step-up, 10.0V±2.5%, 1.5A	MSOP-8A	55xd	DC17	8f	Tor
4CA1A	XC9101CA1AKR	DC-DC-IC	PWM, step-up, 10.1V±2.5%, 1.5A	MSOP-8A	55xd	DC17	8f	Tor
4CA2A	XC9101CA2AKR	DC-DC-IC	PWM, step-up, 10.2V±2.5%, 1.5A	MSOP-8A	55xd	DC17	8f	Tor
4CA3A	XC9101CA3AKR	DC-DC-IC	PWM, step-up, 10.3V±2.5%, 1.5A	MSOP-8A	55xd	DC17	8f	Tor
4CA4A	XC9101CA4AKR	DC-DC-IC	PWM, step-up, 10.4V±2.5%, 1.5A	MSOP-8A	55xd	DC17	8f	Tor
4CA5A	XC9101CA5AKR	DC-DC-IC	PWM, step-up, 10.5V±2.5%, 1.5A	MSOP-8A	55xd	DC17	8f	Tor
4CA6A	XC9101CA6AKR	DC-DC-IC	PWM, step-up, 10.6V±2.5%, 1.5A	MSOP-8A	55xd	DC17	8f	Tor
4CA7A	XC9101CA7AKR	DC-DC-IC	PWM, step-up, 10.7V±2.5%, 1.5A	MSOP-8A	55xd	DC17	8f	Tor
4CA8A	XC9101CA8AKR	DC-DC-IC	PWM, step-up, 10.8V±2.5%, 1.5A	MSOP-8A	55xd	DC17	8f	Tor
4CA9A	XC9101CA9AKR	DC-DC-IC	PWM, step-up, 10.9V±2.5%, 1.5A	MSOP-8A	55xd	DC17	8f	Tor
4CB	FT521Cb	LVR-IC	LDO, Dual out, Vout1/Vout2=1.5V/1.3V±2%, 250mA, +CE	SOT-23-6	33x5	VR19	7d	Fmd
4CB0A	XC9101CB0AKR	DC-DC-IC	PWM, step-up, 11.0V±2.5%, 1.5A	MSOP-8A	55xd	DC17	8f	Tor
4CB1A	XC9101CB1AKR	DC-DC-IC	PWM, step-up, 11.1V±2.5%, 1.5A	MSOP-8A	55xd	DC17	8f	Tor
4CB2A	XC9101CB2AKR	DC-DC-IC	PWM, step-up, 11.2V±2.5%, 1.5A	MSOP-8A	55xd	DC17	8f	Tor
4CB3A	XC9101CB3AKR	DC-DC-IC	PWM, step-up, 11.3V±2.5%, 1.5A	MSOP-8A	55xd	DC17	8f	Tor
4CB4A	XC9101CB4AKR	DC-DC-IC	PWM, step-up, 11.4V±2.5%, 1.5A	MSOP-8A	55xd	DC17	8f	Tor
4CB5A	XC9101CB5AKR	DC-DC-IC	PWM, step-up, 11.5V±2.5%, 1.5A	MSOP-8A	55xd	DC17	8f	Tor
4CB6A	XC9101CB6AKR	DC-DC-IC	PWM, step-up, 11.6V±2.5%, 1.5A	MSOP-8A	55xd	DC17	8f	Tor
4CB7A	XC9101CB7AKR	DC-DC-IC	PWM, step-up, 11.7V±2.5%, 1.5A	MSOP-8A	55xd	DC17	8f	Tor
4CB8A	XC9101CB8AKR	DC-DC-IC	PWM, step-up, 11.8V±2.5%, 1.5A	MSOP-8A	55xd	DC17	8f	Tor
4CB9A	XC9101CB9AKR	DC-DC-IC	PWM, step-up, 11.9V±2.5%, 1.5A	MSOP-8A	55xd	DC17	8f	Tor
4CC	FT521Cc	LVR-IC	LDO, Dual out, Vout1/Vout2=1.5V/1.5V±2%, 250mA, +CE	SOT-23-6	33x5	VR19	7d	Fmd
4CC0A	XC9101CC0AKR	DC-DC-IC	PWM, step-up, 12.0V±2.5%, 1.5A	MSOP-8A	55xd	DC17	8f	Tor
4CC1A	XC9101CC1AKR	DC-DC-IC	PWM, step-up, 12.1V±2.5%, 1.5A	MSOP-8A	55xd	DC17	8f	Tor
4CC2A	XC9101CC2AKR	DC-DC-IC	PWM, step-up, 12.2V±2.5%, 1.5A	MSOP-8A	55xd	DC17	8f	Tor
4CC3A	XC9101CC3AKR	DC-DC-IC	PWM, step-up, 12.3V±2.5%, 1.5A	MSOP-8A	55xd	DC17	8f	Tor
4CC4A	XC9101CC4AKR	DC-DC-IC	PWM, step-up, 12.4V±2.5%, 1.5A	MSOP-8A	55xd	DC17	8f	Tor
4CC5A	XC9101CC5AKR	DC-DC-IC	PWM, step-up, 12.5V±2.5%, 1.5A	MSOP-8A	55xd	DC17	8f	Tor
4CC6A	XC9101CC6AKR	DC-DC-IC	PWM, step-up, 12.6V±2.5%, 1.5A	MSOP-8A	55xd	DC17	8f	Tor
4CC7A	XC9101CC7AKR	DC-DC-IC	PWM, step-up, 12.7V±2.5%, 1.5A	MSOP-8A	55xd	DC17	8f	Tor
4CC8A	XC9101CC8AKR	DC-DC-IC	PWM, step-up, 12.8V±2.5%, 1.5A	MSOP-8A	55xd	DC17	8f	Tor
4CC9A	XC9101CC9AKR	DC-DC-IC	PWM, step-up, 12.9V±2.5%, 1.5A	MSOP-8A	55xd	DC17	8f	Tor
4CD	FT521Cd	LVR-IC	LDO, Dual out, Vout1/Vout2=1.5V/1.8V±2%, 250mA, +CE	SOT-23-6	33x5	VR19	7d	Fmd
4CD0A	XC9101CD0AKR	DC-DC-IC	PWM, step-up, 13.0V±2.5%, 1.5A	MSOP-8A	55xd	DC17	8f	Tor
4CD1A	XC9101CD1AKR	DC-DC-IC	PWM, step-up, 13.1V±2.5%, 1.5A	MSOP-8A	55xd	DC17	8f	Tor
4CD2A	XC9101CD2AKR	DC-DC-IC	PWM, step-up, 13.2V±2.5%, 1.5A	MSOP-8A	55xd	DC17	8f	Tor
4CD3A	XC9101CD3AKR	DC-DC-IC	PWM, step-up, 13.3V±2.5%, 1.5A	MSOP-8A	55xd	DC17	8f	Tor
4CD4A	XC9101CD4AKR	DC-DC-IC	PWM, step-up, 13.4V±2.5%, 1.5A	MSOP-8A	55xd	DC17	8f	Tor
4CD5A	XC9101CD5AKR	DC-DC-IC	PWM, step-up, 13.5V±2.5%, 1.5A	MSOP-8A	55xd	DC17	8f	Tor
4CD6A	XC9101CD6AKR	DC-DC-IC	PWM, step-up, 13.6V±2.5%, 1.5A	MSOP-8A	55xd	DC17	8f	Tor
4CD7A	XC9101CD7AKR	DC-DC-IC	PWM, step-up, 13.7V±2.5%, 1.5A	MSOP-8A	55xd	DC17	8f	Tor
4CD8A	XC9101CD8AKR	DC-DC-IC	PWM, step-up, 13.8V±2.5%, 1.5A	MSOP-8A	55xd	DC17	8f	Tor
4CD9A	XC9101CD9AKR	DC-DC-IC	PWM, step-up, 13.9V±2.5%, 1.5A	MSOP-8A	55xd	DC17	8f	Tor
4CE	FT521Ce	LVR-IC	LDO, Dual out, Vout1/Vout2=1.5V/2.5V±2%, 250mA, +CE	SOT-23-6	33x5	VR19	7d	Fmd



SMD code	Type	Function	Short description	Case	Pinout	Sch.	St.	Mnf.
4CE0A	XC9101CE0AKR	DC-DC-IC	PWM, step-up, 14.0V±2.5%, 1.5A	MSOP-8A	55xd	DC17	8f	Tor
4CE1A	XC9101CE1AKR	DC-DC-IC	PWM, step-up, 14.1V±2.5%, 1.5A	MSOP-8A	55xd	DC17	8f	Tor
4CE2A	XC9101CE2AKR	DC-DC-IC	PWM, step-up, 14.2V±2.5%, 1.5A	MSOP-8A	55xd	DC17	8f	Tor
4CE3A	XC9101CE3AKR	DC-DC-IC	PWM, step-up, 14.3V±2.5%, 1.5A	MSOP-8A	55xd	DC17	8f	Tor
4CE4A	XC9101CE4AKR	DC-DC-IC	PWM, step-up, 14.4V±2.5%, 1.5A	MSOP-8A	55xd	DC17	8f	Tor
4CE5A	XC9101CE5AKR	DC-DC-IC	PWM, step-up, 14.5V±2.5%, 1.5A	MSOP-8A	55xd	DC17	8f	Tor
4CE6A	XC9101CE6AKR	DC-DC-IC	PWM, step-up, 14.6V±2.5%, 1.5A	MSOP-8A	55xd	DC17	8f	Tor
4CE7A	XC9101CE7AKR	DC-DC-IC	PWM, step-up, 14.7V±2.5%, 1.5A	MSOP-8A	55xd	DC17	8f	Tor
4CE8A	XC9101CE8AKR	DC-DC-IC	PWM, step-up, 14.8V±2.5%, 1.5A	MSOP-8A	55xd	DC17	8f	Tor
4CE9A	XC9101CE9AKR	DC-DC-IC	PWM, step-up, 14.9V±2.5%, 1.5A	MSOP-8A	55xd	DC17	8f	Tor
4CF	FT521CFa	LVR-IC	LDO, Dual out, Vout1/Vout2=1.5V/2.7V±2%, 250mA, +CE	SOT-23-6	33x5	VR19	7d	Fmd
4CF0A	XC9101CF0AKR	DC-DC-IC	PWM, step-up, 15.0V±2.5%, 1.5A	MSOP-8A	55xd	DC17	8f	Tor
4CF1A	XC9101CF1AKR	DC-DC-IC	PWM, step-up, 15.1V±2.5%, 1.5A	MSOP-8A	55xd	DC17	8f	Tor
4CF2A	XC9101CF2AKR	DC-DC-IC	PWM, step-up, 15.2V±2.5%, 1.5A	MSOP-8A	55xd	DC17	8f	Tor
4CF3A	XC9101CF3AKR	DC-DC-IC	PWM, step-up, 15.3V±2.5%, 1.5A	MSOP-8A	55xd	DC17	8f	Tor
4CF4A	XC9101CF4AKR	DC-DC-IC	PWM, step-up, 15.4V±2.5%, 1.5A	MSOP-8A	55xd	DC17	8f	Tor
4CF5A	XC9101CF5AKR	DC-DC-IC	PWM, step-up, 15.5V±2.5%, 1.5A	MSOP-8A	55xd	DC17	8f	Tor
4CF6A	XC9101CF6AKR	DC-DC-IC	PWM, step-up, 15.6V±2.5%, 1.5A	MSOP-8A	55xd	DC17	8f	Tor
4CF7A	XC9101CF7AKR	DC-DC-IC	PWM, step-up, 15.7V±2.5%, 1.5A	MSOP-8A	55xd	DC17	8f	Tor
4CF8A	XC9101CF8AKR	DC-DC-IC	PWM, step-up, 15.8V±2.5%, 1.5A	MSOP-8A	55xd	DC17	8f	Tor
4CF9A	XC9101CF9AKR	DC-DC-IC	PWM, step-up, 15.9V±2.5%, 1.5A	MSOP-8A	55xd	DC17	8f	Tor
4CG	FT521CGa	LVR-IC	LDO, Dual out, Vout1/Vout2=1.5V/2.8V±2%, 250mA, +CE	SOT-23-6	33x5	VR19	7d	Fmd
4CH	FT521CHa	LVR-IC	LDO, Dual out, Vout1/Vout2=1.5V/2.85V±2%, 250mA, +CE	SOT-23-6	33x5	VR19	7d	Fmd
4CH0A	XC9101CH0AKR	DC-DC-IC	PWM, step-up, 16.0V±2.5%, 1.5A	MSOP-8A	55xd	DC17	8f	Tor
4CI	FT521CIa	LVR-IC	LDO, Dual out, Vout1/Vout2=1.5V/3.0V±2%, 250mA, +CE	SOT-23-6	33x5	VR19	7d	Fmd
4CJ	FT521CJa	LVR-IC	LDO, Dual out, Vout1/Vout2=1.5V/3.3V±2%, 250mA, +CE	SOT-23-6	33x5	VR19	7d	Fmd
4CK	FT521CKa	LVR-IC	LDO, Dual out, Vout1/Vout2=1.5V/3.6V±2%, 250mA, +CE	SOT-23-6	33x5	VR19	7d	Fmd
4DA	FT521DAa	LVR-IC	LDO, Dual out, Vout1/Vout2=1.8V/1.2V±2%, 250mA, +CE	SOT-23-6	33x5	VR19	7d	Fmd
4DB	FT521DBa	LVR-IC	LDO, Dual out, Vout1/Vout2=1.8V/1.3V±2%, 250mA, +CE	SOT-23-6	33x5	VR19	7d	Fmd
4DC	FT521DCa	LVR-IC	LDO, Dual out, Vout1/Vout2=1.8V/1.5V±2%, 250mA, +CE	SOT-23-6	33x5	VR19	7d	Fmd
4DD	FT521DDa	LVR-IC	LDO, Dual out, Vout1/Vout2=1.8V/1.8V±2%, 250mA, +CE	SOT-23-6	33x5	VR19	7d	Fmd
4DE	FT521DEa	LVR-IC	LDO, Dual out, Vout1/Vout2=1.8V/2.5V±2%, 250mA, +CE	SOT-23-6	33x5	VR19	7d	Fmd
4DF	FT521DFa	LVR-IC	LDO, Dual out, Vout1/Vout2=1.8V/2.7V±2%, 250mA, +CE	SOT-23-6	33x5	VR19	7d	Fmd
4DG	FT521DGa	LVR-IC	LDO, Dual out, Vout1/Vout2=1.8V/2.8V±2%, 250mA, +CE	SOT-23-6	33x5	VR19	7d	Fmd
4DH	FT521DHa	LVR-IC	LDO, Dual out, Vout1/Vout2=1.8V/2.85V±2%, 250mA, +CE	SOT-23-6	33x5	VR19	7d	Fmd
4DI	FT521DIa	LVR-IC	LDO, Dual out, Vout1/Vout2=1.8V/3.0V±2%, 250mA, +CE	SOT-23-6	33x5	VR19	7d	Fmd
4DJ	FT521DJa	LVR-IC	LDO, Dual out, Vout1/Vout2=1.8V/3.3V±2%, 250mA, +CE	SOT-23-6	33x5	VR19	7d	Fmd
4DK	FT521DKa	LVR-IC	LDO, Dual out, Vout1/Vout2=1.8V/3.6V±2%, 250mA, +CE	SOT-23-6	33x5	VR19	7d	Fmd
4EA	FT521EAa	LVR-IC	LDO, Dual out, Vout1/Vout2=2.5V/1.2V±2%, 250mA, +CE	SOT-23-6	33x5	VR19	7d	Fmd
4EB	FT521EBa	LVR-IC	LDO, Dual out, Vout1/Vout2=2.5V/1.3V±2%, 250mA, +CE	SOT-23-6	33x5	VR19	7d	Fmd
4EC	FT521ECa	LVR-IC	LDO, Dual out, Vout1/Vout2=2.5V/1.5V±2%, 250mA, +CE	SOT-23-6	33x5	VR19	7d	Fmd
4ED	FT521EDa	LVR-IC	LDO, Dual out, Vout1/Vout2=2.5V/1.8V±2%, 250mA, +CE	SOT-23-6	33x5	VR19	7d	Fmd
4EE	FT521EEa	LVR-IC	LDO, Dual out, Vout1/Vout2=2.5V/2.5V±2%, 250mA, +CE	SOT-23-6	33x5	VR19	7d	Fmd
4EF	FT521EFa	LVR-IC	LDO, Dual out, Vout1/Vout2=2.5V/2.7V±2%, 250mA, +CE	SOT-23-6	33x5	VR19	7d	Fmd
4EG	FT521EGa	LVR-IC	LDO, Dual out, Vout1/Vout2=2.5V/2.8V±2%, 250mA, +CE	SOT-23-6	33x5	VR19	7d	Fmd
4EH	FT521EHa	LVR-IC	LDO, Dual out, Vout1/Vout2=2.5V/2.85V±2%, 250mA, +CE	SOT-23-6	33x5	VR19	7d	Fmd
4EI	FT521EJa	LVR-IC	LDO, Dual out, Vout1/Vout2=2.5V/3.0V±2%, 250mA, +CE	SOT-23-6	33x5	VR19	7d	Fmd
4EJ	FT521EJa	LVR-IC	LDO, Dual out, Vout1/Vout2=2.5V/3.3V±2%, 250mA, +CE	SOT-23-6	33x5	VR19	7d	Fmd
4EK	FT521EKa	LVR-IC	LDO, Dual out, Vout1/Vout2=2.5V/3.6V±2%, 250mA, +CE	SOT-23-6	33x5	VR19	7d	Fmd
4F	R1161D141B	LVR-IC	LDO, 1.4V±2%, 350mA, +CE, AE(mode)	SON-6	34vrc	VR10	7g	Ric
4FA	FT521FAa	LVR-IC	LDO, Dual out, Vout1/Vout2=2.7V/1.2V±2%, 250mA, +CE	SOT-23-6	33x5	VR19	7d	Fmd
4FB	FT521FBa	LVR-IC	LDO, Dual out, Vout1/Vout2=2.7V/1.3V±2%, 250mA, +CE	SOT-23-6	33x5	VR19	7d	Fmd
4FC	FT521FCa	LVR-IC	LDO, Dual out, Vout1/Vout2=2.7V/1.5V±2%, 250mA, +CE	SOT-23-6	33x5	VR19	7d	Fmd
4FD	FT521FDa	LVR-IC	LDO, Dual out, Vout1/Vout2=2.7V/1.8V±2%, 250mA, +CE	SOT-23-6	33x5	VR19	7d	Fmd
4FE	FT521FEa	LVR-IC	LDO, Dual out, Vout1/Vout2=2.7V/2.5V±2%, 250mA, +CE	SOT-23-6	33x5	VR19	7d	Fmd
4FF	FT521FFa	LVR-IC	LDO, Dual out, Vout1/Vout2=2.7V/2.7V±2%, 250mA, +CE	SOT-23-6	33x5	VR19	7d	Fmd
4FG	FT521FGa	LVR-IC	LDO, Dual out, Vout1/Vout2=2.7V/2.8V±2%, 250mA, +CE	SOT-23-6	33x5	VR19	7d	Fmd
4FH	FT521FHa	LVR-IC	LDO, Dual out, Vout1/Vout2=2.7V/2.85V±2%, 250mA, +CE	SOT-23-6	33x5	VR19	7d	Fmd
4FI	FT521FIa	LVR-IC	LDO, Dual out, Vout1/Vout2=2.7V/3.0V±2%, 250mA, +CE	SOT-23-6	33x5	VR19	7d	Fmd
4FJ	FT521FJa	LVR-IC	LDO, Dual out, Vout1/Vout2=2.7V/3.3V±2%, 250mA, +CE	SOT-23-6	33x5	VR19	7d	Fmd
4FK	FT521FKa	LVR-IC	LDO, Dual out, Vout1/Vout2=2.7V/3.6V±2%, 250mA, +CE	SOT-23-6	33x5	VR19	7d	Fmd
4Ft	BC846S	Si-npn	Dual, GP, 80V, 100mA, 200mW, B=110, >100MHz	SOT-363	33T/8	-	7b	Phi
4G	R1161D241B	LVR-IC	LDO, 2.4V±2%, 350mA, +CE, AE(mode)	SON-6	34vrc	VR10	7g	Ric
4GA	FT521GAa	LVR-IC	LDO, Dual out, Vout1/Vout2=2.8V/1.2V±2%, 250mA, +CE	SOT-23-6	33x5	VR19	7d	Fmd
4GB	FT521GBa	LVR-IC	LDO, Dual out, Vout1/Vout2=2.8V/1.3V±2%, 250mA, +CE	SOT-23-6	33x5	VR19	7d	Fmd
4GC	FT521GCa	LVR-IC	LDO, Dual out, Vout1/Vout2=2.8V/1.5V±2%, 250mA, +CE	SOT-23-6	33x5	VR19	7d	Fmd
4GD	FT521GDa	LVR-IC	LDO, Dual out, Vout1/Vout2=2.8V/1.8V±2%, 250mA, +CE	SOT-23-6	33x5	VR19	7d	Fmd
4GE	FT521GEa	LVR-IC	LDO, Dual out, Vout1/Vout2=2.8V/2.5V±2%, 250mA, +CE	SOT-23-6	33x5	VR19	7d	Fmd
4GF	FT521GFa	LVR-IC	LDO, Dual out, Vout1/Vout2=2.8V/2.7V±2%, 250mA, +CE	SOT-23-6	33x5	VR19	7d	Fmd
4GG	FT521GGa	LVR-IC	LDO, Dual out, Vout1/Vout2=2.8V/2.8V±2%, 250mA, +CE	SOT-23-6	33x5	VR19	7d	Fmd



SMD code	Type	Function	Short description	Case	Pinout	Sch.	St.	Mnf.
4GH	FT521GHa	LVR-IC	LDO, Dual out, Vout1/Vout2=2.8V/2.85V±2%, 250mA, +CE	SOT-23-6	33x5	VR19	7d	Fmd
4GI	FT521GIa	LVR-IC	LDO, Dual out, Vout1/Vout2=2.8V/3.0V±2%, 250mA, +CE	SOT-23-6	33x5	VR19	7d	Fmd
4GJ	FT521GJa	LVR-IC	LDO, Dual out, Vout1/Vout2=2.8V/3.3V±2%, 250mA, +CE	SOT-23-6	33x5	VR19	7d	Fmd
4GK	FT521GKa	LVR-IC	LDO, Dual out, Vout1/Vout2=2.8V/3.6V±2%, 250mA, +CE	SOT-23-6	33x5	VR19	7d	Fmd
4HA	FT521HAa	LVR-IC	LDO, Dual out, Vout1/Vout2=2.85V/1.2V±2%, 250mA, +CE	SOT-23-6	33x5	VR19	7d	Fmd
4HB	FT521HBa	LVR-IC	LDO, Dual out, Vout1/Vout2=2.85V/1.3V±2%, 250mA, +CE	SOT-23-6	33x5	VR19	7d	Fmd
4HC	FT521HCa	LVR-IC	LDO, Dual out, Vout1/Vout2=2.85V/1.5V±2%, 250mA, +CE	SOT-23-6	33x5	VR19	7d	Fmd
4HD	FT521HDa	LVR-IC	LDO, Dual out, Vout1/Vout2=2.85V/1.8V±2%, 250mA, +CE	SOT-23-6	33x5	VR19	7d	Fmd
4HE	FT521HEa	LVR-IC	LDO, Dual out, Vout1/Vout2=2.85V/2.5V±2%, 250mA, +CE	SOT-23-6	33x5	VR19	7d	Fmd
4HF	FT521HFa	LVR-IC	LDO, Dual out, Vout1/Vout2=2.85V/2.7V±2%, 250mA, +CE	SOT-23-6	33x5	VR19	7d	Fmd
4HG	FT521HGa	LVR-IC	LDO, Dual out, Vout1/Vout2=2.85V/2.8V±2%, 250mA, +CE	SOT-23-6	33x5	VR19	7d	Fmd
4HH	FT521HHa	LVR-IC	LDO, Dual out, Vout1/Vout2=2.85V/2.85V±2%, 250mA, +CE	SOT-23-6	33x5	VR19	7d	Fmd
4HI	FT521HIa	LVR-IC	LDO, Dual out, Vout1/Vout2=2.85V/3.0V±2%, 250mA, +CE	SOT-23-6	33x5	VR19	7d	Fmd
4HJ	FT521HIJa	LVR-IC	LDO, Dual out, Vout1/Vout2=2.85V/3.3V±2%, 250mA, +CE	SOT-23-6	33x5	VR19	7d	Fmd
4HK	FT521HKa	LVR-IC	LDO, Dual out, Vout1/Vout2=2.85V/3.6V±2%, 250mA, +CE	SOT-23-6	33x5	VR19	7d	Fmd
4IA	FT521IAa	LVR-IC	LDO, Dual out, Vout1/Vout2=3.0V/1.2V±2%, 250mA, +CE	SOT-23-6	33x5	VR19	7d	Fmd
4IB	FT521IBa	LVR-IC	LDO, Dual out, Vout1/Vout2=3.0V/1.3V±2%, 250mA, +CE	SOT-23-6	33x5	VR19	7d	Fmd
4IC	FT521ICa	LVR-IC	LDO, Dual out, Vout1/Vout2=3.0V/1.5V±2%, 250mA, +CE	SOT-23-6	33x5	VR19	7d	Fmd
4ID	FT521IDa	LVR-IC	LDO, Dual out, Vout1/Vout2=3.0V/1.8V±2%, 250mA, +CE	SOT-23-6	33x5	VR19	7d	Fmd
4IE	FT521IEa	LVR-IC	LDO, Dual out, Vout1/Vout2=3.0V/2.5V±2%, 250mA, +CE	SOT-23-6	33x5	VR19	7d	Fmd
4IF	FT521IFa	LVR-IC	LDO, Dual out, Vout1/Vout2=3.0V/2.7V±2%, 250mA, +CE	SOT-23-6	33x5	VR19	7d	Fmd
4IG	FT521IGa	LVR-IC	LDO, Dual out, Vout1/Vout2=3.0V/2.8V±2%, 250mA, +CE	SOT-23-6	33x5	VR19	7d	Fmd
4IH	FT521IHa	LVR-IC	LDO, Dual out, Vout1/Vout2=3.0V/2.85V±2%, 250mA, +CE	SOT-23-6	33x5	VR19	7d	Fmd
4II	FT521IIa	LVR-IC	LDO, Dual out, Vout1/Vout2=3.0V/3.0V±2%, 250mA, +CE	SOT-23-6	33x5	VR19	7d	Fmd
4IJ	FT521IIJa	LVR-IC	LDO, Dual out, Vout1/Vout2=3.0V/3.3V±2%, 250mA, +CE	SOT-23-6	33x5	VR19	7d	Fmd
4IK	FT521IIKa	LVR-IC	LDO, Dual out, Vout1/Vout2=3.0V/3.6V±2%, 250mA, +CE	SOT-23-6	33x5	VR19	7d	Fmd
4JA	FT521IIJa	LVR-IC	LDO, Dual out, Vout1/Vout2=3.3V/1.2V±2%, 250mA, +CE	SOT-23-6	33x5	VR19	7d	Fmd
4JB	FT521IJBa	LVR-IC	LDO, Dual out, Vout1/Vout2=3.3V/1.3V±2%, 250mA, +CE	SOT-23-6	33x5	VR19	7d	Fmd
4JC	FT521IJCa	LVR-IC	LDO, Dual out, Vout1/Vout2=3.3V/1.5V±2%, 250mA, +CE	SOT-23-6	33x5	VR19	7d	Fmd
4JD	FT521IJDa	LVR-IC	LDO, Dual out, Vout1/Vout2=3.3V/1.8V±2%, 250mA, +CE	SOT-23-6	33x5	VR19	7d	Fmd
4JE	FT521IJEa	LVR-IC	LDO, Dual out, Vout1/Vout2=3.3V/2.5V±2%, 250mA, +CE	SOT-23-6	33x5	VR19	7d	Fmd
4JF	FT521IJFa	LVR-IC	LDO, Dual out, Vout1/Vout2=3.3V/2.7V±2%, 250mA, +CE	SOT-23-6	33x5	VR19	7d	Fmd
4JG	FT521IJGa	LVR-IC	LDO, Dual out, Vout1/Vout2=3.3V/2.8V±2%, 250mA, +CE	SOT-23-6	33x5	VR19	7d	Fmd
4JH	FT521IJHa	LVR-IC	LDO, Dual out, Vout1/Vout2=3.3V/2.85V±2%, 250mA, +CE	SOT-23-6	33x5	VR19	7d	Fmd
4JI	FT521IJa	LVR-IC	LDO, Dual out, Vout1/Vout2=3.3V/3.0V±2%, 250mA, +CE	SOT-23-6	33x5	VR19	7d	Fmd
4JJ	FT521IIJa	LVR-IC	LDO, Dual out, Vout1/Vout2=3.3V/3.3V±2%, 250mA, +CE	SOT-23-6	33x5	VR19	7d	Fmd
4JK	FT521IIKa	LVR-IC	LDO, Dual out, Vout1/Vout2=3.3V/3.6V±2%, 250mA, +CE	SOT-23-6	33x5	VR19	7d	Fmd
4K	R1161D141D	LVR-IC	LDO, 1.4V±2%, 350mA, +CE, CL, AE(mode)	SOM-6	34vrc	VR10	7g	Ric
4KA	FT521IIKa	LVR-IC	LDO, Dual out, Vout1/Vout2=3.6V/1.2V±2%, 250mA, +CE	SOT-23-6	33x5	VR19	7d	Fmd
4KB	FT521IIBa	LVR-IC	LDO, Dual out, Vout1/Vout2=3.6V/1.3V±2%, 250mA, +CE	SOT-23-6	33x5	VR19	7d	Fmd
4KC	FT521IICa	LVR-IC	LDO, Dual out, Vout1/Vout2=3.6V/1.5V±2%, 250mA, +CE	SOT-23-6	33x5	VR19	7d	Fmd
4KD	FT521IKDa	LVR-IC	LDO, Dual out, Vout1/Vout2=3.6V/1.8V±2%, 250mA, +CE	SOT-23-6	33x5	VR19	7d	Fmd
4KE	FT521IKEa	LVR-IC	LDO, Dual out, Vout1/Vout2=3.6V/2.5V±2%, 250mA, +CE	SOT-23-6	33x5	VR19	7d	Fmd
4KF	FT521IKFa	LVR-IC	LDO, Dual out, Vout1/Vout2=3.6V/2.7V±2%, 250mA, +CE	SOT-23-6	33x5	VR19	7d	Fmd
4KG	FT521IKGa	LVR-IC	LDO, Dual out, Vout1/Vout2=3.6V/2.8V±2%, 250mA, +CE	SOT-23-6	33x5	VR19	7d	Fmd
4KH	FT521IKHa	LVR-IC	LDO, Dual out, Vout1/Vout2=3.6V/2.85V±2%, 250mA, +CE	SOT-23-6	33x5	VR19	7d	Fmd
4KI	FT521IKIa	LVR-IC	LDO, Dual out, Vout1/Vout2=3.6V/3.0V±2%, 250mA, +CE	SOT-23-6	33x5	VR19	7d	Fmd
4KJ	FT521IKJa	LVR-IC	LDO, Dual out, Vout1/Vout2=3.6V/3.3V±2%, 250mA, +CE	SOT-23-6	33x5	VR19	7d	Fmd
4KK	FT521IKKa	LVR-IC	LDO, Dual out, Vout1/Vout2=3.6V/3.6V±2%, 250mA, +CE	SOT-23-6	33x5	VR19	7d	Fmd
4L	R1161D241D	LVR-IC	LDO, 2.4V±2%, 350mA, +CE, CL, AE(mode)	SOM-6	34vrc	VR10	7g	Ric
5	ECG002F-G	MMIC	Buff/amp, DC, 6GHz, 20dB (1GHz, 50°C)	SOT-363	33a1	A1	7j	Wjc
50A	TK74050L	LVR-IC	LDO, Dual out, Vout1/Vout2=5.0V/5.0V±2%, 300mA, +CE	SOT-23L-8	47uh	VR22	8d	Tok
50P	TK11250BM	LVR-IC	LDO, 5V±2%, 150mA, +CE	SOT-23L-6	33vf	VR7	7b	Tok
50Q	TK11350BM	LVR-IC	LDO, 5V±2%, 150mA, -CE	SOT-23L-6	33vf	VR7	7b	Tok
50R	TK11350CM	LVR-IC	LDO, 5V, 5%, 150mA, -CE	SOT-23L-6	33vf	VR7	7b	Tok
520	TK11520M	LVR-IC	LDO, 2V±1.5%, 130mA, ±CE	SOP-8	47ho	-	8d	Tok
525	TK11525M	LVR-IC	LDO, 2.5V±1.5%, 130mA, ±CE	SOP-8	47ho	-	8d	Tok
53	KIC7W53FK	CMOS-Logic	2-channel analog multiplexer/demultiplexer	US8	47L,Log58	-	8c	Kec
530	TK11530M	LVR-IC	LDO, 3V±1.5%, 130mA, ±CE	SOP-8	47ho	-	8d	Tok
532	TK11532M	LVR-IC	LDO, 3.2V±1.5%, 130mA, ±CE	SOP-8	47ho	-	8d	Tok
535	TK11535M	LVR-IC	LDO, 3.5V±1.5%, 130mA, ±CE	SOP-8	47ho	-	8d	Tok
537	TK11537M	LVR-IC	LDO, 3.7V±1.5%, 130mA, ±CE	SOP-8	47ho	-	8d	Tok
540	TK11540M	LVR-IC	LDO, 4V±1.5%, 130mA, ±CE	SOP-8	47ho	-	8d	Tok
545	TK11545M	LVR-IC	LDO, 4.5V±1.5%, 130mA, ±CE	SOP-8	47ho	-	8d	Tok
547	TK11547M	LVR-IC	LDO, 4.75V±1.5%, 130mA, ±CE	SOP-8	47ho	-	8d	Tok
55	74AUP1215GW	CMOS-Logic	X-tal driver with enable and internal resistor	SOT-363	33L,Log83	-	7b	Phi
550	TK11550M	LVR-IC	LDO, 5V±1.5%, 130mA, ±CE	SOP-8	47ho	-	8d	Tok
550E	HMC550E	MMIC	GaAs, SPST failsafe switch, DC-6GHz	SOT-26	33ld	SW1	7b	Htt
555	TK11555M	LVR-IC	LDO, 5.5V±1.5%, 130mA, ±CE	SOP-8	47ho	-	8d	Tok
55P	TK11255BM	LVR-IC	LDO, 5.5V±2%, 150mA, +CE	SOT-23L-6	33vf	VR7	7b	Tok



SMD code	Type	Function	Short description	Case	Pinout	Sch.	St.	Mnf.
55Q	TK11355BM	LVR-IC	LDO, 5.5V±2%, 150mA, -CE	SOT-23L-6	33vf	VR7	7b	Tok
55R	TK11355CM	LVR-IC	LDO, 5.5V±5%, 170mA, -CE	SOT-23L-6	33vf	VR7	7b	Tok
577	TK11577M	LVR-IC	LDO, 7.7V±1.5%, 130mA, ±CE	SOP-8	47ho	-	8d	Tok
580	TK11580M	LVR-IC	LDO, 8V±1.5%, 130mA, ±CE	SOP-8	47ho	-	8d	Tok
5A	RP500N111A	DC/DC-IC	PWMVFM st-dwn, 1.1V±24mV, 600mA, +CE	SOT-23-6W	33gi	DC20	7d	Ric
5A6	MMQA5V6	TVS	Quad, 5.6V, 24W(1ms)	SC-74	33axd	-	7b	Ons
5B	R1161D151A	LVR-IC	LDO, 1.5V±2%, 350mA, -CE, AE(mode)	SON-6	34vrc	VR10	7g	Ric
5B	RP500N121A	DC/DC-IC	PWMVFM st-dwn, 1.2V±24mV, 600mA, +CE	SOT-23-6W	33gi	DC20	7d	Ric
5C	R1161D251A	LVR-IC	LDO, 2.5V±2%, 350mA, -CE, AE(mode)	SON-6	34vrc	VR10	7g	Ric
5C	RP500N121A5	DC/DC-IC	PWMVFM st-dwn, 1.25V±24mV, 600mA, +CE	SOT-23-6W	33gi	DC20	7d	Ric
5D	RP500N131A	DC/DC-IC	PWMVFM st-dwn, 1.3V±24mV, 600mA, +CE	SOT-23-6W	33gi	DC20	7d	Ric
5E	RP500N151A	DC/DC-IC	PWMVFM st-dwn, 1.5V±24mV, 600mA, +CE	SOT-23-6W	33gi	DC20	7d	Ric
5F	R1161D151B	LVR-IC	LDO, 1.5V±2%, 350mA, +CE, AE(mode)	SON-6	34vrc	VR10	7g	Ric
5F	RP500N181A	DC/DC-IC	PWMVFM st-dwn, 1.8V±1.5%, 600mA, +CE	SOT-23-6W	33gi	DC20	7d	Ric
5Ft	BC856S	Si-pnp	Dual, AF, 80V, 100mA, 200mW, B=110, >100MHz	SC-88	33T10	-	7b	Phi
5G	R1161D251B	LVR-IC	LDO, 2.5V±2%, 350mA, +CE, AE(mode)	SON-6	34vrc	VR10	7g	Ric
5G	RP500N251A	DC/DC-IC	PWMVFM st-dwn, 2.5V±1.5%, 600mA, +CE	SOT-23-6W	33gi	DC20	7d	Ric
5H	RP500N331A	DC/DC-IC	PWMVFM st-dwn, 3.3V±1.5%, 600mA, +CE	SOT-23-6W	33gi	DC20	7d	Ric
5J	RP500N112A	DC/DC-IC	PWM st-dwn, 1.1V±24mV, 600mA, +CE	SOT-23-6W	33gi	DC20	7d	Ric
5K	R1161D151D	LVR-IC	LDO, 1.5V±2%, 350mA, +CE, CL, AE(mode)	SON-6	34vrc	VR10	7g	Ric
5K	RP500N122A	DC/DC-IC	PWM st-dwn, 1.2V±24mV, 600mA, +CE	SOT-23-6W	33gi	DC20	7d	Ric
5K	W4401DW	Si-pnp	Dual, GP, 60V, 150mA, 380mW, B=120..560, 140MHz	SOT-363	33T10	-	7b	Wtr
5L	R1161D251D	LVR-IC	LDO, 2.5V±2%, 350mA, +CE, CL, AE(mode)	SON-6	34vrc	VR10	7g	Ric
5L	RP500N122A5	DC/DC-IC	PWM st-dwn, 1.25V±24mV, 600mA, +CE	SOT-23-6W	33gi	DC20	7d	Ric
5M	RP500N132A	DC/DC-IC	PWM st-dwn, 1.3V±24mV, 600mA, +CE	SOT-23-6W	33gi	DC20	7d	Ric
5N	RP500N152A	DC/DC-IC	PWM st-dwn, 1.5V±24mV, 600mA, +CE	SOT-23-6W	33gi	DC20	7d	Ric
5P	RP500N182A	DC/DC-IC	PWM st-dwn, 1.8V±1.5%, 600mA, +CE	SOT-23-6W	33gi	DC20	7d	Ric
5Q	DDZX39FTS	Z-diode	Triple, 39V±2.5%, 200mW	SOT-363	335dd	-	7k	Di
5Q	RP500N252A	DC/DC-IC	PWM st-dwn, 2.5V±1.5%, 600mA, +CE	SOT-23-6W	33gi	DC20	7d	Ric
5R	RP500N332A	DC/DC-IC	PWM st-dwn, 3.3V±1.5%, 600mA, +CE	SOT-23-6W	33gi	DC20	7d	Ric
5S	RP500N161A	DC/DC-IC	PWMVFM st-dwn, 1.6V±1.5%, 600mA, +CE	SOT-23-6W	33gi	DC20	7d	Ric
5T	RP500N281A	DC/DC-IC	PWMVFM st-dwn, 2.8V±1.5%, 600mA, +CE	SOT-23-6W	33gi	DC20	7d	Ric
5U	RP500N114A	DC/DC-IC	PWM st-dwn, 1.1V±24mV, 600mA, +CE, CL	SOT-23-6W	33gi	DC20	7d	Ric
5V	RP500N124A	DC/DC-IC	PWM st-dwn, 1.2V±24mV, 600mA, +CE, CL	SOT-23-6W	33gi	DC20	7d	Ric
5W	RP500N154A	DC/DC-IC	PWM st-dwn, 1.5V±24mV, 600mA, +CE, CL	SOT-23-6W	33gi	DC20	7d	Ric
5W51	TC75W51FK	Op-IC	Dual, CMOS, Vcc=±0.75...±3.5V, Icc0=120µA	SM8	47opd	-	7b	Tos
5W51	TC75W51FU	Op-IC	Dual, CMOS, Vcc=±0.75...±3.5V, Icc0=120µA	US8	47opd	-	8d	Tos
5W54	TC75W54FK	Op-IC	Dual, CMOS, Vcc=±0.9...±3.5V, Icc0=200µA	SM8	47opd	-	7b	Tos
5W54	TC75W54FU	Op-IC	Dual, CMOS, Vcc=±0.9...±3.5V, Icc0=200µA	US8	47opd	-	8d	Tos
5W55	TC75W55FK	Op-IC	Dual, CMOS, Vcc=±0.9...±3.5V, Icc0=20µA	SM8	47opd	-	7b	Tos
5W55	TC75W55FU	Op-IC	Dual, CMOS, Vcc=±0.9...±3.5V, Icc0=20µA	US8	47opd	-	8d	Tos
5W60	TC75W60FK	Op-IC	Dual, CMOS, Vcc=±0.9...±3.5V, Icc0=20µA	SM8	47opd	-	7b	Tos
5W60	TC75W60FU	Op-IC	Dual, CMOS, Vcc=±0.9...±3.5V, Icc0=20µA	US8	47opd	-	8d	Tos
5X	RP500N184A	DC/DC-IC	PWM st-dwn, 1.8V±1.5%, 600mA, +CE, CL	SOT-23-6W	33gi	DC20	7d	Ric
5Y	RP500N254A	DC/DC-IC	PWM st-dwn, 2.5V±1.5%, 600mA, +CE, CL	SOT-23-6W	33gi	DC20	7d	Ric
5Z	RP500N284A	DC/DC-IC	PWM st-dwn, 2.8V±1.5%, 600mA, +CE, CL	SOT-23-6W	33gi	DC20	7d	Ric
60LH25	LT1460LHS8-2.5	Vref-IC	µPower, Precision, Series, 2.5V, 0.075%	S8	47af	VR1	8d	Ltc
60LH5	LT1460LHS8-5	Vref-IC	µPower, Precision, Series, 5.0V, 0.075%	S8	47af	VR1	8d	Ltc
60MH25	LT1460MHS8-2.5	Vref-IC	µPower, Precision, Series, 2.5V, 0.075%	S8	47af	VR1	8d	Ltc
60MH5	LT1460MHS8-5	Vref-IC	µPower, Precision, Series, 5.0V, 0.075%	S8	47af	VR1	8d	Ltc
60P	TK11260BM	LVR-IC	LDO, 6V±2%, 150mA, +CE	SOT-23L-6	33vf	VR7	7b	Tok
60Q	TK11360BM	LVR-IC	LDO, 6V±2%, 150mA, -CE	SOT-23L-6	33vf	VR7	7b	Tok
60R	TK11360CM	LVR-IC	LDO, 6V±5%, 170mA, -CE	SOT-23L-6	33vf	VR7	7b	Tok
6100A2	TPA6100A2D	LIN-IC	AF PA, 1.6..3.6V, 2x50mW(3V/16Ω), shutdown	SOP-8	47	AFP17	-	Ti
6101A2	TPA6101A2D	LIN-IC	AF PA, 1.6..3.6V, 2x50mW(3V/16Ω), shutdown	SOP-8	47	AFP17	-	Ti
6102A2	TPA6102A2D	LIN-IC	AF PA, 1.6..3.6V, 2x50mW(3V/16Ω), shutdown	SOP-8	47	AFP17	-	Ti
6105	BL6105MM	LIN-IC	AF PA, BTL, class-D, 2.5..5.5V, 1.4W(5V/4Ω), shutdown	SSOP-8	47	AFP24	-	Shb
6111A2	TPA6111A2D	LIN-IC	AF PA, 2.5..5.5V, 2x150mW(5V/16Ω), shutdown	SOP-8	47	AFP16	-	Ti
6120A2	TPA6120A2DWP	LIN-IC	AF PA, ±5...±15V, 2x80mW(±5V/16Ω)	SOP-20	60	-	-	Ti
613	KV1613L	C-diode	Triple, AM-Tuning, 16V, 50mA, 100mW, 19..446pF(8..1V)	SOT-23-6	33cec	-	7b	X
6205	EUA6205M	LIN-IC	AF PA, BTL, 2.5..5.5V, 1.25W(5V/8Ω), shutdown	SSOP-8	47	AFP22	-	Eut
6214A	EUA6214AM	LIN-IC	AF PA, BTL, 2.5..5.5V, 1.7W(5V/8Ω), shutdown	MSOP-8	55	AFP22	-	Eut
6308G	MS6308MG	LIN-IC	AF PA, 2.8..5.5V, 2x31mW(5V/32Ω), shutdown	SSOP-8	47	-	-	Mos
6331G	MS6331MG	LIN-IC	16-bit DAC, AF PA 2x24mW(5V/32Ω)	MSOP-8	47	AFP39	8d	Mos
66	KIC7W66FK	CMOS-Logic	2-channel analog switch	US8	47Llog68	-	8c	Kec
6853G	MS6853MG	LIN-IC	AF PA, BTL, 2.4..5.5V, 1.9W(5V/4Ω), shutdown	SSOP-10	60	AFP10	-	Mos
6891G	MS6891G	LIN-IC	AF PA, BTL, 2.5..6.5V, 1.5W(5V/4Ω), shutdown	SOP-8	47	AFP11	-	Mos
6891G	MS6891MG	LIN-IC	AF PA, BTL, 2.5..6.5V, 1.5W(5V/4Ω), shutdown	MSOP-8	55	AFP11	-	Mos
6894G	MS6890G	LIN-IC	AF PA, BTL, 2.2..5.5V, 1.1W(5V/8Ω), shutdown	SOP-8	47	AFP12	-	Mos
6894G	MS6890MG	LIN-IC	AF PA, BTL, 2.2..5.5V, 1.1W(5V/8Ω), shutdown	SSOP-8	47	AFP12	-	Mos



SMD code	Type	Function	Short description	Case	Pinout	Sch.	St.	Mnf.
6894G	MS6894MG	LIN-IC	AF PA, BTL, 2.2.5.5V, 1.1W(5V/8Ω), shutdown	SSOP-10	60	AFP19	-	Mos
6895G	MS6895G	LIN-IC	AF PA, BTL, 2.2.5.5V, 1.1W(5V/8Ω), shutdown	SOP-8	47	AFP40	-	Mos
6901G	MS6901MG	LIN-IC	AF PA, BTL, 2.5.5.5V, 1.1W(5V/8Ω), shutdown	SSOP-10	60	AFP26	-	Mos
69s	BAT62-09S	Si-diode	Dual, Schottky, 40V, 20mA; Vf<1.0V, C<0.6pF	SOT-363	33dww	-	7l	Inf
6A	RP500N334A	DC/DC-IC	PWM st-dwn, 3.3V±1.5%, 600mA, +CE, CL	SOT-23-6W	33gi	DC20	7d	Ric
6A	UN601	Si-pnp+Di	pnp: 80V, 1A, 500mW, 120MHz; Di: 40V, 500mA	SOP-6	33th	-	7b	Pan
6A2	MMQA6V2	TVS	Quad, 6.2V, 24W(1ms)	SC-74	33dx	-	7b	Ons
6A8	MMQA6V8	TVS	Quad, 6.8V, 24W(1ms)	SC-74	33dx	-	7b	Ons
6B	R1161D161A	LVR-IC	LDO, 1.6V±2%, 350mA, -CE, AE(mode)	SON-6	34vrc	VR10	7g	Ric
6B	RP500N124A5	DC/DC-IC	PWM st-dwn, 1.25V±24mV, 600mA, +CE, CL	SOT-23-6W	33gi	DC20	7d	Ric
6B	UN602	Si-pnp+Di	pnp: 15V, 3A, 1W, 120MHz; Di: 30V, 300mA	SOP-6	33th	-	7b	Pan
6C	R1161D261A	LVR-IC	LDO, 2.6V±2%, 350mA, -CE, AE(mode)	SON-6	34vrc	VR10	7g	Ric
6C	RP500N134A	DC/DC-IC	PWM st-dwn, 1.3V±24mV, 600mA, +CE, CL	SOT-23-6W	33gi	DC20	7d	Ric
6C	UN603	Si-pnp	Dual, 80V, 1A, 1W, 120MHz, B=120...340	SOP-6	33T/10	-	7b	Pan
6D	RP500N162A	DC/DC-IC	PWM st-dwn, 1.6V±1.5%, 600mA, +CE	SOT-23-6W	33gi	DC20	7d	Ric
6E	RP500N164A	DC/DC-IC	PWM st-dwn, 1.6V±1.5%, 600mA, +CE, CL	SOT-23-6W	33gi	DC20	7d	Ric
6F	R1161D161B	LVR-IC	LDO, 1.6V±2%, 350mA, +CE, AE(mode)	SON-6	34vrc	VR10	7g	Ric
6F	RP500N282A	DC/DC-IC	PWM st-dwn, 2.8V±1.5%, 600mA, +CE	SOT-23-6W	33gi	DC20	7d	Ric
6G	R1161D261B	LVR-IC	LDO, 2.6V±2%, 350mA, +CE, AE(mode)	SON-6	34vrc	VR10	7g	Ric
6G	RP500N301A	DC/DC-IC	PWM/VFM st-dwn, 3.0V±1.5%, 600mA, +CE	SOT-23-6W	33gi	DC20	7d	Ric
6H	RP500N302A	DC/DC-IC	PWM st-dwn, 3.0V±1.5%, 600mA, +CE	SOT-23-6W	33gi	DC20	7d	Ric
6J	RP500N304A	DC/DC-IC	PWM st-dwn, 3.0V±1.5%, 600mA, +CE, CL	SOT-23-6W	33gi	DC20	7d	Ric
6K	R1161D161D	LVR-IC	LDO, 1.6V±2%, 350mA, +CE, CL, AE(mode)	SON-6	34vrc	VR10	7g	Ric
6K	RP500N221A	DC/DC-IC	PWM/VFM st-dwn, 2.2V±1.5%, 600mA, +CE	SOT-23-6W	33gi	DC20	7d	Ric
6L	R1161D261D	LVR-IC	LDO, 2.6V±2%, 350mA, +CE, CL, AE(mode)	SON-6	34vrc	VR10	7g	Ric
6L	RP500N311A	DC/DC-IC	PWM/VFM st-dwn, 3.1V±1.5%, 600mA, +CE	SOT-23-6W	33gi	DC20	7d	Ric
6M	RP500N141A	DC/DC-IC	PWM/VFM st-dwn, 1.4V±24mV, 600mA, +CE	SOT-23-6W	33gi	DC20	7d	Ric
6N	RP500N201A	DC/DC-IC	PWM/VFM st-dwn, 2.0V±1.5%, 600mA, +CE	SOT-23-6W	33gi	DC20	7d	Ric
6O	UN604	Si-n/p+Di	Dual, 20V, 1.5A, 1W, 190MHz, B=200...700	SOP-6	33ti	-	7b	Pan
6P	RP500N231A	DC/DC-IC	PWM/VFM st-dwn, 2.3V±1.5%, 600mA, +CE	SOT-23-6W	33gi	DC20	7d	Ric
6Q	RP500N142A	DC/DC-IC	PWM st-dwn, 1.4V±24mV, 600mA, +CE	SOT-23-6W	33gi	DC20	7d	Ric
6R	RP500N144A	DC/DC-IC	PWM st-dwn, 1.4V±24mV, 600mA, +CE, CL	SOT-23-6W	33gi	DC20	7d	Ric
6S	RP500N171A	DC/DC-IC	PWM/VFM st-dwn, 1.7V±1.5%, 600mA, +CE	SOT-23-6W	33gi	DC20	7d	Ric
6T	RP500N172A	DC/DC-IC	PWM st-dwn, 1.7V±1.5%, 600mA, +CE	SOT-23-6W	33gi	DC20	7d	Ric
6U	RP500N174A	DC/DC-IC	PWM st-dwn, 1.7V±1.5%, 600mA, +CE, CL	SOT-23-6W	33gi	DC20	7d	Ric
6V	RP500N191A	DC/DC-IC	PWM/VFM st-dwn, 1.9V±1.5%, 600mA, +CE	SOT-23-6W	33gi	DC20	7d	Ric
6V	RP500N192A	DC/DC-IC	PWM st-dwn, 1.9V±1.5%, 600mA, +CE	SOT-23-6W	33gi	DC20	7d	Ric
6X	RP500N194A	DC/DC-IC	PWM st-dwn, 1.9V±1.5%, 600mA, +CE, CL	SOT-23-6W	33gi	DC20	7d	Ric
6Y	RP500N202A	DC/DC-IC	PWM st-dwn, 2.0V±1.5%, 600mA, +CE	SOT-23-6W	33gi	DC20	7d	Ric
6Z	RP500N204A	DC/DC-IC	PWM st-dwn, 2.0V±1.5%, 600mA, +CE, CL	SOT-23-6W	33gi	DC20	7d	Ric
6Z	XP6111	Si-pnp-Digi	Dual, 50V, 100mA, 150mW, 80MHz, R1/R2=10k/10k	SMini6	33T/D8	-	7b	Pan
7	ECG006F-G	MMIC	Buff/amp, DC, 5.5GHz, 15dB (1GHz, 50Ω)	SOT-363	33a1	A1	7j	WjS
70	μPA801TC-FB	Si-npn	Dual, VHF/UHF, 20V, 100mA, 200mW, 4.5GHz, B=70...140	SOT-363	33T/2	-	7b	Nec
70-	BA570XY	Si-diode	Quad, Schottky, 70V, 70mA, Vf<1V(15mA), <2pF, 5ns	SOT-363	33D/10	-	7b	NxH
7005	FAN7005M	LIN-IC	AF PA, 2.7.5.5V, 2x300mW(5V/8Ω), shutdown	SOP-8	47	AFP16	-	F
701	TPA701D	LIN-IC	AF PA, BTL, 2.5.5.5V, 700mW(5V/8Ω), shutdown	SOP-8	47	AFP11	-	Ti
70p	BA570XY	Si-diode	Quad, Schottky, 70V, 70mA, Vf<1V(15mA), <2pF, 5ns	SOT-363	33D/10	-	7b	NxH
70t	BA570XY	Si-diode	Quad, Schottky, 70V, 70mA, Vf<1V(15mA), <2pF, 5ns	SOT-363	33D/10	-	7b	NxM
70W	BA570XY	Si-diode	Quad, Schottky, 70V, 70mA, Vf<1V(15mA), <2pF, 5ns	SOT-363	33D/10	-	7b	NxC
71	μPA801TC-GB	Si-npn	Dual, VHF/UHF, 20V, 100mA, 200mW, 4.5GHz, B=125...250	SOT-363	33T/2	-	7b	Nec
711	TPA711D	LIN-IC	AF PA, BTL, 2.5.5.5V, 700mW(5V/8Ω), shutdown	SOP-8	47	AFP23	-	Ti
71C	TSH71CD	Op-IC	Wide-band, LP, St-by, ±5V, 70MHz	SOP-8	47	OP1	8c	Ste
71C	TSH71CPT	Op-IC	Wide-band LP, St-by, ±5V, 70MHz	TSSOP-8	47	OP1	8d	Ste
721	TPA721D	LIN-IC	AF PA, BTL, 2.5.5.5V, 700mW(5V/8Ω), shutdown	SOP-8	47	AFP11	-	Ti
72C	TSH72CD	Op-IC	Dual, WB, LP, St-by, ±5V, 70MHz	SOP-8	47	OP1	8c	Ste
72C	TSH72CPT	Op-IC	Dual, WB, LP, St-by, ±5V, 70MHz	TSSOP-8	33	OP1	8d	Ste
73C	TSH73CD	Op-IC	Triple, WB, LP, St-by, ±5V, 70MHz	SOP-14	60	OP1	-	Ste
73C	TSH73CPT	Op-IC	Triple, WB, LP, St-by, ±5V, 70MHz	TSSOP-14	60	OP1	7b	Ste
73T	μPA813T-FB	Si-npn	Dual, UHF, 9V, 100mA, 4.5GHz, B=40...80	SOT-363	33ff	-	7b	Nec
74	BAT74S	Si-diode	Dual, Sw, 30V, 200mA, 230mW, Vf<0.8V(0.1A), <5ns	SOT-363	33de	-	7b	Phi
74	KIC7W4FK	CMOS-Logic	Positive edge-triggered D-type flip-flop with set and reset	US8	47L/og59	-	8c	Kec
74	XC74WL74AASR	CMOS-Logic	Positive edge-triggered D-type flip-flop with set and reset	MSP08-8B	47L/og59	-	8d	Tor
74C	TSH74CD	Op-IC	Quad, WB, LP, St-by, ±5V, 70MHz	SOP-14	60	OP1	-	Ste
74C	TSH74CPT	Op-IC	Quad, WB, LP, St-by, ±5V, 70MHz	TSSOP-14	60	OP1	7b	Ste
74s	BA570-04S	Si-diode	Quad, Schottky, 70V, 70mA, Vf<1V(15mA), <2pF, 5ns	SOT-363	33D/10	-	7b	Sie
74T	μPA813T-GB	Si-npn	Dual, UHF, 9V, 100mA, 4.5GHz, B=70...140	SOT-363	33ff	-	7b	Nec
75C	TSH75CD	Op-IC	Quad, WB, LP, St-by, ±5V, 70MHz	SOP-16	60	OP1	-	Ste
75C	TSH75PT	Op-IC	Quad, WB, LP, St-by, ±5V, 70MHz	TSSOP-16	60	OP1	-	Ste
77-	BA570-07S	Si-diode	Dual, Schottky, 70V, 70mA, Vf<1V(15mA), <2pF, 5ns	SOT-363	33de	-	7b	NxH
77p	BA570-07S	Si-diode	Dual, Schottky, 70V, 70mA, Vf<1V(15mA), <2pF, 5ns	SOT-363	33de	-	7b	NxH



SMD code	Type	Function	Short description	Case	Pinout	Sch.	St.	Mnf.
77I	BA570-07S	Si-diode	Dual, Schottky, 70V, 70mA, Vf<1V(15mA), <2pF, 5ns	SOT-363	33de	-	7b	NxM
77W	BA570-07S	Si-diode	Dual, Schottky, 70V, 70mA, Vf<1V(15mA), <2pF, 5ns	SOT-363	33de	-	7b	NxM
7A	MUN5211DW	Si-npn-Digi	Dual, Sw, 2x50V, 100mA, 200mW, R1/R2=10/10k	SOT-363	33/TD3	-	7b	Mot
7B	MUN5212DW	Si-npn-Digi	Dual, Sw, 2x50V, 100mA, 200mW, R1/R2=22/22k	SOT-363	33/TD3	-	7b	Mot
7B	R1161D171A	LVR-IC	LDO, 1.7V±2%, 350mA, -CE, AE(mode)	SOM-6	34vrc	VR10	7g	Ric
7C	MUN5213DW	Si-npn-Digi	Dual, Sw, 2x50V, 100mA, 200mW, R1/R2=47k/47k	SOT-363	33/TD3	-	7b	Mot
7C	R1161D271A	LVR-IC	LDO, 2.7V±2%, 350mA, -CE, AE(mode)	SOM-6	34vrc	VR10	7g	Ric
7D	MUN5214DW	Si-npn-Digi	Dual, Sw, 2x50V, 100mA, 200mW, R1/R2=10/47k	SOT-363	33/TD3	-	7b	Mot
7E	MUN5215DW	Si-npn-Digi	Dual, Sw, 2x50V, 100mA, 200mW, R1=10k	SOT-363	33/TD3	-	7b	Mot
7F	MUN5216DW	Si-npn-Digi	Dual, Sw, 2x50V, 100mA, 200mW, R1=4k7	SOT-363	33/TD3	-	7b	Mot
7F	R1161D171B	LVR-IC	LDO, 1.7V±2%, 350mA, +CE, AE(mode)	SOM-6	34vrc	VR10	7g	Ric
7G	MUN5230DW	Si-npn-Digi	Dual, Sw, 2x50V, 100mA, 200mW, R1/R2=1k/1k0	SOT-363	33/TD3	-	7b	Mot
7G	R1161D271B	LVR-IC	LDO, 2.7V±2%, 350mA, +CE, AE(mode)	SOM-6	34vrc	VR10	7g	Ric
7H	MUN5231DW	Si-npn-Digi	Dual, Sw, 2x50V, 100mA, 200mW, R1/R2=2k2/2k2	SOT-363	33/TD3	-	7b	Mot
7J	MUN5232DW	Si-npn-Digi	Dual, Sw, 2x50V, 100mA, 200mW, R1/R2=4k/4k7	SOT-363	33/TD3	-	7b	Mot
7K	MUN5233DW	Si-npn-Digi	Dual, Sw, 2x50V, 100mA, 200mW, R1/R2=4k7/47k	SOT-363	33/TD3	-	7b	Mot
7K	R1161D171D	LVR-IC	LDO, 1.7V±2%, 350mA, +CE, CL, AE(mode)	SOM-6	34vrc	VR10	7g	Ric
7L	MUN5234DW	Si-npn-Digi	Dual, Sw, 2x50V, 100mA, 200mW, R1/R2=22k/47k	SOT-363	33/TD3	-	7b	Mot
7L	R1161D271D	LVR-IC	LDO, 2.7V±2%, 350mA, +CE, CL, AE(mode)	SOM-6	34vrc	VR10	7g	Ric
7N	MUN5236DW	Si-npn-Digi	Dual, Sw, 2x50V, 100mA, 200mW, R1/R2=100k/100k	SOT-363	33/TD3	-	7b	Mot
7P	MUN5237DW	Si-npn-Digi	Dual, Sw, 2x50V, 100mA, 200mW, R1/R2=47k/22k	SOT-363	33/TD3	-	7b	Mot
80P	TK11280BM	LVR-IC	LDO, 8V±2%, 150mA, +CE	SOT-23L-6	33vf	VR7	7b	Tok
80Q	TK11380BM	LVR-IC	LDO, 8V±2%, 150mA, -CE	SOT-23L-6	33vf	VR7	7b	Tok
80R	TK11380CM	LVR-IC	LDO, 8V±5%, 170mA, -CE	SOT-23L-6	33vf	VR7	7b	Tok
81	μPA821TC	Si-npn	Dual, VHF/UHF, LN, 20V, 100mA, 200mW, B=70..140, 4.5GHz	SMM-6	35/T3	-	7b	Nec
83	μPA826TC	Si-npn	Dual, VHF/UHF, LN, 9V, 30mA, 180mW, B=75..150, 12GHz	SMM-6	35/T3	-	7b	Nec
86	XC74WL86AASR	CMOS-Logic	Dual 2-input EXCLUSIVE-OR gates	MSP0-8B	47L.og65	-	8d	Tor
87	μPA814TC	Si-npn	Dual, RF, 9V, 100mA, 200mW, B=80..160, 9GHz	SMM-6	33/T1	-	7b	Nec
87	μPA814TC	Si-npn	Dual, RF, 9V, 100mA, 200mW, B=80..160, 9GHz	SOP-6	33/T1	-	7b	Cel
89	μPA840TC	Si-npn	Dual, VHF/UHF, 9(20)V, 30(65)mA, B=75..150, 12GHz	SMM-6	35/T3	-	7b	Nec
8A	R1161D081A	LVR-IC	LDO, 0.8V±2%, 350mA, -CE, AE(mode)	SOM-6	34vrc	VR10	7g	Ric
8A1T	CMKZ5221B	Z-diode	Triple, 2.280..2.520V, lzt=20mA, Zzt=30Q, 200mW	SOT-363	33dd	-	7b	Cen
8ACT	CMKZ5226B	Z-diode	Triple, 3.135..3.465V, lzt=20mA, Zzt=28Q, 200mW	SOT-363	33dd	-	7b	Cen
8B	R1161D181A	LVR-IC	LDO, 1.8V±2%, 350mA, -CE, AE(mode)	SOM-6	34vrc	VR10	7g	Ric
8B1T	CMKZ5222B	Z-diode	Triple, 2.375..2.625V, lzt=20mA, Zzt=30Q, 200mW	SOT-363	33dd	-	7b	Cen
8BCT	CMKZ5227B	Z-diode	Triple, 3.420..3.780V, lzt=20mA, Zzt=24Q, 200mW	SOT-363	33dd	-	7b	Cen
8C	R1161D281A	LVR-IC	LDO, 2.8V±2%, 350mA, -CE, AE(mode)	SOM-6	34vrc	VR10	7g	Ric
8C1T	CMKZ5223B	Z-diode	Triple, 2.565..2.835V, lzt=20mA, Zzt=30Q, 200mW	SOT-363	33dd	-	7b	Cen
8CCT	CMKZ5228B	Z-diode	Triple, 3.705..4.095V, lzt=20mA, Zzt=23Q, 200mW	SOT-363	33dd	-	7b	Cen
8D1T	CMKZ5224B	Z-diode	Triple, 2.660..2.940V, lzt=20mA, Zzt=30Q, 200mW	SOT-363	33dd	-	7b	Cen
8DCT	CMKZ5229B	Z-diode	Triple, 4.085..4.515V, lzt=20mA, Zzt=22Q, 200mW	SOT-363	33dd	-	7b	Cen
8E	R1161D081B	LVR-IC	LDO, 0.8V±2%, 350mA, +CE, AE(mode)	SOM-6	34vrc	VR10	7g	Ric
8E1T	CMKZ5225B	Z-diode	Triple, 2.850..3.150V, lzt=20mA, Zzt=29Q, 200mW	SOT-363	33dd	-	7b	Cen
8ECT	CMKZ5230B	Z-diode	Triple, 4.465..4.935V, lzt=20mA, Zzt=19Q, 200mW	SOT-363	33dd	-	7b	Cen
8F	R1161D181B	LVR-IC	LDO, 1.8V±2%, 350mA, +CE, AE(mode)	SOM-6	34vrc	VR10	7g	Ric
8FCT	CMKZ5231B	Z-diode	Triple, 4.845..5.335V, lzt=20mA, Zzt=17Q, 200mW	SOT-363	33dd	-	7b	Cen
8G	R1161D281B	LVR-IC	LDO, 2.8V±2%, 350mA, +CE, AE(mode)	SOM-6	34vrc	VR10	7g	Ric
8GCT	CMKZ5232B	Z-diode	Triple, 5.320..5.880V, lzt=20mA, Zzt=11Q, 200mW	SOT-363	33dd	-	7b	Cen
8HCT	CMKZ5233B	Z-diode	Triple, 5.700..6.300V, lzt=20mA, Zzt=7.0Q, 200mW	SOT-363	33dd	-	7b	Cen
8J	R1161D081D	LVR-IC	LDO, 0.8V±2%, 350mA, +CE, CL, AE(mode)	SOM-6	34vrc	VR10	7g	Ric
8JCT	CMKZ5234B	Z-diode	Triple, 5.890..6.510V, lzt=20mA, Zzt=7.0Q, 200mW	SOT-363	33dd	-	7b	Cen
8K	R1161D181D	LVR-IC	LDO, 1.8V±2%, 350mA, +CE, CL, AE(mode)	SOM-6	34vrc	VR10	7g	Ric
8KCT	CMKZ5235B	Z-diode	Triple, 6.460..7.140V, lzt=20mA, Zzt=5.0Q, 200mW	SOT-363	33dd	-	7b	Cen
8L	R1161D281D	LVR-IC	LDO, 2.8V±2%, 350mA, +CE, CL, AE(mode)	SOM-6	34vrc	VR10	7g	Ric
8L05A	MC78L05ABD	LVR-IC	Low Iq, 5V±1.5%, 100mA, -40..+125°C	SOP-8	47vb	VR1	8d	Ons
8L08A	MC78L08ABD	LVR-IC	Low Iq, 8V±1.5%, 100mA, -40..+125°C	SOP-8	47vb	VR1	8d	Ons
8L09A	MC78L09ABD	LVR-IC	Low Iq, 9V±1.5%, 100mA, -40..+125°C	SOP-8	47vb	VR1	8d	Ons
8L12A	MC78L12ABD	LVR-IC	Low Iq, 12V±1.5%, 100mA, -40..+125°C	SOP-8	47vb	VR1	8d	Ons
8L15A	MC78L15ABD	LVR-IC	Low Iq, 15V±1.5%, 100mA, -40..+125°C	SOP-8	47vb	VR1	8d	Ons
8LCT	CMKZ5236B	Z-diode	Triple, 7.125..7.875V, lzt=20mA, Zzt=6.0Q, 200mW	SOT-363	33dd	-	7b	Cen
8MCT	CMKZ5237B	Z-diode	Triple, 7.790..8.610V, lzt=20mA, Zzt=8.0Q, 200mW	SOT-363	33dd	-	7b	Cen
8NCT	CMKZ5238B	Z-diode	Triple, 8.265..9.135V, lzt=20mA, Zzt=8.0Q, 200mW	SOT-363	33dd	-	7b	Cen
8PCT	CMKZ5239B	Z-diode	Triple, 8.645..9.555V, lzt=20mA, Zzt=10Q, 200mW	SOT-363	33dd	-	7b	Cen
8QCT	CMKZ5240B	Z-diode	Triple, 9.500..10.500V, lzt=20mA, Zzt=17Q, 200mW	SOT-363	33dd	-	7b	Cen
8RCT	CMKZ5241B	Z-diode	Triple, 10.450..11.550V, lzt=20mA, Zzt=22Q, 200mW	SOT-363	33dd	-	7b	Cen
8SCT	CMKZ5242B	Z-diode	Triple, 11.400..12.600V, lzt=20mA, Zzt=30Q, 200mW	SOT-363	33dd	-	7b	Cen
8T5	1PS88SB48	Si-diode	Quad, SBD, Hi-Speed, 40V, 120mA, <5pF	SC-88	33/D7	-	7b	Phi
8TCT	CMKZ5243B	Z-diode	Triple, 12.350..13.650V, lzt=9.5mA, Zzt=13Q, 200mW	SOT-363	33dd	-	7b	Cen
8UCT	CMKZ5244B	Z-diode	Triple, 13.300..14.700V, lzt=9.0mA, Zzt=15Q, 200mW	SOT-363	33dd	-	7b	Cen
8VCT	CMKZ5245B	Z-diode	Triple, 14.250..15.750V, lzt=8.5mA, Zzt=16Q, 200mW	SOT-363	33dd	-	7b	Cen



SMD code	Type	Function	Short description	Case	Pinout	Sch.	St.	Mnf.
8WCT	CMKZ5246B	Z-diode	Triple, 15.20..16.80V, Izt=7.8mA, Zzt=17Ω, 200mW	SOT-363	33dd	-	7b	Cen
8XCT	CMKZ5247B	Z-diode	Triple, 16.15..17.85V, Izt=7.4mA, Zzt=19Ω, 200mW	SOT-363	33dd	-	7b	Cen
8YCT	CMKZ5248B	Z-diode	Triple, 17.10..18.90V, Izt=7.0mA, Zzt=21Ω, 200mW	SOT-363	33dd	-	7b	Cen
8ZCT	CMKZ5249B	Z-diode	Triple, 18.05..19.95V, Izt=6.6mA, Zzt=23Ω, 200mW	SOT-363	33dd	-	7b	Cen
9A	R1161D091A	LVR-IC	LDO, 0.9V±2%, 350mA, -CE, AE(mode)	SON-6	34vrc	VR10	7g	Ric
9B	R1161D191A	LVR-IC	LDO, 1.9V±2%, 350mA, -CE, AE(mode)	SON-6	34vrc	VR10	7g	Ric
9C	R1161D291A	LVR-IC	LDO, 2.9V±2%, 350mA, -CE, AE(mode)	SON-6	34vrc	VR10	7g	Ric
9E	R1161D091B	LVR-IC	LDO, 0.9V±2%, 350mA, +CE, AE(mode)	SON-6	34vrc	VR10	7g	Ric
9F	R1161D191B	LVR-IC	LDO, 1.9V±2%, 350mA, +CE, AE(mode)	SON-6	34vrc	VR10	7g	Ric
9G	R1161D291B	LVR-IC	LDO, 2.9V±2%, 350mA, +CE, AE(mode)	SON-6	34vrc	VR10	7g	Ric
9J	R1161D091D	LVR-IC	LDO, 0.9V±2%, 350mA, +CE, CL, AE(mode)	SON-6	34vrc	VR10	7g	Ric
9K	R1161D191D	LVR-IC	LDO, 1.9V±2%, 350mA, +CE, CL, AE(mode)	SON-6	34vrc	VR10	7g	Ric
9L	R1161D291D	LVR-IC	LDO, 2.9V±2%, 350mA, +CE, CL, AE(mode)	SON-6	34vrc	VR10	7g	Ric
A0	TK65910M	LIN-IC	Fluorescent lamp driver, 32mA, 175Hz	SOP-6	33zi	-	7b	Tok
A0-	RT9167B-33PF	LVR-IC	LDO, 3.3V±2%, 600mA, +CE	MSOP-8	47	VR7	8d	Rct
A00	74AHC2G00DC	CMOS-Logic	Dual 2-input NAND gates	SOT765-1	47Llog50	-	8d	Phi
A00	74AHC2G00DP	CMOS-Logic	Dual 2-input NAND gates	SOT505-2	47Llog50	-	8d	Phi
A00	HD74ALVC2G00US	CMOS-Logic	Dual 2-input NAND gates	SSOP-8	47Llog50	-	8c	Ren
A01C	R1230D001C	DC/DC-IC	PWM step-down, adjustable, 800mA, 500kHz	SON-8	44ej	-	8e	Ric
A01C	R5210D001C	DC/DC-IC	PWM step-down, Vr=3.4V, DC/DCout=2.7V, Vdet= 4.2V	HSON-6	34dc2	-	7e	Ric
A01D	R1230D001D	DC/DC-IC	PWM step-down, adjustable, 800mA, 800kHz	SON-8	44ej	-	8e	Ric
A02	HD74ALVC2G02US	CMOS-Logic	Dual 2-input NOR gates	SSOP-8	47Llog53	-	8c	Ren
A02C	R5210D002C	DC/DC-IC	PWM step-down, Vr=3.3V, DC/DCout=2.5V, Vdet= 4V	HSON-6	34dc2	-	7e	Ric
A03C	R5210D003C	DC/DC-IC	PWM step-down, Vr=3.3V, DC/DCout=2.5V, Vdet= 4.2V	HSON-6	34dc2	-	7e	Ric
A04	74AHC3G04DC	CMOS-Logic	Triple inverters	SOT765-1	47Llog56	-	8d	Phi
A04	74AHC3G04DP	CMOS-Logic	Triple inverters	SOT505-2	47Llog56	-	8d	Phi
A04	HD74ALVC2G04US	CMOS-Logic	Triple inverters	SSOP-8	47Llog56	-	8c	Ren
A05C	R5210D005C	DC/DC-IC	PWM step-down, Vr=3.3V, DC/DCout=1.8V, Vdet= 4.2V	HSON-6	34dc2	-	7e	Ric
A06	HD74ALVC2G06US	CMOS-Logic	Triple inverters (ODO)	SSOP-8	47Llog72	-	8c	Ren
A06C	R5210D006C	DC/DC-IC	PWM step-down, Vr=3.3V, DC/DCout=1.8V, Vdet= 4V	HSON-6	34dc2	-	7e	Ric
A07	HD74ALVC2G07US	CMOS-Logic	Triple noninverting buffers/drivers (ODO)	SSOP-8	47Llog73	-	8c	Ren
A0710	APA0710XA	LIN-IC	AF PA, BTL, 2.6..5.5V, 1.1W(5V/8Ω), shutdown	SSOP-8-P	47	AFP23	-	Anp
A0711	APA0711XA	LIN-IC	AF PA, BTL, 2.5..5.5V, 1.1W(5V/8Ω), shutdown	SSOP-8-P	47	AFP12	-	Anp
A07C	R5210D007C	DC/DC-IC	PWM step-down, Vr=3.3V, DC/DCout=1.5V, Vdet= 4.2V	HSON-6	34dc2	-	7e	Ric
A08	74AHC2G08DC	CMOS-Logic	Dual 2-input AND gates	SOT765-1	47Llog51	-	8d	Phi
A08	74AHC2G08DP	CMOS-Logic	Dual 2-input AND gates	SOT505-2	47Llog51	-	8d	Phi
A08	HD74ALVC2G08US	CMOS-Logic	Dual 2-input AND gates	SSOP-8	47Llog51	-	8c	Ren
A08C	R5210D008C	DC/DC-IC	PWM step-down, Vr=3.3V, DC/DCout=1.5V, Vdet= 4V	HSON-6	34dc2	-	7e	Ric
A09A	R3111D091A	Vdet-IC	0.9V±2%, -Reset PPO	SON1612-6	35vd8	VD6	7e	Ric
A09C	R3111D091C	Vdet-IC	0.9V±2%, -Reset ODO	SON1612-6	35vd8	VD6	7e	Ric
A09C	R5210D009C	DC/DC-IC	PWM step-down, Vr=2.5V, DC/DCout=1.8V, Vdet=3 V	HSON-6	34dc2	-	7e	Ric
A1	TK65911M	LIN-IC	Fluorescent lamp driver, 32mA, 200Hz	SOP-6	33zi	-	7b	Tok
A1-	BAW56S	Si-diode	Quad, Fast Sw, 90V, 250mA, 250mW, Vf<1.25V(150mA), 2pF, <6ns	SOT-363	33/D8	-	7b	NxH
A10A	R3111D101A	Vdet-IC	1V±2%, -Reset PPO	SON1612-6	35vd8	VD7	7e	Ric
A10C	R3111D101C	Vdet-IC	1V±2%, -Reset ODO	SON1612-6	35vd8	VD6	7e	Ric
A10C	R5210D010C	DC/DC-IC	PWM step-down, Vr=2.5V, DC/DCout=1.5V, Vdet= 3V	HSON-6	34dc2	-	7e	Ric
A11A	R3111D111A	Vdet-IC	1.1V±2%, -Reset PPO	SON1612-6	35vd8	VD7	7e	Ric
A11C	R3111D111C	Vdet-IC	1.1V±2%, -Reset ODO	SON1612-6	35vd8	VD6	7e	Ric
A11C	R5210D011C	DC/DC-IC	PWM step-down, Vr=2.6V, DC/DCout=1.6V, Vdet= 4.2V	HSON-6	34dc2	-	7e	Ric
A12A	R1230D121A	DC/DC-IC	PWM step-down, 1.2V, 800mA, 500kHz	SON-8	44ej	-	8e	Ric
A12A	R3111D121A	Vdet-IC	1.2V±2%, -Reset PPO	SON1612-6	35vd8	VD7	7e	Ric
A12B	R1230D121B	DC/DC-IC	PWM step-down, 1.2V, 800mA, 800kHz	SON-8	44ej	-	8e	Ric
A12C	R3111D121C	Vdet-IC	1.2V±2%, -Reset ODO	SON1612-6	35vd8	VD6	7e	Ric
A12C	R5210D012C	DC/DC-IC	PWM step-down, Vr=2.5V, DC/DCout=3.3V, Vdet= 3.7V	HSON-6	34dc2	-	7e	Ric
A13A	R1230D131A	DC/DC-IC	PWM step-down, 1.3V, 800mA, 500kHz	SON-8	44ej	-	8e	Ric
A13A	R3111D131A	Vdet-IC	1.3V±2%, -Reset PPO	SON1612-6	35vd8	VD7	7e	Ric
A13B	R1230D131B	DC/DC-IC	PWM step-down, 1.3V, 800mA, 800kHz	SON-8	44ej	-	8e	Ric
A13C	R3111D131C	Vdet-IC	1.3V±2%, -Reset ODO	SON1612-6	35vd8	VD6	7e	Ric
A14	74AHC3G14DC	CMOS-Logic	Triple Schmitt-trigger inverters	SOT765-1	47Llog57	-	8d	Phi
A14	74AHC3G14DP	CMOS-Logic	Triple Schmitt-trigger inverters	SOT505-2	47Llog57	-	8d	Phi
A14	HD74ALVC2G14US	CMOS-Logic	Triple Schmitt-trigger inverters	SSOP-8	47Llog57	-	8c	Ren
A14A	R1230D141A	DC/DC-IC	PWM step-down, 1.4V, 800mA, 500kHz	SON-8	44ej	-	8e	Ric
A14A	R3111D141A	Vdet-IC	1.4V±2%, -Reset PPO	SON1612-6	35vd8	VD7	7e	Ric
A14B	R1230D141B	DC/DC-IC	PWM step-down, 1.4V, 800mA, 800kHz	SON-8	44ej	-	8e	Ric
A14C	R3111D141C	Vdet-IC	1.4V±2%, -Reset ODO	SON1612-6	35vd8	VD6	7e	Ric
A15A	R1170S151A	LVR-IC	LDO, 1.5V±2%, 800mA, -CE	HSOP-6J	29vrc	VR4	7h	Ric
A15A	R1230D151A	DC/DC-IC	PWM step-down, 1.5V, 800mA, 500kHz	SON-8	44ej	-	8e	Ric
A15A	R3111D151A	Vdet-IC	1.5V±2%, -Reset PPO	SON1612-6	35vd8	VD7	7e	Ric
A15B	R1170S151B	LVR-IC	LDO, 1.5V±2%, 800mA, +CE	HSOP-6J	29vrc	VR4	7h	Ric
A15B	R1230D151B	DC/DC-IC	PWM step-down, 1.5V, 800mA, 800kHz	SON-8	44ej	-	8e	Ric



SMD code	Type	Function	Short description	Case	Pinout	Sch.	St.	Mnf.
A15C	R3111D151C	Vdet-IC	1.5V±2%, -Reset ODO	SON1612-6	35vd8	VD6	7e	Ric
A16A	R1170S161A	LVR-IC	LDO, 1.6V±2%, 800mA, -CE	HSOP-6J	29vrk	VR4	7h	Ric
A16A	R1230D161A	DC/DC-IC	PWM step-down, 1.6V, 800mA, 500kHz	SON-8	44ej	-	8e	Ric
A16A	R3111D161A	Vdet-IC	1.6V±2%, -Reset PPO	SON1612-6	35vd8	VD7	7e	Ric
A16B	R1170S161B	LVR-IC	LDO, 1.6V±2%, 800mA, +CE	HSOP-6J	29vrk	VR4	7h	Ric
A16B	R1230D161B	DC/DC-IC	PWM step-down, 1.6V, 800mA, 800kHz	SON-8	44ej	-	8e	Ric
A16C	R3111D161C	Vdet-IC	1.6V±2%, -Reset ODO	SON1612-6	35vd8	VD6	7e	Ric
A17A	R1170S171A	LVR-IC	LDO, 1.7V±2%, 800mA, -CE	HSOP-6J	29vrk	VR4	7h	Ric
A17A	R1230D171A	DC/DC-IC	PWM step-down, 1.7V, 800mA, 500kHz	SON-8	44ej	-	8e	Ric
A17A	R3111D171A	Vdet-IC	1.7V±2%, -Reset PPO	SON1612-6	35vd8	VD7	7e	Ric
A17B	R1170S171B	LVR-IC	LDO, 1.7V±2%, 800mA, +CE	HSOP-6J	29vrk	VR4	7h	Ric
A17B	R1230D171B	DC/DC-IC	PWM step-down, 1.7V, 800mA, 800kHz	SON-8	44ej	-	8e	Ric
A17C	R3111D171C	Vdet-IC	1.7V±2%, -Reset ODO	SON1612-6	35vd8	VD6	7e	Ric
A18A	R1170S181A	LVR-IC	LDO, 1.8V±2%, 800mA, -CE	HSOP-6J	29vrk	VR4	7h	Ric
A18A	R1230D181A	DC/DC-IC	PWM step-down, 1.8V, 800mA, 500kHz	SON-8	44ej	-	8e	Ric
A18A	R3111D181A	Vdet-IC	1.8V±2%, -Reset PPO	SON1612-6	35vd8	VD7	7e	Ric
A18B	R1170S181B	LVR-IC	LDO, 1.8V±2%, 800mA, +CE	HSOP-6J	29vrk	VR4	7h	Ric
A18B	R1230D181B	DC/DC-IC	PWM step-down, 1.8V, 800mA, 800kHz	SON-8	44ej	-	8e	Ric
A18C	R3111D181C	Vdet-IC	1.8V±2%, -Reset ODO	SON1612-6	35vd8	VD6	7e	Ric
A19A	R1170S191A	LVR-IC	LDO, 1.9V±2%, 800mA, -CE	HSOP-6J	29vrk	VR4	7h	Ric
A19A	R1230D191A	DC/DC-IC	PWM step-down, 1.9V, 800mA, 500kHz	SON-8	44ej	-	8e	Ric
A19A	R3111D191A	Vdet-IC	1.9V±2%, -Reset PPO	SON1612-6	35vd8	VD7	7e	Ric
A19B	R1170S191B	LVR-IC	LDO, 1.9V±2%, 800mA, +CE	HSOP-6J	29vrk	VR4	7h	Ric
A19B	R1230D191B	DC/DC-IC	PWM step-down, 1.9V, 800mA, 800kHz	SON-8	44ej	-	8e	Ric
A19C	R3111D191C	Vdet-IC	1.9V±2%, -Reset ODO	SON1612-6	35vd8	VD6	7e	Ric
A1C	SSM2301RMZ	LIN-IC	AF PA, BTL, class-D, 2.5..5.5V, 1.4W(5V/8Ω), shutdown	MSOP-8	55	-	-	Ad
A1p	BAW56S	Si-diode	Quad, Fast Sw, 90V, 250mA, 250mW, Vf<1.25V(150mA), 2pF, <6ns	SOT-363	33/D8	-	7b	NxH
A1s	BAW56S	Si-diode	Quad, Fast Sw, 90V, 250mA, 250mW, Vf<1.25V(150mA), 2pF, <6ns	SOT-363	33/D8	-	7f	Inf
A1t	BAW56S	Si-diode	Quad, Fast Sw, 90V, 250mA, 250mW, Vf<1.25V(150mA), 2pF, <6ns	SOT-363	33/D8	-	7b	NxM
A1W	BAW56S	Si-diode	Quad, Fast Sw, 90V, 250mA, 250mW, Vf<1.25V(150mA), 2pF, <6ns	SOT-363	33/D8	-	7b	NxC
a2	74AUP1G3208GW	CMOS-Logic	3-input OR-AND gate	SOT-363	33/Log46	-	7b	Phi
A2	MBT3906DW	Si-pnp	Dual, AF, 40V, 200mA, 150mW, B=60..300, >250MHz	SOT-363	33/T10	-	7b	Ons
A2	TK65912M	LIN-IC	Fluorescent lamp driver, 32mA, 225Hz	SOP-6	33zi	-	7b	Tok
A20A	R1170S201A	LVR-IC	LDO, 2V±2%, 800mA, -CE	HSOP-6J	29vrk	VR4	7h	Ric
A20A	R1230D201A	DC/DC-IC	PWM step-down, 2V, 800mA, 500kHz	SON-8	44ej	-	8e	Ric
A20A	R3111D201A	Vdet-IC	2V±2%, -Reset PPO	SON1612-6	35vd8	VD7	7e	Ric
A20B	R1170S201B	LVR-IC	LDO, 2V±2%, 800mA, +CE	HSOP-6J	29vrk	VR4	7h	Ric
A20B	R1230D201B	DC/DC-IC	PWM step-down, 2V, 800mA, 800kHz	SON-8	44ej	-	8e	Ric
A20C	R3111D201C	Vdet-IC	2V±2%, -Reset ODO	SON1612-6	35vd8	VD6	7e	Ric
A21A	R1170S211A	LVR-IC	LDO, 2.1V±2%, 800mA, -CE	HSOP-6J	29vrk	VR4	7h	Ric
A21A	R1230D211A	DC/DC-IC	PWM step-down, 2.1V, 800mA, 500kHz	SON-8	44ej	-	8e	Ric
A21A	R3111D211A	Vdet-IC	2.1V±2%, -Reset PPO	SON1612-6	35vd8	VD7	7e	Ric
A21B	R1170S211B	LVR-IC	LDO, 2.1V±2%, 800mA, +CE	HSOP-6J	29vrk	VR4	7h	Ric
A21B	R1230D211B	DC/DC-IC	PWM step-down, 2.1V, 800mA, 800kHz	SON-8	44ej	-	8e	Ric
A21C	R3111D211C	Vdet-IC	2.1V±2%, -Reset ODO	SON1612-6	35vd8	VD6	7e	Ric
A22A	R1170S221A	LVR-IC	LDO, 2.2V±2%, 800mA, -CE	HSOP-6J	29vrk	VR4	7h	Ric
A22A	R1230D221A	DC/DC-IC	PWM step-down, 2.2V, 800mA, 500kHz	SON-8	44ej	-	8e	Ric
A22A	R3111D221A	Vdet-IC	2.2V±2%, -Reset PPO	SON1612-6	35vd8	VD7	7e	Ric
A22B	R1170S221B	LVR-IC	LDO, 2.2V±2%, 800mA, +CE	HSOP-6J	29vrk	VR4	7h	Ric
A22B	R1230D221B	DC/DC-IC	PWM step-down, 2.2V, 800mA, 800kHz	SON-8	44ej	-	8e	Ric
A22C	R3111D221C	Vdet-IC	2.2V±2%, -Reset ODO	SON1612-6	35vd8	VD6	7e	Ric
A23A	R1170S231A	LVR-IC	LDO, 2.3V±2%, 800mA, -CE	HSOP-6J	29vrk	VR4	7h	Ric
A23A	R1230D231A	DC/DC-IC	PWM step-down, 2.3V, 800mA, 500kHz	SON-8	44ej	-	8e	Ric
A23A	R3111D231A	Vdet-IC	2.3V±2%, -Reset PPO	SON1612-6	35vd8	VD7	7e	Ric
A23B	R1170S231B	LVR-IC	LDO, 2.3V±2%, 800mA, +CE	HSOP-6J	29vrk	VR4	7h	Ric
A23B	R1230D231B	DC/DC-IC	PWM step-down, 2.3V, 800mA, 800kHz	SON-8	44ej	-	8e	Ric
A23C	R3111D231C	Vdet-IC	2.3V±2%, -Reset ODO	SON1612-6	35vd8	VD6	7e	Ric
A241	74AHC2G241DP	CMOS-Logic	Dual bus buffer non-inverted with 3-state output	SOT505-2	47/Log60	-	8d	Phi
A24A	R1170S241A	LVR-IC	LDO, 2.4V±2%, 800mA, -CE	HSOP-6J	29vrk	VR4	7h	Ric
A24A	R1230D241A	DC/DC-IC	PWM step-down, 2.4V, 800mA, 500kHz	SON-8	44ej	-	8e	Ric
A24A	R3111D241A	Vdet-IC	2.4V±2%, -Reset PPO	SON1612-6	35vd8	VD7	7e	Ric
A24B	R1170S241B	LVR-IC	LDO, 2.4V±2%, 800mA, +CE	HSOP-6J	29vrk	VR4	7h	Ric
A24B	R1230D241B	DC/DC-IC	PWM step-down, 2.4V, 800mA, 800kHz	SON-8	44ej	-	8e	Ric
A24C	R3111D241C	Vdet-IC	2.4V±2%, -Reset ODO	SON1612-6	35vd8	VD6	7e	Ric
A25	74AHC2G125DC	CMOS-Logic	Dual bus buffer with 3-state output	SOT765-1	47/Log54	-	8d	Phi
A25	74AHC2G125DP	CMOS-Logic	Dual bus buffer with 3-state output	SOT505-2	47/Log54	-	8d	Phi
A25	HD74ALVC2G125US	CMOS-Logic	Dual bus buffer with 3-state output	SSOP-8	47/Log54	-	8c	Ren
A25A	R1170S251A	LVR-IC	LDO, 2.5V±2%, 800mA, -CE	HSOP-6J	29vrk	VR4	7h	Ric
A25A	R1230D251A	DC/DC-IC	PWM step-down, 2.5V, 800mA, 500kHz	SON-8	44ej	-	8e	Ric
A25A	R3111D251A	Vdet-IC	2.5V±2%, -Reset PPO	SON1612-6	35vd8	VD7	7e	Ric



SMD code	Type	Function	Short description	Case	Pinout	Sch.	St.	Mnf.
A25B	R1170S251B	LVR-IC	LDO, 2.5V±2%, 800mA, +CE	HSOP-6J	29vrk	VR4	7h	Ric
A25B	R1230D251B	DC/DC-IC	PWM step-down, 2.5V, 800mA, 800kHz	SON-8	44ej	-	8e	Ric
A25C	R3111D251C	Vdet-IC	2.5V±2%, -Reset ODO	SON1612-6	35vd8	VD6	7e	Ric
A26	74AHC2G126DC	CMOS-Logic	Dual bus buffer with 3-state output	SOT765-1	47Llog55	-	8d	Phi
A26	74AHC2G126DP	CMOS-Logic	Dual bus buffer with 3-state output	SOT505-2	47Llog55	-	8d	Phi
A26	HD74ALVC2G126US	CMOS-Logic	Dual bus buffer with 3-state output	SSOP-8	47Llog55	-	8c	Ren
A26A	R1170S261A	LVR-IC	LDO, 2.6V±2%, 800mA, -CE	HSOP-6J	29vrk	VR4	7h	Ric
A26A	R1230D261A	DC/DC-IC	PWM step-down, 2.6V, 800mA, 500kHz	SON-8	44ej	-	8e	Ric
A26A	R3111D261A	Vdet-IC	2.6V±2%, -Reset PPO	SON1612-6	35vd8	VD7	7e	Ric
A26B	R1170S261B	LVR-IC	LDO, 2.6V±2%, 800mA, +CE	HSOP-6J	29vrk	VR4	7h	Ric
A26B	R1230D261B	DC/DC-IC	PWM step-down, 2.6V, 800mA, 800kHz	SON-8	44ej	-	8e	Ric
A26C	R3111D261C	Vdet-IC	2.6V±2%, -Reset ODO	SON1612-6	35vd8	VD6	7e	Ric
A27A	R1170S271A	LVR-IC	LDO, 2.7V±2%, 800mA, -CE	HSOP-6J	29vrk	VR4	7h	Ric
A27A	R1230D271A	DC/DC-IC	PWM step-down, 2.7V, 800mA, 500kHz	SON-8	44ej	-	8e	Ric
A27A	R3111D271A	Vdet-IC	2.7V±2%, -Reset PPO	SON1612-6	35vd8	VD7	7e	Ric
A27B	R1170S271B	LVR-IC	LDO, 2.7V±2%, 800mA, +CE	HSOP-6J	29vrk	VR4	7h	Ric
A27B	R1230D271B	DC/DC-IC	PWM step-down, 2.7V, 800mA, 800kHz	SON-8	44ej	-	8e	Ric
A27C	R3111D271C	Vdet-IC	2.7V±2%, -Reset ODO	SON1612-6	35vd8	VD6	7e	Ric
A28A	R1170S281A	LVR-IC	LDO, 2.8V±2%, 800mA, -CE	HSOP-6J	29vrk	VR4	7h	Ric
A28A	R1230D281A	DC/DC-IC	PWM step-down, 2.8V, 800mA, 500kHz	SON-8	44ej	-	8e	Ric
A28A	R3111D281A	Vdet-IC	2.8V±2%, -Reset PPO	SON1612-6	35vd8	VD7	7e	Ric
A28B	R1170S281B	LVR-IC	LDO, 2.8V±2%, 800mA, +CE	HSOP-6J	29vrk	VR4	7h	Ric
A28B	R1230D281B	DC/DC-IC	PWM step-down, 2.8V, 800mA, 800kHz	SON-8	44ej	-	8e	Ric
A28C	R3111D281C	Vdet-IC	2.8V±2%, -Reset ODO	SON1612-6	35vd8	VD6	7e	Ric
A29A	R1170S291A	LVR-IC	LDO, 2.9V±2%, 800mA, -CE	HSOP-6J	29vrk	VR4	7h	Ric
A29A	R1230D291A	DC/DC-IC	PWM step-down, 2.9V, 800mA, 500kHz	SON-8	44ej	-	8e	Ric
A29A	R3111D291A	Vdet-IC	2.9V±2%, -Reset PPO	SON1612-6	35vd8	VD7	7e	Ric
A29B	R1170S291B	LVR-IC	LDO, 2.9V±2%, 800mA, +CE	HSOP-6J	29vrk	VR4	7h	Ric
A29B	R1230D291B	DC/DC-IC	PWM step-down, 2.9V, 800mA, 800kHz	SON-8	44ej	-	8e	Ric
A29C	R3111D291C	Vdet-IC	2.9V±2%, -Reset ODO	SON1612-6	35vd8	VD6	7e	Ric
a2P	74AUP2G157DC	CMOS-Logic	2-input multiplexer	SOT765-1	47Llog66	-	8d	Phi
A3	NCT500L6	CMOS-Logic	2-input NAND gate	MPAK-6	33Llog1	-	7b	F
A3	TK65913M	LIN-IC	Fluorescent lamp driver, 32mA, 250Hz	SOP-6	33zi	-	7b	Tok
A3010	APA3010XA	LIN-IC	AF PA, BTL, 2.5..5.5V, 3.3W(5V/3Ω), shutdown	SSOP-8-P	47	AFP11	-	Anp
A3011	APA3011XA	LIN-IC	AF PA, BTL, 2.5..5.5V, 3.3W(5V/3Ω), shutdown	SSOP-8-P	47	AFP12	-	Anp
A3012	APA3012XA	LIN-IC	AF PA, BTL, 2.5..5.5V, 3.3W(5V/3Ω), shutdown	SSOP-8-P	47	AFP11	-	Anp
A30A	R1170S301A	LVR-IC	LDO, 3V±2%, 800mA, -CE	HSOP-6J	29vrk	VR4	7h	Ric
A30A	R1230D301A	DC/DC-IC	PWM step-down, 3V, 800mA, 500kHz	SON-8	44ej	-	8e	Ric
A30A	R3111D301A	Vdet-IC	3±V2.0%, -Reset PPO	SON1612-6	35vd8	VD7	7e	Ric
A30B	R1170S301B	LVR-IC	LDO, 3V±2%, 800mA, +CE	HSOP-6J	29vrk	VR4	7h	Ric
A30B	R1230D301B	DC/DC-IC	PWM step-down, 3V, 800mA, 800kHz	SON-8	44ej	-	8e	Ric
A30C	R3111D301C	Vdet-IC	3.0V±2.0%, -Reset ODO	SON1612-6	35vd8	VD6	7e	Ric
A30C	R3112D301C	Vdet-IC	3.0V±2%, -Reset ODO	SON1612-6	35ur	VD1	7e	Ric
A31A	R1170S311A	LVR-IC	LDO, 3.1V±2%, 800mA, -CE	HSOP-6J	29vrk	VR4	7h	Ric
A31A	R1230D311A	DC/DC-IC	PWM step-down, 3.1V, 800mA, 500kHz	SON-8	44ej	-	8e	Ric
A31A	R3111D311A	Vdet-IC	3.1V±2%, -Reset PPO	SON1612-6	35vd8	VD7	7e	Ric
A31B	R1170S311B	LVR-IC	LDO, 3.1V±2%, 800mA, +CE	HSOP-6J	29vrk	VR4	7h	Ric
A31B	R1230D311B	DC/DC-IC	PWM step-down, 3.1V, 800mA, 800kHz	SON-8	44ej	-	8e	Ric
A31C	R3111D311C	Vdet-IC	3.1V±2%, -Reset ODO	SON1612-6	35vd8	VD6	7e	Ric
A31C	R3112D311C	Vdet-IC	3.1V±2%, -Reset ODO	SON1612-6	35ur	VD1	7e	Ric
A32	74AHC2G32DC	CMOS-Logic	Dual 2-input OR gates	SOT765-1	47Llog52	-	8d	Phi
A32	74AHC2G32DP	CMOS-Logic	Dual 2-input OR gates	SOT505-2	47Llog52	-	8d	Phi
A32	HD74ALVC2G32US	CMOS-Logic	Dual 2-input OR gates	SSOP-8	47Llog52	-	8c	Ren
A32	OPA632N	Op-IC	Single-supply	SOT-23-6	33opc	OP1	7b	Bb
A32A	R1170S321A	LVR-IC	LDO, 3.2V±2%, 800mA, -CE	HSOP-6J	29vrk	VR4	7h	Ric
A32A	R1230D321A	DC/DC-IC	PWM step-down, 3.2V, 800mA, 500kHz	SON-8	44ej	-	8e	Ric
A32A	R3111D321A	Vdet-IC	3.2V±2%, -Reset PPO	SON1612-6	35vd8	VD7	7e	Ric
A32B	R1170S321B	LVR-IC	LDO, 3.2V±2%, 800mA, +CE	HSOP-6J	29vrk	VR4	7h	Ric
A32B	R1230D321B	DC/DC-IC	PWM step-down, 3.2V, 800mA, 800kHz	SON-8	44ej	-	8e	Ric
A32C	R3111D321C	Vdet-IC	3.2V±2%, -Reset ODO	SON1612-6	35vd8	VD6	7e	Ric
A32C	R3112D321C	Vdet-IC	3.2V±2%, -Reset ODO	SON1612-6	35ur	VD1	7e	Ric
A33A	R1170S331A	LVR-IC	LDO, 3.3V±2%, 800mA, -CE	HSOP-6J	29vrk	VR4	7h	Ric
A33A	R1230D331A	DC/DC-IC	PWM step-down, 3.3V, 800mA, 500kHz	SON-8	44ej	-	8e	Ric
A33A	R3111D331A	Vdet-IC	3.3V±2%, -Reset PPO	SON1612-6	35vd8	VD7	7e	Ric
A33B	R1170S331B	LVR-IC	LDO, 3.3V±2%, 800mA, +CE	HSOP-6J	29vrk	VR4	7h	Ric
A33B	R1230D331B	DC/DC-IC	PWM step-down, 3.3V, 800mA, 800kHz	SON-8	44ej	-	8e	Ric
A33C	R3111D331C	Vdet-IC	3.3V±2%, -Reset ODO	SON1612-6	35vd8	VD6	7e	Ric
A33C	R3112D331C	Vdet-IC	3.3V±2%, -Reset ODO	SON1612-6	35ur	VD1	7e	Ric
A34	HD74ALVC2G34US	CMOS-Logic	Triple non-inverter buffers	SSOP-8	47Llog69	-	8c	Ren
A34	OPA234E	Op-IC	Precision, Lo-power, ±1.35..±18V, Icc0=250µA, Vofs=±100µV	SOT-23-8	47ope	OP2	-	Bb



SMD code	Type	Function	Short description	Case	Pinout	Sch.	St.	Mnf.
A34	OPA234EA	Op-IC	Precision, Lo-power, $\pm 1.35_{-1.1} \pm 18V$, $I_{cc0}=250\mu A$, $V_{ofs}=\pm 40\mu V$	SOP-8	47ope	OP2	8d	Bb
A34A	R1170S341A	LVR-IC	LDO, $3.4V \pm 2\%$, 800mA, -CE	HSOP-6J	29wrk	VR4	7h	Ric
A34A	R1230D341A	DC/DC-IC	PWM step-down, 3.4V, 800mA, 500kHz	SON-8	44ej	-	8e	Ric
A34A	R3111D341A	Vdet-IC	$3.4V \pm 2\%$, -Reset PPO	SON1612-6	35vd8	VD7	7e	Ric
A34B	R1170S341B	LVR-IC	LDO, $3.4V \pm 2\%$, 800mA, +CE	HSOP-6J	29wrk	VR4	7h	Ric
A34B	R1230D341B	DC/DC-IC	PWM step-down, 3.4V, 800mA, 800kHz	SON-8	44ej	-	8e	Ric
A34C	R3111D341C	Vdet-IC	$3.4V \pm 2\%$, -Reset ODO	SON1612-6	35vd8	VD6	7e	Ric
A34C	R3112D341C	Vdet-IC	$3.4V \pm 2\%$, -Reset ODO	SON1612-6	35ur	VD1	7e	Ric
A35	OPA635N	Op-IC	Wide-band, single-supply: $+3_{-5} +5V$, 150MHz, $I_{out}=80mA$	SOT-23-6	33opc	OP1	7b	Bb
A35A	R1170S351A	LVR-IC	LDO, $3.5V \pm 2\%$, 800mA, -CE	HSOP-6J	29wrk	VR4	7h	Ric
A35A	R1230D351A	DC/DC-IC	PWM step-down, 3.5V, 800mA, 500kHz	SON-8	44ej	-	8e	Ric
A35A	R3111D351A	Vdet-IC	$3.5V \pm 2\%$, -Reset PPO	SON1612-6	35vd8	VD7	7e	Ric
A35B	R1170S351B	LVR-IC	LDO, $3.5V \pm 2\%$, 800mA, +CE	HSOP-6J	29wrk	VR4	7h	Ric
A35B	R1230D351B	DC/DC-IC	PWM step-down, 3.5V, 800mA, 800kHz	SON-8	44ej	-	8e	Ric
A35C	R3111D351C	Vdet-IC	$3.5V \pm 2\%$, -Reset ODO	SON1612-6	35vd8	VD6	7e	Ric
A35C	R3112D351C	Vdet-IC	$3.5V \pm 2\%$, -Reset ODO	SON1612-6	35ur	VD1	7e	Ric
A36A	R1170S361A	LVR-IC	LDO, $3.6V \pm 2\%$, 800mA, -CE	HSOP-6J	29wrk	VR4	7h	Ric
A36A	R1230D361A	DC/DC-IC	PWM step-down, 3.6V, 800mA, 500kHz	SON-8	44ej	-	8e	Ric
A36A	R3111D361A	Vdet-IC	$3.6V \pm 2\%$, -Reset PPO	SON1612-6	35vd8	VD7	7e	Ric
A36B	R1170S361B	LVR-IC	LDO, $3.6V \pm 2\%$, 800mA, +CE	HSOP-6J	29wrk	VR4	7h	Ric
A36B	R1230D361B	DC/DC-IC	PWM step-down, 3.6V, 800mA, 800kHz	SON-8	44ej	-	8e	Ric
A36C	R3111D361C	Vdet-IC	$3.6V \pm 2\%$, -Reset ODO	SON1612-6	35vd8	VD6	7e	Ric
A36C	R3112D361C	Vdet-IC	$3.6V \pm 2\%$, -Reset ODO	SON1612-6	35ur	VD1	7e	Ric
A37A	R1170S371A	LVR-IC	LDO, $3.7V \pm 2\%$, 800mA, -CE	HSOP-6J	29wrk	VR4	7h	Ric
A37A	R1230D371A	DC/DC-IC	PWM step-down, 3.7V, 800mA, 500kHz	SON-8	44ej	-	8e	Ric
A37A	R3111D371A	Vdet-IC	$3.7V \pm 2\%$, -Reset PPO	SON1612-6	35vd8	VD7	7e	Ric
A37B	R1170S371B	LVR-IC	LDO, $3.7V \pm 2\%$, 800mA, +CE	HSOP-6J	29wrk	VR4	7h	Ric
A37B	R1230D371B	DC/DC-IC	PWM step-down, 3.7V, 800mA, 800kHz	SON-8	44ej	-	8e	Ric
A37C	R3111D371C	Vdet-IC	$3.7V \pm 2\%$, -Reset ODO	SON1612-6	35vd8	VD6	7e	Ric
A37C	R3112D371C	Vdet-IC	$3.7V \pm 2\%$, -Reset ODO	SON1612-6	35ur	VD1	7e	Ric
a38	74AUP2G38DC	CMOS-Logic	Dual 2-input NAND gate (ODO)	SOT765-1	47Llog62	-	8d	Phi
A38A	R1170S381A	LVR-IC	LDO, $3.8V \pm 2\%$, 800mA, -CE	HSOP-6J	29wrk	VR4	7h	Ric
A38A	R1230D381A	DC/DC-IC	PWM step-down, 3.8V, 800mA, 500kHz	SON-8	44ej	-	8e	Ric
A38A	R3111D381A	Vdet-IC	$3.8V \pm 2\%$, -Reset PPO	SON1612-6	35vd8	VD7	7e	Ric
A38B	R1170S381B	LVR-IC	LDO, $3.8V \pm 2\%$, 800mA, +CE	HSOP-6J	29wrk	VR4	7h	Ric
A38B	R1230D381B	DC/DC-IC	PWM step-down, 3.8V, 800mA, 800kHz	SON-8	44ej	-	8e	Ric
A38C	R3111D381C	Vdet-IC	$3.8V \pm 2\%$, -Reset ODO	SON1612-6	35vd8	VD6	7e	Ric
A38C	R3112D381C	Vdet-IC	$3.8V \pm 2\%$, -Reset ODO	SON1612-6	35ur	VD1	7e	Ric
A39A	R1170S391A	LVR-IC	LDO, $3.9V \pm 2\%$, 800mA, -CE	HSOP-6J	29wrk	VR4	7h	Ric
A39A	R1230D391A	DC/DC-IC	PWM step-down, 3.9V, 800mA, 500kHz	SON-8	44ej	-	8e	Ric
A39A	R3111D391A	Vdet-IC	$3.9V \pm 2\%$, -Reset PPO	SON1612-6	35vd8	VD7	7e	Ric
A39B	R1170S391B	LVR-IC	LDO, $3.9V \pm 2\%$, 800mA, +CE	HSOP-6J	29wrk	VR4	7h	Ric
A39B	R1230D391B	DC/DC-IC	PWM step-down, 3.9V, 800mA, 800kHz	SON-8	44ej	-	8e	Ric
A39C	R3111D391C	Vdet-IC	$3.9V \pm 2\%$, -Reset ODO	SON1612-6	35vd8	VD6	7e	Ric
A39C	R3112D391C	Vdet-IC	$3.9V \pm 2\%$, -Reset ODO	SON1612-6	35ur	VD1	7e	Ric
a4	74AUP1Z04GW	CMOS-Logic	X-tal driver with enable and internal resistor	SOT-363	33Llog76	-	7b	Phi
A4	NLAS323US	LIN-IC	Dual SPST analog switch, 20Q(5V)	US8	47	-	8b	Ons
A4	TK65914M	LIN-IC	Fluorescent lamp driver, 32mA, 275Hz	SOP-6	33z	-	7b	Tok
A40	HD74ALVC2G240US	CMOS-Logic	Dual bus buffer inverted with 3-state output	SSOP-8	47Llog67	-	8c	Ren
A40A	R1170S401A	LVR-IC	LDO, $4V \pm 2\%$, 800mA, -CE	HSOP-6J	29wrk	VR4	7h	Ric
A40A	R1230D401A	DC/DC-IC	PWM step-down, 4V, 800mA, 500kHz	SON-8	44ej	-	8e	Ric
A40A	R3111D401A	Vdet-IC	$4V \pm 2\%$, -Reset PPO	SON1612-6	35vd8	VD7	7e	Ric
A40B	R1170S401B	LVR-IC	LDO, $4V \pm 2\%$, 800mA, +CE	HSOP-6J	29wrk	VR4	7h	Ric
A40B	R1230D401B	DC/DC-IC	PWM step-down, 4V, 800mA, 800kHz	SON-8	44ej	-	8e	Ric
A40C	R3111D401C	Vdet-IC	$4.0V \pm 2\%$, -Reset ODO	SON1612-6	35vd8	VD6	7e	Ric
A40C	R3112D401C	Vdet-IC	$4.0V \pm 2\%$, -Reset ODO	SON1612-6	35ur	VD1	7e	Ric
A41	74AHC2G241DC	CMOS-Logic	Dual bus buffer non-inverted with 3-state output	SOT765-1	47Llog60	-	8d	Phi
A41	HD74ALVC2G241US	CMOS-Logic	Dual bus buffer non-inverted with 3-state output	SSOP-8	47Llog60	-	8c	Ren
A41A	R1170S411A	LVR-IC	LDO, $4.1V \pm 2\%$, 800mA, -CE	HSOP-6J	29wrk	VR4	7h	Ric
A41A	R3111D411A	Vdet-IC	$4.1V \pm 2\%$, -Reset PPO	SON1612-6	35vd8	VD7	7e	Ric
A41B	R1170S411B	LVR-IC	LDO, $4.1V \pm 2\%$, 800mA, +CE	HSOP-6J	29wrk	VR4	7h	Ric
A41C	R3111D411C	Vdet-IC	$4.1V \pm 2\%$, -Reset ODO	SON1612-6	35vd8	VD6	7e	Ric
A41C	R3112D411C	Vdet-IC	$4.1V \pm 2\%$, -Reset ODO	SON1612-6	35ur	VD1	7e	Ric
A42A	R1170S421A	LVR-IC	LDO, $4.2V \pm 2\%$, 800mA, -CE	HSOP-6J	29wrk	VR4	7h	Ric
A42A	R3111D421A	Vdet-IC	$4.2V \pm 2\%$, -Reset PPO	SON1612-6	35vd8	VD7	7e	Ric
A42B	R1170S421B	LVR-IC	LDO, $4.2V \pm 2\%$, 800mA, +CE	HSOP-6J	29wrk	VR4	7h	Ric
A42C	R3111D421C	Vdet-IC	$4.2V \pm 2\%$, -Reset ODO	SON1612-6	35vd8	VD6	7e	Ric
A42C	R3112D421C	Vdet-IC	$4.2V \pm 2\%$, -Reset ODO	SON1612-6	35ur	VD1	7e	Ric
A43A	R1170S431A	LVR-IC	LDO, $4.3V \pm 2\%$, 800mA, -CE	HSOP-6J	29wrk	VR4	7h	Ric
A43A	R3111D431A	Vdet-IC	$4.3V \pm 2\%$, -Reset PPO	SON1612-6	35vd8	VD7	7e	Ric



SMD code	Type	Function	Short description	Case	Pinout	Sch.	St.	Mnf.
A43B	R1170S431B	LVR-IC	LDO, 4.3V±2%, 800mA, +CE	HSOP-6J	29vrk	VR4	7h	Ric
A43C	R3111D431C	Vdet-IC	4.3V±2%, -Reset ODO	SON1612-6	35vd8	VD6	7e	Ric
A43C	R3112D431C	Vdet-IC	4.3V±2%, -Reset ODO	SON1612-6	35ur	VD1	7e	Ric
A44A	R1170S441A	LVR-IC	LDO, 4.4V±2%, 800mA, -CE	HSOP-6J	29vrk	VR4	7h	Ric
A44A	R3111D441A	Vdet-IC	4.4V±2%, -Reset PPO	SON1612-6	35vd8	VD7	7e	Ric
A44B	R1170S441B	LVR-IC	LDO, 4.4V±2%, 800mA, +CE	HSOP-6J	29vrk	VR4	7h	Ric
A44C	R3111D441C	Vdet-IC	4.4V±2%, -Reset ODO	SON1612-6	35vd8	VD6	7e	Ric
A44C	R3112D441C	Vdet-IC	4.4V±2%, -Reset ODO	SON1612-6	35ur	VD1	7e	Ric
A45	HD74ALVC2G245US	CMOS-Logic	Dual bus transceivers with 3-state output	SSOP-8	47Llog74	-	8c	Ren
A45A	R1170S451A	LVR-IC	LDO, 4.5V±2%, 800mA, -CE	HSOP-6J	29vrk	VR4	7h	Ric
A45A	R3111D451A	Vdet-IC	4.5V±2%, -Reset PPO	SON1612-6	35vd8	VD7	7e	Ric
A45B	R1170S451B	LVR-IC	LDO, 4.5V±2%, 800mA, +CE	HSOP-6J	29vrk	VR4	7h	Ric
A45C	R3111D451C	Vdet-IC	4.5V±2%, -Reset ODO	SON1612-6	35vd8	VD6	7e	Ric
A45C	R3112D451C	Vdet-IC	4.5V±2%, -Reset ODO	SON1612-6	35ur	VD1	7e	Ric
A46A	R1170S461A	LVR-IC	LDO, 4.6V±2%, 800mA, -CE	HSOP-6J	29vrk	VR4	7h	Ric
A46A	R3111D461A	Vdet-IC	4.6V±2%, -Reset PPO	SON1612-6	35vd8	VD7	7e	Ric
A46B	R1170S461B	LVR-IC	LDO, 4.6V±2%, 800mA, +CE	HSOP-6J	29vrk	VR4	7h	Ric
A46C	R3111D461C	Vdet-IC	4.6V±2%, -Reset ODO	SON1612-6	35vd8	VD6	7e	Ric
A46C	R3112D461C	Vdet-IC	4.6V±2%, -Reset ODO	SON1612-6	35ur	VD1	7e	Ric
A47A	R1170S471A	LVR-IC	LDO, 4.7V±2%, 800mA, -CE	HSOP-6J	29vrk	VR4	7h	Ric
A47A	R3111D471A	Vdet-IC	4.7V±2%, -Reset PPO	SON1612-6	35vd8	VD7	7e	Ric
A47B	R1170S471B	LVR-IC	LDO, 4.7V±2%, 800mA, +CE	HSOP-6J	29vrk	VR4	7h	Ric
A47C	R3111D471C	Vdet-IC	4.7V±2%, -Reset ODO	SON1612-6	35vd8	VD6	7e	Ric
A47C	R3112D471C	Vdet-IC	4.7V±2%, -Reset ODO	SON1612-6	35ur	VD1	7e	Ric
A4890	EUA4890M	LIN-IC	AF PA, BTL, 2.2..5.5V, 1W(5V/8Q), shutdown	SSOP-8	47	AFP12	-	Eut
A48A	R1170S481A	LVR-IC	LDO, 4.8V±2%, 800mA, -CE	HSOP-6J	29vrk	VR4	7h	Ric
A48A	R3111D481A	Vdet-IC	4.8V±2%, -Reset PPO	SON1612-6	35vd8	VD7	7e	Ric
A48B	R1170S481B	LVR-IC	LDO, 4.8V±2%, 800mA, +CE	HSOP-6J	29vrk	VR4	7h	Ric
A48C	R3111D481C	Vdet-IC	4.8V±2%, -Reset ODO	SON1612-6	35vd8	VD6	7e	Ric
A48C	R3112D481C	Vdet-IC	4.8V±2%, -Reset ODO	SON1612-6	35ur	VD1	7e	Ric
A4990D	LY8892UB	LIN-IC	AF PA, BTL, 2.7..5.5V, 2W(5V/4Q), shutdown	MSOP-10	60	AFP26	-	Ltk
A4990M	AUD4990MS08	LIN-IC	AF PA, BTL, 2.7..5.5V, 2W(5V/4Q), shutdown	MSOP-8	55	AFP12	-	Axp
A49A	R1170S491A	LVR-IC	LDO, 4.9V±2%, 800mA, -CE	HSOP-6J	29vrk	VR4	7h	Ric
A49A	R3111D491A	Vdet-IC	4.9V±2%, -Reset PPO	SON1612-6	35vd8	VD7	7e	Ric
A49B	R1170S491B	LVR-IC	LDO, 4.9V±2%, 800mA, +CE	HSOP-6J	29vrk	VR4	7h	Ric
A49C	R3111D491C	Vdet-IC	4.9V±2%, -Reset ODO	SON1612-6	35vd8	VD6	7e	Ric
A49C	R3112D491C	Vdet-IC	4.9V±2%, -Reset ODO	SON1612-6	35ur	VD1	7e	Ric
A4s	BAV70S	Si-diode	Quad, Sw, 80V, 200mA, Vf<1.25V(150mA), <4ns	SOT-363	33/D7	-	7b	Inf
A4s	BAV70U	Si-diode	Quad, Sw, 75V, 150mA, 200mW, Vf<1.25V, <4ns	SOT457	33/D7	-	7b	Sie
A4t	BAV70S	Si-diode	Quad, Sw, 80V, 200mA, Vf<1.25V(150mA), <4ns	SOT-363	33/D7	-	7b	Nxp
A5	TK65915M	LIN-IC	Fluorescent lamp driver, 32mA, 300Hz	SOP-6	33zi	-	7b	Tok
A5-	BGA2011	MMIC	RF amp, DC..900MHz, 19dB (50Q), Vcc=4.5V	SOT-363	33ae	A2	7b	Phi
A5004	AUD5004MS08	LIN-IC	AF PA, BTL, 2.7..5.5V, 2W(5V/4Q), mute, shutdown	MSOP-8	55	-	-	Axp
A50A	R1170S501A	LVR-IC	LDO, 5V±2%, 800mA, -CE	HSOP-6J	29vrk	VR4	7h	Ric
A50A	R3111D501A	Vdet-IC	5V±2%, -Reset PPO	SON1612-6	35vd8	VD7	7e	Ric
A50B	R1170S501B	LVR-IC	LDO, 5V±2%, 800mA, +CE	HSOP-6J	29vrk	VR4	7h	Ric
A50C	R3111D501C	Vdet-IC	5.0V±2%, -Reset ODO	SON1612-6	35vd8	VD6	7e	Ric
A50C	R3112D501C	Vdet-IC	5.0V±2%, -Reset ODO	SON1612-6	35ur	VD1	7e	Ric
A51A	R3111D511A	Vdet-IC	5.1V±2%, -Reset PPO	SON1612-6	35vd8	VD7	7e	Ric
A51C	R3111D511C	Vdet-IC	5.1V±2%, -Reset ODO	SON1612-6	35vd8	VD6	7e	Ric
A52A	R3111D521A	Vdet-IC	5.2V±2%, -Reset PPO	SON1612-6	35vd8	VD7	7e	Ric
A52C	R3111D521C	Vdet-IC	5.2V±2%, -Reset ODO	SON1612-6	35vd8	VD6	7e	Ric
A53	HD74ALVC2G53US	CMOS-Logic	2-channel analog multiplexer/demultiplexer	SSOP-8	47Llog58	-	8c	Ren
A53A	R3111D531A	Vdet-IC	5.3V±2%, -Reset PPO	SON1612-6	35vd8	VD7	7e	Ric
A53C	R3111D531C	Vdet-IC	5.3V±2%, -Reset ODO	SON1612-6	35vd8	VD6	7e	Ric
A54A	R3111D541A	Vdet-IC	5.4V±2%, -Reset PPO	SON1612-6	35vd8	VD7	7e	Ric
A54C	R3111D541C	Vdet-IC	5.4V±2%, -Reset ODO	SON1612-6	35vd8	VD6	7e	Ric
A55A	R3111D551A	Vdet-IC	5.5V±2%, -Reset PPO	SON1612-6	35vd8	VD7	7e	Ric
A55C	R3111D551C	Vdet-IC	5.5V±2%, -Reset ODO	SON1612-6	35vd8	VD6	7e	Ric
A56A	R3111D561A	Vdet-IC	5.6V±2%, -Reset PPO	SON1612-6	35vd8	VD7	7e	Ric
A56C	R3111D561C	Vdet-IC	5.6V±2%, -Reset ODO	SON1612-6	35vd8	VD6	7e	Ric
A57	HD74ALVC2G157US	CMOS-Logic	2-input multiplexer	SSOP-8	47Llog66	-	8c	Ren
A57A	R3111D571A	Vdet-IC	5.7V±2%, -Reset PPO	SON1612-6	35vd8	VD7	7e	Ric
A57C	R3111D571C	Vdet-IC	5.7V±2%, -Reset ODO	SON1612-6	35vd8	VD6	7e	Ric
A58A	R3111D581A	Vdet-IC	5.8V±2%, -Reset PPO	SON1612-6	35vd8	VD7	7e	Ric
A58C	R3111D581C	Vdet-IC	5.8V±2%, -Reset ODO	SON1612-6	35vd8	VD6	7e	Ric
A59A	R3111D591A	Vdet-IC	5.9V±2%, -Reset PPO	SON1612-6	35vd8	VD7	7e	Ric
A59C	R3111D591C	Vdet-IC	5.9V±2%, -Reset ODO	SON1612-6	35vd8	VD6	7e	Ric
A6	TK65916M	LIN-IC	Fluorescent lamp driver, 32mA, 325Hz	SOP-6	33zi	-	7b	Tok
A6-	BGA2012	MMIC	RF amp, DC..1.9GHz, 16dB (50Q), Vcc=4.5V	SOT-363	33ae	A2	7b	Phi



SMD code	Type	Function	Short description	Case	Pinout	Sch.	St.	Mnf.
A6019A	EUA6019Q	LIN-IC	AF PA, BTL, 4.5.5V, 2x3W(4V/3Ω), shutdown, DC volume	TSSOP-24	60	-	-	Eut
A6027A	EUA6027Q	LIN-IC	AF PA, BTL, 4.5.5.5V, 2x2W(5V/3Ω), shutdown	TSSOP-20	60	AFP14	-	Eut
A60A	R3111D601A	Vdet-IC	6V±2%, -Reset PPO	SON1612-6	35vd8	VD7	7e	Ric
A60C	R3111D601C	Vdet-IC	6V±2%, -Reset ODO	SON1612-6	35vd8	VD6	7e	Ric
A6201	EUA6201M	LIN-IC	AF PA, BTL, 2.5.5.5V, 1.36W(5V/8Ω), shutdown	MSOP-8	55	AFP22	-	Eut
A6204	EUA6204M	LIN-IC	AF PA, BTL, 2.5.5.5V, 1.6W(5V/8Ω), shutdown	SSOP-8	47	AFP22	-	Eut
A6210	EUA6210M	LIN-IC	AF PA, BTL, 2.2.5.5V, 2x67mW(5V/16Ω), shutdown	SSOP-8	47	AFP29	-	Eut
A6278F	KIA6278F	LIN-IC	AF PA, 2..10V, 720mW(5V/4Ω), shutdown	SOP-8	47	AFP4	-	Kec
A6412A	EUA6412Q	LIN-IC	AF PA, BTL, 2.7.5.5V, 2W(3V/4Ω), shutdown	TSSOP-24	60	-	-	Eut
A66	HD74ALVC2G66US	CMOS-Logic	2-channel analog switch	SSOP-8	47Llog68	-	8c	Ren
A6s	BAS16S	Si-diode	Triple, Sw, Fast, 80V, 200mA, 250mW, <6ns	SOT-363	33dd	-	7f	Inf
A6s	BAS16U	Si-diode	Triple, Sw, Fast, 80V, 200mA, 250mW, <6ns	SC-74	33dd	-	7b	Inf
A7	NLAS324US	LIN-IC	Dual SPST analog switch, 20Q(5V)	US8	47	-	8b	Ons
A7	TK65917M	LIN-IC	Fluorescent lamp driver, 32mA, 350Hz	SOP-6	33zi	-	7b	Tok
A7-	BAV756S	Si-diode	Quad, Fast Sw, 90V, 250mA, 250mW, Vf<1.25V(150mA), 2pF, <6ns	SOT-363	33D13	-	7b	NxH
A74	HD74ALVC2G74US	CMOS-Logic	D-type flip-flop with preset and clear	SSOP-8	47Llog59	-	8c	Ren
A7p	BAV756S	Si-diode	Quad, Fast Sw, 90V, 250mA, 250mW, Vf<1.25V(150mA), 2pF, <6ns	SOT-363	33D13	-	7b	NxH
A7t	BAV756S	Si-diode	Quad, Fast Sw, 90V, 250mA, 250mW, Vf<1.25V(150mA), 2pF, <6ns	SOT-363	33D13	-	7b	NxM
A7W	BAV756S	Si-diode	Quad, Fast Sw, 90V, 250mA, 250mW, Vf<1.25V(150mA), 2pF, <6ns	SOT-363	33D13	-	7b	NxC
A8	R1160D081A	LVR-IC	LDO, 0.8V±2%, 200mA, -CE, AE(mode)	SOM-6	34vrc	VR10	7g	Ric
A8	TK65918M	LIN-IC	Fluorescent lamp driver, 32mA, 375Hz	SOP-6	33zi	-	7b	Tok
A8-	RT9167B-25PF	LVR-IC	LDO, 2.5V±2%, 600mA, +CE	MSOP-8	47	VR7	8d	Rct
A81	OPA681N	Op-IC	Wide-band, Current Feedback	SOT-23-6	33opc	OP1	7b	Bb
A82	OPA682N	Op-IC	Wide-band , Fix Gain Buffer	SOT-23-6	33opc	OP1	7b	Bb
A85	OPA685N	Op-IC	Wide-band, Current Feedback	SOT-23-6	33opc	OP1	7b	Bb
A86	HD74ALVC2G86US	CMOS-Logic	Dual 2-input EXCLUSIVE-OR gates	SSOP-8	47Llog65	-	8c	Ren
A86A	LMV932MM	Op-IC	Dual, Lo-power, Vcc=1.8..5V, 1.4MHz, 0.35V/μs	SOP-8	47opd	-	8d	Nsc
A87	OPA687N	Op-IC	Wide-band, LN, Current Feedback	SOT-23-6	33opc	OP1	7b	Bb
A8819EM	AME8819A-EHAADJZ	LVR-IC	LDO, Adjustable 0.98..4.5V, 600mA	SOP-8	47	-	4q	Ame
A8827FB	AME8827-AHA330	LVR-IC	LDO, 3.3V±1.5%, 1A, +CE	SOP-8	47	-	4q	Ame
A8827GB	AME8827-BZA330	LVR-IC	LDO, 3.3V±1.5%, 1A, +CE	SOP-8	47	-	4q	Ame
a9	74AUP1G98GW	CMOS-Logic	Configurable multiple function gate	SOT-363	33Llog82	-	7b	Phi
A9	NLAS325US	LIN-IC	Dual SPST analog switch, 20Q(5V)	US8	47	-	8b	Ons
A9	R1160D091A	LVR-IC	LDO, 0.9V±2%, 200mA, -CE, AE(mode)	SOM-6	34vrc	VR10	7g	Ric
A9	TK65919M	LIN-IC	Fluorescent lamp driver, 32mA, 400Hz	SOP-6	33zi	-	7b	Tok
A9-	RT9167B-26PF	LVR-IC	LDO, 2.6V±2%, 600mA, +CE	MSOP-8	47	VR7	8d	Rct
A9G	CP2290GMM	LIN-IC	AF PA, BTL, 2.2.5.5V, 1.25W(5V/8Ω), shutdown	SSOP-8	47	AFP12	-	Cpm
aA	74AUP2G34GW	CMOS-Logic	Dual non-inverter buffers	SOT-363	33Llog23	-	7b	Phi
AA	RP500N211A	DC/DC-IC	PWM/VFM st-dwn, 2.1V±1.5%, 600mA, +CE	SOT-23-6W	33gi	DC20	7d	Ric
AAA	TPA301DGN	LIN-IC	AF PA, BTL, 2.5.5.5V, 350mW(5V/8Ω), shutdown	SSOP-8	47	AFP11	-	Ti
AAAA	MAX9718AEUB	LIN-IC	AF PA, BTL, 2.7.5.5V 1.4W(5V/4Q), select shutdown	SOP-10	60	AFP19	8d	Max
AAAB	MAX9718BEUB	LIN-IC	AF PA, BTL, 2.7.5.5V 1.4W(5V/4Q), select shutdown	SOP-10	60	AFP20	8d	Max
AAAC	MAX9718CEUB	LIN-IC	AF PA, BTL, 2.7.5.5V 1.4W(5V/4Q), select shutdown	SOP-10	60	AFP20	8d	Max
AAAD	MAX9718DEUB	LIN-IC	AF PA, BTL, 2.7.5.5V 1.4W(5V/4Q), select shutdown	SOP-10	60	AFP20	8d	Max
AAAP	MAX9716EUA	LIN-IC	AF PA, BTL, 2.7.5.5V 1.4W(5V/4Q), shutdown	SOP-8	47	AFP11	8d	Max
AAAQ	MAX9717AEUA	LIN-IC	AF PA, BTL, 2.7.5.5V 1.4W(5V/4Q), shutdown	SOP-8	47	AFP23	8d	Max
AAAR	MAX9717BEUA	LIN-IC	AF PA, BTL, 2.7.5.5V 1.4W(5V/4Q), shutdown	SOP-8	47	AFP36	8d	Max
AAAT	MAX9717DEUA	LIN-IC	AF PA, BTL, 2.7.5.5V 1.4W(5V/4Q), shutdown	SOP-8	47	AFP36	8d	Max
AAB	TPA311DGN	LIN-IC	AF PA, BTL, 2.5.5.5V, 250mW(5V/8Ω), shutdown	SSOP-8	47	AFP23	-	Ti
AAC	TPA102DGN	LIN-IC	AF PA, 2.5.5.5V, 2x150mW(5V/8Ω)	SSOP-8	47	AFP17	-	Ti
AAD	TPA112DGN	LIN-IC	AF PA, 2.5.5.5V, 2x100mW(5V/8Ω)	SSOP-8	47	AFP6	-	Ti
AAE	TPA122DGN	LIN-IC	AF PA, 2.5.5.5V, 2x100mW(5V/8Ω), shutdown	SSOP-8	47	AFP16	-	Ti
AAIK	MAX4337EKA-T	LIN-IC	AF PA, 2.7.5.5V, 2x40mW(3V/32Ω)	SOP-8	47	AFP6	8d	Max
AAIO	MAX4366EKA-T	LIN-IC	AF PA, BTL, 2.3.5.5V, 330mW(5V/32Ω), shutdown	SOP-8	47	AFP11	8d	Max
AAIP	MAX4367EKA-T	LIN-IC	AF PA, BTL, 2.3.5.5V, 330mW(5V/32Ω), shutdown	SOP-8	47	AFP27	8d	Max
AAIQ	MAX4368EKA-T	LIN-IC	AF PA, BTL, 2.3.5.5V, 330mW(5V/32Ω), shutdown	SOP-8	47	AFP27	8d	Max
AAKK	MAX6505UTN035	Tdet-IC	-35°C, ODO	SOT-23-6	33hg	TD1	7b	Max
AAKL	MAX6505UTN030	Tdet-IC	-30°C, ODO	SOT-23-6	33hg	TD1	7b	Max
AAKM	MAX6505UTN025	Tdet-IC	-25°C, ODO	SOT-23-6	33hg	TD1	7b	Max
AAKN	MAX6505UTN020	Tdet-IC	-20°C, ODO	SOT-23-6	33hg	TD1	7b	Max
AAKO	MAX6505UTN015	Tdet-IC	-15°C, ODO	SOT-23-6	33hg	TD1	7b	Max
AAKP	MAX6505UTN010	Tdet-IC	-10°C, ODO	SOT-23-6	33hg	TD1	7b	Max
AAKV	MAX6505UTN005	Tdet-IC	-5°C, ODO	SOT-23-6	33hg	TD1	7b	Max
AAKR	MAX6505UTP000	Tdet-IC	0°C, ODO	SOT-23-6	33hg	TD1	7b	Max
AAKS	MAX6505UTP005	Tdet-IC	+5°C, ODO	SOT-23-6	33hg	TD1	7b	Max
AAKT	MAX6505UTP010	Tdet-IC	+10°C, ODO	SOT-23-6	33hg	TD1	7b	Max
AAKU	MAX6505UTP015	Tdet-IC	+15°C, ODO	SOT-23-6	33hg	TD1	7b	Max
AAKV	MAX6505UTP020	Tdet-IC	+20°C, ODO	SOT-23-6	33hg	TD1	7b	Max
AAKW	MAX6505UTP025	Tdet-IC	+25°C, ODO	SOT-23-6	33hg	TD1	7b	Max
AAKX	MAX6505UTP030	Tdet-IC	+30°C, ODO	SOT-23-6	33hg	TD1	7b	Max



SMD code	Type	Function	Short description	Case	Pinout	Sch.	St.	Mnf.
AAKY	MAX6505UTP035	Tdet-IC	+35°C, ODO	SOT-23-6	33hg	TD1	7b	Max
AAKZ	MAX6505UTP040	Tdet-IC	+40°C, ODO	SOT-23-6	33hg	TD1	7b	Max
AALA	MAX6505UTP045	Tdet-IC	+45°C, ODO	SOT-23-6	33hg	TD1	7b	Max
AALB	MAX6505UTP050	Tdet-IC	+50°C, ODO	SOT-23-6	33hg	TD1	7b	Max
AALC	MAX6505UTP055	Tdet-IC	+55°C, ODO	SOT-23-6	33hg	TD1	7b	Max
AALD	MAX6505UTP060	Tdet-IC	+60°C, ODO	SOT-23-6	33hg	TD1	7b	Max
AALE	MAX6505UTP065	Tdet-IC	+65°C, ODO	SOT-23-6	33hg	TD1	7b	Max
AALF	MAX6505UTP070	Tdet-IC	+70°C, ODO	SOT-23-6	33hg	TD1	7b	Max
AALG	MAX6505UTP075	Tdet-IC	+75°C, ODO	SOT-23-6	33hg	TD1	7b	Max
AALH	MAX6505UTP080	Tdet-IC	+80°C, ODO	SOT-23-6	33hg	TD1	7b	Max
AALI	MAX6505UTP085	Tdet-IC	+85°C, ODO	SOT-23-6	33hg	TD1	7b	Max
AALJ	MAX6505UTP090	Tdet-IC	+90°C, ODO	SOT-23-6	33hg	TD1	7b	Max
AALK	MAX6505UTP095	Tdet-IC	+95°C, ODO	SOT-23-6	33hg	TD1	7b	Max
AALL	MAX6505UTP100	Tdet-IC	+100°C, ODO	SOT-23-6	33hg	TD1	7b	Max
AALM	MAX6505UTP105	Tdet-IC	+105°C, ODO	SOT-23-6	33hg	TD1	7b	Max
AALN	MAX6505UTP110	Tdet-IC	+110°C, ODO	SOT-23-6	33hg	TD1	7b	Max
AALO	MAX6505UTP115	Tdet-IC	+115°C, ODO	SOT-23-6	33hg	TD1	7b	Max
AALP	MAX6505UTP120	Tdet-IC	+120°C, ODO	SOT-23-6	33hg	TD1	7b	Max
AALQ	MAX6505UTP125	Tdet-IC	+125°C, ODO	SOT-23-6	33hg	TD1	7b	Max
AALR	MAX6506UTN035	Tdet-IC	-35°C, PPO	SOT-23-6	33hg	TD1	7b	Max
AALS	MAX6506UTN030	Tdet-IC	-30°C, PPO	SOT-23-6	33hg	TD1	7b	Max
AALT	MAX6506UTN025	Tdet-IC	-25°C, PPO	SOT-23-6	33hg	TD1	7b	Max
AALU	MAX6506UTN020	Tdet-IC	-20°C, PPO	SOT-23-6	33hg	TD1	7b	Max
AALV	MAX6506UTN015	Tdet-IC	-15°C, PPO	SOT-23-6	33hg	TD1	7b	Max
AALW	MAX6506UTN010	Tdet-IC	-10°C, PPO	SOT-23-6	33hg	TD1	7b	Max
AALX	MAX6506UTN005	Tdet-IC	-5°C, PPO	SOT-23-6	33hg	TD1	7b	Max
AALY	MAX6506UTP000	Tdet-IC	0°C, PPO	SOT-23-6	33hg	TD1	7b	Max
AALZ	MAX6506UTP005	Tdet-IC	+5°C, PPO	SOT-23-6	33hg	TD1	7b	Max
AAMA	MAX6506UTP010	Tdet-IC	+10°C, PPO	SOT-23-6	33hg	TD1	7b	Max
AAMB	MAX6506UTP015	Tdet-IC	+15°C, PPO	SOT-23-6	33hg	TD1	7b	Max
AAMC	MAX6506UTP020	Tdet-IC	+20°C, PPO	SOT-23-6	33hg	TD1	7b	Max
AAMD	MAX6506UTP025	Tdet-IC	+25°C, PPO	SOT-23-6	33hg	TD1	7b	Max
AAME	MAX6506UTP030	Tdet-IC	+30°C, PPO	SOT-23-6	33hg	TD1	7b	Max
AAMF	MAX6506UTP035	Tdet-IC	+35°C, PPO	SOT-23-6	33hg	TD1	7b	Max
AAMG	MAX6506UTP040	Tdet-IC	+40°C, PPO	SOT-23-6	33hg	TD1	7b	Max
AAMH	MAX6506UTP045	Tdet-IC	+45°C, PPO	SOT-23-6	33hg	TD1	7b	Max
AAMI	MAX6506UTP050	Tdet-IC	+50°C, PPO	SOT-23-6	33hg	TD1	7b	Max
AAMJ	MAX6506UTP055	Tdet-IC	+55°C, PPO	SOT-23-6	33hg	TD1	7b	Max
AAMK	MAX6506UTP060	Tdet-IC	+60°C, PPO	SOT-23-6	33hg	TD1	7b	Max
AAML	MAX6506UTP065	Tdet-IC	+65°C, PPO	SOT-23-6	33hg	TD1	7b	Max
AAMM	MAX6506UTP070	Tdet-IC	+70°C, PPO	SOT-23-6	33hg	TD1	7b	Max
AAMN	MAX6506UTP075	Tdet-IC	+75°C, PPO	SOT-23-6	33hg	TD1	7b	Max
AAMO	MAX6506UTP080	Tdet-IC	+80°C, PPO	SOT-23-6	33hg	TD1	7b	Max
AAMP	MAX6506UTP085	Tdet-IC	+85°C, PPO	SOT-23-6	33hg	TD1	7b	Max
AAMQ	MAX6506UTP090	Tdet-IC	+90°C, PPO	SOT-23-6	33hg	TD1	7b	Max
AAMR	MAX6506UTP095	Tdet-IC	+95°C, PPO	SOT-23-6	33hg	TD1	7b	Max
AAMS	MAX6506UTP100	Tdet-IC	+100°C, PPO	SOT-23-6	33hg	TD1	7b	Max
AAMT	MAX6506UTP105	Tdet-IC	+105°C, PPO	SOT-23-6	33hg	TD1	7b	Max
AAMU	MAX6506UTP110	Tdet-IC	+110°C, PPO	SOT-23-6	33hg	TD1	7b	Max
AAMV	MAX6506UTP115	Tdet-IC	+115°C, PPO	SOT-23-6	33hg	TD1	7b	Max
AAMW	MAX6506UTP120	Tdet-IC	+120°C, PPO	SOT-23-6	33hg	TD1	7b	Max
AAMX	MAX6506UTP125	Tdet-IC	+125°C, PPO	SOT-23-6	33hg	TD1	7b	Max
AAPI	TPA6205A1DGN	LIN-IC	AF PA, BTL, 2.5..5.5V, 1.25W(5V/8Ω), shutdown	SOP-8	47	-	-	Ti
AAs	BCP51M	Si-pnp	AF-Drv/Out, 45V, 1A, 1.7W, B=40..250, 100MHz	SCT-595	7117	-	-	Inf
AAS	MAX9717CEUA	LIN-IC	AF PA, BTL, 2.7..5.5V, 1.4W(5V/4Ω), shutdown	SOP-8	47	AFP36	8d	Max
AAW	MAX4336EXT-T	LIN-IC	AF PA, 2.7..5.5V, 40mW(3V/32Ω), shutdown	SOP-6	33	AFP35	7b	Max
AAX	MAX4335EXT-T	LIN-IC	AF PA, 2.7..5.5V, 40mW(3V/32Ω), shutdown	SOP-6	33	AFP34	7b	Max
aB	74AUP1G38GW	CMOS-Logic	2-input NAND gate (ODO)	SOT-363	33/Log17	-	7b	Phi
AB	RP500N212A	DC/DC-IC	PWM st-dwn, 2.1V±1.5%, 600mA, +CE	SOT-23-6W	33gi	DC20	7d	Ric
ABA	TPA701DGN	LIN-IC	AF PA, BTL, 2.5..5.5V, 700mW(5V/8Ω), shutdown	SSOP-8	47	AFP11	-	Ti
ABB	TPA711DGN	LIN-IC	AF PA, BTL, 2.5..5.5V, 700mW(5V/8Ω), shutdown	SSOP-8	47	AFP23	-	Ti
ABC	TPA721DGN	LIN-IC	AF PA, BTL, 2.5..5.5V, 700mW(5V/8Ω), shutdown	SSOP-8	47	AFP11	-	Ti
ABEL	MAX6449UT16L	Vdet-IC	1.6V±1.5%, ±mR, -Reset PPO	SOT-23-6	33yg	-	7b	Max
ABEM	MAX6450UT16L	Vdet-IC	1.6V±1.5%, ±mR, -Reset ODO	SOT-23-6	33yg	-	7b	Max
ABEN	MAX6451UT23L	Vdet-IC	2.3V±1.5%, ±mR, -Reset PPO	SOT-23-6	33yg	-	7b	Max
ABFF	MAX6469UT28AD3	LVR/Vdet-IC	LDO, 2.8V±1.3%, 300mA, -Reset PPO, Set, +CE	SOT-23-6	33	-	7b	Max
ABFG	MAX6470UT33BD3	LVR/Vdet-IC	LDO, 3.3V±1.3%, 300mA, -Reset ODO, Set, +CE	SOT-23-6	33	-	7b	Max
ABFH	MAX6471UT30BD4	LVR/Vdet-IC	LDO, 3.0V±1.3%, 300mA, -Reset PPO, Set, -MR	SOT-23-6	33	-	7b	Max
ABFI	MAX6472UT18BD3	LVR/Vdet-IC	LDO, 1.8V±1.3%, 300mA, -Reset ODO, Set, -MR	SOT-23-6	33	-	7b	Max
ABFJ	MAX6473UT25AD1	LVR/Vdet-IC	LDO, 2.5V±1.3%, 300mA, -Reset PPO, -MR, +CE	SOT-23-6	33	-	7b	Max



SMD code	Type	Function	Short description	Case	Pinout	Sch.	St.	Mnf.
ABFK	MAX6474UT15BD2	LVR/Vdet-IC	LDO, 1.5V±1.3%, 300mA, -Reset ODO, -MR, +CE	SOT-23-6	33	-	7b	Max
ABFL	MAX6475UT33AD3	LVR/Vdet-IC	LDO, 3.3V±1.3%, 300mA, -Reset PPO, FB, +CE	SOT-23-6	33	-	7b	Max
ABFM	MAX6476UT15AD1	LVR/Vdet-IC	LDO, 1.5V±1.3%, 300mA, -Reset ODO, FB, +CE	SOT-23-6	33	-	7b	Max
ABG	BL6221MM	LIN-IC	AF PA, BTL, 2.5, 5.5V, 1.25W(5V/8Q), shutdown	SOP-8	47	AFP22	-	Shb
ABG	CP2296GMM	LIN-IC	AF PA, BTL, 2.5, 5.5V, 1.25W(5V/8Q), shutdown	SOP-8	47	AFP22	-	Cpm
ABKS	MAX6469UT15BD3	LVR/Vdet-IC	LDO, 1.5V±1.3%, 300mA, -Reset PPO, Set, +CE	SOT-23-6	33	-	7b	Max
ABKT	MAX6469UT18AD3	LVR/Vdet-IC	LDO, 1.8V±1.3%, 300mA, -Reset PPO, Set, +CE	SOT-23-6	33	-	7b	Max
ABKU	MAX6469UT25BD3	LVR/Vdet-IC	LDO, 2.5V±1.3%, 300mA, -Reset PPO, Set, +CE	SOT-23-6	33	-	7b	Max
ABKV	MAX6469UT30BD3	LVR/Vdet-IC	LDO, 3.0V±1.3%, 300mA, -Reset PPO, Set, +CE	SOT-23-6	33	-	7b	Max
ABKW	MAX6469UT33AD3	LVR/Vdet-IC	LDO, 3.3V±1.3%, 300mA, -Reset PPO, Set, +CE	SOT-23-6	33	-	7b	Max
ABKX	MAX6470UT15BD3	LVR/Vdet-IC	LDO, 1.5V±1.3%, 300mA, -Reset ODO, Set, +CE	SOT-23-6	33	-	7b	Max
ABKY	MAX6470UT18AD3	LVR/Vdet-IC	LDO, 1.8V±1.3%, 300mA, -Reset ODO, Set, +CE	SOT-23-6	33	-	7b	Max
ABKZ	MAX6470UT25BD3	LVR/Vdet-IC	LDO, 2.5V±1.3%, 300mA, -Reset ODO, Set, +CE	SOT-23-6	33	-	7b	Max
ABLA	MAX6470UT28AD3	LVR/Vdet-IC	LDO, 2.8V±1.3%, 300mA, -Reset ODO, Set, +CE	SOT-23-6	33	-	7b	Max
ABLB	MAX6470UT30BD3	LVR/Vdet-IC	LDO, 3.0V±1.3%, 300mA, -Reset ODO, Set, +CE	SOT-23-6	33	-	7b	Max
ABLC	MAX6470UT33AD3	LVR/Vdet-IC	LDO, 3.3V±1.3%, 300mA, -Reset ODO, Set, +CE	SOT-23-6	33	-	7b	Max
ABLD	MAX6471UT15AD3	LVR/Vdet-IC	LDO, 1.5V±1.3%, 300mA, -Reset PPO, Set, -MR	SOT-23-6	33	-	7b	Max
ABLE	MAX6471UT18BD3	LVR/Vdet-IC	LDO, 1.8V±1.3%, 300mA, -Reset PPO, Set, -MR	SOT-23-6	33	-	7b	Max
ABLF	MAX6471UT25AD3	LVR/Vdet-IC	LDO, 2.5V±1.3%, 300mA, -Reset PPO, Set, -MR	SOT-23-6	33	-	7b	Max
ABLG	MAX6471UT28BD3	LVR/Vdet-IC	LDO, 2.8V±1.3%, 300mA, -Reset PPO, Set, -MR	SOT-23-6	33	-	7b	Max
ABLH	MAX6471UT30AD3	LVR/Vdet-IC	LDO, 3.0V±1.3%, 300mA, -Reset PPO, Set, -MR	SOT-23-6	33	-	7b	Max
ABLI	MAX6471UT33BD3	LVR/Vdet-IC	LDO, 3.3V±1.3%, 300mA, -Reset PPO, Set, -MR	SOT-23-6	33	-	7b	Max
ABLJ	MAX6472UT15AD3	LVR/Vdet-IC	LDO, 1.5V±1.3%, 300mA, -Reset ODO, Set, -MR	SOT-23-6	33	-	7b	Max
ABLK	MAX6472UT25AD3	LVR/Vdet-IC	LDO, 2.5V±1.3%, 300mA, -Reset ODO, Set, -MR	SOT-23-6	33	-	7b	Max
ABLL	MAX6472UT28BD3	LVR/Vdet-IC	LDO, 2.8V±1.3%, 300mA, -Reset ODO, Set, -MR	SOT-23-6	33	-	7b	Max
ABLM	MAX6472UT30AD3	LVR/Vdet-IC	LDO, 3.0V±1.3%, 300mA, -Reset ODO, Set, -MR	SOT-23-6	33	-	7b	Max
ABLN	MAX6472UT33BD3	LVR/Vdet-IC	LDO, 3.3V±1.3%, 300mA, -Reset ODO, Set, -MR	SOT-23-6	33	-	7b	Max
ABLO	MAX6473UT15AD3	LVR/Vdet-IC	LDO, 1.5V±1.3%, 300mA, -Reset PPO, -MR, +CE	SOT-23-6	33	-	7b	Max
ABLP	MAX6473UT18BD3	LVR/Vdet-IC	LDO, 1.8V±1.3%, 300mA, -Reset PPO, -MR, +CE	SOT-23-6	33	-	7b	Max
ABLQ	MAX6473UT25AD3	LVR/Vdet-IC	LDO, 2.5V±1.3%, 300mA, -Reset PPO, -MR, +CE	SOT-23-6	33	-	7b	Max
ABLR	MAX6473UT28BD3	LVR/Vdet-IC	LDO, 2.8V±1.3%, 300mA, -Reset PPO, -MR, +CE	SOT-23-6	33	-	7b	Max
ABLS	MAX6473UT30AD3	LVR/Vdet-IC	LDO, 3.0V±1.3%, 300mA, -Reset PPO, -MR, +CE	SOT-23-6	33	-	7b	Max
ABLT	MAX6473UT33BD3	LVR/Vdet-IC	LDO, 3.3V±1.3%, 300mA, -Reset PPO, -MR, +CE	SOT-23-6	33	-	7b	Max
ABLU	MAX6474UT15AD3	LVR/Vdet-IC	LDO, 1.5V±1.3%, 300mA, -Reset ODO, -MR, +CE	SOT-23-6	33	-	7b	Max
ABLV	MAX6474UT18BD3	LVR/Vdet-IC	LDO, 1.8V±1.3%, 300mA, -Reset ODO, -MR, +CE	SOT-23-6	33	-	7b	Max
ABLW	MAX6474UT25AD3	LVR/Vdet-IC	LDO, 2.5V±1.3%, 300mA, -Reset ODO, -MR, +CE	SOT-23-6	33	-	7b	Max
ABLX	MAX6474UT28BD3	LVR/Vdet-IC	LDO, 2.8V±1.3%, 300mA, -Reset ODO, -MR, +CE	SOT-23-6	33	-	7b	Max
ABLY	MAX6474UT30AD3	LVR/Vdet-IC	LDO, 3.0V±1.3%, 300mA, -Reset ODO, -MR, +CE	SOT-23-6	33	-	7b	Max
ABLZ	MAX6474UT33BD3	LVR/Vdet-IC	LDO, 3.3V±1.3%, 300mA, -Reset ODO, -MR, +CE	SOT-23-6	33	-	7b	Max
ABMA	MAX6475UT15BD3	LVR/Vdet-IC	LDO, 1.5V±1.3%, 300mA, -Reset PPO, FB, +CE	SOT-23-6	33	-	7b	Max
ABMB	MAX6475UT18AD3	LVR/Vdet-IC	LDO, 1.8V±1.3%, 300mA, -Reset PPO, FB, +CE	SOT-23-6	33	-	7b	Max
ABMC	MAX6475UT25BD3	LVR/Vdet-IC	LDO, 2.5V±1.3%, 300mA, -Reset PPO, FB, +CE	SOT-23-6	33	-	7b	Max
ABMD	MAX6475UT28AD3	LVR/Vdet-IC	LDO, 2.8V±1.3%, 300mA, -Reset PPO, FB, +CE	SOT-23-6	33	-	7b	Max
ABME	MAX6475UT30BD3	LVR/Vdet-IC	LDO, 3.0V±1.3%, 300mA, -Reset PPO, FB, +CE	SOT-23-6	33	-	7b	Max
ABMF	MAX6476UT15BD3	LVR/Vdet-IC	LDO, 1.5V±1.3%, 300mA, -Reset ODO, FB, +CE	SOT-23-6	33	-	7b	Max
ABMG	MAX6476UT18AD3	LVR/Vdet-IC	LDO, 1.8V±1.3%, 300mA, -Reset ODO, FB, +CE	SOT-23-6	33	-	7b	Max
ABMH	MAX6476UT25BD3	LVR/Vdet-IC	LDO, 2.5V±1.3%, 300mA, -Reset ODO, FB, +CE	SOT-23-6	33	-	7b	Max
ABMI	MAX6476UT28AD3	LVR/Vdet-IC	LDO, 2.8V±1.3%, 300mA, -Reset ODO, FB, +CE	SOT-23-6	33	-	7b	Max
ABMJ	MAX6476UT30BD3	LVR/Vdet-IC	LDO, 3.0V±1.3%, 300mA, -Reset ODO, FB, +CE	SOT-23-6	33	-	7b	Max
ABMK	MAX6476UT33AD3	LVR/Vdet-IC	LDO, 3.3V±1.3%, 300mA, -Reset ODO, FB, +CE	SOT-23-6	33	-	7b	Max
ABMZ	MAX6469UT285AD3	LVR/Vdet-IC	LDO, 2.85V±1.3%, 300mA, -Reset PPO, Set, +CE	SOT-23-6	33	-	7b	Max
ABNA	MAX6469UT285BD3	LVR/Vdet-IC	LDO, 2.85V±1.3%, 300mA, -Reset PPO, Set, +CE	SOT-23-6	33	-	7b	Max
ABNB	MAX6470UT285AD3	LVR/Vdet-IC	LDO, 2.85V±1.3%, 300mA, -Reset ODO, Set, +CE	SOT-23-6	33	-	7b	Max
ABNC	MAX6470UT285BD3	LVR/Vdet-IC	LDO, 2.85V±1.3%, 300mA, -Reset ODO, Set, +CE	SOT-23-6	33	-	7b	Max
ABNP	MAX6449UT23L	Vdet-IC	2.3V±1.5%, ±MR, -Reset PPO	SOT-23-6	33yg	-	7b	Max
ABNQ	MAX6449UT26L	Vdet-IC	2.6V±1.5%, ±MR, -Reset PPO	SOT-23-6	33yg	-	7b	Max
ABNR	MAX6449UT29L	Vdet-IC	2.9V±1.5%, ±MR, -Reset PPO	SOT-23-6	33yg	-	7b	Max
ABNS	MAX6449UT46L	Vdet-IC	4.6V±1.5%, ±MR, -Reset PPO	SOT-23-6	33yg	-	7b	Max
ABNT	MAX6451UT16L	Vdet-IC	1.6V±1.5%, ±MR, -Reset PPO	SOT-23-6	33yg	-	7b	Max
ABNU	MAX6451UT26L	Vdet-IC	2.6V±1.5%, ±MR, -Reset PPO	SOT-23-6	33yg	-	7b	Max
ABNV	MAX6451UT29L	Vdet-IC	2.9V±1.5%, ±MR, -Reset PPO	SOT-23-6	33yg	-	7b	Max
ABNW	MAX6451UT46L	Vdet-IC	4.6V±1.5%, ±MR, -Reset PPO	SOT-23-6	33yg	-	7b	Max
ABNX	MAX6450UT23L	Vdet-IC	2.3V±1.5%, ±MR, -Reset ODO	SOT-23-6	33yg	-	7b	Max
ABNY	MAX6450UT26L	Vdet-IC	2.6V±1.5%, ±MR, -Reset ODO	SOT-23-6	33yg	-	7b	Max
ABNZ	MAX6450UT29L	Vdet-IC	2.9V±1.5%, ±MR, -Reset ODO	SOT-23-6	33yg	-	7b	Max
ABOA	MAX6450UT46L	Vdet-IC	4.6V±1.5%, ±MR, -Reset ODO	SOT-23-6	33yg	-	7b	Max
ABOB	MAX6452UT16L	Vdet-IC	1.6V±1.5%, ±MR, -Reset ODO	SOT-23-6	33yg	-	7b	Max
ABOC	MAX6452UT23L	Vdet-IC	2.3V±1.5%, ±MR, -Reset ODO	SOT-23-6	33yg	-	7b	Max
ABOD	MAX6452UT26L	Vdet-IC	2.6V±1.5%, ±MR, -Reset ODO	SOT-23-6	33yg	-	7b	Max
ABOE	MAX6452UT29L	Vdet-IC	2.9V±1.5%, ±MR, -Reset ODO	SOT-23-6	33yg	-	7b	Max



SMD code	Type	Function	Short description	Case	Pinout	Sch.	St.	Mnf.
ABOF	MAX6452UT46L	Vdet-IC	4.6V±1.5%, ±MR, -Reset ODO	SOT-23-6	33yg	-	7b	Max
ABQV	MAX6469UT28AD1	LVR/Vdet-IC	LDO, 2.8V±1.3%, 300mA, -Reset PPO, Set, +CE	SOT-23-6	33	-	7b	Max
ABQX	MAX6469UT28BD1	LVR/Vdet-IC	LDO, 2.8V±1.3%, 300mA, -Reset PPO, Set, +CE	SOT-23-6	33	-	7b	Max
ABQY	MAX6469UT28BD2	LVR/Vdet-IC	LDO, 2.8V±1.3%, 300mA, -Reset PPO, Set, +CE	SOT-23-6	33	-	7b	Max
ABRB	MAX6757UTTD3	Vdet-IC	3.3V±1.5%, -MR, -UV PPO, -OV ODO, 200ms	SOT-23-6	33	-	7b	Max
ABRC	MAX6757UTLD3	Vdet-IC	5.0V±1.5%, -MR, -UV PPO, -OV ODO, 200ms	SOT-23-6	33	-	7b	Max
ABRE	MAX6757UTZD0	Vdet-IC	2.5V±1.5%, -MR, -UV PPO, -OV ODO, 20µs	SOT-23-6	33	-	7b	Max
ABRF	MAX6757UTWD3	Vdet-IC	1.8V±1.5%, -MR, -UV PPO, -OV ODO, 200ms	SOT-23-6	33	-	7b	Max
ABRG	MAX6758UTLD3	Vdet-IC	5.0V±1.5%, -MR, +UV PPO, -OV ODO, 200ms	SOT-23-6	33	-	7b	Max
ABRH	MAX6758UTTD3	Vdet-IC	3.3V±1.5%, -MR, +UV PPO, -OV ODO, 200ms	SOT-23-6	33	-	7b	Max
ABRJ	MAX6758UTZD0	Vdet-IC	2.5V±1.5%, -MR, +UV PPO, -OV ODO, 20µs	SOT-23-6	33	-	7b	Max
ABRK	MAX6758UTWD3	Vdet-IC	1.8V±1.5%, -MR, +UV PPO, -OV ODO, 200ms	SOT-23-6	33	-	7b	Max
ABRL	MAX6759UTLD0	Vdet-IC	5.0V±1.5%, -MR, -UV ODO, -OV ODO, 20µs	SOT-23-6	33	-	7b	Max
ABRM	MAX6759UTTD0	Vdet-IC	3.3V±1.5%, -MR, -UV ODO, -OV ODO, 20µs	SOT-23-6	33	-	7b	Max
ABRO	MAX6759UTZD3	Vdet-IC	2.5V±1.5%, -MR, -UV ODO, -OV ODO, 200ms	SOT-23-6	33	-	7b	Max
ABRP	MAX6759UTWD0	Vdet-IC	1.8V±1.5%, -MR, -UV ODO, -OV ODO, 20µs	SOT-23-6	33	-	7b	Max
ABRQ	MAX6763UT	Vdet-IC	ADJ, -UV PPO, -OV PPO	SOT-23-6	33	-	7b	Max
ABRR	MAX6764UT	Vdet-IC	ADJ, -UV ODO, -OV ODO	SOT-23-6	33	-	7b	Max
ABSE	MAX6469UT27AD3	LVR/Vdet-IC	LDO, 2.7V±1.3%, 300mA, -Reset PPO, Set, +CE	SOT-23-6	33	-	7b	Max
ABSO	MAX6757UTLD0	Vdet-IC	5.0V±1.5%, -MR, -UV PPO, -OV ODO, 20µs	SOT-23-6	33	-	7b	Max
ABST	MAX6757UTTD0	Vdet-IC	3.3V±1.5%, -MR, -UV PPO, -OV ODO, 20µs	SOT-23-6	33	-	7b	Max
ABSW	MAX6757UTZD3	Vdet-IC	2.5V±1.5%, -MR, -UV PPO, -OV ODO, 200ms	SOT-23-6	33	-	7b	Max
ABSX	MAX6757UTWD0	Vdet-IC	1.8V±1.5%, -MR, -UV PPO, -OV ODO, 20µs	SOT-23-6	33	-	7b	Max
ABSY	MAX6758UTLD0	Vdet-IC	5.0V±1.5%, -MR, +UV PPO, -OV ODO, 20µs	SOT-23-6	33	-	7b	Max
ABSZ	MAX6758UTTD0	Vdet-IC	3.3V±1.5%, -MR, +UV PPO, -OV ODO, 20µs	SOT-23-6	33	-	7b	Max
ABTB	MAX6758UTZD3	Vdet-IC	2.5V±1.5%, -MR, +UV PPO, -OV ODO, 200ms	SOT-23-6	33	-	7b	Max
ABTC	MAX6758UTWD0	Vdet-IC	1.8V±1.5%, -MR, +UV PPO, -OV ODO, 20µs	SOT-23-6	33	-	7b	Max
ABTD	MAX6759UTLD3	Vdet-IC	5.0V±1.5%, -MR, -UV ODO, -OV ODO, 200ms	SOT-23-6	33	-	7b	Max
ABTE	MAX6759UTTD3	Vdet-IC	3.3V±1.5%, -MR, -UV ODO, -OV ODO, 200ms	SOT-23-6	33	-	7b	Max
ABTG	MAX6759UTZD0	Vdet-IC	2.5V±1.5%, -MR, -UV ODO, -OV ODO, 20µs	SOT-23-6	33	-	7b	Max
ABTH	MAX6759UTWD3	Vdet-IC	1.8V±1.5%, -MR, -UV ODO, -OV ODO, 200ms	SOT-23-6	33	-	7b	Max
aC	74AUP1G57GW	CMOS-Logic	Configurable multiple-function gate	SOT-363	33L _{Log36}	-	7b	Phi
AC	CP2297SP	LIN-IC	AF PA, BTL, 2.5, 5.5V, 3.1W(5V/8Ω), shutdown	SOP-8	47	AFP22	-	Cpm
AC	NLAS1053US	LIN-IC	2:1 Mux/Demux analog switches, 25Ω(5V)	US8	47	-	8b	Ons
AC	RP500N214A	DC/DC-IC	PWM st-dwn, 2.1V±1.5%, 600mA, +CE, CL	SOT-23-6W	33gi	DC20	7d	Ric
AC=	RT9193-30GF	LVR-IC	LDO, 3.3V±1%, 300mA, +CE	MSOP-8	47v _{tc}	VR7	8d	Rct
ACOR	MAX6469UT29AD4	LVR/Vdet-IC	LDO, 2.9V±1.3%, 300mA, -Reset PPO, Set, +CE	SOT-23-6	33	-	7b	Max
aD	74AUP2GU04GW	CMOS-Logic	Dual inverters	SOT-363	33L _{Log24}	-	7b	Phi
AD	RP500N222A	DC/DC-IC	PWM st-dwn, 2.2V±1.5%, 600mA, +CE	SOT-23-6W	33gi	DC20	7d	Ric
AE	RP500N224A	DC/DC-IC	PWM st-dwn, 2.2V±1.5%, 600mA, +CE, CL	SOT-23-6W	33gi	DC20	7d	Ric
AEH	TPA0213DGQ	LIN-IC	AF PA, BTL, 2.5, 5.5V, 2W(3V/4Ω), shutdown	SSOP-10	60	AFP42	-	Ti
AEI	TPA0223DGQ	LIN-IC	AF PA, BTL, 2.5, 5.5V, 2W(3V/4Ω), shutdown	SSOP-10	60	AFP42	-	Ti
AEJ	TPA0233DGQ	LIN-IC	AF PA, BTL, 2.5, 5.5V, 2W(3V/4Ω), shutdown	SOP-10	60	AFP43	-	Ti
AEK	TPA0243DGQ	LIN-IC	AF PA, BTL, 2.5, 5.5V, 2W(3V/4Ω), shutdown	SSOP-10	60	AFP43	-	Ti
AEL	TPA0253DGQ	LIN-IC	AF PA, BTL, 2.5, 5.5V, 1W(5V/8Ω), shutdown	SSOP-10	60	AFP43	-	Ti
AEs	BCP52M	Si-pnp	AF-Dr/Out, 60V, 1A, 1.7W, B=40, 250, 100MHz	SCT-595	7117	-	-	Inf
AF	RP500N232A	DC/DC-IC	PWM st-dwn, 2.3V±1.5%, 600mA, +CE	SOT-23-6W	33gi	DC20	7d	Ric
aG	74AUP1G332GW	CMOS-Logic	3-input OR gate	SOT-363	33L _{Log32}	-	7b	Phi
AG	CP2297MM	LIN-IC	AF PA, BTL, 2.5, 5.5V, 3.1W(5V/8Ω), shutdown	SSOP-8	47	AFP22	-	Cpm
AG	RP500N234A	DC/DC-IC	PWM st-dwn, 2.3V±1.5%, 600mA, +CE, CL	SOT-23-6W	33gi	DC20	7d	Ric
aH	74AUP1G386GW	CMOS-Logic	3-input EXCLUSIVE-OR gate	SOT-363	33L _{Log33}	-	7b	Phi
AH	RP500N241A	DC/DC-IC	PWM/VFM st-dwn, 2.4V±1.5%, 600mA, +CE	SOT-23-6W	33gi	DC20	7d	Ric
AHs	BCP53M	Si-pnp	AF-Dr/Out, 100V, 1A, 1.7W, B=40, 250, 100MHz	SCT-595	7117	-	-	Inf
AIZ	TPA6110A2DGN	LIN-IC	AF PA, 2.5, 5.5V, 2x150mW(5V/16Ω), shutdown	SSOP-8	47	AFP17	-	Ti
AJ	CP2293MM	LIN-IC	AF PA, BTL, 2.5, 5.5V, 3W(5V/8Ω), shutdown	SOP-8	47	AFP22	-	Cpm
AJ	RP500N242A	DC/DC-IC	PWM st-dwn, 2.4V±1.5%, 600mA, +CE	SOT-23-6W	33gi	DC20	7d	Ric
AJA	TPA6111A2DGN	LIN-IC	AF PA, 2.5, 5.5V, 2x150mW(5V/16Ω), shutdown	SSOP-8	47	AFP16	-	Ti
AJB	TPA321DGN	LIN-IC	AF PA, BTL, 2.2, 5.5V, 350mW(5V/8Ω), shutdown	SSOP-8	47	AFP11	-	Ti
AJC	TPA731DGN	LIN-IC	AF PA, BTL, 2.5, 5.5V, 700mW(5V/8Ω), shutdown	SSOP-8	47	AFP11	-	Ti
AJD	TPA741DGN	LIN-IC	AF PA, BTL, 2.5, 5.5V, 700mW(5V/8Ω), shutdown	SSOP-8	47	AFP11	-	Ti
AJL	TPA6100A2DGK	LIN-IC	AF PA, 1.6, 3.6V, 2x50mW(3V/16Ω), shutdown	SSOP-8	47	AFP17	-	Ti
AJM	TPA6101A2DGK	LIN-IC	AF PA, 1.6, 3.6V, 2x50mW(3V/16Ω), shutdown	SSOP-8	47	AFP17	-	Ti
AJN	TPA6102A2DGK	LIN-IC	AF PA, 1.6, 3.6V, 2x50mW(3V/16Ω), shutdown	SSOP-8	47	AFP17	-	Ti
aK	74AUP1G58GW	CMOS-Logic	Configurable multiple-function gate	SOT-363	33L _{Log37}	-	7b	Phi
AK	HSMS-280K	Si-diode	2x Schottky, RF, 70V, 1A, Vf<0.41V(1mA), <2pF, 35Ω(5mA)	SOT-363	33d _w	-	7b	Agi
AK	RP500N244A	DC/DC-IC	PWM st-dwn, 2.4V±1.5%, 600mA, +CE, CL	SOT-23-6W	33gi	DC20	7d	Ric
AL	HSMS-280L	Si-diode	3x Schottky, RF, 70V, 1A, Vf<0.41V(1mA), <2pF, 35Ω(5mA)	SOT-363	33d _d	-	7b	Agi
AL	RP500N261A	DC/DC-IC	PWM/VFM st-dwn, 2.6V±1.5%, 600mA, +CE	SOT-23-6W	33gi	DC20	7d	Ric
AM	RP500N262A	DC/DC-IC	PWM st-dwn, 2.6V±1.5%, 600mA, +CE	SOT-23-6W	33gi	DC20	7d	Ric
AN	RP500N264A	DC/DC-IC	PWM st-dwn, 2.6V±1.5%, 600mA, +CE, CL	SOT-23-6W	33gi	DC20	7d	Ric



SMD code	Type	Function	Short description	Case	Pinout	Sch.	St.	Mnf.
aP	74AUP1G157GW	CMOS-Logic	2-input multiplexer	SOT-363	33L _{og42}	-	7b	Phi
AP	HSMS-280P	Si-diode	4x Schottky, RF, 70V, 1A, Vf<0.41V(1mA), <2pF, 35Q(5mA)	SOT-363	33bxc	-	7b	Agi
AP	RP500N271A	DC/DC-IC	PWM/VFM st-dwn, 2.7V±1.5%, 600mA, +CE	SOT-23-6W	33gi	DC20	7d	Ric
APA2308	EMA2308-50QA08GRT	LIN-IC	AF PA, 3.6V, 2x845mW(4V/32Q)	TSSOP-8	60	AFP6	-	Emp
APA2308	EMA2308-50SA08GRR	LIN-IC	AF PA, 3.6V, 2x845mW(4V/32Q)	SOP-8	47	AFP6	-	Emp
APD	TPA6112A2DGQ	LIN-IC	AF PA, 2.5.5.5V, 2x150mW(3V/16Q), shutdown	SSOP-8	47	-	-	Ti
AQ	RP500N272A	DC/DC-IC	PWM st-dwn, 2.7V±1.5%, 600mA, +CE	SOT-23-6W	33gi	DC20	7d	Ric
AR	RP500N274A	DC/DC-IC	PWM st-dwn, 2.7V±1.5%, 600mA, +CE, CL	SOT-23-6W	33gi	DC20	7d	Ric
AS	RP500N291A	DC/DC-IC	PWM/VFM st-dwn, 2.9V±1.5%, 600mA, +CE	SOT-23-6W	33gi	DC20	7d	Ric
ASH3	AS1910S-T	Vdet-IC	2.93V±1%, -Reset PPO	SOT-23-6	33	-	7d	Asm
ASH4	AS1910R-T	Vdet-IC	2.63V±1%, -Reset PPO	SOT-23-6	33	-	7d	Asm
ASH5	AS1910Z-T	Vdet-IC	2.32V±1%, -Reset PPO	SOT-23-6	33	-	7d	Asm
ASH6	AS1910V-T	Vdet-IC	1.58V±1%, -Reset PPO	SOT-23-6	33	-	7d	Asm
ASH7	AS1911S-T	Vdet-IC	2.93V±1%, +Reset PPO	SOT-23-6	33	-	7d	Asm
ASH8	AS1911R-T	Vdet-IC	2.63V±1%, +Reset PPO	SOT-23-6	33	-	7d	Asm
ASH9	AS1911Z-T	Vdet-IC	2.32V±1%, +Reset PPO	SOT-23-6	33	-	7d	Asm
ASIA	AS1911V-T	Vdet-IC	1.58V±1%, +Reset PPO	SOT-23-6	33	-	7d	Asm
ASIB	AS1912S-T	Vdet-IC	2.93V±1%, -Reset ODO	SOT-23-6	33	-	7d	Asm
ASIC	AS1912R-T	Vdet-IC	2.63V±1%, -Reset ODO	SOT-23-6	33	-	7d	Asm
ASID	AS1912Z-T	Vdet-IC	2.32V±1%, -Reset ODO	SOT-23-6	33	-	7d	Asm
ASIE	AS1912V-T	Vdet-IC	1.58V±1%, -Reset ODO	SOT-23-6	33	-	7d	Asm
ASIF	AS1913TZ-T	Vdet-IC	3.08V, 2.313V±1%, -Reset PPO, -MR	SOT-23-6	33	-	7d	Asm
ASIG	AS1913SF-T	Vdet-IC	2.93V, 1.05V±1%, -Reset PPO, -MR	SOT-23-6	33	-	7d	Asm
ASIH	AS1913VD-T	Vdet-IC	1.58V, 0.788V±1%, -Reset PPO, -MR	SOT-23-6	33	-	7d	Asm
ASII	AS1914TZ-T	Vdet-IC	3.08V, 2.313V±1%, +Reset PPO	SOT-23-6	33	-	7d	Asm
ASIJ	AS1914SF-T	Vdet-IC	2.93V, 1.05V±1%, +Reset PPO	SOT-23-6	33	-	7d	Asm
ASIK	AS1914VD-T	Vdet-IC	1.58V, 0.788V±1%, +Reset PPO	SOT-23-6	33	-	7d	Asm
ASIL	AS1915TZ-T	Vdet-IC	3.08V, 2.313V±1%, -Reset ODO, -MR	SOT-23-6	33	-	7d	Asm
ASIM	AS1915SF-T	Vdet-IC	2.93V, 1.05V±1%, -Reset ODO, -MR	SOT-23-6	33	-	7d	Asm
ASIN	AS1915VD-T	Vdet-IC	1.58V, 0.788V±1%, -Reset ODO, -MR	SOT-23-6	33	-	7d	Asm
aT	74AUP1G175GW	CMOS-Logic	Positive edge-triggered D-type flip-flop with reset	SOT-363	33L _{og40}	-	7b	Phi
AT	RP500N292A	DC/DC-IC	PWM st-dwn, 2.9V±1.5%, 600mA, +CE	SOT-23-6W	33gi	DC20	7d	Ric
ATC	TPA751DGN	LIN-IC	AF PA, BTL, 2.5.5.5V, 700mW(5V/8Q), shutdown	SSOP-8	47	AFP11	-	Ti
aU	74AUP1G158GW	CMOS-Logic	2-input inverting multiplexer	SOT-363	33L _{og48}	-	7b	Phi
AU	RP500N294A	DC/DC-IC	PWM st-dwn, 2.9V±1.5%, 600mA, +CE, CL	SOT-23-6W	33gi	DC20	7d	Ric
AU04	74AHC3GU04DP	CMOS-Logic	Triple inverters	SOT505-2	47L _{og56}	-	8d	Phi
AU4	74AHC3GU04DC	CMOS-Logic	Triple inverters	SOT765-1	47L _{og56}	-	8d	Phi
aV	74AUP1G97GW	CMOS-Logic	Configurable multiple-function gate	SOT-363	33L _{og41}	-	7b	Phi
AV	RP500N312A	DC/DC-IC	PWM st-dwn, 3.1V±1.5%, 600mA, +CE	SOT-23-6W	33gi	DC20	7d	Ric
aW	74AUP1G373GW	CMOS-Logic	D-type transparent latch with 3-state output	SOT-363	33L _{og35}	-	7b	Phi
AW	RP500N314A	DC/DC-IC	PWM st-dwn, 3.1V±1.5%, 600mA, +CE, CL	SOT-23-6W	33gi	DC20	7d	Ric
aX	74AUP1G374GW	CMOS-Logic	Positive edge-triggered D-type flip-flop with 3-state output	SOT-363	33L _{og28}	-	7b	Phi
AX	RP500N321A	DC/DC-IC	PWM/VFM st-dwn, 3.2V±1.5%, 600mA, +CE	SOT-23-6W	33gi	DC20	7d	Ric
aY	74AUP1G0832GW	CMOS-Logic	3-input AND-OR gate	SOT-363	33L _{og45}	-	7b	Phi
AY	RP500N322A	DC/DC-IC	PWM st-dwn, 3.2V±1.5%, 600mA, +CE	SOT-23-6W	33gi	DC20	7d	Ric
AYK	TPA6211A1DGN	LIN-IC	AF PA, BTL, 2.5.5.5V, 3.2W(5V/3Q), shutdown	SSOP-8	47	AFP22	-	Ti
AZ	RP500N324A	DC/DC-IC	PWM st-dwn, 3.2V±1.5%, 600mA, +CE, CL	SOT-23-6W	33gi	DC20	7d	Ric
B0	R1160D101A	LVR-IC	LDO, 1V±2%, 200mA, -CE, AE(mode)	HSON-6	34vrc	VR10	7g	Ric
B0	R5421N111C	BM-IC	Li-Ion, over-charge/discharge protection, Vd=1.1V	SOT-23-6	33xj	VBM1	7d	Ric
B0	TK65920M	LIN-IC	Fluorescent lamp driver, 52mA, 175Hz	SOP-6	33zi	-	7b	Tok
B00A	R1161D282A5	LVR-IC	LDO, 2.85V±2%, 350mA, -CE, AE(mode)	HSON-6	34vrc	VR10	7e	Ric
B00B	R1161D282B5	LVR-IC	LDO, 2.85V±2%, 350mA, +CE, AE(mode)	HSON-6	34vrc	VR10	7e	Ric
B00D	R1161D282D5	LVR-IC	LDO, 2.85V±2%, 350mA, +CE, CL, AE(mode)	HSON-6	34vrc	VR10	7e	Ric
B01A	R1161D122A5	LVR-IC	LDO, 1.25V±2%, 350mA, -CE, AE(mode)	HSON-6	34vrc	VR10	7e	Ric
B01A	R1172S181A5	LVR-IC	LDO, 1.85V±2%, 1A, -CE	HSOP-6J	29virk	VR4	7h	Ric
B01B	R1161D122B5	LVR-IC	LDO, 1.25V±2%, 350mA, +CE, AE(mode)	HSON-6	34vrc	VR10	7e	Ric
B01B	R1172S181B5	LVR-IC	LDO, 1.85V±2%, 1A, +CE	HSOP-6J	29virk	VR4	7h	Ric
B01D	R1161D122D5	LVR-IC	LDO, 1.25V±2%, 350mA, +CE, CL, AE(mode)	HSON-6	34vrc	VR10	7e	Ric
B01D	R1172S181D5	LVR-IC	LDO, 1.85V±2%, 1A, +CE, CL	HSOP-6J	29virk	VR4	7h	Ric
B02A	R1161D182A5	LVR-IC	LDO, 1.85V±2%, 350mA, -CE, AE(mode)	HSON-6	34vrc	VR10	7e	Ric
B02A	R1172S281A5	LVR-IC	LDO, 2.85V±2%, 1A, -CE	HSOP-6J	29virk	VR4	7h	Ric
B02B	R1161D182B5	LVR-IC	LDO, 1.85V±2%, 350mA, +CE, AE(mode)	HSON-6	34vrc	VR10	7e	Ric
B02B	R1172S281B5	LVR-IC	LDO, 2.85V±2%, 1A, +CE	HSOP-6J	29virk	VR4	7h	Ric
B02D	R1161D182D5	LVR-IC	LDO, 1.85V±2%, 350mA, +CE, CL, AE(mode)	HSON-6	34vrc	VR10	7e	Ric
B02D	R1172S281D5	LVR-IC	LDO, 2.85V±2%, 1A, +CE, CL	HSOP-6J	29virk	VR4	7h	Ric
B08A	R1161D082A	LVR-IC	LDO, 0.8V±2%, 350mA, -CE, AE(mode)	HSON-6	34vrc	VR10	7e	Ric
B08A	R1172S081A	LVR-IC	LDO, 0.8V±2%, 1A, -CE	HSOP-6J	29virk	VR4	7h	Ric
B08B	R1161D082B	LVR-IC	LDO, 0.8V±2%, 350mA, +CE, AE(mode)	HSON-6	34vrc	VR10	7e	Ric
B08B	R1172S081B	LVR-IC	LDO, 0.8V±2%, 1A, +CE	HSOP-6J	29virk	VR4	7h	Ric
B08D	R1161D082D	LVR-IC	LDO, 0.8V±2%, 350mA, +CE, CL, AE(mode)	HSON-6	34vrc	VR10	7e	Ric



SMD code	Type	Function	Short description	Case	Pinout	Sch.	St.	Mnf.
B08D	R1172S081D	LVR-IC	LDO, 0.8V±2%, 1A, +CE, CL	HSOP-6J	29virk	VR4	7h	Ric
B09A	NCP565LSAN09T	LVR-IC	LDO, 0.9V±2%, 350mA, -CEL, AE(Mode)	HSOP-6	35vrc	VR10	7d	Ons
B09A	R1161D092A	LVR-IC	LDO, 0.9V±2%, 350mA, -CE, AE(mode)	HSOP-6	34vrc	VR10	7e	Ric
B09A	R1172S091A	LVR-IC	LDO, 0.9V±2%, 1A, -CE	HSOP-6J	29virk	VR4	7h	Ric
B09A	R3112D091A	Vdet-IC	0.9V±2%, -Reset PPO	SON1612-6	35ur	VD3	7e	Ric
B09B	NCP585HSAN09T	LVR-IC	LDO, 0.9V±2%, 350mA, +CEL, AE(Mode)	HSOP-6	35vrc	VR10	7d	Ons
B09B	R1161D092B	LVR-IC	LDO, 0.9V±2%, 350mA, +CE, AE(mode)	HSOP-6	34vrc	VR10	7e	Ric
B09B	R1172S091B	LVR-IC	LDO, 0.9V±2%, 1A, +CE	HSOP-6J	29virk	VR4	7h	Ric
B09C	R3112D091C	Vdet-IC	0.9V±2%, -Reset ODO	SON1612-6	35ur	VD1	7e	Ric
B09D	NCP585DSAN09T	LVR-IC	LDO, 0.9V±2%, 350mA, +CE, CL, AE(Mode)	HSOP-6	35vrc	VR10	7d	Ons
B09D	R1161D092D	LVR-IC	LDO, 0.9V±2%, 350mA, +CE, CL, AE(mode)	HSOP-6	34vrc	VR10	7e	Ric
B09D	R1172S091D	LVR-IC	LDO, 0.9V±2%, 1A, +CE, CL	HSOP-6J	29virk	VR4	7h	Ric
B1	R1160D111A	LVR-IC	LDO, 1.1V±2%, 200mA, -CE, AE(mode)	SON-6	34vrc	VR10	7g	Ric
B1	R5421N112C	BM-IC	Li-Ion, over-charge/discharge protection, Vd=1.2V	SOT-23-6	33xj	VBM1	7d	Ric
B1	TK65921M	LIN-IC	Fluorescent lamp driver, 52mA, 200Hz	SOP-6	33zi	-	7b	Tok
B10	IMB10A	Si-pnp-Digi	Dual, 50V, 100mA, R1/R2=2.2k/47k	SOT-23-6	33/TD4	-	7b	Rhm
B10A	R1161D102A	LVR-IC	LDO, 1V±2%, 350mA, -CE, AE(mode)	HSOP-6	34vrc	VR10	7e	Ric
B10A	R1172S101A	LVR-IC	LDO, 1V±2%, 1A, -CE	HSOP-6J	29virk	VR4	7h	Ric
B10A	R3112D101A	Vdet-IC	1V±2%, -Reset PPO	SON1612-6	35ur	VD3	7e	Ric
B10B	R1161D102B	LVR-IC	LDO, 1V±2%, 350mA, +CE, AE(mode)	HSOP-6	34vrc	VR10	7e	Ric
B10B	R1172S101B	LVR-IC	LDO, 1V±2%, 1A, +CE	HSOP-6J	29virk	VR4	7h	Ric
B10C	R3112D101C	Vdet-IC	1V±2%, -Reset ODO	SON1612-6	35ur	VD1	7e	Ric
B10D	R1161D102D	LVR-IC	LDO, 1V±2%, 350mA, +CE, CL, AE(mode)	HSOP-6	34vrc	VR10	7e	Ric
B10D	R1172S101D	LVR-IC	LDO, 1V±2%, 1A, +CE, CL	HSOP-6J	29virk	VR4	7h	Ric
B11	IMB11A	Si-pnp-Digi	Dual, 50V, 100mA, R1/R2=10k/10k	SOT-23-6	33/TD4	-	7b	Rhm
B11A	R1161D112A	LVR-IC	LDO, 1.1V±2%, 350mA, -CE, AE(mode)	HSOP-6	34vrc	VR10	7e	Ric
B11A	R1172S111A	LVR-IC	LDO, 1.1V±2%, 1A, -CE	HSOP-6J	29virk	VR4	7h	Ric
B11A	R3112D111A	Vdet-IC	1.1V±2%, -Reset PPO	SON1612-6	35ur	VD3	7e	Ric
B11B	R1161D112B	LVR-IC	LDO, 1.1V±2%, 350mA, +CE, AE(mode)	HSOP-6	34vrc	VR10	7e	Ric
B11B	R1172S111B	LVR-IC	LDO, 1.1V±2%, 1A, +CE	HSOP-6J	29virk	VR4	7h	Ric
B11C	R3112D111C	Vdet-IC	1.1V±2%, -Reset ODO	SON1612-6	35ur	VD1	7e	Ric
B11D	R1161D112D	LVR-IC	LDO, 1.1V±2%, 350mA, +CE, CL, AE(mode)	HSOP-6	34vrc	VR10	7e	Ric
B11D	R1172S111D	LVR-IC	LDO, 1.1V±2%, 1A, +CE, CL	HSOP-6J	29virk	VR4	7h	Ric
B12A	NCP565LSAN12T	LVR-IC	LDO, 1.2V±2%, 350mA, -CEL, AE(Mode)	HSOP-6	35vrc	VR10	7d	Ons
B12A	R1161D122A	LVR-IC	LDO, 1.2V±2%, 350mA, -CE, AE(mode)	HSOP-6	34vrc	VR10	7e	Ric
B12A	R1172S121A	LVR-IC	LDO, 1.2V±2%, 1A, -CE	HSOP-6J	29virk	VR4	7h	Ric
B12A	R3112D121A	Vdet-IC	1.2V±2%, -Reset PPO	SON1612-6	35ur	VD3	7e	Ric
B12B	NCP585HSAN12T	LVR-IC	LDO, 1.2V±2%, 350mA, +CEL, AE(Mode)	HSOP-6	35vrc	VR10	7d	Ons
B12B	R1161D122B	LVR-IC	LDO, 1.2V±2%, 350mA, +CE, AE(mode)	HSOP-6	34vrc	VR10	7e	Ric
B12B	R1172S121B	LVR-IC	LDO, 1.2V±2%, 1A, +CE	HSOP-6J	29virk	VR4	7h	Ric
B12C	R3112D121C	Vdet-IC	1.2V±2%, -Reset ODO	SON1612-6	35ur	VD1	7e	Ric
B12D	NCP585DSAN12T	LVR-IC	LDO, 1.2V±2%, 350mA, +CE, CLL, AE(Mode)	HSOP-6	35vrc	VR10	7d	Ons
B12D	R1161D122D	LVR-IC	LDO, 1.2V±2%, 350mA, +CE, CL, AE(mode)	HSOP-6	34vrc	VR10	7e	Ric
B12D	R1172S121D	LVR-IC	LDO, 1.2V±2%, 1A, +CE, CL	HSOP-6J	29virk	VR4	7h	Ric
B13A	R1161D132A	LVR-IC	LDO, 1.3V±2%, 350mA, -CE, AE(mode)	HSOP-6	34vrc	VR10	7e	Ric
B13A	R1172S131A	LVR-IC	LDO, 1.3V±2%, 1A, -CE	HSOP-6J	29virk	VR4	7h	Ric
B13A	R3112D131A	Vdet-IC	1.3V±2%, -Reset PPO	SON1612-6	35ur	VD3	7e	Ric
B13B	R1161D132B	LVR-IC	LDO, 1.3V±2%, 350mA, +CE, AE(mode)	HSOP-6	34vrc	VR10	7e	Ric
B13B	R1172S131B	LVR-IC	LDO, 1.3V±2%, 1A, +CE	HSOP-6J	29virk	VR4	7h	Ric
B13C	R3112D131C	Vdet-IC	1.3V±2%, -Reset ODO	SON1612-6	35ur	VD1	7e	Ric
B13D	R1161D132D	LVR-IC	LDO, 1.3V±2%, 350mA, +CE, CL, AE(mode)	HSOP-6	34vrc	VR10	7e	Ric
B13D	R1172S131D	LVR-IC	LDO, 1.3V±2%, 1A, +CE, CL	HSOP-6J	29virk	VR4	7h	Ric
B14A	R1161D142A	LVR-IC	LDO, 1.4V±2%, 350mA, -CE, AE(mode)	HSOP-6	34vrc	VR10	7e	Ric
B14A	R1172S141A	LVR-IC	LDO, 1.4V±2%, 1A, -CE	HSOP-6J	29virk	VR4	7h	Ric
B14A	R3112D141A	Vdet-IC	1.4V±2%, -Reset PPO	SON1612-6	35ur	VD3	7e	Ric
B14B	R1161D142B	LVR-IC	LDO, 1.4V±2%, 350mA, +CE, AE(mode)	HSOP-6	34vrc	VR10	7e	Ric
B14B	R1172S141B	LVR-IC	LDO, 1.4V±2%, 1A, +CE	HSOP-6J	29virk	VR4	7h	Ric
B14C	R3112D141C	Vdet-IC	1.4V±2%, -Reset ODO	SON1612-6	35ur	VD1	7e	Ric
B14D	R1161D142D	LVR-IC	LDO, 1.4V±2%, 350mA, +CE, CL, AE(mode)	HSOP-6	34vrc	VR10	7e	Ric
B14D	R1172S141D	LVR-IC	LDO, 1.4V±2%, 1A, +CE, CL	HSOP-6J	29virk	VR4	7h	Ric
B15A	R1161D152A	LVR-IC	LDO, 1.5V±2%, 350mA, -CE, AE(mode)	HSOP-6	34vrc	VR10	7e	Ric
B15A	R1172S151A	LVR-IC	LDO, 1.5V±2%, 1A, -CE	HSOP-6J	29virk	VR4	7h	Ric
B15A	R3112D151A	Vdet-IC	1.5V±2%, -Reset PPO	SON1612-6	35ur	VD3	7e	Ric
B15B	R1161D152B	LVR-IC	LDO, 1.5V±2%, 350mA, +CE, AE(mode)	HSOP-6	34vrc	VR10	7e	Ric
B15B	R1172S151B	LVR-IC	LDO, 1.5V±2%, 1A, +CE	HSOP-6J	29virk	VR4	7h	Ric
B15C	R3112D151C	Vdet-IC	1.5V±2%, -Reset ODO	SON1612-6	35ur	VD1	7e	Ric
B15D	R1161D152D	LVR-IC	LDO, 1.5V±2%, 350mA, +CE, CL, AE(mode)	HSOP-6	34vrc	VR10	7e	Ric
B15D	R1172S151D	LVR-IC	LDO, 1.5V±2%, 1A, +CE, CL	HSOP-6J	29virk	VR4	7h	Ric
B16	IMB16	Si-pnp-Digi	Dual, 50V, 500mA, R1/R2=4.7k/10k	SOT-23-6	33/TD4	-	7b	Rhm
B16A	R1161D162A	LVR-IC	LDO, 1.6V±2%, 350mA, -CE, AE(mode)	HSOP-6	34vrc	VR10	7e	Ric



SMD code	Type	Function	Short description	Case	Pinout	Sch.	St.	Mnf.
B16A	R1172S161A	LVR-IC	LDO, 1.6V±2%, 1A, -CE	HSOP-6J	29vrik	VR4	7h	Ric
B16A	R3112D161A	Vdet-IC	1.6V±2%, -Reset PPO	SON1612-6	35ur	VD3	7e	Ric
B16B	R1161D162B	LVR-IC	LDO, 1.6V±2%, 350mA, +CE, AE(mode)	HSOP-6	34vrc	VR10	7e	Ric
B16B	R1172S161B	LVR-IC	LDO, 1.6V±2%, 1A, +CE	HSOP-6J	29vrik	VR4	7h	Ric
B16C	R3112D161C	Vdet-IC	1.6V±2%, -Reset ODO	SON1612-6	35ur	VD1	7e	Ric
B16D	R1161D162D	LVR-IC	LDO, 1.6V±2%, 350mA, +CE, CL, AE(mode)	HSOP-6	34vrc	VR10	7e	Ric
B16D	R1172S161D	LVR-IC	LDO, 1.6V±2%, 1A, +CE, CL	HSOP-6J	29vrik	VR4	7h	Ric
B17A	R1161D172A	LVR-IC	LDO, 1.7V±2%, 350mA, -CE, AE(mode)	HSOP-6	34vrc	VR10	7e	Ric
B17A	R1172S171A	LVR-IC	LDO, 1.7V±2%, 1A, -CE	HSOP-6J	29vrik	VR4	7h	Ric
B17A	R3112D171A	Vdet-IC	1.7V±2%, -Reset PPO	SON1612-6	35ur	VD3	7e	Ric
B17B	R1161D172B	LVR-IC	LDO, 1.7V±2%, 350mA, +CE, AE(mode)	HSOP-6	34vrc	VR10	7e	Ric
B17B	R1172S171B	LVR-IC	LDO, 1.7V±2%, 1A, +CE	HSOP-6J	29vrik	VR4	7h	Ric
B17C	R3112D171C	Vdet-IC	1.7V±2%, -Reset ODO	SON1612-6	35ur	VD1	7e	Ric
B17D	R1161D172D	LVR-IC	LDO, 1.7V±2%, 350mA, +CE, CL, AE(mode)	HSOP-6	34vrc	VR10	7e	Ric
B17D	R1172S171D	LVR-IC	LDO, 1.7V±2%, 1A, +CE, CL	HSOP-6J	29vrik	VR4	7h	Ric
B18A	NCP585LSAN18T	LVR-IC	LDO, 1.8V±2%, 350mA, -CEL, AE(Mode)	HSOP-6	35vrc	VR10	7d	Ons
B18A	R1161D182A	LVR-IC	LDO, 1.8V±2%, 350mA, -CE, AE(mode)	HSOP-6	34vrc	VR10	7e	Ric
B18A	R1172S181A	LVR-IC	LDO, 1.8V±2%, 1A, -CE	HSOP-6J	29vrik	VR4	7h	Ric
B18A	R3112D181A	Vdet-IC	1.8V±2%, -Reset PPO	SON1612-6	35ur	VD3	7e	Ric
B18B	NCP585HSAN18T	LVR-IC	LDO, 1.8V±2%, 350mA, +CEL, AE(Mode)	HSOP-6	35vrc	VR10	7d	Ons
B18B	R1161D182B	LVR-IC	LDO, 1.8V±2%, 350mA, +CE, AE(mode)	HSOP-6	34vrc	VR10	7e	Ric
B18B	R1172S181B	LVR-IC	LDO, 1.8V±2%, 1A, +CE	HSOP-6J	29vrik	VR4	7h	Ric
B18C	R3112D181C	Vdet-IC	1.8V±2%, -Reset ODO	SON1612-6	35ur	VD1	7e	Ric
B18D	NCP585DSAN18T	LVR-IC	LDO, 1.8V±2%, 350mA, +CE, CLL, AE(Mode)	HSOP-6	35vrc	VR10	7d	Ons
B18D	R1161D182D	LVR-IC	LDO, 1.8V±2%, 350mA, +CE, CL, AE(mode)	HSOP-6	34vrc	VR10	7e	Ric
B18D	R1172S181D	LVR-IC	LDO, 1.8V±2%, 1A, +CE, CL	HSOP-6J	29vrik	VR4	7h	Ric
B19A	R1161D192A	LVR-IC	LDO, 1.9V±2%, 350mA, -CE, AE(mode)	HSOP-6	34vrc	VR10	7e	Ric
B19A	R1172S191A	LVR-IC	LDO, 1.9V±2%, 1A, -CE	HSOP-6J	29vrik	VR4	7h	Ric
B19A	R3112D191A	Vdet-IC	1.9V±2%, -Reset PPO	SON1612-6	35ur	VD3	7e	Ric
B19B	R1161D192B	LVR-IC	LDO, 1.9V±2%, 350mA, +CE, AE(mode)	HSOP-6	34vrc	VR10	7e	Ric
B19B	R1172S191B	LVR-IC	LDO, 1.9V±2%, 1A, +CE	HSOP-6J	29vrik	VR4	7h	Ric
B19C	R3112D191C	Vdet-IC	1.9V±2%, -Reset ODO	SON1612-6	35ur	VD1	7e	Ric
B19D	R1161D192D	LVR-IC	LDO, 1.9V±2%, 350mA, +CE, CL, AE(mode)	HSOP-6	34vrc	VR10	7e	Ric
B19D	R1172S191D	LVR-IC	LDO, 1.9V±2%, 1A, +CE, CL	HSOP-6J	29vrik	VR4	7h	Ric
B2	R1160D121A	LVR-IC	LDO, 1.2V±2%, 200mA, -CE, AE(mode)	SON-6	34vrc	VR10	7g	Ric
B2	R5421N126C	BM-IC	Li-Ion, over-charge/discharge protection, Vd=2.6V	SOT-23-6	33xj	VBM1	7d	Ric
B2	TK65922M	LIN-IC	Fluorescent lamp driver, 52mA, 225Hz	SOP-6	33zi	-	7b	Tok
B20A	R1161D202A	LVR-IC	LDO, 2V±2%, 350mA, -CE, AE(mode)	HSOP-6	34vrc	VR10	7e	Ric
B20A	R1172S201A	LVR-IC	LDO, 2V±2%, 1A, -CE	HSOP-6J	29vrik	VR4	7h	Ric
B20A	R3112D201A	Vdet-IC	2V±2%, -Reset PPO	SON1612-6	35ur	VD3	7e	Ric
B20B	R1161D202B	LVR-IC	LDO, 2V±2%, 350mA, +CE, AE(mode)	HSOP-6	34vrc	VR10	7e	Ric
B20B	R1172S201B	LVR-IC	LDO, 2V±2%, 1A, +CE	HSOP-6J	29vrik	VR4	7h	Ric
B20C	R3112D201C	Vdet-IC	2V±2%, -Reset ODO	SON1612-6	35ur	VD1	7e	Ric
B20D	R1161D202D	LVR-IC	LDO, 2V±2%, 350mA, +CE, CL, AE(mode)	HSOP-6	34vrc	VR10	7e	Ric
B20D	R1172S201D	LVR-IC	LDO, 2V±2%, 1A, +CE, CL	HSOP-6J	29vrik	VR4	7h	Ric
B21A	R1161D212A	LVR-IC	LDO, 2.1V±2%, 350mA, -CE, AE(mode)	HSOP-6	34vrc	VR10	7e	Ric
B21A	R1172S211A	LVR-IC	LDO, 2.1V±2%, 1A, -CE	HSOP-6J	29vrik	VR4	7h	Ric
B21A	R3112D211A	Vdet-IC	2.1V±2%, -Reset PPO	SON1612-6	35ur	VD3	7e	Ric
B21B	R1161D212B	LVR-IC	LDO, 2.1V±2%, 350mA, +CE, AE(mode)	HSOP-6	34vrc	VR10	7e	Ric
B21B	R1172S211B	LVR-IC	LDO, 2.1V±2%, 1A, +CE	HSOP-6J	29vrik	VR4	7h	Ric
B21C	R3112D211C	Vdet-IC	2.1V±2%, -Reset ODO	SON1612-6	35ur	VD1	7e	Ric
B21D	R1161D212D	LVR-IC	LDO, 2.1V±2%, 350mA, +CE, CL, AE(mode)	HSOP-6	34vrc	VR10	7e	Ric
B21D	R1172S211D	LVR-IC	LDO, 2.1V±2%, 1A, +CE, CL	HSOP-6J	29vrik	VR4	7h	Ric
B22A	R1161D222A	LVR-IC	LDO, 2.2V±2%, 350mA, -CE, AE(mode)	HSOP-6	34vrc	VR10	7e	Ric
B22A	R1172S221A	LVR-IC	LDO, 2.2V±2%, 1A, -CE	HSOP-6J	29vrik	VR4	7h	Ric
B22A	R3112D221A	Vdet-IC	2.2V±2%, -Reset PPO	SON1612-6	35ur	VD3	7e	Ric
B22B	R1161D222B	LVR-IC	LDO, 2.2V±2%, 350mA, +CE, AE(mode)	HSOP-6	34vrc	VR10	7e	Ric
B22B	R1172S221B	LVR-IC	LDO, 2.2V±2%, 1A, +CE	HSOP-6J	29vrik	VR4	7h	Ric
B22C	R3112D221C	Vdet-IC	2.2V±2%, -Reset ODO	SON1612-6	35ur	VD1	7e	Ric
B22D	R1161D222D	LVR-IC	LDO, 2.2V±2%, 350mA, +CE, CL, AE(mode)	HSOP-6	34vrc	VR10	7e	Ric
B22D	R1172S221D	LVR-IC	LDO, 2.2V±2%, 1A, +CE, CL	HSOP-6J	29vrik	VR4	7h	Ric
B23A	R1161D232A	LVR-IC	LDO, 2.3V±2%, 350mA, -CE, AE(mode)	HSOP-6	34vrc	VR10	7e	Ric
B23A	R1172S231A	LVR-IC	LDO, 2.3V±2%, 1A, -CE	HSOP-6J	29vrik	VR4	7h	Ric
B23A	R3112D231A	Vdet-IC	2.3V±2%, -Reset PPO	SON1612-6	35ur	VD3	7e	Ric
B23B	R1161D232B	LVR-IC	LDO, 2.3V±2%, 350mA, +CE, AE(mode)	HSOP-6	34vrc	VR10	7e	Ric
B23B	R1172S231B	LVR-IC	LDO, 2.3V±2%, 1A, +CE	HSOP-6J	29vrik	VR4	7h	Ric
B23C	R3112D231C	Vdet-IC	2.3V±2%, -Reset ODO	SON1612-6	35ur	VD1	7e	Ric
B23D	R1161D232D	LVR-IC	LDO, 2.3V±2%, 350mA, +CE, CL, AE(mode)	HSOP-6	34vrc	VR10	7e	Ric
B23D	R1172S231D	LVR-IC	LDO, 2.3V±2%, 1A, +CE, CL	HSOP-6J	29vrik	VR4	7h	Ric
B24A	R1161D242A	LVR-IC	LDO, 2.4V±2%, 350mA, -CE, AE(mode)	HSOP-6	34vrc	VR10	7e	Ric



SMD code	Type	Function	Short description	Case	Pinout	Sch.	St.	Mnf.
B24A	R1172S241A	LVR-IC	LDO, 2.4V±2%, 1A, -CE	HSOP-6J	29vrk	VR4	7h	Ric
B24A	R3112D241A	Vdet-IC	2.4V±2%, -Reset PPO	SON1612-6	35ur	VD3	7e	Ric
B24B	R1161D242B	LVR-IC	LDO, 2.4V±2%, 350mA, +CE, AE(mode)	HSOP-6	34vrc	VR10	7e	Ric
B24B	R1172S241B	LVR-IC	LDO, 2.4V±2%, 1A, +CE	HSOP-6J	29vrk	VR4	7h	Ric
B24C	R3112D241C	Vdet-IC	2.4V±2%, -Reset ODO	SON1612-6	35ur	VD1	7e	Ric
B24D	R1161D242D	LVR-IC	LDO, 2.4V±2%, 350mA, +CE, CL, AE(mode)	HSOP-6	34vrc	VR10	7e	Ric
B24D	R1172S241D	LVR-IC	LDO, 2.4V±2%, 1A, +CE, CL	HSOP-6J	29vrk	VR4	7h	Ric
B25A	R1161D252A	LVR-IC	LDO, 2.5V±2%, 350mA, -CE, AE(mode)	HSOP-6	34vrc	VR10	7e	Ric
B25A	R1172S251A	LVR-IC	LDO, 2.5V±2%, 1A, -CE	HSOP-6J	29vrk	VR4	7h	Ric
B25A	R3112D251A	Vdet-IC	2.5V±2%, -Reset PPO	SON1612-6	35ur	VD3	7e	Ric
B25B	R1161D252B	LVR-IC	LDO, 2.5V±2%, 350mA, +CE, AE(mode)	HSOP-6	34vrc	VR10	7e	Ric
B25B	R1172S251B	LVR-IC	LDO, 2.5V±2%, 1A, +CE	HSOP-6J	29vrk	VR4	7h	Ric
B25C	R3112D251C	Vdet-IC	2.5V±2%, -Reset ODO	SON1612-6	35ur	VD1	7e	Ric
B25D	R1161D252D	LVR-IC	LDO, 2.55V±2%, 350mA, +CE, CL, AE(mode)	HSOP-6	34vrc	VR10	7e	Ric
B25D	R1172S251D	LVR-IC	LDO, 2.5V±2%, 1A, +CE, CL	HSOP-6J	29vrk	VR4	7h	Ric
B26A	R1161D262A	LVR-IC	LDO, 2.6V±2%, 350mA, -CE, AE(mode)	HSOP-6	34vrc	VR10	7e	Ric
B26A	R1172S261A	LVR-IC	LDO, 2.6V±2%, 1A, -CE	HSOP-6J	29vrk	VR4	7h	Ric
B26A	R3112D261A	Vdet-IC	2.6V±2%, -Reset PPO	SON1612-6	35ur	VD3	7e	Ric
B26B	R1161D262B	LVR-IC	LDO, 2.6V±2%, 350mA, +CE, AE(mode)	HSOP-6	34vrc	VR10	7e	Ric
B26B	R1172S261B	LVR-IC	LDO, 2.6V±2%, 1A, +CE	HSOP-6J	29vrk	VR4	7h	Ric
B26C	R3112D261C	Vdet-IC	2.6V±2%, -Reset ODO	SON1612-6	35ur	VD1	7e	Ric
B26D	R1161D262D	LVR-IC	LDO, 2.6V±2%, 350mA, +CE, CL, AE(mode)	HSOP-6	34vrc	VR10	7e	Ric
B26D	R1172S261D	LVR-IC	LDO, 2.6V±2%, 1A, +CE, CL	HSOP-6J	29vrk	VR4	7h	Ric
B27A	R1161D272A	LVR-IC	LDO, 2.7V±2%, 350mA, -CE, AE(mode)	HSOP-6	34vrc	VR10	7e	Ric
B27A	R1172S271A	LVR-IC	LDO, 2.7V±2%, 1A, -CE	HSOP-6J	29vrk	VR4	7h	Ric
B27A	R3112D271A	Vdet-IC	2.7V±2%, -Reset PPO	SON1612-6	35ur	VD3	7e	Ric
B27B	R1161D272B	LVR-IC	LDO, 2.7V±2%, 350mA, +CE, AE(mode)	HSOP-6	34vrc	VR10	7e	Ric
B27B	R1172S271B	LVR-IC	LDO, 2.7V±2%, 1A, +CE	HSOP-6J	29vrk	VR4	7h	Ric
B27C	R3112D271C	Vdet-IC	2.7V±2%, -Reset ODO	SON1612-6	35ur	VD1	7e	Ric
B27D	R1161D272D	LVR-IC	LDO, 2.7V±2%, 350mA, +CE, CL, AE(mode)	HSOP-6	34vrc	VR10	7e	Ric
B27D	R1172S271D	LVR-IC	LDO, 2.7V±2%, 1A, +CE, CL	HSOP-6J	29vrk	VR4	7h	Ric
B28A	R1161D282A	LVR-IC	LDO, 2.8V±2%, 350mA, -CE, AE(mode)	HSOP-6	34vrc	VR10	7e	Ric
B28A	R1172S281A	LVR-IC	LDO, 2.8V±2%, 1A, -CE	HSOP-6J	29vrk	VR4	7h	Ric
B28A	R3112D281A	Vdet-IC	2.8V±2%, -Reset PPO	SON1612-6	35ur	VD3	7e	Ric
B28B	R1161D282B	LVR-IC	LDO, 2.8V±2%, 350mA, +CE, AE(mode)	HSOP-6	34vrc	VR10	7e	Ric
B28B	R1172S281B	LVR-IC	LDO, 2.8V±2%, 1A, +CE	HSOP-6J	29vrk	VR4	7h	Ric
B28C	R3112D281C	Vdet-IC	2.8V±2%, -Reset ODO	SON1612-6	35ur	VD1	7e	Ric
B28D	R1161D282D	LVR-IC	LDO, 2.8V±2%, 350mA, +CE, CL, AE(mode)	HSOP-6	34vrc	VR10	7e	Ric
B28D	R1172S281D	LVR-IC	LDO, 2.8V±2%, 1A, +CE, CL	HSOP-6J	29vrk	VR4	7h	Ric
B29A	R1161D292A	LVR-IC	LDO, 2.9V±2%, 350mA, -CE, AE(mode)	HSOP-6	34vrc	VR10	7e	Ric
B29A	R1172S291A	LVR-IC	LDO, 2.9V±2%, 1A, -CE	HSOP-6J	29vrk	VR4	7h	Ric
B29A	R3112D291A	Vdet-IC	2.9V±2%, -Reset PPO	SON1612-6	35ur	VD3	7e	Ric
B29B	R1161D292B	LVR-IC	LDO, 2.9V±2%, 350mA, +CE, AE(mode)	HSOP-6	34vrc	VR10	7e	Ric
B29B	R1172S291B	LVR-IC	LDO, 2.9V±2%, 1A, +CE	HSOP-6J	29vrk	VR4	7h	Ric
B29C	R3112D291C	Vdet-IC	2.9V±2%, -Reset ODO	SON1612-6	35ur	VD1	7e	Ric
B29D	R1161D292D	LVR-IC	LDO, 2.9V±2%, 350mA, +CE, CL, AE(mode)	HSOP-6	34vrc	VR10	7e	Ric
B29D	R1172S291D	LVR-IC	LDO, 2.9V±2%, 1A, +CE, CL	HSOP-6J	29vrk	VR4	7h	Ric
B3	R1160D131A	LVR-IC	LDO, 1.3V±2%, 200mA, -CE, AE(mode)	SON-6	34vrc	VR10	7g	Ric
B3	R5421N131C	BM-IC	Li-Ion, over-charge/discharge protection, Vd=3.1V	SOT-23-6	33xj	VBM1	7d	Ric
B3	TK65923M	LIN-IC	Fluorescent lamp driver, 52mA, 250Hz	SOP-6	33zi	-	7b	Tok
B30A	R1161D302A	LVR-IC	LDO, 3V±2%, 350mA, -CE, AE(mode)	HSOP-6	34vrc	VR10	7e	Ric
B30A	R1172S301A	LVR-IC	LDO, 3V±2%, 1A, -CE	HSOP-6J	29vrk	VR4	7h	Ric
B30A	R3112D301A	Vdet-IC	3V±2%, -Reset PPO	SON1612-6	35ur	VD3	7e	Ric
B30B	R1161D302B	LVR-IC	LDO, 3V±2%, 350mA, +CE, AE(mode)	HSOP-6	34vrc	VR10	7e	Ric
B30B	R1172S301B	LVR-IC	LDO, 3V±2%, 1A, +CE	HSOP-6J	29vrk	VR4	7h	Ric
B30D	R1161D302D	LVR-IC	LDO, 3V±2%, 350mA, +CE, CL, AE(mode)	HSOP-6	34vrc	VR10	7e	Ric
B30D	R1172S301D	LVR-IC	LDO, 3V±2%, 1A, +CE, CL	HSOP-6J	29vrk	VR4	7h	Ric
B31A	R1161D312A	LVR-IC	LDO, 3.1V±2%, 350mA, -CE, AE(mode)	HSOP-6	34vrc	VR10	7e	Ric
B31A	R1172S311A	LVR-IC	LDO, 3.1V±2%, 1A, -CE	HSOP-6J	29vrk	VR4	7h	Ric
B31A	R3112D311A	Vdet-IC	3.1V±2%, -Reset PPO	SON1612-6	35ur	VD3	7e	Ric
B31B	R1161D312B	LVR-IC	LDO, 3.1V±2%, 350mA, +CE, AE(mode)	HSOP-6	34vrc	VR10	7e	Ric
B31B	R1172S311B	LVR-IC	LDO, 3.1V±2%, 1A, +CE	HSOP-6J	29vrk	VR4	7h	Ric
B31D	R1161D312D	LVR-IC	LDO, 3.1V±2%, 350mA, +CE, CL, AE(mode)	HSOP-6	34vrc	VR10	7e	Ric
B31D	R1172S311D	LVR-IC	LDO, 3.1V±2%, 1A, +CE, CL	HSOP-6J	29vrk	VR4	7h	Ric
B32A	R1161D322A	LVR-IC	LDO, 3.2V±2%, 350mA, -CE, AE(mode)	HSOP-6	34vrc	VR10	7e	Ric
B32A	R1172S321A	LVR-IC	LDO, 3.2V±2%, 1A, -CE	HSOP-6J	29vrk	VR4	7h	Ric
B32A	R3112D321A	Vdet-IC	3.2V±2%, -Reset PPO	SON1612-6	35ur	VD3	7e	Ric
B32B	R1161D322B	LVR-IC	LDO, 3.2V±2%, 350mA, +CE, AE(mode)	HSOP-6	34vrc	VR10	7e	Ric
B32B	R1172S321B	LVR-IC	LDO, 3.2V±2%, 1A, +CE	HSOP-6J	29vrk	VR4	7h	Ric
B32D	R1161D322D	LVR-IC	LDO, 3.2V±2%, 350mA, +CE, CL, AE(mode)	HSOP-6	34vrc	VR10	7e	Ric



SMD code	Type	Function	Short description	Case	Pinout	Sch.	St.	Mnf.
B32D	R1172S321D	LVR-IC	LDO, 3.2V±2%, 1A, +CE, CL	HSOP-6J	29virk	VR4	7h	Ric
B33A	R1161D332A	LVR-IC	LDO, 3.3V±2%, 350mA, -CE, AE(mode)	HSOP-6	34vrc	VR10	7e	Ric
B33A	R1172S331A	LVR-IC	LDO, 3.3V±2%, 1A, -CE	HSOP-6J	29virk	VR4	7h	Ric
B33A	R3112D331A	Vdet-IC	3.3V±2%, -Reset PPO	SOM1612-6	35ur	VD3	7e	Ric
B33B	R1161D332B	LVR-IC	LDO, 3.3V±2%, 350mA, +CE, AE(mode)	HSON-6	34vrc	VR10	7e	Ric
B33B	R1172S331B	LVR-IC	LDO, 3.3V±2%, 1A, +CE	HSOP-6J	29virk	VR4	7h	Ric
B33D	R1161D332D	LVR-IC	LDO, 3.3V±2%, 350mA, +CE, CL, AE(mode)	HSON-6	34vrc	VR10	7e	Ric
B33D	R1172S331D	LVR-IC	LDO, 3.3V±2%, 1A, +CE, CL	HSOP-6J	29virk	VR4	7h	Ric
B34	MIMBD3004BRM	Si-diode	Quad, Sw, 350V, 200mA, Vf<1.25V(200mA), <5pF	SOT-23-6	33/D9	-	7b	Ttr
B34A	R1172S341A	LVR-IC	LDO, 3.4V±2%, 1A, -CE, -CE	HSOP-6J	29virk	VR4	7h	Ric
B34A	R3112D341A	Vdet-IC	3.4V±2%, -Reset PPO	SOM1612-6	35ur	VD3	7e	Ric
B34B	R1172S341B	LVR-IC	LDO, 3.4V±2%, 1A, +CE	HSOP-6J	29virk	VR4	7h	Ric
B34D	R1172S341D	LVR-IC	LDO, 3.4V±2%, 1A, +CE, CL	HSOP-6J	29virk	VR4	7h	Ric
B35A	R1172S351A	LVR-IC	LDO, 3.5V±2%, 1A, -CE	HSOP-6J	29virk	VR4	7h	Ric
B35A	R3112D351A	Vdet-IC	3.5V±2%, -Reset PPO	SOM1612-6	35ur	VD3	7e	Ric
B35B	R1172S351B	LVR-IC	LDO, 3.5V±2%, 1A, +CE	HSOP-6J	29virk	VR4	7h	Ric
B35D	R1172S351D	LVR-IC	LDO, 3.5V±2%, 1A, +CE, CL	HSOP-6J	29virk	VR4	7h	Ric
B36A	R3112D361A	Vdet-IC	3.6V±2%, -Reset PPO	SOM1612-6	35ur	VD3	7e	Ric
B37A	OPA237EA	Op-IC	Dual, GP, Lo-power, ±1.35...±18V, Icc0=350µA, 1.5MHz	SOP-8	47opd	OP3	8d	Bb
B37A	R3112D371A	Vdet-IC	3.7V±2%, -Reset PPO	SOM1612-6	35ur	VD3	7e	Ric
B38A	R3112D381A	Vdet-IC	3.8V±2%, -Reset PPO	SOM1612-6	35ur	VD3	7e	Ric
B39A	R3112D391A	Vdet-IC	3.9V±2%, -Reset PPO	SOM1612-6	35ur	VD3	7e	Ric
B4	R1160D141A	LVR-IC	LDO, 1.4V±2%, 200mA, -CE, AE(mode)	SOM-6	34vrc	VR10	7g	Ric
B4	R5421N133C	BM-IC	Li-Ion, over-charge/discharge protection, Vd=3.3V	SOT-23-6	33xj	VBM1	7d	Ric
B4	TK65924M	LIN-IC	Fluorescent lamp driver, 52mA, 275Hz	SOP-6	33zi	-	7b	Tok
B40A	R3112D401A	Vdet-IC	4V±2%, -Reset PPO	SOM1612-6	35ur	VD3	7e	Ric
B41A	R3112D411A	Vdet-IC	4.1V±2%, -Reset PPO	SOM1612-6	35ur	VD3	7e	Ric
B42A	R3112D421A	Vdet-IC	4.2V±2%, -Reset PPO	SOM1612-6	35ur	VD3	7e	Ric
B43A	R3112D431A	Vdet-IC	4.3V±2%, -Reset PPO	SOM1612-6	35ur	VD3	7e	Ric
B44A	R3112D441A	Vdet-IC	4.4V±2%, -Reset PPO	SOM1612-6	35ur	VD3	7e	Ric
B45A	R3112D451A	Vdet-IC	4.5V±2%, -Reset PPO	SOM1612-6	35ur	VD3	7e	Ric
B46A	R3112D461A	Vdet-IC	4.6V±2%, -Reset PPO	SOM1612-6	35ur	VD3	7e	Ric
B47A	R3112D471A	Vdet-IC	4.7V±2%, -Reset PPO	SOM1612-6	35ur	VD3	7e	Ric
B48A	R3112D481A	Vdet-IC	4.8V±2%, -Reset PPO	SOM1612-6	35ur	VD3	7e	Ric
B49A	R3112D491A	Vdet-IC	4.9V±2%, -Reset PPO	SOM1612-6	35ur	VD3	7e	Ric
B5	74AVC1T45GW	CMOS-Logic	Dual supply translating transceiver with 3-state output	SOT-363	33Llog70	-	7b	Phi
B5	R1160D151A	LVR-IC	LDO, 1.5V±2%, 200mA, -CE, AE(mode)	SOM-6	34vrc	VR10	7g	Ric
B5	R5421N114C	BM-IC	Li-Ion, over-charge/discharge protection, Vd=1.4V	SOT-23-6	33xj	VBM1	7d	Ric
B5	TK65925M	LIN-IC	Fluorescent lamp driver, 52mA, 300Hz	SOP-6	33zi	-	7b	Tok
B50A	R3112D501A	Vdet-IC	5V±2%, -Reset PPO	SOM1612-6	35ur	VD3	7e	Ric
B5A	R5421N165C	BM-IC	Li-Ion, over-charge/discharge protection, Vd=6.5V	SOT-23-6	33xj	VBM1	7d	Ric
B6	LM4919MM	LIN-IC	AF PA, 2.2..5.5V, 2x14mW(5V/16Ω), mute, shutdown	SSOP-10	60	AFP32	-	Nsc
B6	R1160D161A	LVR-IC	LDO, 1.6V±2%, 200mA, -CE, AE(mode)	SOM-6	34vrc	VR10	7g	Ric
B6	R5421N115C	BM-IC	Li-Ion, over-charge/discharge protection, Vd=1.5V	SOT-23-6	33xj	VBM1	7d	Ric
B6	TK65926M	LIN-IC	Fluorescent lamp driver, 52mA, 325Hz	SOP-6	33zi	-	7b	Tok
B7	R1160D171A	LVR-IC	LDO, 1.7V±2%, 200mA, -CE, AE(mode)	SOM-6	34vrc	VR10	7g	Ric
B7	R5421N124C	BM-IC	Li-Ion, over-charge/discharge protection, Vd=2.4V	SOT-23-6	33xj	VBM1	7d	Ric
B7	TK65927M	LIN-IC	Fluorescent lamp driver, 52mA, 350Hz	SOP-6	33zi	-	7b	Tok
B8	R1160D181A	LVR-IC	LDO, 1.8V±2%, 200mA, -CE, AE(mode)	SOM-6	34vrc	VR10	7g	Ric
B8	R5421N125C	BM-IC	Li-Ion, over-charge/discharge protection, Vd=2.5V	SOT-23-6	33xj	VBM1	7d	Ric
B8	TK65928M	LIN-IC	Fluorescent lamp driver, 52mA, 375Hz	SOP-6	33zi	-	7b	Tok
B9	IMB9A	Si-pnp-Digi	Dual, 50V, 100mA, R1/R2=10k/47k	SOT-23-6	33/TD4	-	7b	Rhm
B9	R1160D191A	LVR-IC	LDO, 1.9V±2%, 200mA, -CE, AE(mode)	SOM-6	34vrc	VR10	7g	Ric
B9	R5421N140C	BM-IC	Li-Ion, over-charge/discharge protection, Vd=4V	SOT-23-6	33xj	VBM1	7d	Ric
B9	TK65929M	LIN-IC	Fluorescent lamp driver, 52mA, 400Hz	SOP-6	33zi	-	7b	Tok
BA	R5421N127C	BM-IC	Li-Ion, over-charge/discharge protection, Vd=2.7V	SOT-23-6	33xj	VBM1	7d	Ric
BAL	HA1102	LIN-IC	AF PA, BTL, class-D, 2.5..5.5V, 1.4W(5V/8Ω), shutdown	MSOP-8	55	AFP24	-	Cer
BAL	TPA2005D1DGN	LIN-IC	AF PA, BTL, class-D, 2.5..5.5V, 1.4W(5V/8Ω), shutdown	SSOP-8	47	AFP24	-	Ti
BAs	BCP54M	Si-npn	AF-Dr/Out, 45V, 1A, 1.7W, B=40..250, 100MHz	SCT-595	7117	-	-	Inf
BB	BC846BPDW	Si-np	Dual, GP, 80V, 100mA, 250mW, B=200..450, >100MHz	SOT-363	33/T9	-	7b	Ons
BB	R5421N139F	BM-IC	Li-Ion, over-charge/discharge protection, Vd=3.9V	SOT-23-6	33xj	VBM1	7d	Ric
BBG	A2190MM	LIN-IC	AF PA, BTL, 2.5..5.5V, 1.28W(5V/8Ω), shutdown	MSOP-8	55	AFP12	8h	Aot
BBG	BL6212MM	LIN-IC	AF PA, BTL, 2.5..5.5V, 1.28W(5V/8Ω), shutdown	SSOP-8	47	AFP12	-	Shb
BBG	BL6290M	LIN-IC	AF PA, BTL, 2.5..5.5V, 1.25W(5V/8Ω), shutdown	SOP-8	47	AFP12	-	Shb
BBG	BL6290MM	LIN-IC	AF PA, BTL, 2.5..5.5V, 1.25W(5V/8Ω), shutdown	SSOP-8	47	AFP12	-	Shb
BC	R5421N128F	BM-IC	Li-Ion, over-charge/discharge protection, Vd=2.8V	SOT-23-6	33xj	VBM1	7d	Ric
BD	R5421N132F	BM-IC	Li-Ion, over-charge/discharge protection, Vd=3.2V	SOT-23-6	33xj	VBM1	7d	Ric
BE	R5421N145C	BM-IC	Li-Ion, over-charge/discharge protection, Vd=4.5V	SOT-23-6	33xj	VBM1	7d	Ric
BEs	BCP55M	Si-npn	AF-Dr/Out, 60V, 1A, 1.7W, B=40..250, 100MHz	SCT-595	7117	-	-	Inf
BF	R5421N136C	BM-IC	Li-Ion, over-charge/discharge protection, Vd=3.6V	SOT-23-6	33xj	VBM1	7d	Ric



SMD code	Type	Function	Short description	Case	Pinout	Sch.	St.	Mnf.
BG	NC7SP19L6	CMOS-Logic	1-of-2 decoder/demultiplexer	MPAK-6	33L _{log47}	-	7b	F
BG	R5421N148C	BM-IC	Li-Ion, over-charge/discharge protection, Vd=4.8V	SOT-23-6	33xj	VBM1	7d	Ric
BH	R5421N154F	BM-IC	Li-Ion, over-charge/discharge protection, Vd=5.4V	SOT-23-6	33xj	VBM1	7d	Ric
BHs	BCP56M	Si-npn	AF-Drr/Out, 45V, 1A, 1.7W, B=40, 250, 100MHz	SCT-595	7117	-	-	Inf
BJ	R5421N161C	BM-IC	Li-Ion, over-charge/discharge protection, Vd=6.1V	SOT-23-6	33xj	VBM1	7d	Ric
BK	HSMS-281K	Si-diode	2x Schottky, RF, 20V, 1A, Vf<0.4V(1mA), <1.2pF, 15Ω(5mA)	SOT-363	33dww	-	7c	Agi
BK	R5421N149C	BM-IC	Li-Ion, over-charge/discharge protection, Vd=4.9V	SOT-23-6	33xj	VBM1	7d	Ric
BL	HSMS-281L	Si-diode	3x Schottky, RF, 20V, 1A, Vf<0.4V(1mA), <1.2pF, 15Ω(5mA)	SOT-363	33ddd	-	7c	Agi
BL	MB054DW	Si-diode	Dual, Schottky, UHF/VHF-Det, 30V, 200mW, <1.5pF	SOT-363	33dde	-	7b	Ons
BL	R5421N162F	BM-IC	Li-Ion, over-charge/discharge protection, Vd=6.2V	SOT-23-6	33xj	VBM1	7d	Ric
BM	R5421N163C	BM-IC	Li-Ion, over-charge/discharge protection, Vd=6.3V	SOT-23-6	33xj	VBM1	7d	Ric
BN	R5421N174C	BM-IC	Li-Ion, over-charge/discharge protection, Vd=7.4V	SOT-23-6	33xj	VBM1	7d	Ric
BP	R5421N175C	BM-IC	Li-Ion, over-charge/discharge protection, Vd=7.5V	SOT-23-6	33xj	VBM1	7d	Ric
BR	R5421N164C	BM-IC	Li-Ion, over-charge/discharge protection, Vd=6.4V	SOT-23-6	33xj	VBM1	7d	Ric
BT	R5421N142C	BM-IC	Li-Ion, over-charge/discharge protection, Vd=4.2V	SOT-23-6	33xj	VBM1	7d	Ric
BU	R5421N163F	BM-IC	Li-Ion, over-charge/discharge protection, Vd=6.3V	SOT-23-6	33xj	VBM1	7d	Ric
BV	R5421N129C	BM-IC	Li-Ion, over-charge/discharge protection, Vd=2.9V	SOT-23-6	33xj	VBM1	7d	Ric
BVAAG	AIC1750-AAGGT	LVR-IC	LDO, Dual out, Vout1/Vout2=1.1V/1.1V±2%, 150mA, +CE	SOT-23-6	33x5	VR19	7b	Aic
BVAAP	AIC1750-AAPGT	LVR-IC	LDO, Dual out, Vout1/Vout2=1.1V/1.1V±2%, 150mA, +CE	SOT-23-6	33x5	VR19	7b	Aic
BVABG	AIC1750-ABGGT	LVR-IC	LDO, Dual out, Vout1/Vout2=1.1V/1.2V±2%, 150mA, +CE	SOT-23-6	33x5	VR19	7b	Aic
BVABP	AIC1750-ABPGT	LVR-IC	LDO, Dual out, Vout1/Vout2=1.1V/1.2V±2%, 150mA, +CE	SOT-23-6	33x5	VR19	7b	Aic
BVACG	AIC1750-ACGGT	LVR-IC	LDO, Dual out, Vout1/Vout2=1.1V/1.3V±2%, 150mA, +CE	SOT-23-6	33x5	VR19	7b	Aic
BVACP	AIC1750-ACPGT	LVR-IC	LDO, Dual out, Vout1/Vout2=1.1V/1.3V±2%, 150mA, +CE	SOT-23-6	33x5	VR19	7b	Aic
BVADG	AIC1750-ADGGT	LVR-IC	LDO, Dual out, Vout1/Vout2=1.1V/1.4V±2%, 150mA, +CE	SOT-23-6	33x5	VR19	7b	Aic
BVADP	AIC1750-ADPGT	LVR-IC	LDO, Dual out, Vout1/Vout2=1.1V/1.4V±2%, 150mA, +CE	SOT-23-6	33x5	VR19	7b	Aic
BVAEG	AIC1750-AEGGT	LVR-IC	LDO, Dual out, Vout1/Vout2=1.1V/1.5V±2%, 150mA, +CE	SOT-23-6	33x5	VR19	7b	Aic
BVAEP	AIC1750-AEPGT	LVR-IC	LDO, Dual out, Vout1/Vout2=1.1V/1.5V±2%, 150mA, +CE	SOT-23-6	33x5	VR19	7b	Aic
BVAFG	AIC1750-AFGGT	LVR-IC	LDO, Dual out, Vout1/Vout2=1.1V/1.6V±2%, 150mA, +CE	SOT-23-6	33x5	VR19	7b	Aic
BVAFP	AIC1750-AFPGT	LVR-IC	LDO, Dual out, Vout1/Vout2=1.1V/1.6V±2%, 150mA, +CE	SOT-23-6	33x5	VR19	7b	Aic
BVAGG	AIC1750-AGGGT	LVR-IC	LDO, Dual out, Vout1/Vout2=1.1V/1.7V±2%, 150mA, +CE	SOT-23-6	33x5	VR19	7b	Aic
BVAGP	AIC1750-AGPGT	LVR-IC	LDO, Dual out, Vout1/Vout2=1.1V/1.7V±2%, 150mA, +CE	SOT-23-6	33x5	VR19	7b	Aic
BVAHG	AIC1750-AHGGT	LVR-IC	LDO, Dual out, Vout1/Vout2=1.1V/1.8V±2%, 150mA, +CE	SOT-23-6	33x5	VR19	7b	Aic
BVAHP	AIC1750-AHPGT	LVR-IC	LDO, Dual out, Vout1/Vout2=1.1V/1.8V±2%, 150mA, +CE	SOT-23-6	33x5	VR19	7b	Aic
BVAIG	AIC1750-AIGGT	LVR-IC	LDO, Dual out, Vout1/Vout2=1.1V/1.9V±2%, 150mA, +CE	SOT-23-6	33x5	VR19	7b	Aic
BVAIP	AIC1750-AIPGT	LVR-IC	LDO, Dual out, Vout1/Vout2=1.1V/1.9V±2%, 150mA, +CE	SOT-23-6	33x5	VR19	7b	Aic
BVAJG	AIC1750-AJGGT	LVR-IC	LDO, Dual out, Vout1/Vout2=1.1V/2.0V±2%, 150mA, +CE	SOT-23-6	33x5	VR19	7b	Aic
BVAJP	AIC1750-AJPGT	LVR-IC	LDO, Dual out, Vout1/Vout2=1.1V/2.0V±2%, 150mA, +CE	SOT-23-6	33x5	VR19	7b	Aic
BVAKG	AIC1750-AKGGT	LVR-IC	LDO, Dual out, Vout1/Vout2=1.1V/2.1V±2%, 150mA, +CE	SOT-23-6	33x5	VR19	7b	Aic
BVAKP	AIC1750-AKPGT	LVR-IC	LDO, Dual out, Vout1/Vout2=1.1V/2.1V±2%, 150mA, +CE	SOT-23-6	33x5	VR19	7b	Aic
BVALG	AIC1750-ALGGT	LVR-IC	LDO, Dual out, Vout1/Vout2=1.1V/2.2V±2%, 150mA, +CE	SOT-23-6	33x5	VR19	7b	Aic
BVALP	AIC1750-ALPGT	LVR-IC	LDO, Dual out, Vout1/Vout2=1.1V/2.2V±2%, 150mA, +CE	SOT-23-6	33x5	VR19	7b	Aic
BVAMG	AIC1750-AMGGT	LVR-IC	LDO, Dual out, Vout1/Vout2=1.1V/2.3V±2%, 150mA, +CE	SOT-23-6	33x5	VR19	7b	Aic
BVAMP	AIC1750-AMPGT	LVR-IC	LDO, Dual out, Vout1/Vout2=1.1V/2.3V±2%, 150mA, +CE	SOT-23-6	33x5	VR19	7b	Aic
BVANG	AIC1750-ANGGT	LVR-IC	LDO, Dual out, Vout1/Vout2=1.1V/2.4V±2%, 150mA, +CE	SOT-23-6	33x5	VR19	7b	Aic
BVANP	AIC1750-ANPGT	LVR-IC	LDO, Dual out, Vout1/Vout2=1.1V/2.4V±2%, 150mA, +CE	SOT-23-6	33x5	VR19	7b	Aic
BVAOG	AIC1750-AOGGT	LVR-IC	LDO, Dual out, Vout1/Vout2=1.1V/2.5V±2%, 150mA, +CE	SOT-23-6	33x5	VR19	7b	Aic
BVAOP	AIC1750-AOPGT	LVR-IC	LDO, Dual out, Vout1/Vout2=1.1V/2.5V±2%, 150mA, +CE	SOT-23-6	33x5	VR19	7b	Aic
BVAPG	AIC1750-APGGT	LVR-IC	LDO, Dual out, Vout1/Vout2=1.1V/2.6V±2%, 150mA, +CE	SOT-23-6	33x5	VR19	7b	Aic
BVAPP	AIC1750-APPGT	LVR-IC	LDO, Dual out, Vout1/Vout2=1.1V/2.6V±2%, 150mA, +CE	SOT-23-6	33x5	VR19	7b	Aic
BVAQG	AIC1750-AQGGT	LVR-IC	LDO, Dual out, Vout1/Vout2=1.1V/2.7V±2%, 150mA, +CE	SOT-23-6	33x5	VR19	7b	Aic
BVAQP	AIC1750-AQPGT	LVR-IC	LDO, Dual out, Vout1/Vout2=1.1V/2.7V±2%, 150mA, +CE	SOT-23-6	33x5	VR19	7b	Aic
BVARG	AIC1750-ARGGT	LVR-IC	LDO, Dual out, Vout1/Vout2=1.1V/2.8V±2%, 150mA, +CE	SOT-23-6	33x5	VR19	7b	Aic
BVARP	AIC1750-ARPGT	LVR-IC	LDO, Dual out, Vout1/Vout2=1.1V/2.8V±2%, 150mA, +CE	SOT-23-6	33x5	VR19	7b	Aic
BVASG	AIC1750-ASGGT	LVR-IC	LDO, Dual out, Vout1/Vout2=1.1V/2.9V±2%, 150mA, +CE	SOT-23-6	33x5	VR19	7b	Aic
BVASP	AIC1750-ASPGT	LVR-IC	LDO, Dual out, Vout1/Vout2=1.1V/2.9V±2%, 150mA, +CE	SOT-23-6	33x5	VR19	7b	Aic
BVATG	AIC1750-ATGGT	LVR-IC	LDO, Dual out, Vout1/Vout2=1.1V/3.0V±2%, 150mA, +CE	SOT-23-6	33x5	VR19	7b	Aic
BVATP	AIC1750-ATPGT	LVR-IC	LDO, Dual out, Vout1/Vout2=1.1V/3.0V±2%, 150mA, +CE	SOT-23-6	33x5	VR19	7b	Aic
BVAUG	AIC1750-AUGGT	LVR-IC	LDO, Dual out, Vout1/Vout2=1.1V/3.1V±2%, 150mA, +CE	SOT-23-6	33x5	VR19	7b	Aic
BVAUP	AIC1750-AUPGT	LVR-IC	LDO, Dual out, Vout1/Vout2=1.1V/3.1V±2%, 150mA, +CE	SOT-23-6	33x5	VR19	7b	Aic
BVAVG	AIC1750-AVGGT	LVR-IC	LDO, Dual out, Vout1/Vout2=1.1V/3.2V±2%, 150mA, +CE	SOT-23-6	33x5	VR19	7b	Aic
BVAVP	AIC1750-AVPGT	LVR-IC	LDO, Dual out, Vout1/Vout2=1.1V/3.2V±2%, 150mA, +CE	SOT-23-6	33x5	VR19	7b	Aic
BVAWG	AIC1750-AWGGT	LVR-IC	LDO, Dual out, Vout1/Vout2=1.1V/3.3V±2%, 150mA, +CE	SOT-23-6	33x5	VR19	7b	Aic
BVAWP	AIC1750-AWPGT	LVR-IC	LDO, Dual out, Vout1/Vout2=1.1V/3.3V±2%, 150mA, +CE	SOT-23-6	33x5	VR19	7b	Aic
BVAXG	AIC1750-AXGGT	LVR-IC	LDO, Dual out, Vout1/Vout2=1.1V/2.85V±2%, 150mA, +CE	SOT-23-6	33x5	VR19	7b	Aic
BVAXP	AIC1750-AXPGT	LVR-IC	LDO, Dual out, Vout1/Vout2=1.1V/2.85V±2%, 150mA, +CE	SOT-23-6	33x5	VR19	7b	Aic
BVBAG	AIC1750-BAGGT	LVR-IC	LDO, Dual out, Vout1/Vout2=1.2V/1.1V±2%, 150mA, +CE	SOT-23-6	33x5	VR19	7b	Aic
BVBAP	AIC1750-BAPGT	LVR-IC	LDO, Dual out, Vout1/Vout2=1.2V/1.1V±2%, 150mA, +CE	SOT-23-6	33x5	VR19	7b	Aic
BVBBG	AIC1750-BBGGT	LVR-IC	LDO, Dual out, Vout1/Vout2=1.2V/1.2V±2%, 150mA, +CE	SOT-23-6	33x5	VR19	7b	Aic
BVBBP	AIC1750-BBPGT	LVR-IC	LDO, Dual out, Vout1/Vout2=1.2V/1.2V±2%, 150mA, +CE	SOT-23-6	33x5	VR19	7b	Aic
BVBGG	AIC1750-BGGGT	LVR-IC	LDO, Dual out, Vout1/Vout2=1.2V/1.3V±2%, 150mA, +CE	SOT-23-6	33x5	VR19	7b	Aic



SMD code	Type	Function	Short description	Case	Pinout	Sch.	St.	Mnf.
BZXP	AIC1750-XTPKL	LVR-IC	LDO, Dual out, Vout1/Vout2=2.85V/3.0V±2%, 150mA, +CE	TSOT-23-6	33yf	VR19	7b	Aic
BZXUG	AIC1750-XUGKL	LVR-IC	LDO, Dual out, Vout1/Vout2=2.85V/3.1V±2%, 150mA, +CE	TSOT-23-6	33yf	VR19	7b	Aic
BZXUP	AIC1750-XUPKL	LVR-IC	LDO, Dual out, Vout1/Vout2=2.85V/3.1V±2%, 150mA, +CE	TSOT-23-6	33yf	VR19	7b	Aic
BZXVG	AIC1750-XVGKL	LVR-IC	LDO, Dual out, Vout1/Vout2=2.85V/3.2V±2%, 150mA, +CE	TSOT-23-6	33yf	VR19	7b	Aic
BZXVP	AIC1750-XVPKL	LVR-IC	LDO, Dual out, Vout1/Vout2=2.85V/3.2V±2%, 150mA, +CE	TSOT-23-6	33yf	VR19	7b	Aic
BZXWG	AIC1750-XWVKL	LVR-IC	LDO, Dual out, Vout1/Vout2=2.85V/3.3V±2%, 150mA, +CE	TSOT-23-6	33yf	VR19	7b	Aic
BZXWP	AIC1750-XWPKL	LVR-IC	LDO, Dual out, Vout1/Vout2=2.85V/3.3V±2%, 150mA, +CE	TSOT-23-6	33yf	VR19	7b	Aic
BZXXG	AIC1750-XXGKL	LVR-IC	LDO, Dual out, Vout1/Vout2=2.85V/2.85V±2%, 150mA, +CE	TSOT-23-6	33yf	VR19	7b	Aic
BZXXP	AIC1750-XXPKL	LVR-IC	LDO, Dual out, Vout1/Vout2=2.85V/2.85V±2%, 150mA, +CE	TSOT-23-6	33yf	VR19	7b	Aic
C	Si1024X	n-MOSFET*	Dual, Sw, 20V, 600mA, 280mW, Rds=0.41Ω(600mA), 10/36ns	SOT-563	35/TD13	-	7d	Vs
C0	R1160D201A	LVR-IC	LDO, 2V±2%, 200mA, -CE, AE(mode)	SOM-6	34vrc	VR10	7g	Ric
C0	R5220D301A	DC/DC-IC	PWM step-down, +CE, Vdc=Vldo=3V	SOM-6	34dc3	DC8	7g	Ric
C0	RN1901AFS	Si-npn-Digi	Dual, Sw, 50V, 80mA, 50mW, 250MHz, R1/R2=4k7/4k7	US6	33/TD3	-	7b	Tos
C0	TK65930M	LIN-IC	Fluorescent lamp driver, 97mA, 175Hz	SOP-6	33zi	-	7b	Tok
C00	74AHCT2G00DC	CMOS-Logic	Dual 2-input NAND gates	SOT765-1	47L.og50	-	8d	Phi
C00	74AHCT2G00DP	CMOS-Logic	Dual 2-input NAND gates	SOT505-2	47L.og50	-	8d	Phi
C00	SN74LVC2G00DCU	CMOS-Logic	Dual 2-input NAND gates	VSSOP-8	44L.og50	-	8d	Ti
C00	SN74LVC2G00DCT	CMOS-Logic	Dual 2-input NAND gates	SSOP-8	47L.og50	-	8d	Ti
C00B	R1173S001B	LVR-IC	LDO, Adjustable, 1A, +CE	HSOP-6J	29vta	VR5	7h	Ric
C00D	R1173S001D	LVR-IC	LDO, Adjustable, 1A, +CE, CL	HSOP-6J	29vta	VR5	7h	Ric
C01B	R1173S181B5	LVR-IC	LDO, 1.85V±2%, 1A, +CE	HSOP-6J	29vtb	VR4	7h	Ric
C01C	R1130D001C	LVR-IC	LDO, Adjustable 1.5..5V, 300mA, -CE	HSON-6	34	-	7e	Ric
C01D	R1173S181D5	LVR-IC	LDO, 1.85V±2%, 1A, +CE, CL	HSOP-6J	29vtb	VR4	7h	Ric
C02	SN74LVC2G02DCU	CMOS-Logic	Dual 2-input NOR gates	VSSOP-8	44L.og53	-	8d	Ti
C02	SN74LVC2G02DCT	CMOS-Logic	Dual 2-input NOR gates	SSOP-8	47L.og53	-	8d	Ti
C02B	R1173S281B5	LVR-IC	LDO, 2.85V±2%, 1A, +CE	HSOP-6J	29vtb	VR4	7h	Ric
C02D	R1173S281D5	LVR-IC	LDO, 2.85V±2%, 1A, +CE, CL	HSOP-6J	29vtb	VR4	7h	Ric
C04	74AHCT3G04DC	CMOS-Logic	Triple inverters	SOT765-1	47L.og56	-	8d	Phi
C04	74AHCT3G04DP	CMOS-Logic	Triple inverters	SOT505-2	47L.og56	-	8d	Phi
C04	SN74LVC2G04DBV	CMOS-Logic	Dual inverters	SOT-23-6	33L.og24	-	7d	Ti
C06	DCX123JH	Si-n/p-Digi	Dual, Sw, 50V, 100mA, 150mW, R1/R2=2.2/47k	SOT-563	35/TD2	-	7l	Di
C06	DCX123JK	Si-n/p-Digi	Dual, Sw, 50V, 100mA, 300mW, R1/R2=2k2/47k	SC-74R	33/TD2	-	7l	Di
C06	DCX123JU	Si-n/p-Digi	Dual, Sw, 50V, 100mA, 200mW, R1/R2=2k2/47k	SOT-363	33/TD2	-	7l	Di
C06	SN74LVC2G06DBV	CMOS-Logic	Dual inverter buffers/drivers (ODO)	SOT-23-6	33L.og25	-	7d	Ti
C07	DCX143TH	Si-n/p-Digi	Dual, Sw, 50V, 100mA, 150mW, R1=4.7k	SOT-563	35/TD2	-	7l	Di
C07	DCX143TK	Si-n/p-Digi	Dual, Sw, 50V, 100mA, 300mW, R1=4.7k	SC-74R	33/TD2	-	7l	Di
C07	DCX143TU	Si-n/p-Digi	Dual, Sw, 50V, 100mA, 200mW, R1=4.7k	SOT-363	33/TD2	-	7l	Di
C07	SN74LVC2G07DBV	CMOS-Logic	Dual noninverting buffers/drivers (ODO)	SOT-23-6	33L.og26	-	7d	Ti
C08	74AHCT2G08DC	CMOS-Logic	Dual 2-input AND gates	SOT765-1	47L.og51	-	8d	Phi
C08	74AHCT2G08DP	CMOS-Logic	Dual 2-input AND gates	SOT505-2	47L.og51	-	8d	Phi
C08	DCX143EH	Si-n/p-Digi	Dual, Sw, 50V, 100mA, 150mW, R1/R2=4.7k/4.7k	SOT-563	35/TD2	-	7l	Di
C08	SN74LVC2G08DCU	CMOS-Logic	Dual 2-input AND gates	VSSOP-8	44L.og51	-	8d	Ti
C08	SN74LVC2G08DCT	CMOS-Logic	Dual 2-input AND gates	SSOP-8	47L.og51	-	8d	Ti
C08B	R1173S081B	LVR-IC	LDO, 0.8V±2%, 1A, +CE	HSOP-6J	29vtb	VR4	7h	Ric
C08D	R1173S081D	LVR-IC	LDO, 0.8V±2%, 1A, +CE, CL	HSOP-6J	29vtb	VR4	7h	Ric
C09B	R1173S091B	LVR-IC	LDO, 0.9V±2%, 1A, +CE	HSOP-6J	29vtb	VR4	7h	Ric
C09D	R1173S091D	LVR-IC	LDO, 0.9V±2%, 1A, +CE, CL	HSOP-6J	29vtb	VR4	7h	Ric
C1	R1160D211A	LVR-IC	LDO, 2.1V±2%, 200mA, -CE, AE(mode)	SOM-6	34vrc	VR10	7g	Ric
C1	R5220D311A	DC/DC-IC	PWM step-down, +CE, Vdc=Vldo=3.1V	SOM-6	34dc3	DC8	7g	Ric
C1	RN1902AFS	Si-npn-Digi	Dual, Sw, 50V, 80mA, 50mW, 250MHz, R1/R2=20k/10k	US6	33/TD3	-	7b	Tos
C1	TK65931M	LIN-IC	Fluorescent lamp driver, 97mA, 200Hz	SOP-6	33zi	-	7b	Tok
C10	SN74LVC1G10DBV	CMOS-Logic	3-input NAND gate	SOT-23-6	33L.og29	-	7d	Ti
C10A	R3132D10EA	Vdet-IC	1.0V±2%, -Reset ODO, -MR	SOM1612-6	35vkb	VD5	7e	Ric
C10A	R3133D10EA	Vdet-IC	1.0V±2%, +Reset ODO, -MR	SOM1612-6	35vkb	VD5	7e	Ric
C10B	R1173S101B	LVR-IC	LDO, 1V±2%, 1A, +CE	HSOP-6J	29vtb	VR4	7h	Ric
C10C	R3132D10EC	Vdet-IC	1.0V±2%, -Reset PPO, -MR	SOM1612-6	35vkb	VD4	7e	Ric
C10C	R3133D10EC	Vdet-IC	1.0V±2%, +Reset PPO, -MR	SOM1612-6	35vkb	VD4	7e	Ric
C10D	R1173S101D	LVR-IC	LDO, 1V±2%, 1A, +CE, CL	HSOP-6J	29vtb	VR4	7h	Ric
C11	TK73211M	LVR-IC	LDO, 11V±2%, 100mA, +CE, Ext. transistor	SOT-23-L8	47	-	8d	Tok
C11A	R3132D11EA	Vdet-IC	1.1V±2%, -Reset ODO, -MR	SOM1612-6	35vkb	VD5	7e	Ric
C11A	R3133D11EA	Vdet-IC	1.1V±2%, +Reset ODO, -MR	SOM1612-6	35vkb	VD5	7e	Ric
C11B	R1173S111B	LVR-IC	LDO, 1.1V±2%, 1A, +CE	HSOP-6J	29vtb	VR4	7h	Ric
C11C	R3132D11EC	Vdet-IC	1.1V±2%, -Reset PPO, -MR	SOM1612-6	35vkb	VD4	7e	Ric
C11C	R3133D11EC	Vdet-IC	1.1V±2%, +Reset PPO, -MR	SOM1612-6	35vkb	VD4	7e	Ric
C11D	R1173S111D	LVR-IC	LDO, 1.1V±2%, 1A, +CE, CL	HSOP-6J	29vtb	VR4	7h	Ric
C12	DCX114TH	Si-n/p-Digi	Dual, Sw, 50V, 100mA, 150mW, 250MHz, R1=10k	SOT-563	35/TD2	-	7l	Di
C12	DCX114TK	Si-n/p-Digi	Dual, Sw, 50V, 100mA, 300mW, R1=10k	SC-74R	33/TD2	-	7l	Di
C12	DCX114TU	Si-n/p-Digi	Dual, Sw, 50V, 100mA, 200mW, R1=10k	SOT-363	33/TD2	-	7l	Di
C12A	R3132D12EA	Vdet-IC	1.2V±2%, -Reset ODO, -MR	SOM1612-6	35vkb	VD5	7e	Ric
C12A	R3133D12EA	Vdet-IC	1.2V±2%, +Reset ODO, -MR	SOM1612-6	35vkb	VD5	7e	Ric



SMD code	Type	Function	Short description	Case	Pinout	Sch.	St.	Mnf.
C12B	R1173S121B	LVR-IC	LDO, 1.2V±2%, 1A, +CE	HSOP-6J	29v1b	VR4	7h	Ric
C12C	R3132D12EC	Vdet-IC	1.2V±2%, -Reset PPO, -MR	SON1612-6	35vkb	VD4	7e	Ric
C12C	R3133D12EC	Vdet-IC	1.2V±2%, +Reset PPO, -MR	SON1612-6	35vkb	VD4	7e	Ric
C12D	R1173S121D	LVR-IC	LDO, 1.2V±2%, 1A, +CE, CL	HSOP-6J	29v1b	VR4	7h	Ric
C13	DCX114EH	Si-n/p-Digi	Dual, Sw, 50V, 100mA, 150mW, R1/R2=10/10k	SOT-563	35/TD2	-	7l	Di
C13	DCX114EK	Si-n/p-Digi	Dual, Sw, 50V, 100mA, 300mW, R1/R2=10k/10k	SC-74R	33/TD2	-	7l	Di
C13	DCX114EU	Si-n/p-Digi	Dual, Sw, 50V, 100mA, 200mW, R1/R2=10k/10k	SOT-363	33/TD2	-	7l	Di
C13A	R3132D13EA	Vdet-IC	1.3V±2%, -Reset ODO, -MR	SON1612-6	35vkb	VD5	7e	Ric
C13A	R3133D13EA	Vdet-IC	1.3V±2%, +Reset ODO, -MR	SON1612-6	35vkb	VD5	7e	Ric
C13B	R1173S131B	LVR-IC	LDO, 1.3V±2%, 1A, +CE	HSOP-6J	29v1b	VR4	7h	Ric
C13C	R3132D13EC	Vdet-IC	1.3V±2%, -Reset PPO, -MR	SON1612-6	35vkb	VD4	7e	Ric
C13C	R3133D13EC	Vdet-IC	1.3V±2%, +Reset PPO, -MR	SON1612-6	35vkb	VD4	7e	Ric
C13D	R1173S131D	LVR-IC	LDO, 1.3V±2%, 1A, +CE, CL	HSOP-6J	29v1b	VR4	7h	Ric
C14	74AHCT3G14DC	CMOS-Logic	Triple Schmitt-trigger inverters	SOT765-1	47L.og57	-	8d	Phi
C14	74AHCT3G14DP	CMOS-Logic	Triple Schmitt-trigger inverters	SOT505-2	47L.og57	-	8d	Phi
C14	DCX114YH	Si-n/p-Digi	Dual, Sw, 50V, 100mA, 150mW, R1/R2=10/47k	SOT-563	35/TD2	-	7l	Di
C14	DCX114YK	Si-n/p-Digi	Dual, Sw, 50V, 100mA, 300mW, R1/R2=10k/47k	SC-74R	33/TD2	-	7l	Di
C14	DCX114YU	Si-n/p-Digi	Dual, Sw, 50V, 100mA, 200mW, R1/R2=10k/47k	SOT-363	33/TD2	-	7l	Di
C14_	SN74LVC2G14DBV	CMOS-Logic	Dual Schmitt-trigger inverter buffers	SOT-23-6	33L.og34	-	7d	Ti
C14A	R3132D14EA	Vdet-IC	1.4V±2%, -Reset ODO, -MR	SON1612-6	35vkb	VD5	7e	Ric
C14A	R3133D14EA	Vdet-IC	1.4V±2%, +Reset ODO, -MR	SON1612-6	35vkb	VD5	7e	Ric
C14B	R1173S141B	LVR-IC	LDO, 1.4V±2%, 1A, +CE	HSOP-6J	29v1b	VR4	7h	Ric
C14C	R3132D14EC	Vdet-IC	1.4V±2%, -Reset PPO, -MR	SON1612-6	35vkb	VD4	7e	Ric
C14C	R3133D14EC	Vdet-IC	1.4V±2%, +Reset PPO, -MR	SON1612-6	35vkb	VD4	7e	Ric
C14D	R1173S141D	LVR-IC	LDO, 1.4V±2%, 1A, +CE, CL	HSOP-6J	29v1b	VR4	7h	Ric
C15A	R1130D151A	LVR-IC	LDO, 1.5V±2%, 300mA, -CE	HSO-6	34vq	VR4	7e	Ric
C15A	R3132D15EA	Vdet-IC	1.5V±2%, -Reset ODO, -MR	SON1612-6	35vkb	VD5	7e	Ric
C15A	R3133D15EA	Vdet-IC	1.5V±2%, +Reset ODO, -MR	SON1612-6	35vkb	VD5	7e	Ric
C15B	R1130D151B	LVR-IC	LDO, 1.5V±2%, 300mA, +CE	HSO-6	34vq	VR4	7e	Ric
C15B	R1173S151B	LVR-IC	LDO, 1.5V±2%, 1A, +CE	HSOP-6J	29v1b	VR4	7h	Ric
C15C	R3132D15EC	Vdet-IC	1.5V±2%, -Reset PPO, -MR	SON1612-6	35vkb	VD4	7e	Ric
C15C	R3133D15EC	Vdet-IC	1.5V±2%, +Reset PPO, -MR	SON1612-6	35vkb	VD4	7e	Ric
C15D	R1173S151D	LVR-IC	LDO, 1.5V±2%, 1A, +CE, CL	HSOP-6J	29v1b	VR4	7h	Ric
C16A	R1130D161A	LVR-IC	LDO, 1.6V±2%, 300mA, -CE	HSO-6	34vq	VR4	7e	Ric
C16A	R3132D16EA	Vdet-IC	1.6V±2%, -Reset ODO, -MR	SON1612-6	35vkb	VD5	7e	Ric
C16A	R3133D16EA	Vdet-IC	1.6V±2%, +Reset ODO, -MR	SON1612-6	35vkb	VD5	7e	Ric
C16B	R1130D161B	LVR-IC	LDO, 1.6V±2%, 300mA, +CE	HSO-6	34vq	VR4	7e	Ric
C16B	R1173S161B	LVR-IC	LDO, 1.6V±2%, 1A, +CE	HSOP-6J	29v1b	VR4	7h	Ric
C16C	R3132D16EC	Vdet-IC	1.6V±2%, -Reset PPO, -MR	SON1612-6	35vkb	VD4	7e	Ric
C16C	R3133D16EC	Vdet-IC	1.6V±2%, +Reset PPO, -MR	SON1612-6	35vkb	VD4	7e	Ric
C16D	R1173S161D	LVR-IC	LDO, 1.6V±2%, 1A, +CE, CL	HSOP-6J	29v1b	VR4	7h	Ric
C17	DCX124EH	Si-n/p-Digi	Dual, Sw, 50V, 100mA, 150mW, R1/R2=22k/22k	SOT-563	35/TD2	-	7l	Di
C17	DCX124EK	Si-n/p-Digi	Dual, Sw, 50V, 100mA, 300mW, R1/R2=22k/22k	SC-74R	33/TD2	-	7l	Di
C17	DCX124EU	Si-n/p-Digi	Dual, Sw, 50V, 100mA, 200mW, R1/R2=22k/22k	SOT-363	33/TD2	-	7l	Di
C17_	SN74LVC2G17DBV	CMOS-Logic	Dual Schmitt-trigger buffers	SOT-23-6	33L.og27	-	7d	Ti
C17A	R1130D171A	LVR-IC	LDO, 1.7V±2%, 300mA, -CE	HSO-6	34vq	VR4	7e	Ric
C17A	R3132D17EA	Vdet-IC	1.7V±2%, -Reset ODO, -MR	SON1612-6	35vkb	VD5	7e	Ric
C17A	R3133D17EA	Vdet-IC	1.7V±2%, +Reset ODO, -MR	SON1612-6	35vkb	VD5	7e	Ric
C17B	R1130D171B	LVR-IC	LDO, 1.7V±2%, 300mA, +CE	HSO-6	34vq	VR4	7e	Ric
C17B	R1173S171B	LVR-IC	LDO, 1.7V±2%, 1A, +CE	HSOP-6J	29v1b	VR4	7h	Ric
C17C	R3132D17EC	Vdet-IC	1.7V±2%, -Reset PPO, -MR	SON1612-6	35vkb	VD4	7e	Ric
C17C	R3133D17EC	Vdet-IC	1.7V±2%, +Reset PPO, -MR	SON1612-6	35vkb	VD4	7e	Ric
C17D	R1173S171D	LVR-IC	LDO, 1.7V±2%, 1A, +CE, CL	HSOP-6J	29v1b	VR4	7h	Ric
C18A	R1130D181A	LVR-IC	LDO, 1.8V±2%, 300mA, -CE	HSO-6	34vq	VR4	7e	Ric
C18A	R3132D18EA	Vdet-IC	1.8V±2%, -Reset ODO, -MR	SON1612-6	35vkb	VD5	7e	Ric
C18A	R3133D18EA	Vdet-IC	1.8V±2%, +Reset ODO, -MR	SON1612-6	35vkb	VD5	7e	Ric
C18B	R1130D181B	LVR-IC	LDO, 1.8V±2%, 300mA, +CE	HSO-6	34vq	VR4	7e	Ric
C18B	R1173S181B	LVR-IC	LDO, 1.8V±2%, 1A, +CE	HSOP-6J	29v1b	VR4	7h	Ric
C18C	R3132D18EC	Vdet-IC	1.8V±2%, -Reset PPO, -MR	SON1612-6	35vkb	VD4	7e	Ric
C18C	R3133D18EC	Vdet-IC	1.8V±2%, +Reset PPO, -MR	SON1612-6	35vkb	VD4	7e	Ric
C18D	R1173S181D	LVR-IC	LDO, 1.8V±2%, 1A, +CE, CL	HSOP-6J	29v1b	VR4	7h	Ric
C19A	R1130D191A	LVR-IC	LDO, 1.9V±2%, 300mA, -CE	HSO-6	34vq	VR4	7e	Ric
C19A	R3132D19EA	Vdet-IC	1.9V±2%, -Reset ODO, -MR	SON1612-6	35vkb	VD5	7e	Ric
C19A	R3133D19EA	Vdet-IC	1.9V±2%, +Reset ODO, -MR	SON1612-6	35vkb	VD5	7e	Ric
C19B	R1130D191B	LVR-IC	LDO, 1.9V±2%, 300mA, +CE	HSO-6	34vq	VR4	7e	Ric
C19B	R1173S191B	LVR-IC	LDO, 1.9V±2%, 1A, +CE	HSOP-6J	29v1b	VR4	7h	Ric
C19C	R3132D19EC	Vdet-IC	1.9V±2%, -Reset PPO, -MR	SON1612-6	35vkb	VD4	7e	Ric
C19C	R3133D19EC	Vdet-IC	1.9V±2%, +Reset PPO, -MR	SON1612-6	35vkb	VD4	7e	Ric
C19D	R1173S191D	LVR-IC	LDO, 1.9V±2%, 1A, +CE, CL	HSOP-6J	29v1b	VR4	7h	Ric
C1D	µPC2708T	MMIC	RF amplifier, 2.9GHz, 15dB (50Ω), Ucc=5V	SOP-6	33ab	A2	7b	Nec



SMD code	Type	Function	Short description	Case	Pinout	Sch.	St.	Mnf.
C1E	μPC2709T	MMIC	RF amplifier, 2.3GHz, 23dB (50Ω), Ucc=5V	SOP-6	33ab	A2	7b	Nec
C1F	μPC2710T	MMIC	Cell-phone WB amplifier, 1GHz, Ucc=5V	SOP-6	33ab	A2	7b	Nec
C1G	μPC2711T	MMIC	Wide-band amplifier, 2.9GHz, Ucc=5V	SOP-6	33ab	A2	7b	Nec
C1H	μPC2712T	MMIC	Wide-band amplifier, 2.6GHz, Ucc=5V	SOP-6	33ab	A2	7b	Nec
C1J	μPC2713TB	MMIC	Wide-band LN amplifier, 1.2GHz, Ucc=5V	MSOP-6	41ab	A2	7b	Nec
C1K	μPC2714TB	MMIC	Wide-band amplifier, 1.8GHz, Ucc=3.4V	MSOP-6	41ab	A2	7b	Nec
C1L	μPC2715TB	MMIC	Wide-band amplifier, 1.2GHz, Ucc=3.4V	MSOP-6	41ab	A2	7b	Nec
C1M	μPC2723TB	MMIC	Differential AGC amplifier, 1.1GHz, Ucc=5V	MSOP-6	41xp	-	7b	Nec
C1P	μPC2726TB	MMIC	Differential WB amplifier, 1.6GHz, Ucc=5V	MSOP-6	41xo	-	7b	Nec
C1Q	μPC2745T	MMIC	UHF-amplifier, 2.7GHz, Ucc=3V	SOP-6	33ab	A2	7b	Nec
C1R	μPC2746T	MMIC	UHF-amplifier, 1.5Gz, Ucc=3V	SOP-6	33ab	A2	7b	Nec
C1S	μPC2747T	MMIC	UHF-amplifier, 1.8GHz, Ucc=3V	SOP-6	33ab	A2	7b	Nec
C1T	μPC2748T	MMIC	UHF-amplifier, 0.2..1.5GHz, Ucc=3V	SOP-6	33ab	A2	7b	Nec
C1U	μPC2749T	MMIC	UHF-amplifier, 2.9GHz, Ucc=3V	SOP-6	33ab	A2	7b	Nec
C1U	μPC2749TB	MMIC	RF amplifier, Vcc=2.7..3.3V, 2.9GHz, 16dB	SOT-363	33ab	A2	7b	Nec
C1W	μPC2756TB	MMIC	Mix+osc. freq. downconverter, 0.1..2GHz	MSOP-6	41	-	7b	Nec
C1X	μPC2757T	MMIC	1..2GHz, converter, Ucc=3V	SOP-6	33	-	7b	Nec
C1Y	μPC2758T	MMIC	1..2GHz, converter, Ucc=3V	SOP-6	33	-	7b	Nec
C1Z	μPC2762TB	MMIC	UHF-amplifier, 2.9GHz, Ucc=3V	MSOP-6	41	-	7b	Nec
C2	R1160D221A	LVR-IC	LDO, 2.2V±2%, 200mA, -CE, AE(mode)	SOM-6	34vrc	VR10	7g	Ric
C2	R5220D321A	DC/DC-IC	PWM step-down, +CE, Vdc=Vldo=3.2V	SOM-6	34dc3	DC8	7g	Ric
C2	RN1903AFS	Si-npn-Digi	Dual, Sw, 50V, 80mA, 50mW, 250MHz, R1/R2=22k/22k	US6	33/TD3	-	7b	Tos
C2	TK65932M	LIN-IC	Fluorescent lamp driver, 97mA, 225Hz	SOP-6	33zi	-	7b	Tok
C2_	SN74LVC1G10DCK	CMOS-Logic	3-input NAND gate	SC-70-6	33/Log29	-	7d	Ti
C2_	SN74LVC2G241DCU	CMOS-Logic	Dual bus buffer non-inverted with 3-state output	VSSOP-8	44/Log60	-	8d	Ti
C20	DCX144EH	Si-n/p-Digi	Dual, Sw, 50V, 100mA, 150mW, R1/R2=47k/47k	SOT-563	35/TD2	-	7l	Di
C20	DCX144EK	Si-n/p-Digi	Dual, Sw, 50V, 100mA, 300mW, R1/R2=47k/47k	SC-74R	33/TD2	-	7l	Di
C20	DCX144EU	Si-n/p-Digi	Dual, Sw, 50V, 100mA, 200mW, R1/R2=47k/47k	SOT-363	33/TD2	-	7l	Di
C20	TK73220M	LVR-IC	LDO, 2.0V±2%, 100mA, +CE, Ext. transistor	SOT-23-L8	47	-	8d	Tok
C20A	R1130D201A	LVR-IC	LDO, 2V±2%, 300mA, -CE	HSON-6	34vq	VR4	7e	Ric
C20A	R3132D20EA	Vdet-IC	2.0V±2%, -Reset ODO, -MR	SOM1612-6	35vkb	VD5	7e	Ric
C20A	R3133D20EA	Vdet-IC	2.0V±2%, +Reset ODO, -MR	SOM1612-6	35vkb	VD5	7e	Ric
C20B	R1130D201B	LVR-IC	LDO, 2V±2%, 300mA, +CE	HSON-6	34vq	VR4	7e	Ric
C20B	R1173S201B	LVR-IC	LDO, 2V±2%, 1A, +CE	HSOP-6J	29vrb	VR4	7h	Ric
C20C	R3132D20EC	Vdet-IC	2.0V±2%, -Reset PPO, -MR	SOM1612-6	35vkb	VD4	7e	Ric
C20C	R3133D20EC	Vdet-IC	2.0V±2%, +Reset PPO, -MR	SOM1612-6	35vkb	VD4	7e	Ric
C20D	R1173S201D	LVR-IC	LDO, 2V±2%, 1A, +CE, CL	HSOP-6J	29vrb	VR4	7h	Ric
C21	TK73221M	LVR-IC	LDO, 2.1V±2%, 100mA, +CE, Ext. transistor	SOT-23-L8	47	-	8d	Tok
C21A	R1130D211A	LVR-IC	LDO, 2.1V±2%, 300mA, -CE	HSON-6	34vq	VR4	7e	Ric
C21A	R3132D21EA	Vdet-IC	2.1V±2%, -Reset ODO, -MR	SOM1612-6	35vkb	VD5	7e	Ric
C21A	R3133D21EA	Vdet-IC	2.1V±2%, +Reset ODO, -MR	SOM1612-6	35vkb	VD5	7e	Ric
C21B	R1130D211B	LVR-IC	LDO, 2.1V±2%, 300mA, +CE	HSON-6	34vq	VR4	7e	Ric
C21B	R1173S211B	LVR-IC	LDO, 2.1V±2%, 1A, +CE	HSOP-6J	29vrb	VR4	7h	Ric
C21C	R3132D21EC	Vdet-IC	2.1V±2%, -Reset PPO, -MR	SOM1612-6	35vkb	VD4	7e	Ric
C21C	R3133D21EC	Vdet-IC	2.1V±2%, +Reset PPO, -MR	SOM1612-6	35vkb	VD4	7e	Ric
C21D	R1173S211D	LVR-IC	LDO, 2.1V±2%, 1A, +CE, CL	HSOP-6J	29vrb	VR4	7h	Ric
C22	TK73222M	LVR-IC	LDO, 2.2V±2%, 100mA, +CE, Ext. transistor	SOT-23-L8	47	-	8d	Tok
C22A	R1130D221A	LVR-IC	LDO, 2.2V±2%, 300mA, -CE	HSON-6	34vq	VR4	7e	Ric
C22A	R3132D22EA	Vdet-IC	2.2V±2%, -Reset ODO, -MR	SOM1612-6	35vkb	VD5	7e	Ric
C22A	R3133D22EA	Vdet-IC	2.2V±2%, +Reset ODO, -MR	SOM1612-6	35vkb	VD5	7e	Ric
C22B	R1130D221B	LVR-IC	LDO, 2.2V±2%, 300mA, +CE	HSON-6	34vq	VR4	7e	Ric
C22B	R1173S221B	LVR-IC	LDO, 2.2V±2%, 1A, +CE	HSOP-6J	29vrb	VR4	7h	Ric
C22C	R3132D22EC	Vdet-IC	2.2V±2%, -Reset PPO, -MR	SOM1612-6	35vkb	VD4	7e	Ric
C22C	R3133D22EC	Vdet-IC	2.2V±2%, +Reset PPO, -MR	SOM1612-6	35vkb	VD4	7e	Ric
C22D	R1173S221D	LVR-IC	LDO, 2.2V±2%, 1A, +CE, CL	HSOP-6J	29vrb	VR4	7h	Ric
C23	TK73223M	LVR-IC	LDO, 2.3V±2%, 100mA, +CE, Ext. transistor	SOT-23-L8	47	-	8d	Tok
C23A	R1130D231A	LVR-IC	LDO, 2.3V±2%, 300mA, -CE	HSON-6	34vq	VR4	7e	Ric
C23A	R3132D23EA	Vdet-IC	2.3V±2%, -Reset ODO, -MR	SOM1612-6	35vkb	VD5	7e	Ric
C23A	R3133D23EA	Vdet-IC	2.3V±2%, +Reset ODO, -MR	SOM1612-6	35vkb	VD5	7e	Ric
C23B	R1130D231B	LVR-IC	LDO, 2.3V±2%, 300mA, +CE	HSON-6	34vq	VR4	7e	Ric
C23B	R1173S231B	LVR-IC	LDO, 2.3V±2%, 1A, +CE	HSOP-6J	29vrb	VR4	7h	Ric
C23C	R3132D23EC	Vdet-IC	2.3V±2%, -Reset PPO, -MR	SOM1612-6	35vkb	VD4	7e	Ric
C23C	R3133D23EC	Vdet-IC	2.3V±2%, +Reset PPO, -MR	SOM1612-6	35vkb	VD4	7e	Ric
C23D	R1173S231D	LVR-IC	LDO, 2.3V±2%, 1A, +CE, CL	HSOP-6J	29vrb	VR4	7h	Ric
C24	TK73224M	LVR-IC	LDO, 2.4V±2%, 100mA, +CE, Ext. transistor	SOT-23-L8	47	-	8d	Tok
C241	74AHC2G241DP	CMOS-Logic	Dual bus buffer non-inverted with 3-state output	SOT505-2	47/Log60	-	8d	Phi
C24A	R1130D241A	LVR-IC	LDO, 2.4V±2%, 300mA, -CE	HSON-6	34vq	VR4	7e	Ric
C24A	R3132D24EA	Vdet-IC	2.4V±2%, -Reset ODO, -MR	SOM1612-6	35vkb	VD5	7e	Ric
C24A	R3133D24EA	Vdet-IC	2.4V±2%, +Reset ODO, -MR	SOM1612-6	35vkb	VD5	7e	Ric
C24B	R1130D241B	LVR-IC	LDO, 2.4V±2%, 300mA, +CE	HSON-6	34vq	VR4	7e	Ric



SMD code	Type	Function	Short description	Case	Pinout	Sch.	St.	Mnf.
C24B	R1173S241B	LVR-IC	LDO, 2.4V±2%, 1A, +CE	HSOP-6J	29v1b	VR4	7h	Ric
C24C	R3132D24EC	Vdet-IC	2.4V±2%, -Reset PPO, -MR	SON1612-6	35vkb	VD4	7e	Ric
C24C	R3133D24EC	Vdet-IC	2.4V±2%, +Reset PPO, -MR	SON1612-6	35vkb	VD4	7e	Ric
C24D	R1173S241D	LVR-IC	LDO, 2.4V±2%, 1A, +CE, CL	HSOP-6J	29v1b	VR4	7h	Ric
C25	74AHCT2G125DC	CMOS-Logic	Dual bus buffer with 3-state output	SOT765-1	47Llog54	-	8d	Phi
C25	74AHCT2G125DP	CMOS-Logic	Dual bus buffer with 3-state output	SOT505-2	47Llog54	-	8d	Phi
C25	TK73225M	LVR-IC	LDO, 2.5V±2%, 100mA, +CE, Ext. transistor	SOT-23-L8	47	-	8d	Tok
C25_	N74LVC2G125DCU	CMOS-Logic	Dual bus buffer with 3-state output	VSSOP-8	44Llog54	-	8d	Ti
C25_	SN74LVC2G125DCT	CMOS-Logic	Dual bus buffer with 3-state output	SSOP-8	47Llog54	-	8d	Ti
C25A	R1130D251A	LVR-IC	LDO, 2.5V±2%, 300mA, -CE	HSOP-6	34vq	VR4	7e	Ric
C25A	R3132D25EA	Vdet-IC	2.5V±2%, -Reset ODO, -MR	SON1612-6	35vkb	VD5	7e	Ric
C25A	R3133D25EA	Vdet-IC	2.5V±2%, +Reset ODO, -MR	SON1612-6	35vkb	VD5	7e	Ric
C25B	R1130D251B	LVR-IC	LDO, 2.5V±2%, 300mA, +CE	HSOP-6	34vq	VR4	7e	Ric
C25B	R1173S251B	LVR-IC	LDO, 2.5V±2%, 1A, +CE	HSOP-6J	29v1b	VR4	7h	Ric
C25C	R3132D25EC	Vdet-IC	2.5V±2%, -Reset PPO, -MR	SON1612-6	35vkb	VD4	7e	Ric
C25C	R3133D25EC	Vdet-IC	2.5V±2%, +Reset PPO, -MR	SON1612-6	35vkb	VD4	7e	Ric
C25D	R1173S251D	LVR-IC	LDO, 2.5V±2%, 1A, +CE, CL	HSOP-6J	29v1b	VR4	7h	Ric
C26	74AHCT2G126DC	CMOS-Logic	Dual bus buffer with 3-state output	SOT765-1	47Llog55	-	8d	Phi
C26	74AHCT2G126DP	CMOS-Logic	Dual bus buffer with 3-state output	SOT505-2	47Llog55	-	8d	Phi
C26	TK73226M	LVR-IC	LDO, 2.6V±2%, 100mA, +CE, Ext. transistor	SOT-23-L8	47	-	8d	Tok
C26_	SN74LVC2G126DCT	CMOS-Logic	Bus buffer gate with 3-state output	SSOP-8	47Llog13	-	8d	Ti
C26A	R1130D261A	LVR-IC	LDO, 2.6V±2%, 300mA, -CE	HSOP-6	34vq	VR4	7e	Ric
C26A	R3132D26EA	Vdet-IC	2.6V±2%, -Reset ODO, -MR	SON1612-6	35vkb	VD5	7e	Ric
C26A	R3133D26EA	Vdet-IC	2.6V±2%, +Reset ODO, -MR	SON1612-6	35vkb	VD5	7e	Ric
C26B	R1130D261B	LVR-IC	LDO, 2.6V±2%, 300mA, +CE	HSOP-6	34vq	VR4	7e	Ric
C26B	R1173S261B	LVR-IC	LDO, 2.6V±2%, 1A, +CE	HSOP-6J	29v1b	VR4	7h	Ric
C26C	R3132D26EC	Vdet-IC	2.6V±2%, -Reset PPO, -MR	SON1612-6	35vkb	VD4	7e	Ric
C26C	R3133D26EC	Vdet-IC	2.6V±2%, +Reset PPO, -MR	SON1612-6	35vkb	VD4	7e	Ric
C26D	R1173S261D	LVR-IC	LDO, 2.6V±2%, 1A, +CE, CL	HSOP-6J	29v1b	VR4	7h	Ric
C27	TK73227M	LVR-IC	LDO, 2.7V±2%, 100mA, +CE, Ext. transistor	SOT-23-L8	47	-	8d	Tok
C27_	SN74LVC1G27DBV	CMOS-Logic	3-input NOR gate	SOT-23-6	33Llog31	-	7d	Ti
C27A	R1130D271A	LVR-IC	LDO, 2.7V±2%, 300mA, -CE	HSOP-6	34vq	VR4	7e	Ric
C27A	R3132D27EA	Vdet-IC	2.7V±2%, -Reset ODO, -MR	SON1612-6	35vkb	VD5	7e	Ric
C27A	R3133D27EA	Vdet-IC	2.7V±2%, +Reset ODO, -MR	SON1612-6	35vkb	VD5	7e	Ric
C27B	R1130D271B	LVR-IC	LDO, 2.7V±2%, 300mA, +CE	HSOP-6	34vq	VR4	7e	Ric
C27B	R1173S271B	LVR-IC	LDO, 2.7V±2%, 1A, +CE	HSOP-6J	29v1b	VR4	7h	Ric
C27C	R3132D27EC	Vdet-IC	2.7V±2%, -Reset PPO, -MR	SON1612-6	35vkb	VD4	7e	Ric
C27C	R3133D27EC	Vdet-IC	2.7V±2%, +Reset PPO, -MR	SON1612-6	35vkb	VD4	7e	Ric
C27D	R1173S271D	LVR-IC	LDO, 2.7V±2%, 1A, +CE, CL	HSOP-6J	29v1b	VR4	7h	Ric
C28	TK73228M	LVR-IC	LDO, 2.8V±2%, 100mA, +CE, Ext. transistor	SOT-23-L8	47	-	8d	Tok
C28A	R1130D281A	LVR-IC	LDO, 2.8V±2%, 300mA, -CE	HSOP-6	34vq	VR4	7e	Ric
C28A	R3132D28EA	Vdet-IC	2.8V±2%, -Reset ODO, -MR	SON1612-6	35vkb	VD5	7e	Ric
C28A	R3133D28EA	Vdet-IC	2.8V±2%, +Reset ODO, -MR	SON1612-6	35vkb	VD5	7e	Ric
C28B	R1130D281B	LVR-IC	LDO, 2.8V±2%, 300mA, +CE	HSOP-6	34vq	VR4	7e	Ric
C28B	R1173S281B	LVR-IC	LDO, 2.8V±2%, 1A, +CE	HSOP-6J	29v1b	VR4	7h	Ric
C28C	R3132D28EC	Vdet-IC	2.8V±2%, -Reset PPO, -MR	SON1612-6	35vkb	VD4	7e	Ric
C28C	R3133D28EC	Vdet-IC	2.8V±2%, +Reset PPO, -MR	SON1612-6	35vkb	VD4	7e	Ric
C28D	R1173S281D	LVR-IC	LDO, 2.8V±2%, 1A, +CE, CL	HSOP-6J	29v1b	VR4	7h	Ric
C29	TK73229M	LVR-IC	LDO, 2.9V±2%, 100mA, +CE, Ext. transistor	SOT-23-L8	47	-	8d	Tok
C29A	R1130D291A	LVR-IC	LDO, 2.9V±2%, 300mA, -CE	HSOP-6	34vq	VR4	7e	Ric
C29A	R3132D29EA	Vdet-IC	2.9V±2%, -Reset ODO, -MR	SON1612-6	35vkb	VD5	7e	Ric
C29A	R3133D29EA	Vdet-IC	2.9V±2%, +Reset ODO, -MR	SON1612-6	35vkb	VD5	7e	Ric
C29B	R1130D291B	LVR-IC	LDO, 2.9V±2%, 300mA, +CE	HSOP-6	34vq	VR4	7e	Ric
C29B	R1173S291B	LVR-IC	LDO, 2.9V±2%, 1A, +CE	HSOP-6J	29v1b	VR4	7h	Ric
C29C	R3132D29EC	Vdet-IC	2.9V±2%, -Reset PPO, -MR	SON1612-6	35vkb	VD4	7e	Ric
C29C	R3133D29EC	Vdet-IC	2.9V±2%, +Reset PPO, -MR	SON1612-6	35vkb	VD4	7e	Ric
C29D	R1173S291D	LVR-IC	LDO, 2.9V±2%, 1A, +CE, CL	HSOP-6J	29v1b	VR4	7h	Ric
C2A	μPC2763TB	MMIC	UHF-amplifier, 2.4GHz, Ucc=3V	MSOP-6	41	-	7b	Nec
C2B	μPC8102T	MMIC	Telecom, pager, 150..330MHz amp.	SOP-6	33	-	7b	Nec
C2C	μPC8103T	MMIC	Telecom, pager, 150..330MHz mixer	SOP-6	33	-	7b	Nec
C2D	μPC8106T	MMIC	Cordless phone, Up-Conv., Ucc=3V	SOP-6	33	-	7b	Nec
C2F	μPC8108T	MMIC	Telecom, pager, 150..930MHz mixer	SOP-6	33	-	7b	Nec
C2G	μPC8109T	MMIC	Cordless phone, Up-conv., Ucc=3V	SOP-6	33	-	7b	Nec
C2H	μPC2771TB	MMIC	UHF-amplifier, 2,2GHz, Ucc=3V	MSOP-6	41	-	7b	Nec
C2K	μPC8112T	MMIC	Cordless phone, Down-conv., Ucc=3V	SOP-6	33	-	7b	Nec
C2L	μPC2776TB	MMIC	UHF-amplifier, 2,7GHz, Ucc=3V	MSOP-6	41	-	7b	Nec
C2M	μPC8119T	MMIC	Digital phone, AGC (down), Ucc=3V	SOP-6	33	-	7b	Nec
C2N	MAX972AEUE	LIN-IC	AF PA, 2.4..5.5V, 2x125mW(3V/32Q), shutdown	TSSOP-16	60	-	8d	Max
C2P	μPC8128T	MMIC	Cell/cordl-ph. buff-amp, Ucc=2.4..3.6V, 800..1900MHz	SOP-6	33ab	A2	7b	Nec
C2S	μPC2791TB	MMIC	BS tuner IF system, Ucc=5V	MSOP-6	41	-	7b	Nec



SMD code	Type	Function	Short description	Case	Pinout	Sch.	St.	Mnf.
C2T	μPC2792TB	MMIC	BS tuner IF system, Ucc=5V	MSOP-6	41	-	7b	Nec
C2U	μPC8151T	MMIC	Cell/cordl-ph. buff-amp, Ucc=2.4..3.6V, 800..1900MHz	SOP-6	33ab	A2	7b	Nec
C2V	μPC8152T	MMIC	Cell/cordl-ph. buff-amp, Ucc=2.4..3.6V, 800..1900MHz	SOP-6	33ab	A2	7b	Nec
C3	R1160D231A	LVR-IC	LDO, 2.3V±2%, 200mA, -CE, AE(mode)	SON-6	34vrc	VR10	7g	Ric
C3	R5220D331A	DC/DC-IC	PWM step-down, +CE, Vdc=Vldo=3.3V	SON-6	34dc3	DC8	7g	Ric
C3	RN1904AFS	Si-npn-Digi	Dual, Sw, 50V, 80mA, 50mW, 250MHz, R1/R2=47k/47k	US6	33/TD3	-	7b	Tos
C3	TK65933M	LIN-IC	Fluorescent lamp driver, 97mA, 250Hz	SOP-6	33zi	-	7b	Tok
C30	TK73230M	LVR-IC	LDO, 3.0V±2%, 100mA, +CE, Ext. transistor	SOT-23-L8	47	-	8d	Tok
C30A	R1130D301A	LVR-IC	LDO, 3V±2%, 300mA, -CE	HSON-6	34vq	VR4	7e	Ric
C30A	R3132D30EA	Vdet-IC	3.0V±2%, -Reset ODO, -MR	SON1612-6	35vkb	VD5	7e	Ric
C30A	R3133D30EA	Vdet-IC	3.0V±2%, +Reset ODO, -MR	SON1612-6	35vkb	VD5	7e	Ric
C30B	R1130D301B	LVR-IC	LDO, 3V±2%, 300mA, +CE	HSON-6	34vq	VR4	7e	Ric
C30B	R1173S301B	LVR-IC	LDO, 3V±2%, 1A, +CE	HSOP-6J	29vrb	VR4	7h	Ric
C30C	R3132D30EC	Vdet-IC	3.0V±2%, -Reset PPO, -MR	SON1612-6	35vkb	VD4	7e	Ric
C30C	R3133D30EC	Vdet-IC	3.0V±2%, +Reset PPO, -MR	SON1612-6	35vkb	VD4	7e	Ric
C30D	R1173S301D	LVR-IC	LDO, 3V±2%, 1A, +CE, CL	HSOP-6J	29vrb	VR4	7h	Ric
C31	TK73231M	LVR-IC	LDO, 3.1V±2%, 100mA, +CE, Ext. transistor	SOT-23-L8	47	-	8d	Tok
C31A	R1130D311A	LVR-IC	LDO, 3.1V±2%, 300mA, -CE	HSON-6	34vq	VR4	7e	Ric
C31A	R3132D31EA	Vdet-IC	3.1V±2%, -Reset ODO, -MR	SON1612-6	35vkb	VD5	7e	Ric
C31A	R3133D31EA	Vdet-IC	3.1V±2%, +Reset ODO, -MR	SON1612-6	35vkb	VD5	7e	Ric
C31B	R1130D311B	LVR-IC	LDO, 3.1V±2%, 300mA, +CE	HSON-6	34vq	VR4	7e	Ric
C31B	R1173S311B	LVR-IC	LDO, 3.1V±2%, 1A, +CE	HSOP-6J	29vrb	VR4	7h	Ric
C31C	R3132D31EC	Vdet-IC	3.1V±2%, -Reset PPO, -MR	SON1612-6	35vkb	VD4	7e	Ric
C31C	R3133D31EC	Vdet-IC	3.1V±2%, +Reset PPO, -MR	SON1612-6	35vkb	VD4	7e	Ric
C31D	R1173S311D	LVR-IC	LDO, 3.1V±2%, 1A, +CE, CL	HSOP-6J	29vrb	VR4	7h	Ric
C32	74AHCT2G32DC	CMOS-Logic	Dual 2-input OR gates	SOT765-1	47Llog52	-	8d	Phi
C32	74AHCT2G32DP	CMOS-Logic	Dual 2-input OR gates	SOT505-2	47Llog52	-	8d	Phi
C32	TK73232M	LVR-IC	LDO, 3.2V±2%, 100mA, +CE, Ext. transistor	SOT-23-L8	47	-	8d	Tok
C32_	SN74LVC2G32DCU	CMOS-Logic	Dual 2-input OR gates	VSSOP-8	44Llog52	-	8d	Ti
C32_	SN74LVC2G32DCT	CMOS-Logic	Dual 2-input OR gates	SSOP-8	47Llog52	-	8d	Ti
C32A	R1130D321A	LVR-IC	LDO, 3.2V±2%, 300mA, -CE	HSON-6	34vq	VR4	7e	Ric
C32A	R3132D32EA	Vdet-IC	3.2V±2%, -Reset ODO, -MR	SON1612-6	35vkb	VD5	7e	Ric
C32A	R3133D32EA	Vdet-IC	3.2V±2%, +Reset ODO, -MR	SON1612-6	35vkb	VD5	7e	Ric
C32B	R1130D321B	LVR-IC	LDO, 3.2V±2%, 300mA, +CE	HSON-6	34vq	VR4	7e	Ric
C32B	R1173S321B	LVR-IC	LDO, 3.2V±2%, 1A, +CE	HSOP-6J	29vrb	VR4	7h	Ric
C32C	R3132D32EC	Vdet-IC	3.2V±2%, -Reset PPO, -MR	SON1612-6	35vkb	VD4	7e	Ric
C32C	R3133D32EC	Vdet-IC	3.2V±2%, +Reset PPO, -MR	SON1612-6	35vkb	VD4	7e	Ric
C32D	R1173S321D	LVR-IC	LDO, 3.2V±2%, 1A, +CE, CL	HSOP-6J	29vrb	VR4	7h	Ric
C33	TK73233M	LVR-IC	LDO, 3.3V±2%, 100mA, +CE, Ext. transistor	SOT-23-L8	47	-	8d	Tok
C33A	R1130D331A	LVR-IC	LDO, 3.3V±2%, 300mA, -CE	HSON-6	34vq	VR4	7e	Ric
C33A	R3132D33EA	Vdet-IC	3.3V±2%, -Reset ODO, -MR	SON1612-6	35vkb	VD5	7e	Ric
C33A	R3133D33EA	Vdet-IC	3.3V±2%, +Reset ODO, -MR	SON1612-6	35vkb	VD5	7e	Ric
C33B	R1130D331B	LVR-IC	LDO, 3.3V±2%, 300mA, +CE	HSON-6	34vq	VR4	7e	Ric
C33B	R1173S331B	LVR-IC	LDO, 3.3V±2%, 1A, +CE	HSOP-6J	29vrb	VR4	7h	Ric
C33C	R3132D33EC	Vdet-IC	3.3V±2%, -Reset PPO, -MR	SON1612-6	35vkb	VD4	7e	Ric
C33C	R3133D33EC	Vdet-IC	3.3V±2%, +Reset PPO, -MR	SON1612-6	35vkb	VD4	7e	Ric
C33D	R1173S331D	LVR-IC	LDO, 3.3V±2%, 1A, +CE, CL	HSOP-6J	29vrb	VR4	7h	Ric
C34	TK73234M	LVR-IC	LDO, 3.4V±2%, 100mA, +CE, Ext. transistor	SOT-23-L8	47	-	8d	Tok
C34_	SN74LVC2G34DBV	CMOS-Logic	Dual non-inverter buffers	SOT-23-6	33Llog23	-	7d	Ti
C34A	R1130D341A	LVR-IC	LDO, 3.4V±2%, 300mA, -CE	HSON-6	34vq	VR4	7e	Ric
C34A	R3132D34EA	Vdet-IC	3.4V±2%, -Reset ODO, -MR	SON1612-6	35vkb	VD5	7e	Ric
C34A	R3133D34EA	Vdet-IC	3.4V±2%, +Reset ODO, -MR	SON1612-6	35vkb	VD5	7e	Ric
C34B	R1130D341B	LVR-IC	LDO, 3.4V±2%, 300mA, +CE	HSON-6	34vq	VR4	7e	Ric
C34B	R1173S341B	LVR-IC	LDO, 3.4V±2%, 1A, +CE	HSOP-6J	29vrb	VR4	7h	Ric
C34C	R3132D34EC	Vdet-IC	3.4V±2%, -Reset PPO, -MR	SON1612-6	35vkb	VD4	7e	Ric
C34C	R3133D34EC	Vdet-IC	3.4V±2%, +Reset PPO, -MR	SON1612-6	35vkb	VD4	7e	Ric
C34D	R1173S341D	LVR-IC	LDO, 3.4V±2%, 1A, +CE, CL	HSOP-6J	29vrb	VR4	7h	Ric
C35	TK73235M	LVR-IC	LDO, 3.5V±2%, 100mA, +CE, Ext. transistor	SOT-23-L8	47	-	8d	Tok
C35A	R1130D351A	LVR-IC	LDO, 3.5V±2%, 300mA, -CE	HSON-6	34vq	VR4	7e	Ric
C35A	R3132D35EA	Vdet-IC	3.5V±2%, -Reset ODO, -MR	SON1612-6	35vkb	VD5	7e	Ric
C35A	R3133D35EA	Vdet-IC	3.5V±2%, +Reset ODO, -MR	SON1612-6	35vkb	VD5	7e	Ric
C35B	R1130D351B	LVR-IC	LDO, 3.5V±2%, 300mA, +CE	HSON-6	34vq	VR4	7e	Ric
C35B	R1173S351B	LVR-IC	LDO, 3.5V±2%, 1A, +CE	HSOP-6J	29vrb	VR4	7h	Ric
C35C	R3132D35EC	Vdet-IC	3.5V±2%, -Reset PPO, -MR	SON1612-6	35vkb	VD4	7e	Ric
C35C	R3133D35EC	Vdet-IC	3.5V±2%, +Reset PPO, -MR	SON1612-6	35vkb	VD4	7e	Ric
C35D	R1173S351D	LVR-IC	LDO, 3.5V±2%, 1A, +CE, CL	HSOP-6J	29vrb	VR4	7h	Ric
C36	TK73236M	LVR-IC	LDO, 3.6V±2%, 100mA, +CE, Ext. transistor	SOT-23-L8	47	-	8d	Tok
C36A	R1130D361A	LVR-IC	LDO, 3.6V±2%, 300mA, -CE	HSON-6	34vq	VR4	7e	Ric
C36A	R3132D36EA	Vdet-IC	3.6V±2%, -Reset ODO, -MR	SON1612-6	35vkb	VD5	7e	Ric
C36A	R3133D36EA	Vdet-IC	3.6V±2%, +Reset ODO, -MR	SON1612-6	35vkb	VD5	7e	Ric



SMD code	Type	Function	Short description	Case	Pinout	Sch.	St.	Mnf.
C36B	R1130D361B	LVR-IC	LDO, 3.6V±2%, 300mA, +CE	HSON-6	34vq	VR4	7e	Ric
C36C	R3132D36EC	Vdet-IC	3.6V±2%, -Reset PPO, -MR	SON1612-6	35vkb	VD4	7e	Ric
C36C	R3133D36EC	Vdet-IC	3.6V±2%, +Reset PPO, -MR	SON1612-6	35vkb	VD4	7e	Ric
C37	TK73237M	LVR-IC	LDO, 3.7V±2%, 100mA, +CE, Ext. transistor	SOT-23-L8	47	-	8d	Tok
C37A	R1130D371A	LVR-IC	LDO, 3.7V±2%, 300mA, -CE	HSON-6	34vq	VR4	7e	Ric
C37A	R3132D37EA	Vdet-IC	3.7V±2%, -Reset ODO, -MR	SON1612-6	35vkb	VD5	7e	Ric
C37A	R3133D37EA	Vdet-IC	3.7V±2%, +Reset ODO, -MR	SON1612-6	35vkb	VD5	7e	Ric
C37B	R1130D371B	LVR-IC	LDO, 3.7V±2%, 300mA, +CE	HSON-6	34vq	VR4	7e	Ric
C37C	R3132D37EC	Vdet-IC	3.7V±2%, -Reset PPO, -MR	SON1612-6	35vkb	VD4	7e	Ric
C37C	R3133D37EC	Vdet-IC	3.7V±2%, +Reset PPO, -MR	SON1612-6	35vkb	VD4	7e	Ric
C38	TK73238M	LVR-IC	LDO, 3.8V±2%, 100mA, +CE, Ext. transistor	SOT-23-L8	47	-	8d	Tok
C38	SN74LVC2G38DCU	CMOS-Logic	Dual 2-input NAND gate (ODO)	VSSOP-8	44Llog62	-	8d	Ti
C38	SN74LVC2G38DCT	CMOS-Logic	Dual 2-input NAND gate (ODO)	SSOP-8	47Llog62	-	8d	Ti
C38A	R1130D381A	LVR-IC	LDO, 3.8V±2%, 300mA, -CE	HSON-6	34vq	VR4	7e	Ric
C38A	R3132D38EA	Vdet-IC	3.8V±2%, -Reset ODO, -MR	SON1612-6	35vkb	VD5	7e	Ric
C38A	R3133D38EA	Vdet-IC	3.8V±2%, +Reset ODO, -MR	SON1612-6	35vkb	VD5	7e	Ric
C38B	R1130D381B	LVR-IC	LDO, 3.8V±2%, 300mA, +CE	HSON-6	34vq	VR4	7e	Ric
C38C	R3132D38EC	Vdet-IC	3.8V±2%, -Reset PPO, -MR	SON1612-6	35vkb	VD4	7e	Ric
C38C	R3133D38EC	Vdet-IC	3.8V±2%, +Reset PPO, -MR	SON1612-6	35vkb	VD4	7e	Ric
C39	TK73239M	LVR-IC	LDO, 3.9V±2%, 100mA, +CE, Ext. transistor	SOT-23-L8	47	-	8d	Tok
C39A	R1130D391A	LVR-IC	LDO, 3.9V±2%, 300mA, -CE	HSON-6	34vq	VR4	7e	Ric
C39A	R3132D39EA	Vdet-IC	3.9V±2%, -Reset ODO, -MR	SON1612-6	35vkb	VD5	7e	Ric
C39A	R3133D39EA	Vdet-IC	3.9V±2%, +Reset ODO, -MR	SON1612-6	35vkb	VD5	7e	Ric
C39B	R1130D391B	LVR-IC	LDO, 3.9V±2%, 300mA, +CE	HSON-6	34vq	VR4	7e	Ric
C39C	R3132D39EC	Vdet-IC	3.9V±2%, -Reset PPO, -MR	SON1612-6	35vkb	VD4	7e	Ric
C39C	R3133D39EC	Vdet-IC	3.9V±2%, +Reset PPO, -MR	SON1612-6	35vkb	VD4	7e	Ric
C3B	SN74LVC2G132DCU	CMOS-Logic	Dual 2-input NOR gates with Schmitt-trigger inputs	VSSOP-8	44Llog49	-	8d	Ti
C3B	SN74LVC2G132DCT	CMOS-Logic	Dual 2-input NOR gates with Schmitt-trigger inputs	SSOP-8	47Llog49	-	8d	Ti
C4	R1160D241A	LVR-IC	LDO, 2.4V±2%, 200mA, -CE, AE(mode)	SON-6	34vrc	VR10	7g	Ric
C4	RN1905AFS	Si-npn-Digi	Dual, Sw, 50V, 80mA, 50mV, 250MHz, R1/R2=2k2/47k	US6	33/TD3	-	7b	Tos
C4	TK65934M	LIN-IC	Fluorescent lamp driver, 97mA, 275Hz	SOP-6	33zi	-	7b	Tok
C40	TK73240M	LVR-IC	LDO, 4.0V±2%, 100mA, +CE, Ext. transistor	SOT-23-L8	47	-	8d	Tok
C40	SN74LVC2G240DCU	CMOS-Logic	Dual bus buffer inverted with 3-state output	VSSOP-8	44Llog67	-	8d	Ti
C40	SN74LVC2G240DCT	CMOS-Logic	Dual bus buffer inverted with 3-state output	SSOP-8	47Llog67	-	8d	Ti
C40A	R1130D401A	LVR-IC	LDO, 4V±2%, 300mA, -CE	HSON-6	34vq	VR4	7e	Ric
C40A	R3132D40EA	Vdet-IC	4.0V±2%, -Reset ODO, -MR	SON1612-6	35vkb	VD5	7e	Ric
C40A	R3133D40EA	Vdet-IC	4.0V±2%, +Reset ODO, -MR	SON1612-6	35vkb	VD5	7e	Ric
C40B	R1130D401B	LVR-IC	LDO, 4V±2%, 300mA, +CE	HSON-6	34vq	VR4	7e	Ric
C40C	R3132D40EC	Vdet-IC	4.0V±2%, -Reset PPO, -MR	SON1612-6	35vkb	VD4	7e	Ric
C40C	R3133D40EC	Vdet-IC	4.0V±2%, +Reset PPO, -MR	SON1612-6	35vkb	VD4	7e	Ric
C41	74AHCT2G241DC	CMOS-Logic	Dual bus buffer non-inverted with 3-state output	SOT765-1	47Llog60	-	8d	Phi
C41	TK73241M	LVR-IC	LDO, 4.1V±2%, 100mA, +CE, Ext. transistor	SOT-23-L8	47	-	8d	Tok
C41	SN74LVC2G241DCT	CMOS-Logic	Dual bus buffer non-inverted with 3-state output	SSOP-8	47Llog60	-	8d	Ti
C41A	R1130D411A	LVR-IC	LDO, 4.1V±2%, 300mA, -CE	HSON-6	34vq	VR4	7e	Ric
C41A	R3132D41EA	Vdet-IC	4.1V±2%, -Reset ODO, -MR	SON1612-6	35vkb	VD5	7e	Ric
C41A	R3133D41EA	Vdet-IC	4.1V±2%, +Reset ODO, -MR	SON1612-6	35vkb	VD5	7e	Ric
C41B	R1130D411B	LVR-IC	LDO, 4.1V±2%, 300mA, +CE	HSON-6	34vq	VR4	7e	Ric
C41C	R3132D41EC	Vdet-IC	4.1V±2%, -Reset PPO, -MR	SON1612-6	35vkb	VD4	7e	Ric
C41C	R3133D41EC	Vdet-IC	4.1V±2%, +Reset PPO, -MR	SON1612-6	35vkb	VD4	7e	Ric
C42	TK73242M	LVR-IC	LDO, 4.2V±2%, 100mA, +CE, Ext. transistor	SOT-23-L8	47	-	8d	Tok
C42A	R1130D421A	LVR-IC	LDO, 4.2V±2%, 300mA, -CE	HSON-6	34vq	VR4	7e	Ric
C42A	R3132D42EA	Vdet-IC	4.2V±2%, -Reset ODO, -MR	SON1612-6	35vkb	VD5	7e	Ric
C42A	R3133D42EA	Vdet-IC	4.2V±2%, +Reset ODO, -MR	SON1612-6	35vkb	VD5	7e	Ric
C42B	R1130D421B	LVR-IC	LDO, 4.2V±2%, 300mA, +CE	HSON-6	34vq	VR4	7e	Ric
C42C	R3132D42EC	Vdet-IC	4.2V±2%, -Reset PPO, -MR	SON1612-6	35vkb	VD4	7e	Ric
C42C	R3133D42EC	Vdet-IC	4.2V±2%, +Reset PPO, -MR	SON1612-6	35vkb	VD4	7e	Ric
C43	TK73243M	LVR-IC	LDO, 4.3V±2%, 100mA, +CE, Ext. transistor	SOT-23-L8	47	-	8d	Tok
C43A	R1130D431A	LVR-IC	LDO, 4.3V±2%, 300mA, -CE	HSON-6	34vq	VR4	7e	Ric
C43A	R3132D43EA	Vdet-IC	4.3V±2%, -Reset ODO, -MR	SON1612-6	35vkb	VD5	7e	Ric
C43A	R3133D43EA	Vdet-IC	4.3V±2%, +Reset ODO, -MR	SON1612-6	35vkb	VD5	7e	Ric
C43B	R1130D431B	LVR-IC	LDO, 4.3V±2%, 300mA, +CE	HSON-6	34vq	VR4	7e	Ric
C43C	R3132D43EC	Vdet-IC	4.3V±2%, -Reset PPO, -MR	SON1612-6	35vkb	VD4	7e	Ric
C43C	R3133D43EC	Vdet-IC	4.3V±2%, +Reset PPO, -MR	SON1612-6	35vkb	VD4	7e	Ric
C44	TK73244M	LVR-IC	LDO, 4.4V±2%, 100mA, +CE, Ext. transistor	SOT-23-L8	47	-	8d	Tok
C44A	R1130D441A	LVR-IC	LDO, 4.4V±2%, 300mA, -CE	HSON-6	34vq	VR4	7e	Ric
C44A	R3132D44EA	Vdet-IC	4.4V±2%, -Reset ODO, -MR	SON1612-6	35vkb	VD5	7e	Ric
C44A	R3133D44EA	Vdet-IC	4.4V±2%, +Reset ODO, -MR	SON1612-6	35vkb	VD5	7e	Ric
C44B	R1130D441B	LVR-IC	LDO, 4.4V±2%, 300mA, +CE	HSON-6	34vq	VR4	7e	Ric
C44C	R3132D44EC	Vdet-IC	4.4V±2%, -Reset PPO, -MR	SON1612-6	35vkb	VD4	7e	Ric
C44C	R3133D44EC	Vdet-IC	4.4V±2%, +Reset PPO, -MR	SON1612-6	35vkb	VD4	7e	Ric



SMD code	Type	Function	Short description	Case	Pinout	Sch.	St.	Mnf.
C45	TK73245M	LVR-IC	LDO, 4.5V±2%, 100mA, +CE, Ext. transistor	SOT-23-L8	47	-	8d	Tok
C45A	R1130D451A	LVR-IC	LDO, 4.5V±2%, 300mA, -CE	HSON-6	34vq	VR4	7e	Ric
C45A	R3132D45EA	Vdet-IC	4.5V±2%, -Reset ODO, -MR	SON1612-6	35vkb	VD5	7e	Ric
C45A	R3133D45EA	Vdet-IC	4.5V±2%, +Reset ODO, -MR	SON1612-6	35vkb	VD5	7e	Ric
C45B	R1130D451B	LVR-IC	LDO, 4.5V±2%, 300mA, +CE	HSON-6	34vq	VR4	7e	Ric
C45C	R3132D45EC	Vdet-IC	4.5V±2%, -Reset PPO, -MR	SON1612-6	35vkb	VD4	7e	Ric
C45C	R3133D45EC	Vdet-IC	4.5V±2%, +Reset PPO, -MR	SON1612-6	35vkb	VD4	7e	Ric
C46	TK73246M	LVR-IC	LDO, 4.6V±2%, 100mA, +CE, Ext. transistor	SOT-23-L8	47	-	8d	Tok
C46A	R1130D461A	LVR-IC	LDO, 4.6V±2%, 300mA, -CE	HSON-6	34vq	VR4	7e	Ric
C46A	R3132D46EA	Vdet-IC	4.6V±2%, -Reset ODO, -MR	SON1612-6	35vkb	VD5	7e	Ric
C46A	R3133D46EA	Vdet-IC	4.6V±2%, +Reset ODO, -MR	SON1612-6	35vkb	VD5	7e	Ric
C46B	R1130D461B	LVR-IC	LDO, 4.6V±2%, 300mA, +CE	HSON-6	34vq	VR4	7e	Ric
C46C	R3132D46EC	Vdet-IC	4.6V±2%, -Reset PPO, -MR	SON1612-6	35vkb	VD4	7e	Ric
C46C	R3133D46EC	Vdet-IC	4.6V±2%, +Reset PPO, -MR	SON1612-6	35vkb	VD4	7e	Ric
C47	TK73247M	LVR-IC	LDO, 4.7V±2%, 100mA, +CE, Ext. transistor	SOT-23-L8	47	-	8d	Tok
C47A	R1130D471A	LVR-IC	LDO, 4.7V±2%, 300mA, -CE	HSON-6	34vq	VR4	7e	Ric
C47A	R3132D47EA	Vdet-IC	4.7V±2%, -Reset ODO, -MR	SON1612-6	35vkb	VD5	7e	Ric
C47A	R3133D47EA	Vdet-IC	4.7V±2%, +Reset ODO, -MR	SON1612-6	35vkb	VD5	7e	Ric
C47B	R1130D471B	LVR-IC	LDO, 4.7V±2%, 300mA, +CE	HSON-6	34vq	VR4	7e	Ric
C47C	R3132D47EC	Vdet-IC	4.7V±2%, -Reset PPO, -MR	SON1612-6	35vkb	VD4	7e	Ric
C47C	R3133D47EC	Vdet-IC	4.7V±2%, +Reset PPO, -MR	SON1612-6	35vkb	VD4	7e	Ric
C48	TK73248M	LVR-IC	LDO, 4.8V±2%, 100mA, +CE, Ext. transistor	SOT-23-L8	47	-	8d	Tok
C48A	R1130D481A	LVR-IC	LDO, 4.8V±2%, 300mA, -CE	HSON-6	34vq	VR4	7e	Ric
C48A	R3132D48EA	Vdet-IC	4.8V±2%, -Reset ODO, -MR	SON1612-6	35vkb	VD5	7e	Ric
C48A	R3133D48EA	Vdet-IC	4.8V±2%, +Reset ODO, -MR	SON1612-6	35vkb	VD5	7e	Ric
C48B	R1130D481B	LVR-IC	LDO, 4.8V±2%, 300mA, +CE	HSON-6	34vq	VR4	7e	Ric
C48C	R3132D48EC	Vdet-IC	4.8V±2%, -Reset PPO, -MR	SON1612-6	35vkb	VD4	7e	Ric
C48C	R3133D48EC	Vdet-IC	4.8V±2%, +Reset PPO, -MR	SON1612-6	35vkb	VD4	7e	Ric
C49	TK73249M	LVR-IC	LDO, 4.9V±2%, 100mA, +CE, Ext. transistor	SOT-23-L8	47	-	8d	Tok
C49A	R1130D491A	LVR-IC	LDO, 4.9V±2%, 300mA, -CE	HSON-6	34vq	VR4	7e	Ric
C49A	R3132D49EA	Vdet-IC	4.9V±2%, -Reset ODO, -MR	SON1612-6	35vkb	VD5	7e	Ric
C49A	R3133D49EA	Vdet-IC	4.9V±2%, +Reset ODO, -MR	SON1612-6	35vkb	VD5	7e	Ric
C49B	R1130D491B	LVR-IC	LDO, 4.9V±2%, 300mA, +CE	HSON-6	34vq	VR4	7e	Ric
C49C	R3132D49EC	Vdet-IC	4.9V±2%, -Reset PPO, -MR	SON1612-6	35vkb	VD4	7e	Ric
C49C	R3133D49EC	Vdet-IC	4.9V±2%, +Reset PPO, -MR	SON1612-6	35vkb	VD4	7e	Ric
C4A	S-812C20BPI-C4ATFG	LVR-IC	2.0V±2%, 50mA, +CE	SNT-6A	35rx	VR4	7g	Sii
C4B	S-812C21BPI-C4BTFG	LVR-IC	2.1V±2%, 50mA, +CE	SNT-6A	35rx	VR4	7g	Sii
C4C	S-812C22BPI-C4CTFG	LVR-IC	2.2V±2%, 50mA, +CE	SNT-6A	35rx	VR4	7g	Sii
C4D	S-812C23BPI-C4DTFG	LVR-IC	2.3V±2%, 50mA, +CE	SNT-6A	35rx	VR4	7g	Sii
C4E	S-812C24BPI-C4ETFG	LVR-IC	2.4V±2%, 50mA, +CE	SNT-6A	35rx	VR4	7g	Sii
C4F	S-812C25BPI-C4FTFG	LVR-IC	2.5V±2%, 50mA, +CE	SNT-6A	35rx	VR4	7g	Sii
C4G	S-812C26BPI-C4GTFG	LVR-IC	2.6V±2%, 50mA, +CE	SNT-6A	35rx	VR4	7g	Sii
C4H	S-812C27BPI-C4HTFG	LVR-IC	2.7V±2%, 50mA, +CE	SNT-6A	35rx	VR4	7g	Sii
C4I	S-812C28BPI-C4ITFG	LVR-IC	2.8V±2%, 50mA, +CE	SNT-6A	35rx	VR4	7g	Sii
C4J	S-812C29BPI-C4JTFG	LVR-IC	2.9V±2%, 50mA, +CE	SNT-6A	35rx	VR4	7g	Sii
C4K	S-812C30BPI-C4KTFG	LVR-IC	3.0V±2%, 50mA, +CE	SNT-6A	35rx	VR4	7g	Sii
C4L	S-812C31BPI-C4LTFG	LVR-IC	3.1V±2%, 50mA, +CE	SNT-6A	35rx	VR4	7g	Sii
C4M	S-812C32BPI-C4MTFG	LVR-IC	3.2V±2%, 50mA, +CE	SNT-6A	35rx	VR4	7g	Sii
C4N	S-812C33BPI-C4NTFG	LVR-IC	3.3V±2%, 50mA, +CE	SNT-6A	35rx	VR4	7g	Sii
C4O	S-812C34BPI-C4OTFG	LVR-IC	3.4V±2%, 50mA, +CE	SNT-6A	35rx	VR4	7g	Sii
C4P	S-812C35BPI-C4PTFG	LVR-IC	3.5V±2%, 50mA, +CE	SNT-6A	35rx	VR4	7g	Sii
C4Q	MAX9722BEUE	LIN-IC	AF PA, 2.4..5.5V, 2x125mW(3V/32Q), shutdown	TSSOP-16	60	-	8d	Max
C4Q	S-812C36BPI-C4QTFG	LVR-IC	3.6V±2%, 50mA, +CE	SNT-6A	35rx	VR4	7g	Sii
C4R	S-812C37BPI-C4RTFG	LVR-IC	3.7V±2%, 50mA, +CE	SNT-6A	35rx	VR4	7g	Sii
C4S	S-812C38BPI-C4STFG	LVR-IC	3.8V±2%, 50mA, +CE	SNT-6A	35rx	VR4	7g	Sii
C4T	S-812C39BPI-C4TTFG	LVR-IC	3.9V±2%, 50mA, +CE	SNT-6A	35rx	VR4	7g	Sii
C4U	S-812C40BPI-C4UTFG	LVR-IC	4.0V±2%, 50mA, +CE	SNT-6A	35rx	VR4	7g	Sii
C4V	S-812C41BPI-C4VTFG	LVR-IC	4.1V±2%, 50mA, +CE	SNT-6A	35rx	VR4	7g	Sii
C4W	S-812C42BPI-C4WTFG	LVR-IC	4.2V±2%, 50mA, +CE	SNT-6A	35rx	VR4	7g	Sii
C4X	S-812C43BPI-C4XTFG	LVR-IC	4.3V±2%, 50mA, +CE	SNT-6A	35rx	VR4	7g	Sii
C4Y	S-812C44BPI-C4YTFG	LVR-IC	4.4V±2%, 50mA, +CE	SNT-6A	35rx	VR4	7g	Sii
C4Z	S-812C45BPI-C4ZTFG	LVR-IC	4.5V±2%, 50mA, +CE	SNT-6A	35rx	VR4	7g	Sii
C5	LM4665MM	LIN-IC	AF PA, BTL, class-D, 2.7..5.5V, 1W(5V/8Q), shutdown	SOP-10	60	AFP5	-	Nsc
C5	R1160D251A	LVR-IC	LDO, 2.5V±2%, 200mA, -CE, AE(mode)	SON-6	34vrc	VR10	7g	Ric
C5	RN1906AFS	Si-nprn-Digi	Dual, Sw, 50V, 80mA, 50mW, 250MHz, R1/R2=4k7/47k	US6	33/TD3	-	7b	Tos
C5	TK65935M	LIN-IC	Fluorescent lamp driver, 97mA, 300Hz	SOP-6	33zi	-	7b	Tok
C50	TK73250M	LVR-IC	LDO, 5.0V±2%, 100mA, +CE, Ext. transistor	SOT-23-L8	47	-	8d	Tok
C50A	R1130D501A	LVR-IC	LDO, 5V±2%, 300mA, -CE	HSON-6	34vq	VR4	7e	Ric
C50A	R3132D50EA	Vdet-IC	5.0V±2%, -Reset ODO, -MR	SON1612-6	35vkb	VD5	7e	Ric
C50A	R3133D50EA	Vdet-IC	5.0V±2%, +Reset ODO, -MR	SON1612-6	35vkb	VD5	7e	Ric



SMD code	Type	Function	Short description	Case	Pinout	Sch.	St.	Mnf.
C50B	R1130D501B	LVR-IC	LDO, 5V±2%, 300mA, +CE	HSON-6	34vq	VR4	7e	Ric
C50C	R3132D50EC	Vdet-IC	5.0V±2%, -Reset PPO, -MR	SON1612-6	35vkb	VD4	7e	Ric
C50C	R3133D50EC	Vdet-IC	5.0V±2%, +Reset PPO, -MR	SON1612-6	35vkb	VD4	7e	Ric
C53_	SN74LVC2G53DCU	CMOS-Logic	2-channel analog multiplexer/demultiplexer	VSSOP-8	44L.og58	-	8d	Ti
C53_	SN74LVC2G53DCT	CMOS-Logic	2-channel analog multiplexer/demultiplexer	SSOP-8	47L.og58	-	8d	Ti
C55	TK73255M	LVR-IC	LDO, 5.5V±2%, 100mA, +CE, Ext. transistor	SOT-23-L8	47	-	8d	Tok
C57_	SN74LVC2G157DCU	CMOS-Logic	2-input multiplexer	VSSOP-8	44L.og66	-	8d	Ti
C57_	SN74LVC2G157DCT	CMOS-Logic	2-input multiplexer	SSOP-8	47L.og66	-	8d	Ti
C5A	S-812C46BPI-C5ATFG	LVR-IC	4.6V±2%, 50mA, +CE	SNT-6A	35rx	VR4	7g	Sii
C5B	S-812C47BPI-C5BTFG	LVR-IC	4.7V±2%, 50mA, +CE	SNT-6A	35rx	VR4	7g	Sii
C5C	S-812C48BPI-C5CTFG	LVR-IC	4.8V±2%, 50mA, +CE	SNT-6A	35rx	VR4	7g	Sii
C5D	S-812C49BPI-C5DTFG	LVR-IC	4.9V±2%, 50mA, +CE	SNT-6A	35rx	VR4	7g	Sii
C5E	S-812C50BPI-C5ETFG	LVR-IC	5.0V±2%, 50mA, +CE	SNT-6A	35rx	VR4	7g	Sii
C5F	S-812C51BPI-C5FTFG	LVR-IC	5.1V±2%, 50mA, +CE	SNT-6A	35rx	VR4	7g	Sii
C5G	S-812C52BPI-C5GTFG	LVR-IC	5.2V±2%, 50mA, +CE	SNT-6A	35rx	VR4	7g	Sii
C5H	S-812C53BPI-C5HTFG	LVR-IC	5.3V±2%, 50mA, +CE	SNT-6A	35rx	VR4	7g	Sii
C5I	S-812C54BPI-C5ITFG	LVR-IC	5.4V±2%, 50mA, +CE	SNT-6A	35rx	VR4	7g	Sii
C5J	S-812C55BPI-C5JTFG	LVR-IC	5.5V±2%, 50mA, +CE	SNT-6A	35rx	VR4	7g	Sii
C5K	S-812C56BPI-C5KTFG	LVR-IC	5.6V±2%, 50mA, +CE	SNT-6A	35rx	VR4	7g	Sii
C5L	S-812C57BPI-C5LTFG	LVR-IC	5.7V±2%, 50mA, +CE	SNT-6A	35rx	VR4	7g	Sii
C5M	S-812C58BPI-C5MTFG	LVR-IC	5.8V±2%, 50mA, +CE	SNT-6A	35rx	VR4	7g	Sii
C5N	S-812C59BPI-C5NTFG	LVR-IC	5.9V±2%, 50mA, +CE	SNT-6A	35rx	VR4	7g	Sii
C5O	S-812C60BPI-C5OTFG	LVR-IC	6.0V±2%, 50mA, +CE	SNT-6A	35rx	VR4	7g	Sii
C6	R1160D261A	LVR-IC	LDO, 2.6V±2%, 200mA, -CE, AE(mode)	SON-6	34vrc	VR10	7g	Ric
C6	RN1907AFS	Si-npn-Digi	Dual, Sw, 50V, 80mA, 50mW, 250MHz, R1/R2=10k/47k	FS6	35/TD3	-	7b	Tos
C6	TK65936M	LIN-IC	Fluorescent lamp driver, 97mA, 325Hz	SOP-6	33zi	-	7b	Tok
C60A	R3132D23EA2	Vdet-IC	2.32V±2%, -Reset ODO, -MR	SON1612-6	35vkb	VD5	7e	Ric
C60A	R3133D23EA2	Vdet-IC	2.32V±2%, +Reset ODO, -MR	SON1612-6	35vkb	VD5	7e	Ric
C60C	R3132D23EC2	Vdet-IC	2.32V±2%, -Reset PPO, -MR	SON1612-6	35vkb	VD4	7e	Ric
C60C	R3133D23EC2	Vdet-IC	2.32V±2%, +Reset PPO, -MR	SON1612-6	35vkb	VD4	7e	Ric
C61A	R3132D26EA3	Vdet-IC	2.63V±2%, -Reset ODO, -MR	SON1612-6	35vkb	VD5	7e	Ric
C61A	R3133D26EA3	Vdet-IC	2.63V±2%, +Reset ODO, -MR	SON1612-6	35vkb	VD5	7e	Ric
C61C	R3132D26EC3	Vdet-IC	2.63V±2%, -Reset PPO, -MR	SON1612-6	35vkb	VD4	7e	Ric
C61C	R3133D26EC3	Vdet-IC	2.63V±2%, +Reset PPO, -MR	SON1612-6	35vkb	VD4	7e	Ric
C62A	R3132D29EA3	Vdet-IC	2.93V±2%, -Reset ODO, -MR	SON1612-6	35vkb	VD5	7e	Ric
C62A	R3133D29EA3	Vdet-IC	2.93V±2%, +Reset ODO, -MR	SON1612-6	35vkb	VD5	7e	Ric
C62C	R3132D29EC3	Vdet-IC	2.93V±2%, -Reset PPO, -MR	SON1612-6	35vkb	VD4	7e	Ric
C62C	R3133D29EC3	Vdet-IC	2.93V±2%, +Reset PPO, -MR	SON1612-6	35vkb	VD4	7e	Ric
C63	DCX114EK	Si-n/p-Digi	Dual, Sw, 50V, 100mA, 300mW, R1/R2=10k/10k	SC-74R	33/TD2	-	7l	Di
C63A	R3132D30EA8	Vdet-IC	3.08V±2%, -Reset ODO, -MR	SON1612-6	35vkb	VD5	7e	Ric
C63A	R3133D30EA8	Vdet-IC	3.08V±2%, +Reset ODO, -MR	SON1612-6	35vkb	VD5	7e	Ric
C63C	R3132D30EC8	Vdet-IC	3.08V±2%, -Reset PPO, -MR	SON1612-6	35vkb	VD5	7e	Ric
C63C	R3133D30EC8	Vdet-IC	3.08V±2%, +Reset PPO, -MR	SON1612-6	35vkb	VD4	7e	Ric
C64A	R3132D43EA8	Vdet-IC	4.38V±2%, -Reset ODO, -MR	SON1612-6	35vkb	VD5	7e	Ric
C64A	R3133D43EA8	Vdet-IC	4.38V±2%, +Reset ODO, -MR	SON1612-6	35vkb	VD5	7e	Ric
C64C	R3132D43EC8	Vdet-IC	4.38V±2%, -Reset PPO, -MR	SON1612-6	35vkb	VD4	7e	Ric
C64C	R3133D43EC8	Vdet-IC	4.38V±2%, +Reset PPO, -MR	SON1612-6	35vkb	VD4	7e	Ric
C65A	R3132D46EA3	Vdet-IC	4.63V±2%, -Reset ODO, -MR	SON1612-6	35vkb	VD5	7e	Ric
C65A	R3133D46EA3	Vdet-IC	4.63V±2%, +Reset ODO, -MR	SON1612-6	35vkb	VD5	7e	Ric
C65C	R3132D46EC3	Vdet-IC	4.63V±2%, -Reset PPO, -MR	SON1612-6	35vkb	VD4	7e	Ric
C65C	R3133D46EC3	Vdet-IC	4.63V±2%, +Reset PPO, -MR	SON1612-6	35vkb	VD4	7e	Ric
C66_	SN74LVC2G66DCU	CMOS-Logic	2-channel analog switch	VSSOP-8	44L.og68	-	8d	Ti
C66_	SN74LVC2G66DCT	CMOS-Logic	2-channel analog switch	SSOP-8	47L.og68	-	8d	Ti
C7	R1160D271A	LVR-IC	LDO, 2.7V±2%, 200mA, -CE, AE(mode)	SON-6	34vrc	VR10	7g	Ric
C7	RN1908AFS	Si-npn-Digi	Dual, Sw, 50V, 80mA, 50mW, 250MHz, R1/R2=22k/47k	FS6	35/TD3	-	7b	Tos
C7	TK65937M	LIN-IC	Fluorescent lamp driver, 97mA, 350Hz	SOP-6	33zi	-	7b	Tok
C7_	SN74LVC2G17DCK	CMOS-Logic	Dual Schmitt-trigger buffers	SC-70-6	33L.og27	-	7d	Ti
C70	DCX143TK	Si-n/p-Digi	Dual, Sw, 50V, 100mA, 300mW, R1=4.7k	SC-74R	33/TD2	-	7l	Di
C70	TK73270M	LVR-IC	LDO, 7.0V±2%, 100mA, +CE, Ext. transistor	SOT-23-L8	47	-	8d	Tok
C71	DCX114TK	Si-n/p-Digi	Dual, Sw, 50V, 100mA, 300mW, R1=10k	SC-74R	33/TD2	-	7l	Di
C8	R1160D281A	LVR-IC	LDO, 2.8V±2%, 200mA, -CE, AE(mode)	SON-6	34vrc	VR10	7g	Ric
C8	RN1909AFS	Si-npn-Digi	Dual, Sw, 50V, 80mA, 50mW, 250MHz, R1/R2=47k/22k	FS6	35/TD3	-	7b	Tos
C8	TK65938M	LIN-IC	Fluorescent lamp driver, 97mA, 375Hz	SOP-6	33zi	-	7b	Tok
C80	TK73280M	LVR-IC	LDO, 8.0V±2%, 100mA, +CE, Ext. transistor	SOT-23-L8	47	-	8d	Tok
C81	DCX122LH	Si-n/p-Digi	Dual, Sw, 50V, 100mA, 150mW, R1/R2=0.22k/10k	SOT-563	35/TD2	-	7l	Di
C81	DCX122LU	Si-n/p-Digi	Dual, Sw, 50V, 100mA, 200mW, R1/R2=0.22k/10k	SOT-363	33/TD2	-	7l	Di
C82	DCX142JU	Si-n/p-Digi	Dual, Sw, 50V, 100mA, 200mW, R1/R2=0.47k/10k	SOT-363	33/TD2	-	7l	Di
C83	DCX122TH	Si-n/p-Digi	Dual, Sw, 50V, 100mA, 150mW, R1=0.22k	SOT-563	35/TD2	-	7l	Di
C83	DCX122TU	Si-n/p-Digi	Dual, Sw, 50V, 100mA, 200mW, R1=0.22k	SOT-363	33/TD2	-	7l	Di
C84	DCX142TH	Si-n/p-Digi	Dual, Sw, 50V, 100mA, 150mW, R1=0.47k	SOT-563	35/TD2	-	7l	Di



SMD code	Type	Function	Short description	Case	Pinout	Sch.	St.	Mnf.
C84	DCX142TU	Si-n/p-Digi	Dual, Sw, 50V, 100mA, 200mW, R1=0.47k	SOT-363	33/TD2	-	7I	Di
C9	R1160D291A	LVR-IC	LDO, 2.9V±2%, 200mA, -CE, AE(mode)	SON-6	34wrc	VR10	7g	Ric
C9	RN1910AFS	Si-npn-Digi	Dual, Sw, 50V, 80mA, 50mW, 250MHz, R1=4k7	FS6	35/TD3	-	7b	Tos
C9	TK65939M	LIN-IC	Fluorescent lamp driver, 97mA, 400Hz	SOP-6	33zi	-	7b	Tok
C9_	SN74LVC2G34DCK	CMOS-Logic	Dual non-inverter buffers	SC-70-6	33Llog23	-	7d	Ti
C9_	SN74LVC2G34DRL	CMOS-Logic	Dual non-inverter buffers	SOT-563-6	35Llog23	-	7d	Ti
CA	R5220D101A	DC/DC-IC	PWM step-down, +CE, Vdc=Vldo=1V	SON-6	34dc3	DC8	7g	Ric
CA	RP152N001A	LVR-IC	LDO, Dual out, Vout1/Vout2=2.8V/2.8V±1%, 150mA, +CE	SOT-23-6	33x5	VR19	7d	Ric
CA3_	SN74LVC1G373DDBV	CMOS-Logic	D-type transparent latch with 3-state output	SOT-23-6	33Llog35	-	7d	Ti
CB	BH15MA3WHFV	LVR-IC	LDO, 1.5V, 150mA, +CE	HVSO6F6	35w5	VR7	7i	Rhm
CB	R5220D111A	DC/DC-IC	PWM step-down, +CE, Vdc=Vldo=1.1V	SON-6	34dc3	DC8	7g	Ric
CB	RP152N002A	LVR-IC	LDO, Dual out, Vout1/Vout2=1.8V/2.8V±1%, 150mA, +CE	SOT-23-6	33x5	VR19	7d	Ric
CC	BH18MA3WHFV	LVR-IC	LDO, 1.8V, 150mA, +CE	HVSO6F6	35w5	VR7	7i	Rhm
CC	R5220D121A	DC/DC-IC	PWM step-down, +CE, Vdc=Vldo=1.2V	SON-6	34dc3	DC8	7g	Ric
CC	RP152N003A	LVR-IC	LDO, Dual out, Vout1/Vout2=1.5V/2.8V±1%, 150mA, +CE	SOT-23-6	33x5	VR19	7d	Ric
CC_	SN74LVC2G04DRL	CMOS-Logic	Dual inverters	SOT-563-6	35Llog24	-	7d	Ti
CD	BH25MA3WHFV	LVR-IC	LDO, 2.5V, 150mA, +CE	HVSO6F6	35w5	VR7	7i	Rhm
CD	R5220D131A	DC/DC-IC	PWM step-down, +CE, Vdc=Vldo=1.3V	SON-6	34dc3	DC8	7g	Ric
CD	RP152N004A	LVR-IC	LDO, Dual out, Vout1/Vout2=1.2V/1.8V±1%, 150mA, +CE	SOT-23-6	33x5	VR19	7d	Ric
CD6	CIMD6A	Si-n/p-Digi	Dual, Sw, 50V, 100mA, 350mW, 250MHz, R1=4.7k	SOT-26R	33/TD2	-	7d	Cen
CDA1	CMEDA-6i	Si-diode	Quad, Sw, 60V, 250mA, 350mW, Vf<1V(10mA), <3pF	SOT-28	47	-	7j	Cen
CE	BH28MA3WHFV	LVR-IC	LDO, 2.8V, 150mA, +CE	HVSO6F6	35w5	VR7	7i	Rhm
CE	R5220D141A	DC/DC-IC	PWM step-down, +CE, Vdc=Vldo=1.4V	SON-6	34dc3	DC8	7g	Ric
CE	RP152N005A	LVR-IC	LDO, Dual out, Vout1/Vout2=3.3V/1.2V±1%, 150mA, +CE	SOT-23-6	33x5	VR19	7d	Ric
CF	BH29MA3WHFV	LVR-IC	LDO, 2.9V, 150mA, +CE	HVSO6F6	35w5	VR7	7i	Rhm
CF	R5220D151A	DC/DC-IC	PWM step-down, +CE, Vdc=Vldo=1.5V	SON-6	34dc3	DC8	7g	Ric
CF	RN1911AFS	Si-npn-Digi	Dual, Sw, 50V, 80mA, 50mW, 250MHz, R1=10k	FS6	35/TD3	-	7b	Tos
CF	RP152N006A	LVR-IC	LDO, Dual out, Vout1/Vout2=3.3V/1.8V±1%, 150mA, +CE	SOT-23-6	33x5	VR19	7d	Ric
CF_	SN74LVC2G14DCK	CMOS-Logic	Dual Schmitt-trigger inverter buffers	SC-70-6	33Llog34	-	7d	Ti
CG	BH30MA3WHFV	LVR-IC	LDO, 3.0V, 150mA, +CE	HVSO6F6	35w5	VR7	7i	Rhm
CG	R5220D161A	DC/DC-IC	PWM step-down, +CE, Vdc=Vldo=1.6V	SON-6	34dc3	DC8	7g	Ric
CG	RP152N007A	LVR-IC	LDO, Dual out, Vout1/Vout2=2.85V/2.85V±1%, 150mA, +CE	SOT-23-6	33x5	VR19	7d	Ric
CH	BH31MA3WHFV	LVR-IC	LDO, 3.1V, 150mA, +CE	HVSO6F6	35w5	VR7	7i	Rhm
CH	R5220D171A	DC/DC-IC	PWM step-down, +CE, Vdc=Vldo=1.7V	SON-6	34dc3	DC8	7g	Ric
CH	RP152N008A	LVR-IC	LDO, Dual out, Vout1/Vout2=3.0V/2.8V±1%, 150mA, +CE	SOT-23-6	33x5	VR19	7d	Ric
CJ	BH33MA3WHFV	LVR-IC	LDO, 3.3V, 150mA, +CE	HVSO6F6	35w5	VR7	7i	Rhm
CJ	R5220D181A	DC/DC-IC	PWM step-down, +CE, Vdc=Vldo=1.8V	SON-6	34dc3	DC8	7g	Ric
CJ	RP152N009A	LVR-IC	LDO, Dual out, Vout1/Vout2=3.0V/2.8V±1%, 150mA, +CE	SOT-23-6	33x5	VR19	7d	Ric
CK	HSMS-282K	Si-diode	2x Schottky, RF, 15V, 1A, Vf<0.34V(1mA), <1pF, 12Q(5mA)	SOT-363	33dw	-	7b	Agi
CK	R5220D191A	DC/DC-IC	PWM step-down, +CE, Vdc=Vldo=1.9V	SON-6	34dc3	DC8	7g	Ric
CK	RP152N010A	LVR-IC	LDO, Dual out, Vout1/Vout2=3.0V/1.8V±1%, 150mA, +CE	SOT-23-6	33x5	VR19	7d	Ric
CL	HSMS-282L	Si-diode	3x Schottky, RF, 15V, 1A, Vf<0.34V(1mA), <1pF, 12Q(5mA)	SOT-363	33dd	-	7b	Agi
CL	R5220D201A	DC/DC-IC	PWM step-down, +CE, Vdc=Vldo=2V	SON-6	34dc3	DC8	7g	Ric
CL	RP152N011A	LVR-IC	LDO, Dual out, Vout1/Vout2=1.8V/1.5V±1%, 150mA, +CE	SOT-23-6	33x5	VR19	7d	Ric
CM	R5220D211A	DC/DC-IC	PWM step-down, +CE, Vdc=Vldo=2.1V	SON-6	34dc3	DC8	7g	Ric
CM	RP152N012A	LVR-IC	LDO, Dual out, Vout1/Vout2=2.8V/2.6V±1%, 150mA, +CE	SOT-23-6	33x5	VR19	7d	Ric
CN	MCP73826-4.1	BM-IC	Li-Ion, charge management, Vc=4.1V±1%	SOT-23-6	33yh	VBM2	7d	Mcc
CN	R5220D221A	DC/DC-IC	PWM step-down, +CE, Vdc=Vldo=2.2V	SON-6	34dc3	DC8	7g	Ric
CN	RP152N013A	LVR-IC	LDO, Dual out, Vout1/Vout2=3.3V/2.8V±1%, 150mA, +CE	SOT-23-6	33x5	VR19	7d	Ric
CN_	SN74LVC2G126DCU	CMOS-Logic	Bus buffer gate with 3-state output	VSSOP-8	44Llog13	-	8d	Ti
CP	HSMS-282P	Si-diode	4x Schottky, RF, 15V, 1A, Vf<0.34V(1mA), <1pF, 12Q(5mA)	SOT-363	33bx	-	7b	Agi
CP	MCP73826-4.2	BM-IC	Li-Ion, charge management, Vc=4.2V±1%	SOT-23-6	33yh	VBM2	7d	Mcc
CP	R5220D231A	DC/DC-IC	PWM step-down, +CE, Vdc=Vldo=2.3V	SON-6	34dc3	DC8	7g	Ric
CP	RP152N014A	LVR-IC	LDO, Dual out, Vout1/Vout2=3.3V/3.3V±1%, 150mA, +CE	SOT-23-6	33x5	VR19	7d	Ric
CQ	R5220D241A	DC/DC-IC	PWM step-down, +CE, Vdc=Vldo=2.4V	SON-6	34dc3	DC8	7g	Ric
CQ	RP152N015A	LVR-IC	LDO, Dual out, Vout1/Vout2=1.5V/2.5V±1%, 150mA, +CE	SOT-23-6	33x5	VR19	7d	Ric
CR	R5220D251A	DC/DC-IC	PWM step-down, +CE, Vdc=Vldo=2.5V	SON-6	34dc3	DC8	7g	Ric
CR	RP152N016A	LVR-IC	LDO, Dual out, Vout1/Vout2=1.5V/3.0V±1%, 150mA, +CE	SOT-23-6	33x5	VR19	7d	Ric
CS	R5220D261A	DC/DC-IC	PWM step-down, +CE, Vdc=Vldo=2.6V	SON-6	34dc3	DC8	7g	Ric
CS	RP152N017A	LVR-IC	LDO, Dual out, Vout1/Vout2=2.5V/3.0V±1%, 150mA, +CE	SOT-23-6	33x5	VR19	7d	Ric
CT	R5220D271A	DC/DC-IC	PWM step-down, +CE, Vdc=Vldo=2.7V	SON-6	34dc3	DC8	7g	Ric
CT	RP152N018A	LVR-IC	LDO, Dual out, Vout1/Vout2=1.8V/1.8V±1%, 150mA, +CE	SOT-23-6	33x5	VR19	7d	Ric
CT_	SN74LVC2G06DCK	CMOS-Logic	Dual inverter buffers/drivers (ODO)	SC-70-6	33Llog25	-	7d	Ti
CU	R5220D281A	DC/DC-IC	PWM step-down, +CE, Vdc=Vldo=2.8V	SON-6	34dc3	DC8	7g	Ric
CU	RP152N019A	LVR-IC	LDO, Dual out, Vout1/Vout2=1.5V/2.6V±1%, 150mA, +CE	SOT-23-6	33x5	VR19	7d	Ric
CU_	SN74LVC1G27DCK	CMOS-Logic	3-input NOR gate	SC-70-6	33Llog31	-	7d	Ti
CV	R5220D291A	DC/DC-IC	PWM step-down, +CE, Vdc=Vldo=2.9V	SON-6	34dc3	DC8	7g	Ric
CV	RP152N020A	LVR-IC	LDO, Dual out, Vout1/Vout2=2.8V/1.8V±1%, 150mA, +CE	SOT-23-6	33x5	VR19	7d	Ric
CV_	SN74LVC2G07DCK	CMOS-Logic	Dual noninverting buffers/drivers (ODO)	SC-70-6	33Llog26	-	7d	Ti
CW	R5220D012A	DC/DC-IC	PWM step-down, +CE, Vdc=1.2V, Vldo=1.1V	SON-6	34dc3	DC8	7g	Ric



SMD code	Type	Function	Short description	Case	Pinout	Sch.	St.	Mnf.
CW	RP152N021A	LVR-IC	LDO, Dual out, $V_{out1}/V_{out2}=1.2V/2.8V\pm1\%$, 150mA, +CE	SOT-23-6	33x5	VR19	7d	Ric
CW3	CMLZDA2V4	Z-diode	Dual (CA), 2.2..2.6V, $Z_{t}<100\Omega$, 63mA, 250mW	SOT-563	35ed	-	7c	Cen
CW4	CMLZDA2V7	Z-diode	Dual (CA), 2.5..2.9V, $Z_{t}<100\Omega$, 57mA, 250mW	SOT-563	35ed	-	7c	Cen
CW5	CMLZDA3V0	Z-diode	Dual (CA), 2.8..3.2V, $Z_{t}<95\Omega$, 54mA, 250mW	SOT-563	35ed	-	7c	Cen
CW6	CMLZDA3V3	Z-diode	Dual (CA), 3.1..3.5V, $Z_{t}<95\Omega$, 47mA, 250mW	SOT-563	35ed	-	7c	Cen
CW7	CMLZDA3V6	Z-diode	Dual (CA), 3.4..3.8V, $Z_{t}<95\Omega$, 46mA, 250mW	SOT-563	35ed	-	7c	Cen
CW8	CMLZDA3V9	Z-diode	Dual (CA), 3.7..4.1V, $Z_{t}<90\Omega$, 43mA, 250mW	SOT-563	35ed	-	7c	Cen
CW9	CMLZDA4V3	Z-diode	Dual (CA), 4.0..4.6V, $Z_{t}<90\Omega$, 40mA, 250mW	SOT-563	35ed	-	7c	Cen
CX	R5220D022A	DC/DC-IC	PWM step-down, +CE, $V_{dc}=1.5V$, $V_{ldo}=1.1V$	SON-6	34dc3	DC8	7g	Ric
CX	RP152N022A	LVR-IC	LDO, Dual out, $V_{out1}/V_{out2}=2.8V/1.2V\pm1\%$, 150mA, +CE	SOT-23-6	33x5	VR19	7d	Ric
CY	R5220D032A	DC/DC-IC	PWM step-down, +CE, $V_{dc}=1.3V$, $V_{ldo}=1.05V$	SON-6	34dc3	DC8	7g	Ric
CY	RP152N023A	LVR-IC	LDO, Dual out, $V_{out1}/V_{out2}=2.5V/2.5V\pm1\%$, 150mA, +CE	SOT-23-6	33x5	VR19	7d	Ric
CY1	CMLZDA11V	Z-diode	Dual (CA), 10.4..11.6V, $Z_{t}<20\Omega$, 15mA, 250mW	SOT-563	35ed	-	7c	Cen
CY2	CMLZDA12V	Z-diode	Dual (CA), 11.4..12.7V, $Z_{t}<25\Omega$, 13mA, 250mW	SOT-563	35ed	-	7c	Cen
CY3	CMLZDA13V	Z-diode	Dual (CA), 12.4..14.1V, $Z_{t}<30\Omega$, 12mA, 250mW	SOT-563	35ed	-	7c	Cen
CY4	CMLZDA15V	Z-diode	Dual (CA), 13.8..15.6V, $Z_{t}<30\Omega$, 11mA, 250mW	SOT-563	35ed	-	7c	Cen
CY5	CMLZDA16V	Z-diode	Dual (CA), 15.3..17.1V, $Z_{t}<40\Omega$, 10mA, 250mW	SOT-563	35ed	-	7c	Cen
CY6	CMLZDA18V	Z-diode	Dual (CA), 16.8..19.1V, $Z_{t}<45\Omega$, 9.2mA, 250mW	SOT-563	35ed	-	7c	Cen
CY7	CMLZDA20V	Z-diode	Dual (CA), 18.8..21.2V, $Z_{t}<55\Omega$, 8.3mA, 250mW	SOT-563	35ed	-	7c	Cen
CY8	CMLZDA22V	Z-diode	Dual (CA), 20.8..23.3V, $Z_{t}<55\Omega$, 7.6mA, 250mW	SOT-563	35ed	-	7c	Cen
CY9	CMLZDA24V	Z-diode	Dual (CA), 22.8..25.6V, $Z_{t}<70\Omega$, 7.0mA, 250mW	SOT-563	35ed	-	7c	Cen
CYA	CMLZDA27V	Z-diode	Dual (CA), 25.1..28.9V, $Z_{t}<80\Omega$, 6.2mA, 250mW	SOT-563	35ed	-	7c	Cen
CYB	CMLZDA30V	Z-diode	Dual (CA), 28.0..32.0V, $Z_{t}<80\Omega$, 5.6mA, 250mW	SOT-563	35ed	-	7c	Cen
CYC	CMLZDA33V	Z-diode	Dual (CA), 31.0..35.0V, $Z_{t}<80\Omega$, 5.0mA, 250mW	SOT-563	35ed	-	7c	Cen
CYD	CMLZDA36V	Z-diode	Dual (CA), 34.0..38.0V, $Z_{t}<90\Omega$, 4.6mA, 250mW	SOT-563	35ed	-	7c	Cen
CYE	CMLZDA39V	Z-diode	Dual (CA), 37.0..41.0V, $Z_{t}<130\Omega$, 4.3mA, 250mW	SOT-563	35ed	-	7c	Cen
CYF	CMLZDA43V	Z-diode	Dual (CA), 40.0..46.0V, $Z_{t}<150\Omega$, 3.9mA, 250mW	SOT-563	35ed	-	7c	Cen
CYH	CMLZDA47V	Z-diode	Dual (CA), 44.0..50.0V, $Z_{t}<170\Omega$, 3.5mA, 250mW	SOT-563	35ed	-	7c	Cen
CZ	R5220D042A	DC/DC-IC	PWM step-down, +CE, $V_{dc}=1.3V$, $V_{ldo}=1.1V$	SON-6	34dc3	DC8	7g	Ric
CZ	RP152N024A	LVR-IC	LDO, Dual out, $V_{out1}/V_{out2}=3.3V/3.0V\pm1\%$, 150mA, +CE	SOT-23-6	33x5	VR19	7d	Ric
CZ1	CMLZDA4V7	Z-diode	Dual (CA), 4.4..5.0V, $Z_{t}<80\Omega$, 38mA, 250mW	SOT-563	35ed	-	7c	Cen
CZ2	CMLZDA5V1	Z-diode	Dual (CA), 4.8..5.4V, $Z_{t}<60\Omega$, 35mA, 250mW	SOT-563	35ed	-	7c	Cen
CZ3	CMLZDA5V6	Z-diode	Dual (CA), 5.2..6.0V, $Z_{t}<40\Omega$, 32mA, 250mW	SOT-563	35ed	-	7c	Cen
CZ4	CMLZDA6V2	Z-diode	Dual (CA), 5.8..6.6V, $Z_{t}<10\Omega$, 28mA, 250mW	SOT-563	35ed	-	7c	Cen
CZ5	CMLZDA6V8	Z-diode	Dual (CA), 6.5..7.2V, $Z_{t}<15\Omega$, 25mA, 250mW	SOT-563	35ed	-	7c	Cen
CZ6	CMLZDA7V5	Z-diode	Dual (CA), 7.0..7.9V, $Z_{t}<15\Omega$, 23mA, 250mW	SOT-563	35ed	-	7c	Cen
CZ7	CMLZDA8V2	Z-diode	Dual (CA), 7.7..8.7V, $Z_{t}<15\Omega$, 21mA, 250mW	SOT-563	35ed	-	7c	Cen
CZ8	CMLZDA9V1	Z-diode	Dual (CA), 8.5..9.6V, $Z_{t}<15\Omega$, 18mA, 250mW	SOT-563	35ed	-	7c	Cen
CZ9	CMLZDA10V	Z-diode	Dual (CA), 9.4..10.6V, $Z_{t}<20\Omega$, 16mA, 250mW	SOT-563	35ed	-	7c	Cen
D0	R1160D301A	LVR-IC	LDO, $3V\pm2\%$, 200mA, -CE, AE(mode)	SON-6	34vrc	VR10	7g	Ric
D0	R5220D301B	DC/DC-IC	PWM step-down, +CE, $V_{dc}=V_{ldo}=3V$	SON-6	34dc3	DC8	7g	Ric
D0	RN2901AFS	Si-pnp-Digi	Dual, Sw, 50V, 80mA, 50mW, $R1/R2=4.7k/4.7k$	FS6	35/TD4	-	7b	Tos
D01A	R1171S181A5	LVR-IC	LDO, $1.85V\pm2\%$, 1.5A, +CE	HSOP-6J	29virk	VR4	7h	Ric
D01B	R1171S181B5	LVR-IC	LDO, $1.85V\pm2\%$, 1.5A, +CE	HSOP-6J	29virk	VR4	7h	Ric
D02A	R1171S281A5	LVR-IC	LDO, $2.85V\pm2\%$, 1.5A, +CE	HSOP-6J	29virk	VR4	7h	Ric
D02B	R1171S281B5	LVR-IC	LDO, $2.85V\pm2\%$, 1.5A, +CE	HSOP-6J	29virk	VR4	7h	Ric
D1	IMD1A	Si-n/p-Digi	Sw, 50V, 100mA, 250MHz, $R1=22k$	SOT-23-6	33/TD2	-	7b	Rhm
D1	MBMT3904D	Si-npn	Dual, Sw, 60V, 100mA, 150mW, $B=100..300$, $>300MHz$	SC-74	33/T8	-	7b	Phi
D1	R1160D311A	LVR-IC	LDO, $3.1V\pm2\%$, 200mA, -CE, AE(mode)	SON-6	34vrc	VR10	7g	Ric
D1	R5220D311B	DC/DC-IC	PWM step-down, +CE, $V_{dc}=V_{ldo}=3.1V$	SON-6	34dc3	DC8	7g	Ric
D1	RN2902AFS	Si-pnp-Digi	Dual, Sw, 50V, 80mA, 50mW, $R1/R2=10k/10k$	FS6	35/TD4	-	7b	Tos
D10	IMD10A	Si-n/p-Digi	Sw, 50V, 300mW, 500mA(p), 100mA(n), $n.R1=10k$; $p.R1/R2=100R/10k$	SOT-23-6	33/TD2	-	7b	Rhm
D14	IMD14	Si-n/p-Digi	Sw, 50V, 500mA, $R1/R2=220R/10k$	SOT-23-6	33/TD2	-	7b	Rhm
D15A	R1171S151A	LVR-IC	LDO, $1.5V\pm2\%$, 1.5A, -CE	HSOP-6J	29virk	VR4	7h	Ric
D15B	R1171S151B	LVR-IC	LDO, $1.5V\pm2\%$, 1.5A, +CE	HSOP-6J	29virk	VR4	7h	Ric
D16	IMD16A	Si-n/p-Digi	Sw, 50V, $p:500mA$, $n:100mA$, $R1/R2=2.2k/22k$	SOT-23-6	33/TD2	-	7b	Rhm
D16A	R1171S161A	LVR-IC	LDO, $1.6V\pm2\%$, 1.5A, -CE	HSOP-6J	29virk	VR4	7h	Ric
D16B	R1171S161B	LVR-IC	LDO, $1.6V\pm2\%$, 1.5A, +CE	HSOP-6J	29virk	VR4	7h	Ric
D17A	R1171S171A	LVR-IC	LDO, $1.7V\pm2\%$, 1.5A, -CE	HSOP-6J	29virk	VR4	7h	Ric
D17B	R1171S171B	LVR-IC	LDO, $1.7V\pm2\%$, 1.5A, +CE	HSOP-6J	29virk	VR4	7h	Ric
D18A	R1171S181A	LVR-IC	LDO, $1.8V\pm2\%$, 1.5A, -CE	HSOP-6J	29virk	VR4	7h	Ric
D18B	R1171S181B	LVR-IC	LDO, $1.8V\pm2\%$, 1.5A, -CE	HSOP-6J	29virk	VR4	7h	Ric
D19A	R1171S191A	LVR-IC	LDO, $1.9V\pm2\%$, 1.5A, -CE	HSOP-6J	29virk	VR4	7h	Ric
D19B	R1171S191B	LVR-IC	LDO, $1.9V\pm2\%$, 1.5A, +CE	HSOP-6J	29virk	VR4	7h	Ric
D2	R1160D321A	LVR-IC	LDO, $3.2V\pm2\%$, 200mA, -CE, AE(mode)	SON-6	34vrc	VR10	7g	Ric
D2	R5220D321B	DC/DC-IC	PWM step-down, +CE, $V_{dc}=V_{ldo}=3.2V$	SON-6	34dc3	DC8	7g	Ric
D2	RN2903AFS	Si-pnp-Digi	Dual, Sw, 50V, 80mA, 50mW, $R1/R2=22k/22k$	FS6	35/TD4	-	7b	Tos
D20A	R1171S201A	LVR-IC	LDO, $2V\pm2\%$, 1.5A, -CE	HSOP-6J	29virk	VR4	7h	Ric
D20B	R1171S201B	LVR-IC	LDO, $2V\pm2\%$, 1.5A, +CE	HSOP-6J	29virk	VR4	7h	Ric
D21A	R1171S211A	LVR-IC	LDO, $2.1V\pm2\%$, 1.5A, -CE	HSOP-6J	29virk	VR4	7h	Ric



SMD code	Type	Function	Short description	Case	Pinout	Sch.	St.	Mnf.
D21B	R1171S211B	LVR-IC	LDO, 2.1V±2%, 1.5A, +CE	HSOP-6J	29vrk	VR4	7h	Ric
D22A	R1171S221A	LVR-IC	LDO, 2.2V±2%, 1.5A, -CE	HSOP-6J	29vrk	VR4	7h	Ric
D22B	R1171S221B	LVR-IC	LDO, 2.2V±2%, 1.5A, +CE	HSOP-6J	29vrk	VR4	7h	Ric
D23A	R1171S231A	LVR-IC	LDO, 2.3V±2%, 1.5A, -CE	HSOP-6J	29vrk	VR4	7h	Ric
D23B	R1171S231B	LVR-IC	LDO, 2.3V±2%, 1.5A, +CE	HSOP-6J	29vrk	VR4	7h	Ric
D24A	R1171S241A	LVR-IC	LDO, 2.4V±2%, 1.5A, -CE	HSOP-6J	29vrk	VR4	7h	Ric
D24B	R1171S241B	LVR-IC	LDO, 2.4V±2%, 1.5A, +CE	HSOP-6J	29vrk	VR4	7h	Ric
D25A	R1171S251A	LVR-IC	LDO, 2.5V±2%, 1.5A, -CE	HSOP-6J	29vrk	VR4	7h	Ric
D25B	R1171S251B	LVR-IC	LDO, 2.5V±2%, 1.5A, +CE	HSOP-6J	29vrk	VR4	7h	Ric
D26A	R1171S261A	LVR-IC	LDO, 2.6V±2%, 1.5A, -CE	HSOP-6J	29vrk	VR4	7h	Ric
D26B	R1171S261B	LVR-IC	LDO, 2.6V±2%, 1.5A, +CE	HSOP-6J	29vrk	VR4	7h	Ric
D27A	R1171S271A	LVR-IC	LDO, 2.7V±2%, 1.5A, -CE	HSOP-6J	29vrk	VR4	7h	Ric
D27B	R1171S271B	LVR-IC	LDO, 2.7V±2%, 1.5A, +CE	HSOP-6J	29vrk	VR4	7h	Ric
D28A	R1171S281A	LVR-IC	LDO, 2.8V±2%, 1.5A, -CE	HSOP-6J	29vrk	VR4	7h	Ric
D28B	R1171S281B	LVR-IC	LDO, 2.8V±2%, 1.5A, -CE	HSOP-6J	29vrk	VR4	7h	Ric
D29A	R1171S291A	LVR-IC	LDO, 2.9V±2%, 1.5A, -CE	HSOP-6J	29vrk	VR4	7h	Ric
D29B	R1171S291B	LVR-IC	LDO, 2.9V±2%, 1.5A, +CE	HSOP-6J	29vrk	VR4	7h	Ric
D2P01	MMDF2P01HD	p-MOSFET-e*	V-MOS, Dual, LogL, 12V, 3.4A, <0.18Ω	SOP-8	47	-	8d	Mot
D2P02	MMDF2P02HD	p-MOSFET-e*	V-MOS, Dual, LogL, 20V, 3.3A, <0.16Ω	SOP-8	47	-	8d	Mot
D2P03	MMDF2P03HD	p-MOSFET-e*	V-MOS, Dual, LogL, 30V, 3A, <0.2Ω	SOP-8	47	-	8d	Mot
D3	R1160D331A	LVR-IC	LDO, 3.3V±2%, 200mA, -CE, AE(mode)	SON-6	34vrcc	VR10	7g	Ric
D3	R5220D331B	DC/DC-IC	PWM step-down, +CE, V _{dc} =V _{ldo} =3.3V	SON-6	34dc3	DC8	7g	Ric
D3	RN2904AFS	Si-pnp-Digi	Dual, Sw, 50V, 80mA, 50mW, R1/R2=47k/47k	FS6	35/TD4	-	7b	Tos
D3_	SN74LVC1G373DCK	CMOS-Logic	D-type transparent latch with 3-state output	SC-70-6	33/Log35	-	7d	Ti
D30A	R1171S301A	LVR-IC	LDO, 3V±2%, 1.5A, -CE	HSOP-6J	29vrk	VR4	7h	Ric
D30B	R1171S301B	LVR-IC	LDO, 3V±2%, 1.5A, +CE	HSOP-6J	29vrk	VR4	7h	Ric
D31A	R1171S311A	LVR-IC	LDO, 3.1V±2%, 1.5A, -CE	HSOP-6J	29vrk	VR4	7h	Ric
D31B	R1171S311B	LVR-IC	LDO, 3.1V±2%, 1.5A, +CE	HSOP-6J	29vrk	VR4	7h	Ric
D32A	R1171S321A	LVR-IC	LDO, 3.2V±2%, 1.5A, -CE	HSOP-6J	29vrk	VR4	7h	Ric
D32B	R1171S321B	LVR-IC	LDO, 3.2V±2%, 1.5A, +CE	HSOP-6J	29vrk	VR4	7h	Ric
D33A	R1171S331A	LVR-IC	LDO, 3.3V±2%, 1.5A, -CE	HSOP-6J	29vrk	VR4	7h	Ric
D33B	R1171S331B	LVR-IC	LDO, 3.3V±2%, 1.5A, +CE	HSOP-6J	29vrk	VR4	7h	Ric
D34A	R1171S341A	LVR-IC	LDO, 3.4V±2%, 1.5A, -CE	HSOP-6J	29vrk	VR4	7h	Ric
D34B	R1171S341B	LVR-IC	LDO, 3.4V±2%, 1.5A, +CE	HSOP-6J	29vrk	VR4	7h	Ric
D35A	R1171S351A	LVR-IC	LDO, 3.5V±2%, 1.5A, -CE	HSOP-6J	29vrk	VR4	7h	Ric
D35B	R1171S351B	LVR-IC	LDO, 3.5V±2%, 1.5A, +CE	HSOP-6J	29vrk	VR4	7h	Ric
D36A	R1171S361A	LVR-IC	LDO, 3.6V±2%, 1.5A, -CE	HSOP-6J	29vrk	VR4	7h	Ric
D36B	R1171S361B	LVR-IC	LDO, 3.6V±2%, 1.5A, +CE	HSOP-6J	29vrk	VR4	7h	Ric
D37A	R1171S371A	LVR-IC	LDO, 3.7V±2%, 1.5A, -CE	HSOP-6J	29vrk	VR4	7h	Ric
D37B	R1171S371B	LVR-IC	LDO, 3.7V±2%, 1.5A, +CE	HSOP-6J	29vrk	VR4	7h	Ric
D38A	R1171S381A	LVR-IC	LDO, 3.8V±2%, 1.5A, -CE	HSOP-6J	29vrk	VR4	7h	Ric
D38B	R1171S381B	LVR-IC	LDO, 3.8V±2%, 1.5A, +CE	HSOP-6J	29vrk	VR4	7h	Ric
D39A	R1171S391A	LVR-IC	LDO, 3.9V±2%, 1.5A, -CE	HSOP-6J	29vrk	VR4	7h	Ric
D39B	R1171S391B	LVR-IC	LDO, 3.9V±2%, 1.5A, +CE	HSOP-6J	29vrk	VR4	7h	Ric
D3N02	MMDF3N02HD	n-MOSFET-e	V-MOS, Dual, LogL, 20V, 3.8A, <90mΩ	SOP-8	47	-	8d	Mot
D3N03	MMDF3N03HD	n-MOSFET-e	V-MOS, Dual, 30V, 4.1A, <70mΩ	SOP-8	47	-	8d	Mot
D4	RN2905AFS	Si-pnp-Digi	Dual, Sw, 50V, 80mA, 50mW, R1/R2=2.2k/47k	FS6	35/TD4	-	7b	Tos
D40A	R1171S401A	LVR-IC	LDO, 4V±2%, 1.5A, -CE	HSOP-6J	29vrk	VR4	7h	Ric
D40B	R1171S401B	LVR-IC	LDO, 4V±2%, 1.5A, +CE	HSOP-6J	29vrk	VR4	7h	Ric
D41A	R1171S411A	LVR-IC	LDO, 4.1V±2%, 1.5A, -CE	HSOP-6J	29vrk	VR4	7h	Ric
D41B	R1171S411B	LVR-IC	LDO, 4.1V±2%, 1.5A, +CE	HSOP-6J	29vrk	VR4	7h	Ric
D42A	R1171S421A	LVR-IC	LDO, 4.2V±2%, 1.5A, -CE	HSOP-6J	29vrk	VR4	7h	Ric
D42B	R1171S421B	LVR-IC	LDO, 4.2V±2%, 1.5A, +CE	HSOP-6J	29vrk	VR4	7h	Ric
D43A	R1171S431A	LVR-IC	LDO, 4.3V±2%, 1.5A, -CE	HSOP-6J	29vrk	VR4	7h	Ric
D43B	R1171S431B	LVR-IC	LDO, 4.3V±2%, 1.5A, +CE	HSOP-6J	29vrk	VR4	7h	Ric
D44A	R1171S441A	LVR-IC	LDO, 4.4V±2%, 1.5A, -CE	HSOP-6J	29vrk	VR4	7h	Ric
D44B	R1171S441B	LVR-IC	LDO, 4.4V±2%, 1.5A, +CE	HSOP-6J	29vrk	VR4	7h	Ric
D45A	R1171S451A	LVR-IC	LDO, 4.5V±2%, 1.5A, -CE	HSOP-6J	29vrk	VR4	7h	Ric
D45B	R1171S451B	LVR-IC	LDO, 4.5V±2%, 1.5A, +CE	HSOP-6J	29vrk	VR4	7h	Ric
D46A	R1171S461A	LVR-IC	LDO, 4.6V±2%, 1.5A, -CE	HSOP-6J	29vrk	VR4	7h	Ric
D46B	R1171S461B	LVR-IC	LDO, 4.6V±2%, 1.5A, +CE	HSOP-6J	29vrk	VR4	7h	Ric
D47A	R1171S471A	LVR-IC	LDO, 4.7V±2%, 1.5A, -CE	HSOP-6J	29vrk	VR4	7h	Ric
D47B	R1171S471B	LVR-IC	LDO, 4.7V±2%, 1.5A, +CE	HSOP-6J	29vrk	VR4	7h	Ric
D48A	R1171S481A	LVR-IC	LDO, 4.8V±2%, 1.5A	HSOP-6J	29vrk	VR4	7h	Ric
D48B	R1171S481B	LVR-IC	LDO, 4.8V±2%, 1.5A, +CE	HSOP-6J	29vrk	VR4	7h	Ric
D49A	R1171S491A	LVR-IC	LDO, 4.9V±2%, 1.5A, -CE	HSOP-6J	29vrk	VR4	7h	Ric
D49B	R1171S491B	LVR-IC	LDO, 4.9V±2%, 1.5A, +CE	HSOP-6J	29vrk	VR4	7h	Ric
D4N01	MMDF4N01HD	n-MOSFET-e	V-MOS, Dual, LogL, 20V, 5.2A, <45mΩ	SOP-8	47	-	8d	Mot
D4N01Z	MMDF4N01Z	n-MOSFET-e	V-MOS, Dual, LogL, 20V, 4.5A, <45mΩ	SOP-8	47	-	8d	Mot
D5	RN2906AFS	Si-pnp-Digi	Dual, Sw, 50V, 80mA, 50mW, R1/R2=4.7k/47k	FS6	35/TD4	-	7b	Tos



SMD code	Type	Function	Short description	Case	Pinout	Sch.	St.	Mnf.
D50A	R1171S501A	LVR-IC	LDO, 5V±2%, 1.5A, -CE	HSOP-6J	29vrk	VR4	7h	Ric
D50B	R1171S501B	LVR-IC	LDO, 5V±2%, 1.5A, +CE	HSOP-6J	29vrk	VR4	7h	Ric
D5632	BD5632NUX	LIN-IC	AF PA, BTL, class-D, 2.4..5.5V, 2.25W(5V/4Q), stand-by	VSON-8	44	-	9r	Rhm
D5634	BD5634NUX	LIN-IC	AF PA, BTL, class-D, 2.4..5.5V, 2.25W(5V/4Q), stand-by	VSON-8	44	-	9r	Rhm
D5638	BD5638NUX	LIN-IC	AF PA, BTL, class-D, 2.4..5.5V, 2.25W(5V/4Q), stand-by	VSON-8	44	-	9r	Rhm
D6	RN2907AFS	Si-pnp-Digi	Dual, Sw, 50V, 80mA, 50mW, R1/R2=10k/47k	FS6	35/TD4	-	7b	Tos
D7	RN2908AFS	Si-pnp-Digi	Dual, Sw, 50V, 80mA, 50mW, R1/R2=22k/47k	FS6	35/TD4	-	7b	Tos
D7830	BD7830NUV	LIN-IC	AF PA, BTL, 2.4..5.5V, 2.25W(5V/4Q), stand-by	VSON-8	44	-	9r	Rhm
D8	IMD8A	Si-n/p-Digi	Sw, 50V, 100mA, 250MHz, R1=47k	SOT-23-6	33/TD2	-	7b	Rhm
D8	RN2909AFS	Si-pnp-Digi	Dual, Sw, 50V, 80mA, 50mW, R1/R2=47k/22k	FS6	35/TD4	-	7b	Tos
D9	IMD9A	Si-n/p-Digi	Sw, 50V, 100mA, 250MHz, R1/R2=10k/47k	SOT-23-6	33/TD2	-	7b	Rhm
D9	RN2910AFS	Si-pnp-Digi	Dual, Sw, 50V, 80mA, 50mW, R1=4.7k	FS6	35/TD4	-	7b	Tos
DA	R5220D101B	DC/DC-IC	PWM step-down, +CE, Vdc=Vldo=1V	SON-6	34dc3	DC8	7g	Ric
DA	RP152N025A	LVR-IC	LDO, Dual out, Vout1/Vout2=3.0V/3.0V±1%, 150mA, +CE	SOT-23-6	33x5	VR19	7d	Ric
DB	R5220D111B	DC/DC-IC	PWM step-down, +CE, Vdc=Vldo=1.1V	SON-6	34dc3	DC8	7g	Ric
DB	RP152N026A	LVR-IC	LDO, Dual out, Vout1/Vout2=2.8V/3.1V±1%, 150mA, +CE	SOT-23-6	33x5	VR19	7d	Ric
DC	R5220D121B	DC/DC-IC	PWM step-down, +CE, Vdc=Vldo=1.2V	SON-6	34dc3	DC8	7g	Ric
DC	RP152N027A	LVR-IC	LDO, Dual out, Vout1/Vout2=2.3V/2.8V±1%, 150mA, +CE	SOT-23-6	33x5	VR19	7d	Ric
DC	SSM6104FU	n-MOSFET-e*	Dual, LogL, 20V, 100mA, 200mW, <12Q(10mA), 0.16/0.19µs	US6	33/T13	-	7b	Tos
DD	R5220D131B	DC/DC-IC	PWM step-down, +CE, Vdc=Vldo=1.3V	SON-6	34dc3	DC8	7g	Ric
DD	RP152N028A	LVR-IC	LDO, Dual out, Vout1/Vout2=2.8V/1.0V±1%, 150mA, +CE	SOT-23-6	33x5	VR19	7d	Ric
DE	R5220D141B	DC/DC-IC	PWM step-down, +CE, Vdc=Vldo=1.4V	SON-6	34dc3	DC8	7g	Ric
DE	RP152N029A	LVR-IC	LDO, Dual out, Vout1/Vout2=1.5V/1.5V±1%, 150mA, +CE	SOT-23-6	33x5	VR19	7d	Ric
DE-	RT9198-4GPF	LVR-IC	LDO, 4.75V±1%, 300mA, +CE	MSOP-8	47	VR4	8d	Ret
DF	R5220D151B	DC/DC-IC	PWM step-down, +CE, Vdc=Vldo=1.5V	SON-6	34dc3	DC8	7g	Ric
DF	RN2911AFS	Si-pnp-Digi	Dual, Sw, 50V, 80mA, 50mW, R1=10k	FS6	35/TD4	-	7b	Tos
DF	RP152N030A	LVR-IC	LDO, Dual out, Vout1/Vout2=1.5V/3.3V±1%, 150mA, +CE	SOT-23-6	33x5	VR19	7d	Ric
DG	R5220D161B	DC/DC-IC	PWM step-down, +CE, Vdc=Vldo=1.6V	SON-6	34dc3	DC8	7g	Ric
DG	RP152N031A	LVR-IC	LDO, Dual out, Vout1/Vout2=1.8V/2.7V±1%, 150mA, +CE	SOT-23-6	33x5	VR19	7d	Ric
DGR	KTX102U-GR	Si-n/p	Dual, GP, 60(50)V, 150mA, 200mW, B=200..400, >80MHz	US6	33/T15	-	7b	Kec
DH	R5220D171B	DC/DC-IC	PWM step-down, +CE, Vdc=Vldo=1.7V	SON-6	34dc3	DC8	7g	Ric
DH	RP152N032A	LVR-IC	LDO, Dual out, Vout1/Vout2=1.2V/3.0V±1%, 150mA, +CE	SOT-23-6	33x5	VR19	7d	Ric
DH-	RT9193-25PF	LVR-IC	LDO, 2.5V±1%, 300mA, +CE	MSOP-8	47vltc	VR7	8d	Rct
DH-	RT9193-25GF	LVR-IC	LDO, 2.5V±1%, 300mA, +CE	MSOP-8	47vltc	VR7	8d	Rct
DJ	R5220D181B	DC/DC-IC	PWM step-down, +CE, Vdc=Vldo=1.8V	SON-6	34dc3	DC8	7g	Ric
DJ	RP152N033A	LVR-IC	LDO, Dual out, Vout1/Vout2=3.1V/3.1V±1%, 150mA, +CE	SOT-23-6	33x5	VR19	7d	Ric
DJ-	RT9193-28PF	LVR-IC	LDO, 2.8V±1%, 300mA, +CE	MSOP-8	47vltc	VR7	8d	Rct
DJ-	RT9193-28GF	LVR-IC	LDO, 2.8V±1%, 300mA, +CE	MSOP-8	47vltc	VR7	8d	Rct
DK	R5220D191B	DC/DC-IC	PWM step-down, +CE, Vdc=Vldo=1.9V	SON-6	34dc3	DC8	7g	Ric
DK	RP152N034A	LVR-IC	LDO, Dual out, Vout1/Vout2=1.8V/2.6V±1%, 150mA, +CE	SOT-23-6	33x5	VR19	7d	Ric
DK-	RT9193-33PF	LVR-IC	LDO, 3.3V±1%, 300mA, +CE	MSOP-8	47vltc	VR7	8d	Rct
DL	R5220D201B	DC/DC-IC	PWM step-down, +CE, Vdc=Vldo=2V	SON-6	34dc3	DC8	7g	Ric
DL	RP152N035A	LVR-IC	LDO, Dual out, Vout1/Vout2=2.5V/1.2V±1%, 150mA, +CE	SOT-23-6	33x5	VR19	7d	Ric
DM	AIC1648CK	LDR-IC	1.2 MHz PWM White LED driver, OVP 4.2V	TSOT-23-6	33sv	LD2	7b	Aic
DM	R5220D211B	DC/DC-IC	PWM step-down, +CE, Vdc=Vldo=2.1V	SON-6	34dc3	DC8	7g	Ric
DM	RP152N036A	LVR-IC	LDO, Dual out, Vout1/Vout2=1.2V/2.9V±1%, 150mA, +CE	SOT-23-6	33x5	VR19	7d	Ric
DMP	AIC1648PK	LDR-IC	1.2 MHz PWM White LED driver, OVP 4.2V	TSOT-23-6	33sv	LD2	7b	Aic
DN	R5220D221B	DC/DC-IC	PWM step-down, +CE, Vdc=Vldo=2.2V	SON-6	34dc3	DC8	7g	Ric
DN	RP152N037A	LVR-IC	LDO, Dual out, Vout1/Vout2=3.3V/2.0V±1%, 150mA, +CE	SOT-23-6	33x5	VR19	7d	Ric
DP	R5220D231B	DC/DC-IC	PWM step-down, +CE, Vdc=Vldo=2.3V	SON-6	34dc3	DC8	7g	Ric
DP	RP152N038A	LVR-IC	LDO, Dual out, Vout1/Vout2=1.2V/2.85V±1%, 150mA, +CE	SOT-23-6	33x5	VR19	7d	Ric
DPE	XC6214P152MR	LVR-IC	LDO, 1.5V±2%, 500mA	SOT-26	33yt	VR1	7d	Tor
DPF	XC6214P162MR	LVR-IC	LDO, 1.6V±2%, 500mA	SOT-26	33yt	VR1	7d	Tor
DPH	XC6214P172MR	LVR-IC	LDO, 1.7V±2%, 500mA	SOT-26	33yt	VR1	7d	Tor
DPK	XC6214P182MR	LVR-IC	LDO, 1.8V±2%, 500mA	SOT-26	33yt	VR1	7d	Tor
DPL	XC6214P192MR	LVR-IC	LDO, 1.9V±2%, 500mA	SOT-26	33yt	VR1	7d	Tor
DPM	XC6214P202MR	LVR-IC	LDO, 2V±2%, 500mA	SOT-26	33yt	VR1	7d	Tor
DPN	XC6214P212MR	LVR-IC	LDO, 2.1V±2%, 500mA	SOT-26	33yt	VR1	7d	Tor
DPP	XC6214P222MR	LVR-IC	LDO, 2.2V±2%, 500mA	SOT-26	33yt	VR1	7d	Tor
DPR	XC6214P232MR	LVR-IC	LDO, 2.3V±2%, 500mA	SOT-26	33yt	VR1	7d	Tor
DPS	XC6214P242MR	LVR-IC	LDO, 2.4V±2%, 500mA	SOT-26	33yt	VR1	7d	Tor
DPT	XC6214P252MR	LVR-IC	LDO, 2.5V±2%, 500mA	SOT-26	33yt	VR1	7d	Tor
DPU	XC6214P262MR	LVR-IC	LDO, 2.6V±2%, 500mA	SOT-26	33yt	VR1	7d	Tor
DPV	XC6214P272MR	LVR-IC	LDO, 2.7V±2%, 500mA	SOT-26	33yt	VR1	7d	Tor
DPX	XC6214P282MR	LVR-IC	LDO, 2.8V±2%, 500mA	SOT-26	33yt	VR1	7d	Tor
DPY	XC6214P292MR	LVR-IC	LDO, 2.9V±2%, 500mA	SOT-26	33yt	VR1	7d	Tor
DPZ	XC6214P302MR	LVR-IC	LDO, 3V±2%, 500mA	SOT-26	33yt	VR1	7d	Tor
DQ	R5220D241B	DC/DC-IC	PWM step-down, +CE, Vdc=Vldo=2.4V	SON-6	34dc3	DC8	7g	Ric
DQ	RP152N039A	LVR-IC	LDO, Dual out, Vout1/Vout2=2.1V/3.3V±1%, 150mA, +CE	SOT-23-6	33x5	VR19	7d	Ric
DR	R5220D251B	DC/DC-IC	PWM step-down, +CE, Vdc=Vldo=2.5V	SON-6	34dc3	DC8	7g	Ric



SMD code	Type	Function	Short description	Case	Pinout	Sch.	St.	Mnf.
DR	RP152N040A	LVR-IC	LDO, Dual out, Vout1/Vout2=2.8V/2.85V±1%, 150mA, +CE	SOT-23-6	33x5	VR19	7d	Ric
DR0	XC6214P312MR	LVR-IC	LDO, 3.1V±2%, 500mA	SOT-26	33yt	VR1	7d	Tor
DR1	XC6214P322MR	LVR-IC	LDO, 3.2V±2%, 500mA	SOT-26	33yt	VR1	7d	Tor
DR2	XC6214P332MR	LVR-IC	LDO, 3.3V±2%, 500mA	SOT-26	33yt	VR1	7d	Tor
DR3	XC6214P342MR	LVR-IC	LDO, 3.4V±2%, 500mA	SOT-26	33yt	VR1	7d	Tor
DR4	XC6214P352MR	LVR-IC	LDO, 3.5V±2%, 500mA	SOT-26	33yt	VR1	7d	Tor
DR5	XC6214P362MR	LVR-IC	LDO, 3.6V±2%, 500mA	SOT-26	33yt	VR1	7d	Tor
DR6	XC6214P372MR	LVR-IC	LDO, 3.7V±2%, 500mA	SOT-26	33yt	VR1	7d	Tor
DR7	XC6214P382MR	LVR-IC	LDO, 3.8V±2%, 500mA	SOT-26	33yt	VR1	7d	Tor
DR8	XC6214P392MR	LVR-IC	LDO, 3.9V±2%, 500mA	SOT-26	33yt	VR1	7d	Tor
DR9	XC6214P402MR	LVR-IC	LDO, 4V±2%, 500mA	SOT-26	33yt	VR1	7d	Tor
DRA	XC6214P412MR	LVR-IC	LDO, 4.1V±2%, 500mA	SOT-26	33yt	VR1	7d	Tor
DRB	XC6214P422MR	LVR-IC	LDO, 4.2V±2%, 500mA	SOT-26	33yt	VR1	7d	Tor
DRC	XC6214P432MR	LVR-IC	LDO, 4.3V±2%, 500mA	SOT-26	33yt	VR1	7d	Tor
DRD	XC6214P442MR	LVR-IC	LDO, 4.4V±2%, 500mA	SOT-26	33yt	VR1	7d	Tor
DRE	XC6214P452MR	LVR-IC	LDO, 4.5V±2%, 500mA	SOT-26	33yt	VR1	7d	Tor
DRF	XC6214P462MR	LVR-IC	LDO, 4.6V±2%, 500mA	SOT-26	33yt	VR1	7d	Tor
DRH	XC6214P472MR	LVR-IC	LDO, 4.7V±2%, 500mA	SOT-26	33yt	VR1	7d	Tor
DRK	XC6214P482MR	LVR-IC	LDO, 4.8V±2%, 500mA	SOT-26	33yt	VR1	7d	Tor
DRL	XC6214P492MR	LVR-IC	LDO, 4.9V±2%, 500mA	SOT-26	33yt	VR1	7d	Tor
DRN	XC6214P502MR	LVR-IC	LDO, 5V±2%, 500mA	SOT-26	33yt	VR1	7d	Tor
DS	R5220D261B	DC/DC-IC	PWM step-down, +CE, Vdc=Vldo=2.6V	SON-6	34dc3	DC8	7g	Ric
DS	RP152N041A	LVR-IC	LDO, Dual out, Vout1/Vout2=1.8V/3.0V±1%, 150mA, +CE	SOT-23-6	33x5	VR19	7d	Ric
DT	R5220D271B	DC/DC-IC	PWM step-down, +CE, Vdc=Vldo=2.7V	SON-6	34dc3	DC8	7g	Ric
DT	RP152N042A	LVR-IC	LDO, Dual out, Vout1/Vout2=1.2V/2.6V±1%, 150mA, +CE	SOT-23-6	33x5	VR19	7d	Ric
DU	R5220D281B	DC/DC-IC	PWM step-down, +CE, Vdc=Vldo=2.8V	SON-6	34dc3	DC8	7g	Ric
DU	RP152N043A	LVR-IC	LDO, Dual out, Vout1/Vout2=1.3V/2.8V±1%, 150mA, +CE	SOT-23-6	33x5	VR19	7d	Ric
DV	R5220D291B	DC/DC-IC	PWM step-down, +CE, Vdc=Vldo=2.9V	SON-6	34dc3	DC8	7g	Ric
DV	RP152N044A	LVR-IC	LDO, Dual out, Vout1/Vout2=1.1V/1.5V±1%, 150mA, +CE	SOT-23-6	33x5	VR19	7d	Ric
DW	R5220D012B	DC/DC-IC	PWM step-down, +CE, Vdc=1.2V, Vldo=1.1V	SON-6	34dc3	DC8	7g	Ric
DW	RP152N045A	LVR-IC	LDO, Dual out, Vout1/Vout2=2.8V/3.3V±1%, 150mA, +CE	SOT-23-6	33x5	VR19	7d	Ric
DX	R5220D022B	DC/DC-IC	PWM step-down, +CE, Vdc=1.5V, Vldo=1.1V	SON-6	34dc3	DC8	7g	Ric
DX	RP152N046A	LVR-IC	LDO, Dual out, Vout1/Vout2=2.8V/3.0V±1%, 150mA, +CE	SOT-23-6	33x5	VR19	7d	Ric
DY	KTX102U-Y	Si-n/p	Dual, GP, 60(50)V, 150mA, 200mW, B=120..240, >80MHz	US6	33/T/15	-	7b	Kec
DY	R5220D032B	DC/DC-IC	PWM step-down, +CE, Vdc=1.3V, Vldo=1.05V	SON-6	34dc3	DC8	7g	Ric
DY	RP152N047A	LVR-IC	LDO, Dual out, Vout1/Vout2=2.5V/2.8V±1%, 150mA, +CE	SOT-23-6	33x5	VR19	7d	Ric
DZ	R5220D042B	DC/DC-IC	PWM step-down, +CE, Vdc=1.3V, Vldo=1.1V	SON-6	34dc3	DC8	7g	Ric
DZ	RP152N048A	LVR-IC	LDO, Dual out, Vout1/Vout2=2.5V/3.2V±1%, 150mA, +CE	SOT-23-6	33x5	VR19	7d	Ric
E0	TC1072-4.0VCH	LVR-IC	LDO, 4V±2%, 50mA, +CE, -Error	SOT-23-6	33uj	VR9	7d	Mcc
E01A	R5324D001A	LVR-IC	LDO, Triple out, V1/V2/V3=2.8V/2.8V/2.8V±1%, 200mA, +CE, CL	SON-8	44zj	VR21	8c	Ric
E01B	R5324D001B	LVR-IC	LDO, Triple out, V1/V2/V3=2.8V/2.8V/2.8V±1%, 200mA, +CE	SON-8	44zj	VR21	8c	Ric
E020	R1514S020B	LVR-IC	2V±2%, 150mA, +CE	HSOP-6J	29wh	VR4	7h	Ric
E021	R1514S021B	LVR-IC	2.1V±2%, 150mA, +CE	HSOP-6J	29wh	VR4	7h	Ric
E022	R1514S022B	LVR-IC	2.2V±2%, 150mA, +CE	HSOP-6J	29wh	VR4	7h	Ric
E023	R1514S023B	LVR-IC	2.3V±2%, 150mA, +CE	HSOP-6J	29wh	VR4	7h	Ric
E024	R1514S024B	LVR-IC	2.4V±2%, 150mA, +CE	HSOP-6J	29wh	VR4	7h	Ric
E025	R1514S025B	LVR-IC	2.5V±2%, 150mA, +CE	HSOP-6J	29wh	VR4	7h	Ric
E026	R1514S026B	LVR-IC	2.6V±2%, 150mA, +CE	HSOP-6J	29wh	VR4	7h	Ric
E027	R1514S027B	LVR-IC	2.7V±2%, 150mA, +CE	HSOP-6J	29wh	VR4	7h	Ric
E028	R1514S028B	LVR-IC	2.8V±2%, 150mA, +CE	HSOP-6J	29wh	VR4	7h	Ric
E029	R1514S029B	LVR-IC	2.9V±2%, 150mA, +CE	HSOP-6J	29wh	VR4	7h	Ric
E02A	R5324D002A	LVR-IC	LDO, Triple out, V1/V2/V3=2.9V/2.9V/2.9V±1%, 200mA, +CE, CL	SON-8	44zj	VR21	8c	Ric
E02B	R5324D002B	LVR-IC	LDO, Triple out, V1/V2/V3=2.9V/2.9V/2.9V±1%, 200mA, +CE	SON-8	44zj	VR21	8c	Ric
E030	R1514S030B	LVR-IC	3V±2%, 150mA, +CE	HSOP-6J	29wh	VR4	7h	Ric
E031	R1514S031B	LVR-IC	3.1V±2%, 150mA, +CE	HSOP-6J	29wh	VR4	7h	Ric
E032	R1514S032B	LVR-IC	3.2V±2%, 150mA, +CE	HSOP-6J	29wh	VR4	7h	Ric
E033	R1514S033B	LVR-IC	3.3V±2%, 150mA, +CE	HSOP-6J	29wh	VR4	7h	Ric
E034	R1514S034B	LVR-IC	3.4V±2%, 150mA, +CE	HSOP-6J	29wh	VR4	7h	Ric
E035	R1514S035B	LVR-IC	3.5V±2%, 150mA, +CE	HSOP-6J	29wh	VR4	7h	Ric
E036	R1514S036B	LVR-IC	3.6V±2%, 150mA, +CE	HSOP-6J	29wh	VR4	7h	Ric
E037	R1514S037B	LVR-IC	3.7V±2%, 150mA, +CE	HSOP-6J	29wh	VR4	7h	Ric
E038	R1514S038B	LVR-IC	3.8V±2%, 150mA, +CE	HSOP-6J	29wh	VR4	7h	Ric
E039	R1514S039B	LVR-IC	3.9V±2%, 150mA, +CE	HSOP-6J	29wh	VR4	7h	Ric
E03A	R5324D003A	LVR-IC	LDO, Triple out, V1/V2/V3=3.0V/3.0V/3.0V±1%, 200mA, +CE, CL	SON-8	44zj	VR21	8c	Ric
E03B	R5324D003B	LVR-IC	LDO, Triple out, V1/V2/V3=3.0V/3.0V/3.0V±1%, 200mA, +CE	SON-8	44zj	VR21	8c	Ric
E040	R1514S040B	LVR-IC	4V±2%, 150mA, +CE	HSOP-6J	29wh	VR4	7h	Ric
E041	R1514S041B	LVR-IC	4.1V±2%, 150mA, +CE	HSOP-6J	29wh	VR4	7h	Ric
E042	R1514S042B	LVR-IC	4.2V±2%, 150mA, +CE	HSOP-6J	29wh	VR4	7h	Ric
E043	R1514S043B	LVR-IC	4.3V±2%, 150mA, +CE	HSOP-6J	29wh	VR4	7h	Ric
E044	R1514S044B	LVR-IC	4.4V±2%, 150mA, +CE	HSOP-6J	29wh	VR4	7h	Ric



SMD code	Type	Function	Short description	Case	Pinout	Sch.	St.	Mnf.
E045	R1514S045B	LVR-IC	4.5V±2%, 150mA, +CE	HSOP-6J	29wh	VR4	7h	Ric
E046	R1514S046B	LVR-IC	4.6V±2%, 150mA, +CE	HSOP-6J	29wh	VR4	7h	Ric
E047	R1514S047B	LVR-IC	4.7V±2%, 150mA, +CE	HSOP-6J	29wh	VR4	7h	Ric
E048	R1514S048B	LVR-IC	4.8V±2%, 150mA, +CE	HSOP-6J	29wh	VR4	7h	Ric
E049	R1514S049B	LVR-IC	4.9V±2%, 150mA, +CE	HSOP-6J	29wh	VR4	7h	Ric
E04A	R5324D004A	LVR-IC	LDO, Triple out, V1/V2/V3=3.3V/3.0V/2.5V±1%, 200mA, +CE, CL	SOM-8	44zj	VR21	8c	Ric
E04B	R5324D004B	LVR-IC	LDO, Triple out, V1/V2/V3=3.3V/3.0V/2.5V±1%, 200mA, +CE	SOM-8	44zj	VR21	8c	Ric
E050	R1514S050B	LVR-IC	5V±2%, 150mA, +CE	HSOP-6J	29wh	VR4	7h	Ric
E051	R1514S051B	LVR-IC	5.1V±2%, 150mA, +CE	HSOP-6J	29wh	VR4	7h	Ric
E052	R1514S052B	LVR-IC	5.2V±2%, 150mA, +CE	HSOP-6J	29wh	VR4	7h	Ric
E053	R1514S053B	LVR-IC	5.3V±2%, 150mA, +CE	HSOP-6J	29wh	VR4	7h	Ric
E054	R1514S054B	LVR-IC	5.4V±2%, 150mA, +CE	HSOP-6J	29wh	VR4	7h	Ric
E055	R1514S055B	LVR-IC	5.5V±2%, 150mA, +CE	HSOP-6J	29wh	VR4	7h	Ric
E056	R1514S056B	LVR-IC	5.6V±2%, 150mA, +CE	HSOP-6J	29wh	VR4	7h	Ric
E057	R1514S057B	LVR-IC	5.7V±2%, 150mA, +CE	HSOP-6J	29wh	VR4	7h	Ric
E058	R1514S058B	LVR-IC	5.8V±2%, 150mA, +CE	HSOP-6J	29wh	VR4	7h	Ric
E059	R1514S059B	LVR-IC	5.9V±2%, 150mA, +CE	HSOP-6J	29wh	VR4	7h	Ric
E05B	R5324D005B	LVR-IC	LDO, Triple out, V1/V2/V3=1.5V/2.9V/1.5V±1%, 200mA, +CE	SOM-8	44zj	VR21	8c	Ric
E060	R1514S060B	LVR-IC	6V±2%, 150mA, +CE	HSOP-6J	29wh	VR4	7h	Ric
E061	R1514S061B	LVR-IC	6.1V±2%, 150mA, +CE	HSOP-6J	29wh	VR4	7h	Ric
E062	R1514S062B	LVR-IC	6.2V±2%, 150mA, +CE	HSOP-6J	29wh	VR4	7h	Ric
E063	R1514S063B	LVR-IC	6.3V±2%, 150mA, +CE	HSOP-6J	29wh	VR4	7h	Ric
E064	R1514S064B	LVR-IC	6.4V±2%, 150mA, +CE	HSOP-6J	29wh	VR4	7h	Ric
E065	R1514S065B	LVR-IC	6.5V±2%, 150mA, +CE	HSOP-6J	29wh	VR4	7h	Ric
E066	R1514S066B	LVR-IC	6.6V±2%, 150mA, +CE	HSOP-6J	29wh	VR4	7h	Ric
E067	R1514S067B	LVR-IC	6.7V±2%, 150mA, +CE	HSOP-6J	29wh	VR4	7h	Ric
E068	R1514S068B	LVR-IC	6.8V±2%, 150mA, +CE	HSOP-6J	29wh	VR4	7h	Ric
E069	R1514S069B	LVR-IC	6.9V±2%, 150mA, +CE	HSOP-6J	29wh	VR4	7h	Ric
E06B	R5324D006B	LVR-IC	LDO, Triple out, V1/V2/V3=2.8V/2.8V/2.9V±1%, 200mA, +CE	SOM-8	44zj	VR21	8c	Ric
E070	R1514S070B	LVR-IC	7V±2%, 150mA, +CE	HSOP-6J	29wh	VR4	7h	Ric
E071	R1514S071B	LVR-IC	7.1V±2%, 150mA, +CE	HSOP-6J	29wh	VR4	7h	Ric
E072	R1514S072B	LVR-IC	7.2V±2%, 150mA, +CE	HSOP-6J	29wh	VR4	7h	Ric
E073	R1514S073B	LVR-IC	7.3V±2%, 150mA, +CE	HSOP-6J	29wh	VR4	7h	Ric
E074	R1514S074B	LVR-IC	7.4V±2%, 150mA, +CE	HSOP-6J	29wh	VR4	7h	Ric
E075	R1514S075B	LVR-IC	7.5V±2%, 150mA, +CE	HSOP-6J	29wh	VR4	7h	Ric
E076	R1514S076B	LVR-IC	7.6V±2%, 150mA, +CE	HSOP-6J	29wh	VR4	7h	Ric
E077	R1514S077B	LVR-IC	7.7V±2%, 150mA, +CE	HSOP-6J	29wh	VR4	7h	Ric
E078	R1514S078B	LVR-IC	7.8V±2%, 150mA, +CE	HSOP-6J	29wh	VR4	7h	Ric
E079	R1514S079B	LVR-IC	7.9V±2%, 150mA, +CE	HSOP-6J	29wh	VR4	7h	Ric
E07B	R5324D007B	LVR-IC	LDO, Triple out, V1/V2/V3=3.3V/2.5V/1.8V±1%, 200mA, +CE	SOM-8	44zj	VR21	8c	Ric
E080	R1514S080B	LVR-IC	8V±2%, 150mA, +CE	HSOP-6J	29wh	VR4	7h	Ric
E081	R1514S081B	LVR-IC	8.1V±2%, 150mA, +CE	HSOP-6J	29wh	VR4	7h	Ric
E082	R1514S082B	LVR-IC	8.2V±2%, 150mA, +CE	HSOP-6J	29wh	VR4	7h	Ric
E083	R1514S083B	LVR-IC	8.3V±2%, 150mA, +CE	HSOP-6J	29wh	VR4	7h	Ric
E084	R1514S084B	LVR-IC	8.4V±2%, 150mA, +CE	HSOP-6J	29wh	VR4	7h	Ric
E085	R1514S085B	LVR-IC	8.5V±2%, 150mA, +CE	HSOP-6J	29wh	VR4	7h	Ric
E086	R1514S086B	LVR-IC	8.6V±2%, 150mA, +CE	HSOP-6J	29wh	VR4	7h	Ric
E087	R1514S087B	LVR-IC	8.7V±2%, 150mA, +CE	HSOP-6J	29wh	VR4	7h	Ric
E088	R1514S088B	LVR-IC	8.8V±2%, 150mA, +CE	HSOP-6J	29wh	VR4	7h	Ric
E089	R1514S089B	LVR-IC	8.9V±2%, 150mA, +CE	HSOP-6J	29wh	VR4	7h	Ric
E08B	R5324D008B	LVR-IC	LDO, Triple out, V1/V2/V3=3.3V/2.8V/2.7V±1%, 200mA, +CE	SOM-8	44zj	VR21	8c	Ric
E090	R1514S090B	LVR-IC	9V±2%, 150mA, +CE	HSOP-6J	29wh	VR4	7h	Ric
E091	R1514S091B	LVR-IC	9.1V±2%, 150mA, +CE	HSOP-6J	29wh	VR4	7h	Ric
E092	R1514S092B	LVR-IC	9.2V±2%, 150mA, +CE	HSOP-6J	29wh	VR4	7h	Ric
E093	R1514S093B	LVR-IC	9.3V±2%, 150mA, +CE	HSOP-6J	29wh	VR4	7h	Ric
E094	R1514S094B	LVR-IC	9.4V±2%, 150mA, +CE	HSOP-6J	29wh	VR4	7h	Ric
E095	R1514S095B	LVR-IC	9.5V±2%, 150mA, +CE	HSOP-6J	29wh	VR4	7h	Ric
E096	R1514S096B	LVR-IC	9.6V±2%, 150mA, +CE	HSOP-6J	29wh	VR4	7h	Ric
E097	R1514S097B	LVR-IC	9.7V±2%, 150mA, +CE	HSOP-6J	29wh	VR4	7h	Ric
E098	R1514S098B	LVR-IC	9.8V±2%, 150mA, +CE	HSOP-6J	29wh	VR4	7h	Ric
E099	R1514S099B	LVR-IC	9.9V±2%, 150mA, +CE	HSOP-6J	29wh	VR4	7h	Ric
E09B	R5324D009B	LVR-IC	LDO, Triple out, V1/V2/V3=3.1V/2.8V/1.8V±1%, 200mA, +CE	SOM-8	44zj	VR21	8c	Ric
E1	1PS88SB82	Si-diode	Triple, Schottky, Sw, 15V, 30mA, Vf<0.7V(30mA), <1pF	SOT-363	33dd	-	7b	PHH
E1	TC1072-2.5VCH	LVR-IC	LDO, 2.5V±2%, 50mA, +CE, -Error	SOT-23-6	33uj	VR9	7d	Mcc
E100	R1514S100B	LVR-IC	10V±2%, 150mA, +CE	HSOP-6J	29wh	VR4	7h	Ric
E101	R1514S101B	LVR-IC	10.1V±2%, 150mA, +CE	HSOP-6J	29wh	VR4	7h	Ric
E102	R1514S102B	LVR-IC	10.2V±2%, 150mA, +CE	HSOP-6J	29wh	VR4	7h	Ric
E103	R1514S103B	LVR-IC	10.3V±2%, 150mA, +CE	HSOP-6J	29wh	VR4	7h	Ric
E104	R1514S104B	LVR-IC	10.4V±2%, 150mA, +CE	HSOP-6J	29wh	VR4	7h	Ric
E105	R1514S105B	LVR-IC	10.5V±2%, 150mA, +CE	HSOP-6J	29wh	VR4	7h	Ric



SMD code	Type	Function	Short description	Case	Pinout	Sch.	St.	Mnf.
E106	R1514S106B	LVR-IC	10.6V±2%, 150mA, +CE	HSOP-6J	29wh	VR4	7h	Ric
E107	R1514S107B	LVR-IC	10.7V±2%, 150mA, +CE	HSOP-6J	29wh	VR4	7h	Ric
E108	R1514S108B	LVR-IC	10.8V±2%, 150mA, +CE	HSOP-6J	29wh	VR4	7h	Ric
E109	R1514S109B	LVR-IC	10.9V±2%, 150mA, +CE	HSOP-6J	29wh	VR4	7h	Ric
E10B	R5324D010B	LVR-IC	LDO, Triple out, V1/V2/V3=1.8V/3.1V/3.1V±1%, 200mA, +CE	SON-8	44zj	VR21	8c	Ric
E110	R1514S110B	LVR-IC	11V±2%, 150mA, +CE	HSOP-6J	29wh	VR4	7h	Ric
E111	R1514S111B	LVR-IC	11.1V±2%, 150mA, +CE	HSOP-6J	29wh	VR4	7h	Ric
E112	R1514S112B	LVR-IC	11.2V±2%, 150mA, +CE	HSOP-6J	29wh	VR4	7h	Ric
E113	R1514S113B	LVR-IC	11.3V±2%, 150mA, +CE	HSOP-6J	29wh	VR4	7h	Ric
E114	R1514S114B	LVR-IC	11.4V±2%, 150mA, +CE	HSOP-6J	29wh	VR4	7h	Ric
E115	R1514S115B	LVR-IC	11.5V±2%, 150mA, +CE	HSOP-6J	29wh	VR4	7h	Ric
E116	R1514S116B	LVR-IC	11.6V±2%, 150mA, +CE	HSOP-6J	29wh	VR4	7h	Ric
E117	R1514S117B	LVR-IC	11.7V±2%, 150mA, +CE	HSOP-6J	29wh	VR4	7h	Ric
E118	R1514S118B	LVR-IC	11.8V±2%, 150mA, +CE	HSOP-6J	29wh	VR4	7h	Ric
E119	R1514S119B	LVR-IC	11.9V±2%, 150mA, +CE	HSOP-6J	29wh	VR4	7h	Ric
E11B	R5324D011B	LVR-IC	LDO, Triple out, V1/V2/V3=3.0V/2.5V/1.8V±1%, 200mA, +CE	SON-8	44zj	VR21	8c	Ric
E120	R1514S120B	LVR-IC	12V±2%, 150mA, +CE	HSOP-6J	29wh	VR4	7h	Ric
E12B	R5324D012B	LVR-IC	LDO, Triple out, V1/V2/V3=3.3V/3.0V/1.8V±1%, 200mA, +CE	SON-8	44zj	VR21	8c	Ric
E13B	R5324D013B	LVR-IC	LDO, Triple out, V1/V2/V3=3.0V/1.8V/1.8V±1%, 200mA, +CE	SON-8	44zj	VR21	8c	Ric
E14B	R5324D014B	LVR-IC	LDO, Triple out, V1/V2/V3=3.3V/3.0V/3.5V±1%, 200mA, +CE	SON-8	44zj	VR21	8c	Ric
E15A	R1170D151A	LVR-IC	LDO, 1.5V±2%, 800mA, -CE	HSOP-6	35vr	VR4	7e	Ric
E15A	RD5RW15AA	LVR-IC	LDO, -Enable, 1.5V±2%, 150mA	SON1612-6	35v1	VR4	7e	Ric
E15B	R1170D151B	LVR-IC	LDO, 1.5V±2%, 800mA, +CE	HSOP-6	35vr	VR4	7e	Ric
E15B	R5324D015B	LVR-IC	LDO, Triple out, V1/V2/V3=3.3V/1.8V/1.8V±1%, 200mA, +CE	SON-8	44zj	VR21	8c	Ric
E15B	RD5RW15BA	LVR-IC	LDO, 1.5V±2%, 150mA, +CE	SON1612-6	35v1	VR4	7e	Ric
E15C	RD5RW15CA	LVR-IC	LDO, 1.5V±2%, 150mA	SON1612-6	35v2	VR1	7e	Ric
E16A	R1170D161A	LVR-IC	LDO, 1.6V±2%, 800mA, -CE	HSOP-6	35vr	VR4	7e	Ric
E16A	RD5RW16AA	LVR-IC	LDO, 1.6V±2%, 150mA, -CE	SON1612-6	35v1	VR4	7e	Ric
E16B	R1170D161B	LVR-IC	LDO, 1.6V±2%, 800mA, +CE	HSOP-6	35vr	VR4	7e	Ric
E16B	R5324D016B	LVR-IC	LDO, Triple out, V1/V2/V3=3.0V/2.8V/1.8V±1%, 200mA, +CE	SON-8	44zj	VR21	8c	Ric
E16B	RD5RW16BA	LVR-IC	LDO, 1.6V±2%, 150mA, +CE	SON1612-6	35v1	VR4	7e	Ric
E16C	RD5RW16CA	LVR-IC	LDO, 1.6V±2%, 150mA	SON1612-6	35v2	VR1	7e	Ric
E17A	R1170D171A	LVR-IC	LDO, 1.7V±2%, 800mA, -CE	HSOP-6	35vr	VR4	7e	Ric
E17A	RD5RW17AA	LVR-IC	LDO, 1.7V±2%, 150mA, -CE	SON1612-6	35v1	VR4	7e	Ric
E17B	R1170D171B	LVR-IC	LDO, 1.7V±2%, 800mA, +CE	HSOP-6	35vr	VR4	7e	Ric
E17B	R5324D017B	LVR-IC	LDO, Triple out, V1/V2/V3=2.9V/1.5V/2.9V±1%, 200mA, +CE	SON-8	44zj	VR21	8c	Ric
E17B	RD5RW17BA	LVR-IC	LDO, 1.7V±2%, 150mA, +CE	SON1612-6	35v1	VR4	7e	Ric
E17C	RD5RW17CA	LVR-IC	LDO, 1.7V±2%, 150mA	SON1612-6	35v2	VR1	7e	Ric
E18A	R1170D181A	LVR-IC	LDO, 1.8V±2%, 800mA, -CE	HSOP-6	35vr	VR4	7e	Ric
E18A	RD5RW18AA	LVR-IC	LDO, 1.8V±2%, 150mA, -CE	SON1612-6	35v1	VR4	7e	Ric
E18B	R1170D181B	LVR-IC	LDO, 1.8V±2%, 800mA, +CE	HSOP-6	35vr	VR4	7e	Ric
E18B	R5324D018B	LVR-IC	LDO, Triple out, V1/V2/V3=3.3V/3.3V/3.3V±1%, 200mA, +CE	SON-8	44zj	VR21	8c	Ric
E18B	RD5RW18BA	LVR-IC	LDO, 1.8V±2%, 150mA, +CE	SON1612-6	35v1	VR4	7e	Ric
E18C	RD5RW18CA	LVR-IC	LDO, 1.8V±2%, 150mA	SON1612-6	35v2	VR1	7e	Ric
E19A	R1170D191A	LVR-IC	LDO, 1.9V±2%, 800mA, -CE	HSOP-6	35vr	VR4	7e	Ric
E19A	RD5RW19AA	LVR-IC	LDO, 1.9V±2%, 150mA, -CE	SON1612-6	35v1	VR4	7e	Ric
E19B	R1170D191B	LVR-IC	LDO, 1.9V±2%, 800mA, +CE	HSOP-6	35vr	VR4	7e	Ric
E19B	R5324D019B	LVR-IC	LDO, Triple out, V1/V2/V3=1.5V/1.85V/2.85V±1%, 200mA, +CE	SON-8	44zj	VR21	8c	Ric
E19B	RD5RW19BA	LVR-IC	LDO, 1.9V±2%, 150mA, +CE	SON1612-6	35v1	VR4	7e	Ric
E19C	RD5RW19CA	LVR-IC	LDO, 1.9V±2%, 150mA	SON1612-6	35v2	VR1	7e	Ric
E1p	1PS88SB82	Si-diode	Triple, Schottky, Sw, 15V, 30mA, Vf<0.7V(30mA), <1pF	SOT-363	33dd	-	7b	PHH
E1t	1PS88SB82	Si-diode	Triple, Schottky, Sw, 15V, 30mA, Vf<0.7V(30mA), <1pF	SOT-363	33dd	-	7b	PHM
E1W	1PS88SB82	Si-diode	Triple, Schottky, Sw, 15V, 30mA, Vf<0.7V(30mA), <1pF	SOT-363	33dd	-	7b	PhC
E2	TC1072-2.7VCH	LVR-IC	LDO, 2.7V±2%, 50mA, +CE, -Error	SOT-23-6	33uj	VR9	7d	Mcc
E20A	R1170D201A	LVR-IC	LDO, 2V±2%, 800mA, -CE	HSOP-6	35vr	VR4	7e	Ric
E20A	RD5RW20AA	LVR-IC	LDO, 2V±2%, 150mA, -CE	SON1612-6	35v1	VR4	7e	Ric
E20B	R1170D201B	LVR-IC	LDO, 2V±2%, 800mA, +CE	HSOP-6	35vr	VR4	7e	Ric
E20B	R5324D020B	LVR-IC	LDO, Triple out, V1/V2/V3=3.0V/2.8V/1.5V±1%, 200mA, +CE	SON-8	44zj	VR21	8c	Ric
E20B	RD5RW20BA	LVR-IC	LDO, 2V±2%, 150mA, +CE	SON1612-6	35v1	VR4	7e	Ric
E20C	RD5RW20CA	LVR-IC	LDO, 2V±2%, 150mA	SON1612-6	35v2	VR1	7e	Ric
E21A	R1170D211A	LVR-IC	LDO, 2.1V±2%, 800mA, -CE	HSOP-6	35vr	VR4	7e	Ric
E21A	RD5RW21AA	LVR-IC	LDO, 2.1V±2%, 150mA, -CE	SON1612-6	35v1	VR4	7e	Ric
E21B	R1170D211B	LVR-IC	LDO, 2.1V±2%, 800mA, +CE	HSOP-6	35vr	VR4	7e	Ric
E21B	R5324D021B	LVR-IC	LDO, Triple out, V1/V2/V3=2.5V/3.0V/3.3V±1%, 200mA, +CE	SON-8	44zj	VR21	8c	Ric
E21B	RD5RW21BA	LVR-IC	LDO, 2.1V±2%, 150mA, +CE	SON1612-6	35v1	VR4	7e	Ric
E21C	RD5RW21CA	LVR-IC	LDO, 2.1V±2%, 150mA	SON1612-6	35v2	VR1	7e	Ric
E22A	R1170D221A	LVR-IC	LDO, 2.2V±2%, 800mA, -CE	HSOP-6	35vr	VR4	7e	Ric
E22A	RD5RW22AA	LVR-IC	LDO, 2.2V±2%, 150mA, -CE	SON1612-6	35v1	VR4	7e	Ric
E22B	R1170D221B	LVR-IC	LDO, 2.2V±2%, 800mA, +CE	HSOP-6	35vr	VR4	7e	Ric
E22B	R5324D022B	LVR-IC	LDO, Triple out, V1/V2/V3=1.8V/2.5V/2.8V±1%, 200mA, +CE	SON-8	44zj	VR21	8c	Ric



SMD code	Type	Function	Short description	Case	Pinout	Sch.	St.	Mnf.
E22B	RD5RW22BA	LVR-IC	LDO, 2.2V±2%, 150mA, +CE	SON1612-6	35v1	VR4	7e	Ric
E22C	RD5RW22CA	LVR-IC	LDO, 2.2V±2%, 150mA	SON1612-6	35v2	VR1	7e	Ric
E23A	R1170D231A	LVR-IC	LDO, 2.3V±2%, 800mA, -CE	HSON-6	35vr	VR4	7e	Ric
E23A	RD5RW23AA	LVR-IC	LDO, 2.3V±2%, 150mA, -CE	SON1612-6	35v1	VR4	7e	Ric
E23B	R1170D231B	LVR-IC	LDO, 2.3V±2%, 800mA, +CE	HSON-6	35vr	VR4	7e	Ric
E23B	R5324D023B	LVR-IC	LDO, Triple out, V1/V2/V3=2.8V/1.8V/1.8V±1%, 200mA, +CE	SON-8	44zj	VR21	8c	Ric
E23B	RD5RW23BA	LVR-IC	LDO, 2.3V±2%, 150mA, +CE	SON1612-6	35v1	VR4	7e	Ric
E23C	RD5RW23CA	LVR-IC	LDO, 2.3V±2%, 150mA	SON1612-6	35v2	VR1	7e	Ric
E24A	R1170D241A	LVR-IC	LDO, 2.4V±2%, 800mA, -CE	HSON-6	35vr	VR4	7e	Ric
E24A	RD5RW24AA	LVR-IC	LDO, 2.4V±2%, 150mA, -CE	SON1612-6	35v1	VR4	7e	Ric
E24B	R1170D241B	LVR-IC	LDO, 2.4V±2%, 800mA, +CE	HSON-6	35vr	VR4	7e	Ric
E24B	R5324D024B	LVR-IC	LDO, Triple out, V1/V2/V3=2.8V/1.8V/2.85V±1%, 200mA, +CE	SON-8	44zj	VR21	8c	Ric
E24B	RD5RW24BA	LVR-IC	LDO, 2.4V±2%, 150mA, +CE	SON1612-6	35v1	VR4	7e	Ric
E24C	RD5RW24CA	LVR-IC	LDO, 2.4V±2%, 150mA	SON1612-6	35v2	VR1	7e	Ric
E25A	R1170D251A	LVR-IC	LDO, 2.5V±2%, 800mA, -CE	HSON-6	35vr	VR4	7e	Ric
E25A	RD5RW25AA	LVR-IC	LDO, 2.5V±2%, 150mA, -CE	SON1612-6	35v1	VR4	7e	Ric
E25B	R1170D251B	LVR-IC	LDO, 2.5V±2%, 800mA, +CE	HSON-6	35vr	VR4	7e	Ric
E25B	R5324D025B	LVR-IC	LDO, Triple out, V1/V2/V3=2.8V/2.6V/1.8V±1%, 200mA, +CE	SON-8	44zj	VR21	8c	Ric
E25B	RD5RW25BA	LVR-IC	LDO, 2.5V±2%, 150mA, +CE	SON1612-6	35v1	VR4	7e	Ric
E25C	RD5RW25CA	LVR-IC	LDO, 2.5V±2%, 150mA	SON1612-6	35v2	VR1	7e	Ric
E26A	R1170D261A	LVR-IC	LDO, 2.6V±2%, 800mA, -CE	HSON-6	35vr	VR4	7e	Ric
E26A	RD5RW26AA	LVR-IC	LDO, 2.6V±2%, 150mA, -CE	SON1612-6	35v1	VR4	7e	Ric
E26B	R1170D261B	LVR-IC	LDO, 2.6V±2%, 800mA, +CE	HSON-6	35vr	VR4	7e	Ric
E26B	R5324D026B	LVR-IC	LDO, Triple out, V1/V2/V3=2.8V/2.8V/1.8V±1%, 200mA, +CE	SON-8	44zj	VR21	8c	Ric
E26B	RD5RW26BA	LVR-IC	LDO, 2.6V±2%, 150mA, +CE	SON1612-6	35v1	VR4	7e	Ric
E26C	RD5RW26CA	LVR-IC	LDO, 2.6V±2%, 150mA	SON1612-6	35v2	VR1	7e	Ric
E27A	R1170D271A	LVR-IC	LDO, 2.7V±2%, 800mA, -CE	HSON-6	35vr	VR4	7e	Ric
E27A	RD5RW27AA	LVR-IC	LDO, 2.7V±2%, 150mA, -CE	SON1612-6	35v1	VR4	7e	Ric
E27B	R1170D271B	LVR-IC	LDO, 2.7V±2%, 800mA, +CE	HSON-6	35vr	VR4	7e	Ric
E27B	RD5RW27BA	LVR-IC	LDO, 2.7V±2%, 150mA, +CE	SON1612-6	35v1	VR4	7e	Ric
E27C	RD5RW27CA	LVR-IC	LDO, 2.7V±2%, 150mA	SON1612-6	35v2	VR1	7e	Ric
E28A	R1170D281A	LVR-IC	LDO, 2.8V±2%, 800mA, -CE	HSON-6	35vr	VR4	7e	Ric
E28A	RD5RW28AA	LVR-IC	LDO, 2.8V±2%, 150mA, -CE	SON1612-6	35v1	VR4	7e	Ric
E28B	R1170D281B	LVR-IC	LDO, 2.8V±2%, 800mA, +CE	HSON-6	35vr	VR4	7e	Ric
E28B	RD5RW28BA	LVR-IC	LDO, 2.8V±2%, 150mA, +CE	SON1612-6	35v1	VR4	7e	Ric
E28C	RD5RW28CA	LVR-IC	LDO, 2.8V±2%, 150mA	SON1612-6	35v2	VR1	7e	Ric
E29A	R1170D291A	LVR-IC	LDO, 2.9V±2%, 800mA, -CE	HSON-6	35vr	VR4	7e	Ric
E29A	RD5RW29AA	LVR-IC	LDO, 2.9V±2%, 150mA, -CE	SON1612-6	35v1	VR4	7e	Ric
E29B	R1170D291B	LVR-IC	LDO, 2.9V±2%, 800mA, +CE	HSON-6	35vr	VR4	7e	Ric
E29B	RD5RW29BA	LVR-IC	LDO, 2.9V±2%, 150mA, +CE	SON1612-6	35v1	VR4	7e	Ric
E29C	RD5RW29CA	LVR-IC	LDO, 2.9V±2%, 150mA	SON1612-6	35v2	VR1	7e	Ric
E3	NC7ST00L6	CMOS-Logic	2-input NAND gate	MPAK-6	33fLog1	-	7b	F
E3	TC1072-3.0VCH	LVR-IC	LDO, 3V±2%, 50mA, +CE, -Error	SOT-23-6	33uj	VR9	7d	Mcc
E30A	R1170D301A	LVR-IC	LDO, 3V±2%, 800mA, -CE	HSON-6	35vr	VR4	7e	Ric
E30A	RD5RW30AA	LVR-IC	LDO, 3V±2%, 150mA, -CE	SON1612-6	35v1	VR4	7e	Ric
E30B	R1170D301B	LVR-IC	LDO, 3V±2%, 800mA, +CE	HSON-6	35vr	VR4	7e	Ric
E30B	RD5RW30BA	LVR-IC	LDO, 3V±2%, 150mA, +CE	SON1612-6	35v1	VR4	7e	Ric
E30C	RD5RW30CA	LVR-IC	LDO, 3V±2%, 150mA	SON1612-6	35v2	VR1	7e	Ric
E31A	R1170D311A	LVR-IC	LDO, 3.1V±2%, 800mA, -CE	HSON-6	35vr	VR4	7e	Ric
E31A	RD5RW31AA	LVR-IC	LDO, 3.1V±2%, 150mA, -CE	SON1612-6	35v1	VR4	7e	Ric
E31B	R1170D311B	LVR-IC	LDO, 3.1V±2%, 800mA, +CE	HSON-6	35vr	VR4	7e	Ric
E31B	RD5RW31BA	LVR-IC	LDO, 3.1V±2%, 150mA, +CE	SON1612-6	35v1	VR4	7e	Ric
E31C	RD5RW31CA	LVR-IC	LDO, 3.1V±2%, 150mA	SON1612-6	35v2	VR1	7e	Ric
E32A	R1170D321A	LVR-IC	LDO, 3.2V±2%, 800mA, -CE	HSON-6	35vr	VR4	7e	Ric
E32A	RD5RW32AA	LVR-IC	LDO, 3.2V±2%, 150mA, -CE	SON1612-6	35v1	VR4	7e	Ric
E32B	R1170D321B	LVR-IC	LDO, 3.2V±2%, 800mA, +CE	HSON-6	35vr	VR4	7e	Ric
E32B	RD5RW32BA	LVR-IC	LDO, 3.2V±2%, 150mA, +CE	SON1612-6	35v1	VR4	7e	Ric
E32C	RD5RW32CA	LVR-IC	LDO, 3.2V±2%, 150mA	SON1612-6	35v2	VR1	7e	Ric
E33A	R1170D331A	LVR-IC	LDO, 3.3V±2%, 800mA, -CE	HSON-6	35vr	VR4	7e	Ric
E33A	RD5RW33AA	LVR-IC	LDO, 3.3V±2%, 150mA, -CE	SON1612-6	35v1	VR4	7e	Ric
E33B	R1170D331B	LVR-IC	LDO, 3.3V±2%, 800mA, +CE	HSON-6	35vr	VR4	7e	Ric
E33B	RD5RW33BA	LVR-IC	LDO, 3.3V±2%, 150mA, +CE	SON1612-6	35v1	VR4	7e	Ric
E33C	RD5RW33CA	LVR-IC	LDO, 3.3V±2%, 150mA	SON1612-6	35v2	VR1	7e	Ric
E34A	R1170D341A	LVR-IC	LDO, 3.4V±2%, 800mA, -CE	HSON-6	35vr	VR4	7e	Ric
E34A	RD5RW34AA	LVR-IC	LDO, 3.4V±2%, 150mA, -CE	SON1612-6	35v1	VR4	7e	Ric
E34B	R1170D341B	LVR-IC	LDO, 3.4V±2%, 800mA, +CE	HSON-6	35vr	VR4	7e	Ric
E34B	RD5RW34BA	LVR-IC	LDO, 3.4V±2%, 150mA, +CE	SON1612-6	35v1	VR4	7e	Ric
E34C	RD5RW34CA	LVR-IC	LDO, 3.4V±2%, 150mA	SON1612-6	35v2	VR1	7e	Ric
E35A	R1170D351A	LVR-IC	LDO, 3.5V±2%, 800mA, -CE	HSON-6	35vr	VR4	7e	Ric
E35A	RD5RW35AA	LVR-IC	LDO, 3.5V±2%, 150mA, -CE	SON1612-6	35v1	VR4	7e	Ric



SMD code	Type	Function	Short description	Case	Pinout	Sch.	St.	Mnf.
E35B	R1170D351B	LVR-IC	LDO, 3.5V±2%, 800mA, +CE	HS0N-6	35vr	VR4	7e	Ric
E35B	RD5RW35BA	LVR-IC	LDO, 3.5V±2%, 150mA, +CE	SON1612-6	35v1	VR4	7e	Ric
E35C	RD5RW35CA	LVR-IC	LDO, 3.5V±2%, 150mA	SON1612-6	35v2	VR1	7e	Ric
E36A	R1170D361A	LVR-IC	LDO, 3.6V±2%, 800mA, -CE	HS0N-6	35vr	VR4	7e	Ric
E36A	RD5RW36AA	LVR-IC	LDO, 3.6V±2%, 150mA, -CE	SON1612-6	35v1	VR4	7e	Ric
E36B	R1170D361B	LVR-IC	LDO, 3.6V±2%, 800mA, +CE	HS0N-6	35vr	VR4	7e	Ric
E36B	RD5RW36BA	LVR-IC	LDO, 3.6V±2%, 150mA, +CE	SON1612-6	35v1	VR4	7e	Ric
E36C	RD5RW36CA	LVR-IC	LDO, 3.6V±2%, 150mA	SON1612-6	35v2	VR1	7e	Ric
E37	OPA2137N	Op-IC	Dual, FET-Input, ±2.25V, ±18V, 1MHz	SOP-8	47opd	-	8d	Bb
E37A	R1170D371A	LVR-IC	LDO, 3.7V±2%, 800mA, -CE	HS0N-6	35vr	VR4	7e	Ric
E37A	RD5RW37AA	LVR-IC	LDO, 3.7V±2%, 150mA, -CE	SON1612-6	35v1	VR4	7e	Ric
E37B	R1170D371B	LVR-IC	LDO, 3.7V±2%, 800mA, +CE	HS0N-6	35vr	VR4	7e	Ric
E37B	RD5RW37BA	LVR-IC	LDO, 3.7V±2%, 150mA, +CE	SON1612-6	35v1	VR4	7e	Ric
E37C	RD5RW37CA	LVR-IC	LDO, 3.7V±2%, 150mA	SON1612-6	35v2	VR1	7e	Ric
E38A	R1170D381A	LVR-IC	LDO, 3.8V±2%, 800mA, -CE	HS0N-6	35vr	VR4	7e	Ric
E38A	RD5RW38AA	LVR-IC	LDO, 3.8V±2%, 150mA, -CE	SON1612-6	35v1	VR4	7e	Ric
E38B	R1170D381B	LVR-IC	LDO, 3.8V±2%, 800mA, +CE	HS0N-6	35vr	VR4	7e	Ric
E38B	RD5RW38BA	LVR-IC	LDO, 3.8V±2%, 150mA, +CE	SON1612-6	35v1	VR4	7e	Ric
E38C	RD5RW38CA	LVR-IC	LDO, 3.8V±2%, 150mA	SON1612-6	35v2	VR1	7e	Ric
E39A	R1170D391A	LVR-IC	LDO, 3.9V±2%, 800mA, -CE	HS0N-6	35vr	VR4	7e	Ric
E39A	RD5RW39AA	LVR-IC	LDO, 3.9V±2%, 150mA, -CE	SON1612-6	35v1	VR4	7e	Ric
E39B	R1170D391B	LVR-IC	LDO, 3.9V±2%, 800mA, +CE	HS0N-6	35vr	VR4	7e	Ric
E39B	RD5RW39BA	LVR-IC	LDO, 3.9V±2%, 150mA, +CE	SON1612-6	35v1	VR4	7e	Ric
E39C	RD5RW39CA	LVR-IC	LDO, 3.9V±2%, 150mA	SON1612-6	35v2	VR1	7e	Ric
E4	NC7S02L6	CMOS-Logic	2-input NOR gate	MPAK-6	33L,Log2	-	7b	F
E40A	R1170D401A	LVR-IC	LDO, 4V±2%, 800mA, -CE	HS0N-6	35vr	VR4	7e	Ric
E40A	RD5RW40AA	LVR-IC	LDO, 4V±2%, 150mA, -CE	SON1612-6	35v1	VR4	7e	Ric
E40B	R1170D401B	LVR-IC	LDO, 4V±2%, 800mA, +CE	HS0N-6	35vr	VR4	7e	Ric
E40B	RD5RW40BA	LVR-IC	LDO, 4V±2%, 150mA, +CE	SON1612-6	35v1	VR4	7e	Ric
E40C	RD5RW40CA	LVR-IC	LDO, 4V±2%, 150mA	SON1612-6	35v2	VR1	7e	Ric
E41A	R1170D411A	LVR-IC	LDO, 4.1V±2%, 800mA, -CE	HS0N-6	35vr	VR4	7e	Ric
E41A	RD5RW41AA	LVR-IC	LDO, 4.1V±2%, 150mA, -CE	SON1612-6	35v1	VR4	7e	Ric
E41B	R1170D411B	LVR-IC	LDO, 4.1V±2%, 800mA, +CE	HS0N-6	35vr	VR4	7e	Ric
E41B	RD5RW41BA	LVR-IC	LDO, 4.1V±2%, 150mA, +CE	SON1612-6	35v1	VR4	7e	Ric
E41C	RD5RW41CA	LVR-IC	LDO, 4.1V±2%, 150mA	SON1612-6	35v2	VR1	7e	Ric
E42A	R1170D421A	LVR-IC	LDO, 4.2V±2%, 800mA, -CE	HS0N-6	35vr	VR4	7e	Ric
E42A	RD5RW42AA	LVR-IC	LDO, 4.2V±2%, 150mA, -CE	SON1612-6	35v1	VR4	7e	Ric
E42B	R1170D421B	LVR-IC	LDO, 4.2V±2%, 800mA, +CE	HS0N-6	35vr	VR4	7e	Ric
E42B	RD5RW42BA	LVR-IC	LDO, 4.2V±2%, 150mA, +CE	SON1612-6	35v1	VR4	7e	Ric
E42C	RD5RW42CA	LVR-IC	LDO, 4.2V±2%, 150mA	SON1612-6	35v2	VR1	7e	Ric
E43A	R1170D431A	LVR-IC	LDO, 4.3V±2%, 800mA, -CE	HS0N-6	35vr	VR4	7e	Ric
E43A	RD5RW43AA	LVR-IC	LDO, 4.3V±2%, 150mA, -CE	SON1612-6	35v1	VR4	7e	Ric
E43B	R1170D431B	LVR-IC	LDO, 4.3V±2%, 800mA, +CE	HS0N-6	35vr	VR4	7e	Ric
E43B	RD5RW43BA	LVR-IC	LDO, 4.3V±2%, 150mA, +CE	SON1612-6	35v1	VR4	7e	Ric
E43C	RD5RW43CA	LVR-IC	LDO, 4.3V±2%, 150mA	SON1612-6	35v2	VR1	7e	Ric
E44A	R1170D441A	LVR-IC	LDO, 4.4V±2%, 800mA, -CE	HS0N-6	35vr	VR4	7e	Ric
E44A	RD5RW44AA	LVR-IC	LDO, 4.4V±2%, 150mA, -CE	SON1612-6	35v1	VR4	7e	Ric
E44B	R1170D441B	LVR-IC	LDO, 4.4V±2%, 800mA, +CE	HS0N-6	35vr	VR4	7e	Ric
E44B	RD5RW44BA	LVR-IC	LDO, 4.4V±2%, 150mA, +CE	SON1612-6	35v1	VR4	7e	Ric
E44C	RD5RW44CA	LVR-IC	LDO, 4.4V±2%, 150mA	SON1612-6	35v2	VR1	7e	Ric
E45A	R1170D451A	LVR-IC	LDO, 4.5V±2%, 800mA, -CE	HS0N-6	35vr	VR4	7e	Ric
E45A	RD5RW45AA	LVR-IC	LDO, 4.5V±2%, 150mA, -CE	SON1612-6	35v1	VR4	7e	Ric
E45B	R1170D451B	LVR-IC	LDO, 4.5V±2%, 800mA, +CE	HS0N-6	35vr	VR4	7e	Ric
E45B	RD5RW45BA	LVR-IC	LDO, 4.5V±2%, 150mA, +CE	SON1612-6	35v1	VR4	7e	Ric
E45C	RD5RW45CA	LVR-IC	LDO, 4.5V±2%, 150mA	SON1612-6	35v2	VR1	7e	Ric
E46A	R1170D461A	LVR-IC	LDO, 4.6V±2%, 800mA, -CE	HS0N-6	35vr	VR4	7e	Ric
E46A	RD5RW46AA	LVR-IC	LDO, 4.6V±2%, 150mA, -CE	SON1612-6	35v1	VR4	7e	Ric
E46B	R1170D461B	LVR-IC	LDO, 4.6V±2%, 800mA, +CE	HS0N-6	35vr	VR4	7e	Ric
E46B	RD5RW46BA	LVR-IC	LDO, 4.6V±2%, 150mA, +CE	SON1612-6	35v1	VR4	7e	Ric
E46C	RD5RW46CA	LVR-IC	LDO, 4.6V±2%, 150mA	SON1612-6	35v2	VR1	7e	Ric
E47A	R1170D471A	LVR-IC	LDO, 4.7V±2%, 800mA, -CE	HS0N-6	35vr	VR4	7e	Ric
E47A	RD5RW47AA	LVR-IC	LDO, 4.7V±2%, 150mA, -CE	SON1612-6	35v1	VR4	7e	Ric
E47B	R1170D471B	LVR-IC	LDO, 4.7V±2%, 800mA, +CE	HS0N-6	35vr	VR4	7e	Ric
E47B	RD5RW47BA	LVR-IC	LDO, 4.7V±2%, 150mA, +CE	SON1612-6	35v1	VR4	7e	Ric
E47C	RD5RW47CA	LVR-IC	LDO, 4.7V±2%, 150mA	SON1612-6	35v2	VR1	7e	Ric
E48A	R1170D481A	LVR-IC	LDO, 4.8V±2%, 800mA, -CE	HS0N-6	35vr	VR4	7e	Ric
E48A	RD5RW48AA	LVR-IC	LDO, 4.8V±2%, 150mA, -CE	SON1612-6	35v1	VR4	7e	Ric
E48B	R1170D481B	LVR-IC	LDO, 4.8V±2%, 800mA, +CE	HS0N-6	35vr	VR4	7e	Ric
E48B	RD5RW48BA	LVR-IC	LDO, 4.8V±2%, 150mA, +CE	SON1612-6	35v1	VR4	7e	Ric
E48C	RD5RW48CA	LVR-IC	LDO, 4.8V±2%, 150mA	SON1612-6	35v2	VR1	7e	Ric



SMD code	Type	Function	Short description	Case	Pinout	Sch.	St.	Mnf.
E49A	R1170D491A	LVR-IC	LDO, 4.9V±2%, 800mA, -CE	HS0N-6	35vr	VR4	7e	Ric
E49A	RD5RW49AA	LVR-IC	LDO, 4.9V±2%, 150mA, -CE	SON1612-6	35v1	VR4	7e	Ric
E49B	R1170D491B	LVR-IC	LDO, 4.9V±2%, 800mA, +CE	HS0N-6	35vr	VR4	7e	Ric
E49B	RD5RW49BA	LVR-IC	LDO, 4.9V±2%, 150mA, +CE	SON1612-6	35v1	VR4	7e	Ric
E49C	RD5RW49CA	LVR-IC	LDO, 4.9V±2%, 150mA	SON1612-6	35v2	VR1	7e	Ric
E5	TC1072-3.3VCH	LVR-IC	LDO, 3.3V±2%, 50mA, +CE, -Error	SOT-23-6	33uj	VR9	7d	Mcc
E50A	R1170D501A	LVR-IC	LDO, 5V±2%, 800mA, -CE	HS0N-6	35vr	VR4	7e	Ric
E50A	RD5RW50AA	LVR-IC	LDO, 5V±2%, 150mA, -CE	SON1612-6	35v1	VR4	7e	Ric
E50B	R1170D501B	LVR-IC	LDO, 5V±2%, 800mA, +CE	HS0N-6	35vr	VR4	7e	Ric
E50B	RD5RW50BA	LVR-IC	LDO, 5V±2%, 150mA, +CE	SON1612-6	35v1	VR4	7e	Ric
E50C	RD5RW50CA	LVR-IC	LDO, 5V±2%, 150mA	SON1612-6	35v2	VR1	7e	Ric
E51A	RD5RW51AA	LVR-IC	LDO, 5.1V±2%, 150mA, -CE	SON1612-6	35v1	VR4	7e	Ric
E51B	RD5RW51BA	LVR-IC	LDO, 5.1V±2%, 150mA, +CE	SON1612-6	35v1	VR4	7e	Ric
E51C	RD5RW51CA	LVR-IC	LDO, 5.1V±2%, 150mA	SON1612-6	35v2	VR1	7e	Ric
E52A	RD5RW52AA	LVR-IC	LDO, 5.2V±2%, 150mA, -CE	SON1612-6	35v1	VR4	7e	Ric
E52B	RD5RW52BA	LVR-IC	LDO, 5.2V±2%, 150mA, +CE	SON1612-6	35v1	VR4	7e	Ric
E52C	RD5RW52CA	LVR-IC	LDO, 5.2V±2%, 150mA	SON1612-6	35v2	VR1	7e	Ric
E53A	RD5RW53AA	LVR-IC	LDO, 5.3V±2%, 150mA, -CE	SON1612-6	35v1	VR4	7e	Ric
E53B	RD5RW53BA	LVR-IC	LDO, 5.3V±2%, 150mA, +CE	SON1612-6	35v1	VR4	7e	Ric
E53C	RD5RW53CA	LVR-IC	LDO, 5.3V±2%, 150mA	SON1612-6	35v2	VR1	7e	Ric
E54A	RD5RW54AA	LVR-IC	LDO, 5.4V±2%, 150mA, -CE	SON1612-6	35v1	VR4	7e	Ric
E54B	RD5RW54BA	LVR-IC	LDO, 5.4V±2%, 150mA, +CE	SON1612-6	35v1	VR4	7e	Ric
E54C	RD5RW54CA	LVR-IC	LDO, 5.4V±2%, 150mA	SON1612-6	35v2	VR1	7e	Ric
E55A	RD5RW55AA	LVR-IC	LDO, 5.5V±2%, 150mA, -CE	SON1612-6	35v1	VR4	7e	Ric
E55B	RD5RW55BA	LVR-IC	LDO, 5.5V±2%, 150mA, +CE	SON1612-6	35v1	VR4	7e	Ric
E55C	RD5RW55CA	LVR-IC	LDO, 5.5V±2%, 150mA	SON1612-6	35v2	VR1	7e	Ric
E56A	RD5RW56AA	LVR-IC	LDO, 5.6V±2%, 150mA, -CE	SON1612-6	35v1	VR4	7e	Ric
E56B	RD5RW56BA	LVR-IC	LDO, 5.6V±2%, 150mA, +CE	SON1612-6	35v1	VR4	7e	Ric
E56C	RD5RW56CA	LVR-IC	LDO, 5.6V±2%, 150mA	SON1612-6	35v2	VR1	7e	Ric
E57A	RD5RW57AA	LVR-IC	LDO, 5.7V±2%, 150mA, -CE	SON1612-6	35v1	VR4	7e	Ric
E57B	RD5RW57BA	LVR-IC	LDO, 5.7V±2%, 150mA, +CE	SON1612-6	35v1	VR4	7e	Ric
E57C	RD5RW57CA	LVR-IC	LDO, 5.7V±2%, 150mA	SON1612-6	35v2	VR1	7e	Ric
E58A	RD5RW58AA	LVR-IC	LDO, 5.8V±2%, 150mA, -CE	SON1612-6	35v1	VR4	7e	Ric
E58B	RD5RW58BA	LVR-IC	LDO, 5.8V±2%, 150mA, +CE	SON1612-6	35v1	VR4	7e	Ric
E58C	RD5RW58CA	LVR-IC	LDO, 5.8V±2%, 150mA	SON1612-6	35v2	VR1	7e	Ric
E59A	RD5RW59AA	LVR-IC	LDO, 5.9V±2%, 150mA, -CE	SON1612-6	35v1	VR4	7e	Ric
E59B	RD5RW59BA	LVR-IC	LDO, 5.9V±2%, 150mA, +CE	SON1612-6	35v1	VR4	7e	Ric
E59C	RD5RW59CA	LVR-IC	LDO, 5.9V±2%, 150mA	SON1612-6	35v2	VR1	7e	Ric
E60A	RD5RW60AA	LVR-IC	LDO, 6V±2%, 150mA, -CE	SON1612-6	35v1	VR4	7e	Ric
E60B	RD5RW60BA	LVR-IC	LDO, 6V±2%, 150mA, +CE	SON1612-6	35v1	VR4	7e	Ric
E60C	RD5RW60CA	LVR-IC	LDO, 6V±2%, 150mA	SON1612-6	35v2	VR1	7e	Ric
E7	TC1072-5.0VCH	LVR-IC	LDO, 5V±2%, 50mA, +CE, -Error	SOT-23-6	33uj	VR9	7d	Mcc
E8	R1160D081B	LVR-IC	LDO, 0.8V±2%, 200mA, +CE, AE(mode)	SON-6	34vrc	VR10	7g	Ric
E8	TC1072-2.85VCH	LVR-IC	LDO, 2.85V±2%, 50mA, +CE, -Error	SOT-23-6	33uj	VR9	7d	Mcc
E9	R1160D091B	LVR-IC	LDO, 0.9V±2%, 200mA, +CE, AE(mode)	SON-6	34vrc	VR10	7g	Ric
E9	TC1072-3.6VCH	LVR-IC	LDO, 3.6V±2%, 50mA, +CE, -Error	SOT-23-6	33uj	VR9	7d	Mcc
EA	RP152N001B	LVR-IC	LDO, Dual out, Vout1/Vout2=2.8V/2.8V±1%, 150mA, +CE, CL	SOT-23-6	33x5	VR19	7d	Ric
EB	ELM7SU04BW	CMOS-Logic	Dual unbuffered inverters	SOT-26	33Llog77	-	7d	Elm
EB	RP152N002B	LVR-IC	LDO, Dual out, Vout1/Vout2=1.8V/2.8V±1%, 150mA, +CE, CL	SOT-23-6	33x5	VR19	7d	Ric
EC	RP152N003B	LVR-IC	LDO, Dual out, Vout1/Vout2=1.5V/2.8V±1%, 150mA, +CE, CL	SOT-23-6	33x5	VR19	7d	Ric
ED	RP152N004B	LVR-IC	LDO, Dual out, Vout1/Vout2=1.2V/1.8V±1%, 150mA, +CE, CL	SOT-23-6	33x5	VR19	7d	Ric
EE	RP152N005B	LVR-IC	LDO, Dual out, Vout1/Vout2=3.3V/1.2V±1%, 150mA, +CE, CL	SOT-23-6	33x5	VR19	7d	Ric
EF	RP152N006B	LVR-IC	LDO, Dual out, Vout1/Vout2=3.3V/1.8V±1%, 150mA, +CE, CL	SOT-23-6	33x5	VR19	7d	Ric
EG	RP152N007B	LVR-IC	LDO, Dual out, Vout1/Vout2=2.85V/2.85V±1%, 150mA, +CE, CL	SOT-23-6	33x5	VR19	7d	Ric
EH	RP152N008B	LVR-IC	LDO, Dual out, Vout1/Vout2=2.85V/2.6V±1%, 150mA, +CE, CL	SOT-23-6	33x5	VR19	7d	Ric
EJ	RP152N009B	LVR-IC	LDO, Dual out, Vout1/Vout2=3.0V/2.8V±1%, 150mA, +CE, CL	SOT-23-6	33x5	VR19	7d	Ric
EK	RP152N010B	LVR-IC	LDO, Dual out, Vout1/Vout2=3.0V/1.8V±1%, 150mA, +CE, CL	SOT-23-6	33x5	VR19	7d	Ric
EL	RP152N011B	LVR-IC	LDO, Dual out, Vout1/Vout2=1.8V/1.5V±1%, 150mA, +CE, CL	SOT-23-6	33x5	VR19	7d	Ric
EM	RP152N012B	LVR-IC	LDO, Dual out, Vout1/Vout2=2.8V/2.6V±1%, 150mA, +CE, CL	SOT-23-6	33x5	VR19	7d	Ric
EN	RP152N013B	LVR-IC	LDO, Dual out, Vout1/Vout2=3.3V/2.8V±1%, 150mA, +CE, CL	SOT-23-6	33x5	VR19	7d	Ric
EP	RP152N014B	LVR-IC	LDO, Dual out, Vout1/Vout2=3.3V/3.3V±1%, 150mA, +CE, CL	SOT-23-6	33x5	VR19	7d	Ric
EQ	RP152N015B	LVR-IC	LDO, Dual out, Vout1/Vout2=1.5V/2.5V±1%, 150mA, +CE, CL	SOT-23-6	33x5	VR19	7d	Ric
ER	RP152N016B	LVR-IC	LDO, Dual out, Vout1/Vout2=1.5V/3.0V±1%, 150mA, +CE, CL	SOT-23-6	33x5	VR19	7d	Ric
ES	RP152N017B	LVR-IC	LDO, Dual out, Vout1/Vout2=2.5V/3.0V±1%, 150mA, +CE, CL	SOT-23-6	33x5	VR19	7d	Ric
ET	RP152N018B	LVR-IC	LDO, Dual out, Vout1/Vout2=1.8V/1.8V±1%, 150mA, +CE, CL	SOT-23-6	33x5	VR19	7d	Ric
EU	RP152N019B	LVR-IC	LDO, Dual out, Vout1/Vout2=1.5V/2.6V±1%, 150mA, +CE, CL	SOT-23-6	33x5	VR19	7d	Ric
EV	RP152N020B	LVR-IC	LDO, Dual out, Vout1/Vout2=2.8V/1.8V±1%, 150mA, +CE, CL	SOT-23-6	33x5	VR19	7d	Ric
EW	RP152N021B	LVR-IC	LDO, Dual out, Vout1/Vout2=1.2V/2.8V±1%, 150mA, +CE, CL	SOT-23-6	33x5	VR19	7d	Ric
EX	RP152N022B	LVR-IC	LDO, Dual out, Vout1/Vout2=2.8V/1.2V±1%, 150mA, +CE, CL	SOT-23-6	33x5	VR19	7d	Ric
EY	AP1603W	DC/DC-IC	Step-up DC-DC converter for NiMH battery charge (3.3V)	SOT-23-6	33su	-	7b	Ana



SMD code	Type	Function	Short description	Case	Pinout	Sch.	St.	Mnf.
EY	RP152N023B	LVR-IC	LDO, Dual out, Vout1/Vout2=2.5V/2.5V±1%, 150mA, +CE, CL	SOT-23-6	33x5	VR19	7d	Ric
EZ	RP152N024B	LVR-IC	LDO, Dual out, Vout1/Vout2=3.3V/3.0V±1%, 150mA, +CE, CL	SOT-23-6	33x5	VR19	7d	Ric
EZ	TC1072-2.8VCH	LVR-IC	LDO, 2.8V±2%, 50mA, +CE, -Error	SOT-23-6	33uj	VR9	7d	Mcc
F	AG201-63G	MMIC	Buff/amp, DC, 6GHz, 11dB (900MHz, 50Q)	SOT-363	33a1	A1	7d	Wjg
F0	R1160D101B	LVR-IC	LDO, 1V±2%, 200mA, +CE, AE(mode)	SON-6	34vrc	VR10	7g	Ric
F0	R5421N177C	BM-IC	Li-Ion, over-charge/discharge protection, Vd=7.7V	SOT-23-6	33xj	VBM1	7d	Ric
F0	TC1073-4.0VCH	LVR-IC	LDO, 4V±2%, 100mA, +CE, -Error	SOT-23-6	33uj	VR9	7d	Mcc
F00A	R1131D182A5	LVR-IC	LDO, 1.85V±2%, 300mA, +CE	HSON-6	35hq	VR4	7e	Ric
F00B	R1131D182B5	LVR-IC	LDO, 1.8V±2%, 300mA, -CE	HSON-6	35hq	VR4	7e	Ric
F00D	R1131D182D5	LVR-IC	LDO, 1.85V±2%, 300mA, +CE, CL	HSON-6	35hq	VR4	7e	Ric
F01A	R1131D282A5	LVR-IC	LDO, 2.85V±2%, 300mA, +CE	HSON-6	35hq	VR4	7e	Ric
F01B	R1131D282B5	LVR-IC	LDO, 2.8V±2%, 300mA, -CE	HSON-6	35hq	VR4	7e	Ric
F01D	R1131D282D5	LVR-IC	LDO, 2.85V±2%, 300mA, +CE, CL	HSON-6	35hq	VR4	7e	Ric
F020	R1515S020B	LVR-IC	2V±2%, 50mA, +CE	HSOP-6J	29wh	VR4	7h	Ric
F021	R1515S021B	LVR-IC	2.1V±2%, 50mA, +CE	HSOP-6J	29wh	VR4	7h	Ric
F022	R1515S022B	LVR-IC	2.2V±2%, 50mA, +CE	HSOP-6J	29wh	VR4	7h	Ric
F023	R1515S023B	LVR-IC	2.3V±2%, 50mA, +CE	HSOP-6J	29wh	VR4	7h	Ric
F024	R1515S024B	LVR-IC	2.4V±2%, 50mA, +CE	HSOP-6J	29wh	VR4	7h	Ric
F025	R1515S025B	LVR-IC	2.5V±2%, 50mA, +CE	HSOP-6J	29wh	VR4	7h	Ric
F026	R1515S026B	LVR-IC	2.6V±2%, 50mA, +CE	HSOP-6J	29wh	VR4	7h	Ric
F027	R1515S027B	LVR-IC	2.7V±2%, 50mA, +CE	HSOP-6J	29wh	VR4	7h	Ric
F028	R1515S028B	LVR-IC	2.8V±2%, 50mA, +CE	HSOP-6J	29wh	VR4	7h	Ric
F029	R1515S029B	LVR-IC	2.9V±2%, 50mA, +CE	HSOP-6J	29wh	VR4	7h	Ric
F02A	R1131D122A5	LVR-IC	LDO, 1.25V±2%, 300mA, +CE	HSON-6	35hq	VR4	7e	Ric
F02B	R1131D122B5	LVR-IC	LDO, 1.25V±2%, 300mA, -CE	HSON-6	35hq	VR4	7e	Ric
F02D	R1131D122D5	LVR-IC	LDO, 1.25V±2%, 300mA, +CE, CL	HSON-6	35hq	VR4	7e	Ric
F030	R1515S030B	LVR-IC	3V±2%, 50mA, +CE	HSOP-6J	29wh	VR4	7h	Ric
F031	R1515S031B	LVR-IC	3.1V±2%, 50mA, +CE	HSOP-6J	29wh	VR4	7h	Ric
F032	R1515S032B	LVR-IC	3.2V±2%, 50mA, +CE	HSOP-6J	29wh	VR4	7h	Ric
F033	R1515S033B	LVR-IC	3.3V±2%, 50mA, +CE	HSOP-6J	29wh	VR4	7h	Ric
F034	R1515S034B	LVR-IC	3.4V±2%, 50mA, +CE	HSOP-6J	29wh	VR4	7h	Ric
F035	R1515S035B	LVR-IC	3.5V±2%, 50mA, +CE	HSOP-6J	29wh	VR4	7h	Ric
F036	R1515S036B	LVR-IC	3.6V±2%, 50mA, +CE	HSOP-6J	29wh	VR4	7h	Ric
F037	R1515S037B	LVR-IC	3.7V±2%, 50mA, +CE	HSOP-6J	29wh	VR4	7h	Ric
F038	R1515S038B	LVR-IC	3.8V±2%, 50mA, +CE	HSOP-6J	29wh	VR4	7h	Ric
F039	R1515S039B	LVR-IC	3.9V±2%, 50mA, +CE	HSOP-6J	29wh	VR4	7h	Ric
F040	R1515S040B	LVR-IC	4V±2%, 50mA, +CE	HSOP-6J	29wh	VR4	7h	Ric
F041	R1515S041B	LVR-IC	4.1V±2%, 50mA, +CE	HSOP-6J	29wh	VR4	7h	Ric
F042	R1515S042B	LVR-IC	4.2V±2%, 50mA, +CE	HSOP-6J	29wh	VR4	7h	Ric
F043	R1515S043B	LVR-IC	4.3V±2%, 50mA, +CE	HSOP-6J	29wh	VR4	7h	Ric
F044	R1515S044B	LVR-IC	4.4V±2%, 50mA, +CE	HSOP-6J	29wh	VR4	7h	Ric
F045	R1515S045B	LVR-IC	4.5V±2%, 50mA, +CE	HSOP-6J	29wh	VR4	7h	Ric
F046	R1515S046B	LVR-IC	4.6V±2%, 50mA, +CE	HSOP-6J	29wh	VR4	7h	Ric
F047	R1515S047B	LVR-IC	4.7V±2%, 50mA, +CE	HSOP-6J	29wh	VR4	7h	Ric
F048	R1515S048B	LVR-IC	4.8V±2%, 50mA, +CE	HSOP-6J	29wh	VR4	7h	Ric
F049	R1515S049B	LVR-IC	4.9V±2%, 50mA, +CE	HSOP-6J	29wh	VR4	7h	Ric
F050	R1515S050B	LVR-IC	5V±2%, 50mA, +CE	HSOP-6J	29wh	VR4	7h	Ric
F051	R1515S051B	LVR-IC	5.1V±2%, 50mA, +CE	HSOP-6J	29wh	VR4	7h	Ric
F052	R1515S052B	LVR-IC	5.2V±2%, 50mA, +CE	HSOP-6J	29wh	VR4	7h	Ric
F053	R1515S053B	LVR-IC	5.3V±2%, 50mA, +CE	HSOP-6J	29wh	VR4	7h	Ric
F054	R1515S054B	LVR-IC	5.4V±2%, 50mA, +CE	HSOP-6J	29wh	VR4	7h	Ric
F055	R1515S055B	LVR-IC	5.5V±2%, 50mA, +CE	HSOP-6J	29wh	VR4	7h	Ric
F056	R1515S056B	LVR-IC	5.6V±2%, 50mA, +CE	HSOP-6J	29wh	VR4	7h	Ric
F057	R1515S057B	LVR-IC	5.7V±2%, 50mA, +CE	HSOP-6J	29wh	VR4	7h	Ric
F058	R1515S058B	LVR-IC	5.8V±2%, 50mA, +CE	HSOP-6J	29wh	VR4	7h	Ric
F059	R1515S059B	LVR-IC	5.9V±2%, 50mA, +CE	HSOP-6J	29wh	VR4	7h	Ric
F060	R1515S060B	LVR-IC	6V±2%, 50mA, +CE	HSOP-6J	29wh	VR4	7h	Ric
F061	R1515S061B	LVR-IC	6.1V±2%, 50mA, +CE	HSOP-6J	29wh	VR4	7h	Ric
F062	R1515S062B	LVR-IC	6.2V±2%, 50mA, +CE	HSOP-6J	29wh	VR4	7h	Ric
F063	R1515S063B	LVR-IC	6.3V±2%, 50mA, +CE	HSOP-6J	29wh	VR4	7h	Ric
F064	R1515S064B	LVR-IC	6.4V±2%, 50mA, +CE	HSOP-6J	29wh	VR4	7h	Ric
F065	R1515S065B	LVR-IC	6.5V±2%, 50mA, +CE	HSOP-6J	29wh	VR4	7h	Ric
F066	R1515S066B	LVR-IC	6.6V±2%, 50mA, +CE	HSOP-6J	29wh	VR4	7h	Ric
F067	R1515S067B	LVR-IC	6.7V±2%, 50mA, +CE	HSOP-6J	29wh	VR4	7h	Ric
F068	R1515S068B	LVR-IC	6.8V±2%, 50mA, +CE	HSOP-6J	29wh	VR4	7h	Ric
F069	R1515S069B	LVR-IC	6.9V±2%, 50mA, +CE	HSOP-6J	29wh	VR4	7h	Ric
F070	R1515S070B	LVR-IC	7V±2%, 50mA, +CE	HSOP-6J	29wh	VR4	7h	Ric
F071	R1515S071B	LVR-IC	7.1V±2%, 50mA, +CE	HSOP-6J	29wh	VR4	7h	Ric
F072	R1515S072B	LVR-IC	7.2V±2%, 50mA, +CE	HSOP-6J	29wh	VR4	7h	Ric
F073	R1515S073B	LVR-IC	7.3V±2%, 50mA, +CE	HSOP-6J	29wh	VR4	7h	Ric



SMD code	Type	Function	Short description	Case	Pinout	Sch.	St.	Mnf.
F074	R1515S074B	LVR-IC	7.4V±2%, 50mA, +CE	HSOP-6J	29wh	VR4	7h	Ric
F075	R1515S075B	LVR-IC	7.5V±2%, 50mA, +CE	HSOP-6J	29wh	VR4	7h	Ric
F076	R1515S076B	LVR-IC	7.6V±2%, 50mA, +CE	HSOP-6J	29wh	VR4	7h	Ric
F077	R1515S077B	LVR-IC	7.7V±2%, 50mA, +CE	HSOP-6J	29wh	VR4	7h	Ric
F078	R1515S078B	LVR-IC	7.8V±2%, 50mA, +CE	HSOP-6J	29wh	VR4	7h	Ric
F079	R1515S079B	LVR-IC	7.9V±2%, 50mA, +CE	HSOP-6J	29wh	VR4	7h	Ric
F080	R1515S080B	LVR-IC	8V±2%, 50mA, +CE	HSOP-6J	29wh	VR4	7h	Ric
F081	R1515S081B	LVR-IC	8.1V±2%, 50mA, +CE	HSOP-6J	29wh	VR4	7h	Ric
F082	R1515S082B	LVR-IC	8.2V±2%, 50mA, +CE	HSOP-6J	29wh	VR4	7h	Ric
F083	R1515S083B	LVR-IC	8.3V±2%, 50mA, +CE	HSOP-6J	29wh	VR4	7h	Ric
F084	R1515S084B	LVR-IC	8.4V±2%, 50mA, +CE	HSOP-6J	29wh	VR4	7h	Ric
F085	R1515S085B	LVR-IC	8.5V±2%, 50mA, +CE	HSOP-6J	29wh	VR4	7h	Ric
F086	R1515S086B	LVR-IC	8.6V±2%, 50mA, +CE	HSOP-6J	29wh	VR4	7h	Ric
F087	R1515S087B	LVR-IC	8.7V±2%, 50mA, +CE	HSOP-6J	29wh	VR4	7h	Ric
F088	R1515S088B	LVR-IC	8.8V±2%, 50mA, +CE	HSOP-6J	29wh	VR4	7h	Ric
F089	R1515S089B	LVR-IC	8.9V±2%, 50mA, +CE	HSOP-6J	29wh	VR4	7h	Ric
F08A	R1131D082A	LVR-IC	LDO, 0.8V±2%, 300mA, +CE	HSON-6	35hq	VR4	7e	Ric
F08B	R1131D082B	LVR-IC	LDO, 0.8V±2%, 300mA, -CE	HSON-6	35hq	VR4	7e	Ric
F08D	R1131D082D	LVR-IC	LDO, 0.8V±2%, 300mA, +CE, CL	HSON-6	35hq	VR4	7e	Ric
F090	R1515S090B	LVR-IC	9V±2%, 50mA, +CE	HSOP-6J	29wh	VR4	7h	Ric
F091	R1515S091B	LVR-IC	9.1V±2%, 50mA, +CE	HSOP-6J	29wh	VR4	7h	Ric
F092	R1515S092B	LVR-IC	9.2V±2%, 50mA, +CE	HSOP-6J	29wh	VR4	7h	Ric
F093	R1515S093B	LVR-IC	9.3V±2%, 50mA, +CE	HSOP-6J	29wh	VR4	7h	Ric
F094	R1515S094B	LVR-IC	9.4V±2%, 50mA, +CE	HSOP-6J	29wh	VR4	7h	Ric
F095	R1515S095B	LVR-IC	9.5V±2%, 50mA, +CE	HSOP-6J	29wh	VR4	7h	Ric
F096	R1515S096B	LVR-IC	9.6V±2%, 50mA, +CE	HSOP-6J	29wh	VR4	7h	Ric
F097	R1515S097B	LVR-IC	9.7V±2%, 50mA, +CE	HSOP-6J	29wh	VR4	7h	Ric
F098	R1515S098B	LVR-IC	9.8V±2%, 50mA, +CE	HSOP-6J	29wh	VR4	7h	Ric
F099	R1515S099B	LVR-IC	9.9V±2%, 50mA, +CE	HSOP-6J	29wh	VR4	7h	Ric
F09A	R1131D092A	LVR-IC	LDO, 0.9V±2%, 300mA, +CE	HSON-6	35hq	VR4	7e	Ric
F09B	R1131D092B	LVR-IC	LDO, 0.9V±2%, 300mA, -CE	HSON-6	35hq	VR4	7e	Ric
F09D	R1131D092D	LVR-IC	LDO, 0.9V±2%, 300mA, +CE, CL	HSON-6	35hq	VR4	7e	Ric
F1	R1160D111B	LVR-IC	LDO, 1.1V±2%, 200mA, +CE, AE(mode)	SOM-6	34vrc	VR10	7g	Ric
F1	R5421N162C	BM-IC	Li-Ion, over-charge/discharge protection, Vd=6.2V	SOT-23-6	33xj	VBM1	7d	Ric
F1	TC1073-2.5VCH	LVR-IC	LDO, 2.5V±2%, 50mA, +CE, -Error	SOT-23-6	33uj	VR9	7d	Mcc
F100	R1515S100B	LVR-IC	10V±2%, 50mA, +CE	HSOP-6J	29wh	VR4	7h	Ric
F101	R1515S101B	LVR-IC	10.1V±2%, 50mA, +CE	HSOP-6J	29wh	VR4	7h	Ric
F102	R1515S102B	LVR-IC	10.2V±2%, 50mA, +CE	HSOP-6J	29wh	VR4	7h	Ric
F103	R1515S103B	LVR-IC	10.3V±2%, 50mA, +CE	HSOP-6J	29wh	VR4	7h	Ric
F104	R1515S104B	LVR-IC	10.4V±2%, 50mA, +CE	HSOP-6J	29wh	VR4	7h	Ric
F105	R1515S105B	LVR-IC	10.5V±2%, 50mA, +CE	HSOP-6J	29wh	VR4	7h	Ric
F106	R1515S106B	LVR-IC	10.6V±2%, 50mA, +CE	HSOP-6J	29wh	VR4	7h	Ric
F107	R1515S107B	LVR-IC	10.7V±2%, 50mA, +CE	HSOP-6J	29wh	VR4	7h	Ric
F108	R1515S108B	LVR-IC	10.8V±2%, 50mA, +CE	HSOP-6J	29wh	VR4	7h	Ric
F109	R1515S109B	LVR-IC	10.9V±2%, 50mA, +CE	HSOP-6J	29wh	VR4	7h	Ric
F10A	R1131D102A	LVR-IC	LDO, 1V±2%, 300mA, +CE	HSON-6	35hq	VR4	7e	Ric
F10B	R1131D102B	LVR-IC	LDO, 1V±2%, 300mA, -CE	HSON-6	35hq	VR4	7e	Ric
F10D	R1131D102D	LVR-IC	LDO, 1V±2%, 300mA, +CE, CL	HSON-6	35hq	VR4	7e	Ric
F110	R1515S110B	LVR-IC	11V±2%, 50mA, +CE	HSOP-6J	29wh	VR4	7h	Ric
F111	R1515S111B	LVR-IC	11.1V±2%, 50mA, +CE	HSOP-6J	29wh	VR4	7h	Ric
F112	R1515S112B	LVR-IC	11.2V±2%, 50mA, +CE	HSOP-6J	29wh	VR4	7h	Ric
F113	R1515S113B	LVR-IC	11.3V±2%, 50mA, +CE	HSOP-6J	29wh	VR4	7h	Ric
F114	R1515S114B	LVR-IC	11.4V±2%, 50mA, +CE	HSOP-6J	29wh	VR4	7h	Ric
F115	R1515S115B	LVR-IC	11.5V±2%, 50mA, +CE	HSOP-6J	29wh	VR4	7h	Ric
F116	R1515S116B	LVR-IC	11.6V±2%, 50mA, +CE	HSOP-6J	29wh	VR4	7h	Ric
F117	R1515S117B	LVR-IC	11.7V±2%, 50mA, +CE	HSOP-6J	29wh	VR4	7h	Ric
F118	R1515S118B	LVR-IC	11.8V±2%, 50mA, +CE	HSOP-6J	29wh	VR4	7h	Ric
F119	R1515S119B	LVR-IC	11.9V±2%, 50mA, +CE	HSOP-6J	29wh	VR4	7h	Ric
F11A	R1131D112A	LVR-IC	LDO, 1.1V±2%, 300mA, +CE	HSON-6	35hq	VR4	7e	Ric
F11B	R1131D112B	LVR-IC	LDO, 1.1V±2%, 300mA, -CE	HSON-6	35hq	VR4	7e	Ric
F11D	R1131D112D	LVR-IC	LDO, 1.1V±2%, 300mA, +CE, CL	HSON-6	35hq	VR4	7e	Ric
F120	R1515S120B	LVR-IC	12V±2%, 50mA, +CE	HSOP-6J	29wh	VR4	7h	Ric
F12A	R1131D122A	LVR-IC	LDO, 1.2V±2%, 300mA, +CE	HSON-6	35hq	VR4	7e	Ric
F12B	R1131D122B	LVR-IC	LDO, 1.2V±2%, 300mA, -CE	HSON-6	35hq	VR4	7e	Ric
F12D	R1131D122D	LVR-IC	LDO, 1.2V±2%, 300mA, +CE, CL	HSON-6	35hq	VR4	7e	Ric
F13A	R1131D132A	LVR-IC	LDO, 1.3V±2%, 300mA, +CE	HSON-6	35hq	VR4	7e	Ric
F13B	R1131D132B	LVR-IC	LDO, 1.3V±2%, 300mA, -CE	HSON-6	35hq	VR4	7e	Ric
F13D	R1131D132D	LVR-IC	LDO, 1.3V±2%, 300mA, +CE, CL	HSON-6	35hq	VR4	7e	Ric
F14A	R1131D142A	LVR-IC	LDO, 1.4V±2%, 300mA, +CE	HSON-6	35hq	VR4	7e	Ric
F14B	R1131D142B	LVR-IC	LDO, 1.4V±2%, 300mA, -CE	HSON-6	35hq	VR4	7e	Ric



SMD code	Type	Function	Short description	Case	Pinout	Sch.	St.	Mnf.
F14D	R1131D142D	LVR-IC	LDO, 1.4V±2%, 300mA, +CE, CL	HSON-6	35hq	VR4	7e	Ric
F15A	R1114D151A	LVR-IC	LDO, LN, -CE, 1.5V±2%, 150mA	SON1612-6	35vra	VR4	7e	Ric
F15A	R1131D152A	LVR-IC	LDO, 1.5V±2%, 300mA, +CE	HSON-6	35hq	VR4	7e	Ric
F15B	R1114D151B	LVR-IC	LDO, LN, +CE, 1.5V±2%, 150mA	SON1612-6	35vra	VR4	7e	Ric
F15B	R1131D152B	LVR-IC	LDO, 1.5V±2%, 300mA, -CE	HSON-6	35hq	VR4	7e	Ric
F15D	R1114D151D	LVR-IC	LDO, LN, +CE, CL, 1.5V±2%, 150mA	SON1612-6	35vra	VR4	7e	Ric
F15D	R1131D152D	LVR-IC	LDO, 1.5V±2%, 300mA, +CE, CL	HSON-6	35hq	VR4	7e	Ric
F16A	R1114D161A	LVR-IC	LDO, LN, -CE, 1.6V±2%, 150mA	SON1612-6	35vra	VR4	7e	Ric
F16A	R1131D162A	LVR-IC	LDO, 1.6V±2%, 300mA, +CE	HSON-6	35hq	VR4	7e	Ric
F16B	R1114D161B	LVR-IC	LDO, LN, +CE, 1.6V±2%, 150mA	SON1612-6	35vra	VR4	7e	Ric
F16B	R1131D162B	LVR-IC	LDO, 1.6V±2%, 300mA, -CE	HSON-6	35hq	VR4	7e	Ric
F16D	R1114D161D	LVR-IC	LDO, LN, +CE, CL, 1.6V±2%, 150mA	SON1612-6	35vra	VR4	7e	Ric
F16D	R1131D162D	LVR-IC	LDO, 1.6V±2%, 300mA, +CE, CL	HSON-6	35hq	VR4	7e	Ric
F17A	R1114D171A	LVR-IC	LDO, LN, -CE, 1.7V±2%, 150mA	SON1612-6	35vra	VR4	7e	Ric
F17A	R1131D172A	LVR-IC	LDO, 1.7V±2%, 300mA, +CE	HSON-6	35hq	VR4	7e	Ric
F17B	R1114D171B	LVR-IC	LDO, LN, +CE, 1.7V±2%, 150mA	SON1612-6	35vra	VR4	7e	Ric
F17B	R1131D172B	LVR-IC	LDO, 1.7V±2%, 300mA, -CE	HSON-6	35hq	VR4	7e	Ric
F17D	R1114D171D	LVR-IC	LDO, LN, +CE, CL, 1.7V±2%, 150mA	SON1612-6	35vra	VR4	7e	Ric
F17D	R1131D172D	LVR-IC	LDO, 1.7V±2%, 300mA, +CE, CL	HSON-6	35hq	VR4	7e	Ric
F18A	R1114D181A	LVR-IC	LDO, LN, -CE, 1.8V±2%, 150mA	SON1612-6	35vra	VR4	7e	Ric
F18A	R1131D182A	LVR-IC	LDO, 1.8V±2%, 300mA, +CE	HSON-6	35hq	VR4	7e	Ric
F18B	R1114D181B	LVR-IC	LDO, LN, +CE, 1.8V±2%, 150mA	SON1612-6	35vra	VR4	7e	Ric
F18B	R1131D182B	LVR-IC	LDO, 1.8V±2%, 300mA, -CE	HSON-6	35hq	VR4	7e	Ric
F18D	R1114D181D	LVR-IC	LDO, LN, +CE, CL, 1.8V±2%, 150mA	SON1612-6	35vra	VR4	7e	Ric
F18D	R1131D182D	LVR-IC	LDO, 1.8V±2%, 300mA, +CE, CL	HSON-6	35hq	VR4	7e	Ric
F19A	R1114D191A	LVR-IC	LDO, LN, -CE, 1.9V±2%, 150mA	SON1612-6	35vra	VR4	7e	Ric
F19A	R1131D192A	LVR-IC	LDO, 1.9V±2%, 300mA, +CE	HSON-6	35hq	VR4	7e	Ric
F19B	R1114D191B	LVR-IC	LDO, LN, +CE, 1.9V±2%, 150mA	SON1612-6	35vra	VR4	7e	Ric
F19B	R1131D192B	LVR-IC	LDO, 1.9V±2%, 300mA, -CE	HSON-6	35hq	VR4	7e	Ric
F19D	R1114D191D	LVR-IC	LDO, LN, +CE, CL, 1.9V±2%, 150mA	SON1612-6	35vra	VR4	7e	Ric
F19D	R1131D192D	LVR-IC	LDO, 1.9V±2%, 300mA, +CE, CL	HSON-6	35hq	VR4	7e	Ric
F1N05	MMDF1N05E	n-MOSFET-e	V-MOS, Dual, 50V, 2A, <0.3Ω(1.5A)	SOP-8	47	-	8d	Mot
F2	R1160D121B	LVR-IC	LDO, 1.2V±2%, 200mA, +CE, AE(mode)	SON-6	34wrc	VR10	7g	Ric
F2	R5421N148F	BM-IC	Li-Ion, over-charge/discharge protection, Vd=4.8V	SOT-23-6	33xj	VBM1	7d	Ric
F2	RN1903FS	Si-npn-Digi	Dual, Sw, 20V, 50mA, 50mW, 250MHz, R1/R2=22k/22k	US6	33/TD3	-	7b	Tos
F2	TC1073-2.7VCH	LVR-IC	LDO, 2.7V±2%, 100mA, +CE, -Error	SOT-23-6	33uj	VR9	7d	Mcc
F20A	R1114D201A	LVR-IC	LDO, LN, -CE, 2V±2%, 150mA	SON1612-6	35vra	VR4	7e	Ric
F20A	R1131D202A	LVR-IC	LDO, 2V±2%, 300mA, +CE	HSON-6	35hq	VR4	7e	Ric
F20B	R1114D201B	LVR-IC	LDO, LN, +CE, 2V±2%, 150mA	SON1612-6	35vra	VR4	7e	Ric
F20B	R1131D202B	LVR-IC	LDO, 2V±2%, 300mA, -CE	HSON-6	35hq	VR4	7e	Ric
F20D	R1114D201D	LVR-IC	LDO, LN, +CE, CL, 2V±2%, 150mA	SON1612-6	35vra	VR4	7e	Ric
F20D	R1131D202D	LVR-IC	LDO, 2V±2%, 300mA, +CE, CL	HSON-6	35hq	VR4	7e	Ric
F21A	R1114D211A	LVR-IC	LDO, LN, -CE, 2.1V±2%, 150mA	SON1612-6	35vra	VR4	7e	Ric
F21A	R1131D212A	LVR-IC	LDO, 2.1V±2%, 300mA, +CE	HSON-6	35hq	VR4	7e	Ric
F21B	R1114D211B	LVR-IC	LDO, LN, +CE, 2.1V±2%, 150mA	SON1612-6	35vra	VR4	7e	Ric
F21B	R1131D212B	LVR-IC	LDO, 2.1V±2%, 300mA, -CE	HSON-6	35hq	VR4	7e	Ric
F21D	R1114D211D	LVR-IC	LDO, LN, +CE, CL, 2.1V±2%, 150mA	SON1612-6	35vra	VR4	7e	Ric
F21D	R1131D212D	LVR-IC	LDO, 2.1V±2%, 300mA, +CE, CL	HSON-6	35hq	VR4	7e	Ric
F22A	R1114D221A	LVR-IC	LDO, LN, -CE, 2.2V±2%, 150mA	SON1612-6	35vra	VR4	7e	Ric
F22A	R1131D222A	LVR-IC	LDO, 2.2V±2%, 300mA, +CE	HSON-6	35hq	VR4	7e	Ric
F22B	R1114D221B	LVR-IC	LDO, LN, +CE, 2.2V±2%, 150mA	SON1612-6	35vra	VR4	7e	Ric
F22B	R1131D222B	LVR-IC	LDO, 2.2V±2%, 300mA, -CE	HSON-6	35hq	VR4	7e	Ric
F22D	R1114D221D	LVR-IC	LDO, LN, +CE, CL, 2.2V±2%, 150mA	SON1612-6	35vra	VR4	7e	Ric
F22D	R1131D222D	LVR-IC	LDO, 2.2V±2%, 300mA, +CE, CL	HSON-6	35hq	VR4	7e	Ric
F23A	R1114D231A	LVR-IC	LDO, LN, -CE, 2.3V±2%, 150mA	SON1612-6	35vra	VR4	7e	Ric
F23A	R1131D232A	LVR-IC	LDO, 2.3V±2%, 300mA, +CE	HSON-6	35hq	VR4	7e	Ric
F23B	R1114D231B	LVR-IC	LDO, LN, +CE, 2.3V±2%, 150mA	SON1612-6	35vra	VR4	7e	Ric
F23B	R1131D232B	LVR-IC	LDO, 2.3V±2%, 300mA, -CE	HSON-6	35hq	VR4	7e	Ric
F23D	R1114D231D	LVR-IC	LDO, LN, +CE, CL, 2.3V±2%, 150mA	SON1612-6	35vra	VR4	7e	Ric
F23D	R1131D232D	LVR-IC	LDO, 2.3V±2%, 300mA, +CE, CL	HSON-6	35hq	VR4	7e	Ric
F24A	R1114D241A	LVR-IC	LDO, LN, -CE, 2.4V±2%, 150mA	SON1612-6	35vra	VR4	7e	Ric
F24A	R1131D242A	LVR-IC	LDO, 2.4V±2%, 300mA, +CE	HSON-6	35hq	VR4	7e	Ric
F24B	R1114D241B	LVR-IC	LDO, LN, +CE, 2.4V±2%, 150mA	SON1612-6	35vra	VR4	7e	Ric
F24B	R1131D242B	LVR-IC	LDO, 2.4V±2%, 300mA, -CE	HSON-6	35hq	VR4	7e	Ric
F24D	R1114D241D	LVR-IC	LDO, LN, +CE, CL, 2.4V±2%, 150mA	SON1612-6	35vra	VR4	7e	Ric
F24D	R1131D242D	LVR-IC	LDO, 2.4V±2%, 300mA, +CE, CL	HSON-6	35hq	VR4	7e	Ric
F25A	R1114D251A	LVR-IC	LDO, LN, -CE, 2.5V±2%, 150mA	SON1612-6	35vra	VR4	7e	Ric
F25A	R1131D252A	LVR-IC	LDO, 2.5V±2%, 300mA, +CE	HSON-6	35hq	VR4	7e	Ric
F25B	R1114D251B	LVR-IC	LDO, LN, +CE, 2.5V±2%, 150mA	SON1612-6	35vra	VR4	7e	Ric
F25B	R1131D252B	LVR-IC	LDO, 2.5V±2%, 300mA, -CE	HSON-6	35hq	VR4	7e	Ric



SMD code	Type	Function	Short description	Case	Pinout	Sch.	St.	Mnf.
F25D	R1114D251D	LVR-IC	LDO, LN, +CE, CL, 2.5V±2%, 150mA	SON1612-6	35vra	VR4	7e	Ric
F25D	R1131D252D	LVR-IC	LDO, 2.5V±2%, 300mA, +CE, CL	HSON-6	35hq	VR4	7e	Ric
I26	XC7WH126DC	CMOS-Logic	Dual bus buffer with 3-state output	SOT765-1	47/Log54	-	8d	Phi
I26	XC7WH126DP	CMOS-Logic	Dual bus buffer with 3-state output	SOT505-2	47/Log54	-	8d	Phi
F26A	R1114D261A	LVR-IC	LDO, LN, -CE, 2.6V±2%, 150mA	SON1612-6	35vra	VR4	7e	Ric
F26A	R1131D262A	LVR-IC	LDO, 2.6V±2%, 300mA, +CE	HSON-6	35hq	VR4	7e	Ric
F26B	R1114D261B	LVR-IC	LDO, LN, +CE, 2.6V±2%, 150mA	SON1612-6	35vra	VR4	7e	Ric
F26B	R1131D262B	LVR-IC	LDO, 2.6V±2%, 300mA, -CE	HSON-6	35hq	VR4	7e	Ric
F26D	R1114D261D	LVR-IC	LDO, LN, +CE, CL, 2.6V±2%, 150mA	SON1612-6	35vra	VR4	7e	Ric
F26D	R1131D262D	LVR-IC	LDO, 2.6V±2%, 300mA, +CE, CL	HSON-6	35hq	VR4	7e	Ric
F27A	R1114D271A	LVR-IC	LDO, LN, -CE, 2.7V±2%, 150mA	SON1612-6	35vra	VR4	7e	Ric
F27A	R1131D272A	LVR-IC	LDO, 2.7V±2%, 300mA, +CE	HSON-6	35hq	VR4	7e	Ric
F27B	R1114D271B	LVR-IC	LDO, LN, +CE, 2.7V±2%, 150mA	SON1612-6	35vra	VR4	7e	Ric
F27B	R1131D272B	LVR-IC	LDO, 2.7V±2%, 300mA, -CE	HSON-6	35hq	VR4	7e	Ric
F27D	R1114D271D	LVR-IC	LDO, LN, +CE, CL, 2.7V±2%, 150mA	SON1612-6	35vra	VR4	7e	Ric
F27D	R1131D272D	LVR-IC	LDO, 2.7V±2%, 300mA, +CE, CL	HSON-6	35hq	VR4	7e	Ric
F28A	R1114D281A	LVR-IC	LDO, LN, -CE, 2.8V±2%, 150mA	SON1612-6	35vra	VR4	7e	Ric
F28A	R1131D282A	LVR-IC	LDO, 2.8V±2%, 300mA, +CE	HSON-6	35hq	VR4	7e	Ric
F28B	R1114D281B	LVR-IC	LDO, LN, +CE, 2.8V±2%, 150mA	SON1612-6	35vra	VR4	7e	Ric
F28B	R1131D282B	LVR-IC	LDO, 2.8V±2%, 300mA, -CE	HSON-6	35hq	VR4	7e	Ric
F28D	R1114D281D	LVR-IC	LDO, LN, +CE, CL, 2.8V±2%, 150mA	SON1612-6	35vra	VR4	7e	Ric
F28D	R1131D282D	LVR-IC	LDO, 2.8V±2%, 300mA, +CE, CL	HSON-6	35hq	VR4	7e	Ric
F29A	R1114D291A	LVR-IC	LDO, LN, -CE, 2.9V±2%, 150mA	SON1612-6	35vra	VR4	7e	Ric
F29A	R1131D292A	LVR-IC	LDO, 2.9V±2%, 300mA, +CE	HSON-6	35hq	VR4	7e	Ric
F29B	R1114D291B	LVR-IC	LDO, LN, +CE, 2.9V±2%, 150mA	SON1612-6	35vra	VR4	7e	Ric
F29B	R1131D292B	LVR-IC	LDO, 2.9V±2%, 300mA, -CE	HSON-6	35hq	VR4	7e	Ric
F29D	R1114D291D	LVR-IC	LDO, LN, +CE, CL, 2.9V±2%, 150mA	SON1612-6	35vra	VR4	7e	Ric
F29D	R1131D292D	LVR-IC	LDO, 2.9V±2%, 300mA, +CE, CL	HSON-6	35hq	VR4	7e	Ric
F2N02E	MMDF2N02E	n-MOSFET-e	V-MOS, Dual, 25V, 3.6A, <0.1Ω	SOP-8	47	-	8d	Mot
F2P02E	MMDF2P02E	p-MOSFET-e*	V-MOS, Dual, 25V, 2.5A, <0.25Ω	SOP-8	47	-	8d	Mot
F3	R1160D131B	LVR-IC	LDO, 1.3V±2%, 200mA, +CE, AE(mode)	SON-6	34vrc	VR10	7g	Ric
F3	R5421N173C	BM-IC	Li-Ion, over-charge/discharge protection, Vd=7.3V	SOT-23-6	33xj	VBM1	7d	Ric
F3	RN1904FS	Si-npn-Digi	Dual, Sw, 20V, 50mA, 50mV, 250MHz, R1/R2=47k/47k	US6	33/TD3	-	7b	Tos
F3	TC1073-3.0VCH	LVR-IC	LDO, 3V±2%, 100mA, +CE, -Error	SOT-23-6	33uj	VR9	7d	Mcc
F30A	R1114D301A	LVR-IC	LDO, LN, -CE, 3V±2%, 150mA	SON1612-6	35vra	VR4	7e	Ric
F30A	R1131D302A	LVR-IC	LDO, 3V±2%, 300mA, +CE	HSON-6	35hq	VR4	7e	Ric
F30B	R1114D301B	LVR-IC	LDO, LN, +CE, 3V±2%, 150mA	SON1612-6	35vra	VR4	7e	Ric
F30B	R1131D302B	LVR-IC	LDO, 3V±2%, 300mA, -CE	HSON-6	35hq	VR4	7e	Ric
F30D	R1114D301D	LVR-IC	LDO, LN, +CE, CL, 3V±2%, 150mA	SON1612-6	35vra	VR4	7e	Ric
F30D	R1131D302D	LVR-IC	LDO, 3V±2%, 300mA, +CE, CL	HSON-6	35hq	VR4	7e	Ric
F31A	R1114D311A	LVR-IC	LDO, LN, -CE, 3.1V±2%, 150mA	SON1612-6	35vra	VR4	7e	Ric
F31A	R1131D312A	LVR-IC	LDO, 3.1V±2%, 300mA, +CE	HSON-6	35hq	VR4	7e	Ric
F31B	R1114D311B	LVR-IC	LDO, LN, +CE, 3.1V±2%, 150mA	SON1612-6	35vra	VR4	7e	Ric
F31B	R1131D312B	LVR-IC	LDO, 3.1V±2%, 300mA, -CE	HSON-6	35hq	VR4	7e	Ric
F31D	R1114D311D	LVR-IC	LDO, LN, +CE, CL, 3.1V±2%, 150mA	SON1612-6	35vra	VR4	7e	Ric
F31D	R1131D312D	LVR-IC	LDO, 3.1V±2%, 300mA, +CE, CL	HSON-6	35hq	VR4	7e	Ric
F32A	R1114D321A	LVR-IC	LDO, LN, -CE, 3.2V±2%, 150mA	SON1612-6	35vra	VR4	7e	Ric
F32A	R1131D322A	LVR-IC	LDO, 3.2V±2%, 300mA, +CE	HSON-6	35hq	VR4	7e	Ric
F32B	R1114D321B	LVR-IC	LDO, LN, +CE, 3.2V±2%, 150mA	SON1612-6	35vra	VR4	7e	Ric
F32B	R1131D322B	LVR-IC	LDO, 3.2V±2%, 300mA, -CE	HSON-6	35hq	VR4	7e	Ric
F32D	R1114D321D	LVR-IC	LDO, LN, +CE, CL, 3.2V±2%, 150mA	SON1612-6	35vra	VR4	7e	Ric
F32D	R1131D322D	LVR-IC	LDO, 3.2V±2%, 300mA, +CE, CL	HSON-6	35hq	VR4	7e	Ric
F33A	R1114D331A	LVR-IC	LDO, LN, -CE, 3.3V±2%, 150mA	SON1612-6	35vra	VR4	7e	Ric
F33A	R1131D332A	LVR-IC	LDO, 3.3V±2%, 300mA, +CE	HSON-6	35hq	VR4	7e	Ric
F33B	R1114D331B	LVR-IC	LDO, LN, +CE, 3.3V±2%, 150mA	SON1612-6	35vra	VR4	7e	Ric
F33B	R1131D332B	LVR-IC	LDO, 3.3V±2%, 300mA, -CE	HSON-6	35hq	VR4	7e	Ric
F33D	R1114D331D	LVR-IC	LDO, LN, +CE, CL, 3.3V±2%, 150mA	SON1612-6	35vra	VR4	7e	Ric
F33D	R1131D332D	LVR-IC	LDO, 3.3V±2%, 300mA, +CE, CL	HSON-6	35hq	VR4	7e	Ric
F34A	R1114D341A	LVR-IC	LDO, LN, -CE, 3.4V±2%, 150mA	SON1612-6	35vra	VR4	7e	Ric
F34B	R1114D341B	LVR-IC	LDO, LN, +CE, 3.4V±2%, 150mA	SON1612-6	35vra	VR4	7e	Ric
F34D	R1114D341D	LVR-IC	LDO, LN, +CE, CL, 3.4V±2%, 150mA	SON1612-6	35vra	VR4	7e	Ric
F35A	R1114D351A	LVR-IC	LDO, LN, -CE, 3.5V±2%, 150mA	SON1612-6	35vra	VR4	7e	Ric
F35B	R1114D351B	LVR-IC	LDO, LN, +CE, 3.5V±2%, 150mA	SON1612-6	35vra	VR4	7e	Ric
F35D	R1114D351D	LVR-IC	LDO, LN, +CE, CL, 3.5V±2%, 150mA	SON1612-6	35vra	VR4	7e	Ric
F36A	R1114D361A	LVR-IC	LDO, LN, -CE, 3.6V±2%, 150mA	SON1612-6	35vra	VR4	7e	Ric
F36B	R1114D361B	LVR-IC	LDO, LN, +CE, 3.6V±2%, 150mA	SON1612-6	35vra	VR4	7e	Ric
F36D	R1114D361D	LVR-IC	LDO, LN, +CE, CL, 3.6V±2%, 150mA	SON1612-6	35vra	VR4	7e	Ric
F37A	R1114D371A	LVR-IC	LDO, LN, -CE, 3.7V±2%, 150mA	SON1612-6	35vra	VR4	7e	Ric
F37B	R1114D371B	LVR-IC	LDO, LN, +CE, 3.7V±2%, 150mA	SON1612-6	35vra	VR4	7e	Ric
F37D	R1114D371D	LVR-IC	LDO, LN, +CE, CL, 3.7V±2%, 150mA	SON1612-6	35vra	VR4	7e	Ric



SMD code	Type	Function	Short description	Case	Pinout	Sch.	St.	Mnf.
F38A	R1114D381A	LVR-IC	LDO, LN, -CE, 3.8V±2%, 150mA	SON1612-6	35vra	VR4	7e	Ric
F38B	R1114D381B	LVR-IC	LDO, LN, +CE, 3.8V±2%, 150mA	SON1612-6	35vra	VR4	7e	Ric
F38D	R1114D381D	LVR-IC	LDO, LN, +CE, CL, 3.8V±2%, 150mA	SON1612-6	35vra	VR4	7e	Ric
F39A	R1114D391A	LVR-IC	LDO, LN, -CE, 3.9V±2%, 150mA	SON1612-6	35vra	VR4	7e	Ric
F39B	R1114D391B	LVR-IC	LDO, LN, +CE, 3.9V±2%, 150mA	SON1612-6	35vra	VR4	7e	Ric
F39D	R1114D391D	LVR-IC	LDO, LN, +CE, CL, 3.9V±2%, 150mA	SON1612-6	35vra	VR4	7e	Ric
F4	R1160D141B	LVR-IC	LDO, 1.4V±2%, 200mA, +CE, AE(mode)	SON-6	34vrc	VR10	7g	Ric
F4	RN1905FS	Si-npn-Digi	Dual, Sw, 20V, 50mA, 50mW, 250MHz, R1/R2=2k2/47k	US6	33/TD3	-	7b	Tos
F40A	R1114D401A	LVR-IC	LDO, LN, -CE, 4V±2%, 150mA	SON1612-6	35vra	VR4	7e	Ric
F40B	R1114D401B	LVR-IC	LDO, LN, +CE, 4V±2%, 150mA	SON1612-6	35vra	VR4	7e	Ric
F40D	R1114D401D	LVR-IC	LDO, LN, +CE, CL, 4V±2%, 150mA	SON1612-6	35vra	VR4	7e	Ric
F41A	R1114D281A5	LVR-IC	LDO, LN, -CE, 2.85V±2%, 150mA	SON1612-6	35vra	VR4	7e	Ric
F41B	R1114D281B5	LVR-IC	LDO, LN, +CE, 2.85V±2%, 150mA	SON1612-6	35vra	VR4	7e	Ric
F41D	R1114D281D5	LVR-IC	LDO, LN, +CE, CL, 2.85V±2%, 150mA	SON1612-6	35vra	VR4	7e	Ric
F42A	R1114D181A5	LVR-IC	LDO, LN, -CE, 1.85V±2%, 150mA	SON1612-6	35vra	VR4	7e	Ric
F42B	R1114D181B5	LVR-IC	LDO, LN, +CE, 1.85V±2%, 150mA	SON1612-6	35vra	VR4	7e	Ric
F42D	R1114D181D5	LVR-IC	LDO, LN, +CE, CL, 1.85V±2%, 150mA	SON1612-6	35vra	VR4	7e	Ric
F5	R1160D151B	LVR-IC	LDO, 1.5V±2%, 200mA, +CE, AE(mode)	SON-6	34vrc	VR10	7g	Ric
F5	RN1906FS	Si-npn-Digi	Dual, Sw, 20V, 50mA, 50mW, 250MHz, R1/R2=4k7/47k	US6	33/TD3	-	7b	Tos
F5	TC1073-3.3VCH	LVR-IC	LDO, 3.3V±2%, 100mA, +CE, -Error	SOT-23-6	33uj	VR9	7d	Mcc
F6	R1160D161B	LVR-IC	LDO, 1.6V±2%, 200mA, +CE, AE(mode)	SON-6	34vrc	VR10	7g	Ric
F6	RN1907FS	Si-npn-Digi	Dual, Sw, 20V, 50mA, 50mW, 250MHz, R1/R2=10k/47k	FS6	35/TD3	-	7b	Tos
F7	R1160D171B	LVR-IC	LDO, 1.7V±2%, 200mA, +CE, AE(mode)	SON-6	34vrc	VR10	7g	Ric
F7	RN1908FS	Si-npn-Digi	Dual, Sw, 20V, 50mA, 50mW, 250MHz, R1/R2=22k/47k	FS6	35/TD3	-	7b	Tos
F7	TC1073-5.0VCH	LVR-IC	LDO, 5V±2%, 100mA, +CE, -Error	SOT-23-6	33uj	VR9	7d	Mcc
F8	R1131D081A	LVR-IC	LDO, 0.8V±2%, 300mA, +CE	SON-6	34hq	VR4	7g	Ric
F8	R1160D181B	LVR-IC	LDO, 1.8V±2%, 200mA, +CE, AE(mode)	SON-6	34vrc	VR10	7g	Ric
F8	RN1909FS	Si-npn-Digi	Dual, Sw, 20V, 50mA, 50mW, 250MHz, R1/R2=47k/22k	FS6	35/TD3	-	7b	Tos
F8	TC1073-2.85VCH	LVR-IC	LDO, 2.85V±2%, 100mA, +CE, -Error	SOT-23-6	33uj	VR9	7d	Mcc
F9	R1131D091A	LVR-IC	LDO, 0.9V±2%, 300mA, +CE	SON-6	34hq	VR4	7g	Ric
F9	R1160D191B	LVR-IC	LDO, 1.9V±2%, 200mA, +CE, AE(mode)	SON-6	34vrc	VR10	7g	Ric
F9	RN1910FS	Si-npn-Digi	Dual, Sw, 20V, 50mA, 50mW, 250MHz, R1=4k7	FS6	35/TD3	-	7b	Tos
F9	TC1073-3.6VCH	LVR-IC	LDO, 3.6V±2%, 100mA, +CE, -Error	SOT-23-6	33uj	VR9	7d	Mcc
fA	FP6121-AS6P	LVR-IC	LDO, Dual out, Vout1/Vout2=3.3V/2.8V±2%, 150mA, +CE	SOT-23-6	33x5	VR19	7b	Fit
fA	RP152N025B	LVR-IC	LDO, Dual out, Vout1/Vout2=3.0V/3.0V±1%, 150mA, +CE, CL	SOT-23-6	33x5	VR19	7d	Ric
fB	FP6121-BS6P	LVR-IC	LDO, Dual out, Vout1/Vout2=3.3V/2.5V±2%, 150mA, +CE	SOT-23-6	33x5	VR19	7b	Fit
fB	RP152N026B	LVR-IC	LDO, Dual out, Vout1/Vout2=2.8V/3.1V±1%, 150mA, +CE, CL	SOT-23-6	33x5	VR19	7d	Ric
fC	FP6121-CS6P	LVR-IC	LDO, Dual out, Vout1/Vout2=2.8V/1.8V±2%, 150mA, +CE	SOT-23-6	33x5	VR19	7b	Fit
fC	RP152N027B	LVR-IC	LDO, Dual out, Vout1/Vout2=2.3V/2.8V±1%, 150mA, +CE, CL	SOT-23-6	33x5	VR19	7d	Ric
fD	FP6121-DS6P	LVR-IC	LDO, Dual out, Vout1/Vout2=2.5V/1.8V±2%, 150mA, +CE	SOT-23-6	33x5	VR19	7b	Fit
fD	RP152N028B	LVR-IC	LDO, Dual out, Vout1/Vout2=2.8V/1.0V±1%, 150mA, +CE, CL	SOT-23-6	33x5	VR19	7d	Ric
fE	FP6121-ES6P	LVR-IC	LDO, Dual out, Vout1/Vout2=3.0V/1.8V±2%, 150mA, +CE	SOT-23-6	33x5	VR19	7b	Fit
fE	RP152N029B	LVR-IC	LDO, Dual out, Vout1/Vout2=1.5V/1.5V±1%, 150mA, +CE, CL	SOT-23-6	33x5	VR19	7d	Ric
fF	FP6121-FS6P	LVR-IC	LDO, Dual out, Vout1/Vout2=1.8V/2.8V±2%, 150mA, +CE	SOT-23-6	33x5	VR19	7b	Fit
fF	RN1911FS	Si-npn-Digi	Dual, Sw, 20V, 50mA, 50mW, 250MHz, R1=10k	FS6	35/TD3	-	7b	Tos
fF	RP152N030B	LVR-IC	LDO, Dual out, Vout1/Vout2=1.5V/3.3V±1%, 150mA, +CE, CL	SOT-23-6	33x5	VR19	7d	Ric
fF=	FP6121-FS6G	LVR-IC	LDO, Dual out, Vout1/Vout2=1.8V/2.8V±2%, 150mA, +CE	SOT-23-6	33x5	VR19	7b	Fit
fG	FP6121-GS6P	LVR-IC	LDO, Dual out, Vout1/Vout2=2.8V/2.8V±2%, 150mA, +CE	SOT-23-6	33x5	VR19	7b	Fit
fG	RP152N031B	LVR-IC	LDO, Dual out, Vout1/Vout2=1.8V/2.7V±1%, 150mA, +CE, CL	SOT-23-6	33x5	VR19	7d	Ric
fH	FP6121-HS6P	LVR-IC	LDO, Dual out, Vout1/Vout2=1.5V/2.8V±2%, 150mA, +CE	SOT-23-6	33x5	VR19	7b	Fit
fH	RP152N032B	LVR-IC	LDO, Dual out, Vout1/Vout2=1.2V/3.0V±1%, 150mA, +CE, CL	SOT-23-6	33x5	VR19	7d	Ric
fi	FP6121-IS9P	LVR-IC	LDO, Dual out, Vout1/Vout2=1.8V/3.3V±2%, 150mA, +CE	TSOT-23-6	33x5	VR19	7b	Fit
fJ	RP152N033B	LVR-IC	LDO, Dual out, Vout1/Vout2=3.1V/3.1V±1%, 150mA, +CE, CL	SOT-23-6	33x5	VR19	7d	Ric
fK	FP6121-JS6P	LVR-IC	LDO, Dual out, Vout1/Vout2=1.3V/2.8V±2%, 150mA, +CE	SOT-23-6	33x5	VR19	7b	Fit
fK	FP6121-NS6P	LVR-IC	LDO, Dual out, Vout1/Vout2=2.8V/3.3V±2%, 150mA, +CE	SOT-23-6	33x5	VR19	7b	Fit
fK	RP152N034B	LVR-IC	LDO, Dual out, Vout1/Vout2=1.8V/2.6V±1%, 150mA, +CE, CL	SOT-23-6	33x5	VR19	7d	Ric
fL	FP6121-OS6P	LVR-IC	LDO, Dual out, Vout1/Vout2=1.8V/1.8V±2%, 150mA, +CE	SOT-23-6	33x5	VR19	7b	Fit
fL	RP152N035B	LVR-IC	LDO, Dual out, Vout1/Vout2=1.2V/2.9V±1%, 150mA, +CE, CL	SOT-23-6	33x5	VR19	7d	Ric
fM	FP6121-IS9P	LVR-IC	LDO, Dual out, Vout1/Vout2=1.3V/2.8V±2%, 150mA, +CE	TSOT-23-6	33x5	VR19	7b	Fit
fM	FP6121-NS9P	LVR-IC	LDO, Dual out, Vout1/Vout2=2.8V/3.3V±2%, 150mA, +CE	TSOT-23-6	33x5	VR19	7b	Fit
fM	RP152N036B	LVR-IC	LDO, Dual out, Vout1/Vout2=1.2V/2.9V±1%, 150mA, +CE, CL	SOT-23-6	33x5	VR19	7d	Ric
fN	FP6121-KS6P	LVR-IC	LDO, Dual out, Vout1/Vout2=1.2V/2.8V±2%, 150mA, +CE	SOT-23-6	33x5	VR19	7b	Fit
fN	FP6121-OS9P	LVR-IC	LDO, Dual out, Vout1/Vout2=1.8V/1.8V±2%, 150mA, +CE	TSOT-23-6	33x5	VR19	7b	Fit
fN	RP152N037B	LVR-IC	LDO, Dual out, Vout1/Vout2=3.3V/2.0V±1%, 150mA, +CE, CL	SOT-23-6	33x5	VR19	7d	Ric
FP	PAM8301AAF	LIN-IC	AF PA, BTL, class-D, 2.5..5.5V, 1.5W(5V/8Ω), shutdown	SOP-6	33	-	7b	Pam
FP	RP152N038B	LVR-IC	LDO, Dual out, Vout1/Vout2=1.2V/2.85V±1%, 150mA, +CE, CL	SOT-23-6	33x5	VR19	7d	Ric
FQ	RP152N039B	LVR-IC	LDO, Dual out, Vout1/Vout2=2.1V/3.3V±1%, 150mA, +CE, CL	SOT-23-6	33x5	VR19	7d	Ric
fr	FP6121-KS9P	LVR-IC	LDO, Dual out, Vout1/Vout2=1.2V/2.8V±2%, 150mA, +CE	TSOT-23-6	33x5	VR19	7b	Fit
fR	FP6121-AS9P	LVR-IC	LDO, Dual out, Vout1/Vout2=3.3V/2.8V±2%, 150mA, +CE	TSOT-23-6	33x5	VR19	7b	Fit
FR	RP152N040B	LVR-IC	LDO, Dual out, Vout1/Vout2=2.8V/2.85V±1%, 150mA, +CE, CL	SOT-23-6	33x5	VR19	7d	Ric



SMD code	Type	Function	Short description	Case	Pinout	Sch.	St.	Mnf.
IS	FP6121-BS9P	LVR-IC	LDO, Dual out, Vout1/Vout2=3.3V/2.5V±2%, 150mA, +CE	TSOT-23-6	33x5	VR19	7b	Fit
FS	RP152N041B	LVR-IC	LDO, Dual out, Vout1/Vout2=1.8V/3.0V±1%, 150mA, +CE, CL	SOT-23-6	33x5	VR19	7d	Ric
ft	FP6121-L56P	LVR-IC	LDO, Dual out, Vout1/Vout2=1.8V/2.6V±2%, 150mA, +CE	SOT-23-6	33x5	VR19	7b	Fit
ft	FP6121-CS9P	LVR-IC	LDO, Dual out, Vout1/Vout2=2.8V/1.8V±2%, 150mA, +CE	TSOT-23-6	33x5	VR19	7b	Fit
FT	FP6121-PS6P	LVR-IC	LDO, Dual out, Vout1/Vout2=2.85V/2.85V±2%, 150mA, +CE	SOT-23-6	33x5	VR19	7b	Fit
FT	RP152N042B	LVR-IC	LDO, Dual out, Vout1/Vout2=1.2V/2.6V±1%, 150mA, +CE, CL	SOT-23-6	33x5	VR19	7d	Ric
fu	FP6121-MS6P	LVR-IC	LDO, Dual out, Vout1/Vout2=1.8V/3.0V±2%, 150mA, +CE	SOT-23-6	33x5	VR19	7b	Fit
fU	FP6121-DS9P	LVR-IC	LDO, Dual out, Vout1/Vout2=2.5V/1.8V±2%, 150mA, +CE	TSOT-23-6	33x5	VR19	7b	Fit
FU	FP6121-PS9P	LVR-IC	LDO, Dual out, Vout1/Vout2=2.85V/2.85V±2%, 150mA, +CE	TSOT-23-6	33x5	VR19	7b	Fit
FU	RP152N043B	LVR-IC	LDO, Dual out, Vout1/Vout2=1.3V/2.8V±1%, 150mA, +CE, CL	SOT-23-6	33x5	VR19	7d	Ric
fv	FP6121-L59P	LVR-IC	LDO, Dual out, Vout1/Vout2=1.8V/2.6V±2%, 150mA, +CE	TSOT-23-6	33x5	VR19	7b	Fit
fv	FP6121-ES9P	LVR-IC	LDO, Dual out, Vout1/Vout2=3.0V/1.8V±2%, 150mA, +CE	TSOT-23-6	33x5	VR19	7b	Fit
FV	RP152N044B	LVR-IC	LDO, Dual out, Vout1/Vout2=1.1V/1.5V±1%, 150mA, +CE, CL	SOT-23-6	33x5	VR19	7d	Ric
fW	FP6121-MS9P	LVR-IC	LDO, Dual out, Vout1/Vout2=1.8V/3.0V±2%, 150mA, +CE	TSOT-23-6	33x5	VR19	7b	Fit
fW	FP6121-FS9P	LVR-IC	LDO, Dual out, Vout1/Vout2=2.8V/2.8V±2%, 150mA, +CE	TSOT-23-6	33x5	VR19	7b	Fit
FW	RP152N045B	LVR-IC	LDO, Dual out, Vout1/Vout2=2.8V/3.3V±1%, 150mA, +CE, CL	SOT-23-6	33x5	VR19	7d	Ric
fX	FP6121-GS9P	LVR-IC	LDO, Dual out, Vout1/Vout2=2.8V/2.8V±2%, 150mA, +CE	TSOT-23-6	33x5	VR19	7b	Fit
FX	RP152N046B	LVR-IC	LDO, Dual out, Vout1/Vout2=2.8V/3.0V±1%, 150mA, +CE, CL	SOT-23-6	33x5	VR19	7d	Ric
fy	FP6121-HS9P	LVR-IC	LDO, Dual out, Vout1/Vout2=1.5V/2.8V±2%, 150mA, +CE	TSOT-23-6	33x5	VR19	7b	Fit
FY	RP152N047B	LVR-IC	LDO, Dual out, Vout1/Vout2=2.5V/2.8V±1%, 150mA, +CE, CL	SOT-23-6	33x5	VR19	7d	Ric
fZ	FP6121-IS6P	LVR-IC	LDO, Dual out, Vout1/Vout2=1.8V/3.3V±2%, 150mA, +CE	SOT-23-6	33x5	VR19	7b	Fit
FZ	RP152N048B	LVR-IC	LDO, Dual out, Vout1/Vout2=2.5V/3.2V±1%, 150mA, +CE, CL	SOT-23-6	33x5	VR19	7d	Ric
FZ	TC1073-2.8VCH	LVR-IC	LDO, 2.8V±2%, 100mA, +CE, -Error	SOT-23-6	33uj	VR9	7d	Mcc
G0	R1131D101A	LVR-IC	LDO, 1V±2%, 300mA, +CE	SON-6	34hq	VR4	7g	Ric
G0	R1160D201B	LVR-IC	LDO, 2V±2%, 200mA, +CE, AE(mode)	SON-6	34wrc	VR10	7g	Ric
G00B	R1180D181B5	LVR-IC	LDO, 1.85V±2%, 150mA, +CE	SON1612-6	35vra	VR4	7e	Ric
G01A	R1172D181A5	LVR-IC	LDO, 1.85V±2%, 1A, -CE	HSON-6	35vr	VR4	7e	Ric
G01B	R1172D181B5	LVR-IC	LDO, 1.85V±2%, 1A, +CE	HSON-6	35vr	VR4	7e	Ric
G01B	RP131S121B5	LVR-IC	LDO, 1.25V±1%, 1A, +CE	HSOP-6J	29vrb	VR4	7h	Ric
G01D	R1172D181D5	LVR-IC	LDO, 1.85V±2%, 1A, +CE, CL	HSON-6	35vr	VR4	7e	Ric
G01D	RP131S121D5	LVR-IC	LDO, 1.25V±1%, 1A, +CE, CL	HSOP-6J	29vrb	VR4	7h	Ric
G02A	R1172D281A5	LVR-IC	LDO, 2.85V±2%, 1A, -CE	HSON-6	35vr	VR4	7e	Ric
G02B	R1172D281B5	LVR-IC	LDO, 2.85V±2%, 1A, +CE	HSON-6	35vr	VR4	7e	Ric
G02B	RP131S181B5	LVR-IC	LDO, 1.85V±1%, 1A, +CE	HSOP-6J	29vrb	VR4	7h	Ric
G02D	R1172D281D5	LVR-IC	LDO, 2.85V±2%, 1A, +CE, CL	HSON-6	35vr	VR4	7e	Ric
G02D	RP131S181D5	LVR-IC	LDO, 1.85V±1%, 1A, +CE, CL	HSOP-6J	29vrb	VR4	7h	Ric
G03B	RP131S281B5	LVR-IC	LDO, 2.85V±1%, 1A, +CE	HSOP-6J	29vrb	VR4	7h	Ric
G03D	RP131S281D5	LVR-IC	LDO, 2.85V±1%, 1A, +CE, CL	HSOP-6J	29vrb	VR4	7h	Ric
G04B	RP131S101B5	LVR-IC	LDO, 1.05V±1%, 1A, +CE	HSOP-6J	29vrb	VR4	7h	Ric
G04D	RP131S101D5	LVR-IC	LDO, 1.05V±1%, 1A, +CE, CL	HSOP-6J	29vrb	VR4	7h	Ric
G08	LM4808MM	LIN-IC	AF PA, 2.5.5V, 2x105mW(4V/16Ω)	SSOP-8	47	AFP6	-	Nsc
G08A	R1172D081A	LVR-IC	LDO, 0.8V±2%, 1A, -CE	HSON-6	35vr	VR4	7e	Ric
G08B	R1172D081B	LVR-IC	LDO, 0.8V±2%, 1A, +CE	HSON-6	35vr	VR4	7e	Ric
G08B	RP131S081B	LVR-IC	LDO, 0.8V±1%, 1A, +CE	HSOP-6J	29vrb	VR4	7h	Ric
G08D	R1172D081D	LVR-IC	LDO, 0.8V±2%, 1A, +CE, CL	HSON-6	35vr	VR4	7e	Ric
G08D	RP131S081D	LVR-IC	LDO, 0.8V±1%, 1A, +CE, CL	HSOP-6J	29vrb	VR4	7h	Ric
G09	LM4809MM	LIN-IC	AF PA, 2.5.5V, 2x105mW(4V/16Ω), shutdown	MSOP-8	55	AFP7	-	Nsc
G09A	R1172D091A	LVR-IC	LDO, 0.8V±2%, 1A, -CE	HSON-6	35vr	VR4	7e	Ric
G09B	R1172D091B	LVR-IC	LDO, 0.9V±2%, 1A, +CE	HSON-6	35vr	VR4	7e	Ric
G09B	RP131S091B	LVR-IC	LDO, 0.9V±1%, 1A, +CE	HSOP-6J	29vrb	VR4	7h	Ric
G09D	R1172D091D	LVR-IC	LDO, 0.9V±2%, 1A, +CE, CL	HSON-6	35vr	VR4	7e	Ric
G09D	RP131S091D	LVR-IC	LDO, 0.9V±1%, 1A, +CE, CL	HSOP-6J	29vrb	VR4	7h	Ric
G1	R1131D111A	LVR-IC	LDO, 1.1V±2%, 300mA, +CE	SON-6	34hq	VR4	7g	Ric
G1	R1160D211B	LVR-IC	LDO, 2.1V±2%, 200mA, +CE, AE(mode)	SON-6	34wrc	VR10	7g	Ric
G10	LM4810MM	LIN-IC	AF PA, 2.5.5V, 2x105mW(4V/16Ω), shutdown	SSOP-8	47	AFP16	-	Nsc
G10A	R1172D101A	LVR-IC	LDO, 1V±2%, 1A, -CE	HSON-6	35vr	VR4	7e	Ric
G10B	R1172D101B	LVR-IC	LDO, 1V±2%, 1A, +CE	HSON-6	35vr	VR4	7e	Ric
G10B	RP131S101B	LVR-IC	LDO, 1V±1%, 1A, +CE	HSOP-6J	29vrb	VR4	7h	Ric
G10D	R1172D101D	LVR-IC	LDO, 1V±2%, 1A, +CE, CL	HSON-6	35vr	VR4	7e	Ric
G10D	RP131S101D	LVR-IC	LDO, 1V±1%, 1A, +CE, CL	HSOP-6J	29vrb	VR4	7h	Ric
G11A	R1172D111A	LVR-IC	LDO, 1.1V±2%, 1A, -CE	HSON-6	35vr	VR4	7e	Ric
G11B	R1172D111B	LVR-IC	LDO, 1.1V±2%, 1A, +CE	HSON-6	35vr	VR4	7e	Ric
G11B	RP131S111B	LVR-IC	LDO, 1.1V±1%, 1A	HSOP-6J	29vrb	VR4	7h	Ric
G11D	R1172D111D	LVR-IC	LDO, 1.1V±2%, 1A, +CE, CL	HSON-6	35vr	VR4	7e	Ric
G11D	RP131S111D	LVR-IC	LDO, 1.1V±1%, 1A, +CE, CL	HSOP-6J	29vrb	VR4	7h	Ric
G12A	R1172D121A	LVR-IC	LDO, 1.2V±2%, 1A, -CE	HSON-6	35vr	VR4	7e	Ric
G12B	R1172D121B	LVR-IC	LDO, 1.2V±2%, 1A, +CE	HSON-6	35vr	VR4	7e	Ric
G12B	R1180D121B	LVR-IC	LDO, 1.2V±2%, 150mA, +CE	SON1612-6	35vra	VR4	7e	Ric
G12B	RP131S121B	LVR-IC	LDO, 1.2V±1%, 1A, +CE	HSOP-6J	29vrb	VR4	7h	Ric
G12C	R1180D121C	LVR-IC	LDO, 1.2V±2%, 150mA	SON1612-6	35yl	VR1	7e	Ric



SMD code	Type	Function	Short description	Case	Pinout	Sch.	St.	Mnf.
G12D	R1172D121D	LVR-IC	LDO, 1.2V±2%, 1A, +CE, CL	HSON-6	35vr	VR4	7e	Ric
G12D	RP131S121D	LVR-IC	LDO, 1.2V±1%, 1A, +CE, CL	HSOP-6J	29vtb	VR4	7h	Ric
G13A	R1172D131A	LVR-IC	LDO, 1.3V±2%, 1A, -CE	HSON-6	35vr	VR4	7e	Ric
G13B	R1172D131B	LVR-IC	LDO, 1.3V±2%, 1A, +CE	HSON-6	35vr	VR4	7e	Ric
G13B	R1180D131B	LVR-IC	LDO, 1.3V±2%, 150mA, +CE	SON1612-6	35vra	VR4	7e	Ric
G13B	RP131S131B	LVR-IC	LDO, 1.3V±1%, 1A, +CE	HSOP-6J	29vtb	VR4	7h	Ric
G13C	R1180D131C	LVR-IC	LDO, 1.3V±2%, 150mA	SON1612-6	35yl	VR1	7e	Ric
G13D	R1172D131D	LVR-IC	LDO, 1.3V±2%, 1A, +CE, CL	HSON-6	35vr	VR4	7e	Ric
G13D	RP131S131D	LVR-IC	LDO, 1.3V±1%, 1A, +CE, CL	HSOP-6J	29vtb	VR4	7h	Ric
G14A	R1172D141A	LVR-IC	LDO, 1.4V±2%, 1A, -CE	HSON-6	35vr	VR4	7e	Ric
G14B	R1172D141B	LVR-IC	LDO, 1.4V±2%, 1A, +CE	HSON-6	35vr	VR4	7e	Ric
G14B	R1180D141B	LVR-IC	LDO, 1.4V±2%, 150mA, +CE	SON1612-6	35vra	VR4	7e	Ric
G14B	RP131S141B	LVR-IC	LDO, 1.4V±1%, 1A, +CE	HSOP-6J	29vtb	VR4	7h	Ric
G14C	R1180D141C	LVR-IC	LDO, 1.4V±2%, 150mA	SON1612-6	35yl	VR1	7e	Ric
G14D	R1172D141D	LVR-IC	LDO, 1.4V±2%, 1A, +CE, CL	HSON-6	35vr	VR4	7e	Ric
G14D	RP131S141D	LVR-IC	LDO, 1.4V±1%, 1A, +CE, CL	HSOP-6J	29vtb	VR4	7h	Ric
G15A	R1172D151A	LVR-IC	LDO, 1.5V±2%, 1A, -CE	HSON-6	35vr	VR4	7e	Ric
G15B	R1172D151B	LVR-IC	LDO, 1.5V±2%, 1A, +CE	HSON-6	35vr	VR4	7e	Ric
G15B	R1180D151B	LVR-IC	LDO, 1.5V±2%, 150mA, +CE	SON1612-6	35vra	VR4	7e	Ric
G15B	RP131S151B	LVR-IC	LDO, 1.5V±1%, 1A, +CE	HSOP-6J	29vtb	VR4	7h	Ric
G15C	R1180D151C	LVR-IC	LDO, 1.5V±2%, 150mA	SON1612-6	35yl	VR1	7e	Ric
G15D	R1172D151D	LVR-IC	LDO, 1.5V±2%, 1A, +CE, CL	HSON-6	35vr	VR4	7e	Ric
G15D	RP131S151D	LVR-IC	LDO, 1.5V±1%, 1A, +CE, CL	HSOP-6J	29vtb	VR4	7h	Ric
G16A	R1172D161A	LVR-IC	LDO, 1.6V±2%, 1A, -CE	HSON-6	35vr	VR4	7e	Ric
G16B	R1172D161B	LVR-IC	LDO, 1.6V±2%, 1A, +CE	HSON-6	35vr	VR4	7e	Ric
G16B	R1180D161B	LVR-IC	LDO, 1.6V±2%, 150mA, +CE	SON1612-6	35vra	VR4	7e	Ric
G16B	RP131S161B	LVR-IC	LDO, 1.6V±1%, 1A, +CE	HSOP-6J	29vtb	VR4	7h	Ric
G16C	R1180D161C	LVR-IC	LDO, 1.6V±2%, 150mA	SON1612-6	35yl	VR1	7e	Ric
G16D	R1172D161D	LVR-IC	LDO, 1.6V±2%, 1A, +CE, CL	HSON-6	35vr	VR4	7e	Ric
G16D	RP131S161D	LVR-IC	LDO, 1.6V±1%, 1A, +CE, CL	HSOP-6J	29vtb	VR4	7h	Ric
G17A	R1172D171A	LVR-IC	LDO, 1.7V±2%, 1A, -CE	HSON-6	35vr	VR4	7e	Ric
G17B	R1172D171B	LVR-IC	LDO, 1.7V±2%, 1A, +CE	HSON-6	35vr	VR4	7e	Ric
G17B	R1180D171B	LVR-IC	LDO, 1.7V±2%, 150mA, +CE	SON1612-6	35vra	VR4	7e	Ric
G17B	RP131S171B	LVR-IC	LDO, 1.7V±1%, 1A, +CE	HSOP-6J	29vtb	VR4	7h	Ric
G17C	R1180D171C	LVR-IC	LDO, 1.7V±2%, 150mA	SON1612-6	35yl	VR1	7e	Ric
G17D	R1172D171D	LVR-IC	LDO, 1.7V±2%, 1A, +CE, CL	HSON-6	35vr	VR4	7e	Ric
G17D	RP131S171D	LVR-IC	LDO, 1.7V±1%, 1A, +CE, CL	HSOP-6J	29vtb	VR4	7h	Ric
G18A	R1172D181A	LVR-IC	LDO, 1.8V±2%, 1A, -CE	HSON-6	35vr	VR4	7e	Ric
G18B	R1172D181B	LVR-IC	LDO, 1.8V±2%, 1A, +CE	HSON-6	35vr	VR4	7e	Ric
G18B	R1180D181B	LVR-IC	LDO, 1.8V±2%, 150mA, +CE	SON1612-6	35vra	VR4	7e	Ric
G18B	RP131S181B	LVR-IC	LDO, 1.8V±1%, 1A, +CE	HSOP-6J	29vtb	VR4	7h	Ric
G18C	R1180D181C	LVR-IC	LDO, 1.8V±2%, 150mA	SON1612-6	35yl	VR1	7e	Ric
G18D	R1172D181D	LVR-IC	LDO, 1.8V±2%, 1A, +CE, CL	HSON-6	35vr	VR4	7e	Ric
G18D	RP131S181D	LVR-IC	LDO, 1.8V±1%, 1A, +CE, CL	HSOP-6J	29vtb	VR4	7h	Ric
G19	HWD2119MM	LIN-IC	AF PA, BTL, 2.5-5.5V, 3W(5V/3Q), shutdown	SSOP-8	47	AFP11	-	Csm
G19	LM4819M	LIN-IC	AF PA, BTL, 2.5-5.5V, 35mW(3.5V/8Q), shutdown	SOP-8	47	AFP11	-	Nsc
G19A	R1172D191A	LVR-IC	LDO, 1.9V±2%, 1A, -CE	HSON-6	35vr	VR4	7e	Ric
G19B	R1172D191B	LVR-IC	LDO, 1.9V±2%, 1A, +CE	HSON-6	35vr	VR4	7e	Ric
G19B	R1180D191B	LVR-IC	LDO, 1.9V±2%, 150mA, +CE	SON1612-6	35vra	VR4	7e	Ric
G19B	RP131S191B	LVR-IC	LDO, 1.9V±1%, 1A, +CE	HSOP-6J	29vtb	VR4	7h	Ric
G19C	R1180D191C	LVR-IC	LDO, 1.9V±2%, 150mA	SON1612-6	35yl	VR1	7e	Ric
G19D	R1172D191D	LVR-IC	LDO, 1.9V±2%, 1A, +CE, CL	HSON-6	35vr	VR4	7e	Ric
G19D	RP131S191D	LVR-IC	LDO, 1.9V±1%, 1A, +CE, CL	HSOP-6J	29vtb	VR4	7h	Ric
G2	R1131D121A	LVR-IC	LDO, 1.2V±2%, 300mA, +CE	SON-6	34hq	VR4	7g	Ric
G2	R1160D221B	LVR-IC	LDO, 2.2V±2%, 200mA, +CE, AE(mode)	SON-6	34vrc	VR10	7g	Ric
G20A	R1172D201A	LVR-IC	LDO, 2V±2%, 1A, -CE	HSON-6	35vr	VR4	7e	Ric
G20B	R1172D201B	LVR-IC	LDO, 2V±2%, 1A, +CE	HSON-6	35vr	VR4	7e	Ric
G20B	R1180D201B	LVR-IC	LDO, 2V±2%, 150mA, +CE	SON1612-6	35vra	VR4	7e	Ric
G20B	RP131S201B	LVR-IC	LDO, 2V±1%, 1A, +CE	HSOP-6J	29vtb	VR4	7h	Ric
G20C	R1180D201C	LVR-IC	LDO, 2V±2%, 150mA	SON1612-6	35yl	VR1	7e	Ric
G20D	R1172D201D	LVR-IC	LDO, 2V±2%, 1A, +CE, CL	HSON-6	35vr	VR4	7e	Ric
G20D	RP131S201D	LVR-IC	LDO, 2V±1%, 1A, +CE, CL	HSOP-6J	29vtb	VR4	7h	Ric
G21A	R1172D211A	LVR-IC	LDO, 2.1V±2%, 1A, -CE	HSON-6	35vr	VR4	7e	Ric
G21B	R1172D211B	LVR-IC	LDO, 2.1V±2%, 1A, +CE	HSON-6	35vr	VR4	7e	Ric
G21B	R1180D211B	LVR-IC	LDO, 2.1V±2%, 150mA, +CE	SON1612-6	35vra	VR4	7e	Ric
G21B	RP131S211B	LVR-IC	LDO, 2.1V±1%, 1A, +CE	HSOP-6J	29vtb	VR4	7h	Ric
G21C	R1180D211C	LVR-IC	LDO, 2.1V±2%, 150mA	SON1612-6	35yl	VR1	7e	Ric
G21D	R1172D211D	LVR-IC	LDO, 2.1V±2%, 1A, +CE, CL	HSON-6	35vr	VR4	7e	Ric
G21D	RP131S211D	LVR-IC	LDO, 2.1V±1%, 1A, +CE, CL	HSOP-6J	29vtb	VR4	7h	Ric
G22A	R1172D221A	LVR-IC	LDO, 2.2V±2%, 1A, -CE	HSON-6	35vr	VR4	7e	Ric



SMD code	Type	Function	Short description	Case	Pinout	Sch.	St.	Mnf.
G22B	R1172D221B	LVR-IC	LDO, 2.2V±2%, 1A, +CE	HSO6-6	35vr	VR4	7e	Ric
G22B	R1180D221B	LVR-IC	LDO, 2.2V±2%, 150mA, +CE	SON1612-6	35vra	VR4	7e	Ric
G22B	RP131S221B	LVR-IC	LDO, 2.2V±1%, 1A, +CE	HSOP-6J	29vrb	VR4	7h	Ric
G22C	R1180D221C	LVR-IC	LDO, 2.2V±2%, 150mA	SON1612-6	35yl	VR1	7e	Ric
G22D	R1172D221D	LVR-IC	LDO, 2.2V±2%, 1A, +CE, CL	HSO6-6	35vr	VR4	7e	Ric
G22D	RP131S221D	LVR-IC	LDO, 2.2V±1%, 1A, +CE, CL	HSOP-6J	29vrb	VR4	7h	Ric
G23A	R1172D231A	LVR-IC	LDO, 2.3V±2%, 1A, -CE	HSO6-6	35vr	VR4	7e	Ric
G23B	R1172D231B	LVR-IC	LDO, 2.3V±2%, 1A, +CE	HSO6-6	35vr	VR4	7e	Ric
G23B	R1180D231B	LVR-IC	LDO, 2.3V±2%, 150mA, +CE	SON1612-6	35vra	VR4	7e	Ric
G23B	RP131S231B	LVR-IC	LDO, 2.3V±1%, 1A, +CE	HSOP-6J	29vrb	VR4	7h	Ric
G23C	R1180D231C	LVR-IC	LDO, 2.3V±2%, 150mA	SON1612-6	35yl	VR1	7e	Ric
G23D	R1172D231D	LVR-IC	LDO, 2.3V±2%, 1A, +CE, CL	HSO6-6	35vr	VR4	7e	Ric
G23D	RP131S231D	LVR-IC	LDO, 2.3V±1%, 1A, +CE, CL	HSOP-6J	29vrb	VR4	7h	Ric
G24A	R1172D241A	LVR-IC	LDO, 2.4V±2%, 1A, -CE	HSO6-6	35vr	VR4	7e	Ric
G24B	R1172D241B	LVR-IC	LDO, 2.4V±2%, 1A, +CE	HSO6-6	35vr	VR4	7e	Ric
G24B	R1180D241B	LVR-IC	LDO, 2.4V±2%, 150mA, +CE	SON1612-6	35vra	VR4	7e	Ric
G24B	RP131S241B	LVR-IC	LDO, 2.4V±1%, 1A, +CE	HSOP-6J	29vrb	VR4	7h	Ric
G24C	R1180D241C	LVR-IC	LDO, 2.4V±2%, 150mA	SON1612-6	35yl	VR1	7e	Ric
G24D	R1172D241D	LVR-IC	LDO, 2.4V±2%, 1A, +CE, CL	HSO6-6	35vr	VR4	7e	Ric
G24D	RP131S241D	LVR-IC	LDO, 2.4V±1%, 1A, +CE, CL	HSOP-6J	29vrb	VR4	7h	Ric
G25A	R1172D251A	LVR-IC	LDO, 2.5V±2%, 1A, -CE	HSO6-6	35vr	VR4	7e	Ric
G25B	R1172D251B	LVR-IC	LDO, 2.5V±2%, 1A, +CE	HSO6-6	35vr	VR4	7e	Ric
G25B	R1180D251B	LVR-IC	LDO, 2.5V±2%, 150mA, +CE	SON1612-6	35vra	VR4	7e	Ric
G25B	RP131S251B	LVR-IC	LDO, 2.5V±1%, 1A, +CE	HSOP-6J	29vrb	VR4	7h	Ric
G25C	R1180D251C	LVR-IC	LDO, 2.5V±2%, 150mA	SON1612-6	35yl	VR1	7e	Ric
G25D	R1172D251D	LVR-IC	LDO, 2.5V±2%, 1A, +CE, CL	HSO6-6	35vr	VR4	7e	Ric
G25D	RP131S251D	LVR-IC	LDO, 2.5V±1%, 1A, +CE, CL	HSOP-6J	29vrb	VR4	7h	Ric
G26	LM4820MM-6	LIN-IC	AF PA, BTL, 2.5-5V, 1W(5V/8Ω), shutdown	SSOP-8	47	AFP9	-	Nsc
G26A	R1172D261A	LVR-IC	LDO, 2.6V±2%, 1A, -CE	HSO6-6	35vr	VR4	7e	Ric
G26B	R1172D261B	LVR-IC	LDO, 2.6V±2%, 1A, +CE	HSO6-6	35vr	VR4	7e	Ric
G26B	R1180D261B	LVR-IC	LDO, 2.6V±2%, 150mA, +CE	SON1612-6	35vra	VR4	7e	Ric
G26B	RP131S261B	LVR-IC	LDO, 2.6V±1%, 1A, +CE	HSOP-6J	29vrb	VR4	7h	Ric
G26C	R1180D261C	LVR-IC	LDO, 2.6V±2%, 150mA	SON1612-6	35yl	VR1	7e	Ric
G26D	R1172D261D	LVR-IC	LDO, 2.6V±2%, 1A, +CE, CL	HSO6-6	35vr	VR4	7e	Ric
G26D	RP131S261D	LVR-IC	LDO, 2.6V±1%, 1A, +CE, CL	HSOP-6J	29vrb	VR4	7h	Ric
G27A	R1172D271A	LVR-IC	LDO, 2.7V±2%, 1A, -CE	HSO6-6	35vr	VR4	7e	Ric
G27B	R1172D271B	LVR-IC	LDO, 2.7V±2%, 1A, +CE	HSO6-6	35vr	VR4	7e	Ric
G27B	R1180D271B	LVR-IC	LDO, 2.7V±2%, 150mA, +CE	SON1612-6	35vra	VR4	7e	Ric
G27B	RP131S271B	LVR-IC	LDO, 2.7V±1%, 1A, +CE	HSOP-6J	29vrb	VR4	7h	Ric
G27C	R1180D271C	LVR-IC	LDO, 2.7V±2%, 150mA	SON1612-6	35yl	VR1	7e	Ric
G27D	R1172D271D	LVR-IC	LDO, 2.7V±2%, 1A, +CE, CL	HSO6-6	35vr	VR4	7e	Ric
G27D	RP131S271D	LVR-IC	LDO, 2.7V±1%, 1A, +CE, CL	HSOP-6J	29vrb	VR4	7h	Ric
G28A	R1172D281A	LVR-IC	LDO, 2.8V±2%, 1A, -CE	HSO6-6	35vr	VR4	7e	Ric
G28B	R1172D281B	LVR-IC	LDO, 2.8V±2%, 1A, +CE	HSO6-6	35vr	VR4	7e	Ric
G28B	R1180D281B	LVR-IC	LDO, 2.8V±2%, 150mA, +CE	SON1612-6	35vra	VR4	7e	Ric
G28B	RP131S281B	LVR-IC	LDO, 2.8V±1%, 1A, +CE	HSOP-6J	29vrb	VR4	7h	Ric
G28C	R1180D281C	LVR-IC	LDO, 2.8V±2%, 150mA	SON1612-6	35yl	VR1	7e	Ric
G28D	R1172D281D	LVR-IC	LDO, 2.8V±2%, 1A, +CE, CL	HSO6-6	35vr	VR4	7e	Ric
G28D	RP131S281D	LVR-IC	LDO, 2.8V±1%, 1A, +CE, CL	HSOP-6J	29vrb	VR4	7h	Ric
G29A	R1172D291A	LVR-IC	LDO, 2.9V±2%, 1A, -CE	HSO6-6	35vr	VR4	7e	Ric
G29B	R1172D291B	LVR-IC	LDO, 2.9V±2%, 1A, +CE	HSO6-6	35vr	VR4	7e	Ric
G29B	R1180D291B	LVR-IC	LDO, 2.9V±2%, 150mA, +CE	SON1612-6	35vra	VR4	7e	Ric
G29B	RP131S291B	LVR-IC	LDO, 2.9V±1%, 1A, +CE	HSOP-6J	29vrb	VR4	7h	Ric
G29C	R1180D291C	LVR-IC	LDO, 2.9V±2%, 150mA	SON1612-6	35yl	VR1	7e	Ric
G29D	R1172D291D	LVR-IC	LDO, 2.9V±2%, 1A, +CE, CL	HSO6-6	35vr	VR4	7e	Ric
G29D	RP131S291D	LVR-IC	LDO, 2.9V±1%, 1A, +CE, CL	HSOP-6J	29vrb	VR4	7h	Ric
G3	R1131D131A	LVR-IC	LDO, 1.3V±2%, 300mA, +CE	SON-6	34hq	VR4	7g	Ric
G3	R1160D231B	LVR-IC	LDO, 2.3V±2%, 200mA, +CE, AE(mode)	SON-6	34vrc	VR10	7g	Ric
G30A	R1172D301A	LVR-IC	LDO, 3V±2%, 1A, -CE	HSO6-6	35vr	VR4	7e	Ric
G30B	R1172D301B	LVR-IC	LDO, 3V±2%, 1A, +CE	HSO6-6	35vr	VR4	7e	Ric
G30B	R1180D301B	LVR-IC	LDO, 3V±2%, 150mA, +CE	SON1612-6	35vra	VR4	7e	Ric
G30B	RP131S301B	LVR-IC	LDO, 3V±1%, 1A, +CE	HSOP-6J	29vrb	VR4	7h	Ric
G30C	R1180D301C	LVR-IC	LDO, 3V±2%, 150mA	SON1612-6	35yl	VR1	7e	Ric
G30D	R1172D301D	LVR-IC	LDO, 3V±2%, 1A, +CE, CL	HSO6-6	35vr	VR4	7e	Ric
G30D	RP131S301D	LVR-IC	LDO, 3V±1%, 1A, +CE, CL	HSOP-6J	29vrb	VR4	7h	Ric
G31A	R1172D311A	LVR-IC	LDO, 3.1V±2%, 1A, -CE	HSO6-6	35vr	VR4	7e	Ric
G31B	R1172D311B	LVR-IC	LDO, 3.1V±2%, 1A, +CE	HSO6-6	35vr	VR4	7e	Ric
G31B	R1180D311B	LVR-IC	LDO, 3.1V±2%, 150mA, +CE	SON1612-6	35vra	VR4	7e	Ric
G31B	RP131S311B	LVR-IC	LDO, 3.1V±1%, 1A, +CE	HSOP-6J	29vrb	VR4	7h	Ric
G31C	R1180D311C	LVR-IC	LDO, 3.1V±2%, 150mA	SON1612-6	35yl	VR1	7e	Ric



SMD code	Type	Function	Short description	Case	Pinout	Sch.	St.	Mnf.
G31D	R1172D311D	LVR-IC	LDO, 3.1V±2%, 1A, +CE, CL	HS0N-6	35vr	VR4	7e	Ric
G31D	RP131S311D	LVR-IC	LDO, 3.1V±1%, 1A, +CE, CL	HSOP-6J	29vrb	VR4	7h	Ric
G32A	R1172D321A	LVR-IC	LDO, 3.2V±2%, 1A, -CE	HS0N-6	35vr	VR4	7e	Ric
G32B	R1172D321B	LVR-IC	LDO, 3.2V±2%, 1A, +CE	HS0N-6	35vr	VR4	7e	Ric
G32B	R1180D321B	LVR-IC	LDO, 3.2V±2%, 150mA, +CE	SON1612-6	35vra	VR4	7e	Ric
G32B	RP131S321B	LVR-IC	LDO, 3.2V±1%, 1A, +CE	HSOP-6J	29vrb	VR4	7h	Ric
G32C	R1180D321C	LVR-IC	LDO, 3.2V±2%, 150mA	SON1612-6	35yl	VR1	7e	Ric
G32D	R1172D321D	LVR-IC	LDO, 3.2V±2%, 1A, +CE, CL	HS0N-6	35vr	VR4	7e	Ric
G32D	RP131S321D	LVR-IC	LDO, 3.2V±1%, 1A, +CE, CL	HSOP-6J	29vrb	VR4	7h	Ric
G33A	R1172D331A	LVR-IC	LDO, 3.3V±2%, 1A, -CE	HS0N-6	35vr	VR4	7e	Ric
G33B	R1172D331B	LVR-IC	LDO, 3.3V±2%, 1A, +CE	HS0N-6	35vr	VR4	7e	Ric
G33B	R1180D331B	LVR-IC	LDO, 3.3V±2%, 150mA, +CE	SON1612-6	35vra	VR4	7e	Ric
G33B	RP131S331B	LVR-IC	LDO, 3.3V±1%, 1A, +CE	HSOP-6J	29vrb	VR4	7h	Ric
G33C	R1180D331C	LVR-IC	LDO, 3.3V±2%, 150mA	SON1612-6	35yl	VR1	7e	Ric
G33D	R1172D331D	LVR-IC	LDO, 3.3V±2%, 1A, +CE, CL	HS0N-6	35vr	VR4	7e	Ric
G33D	RP131S331D	LVR-IC	LDO, 3.3V±1%, 1A, +CE, CL	HSOP-6J	29vrb	VR4	7h	Ric
G34A	R1172D341A	LVR-IC	LDO, 3.4V±2%, 1A, -CE, -CE	HS0N-6	35vr	VR4	7e	Ric
G34B	R1172D341B	LVR-IC	LDO, 3.4V±2%, 1A, +CE	HS0N-6	35vr	VR4	7e	Ric
G34B	R1180D341B	LVR-IC	LDO, 3.4V±2%, 150mA, +CE	SON1612-6	35vra	VR4	7e	Ric
G34B	RP131S341B	LVR-IC	LDO, 3.4V±1%, 1A, +CE	HSOP-6J	29vrb	VR4	7h	Ric
G34C	R1180D341C	LVR-IC	LDO, 3.4V±2%, 150mA	SON1612-6	35yl	VR1	7e	Ric
G34D	R1172D341D	LVR-IC	LDO, 3.4V±2%, 1A, +CE, CL	HS0N-6	35vr	VR4	7e	Ric
G34D	RP131S341D	LVR-IC	LDO, 3.4V±1%, 1A, +CE, CL	HSOP-6J	29vrb	VR4	7h	Ric
G35A	R1172D351A	LVR-IC	LDO, 3.5V±2%, 1A, -CE	HS0N-6	35vr	VR4	7e	Ric
G35B	R1172D351B	LVR-IC	LDO, 3.5V±2%, 1A, +CE	HS0N-6	35vr	VR4	7e	Ric
G35B	R1180D351B	LVR-IC	LDO, 3.5V±2%, 150mA, +CE	SON1612-6	35vra	VR4	7e	Ric
G35B	RP131S351B	LVR-IC	LDO, 3.5V±1%, 1A, +CE	HSOP-6J	29vrb	VR4	7h	Ric
G35C	R1180D351C	LVR-IC	LDO, 3.5V±2%, 150mA	SON1612-6	35yl	VR1	7e	Ric
G35D	R1172D351D	LVR-IC	LDO, 3.5V±2%, 1A, +CE, CL	HS0N-6	35vr	VR4	7e	Ric
G35D	RP131S351D	LVR-IC	LDO, 3.5V±1%, 1A, +CE, CL	HSOP-6J	29vrb	VR4	7h	Ric
G36A	R1172D361A	LVR-IC	LDO, 3.6V±2%, 1A, -CE	HS0N-6	35vr	VR4	7e	Ric
G36B	R1172D361B	LVR-IC	LDO, 3.6V±2%, 1A, +CE	HS0N-6	35vr	VR4	7e	Ric
G36B	R1180D361B	LVR-IC	LDO, 3.6V±2%, 150mA, +CE	SON1612-6	35vra	VR4	7e	Ric
G36B	RP131S361B	LVR-IC	LDO, 3.6V±1%, 1A, +CE	HSOP-6J	29vrb	VR4	7h	Ric
G36C	R1180D361C	LVR-IC	LDO, 3.6V±2%, 150mA	SON1612-6	35yl	VR1	7e	Ric
G36D	R1172D361D	LVR-IC	LDO, 3.6V±2%, 1A, +CE, CL	HS0N-6	35vr	VR4	7e	Ric
G36D	RP131S361D	LVR-IC	LDO, 3.6V±1%, 1A, +CE, CL	HSOP-6J	29vrb	VR4	7h	Ric
G37A	R1172D371A	LVR-IC	LDO, 3.7V±2%, 1A, -CE	HS0N-6	35vr	VR4	7e	Ric
G37B	R1172D371B	LVR-IC	LDO, 3.7V±2%, 1A, +CE	HS0N-6	35vr	VR4	7e	Ric
G37B	RP131S371B	LVR-IC	LDO, 3.7V±1%, 1A, +CE	HSOP-6J	29vrb	VR4	7h	Ric
G37D	R1172D371D	LVR-IC	LDO, 3.7V±2%, 1A, +CE, CL	HS0N-6	35vr	VR4	7e	Ric
G37D	RP131S371D	LVR-IC	LDO, 3.7V±1%, 1A, +CE, CL	HSOP-6J	29vrb	VR4	7h	Ric
G38A	R1172D381A	LVR-IC	LDO, 3.8V±2%, 1A, -CE	HS0N-6	35vr	VR4	7e	Ric
G38B	R1172D381B	LVR-IC	LDO, 3.8V±2%, 1A, +CE	HS0N-6	35vr	VR4	7e	Ric
G38B	RP131S381B	LVR-IC	LDO, 3.8V±1%, 1A, +CE	HSOP-6J	29vrb	VR4	7h	Ric
G38D	R1172D381D	LVR-IC	LDO, 3.8V±2%, 1A, +CE, CL	HS0N-6	35vr	VR4	7e	Ric
G38D	RP131S381D	LVR-IC	LDO, 3.8V±1%, 1A, +CE, CL	HSOP-6J	29vrb	VR4	7h	Ric
G39A	R1172D391A	LVR-IC	LDO, 3.9V±2%, 1A, -CE	HS0N-6	35vr	VR4	7e	Ric
G39B	R1172D391B	LVR-IC	LDO, 3.9V±2%, 1A, +CE	HS0N-6	35vr	VR4	7e	Ric
G39B	RP131S391B	LVR-IC	LDO, 3.9V±1%, 1A, +CE	HSOP-6J	29vrb	VR4	7h	Ric
G39D	R1172D391D	LVR-IC	LDO, 3.9V±2%, 1A, +CE, CL	HS0N-6	35vr	VR4	7e	Ric
G39D	RP131S391D	LVR-IC	LDO, 3.9V±1%, 1A, +CE, CL	HSOP-6J	29vrb	VR4	7h	Ric
G4	MBT35200M	Si-pnp	GP, 55V, 2A, 625mW, B=100...200, >100MHz	TSOP-6	3314	-	7b	Ons
G4	R1131D141A	LVR-IC	LDO, 1.4V±2%, 300mA, +CE	SON-6	341q	VR4	7g	Ric
G4	R1160D241B	LVR-IC	LDO, 2.4V±2%, 200mA, +CE, AE(mode)	SON-6	34vrc	VR10	7g	Ric
G40A	R1172D401A	LVR-IC	LDO, 4V±2%, 1A, -CE	HS0N-6	35vr	VR4	7e	Ric
G40B	R1172D401B	LVR-IC	LDO, 4V±2%, 1A, +CE	HS0N-6	35vr	VR4	7e	Ric
G40B	RP131S401B	LVR-IC	LDO, 4V±1%, 1A, +CE	HSOP-6J	29vrb	VR4	7h	Ric
G40D	R1172D401D	LVR-IC	LDO, 4V±2%, 1A, +CE, CL	HS0N-6	35vr	VR4	7e	Ric
G40D	RP131S401D	LVR-IC	LDO, 4V±1%, 1A, +CE, CL	HSOP-6J	29vrb	VR4	7h	Ric
G41A	R1172D411A	LVR-IC	LDO, 4.1V±2%, 1A, -CE	HS0N-6	35vr	VR4	7e	Ric
G41B	R1172D411B	LVR-IC	LDO, 4.1V±2%, 1A, +CE	HS0N-6	35vr	VR4	7e	Ric
G41B	RP131S411B	LVR-IC	LDO, 4.1V±1%, 1A, +CE	HSOP-6J	29vrb	VR4	7h	Ric
G41D	R1172D411D	LVR-IC	LDO, 4.1V±2%, 1A, +CE, CL	HS0N-6	35vr	VR4	7e	Ric
G41D	RP131S411D	LVR-IC	LDO, 4.1V±1%, 1A, +CE, CL	HSOP-6J	29vrb	VR4	7h	Ric
G42A	R1172D421A	LVR-IC	LDO, 4.2V±2%, 1A, -CE	HS0N-6	35vr	VR4	7e	Ric
G42B	R1172D421B	LVR-IC	LDO, 4.2V±2%, 1A, +CE	HS0N-6	35vr	VR4	7e	Ric
G42B	RP131S421B	LVR-IC	LDO, 4.2V±1%, 1A, +CE	HSOP-6J	29vrb	VR4	7h	Ric
G42D	R1172D421D	LVR-IC	LDO, 4.2V±2%, 1A, +CE, CL	HS0N-6	35vr	VR4	7e	Ric
G42D	RP131S421D	LVR-IC	LDO, 4.2V±1%, 1A, +CE, CL	HSOP-6J	29vrb	VR4	7h	Ric



SMD code	Type	Function	Short description	Case	Pinout	Sch.	St.	Mnf.
G43A	R1172D431A	LVR-IC	LDO, 4.3V±2%, 1A, -CE	HSON-6	35vr	VR4	7e	Ric
G43B	R1172D431B	LVR-IC	LDO, 4.3V±2%, 1A, +CE	HSON-6	35vr	VR4	7e	Ric
G43B	RP131S431B	LVR-IC	LDO, 4.3V±1%, 1A, +CE	HSOP-6J	29vfb	VR4	7h	Ric
G43D	R1172D431D	LVR-IC	LDO, 4.3V±2%, 1A, +CE, CL	HSON-6	35vr	VR4	7e	Ric
G43D	RP131S431D	LVR-IC	LDO, 4.3V±1%, 1A, +CE, CL	HSOP-6J	29vfb	VR4	7h	Ric
G44A	R1172D441A	LVR-IC	LDO, 4.4V±2%, 1A, -CE	HSON-6	35vr	VR4	7e	Ric
G44B	R1172D441B	LVR-IC	LDO, 4.4V±2%, 1A, +CE	HSON-6	35vr	VR4	7e	Ric
G44B	RP131S441B	LVR-IC	LDO, 4.4V±1%, 1A, +CE	HSOP-6J	29vfb	VR4	7h	Ric
G44D	R1172D441D	LVR-IC	LDO, 4.4V±2%, 1A, +CE, CL	HSON-6	35vr	VR4	7e	Ric
G44D	RP131S441D	LVR-IC	LDO, 4.4V±1%, 1A, +CE, CL	HSOP-6J	29vfb	VR4	7h	Ric
G45A	R1172D451A	LVR-IC	LDO, 4.5V±2%, 1A, -CE	HSON-6	35vr	VR4	7e	Ric
G45B	R1172D451B	LVR-IC	LDO, 4.5V±2%, 1A, +CE	HSON-6	35vr	VR4	7e	Ric
G45B	RP131S451B	LVR-IC	LDO, 4.5V±1%, 1A, +CE	HSOP-6J	29vfb	VR4	7h	Ric
G45D	R1172D451D	LVR-IC	LDO, 4.5V±2%, 1A, +CE, CL	HSON-6	35vr	VR4	7e	Ric
G45D	RP131S451D	LVR-IC	LDO, 4.5V±1%, 1A, +CE, CL	HSOP-6J	29vfb	VR4	7h	Ric
G46A	R1172D461A	LVR-IC	LDO, 4.6V±2%, 1A, -CE	HSON-6	35vr	VR4	7e	Ric
G46B	R1172D461B	LVR-IC	LDO, 4.6V±2%, 1A, +CE	HSON-6	35vr	VR4	7e	Ric
G46B	RP131S461B	LVR-IC	LDO, 4.6V±1%, 1A, +CE	HSOP-6J	29vfb	VR4	7h	Ric
G46D	R1172D461D	LVR-IC	LDO, 4.6V±2%, 1A, +CE, CL	HSON-6	35vr	VR4	7e	Ric
G46D	RP131S461D	LVR-IC	LDO, 4.6V±1%, 1A, +CE, CL	HSOP-6J	29vfb	VR4	7h	Ric
G47A	R1172D471A	LVR-IC	LDO, 4.7V±2%, 1A, -CE	HSON-6	35vr	VR4	7e	Ric
G47B	R1172D471B	LVR-IC	LDO, 4.7V±2%, 1A, +CE	HSON-6	35vr	VR4	7e	Ric
G47B	RP131S471B	LVR-IC	LDO, 4.7V±1%, 1A, +CE	HSOP-6J	29vfb	VR4	7h	Ric
G47D	R1172D471D	LVR-IC	LDO, 4.7V±2%, 1A, +CE, CL	HSON-6	35vr	VR4	7e	Ric
G47D	RP131S471D	LVR-IC	LDO, 4.7V±1%, 1A, +CE, CL	HSOP-6J	29vfb	VR4	7h	Ric
G48A	R1172D481A	LVR-IC	LDO, 4.8V±2%, 1A, -CE	HSON-6	35vr	VR4	7e	Ric
G48B	R1172D481B	LVR-IC	LDO, 4.8V±2%, 1A, +CE	HSON-6	35vr	VR4	7e	Ric
G48B	RP131S481B	LVR-IC	LDO, 4.8V±1%, 1A, +CE	HSOP-6J	29vfb	VR4	7h	Ric
G48D	R1172D481D	LVR-IC	LDO, 4.8V±2%, 1A, +CE, CL	HSON-6	35vr	VR4	7e	Ric
G48D	RP131S481D	LVR-IC	LDO, 4.8V±1%, 1A, +CE, CL	HSOP-6J	29vfb	VR4	7h	Ric
G49A	R1172D491A	LVR-IC	LDO, 4.9V±2%, 1A, -CE	HSON-6	35vr	VR4	7e	Ric
G49B	R1172D491B	LVR-IC	LDO, 4.9V±2%, 1A, +CE	HSON-6	35vr	VR4	7e	Ric
G49B	RP131S491B	LVR-IC	LDO, 4.9V±1%, 1A, +CE	HSOP-6J	29vfb	VR4	7h	Ric
G49D	R1172D491D	LVR-IC	LDO, 4.9V±2%, 1A, +CE, CL	HSON-6	35vr	VR4	7e	Ric
G49D	RP131S491D	LVR-IC	LDO, 4.9V±1%, 1A, +CE, CL	HSOP-6J	29vfb	VR4	7h	Ric
G5	R1131D151A	LVR-IC	LDO, 1.5V±2%, 300mA, +CE	SON-6	34hq	VR4	7g	Ric
G5	R1160D251B	LVR-IC	LDO, 2.5V±2%, 200mA, +CE, AE(mode)	SON-6	34vrc	VR10	7g	Ric
G50A	R1172D501A	LVR-IC	LDO, 5V±2%, 1A, -CE	HSON-6	35vr	VR4	7e	Ric
G50B	R1172D501B	LVR-IC	LDO, 5V±2%, 1A, +CE	HSON-6	35vr	VR4	7e	Ric
G50B	RP131S501B	LVR-IC	LDO, 5V±1%, 1A, +CE	HSOP-6J	29vfb	VR4	7h	Ric
G50D	R1172D501D	LVR-IC	LDO, 5V±2%, 1A, +CE, CL	HSON-6	35vr	VR4	7e	Ric
G50D	RP131S501D	LVR-IC	LDO, 5V±1%, 1A, +CE, CL	HSOP-6J	29vfb	VR4	7h	Ric
G53	LM4853MM	LIN-IC	AF PA, BTL, 2.7..5.5V, 1.5W(5V/4Ω), shutdown	SSOP-10	60	AFP10	-	Nsc
G6	NCT5V32FX	CMOS-Logic	2-input OR gate	MPAK-6	33Llog4	-	7b	F
G6	NCT5V32L6	CMOS-Logic	2-input OR gate	MPAK-6	33Llog4	-	7b	F
G6	R1131D161A	LVR-IC	LDO, 1.6V±2%, 300mA, +CE	SON-6	34hq	VR4	7g	Ric
G6	R1160D261B	LVR-IC	LDO, 2.6V±2%, 200mA, +CE, AE(mode)	SON-6	34vrc	VR10	7g	Ric
G7	R1131D171A	LVR-IC	LDO, 1.7V±2%, 300mA, +CE	SON-6	34hq	VR4	7g	Ric
G7	R1160D271B	LVR-IC	LDO, 2.7V±2%, 200mA, +CE, AE(mode)	SON-6	34vrc	VR10	7g	Ric
G71	LM4871MM	LIN-IC	AF PA, BTL, 2..5.5V, 1.1W(5V/8Ω), shutdown	SSOP-8	47	AFP12	-	Nsc
G71	SA4871XA	LIN-IC	AF PA, BTL, 2..5.5V, 1.1W(5V/8Ω), shutdown	MSOP-8	55	AFP12	-	Sup
G75	LM4875MM	LIN-IC	AF PA, BTL, 2.7..5.5V, 750mW(5V/8Ω), DC volume	SSOP-8	47	AFP13	-	Nsc
G79	LM4879MM	LIN-IC	AF PA, BTL, 2.2..5V, 1.1W(5V/8Ω), shutdown	SOP-10	60	AFP15	-	Nsc
G8	R1131D181A	LVR-IC	LDO, 1.8V±2%, 300mA, +CE	SON-6	34hq	VR4	7g	Ric
G8	R1160D281B	LVR-IC	LDO, 2.8V±2%, 200mA, +CE, AE(mode)	SON-6	34vrc	VR10	7g	Ric
G9	R1131D191A	LVR-IC	LDO, 1.9V±2%, 300mA, +CE	SON-6	34hq	VR4	7g	Ric
G9	R1160D291B	LVR-IC	LDO, 2.9V±2%, 200mA, +CE, AE(mode)	SON-6	34vrc	VR10	7g	Ric
G90	LM4890MM	LIN-IC	AF PA, BTL, 2.2..5.5V, 1.1W(5V/8Ω), shutdown	SSOP-8	47	AFP12	8d	Nsc
G90	SH4890MM	LIN-IC	AF PA, BTL, 2.2..5.5V, 1W(5V/8Ω), shutdown	SSOP-8	47	AFP12	-	Sit
G91	LM4891MM	LIN-IC	AF PA, BTL, 2.2..5.5V, 1.1W(5V/8Ω), shutdown	SSOP-8	47	AFP11	-	Nsc
G92	LM4892MM	LIN-IC	AF PA, BTL, 2.2..5.5V, 1.1W(5V/8Ω), shutdown	SSOP-8	47	AFP23	8d	Nsc
G93	LM4893MM	LIN-IC	AF PA, BTL, 2.2..5.5V, 1.1W(5V/8Ω), shutdown	SSOP-10	60	AFP15	-	Nsc
G94	LM4894MM	LIN-IC	AF PA, BTL, 2.2..5.5V, 1W(5V/8Ω), shutdown	SSOP-10	60	AFP19	-	Nsc
G95	LM4895MM	LIN-IC	AF PA, BTL, 2.2..5.5V, 1W(5V/8Ω), shutdown	SSOP-10	60	AFP20	-	Nsc
G97	LM4897MM	LIN-IC	AF PA, BTL, 2.2..5.5V, 1.1W(5V/8Ω), shutdown	SOP-10	60	AFP21	-	Nsc
GA	μPA600T	Si-npn	Dual, 60V, 100mA, 250MHz	SOT-23-6	33ff	-	7b	Nec
GA	RP152N001C	LVR-IC	LDO, Dual out, Vout1/Vout2=2.8V/2.8V±1%, 150mA, +CE, CL	SOT-23-6	33x5	VR19	7d	Ric
GA2	LM4889MM	LIN-IC	AF PA, BTL, 2.2..5.5V, 1W(5V/8Ω), shutdown	SSOP-8	47	AFP12	-	Nsc
GA3	LM4911MM	LIN-IC	AF PA, BTL, 2.2..5.5V, 2x40mW(3V/16Ω), mute, shutdown	SSOP-10	60	AFP30	-	Nsc
GA4	LM4903MM	LIN-IC	AF PA, BTL, 2..5.5V, 1W(5V/8Ω), shutdown	SSOP-8	47	AFP12	-	Nsc



SMD code	Type	Function	Short description	Case	Pinout	Sch.	St.	Mnf.
GA5	LM4990MM	LIN-IC	AF PA, BTL, 2.5..5.5V, 1.25W(5V/8Q), shutdown	SSOP-8	47	AFP12	-	Nsc
GA5	SH4990MM	LIN-IC	AF PA, BTL, 2.2..5.5V, 2W(5V/4Q), select shutdown	SSOP-10	60	AFP26	-	Sit
GA7	LM4912MM	LIN-IC	AF PA, 2.2..5.5V, 2x40mW(5V/16Q), mute, shutdown	SSOP-10	60	AFP31	-	Nsc
GA8	LM4906MM	LIN-IC	AF PA, BTL, 2.5..5.5V, 1W(5V/8Q), shutdown	SSOP-8	47	AFP28	-	Nsc
GA9	LM4916MM	LIN-IC	AF PA, BTL, 2.2..5.5V, 85mW(3V/32Q), shutdown	SSOP-10	60	AFP32	-	Nsc
GB	RP152N002C	LVR-IC	LDO, Dual out, Vout1/Vout2=1.8V/2.8V±1%, 150mA, +CE, CL	SOT-23-6	33x5	VR19	7d	Ric
GB2	LM4899MM	LIN-IC	AF PA, BTL, 2.2..5.5V, 1W(5V/8Q), shutdown	SSOP-10	60	AFP20	-	Nsc
GB3	LM4898MM	LIN-IC	AF PA, BTL, 2.2..5.5V, 1W(5V/8Q), shutdown	SSOP-10	60	AFP19	-	Nsc
GB4	LM4905MM	LIN-IC	AF PA, BTL, 2.2..5.5V, 1W(5V/8Q), shutdown	SSOP-8	47	AFP12	-	Nsc
GB5	LM4908MM	LIN-IC	AF PA, 2.2..5.5V, 2x120mW(4V/16Q)	SSOP-8	47	AFP6	-	Nsc
GB7	LM4924MM	LIN-IC	AF PA, BTL, 1.5..3.6V, 2x40mW(5V/16Q), mute, shutdown	MSOP-10	60	AFP33	-	Nsc
GC	RP152N003C	LVR-IC	LDO, Dual out, Vout1/Vout2=1.5V/2.8V±1%, 150mA, +CE, CL	SOT-23-6	33x5	VR19	7d	Ric
GC0	LM4900MM	LIN-IC	AF PA, BTL, 2.2..5.5V, 265mW(3V/8Q), shutdown	SSOP-8	47	AFP12	-	Nsc
GC1	LM4901MM	LIN-IC	AF PA, BTL, 2.2..5.5V, 1.6W(5V/8Q), shutdown	SSOP-10	60	AFP26	-	Nsc
GC2	LM4910MM	LIN-IC	AF PA, BTL, 2.2..5.5V, 2x350mW(5V/32Q), shutdown	SSOP-8	47	AFP29	-	Nsc
GC3	LM4902MM	LIN-IC	AF PA, BTL, 2.2..5.5V, 265mW(3V/8Q), shutdown	SSOP-8	47	AFP12	-	Nsc
GD	RP152N004C	LVR-IC	LDO, Dual out, Vout1/Vout2=1.2V/1.8V±1%, 150mA, +CE, CL	SOT-23-6	33x5	VR19	7d	Ric
GE	RP152N005C	LVR-IC	LDO, Dual out, Vout1/Vout2=3.3V/1.2V±1%, 150mA, +CE, CL	SOT-23-6	33x5	VR19	7d	Ric
GF	RP152N006C	LVR-IC	LDO, Dual out, Vout1/Vout2=3.3V/1.8V±1%, 150mA, +CE, CL	SOT-23-6	33x5	VR19	7d	Ric
GG	NC7S208L6	CMOS-Logic	2-input AND gate	MPAK-6	33L0g3	-	7b	F
GG	RP152N007C	LVR-IC	LDO, Dual out, Vout1/Vout2=2.85V/2.85V±1%, 150mA, +CE, CL	SOT-23-6	33x5	VR19	7d	Ric
GH	RP152N008C	LVR-IC	LDO, Dual out, Vout1/Vout2=2.85V/2.6V±1%, 150mA, +CE, CL	SOT-23-6	33x5	VR19	7d	Ric
GJ	RP152N009C	LVR-IC	LDO, Dual out, Vout1/Vout2=3.0V/2.8V±1%, 150mA, +CE, CL	SOT-23-6	33x5	VR19	7d	Ric
GK	RP152N010C	LVR-IC	LDO, Dual out, Vout1/Vout2=3.0V/1.8V±1%, 150mA, +CE, CL	SOT-23-6	33x5	VR19	7d	Ric
GL	RP152N011C	LVR-IC	LDO, Dual out, Vout1/Vout2=1.8V/1.5V±1%, 150mA, +CE, CL	SOT-23-6	33x5	VR19	7d	Ric
GM	RP152N012C	LVR-IC	LDO, Dual out, Vout1/Vout2=2.8V/2.6V±1%, 150mA, +CE, CL	SOT-23-6	33x5	VR19	7d	Ric
GN	RP152N013C	LVR-IC	LDO, Dual out, Vout1/Vout2=3.3V/2.8V±1%, 150mA, +CE, CL	SOT-23-6	33x5	VR19	7d	Ric
GP	RP152N014C	LVR-IC	LDO, Dual out, Vout1/Vout2=3.3V/3.3V±1%, 150mA, +CE, CL	SOT-23-6	33x5	VR19	7d	Ric
GP33G	AIC1952-33GG6A	LVR-IC	LDO, Dual out, Vout1/Vout2=2.85V/2.85V±2%, 300mA, +CE	SOT-23-6	33zc	VR19	7b	Aic
GP34G	AIC1952-34GG6A	LVR-IC	LDO, Dual out, Vout1/Vout2=2.85V/3.4V±2%, 300mA, +CE	SOT-23-6	33zc	VR19	7b	Aic
GP35G	AIC1952-35GG6A	LVR-IC	LDO, Dual out, Vout1/Vout2=2.85V/3.5V±2%, 300mA, +CE	SOT-23-6	33zc	VR19	7b	Aic
GP36G	AIC1952-36GG6A	LVR-IC	LDO, Dual out, Vout1/Vout2=2.85V/3.6V±2%, 300mA, +CE	SOT-23-6	33zc	VR19	7b	Aic
GP37G	AIC1952-37GG6A	LVR-IC	LDO, Dual out, Vout1/Vout2=2.85V/3.7V±2%, 300mA, +CE	SOT-23-6	33zc	VR19	7b	Aic
GP38G	AIC1952-38GG6A	LVR-IC	LDO, Dual out, Vout1/Vout2=2.85V/3.8V±2%, 300mA, +CE	SOT-23-6	33zc	VR19	7b	Aic
GP3AG	AIC1952-3AGG6A	LVR-IC	LDO, Dual out, Vout1/Vout2=2.85V/0.8V±2%, 300mA, +CE	SOT-23-6	33zc	VR19	7b	Aic
GP3BG	AIC1952-3BGG6A	LVR-IC	LDO, Dual out, Vout1/Vout2=2.85V/0.9V±2%, 300mA, +CE	SOT-23-6	33zc	VR19	7b	Aic
GP3CG	AIC1952-3CGG6A	LVR-IC	LDO, Dual out, Vout1/Vout2=2.85V/1.0V±2%, 300mA, +CE	SOT-23-6	33zc	VR19	7b	Aic
GP3DG	AIC1952-3DGG6A	LVR-IC	LDO, Dual out, Vout1/Vout2=2.85V/1.1V±2%, 300mA, +CE	SOT-23-6	33zc	VR19	7b	Aic
GP3EG	AIC1952-3EGG6A	LVR-IC	LDO, Dual out, Vout1/Vout2=2.85V/1.2V±2%, 300mA, +CE	SOT-23-6	33zc	VR19	7b	Aic
GP3FG	AIC1952-3FGG6A	LVR-IC	LDO, Dual out, Vout1/Vout2=2.85V/1.3V±2%, 300mA, +CE	SOT-23-6	33zc	VR19	7b	Aic
GP3GG	AIC1952-3GGG6A	LVR-IC	LDO, Dual out, Vout1/Vout2=2.85V/1.4V±2%, 300mA, +CE	SOT-23-6	33zc	VR19	7b	Aic
GP3HG	AIC1952-3HGG6A	LVR-IC	LDO, Dual out, Vout1/Vout2=2.85V/1.5V±2%, 300mA, +CE	SOT-23-6	33zc	VR19	7b	Aic
GP3IG	AIC1952-3IGG6A	LVR-IC	LDO, Dual out, Vout1/Vout2=2.85V/1.6V±2%, 300mA, +CE	SOT-23-6	33zc	VR19	7b	Aic
GP3JG	AIC1952-3JGG6A	LVR-IC	LDO, Dual out, Vout1/Vout2=2.85V/1.7V±2%, 300mA, +CE	SOT-23-6	33zc	VR19	7b	Aic
GP3KG	AIC1952-3KGG6A	LVR-IC	LDO, Dual out, Vout1/Vout2=2.85V/1.8V±2%, 300mA, +CE	SOT-23-6	33zc	VR19	7b	Aic
GP3LG	AIC1952-3LGG6A	LVR-IC	LDO, Dual out, Vout1/Vout2=2.85V/1.9V±2%, 300mA, +CE	SOT-23-6	33zc	VR19	7b	Aic
GP3MG	AIC1952-3MGG6A	LVR-IC	LDO, Dual out, Vout1/Vout2=2.85V/2.0V±2%, 300mA, +CE	SOT-23-6	33zc	VR19	7b	Aic
GP3NG	AIC1952-3NGG6A	LVR-IC	LDO, Dual out, Vout1/Vout2=2.85V/2.1V±2%, 300mA, +CE	SOT-23-6	33zc	VR19	7b	Aic
GP3OG	AIC1952-3OGG6A	LVR-IC	LDO, Dual out, Vout1/Vout2=2.85V/2.2V±2%, 300mA, +CE	SOT-23-6	33zc	VR19	7b	Aic
GP3PG	AIC1952-3PGG6A	LVR-IC	LDO, Dual out, Vout1/Vout2=2.85V/2.3V±2%, 300mA, +CE	SOT-23-6	33zc	VR19	7b	Aic
GP3QG	AIC1952-3QGG6A	LVR-IC	LDO, Dual out, Vout1/Vout2=2.85V/2.4V±2%, 300mA, +CE	SOT-23-6	33zc	VR19	7b	Aic
GP3RG	AIC1952-3RGG6A	LVR-IC	LDO, Dual out, Vout1/Vout2=2.85V/2.5V±2%, 300mA, +CE	SOT-23-6	33zc	VR19	7b	Aic
GP3SG	AIC1952-3SGG6A	LVR-IC	LDO, Dual out, Vout1/Vout2=2.85V/2.6V±2%, 300mA, +CE	SOT-23-6	33zc	VR19	7b	Aic
GP3TG	AIC1952-3TGG6A	LVR-IC	LDO, Dual out, Vout1/Vout2=2.85V/2.7V±2%, 300mA, +CE	SOT-23-6	33zc	VR19	7b	Aic
GP3UG	AIC1952-3UGG6A	LVR-IC	LDO, Dual out, Vout1/Vout2=2.85V/2.8V±2%, 300mA, +CE	SOT-23-6	33zc	VR19	7b	Aic
GP3VG	AIC1952-3VGG6A	LVR-IC	LDO, Dual out, Vout1/Vout2=2.85V/2.9V±2%, 300mA, +CE	SOT-23-6	33zc	VR19	7b	Aic
GP3WG	AIC1952-3WGG6A	LVR-IC	LDO, Dual out, Vout1/Vout2=2.85V/3.0V±2%, 300mA, +CE	SOT-23-6	33zc	VR19	7b	Aic
GP3XG	AIC1952-3XGG6A	LVR-IC	LDO, Dual out, Vout1/Vout2=2.85V/3.1V±2%, 300mA, +CE	SOT-23-6	33zc	VR19	7b	Aic
GP3YG	AIC1952-3YGG6A	LVR-IC	LDO, Dual out, Vout1/Vout2=2.85V/3.2V±2%, 300mA, +CE	SOT-23-6	33zc	VR19	7b	Aic
GP3ZG	AIC1952-3ZGG6A	LVR-IC	LDO, Dual out, Vout1/Vout2=2.85V/3.3V±2%, 300mA, +CE	SOT-23-6	33zc	VR19	7b	Aic
GP43G	AIC1952-43GG6A	LVR-IC	LDO, Dual out, Vout1/Vout2=3.4V/2.85V±2%, 300mA, +CE	SOT-23-6	33zc	VR19	7b	Aic
GP44G	AIC1952-44GG6A	LVR-IC	LDO, Dual out, Vout1/Vout2=3.4V/3.4V±2%, 300mA, +CE	SOT-23-6	33zc	VR19	7b	Aic
GP45G	AIC1952-45GG6A	LVR-IC	LDO, Dual out, Vout1/Vout2=3.4V/3.5V±2%, 300mA, +CE	SOT-23-6	33zc	VR19	7b	Aic
GP46G	AIC1952-46GG6A	LVR-IC	LDO, Dual out, Vout1/Vout2=3.4V/3.6V±2%, 300mA, +CE	SOT-23-6	33zc	VR19	7b	Aic
GP47G	AIC1952-47GG6A	LVR-IC	LDO, Dual out, Vout1/Vout2=3.4V/3.7V±2%, 300mA, +CE	SOT-23-6	33zc	VR19	7b	Aic
GP48G	AIC1952-48GG6A	LVR-IC	LDO, Dual out, Vout1/Vout2=3.4V/3.8V±2%, 300mA, +CE	SOT-23-6	33zc	VR19	7b	Aic
GP4AG	AIC1952-4AGG6A	LVR-IC	LDO, Dual out, Vout1/Vout2=3.4V/0.8V±2%, 300mA, +CE	SOT-23-6	33zc	VR19	7b	Aic
GP4BG	AIC1952-4BGG6A	LVR-IC	LDO, Dual out, Vout1/Vout2=3.4V/0.9V±2%, 300mA, +CE	SOT-23-6	33zc	VR19	7b	Aic
GP4CG	AIC1952-4CGG6A	LVR-IC	LDO, Dual out, Vout1/Vout2=3.4V/1.0V±2%, 300mA, +CE	SOT-23-6	33zc	VR19	7b	Aic
GP4DG	AIC1952-4DGG6A	LVR-IC	LDO, Dual out, Vout1/Vout2=3.4V/1.1V±2%, 300mA, +CE	SOT-23-6	33zc	VR19	7b	Aic



SMD code	Type	Function	Short description	Case	Pinout	Sch.	St.	Mnf.
GW	RP152N021C	LVR-IC	LDO, Dual out, Vout1/Vout2=1.2V/2.8V±1%, 150mA, +CE, CL	SOT-23-6	33x5	VR19	7d	Ric
GX	DDZX14TS	Z-diode	Triple, 14V ±2.5%, 200mW	SOT-363	33ddd	-	7k	Di
GX	RP152N022C	LVR-IC	LDO, Dual out, Vout1/Vout2=2.8V/1.2V±1%, 150mA, +CE, CL	SOT-23-6	33x5	VR19	7d	Ric
GY	DDZX15TS	Z-diode	Triple, 15V ±2.5%, 200mW	SOT-363	33ddd	-	7k	Di
GY	RP152N023C	LVR-IC	LDO, Dual out, Vout1/Vout2=2.5V/2.5V±1%, 150mA, +CE, CL	SOT-23-6	33x5	VR19	7d	Ric
GZ	RP152N024C	LVR-IC	LDO, Dual out, Vout1/Vout2=3.3V/3.0V±1%, 150mA, +CE, CL	SOT-23-6	33x5	VR19	7d	Ric
H	AG203-63G	MMIC	Buffamp, DC, 6GHz, 20dB (900MHz, 50Ω)	SOT-363	33a1	A1	7d	Wjfe
H	HSMS-280M	Si-diode	4x Schottky, RF, 70V, 1A, Vf<0.41V(1mA), <2pF, 35Ω(5mA)	SOT-363	33bw	-	7b	Agj
H	Si1029X	n/p-MOSFET-e	Dual, T-FET, Sw, 60V, 0.5A, 250mW, <1.4Ω(0.5A), 15/35ns	SOT-363	33/T6	-	7b	Six
H0	R1131D201A	LVR-IC	LDO, 2V±2%, 300mA, +CE	SON-6	34hq	VR4	7g	Ric
H0	R1160D301B	LVR-IC	LDO, 3V±2%, 200mA, +CE, AE(mode)	SON-6	34vrc	VR10	7g	Ric
H0	RN2901FS	Si-pnp-Digi	Dual, Sw, 20V, 50mA, 50mW, R1/R2=4.7k/4.7k	F56	35/TD4	-	7b	Tos
H00	74HC2G00DC	CMOS-Logic	Dual 2-input NAND gates	SOT765-1	47Llog50	-	8d	Phi
H00	74HC2G00DP	CMOS-Logic	Dual 2-input NAND gates	SOT505-2	47Llog50	-	8d	Phi
H00B	R1173D001B	LVR-IC	LDO, Adjustable, 1A, +CE	HSON-6	35vm	VR5	7e	Ric
H00D	R1173D001D	LVR-IC	LDO, Adjustable, 1A, +CE, CL	HSON-6	35vm	VR5	7e	Ric
H01B	R1173D181B5	LVR-IC	LDO, 1.85V±2%, 1A, +CE	HSON-6	35vm	VR4	7e	Ric
H01C	R1234D001C	DC/DC-IC	PWM step-down, adjustable, 500kHz	SON-8	44ej	-	8c	Ric
H01D	R1173D181D5	LVR-IC	LDO, 1.85V±2%, 1A, +CE, CL	HSON-6	35vm	VR4	7e	Ric
H01D	R1234D001D	DC/DC-IC	PWM step-down, adjustable, 800kHz	SON-8	44ej	-	8c	Ric
H02	74HC2G02DC	CMOS-Logic	Dual 2-input NOR gates	SOT765-1	47Llog53	-	8d	Phi
H02	74HC2G02DP	CMOS-Logic	Dual 2-input NOR gates	SOT505-2	47Llog53	-	8d	Phi
H02B	R1173D281B5	LVR-IC	LDO, 2.85V±2%, 1A, +CE	HSON-6	35vm	VR4	7e	Ric
H02D	R1173D281D5	LVR-IC	LDO, 2.85V±2%, 1A, +CE, CL	HSON-6	35vm	VR4	7e	Ric
H030	R1501S030B	LVR-IC	LDO, 3.0V±2%, 1A, +CE	HSOP-6J	29x3	VR4	7h	Ric
H031	R1501S031B	LVR-IC	LDO, 3.1V±2%, 1A, +CE	HSOP-6J	29x3	VR4	7h	Ric
H032	R1501S032B	LVR-IC	LDO, 3.2V±2%, 1A, +CE	HSOP-6J	29x3	VR4	7h	Ric
H033	R1501S033B	LVR-IC	LDO, 3.3V±2%, 1A, +CE	HSOP-6J	29x3	VR4	7h	Ric
H034	R1501S034B	LVR-IC	LDO, 3.4V±2%, 1A, +CE	HSOP-6J	29x3	VR4	7h	Ric
H035	R1501S035B	LVR-IC	LDO, 3.5V±2%, 1A, +CE	HSOP-6J	29x3	VR4	7h	Ric
H036	R1501S036B	LVR-IC	LDO, 3.6V±2%, 1A, +CE	HSOP-6J	29x3	VR4	7h	Ric
H037	R1501S037B	LVR-IC	LDO, 3.7V±2%, 1A, +CE	HSOP-6J	29x3	VR4	7h	Ric
H038	R1501S038B	LVR-IC	LDO, 3.8V±2%, 1A, +CE	HSOP-6J	29x3	VR4	7h	Ric
H039	R1501S039B	LVR-IC	LDO, 3.9V±2%, 1A, +CE	HSOP-6J	29x3	VR4	7h	Ric
H04	74HC3G04DC	CMOS-Logic	Triple inverters	SOT765-1	47Llog56	-	8d	Phi
H04	74HC3G04DP	CMOS-Logic	Triple inverters	SOT505-2	47Llog56	-	8d	Phi
H040	R1501S040B	LVR-IC	LDO, 4.0V±2%, 1A, +CE	HSOP-6J	29x3	VR4	7h	Ric
H041	R1501S041B	LVR-IC	LDO, 4.1V±2%, 1A, +CE	HSOP-6J	29x3	VR4	7h	Ric
H042	R1501S042B	LVR-IC	LDO, 4.2V±2%, 1A, +CE	HSOP-6J	29x3	VR4	7h	Ric
H043	R1501S043B	LVR-IC	LDO, 4.3V±2%, 1A, +CE	HSOP-6J	29x3	VR4	7h	Ric
H044	R1501S044B	LVR-IC	LDO, 4.4V±2%, 1A, +CE	HSOP-6J	29x3	VR4	7h	Ric
H045	R1501S045B	LVR-IC	LDO, 4.5V±2%, 1A, +CE	HSOP-6J	29x3	VR4	7h	Ric
H046	R1501S046B	LVR-IC	LDO, 4.6V±2%, 1A, +CE	HSOP-6J	29x3	VR4	7h	Ric
H047	R1501S047B	LVR-IC	LDO, 4.7V±2%, 1A, +CE	HSOP-6J	29x3	VR4	7h	Ric
H048	R1501S048B	LVR-IC	LDO, 4.8V±2%, 1A, +CE	HSOP-6J	29x3	VR4	7h	Ric
H049	R1501S049B	LVR-IC	LDO, 4.9V±2%, 1A, +CE	HSOP-6J	29x3	VR4	7h	Ric
H050	R1501S050B	LVR-IC	LDO, 4.0V±2%, 1A, +CE	HSOP-6J	29x3	VR4	7h	Ric
H051	R1501S051B	LVR-IC	LDO, 5.1V±2%, 1A, +CE	HSOP-6J	29x3	VR4	7h	Ric
H052	R1501S052B	LVR-IC	LDO, 5.2V±2%, 1A, +CE	HSOP-6J	29x3	VR4	7h	Ric
H053	R1501S053B	LVR-IC	LDO, 5.3V±2%, 1A, +CE	HSOP-6J	29x3	VR4	7h	Ric
H054	R1501S054B	LVR-IC	LDO, 5.4V±2%, 1A, +CE	HSOP-6J	29x3	VR4	7h	Ric
H055	R1501S055B	LVR-IC	LDO, 5.5V±2%, 1A, +CE	HSOP-6J	29x3	VR4	7h	Ric
H056	R1501S056B	LVR-IC	LDO, 5.6V±2%, 1A, +CE	HSOP-6J	29x3	VR4	7h	Ric
H057	R1501S057B	LVR-IC	LDO, 5.7V±2%, 1A, +CE	HSOP-6J	29x3	VR4	7h	Ric
H058	R1501S058B	LVR-IC	LDO, 5.8V±2%, 1A, +CE	HSOP-6J	29x3	VR4	7h	Ric
H059	R1501S059B	LVR-IC	LDO, 5.9V±2%, 1A, +CE	HSOP-6J	29x3	VR4	7h	Ric
H06	74HC3G06DC	CMOS-Logic	Triple inverters (ODO)	SOT765-1	47Llog72	-	8d	Phi
H06	74HC3G06DP	CMOS-Logic	Triple inverters (ODO)	SOT505-2	47Llog72	-	8d	Phi
H060	R1501S060B	LVR-IC	LDO, 6.0V±2%, 1A, +CE	HSOP-6J	29x3	VR4	7h	Ric
H061	R1501S061B	LVR-IC	LDO, 6.1V±2%, 1A, +CE	HSOP-6J	29x3	VR4	7h	Ric
H062	R1501S062B	LVR-IC	LDO, 6.2V±2%, 1A, +CE	HSOP-6J	29x3	VR4	7h	Ric
H063	R1501S063B	LVR-IC	LDO, 6.3V±2%, 1A, +CE	HSOP-6J	29x3	VR4	7h	Ric
H064	R1501S064B	LVR-IC	LDO, 6.4V±2%, 1A, +CE	HSOP-6J	29x3	VR4	7h	Ric
H065	R1501S065B	LVR-IC	LDO, 6.5V±2%, 1A, +CE	HSOP-6J	29x3	VR4	7h	Ric
H066	R1501S066B	LVR-IC	LDO, 6.6V±2%, 1A, +CE	HSOP-6J	29x3	VR4	7h	Ric
H067	R1501S067B	LVR-IC	LDO, 6.7V±2%, 1A, +CE	HSOP-6J	29x3	VR4	7h	Ric
H068	R1501S068B	LVR-IC	LDO, 6.8V±2%, 1A, +CE	HSOP-6J	29x3	VR4	7h	Ric
H069	R1501S069B	LVR-IC	LDO, 6.9V±2%, 1A, +CE	HSOP-6J	29x3	VR4	7h	Ric
H07	74HC3G07DC	CMOS-Logic	Triple noninverting buffers/drivers (ODO)	SOT765-1	47Llog73	-	8d	Phi
H07	74HC3G07DP	CMOS-Logic	Triple noninverting buffers/drivers (ODO)	SOT505-2	47Llog73	-	8d	Phi



SMD code	Type	Function	Short description	Case	Pinout	Sch.	St.	Mnf.
H070	R1501S070B	LVR-IC	LDO, 7.0V±2%, 1A, +CE	HSOP-6J	29x3	VR4	7h	Ric
H071	R1501S071B	LVR-IC	LDO, 7.1V±2%, 1A, +CE	HSOP-6J	29x3	VR4	7h	Ric
H072	R1501S072B	LVR-IC	LDO, 7.2V±2%, 1A, +CE	HSOP-6J	29x3	VR4	7h	Ric
H073	R1501S073B	LVR-IC	LDO, 7.3V±2%, 1A, +CE	HSOP-6J	29x3	VR4	7h	Ric
H074	R1501S074B	LVR-IC	LDO, 7.4V±2%, 1A, +CE	HSOP-6J	29x3	VR4	7h	Ric
H075	R1501S075B	LVR-IC	LDO, 7.5V±2%, 1A, +CE	HSOP-6J	29x3	VR4	7h	Ric
H076	R1501S076B	LVR-IC	LDO, 7.6V±2%, 1A, +CE	HSOP-6J	29x3	VR4	7h	Ric
H077	R1501S077B	LVR-IC	LDO, 7.7V±2%, 1A, +CE	HSOP-6J	29x3	VR4	7h	Ric
H078	R1501S078B	LVR-IC	LDO, 7.8V±2%, 1A, +CE	HSOP-6J	29x3	VR4	7h	Ric
H079	R1501S079B	LVR-IC	LDO, 7.9V±2%, 1A, +CE	HSOP-6J	29x3	VR4	7h	Ric
H08	74HC2G08DC	CMOS-Logic	Dual 2-input AND gates	SOT765-1	47LLog51	-	8d	Phi
H08	74HC2G08DP	CMOS-Logic	Dual 2-input AND gates	SOT505-2	47LLog51	-	8d	Phi
H08_	SN74AUP2G08DCU	CMOS-Logic	Dual 2-input AND gates	VSSOP-8	44LLog51	-	8d	Ti
H080	R1501S080B	LVR-IC	LDO, 8.0V±2%, 1A, +CE	HSOP-6J	29x3	VR4	7h	Ric
H081	R1501S081B	LVR-IC	LDO, 8.1V±2%, 1A, +CE	HSOP-6J	29x3	VR4	7h	Ric
H082	R1501S082B	LVR-IC	LDO, 8.2V±2%, 1A, +CE	HSOP-6J	29x3	VR4	7h	Ric
H083	R1501S083B	LVR-IC	LDO, 8.3V±2%, 1A, +CE	HSOP-6J	29x3	VR4	7h	Ric
H084	R1501S084B	LVR-IC	LDO, 8.4V±2%, 1A, +CE	HSOP-6J	29x3	VR4	7h	Ric
H085	R1501S085B	LVR-IC	LDO, 8.5V±2%, 1A, +CE	HSOP-6J	29x3	VR4	7h	Ric
H086	R1501S086B	LVR-IC	LDO, 8.6V±2%, 1A, +CE	HSOP-6J	29x3	VR4	7h	Ric
H087	R1501S087B	LVR-IC	LDO, 8.7V±2%, 1A, +CE	HSOP-6J	29x3	VR4	7h	Ric
H088	R1501S088B	LVR-IC	LDO, 8.8V±2%, 1A, +CE	HSOP-6J	29x3	VR4	7h	Ric
H089	R1501S089B	LVR-IC	LDO, 8.9V±2%, 1A, +CE	HSOP-6J	29x3	VR4	7h	Ric
H08B	R1173D081B	LVR-IC	LDO, 0.8V±2%, 1A, +CE	HSOP-6J	29x3	VR4	7h	Ric
H08D	R1173D081D	LVR-IC	LDO, 0.8V±2%, 1A, +CE, CL	HSOP-6J	29x3	VR4	7h	Ric
H090	R1501S090B	LVR-IC	LDO, 9.0V±2%, 1A, +CE	HSOP-6J	29x3	VR4	7h	Ric
H091	R1501S091B	LVR-IC	LDO, 9.1V±2%, 1A, +CE	HSOP-6J	29x3	VR4	7h	Ric
H092	R1501S092B	LVR-IC	LDO, 9.2V±2%, 1A, +CE	HSOP-6J	29x3	VR4	7h	Ric
H093	R1501S093B	LVR-IC	LDO, 9.3V±2%, 1A, +CE	HSOP-6J	29x3	VR4	7h	Ric
H094	R1501S094B	LVR-IC	LDO, 9.4V±2%, 1A, +CE	HSOP-6J	29x3	VR4	7h	Ric
H095	R1501S095B	LVR-IC	LDO, 9.5V±2%, 1A, +CE	HSOP-6J	29x3	VR4	7h	Ric
H096	R1501S096B	LVR-IC	LDO, 9.6V±2%, 1A, +CE	HSOP-6J	29x3	VR4	7h	Ric
H097	R1501S097B	LVR-IC	LDO, 9.7V±2%, 1A, +CE	HSOP-6J	29x3	VR4	7h	Ric
H098	R1501S098B	LVR-IC	LDO, 9.8V±2%, 1A, +CE	HSOP-6J	29x3	VR4	7h	Ric
H099	R1501S099B	LVR-IC	LDO, 9.9V±2%, 1A, +CE	HSOP-6J	29x3	VR4	7h	Ric
H09B	R1173D091B	LVR-IC	LDO, 0.9V±2%, 1A, +CE	HSOP-6J	29x3	VR4	7h	Ric
H09D	R1173D091D	LVR-IC	LDO, 0.9V±2%, 1A, +CE, CL	HSOP-6J	29x3	VR4	7h	Ric
H1	R1131D211A	LVR-IC	LDO, 2.1V±2%, 300mA, +CE	SON-6	34hq	VR4	7g	Ric
H1	R1160D311B	LVR-IC	LDO, 3.1V±2%, 200mA, +CE, AE(mode)	SON-6	34wrc	VR10	7g	Ric
H1	RN2902FS	Si-pnp-Digi	Dual, Sw, 20V, 50mA, 50mW, R1/R2=10k/10k	F56	35TD4	-	7b	Tos
H10	IMH10A	Si-npn-Digi	Dual, 50V, 100mA, R1/R2=2.2k/47k	SOT-23-6	33TD3	-	7b	Rhm
H100	R1501S100B	LVR-IC	LDO, 10.0V±2%, 1A, +CE	HSOP-6J	29x3	VR4	7h	Ric
H101	R1501S101B	LVR-IC	LDO, 10.1V±2%, 1A, +CE	HSOP-6J	29x3	VR4	7h	Ric
H102	R1501S102B	LVR-IC	LDO, 10.2V±2%, 1A, +CE	HSOP-6J	29x3	VR4	7h	Ric
H103	R1501S103B	LVR-IC	LDO, 10.3V±2%, 1A, +CE	HSOP-6J	29x3	VR4	7h	Ric
H104	R1501S104B	LVR-IC	LDO, 10.4V±2%, 1A, +CE	HSOP-6J	29x3	VR4	7h	Ric
H105	R1501S105B	LVR-IC	LDO, 10.5V±2%, 1A, +CE	HSOP-6J	29x3	VR4	7h	Ric
H106	R1501S106B	LVR-IC	LDO, 10.6V±2%, 1A, +CE	HSOP-6J	29x3	VR4	7h	Ric
H107	R1501S107B	LVR-IC	LDO, 10.7V±2%, 1A, +CE	HSOP-6J	29x3	VR4	7h	Ric
H108	R1501S108B	LVR-IC	LDO, 10.8V±2%, 1A, +CE	HSOP-6J	29x3	VR4	7h	Ric
H109	R1501S109B	LVR-IC	LDO, 10.9V±2%, 1A, +CE	HSOP-6J	29x3	VR4	7h	Ric
H10B	R1173D101B	LVR-IC	LDO, 1V±2%, 1A, +CE	HSOP-6J	29x3	VR4	7h	Ric
H10D	R1173D101D	LVR-IC	LDO, 1V±2%, 1A, +CE, CL	HSOP-6J	29x3	VR4	7h	Ric
H11	IMH11A	Si-npn-Digi	Dual, 50V, 100mA, R1/R2=10k/10k	SOT-23-6	33TD3	-	7b	Rhm
H110	R1501S110B	LVR-IC	LDO, 11.0V±2%, 1A, +CE	HSOP-6J	29x3	VR4	7h	Ric
H111	R1501S111B	LVR-IC	LDO, 11.1V±2%, 1A, +CE	HSOP-6J	29x3	VR4	7h	Ric
H112	R1501S112B	LVR-IC	LDO, 11.2V±2%, 1A, +CE	HSOP-6J	29x3	VR4	7h	Ric
H113	R1501S113B	LVR-IC	LDO, 11.3V±2%, 1A, +CE	HSOP-6J	29x3	VR4	7h	Ric
H114	R1501S114B	LVR-IC	LDO, 11.4V±2%, 1A, +CE	HSOP-6J	29x3	VR4	7h	Ric
H115	R1501S115B	LVR-IC	LDO, 11.5V±2%, 1A, +CE	HSOP-6J	29x3	VR4	7h	Ric
H116	R1501S116B	LVR-IC	LDO, 11.6V±2%, 1A, +CE	HSOP-6J	29x3	VR4	7h	Ric
H117	R1501S117B	LVR-IC	LDO, 11.7V±2%, 1A, +CE	HSOP-6J	29x3	VR4	7h	Ric
H118	R1501S118B	LVR-IC	LDO, 11.8V±2%, 1A, +CE	HSOP-6J	29x3	VR4	7h	Ric
H119	R1501S119B	LVR-IC	LDO, 11.9V±2%, 1A, +CE	HSOP-6J	29x3	VR4	7h	Ric
H11B	R1173D111B	LVR-IC	LDO, 1.1V±2%, 1A, +CE	HSOP-6J	29x3	VR4	7h	Ric
H11D	R1173D111D	LVR-IC	LDO, 1.1V±2%, 1A, +CE, CL	HSOP-6J	29x3	VR4	7h	Ric
H120	R1501S120B	LVR-IC	LDO, 12.0V±2%, 1A, +CE	HSOP-6J	29x3	VR4	7h	Ric
H125	R1501S125B	LVR-IC	LDO, 12.5V±2%, 1A, +CE	HSOP-6J	29x3	VR4	7h	Ric
H12A	R1234D121A	DC/DC-IC	PWM step-down, 1.2V±2%, 500kHz	SON-8	44ej	-	8c	Ric
H12B	R1173D121B	LVR-IC	LDO, 1.2V±2%, 1A, +CE	HSOP-6J	29x3	VR4	7h	Ric



SMD code	Type	Function	Short description	Case	Pinout	Sch.	St.	Mnf.
H12B	R1234D121B	DC/DC-IC	PWM step-down, 1.2V±2%, 800kHz	SON-8	44ej	-	8c	Ric
H12D	R1173D121D	LVR-IC	LDO, 1.2V±2%, 1A, +CE, CL	HSOP-6	35vm	VR4	7e	Ric
H130	R1501S130B	LVR-IC	LDO, 13.0V±2%, 1A, +CE	HSOP-6J	29x3	VR4	7h	Ric
H135	R1501S135B	LVR-IC	LDO, 13.5V±2%, 1A, +CE	HSOP-6J	29x3	VR4	7h	Ric
H13A	R1234D131A	DC/DC-IC	PWM step-down, 1.3V±2%, 500kHz	SON-8	44ej	-	8c	Ric
H13B	R1173D131B	LVR-IC	LDO, 1.3V±2%, 1A, +CE	HSOP-6	35vm	VR4	7e	Ric
H13B	R1234D131B	DC/DC-IC	PWM step-down, 1.3V±2%, 800kHz	SON-8	44ej	-	8c	Ric
H13D	R1173D131D	LVR-IC	LDO, 1.3V±2%, 1A, +CE, CL	HSOP-6	35vm	VR4	7e	Ric
H14	74HC2G14GV	CMOS-Logic	Dual Schmitt-trigger inverter buffers	SOT-363	33/Log34	-	7b	Phi
H14	74HC3G14DC	CMOS-Logic	Triple Schmitt-trigger inverters	SOT765-1	47/Log57	-	8d	Phi
H14	74HC3G14DP	CMOS-Logic	Triple Schmitt-trigger inverters	SOT505-2	47/Log57	-	8d	Phi
H14	74HCT2G14GV	CMOS-Logic	Dual Schmitt-trigger inverter buffers	SOT-363	33/Log34	-	7b	Phi
H140	R1501S140B	LVR-IC	LDO, 14.0V±2%, 1A, +CE	HSOP-6J	29x3	VR4	7h	Ric
H145	R1501S145B	LVR-IC	LDO, 14.5V±2%, 1A, +CE	HSOP-6J	29x3	VR4	7h	Ric
H14A	R1234D141A	DC/DC-IC	PWM step-down, 1.4V±2%, 500kHz	SON-8	44ej	-	8c	Ric
H14B	R1173D141B	LVR-IC	LDO, 1.4V±2%, 1A, +CE	HSOP-6	35vm	VR4	7e	Ric
H14B	R1234D141B	DC/DC-IC	PWM step-down, 1.4V±2%, 800kHz	SON-8	44ej	-	8c	Ric
H14D	R1173D141D	LVR-IC	LDO, 1.4V±2%, 1A, +CE, CL	HSOP-6	35vm	VR4	7e	Ric
H15	IMH15A	Si-npn-Digi	Dual, 50V, 100mA, R1=47k	SOT-23-6	33/TD3	-	7b	Rhm
H150	R1501S150B	LVR-IC	LDO, 15.0V±2%, 1A, +CE	HSOP-6J	29x3	VR4	7h	Ric
H155	R1501S155B	LVR-IC	LDO, 15.5V±2%, 1A, +CE	HSOP-6J	29x3	VR4	7h	Ric
H15A	R1234D151A	DC/DC-IC	PWM step-down, 1.5V±2%, 500kHz	SON-8	44ej	-	8c	Ric
H15B	R1162D151B	LVR-IC	LDO, 1.5V±2%, 150mA, +CE, AE(mode)	SOM1612-6	35vwh	VR10	7e	Ric
H15B	R1173D151B	LVR-IC	LDO, 1.5V±2%, 1A, +CE	HSOP-6	35vm	VR4	7e	Ric
H15B	R1234D151B	DC/DC-IC	PWM step-down, 1.5V±2%, 800kHz	SON-8	44ej	-	8c	Ric
H15D	R1162D151D	LVR-IC	LDO, 1.5V±2%, 350mA, +CE, CL, AE(mode)	SOM1612-6	35vwh	VR10	7e	Ric
H15D	R1173D151D	LVR-IC	LDO, 1.5V±2%, 1A, +CE, CL	HSOP-6	35vm	VR4	7e	Ric
H160	R1501S160B	LVR-IC	LDO, 16.0V±2%, 1A, +CE	HSOP-6J	29x3	VR4	7h	Ric
H165	R1501S165B	LVR-IC	LDO, 16.5V±2%, 1A, +CE	HSOP-6J	29x3	VR4	7h	Ric
H16A	R1234D161A	DC/DC-IC	PWM step-down, 1.6V±2%, 500kHz	SON-8	44ej	-	8c	Ric
H16B	R1162D161B	LVR-IC	LDO, 1.6V±2%, 150mA, +CE, AE(mode)	SOM1612-6	35vwh	VR10	7e	Ric
H16B	R1173D161B	LVR-IC	LDO, 1.6V±2%, 1A, +CE	HSOP-6	35vm	VR4	7e	Ric
H16B	R1234D161B	DC/DC-IC	PWM step-down, 1.6V±2%, 800kHz	SON-8	44ej	-	8c	Ric
H16D	R1162D161D	LVR-IC	LDO, 1.6V±2%, 350mA, +CE, CL, AE(mode)	SOM1612-6	35vwh	VR10	7e	Ric
H16D	R1173D161D	LVR-IC	LDO, 1.6V±2%, 1A, +CE, CL	HSOP-6	35vm	VR4	7e	Ric
H170	R1501S170B	LVR-IC	LDO, 17.0V±2%, 1A, +CE	HSOP-6J	29x3	VR4	7h	Ric
H175	R1501S175B	LVR-IC	LDO, 17.5V±2%, 1A, +CE	HSOP-6J	29x3	VR4	7h	Ric
H17A	R1234D171A	DC/DC-IC	PWM step-down, 1.7V±2%, 500kHz	SON-8	44ej	-	8c	Ric
H17B	R1162D171B	LVR-IC	LDO, 1.7V±2%, 150mA, +CE, AE(mode)	SOM1612-6	35vwh	VR10	7e	Ric
H17B	R1173D171B	LVR-IC	LDO, 1.7V±2%, 1A, +CE	HSOP-6	35vm	VR4	7e	Ric
H17B	R1234D171B	DC/DC-IC	PWM step-down, 1.7V±2%, 800kHz	SON-8	44ej	-	8c	Ric
H17D	R1162D171D	LVR-IC	LDO, 1.7V±2%, 350mA, +CE, CL, AE(mode)	SOM1612-6	35vwh	VR10	7e	Ric
H17D	R1173D171D	LVR-IC	LDO, 1.7V±2%, 1A, +CE, CL	HSOP-6	35vm	VR4	7e	Ric
H180	R1501S180B	LVR-IC	LDO, 18.0V±2%, 1A, +CE	HSOP-6J	29x3	VR4	7h	Ric
H18A	R1234D181A	DC/DC-IC	PWM step-down, 1.8V±2%, 500kHz	SON-8	44ej	-	8c	Ric
H18B	R1162D181B	LVR-IC	LDO, 1.8V±2%, 150mA, +CE, AE(mode)	SOM1612-6	35vwh	VR10	7e	Ric
H18B	R1173D181B	LVR-IC	LDO, 1.8V±2%, 1A, +CE	HSOP-6	35vm	VR4	7e	Ric
H18B	R1234D181B	DC/DC-IC	PWM step-down, 1.8V±2%, 800kHz	SON-8	44ej	-	8c	Ric
H18D	R1162D181D	LVR-IC	LDO, 1.8V±2%, 350mA, +CE, CL, AE(mode)	SOM1612-6	35vwh	VR10	7e	Ric
H18D	R1173D181D	LVR-IC	LDO, 1.8V±2%, 1A, +CE, CL	HSOP-6	35vm	VR4	7e	Ric
H19A	R1234D191A	DC/DC-IC	PWM step-down, 1.9V±2%, 500kHz	SON-8	44ej	-	8c	Ric
H19B	R1162D191B	LVR-IC	LDO, 1.9V±2%, 150mA, +CE, AE(mode)	SOM1612-6	35vwh	VR10	7e	Ric
H19B	R1173D191B	LVR-IC	LDO, 1.9V±2%, 1A, +CE	HSOP-6	35vm	VR4	7e	Ric
H19B	R1234D191B	DC/DC-IC	PWM step-down, 1.9V±2%, 800kHz	SON-8	44ej	-	8c	Ric
H19D	R1162D191D	LVR-IC	LDO, 1.9V±2%, 350mA, +CE, CL, AE(mode)	SOM1612-6	35vwh	VR10	7e	Ric
H19D	R1173D191D	LVR-IC	LDO, 1.9V±2%, 1A, +CE, CL	HSOP-6	35vm	VR4	7e	Ric
H2	R1131D221A	LVR-IC	LDO, 2.2V±2%, 300mA, +CE	SON-6	34hq	VR4	7g	Ric
H2	R1160D321B	LVR-IC	LDO, 3.2V±2%, 200mA, +CE, AE(mode)	SON-6	34vrc	VR10	7g	Ric
H2	RN2903FS	Si-pnp-Digi	Dual, Sw, 20V, 50mA, 50mW, R1/R2=22k/22k	F56	35/TD4	-	7b	Tos
H20A	R1234D201A	DC/DC-IC	PWM step-down, 2V±2%, 500kHz	SON-8	44ej	-	8c	Ric
H20B	R1162D201B	LVR-IC	LDO, 2V±2%, 150mA, +CE, AE(mode)	SOM1612-6	35vwh	VR10	7e	Ric
H20B	R1173D201B	LVR-IC	LDO, 2V±2%, 1A, +CE	HSOP-6	35vm	VR4	7e	Ric
H20B	R1234D201B	DC/DC-IC	PWM step-down, 2V±2%, 800kHz	SON-8	44ej	-	8c	Ric
H20D	R1162D201D	LVR-IC	LDO, 2V±2%, 350mA, +CE, CL, AE(mode)	SOM1612-6	35vwh	VR10	7e	Ric
H20D	R1173D201D	LVR-IC	LDO, 2V±2%, 1A, +CE, CL	HSOP-6	35vm	VR4	7e	Ric
H21A	R1234D211A	DC/DC-IC	PWM step-down, 2.1V±2%, 500kHz	SON-8	44ej	-	8c	Ric
H21B	R1162D211B	LVR-IC	LDO, 2.1V±2%, 150mA, +CE, AE(mode)	SOM1612-6	35vwh	VR10	7e	Ric
H21B	R1173D211B	LVR-IC	LDO, 2.1V±2%, 1A, +CE	HSOP-6	35vm	VR4	7e	Ric
H21B	R1234D211B	DC/DC-IC	PWM step-down, 2.1V±2%, 800kHz	SON-8	44ej	-	8c	Ric
H21D	R1162D211D	LVR-IC	LDO, 2.1V±2%, 350mA, +CE, CL, AE(mode)	SOM1612-6	35vwh	VR10	7e	Ric



SMD code	Type	Function	Short description	Case	Pinout	Sch.	St.	Mnf.
H21D	R1173D211D	LVR-IC	LDO, 2.1V±2%, 1A, +CE, CL	HSON-6	35vm	VR4	7e	Ric
H22A	R1234D221A	DC/DC-IC	PWM step-down, 2.2V±2%, 500kHz	SON-8	44ej	-	8c	Ric
H22B	R1162D221B	LVR-IC	LDO, 2.2V±2%, 150mA, +CE, AE(mode)	SON1612-6	35vth	VR10	7e	Ric
H22B	R1173D221B	LVR-IC	LDO, 2.2V±2%, 1A, +CE	HSON-6	35vm	VR4	7e	Ric
H22B	R1234D221B	DC/DC-IC	PWM step-down, 2.2V±2%, 800kHz	SON-8	44ej	-	8c	Ric
H22D	R1162D221D	LVR-IC	LDO, 2.2V±2%, 350mA, +CE, CL, AE(mode)	SON1612-6	35vth	VR10	7e	Ric
H22D	R1173D221D	LVR-IC	LDO, 2.2V±2%, 1A, +CE, CL	HSON-6	35vm	VR4	7e	Ric
H23A	R1234D231A	DC/DC-IC	PWM step-down, 2.3V±2%, 500kHz	SON-8	44ej	-	8c	Ric
H23B	R1162D231B	LVR-IC	LDO, 2.3V±2%, 150mA, +CE, AE(mode)	SON1612-6	35vth	VR10	7e	Ric
H23B	R1173D231B	LVR-IC	LDO, 2.3V±2%, 1A, +CE	HSON-6	35vm	VR4	7e	Ric
H23B	R1234D231B	DC/DC-IC	PWM step-down, 2.3V±2%, 800kHz	SON-8	44ej	-	8c	Ric
H23D	R1162D231D	LVR-IC	LDO, 2.3V±2%, 350mA, +CE, CL, AE(mode)	SON1612-6	35vth	VR10	7e	Ric
H23D	R1173D231D	LVR-IC	LDO, 2.3V±2%, 1A, +CE, CL	HSON-6	35vm	VR4	7e	Ric
H24A	R1234D241A	DC/DC-IC	PWM step-down, 2.4V±2%, 500kHz	SON-8	44ej	-	8c	Ric
H24B	R1162D241B	LVR-IC	LDO, 2.4V±2%, 150mA, +CE, AE(mode)	SON1612-6	35vth	VR10	7e	Ric
H24B	R1173D241B	LVR-IC	LDO, 2.4V±2%, 1A, +CE	HSON-6	35vm	VR4	7e	Ric
H24B	R1234D241B	DC/DC-IC	PWM step-down, 2.4V±2%, 800kHz	SON-8	44ej	-	8c	Ric
H24D	R1162D241D	LVR-IC	LDO, 2.4V±2%, 350mA, +CE, CL, AE(mode)	SON1612-6	35vth	VR10	7e	Ric
H24D	R1173D241D	LVR-IC	LDO, 2.4V±2%, 1A, +CE, CL	HSON-6	35vm	VR4	7e	Ric
H25	74HC2G125DC	CMOS-Logic	Dual bus buffer with 3-state output	SOT765-1	47Llog54	-	8d	Phi
H25	74HC2G125DP	CMOS-Logic	Dual bus buffer with 3-state output	SOT505-2	47Llog54	-	8d	Phi
H25	SN74AUP2G125DCT	CMOS-Logic	Dual bus buffer with 3-state output	SSOP-8	47Llog54	-	8d	Ti
H25A	R1234D251A	DC/DC-IC	PWM step-down, 2.5V±2%, 500kHz	SON-8	44ej	-	8c	Ric
H25B	R1162D251B	LVR-IC	LDO, 2.5V±2%, 150mA, +CE, AE(mode)	SON1612-6	35vth	VR10	7e	Ric
H25B	R1173D251B	LVR-IC	LDO, 2.5V±2%, 1A, +CE	HSON-6	35vm	VR4	7e	Ric
H25B	R1234D251B	DC/DC-IC	PWM step-down, 2.5V±2%, 800kHz	SON-8	44ej	-	8c	Ric
H25D	R1162D251D	LVR-IC	LDO, 2.5V±2%, 350mA, +CE, CL, AE(mode)	SON1612-6	35vth	VR10	7e	Ric
H25D	R1173D251D	LVR-IC	LDO, 2.5V±2%, 1A, +CE, CL	HSON-6	35vm	VR4	7e	Ric
H26	74HC2G126DC	CMOS-Logic	Dual bus buffer with 3-state output	SOT765-1	47Llog55	-	8d	Phi
H26	74HC2G126DP	CMOS-Logic	Dual bus buffer with 3-state output	SOT505-2	47Llog55	-	8d	Phi
H26A	R1234D261A	DC/DC-IC	PWM step-down, 2.6V±2%, 500kHz	SON-8	44ej	-	8c	Ric
H26B	R1162D261B	LVR-IC	LDO, 2.6V±2%, 150mA, +CE, AE(mode)	SON1612-6	35vth	VR10	7e	Ric
H26B	R1173D261B	LVR-IC	LDO, 2.6V±2%, 1A, +CE	HSON-6	35vm	VR4	7e	Ric
H26B	R1234D261B	DC/DC-IC	PWM step-down, 2.6V±2%, 800kHz	SON-8	44ej	-	8c	Ric
H26D	R1162D261D	LVR-IC	LDO, 2.6V±2%, 350mA, +CE, CL, AE(mode)	SON1612-6	35vth	VR10	7e	Ric
H26D	R1173D261D	LVR-IC	LDO, 2.6V±2%, 1A, +CE, CL	HSON-6	35vm	VR4	7e	Ric
H27A	R1234D271A	DC/DC-IC	PWM step-down, 2.7V±2%, 500kHz	SON-8	44ej	-	8c	Ric
H27B	R1162D271B	LVR-IC	LDO, 2.7V±2%, 150mA, +CE, AE(mode)	SON1612-6	35vth	VR10	7e	Ric
H27B	R1173D271B	LVR-IC	LDO, 2.7V±2%, 1A, +CE	HSON-6	35vm	VR4	7e	Ric
H27B	R1234D271B	DC/DC-IC	PWM step-down, 2.7V±2%, 800kHz	SON-8	44ej	-	8c	Ric
H27D	R1162D271D	LVR-IC	LDO, 2.7V±2%, 350mA, +CE, CL, AE(mode)	SON1612-6	35vth	VR10	7e	Ric
H27D	R1173D271D	LVR-IC	LDO, 2.7V±2%, 1A, +CE, CL	HSON-6	35vm	VR4	7e	Ric
H28A	R1234D281A	DC/DC-IC	PWM step-down, 2.8V±2%, 500kHz	SON-8	44ej	-	8c	Ric
H28B	R1162D281B	LVR-IC	LDO, 2.8V±2%, 150mA, +CE, AE(mode)	SON1612-6	35vth	VR10	7e	Ric
H28B	R1173D281B	LVR-IC	LDO, 2.8V±2%, 1A, +CE	HSON-6	35vm	VR4	7e	Ric
H28B	R1234D281B	DC/DC-IC	PWM step-down, 2.8V±2%, 800kHz	SON-8	44ej	-	8c	Ric
H28D	R1162D281D	LVR-IC	LDO, 2.8V±2%, 350mA, +CE, CL, AE(mode)	SON1612-6	35vth	VR10	7e	Ric
H28D	R1173D281D	LVR-IC	LDO, 2.8V±2%, 1A, +CE, CL	HSON-6	35vm	VR4	7e	Ric
H29A	R1234D291A	DC/DC-IC	PWM step-down, 2.9V±2%, 500kHz	SON-8	44ej	-	8c	Ric
H29B	R1162D291B	LVR-IC	LDO, 2.9V±2%, 150mA, +CE, AE(mode)	SON1612-6	35vth	VR10	7e	Ric
H29B	R1173D291B	LVR-IC	LDO, 2.9V±2%, 1A, +CE	HSON-6	35vm	VR4	7e	Ric
H29B	R1234D291B	DC/DC-IC	PWM step-down, 2.9V±2%, 800kHz	SON-8	44ej	-	8c	Ric
H29D	R1162D291D	LVR-IC	LDO, 2.9V±2%, 350mA, +CE, CL, AE(mode)	SON1612-6	35vth	VR10	7e	Ric
H29D	R1173D291D	LVR-IC	LDO, 2.9V±2%, 1A, +CE, CL	HSON-6	35vm	VR4	7e	Ric
H3	R1131D231A	LVR-IC	LDO, 2.3V±2%, 300mA, +CE	SON-6	34hq	VR4	7g	Ric
H3	R1160D331B	LVR-IC	LDO, 3.3V±2%, 200mA, +CE, AE(mode)	SON-6	34rc	VR10	7g	Ric
H3	RN2904FS	Si-pnp-Digi	Dual, Sw, 20V, 50mA, 50mW, R1/R2=47k/47k	FS6	35/TD4	-	7b	Tos
H30A	R1234D301A	DC/DC-IC	PWM step-down, 3V±2%, 500kHz	SON-8	44ej	-	8c	Ric
H30B	R1162D301B	LVR-IC	LDO, 3V±2%, 150mA, +CE, AE(mode)	SON1612-6	35vth	VR10	7e	Ric
H30B	R1173D301B	LVR-IC	LDO, 3V±2%, 1A, +CE	HSON-6	35vm	VR4	7e	Ric
H30B	R1234D301B	DC/DC-IC	PWM step-down, 3V±2%, 800kHz	SON-8	44ej	-	8c	Ric
H30D	R1162D301D	LVR-IC	LDO, 3V±2%, 350mA, +CE, CL, AE(mode)	SON1612-6	35vth	VR10	7e	Ric
H30D	R1173D301D	LVR-IC	LDO, 3V±2%, 1A, +CE, CL	HSON-6	35vm	VR4	7e	Ric
H31A	R1234D311A	DC/DC-IC	PWM step-down, 3.1V±2%, 500kHz	SON-8	44ej	-	8c	Ric
H31B	R1162D311B	LVR-IC	LDO, 3.1V±2%, 150mA, +CE, AE(mode)	SON1612-6	35vth	VR10	7e	Ric
H31B	R1173D311B	LVR-IC	LDO, 3.1V±2%, 1A, +CE	HSON-6	35vm	VR4	7e	Ric
H31B	R1234D311B	DC/DC-IC	PWM step-down, 3.1V±2%, 800kHz	SON-8	44ej	-	8c	Ric
H31D	R1162D311D	LVR-IC	LDO, 3.1V±2%, 350mA, +CE, CL, AE(mode)	SON1612-6	35vth	VR10	7e	Ric
H31D	R1173D311D	LVR-IC	LDO, 3.1V±2%, 1A, +CE, CL	HSON-6	35vm	VR4	7e	Ric
H32	74HC2G32DC	CMOS-Logic	Dual 2-input OR gates	SOT765-1	47Llog52	-	8d	Phi



SMD code	Type	Function	Short description	Case	Pinout	Sch.	St.	Mnf.
H32	74HC2G32DP	CMOS-Logic	Dual 2-input OR gates	SOT505-2	47/L,og52	-	8d	Phi
H32A	R1234D321A	DC/DC-IC	PWM step-down, 3.2V±2%, 500kHz	SON-8	44ej	-	8c	Ric
H32B	R1162D321B	LVR-IC	LDO, 3.2V±2%, 150mA, +CE, AE(mode)	SON1612-6	35vwh	VR10	7e	Ric
H32B	R1173D321B	LVR-IC	LDO, 3.2V±2%, 1A, +CE	HSON-6	35vm	VR4	7e	Ric
H32B	R1234D321B	DC/DC-IC	PWM step-down, 3.2V±2%, 800kHz	SON-8	44ej	-	8c	Ric
H32D	R1162D321D	LVR-IC	LDO, 3.2V±2%, 350mA, +CE, CL, AE(mode)	SON1612-6	35vwh	VR10	7e	Ric
H32D	R1173D321D	LVR-IC	LDO, 3.2V±2%, 1A, +CE, CL	HSON-6	35vm	VR4	7e	Ric
H33A	R1234D331A	DC/DC-IC	PWM step-down, 3.3V±2%, 500kHz	SON-8	44ej	-	8c	Ric
H33B	R1162D331B	LVR-IC	LDO, 3.3V±2%, 150mA, +CE, AE(mode)	SON1612-6	35vwh	VR10	7e	Ric
H33B	R1173D331B	LVR-IC	LDO, 3.3V±2%, 1A, +CE	HSON-6	35vm	VR4	7e	Ric
H33B	R1234D331B	DC/DC-IC	PWM step-down, 3.3V±2%, 800kHz	SON-8	44ej	-	8c	Ric
H33D	R1162D331D	LVR-IC	LDO, 3.3V±2%, 350mA, +CE, CL, AE(mode)	SON1612-6	35vwh	VR10	7e	Ric
H33D	R1173D331D	LVR-IC	LDO, 3.3V±2%, 1A, +CE, CL	HSON-6	35vm	VR4	7e	Ric
H34	74HC3G34DP	CMOS-Logic	Triple non-inverter buffers	SOT505-2	47/L,og69	-	8d	Phi
H34B	R1162D341B	LVR-IC	LDO, 3.4V±2%, 150mA, +CE, AE(mode)	SON1612-6	35vwh	VR10	7e	Ric
H34B	R1173D341B	LVR-IC	LDO, 3.4V±2%, 1A, +CE	HSON-6	35vm	VR4	7e	Ric
H34D	R1162D341D	LVR-IC	LDO, 3.4V±2%, 350mA, +CE, CL, AE(mode)	SON1612-6	35vwh	VR10	7e	Ric
H34D	R1173D341D	LVR-IC	LDO, 3.4V±2%, 1A, +CE, CL	HSON-6	35vm	VR4	7e	Ric
H35B	R1162D351B	LVR-IC	LDO, 3.5V±2%, 150mA, +CE, AE(mode)	SON1612-6	35vwh	VR10	7e	Ric
H35B	R1173D351B	LVR-IC	LDO, 3.5V±2%, 1A, +CE	HSON-6	35vm	VR4	7e	Ric
H35D	R1162D351D	LVR-IC	LDO, 3.5V±2%, 350mA, +CE, CL, AE(mode)	SON1612-6	35vwh	VR10	7e	Ric
H35D	R1173D351D	LVR-IC	LDO, 3.5V±2%, 1A, +CE, CL	HSON-6	35vm	VR4	7e	Ric
H36B	R1162D361B	LVR-IC	LDO, 3.6V±2%, 150mA, +CE, AE(mode)	SON1612-6	35vwh	VR10	7e	Ric
H36B	R1173D361B	LVR-IC	LDO, 3.6V±2%, 1A, +CE	HSON-6	35vm	VR4	7e	Ric
H36D	R1162D361D	LVR-IC	LDO, 3.6V±2%, 350mA, +CE, CL, AE(mode)	SON1612-6	35vwh	VR10	7e	Ric
H36D	R1173D361D	LVR-IC	LDO, 3.6V±2%, 1A, +CE, CL	HSON-6	35vm	VR4	7e	Ric
H37B	R1162D371B	LVR-IC	LDO, 3.7V±2%, 150mA, +CE, AE(mode)	SON1612-6	35vwh	VR10	7e	Ric
H37B	R1173D371B	LVR-IC	LDO, 3.7V±2%, 1A, +CE	HSON-6	35vm	VR4	7e	Ric
H37D	R1162D371D	LVR-IC	LDO, 3.7V±2%, 350mA, +CE, CL, AE(mode)	SON1612-6	35vwh	VR10	7e	Ric
H37D	R1173D371D	LVR-IC	LDO, 3.7V±2%, 1A, +CE, CL	HSON-6	35vm	VR4	7e	Ric
H38B	R1162D381B	LVR-IC	LDO, 3.8V±2%, 150mA, +CE, AE(mode)	SON1612-6	35vwh	VR10	7e	Ric
H38B	R1173D381B	LVR-IC	LDO, 3.8V±2%, 1A, +CE	HSON-6	35vm	VR4	7e	Ric
H38D	R1162D381D	LVR-IC	LDO, 3.8V±2%, 350mA, +CE, CL, AE(mode)	SON1612-6	35vwh	VR10	7e	Ric
H38D	R1173D381D	LVR-IC	LDO, 3.8V±2%, 1A, +CE, CL	HSON-6	35vm	VR4	7e	Ric
H39B	R1162D391B	LVR-IC	LDO, 3.9V±2%, 150mA, +CE, AE(mode)	SON1612-6	35vwh	VR10	7e	Ric
H39B	R1173D391B	LVR-IC	LDO, 3.9V±2%, 1A, +CE	HSON-6	35vm	VR4	7e	Ric
H39D	R1162D391D	LVR-IC	LDO, 3.9V±2%, 350mA, +CE, CL, AE(mode)	SON1612-6	35vwh	VR10	7e	Ric
H39D	R1173D391D	LVR-IC	LDO, 3.9V±2%, 1A, +CE, CL	HSON-6	35vm	VR4	7e	Ric
H4	R1131D241A	LVR-IC	LDO, 2.4V±2%, 300mA, +CE	SON-6	34hq	VR4	7g	Ric
H4	RN2906FS	Si-pnp-Digi	Dual, Sw, 20V, 50mA, 50mW, R1/R2=2.2k/47k	FS6	35/TD4	-	7b	Tos
H40B	R1162D401B	LVR-IC	LDO, 4V±2%, 150mA, +CE, AE(mode)	SON1612-6	35vwh	VR10	7e	Ric
H40B	R1173D401B	LVR-IC	LDO, 4V±2%, 1A, +CE	HSON-6	35vm	VR4	7e	Ric
H40D	R1162D401D	LVR-IC	LDO, 4V±2%, 350mA, +CE, CL, AE(mode)	SON1612-6	35vwh	VR10	7e	Ric
H40D	R1173D401D	LVR-IC	LDO, 4V±2%, 1A, +CE, CL	HSON-6	35vm	VR4	7e	Ric
H41B	R1162D181B5	LVR-IC	LDO, 1.85V±2%, 150mA, +CE, AE(mode)	SON1612-6	35vwh	VR10	7e	Ric
H41B	R1173D411B	LVR-IC	LDO, 4.1V±2%, 1A, +CE	HSON-6	35vm	VR4	7e	Ric
H41D	R1162D181D5	LVR-IC	LDO, 1.85V±2%, 350mA, +CE, CL, AE(mode)	SON1612-6	35vwh	VR10	7e	Ric
H41D	R1173D411D	LVR-IC	LDO, 4.1V±2%, 1A, +CE, CL	HSON-6	35vm	VR4	7e	Ric
H42B	R1162D281B5	LVR-IC	LDO, 2.85V±2%, 150mA, +CE, AE(mode)	SON1612-6	35vwh	VR10	7e	Ric
H42B	R1173D421B	LVR-IC	LDO, 4.2V±2%, 1A, +CE	HSON-6	35vm	VR4	7e	Ric
H42D	R1162D281D5	LVR-IC	LDO, 2.85V±2%, 350mA, +CE, CL, AE(mode)	SON1612-6	35vwh	VR10	7e	Ric
H42D	R1173D421D	LVR-IC	LDO, 4.2V±2%, 1A, +CE, CL	HSON-6	35vm	VR4	7e	Ric
H43B	R1173D431B	LVR-IC	LDO, 4.3V±2%, 1A, +CE	HSON-6	35vm	VR4	7e	Ric
H43D	R1173D431D	LVR-IC	LDO, 4.3V±2%, 1A, +CE, CL	HSON-6	35vm	VR4	7e	Ric
H44B	R1173D441B	LVR-IC	LDO, 4.4V±2%, 1A, +CE	HSON-6	35vm	VR4	7e	Ric
H44D	R1173D441D	LVR-IC	LDO, 4.4V±2%, 1A, +CE, CL	HSON-6	35vm	VR4	7e	Ric
H45B	R1173D451B	LVR-IC	LDO, 4.5V±2%, 1A, +CE	HSON-6	35vm	VR4	7e	Ric
H45D	R1173D451D	LVR-IC	LDO, 4.5V±2%, 1A, +CE, CL	HSON-6	35vm	VR4	7e	Ric
H46B	R1173D461B	LVR-IC	LDO, 4.6V±2%, 1A, +CE	HSON-6	35vm	VR4	7e	Ric
H46D	R1173D461D	LVR-IC	LDO, 4.6V±2%, 1A, +CE, CL	HSON-6	35vm	VR4	7e	Ric
H47B	R1173D471B	LVR-IC	LDO, 4.7V±2%, 1A, +CE	HSON-6	35vm	VR4	7e	Ric
H47D	R1173D471D	LVR-IC	LDO, 4.7V±2%, 1A, +CE, CL	HSON-6	35vm	VR4	7e	Ric
H48B	R1173D481B	LVR-IC	LDO, 4.8V±2%, 1A, +CE	HSON-6	35vm	VR4	7e	Ric
H48D	R1173D481D	LVR-IC	LDO, 4.8V±2%, 1A, +CE, CL	HSON-6	35vm	VR4	7e	Ric
H49B	R1173D491B	LVR-IC	LDO, 4.9V±2%, 1A, +CE	HSON-6	35vm	VR4	7e	Ric
H49D	R1173D491D	LVR-IC	LDO, 4.9V±2%, 1A, +CE, CL	HSON-6	35vm	VR4	7e	Ric
H5	MBD770DW	Si-diode	Dual, Schottky, UHFV/HF-Det, 70V, 120mW, <1pF	SOT-363	33de	-	7b	Ons
H5	R1131D251A	LVR-IC	LDO, 2.5V±2%, 300mA, +CE	SON-6	34hq	VR4	7g	Ric
H5	RN2906FS	Si-pnp-Digi	Dual, Sw, 20V, 50mA, 50mW, R1/R2=4.7k/47k	FS6	35/TD4	-	7b	Tos
H50B	R1173D501B	LVR-IC	LDO, 5V±2%, 1A, +CE	HSON-6	35vm	VR4	7e	Ric



SMD code	Type	Function	Short description	Case	Pinout	Sch.	St.	Mnf.
H50D	R1173D501D	LVR-IC	LDO, 5V±2%, 1A, +CE, CL	HS0N-6	35vm	VR4	7e	Ric
H50H	HMC550	MMIC	GaAs, SPST failsafe switch, DC-6GHz	SOT-26	33ld	SW1	7b	Htt
H6	R1131D261A	LVR-IC	LDO, 2.6V±2%, 300mA, +CE	SON-6	34hq	VR4	7g	Ric
H6	RN2907FS	Si-pnp-Digi	Dual, Sw, 20V, 50mA, 50mW, R1/R2=10k/47k	FS6	35/TD4	-	7b	Tos
H66	74HC2G66DP	CMOS-Logic	2-channel analog switch	SOT505-2	47L.og68	-	8d	Phi
H7	R1131D271A	LVR-IC	LDO, 2.7V±2%, 300mA, +CE	SON-6	34hq	VR4	7g	Ric
H7	RN2908FS	Si-pnp-Digi	Dual, Sw, 20V, 50mA, 50mW, R1/R2=22k/47k	FS6	35/TD4	-	7b	Tos
H7824	BH7824FVM	LIN-IC	AF PA, BTL, 2.4..5.5V, 500mW(5V/8Ω), shutdown	SOP-8	47	AFP12	8a	Rhm
H7826	BH7826FVM	LIN-IC	AF PA, BTL, 2.6..5.5V, 500mW(5V/8Ω), shutdown	SOP-8	47	AFP3	8a	Rhm
H8	R1131D281A	LVR-IC	LDO, 2.8V±2%, 300mA, +CE	SON-6	34hq	VR4	7g	Ric
H8	RN2909FS	Si-pnp-Digi	Dual, Sw, 20V, 50mA, 50mW, R1/R2=47k/22k	FS6	35/TD4	-	7b	Tos
H86	74HC2G86DC	CMOS-Logic	Dual 2-input EXCLUSIVE-OR gates	SOT765-1	47L.og65	-	8d	Phi
H86	74HC2G86DP	CMOS-Logic	Dual 2-input EXCLUSIVE-OR gates	SOT505-2	47L.og65	-	8d	Phi
H9	IMH9A	Si-npn-Digi	Dual, 50V, 100mA, R1/R2=10k/47k	SOT-23-6	33/TD3	-	7b	Rhm
H9	R1131D291A	LVR-IC	LDO, 2.9V±2%, 300mA, +CE	SON-6	34hq	VR4	7g	Ric
H9	RN2910FS	Si-pnp-Digi	Dual, Sw, 20V, 50mA, 50mW, R1=4.7k	FS6	35/TD4	-	7b	Tos
H97	SN74AUP1G97DBV	CMOS-Logic	Configurable multiple-function gate	SOT-23-6	33L.og41	-	7d	Ti
H98	SN74AUP1G98DBV	CMOS-Logic	Configurable multiple-function gate	SOT-23-6	33L.og43	-	7d	Ti
HA	μPA601T	Si-pnp	Dual, 60V, 100mA, 180mHz	SOT-23-6	33ff	-	7b	Nec
HA	DDZX9682TS	Z-diode	Triple, 2.7V±5%, 200mW	SOT-363	33dd	-	7k	Di
HA	RP152N025C	LVR-IC	LDO, Dual out, Vout1/Vout2=3.0V/3.0V±1%, 150mA, +CE, CL	SOT-23-6	33x5	VR19	7d	Ric
HB	DDZX9683TS	Z-diode	Triple, 3V±5%, 200mW	SOT-363	33dd	-	7k	Di
HB	RP152N026C	LVR-IC	LDO, Dual out, Vout1/Vout2=2.8V/3.1V±1%, 150mA, +CE, CL	SOT-23-6	33x5	VR19	7d	Ric
HC	DDZX9684TS	Z-diode	Triple, 3.3V±5%, 200mW	SOT-363	33dd	-	7k	Di
HC	RP152N027C	LVR-IC	LDO, Dual out, Vout1/Vout2=2.3V/2.8V±1%, 150mA, +CE, CL	SOT-23-6	33x5	VR19	7d	Ric
HD	DDZX9685TS	Z-diode	Triple, 3.6V±5%, 200mW	SOT-363	33dd	-	7k	Di
HD	RP152N028C	LVR-IC	LDO, Dual out, Vout1/Vout2=2.8V/1.0V±1%, 150mA, +CE, CL	SOT-23-6	33x5	VR19	7d	Ric
HE	DDZX9686TS	Z-diode	Triple, 3.9V±5%, 200mW	SOT-363	33dd	-	7k	Di
HE	RP152N029C	LVR-IC	LDO, Dual out, Vout1/Vout2=1.5V/1.5V±1%, 150mA, +CE, CL	SOT-23-6	33x5	VR19	7d	Ric
HF	DDZX9687TS	Z-diode	Triple, 4.3V±5%, 200mW	SOT-363	33dd	-	7k	Di
HF	RN2911FS	Si-pnp-Digi	Dual, Sw, 20V, 50mA, 50mW, R1=10k	FS6	35/TD4	-	7b	Tos
HF	RP152N030C	LVR-IC	LDO, Dual out, Vout1/Vout2=1.5V/3.3V±1%, 150mA, +CE, CL	SOT-23-6	33x5	VR19	7d	Ric
HG	DDZX9688TS	Z-diode	Triple, 4.7V±5%, 200mW	SOT-363	33dd	-	7k	Di
HG	RP152N031C	LVR-IC	LDO, Dual out, Vout1/Vout2=1.8V/2.7V±1%, 150mA, +CE, CL	SOT-23-6	33x5	VR19	7d	Ric
HH	DDZX9689TS	Z-diode	Triple, 5.1V±5%, 200mW	SOT-363	33dd	-	7k	Di
HH	HSMS-282M	Si-diode	4x Schottky, RF, 15V, 1A, Vf<0.34V(1mA), <1pF, 12Ω(5mA)	SOT-363	33bw	-	7b	Agil
HH	RP152N032C	LVR-IC	LDO, Dual out, Vout1/Vout2=1.2V/3.0V±1%, 150mA, +CE, CL	SOT-23-6	33x5	VR19	7d	Ric
HJ	DDZX9690TS	Z-diode	Triple, 5.6V±5%, 200mW	SOT-363	33dd	-	7k	Di
HJ	RP152N033C	LVR-IC	LDO, Dual out, Vout1/Vout2=3.1V/3.1V±1%, 150mA, +CE, CL	SOT-23-6	33x5	VR19	7d	Ric
HK	74HC2G14GW	CMOS-Logic	Dual Schmitt-trigger inverter buffers	SOT-363	33L.og34	-	7b	Phi
HK	74HCT2G14GW	CMOS-Logic	Dual Schmitt-trigger inverter buffers	SOT-363	33L.og34	-	7b	Phi
HK	DDZX9691TS	Z-diode	Triple, 6.2V±5%, 200mW	SOT-363	33dd	-	7k	Di
HK	RP152N034C	LVR-IC	LDO, Dual out, Vout1/Vout2=1.8V/2.6V±1%, 150mA, +CE, CL	SOT-23-6	33x5	VR19	7d	Ric
HL	DDZX9692TS	Z-diode	Triple, 6.8V±5%, 200mW	SOT-363	33dd	-	7k	Di
HL	RP152N035C	LVR-IC	LDO, Dual out, Vout1/Vout2=2.5V/1.2V±1%, 150mA, +CE, CL	SOT-23-6	33x5	VR19	7d	Ric
HM	DDZX9693TS	Z-diode	Triple, 7.5V±5%, 200mW	SOT-363	33dd	-	7k	Di
HM	RP152N036C	LVR-IC	LDO, Dual out, Vout1/Vout2=1.2V/2.9V±1%, 150mA, +CE, CL	SOT-23-6	33x5	VR19	7d	Ric
HN	DDZX9694TS	Z-diode	Triple, 8.2V±5%, 200mW	SOT-363	33dd	-	7k	Di
HN	RP152N037C	LVR-IC	LDO, Dual out, Vout1/Vout2=3.3V/2.0V±1%, 150mA, +CE, CL	SOT-23-6	33x5	VR19	7d	Ric
HN26	SN74AUP2G126DCU	CMOS-Logic	Bus buffer gate with 3-state output	SSOP-8	47L.og13	-	8d	Ti
HP	DDZX9696TS	Z-diode	Triple, 9.1V±5%, 200mW	SOT-363	33dd	-	7k	Di
HP	RP152N038C	LVR-IC	LDO, Dual out, Vout1/Vout2=1.2V/2.85V±1%, 150mA, +CE, CL	SOT-23-6	33x5	VR19	7d	Ric
HP	SN74AUP1G97DCK	CMOS-Logic	Configurable multiple-function gate	SC-70-6	33L.og41	-	7d	Ti
HP	SN74AUP1G97DRL	CMOS-Logic	Configurable multiple-function gate	SOT-553-6	35L.og41	-	7d	Ti
HQ	DDZX9697TS	Z-diode	Triple, 10V±5%, 200mW	SOT-363	33dd	-	7k	Di
HQ	RP152N039C	LVR-IC	LDO, Dual out, Vout1/Vout2=2.1V/3.3V±1%, 150mA, +CE, CL	SOT-23-6	33x5	VR19	7d	Ric
HR	DDZX9698TS	Z-diode	Triple, 11V±5%, 200mW	SOT-363	33dd	-	7k	Di
HR	RP152N040C	LVR-IC	LDO, Dual out, Vout1/Vout2=2.8V/2.85V±1%, 150mA, +CE, CL	SOT-23-6	33x5	VR19	7d	Ric
HR	SN74AUP1G98DCK	CMOS-Logic	Configurable multiple-function gate	SC-70-6	33L.og43	-	7d	Ti
HR	SN74AUP1G98DRL	CMOS-Logic	Configurable multiple-function gate	SOT-553-6	35L.og43	-	7d	Ti
HS	DDZX9699TS	Z-diode	Triple, 12V±5%, 200mW	SOT-363	33dd	-	7k	Di
HS	RP152N041C	LVR-IC	LDO, Dual out, Vout1/Vout2=1.8V/3.0V±1%, 150mA, +CE, CL	SOT-23-6	33x5	VR19	7d	Ric
HT	DDZX9700TS	Z-diode	Triple, 13V±5%, 200mW	SOT-363	33dd	-	7k	Di
HT	RP152N042C	LVR-IC	LDO, Dual out, Vout1/Vout2=1.2V/2.6V±1%, 150mA, +CE, CL	SOT-23-6	33x5	VR19	7d	Ric
HU	DDZX9701TS	Z-diode	Triple, 14V±5%, 200mW	SOT-363	33dd	-	7k	Di
HU	RP152N043C	LVR-IC	LDO, Dual out, Vout1/Vout2=1.3V/2.8V±1%, 150mA, +CE, CL	SOT-23-6	33x5	VR19	7d	Ric
HU4	74HC3G04DC	CMOS-Logic	Triple inverters	SOT765-1	47L.og56	-	8d	Phi
HV	DDZX9702TS	Z-diode	Triple, 15V±5%, 200mW	SOT-363	33dd	-	7k	Di
HV	RP152N044C	LVR-IC	LDO, Dual out, Vout1/Vout2=1.1V/1.5V±1%, 150mA, +CE, CL	SOT-23-6	33x5	VR19	7d	Ric
HW	DDZX9703TS	Z-diode	Triple, 16V±5%, 200mW	SOT-363	33dd	-	7k	Di



SMD code	Type	Function	Short description	Case	Pinout	Sch.	St.	Mnf.
HW	RP152N045C	LVR-IC	LDO, Dual out, Vout1/Vout2=2.8V/3.3V±1%, 150mA, +CE, CL	SOT-23-6	33x5	VR19	7d	Ric
HX	RP152N046C	LVR-IC	LDO, Dual out, Vout1/Vout2=2.8V/3.0V±1%, 150mA, +CE, CL	SOT-23-6	33x5	VR19	7d	Ric
HY	DDZX9705TS	Z-diode	Triple, 18V±5%, 200mW	SOT-363	33dd	-	7k	Di
HY	RP152N047C	LVR-IC	LDO, Dual out, Vout1/Vout2=2.5V/2.8V±1%, 150mA, +CE, CL	SOT-23-6	33x5	VR19	7d	Ric
HZ	RP152N048C	LVR-IC	LDO, Dual out, Vout1/Vout2=2.5V/3.2V±1%, 150mA, +CE, CL	SOT-23-6	33x5	VR19	7d	Ric
I	AG302-63G	MMIC	Buff/amp, DC, 6GHz, 15.5dB (900MHz, 50Ω)	SOT-363	33a1	A1	7d	Wjje
IA	μPA602T	n-MOSFET-e*	Dual, V-MOS, 50V, 100mA, <25Ω(10mA)	SOT-23-6	33fe	-	7b	Nec
IB	μPA611TA	n-MOSFET-e*	Dual, V-MOS, LogL, 30V, ±100mA, <15Ω	SOT-23-6	33fe	-	7b	Nec
IT	XP04387	Si-npn-Digi	Dual, 50V, 100mA, 150mW, 50MHz, R1/R2=1k/10k	SMini6	33/TD2	-	7b	Pan
J	AG303-63G	MMIC	Buff/amp, DC, 6GHz, 20.5dB (900MHz, 50Ω)	SOT-363	33a1	A1	7d	Wjje
J0	R1131D301A	LVR-IC	LDO, 3V±2%, 300mA, +CE	SON-6	34hq	VR4	7g	Ric
J0	RN1961FS	Si-npn-Digi	Dual, Sw, 20V, 50mA, 50mW, 250MHz, R1/R2=4k7/4k7	FS6	35/TD8	-	7b	Tos
J1	R1131D311A	LVR-IC	LDO, 3.1V±2%, 300mA, +CE	SON-6	34hq	VR4	7g	Ric
J1	RN1962FS	Si-npn-Digi	Dual, Sw, 20V, 50mA, 50mW, 250MHz, R1/R2=20k/10k	FS6	35/TD8	-	7b	Tos
J2	KRA736E	Si-pnp-Digi	Dual, Sw, 50V, 100mA, 200mW, R1/R2=1k/10k	TES6	35/TD7	-	7k	Kec
J2	KRA736U	Si-pnp-Digi	Dual, Sw, 50V, 100mA, 200mW, R1/R2=1k/10k	US6	33/TD4	-	7k	Kec
J2	R1131D321A	LVR-IC	LDO, 3.2V±2%, 300mA, +CE	SON-6	34hq	VR4	7g	Ric
J2	RN1963FS	Si-npn-Digi	Dual, Sw, 20V, 50mA, 50mW, 250MHz, R1/R2=22k/22k	FS6	35/TD8	-	7b	Tos
J3	R1131D331A	LVR-IC	LDO, 3.3V±2%, 300mA, +CE	SON-6	34hq	VR4	7g	Ric
J3	RN1964FS	Si-npn-Digi	Dual, Sw, 20V, 50mA, 50mW, 250MHz, R1/R2=47k/47k	FS6	35/TD8	-	7b	Tos
J4	KRA737E	Si-pnp-Digi	Dual, Sw, 50V, 100mA, 200mW, R1/R2=2.2k/2.2k	TES6	35/TD7	-	7k	Kec
J4	KRA737U	Si-pnp-Digi	Dual, Sw, 50V, 100mA, 200mW, R1/R2=2.2k/2.2k	US6	33/TD4	-	7k	Kec
J4	RN1965FS	Si-npn-Digi	Dual, Sw, 20V, 50mA, 50mW, 250MHz, R1/R2=2k2/47k	FS6	35/TD8	-	7b	Tos
J5	KRA738E	Si-pnp-Digi	Dual, Sw, 50V, 100mA, 200mW, R1/R2=2.2k/10k	TES6	35/TD7	-	7k	Kec
J5	KRA738U	Si-pnp-Digi	Dual, Sw, 50V, 100mA, 200mW, R1/R2=2.2k/10k	US6	33/TD4	-	7k	Kec
J5	RN1966FS	Si-npn-Digi	Dual, Sw, 20V, 50mA, 50mW, 250MHz, R1/R2=4k7/47k	FS6	35/TD8	-	7b	Tos
J6	KRA739E	Si-pnp-Digi	Dual, Sw, 50V, 100mA, 200mW, R1/R2=4.7k/10k	TES6	35/TD7	-	7k	Kec
J6	KRA739U	Si-pnp-Digi	Dual, Sw, 50V, 100mA, 200mW, R1/R2=4.7k/10k	US6	33/TD4	-	7k	Kec
J6	RN1967FS	Si-npn-Digi	Dual, Sw, 20V, 50mA, 50mW, 250MHz, R1/R2=10k/47k	FS6	35/TD8	-	7b	Tos
J7	KRA740E	Si-pnp-Digi	Dual, Sw, 50V, 100mA, 200mW, R1/R2=10k/4.7k	TES6	35/TD7	-	7k	Kec
J7	KRA740U	Si-pnp-Digi	Dual, Sw, 50V, 100mA, 200mW, R1/R2=10k/4.7k	US6	33/TD4	-	7k	Kec
J7	RN1968FS	Si-npn-Digi	Dual, Sw, 20V, 50mA, 50mW, 250MHz, R1/R2=22k/47k	FS6	35/TD8	-	7b	Tos
J8	KRA741E	Si-pnp-Digi	Dual, Sw, 50V, 100mA, 200mW, R1/R2=47k/10k	TES6	35/TD7	-	7k	Kec
J8	KRA741U	Si-pnp-Digi	Dual, Sw, 50V, 100mA, 200mW, R1/R2=47k/10k	US6	33/TD4	-	7k	Kec
J8	RN1969FS	Si-npn-Digi	Dual, Sw, 20V, 50mA, 50mW, 250MHz, R1/R2=47k/22k	FS6	35/TD8	-	7b	Tos
J9	KRA742E	Si-pnp-Digi	Dual, Sw, 50V, 100mA, 200mW, R1/R2=100k/100k	TES6	35/TD7	-	7k	Kec
J9	KRA742U	Si-pnp-Digi	Dual, Sw, 50V, 100mA, 200mW, R1/R2=100k/100k	US6	33/TD4	-	7k	Kec
J9	RN1901FS	Si-npn-Digi	Dual, Sw, 20V, 50mA, 50mW, 250MHz, R1/R2=4k7/4k7	US6	33/TD3	-	7b	Tos
J9	RN1970FS	Si-npn-Digi	Dual, Sw, 20V, 50mA, 50mW, 250MHz, R1=4k7	FS6	35/TD8	-	7b	Tos
JA	μPA603T	p-MOSFET-e*	Dual, V-MOS, 50V, 100mA, <60Ω(10mA)	SOT-23-6	33fe	-	7b	Nec
JA	KRA721E	Si-pnp-Digi	Dual, Sw, 50V, 100mA, 200mW, R1/R2=4.7k/4.7k	TES6	35/TD7	-	7k	Kec
JA	KRA721U	Si-pnp-Digi	Dual, Sw, 50V, 100mA, 200mW, R1/R2=4.7k/4.7k	US6	33/TD4	-	7k	Kec
JA	RP154N001A	LVR-IC	LDO, Dual out, Vout1/Vout2=2.8V/2.8V±1%, 300mA, +CE	SOT-23-6	33x5	VR19	7d	Ric
JA	TWG4148CD-70WS	Si-diode	Quad, Sw, 100V, 150mA, Vf<1.25V(150mA), <4pF	SOT-363	33/D6	-	7b	Tlr
JAB	MMBD4448HSDW	Si-diode	Quad, Sw, Fast, 75V, 500mA, Vf<1.25V(150mA), <4ns	SOT-363	33/D10	-	7k	Di
JB	μPA610TA	p-MOSFET-e	Dual, V-MOS, LogL, 30V, ±100mA, <60Ω	SOT-23-6	33fe	-	7b	Nec
JB	KRA722E	Si-pnp-Digi	Dual, Sw, 50V, 100mA, 200mW, R1/R2=10k/10k	TES6	35/TD7	-	7k	Kec
JB	KRA722U	Si-pnp-Digi	Dual, Sw, 50V, 100mA, 200mW, R1/R2=10k/10k	US6	33/TD4	-	7k	Kec
JB	RP154N002A	LVR-IC	LDO, Dual out, Vout1/Vout2=1.8V/2.8V±1%, 300mA, +CE	SOT-23-6	33x5	VR19	7d	Ric
JC	KRA723E	Si-pnp-Digi	Dual, Sw, 50V, 100mA, 200mW, R1/R2=22k/22k	TES6	35/TD7	-	7k	Kec
JC	KRA723U	Si-pnp-Digi	Dual, Sw, 50V, 100mA, 200mW, R1/R2=22k/22k	US6	33/TD4	-	7k	Kec
JC	RP154N003A	LVR-IC	LDO, Dual out, Vout1/Vout2=1.5V/2.8V±1%, 300mA, +CE	SOT-23-6	33x5	VR19	7d	Ric
JC	TWG4148AD-56WS	Si-diode	Quad, Sw, 100V, 150mA, Vf<1.25V(150mA), <4pF	SOT-363	33/D8	-	7b	Tlr
JD	KRA724E	Si-pnp-Digi	Dual, Sw, 50V, 100mA, 200mW, R1/R2=47k/47k	TES6	35/TD7	-	7k	Kec
JD	KRA724U	Si-pnp-Digi	Dual, Sw, 50V, 100mA, 200mW, R1/R2=47k/47k	US6	33/TD4	-	7k	Kec
JD	RP154N004A	LVR-IC	LDO, Dual out, Vout1/Vout2=1.2V/1.8V±1%, 300mA, +CE	SOT-23-6	33x5	VR19	7d	Ric
JE	KRA725E	Si-pnp-Digi	Dual, Sw, 50V, 100mA, 200mW, R1/R2=2.2k/47k	TES6	35/TD7	-	7k	Kec
JE	KRA725U	Si-pnp-Digi	Dual, Sw, 50V, 100mA, 200mW, R1/R2=2.2k/47k	US6	33/TD4	-	7k	Kec
JE	RP154N005A	LVR-IC	LDO, Dual out, Vout1/Vout2=3.3V/1.2V±1%, 300mA, +CE	SOT-23-6	33x5	VR19	7d	Ric
JF	KRA726E	Si-pnp-Digi	Dual, Sw, 50V, 100mA, 200mW, R1/R2=4.7k/47k	TES6	35/TD7	-	7k	Kec
JF	KRA726U	Si-pnp-Digi	Dual, Sw, 50V, 100mA, 200mW, R1/R2=4.7k/47k	US6	33/TD4	-	7k	Kec
JF	RN1902FS	Si-npn-Digi	Dual, Sw, 20V, 50mA, 50mW, 250MHz, R1/R2=20k/10k	US6	33/TD3	-	7b	Tos
JF	RN1971FS	Si-npn-Digi	Dual, Sw, 20V, 50mA, 50mW, 250MHz, R1=10k	FS6	35/TD8	-	7b	Tos
JF	RP154N006A	LVR-IC	LDO, Dual out, Vout1/Vout2=3.3V/1.8V±1%, 300mA, +CE	SOT-23-6	33x5	VR19	7d	Ric
JG	RP154N007A	LVR-IC	LDO, Dual out, Vout1/Vout2=2.85V/2.85V±1%, 300mA, +CE	SOT-23-6	33x5	VR19	7d	Ric
JG	TWG4148SD-99WS	Si-diode	Quad, Sw, 100V, 150mA, Vf<1.25V(150mA), <4pF	SOT-363	33/D10	-	7b	Tlr
JH	KRA727E	Si-pnp-Digi	Dual, Sw, 50V, 100mA, 200mW, R1/R2=10k/47k	TES6	35/TD7	-	7k	Kec
JH	KRA727U	Si-pnp-Digi	Dual, Sw, 50V, 100mA, 200mW, R1/R2=10k/47k	US6	33/TD4	-	7k	Kec
JH	RP154N008A	LVR-IC	LDO, Dual out, Vout1/Vout2=2.85V/2.6V±1%, 300mA, +CE	SOT-23-6	33x5	VR19	7d	Ric
JI	KRA728E	Si-pnp-Digi	Dual, Sw, 50V, 100mA, 200mW, R1/R2=22k/47k	TES6	35/TD7	-	7k	Kec



SMD code	Type	Function	Short description	Case	Pinout	Sch.	St.	Mnf.
JJ	KRA728U	Si-pnp-Digi	Dual, Sw, 50V, 100mA, 200mW, R1/R2=22k/47k	US6	33/TD4	-	7k	Kec
JJ	KRA729E	Si-pnp-Digi	Dual, Sw, 50V, 100mA, 200mW, R1/R2=47k/22k	TES6	35/TD7	-	7k	Kec
JJ	KRA729U	Si-pnp-Digi	Dual, Sw, 50V, 100mA, 200mW, R1/R2=47k/22k	US6	33/TD4	-	7k	Kec
JJ	NC7S202L6	CMOS-Logic	2-input NOR gate	MPAK-6	33L.oq2	-	7b	F
JJ	RP154N009A	LVR-IC	LDO, Dual out, Vout1/Vout2=3.0V/2.8V±1%, 300mA, +CE	SOT-23-6	33x5	VR19	7d	Ric
JK	KRA730E	Si-pnp-Digi	Dual, Sw, 50V, 100mA, 200mW, R1=4.7k	TES6	35/TD7	-	7k	Kec
JK	KRA730U	Si-pnp-Digi	Dual, Sw, 50V, 100mA, 200mW, R1=4.7k	US6	33/TD4	-	7k	Kec
JK	RP154N010A	LVR-IC	LDO, Dual out, Vout1/Vout2=3.0V/1.8V±1%, 300mA, +CE	SOT-23-6	33x5	VR19	7d	Ric
JL	RP154N011A	LVR-IC	LDO, Dual out, Vout1/Vout2=1.8V/1.5V±1%, 300mA, +CE	SOT-23-6	33x5	VR19	7d	Ric
JM	KRA731E	Si-pnp-Digi	Dual, Sw, 50V, 100mA, 200mW, R1=10k	TES6	35/TD7	-	7k	Kec
JM	KRA731U	Si-pnp-Digi	Dual, Sw, 50V, 100mA, 200mW, R1=10k	US6	33/TD4	-	7k	Kec
JM	RP154N012A	LVR-IC	LDO, Dual out, Vout1/Vout2=2.8V/2.6V±1%, 300mA, +CE	SOT-23-6	33x5	VR19	7d	Ric
JN	KRA732E	Si-pnp-Digi	Dual, Sw, 50V, 100mA, 200mW, R1=100k	TES6	35/TD7	-	7k	Kec
JN	KRA732U	Si-pnp-Digi	Dual, Sw, 50V, 100mA, 200mW, R1=100k	US6	33/TD4	-	7k	Kec
JN	RP154N013A	LVR-IC	LDO, Dual out, Vout1/Vout2=3.3V/2.8V±1%, 300mA, +CE	SOT-23-6	33x5	VR19	7d	Ric
JO	KRA733E	Si-pnp-Digi	Dual, Sw, 50V, 100mA, 200mW, R1=22k	TES6	35/TD7	-	7k	Kec
JO	KRA733U	Si-pnp-Digi	Dual, Sw, 50V, 100mA, 200mW, R1=22k	US6	33/TD4	-	7k	Kec
JP	KRA734E	Si-pnp-Digi	Dual, Sw, 50V, 100mA, 200mW, R1=47k	TES6	35/TD7	-	7k	Kec
JP	KRA734U	Si-pnp-Digi	Dual, Sw, 50V, 100mA, 200mW, R1=47k	US6	33/TD4	-	7k	Kec
JP	RP154N014A	LVR-IC	LDO, Dual out, Vout1/Vout2=3.3V/3.3V±1%, 300mA, +CE	SOT-23-6	33x5	VR19	7d	Ric
JQ	RP154N015A	LVR-IC	LDO, Dual out, Vout1/Vout2=1.5V/2.5V±1%, 300mA, +CE	SOT-23-6	33x5	VR19	7d	Ric
JR	RP154N016A	LVR-IC	LDO, Dual out, Vout1/Vout2=1.5V/3.0V±1%, 300mA, +CE	SOT-23-6	33x5	VR19	7d	Ric
JS	RP154N017A	LVR-IC	LDO, Dual out, Vout1/Vout2=2.5V/3.0V±1%, 300mA, +CE	SOT-23-6	33x5	VR19	7d	Ric
JSs	BA52IU	Si-diode	Triple, Sw, Fast, 200V, 250mA, Vf=1V(0.1A), 250mW, <50ns	SC-74	33dd	-	7b	Inf
JT	RP154N018A	LVR-IC	LDO, Dual out, Vout1/Vout2=1.8V/1.8V±1%, 300mA, +CE	SOT-23-6	33x5	VR19	7d	Ric
JU	RP154N019A	LVR-IC	LDO, Dual out, Vout1/Vout2=1.5V/2.6V±1%, 300mA, +CE	SOT-23-6	33x5	VR19	7d	Ric
JV	RP154N020A	LVR-IC	LDO, Dual out, Vout1/Vout2=2.8V/1.8V±1%, 300mA, +CE	SOT-23-6	33x5	VR19	7d	Ric
JW	RP154N021A	LVR-IC	LDO, Dual out, Vout1/Vout2=1.2V/2.8V±1%, 300mA, +CE	SOT-23-6	33x5	VR19	7d	Ric
JX	RP154N022A	LVR-IC	LDO, Dual out, Vout1/Vout2=2.8V/1.2V±1%, 300mA, +CE	SOT-23-6	33x5	VR19	7d	Ric
JY	RP154N023A	LVR-IC	LDO, Dual out, Vout1/Vout2=2.5V/2.5V±1%, 300mA, +CE	SOT-23-6	33x5	VR19	7d	Ric
JZ	RP154N024A	LVR-IC	LDO, Dual out, Vout1/Vout2=3.3V/3.0V±1%, 300mA, +CE	SOT-23-6	33x5	VR19	7d	Ric
K0	R1131D181A5	LVR-IC	LDO, 1.85V±2%, 300mA, +CE	SON-6	34hq	VR4	7g	Ric
K0	R5426D101AA	BM-IC	Li-Ion, over-charge/discharge protection, Vc/d=1.01V	SON-6	34xk	VBM1	7g	Ric
K0	R5426N101AA	BM-IC	Li-Ion, over-charge/discharge protection, Vc/d=1.01V	SOT-23-6	33xk	VBM1	7d	Ric
K0	RN2961FS	Si-pnp-Digi	Dual, Sw, 20V, 50mA, 50mW, R1/R2=4.7k/4.7k	FS6	35/TD8	-	7b	Tos
K01	TLC363C5V5	Z-diode	Triple, 5.5V±5%, 200mW, Bidirectional	SOT-363	33dy	-	7k	Di
K01C	R1232D001C	DC/DC-IC	PWM step-down, adjustable, 1MHz	SON-8	44el	-	8c	Ric
K01D	R1232D001D	DC/DC-IC	PWM step-down, adjustable, 2.25MHz	SON-8	44el	-	8c	Ric
K03	TLC363C6V4	Z-diode	Triple, 6.4V±5%, 200mW, Bidirectional	SOT-363	33dy	-	7k	Di
K05	TLC363C7V0	Z-diode	Triple, 7V±5%, 200mW, Bidirectional	SOT-363	33dy	-	7k	Di
K07	TLC363C20V8	Z-diode	Triple, 20V±5%, 200mW, Bidirectional	SOT-363	33dy	-	7k	Di
K09A	R1232D091A	DC/DC-IC	PWM step-down, 0.91V±2%, 1MHz	SON-8	44el	-	8c	Ric
K09B	R1232D091B	DC/DC-IC	PWM step-down, 0.91V±2%, 2.25MHz	SON-8	44el	-	8c	Ric
K1	R1131D281A5	LVR-IC	LDO, 2.85V±2%, 300mA, +CE	SON-6	34hq	VR4	7g	Ric
K1	R5426D102AA	BM-IC	Li-Ion, over-charge/discharge protection, Vc/d=1.02V	SON-6	34xk	VBM1	7g	Ric
K1	R5426N102AA	BM-IC	Li-Ion, over-charge/discharge protection, Vc/d=1.02V	SOT-23-6	33xk	VBM1	7d	Ric
K1	RN2962FS	Si-pnp-Digi	Dual, Sw, 20V, 50mA, 50mW, R1/R2=10k/10k	FS6	35/TD8	-	7b	Tos
K10A	R1232D101A	DC/DC-IC	PWM step-down, 1V±2%, 1MHz	SON-8	44el	-	8c	Ric
K10B	R1232D101B	DC/DC-IC	PWM step-down, 1V±2%, 2.25MHz	SON-8	44el	-	8c	Ric
K11A	R1232D111A	DC/DC-IC	PWM step-down, 1.1V±2%, 1MHz	SON-8	44el	-	8c	Ric
K11B	R1232D111B	DC/DC-IC	PWM step-down, 1.1V±2%, 2.25MHz	SON-8	44el	-	8c	Ric
K12A	R1232D121A	DC/DC-IC	PWM step-down, 1.2V±2%, 1MHz	SON-8	44el	-	8c	Ric
K12B	R1232D121B	DC/DC-IC	PWM step-down, 1.2V±2%, 2.25MHz	SON-8	44el	-	8c	Ric
K13A	R1232D131A	DC/DC-IC	PWM step-down, 1.3V±2%, 1MHz	SON-8	44el	-	8c	Ric
K13B	R1232D131B	DC/DC-IC	PWM step-down, 1.3V±2%, 2.25MHz	SON-8	44el	-	8c	Ric
K14A	R1232D141A	DC/DC-IC	PWM step-down, 1.4V±2%, 1MHz	SON-8	44el	-	8c	Ric
K14B	R1232D141B	DC/DC-IC	PWM step-down, 1.4V±2%, 2.25MHz	SON-8	44el	-	8c	Ric
K15A	R1232D151A	DC/DC-IC	PWM step-down, 1.5V±2%, 1MHz	SON-8	44el	-	8c	Ric
K15B	R1116D151B	LVR-IC	LDO, LN, +CE, 1.5V±1.5%, 150mA	SON1612-6	35ve	VR4	7e	Ric
K15B	R1232D151B	DC/DC-IC	PWM step-down, 1.5V±2%, 2.25MHz	SON-8	44el	-	8c	Ric
K15D	R1116D151D	LVR-IC	LDO, LN, +CE, CL, 1.5V±1.5%, 150mA	SON1612-6	35ve	VR4	7e	Ric
K16A	R1232D161A	DC/DC-IC	PWM step-down, 1.6V±2%, 1MHz	SON-8	44el	-	8c	Ric
K16B	R1116D161B	LVR-IC	LDO, LN, +CE, 1.6V±1.5%, 150mA	SON1612-6	35ve	VR4	7e	Ric
K16B	R1232D161B	DC/DC-IC	PWM step-down, 1.6V±2%, 2.25MHz	SON-8	44el	-	8c	Ric
K16D	R1116D161D	LVR-IC	LDO, LN, +CE, CL, 1.6V±1.5%, 150mA	SON1612-6	35ve	VR4	7e	Ric
K17A	R1232D171A	DC/DC-IC	PWM step-down, 1.7V±2%, 1MHz	SON-8	44el	-	8c	Ric
K17B	R1116D171B	LVR-IC	LDO, LN, +CE, 1.7V±1.5%, 150mA	SON1612-6	35ve	VR4	7e	Ric
K17B	R1232D171B	DC/DC-IC	PWM step-down, 1.7V±2%, 2.25MHz	SON-8	44el	-	8c	Ric
K17D	R1116D171D	LVR-IC	LDO, LN, +CE, CL, 1.7V±1.5%, 150mA	SON1612-6	35ve	VR4	7e	Ric
K18A	R1232D181A	DC/DC-IC	PWM step-down, 1.8V±2%, 1MHz	SON-8	44el	-	8c	Ric



SMD code	Type	Function	Short description	Case	Pinout	Sch.	St.	Mnf.
K18B	R1116D181B	LVR-IC	LDO, LN, +CE, 1.8V±1.5%, 150mA	SON1612-6	35ve	VR4	7e	Ric
K18B	R1232D181B	DC/DC-IC	PWM step-down, 1.8V±2%, 2.25MHz	SON-8	44el	-	8c	Ric
K18D	R1116D181D	LVR-IC	LDO, LN, +CE, CL, 1.8V±1.5%, 150mA	SON1612-6	35ve	VR4	7e	Ric
K19A	R1232D191A	DC/DC-IC	PWM step-down, 1.9V±2%, 1MHz	SON-8	44el	-	8c	Ric
K19A	TS4191DT	LIN-IC	AF PA, BTL, 2.5.5V, 367mW(5V/16Q), shutdown	SOP-8	47	AFP11	-	Ste
K19A	TS4191ST	LIN-IC	AF PA, BTL, 2.5.5V, 367mW(5V/16Q), shutdown	SSOP-8	47	AFP11	-	Ste
K19B	R1116D191B	LVR-IC	LDO, LN, +CE, 1.9V±1.5%, 150mA	SON1612-6	35ve	VR4	7e	Ric
K19B	R1232D191B	DC/DC-IC	PWM step-down, 1.9V±2%, 2.25MHz	SON-8	44el	-	8c	Ric
K19B	TS419-21ST	LIN-IC	AF PA, BTL, 2.5.5V, 367mW(5V/16Q), shutdown	SSOP-8	47	AFP38	-	Ste
K19C	TS419-41ST	LIN-IC	AF PA, BTL, 2.5.5V, 367mW(5V/16Q), shutdown	SSOP-8	47	AFP38	-	Ste
K19D	R1116D191D	LVR-IC	LDO, LN, +CE, CL, 1.9V±1.5%, 150mA	SON1612-6	35ve	VR4	7e	Ric
K19D	TS419-81ST	LIN-IC	AF PA, BTL, 2.5.5V, 367mW(5V/16Q), shutdown	SSOP-8	47	AFP38	-	Ste
K1B	MMDT4124	Si-npn	Dual, Sw, 30V, 200mA, 330mW, B=120..360, >300MHz	SOT-363	33/T8	-	7k	Di
K1F	BC847BS	Si-npn	Dual, GP, 50V, 100mA, 200mW, B=200..450, >100MHz	SOT-363	33/T8	-	7k	Di
K1P	MMDT2222A	Si-npn	Dual, GP, 75V, 600mA, 330mW, B=120..360, >300MHz	SOT-363	33/T8	-	7k	Di
K2	HN1L02FU	n/p-MOSFET-e	Dual, LogL, 20V, 50mA, <40Ω(10mA)	US6	33/T6	-	7b	Tos
K2	R1131D121A5	LVR-IC	LDO, 1.25V±2%, 300mA, +CE	SON-6	34hq	VR4	7g	Ric
K2	R5426D103BB	BM-IC	Li-Ion, over-charge/discharge protection, Vc/d=1.03V	SON-6	34xx	VBM1	7g	Ric
K2	R5426N103BB	BM-IC	Li-Ion, over-charge/discharge protection, Vc/d=1.03V	SOT-23-6	33xx	VBM1	7d	Ric
K2	RN2963FS	Si-pnp-Digi	Dual, Sw, 20V, 50mA, 50mW, R1/R2=22k/22k	FS6	35/TD8	-	7b	Tos
K20A	R1232D201A	DC/DC-IC	PWM step-down, 2V±2%, 1MHz	SON-8	44el	-	8c	Ric
K20B	R1116D201B	LVR-IC	LDO, LN, +CE, 2V±1.5%, 150mA	SON1612-6	35ve	VR4	7e	Ric
K20B	R1232D201B	DC/DC-IC	PWM step-down, 2V±2%, 2.25MHz	SON-8	44el	-	8c	Ric
K20D	R1116D201D	LVR-IC	LDO, LN, +CE, CL, 2V±1.5%, 150mA	SON1612-6	35ve	VR4	7e	Ric
K21	TS4210DT	LIN-IC	AF PA, BTL, 2.5.5V, 367mW(5V/16Q), shutdown	SOP-8	47	AFP12	-	Ste
K21	TS4211ST	LIN-IC	AF PA, BTL, 2.5.5V, 367mW(5V/16Q), shutdown	SSOP-8	47	AFP12	-	Ste
K21A	R1232D211A	DC/DC-IC	PWM step-down, 2.1V±2%, 1MHz	SON-8	44el	-	8c	Ric
K21A	TS421-21ST	LIN-IC	AF PA, BTL, 2.5.5V, 367mW(5V/16Q), shutdown	SSOP-8	47	AFP27	-	Ste
K21B	R1116D211B	LVR-IC	LDO, LN, +CE, 2.1V±1.5%, 150mA	SON1612-6	35ve	VR4	7e	Ric
K21B	R1232D211B	DC/DC-IC	PWM step-down, 2.1V±2%, 2.25MHz	SON-8	44el	-	8c	Ric
K21B	TS421-41ST	LIN-IC	AF PA, BTL, 2.5.5V, 367mW(5V/16Q), shutdown	SSOP-8	47	AFP27	-	Ste
K21C	TS421-81ST	LIN-IC	AF PA, BTL, 2.5.5V, 367mW(5V/16Q), shutdown	SSOP-8	47	AFP27	-	Ste
K21D	R1116D211D	LVR-IC	LDO, LN, +CE, CL, 2.1V±1.5%, 150mA	SON1612-6	35ve	VR4	7e	Ric
K22A	R1232D221A	DC/DC-IC	PWM step-down, 2.2V±2%, 1MHz	SON-8	44el	-	8c	Ric
K22B	R1116D221B	LVR-IC	LDO, LN, +CE, 2.2V±1.5%, 150mA	SON1612-6	35ve	VR4	7e	Ric
K22B	R1232D221B	DC/DC-IC	PWM step-down, 2.2V±2%, 2.25MHz	SON-8	44el	-	8c	Ric
K22D	R1116D221D	LVR-IC	LDO, LN, +CE, CL, 2.2V±1.5%, 150mA	SON1612-6	35ve	VR4	7e	Ric
K23A	R1232D231A	DC/DC-IC	PWM step-down, 2.3V±2%, 1MHz	SON-8	44el	-	8c	Ric
K23B	R1116D231B	LVR-IC	LDO, LN, +CE, 2.3V±1.5%, 150mA	SON1612-6	35ve	VR4	7e	Ric
K23B	R1232D231B	DC/DC-IC	PWM step-down, 2.3V±2%, 2.25MHz	SON-8	44el	-	8c	Ric
K23D	R1116D231D	LVR-IC	LDO, LN, +CE, CL, 2.3V±1.5%, 150mA	SON1612-6	35ve	VR4	7e	Ric
K24A	R1232D241A	DC/DC-IC	PWM step-down, 2.4V±2%, 1MHz	SON-8	44el	-	8c	Ric
K24B	R1116D241B	LVR-IC	LDO, LN, +CE, 2.4V±1.5%, 150mA	SON1612-6	35ve	VR4	7e	Ric
K24B	R1232D241B	DC/DC-IC	PWM step-down, 2.4V±2%, 2.25MHz	SON-8	44el	-	8c	Ric
K24D	R1116D241D	LVR-IC	LDO, LN, +CE, CL, 2.4V±1.5%, 150mA	SON1612-6	35ve	VR4	7e	Ric
K25A	R1232D251A	DC/DC-IC	PWM step-down, 2.5V±2%, 1MHz	SON-8	44el	-	8c	Ric
K25B	R1116D251B	LVR-IC	LDO, LN, +CE, 2.5V±1.5%, 150mA	SON1612-6	35ve	VR4	7e	Ric
K25B	R1232D251B	DC/DC-IC	PWM step-down, 2.5V±2%, 2.25MHz	SON-8	44el	-	8c	Ric
K25D	R1116D251D	LVR-IC	LDO, LN, +CE, CL, 2.5V±1.5%, 150mA	SON1612-6	35ve	VR4	7e	Ric
K26A	R1232D261A	DC/DC-IC	PWM step-down, 2.6V±2%, 1MHz	SON-8	44el	-	8c	Ric
K26B	R1116D261B	LVR-IC	LDO, LN, +CE, 2.6V±1.5%, 150mA	SON1612-6	35ve	VR4	7e	Ric
K26B	R1232D261B	DC/DC-IC	PWM step-down, 2.6V±2%, 2.25MHz	SON-8	44el	-	8c	Ric
K26D	R1116D261D	LVR-IC	LDO, LN, +CE, CL, 2.6V±1.5%, 150mA	SON1612-6	35ve	VR4	7e	Ric
K27A	R1232D271A	DC/DC-IC	PWM step-down, 2.7V±2%, 1MHz	SON-8	44el	-	8c	Ric
K27B	R1116D271B	LVR-IC	LDO, LN, +CE, 2.7V±1.5%, 150mA	SON1612-6	35ve	VR4	7e	Ric
K27B	R1232D271B	DC/DC-IC	PWM step-down, 2.7V±2%, 2.25MHz	SON-8	44el	-	8c	Ric
K27D	R1116D271D	LVR-IC	LDO, LN, +CE, CL, 2.7V±1.5%, 150mA	SON1612-6	35ve	VR4	7e	Ric
K28A	R1232D281A	DC/DC-IC	PWM step-down, 2.8V±2%, 1MHz	SON-8	44el	-	8c	Ric
K28B	R1116D281B	LVR-IC	LDO, LN, +CE, 2.8V±1.5%, 150mA	SON1612-6	35ve	VR4	7e	Ric
K28B	R1232D281B	DC/DC-IC	PWM step-down, 2.8V±2%, 2.25MHz	SON-8	44el	-	8c	Ric
K28D	R1116D281D	LVR-IC	LDO, LN, +CE, CL, 2.8V±1.5%, 150mA	SON1612-6	35ve	VR4	7e	Ric
K29A	R1232D291A	DC/DC-IC	PWM step-down, 2.9V±2%, 1MHz	SON-8	44el	-	8c	Ric
K29B	R1116D291B	LVR-IC	LDO, LN, +CE, 2.9V±1.5%, 150mA	SON1612-6	35ve	VR4	7e	Ric
K29B	R1232D291B	DC/DC-IC	PWM step-down, 2.9V±2%, 2.25MHz	SON-8	44el	-	8c	Ric
K29D	R1116D291D	LVR-IC	LDO, LN, +CE, CL, 2.9V±1.5%, 150mA	SON1612-6	35ve	VR4	7e	Ric
K2B	MMDT4126	Si-pnp	GP, 25V, 200mA, 350mW, B=120..360, >250MHz	SOT-363	33/T10	-	7k	Di
K2F	MMDT2907A	Si-pnp	Dual, GP, 60V, 600mA, 330mW, B=100..300, >200MHz	SOT-363	33/T10	-	7k	Di
K3	R5426D104BB	BM-IC	Li-Ion, over-charge/discharge protection, Vc/d=1.03V	SON-6	34xx	VBM1	7g	Ric
K3	R5426N104BB	BM-IC	Li-Ion, over-charge/discharge protection, Vc/d=1.04V	SOT-23-6	33xx	VBM1	7d	Ric
K3	RN2964FS	Si-pnp-Digi	Dual, Sw, 20V, 50mA, 50mW, R1/R2=47k/47k	FS6	35/TD8	-	7b	Tos



SMD code	Type	Function	Short description	Case	Pinout	Sch.	St.	Mnf.
K30A	R1232D301A	DC/DC-IC	PWM step-down, 3V±2%, 1MHz	SON-8	44el	-	8c	Ric
K30B	R1116D301B	LVR-IC	LDO, LN, +CE, 3V±1.5%, 150mA	SON1612-6	35ve	VR4	7e	Ric
K30B	R1232D301B	DC/DC-IC	PWM step-down, 3V±2%, 2.25MHz	SON-8	44el	-	8c	Ric
K30D	R1116D301D	LVR-IC	LDO, LN, +CE, CL, 3V±1.5%, 150mA	SON1612-6	35ve	VR4	7e	Ric
K31A	R1232D311A	DC/DC-IC	PWM step-down, 3.1V±2%, 1MHz	SON-8	44el	-	8c	Ric
K31B	R1116D311B	LVR-IC	LDO, LN, +CE, 3.1V±2%, 150mA	SON1612-6	35ve	VR4	7e	Ric
K31B	R1232D311B	DC/DC-IC	PWM step-down, 3.1V±2%, 2.25MHz	SON-8	44el	-	8c	Ric
K31D	R1116D311D	LVR-IC	LDO, LN, +CE, CL, 3.1V±2%, 150mA	SON1612-6	35ve	VR4	7e	Ric
K32A	R1232D321A	DC/DC-IC	PWM step-down, 3.2V±2%, 1MHz	SON-8	44el	-	8c	Ric
K32B	R1116D321B	LVR-IC	LDO, LN, +CE, 3.2V±2%, 150mA	SON1612-6	35ve	VR4	7e	Ric
K32B	R1232D321B	DC/DC-IC	PWM step-down, 3.2V±2%, 2.25MHz	SON-8	44el	-	8c	Ric
K32D	R1116D321D	LVR-IC	LDO, LN, +CE, CL, 3.2V±2%, 150mA	SON1612-6	35ve	VR4	7e	Ric
K33A	R1232D331A	DC/DC-IC	PWM step-down, 3.3V±2%, 1MHz	SON-8	44el	-	8c	Ric
K33B	R1116D331B	LVR-IC	LDO, LN, +CE, 3.3V±2%, 150mA	SON1612-6	35ve	VR4	7e	Ric
K33B	R1232D331B	DC/DC-IC	PWM step-down, 3.3V±2%, 2.25MHz	SON-8	44el	-	8c	Ric
K33D	R1116D331D	LVR-IC	LDO, LN, +CE, CL, 3.3V±2%, 150mA	SON1612-6	35ve	VR4	7e	Ric
K34B	R1116D341B	LVR-IC	LDO, LN, +CE, 3.4V±2%, 150mA	SON1612-6	35ve	VR4	7e	Ric
K34D	R1116D341D	LVR-IC	LDO, LN, +CE, CL, 3.4V±2%, 150mA	SON1612-6	35ve	VR4	7e	Ric
K35B	R1116D351B	LVR-IC	LDO, LN, +CE, 3.5V±2%, 150mA	SON1612-6	35ve	VR4	7e	Ric
K35D	R1116D351D	LVR-IC	LDO, LN, +CE, CL, 3.5V±2%, 150mA	SON1612-6	35ve	VR4	7e	Ric
K36B	R1116D361B	LVR-IC	LDO, LN, +CE, 3.6V±2%, 150mA	SON1612-6	35ve	VR4	7e	Ric
K36D	R1116D361D	LVR-IC	LDO, LN, +CE, CL, 3.6V±2%, 150mA	SON1612-6	35ve	VR4	7e	Ric
K37B	R1116D371B	LVR-IC	LDO, LN, +CE, 3.7V±2%, 150mA	SON1612-6	35ve	VR4	7e	Ric
K37D	R1116D371D	LVR-IC	LDO, LN, +CE, CL, 3.7V±2%, 150mA	SON1612-6	35ve	VR4	7e	Ric
K38	BSS138DW	n-MOSFET-e*	Dual, SiPMOS, LogL, 50V, 200mA, 200mW, 1.4Ω(0.22A), 20/20ns	SOT-363	33/T13	-	7k	Di
K38B	R1116D381B	LVR-IC	LDO, LN, +CE, 3.8V±2%, 150mA	SON1612-6	35ve	VR4	7e	Ric
K38D	R1116D381D	LVR-IC	LDO, LN, +CE, CL, 3.8V±2%, 150mA	SON1612-6	35ve	VR4	7e	Ric
K39B	R1116D391B	LVR-IC	LDO, LN, +CE, 3.9V±2%, 150mA	SON1612-6	35ve	VR4	7e	Ric
K39D	R1116D391D	LVR-IC	LDO, LN, +CE, CL, 3.9V±2%, 150mA	SON1612-6	35ve	VR4	7e	Ric
K3N	MMDT3906	Si-pnp	Dual, GP, 40V, 200mA, 250mW, B=60..300, >250MHz	SOT-363	33/T10	-	7k	Di
K3W	BC857BS	Si-pnp	Dual, AF, 50V, 100mA, 310mW, B=90..270, >100MHz	SOT-363	33/T10	-	7k	Di
K4	R5426N105CA	BM-IC	Li-Ion, over-charge/discharge protection, Vc/d=1.05V	SON-6	34xx	VBM1	7g	Ric
K4	R5426N105CA	BM-IC	Li-Ion, over-charge/discharge protection, Vc/d=1.05V	SOT-23-6	33xx	VBM1	7d	Ric
K4	RN2965FS	Si-pnp-Digi	Dual, Sw, 20V, 50mA, 50mW, R1/R2=2.2k/47k	FS6	35/TD8	-	7b	Tos
K40B	R1116D401B	LVR-IC	LDO, LN, +CE, 4V±2%, 150mA	SON1612-6	35ve	VR4	7e	Ric
K40D	R1116D401D	LVR-IC	LDO, LN, +CE, CL, 4V±2%, 150mA	SON1612-6	35ve	VR4	7e	Ric
K41B	R1116D181B5	LVR-IC	LDO, LN, +CE, 1.8V±1.5%, 1.85V±1.5%, 150mA	SON1612-6	35ve	VR4	7e	Ric
K41D	R1116D181D5	LVR-IC	LDO, LN, +CE, CL, 1.85V±1.5%, 150mA	SON1612-6	35ve	VR4	7e	Ric
K42B	R1116D281B5	LVR-IC	LDO, LN, +CE, 2.85V±1.5%, 150mA	SON1612-6	35ve	VR4	7e	Ric
K42D	R1116D281D5	LVR-IC	LDO, LN, +CE, CL, 2.85V±1.5%, 150mA	SON1612-6	35ve	VR4	7e	Ric
K43	BAS40TW	Si-diode	Triple, SBD, 40V, 200mA, Vf<1V(40mA), 5ns	SOT-363	33dd	-	7l	Di
K44	BAS40DW-04	Si-diode	Quad, SBD, 40V, 200mA, Vf<1V(40mA), 5ns	SOT-363	33/D10	-	7o	Di
K45	BAS40DW-05	Si-diode	Quad, SBD, 40V, 200mA, Vf<1V(40mA), 5ns	SOT-363	33/D7	-	7o	Di
K46	BAS40DW-06	Si-diode	Quad, SBD, 40V, 200mA, Vf<1V(40mA), 5ns	SOT-363	33/D8	-	7o	Di
K46	MMDT3946	Si-np	Dual, GP, 60V, 200mA, 150mW, B= 100..300, >300MHz	SOT-363	33/T9	-	7k	Di
K47	BAS40BRW	Si-diode	Quad, SBD, 40V, 200mA, Vf<1V(40mA), 5ns	SOT-363	33/D9	-	7o	Di
K488	TS4881ST	LIN-IC	AF PA, 2.5..5.5V, 2x120mW(16Ω), shutdown	MSOP-8	55	AFP7	-	Ste
K489	TS4891ST	LIN-IC	AF PA, 2.5..5.5V, 2x120mW(16Ω), shutdown	SSOP-8	47	AFP16	-	Ste
K4N	MMDT5551	Si-npn	Dual, GP, 180V, 200mA, 200mW, B=80..250, <300MHz	SOT-363	33/T8	-	7k	Di
K4V	BC847BV	Si-npn	Dual, GP, 50V, 100mA, 200mW, B=200..450, >100MHz	SOT-666	35/T8	-	7k	Di
K5	74AVCH1T45GW	CMOS-Logic	Dual supply translating transceiver with 3-state output	SOT-363	33/Log70	-	7b	Phi
K5	NCT7SP32L6	CMOS-Logic	2-input OR gate	MPAK-6	33/Log4	-	7b	F
K5	R5426D105DA	BM-IC	Li-Ion, over-charge/discharge protection, Vc/d=1.05V	SON-6	34xx	VBM1	7g	Ric
K5	R5426N105DA	BM-IC	Li-Ion, over-charge/discharge protection, Vc/d=1.05V	SOT-23-6	33xxk	VBM1	7d	Ric
K5	RN2966FS	Si-pnp-Digi	Dual, Sw, 20V, 50mA, 50mW, R1/R2=4.7k/47k	FS6	35/TD8	-	7b	Tos
K52	BAV199DW	Si-diode	Quad, Sw, 60V, 150mA, Vf<1.25V(150mA), <3μs	SOT-363	33/D10	-	7o	Di
K5A	R5426D116GA	BM-IC	Li-Ion, over-charge/discharge protection, Vc/d=1.16V	SON-6	34xx	VBM1	7g	Ric
K5A	R5426N116GA	BM-IC	Li-Ion, over-charge/discharge protection, Vc/d=1.16V	SOT-23-6	33xxk	VBM1	7d	Ric
K5F	QZX363C5V6	Z-diode	Quad, 5.6V±5%, 200mW	SOT-363	33c	-	7k	Di
K5V	BC857BV	Si-pnp	Dual, AF, 50V, 100mA, 310mW, B=90..270, >100MHz	SOT-666	35/T10	-	7k	Di
K6	R5426D106CA	BM-IC	Li-Ion, over-charge/discharge protection, Vc/d=1.06V	SON-6	34xx	VBM1	7g	Ric
K6	R5426N106CA	BM-IC	Li-Ion, over-charge/discharge protection, Vc/d=1.06V	SOT-23-6	33xxk	VBM1	7d	Ric
K6	RN2967FS	Si-pnp-Digi	Dual, Sw, 20V, 50mA, 50mW, R1/R2=10k/47k	FS6	35/TD8	-	7b	Tos
K6F	QZX363C6V8	Z-diode	Quad, 6.8V±5%, 200mW	SOT-363	33c	-	7k	Di
K6N	MMDT3904	Si-npn	Dual, GP, 60V, 200mA, 250mW, B=100..300, >300MHz	SOT-363	33/T8	-	7k	Di
K7	NCT7SP38L6	CMOS-Logic	2-input NAND gate (ODO)	MPAK-6	33/Log17	-	7b	F
K7	R5426D106EA	BM-IC	Li-Ion, over-charge/discharge protection, Vc/d=1.06V	SON-6	34xx	VBM1	7g	Ric
K7	R5426N106EA	BM-IC	Li-Ion, over-charge/discharge protection, Vc/d=1.06V	SOT-23-6	33xxk	VBM1	7d	Ric
K7	RN2968FS	Si-pnp-Digi	Dual, Sw, 20V, 50mA, 50mW, R1/R2=22k/47k	FS6	35/TD8	-	7b	Tos
K71	BAS70DW-05	Si-diode	Quad, Schottky, 70V, 70mA, Vf<1V(15mA), <2pF, 5ns	SOT-363	33/D7	-	7f	Di



SMD code	Type	Function	Short description	Case	Pinout	Sch.	St.	Mnf.
K72	2N7002DW	n-MOSFET-e	Dual, TMOS, 60V, 150mA, 200mW, <7.5Ω(0.5A), 7/11ns	SOT-363	33/T13	-	7b	Trs
K73	BAS70TW	Si-diode	Triple, Schottky, 70V, 70mA, Vf<1V(15mA), <2pF, 5ns	SOT-363	33dd	-	7l	Di
K74	BAS70DW-04	Si-diode	Quad, Schottky, 70V, 70mA, Vf<1V(15mA), <2pF, 5ns	SOT-363	33/D10	-	7f	Di
K75	BAS70BRW	Si-diode	Quad, Schottky, 70V, 70mA, Vf<1V(15mA), <2pF, 5ns	SOT-363	33/D9	-	7f	Di
K76	BAS70DW-06	Si-diode	Quad, Schottky, 70V, 70mA, Vf<1V(15mA), <2pF, 5ns	SOT-363	33/D8	-	7f	Di
K78	BAS70JW	Si-diode	Dual, Schottky, 70V, 70mA, Vf<1V(15mA), <2pF, 5ns	SOT-363	33dw	-	7l	Di
K7P	BC847PN	Si-n/p	Dual, AF, 50V, 100mA, 250mW, B=110..800, >100MHz	SOT-363	33/T9	-	7k	Di
K8	R5426D107CA	BM-IC	Li-Ion, over-charge/discharge protection, Vc/d=1.07V	SON-6	34xx	VBM1	7g	Ric
K8	R5426N107CA	BM-IC	Li-Ion, over-charge/discharge protection, Vc/d=1.07V	SOT-23-6	33xx	VBM1	7d	Ric
K8	RN2969FS	Si-pnp-Digi	Dual, Sw, 20V, 50mA, 50mW, R1/R2=47k/22k	FS6	35/TD8	-	7b	Tos
K84	BS584DW	p-MOSFET-e*	Dual, V-MOS, LogL, 50V, 130mA, 300mW, 6Ω(100mA), 10/18ns	SOT-363	33/T14	-	7k	Di
K86A	TS486IDT	LIN-IC	AF PA, 2.5.5V, 2x100mW(16Ω), shutdown	SOP-8	47	AFP7	-	Ste
K86A	TS486IST	LIN-IC	AF PA, 2.5.5V, 2x100mW(5V/16Ω), shutdown	MSOP-8	55	AFP7	-	Ste
K86B	TS486-11ST	LIN-IC	AF PA, 2.5.5V, 2x100mW(5V/16Ω), shutdown	SSOP-8	47	AFP25	-	Ste
K86C	TS486-21ST	LIN-IC	AF PA, 2.5.5V, 2x100mW(5V/16Ω), shutdown	SSOP-8	47	AFP25	-	Ste
K86D	TS486-41ST	LIN-IC	AF PA, 2.5.5V, 2x100mW(5V/16Ω), shutdown	SSOP-8	47	AFP25	-	Ste
K87A	TS487IDT	LIN-IC	AF PA, 2.5.5V, 2x100mW(16Ω), shutdown	SOP-8	47	AFP16	-	Ste
K87A	TS487IST	LIN-IC	AF PA, 2.5.5V, 2x100mW(5V/16Ω), shutdown	SSOP-8	47	AFP16	-	Ste
K87B	TS487-11ST	LIN-IC	AF PA, 2.5.5V, 2x100mW(5V/16Ω), shutdown	SSOP-8	47	AFP64	-	Ste
K87C	TS487-21ST	LIN-IC	AF PA, 2.5.5V, 2x100mW(5V/16Ω), shutdown	SSOP-8	47	AFP64	-	Ste
K87D	TS487-41ST	LIN-IC	AF PA, 2.5.5V, 2x100mW(5V/16Ω), shutdown	SSOP-8	47	AFP64	-	Ste
K9	R5426D108CA	BM-IC	Li-Ion, over-charge/discharge protection, Vc/d=1.08V	SON-6	34xx	VBM1	7g	Ric
K9	R5426N108CA	BM-IC	Li-Ion, over-charge/discharge protection, Vc/d=1.08V	SOT-23-6	33xx	VBM1	7d	Ric
K9	RN2970FS	Si-pnp-Digi	Dual, Sw, 20V, 50mA, 50mW, R1=4.7k	FS6	35/TD8	-	7b	Tos
K990	TS4990IST	LIN-IC	AF PA, BTL, 2.5.5.5V, 1.2W(5V/8Ω), shutdown	SSOP-8	47	AFP12	-	Ste
K994	TS4994IST	LIN-IC	AF PA, BTL, 2.5.5.5V, 1.2W(5V/8Ω), select shutdown	SSOP-10	60	AFP19	-	Ste
KA	μPA604T	Si-npn	Dual, 60V, 100mA, 250MHz	SOT-23-6	33/T8	-	7b	Nec
KA	μPA670T	Si-npn	Dual, 60V, 100mA, 250MHz	SOT-363	33/T8	-	7b	Nec
KA	KRA751F	Si-pnp-Digi	Dual, Sw, 20V, 50mA, 50mW, R1/R2=4.7k/4.7k	TFS6	35/TD4	-	7b	Kec
KA	R5426D109EA	BM-IC	Li-Ion, over-charge/discharge protection, Vc/d=1.09V	SON-6	34xx	VBM1	7g	Ric
KA	R5426N109EA	BM-IC	Li-Ion, over-charge/discharge protection, Vc/d=1.09V	SOT-23-6	33xx	VBM1	7d	Ric
KA	RP154N025A	LVR-IC	LDO, Dual out, Vout1/Vout2=3.0V/3.0V±1%, 300mA, +CE	SOT-23-6	33x5	VR19	7d	Ric
KA2	BA516TW	Si-diode	Triple, Sw, Fast, 75V, 300mA, Vf<1.25V(150mA), <4ns, 2pF	SOT-363	33dd	-	7k	Di
KA2	MMBD4148TW	Si-diode	Triple, Sw, Fast, 75V, 300mA, Vf<1.25V(150mA), <4ns, 2pF	SOT-363	33dd	-	7k	Di
KA3	MMBD4448DW	Si-diode	Dual, Sw, Fast, 75V, 500mA, Vf<1.25V(150mA), <4ns	SOT-363	33de	-	7k	Di
KA6	MMBD4448HADW	Si-diode	Quad, Sw, Fast, 75V, 500mA, Vf<1.25V(150mA), <4ns	SOT-363	33/d7	-	7k	Di
KA7	MMBD4448HCDW	Si-diode	Quad, Sw, Fast, 75V, 500mA, Vf<1.25V(150mA), <4ns	SOT-363	33/D7	-	7k	Di
KAA	MMBD4448HTW	Si-diode	Triple, Sw, Fast, 75V, 500mA, Vf<1.25V(150mA), <4ns	SOT-363	33dd	-	7k	Di
KAB	MMBD4448HSDW	Si-diode	Quad, Sw, Fast, 75V, 500mA, Vf<1.25V(150mA), <4ns	SOT-363	33/D10	-	7k	Di
KAD	MMBD4448HTM	Si-diode	Triple, Sw, Fast, 75V, 500mA, Vf<1.25V(150mA), <4ns	SOT-26	33bb	-	7k	Di
KB	KRA752F	Si-pnp-Digi	Dual, Sw, 20V, 50mA, 50mW, R1/R2=10k/10k	TFS6	35/TD4	-	7b	Kec
KB	R5426D110FA	BM-IC	Li-Ion, over-charge/discharge protection, Vc/d=1.1V	SON-6	34xx	VBM1	7g	Ric
KB	R5426N110FA	BM-IC	Li-Ion, over-charge/discharge protection, Vc/d=1.1V	SOT-23-6	33xx	VBM1	7d	Ric
KB	RP154N026A	LVR-IC	LDO, Dual out, Vout1/Vout2=2.8V/3.1V±1%, 300mA, +CE	SOT-23-6	33x5	VR19	7d	Ric
KC	KRA753F	Si-pnp-Digi	Dual, Sw, 20V, 50mA, 50mW, R1/R2=22k/22k	TFS6	35/TD4	-	7b	Kec
KC	R5426D111DA	BM-IC	Li-Ion, over-charge/discharge protection, Vc/d=1.11V	SON-6	34xx	VBM1	7g	Ric
KC	R5426N111DA	BM-IC	Li-Ion, over-charge/discharge protection, Vc/d=1.11V	SOT-23-6	33xx	VBM1	7d	Ric
KC	RP154N027A	LVR-IC	LDO, Dual out, Vout1/Vout2=2.3V/2.8V±1%, 300mA, +CE	SOT-23-6	33x5	VR19	7d	Ric
KC1	MMBZ5221BS	Z-diode	Dual, 2.28..2.52V, Iz=20mA, Zzt=30Ω, 200mW	SOT-363	33de	-	7f	Di
KC3	MMBZ5223BS	Z-diode	Dual, 2.57..2.84V, Zzt=30Ω, Iz=20mA, 200mW	SOT-363	33de	-	7f	Di
KC5	MMBZ5225BS	Z-diode	Dual, 3V±5%, Zzt=29Ω, 200mW	SOT-363	33de	-	7f	Di
KCA	BAV756DW	Si-diode	Quad, Fast Sw, 90V, 250mA, 250mW, Vf<1.25V(150mA), 2pF, <6ns	SOT-363	33/D13	-	7l	Di
KD	KRA754F	Si-pnp-Digi	Dual, Sw, 20V, 50mA, 50mW, R1/R2=4.7k/4.7k	TFS6	35/TD4	-	7b	Kec
KD	R5426D112FA	BM-IC	Li-Ion, over-charge/discharge protection, Vc/d=1.12V	SON-6	34xx	VBM1	7g	Ric
KD	R5426N112FA	BM-IC	Li-Ion, over-charge/discharge protection, Vc/d=1.12V	SOT-23-6	33xx	VBM1	7d	Ric
KD	RP154N028A	LVR-IC	LDO, Dual out, Vout1/Vout2=1.5V/1.5V±1%, 300mA, +CE	SOT-23-6	33x5	VR19	7d	Ric
KDA	SSM6K06FU	n-MOSFET-e*	Sw, LogL, 20V, 1.1A, 300mW, <0.21Ω(500mA), 42/100ns	US6	33fc	-	7b	Tos
KDB	SSM6J06FU	p-MOSFET-e*	Sw, LogL, 20V, 650mA, <0.7Ω(500mA)	US6	33fc	-	7b	Tos
KDE	SSM6K07FU	n-MOSFET-e*	Sw, LogL, 30V, 1.5A, 300mW, <0.22Ω(750mA), 46/65ns	US6	33fc	-	7b	Tos
KDF	SSM6J07FU	p-MOSFET-e*	Sw, LogL, 30V, 800mA, <0.8Ω(500mA)	US6	33fc	-	7b	Tos
KE	R5426D113CA	BM-IC	Li-Ion, over-charge/discharge protection, Vc/d=1.13V	SON-6	34xx	VBM1	7g	Ric
KE	R5426N113CA	BM-IC	Li-Ion, over-charge/discharge protection, Vc/d=1.13V	SOT-23-6	33xx	VBM1	7d	Ric
KE	RP154N029A	LVR-IC	LDO, Dual out, Vout1/Vout2=1.5V/1.5V±1%, 300mA, +CE	SOT-23-6	33x5	VR19	7d	Ric
KE1	MMBZ5231BS	Z-diode	Dual, 5.1V±5%, Zzt=17Ω, 200mW	SOT-363	33de	-	7f	Di
KE2	MMBZ5232BS	Z-diode	Dual, 5.6V±5%, Zzt=11Ω, 200mW	SOT-363	33de	-	7f	Di
KE3	MMBZ5233BS	Z-diode	Dual, 6V±5%, Zzt=7Ω, 200mW	SOT-363	33de	-	7f	Di
KE4	MMBZ5234BS	Z-diode	Dual, 6.2V±5%, Zzt=7Ω, 200mW	SOT-363	33de	-	7f	Di
KE5	MMBZ5235BS	Z-diode	Dual, 6.8V±5%, Zzt=5Ω, 200mW	SOT-363	33de	-	7f	Di
KF	R5426D114CA	BM-IC	Li-Ion, over-charge/discharge protection, Vc/d=1.14V	SON-6	34xx	VBM1	7g	Ric
KF	R5426N114CA	BM-IC	Li-Ion, over-charge/discharge protection, Vc/d=1.14V	SOT-23-6	33xx	VBM1	7d	Ric



SMD code	Type	Function	Short description	Case	Pinout	Sch.	St.	Mnf.
KF	RN2971FS	Si-pnp-Digi	Dual, Sw, 20V, 50mA, 50mW, R1=10k	FS6	35/TD8	-	7b	Tos
KF	RP154N030A	LVR-IC	LDO, Dual out, Vout1/Vout2=1.2V/2.9V±1%, 300mA, +CE	SOT-23-6	33x5	VR19	7d	Ric
KF1	MMBZ5236BS	Z-diode	Dual, 7.5V±5%, Zzt=60Ω, 200mW	SOT-363	33de	-	7f	Di
KF2	MMBZ5237BS	Z-diode	Dual, 8.2V±5%, Zzt=80Ω, 200mW	SOT-363	33de	-	7f	Di
KF3	MMBZ5238BS	Z-diode	Dual, 8.7V±5%, Zzt=80Ω, 200mW	SOT-363	33de	-	7f	Di
KF4	MMBZ5239BS	Z-diode	Dual, 9.1V±5%, Zzt=100Ω, 200mW	SOT-363	33de	-	7f	Di
KF5	MMBZ5240BS	Z-diode	Dual, 10V±5%, Zzt=170Ω, 200mW	SOT-363	33de	-	7f	Di
KFF	QZX363C12	Z-diode	Quad, 12V±5%, 200mW	SOT-363	33c	-	7k	Di
KG	KRA757F	Si-pnp-Digi	Dual, Sw, 20V, 50mA, 50mW, R1/R2=10k/47k	TFS6	35/TD4	-	7b	Kec
KG	R5426D111CA	BM-IC	Li-Ion, over-charge/discharge protection, Vc/d=1.11V	SON-6	34xk	VBM1	7g	Ric
KG	R5426N111CA	BM-IC	Li-Ion, over-charge/discharge protection, Vc/d=1.11V	SOT-23-6	33xk	VBM1	7d	Ric
KG	RP154N031A	LVR-IC	LDO, Dual out, Vout1/Vout2=2.65V/2.85V±1%, 300mA, +CE	SOT-23-6	33x5	VR19	7d	Ric
KG1	MMBZ5226BS	Z-diode	Dual, 3.3V±5%, Zzt=280Ω, 200mW	SOT-363	33de	-	7f	Di
KG2	MMBZ5227BS	Z-diode	Dual, 3.42...3.78V, Zzt=240Ω, lz=20mA, 200mW	SOT-363	33de	-	7f	Di
KG3	MMBZ5228BS	Z-diode	Dual, 3.71...4.10V, lz=20mA, Zzt=230Ω, 200mW	SOT-363	33de	-	7f	Di
KG4	MMBZ5229BS	Z-diode	Dual, 4.3V±5%, Zzt=220Ω, 200mW	SOT-363	33de	-	7f	Di
KG5	MMBZ5230BS	Z-diode	Dual, 4.7V±5%, Zzt=190Ω, 200mW	SOT-363	33de	-	7f	Di
KGJ	BAV99BRW	Si-diode	Quad, Sw, 75V, 200mA, Vf<1.25V(150mA), <4ns	SOT-363	33/D9	-	7l	Di
KH	KRA758F	Si-pnp-Digi	Dual, Sw, 20V, 50mA, 50mW, R1/R2=22k/47k	TFS6	35/TD4	-	7b	Kec
KH	R5426D101CA	BM-IC	Li-Ion, over-charge/discharge protection, Vc/d=1.01V	SON-6	34xk	VBM1	7g	Ric
KH	R5426N101CA	BM-IC	Li-Ion, over-charge/discharge protection, Vc/d=1.01V	SOT-23-6	33xk	VBM1	7d	Ric
KH	RP154N032A	LVR-IC	LDO, Dual out, Vout1/Vout2=3.3V/2.85V±1%, 300mA, +CE	SOT-23-6	33x5	VR19	7d	Ric
KH1	MMBZ5241BS	Z-diode	Dual, 11V±5%, Zzt=220Ω, 200mW	SOT-363	33de	-	7f	Di
KH2	MMBZ5242BS	Z-diode	Dual, 12V±5%, Zzt=300Ω, 200mW	SOT-363	33de	-	7f	Di
KH3	MMBZ5243BS	Z-diode	Dual, 13V±5%, Zzt=130Ω, 200mW	SOT-363	33de	-	7f	Di
KH4	MMBZ5244BS	Z-diode	Dual, 14V±5%, Zzt=150Ω, 200mW	SOT-363	33de	-	7f	Di
KH5	MMBZ5245BS	Z-diode	Dual, 15V±5%, Zzt=160Ω, 200mW	SOT-363	33de	-	7l	Di
KI	HN1K02FU	n-MOSFET-e*	Dual, LogL, 20V, 50mA, <40Ω(10mA)	US6	33/T13	-	7b	Tos
KJ	KRA759F	Si-pnp-Digi	Dual, Sw, 20V, 50mA, 50mW, R1/R2=47k/22k	TFS6	35/TD4	-	7b	Kec
KJ	R5426D102CA	BM-IC	Li-Ion, over-charge/discharge protection, Vc/d=1.02V	SON-6	34xk	VBM1	7g	Ric
KJ	R5426N102CA	BM-IC	Li-Ion, over-charge/discharge protection, Vc/d=1.02V	SOT-23-6	33xk	VBM1	7d	Ric
KJ	RP154N033A	LVR-IC	LDO, Dual out, Vout1/Vout2=1.8V/2.9V±1%, 300mA, +CE	SOT-23-6	33x5	VR19	7d	Ric
KJ1	MMBZ5246BS	Z-diode	Dual, 16V±5%, Zzt=170Ω, 200mW	SOT-363	33de	-	7l	Di
KJ2	MMBZ5247BS	Z-diode	Dual, 17V±5%, Zzt=190Ω, 200mW	SOT-363	33de	-	7l	Di
KJ3	MMBZ5248BS	Z-diode	Dual, 18V±5%, Zzt=210Ω, 200mW	SOT-363	33de	-	7f	Di
KJ4	MMBZ5249BS	Z-diode	Dual, 19V±5%, Zzt=230Ω, 200mW	SOT-363	33de	-	7f	Di
KJ5	MMBZ5250BS	Z-diode	Dual, 20V±5%, Zzt=250Ω, 200mW	SOT-363	33de	-	7l	Di
KJA	BAV70DW	Si-diode	Quad, Sw, 75V, 200mA, Vf<1.25V(150mA), <4ns	SOT-363	33/D7	-	7o	Di
KJA	BAW567DW	Si-diode	Quad, Sw, 100V, 300mA, 200mW, Vf<1.25V(100mA), <4ns	SOT-363	33/D7	-	7o	Di
KJC	BAV56DW	Si-diode	Quad, Fast Sw, 100V, 300mA, 200mW, <6ns	SOT-363	33/D8	-	7o	Di
KJF	QZX363C15	Z-diode	Quad, 15V±5%, 200mW	SOT-363	33c	-	7k	Di
KK	KRA760F	Si-pnp-Digi	Dual, Sw, 20V, 50mA, 50mW, R1=4.7k	TFS6	35/TD4	-	7b	Kec
KK	R5426D110EA	BM-IC	Li-Ion, over-charge/discharge protection, Vc/d=1.1V	SON-6	34xk	VBM1	7g	Ric
KK	R5426N110EA	BM-IC	Li-Ion, over-charge/discharge protection, Vc/d=1.1V	SOT-23-6	33xk	VBM1	7d	Ric
KK	RP154N034A	LVR-IC	LDO, Dual out, Vout1/Vout2=3.1V/3.1V±1%, 300mA, +CE	SOT-23-6	33x5	VR19	7d	Ric
KK1	MMBZ5251BS	Z-diode	Dual, 22V±5%, Zzt=290Ω, 200mW	SOT-363	33de	-	7l	Di
KK2	MMBZ5252BS	Z-diode	Dual, 24V±5%, Zzt=330Ω, 200mW	SOT-363	33de	-	7l	Di
KK3	MMBZ5253BS	Z-diode	Dual, 25V±5%, Zzt=350Ω, 200mW	SOT-363	33de	-	7l	Di
KK4	MMBZ5254BS	Z-diode	Dual, 27V±5%, Zzt=410Ω, 200mW	SOT-363	33de	-	7f	Di
KK5	MMBZ5255BS	Z-diode	Dual, 28V±5%, Zzt=440Ω, 200mW	SOT-363	33de	-	7f	Di
KL	KRA761F	Si-pnp-Digi	Dual, Sw, 20V, 50mA, 50mW, R1=10k	TFS6	35/TD4	-	7b	Kec
KL	R5426D116EA	BM-IC	Li-Ion, over-charge/discharge protection, Vc/d=1.16V	SON-6	34xk	VBM1	7g	Ric
KL	R5426N116EA	BM-IC	Li-Ion, over-charge/discharge protection, Vc/d=1.16V	SOT-23-6	33xk	VBM1	7d	Ric
KL	RP154N035A	LVR-IC	LDO, Dual out, Vout1/Vout2=2.8V/2.7V±1%, 300mA, +CE	SOT-23-6	33x5	VR19	7d	Ric
KL1	TBZ363C5V5	Z-diode	Triple, 5.5V±5%, 200mW, Bidirectional	SOT-363	33dt	-	7k	Di
KL3	TBZ363C6V4	Z-diode	Triple, 6.4V±5%, 200mW, Bidirectional	SOT-363	33dt	-	7k	Di
KL5	TBZ363C7V0	Z-diode	Triple, 7V±5%, 200mW, Bidirectional	SOT-363	33dt	-	7k	Di
KL6	BAT54ADW	Si-diode	Quad, SBD, 30V, 200mA, Vf<1V(100mA), <5ns	SOT-363	33/D8	-	7f	Di
KL7	BAT54CDW	Si-diode	Quad, SBD, 30V, 200mA, Vf<1V(100mA), <5ns	SOT-363	33/D7	-	7f	Di
KL8	BAT54SDW	Si-diode	Quad, SBD, 30V, 200mA, Vf<1V(100mA), <5ns	SOT-363	33/D10	-	7f	Di
KLA	BAT54TW	Si-diode	Triple, SBD, 30V, 200mA, Vf<1V(100mA), <5ns	SOT-363	33bb	-	7f	Di
KLB	BAT54BDW	Si-diode	Quad, SBD, 30V, 200mA, Vf<1V(100mA), <5ns	SOT-363	33/D9	-	7f	Di
KM	DDZ5V1BTS	Z-diode	Triple, 5.1V±2.5%, 200mW	SOT-363	33dd	-	7k	Di
KM	R5426D102FA	BM-IC	Li-Ion, over-charge/discharge protection, Vc/d=1.02V	SON-6	34xk	VBM1	7g	Ric
KM	R5426N102FA	BM-IC	Li-Ion, over-charge/discharge protection, Vc/d=1.02V	SOT-23-6	33xk	VBM1	7d	Ric
KM	RP154N036A	LVR-IC	LDO, Dual out, Vout1/Vout2=1.0V/1.8V±1%, 300mA, +CE	SOT-23-6	33x5	VR19	7d	Ric
KM1	MMBZ5256BS	Z-diode	Dual, 30V±5%, Zzt=490Ω, 200mW	SOT-363	33de	-	7f	Di
KM2	MMBZ5257BS	Z-diode	Dual, 33V±5%, Zzt=580Ω, 200mW	SOT-363	33de	-	7f	Di
KM3	MMBZ5258BS	Z-diode	Dual, 36V±5%, Zzt=700Ω, 200mW	SOT-363	33de	-	7f	Di
KM4	MMBZ5259BS	Z-diode	Dual, 39V±5%, Zzt=800Ω, 200mW	SOT-363	33de	-	7f	Di



SMD code	Type	Function	Short description	Case	Pinout	Sch.	St.	Mnf.
KMF	QZX363C20	Z-diode	Quad, 20V±5%, 200mW	SOT-363	33c	-	7k	Di
KN	DDZX5V6BTS	Z-diode	Triple, 5.6V±2.5%, 200mW	SOT-363	33dd	-	7k	Di
KN	KRA763F	Si-pnp-Digi	Dual, Sw, 20V, 50mA, 50mW, R1=22k	TFS6	35/TD4	-	7b	Kec
KN	R5426D119FA	BM-IC	Li-Ion, over-charge/discharge protection, Vc/d=1.19V	SON-6	34xx	VBM1	7g	Ric
KN	R5426N119FA	BM-IC	Li-Ion, over-charge/discharge protection, Vc/d=1.19V	SOT-23-6	33xx	VBM1	7d	Ric
KO	DDZX6V2BTS	Z-diode	Triple, 6.2V±2.5%, 200mW	SOT-363	33dd	-	7k	Di
KP	μPA895TD	Si-npn	Dual, RF-Osc, 9V, 100mA, 190mW, B=100..145, 6.5GHz	SOT-363	33T1	-	7b	Cel
KP	μPA895TD	Si-npn	Dual, RF-Osc, 9V, 100mA, 190mW, B=100..145, 6.5GHz	SON-6	33/T3	-	7b	Nec
KP	HN1K03FU	n-MOSFET-e*	Dual, LogL, 20V, 0.1A, <12Q(10mA)	US6	33/T13	-	7b	Tos
KP	KRA764F	Si-pnp-Digi	Dual, Sw, 20V, 50mA, 50mW, R1=47k	TFS6	35/TD4	-	7b	Kec
KP	R5426D120CA	BM-IC	Li-Ion, over-charge/discharge protection, Vc/d=1.2V	SON-6	34xx	VBM1	7g	Ric
KP	R5426N120CA	BM-IC	Li-Ion, over-charge/discharge protection, Vc/d=1.2V	SOT-23-6	33xx	VBM1	7d	Ric
KPB	BZX84-C30TS	Z-diode	Triple, 30V±5%, 200mW	SOT-363	33dd	-	7l	Di
KPC	BZX84-C33TS	Z-diode	Triple, 33V±5%, 200mW	SOT-363	33dd	-	7l	Di
KPD	BZX84-C36TS	Z-diode	Triple, 36V±5%, 200mW	SOT-363	33dd	-	7l	Di
KPE	BZX84-C39TS	Z-diode	Triple, 39V±5%, 200mW	SOT-363	33dd	-	7l	Di
KR	R5426D121BB	BM-IC	Li-Ion, over-charge/discharge protection, Vc/d=1.21V	SON-6	34xx	VBM1	7g	Ric
KR	R5426N121BB	BM-IC	Li-Ion, over-charge/discharge protection, Vc/d=1.21V	SOT-23-6	33xx	VBM1	7d	Ric
KR1	BZX84-C4V7TS	Z-diode	Triple, 4.7V±5%, 200mW	SOT-363	33dd	-	7l	Di
KR1	MMBZ5241BTS	Z-diode	Triple, 11V±5%, Zzt=22Q, 200mW	SOT-363	33dd	-	7l	Di
KR2	BZX84-C5V1TS	Z-diode	Triple, 5.1V±5%, 200mW	SOT-363	33dd	-	7l	Di
KR2	MMBZ5242BTS	Z-diode	Triple, 12V±5%, Zzt=30Q, 200mW	SOT-363	33dd	-	7l	Di
KR3	BZX84-C5V6TS	Z-diode	Triple, 5.6V±5%, 200mW	SOT-363	33dd	-	7l	Di
KR3	MMBZ5243BTS	Z-diode	Triple, 13V±5%, Zzt=13Q, 200mW	SOT-363	33dd	-	7l	Di
KR4	BZX84-C6V2TS	Z-diode	Triple, 6.2V±5%, 200mW	SOT-363	33dd	-	7l	Di
KR4	MMBZ5245BTS	Z-diode	Triple, 15V±5%, Zzt=16Q, 200mW	SOT-363	33dd	-	7f	Di
KR5	BZX84-C6V8TS	Z-diode	Triple, 6.8V±5%, 200mW	SOT-363	33dd	-	7l	Di
KR5	MMBZ5246BTS	Z-diode	Triple, 16V±5%, Zzt=17Q, 200mW	SOT-363	33dd	-	7f	Di
KR6	BZX84-C7V5TS	Z-diode	Triple, 7.5V±5%, 200mW	SOT-363	33dd	-	7l	Di
KR6	MMBZ5248BTS	Z-diode	Triple, 18V±5%, Zzt=21Q, 200mW	SOT-363	33dd	-	7l	Di
KR7	BZX84-C8V2TS	Z-diode	Triple, 8.2V±5%, 200mW	SOT-363	33dd	-	7l	Di
KR7	MMBZ5250BTS	Z-diode	Triple, 20V±5%, Zzt=25Q, 200mW	SOT-363	33dd	-	7f	Di
KR8	BZX84-C9V1TS	Z-diode	Triple, 9.1V±5%, 200mW	SOT-363	33dd	-	7l	Di
KR8	MMBZ5251BTS	Z-diode	Triple, 22V±5%, Zzt=29Q, 200mW	SOT-363	33dd	-	7f	Di
KR9	MMBZ5252BTS	Z-diode	Triple, 24V±5%, Zzt=33Q, 200mW	SOT-363	33dd	-	7f	Di
KRA	MMBZ5254BTS	Z-diode	Triple, 27V±5%, Zzt=41Q, 200mW	SOT-363	33dd	-	7l	Di
KRB	BZX84-C2V4TS	Z-diode	Triple, 2.4V±5%, 200mW	SOT-363	33dd	-	7l	Di
KRB	MMBZ5256BTS	Z-diode	Triple, 30V±5%, Zzt=49Q, 200mW	SOT-363	33dd	-	7l	Di
KRC	BZX84-C2V7TS	Z-diode	Triple, 2.7V±5%, 200mW	SOT-363	33dd	-	7l	Di
KRC	MMBZ5257BTS	Z-diode	Triple, 33V±5%, Zzt=58Q, 200mW	SOT-363	33dd	-	7l	Di
KRD	BZX84-C3V0TS	Z-diode	Triple, 3V±5%, 200mW	SOT-363	33dd	-	7l	Di
KRD	MMBZ5258BTS	Z-diode	Triple, 36V±5%, Zzt=70Q, 200mW	SOT-363	33dd	-	7l	Di
KRE	BZX84-C3V3TS	Z-diode	Triple, 3.3V±5%, 200mW	SOT-363	33dd	-	7l	Di
KRE	MMBZ5259BTS	Z-diode	Triple, 39V±5%, Zzt=80Q, 200mW	SOT-363	33dd	-	7l	Di
KRF	BZX84-C3V6TS	Z-diode	Triple, 3.6V±5%, 200mW	SOT-363	33dd	-	7l	Di
KRF	MMBZ5233BTS	Z-diode	Triple, 6V±5%, Zzt=7Q, 200mW	SOT-363	33dd	-	7l	Di
KRG	BZX84-C3V9TS	Z-diode	Triple, 3.9V±5%, 200mW	SOT-363	33dd	-	7l	Di
KRG	MMBZ5238BTS	Z-diode	Triple, 8.7V±5%, Zzt=8Q, 200mW	SOT-363	33dd	-	7l	Di
KRH	BZX84-C4V3TS	Z-diode	Triple, 4.3V±5%, 200mW	SOT-363	33dd	-	7l	Di
KRH	MMBZ5255BTS	Z-diode	Triple, 28V±5%, Zzt=44Q, 200mW	SOT-363	33dd	-	7l	Di
KS	HN1J02FU	p-MOSFET-e*	Dual, LogL, 20V, 50mA, <40Q(10mA)	US6	33/T14	-	7b	Tos
KS1	MMBZ5230BTS	Z-diode	Triple, 4.7V±5%, Zzt=19Q, 200mW	SOT-363	33dd	-	7l	Di
KS2	MMBZ5231BTS	Z-diode	Triple, 5.1V±5%, Zzt=17Q, 200mW	SOT-363	33dd	-	7l	Di
KS3	MMBZ5232BTS	Z-diode	Triple, 5.6V±5%, Zzt=11Q, 200mW	SOT-363	33dd	-	7l	Di
KS4	MMBZ5234BTS	Z-diode	Triple, 6.2V±5%, Zzt=7Q, 200mW	SOT-363	33dd	-	7l	Di
KS5	MMBZ5235BTS	Z-diode	Triple, 6.8V±5%, Zzt=5Q, 200mW	SOT-363	33dd	-	7l	Di
KS6	MMBZ5236BTS	Z-diode	Triple, 7.5V±5%, Zzt=6Q, 200mW	SOT-363	33dd	-	7l	Di
KS7	MMBZ5237BTS	Z-diode	Triple, 8.2V±5%, Zzt=8Q, 200mW	SOT-363	33dd	-	7l	Di
KS8	MMBZ5239BTS	Z-diode	Triple, 9.1V±5%, Zzt=10Q, 200mW	SOT-363	33dd	-	7l	Di
KS9	MMBZ5240BTS	Z-diode	Triple, 10V±5%, Zzt=17Q, 200mW	SOT-363	33dd	-	7l	Di
KSb	MMBZ5221BTS	Z-diode	Triple, 2.28..2.52V, lzt=20mA, Zzt=30Q, 200mW	SOT-363	33dd	-	7l	Di
KSC	MMBZ5223BTS	Z-diode	Triple, 2.57..2.84V, Zzt=30Q, lzt=20mA, 200mW	SOT-363	33dd	-	7l	Di
KSD	MMBZ5225BTS	Z-diode	Triple, 3V±5%, Zzt=29Q, 200mW	SOT-363	33dd	-	7l	Di
KSE	MMBZ5226BTS	Z-diode	Triple, 3.3V±5%, Zzt=28Q, 200mW	SOT-363	33dd	-	7l	Di
KSF	MMBZ5227BTS	Z-diode	Triple, 3.42..3.78V, Zzt=24Q, lzt=20mA, 200mW	SOT-363	33dd	-	7l	Di
KSG	MMBZ5228BTS	Z-diode	Triple, 3.71..4.10V, lzt=20mA, Zzt=23Q, 200mW	SOT-363	33dd	-	7l	Di
KSH	MMBZ5229BTS	Z-diode	Triple, 4.3V±5%, Zzt=22Q, 200mW	SOT-363	33dd	-	7l	Di
KSU	SD103ASDM	Si-diode	Quad, SBD, Sw, 40V, 350mA, 50pF, 10ns	SOT-26	33/D10	-	7k	Di
KT	R5426D122CD	BM-IC	Li-Ion, over-charge/discharge protection, Vc/d=1.22V	SON-6	34xx	VBM1	7g	Ric
KT	R5426N122CD	BM-IC	Li-Ion, over-charge/discharge protection, Vc/d=1.22V	SOT-23-6	33xx	VBM1	7d	Ric



SMD code	Type	Function	Short description	Case	Pinout	Sch.	St.	Mnf.
KJ	R5426D102DA	BM-IC	Li-Ion, over-charge/discharge protection, Vc/d=1.02V	SON-6	34xx	VBM1	7g	Ric
KJ	R5426N102DA	BM-IC	Li-Ion, over-charge/discharge protection, Vc/d=1.02V	SOT-23-6	33xx	VBM1	7d	Ric
KV	R5426D110FD	BM-IC	Li-Ion, over-charge/discharge protection, Vc/d=1.1V	SON-6	34xx	VBM1	7g	Ric
KV	R5426N110FD	BM-IC	Li-Ion, over-charge/discharge protection, Vc/d=1.1V	SOT-23-6	33xx	VBM1	7d	Ric
KV7	TBZ363C20V8	Z-diode	Triple, 20V±5%, 200mW, Bidirectional	SOT-363	33dt	-	7k	Di
KW	DDZX13BTS	Z-diode	Triple, 13V ±2.5%, 200mW	SOT-363	33dd	-	7k	Di
KW	R5426D112FD	BM-IC	Li-Ion, over-charge/discharge protection, Vc/d=1.12V	SON-6	34xx	VBM1	7g	Ric
KW	R5426N112FD	BM-IC	Li-Ion, over-charge/discharge protection, Vc/d=1.12V	SOT-23-6	33xx	VBM1	7d	Ric
KX	R5426D111DD	BM-IC	Li-Ion, over-charge/discharge protection, Vc/d=1.11V	SON-6	34xx	VBM1	7g	Ric
KX	R5426N111DD	BM-IC	Li-Ion, over-charge/discharge protection, Vc/d=1.11V	SOT-23-6	33xx	VBM1	7d	Ric
KY	R5426D112EA	BM-IC	Li-Ion, over-charge/discharge protection, Vc/d=1.12V	SON-6	34xx	VBM1	7g	Ric
KY	R5426N112EA	BM-IC	Li-Ion, over-charge/discharge protection, Vc/d=1.12V	SOT-23-6	33xx	VBM1	7d	Ric
KY1	BZX84-C11S	Z-diode	Dual, 11V±5%, 200mW	SOT-363	33dn	-	7f	Di
KY2	BZX84-C12S	Z-diode	Dual, 12V±5%, 200mW	SOT-363	33dn	-	7f	Di
KY3	BZX84-C13S	Z-diode	Dual, 13V±5%, 200mW	SOT-363	33dn	-	7f	Di
KY4	BZX84-C15S	Z-diode	Dual, 15V±5%, 200mW	SOT-363	33dn	-	7f	Di
KY5	BZX84-C16S	Z-diode	Dual, 16V±5%, 200mW	SOT-363	33dn	-	7f	Di
KY6	BZX84-C18S	Z-diode	Dual, 18V±5%, 200mW	SOT-363	33dn	-	7f	Di
KY7	BZX84-C20S	Z-diode	Dual, 20V±5%, 200mW	SOT-363	33dn	-	7f	Di
KY8	BZX84-C22S	Z-diode	Dual, 22V±5%, 200mW	SOT-363	33dn	-	7f	Di
KY9	BZX84-C24S	Z-diode	Dual, 24V±5%, 200mW	SOT-363	33dn	-	7f	Di
KYA	BZX84-C27S	Z-diode	Dual, 27V±5%, 200mW	SOT-363	33dn	-	7f	Di
KYB	BZX84-C30S	Z-diode	Dual, 30V±5%, 200mW	SOT-363	33dn	-	7f	Di
KYC	BZX84-C33S	Z-diode	Dual, 33V±5%, 200mW	SOT-363	33dn	-	7f	Di
KYD	BZX84-C36S	Z-diode	Dual, 36V±5%, 200mW	SOT-363	33dn	-	7f	Di
KYE	BZX84-C39S	Z-diode	Dual, 39V±5%, 200mW	SOT-363	33dn	-	7f	Di
KZ	R5426D116DA	BM-IC	Li-Ion, over-charge/discharge protection, Vc/d=1.16V	SON-6	34xx	VBM1	7g	Ric
KZ	R5426N116DA	BM-IC	Li-Ion, over-charge/discharge protection, Vc/d=1.16V	SOT-23-6	33xx	VBM1	7d	Ric
KZ1	BZX84-C4V7S	Z-diode	Dual, 4.7V±5%, 200mW	SOT-363	33dn	-	7f	Di
KZ2	BZX84-C5V1S	Z-diode	Dual, 5.1V±5%, 200mW	SOT-363	33dn	-	7f	Di
KZ3	BZX84-C5V6S	Z-diode	Dual, 5.6V±5%, 200mW	SOT-363	33dn	-	7f	Di
KZ4	BZX84-C6V2S	Z-diode	Dual, 6.2V±5%, 200mW	SOT-363	33dn	-	7f	Di
KZ5	BZX84-C6V8S	Z-diode	Dual, 6.8V±5%, 200mW	SOT-363	33dn	-	7f	Di
KZ6	BZX84-C7V5S	Z-diode	Dual, 7.5V±5%, 200mW	SOT-363	33dn	-	7f	Di
KZ7	BZX84-C8V2S	Z-diode	Dual, 8.2V±5%, 200mW	SOT-363	33dn	-	7f	Di
KZ8	BZX84-C9V1S	Z-diode	Dual, 9.1V±5%, 200mW	SOT-363	33dn	-	7f	Di
KZ9	BZX84-C10S	Z-diode	Dual, 10V±5%, 200mW	SOT-363	33dn	-	7f	Di
KZB	BZX84-C2V4S	Z-diode	Dual, 2.4V±5%, 200mW	SOT-363	33dn	-	7f	Di
KZC	BZX84-C2V7S	Z-diode	Dual, 2.7V±5%, 200mW	SOT-363	33dn	-	7f	Di
KZD	BZX84-C3V0S	Z-diode	Dual, 3V±5%, 200mW	SOT-363	33dn	-	7f	Di
KZE	BZX84-C3V3S	Z-diode	Dual, 3.3V±5%, 200mW	SOT-363	33dn	-	7f	Di
KZF	BZX84-C3V6S	Z-diode	Dual, 3.6V±5%, 200mW	SOT-363	33dn	-	7f	Di
KZG	BZX84-C3V9S	Z-diode	Dual, 3.9V±5%, 200mW	SOT-363	33dn	-	7f	Di
KZH	BZX84-C4V3S	Z-diode	Dual, 4.3V±5%, 200mW	SOT-363	33dn	-	7f	Di
KZZ	PZX363C3V9	Z-diode	5x 3.9V±10%, 200mW	SOT-363	33bf	-	7k	Di
L0	R1211D002A	DC/DC-IC	PWM step-up, ULVO=2.2V, 700kHz	SON-6	34sf	DC15	7d	Ric
L0	R1211N002A	DC/DC-IC	PWM step-up, ULVO=2.2V, 700kHz	SOT-23-6W	33se	DC15	7d	Ric
L00	HD74LV2G00AUS	CMOS-Logic	Dual 2-input NAND gates	SSOP-8	47L0g50	-	8c	Ren
L02	HD74LV2G02AUS	CMOS-Logic	Dual 2-input NOR gates	SSOP-8	47L0g53	-	8c	Ren
L020	R1190S020B	LVR-IC	2.0V±1.5%, 1A, +CE	HSOP-6J	29zu	VR7	7h	Ric
L021	R1190S021B	LVR-IC	2.1V±1.5%, 1A, +CE	HSOP-6J	29zu	VR7	7h	Ric
L022	R1190S022B	LVR-IC	2.2V±1.5%, 1A, +CE	HSOP-6J	29zu	VR7	7h	Ric
L023	R1190S023B	LVR-IC	2.3V±1.5%, 1A, +CE	HSOP-6J	29zu	VR7	7h	Ric
L024	R1190S024B	LVR-IC	2.5V±1.5%, 1A, +CE	HSOP-6J	29zu	VR7	7h	Ric
L025	R1190S025B	LVR-IC	2.6V±1.5%, 1A, +CE	HSOP-6J	29zu	VR7	7h	Ric
L026	R1190S026B	LVR-IC	2.7V±1.5%, 1A, +CE	HSOP-6J	29zu	VR7	7h	Ric
L027	R1190S027B	LVR-IC	2.8V±1.5%, 1A, +CE	HSOP-6J	29zu	VR7	7h	Ric
L028	R1190S028B	LVR-IC	2.9V±1.5%, 1A, +CE	HSOP-6J	29zu	VR7	7h	Ric
L029	R1190S029B	LVR-IC	2.0V±1.5%, 1A, +CE	HSOP-6J	29zu	VR7	7h	Ric
L030	R1190S030B	LVR-IC	3.1V±1.5%, 1A, +CE	HSOP-6J	29zu	VR7	7h	Ric
L031	R1190S031B	LVR-IC	3.2V±1.5%, 1A, +CE	HSOP-6J	29zu	VR7	7h	Ric
L032	R1190S032B	LVR-IC	3.3V±1.5%, 1A, +CE	HSOP-6J	29zu	VR7	7h	Ric
L033	R1190S033B	LVR-IC	3.4V±1.5%, 1A, +CE	HSOP-6J	29zu	VR7	7h	Ric
L034	R1190S034B	LVR-IC	3.5V±1.5%, 1A, +CE	HSOP-6J	29zu	VR7	7h	Ric
L035	R1190S035B	LVR-IC	3.6V±1.5%, 1A, +CE	HSOP-6J	29zu	VR7	7h	Ric
L036	R1190S036B	LVR-IC	3.7V±1.5%, 1A, +CE	HSOP-6J	29zu	VR7	7h	Ric
L037	R1190S037B	LVR-IC	3.8V±1.5%, 1A, +CE	HSOP-6J	29zu	VR7	7h	Ric
L038	R1190S038B	LVR-IC	3.9V±1.5%, 1A, +CE	HSOP-6J	29zu	VR7	7h	Ric
L039	R1190S039B	LVR-IC	3.0V±1.5%, 1A, +CE	HSOP-6J	29zu	VR7	7h	Ric
L04	HD74LV2G04AUS	CMOS-Logic	Triple inverters	SSOP-8	47L0g56	-	8c	Ren



SMD code	Type	Function	Short description	Case	Pinout	Sch.	St.	Mnf.
L040	R1190S040B	LVR-IC	4.1V±1.5%, 1A, +CE	HSOP-6J	29zu	VR7	7h	Ric
L041	R1190S041B	LVR-IC	4.2V±1.5%, 1A, +CE	HSOP-6J	29zu	VR7	7h	Ric
L042	R1190S042B	LVR-IC	4.3V±1.5%, 1A, +CE	HSOP-6J	29zu	VR7	7h	Ric
L043	R1190S043B	LVR-IC	4.4V±1.5%, 1A, +CE	HSOP-6J	29zu	VR7	7h	Ric
L044	R1190S044B	LVR-IC	4.5V±1.5%, 1A, +CE	HSOP-6J	29zu	VR7	7h	Ric
L045	R1190S045B	LVR-IC	4.6V±1.5%, 1A, +CE	HSOP-6J	29zu	VR7	7h	Ric
L046	R1190S046B	LVR-IC	4.7V±1.5%, 1A, +CE	HSOP-6J	29zu	VR7	7h	Ric
L047	R1190S047B	LVR-IC	4.8V±1.5%, 1A, +CE	HSOP-6J	29zu	VR7	7h	Ric
L048	R1190S048B	LVR-IC	4.9V±1.5%, 1A, +CE	HSOP-6J	29zu	VR7	7h	Ric
L049	R1190S049B	LVR-IC	4.0V±1.5%, 1A, +CE	HSOP-6J	29zu	VR7	7h	Ric
L050	R1190S050B	LVR-IC	5.1V±1.5%, 1A, +CE	HSOP-6J	29zu	VR7	7h	Ric
L051	R1190S051B	LVR-IC	5.2V±1.5%, 1A, +CE	HSOP-6J	29zu	VR7	7h	Ric
L052	R1190S052B	LVR-IC	5.3V±1.5%, 1A, +CE	HSOP-6J	29zu	VR7	7h	Ric
L054	R1190S054B	LVR-IC	5.4V±1.5%, 1A, +CE	HSOP-6J	29zu	VR7	7h	Ric
L055	R1190S055B	LVR-IC	5.5V±1.5%, 1A, +CE	HSOP-6J	29zu	VR7	7h	Ric
L056	R1190S056B	LVR-IC	5.6V±1.5%, 1A, +CE	HSOP-6J	29zu	VR7	7h	Ric
L057	R1190S057B	LVR-IC	5.7V±1.5%, 1A, +CE	HSOP-6J	29zu	VR7	7h	Ric
L058	R1190S058B	LVR-IC	5.8V±1.5%, 1A, +CE	HSOP-6J	29zu	VR7	7h	Ric
L059	R1190S059B	LVR-IC	5.9V±1.5%, 1A, +CE	HSOP-6J	29zu	VR7	7h	Ric
L060	R1190S060B	LVR-IC	6.0V±1.5%, 1A, +CE	HSOP-6J	29zu	VR7	7h	Ric
L061	R1190S061B	LVR-IC	6.1V±1.5%, 1A, +CE	HSOP-6J	29zu	VR7	7h	Ric
L062	R1190S062B	LVR-IC	6.2V±1.5%, 1A, +CE	HSOP-6J	29zu	VR7	7h	Ric
L063	R1190S063B	LVR-IC	6.3V±1.5%, 1A, +CE	HSOP-6J	29zu	VR7	7h	Ric
L064	R1190S064B	LVR-IC	6.4V±1.5%, 1A, +CE	HSOP-6J	29zu	VR7	7h	Ric
L065	R1190S065B	LVR-IC	6.5V±1.5%, 1A, +CE	HSOP-6J	29zu	VR7	7h	Ric
L066	R1190S066B	LVR-IC	6.6V±1.5%, 1A, +CE	HSOP-6J	29zu	VR7	7h	Ric
L067	R1190S067B	LVR-IC	6.7V±1.5%, 1A, +CE	HSOP-6J	29zu	VR7	7h	Ric
L068	R1190S068B	LVR-IC	6.8V±1.5%, 1A, +CE	HSOP-6J	29zu	VR7	7h	Ric
L069	R1190S069B	LVR-IC	6.9V±1.5%, 1A, +CE	HSOP-6J	29zu	VR7	7h	Ric
L070	R1190S070B	LVR-IC	7.0V±1.5%, 1A, +CE	HSOP-6J	29zu	VR7	7h	Ric
L071	R1190S071B	LVR-IC	7.1V±1.5%, 1A, +CE	HSOP-6J	29zu	VR7	7h	Ric
L072	R1190S072B	LVR-IC	7.2V±1.5%, 1A, +CE	HSOP-6J	29zu	VR7	7h	Ric
L073	R1190S073B	LVR-IC	7.3V±1.5%, 1A, +CE	HSOP-6J	29zu	VR7	7h	Ric
L074	R1190S074B	LVR-IC	7.4V±1.5%, 1A, +CE	HSOP-6J	29zu	VR7	7h	Ric
L075	R1190S075B	LVR-IC	7.5V±1.5%, 1A, +CE	HSOP-6J	29zu	VR7	7h	Ric
L076	R1190S076B	LVR-IC	7.6V±1.5%, 1A, +CE	HSOP-6J	29zu	VR7	7h	Ric
L077	R1190S077B	LVR-IC	7.7V±1.5%, 1A, +CE	HSOP-6J	29zu	VR7	7h	Ric
L078	R1190S078B	LVR-IC	7.8V±1.5%, 1A, +CE	HSOP-6J	29zu	VR7	7h	Ric
L079	R1190S079B	LVR-IC	7.9V±1.5%, 1A, +CE	HSOP-6J	29zu	VR7	7h	Ric
L08	HD74LV2G08AUS	CMOS-Logic	Dual 2-input AND gates	SSOP-8	47L_log51	-	8c	Ren
L080	R1190S080B	LVR-IC	8.0V±1.5%, 1A, +CE	HSOP-6J	29zu	VR7	7h	Ric
L081	R1190S081B	LVR-IC	8.1V±1.5%, 1A, +CE	HSOP-6J	29zu	VR7	7h	Ric
L082	R1190S082B	LVR-IC	8.2V±1.5%, 1A, +CE	HSOP-6J	29zu	VR7	7h	Ric
L083	R1190S083B	LVR-IC	8.3V±1.5%, 1A, +CE	HSOP-6J	29zu	VR7	7h	Ric
L084	R1190S084B	LVR-IC	8.4V±1.5%, 1A, +CE	HSOP-6J	29zu	VR7	7h	Ric
L085	R1190S085B	LVR-IC	8.5V±1.5%, 1A, +CE	HSOP-6J	29zu	VR7	7h	Ric
L086	R1190S086B	LVR-IC	8.6V±1.5%, 1A, +CE	HSOP-6J	29zu	VR7	7h	Ric
L087	R1190S087B	LVR-IC	8.7V±1.5%, 1A, +CE	HSOP-6J	29zu	VR7	7h	Ric
L088	R1190S088B	LVR-IC	8.8V±1.5%, 1A, +CE	HSOP-6J	29zu	VR7	7h	Ric
L089	R1190S089B	LVR-IC	8.9V±1.5%, 1A, +CE	HSOP-6J	29zu	VR7	7h	Ric
L090	R1190S090B	LVR-IC	9.0V±1.5%, 1A, +CE	HSOP-6J	29zu	VR7	7h	Ric
L091	R1190S091B	LVR-IC	9.1V±1.5%, 1A, +CE	HSOP-6J	29zu	VR7	7h	Ric
L092	R1190S092B	LVR-IC	9.2V±1.5%, 1A, +CE	HSOP-6J	29zu	VR7	7h	Ric
L093	R1190S093B	LVR-IC	9.3V±1.5%, 1A, +CE	HSOP-6J	29zu	VR7	7h	Ric
L094	R1190S094B	LVR-IC	9.4V±1.5%, 1A, +CE	HSOP-6J	29zu	VR7	7h	Ric
L095	R1190S095B	LVR-IC	9.5V±1.5%, 1A, +CE	HSOP-6J	29zu	VR7	7h	Ric
L096	R1190S096B	LVR-IC	9.6V±1.5%, 1A, +CE	HSOP-6J	29zu	VR7	7h	Ric
L097	R1190S097B	LVR-IC	9.7V±1.5%, 1A, +CE	HSOP-6J	29zu	VR7	7h	Ric
L098	R1190S098B	LVR-IC	9.8V±1.5%, 1A, +CE	HSOP-6J	29zu	VR7	7h	Ric
L099	R1190S099B	LVR-IC	9.9V±1.5%, 1A, +CE	HSOP-6J	29zu	VR7	7h	Ric
L1	NL27WZ00US	CMOS-Logic	Dual 2-input NAND gates	SOP-8	47L_log50	-	8a	Ons
L1	R1211D002B	DC/DC-IC	PWM step-up, ULVO=2.2V, 700kHz	SOM-6	34si	DC15	7d	Ric
L1	R1211N002B	DC/DC-IC	PWM step-up, ULVO=2.2V, 700kHz	SOT-23-6W	33sl	DC15	7d	Ric
L100	R1190S100B	LVR-IC	10.0V±1.5%, 1A, +CE	HSOP-6J	29zu	VR7	7h	Ric
L101	R1190S101B	LVR-IC	10.1V±1.5%, 1A, +CE	HSOP-6J	29zu	VR7	7h	Ric
L102	R1190S102B	LVR-IC	10.2V±1.5%, 1A, +CE	HSOP-6J	29zu	VR7	7h	Ric
L103	R1190S103B	LVR-IC	10.3V±1.5%, 1A, +CE	HSOP-6J	29zu	VR7	7h	Ric
L104	R1190S104B	LVR-IC	10.4V±1.5%, 1A, +CE	HSOP-6J	29zu	VR7	7h	Ric
L105	R1190S105B	LVR-IC	10.5V±1.5%, 1A, +CE	HSOP-6J	29zu	VR7	7h	Ric
L106	R1190S106B	LVR-IC	10.6V±1.5%, 1A, +CE	HSOP-6J	29zu	VR7	7h	Ric



SMD code	Type	Function	Short description	Case	Pinout	Sch.	St.	Mnf.
L107	R1190S107B	LVR-IC	10.7V±1.5%, 1A, +CE	HSOP-6J	29zu	VR7	7h	Ric
L108	R1190S108B	LVR-IC	10.8V±1.5%, 1A, +CE	HSOP-6J	29zu	VR7	7h	Ric
L109	R1190S109B	LVR-IC	10.9V±1.5%, 1A, +CE	HSOP-6J	29zu	VR7	7h	Ric
L110	R1190S110B	LVR-IC	11.0V±1.5%, 1A, +CE	HSOP-6J	29zu	VR7	7h	Ric
L111	R1190S111B	LVR-IC	11.1V±1.5%, 1A, +CE	HSOP-6J	29zu	VR7	7h	Ric
L112	R1190S112B	LVR-IC	11.2V±1.5%, 1A, +CE	HSOP-6J	29zu	VR7	7h	Ric
L113	R1190S113B	LVR-IC	11.3V±1.5%, 1A, +CE	HSOP-6J	29zu	VR7	7h	Ric
L114	R1190S114B	LVR-IC	11.4V±1.5%, 1A, +CE	HSOP-6J	29zu	VR7	7h	Ric
L115	R1190S115B	LVR-IC	11.5V±1.5%, 1A, +CE	HSOP-6J	29zu	VR7	7h	Ric
L116	R1190S116B	LVR-IC	11.6V±1.5%, 1A, +CE	HSOP-6J	29zu	VR7	7h	Ric
L117	R1190S117B	LVR-IC	11.7V±1.5%, 1A, +CE	HSOP-6J	29zu	VR7	7h	Ric
L118	R1190S118B	LVR-IC	11.8V±1.5%, 1A, +CE	HSOP-6J	29zu	VR7	7h	Ric
L119	R1190S119B	LVR-IC	11.9V±1.5%, 1A, +CE	HSOP-6J	29zu	VR7	7h	Ric
L120	R1190S120B	LVR-IC	12.0V±1.5%, 1A, +CE	HSOP-6J	29zu	VR7	7h	Ric
L14	HD74LV2G14AUS	CMOS-Logic	Triple Schmitt-trigger inverters	SSOP-8	47L.og57	-	8c	Ren
L2	NL27WZ08US	CMOS-Logic	Dual 2-input AND gates	SOP-8	47L.og51	-	8a	Ons
L2	R1211D002C	DC/DC-IC	PWM step-up, ULVO=2.2V, 300kHz	SON-6	34sf	DC15	7d	Ric
L2	R1211N002C	DC/DC-IC	PWM step-up, ULVO=2.2V, 300kHz	SOT-23-6W	33se	DC15	7d	Ric
L23	HD74LV2G123AUS	CMOS-Logic	Retriggerable monostable multivibrator	SSOP-8	47L.og75	-	8c	Ren
L25	HD74LV2G125AUS	CMOS-Logic	Dual bus buffer with 3-state output	SSOP-8	47L.og54	-	8c	Ren
L26	HD74LV2G126AUS	CMOS-Logic	Dual bus buffer with 3-state output	SSOP-8	47L.og55	-	8c	Ren
L3	NL27WZ02US	CMOS-Logic	Dual 2-input NOR gates	SOP-8	47L.og53	-	8a	Ons
L3	R1211D002D	DC/DC-IC	PWM step-up, ULVO=2.2V, 300kHz	SON-6	34si	DC15	7d	Ric
L3	R1211N002D	DC/DC-IC	PWM step-up, ULVO=2.2V, 300kHz	SOT-23-6W	33sl	DC15	7d	Ric
L32	HD74LV2G32AUS	CMOS-Logic	Dual 2-input OR gates	SSOP-8	47L.og52	-	8c	Ren
L34	HD74LV2G34AUS	CMOS-Logic	Triple non-inverter buffers	SSOP-8	47L.og69	-	8c	Ren
L39A	LP2986AIMM-3.0	LVR-IC	Ultra-LDO, +CE, -Error, 3V±0.5%, 200mA	SOP-8	47wa	-	8d	Nsc
L39B	LP2986IMM-3.0	LVR-IC	Ultra-LDO, +CE, -Error, 3V±1%, 200mA	SOP-8	47wa	-	8d	Nsc
L4	BAT54TW	Si-diode	Triple, SBD, 30V, 200mA, Vf<1V(100mA), <5ns	SOT-363	33bb	-	7f	Pjt
L4	NCT5P86L6	CMOS-Logic	2-input EXCLUSIVE-OR gate	MPAK-6	33L.og5	-	7b	F
L4	NL27WZ32US	CMOS-Logic	Dual 2-input OR gates	SOP-8	47L.og52	-	8a	Ons
L4	R1211D100A	DC/DC-IC	PWM step-up, ULVO=2.2V, 700kHz	SON-6	34sf	DC15	7d	Ric
L40	HD74LV2G240AUS	CMOS-Logic	Dual bus buffer inverted with 3-state output	SSOP-8	47L.og67	-	8c	Ren
L40A	LP2986AIMM-3.3	LVR-IC	Ultra-LDO, +CE, -Error, 3.3V±0.5%, 200mA	SOP-8	47wa	-	8d	Nsc
L40B	LP2986IMM-3.3	LVR-IC	Ultra-LDO, +CE, -Error, 3.3V±1%, 200mA	SOP-8	47wa	-	8d	Nsc
L41	HD74LV2G241AUS	CMOS-Logic	Dual bus buffer non-inverted with 3-state output	SSOP-8	47L.og60	-	8c	Ren
L41A	LP2986AIMM-5.0	LVR-IC	Ultra-LDO, +CE, -Error, 5V±0.5%, 200mA	SOP-8	47wa	-	8d	Nsc
L41B	LP2986IMM-5.0	LVR-IC	Ultra-LDO, +CE, -Error, 5V±1%, 200mA	SOP-8	47wa	-	8d	Nsc
L42	BAT54ADW	Si-diode	Quad, SBD, 30V, 200mA, Vf<1V(100mA), <5ns	SOT-363	33/D8	-	7f	Pjt
L43	BAT54CDW	Si-diode	Quad, SBD, 30V, 200mA, Vf<1V(100mA), <5ns	SOT-363	33/D7	-	7f	Pjt
L44	BAT54SDW	Si-diode	Quad, SBD, 30V, 200mA, Vf<1V(100mA), <5ns	SOT-363	33/D10	-	7f	Pjt
L45	HD74LV2G245AUS	CMOS-Logic	Dual bus transceivers with 3-state output	SSOP-8	47L.og74	-	8c	Ren
L48100Q	LM48100QMH	LIN-IC	AF PA, BTL, 3.5 V, 1.3W(4V/8Q), shutdown, I2C control	TSSOP-14	60	AFP8	-	Nsc
L4917MT	LM4917MT	LIN-IC	AF PA, 2.2-5.5V, 2x95mW(5V/16Q), shutdown	SSOP-14	60	-	-	Nsc
L4990	LM4990MH	LIN-IC	AF PA, BTL, 2.7-5.5V, 2W(5V/4Q), shutdown	SSOP-10	60	AFP26	-	Nsc
L5	NL37WZ04US	CMOS-Logic	Triple inverters	SOP-8	47L.og56	-	8a	Ons
L5	R1211D101A	DC/DC-IC	PWM step-up, ULVO=2.2V, 700kHz	SON-6	34sf	DC15	7d	Ric
L53	HD74LV2G53AUS	CMOS-Logic	2-channel analog multiplexer/demultiplexer	SSOP-8	47L.og58	-	8c	Ren
L57	HD74LV2G157AUS	CMOS-Logic	2-input multiplexer	SSOP-8	47L.og66	-	8c	Ren
L6	R1211D102A	DC/DC-IC	PWM step-up, ULVO=2.2V, 700kHz	SON-6	34sf	DC15	7d	Ric
L66	HD74LV2G66AUS	CMOS-Logic	2-channel analog switch	SSOP-8	47L.og68	-	8c	Ren
L6A	S-1112B15PI	LVR-IC	LDO, 1.5V±1.0%, 150mA, +CE	SNT-6A	35vr2	VR4	7g	Sii
L6B	S-1112B16PI	LVR-IC	LDO, 1.6V±1.0%, 150mA, +CE	SNT-6A	35vr2	VR4	7g	Sii
L6C	S-1112B17PI	LVR-IC	LDO, 1.7V±1.0%, 150mA, +CE	SNT-6A	35vr2	VR4	7g	Sii
L6D	S-1112B18PI	LVR-IC	LDO, 1.8V±1.0%, 150mA, +CE	SNT-6A	35vr2	VR4	7g	Sii
L6E	S-1112B19PI	LVR-IC	LDO, 1.9V±1.0%, 150mA, +CE	SNT-6A	35vr2	VR4	7g	Sii
L6F	S-1112B20PI	LVR-IC	LDO, 2.0V±1.0%, 150mA, +CE	SNT-6A	35vr2	VR4	7g	Sii
L6G	S-1112B21PI	LVR-IC	LDO, 2.1V±1.0%, 150mA, +CE	SNT-6A	35vr2	VR4	7g	Sii
L6H	S-1112B22PI	LVR-IC	LDO, 2.2V±1.0%, 150mA, +CE	SNT-6A	35vr2	VR4	7g	Sii
L6I	S-1112B23PI	LVR-IC	LDO, 2.3V±1.0%, 150mA, +CE	SNT-6A	35vr2	VR4	7g	Sii
L6J	S-1112B24PI	LVR-IC	LDO, 2.4V±1.0%, 150mA, +CE	SNT-6A	35vr2	VR4	7g	Sii
L6K	S-1112B25PI	LVR-IC	LDO, 2.5V±1.0%, 150mA, +CE	SNT-6A	35vr2	VR4	7g	Sii
L6L	S-1112B26PI	LVR-IC	LDO, 2.6V±1.0%, 150mA, +CE	SNT-6A	35vr2	VR4	7g	Sii
L6M	S-1112B27PI	LVR-IC	LDO, 2.7V±1.0%, 150mA, +CE	SNT-6A	35vr2	VR4	7g	Sii
L6N	S-1112B28PI	LVR-IC	LDO, 2.8V±1.0%, 150mA, +CE	SNT-6A	35vr2	VR4	7g	Sii
L6O	S-1112B29PI	LVR-IC	LDO, 2.9V±1.0%, 150mA, +CE	SNT-6A	35vr2	VR4	7g	Sii
L6P	S-1112B30PI	LVR-IC	LDO, 3.0V±1.0%, 150mA, +CE	SNT-6A	35vr2	VR4	7g	Sii
L6Q	S-1112B31PI	LVR-IC	LDO, 3.1V±1.0%, 150mA, +CE	SNT-6A	35vr2	VR4	7g	Sii
L6R	S-1112B32PI	LVR-IC	LDO, 3.2V±1.0%, 150mA, +CE	SNT-6A	35vr2	VR4	7g	Sii
L6S	S-1112B33PI	LVR-IC	LDO, 3.3V±1.0%, 150mA, +CE	SNT-6A	35vr2	VR4	7g	Sii



SMD code	Type	Function	Short description	Case	Pinout	Sch.	St.	Mnf.
L6T	S-1112B34PI	LVR-IC	LDO, 3.4V±1.0%, 150mA, +CE	SNT-6A	35vr2	VR4	7g	Sii
L6U	S-1112B35PI	LVR-IC	LDO, 3.5V±1.0%, 150mA, +CE	SNT-6A	35vr2	VR4	7g	Sii
L6V	S-1112B36PI	LVR-IC	LDO, 3.6V±1.0%, 150mA, +CE	SNT-6A	35vr2	VR4	7g	Sii
L6W	S-1112B37PI	LVR-IC	LDO, 3.7V±1.0%, 150mA, +CE	SNT-6A	35vr2	VR4	7g	Sii
L6X	S-1112B38PI	LVR-IC	LDO, 3.8V±1.0%, 150mA, +CE	SNT-6A	35vr2	VR4	7g	Sii
L6Y	S-1112B39PI	LVR-IC	LDO, 3.9V±1.0%, 150mA, +CE	SNT-6A	35vr2	VR4	7g	Sii
L6Z	S-1112B40PI	LVR-IC	LDO, 4.0V±1.0%, 150mA, +CE	SNT-6A	35vr2	VR4	7g	Sii
L7	NL37WZ07US	CMOS-Logic	Triple noninverting buffers/drivers (ODO)	SOP-8	47Llog73	-	8a	Ons
L7	NLAS2066US	LIN-IC	Dual SPST analog switch, 1.65..5.5V, 15Q(3V)	US8	47	-	8b	Ons
L7	R1211D101C	DCDC-IC	PWM step-up, ULVO=2.2V, 300kHz	SON-6	34sf	DC15	7d	Ric
L74	HD74LV2G74AUS	CMOS-Logic	D-type flip-flop with preset and clear	SSOP-8	47Llog59	-	8c	Ren
L7A	S-1112B41PI	LVR-IC	LDO, 4.1V±1.0%, 150mA, +CE	SNT-6A	35vr2	VR4	7g	Sii
L7B	S-1112B42PI	LVR-IC	LDO, 4.2V±1.0%, 150mA, +CE	SNT-6A	35vr2	VR4	7g	Sii
L7C	S-1112B43PI	LVR-IC	LDO, 4.3V±1.0%, 150mA, +CE	SNT-6A	35vr2	VR4	7g	Sii
L7D	S-1112B44PI	LVR-IC	LDO, 4.4V±1.0%, 150mA, +CE	SNT-6A	35vr2	VR4	7g	Sii
L7E	S-1112B45PI	LVR-IC	LDO, 4.5V±1.0%, 150mA, +CE	SNT-6A	35vr2	VR4	7g	Sii
L7F	S-1112B46PI	LVR-IC	LDO, 4.6V±1.0%, 150mA, +CE	SNT-6A	35vr2	VR4	7g	Sii
L7G	S-1112B47PI	LVR-IC	LDO, 4.7V±1.0%, 150mA, +CE	SNT-6A	35vr2	VR4	7g	Sii
L7H	S-1112B48PI	LVR-IC	LDO, 4.8V±1.0%, 150mA, +CE	SNT-6A	35vr2	VR4	7g	Sii
L7I	S-1112B49PI	LVR-IC	LDO, 4.9V±1.0%, 150mA, +CE	SNT-6A	35vr2	VR4	7g	Sii
L7J	S-1112B50PI	LVR-IC	LDO, 5.0V±1.0%, 150mA, +CE	SNT-6A	35vr2	VR4	7g	Sii
L7K	S-1112B51PI	LVR-IC	LDO, 5.1V±1.0%, 150mA, +CE	SNT-6A	35vr2	VR4	7g	Sii
L7L	S-1112B52PI	LVR-IC	LDO, 5.2V±1.0%, 150mA, +CE	SNT-6A	35vr2	VR4	7g	Sii
L7M	S-1112B53PI	LVR-IC	LDO, 5.3V±1.0%, 150mA, +CE	SNT-6A	35vr2	VR4	7g	Sii
L7N	S-1112B54PI	LVR-IC	LDO, 5.4V±1.0%, 150mA, +CE	SNT-6A	35vr2	VR4	7g	Sii
L8	NL27WZ86US	CMOS-Logic	Dual 2-input EXCLUSIVE-OR gates	SOP-8	47Llog65	-	8a	Ons
L8	R1131D081B	LVR-IC	LDO, 0.8V±2%, 300mA, -CE	SON-6	34hq	VR4	7g	Ric
L8	R1211D102C	DCDC-IC	PWM step-up, ULVO=2.2V, 300kHz	SON-6	34sf	DC15	7d	Ric
L9	R1131D091B	LVR-IC	LDO, 0.9V±2%, 300mA, -CE	SON-6	34hq	VR4	7g	Ric
L9	R1211D103A	DCDC-IC	PWM step-up, ULVO=2.2V, 700kHz	SON-6	34sf	DC15	7d	Ric
La	AX6605ACA	LVR-IC	LDO, Dual out, Vout1/Vout2=1.5/2.8V±2%, 200mA, +CE	SOT-23-6	33rg	VR19	7p	Axl
LA	µPA605T	Si-pnp	Dual, 60V, 100mA, 180MHz	SOT-23-6	33T10	-	7b	Nec
LA	µPA671T	Si-pnp	Dual, 60V, 100mA, 180MHz	SOT-363	33T10	-	7b	Nec
LA	AX6604ACA	LVR-IC	LDO, Dual out, Vout1/Vout2=1.5/2.8V±2%, 200mA, +CE	SOT-23-6	33x5	VR19	7p	Axl
LA	KRC851F	Si-npn-Digi	Dual, Sw, 20V, 50mA, 50mW, R1/R2=4.7k/4.7k	TFS6	35/TD3	-	7b	Kec
LA	R1211D103C	DCDC-IC	PWM step-up, ULVO=2.2V, 300kHz	SON-6	34sf	DC15	7d	Ric
LA	RP154N001B	LVR-IC	LDO, Dual out, Vout1/Vout2=2.8V/2.8V±1%, 300mA, +CE	SOT-23-6	33x5	VR19	7d	Ric
Lb	AX6605BCA	LVR-IC	LDO, Dual out, Vout1/Vout2=1.8/2.6V±2%, 200mA, +CE	SOT-23-6	33rg	VR19	7p	Axl
LB	AX6604BCA	LVR-IC	LDO, Dual out, Vout1/Vout2=1.8/2.8V±2%, 200mA, +CE	SOT-23-6	33x5	VR19	7p	Axl
LB	KRC852F	Si-npn-Digi	Dual, Sw, 20V, 50mA, 50mW, R1/R2=10k/10k	TFS6	35/TD3	-	7b	Kec
LB	R1211D104A	DCDC-IC	PWM step-up, ULVO=2.2V, 700kHz	SON-6	34sf	DC15	7d	Ric
LB	RP154N002B	LVR-IC	LDO, Dual out, Vout1/Vout2=1.8V/2.8V±1%, 300mA, +CE	SOT-23-6	33x5	VR19	7d	Ric
Lc	AX6605CCA	LVR-IC	LDO, Dual out, Vout1/Vout2=1.8/2.6V±2%, 200mA, +CE	SOT-23-6	33rg	VR19	7p	Axl
LC	AX6604CCA	LVR-IC	LDO, Dual out, Vout1/Vout2=1.8/2.6V±2%, 200mA, +CE	SOT-23-6	33x5	VR19	7p	Axl
LC	KRC853F	Si-npn-Digi	Dual, Sw, 20V, 50mA, 50mW, R1/R2=22k/22k	TFS6	35/TD3	-	7b	Kec
LC	RP154N003B	LVR-IC	LDO, Dual out, Vout1/Vout2=1.5V/2.8V±1%, 300mA, +CE	SOT-23-6	33x5	VR19	7d	Ric
Ld	AX6605DCA	LVR-IC	LDO, Dual out, Vout1/Vout2=1.8/3.3V±2%, 200mA, +CE	SOT-23-6	33rg	VR19	7p	Axl
LD	AX6604DCA	LVR-IC	LDO, Dual out, Vout1/Vout2=1.8/3.3V±2%, 200mA, +CE	SOT-23-6	33x5	VR19	7p	Axl
LD	KRC854F	Si-npn-Digi	Dual, Sw, 20V, 50mA, 50mW, R1/R2=47k/47k	TFS6	35/TD3	-	7b	Kec
LD	RP154N004B	LVR-IC	LDO, Dual out, Vout1/Vout2=1.2V/1.8V±1%, 300mA, +CE	SOT-23-6	33x5	VR19	7d	Ric
Le	AX6605ECA	LVR-IC	LDO, Dual out, Vout1/Vout2=2.5/2.8V±2%, 200mA, +CE	SOT-23-6	33rg	VR19	7p	Axl
LE	AX6604ECA	LVR-IC	LDO, Dual out, Vout1/Vout2=2.5/2.8V±2%, 200mA, +CE	SOT-23-6	33x5	VR19	7p	Axl
LE	RP154N005B	LVR-IC	LDO, Dual out, Vout1/Vout2=3.3V/1.2V±1%, 300mA, +CE	SOT-23-6	33x5	VR19	7d	Ric
Lf	AX6605FCA	LVR-IC	LDO, Dual out, Vout1/Vout2=2.8/1.2V±2%, 200mA, +CE	SOT-23-6	33rg	VR19	7p	Axl
LF	AX6604FCA	LVR-IC	LDO, Dual out, Vout1/Vout2=2.8/1.2V±2%, 200mA, +CE	SOT-23-6	33x5	VR19	7p	Axl
LF	NL37WZ06US	CMOS-Logic	Triple inverters (ODO)	SOP-8	47Llog72	-	8a	Ons
LF	RP154N006B	LVR-IC	LDO, Dual out, Vout1/Vout2=3.3V/1.8V±1%, 300mA, +CE	SOT-23-6	33x5	VR19	7d	Ric
LFBB	MIC5211-1.8BM6	LVR-IC	LDO, Dual out, Vout1/Vout2=1.8V/1.8V±1.5%, 50mA, +CE	SOT-23-6	33yf	VR19	7b	Mcr
LEBB	MIC5211-1.8YM6	LVR-IC	LDO, Dual out, Vout1/Vout2=1.8V/1.8V±1.5%, 50mA, +CE	SOT-23-6	33yf	VR19	7b	Mcr
LFBC	MIC5211-1.8/2.5BM6	LVR-IC	LDO, Dual out, Vout1/Vout2=1.8V/2.5V±1.5%, 50mA, +CE	SOT-23-6	33yf	VR19	7b	Mcr
LFBC	MIC5211-1.8/2.5YM6	LVR-IC	LDO, Dual out, Vout1/Vout2=1.8V/2.5V±1.5%, 50mA, +CE	SOT-23-6	33yf	VR19	7b	Mcr
LFBL	MIC5211-1.8/3.3BM6	LVR-IC	LDO, Dual out, Vout1/Vout2=1.8V/3.3V±1.5%, 50mA, +CE	SOT-23-6	33yf	VR19	7b	Mcr
LEBL	MIC5211-1.8/3.3YM6	LVR-IC	LDO, Dual out, Vout1/Vout2=1.8V/3.3V±1.5%, 50mA, +CE	SOT-23-6	33yf	VR19	7b	Mcr
LFCC	MIC5211-2.5BM6	LVR-IC	LDO, Dual out, Vout1/Vout2=2.5V/2.5V±1.5%, 50mA, +CE	SOT-23-6	33yf	VR19	7b	Mcr
LFCC	MIC5211-2.5YM6	LVR-IC	LDO, Dual out, Vout1/Vout2=2.5V/2.5V±1.5%, 50mA, +CE	SOT-23-6	33yf	VR19	7b	Mcr
LFCL	MIC5211-2.5/3.3BM6	LVR-IC	LDO, Dual out, Vout1/Vout2=2.5V/3.3V±1.5%, 50mA, +CE	SOT-23-6	33yf	VR19	7b	Mcr
LECL	MIC5211-2.5/3.3YM6	LVR-IC	LDO, Dual out, Vout1/Vout2=2.5V/3.3V±1.5%, 50mA, +CE	SOT-23-6	33yf	VR19	7b	Mcr
LFDD	MIC5211-2.7BM6	LVR-IC	LDO, Dual out, Vout1/Vout2=2.7V/2.7V±1.5%, 50mA, +CE	SOT-23-6	33yf	VR19	7b	Mcr
LFDD	MIC5211-2.7YM6	LVR-IC	LDO, Dual out, Vout1/Vout2=2.7V/2.7V±1.5%, 50mA, +CE	SOT-23-6	33yf	VR19	7b	Mcr
LFEE	MIC5211-2.8BM6	LVR-IC	LDO, Dual out, Vout1/Vout2=2.8V/2.8V±1.5%, 50mA, +CE	SOT-23-6	33yf	VR19	7b	Mcr



SMD code	Type	Function	Short description	Case	Pinout	Sch.	St.	Mnf.
M094	R1190S094D	LVR-IC	9.4V±1.5%, 1A, +CE, CL	HSOP-6J	29zu	VR7	7h	Ric
M095	R1190S095D	LVR-IC	9.5V±1.5%, 1A, +CE, CL	HSOP-6J	29zu	VR7	7h	Ric
M096	R1190S096D	LVR-IC	9.6V±1.5%, 1A, +CE, CL	HSOP-6J	29zu	VR7	7h	Ric
M097	R1190S097D	LVR-IC	9.7V±1.5%, 1A, +CE, CL	HSOP-6J	29zu	VR7	7h	Ric
M098	R1190S098D	LVR-IC	9.8V±1.5%, 1A, +CE, CL	HSOP-6J	29zu	VR7	7h	Ric
M099	R1190S099D	LVR-IC	9.9V±1.5%, 1A, +CE, CL	HSOP-6J	29zu	VR7	7h	Ric
M1	NL27WZ126US	CMOS-Logic	Dual bus buffer with 3-state output	SOP-8	47L.og55	-	8a	Ons
M1	R1131D111B	LVR-IC	LDO, 1.1V±2%, 300mA, -CE	SON-6	34hq	VR4	7g	Ric
M1	R1151N002C	LVR-IC	Boost, +CE, 2V±2%, 150mA, Vdet ODO	SOT-23-6	33vre	-	7d	Ric
M100	R1190S100D	LVR-IC	10.0V±1.5%, 1A, +CE, CL	HSOP-6J	29zu	VR7	7h	Ric
M101	R1190S101D	LVR-IC	10.1V±1.5%, 1A, +CE, CL	HSOP-6J	29zu	VR7	7h	Ric
M102	R1190S102D	LVR-IC	10.2V±1.5%, 1A, +CE, CL	HSOP-6J	29zu	VR7	7h	Ric
M103	R1190S103D	LVR-IC	10.3V±1.5%, 1A, +CE, CL	HSOP-6J	29zu	VR7	7h	Ric
M104	R1190S104D	LVR-IC	10.4V±1.5%, 1A, +CE, CL	HSOP-6J	29zu	VR7	7h	Ric
M105	R1190S105D	LVR-IC	10.5V±1.5%, 1A, +CE, CL	HSOP-6J	29zu	VR7	7h	Ric
M106	R1190S106D	LVR-IC	10.6V±1.5%, 1A, +CE, CL	HSOP-6J	29zu	VR7	7h	Ric
M107	R1190S107D	LVR-IC	10.7V±1.5%, 1A, +CE, CL	HSOP-6J	29zu	VR7	7h	Ric
M108	R1190S108D	LVR-IC	10.8V±1.5%, 1A, +CE, CL	HSOP-6J	29zu	VR7	7h	Ric
M109	R1190S109D	LVR-IC	10.9V±1.5%, 1A, +CE, CL	HSOP-6J	29zu	VR7	7h	Ric
M110	R1190S110D	LVR-IC	11.0V±1.5%, 1A, +CE, CL	HSOP-6J	29zu	VR7	7h	Ric
M111	R1190S111D	LVR-IC	11.1V±1.5%, 1A, +CE, CL	HSOP-6J	29zu	VR7	7h	Ric
M112	R1190S112D	LVR-IC	11.2V±1.5%, 1A, +CE, CL	HSOP-6J	29zu	VR7	7h	Ric
M113	R1190S113D	LVR-IC	11.3V±1.5%, 1A, +CE, CL	HSOP-6J	29zu	VR7	7h	Ric
M114	R1190S114D	LVR-IC	11.4V±1.5%, 1A, +CE, CL	HSOP-6J	29zu	VR7	7h	Ric
M115	R1190S115D	LVR-IC	11.5V±1.5%, 1A, +CE, CL	HSOP-6J	29zu	VR7	7h	Ric
M116	R1190S116D	LVR-IC	11.6V±1.5%, 1A, +CE, CL	HSOP-6J	29zu	VR7	7h	Ric
M117	R1190S117D	LVR-IC	11.7V±1.5%, 1A, +CE, CL	HSOP-6J	29zu	VR7	7h	Ric
M118	R1190S118D	LVR-IC	11.8V±1.5%, 1A, +CE, CL	HSOP-6J	29zu	VR7	7h	Ric
M119	R1190S119D	LVR-IC	11.9V±1.5%, 1A, +CE, CL	HSOP-6J	29zu	VR7	7h	Ric
M120	R1190S120D	LVR-IC	12.0V±1.5%, 1A, +CE, CL	HSOP-6J	29zu	VR7	7h	Ric
M2	R1131D121B	LVR-IC	LDO, 1.2V±2%, 300mA, -CE	SON-6	34hq	VR4	7g	Ric
M2	R1151N003C	LVR-IC	Boost, +CE, 3V±2%, 150mA, Vdet ODO	SOT-23-6	33vre	-	7d	Ric
M2A	MA122	Si-diode	Quad, Fast, Sw, 80V, 100mA, Vf<1.2V(100mA), <10ns	SOT-23-6	33/D12	-	7b	X
M2C	MA124	Si-diode	Quad, Fast, Sw, 80V, 100mA, Vf<1.2V(100mA), <3ns	SOT-23-6	33bw	-	7b	X
M2D	MA121	Si-diode	Triple, Fast, Sw, 80V, 100mA, Vf<1.2V(100mA), <3ns	SOT-23-6	33bb	-	7b	X
M2D	MA6X121	Si-diode	Triple, Sw, 80V, 100mA, Vf<1.2V(100mA), <3ns	SOT-23-6	33bb	-	7b	Pan
M2K	MA351	C-diode	Triple, FM-AFC, 15V, 10/16pF(10V)	SOT-23-6	33bb	-	7b	Pan
M2L	MA6X078	Si-diode	Triple, Band-sw, 35V, 100mA, Vf=0.92V(100mA), 0.9pF	SOT-23-6	33bb	-	7b	Pan
M2L	MA78	Si-diode	Triple, Band-sw, 35V, 100mA, Vf=0.92V(100mA), 0.9pF	SOT-23-6	33bb	-	7b	Pan
M2T	MA556	PIN-diode	UHF/SHF-AGC, 40V, 100mA, Vf=1.05V(100mA), 0.3pF	SOT-23-6	33bb	-	7b	Pan
M2T	MA6X556	PIN-diode	UHF/SHF-AGC, 40V, 100mA, Vf=1.05V(100mA), 0.3pF	SOT-23-6	33bb	-	7b	Pan
M3	R1131D131B	LVR-IC	LDO, 1.3V±2%, 300mA, -CE	SON-6	34hq	VR4	7g	Ric
M3	R1151N004C	LVR-IC	Boost, +CE, 4V±2%, 150mA, Vdet ODO	SOT-23-6	33vre	-	7d	Ric
M4	MBD110DW	Si-diode	Dual, Schottky, UHFV/HF-Det, 7V, 120mW, <1pF	SOT-363	33de	-	7b	Ons
M4	R1131D141B	LVR-IC	LDO, 1.4V±2%, 300mA, -CE	SON-6	34hq	VR4	7g	Ric
M4	R1151N005C	LVR-IC	Boost, +CE, 5V±2%, 150mA, Vdet ODO	SOT-23-6	33vre	-	7d	Ric
MA4206N	ZDM4206N	n-MOSFET-e	V-MOS, Dual, 60V, 1A, 2.25W, 8.12ns, <Iq(1.5A)	SOP-8	47fo	-	8d	Zx
MA4306N	ZDM4306N	n-MOSFET-e	V-MOS, Dual, 60V, 2A, 2.5W, 8/30ns, <0.33Q(3A)	SOP-8	47fo	-	8d	Zx
M5	NL27WZ04DF	CMOS-Logic	Dual inverters	SC-70-6	33L.og24	-	7d	Ons
M5	NL27WZ04DT	CMOS-Logic	Dual inverters	SOT-23-6	33L.og24	-	7m	Ons
M5	R1131D151B	LVR-IC	LDO, 1.5V±2%, 300mA, -CE	SON-6	34hq	VR4	7g	Ric
M5	R1151N006C	LVR-IC	Boost, +CE, 6V±2%, 150mA, Vdet ODO	SOT-23-6	33vre	-	7d	Ric
M6	NL27WZU04DF	CMOS-Logic	Dual unbuffered inverters	SOT-363	33L.og24	-	7m	Ons
M6	NL27WZU04DT	CMOS-Logic	Dual unbuffered inverters	TSOP-6	33L.og24	-	7b	Ons
M6	R1131D161B	LVR-IC	LDO, 1.6V±2%, 300mA, -CE	SON-6	34hq	VR4	7g	Ric
M6	R1151N007C	LVR-IC	Boost, +CE, 7V±2%, 150mA, Vdet ODO	SOT-23-6	33vre	-	7d	Ric
M7	NL27WZ07DF	CMOS-Logic	Dual noninverting buffers/drivers (ODO)	SC-70-6	33L.og26	-	7m	Ons
M7	NL27WZ07DT	CMOS-Logic	Dual noninverting buffers/drivers (ODO)	SOT-23-6	33L.og26	-	7m	Ons
M7	R1131D171B	LVR-IC	LDO, 1.7V±2%, 300mA, -CE	SON-6	34hq	VR4	7g	Ric
M7	R1151N008C	LVR-IC	Boost, +CE, 8V±2%, 150mA, Vdet ODO	SOT-23-6	33vre	-	7d	Ric
M7A	MA6XD16	Si-diode	Quad, SBD, Sw, 30V, 30mA, Vf<1V(30mA), <1ns	SOT-23-6	33/D4	-	7b	Pan
M8	R1131D181B	LVR-IC	LDO, 1.8V±2%, 300mA, -CE	SON-6	34hq	VR4	7g	Ric
M8	R1151N009C	LVR-IC	Boost, +CE, 9V±2%, 150mA, Vdet ODO	SOT-23-6	33vre	-	7d	Ric
M9	R1131D191B	LVR-IC	LDO, 1.9V±2%, 300mA, -CE	SON-6	34hq	VR4	7g	Ric
M9	R1151N010C	LVR-IC	Boost, +CE, 10V±2%, 150mA, Vdet ODO	SOT-23-6	33vre	-	7d	Ric
MA	μPA672T	n-MOSFET-e*	Dual, V-MOS, 50V, 100mA, <20Q(10mA)	SOT-363	33fc	-	7b	Kec
MA	KRA721F	Si-pnp-Digi	Dual, Sw, 20V, 50mA, 50mW, R1/R2=4.7k/4.7k	TSF6	35/TD7	-	7b	NeC
MA	MBT3904DW	Si-npn	Dual, GP, 60V, 200mA, 150mW, B=100..300, >300MHz	SOT-363	33/T8	-	7b	Ons
MA	NL27WZ14DF	CMOS-Logic	Dual Schmitt-trigger inverter buffers	SC-70-6	33L.og34	-	7m	Ons
MA	NL27WZ14DT	CMOS-Logic	Dual Schmitt-trigger inverter buffers	SOT-23-6	33L.og34	-	7m	Ons



SMD code	Type	Function	Short description	Case	Pinout	Sch.	St.	Mnf.
MA	NL37WZ14US	CMOS-Logic	Triple Schmitt-trigger inverters	SOP-8	47/Log57	-	8a	Ons
MA	R1151N001B	LVR-IC	Boost, +CE, 1V±2%, 150mA, Vdet ODO	SOT-23-6	33vre	-	7d	Ric
MA	RP154N025B	LVR-IC	LDO, Dual out, Vout1/Vout2=3.0V/3.0V±1%, 300mA, +CE	SOT-23-6	33x5	VR19	7d	Ric
MAB	NCP2890DMR2	LIN-IC	AF PA, BTL, 2.2.5.5V, 1W(5V/8Q), shutdown	SSOP-8	47	AFP12	-	Ons
MAB	NCP2890DMR2G	LIN-IC	AF PA, 2.2.5.5V, 2x131mW(5V/16Q), shutdown	SSOP-8	47	AFP12	-	Ons
MAC	NCP2809BDMR2	LIN-IC	AF PA, 2.2.5.5V, 2x131mW(5V/16Q), shutdown	SSOP-10	60	AFP41	-	Ons
MAC	NCP2809BDMR2G	LIN-IC	AF PA, 2.2.5.5V, 2x131mW(5V/16Q), shutdown	SSOP-10	60	AFP41	-	Ons
MAE	NCP2809ADM2	LIN-IC	AF PA, 2.2.5.5V, 2x131mW(5V/16Q), shutdown	SSOP-10	60	AFP41	-	Ons
MAE	NCP2809ADM2G	LIN-IC	AF PA, 2.2.5.5V, 2x131mW(5V/16Q), shutdown	SSOP-10	60	AFP41	-	Ons
MAK	NCP4894DMR2	LIN-IC	AF PA, BTL, 2.2.5.5V, 1W(5V/8Q), shutdown	SSOP-10	60	AFP19	-	Ons
MB	KRA722F	Si-pnp-Digi	Dual, Sw, 20V, 50mA, 50mW, R1/R2=10k/10k	TFS6	35/TD7	-	7b	Kec
MB	RP154N026B	LVR-IC	LDO, Dual out, Vout1/Vout2=2.8V/3.1V±1%, 300mA, +CE	SOT-23-6	33x5	VR19	7d	Ric
MC	KRA723F	Si-pnp-Digi	Dual, Sw, 20V, 50mA, 50mW, R1/R2=22k/22k	TFS6	35/TD7	-	7b	Kec
MC	RP154N027B	LVR-IC	LDO, Dual out, Vout1/Vout2=2.3V/2.8V±1%, 300mA, +CE	SOT-23-6	33x5	VR19	7d	Ric
MD	DDZX9707TS	Z-diode	Triple, 20V±5%, 200mW	SOT-363	33ddd	-	7k	Di
MD	KRA724F	Si-pnp-Digi	Dual, Sw, 20V, 50mA, 50mW, R1/R2=47k/47k	TFS6	35/TD7	-	7b	Kec
MD	RP154N028B	LVR-IC	LDO, Dual out, Vout1/Vout2=2.8V/1.0V±1%, 300mA, +CE	SOT-23-6	33x5	VR19	7d	Ric
ME	DDZX9708TS	Z-diode	Triple, 22V±5%, 200mW	SOT-363	33ddd	-	7k	Di
ME	RP154N029B	LVR-IC	LDO, Dual out, Vout1/Vout2=1.5V/1.5V±1%, 300mA, +CE	SOT-23-6	33x5	VR19	7d	Ric
MF	DDZX9709TS	Z-diode	Triple, 24V±5%, 200mW	SOT-363	33ddd	-	7k	Di
MF	NL27WZ06DF	CMOS-Logic	Dual inverter buffers/drivers (ODO)	SC-70-6	33/Log25	-	7m	Ons
MF	NL27WZ06DT	CMOS-Logic	Dual inverter buffers/drivers (ODO)	SOT-23-6	33/Log25	-	7m	Ons
MF	RP154N030B	LVR-IC	LDO, Dual out, Vout1/Vout2=1.2V/2.9V±1%, 300mA, +CE	SOT-23-6	33x5	VR19	7d	Ric
MG	KRA727F	Si-pnp-Digi	Dual, Sw, 20V, 50mA, 50mW, R1/R2=10k/47k	TFS6	35/TD7	-	7b	Kec
MG	RP154N031B	LVR-IC	LDO, Dual out, Vout1/Vout2=2.65V/2.85V±1%, 300mA, +CE	SOT-23-6	33x5	VR19	7d	Ric
MH	DDZX9711TS	Z-diode	Triple, 27V±5%, 200mW	SOT-363	33ddd	-	7k	Di
MH	KRA728F	Si-pnp-Digi	Dual, Sw, 20V, 50mA, 50mW, R1/R2=22k/47k	TFS6	35/TD7	-	7b	Kec
MH	RP154N032B	LVR-IC	LDO, Dual out, Vout1/Vout2=3.3V/2.85V±1%, 300mA, +CE	SOT-23-6	33x5	VR19	7d	Ric
MI	NX3L1T3157GW	CMOS-Logic	Single-pole double-throw analog switch	SOT-363	33/Log38	-	7b	Phi
MJ	DDZX9712TS	Z-diode	Triple, 28V±5%, 200mW	SOT-363	33ddd	-	7k	Di
MJ	KRA729F	Si-pnp-Digi	Dual, Sw, 20V, 50mA, 50mW, R1/R2=47k/22k	TFS6	35/TD7	-	7b	Kec
MJ	NX3L1G3157GW	CMOS-Logic	Single-pole double-throw analog switch	SOT-363	33/Log38	-	7b	Phi
MJ	RP154N033B	LVR-IC	LDO, Dual out, Vout1/Vout2=1.8V/2.9V±1%, 300mA, +CE	SOT-23-6	33x5	VR19	7d	Ric
MK	DDZX9713TS	Z-diode	Triple, 30V±5%, 200mW	SOT-363	33ddd	-	7k	Di
MK	KRA730F	Si-pnp-Digi	Dual, Sw, 20V, 50mA, 50mW, R1=4.7k	TFS6	35/TD7	-	7b	Kec
MK	RP154N034B	LVR-IC	LDO, Dual out, Vout1/Vout2=3.1V/3.1V±1%, 300mA, +CE	SOT-23-6	33x5	VR19	7d	Ric
ML	DDZX9714TS	Z-diode	Triple, 33V±5%, 200mW	SOT-363	33ddd	-	7k	Di
ML	KRA731F	Si-pnp-Digi	Dual, Sw, 20V, 50mA, 50mW, R1=10k	TFS6	35/TD7	-	7b	Kec
ML	RP154N035B	LVR-IC	LDO, Dual out, Vout1/Vout2=2.8V/2.7V±1%, 300mA, +CE	SOT-23-6	33x5	VR19	7d	Ric
MM	DDZX9715TS	Z-diode	Triple, 36V±5%, 200mW	SOT-363	33ddd	-	7k	Di
MM	RP154N036B	LVR-IC	LDO, Dual out, Vout1/Vout2=1.0V/1.8V±1%, 300mA, +CE	SOT-23-6	33x5	VR19	7d	Ric
MN	DDZX9716TS	Z-diode	Triple, 39V±5%, 200mW	SOT-363	33ddd	-	7k	Di
MN	KRA733F	Si-pnp-Digi	Dual, Sw, 20V, 50mA, 50mW, R1=22k	TFS6	35/TD7	-	7b	Kec
MP	KRA734F	Si-pnp-Digi	Dual, Sw, 20V, 50mA, 50mW, R1=47k	TFS6	35/TD7	-	7b	Kec
MQB	KRC881T	Si-npn-Digi	Dual, Sw, 20V, 300mA, 900mW, R1=2.2k	TS6	33/TD3	-	7k	Kec
MR	NL27WZ16DF	CMOS-Logic	Dual non-inverter buffers	SC-70-6	33/Log23	-	7d	Ons
MR	NL27WZ16DT	CMOS-Logic	Dual non-inverter buffers	SOT-23-6	33/Log23	-	7m	Ons
MRB	KRC882T	Si-npn-Digi	Dual, Sw, 20V, 300mA, 900mW, R1=4.7k	TS6	33/TD3	-	7k	Kec
MSB	KRC883T	Si-npn-Digi	Dual, Sw, 20V, 300mA, 900mW, R1=5.6k	TS6	33/TD3	-	7k	Kec
MTB	KRC884T	Si-npn-Digi	Dual, Sw, 20V, 300mA, 900mW, R1=6.8k	TS6	33/TD3	-	7k	Kec
MUB	KRC885T	Si-npn-Digi	Dual, Sw, 20V, 300mA, 900mW, R1=10k	TS6	33/TD3	-	7k	Kec
MVB	KRC886T	Si-npn-Digi	Dual, Sw, 20V, 300mA, 900mW, R1=22k	TS6	33/TD3	-	7k	Kec
N	HSMS-280N	Si-diode	4x Schottky, RF, 70V, 1A, Vf<0.41V(1mA), <2pF, 35Q(5mA)	SOT-363	33dx	-	7b	Agil
N0	R1131D201B	LVR-IC	LDO, 2V±2%, 300mA, -CE	SOM-6	34hq	VR4	7g	Ric
N0	R5323N001B	LVR-IC	LDO, Dual out, Vout1/Vout2=2.8V/2.8V±1%, 150mA, +CE, CL	SOT-23-6	33rg	VR19	7d	Ric
N06	DDC123JH	Si-npn-Digi	Dual, Sw, 50V, 100mA, 150mW, R1/R2=2.2/47k	SOT-563	35/TD3	-	7k	Di
N06	DDC123JK	Si-npn-Digi	Dual, Sw, 50V, 100mA, 200mW, R1/R2=2k2/47k	SC-74R	33/TD3	-	7k	Di
N06	DDC123JU	Si-npn-Digi	Dual, Sw, 50V, 100mA, 200mW, R1/R2=2k2/47k	SOT-363	33/TD3	-	7k	Di
N07	DDC143TH	Si-npn-Digi	Dual, Sw, 50V, 100mA, 150mW, 250MHz, R1=4.7k	SOT-563	35/TD3	-	7k	Di
N07	DDC143TK	Si-npn-Digi	Dual, Sw, 50V, 100mA, 200mW, R1=4k7	SC-74R	33/TD3	-	7k	Di
N07	DDC143TU	Si-npn-Digi	Dual, Sw, 50V, 100mA, 200mW, R1=4k7	SOT-363	33/TD3	-	7k	Di
N08	DDC143EH	Si-npn-Digi	Dual, Sw, 50V, 100mA, 150mW, R1/R2=4.7/4.7k	SOT-563	35/TD3	-	7k	Di
N1	R1131D211B	LVR-IC	LDO, 2.1V±2%, 300mA, -CE	SOM-6	34hq	VR4	7g	Ric
N1	R5323N002B	LVR-IC	LDO, Dual out, Vout1/Vout2=2.9V/2.9V±1%, 150mA, +CE, CL	SOT-23-6	33rg	VR19	7d	Ric
N12	DDC114TH	Si-npn-Digi	Dual, Sw, 50V, 100mA, 150mW, R1=10k	SOT-563	35/TD3	-	7k	Di
N12	DDC114TK	Si-npn-Digi	Dual, Sw, 50V, 100mA, 200mW, R1=10k	SC-74R	33/TD3	-	7k	Di
N12	DDC114TU	Si-npn-Digi	Dual, Sw, 50V, 100mA, 200mW, R1=10k	SOT-363	33/TD3	-	7k	Di
N13	DDC114EH	Si-npn-Digi	Dual, Sw, 50V, 100mA, 150mW, R1/R2=10/10k	SOT-563	35/TD3	-	7k	Di
N13	DDC114EK	Si-npn-Digi	Dual, Sw, 50V, 100mA, 200mW, R1/R2=10k/10k	SC-74R	33/TD3	-	7k	Di
N13	DDC114EU	Si-npn-Digi	Dual, Sw, 50V, 100mA, 200mW, R1/R2=10k/10k	SOT-363	33/TD3	-	7k	Di



SMD code	Type	Function	Short description	Case	Pinout	Sch.	St.	Mnf.
N14	DDC114YH	Si-npn-Digi	Dual, Sw, 50V, 100mA, 150mW, R1/R2=10/47k	SOT-563	35/TD3	-	7k	Di
N14	DDC114YK	Si-npn-Digi	Dual, Sw, 50V, 100mA, 200mW, R1/R2=10k/47k	SC-74R	33/TD3	-	7k	Di
N14	DDC114YU	Si-npn-Digi	Dual, Sw, 50V, 100mA, 200mW, R1/R2=10k/47k	SOT-363	33/TD3	-	7k	Di
N15D	ZXT13N15DE6TA	Si-npn	Lo-sat, Sw, 40V, 5A, 1.1W, B=250..900, 72MHz	SOT-23-6	33/4	-	7b	Zx
N17	DDC124EH	Si-npn-Digi	Dual, Sw, 50V, 100mA, 150mW, R1/R2=22/22k	SOT-563	35/TD3	-	7k	Di
N17	DDC124EK	Si-npn-Digi	Dual, Sw, 50V, 100mA, 200mW, R1/R2=22k/22k	SC-74R	33/TD3	-	7l	Di
N17	DDC124EU	Si-npn-Digi	Dual, Sw, 50V, 100mA, 200mW, R1/R2=22k/22k	SOT-363	33/TD3	-	7l	Di
N2	1PS66SB17	Si-diode	Triple, Schottky, Sw, 4V, 30mA, Vf<0.6V(10mA), <0.65pF	SOT-666	35dd	-	7b	Phi
N2	BC807DS	Si-npn	Dual, GP, 50V, 500mA, 370mW, B=160..400, 80MHz	SOT457	33/T10	-	7b	Phi
N2	KRC866E	Si-npn-Digi	Dual, Sw, 50V, 100mA, 200mW, R1/R2=1k/10k	TE56	35/TD3	-	7k	Kec
N2	KRC866U	Si-npn-Digi	Dual, Sw, 50V, 100mA, 200mW, R1/R2=1k/10k	US6	33/TD8	-	7k	Kec
N2	R1131D221B	LVR-IC	LDO, 2.2V±2%, 300mA, -CE	SOM-6	34hq VR4	VR4	7g	Ric
N2	R5323N003B	LVR-IC	LDO, Dual out, Vout1/Vout2=3V/3V±1%, 150mA, +CE, CL	SOT-23-6	33rg	VR19	7d	Ric
N20	DDC144EH	Si-npn-Digi	Dual, Sw, 50V, 100mA, 150mW, R1/R2=47/47k	SOT-563	35/TD3	-	7k	Di
N20	DDC144EK	Si-npn-Digi	Dual, Sw, 50V, 100mA, 200mW, R1/R2=47k/47k	SC-74R	33/TD3	-	7k	Di
N20	DDC144EU	Si-npn-Digi	Dual, Sw, 50V, 100mA, 200mW, R1/R2=47k/47k	SOT-363	33/TD3	-	7k	Di
N20D	ZXT13N20DE6E	Si-npn	Lo-sat, Sw, 50V, 4.5A, 96MHz	SOT-363	33/4	-	7b	Zx
N2211	NCS2211D	LIN-IC	AF PA, BTL 2.7..5.5V, 1.5W(5V/4Q), shutdown	SOP-8	47	AFP11	-	Ons
N3	1PS66SB62	Si-diode	Triple, Schottky, Sw, 40V, 20mA, Vf<0.8V(2mA), <0.6pF	SOT-666	35dd	-	7b	Phi
N3	BC817DS	Si-npn	Dual, GP, 50V, 500mA, 370mW, B=160..400, 100MHz	SOT457	33/T8	-	7b	Phi
N3	R1131D231B	LVR-IC	LDO, 2.3V±2%, 300mA, -CE	SOM-6	34hq VR4	VR4	7g	Ric
N3	R5323N004B	LVR-IC	LDO, Dual out, Vout1/Vout2=1.8V/1.8V±1%, 150mA, +CE, CL	SOT-23-6	33rg	VR19	7d	Ric
N4	1PS66SB63	Si-diode	Triple, Schottky, Sw, 5V, 20mA, Vf<0.3V(1mA), <0.5pF	SOT-666	35dd	-	7b	Phi
N4	BC817DPN	Si-npn	Dual, GP, 50V, 500mA, 370mW, B=160..400, 100MHz	SOT457	33/T9	-	7b	Phi
N4	KRC867E	Si-npn-Digi	Dual, Sw, 50V, 100mA, 200mW, R1/R2=2.2k/2.2k	TE56	35/TD3	-	7k	Kec
N4	KRC867U	Si-npn-Digi	Dual, Sw, 50V, 100mA, 200mW, R1/R2=2.2k/2.2k	US6	33/TD8	-	7k	Kec
N4	R1131D241B	LVR-IC	LDO, 2.4V±2%, 300mA, -CE	SOM-6	34hq VR4	VR4	7g	Ric
N4	R5323N005B	LVR-IC	LDO, Dual out, Vout1/Vout2=2.7V/2.7V±1%, 150mA, +CE, CL	SOT-23-6	33rg	VR19	7d	Ric
N4A	S-1131B15PD	LVR-IC	LDO, 1.5V±1%, 300mA, +CE	HSON-6	34va VR4	VR4	7b	Sii
N4B	S-1131B16PD	LVR-IC	LDO, 1.6V±1%, 300mA, +CE	HSON-6	34va VR4	VR4	7b	Sii
N4C	S-1131B17PD	LVR-IC	LDO, 1.7V±1%, 300mA, +CE	HSON-6	34va VR4	VR4	7b	Sii
N4D	S-1131B18PD	LVR-IC	LDO, 1.8V±1%, 300mA, +CE	HSON-6	34va VR4	VR4	7b	Sii
N4E	S-1131B19PD	LVR-IC	LDO, 1.9V±1%, 300mA, +CE	HSON-6	34va VR4	VR4	7b	Sii
N4F	S-1131B20PD	LVR-IC	LDO, 2.0V±1%, 300mA, +CE	HSON-6	34va VR4	VR4	7b	Sii
N4G	S-1131B21PD	LVR-IC	LDO, 2.1V±1%, 300mA, +CE	HSON-6	34va VR4	VR4	7b	Sii
N4H	S-1131B22PD	LVR-IC	LDO, 2.2V±1%, 300mA, +CE	HSON-6	34va VR4	VR4	7b	Sii
N4I	S-1131B23PD	LVR-IC	LDO, 2.3V±1%, 300mA, +CE	HSON-6	34va VR4	VR4	7b	Sii
N4J	S-1131B24PD	LVR-IC	LDO, 2.4V±1%, 300mA, +CE	HSON-6	34va VR4	VR4	7b	Sii
N4K	S-1131B25PD	LVR-IC	LDO, 2.5V±1%, 300mA, +CE	HSON-6	34va VR4	VR4	7b	Sii
N4L	S-1131B26PD	LVR-IC	LDO, 2.6V±1%, 300mA, +CE	HSON-6	34va VR4	VR4	7b	Sii
N4M	S-1131B27PD	LVR-IC	LDO, 2.7V±1%, 300mA, +CE	HSON-6	34va VR4	VR4	7b	Sii
N4N	S-1131B28PD	LVR-IC	LDO, 2.8V±1%, 300mA, +CE	HSON-6	34va VR4	VR4	7b	Sii
N4O	S-1131B29PD	LVR-IC	LDO, 2.9V±1%, 300mA, +CE	HSON-6	34va VR4	VR4	7b	Sii
N4P	S-1131B30PD	LVR-IC	LDO, 3.0V±1%, 300mA, +CE	HSON-6	34va VR4	VR4	7b	Sii
N4Q	S-1131B31PD	LVR-IC	LDO, 3.1V±1%, 300mA, +CE	HSON-6	34va VR4	VR4	7b	Sii
N4R	S-1131B32PD	LVR-IC	LDO, 3.2V±1%, 300mA, +CE	HSON-6	34va VR4	VR4	7b	Sii
N4S	S-1131B33PD	LVR-IC	LDO, 3.3V±1%, 300mA, +CE	HSON-6	34va VR4	VR4	7b	Sii
N4T	S-1131B34PD	LVR-IC	LDO, 3.4V±1%, 300mA, +CE	HSON-6	34va VR4	VR4	7b	Sii
N4U	S-1131B35PD	LVR-IC	LDO, 3.5V±1%, 300mA, +CE	HSON-6	34va VR4	VR4	7b	Sii
N4V	S-1131B36PD	LVR-IC	LDO, 3.6V±1%, 300mA, +CE	HSON-6	34va VR4	VR4	7b	Sii
N4W	S-1131B37PD	LVR-IC	LDO, 3.7V±1%, 300mA, +CE	HSON-6	34va VR4	VR4	7b	Sii
N4X	S-1131B38PD	LVR-IC	LDO, 3.8V±1%, 300mA, +CE	HSON-6	34va VR4	VR4	7b	Sii
N4Y	S-1131B39PD	LVR-IC	LDO, 3.9V±1%, 300mA, +CE	HSON-6	34va VR4	VR4	7b	Sii
N4Z	S-1131B40PD	LVR-IC	LDO, 4.0V±1%, 300mA, +CE	HSON-6	34va VR4	VR4	7b	Sii
N5	1PS66SB82	Si-diode	Triple, Schottky, Sw, 15V, 30mA, Vf<0.7V(30mA), <1pF	SOT-666	35dd	-	7b	Phi
N5	KRC868E	Si-npn-Digi	Dual, Sw, 50V, 100mA, 200mW, R1/R2=2.2k/10k	TE56	35/TD3	-	7k	Kec
N5	KRC868U	Si-npn-Digi	Dual, Sw, 50V, 100mA, 200mW, R1/R2=2.2k/10k	US6	33/TD8	-	7k	Kec
N5	R1131D251B	LVR-IC	LDO, 2.5V±2%, 300mA, -CE	SOM-6	34hq VR4	VR4	7g	Ric
N5	R5323N006B	LVR-IC	LDO, Dual out, Vout1/Vout2=2.5V/2.5V±1%, 150mA, +CE, CL	SOT-23-6	33rg	VR19	7d	Ric
N50D	ZXT13N50DE6	Si-npn	Lo-sat, Sw, 100V, 4A, 115MHz	SOT-363	33/4	-	7b	Zx
N5A	S-1131B41PD	LVR-IC	LDO, 4.1V±1%, 300mA, +CE	HSON-6	34va VR4	VR4	7b	Sii
N5B	S-1131B42PD	LVR-IC	LDO, 4.2V±1%, 300mA, +CE	HSON-6	34va VR4	VR4	7b	Sii
N5C	S-1131B43PD	LVR-IC	LDO, 4.3V±1%, 300mA, +CE	HSON-6	34va VR4	VR4	7b	Sii
N5D	S-1131B44PD	LVR-IC	LDO, 4.4V±1%, 300mA, +CE	HSON-6	34va VR4	VR4	7b	Sii
N5E	S-1131B45PD	LVR-IC	LDO, 4.5V±1%, 300mA, +CE	HSON-6	34va VR4	VR4	7b	Sii
N5F	S-1131B46PD	LVR-IC	LDO, 4.6V±1%, 300mA, +CE	HSON-6	34va VR4	VR4	7b	Sii
N5G	S-1131B47PD	LVR-IC	LDO, 4.7V±1%, 300mA, +CE	HSON-6	34va VR4	VR4	7b	Sii
N5H	S-1131B48PD	LVR-IC	LDO, 4.8V±1%, 300mA, +CE	HSON-6	34va VR4	VR4	7b	Sii
N5I	S-1131B49PD	LVR-IC	LDO, 4.9V±1%, 300mA, +CE	HSON-6	34va VR4	VR4	7b	Sii
N5J	S-1131B50PD	LVR-IC	LDO, 5.0V±1%, 300mA, +CE	HSON-6	34va VR4	VR4	7b	Sii



SMD code	Type	Function	Short description	Case	Pinout	Sch.	St.	Mnf.
N5K	S-1131B51PD	LVR-IC	LDO, 5.1V±1%, 300mA, +CE	HS0N-6	34va	VR4	7b	Sii
N5L	S-1131B52PD	LVR-IC	LDO, 5.2V±1%, 300mA, +CE	HS0N-6	34va	VR4	7b	Sii
N5M	S-1131B53PD	LVR-IC	LDO, 5.3V±1%, 300mA, +CE	HS0N-6	34va	VR4	7b	Sii
N5N	S-1131B54PD	LVR-IC	LDO, 5.4V±1%, 300mA, +CE	HS0N-6	34va	VR4	7b	Sii
N5O	S-1131B55PD	LVR-IC	LDO, 5.5V±1%, 300mA, +CE	HS0N-6	34va	VR4	7b	Sii
N6	KRC869E	Si-npn-Digi	Dual, Sw, 50V, 100mA, 200mW, R1/R2=4.7k/10k	TES6	35/TD3	-	7k	Kec
N6	KRC869U	Si-npn-Digi	Dual, Sw, 50V, 100mA, 200mW, R1/R2=4.7k/10k	US6	33/TD8	-	7k	Kec
N6	R1131D261B	LVR-IC	LDO, 2.6V±2%, 300mA, -CE	SON-6	34qh	VR4	7g	Ric
N6	R5323N007B	LVR-IC	LDO, Dual out, Vout1/Vout2=1.5V/1.5V±1%, 150mA, +CE, CL	SOT-23-6	33rg	VR19	7d	Ric
N7	KRC870E	Si-npn-Digi	Dual, Sw, 50V, 100mA, 200mW, R1/R2=10k/4.7k	TES6	35/TD3	-	7k	Kec
N7	KRC870U	Si-npn-Digi	Dual, Sw, 50V, 100mA, 200mW, R1/R2=10k/4.7k	US6	33/TD8	-	7k	Kec
N7	R1131D271B	LVR-IC	LDO, 2.7V±2%, 300mA, -CE	SOM-6	34qh	VR4	7g	Ric
N7	R5323N008B	LVR-IC	LDO, Dual out, Vout1/Vout2=2.8V/4V±1%, 150mA, +CE, CL	SOT-23-6	33rg	VR19	7d	Ric
N8	KRC871E	Si-npn-Digi	Dual, Sw, 50V, 100mA, 200mW, R1/R2=47k/10k	TES6	35/TD3	-	7k	Kec
N8	KRC871U	Si-npn-Digi	Dual, Sw, 50V, 100mA, 200mW, R1/R2=47k/10k	US6	33/TD8	-	7k	Kec
N8	R1131D281B	LVR-IC	LDO, 2.8V±2%, 300mA, -CE	SON-6	34qh	VR4	7g	Ric
N8	R5323N009B	LVR-IC	LDO, Dual out, Vout1/Vout2=2.5V/2.7V±1%, 150mA, +CE, CL	SOT-23-6	33rg	VR19	7d	Ric
N81	DDC122LH	Si-npn-Digi	Dual, Sw, 50V, 100mA, 150mW, R1/R2=0.22k/10k	SOT-563	35/TD3	-	7k	Di
N82	DDC142JH	Si-npn-Digi	Dual, Sw, 50V, 100mA, 150mW, R1/R2=0.47k/10k	SOT-563	35/TD3	-	7k	Di
N83	DDC122TH	Si-npn-Digi	Dual, Sw, 50V, 100mA, 150mW, R1=0.22k	SOT-563	35/TD3	-	7k	Di
N84	DDC142TH	Si-npn-Digi	Dual, Sw, 50V, 100mA, 150mW, R1=0.47k	SOT-563	35/TD3	-	7k	Di
N9	KRC872E	Si-npn-Digi	Dual, Sw, 50V, 100mA, 200mW, R1/R2=100k/100k	TES6	35/TD3	-	7k	Kec
N9	KRC872U	Si-npn-Digi	Dual, Sw, 50V, 100mA, 200mW, R1/R2=100k/100k	US6	33/TD8	-	7k	Kec
N9	R1131D291B	LVR-IC	LDO, 2.9V±2%, 300mA, -CE	SON-6	34qh	VR4	7g	Ric
N9	R5323N002A	LVR-IC	LDO, Dual out, Vout1/Vout2=2.9V/2.9V±1%, 150mA, +CE	SOT-23-6	33rg	VR19	7d	Ric
NA	EUP7201-1.8/2.8V	LVR-IC	LDO, Dual out, Vout1/Vout2=1.8V/2.8V±2%, 150mA, +CE	SOT23-6	33x5	VR19	7b	Eut
NA	KRC821F	Si-npn-Digi	Dual, Sw, 20V, 50mA, 50mW, R1/R2=4.7k/4.7k	TF56	35/TD8	-	7b	Kec
NA	KRC841T	Si-npn-Digi	Dual, Sw, 50V, 800mA, 900mW, R1/R2=1k/1k	TS6	33/TD3	-	7k	Kec
NA	KRC851E	Si-npn-Digi	Dual, Sw, 50V, 100mA, 200mW, R1/R2=4.7k/4.7k	TES6	35/TD3	-	7k	Kec
NA	KRC851U	Si-npn-Digi	Dual, Sw, 50V, 100mA, 200mW, R1/R2=4.7k/4.7k	US6	33/TD8	-	7k	Kec
NA	R5323N003A	LVR-IC	LDO, Dual out, Vout1/Vout2=3V/3V±1%, 150mA, +CE	SOT-23-6	33rg	VR19	7d	Ric
NB	KRC822F	Si-npn-Digi	Dual, Sw, 20V, 50mA, 50mW, R1/R2=10k/10k	TF56	35/TD8	-	7b	Kec
NB	KRC842T	Si-npn-Digi	Dual, Sw, 50V, 800mA, 900mW, R1/R2=2.2k/2.2k	TS6	33/TD3	-	7k	Kec
NB	KRC852E	Si-npn-Digi	Dual, Sw, 50V, 100mA, 200mW, R1/R2=10k/10k	TES6	35/TD3	-	7k	Kec
NB	KRC852U	Si-npn-Digi	Dual, Sw, 50V, 100mA, 200mW, R1/R2=10k/10k	US6	33/TD8	-	7k	Kec
NB	R5323N010B	LVR-IC	LDO, Dual out, Vout1/Vout2=2.6V/2.6V±1%, 150mA, +CE, CL	SOT-23-6	33rg	VR19	7d	Ric
NC	EUP7201-1.5/2.8V	LVR-IC	LDO, Dual out, Vout1/Vout2=1.5V/2.8V±2%, 150mA, +CE	SOT23-6	33x5	VR19	7b	Eut
NC	KRC823F	Si-npn-Digi	Dual, Sw, 20V, 50mA, 50mW, R1/R2=22k/22k	TF56	35/TD8	-	7b	Kec
NC	KRC843T	Si-npn-Digi	Dual, Sw, 50V, 800mA, 900mW, R1/R2=4.7k/4.7k	TS6	33/TD3	-	7k	Kec
NC	KRC853E	Si-npn-Digi	Dual, Sw, 50V, 100mA, 200mW, R1/R2=22k/22k	TES6	35/TD3	-	7k	Kec
NC	KRC853U	Si-npn-Digi	Dual, Sw, 50V, 100mA, 200mW, R1/R2=22k/22k	US6	33/TD8	-	7k	Kec
NC	R5323N013A	LVR-IC	LDO, Dual out, Vout1/Vout2=1.8V/3.3V±1%, 150mA, +CE	SOT-23-6	33rg	VR19	7d	Ric
ND	EUP7201-2.5/2.8V	LVR-IC	LDO, Dual out, Vout1/Vout2=2.5V/2.8V±2%, 150mA, +CE	SOT23-6	33x5	VR19	7b	Eut
ND	KRC824F	Si-npn-Digi	Dual, Sw, 20V, 50mA, 50mW, R1/R2=47k/47k	TF56	35/TD8	-	7b	Kec
ND	KRC844T	Si-npn-Digi	Dual, Sw, 50V, 800mA, 900mW, R1/R2=10k/10k	TS6	33/TD3	-	7k	Kec
ND	KRC854E	Si-npn-Digi	Dual, Sw, 50V, 100mA, 200mW, R1/R2=47k/47k	TES6	35/TD3	-	7k	Kec
ND	KRC854U	Si-npn-Digi	Dual, Sw, 50V, 100mA, 200mW, R1/R2=47k/47k	US6	33/TD8	-	7k	Kec
ND	R5323N014B	LVR-IC	LDO, Dual out, Vout1/Vout2=2.8V/2.9V±1%, 150mA, +CE, CL	SOT-23-6	33rg	VR19	7d	Ric
NE	KRC845T	Si-npn-Digi	Dual, Sw, 50V, 800mA, 900mW, R1/R2=1k/10k	TS6	33/TD3	-	7k	Kec
NE	KRC855E	Si-npn-Digi	Dual, Sw, 50V, 100mA, 200mW, R1/R2=2.2k/47k	TES6	35/TD3	-	7k	Kec
NE	KRC855U	Si-npn-Digi	Dual, Sw, 50V, 100mA, 200mW, R1/R2=2.2k/47k	US6	33/TD8	-	7k	Kec
NE	R5323N015B	LVR-IC	LDO, Dual out, Vout1/Vout2=1.5V/3.3V±1%, 150mA, +CE, CL	SOT-23-6	33rg	VR19	7d	Ric
NF	KRC846T	Si-npn-Digi	Dual, Sw, 50V, 800mA, 900mW, R1/R2=2.2k/10k	TS6	33/TD3	-	7k	Kec
NF	KRC856E	Si-npn-Digi	Dual, Sw, 50V, 100mA, 200mW, R1/R2=4.7k/47k	TES6	35/TD3	-	7k	Kec
NF	KRC856U	Si-npn-Digi	Dual, Sw, 50V, 100mA, 200mW, R1/R2=4.7k/47k	US6	33/TD8	-	7k	Kec
NF	R5323N016B	LVR-IC	LDO, Dual out, Vout1/Vout2=1.5V/2.8V±1%, 150mA, +CE, CL	SOT-23-6	33rg	VR19	7d	Ric
NG	KRC827F	Si-npn-Digi	Dual, Sw, 20V, 50mA, 50mW, R1/R2=10k/47k	TF56	35/TD8	-	7b	Kec
NG	R5323N017B	LVR-IC	LDO, Dual out, Vout1/Vout2=1.5V/2.5V±1%, 150mA, +CE, CL	SOT-23-6	33rg	VR19	7d	Ric
NH	EUP7201-1.8/3.3V	LVR-IC	LDO, Dual out, Vout1/Vout2=1.8V/3.3V±2%, 150mA, +CE	SOT23-6	33x5	VR19	7b	Eut
NH	KRC828F	Si-npn-Digi	Dual, Sw, 20V, 50mA, 50mW, R1/R2=22k/47k	TF56	35/TD8	-	7b	Kec
NH	KRC857E	Si-npn-Digi	Dual, Sw, 50V, 100mA, 200mW, R1/R2=10k/47k	TES6	35/TD3	-	7k	Kec
NH	KRC857U	Si-npn-Digi	Dual, Sw, 50V, 100mA, 200mW, R1/R2=10k/47k	US6	33/TD8	-	7k	Kec
NH	R5323N018B	LVR-IC	LDO, Dual out, Vout1/Vout2=3.2V/3V±1%, 150mA, +CE, CL	SOT-23-6	33rg	VR19	7d	Ric
NI	KRC858E	Si-npn-Digi	Dual, Sw, 50V, 100mA, 200mW, R1/R2=22k/47k	TES6	35/TD3	-	7k	Kec
NI	KRC858U	Si-npn-Digi	Dual, Sw, 50V, 100mA, 200mW, R1/R2=22k/47k	US6	33/TD8	-	7k	Kec
NJ	EUP7201-3.3/3.3V	LVR-IC	LDO, Dual out, Vout1/Vout2=3.3V/3.3V±2%, 150mA, +CE	SOT23-6	33x5	VR19	7b	Eut
NJ	KRC829F	Si-npn-Digi	Dual, Sw, 20V, 50mA, 50mW, R1/R2=47k/22k	TF56	35/TD8	-	7b	Kec
NJ	KRC859E	Si-npn-Digi	Dual, Sw, 50V, 100mA, 200mW, R1/R2=47k/22k	TES6	35/TD3	-	7k	Kec
NJ	KRC859U	Si-npn-Digi	Dual, Sw, 50V, 100mA, 200mW, R1/R2=47k/22k	US6	33/TD8	-	7k	Kec
NJ	R5323N019A	LVR-IC	LDO, Dual out, Vout1/Vout2=2.8V/3V±1%, 150mA, +CE	SOT-23-6	33rg	VR19	7d	Ric



SMD code	Type	Function	Short description	Case	Pinout	Sch.	St.	Mnf.
NK	EUP7201-2.8/3.0V	LVR-IC	LDO, Dual out, Vout1/Vout2=2.8V/3.0V±2%, 150mA, +CE	SOT23-6	33x5	VR19	7b	Eut
NK	KRC830F	Si-npn-Digi	Dual, Sw, 20V, 50mA, 50mW, R1=4.7k	TFS6	35/TD8	-	7b	Kec
NK	KRC860E	Si-npn-Digi	Dual, Sw, 50V, 100mA, 200mW, R1=4.7k	TES6	35/TD3	-	7k	Kec
NK	KRC860U	Si-npn-Digi	Dual, Sw, 50V, 100mA, 200mW, R1=4.7k	US6	33/TD8	-	7k	Kec
NK	R5323N019B	LVR-IC	LDO, Dual out, Vout1/Vout2=2.8V/3V±1%, 150mA, +CE, CL	SOT-23-6	33rg	VR19	7d	Ric
NL	EUP7201-2.8/3.3V	LVR-IC	LDO, Dual out, Vout1/Vout2=2.8V/3.3V±2%, 150mA, +CE	SOT23-6	33x5	VR19	7b	Eut
NL	KRC831F	Si-npn-Digi	Dual, Sw, 20V, 50mA, 50mW, R1=10k	TFS6	35/TD8	-	7b	Kec
NL	R5323N020A	LVR-IC	LDO, Dual out, Vout1/Vout2=1.5V/2.9V±1%, 150mA, +CE	SOT-23-6	33rg	VR19	7d	Ric
NM	EUP7201-2.8/2.8V	LVR-IC	LDO, Dual out, Vout1/Vout2=2.8V/2.8V±2%, 150mA, +CE	SOT23-6	33x5	VR19	7b	Eut
NM	KRC861E	Si-npn-Digi	Dual, Sw, 50V, 100mA, 200mW, R1=10k	TES6	35/TD3	-	7k	Kec
NM	KRC861U	Si-npn-Digi	Dual, Sw, 50V, 100mA, 200mW, R1=10k	US6	33/TD8	-	7k	Kec
NM	R5323N020B	LVR-IC	LDO, Dual out, Vout1/Vout2=1.5V/2.9V±1%, 150mA, +CE, CL	SOT-23-6	33rg	VR19	7d	Ric
NN	EUP7201-3.0/3.0V	LVR-IC	LDO, Dual out, Vout1/Vout2=3.0V/3.0V±2%, 150mA, +CE	SOT23-6	33x5	VR19	7b	Eut
NN	HSMS-282N	Si-diode	4x Schottky, RF, 15V, 1A, Vf<0.34V(1mA), <1pF, 12Q(5mA)	SOT-363	33dx	-	7b	Agj
NN	KRC833F	Si-npn-Digi	Dual, Sw, 20V, 50mA, 50mW, R1=22k	TFS6	35/TD8	-	7b	Kec
NN	KRC862E	Si-npn-Digi	Dual, Sw, 50V, 100mA, 200mW, R1=100k	TES6	35/TD3	-	7k	Kec
NN	KRC862U	Si-npn-Digi	Dual, Sw, 50V, 100mA, 200mW, R1=100k	US6	33/TD8	-	7k	Kec
NN	R5323N021B	LVR-IC	LDO, Dual out, Vout1/Vout2=2.9V/1.8V±1%, 150mA, +CE, CL	SOT-23-6	33rg	VR19	7d	Ric
NO	KRC863E	Si-npn-Digi	Dual, Sw, 50V, 100mA, 200mW, R1=22k	TES6	35/TD3	-	7k	Kec
NO	KRC863U	Si-npn-Digi	Dual, Sw, 50V, 100mA, 200mW, R1=22k	US6	33/TD8	-	7k	Kec
NP	EUP7201-2.8/1.2V	LVR-IC	LDO, Dual out, Vout1/Vout2=2.8V/1.2V±2%, 150mA, +CE	SOT23-6	33x5	VR19	7b	Eut
NP	KRC834F	Si-npn-Digi	Dual, Sw, 20V, 50mA, 50mW, R1=47k	TFS6	35/TD8	-	7b	Kec
NP	KRC864E	Si-npn-Digi	Dual, Sw, 50V, 100mA, 200mW, R1=47k	TES6	35/TD3	-	7k	Kec
NP	KRC864U	Si-npn-Digi	Dual, Sw, 50V, 100mA, 200mW, R1=47k	US6	33/TD8	-	7k	Kec
NP	R5323N022B	LVR-IC	LDO, Dual out, Vout1/Vout2=2.8V/1.8V±1%, 150mA, +CE, CL	SOT-23-6	33rg	VR19	7d	Ric
NP34	NC7NP34K8	CMOS-Logic	Triple non-inverter buffers	US8	47L.og69	-	8d	F
NQ	R5323N023A	LVR-IC	LDO, Dual out, Vout1/Vout2=2.8V/3.3V±1%, 150mA, +CE	SOT-23-6	33rg	VR19	7d	Ric
NR	R5323N023B	LVR-IC	LDO, Dual out, Vout1/Vout2=2.8V/3.3V±1%, 150mA, +CE, CL	SOT-23-6	33rg	VR19	7d	Ric
NS	R5323N024A	LVR-IC	LDO, Dual out, Vout1/Vout2=3V/3.1V±1%, 150mA, +CE	SOT-23-6	33rg	VR19	7d	Ric
NT	EUP7201-3.0/3.3V	LVR-IC	LDO, Dual out, Vout1/Vout2=3.0V/3.3V±2%, 150mA, +CE	SOT23-6	33x5	VR19	7b	Eut
NT	R5323N013B	LVR-IC	LDO, Dual out, Vout1/Vout2=1.8V/3.3V±1%, 150mA, +CE, CL	SOT-23-6	33rg	VR19	7d	Ric
NU	EUP7201-1.8/2.6V	LVR-IC	LDO, Dual out, Vout1/Vout2=1.8V/2.6V±2%, 150mA, +CE	SOT23-6	33x5	VR19	7b	Eut
NU	R5323N027B	LVR-IC	LDO, Dual out, Vout1/Vout2=1.8V/2.5V±1%, 150mA, +CE, CL	SOT-23-6	33rg	VR19	7d	Ric
NV	R5323N029B	LVR-IC	LDO, Dual out, Vout1/Vout2=2.85V/2.85V±1%, 150mA, +CE, CL	SOT-23-6	33rg	VR19	7d	Ric
NW	R5323N012B	LVR-IC	LDO, Dual out, Vout1/Vout2=3.3V/2.5V±1%, 150mA, +CE, CL	SOT-23-6	33rg	VR19	7d	Ric
NX	R5323N026B	LVR-IC	LDO, Dual out, Vout1/Vout2=3.3V/1.9V±1%, 150mA, +CE, CL	SOT-23-6	33rg	VR19	7d	Ric
NZ	R5323N030A	LVR-IC	LDO, Dual out, Vout1/Vout2=2.7V/3V±1%, 150mA, +CE	SOT-23-6	33rg	VR19	7d	Ric
NY	R5323N030B	LVR-IC	LDO, Dual out, Vout1/Vout2=2.7V/3V±1%, 150mA, +CE, CL	SOT-23-6	33rg	VR19	7d	Ric
O	HSMS-280R	Si-diode	4x Schottky, RF, 70V, 1A, Vf<0.41V(1mA), <2pF, 35Q(5mA)	SOT-363	33by	-	7b	Agj
OA	µPA608T	Si-n/p	Dual, GP, pnp: 25V, 100mA; npn: 60V, 100mA	SOT-23-6	33/T9	-	7b	Nec
OA	Si1403DL	p-MOSFET-e	Dual, V-MOS, LogL, 20V, ±1.4A, <0.265Ω	SOT-363	33fc	-	7b	Six
OB	Si1405DL	p-MOSFET-e	Dual, V-MOS, LogL, 8V, ±1.6A, <0.21Ω	SOT-363	33fc	-	7b	Six
OB2	S-8337AAAC	SVR-IC	Reg. step-up, PWM control SW., UVLQ(2.3V)	SON-8	44ug	-	8d	Sii
OBA	S-8337AAAA	SVR-IC	Reg. step-up, PWM control SW., UVLQ(2.3V)	SON-8	44ug	-	8d	Sii
OB5	S-8337AAAB	SVR-IC	Reg. step-up, PWM control SW., UVLQ(2.3V)	SON-8	44ug	-	8d	Sii
OBC	S-8337AABA	SVR-IC	Reg. step-up, PWM control SW., UVLQ(2.2V)	SON-8	44ug	-	8d	Sii
OBD	S-8337AABB	SVR-IC	Reg. step-up, PWM control SW., UVLQ(2.2V)	SON-8	44ug	-	8d	Sii
OBE	S-8337AABC	SVR-IC	Reg. step-up, PWM control SW., UVLQ(2.2V)	SON-8	44ug	-	8d	Sii
OBF	S-8337AACA	SVR-IC	Reg. step-up, PWM control SW., UVLQ(2.1V)	SON-8	44ug	-	8d	Sii
OBG	S-8337AACB	SVR-IC	Reg. step-up, PWM control SW., UVLQ(2.1V)	SON-8	44ug	-	8d	Sii
OBH	S-8337AACCC	SVR-IC	Reg. step-up, PWM control SW., UVLQ(2.1V)	SON-8	44ug	-	8d	Sii
OBI	S-8337AADA	SVR-IC	Reg. step-up, PWM control SW., UVLQ(2.0V)	SON-8	44ug	-	8d	Sii
OBJ	S-8337AADB	SVR-IC	Reg. step-up, PWM control SW., UVLQ(2.0V)	SON-8	44ug	-	8d	Sii
OBK	S-8337AADCC	SVR-IC	Reg. step-up, PWM control SW., UVLQ(2.0V)	SON-8	44ug	-	8d	Sii
OBL	S-8337AAEA	SVR-IC	Reg. step-up, PWM control SW., UVLQ(1.9V)	SON-8	44ug	-	8d	Sii
OBM	S-8337AAEB	SVR-IC	Reg. step-up, PWM control SW., UVLQ(1.9V)	SON-8	44ug	-	8d	Sii
OBN	S-8337AAEC	SVR-IC	Reg. step-up, PWM control SW., UVLQ(1.9V)	SON-8	44ug	-	8d	Sii
OBO	S-8337AAFA	SVR-IC	Reg. step-up, PWM control SW., UVLQ(1.8V)	SON-8	44ug	-	8d	Sii
OBP	S-8337AAFB	SVR-IC	Reg. step-up, PWM control SW., UVLQ(1.8V)	SON-8	44ug	-	8d	Sii
OBQ	S-8337AAFC	SVR-IC	Reg. step-up, PWM control SW., UVLQ(1.8V)	SON-8	44ug	-	8d	Sii
OB5	S-8337AAGA	SVR-IC	Reg. step-up, PWM control SW., UVLQ(1.7V)	SON-8	44ug	-	8d	Sii
OBS	S-8337AAGB	SVR-IC	Reg. step-up, PWM control SW., UVLQ(1.7V)	SON-8	44ug	-	8d	Sii
OB5	S-8337AAGC	SVR-IC	Reg. step-up, PWM control SW., UVLQ(1.7V)	SON-8	44ug	-	8d	Sii
OB5	S-8337AAHA	SVR-IC	Reg. step-up, PWM control SW., UVLQ(1.6V)	SON-8	44ug	-	8d	Sii
OBV	S-8337AAHB	SVR-IC	Reg. step-up, PWM control SW., UVLQ(1.6V)	SON-8	44ug	-	8d	Sii
OBW	S-8337AAHC	SVR-IC	Reg. step-up, PWM control SW., UVLQ(1.6V)	SON-8	44ug	-	8d	Sii
OBX	S-8337AAIA	SVR-IC	Reg. step-up, PWM control SW., UVLQ(1.5V)	SON-8	44ug	-	8d	Sii
OB5	S-8337AAIB	SVR-IC	Reg. step-up, PWM control SW., UVLQ(1.5V)	SON-8	44ug	-	8d	Sii
OBZ	S-8337AAIC	SVR-IC	Reg. step-up, PWM control SW., UVLQ(1.5V)	SON-8	44ug	-	8d	Sii
OC	Si1407DL	p-MOSFET-e	Dual, V-MOS, LogL, 12V, ±1.6A, <0.225Ω	SOT-363	33fc	-	7b	Six



SMD code	Type	Function	Short description	Case	Pinout	Sch.	St.	Mnf.
OIP	S-8338ABFB	SVR-IC	Reg, step-up, PWM control SW., UVLO(1.8V), -Shutdwn	SON-8	44ue	-	8d	Sii
OIQ	S-8338ABFC	SVR-IC	Reg, step-up, PWM control SW., UVLO(1.8V), -Shutdwn	SON-8	44ue	-	8d	Sii
OIR	S-8338ABGA	SVR-IC	Reg, step-up, PWM control SW., UVLO(1.7V), -Shutdwn	SON-8	44ue	-	8d	Sii
OIS	S-8338ABGB	SVR-IC	Reg, step-up, PWM control SW., UVLO(1.7V), -Shutdwn	SON-8	44ue	-	8d	Sii
OIT	S-8338ABGC	SVR-IC	Reg, step-up, PWM control SW., UVLO(1.7V), -Shutdwn	SON-8	44ue	-	8d	Sii
OIU	S-8338ABHA	SVR-IC	Reg, step-up, PWM control SW., UVLO(1.6V), -Shutdwn	SON-8	44ue	-	8d	Sii
OIV	S-8338ABHB	SVR-IC	Reg, step-up, PWM control SW., UVLO(1.6V), -Shutdwn	SON-8	44ue	-	8d	Sii
OIW	S-8338ABHC	SVR-IC	Reg, step-up, PWM control SW., UVLO(1.6V), -Shutdwn	SON-8	44ue	-	8d	Sii
OIX	S-8338ABIA	SVR-IC	Reg, step-up, PWM control SW., UVLO(1.5V), -Shutdwn	SON-8	44ue	-	8d	Sii
OIY	S-8338ABIB	SVR-IC	Reg, step-up, PWM control SW., UVLO(1.5V), -Shutdwn	SON-8	44ue	-	8d	Sii
OIZ	S-8338ABIC	SVR-IC	Reg, step-up, PWM control SW., UVLO(1.5V), -Shutdwn	SON-8	44ue	-	8d	Sii
OJ2	S-8337ACAC	SVR-IC	Reg, step-up, PWM control SW., UVLO(2.3V)	SON-8	44ug	-	8d	Sii
OJA	S-8337ACAA	SVR-IC	Reg, step-up, PWM control SW., UVLO(2.3V)	SON-8	44ug	-	8d	Sii
OJB	S-8337ACAB	SVR-IC	Reg, step-up, PWM control SW., UVLO(2.3V)	SON-8	44ug	-	8d	Sii
OJC	S-8337ACBA	SVR-IC	Reg, step-up, PWM control SW., UVLO(2.2V)	SON-8	44ug	-	8d	Sii
OJD	S-8337ACBB	SVR-IC	Reg, step-up, PWM control SW., UVLO(2.2V)	SON-8	44ug	-	8d	Sii
OJE	S-8337ACBC	SVR-IC	Reg, step-up, PWM control SW., UVLO(2.2V)	SON-8	44ug	-	8d	Sii
OJF	S-8337ACCA	SVR-IC	Reg, step-up, PWM control SW., UVLO(2.1V)	SON-8	44ug	-	8d	Sii
OJG	S-8337ACCB	SVR-IC	Reg, step-up, PWM control SW., UVLO(2.1V)	SON-8	44ug	-	8d	Sii
OJH	S-8337ACCC	SVR-IC	Reg, step-up, PWM control SW., UVLO(2.1V)	SON-8	44ug	-	8d	Sii
OJI	S-8337ACDA	SVR-IC	Reg, step-up, PWM control SW., UVLO(2.0V)	SON-8	44ug	-	8d	Sii
OJJ	S-8337ACDB	SVR-IC	Reg, step-up, PWM control SW., UVLO(2.0V)	SON-8	44ug	-	8d	Sii
OJK	S-8337ACDC	SVR-IC	Reg, step-up, PWM control SW., UVLO(2.0V)	SON-8	44ug	-	8d	Sii
OJL	S-8337ACEA	SVR-IC	Reg, step-up, PWM control SW., UVLO(1.9V)	SON-8	44ug	-	8d	Sii
OJM	S-8337ACEB	SVR-IC	Reg, step-up, PWM control SW., UVLO(1.9V)	SON-8	44ug	-	8d	Sii
OJN	S-8337ACEC	SVR-IC	Reg, step-up, PWM control SW., UVLO(1.9V)	SON-8	44ug	-	8d	Sii
OJO	S-8337ACFA	SVR-IC	Reg, step-up, PWM control SW., UVLO(1.8V)	SON-8	44ug	-	8d	Sii
OJP	S-8337ACFB	SVR-IC	Reg, step-up, PWM control SW., UVLO(1.8V)	SON-8	44ug	-	8d	Sii
OJQ	S-8337ACFC	SVR-IC	Reg, step-up, PWM control SW., UVLO(1.8V)	SON-8	44ug	-	8d	Sii
OJR	S-8337ACGA	SVR-IC	Reg, step-up, PWM control SW., UVLO(1.7V)	SON-8	44ug	-	8d	Sii
OJS	S-8337ACGB	SVR-IC	Reg, step-up, PWM control SW., UVLO(1.7V)	SON-8	44ug	-	8d	Sii
OJT	S-8337ACGC	SVR-IC	Reg, step-up, PWM control SW., UVLO(1.7V)	SON-8	44ug	-	8d	Sii
OJU	S-8337ACHA	SVR-IC	Reg, step-up, PWM control SW., UVLO(1.6V)	SON-8	44ug	-	8d	Sii
OJV	S-8337ACHB	SVR-IC	Reg, step-up, PWM control SW., UVLO(1.6V)	SON-8	44ug	-	8d	Sii
OJW	S-8337ACHC	SVR-IC	Reg, step-up, PWM control SW., UVLO(1.6V)	SON-8	44ug	-	8d	Sii
OJX	S-8337ACIA	SVR-IC	Reg, step-up, PWM control SW., UVLO(1.5V)	SON-8	44ug	-	8d	Sii
OJY	S-8337ACIB	SVR-IC	Reg, step-up, PWM control SW., UVLO(1.5V)	SON-8	44ug	-	8d	Sii
OJZ	S-8337ACIC	SVR-IC	Reg, step-up, PWM control SW., UVLO(1.5V)	SON-8	44ug	-	8d	Sii
OK2	S-8338ACAC	SVR-IC	Reg, step-up, PWM control SW., UVLO(2.3V), -Shutdwn	SON-8	44ue	-	8d	Sii
OKA	S-8338ACAA	SVR-IC	Reg, step-up, PWM control SW., UVLO(2.3V), -Shutdwn	SON-8	44ue	-	8d	Sii
OKB	S-8338ACAB	SVR-IC	Reg, step-up, PWM control SW., UVLO(2.3V), -Shutdwn	SON-8	44ue	-	8d	Sii
OKC	S-8338ACBA	SVR-IC	Reg, step-up, PWM control SW., UVLO(2.2V), -Shutdwn	SON-8	44ue	-	8d	Sii
OKD	S-8338ACBB	SVR-IC	Reg, step-up, PWM control SW., UVLO(2.2V), -Shutdwn	SON-8	44ue	-	8d	Sii
OKE	S-8338ACBC	SVR-IC	Reg, step-up, PWM control SW., UVLO(2.2V), -Shutdwn	SON-8	44ue	-	8d	Sii
OKF	S-8338ACCA	SVR-IC	Reg, step-up, PWM control SW., UVLO(2.1V), -Shutdwn	SON-8	44ue	-	8d	Sii
OKG	S-8338ACCB	SVR-IC	Reg, step-up, PWM control SW., UVLO(2.1V), -Shutdwn	SON-8	44ue	-	8d	Sii
OKH	S-8338ACCC	SVR-IC	Reg, step-up, PWM control SW., UVLO(2.1V), -Shutdwn	SON-8	44ue	-	8d	Sii
OKI	S-8338ACDA	SVR-IC	Reg, step-up, PWM control SW., UVLO(2.0V), -Shutdwn	SON-8	44ue	-	8d	Sii
OKJ	S-8338ACDB	SVR-IC	Reg, step-up, PWM control SW., UVLO(2.0V), -Shutdwn	SON-8	44ue	-	8d	Sii
OKK	S-8338ACDC	SVR-IC	Reg, step-up, PWM control SW., UVLO(2.0V), -Shutdwn	SON-8	44ue	-	8d	Sii
OKL	S-8338ACEA	SVR-IC	Reg, step-up, PWM control SW., UVLO(1.9V), -Shutdwn	SON-8	44ue	-	8d	Sii
OKM	S-8338ACEB	SVR-IC	Reg, step-up, PWM control SW., UVLO(1.9V), -Shutdwn	SON-8	44ue	-	8d	Sii
OKN	S-8338ACEC	SVR-IC	Reg, step-up, PWM control SW., UVLO(1.9V), -Shutdwn	SON-8	44ue	-	8d	Sii
OKO	S-8338ACFA	SVR-IC	Reg, step-up, PWM control SW., UVLO(1.8V), -Shutdwn	SON-8	44ue	-	8d	Sii
OKP	S-8338ACFB	SVR-IC	Reg, step-up, PWM control SW., UVLO(1.8V), -Shutdwn	SON-8	44ue	-	8d	Sii
OKQ	S-8338ACFC	SVR-IC	Reg, step-up, PWM control SW., UVLO(1.8V), -Shutdwn	SON-8	44ue	-	8d	Sii
OKR	S-8338ACGA	SVR-IC	Reg, step-up, PWM control SW., UVLO(1.7V), -Shutdwn	SON-8	44ue	-	8d	Sii
OKS	S-8338ACGB	SVR-IC	Reg, step-up, PWM control SW., UVLO(1.7V), -Shutdwn	SON-8	44ue	-	8d	Sii
OKT	S-8338ACGC	SVR-IC	Reg, step-up, PWM control SW., UVLO(1.7V), -Shutdwn	SON-8	44ue	-	8d	Sii
OKU	S-8338ACHA	SVR-IC	Reg, step-up, PWM control SW., UVLO(1.6V), -Shutdwn	SON-8	44ue	-	8d	Sii
OKV	S-8338ACHB	SVR-IC	Reg, step-up, PWM control SW., UVLO(1.6V), -Shutdwn	SON-8	44ue	-	8d	Sii
OKW	S-8338ACHC	SVR-IC	Reg, step-up, PWM control SW., UVLO(1.6V), -Shutdwn	SON-8	44ue	-	8d	Sii
OKX	S-8338ACIA	SVR-IC	Reg, step-up, PWM control SW., UVLO(1.5V), -Shutdwn	SON-8	44ue	-	8d	Sii
OKY	S-8338ACIB	SVR-IC	Reg, step-up, PWM control SW., UVLO(1.5V), -Shutdwn	SON-8	44ue	-	8d	Sii
OKZ	S-8338ACIC	SVR-IC	Reg, step-up, PWM control SW., UVLO(1.5V), -Shutdwn	SON-8	44ue	-	8d	Sii
OO	HSMS-282R	Si-diode	4x Schottky, RF, 15V, 1A, Vf<0.34V(1mA), <1pF, 12Q(5mA)	SOT-363	33by	-	7b	Agf
OTA	S-1170B15PD	LVR-IC	LDO, 1.5V±1.0%, 800mA, +CE	HSON-6	35vr	VR4	7g	Sii
OTB	S-1170B16PD	LVR-IC	LDO, 1.6V±1.0%, 800mA, +CE	HSON-6	35vr	VR4	7g	Sii
OTC	S-1170B17PD	LVR-IC	LDO, 1.7V±1.0%, 800mA, +CE	HSON-6	35vr	VR4	7g	Sii
OTD	S-1170B18PD	LVR-IC	LDO, 1.8V±1.0%, 800mA, +CE	HSON-6	35vr	VR4	7g	Sii



SMD code	Type	Function	Short description	Case	Pinout	Sch.	St.	Mnf.
OTE	S-1170B19PD	LVR-IC	LDO, 1.9V±1.0%, 800mA, +CE	HSON-6	35vr	VR4	7g	Sii
OTF	S-1170B20PD	LVR-IC	LDO, 2.0V±1.0%, 800mA, +CE	HSON-6	35vr	VR4	7g	Sii
OTG	S-1170B21PD	LVR-IC	LDO, 2.1V±1.0%, 800mA, +CE	HSON-6	35vr	VR4	7g	Sii
OTH	S-1170B22PD	LVR-IC	LDO, 2.2V±1.0%, 800mA, +CE	HSON-6	35vr	VR4	7g	Sii
OTI	S-1170B23PD	LVR-IC	LDO, 2.3V±1.0%, 800mA, +CE	HSON-6	35vr	VR4	7g	Sii
OTJ	S-1170B24PD	LVR-IC	LDO, 2.4V±1.0%, 800mA, +CE	HSON-6	35vr	VR4	7g	Sii
OTK	S-1170B25PD	LVR-IC	LDO, 2.5V±1.0%, 800mA, +CE	HSON-6	35vr	VR4	7g	Sii
OTL	S-1170B26PD	LVR-IC	LDO, 2.6V±1.0%, 800mA, +CE	HSON-6	35vr	VR4	7g	Sii
OTM	S-1170B27PD	LVR-IC	LDO, 2.7V±1.0%, 800mA, +CE	HSON-6	35vr	VR4	7g	Sii
OTN	S-1170B28PD	LVR-IC	LDO, 2.8V±1.0%, 800mA, +CE	HSON-6	35vr	VR4	7g	Sii
OTO	S-1170B29PD	LVR-IC	LDO, 2.9V±1.0%, 800mA, +CE	HSON-6	35vr	VR4	7g	Sii
OTP	S-1170B30PD	LVR-IC	LDO, 3.0V±1.0%, 800mA, +CE	HSON-6	35vr	VR4	7g	Sii
OTQ	S-1170B31PD	LVR-IC	LDO, 3.1V±1.0%, 800mA, +CE	HSON-6	35vr	VR4	7g	Sii
OTR	S-1170B32PD	LVR-IC	LDO, 3.2V±1.0%, 800mA, +CE	HSON-6	35vr	VR4	7g	Sii
OTS	S-1170B33PD	LVR-IC	LDO, 3.3V±1.0%, 800mA, +CE	HSON-6	35vr	VR4	7g	Sii
OTT	S-1170B34PD	LVR-IC	LDO, 3.4V±1.0%, 800mA, +CE	HSON-6	35vr	VR4	7g	Sii
OTU	S-1170B35PD	LVR-IC	LDO, 3.5V±1.0%, 800mA, +CE	HSON-6	35vr	VR4	7g	Sii
OTV	S-1170B36PD	LVR-IC	LDO, 3.6V±1.0%, 800mA, +CE	HSON-6	35vr	VR4	7g	Sii
OTW	S-1170B37PD	LVR-IC	LDO, 3.7V±1.0%, 800mA, +CE	HSON-6	35vr	VR4	7g	Sii
OTX	S-1170B38PD	LVR-IC	LDO, 3.8V±1.0%, 800mA, +CE	HSON-6	35vr	VR4	7g	Sii
OTY	S-1170B39PD	LVR-IC	LDO, 3.9V±1.0%, 800mA, +CE	HSON-6	35vr	VR4	7g	Sii
OTZ	S-1170B40PD	LVR-IC	LDO, 4.0V±1.0%, 800mA, +CE	HSON-6	35vr	VR4	7g	Sii
OJA	S-1170B41PD	LVR-IC	LDO, 4.1V±1.0%, 800mA, +CE	HSON-6	35vr	VR4	7g	Sii
OJB	S-1170B42PD	LVR-IC	LDO, 4.2V±1.0%, 800mA, +CE	HSON-6	35vr	VR4	7g	Sii
OJC	S-1170B43PD	LVR-IC	LDO, 4.3V±1.0%, 800mA, +CE	HSON-6	35vr	VR4	7g	Sii
ODJ	S-1170B44PD	LVR-IC	LDO, 4.4V±1.0%, 800mA, +CE	HSON-6	35vr	VR4	7g	Sii
OUE	S-1170B45PD	LVR-IC	LDO, 4.5V±1.0%, 800mA, +CE	HSON-6	35vr	VR4	7g	Sii
OUF	S-1170B46PD	LVR-IC	LDO, 4.6V±1.0%, 800mA, +CE	HSON-6	35vr	VR4	7g	Sii
OUG	S-1170B47PD	LVR-IC	LDO, 4.7V±1.0%, 800mA, +CE	HSON-6	35vr	VR4	7g	Sii
OUH	S-1170B48PD	LVR-IC	LDO, 4.8V±1.0%, 800mA, +CE	HSON-6	35vr	VR4	7g	Sii
OUI	S-1170B49PD	LVR-IC	LDO, 4.9V±1.0%, 800mA, +CE	HSON-6	35vr	VR4	7g	Sii
OJJ	S-1170B50PD	LVR-IC	LDO, 5.0V±1.0%, 800mA, +CE	HSON-6	35vr	VR4	7g	Sii
OUK	S-1170B51PD	LVR-IC	LDO, 5.1V±1.0%, 800mA, +CE	HSON-6	35vr	VR4	7g	Sii
OUL	S-1170B52PD	LVR-IC	LDO, 5.2V±1.0%, 800mA, +CE	HSON-6	35vr	VR4	7g	Sii
OUM	S-1170B53PD	LVR-IC	LDO, 5.3V±1.0%, 800mA, +CE	HSON-6	35vr	VR4	7g	Sii
OUN	S-1170B54PD	LVR-IC	LDO, 5.4V±1.0%, 800mA, +CE	HSON-6	35vr	VR4	7g	Sii
OJO	S-1170B55PD	LVR-IC	LDO, 5.5V±1.0%, 800mA, +CE	HSON-6	35vr	VR4	7g	Sii
P0	R1131D301B	LVR-IC	LDO, 3V±2%, 300mA, -CE	SON-6	34hq	VR4	7g	Ric
P0	R1225N122A	DC/DC-IC	VFM/PWM step-down, 1.2V, 300kHz	SOT-23-6W	33so	DC7	7d	Ric
p00	74AUP2G00DC	CMOS-Logic	Dual 2-input NAND gates	SOT765-1	47Llog50	-	8d	Phi
p02	74AUP2G02DC	CMOS-Logic	Dual 2-input NOR gates	SOT765-1	47Llog53	-	8d	Phi
P06	DDA123JH	Si-pnp-Digi	Dual, Sw, 50V, 100mA, 150mW, R1/R2=2.2k/47k	SOT-563	35/T10	-	7k	Di
P06	DDA123JK	Si-pnp-Digi	Dual, Sw, 50V, 100mA, 300mW, R1/R2=2k2/47k	SOT-26	33/TD4	-	7k	Di
P06	DDA123JU	Si-pnp-Digi	Dual, Sw, 50V, 100mA, 200mW, R1/R2=2k2/47k	SOT-363	33/TD4	-	7k	Di
P07	DDA143TH	Si-pnp-Digi	Dual, Sw, 50V, 100mA, 150mW, R1=4.7k	SOT-563	35/T10	-	7k	Di
P07	DDA143TK	Si-pnp-Digi	Dual, Sw, 50V, 100mA, 300mW, R1=4.7k	SOT-26	33/TD4	-	7k	Di
P07	DDA143TU	Si-pnp-Digi	Dual, Sw, 50V, 100mA, 200mW, R1=4k7	SOT-363	33/TD4	-	7k	Di
p08	74AUP2G08DC	CMOS-Logic	Dual 2-input AND gates	SOT765-1	47Llog51	-	8d	Phi
P08	DDA143EH	Si-pnp-Digi	Dual, Sw, 50V, 100mA, 150mW, R1/R2=4.7/4.7k	SOT-563	35/T10	-	7k	Di
P1	1PS74SB23	Si-diode	SBD, U-Fast, Sw, 25V, 1A, <100pF	SOT457	33bi	-	7b	Phi
P1	BZX84-C11TS	Z-diode	Triple, 11V±5%, 200mW	SOT-363	33dd	-	7l	Di
P1	R1131D311B	LVR-IC	LDO, 3.1V±2%, 300mA, -CE	SON-6	34hq	VR4	7g	Ric
P1	R1225N152A	DC/DC-IC	VFM/PWM step-down, 1.5V, 300kHz	SOT-23-6W	33so	DC7	7d	Ric
P12	DDA114TH	Si-pnp-Digi	Dual, Sw, 50V, 100mA, 150mW, R=10k	SOT-563	35/TD2	-	7k	Di
P12	DDA114TK	Si-pnp-Digi	Dual, Sw, 50V, 100mA, 300mW, R1=10k	SOT-26	33/TD2	-	7k	Di
P12	DDA114TU	Si-pnp-Digi	Dual, Sw, 50V, 100mA, 200mW, R1=10k	SOT-363	33/TD2	-	7k	Di
P12D	ZXT13P12DE6	Si-pnp	Lo-sat, Sw, 20V, 4A, 55MHz	SOT-363	33t4	-	7b	Zx
P13	DDA114EH	Si-pnp-Digi	Dual, Sw, 50V, 100mA, 150mW, R1/R2=10k/10k	SOT-563	35/TD2	-	7k	Di
P13	DDA114EK	Si-pnp-Digi	Dual, Sw, 50V, 100mA, 300mW, R1/R2=10k/10k	SOT-26	33/TD2	-	7k	Di
P13	DDA114EU	Si-pnp-Digi	Dual, Sw, 50V, 100mA, 200mW, R1/R2=10k/10k	SOT-363	33/TD2	-	7k	Di
P14	DDA114YH	Si-pnp-Digi	Dual, Sw, 50V, 0.1A, 0.15W, R1/R2=10k/47k	SOT-563	35/TD2	-	7k	Di
P14	DDA114YK	Si-pnp-Digi	Dual, Sw, 50V, 100mA, 300mW, R1/R2=10k/47k	SOT-26	33/TD4	-	7k	Di
P14	DDA114YU	Si-pnp-Digi	Dual, Sw, 50V, 100mA, 200mW, R1/R2=10k/47k	SOT-363	33/TD4	-	7k	Di
P17	DDA124EH	Si-pnp-Digi	Dual, Sw, 50V, 100mA, 150mW, R1/R2=22/22k	SOT-563	35/T10	-	7k	Di
P17	DDA124EK	Si-pnp-Digi	Dual, Sw, 50V, 100mA, 300mW, R1/R2=22k/22k	SOT-26	33/TD4	-	7k	Di
P17	DDA124EU	Si-pnp-Digi	Dual, Sw, 50V, 100mA, 200mW, R1/R2=22k/22k	SOT-363	33/TD4	-	7k	Di
P17	DDC124EK	Si-npn-Digi	Dual, Sw, 50V, 100mA, 200mW, R1/R2=22k/22k	SC-74R	33/TD3	-	7l	Di
P2	1PS74SB43	Si-diode	SBD, U-Fast, Sw, 40V, 1A, <80pF	SOT457	33bi	-	7b	Phi
P2	BZX84-C12TS	Z-diode	Triple, 12V±5%, 200mW	SOT-363	33dd	-	7l	Di
P2	KRA766E	Si-pnp-Digi	Dual, Sw, 50V, 100mA, 200mW, R1/R2=1k/10k	TES6	35/TD4	-	7k	Kec



SMD code	Type	Function	Short description	Case	Pinout	Sch.	St.	Mnf.
P2	KRA766U	Si-pnp-Digi	Dual, Sw, 50V, 100mA, 200mW, R1/R2=1k/10k	US6	33/TD7	-	7k	Kec
P2	R1131D321B	LVR-IC	LDO, 3.2V±2%, 300mA, -CE	SON-6	34hq	VR4	7g	Ric
P2	R1225N182A	DC/DC-IC	VFM/PWM step-down, 1.8V, 300kHz	SOT-23-6W	33so	DC7	7d	Ric
P2	TK11220M	LVR-IC	LDO, 2V±5%, 170mA, +CE	SOT-23L-6	33vf	VR7	7b	Tok
P2	TK11222M	LVR-IC	LDO, 2.2V±5%, 170mA, +CE	SOT-23L-6	33vf	VR7	7b	Tok
P2	TK11225M	LVR-IC	LDO, 2.5V±5%, 170mA, +CE	SOT-23L-6	33vf	VR7	7b	Tok
P2	TK11227M	LVR-IC	LDO, 2.7V±5%, 170mA, +CE	SOT-23L-6	33vf	VR7	7b	Tok
P20	DDA144EH	Si-pnp-Digi	Dual, Sw, 50V, 100mA, 150mW, R1/R2=47/47k	SOT-563	35/T10	-	7k	Di
P20	DDA144EK	Si-pnp-Digi	Dual, Sw, 50V, 100mA, 300mW, R1/R2=47k/47k	SOT-266	33/TD4	-	7k	Di
P20	DDA144EU	Si-pnp-Digi	Dual, Sw, 50V, 100mA, 200mW, R1/R2=47k/47k	SOT-363	33/TD4	-	7k	Di
P20	TK11220AM	LVR-IC	LDO, 2V±2.4%, 150mA, +CE	SOT-23L-6	33vf	VR7	7b	Tok
P20D	ZXT13P20DE6	Si-pnp	Lo-sat, Sw, 25V, 4A, 90MHz	SOT-363	33t4	-	7b	Zx
P21	TK11221AM	LVR-IC	LDO, 2.1V±2.4%, 150mA, +CE	SOT-23L-6	33vf	VR7	7b	Tok
P22	TK11222AM	LVR-IC	LDO, 2.2V±2.4%, 150mA, +CE	SOT-23L-6	33vf	VR7	7b	Tok
p25	74AUP2G125DC	CMOS-Logic	Dual bus buffer with 3-state output	SOT765-1	47L.og54	-	8d	Phi
P25	TK11225AM	LVR-IC	LDO, 2.5V±2.4%, 150mA, +CE	SOT-23L-6	33vf	VR7	7b	Tok
p26	74AUP2G126DC	CMOS-Logic	Dual bus buffer with 3-state output	SOT765-1	47L.og55	-	8d	Phi
P28	TK11228AM	LVR-IC	LDO, 2.8V±2.4%, 150mA, +CE	SOT-23L-6	33vf	VR7	7b	Tok
P29	TK11229AM	LVR-IC	LDO, 2.9V±2.4%, 150mA, +CE	SOT-23L-6	33vf	VR7	7b	Tok
P3	BZX84-C13TS	Z-diode	Triple, 13V±5%, 200mW	SOT-363	33dd	-	7l	Di
P3	R1131D331B	LVR-IC	LDO, 3.3V±2%, 300mA, -CE	SON-6	34hq	VR4	7g	Ric
P3	R1225N252A	DC/DC-IC	VFM/PWM step-down, 2.5V, 300kHz	SOT-23-6W	33so	DC7	7d	Ric
P3	TK11230M	LVR-IC	LDO, 3V±5%, 170mA, +CE	SOT-23L-6	33vf	VR7	7b	Tok
P3	TK11232M	LVR-IC	LDO, 3.2V±5%, 170mA, +CE	SOT-23L-6	33vf	VR7	7b	Tok
P3	TK11235M	LVR-IC	LDO, 3.5V±5%, 170mA, +CE	SOT-23L-6	33vf	VR7	7b	Tok
P30	TK11230AM	LVR-IC	LDO, 3V±2.4%, 150mA, +CE	SOT-23L-6	33vf	VR7	7b	Tok
P31	TK11231AM	LVR-IC	LDO, 3.1V±2.4%, 150mA, +CE	SOT-23L-6	33vf	VR7	7b	Tok
p32	74AUP2G32DC	CMOS-Logic	Dual 2-input OR gates	SOT765-1	47L.og52	-	8d	Phi
P33	TK11233AM	LVR-IC	LDO, 3.3V±2.4%, 150mA, +CE	SOT-23L-6	33vf	VR7	7b	Tok
P34	74HC3G34DC	CMOS-Logic	Triple non-inverter buffers	SOT765-1	47L.og69	-	8d	Phi
P35	TK11235AM	LVR-IC	LDO, 3.5V±2.4%, 150mA, +CE	SOT-23L-6	33vf	VR7	7b	Tok
P36	TK11236AM	LVR-IC	LDO, 3.6V±2.4%, 150mA, +CE	SOT-23L-6	33vf	VR7	7b	Tok
P38	TK11238AM	LVR-IC	LDO, 3.8V±2.4%, 150mA, +CE	SOT-23L-6	33vf	VR7	7b	Tok
p4	74AUP2G04GW	CMOS-Logic	Dual inverters	SOT-363	33L.og24	-	7b	Phi
P4	BZX84-C15TS	Z-diode	Triple, 15V±5%, 200mW	SOT-363	33dd	-	7l	Di
P4	KRA767E	Si-pnp-Digi	Dual, Sw, 50V, 100mA, 200mW, R1/R2=2.2k/2.2k	TES6	35/TD4	-	7k	Kec
P4	KRA767U	Si-pnp-Digi	Dual, Sw, 50V, 100mA, 200mW, R1/R2=2.2k/2.2k	US6	33/TD7	-	7k	Kec
P4	R1225N332A	DC/DC-IC	VFM/PWM step-down, 3.3V, 300kHz	SOT-23-6W	33so	DC7	7d	Ric
P4	TK11240M	LVR-IC	LDO, 4V±5%, 170mA, +CE	SOT-23L-6	33vf	VR7	7b	Tok
P4	TK11245M	LVR-IC	LDO, 4.5V±5%, 170mA, +CE	SOT-23L-6	33vf	VR7	7b	Tok
P4	TK11247M	LVR-IC	LDO, 4.7V±5%, 170mA, +CE	SOT-23L-6	33vf	VR7	7b	Tok
p40	74AUP2G240DC	CMOS-Logic	Dual bus buffer inverted with 3-state output	SOT765-1	47L.og67	-	8d	Phi
P40	TK11240AM	LVR-IC	LDO, 4V±2.4%, 150mA, +CE	SOT-23L-6	33vf	VR7	7b	Tok
p41	74AUP2G241DC	CMOS-Logic	Dual bus buffer non-inverted with 3-state output	SOT765-1	47L.og60	-	8d	Phi
P42	TK11242AM	LVR-IC	LDO, 4.2V±2.4%, 150mA, +CE	SOT-23L-6	33vf	VR7	7b	Tok
P45	TK11245AM	LVR-IC	LDO, 4.5V±2.4%, 150mA, +CE	SOT-23L-6	33vf	VR7	7b	Tok
P48	TK11248AM	LVR-IC	LDO, 4.8V±2.4%, 150mA, +CE	SOT-23L-6	33vf	VR7	7b	Tok
P49	TK11249AM	LVR-IC	LDO, 4.9V±2.4%, 150mA, +CE	SOT-23L-6	33vf	VR7	7b	Tok
P4A	S-1167B15-I6T2G	LVR-IC	LDO, 1.5V±1.0%, 150mA, +CE	SNT-6A	35vib	VR4	7g	Sii
P4B	S-1167B16-I6T2G	LVR-IC	LDO, 1.6V±1.0%, 150mA, +CE	SNT-6A	35vib	VR4	7g	Sii
P4C	S-1167B17-I6T2G	LVR-IC	LDO, 1.7V±1.0%, 150mA, +CE	SNT-6A	35vib	VR4	7g	Sii
P4D	S-1167B18-I6T2G	LVR-IC	LDO, 1.8V±1.0%, 150mA, +CE	SNT-6A	35vib	VR4	7g	Sii
P4E	S-1167B19-I6T2G	LVR-IC	LDO, 1.9V±1.0%, 150mA, +CE	SNT-6A	35vib	VR4	7g	Sii
P4F	S-1167B20-I6T2G	LVR-IC	LDO, 2.0V±1.0%, 150mA, +CE	SNT-6A	35vib	VR4	7g	Sii
P4G	S-1167B21-I6T2G	LVR-IC	LDO, 2.1V±1.0%, 150mA, +CE	SNT-6A	35vib	VR4	7g	Sii
P4H	S-1167B22-I6T2G	LVR-IC	LDO, 2.2V±1.0%, 150mA, +CE	SNT-6A	35vib	VR4	7g	Sii
P4I	S-1167B23-I6T2G	LVR-IC	LDO, 2.3V±1.0%, 150mA, +CE	SNT-6A	35vib	VR4	7g	Sii
P4J	S-1167B24-I6T2G	LVR-IC	LDO, 2.4V±1.0%, 150mA, +CE	SNT-6A	35vib	VR4	7g	Sii
P4K	S-1167B25-I6T2G	LVR-IC	LDO, 2.5V±1.0%, 150mA, +CE	SNT-6A	35vib	VR4	7g	Sii
P4L	S-1167B26-I6T2G	LVR-IC	LDO, 2.6V±1.0%, 150mA, +CE	SNT-6A	35vib	VR4	7g	Sii
P4M	S-1167B27-I6T2G	LVR-IC	LDO, 2.7V±1.0%, 150mA, +CE	SNT-6A	35vib	VR4	7g	Sii
P4N	S-1167B28-I6T2G	LVR-IC	LDO, 2.8V±1.0%, 150mA, +CE	SNT-6A	35vib	VR4	7g	Sii
P4O	S-1167B29-I6T2G	LVR-IC	LDO, 2.9V±1.0%, 150mA, +CE	SNT-6A	35vib	VR4	7g	Sii
P4P	S-1167B30-I6T2G	LVR-IC	LDO, 3.0V±1.0%, 150mA, +CE	SNT-6A	35vib	VR4	7g	Sii
P4Q	S-1167B31-I6T2G	LVR-IC	LDO, 3.1V±1.0%, 150mA, +CE	SNT-6A	35vib	VR4	7g	Sii
P4R	S-1167B32-I6T2G	LVR-IC	LDO, 3.2V±1.0%, 150mA, +CE	SNT-6A	35vib	VR4	7g	Sii
P4S	S-1167B33-I6T2G	LVR-IC	LDO, 3.3V±1.0%, 150mA, +CE	SNT-6A	35vib	VR4	7g	Sii
P4T	S-1167B34-I6T2G	LVR-IC	LDO, 3.4V±1.0%, 150mA, +CE	SNT-6A	35vib	VR4	7g	Sii
P4U	S-1167B35-I6T2G	LVR-IC	LDO, 3.5V±1.0%, 150mA, +CE	SNT-6A	35vib	VR4	7g	Sii
P4V	S-1167B36-I6T2G	LVR-IC	LDO, 3.6V±1.0%, 150mA, +CE	SNT-6A	35vib	VR4	7g	Sii



SMD code	Type	Function	Short description	Case	Pinout	Sch.	St.	Mnf.
P4W	S-1167B37-I6T2G	LVR-IC	LDO, 3.7V±1.0%, 150mA, +CE	SNT-6A	35v1b	VR4	7g	Sii
P4X	S-1167B38-I6T2G	LVR-IC	LDO, 3.8V±1.0%, 150mA, +CE	SNT-6A	35v1b	VR4	7g	Sii
P4Y	S-1167B39-I6T2G	LVR-IC	LDO, 3.9V±1.0%, 150mA, +CE	SNT-6A	35v1b	VR4	7g	Sii
P4Z	S-1167B40-I6T2G	LVR-IC	LDO, 4.0V±1.0%, 150mA, +CE	SNT-6A	35v1b	VR4	7g	Sii
p5	74AUP1T45GW	CMOS-Logic	Dual supply translating transceiver with 3-state output	SOT-363	33L.og70	-	7b	Phi
P5	BZX84-C16TS	Z-diode	Triple, 16V±5%, 200mW	SOT-363	33dd	-	7l	Di
P5	KRA768E	Si-pnp-Digi	Dual, Sw, 50V, 100mA, 200mW, R1/R2=2.2k/10k	TES6	35TD4	-	7k	Kec
P5	KRA768U	Si-pnp-Digi	Dual, Sw, 50V, 100mA, 200mW, R1/R2=2.2k/10k	US6	33TD7	-	7k	Kec
P5	R1225N502A	DC/DC-IC	VFM/PWM step-down, 5V, 300kHz	SOT-23-6W	33so	DC7	7d	Ric
P5	TK11250M	LVR-IC	LDO, 5V±5%, 170mA, +CE	SOT-23L-6	33vf	VR7	7b	Tok
P5	TK11255M	LVR-IC	LDO, 5.5V±5%, 170mA, +CE	SOT-23L-6	33vf	VR7	7b	Tok
P50	TK11250AM	LVR-IC	LDO, 5V±2.4%, 150mA, +CE	SOT-23L-6	33vf	VR7	7b	Tok
P55	TK11255AM	LVR-IC	LDO, 5.5V±2.4%, 150mA, +CE	SOT-23L-6	33vf	VR7	7b	Tok
P5A	S-1167B41-I6T2G	LVR-IC	LDO, 4.1V±1.0%, 150mA, +CE	SNT-6A	35v1b	VR4	7g	Sii
P5B	S-1167B42-I6T2G	LVR-IC	LDO, 4.2V±1.0%, 150mA, +CE	SNT-6A	35v1b	VR4	7g	Sii
P5C	S-1167B43-I6T2G	LVR-IC	LDO, 4.3V±1.0%, 150mA, +CE	SNT-6A	35v1b	VR4	7g	Sii
P5D	S-1167B44-I6T2G	LVR-IC	LDO, 4.4V±1.0%, 150mA, +CE	SNT-6A	35v1b	VR4	7g	Sii
P5E	S-1167B45-I6T2G	LVR-IC	LDO, 4.5V±1.0%, 150mA, +CE	SNT-6A	35v1b	VR4	7g	Sii
P5F	S-1167B46-I6T2G	LVR-IC	LDO, 4.6V±1.0%, 150mA, +CE	SNT-6A	35v1b	VR4	7g	Sii
P5G	S-1167B47-I6T2G	LVR-IC	LDO, 4.7V±1.0%, 150mA, +CE	SNT-6A	35v1b	VR4	7g	Sii
P5H	S-1167B48-I6T2G	LVR-IC	LDO, 4.8V±1.0%, 150mA, +CE	SNT-6A	35v1b	VR4	7g	Sii
P5I	S-1167B49-I6T2G	LVR-IC	LDO, 4.9V±1.0%, 150mA, +CE	SNT-6A	35v1b	VR4	7g	Sii
P5J	S-1167B50-I6T2G	LVR-IC	LDO, 5.0V±1.0%, 150mA, +CE	SNT-6A	35v1b	VR4	7g	Sii
P5K	S-1167B51-I6T2G	LVR-IC	LDO, 5.1V±1.0%, 150mA, +CE	SNT-6A	35v1b	VR4	7g	Sii
P5L	S-1167B52-I6T2G	LVR-IC	LDO, 5.2V±1.0%, 150mA, +CE	SNT-6A	35v1b	VR4	7g	Sii
P5M	S-1167B53-I6T2G	LVR-IC	LDO, 5.3V±1.0%, 150mA, +CE	SNT-6A	35v1b	VR4	7g	Sii
P5N	S-1167B54-I6T2G	LVR-IC	LDO, 5.4V±1.0%, 150mA, +CE	SNT-6A	35v1b	VR4	7g	Sii
P5O	S-1167B55-I6T2G	LVR-IC	LDO, 5.5V±1.0%, 150mA, +CE	SNT-6A	35v1b	VR4	7g	Sii
P6	BZX84-C18TS	Z-diode	Triple, 18V±5%, 200mW	SOT-363	33dd	-	7l	Di
P6	KRA769E	Si-pnp-Digi	Dual, Sw, 50V, 100mA, 200mW, R1/R2=4.7k/10k	TES6	35TD4	-	7k	Kec
P6	KRA769U	Si-pnp-Digi	Dual, Sw, 50V, 100mA, 200mW, R1/R2=4.7k/10k	US6	33TD7	-	7k	Kec
P6	R1225N552A	DC/DC-IC	VFM/PWM step-down, 5.5V, 300kHz	SOT-23-6W	33so	DC7	7d	Ric
p7	74AUP2G07GW	CMOS-Logic	Dual noninverting buffers/drivers (ODO)	SOT-363	33L.og26	-	7b	Phi
P7	BZX84-C20TS	Z-diode	Triple, 20V±5%, 200mW	SOT-363	33dd	-	7l	Di
P7	KRA770E	Si-pnp-Digi	Dual, Sw, 50V, 100mA, 200mW, R1/R2=10k/4.7k	TES6	35TD4	-	7k	Kec
P7	KRA770U	Si-pnp-Digi	Dual, Sw, 50V, 100mA, 200mW, R1/R2=10k/4.7k	US6	33TD7	-	7k	Kec
P7	R1225N602A	DC/DC-IC	VFM/PWM step-down, 6V, 300kHz	SOT-23-6W	33so	DC7	7d	Ric
p74	74AUP1G74DC	CMOS-Logic	Positive edge-triggered D-type flip-flop with set and reset	SOT765-1	47L.og59	-	8d	Phi
p79	74AUP2G79DC	CMOS-Logic	Dual positive-edge triggered D-type flip-flop	SOT765-1	47L.og63	-	8d	Phi
P8	BZX84-C22TS	Z-diode	Triple, 22V±5%, 200mW	SOT-363	33dd	-	7l	Di
P8	KRA771E	Si-pnp-Digi	Dual, Sw, 50V, 100mA, 200mW, R1/R2=47k/10k	TES6	35TD4	-	7k	Kec
P8	KRA771U	Si-pnp-Digi	Dual, Sw, 50V, 100mA, 200mW, R1/R2=47k/10k	US6	33TD7	-	7k	Kec
P8	R1225N122B	DC/DC-IC	VFM/PWM step-down, 1.2V, 500kHz	SOT-23-6W	33so	DC7	7d	Ric
p80	74AUP2G80DC	CMOS-Logic	Dual positive-edge triggered D-type flip-flop	SOT765-1	47L.og64	-	8d	Phi
P81	DDA122LH	Si-pnp-Digi	Dual, Sw, 50V, 100mA, 150mW, R1/R2=0.22k/10k	SOT-563	35T10	-	7k	Di
P81	DDA122LU	Si-pnp-Digi	Dual, Sw, 50V, 100mA, 200mW, R1/R2=0.22k/10k	SOT-363	33TD4	-	7k	Di
P82	DDA142JH	Si-pnp-Digi	Dual, Sw, 50V, 100mA, 150mW, R1/R2=0.47k/10k	SOT-563	35T10	-	7k	Di
P82	DDA142JU	Si-pnp-Digi	Dual, Sw, 50V, 100mA, 200mW, R1/R2=0.47k/10k	SOT-363	33TD4	-	7k	Di
P83	DDA122TH	Si-pnp-Digi	Dual, Sw, 50V, 100mA, 150mW, R1=0.22k	SOT-563	35T10	-	7k	Di
P83	DDA122TU	Si-pnp-Digi	Dual, Sw, 50V, 100mA, 200mW, R1=0.22k	SOT-363	33TD4	-	7k	Di
P8303A	PAM8303ABSC	LIN-IC	AF PA, BTL, class-D, 2.8..5.5V, 3W(5V/4Q), shutdown	MSOP-8	55	AFP63	-	Pam
P8303C	PAM8303CBSC	LIN-IC	AF PA, BTL, class-D, 2.8..5.5V, 3W(5V/4Q), shutdown	MSOP-8	55	AFP63	-	Pam
P8303D	PAM8303DBSC	LIN-IC	AF PA, BTL, class-D, 2.8..5.5V, 3W(5V/4Q), shutdown	MSOP-8	55	AFP63	-	Pam
P84	DDA142TH	Si-pnp-Digi	Dual, Sw, 50V, 100mA, 150mW, R1=0.47k	SOT-563	35T10	-	7k	Di
P84	DDA142TU	Si-pnp-Digi	Dual, Sw, 50V, 100mA, 200mW, R1=0.47k	SOT-363	33TD4	-	7k	Di
P8401	PAM8401ASM	LIN-IC	AF PA, BTL, class-D, 2.5..5.5V, 2x1.5W(5V/8Q), shutdown	MSOP-10	60	-	-	Pam
p86	74AUP2G86DC	CMOS-Logic	Dual 2-input EXCLUSIVE-OR gates	SOT765-1	47L.og65	-	8d	Phi
P9	BZX84-C24TS	Z-diode	Triple, 24V±5%, 200mW	SOT-363	33dd	-	7l	Di
P9	KRA772E	Si-pnp-Digi	Dual, Sw, 50V, 100mA, 200mW, R1/R2=100k/100k	TES6	35TD4	-	7k	Kec
P9	KRA772U	Si-pnp-Digi	Dual, Sw, 50V, 100mA, 200mW, R1/R2=100k/100k	US6	33TD7	-	7k	Kec
P9	R1225N152B	DC/DC-IC	VFM/PWM step-down, 1.5V, 500kHz	SOT-23-6W	33so	DC7	7d	Ric
PA	BZX84-C27TS	Z-diode	Triple, 27V±5%, 200mW	SOT-363	33dd	-	7l	Di
PA	KRA721T	Si-pnp-Digi	Dual, Sw, 50V, 80mA, 900mW, R1/R2=1k/1k	TS6	33TD4	-	7k	Kec
PA	KRA751E	Si-pnp-Digi	Dual, Sw, 50V, 100mA, 200mW, R1/R2=4.7k/4.7k	TES6	35TD4	-	7k	Kec
PA	KRA751U	Si-pnp-Digi	Dual, Sw, 50V, 100mA, 200mW, R1/R2=4.7k/4.7k	US6	33TD7	-	7k	Kec
PA	R1225N182B	DC/DC-IC	VFM/PWM step-down, 1.8V, 500kHz	SOT-23-6W	33so	DC7	7d	Ric
PA	Si1902DL	n-MOSFET-e	Dual, V-MOS, LogL, 20V, ±0.66A, <0.63Q(0.4A), <50/40ns	SOT-363	33T13	-	7b	Six
PA	XC6602A051MR-G	LVR-IC	LDO, 0.5V±15mV, 1A, +CE, soft start	SOT-26W	33zk	VR11	7d	Tor
PAs	BCP72M	Si-pnp	AF-Drv/Out, 10V, 3A, 1.7W, BE=85, 475, 100MHz	SCT-595	71uo	-	-	Inf
PB	KRA722T	Si-pnp-Digi	Dual, Sw, 50V, 80mA, 900mW, R1/R2=2.2k/2.2k	TS6	33TD4	-	7k	Kec



SMD code	Type	Function	Short description	Case	Pinout	Sch.	St.	Mnf.
PB	KRA752E	Si-pnp-Digi	Dual, Sw, 50V, 100mA, 200mW, R1/R2=10k/10k	TES6	35/TD4	-	7k	Kec
PB	KRA752U	Si-pnp-Digi	Dual, Sw, 50V, 100mA, 200mW, R1/R2=10k/10k	US6	33/TD7	-	7k	Kec
PB	R1225N252B	DC/DC-IC	VFM/PWM step-down, 2.5V, 500kHz	SOT-23-6W	33so	DC7	7d	Ric
PB	XC6602A061MR-G	LVR-IC	LDO, 0.6V±15mV, 1A, +CE, soft start	SOT-26W	33zk	VR11	7d	Tor
PBs	BCP70M	Si-pnp	AF-Dr/Out, 25V, 3A, 1.7V, B=85..475, 100MHz	SCT-595	71uo	-	-	Inf
PC	KRA723T	Si-pnp-Digi	Dual, Sw, 50V, 800mA, 900mW, R1/R2=4.7k/4.7k	TS6	33/TD4	-	7k	Kec
PC	KRA753E	Si-pnp-Digi	Dual, Sw, 50V, 100mA, 200mW, R1/R2=22k/22k	TES6	35/TD4	-	7k	Kec
PC	KRA753U	Si-pnp-Digi	Dual, Sw, 50V, 100mA, 200mW, R1/R2=22k/22k	US6	33/TD7	-	7k	Kec
PC	R1225N332B	DC/DC-IC	VFM/PWM step-down, 3.3V, 500kHz	SOT-23-6W	33so	DC7	7d	Ric
PC	XC6602A071MR-G	LVR-IC	LDO, 0.7V±15mV, 1A, +CE, soft start	SOT-26W	33zk	VR11	7d	Tor
PCs	BCP71M	Si-npn	AF-Dr/Out, 32V, 3A, 1.7V, B=85..475, 100MHz	SCT-595	71uo	-	-	Inf
PD	KRA724T	Si-pnp-Digi	Dual, Sw, 50V, 800mA, 900mW, R1/R2=10k/10k	TS6	33/TD4	-	7k	Kec
PD	KRA754E	Si-pnp-Digi	Dual, Sw, 50V, 100mA, 200mW, R1/R2=47k/47k	TES6	35/TD4	-	7k	Kec
PD	KRA754U	Si-pnp-Digi	Dual, Sw, 50V, 100mA, 200mW, R1/R2=47k/47k	US6	33/TD7	-	7k	Kec
PD	R1225N502B	DC/DC-IC	VFM/PWM step-down, 5V, 500kHz	SOT-23-6W	33so	DC7	7d	Ric
PD	XC6602A081MR-G	LVR-IC	LDO, 0.8V±15mV, 1A, +CE, soft start	SOT-26W	33zk	VR11	7d	Tor
PE	KRA725T	Si-pnp-Digi	Dual, Sw, 50V, 800mA, 900mW, R1/R2=1k/10k	TS6	33/TD4	-	7k	Kec
PE	KRA755E	Si-pnp-Digi	Dual, Sw, 50V, 100mA, 200mW, R1/R2=2.2k/47k	TES6	35/TD4	-	7k	Kec
PE	KRA755U	Si-pnp-Digi	Dual, Sw, 50V, 100mA, 200mW, R1/R2=2.2k/47k	US6	33/TD7	-	7k	Kec
PE	R1225N552B	DC/DC-IC	VFM/PWM step-down, 5.5V, 500kHz	SOT-23-6W	33so	DC7	7d	Ric
PE	XC6602A091MR-G	LVR-IC	LDO, 0.9V±15mV, 1A, +CE, soft start	SOT-26W	33zk	VR11	7d	Tor
PF	KRA726T	Si-pnp-Digi	Dual, Sw, 50V, 800mA, 900mW, R1/R2=2.2k/10k	TS6	33/TD4	-	7k	Kec
PF	KRA756E	Si-pnp-Digi	Dual, Sw, 50V, 100mA, 200mW, R1/R2=4.7k/47k	TES6	35/TD4	-	7k	Kec
PF	KRA756U	Si-pnp-Digi	Dual, Sw, 50V, 100mA, 200mW, R1/R2=4.7k/47k	US6	33/TD7	-	7k	Kec
PF	R1225N602B	DC/DC-IC	VFM/PWM step-down, 6V, 500kHz	SOT-23-6W	33so	DC7	7d	Ric
PF	XC6602A101MR-G	LVR-IC	LDO, 1.0V±15mV, 1A, +CE, soft start	SOT-26W	33zk	VR11	7d	Tor
PFWI	TPS3103E12D	Vdet-IC	1.142V, -MR, -Reset ODO	SOP-6	33ma	-	7b	Ti
PFXI	TPS3103E15D	Vdet-IC	1.434V, -MR, -Reset ODO	SOP-6	33ma	-	7b	Ti
PFYI	TPS3103H20D	Vdet-IC	1.84V, -MR, -Reset ODO	SOP-6	33ma	-	7b	Ti
PFZI	TPS3106E09D	Vdet-IC	0.86V, -MR, -Reset ODO	SOP-6	33mb	-	7b	Ti
PG	R1225N122J	DC/DC-IC	VFM/PWM step-down, 1.2V, 180kHz	SOT-23-6W	33so	DC7	7d	Ric
PGBI	TPS3106K33D	Vdet-IC	2.941V, -MR, -Reset ODO	SOP-6	33mb	-	7b	Ti
PGJI	TPS3110E09D	Vdet-IC	0.86V, -MR, -Reset PPO	SOP-6	33mc	-	7b	Ti
PGJI	TPS3110E12D	Vdet-IC	1.142V, -MR, -Reset PPO	SOP-6	33mc	-	7b	Ti
PGKI	TPS3110E15D	Vdet-IC	1.434V, -MR, -Reset PPO	SOP-6	33mc	-	7b	Ti
PGLI	TPS3110K33D	Vdet-IC	2.941V, -MR, -Reset PPO	SOP-6	33mc	-	7b	Ti
PGRI	TPS3103K33D	Vdet-IC	2.941V, -MR, -Reset ODO	SOP-6	33ma	-	7b	Ti
PGSI	TPS3106E16D	Vdet-IC	1.521V, -MR, -Reset ODO	SOP-6	33mb	-	7b	Ti
PH	KRA757E	Si-pnp-Digi	Dual, Sw, 50V, 100mA, 200mW, R1/R2=10k/47k	TES6	35/TD4	-	7k	Kec
PH	KRA757U	Si-pnp-Digi	Dual, Sw, 50V, 100mA, 200mW, R1/R2=10k/47k	US6	33/TD7	-	7k	Kec
PH	R1225N152J	DC/DC-IC	VFM/PWM step-down, 1.5V, 180kHz	SOT-23-6W	33so	DC7	7d	Ric
PH	XC6602A111MR-G	LVR-IC	LDO, 1.1V±15mV, 1A, +CE, soft start	SOT-26W	33zk	VR11	7d	Tor
PI	KRA758E	Si-pnp-Digi	Dual, Sw, 50V, 100mA, 200mW, R1/R2=22k/47k	TES6	35/TD4	-	7k	Kec
PI	KRA758U	Si-pnp-Digi	Dual, Sw, 50V, 100mA, 200mW, R1/R2=22k/47k	US6	33/TD7	-	7k	Kec
PJ	DDZX20CTS	Z-diode	Triple, 20V±2.5%, 200mW	SOT-363	33dd	-	7k	Di
PJ	KRA759E	Si-pnp-Digi	Dual, Sw, 50V, 100mA, 200mW, R1/R2=47k/22k	TES6	35/TD4	-	7k	Kec
PJ	KRA759U	Si-pnp-Digi	Dual, Sw, 50V, 100mA, 200mW, R1/R2=47k/22k	US6	33/TD7	-	7k	Kec
PJ	R1225N182J	DC/DC-IC	VFM/PWM step-down, 1.8V, 180kHz	SOT-23-6W	33so	DC7	7d	Ric
PJAI	TPS64200DBVR	SVR-IC	Step-down controller, adjustable 1.2V..Vin	SOT-23-6	33yk	-	7b	Ti
PJBI	TPS64201DBVR	SVR-IC	Step-down controller, adjustable 1.2V..Vin	SOT-23-6	33yk	-	7b	Ti
PJCI	TPS64202DBVR	SVR-IC	Step-down controller, adjustable 1.2V..Vin	SOT-23-6	33yk	-	7b	Ti
PJDI	TPS64203DBVR	SVR-IC	Step-down controller, adjustable 1.2V..Vin	SOT-23-6	33yk	-	7b	Ti
pK	74AUP2G14GW	CMOS-Logic	Dual Schmitt-trigger inverter buffers	SOT-363	33L,log34	-	7b	Phi
PK	KRA760E	Si-pnp-Digi	Dual, Sw, 50V, 100mA, 200mW, R1=4.7k	TES6	35/TD4	-	7k	Kec
PK	KRA760U	Si-pnp-Digi	Dual, Sw, 50V, 100mA, 200mW, R1=4.7k	US6	33/TD7	-	7k	Kec
PK	R1225N252J	DC/DC-IC	VFM/PWM step-down, 2.5V, 180kHz	SOT-23-6W	33so	DC7	7d	Ric
PK	XC6602A121MR-G	LVR-IC	LDO, 1.2V±20mV, 1A, +CE, soft start	SOT-26W	33zk	VR11	7d	Tor
PL	DDZX24CTS	Z-diode	Triple, 24V±2.5%, 200mW	SOT-363	33dd	-	7k	Di
PL	R1225N332J	DC/DC-IC	VFM/PWM step-down, 3.3V, 180kHz	SOT-23-6W	33so	DC7	7d	Ric
PL	XC6602A131MR-G	LVR-IC	LDO, 1.3V±20mV, 1A, +CE, soft start	SOT-26W	33zk	VR11	7d	Tor
PM	KRA761E	Si-pnp-Digi	Dual, Sw, 50V, 100mA, 200mW, R1=10k	TES6	35/TD4	-	7k	Kec
PM	KRA761U	Si-pnp-Digi	Dual, Sw, 50V, 100mA, 200mW, R1=10k	US6	33/TD7	-	7k	Kec
PM	R1225N502J	DC/DC-IC	PWM step-down, 5V, 180kHz	SOT-23-6W	33so	DC7	7d	Ric
PM	XC6602A141MR-G	LVR-IC	LDO, 1.4V±20mV, 1A, +CE, soft start	SOT-26W	33zk	VR11	7d	Tor
PN	KRA762E	Si-pnp-Digi	Dual, Sw, 50V, 100mA, 200mW, R1=100k	TES6	35/TD4	-	7k	Kec
PN	KRA762U	Si-pnp-Digi	Dual, Sw, 50V, 100mA, 200mW, R1=100k	US6	33/TD7	-	7k	Kec
PN	R1225N552J	DC/DC-IC	VFM/PWM step-down, 5.5V, 180kHz	SOT-23-6W	33so	DC7	7d	Ric
PN	XC6602A151MR-G	LVR-IC	LDO, 1.5V±20mV, 1A, +CE, soft start	SOT-26W	33zk	VR11	7d	Tor
PO	KRA763E	Si-pnp-Digi	Dual, Sw, 50V, 100mA, 200mW, R1=22k	TES6	35/TD4	-	7k	Kec
PO	KRA763U	Si-pnp-Digi	Dual, Sw, 50V, 100mA, 200mW, R1=22k	US6	33/TD7	-	7k	Kec



SMD code	Type	Function	Short description	Case	Pinout	Sch.	St.	Mnf.
POA	S-1200B15-A6T1S	LVR-IC	LDO, 1.5V±1.0%, 150mA, +CE	HSNT-6A	43ep	VR4	7g	Sii
POA	S-1200B15-I6T2G	LVR-IC	LDO, 1.5V±1.0%, 150mA, +CE	SNT-6A	35vrb	VR4	7g	Sii
POB	S-1200B16-A6T1S	LVR-IC	LDO, 1.6V±1.0%, 150mA, +CE	HSNT-6A	43ep	VR4	7g	Sii
POB	S-1200B16-I6T2G	LVR-IC	LDO, 1.6V±1.0%, 150mA, +CE	SNT-6A	35vrb	VR4	7g	Sii
POC	S-1200B17-A6T1S	LVR-IC	LDO, 1.7V±1.0%, 150mA, +CE	HSNT-6A	43ep	VR4	7g	Sii
POC	S-1200B17-I6T2G	LVR-IC	LDO, 1.7V±1.0%, 150mA, +CE	SNT-6A	35vrb	VR4	7g	Sii
POD	S-1200B18-A6T1S	LVR-IC	LDO, 1.8V±1.0%, 150mA, +CE	HSNT-6A	43ep	VR4	7g	Sii
POD	S-1200B18-I6T2G	LVR-IC	LDO, 1.8V±1.0%, 150mA, +CE	SNT-6A	35vrb	VR4	7g	Sii
POE	S-1200B19-A6T1S	LVR-IC	LDO, 1.9V±1.0%, 150mA, +CE	HSNT-6A	43ep	VR4	7g	Sii
POE	S-1200B19-I6T2G	LVR-IC	LDO, 1.9V±1.0%, 150mA, +CE	SNT-6A	35vrb	VR4	7g	Sii
POF	S-1200B20-A6T1S	LVR-IC	LDO, 2.0V±1.0%, 150mA, +CE	HSNT-6A	43ep	VR4	7g	Sii
POF	S-1200B20-I6T2G	LVR-IC	LDO, 2.0V±1.0%, 150mA, +CE	SNT-6A	35vrb	VR4	7g	Sii
POG	S-1200B21-A6T1S	LVR-IC	LDO, 2.1V±1.0%, 150mA, +CE	HSNT-6A	43ep	VR4	7g	Sii
POG	S-1200B21-I6T2G	LVR-IC	LDO, 2.1V±1.0%, 150mA, +CE	SNT-6A	35vrb	VR4	7g	Sii
POH	S-1200B22-A6T1S	LVR-IC	LDO, 2.2V±1.0%, 150mA, +CE	HSNT-6A	43ep	VR4	7g	Sii
POH	S-1200B22-I6T2G	LVR-IC	LDO, 2.2V±1.0%, 150mA, +CE	SNT-6A	35vrb	VR4	7g	Sii
POI	S-1200B23-A6T1S	LVR-IC	LDO, 2.3V±1.0%, 150mA, +CE	HSNT-6A	43ep	VR4	7g	Sii
POI	S-1200B23-I6T2G	LVR-IC	LDO, 2.3V±1.0%, 150mA, +CE	SNT-6A	35vrb	VR4	7g	Sii
POJ	S-1200B24-A6T1S	LVR-IC	LDO, 2.4V±1.0%, 150mA, +CE	HSNT-6A	43ep	VR4	7g	Sii
POJ	S-1200B24-I6T2G	LVR-IC	LDO, 2.4V±1.0%, 150mA, +CE	SNT-6A	35vrb	VR4	7g	Sii
POK	S-1200B25-A6T1S	LVR-IC	LDO, 2.5V±1.0%, 150mA, +CE	HSNT-6A	43ep	VR4	7g	Sii
POK	S-1200B25-I6T2G	LVR-IC	LDO, 2.5V±1.0%, 150mA, +CE	SNT-6A	35vrb	VR4	7g	Sii
POL	S-1200B26-A6T1S	LVR-IC	LDO, 2.6V±1.0%, 150mA, +CE	HSNT-6A	43ep	VR4	7g	Sii
POL	S-1200B26-I6T2G	LVR-IC	LDO, 2.6V±1.0%, 150mA, +CE	SNT-6A	35vrb	VR4	7g	Sii
POM	S-1200B27-A6T1S	LVR-IC	LDO, 2.7V±1.0%, 150mA, +CE	HSNT-6A	43ep	VR4	7g	Sii
POM	S-1200B27-I6T2G	LVR-IC	LDO, 2.7V±1.0%, 150mA, +CE	SNT-6A	35vrb	VR4	7g	Sii
PON	S-1200B28-A6T1S	LVR-IC	LDO, 2.8V±1.0%, 150mA, +CE	HSNT-6A	43ep	VR4	7g	Sii
PON	S-1200B28-I6T2G	LVR-IC	LDO, 2.8V±1.0%, 150mA, +CE	SNT-6A	35vrb	VR4	7g	Sii
POO	S-1200B29-A6T1S	LVR-IC	LDO, 2.9V±1.0%, 150mA, +CE	HSNT-6A	43ep	VR4	7g	Sii
POO	S-1200B29-I6T2G	LVR-IC	LDO, 2.9V±1.0%, 150mA, +CE	SNT-6A	35vrb	VR4	7g	Sii
POP	S-1200B30-A6T1S	LVR-IC	LDO, 3.0V±1.0%, 150mA, +CE	HSNT-6A	43ep	VR4	7g	Sii
POP	S-1200B30-I6T2G	LVR-IC	LDO, 3.0V±1.0%, 150mA, +CE	SNT-6A	35vrb	VR4	7g	Sii
POQ	S-1200B31-A6T1S	LVR-IC	LDO, 3.1V±1.0%, 150mA, +CE	HSNT-6A	43ep	VR4	7g	Sii
POQ	S-1200B31-I6T2G	LVR-IC	LDO, 3.1V±1.0%, 150mA, +CE	SNT-6A	35vrb	VR4	7g	Sii
POR	S-1200B32-A6T1S	LVR-IC	LDO, 3.2V±1.0%, 150mA, +CE	HSNT-6A	43ep	VR4	7g	Sii
POR	S-1200B32-I6T2G	LVR-IC	LDO, 3.2V±1.0%, 150mA, +CE	SNT-6A	35vrb	VR4	7g	Sii
POS	S-1200B33-A6T1S	LVR-IC	LDO, 3.3V±1.0%, 150mA, +CE	HSNT-6A	43ep	VR4	7g	Sii
POS	S-1200B33-I6T2G	LVR-IC	LDO, 3.3V±1.0%, 150mA, +CE	SNT-6A	35vrb	VR4	7g	Sii
POT	S-1200B34-A6T1S	LVR-IC	LDO, 3.4V±1.0%, 150mA, +CE	HSNT-6A	43ep	VR4	7g	Sii
POT	S-1200B34-I6T2G	LVR-IC	LDO, 3.4V±1.0%, 150mA, +CE	SNT-6A	35vrb	VR4	7g	Sii
POU	S-1200B35-A6T1S	LVR-IC	LDO, 3.5V±1.0%, 150mA, +CE	HSNT-6A	43ep	VR4	7g	Sii
POU	S-1200B35-I6T2G	LVR-IC	LDO, 3.5V±1.0%, 150mA, +CE	SNT-6A	35vrb	VR4	7g	Sii
POV	S-1200B36-A6T1S	LVR-IC	LDO, 3.6V±1.0%, 150mA, +CE	HSNT-6A	43ep	VR4	7g	Sii
POV	S-1200B36-I6T2G	LVR-IC	LDO, 3.6V±1.0%, 150mA, +CE	SNT-6A	35vrb	VR4	7g	Sii
POW	S-1200B37-A6T1S	LVR-IC	LDO, 3.7V±1.0%, 150mA, +CE	HSNT-6A	43ep	VR4	7g	Sii
POW	S-1200B37-I6T2G	LVR-IC	LDO, 3.7V±1.0%, 150mA, +CE	SNT-6A	35vrb	VR4	7g	Sii
POX	S-1200B38-A6T1S	LVR-IC	LDO, 3.8V±1.0%, 150mA, +CE	HSNT-6A	43ep	VR4	7g	Sii
POX	S-1200B38-I6T2G	LVR-IC	LDO, 3.8V±1.0%, 150mA, +CE	SNT-6A	35vrb	VR4	7g	Sii
POY	S-1200B39-A6T1S	LVR-IC	LDO, 3.9V±1.0%, 150mA, +CE	HSNT-6A	43ep	VR4	7g	Sii
POY	S-1200B39-I6T2G	LVR-IC	LDO, 3.9V±1.0%, 150mA, +CE	SNT-6A	35vrb	VR4	7g	Sii
POZ	S-1200B40-A6T1S	LVR-IC	LDO, 4.0V±1.0%, 150mA, +CE	HSNT-6A	43ep	VR4	7g	Sii
POZ	S-1200B40-I6T2G	LVR-IC	LDO, 4.0V±1.0%, 150mA, +CE	SNT-6A	35vrb	VR4	7g	Sii
PP	KRA764E	Si-pnp-Digi	Dual, Sw, 50V, 100mA, 200mW, R1=47k	TES6	35/TD4	-	7k	Kec
PP	KRA764J	Si-pnp-Digi	Dual, Sw, 50V, 100mA, 200mW, R1=47k	US6	33/TD7	-	7k	Kec
PP	NC7S08L6	CMOS-Logic	2-input AND gate	MPAK-6	33/Log3	-	7b	F
PP	R1225N602J	DC/DC-IC	VFMP/PWM step-down, 6V, 180kHz	SOT-23-6W	33so	DC7	7d	Ric
PP	XC6602A161MR-G	LVR-IC	LDO, 1.6V±20mV, 1A, +CE, soft start	SOT-26W	33zk	VR11	7d	Tor
PPA	S-1200B41-A6T1S	LVR-IC	LDO, 4.1V±1.0%, 150mA, +CE	HSNT-6A	43ep	VR4	7g	Sii
PPA	S-1200B41-I6T2G	LVR-IC	LDO, 4.1V±1.0%, 150mA, +CE	SNT-6A	35vrb	VR4	7g	Sii
PPB	S-1200B42-A6T1S	LVR-IC	LDO, 4.2V±1.0%, 150mA, +CE	HSNT-6A	43ep	VR4	7g	Sii
PPB	S-1200B42-I6T2G	LVR-IC	LDO, 4.2V±1.0%, 150mA, +CE	SNT-6A	35vrb	VR4	7g	Sii
PPC	S-1200B43-A6T1S	LVR-IC	LDO, 4.3V±1.0%, 150mA, +CE	HSNT-6A	43ep	VR4	7g	Sii
PPC	S-1200B43-I6T2G	LVR-IC	LDO, 4.3V±1.0%, 150mA, +CE	SNT-6A	35vrb	VR4	7g	Sii
PPD	S-1200B44-A6T1S	LVR-IC	LDO, 4.4V±1.0%, 150mA, +CE	HSNT-6A	43ep	VR4	7g	Sii
PPD	S-1200B44-I6T2G	LVR-IC	LDO, 4.4V±1.0%, 150mA, +CE	SNT-6A	35vrb	VR4	7g	Sii
PPE	S-1200B45-A6T1S	LVR-IC	LDO, 4.5V±1.0%, 150mA, +CE	HSNT-6A	43ep	VR4	7g	Sii
PPE	S-1200B45-I6T2G	LVR-IC	LDO, 4.5V±1.0%, 150mA, +CE	SNT-6A	35vrb	VR4	7g	Sii
PPF	S-1200B46-A6T1S	LVR-IC	LDO, 4.6V±1.0%, 150mA, +CE	HSNT-6A	43ep	VR4	7g	Sii
PPF	S-1200B46-I6T2G	LVR-IC	LDO, 4.6V±1.0%, 150mA, +CE	SNT-6A	35vrb	VR4	7g	Sii
PPG	S-1200B47-A6T1S	LVR-IC	LDO, 4.7V±1.0%, 150mA, +CE	HSNT-6A	43ep	VR4	7g	Sii



SMD code	Type	Function	Short description	Case	Pinout	Sch.	St.	Mnf.
PPG	S-1200B47-I6T2G	LVR-IC	LDO, 4.7V±1.0%, 150mA, +CE	SNT-6A	35v1b	VR4	7g	Sii
PPH	S-1200B48-A6T1S	LVR-IC	LDO, 4.8V±1.0%, 150mA, +CE	HSNT-6A	43ep	VR4	7g	Sii
PPH	S-1200B48-I6T2G	LVR-IC	LDO, 4.8V±1.0%, 150mA, +CE	SNT-6A	35v1b	VR4	7g	Sii
PPI	S-1200B49-A6T1S	LVR-IC	LDO, 4.9V±1.0%, 150mA, +CE	HSNT-6A	43ep	VR4	7g	Sii
PPI	S-1200B49-I6T2G	LVR-IC	LDO, 4.9V±1.0%, 150mA, +CE	SNT-6A	35v1b	VR4	7g	Sii
PPJ	S-1200B50-A6T1S	LVR-IC	LDO, 5.0V±1.0%, 150mA, +CE	HSNT-6A	43ep	VR4	7g	Sii
PPJ	S-1200B50-I6T2G	LVR-IC	LDO, 5.0V±1.0%, 150mA, +CE	SNT-6A	35v1b	VR4	7g	Sii
PPK	S-1200B51-A6T1S	LVR-IC	LDO, 5.1V±1.0%, 150mA, +CE	HSNT-6A	43ep	VR4	7g	Sii
PPK	S-1200B51-I6T2G	LVR-IC	LDO, 5.1V±1.0%, 150mA, +CE	SNT-6A	35v1b	VR4	7g	Sii
PPL	S-1200B52-A6T1S	LVR-IC	LDO, 5.2V±1.0%, 150mA, +CE	HSNT-6A	43ep	VR4	7g	Sii
PPL	S-1200B52-I6T2G	LVR-IC	LDO, 5.2V±1.0%, 150mA, +CE	SNT-6A	35v1b	VR4	7g	Sii
PPM	S-1200B53-A6T1S	LVR-IC	LDO, 5.3V±1.0%, 150mA, +CE	HSNT-6A	43ep	VR4	7g	Sii
PPM	S-1200B53-I6T2G	LVR-IC	LDO, 5.3V±1.0%, 150mA, +CE	SNT-6A	35v1b	VR4	7g	Sii
PPN	S-1200B54-A6T1S	LVR-IC	LDO, 5.4V±1.0%, 150mA, +CE	HSNT-6A	43ep	VR4	7g	Sii
PPN	S-1200B54-I6T2G	LVR-IC	LDO, 5.4V±1.0%, 150mA, +CE	SNT-6A	35v1b	VR4	7g	Sii
PPO	S-1200B55-A6T1S	LVR-IC	LDO, 5.5V±1.0%, 150mA, +CE	HSNT-6A	43ep	VR4	7g	Sii
PPO	S-1200B55-I6T2G	LVR-IC	LDO, 5.5V±1.0%, 150mA, +CE	SNT-6A	35v1b	VR4	7g	Sii
PQ	R1225N302A	DC/DC-IC	VFM/PWM step-down, 3V, 300kHz	SOT-23-6W	33so	DC7	7d	Ric
PR	R1225N302B	DC/DC-IC	VFM/PWM step-down, 3V, 500kHz	SOT-23-6W	33so	DC7	7d	Ric
PR	XC6602A171MR-G	LVR-IC	LDO, 1.7V±20mV, 1A, +CE, soft start	SOT-26W	33zk	VR11	7d	Tor
pS	74AUP1G07GW	CMOS-Logic	Noninverting buffer/driver (ODO)	SOT-363	33Llog8	-	7b	Phi
PS	R1225N302J	DC/DC-IC	VFM/PWM step-down, 3V, 180kHz	SOT-23-6W	33so	DC7	7d	Ric
PS	XC6602A181MR-G	LVR-IC	LDO, 1.8V±20mV, 1A, +CE, soft start	SOT-26W	33zk	VR11	7d	Tor
pS8	74AUP1G885DC	CMOS-Logic	Dual function gate	SOT765-1	47Llog61	-	8b	Phi
PT	74AUP1G80GW	CMOS-Logic	Positive edge-triggered D-type flip-flop	SOT-363	33Llog21	-	7b	Phi
PT	R1225N162B	DC/DC-IC	VFM/PWM step-down, 1.6V, 500kHz	SOT-23-6W	33so	DC7	7d	Ric
pU	74AUP1G11GW	CMOS-Logic	3-input AND gate	SOT-363	33Llog30	-	7b	Phi
PJ	R1225N122C	DC/DC-IC	PWM step-down, 1.2V, 300kHz	SOT-23-6W	33so	DC7	7d	Ric
PV	R1225N152C	DC/DC-IC	PWM step-down, 1.5V, 300kHz	SOT-23-6W	33so	DC7	7d	Ric
pW	74AUP1G18GW	CMOS-Logic	Noninverting 1-of-2 demultiplexer with 3-state deselected output	SOT-363	33Llog44	-	7b	Phi
PW	R1225N182C	DC/DC-IC	PWM step-down, 1.8V, 300kHz	SOT-23-6W	33so	DC7	7d	Ric
PX	R1225N252C	DC/DC-IC	PWM step-down, 2.5V, 300kHz	SOT-23-6W	33so	DC7	7d	Ric
pY	74AUP1G19GW	CMOS-Logic	1-of-2 decoder/demultiplexer	SOT-363	33Llog47	-	7b	Phi
PY	R1225N332C	DC/DC-IC	PWM step-down, 3.3V, 300kHz	SOT-23-6W	33so	DC7	7d	Ric
PZ	R1225N502C	DC/DC-IC	PWM step-down, 5V, 300kHz	SOT-23-6W	33so	DC7	7d	Ric
Q0	R1131D181B5	LVR-IC	LDO, 1.85V±2%, 300mA, -CE	SON-6	34hq	VR4	7g	Ric
Q0	R5210N001A	DC/DC-IC	PWM step-down, Vr=3.4V, DC/DCout=2.7V, Vdet= 4.2V	SOT-23-6W	33dc1	-	7d	Ric
Q1	R1131D281B5	LVR-IC	LDO, 2.85V±2%, 300mA, -CE	SON-6	34hq	VR4	7g	Ric
Q1	R5210N002A	DC/DC-IC	PWM step-down, Vr=3.3V, DC/DCout=2.5V, Vdet= 4V	SOT-23-6W	33dc1	-	7d	Ric
Q2	R1131D121B5	LVR-IC	LDO, 1.25V±2%, 300mA, -CE	SON-6	34hq	VR4	7g	Ric
Q2	R5210N011C	DC/DC-IC	PWM step-down, Vr=2.6V, DC/DCout=1.6V, Vdet= 4.2V	SOT-23-6W	33dc1	-	7d	Ric
Q20	TK11320M	LVR-IC	LDO, 2V±5%, 170mA, -CE	SOT-23L-6	33vf	VR7	7b	Tok
Q3	R5210N001C	DC/DC-IC	PWM step-down, Vr=3.4V, DC/DCout=2.7V, Vdet= 4.2V	SOT-23-6W	33dc1	-	7d	Ric
Q30	TK11330M	LVR-IC	LDO, 3V±5%, 170mA, -CE	SOT-23L-6	33vf	VR7	7b	Tok
Q33	TK11333M	LVR-IC	LDO, 3.3V±5%, 170mA, -CE	SOT-23L-6	33vf	VR7	7b	Tok
Q4	R5210N002C	DC/DC-IC	PWM step-down, Vr=3.3V, DC/DCout=2.5V, Vdet= 4V	SOT-23-6W	33dc1	-	7d	Ric
Q40	TK11340M	LVR-IC	LDO, 4V±5%, 170mA, -CE	SOT-23L-6	33vf	VR7	7b	Tok
Q45	TK11345M	LVR-IC	LDO, 4.5V±5%, 170mA, -CE	SOT-23L-6	33vf	VR7	7b	Tok
Q48	TK11348M	LVR-IC	LDO, 4.8V±5%, 170mA, -CE	SOT-23L-6	33vf	VR7	7b	Tok
Q5	R5210N003C	DC/DC-IC	PWM step-down, Vr=3.3V, DC/DCout=2.5V, Vdet= 4.2V	SOT-23-6W	33dc1	-	7d	Ric
Q50	TK11350M	LVR-IC	LDO, 5V±5%, 170mA, -CE	SOT-23L-6	33vf	VR7	7b	Tok
Q6	R5210N005C	DC/DC-IC	PWM step-down, Vr=3.3V, DC/DCout=1.8V, Vdet= 4.2V	SOT-23-6W	33dc1	-	7d	Ric
Q7	R5210N006C	DC/DC-IC	PWM step-down, Vr=3.3V, DC/DCout=1.8V, Vdet= 4V	SOT-23-6W	33dc1	-	7d	Ric
Q8	R5210N007C	DC/DC-IC	PWM step-down, Vr=3.3V, DC/DCout=1.5V, Vdet= 4.2V	SOT-23-6W	33dc1	-	7d	Ric
Q8B	S-1133B12-I8T1G	LVR-IC	LDO, 1.2V±15mV, 300mA, +CE	SNT-8A	44eq	VR4	8a	Sii
Q8C	S-1133B13-I8T1G	LVR-IC	LDO, 1.3V±15mV, 300mA, +CE	SNT-8A	44eq	VR4	8a	Sii
Q8D	S-1133B14-I8T1G	LVR-IC	LDO, 1.4V±15mV, 300mA, +CE	SNT-8A	44eq	VR4	8a	Sii
Q8E	S-1133B15-I8T1G	LVR-IC	LDO, 1.5V±1.0%, 300mA, +CE	SNT-8A	44eq	VR4	8a	Sii
Q8F	S-1133B16-I8T1G	LVR-IC	LDO, 1.6V±1.0%, 300mA, +CE	SNT-8A	44eq	VR4	8a	Sii
Q8G	S-1133B17-I8T1G	LVR-IC	LDO, 1.7V±1.0%, 300mA, +CE	SNT-8A	44eq	VR4	8a	Sii
Q8H	S-1133B18-I8T1G	LVR-IC	LDO, 1.8V±1.0%, 300mA, +CE	SNT-8A	44eq	VR4	8a	Sii
Q8I	S-1133B19-I8T1G	LVR-IC	LDO, 1.9V±1.0%, 300mA, +CE	SNT-8A	44eq	VR4	8a	Sii
Q8J	S-1133B20-I8T1G	LVR-IC	LDO, 2.0V±1.0%, 300mA, +CE	SNT-8A	44eq	VR4	8a	Sii
Q8K	S-1133B21-I8T1G	LVR-IC	LDO, 2.1V±1.0%, 300mA, +CE	SNT-8A	44eq	VR4	8a	Sii
Q8L	S-1133B22-I8T1G	LVR-IC	LDO, 2.2V±1.0%, 300mA, +CE	SNT-8A	44eq	VR4	8a	Sii
Q8M	S-1133B23-I8T1G	LVR-IC	LDO, 2.3V±1.0%, 300mA, +CE	SNT-8A	44eq	VR4	8a	Sii
Q8N	S-1133B24-I8T1G	LVR-IC	LDO, 2.4V±1.0%, 300mA, +CE	SNT-8A	44eq	VR4	8a	Sii
Q8O	S-1133B25-I8T1G	LVR-IC	LDO, 2.5V±1.0%, 300mA, +CE	SNT-8A	44eq	VR4	8a	Sii
Q8P	S-1133B26-I8T1G	LVR-IC	LDO, 2.6V±1.0%, 300mA, +CE	SNT-8A	44eq	VR4	8a	Sii
Q8Q	S-1133B27-I8T1G	LVR-IC	LDO, 2.7V±1.0%, 300mA, +CE	SNT-8A	44eq	VR4	8a	Sii



SMD code	Type	Function	Short description	Case	Pinout	Sch.	St.	Mnf.
Q8R	S-1133B28-18T1G	LVR-IC	LDO, 2.8V±1.0%, 300mA, +CE	SNT-8A	44eq	VR4	8a	Sii
Q8S	S-1133B29-18T1G	LVR-IC	LDO, 2.9V±1.0%, 300mA, +CE	SNT-8A	44eq	VR4	8a	Sii
Q8T	S-1133B30-18T1G	LVR-IC	LDO, 3.0V±1.0%, 300mA, +CE	SNT-8A	44eq	VR4	8a	Sii
Q8U	S-1133B31-18T1G	LVR-IC	LDO, 3.1V±1.0%, 300mA, +CE	SNT-8A	44eq	VR4	8a	Sii
Q8V	S-1133B32-18T1G	LVR-IC	LDO, 3.2V±1.0%, 300mA, +CE	SNT-8A	44eq	VR4	8a	Sii
Q8W	S-1133B33-18T1G	LVR-IC	LDO, 3.3V±1.0%, 300mA, +CE	SNT-8A	44eq	VR4	8a	Sii
Q8X	S-1133B34-18T1G	LVR-IC	LDO, 3.4V±1.0%, 300mA, +CE	SNT-8A	44eq	VR4	8a	Sii
Q8Y	S-1133B35-18T1G	LVR-IC	LDO, 3.5V±1.0%, 300mA, +CE	SNT-8A	44eq	VR4	8a	Sii
Q8Z	S-1133B36-18T1G	LVR-IC	LDO, 3.6V±1.0%, 300mA, +CE	SNT-8A	44eq	VR4	8a	Sii
Q9	R5210N008C	DC/DC-IC	PWM step-down, Vr=3.3V, DC/DCout=1.5V, Vdet= 4V	SOT-23-6W	33dc1	-	7d	Ric
Q9A	S-1133B37-18T1G	LVR-IC	LDO, 3.7V±1.0%, 300mA, +CE	SNT-8A	44eq	VR4	8a	Sii
Q9B	S-1133B38-18T1G	LVR-IC	LDO, 3.8V±1.0%, 300mA, +CE	SNT-8A	44eq	VR4	8a	Sii
Q9C	S-1133B39-18T1G	LVR-IC	LDO, 3.9V±1.0%, 300mA, +CE	SNT-8A	44eq	VR4	8a	Sii
Q9D	S-1133B40-18T1G	LVR-IC	LDO, 4.0V±1.0%, 300mA, +CE	SNT-8A	44eq	VR4	8a	Sii
Q9E	S-1133B41-18T1G	LVR-IC	LDO, 4.1V±1.0%, 300mA, +CE	SNT-8A	44eq	VR4	8a	Sii
Q9F	S-1133B42-18T1G	LVR-IC	LDO, 4.2V±1.0%, 300mA, +CE	SNT-8A	44eq	VR4	8a	Sii
Q9G	S-1133B43-18T1G	LVR-IC	LDO, 4.3V±1.0%, 300mA, +CE	SNT-8A	44eq	VR4	8a	Sii
Q9H	S-1133B44-18T1G	LVR-IC	LDO, 4.4V±1.0%, 300mA, +CE	SNT-8A	44eq	VR4	8a	Sii
Q9I	S-1133B45-18T1G	LVR-IC	LDO, 4.5V±1.0%, 300mA, +CE	SNT-8A	44eq	VR4	8a	Sii
Q9J	S-1133B46-18T1G	LVR-IC	LDO, 4.6V±1.0%, 300mA, +CE	SNT-8A	44eq	VR4	8a	Sii
Q9K	S-1133B47-18T1G	LVR-IC	LDO, 4.7V±1.0%, 300mA, +CE	SNT-8A	44eq	VR4	8a	Sii
Q9L	S-1133B48-18T1G	LVR-IC	LDO, 4.8V±1.0%, 300mA, +CE	SNT-8A	44eq	VR4	8a	Sii
Q9M	S-1133B49-18T1G	LVR-IC	LDO, 4.9V±1.0%, 300mA, +CE	SNT-8A	44eq	VR4	8a	Sii
Q9N	S-1133B50-18T1G	LVR-IC	LDO, 5.0V±1.0%, 300mA, +CE	SNT-8A	44eq	VR4	8a	Sii
Q9O	S-1133B51-18T1G	LVR-IC	LDO, 5.1V±1.0%, 300mA, +CE	SNT-8A	44eq	VR4	8a	Sii
Q9P	S-1133B52-18T1G	LVR-IC	LDO, 5.2V±1.0%, 300mA, +CE	SNT-8A	44eq	VR4	8a	Sii
Q9Q	S-1133B53-18T1G	LVR-IC	LDO, 5.3V±1.0%, 300mA, +CE	SNT-8A	44eq	VR4	8a	Sii
Q9R	S-1133B54-18T1G	LVR-IC	LDO, 5.4V±1.0%, 300mA, +CE	SNT-8A	44eq	VR4	8a	Sii
Q9S	S-1133B55-18T1G	LVR-IC	LDO, 5.5V±1.0%, 300mA, +CE	SNT-8A	44eq	VR4	8a	Sii
Q9T	S-1133B56-18T1G	LVR-IC	LDO, 5.6V±1.0%, 300mA, +CE	SNT-8A	44eq	VR4	8a	Sii
Q9U	S-1133B57-18T1G	LVR-IC	LDO, 5.7V±1.0%, 300mA, +CE	SNT-8A	44eq	VR4	8a	Sii
Q9V	S-1133B58-18T1G	LVR-IC	LDO, 5.8V±1.0%, 300mA, +CE	SNT-8A	44eq	VR4	8a	Sii
Q9W	S-1133B59-18T1G	LVR-IC	LDO, 5.9V±1.0%, 300mA, +CE	SNT-8A	44eq	VR4	8a	Sii
Q9X	S-1133B60-18T1G	LVR-IC	LDO, 6.0V±1.0%, 300mA, +CE	SNT-8A	44eq	VR4	8a	Sii
QA	µPA673T	Si-npn	Dual, 40V, 200mA, 500MHz, 12/25ns	SOT-363	33/T2	-	7b	Nec
QA	R5210N009C	DC/DC-IC	PWM step-down, Vr=2.5V, DC/DCout=1.8V, Vdet=3 V	SOT-23-6W	33dc1	-	7d	Ric
QA	RP1520N049A	LVR-IC	LDO, Dual out, Vout1/Vout2=1.5V/2.85V±1%, 150mA, +CE	SOT-23-6	33x5	VR19	7d	Ric
QA	Si1903DL	p-MOSFET-e	Dual, V-MOS, LogL, 20V, ±0.41A, <1.8Q(0.25A), <55/41ns	SOT-363	33/T14	-	7b	Six
QB	R5210N010C	DC/DC-IC	PWM step-down, Vr=2.5V, DC/DCout=1.5V, Vdet= 3V	SOT-23-6W	33dc1	-	7d	Ric
QB	Si1905DL	p-MOSFET-e	Dual, V-MOS, LogL, 8V, ±0.57A, <1.2Q(0.2A), <62/40ns	SOT-363	33/T14	-	7b	Six
QC	R5210N012C	DC/DC-IC	PWM step-down, Vr=2.5V, DC/DCout=3.3V, Vdet= 3.7V	SOT-23-6W	33dc1	-	7d	Ric
QC	Si1907DL	p-MOSFET-e	Dual, V-MOS, LogL, 12V, ±0.53A, <1.31Q(0.2A), <52/40ns	SOT-363	33/T14	-	7b	Six
QLA	S-1132B15-16T2G	LVR-IC	LDO, 1.5V±1.0%, 300mA, +CE	SNT-6A	35v1b	VR4	7g	Sii
QLB	S-1132B16-16T2G	LVR-IC	LDO, 1.6V±1.0%, 300mA, +CE	SNT-6A	35v1b	VR4	7g	Sii
QLC	S-1132B17-16T2G	LVR-IC	LDO, 1.7V±1.0%, 300mA, +CE	SNT-6A	35v1b	VR4	7g	Sii
QLD	S-1132B18-16T2G	LVR-IC	LDO, 1.8V±1.0%, 300mA, +CE	SNT-6A	35v1b	VR4	7g	Sii
QLE	S-1132B19-16T2G	LVR-IC	LDO, 1.9V±1.0%, 300mA, +CE	SNT-6A	35v1b	VR4	7g	Sii
QLF	S-1132B20-16T2G	LVR-IC	LDO, 2.0V±1.0%, 300mA, +CE	SNT-6A	35v1b	VR4	7g	Sii
QLG	S-1132B21-16T2G	LVR-IC	LDO, 2.1V±1.0%, 300mA, +CE	SNT-6A	35v1b	VR4	7g	Sii
QLH	S-1132B22-16T2G	LVR-IC	LDO, 2.2V±1.0%, 300mA, +CE	SNT-6A	35v1b	VR4	7g	Sii
QLI	S-1132B23-16T2G	LVR-IC	LDO, 2.3V±1.0%, 300mA, +CE	SNT-6A	35v1b	VR4	7g	Sii
QLJ	S-1132B24-16T2G	LVR-IC	LDO, 2.4V±1.0%, 300mA, +CE	SNT-6A	35v1b	VR4	7g	Sii
QLK	S-1132B25-16T2G	LVR-IC	LDO, 2.5V±1.0%, 300mA, +CE	SNT-6A	35v1b	VR4	7g	Sii
QLL	S-1132B26-16T2G	LVR-IC	LDO, 2.6V±1.0%, 300mA, +CE	SNT-6A	35v1b	VR4	7g	Sii
QLM	S-1132B27-16T2G	LVR-IC	LDO, 2.7V±1.0%, 300mA, +CE	SNT-6A	35v1b	VR4	7g	Sii
QLN	S-1132B28-16T2G	LVR-IC	LDO, 2.8V±1.0%, 300mA, +CE	SNT-6A	35v1b	VR4	7g	Sii
QLO	S-1132B29-16T2G	LVR-IC	LDO, 2.9V±1.0%, 300mA, +CE	SNT-6A	35v1b	VR4	7g	Sii
QLP	S-1132B30-16T2G	LVR-IC	LDO, 3.0V±1.0%, 300mA, +CE	SNT-6A	35v1b	VR4	7g	Sii
QLQ	S-1132B31-16T2G	LVR-IC	LDO, 3.1V±1.0%, 300mA, +CE	SNT-6A	35v1b	VR4	7g	Sii
QLR	S-1132B32-16T2G	LVR-IC	LDO, 3.2V±1.0%, 300mA, +CE	SNT-6A	35v1b	VR4	7g	Sii
QLS	S-1132B33-16T2G	LVR-IC	LDO, 3.3V±1.0%, 300mA, +CE	SNT-6A	35v1b	VR4	7g	Sii
QLT	S-1132B34-16T2G	LVR-IC	LDO, 3.4V±1.0%, 300mA, +CE	SNT-6A	35v1b	VR4	7g	Sii
QLU	S-1132B35-16T2G	LVR-IC	LDO, 3.5V±1.0%, 300mA, +CE	SNT-6A	35v1b	VR4	7g	Sii
QLV	S-1132B36-16T2G	LVR-IC	LDO, 3.6V±1.0%, 300mA, +CE	SNT-6A	35v1b	VR4	7g	Sii
QLW	S-1132B37-16T2G	LVR-IC	LDO, 3.7V±1.0%, 300mA, +CE	SNT-6A	35v1b	VR4	7g	Sii
QLX	S-1132B38-16T2G	LVR-IC	LDO, 3.8V±1.0%, 300mA, +CE	SNT-6A	35v1b	VR4	7g	Sii
QLY	S-1132B39-16T2G	LVR-IC	LDO, 3.9V±1.0%, 300mA, +CE	SNT-6A	35v1b	VR4	7g	Sii
QLZ	S-1132B40-16T2G	LVR-IC	LDO, 4.0V±1.0%, 300mA, +CE	SNT-6A	35v1b	VR4	7g	Sii
QMA	S-1132B41-16T2G	LVR-IC	LDO, 4.1V±1.0%, 300mA, +CE	SNT-6A	35v1b	VR4	7g	Sii
QMB	S-1132B42-16T2G	LVR-IC	LDO, 4.2V±1.0%, 300mA, +CE	SNT-6A	35v1b	VR4	7g	Sii



SMD code	Type	Function	Short description	Case	Pinout	Sch.	St.	Mnf.
QMC	S-1132B43-I6T2G	LVR-IC	LDO, 4.3V±1.0%, 300mA, +CE	SNT-6A	35v1b	VR4	7g	Sii
QMD	S-1132B44-I6T2G	LVR-IC	LDO, 4.4V±1.0%, 300mA, +CE	SNT-6A	35v1b	VR4	7g	Sii
QME	S-1132B45-I6T2G	LVR-IC	LDO, 4.5V±1.0%, 300mA, +CE	SNT-6A	35v1b	VR4	7g	Sii
QMF	S-1132B46-I6T2G	LVR-IC	LDO, 4.6V±1.0%, 300mA, +CE	SNT-6A	35v1b	VR4	7g	Sii
QMG	S-1132B47-I6T2G	LVR-IC	LDO, 4.7V±1.0%, 300mA, +CE	SNT-6A	35v1b	VR4	7g	Sii
QMH	S-1132B48-I6T2G	LVR-IC	LDO, 4.8V±1.0%, 300mA, +CE	SNT-6A	35v1b	VR4	7g	Sii
QMI	S-1132B49-I6T2G	LVR-IC	LDO, 4.9V±1.0%, 300mA, +CE	SNT-6A	35v1b	VR4	7g	Sii
QMJ	S-1132B50-I6T2G	LVR-IC	LDO, 5.0V±1.0%, 300mA, +CE	SNT-6A	35v1b	VR4	7g	Sii
QMK	S-1132B51-I6T2G	LVR-IC	LDO, 5.1V±1.0%, 300mA, +CE	SNT-6A	35v1b	VR4	7g	Sii
QML	S-1132B52-I6T2G	LVR-IC	LDO, 5.2V±1.0%, 300mA, +CE	SNT-6A	35v1b	VR4	7g	Sii
QMM	S-1132B53-I6T2G	LVR-IC	LDO, 5.3V±1.0%, 300mA, +CE	SNT-6A	35v1b	VR4	7g	Sii
QMN	S-1132B54-I6T2G	LVR-IC	LDO, 5.4V±1.0%, 300mA, +CE	SNT-6A	35v1b	VR4	7g	Sii
QMO	S-1132B55-I6T2G	LVR-IC	LDO, 5.5V±1.0%, 300mA, +CE	SNT-6A	35v1b	VR4	7g	Sii
R0	R5426D111EA	BM-IC	Li-Ion, over-charge/discharge protection, Vc/d=1.11V	SON-6	34xx	VBM1	7g	Ric
R0	R5426N111EA	BM-IC	Li-Ion, over-charge/discharge protection, Vc/d=1.11V	SOT-23-6	33xx	VBM1	7d	Ric
R1	R5426D105BB	BM-IC	Li-Ion, over-charge/discharge protection, Vc/d=1.04V	SON-6	34xx	VBM1	7g	Ric
R1	R5426N105BB	BM-IC	Li-Ion, over-charge/discharge protection, Vc/d=1.05V	SOT-23-6	33xx	VBM1	7d	Ric
R15	TK11215CM	LVR-IC	LDO, 1.5V±5%, 170mA, +CE	SOT-23L-6	33vf	VR7	7b	Tok
R16	TK11216CM	LVR-IC	LDO, 1.6V±5%, 170mA, +CE	SOT-23L-6	33vf	VR7	7b	Tok
R17	TK11217CM	LVR-IC	LDO, 1.7V±5%, 170mA, +CE	SOT-23L-6	33vf	VR7	7b	Tok
R18	TK11218CM	LVR-IC	LDO, 1.8V±5%, 170mA, +CE	SOT-23L-6	33vf	VR7	7b	Tok
R19	TK11219CM	LVR-IC	LDO, 1.9V±5%, 170mA, +CE	SOT-23L-6	33vf	VR7	7b	Tok
R2	R5426D124CA	BM-IC	Li-Ion, over-charge/discharge protection, Vc/d=1.24V	SON-6	34xx	VBM1	7g	Ric
R2	R5426N124CA	BM-IC	Li-Ion, over-charge/discharge protection, Vc/d=1.24V	SOT-23-6	33xx	VBM1	7d	Ric
R2	TK11420CM	LVR-IC	LDO, 2V±1.5%, 110mA, +CE	SOT-23L-6	33hp	VR4	7b	Tok
R2	TK11425M	LVR-IC	LDO, 2.5V±1.5%, 110mA, +CE	SOT-23L-6	33hp	VR4	7b	Tok
R20	TK11220CM	LVR-IC	LDO, 2V±5%, 150mA, +CE	SOT-23L-6	33vf	VR7	7b	Tok
R21	TK11221CM	LVR-IC	LDO, 2.1V±5%, 170mA, +CE	SOT-23L-6	33vf	VR7	7b	Tok
R22	TK11222CM	LVR-IC	LDO, 2.2V±5%, 170mA, +CE	SOT-23L-6	33vf	VR7	7b	Tok
R23	TK11223CM	LVR-IC	LDO, 2.3V±5%, 170mA, +CE	SOT-23L-6	33vf	VR7	7b	Tok
R24	TK11224CM	LVR-IC	LDO, 2.4V±5%, 170mA, +CE	SOT-23L-6	33vf	VR7	7b	Tok
R25	TK11225CM	LVR-IC	LDO, 2.5V±5%, 170mA, +CE	SOT-23L-6	33vf	VR7	7b	Tok
R26	TK11226CM	LVR-IC	LDO, 2.6V±5%, 170mA, +CE	SOT-23L-6	33vf	VR7	7b	Tok
R27	TK11227CM	LVR-IC	LDO, 2.7V±5%, 170mA, +CE	SOT-23L-6	33vf	VR7	7b	Tok
R28	TK11228CM	LVR-IC	LDO, 2.8V±5%, 170mA, +CE	SOT-23L-6	33vf	VR7	7b	Tok
R29	TK11229CM	LVR-IC	LDO, 2.9V±5%, 170mA, +CE	SOT-23L-6	33vf	VR7	7b	Tok
R3	R5426D105DF	BM-IC	Li-Ion, over-charge/discharge protection, Vc/d=1.05V	SON-6	34xx	VBM1	7g	Ric
R3	R5426N105DF	BM-IC	Li-Ion, over-charge/discharge protection, Vc/d=1.05V	SOT-23-6	33xx	VBM1	7d	Ric
R3	TK11430M	LVR-IC	LDO, 3V±1.5%, 110mA, +CE	SOT-23L-6	33hp	VR4	7b	Tok
R3	TK11431M	LVR-IC	LDO, 3.1V±1.5%, 110mA, +CE	SOT-23L-6	33hp	VR4	7b	Tok
R3	TK11432M	LVR-IC	LDO, 3.2V±1.5%, 110mA, +CE	SOT-23L-6	33hp	VR4	7b	Tok
R3	TK11435M	LVR-IC	LDO, 3.5V±1.5%, 110mA, +CE	SOT-23L-6	33hp	VR4	7b	Tok
R3	TK11437M	LVR-IC	LDO, 3.7V±1.5%, 110mA, +CE	SOT-23L-6	33hp	VR4	7b	Tok
R30	TK11230CM	LVR-IC	LDO, 3V±5%, 170mA, +CE	SOT-23L-6	33vf	VR7	7b	Tok
R31	TK11231CM	LVR-IC	LDO, 3.1V±5%, 170mA, +CE	SOT-23L-6	33vf	VR7	7b	Tok
R32	TK11232CM	LVR-IC	LDO, 3.2V±5%, 170mA, +CE	SOT-23L-6	33vf	VR7	7b	Tok
R33	TK11233CM	LVR-IC	LDO, 3.3V±5%, 170mA, +CE	SOT-23L-6	33vf	VR7	7b	Tok
R34	μPA802T-FB	Si-npn	Dual, VHF/UHF, 20V, 65mA, 150mW, 7GHz, B=70..140	SOT-363	33/T2	-	7b	Nec
R34	TK11234CM	LVR-IC	LDO, 3.4V±5%, 170mA, +CE	SOT-23L-6	33vf	VR7	7b	Tok
R35	μPA802T-GB	Si-npn	Dual, VHF/UHF, 20V, 65mA, 150mW, 7GHz, B=110..240	SOT-363	33/T2	-	7b	Nec
R35	TK11235CM	LVR-IC	LDO, 3.5V±5%, 170mA, +CE	SOT-23L-6	33vf	VR7	7b	Tok
R36	TK11236CM	LVR-IC	LDO, 3.6V±5%, 170mA, +CE	SOT-23L-6	33vf	VR7	7b	Tok
R37	TK11237CM	LVR-IC	LDO, 3.7V±5%, 170mA, +CE	SOT-23L-6	33vf	VR7	7b	Tok
R38	TK11238CM	LVR-IC	LDO, 3.8V±5%, 170mA, +CE	SOT-23L-6	33vf	VR7	7b	Tok
R39	TK11239CM	LVR-IC	LDO, 3.9V±5%, 170mA, +CE	SOT-23L-6	33vf	VR7	7b	Tok
R4	R5426D106DA	BM-IC	Li-Ion, over-charge/discharge protection, Vc/d=1.06V	SON-6	34xx	VBM1	7g	Ric
R4	R5426N106DA	BM-IC	Li-Ion, over-charge/discharge protection, Vc/d=1.06V	SOT-23-6	33xx	VBM1	7d	Ric
R4	TK11440M	LVR-IC	LDO, 4V±1.5%, 110mA, +CE	SOT-23L-6	33hp	VR4	7b	Tok
R4	TK11445M	LVR-IC	LDO, 4.5V±1.5%, 110mA, +CE	SOT-23L-6	33hp	VR4	7b	Tok
R4	TK11447M	LVR-IC	LDO, 4.7V±1.5%, 110mA, +CE	SOT-23L-6	33hp	VR4	7b	Tok
R4	TK11448M	LVR-IC	LDO, 4.8V±1.5%, 110mA, +CE	SOT-23L-6	33hp	VR4	7b	Tok
R40	TK11240CM	LVR-IC	LDO, 4V±5%, 170mA, +CE	SOT-23L-6	33vf	VR7	7b	Tok
R41	TK11241CM	LVR-IC	LDO, 4.1V±5%, 170mA, +CE	SOT-23L-6	33vf	VR7	7b	Tok
R42	TK11242CM	LVR-IC	LDO, 4.2V±5%, 170mA, +CE	SOT-23L-6	33vf	VR7	7b	Tok
R43	TK11243CM	LVR-IC	LDO, 4.3V±5%, 170mA, +CE	SOT-23L-6	33vf	VR7	7b	Tok
R44	TK11244CM	LVR-IC	LDO, 4.4V±5%, 170mA, +CE	SOT-23L-6	33vf	VR7	7b	Tok
R45	TK11245CM	LVR-IC	LDO, 4.5V±5%, 170mA, +CE	SOT-23L-6	33vf	VR7	7b	Tok
R46	TK11246CM	LVR-IC	LDO, 4.6V±5%, 170mA, +CE	SOT-23L-6	33vf	VR7	7b	Tok
R47	TK11247CM	LVR-IC	LDO, 4.7V±5%, 170mA, +CE	SOT-23L-6	33vf	VR7	7b	Tok
R48	TK11248CM	LVR-IC	LDO, 4.8V±5%, 170mA, +CE	SOT-23L-6	33vf	VR7	7b	Tok



SMD code	Type	Function	Short description	Case	Pinout	Sch.	St.	Mnf.
R49	TK11249CM	LVR-IC	LDO, 4.9V±5%, 170mA, +CE	SOT-23L-6	33vf	VR7	7b	Tok
R5	R5426D111DG	BM-IC	Li-Ion, over-charge/discharge protection, Vc/d=1.11V	SON-6	34xx	VBM1	7g	Ric
R5	R5426N111DG	BM-IC	Li-Ion, over-charge/discharge protection, Vc/d=1.11V	SOT-23-6	33xx	VBM1	7d	Ric
R5	TK11450M	LVR-IC	LDO, 5V±1.5%, 110mA, +CE	SOT-23L-6	33hp	VR4	7b	Tok
R5	TK11455M	LVR-IC	LDO, 5.5V±1.5%, 110mA, +CE	SOT-23L-6	33hp	VR4	7b	Tok
R5	TK11457M	LVR-IC	LDO, 5.75V±1.5%, 110mA, +CE	SOT-23L-6	33hp	VR4	7b	Tok
R50	TK11250CM	LVR-IC	LDO, 5V±5%, 170mA, +CE	SOT-23L-6	33vf	VR7	7b	Tok
R6	R5426D125BB	BM-IC	Li-Ion, over-charge/discharge protection, Vc/d=1.25V	SON-6	34xx	VBM1	7g	Ric
R6	R5426N125BB	BM-IC	Li-Ion, over-charge/discharge protection, Vc/d=1.25V	SOT-23-6	33xx	VBM1	7d	Ric
R6	TK11460CM	LVR-IC	LDO, 6V±1.5%, 110mA, +CE	SOT-23L-6	33hp	VR4	7b	Tok
R7	R5426D126FA	BM-IC	Li-Ion, over-charge/discharge protection, Vc/d=1.26V	SON-6	34xx	VBM1	7g	Ric
R7	R5426N126FA	BM-IC	Li-Ion, over-charge/discharge protection, Vc/d=1.26V	SOT-23-6	33xx	VBM1	7d	Ric
R7A	S-8211CBA-16T1G	BM-IC	1-cell Li-Ion overcharge prot, Ucu=4.275V, Tcy=1.2s	SNT-6A	35bm1	VBM1	7g	Ric
R7B	S-8211CBB-16T1G	BM-IC	1-cell Li-Ion overcharge prot, Ucu=4.30V, Tcy=1.2s	SNT-6A	35bm1	VBM1	7g	Ric
R7D	S-8211CBD-16T1G	BM-IC	1-cell Li-Ion overcharge prot, Ucu=4.275V, Tcy=1.2s	SNT-6A	35bm1	VBM1	7g	Ric
R7N	S-8211CBN-16T1G	BM-IC	1-cell Li-Ion overcharge prot, Ucu=4.225V, Tcy=573ms	SNT-6A	35bm1	VBM1	7g	Ric
R7O	S-8211CBO-16T1G	BM-IC	1-cell Li-Ion overcharge prot, Ucu=4.270V, Tcy=1.2s	SNT-6A	35bm1	VBM1	7g	Ric
R7R	S-8211CBR-16T1G	BM-IC	1-cell Li-Ion overcharge prot, Ucu=4.280V, Tcy=1.2s	SNT-6A	35bm1	VBM1	7g	Ric
R8	R1131D081D	LVR-IC	LDO, 0.8V±2%, 300mA, +CE, CL	SON-6	34hq	VR4	7g	Ric
R8	TK11480CM	LVR-IC	LDO, 8V±1.5%, 110mA, +CE	SOT-23L-6	33hp	VR4	7b	Tok
R8	TK11487CM	LVR-IC	LDO, 8.75V±1.5%, 110mA, +CE	SOT-23L-6	33hp	VR4	7b	Tok
R81	μPA821TF	Si-npn	Dual, VHF/UHF, LN, 20V, 100mA, 200mW, B=70..140, 4.5GHz	SOT-363	33/T3	-	7b	Nec
R84	μPA827TF	Si-npn	Dual, VHF/UHF, LN, 5V, 10mA, 30mW, B=70..140, 13GHz	SOT-363	33/T3	-	7b	Nec
R86	μPA828TF	Si-npn	Dual, VHF/UHF, LN, 5V, 30mA, 90mW, B=70..140, 11GHz	SOT-363	33/T3	-	7b	Nec
R9	BZX84-C10TS	Z-diode	Triple, 10V±5%, 200mW	SOT-363	33dd	-	7l	Di
R9	R1131D091D	LVR-IC	LDO, 0.9V±2%, 300mA, +CE, CL	SON-6	34hq	VR4	7g	Ric
RA	RP152N049B	LVR-IC	LDO, Dual out, Vout1/Vout2=1.5V/2.85V±1%, 150mA, +CE, CL	SOT-23-6	33x5	VR19	7d	Ric
RA	Si1553DL	n/p-MOSFET-e	Dual, V-MOS, LogL, 20V, N: 1.3A, <0.63Q, P: 0.82A, <1.8Q	SOT-363	33/T6	-	7b	Six
RA	XC6602B051MR-G	LVR-IC	LDO, 0.5V±15mV, 1A, +CE	SOT-26W	33zk	VR11	7d	Tor
RB	Si1555DL	n/p-MOSFET-e	Dual, V-MOS, LogL, 20V, N: 1.3A, <0.63Q, P: ±1.2A, <1.2Q	SOT-363	33/T6	-	7b	Six
RB	XC6602B061MR-G	LVR-IC	LDO, 0.6V±15mV, 1A, +CE	SOT-26W	33zk	VR11	7d	Tor
RC	XC6602B071MR-G	LVR-IC	LDO, 0.7V±15mV, 1A, +CE	SOT-26W	33zk	VR11	7d	Tor
RD	XC6602B081MR-G	LVR-IC	LDO, 0.8V±15mV, 1A, +CE	SOT-26W	33zk	VR11	7d	Tor
RE	XC6602B091MR-G	LVR-IC	LDO, 0.9V±15mV, 1A, +CE	SOT-26W	33zk	VR11	7d	Tor
REs	BFS480	Si-npn	Dual, UHF, 10V, 10mA, >5GHz	SOT-363	33i2	-	7b	Sie
RF	XC6602B101MR-G	LVR-IC	LDO, 1.0V±15mV, 1A, +CE	SOT-26W	33zk	VR11	7d	Tor
RFs	BFS481	Si-npn	Dual, UHF, 20V, 20mA, >6GHz	SOT-363	33i2	-	7b	Sie
RGs	BFS482	Si-npn	Dual, UHF, 20V, 35mA, >6GHz	SOT-363	33i2	-	7b	Sie
RH	XC6602B111MR-G	LVR-IC	LDO, 1.1V±15mV, 1A, +CE	SOT-26W	33zk	VR11	7d	Tor
RHs	BFS483	Si-npn	Dual, UHF, 20V, 65mA, >6GHz	SOT-363	33i2	-	7b	Sie
RK	XC6602B121MR-G	LVR-IC	LDO, 1.2V±20mV, 1A, +CE	SOT-26W	33zk	VR11	7d	Tor
RL	μPA800T-KB	Si-npn	Dual, VHF/UHF, 20V, 35mA, 150mW, 8.5GHz, B=80..200	SOT-363	33/T2	-	7b	Nec
RL	XC6602B131MR-G	LVR-IC	LDO, 1.3V±20mV, 1A, +CE	SOT-26W	33zk	VR11	7d	Tor
RM	XC6602B141MR-G	LVR-IC	LDO, 1.4V±20mV, 1A, +CE	SOT-26W	33zk	VR11	7d	Tor
RN	XC6602B151MR-G	LVR-IC	LDO, 1.5V±20mV, 1A, +CE	SOT-26W	33zk	VR11	7d	Tor
RP	DDZX33TS	Z-diode	Triple, 33V±2.5%, 200mW	SOT-363	33dd	-	7k	Di
RP	XC6602B161MR-G	LVR-IC	LDO, 1.6V±20mV, 1A, +CE	SOT-26W	33zk	VR11	7d	Tor
RR	XC6602B171MR-G	LVR-IC	LDO, 1.7V±20mV, 1A, +CE	SOT-26W	33zk	VR11	7d	Tor
RS	XC6602B181MR-G	LVR-IC	LDO, 1.8V±20mV, 1A, +CE	SOT-26W	33zk	VR11	7d	Tor
RZ5A	S-8211CAS-16T1G	BM-IC	1-cell Li-Ion overcharge prot, Ucu=4.280V, Tcy=1.2s	SNT-6A	35bm1	VBM1	7g	Ric
RZA	S-8211CAA-16T1G	BM-IC	1-cell Li-Ion overcharge prot, Ucu=4.275V, Tcy=1.2s	SNT-6A	35bm1	VBM1	7g	Ric
RZB	S-8211CAB-16T1G	BM-IC	1-cell Li-Ion overcharge prot, Ucu=4.325V, Tcy=1.2s	SNT-6A	35bm1	VBM1	7g	Ric
RZD	S-8211CAD-16T1G	BM-IC	1-cell Li-Ion overcharge prot, Ucu=4.350V, Tcy=143ms	SNT-6A	35bm1	VBM1	7g	Ric
RZE	S-8211CAE-16T1G	BM-IC	1-cell Li-Ion overcharge prot, Ucu=4.280V, Tcy=1.2s	SNT-6A	35bm1	VBM1	7g	Ric
RZF	S-8211CAF-16T1G	BM-IC	1-cell Li-Ion overcharge prot, Ucu=4.275V, Tcy=1.2s	SNT-6A	35bm1	VBM1	7g	Ric
RZH	S-8211CAH-16T1G	BM-IC	1-cell Li-Ion overcharge prot, Ucu=4.280V, Tcy=1.2s	SNT-6A	35bm1	VBM1	7g	Ric
RZI	S-8211CAI-16T1G	BM-IC	1-cell Li-Ion overcharge prot, Ucu=4.280V, Tcy=1.2s	SNT-6A	35bm1	VBM1	7g	Ric
RZJ	S-8211CAJ-16T1G	BM-IC	1-cell Li-Ion overcharge prot, Ucu=4.280V, Tcy=1.2s	SNT-6A	35bm1	VBM1	7g	Ric
RZK	S-8211CAK-16T1G	BM-IC	1-cell Li-Ion overcharge prot, Ucu=4.280V, Tcy=1.2s	SNT-6A	35bm1	VBM1	7g	Ric
RZL	S-8211CAL-16T1G	BM-IC	1-cell Li-Ion overcharge prot, Ucu=4.280V, Tcy=1.2s	SNT-6A	35bm1	VBM1	7g	Ric
RZM	S-8211CAM-16T1G	BM-IC	1-cell Li-Ion overcharge prot, Ucu=4.280V, Tcy=1.2s	SNT-6A	35bm1	VBM1	7g	Ric
RZN	S-8211CAN-16T1G	BM-IC	1-cell Li-Ion overcharge prot, Ucu=4.20V, Tcy=1.2s	SNT-6A	35bm1	VBM1	7g	Ric
RZO	S-8211CAO-16T1G	BM-IC	1-cell Li-Ion overcharge prot, Ucu=4.275V, Tcy=1.2s	SNT-6A	35bm1	VBM1	7g	Ric
RZP	S-8211CAP-16T1G	BM-IC	1-cell Li-Ion overcharge prot, Ucu=4.275V, Tcy=1.2s	SNT-6A	35bm1	VBM1	7g	Ric
RZQ	S-8211CAQ-16T1G	BM-IC	1-cell Li-Ion overcharge prot, Ucu=4.275V, Tcy=1.2s	SNT-6A	35bm1	VBM1	7g	Ric
RZR	S-8211CAR-16T1G	BM-IC	1-cell Li-Ion overcharge prot, Ucu=4.275V, Tcy=1.2s	SNT-6A	35bm1	VBM1	7g	Ric
RZT	S-8211CAT-16T1G	BM-IC	1-cell Li-Ion overcharge prot, Ucu=4.275V, Tcy=1.2s	SNT-6A	35bm1	VBM1	7g	Ric
RZU	S-8211CAU-16T1G	BM-IC	1-cell Li-Ion overcharge prot, Ucu=4.280V, Tcy=1.2s	SNT-6A	35bm1	VBM1	7g	Ric
RZV	S-8211CAV-16T1G	BM-IC	1-cell Li-Ion overcharge prot, Ucu=4.325V, Tcy=1.2s	SNT-6A	35bm1	VBM1	7g	Ric
RZW	S-8211CAW-16T1G	BM-IC	1-cell Li-Ion overcharge prot, Ucu=4.280V, Tcy=1.2s	SNT-6A	35bm1	VBM1	7g	Ric



SMD code	Type	Function	Short description	Case	Pinout	Sch.	St.	Mnf.
RZX	S-8211CAX-16T1G	BM-IC	1-cell Li-Ion overcharge prot, Ucu=4.275V, Tcy=1.2s	SNT-6A	35bm1	VBM1	7g	Ric
RZY	S-8211CAY-16T1G	BM-IC	1-cell Li-Ion overcharge prot, Ucu=4.280V, Tcy=1.2s	SNT-6A	35bm1	VBM1	7g	Ric
S0	R1131D101D	LVR-IC	LDO, 1V±2%, 300mA, +CE, CL	SON-6	34hq	VR4	7g	Ric
S0	R1225N552C	DC/DC-IC	PWM step-down, 5.5V, 300kHz	SOT-23-6W	33so	DC7	7d	Ric
S03A	LM2664M6	Lin-IC	Switched Capacitor Voltage Converter 1.8..5.5V, 40mA	SOT-23-6	33uf	-	7b	X
S04A	LM2665M6	Lin-IC	Switched Capacitor Voltage Converter 2.5..5.5V, 40mA	SOT-23-6	33vh	-	7b	X
S0C	SGM2122-AYN6G	LVR-IC	LDO, Dual out, Vout1/Vout2=2.8V/2.8V±2%, 250mA, +CE	SOT-23-6L	33zc	VR19	7c	Sgm
S0D	SGM2122-CYN6G	LVR-IC	LDO, Dual out, Vout1/Vout2=2.8V/3.0V±2%, 250mA, +CE	SOT-23-6L	33zc	VR19	7d	Sgm
S0E	SGM2122-DYN6G	LVR-IC	LDO, Dual out, Vout1/Vout2=2.8V/2.5V±2%, 250mA, +CE	SOT-23-6L	33zc	VR19	7c	Sgm
S0F	SGM2122-EYN6G	LVR-IC	LDO, Dual out, Vout1/Vout2=2.8V/1.8V±2%, 250mA, +CE	SOT-23-6L	33zc	VR19	7d	Sgm
S1	R1131D111D	LVR-IC	LDO, 1.1V±2%, 300mA, +CE, CL	SON-6	34hq	VR4	7g	Ric
S1	R1225N602C	DC/DC-IC	PWM step-down, 6V, 300kHz	SOT-23-6W	33so	DC7	7d	Ric
S10	SGM2122-GYN6G	LVR-IC	LDO, Dual out, Vout1/Vout2=2.5V/1.8V±2%, 250mA, +CE	SOT-23-6L	33zc	VR19	7c	Sgm
S10A	LM2681M6	Lin-IC	Switched Capacitor Voltage Converter 2.5..5.5V, 20mA	SOT-23-6	33vcd	-	7b	X
S11	SGM2122-HYN6G	LVR-IC	LDO, Dual out, Vout1/Vout2=3.3V/2.5V±2%, 250mA, +CE	SOT-23-6L	33zc	VR19	7d	Sgm
S12	SGM2122-IYN6G	LVR-IC	LDO, Dual out, Vout1/Vout2=3.3V/1.8V±2%, 250mA, +CE	SOT-23-6L	33zc	VR19	7c	Sgm
S13	SGM2122-KYN6G	LVR-IC	LDO, Dual out, Vout1/Vout2=3.0V/1.8V±2%, 250mA, +CE	SOT-23-6L	33zc	VR19	7c	Sgm
S14	SGM2122-MYN6G	LVR-IC	LDO, Dual out, Vout1/Vout2=2.8V/1.2V±2%, 250mA, +CE	SOT-23-6L	33zc	VR19	7d	Sgm
S15	SGM2122-NYN6G	LVR-IC	LDO, Dual out, Vout1/Vout2=2.8V/1.3V±2%, 250mA, +CE	SOT-23-6L	33zc	VR19	7c	Sgm
S16	SGM2122-OYN6G	LVR-IC	LDO, Dual out, Vout1/Vout2=2.8V/1.5V±2%, 250mA, +CE	SOT-23-6L	33zc	VR19	7d	Sgm
S17	SGM2122-PYN6G	LVR-IC	LDO, Dual out, Vout1/Vout2=1.5V/2.8V±2%, 250mA, +CE	SOT-23-6L	33zc	VR19	7c	Sgm
S18	SGM2122-QYN6G	LVR-IC	LDO, Dual out, Vout1/Vout2=1.5V/2.5V±2%, 250mA, +CE	SOT-23-6L	33zc	VR19	7d	Sgm
S19	SGM2122-RYN6G	LVR-IC	LDO, Dual out, Vout1/Vout2=2.5V/2.8V±2%, 250mA, +CE	SOT-23-6L	33zc	VR19	7d	Sgm
S1A	SGM2122-SYN6G	LVR-IC	LDO, Dual out, Vout1/Vout2=1.3V/2.8V±2%, 250mA, +CE	SOT-23-6L	33zc	VR19	7d	Sgm
S1B	SGM2122-TYN6G	LVR-IC	LDO, Dual out, Vout1/Vout2=1.5V 3.3V±2%, 250mA, +CE	SOT-23-6L	33zc	VR19	7c	Sgm
S1C	SGM2122-UYN6G	LVR-IC	LDO, Dual out, Vout1/Vout2=3.3V 3.0V±2%, 250mA, +CE	SOT-23-6L	33zc	VR19	7c	Sgm
S1D	SGM2122-VYN6G	LVR-IC	LDO, Dual out, Vout1/Vout2=1.8V 3.3V±2%, 250mA, +CE	SOT-23-6L	33zc	VR19	7c	Sgm
S1E	SGM2122-WYN6G	LVR-IC	LDO, Dual out, Vout1/Vout2=1.2V/2.8V±2%, 250mA, +CE	SOT-23-6L	33zc	VR19	7d	Sgm
S2	R1131D121D	LVR-IC	LDO, 1.2V±2%, 300mA, +CE, CL	SON-6	34hq	VR4	7g	Ric
S2	R1225N122D	DC/DC-IC	PWM step-down, 1.2V, 500kHz	SOT-23-6W	33so	DC7	7d	Ric
S28	SGM2122-XYN6G	LVR-IC	LDO, Dual out, Vout1/Vout2=3.3V 2.8V±2%, 250mA, +CE	SOT-23-6L	33zc	VR19	7c	Sgm
S29	SGM2122-YYN6G	LVR-IC	LDO, Dual out, Vout1/Vout2=1.8V/2.8V±2%, 250mA, +CE	SOT-23-6L	33zc	VR19	7d	Sgm
S2P02	MMSF2P02E	p-MOSFET-e	V-MOS, LogL, 20V, 2.5A, 2.5V, <0.25Q(5A)	SOP-8	47fr	-	8d	Mot
S3	R1131D131D	LVR-IC	LDO, 1.3V±2%, 300mA, +CE, CL	SON-6	34hq	VR4	7g	Ric
S3	R1225N152D	DC/DC-IC	PWM step-down, 1.5V, 500kHz	SOT-23-6W	33so	DC7	7d	Ric
S35	SGM2027-PYTN6G	LVR-IC	LDO, Dual out, Vout1/Vout2=1.5V/2.8V±2%, 250mA, +CE	TSOT-23-6L	33x5	VR19	7d	Sgm
S3B	SGM2027-VYTN6G	LVR-IC	LDO, Dual out, Vout1/Vout2=1.8V/3.3V±2%, 250mA, +CE	TSOT-23-6L	33x5	VR19	7d	Sgm
S3C	SGM2027-WYTN6G	LVR-IC	LDO, Dual out, Vout1/Vout2=1.2V/2.8V±2%, 250mA, +CE	TSOT-23-6L	33x5	VR19	7d	Sgm
S3E	SGM2027-YYTN6G	LVR-IC	LDO, Dual out, Vout1/Vout2=1.8V/2.8V±2%, 250mA, +CE	TSOT-23-6L	33x5	VR19	7d	Sgm
S3P02	MMSF3P02HD	p-MOSFET-e	V-MOS, LogL, 20V, 5.6A, 2.5V, <75mQ(5A)	SOP-8	47fr	-	8d	Mot
S3P02Z	MMSF3P02Z	p-MOSFET-e	V-MOS, LogL, 20V, 6.5A, 2.5V, <60mQ(5A)	SOP-8	47fr	-	8d	Mot
S3P03	MMSF3P03HD	p-MOSFET-e	V-MOS, LogL, 30V, 4.6A, 2.5V, <0.1Q(5A)	SOP-8	47fr	-	8d	Mot
S4	R1131D141D	LVR-IC	LDO, 1.4V±2%, 300mA, +CE, CL	SON-6	34hq	VR4	7g	Ric
S4	R1225N182D	DC/DC-IC	PWM step-down, 1.8V, 500kHz	SOT-23-6W	33so	DC7	7d	Ric
S42	SGM2122-ABYN6G	LVR-IC	LDO, Dual out, Vout1/Vout2=1.8V/1.2V±2%, 250mA, +CE	SOT-23-6L	33zc	VR19	7d	Sgm
S43	SGM2027-ACYTN6G	LVR-IC	LDO, Dual out, Vout1/Vout2=2.8V/3.3V±2%, 250mA, +CE	TSOT-23-6L	33x5	VR19	7d	Sgm
S4P01	MMSF4P01HD	p-MOSFET-e	V-MOS, LogL, 12V, 5.1A, 2.5V, <80mQ(5A)	SOP-8	47fr	-	8d	Mot
S4P01Z	MMSF4P01Z	p-MOSFET-e	V-MOS, LogL, 20V, 5.7A, 2.5V, <70mQ(5A)	SOP-8	47fr	-	8d	Mot
S5	R1131D151D	LVR-IC	LDO, 1.5V±2%, 300mA, +CE, CL	SON-6	34hq	VR4	7g	Ric
S5	R1163D151B	LVR-IC	LDO, 1.5V±1.5%, 150mA, +CE, AE(mode)	SON-6	34vrc	VR10	7g	Ric
S5	R1225N252D	DC/DC-IC	PWM step-down, 2.5V, 500kHz	SOT-23-6W	33so	DC7	7d	Ric
S5	TWG4148AD-125W	Si-diode	Quad, Sw, 85V, 100mA, Vf<1.2V(100mA), <4pF	SOT-23-6	33/D8	-	7b	Ttr
S5	TWG4148AD-125WS	Si-diode	Quad, Sw, 85V, 100mA, Vf<1.2V(100mA), <4pF	SOT-363	33/D8	-	7b	Ttr
S5N02	MMSF5N02HD	n-MOSFET-e	V-MOS, LogL, 20V, 8.2A, 2.5V, <25mQ(5A)	SOP-8	47fr	-	8d	Mot
S5N03	MMSF5N03HD	n-MOSFET-e	V-MOS, LogL, 30V, 6.5A, 2.5V, <40mQ(5A)	SOP-8	47fr	-	8d	Mot
S5N03Z	MMSF5N03Z	n-MOSFET-e	V-MOS, LogL, 30V, 7.5A, 2.5V, <30mQ(5A)	SOP-8	47fr	-	8d	Mot
S6	R1131D161D	LVR-IC	LDO, 1.6V±2%, 300mA, +CE, CL	SON-6	34hq	VR4	7g	Ric
S6	R1163D161B	LVR-IC	LDO, 1.6V±1.5%, 150mA, +CE, AE(mode)	SON-6	34vrc	VR10	7g	Ric
S6	R1225N332D	DC/DC-IC	PWM step-down, 3.3V, 500kHz	SOT-23-6W	33so	DC7	7d	Ric
S7	R1131D171D	LVR-IC	LDO, 1.7V±2%, 300mA, +CE, CL	SON-6	34hq	VR4	7g	Ric
S7	R1163D171B	LVR-IC	LDO, 1.7V±1.5%, 150mA, +CE, AE(mode)	SON-6	34vrc	VR10	7g	Ric
S7	R1225N502D	DC/DC-IC	VFMPWM step-down, 5V, 500kHz	SOT-23-6W	33so	DC7	7d	Ric
S7N03	MMSF7N03HD	n-MOSFET-e	V-MOS, LogL, 30V, 8.2A, 2.5V, <28mQ(5A), 15/35ns	SOP-8	47fr	-	8d	Mot
S8	R1131D181D	LVR-IC	LDO, 1.8V±2%, 300mA, +CE, CL	SON-6	34hq	VR4	7g	Ric
S8	R1163D181B	LVR-IC	LDO, 1.8V±1.5%, 150mA, +CE, AE(mode)	SON-6	34vrc	VR10	7g	Ric
S8	R1225N552D	DC/DC-IC	PWM step-down, 5.5V, 500kHz	SOT-23-6W	33so	DC7	7d	Ric
S8	TWG4148AC-128W	Si-diode	Quad, Sw, 85V, 100mA, Vf<1.2V(100mA), <4pF	SOT-23-6	33/D11	-	7b	Ttr
S8	TWG4148AC-128WS	Si-diode	Quad, Sw, 85V, 100mA, Vf<1.2V(100mA), <4pF	SOT-363	33/D11	-	7b	Ttr
S84	BSS84DW	p-MOSFET-e*	Dual, V-MOS, LogL, 50V, 130mA, 300mW, 6Q(100mA), 10/18ns	SOT-363	33/T14	-	7k	Pjt
S8B	TWG4148CD-128WT	Si-diode	Quad, Sw, 85V, 100mA, Vf<1.2V(100mA), <4pF	SOT-563	35/D11	-	7b	Ttr



SMD code	Type	Function	Short description	Case	Pinout	Sch.	St.	Mnf.
S9	R1131D191D	LVR-IC	LDO, 1.9V±2%, 300mA, +CE, CL	SON-6	34hq	VR4	7g	Ric
S9	R1163D191B	LVR-IC	LDO, 1.9V±1.5%, 150mA, +CE, AE(mode)	SON-6	34wrc	VR10	7g	Ric
S9	R1225N602D	DC/DC-IC	PWM step-down, 6V, 500kHz	SOT-23-6W	33so	DC7	7d	Ric
SA	R1225N122K	DC/DC-IC	PWM step-down, 1.2V, 180kHz	SOT-23-6W	33so	DC7	7d	Ric
SA	RP152N049C	LVR-IC	LDO, Dual out, Vout1/Vout2=1.5V/2.85V±1%, 150mA, +CE, CL	SOT-23-6	33x5	VR19	7d	Ric
SAA	S-1206B12-I6T2G	LVR-IC	LDO, 1.2V±15mV, 250mA	SNT-6A	35ev	VR1	7g	Sii
SAB	S-1206B13-I6T2G	LVR-IC	LDO, 1.3V±15mV, 250mA	SNT-6A	35ev	VR1	7g	Sii
SAC	S-1206B14-I6T2G	LVR-IC	LDO, 1.4V±15mV, 250mA	SNT-6A	35ev	VR1	7g	Sii
SAD	S-1206B15-I6T2G	LVR-IC	LDO, 1.5V±1.0%, 250mA	SNT-6A	35ev	VR1	7g	Sii
SAE	S-1206B16-I6T2G	LVR-IC	LDO, 1.6V±1.0%, 250mA	SNT-6A	35ev	VR1	7g	Sii
SAF	S-1206B17-I6T2G	LVR-IC	LDO, 1.7V±1.0%, 250mA	SNT-6A	35ev	VR1	7g	Sii
SAG	S-1206B18-I6T2G	LVR-IC	LDO, 1.8V±1.0%, 250mA	SNT-6A	35ev	VR1	7g	Sii
SAH	S-1206B1J-I6T2G	LVR-IC	LDO, 1.85V±1.0%, 250mA	SNT-6A	35ev	VR1	7g	Sii
SAI	S-1206B19-I6T2G	LVR-IC	LDO, 1.9V±1.0%, 250mA	SNT-6A	35ev	VR1	7g	Sii
SAJ	S-1206B20-I6T2G	LVR-IC	LDO, 2.0V±1.0%, 250mA	SNT-6A	35ev	VR1	7g	Sii
SAK	S-1206B21-I6T2G	LVR-IC	LDO, 2.1V±1.0%, 250mA	SNT-6A	35ev	VR1	7g	Sii
SAL	S-1206B22-I6T2G	LVR-IC	LDO, 2.2V±1.0%, 250mA	SNT-6A	35ev	VR1	7g	Sii
SAM	S-1206B23-I6T2G	LVR-IC	LDO, 2.3V±1.0%, 250mA	SNT-6A	35ev	VR1	7g	Sii
SAN	S-1206B24-I6T2G	LVR-IC	LDO, 2.4V±1.0%, 250mA	SNT-6A	35ev	VR1	7g	Sii
SAO	S-1206B25-I6T2G	LVR-IC	LDO, 2.5V±1.0%, 250mA	SNT-6A	35ev	VR1	7g	Sii
SAP	S-1206B26-I6T2G	LVR-IC	LDO, 2.6V±1.0%, 250mA	SNT-6A	35ev	VR1	7g	Sii
SAQ	S-1206B27-I6T2G	LVR-IC	LDO, 2.7V±1.0%, 250mA	SNT-6A	35ev	VR1	7g	Sii
SAR	S-1206B28-I6T2G	LVR-IC	LDO, 2.8V±1.0%, 250mA	SNT-6A	35ev	VR1	7g	Sii
SAS	S-1206B2J-I6T2G	LVR-IC	LDO, 2.85V±1.0%, 250mA	SNT-6A	35ev	VR1	7g	Sii
SAT	S-1206B29-I6T2G	LVR-IC	LDO, 2.9V±1.0%, 250mA	SNT-6A	35ev	VR1	7g	Sii
SAU	S-1206B30-I6T2G	LVR-IC	LDO, 3.0V±1.0%, 250mA	SNT-6A	35ev	VR1	7g	Sii
SAV	S-1206B31-I6T2G	LVR-IC	LDO, 3.1V±1.0%, 250mA	SNT-6A	35ev	VR1	7g	Sii
SAW	S-1206B32-I6T2G	LVR-IC	LDO, 3.2V±1.0%, 250mA	SNT-6A	35ev	VR1	7g	Sii
SAX	S-1206B33-I6T2G	LVR-IC	LDO, 3.3V±1.0%, 250mA	SNT-6A	35ev	VR1	7g	Sii
SAY	S-1206B34-I6T2G	LVR-IC	LDO, 3.4V±1.0%, 250mA	SNT-6A	35ev	VR1	7g	Sii
SAZ	S-1206B35-I6T2G	LVR-IC	LDO, 3.5V±1.0%, 250mA	SNT-6A	35ev	VR1	7g	Sii
SB	R1225N152K	DC/DC-IC	PWM step-down, 1.5V, 180kHz	SOT-23-6W	33so	DC7	7d	Ric
SBA	S-1206B36-I6T2G	LVR-IC	LDO, 3.6V±1.0%, 250mA	SNT-6A	35ev	VR1	7g	Sii
SBB	S-1206B37-I6T2G	LVR-IC	LDO, 3.7V±1.0%, 250mA	SNT-6A	35ev	VR1	7g	Sii
SBC	S-1206B38-I6T2G	LVR-IC	LDO, 3.8V±1.0%, 250mA	SNT-6A	35ev	VR1	7g	Sii
SBD	S-1206B39-I6T2G	LVR-IC	LDO, 3.9V±1.0%, 250mA	SNT-6A	35ev	VR1	7g	Sii
SBE	S-1206B40-I6T2G	LVR-IC	LDO, 4.0V±1.0%, 250mA	SNT-6A	35ev	VR1	7g	Sii
SBF	S-1206B41-I6T2G	LVR-IC	LDO, 4.1V±1.0%, 250mA	SNT-6A	35ev	VR1	7g	Sii
SBG	S-1206B42-I6T2G	LVR-IC	LDO, 4.2V±1.0%, 250mA	SNT-6A	35ev	VR1	7g	Sii
SBH	S-1206B43-I6T2G	LVR-IC	LDO, 4.3V±1.0%, 250mA	SNT-6A	35ev	VR1	7g	Sii
SBI	S-1206B44-I6T2G	LVR-IC	LDO, 4.4V±1.0%, 250mA	SNT-6A	35ev	VR1	7g	Sii
SBJ	S-1206B45-I6T2G	LVR-IC	LDO, 4.5V±1.0%, 250mA	SNT-6A	35ev	VR1	7g	Sii
SBK	S-1206B46-I6T2G	LVR-IC	LDO, 4.6V±1.0%, 250mA	SNT-6A	35ev	VR1	7g	Sii
SBL	S-1206B47-I6T2G	LVR-IC	LDO, 4.7V±1.0%, 250mA	SNT-6A	35ev	VR1	7g	Sii
SBM	S-1206B48-I6T2G	LVR-IC	LDO, 4.8V±1.0%, 250mA	SNT-6A	35ev	VR1	7g	Sii
SBN	S-1206B49-I6T2G	LVR-IC	LDO, 4.9V±1.0%, 250mA	SNT-6A	35ev	VR1	7g	Sii
SBO	S-1206B50-I6T2G	LVR-IC	LDO, 5.0V±1.0%, 250mA	SNT-6A	35ev	VR1	7g	Sii
SBP	S-1206B51-I6T2G	LVR-IC	LDO, 5.1V±1.0%, 250mA	SNT-6A	35ev	VR1	7g	Sii
SBQ	S-1206B52-I6T2G	LVR-IC	LDO, 5.2V±1.0%, 250mA	SNT-6A	35ev	VR1	7g	Sii
SC	R1225N182K	DC/DC-IC	PWM step-down, 1.8V, 180kHz	SOT-23-6W	33so	DC7	7d	Ric
SD	R1225N252K	DC/DC-IC	PWM step-down, 2.5V, 180kHz	SOT-23-6W	33so	DC7	7d	Ric
SE	R1225N332K	DC/DC-IC	PWM step-down, 3.3V, 180kHz	SOT-23-6W	33so	DC7	7d	Ric
SE2	S-1135A34-A6T1S	LVR-IC	LDO, 3.4V±1.0%, 300mA, +CE, CL, PDR	HSNT-6A	43er	VR4	7g	Sii
SE3	S-1135A35-A6T1S	LVR-IC	LDO, 3.5V±1.0%, 300mA, +CE, CL, PDR	HSNT-6A	43er	VR4	7g	Sii
SEA	S-1135A10-A6T1S	LVR-IC	LDO, 1.0V±15mV, 300mA, +CE, PDR, CL	HSNT-6A	43er	VR4	7g	Sii
SEB	S-1135A11-A6T1S	LVR-IC	LDO, 1.1V±15mV, 300mA, +CE, PDR, CL	HSNT-6A	43er	VR4	7g	Sii
SEC	S-1135A12-A6T1S	LVR-IC	LDO, 1.2V±15mV, 300mA, +CE, CL, PDR	HSNT-6A	43er	VR4	7g	Sii
SED	S-1135A13-A6T1S	LVR-IC	LDO, 1.3V±15mV, 300mA, +CE, CL, PDR	HSNT-6A	43er	VR4	7g	Sii
SEE	S-1135A14-A6T1S	LVR-IC	LDO, 1.4V±15mV, 300mA, +CE, CL, PDR	HSNT-6A	43er	VR4	7g	Sii
SEF	S-1135A15-A6T1S	LVR-IC	LDO, 1.5V±1.0%, 300mA, +CE, CL, PDR	HSNT-6A	43er	VR4	7g	Sii
SEG	S-1135A16-A6T1S	LVR-IC	LDO, 1.6V±1.0%, 300mA, +CE, CL, PDR	HSNT-6A	43er	VR4	7g	Sii
SEH	S-1135A17-A6T1S	LVR-IC	LDO, 1.7V±1.0%, 300mA, +CE, CL, PDR	HSNT-6A	43er	VR4	7g	Sii
SEI	S-1135A18-A6T1S	LVR-IC	LDO, 1.8V±1.0%, 300mA, +CE, CL, PDR	HSNT-6A	43er	VR4	7g	Sii
SEJ	S-1135A1J-A6T1S	LVR-IC	LDO, 1.85V±1.0%, 300mA, +CE, CL, PDR	HSNT-6A	43er	VR4	7g	Sii
SEK	S-1135A19-A6T1S	LVR-IC	LDO, 1.9V±1.0%, 300mA, +CE, CL, PDR	HSNT-6A	43er	VR4	7g	Sii
SEL	S-1135A20-A6T1S	LVR-IC	LDO, 2.0V±1.0%, 300mA, +CE, CL, PDR	HSNT-6A	43er	VR4	7g	Sii
SEM	S-1135A21-A6T1S	LVR-IC	LDO, 2.1V±1.0%, 300mA, +CE, CL, PDR	HSNT-6A	43er	VR4	7g	Sii
SEN	S-1135A22-A6T1S	LVR-IC	LDO, 2.2V±1.0%, 300mA, +CE, CL, PDR	HSNT-6A	43er	VR4	7g	Sii
SEO	S-1135A23-A6T1S	LVR-IC	LDO, 2.3V±1.0%, 300mA, +CE, CL, PDR	HSNT-6A	43er	VR4	7g	Sii
SEP	S-1135A24-A6T1S	LVR-IC	LDO, 2.4V±1.0%, 300mA, +CE, CL, PDR	HSNT-6A	43er	VR4	7g	Sii



SMD code	Type	Function	Short description	Case	Pinout	Sch.	St.	Mnf.
SEQ	S-1135A25-A6T1S	LVR-IC	LDO, 2.5V±1.0%, 300mA, +CE, CL, PDR	HSNT-6A	43er	VR4	7g	Sii
SER	S-1135A26-A6T1S	LVR-IC	LDO, 2.6V±1.0%, 300mA, +CE, CL, PDR	HSNT-6A	43er	VR4	7g	Sii
SES	S-1135A27-A6T1S	LVR-IC	LDO, 2.7V±1.0%, 300mA, +CE, CL, PDR	HSNT-6A	43er	VR4	7g	Sii
SET	S-1135A28-A6T1S	LVR-IC	LDO, 2.8V±1.0%, 300mA, +CE, CL, PDR	HSNT-6A	43er	VR4	7g	Sii
SEU	S-1135A2J-A6T1S	LVR-IC	LDO, 2.85V±1.0%, 300mA, +CE, CL, PDR	HSNT-6A	43er	VR4	7g	Sii
SEV	S-1135A29-A6T1S	LVR-IC	LDO, 2.9V±1.0%, 300mA, +CE, CL, PDR	HSNT-6A	43er	VR4	7g	Sii
SEW	S-1135A30-A6T1S	LVR-IC	LDO, 3.0V±1.0%, 300mA, +CE, CL, PDR	HSNT-6A	43er	VR4	7g	Sii
SEX	S-1135A31-A6T1S	LVR-IC	LDO, 3.1V±1.0%, 300mA, +CE, CL, PDR	HSNT-6A	43er	VR4	7g	Sii
SEY	S-1135A32-A6T1S	LVR-IC	LDO, 3.2V±1.0%, 300mA, +CE, CL, PDR	HSNT-6A	43er	VR4	7g	Sii
SEZ	S-1135A33-A6T1S	LVR-IC	LDO, 3.3V±1.0%, 300mA, +CE, CL, PDR	HSNT-6A	43er	VR4	7g	Sii
SF	R1225N502K	DC/DC-IC	PWM step-down, 5V, 180kHz	SOT-23-6W	33so	DC7	7d	Ric
SG	R1225N552K	DC/DC-IC	PWM step-down, 5.5V, 180kHz	SOT-23-6W	33so	DC7	7d	Ric
SG2	S-1135B34-A6T1S	LVR-IC	LDO, 3.4V±1.0%, 300mA, +CE, CL	HSNT-6A	43er	VR4	7g	Sii
SG3	S-1135B35-A6T1S	LVR-IC	LDO, 3.5V±1.0%, 300mA, +CE, CL	HSNT-6A	43er	VR4	7g	Sii
SGA	S-1135B10-A6T1S	LVR-IC	LDO, 1.0V±15mV, 300mA, +CE, CL	HSNT-6A	43er	VR4	7g	Sii
SGB	S-1135B11-A6T1S	LVR-IC	LDO, 1.1V±15mV, 300mA, +CE, CL	HSNT-6A	43er	VR4	7g	Sii
SGC	S-1135B12-A6T1S	LVR-IC	LDO, 1.2V±15mV, 300mA, +CE, CL	HSNT-6A	43er	VR4	7g	Sii
SGD	S-1135B13-A6T1S	LVR-IC	LDO, 1.3V±15mV, 300mA, +CE, CL	HSNT-6A	43er	VR4	7g	Sii
SGE	S-1135B14-A6T1S	LVR-IC	LDO, 1.4V±15mV, 300mA, +CE, CL	HSNT-6A	43er	VR4	7g	Sii
SGF	S-1135B15-A6T1S	LVR-IC	LDO, 1.5V±1.0%, 300mA, +CE, CL	HSNT-6A	43er	VR4	7g	Sii
SGG	S-1135B16-A6T1S	LVR-IC	LDO, 1.6V±1.0%, 300mA, +CE, CL	HSNT-6A	43er	VR4	7g	Sii
SGH	S-1135B17-A6T1S	LVR-IC	LDO, 1.7V±1.0%, 300mA, +CE, CL	HSNT-6A	43er	VR4	7g	Sii
SGI	S-1135B18-A6T1S	LVR-IC	LDO, 1.8V±1.0%, 300mA, +CE, CL	HSNT-6A	43er	VR4	7g	Sii
SGJ	S-1135B1J-A6T1S	LVR-IC	LDO, 1.85V±1.0%, 300mA, +CE, CL	HSNT-6A	43er	VR4	7g	Sii
SGK	S-1135B19-A6T1S	LVR-IC	LDO, 1.9V±1.0%, 300mA, +CE, CL	HSNT-6A	43er	VR4	7g	Sii
SGL	S-1135B20-A6T1S	LVR-IC	LDO, 2.0V±1.0%, 300mA, +CE, CL	HSNT-6A	43er	VR4	7g	Sii
SGM	S-1135B21-A6T1S	LVR-IC	LDO, 2.1V±1.0%, 300mA, +CE, CL	HSNT-6A	43er	VR4	7g	Sii
SGN	S-1135B22-A6T1S	LVR-IC	LDO, 2.2V±1.0%, 300mA, +CE, CL	HSNT-6A	43er	VR4	7g	Sii
SGO	S-1135B23-A6T1S	LVR-IC	LDO, 2.3V±1.0%, 300mA, +CE, CL	HSNT-6A	43er	VR4	7g	Sii
SGP	S-1135B24-A6T1S	LVR-IC	LDO, 2.4V±1.0%, 300mA, +CE, CL	HSNT-6A	43er	VR4	7g	Sii
SGQ	S-1135B25-A6T1S	LVR-IC	LDO, 2.5V±1.0%, 300mA, +CE, CL	HSNT-6A	43er	VR4	7g	Sii
SGR	S-1135B26-A6T1S	LVR-IC	LDO, 2.6V±1.0%, 300mA, +CE, CL	HSNT-6A	43er	VR4	7g	Sii
SGS	S-1135B27-A6T1S	LVR-IC	LDO, 2.7V±1.0%, 300mA, +CE, CL	HSNT-6A	43er	VR4	7g	Sii
SGT	S-1135B28-A6T1S	LVR-IC	LDO, 2.8V±1.0%, 300mA, +CE, CL	HSNT-6A	43er	VR4	7g	Sii
SGU	S-1135B2J-A6T1S	LVR-IC	LDO, 2.85V±1.0%, 300mA, +CE, CL	HSNT-6A	43er	VR4	7g	Sii
SGV	S-1135B29-A6T1S	LVR-IC	LDO, 2.9V±1.0%, 300mA, +CE, CL	HSNT-6A	43er	VR4	7g	Sii
SGW	S-1135B30-A6T1S	LVR-IC	LDO, 3.0V±1.0%, 300mA, +CE, CL	HSNT-6A	43er	VR4	7g	Sii
SGX	S-1135B31-A6T1S	LVR-IC	LDO, 3.1V±1.0%, 300mA, +CE, CL	HSNT-6A	43er	VR4	7g	Sii
SGY	S-1135B32-A6T1S	LVR-IC	LDO, 3.2V±1.0%, 300mA, +CE, CL	HSNT-6A	43er	VR4	7g	Sii
SGZ	S-1135B33-A6T1S	LVR-IC	LDO, 3.3V±1.0%, 300mA, +CE, CL	HSNT-6A	43er	VR4	7g	Sii
SH	R1225N602K	DC/DC-IC	PWM step-down, 6V, 180kHz	SOT-23-6W	33so	DC7	7d	Ric
SJ	R1225N302C	DC/DC-IC	PWM step-down, 3V, 300kHz	SOT-23-6W	33so	DC7	7d	Ric
SK	R1225N302D	DC/DC-IC	PWM step-down, 3V, 500kHz	SOT-23-6W	33so	DC7	7d	Ric
SL	R1225N302K	DC/DC-IC	PWM step-down, 3V, 180kHz	SOT-23-6W	33so	DC7	7d	Ric
SM	R1225N162D	DC/DC-IC	PWM step-down, 1.6V, 500kHz	SOT-23-6W	33so	DC7	7d	Ric
T0	R1131D201D	LVR-IC	LDO, 2V±2%, 300mA, +CE, CL	SON-6	34hq	VR4	7g	Ric
T0	R1163D201B	LVR-IC	LDO, 2V±1.5%, 150mA, +CE, AE(mode)	SON-6	34vrc	VR10	7g	Ric
T00	74HCT2G00DC	CMOS-Logic	Dual 2-input NAND gates	SOT765-1	47L.og50	-	8d	Phi
T00	74HCT2G00DP	CMOS-Logic	Dual 2-input NAND gates	SOT505-2	47L.og50	-	8d	Phi
T00	HD74LV2GT00AUS	CMOS-Logic	Dual 2-input NAND gates	SSOP-8	47L.og50	-	8c	Ren
T02	74HCT2G02DC	CMOS-Logic	Dual 2-input NOR gates	SOT765-1	47L.og53	-	8d	Phi
T02	74HCT2G02DP	CMOS-Logic	Dual 2-input NOR gates	SOT505-2	47L.og53	-	8d	Phi
T02	HD74LV2GT02AUS	CMOS-Logic	Dual 2-input NOR gates	SSOP-8	47L.og53	-	8c	Ren
T04	74HCT3G04DC	CMOS-Logic	Triple inverters	SOT765-1	47L.og56	-	8d	Phi
T04	74HCT3G04DP	CMOS-Logic	Triple inverters	SOT505-2	47L.og56	-	8d	Phi
T04	HD74LV2GT04AUS	CMOS-Logic	Triple inverters	SSOP-8	47L.og56	-	8c	Ren
T06	74HCT3G06DC	CMOS-Logic	Triple inverters (ODO)	SOT765-1	47L.og72	-	8d	Phi
T06	74HCT3G06DP	CMOS-Logic	Triple inverters (ODO)	SOT505-2	47L.og72	-	8d	Phi
T07	74HCT3G07DC	CMOS-Logic	Triple noninverting buffers/drivers (ODO)	SOT765-1	47L.og73	-	8d	Phi
T07	74HCT3G07DP	CMOS-Logic	Triple noninverting buffers/drivers (ODO)	SOT505-2	47L.og73	-	8d	Phi
T08	74HCT2G08DC	CMOS-Logic	Dual 2-input AND gates	SOT765-1	47L.og51	-	8d	Phi
T08	74HCT2G08DP	CMOS-Logic	Dual 2-input AND gates	SOT505-2	47L.og51	-	8d	Phi
T08	HD74LV2GT08AUS	CMOS-Logic	Dual 2-input AND gates	SSOP-8	47L.og51	-	8c	Ren
T1	IMT1A	Si-pnp	Dual, 60V, 500mA, 200MHz	SOT-363	33T/10	-	7b	Rhm
T1	R1131D211D	LVR-IC	LDO, 2.1V±2%, 300mA, +CE, CL	SON-6	34hq	VR4	7g	Ric
T1	R1163D211B	LVR-IC	LDO, 2.1V±1.5%, 150mA, +CE, AE(mode)	SON-6	34vrc	VR10	7g	Ric
T125	74HCT2G125DP	CMOS-Logic	Dual bus buffer with 3-state output	SOT505-2	47L.og54	-	8d	Phi
T126	74HCT2G126DP	CMOS-Logic	Dual bus buffer with 3-state output	SOT505-2	47L.og55	-	8d	Phi
T14	74HCT3G14DC	CMOS-Logic	Triple Schmitt-trigger inverters	SOT765-1	47L.og57	-	8d	Phi
T14	74HCT3G14DP	CMOS-Logic	Triple Schmitt-trigger inverters	SOT505-2	47L.og57	-	8d	Phi



SMD code	Type	Function	Short description	Case	Pinout	Sch.	St.	Mnf.
T14	HD74LV2GT14AUS	CMOS-Logic	Triple Schmitt-trigger inverters	SSOP-8	47L.og57	-	8c	Ren
T2	R1131D221D	LVR-IC	LDO, 2.2V±2%, 300mA, +CE, CL	SON-6	34hq	VR4	7g	Ric
T2	R1163D221B	LVR-IC	LDO, 2.2V±1.5%, 150mA, +CE, AE(mode)	SON-6	34vrc	VR10	7g	Ric
T23	HD74LV2GT123AUS	CMOS-Logic	Retriggerable monostable multivibrator	SSOP-8	47L.og75	-	8c	Ren
T25	74HCT2G125DC	CMOS-Logic	Dual bus buffer with 3-state output	SOT765-1	47L.og54	-	8d	Phi
T25	HD74LV2GT125AUS	CMOS-Logic	Dual bus buffer with 3-state output	SSOP-8	47L.og54	-	8c	Ren
T26	74HCT2G126DC	CMOS-Logic	Dual bus buffer with 3-state output	SOT765-1	47L.og55	-	8d	Phi
T26	HD74LV2GT126AUS	CMOS-Logic	Dual bus buffer with 3-state output	SSOP-8	47L.og55	-	8c	Ren
T3	R1131D231D	LVR-IC	LDO, 2.3V±2%, 300mA, +CE, CL	SON-6	34hq	VR4	7g	Ric
T3	R1163D231B	LVR-IC	LDO, 2.3V±1.5%, 150mA, +CE, AE(mode)	SON-6	34vrc	VR10	7g	Ric
T32	74HCT2G32DC	CMOS-Logic	Dual 2-input OR gates	SOT765-1	47L.og52	-	8d	Phi
T32	74HCT2G32DP	CMOS-Logic	Dual 2-input OR gates	SOT505-2	47L.og52	-	8d	Phi
T32	HD74LV2GT32AUS	CMOS-Logic	Dual 2-input OR gates	SSOP-8	47L.og52	-	8c	Ren
T34	74HCT3G34DP	CMOS-Logic	Triple non-inverter buffers	SOT505-2	47L.og69	-	8d	Phi
T34	HD74LV2GT34AUS	CMOS-Logic	Triple non-inverter buffers	SSOP-8	47L.og69	-	8c	Ren
T4	IMT4	Si-pnp	Dual, 120V, 50mA, 140MHz	SOT-363	33/T16	-	7b	Rhm
T4	MBD330DW	Si-diode	Dual, Schottky, UHF/VHF-Det, 30V, 120mW, <1pF	SOT-363	33de	-	7b	Ons
T4	R1131D241D	LVR-IC	LDO, 2.4V±2%, 300mA, +CE, CL	SON-6	34hq	VR4	7g	Ric
T4	R1163D241B	LVR-IC	LDO, 2.4V±1.5%, 150mA, +CE, AE(mode)	SON-6	34vrc	VR10	7g	Ric
T40	HD74LV2GT240AUS	CMOS-Logic	Dual bus buffer inverted with 3-state output	SSOP-8	47L.og67	-	8c	Ren
T41	HD74LV2GT241AUS	CMOS-Logic	Dual bus buffer non-inverted with 3-state output	SSOP-8	47L.og67	-	8c	Ren
T45	HD74LV2GT245AUS	CMOS-Logic	Dual bus transceivers with 3-state output	SSOP-8	47L.og74	-	8c	Ren
T5	R1131D251D	LVR-IC	LDO, 2.5V±2%, 300mA, +CE, CL	SON-6	34hq	VR4	7g	Ric
T5	R1163D251B	LVR-IC	LDO, 2.5V±1.5%, 150mA, +CE, AE(mode)	SON-6	34vrc	VR10	7g	Ric
T53	HD74LV2GT53AUS	CMOS-Logic	2-channel analog multiplexer/demultiplexer	SSOP-8	47L.og58	-	8c	Ren
T57	HD74LV2GT157AUS	CMOS-Logic	2-input multiplexer	SSOP-8	47L.og66	-	8c	Ren
T6	R1131D261D	LVR-IC	LDO, 2.6V±2%, 300mA, +CE, CL	SON-6	34hq	VR4	7g	Ric
T6	R1163D261B	LVR-IC	LDO, 2.6V±1.5%, 150mA, +CE, AE(mode)	SON-6	34vrc	VR10	7g	Ric
T605	ZDT605	Si-npn-Darl	Dual, 140/120V, 1A, B=2k..100k	SOP-8	47tl	-	8d	Zx
T617	ZDT617	Si-npn	Dual, Hi-beta, Lo-sat, 15V, 3A, >80MHz, B>300, 120/160ns	SOP-8	47tl	-	8d	Zx
T619	ZDT619	Si-npn	Dual, Hi-beta, Lo-sat, 50V, 2A, >100MHz, B>300, 170/750ns	SOP-8	47tl	-	8d	Zx
T649	ZDT649	Si-npn	Dual, lo-sat, 35V, 2A, >150MHz, 55/300ns	SOP-8	47tl	-	8d	Zx
T651	ZDT651	Si-npn	Dual, lo-sat, 80V, 2A, >150MHz	SOP-8	47tl	-	8d	Zx
T66	74HCT2G66DP	CMOS-Logic	2-channel analog switch	SOT505-2	47L.og68	-	8d	Phi
T66	HD74LV2GT66AUS	CMOS-Logic	2-channel analog switch	SSOP-8	47L.og68	-	8c	Ren
T6702	ZDT6702	Si-n/p-Darl	T1=pnp, T2=nnp, 80V, 2A, B>2000	SOP-8	47tl	-	8d	Zx
T6705	ZDT6705	Si-n/p-Darl	T1=pnp, T2=nnp, 140V, 1A, B>2000	SOP-8	47tl	-	8d	Zx
T6718	ZDT6718	Si-n/p	T1=pnp, T2=nnp, 20V, 1.5-2A, B>300, >150MHz=>100MHz	SOP-8	47tl	-	8d	Zx
T6753	ZDT6753	Si-n/p	T1=pnp, T2=nnp, Lo-sat, 120/100V, 2A, >100MHz=>150MHz	SOP-8	47tl	-	8d	Zx
T6757	ZDT6757	Si-n/p	T1=pnp, T2=nnp, 300/300V, 0.5A, >30MHz	SOP-8	47tl	-	8d	Zx
T6790	ZDT6790	Si-n/p	Dual, Hi-beta, lo-sat, 50-45V, 1A, B>200+B>400, >100=>150MHz	SOP-8	47tl	-	8d	Zx
T690	ZDT690	Si-npn	Dual, Hi-beta, Lo-sat, 45V, 2A, >150MHz, B>400, 33/1300ns	SOP-8	47tl	-	8d	Zx
T694	ZDT694	Si-npn	Dual, Hi-beta, Lo-sat, 120V, 0.5A, >130MHz, B>400, 80/290ns	SOP-8	47tl	-	8d	Zx
T7	R1131D271D	LVR-IC	LDO, 2.7V±2%, 300mA, +CE, CL	SON-6	34hq	VR4	7g	Ric
T7	R1163D271B	LVR-IC	LDO, 2.7V±1.5%, 150mA, +CE, AE(mode)	SON-6	34vrc	VR10	7g	Ric
T705	ZDT705	Si-pnp-Darl	Dual, 140/120V, 1A, B=3k..30k	SOP-8	47tl	-	8d	Zx
T717	ZDT717	Si-pnp	Dual, Hi-beta, Lo-sat, 12V, 2.5A, >80MHz, B>300, 70/130ns	SOP-8	47tl	-	8d	Zx
T73	µPA803T-FB	Si-npn	Dual, VHF/UHF, 20V, 30mA, 120mW, 5.5GHz, B=60..120	SOT-363	33/T2	-	7b	Nec
T74	µPA803T-GB	Si-npn	Dual, VHF/UHF, 20V, 30mA, 120mW, 5.5GHz, B=100.200	SOT-363	33/T2	-	7b	Nec
T74	HD74LV2GT74AUS	CMOS-Logic	D-type flip-flop with preset and clear	SSOP-8	47L.og59	-	8c	Ren
T749	ZDT749	Si-pnp	Dual, lo-sat, 35V, 2A, >100MHz	SOP-8	47tl	-	8d	Zx
T758	ZDT758	Si-pnp	Dual, Sw, 400/400V, 0.5A, >50MHz	SOP-8	47tl	-	8d	Zx
T76	µPA804T-FB	Si-npn	Dual, VHF/UHF, 20V, 60mA, 120mW, 5GHz, B=60..120	SOT-363	33/T2	-	7b	Nec
T77	µPA804T-GB	Si-npn	Dual, VHF/UHF, 20V, 60mA, 120mW, 5GHz, B=100..200	SOT-363	33/T2	-	7b	Nec
T8	R1131D281D	LVR-IC	LDO, 2.8V±2%, 300mA, +CE, CL	SON-6	34hq	VR4	7g	Ric
T8	R1163D281B	LVR-IC	LDO, 2.8V±1.5%, 150mA, +CE, AE(mode)	SON-6	34vrc	VR10	7g	Ric
T82	µPA805T-KB	Si-npn	Dual, VHF/UHF, 9V, 10mA, 60mW, 12GHz, B=75..150	SOT-363	33/T2	-	7b	Nec
T83	µPA806T-KB	Si-npn	Dual, VHF/UHF, 9V, 30mA, 150mW, 12GHz, B=75..150	SOT-363	33/T2	-	7b	Nec
T84	µPA807T-KB	Si-npn	Dual, VHF/UHF, 5V, 10mA, 30mW, 13GHz, B=70..140	SOT-363	33/T2	-	7b	Nec
T86	µPA808T-KB	Si-npn	Dual, VHF/UHF, 5V, 30mA, 90mW, 11GHz, B=70..140	SOT-363	33/T2	-	7b	Nec
T86	74HCT2G86DC	CMOS-Logic	Dual 2-input EXCLUSIVE-OR gates	SOT765-1	47L.og65	-	8d	Phi
T86	74HCT2G86DP	CMOS-Logic	Dual 2-input EXCLUSIVE-OR gates	SOT505-2	47L.og65	-	8d	Phi
T86	HD74LV2GT86AUS	CMOS-Logic	Dual 2-input EXCLUSIVE-OR gates	SSOP-8	47L.og65	-	8c	Ren
T88	µPA809T-KB	Si-npn	Dual, VHF/UHF, 9V, 100mA, 150mW, 4.5GHz, B=80..160	SOT-363	33/T2	-	7b	Nec
T9	R1131D291D	LVR-IC	LDO, 2.9V±2%, 300mA, +CE, CL	SON-6	34hq	VR4	7g	Ric
T9	R1163D291B	LVR-IC	LDO, 2.9V±1.5%, 150mA, +CE, AE(mode)	SON-6	34vrc	VR10	7g	Ric
T97	2SC5409-T1	Si-npn	UHF, 5V, 30mA, 90mW, B=70..140, 16GHz	SOT-363	33ah	-	7b	Nec
TA00	MIC280-0BM6	Tdet-IC	Settable Thermal Supervisor (-60..+100C°), I2C- bus	SOT-23-6	33hb	-	7b	Mcr
TA01	MIC280-1BM6	Tdet-IC	Settable Thermal Supervisor (-60..+100C°), I2C- bus	SOT-23-6	33hb	-	7b	Mcr
TA02	MIC280-2BM6	Tdet-IC	Settable Thermal Supervisor (-60..+100C°), I2C- bus	SOT-23-6	33hb	-	7b	Mcr



SMD code	Type	Function	Short description	Case	Pinout	Sch.	St.	Mnf.
TA03	MIC280-3BM6	Tdet-IC	Setable Thermal Supervisor (-60...+100C*), I2C- bus	SOT-23-6	33hb	-	7b	Mcr
TA04	MIC280-4BM6	Tdet-IC	Setable Thermal Supervisor (-60...+100C*), I2C- bus	SOT-23-6	33hb	-	7b	Mcr
TA05	MIC280-5BM6	Tdet-IC	Setable Thermal Supervisor (-60...+100C*), I2C- bus	SOT-23-6	33hb	-	7b	Mcr
TA06	MIC280-6BM6	Tdet-IC	Setable Thermal Supervisor (-60...+100C*), I2C- bus	SOT-23-6	33hb	-	7b	Mcr
TA07	MIC280-7BM6	Tdet-IC	Setable Thermal Supervisor (-60...+100C*), I2C- bus	SOT-23-6	33hb	-	7b	Mcr
TB	μPA1910	p-MOSFET-e*	V-MOS, LogL, 12V, ±2.5A, <130mΩ	SOT-363	33fc	-	7b	Nec
TB00	MIC281-0BM6	Tdet-IC	Setable Thermal Supervisor (0...+100C*), I2C- bus	SOT-23-6	33hc	-	7b	Mcr
TB01	MIC281-1BM6	Tdet-IC	Setable Thermal Supervisor (0...+100C*), I2C- bus	SOT-23-6	33hc	-	7b	Mcr
TB02	MIC281-2BM6	Tdet-IC	Setable Thermal Supervisor (0...+100C*), I2C- bus	SOT-23-6	33hc	-	7b	Mcr
TB03	MIC281-3BM6	Tdet-IC	Setable Thermal Supervisor (0...+100C*), I2C- bus	SOT-23-6	33hc	-	7b	Mcr
TB04	MIC281-4BM6	Tdet-IC	Setable Thermal Supervisor (0...+100C*), I2C- bus	SOT-23-6	33hc	-	7b	Mcr
TB05	MIC281-5BM6	Tdet-IC	Setable Thermal Supervisor (0...+100C*), I2C- bus	SOT-23-6	33hc	-	7b	Mcr
TB06	MIC281-6BM6	Tdet-IC	Setable Thermal Supervisor (0...+100C*), I2C- bus	SOT-23-6	33hc	-	7b	Mcr
TB07	MIC281-7BM6	Tdet-IC	Setable Thermal Supervisor (0...+100C*), I2C- bus	SOT-23-6	33hc	-	7b	Mcr
TBD	TPA6204A1DGN	LIN-IC	AF PA, BTL, 2.5..5.5V, 1.7W(5V/8Ω), shutdown	SSOP-8	47	AFP22	-	Ti
TC	μPA1911	p-MOSFET-e*	V-MOS, LogL, 20V, ±2.5A, <190mΩ	SOT-363	33fc	-	7b	Nec
TD	μPA1912	p-MOSFET-e*	V-MOS, LogL, 12V, ±4.5A, <70mΩ	SOT-363	33fc	-	7b	Nec
TE	μPA1913	p-MOSFET-e*	V-MOS, LogL, 20V, ±4.5A, <90mΩ	SOT-363	33fc	-	7b	Nec
TF	μPA1914	p-MOSFET-e*	V-MOS, LogL, 30V, ±4.5A, <96mΩ	SOT-363	33fc	-	7b	Nec
TG	μPA1900	n-MOSFET-e*	V-MOS, LogL, 20V, ±5.5A, <45mΩ	SOT-363	33fc	-	7b	Nec
TH	μPA1915	p-MOSFET-e*	V-MOS, LogL, 20V, ±4.5A, <90mΩ	SOT-363	33fc	-	7b	Nec
TM	KIC7S2241FU	CMOS-Logic	Dual bus buffer inverted with 3-state output	US8	47/Log60	-	8c	Kec
TT	NC7S32L6	CMOS-Logic	2-input OR gate	MPAK-6	33/Log4	-	7b	F
TVA	S-11L10B08-16T2G	LVR-IC	LDO, 0.8V±15mV, 150mA, +CE, PDR	SNT-6A	35v/4	VR4	7g	Sii
TVB	S-11L10B09-16T2G	LVR-IC	LDO, 0.9V±15mV, 150mA, +CE, PDR	SNT-6A	35v/4	VR4	7g	Sii
TVC	S-11L10B10-16T2G	LVR-IC	LDO, 1.0V±15mV, 150mA, +CE, PDR	SNT-6A	35v/4	VR4	7g	Sii
TVD	S-11L10B11-16T2G	LVR-IC	LDO, 1.1V±15mV, 150mA, +CE, PDR	SNT-6A	35v/4	VR4	7g	Sii
TVE	S-11L10B12-16T2G	LVR-IC	LDO, 1.2V±15mV, 150mA, +CE, PDR	SNT-6A	35v/4	VR4	7g	Sii
TVF	S-11L10B13-16T2G	LVR-IC	LDO, 1.3V±15mV, 150mA, +CE, PDR	SNT-6A	35v/4	VR4	7g	Sii
TVG	S-11L10B14-16T2G	LVR-IC	LDO, 1.4V±15mV, 150mA, +CE, PDR	SNT-6A	35v/4	VR4	7g	Sii
TVH	S-11L10B15-16T2G	LVR-IC	LDO, 1.5V±1.0%, 150mA, +CE, PDR	SNT-6A	35v/4	VR4	7g	Sii
TVI	S-11L10B16-16T2G	LVR-IC	LDO, 1.6V±1.0%, 150mA, +CE, PDR	SNT-6A	35v/4	VR4	7g	Sii
TVJ	S-11L10B17-16T2G	LVR-IC	LDO, 1.7V±1.0%, 150mA, +CE, PDR	SNT-6A	35v/4	VR4	7g	Sii
TVK	S-11L10B18-16T2G	LVR-IC	LDO, 1.8V±1.0%, 150mA, +CE, PDR	SNT-6A	35v/4	VR4	7g	Sii
TVL	S-11L10B19-16T2G	LVR-IC	LDO, 1.9V±1.0%, 150mA, +CE, PDR	SNT-6A	35v/4	VR4	7g	Sii
TVM	S-11L10B20-16T2G	LVR-IC	LDO, 2.0V±1.0%, 150mA, +CE, PDR	SNT-6A	35v/4	VR4	7g	Sii
TVN	S-11L10B21-16T2G	LVR-IC	LDO, 2.1V±1.0%, 150mA, +CE, PDR	SNT-6A	35v/4	VR4	7g	Sii
TVO	S-11L10B22-16T2G	LVR-IC	LDO, 2.2V±1.0%, 150mA, +CE, PDR	SNT-6A	35v/4	VR4	7g	Sii
TVP	S-11L10B23-16T2G	LVR-IC	LDO, 2.3V±1.0%, 150mA, +CE, PDR	SNT-6A	35v/4	VR4	7g	Sii
TVQ	S-11L10B24-16T2G	LVR-IC	LDO, 2.4V±1.0%, 150mA, +CE, PDR	SNT-6A	35v/4	VR4	7g	Sii
TVR	S-11L10B25-16T2G	LVR-IC	LDO, 2.5V±1.0%, 150mA, +CE, PDR	SNT-6A	35v/4	VR4	7g	Sii
TVS	S-11L10B26-16T2G	LVR-IC	LDO, 2.6V±1.0%, 150mA, +CE, PDR	SNT-6A	35v/4	VR4	7g	Sii
TVT	S-11L10B27-16T2G	LVR-IC	LDO, 2.7V±1.0%, 150mA, +CE, PDR	SNT-6A	35v/4	VR4	7g	Sii
TVU	S-11L10B28-16T2G	LVR-IC	LDO, 2.8V±1.0%, 150mA, +CE, PDR	SNT-6A	35v/4	VR4	7g	Sii
TVV	S-11L10B29-16T2G	LVR-IC	LDO, 2.9V±1.0%, 150mA, +CE, PDR	SNT-6A	35v/4	VR4	7g	Sii
TVW	S-11L10B30-16T2G	LVR-IC	LDO, 3.0V±1.0%, 150mA, +CE, PDR	SNT-6A	35v/4	VR4	7g	Sii
TVX	S-11L10B31-16T2G	LVR-IC	LDO, 3.1V±1.0%, 150mA, +CE, PDR	SNT-6A	35v/4	VR4	7g	Sii
TVY	S-11L10B32-16T2G	LVR-IC	LDO, 3.2V±1.0%, 150mA, +CE, PDR	SNT-6A	35v/4	VR4	7g	Sii
TVZ	S-11L10B33-16T2G	LVR-IC	LDO, 3.3V±1.0%, 150mA, +CE, PDR	SNT-6A	35v/4	VR4	7g	Sii
TXA	S-11L10D08-16T2G	LVR-IC	LDO, 0.8V±15mV, 150mA, +CE	SNT-6A	35v/4	VR4	7g	Sii
TXB	S-11L10D09-16T2G	LVR-IC	LDO, 0.9V±15mV, 150mA, +CE	SNT-6A	35v/4	VR4	7g	Sii
TXC	S-11L10D10-16T2G	LVR-IC	LDO, 1.0V±15mV, 150mA, +CE	SNT-6A	35v/4	VR4	7g	Sii
TXD	S-11L10D11-16T2G	LVR-IC	LDO, 1.1V±15mV, 150mA, +CE	SNT-6A	35v/4	VR4	7g	Sii
TXE	S-11L10D12-16T2G	LVR-IC	LDO, 1.2V±15mV, 150mA, +CE	SNT-6A	35v/4	VR4	7g	Sii
TXF	S-11L10D13-16T2G	LVR-IC	LDO, 1.3V±15mV, 150mA, +CE	SNT-6A	35v/4	VR4	7g	Sii
TXG	S-11L10D14-16T2G	LVR-IC	LDO, 1.4V±15mV, 150mA, +CE	SNT-6A	35v/4	VR4	7g	Sii
TXH	S-11L10D15-16T2G	LVR-IC	LDO, 1.5V±1.0%, 150mA, +CE	SNT-6A	35v/4	VR4	7g	Sii
TXI	S-11L10D16-16T2G	LVR-IC	LDO, 1.6V±1.0%, 150mA, +CE	SNT-6A	35v/4	VR4	7g	Sii
TXJ	S-11L10D17-16T2G	LVR-IC	LDO, 1.7V±1.0%, 150mA, +CE	SNT-6A	35v/4	VR4	7g	Sii
TXK	S-11L10D18-16T2G	LVR-IC	LDO, 1.8V±1.0%, 150mA, +CE	SNT-6A	35v/4	VR4	7g	Sii
TXL	S-11L10D19-16T2G	LVR-IC	LDO, 1.9V±1.0%, 150mA, +CE	SNT-6A	35v/4	VR4	7g	Sii
TXM	S-11L10D20-16T2G	LVR-IC	LDO, 2.0V±1.0%, 150mA, +CE	SNT-6A	35v/4	VR4	7g	Sii
TXN	S-11L10D21-16T2G	LVR-IC	LDO, 2.1V±1.0%, 150mA, +CE	SNT-6A	35v/4	VR4	7g	Sii
TXO	S-11L10D22-16T2G	LVR-IC	LDO, 2.2V±1.0%, 150mA, +CE	SNT-6A	35v/4	VR4	7g	Sii
TXP	S-11L10D23-16T2G	LVR-IC	LDO, 2.3V±1.0%, 150mA, +CE	SNT-6A	35v/4	VR4	7g	Sii
TXQ	S-11L10D24-16T2G	LVR-IC	LDO, 2.4V±1.0%, 150mA, +CE	SNT-6A	35v/4	VR4	7g	Sii
TXR	S-11L10D25-16T2G	LVR-IC	LDO, 2.5V±1.0%, 150mA, +CE	SNT-6A	35v/4	VR4	7g	Sii
TXS	S-11L10D26-16T2G	LVR-IC	LDO, 2.6V±1.0%, 150mA, +CE	SNT-6A	35v/4	VR4	7g	Sii
TXT	S-11L10D27-16T2G	LVR-IC	LDO, 2.7V±1.0%, 150mA, +CE	SNT-6A	35v/4	VR4	7g	Sii
TXU	S-11L10D28-16T2G	LVR-IC	LDO, 2.8V±1.0%, 150mA, +CE	SNT-6A	35v/4	VR4	7g	Sii



SMD code	Type	Function	Short description	Case	Pinout	Sch.	St.	Mnf.
TXV	S-11L10D29-16T2G	LVR-IC	LDO, 2.9V±1.0%, 150mA, +CE	SNT-6A	35vr4	VR4	7g	Sii
TXW	S-11L10D30-16T2G	LVR-IC	LDO, 3.0V±1.0%, 150mA, +CE	SNT-6A	35vr4	VR4	7g	Sii
TXX	S-11L10D31-16T2G	LVR-IC	LDO, 3.1V±1.0%, 150mA, +CE	SNT-6A	35vr4	VR4	7g	Sii
TXY	S-11L10D32-16T2G	LVR-IC	LDO, 3.2V±1.0%, 150mA, +CE	SNT-6A	35vr4	VR4	7g	Sii
TXZ	S-11L10D33-16T2G	LVR-IC	LDO, 3.3V±1.0%, 150mA, +CE	SNT-6A	35vr4	VR4	7g	Sii
U0	R1131D301D	LVR-IC	LDO, 3V±2%, 300mA, +CE, CL	SON-6	34hq	VR4	7g	Ric
U0	R1163D301B	LVR-IC	LDO, 3V±1.5%, 150mA, +CE, AE(mode)	SON-6	34vrc	VR10	7g	Ric
U0	R5323N031B	LVR-IC	LDO, Dual out, Vout1/Vout2=1.9V/2.8V±1%, 150mA, +CE, CL	SOT-23-6	33rg	VR19	7d	Ric
U00_	SN74AUC2G00DCT	CMOS-Logic	Dual 2-input NAND gates	SSOP-8	47Llog50	-	8d	Ti
U00_	SN74AUC2G00DCU	CMOS-Logic	Dual 2-input NAND gates	VSSOP-8	44Llog50	-	8d	Ti
U02_	SN74AUC2G02DCT	CMOS-Logic	Dual 2-input NOR gates	SSOP-8	47Llog53	-	8d	Ti
U02_	SN74AUC2G02DCU	CMOS-Logic	Dual 2-input NOR gates	VSSOP-8	44Llog53	-	8d	Ti
U04	74HC3GU04DP	CMOS-Logic	Triple inverters	SOT505-2	47Llog56	-	8d	Phi
U04	KIC7WU04FK	CMOS-Logic	Triple inverters	US8	47Llog56	-	8c	Kec
U04	XC74WLU04ASR	CMOS-Logic	Triple unbuffered inverters	MSP08-8B	47Llog56	-	8d	Tor
U04_	SN74AUC2G04DBV	CMOS-Logic	Dual inverters	SOT-23-6	33Llog24	-	7d	Ti
U06_	SN74AUC2G06DBV	CMOS-Logic	Dual inverter buffers/drivers (ODO)	SOT-23-6	33Llog25	-	7d	Ti
U07_	SN74AUC2G07DBV	CMOS-Logic	Dual noninverting buffers/drivers (ODO)	SOT-23-6	33Llog26	-	7d	Ti
U08_	SN74AUC2G08DCU	CMOS-Logic	Dual 2-input AND gates	VSSOP-8	44Llog51	-	8d	Ti
U08_	SN74AUC2G08DCT	CMOS-Logic	Dual 2-input AND gates	SSOP-8	47Llog51	-	8d	Ti
U1	R1131D311D	LVR-IC	LDO, 3.1V±2%, 300mA, +CE, CL	SON-6	34hq	VR4	7g	Ric
U1	R1163D311B	LVR-IC	LDO, 3.1V±1.5%, 150mA, +CE, AE(mode)	SON-6	34vrc	VR10	7g	Ric
U1	R5323N032B	LVR-IC	LDO, Dual out, Vout1/Vout2=2.5V/2.8V±1%, 150mA, +CE, CL	SOT-23-6	33rg	VR19	7d	Ric
U2	R1131D321D	LVR-IC	LDO, 3.2V±2%, 300mA, +CE, CL	SON-6	34hq	VR4	7g	Ric
U2	R1163D321B	LVR-IC	LDO, 3.2V±1.5%, 150mA, +CE, AE(mode)	SON-6	34vrc	VR10	7g	Ric
U2	R5323N033B	LVR-IC	LDO, Dual out, Vout1/Vout2=2.4V/3V±1%, 150mA, +CE, CL	SOT-23-6	33rg	VR19	7d	Ric
U2_	SN74AUC2G241DCU	CMOS-Logic	Dual bus buffer non-inverted with 3-state output	VSSOP-8	44Llog60	-	8d	Ti
U25_	SN74AUC2G125DCU	CMOS-Logic	Dual bus buffer with 3-state output	VSSOP-8	44Llog54	-	8d	Ti
U25_	SN74AUC2G125DCT	CMOS-Logic	Dual bus buffer with 3-state output	SSOP-8	47Llog54	-	8d	Ti
U26_	SN74AUC2G126DCT	CMOS-Logic	Bus buffer gate with 3-state output	SSOP-8	47Llog13	-	8d	Ti
U3	R1131D331D	LVR-IC	LDO, 3.3V±2%, 300mA, +CE, CL	SON-6	34hq	VR4	7g	Ric
U3	R1163D331B	LVR-IC	LDO, 3.3V±1.5%, 150mA, +CE, AE(mode)	SON-6	34vrc	VR10	7g	Ric
U3	R5323N034B	LVR-IC	LDO, Dual out, Vout1/Vout2=2.5V/2.9V±1%, 150mA, +CE, CL	SOT-23-6	33rg	VR19	7d	Ric
U32_	SN74AUC2G32DCT	CMOS-Logic	Dual 2-input OR gates	VSSOP-8	44Llog52	-	8d	Ti
U32_	SN74AUC2G32DCU	CMOS-Logic	Dual 2-input OR gates	SSOP-8	47Llog52	-	8d	Ti
U34	74HCT3G34DC	CMOS-Logic	Triple non-inverter buffers	SOT765-1	47Llog69	-	8d	Phi
U34_	SN74AUC2G34DBV	CMOS-Logic	Dual non-inverter buffers	SOT-23-6	33Llog23	-	7d	Ti
U4	R1163D341B	LVR-IC	LDO, 3.4V±1.5%, 150mA, +CE, AE(mode)	SON-6	34vrc	VR10	7g	Ric
U4	R5323N035B	LVR-IC	LDO, Dual out, Vout1/Vout2=1.5V/2.7V±1%, 150mA, +CE, CL	SOT-23-6	33rg	VR19	7d	Ric
U40_	SN74AUC2G240DCT	CMOS-Logic	Dual bus buffer inverted with 3-state output	SSOP-8	47Llog67	-	8d	Ti
U41_	SN74AUC2G241DCT	CMOS-Logic	Dual bus buffer non-inverted with 3-state output	SSOP-8	47Llog60	-	8d	Ti
U5	R1163D351B	LVR-IC	LDO, 3.5V±1.5%, 150mA, +CE, AE(mode)	SON-6	34vrc	VR10	7g	Ric
U5	R5323N036B	LVR-IC	LDO, Dual out, Vout1/Vout2=2.6V/2.9V±1%, 150mA, +CE, CL	SOT-23-6	33rg	VR19	7d	Ric
U6	R1163D361B	LVR-IC	LDO, 3.6V±1.5%, 150mA, +CE, AE(mode)	SON-6	34vrc	VR10	7g	Ric
U6	R5323N011B	LVR-IC	LDO, Dual out, Vout1/Vout2=3.3V/3V±1%, 150mA, +CE, CL	SOT-23-6	33rg	VR19	7d	Ric
U66_	SN74AUC2G66DCU	CMOS-Logic	2-channel analog switch	VSSOP-8	44Llog68	-	8d	Ti
U66_	SN74AUC2G66DCT	CMOS-Logic	2-channel analog switch	SSOP-8	47Llog68	-	8d	Ti
U7	R1163D371B	LVR-IC	LDO, 3.7V±1.5%, 150mA, +CE, AE(mode)	SON-6	34vrc	VR10	7g	Ric
U7	R5323N037B	LVR-IC	LDO, Dual out, Vout1/Vout2=1.8V/2.6V±1%, 150mA, +CE, CL	SOT-23-6	33rg	VR19	7d	Ric
U74_	SN74AUP1G74DCT	CMOS-Logic	Positive edge-triggered D-type flip-flop with set and reset	SSOP-8	47Llog59	-	8d	Ti
U79_	SN74AUC2G79DCU	CMOS-Logic	Dual positive-edge triggered D-type flip-flop	VSSOP-8	44Llog63	-	8d	Ti
U79_	SN74AUC2G79DCT	CMOS-Logic	Dual positive-edge triggered D-type flip-flop	SSOP-8	47Llog63	-	8d	Ti
U8	R1163D381B	LVR-IC	LDO, 3.8V±1.5%, 150mA, +CE, AE(mode)	SON-6	34vrc	VR10	7g	Ric
U8	R5323N038B	LVR-IC	LDO, Dual out, Vout1/Vout2=1.7V/2.8V±1%, 150mA, +CE, CL	SOT-23-6	33rg	VR19	7d	Ric
U80_	SN74AUC2G80DCT	CMOS-Logic	Dual positive-edge triggered D-type flip-flop	SSOP-8	47Llog64	-	8d	Ti
U86_	SN74AUC2G86DCU	CMOS-Logic	Dual 2-input EXCLUSIVE-OR gates	VSSOP-8	44Llog65	-	8d	Ti
U86_	SN74AUC2G86DCT	CMOS-Logic	Dual 2-input EXCLUSIVE-OR gates	SSOP-8	47Llog65	-	8d	Ti
U9	R1163D391B	LVR-IC	LDO, 3.9V±1.5%, 150mA, +CE, AE(mode)	SON-6	34vrc	VR10	7g	Ric
U9	R5323N039B	LVR-IC	LDO, Dual out, Vout1/Vout2=1.8V/3.1V±1%, 150mA, +CE, CL	SOT-23-6	33rg	VR19	7d	Ric
U9_	SN74AUC2G34DCK	CMOS-Logic	Dual non-inverter buffers	SC-70-6	33Llog23	-	7d	Ti
U9_	SN74AUC2G34DRL	CMOS-Logic	Dual non-inverter buffers	SOT-563-6	35Llog23	-	7d	Ti
UA	R5323N040B	LVR-IC	LDO, Dual out, Vout1/Vout2=1.8V/3V±1%, 150mA, +CE, CL	SOT-23-6	33rg	VR19	7d	Ric
UB	R5323N041B	LVR-IC	LDO, Dual out, Vout1/Vout2=2.7V/1.8V±1%, 150mA, +CE, CL	SOT-23-6	33rg	VR19	7d	Ric
UB	TWG4148CD-126W	Si-diode	Quad, Sw, 85V, 100mA, Vf<1.2V(100mA), <4pF	SOT-23-6	33/D6	-	7b	Ttr
UB	TWG4148CD-126WS	Si-diode	Quad, Sw, 85V, 100mA, Vf<1.2V(100mA), <4pF	SOT-363	33/D6	-	7b	Ttr
UB	TWG4148CD-126WT	Si-diode	Quad, Sw, 85V, 100mA, Vf<1.2V(100mA), <3pF	SOT-563	35/D6	-	7b	Ttr
UC	R5323N042B	LVR-IC	LDO, Dual out, Vout1/Vout2=3.3V/3.3V±1%, 150mA, +CE, CL	SOT-23-6	33rg	VR19	7d	Ric
UC_	SN74AUC2G04DCK	CMOS-Logic	Dual inverters	SC-70-6	33Llog24	-	7d	Ti
UD	R5323N024B	LVR-IC	LDO, Dual out, Vout1/Vout2=3V/3.1V±1%, 150mA, +CE, CL	SOT-23-6	33rg	VR19	7d	Ric
UD_	SN74AUC2GU04DCK	CMOS-Logic	Dual inverters	SC-70-6	33Llog24	-	7d	Ti



SMD code	Type	Function	Short description	Case	Pinout	Sch.	St.	Mnf.
UE	R5323N025B	LVR-IC	LDO, Dual out, Vout1/Vout2=2.9V/3V±1%, 150mA, +CE, CL	SOT-23-6	33rg	VR19	7d	Ric
UF	R5323N028B	LVR-IC	LDO, Dual out, Vout1/Vout2=3.1V/3.1V±1%, 150mA, +CE, CL	SOT-23-6	33rg	VR19	7d	Ric
UG	R5323N001A	LVR-IC	LDO, Dual out, Vout1/Vout2=2.8V/2.8V±1%, 150mA, +CE	SOT-23-6	33rg	VR19	7d	Ric
UH	R5323N043B	LVR-IC	LDO, Dual out, Vout1/Vout2=2.7V/2.85V±1%, 150mA, +CE, CL	SOT-23-6	33rg	VR19	7d	Ric
UJ	R5323N044B	LVR-IC	LDO, Dual out, Vout1/Vout2=2.6V/3.3V±1%, 150mA, +CE, CL	SOT-23-6	33rg	VR19	7d	Ric
UK	R5323N045B	LVR-IC	LDO, Dual out, Vout1/Vout2=1.5V/2.85V±1%, 150mA, +CE, CL	SOT-23-6	33rg	VR19	7d	Ric
UK_	SN74AUC2G240DCU	CMOS-Logic	Dual bus buffer inverted with 3-state output	VSSOP-8	44L.og67	-	8d	Ti
UL	R5323N046B	LVR-IC	LDO, Dual out, Vout1/Vout2=1.5V/3.0V±1%, 150mA, +CE, CL	SOT-23-6	33rg	VR19	7d	Ric
UM	R5323N047B	LVR-IC	LDO, Dual out, Vout1/Vout2=2.6V/2.8V±1%, 150mA, +CE, CL	SOT-23-6	33rg	VR19	7d	Ric
UN	R5323N011A	LVR-IC	LDO, Dual out, Vout1/Vout2=3.3V/3.0V±1%, 150mA, +CE	SOT-23-6	33rg	VR19	7d	Ric
UN_	SN74AUC2G126DCU	CMOS-Logic	Bus buffer gate with 3-state output	VSSOP-8	44L.og13	-	8d	Ti
UP	R5323N048B	LVR-IC	LDO, Dual out, Vout1/Vout2=1.5V/2.6V±1%, 150mA, +CE, CL	SOT-23-6	33rg	VR19	7d	Ric
UP_	SN74AUP1G74DCU	CMOS-Logic	Positive edge-triggered D-type flip-flop with set and reset	VSSOP-8	44L.og59	-	8d	Ti
UQ	R5323N049B	LVR-IC	LDO, Dual out, Vout1/Vout2=1.5V/1.8V±1%, 150mA, +CE, CL	SOT-23-6	33rg	VR19	7d	Ric
UR	R5323N050B	LVR-IC	LDO, Dual out, Vout1/Vout2=2.1V/2.1V±1%, 150mA, +CE, CL	SOT-23-6	33rg	VR19	7d	Ric
US	R5323N051B	LVR-IC	LDO, Dual out, Vout1/Vout2=2.7V/2.8V±1%, 150mA, +CE, CL	SOT-23-6	33rg	VR19	7d	Ric
UT	R5323N052B	LVR-IC	LDO, Dual out, Vout1/Vout2=1.5V/3.1V±1%, 150mA, +CE, CL	SOT-23-6	33rg	VR19	7d	Ric
UT_	SN74AUC2G06DCK	CMOS-Logic	Dual inverter buffers/drivers (ODO)	SC-70-6	33L.og25	-	7d	Ti
UU	R5323N053B	LVR-IC	LDO, Dual out, Vout1/Vout2=2.5V/3.0V±1%, 150mA, +CE, CL	SOT-23-6	33rg	VR19	7d	Ric
UU4_	SN74AUC2GU04DBV	CMOS-Logic	Dual inverters	SOT-23-6	33L.og24	-	7d	Ti
UV	R5323N054A	LVR-IC	LDO, Dual out, Vout1/Vout2=2.8V/2.85V±1%, 150mA, +CE	SOT-23-6	33rg	VR19	7d	Ric
UV_	SN74AUC2G07DCK	CMOS-Logic	Dual noninverting buffers/drivers (ODO)	SC-70-6	33L.og26	-	7d	Ti
UW	R5323N054B	LVR-IC	LDO, Dual out, Vout1/Vout2=2.8V/2.85V±1%, 150mA, +CE, CL	SOT-23-6	33rg	VR19	7d	Ric
UX_	SN74AUC2G80DCU	CMOS-Logic	Dual positive-edge triggered D-type flip-flop	VSSOP-8	44L.og64	-	8d	Ti
V0	R1131D181D5	LVR-IC	LDO, 1.85V±2%, 300mA, +CE, CL	SON-6	34hq	VR4	7g	Ric
V0	R1163D401B	LVR-IC	LDO, 4V±1.5%, 150mA, +CE, AE(mode)	SON-6	34vrc	VR10	7g	Ric
V00	74LVC2G00DC	CMOS-Logic	Dual 2-input NAND gates	SOT765-1	47L.og50	-	8d	Phi
V02	74LVC2G02DC	CMOS-Logic	Dual 2-input NOR gates	SOT765-1	47L.og53	-	8d	Phi
V02	74LVC2G02DP	CMOS-Logic	Dual 2-input NOR gates	SOT505-2	47L.og53	-	8d	Phi
V04	74LVC2G04GV	CMOS-Logic	Dual inverters	SOT457	33L.og24	-	7b	Phi
V04	74LVC3G04DC	CMOS-Logic	Triple inverters	SOT765-1	47L.og56	-	8d	Phi
V04	74LVC3G04DP	CMOS-Logic	Triple inverters	SOT505-2	47L.og56	-	8d	Phi
V06	74LVC2G06GV	CMOS-Logic	Dual inverter buffers/drivers (ODO)	SOT457	33L.og25	-	7b	Phi
V06	74LVC3G06DC	CMOS-Logic	Triple inverters (ODO)	SOT765-1	47L.og72	-	8d	Phi
V06	74LVC3G06DP	CMOS-Logic	Triple inverters (ODO)	SOT505-2	47L.og72	-	8d	Phi
V07	74LVC2G07GV	CMOS-Logic	Dual noninverting buffers/drivers (ODO)	SOT457	33L.og26	-	7b	Phi
V07	74LVC3G07DC	CMOS-Logic	Triple noninverting buffers/drivers (ODO)	SOT765-1	47L.og73	-	8d	Phi
V07	74LVC3G07DP	CMOS-Logic	Triple noninverting buffers/drivers (ODO)	SOT505-2	47L.og73	-	8d	Phi
V08	74LVC2G08DC	CMOS-Logic	Dual 2-input AND gates	SOT765-1	47L.og51	-	8d	Phi
V1	NL17S2374DF	CMOS-Logic	Positive edge-triggered D-type flip-flop with 3-state output	SC-70-6	33L.og28	-	7m	Ons
V1	R1131D281D5	LVR-IC	LDO, 2.85V±2%, 300mA, +CE, CL	SON-6	34hq	VR4	7g	Ric
V1	R1163D181B5	LVR-IC	LDO, 1.85V±1.5%, 150mA, +CE, AE(mode)	SON-6	34vrc	VR10	7g	Ric
V11	74LVC1G11GV	CMOS-Logic	3-input AND gate	SOT457	33L.og30	-	7b	Phi
V125	74LVC2G125DP	CMOS-Logic	Dual bus buffer with 3-state output	SOT505-2	47L.og54	-	8d	Phi
V126	74LVC2G126DP	CMOS-Logic	Dual bus buffer with 3-state output	SOT505-2	47L.og54	-	8d	Phi
V14	74LVC2G14GV	CMOS-Logic	Dual Schmitt-trigger inverter buffers	SOT457	33L.og34	-	7b	Phi
V14	74LVC3G14DC	CMOS-Logic	Triple Schmitt-trigger inverters	SOT765-1	47L.og57	-	8d	Phi
V14	74LVC3G14DP	CMOS-Logic	Triple Schmitt-trigger inverters	SOT505-2	47L.og57	-	8d	Phi
V17	74LVC3G17DC	CMOS-Logic	Triple non-inverting Schmitt-trigger	SOT765-1	47L.og71	-	8d	Phi
V17	74LVC3G17DP	CMOS-Logic	Triple non-inverting Schmitt-trigger	SOT505-2	47L.og71	-	8d	Phi
V18	74LVC1G18GV	CMOS-Logic	Noninverting 1-of-2 demultiplexer with 3-state deselected output	SOT457	33L.og44	-	7b	Phi
V19	74LVC1G19GV	CMOS-Logic	1-of-2 decoder/demultiplexer	SOT457	33L.og47	-	7b	Phi
V2	R1131D121D5	LVR-IC	LDO, 1.25V±2%, 300mA, +CE, CL	SON-6	34hq	VR4	7g	Ric
V2	R1163D281B5	LVR-IC	LDO, 2.85V±1.5%, 150mA, +CE, AE(mode)	SON-6	34vrc	VR10	7g	Ric
V240	74LVC2G240DP	CMOS-Logic	Dual bus buffer inverted with 3-state output	SOT505-2	47L.og67	-	8d	Phi
V241	74LVC2G241DP	CMOS-Logic	Dual bus buffer non-inverted with 3-state output	SOT505-2	47L.og60	-	8d	Phi
V25	74LVC2G125DC	CMOS-Logic	Dual bus buffer with 3-state output	SOT765-1	47L.og54	-	8d	Phi
V26	74LVC2G126DC	CMOS-Logic	Dual bus buffer with 3-state output	SOT765-1	47L.og55	-	8d	Phi
V27	μPA834TF	Si-npn	Dual, VHF/UHF, 20V, 65(100)mA, B=75..150, 7GHz	SOT-363	33T/3	-	7b	Nec
V2G00	74LVC2G00DP	CMOS-Logic	Dual 2-input NAND gates	SOT505-2	47L.og50	-	8d	Phi
V2G08	74LVC2G08DP	CMOS-Logic	Dual 2-input AND gates	SOT505-2	47L.og51	-	8d	Phi
V2G38	74LVC2G38DP	CMOS-Logic	Dual 2-input NAND gate (ODO)	SOT505-2	47L.og62	-	8d	Phi
V32	74LVC2G32DC	CMOS-Logic	Dual 2-input OR gates	SOT765-1	47L.og52	-	8d	Phi
V32	74LVC2G32DP	CMOS-Logic	Dual 2-input OR gates	SOT505-2	47L.og52	-	8d	Phi
V34	μPA832TF	Si-npn	Dual, VHF/UHF, 20(9)V, 100(30)mA, B=100..145, 4.5GHz	SOT-363	33T/3	-	7b	Nec
V34	74LVC3G34DP	CMOS-Logic	Triple non-inverter buffers	SOT505-2	47L.og69	-	8d	Phi
V4	74LVC2G04GW	CMOS-Logic	Dual inverters	SOT-363	33L.og24	-	7b	Phi
V40	74LVC2G240DC	CMOS-Logic	Dual bus buffer inverted with 3-state output	SOT765-1	47L.og67	-	8d	Phi
V41	74LVC2G241DC	CMOS-Logic	Dual bus buffer non-inverted with 3-state output	SOT765-1	47L.og60	-	8d	Phi
V44	μPA833TF	Si-npn	Dual, VHF/UHF, 9V, 100(30)mA, B=100..145, 4.5GHz	SOT-363	33T/3	-	7b	Nec



SMD code	Type	Function	Short description	Case	Pinout	Sch.	St.	Mnf.
V47	μPA836TF	Si-npn	Dual, VHF/UHF, 9V, 30(100)mA, B=75..150, 12GHz	SOT-363	33/T3	-	7b	Nec
V5	74LVC1T45GW	CMOS-Logic	Dual supply translating transceiver with 3-state output	SOT-363	33L.o.g70	-	7b	Phi
V53	74LVC1G53DC	CMOS-Logic	2-channel analog multiplexer/demultiplexer	SOT765-1	47L.o.g58	-	8d	Phi
V53	74LVC1G53DP	CMOS-Logic	2-channel analog multiplexer/demultiplexer	SOT505-2	47L.o.g58	-	8d	Phi
V53	74LVC2G53DC	CMOS-Logic	2-channel analog multiplexer/demultiplexer	SOT765-1	47L.o.g58	-	8d	Phi
V57	74LVC1G57GV	CMOS-Logic	Configurable multiple-function gate	SOT457	33L.o.g36	-	7b	Phi
V58	74LVC1G58GV	CMOS-Logic	Configurable multiple-function gate	SOT457	33L.o.g37	-	7b	Phi
V6	74LVC2G06GW	CMOS-Logic	Dual inverter buffers/drivers (ODO)	SOT-363	33L.o.g25	-	7b	Phi
V66	74LVC2G66DC	CMOS-Logic	2-channel analog switch	SOT765-1	47L.o.g68	-	8d	Phi
V66	74LVC2G66DP	CMOS-Logic	2-channel analog switch	SOT505-2	47L.o.g68	-	8d	Phi
V7	74LVC2G07GW	CMOS-Logic	Dual noninverting buffers/drivers (ODO)	SOT-363	33L.o.g26	-	7b	Phi
V74	74LVC1G74DC	CMOS-Logic	Positive edge-triggered D-type flip-flop with set and reset	SOT765-1	47L.o.g59	-	8d	Phi
V74	74LVC1G74DP	CMOS-Logic	Positive edge-triggered D-type flip-flop with set and reset	SOT505-2	47L.o.g59	-	8d	Phi
V74	74LVC2G74DC	CMOS-Logic	D-type flip-flop with preset and clear	SOT765-1	47L.o.g59	-	8d	Phi
V74	74LVC2G74DP	CMOS-Logic	D-type flip-flop with preset and clear	SOT505-2	47L.o.g59	-	8d	Phi
V75	74LVC1G75GV	CMOS-Logic	Positive edge-triggered D-type flip-flop with reset	SOT457	33L.o.g40	-	7b	Phi
V86	74LVC2G86DC	CMOS-Logic	Dual 2-input EXCLUSIVE-OR gates	SOT765-1	47L.o.g65	-	8d	Phi
V86	74LVC2G86DP	CMOS-Logic	Dual 2-input EXCLUSIVE-OR gates	SOT505-2	47L.o.g65	-	8d	Phi
V99	74LVC1G99DP	CMOS-Logic	Ultra-configurable multiple function gate with 3-state output	SOT505-2	47L.o.g84	-	8d	Phi
VA2	S-1135C34-A6T1S	LVR-IC	LDO, 3.4V±1.0%, 300mA, +CE, PDR	HSNT-6A	43er	VR4	7g	Sii
VA3	S-1135C35-A6T1S	LVR-IC	LDO, 3.5V±1.0%, 300mA, +CE, PDR	HSNT-6A	43er	VR4	7g	Sii
VAA	S-1135C10-A6T1S	LVR-IC	LDO, 1.0V±15mV, 300mA, +CE, PDR	HSNT-6A	43er	VR4	7g	Sii
VAB	S-1135C11-A6T1S	LVR-IC	LDO, 1.1V±15mV, 300mA, +CE, PDR	HSNT-6A	43er	VR4	7g	Sii
VAC	S-1135C12-A6T1S	LVR-IC	LDO, 1.2V±15mV, 300mA, +CE, PDR	HSNT-6A	43er	VR4	7g	Sii
VAD	S-1135C13-A6T1S	LVR-IC	LDO, 1.3V±15mV, 300mA, +CE, PDR	HSNT-6A	43er	VR4	7g	Sii
VAE	S-1135C14-A6T1S	LVR-IC	LDO, 1.4V±15mV, 300mA, +CE, PDR	HSNT-6A	43er	VR4	7g	Sii
VAF	S-1135C15-A6T1S	LVR-IC	LDO, 1.5V±1.0%, 300mA, +CE, PDR	HSNT-6A	43er	VR4	7g	Sii
VAG	S-1135C16-A6T1S	LVR-IC	LDO, 1.6V±1.0%, 300mA, +CE, PDR	HSNT-6A	43er	VR4	7g	Sii
VAH	S-1135C17-A6T1S	LVR-IC	LDO, 1.7V±1.0%, 300mA, +CE, PDR	HSNT-6A	43er	VR4	7g	Sii
VAI	S-1135C18-A6T1S	LVR-IC	LDO, 1.8V±1.0%, 300mA, +CE, PDR	HSNT-6A	43er	VR4	7g	Sii
VAJ	S-1135C1J-A6T1S	LVR-IC	LDO, 1.85V±1.0%, 300mA, +CE, PDR	HSNT-6A	43er	VR4	7g	Sii
VAK	S-1135C19-A6T1S	LVR-IC	LDO, 1.9V±1.0%, 300mA, +CE, PDR	HSNT-6A	43er	VR4	7g	Sii
VAL	S-1135C20-A6T1S	LVR-IC	LDO, 2.0V±1.0%, 300mA, +CE, PDR	HSNT-6A	43er	VR4	7g	Sii
VAM	S-1135C21-A6T1S	LVR-IC	LDO, 2.1V±1.0%, 300mA, +CE, PDR	HSNT-6A	43er	VR4	7g	Sii
VAN	S-1135C22-A6T1S	LVR-IC	LDO, 2.2V±1.0%, 300mA, +CE, PDR	HSNT-6A	43er	VR4	7g	Sii
VAO	S-1135C23-A6T1S	LVR-IC	LDO, 2.3V±1.0%, 300mA, +CE, PDR	HSNT-6A	43er	VR4	7g	Sii
VAP	S-1135C24-A6T1S	LVR-IC	LDO, 2.4V±1.0%, 300mA, +CE, PDR	HSNT-6A	43er	VR4	7g	Sii
VAQ	S-1135C25-A6T1S	LVR-IC	LDO, 2.5V±1.0%, 300mA, +CE, PDR	HSNT-6A	43er	VR4	7g	Sii
VAR	S-1135C26-A6T1S	LVR-IC	LDO, 2.6V±1.0%, 300mA, +CE, PDR	HSNT-6A	43er	VR4	7g	Sii
VAS	S-1135C27-A6T1S	LVR-IC	LDO, 2.7V±1.0%, 300mA, +CE, PDR	HSNT-6A	43er	VR4	7g	Sii
VAT	S-1135C28-A6T1S	LVR-IC	LDO, 2.8V±1.0%, 300mA, +CE, PDR	HSNT-6A	43er	VR4	7g	Sii
VAU	S-1135C2J-A6T1S	LVR-IC	LDO, 2.85V±1.0%, 300mA, +CE, PDR	HSNT-6A	43er	VR4	7g	Sii
VAV	S-1135C29-A6T1S	LVR-IC	LDO, 2.9V±1.0%, 300mA, +CE, PDR	HSNT-6A	43er	VR4	7g	Sii
VAW	S-1135C30-A6T1S	LVR-IC	LDO, 3.0V±1.0%, 300mA, +CE, PDR	HSNT-6A	43er	VR4	7g	Sii
VAX	S-1135C31-A6T1S	LVR-IC	LDO, 3.1V±1.0%, 300mA, +CE, PDR	HSNT-6A	43er	VR4	7g	Sii
VAY	S-1135C32-A6T1S	LVR-IC	LDO, 3.2V±1.0%, 300mA, +CE, PDR	HSNT-6A	43er	VR4	7g	Sii
VAZ	S-1135C33-A6T1S	LVR-IC	LDO, 3.3V±1.0%, 300mA, +CE, PDR	HSNT-6A	43er	VR4	7g	Sii
VB2	S-1135D34-A6T1S	LVR-IC	LDO, 3.4V±1.0%, 300mA, +CE	HSNT-6A	43er	VR4	7g	Sii
VB3	S-1135D35-A6T1S	LVR-IC	LDO, 3.5V±1.0%, 300mA, +CE	HSNT-6A	43er	VR4	7g	Sii
VBA	S-1135D10-A6T1S	LVR-IC	LDO, 1.0V±15mV, 300mA, +CE	HSNT-6A	43er	VR4	7g	Sii
VBB	S-1135D11-A6T1S	LVR-IC	LDO, 1.1V±15mV, 300mA, +CE	HSNT-6A	43er	VR4	7g	Sii
VBC	S-1135D12-A6T1S	LVR-IC	LDO, 1.2V±15mV, 300mA, +CE	HSNT-6A	43er	VR4	7g	Sii
VBD	S-1135D13-A6T1S	LVR-IC	LDO, 1.3V±15mV, 300mA, +CE	HSNT-6A	43er	VR4	7g	Sii
VBE	S-1135D14-A6T1S	LVR-IC	LDO, 1.4V±15mV, 300mA, +CE	HSNT-6A	43er	VR4	7g	Sii
VBF	S-1135D15-A6T1S	LVR-IC	LDO, 1.5V±1.0%, 300mA, +CE	HSNT-6A	43er	VR4	7g	Sii
VBG	S-1135D16-A6T1S	LVR-IC	LDO, 1.6V±1.0%, 300mA, +CE	HSNT-6A	43er	VR4	7g	Sii
VBH	S-1135D17-A6T1S	LVR-IC	LDO, 1.7V±1.0%, 300mA, +CE	HSNT-6A	43er	VR4	7g	Sii
VBI	S-1135D18-A6T1S	LVR-IC	LDO, 1.8V±1.0%, 300mA, +CE	HSNT-6A	43er	VR4	7g	Sii
VBJ	S-1135D1J-A6T1S	LVR-IC	LDO, 1.85V±1.0%, 300mA, +CE	HSNT-6A	43er	VR4	7g	Sii
VBK	S-1135D19-A6T1S	LVR-IC	LDO, 1.9V±1.0%, 300mA, +CE	HSNT-6A	43er	VR4	7g	Sii
VBL	S-1135D20-A6T1S	LVR-IC	LDO, 2.0V±1.0%, 300mA, +CE	HSNT-6A	43er	VR4	7g	Sii
VBM	S-1135D21-A6T1S	LVR-IC	LDO, 2.1V±1.0%, 300mA, +CE	HSNT-6A	43er	VR4	7g	Sii
VBN	S-1135D22-A6T1S	LVR-IC	LDO, 2.2V±1.0%, 300mA, +CE	HSNT-6A	43er	VR4	7g	Sii
VBO	S-1135D23-A6T1S	LVR-IC	LDO, 2.3V±1.0%, 300mA, +CE	HSNT-6A	43er	VR4	7g	Sii
VBP	S-1135D24-A6T1S	LVR-IC	LDO, 2.4V±1.0%, 300mA, +CE	HSNT-6A	43er	VR4	7g	Sii
VBQ	S-1135D25-A6T1S	LVR-IC	LDO, 2.5V±1.0%, 300mA, +CE	HSNT-6A	43er	VR4	7g	Sii
VBR	S-1135D26-A6T1S	LVR-IC	LDO, 2.6V±1.0%, 300mA, +CE	HSNT-6A	43er	VR4	7g	Sii
VBS	S-1135D27-A6T1S	LVR-IC	LDO, 2.7V±1.0%, 300mA, +CE	HSNT-6A	43er	VR4	7g	Sii
VBT	S-1135D28-A6T1S	LVR-IC	LDO, 2.8V±1.0%, 300mA, +CE	HSNT-6A	43er	VR4	7g	Sii
VBU	S-1135D2J-A6T1S	LVR-IC	LDO, 2.85V±1.0%, 300mA, +CE	HSNT-6A	43er	VR4	7g	Sii



SMD code	Type	Function	Short description	Case	Pinout	Sch.	St.	Mnf.
VJN	S-1137C22-16T2G	LVR-IC	LDO, 2.2V±1.0%, 300mA, +CE, PDR	SNT-6A	35et	VR7	7g	Sii
VJO	S-1137C23-16T2G	LVR-IC	LDO, 2.3V±1.0%, 300mA, +CE, PDR	SNT-6A	35et	VR7	7g	Sii
VJP	S-1137C24-16T2G	LVR-IC	LDO, 2.4V±1.0%, 300mA, +CE, PDR	SNT-6A	35et	VR7	7g	Sii
VJQ	S-1137C25-16T2G	LVR-IC	LDO, 2.5V±1.0%, 300mA, +CE, PDR	SNT-6A	35et	VR7	7g	Sii
VJR	S-1137C26-16T2G	LVR-IC	LDO, 2.6V±1.0%, 300mA, +CE, PDR	SNT-6A	35et	VR7	7g	Sii
VJS	S-1137C27-16T2G	LVR-IC	LDO, 2.7V±1.0%, 300mA, +CE, PDR	SNT-6A	35et	VR7	7g	Sii
VJT	S-1137C28-16T2G	LVR-IC	LDO, 2.8V±1.0%, 300mA, +CE, PDR	SNT-6A	35et	VR7	7g	Sii
VJU	S-1137C2J-16T2G	LVR-IC	LDO, 2.85V±1.0%, 300mA, +CE, PDR	SNT-6A	35et	VR7	7g	Sii
VJV	S-1137C29-16T2G	LVR-IC	LDO, 2.9V±1.0%, 300mA, +CE, PDR	SNT-6A	35et	VR7	7g	Sii
VJW	S-1137C30-16T2G	LVR-IC	LDO, 3.0V±1.0%, 300mA, +CE, PDR	SNT-6A	35et	VR7	7g	Sii
VJX	S-1137C31-16T2G	LVR-IC	LDO, 3.1V±1.0%, 300mA, +CE, PDR	SNT-6A	35et	VR7	7g	Sii
VJY	S-1137C32-16T2G	LVR-IC	LDO, 3.2V±1.0%, 300mA, +CE, PDR	SNT-6A	35et	VR7	7g	Sii
VJZ	S-1137C33-16T2G	LVR-IC	LDO, 3.3V±1.0%, 300mA, +CE, PDR	SNT-6A	35et	VR7	7g	Sii
VK	74LVC2G14GW	CMOS-Logic	Dual Schmitt-trigger inverter buffers	SOT-363	33L _{og} 34	-	7b	Phi
VK2	S-1137D34-16T2G	LVR-IC	LDO, 3.4V±1.0%	SNT-6A	35et	VR7	7g	Sii
VK3	S-1137D35-16T2G	LVR-IC	LDO, 3.5V±1.0%	SNT-6A	35et	VR7	7g	Sii
VKC	S-1137D12-16T2G	LVR-IC	LDO, 1.2V±15mV	SNT-6A	35et	VR7	7g	Sii
VKD	S-1137D13-16T2G	LVR-IC	LDO, 1.3V±15mV	SNT-6A	35et	VR7	7g	Sii
VKE	S-1137D14-16T2G	LVR-IC	LDO, 1.4V±15mV	SNT-6A	35et	VR7	7g	Sii
VKF	S-1137D15-16T2G	LVR-IC	LDO, 1.5V±1.0%	SNT-6A	35et	VR7	7g	Sii
VKG	S-1137D16-16T2G	LVR-IC	LDO, 1.6V±1.0%	SNT-6A	35et	VR7	7g	Sii
VKH	S-1137D17-16T2G	LVR-IC	LDO, 1.7V±1.0%	SNT-6A	35et	VR7	7g	Sii
VKI	S-1137D18-16T2G	LVR-IC	LDO, 1.8V±1.0%	SNT-6A	35et	VR7	7g	Sii
VKJ	S-1137D1J-16T2G	LVR-IC	LDO, 1.85V±1.0%	SNT-6A	35et	VR7	7g	Sii
VKK	S-1137D19-16T2G	LVR-IC	LDO, 1.9V±1.0%	SNT-6A	35et	VR7	7g	Sii
VKL	S-1137D20-16T2G	LVR-IC	LDO, 2.0V±1.0%	SNT-6A	35et	VR7	7g	Sii
VKM	S-1137D21-16T2G	LVR-IC	LDO, 2.1V±1.0%	SNT-6A	35et	VR7	7g	Sii
VKN	S-1137D22-16T2G	LVR-IC	LDO, 2.2V±1.0%	SNT-6A	35et	VR7	7g	Sii
VKO	S-1137D23-16T2G	LVR-IC	LDO, 2.3V±1.0%	SNT-6A	35et	VR7	7g	Sii
VKP	S-1137D24-16T2G	LVR-IC	LDO, 2.4V±1.0%	SNT-6A	35et	VR7	7g	Sii
VKQ	S-1137D25-16T2G	LVR-IC	LDO, 2.5V±1.0%	SNT-6A	35et	VR7	7g	Sii
VKR	S-1137D26-16T2G	LVR-IC	LDO, 2.6V±1.0%	SNT-6A	35et	VR7	7g	Sii
VKS	S-1137D27-16T2G	LVR-IC	LDO, 2.7V±1.0%	SNT-6A	35et	VR7	7g	Sii
VKT	S-1137D28-16T2G	LVR-IC	LDO, 2.8V±1.0%	SNT-6A	35et	VR7	7g	Sii
VKU	S-1137D2J-16T2G	LVR-IC	LDO, 2.85V±1.0%	SNT-6A	35et	VR7	7g	Sii
VKV	S-1137D29-16T2G	LVR-IC	LDO, 2.9V±1.0%	SNT-6A	35et	VR7	7g	Sii
VKW	S-1137D30-16T2G	LVR-IC	LDO, 3.0V±1.0%	SNT-6A	35et	VR7	7g	Sii
VKX	S-1137D31-16T2G	LVR-IC	LDO, 3.1V±1.0%	SNT-6A	35et	VR7	7g	Sii
VKY	S-1137D32-16T2G	LVR-IC	LDO, 3.2V±1.0%	SNT-6A	35et	VR7	7g	Sii
VKZ	S-1137D33-16T2G	LVR-IC	LDO, 3.3V±1.0%	SNT-6A	35et	VR7	7g	Sii
VU	74LVC1G11GW	CMOS-Logic	3-input AND gate	SOT-363	33L _{og} 30	-	7b	Phi
VU04	74LVC3GU04DP	CMOS-Logic	Triple inverters	SOT505-2	47L _{og} 56	-	8d	Phi
VU4	74LVC2GU04GV	CMOS-Logic	Dual inverters	SOT457	33L _{og} 24	-	7b	Phi
VU4	74LVC3GU04DC	CMOS-Logic	Triple inverters	SOT765-1	47L _{og} 56	-	8d	Phi
VV	74LVC2G17GV	CMOS-Logic	Dual Schmitt-trigger buffers	SOT457	33L _{og} 27	-	7b	Phi
VV	74LVC2G17GW	CMOS-Logic	Dual Schmitt-trigger buffers	SOT-363	33L _{og} 27	-	7b	Phi
VW	74LVC1G18GW	CMOS-Logic	Noninverting 1-of-2 demultiplexer with 3-state deselected output	SOT-363	33L _{og} 44	-	7b	Phi
vX	μPA861TD	Si-npn	Dual, RF, (5V)9V, (30)35mA, (90)105mW, B=70..110, (12)20GHz	SNT-6	33/T3	-	7b	Nec
vX	μPA861TD	Si-npn	Dual, RF, (5V)9V, (30)35mA, (90)105mW, B=70..110, (17)20GHz	SOT-363	33/T3	-	7b	Cel
VX	74LVC1GX04GW	CMOS-Logic	X-tal oscillator driver	SOT-363	33L _{og} 39	-	7b	Phi
VX4	74LVC1GX04GV	CMOS-Logic	X-tal oscillator driver	SOT457	33L _{og} 39	-	7b	Phi
VY	74LVC1G19GW	CMOS-Logic	1-of-2 decoder/demultiplexer	SOT-363	33L _{og} 47	-	7b	Phi
W1	HD74LV1GW98ACM	CMOS-Logic	Configurable multiple-function gate	CMPAK-6	33L _{og} 43	-	7d	Ren
W1	R5325N001B	LVR-IC	LDO, Dual out, Vout1/Vout2=2V/2V±1%, 150mA, +CE, CL	SOT-23-6	33rg	VR19	7d	Ric
W10	FMW10	Si-npn	Dual, HF, 30V, 50mA, 300mW, B=27..270, 1.5GHz	SC-74	33/T11	-	7b	Rhm
W10	UMW10N	Si-npn	Dual, HF, 30V, 50mA, 300mW, B=27..270, 1.5GHz	SC-88	33/T11	-	7b	Rhm
W1s	BCR10PN	Si-n/p-Digi	Dual, Sw, 50V, 100mA, 250mW, R1/R2=10k/10k	SOT-363	33/TD2	-	7l	Inf
W2	HD74LV1GW97ACM	CMOS-Logic	Configurable multiple-function gate	CMPAK-6	33L _{og} 41	-	7d	Ren
W2	R5325N002B	LVR-IC	LDO, Dual out, Vout1/Vout2=2.8V/2.8V±1%, 150mA, +CE, CL	SOT-23-6	33rg	VR19	7d	Ric
W20	TK11120M	LVR-IC	LDO, 2V±1.5%, 200mA, -CE	SOT-23L-6	33up	-	7b	Tok
W21	TK11121M	LVR-IC	LDO, 2.1V±1.5%, 200mA, -CE	SOT-23L-6	33up	-	7b	Tok
W23	TK11123M	LVR-IC	LDO, 2.3V±1.5%, 200mA, -CE	SOT-23L-6	33up	-	7b	Tok
W24	TK11124M	LVR-IC	LDO, 2.4V±1.5%, 200mA, -CE	SOT-23L-6	33up	-	7b	Tok
W25	TK11125M	LVR-IC	LDO, 2.5V±1.5%, 200mA, -CE	SOT-23L-6	33up	-	7b	Tok
W26	TK11126M	LVR-IC	LDO, 2.6V±1.5%, 200mA, -CE	SOT-23L-6	33up	-	7b	Tok
W27	TK11127M	LVR-IC	LDO, 2.7V±1.5%, 200mA, -CE	SOT-23L-6	33up	-	7b	Tok
W28	TK11128M	LVR-IC	LDO, 2.8V±1.5%, 200mA, -CE	SOT-23L-6	33up	-	7b	Tok
W29	TK11129M	LVR-IC	LDO, 2.9V±1.5%, 200mA, -CE	SOT-23L-6	33up	-	7b	Tok
W3	R5325N003B	LVR-IC	LDO, Dual out, Vout1/Vout2=1.8V/3V±1%, 150mA, +CE, CL	SOT-23-6	33rg	VR19	7d	Ric
W30	TK11130M	LVR-IC	LDO, 3V±1.5%, 200mA, -CE	SOT-23L-6	33up	-	7b	Tok



SMD code	Type	Function	Short description	Case	Pinout	Sch.	St.	Mnf.
W31	TK11131M	LVR-IC	LDO, 3.1V±1.5%, 200mA, -CE	SOT-23L-6	33up	-	7b	Tok
W32	TK11132M	LVR-IC	LDO, 3.2V±1.5%, 200mA, -CE	SOT-23L-6	33up	-	7b	Tok
W33	TK11133M	LVR-IC	LDO, 3.3V±1.5%, 200mA, -CE	SOT-23L-6	33up	-	7b	Tok
W34	TK11134M	LVR-IC	LDO, 3.4V±1.5%, 200mA, -CE	SOT-23L-6	33up	-	7b	Tok
W35	TK11135M	LVR-IC	LDO, 3.5V±1.5%, 200mA, -CE	SOT-23L-6	33up	-	7b	Tok
W36	TK11136M	LVR-IC	LDO, 3.6V±1.5%, 200mA, -CE	SOT-23L-6	33up	-	7b	Tok
W37	TK11137M	LVR-IC	LDO, 3.7V±1.5%, 200mA, -CE	SOT-23L-6	33up	-	7b	Tok
W38	TK11138M	LVR-IC	LDO, 3.8V±1.5%, 200mA, -CE	SOT-23L-6	33up	-	7b	Tok
W39	TK11139M	LVR-IC	LDO, 3.9V±1.5%, 200mA, -CE	SOT-23L-6	33up	-	7b	Tok
W4	R5325N004B	LVR-IC	LDO, Dual out, Vout1/Vout2=2.5V/3V±1%, 150mA, +CE, CL	SOT-23-6	33rg	VR19	7d	Ric
W40	TK11140M	LVR-IC	LDO, 4V±1.5%, 200mA, -CE	SOT-23L-6	33up	-	7b	Tok
W41	TK11141M	LVR-IC	LDO, 4.1V±1.5%, 200mA, -CE	SOT-23L-6	33up	-	7b	Tok
W42	TK11142M	LVR-IC	LDO, 4.2V±1.5%, 200mA, -CE	SOT-23L-6	33up	-	7b	Tok
W43	TK11143M	LVR-IC	LDO, 4.3V±1.5%, 200mA, -CE	SOT-23L-6	33up	-	7b	Tok
W44	TK11144M	LVR-IC	LDO, 4.4V±1.5%, 200mA, -CE	SOT-23L-6	33up	-	7b	Tok
W45	TK11145M	LVR-IC	LDO, 4.5V±1.5%, 200mA, -CE	SOT-23L-6	33up	-	7b	Tok
W46	TK11146M	LVR-IC	LDO, 4.6V±1.5%, 200mA, -CE	SOT-23L-6	33up	-	7b	Tok
W47	TK11147M	LVR-IC	LDO, 4.7V±1.5%, 200mA, -CE	SOT-23L-6	33up	-	7b	Tok
W48	TK11148M	LVR-IC	LDO, 4.8V±1.5%, 200mA, -CE	SOT-23L-6	33up	-	7b	Tok
W49	TK11149M	LVR-IC	LDO, 4.9V±1.5%, 200mA, -CE	SOT-23L-6	33up	-	7b	Tok
W5	HD74LV1GW04ACM	CMOS-Logic	Dual inverters	CMPAK-6	33L _{og} 24	-	7d	Ren
W5	R1163D151D	LVR-IC	LDO, 1.5V±1.5%, 150mA, +CE, CL, AE(mode)	SON-6	34vrc	VR10	7g	Ric
W5	R5325N005B	LVR-IC	LDO, Dual out, Vout1/Vout2=1.8V/2.5V±1%, 150mA, +CE, CL	SOT-23-6	33rg	VR19	7d	Ric
W50	TK11150M	LVR-IC	LDO, 5V±1.5%, 200mA, -CE	SOT-23L-6	33up	-	7b	Tok
W6	HD74LV1GWU04ACM	CMOS-Logic	Dual inverters	CMPAK-6	33L _{og} 24	-	7d	Ren
W6	R1163D161D	LVR-IC	LDO, 1.6V±1.5%, 150mA, +CE, CL, AE(mode)	SON-6	34vrc	VR10	7g	Ric
W6	R5325N006B	LVR-IC	LDO, Dual out, Vout1/Vout2=1.8V/3.3V±1%, 150mA, +CE, CL	SOT-23-6	33rg	VR19	7d	Ric
W7	R1163D171D	LVR-IC	LDO, 1.7V±1.5%, 150mA, +CE, CL, AE(mode)	SON-6	34vrc	VR10	7g	Ric
W7	R5325N007B	LVR-IC	LDO, Dual out, Vout1/Vout2=2.5V/2.8V±1%, 150mA, +CE, CL	SOT-23-6	33rg	VR19	7d	Ric
W8	R1163D181D	LVR-IC	LDO, 1.8V±1.5%, 150mA, +CE, CL, AE(mode)	SON-6	34vrc	VR10	7g	Ric
W8	R5325N008B	LVR-IC	LDO, Dual out, Vout1/Vout2=1.2V/1.2V±1%, 150mA, +CE, CL	SOT-23-6	33rg	VR19	7d	Ric
W9	R1163D191D	LVR-IC	LDO, 1.9V±1.5%, 150mA, +CE, CL, AE(mode)	SON-6	34vrc	VR10	7g	Ric
W9	R5325N009B	LVR-IC	LDO, Dual out, Vout1/Vout2=1.5V/1.6V±1%, 150mA, +CE, CL	SOT-23-6	33rg	VR19	7d	Ric
W92	TK11122M	LVR-IC	LDO, 2.2V±1.5%, 200mA, -CE	SOT-23L-6	33up	-	7b	Tok
WA	HD74LV1GW14ACM	CMOS-Logic	Dual Schmitt-trigger inverter buffers	CMPAK-6	33L _{og} 34	-	7d	Ren
WA	R5325N010B	LVR-IC	LDO, Dual out, Vout1/Vout2=1.5V/2.8V±1%, 150mA, +CE, CL	SOT-23-6	33rg	VR19	7d	Ric
WA	R5325N011B	LVR-IC	LDO, Dual out, Vout1/Vout2=3V/3V±1%, 150mA, +CE, CL	SOT-23-6	33rg	VR19	7d	Ric
WB	R5325N012B	LVR-IC	LDO, Dual out, Vout1/Vout2=3.1V/3.1V±1%, 150mA, +CE, CL	SOT-23-6	33rg	VR19	7d	Ric
WD	HD74LV1GW06ACM	CMOS-Logic	Dual inverter buffers/drivers (ODO)	CMPAK-6	33L _{og} 25	-	7d	Ren
WD	R5325N013B	LVR-IC	LDO, Dual out, Vout1/Vout2=1.7V/1.8V±1%, 150mA, +CE, CL	SOT-23-6	33rg	VR19	7d	Ric
WE	HD74LV1GW07ACM	CMOS-Logic	Dual noninverting buffers/drivers (ODO)	CMPAK-6	33L _{og} 26	-	7d	Ren
WE	R5325N016B	LVR-IC	LDO, Dual out, Vout1/Vout2=2.85V/2.85V±1%, 150mA, +CE, CL	SOT-23-6	33rg	VR19	7d	Ric
WF	R5325N017B	LVR-IC	LDO, Dual out, Vout1/Vout2=2.9V/2.9V±1%, 150mA, +CE, CL	SOT-23-6	33rg	VR19	7d	Ric
WFs	BCR08PN	Si-n/p-Digi	Dual, Sw, 50V, 100mA, 250mW, R1/R2=2k2/47k	SOT-363	33/TD2	-	7l	Inf
WG	R5325N014B	LVR-IC	LDO, Dual out, Vout1/Vout2=1.8V/1.8V±1%, 150mA, +CE, CL	SOT-23-6	33rg	VR19	7d	Ric
WH	R5325N015B	LVR-IC	LDO, Dual out, Vout1/Vout2=3.3V/3.3V±1%, 150mA, +CE, CL	SOT-23-6	33rg	VR19	7d	Ric
WHs	BCR108S	Si-npn-Digi	Dual, Sw, 50V, 100mA, 200mW, R1/R2=2.2k/47k, 170MHz	SOT-363	33/TD3	-	7l	Inf
WJ	HD74LV1GW16ACM	CMOS-Logic	Dual noninverting buffers	CMPAK-6	33L _{og} 23	-	7d	Ren
WJ	R5325N018B	LVR-IC	LDO, Dual out, Vout1/Vout2=1.2V/2.6V±1%, 150mA, +CE, CL	SOT-23-6	33rg	VR19	7d	Ric
WK	HD74LV1GW17ACM	CMOS-Logic	Dual Schmitt-trigger inverter buffers	CMPAK-6	33L _{og} 34	-	7d	Ren
WK	R5325N019B	LVR-IC	LDO, Dual out, Vout1/Vout2=2.8V/2.9V±1%, 150mA, +CE, CL	SOT-23-6	33rg	VR19	7d	Ric
WKs	BCR119S	Si-npn-Digi	Dual, Sw, 50V, 100mA, 200mW, R1=4.7k, 150MHz	SOT-363	33/TD3	-	7l	Inf
WL	R5325N020B	LVR-IC	LDO, Dual out, Vout1/Vout2=1.2V/1.8V±1%, 150mA, +CE, CL	SOT-23-6	33rg	VR19	7d	Ric
WM	R5325N021B	LVR-IC	LDO, Dual out, Vout1/Vout2=2.5V/1.2V±1%, 150mA, +CE, CL	SOT-23-6	33rg	VR19	7d	Ric
WN	R5325N022B	LVR-IC	LDO, Dual out, Vout1/Vout2=2.7V/2.85V±1%, 150mA, +CE, CL	SOT-23-6	33rg	VR19	7d	Ric
WP	HD74LV1GW53ACM	CMOS-Logic	2-channel analog multiplexer/demultiplexer	CMPAK-6	33L _{og} 38	-	7d	Ren
WP	R5325N023B	LVR-IC	LDO, Dual out, Vout1/Vout2=1.2V/2.8V±1%, 150mA, +CE, CL	SOT-23-6	33rg	VR19	7d	Ric
WQ	R5325N024B	LVR-IC	LDO, Dual out, Vout1/Vout2=1.2V/2.7V±1%, 150mA, +CE, CL	SOT-23-6	33rg	VR19	7d	Ric
WR	HD74LV1GW57ACM	CMOS-Logic	Configurable multiple-function gate	CMPAK-6	33L _{og} 36	-	7d	Ren
WR	R5325N025B	LVR-IC	LDO, Dual out, Vout1/Vout2=2.5V/2.9V±1%, 150mA, +CE, CL	SOT-23-6	33rg	VR19	7d	Ric
WS	R5325N026B	LVR-IC	LDO, Dual out, Vout1/Vout2=1.2V/2.7V±1%, 150mA, +CE, CL	SOT-23-6	33rg	VR19	7d	Ric
WT	HD74LV1GW58ACM	CMOS-Logic	Configurable multiple-function gate	CMPAK-6	33L _{og} 37	-	7d	Ren
WT	R5325N027B	LVR-IC	LDO, Dual out, Vout1/Vout2=2.9V/1.8V±1%, 150mA, +CE, CL	SOT-23-6	33rg	VR19	7d	Ric
WU	R5325N028B	LVR-IC	LDO, Dual out, Vout1/Vout2=1.5V/1.8V±1%, 150mA, +CE, CL	SOT-23-6	33rg	VR19	7d	Ric
WV	R5325N029B	LVR-IC	LDO, Dual out, Vout1/Vout2=3.3V/3.3V±1%, 150mA, +CE, CL	SOT-23-6	33rg	VR19	7d	Ric
WW	R5325N030B	LVR-IC	LDO, Dual out, Vout1/Vout2=3.45V/2.3V±1%, 150mA, +CE, CL	SOT-23-6	33rg	VR19	7d	Ric
WX	R5325N031B	LVR-IC	LDO, Dual out, Vout1/Vout2=1.3V/1.8V±1%, 150mA, +CE, CL	SOT-23-6	33rg	VR19	7d	Ric
WY	R5325N032B	LVR-IC	LDO, Dual out, Vout1/Vout2=1.8V/1.8V±1%, 150mA, +CE, CL	SOT-23-6	33rg	VR19	7d	Ric
WZ	R5325N033B	LVR-IC	LDO, Dual out, Vout1/Vout2=3.1V/3.0V±1%, 150mA, +CE, CL	SOT-23-6	33rg	VR19	7d	Ric
X0	R1163D201D	LVR-IC	LDO, 2V±1.5%, 150mA, +CE, CL, AE(mode)	SON-6	34vrc	VR10	7g	Ric



SMD code	Type	Function	Short description	Case	Pinout	Sch.	St.	Mnf.
X1	IMX1	Si-npn	Dual, 60V, 150mA, 180MHz	SOT-363	33/T8	-	7b	Rhm
X1	R1163D211D	LVR-IC	LDO, 2.1V±1.5%, 150mA, +CE, CL, AE(mode)	SON-6	34vrc	VR10	7g	Ric
X11	IMX11	Si-npn	Dual, HF, 25V, 20mA	SOT-363	33/T16	-	7b	Rhm
X17	IMX17	Si-npn	Dual, 60V, 500mA, 250MHz	SOT-363	33/T8	-	7b	Rhm
X2	IMX2	Si-npn	Dual, 60V, 0.15A, 180MHz	SOT-363	33ff	-	7b	Rhm
X2	R1163D221D	LVR-IC	LDO, 2.2V±1.5%, 150mA, +CE, CL, AE(mode)	SON-6	34vrc	VR10	7g	Ric
X3	IMX3	Si-npn	Dual, 60V, 0.15A, 180MHz	SOT-363	33/T16	-	7b	Rhm
X3	R1163D231D	LVR-IC	LDO, 2.3V±1.5%, 150mA, +CE, CL, AE(mode)	SON-6	34vrc	VR10	7g	Ric
X4	EMX4	Si-npn	Dual, HF, 30V, 50mA, 150mW, B=27..270, 1.5GHz	EMT6	35/T17	-	7b	Rhm
X4	IMX4	Si-npn	Dual, HF, 30V, 50mA, 300mW, B=27..270, 1.5GHz	SC-74	33/T16	-	7b	Rhm
X4	IMX8	Si-npn	Dual, 120V, 50mA, 300mW, B=180..820, 140MHz	SC-74	33/T16	-	7b	Rhm
X4	R1163D241D	LVR-IC	LDO, 2.4V±1.5%, 150mA, +CE, CL, AE(mode)	SON-6	34vrc	VR10	7g	Ric
X4	UMX4N	Si-npn	Dual, HF, 30V, 50mA, 150mW, B=27..270, 1.5GHz	SC-88	33/T17	-	7b	Rhm
X5	74LVCH1T45GW	CMOS-Logic	Dual supply translating transceiver with 3-state output	SOT-363	333_log70	-	7b	Phi
X5	IMX5	Si-npn	Dual, HF, 20V, 50mA, >1400MHz	SOT-363	33/T16	-	7b	Rhm
X5	R1163D251D	LVR-IC	LDO, 2.5V±1.5%, 150mA, +CE, CL, AE(mode)	SON-6	34vrc	VR10	7g	Ric
X6	IMX6	Si-npn	Dual, HF, 40V, 50mA, >1500MHz	SOT-363	33ff	-	7b	Rhm
X6	R1163D261D	LVR-IC	LDO, 2.6V±1.5%, 150mA, +CE, CL, AE(mode)	SON-6	34vrc	VR10	7g	Ric
X7	NCTNP34L8	CMOS-Logic	Triple non-inverter buffers	MPAK-8	47/Log69	-	8d	F
X7	R1163D271D	LVR-IC	LDO, 2.7V±1.5%, 150mA, +CE, CL, AE(mode)	SON-6	34vrc	VR10	7g	Ric
X8	R1163D281D	LVR-IC	LDO, 2.8V±1.5%, 150mA, +CE, CL, AE(mode)	SON-6	34vrc	VR10	7g	Ric
X9	IMX9	Si-npn	Dual, Hi-beta, 25V, 0.5A, B>560	SOT-363	33/T8	-	7b	Rhm
X9	R1163D291D	LVR-IC	LDO, 2.9V±1.5%, 150mA, +CE, CL, AE(mode)	SON-6	34vrc	VR10	7g	Ric
XA	RN1601	Si-npn-Digi	Dual, Sw, 50V, 100mA, 300mW, 250MHz, R1/R2=4k7/4k7	SM6	33/TD3	-	7b	Tos
XA	RN1901	Si-npn-Digi	Dual, Sw, 50V, 100mA, 200mW, 250MHz, R1/R2=4k7/4k7	US6	33/TD3	-	7b	Tos
XA	RN1901FE	Si-npn-Digi	Dual, Sw, 50V, 100mA, 100mW, 250MHz, R1/R2=4k7/4k7	US6	33/TD3	-	7b	Tos
XB	RN1602	Si-npn-Digi	Dual, Sw, 50V, 100mA, 300mW, 250MHz, R1/R2=20k/10k	SM6	33/TD3	-	7b	Tos
XB	RN1902	Si-npn-Digi	Dual, Sw, 50V, 100mA, 200mW, 250MHz, R1/R2=20k/10k	US6	33/TD3	-	7b	Tos
XB	RN1902FE	Si-npn-Digi	Dual, Sw, 50V, 100mA, 100mW, 250MHz, R1/R2=20k/10k	US6	33/TD3	-	7b	Tos
XC	RN1603	Si-npn-Digi	Dual, Sw, 50V, 100mA, 300mW, 250MHz, R1/R2=22k/22k	SM6	33/TD3	-	7b	Tos
XC	RN1903	Si-npn-Digi	Dual, Sw, 50V, 100mA, 200mW, 250MHz, R1/R2=22k/22k	US6	33/TD3	-	7b	Tos
XC	RN1903FE	Si-npn-Digi	Dual, Sw, 50V, 100mA, 100mW, 250MHz, R1/R2=22k/22k	US6	33/TD3	-	7b	Tos
XD	RN1604	Si-npn-Digi	Dual, Sw, 50V, 100mA, 300mW, 250MHz, R1/R2=47k/47k	SM6	33/TD3	-	7b	Tos
XD	RN1904	Si-npn-Digi	Dual, Sw, 50V, 100mA, 200mW, 250MHz, R1/R2=47k/47k	US6	33/TD3	-	7b	Tos
XD	RN1904FE	Si-npn-Digi	Dual, Sw, 50V, 100mA, 100mW, 250MHz, R1/R2=47k/47k	US6	33/TD3	-	7b	Tos
XE	RN1605	Si-npn-Digi	Dual, Sw, 50V, 100mA, 300mW, 250MHz, R1/R2=2k2/47k	SM6	33/TD3	-	7b	Tos
XE	RN1905	Si-npn-Digi	Dual, Sw, 50V, 100mA, 200mW, 250MHz, R1/R2=2k2/47k	US6	33/TD3	-	7b	Tos
XE	RN1905FE	Si-npn-Digi	Dual, Sw, 50V, 100mA, 100mW, 250MHz, R1/R2=2k2/47k	US6	33/TD3	-	7b	Tos
XF	RN1606	Si-npn-Digi	Dual, Sw, 50V, 100mA, 300mW, 250MHz, R1/R2=4k7/47k	SM6	33/TD3	-	7b	Tos
XF	RN1906	Si-npn-Digi	Dual, Sw, 50V, 100mA, 200mW, 250MHz, R1/R2=4k7/47k	US6	33/TD3	-	7b	Tos
XF	RN1906FE	Si-npn-Digi	Dual, Sw, 50V, 100mA, 100mW, 250MHz, R1/R2=4k7/47k	US6	33/TD3	-	7b	Tos
XH	RN1607	Si-npn-Digi	Dual, Sw, 50V, 100mA, 300mW, 250MHz, R1/R2=10k/47k	SM6	33/TD3	-	7b	Tos
XH	RN1907	Si-npn-Digi	Dual, Sw, 50V, 100mA, 200mW, 250MHz, R1/R2=10k/47k	US6	33/TD3	-	7b	Tos
XH	RN1907FE	Si-npn-Digi	Dual, Sw, 50V, 100mA, 100mW, 250MHz, R1/R2=10k/47k	ES6	35/TD3	-	7b	Tos
XI	RN1608	Si-npn-Digi	Dual, Sw, 50V, 100mA, 300mW, 250MHz, R1/R2=22k/47k	SM6	33/TD3	-	7b	Tos
XI	RN1908	Si-npn-Digi	Dual, Sw, 50V, 100mA, 200mW, 250MHz, R1/R2=22k/47k	US6	33/TD3	-	7b	Tos
XI	RN1908FE	Si-npn-Digi	Dual, Sw, 50V, 100mA, 100mW, 250MHz, R1/R2=22k/47k	ES6	35/TD3	-	7b	Tos
XJ	RN1609	Si-npn-Digi	Dual, Sw, 50V, 100mA, 300mW, 250MHz, R1/R2=47k/22k	SM6	33/TD3	-	7b	Tos
XJ	RN1909	Si-npn-Digi	Dual, Sw, 50V, 100mA, 200mW, 250MHz, R1/R2=47k/22k	US6	33/TD3	-	7b	Tos
XJ	RN1909FE	Si-npn-Digi	Dual, Sw, 50V, 100mA, 100mW, 250MHz, R1/R2=47k/22k	ES6	35/TD3	-	7b	Tos
XK	RN1610	Si-npn-Digi	Dual, Sw, 50V, 100mA, 300mW, 250MHz, R1=4k7	SM6	33/TD3	-	7b	Tos
XK	RN1910	Si-npn-Digi	Dual, Sw, 50V, 100mA, 200mW, 250MHz, R1=4k7	US6	33/TD3	-	7b	Tos
XK	RN1910FE	Si-npn-Digi	Dual, Sw, 50V, 100mA, 100mW, 250MHz, R1=4k7	ES6	35/TD3	-	7b	Tos
XM	RN1611	Si-npn-Digi	Dual, Sw, 50V, 100mA, 300mW, 250MHz, R1=10k	SM6	33/TD3	-	7b	Tos
XM	RN1911	Si-npn-Digi	Dual, Sw, 50V, 100mA, 200mW, 250MHz, R1=10k	US6	33/TD3	-	7b	Tos
XM	RN1911FE	Si-npn-Digi	Dual, Sw, 50V, 100mA, 100mW, 250MHz, R1=10k	ES6	35/TD3	-	7b	Tos
XMAA	YB1220ST26MAA	LVR-IC	LDO, Dual out, Vout1/Vout2=1.2V/1.2V±2%, 200mA, +CE	SOT-23-6	33yf	VR19	7b	Ybn
XMAB	YB1220ST26MAB	LVR-IC	LDO, Dual out, Vout1/Vout2=1.2V/1.3V±2%, 200mA, +CE	SOT-23-6	33yf	VR19	7b	Ybn
XMAC	YB1220ST26MAC	LVR-IC	LDO, Dual out, Vout1/Vout2=1.2V/1.4V±2%, 200mA, +CE	SOT-23-6	33yf	VR19	7b	Ybn
XMAD	YB1220ST26MAD	LVR-IC	LDO, Dual out, Vout1/Vout2=1.2V/1.5V±2%, 200mA, +CE	SOT-23-6	33yf	VR19	7b	Ybn
XMAE	YB1220ST26MAE	LVR-IC	LDO, Dual out, Vout1/Vout2=1.2V/1.6V±2%, 200mA, +CE	SOT-23-6	33yf	VR19	7b	Ybn
XMAF	YB1220ST26MAF	LVR-IC	LDO, Dual out, Vout1/Vout2=1.2V/1.7V±2%, 200mA, +CE	SOT-23-6	33yf	VR19	7b	Ybn
XMAG	YB1220ST26MAG	LVR-IC	LDO, Dual out, Vout1/Vout2=1.2V/1.8V±2%, 200mA, +CE	SOT-23-6	33yf	VR19	7b	Ybn
XMAH	YB1220ST26MAH	LVR-IC	LDO, Dual out, Vout1/Vout2=1.2V/1.9V±2%, 200mA, +CE	SOT-23-6	33yf	VR19	7b	Ybn
XMAI	YB1220ST26MAI	LVR-IC	LDO, Dual out, Vout1/Vout2=1.2V/2.0V±2%, 200mA, +CE	SOT-23-6	33yf	VR19	7b	Ybn
XMAJ	YB1220ST26MAJ	LVR-IC	LDO, Dual out, Vout1/Vout2=1.2V/2.1V±2%, 200mA, +CE	SOT-23-6	33yf	VR19	7b	Ybn
XMAK	YB1220ST26MAK	LVR-IC	LDO, Dual out, Vout1/Vout2=1.2V/2.2V±2%, 200mA, +CE	SOT-23-6	33yf	VR19	7b	Ybn
XMAL	YB1220ST26MAL	LVR-IC	LDO, Dual out, Vout1/Vout2=1.2V/2.3V±2%, 200mA, +CE	SOT-23-6	33yf	VR19	7b	Ybn
XMAM	YB1220ST26MAM	LVR-IC	LDO, Dual out, Vout1/Vout2=1.2V/2.4V±2%, 200mA, +CE	SOT-23-6	33yf	VR19	7b	Ybn
XMAN	YB1220ST26MAN	LVR-IC	LDO, Dual out, Vout1/Vout2=1.2V/2.5V±2%, 200mA, +CE	SOT-23-6	33yf	VR19	7b	Ybn



SMD code	Type	Function	Short description	Case	Pinout	Sch.	St.	Mnf.
XTXJ	YB1220ST26TXJ	LVR-IC	LDO, Dual out, Vout1/Vout2=3.5V/2.1V±2%, 200mA, +CE	SOT-23-6	33x5	VR19	7b	Ybn
XTXK	YB1220ST26TXK	LVR-IC	LDO, Dual out, Vout1/Vout2=3.5V/2.2V±2%, 200mA, +CE	SOT-23-6	33x5	VR19	7b	Ybn
XTXL	YB1220ST26TXL	LVR-IC	LDO, Dual out, Vout1/Vout2=3.5V/2.3V±2%, 200mA, +CE	SOT-23-6	33x5	VR19	7b	Ybn
XTXM	YB1220ST26TXM	LVR-IC	LDO, Dual out, Vout1/Vout2=3.5V/2.4V±2%, 200mA, +CE	SOT-23-6	33x5	VR19	7b	Ybn
XTXN	YB1220ST26TXN	LVR-IC	LDO, Dual out, Vout1/Vout2=3.5V/2.5V±2%, 200mA, +CE	SOT-23-6	33x5	VR19	7b	Ybn
XTXO	YB1220ST26TXO	LVR-IC	LDO, Dual out, Vout1/Vout2=3.5V/2.6V±2%, 200mA, +CE	SOT-23-6	33x5	VR19	7b	Ybn
XTXP	YB1220ST26TXP	LVR-IC	LDO, Dual out, Vout1/Vout2=3.5V/2.7V±2%, 200mA, +CE	SOT-23-6	33x5	VR19	7b	Ybn
XTXQ	YB1220ST26TXQ	LVR-IC	LDO, Dual out, Vout1/Vout2=3.5V/2.8V±2%, 200mA, +CE	SOT-23-6	33x5	VR19	7b	Ybn
XTXR	YB1220ST26TXR	LVR-IC	LDO, Dual out, Vout1/Vout2=3.5V/2.9V±2%, 200mA, +CE	SOT-23-6	33x5	VR19	7b	Ybn
XTXS	YB1220ST26TXS	LVR-IC	LDO, Dual out, Vout1/Vout2=3.5V/3.0V±2%, 200mA, +CE	SOT-23-6	33x5	VR19	7b	Ybn
XTXT	YB1220ST26TXT	LVR-IC	LDO, Dual out, Vout1/Vout2=3.5V/3.1V±2%, 200mA, +CE	SOT-23-6	33x5	VR19	7b	Ybn
XTXU	YB1220ST26TXU	LVR-IC	LDO, Dual out, Vout1/Vout2=3.5V/3.2V±2%, 200mA, +CE	SOT-23-6	33x5	VR19	7b	Ybn
XTXV	YB1220ST26TXV	LVR-IC	LDO, Dual out, Vout1/Vout2=3.5V/3.3V±2%, 200mA, +CE	SOT-23-6	33x5	VR19	7b	Ybn
XTXW	YB1220ST26TXW	LVR-IC	LDO, Dual out, Vout1/Vout2=3.5V/3.4V±2%, 200mA, +CE	SOT-23-6	33x5	VR19	7b	Ybn
XTXX	YB1220ST26TXX	LVR-IC	LDO, Dual out, Vout1/Vout2=3.5V/3.5V±2%, 200mA, +CE	SOT-23-6	33x5	VR19	7b	Ybn
XTXY	YB1220ST26TXY	LVR-IC	LDO, Dual out, Vout1/Vout2=3.5V/3.6V±2%, 200mA, +CE	SOT-23-6	33x5	VR19	7b	Ybn
XTYA	YB1220ST26TYA	LVR-IC	LDO, Dual out, Vout1/Vout2=3.6V/1.2V±2%, 200mA, +CE	SOT-23-6	33x5	VR19	7b	Ybn
XTYB	YB1220ST26TYB	LVR-IC	LDO, Dual out, Vout1/Vout2=3.6V/1.3V±2%, 200mA, +CE	SOT-23-6	33x5	VR19	7b	Ybn
XTYC	YB1220ST26TYC	LVR-IC	LDO, Dual out, Vout1/Vout2=3.6V/1.4V±2%, 200mA, +CE	SOT-23-6	33x5	VR19	7b	Ybn
XTYD	YB1220ST26TYD	LVR-IC	LDO, Dual out, Vout1/Vout2=3.6V/1.5V±2%, 200mA, +CE	SOT-23-6	33x5	VR19	7b	Ybn
XTYE	YB1220ST26TYE	LVR-IC	LDO, Dual out, Vout1/Vout2=3.6V/1.6V±2%, 200mA, +CE	SOT-23-6	33x5	VR19	7b	Ybn
XTYF	YB1220ST26TYF	LVR-IC	LDO, Dual out, Vout1/Vout2=3.6V/1.7V±2%, 200mA, +CE	SOT-23-6	33x5	VR19	7b	Ybn
XTYG	YB1220ST26TYG	LVR-IC	LDO, Dual out, Vout1/Vout2=3.6V/1.8V±2%, 200mA, +CE	SOT-23-6	33x5	VR19	7b	Ybn
XTYH	YB1220ST26TYH	LVR-IC	LDO, Dual out, Vout1/Vout2=3.6V/1.9V±2%, 200mA, +CE	SOT-23-6	33x5	VR19	7b	Ybn
XTYI	YB1220ST26TYI	LVR-IC	LDO, Dual out, Vout1/Vout2=3.6V/2.0V±2%, 200mA, +CE	SOT-23-6	33x5	VR19	7b	Ybn
XTYJ	YB1220ST26TYJ	LVR-IC	LDO, Dual out, Vout1/Vout2=3.6V/2.1V±2%, 200mA, +CE	SOT-23-6	33x5	VR19	7b	Ybn
XTYK	YB1220ST26TYK	LVR-IC	LDO, Dual out, Vout1/Vout2=3.6V/2.2V±2%, 200mA, +CE	SOT-23-6	33x5	VR19	7b	Ybn
XTYL	YB1220ST26TYL	LVR-IC	LDO, Dual out, Vout1/Vout2=3.6V/2.3V±2%, 200mA, +CE	SOT-23-6	33x5	VR19	7b	Ybn
XTYM	YB1220ST26TYM	LVR-IC	LDO, Dual out, Vout1/Vout2=3.6V/2.4V±2%, 200mA, +CE	SOT-23-6	33x5	VR19	7b	Ybn
XTYN	YB1220ST26TYN	LVR-IC	LDO, Dual out, Vout1/Vout2=3.6V/2.5V±2%, 200mA, +CE	SOT-23-6	33x5	VR19	7b	Ybn
XTYO	YB1220ST26TYO	LVR-IC	LDO, Dual out, Vout1/Vout2=3.6V/2.6V±2%, 200mA, +CE	SOT-23-6	33x5	VR19	7b	Ybn
XTYP	YB1220ST26TYP	LVR-IC	LDO, Dual out, Vout1/Vout2=3.6V/2.7V±2%, 200mA, +CE	SOT-23-6	33x5	VR19	7b	Ybn
XTYQ	YB1220ST26TYQ	LVR-IC	LDO, Dual out, Vout1/Vout2=3.6V/2.8V±2%, 200mA, +CE	SOT-23-6	33x5	VR19	7b	Ybn
XTYR	YB1220ST26TYR	LVR-IC	LDO, Dual out, Vout1/Vout2=3.6V/2.9V±2%, 200mA, +CE	SOT-23-6	33x5	VR19	7b	Ybn
XTYS	YB1220ST26TYS	LVR-IC	LDO, Dual out, Vout1/Vout2=3.6V/3.0V±2%, 200mA, +CE	SOT-23-6	33x5	VR19	7b	Ybn
XTYT	YB1220ST26TYT	LVR-IC	LDO, Dual out, Vout1/Vout2=3.6V/3.1V±2%, 200mA, +CE	SOT-23-6	33x5	VR19	7b	Ybn
XTYU	YB1220ST26TYU	LVR-IC	LDO, Dual out, Vout1/Vout2=3.6V/3.2V±2%, 200mA, +CE	SOT-23-6	33x5	VR19	7b	Ybn
XTYV	YB1220ST26TYV	LVR-IC	LDO, Dual out, Vout1/Vout2=3.6V/3.3V±2%, 200mA, +CE	SOT-23-6	33x5	VR19	7b	Ybn
XTYW	YB1220ST26TYW	LVR-IC	LDO, Dual out, Vout1/Vout2=3.6V/3.4V±2%, 200mA, +CE	SOT-23-6	33x5	VR19	7b	Ybn
XTYX	YB1220ST26TYX	LVR-IC	LDO, Dual out, Vout1/Vout2=3.6V/3.5V±2%, 200mA, +CE	SOT-23-6	33x5	VR19	7b	Ybn
XTYY	YB1220ST26TYY	LVR-IC	LDO, Dual out, Vout1/Vout2=3.6V/3.6V±2%, 200mA, +CE	SOT-23-6	33x5	VR19	7b	Ybn
XX1	RN1970HFE	Si-npn-Digi	Dual, Sw, 40V, 100mA, 100mW, 250MHz, R1=4k7	ES6	35/TD8	-	7b	Tos
XX2	RN1971HFE	Si-npn-Digi	Dual, Sw, 40V, 100mA, 100mW, 250MHz, R1=10k	ES6	35/TD8	-	7b	Tos
XXA	RN1961	Si-npn-Digi	Dual, Sw, 50V, 100mA, 200mW, 250MHz, R1/R2=4k7/4k7	US6	33/TD8	-	7b	Tos
XXA	RN1961FE	Si-npn-Digi	Dual, Sw, 50V, 100mA, 100mW, 250MHz, R1/R2=4k7/4k7	ES6	35/TD8	-	7b	Tos
XXB	RN1962	Si-npn-Digi	Dual, Sw, 50V, 100mA, 200mW, 250MHz, R1/R2=20k/10k	US6	33/TD8	-	7b	Tos
XXB	RN1962FE	Si-npn-Digi	Dual, Sw, 50V, 100mA, 100mW, 250MHz, R1/R2=20k/10k	ES6	35/TD8	-	7b	Tos
XXC	RN1963	Si-npn-Digi	Dual, Sw, 50V, 100mA, 200mW, 250MHz, R1/R2=22k/22k	US6	33/TD8	-	7b	Tos
XXC	RN1963FE	Si-npn-Digi	Dual, Sw, 50V, 100mA, 100mW, 250MHz, R1/R2=22k/22k	ES6	35/TD8	-	7b	Tos
XXD	RN1964	Si-npn-Digi	Dual, Sw, 50V, 100mA, 200mW, 250MHz, R1/R2=47k/47k	US6	33/TD8	-	7b	Tos
XXD	RN1964FE	Si-npn-Digi	Dual, Sw, 50V, 100mA, 100mW, 250MHz, R1/R2=47k/47k	ES6	35/TD8	-	7b	Tos
XXE	RN1965	Si-npn-Digi	Dual, Sw, 50V, 100mA, 200mW, 250MHz, R1/R2=2k2/47k	US6	33/TD8	-	7b	Tos
XXE	RN1965FE	Si-npn-Digi	Dual, Sw, 50V, 100mA, 100mW, 250MHz, R1/R2=2k2/47k	ES6	35/TD8	-	7b	Tos
XXF	RN1966	Si-npn-Digi	Dual, Sw, 50V, 100mA, 200mW, 250MHz, R1/R2=4k7/47k	US6	33/TD8	-	7b	Tos
XXF	RN1966FE	Si-npn-Digi	Dual, Sw, 50V, 100mA, 100mW, 250MHz, R1/R2=4k7/47k	ES6	35/TD8	-	7b	Tos
XXH	RN1967	Si-npn-Digi	Dual, Sw, 50V, 100mA, 200mW, 250MHz, R1/R2=10k/47k	US6	33/TD8	-	7b	Tos
XXH	RN1967FE	Si-npn-Digi	Dual, Sw, 50V, 100mA, 100mW, 250MHz, R1/R2=10k/47k	ES6	35/TD8	-	7b	Tos
XXI	RN1968	Si-npn-Digi	Dual, Sw, 50V, 100mA, 200mW, 250MHz, R1/R2=22k/47k	US6	33/TD8	-	7b	Tos
XXI	RN1968FE	Si-npn-Digi	Dual, Sw, 50V, 100mA, 100mW, 250MHz, R1/R2=22k/47k	ES6	35/TD8	-	7b	Tos
XXJ	RN1969	Si-npn-Digi	Dual, Sw, 50V, 100mA, 200mW, 250MHz, R1/R2=47k/22k	US6	33/TD8	-	7b	Tos
XXJ	RN1969FE	Si-npn-Digi	Dual, Sw, 50V, 100mA, 100mW, 250MHz, R1/R2=47k/22k	ES6	35/TD8	-	7b	Tos
XXK	RN1970	Si-npn-Digi	Dual, Sw, 50V, 100mA, 200mW, 250MHz, R1=4k7	US6	33/TD8	-	7b	Tos
XXK	RN1970FE	Si-npn-Digi	Dual, Sw, 50V, 100mA, 100mW, 250MHz, R1=4k7	ES6	35/TD8	-	7b	Tos
XXM	RN1971	Si-npn-Digi	Dual, Sw, 50V, 100mA, 200mW, 250MHz, R1=10k	US6	33/TD8	-	7b	Tos
XXM	RN1971FE	Si-npn-Digi	Dual, Sw, 50V, 100mA, 100mW, 250MHz, R1=10k	ES6	35/TD8	-	7b	Tos
Y0	R1163D301D	LVR-IC	LDO, 3V±1.5%, 150mA, +CE, CL, AE(mode)	SON-6	34vrc	VR10	7g	Ric
Y1	R1163D311D	LVR-IC	LDO, 3.1V±1.5%, 150mA, +CE, CL, AE(mode)	SON-6	34vrc	VR10	7g	Ric
Y1	R5325N001A	LVR-IC	LDO, Dual out, Vout1/Vout2=2V/2V±1%, 150mA, +CE	SOT-23-6	33rg	VR19	7d	Ric
Y10	SSM2305RSMZ	LIN-IC	AF PA, BTL, class-D, 2.5..5.5V, 2.8W(SV/4C), shutdown	SOP-8	47	AFP24	-	Ad
Y1S	CGY195	MMIC	GaAs UHF multiband power amp. 3..6V, 0.8..3GHz (30dB)	SCT-595	71ad	A2	7l	Inf



SMD code	Type	Function	Short description	Case	Pinout	Sch.	St.	Mnf.
Y2	KRC836E	Si-npn-Digi	Dual, Sw, 50V, 100mA, 200mW, R1/R2=1k/10k	TES6	35/TD8	-	7k	Kec
Y2	KRC836U	Si-npn-Digi	Dual, Sw, 50V, 100mA, 200mW, R1/R2=1k/10k	US6	33/TD3	-	7k	Kec
Y2	R1163D321D	LVR-IC	LDO, 3.2V±1.5%, 150mA, +CE, CL, AE(mode)	SON-6	34vrc	VR10	7g	Ric
Y2	R5325N002A	LVR-IC	LDO, Dual out, Vout1/Vout2=2.8V/2.8V±1%, 150mA, +CE	SOT-23-6	33rg	VR19	7d	Ric
Y3	R1163D331D	LVR-IC	LDO, 3.3V±1.5%, 150mA, +CE, CL, AE(mode)	SON-6	34vrc	VR10	7g	Ric
Y3	R5325N003A	LVR-IC	LDO, Dual out, Vout1/Vout2=1.8V/3V±1%, 150mA, +CE	SOT-23-6	33rg	VR19	7d	Ric
Y34	74LVC2G34GV	CMOS-Logic	Dual non-inverter buffers	SOT457	33Llog23	-	7b	Phi
Y34	74LVC3G34DC	CMOS-Logic	Triple non-inverter buffers	SOT765-1	47Llog69	-	8d	Phi
Y38	74LVC2G38DC	CMOS-Logic	Dual 2-input NAND gate (ODO)	SOT765-1	47Llog62	-	8d	Phi
Y4	KRC837E	Si-npn-Digi	Dual, Sw, 50V, 100mA, 200mW, R1/R2=2.2k/2.2k	TES6	35/TD8	-	7k	Kec
Y4	KRC837U	Si-npn-Digi	Dual, Sw, 50V, 100mA, 200mW, R1/R2=2.2k/2.2k	US6	33/TD3	-	7k	Kec
Y4	R1163D341D	LVR-IC	LDO, 3.4V±1.5%, 150mA, +CE, CL, AE(mode)	SON-6	34vrc	VR10	7g	Ric
Y4	R5325N004A	LVR-IC	LDO, Dual out, Vout1/Vout2=2.5V/3V±1%, 150mA, +CE	SOT-23-6	33rg	VR19	7d	Ric
Y5	KRC838E	Si-npn-Digi	Dual, Sw, 50V, 100mA, 200mW, R1/R2=2.2k/10k	TES6	35/TD8	-	7k	Kec
Y5	KRC838U	Si-npn-Digi	Dual, Sw, 50V, 100mA, 200mW, R1/R2=2.2k/10k	US6	33/TD3	-	7k	Kec
Y5	R1163D351D	LVR-IC	LDO, 3.5V±1.5%, 150mA, +CE, CL, AE(mode)	SON-6	34vrc	VR10	7g	Ric
Y5	R5325N005A	LVR-IC	LDO, Dual out, Vout1/Vout2=1.8V/2.5V±1%, 150mA, +CE	SOT-23-6	33rg	VR19	7d	Ric
Y5S	CGY59W	MMIC	GaAs UHF preamp. 8V, 0.2...2.5GHz (13dB)	SOT-363	33	-	7l	Inf
Y6	KRC839E	Si-npn-Digi	Dual, Sw, 50V, 100mA, 200mW, R1/R2=4.7k/10k	TES6	35/TD8	-	7k	Kec
Y6	KRC839U	Si-npn-Digi	Dual, Sw, 50V, 100mA, 200mW, R1/R2=4.7k/10k	US6	33/TD3	-	7k	Kec
Y6	R1163D361D	LVR-IC	LDO, 3.6V±1.5%, 150mA, +CE, CL, AE(mode)	SON-6	34vrc	VR10	7g	Ric
Y6	R5325N006A	LVR-IC	LDO, Dual out, Vout1/Vout2=1.8V/3.3V±1%, 150mA, +CE	SOT-23-6	33rg	VR19	7d	Ric
Y66	74LVCV2G66DC	CMOS-Logic	2-channel analog switch	SOT765-1	47Llog68	-	8d	Phi
Y66	74LVCV2G66DP	CMOS-Logic	2-channel analog switch	SOT505-2	47Llog68	-	8d	Phi
Y6S	CGY62	MMIC	GaAs UHF two-stage broadband amp, 6V, 0.2...2.5GHz (20dB)	MW-6	72	-	7k	Inf
Y7	KRC840E	Si-npn-Digi	Dual, Sw, 50V, 100mA, 200mW, R1/R2=10k/4.7k	TES6	35/TD8	-	7k	Kec
Y7	KRC840U	Si-npn-Digi	Dual, Sw, 50V, 100mA, 200mW, R1/R2=10k/4.7k	US6	33/TD3	-	7k	Kec
Y7	R1163D371D	LVR-IC	LDO, 3.7V±1.5%, 150mA, +CE, CL, AE(mode)	SON-6	34vrc	VR10	7g	Ric
Y7	R5325N007A	LVR-IC	LDO, Dual out, Vout1/Vout2=2.5V/2.8V±1%, 150mA, +CE	SOT-23-6	33rg	VR19	7d	Ric
Y7S	CGY60	MMIC	GaAs UHF preamp. 8V, 1.7...2GHz (12.5dB)	MW-6	72	-	7k	Inf
Y8	KRC841E	Si-npn-Digi	Dual, Sw, 50V, 100mA, 200mW, R1/R2=47k/10k	TES6	35/TD8	-	7k	Kec
Y8	KRC841U	Si-npn-Digi	Dual, Sw, 50V, 100mA, 200mW, R1/R2=47k/10k	US6	33/TD3	-	7k	Kec
Y8	R1163D381D	LVR-IC	LDO, 3.8V±1.5%, 150mA, +CE, CL, AE(mode)	SON-6	34vrc	VR10	7g	Ric
Y8	R5325N008A	LVR-IC	LDO, Dual out, Vout1/Vout2=1.2V/1.2V±1%, 150mA, +CE	SOT-23-6	33rg	VR19	7d	Ric
Y8S	CGY63	MMIC	GaAs UHF broadband driver amp. 2.7...6V, 0.8...2.5GHz (22dB)	SCT-595	71an	A2	7l	Inf
Y9	KRC842E	Si-npn-Digi	Dual, Sw, 50V, 100mA, 200mW, R1/R2=100k/100k	TES6	35/TD8	-	7k	Kec
Y9	KRC842U	Si-npn-Digi	Dual, Sw, 50V, 100mA, 200mW, R1/R2=100k/100k	US6	33/TD3	-	7k	Kec
Y9	R1163D391D	LVR-IC	LDO, 3.9V±1.5%, 150mA, +CE, CL, AE(mode)	SON-6	34vrc	VR10	7g	Ric
Y9	R5325N009A	LVR-IC	LDO, Dual out, Vout1/Vout2=1.5V/1.6V±1%, 150mA, +CE	SOT-23-6	33rg	VR19	7d	Ric
YA	74LVC2G34GV	CMOS-Logic	Dual non-inverter buffers	SOT-363	33Llog23	-	7b	Phi
YA	KRC821E	Si-npn-Digi	Dual, Sw, 50V, 100mA, 200mW, R1/R2=4.7k/4.7k	TES6	35/TD8	-	7k	Kec
YA	KRC821U	Si-npn-Digi	Dual, Sw, 50V, 100mA, 200mW, R1/R2=4.7k/4.7k	US6	33/TD3	-	7k	Kec
YA	R5325N010A	LVR-IC	LDO, Dual out, Vout1/Vout2=1.5V/2.8V±1%, 150mA, +CE	SOT-23-6	33rg	VR19	7d	Ric
YA	RN2601	Si-pnp-Digi	Dual, Sw, 50V, 100mA, 300mW, R1/R2=4.7k/4.7k	SM6	33/TD4	-	7b	Tos
YA	RN2901	Si-pnp-Digi	Dual, Sw, 50V, 100mA, 200mW, R1/R2=4.7k/4.7k	US6	33/TD4	-	7b	Tos
YA	RN2901FE	Si-pnp-Digi	Dual, Sw, 50V, 100mA, 100mW, R1/R2=4.7k/4.7k	SOT-563	35/TD4	-	7b	Tos
YB	KRC822E	Si-npn-Digi	Dual, Sw, 50V, 100mA, 200mW, R1/R2=10k/10k	TES6	35/TD8	-	7k	Kec
YB	KRC822U	Si-npn-Digi	Dual, Sw, 50V, 100mA, 200mW, R1/R2=10k/10k	US6	33/TD3	-	7k	Kec
YB	R5325N011A	LVR-IC	LDO, Dual out, Vout1/Vout2=3V/3V±1%, 150mA, +CE	SOT-23-6	33rg	VR19	7d	Ric
YB	RN2602	Si-pnp-Digi	Dual, Sw, 50V, 100mA, 300mW, R1/R2=10k/10k	SM6	33/TD4	-	7b	Tos
YB	RN2902	Si-pnp-Digi	Dual, Sw, 50V, 100mA, 200mW, R1/R2=10k/10k	US6	33/TD4	-	7b	Tos
YB	RN2902FE	Si-pnp-Digi	Dual, Sw, 50V, 100mA, 100mW, R1/R2=10k/10k	SOT-563	35/TD4	-	7b	Tos
YC	74LVC1G57GW	CMOS-Logic	Configurable multiple-function gate	SOT-363	33Llog36	-	7b	Phi
YC	KRC823E	Si-npn-Digi	Dual, Sw, 50V, 100mA, 200mW, R1/R2=22k/22k	TES6	35/TD8	-	7k	Kec
YC	KRC823U	Si-npn-Digi	Dual, Sw, 50V, 100mA, 200mW, R1/R2=22k/22k	US6	33/TD3	-	7k	Kec
YC	R5325N012A	LVR-IC	LDO, Dual out, Vout1/Vout2=3.1V/3.1V±1%, 150mA, +CE	SOT-23-6	33rg	VR19	7d	Ric
YC	RN2603	Si-pnp-Digi	Dual, Sw, 50V, 100mA, 300mW, R1/R2=22k/22k	SM6	33/TD4	-	7b	Tos
YC	RN2903	Si-pnp-Digi	Dual, Sw, 50V, 100mA, 200mW, R1/R2=22k/22k	US6	33/TD4	-	7b	Tos
YC	RN2903FE	Si-pnp-Digi	Dual, Sw, 50V, 100mA, 100mW, R1/R2=22k/22k	SOT-563	35/TD4	-	7b	Tos
YD	74LVC2GU04GW	CMOS-Logic	Dual inverters	SOT-363	33Llog24	-	7b	Phi
YD	KRC824E	Si-npn-Digi	Dual, Sw, 50V, 100mA, 200mW, R1/R2=47k/47k	TES6	35/TD8	-	7k	Kec
YD	KRC824U	Si-npn-Digi	Dual, Sw, 50V, 100mA, 200mW, R1/R2=47k/47k	US6	33/TD3	-	7k	Kec
YD	R5325N013A	LVR-IC	LDO, Dual out, Vout1/Vout2=2.7V/1.8V±1%, 150mA, +CE	SOT-23-6	33rg	VR19	7d	Ric
YD	RN2604	Si-pnp-Digi	Dual, Sw, 50V, 100mA, 300mW, R1/R2=47k/47k	SM6	33/TD4	-	7b	Tos
YD	RN2904	Si-pnp-Digi	Dual, Sw, 50V, 100mA, 200mW, R1/R2=47k/47k	US6	33/TD4	-	7b	Tos
YD	RN2904FE	Si-pnp-Digi	Dual, Sw, 50V, 100mA, 100mW, R1/R2=47k/47k	SOT-563	35/TD4	-	7b	Tos
YE	KRC825E	Si-npn-Digi	Dual, Sw, 50V, 100mA, 200mW, R1/R2=2.2k/47k	TES6	35/TD8	-	7k	Kec
YE	KRC825U	Si-npn-Digi	Dual, Sw, 50V, 100mA, 200mW, R1/R2=2.2k/47k	US6	33/TD3	-	7k	Kec
YE	R5325N016A	LVR-IC	LDO, Dual out, Vout1/Vout2=2.85V/2.85V±1%, 150mA, +CE	SOT-23-6	33rg	VR19	7d	Ric
YE	RN2605	Si-pnp-Digi	Dual, Sw, 50V, 100mA, 300mW, R1/R2=2.2k/47k	SM6	33/TD4	-	7b	Tos



SMD code	Type	Function	Short description	Case	Pinout	Sch.	St.	Mnf.
YE	RN2905	Si-pnp-Digi	Dual, Sw, 50V, 100mA, 200mW, R1/R2=2.2k/47k	US6	33/TD4	-	7b	Tos
YE	RN2905FE	Si-pnp-Digi	Dual, Sw, 50V, 100mA, 100mW, R1/R2=2.2k/47k	SOT-563	35/TD4	-	7b	Tos
YF	KRC826E	Si-npn-Digi	Dual, Sw, 50V, 100mA, 200mW, R1/R2=4.7k/47k	TES6	35/TD8	-	7k	Kec
YF	KRC826U	Si-npn-Digi	Dual, Sw, 50V, 100mA, 200mW, R1/R2=4.7k/47k	US6	33/TD3	-	7k	Kec
YF	R5325N017A	LVR-IC	LDO, Dual out, Vout1/Vout2=2.9V/2.9V±1%, 150mA, +CE	SOT-23-6	33rg	VR19	7d	Ric
YF	RN2606	Si-pnp-Digi	Dual, Sw, 50V, 100mA, 300mW, R1/R2=4.7k/47k	SM6	33/TD4	-	7b	Tos
YF	RN2906	Si-pnp-Digi	Dual, Sw, 50V, 100mA, 200mW, R1/R2=4.7k/47k	US6	33/TD4	-	7b	Tos
YF	RN2906FE	Si-pnp-Digi	Dual, Sw, 50V, 100mA, 100mW, R1/R2=4.7k/47k	SOT-563	35/TD4	-	7b	Tos
YG	74LVC1G332GV	CMOS-Logic	3-input OR gate	SOT457	33Lg32	-	7b	Phi
YG	74LVC1G332GW	CMOS-Logic	3-input OR gate	SOT-363	33Lg32	-	7b	Phi
YG	R5325N014A	LVR-IC	LDO, Dual out, Vout1/Vout2=1.8V/2.6V±1%, 150mA, +CE	SOT-23-6	33rg	VR19	7d	Ric
YH	74LVC1G386GV	CMOS-Logic	3-input EXCLUSIVE-OR gate	SOT-363	33Lg33	-	7b	Phi
YH	74LVC1G386GW	CMOS-Logic	3-input EXCLUSIVE-OR gate	SOT457	33Lg33	-	7b	Phi
YH	KRC827E	Si-npn-Digi	Dual, Sw, 50V, 100mA, 200mW, R1/R2=10k/47k	TES6	35/TD8	-	7k	Kec
YH	KRC827U	Si-npn-Digi	Dual, Sw, 50V, 100mA, 200mW, R1/R2=10k/47k	US6	33/TD3	-	7k	Kec
YH	R5325N015A	LVR-IC	LDO, Dual out, Vout1/Vout2=3.3V/3.3V±1%, 150mA, +CE	SOT-23-6	33rg	VR19	7d	Ric
YH	RN2607	Si-pnp-Digi	Dual, Sw, 50V, 100mA, 300mW, R1/R2=10k/47k	SM6	33/TD4	-	7b	Tos
YH	RN2907	Si-pnp-Digi	Dual, Sw, 50V, 100mA, 200mW, R1/R2=10k/47k	US6	33/TD4	-	7b	Tos
YH	RN2907FE	Si-pnp-Digi	Dual, Sw, 50V, 100mA, 100mW, R1/R2=10k/47k	ES6	35/TD4	-	7b	Tos
YI	KRC828E	Si-npn-Digi	Dual, Sw, 50V, 100mA, 200mW, R1/R2=22k/47k	TES6	35/TD8	-	7k	Kec
YI	KRC828U	Si-npn-Digi	Dual, Sw, 50V, 100mA, 200mW, R1/R2=22k/47k	US6	33/TD3	-	7k	Kec
YI	RN2608	Si-pnp-Digi	Dual, Sw, 50V, 100mA, 300mW, R1/R2=22k/47k	SM6	33/TD4	-	7b	Tos
YI	RN2908	Si-pnp-Digi	Dual, Sw, 50V, 100mA, 200mW, R1/R2=22k/47k	US6	33/TD4	-	7b	Tos
YI	RN2908FE	Si-pnp-Digi	Dual, Sw, 50V, 100mA, 100mW, R1/R2=22k/47k	ES6	35/TD4	-	7b	Tos
YJ	74LVC1G3157GV	CMOS-Logic	2-channel analog multiplexer/demultiplexer	SOT457	33Lg38	-	7b	Phi
YJ	74LVC1G3157GW	CMOS-Logic	2-channel analog multiplexer/demultiplexer	SOT-363	33Lg38	-	7b	Phi
YJ	KRC829E	Si-npn-Digi	Dual, Sw, 50V, 100mA, 200mW, R1/R2=47k/22k	TES6	35/TD8	-	7k	Kec
YJ	KRC829U	Si-npn-Digi	Dual, Sw, 50V, 100mA, 200mW, R1/R2=47k/22k	US6	33/TD3	-	7k	Kec
YJ	R5325N018A	LVR-IC	LDO, Dual out, Vout1/Vout2=1.2V/2.6V±1%, 150mA, +CE	SOT-23-6	33rg	VR19	7d	Ric
YJ	RN2609	Si-pnp-Digi	Dual, Sw, 50V, 100mA, 300mW, R1/R2=47k/22k	SM6	33/TD4	-	7b	Tos
YJ	RN2909	Si-pnp-Digi	Dual, Sw, 50V, 100mA, 200mW, R1/R2=47k/22k	US6	33/TD4	-	7b	Tos
YJ	RN2909FE	Si-pnp-Digi	Dual, Sw, 50V, 100mA, 100mW, R1/R2=47k/22k	ES6	35/TD4	-	7b	Tos
YK	74LVC1G58GW	CMOS-Logic	Configurable multiple-function gate	SOT-363	33Lg37	-	7b	Phi
YK	KRC830E	Si-npn-Digi	Dual, Sw, 50V, 100mA, 200mW, R1=4.7k	TES6	35/TD8	-	7k	Kec
YK	KRC830U	Si-npn-Digi	Dual, Sw, 50V, 100mA, 200mW, R1=4.7k	US6	33/TD3	-	7k	Kec
YK	R5325N019A	LVR-IC	LDO, Dual out, Vout1/Vout2=2.8V/2.9V±1%, 150mA, +CE	SOT-23-6	33rg	VR19	7d	Ric
YK	RN2610	Si-pnp-Digi	Dual, Sw, 50V, 100mA, 300mW, R1=4.7k	SM6	33/TD4	-	7b	Tos
YK	RN2910	Si-pnp-Digi	Dual, Sw, 50V, 100mA, 200mW, R1=4.7k	US6	33/TD4	-	7b	Tos
YK	RN2910FE	Si-pnp-Digi	Dual, Sw, 50V, 100mA, 100mW, R1=4.7k	ES6	35/TD4	-	7b	Tos
YL	R5325N020A	LVR-IC	LDO, Dual out, Vout1/Vout2=1.2V/1.8V±1%, 150mA, +CE	SOT-23-6	33rg	VR19	7d	Ric
YM	74LVC1G10GV	CMOS-Logic	3-input NAND gate	SOT457	33Lg29	-	7b	Phi
YM	74LVC1G10GW	CMOS-Logic	3-input NAND gate	SOT-363	33Lg29	-	7b	Phi
YM	KRC831E	Si-npn-Digi	Dual, Sw, 50V, 100mA, 200mW, R1=10k	TES6	35/TD8	-	7k	Kec
YM	KRC831U	Si-npn-Digi	Dual, Sw, 50V, 100mA, 200mW, R1=10k	US6	33/TD3	-	7k	Kec
YM	R5325N021A	LVR-IC	LDO, Dual out, Vout1/Vout2=2.5V/1.2V±1%, 150mA, +CE	SOT-23-6	33rg	VR19	7d	Ric
YM	RN2611	Si-pnp-Digi	Dual, Sw, 50V, 100mA, 300mW, R1=10k	SM6	33/TD4	-	7b	Tos
YM	RN2911	Si-pnp-Digi	Dual, Sw, 50V, 100mA, 200mW, R1=10k	US6	33/TD4	-	7b	Tos
YM	RN2911FE	Si-pnp-Digi	Dual, Sw, 50V, 100mA, 100mW, R1=10k	ES6	35/TD4	-	7b	Tos
YN	KRC832E	Si-npn-Digi	Dual, Sw, 50V, 100mA, 200mW, R1=100k	TES6	35/TD8	-	7k	Kec
YN	KRC832U	Si-npn-Digi	Dual, Sw, 50V, 100mA, 200mW, R1=100k	US6	33/TD3	-	7k	Kec
YN	R5325N022A	LVR-IC	LDO, Dual out, Vout1/Vout2=2.7V/2.85V±1%, 150mA, +CE	SOT-23-6	33rg	VR19	7d	Ric
YO	KRC833E	Si-npn-Digi	Dual, Sw, 50V, 100mA, 200mW, R1=22k	TES6	35/TD8	-	7k	Kec
YO	KRC833U	Si-npn-Digi	Dual, Sw, 50V, 100mA, 200mW, R1=22k	US6	33/TD3	-	7k	Kec
YP	74LVC1G157GV	CMOS-Logic	2-input multiplexer	SOT457	33Lg42	-	7b	Phi
YP	74LVC1G157GW	CMOS-Logic	2-input multiplexer	SOT-363	33Lg42	-	7b	Phi
YP	DDZX6V8CTS	Z-diode	Triple, 6.8V±2.5%, 200mW	SOT-363	33dd	-	7k	Di
YP	KRC834E	Si-npn-Digi	Dual, Sw, 50V, 100mA, 200mW, R1=47k	TES6	35/TD8	-	7k	Kec
YP	KRC834U	Si-npn-Digi	Dual, Sw, 50V, 100mA, 200mW, R1=47k	US6	33/TD3	-	7k	Kec
YP	R5325N023A	LVR-IC	LDO, Dual out, Vout1/Vout2=1.2V/2.8V±1%, 150mA, +CE	SOT-23-6	33rg	VR19	7d	Ric
YQ	DDZX7V5CTS	Z-diode	Triple, 7.5V±2.5%, 200mW	SOT-363	33dd	-	7k	Di
YQ	R5325N024A	LVR-IC	LDO, Dual out, Vout1/Vout2=1.2V/3V±1%, 150mA, +CE	SOT-23-6	33rg	VR19	7d	Ric
YR	DDZX8V2CTS	Z-diode	Triple, 8.2V±2.5%, 200mW	SOT-363	33dd	-	7k	Di
YR	R5325N025A	LVR-IC	LDO, Dual out, Vout1/Vout2=2.5V/2.9V±1%, 150mA, +CE	SOT-23-6	33rg	VR19	7d	Ric
YS	DDZX9V1CTS	Z-diode	Triple, 9.1V±2.5%, 200mW	SOT-363	33dd	-	7k	Di
YS	R5325N026A	LVR-IC	LDO, Dual out, Vout1/Vout2=1.2V/2.7V±1%, 150mA, +CE	SOT-23-6	33rg	VR19	7d	Ric
YT	74LVC1G175GW	CMOS-Logic	Positive edge-triggered D-type flip-flop with reset	SOT-363	33Lg40	-	7b	Phi
YT	DDZX10CTS	Z-diode	Triple, 10V±2.5%, 200mW	SOT-363	33dd	-	7k	Di
YT	R5325N027A	LVR-IC	LDO, Dual out, Vout1/Vout2=2.9V/1.8V±1%, 150mA, +CE	SOT-23-6	33rg	VR19	7d	Ric
YU	DDZX11CTS	Z-diode	Triple, 11V ±2.5%, 200mW	SOT-363	33dd	-	7k	Di
YU	R5325N028A	LVR-IC	LDO, Dual out, Vout1/Vout2=1.5V/1.8V±1%, 150mA, +CE	SOT-23-6	33rg	VR19	7d	Ric



SMD code	Type	Function	Short description	Case	Pinout	Sch.	St.	Mnf.
YV	DDZX12CTS	Z-diode	Triple, 12V \pm 2.5%, 200mW	SOT-363	33dd	-	7k	Di
YV	R5325N029A	LVR-IC	LDO, Dual out, Vout1/Vout2=3.3V/3.3V \pm 1%, 150mA, +CE	SOT-23-6	33rg	VR19	7d	Ric
YW	R5325N030A	LVR-IC	LDO, Dual out, Vout1/Vout2=3.45V/2.3V \pm 1%, 150mA, +CE	SOT-23-6	33rg	VR19	7d	Ric
YX	R5325N031A	LVR-IC	LDO, Dual out, Vout1/Vout2=1.3V/1.8V \pm 1%, 150mA, +CE	SOT-23-6	33rg	VR19	7d	Ric
YY	DDZX16TS	Z-diode	Triple, 16V \pm 2.5%, 200mW	SOT-363	33dd	-	7k	Di
YY	NCT5200L6	CMOS-Logic	2-input NAND gate	MPAK-6	33log1	-	7b	F
YY	R5325N032A	LVR-IC	LDO, Dual out, Vout1/Vout2=1.8V/1.8V \pm 1%, 150mA, +CE	SOT-23-6	33rg	VR19	7d	Ric
YY1	RN2970HFE	Si-pnp-Digi	Dual, Sw, 30V, 100mA, 100mW, R1=4.7k	SOT-563	35/TD8	-	7b	Tos
YY2	RN2971HFE	Si-pnp-Digi	Dual, Sw, 30V, 100mA, 100mW, R1=10k	SOT-563	35/TD8	-	7b	Tos
YYA	RN2961	Si-pnp-Digi	Dual, Sw, 50V, 100mA, 200mW, R1/R2=4.7k/4.7k	US6	33/TD8	-	7b	Tos
YYA	RN2961FE	Si-pnp-Digi	Dual, Sw, 50V, 100mA, 100mW, R1/R2=4.7k/4.7k	ES6	35/TD8	-	7b	Tos
YYB	RN2962	Si-pnp-Digi	Dual, Sw, 50V, 100mA, 200mW, R1/R2=10k/10k	US6	33/TD8	-	7b	Tos
YYB	RN2962FE	Si-pnp-Digi	Dual, Sw, 50V, 100mA, 100mW, R1/R2=10k/10k	ES6	35/TD8	-	7b	Tos
YYC	RN2963	Si-pnp-Digi	Dual, Sw, 50V, 100mA, 200mW, R1/R2=22k/22k	US6	33/TD8	-	7b	Tos
YYC	RN2963FE	Si-pnp-Digi	Dual, Sw, 50V, 100mA, 100mW, R1/R2=22k/22k	ES6	35/TD8	-	7b	Tos
YYD	RN2964	Si-pnp-Digi	Dual, Sw, 50V, 100mA, 200mW, R1/R2=47k/47k	US6	33/TD8	-	7b	Tos
YYD	RN2964FE	Si-pnp-Digi	Dual, Sw, 50V, 100mA, 100mW, R1/R2=47k/47k	ES6	35/TD8	-	7b	Tos
YYE	RN2965	Si-pnp-Digi	Dual, Sw, 50V, 100mA, 200mW, R1/R2=2.2k/47k	US6	33/TD8	-	7b	Tos
YYE	RN2965FE	Si-pnp-Digi	Dual, Sw, 50V, 100mA, 100mW, R1/R2=2.2k/47k	ES6	35/TD8	-	7b	Tos
YYF	RN2966	Si-pnp-Digi	Dual, Sw, 50V, 100mA, 200mW, R1/R2=4.7k/47k	US6	33/TD8	-	7b	Tos
YYF	RN2966FE	Si-pnp-Digi	Dual, Sw, 50V, 100mA, 100mW, R1/R2=4.7k/47k	ES6	35/TD8	-	7b	Tos
YYH	RN2967	Si-pnp-Digi	Dual, Sw, 50V, 100mA, 200mW, R1/R2=10k/47k	US6	33/TD8	-	7b	Tos
YYH	RN2967FE	Si-pnp-Digi	Dual, Sw, 50V, 100mA, 100mW, R1/R2=10k/47k	SOT-563	35/TD8	-	7b	Tos
YYI	RN2968	Si-pnp-Digi	Dual, Sw, 50V, 100mA, 200mW, R1/R2=22k/47k	US6	33/TD8	-	7b	Tos
YYI	RN2968FE	Si-pnp-Digi	Dual, Sw, 50V, 100mA, 100mW, R1/R2=22k/47k	SOT-563	35/TD8	-	7b	Tos
YYJ	RN2969	Si-pnp-Digi	Dual, Sw, 50V, 100mA, 200mW, R1/R2=47k/22k	US6	33/TD8	-	7b	Tos
YYJ	RN2969FE	Si-pnp-Digi	Dual, Sw, 50V, 100mA, 100mW, R1/R2=47k/22k	SOT-563	35/TD8	-	7b	Tos
YYK	RN2970	Si-pnp-Digi	Dual, Sw, 50V, 100mA, 200mW, R1=4.7k	US6	33/TD8	-	7b	Tos
YYK	RN2970FE	Si-pnp-Digi	Dual, Sw, 50V, 100mA, 100mW, R1=4.7k	SOT-563	35/TD8	-	7b	Tos
YYM	RN2971	Si-pnp-Digi	Dual, Sw, 50V, 100mA, 200mW, R1=10k	US6	33/TD8	-	7b	Tos
YYM	RN2971FE	Si-pnp-Digi	Dual, Sw, 50V, 100mA, 100mW, R1=10k	SOT-563	35/TD8	-	7b	Tos
YZ	DDZX18CTS	Z-diode	Triple, 18V \pm 2.5%, 200mW	SOT-363	33dd	-	7k	Di
YZ	R5325N033A	LVR-IC	LDO, Dual out, Vout1/Vout2=3.1V/3.0V \pm 1%, 150mA, +CE	SOT-23-6	33rg	VR19	7d	Ric
Z0	BZA420A	TVS	Quad, 4.2V, 3.75A, 24W(1ms)	SOT457	33dx	-	7b	Phi
Z0	R1163D401D	LVR-IC	LDO, 4V \pm 1.5%, 150mA, +CE, CL, AE(mode)	SOM-6	34wrc	VR10	7g	Ric
Z00	KIC7WZ00FK	CMOS-Logic	Dual 2-input NAND gates	US8	47L og50	-	8c	Kec
Z02	KIC7WZ02FK	CMOS-Logic	Dual 2-input NOR gates	US8	47L og53	-	8c	Kec
Z04	KIC7WZ04FK	CMOS-Logic	Triple inverters	US8	47L og56	-	8c	Kec
Z05	KIC7WZ05FK	CMOS-Logic	Triple inverters (ODO)	US8	47L og72	-	8c	Kec
Z08	KIC7WZ08FK	CMOS-Logic	Dual 2-input AND gates	US8	47L og51	-	8c	Kec
Z1	R1163D181D5	LVR-IC	LDO, 1.85V \pm 1.5%, 150mA, +CE, CL, AE(mode)	SOM-6	34wrc	VR10	7g	Ric
Z123	KIC7WZ123FK	CMOS-Logic	Monostable multivibrator	US8	47L og75	-	8c	Kec
Z126	KIC7WZ126FK	CMOS-Logic	Dual bus buffer with 3-state output	US8	47L og54	-	8c	Kec
Z14	KIC7WZ14FK	CMOS-Logic	Triple Schmitt-trigger inverters	US8	47L og57	-	8c	Kec
Z157	KIC7WZ157FK	CMOS-Logic	2-input multiplexer	US8	47L og42	-	8c	Kec
Z2	R1163D281D5	LVR-IC	LDO, 2.85V \pm 1.5%, 150mA, +CE, CL, AE(mode)	SOM-6	34wrc	VR10	7g	Ric
Z240	KIC7WZ240FK	CMOS-Logic	Dual bus buffer inverted with 3-state output	US8	47L og67	-	8c	Kec
Z241	KIC7WZ241FK	CMOS-Logic	Dual bus buffer non-inverted with 3-state output	US8	47L og60	-	8c	Kec
Z245	KIC7WZ245FK	CMOS-Logic	Dual bus transceivers with 3-state output	US8	47L og74	-	8c	Kec
Z2t	BZA462A	TVS	Quad, 6.2V, 2.66A, 24W(1ms)	SOT457	33dx	-	7b	Phi
Z32	KIC7WZ32FK	CMOS-Logic	Dual 2-input OR gates	US8	47L og52	-	8c	Kec
Z34	KIC7WZ34FK	CMOS-Logic	Triple non-inverter buffers	US8	47L og69	-	8c	Kec
Z38	KIC7WZ38FK	CMOS-Logic	Dual 2-input NAND gate (ODO)	US8	47L og62	-	8c	Kec
Z6	BZA456A	TVS	Quad, 5.6V, 3A, 24W(1ms)	SOT457	33dx	-	7b	Phi
Z64	LM4864MM	LIN-IC	AF PA, BTL, 2.7..5.5V, 725mW(5V/8Q), shutdown	SSOP-8	47	AFP12	-	Nsc
Z65	LM4865MM	LIN-IC	AF PA, BTL, 2.7..5.5V, 750mW(5V/8Q), DC volume	SSOP-8	47	AFP13	-	Nsc
Z74	KIC7WZ74FK	CMOS-Logic	Positive edge-triggered D-type flip-flop with set and reset	US8	47L og59	-	8c	Kec
Z8	BZA408B	TVS	Quad, 5V, 2A, 20W(1ms)	SOT457	33dx	-	7b	Phi
Z82	LM4882MM	LIN-IC	AF PA, 2.4..5.5V, 250mW(8Q), shutdown	SSOP-8	47	AFP18	-	Nsc
Z86	KIC7WZ86FK	CMOS-Logic	Dual 2-input EXCLUSIVE-OR gates	US8	47L og65	-	8c	Kec
ZA	R5326N025B	LVR-IC	LDO, Dual out, Vout1/Vout2=1.8V/1.85V \pm 1%, 150mA, +CE, CL	SOT-23-6	33rg	VR19	7d	Ric
ZB	R5326N025A	LVR-IC	LDO, Dual out, Vout1/Vout2=1.8V/1.85V \pm 1%, 150mA, +CE	SOT-23-6	33rg	VR19	7d	Ric
ZC	R5326N026B	LVR-IC	LDO, Dual out, Vout1/Vout2=1.8V/2.85V \pm 1%, 150mA, +CE, CL	SOT-23-6	33rg	VR19	7d	Ric
ZD	R5326N026A	LVR-IC	LDO, Dual out, Vout1/Vout2=1.8V/2.85V \pm 1%, 150mA, +CE	SOT-23-6	33rg	VR19	7d	Ric
ZQ	DDZX36TS	Z-diode	Triple, 36V \pm 2.5%, 200mW	SOT-363	33dd	-	7k	Di
ZR	DDZX43TS	Z-diode	Triple, 43V \pm 2.5%, 200mW	SOT-363	33dd	-	7k	Di
ZS	DDZX47TS	Z-diode	Triple, 47V \pm 2.5%, 200mW	SOT-363	33dd	-	7k	Di
ZU04	KIC7WZU04FK	CMOS-Logic	Triple unbuffered inverters	US8	47L og56	-	8c	Kec
ZZ	NCT586L6	CMOS-Logic	2-input EXCLUSIVE-OR gate	MPAK-6	33L og5	-	7b	F



SECTION 10
BGA, DFN and QFN CASES SMD SEMICONDUCTOR COMPONENTS

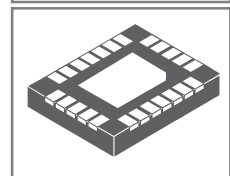
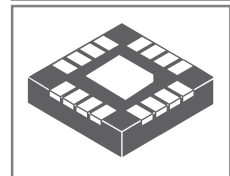
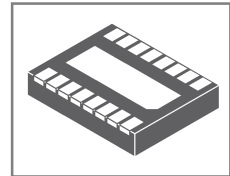
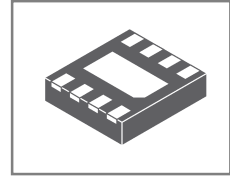
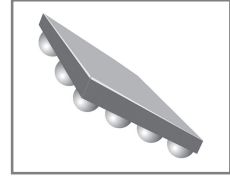
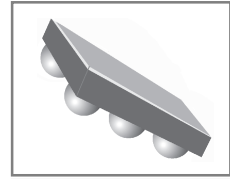

SMD code	Type	Function	Short description	Case	Pinout	Sch.	St.	Mnf.
---HE	SN74AUP2G08YFP	CMOS-Logic	Dual 2-input AND gates	MBGA-8	50Log51	-	9d	Ti
---HE	SN74AUP2G08YZP	CMOS-Logic	Dual 2-input AND gates	BGA-8	50Log51	-	9d	Ti
---HM	SN74AUP2G125YFP	CMOS-Logic	Dual bus buffer with 3-state output	MBGA-8	50Log54	-	9d	Ti
---HM	SN74AUP2G125YZP	CMOS-Logic	Dual bus buffer with 3-state output	BGA-8	50Log54	-	9d	Ti
---HN	SN74AUP2G126YFP	CMOS-Logic	Bus buffer gate with 3-state output	MBGA-8	50Log13	-	9d	Ti
---HN	SN74AUP2G126YZP	CMOS-Logic	Bus buffer gate with 3-state output	BGA-8	50Log13	-	9d	Ti
---C2	SN74LVC1G10YZP	CMOS-Logic	3-input NAND gate	BGA-6	40Log29	-	9d	Ti
---C2	SN74LVC2G241YZP	CMOS-Logic	Dual bus buffer non-inverted with 3-state output	BGA-8	50Log60	-	9d	Ti
---C3	SN74LVC2G157YZP	CMOS-Logic	2-input multiplexer	BGA-8	50Log66	-	9d	Ti
---C4	SN74LVC2G53YZP	CMOS-Logic	2-channel analog multiplexer/demultiplexer	BGA-8	50Log58	-	9d	Ti
---C6	SN74LVC2G66YZP	CMOS-Logic	2-channel analog switch	BGA-8	50Log68	-	9d	Ti
---C7	SN74LVC2G17YZP	CMOS-Logic	Dual Schmitt-trigger buffers	BGA-6	40Log27	-	9d	Ti
---C9	SN74LVC2G34YZP	CMOS-Logic	Dual non-inverter buffers	BGA-6	40Log23	-	9d	Ti
---CA	SN74LVC2G00YZP	CMOS-Logic	Dual 2-input NAND gates	BGA-8	50Log50	-	9d	Ti
---CB	SN74LVC2G02YZP	CMOS-Logic	Dual 2-input NOR gates	BGA-8	50Log53	-	9d	Ti
---CC	SN74LVC2G04YZP	CMOS-Logic	Dual inverters	BGA-6	40Log24	-	9d	Ti
---CE	SN74LVC2G08YZP	CMOS-Logic	Dual 2-input AND gates	BGA-8	50Log51	-	9d	Ti
---CF	SN74LVC2G14YZP	CMOS-Logic	Dual Schmitt-trigger inverter buffers	BGA-6	40Log34	-	9d	Ti
---CG	SN74LVC2G32YZP	CMOS-Logic	Dual 2-input OR gates	BGA-8	50Log52	-	9d	Ti
---CK	SN74LVC2G240YZP	CMOS-Logic	Dual bus buffer inverted with 3-state output	BGA-8	50Log67	-	9d	Ti
---CM	SN74LVC2G125YZP	CMOS-Logic	Dual bus buffer with 3-state output	BGA-8	50Log54	-	9d	Ti
---CN	SN74LVC2G126YZP	CMOS-Logic	Bus buffer gate with 3-state output	BGA-8	50Log13	-	9d	Ti
---CT	SN74LVC2G06YZP	CMOS-Logic	Dual inverter buffers/drivers (ODO)	BGA-6	40Log25	-	9d	Ti
---CU	SN74LVC1G27YZP	CMOS-Logic	3-input NOR gate	WCSP-6	40Log31	-	9d	Ti
---CV	SN74LVC2G07YZP	CMOS-Logic	Dual noninverting buffers/drivers (ODO)	BGA-6	40Log26	-	9d	Ti
---D3	SN74LVC1G373YZP	CMOS-Logic	D-type transparent latch with 3-state output	WCSP-6	40Log35	-	9d	Ti
---D5	SN74LVC2G132YZP	CMOS-Logic	Dual 2-input NOR gates with Schmitt-trigger inputs	BGA-8	50Log49	-	9d	Ti
---D7	SN74LVC1G38YEP	CMOS-Logic	2-input NAND gate (ODO)	BGA-5	46Log17	-	9a	Ti
---D7	SN74LVC2G38YZP	CMOS-Logic	Dual 2-input NAND gate (ODO)	BGA-8	50Log62	-	9d	Ti
---HP	SN74AUP1G97YZP	CMOS-Logic	Configurable multiple-function gate	WCSP-6	40Log41	-	9d	Ti
---HR	SN74AUP1G98YZP	CMOS-Logic	Configurable multiple-function gate	WCSP-6	40Log43	-	9d	Ti
---HV	SN74AUP1G07YEP	CMOS-Logic	Noninverting buffer/driver (ODO)	BGA-5	46Log8	-	9a	Ti
---HW	SN74AUP1G79YEP	CMOS-Logic	Positive edge-triggered D-type flip-flop	BGA-5	46Log20	-	9a	Ti
---HX	SN74AUP1G80YEP	CMOS-Logic	Positive edge-triggered D-type flip-flop	BGA-5	46Log21	-	9a	Ti
---U2	SN74AUC2G241YZP	CMOS-Logic	Dual bus buffer non-inverted with 3-state output	BGA-8	50Log60	-	9d	Ti
---U6	SN74AUC2G66YZP	CMOS-Logic	2-channel analog switch	BGA-8	50Log68	-	9d	Ti
---U7	SN74AUC1G17YEA	CMOS-Logic	Schmitt-trigger	BGA-5	46Log11	-	9a	Ti
---U9	SN74AUC2G34YZP	CMOS-Logic	Dual non-inverter buffers	BGA-6	40Log23	-	9d	Ti
---UA	SN74AUC1G00YEA	CMOS-Logic	2-input NAND gate	BGA-5	46Log1	-	9a	Ti
---UA	SN74AUC2G00YZP	CMOS-Logic	Dual 2-input NAND gates	BGA-8	50Log50	-	9d	Ti
---UB	SN74AUC2G02YZP	CMOS-Logic	Dual 2-input NOR gates	BGA-8	50Log53	-	9d	Ti
---UC	SN74AUC2G04YEP	CMOS-Logic	Dual inverters	BGA-6	40Log24	-	9d	Ti
---UD	SN74AUC2GU04YZP	CMOS-Logic	Dual inverters	BGA-6	40Log24	-	9d	Ti
---UE	SN74AUC2G08YZP	CMOS-Logic	Dual 2-input AND gates	BGA-8	50Log51	-	9d	Ti
---UF	SN74AUC1G14YEA	CMOS-Logic	Inverting Schmitt-trigger	BGA-5	46Log7	-	9a	Ti
---UG	SN74AUC1G32YEA	CMOS-Logic	2-input OR gate	BGA-5	46Log4	-	9a	Ti
---UG	SN74AUC2G32YZP	CMOS-Logic	Dual 2-input OR gates	BGA-8	50Log52	-	9d	Ti
---UH	SN74AUC2G86YZP	CMOS-Logic	Dual 2-input EXCLUSIVE-OR gates	BGA-8	50Log65	-	9d	Ti
---UK	SN74AUC1G240YEP	CMOS-Logic	Bus buffer inverted with 3-state output	BGA-5	46Log22	-	9a	Ti
---UK	SN74AUC2G240YZP	CMOS-Logic	Dual bus buffer inverted with 3-state output	BGA-8	50Log67	-	9d	Ti
---UM	SN74AUC1G125YEA	CMOS-Logic	Bus buffer gate with 3-state output	BGA-5	46Log14	-	9a	Ti
---UM	SN74AUC2G125YZP	CMOS-Logic	Dual bus buffer with 3-state output	BGA-8	50Log54	-	9d	Ti
---UN	SN74AUC1G126YEP	CMOS-Logic	Bus buffer gate with 3-state output	BGA-5	46Log13	-	9a	Ti
---UN	SN74AUC2G126YZP	CMOS-Logic	Bus buffer gate with 3-state output	BGA-8	50Log13	-	9d	Ti
---UP	SN74AUP1G74YEP	CMOS-Logic	Positive edge-triggered D-type flip-flop with set and reset	WCSP-8	50Log59	-	9d	Ti
---UR	SN74AUC2G79YZP	CMOS-Logic	Dual positive-edge triggered D-type flip-flop	BGA-8	50Log63	-	9d	Ti
---UT	SN74AUC2G06YZP	CMOS-Logic	Dual inverter buffers/drivers (ODO)	BGA-6	40Log25	-	9d	Ti
---UV	SN74AUC2G07YZP	CMOS-Logic	Dual noninverting buffers/drivers (ODO)	BGA-6	40Log26	-	9d	Ti
---UX	SN74AUC2G80YZP	CMOS-Logic	Dual positive-edge triggered D-type flip-flop	BGA-8	50Log64	-	9d	Ti
+AAT	MAX9724AETC+	LIN-IC	AF PA, 2.7..5.5V, 2x60mW(3V/32Q), shutdown	QFN-12	38	-	9m	Max
+AAU	MAX9724BETC+	LIN-IC	AF PA, 2.7..5.5V, 2x60mW(3V/32Q), shutdown	QFN-12	38	-	9m	Max
+AAW	MAX9718BETB+T	LIN-IC	AF PA, BTL, 2.7..5.5V 1.4W(5V/4Q), select shutdown	DFN-10	37	AFP20	9m	Max
+AAX	MAX9718CETB+T	LIN-IC	AF PA, BTL, 2.7..5.5V, 1.4W(5V/4Q), select shutdown	DFN-10	37	AFP20	9m	Max
+AAY	MAX9718DETBT	LIN-IC	AF PA, BTL, 2.7..5.5V, 1.4W(5V/4Q), select shutdown	DFN-10	37	AFP20	9m	Max
+ABJ	MAX9724CETC+	LIN-IC	AF PA, 2.7..5.5V, 2x60mW(3V/32Q), shutdown	QFN-12	38	-	9m	Max
+ABK	MAX9724DETCT+	LIN-IC	AF PA, 2.7..5.5V, 2x60mW(3V/32Q), shutdown	QFN-12	38	-	9m	Max
+ADH	MAX9724AEBCT	LIN-IC	AF PA, 2.7..5.5V, 2x60mW(3V/32Q), shutdown	BGA-12	39	-	9m	Max
+ADI	MAX9724BEBCT	LIN-IC	AF PA, 2.7..5.5V, 2x60mW(3V/32Q), shutdown	BGA-12	39	-	9m	Max
+ADX	MAX9718BEBL+TG45	LIN-IC	AF PA, BTL, 2.7..5.5V, 1.4W(5V/4Q), select shutdown	BGA-9	39	AFP54	9m	Max
+ADZ	MAX9718CEBL+TG45	LIN-IC	AF PA, BTL, 2.7..5.5V, 1.4W(5V/4Q), select shutdown	BGA-9	39	AFP54	9m	Max



SMD
code

Type

Function

Short description

Case

Pinout Sch. St.Mnf.

SMD code	Type	Function	Short description	Case	Pinout	Sch.	St.Mnf.
+AEA	MAX9718DEBL+TG45	LIN-IC	AF PA, BTL, 2.7..5.5V, 1.4W(5V/4Q), select shutdown	BGA-9	39	AFP54	9m Max
+AEH	MAX9724DEBC+T	LIN-IC	AF PA, 2.7..5.5V, 2x60mW(3V/32Q), shutdown	BGA-12	39	-	9m Max
+AFB	MAX9718EEBL+TG45	LIN-IC	AF PA, BTL, 2.7..5.5V, 1.4W(5V/4Q), select shutdown	BGA-9	39	AFP54	9m Max
+AFC	MAX9718FEEL+TG45	LIN-IC	AF PA, BTL, 2.7..5.5V, 1.4W(5V/4Q), select shutdown	BGA-9	39	AFP54	9m Max
+AFD	MAX9718GEEL+TG45	LIN-IC	AF PA, BTL, 2.7..5.5V, 1.4W(5V/4Q), select shutdown	BGA-9	39	AFP54	9m Max
+AFE	MAX9718HEBL+TG45	LIN-IC	AF PA, BTL, 2.7..5.5V, 1.4W(5V/4Q), select shutdown	BGA-9	39	AFP54	9m Max
+AGE	MAX9724CEBC+T	LIN-IC	AF PA, 2.7..5.5V, 2x60mW(3V/32Q), shutdown	BGA-12	39	-	9m Max
+ASY	MAX9718EETB+T	LIN-IC	AF PA, BTL, 2.7..5.5V, 1.4W(5V/4Q), select shutdown	DFN-10	37	AFP20	9m Max
+ASZ	MAX9718FETB+T	LIN-IC	AF PA, BTL, 2.7..5.5V, 1.4W(5V/4Q), select shutdown	DFN-10	37	AFP20	9m Max
+ATA	MAX9718GETB+T	LIN-IC	AF PA, BTL, 2.7..5.5V, 1.4W(5V/4Q), select shutdown	DFN-10	37	AFP20	9m Max
+ATB	MAX9718HETB+T	LIN-IC	AF PA, BTL, 2.7..5.5V, 1.4W(5V/4Q), select shutdown	DFN-10	37	AFP20	9m Max
00	RP110L081B	LVR-IC	LDO, 0.8V±1%, 150mA, +CE	DFN1010-4	48vm	VR4	9a Ric
00	XC6224A0817R	LVR-IC	LDO, 0.8V±20mV, 150mA, +CE	USPN-4B02	58vm	VR4	9e Tor
00	XC6229D1211R-G	LVR-IC	LDO, 1.2V±20mV, 300mA, +CE	BGA-4	63ba*	VR4	9a Tor
00	XC6221C0817R	LVR-IC	LDO, 0.8V±20mV, 200mA, +CE, PDR	USPN-4	58vm	VR4	9a Tor
01	RP110L091B	LVR-IC	LDO, 0.9V±1%, 150mA, +CE	DFN1010-4	48vm	VR4	9a Ric
01	TS4601E1JT	LIN-IC	AF PA, 2.7..5.5V, 2x75mW(5V/16Q), stand-by, I2C	BGA-16	39	-	9p Ste
01	XC6224A0917R	LVR-IC	LDO, 0.9V±20mV, 150mA, +CE	USPN-4B02	58vm	VR4	9e Tor
01	XC6229D12B1R-G	LVR-IC	LDO, 1.25V±20mV, 300mA, +CE	BGA-4	63ba*	VR4	9a Tor
01	XC6240AB017R-G	LVR-IC	LDO, Dual out, Vout1/Vout2=1.20/1.20V±2%, 150mA, +CE	USPN-6	52xv	VR19	9a Tor
01	XC6240AB01DR-G	LVR-IC	LDO, Dual out, Vout1/Vout2=1.20/1.20V±2%, 150mA, +CE	USP-6B04	73x4	VR19	9a Tor
01	XC6221C0917R	LVR-IC	LDO, 0.9V±20mV, 200mA, +CE, PDR	USPN-4	58vm	VR4	9a Tor
011	EC49222-1-F	LVR-IC	LDO, Dual out, V1=3.0V±2%, V2=3.3V±2%, 250mA, +CE	UFN-6	56xv	VR19	9i Ecom
0113	XC6201132DR	LVR-IC	1.3V±2%, 250mA	USP-6B	49hs	VR1	9b Tor
0114	XC6201142DR	LVR-IC	1.4V±2%, 250mA	USP-6B	49hs	VR1	9b Tor
0115	XC6201152DR	LVR-IC	1.5V±2%, 250mA	USP-6B	49hs	VR1	9b Tor
0116	XC6201162DR	LVR-IC	1.6V±2%, 250mA	USP-6B	49hs	VR1	9b Tor
0117	XC6201172DR	LVR-IC	1.7V±2%, 250mA	USP-6B	49hs	VR1	9b Tor
0118	XC6201182DR	LVR-IC	1.8V±2%, 250mA	USP-6B	49hs	VR1	9b Tor
0119	XC6201192DR	LVR-IC	1.9V±2%, 250mA	USP-6B	49hs	VR1	9b Tor
012	EC49222-2-F	LVR-IC	LDO, Dual out, V1=1.8V±2%, V2=3.0V±2%, 250mA, +CE	UFN-6	56xv	VR19	9i Ecom
0120	XC6201202DR	LVR-IC	2V±2%, 250mA	USP-6B	49hs	VR1	9b Tor
0121	XC6201212DR	LVR-IC	2.1V±2%, 250mA	USP-6B	49hs	VR1	9b Tor
0122	XC6201222DR	LVR-IC	2.2V±2%, 250mA	USP-6B	49hs	VR1	9b Tor
0123	XC6201232DR	LVR-IC	2.3V±2%, 250mA	USP-6B	49hs	VR1	9b Tor
0124	XC6201242DR	LVR-IC	2.4V±2%, 250mA	USP-6B	49hs	VR1	9b Tor
0125	XC6201252DR	LVR-IC	2.5V±2%, 250mA	USP-6B	49hs	VR1	9b Tor
0126	XC6201262DR	LVR-IC	2.6V±2%, 250mA	USP-6B	49hs	VR1	9b Tor
0127	XC6201272DR	LVR-IC	2.7V±2%, 250mA	USP-6B	49hs	VR1	9b Tor
0128	XC6201282DR	LVR-IC	2.8V±2%, 250mA	USP-6B	49hs	VR1	9b Tor
0129	XC6201292DR	LVR-IC	2.9V±2%, 250mA	USP-6B	49hs	VR1	9b Tor
013	EC49222-3-F	LVR-IC	LDO, Dual out, V1=3.0V±2%, V2=3.0V±2%, 250mA, +CE	UFN-6	56xv	VR19	9i Ecom
0130	XC6201302DR	LVR-IC	3V±2%, 250mA	USP-6B	49hs	VR1	9b Tor
0131	XC6201312DR	LVR-IC	3.1V±2%, 250mA	USP-6B	49hs	VR1	9b Tor
0132	XC6201322DR	LVR-IC	3.2V±2%, 250mA	USP-6B	49hs	VR1	9b Tor
0133	XC6201332DR	LVR-IC	3.3V±2%, 250mA	USP-6B	49hs	VR1	9b Tor
0134	XC6201342DR	LVR-IC	3.4V±2%, 250mA	USP-6B	49hs	VR1	9b Tor
0135	XC6201352DR	LVR-IC	3.5V±2%, 250mA	USP-6B	49hs	VR1	9b Tor
0136	XC6201362DR	LVR-IC	3.6V±2%, 250mA	USP-6B	49hs	VR1	9b Tor
0137	XC6201372DR	LVR-IC	3.7V±2%, 250mA	USP-6B	49hs	VR1	9b Tor
0138	XC6201382DR	LVR-IC	3.8V±2%, 250mA	USP-6B	49hs	VR1	9b Tor
0139	XC6201392DR	LVR-IC	3.9V±2%, 250mA	USP-6B	49hs	VR1	9b Tor
014	EC49222-4-F	LVR-IC	LDO, Dual out, V1=1.3V±2%, V2=2.8V±2%, 250mA, +CE	UFN-6	56xv	VR19	9i Ecom
0140	XC6201402DR	LVR-IC	4V±2%, 250mA	USP-6B	49hs	VR1	9b Tor
0141	XC6201412DR	LVR-IC	4.1V±2%, 250mA	USP-6B	49hs	VR1	9b Tor
0142	XC6201422DR	LVR-IC	4.2V±2%, 250mA	USP-6B	49hs	VR1	9b Tor
0143	XC6201432DR	LVR-IC	4.3V±2%, 250mA	USP-6B	49hs	VR1	9b Tor
0144	XC6201442DR	LVR-IC	4.4V±2%, 250mA	USP-6B	49hs	VR1	9b Tor
0145	XC6201452DR	LVR-IC	4.5V±2%, 250mA	USP-6B	49hs	VR1	9b Tor
0146	XC6201462DR	LVR-IC	4.6V±2%, 250mA	USP-6B	49hs	VR1	9b Tor
0147	XC6201472DR	LVR-IC	4.7V±2%, 250mA	USP-6B	49hs	VR1	9b Tor
0148	XC6201482DR	LVR-IC	4.8V±2%, 250mA	USP-6B	49hs	VR1	9b Tor
0149	XC6201492DR	LVR-IC	4.9V±2%, 250mA	USP-6B	49hs	VR1	9b Tor
0150	XC6201502DR	LVR-IC	5V±2%, 250mA	USP-6B	49hs	VR1	9b Tor
0151	XC6201512DR	LVR-IC	5.1V±2%, 250mA	USP-6B	49hs	VR1	9b Tor
0152	XC6201522DR	LVR-IC	5.2V±2%, 250mA	USP-6B	49hs	VR1	9b Tor
0153	XC6201532DR	LVR-IC	5.3V±2%, 250mA	USP-6B	49hs	VR1	9b Tor
0154	XC6201542DR	LVR-IC	5.4V±2%, 250mA	USP-6B	49hs	VR1	9b Tor
0155	XC6201552DR	LVR-IC	5.5V±2%, 250mA	USP-6B	49hs	VR1	9b Tor
0156	XC6201562DR	LVR-IC	5.6V±2%, 250mA	USP-6B	49hs	VR1	9b Tor



SMD code	Type	Function	Short description	Case	Pinout	Sch.	St.	Mnf.
0157	XC6201572DR	LVR-IC	5.7V±2%, 250mA	USP-6B	49hs	VR1	9b	Tor
0158	XC6201582DR	LVR-IC	5.8V±2%, 250mA	USP-6B	49hs	VR1	9b	Tor
0159	XC6201592DR	LVR-IC	5.9V±2%, 250mA	USP-6B	49hs	VR1	9b	Tor
0160	XC6201602DR	LVR-IC	6V±2%, 250mA	USP-6B	49hs	VR1	9b	Tor
01A	EC49222-A-F	LVR-IC	LDO, Dual out, V1=3.3V±2%, V2=3.3V±2%, 250mA, +CE	UFN-6	56xv	VR19	9i	Ecom
01B	EC49222-B-F	LVR-IC	LDO, Dual out, V1=2.8V±2%, V2=3.3V±2%, 250mA, +CE	UFN-6	56xv	VR19	9i	Ecom
01C	EC49222-C-F	LVR-IC	LDO, Dual out, V1=2.5V±2%, V2=3.3V±2%, 250mA, +CE	UFN-6	56xv	VR19	9i	Ecom
01D	EC49222-D-F	LVR-IC	LDO, Dual out, V1=1.8V±2%, V2=3.3V±2%, 250mA, +CE	UFN-6	56xv	VR19	9i	Ecom
01E	EC49222-E-F	LVR-IC	LDO, Dual out, V1=1.5V±2%, V2=3.3V±2%, 250mA, +CE	UFN-6	56xv	VR19	9i	Ecom
01F	EC49222-F-F	LVR-IC	LDO, Dual out, V1=1.2V±2%, V2=3.3V±2%, 250mA, +CE	UFN-6	56xv	VR19	9i	Ecom
01G	EC49222-G-F	LVR-IC	LDO, Dual out, V1=2.8V±2%, V2=2.8V±2%, 250mA, +CE	UFN-6	56xv	VR19	9i	Ecom
01H	EC49222-H-F	LVR-IC	LDO, Dual out, V1=2.5V±2%, V2=2.8V±2%, 250mA, +CE	UFN-6	56xv	VR19	9i	Ecom
01J	EC49222-J-F	LVR-IC	LDO, Dual out, V1=1.8V±2%, V2=2.8V±2%, 250mA, +CE	UFN-6	56xv	VR19	9i	Ecom
01K	EC49222-K-F	LVR-IC	LDO, Dual out, V1=1.5V±2%, V2=2.8V±2%, 250mA, +CE	UFN-6	56xv	VR19	9i	Ecom
01L	EC49222-L-F	LVR-IC	LDO, Dual out, V1=1.2V±2%, V2=2.8V±2%, 250mA, +CE	UFN-6	56xv	VR19	9i	Ecom
01M	EC49222-M-F	LVR-IC	LDO, Dual out, V1=2.5V±2%, V2=2.5V±2%, 250mA, +CE	UFN-6	56xv	VR19	9i	Ecom
01N	EC49222-N-F	LVR-IC	LDO, Dual out, V1=1.8V±2%, V2=2.5V±2%, 250mA, +CE	UFN-6	56xv	VR19	9i	Ecom
01P	EC49222-P-F	LVR-IC	LDO, Dual out, V1=1.5V±2%, V2=2.5V±2%, 250mA, +CE	UFN-6	56xv	VR19	9i	Ecom
01Q	EC49222-Q-F	LVR-IC	LDO, Dual out, V1=1.2V±2%, V2=2.5V±2%, 250mA, +CE	UFN-6	56xv	VR19	9i	Ecom
01R	EC49222-R-F	LVR-IC	LDO, Dual out, V1=1.8V±2%, V2=1.8V±2%, 250mA, +CE	UFN-6	56xv	VR19	9i	Ecom
01S	EC49222-S-F	LVR-IC	LDO, Dual out, V1=1.5V±2%, V2=1.8V±2%, 250mA, +CE	UFN-6	56xv	VR19	9i	Ecom
01T	EC49222-T-F	LVR-IC	LDO, Dual out, V1=1.2V±2%, V2=1.8V±2%, 250mA, +CE	UFN-6	56xv	VR19	9i	Ecom
01U	EC49222-U-F	LVR-IC	LDO, Dual out, V1=1.5V±2%, V2=1.5V±2%, 250mA, +CE	UFN-6	56xv	VR19	9i	Ecom
01V	EC49222-V-F	LVR-IC	LDO, Dual out, V1=1.2V±2%, V2=1.5V±2%, 250mA, +CE	UFN-6	56xv	VR19	9i	Ecom
01W	EC49222-W-F	LVR-IC	LDO, Dual out, V1=2.85V±2%, V2=2.85V±2%, 250mA, +CE	UFN-6	56xv	VR19	9i	Ecom
02	RP110L101B	LVR-IC	LDO, 1.0V±1%, 150mA, +CE	DFN1010-4	48vm	VR4	9a	Ric
02	XC6223A1219R-G	LVR-IC	LDO, 1.2V±20mV, 300mA, +CE	USPQ-4B03	48vm	VR4	9a	Tor
02	XC6224A1017R	LVR-IC	LDO, 1.0V±20mV, 150mA, +CE	USPN-4B02	58vm	VR4	9e	Tor
02	XC6229D1311R-G	LVR-IC	LDO, 1.3V±20mV, 300mA, +CE	BGA-4	63ba*	VR4	9a	Tor
02	XC6420AB027R-G	LVR-IC	LDO, Dual out, Vout1/Vout2=1.20/1.50V±2%, 150mA, +CE	USPN-6	52xv	VR19	9a	Tor
02	XC6420AB02DR-G	LVR-IC	LDO, Dual out, Vout1/Vout2=1.20/1.50V±2%, 150mA, +CE	USP-B004	73x4	VR19	9a	Tor
02	XC6221C1017R	LVR-IC	LDO, 1V±20mV, 200mA, +CE, PDR	USPN-4	58vm	VR4	9a	Tor
024	FAN7024MPX	LIN-IC	AF PA, BTL, 2.3 5.5V, 675mW(5V/8Ω), shutdown	DFN-10	37	AFP15	-	F
02P18	XC6202P182DR	LVR-IC	LDO, 1.8V±2%, 150mA	USP-6B	49hs	VR1	9b	Tor
02P19	XC6202P192DR	LVR-IC	LDO, 1.9V±2%, 150mA	USP-6B	49hs	VR1	9b	Tor
02P20	XC6202P202DR	LVR-IC	LDO, 2V±2%, 150mA	USP-6B	49hs	VR1	9b	Tor
02P21	XC6202P212DR	LVR-IC	LDO, 2.1V±2%, 150mA	USP-6B	49hs	VR1	9b	Tor
02P22	XC6202P222DR	LVR-IC	LDO, 2.2V±2%, 150mA	USP-6B	49hs	VR1	9b	Tor
02P23	XC6202P232DR	LVR-IC	LDO, 2.3V±2%, 150mA	USP-6B	49hs	VR1	9b	Tor
02P24	XC6202P242DR	LVR-IC	LDO, 2.4V±2%, 150mA	USP-6B	49hs	VR1	9b	Tor
02P25	XC6202P252DR	LVR-IC	LDO, 2.5V±2%, 150mA	USP-6B	49hs	VR1	9b	Tor
02P26	XC6202P262DR	LVR-IC	LDO, 2.6V±2%, 150mA	USP-6B	49hs	VR1	9b	Tor
02P27	XC6202P272DR	LVR-IC	LDO, 2.7V±2%, 150mA	USP-6B	49hs	VR1	9b	Tor
02P28	XC6202P282DR	LVR-IC	LDO, 2.8V±2%, 150mA	USP-6B	49hs	VR1	9b	Tor
02P29	XC6202P292DR	LVR-IC	LDO, 2.9V±2%, 150mA	USP-6B	49hs	VR1	9b	Tor
02P30	XC6202P302DR	LVR-IC	LDO, 3V±2%, 150mA	USP-6B	49hs	VR1	9b	Tor
02P31	XC6202P312DR	LVR-IC	LDO, 3.1V±2%, 150mA	USP-6B	49hs	VR1	9b	Tor
02P32	XC6202P322DR	LVR-IC	LDO, 3.2V±2%, 150mA	USP-6B	49hs	VR1	9b	Tor
02P33	XC6202P332DR	LVR-IC	LDO, 3.3V±2%, 150mA	USP-6B	49hs	VR1	9b	Tor
02P34	XC6202P342DR	LVR-IC	LDO, 3.4V±2%, 150mA	USP-6B	49hs	VR1	9b	Tor
02P35	XC6202P352DR	LVR-IC	LDO, 3.5V±2%, 150mA	USP-6B	49hs	VR1	9b	Tor
02P36	XC6202P362DR	LVR-IC	LDO, 3.6V±2%, 150mA	USP-6B	49hs	VR1	9b	Tor
02P37	XC6202P372DR	LVR-IC	LDO, 3.7V±2%, 150mA	USP-6B	49hs	VR1	9b	Tor
02P38	XC6202P382DR	LVR-IC	LDO, 3.8V±2%, 150mA	USP-6B	49hs	VR1	9b	Tor
02P39	XC6202P392DR	LVR-IC	LDO, 3.9V±2%, 150mA	USP-6B	49hs	VR1	9b	Tor
02P40	XC6202P402DR	LVR-IC	LDO, 4V±2%, 150mA	USP-6B	49hs	VR1	9b	Tor
02P41	XC6202P412DR	LVR-IC	LDO, 4.1V±2%, 150mA	USP-6B	49hs	VR1	9b	Tor
02P42	XC6202P422DR	LVR-IC	LDO, 4.2V±2%, 150mA	USP-6B	49hs	VR1	9b	Tor
02P43	XC6202P432DR	LVR-IC	LDO, 4.3V±2%, 150mA	USP-6B	49hs	VR1	9b	Tor
02P44	XC6202P442DR	LVR-IC	LDO, 4.4V±2%, 150mA	USP-6B	49hs	VR1	9b	Tor
02P45	XC6202P452DR	LVR-IC	LDO, 4.5V±2%, 150mA	USP-6B	49hs	VR1	9b	Tor
02P46	XC6202P462DR	LVR-IC	LDO, 4.6V±2%, 150mA	USP-6B	49hs	VR1	9b	Tor
02P47	XC6202P472DR	LVR-IC	LDO, 4.7V±2%, 150mA	USP-6B	49hs	VR1	9b	Tor
02P48	XC6202P482DR	LVR-IC	LDO, 4.8V±2%, 150mA	USP-6B	49hs	VR1	9b	Tor
02P49	XC6202P492DR	LVR-IC	LDO, 4.9V±2%, 150mA	USP-6B	49hs	VR1	9b	Tor
02P50	XC6202P502DR	LVR-IC	LDO, 5V±2%, 150mA	USP-6B	49hs	VR1	9b	Tor
02P51	XC6202P512DR	LVR-IC	LDO, 5.1V±2%, 150mA	USP-6B	49hs	VR1	9b	Tor
02P52	XC6202P522DR	LVR-IC	LDO, 5.2V±2%, 150mA	USP-6B	49hs	VR1	9b	Tor
02P53	XC6202P532DR	LVR-IC	LDO, 5.3V±2%, 150mA	USP-6B	49hs	VR1	9b	Tor
02P54	XC6202P542DR	LVR-IC	LDO, 5.4V±2%, 150mA	USP-6B	49hs	VR1	9b	Tor



SMD code	Type	Function	Short description	Case	Pinout	Sch.	St.	Mnf.
02P55	XC6202P552DR	LVR-IC	LDO, 5.5V±2%, 150mA	USP-6B	49hs	VR1	9b	Tor
02P56	XC6202P562DR	LVR-IC	LDO, 5.6V±2%, 150mA	USP-6B	49hs	VR1	9b	Tor
02P57	XC6202P572DR	LVR-IC	LDO, 5.7V±2%, 150mA	USP-6B	49hs	VR1	9b	Tor
02P58	XC6202P582DR	LVR-IC	LDO, 5.8V±2%, 150mA	USP-6B	49hs	VR1	9b	Tor
02P59	XC6202P592DR	LVR-IC	LDO, 5.9V±2%, 150mA	USP-6B	49hs	VR1	9b	Tor
02P60	XC6202P602DR	LVR-IC	LDO, 6V±2%, 150mA	USP-6B	49hs	VR1	9b	Tor
02P61	XC6202P612DR	LVR-IC	LDO, 6.1V±2%, 150mA	USP-6B	49hs	VR1	9b	Tor
02P62	XC6202P622DR	LVR-IC	LDO, 6.2V±2%, 150mA	USP-6B	49hs	VR1	9b	Tor
02P63	XC6202P632DR	LVR-IC	LDO, 6.3V±2%, 150mA	USP-6B	49hs	VR1	9b	Tor
02P64	XC6202P642DR	LVR-IC	LDO, 6.4V±2%, 150mA	USP-6B	49hs	VR1	9b	Tor
02P65	XC6202P652DR	LVR-IC	LDO, 6.5V±2%, 150mA	USP-6B	49hs	VR1	9b	Tor
02P66	XC6202P662DR	LVR-IC	LDO, 6.6V±2%, 150mA	USP-6B	49hs	VR1	9b	Tor
02P67	XC6202P672DR	LVR-IC	LDO, 6.7V±2%, 150mA	USP-6B	49hs	VR1	9b	Tor
02P68	XC6202P682DR	LVR-IC	LDO, 6.8V±2%, 150mA	USP-6B	49hs	VR1	9b	Tor
02P69	XC6202P692DR	LVR-IC	LDO, 6.9V±2%, 150mA	USP-6B	49hs	VR1	9b	Tor
02P70	XC6202P702DR	LVR-IC	LDO, 7V±2%, 150mA	USP-6B	49hs	VR1	9b	Tor
02P71	XC6202P712DR	LVR-IC	LDO, 7.1V±2%, 150mA	USP-6B	49hs	VR1	9b	Tor
02P72	XC6202P722DR	LVR-IC	LDO, 7.2V±2%, 150mA	USP-6B	49hs	VR1	9b	Tor
02P73	XC6202P732DR	LVR-IC	LDO, 7.3V±2%, 150mA	USP-6B	49hs	VR1	9b	Tor
02P74	XC6202P742DR	LVR-IC	LDO, 7.4V±2%, 150mA	USP-6B	49hs	VR1	9b	Tor
02P75	XC6202P752DR	LVR-IC	LDO, 7.5V±2%, 150mA	USP-6B	49hs	VR1	9b	Tor
02P76	XC6202P762DR	LVR-IC	LDO, 7.6V±2%, 150mA	USP-6B	49hs	VR1	9b	Tor
02P77	XC6202P772DR	LVR-IC	LDO, 7.7V±2%, 150mA	USP-6B	49hs	VR1	9b	Tor
02P78	XC6202P782DR	LVR-IC	LDO, 7.8V±2%, 150mA	USP-6B	49hs	VR1	9b	Tor
02P79	XC6202P792DR	LVR-IC	LDO, 7.9V±2%, 150mA	USP-6B	49hs	VR1	9b	Tor
02P80	XC6202P802DR	LVR-IC	LDO, 8V±2%, 150mA	USP-6B	49hs	VR1	9b	Tor
02P81	XC6202P812DR	LVR-IC	LDO, 8.1V±2%, 150mA	USP-6B	49hs	VR1	9b	Tor
02P82	XC6202P822DR	LVR-IC	LDO, 8.2V±2%, 150mA	USP-6B	49hs	VR1	9b	Tor
02P83	XC6202P832DR	LVR-IC	LDO, 8.3V±2%, 150mA	USP-6B	49hs	VR1	9b	Tor
02P84	XC6202P842DR	LVR-IC	LDO, 8.4V±2%, 150mA	USP-6B	49hs	VR1	9b	Tor
02P85	XC6202P852DR	LVR-IC	LDO, 8.5V±2%, 150mA	USP-6B	49hs	VR1	9b	Tor
02P86	XC6202P862DR	LVR-IC	LDO, 8.6V±2%, 150mA	USP-6B	49hs	VR1	9b	Tor
02P87	XC6202P872DR	LVR-IC	LDO, 8.7V±2%, 150mA	USP-6B	49hs	VR1	9b	Tor
02P88	XC6202P882DR	LVR-IC	LDO, 8.8V±2%, 150mA	USP-6B	49hs	VR1	9b	Tor
02P89	XC6202P892DR	LVR-IC	LDO, 8.9V±2%, 150mA	USP-6B	49hs	VR1	9b	Tor
02P90	XC6202P902DR	LVR-IC	LDO, 9V±2%, 150mA	USP-6B	49hs	VR1	9b	Tor
02P91	XC6202P912DR	LVR-IC	LDO, 9.1V±2%, 150mA	USP-6B	49hs	VR1	9b	Tor
02P92	XC6202P922DR	LVR-IC	LDO, 9.2V±2%, 150mA	USP-6B	49hs	VR1	9b	Tor
02P93	XC6202P932DR	LVR-IC	LDO, 9.3V±2%, 150mA	USP-6B	49hs	VR1	9b	Tor
02P94	XC6202P942DR	LVR-IC	LDO, 9.4V±2%, 150mA	USP-6B	49hs	VR1	9b	Tor
02P95	XC6202P952DR	LVR-IC	LDO, 9.5V±2%, 150mA	USP-6B	49hs	VR1	9b	Tor
02P96	XC6202P962DR	LVR-IC	LDO, 9.6V±2%, 150mA	USP-6B	49hs	VR1	9b	Tor
02P97	XC6202P972DR	LVR-IC	LDO, 9.7V±2%, 150mA	USP-6B	49hs	VR1	9b	Tor
02P98	XC6202P982DR	LVR-IC	LDO, 9.8V±2%, 150mA	USP-6B	49hs	VR1	9b	Tor
02P99	XC6202P992DR	LVR-IC	LDO, 9.9V±2%, 150mA	USP-6B	49hs	VR1	9b	Tor
02PA0	XC6202PA02DR	LVR-IC	LDO, 10V±2%, 150mA	USP-6B	49hs	VR1	9b	Tor
02PA1	XC6202PA12DR	LVR-IC	LDO, 10.1V±2%, 150mA	USP-6B	49hs	VR1	9b	Tor
02PA2	XC6202PA22DR	LVR-IC	LDO, 10.2V±2%, 150mA	USP-6B	49hs	VR1	9b	Tor
02PA3	XC6202PA32DR	LVR-IC	LDO, 10.3V±2%, 150mA	USP-6B	49hs	VR1	9b	Tor
02PA4	XC6202PA42DR	LVR-IC	LDO, 10.4V±2%, 150mA	USP-6B	49hs	VR1	9b	Tor
02PA5	XC6202PA52DR	LVR-IC	LDO, 10.5V±2%, 150mA	USP-6B	49hs	VR1	9b	Tor
02PA6	XC6202PA62DR	LVR-IC	LDO, 10.6V±2%, 150mA	USP-6B	49hs	VR1	9b	Tor
02PA7	XC6202PA72DR	LVR-IC	LDO, 10.7V±2%, 150mA	USP-6B	49hs	VR1	9b	Tor
02PA8	XC6202PA82DR	LVR-IC	LDO, 10.8V±2%, 150mA	USP-6B	49hs	VR1	9b	Tor
02PA9	XC6202PA92DR	LVR-IC	LDO, 10.9V±2%, 150mA	USP-6B	49hs	VR1	9b	Tor
02PB0	XC6202PB02DR	LVR-IC	LDO, 11V±2%, 150mA	USP-6B	49hs	VR1	9b	Tor
02PB1	XC6202PB12DR	LVR-IC	LDO, 11.1V±2%, 150mA	USP-6B	49hs	VR1	9b	Tor
02PB2	XC6202PB22DR	LVR-IC	LDO, 11.2V±2%, 150mA	USP-6B	49hs	VR1	9b	Tor
02PB3	XC6202PB32DR	LVR-IC	LDO, 11.3V±2%, 150mA	USP-6B	49hs	VR1	9b	Tor
02PB4	XC6202PB42DR	LVR-IC	LDO, 11.4V±2%, 150mA	USP-6B	49hs	VR1	9b	Tor
02PB5	XC6202PB52DR	LVR-IC	LDO, 11.5V±2%, 150mA	USP-6B	49hs	VR1	9b	Tor
02PB6	XC6202PB62DR	LVR-IC	LDO, 11.6V±2%, 150mA	USP-6B	49hs	VR1	9b	Tor
02PB7	XC6202PB72DR	LVR-IC	LDO, 11.7V±2%, 150mA	USP-6B	49hs	VR1	9b	Tor
02PB8	XC6202PB82DR	LVR-IC	LDO, 11.8V±2%, 150mA	USP-6B	49hs	VR1	9b	Tor
02PB9	XC6202PB92DR	LVR-IC	LDO, 11.9V±2%, 150mA	USP-6B	49hs	VR1	9b	Tor
02PC0	XC6202PC02DR	LVR-IC	LDO, 12V±2%, 150mA	USP-6B	49hs	VR1	9b	Tor
02PC1	XC6202PC12DR	LVR-IC	LDO, 12.1V±2%, 150mA	USP-6B	49hs	VR1	9b	Tor
02PC2	XC6202PC22DR	LVR-IC	LDO, 12.2V±2%, 150mA	USP-6B	49hs	VR1	9b	Tor
02PC3	XC6202PC32DR	LVR-IC	LDO, 12.3V±2%, 150mA	USP-6B	49hs	VR1	9b	Tor
02PC4	XC6202PC42DR	LVR-IC	LDO, 12.4V±2%, 150mA	USP-6B	49hs	VR1	9b	Tor



SMD code	Type	Function	Short description	Case	Pinout	Sch.	St.	Mnf.
02PC5	XC6202PC52DR	LVR-IC	LDO, 12.5V±2%, 150mA	USP-6B	49hs	VR1	9b	Tor
02PC6	XC6202PC62DR	LVR-IC	LDO, 12.6V±2%, 150mA	USP-6B	49hs	VR1	9b	Tor
02PC7	XC6202PC72DR	LVR-IC	LDO, 12.7V±2%, 150mA	USP-6B	49hs	VR1	9b	Tor
02PC8	XC6202PC82DR	LVR-IC	LDO, 12.8V±2%, 150mA	USP-6B	49hs	VR1	9b	Tor
02PC9	XC6202PC92DR	LVR-IC	LDO, 12.9V±2%, 150mA	USP-6B	49hs	VR1	9b	Tor
02PD0	XC6202PD02DR	LVR-IC	LDO, 13V±2%, 150mA	USP-6B	49hs	VR1	9b	Tor
02PD1	XC6202PD12DR	LVR-IC	LDO, 13.1V±2%, 150mA	USP-6B	49hs	VR1	9b	Tor
02PD2	XC6202PD22DR	LVR-IC	LDO, 13.2V±2%, 150mA	USP-6B	49hs	VR1	9b	Tor
02PD3	XC6202PD32DR	LVR-IC	LDO, 13.3V±2%, 150mA	USP-6B	49hs	VR1	9b	Tor
02PD4	XC6202PD42DR	LVR-IC	LDO, 13.4V±2%, 150mA	USP-6B	49hs	VR1	9b	Tor
02PD5	XC6202PD52DR	LVR-IC	LDO, 13.5V±2%, 150mA	USP-6B	49hs	VR1	9b	Tor
02PD6	XC6202PD62DR	LVR-IC	LDO, 13.6V±2%, 150mA	USP-6B	49hs	VR1	9b	Tor
02PD7	XC6202PD72DR	LVR-IC	LDO, 13.7V±2%, 150mA	USP-6B	49hs	VR1	9b	Tor
02PD8	XC6202PD82DR	LVR-IC	LDO, 13.8V±2%, 150mA	USP-6B	49hs	VR1	9b	Tor
02PD9	XC6202PD92DR	LVR-IC	LDO, 13.9V±2%, 150mA	USP-6B	49hs	VR1	9b	Tor
02PE0	XC6202PE02DR	LVR-IC	LDO, 14V±2%, 150mA	USP-6B	49hs	VR1	9b	Tor
02PE1	XC6202PE12DR	LVR-IC	LDO, 14.1V±2%, 150mA	USP-6B	49hs	VR1	9b	Tor
02PE2	XC6202PE22DR	LVR-IC	LDO, 14.2V±2%, 150mA	USP-6B	49hs	VR1	9b	Tor
02PE3	XC6202PE32DR	LVR-IC	LDO, 14.3V±2%, 150mA	USP-6B	49hs	VR1	9b	Tor
02PE4	XC6202PE42DR	LVR-IC	LDO, 14.4V±2%, 150mA	USP-6B	49hs	VR1	9b	Tor
02PE5	XC6202PE52DR	LVR-IC	LDO, 14.5V±2%, 150mA	USP-6B	49hs	VR1	9b	Tor
02PE6	XC6202PE62DR	LVR-IC	LDO, 14.6V±2%, 150mA	USP-6B	49hs	VR1	9b	Tor
02PE7	XC6202PE72DR	LVR-IC	LDO, 14.7V±2%, 150mA	USP-6B	49hs	VR1	9b	Tor
02PE8	XC6202PE82DR	LVR-IC	LDO, 14.8V±2%, 150mA	USP-6B	49hs	VR1	9b	Tor
02PE9	XC6202PE92DR	LVR-IC	LDO, 14.9V±2%, 150mA	USP-6B	49hs	VR1	9b	Tor
02PF0	XC6202PF02DR	LVR-IC	LDO, 15V±2%, 150mA	USP-6B	49hs	VR1	9b	Tor
02PF1	XC6202PF12DR	LVR-IC	LDO, 15.1V±2%, 150mA	USP-6B	49hs	VR1	9b	Tor
02PF2	XC6202PF22DR	LVR-IC	LDO, 15.2V±2%, 150mA	USP-6B	49hs	VR1	9b	Tor
02PF3	XC6202PF32DR	LVR-IC	LDO, 15.3V±2%, 150mA	USP-6B	49hs	VR1	9b	Tor
02PF4	XC6202PF42DR	LVR-IC	LDO, 15.4V±2%, 150mA	USP-6B	49hs	VR1	9b	Tor
02PF5	XC6202PF52DR	LVR-IC	LDO, 15.5V±2%, 150mA	USP-6B	49hs	VR1	9b	Tor
02PF6	XC6202PF62DR	LVR-IC	LDO, 15.6V±2%, 150mA	USP-6B	49hs	VR1	9b	Tor
02PF7	XC6202PF72DR	LVR-IC	LDO, 15.7V±2%, 150mA	USP-6B	49hs	VR1	9b	Tor
02PF8	XC6202PF82DR	LVR-IC	LDO, 15.8V±2%, 150mA	USP-6B	49hs	VR1	9b	Tor
02PF9	XC6202PF92DR	LVR-IC	LDO, 15.9V±2%, 150mA	USP-6B	49hs	VR1	9b	Tor
02PG0	XC6202PG02DR	LVR-IC	LDO, 16V±2%, 150mA	USP-6B	49hs	VR1	9b	Tor
02PG1	XC6202PG12DR	LVR-IC	LDO, 16.1V±2%, 150mA	USP-6B	49hs	VR1	9b	Tor
02PG2	XC6202PG22DR	LVR-IC	LDO, 16.2V±2%, 150mA	USP-6B	49hs	VR1	9b	Tor
02PG3	XC6202PG32DR	LVR-IC	LDO, 16.3V±2%, 150mA	USP-6B	49hs	VR1	9b	Tor
02PG4	XC6202PG42DR	LVR-IC	LDO, 16.4V±2%, 150mA	USP-6B	49hs	VR1	9b	Tor
02PG5	XC6202PG52DR	LVR-IC	LDO, 16.5V±2%, 150mA	USP-6B	49hs	VR1	9b	Tor
02PG6	XC6202PG62DR	LVR-IC	LDO, 16.6V±2%, 150mA	USP-6B	49hs	VR1	9b	Tor
02PG7	XC6202PG72DR	LVR-IC	LDO, 16.7V±2%, 150mA	USP-6B	49hs	VR1	9b	Tor
02PG8	XC6202PG82DR	LVR-IC	LDO, 16.8V±2%, 150mA	USP-6B	49hs	VR1	9b	Tor
02PG9	XC6202PG92DR	LVR-IC	LDO, 16.9V±2%, 150mA	USP-6B	49hs	VR1	9b	Tor
02PH0	XC6202PH02DR	LVR-IC	LDO, 17V±2%, 150mA	USP-6B	49hs	VR1	9b	Tor
02PH1	XC6202PH12DR	LVR-IC	LDO, 17.1V±2%, 150mA	USP-6B	49hs	VR1	9b	Tor
02PH2	XC6202PH22DR	LVR-IC	LDO, 17.2V±2%, 150mA	USP-6B	49hs	VR1	9b	Tor
02PH3	XC6202PH32DR	LVR-IC	LDO, 17.3V±2%, 150mA	USP-6B	49hs	VR1	9b	Tor
02PH4	XC6202PH42DR	LVR-IC	LDO, 17.4V±2%, 150mA	USP-6B	49hs	VR1	9b	Tor
02PH5	XC6202PH52DR	LVR-IC	LDO, 17.5V±2%, 150mA	USP-6B	49hs	VR1	9b	Tor
02PH6	XC6202PH62DR	LVR-IC	LDO, 17.6V±2%, 150mA	USP-6B	49hs	VR1	9b	Tor
02PH7	XC6202PH72DR	LVR-IC	LDO, 17.7V±2%, 150mA	USP-6B	49hs	VR1	9b	Tor
02PH8	XC6202PH82DR	LVR-IC	LDO, 17.8V±2%, 150mA	USP-6B	49hs	VR1	9b	Tor
02PH9	XC6202PH92DR	LVR-IC	LDO, 17.9V±2%, 150mA	USP-6B	49hs	VR1	9b	Tor
02PJ0	XC6202PJ02DR	LVR-IC	LDO, 18V±2%, 150mA	USP-6B	49hs	VR1	9b	Tor
03	RP110L111B	LVR-IC	LDO, 1.1V±1%, 150mA, +CE	DFN1010-4	48vm	VR4	9a	Ric
03	XC6223A1319R-G	LVR-IC	LDO, 1.3V±20mV, 300mA, +CE	USPQ-4B03	48vm	VR4	9a	Tor
03	XC6224A1117R	LVR-IC	LDO, 1.1V±20mV, 150mA, +CE	USPN-4B02	58vm	VR4	9a	Tor
03	XC6229D13B1R-G	LVR-IC	LDO, 1.35V±20mV, 300mA, +CE	BGA-4	63ba*	VR4	9a	Tor
03	XC6420AB037R-G	LVR-IC	LDO, Dual out, Vout1/Vout2=1.20/2.50V±2%, 150mA, +CE	USPN-6	52xv	VR19	9a	Tor
03	XC6420AB03DR-G	LVR-IC	LDO, Dual out, Vout1/Vout2=1.20/2.50V±2%, 150mA, +CE	USP-6B04	73x4	VR19	9a	Tor
03	XC6221C1117R	LVR-IC	LDO, 1.1V±20mV, 200mA, +CE, PDR	USPN-4	58vm	VR4	9a	Tor
04	RP110L121B	LVR-IC	LDO, 1.2V±1%, 150mA, +CE	DFN1010-4	48vm	VR4	9a	Ric
04	XC6223A1419R-G	LVR-IC	LDO, 1.4V±20mV, 300mA, +CE	USPQ-4B03	48vm	VR4	9a	Tor
04	XC6224A1217R	LVR-IC	LDO, 1.2V±20mV, 150mA, +CE	USPN-4B02	58vm	VR4	9a	Tor
04	XC6229D1411R-G	LVR-IC	LDO, 1.4V±20mV, 300mA, +CE	BGA-4	63ba*	VR4	9a	Tor
04	XC6420AB047R-G	LVR-IC	LDO, Dual out, Vout1/Vout2=1.20/2.85V±2%, 150mA, +CE	USPN-6	52xv	VR19	9a	Tor
04	XC6420AB04DR-G	LVR-IC	LDO, Dual out, Vout1/Vout2=1.20/2.85V±2%, 150mA, +CE	USP-6B04	73x4	VR19	9a	Tor
04	XC6221C1217R	LVR-IC	LDO, 1.2V±20mV, 200mA, +CE, PDR	USPN-4	58vm	VR4	9a	Tor



SMD code	Type	Function	Short description	Case	Pinout	Sch.	St.Mnf.
0410	SI2704-A10-GM	LIN-IC	AF PA, BTL, class-D, 2.7..6.6V, 5W(5V/3Q), shutdown, I2C	QFN-24	38	-	9m Sib
04A18	XC6204A182DR	LVR-IC	LDO, 1.8V±2%, 150mA, +CE, PDR	USP-6B	49hq	VR4	9b Tor
04A19	XC6204A192DR	LVR-IC	LDO, 1.9V±2%, 150mA, +CE, PDR	USP-6B	49hq	VR4	9b Tor
04A1L	XC6204A18ADR	LVR-IC	LDO, 1.85V±2%, 150mA, +CE, PDR	USP-6B	49hq	VR4	9b Tor
04A1M	XC6204A19ADR	LVR-IC	LDO, 1.95V±2%, 150mA, +CE, PDR	USP-6B	49hq	VR4	9b Tor
04A20	XC6204A202DR	LVR-IC	LDO, 2V±2%, 150mA, +CE, PDR	USP-6B	49hq	VR4	9b Tor
04A21	XC6204A212DR	LVR-IC	LDO, 2.1V±2%, 150mA, +CE, PDR	USP-6B	49hq	VR4	9b Tor
04A22	XC6204A222DR	LVR-IC	LDO, 2.2V±2%, 150mA, +CE, PDR	USP-6B	49hq	VR4	9b Tor
04A23	XC6204A232DR	LVR-IC	LDO, 2.3V±2%, 150mA, +CE, PDR	USP-6B	49hq	VR4	9b Tor
04A24	XC6204A242DR	LVR-IC	LDO, 2.4V±2%, 150mA, +CE, PDR	USP-6B	49hq	VR4	9b Tor
04A25	XC6204A252DR	LVR-IC	LDO, 2.5V±2%, 150mA, +CE, PDR	USP-6B	49hq	VR4	9b Tor
04A26	XC6204A262DR	LVR-IC	LDO, 2.6V±2%, 150mA, +CE, PDR	USP-6B	49hq	VR4	9b Tor
04A27	XC6204A272DR	LVR-IC	LDO, 2.7V±2%, 150mA, +CE, PDR	USP-6B	49hq	VR4	9b Tor
04A28	XC6204A282DR	LVR-IC	LDO, 2.8V±2%, 150mA, +CE, PDR	USP-6B	49hq	VR4	9b Tor
04A29	XC6204A292DR	LVR-IC	LDO, 2.9V±2%, 150mA, +CE, PDR	USP-6B	49hq	VR4	9b Tor
04A2A	XC6204A20ADR	LVR-IC	LDO, 2.05V±2%, 150mA, +CE, PDR	USP-6B	49hq	VR4	9b Tor
04A2B	XC6204A21ADR	LVR-IC	LDO, 2.15V±2%, 150mA, +CE, PDR	USP-6B	49hq	VR4	9b Tor
04A2C	XC6204A22ADR	LVR-IC	LDO, 2.25V±2%, 150mA, +CE, PDR	USP-6B	49hq	VR4	9b Tor
04A2D	XC6204A23ADR	LVR-IC	LDO, 2.35V±2%, 150mA, +CE, PDR	USP-6B	49hq	VR4	9b Tor
04A2E	XC6204A24ADR	LVR-IC	LDO, 2.45V±2%, 150mA, +CE, PDR	USP-6B	49hq	VR4	9b Tor
04A2F	XC6204A25ADR	LVR-IC	LDO, 2.55V±2%, 150mA, +CE, PDR	USP-6B	49hq	VR4	9b Tor
04A2H	XC6204A26ADR	LVR-IC	LDO, 2.65V±2%, 150mA, +CE, PDR	USP-6B	49hq	VR4	9b Tor
04A2K	XC6204A27ADR	LVR-IC	LDO, 2.75V±2%, 150mA, +CE, PDR	USP-6B	49hq	VR4	9b Tor
04A2L	XC6204A28ADR	LVR-IC	LDO, 2.85V±2%, 150mA, +CE, PDR	USP-6B	49hq	VR4	9b Tor
04A2M	XC6204A29ADR	LVR-IC	LDO, 2.95V±2%, 150mA, +CE, PDR	USP-6B	49hq	VR4	9b Tor
04A30	XC6204A302DR	LVR-IC	LDO, 3V±2%, 150mA, +CE, PDR	USP-6B	49hq	VR4	9b Tor
04A31	XC6204A312DR	LVR-IC	LDO, 3.1V±2%, 150mA, +CE, PDR	USP-6B	49hq	VR4	9b Tor
04A32	XC6204A322DR	LVR-IC	LDO, 3.2V±2%, 150mA, +CE, PDR	USP-6B	49hq	VR4	9b Tor
04A33	XC6204A332DR	LVR-IC	LDO, 3.3V±2%, 150mA, +CE, PDR	USP-6B	49hq	VR4	9b Tor
04A34	XC6204A342DR	LVR-IC	LDO, 3.4V±2%, 150mA, +CE, PDR	USP-6B	49hq	VR4	9b Tor
04A35	XC6204A352DR	LVR-IC	LDO, 3.5V±2%, 150mA, +CE, PDR	USP-6B	49hq	VR4	9b Tor
04A36	XC6204A362DR	LVR-IC	LDO, 3.6V±2%, 150mA, +CE, PDR	USP-6B	49hq	VR4	9b Tor
04A37	XC6204A372DR	LVR-IC	LDO, 3.7V±2%, 150mA, +CE, PDR	USP-6B	49hq	VR4	9b Tor
04A38	XC6204A382DR	LVR-IC	LDO, 3.8V±2%, 150mA, +CE, PDR	USP-6B	49hq	VR4	9b Tor
04A39	XC6204A392DR	LVR-IC	LDO, 3.9V±2%, 150mA, +CE, PDR	USP-6B	49hq	VR4	9b Tor
04A3A	XC6204A30ADR	LVR-IC	LDO, 3.05V±2%, 150mA, +CE, PDR	USP-6B	49hq	VR4	9b Tor
04A3B	XC6204A31ADR	LVR-IC	LDO, 3.15V±2%, 150mA, +CE, PDR	USP-6B	49hq	VR4	9b Tor
04A3C	XC6204A32ADR	LVR-IC	LDO, 3.25V±2%, 150mA, +CE, PDR	USP-6B	49hq	VR4	9b Tor
04A3D	XC6204A33ADR	LVR-IC	LDO, 3.35V±2%, 150mA, +CE, PDR	USP-6B	49hq	VR4	9b Tor
04A3E	XC6204A34ADR	LVR-IC	LDO, 3.45V±2%, 150mA, +CE, PDR	USP-6B	49hq	VR4	9b Tor
04A3F	XC6204A35ADR	LVR-IC	LDO, 3.55V±2%, 150mA, +CE, PDR	USP-6B	49hq	VR4	9b Tor
04A3H	XC6204A36ADR	LVR-IC	LDO, 3.65V±2%, 150mA, +CE, PDR	USP-6B	49hq	VR4	9b Tor
04A3K	XC6204A37ADR	LVR-IC	LDO, 3.75V±2%, 150mA, +CE, PDR	USP-6B	49hq	VR4	9b Tor
04A3L	XC6204A38ADR	LVR-IC	LDO, 3.85V±2%, 150mA, +CE, PDR	USP-6B	49hq	VR4	9b Tor
04A3M	XC6204A39ADR	LVR-IC	LDO, 3.95V±2%, 150mA, +CE, PDR	USP-6B	49hq	VR4	9b Tor
04A40	XC6204A402DR	LVR-IC	LDO, 4V±2%, 150mA, +CE, PDR	USP-6B	49hq	VR4	9b Tor
04A41	XC6204A412DR	LVR-IC	LDO, 4.1V±2%, 150mA, +CE, PDR	USP-6B	49hq	VR4	9b Tor
04A42	XC6204A422DR	LVR-IC	LDO, 4.2V±2%, 150mA, +CE, PDR	USP-6B	49hq	VR4	9b Tor
04A43	XC6204A432DR	LVR-IC	LDO, 4.3V±2%, 150mA, +CE, PDR	USP-6B	49hq	VR4	9b Tor
04A44	XC6204A442DR	LVR-IC	LDO, 4.4V±2%, 150mA, +CE, PDR	USP-6B	49hq	VR4	9b Tor
04A45	XC6204A452DR	LVR-IC	LDO, 4.5V±2%, 150mA, +CE, PDR	USP-6B	49hq	VR4	9b Tor
04A46	XC6204A462DR	LVR-IC	LDO, 4.6V±2%, 150mA, +CE, PDR	USP-6B	49hq	VR4	9b Tor
04A47	XC6204A472DR	LVR-IC	LDO, 4.7V±2%, 150mA, +CE, PDR	USP-6B	49hq	VR4	9b Tor
04A48	XC6204A482DR	LVR-IC	LDO, 4.8V±2%, 150mA, +CE, PDR	USP-6B	49hq	VR4	9b Tor
04A49	XC6204A492DR	LVR-IC	LDO, 4.9V±2%, 150mA, +CE, PDR	USP-6B	49hq	VR4	9b Tor
04A4A	XC6204A40ADR	LVR-IC	LDO, 4.05V±2%, 150mA, +CE, PDR	USP-6B	49hq	VR4	9b Tor
04A4B	XC6204A41ADR	LVR-IC	LDO, 4.15V±2%, 150mA, +CE, PDR	USP-6B	49hq	VR4	9b Tor
04A4C	XC6204A42ADR	LVR-IC	LDO, 4.25V±2%, 150mA, +CE, PDR	USP-6B	49hq	VR4	9b Tor
04A4D	XC6204A43ADR	LVR-IC	LDO, 4.35V±2%, 150mA, +CE, PDR	USP-6B	49hq	VR4	9b Tor
04A4E	XC6204A44ADR	LVR-IC	LDO, 4.45V±2%, 150mA, +CE, PDR	USP-6B	49hq	VR4	9b Tor
04A4F	XC6204A45ADR	LVR-IC	LDO, 4.55V±2%, 150mA, +CE, PDR	USP-6B	49hq	VR4	9b Tor
04A4H	XC6204A46ADR	LVR-IC	LDO, 4.65V±2%, 150mA, +CE, PDR	USP-6B	49hq	VR4	9b Tor
04A4K	XC6204A47ADR	LVR-IC	LDO, 4.75V±2%, 150mA, +CE, PDR	USP-6B	49hq	VR4	9b Tor
04A4L	XC6204A48ADR	LVR-IC	LDO, 4.85V±2%, 150mA, +CE, PDR	USP-6B	49hq	VR4	9b Tor
04A4M	XC6204A49ADR	LVR-IC	LDO, 4.95V±2%, 150mA, +CE, PDR	USP-6B	49hq	VR4	9b Tor
04A50	XC6204A502DR	LVR-IC	LDO, 5V±2%, 150mA, +CE, PDR	USP-6B	49hq	VR4	9b Tor
04A51	XC6204A512DR	LVR-IC	LDO, 5.1V±2%, 150mA, +CE, PDR	USP-6B	49hq	VR4	9b Tor
04A52	XC6204A522DR	LVR-IC	LDO, 5.2V±2%, 150mA, +CE, PDR	USP-6B	49hq	VR4	9b Tor
04A53	XC6204A532DR	LVR-IC	LDO, 5.3V±2%, 150mA, +CE, PDR	USP-6B	49hq	VR4	9b Tor
04A54	XC6204A542DR	LVR-IC	LDO, 5.4V±2%, 150mA, +CE, PDR	USP-6B	49hq	VR4	9b Tor



SMD code	Type	Function	Short description	Case	Pinout	Sch.	St.	Mnf.
04A55	XC6204A552DR	LVR-IC	LDO, 5.5V±2%, 150mA, +CE, PDR	USP-6B	49hq	VR4	9b	Tor
04A56	XC6204A562DR	LVR-IC	LDO, 5.6V±2%, 150mA, +CE, PDR	USP-6B	49hq	VR4	9b	Tor
04A57	XC6204A572DR	LVR-IC	LDO, 5.7V±2%, 150mA, +CE, PDR	USP-6B	49hq	VR4	9b	Tor
04A58	XC6204A582DR	LVR-IC	LDO, 5.8V±2%, 150mA, +CE, PDR	USP-6B	49hq	VR4	9b	Tor
04A59	XC6204A592DR	LVR-IC	LDO, 5.9V±2%, 150mA, +CE, PDR	USP-6B	49hq	VR4	9b	Tor
04A5A	XC6204A50ADR	LVR-IC	LDO, 5.05V±2%, 150mA, +CE, PDR	USP-6B	49hq	VR4	9b	Tor
04A5B	XC6204A51ADR	LVR-IC	LDO, 5.15V±2%, 150mA, +CE, PDR	USP-6B	49hq	VR4	9b	Tor
04A5C	XC6204A52ADR	LVR-IC	LDO, 5.25V±2%, 150mA, +CE, PDR	USP-6B	49hq	VR4	9b	Tor
04A5D	XC6204A53ADR	LVR-IC	LDO, 5.35V±2%, 150mA, +CE, PDR	USP-6B	49hq	VR4	9b	Tor
04A5E	XC6204A54ADR	LVR-IC	LDO, 5.45V±2%, 150mA, +CE, PDR	USP-6B	49hq	VR4	9b	Tor
04A5F	XC6204A55ADR	LVR-IC	LDO, 5.55V±2%, 150mA, +CE, PDR	USP-6B	49hq	VR4	9b	Tor
04A5H	XC6204A56ADR	LVR-IC	LDO, 5.65V±2%, 150mA, +CE, PDR	USP-6B	49hq	VR4	9b	Tor
04A5K	XC6204A57ADR	LVR-IC	LDO, 5.75V±2%, 150mA, +CE, PDR	USP-6B	49hq	VR4	9b	Tor
04A5L	XC6204A58ADR	LVR-IC	LDO, 5.85V±2%, 150mA, +CE, PDR	USP-6B	49hq	VR4	9b	Tor
04A5M	XC6204A59ADR	LVR-IC	LDO, 5.95V±2%, 150mA, +CE, PDR	USP-6B	49hq	VR4	9b	Tor
04A60	XC6204A602DR	LVR-IC	LDO, 6V±2%, 150mA, +CE, PDR	USP-6B	49hq	VR4	9b	Tor
04B18	XC6204B182DR	LVR-IC	LDO, 1.8V±2%, 150mA, +CE	USP-6B	49hq	VR4	9b	Tor
04B19	XC6204B192DR	LVR-IC	LDO, 1.9V±2%, 150mA, +CE	USP-6B	49hq	VR4	9b	Tor
04B1L	XC6204B18ADR	LVR-IC	LDO, 1.85V±2%, 150mA, +CE	USP-6B	49hq	VR4	9b	Tor
04B1M	XC6204B19ADR	LVR-IC	LDO, 1.95V±2%, 150mA, +CE	USP-6B	49hq	VR4	9b	Tor
04B20	XC6204B202DR	LVR-IC	LDO, 2V±2%, 150mA, +CE	USP-6B	49hq	VR4	9b	Tor
04B21	XC6204B212DR	LVR-IC	LDO, 2.1V±2%, 150mA, +CE	USP-6B	49hq	VR4	9b	Tor
04B22	XC6204B222DR	LVR-IC	LDO, 2.2V±2%, 150mA, +CE	USP-6B	49hq	VR4	9b	Tor
04B23	XC6204B232DR	LVR-IC	LDO, 2.3V±2%, 150mA, +CE	USP-6B	49hq	VR4	9b	Tor
04B24	XC6204B242DR	LVR-IC	LDO, 2.4V±2%, 150mA, +CE	USP-6B	49hq	VR4	9b	Tor
04B25	XC6204B252DR	LVR-IC	LDO, 2.5V±2%, 150mA, +CE	USP-6B	49hq	VR4	9b	Tor
04B26	XC6204B262DR	LVR-IC	LDO, 2.6V±2%, 150mA, +CE	USP-6B	49hq	VR4	9b	Tor
04B27	XC6204B272DR	LVR-IC	LDO, 2.7V±2%, 150mA, +CE	USP-6B	49hq	VR4	9b	Tor
04B28	XC6204B282DR	LVR-IC	LDO, 2.8V±2%, 150mA, +CE	USP-6B	49hq	VR4	9b	Tor
04B29	XC6204B292DR	LVR-IC	LDO, 2.9V±2%, 150mA, +CE	USP-6B	49hq	VR4	9b	Tor
04B2A	XC6204B20ADR	LVR-IC	LDO, 2.05V±2%, 150mA, +CE	USP-6B	49hq	VR4	9b	Tor
04B2B	XC6204B21ADR	LVR-IC	LDO, 2.15V±2%, 150mA, +CE	USP-6B	49hq	VR4	9b	Tor
04B2C	XC6204B22ADR	LVR-IC	LDO, 2.25V±2%, 150mA, +CE	USP-6B	49hq	VR4	9b	Tor
04B2D	XC6204B23ADR	LVR-IC	LDO, 2.35V±2%, 150mA, +CE	USP-6B	49hq	VR4	9b	Tor
04B2E	XC6204B24ADR	LVR-IC	LDO, 2.45V±2%, 150mA, +CE	USP-6B	49hq	VR4	9b	Tor
04B2F	XC6204B25ADR	LVR-IC	LDO, 2.55V±2%, 150mA, +CE	USP-6B	49hq	VR4	9b	Tor
04B2H	XC6204B26ADR	LVR-IC	LDO, 2.65V±2%, 150mA, +CE	USP-6B	49hq	VR4	9b	Tor
04B2K	XC6204B27ADR	LVR-IC	LDO, 2.75V±2%, 150mA, +CE	USP-6B	49hq	VR4	9b	Tor
04B2L	XC6204B28ADR	LVR-IC	LDO, 2.85V±2%, 150mA, +CE	USP-6B	49hq	VR4	9b	Tor
04B2M	XC6204B29ADR	LVR-IC	LDO, 2.95V±2%, 150mA, +CE	USP-6B	49hq	VR4	9b	Tor
04B30	XC6204B302DR	LVR-IC	LDO, 3V±2%, 150mA, +CE	USP-6B	49hq	VR4	9b	Tor
04B31	XC6204B312DR	LVR-IC	LDO, 3.1V±2%, 150mA, +CE	USP-6B	49hq	VR4	9b	Tor
04B32	XC6204B322DR	LVR-IC	LDO, 3.2V±2%, 150mA, +CE	USP-6B	49hq	VR4	9b	Tor
04B33	XC6204B332DR	LVR-IC	LDO, 3.3V±2%, 150mA, +CE	USP-6B	49hq	VR4	9b	Tor
04B34	XC6204B342DR	LVR-IC	LDO, 3.4V±2%, 150mA, +CE	USP-6B	49hq	VR4	9b	Tor
04B35	XC6204B352DR	LVR-IC	LDO, 3.5V±2%, 150mA, +CE	USP-6B	49hq	VR4	9b	Tor
04B36	XC6204B362DR	LVR-IC	LDO, 3.6V±2%, 150mA, +CE	USP-6B	49hq	VR4	9b	Tor
04B37	XC6204B372DR	LVR-IC	LDO, 3.7V±2%, 150mA, +CE	USP-6B	49hq	VR4	9b	Tor
04B38	XC6204B382DR	LVR-IC	LDO, 3.8V±2%, 150mA, +CE	USP-6B	49hq	VR4	9b	Tor
04B39	XC6204B392DR	LVR-IC	LDO, 3.9V±2%, 150mA, +CE	USP-6B	49hq	VR4	9b	Tor
04B3A	XC6204B30ADR	LVR-IC	LDO, 3.05V±2%, 150mA, +CE	USP-6B	49hq	VR4	9b	Tor
04B3B	XC6204B31ADR	LVR-IC	LDO, 3.15V±2%, 150mA, +CE	USP-6B	49hq	VR4	9b	Tor
04B3C	XC6204B32ADR	LVR-IC	LDO, 3.25V±2%, 150mA, +CE	USP-6B	49hq	VR4	9b	Tor
04B3D	XC6204B33ADR	LVR-IC	LDO, 3.35V±2%, 150mA, +CE	USP-6B	49hq	VR4	9b	Tor
04B3E	XC6204B34ADR	LVR-IC	LDO, 3.45V±2%, 150mA, +CE	USP-6B	49hq	VR4	9b	Tor
04B3F	XC6204B35ADR	LVR-IC	LDO, 3.55V±2%, 150mA, +CE	USP-6B	49hq	VR4	9b	Tor
04B3H	XC6204B36ADR	LVR-IC	LDO, 3.65V±2%, 150mA, +CE	USP-6B	49hq	VR4	9b	Tor
04B3K	XC6204B37ADR	LVR-IC	LDO, 3.75V±2%, 150mA, +CE	USP-6B	49hq	VR4	9b	Tor
04B3L	XC6204B38ADR	LVR-IC	LDO, 3.85V±2%, 150mA, +CE	USP-6B	49hq	VR4	9b	Tor
04B3M	XC6204B39ADR	LVR-IC	LDO, 3.95V±2%, 150mA, +CE	USP-6B	49hq	VR4	9b	Tor
04B40	XC6204B402DR	LVR-IC	LDO, 4V±2%, 150mA, +CE	USP-6B	49hq	VR4	9b	Tor
04B41	XC6204B412DR	LVR-IC	LDO, 4.1V±2%, 150mA, +CE	USP-6B	49hq	VR4	9b	Tor
04B42	XC6204B422DR	LVR-IC	LDO, 4.2V±2%, 150mA, +CE	USP-6B	49hq	VR4	9b	Tor
04B43	XC6204B432DR	LVR-IC	LDO, 4.3V±2%, 150mA, +CE	USP-6B	49hq	VR4	9b	Tor
04B44	XC6204B442DR	LVR-IC	LDO, 4.4V±2%, 150mA, +CE	USP-6B	49hq	VR4	9b	Tor
04B45	XC6204B452DR	LVR-IC	LDO, 4.5V±2%, 150mA, +CE	USP-6B	49hq	VR4	9b	Tor
04B46	XC6204B462DR	LVR-IC	LDO, 4.6V±2%, 150mA, +CE	USP-6B	49hq	VR4	9b	Tor
04B47	XC6204B472DR	LVR-IC	LDO, 4.7V±2%, 150mA, +CE	USP-6B	49hq	VR4	9b	Tor
04B48	XC6204B482DR	LVR-IC	LDO, 4.8V±2%, 150mA, +CE	USP-6B	49hq	VR4	9b	Tor
04B49	XC6204B492DR	LVR-IC	LDO, 4.9V±2%, 150mA, +CE	USP-6B	49hq	VR4	9b	Tor



SMD code	Type	Function	Short description	Case	Pinout	Sch.	St.	Mnf.
04B4A	XC6204B40ADR	LVR-IC	LDO, 4.05V±2%, 150mA, +CE	USP-6B	49hq	VR4	9b	Tor
04B4B	XC6204B41ADR	LVR-IC	LDO, 4.15V±2%, 150mA, +CE	USP-6B	49hq	VR4	9b	Tor
04B4C	XC6204B42ADR	LVR-IC	LDO, 4.25V±2%, 150mA, +CE	USP-6B	49hq	VR4	9b	Tor
04B4D	XC6204B43ADR	LVR-IC	LDO, 4.35V±2%, 150mA, +CE	USP-6B	49hq	VR4	9b	Tor
04B4E	XC6204B44ADR	LVR-IC	LDO, 4.45V±2%, 150mA, +CE	USP-6B	49hq	VR4	9b	Tor
04B4F	XC6204B45ADR	LVR-IC	LDO, 4.55V±2%, 150mA, +CE	USP-6B	49hq	VR4	9b	Tor
04B4H	XC6204B46ADR	LVR-IC	LDO, 4.65V±2%, 150mA, +CE	USP-6B	49hq	VR4	9b	Tor
04B4K	XC6204B47ADR	LVR-IC	LDO, 4.75V±2%, 150mA, +CE	USP-6B	49hq	VR4	9b	Tor
04B4L	XC6204B48ADR	LVR-IC	LDO, 4.85V±2%, 150mA, +CE	USP-6B	49hq	VR4	9b	Tor
04B4M	XC6204B49ADR	LVR-IC	LDO, 4.95V±2%, 150mA, +CE	USP-6B	49hq	VR4	9b	Tor
04B50	XC6204B502DR	LVR-IC	LDO, 5V±2%, 150mA, +CE	USP-6B	49hq	VR4	9b	Tor
04B51	XC6204B512DR	LVR-IC	LDO, 5.1V±2%, 150mA, +CE	USP-6B	49hq	VR4	9b	Tor
04B52	XC6204B522DR	LVR-IC	LDO, 5.2V±2%, 150mA, +CE	USP-6B	49hq	VR4	9b	Tor
04B53	XC6204B532DR	LVR-IC	LDO, 5.3V±2%, 150mA, +CE	USP-6B	49hq	VR4	9b	Tor
04B54	XC6204B542DR	LVR-IC	LDO, 5.4V±2%, 150mA, +CE	USP-6B	49hq	VR4	9b	Tor
04B55	XC6204B552DR	LVR-IC	LDO, 5.5V±2%, 150mA, +CE	USP-6B	49hq	VR4	9b	Tor
04B56	XC6204B562DR	LVR-IC	LDO, 5.6V±2%, 150mA, +CE	USP-6B	49hq	VR4	9b	Tor
04B57	XC6204B572DR	LVR-IC	LDO, 5.7V±2%, 150mA, +CE	USP-6B	49hq	VR4	9b	Tor
04B58	XC6204B582DR	LVR-IC	LDO, 5.8V±2%, 150mA, +CE	USP-6B	49hq	VR4	9b	Tor
04B59	XC6204B592DR	LVR-IC	LDO, 5.9V±2%, 150mA, +CE	USP-6B	49hq	VR4	9b	Tor
04B5A	XC6204B50ADR	LVR-IC	LDO, 5.05V±2%, 150mA, +CE	USP-6B	49hq	VR4	9b	Tor
04B5B	XC6204B51ADR	LVR-IC	LDO, 5.15V±2%, 150mA, +CE	USP-6B	49hq	VR4	9b	Tor
04B5C	XC6204B52ADR	LVR-IC	LDO, 5.25V±2%, 150mA, +CE	USP-6B	49hq	VR4	9b	Tor
04B5D	XC6204B53ADR	LVR-IC	LDO, 5.35V±2%, 150mA, +CE	USP-6B	49hq	VR4	9b	Tor
04B5E	XC6204B54ADR	LVR-IC	LDO, 5.45V±2%, 150mA, +CE	USP-6B	49hq	VR4	9b	Tor
04B5F	XC6204B55ADR	LVR-IC	LDO, 5.55V±2%, 150mA, +CE	USP-6B	49hq	VR4	9b	Tor
04B5H	XC6204B56ADR	LVR-IC	LDO, 5.65V±2%, 150mA, +CE	USP-6B	49hq	VR4	9b	Tor
04B5K	XC6204B57ADR	LVR-IC	LDO, 5.75V±2%, 150mA, +CE	USP-6B	49hq	VR4	9b	Tor
04B5L	XC6204B58ADR	LVR-IC	LDO, 5.85V±2%, 150mA, +CE	USP-6B	49hq	VR4	9b	Tor
04B5M	XC6204B59ADR	LVR-IC	LDO, 5.95V±2%, 150mA, +CE	USP-6B	49hq	VR4	9b	Tor
04B60	XC6204B602DR	LVR-IC	LDO, 6V±2%, 150mA, +CE	USP-6B	49hq	VR4	9b	Tor
04C18	XC6204C182DR	LVR-IC	LDO, 1.8V±2%, 150mA, -CE, PDR	USP-6B	49hq	VR4	9b	Tor
04C19	XC6204C192DR	LVR-IC	LDO, 1.9V±2%, 150mA, -CE, PDR	USP-6B	49hq	VR4	9b	Tor
04C1L	XC6204C18ADR	LVR-IC	LDO, 1.85V±2%, 150mA, -CE, PDR	USP-6B	49hq	VR4	9b	Tor
04C1M	XC6204C19ADR	LVR-IC	LDO, 1.95V±2%, 150mA, -CE, PDR	USP-6B	49hq	VR4	9b	Tor
04C20	XC6204C202DR	LVR-IC	LDO, 2V±2%, 150mA, -CE, PDR	USP-6B	49hq	VR4	9b	Tor
04C21	XC6204C212DR	LVR-IC	LDO, 2.1V±2%, 150mA, -CE, PDR	USP-6B	49hq	VR4	9b	Tor
04C22	XC6204C222DR	LVR-IC	LDO, 2.2V±2%, 150mA, -CE, PDR	USP-6B	49hq	VR4	9b	Tor
04C23	XC6204C232DR	LVR-IC	LDO, 2.3V±2%, 150mA, -CE, PDR	USP-6B	49hq	VR4	9b	Tor
04C24	XC6204C242DR	LVR-IC	LDO, 2.4V±2%, 150mA, -CE, PDR	USP-6B	49hq	VR4	9b	Tor
04C25	XC6204C252DR	LVR-IC	LDO, 2.5V±2%, 150mA, -CE, PDR	USP-6B	49hq	VR4	9b	Tor
04C26	XC6204C262DR	LVR-IC	LDO, 2.6V±2%, 150mA, -CE, PDR	USP-6B	49hq	VR4	9b	Tor
04C27	XC6204C272DR	LVR-IC	LDO, 2.7V±2%, 150mA, -CE, PDR	USP-6B	49hq	VR4	9b	Tor
04C28	XC6204C282DR	LVR-IC	LDO, 2.8V±2%, 150mA, -CE, PDR	USP-6B	49hq	VR4	9b	Tor
04C29	XC6204C292DR	LVR-IC	LDO, 2.9V±2%, 150mA, -CE, PDR	USP-6B	49hq	VR4	9b	Tor
04C2A	XC6204C20ADR	LVR-IC	LDO, 2.05V±2%, 150mA, -CE, PDR	USP-6B	49hq	VR4	9b	Tor
04C2B	XC6204C21ADR	LVR-IC	LDO, 2.15V±2%, 150mA, -CE, PDR	USP-6B	49hq	VR4	9b	Tor
04C2C	XC6204C22ADR	LVR-IC	LDO, 2.25V±2%, 150mA, -CE, PDR	USP-6B	49hq	VR4	9b	Tor
04C2D	XC6204C23ADR	LVR-IC	LDO, 2.35V±2%, 150mA, -CE, PDR	USP-6B	49hq	VR4	9b	Tor
04C2E	XC6204C24ADR	LVR-IC	LDO, 2.45V±2%, 150mA, -CE, PDR	USP-6B	49hq	VR4	9b	Tor
04C2F	XC6204C25ADR	LVR-IC	LDO, 2.55V±2%, 150mA, -CE, PDR	USP-6B	49hq	VR4	9b	Tor
04C2H	XC6204C26ADR	LVR-IC	LDO, 2.65V±2%, 150mA, -CE, PDR	USP-6B	49hq	VR4	9b	Tor
04C2K	XC6204C27ADR	LVR-IC	LDO, 2.75V±2%, 150mA, -CE, PDR	USP-6B	49hq	VR4	9b	Tor
04C2L	XC6204C28ADR	LVR-IC	LDO, 2.85V±2%, 150mA, -CE, PDR	USP-6B	49hq	VR4	9b	Tor
04C2M	XC6204C29ADR	LVR-IC	LDO, 2.95V±2%, 150mA, -CE, PDR	USP-6B	49hq	VR4	9b	Tor
04C30	XC6204C302DR	LVR-IC	LDO, 3V±2%, 150mA, -CE, PDR	USP-6B	49hq	VR4	9b	Tor
04C31	XC6204C312DR	LVR-IC	LDO, 3.1V±2%, 150mA, -CE, PDR	USP-6B	49hq	VR4	9b	Tor
04C32	XC6204C322DR	LVR-IC	LDO, 3.2V±2%, 150mA, -CE, PDR	USP-6B	49hq	VR4	9b	Tor
04C33	XC6204C332DR	LVR-IC	LDO, 3.3V±2%, 150mA, -CE, PDR	USP-6B	49hq	VR4	9b	Tor
04C34	XC6204C342DR	LVR-IC	LDO, 3.4V±2%, 150mA, -CE, PDR	USP-6B	49hq	VR4	9b	Tor
04C35	XC6204C352DR	LVR-IC	LDO, 3.5V±2%, 150mA, -CE, PDR	USP-6B	49hq	VR4	9b	Tor
04C36	XC6204C362DR	LVR-IC	LDO, 3.6V±2%, 150mA, -CE, PDR	USP-6B	49hq	VR4	9b	Tor
04C37	XC6204C372DR	LVR-IC	LDO, 3.7V±2%, 150mA, -CE, PDR	USP-6B	49hq	VR4	9b	Tor
04C38	XC6204C382DR	LVR-IC	LDO, 3.8V±2%, 150mA, -CE, PDR	USP-6B	49hq	VR4	9b	Tor
04C39	XC6204C392DR	LVR-IC	LDO, 3.9V±2%, 150mA, -CE, PDR	USP-6B	49hq	VR4	9b	Tor
04C3A	XC6204C30ADR	LVR-IC	LDO, 3.05V±2%, 150mA, -CE, PDR	USP-6B	49hq	VR4	9b	Tor
04C3B	XC6204C31ADR	LVR-IC	LDO, 3.15V±2%, 150mA, -CE, PDR	USP-6B	49hq	VR4	9b	Tor
04C3C	XC6204C32ADR	LVR-IC	LDO, 3.25V±2%, 150mA, -CE, PDR	USP-6B	49hq	VR4	9b	Tor
04C3D	XC6204C33ADR	LVR-IC	LDO, 3.35V±2%, 150mA, -CE, PDR	USP-6B	49hq	VR4	9b	Tor
04C3E	XC6204C34ADR	LVR-IC	LDO, 3.45V±2%, 150mA, -CE, PDR	USP-6B	49hq	VR4	9b	Tor



SMD code	Type	Function	Short description	Case	Pinout	Sch.	St.	Mnf.
04D30	XC6204D302DR	LVR-IC	LDO, 3V±2%, 150mA, -CE	USP-6B	49hq	VR4	9b	Tor
04D31	XC6204D312DR	LVR-IC	LDO, 3.1V±2%, 150mA, -CE	USP-6B	49hq	VR4	9b	Tor
04D32	XC6204D322DR	LVR-IC	LDO, 3.2V±2%, 150mA, -CE	USP-6B	49hq	VR4	9b	Tor
04D33	XC6204D332DR	LVR-IC	LDO, 3.3V±2%, 150mA, -CE	USP-6B	49hq	VR4	9b	Tor
04D34	XC6204D342DR	LVR-IC	LDO, 3.4V±2%, 150mA, -CE	USP-6B	49hq	VR4	9b	Tor
04D35	XC6204D352DR	LVR-IC	LDO, 3.5V±2%, 150mA, -CE	USP-6B	49hq	VR4	9b	Tor
04D36	XC6204D362DR	LVR-IC	LDO, 3.6V±2%, 150mA, -CE	USP-6B	49hq	VR4	9b	Tor
04D37	XC6204D372DR	LVR-IC	LDO, 3.7V±2%, 150mA, -CE	USP-6B	49hq	VR4	9b	Tor
04D38	XC6204D382DR	LVR-IC	LDO, 3.8V±2%, 150mA, -CE	USP-6B	49hq	VR4	9b	Tor
04D39	XC6204D392DR	LVR-IC	LDO, 3.9V±2%, 150mA, -CE	USP-6B	49hq	VR4	9b	Tor
04D3A	XC6204D30ADR	LVR-IC	LDO, 3.05V±2%, 150mA, -CE	USP-6B	49hq	VR4	9b	Tor
04D3B	XC6204D31ADR	LVR-IC	LDO, 3.15V±2%, 150mA, -CE	USP-6B	49hq	VR4	9b	Tor
04D3C	XC6204D32ADR	LVR-IC	LDO, 3.25V±2%, 150mA, -CE	USP-6B	49hq	VR4	9b	Tor
04D3D	XC6204D33ADR	LVR-IC	LDO, 3.35V±2%, 150mA, -CE	USP-6B	49hq	VR4	9b	Tor
04D3E	XC6204D34ADR	LVR-IC	LDO, 3.45V±2%, 150mA, -CE	USP-6B	49hq	VR4	9b	Tor
04D3F	XC6204D35ADR	LVR-IC	LDO, 3.55V±2%, 150mA, -CE	USP-6B	49hq	VR4	9b	Tor
04D3H	XC6204D36ADR	LVR-IC	LDO, 3.65V±2%, 150mA, -CE	USP-6B	49hq	VR4	9b	Tor
04D3K	XC6204D37ADR	LVR-IC	LDO, 3.75V±2%, 150mA, -CE	USP-6B	49hq	VR4	9b	Tor
04D3L	XC6204D38ADR	LVR-IC	LDO, 3.85V±2%, 150mA, -CE	USP-6B	49hq	VR4	9b	Tor
04D3M	XC6204D39ADR	LVR-IC	LDO, 3.95V±2%, 150mA, -CE	USP-6B	49hq	VR4	9b	Tor
04D40	XC6204D402DR	LVR-IC	LDO, 4V±2%, 150mA, -CE	USP-6B	49hq	VR4	9b	Tor
04D41	XC6204D412DR	LVR-IC	LDO, 4.1V±2%, 150mA, -CE	USP-6B	49hq	VR4	9b	Tor
04D42	XC6204D422DR	LVR-IC	LDO, 4.2V±2%, 150mA, -CE	USP-6B	49hq	VR4	9b	Tor
04D43	XC6204D432DR	LVR-IC	LDO, 4.3V±2%, 150mA, -CE	USP-6B	49hq	VR4	9b	Tor
04D44	XC6204D442DR	LVR-IC	LDO, 4.4V±2%, 150mA, -CE	USP-6B	49hq	VR4	9b	Tor
04D45	XC6204D452DR	LVR-IC	LDO, 4.5V±2%, 150mA, -CE	USP-6B	49hq	VR4	9b	Tor
04D46	XC6204D462DR	LVR-IC	LDO, 4.6V±2%, 150mA, -CE	USP-6B	49hq	VR4	9b	Tor
04D47	XC6204D472DR	LVR-IC	LDO, 4.7V±2%, 150mA, -CE	USP-6B	49hq	VR4	9b	Tor
04D48	XC6204D482DR	LVR-IC	LDO, 4.8V±2%, 150mA, -CE	USP-6B	49hq	VR4	9b	Tor
04D49	XC6204D492DR	LVR-IC	LDO, 4.9V±2%, 150mA, -CE	USP-6B	49hq	VR4	9b	Tor
04D4A	XC6204D40ADR	LVR-IC	LDO, 4.05V±2%, 150mA, -CE	USP-6B	49hq	VR4	9b	Tor
04D4B	XC6204D41ADR	LVR-IC	LDO, 4.15V±2%, 150mA, -CE	USP-6B	49hq	VR4	9b	Tor
04D4C	XC6204D42ADR	LVR-IC	LDO, 4.25V±2%, 150mA, -CE	USP-6B	49hq	VR4	9b	Tor
04D4D	XC6204D43ADR	LVR-IC	LDO, 4.35V±2%, 150mA, -CE	USP-6B	49hq	VR4	9b	Tor
04D4E	XC6204D44ADR	LVR-IC	LDO, 4.45V±2%, 150mA, -CE	USP-6B	49hq	VR4	9b	Tor
04D4F	XC6204D45ADR	LVR-IC	LDO, 4.55V±2%, 150mA, -CE	USP-6B	49hq	VR4	9b	Tor
04D4H	XC6204D46ADR	LVR-IC	LDO, 4.65V±2%, 150mA, -CE	USP-6B	49hq	VR4	9b	Tor
04D4K	XC6204D47ADR	LVR-IC	LDO, 4.75V±2%, 150mA, -CE	USP-6B	49hq	VR4	9b	Tor
04D4L	XC6204D48ADR	LVR-IC	LDO, 4.85V±2%, 150mA, -CE	USP-6B	49hq	VR4	9b	Tor
04D4M	XC6204D49ADR	LVR-IC	LDO, 4.95V±2%, 150mA, -CE	USP-6B	49hq	VR4	9b	Tor
04D50	XC6204D502DR	LVR-IC	LDO, 5V±2%, 150mA, -CE	USP-6B	49hq	VR4	9b	Tor
04D51	XC6204D512DR	LVR-IC	LDO, 5.1V±2%, 150mA, -CE	USP-6B	49hq	VR4	9b	Tor
04D52	XC6204D522DR	LVR-IC	LDO, 5.2V±2%, 150mA, -CE	USP-6B	49hq	VR4	9b	Tor
04D53	XC6204D532DR	LVR-IC	LDO, 5.3V±2%, 150mA, -CE	USP-6B	49hq	VR4	9b	Tor
04D54	XC6204D542DR	LVR-IC	LDO, 5.4V±2%, 150mA, -CE	USP-6B	49hq	VR4	9b	Tor
04D55	XC6204D552DR	LVR-IC	LDO, 5.5V±2%, 150mA, -CE	USP-6B	49hq	VR4	9b	Tor
04D56	XC6204D562DR	LVR-IC	LDO, 5.6V±2%, 150mA, -CE	USP-6B	49hq	VR4	9b	Tor
04D57	XC6204D572DR	LVR-IC	LDO, 5.7V±2%, 150mA, -CE	USP-6B	49hq	VR4	9b	Tor
04D58	XC6204D582DR	LVR-IC	LDO, 5.8V±2%, 150mA, -CE	USP-6B	49hq	VR4	9b	Tor
04D59	XC6204D592DR	LVR-IC	LDO, 5.9V±2%, 150mA, -CE	USP-6B	49hq	VR4	9b	Tor
04D5A	XC6204D50ADR	LVR-IC	LDO, 5.05V±2%, 150mA, -CE	USP-6B	49hq	VR4	9b	Tor
04D5B	XC6204D51ADR	LVR-IC	LDO, 5.15V±2%, 150mA, -CE	USP-6B	49hq	VR4	9b	Tor
04D5C	XC6204D52ADR	LVR-IC	LDO, 5.25V±2%, 150mA, -CE	USP-6B	49hq	VR4	9b	Tor
04D5D	XC6204D53ADR	LVR-IC	LDO, 5.35V±2%, 150mA, -CE	USP-6B	49hq	VR4	9b	Tor
04D5E	XC6204D54ADR	LVR-IC	LDO, 5.45V±2%, 150mA, -CE	USP-6B	49hq	VR4	9b	Tor
04D5F	XC6204D55ADR	LVR-IC	LDO, 5.55V±2%, 150mA, -CE	USP-6B	49hq	VR4	9b	Tor
04D5H	XC6204D56ADR	LVR-IC	LDO, 5.65V±2%, 150mA, -CE	USP-6B	49hq	VR4	9b	Tor
04D5K	XC6204D57ADR	LVR-IC	LDO, 5.75V±2%, 150mA, -CE	USP-6B	49hq	VR4	9b	Tor
04D5L	XC6204D58ADR	LVR-IC	LDO, 5.85V±2%, 150mA, -CE	USP-6B	49hq	VR4	9b	Tor
04D5M	XC6204D59ADR	LVR-IC	LDO, 5.95V±2%, 150mA, -CE	USP-6B	49hq	VR4	9b	Tor
04D60	XC6204D602DR	LVR-IC	LDO, 6V±2%, 150mA, -CE	USP-6B	49hq	VR4	9b	Tor
05	RP110L121B5	LVR-IC	LDO, 1.25V±1%, 150mA, +CE	DFN1010-4	48vm	VR4	9a	Ric
05	XC6223A1519R-G	LVR-IC	LDO, 1.5V±20mV, 300mA, +CE	USPQ-4B03	48vm	VR4	9a	Tor
05	XC6224A1317R	LVR-IC	LDO, 1.3V±1.5%, 150mA, +CE	USPN-4B02	58vm	VR4	9e	Tor
05	XC6229D14B1R-G	LVR-IC	LDO, 1.45V±20mV, 300mA, +CE	BGA-4	63ba*	VR4	9a	Tor
05	XC6420AB057R-G	LVR-IC	LDO, Dual out, Vout1/Vout2=1.20/3.00V±2%, 150mA, +CE	USPN-6	52xv	VR19	9a	Tor
05	XC6420AB05DR-G	LVR-IC	LDO, Dual out, Vout1/Vout2=1.20/3.00V±2%, 150mA, +CE	USP-6B04	73x4	VR19	9a	Tor
05	XC6221C1317R	LVR-IC	LDO, 1.3V±20mV, 200mA, +CE, PDR	USPN-4	58vm	VR4	9a	Tor
0510	SI2705-A10-GM	LIN-IC	AF PA, BTL, class-D, 2.7..6.6V, 5W(5V/3Q), shutdown, 12C	QFN-24	38	-	9m	Slb
05A09	XC6205A092DR	LVR-IC	LDO, 0.9V±2%, 150mA, +CE, PDR	USP-6B	49hq	VR4	9b	Tor



SMD code	Type	Function	Short description	Case	Pinout	Sch.	St.	Mnf.
05A0M	XC6205A09ADR	LVR-IC	LDO, 0.95V±2%, 150mA, +CE, PDR	USP-6B	49hq	VR4	9b	Tor
05A10	XC6205A102DR	LVR-IC	LDO, 1V±2%, 150mA, +CE, PDR	USP-6B	49hq	VR4	9b	Tor
05A11	XC6205A112DR	LVR-IC	LDO, 1.1V±2%, 150mA, +CE, PDR	USP-6B	49hq	VR4	9b	Tor
05A12	XC6205A122DR	LVR-IC	LDO, 1.2V±2%, 150mA, +CE, PDR	USP-6B	49hq	VR4	9b	Tor
05A13	XC6205A132DR	LVR-IC	LDO, 1.3V±2%, 150mA, +CE, PDR	USP-6B	49hq	VR4	9b	Tor
05A14	XC6205A142DR	LVR-IC	LDO, 1.4V±2%, 150mA, +CE, PDR	USP-6B	49hq	VR4	9b	Tor
05A15	XC6205A152DR	LVR-IC	LDO, 1.5V±2%, 150mA, +CE, PDR	USP-6B	49hq	VR4	9b	Tor
05A16	XC6205A162DR	LVR-IC	LDO, 1.6V±2%, 150mA, +CE, PDR	USP-6B	49hq	VR4	9b	Tor
05A17	XC6205A172DR	LVR-IC	LDO, 1.7V±2%, 150mA, +CE, PDR	USP-6B	49hq	VR4	9b	Tor
05A1A	XC6205A10ADR	LVR-IC	LDO, 1.05V±2%, 150mA, +CE, PDR	USP-6B	49hq	VR4	9b	Tor
05A1B	XC6205A11ADR	LVR-IC	LDO, 1.15V±2%, 150mA, +CE, PDR	USP-6B	49hq	VR4	9b	Tor
05A1C	XC6205A12ADR	LVR-IC	LDO, 1.25V±2%, 150mA, +CE, PDR	USP-6B	49hq	VR4	9b	Tor
05A1D	XC6205A13ADR	LVR-IC	LDO, 1.35V±2%, 150mA, +CE, PDR	USP-6B	49hq	VR4	9b	Tor
05A1E	XC6205A14ADR	LVR-IC	LDO, 1.45V±2%, 150mA, +CE, PDR	USP-6B	49hq	VR4	9b	Tor
05A1F	XC6205A15ADR	LVR-IC	LDO, 1.55V±2%, 150mA, +CE, PDR	USP-6B	49hq	VR4	9b	Tor
05A1H	XC6205A16ADR	LVR-IC	LDO, 1.65V±2%, 150mA, +CE, PDR	USP-6B	49hq	VR4	9b	Tor
05A1K	XC6205A17ADR	LVR-IC	LDO, 1.75V±2%, 150mA, +CE, PDR	USP-6B	49hq	VR4	9b	Tor
05B08	XC6205B092DR	LVR-IC	LDO, 0.9V±2%, 150mA, +CE	USP-6B	49hq	VR4	9b	Tor
05B0L	XC6205B09ADR	LVR-IC	LDO, 0.95V±2%, 150mA, +CE	USP-6B	49hq	VR4	9b	Tor
05B10	XC6205B102DR	LVR-IC	LDO, 1V±2%, 150mA, +CE	USP-6B	49hq	VR4	9b	Tor
05B11	XC6205B112DR	LVR-IC	LDO, 1.1V±2%, 150mA, +CE	USP-6B	49hq	VR4	9b	Tor
05B12	XC6205B122DR	LVR-IC	LDO, 1.2V±2%, 150mA, +CE	USP-6B	49hq	VR4	9b	Tor
05B13	XC6205B132DR	LVR-IC	LDO, 1.3V±2%, 150mA, +CE	USP-6B	49hq	VR4	9b	Tor
05B14	XC6205B142DR	LVR-IC	LDO, 1.4V±2%, 150mA, +CE	USP-6B	49hq	VR4	9b	Tor
05B15	XC6205B152DR	LVR-IC	LDO, 1.5V±2%, 150mA, +CE	USP-6B	49hq	VR4	9b	Tor
05B16	XC6205B162DR	LVR-IC	LDO, 1.6V±2%, 150mA, +CE	USP-6B	49hq	VR4	9b	Tor
05B17	XC6205B172DR	LVR-IC	LDO, 1.7V±2%, 150mA, +CE	USP-6B	49hq	VR4	9b	Tor
05B1A	XC6205B10ADR	LVR-IC	LDO, 1.05V±2%, 150mA, +CE	USP-6B	49hq	VR4	9b	Tor
05B1B	XC6205B11ADR	LVR-IC	LDO, 1.15V±2%, 150mA, +CE	USP-6B	49hq	VR4	9b	Tor
05B1C	XC6205B12ADR	LVR-IC	LDO, 1.25V±2%, 150mA, +CE	USP-6B	49hq	VR4	9b	Tor
05B1D	XC6205B13ADR	LVR-IC	LDO, 1.35V±2%, 150mA, +CE	USP-6B	49hq	VR4	9b	Tor
05B1E	XC6205B14ADR	LVR-IC	LDO, 1.45V±2%, 150mA, +CE	USP-6B	49hq	VR4	9b	Tor
05B1F	XC6205B15ADR	LVR-IC	LDO, 1.55V±2%, 150mA, +CE	USP-6B	49hq	VR4	9b	Tor
05B1H	XC6205B16ADR	LVR-IC	LDO, 1.65V±2%, 150mA, +CE	USP-6B	49hq	VR4	9b	Tor
05B1K	XC6205B17ADR	LVR-IC	LDO, 1.75V±2%, 150mA, +CE	USP-6B	49hq	VR4	9b	Tor
05C09	XC6205C092DR	LVR-IC	LDO, 0.9V±2%, 150mA, -CE, PDR	USP-6B	49hq	VR4	9b	Tor
05C0M	XC6205C09ADR	LVR-IC	LDO, 0.95V±2%, 150mA, -CE, PDR	USP-6B	49hq	VR4	9b	Tor
05C10	XC6205C102DR	LVR-IC	LDO, 1V±2%, 150mA, -CE, PDR	USP-6B	49hq	VR4	9b	Tor
05C11	XC6205C112DR	LVR-IC	LDO, 1.1V±2%, 150mA, -CE, PDR	USP-6B	49hq	VR4	9b	Tor
05C12	XC6205C122DR	LVR-IC	LDO, 1.2V±2%, 150mA, -CE, PDR	USP-6B	49hq	VR4	9b	Tor
05C13	XC6205C132DR	LVR-IC	LDO, 1.3V±2%, 150mA, -CE, PDR	USP-6B	49hq	VR4	9b	Tor
05C14	XC6205C142DR	LVR-IC	LDO, 1.4V±2%, 150mA, -CE, PDR	USP-6B	49hq	VR4	9b	Tor
05C15	XC6205C152DR	LVR-IC	LDO, 1.5V±2%, 150mA, -CE, PDR	USP-6B	49hq	VR4	9b	Tor
05C16	XC6205C162DR	LVR-IC	LDO, 1.6V±2%, 150mA, -CE, PDR	USP-6B	49hq	VR4	9b	Tor
05C17	XC6205C172DR	LVR-IC	LDO, 1.7V±2%, 150mA, -CE, PDR	USP-6B	49hq	VR4	9b	Tor
05C1A	XC6205C10ADR	LVR-IC	LDO, 1.05V±2%, 150mA, -CE, PDR	USP-6B	49hq	VR4	9b	Tor
05C1B	XC6205C11ADR	LVR-IC	LDO, 1.15V±2%, 150mA, -CE, PDR	USP-6B	49hq	VR4	9b	Tor
05C1C	XC6205C12ADR	LVR-IC	LDO, 1.25V±2%, 150mA, -CE, PDR	USP-6B	49hq	VR4	9b	Tor
05C1D	XC6205C13ADR	LVR-IC	LDO, 1.35V±2%, 150mA, -CE, PDR	USP-6B	49hq	VR4	9b	Tor
05C1E	XC6205C14ADR	LVR-IC	LDO, 1.45V±2%, 150mA, -CE, PDR	USP-6B	49hq	VR4	9b	Tor
05C1F	XC6205C15ADR	LVR-IC	LDO, 1.55V±2%, 150mA, -CE, PDR	USP-6B	49hq	VR4	9b	Tor
05C1H	XC6205C16ADR	LVR-IC	LDO, 1.65V±2%, 150mA, -CE, PDR	USP-6B	49hq	VR4	9b	Tor
05C1K	XC6205C17ADR	LVR-IC	LDO, 1.75V±2%, 150mA, -CE, PDR	USP-6B	49hq	VR4	9b	Tor
05D09	XC6205D092DR	LVR-IC	LDO, 0.9V±2%, 150mA, -CE	USP-6B	49hq	VR4	9b	Tor
05D0M	XC6205D09ADR	LVR-IC	LDO, 0.95V±2%, 150mA, -CE	USP-6B	49hq	VR4	9b	Tor
05D10	XC6205D102DR	LVR-IC	LDO, 1V±2%, 150mA, -CE	USP-6B	49hq	VR4	9b	Tor
05D11	XC6205D112DR	LVR-IC	LDO, 1.1V±2%, 150mA, -CE	USP-6B	49hq	VR4	9b	Tor
05D12	XC6205D122DR	LVR-IC	LDO, 1.2V±2%, 150mA, -CE	USP-6B	49hq	VR4	9b	Tor
05D13	XC6205D132DR	LVR-IC	LDO, 1.3V±2%, 150mA, -CE	USP-6B	49hq	VR4	9b	Tor
05D14	XC6205D142DR	LVR-IC	LDO, 1.4V±2%, 150mA, -CE	USP-6B	49hq	VR4	9b	Tor
05D15	XC6205D152DR	LVR-IC	LDO, 1.5V±2%, 150mA, -CE	USP-6B	49hq	VR4	9b	Tor
05D16	XC6205D162DR	LVR-IC	LDO, 1.6V±2%, 150mA, -CE	USP-6B	49hq	VR4	9b	Tor
05D17	XC6205D172DR	LVR-IC	LDO, 1.7V±2%, 150mA, -CE	USP-6B	49hq	VR4	9b	Tor
05D1A	XC6205D10ADR	LVR-IC	LDO, 1.05V±2%, 150mA, -CE	USP-6B	49hq	VR4	9b	Tor
05D1B	XC6205D11ADR	LVR-IC	LDO, 1.15V±2%, 150mA, -CE	USP-6B	49hq	VR4	9b	Tor
05D1C	XC6205D12ADR	LVR-IC	LDO, 1.25V±2%, 150mA, -CE	USP-6B	49hq	VR4	9b	Tor
05D1D	XC6205D13ADR	LVR-IC	LDO, 1.35V±2%, 150mA, -CE	USP-6B	49hq	VR4	9b	Tor
05D1E	XC6205D14ADR	LVR-IC	LDO, 1.45V±2%, 150mA, -CE	USP-6B	49hq	VR4	9b	Tor
05D1F	XC6205D15ADR	LVR-IC	LDO, 1.55V±2%, 150mA, -CE	USP-6B	49hq	VR4	9b	Tor
05D1H	XC6205D16ADR	LVR-IC	LDO, 1.65V±2%, 150mA, -CE	USP-6B	49hq	VR4	9b	Tor



SMD code	Type	Function	Short description	Case	Pinout	Sch.	St.	Mnf.
05D1K	XC6205D17ADR	LVR-IC	LDO, 1.75V±2%, 150mA, -CE	USP-6B	49hq	VR4	9b	Tor
06	RP110L131B	LVR-IC	LDO, 1.3V±1%, 150mA, +CE	DFM1010-4	48vm	VR4	9a	Ric
06	XC6223A1619R-G	LVR-IC	LDO, 1.6V±20mV, 300mA, +CE	USPQ-4B03	48vm	VR4	9a	Tor
06	XC6224A1417R	LVR-IC	LDO, 1.4V±1.5%, 150mA, +CE	USPN-4B02	58vm	VR4	9e	Tor
06	XC6229D1511R-G	LVR-IC	LDO, 1.5V±20mV, 300mA, +CE	BGA-4	63ba*	VR4	9a	Tor
06	XC6420AB067R-G	LVR-IC	LDO, Dual out, Vout1/Vout2=1.20/3.30V±2%, 150mA, +CE	USPN-6	52xv	VR19	9a	Tor
06	XC6420AB06DR-G	LVR-IC	LDO, Dual out, Vout1/Vout2=1.20/3.30V±2%, 150mA, +CE	USP-6B04	73x4	VR19	9a	Tor
06	XC6221C1417R	LVR-IC	LDO, 1.4V±20mV, 200mA, +CE, PDR	USPN-4	58vm	VR4	9a	Tor
0610	SI2706-A10-GM	LIN-IC	AF PA, BTL, class-D, 2.7..6.6V, 5W(5V/3Q), shutdown, 12C	QFN-24	38	-	9m	Sib
06P12	XC6206P122DR	LVR-IC	LDO, 1.2V±2%, 250mA	USP-6B	49us	VR1	9b	Tor
06P13	XC6206P132DR	LVR-IC	LDO, 1.3V±2%, 250mA	USP-6B	49us	VR1	9b	Tor
06P14	XC6206P142DR	LVR-IC	LDO, 1.4V±2%, 250mA	USP-6B	49us	VR1	9b	Tor
06P15	XC6206P152DR	LVR-IC	LDO, 1.5V±2%, 250mA	USP-6B	49us	VR1	9b	Tor
06P16	XC6206P162DR	LVR-IC	LDO, 1.6V±2%, 250mA	USP-6B	49us	VR1	9b	Tor
06P17	XC6206P172DR	LVR-IC	LDO, 1.7V±2%, 250mA	USP-6B	49us	VR1	9b	Tor
06P18	XC6206P182DR	LVR-IC	LDO, 1.8V±2%, 250mA	USP-6B	49us	VR1	9b	Tor
06P19	XC6206P192DR	LVR-IC	LDO, 1.9V±2%, 250mA	USP-6B	49us	VR1	9b	Tor
06P20	XC6206P202DR	LVR-IC	LDO, 2V±2%, 250mA	USP-6B	49us	VR1	9b	Tor
06P21	XC6206P212DR	LVR-IC	LDO, 2.1V±2%, 250mA	USP-6B	49us	VR1	9b	Tor
06P22	XC6206P222DR	LVR-IC	LDO, 2.2V±2%, 250mA	USP-6B	49us	VR1	9b	Tor
06P23	XC6206P232DR	LVR-IC	LDO, 2.3V±2%, 250mA	USP-6B	49us	VR1	9b	Tor
06P24	XC6206P242DR	LVR-IC	LDO, 2.4V±2%, 250mA	USP-6B	49us	VR1	9b	Tor
06P25	XC6206P252DR	LVR-IC	LDO, 2.5V±2%, 250mA	USP-6B	49us	VR1	9b	Tor
06P26	XC6206P262DR	LVR-IC	LDO, 2.6V±2%, 250mA	USP-6B	49us	VR1	9b	Tor
06P27	XC6206P272DR	LVR-IC	LDO, 2.7V±2%, 250mA	USP-6B	49us	VR1	9b	Tor
06P28	XC6206P282DR	LVR-IC	LDO, 2.8V±2%, 250mA	USP-6B	49us	VR1	9b	Tor
06P29	XC6206P292DR	LVR-IC	LDO, 2.9V±2%, 250mA	USP-6B	49us	VR1	9b	Tor
06P30	XC6206P302DR	LVR-IC	LDO, 3V±2%, 250mA	USP-6B	49us	VR1	9b	Tor
06P31	XC6206P311DR	LVR-IC	LDO, 3.1V±2%, 250mA	USP-6B	49us	VR1	9b	Tor
06P32	XC6206P322DR	LVR-IC	LDO, 3.2V±2%, 250mA	USP-6B	49us	VR1	9b	Tor
06P33	XC6206P332DR	LVR-IC	LDO, 3.3V±2%, 250mA	USP-6B	49us	VR1	9b	Tor
06P34	XC6206P342DR	LVR-IC	LDO, 3.4V±2%, 250mA	USP-6B	49us	VR1	9b	Tor
06P35	XC6206P352DR	LVR-IC	LDO, 3.5V±2%, 250mA	USP-6B	49us	VR1	9b	Tor
06P36	XC6206P362DR	LVR-IC	LDO, 3.6V±2%, 250mA	USP-6B	49us	VR1	9b	Tor
06P37	XC6206P372DR	LVR-IC	LDO, 3.7V±2%, 250mA	USP-6B	49us	VR1	9b	Tor
06P38	XC6206P382DR	LVR-IC	LDO, 3.8V±2%, 250mA	USP-6B	49us	VR1	9b	Tor
06P39	XC6206P392DR	LVR-IC	LDO, 3.9V±2%, 250mA	USP-6B	49us	VR1	9b	Tor
06P40	XC6206P402DR	LVR-IC	LDO, 4V±2%, 250mA	USP-6B	49us	VR1	9b	Tor
06P41	XC6206P412DR	LVR-IC	LDO, 4.1V±2%, 250mA	USP-6B	49us	VR1	9b	Tor
06P42	XC6206P422DR	LVR-IC	LDO, 4.2V±2%, 250mA	USP-6B	49us	VR1	9b	Tor
06P43	XC6206P432DR	LVR-IC	LDO, 4.3V±2%, 250mA	USP-6B	49us	VR1	9b	Tor
06P44	XC6206P442DR	LVR-IC	LDO, 4.4V±2%, 250mA	USP-6B	49us	VR1	9b	Tor
06P45	XC6206P452DR	LVR-IC	LDO, 4.5V±2%, 250mA	USP-6B	49us	VR1	9b	Tor
06P46	XC6206P462DR	LVR-IC	LDO, 4.6V±2%, 250mA	USP-6B	49us	VR1	9b	Tor
06P47	XC6206P472DR	LVR-IC	LDO, 4.7V±2%, 250mA	USP-6B	49us	VR1	9b	Tor
06P48	XC6206P482DR	LVR-IC	LDO, 4.8V±2%, 250mA	USP-6B	49us	VR1	9b	Tor
06P49	XC6206P492DR	LVR-IC	LDO, 4.9V±2%, 250mA	USP-6B	49us	VR1	9b	Tor
06P50	XC6206P502DR	LVR-IC	LDO, 5V±2%, 250mA	USP-6B	49us	VR1	9b	Tor
07	RP110L141B	LVR-IC	LDO, 1.4V±1%, 150mA, +CE	DFM1010-4	48vm	VR4	9a	Ric
07	XC6223A1719R-G	LVR-IC	LDO, 1.7V±20mV, 300mA, +CE	USPQ-4B03	48vm	VR4	9a	Tor
07	XC6224A1517R	LVR-IC	LDO, 1.5V±1.5%, 150mA, +CE	USPN-4B02	58vm	VR4	9e	Tor
07	XC6229D15B1R-G	LVR-IC	LDO, 1.55V±20mV, 300mA, +CE	BGA-4	63ba*	VR4	9a	Tor
07	XC6420AB077R-G	LVR-IC	LDO, Dual out, Vout1/Vout2=1.50/1.50V±2%, 150mA, +CE	USPN-6	52xv	VR19	9a	Tor
07	XC6420AB07DR-G	LVR-IC	LDO, Dual out, Vout1/Vout2=1.50/1.50V±2%, 150mA, +CE	USP-6B04	73x4	VR19	9a	Tor
07	XC6221C1517R	LVR-IC	LDO, 1.5V±20mV, 200mA, +CE, PDR	USPN-4	58vm	VR4	9a	Tor
0710	SI2707-A10-GM	LIN-IC	AF PA, BTL, class-D, 2.7..6.6V, 5W(5V/3Q), shutdown, 12C	QFN-24	38	-	9m	Sib
07A12	XC6207A122DR	LVR-IC	LDO, 1.2V±2%, 300mA, -CE, Shutdown	USP-6C	49vrc	VR4a	9b	Tor
07A13	XC6207A132DR	LVR-IC	LDO, 1.3V±2%, 300mA, -CE, Shutdown	USP-6C	49vrc	VR4a	9b	Tor
07A14	XC6207A142DR	LVR-IC	LDO, 1.4V±2%, 300mA, -CE, Shutdown	USP-6C	49vrc	VR4a	9b	Tor
07A15	XC6207A152DR	LVR-IC	LDO, 1.5V±2%, 300mA, -CE, Shutdown	USP-6C	49vrc	VR4a	9b	Tor
07A16	XC6207A162DR	LVR-IC	LDO, 1.6V±2%, 300mA, -CE, Shutdown	USP-6C	49vrc	VR4a	9b	Tor
07A17	XC6207A172DR	LVR-IC	LDO, 1.7V±2%, 300mA, -CE, Shutdown	USP-6C	49vrc	VR4a	9b	Tor
07A18	XC6207A182DR	LVR-IC	LDO, 1.8V±2%, 300mA, -CE, Shutdown	USP-6C	49vrc	VR4a	9b	Tor
07A19	XC6207A192DR	LVR-IC	LDO, 1.9V±2%, 300mA, -CE, Shutdown	USP-6C	49vrc	VR4a	9b	Tor
07A1C	XC6207A12ADR	LVR-IC	LDO, 1.25V±2%, 300mA, -CE, Shutdown	USP-6C	49vrc	VR4a	9b	Tor
07A1D	XC6207A13ADR	LVR-IC	LDO, 1.35V±2%, 300mA, -CE, Shutdown	USP-6C	49vrc	VR4a	9b	Tor
07A1E	XC6207A14ADR	LVR-IC	LDO, 1.45V±2%, 300mA, -CE, Shutdown	USP-6C	49vrc	VR4a	9b	Tor
07A1F	XC6207A15ADR	LVR-IC	LDO, 1.55V±2%, 300mA, -CE, Shutdown	USP-6C	49vrc	VR4a	9b	Tor
07A1H	XC6207A16ADR	LVR-IC	LDO, 1.65V±2%, 300mA, -CE, Shutdown	USP-6C	49vrc	VR4a	9b	Tor
07A1K	XC6207A17ADR	LVR-IC	LDO, 1.75V±2%, 300mA, -CE, Shutdown	USP-6C	49vrc	VR4a	9b	Tor



SMD code	Type	Function	Short description	Case	Pinout	Sch.	St.	Mnf.
08	RP110L151B	LVR-IC	LDO, 1.5V±1%, 150mA, +CE	DFN1010-4	48vm	VR4	9a	Ric
08	XC6223A1819R-G	LVR-IC	LDO, 1.8V±20mV, 300mA, +CE	USPQ-4B03	48vm	VR4	9a	Tor
08	XC6224A1617R	LVR-IC	LDO, 1.6V±1.5%, 150mA, +CE	USPN-4B02	58vm	VR4	9e	Tor
08	XC6229D1611R-G	LVR-IC	LDO, 1.6V±20mV, 300mA, +CE	BGA-4	63ba*	VR4	9a	Tor
08	XC6420AB087R-G	LVR-IC	LDO, Dual out, Vout1/Vout2=1.50/1.80V±2%, 150mA, +CE	USPN-6	52xv	VR19	9a	Tor
08	XC6420AB08DR-G	LVR-IC	LDO, Dual out, Vout1/Vout2=1.50/1.80V±2%, 150mA, +CE	USP-6B04	73x4	VR19	9a	Tor
08	XC6221C1617R	LVR-IC	LDO, 1.6V±20mV, 200mA, +CE, PDR	USPN-4	58vm	VR4	9a	Tor
0808A	EC8908-08AW1	LVR-IC	LDO, 0.8V±1.5%, 300mA, +CE	WDFN-6	56zg	VR4	9i	Ecom
0808B	EC8908-08BW1	LVR-IC	LDO, 0.8V±1.5%, 500mA, +CE	WDFN-6	56zg	VR4	9i	Ecom
0808C	EC8908-08CW1	LVR-IC	LDO, 0.8V±1.5%, 300mA, -CE	WDFN-6	56zg	VR4	9i	Ecom
0808D	EC8908-08DW1	LVR-IC	LDO, 0.8V±1.5%, 500mA, -CE	WDFN-6	56zg	VR4	9i	Ecom
0809A	EC8908-09AW1	LVR-IC	LDO, 0.9V±1.5%, 300mA, +CE	WDFN-6	56zg	VR4	9i	Ecom
0809B	EC8908-09BW1	LVR-IC	LDO, 0.9V±1.5%, 500mA, +CE	WDFN-6	56zg	VR4	9i	Ecom
0809C	EC8908-09CW1	LVR-IC	LDO, 0.9V±1.5%, 300mA, -CE	WDFN-6	56zg	VR4	9i	Ecom
0809D	EC8908-09DW1	LVR-IC	LDO, 0.9V±1.5%, 500mA, -CE	WDFN-6	56zg	VR4	9i	Ecom
0810A	EC8908-10AW1	LVR-IC	LDO, 1.0V±1.5%, 300mA, +CE	WDFN-6	56zg	VR4	9i	Ecom
0810B	EC8908-10BW1	LVR-IC	LDO, 1.0V±1.5%, 500mA, +CE	WDFN-6	56zg	VR4	9i	Ecom
0810C	EC8908-10CW1	LVR-IC	LDO, 1.0V±1.5%, 300mA, -CE	WDFN-6	56zg	VR4	9i	Ecom
0810D	EC8908-10DW1	LVR-IC	LDO, 1.0V±1.5%, 500mA, -CE	WDFN-6	56zg	VR4	9i	Ecom
0811A	EC8908-11AW1	LVR-IC	LDO, 1.1V±1.5%, 300mA, +CE	WDFN-6	56zg	VR4	9i	Ecom
0811B	EC8908-11BW1	LVR-IC	LDO, 1.1V±1.5%, 500mA, +CE	WDFN-6	56zg	VR4	9i	Ecom
0811C	EC8908-11CW1	LVR-IC	LDO, 1.1V±1.5%, 300mA, -CE	WDFN-6	56zg	VR4	9i	Ecom
0811D	EC8908-11DW1	LVR-IC	LDO, 1.1V±1.5%, 500mA, -CE	WDFN-6	56zg	VR4	9i	Ecom
0812A	EC8908-12AW1	LVR-IC	LDO, 1.2V±1.5%, 300mA, +CE	WDFN-6	56zg	VR4	9i	Ecom
0812B	EC8908-12BW1	LVR-IC	LDO, 1.2V±1.5%, 500mA, +CE	WDFN-6	56zg	VR4	9i	Ecom
0812C	EC8908-12CW1	LVR-IC	LDO, 1.2V±1.5%, 300mA, -CE	WDFN-6	56zg	VR4	9i	Ecom
0812D	EC8908-12DW1	LVR-IC	LDO, 1.2V±1.5%, 500mA, -CE	WDFN-6	56zg	VR4	9i	Ecom
0813A	EC8908-13AW1	LVR-IC	LDO, 1.3V±1.5%, 300mA, +CE	WDFN-6	56zg	VR4	9i	Ecom
0813B	EC8908-13BW1	LVR-IC	LDO, 1.3V±1.5%, 500mA, +CE	WDFN-6	56zg	VR4	9i	Ecom
0813C	EC8908-13CW1	LVR-IC	LDO, 1.3V±1.5%, 300mA, -CE	WDFN-6	56zg	VR4	9i	Ecom
0813D	EC8908-13DW1	LVR-IC	LDO, 1.3V±1.5%, 500mA, -CE	WDFN-6	56zg	VR4	9i	Ecom
0814A	EC8908-14AW1	LVR-IC	LDO, 1.4V±1.5%, 300mA, +CE	WDFN-6	56zg	VR4	9i	Ecom
0814B	EC8908-14BW1	LVR-IC	LDO, 1.4V±1.5%, 500mA, +CE	WDFN-6	56zg	VR4	9i	Ecom
0814C	EC8908-14CW1	LVR-IC	LDO, 1.4V±1.5%, 300mA, -CE	WDFN-6	56zg	VR4	9i	Ecom
0814D	EC8908-14DW1	LVR-IC	LDO, 1.4V±1.5%, 500mA, -CE	WDFN-6	56zg	VR4	9i	Ecom
0815A	EC8908-15AW1	LVR-IC	LDO, 1.5V±1.5%, 300mA, +CE	WDFN-6	56zg	VR4	9i	Ecom
0815B	EC8908-15BW1	LVR-IC	LDO, 1.5V±1.5%, 500mA, +CE	WDFN-6	56zg	VR4	9i	Ecom
0815C	EC8908-15CW1	LVR-IC	LDO, 1.5V±1.5%, 300mA, -CE	WDFN-6	56zg	VR4	9i	Ecom
0815D	EC8908-15DW1	LVR-IC	LDO, 1.5V±1.5%, 500mA, -CE	WDFN-6	56zg	VR4	9i	Ecom
0816A	EC8908-16AW1	LVR-IC	LDO, 1.6V±1.5%, 300mA, +CE	WDFN-6	56zg	VR4	9i	Ecom
0816B	EC8908-16BW1	LVR-IC	LDO, 1.6V±1.5%, 500mA, +CE	WDFN-6	56zg	VR4	9i	Ecom
0816C	EC8908-16CW1	LVR-IC	LDO, 1.6V±1.5%, 300mA, -CE	WDFN-6	56zg	VR4	9i	Ecom
0816D	EC8908-16DW1	LVR-IC	LDO, 1.6V±1.5%, 500mA, -CE	WDFN-6	56zg	VR4	9i	Ecom
0817A	EC8908-17AW1	LVR-IC	LDO, 1.7V±1.5%, 300mA, +CE	WDFN-6	56zg	VR4	9i	Ecom
0817B	EC8908-17BW1	LVR-IC	LDO, 1.7V±1.5%, 500mA, +CE	WDFN-6	56zg	VR4	9i	Ecom
0817C	EC8908-17CW1	LVR-IC	LDO, 1.7V±1.5%, 300mA, -CE	WDFN-6	56zg	VR4	9i	Ecom
0817D	EC8908-17DW1	LVR-IC	LDO, 1.7V±1.5%, 500mA, -CE	WDFN-6	56zg	VR4	9i	Ecom
0818A	EC8908-18AW1	LVR-IC	LDO, 1.8V±1.5%, 300mA, +CE	WDFN-6	56zg	VR4	9i	Ecom
0818B	EC8908-18BW1	LVR-IC	LDO, 1.8V±1.5%, 500mA, +CE	WDFN-6	56zg	VR4	9i	Ecom
0818C	EC8908-18CW1	LVR-IC	LDO, 1.8V±1.5%, 300mA, -CE	WDFN-6	56zg	VR4	9i	Ecom
0818D	EC8908-18DW1	LVR-IC	LDO, 1.8V±1.5%, 500mA, -CE	WDFN-6	56zg	VR4	9i	Ecom
0819A	EC8908-19AW1	LVR-IC	LDO, 1.9V±1.5%, 300mA, +CE	WDFN-6	56zg	VR4	9i	Ecom
0819B	EC8908-19BW1	LVR-IC	LDO, 1.9V±1.5%, 500mA, +CE	WDFN-6	56zg	VR4	9i	Ecom
0819C	EC8908-19CW1	LVR-IC	LDO, 1.9V±1.5%, 300mA, -CE	WDFN-6	56zg	VR4	9i	Ecom
0819D	EC8908-19DW1	LVR-IC	LDO, 1.9V±1.5%, 500mA, -CE	WDFN-6	56zg	VR4	9i	Ecom
0820A	EC8908-20AW1	LVR-IC	LDO, 2.0V±1.5%, 300mA, +CE	WDFN-6	56zg	VR4	9i	Ecom
0820B	EC8908-20BW1	LVR-IC	LDO, 2.0V±1.5%, 500mA, +CE	WDFN-6	56zg	VR4	9i	Ecom
0820C	EC8908-20CW1	LVR-IC	LDO, 2.0V±1.5%, 300mA, -CE	WDFN-6	56zg	VR4	9i	Ecom
0820D	EC8908-20DW1	LVR-IC	LDO, 2.0V±1.5%, 500mA, -CE	WDFN-6	56zg	VR4	9i	Ecom
0821A	EC8908-21AW1	LVR-IC	LDO, 2.1V±1.5%, 300mA, +CE	WDFN-6	56zg	VR4	9i	Ecom
0821B	EC8908-21BW1	LVR-IC	LDO, 2.1V±1.5%, 500mA, +CE	WDFN-6	56zg	VR4	9i	Ecom
0821C	EC8908-21CW1	LVR-IC	LDO, 2.1V±1.5%, 300mA, -CE	WDFN-6	56zg	VR4	9i	Ecom
0821D	EC8908-21DW1	LVR-IC	LDO, 2.1V±1.5%, 500mA, -CE	WDFN-6	56zg	VR4	9i	Ecom
0822A	EC8908-22AW1	LVR-IC	LDO, 2.2V±1.5%, 300mA, +CE	WDFN-6	56zg	VR4	9i	Ecom
0822B	EC8908-22BW1	LVR-IC	LDO, 2.2V±1.5%, 500mA, +CE	WDFN-6	56zg	VR4	9i	Ecom
0822C	EC8908-22CW1	LVR-IC	LDO, 2.2V±1.5%, 300mA, -CE	WDFN-6	56zg	VR4	9i	Ecom
0822D	EC8908-22DW1	LVR-IC	LDO, 2.2V±1.5%, 500mA, -CE	WDFN-6	56zg	VR4	9i	Ecom
0823A	EC8908-23AW1	LVR-IC	LDO, 2.3V±1.5%, 300mA, +CE	WDFN-6	56zg	VR4	9i	Ecom
0823B	EC8908-23BW1	LVR-IC	LDO, 2.3V±1.5%, 500mA, +CE	WDFN-6	56zg	VR4	9i	Ecom
0823C	EC8908-23CW1	LVR-IC	LDO, 2.3V±1.5%, 300mA, -CE	WDFN-6	56zg	VR4	9i	Ecom



SMD code	Type	Function	Short description	Case	Pinout	Sch.	St.	Mnf.
0841B	EC8908-41BW1	LVR-IC	LDO, 4.1V±1.5%, 500mA, +CE	WDFN-6	56zg	VR4	9i	Ecom
0841C	EC8908-41CW1	LVR-IC	LDO, 4.1V±1.5%, 300mA, -CE	WDFN-6	56zg	VR4	9i	Ecom
0841D	EC8908-41DW1	LVR-IC	LDO, 4.1V±1.5%, 500mA, -CE	WDFN-6	56zg	VR4	9i	Ecom
0842A	EC8908-42AW1	LVR-IC	LDO, 4.2V±1.5%, 300mA, +CE	WDFN-6	56zg	VR4	9i	Ecom
0842B	EC8908-42BW1	LVR-IC	LDO, 4.2V±1.5%, 500mA, +CE	WDFN-6	56zg	VR4	9i	Ecom
0842C	EC8908-42CW1	LVR-IC	LDO, 4.2V±1.5%, 300mA, -CE	WDFN-6	56zg	VR4	9i	Ecom
0842D	EC8908-42DW1	LVR-IC	LDO, 4.2V±1.5%, 500mA, -CE	WDFN-6	56zg	VR4	9i	Ecom
0843A	EC8908-43AW1	LVR-IC	LDO, 4.3V±1.5%, 300mA, +CE	WDFN-6	56zg	VR4	9i	Ecom
0843B	EC8908-43BW1	LVR-IC	LDO, 4.3V±1.5%, 500mA, +CE	WDFN-6	56zg	VR4	9i	Ecom
0843C	EC8908-43CW1	LVR-IC	LDO, 4.3V±1.5%, 300mA, -CE	WDFN-6	56zg	VR4	9i	Ecom
0843D	EC8908-43DW1	LVR-IC	LDO, 4.3V±1.5%, 500mA, -CE	WDFN-6	56zg	VR4	9i	Ecom
0844A	EC8908-44AW1	LVR-IC	LDO, 4.4V±1.5%, 300mA, +CE	WDFN-6	56zg	VR4	9i	Ecom
0844B	EC8908-44BW1	LVR-IC	LDO, 4.4V±1.5%, 500mA, +CE	WDFN-6	56zg	VR4	9i	Ecom
0844C	EC8908-44CW1	LVR-IC	LDO, 4.4V±1.5%, 300mA, -CE	WDFN-6	56zg	VR4	9i	Ecom
0844D	EC8908-44DW1	LVR-IC	LDO, 4.4V±1.5%, 500mA, -CE	WDFN-6	56zg	VR4	9i	Ecom
0845A	EC8908-45AW1	LVR-IC	LDO, 4.5V±1.5%, 300mA, +CE	WDFN-6	56zg	VR4	9i	Ecom
0845B	EC8908-45BW1	LVR-IC	LDO, 4.5V±1.5%, 500mA, +CE	WDFN-6	56zg	VR4	9i	Ecom
0845C	EC8908-45CW1	LVR-IC	LDO, 4.5V±1.5%, 300mA, -CE	WDFN-6	56zg	VR4	9i	Ecom
0845D	EC8908-45DW1	LVR-IC	LDO, 4.5V±1.5%, 500mA, -CE	WDFN-6	56zg	VR4	9i	Ecom
0846A	EC8908-46AW1	LVR-IC	LDO, 4.6V±1.5%, 300mA, +CE	WDFN-6	56zg	VR4	9i	Ecom
0846B	EC8908-46BW1	LVR-IC	LDO, 4.6V±1.5%, 500mA, +CE	WDFN-6	56zg	VR4	9i	Ecom
0846C	EC8908-46CW1	LVR-IC	LDO, 4.6V±1.5%, 300mA, -CE	WDFN-6	56zg	VR4	9i	Ecom
0846D	EC8908-46DW1	LVR-IC	LDO, 4.6V±1.5%, 500mA, -CE	WDFN-6	56zg	VR4	9i	Ecom
0847A	EC8908-47AW1	LVR-IC	LDO, 4.7V±1.5%, 300mA, +CE	WDFN-6	56zg	VR4	9i	Ecom
0847B	EC8908-47BW1	LVR-IC	LDO, 4.7V±1.5%, 500mA, +CE	WDFN-6	56zg	VR4	9i	Ecom
0847C	EC8908-47CW1	LVR-IC	LDO, 4.7V±1.5%, 300mA, -CE	WDFN-6	56zg	VR4	9i	Ecom
0847D	EC8908-47DW1	LVR-IC	LDO, 4.7V±1.5%, 500mA, -CE	WDFN-6	56zg	VR4	9i	Ecom
0848A	EC8908-48AW1	LVR-IC	LDO, 4.8V±1.5%, 300mA, +CE	WDFN-6	56zg	VR4	9i	Ecom
0848B	EC8908-48BW1	LVR-IC	LDO, 4.8V±1.5%, 500mA, +CE	WDFN-6	56zg	VR4	9i	Ecom
0848C	EC8908-48CW1	LVR-IC	LDO, 4.8V±1.5%, 300mA, -CE	WDFN-6	56zg	VR4	9i	Ecom
084HA	EC8908-4HAW1	LVR-IC	LDO, 4.75V±1.5%, 300mA, +CE	WDFN-6	56zg	VR4	9i	Ecom
084HB	EC8908-4HBW1	LVR-IC	LDO, 4.75V±1.5%, 500mA, +CE	WDFN-6	56zg	VR4	9i	Ecom
084HC	EC8908-4HCW1	LVR-IC	LDO, 4.75V±1.5%, 300mA, -CE	WDFN-6	56zg	VR4	9i	Ecom
084HD	EC8908-4HDW1	LVR-IC	LDO, 4.75V±1.5%, 500mA, -CE	WDFN-6	56zg	VR4	9i	Ecom
09	RP110L161B	LVR-IC	LDO, 1.6V±1%, 150mA, +CE	DFN1010-4	48vm	VR4	9a	Ric
09	XC6223A1919R-G	LVR-IC	LDO, 1.9V±20mV, 300mA, +CE	USPQ-4B03	48vm	VR4	9a	Tor
09	XC6224A1717R	LVR-IC	LDO, 1.7V±1.5%, 150mA, +CE	USPN-4B02	58vm	VR4	9e	Tor
09	XC6229D16B1R-G	LVR-IC	LDO, 1.65V±20mV, 300mA, +CE	BGA-4	63ba*	VR4	9a	Tor
09	XC6420AB097R-G	LVR-IC	LDO, Dual out, Vout1/Vout2=1.50/2.50V±2%, 150mA, +CE	USPN-6	52xv	VR19	9a	Tor
09	XC6420AB09DR-G	LVR-IC	LDO, Dual out, Vout1/Vout2=1.50/2.50V±2%, 150mA, +CE	USP-6B04	73x4	VR19	9a	Tor
09	XC6221C1717R	LVR-IC	LDO, 1.7V±20mV, 200mA, +CE, PDR	USPN-4	58vm	VR4	9a	Tor
09A09	XC6209A092DR	LVR-IC	LDO, 0.9V±2%, 150mA, +CE, PDR	USP-6B	49hq	VR4	9b	Tor
09A0M	XC6209A09ADR	LVR-IC	LDO, 0.95V±2%, 150mA, +CE, PDR	USP-6B	49hq	VR4	9b	Tor
09A10	XC6209A102DR	LVR-IC	LDO, 1V±2%, 150mA, +CE, PDR	USP-6B	49hq	VR4	9b	Tor
09A11	XC6209A112DR	LVR-IC	LDO, 1.1V±2%, 150mA, +CE, PDR	USP-6B	49hq	VR4	9b	Tor
09A12	XC6209A122DR	LVR-IC	LDO, 1.2V±2%, 150mA, +CE, PDR	USP-6B	49hq	VR4	9b	Tor
09A13	XC6209A132DR	LVR-IC	LDO, 1.3V±2%, 150mA, +CE, PDR	USP-6B	49hq	VR4	9b	Tor
09A14	XC6209A142DR	LVR-IC	LDO, 1.4V±2%, 150mA, +CE, PDR	USP-6B	49hq	VR4	9b	Tor
09A15	XC6209A152DR	LVR-IC	LDO, 1.5V±2%, 150mA, +CE, PDR	USP-6B	49hq	VR4	9b	Tor
09A16	XC6209A162DR	LVR-IC	LDO, 1.6V±2%, 150mA, +CE, PDR	USP-6B	49hq	VR4	9b	Tor
09A17	XC6209A172DR	LVR-IC	LDO, 1.7V±2%, 150mA, +CE, PDR	USP-6B	49hq	VR4	9b	Tor
09A18	XC6209A182DR	LVR-IC	LDO, 1.8V±2%, 150mA, +CE, PDR	USP-6B	49hq	VR4	9b	Tor
09A19	XC6209A192DR	LVR-IC	LDO, 1.9V±2%, 150mA, +CE, PDR	USP-6B	49hq	VR4	9b	Tor
09A1A	XC6209A10ADR	LVR-IC	LDO, 1.05V±2%, 150mA, +CE, PDR	USP-6B	49hq	VR4	9b	Tor
09A1B	XC6209A11ADR	LVR-IC	LDO, 1.15V±2%, 150mA, +CE, PDR	USP-6B	49hq	VR4	9b	Tor
09A1C	XC6209A12ADR	LVR-IC	LDO, 1.25V±2%, 150mA, +CE, PDR	USP-6B	49hq	VR4	9b	Tor
09A1D	XC6209A13ADR	LVR-IC	LDO, 1.35V±2%, 150mA, +CE, PDR	USP-6B	49hq	VR4	9b	Tor
09A1E	XC6209A14ADR	LVR-IC	LDO, 1.45V±2%, 150mA, +CE, PDR	USP-6B	49hq	VR4	9b	Tor
09A1F	XC6209A15ADR	LVR-IC	LDO, 1.55V±2%, 150mA, +CE, PDR	USP-6B	49hq	VR4	9b	Tor
09A1H	XC6209A16ADR	LVR-IC	LDO, 1.65V±2%, 150mA, +CE, PDR	USP-6B	49hq	VR4	9b	Tor
09A1K	XC6209A17ADR	LVR-IC	LDO, 1.75V±2%, 150mA, +CE, PDR	USP-6B	49hq	VR4	9b	Tor
09A1L	XC6209A18ADR	LVR-IC	LDO, 1.85V±2%, 150mA, +CE, PDR	USP-6B	49hq	VR4	9b	Tor
09A1M	XC6209A19ADR	LVR-IC	LDO, 1.95V±2%, 150mA, +CE, PDR	USP-6B	49hq	VR4	9b	Tor
09A20	XC6209A202DR	LVR-IC	LDO, 2V±2%, 150mA, +CE, PDR	USP-6B	49hq	VR4	9b	Tor
09A21	XC6209A212DR	LVR-IC	LDO, 2.1V±2%, 150mA, +CE, PDR	USP-6B	49hq	VR4	9b	Tor
09A22	XC6209A222DR	LVR-IC	LDO, 2.2V±2%, 150mA, +CE, PDR	USP-6B	49hq	VR4	9b	Tor
09A23	XC6209A232DR	LVR-IC	LDO, 2.3V±2%, 150mA, +CE, PDR	USP-6B	49hq	VR4	9b	Tor
09A24	XC6209A242DR	LVR-IC	LDO, 2.4V±2%, 150mA, +CE, PDR	USP-6B	49hq	VR4	9b	Tor
09A25	XC6209A252DR	LVR-IC	LDO, 2.5V±2%, 150mA, +CE, PDR	USP-6B	49hq	VR4	9b	Tor
09A26	XC6209A262DR	LVR-IC	LDO, 2.6V±2%, 150mA, +CE, PDR	USP-6B	49hq	VR4	9b	Tor



SMD code	Type	Function	Short description	Case	Pinout	Sch.	St.	Mnf.
09B44	XC6209B442DR	LVR-IC	LDO, 4.4V±2%, 150mA, +CE	USP-6B	49hq	VR4	9b	Tor
09B45	XC6209B452DR	LVR-IC	LDO, 4.5V±2%, 150mA, +CE	USP-6B	49hq	VR4	9b	Tor
09B46	XC6209B462DR	LVR-IC	LDO, 4.6V±2%, 150mA, +CE	USP-6B	49hq	VR4	9b	Tor
09B47	XC6209B472DR	LVR-IC	LDO, 4.7V±2%, 150mA, +CE	USP-6B	49hq	VR4	9b	Tor
09B48	XC6209B482DR	LVR-IC	LDO, 4.8V±2%, 150mA, +CE	USP-6B	49hq	VR4	9b	Tor
09B49	XC6209B492DR	LVR-IC	LDO, 4.9V±2%, 150mA, +CE	USP-6B	49hq	VR4	9b	Tor
09B4A	XC6209B40ADR	LVR-IC	LDO, 4.05V±2%, 150mA, +CE	USP-6B	49hq	VR4	9b	Tor
09B4B	XC6209B41ADR	LVR-IC	LDO, 4.15V±2%, 150mA, +CE	USP-6B	49hq	VR4	9b	Tor
09B4C	XC6209B42ADR	LVR-IC	LDO, 4.25V±2%, 150mA, +CE	USP-6B	49hq	VR4	9b	Tor
09B4D	XC6209B43ADR	LVR-IC	LDO, 4.35V±2%, 150mA, +CE	USP-6B	49hq	VR4	9b	Tor
09B4E	XC6209B44ADR	LVR-IC	LDO, 4.45V±2%, 150mA, +CE	USP-6B	49hq	VR4	9b	Tor
09B4F	XC6209B45ADR	LVR-IC	LDO, 4.55V±2%, 150mA, +CE	USP-6B	49hq	VR4	9b	Tor
09B4H	XC6209B46ADR	LVR-IC	LDO, 4.65V±2%, 150mA, +CE	USP-6B	49hq	VR4	9b	Tor
09B4K	XC6209B47ADR	LVR-IC	LDO, 4.75V±2%, 150mA, +CE	USP-6B	49hq	VR4	9b	Tor
09B4L	XC6209B48ADR	LVR-IC	LDO, 4.85V±2%, 150mA, +CE	USP-6B	49hq	VR4	9b	Tor
09B4M	XC6209B49ADR	LVR-IC	LDO, 4.95V±2%, 150mA, +CE	USP-6B	49hq	VR4	9b	Tor
09B50	XC6209B502DR	LVR-IC	LDO, 5V±2%, 150mA, +CE	USP-6B	49hq	VR4	9b	Tor
09B51	XC6209B512DR	LVR-IC	LDO, 5.1V±2%, 150mA, +CE	USP-6B	49hq	VR4	9b	Tor
09B52	XC6209B522DR	LVR-IC	LDO, 5.2V±2%, 150mA, +CE	USP-6B	49hq	VR4	9b	Tor
09B53	XC6209B532DR	LVR-IC	LDO, 5.3V±2%, 150mA, +CE	USP-6B	49hq	VR4	9b	Tor
09B54	XC6209B542DR	LVR-IC	LDO, 5.4V±2%, 150mA, +CE	USP-6B	49hq	VR4	9b	Tor
09B55	XC6209B552DR	LVR-IC	LDO, 5.5V±2%, 150mA, +CE	USP-6B	49hq	VR4	9b	Tor
09B56	XC6209B562DR	LVR-IC	LDO, 5.6V±2%, 150mA, +CE	USP-6B	49hq	VR4	9b	Tor
09B57	XC6209B572DR	LVR-IC	LDO, 5.7V±2%, 150mA, +CE	USP-6B	49hq	VR4	9b	Tor
09B58	XC6209B582DR	LVR-IC	LDO, 5.8V±2%, 150mA, +CE	USP-6B	49hq	VR4	9b	Tor
09B59	XC6209B592DR	LVR-IC	LDO, 5.9V±2%, 150mA, +CE	USP-6B	49hq	VR4	9b	Tor
09B5A	XC6209B50ADR	LVR-IC	LDO, 5.05V±2%, 150mA, +CE	USP-6B	49hq	VR4	9b	Tor
09B5B	XC6209B51ADR	LVR-IC	LDO, 5.15V±2%, 150mA, +CE	USP-6B	49hq	VR4	9b	Tor
09B5C	XC6209B52ADR	LVR-IC	LDO, 5.25V±2%, 150mA, +CE	USP-6B	49hq	VR4	9b	Tor
09B5D	XC6209B53ADR	LVR-IC	LDO, 5.35V±2%, 150mA, +CE	USP-6B	49hq	VR4	9b	Tor
09B5E	XC6209B54ADR	LVR-IC	LDO, 5.45V±2%, 150mA, +CE	USP-6B	49hq	VR4	9b	Tor
09B5F	XC6209B55ADR	LVR-IC	LDO, 5.55V±2%, 150mA, +CE	USP-6B	49hq	VR4	9b	Tor
09B5H	XC6209B56ADR	LVR-IC	LDO, 5.65V±2%, 150mA, +CE	USP-6B	49hq	VR4	9b	Tor
09B5K	XC6209B57ADR	LVR-IC	LDO, 5.75V±2%, 150mA, +CE	USP-6B	49hq	VR4	9b	Tor
09B5L	XC6209B58ADR	LVR-IC	LDO, 5.85V±2%, 150mA, +CE	USP-6B	49hq	VR4	9b	Tor
09B5M	XC6209B59ADR	LVR-IC	LDO, 5.95V±2%, 150mA, +CE	USP-6B	49hq	VR4	9b	Tor
09B60	XC6209B602DR	LVR-IC	LDO, 6V±2%, 150mA, +CE	USP-6B	49hq	VR4	9b	Tor
09C09	XC6209C092DR	LVR-IC	LDO, 0.9V±2%, 150mA, -CE, PDR	USP-6B	49hq	VR4	9b	Tor
09C0M	XC6209C09ADR	LVR-IC	LDO, 0.95V±2%, 150mA, -CE, PDR	USP-6B	49hq	VR4	9b	Tor
09C10	XC6209C102DR	LVR-IC	LDO, 1V±2%, 150mA, -CE, PDR	USP-6B	49hq	VR4	9b	Tor
09C11	XC6209C112DR	LVR-IC	LDO, 1.1V±2%, 150mA, -CE, PDR	USP-6B	49hq	VR4	9b	Tor
09C12	XC6209C122DR	LVR-IC	LDO, 1.2V±2%, 150mA, -CE, PDR	USP-6B	49hq	VR4	9b	Tor
09C13	XC6209C132DR	LVR-IC	LDO, 1.3V±2%, 150mA, -CE, PDR	USP-6B	49hq	VR4	9b	Tor
09C14	XC6209C142DR	LVR-IC	LDO, 1.4V±2%, 150mA, -CE, PDR	USP-6B	49hq	VR4	9b	Tor
09C15	XC6209C152DR	LVR-IC	LDO, 1.5V±2%, 150mA, -CE, PDR	USP-6B	49hq	VR4	9b	Tor
09C16	XC6209C162DR	LVR-IC	LDO, 1.6V±2%, 150mA, -CE, PDR	USP-6B	49hq	VR4	9b	Tor
09C17	XC6209C172DR	LVR-IC	LDO, 1.7V±2%, 150mA, -CE, PDR	USP-6B	49hq	VR4	9b	Tor
09C18	XC6209C182DR	LVR-IC	LDO, 1.8V±2%, 150mA, -CE, PDR	USP-6B	49hq	VR4	9b	Tor
09C19	XC6209C192DR	LVR-IC	LDO, 1.9V±2%, 150mA, -CE, PDR	USP-6B	49hq	VR4	9b	Tor
09C1A	XC6209C10ADR	LVR-IC	LDO, 1.05V±2%, 150mA, -CE, PDR	USP-6B	49hq	VR4	9b	Tor
09C1B	XC6209C11ADR	LVR-IC	LDO, 1.15V±2%, 150mA, -CE, PDR	USP-6B	49hq	VR4	9b	Tor
09C1C	XC6209C12ADR	LVR-IC	LDO, 1.25V±2%, 150mA, -CE, PDR	USP-6B	49hq	VR4	9b	Tor
09C1D	XC6209C13ADR	LVR-IC	LDO, 1.35V±2%, 150mA, -CE, PDR	USP-6B	49hq	VR4	9b	Tor
09C1E	XC6209C14ADR	LVR-IC	LDO, 1.45V±2%, 150mA, -CE, PDR	USP-6B	49hq	VR4	9b	Tor
09C1F	XC6209C15ADR	LVR-IC	LDO, 1.55V±2%, 150mA, -CE, PDR	USP-6B	49hq	VR4	9b	Tor
09C1H	XC6209C16ADR	LVR-IC	LDO, 1.65V±2%, 150mA, -CE, PDR	USP-6B	49hq	VR4	9b	Tor
09C1K	XC6209C17ADR	LVR-IC	LDO, 1.75V±2%, 150mA, -CE, PDR	USP-6B	49hq	VR4	9b	Tor
09C1L	XC6209C18ADR	LVR-IC	LDO, 1.85V±2%, 150mA, -CE, PDR	USP-6B	49hq	VR4	9b	Tor
09C1M	XC6209C19ADR	LVR-IC	LDO, 1.95V±2%, 150mA, -CE, PDR	USP-6B	49hq	VR4	9b	Tor
09C20	XC6209C202DR	LVR-IC	LDO, 2V±2%, 150mA, -CE, PDR	USP-6B	49hq	VR4	9b	Tor
09C21	XC6209C212DR	LVR-IC	LDO, 2.1V±2%, 150mA, -CE, PDR	USP-6B	49hq	VR4	9b	Tor
09C22	XC6209C222DR	LVR-IC	LDO, 2.2V±2%, 150mA, -CE, PDR	USP-6B	49hq	VR4	9b	Tor
09C23	XC6209C232DR	LVR-IC	LDO, 2.3V±2%, 150mA, -CE, PDR	USP-6B	49hq	VR4	9b	Tor
09C24	XC6209C242DR	LVR-IC	LDO, 2.4V±2%, 150mA, -CE, PDR	USP-6B	49hq	VR4	9b	Tor
09C25	XC6209C252DR	LVR-IC	LDO, 2.5V±2%, 150mA, -CE, PDR	USP-6B	49hq	VR4	9b	Tor
09C26	XC6209C262DR	LVR-IC	LDO, 2.6V±2%, 150mA, -CE, PDR	USP-6B	49hq	VR4	9b	Tor
09C27	XC6209C272DR	LVR-IC	LDO, 2.7V±2%, 150mA, -CE, PDR	USP-6B	49hq	VR4	9b	Tor
09C28	XC6209C282DR	LVR-IC	LDO, 2.8V±2%, 150mA, -CE, PDR	USP-6B	49hq	VR4	9b	Tor
09C29	XC6209C292DR	LVR-IC	LDO, 2.9V±2%, 150mA, -CE, PDR	USP-6B	49hq	VR4	9b	Tor
09C2A	XC6209C20ADR	LVR-IC	LDO, 2.05V±2%, 150mA, -CE, PDR	USP-6B	49hq	VR4	9b	Tor



SMD code	Type	Function	Short description	Case	Pinout	Sch.	St.	Mnf.
09D00	XC6209D092DR	LVR-IC	LDO, 0.9V±2%, 150mA, -CE	USP-6B	49hq	VR4	9b	Tor
09D0M	XC6209D09ADR	LVR-IC	LDO, 0.95V±2%, 150mA, -CE	USP-6B	49hq	VR4	9b	Tor
09D10	XC6209D102DR	LVR-IC	LDO, 1V±2%, 150mA, -CE	USP-6B	49hq	VR4	9b	Tor
09D11	XC6209D112DR	LVR-IC	LDO, 1.1V±2%, 150mA, -CE	USP-6B	49hq	VR4	9b	Tor
09D12	XC6209D122DR	LVR-IC	LDO, 1.2V±2%, 150mA, -CE	USP-6B	49hq	VR4	9b	Tor
09D13	XC6209D132DR	LVR-IC	LDO, 1.3V±2%, 150mA, -CE	USP-6B	49hq	VR4	9b	Tor
09D14	XC6209D142DR	LVR-IC	LDO, 1.4V±2%, 150mA, -CE	USP-6B	49hq	VR4	9b	Tor
09D15	XC6209D152DR	LVR-IC	LDO, 1.5V±2%, 150mA, -CE	USP-6B	49hq	VR4	9b	Tor
09D16	XC6209D162DR	LVR-IC	LDO, 1.6V±2%, 150mA, -CE	USP-6B	49hq	VR4	9b	Tor
09D17	XC6209D172DR	LVR-IC	LDO, 1.7V±2%, 150mA, -CE	USP-6B	49hq	VR4	9b	Tor
09D18	XC6209D182DR	LVR-IC	LDO, 1.8V±2%, 150mA, -CE	USP-6B	49hq	VR4	9b	Tor
09D19	XC6209D192DR	LVR-IC	LDO, 1.9V±2%, 150mA, -CE	USP-6B	49hq	VR4	9b	Tor
09D1A	XC6209D10ADR	LVR-IC	LDO, 1.05V±2%, 150mA, -CE	USP-6B	49hq	VR4	9b	Tor
09D1B	XC6209D11ADR	LVR-IC	LDO, 1.15V±2%, 150mA, -CE	USP-6B	49hq	VR4	9b	Tor
09D1C	XC6209D12ADR	LVR-IC	LDO, 1.25V±2%, 150mA, -CE	USP-6B	49hq	VR4	9b	Tor
09D1D	XC6209D13ADR	LVR-IC	LDO, 1.35V±2%, 150mA, -CE	USP-6B	49hq	VR4	9b	Tor
09D1E	XC6209D14ADR	LVR-IC	LDO, 1.45V±2%, 150mA, -CE	USP-6B	49hq	VR4	9b	Tor
09D1F	XC6209D15ADR	LVR-IC	LDO, 1.55V±2%, 150mA, -CE	USP-6B	49hq	VR4	9b	Tor
09D1H	XC6209D16ADR	LVR-IC	LDO, 1.65V±2%, 150mA, -CE	USP-6B	49hq	VR4	9b	Tor
09D1K	XC6209D17ADR	LVR-IC	LDO, 1.75V±2%, 150mA, -CE	USP-6B	49hq	VR4	9b	Tor
09D1L	XC6209D18ADR	LVR-IC	LDO, 1.85V±2%, 150mA, -CE	USP-6B	49hq	VR4	9b	Tor
09D1M	XC6209D19ADR	LVR-IC	LDO, 1.95V±2%, 150mA, -CE	USP-6B	49hq	VR4	9b	Tor
09D20	XC6209D202DR	LVR-IC	LDO, 2V±2%, 150mA, -CE	USP-6B	49hq	VR4	9b	Tor
09D21	XC6209D212DR	LVR-IC	LDO, 2.1V±2%, 150mA, -CE	USP-6B	49hq	VR4	9b	Tor
09D22	XC6209D222DR	LVR-IC	LDO, 2.2V±2%, 150mA, -CE	USP-6B	49hq	VR4	9b	Tor
09D23	XC6209D232DR	LVR-IC	LDO, 2.3V±2%, 150mA, -CE	USP-6B	49hq	VR4	9b	Tor
09D24	XC6209D242DR	LVR-IC	LDO, 2.4V±2%, 150mA, -CE	USP-6B	49hq	VR4	9b	Tor
09D25	XC6209D252DR	LVR-IC	LDO, 2.5V±2%, 150mA, -CE	USP-6B	49hq	VR4	9b	Tor
09D26	XC6209D262DR	LVR-IC	LDO, 2.6V±2%, 150mA, -CE	USP-6B	49hq	VR4	9b	Tor
09D27	XC6209D272DR	LVR-IC	LDO, 2.7V±2%, 150mA, -CE	USP-6B	49hq	VR4	9b	Tor
09D28	XC6209D282DR	LVR-IC	LDO, 2.8V±2%, 150mA, -CE	USP-6B	49hq	VR4	9b	Tor
09D29	XC6209D292DR	LVR-IC	LDO, 2.9V±2%, 150mA, -CE	USP-6B	49hq	VR4	9b	Tor
09D2A	XC6209D20ADR	LVR-IC	LDO, 2.05V±2%, 150mA, -CE	USP-6B	49hq	VR4	9b	Tor
09D2B	XC6209D21ADR	LVR-IC	LDO, 2.15V±2%, 150mA, -CE	USP-6B	49hq	VR4	9b	Tor
09D2C	XC6209D22ADR	LVR-IC	LDO, 2.25V±2%, 150mA, -CE	USP-6B	49hq	VR4	9b	Tor
09D2D	XC6209D23ADR	LVR-IC	LDO, 2.35V±2%, 150mA, -CE	USP-6B	49hq	VR4	9b	Tor
09D2E	XC6209D24ADR	LVR-IC	LDO, 2.45V±2%, 150mA, -CE	USP-6B	49hq	VR4	9b	Tor
09D2F	XC6209D25ADR	LVR-IC	LDO, 2.55V±2%, 150mA, -CE	USP-6B	49hq	VR4	9b	Tor
09D2H	XC6209D26ADR	LVR-IC	LDO, 2.65V±2%, 150mA, -CE	USP-6B	49hq	VR4	9b	Tor
09D2K	XC6209D27ADR	LVR-IC	LDO, 2.75V±2%, 150mA, -CE	USP-6B	49hq	VR4	9b	Tor
09D2L	XC6209D28ADR	LVR-IC	LDO, 2.85V±2%, 150mA, -CE	USP-6B	49hq	VR4	9b	Tor
09D2M	XC6209D29ADR	LVR-IC	LDO, 2.95V±2%, 150mA, -CE	USP-6B	49hq	VR4	9b	Tor
09D30	XC6209D302DR	LVR-IC	LDO, 3V±2%, 150mA, -CE	USP-6B	49hq	VR4	9b	Tor
09D31	XC6209D312DR	LVR-IC	LDO, 3.1V±2%, 150mA, -CE	USP-6B	49hq	VR4	9b	Tor
09D32	XC6209D322DR	LVR-IC	LDO, 3.2V±2%, 150mA, -CE	USP-6B	49hq	VR4	9b	Tor
09D33	XC6209D332DR	LVR-IC	LDO, 3.3V±2%, 150mA, -CE	USP-6B	49hq	VR4	9b	Tor
09D34	XC6209D342DR	LVR-IC	LDO, 3.4V±2%, 150mA, -CE	USP-6B	49hq	VR4	9b	Tor
09D35	XC6209D352DR	LVR-IC	LDO, 3.5V±2%, 150mA, -CE	USP-6B	49hq	VR4	9b	Tor
09D36	XC6209D362DR	LVR-IC	LDO, 3.6V±2%, 150mA, -CE	USP-6B	49hq	VR4	9b	Tor
09D37	XC6209D372DR	LVR-IC	LDO, 3.7V±2%, 150mA, -CE	USP-6B	49hq	VR4	9b	Tor
09D38	XC6209D382DR	LVR-IC	LDO, 3.8V±2%, 150mA, -CE	USP-6B	49hq	VR4	9b	Tor
09D39	XC6209D392DR	LVR-IC	LDO, 3.9V±2%, 150mA, -CE	USP-6B	49hq	VR4	9b	Tor
09D3A	XC6209D30ADR	LVR-IC	LDO, 3.05V±2%, 150mA, -CE	USP-6B	49hq	VR4	9b	Tor
09D3B	XC6209D31ADR	LVR-IC	LDO, 3.15V±2%, 150mA, -CE	USP-6B	49hq	VR4	9b	Tor
09D3C	XC6209D32ADR	LVR-IC	LDO, 3.25V±2%, 150mA, -CE	USP-6B	49hq	VR4	9b	Tor
09D3D	XC6209D33ADR	LVR-IC	LDO, 3.35V±2%, 150mA, -CE	USP-6B	49hq	VR4	9b	Tor
09D3E	XC6209D34ADR	LVR-IC	LDO, 3.45V±2%, 150mA, -CE	USP-6B	49hq	VR4	9b	Tor
09D3F	XC6209D35ADR	LVR-IC	LDO, 3.55V±2%, 150mA, -CE	USP-6B	49hq	VR4	9b	Tor
09D3H	XC6209D36ADR	LVR-IC	LDO, 3.65V±2%, 150mA, -CE	USP-6B	49hq	VR4	9b	Tor
09D3K	XC6209D37ADR	LVR-IC	LDO, 3.75V±2%, 150mA, -CE	USP-6B	49hq	VR4	9b	Tor
09D3L	XC6209D38ADR	LVR-IC	LDO, 3.85V±2%, 150mA, -CE	USP-6B	49hq	VR4	9b	Tor
09D3M	XC6209D39ADR	LVR-IC	LDO, 3.95V±2%, 150mA, -CE	USP-6B	49hq	VR4	9b	Tor
09D40	XC6209D402DR	LVR-IC	LDO, 4V±2%, 150mA, -CE	USP-6B	49hq	VR4	9b	Tor
09D41	XC6209D412DR	LVR-IC	LDO, 4.1V±2%, 150mA, -CE	USP-6B	49hq	VR4	9b	Tor
09D42	XC6209D422DR	LVR-IC	LDO, 4.2V±2%, 150mA, -CE	USP-6B	49hq	VR4	9b	Tor
09D43	XC6209D432DR	LVR-IC	LDO, 4.3V±2%, 150mA, -CE	USP-6B	49hq	VR4	9b	Tor
09D44	XC6209D442DR	LVR-IC	LDO, 4.4V±2%, 150mA, -CE	USP-6B	49hq	VR4	9b	Tor
09D45	XC6209D452DR	LVR-IC	LDO, 4.5V±2%, 150mA, -CE	USP-6B	49hq	VR4	9b	Tor
09D46	XC6209D462DR	LVR-IC	LDO, 4.6V±2%, 150mA, -CE	USP-6B	49hq	VR4	9b	Tor
09D47	XC6209D472DR	LVR-IC	LDO, 4.7V±2%, 150mA, -CE	USP-6B	49hq	VR4	9b	Tor



SMD code	Type	Function	Short description	Case	Pinout	Sch.	St.	Mnf.
09D48	XC6209D482DR	LVR-IC	LDO, 4.8V±2%, 150mA, -CE	USP-6B	49hq	VR4	9b	Tor
09D49	XC6209D492DR	LVR-IC	LDO, 4.9V±2%, 150mA, -CE	USP-6B	49hq	VR4	9b	Tor
09D4A	XC6209D40ADR	LVR-IC	LDO, 4.05V±2%, 150mA, -CE	USP-6B	49hq	VR4	9b	Tor
09D4B	XC6209D41ADR	LVR-IC	LDO, 4.15V±2%, 150mA, -CE	USP-6B	49hq	VR4	9b	Tor
09D4C	XC6209D42ADR	LVR-IC	LDO, 4.25V±2%, 150mA, -CE	USP-6B	49hq	VR4	9b	Tor
09D4D	XC6209D43ADR	LVR-IC	LDO, 4.35V±2%, 150mA, -CE	USP-6B	49hq	VR4	9b	Tor
09D4E	XC6209D44ADR	LVR-IC	LDO, 4.45V±2%, 150mA, -CE	USP-6B	49hq	VR4	9b	Tor
09D4F	XC6209D45ADR	LVR-IC	LDO, 4.55V±2%, 150mA, -CE	USP-6B	49hq	VR4	9b	Tor
09D4H	XC6209D46ADR	LVR-IC	LDO, 4.65V±2%, 150mA, -CE	USP-6B	49hq	VR4	9b	Tor
09D4K	XC6209D47ADR	LVR-IC	LDO, 4.75V±2%, 150mA, -CE	USP-6B	49hq	VR4	9b	Tor
09D4L	XC6209D48ADR	LVR-IC	LDO, 4.85V±2%, 150mA, -CE	USP-6B	49hq	VR4	9b	Tor
09D4M	XC6209D49ADR	LVR-IC	LDO, 4.95V±2%, 150mA, -CE	USP-6B	49hq	VR4	9b	Tor
09D50	XC6209D502DR	LVR-IC	LDO, 5V±2%, 150mA, -CE	USP-6B	49hq	VR4	9b	Tor
09D51	XC6209D512DR	LVR-IC	LDO, 5.1V±2%, 150mA, -CE	USP-6B	49hq	VR4	9b	Tor
09D52	XC6209D522DR	LVR-IC	LDO, 5.2V±2%, 150mA, -CE	USP-6B	49hq	VR4	9b	Tor
09D53	XC6209D532DR	LVR-IC	LDO, 5.3V±2%, 150mA, -CE	USP-6B	49hq	VR4	9b	Tor
09D54	XC6209D542DR	LVR-IC	LDO, 5.4V±2%, 150mA, -CE	USP-6B	49hq	VR4	9b	Tor
09D55	XC6209D552DR	LVR-IC	LDO, 5.5V±2%, 150mA, -CE	USP-6B	49hq	VR4	9b	Tor
09D56	XC6209D562DR	LVR-IC	LDO, 5.6V±2%, 150mA, -CE	USP-6B	49hq	VR4	9b	Tor
09D57	XC6209D572DR	LVR-IC	LDO, 5.7V±2%, 150mA, -CE	USP-6B	49hq	VR4	9b	Tor
09D58	XC6209D582DR	LVR-IC	LDO, 5.8V±2%, 150mA, -CE	USP-6B	49hq	VR4	9b	Tor
09D59	XC6209D592DR	LVR-IC	LDO, 5.9V±2%, 150mA, -CE	USP-6B	49hq	VR4	9b	Tor
09D5A	XC6209D50ADR	LVR-IC	LDO, 5.05V±2%, 150mA, -CE	USP-6B	49hq	VR4	9b	Tor
09D5B	XC6209D51ADR	LVR-IC	LDO, 5.15V±2%, 150mA, -CE	USP-6B	49hq	VR4	9b	Tor
09D5C	XC6209D52ADR	LVR-IC	LDO, 5.25V±2%, 150mA, -CE	USP-6B	49hq	VR4	9b	Tor
09D5D	XC6209D53ADR	LVR-IC	LDO, 5.35V±2%, 150mA, -CE	USP-6B	49hq	VR4	9b	Tor
09D5E	XC6209D54ADR	LVR-IC	LDO, 5.45V±2%, 150mA, -CE	USP-6B	49hq	VR4	9b	Tor
09D5F	XC6209D55ADR	LVR-IC	LDO, 5.55V±2%, 150mA, -CE	USP-6B	49hq	VR4	9b	Tor
09D5H	XC6209D56ADR	LVR-IC	LDO, 5.65V±2%, 150mA, -CE	USP-6B	49hq	VR4	9b	Tor
09D5K	XC6209D57ADR	LVR-IC	LDO, 5.75V±2%, 150mA, -CE	USP-6B	49hq	VR4	9b	Tor
09D5L	XC6209D58ADR	LVR-IC	LDO, 5.85V±2%, 150mA, -CE	USP-6B	49hq	VR4	9b	Tor
09D5M	XC6209D59ADR	LVR-IC	LDO, 5.95V±2%, 150mA, -CE	USP-6B	49hq	VR4	9b	Tor
09D60	XC6209D602DR	LVR-IC	LDO, 6V±2%, 150mA, -CE	USP-6B	49hq	VR4	9b	Tor
0A	RP103K241D	LVR-IC	LDO, 2.4V±1%, 150mA, +CE, CL	DFN1010-4	48vm	VR4	9a	Ric
0A	XC6221A4117R	LVR-IC	LDO, 4.1V±1%, 200mA, +CE	USPN-4	58vm	VR4	9a	Tor
0A	XC6223A2019R-G	LVR-IC	LDO, 2.0V±1%, 300mA, +CE	USPQ-4B03	48vm	VR4	9a	Tor
0A	XC6224A1817R	LVR-IC	LDO, 1.8V±1.5%, 150mA, +CE	USPN-4B02	58vm	VR4	9e	Tor
0A	XC6229D1711R-G	LVR-IC	LDO, 1.7V±20mV, 300mA, +CE	BGA-4	63ba*	VR4	9a	Tor
0A	XC6221C1817R	LVR-IC	LDO, 1.8V±20mV, 200mA, +CE, PDR	USPN-4	58vm	VR4	9a	Tor
0A0	XC6221C311GR	LVR-IC	LDO, 3.1V±1%, 200mA, +CE, PDR	USP-4	45vm	VR4	9a	Tor
0A1	XC6221C321GR	LVR-IC	LDO, 3.2V±1%, 200mA, +CE, PDR	USP-4	45vm	VR4	9a	Tor
0A151	XC6366A151ER	DC/DC-IC	PWM/PFM st-down, 100kHz, 1.5V±2.5%, 1A, +CE	USP-6C	49zo	DC7	9b	Tor
0A152	XC6366A152ER	DC/DC-IC	PWM/PFM st-down, 180kHz, 1.5V±2.5%, 1A, +CE	USP-6C	49zo	DC7	9b	Tor
0A153	XC6366A153ER	DC/DC-IC	PWM/PFM st-down, 300kHz, 1.5V±2.5%, 1A, +CE	USP-6C	49zo	DC7	9b	Tor
0A155	XC6366A155ER	DC/DC-IC	PWM/PFM st-down, 500kHz, 1.5V±2.5%, 1A, +CE	USP-6C	49zo	DC7	9b	Tor
0A161	XC6366A161ER	DC/DC-IC	PWM/PFM st-down, 100kHz, 1.6V±2.5%, 1A, +CE	USP-6C	49zo	DC7	9b	Tor
0A162	XC6366A162ER	DC/DC-IC	PWM/PFM st-down, 180kHz, 1.6V±2.5%, 1A, +CE	USP-6C	49zo	DC7	9b	Tor
0A163	XC6366A163ER	DC/DC-IC	PWM/PFM st-down, 300kHz, 1.6V±2.5%, 1A, +CE	USP-6C	49zo	DC7	9b	Tor
0A165	XC6366A165ER	DC/DC-IC	PWM/PFM st-down, 500kHz, 1.6V±2.5%, 1A, +CE	USP-6C	49zo	DC7	9b	Tor
0A171	XC6366A171ER	DC/DC-IC	PWM/PFM st-down, 100kHz, 1.7V±2.5%, 1A, +CE	USP-6C	49zo	DC7	9b	Tor
0A172	XC6366A172ER	DC/DC-IC	PWM/PFM st-down, 180kHz, 1.7V±2.5%, 1A, +CE	USP-6C	49zo	DC7	9b	Tor
0A173	XC6366A173ER	DC/DC-IC	PWM/PFM st-down, 300kHz, 1.7V±2.5%, 1A, +CE	USP-6C	49zo	DC7	9b	Tor
0A175	XC6366A175ER	DC/DC-IC	PWM/PFM st-down, 500kHz, 1.7V±2.5%, 1A, +CE	USP-6C	49zo	DC7	9b	Tor
0A181	XC6366A181ER	DC/DC-IC	PWM/PFM st-down, 100kHz, 1.8V±2.5%, 1A, +CE	USP-6C	49zo	DC7	9b	Tor
0A182	XC6366A182ER	DC/DC-IC	PWM/PFM st-down, 180kHz, 1.8V±2.5%, 1A, +CE	USP-6C	49zo	DC7	9b	Tor
0A183	XC6366A183ER	DC/DC-IC	PWM/PFM st-down, 300kHz, 1.8V±2.5%, 1A, +CE	USP-6C	49zo	DC7	9b	Tor
0A185	XC6366A185ER	DC/DC-IC	PWM/PFM st-down, 500kHz, 1.8V±2.5%, 1A, +CE	USP-6C	49zo	DC7	9b	Tor
0A191	XC6366A191ER	DC/DC-IC	PWM/PFM st-down, 100kHz, 1.9V±2.5%, 1A, +CE	USP-6C	49zo	DC7	9b	Tor
0A192	XC6366A192ER	DC/DC-IC	PWM/PFM st-down, 180kHz, 1.9V±2.5%, 1A, +CE	USP-6C	49zo	DC7	9b	Tor
0A193	XC6366A193ER	DC/DC-IC	PWM/PFM st-down, 300kHz, 1.9V±2.5%, 1A, +CE	USP-6C	49zo	DC7	9b	Tor
0A195	XC6366A195ER	DC/DC-IC	PWM/PFM st-down, 500kHz, 1.9V±2.5%, 1A, +CE	USP-6C	49zo	DC7	9b	Tor
0A2	XC6221C331GR	LVR-IC	LDO, 3.3V±1%, 200mA, +CE, PDR	USP-4	45vm	VR4	9a	Tor
0A201	XC6366A201ER	DC/DC-IC	PWM/PFM st-down, 100kHz, 2.0V±2.5%, 1A, +CE	USP-6C	49zo	DC7	9b	Tor
0A202	XC6366A202ER	DC/DC-IC	PWM/PFM st-down, 180kHz, 2.0V±2.5%, 1A, +CE	USP-6C	49zo	DC7	9b	Tor
0A203	XC6366A203ER	DC/DC-IC	PWM/PFM st-down, 300kHz, 2.0V±2.5%, 1A, +CE	USP-6C	49zo	DC7	9b	Tor
0A205	XC6366A205ER	DC/DC-IC	PWM/PFM st-down, 500kHz, 2.0V±2.5%, 1A, +CE	USP-6C	49zo	DC7	9b	Tor
0A211	XC6366A211ER	DC/DC-IC	PWM/PFM st-down, 100kHz, 2.1V±2.5%, 1A, +CE	USP-6C	49zo	DC7	9b	Tor
0A212	XC6366A212ER	DC/DC-IC	PWM/PFM st-down, 180kHz, 2.1V±2.5%, 1A, +CE	USP-6C	49zo	DC7	9b	Tor
0A213	XC6366A213ER	DC/DC-IC	PWM/PFM st-down, 300kHz, 2.1V±2.5%, 1A, +CE	USP-6C	49zo	DC7	9b	Tor
0A215	XC6366A215ER	DC/DC-IC	PWM/PFM st-down, 500kHz, 2.1V±2.5%, 1A, +CE	USP-6C	49zo	DC7	9b	Tor



SMD code	Type	Function	Short description	Case	Pinout	Sch.	St.	Mnf.
0A562	XC6366A562ER	DC/DC-IC	PWM/PFM st-down, 180kHz, 5.6V±2.5%, 1A, +CE	USP-6C	49zo	DC7	9b	Tor
0A563	XC6366A563ER	DC/DC-IC	PWM/PFM st-down, 300kHz, 5.6V±2.5%, 1A, +CE	USP-6C	49zo	DC7	9b	Tor
0A565	XC6366A565ER	DC/DC-IC	PWM/PFM st-down, 500kHz, 5.6V±2.5%, 1A, +CE	USP-6C	49zo	DC7	9b	Tor
0A571	XC6366A571ER	DC/DC-IC	PWM/PFM st-down, 100kHz, 5.7V±2.5%, 1A, +CE	USP-6C	49zo	DC7	9b	Tor
0A572	XC6366A572ER	DC/DC-IC	PWM/PFM st-down, 180kHz, 5.7V±2.5%, 1A, +CE	USP-6C	49zo	DC7	9b	Tor
0A573	XC6366A573ER	DC/DC-IC	PWM/PFM st-down, 300kHz, 5.7V±2.5%, 1A, +CE	USP-6C	49zo	DC7	9b	Tor
0A575	XC6366A575ER	DC/DC-IC	PWM/PFM st-down, 500kHz, 5.7V±2.5%, 1A, +CE	USP-6C	49zo	DC7	9b	Tor
0A581	XC6366A581ER	DC/DC-IC	PWM/PFM st-down, 100kHz, 5.8V±2.5%, 1A, +CE	USP-6C	49zo	DC7	9b	Tor
0A582	XC6366A582ER	DC/DC-IC	PWM/PFM st-down, 180kHz, 5.8V±2.5%, 1A, +CE	USP-6C	49zo	DC7	9b	Tor
0A583	XC6366A583ER	DC/DC-IC	PWM/PFM st-down, 300kHz, 5.8V±2.5%, 1A, +CE	USP-6C	49zo	DC7	9b	Tor
0A585	XC6366A585ER	DC/DC-IC	PWM/PFM st-down, 500kHz, 5.8V±2.5%, 1A, +CE	USP-6C	49zo	DC7	9b	Tor
0A591	XC6366A591ER	DC/DC-IC	PWM/PFM st-down, 100kHz, 5.9V±2.5%, 1A, +CE	USP-6C	49zo	DC7	9b	Tor
0A592	XC6366A592ER	DC/DC-IC	PWM/PFM st-down, 180kHz, 5.9V±2.5%, 1A, +CE	USP-6C	49zo	DC7	9b	Tor
0A593	XC6366A593ER	DC/DC-IC	PWM/PFM st-down, 300kHz, 5.9V±2.5%, 1A, +CE	USP-6C	49zo	DC7	9b	Tor
0A595	XC6366A595ER	DC/DC-IC	PWM/PFM st-down, 500kHz, 5.9V±2.5%, 1A, +CE	USP-6C	49zo	DC7	9b	Tor
0A6	XC6221C371GR	LVR-IC	LDO, 3.7V±1%, 200mA, +CE, PDR	USP-4	45vm	VR4	9a	Tor
0A601	XC6366A601ER	DC/DC-IC	PWM/PFM st-down, 100kHz, 6.0V±2.5%, 1A, +CE	USP-6C	49zo	DC7	9b	Tor
0A602	XC6366A602ER	DC/DC-IC	PWM/PFM st-down, 180kHz, 6.0V±2.5%, 1A, +CE	USP-6C	49zo	DC7	9b	Tor
0A603	XC6366A603ER	DC/DC-IC	PWM/PFM st-down, 300kHz, 6.0V±2.5%, 1A, +CE	USP-6C	49zo	DC7	9b	Tor
0A605	XC6366A605ER	DC/DC-IC	PWM/PFM st-down, 500kHz, 6.0V±2.5%, 1A, +CE	USP-6C	49zo	DC7	9b	Tor
0A7	XC6221C381GR	LVR-IC	LDO, 3.8V±1%, 200mA, +CE, PDR	USP-4	45vm	VR4	9a	Tor
0A8	XC6221C391GR	LVR-IC	LDO, 3.9V±1%, 200mA, +CE, PDR	USP-4	45vm	VR4	9a	Tor
0A9	XC6221C401GR	LVR-IC	LDO, 4V±1%, 200mA, +CE, PDR	USP-4	45vm	VR4	9a	Tor
0AA	XC6221C411GR	LVR-IC	LDO, 4.1±1%, 200mA, +CE, PDR	USP-4	45vm	VR4	9a	Tor
0AB	XC6221C421GR	LVR-IC	LDO, 4.2±1%, 200mA, +CE, PDR	USP-4	45vm	VR4	9a	Tor
0AC	XC6221C431GR	LVR-IC	LDO, 4.3±1%, 200mA, +CE, PDR	USP-4	45vm	VR4	9a	Tor
0AD	XC6221C441GR	LVR-IC	LDO, 4.4±1%, 200mA, +CE, PDR	USP-4	45vm	VR4	9a	Tor
0AE	XC6221C451GR	LVR-IC	LDO, 4.5±1%, 200mA, +CE, PDR	USP-4	45vm	VR4	9a	Tor
0AF	XC6221C461GR	LVR-IC	LDO, 4.6±1%, 200mA, +CE, PDR	USP-4	45vm	VR4	9a	Tor
0AH	XC6221C471GR	LVR-IC	LDO, 4.7±1%, 200mA, +CE, PDR	USP-4	45vm	VR4	9a	Tor
0AK	XC6221C481GR	LVR-IC	LDO, 4.8±1%, 200mA, +CE, PDR	USP-4	45vm	VR4	9a	Tor
0AL	XC6221C491GR	LVR-IC	LDO, 4.9±1%, 200mA, +CE, PDR	USP-4	45vm	VR4	9a	Tor
0AM	XC6221C501GR	LVR-IC	LDO, 5.0±1%, 200mA, +CE, PDR	USP-4	45vm	VR4	9a	Tor
0B	XC6221A4217R	LVR-IC	LDO, 4.2V±1%, 200mA, +CE	USPN-4	58vm	VR4	9a	Tor
0B	XC6223A2119R-G	LVR-IC	LDO, 2.1V±1%, 300mA, +CE	USPQ-4B03	48vm	VR4	9a	Tor
0B	XC6224A1917R	LVR-IC	LDO, 1.9V±1.5%, 150mA, +CE	USPN-4B02	58vm	VR4	9e	Tor
0B	XC6229D17B1R-G	LVR-IC	LDO, 1.75V±20mV, 300mA, +CE	BGA-4	63ba*	VR4	9a	Tor
0B	XC6221C1917R	LVR-IC	LDO, 1.9V±20mV, 200mA, +CE, PDR	USPN-4	58vm	VR4	9a	Tor
0B1	XC6221D321GR	LVR-IC	LDO, 3.2V±1%, 200mA, +CE, CL, PDR	USP-4	45vm	VR4	9a	Tor
0B101	XC6366B101ER	DC/DC-IC	PWM/PFM st-down, 100kHz, Adj. 1.5..6V±2.5%, 1A, +CE	USP-6C	49zp	DC18	9b	Tor
0B102	XC6366B102ER	DC/DC-IC	PWM/PFM st-down, 180kHz, Adj. 1.5..6V±2.5%, 1A, +CE	USP-6C	49zp	DC18	9b	Tor
0B103	XC6366B103ER	DC/DC-IC	PWM/PFM st-down, 300kHz, Adj. 1.5..6V±2.5%, 1A, +CE	USP-6C	49zp	DC18	9b	Tor
0B104	XC6366B105ER	DC/DC-IC	PWM/PFM st-down, 500kHz, Adj. 1.5..6V±2.5%, 1A, +CE	USP-6C	49zp	DC18	9b	Tor
0B2	XC6221D331GR	LVR-IC	LDO, 3.3V±1%, 200mA, +CE, CL, PDR	USP-4	45vm	VR4	9a	Tor
0B3	XC6221D341GR	LVR-IC	LDO, 3.4V±1%, 200mA, +CE, CL, PDR	USP-4	45vm	VR4	9a	Tor
0B4	XC6221D351GR	LVR-IC	LDO, 3.5V±1%, 200mA, +CE, CL, PDR	USP-4	45vm	VR4	9a	Tor
0B5	XC6221D361GR	LVR-IC	LDO, 3.6V±1%, 200mA, +CE, CL, PDR	USP-4	45vm	VR4	9a	Tor
0B6	XC6221D371GR	LVR-IC	LDO, 3.7V±1%, 200mA, +CE, CL, PDR	USP-4	45vm	VR4	9a	Tor
0B7	XC6221D381GR	LVR-IC	LDO, 3.8V±1%, 200mA, +CE, CL, PDR	USP-4	45vm	VR4	9a	Tor
0B8	XC6221D391GR	LVR-IC	LDO, 3.9V±1%, 200mA, +CE, CL, PDR	USP-4	45vm	VR4	9a	Tor
0B9	XC6221D401GR	LVR-IC	LDO, 4V±1%, 200mA, +CE, CL, PDR	USP-4	45vm	VR4	9a	Tor
0BA	XC6221D411GR	LVR-IC	LDO, 4.1V±1%, 200mA, +CE, CL, PDR	USP-4	45vm	VR4	9a	Tor
0BB	XC6221D421GR	LVR-IC	LDO, 4.2V±1%, 200mA, +CE, CL, PDR	USP-4	45vm	VR4	9a	Tor
0BC	XC6221D431GR	LVR-IC	LDO, 4.3V±1%, 200mA, +CE, CL, PDR	USP-4	45vm	VR4	9a	Tor
0BD	XC6221D441GR	LVR-IC	LDO, 4.4V±1%, 200mA, +CE, CL, PDR	USP-4	45vm	VR4	9a	Tor
0BE	XC6221D451GR	LVR-IC	LDO, 4.5V±1%, 200mA, +CE, CL, PDR	USP-4	45vm	VR4	9a	Tor
0BF	XC6221D461GR	LVR-IC	LDO, 4.6V±1%, 200mA, +CE, CL, PDR	USP-4	45vm	VR4	9a	Tor
0BH	XC6221D471GR	LVR-IC	LDO, 4.7V±1%, 200mA, +CE, CL, PDR	USP-4	45vm	VR4	9a	Tor
0BK	XC6221D481GR	LVR-IC	LDO, 4.8V±1%, 200mA, +CE, CL, PDR	USP-4	45vm	VR4	9a	Tor
0BL	XC6221D491GR	LVR-IC	LDO, 4.9V±1%, 200mA, +CE, CL, PDR	USP-4	45vm	VR4	9a	Tor
0BM	XC6221D501GR	LVR-IC	LDO, 5.0V±1%, 200mA, +CE, CL, PDR	USP-4	45vm	VR4	9a	Tor
0C	XC6221A4317R	LVR-IC	LDO, 4.3V±1%, 200mA, +CE	USPN-4	58vm	VR4	9a	Tor
0C	XC6223A2219R-G	LVR-IC	LDO, 2.2V±1%, 300mA, +CE	USPQ-4B03	48vm	VR4	9a	Tor
0C	XC6224A2017R	LVR-IC	LDO, 2.0V±1.5%, 150mA, +CE	USPN-4B02	58vm	VR4	9e	Tor
0C	XC6229D1811R-G	LVR-IC	LDO, 1.8V±20mV, 300mA, +CE	BGA-4	63ba*	VR4	9a	Tor
0C	XC6221C2017R	LVR-IC	LDO, 2V±1%, 200mA, +CE, PDR	USPN-4	58vm	VR4	9a	Tor
0C151	XC6366C151ER	DC/DC-IC	PWM/PFM st-down, 100kHz, 1.5V±2.5%, 1A, +CE, soft start	USP-6C	49zo	DC7	9b	Tor
0C152	XC6366C152ER	DC/DC-IC	PWM/PFM st-down, 180kHz, 1.5V±2.5%, 1A, +CE, soft start	USP-6C	49zo	DC7	9b	Tor
0C153	XC6366C153ER	DC/DC-IC	PWM/PFM st-down, 300kHz, 1.5V±2.5%, 1A, +CE, soft start	USP-6C	49zo	DC7	9b	Tor
0C155	XC6366C155ER	DC/DC-IC	PWM/PFM st-down, 500kHz, 1.5V±2.5%, 1A, +CE, soft start	USP-6C	49zo	DC7	9b	Tor



SMD code	Type	Function	Short description	Case	Pinout	Sch.	St.	Mnf.
0C511	XC6366C511ER	DC/DC-IC	PWM/PFM st-down, 100kHz, 5.1V±2.5%, 1A, +CE, soft start	USP-6C	49zo	DC7	9b	Tor
0C512	XC6366C512ER	DC/DC-IC	PWM/PFM st-down, 180kHz, 5.1V±2.5%, 1A, +CE, soft start	USP-6C	49zo	DC7	9b	Tor
0C513	XC6366C513ER	DC/DC-IC	PWM/PFM st-down, 300kHz, 5.1V±2.5%, 1A, +CE, soft start	USP-6C	49zo	DC7	9b	Tor
0C515	XC6366C515ER	DC/DC-IC	PWM/PFM st-down, 500kHz, 5.1V±2.5%, 1A, +CE, soft start	USP-6C	49zo	DC7	9b	Tor
0C521	XC6366C521ER	DC/DC-IC	PWM/PFM st-down, 100kHz, 5.2V±2.5%, 1A, +CE, soft start	USP-6C	49zo	DC7	9b	Tor
0C522	XC6366C522ER	DC/DC-IC	PWM/PFM st-down, 180kHz, 5.2V±2.5%, 1A, +CE, soft start	USP-6C	49zo	DC7	9b	Tor
0C523	XC6366C523ER	DC/DC-IC	PWM/PFM st-down, 300kHz, 5.2V±2.5%, 1A, +CE, soft start	USP-6C	49zo	DC7	9b	Tor
0C525	XC6366C525ER	DC/DC-IC	PWM/PFM st-down, 500kHz, 5.2V±2.5%, 1A, +CE, soft start	USP-6C	49zo	DC7	9b	Tor
0C531	XC6366C531ER	DC/DC-IC	PWM/PFM st-down, 100kHz, 5.3V±2.5%, 1A, +CE, soft start	USP-6C	49zo	DC7	9b	Tor
0C532	XC6366C532ER	DC/DC-IC	PWM/PFM st-down, 180kHz, 5.3V±2.5%, 1A, +CE, soft start	USP-6C	49zo	DC7	9b	Tor
0C533	XC6366C533ER	DC/DC-IC	PWM/PFM st-down, 300kHz, 5.3V±2.5%, 1A, +CE, soft start	USP-6C	49zo	DC7	9b	Tor
0C535	XC6366C535ER	DC/DC-IC	PWM/PFM st-down, 500kHz, 5.3V±2.5%, 1A, +CE, soft start	USP-6C	49zo	DC7	9b	Tor
0C541	XC6366C541ER	DC/DC-IC	PWM/PFM st-down, 100kHz, 5.4V±2.5%, 1A, +CE, soft start	USP-6C	49zo	DC7	9b	Tor
0C542	XC6366C542ER	DC/DC-IC	PWM/PFM st-down, 180kHz, 5.4V±2.5%, 1A, +CE, soft start	USP-6C	49zo	DC7	9b	Tor
0C543	XC6366C543ER	DC/DC-IC	PWM/PFM st-down, 300kHz, 5.4V±2.5%, 1A, +CE, soft start	USP-6C	49zo	DC7	9b	Tor
0C545	XC6366C545ER	DC/DC-IC	PWM/PFM st-down, 500kHz, 5.4V±2.5%, 1A, +CE, soft start	USP-6C	49zo	DC7	9b	Tor
0C551	XC6366C551ER	DC/DC-IC	PWM/PFM st-down, 100kHz, 5.5V±2.5%, 1A, +CE, soft start	USP-6C	49zo	DC7	9b	Tor
0C552	XC6366C552ER	DC/DC-IC	PWM/PFM st-down, 180kHz, 5.5V±2.5%, 1A, +CE, soft start	USP-6C	49zo	DC7	9b	Tor
0C553	XC6366C553ER	DC/DC-IC	PWM/PFM st-down, 300kHz, 5.5V±2.5%, 1A, +CE, soft start	USP-6C	49zo	DC7	9b	Tor
0C555	XC6366C555ER	DC/DC-IC	PWM/PFM st-down, 500kHz, 5.5V±2.5%, 1A, +CE, soft start	USP-6C	49zo	DC7	9b	Tor
0C561	XC6366C561ER	DC/DC-IC	PWM/PFM st-down, 100kHz, 5.6V±2.5%, 1A, +CE, soft start	USP-6C	49zo	DC7	9b	Tor
0C562	XC6366C562ER	DC/DC-IC	PWM/PFM st-down, 180kHz, 5.6V±2.5%, 1A, +CE, soft start	USP-6C	49zo	DC7	9b	Tor
0C563	XC6366C563ER	DC/DC-IC	PWM/PFM st-down, 300kHz, 5.6V±2.5%, 1A, +CE, soft start	USP-6C	49zo	DC7	9b	Tor
0C565	XC6366C565ER	DC/DC-IC	PWM/PFM st-down, 500kHz, 5.6V±2.5%, 1A, +CE, soft start	USP-6C	49zo	DC7	9b	Tor
0C571	XC6366C571ER	DC/DC-IC	PWM/PFM st-down, 100kHz, 5.7V±2.5%, 1A, +CE, soft start	USP-6C	49zo	DC7	9b	Tor
0C572	XC6366C572ER	DC/DC-IC	PWM/PFM st-down, 180kHz, 5.7V±2.5%, 1A, +CE, soft start	USP-6C	49zo	DC7	9b	Tor
0C573	XC6366C573ER	DC/DC-IC	PWM/PFM st-down, 300kHz, 5.7V±2.5%, 1A, +CE, soft start	USP-6C	49zo	DC7	9b	Tor
0C575	XC6366C575ER	DC/DC-IC	PWM/PFM st-down, 500kHz, 5.7V±2.5%, 1A, +CE, soft start	USP-6C	49zo	DC7	9b	Tor
0C581	XC6366C581ER	DC/DC-IC	PWM/PFM st-down, 100kHz, 5.8V±2.5%, 1A, +CE, soft start	USP-6C	49zo	DC7	9b	Tor
0C582	XC6366C582ER	DC/DC-IC	PWM/PFM st-down, 180kHz, 5.8V±2.5%, 1A, +CE, soft start	USP-6C	49zo	DC7	9b	Tor
0C583	XC6366C583ER	DC/DC-IC	PWM/PFM st-down, 300kHz, 5.8V±2.5%, 1A, +CE, soft start	USP-6C	49zo	DC7	9b	Tor
0C585	XC6366C585ER	DC/DC-IC	PWM/PFM st-down, 500kHz, 5.8V±2.5%, 1A, +CE, soft start	USP-6C	49zo	DC7	9b	Tor
0C591	XC6366C591ER	DC/DC-IC	PWM/PFM st-down, 100kHz, 5.9V±2.5%, 1A, +CE, soft start	USP-6C	49zo	DC7	9b	Tor
0C592	XC6366C592ER	DC/DC-IC	PWM/PFM st-down, 180kHz, 5.9V±2.5%, 1A, +CE, soft start	USP-6C	49zo	DC7	9b	Tor
0C593	XC6366C593ER	DC/DC-IC	PWM/PFM st-down, 300kHz, 5.9V±2.5%, 1A, +CE, soft start	USP-6C	49zo	DC7	9b	Tor
0C595	XC6366C595ER	DC/DC-IC	PWM/PFM st-down, 500kHz, 5.9V±2.5%, 1A, +CE, soft start	USP-6C	49zo	DC7	9b	Tor
0C601	XC6366C601ER	DC/DC-IC	PWM/PFM st-down, 100kHz, 6.0V±2.5%, 1A, +CE, soft start	USP-6C	49zo	DC7	9b	Tor
0C602	XC6366C602ER	DC/DC-IC	PWM/PFM st-down, 180kHz, 6.0V±2.5%, 1A, +CE, soft start	USP-6C	49zo	DC7	9b	Tor
0C603	XC6366C603ER	DC/DC-IC	PWM/PFM st-down, 300kHz, 6.0V±2.5%, 1A, +CE, soft start	USP-6C	49zo	DC7	9b	Tor
0C605	XC6366C605ER	DC/DC-IC	PWM/PFM st-down, 500kHz, 6.0V±2.5%, 1A, +CE, soft start	USP-6C	49zo	DC7	9b	Tor
0D	XC6221A4417R	LVR-IC	LDO, 4.4V±1%, 200mA, +CE	USPN-4	58vm	VR4	9a	Tor
0D	XC6223A2319R-G	LVR-IC	LDO, 2.3V±1%, 300mA, +CE	USPQ-4B03	48vm	VR4	9a	Tor
0D	XC6224A2117R	LVR-IC	LDO, 2.1V±1.5%, 150mA, +CE	USPN-4B02	58vm	VR4	9e	Tor
0D	XC6229D18B1R-G	LVR-IC	LDO, 1.85V±20mV, 300mA, +CE	BGA-4	63ba*	VR4	9a	Tor
0D	XC6221C2117R	LVR-IC	LDO, 2.1V±1%, 200mA, +CE, PDR	USPN-4	58vm	VR4	9a	Tor
0D101	XC6366D101ER	DC/DC-IC	PWM/PFM st-down, 100kHz, Adj. 1.5..6V±2.5%, 1A, +CE, soft start	USP-6C	49zp	DC18	9b	Tor
0D102	XC6366D102ER	DC/DC-IC	PWM/PFM st-down, 180kHz, Adj. 1.5..6V±2.5%, 1A, +CE, soft start	USP-6C	49zp	DC18	9b	Tor
0D103	XC6366D103ER	DC/DC-IC	PWM/PFM st-down, 300kHz, Adj. 1.5..6V±2.5%, 1A, +CE, soft start	USP-6C	49zp	DC18	9b	Tor
0D104	XC6366D104ER	DC/DC-IC	PWM/PFM st-down, 500kHz, Adj. 1.5..6V±2.5%, 1A, +CE, soft start	USP-6C	49zp	DC18	9b	Tor
0E	XC6221A4517R	LVR-IC	LDO, 4.5V±1%, 200mA, +CE	USPN-4	58vm	VR4	9a	Tor
0E	XC6223A2419R-G	LVR-IC	LDO, 2.4V±1%, 300mA, +CE	USPQ-4B03	48vm	VR4	9a	Tor
0E	XC6224A2217R	LVR-IC	LDO, 2.2V±1.5%, 150mA, +CE	USPN-4B02	58vm	VR4	9e	Tor
0E	XC6229D1911R-G	LVR-IC	LDO, 1.9V±20mV, 300mA, +CE	BGA-4	63ba*	VR4	9a	Tor
0E	XC6221C2217R	LVR-IC	LDO, 2.2V±1%, 200mA, +CE, PDR	USPN-4	58vm	VR4	9a	Tor
0E7	XC6221C08BGR	LVR-IC	LDO, 0.85V±20mV, 200mA, +CE, PDR	USP-4	45vm	VR4	9a	Tor
0E8	XC6221C09BGR	LVR-IC	LDO, 0.95V±20mV, 200mA, +CE, PDR	USP-4	45vm	VR4	9a	Tor
0E9	XC6221C10BGR	LVR-IC	LDO, 1.05V±20mV, 200mA, +CE, PDR	USP-4	45vm	VR4	9a	Tor
0EA	XC6221C11BGR	LVR-IC	LDO, 1.15V±20mV, 200mA, +CE, PDR	USP-4	45vm	VR4	9a	Tor
0EB	XC6221C12BGR	LVR-IC	LDO, 1.25V±20mV, 200mA, +CE, PDR	USP-4	45vm	VR4	9a	Tor
0EC	XC6221C13BGR	LVR-IC	LDO, 1.35V±20mV, 200mA, +CE, PDR	USP-4	45vm	VR4	9a	Tor
0ED	XC6221C14BGR	LVR-IC	LDO, 1.45V±20mV, 200mA, +CE, PDR	USP-4	45vm	VR4	9a	Tor
0EE	XC6221C15BGR	LVR-IC	LDO, 1.55V±20mV, 200mA, +CE, PDR	USP-4	45vm	VR4	9a	Tor
0EF	XC6221C16BGR	LVR-IC	LDO, 1.65V±20mV, 200mA, +CE, PDR	USP-4	45vm	VR4	9a	Tor
0EH	XC6221C17BGR	LVR-IC	LDO, 1.75V±20mV, 200mA, +CE, PDR	USP-4	45vm	VR4	9a	Tor
0EK	XC6221C18BGR	LVR-IC	LDO, 1.85V±20mV, 200mA, +CE, PDR	USP-4	45vm	VR4	9a	Tor
0EL	XC6221C19BGR	LVR-IC	LDO, 1.95V±20mV, 200mA, +CE, PDR	USP-4	45vm	VR4	9a	Tor
0EM	XC6221C20BGR	LVR-IC	LDO, 2.05V±1%, 200mA, +CE, PDR	USP-4	45vm	VR4	9a	Tor
0EN	XC6221C21BGR	LVR-IC	LDO, 2.15V±1%, 200mA, +CE, PDR	USP-4	45vm	VR4	9a	Tor
0EP	XC6221C22BGR	LVR-IC	LDO, 2.25V±1%, 200mA, +CE, PDR	USP-4	45vm	VR4	9a	Tor
0ER	XC6221C23BGR	LVR-IC	LDO, 2.35V±1%, 200mA, +CE, PDR	USP-4	45vm	VR4	9a	Tor



SMD code	Type	Function	Short description	Case	Pinout	Sch.	St.	Mnf.
0ES	XC6221C24BGR	LVR-IC	LDO, 2.45V±1%, 200mA, +CE, PDR	USP-4	45vm	VR4	9a	Tor
0ET	XC6221C25BGR	LVR-IC	LDO, 2.55V±1%, 200mA, +CE, PDR	USP-4	45vm	VR4	9a	Tor
0EU	XC6221C26BGR	LVR-IC	LDO, 2.65V±1%, 200mA, +CE, PDR	USP-4	45vm	VR4	9a	Tor
0EV	XC6221C27BGR	LVR-IC	LDO, 2.75V±1%, 200mA, +CE, PDR	USP-4	45vm	VR4	9a	Tor
0EX	XC6221C28BGR	LVR-IC	LDO, 2.85V±1%, 200mA, +CE, PDR	USP-4	45vm	VR4	9a	Tor
0EY	XC6221C29BGR	LVR-IC	LDO, 2.95V±1%, 200mA, +CE, PDR	USP-4	45vm	VR4	9a	Tor
0EZ	XC6221C30BGR	LVR-IC	LDO, 3.05V±1%, 200mA, +CE, PDR	USP-4	45vm	VR4	9a	Tor
0F	XC6221A4617R	LVR-IC	LDO, 4.6V±1%, 200mA, +CE	USPN-4	58vm	VR4	9a	Tor
0F	XC6223A2519R-G	LVR-IC	LDO, 2.5V±1%, 300mA, +CE	USPQ-4B03	48vm	VR4	9a	Tor
0F	XC6224A2317R	LVR-IC	LDO, 2.3V±1.5%, 150mA, +CE	USPN-4B02	58vm	VR4	9e	Tor
0F	XC6229D19B1R-G	LVR-IC	LDO, 1.95V±20mV, 300mA, +CE	BGA-4	63ba*	VR4	9a	Tor
0F	XC6221C2317R	LVR-IC	LDO, 2.3V±1%, 200mA, +CE, PDR	USPN-4	58vm	VR4	9a	Tor
0F7	XC6221D08BGR	LVR-IC	LDO, 0.85V±20mV, 200mA, +CE, CL, PDR	USP-4	45vm	VR4	9a	Tor
0F8	XC6221D09BGR	LVR-IC	LDO, 0.95V±20mV, 200mA, +CE, CL, PDR	USP-4	45vm	VR4	9a	Tor
0F9	XC6221D10BGR	LVR-IC	LDO, 1.05V±20mV, 200mA, +CE, CL, PDR	USP-4	45vm	VR4	9a	Tor
0FA	XC6221D11BGR	LVR-IC	LDO, 1.15V±20mV, 200mA, +CE, CL, PDR	USP-4	45vm	VR4	9a	Tor
0FB	XC6221D12BGR	LVR-IC	LDO, 1.25V±20mV, 200mA, +CE, CL, PDR	USP-4	45vm	VR4	9a	Tor
0FC	XC6221D13BGR	LVR-IC	LDO, 1.35V±20mV, 200mA, +CE, CL, PDR	USP-4	45vm	VR4	9a	Tor
0FD	XC6221D14BGR	LVR-IC	LDO, 1.45V±20mV, 200mA, +CE, CL, PDR	USP-4	45vm	VR4	9a	Tor
0FE	XC6221D15BGR	LVR-IC	LDO, 1.55V±20mV, 200mA, +CE, CL, PDR	USP-4	45vm	VR4	9a	Tor
0FF	XC6221D16BGR	LVR-IC	LDO, 1.65V±20mV, 200mA, +CE, CL, PDR	USP-4	45vm	VR4	9a	Tor
0FH	XC6221D17BGR	LVR-IC	LDO, 1.75V±20mV, 200mA, +CE, CL, PDR	USP-4	45vm	VR4	9a	Tor
0FK	XC6221D18BGR	LVR-IC	LDO, 1.85V±20mV, 200mA, +CE, CL, PDR	USP-4	45vm	VR4	9a	Tor
0FL	XC6221D19BGR	LVR-IC	LDO, 1.95V±20mV, 200mA, +CE, CL, PDR	USP-4	45vm	VR4	9a	Tor
0FM	XC6221D20BGR	LVR-IC	LDO, 2.05V±1%, 200mA, +CE, CL, PDR	USP-4	45vm	VR4	9a	Tor
0FN	XC6221D21BGR	LVR-IC	LDO, 2.15V±1%, 200mA, +CE, CL, PDR	USP-4	45vm	VR4	9a	Tor
0FP	XC6221D22BGR	LVR-IC	LDO, 2.25V±1%, 200mA, +CE, CL, PDR	USP-4	45vm	VR4	9a	Tor
0FR	XC6221D23BGR	LVR-IC	LDO, 2.35V±1%, 200mA, +CE, CL, PDR	USP-4	45vm	VR4	9a	Tor
0FS	XC6221D24BGR	LVR-IC	LDO, 2.45V±1%, 200mA, +CE, CL, PDR	USP-4	45vm	VR4	9a	Tor
0FT	XC6221D25BGR	LVR-IC	LDO, 2.55V±1%, 200mA, +CE, CL, PDR	USP-4	45vm	VR4	9a	Tor
0FU	XC6221D26BGR	LVR-IC	LDO, 2.65V±1%, 200mA, +CE, CL, PDR	USP-4	45vm	VR4	9a	Tor
0FV	XC6221D27BGR	LVR-IC	LDO, 2.75V±1%, 200mA, +CE, CL, PDR	USP-4	45vm	VR4	9a	Tor
0FX	XC6221D28BGR	LVR-IC	LDO, 2.85V±1%, 200mA, +CE, CL, PDR	USP-4	45vm	VR4	9a	Tor
0FY	XC6221D29BGR	LVR-IC	LDO, 2.95V±1%, 200mA, +CE, CL, PDR	USP-4	45vm	VR4	9a	Tor
0FZ	XC6221D30BGR	LVR-IC	LDO, 3.05V±1%, 200mA, +CE, CL, PDR	USP-4	45vm	VR4	9a	Tor
0H	XC6221A4717R	LVR-IC	LDO, 4.7V±1%, 200mA, +CE	USPN-4	58vm	VR4	9a	Tor
0H	XC6223A2619R-G	LVR-IC	LDO, 2.6V±1%, 300mA, +CE	USPQ-4B03	48vm	VR4	9a	Tor
0H	XC6224A2417R	LVR-IC	LDO, 2.4V±1.5%, 150mA, +CE	USPN-4B02	58vm	VR4	9e	Tor
0H	XC6229D2011R-G	LVR-IC	LDO, 2.0V±1%, 300mA, +CE	BGA-4	63ba*	VR4	9a	Tor
0H	XC6221C2417R	LVR-IC	LDO, 2.4V±1%, 200mA, +CE, PDR	USPN-4	58vm	VR4	9a	Tor
0K	XC6221A4817R	LVR-IC	LDO, 4.8V±1%, 200mA, +CE	USPN-4	58vm	VR4	9a	Tor
0K	XC6223A2719R-G	LVR-IC	LDO, 2.7V±1%, 300mA, +CE	USPQ-4B03	48vm	VR4	9a	Tor
0K	XC6224A2517R	LVR-IC	LDO, 2.5V±1.5%, 150mA, +CE	USPN-4B02	58vm	VR4	9e	Tor
0K	XC6229D20B1R-G	LVR-IC	LDO, 2.05V±1%, 300mA, +CE	BGA-4	63ba*	VR4	9a	Tor
0K	XC6221C2517R	LVR-IC	LDO, 2.5V±1%, 200mA, +CE, PDR	USPN-4	58vm	VR4	9a	Tor
0L	XC6221A4917R	LVR-IC	LDO, 4.9V±1%, 200mA, +CE	USPN-4	58vm	VR4	9a	Tor
0L	XC6223A2819R-G	LVR-IC	LDO, 2.8V±1%, 300mA, +CE	USPQ-4B03	48vm	VR4	9a	Tor
0L	XC6224A2617R	LVR-IC	LDO, 2.6V±1.5%, 150mA, +CE	USPN-4B02	58vm	VR4	9e	Tor
0L	XC6229D2111R-G	LVR-IC	LDO, 2.1V±1%, 300mA, +CE	BGA-4	63ba*	VR4	9a	Tor
0L	XC6221C2617R	LVR-IC	LDO, 2.6V±1%, 200mA, +CE, PDR	USPN-4	58vm	VR4	9a	Tor
0L0	XC6221C31BGR	LVR-IC	LDO, 3.15V±1%, 200mA, +CE, PDR	USP-4	45vm	VR4	9a	Tor
0L1	XC6221C32BGR	LVR-IC	LDO, 3.25V±1%, 200mA, +CE, PDR	USP-4	45vm	VR4	9a	Tor
0L2	XC6221C33BGR	LVR-IC	LDO, 3.35V±1%, 200mA, +CE, PDR	USP-4	45vm	VR4	9a	Tor
0L3	XC6221C34BGR	LVR-IC	LDO, 3.45V±1%, 200mA, +CE, PDR	USP-4	45vm	VR4	9a	Tor
0L4	XC6221C35BGR	LVR-IC	LDO, 3.55V±1%, 200mA, +CE, PDR	USP-4	45vm	VR4	9a	Tor
0L5	XC6221C36BGR	LVR-IC	LDO, 3.65V±1%, 200mA, +CE, PDR	USP-4	45vm	VR4	9a	Tor
0L6	XC6221C37BGR	LVR-IC	LDO, 3.75V±1%, 200mA, +CE, PDR	USP-4	45vm	VR4	9a	Tor
0L7	XC6221C38BGR	LVR-IC	LDO, 3.85V±1%, 200mA, +CE, PDR	USP-4	45vm	VR4	9a	Tor
0L8	XC6221C39BGR	LVR-IC	LDO, 3.95V±1%, 200mA, +CE, PDR	USP-4	45vm	VR4	9a	Tor
0L9	XC6221C40BGR	LVR-IC	LDO, 4.05V±1%, 200mA, +CE, PDR	USP-4	45vm	VR4	9a	Tor
0LA	XC6221C41BGR	LVR-IC	LDO, 4.15V±1%, 200mA, +CE, PDR	USP-4	45vm	VR4	9a	Tor
0LB	XC6221C42BGR	LVR-IC	LDO, 4.25V±1%, 200mA, +CE, PDR	USP-4	45vm	VR4	9a	Tor
0LC	XC6221C43BGR	LVR-IC	LDO, 4.35V±1%, 200mA, +CE, PDR	USP-4	45vm	VR4	9a	Tor
0LD	XC6221C44BGR	LVR-IC	LDO, 4.45V±1%, 200mA, +CE, PDR	USP-4	45vm	VR4	9a	Tor
0LE	XC6221C45BGR	LVR-IC	LDO, 4.55V±1%, 200mA, +CE, PDR	USP-4	45vm	VR4	9a	Tor
0LF	XC6221C46BGR	LVR-IC	LDO, 4.65V±1%, 200mA, +CE, PDR	USP-4	45vm	VR4	9a	Tor
0LH	XC6221C47BGR	LVR-IC	LDO, 4.75V±1%, 200mA, +CE, PDR	USP-4	45vm	VR4	9a	Tor
0LK	XC6221C48BGR	LVR-IC	LDO, 4.85V±1%, 200mA, +CE, PDR	USP-4	45vm	VR4	9a	Tor
0LL	XC6221C49BGR	LVR-IC	LDO, 4.95V±1%, 200mA, +CE, PDR	USP-4	45vm	VR4	9a	Tor
0LM	XC6221A5017R	LVR-IC	LDO, 5.0V±1%, 200mA, +CE	USPN-4	58vm	VR4	9a	Tor



SMD code	Type	Function	Short description	Case	Pinout	Sch.	St.	Mnf.
OMI	XC6223A2919R-G	LVR-IC	LDO, 2.9V±1%, 300mA, +CE	USPQ-4B03	48vm	VR4	9a	Tor
OMI	XC6224A217R	LVR-IC	LDO, 2.7V±1.5%, 150mA, +CE	USPN-4B02	58vm	VR4	9e	Tor
OMI	XC6229D21B1R-G	LVR-IC	LDO, 2.15V±1%, 300mA, +CE	BGA-4	63ba*	VR4	9a	Tor
OMI	XC6221C217R	LVR-IC	LDO, 2.7V±1%, 200mA, +CE, PDR	USPN-4	58vm	VR4	9a	Tor
OM0	XC6221D31BGR	LVR-IC	LDO, 3.15V±1%, 200mA, +CE, CL, PDR	USP-4	45vm	VR4	9a	Tor
OM1	XC6221D32BGR	LVR-IC	LDO, 3.25V±1%, 200mA, +CE, CL, PDR	USP-4	45vm	VR4	9a	Tor
OM2	XC6221D33BGR	LVR-IC	LDO, 3.35V±1%, 200mA, +CE, CL, PDR	USP-4	45vm	VR4	9a	Tor
OM3	XC6221D34BGR	LVR-IC	LDO, 3.45V±1%, 200mA, +CE, CL, PDR	USP-4	45vm	VR4	9a	Tor
OM4	XC6221D35BGR	LVR-IC	LDO, 3.55V±1%, 200mA, +CE, CL, PDR	USP-4	45vm	VR4	9a	Tor
OM5	XC6221D36BGR	LVR-IC	LDO, 3.65V±1%, 200mA, +CE, CL, PDR	USP-4	45vm	VR4	9a	Tor
OM6	XC6221D37BGR	LVR-IC	LDO, 3.75V±1%, 200mA, +CE, CL, PDR	USP-4	45vm	VR4	9a	Tor
OM7	XC6221D38BGR	LVR-IC	LDO, 3.85V±1%, 200mA, +CE, CL, PDR	USP-4	45vm	VR4	9a	Tor
OM8	XC6221D39BGR	LVR-IC	LDO, 3.95V±1%, 200mA, +CE, CL, PDR	USP-4	45vm	VR4	9a	Tor
OM9	XC6221D40BGR	LVR-IC	LDO, 4.05V±1%, 200mA, +CE, CL, PDR	USP-4	45vm	VR4	9a	Tor
OMA	XC6221D41BGR	LVR-IC	LDO, 4.15V±1%, 200mA, +CE, CL, PDR	USP-4	45vm	VR4	9a	Tor
OMB	XC6221D42BGR	LVR-IC	LDO, 4.25V±1%, 200mA, +CE, CL, PDR	USP-4	45vm	VR4	9a	Tor
OMC	XC6221D43BGR	LVR-IC	LDO, 4.35V±1%, 200mA, +CE, CL, PDR	USP-4	45vm	VR4	9a	Tor
OMD	XC6221D44BGR	LVR-IC	LDO, 4.45V±1%, 200mA, +CE, CL, PDR	USP-4	45vm	VR4	9a	Tor
OME	XC6221D45BGR	LVR-IC	LDO, 4.55V±1%, 200mA, +CE, CL, PDR	USP-4	45vm	VR4	9a	Tor
OMF	XC6221D46BGR	LVR-IC	LDO, 4.65V±1%, 200mA, +CE, CL, PDR	USP-4	45vm	VR4	9a	Tor
OMH	XC6221D47BGR	LVR-IC	LDO, 4.75V±1%, 200mA, +CE, CL, PDR	USP-4	45vm	VR4	9a	Tor
OMK	XC6221D48BGR	LVR-IC	LDO, 4.85V±1%, 200mA, +CE, CL, PDR	USP-4	45vm	VR4	9a	Tor
OML	XC6221D49BGR	LVR-IC	LDO, 4.95V±1%, 200mA, +CE, CL, PDR	USP-4	45vm	VR4	9a	Tor
ON	XC6221A40B7R	LVR-IC	LDO, 4.05V±1%, 200mA, +CE	USPN-4	58vm	VR4	9a	Tor
ON	XC6223A3019R-G	LVR-IC	LDO, 3.0V±1%, 300mA, +CE	USPQ-4B03	48vm	VR4	9a	Tor
ON	XC6224A2817R	LVR-IC	LDO, 2.8V±1.5%, 150mA, +CE	USPN-4B02	58vm	VR4	9e	Tor
ON	XC6229D2211R-G	LVR-IC	LDO, 2.2V±1%, 300mA, +CE	BGA-4	63ba*	VR4	9a	Tor
ON	XC6221C2817R	LVR-IC	LDO, 2.8V±1%, 200mA, +CE, PDR	USPN-4	58vm	VR4	9a	Tor
OP	XC6221A41B7R	LVR-IC	LDO, 4.15V±1%, 200mA, +CE	USPN-4	58vm	VR4	9a	Tor
OP	XC6223A3119R-G	LVR-IC	LDO, 3.1V±1%, 300mA, +CE	USPQ-4B03	48vm	VR4	9a	Tor
OP	XC6224A2917R	LVR-IC	LDO, 2.9V±1.5%, 150mA, +CE	USPN-4B02	58vm	VR4	9e	Tor
OP	XC6229D22B1R-G	LVR-IC	LDO, 2.25V±1%, 300mA, +CE	BGA-4	63ba*	VR4	9a	Tor
OP	XC6221C2917R	LVR-IC	LDO, 2.9V±1%, 200mA, +CE, PDR	USPN-4	58vm	VR4	9a	Tor
OR	XC6221A42B7R	LVR-IC	LDO, 4.25V±1%, 200mA, +CE	USPN-4	58vm	VR4	9a	Tor
OR	XC6223A3219R-G	LVR-IC	LDO, 3.2V±1%, 300mA, +CE	USPQ-4B03	48vm	VR4	9a	Tor
OR	XC6224A3017R	LVR-IC	LDO, 3.0V±1.5%, 150mA, +CE	USPN-4B02	58vm	VR4	9e	Tor
OR	XC6229D2311R-G	LVR-IC	LDO, 2.3V±1%, 300mA, +CE	BGA-4	63ba*	VR4	9a	Tor
OR	XC6221C3017R	LVR-IC	LDO, 3V±1%, 200mA, +CE, PDR	USPN-4	58vm	VR4	9a	Tor
OS	XC6221A43B7R	LVR-IC	LDO, 4.35V±1%, 200mA, +CE	USPN-4	58vm	VR4	9a	Tor
OS	XC6223A3319R-G	LVR-IC	LDO, 3.3V±1%, 300mA, +CE	USPQ-4B03	48vm	VR4	9a	Tor
OS	XC6229D23B1R-G	LVR-IC	LDO, 2.35V±1%, 300mA, +CE	BGA-4	63ba*	VR4	9a	Tor
OS	XC6221C3117R	LVR-IC	LDO, 3.1V±1%, 200mA, +CE, PDR	USPN-4	58vm	VR4	9a	Tor
OT	XC6221A44B7R	LVR-IC	LDO, 4.45V±1%, 200mA, +CE	USPN-4	58vm	VR4	9a	Tor
OT	XC6223A3419R-G	LVR-IC	LDO, 3.4V±1%, 300mA, +CE	USPQ-4B03	48vm	VR4	9a	Tor
OT	XC6229D2411R-G	LVR-IC	LDO, 2.4V±1%, 300mA, +CE	BGA-4	63ba*	VR4	9a	Tor
OT	XC6221C3217R	LVR-IC	LDO, 3.2V±1%, 200mA, +CE, PDR	USPN-4	58vm	VR4	9a	Tor
OU	XC6221A45B7R	LVR-IC	LDO, 4.55V±1%, 200mA, +CE	USPN-4	58vm	VR4	9a	Tor
OU	XC6223A3519R-G	LVR-IC	LDO, 3.5V±1%, 300mA, +CE	USPQ-4B03	48vm	VR4	9a	Tor
OU	XC6229D24B1R-G	LVR-IC	LDO, 2.45V±1%, 300mA, +CE	BGA-4	63ba*	VR4	9a	Tor
OU	XC6221C3317R	LVR-IC	LDO, 3.3V±1%, 200mA, +CE, PDR	USPN-4	58vm	VR4	9a	Tor
OV	XC6221A46B7R	LVR-IC	LDO, 4.65V±1%, 200mA, +CE	USPN-4	58vm	VR4	9a	Tor
OV	XC6223A3619R-G	LVR-IC	LDO, 3.6V±1%, 300mA, +CE	USPQ-4B03	48vm	VR4	9a	Tor
OV	XC6229D2511R-G	LVR-IC	LDO, 2.5V±1%, 300mA, +CE	BGA-4	63ba*	VR4	9a	Tor
OV	XC6221C3417R	LVR-IC	LDO, 3.4V±1%, 200mA, +CE, PDR	USPN-4	58vm	VR4	9a	Tor
OV7	XC6221C081GR	LVR-IC	LDO, 0.8V±20mV, 200mA, +CE, PDR	USP-4	45vm	VR4	9a	Tor
OV8	XC6221C091GR	LVR-IC	LDO, 0.9V±20mV, 200mA, +CE, PDR	USP-4	45vm	VR4	9a	Tor
OV9	XC6221C101GR	LVR-IC	LDO, 1V±20mV, 200mA, +CE, PDR	USP-4	45vm	VR4	9a	Tor
OVA	XC6221C111GR	LVR-IC	LDO, 1.1V±20mV, 200mA, +CE, PDR	USP-4	45vm	VR4	9a	Tor
OVB	XC6221C121GR	LVR-IC	LDO, 1.2V±20mV, 200mA, +CE, PDR	USP-4	45vm	VR4	9a	Tor
OVC	XC6221C131GR	LVR-IC	LDO, 1.3V±20mV, 200mA, +CE, PDR	USP-4	45vm	VR4	9a	Tor
OVD	XC6221C141GR	LVR-IC	LDO, 1.4V±20mV, 200mA, +CE, PDR	USP-4	45vm	VR4	9a	Tor
OVE	XC6221C151GR	LVR-IC	LDO, 1.5V±20mV, 200mA, +CE, PDR	USP-4	45vm	VR4	9a	Tor
OVF	XC6221C161GR	LVR-IC	LDO, 1.6V±20mV, 200mA, +CE, PDR	USP-4	45vm	VR4	9a	Tor
OVH	XC6221C171GR	LVR-IC	LDO, 1.7V±20mV, 200mA, +CE, PDR	USP-4	45vm	VR4	9a	Tor
OVK	XC6221C181GR	LVR-IC	LDO, 1.8V±20mV, 200mA, +CE, PDR	USP-4	45vm	VR4	9a	Tor
OVL	XC6221C191GR	LVR-IC	LDO, 1.9V±20mV, 200mA, +CE, PDR	USP-4	45vm	VR4	9a	Tor
OVM	XC6221C201GR	LVR-IC	LDO, 2V±1%, 200mA, +CE, PDR	USP-4	45vm	VR4	9a	Tor
OVN	XC6221C211GR	LVR-IC	LDO, 2.1V±1%, 200mA, +CE, PDR	USP-4	45vm	VR4	9a	Tor
OVV	XC6221C221GR	LVR-IC	LDO, 2.2V±1%, 200mA, +CE, PDR	USP-4	45vm	VR4	9a	Tor
OVR	XC6221C231GR	LVR-IC	LDO, 2.3V±1%, 200mA, +CE, PDR	USP-4	45vm	VR4	9a	Tor



SMD code	Type	Function	Short description	Case	Pinout	Sch.	St.	Mnf.
0VS	XC6221C241GR	LVR-IC	LDO, 2.4V±1%, 200mA, +CE, PDR	USP-4	45vm	VR4	9a	Tor
0VT	XC6221C251GR	LVR-IC	LDO, 2.5V±1%, 200mA, +CE, PDR	USP-4	45vm	VR4	9a	Tor
0VU	XC6221C261GR	LVR-IC	LDO, 2.6V±1%, 200mA, +CE, PDR	USP-4	45vm	VR4	9a	Tor
0VV	XC6221C271GR	LVR-IC	LDO, 2.7V±1%, 200mA, +CE, PDR	USP-4	45vm	VR4	9a	Tor
0VX	XC6221C281GR	LVR-IC	LDO, 2.8V±1%, 200mA, +CE, PDR	USP-4	45vm	VR4	9a	Tor
0VY	XC6221C291GR	LVR-IC	LDO, 2.9V±1%, 200mA, +CE, PDR	USP-4	45vm	VR4	9a	Tor
0VZ	XC6221C301GR	LVR-IC	LDO, 3V±1%, 200mA, +CE, PDR	USP-4	45vm	VR4	9a	Tor
0X	XC6221A47B7R	LVR-IC	LDO, 4.75V±1%, 200mA, +CE	USPN-4	58vm	VR4	9a	Tor
0X	XC6223A3719R-G	LVR-IC	LDO, 3.7V±1%, 300mA, +CE	USPQ-4B03	48vm	VR4	9a	Tor
0X	XC6229D25B1R-G	LVR-IC	LDO, 2.55V±1%, 300mA, +CE	BGA-4	63ba*	VR4	9a	Tor
0X	XC6221C3517R	LVR-IC	LDO, 3.5V±1%, 200mA, +CE, PDR	USPN-4	58vm	VR4	9a	Tor
0X0	XC6221D311GR	LVR-IC	LDO, 3.1V±1%, 200mA, +CE, CL, PDR	USP-4	45vm	VR4	9a	Tor
0X7	XC6221D081GR	LVR-IC	LDO, 0.8V±20mV, 200mA, +CE, CL, PDR	USP-4	45vm	VR4	9a	Tor
0X8	XC6221D091GR	LVR-IC	LDO, 0.9V±20mV, 200mA, +CE, CL, PDR	USP-4	45vm	VR4	9a	Tor
0X9	XC6221D101GR	LVR-IC	LDO, 1V±20mV, 200mA, +CE, CL, PDR	USP-4	45vm	VR4	9a	Tor
0XA	XC6221D111GR	LVR-IC	LDO, 1.1V±20mV, 200mA, +CE, CL, PDR	USP-4	45vm	VR4	9a	Tor
0XB	XC6221D121GR	LVR-IC	LDO, 1.2V±20mV, 200mA, +CE, CL, PDR	USP-4	45vm	VR4	9a	Tor
0XC	XC6221D131GR	LVR-IC	LDO, 1.3V±20mV, 200mA, +CE, CL, PDR	USP-4	45vm	VR4	9a	Tor
0XD	XC6221D141GR	LVR-IC	LDO, 1.4V±20mV, 200mA, +CE, CL, PDR	USP-4	45vm	VR4	9a	Tor
0XE	XC6221D151GR	LVR-IC	LDO, 1.5V±20mV, 200mA, +CE, CL, PDR	USP-4	45vm	VR4	9a	Tor
0XF	XC6221D161GR	LVR-IC	LDO, 1.6V±20mV, 200mA, +CE, CL, PDR	USP-4	45vm	VR4	9a	Tor
0XH	XC6221D171GR	LVR-IC	LDO, 1.7V±20mV, 200mA, +CE, CL, PDR	USP-4	45vm	VR4	9a	Tor
0XK	XC6221D181GR	LVR-IC	LDO, 1.8V±20mV, 200mA, +CE, CL, PDR	USP-4	45vm	VR4	9a	Tor
0XL	XC6221D191GR	LVR-IC	LDO, 1.9V±20mV, 200mA, +CE, CL, PDR	USP-4	45vm	VR4	9a	Tor
0XM	XC6221D201GR	LVR-IC	LDO, 2V±1%, 200mA, +CE, CL, PDR	USP-4	45vm	VR4	9a	Tor
0XN	XC6221D211GR	LVR-IC	LDO, 2.1V±1%, 200mA, +CE, CL, PDR	USP-4	45vm	VR4	9a	Tor
0XP	XC6221D221GR	LVR-IC	LDO, 2.2V±1%, 200mA, +CE, CL, PDR	USP-4	45vm	VR4	9a	Tor
0XR	XC6221D231GR	LVR-IC	LDO, 2.3V±1%, 200mA, +CE, CL, PDR	USP-4	45vm	VR4	9a	Tor
0XS	XC6221D241GR	LVR-IC	LDO, 2.4V±1%, 200mA, +CE, CL, PDR	USP-4	45vm	VR4	9a	Tor
0XT	XC6221D251GR	LVR-IC	LDO, 2.5V±1%, 200mA, +CE, CL, PDR	USP-4	45vm	VR4	9a	Tor
0XU	XC6221D261GR	LVR-IC	LDO, 2.6V±1%, 200mA, +CE, CL, PDR	USP-4	45vm	VR4	9a	Tor
0XV	XC6221D271GR	LVR-IC	LDO, 2.7V±1%, 200mA, +CE, CL, PDR	USP-4	45vm	VR4	9a	Tor
0XX	XC6221D281GR	LVR-IC	LDO, 2.8V±1%, 200mA, +CE, CL, PDR	USP-4	45vm	VR4	9a	Tor
0XY	XC6221D291GR	LVR-IC	LDO, 2.9V±1%, 200mA, +CE, CL, PDR	USP-4	45vm	VR4	9a	Tor
0XZ	XC6221D301GR	LVR-IC	LDO, 3V±1%, 200mA, +CE, CL, PDR	USP-4	45vm	VR4	9a	Tor
0Y	XC6221A48B7R	LVR-IC	LDO, 4.85V±1%, 200mA, +CE	USPN-4	58vm	VR4	9a	Tor
0Y	XC6223A3819R-G	LVR-IC	LDO, 3.8V±1%, 300mA, +CE	USPQ-4B03	48vm	VR4	9a	Tor
0Y	XC6229D2611R-G	LVR-IC	LDO, 2.6V±1%, 300mA, +CE	BGA-4	63ba*	VR4	9a	Tor
0Y	XC6221C3617R	LVR-IC	LDO, 3.6V±1%, 200mA, +CE, PDR	USPN-4	58vm	VR4	9a	Tor
0Z	XC6221A49B7R	LVR-IC	LDO, 4.95V±1%, 200mA, +CE	USPN-4	58vm	VR4	9a	Tor
0Z	XC6223A3919R-G	LVR-IC	LDO, 3.9V±1%, 300mA, +CE	USPQ-4B03	48vm	VR4	9a	Tor
0Z	XC6221C3717R	LVR-IC	LDO, 3.7V±1%, 200mA, +CE, PDR	USPN-4	58vm	VR4	9a	Tor
10	RP110L171B	LVR-IC	LDO, 1.7V±1%, 150mA, +CE	DFN11010-4	48vm	VR4	9a	Ric
10	XC6224A08B7R	LVR-IC	LDO, 0.85V±20mV, 150mA, +CE	USPN-4B02	58vm	VR4	9e	Tor
10	XC6229D26B1R-G	LVR-IC	LDO, 2.6V±1%, 300mA, +CE	BGA-4	63ba*	VR4	9a	Tor
10	XC6420AB107R-G	LVR-IC	LDO, Dual out, Vout1/Vout2=1.50/2.85V±2%, 150mA, +CE	USPN-6	52xv	VR19	9a	Tor
10	XC6420AB10DR-G	LVR-IC	LDO, Dual out, Vout1/Vout2=1.50/2.85V±2%, 150mA, +CE	USP-6B04	73x4	VR19	9a	Tor
10	XC6221C3817R	LVR-IC	LDO, 3.8V±1%, 200mA, +CE, PDR	USPN-4	58vm	VR4	9a	Tor
101	XC6415AA017R-G	LVR-IC	LDO, Dual out, Vot1/Vout2=1.80/2.80V±1%, 200mA, +CE	USPN-6	52xv	VR19	9b	Tor
101	XC6415AA01ER-G	LVR-IC	LDO, Dual out, Vot1/Vout2=1.80/2.80V±1%, 200mA, +CE	USP-6C	49xv	VR19	9a	Tor
102	XC6415AA027R-G	LVR-IC	LDO, Dual out, Vot1/Vout2=1.20/2.90V±1%, 200mA, +CE	USPN-6	52xv	VR19	9b	Tor
102	XC6415AA02ER-G	LVR-IC	LDO, Dual out, Vot1/Vout2=1.20/2.90V±1%, 200mA, +CE	USP-6C	49xv	VR19	9a	Tor
103	XC6415AA037R-G	LVR-IC	LDO, Dual out, Vot1/Vout2=1.80/1.80V±1%, 200mA, +CE	USPN-6	52xv	VR19	9b	Tor
103	XC6415AA03ER-G	LVR-IC	LDO, Dual out, Vot1/Vout2=1.80/1.80V±1%, 200mA, +CE	USP-6C	49xv	VR19	9a	Tor
104	XC6415AA047R-G	LVR-IC	LDO, Dual out, Vot1/Vout2=1.50/2.70V±1%, 200mA, +CE	USPN-6	52xv	VR19	9b	Tor
104	XC6415AA04ER-G	LVR-IC	LDO, Dual out, Vot1/Vout2=1.50/2.70V±1%, 200mA, +CE	USP-6C	49xv	VR19	9a	Tor
105	XC6415AA057R-G	LVR-IC	LDO, Dual out, Vot1/Vout2=2.85/2.85V±1%, 200mA, +CE	USPN-6	52xv	VR19	9b	Tor
105	XC6415AA05ER-G	LVR-IC	LDO, Dual out, Vot1/Vout2=2.85/2.85V±1%, 200mA, +CE	USP-6C	49xv	VR19	9a	Tor
106	XC6415AA067R-G	LVR-IC	LDO, Dual out, Vot1/Vout2=1.80/3.30V±1%, 200mA, +CE	USPN-6	52xv	VR19	9b	Tor
106	XC6415AA06ER-G	LVR-IC	LDO, Dual out, Vot1/Vout2=1.80/3.30V±1%, 200mA, +CE	USP-6C	49xv	VR19	9a	Tor
107	XC6415AA077R-G	LVR-IC	LDO, Dual out, Vot1/Vout2=3.00/3.00V±1%, 200mA, +CE	USPN-6	52xv	VR19	9b	Tor
107	XC6415AA07ER-G	LVR-IC	LDO, Dual out, Vot1/Vout2=3.00/3.00V±1%, 200mA, +CE	USP-6C	49xv	VR19	9a	Tor
108	XC6415AA087R-G	LVR-IC	LDO, Dual out, Vot1/Vout2=2.80/1.80V±1%, 200mA, +CE	USPN-6	52xv	VR19	9b	Tor
108	XC6415AA08ER-G	LVR-IC	LDO, Dual out, Vot1/Vout2=2.80/1.80V±1%, 200mA, +CE	USP-6C	49xv	VR19	9a	Tor
109	XC6415AA097R-G	LVR-IC	LDO, Dual out, Vot1/Vout2=1.20/1.20V±1%, 200mA, +CE	USPN-6	52xv	VR19	9b	Tor
109	XC6415AA09ER-G	LVR-IC	LDO, Dual out, Vot1/Vout2=1.20/1.20V±1%, 200mA, +CE	USP-6C	49xv	VR19	9a	Tor
10A08	XC6210A082DR	LVR-IC	LDO, 0.8V±2%, 700mA, +CE, PDR	USP-6B	49hr	VR4	9b	Tor
10A09	XC6210A092DR	LVR-IC	LDO, 0.9V±2%, 700mA, +CE, PDR	USP-6B	49hr	VR4	9b	Tor
10A0L	XC6210A08ADR	LVR-IC	LDO, 0.85V±2%, 700mA, +CE, PDR	USP-6B	49hr	VR4	9b	Tor
10A0M	XC6210A09ADR	LVR-IC	LDO, 0.95V±2%, 700mA, +CE, PDR	USP-6B	49hr	VR4	9b	Tor



SMD code	Type	Function	Short description	Case	Pinout	Sch.	St.	Mnf.
10A10	XC6210A102DR	LVR-IC	LDO, 1V±2%, 700mA, +CE, PDR	USP-6B	49hr	VR4	9b	Tor
10A11	XC6210A112DR	LVR-IC	LDO, 1.1V±2%, 700mA, +CE, PDR	USP-6B	49hr	VR4	9b	Tor
10A12	XC6210A122DR	LVR-IC	LDO, 1.2V±2%, 700mA, +CE, PDR	USP-6B	49hr	VR4	9b	Tor
10A13	XC6210A132DR	LVR-IC	LDO, 1.3V±2%, 700mA, +CE, PDR	USP-6B	49hr	VR4	9b	Tor
10A14	XC6210A142DR	LVR-IC	LDO, 1.4V±2%, 700mA, +CE, PDR	USP-6B	49hr	VR4	9b	Tor
10A15	XC6210A152DR	LVR-IC	LDO, 1.5V±2%, 700mA, +CE, PDR	USP-6B	49hr	VR4	9b	Tor
10A16	XC6210A162DR	LVR-IC	LDO, 1.6V±2%, 700mA, +CE, PDR	USP-6B	49hr	VR4	9b	Tor
10A17	XC6210A172DR	LVR-IC	LDO, 1.7V±2%, 700mA, +CE, PDR	USP-6B	49hr	VR4	9b	Tor
10A18	XC6210A182DR	LVR-IC	LDO, 1.8V±2%, 700mA, +CE, PDR	USP-6B	49hr	VR4	9b	Tor
10A19	XC6210A192DR	LVR-IC	LDO, 1.9V±2%, 700mA, +CE, PDR	USP-6B	49hr	VR4	9b	Tor
10A1B	XC6210A11ADR	LVR-IC	LDO, 1.15V±2%, 700mA, +CE, PDR	USP-6B	49hr	VR4	9b	Tor
10A1C	XC6210A12ADR	LVR-IC	LDO, 1.25V±2%, 700mA, +CE, PDR	USP-6B	49hr	VR4	9b	Tor
10A1D	XC6210A13ADR	LVR-IC	LDO, 1.35V±2%, 700mA, +CE, PDR	USP-6B	49hr	VR4	9b	Tor
10A1E	XC6210A14ADR	LVR-IC	LDO, 1.45V±2%, 700mA, +CE, PDR	USP-6B	49hr	VR4	9b	Tor
10A1F	XC6210A15ADR	LVR-IC	LDO, 1.55V±2%, 700mA, +CE, PDR	USP-6B	49hr	VR4	9b	Tor
10A1H	XC6210A16ADR	LVR-IC	LDO, 1.65V±2%, 700mA, +CE, PDR	USP-6B	49hr	VR4	9b	Tor
10A1K	XC6210A17ADR	LVR-IC	LDO, 1.75V±2%, 700mA, +CE, PDR	USP-6B	49hr	VR4	9b	Tor
10A1L	XC6210A18ADR	LVR-IC	LDO, 1.85V±2%, 700mA, +CE, PDR	USP-6B	49hr	VR4	9b	Tor
10A1M	XC6210A19ADR	LVR-IC	LDO, 1.95V±2%, 700mA, +CE, PDR	USP-6B	49hr	VR4	9b	Tor
10A20	XC6210A202DR	LVR-IC	LDO, 2V±2%, 700mA, +CE, PDR	USP-6B	49hr	VR4	9b	Tor
10A21	XC6210A212DR	LVR-IC	LDO, 2.1V±2%, 700mA, +CE, PDR	USP-6B	49hr	VR4	9b	Tor
10A22	XC6210A222DR	LVR-IC	LDO, 2.2V±2%, 700mA, +CE, PDR	USP-6B	49hr	VR4	9b	Tor
10A23	XC6210A232DR	LVR-IC	LDO, 2.3V±2%, 700mA, +CE, PDR	USP-6B	49hr	VR4	9b	Tor
10A24	XC6210A242DR	LVR-IC	LDO, 2.4V±2%, 700mA, +CE, PDR	USP-6B	49hr	VR4	9b	Tor
10A25	XC6210A252DR	LVR-IC	LDO, 2.5V±2%, 700mA, +CE, PDR	USP-6B	49hr	VR4	9b	Tor
10A26	XC6210A262DR	LVR-IC	LDO, 2.6V±2%, 700mA, +CE, PDR	USP-6B	49hr	VR4	9b	Tor
10A27	XC6210A272DR	LVR-IC	LDO, 2.7V±2%, 700mA, +CE, PDR	USP-6B	49hr	VR4	9b	Tor
10A28	XC6210A282DR	LVR-IC	LDO, 2.8V±2%, 700mA, +CE, PDR	USP-6B	49hr	VR4	9b	Tor
10A29	XC6210A292DR	LVR-IC	LDO, 2.9V±2%, 700mA, +CE, PDR	USP-6B	49hr	VR4	9b	Tor
10A2A	XC6210A20ADR	LVR-IC	LDO, 2.05V±2%, 700mA, +CE, PDR	USP-6B	49hr	VR4	9b	Tor
10A2B	XC6210A21ADR	LVR-IC	LDO, 2.15V±2%, 700mA, +CE, PDR	USP-6B	49hr	VR4	9b	Tor
10A2C	XC6210A22ADR	LVR-IC	LDO, 2.25V±2%, 700mA, +CE, PDR	USP-6B	49hr	VR4	9b	Tor
10A2D	XC6210A23ADR	LVR-IC	LDO, 2.35V±2%, 700mA, +CE, PDR	USP-6B	49hr	VR4	9b	Tor
10A2E	XC6210A24ADR	LVR-IC	LDO, 2.45V±2%, 700mA, +CE, PDR	USP-6B	49hr	VR4	9b	Tor
10A2F	XC6210A25ADR	LVR-IC	LDO, 2.55V±2%, 700mA, +CE, PDR	USP-6B	49hr	VR4	9b	Tor
10A2H	XC6210A26ADR	LVR-IC	LDO, 2.65V±2%, 700mA, +CE, PDR	USP-6B	49hr	VR4	9b	Tor
10A2K	XC6210A27ADR	LVR-IC	LDO, 2.75V±2%, 700mA, +CE, PDR	USP-6B	49hr	VR4	9b	Tor
10A2L	XC6210A28ADR	LVR-IC	LDO, 2.85V±2%, 700mA, +CE, PDR	USP-6B	49hr	VR4	9b	Tor
10A2M	XC6210A29ADR	LVR-IC	LDO, 2.95V±2%, 700mA, +CE, PDR	USP-6B	49hr	VR4	9b	Tor
10A30	XC6210A302DR	LVR-IC	LDO, 3V±2%, 700mA, +CE, PDR	USP-6B	49hr	VR4	9b	Tor
10A31	XC6210A312DR	LVR-IC	LDO, 3.1V±2%, 700mA, +CE, PDR	USP-6B	49hr	VR4	9b	Tor
10A32	XC6210A322DR	LVR-IC	LDO, 3.2V±2%, 700mA, +CE, PDR	USP-6B	49hr	VR4	9b	Tor
10A33	XC6210A332DR	LVR-IC	LDO, 3.3V±2%, 700mA, +CE, PDR	USP-6B	49hr	VR4	9b	Tor
10A34	XC6210A342DR	LVR-IC	LDO, 3.4V±2%, 700mA, +CE, PDR	USP-6B	49hr	VR4	9b	Tor
10A35	XC6210A352DR	LVR-IC	LDO, 3.5V±2%, 700mA, +CE, PDR	USP-6B	49hr	VR4	9b	Tor
10A36	XC6210A362DR	LVR-IC	LDO, 3.6V±2%, 700mA, +CE, PDR	USP-6B	49hr	VR4	9b	Tor
10A37	XC6210A372DR	LVR-IC	LDO, 3.7V±2%, 700mA, +CE, PDR	USP-6B	49hr	VR4	9b	Tor
10A38	XC6210A382DR	LVR-IC	LDO, 3.8V±2%, 700mA, +CE, PDR	USP-6B	49hr	VR4	9b	Tor
10A39	XC6210A392DR	LVR-IC	LDO, 3.9V±2%, 700mA, +CE, PDR	USP-6B	49hr	VR4	9b	Tor
10A3A	XC6210A30ADR	LVR-IC	LDO, 3.05V±2%, 700mA, +CE, PDR	USP-6B	49hr	VR4	9b	Tor
10A3B	XC6210A31ADR	LVR-IC	LDO, 3.15V±2%, 700mA, +CE, PDR	USP-6B	49hr	VR4	9b	Tor
10A3C	XC6210A32ADR	LVR-IC	LDO, 3.25V±2%, 700mA, +CE, PDR	USP-6B	49hr	VR4	9b	Tor
10A3D	XC6210A33ADR	LVR-IC	LDO, 3.35V±2%, 700mA, +CE, PDR	USP-6B	49hr	VR4	9b	Tor
10A3E	XC6210A34ADR	LVR-IC	LDO, 3.45V±2%, 700mA, +CE, PDR	USP-6B	49hr	VR4	9b	Tor
10A3F	XC6210A35ADR	LVR-IC	LDO, 3.55V±2%, 700mA, +CE, PDR	USP-6B	49hr	VR4	9b	Tor
10A3H	XC6210A36ADR	LVR-IC	LDO, 3.65V±2%, 700mA, +CE, PDR	USP-6B	49hr	VR4	9b	Tor
10A3K	XC6210A37ADR	LVR-IC	LDO, 3.75V±2%, 700mA, +CE, PDR	USP-6B	49hr	VR4	9b	Tor
10A3L	XC6210A38ADR	LVR-IC	LDO, 3.85V±2%, 700mA, +CE, PDR	USP-6B	49hr	VR4	9b	Tor
10A3M	XC6210A39ADR	LVR-IC	LDO, 3.95V±2%, 700mA, +CE, PDR	USP-6B	49hr	VR4	9b	Tor
10A40	XC6210A402DR	LVR-IC	LDO, 4V±2%, 700mA, +CE, PDR	USP-6B	49hr	VR4	9b	Tor
10A41	XC6210A412DR	LVR-IC	LDO, 4.1V±2%, 700mA, +CE, PDR	USP-6B	49hr	VR4	9b	Tor
10A42	XC6210A422DR	LVR-IC	LDO, 4.2V±2%, 700mA, +CE, PDR	USP-6B	49hr	VR4	9b	Tor
10A43	XC6210A432DR	LVR-IC	LDO, 4.3V±2%, 700mA, +CE, PDR	USP-6B	49hr	VR4	9b	Tor
10A44	XC6210A442DR	LVR-IC	LDO, 4.4V±2%, 700mA, +CE, PDR	USP-6B	49hr	VR4	9b	Tor
10A45	XC6210A452DR	LVR-IC	LDO, 4.5V±2%, 700mA, +CE, PDR	USP-6B	49hr	VR4	9b	Tor
10A46	XC6210A462DR	LVR-IC	LDO, 4.6V±2%, 700mA, +CE, PDR	USP-6B	49hr	VR4	9b	Tor
10A47	XC6210A472DR	LVR-IC	LDO, 4.7V±2%, 700mA, +CE, PDR	USP-6B	49hr	VR4	9b	Tor
10A48	XC6210A482DR	LVR-IC	LDO, 4.8V±2%, 700mA, +CE, PDR	USP-6B	49hr	VR4	9b	Tor
10A49	XC6210A492DR	LVR-IC	LDO, 4.9V±2%, 700mA, +CE, PDR	USP-6B	49hr	VR4	9b	Tor
10A4A	XC6210A40ADR	LVR-IC	LDO, 4.05V±2%, 700mA, +CE, PDR	USP-6B	49hr	VR4	9b	Tor



SMD code	Type	Function	Short description	Case	Pinout	Sch.	St.	Mnf.
10A4B	XC6210A41ADR	LVR-IC	LDO, 4.15V±2%, 700mA, +CE, PDR	USP-6B	49hr	VR4	9b	Tor
10A4C	XC6210A42ADR	LVR-IC	LDO, 4.25V±2%, 700mA, +CE, PDR	USP-6B	49hr	VR4	9b	Tor
10A4D	XC6210A43ADR	LVR-IC	LDO, 4.35V±2%, 700mA, +CE, PDR	USP-6B	49hr	VR4	9b	Tor
10A4E	XC6210A44ADR	LVR-IC	LDO, 4.45V±2%, 700mA, +CE, PDR	USP-6B	49hr	VR4	9b	Tor
10A4F	XC6210A45ADR	LVR-IC	LDO, 4.55V±2%, 700mA, +CE, PDR	USP-6B	49hr	VR4	9b	Tor
10A4H	XC6210A46ADR	LVR-IC	LDO, 4.65V±2%, 700mA, +CE, PDR	USP-6B	49hr	VR4	9b	Tor
10A4K	XC6210A47ADR	LVR-IC	LDO, 4.75V±2%, 700mA, +CE, PDR	USP-6B	49hr	VR4	9b	Tor
10A4L	XC6210A48ADR	LVR-IC	LDO, 4.85V±2%, 700mA, +CE, PDR	USP-6B	49hr	VR4	9b	Tor
10A4M	XC6210A49ADR	LVR-IC	LDO, 4.95V±2%, 700mA, +CE, PDR	USP-6B	49hr	VR4	9b	Tor
10A50	XC6210A502DR	LVR-IC	LDO, 5V±2%, 700mA, +CE, PDR	USP-6B	49hr	VR4	9b	Tor
10B08	XC6210B082DR	LVR-IC	LDO, 0.8V±2%, 700mA, +CE	USP-6B	49hr	VR4	9b	Tor
10B09	XC6210B092DR	LVR-IC	LDO, 0.9V±2%, 700mA, +CE	USP-6B	49hr	VR4	9b	Tor
10B0L	XC6210B08ADR	LVR-IC	LDO, 0.85V±2%, 700mA, +CE	USP-6B	49hr	VR4	9b	Tor
10B0M	XC6210B09ADR	LVR-IC	LDO, 0.95V±2%, 700mA, +CE	USP-6B	49hr	VR4	9b	Tor
10B10	XC6210B102DR	LVR-IC	LDO, 1V±2%, 700mA, +CE	USP-6B	49hr	VR4	9b	Tor
10B11	XC6210B112DR	LVR-IC	LDO, 1.1V±2%, 700mA, +CE	USP-6B	49hr	VR4	9b	Tor
10B12	XC6210B122DR	LVR-IC	LDO, 1.2V±2%, 700mA, +CE	USP-6B	49hr	VR4	9b	Tor
10B13	XC6210B132DR	LVR-IC	LDO, 1.3V±2%, 700mA, +CE	USP-6B	49hr	VR4	9b	Tor
10B14	XC6210B142DR	LVR-IC	LDO, 1.4V±2%, 700mA, +CE	USP-6B	49hr	VR4	9b	Tor
10B15	XC6210B152DR	LVR-IC	LDO, 1.5V±2%, 700mA, +CE	USP-6B	49hr	VR4	9b	Tor
10B16	XC6210B162DR	LVR-IC	LDO, 1.6V±2%, 700mA, +CE	USP-6B	49hr	VR4	9b	Tor
10B17	XC6210B172DR	LVR-IC	LDO, 1.7V±2%, 700mA, +CE	USP-6B	49hr	VR4	9b	Tor
10B18	XC6210B182DR	LVR-IC	LDO, 1.8V±2%, 700mA, +CE	USP-6B	49hr	VR4	9b	Tor
10B19	XC6210B192DR	LVR-IC	LDO, 1.9V±2%, 700mA, +CE	USP-6B	49hr	VR4	9b	Tor
10B1A	XC6210B11ADR	LVR-IC	LDO, 1.15V±2%, 700mA, +CE	USP-6B	49hr	VR4	9b	Tor
10B1B	XC6210B12ADR	LVR-IC	LDO, 1.25V±2%, 700mA, +CE	USP-6B	49hr	VR4	9b	Tor
10B1C	XC6210B13ADR	LVR-IC	LDO, 1.35V±2%, 700mA, +CE	USP-6B	49hr	VR4	9b	Tor
10B1D	XC6210B14ADR	LVR-IC	LDO, 1.45V±2%, 700mA, +CE	USP-6B	49hr	VR4	9b	Tor
10B1E	XC6210B15ADR	LVR-IC	LDO, 1.55V±2%, 700mA, +CE	USP-6B	49hr	VR4	9b	Tor
10B1F	XC6210B16ADR	LVR-IC	LDO, 1.65V±2%, 700mA, +CE	USP-6B	49hr	VR4	9b	Tor
10B1H	XC6210B17ADR	LVR-IC	LDO, 1.75V±2%, 700mA, +CE	USP-6B	49hr	VR4	9b	Tor
10B1L	XC6210B18ADR	LVR-IC	LDO, 1.85V±2%, 700mA, +CE	USP-6B	49hr	VR4	9b	Tor
10B1M	XC6210B19ADR	LVR-IC	LDO, 1.95V±2%, 700mA, +CE	USP-6B	49hr	VR4	9b	Tor
10B20	XC6210B202DR	LVR-IC	LDO, 2V±2%, 700mA, +CE	USP-6B	49hr	VR4	9b	Tor
10B21	XC6210B212DR	LVR-IC	LDO, 2.1V±2%, 700mA, +CE	USP-6B	49hr	VR4	9b	Tor
10B22	XC6210B222DR	LVR-IC	LDO, 2.2V±2%, 700mA, +CE	USP-6B	49hr	VR4	9b	Tor
10B23	XC6210B232DR	LVR-IC	LDO, 2.3V±2%, 700mA, +CE	USP-6B	49hr	VR4	9b	Tor
10B24	XC6210B242DR	LVR-IC	LDO, 2.4V±2%, 700mA, +CE	USP-6B	49hr	VR4	9b	Tor
10B25	XC6210B252DR	LVR-IC	LDO, 2.5V±2%, 700mA, +CE	USP-6B	49hr	VR4	9b	Tor
10B26	XC6210B262DR	LVR-IC	LDO, 2.6V±2%, 700mA, +CE	USP-6B	49hr	VR4	9b	Tor
10B27	XC6210B272DR	LVR-IC	LDO, 2.7V±2%, 700mA, +CE	USP-6B	49hr	VR4	9b	Tor
10B28	XC6210B282DR	LVR-IC	LDO, 2.8V±2%, 700mA, +CE	USP-6B	49hr	VR4	9b	Tor
10B29	XC6210B292DR	LVR-IC	LDO, 2.9V±2%, 700mA, +CE	USP-6B	49hr	VR4	9b	Tor
10B2A	XC6210B20ADR	LVR-IC	LDO, 2.05V±2%, 700mA, +CE	USP-6B	49hr	VR4	9b	Tor
10B2B	XC6210B21ADR	LVR-IC	LDO, 2.15V±2%, 700mA, +CE	USP-6B	49hr	VR4	9b	Tor
10B2C	XC6210B22ADR	LVR-IC	LDO, 2.25V±2%, 700mA, +CE	USP-6B	49hr	VR4	9b	Tor
10B2D	XC6210B23ADR	LVR-IC	LDO, 2.35V±2%, 700mA, +CE	USP-6B	49hr	VR4	9b	Tor
10B2E	XC6210B24ADR	LVR-IC	LDO, 2.45V±2%, 700mA, +CE	USP-6B	49hr	VR4	9b	Tor
10B2F	XC6210B25ADR	LVR-IC	LDO, 2.55V±2%, 700mA, +CE	USP-6B	49hr	VR4	9b	Tor
10B2H	XC6210B26ADR	LVR-IC	LDO, 2.65V±2%, 700mA, +CE	USP-6B	49hr	VR4	9b	Tor
10B2K	XC6210B27ADR	LVR-IC	LDO, 2.75V±2%, 700mA, +CE	USP-6B	49hr	VR4	9b	Tor
10B2L	XC6210B28ADR	LVR-IC	LDO, 2.85V±2%, 700mA, +CE	USP-6B	49hr	VR4	9b	Tor
10B2M	XC6210B29ADR	LVR-IC	LDO, 2.95V±2%, 700mA, +CE	USP-6B	49hr	VR4	9b	Tor
10B30	XC6210B302DR	LVR-IC	LDO, 3V±2%, 700mA, +CE	USP-6B	49hr	VR4	9b	Tor
10B31	XC6210B312DR	LVR-IC	LDO, 3.1V±2%, 700mA, +CE	USP-6B	49hr	VR4	9b	Tor
10B32	XC6210B322DR	LVR-IC	LDO, 3.2V±2%, 700mA, +CE	USP-6B	49hr	VR4	9b	Tor
10B33	XC6210B332DR	LVR-IC	LDO, 3.3V±2%, 700mA, +CE	USP-6B	49hr	VR4	9b	Tor
10B34	XC6210B342DR	LVR-IC	LDO, 3.4V±2%, 700mA, +CE	USP-6B	49hr	VR4	9b	Tor
10B35	XC6210B352DR	LVR-IC	LDO, 3.5V±2%, 700mA, +CE	USP-6B	49hr	VR4	9b	Tor
10B36	XC6210B362DR	LVR-IC	LDO, 3.6V±2%, 700mA, +CE	USP-6B	49hr	VR4	9b	Tor
10B37	XC6210B372DR	LVR-IC	LDO, 3.7V±2%, 700mA, +CE	USP-6B	49hr	VR4	9b	Tor
10B38	XC6210B382DR	LVR-IC	LDO, 3.8V±2%, 700mA, +CE	USP-6B	49hr	VR4	9b	Tor
10B39	XC6210B392DR	LVR-IC	LDO, 3.9V±2%, 700mA, +CE	USP-6B	49hr	VR4	9b	Tor
10B3A	XC6210B30ADR	LVR-IC	LDO, 3.05V±2%, 700mA, +CE	USP-6B	49hr	VR4	9b	Tor
10B3B	XC6210B31ADR	LVR-IC	LDO, 3.15V±2%, 700mA, +CE	USP-6B	49hr	VR4	9b	Tor
10B3C	XC6210B32ADR	LVR-IC	LDO, 3.25V±2%, 700mA, +CE	USP-6B	49hr	VR4	9b	Tor
10B3D	XC6210B33ADR	LVR-IC	LDO, 3.35V±2%, 700mA, +CE	USP-6B	49hr	VR4	9b	Tor
10B3E	XC6210B34ADR	LVR-IC	LDO, 3.45V±2%, 700mA, +CE	USP-6B	49hr	VR4	9b	Tor
10B3F	XC6210B35ADR	LVR-IC	LDO, 3.55V±2%, 700mA, +CE	USP-6B	49hr	VR4	9b	Tor
10B3H	XC6210B36ADR	LVR-IC	LDO, 3.65V±2%, 700mA, +CE	USP-6B	49hr	VR4	9b	Tor



SMD code	Type	Function	Short description	Case	Pinout	Sch.	St.	Mnf.
10B3K	XC6210B37ADR	LVR-IC	LDO, 3.75V±2%, 700mA, +CE	USP-6B	49hr	VR4	9b	Tor
10B3L	XC6210B38ADR	LVR-IC	LDO, 3.85V±2%, 700mA, +CE	USP-6B	49hr	VR4	9b	Tor
10B3M	XC6210B39ADR	LVR-IC	LDO, 3.95V±2%, 700mA, +CE	USP-6B	49hr	VR4	9b	Tor
10B40	XC6210B402DR	LVR-IC	LDO, 4V±2%, 700mA, +CE	USP-6B	49hr	VR4	9b	Tor
10B41	XC6210B412DR	LVR-IC	LDO, 4.1V±2%, 700mA, +CE	USP-6B	49hr	VR4	9b	Tor
10B42	XC6210B422DR	LVR-IC	LDO, 4.2V±2%, 700mA, +CE	USP-6B	49hr	VR4	9b	Tor
10B43	XC6210B432DR	LVR-IC	LDO, 4.3V±2%, 700mA, +CE	USP-6B	49hr	VR4	9b	Tor
10B44	XC6210B442DR	LVR-IC	LDO, 4.4V±2%, 700mA, +CE	USP-6B	49hr	VR4	9b	Tor
10B45	XC6210B452DR	LVR-IC	LDO, 4.5V±2%, 700mA, +CE	USP-6B	49hr	VR4	9b	Tor
10B46	XC6210B462DR	LVR-IC	LDO, 4.6V±2%, 700mA, +CE	USP-6B	49hr	VR4	9b	Tor
10B47	XC6210B472DR	LVR-IC	LDO, 4.7V±2%, 700mA, +CE	USP-6B	49hr	VR4	9b	Tor
10B48	XC6210B482DR	LVR-IC	LDO, 4.8V±2%, 700mA, +CE	USP-6B	49hr	VR4	9b	Tor
10B49	XC6210B492DR	LVR-IC	LDO, 4.9V±2%, 700mA, +CE	USP-6B	49hr	VR4	9b	Tor
10B4A	XC6210B40ADR	LVR-IC	LDO, 4.05V±2%, 700mA, +CE	USP-6B	49hr	VR4	9b	Tor
10B4B	XC6210B41ADR	LVR-IC	LDO, 4.15V±2%, 700mA, +CE	USP-6B	49hr	VR4	9b	Tor
10B4C	XC6210B42ADR	LVR-IC	LDO, 4.25V±2%, 700mA, +CE	USP-6B	49hr	VR4	9b	Tor
10B4D	XC6210B43ADR	LVR-IC	LDO, 4.35V±2%, 700mA, +CE	USP-6B	49hr	VR4	9b	Tor
10B4E	XC6210B44ADR	LVR-IC	LDO, 4.45V±2%, 700mA, +CE	USP-6B	49hr	VR4	9b	Tor
10B4F	XC6210B45ADR	LVR-IC	LDO, 4.55V±2%, 700mA, +CE	USP-6B	49hr	VR4	9b	Tor
10B4H	XC6210B46ADR	LVR-IC	LDO, 4.65V±2%, 700mA, +CE	USP-6B	49hr	VR4	9b	Tor
10B4K	XC6210B47ADR	LVR-IC	LDO, 4.75V±2%, 700mA, +CE	USP-6B	49hr	VR4	9b	Tor
10B4L	XC6210B48ADR	LVR-IC	LDO, 4.85V±2%, 700mA, +CE	USP-6B	49hr	VR4	9b	Tor
10B4M	XC6210B49ADR	LVR-IC	LDO, 4.95V±2%, 700mA, +CE	USP-6B	49hr	VR4	9b	Tor
10B50	XC6210B502DR	LVR-IC	LDO, 5V±2%, 700mA, +CE	USP-6B	49hr	VR4	9b	Tor
10C08	XC6210C082DR	LVR-IC	LDO, 0.8V±2%, 700mA, -CE, PDR	USP-6B	49hr	VR4	9b	Tor
10C09	XC6210C092DR	LVR-IC	LDO, 0.9V±2%, 700mA, -CE, PDR	USP-6B	49hr	VR4	9b	Tor
10C0L	XC6210C08ADR	LVR-IC	LDO, 0.85V±2%, 700mA, -CE, PDR	USP-6B	49hr	VR4	9b	Tor
10C0M	XC6210C09ADR	LVR-IC	LDO, 0.95V±2%, 700mA, -CE, PDR	USP-6B	49hr	VR4	9b	Tor
10C10	XC6210C102DR	LVR-IC	LDO, 1V±2%, 700mA, -CE, PDR	USP-6B	49hr	VR4	9b	Tor
10C11	XC6210C112DR	LVR-IC	LDO, 1.1V±2%, 700mA, -CE, PDR	USP-6B	49hr	VR4	9b	Tor
10C12	XC6210C122DR	LVR-IC	LDO, 1.2V±2%, 700mA, -CE, PDR	USP-6B	49hr	VR4	9b	Tor
10C13	XC6210C132DR	LVR-IC	LDO, 1.3V±2%, 700mA, -CE, PDR	USP-6B	49hr	VR4	9b	Tor
10C14	XC6210C142DR	LVR-IC	LDO, 1.4V±2%, 700mA, -CE, PDR	USP-6B	49hr	VR4	9b	Tor
10C15	XC6210C152DR	LVR-IC	LDO, 1.5V±2%, 700mA, -CE, PDR	USP-6B	49hr	VR4	9b	Tor
10C16	XC6210C162DR	LVR-IC	LDO, 1.6V±2%, 700mA, -CE, PDR	USP-6B	49hr	VR4	9b	Tor
10C17	XC6210C172DR	LVR-IC	LDO, 1.7V±2%, 700mA, -CE, PDR	USP-6B	49hr	VR4	9b	Tor
10C18	XC6210C182DR	LVR-IC	LDO, 1.8V±2%, 700mA, -CE, PDR	USP-6B	49hr	VR4	9b	Tor
10C19	XC6210C192DR	LVR-IC	LDO, 1.9V±2%, 700mA, -CE, PDR	USP-6B	49hr	VR4	9b	Tor
10C1A	XC6210C11ADR	LVR-IC	LDO, 1.15V±2%, 700mA, -CE, PDR	USP-6B	49hr	VR4	9b	Tor
10C1B	XC6210C12ADR	LVR-IC	LDO, 1.25V±2%, 700mA, -CE, PDR	USP-6B	49hr	VR4	9b	Tor
10C1C	XC6210C13ADR	LVR-IC	LDO, 1.35V±2%, 700mA, -CE, PDR	USP-6B	49hr	VR4	9b	Tor
10C1D	XC6210C14ADR	LVR-IC	LDO, 1.45V±2%, 700mA, -CE, PDR	USP-6B	49hr	VR4	9b	Tor
10C1E	XC6210C15ADR	LVR-IC	LDO, 1.55V±2%, 700mA, -CE, PDR	USP-6B	49hr	VR4	9b	Tor
10C1F	XC6210C16ADR	LVR-IC	LDO, 1.65V±2%, 700mA, -CE, PDR	USP-6B	49hr	VR4	9b	Tor
10C1H	XC6210C17ADR	LVR-IC	LDO, 1.75V±2%, 700mA, -CE, PDR	USP-6B	49hr	VR4	9b	Tor
10C1K	XC6210C18ADR	LVR-IC	LDO, 1.85V±2%, 700mA, -CE, PDR	USP-6B	49hr	VR4	9b	Tor
10C1L	XC6210C19ADR	LVR-IC	LDO, 1.95V±2%, 700mA, -CE, PDR	USP-6B	49hr	VR4	9b	Tor
10C20	XC6210C202DR	LVR-IC	LDO, 2V±2%, 700mA, -CE, PDR	USP-6B	49hr	VR4	9b	Tor
10C21	XC6210C212DR	LVR-IC	LDO, 2.1V±2%, 700mA, -CE, PDR	USP-6B	49hr	VR4	9b	Tor
10C22	XC6210C222DR	LVR-IC	LDO, 2.2V±2%, 700mA, -CE, PDR	USP-6B	49hr	VR4	9b	Tor
10C23	XC6210C232DR	LVR-IC	LDO, 2.3V±2%, 700mA, -CE, PDR	USP-6B	49hr	VR4	9b	Tor
10C24	XC6210C242DR	LVR-IC	LDO, 2.4V±2%, 700mA, -CE, PDR	USP-6B	49hr	VR4	9b	Tor
10C25	XC6210C252DR	LVR-IC	LDO, 2.5V±2%, 700mA, -CE, PDR	USP-6B	49hr	VR4	9b	Tor
10C26	XC6210C262DR	LVR-IC	LDO, 2.6V±2%, 700mA, -CE, PDR	USP-6B	49hr	VR4	9b	Tor
10C27	XC6210C272DR	LVR-IC	LDO, 2.7V±2%, 700mA, -CE, PDR	USP-6B	49hr	VR4	9b	Tor
10C28	XC6210C282DR	LVR-IC	LDO, 2.8V±2%, 700mA, -CE, PDR	USP-6B	49hr	VR4	9b	Tor
10C29	XC6210C292DR	LVR-IC	LDO, 2.9V±2%, 700mA, -CE, PDR	USP-6B	49hr	VR4	9b	Tor
10C2A	XC6210C20ADR	LVR-IC	LDO, 2.05V±2%, 700mA, -CE, PDR	USP-6B	49hr	VR4	9b	Tor
10C2B	XC6210C21ADR	LVR-IC	LDO, 2.15V±2%, 700mA, -CE, PDR	USP-6B	49hr	VR4	9b	Tor
10C2C	XC6210C22ADR	LVR-IC	LDO, 2.25V±2%, 700mA, -CE, PDR	USP-6B	49hr	VR4	9b	Tor
10C2D	XC6210C23ADR	LVR-IC	LDO, 2.35V±2%, 700mA, -CE, PDR	USP-6B	49hr	VR4	9b	Tor
10C2E	XC6210C24ADR	LVR-IC	LDO, 2.45V±2%, 700mA, -CE, PDR	USP-6B	49hr	VR4	9b	Tor
10C2F	XC6210C25ADR	LVR-IC	LDO, 2.55V±2%, 700mA, -CE, PDR	USP-6B	49hr	VR4	9b	Tor
10C2H	XC6210C26ADR	LVR-IC	LDO, 2.65V±2%, 700mA, -CE, PDR	USP-6B	49hr	VR4	9b	Tor
10C2K	XC6210C27ADR	LVR-IC	LDO, 2.75V±2%, 700mA, -CE, PDR	USP-6B	49hr	VR4	9b	Tor
10C2L	XC6210C28ADR	LVR-IC	LDO, 2.85V±2%, 700mA, -CE, PDR	USP-6B	49hr	VR4	9b	Tor
10C2M	XC6210C29ADR	LVR-IC	LDO, 2.95V±2%, 700mA, -CE, PDR	USP-6B	49hr	VR4	9b	Tor
10C30	XC6210C302DR	LVR-IC	LDO, 3V±2%, 700mA, -CE, PDR	USP-6B	49hr	VR4	9b	Tor
10C31	XC6210C312DR	LVR-IC	LDO, 3.1V±2%, 700mA, -CE, PDR	USP-6B	49hr	VR4	9b	Tor
10C32	XC6210C322DR	LVR-IC	LDO, 3.2V±2%, 700mA, -CE, PDR	USP-6B	49hr	VR4	9b	Tor



SMD code	Type	Function	Short description	Case	Pinout	Sch.	St.	Mnf.
10C33	XC6210C332DR	LVR-IC	LDO, 3.3V±2%, 700mA, -CE, PDR	USP-6B	49hr	VR4	9b	Tor
10C34	XC6210C342DR	LVR-IC	LDO, 3.4V±2%, 700mA, -CE, PDR	USP-6B	49hr	VR4	9b	Tor
10C35	XC6210C352DR	LVR-IC	LDO, 3.5V±2%, 700mA, -CE, PDR	USP-6B	49hr	VR4	9b	Tor
10C36	XC6210C362DR	LVR-IC	LDO, 3.6V±2%, 700mA, -CE, PDR	USP-6B	49hr	VR4	9b	Tor
10C37	XC6210C372DR	LVR-IC	LDO, 3.7V±2%, 700mA, -CE, PDR	USP-6B	49hr	VR4	9b	Tor
10C38	XC6210C382DR	LVR-IC	LDO, 3.8V±2%, 700mA, -CE, PDR	USP-6B	49hr	VR4	9b	Tor
10C39	XC6210C392DR	LVR-IC	LDO, 3.9V±2%, 700mA, -CE, PDR	USP-6B	49hr	VR4	9b	Tor
10C3A	XC6210C30ADR	LVR-IC	LDO, 3.05V±2%, 700mA, -CE, PDR	USP-6B	49hr	VR4	9b	Tor
10C3B	XC6210C31ADR	LVR-IC	LDO, 3.15V±2%, 700mA, -CE, PDR	USP-6B	49hr	VR4	9b	Tor
10C3C	XC6210C32ADR	LVR-IC	LDO, 3.25V±2%, 700mA, -CE, PDR	USP-6B	49hr	VR4	9b	Tor
10C3D	XC6210C33ADR	LVR-IC	LDO, 3.35V±2%, 700mA, -CE, PDR	USP-6B	49hr	VR4	9b	Tor
10C3E	XC6210C34ADR	LVR-IC	LDO, 3.45V±2%, 700mA, -CE, PDR	USP-6B	49hr	VR4	9b	Tor
10C3F	XC6210C35ADR	LVR-IC	LDO, 3.55V±2%, 700mA, -CE, PDR	USP-6B	49hr	VR4	9b	Tor
10C3H	XC6210C36ADR	LVR-IC	LDO, 3.65V±2%, 700mA, -CE, PDR	USP-6B	49hr	VR4	9b	Tor
10C3K	XC6210C37ADR	LVR-IC	LDO, 3.75V±2%, 700mA, -CE, PDR	USP-6B	49hr	VR4	9b	Tor
10C3L	XC6210C38ADR	LVR-IC	LDO, 3.85V±2%, 700mA, -CE, PDR	USP-6B	49hr	VR4	9b	Tor
10C3M	XC6210C39ADR	LVR-IC	LDO, 3.95V±2%, 700mA, -CE, PDR	USP-6B	49hr	VR4	9b	Tor
10C40	XC6210C402DR	LVR-IC	LDO, 4V±2%, 700mA, -CE, PDR	USP-6B	49hr	VR4	9b	Tor
10C41	XC6210C412DR	LVR-IC	LDO, 4.1V±2%, 700mA, -CE, PDR	USP-6B	49hr	VR4	9b	Tor
10C42	XC6210C422DR	LVR-IC	LDO, 4.2V±2%, 700mA, -CE, PDR	USP-6B	49hr	VR4	9b	Tor
10C43	XC6210C432DR	LVR-IC	LDO, 4.3V±2%, 700mA, -CE, PDR	USP-6B	49hr	VR4	9b	Tor
10C44	XC6210C442DR	LVR-IC	LDO, 4.4V±2%, 700mA, -CE, PDR	USP-6B	49hr	VR4	9b	Tor
10C45	XC6210C452DR	LVR-IC	LDO, 4.5V±2%, 700mA, -CE, PDR	USP-6B	49hr	VR4	9b	Tor
10C46	XC6210C462DR	LVR-IC	LDO, 4.6V±2%, 700mA, -CE, PDR	USP-6B	49hr	VR4	9b	Tor
10C47	XC6210C472DR	LVR-IC	LDO, 4.7V±2%, 700mA, -CE, PDR	USP-6B	49hr	VR4	9b	Tor
10C48	XC6210C482DR	LVR-IC	LDO, 4.8V±2%, 700mA, -CE, PDR	USP-6B	49hr	VR4	9b	Tor
10C49	XC6210C492DR	LVR-IC	LDO, 4.9V±2%, 700mA, -CE, PDR	USP-6B	49hr	VR4	9b	Tor
10C4A	XC6210C40ADR	LVR-IC	LDO, 4.05V±2%, 700mA, -CE, PDR	USP-6B	49hr	VR4	9b	Tor
10C4B	XC6210C41ADR	LVR-IC	LDO, 4.15V±2%, 700mA, -CE, PDR	USP-6B	49hr	VR4	9b	Tor
10C4C	XC6210C42ADR	LVR-IC	LDO, 4.25V±2%, 700mA, -CE, PDR	USP-6B	49hr	VR4	9b	Tor
10C4D	XC6210C43ADR	LVR-IC	LDO, 4.35V±2%, 700mA, -CE, PDR	USP-6B	49hr	VR4	9b	Tor
10C4E	XC6210C44ADR	LVR-IC	LDO, 4.45V±2%, 700mA, -CE, PDR	USP-6B	49hr	VR4	9b	Tor
10C4F	XC6210C45ADR	LVR-IC	LDO, 4.55V±2%, 700mA, -CE, PDR	USP-6B	49hr	VR4	9b	Tor
10C4H	XC6210C46ADR	LVR-IC	LDO, 4.65V±2%, 700mA, -CE, PDR	USP-6B	49hr	VR4	9b	Tor
10C4K	XC6210C47ADR	LVR-IC	LDO, 4.75V±2%, 700mA, -CE, PDR	USP-6B	49hr	VR4	9b	Tor
10C4L	XC6210C48ADR	LVR-IC	LDO, 4.85V±2%, 700mA, -CE, PDR	USP-6B	49hr	VR4	9b	Tor
10C4M	XC6210C49ADR	LVR-IC	LDO, 4.95V±2%, 700mA, -CE, PDR	USP-6B	49hr	VR4	9b	Tor
10C50	XC6210C502DR	LVR-IC	LDO, 5V±2%, 700mA, -CE, PDR	USP-6B	49hr	VR4	9b	Tor
10D08	XC6210D082DR	LVR-IC	LDO, 0.8V±2%, 700mA, -CE	USP-6B	49hr	VR4	9b	Tor
10D09	XC6210D092DR	LVR-IC	LDO, 0.9V±2%, 700mA, -CE	USP-6B	49hr	VR4	9b	Tor
10D0L	XC6210D08ADR	LVR-IC	LDO, 0.85V±2%, 700mA, -CE	USP-6B	49hr	VR4	9b	Tor
10D0M	XC6210D09ADR	LVR-IC	LDO, 0.95V±2%, 700mA, -CE	USP-6B	49hr	VR4	9b	Tor
10D10	XC6210D102DR	LVR-IC	LDO, 1V±2%, 700mA, -CE	USP-6B	49hr	VR4	9b	Tor
10D11	XC6210D112DR	LVR-IC	LDO, 1.1V±2%, 700mA, -CE	USP-6B	49hr	VR4	9b	Tor
10D12	XC6210D122DR	LVR-IC	LDO, 1.2V±2%, 700mA, -CE	USP-6B	49hr	VR4	9b	Tor
10D13	XC6210D132DR	LVR-IC	LDO, 1.3V±2%, 700mA, -CE	USP-6B	49hr	VR4	9b	Tor
10D14	XC6210D142DR	LVR-IC	LDO, 1.4V±2%, 700mA, -CE	USP-6B	49hr	VR4	9b	Tor
10D15	XC6210D152DR	LVR-IC	LDO, 1.5V±2%, 700mA, -CE	USP-6B	49hr	VR4	9b	Tor
10D16	XC6210D162DR	LVR-IC	LDO, 1.6V±2%, 700mA, -CE	USP-6B	49hr	VR4	9b	Tor
10D17	XC6210D172DR	LVR-IC	LDO, 1.7V±2%, 700mA, -CE	USP-6B	49hr	VR4	9b	Tor
10D18	XC6210D182DR	LVR-IC	LDO, 1.8V±2%, 700mA, -CE	USP-6B	49hr	VR4	9b	Tor
10D19	XC6210D192DR	LVR-IC	LDO, 1.9V±2%, 700mA, -CE	USP-6B	49hr	VR4	9b	Tor
10D1B	XC6210D11ADR	LVR-IC	LDO, 1.15V±2%, 700mA, -CE	USP-6B	49hr	VR4	9b	Tor
10D1C	XC6210D12ADR	LVR-IC	LDO, 1.25V±2%, 700mA, -CE	USP-6B	49hr	VR4	9b	Tor
10D1D	XC6210D13ADR	LVR-IC	LDO, 1.35V±2%, 700mA, -CE	USP-6B	49hr	VR4	9b	Tor
10D1E	XC6210D14ADR	LVR-IC	LDO, 1.45V±2%, 700mA, -CE	USP-6B	49hr	VR4	9b	Tor
10D1F	XC6210D15ADR	LVR-IC	LDO, 1.55V±2%, 700mA, -CE	USP-6B	49hr	VR4	9b	Tor
10D1H	XC6210D16ADR	LVR-IC	LDO, 1.65V±2%, 700mA, -CE	USP-6B	49hr	VR4	9b	Tor
10D1K	XC6210D17ADR	LVR-IC	LDO, 1.75V±2%, 700mA, -CE	USP-6B	49hr	VR4	9b	Tor
10D1L	XC6210D18ADR	LVR-IC	LDO, 1.85V±2%, 700mA, -CE	USP-6B	49hr	VR4	9b	Tor
10D1M	XC6210D19ADR	LVR-IC	LDO, 1.95V±2%, 700mA, -CE	USP-6B	49hr	VR4	9b	Tor
10D20	XC6210D202DR	LVR-IC	LDO, 2V±2%, 700mA, -CE	USP-6B	49hr	VR4	9b	Tor
10D21	XC6210D212DR	LVR-IC	LDO, 2.1V±2%, 700mA, -CE	USP-6B	49hr	VR4	9b	Tor
10D22	XC6210D222DR	LVR-IC	LDO, 2.2V±2%, 700mA, -CE	USP-6B	49hr	VR4	9b	Tor
10D23	XC6210D232DR	LVR-IC	LDO, 2.3V±2%, 700mA, -CE	USP-6B	49hr	VR4	9b	Tor
10D24	XC6210D242DR	LVR-IC	LDO, 2.4V±2%, 700mA, -CE	USP-6B	49hr	VR4	9b	Tor
10D25	XC6210D252DR	LVR-IC	LDO, 2.5V±2%, 700mA, -CE	USP-6B	49hr	VR4	9b	Tor
10D26	XC6210D262DR	LVR-IC	LDO, 2.6V±2%, 700mA, -CE	USP-6B	49hr	VR4	9b	Tor
10D27	XC6210D272DR	LVR-IC	LDO, 2.7V±2%, 700mA, -CE	USP-6B	49hr	VR4	9b	Tor
10D28	XC6210D282DR	LVR-IC	LDO, 2.8V±2%, 700mA, -CE	USP-6B	49hr	VR4	9b	Tor



SMD code	Type	Function	Short description	Case	Pinout	Sch.	St.	Mnf.
10D29	XC6210D292DR	LVR-IC	LDO, 2.9V±2%, 700mA, -CE	USP-6B	49hr	VR4	9b	Tor
10D2A	XC6210D20ADR	LVR-IC	LDO, 2.05V±2%, 700mA, -CE	USP-6B	49hr	VR4	9b	Tor
10D2B	XC6210D21ADR	LVR-IC	LDO, 2.15V±2%, 700mA, -CE	USP-6B	49hr	VR4	9b	Tor
10D2C	XC6210D22ADR	LVR-IC	LDO, 2.25V±2%, 700mA, -CE	USP-6B	49hr	VR4	9b	Tor
10D2D	XC6210D23ADR	LVR-IC	LDO, 2.35V±2%, 700mA, -CE	USP-6B	49hr	VR4	9b	Tor
10D2E	XC6210D24ADR	LVR-IC	LDO, 2.45V±2%, 700mA, -CE	USP-6B	49hr	VR4	9b	Tor
10D2F	XC6210D25ADR	LVR-IC	LDO, 2.55V±2%, 700mA, -CE	USP-6B	49hr	VR4	9b	Tor
10D2H	XC6210D26ADR	LVR-IC	LDO, 2.65V±2%, 700mA, -CE	USP-6B	49hr	VR4	9b	Tor
10D2K	XC6210D27ADR	LVR-IC	LDO, 2.75V±2%, 700mA, -CE	USP-6B	49hr	VR4	9b	Tor
10D2L	XC6210D28ADR	LVR-IC	LDO, 2.85V±2%, 700mA, -CE	USP-6B	49hr	VR4	9b	Tor
10D2M	XC6210D29ADR	LVR-IC	LDO, 2.95V±2%, 700mA, -CE	USP-6B	49hr	VR4	9b	Tor
10D30	XC6210D302DR	LVR-IC	LDO, 3V±2%, 700mA, -CE	USP-6B	49hr	VR4	9b	Tor
10D31	XC6210D312DR	LVR-IC	LDO, 3.1V±2%, 700mA, -CE	USP-6B	49hr	VR4	9b	Tor
10D32	XC6210D322DR	LVR-IC	LDO, 3.2V±2%, 700mA, -CE	USP-6B	49hr	VR4	9b	Tor
10D33	XC6210D332DR	LVR-IC	LDO, 3.3V±2%, 700mA, -CE	USP-6B	49hr	VR4	9b	Tor
10D34	XC6210D342DR	LVR-IC	LDO, 3.4V±2%, 700mA, -CE	USP-6B	49hr	VR4	9b	Tor
10D35	XC6210D352DR	LVR-IC	LDO, 3.5V±2%, 700mA, -CE	USP-6B	49hr	VR4	9b	Tor
10D36	XC6210D362DR	LVR-IC	LDO, 3.6V±2%, 700mA, -CE	USP-6B	49hr	VR4	9b	Tor
10D37	XC6210D372DR	LVR-IC	LDO, 3.7V±2%, 700mA, -CE	USP-6B	49hr	VR4	9b	Tor
10D38	XC6210D382DR	LVR-IC	LDO, 3.8V±2%, 700mA, -CE	USP-6B	49hr	VR4	9b	Tor
10D39	XC6210D392DR	LVR-IC	LDO, 3.9V±2%, 700mA, -CE	USP-6B	49hr	VR4	9b	Tor
10D3A	XC6210D30ADR	LVR-IC	LDO, 3.05V±2%, 700mA, -CE	USP-6B	49hr	VR4	9b	Tor
10D3B	XC6210D31ADR	LVR-IC	LDO, 3.15V±2%, 700mA, -CE	USP-6B	49hr	VR4	9b	Tor
10D3C	XC6210D32ADR	LVR-IC	LDO, 3.25V±2%, 700mA, -CE	USP-6B	49hr	VR4	9b	Tor
10D3D	XC6210D33ADR	LVR-IC	LDO, 3.35V±2%, 700mA, -CE	USP-6B	49hr	VR4	9b	Tor
10D3E	XC6210D34ADR	LVR-IC	LDO, 3.45V±2%, 700mA, -CE	USP-6B	49hr	VR4	9b	Tor
10D3F	XC6210D35ADR	LVR-IC	LDO, 3.55V±2%, 700mA, -CE	USP-6B	49hr	VR4	9b	Tor
10D3H	XC6210D36ADR	LVR-IC	LDO, 3.65V±2%, 700mA, -CE	USP-6B	49hr	VR4	9b	Tor
10D3K	XC6210D37ADR	LVR-IC	LDO, 3.75V±2%, 700mA, -CE	USP-6B	49hr	VR4	9b	Tor
10D3L	XC6210D38ADR	LVR-IC	LDO, 3.85V±2%, 700mA, -CE	USP-6B	49hr	VR4	9b	Tor
10D3M	XC6210D39ADR	LVR-IC	LDO, 3.95V±2%, 700mA, -CE	USP-6B	49hr	VR4	9b	Tor
10D40	XC6210D402DR	LVR-IC	LDO, 4V±2%, 700mA, -CE	USP-6B	49hr	VR4	9b	Tor
10D41	XC6210D412DR	LVR-IC	LDO, 4.1V±2%, 700mA, -CE	USP-6B	49hr	VR4	9b	Tor
10D42	XC6210D422DR	LVR-IC	LDO, 4.2V±2%, 700mA, -CE	USP-6B	49hr	VR4	9b	Tor
10D43	XC6210D432DR	LVR-IC	LDO, 4.3V±2%, 700mA, -CE	USP-6B	49hr	VR4	9b	Tor
10D44	XC6210D442DR	LVR-IC	LDO, 4.4V±2%, 700mA, -CE	USP-6B	49hr	VR4	9b	Tor
10D45	XC6210D452DR	LVR-IC	LDO, 4.5V±2%, 700mA, -CE	USP-6B	49hr	VR4	9b	Tor
10D46	XC6210D462DR	LVR-IC	LDO, 4.6V±2%, 700mA, -CE	USP-6B	49hr	VR4	9b	Tor
10D47	XC6210D472DR	LVR-IC	LDO, 4.7V±2%, 700mA, -CE	USP-6B	49hr	VR4	9b	Tor
10D48	XC6210D482DR	LVR-IC	LDO, 4.8V±2%, 700mA, -CE	USP-6B	49hr	VR4	9b	Tor
10D49	XC6210D492DR	LVR-IC	LDO, 4.9V±2%, 700mA, -CE	USP-6B	49hr	VR4	9b	Tor
10D4A	XC6210D40ADR	LVR-IC	LDO, 4.05V±2%, 700mA, -CE	USP-6B	49hr	VR4	9b	Tor
10D4B	XC6210D41ADR	LVR-IC	LDO, 4.15V±2%, 700mA, -CE	USP-6B	49hr	VR4	9b	Tor
10D4C	XC6210D42ADR	LVR-IC	LDO, 4.25V±2%, 700mA, -CE	USP-6B	49hr	VR4	9b	Tor
10D4D	XC6210D43ADR	LVR-IC	LDO, 4.35V±2%, 700mA, -CE	USP-6B	49hr	VR4	9b	Tor
10D4E	XC6210D44ADR	LVR-IC	LDO, 4.45V±2%, 700mA, -CE	USP-6B	49hr	VR4	9b	Tor
10D4F	XC6210D45ADR	LVR-IC	LDO, 4.55V±2%, 700mA, -CE	USP-6B	49hr	VR4	9b	Tor
10D4H	XC6210D46ADR	LVR-IC	LDO, 4.65V±2%, 700mA, -CE	USP-6B	49hr	VR4	9b	Tor
10D4K	XC6210D47ADR	LVR-IC	LDO, 4.75V±2%, 700mA, -CE	USP-6B	49hr	VR4	9b	Tor
10D4L	XC6210D48ADR	LVR-IC	LDO, 4.85V±2%, 700mA, -CE	USP-6B	49hr	VR4	9b	Tor
10D4M	XC6210D49ADR	LVR-IC	LDO, 4.95V±2%, 700mA, -CE	USP-6B	49hr	VR4	9b	Tor
10D50	XC6210D502DR	LVR-IC	LDO, 5V±2%, 700mA, -CE	USP-6B	49hr	VR4	9b	Tor
11	MAV-11BSM	MMIC	RF amplifier, 50MHz..8GHz, 9.5dB (50Ω)	LLP-X	36aa	A1	9a	Mc
11	1R110L181B	LVR-IC	LDO, 1.8V±1%, 150mA, +CE	DFN1010-4	48vm	VR4	9a	Ric
11	XC6224A09B7R	LVR-IC	LDO, 0.95V±20mV, 150mA, +CE	USPN-4B02	58vm	VR4	9e	Tor
11	XC6229D211R-G	LVR-IC	LDO, 2.7V±1%, 300mA, +CE	BGA-4	63ba*	VR4	9a	Tor
11	XC6420AB117R-G	LVR-IC	LDO, Dual out, Vout1/Vout2=1.50/3.00V±2%, 150mA, +CE	USPN-6	52xv	VR19	9a	Tor
11	XC6420AB11DR-G	LVR-IC	LDO, Dual out, Vout1/Vout2=1.50/3.00V±2%, 150mA, +CE	USP-6B04	73x4	VR19	9a	Tor
11	XC6221C3917R	LVR-IC	LDO, 3.9V±1%, 200mA, +CE, PDR	USPN-4	58vm	VR4	9a	Tor
110	XC6415AA107R-G	LVR-IC	LDO, Dual out, Vot1/Vout2=1.10/1.30V±1%, 200mA, +CE	USPN-6	52xv	VR19	9b	Tor
110	XC6415AA10ER-G	LVR-IC	LDO, Dual out, Vot1/Vout2=1.10/1.30V±1%, 200mA, +CE	USP-6C	49xv	VR19	9a	Tor
111	XC6415AA117R-G	LVR-IC	LDO, Dual out, Vot1/Vout2=1.30/1.50V±1%, 200mA, +CE	USPN-6	52xv	VR19	9b	Tor
111	XC6415AA11ER-G	LVR-IC	LDO, Dual out, Vot1/Vout2=1.30/1.50V±1%, 200mA, +CE	USP-6C	49xv	VR19	9a	Tor
1117-18	LM1117LDX-1.8	LVR-IC	LDO, 1.8V±2%, 800mA, 0..+125°	DFN-8	37cf	VR1	-	Nsc
1117-25	LM1117LDX-2.5	LVR-IC	LDO, 2.5V±2%, 800mA, 0..+125°	DFN-8	37cf	VR1	-	Nsc
1117-28	LM1117LDX-2.85	LVR-IC	LDO, 2.85V±2%, 800mA, 0..+125°	DFN-8	37cf	VR1	-	Nsc
1117-33	LM1117LDX-3.3	LVR-IC	LDO, 3.3V±2%, 800mA, 0..+125°	DFN-8	37cf	VR1	-	Nsc
1117-50	LM1117LDX-5.0	LVR-IC	LDO, 5V±2%, 800mA, 0..+125°	DFN-8	37cf	VR1	-	Nsc
1117ADJ	LM1117LDX-ADJ	LVR-IC	LDO, Adjustable 1.25..13.8V, 0.8A, 0..+125°	DFN-8	37vrs	-	-	Nsc
1117133	LM1117LDX-3.3	LVR-IC	LDO, 3.3V±2%, 800mA, -40..+125°	DFN-8	37cf	VR1	-	Nsc



SMD code	Type	Function	Short description	Case	Pinout	Sch.	St.	Mnf.
1117150	LM1117LDX-5.0	LVR-IC	LDO, 5V±2%, 800mA, -40...+125°	DFN-8	37cf	VR1	-	Nsc
11171AD	LM1117LDX-ADJ	LVR-IC	LDO, Adjustable 1.25...13.8V, 0.8A, -40...+125°	DFN-8	37vrs	-	-	Nsc
112	XC6415AA127R-G	LVR-IC	LDO, Dual out, Vot1/Vout2=2.80/2.80V±1%, 200mA, +CE	USPN-6	52xv	VR19	9b	Tor
112	XC6415AA12ER-G	LVR-IC	LDO, Dual out, Vot1/Vout2=2.80/2.80V±1%, 200mA, +CE	USP-6C	49xv	VR19	9a	Tor
113	XC6415AA137R-G	LVR-IC	LDO, Dual out, Vot1/Vout2=2.50/3.30V±1%, 200mA, +CE	USPN-6	52xv	VR19	9b	Tor
113	XC6415AA13ER-G	LVR-IC	LDO, Dual out, Vot1/Vout2=2.50/3.30V±1%, 200mA, +CE	USP-6C	49xv	VR19	9a	Tor
114	XC6415AA147R-G	LVR-IC	LDO, Dual out, Vot1/Vout2=3.00/3.30V±1%, 200mA, +CE	USPN-6	52xv	VR19	9b	Tor
114	XC6415AA14ER-G	LVR-IC	LDO, Dual out, Vot1/Vout2=3.00/3.30V±1%, 200mA, +CE	USP-6C	49xv	VR19	9a	Tor
115	XC6415AA157R-G	LVR-IC	LDO, Dual out, Vot1/Vout2=1.20/1.80V±1%, 200mA, +CE	USPN-6	52xv	VR19	9b	Tor
115	XC6415AA15ER-G	LVR-IC	LDO, Dual out, Vot1/Vout2=1.20/1.80V±1%, 200mA, +CE	USP-6C	49xv	VR19	9a	Tor
116	XC6415AA167R-G	LVR-IC	LDO, Dual out, Vot1/Vout2=2.80/3.30V±1%, 200mA, +CE	USPN-6	52xv	VR19	9b	Tor
116	XC6415AA16ER-G	LVR-IC	LDO, Dual out, Vot1/Vout2=2.80/3.30V±1%, 200mA, +CE	USP-6C	49xv	VR19	9a	Tor
117	XC6415AA177R-G	LVR-IC	LDO, Dual out, Vot1/Vout2=3.30/3.30V±1%, 200mA, +CE	USPN-6	52xv	VR19	9b	Tor
117	XC6415AA17ER-G	LVR-IC	LDO, Dual out, Vot1/Vout2=3.30/3.30V±1%, 200mA, +CE	USP-6C	49xv	VR19	9a	Tor
118	XC6415AA187R-G	LVR-IC	LDO, Dual out, Vot1/Vout2=3.10/3.10V±1%, 200mA, +CE	USPN-6	52xv	VR19	9b	Tor
118	XC6415AA18ER-G	LVR-IC	LDO, Dual out, Vot1/Vout2=3.10/3.10V±1%, 200mA, +CE	USP-6C	49xv	VR19	9a	Tor
119	XC6415AA197R-G	LVR-IC	LDO, Dual out, Vot1/Vout2=2.80/1.50V±1%, 200mA, +CE	USPN-6	52xv	VR19	9b	Tor
119	XC6415AA19ER-G	LVR-IC	LDO, Dual out, Vot1/Vout2=2.80/1.50V±1%, 200mA, +CE	USP-6C	49xv	VR19	9a	Tor
12	RP110L181B5	LVR-IC	LDO, 1.85V±1%, 150mA, +CE	DFN1010-4	48vm	VR4	9a	Ric
12	XC6223B1219R-G	LVR-IC	LDO, 1.2V±20mV, 300mA, +CE, CL	USPQ-4B03	48vm	VR4	9a	Tor
12	XC6224A10B7R	LVR-IC	LDO, 1.05V±20mV, 150mA, +CE	USPN-4B02	58vm	VR4	9e	Tor
12	XC6229D27B1R-G	LVR-IC	LDO, 2.75V±1%, 300mA, +CE	BGA-4	63ba*	VR4	9a	Tor
12	XC6420AB127R-G	LVR-IC	LDO, Dual out, Vout1/Vout2=1.50/3.30V±2%, 150mA, +CE	USPN-6	52xv	VR19	9a	Tor
12	XC6420AB12DR-G	LVR-IC	LDO, Dual out, Vout1/Vout2=1.50/3.30V±2%, 150mA, +CE	USP-6B04	73x4	VR19	9a	Tor
12	XC6221C4017R	LVR-IC	LDO, 4V±1%, 200mA, +CE, PDR	USPN-4	58vm	VR4	9a	Tor
120	XC6415AA207R-G	LVR-IC	LDO, Dual out, Vot1/Vout2=1.30/2.80V±1%, 200mA, +CE	USPN-6	52xv	VR19	9b	Tor
120	XC6415AA20ER-G	LVR-IC	LDO, Dual out, Vot1/Vout2=1.30/2.80V±1%, 200mA, +CE	USP-6C	49xv	VR19	9a	Tor
121	XC6415AA217R-G	LVR-IC	LDO, Dual out, Vot1/Vout2=1.50/2.80V±1%, 200mA, +CE	USPN-6	52xv	VR19	9b	Tor
121	XC6415AA21ER-G	LVR-IC	LDO, Dual out, Vot1/Vout2=1.50/2.80V±1%, 200mA, +CE	USP-6C	49xv	VR19	9a	Tor
122	XC6415AA227R-G	LVR-IC	LDO, Dual out, Vot1/Vout2=1.80/3.00V±1%, 200mA, +CE	USPN-6	52xv	VR19	9b	Tor
122	XC6415AA22ER-G	LVR-IC	LDO, Dual out, Vot1/Vout2=1.80/3.00V±1%, 200mA, +CE	USP-6C	49xv	VR19	9a	Tor
123	XC6415AA237R-G	LVR-IC	LDO, Dual out, Vot1/Vout2=1.85/2.80V±1%, 200mA, +CE	USPN-6	52xv	VR19	9b	Tor
123	XC6415AA23ER-G	LVR-IC	LDO, Dual out, Vot1/Vout2=1.85/2.80V±1%, 200mA, +CE	USP-6C	49xv	VR19	9a	Tor
124	XC6415AA247R-G	LVR-IC	LDO, Dual out, Vot1/Vout2=1.85/3.30V±1%, 200mA, +CE	USPN-6	52xv	VR19	9b	Tor
124	XC6415AA24ER-G	LVR-IC	LDO, Dual out, Vot1/Vout2=1.85/3.30V±1%, 200mA, +CE	USP-6C	49xv	VR19	9a	Tor
125	XC6415AA257R-G	LVR-IC	LDO, Dual out, Vot1/Vout2=2.60/2.80V±1%, 200mA, +CE	USPN-6	52xv	VR19	9b	Tor
125	XC6415AA25ER-G	LVR-IC	LDO, Dual out, Vot1/Vout2=2.60/2.80V±1%, 200mA, +CE	USP-6C	49xv	VR19	9a	Tor
126	XC6415AA267R-G	LVR-IC	LDO, Dual out, Vot1/Vout2=1.50/1.50V±1%, 200mA, +CE	USPN-6	52xv	VR19	9b	Tor
126	XC6415AA26ER-G	LVR-IC	LDO, Dual out, Vot1/Vout2=1.50/1.50V±1%, 200mA, +CE	USP-6C	49xv	VR19	9a	Tor
127	XC6415AA277R-G	LVR-IC	LDO, Dual out, Vot1/Vout2=2.00/3.00V±1%, 200mA, +CE	USPN-6	52xv	VR19	9b	Tor
127	XC6415AA27ER-G	LVR-IC	LDO, Dual out, Vot1/Vout2=2.00/3.00V±1%, 200mA, +CE	USP-6C	49xv	VR19	9a	Tor
128	XC6415AA287R-G	LVR-IC	LDO, Dual out, Vot1/Vout2=3.30/1.80V±1%, 200mA, +CE	USPN-6	52xv	VR19	9b	Tor
128	XC6415AA28ER-G	LVR-IC	LDO, Dual out, Vot1/Vout2=3.30/1.80V±1%, 200mA, +CE	USP-6C	49xv	VR19	9a	Tor
129	XC6415AA297R-G	LVR-IC	LDO, Dual out, Vot1/Vout2=3.30/1.75V±1%, 200mA, +CE	USPN-6	52xv	VR19	9b	Tor
129	XC6415AA29ER-G	LVR-IC	LDO, Dual out, Vot1/Vout2=3.30/1.75V±1%, 200mA, +CE	USP-6C	49xv	VR19	9a	Tor
13	RP110L191B	LVR-IC	LDO, 1.9V±1%, 150mA, +CE	DFN1010-4	48vm	VR4	9a	Ric
13	XC6223B1319R-G	LVR-IC	LDO, 1.3V±20mV, 300mA, +CE, CL	USPQ-4B03	48vm	VR4	9a	Tor
13	XC6224A11B7R	LVR-IC	LDO, 1.15V±20mV, 150mA, +CE	USPN-4B02	58vm	VR4	9e	Tor
13	XC6229D2811R-G	LVR-IC	LDO, 2.8V±1%, 300mA, +CE	BGA-4	63ba*	VR4	9a	Tor
13	XC6420AB137R-G	LVR-IC	LDO, Dual out, Vout1/Vout2=1.80/1.80V±2%, 150mA, +CE	USPN-6	52xv	VR19	9a	Tor
13	XC6420AB13DR-G	LVR-IC	LDO, Dual out, Vout1/Vout2=1.80/1.80V±2%, 150mA, +CE	USP-6B04	73x4	VR19	9a	Tor
13	XC6221C4117R	LVR-IC	LDO, 4.1V±1%, 200mA, +CE, PDR	USPN-4	58vm	VR4	9a	Tor
130	XC6415AA307R-G	LVR-IC	LDO, Dual out, Vot1/Vout2=2.10/4.10V±1%, 200mA, +CE	USPN-6	52xv	VR19	9b	Tor
130	XC6415AA30ER-G	LVR-IC	LDO, Dual out, Vot1/Vout2=2.10/4.10V±1%, 200mA, +CE	USP-6C	49xv	VR19	9a	Tor
131	XC6415AA317R-G	LVR-IC	LDO, Dual out, Vot1/Vout2=1.20/2.80V±1%, 200mA, +CE	USPN-6	52xv	VR19	9b	Tor
131	XC6415AA31ER-G	LVR-IC	LDO, Dual out, Vot1/Vout2=1.20/2.80V±1%, 200mA, +CE	USP-6C	49xv	VR19	9a	Tor
132	XC6415AA327R-G	LVR-IC	LDO, Dual out, Vot1/Vout2=1.50/1.80V±1%, 200mA, +CE	USPN-6	52xv	VR19	9b	Tor
132	XC6415AA32ER-G	LVR-IC	LDO, Dual out, Vot1/Vout2=1.50/1.80V±1%, 200mA, +CE	USP-6C	49xv	VR19	9a	Tor
133	XC6415AA337R-G	LVR-IC	LDO, Dual out, Vot1/Vout2=1.50/3.00V±1%, 200mA, +CE	USPN-6	52xv	VR19	9b	Tor
133	XC6415AA33ER-G	LVR-IC	LDO, Dual out, Vot1/Vout2=1.50/3.00V±1%, 200mA, +CE	USP-6C	49xv	VR19	9a	Tor
134	XC6415AA347R-G	LVR-IC	LDO, Dual out, Vot1/Vout2=1.50/3.30V±1%, 200mA, +CE	USPN-6	52xv	VR19	9b	Tor
134	XC6415AA34ER-G	LVR-IC	LDO, Dual out, Vot1/Vout2=1.50/3.30V±1%, 200mA, +CE	USP-6C	49xv	VR19	9a	Tor
135	XC6415AA357R-G	LVR-IC	LDO, Dual out, Vot1/Vout2=1.50/2.60V±1%, 200mA, +CE	USPN-6	52xv	VR19	9b	Tor
135	XC6415AA35ER-G	LVR-IC	LDO, Dual out, Vot1/Vout2=1.50/2.60V±1%, 200mA, +CE	USP-6C	49xv	VR19	9a	Tor
136	XC6415AA367R-G	LVR-IC	LDO, Dual out, Vot1/Vout2=2.00/2.50V±1%, 200mA, +CE	USPN-6	52xv	VR19	9b	Tor
136	XC6415AA36ER-G	LVR-IC	LDO, Dual out, Vot1/Vout2=2.00/2.50V±1%, 200mA, +CE	USP-6C	49xv	VR19	9a	Tor
137	XC6415AA377R-G	LVR-IC	LDO, Dual out, Vot1/Vout2=3.30/4.50V±1%, 200mA, +CE	USPN-6	52xv	VR19	9b	Tor
137	XC6415AA37ER-G	LVR-IC	LDO, Dual out, Vot1/Vout2=3.30/4.50V±1%, 200mA, +CE	USP-6C	49xv	VR19	9a	Tor
138	XC6415AA387R-G	LVR-IC	LDO, Dual out, Vot1/Vout2=2.50/2.50V±1%, 200mA, +CE	USPN-6	52xv	VR19	9b	Tor
138	XC6415AA38ER-G	LVR-IC	LDO, Dual out, Vot1/Vout2=2.50/2.50V±1%, 200mA, +CE	USP-6C	49xv	VR19	9a	Tor



SMD code	Type	Function	Short description	Case	Pinout	Sch.	St.	Mnf.
139	XC6415AA397R-G	LVR-IC	LDO, Dual out, Vot1/Vout2=1.80/2.50V±1%, 200mA, +CE	USPN-6	52xv	VR19	9b	Tor
139	XC6415AA39ER-G	LVR-IC	LDO, Dual out, Vot1/Vout2=1.80/2.50V±1%, 200mA, +CE	USP-6C	49xv	VR19	9a	Tor
14	RP110L201B	LVR-IC	LDO, 2.0V±1%, 150mA, +CE	DFN1010-4	48vm	VR4	9a	Ric
14	XC6223B1419R-G	LVR-IC	LDO, 1.4V±20mV, 300mA, +CE, CL	USPQ-4B03	48vm	VR4	9a	Tor
14	XC6224A12B7R	LVR-IC	LDO, 1.25V±1.5%, 150mA, +CE	USPN-4B02	58vm	VR4	9e	Tor
14	XC6229D28B1R-G	LVR-IC	LDO, 2.85V±1%, 300mA, +CE	BGA-4	63ba*	VR4	9a	Tor
14	XC6420AB147R-G	LVR-IC	LDO, Dual out, Vout1/Vout2=1.80/2.50V±2%, 150mA, +CE	USPN-6	52xv	VR19	9a	Tor
14	XC6420AB14DR-G	LVR-IC	LDO, Dual out, Vout1/Vout2=1.80/2.50V±2%, 150mA, +CE	USP-6B04	73x4	VR19	9a	Tor
14	XC6221C4217R	LVR-IC	LDO, 4.2V±1%, 200mA, +CE, PDR	USPN-4	58vm	VR4	9a	Tor
140	XC6415AA407R-G	LVR-IC	LDO, Dual out, Vot1/Vout2=1.20/2.50V±1%, 200mA, +CE	USPN-6	52xv	VR19	9b	Tor
140	XC6415AA40ER-G	LVR-IC	LDO, Dual out, Vot1/Vout2=1.20/2.50V±1%, 200mA, +CE	USP-6C	49xv	VR19	9a	Tor
141	XC6415AA417R-G	LVR-IC	LDO, Dual out, Vot1/Vout2=2.80/3.00V±1%, 200mA, +CE	USPN-6	52xv	VR19	9b	Tor
141	XC6415AA41ER-G	LVR-IC	LDO, Dual out, Vot1/Vout2=2.80/3.00V±1%, 200mA, +CE	USP-6C	49xv	VR19	9a	Tor
142	XC6415AA427R-G	LVR-IC	LDO, Dual out, Vot1/Vout2=2.90/1.80V±1%, 200mA, +CE	USPN-6	52xv	VR19	9b	Tor
142	XC6415AA42ER-G	LVR-IC	LDO, Dual out, Vot1/Vout2=2.90/1.80V±1%, 200mA, +CE	USP-6C	49xv	VR19	9a	Tor
143	XC6415AA437R-G	LVR-IC	LDO, Dual out, Vot1/Vout2=3.00/1.80V±1%, 200mA, +CE	USPN-6	52xv	VR19	9b	Tor
143	XC6415AA43ER-G	LVR-IC	LDO, Dual out, Vot1/Vout2=3.00/1.80V±1%, 200mA, +CE	USP-6C	49xv	VR19	9a	Tor
144	XC6415AA447R-G	LVR-IC	LDO, Dual out, Vot1/Vout2=2.50/1.80V±1%, 200mA, +CE	USPN-6	52xv	VR19	9b	Tor
144	XC6415AA44ER-G	LVR-IC	LDO, Dual out, Vot1/Vout2=2.50/1.80V±1%, 200mA, +CE	USP-6C	49xv	VR19	9a	Tor
1442	G1442RD1D	LIN-IC	AF PA, BTL, 2.7..5.5V, 2.6W(5V/3Q), shutdown	DFN-8	37	AFP12	-	Gmt
1445	G1445B31U	LIN-IC	AF PA, BTL, 2.7..5.5V, 2.6W(5V/3Q), shutdown	BGA-8	39	-	-	Gmt
1445	G1445RD1D	LIN-IC	AF PA, BTL, 2.7..5.5V, 2.6W(5V/3Q), shutdown	DFN-8	37	AFP12	-	Gmt
145	XC6415AA457R-G	LVR-IC	LDO, Dual out, Vot1/Vout2=1.80/2.85V±1%, 200mA, +CE	USPN-6	52xv	VR19	9b	Tor
145	XC6415AA45ER-G	LVR-IC	LDO, Dual out, Vot1/Vout2=1.80/2.85V±1%, 200mA, +CE	USP-6C	49xv	VR19	9a	Tor
1453	G1453R41U	LIN-IC	AF PA, BTL, 3..5.5V, 2.6W(5V/3Q), shutdown	TQFN-16	38	-	-	Gmt
1453L	G1453LR41U	LIN-IC	AF PA, BTL, 3..5.5V, 2.6W(5V/3Q), shutdown	TQFN-16	38	-	-	Gmt
1454	G1454R41U	LIN-IC	AF PA, BTL, 3..5.5V, 2x2.1W(5V/3Q), shutdown	TQFN-16	38	-	-	Gmt
1454L	G1454LR41U	LIN-IC	AF PA, BTL, 3..5.5V, 2x2.1W(5V/3Q), shutdown	TQFN-16	38	-	-	Gmt
146	XC6415AA467R-G	LVR-IC	LDO, Dual out, Vot1/Vout2=1.50/1.20V±1%, 200mA, +CE	USPN-6	52xv	VR19	9b	Tor
146	XC6415AA46ER-G	LVR-IC	LDO, Dual out, Vot1/Vout2=1.50/1.20V±1%, 200mA, +CE	USP-6C	49xv	VR19	9a	Tor
147	XC6415AA477R-G	LVR-IC	LDO, Dual out, Vot1/Vout2=2.85/1.50V±1%, 200mA, +CE	USPN-6	52xv	VR19	9b	Tor
147	XC6415AA47ER-G	LVR-IC	LDO, Dual out, Vot1/Vout2=2.85/1.50V±1%, 200mA, +CE	USP-6C	49xv	VR19	9a	Tor
148	XC6415AA487R-G	LVR-IC	LDO, Dual out, Vot1/Vout2=3.20/3.20V±1%, 200mA, +CE	USPN-6	52xv	VR19	9b	Tor
148	XC6415AA48ER-G	LVR-IC	LDO, Dual out, Vot1/Vout2=3.20/3.20V±1%, 200mA, +CE	USP-6C	49xv	VR19	9a	Tor
149	XC6415AA497R-G	LVR-IC	LDO, Dual out, Vot1/Vout2=1.20/3.00V±1%, 200mA, +CE	USPN-6	52xv	VR19	9b	Tor
149	XC6415AA49ER-G	LVR-IC	LDO, Dual out, Vot1/Vout2=1.20/3.00V±1%, 200mA, +CE	USP-6C	49xv	VR19	9a	Tor
15	RP110L211B	LVR-IC	LDO, 2.1V±1%, 150mA, +CE	DFN1010-4	48vm	VR4	9a	Ric
15	XC6223B1519R-G	LVR-IC	LDO, 1.5V±20mV, 300mA, +CE, CL	USPQ-4B03	48vm	VR4	9a	Tor
15	XC6224A13B7R	LVR-IC	LDO, 1.25V±1.5%, 150mA, +CE	USPN-4B02	58vm	VR4	9e	Tor
15	XC6229D2911R-G	LVR-IC	LDO, 2.9V±1%, 300mA, +CE	BGA-4	63ba*	VR4	9a	Tor
15	XC6420AB157R-G	LVR-IC	LDO, Dual out, Vout1/Vout2=2.85/2.85V±2%, 150mA, +CE	USPN-6	52xv	VR19	9a	Tor
15	XC6420AB15DR-G	LVR-IC	LDO, Dual out, Vout1/Vout2=2.85/2.85V±2%, 150mA, +CE	USP-6B04	73x4	VR19	9a	Tor
15	XC6221C4317R	LVR-IC	LDO, 4.3V±1%, 200mA, +CE, PDR	USPN-4	58vm	VR4	9a	Tor
150	XC6415AA507R-G	LVR-IC	LDO, Dual out, Vot1/Vout2=2.60/2.85V±1%, 200mA, +CE	USPN-6	52xv	VR19	9b	Tor
150	XC6415AA50ER-G	LVR-IC	LDO, Dual out, Vot1/Vout2=2.60/2.85V±1%, 200mA, +CE	USP-6C	49xv	VR19	9a	Tor
151	XC6415AA517R-G	LVR-IC	LDO, Dual out, Vot1/Vout2=4.20/3.10V±1%, 200mA, +CE	USPN-6	52xv	VR19	9b	Tor
151	XC6415AA51ER-G	LVR-IC	LDO, Dual out, Vot1/Vout2=4.20/3.10V±1%, 200mA, +CE	USP-6C	49xv	VR19	9a	Tor
152	XC6415AA527R-G	LVR-IC	LDO, Dual out, Vot1/Vout2=5.00/3.60V±1%, 200mA, +CE	USPN-6	52xv	VR19	9b	Tor
152	XC6415AA52ER-G	LVR-IC	LDO, Dual out, Vot1/Vout2=5.00/3.60V±1%, 200mA, +CE	USP-6C	49xv	VR19	9a	Tor
153	XC6415AA537R-G	LVR-IC	LDO, Dual out, Vot1/Vout2=1.80/1.20V±1%, 200mA, +CE	USPN-6	52xv	VR19	9b	Tor
153	XC6415AA53ER-G	LVR-IC	LDO, Dual out, Vot1/Vout2=1.80/1.20V±1%, 200mA, +CE	USP-6C	49xv	VR19	9a	Tor
154	XC6415AA547R-G	LVR-IC	LDO, Dual out, Vot1/Vout2=2.60/3.00V±1%, 200mA, +CE	USPN-6	52xv	VR19	9b	Tor
154	XC6415AA54ER-G	LVR-IC	LDO, Dual out, Vot1/Vout2=2.60/3.00V±1%, 200mA, +CE	USP-6C	49xv	VR19	9a	Tor
155	XC6415AA557R-G	LVR-IC	LDO, Dual out, Vot1/Vout2=2.60/2.60V±1%, 200mA, +CE	USPN-6	52xv	VR19	9b	Tor
155	XC6415AA55ER-G	LVR-IC	LDO, Dual out, Vot1/Vout2=2.60/2.60V±1%, 200mA, +CE	USP-6C	49xv	VR19	9a	Tor
156	XC6415AA567R-G	LVR-IC	LDO, Dual out, Vot1/Vout2=1.80/2.60V±1%, 200mA, +CE	USPN-6	52xv	VR19	9b	Tor
156	XC6415AA56ER-G	LVR-IC	LDO, Dual out, Vot1/Vout2=1.80/2.60V±1%, 200mA, +CE	USP-6C	49xv	VR19	9a	Tor
157	XC6415AA577R-G	LVR-IC	LDO, Dual out, Vot1/Vout2=2.60/3.30V±1%, 200mA, +CE	USPN-6	52xv	VR19	9b	Tor
157	XC6415AA57ER-G	LVR-IC	LDO, Dual out, Vot1/Vout2=2.60/3.30V±1%, 200mA, +CE	USP-6C	49xv	VR19	9a	Tor
158	XC6415AA587R-G	LVR-IC	LDO, Dual out, Vot1/Vout2=2.50/2.90V±1%, 200mA, +CE	USPN-6	52xv	VR19	9b	Tor
158	XC6415AA58ER-G	LVR-IC	LDO, Dual out, Vot1/Vout2=2.50/2.90V±1%, 200mA, +CE	USP-6C	49xv	VR19	9a	Tor
159	XC6415AA597R-G	LVR-IC	LDO, Dual out, Vot1/Vout2=1.80/2.70V±1%, 200mA, +CE	USPN-6	52xv	VR19	9b	Tor
159	XC6415AA59ER-G	LVR-IC	LDO, Dual out, Vot1/Vout2=1.80/2.70V±1%, 200mA, +CE	USP-6C	49xv	VR19	9a	Tor
16	RP110L221B	LVR-IC	LDO, 2.2V±1%, 150mA, +CE	DFN1010-4	48vm	VR4	9a	Ric
16	XC6223B1619R-G	LVR-IC	LDO, 1.6V±20mV, 300mA, +CE, CL	USPQ-4B03	48vm	VR4	9a	Tor
16	XC6224A14B7R	LVR-IC	LDO, 1.45V±1.5%, 150mA, +CE	USPN-4B02	58vm	VR4	9e	Tor
16	XC6229D29B1R-G	LVR-IC	LDO, 2.95V±1%, 300mA, +CE	BGA-4	63ba*	VR4	9a	Tor
16	XC6420AB167R-G	LVR-IC	LDO, Dual out, Vout1/Vout2=1.80/2.85V±2%, 150mA, +CE	USPN-6	52xv	VR19	9a	Tor
16	XC6420AB16DR-G	LVR-IC	LDO, Dual out, Vout1/Vout2=1.80/2.85V±2%, 150mA, +CE	USP-6B04	73x4	VR19	9a	Tor
16	XC6221C4417R	LVR-IC	LDO, 4.4V±1%, 200mA, +CE, PDR	USPN-4	58vm	VR4	9a	Tor



SMD code	Type	Function	Short description	Case	Pinout	Sch.	St.	Mnf.
160	XC6415AA607R-G	LVR-IC	LDO, Dual out, $V_{out1}/V_{out2}=1.00/2.80V\pm1\%$, 200mA, +CE	USPN-6	52xv	VR19	9b	Tor
160	XC6415AA60ER-G	LVR-IC	LDO, Dual out, $V_{out1}/V_{out2}=1.00/2.80V\pm1\%$, 200mA, +CE	USP-6C	49xv	VR19	9a	Tor
161	XC6415AA617R-G	LVR-IC	LDO, Dual out, $V_{out1}/V_{out2}=3.00/1.50V\pm1\%$, 200mA, +CE	USPN-6	52xv	VR19	9b	Tor
161	XC6415AA61ER-G	LVR-IC	LDO, Dual out, $V_{out1}/V_{out2}=3.00/1.50V\pm1\%$, 200mA, +CE	USP-6C	49xv	VR19	9a	Tor
162	XC6415AA627R-G	LVR-IC	LDO, Dual out, $V_{out1}/V_{out2}=2.70/1.80V\pm1\%$, 200mA, +CE	USPN-6	52xv	VR19	9b	Tor
162	XC6415AA62ER-G	LVR-IC	LDO, Dual out, $V_{out1}/V_{out2}=2.70/1.80V\pm1\%$, 200mA, +CE	USP-6C	49xv	VR19	9a	Tor
163	XC6415AA637R-G	LVR-IC	LDO, Dual out, $V_{out1}/V_{out2}=2.80/2.70V\pm1\%$, 200mA, +CE	USPN-6	52xv	VR19	9b	Tor
163	XC6415AA63ER-G	LVR-IC	LDO, Dual out, $V_{out1}/V_{out2}=2.80/2.70V\pm1\%$, 200mA, +CE	USP-6C	49xv	VR19	9a	Tor
164	XC6415AA647R-G	LVR-IC	LDO, Dual out, $V_{out1}/V_{out2}=2.80/3.10V\pm1\%$, 200mA, +CE	USPN-6	52xv	VR19	9b	Tor
164	XC6415AA64ER-G	LVR-IC	LDO, Dual out, $V_{out1}/V_{out2}=2.80/3.10V\pm1\%$, 200mA, +CE	USP-6C	49xv	VR19	9a	Tor
165	XC6415AA657R-G	LVR-IC	LDO, Dual out, $V_{out1}/V_{out2}=2.85/3.30V\pm1\%$, 200mA, +CE	USPN-6	52xv	VR19	9b	Tor
165	XC6415AA65ER-G	LVR-IC	LDO, Dual out, $V_{out1}/V_{out2}=2.85/3.30V\pm1\%$, 200mA, +CE	USP-6C	49xv	VR19	9a	Tor
166	XC6415AA667R-G	LVR-IC	LDO, Dual out, $V_{out1}/V_{out2}=1.20/3.30V\pm1\%$, 200mA, +CE	USPN-6	52xv	VR19	9b	Tor
166	XC6415AA66ER-G	LVR-IC	LDO, Dual out, $V_{out1}/V_{out2}=1.20/3.30V\pm1\%$, 200mA, +CE	USP-6C	49xv	VR19	9a	Tor
167	XC6415AA677R-G	LVR-IC	LDO, Dual out, $V_{out1}/V_{out2}=2.80/2.50V\pm1\%$, 200mA, +CE	USPN-6	52xv	VR19	9b	Tor
167	XC6415AA67ER-G	LVR-IC	LDO, Dual out, $V_{out1}/V_{out2}=2.80/2.50V\pm1\%$, 200mA, +CE	USP-6C	49xv	VR19	9a	Tor
168	XC6415AA687R-G	LVR-IC	LDO, Dual out, $V_{out1}/V_{out2}=2.85/1.20V\pm1\%$, 200mA, +CE	USPN-6	52xv	VR19	9b	Tor
168	XC6415AA68ER-G	LVR-IC	LDO, Dual out, $V_{out1}/V_{out2}=2.85/1.20V\pm1\%$, 200mA, +CE	USP-6C	49xv	VR19	9a	Tor
169	XC6415AA697R-G	LVR-IC	LDO, Dual out, $V_{out1}/V_{out2}=2.75/2.75V\pm1\%$, 200mA, +CE	USPN-6	52xv	VR19	9b	Tor
169	XC6415AA69ER-G	LVR-IC	LDO, Dual out, $V_{out1}/V_{out2}=2.75/2.75V\pm1\%$, 200mA, +CE	USP-6C	49xv	VR19	9a	Tor
17	RP110L231B	LVR-IC	LDO, 2.3V \pm 1%, 150mA, +CE	DFN1010-4	48vm	VR4	9a	Ric
17	XC6217C0827R-G	LVR-IC	LDO, 0.8V \pm 2%, 200mA, +CE	USPN-4	58vm	VR4	9a	Tor
17	XC6223B1719R-G	LVR-IC	LDO, 1.7V \pm 20mV, 300mA, +CE, CL	USPQ-4B03	48vm	VR4	9a	Tor
17	XC6224A15B7R	LVR-IC	LDO, 1.55V \pm 1.5%, 150mA, +CE	USPN-4B02	58vm	VR4	9e	Tor
17	XC6229D3011R-G	LVR-IC	LDO, 3.0V \pm 1%, 300mA, +CE	BGA-4	63ba*	VR4	9a	Tor
17	XC6420AB177R-G	LVR-IC	LDO, Dual out, $V_{out1}/V_{out2}=1.80/3.00V\pm2\%$, 150mA, +CE	USPN-6	52xv	VR19	9a	Tor
17	XC6420AB17DR-G	LVR-IC	LDO, Dual out, $V_{out1}/V_{out2}=1.80/3.00V\pm2\%$, 150mA, +CE	USP-6B04	73x4	VR19	9a	Tor
17	XC6221C4517R	LVR-IC	LDO, 4.5V \pm 1%, 200mA, +CE, PDR	USPN-4	58vm	VR4	9a	Tor
170	XC6415AA707R-G	LVR-IC	LDO, Dual out, $V_{out1}/V_{out2}=3.00/2.90V\pm1\%$, 200mA, +CE	USPN-6	52xv	VR19	9b	Tor
170	XC6415AA70ER-G	LVR-IC	LDO, Dual out, $V_{out1}/V_{out2}=3.00/2.90V\pm1\%$, 200mA, +CE	USP-6C	49xv	VR19	9a	Tor
171	XC6415AA717R-G	LVR-IC	LDO, Dual out, $V_{out1}/V_{out2}=3.00/2.95V\pm1\%$, 200mA, +CE	USPN-6	52xv	VR19	9b	Tor
171	XC6415AA71ER-G	LVR-IC	LDO, Dual out, $V_{out1}/V_{out2}=3.00/2.95V\pm1\%$, 200mA, +CE	USP-6C	49xv	VR19	9a	Tor
172	XC6415AA727R-G	LVR-IC	LDO, Dual out, $V_{out1}/V_{out2}=3.00/3.05V\pm1\%$, 200mA, +CE	USPN-6	52xv	VR19	9b	Tor
172	XC6415AA72ER-G	LVR-IC	LDO, Dual out, $V_{out1}/V_{out2}=3.00/3.05V\pm1\%$, 200mA, +CE	USP-6C	49xv	VR19	9a	Tor
173	XC6415AA737R-G	LVR-IC	LDO, Dual out, $V_{out1}/V_{out2}=3.10/2.90V\pm1\%$, 200mA, +CE	USPN-6	52xv	VR19	9b	Tor
173	XC6415AA73ER-G	LVR-IC	LDO, Dual out, $V_{out1}/V_{out2}=3.10/2.90V\pm1\%$, 200mA, +CE	USP-6C	49xv	VR19	9a	Tor
174	XC6415AA747R-G	LVR-IC	LDO, Dual out, $V_{out1}/V_{out2}=3.10/2.95V\pm1\%$, 200mA, +CE	USPN-6	52xv	VR19	9b	Tor
174	XC6415AA74ER-G	LVR-IC	LDO, Dual out, $V_{out1}/V_{out2}=3.10/2.95V\pm1\%$, 200mA, +CE	USP-6C	49xv	VR19	9a	Tor
175	XC6415AA757R-G	LVR-IC	LDO, Dual out, $V_{out1}/V_{out2}=3.10/3.00V\pm1\%$, 200mA, +CE	USPN-6	52xv	VR19	9b	Tor
175	XC6415AA75ER-G	LVR-IC	LDO, Dual out, $V_{out1}/V_{out2}=3.10/3.00V\pm1\%$, 200mA, +CE	USP-6C	49xv	VR19	9a	Tor
176	XC6415AA767R-G	LVR-IC	LDO, Dual out, $V_{out1}/V_{out2}=3.10/3.05V\pm1\%$, 200mA, +CE	USPN-6	52xv	VR19	9b	Tor
176	XC6415AA76ER-G	LVR-IC	LDO, Dual out, $V_{out1}/V_{out2}=3.10/3.05V\pm1\%$, 200mA, +CE	USP-6C	49xv	VR19	9a	Tor
177	XC6415AA777R-G	LVR-IC	LDO, Dual out, $V_{out1}/V_{out2}=3.00/3.10V\pm1\%$, 200mA, +CE	USPN-6	52xv	VR19	9b	Tor
177	XC6415AA77ER-G	LVR-IC	LDO, Dual out, $V_{out1}/V_{out2}=3.00/3.10V\pm1\%$, 200mA, +CE	USP-6C	49xv	VR19	9a	Tor
178	XC6415AA787R-G	LVR-IC	LDO, Dual out, $V_{out1}/V_{out2}=1.20/2.60V\pm1\%$, 200mA, +CE	USPN-6	52xv	VR19	9b	Tor
178	XC6415AA78ER-G	LVR-IC	LDO, Dual out, $V_{out1}/V_{out2}=1.20/2.60V\pm1\%$, 200mA, +CE	USP-6C	49xv	VR19	9a	Tor
179	XC6415AA797R-G	LVR-IC	LDO, Dual out, $V_{out1}/V_{out2}=3.50/3.50V\pm1\%$, 200mA, +CE	USPN-6	52xv	VR19	9b	Tor
179	XC6415AA79ER-G	LVR-IC	LDO, Dual out, $V_{out1}/V_{out2}=3.50/3.50V\pm1\%$, 200mA, +CE	USP-6C	49xv	VR19	9a	Tor
18	RP110L241B	LVR-IC	LDO, 2.4V \pm 1%, 150mA, +CE	DFN1010-4	48vm	VR4	9a	Ric
18	XC6217C0927R-G	LVR-IC	LDO, 0.9V \pm 2%, 200mA, +CE	USPN-4	58vm	VR4	9a	Tor
18	XC6223B1819R-G	LVR-IC	LDO, 1.8V \pm 20mV, 300mA, +CE, CL	USPQ-4B03	48vm	VR4	9a	Tor
18	XC6224A16B7R	LVR-IC	LDO, 1.65V \pm 1.5%, 150mA, +CE	USPN-4B02	58vm	VR4	9e	Tor
18	XC6229D30B1R-G	LVR-IC	LDO, 3.05V \pm 1%, 300mA, +CE	BGA-4	63ba*	VR4	9a	Tor
18	XC6420AB187R-G	LVR-IC	LDO, Dual out, $V_{out1}/V_{out2}=3.00/1.80V\pm2\%$, 150mA, +CE	USPN-6	52xv	VR19	9a	Tor
18	XC6420AB18DR-G	LVR-IC	LDO, Dual out, $V_{out1}/V_{out2}=3.00/1.80V\pm2\%$, 150mA, +CE	USP-6B04	73x4	VR19	9a	Tor
18	XC6221C4617R	LVR-IC	LDO, 4.6V \pm 1%, 200mA, +CE, PDR	USPN-4	58vm	VR4	9a	Tor
180	XC6415AA807R-G	LVR-IC	LDO, Dual out, $V_{out1}/V_{out2}=1.10/1.50V\pm1\%$, 200mA, +CE	USPN-6	52xv	VR19	9b	Tor
180	XC6415AA80ER-G	LVR-IC	LDO, Dual out, $V_{out1}/V_{out2}=1.10/1.50V\pm1\%$, 200mA, +CE	USP-6C	49xv	VR19	9a	Tor
181	XC6415AA817R-G	LVR-IC	LDO, Dual out, $V_{out1}/V_{out2}=2.00/3.30V\pm1\%$, 200mA, +CE	USPN-6	52xv	VR19	9b	Tor
181	XC6415AA81ER-G	LVR-IC	LDO, Dual out, $V_{out1}/V_{out2}=2.00/3.30V\pm1\%$, 200mA, +CE	USP-6C	49xv	VR19	9a	Tor
182	XC6415AA827R-G	LVR-IC	LDO, Dual out, $V_{out1}/V_{out2}=3.30/2.00V\pm1\%$, 200mA, +CE	USPN-6	52xv	VR19	9b	Tor
182	XC6415AA82ER-G	LVR-IC	LDO, Dual out, $V_{out1}/V_{out2}=3.30/2.00V\pm1\%$, 200mA, +CE	USP-6C	49xv	VR19	9a	Tor
183	XC6415AA837R-G	LVR-IC	LDO, Dual out, $V_{out1}/V_{out2}=2.80/1.20V\pm1\%$, 200mA, +CE	USPN-6	52xv	VR19	9b	Tor
183	XC6415AA83ER-G	LVR-IC	LDO, Dual out, $V_{out1}/V_{out2}=2.80/1.20V\pm1\%$, 200mA, +CE	USP-6C	49xv	VR19	9a	Tor
184	XC6415AA847R-G	LVR-IC	LDO, Dual out, $V_{out1}/V_{out2}=1.00/3.30V\pm1\%$, 200mA, +CE	USPN-6	52xv	VR19	9b	Tor
184	XC6415AA84ER-G	LVR-IC	LDO, Dual out, $V_{out1}/V_{out2}=1.00/3.30V\pm1\%$, 200mA, +CE	USP-6C	49xv	VR19	9a	Tor
185	XC6415AA857R-G	LVR-IC	LDO, Dual out, $V_{out1}/V_{out2}=2.70/2.70V\pm1\%$, 200mA, +CE	USPN-6	52xv	VR19	9b	Tor
185	XC6415AA85ER-G	LVR-IC	LDO, Dual out, $V_{out1}/V_{out2}=2.70/2.70V\pm1\%$, 200mA, +CE	USP-6C	49xv	VR19	9a	Tor
186	XC6415AA867R-G	LVR-IC	LDO, Dual out, $V_{out1}/V_{out2}=2.70/3.30V\pm1\%$, 200mA, +CE	USPN-6	52xv	VR19	9b	Tor
186	XC6415AA86ER-G	LVR-IC	LDO, Dual out, $V_{out1}/V_{out2}=2.70/3.30V\pm1\%$, 200mA, +CE	USP-6C	49xv	VR19	9a	Tor



SMD code	Type	Function	Short description	Case	Pinout	Sch.	St.	Mnf.
187	XC6415AA877R-G	LVR-IC	LDO, Dual out, Vot1/Vout2=2.90/2.90V±1%, 200mA, +CE	USPN-6	52xv	VR19	9b	Tor
187	XC6415AA87ER-G	LVR-IC	LDO, Dual out, Vot1/Vout2=2.90/2.90V±1%, 200mA, +CE	USP-6C	49xv	VR19	9a	Tor
188	XC6415AA887R-G	LVR-IC	LDO, Dual out, Vot1/Vout2=2.50/2.80V±1%, 200mA, +CE	USPN-6	52xv	VR19	9b	Tor
188	XC6415AA88ER-G	LVR-IC	LDO, Dual out, Vot1/Vout2=2.50/2.80V±1%, 200mA, +CE	USP-6C	49xv	VR19	9a	Tor
189	XC6415AA897R-G	LVR-IC	LDO, Dual out, Vot1/Vout2=2.50/3.00V±1%, 200mA, +CE	USPN-6	52xv	VR19	9b	Tor
189	XC6415AA89ER-G	LVR-IC	LDO, Dual out, Vot1/Vout2=2.50/3.00V±1%, 200mA, +CE	USP-6C	49xv	VR19	9a	Tor
19	LEE-19+	MMIC	RF amplifier, DC, 8GHz, 9.6dB (50Ω)	FG873	36aa	A1	9b	Mc
19	RP110L251B	LVR-IC	LDO, 2.5V±1%, 150mA, +CE	DFN1010-4	48vm	VR4	9a	Ric
19	XC6217C1027R-G	LVR-IC	LDO, 1V±2%, 200mA, +CE	USPN-4	58vm	VR4	9a	Tor
19	XC6223B1919R-G	LVR-IC	LDO, 1.9V±20mV, 300mA, +CE, CL	USPQ-4B03	48vm	VR4	9a	Tor
19	XC6224A17B7R	LVR-IC	LDO, 1.75V±1.5%, 150mA, +CE	USPN-4B02	58vm	VR4	9e	Tor
19	XC6229D3111R-G	LVR-IC	LDO, 3.1V±1%, 300mA, +CE	BGA-4	63ba*	VR4	9a	Tor
19	XC6420AB197R-G	LVR-IC	LDO, Dual out, Vout1/Vout2=1.80/3.30V±2%, 150mA, +CE	USPN-6	52xv	VR19	9a	Tor
19	XC6420AB19DR-G	LVR-IC	LDO, Dual out, Vout1/Vout2=1.80/3.30V±2%, 150mA, +CE	USP-6B04	73x4	VR19	9a	Tor
19	XC6221C4171R-G	LVR-IC	LDO, 4.7V±1%, 200mA, +CE, PDR	USPN-4	58vm	VR4	9a	Tor
190	XC6415AA907R-G	LVR-IC	LDO, Dual out, Vot1/Vout2=4.50/4.50V±1%, 200mA, +CE	USPN-6	52xv	VR19	9b	Tor
190	XC6415AA90ER-G	LVR-IC	LDO, Dual out, Vot1/Vout2=4.50/4.50V±1%, 200mA, +CE	USP-6C	49xv	VR19	9a	Tor
191	XC6415AA917R-G	LVR-IC	LDO, Dual out, Vot1/Vout2=3.30/5.00V±1%, 200mA, +CE	USPN-6	52xv	VR19	9b	Tor
191	XC6415AA91ER-G	LVR-IC	LDO, Dual out, Vot1/Vout2=3.30/5.00V±1%, 200mA, +CE	USP-6C	49xv	VR19	9a	Tor
192	XC6415AA927R-G	LVR-IC	LDO, Dual out, Vot1/Vout2=3.00/5.00V±1%, 200mA, +CE	USPN-6	52xv	VR19	9b	Tor
192	XC6415AA92ER-G	LVR-IC	LDO, Dual out, Vot1/Vout2=3.00/5.00V±1%, 200mA, +CE	USP-6C	49xv	VR19	9a	Tor
193	XC6415AA937R-G	LVR-IC	LDO, Dual out, Vot1/Vout2=1.80/2.90V±1%, 200mA, +CE	USPN-6	52xv	VR19	9b	Tor
193	XC6415AA93ER-G	LVR-IC	LDO, Dual out, Vot1/Vout2=1.80/2.90V±1%, 200mA, +CE	USP-6C	49xv	VR19	9a	Tor
194	XC6415AA947R-G	LVR-IC	LDO, Dual out, Vot1/Vout2=1.10/1.80V±1%, 200mA, +CE	USPN-6	52xv	VR19	9b	Tor
194	XC6415AA94ER-G	LVR-IC	LDO, Dual out, Vot1/Vout2=1.10/1.80V±1%, 200mA, +CE	USP-6C	49xv	VR19	9a	Tor
195	XC6415AA957R-G	LVR-IC	LDO, Dual out, Vot1/Vout2=1.20/1.30V±1%, 200mA, +CE	USPN-6	52xv	VR19	9b	Tor
195	XC6415AA95ER-G	LVR-IC	LDO, Dual out, Vot1/Vout2=1.20/1.30V±1%, 200mA, +CE	USP-6C	49xv	VR19	9a	Tor
196	XC6415AA967R-G	LVR-IC	LDO, Dual out, Vot1/Vout2=1.00/1.20V±1%, 200mA, +CE	USPN-6	52xv	VR19	9b	Tor
196	XC6415AA96ER-G	LVR-IC	LDO, Dual out, Vot1/Vout2=1.00/1.20V±1%, 200mA, +CE	USP-6C	49xv	VR19	9a	Tor
197	XC6415AA977R-G	LVR-IC	LDO, Dual out, Vot1/Vout2=1.50/2.50V±1%, 200mA, +CE	USPN-6	52xv	VR19	9b	Tor
197	XC6415AA97ER-G	LVR-IC	LDO, Dual out, Vot1/Vout2=1.50/2.50V±1%, 200mA, +CE	USP-6C	49xv	VR19	9a	Tor
198	XC6415AA987R-G	LVR-IC	LDO, Dual out, Vot1/Vout2=1.20/0.90V±1%, 200mA, +CE	USPN-6	52xv	VR19	9b	Tor
198	XC6415AA98ER-G	LVR-IC	LDO, Dual out, Vot1/Vout2=1.20/0.90V±1%, 200mA, +CE	USP-6C	49xv	VR19	9a	Tor
199	XC6415AA997R-G	LVR-IC	LDO, Dual out, Vot1/Vout2=3.15/3.15V±1%, 200mA, +CE	USPN-6	52xv	VR19	9b	Tor
199	XC6415AA99ER-G	LVR-IC	LDO, Dual out, Vot1/Vout2=3.15/3.15V±1%, 200mA, +CE	USP-6C	49xv	VR19	9a	Tor
1A	R3117K071A	Vdet-IC	0.7V±15mV, -Reset ODO, Sense	DFN1010-4	48rq	VD11	9a	Ric
1A	RP100K121B	LVR-IC	LDO, LN, +CE, 1.2V±0.8%, 200mA	PLP1612-4	45vm	VR4	9a	Ric
1A	XC6217C1127R-G	LVR-IC	LDO, 1.1V±2%, 200mA, +CE	USPN-4	58vm	VR4	9a	Tor
1A	XC6223B2019R-G	LVR-IC	LDO, 2.0V±1%, 300mA, +CE, CL	USPQ-4B03	48vm	VR4	9a	Tor
1A	XC6224A18B7R	LVR-IC	LDO, 1.85V±1.5%, 150mA, +CE	USPN-4B02	58vm	VR4	9e	Tor
1A	XC6229D31B1R-G	LVR-IC	LDO, 3.15V±1%, 300mA, +CE	BGA-4	63ba*	VR4	9a	Tor
1A	XC6221C4817R	LVR-IC	LDO, 4.8V±1%, 200mA, +CE, PDR	USPN-4	58vm	VR4	9a	Tor
1A0	XC6415AAA07R-G	LVR-IC	LDO, Dual out, Vot1/Vout2=3.10/1.80V±1%, 200mA, +CE	USPN-6	52xv	VR19	9b	Tor
1A0	XC6415AAA0ER-G	LVR-IC	LDO, Dual out, Vot1/Vout2=3.10/1.80V±1%, 200mA, +CE	USP-6C	49xv	VR19	9a	Tor
1A08	XC6217A082DR	LVR-IC	LDO, 0.8V±2%, 200mA, +CE, Shutdown	USP-4D	45cv	VR4a	9b	Tor
1A09	XC6217A092DR	LVR-IC	LDO, 0.9V±2%, 200mA, +CE, Shutdown	USP-4D	45cv	VR4a	9b	Tor
1A0L	XC6217A08ADR	LVR-IC	LDO, 0.85V±2%, 200mA, +CE, Shutdown	USP-4D	45cv	VR4a	9b	Tor
1A0M	XC6217A09ADR	LVR-IC	LDO, 0.95V±2%, 200mA, +CE, Shutdown	USP-4D	45cv	VR4a	9b	Tor
1A1	XC6415AAA17R-G	LVR-IC	LDO, Dual out, Vot1/Vout2=1.80/2.00V±1%, 200mA, +CE	USPN-6	52xv	VR19	9b	Tor
1A1	XC6415AAA1ER-G	LVR-IC	LDO, Dual out, Vot1/Vout2=1.80/2.00V±1%, 200mA, +CE	USP-6C	49xv	VR19	9a	Tor
1A10	XC6217A102DR	LVR-IC	LDO, 1V±2%, 200mA, +CE, Shutdown	USP-4D	45cv	VR4a	9b	Tor
1A11	XC6217A112DR	LVR-IC	LDO, 1.1V±2%, 200mA, +CE, Shutdown	USP-4D	45cv	VR4a	9b	Tor
1A12	XC6217A122DR	LVR-IC	LDO, 1.2V±2%, 200mA, +CE, Shutdown	USP-4D	45cv	VR4a	9b	Tor
1A13	XC6217A132DR	LVR-IC	LDO, 1.3V±2%, 200mA, +CE, Shutdown	USP-4D	45cv	VR4a	9b	Tor
1A14	XC6217A142DR	LVR-IC	LDO, 1.4V±2%, 200mA, +CE, Shutdown	USP-4D	45cv	VR4a	9b	Tor
1A15	XC6217A152DR	LVR-IC	LDO, 1.5V±2%, 200mA, +CE, Shutdown	USP-4D	45cv	VR4a	9b	Tor
1A16	XC6217A162DR	LVR-IC	LDO, 1.6V±2%, 200mA, +CE, Shutdown	USP-4D	45cv	VR4a	9b	Tor
1A17	XC6217A172DR	LVR-IC	LDO, 1.7V±2%, 200mA, +CE, Shutdown	USP-4D	45cv	VR4a	9b	Tor
1A18	XC6217A182DR	LVR-IC	LDO, 1.8V±2%, 200mA, +CE, Shutdown	USP-4D	45cv	VR4a	9b	Tor
1A19	XC6217A192DR	LVR-IC	LDO, 1.9V±2%, 200mA, +CE, Shutdown	USP-4D	45cv	VR4a	9b	Tor
1A1A	XC6217A10ADR	LVR-IC	LDO, 1.05V±2%, 200mA, +CE, Shutdown	USP-4D	45cv	VR4a	9b	Tor
1A1B	XC6217A11ADR	LVR-IC	LDO, 1.15V±2%, 200mA, +CE, Shutdown	USP-4D	45cv	VR4a	9b	Tor
1A1C	XC6217A12ADR	LVR-IC	LDO, 1.25V±2%, 200mA, +CE, Shutdown	USP-4D	45cv	VR4a	9b	Tor
1A1D	XC6217A13ADR	LVR-IC	LDO, 1.35V±2%, 200mA, +CE, Shutdown	USP-4D	45cv	VR4a	9b	Tor
1A1E	XC6217A14ADR	LVR-IC	LDO, 1.45V±2%, 200mA, +CE, Shutdown	USP-4D	45cv	VR4a	9b	Tor
1A1F	XC6217A15ADR	LVR-IC	LDO, 1.55V±2%, 200mA, +CE, Shutdown	USP-4D	45cv	VR4a	9b	Tor
1A1H	XC6217A16ADR	LVR-IC	LDO, 1.65V±2%, 200mA, +CE, Shutdown	USP-4D	45cv	VR4a	9b	Tor
1A1K	XC6217A17ADR	LVR-IC	LDO, 1.75V±2%, 200mA, +CE, Shutdown	USP-4D	45cv	VR4a	9b	Tor
1A1L	XC6217A18ADR	LVR-IC	LDO, 1.85V±2%, 200mA, +CE, Shutdown	USP-4D	45cv	VR4a	9b	Tor
1A1M	XC6217A19ADR	LVR-IC	LDO, 1.95V±2%, 200mA, +CE, Shutdown	USP-4D	45cv	VR4a	9b	Tor



SMD code	Type	Function	Short description	Case	Pinout	Sch.	St.	Mnf.
1A2	XC6415AAA27R-G	LVR-IC	LDO, Dual out, $V_{ot1}/V_{out2}=1.50/1.30V\pm1\%$, 200mA, +CE	USPN-6	52xv	VR19	9b	Tor
1A2	XC6415AAA2ER-G	LVR-IC	LDO, Dual out, $V_{ot1}/V_{out2}=1.50/1.30V\pm1\%$, 200mA, +CE	USP-6C	49xv	VR19	9a	Tor
1A20	XC6217A202DR	LVR-IC	LDO, $2V\pm2\%$, 200mA, +CE, Shutdown	USP-4D	45cv	VR4a	9b	Tor
1A21	XC6217A212DR	LVR-IC	LDO, $2.1V\pm2\%$, 200mA, +CE, Shutdown	USP-4D	45cv	VR4a	9b	Tor
1A22	XC6217A222DR	LVR-IC	LDO, $2.2V\pm2\%$, 200mA, +CE, Shutdown	USP-4D	45cv	VR4a	9b	Tor
1A23	XC6217A232DR	LVR-IC	LDO, $2.3V\pm2\%$, 200mA, +CE, Shutdown	USP-4D	45cv	VR4a	9b	Tor
1A24	XC6217A242DR	LVR-IC	LDO, $2.4V\pm2\%$, 200mA, +CE, Shutdown	USP-4D	45cv	VR4a	9b	Tor
1A25	XC6217A252DR	LVR-IC	LDO, $2.5V\pm2\%$, 200mA, +CE, Shutdown	USP-4D	45cv	VR4a	9b	Tor
1A26	XC6217A262DR	LVR-IC	LDO, $2.6V\pm2\%$, 200mA, +CE, Shutdown	USP-4D	45cv	VR4a	9b	Tor
1A27	XC6217A272DR	LVR-IC	LDO, $2.7V\pm2\%$, 200mA, +CE, Shutdown	USP-4D	45cv	VR4a	9b	Tor
1A28	XC6217A282DR	LVR-IC	LDO, $2.8V\pm2\%$, 200mA, +CE, Shutdown	USP-4D	45cv	VR4a	9b	Tor
1A29	XC6217A292DR	LVR-IC	LDO, $2.9V\pm2\%$, 200mA, +CE, Shutdown	USP-4D	45cv	VR4a	9b	Tor
1A2A	XC6217A20ADR	LVR-IC	LDO, $2.05V\pm2\%$, 200mA, +CE, Shutdown	USP-4D	45cv	VR4a	9b	Tor
1A2B	XC6217A21ADR	LVR-IC	LDO, $2.15V\pm2\%$, 200mA, +CE, Shutdown	USP-4D	45cv	VR4a	9b	Tor
1A2C	XC6217A22ADR	LVR-IC	LDO, $2.25V\pm2\%$, 200mA, +CE, Shutdown	USP-4D	45cv	VR4a	9b	Tor
1A2D	XC6217A23ADR	LVR-IC	LDO, $2.35V\pm2\%$, 200mA, +CE, Shutdown	USP-4D	45cv	VR4a	9b	Tor
1A2E	XC6217A24ADR	LVR-IC	LDO, $2.45V\pm2\%$, 200mA, +CE, Shutdown	USP-4D	45cv	VR4a	9b	Tor
1A2F	XC6217A25ADR	LVR-IC	LDO, $2.55V\pm2\%$, 200mA, +CE, Shutdown	USP-4D	45cv	VR4a	9b	Tor
1A2H	XC6217A26ADR	LVR-IC	LDO, $2.65V\pm2\%$, 200mA, +CE, Shutdown	USP-4D	45cv	VR4a	9b	Tor
1A2K	XC6217A27ADR	LVR-IC	LDO, $2.75V\pm2\%$, 200mA, +CE, Shutdown	USP-4D	45cv	VR4a	9b	Tor
1A2L	XC6217A28ADR	LVR-IC	LDO, $2.85V\pm2\%$, 200mA, +CE, Shutdown	USP-4D	45cv	VR4a	9b	Tor
1A2M	XC6217A29ADR	LVR-IC	LDO, $2.95V\pm2\%$, 200mA, +CE, Shutdown	USP-4D	45cv	VR4a	9b	Tor
1A3	XC6415AAA37R-G	LVR-IC	LDO, Dual out, $V_{ot1}/V_{out2}=2.85/2.60V\pm1\%$, 200mA, +CE	USPN-6	52xv	VR19	9b	Tor
1A3	XC6415AAA3ER-G	LVR-IC	LDO, Dual out, $V_{ot1}/V_{out2}=2.85/2.60V\pm1\%$, 200mA, +CE	USP-6C	49xv	VR19	9a	Tor
1A30	XC6217A302DR	LVR-IC	LDO, $3V\pm2\%$, 200mA, +CE, Shutdown	USP-4D	45cv	VR4a	9b	Tor
1A31	XC6217A312DR	LVR-IC	LDO, $3.1V\pm2\%$, 200mA, +CE, Shutdown	USP-4D	45cv	VR4a	9b	Tor
1A32	XC6217A322DR	LVR-IC	LDO, $3.2V\pm2\%$, 200mA, +CE, Shutdown	USP-4D	45cv	VR4a	9b	Tor
1A33	XC6217A332DR	LVR-IC	LDO, $3.3V\pm2\%$, 200mA, +CE, Shutdown	USP-4D	45cv	VR4a	9b	Tor
1A34	XC6217A342DR	LVR-IC	LDO, $3.4V\pm2\%$, 200mA, +CE, Shutdown	USP-4D	45cv	VR4a	9b	Tor
1A35	XC6217A352DR	LVR-IC	LDO, $3.5V\pm2\%$, 200mA, +CE, Shutdown	USP-4D	45cv	VR4a	9b	Tor
1A36	XC6217A362DR	LVR-IC	LDO, $3.6V\pm2\%$, 200mA, +CE, Shutdown	USP-4D	45cv	VR4a	9b	Tor
1A37	XC6217A372DR	LVR-IC	LDO, $3.7V\pm2\%$, 200mA, +CE, Shutdown	USP-4D	45cv	VR4a	9b	Tor
1A38	XC6217A382DR	LVR-IC	LDO, $3.8V\pm2\%$, 200mA, +CE, Shutdown	USP-4D	45cv	VR4a	9b	Tor
1A39	XC6217A392DR	LVR-IC	LDO, $3.9V\pm2\%$, 200mA, +CE, Shutdown	USP-4D	45cv	VR4a	9b	Tor
1A3A	XC6217A30ADR	LVR-IC	LDO, $3.05V\pm2\%$, 200mA, +CE, Shutdown	USP-4D	45cv	VR4a	9b	Tor
1A3B	XC6217A31ADR	LVR-IC	LDO, $3.15V\pm2\%$, 200mA, +CE, Shutdown	USP-4D	45cv	VR4a	9b	Tor
1A3C	XC6217A32ADR	LVR-IC	LDO, $3.25V\pm2\%$, 200mA, +CE, Shutdown	USP-4D	45cv	VR4a	9b	Tor
1A3D	XC6217A33ADR	LVR-IC	LDO, $3.35V\pm2\%$, 200mA, +CE, Shutdown	USP-4D	45cv	VR4a	9b	Tor
1A3E	XC6217A34ADR	LVR-IC	LDO, $3.45V\pm2\%$, 200mA, +CE, Shutdown	USP-4D	45cv	VR4a	9b	Tor
1A3F	XC6217A35ADR	LVR-IC	LDO, $3.55V\pm2\%$, 200mA, +CE, Shutdown	USP-4D	45cv	VR4a	9b	Tor
1A3H	XC6217A36ADR	LVR-IC	LDO, $3.65V\pm2\%$, 200mA, +CE, Shutdown	USP-4D	45cv	VR4a	9b	Tor
1A3K	XC6217A37ADR	LVR-IC	LDO, $3.75V\pm2\%$, 200mA, +CE, Shutdown	USP-4D	45cv	VR4a	9b	Tor
1A3L	XC6217A38ADR	LVR-IC	LDO, $3.85V\pm2\%$, 200mA, +CE, Shutdown	USP-4D	45cv	VR4a	9b	Tor
1A3M	XC6217A39ADR	LVR-IC	LDO, $3.95V\pm2\%$, 200mA, +CE, Shutdown	USP-4D	45cv	VR4a	9b	Tor
1A4	XC6415AAA47R-G	LVR-IC	LDO, Dual out, $V_{ot1}/V_{out2}=1.25/2.50V\pm1\%$, 200mA, +CE	USPN-6	52xv	VR19	9b	Tor
1A4	XC6415AAA4ER-G	LVR-IC	LDO, Dual out, $V_{ot1}/V_{out2}=1.25/2.50V\pm1\%$, 200mA, +CE	USP-6C	49xv	VR19	9a	Tor
1A40	XC6217A402DR	LVR-IC	LDO, $4V\pm2\%$, 200mA, +CE, Shutdown	USP-4D	45cv	VR4a	9b	Tor
1A5	XC6415AAA57R-G	LVR-IC	LDO, Dual out, $V_{ot1}/V_{out2}=1.85/1.20V\pm1\%$, 200mA, +CE	USPN-6	52xv	VR19	9b	Tor
1A5	XC6415AAA5ER-G	LVR-IC	LDO, Dual out, $V_{ot1}/V_{out2}=1.85/1.20V\pm1\%$, 200mA, +CE	USP-6C	49xv	VR19	9a	Tor
1A6	XC6415AAA67R-G	LVR-IC	LDO, Dual out, $V_{ot1}/V_{out2}=3.30/1.20V\pm1\%$, 200mA, +CE	USPN-6	52xv	VR19	9b	Tor
1A6	XC6415AAA6ER-G	LVR-IC	LDO, Dual out, $V_{ot1}/V_{out2}=3.30/1.20V\pm1\%$, 200mA, +CE	USP-6C	49xv	VR19	9a	Tor
1A7	XC6415AAA77R-G	LVR-IC	LDO, Dual out, $V_{ot1}/V_{out2}=1.80/1.95V\pm1\%$, 200mA, +CE	USPN-6	52xv	VR19	9b	Tor
1A7	XC6415AAA7ER-G	LVR-IC	LDO, Dual out, $V_{ot1}/V_{out2}=1.80/1.95V\pm1\%$, 200mA, +CE	USP-6C	49xv	VR19	9a	Tor
1A8	XC6415AAA87R-G	LVR-IC	LDO, Dual out, $V_{ot1}/V_{out2}=2.85/3.00V\pm1\%$, 200mA, +CE	USPN-6	52xv	VR19	9b	Tor
1A8	XC6415AAA8ER-G	LVR-IC	LDO, Dual out, $V_{ot1}/V_{out2}=2.85/3.00V\pm1\%$, 200mA, +CE	USP-6C	49xv	VR19	9a	Tor
1A9	XC6415AAA97R-G	LVR-IC	LDO, Dual out, $V_{ot1}/V_{out2}=1.55/2.80V\pm1\%$, 200mA, +CE	USPN-6	52xv	VR19	9b	Tor
1A9	XC6415AAA9ER-G	LVR-IC	LDO, Dual out, $V_{ot1}/V_{out2}=1.55/2.80V\pm1\%$, 200mA, +CE	USP-6C	49xv	VR19	9a	Tor
1B	R3117K081A	Vdel-IC	LDO, $0.8V\pm15mV$, -Reset ODO, Sense	DFN1010-4	48rq	VD11	9a	Ric
1B	RP100K131B	LVR-IC	LDO, LN, +CE, $1.3V\pm0.8\%$, 200mA	PLP1612-4	45vm	VR4	9a	Ric
1B	XC6217C1227R-G	LVR-IC	LDO, $1.2V\pm2\%$, 200mA, +CE	USPN-4	58vm	VR4	9a	Tor
1B	XC6223B2119R-G	LVR-IC	LDO, $2.1V\pm1\%$, 300mA, +CE, CL	USPQ-4B03	48vm	VR4	9a	Tor
1B	XC6224A19B7R	LVR-IC	LDO, $1.95V\pm1.5\%$, 150mA, +CE	USPN-4B02	58vm	VR4	9e	Tor
1B	XC6229D3211R-G	LVR-IC	LDO, $3.2V\pm1\%$, 300mA, +CE	BGA-4	63ba*	VR4	9a	Tor
1B	XC6221C4917R	LVR-IC	LDO, $4.9V\pm1\%$, 200mA, +CE, PDR	USPN-4	58vm	VR4	9a	Tor
1B0	XC6415AAB07R-G	LVR-IC	LDO, Dual out, $V_{ot1}/V_{out2}=1.90/1.90V\pm1\%$, 200mA, +CE	USPN-6	52xv	VR19	9b	Tor
1B0	XC6415AAB0ER-G	LVR-IC	LDO, Dual out, $V_{ot1}/V_{out2}=1.90/1.90V\pm1\%$, 200mA, +CE	USP-6C	49xv	VR19	9a	Tor
1B08	XC6217B082DR	LVR-IC	LDO, $0.8V\pm2\%$, 200mA, +CE, CL, Shutdown	USP-4D	45cv	VR4a	9b	Tor
1B09	XC6217B092DR	LVR-IC	LDO, $0.9V\pm2\%$, 200mA, +CE, CL, Shutdown	USP-4D	45cv	VR4a	9b	Tor
1B0L	XC6217B08ADR	LVR-IC	LDO, $0.85V\pm2\%$, 200mA, +CE, CL, Shutdown	USP-4D	45cv	VR4a	9b	Tor
1B0M	XC6217B09ADR	LVR-IC	LDO, $0.95V\pm2\%$, 200mA, +CE, CL, Shutdown	USP-4D	45cv	VR4a	9b	Tor



SMD code	Type	Function	Short description	Case	Pinout	Sch.	St.	Mnf.
1B6	XC6415AAB6ER-G	LVR-IC	LDO, Dual out, $V_{ot1}/V_{ot2}=2.50/0.90V\pm1\%$, 200mA, +CE	USP-6C	49xv	VR19	9a	Tor
1B7	XC6415AAB77R-G	LVR-IC	LDO, Dual out, $V_{ot1}/V_{ot2}=3.15/2.85V\pm1\%$, 200mA, +CE	USPN-6	52xv	VR19	9b	Tor
1B7	XC6415AAB7ER-G	LVR-IC	LDO, Dual out, $V_{ot1}/V_{ot2}=3.15/2.85V\pm1\%$, 200mA, +CE	USP-6C	49xv	VR19	9a	Tor
1B8	XC6415AAB87R-G	LVR-IC	LDO, Dual out, $V_{ot1}/V_{ot2}=2.60/1.30V\pm1\%$, 200mA, +CE	USPN-6	52xv	VR19	9b	Tor
1B8	XC6415AAB8ER-G	LVR-IC	LDO, Dual out, $V_{ot1}/V_{ot2}=2.60/1.30V\pm1\%$, 200mA, +CE	USP-6C	49xv	VR19	9a	Tor
1B9	XC6415AAB97R-G	LVR-IC	LDO, Dual out, $V_{ot1}/V_{ot2}=3.00/2.50V\pm1\%$, 200mA, +CE	USPN-6	52xv	VR19	9b	Tor
1B9	XC6415AAB9ER-G	LVR-IC	LDO, Dual out, $V_{ot1}/V_{ot2}=3.00/2.50V\pm1\%$, 200mA, +CE	USP-6C	49xv	VR19	9a	Tor
1BX	XC6217B282DR	LVR-IC	LDO, 2.8V \pm 2%, 200mA, +CE, CL, Shutdown	USP-4D	45cv	VR4a	9b	Tor
1BY	XC6217B292DR	LVR-IC	LDO, 2.9V \pm 2%, 200mA, +CE, CL, Shutdown	USP-4D	45cv	VR4a	9b	Tor
1C	R3117K091A	Vdet-IC	0.9V \pm 15mV, -Reset ODO, Sense	DFN1010-4	48rq	VD11	9a	Ric
1C	RP100K151B	LVR-IC	LDO, LN, +CE, 1.5V \pm 0.8%, 200mA	PLP1612-4	45vm	VR4	9a	Ric
1C	XC6217C1327R-G	LVR-IC	LDO, 1.3V \pm 2%, 200mA, +CE	USPN-4	58vm	VR4	9a	Tor
1C	XC6223B2219R-G	LVR-IC	LDO, 2.2V \pm 1%, 300mA, +CE, CL	USPQ-4B03	48vm	VR4	9a	Tor
1C	XC6224A20B7R	LVR-IC	LDO, 2.05V \pm 1.5%, 150mA, +CE	USPN-4B02	58vm	VR4	9e	Tor
1C	XC6229D32B1R-G	LVR-IC	LDO, 3.25V \pm 1%, 300mA, +CE	BGA-4	63ba*	VR4	9a	Tor
1C	XC6221C5017R	LVR-IC	LDO, 5.0V \pm 1%, 200mA, +CE, PDR	USPN-4	58vm	VR4	9a	Tor
1C0	XC6415AAC07R-G	LVR-IC	LDO, Dual out, $V_{ot1}/V_{ot2}=3.30/1.10V\pm1\%$, 200mA, +CE	USPN-6	52xv	VR19	9b	Tor
1C0	XC6415AAC0ER-G	LVR-IC	LDO, Dual out, $V_{ot1}/V_{ot2}=3.30/1.10V\pm1\%$, 200mA, +CE	USP-6C	49xv	VR19	9a	Tor
1C0	XC6503D121GR-G	LVR-IC	LDO, 1.2V \pm 20mV, 500mA, +CE	USP-4	45vm	VR4	9a	Tor
1C1	XC6415AAC17R-G	LVR-IC	LDO, Dual out, $V_{ot1}/V_{ot2}=3.30/2.50V\pm1\%$, 200mA, +CE	USPN-6	52xv	VR19	9b	Tor
1C1	XC6415AAC1ER-G	LVR-IC	LDO, Dual out, $V_{ot1}/V_{ot2}=3.30/2.50V\pm1\%$, 200mA, +CE	USP-6C	49xv	VR19	9a	Tor
1C1	XC6503D131GR-G	LVR-IC	LDO, 1.3V \pm 20mV, 500mA, +CE	USP-4	45vm	VR4	9a	Tor
1C2	XC6415AAC27R-G	LVR-IC	LDO, Dual out, $V_{ot1}/V_{ot2}=1.85/2.85V\pm1\%$, 200mA, +CE	USPN-6	52xv	VR19	9b	Tor
1C2	XC6415AAC2ER-G	LVR-IC	LDO, Dual out, $V_{ot1}/V_{ot2}=1.85/2.85V\pm1\%$, 200mA, +CE	USP-6C	49xv	VR19	9a	Tor
1C2	XC6503D141GR-G	LVR-IC	LDO, 1.4V \pm 20mV, 500mA, +CE	USP-4	45vm	VR4	9a	Tor
1C3	XC6415AAC37R-G	LVR-IC	LDO, Dual out, $V_{ot1}/V_{ot2}=1.50/2.90V\pm1\%$, 200mA, +CE	USPN-6	52xv	VR19	9b	Tor
1C3	XC6415AAC3ER-G	LVR-IC	LDO, Dual out, $V_{ot1}/V_{ot2}=1.50/2.90V\pm1\%$, 200mA, +CE	USP-6C	49xv	VR19	9a	Tor
1C3	XC6503D151GR-G	LVR-IC	LDO, 1.5V \pm 20mV, 500mA, +CE	USP-4	45vm	VR4	9a	Tor
1C4	XC6415AAC47R-G	LVR-IC	LDO, Dual out, $V_{ot1}/V_{ot2}=1.80/3.20V\pm1\%$, 200mA, +CE	USPN-6	52xv	VR19	9b	Tor
1C4	XC6415AAC4ER-G	LVR-IC	LDO, Dual out, $V_{ot1}/V_{ot2}=1.80/3.20V\pm1\%$, 200mA, +CE	USP-6C	49xv	VR19	9a	Tor
1C4	XC6503D161GR-G	LVR-IC	LDO, 1.6V \pm 20mV, 500mA, +CE	USP-4	45vm	VR4	9a	Tor
1C5	XC6415AAC57R-G	LVR-IC	LDO, Dual out, $V_{ot1}/V_{ot2}=1.00/2.50V\pm1\%$, 200mA, +CE	USPN-6	52xv	VR19	9b	Tor
1C5	XC6415AAC5ER-G	LVR-IC	LDO, Dual out, $V_{ot1}/V_{ot2}=1.00/2.50V\pm1\%$, 200mA, +CE	USP-6C	49xv	VR19	9a	Tor
1C5	XC6503D171GR-G	LVR-IC	LDO, 1.7V \pm 20mV, 500mA, +CE	USP-4	45vm	VR4	9a	Tor
1C6	XC6415AAC67R-G	LVR-IC	LDO, Dual out, $V_{ot1}/V_{ot2}=3.10/2.80V\pm1\%$, 200mA, +CE	USPN-6	52xv	VR19	9b	Tor
1C6	XC6415AAC6ER-G	LVR-IC	LDO, Dual out, $V_{ot1}/V_{ot2}=3.10/2.80V\pm1\%$, 200mA, +CE	USP-6C	49xv	VR19	9a	Tor
1C6	XC6503D181GR-G	LVR-IC	LDO, 1.8V \pm 20mV, 500mA, +CE	USP-4	45vm	VR4	9a	Tor
1C7	XC6415AAC77R-G	LVR-IC	LDO, Dual out, $V_{ot1}/V_{ot2}=3.00/3.60V\pm1\%$, 200mA, +CE	USPN-6	52xv	VR19	9b	Tor
1C7	XC6415AAC7ER-G	LVR-IC	LDO, Dual out, $V_{ot1}/V_{ot2}=3.00/3.60V\pm1\%$, 200mA, +CE	USP-6C	49xv	VR19	9a	Tor
1C7	XC6503D191GR-G	LVR-IC	LDO, 1.9V \pm 20mV, 500mA, +CE	USP-4	45vm	VR4	9a	Tor
1C8	XC6415AAC87R-G	LVR-IC	LDO, Dual out, $V_{ot1}/V_{ot2}=1.30/3.00V\pm1\%$, 200mA, +CE	USPN-6	52xv	VR19	9b	Tor
1C8	XC6415AAC8ER-G	LVR-IC	LDO, Dual out, $V_{ot1}/V_{ot2}=1.30/3.00V\pm1\%$, 200mA, +CE	USP-6C	49xv	VR19	9a	Tor
1C8	XC6503D201GR-G	LVR-IC	LDO, 2.0V \pm 1%, 500mA, +CE	USP-4	45vm	VR4	9a	Tor
1C9	XC6415AAC97R-G	LVR-IC	LDO, Dual out, $V_{ot1}/V_{ot2}=1.50/2.40V\pm1\%$, 200mA, +CE	USPN-6	52xv	VR19	9b	Tor
1C9	XC6415AAC9ER-G	LVR-IC	LDO, Dual out, $V_{ot1}/V_{ot2}=1.50/2.40V\pm1\%$, 200mA, +CE	USP-6C	49xv	VR19	9a	Tor
1C9	XC6503D211GR-G	LVR-IC	LDO, 2.1V \pm 1%, 500mA, +CE	USP-4	45vm	VR4	9a	Tor
1CA	XC6503D221GR-G	LVR-IC	LDO, 2.2V \pm 1%, 500mA, +CE	USP-4	45vm	VR4	9a	Tor
1CB	XC6503D231GR-G	LVR-IC	LDO, 2.3V \pm 1%, 500mA, +CE	USP-4	45vm	VR4	9a	Tor
1CC	XC6503D241GR-G	LVR-IC	LDO, 2.4V \pm 1%, 500mA, +CE	USP-4	45vm	VR4	9a	Tor
1CD	XC6503D251GR-G	LVR-IC	LDO, 2.5V \pm 1%, 500mA, +CE	USP-4	45vm	VR4	9a	Tor
1CE	XC6503D261GR-G	LVR-IC	LDO, 2.6V \pm 1%, 500mA, +CE	USP-4	45vm	VR4	9a	Tor
1CF	XC6503D271GR-G	LVR-IC	LDO, 2.7V \pm 1%, 500mA, +CE	USP-4	45vm	VR4	9a	Tor
1CH	XC6503D281GR-G	LVR-IC	LDO, 2.8V \pm 1%, 500mA, +CE	USP-4	45vm	VR4	9a	Tor
1CK	XC6503D291GR-G	LVR-IC	LDO, 2.9V \pm 1%, 500mA, +CE	USP-4	45vm	VR4	9a	Tor
1CL	XC6503D301GR-G	LVR-IC	LDO, 3.0V \pm 1%, 500mA, +CE	USP-4	45vm	VR4	9a	Tor
1CM	XC6503D311GR-G	LVR-IC	LDO, 3.1V \pm 1%, 500mA, +CE	USP-4	45vm	VR4	9a	Tor
1CN	XC6503D321GR-G	LVR-IC	LDO, 3.2V \pm 1%, 500mA, +CE	USP-4	45vm	VR4	9a	Tor
1CP	XC6503D331GR-G	LVR-IC	LDO, 3.3V \pm 1%, 500mA, +CE	USP-4	45vm	VR4	9a	Tor
1CR	XC6503D341GR-G	LVR-IC	LDO, 3.4V \pm 1%, 500mA, +CE	USP-4	45vm	VR4	9a	Tor
1CS	XC6503D351GR-G	LVR-IC	LDO, 3.5V \pm 1%, 500mA, +CE	USP-4	45vm	VR4	9a	Tor
1CT	XC6503D361GR-G	LVR-IC	LDO, 3.6V \pm 1%, 500mA, +CE	USP-4	45vm	VR4	9a	Tor
1CU	XC6503D371GR-G	LVR-IC	LDO, 3.7V \pm 1%, 500mA, +CE	USP-4	45vm	VR4	9a	Tor
1CV	XC6503D381GR-G	LVR-IC	LDO, 3.8V \pm 1%, 500mA, +CE	USP-4	45vm	VR4	9a	Tor
1CX	XC6503D391GR-G	LVR-IC	LDO, 3.9V \pm 1%, 500mA, +CE	USP-4	45vm	VR4	9a	Tor
1CY	XC6503D401GR-G	LVR-IC	LDO, 4.0V \pm 1%, 500mA, +CE	USP-4	45vm	VR4	9a	Tor
1CZ	XC6503D411GR-G	LVR-IC	LDO, 4.1V \pm 1%, 500mA, +CE	USP-4	45vm	VR4	9a	Tor
1D	R3117K101A	Vdet-IC	1.0V \pm 15mV, -Reset ODO, Sense	DFN1010-4	48rq	VD11	9a	Ric
1D	RP100K181B	LVR-IC	LDO, LN, +CE, 1.8V \pm 0.8%, 200mA	PLP1612-4	45vm	VR4	9a	Ric
1D	XC6217C1427R-G	LVR-IC	LDO, 1.4V \pm 2%, 200mA, +CE	USPN-4	58vm	VR4	9a	Tor
1D	XC6223B2319R-G	LVR-IC	LDO, 2.3V \pm 1%, 300mA, +CE, CL	USPQ-4B03	48vm	VR4	9a	Tor



SMD code	Type	Function	Short description	Case	Pinout	Sch.	St.	Mnf.
1D	XC6224A21B7R	LVR-IC	LDO, 2.15V±1.5%, 150mA, +CE	USPN-4B02	58vm	VR4	9e	Tor
1D	XC6229D3311R-G	LVR-IC	LDO, 3.3V±1%, 300mA, +CE	BGA-4	63ba*	VR4	9a	Tor
1D0	XC6415AAD07R-G	LVR-IC	LDO, Dual out, Vot1/Vout2=3.30/3.60V±1%, 200mA, +CE	USPN-6	52xv	VR19	9b	Tor
1D0	XC6415AAD0ER-G	LVR-IC	LDO, Dual out, Vot1/Vout2=3.30/3.60V±1%, 200mA, +CE	USP-6C	49xv	VR19	9a	Tor
1D0	XC6503D421GR-G	LVR-IC	LDO, 4.2V±1%, 500mA, +CE	USP-4	45vm	VR4	9a	Tor
1D1	XC6415AAD17R-G	LVR-IC	LDO, Dual out, Vot1/Vout2=1.00/2.85V±1%, 200mA, +CE	USPN-6	52xv	VR19	9b	Tor
1D1	XC6415AAD1ER-G	LVR-IC	LDO, Dual out, Vot1/Vout2=1.00/2.85V±1%, 200mA, +CE	USP-6C	49xv	VR19	9a	Tor
1D1	XC6503D431GR-G	LVR-IC	LDO, 4.3V±1%, 500mA, +CE	USP-4	45vm	VR4	9a	Tor
1D2	XC6415AAD27R-G	LVR-IC	LDO, Dual out, Vot1/Vout2=1.80/1.85V±1%, 200mA, +CE	USPN-6	52xv	VR19	9b	Tor
1D2	XC6415AAD2ER-G	LVR-IC	LDO, Dual out, Vot1/Vout2=1.80/1.85V±1%, 200mA, +CE	USP-6C	49xv	VR19	9a	Tor
1D2	XC6503D441GR-G	LVR-IC	LDO, 4.4V±1%, 500mA, +CE	USP-4	45vm	VR4	9a	Tor
1D3	XC6415AAD37R-G	LVR-IC	LDO, Dual out, Vot1/Vout2=3.60/1.50V±1%, 200mA, +CE	USPN-6	52xv	VR19	9b	Tor
1D3	XC6415AAD3ER-G	LVR-IC	LDO, Dual out, Vot1/Vout2=3.60/1.50V±1%, 200mA, +CE	USP-6C	49xv	VR19	9a	Tor
1D3	XC6503D451GR-G	LVR-IC	LDO, 4.5V±1%, 500mA, +CE	USP-4	45vm	VR4	9a	Tor
1D4	XC6415AAD47R-G	LVR-IC	LDO, Dual out, Vot1/Vout2=3.00/2.80V±1%, 200mA, +CE	USPN-6	52xv	VR19	9b	Tor
1D4	XC6415AAD4ER-G	LVR-IC	LDO, Dual out, Vot1/Vout2=3.00/2.80V±1%, 200mA, +CE	USP-6C	49xv	VR19	9a	Tor
1D4	XC6503D461GR-G	LVR-IC	LDO, 4.6V±1%, 500mA, +CE	USP-4	45vm	VR4	9a	Tor
1D5	XC6415AAD57R-G	LVR-IC	LDO, Dual out, Vot1/Vout2=4.50/2.60V±1%, 200mA, +CE	USPN-6	52xv	VR19	9b	Tor
1D5	XC6415AAD5ER-G	LVR-IC	LDO, Dual out, Vot1/Vout2=4.50/2.60V±1%, 200mA, +CE	USP-6C	49xv	VR19	9a	Tor
1D5	XC6503D471GR-G	LVR-IC	LDO, 4.7V±1%, 500mA, +CE	USP-4	45vm	VR4	9a	Tor
1D6	XC6415AAD67R-G	LVR-IC	LDO, Dual out, Vot1/Vout2=2.00/1.80V±1%, 200mA, +CE	USPN-6	52xv	VR19	9b	Tor
1D6	XC6415AAD6ER-G	LVR-IC	LDO, Dual out, Vot1/Vout2=2.00/1.80V±1%, 200mA, +CE	USP-6C	49xv	VR19	9a	Tor
1D6	XC6503D481GR-G	LVR-IC	LDO, 4.8V±1%, 500mA, +CE	USP-4	45vm	VR4	9a	Tor
1D7	XC6415AAD77R-G	LVR-IC	LDO, Dual out, Vot1/Vout2=3.30/3.10V±1%, 200mA, +CE	USPN-6	52xv	VR19	9b	Tor
1D7	XC6415AAD7ER-G	LVR-IC	LDO, Dual out, Vot1/Vout2=3.30/3.10V±1%, 200mA, +CE	USP-6C	49xv	VR19	9a	Tor
1D7	XC6503D491GR-G	LVR-IC	LDO, 4.9V±1%, 500mA, +CE	USP-4	45vm	VR4	9a	Tor
1D8	XC6415AAD87R-G	LVR-IC	LDO, Dual out, Vot1/Vout2=3.20/3.10V±1%, 200mA, +CE	USPN-6	52xv	VR19	9b	Tor
1D8	XC6415AAD8ER-G	LVR-IC	LDO, Dual out, Vot1/Vout2=3.20/3.10V±1%, 200mA, +CE	USP-6C	49xv	VR19	9a	Tor
1D8	XC6503D501GR-G	LVR-IC	LDO, 5.0V±1%, 500mA, +CE	USP-4	45vm	VR4	9a	Tor
1D9	XC6415AAD97R-G	LVR-IC	LDO, Dual out, Vot1/Vout2=3.40/3.10V±1%, 200mA, +CE	USPN-6	52xv	VR19	9b	Tor
1D9	XC6415AAD9ER-G	LVR-IC	LDO, Dual out, Vot1/Vout2=3.40/3.10V±1%, 200mA, +CE	USP-6C	49xv	VR19	9a	Tor
1E	R3117K111A	Vdel-IC	1.1V±15mV, -, Reset ODO, Sense	DFN1010-4	48rq	VD11	9a	Ric
1E	RP100K181B5	LVR-IC	LDO, LN, +CE, 1.85V±0.8%, 200mA	PLP1612-4	45vm	VR4	9a	Ric
1E	XC6217C1527R-G	LVR-IC	LDO, 1.5V±2%, 200mA, +CE	USPN-4	58vm	VR4	9a	Tor
1E	XC6223B2419R-G	LVR-IC	LDO, 2.4V±1%, 300mA, +CE, CL	USPQ-4B03	48vm	VR4	9a	Tor
1E	XC6224A22B7R	LVR-IC	LDO, 2.25V±1.5%, 150mA, +CE	USPN-4B02	58vm	VR4	9e	Tor
1E	XC6229D33B1R-G	LVR-IC	LDO, 3.35V±1%, 300mA, +CE	BGA-4	63ba*	VR4	9a	Tor
1E0	XC6415AAE07R-G	LVR-IC	LDO, Dual out, Vot1/Vout2=3.10/2.50V±1%, 200mA, +CE	USPN-6	52xv	VR19	9b	Tor
1E0	XC6415AAE0ER-G	LVR-IC	LDO, Dual out, Vot1/Vout2=3.10/2.50V±1%, 200mA, +CE	USP-6C	49xv	VR19	9a	Tor
1E0	XC6503D12AGR-G	LVR-IC	LDO, 1.25V±20mV, 500mA, +CE	USP-4	45vm	VR4	9a	Tor
1E1	XC6415AAE17R-G	LVR-IC	LDO, Dual out, Vot1/Vout2=2.50/3.10V±1%, 200mA, +CE	USPN-6	52xv	VR19	9b	Tor
1E1	XC6415AAE1ER-G	LVR-IC	LDO, Dual out, Vot1/Vout2=2.50/3.10V±1%, 200mA, +CE	USP-6C	49xv	VR19	9a	Tor
1E1	XC6503D13AGR-G	LVR-IC	LDO, 1.35V±20mV, 500mA, +CE	USP-4	45vm	VR4	9a	Tor
1E2	XC6415AAE27R-G	LVR-IC	LDO, Dual out, Vot1/Vout2=3.40/3.40V±1%, 200mA, +CE	USPN-6	52xv	VR19	9b	Tor
1E2	XC6415AAE2ER-G	LVR-IC	LDO, Dual out, Vot1/Vout2=3.40/3.40V±1%, 200mA, +CE	USP-6C	49xv	VR19	9a	Tor
1E2	XC6503D14AGR-G	LVR-IC	LDO, 1.45V±20mV, 500mA, +CE	USP-4	45vm	VR4	9a	Tor
1E3	XC6503D15AGR-G	LVR-IC	LDO, 1.55V±20mV, 500mA, +CE	USP-4	45vm	VR4	9a	Tor
1E4	XC6503D16AGR-G	LVR-IC	LDO, 1.65V±20mV, 500mA, +CE	USP-4	45vm	VR4	9a	Tor
1E5	XC6503D17AGR-G	LVR-IC	LDO, 1.75V±20mV, 500mA, +CE	USP-4	45vm	VR4	9a	Tor
1E6	XC6503D18AGR-G	LVR-IC	LDO, 1.85V±20mV, 500mA, +CE	USP-4	45vm	VR4	9a	Tor
1E7	XC6503D19AGR-G	LVR-IC	LDO, 1.95V±20mV, 500mA, +CE	USP-4	45vm	VR4	9a	Tor
1E8	XC6503D20AGR-G	LVR-IC	LDO, 2.05V±1%, 500mA, +CE	USP-4	45vm	VR4	9a	Tor
1E9	XC6503D21AGR-G	LVR-IC	LDO, 2.15V±1%, 500mA, +CE	USP-4	45vm	VR4	9a	Tor
1EA	XC6503D22AGR-G	LVR-IC	LDO, 2.25V±1%, 500mA, +CE	USP-4	45vm	VR4	9a	Tor
1EB	XC6503D23AGR-G	LVR-IC	LDO, 2.35V±1%, 500mA, +CE	USP-4	45vm	VR4	9a	Tor
1EC	XC6503D24AGR-G	LVR-IC	LDO, 2.45V±1%, 500mA, +CE	USP-4	45vm	VR4	9a	Tor
1ED	XC6503D25AGR-G	LVR-IC	LDO, 2.55V±1%, 500mA, +CE	USP-4	45vm	VR4	9a	Tor
1EE	XC6503D26AGR-G	LVR-IC	LDO, 2.65V±1%, 500mA, +CE	USP-4	45vm	VR4	9a	Tor
1EF	XC6503D27AGR-G	LVR-IC	LDO, 2.75V±1%, 500mA, +CE	USP-4	45vm	VR4	9a	Tor
1EH	XC6503D28AGR-G	LVR-IC	LDO, 2.85V±1%, 500mA, +CE	USP-4	45vm	VR4	9a	Tor
1EK	XC6503D29AGR-G	LVR-IC	LDO, 2.95V±1%, 500mA, +CE	USP-4	45vm	VR4	9a	Tor
1EL	XC6503D30AGR-G	LVR-IC	LDO, 3.05V±1%, 500mA, +CE	USP-4	45vm	VR4	9a	Tor
1EM	XC6503D31AGR-G	LVR-IC	LDO, 3.15V±1%, 500mA, +CE	USP-4	45vm	VR4	9a	Tor
1EN	XC6503D32AGR-G	LVR-IC	LDO, 3.25V±1%, 500mA, +CE	USP-4	45vm	VR4	9a	Tor
1EP	XC6503D33AGR-G	LVR-IC	LDO, 3.35V±1%, 500mA, +CE	USP-4	45vm	VR4	9a	Tor
1ER	XC6503D34AGR-G	LVR-IC	LDO, 3.45V±1%, 500mA, +CE	USP-4	45vm	VR4	9a	Tor
1ES	XC6503D35AGR-G	LVR-IC	LDO, 3.55V±1%, 500mA, +CE	USP-4	45vm	VR4	9a	Tor
1ET	XC6503D36AGR-G	LVR-IC	LDO, 3.65V±1%, 500mA, +CE	USP-4	45vm	VR4	9a	Tor
1EU	XC6503D37AGR-G	LVR-IC	LDO, 3.75V±1%, 500mA, +CE	USP-4	45vm	VR4	9a	Tor
1EV	XC6503D38AGR-G	LVR-IC	LDO, 3.85V±1%, 500mA, +CE	USP-4	45vm	VR4	9a	Tor



SMD
code

Type

Function

Short description

Case

Pinout Sch. St.Mnf.

SMD code	Type	Function	Short description	Case	Pinout	Sch.	St.Mnf.
1EX	XC6503D39AGR-G	LVR-IC	LDO, 3.95V±1%, 500mA, +CE	USP-4	45vm	VR4	9a Tor
1EY	XC6503D40AGR-G	LVR-IC	LDO, 4.05V±1%, 500mA, +CE	USP-4	45vm	VR4	9a Tor
1EZ	XC6503D41AGR-G	LVR-IC	LDO, 4.15V±1%, 500mA, +CE	USP-4	45vm	VR4	9a Tor
1F	R3117K121A	Vdet-IC	1.2V±15mV, -Reset ODO, Sense	DFN1010-4	48rq	VD11	9a Ric
1F	RP100K191B	LVR-IC	LDO, LN, +CE, 1.9V±0.8%, 200mA	PLP1612-4	45vm	VR4	9a Ric
1F	XC6217C1627R-G	LVR-IC	LDO, 1.6V±2%, 200mA, +CE	USPN-4	58vm	VR4	9a Tor
1F	XC6223B2519R-G	LVR-IC	LDO, 2.5V±1%, 300mA, +CE, CL	USPQ-4B03	48vm	VR4	9a Tor
1F	XC6224A23B7R	LVR-IC	LDO, 2.25V±1.5%, 150mA, +CE	USPN-4B02	58vm	VR4	9e Tor
1F	XC6229D3411R-G	LVR-IC	LDO, 3.4V±1%, 300mA, +CE	BGA-4	63ba*	VR4	9a Tor
1F0	XC6503D42AGR-G	LVR-IC	LDO, 4.25V±1%, 500mA, +CE	USP-4	45vm	VR4	9a Tor
1F1	XC6503D43AGR-G	LVR-IC	LDO, 4.35V±1%, 500mA, +CE	USP-4	45vm	VR4	9a Tor
1F2	XC6503D44AGR-G	LVR-IC	LDO, 4.45V±1%, 500mA, +CE	USP-4	45vm	VR4	9a Tor
1F3	XC6503D45AGR-G	LVR-IC	LDO, 4.55V±1%, 500mA, +CE	USP-4	45vm	VR4	9a Tor
1F4	XC6503D46AGR-G	LVR-IC	LDO, 4.65V±1%, 500mA, +CE	USP-4	45vm	VR4	9a Tor
1F5	XC6503D47AGR-G	LVR-IC	LDO, 4.75V±1%, 500mA, +CE	USP-4	45vm	VR4	9a Tor
1F6	XC6503D48AGR-G	LVR-IC	LDO, 4.85V±1%, 500mA, +CE	USP-4	45vm	VR4	9a Tor
1F7	XC6503D49AGR-G	LVR-IC	LDO, 4.95V±1%, 500mA, +CE	USP-4	45vm	VR4	9a Tor
1G	R3117K131A	Vdet-IC	1.3V±15mV, -Reset ODO, Sense	DFN1010-4	48rq	VD11	9a Ric
1G	RP100K201B	LVR-IC	LDO, LN, +CE, 2V±0.8%, 200mA	PLP1612-4	45vm	VR4	9a Ric
1H	R3117K141A	Vdet-IC	1.4V±15mV, -Reset ODO, Sense	DFN1010-4	48rq	VD11	9a Ric
1H	RP100K251B	LVR-IC	LDO, LN, +CE, 2.5V±0.8%, 200mA	PLP1612-4	45vm	VR4	9a Ric
1H	XC6217C1727R-G	LVR-IC	LDO, 1.7V±2%, 200mA, +CE	USPN-4	58vm	VR4	9a Tor
1H	XC6223B2619R-G	LVR-IC	LDO, 2.6V±1%, 300mA, +CE, CL	USPQ-4B03	48vm	VR4	9a Tor
1H	XC6224A24B7R	LVR-IC	LDO, 2.45V±1.5%, 150mA, +CE	USPN-4B02	58vm	VR4	9e Tor
1H	XC6229D34B1R-G	LVR-IC	LDO, 3.45V±1%, 300mA, +CE	BGA-4	63ba*	VR4	9a Tor
1J	R3117K151A	Vdet-IC	1.5V±15mV, -Reset ODO, Sense	DFN1010-4	48rq	VD11	9a Ric
1J	RP100K261B	LVR-IC	LDO, LN, +CE, 2.6V±0.8%, 200mA	PLP1612-4	45vm	VR4	9a Ric
1K	R3117K161A	Vdet-IC	1.6V±1%, -Reset ODO, Sense	DFN1010-4	48rq	VD11	9a Ric
1K	RP100K271B	LVR-IC	LDO, LN, +CE, 2.7V±0.8%, 200mA	PLP1612-4	45vm	VR4	9a Ric
1K	XC6217C1827R-G	LVR-IC	LDO, 1.8V±2%, 200mA, +CE	USPN-4	58vm	VR4	9a Tor
1K	XC6223B2719R-G	LVR-IC	LDO, 2.7V±1%, 300mA, +CE, CL	USPQ-4B03	48vm	VR4	9a Tor
1K	XC6224A25B7R	LVR-IC	LDO, 2.55V±1.5%, 150mA, +CE	USPN-4B02	58vm	VR4	9e Tor
1K	XC6229D3511R-G	LVR-IC	LDO, 3.5V±1%, 300mA, +CE	BGA-4	63ba*	VR4	9a Tor
1L	R3117K171A	Vdet-IC	1.7V±1%, -Reset ODO, Sense	DFN1010-4	48rq	VD11	9a Ric
1L	RP100K281B	LVR-IC	LDO, LN, +CE, 2.8V±0.8%, 200mA	PLP1612-4	45vm	VR4	9a Ric
1L	XC6217C1927R-G	LVR-IC	LDO, 1.9V±2%, 200mA, +CE	USPN-4	58vm	VR4	9a Tor
1L	XC6223B2819R-G	LVR-IC	LDO, 2.8V±1%, 300mA, +CE, CL	USPQ-4B03	48vm	VR4	9a Tor
1L	XC6224A26B7R	LVR-IC	LDO, 2.65V±1.5%, 150mA, +CE	USPN-4B02	58vm	VR4	9e Tor
1L	XC6229D35B1R-G	LVR-IC	LDO, 3.55V±1%, 300mA, +CE	BGA-4	63ba*	VR4	9a Tor
1M	R3117K181A	Vdet-IC	1.8V±1%, -Reset ODO, Sense	DFN1010-4	48rq	VD11	9a Ric
1M	RP100K281B5	LVR-IC	LDO, LN, +CE, 2.85V±0.8%, 200mA	PLP1612-4	45vm	VR4	9a Ric
1M	XC6217C2027R-G	LVR-IC	LDO, 2V±2%, 200mA, +CE	USPN-4	58vm	VR4	9a Tor
1M	XC6223B2919R-G	LVR-IC	LDO, 2.9V±1%, 300mA, +CE, CL	USPQ-4B03	48vm	VR4	9a Tor
1M	XC6224A27B7R	LVR-IC	LDO, 2.75V±1.5%, 150mA, +CE	USPN-4B02	58vm	VR4	9e Tor
1M	XC6229D3611R-G	LVR-IC	LDO, 3.6V±1%, 300mA, +CE	BGA-4	63ba*	VR4	9a Tor
1N	R3117K191A	Vdet-IC	1.9V±1%, -Reset ODO, Sense	DFN1010-4	48rq	VD11	9a Ric
1N	RP100K291B	LVR-IC	LDO, LN, +CE, 2.9V±0.8%, 200mA	PLP1612-4	45vm	VR4	9a Ric
1N	XC6217C2127R-G	LVR-IC	LDO, 2.1V±2%, 200mA, +CE	USPN-4	58vm	VR4	9a Tor
1N	XC6223B3019R-G	LVR-IC	LDO, 3.0V±1%, 300mA, +CE, CL	USPQ-4B03	48vm	VR4	9a Tor
1N	XC6224A28B7R	LVR-IC	LDO, 2.85V±1.5%, 150mA, +CE	USPN-4B02	58vm	VR4	9e Tor
1N	XC6229D36B1R-G	LVR-IC	LDO, 3.65V±1%, 300mA, +CE	BGA-4	63ba*	VR4	9a Tor
1P	R3117K201A	Vdet-IC	2V±1%, -Reset ODO, Sense	DFN1010-4	48rq	VD11	9a Ric
1P	RP100K301B	LVR-IC	LDO, LN, +CE, 3V±0.8%, 200mA	PLP1612-4	45vm	VR4	9a Ric
1P	XC6217C2227R-G	LVR-IC	LDO, 2.2V±2%, 200mA, +CE	USPN-4	58vm	VR4	9a Tor
1P	XC6223B3119R-G	LVR-IC	LDO, 3.1V±1%, 300mA, +CE, CL	USPQ-4B03	48vm	VR4	9a Tor
1P	XC6224A29B7R	LVR-IC	LDO, 2.95V±1.5%, 150mA, +CE	USPN-4B02	58vm	VR4	9e Tor
1P	XC6229D3711R-G	LVR-IC	LDO, 3.7V±1%, 300mA, +CE	BGA-4	63ba*	VR4	9a Tor
1Q	R3117K211A	Vdet-IC	2.1V±1%, -Reset ODO, Sense	DFN1010-4	48rq	VD11	9a Ric
1Q	RP100K311B	LVR-IC	LDO, LN, +CE, 3.1V±0.8%, 200mA	PLP1612-4	45vm	VR4	9a Ric
1R	R3117K221A	Vdet-IC	2.2V±1%, -Reset ODO, Sense	DFN1010-4	48rq	VD11	9a Ric
1R	RP100K331B	LVR-IC	LDO, LN, +CE, 3.3V±0.8%, 200mA	PLP1612-4	45vm	VR4	9a Ric
1R	XC6217C2327R-G	LVR-IC	LDO, 2.3V±2%, 200mA, +CE	USPN-4	58vm	VR4	9a Tor
1R	XC6223B3219R-G	LVR-IC	LDO, 3.2V±1%, 300mA, +CE, CL	USPQ-4B03	48vm	VR4	9a Tor
1R	XC6229D37B1R-G	LVR-IC	LDO, 3.75V±1%, 300mA, +CE	BGA-4	63ba*	VR4	9a Tor
1S	R3117K231A	Vdet-IC	2.3V±1%, -Reset ODO, Sense	DFN1010-4	48rq	VD11	9a Ric
1S	XC6217C2427R-G	LVR-IC	LDO, 2.4V±2%, 200mA, +CE	USPN-4	58vm	VR4	9a Tor
1S	XC6223B3319R-G	LVR-IC	LDO, 3.3V±1%, 300mA, +CE, CL	USPQ-4B03	48vm	VR4	9a Tor
1S	XC6229D3811R-G	LVR-IC	LDO, 3.8V±1%, 300mA, +CE	BGA-4	63ba*	VR4	9a Tor
1T	R3117K241A	Vdet-IC	2.4V±1%, -Reset ODO, Sense	DFN1010-4	48rq	VD11	9a Ric
1T	XC6217C2527R-G	LVR-IC	LDO, 2.5V±2%, 200mA, +CE	USPN-4	58vm	VR4	9a Tor



SMD code	Type	Function	Short description	Case	Pinout	Sch.	St.	Mnf.
1T	XC6223B3419R-G	LVR-IC	LDO, 3.4V±1%, 300mA, +CE, CL	USPQ-4B03	48vm	VR4	9a	Tor
1T	XC6229D38B1R-G	LVR-IC	LDO, 3.85V±1%, 300mA, +CE	BGA-4	63ba*	VR4	9a	Tor
1U	R3117K251A	Vdet-IC	2.5V±1%, -Reset ODO, Sense	DFN1010-4	48rq	VD11	9a	Ric
1U	XC6217C2627R-G	LVR-IC	LDO, 2.6V±2%, 200mA, +CE	USPN-4	58vm	VR4	9a	Tor
1U	XC6223B3519R-G	LVR-IC	LDO, 3.5V±1%, 300mA, +CE, CL	USPQ-4B03	48vm	VR4	9a	Tor
1U	XC6229D3911R-G	LVR-IC	LDO, 3.9V±1%, 300mA, +CE	BGA-4	63ba*	VR4	9a	Tor
1V	R3117K261A	Vdet-IC	2.6V±1%, -Reset ODO, Sense	DFN1010-4	48rq	VD11	9a	Ric
1V	XC6217C2727R-G	LVR-IC	LDO, 2.7V±2%, 200mA, +CE	USPN-4	58vm	VR4	9a	Tor
1V	XC6223B3619R-G	LVR-IC	LDO, 3.6V±1%, 300mA, +CE, CL	USPQ-4B03	48vm	VR4	9a	Tor
1V	XC6229D39B1R-G	LVR-IC	LDO, 3.95V±1%, 300mA, +CE	BGA-4	63ba*	VR4	9a	Tor
1W	R3117K271A	Vdet-IC	2.7V±1%, -Reset ODO, Sense	DFN1010-4	48rq	VD11	9a	Ric
1X	R3117K281A	Vdet-IC	2.8V±1%, -Reset ODO, Sense	DFN1010-4	48rq	VD11	9a	Ric
1X	XC6217C2827R-G	LVR-IC	LDO, 2.8V±2%, 200mA, +CE	USPN-4	58vm	VR4	9a	Tor
1X	XC6223B3719R-G	LVR-IC	LDO, 3.7V±1%, 300mA, +CE, CL	USPQ-4B03	48vm	VR4	9a	Tor
1X	XC6229D4011R-G	LVR-IC	LDO, 4.0V±1%, 300mA, +CE	BGA-4	63ba*	VR4	9a	Tor
1Y	R3117K291A	Vdet-IC	2.9V±1%, -Reset ODO, Sense	DFN1010-4	48rq	VD11	9a	Ric
1Y	XC6217C2927R-G	LVR-IC	LDO, 2.9V±2%, 200mA, +CE	USPN-4	58vm	VR4	9a	Tor
1Y	XC6223B3819R-G	LVR-IC	LDO, 3.8V±1%, 300mA, +CE, CL	USPQ-4B03	48vm	VR4	9a	Tor
1Z	R3117K301A	Vdet-IC	3.0V±1%, -Reset ODO, Sense	DFN1010-4	48rq	VD11	9a	Ric
1Z	XC6217C3027R-G	LVR-IC	LDO, 3V±2%, 200mA, +CE	USPN-4	58vm	VR4	9a	Tor
1Z	XC6223B3919R-G	LVR-IC	LDO, 3.9V±1%, 300mA, +CE, CL	USPQ-4B03	48vm	VR4	9a	Tor
20	RP110L261B	LVR-IC	LDO, 2.6V±1%, 150mA, +CE	DFN1010-4	48vm	VR4	9a	Ric
20	XC6217C3127R-G	LVR-IC	LDO, 3.1V±2%, 200mA, +CE	USPN-4	58vm	VR4	9a	Tor
20	XC6224B0817R	LVR-IC	LDO, 0.8V±20mV, 150mA, +CE, PDR	USPN-4B02	58vm	VR4	9e	Tor
20	XC6229H1211R-G	LVR-IC	LDO, 1.2V±20mV, 300mA, +CE, ICP	BGA-4	63ba*	VR4	9a	Tor
20	XC6420AB207R-G	LVR-IC	LDO, Dual out, Vout1/Vout2=2.50/2.50V±2%, 150mA, +CE	USPN-6	52xv	VR19	9a	Tor
20	XC6420AB20DR-G	LVR-IC	LDO, Dual out, Vout1/Vout2=2.50/2.50V±2%, 150mA, +CE	USP-6B04	73x4	VR19	9a	Tor
20	XC6221C08B7R	LVR-IC	LDO, 0.85V±20mV, 200mA, +CE, PDR	USPN-4	58vm	VR4	9a	Tor
2000D1	TPA2000D1GQC	LIN-IC	AF PA, BTL, class-D, 2.7. 5.5V, 2W(5V/4Q)	BGA-48	39	-	-	Ti
2001D1	TPA2001D1GQC	LIN-IC	AF PA, BTL, class-D, 2.7. 5.5V, 1W(5V/8Q)	BGA-48	39	-	-	Ti
2004	PT2004	LIN-IC	AF PA, BTL, class-D, 2.5. 5.5V, 2x2.2W(5V/4Q), shutdown	BGA-16	39	AFP46	-	Eut
2005A	EUA2005J	LIN-IC	AF PA, BTL, class-D, 2.2. 5.5V, 1.5W(5V/8Q), shutdown	DFN-8	37	AFP24	-	Pct
2010A	EUA2010J	LIN-IC	AF PA, BTL, class-D, 2.5. 5.5V, 3W(5V/8Q), shutdown	DFN-8	37	-	-	Eut
2010B	EUA2010BJ	LIN-IC	AF PA, BTL, class-D, 2.5. 5.5V, 3W(5V/4Q), shutdown	DFN-8	37	AFP24	-	Eut
2011A	EUA2011AJ	LIN-IC	AF PA, BTL, class-D, 2.5. 5.5V, 2.5W(5V/4Q), shutdown	DFN-8	37	AFP24	-	Eut
201A	ISL99201IAZ	LIN-IC	AF PA, BTL, class-D, 2.4. 5.5V, 1.5W(5V/8Q), shutdown	BGA-9	39	AFP62	9m	Isl
201A	ISL99201IRTAZ	LIN-IC	AF PA, BTL, class-D, 2.4. 5.5V, 1.5W(5V/8Q), shutdown	TDFN-8	37	AFP61	9m	Isl
201B	ISL99201IBZ	LIN-IC	AF PA, BTL, class-D, 2.4. 5.5V, 1.5W(5V/8Q), shutdown	BGA-9	39	AFP62	9m	Isl
201B	ISL99201IRTBZ	LIN-IC	AF PA, BTL, class-D, 2.4. 5.5V, 1.5W(5V/8Q), shutdown	TDFN-8	37	AFP61	9m	Isl
201C	ISL99201IICZ	LIN-IC	AF PA, BTL, class-D, 2.4. 5.5V, 1.5W(5V/8Q), shutdown	BGA-9	39	AFP62	9m	Isl
201C	ISL99201IRTCZ	LIN-IC	AF PA, BTL, class-D, 2.4. 5.5V, 1.5W(5V/8Q), shutdown	TDFN-8	37	AFP61	9m	Isl
201D	ISL99201IIDZ	LIN-IC	AF PA, BTL, class-D, 2.4. 5.5V, 1.5W(5V/8Q), shutdown	BGA-9	39	AFP62	9m	Isl
201D	ISL99201IRTDZ	LIN-IC	AF PA, BTL, class-D, 2.4. 5.5V, 1.5W(5V/8Q), shutdown	TDFN-8	37	AFP61	9m	Isl
202A	ISL99202IIAZ	LIN-IC	AF PA, 2.4. 5.5V, 2x70mW(5V/16Q), shutdown	BGA-12	39	-	9m	Isl
202A	ISL99202IRTAZ	LIN-IC	AF PA, 2.4. 5.5V, 2x70mW(5V/16Q), shutdown	TQFN-12	38	-	9m	Isl
202B	ISL99202IIBZ	LIN-IC	AF PA, 2.4. 5.5V, 2x70mW(5V/16Q), shutdown	BGA-12	39	-	9m	Isl
202B	ISL99202IRTBZ	LIN-IC	AF PA, 2.4. 5.5V, 2x70mW(5V/16Q), shutdown	TQFN-12	38	-	9m	Isl
20M	XC6216B202ER	LVR-IC	2.0V±2%, 150mA, +CE	USP-6C	49hu	VR4	9a	Tor
20N	XC6216B212ER	LVR-IC	2.1V±2%, 150mA, +CE	USP-6C	49hu	VR4	9a	Tor
20P	XC6216B222ER	LVR-IC	2.2V±2%, 150mA, +CE	USP-6C	49hu	VR4	9a	Tor
20R	XC6216B232ER	LVR-IC	2.3V±2%, 150mA, +CE	USP-6C	49hu	VR4	9a	Tor
20S	XC6216B242ER	LVR-IC	2.4V±2%, 150mA, +CE	USP-6C	49hu	VR4	9a	Tor
20T	XC6216B252ER	LVR-IC	2.5V±2%, 150mA, +CE	USP-6C	49hu	VR4	9a	Tor
20U	XC6216B262ER	LVR-IC	2.6V±2%, 150mA, +CE	USP-6C	49hu	VR4	9a	Tor
20V	XC6216B272ER	LVR-IC	2.7V±2%, 150mA, +CE	USP-6C	49hu	VR4	9a	Tor
20X	XC6216B282ER	LVR-IC	2.8V±2%, 150mA, +CE	USP-6C	49hu	VR4	9a	Tor
20Y	XC6216B292ER	LVR-IC	2.9V±2%, 150mA, +CE	USP-6C	49hu	VR4	9a	Tor
20Z	XC6216B302ER	LVR-IC	3.0V±2%, 150mA, +CE	USP-6C	49hu	VR4	9a	Tor
21	RP110L271B	LVR-IC	LDO, 2.7V±1%, 150mA, +CE	DFN1010-4	48vm	VR4	9a	Ric
21	TS4621E1JT	LIN-IC	AF PA, 1.5. 4.5V, 2x50mW(3V/32Q), I2C	BGA-16	39	-	9p	Ste
21	XC6217C3227R-G	LVR-IC	LDO, 3.2V±2%, 200mA, +CE	USPN-4	58vm	VR4	9a	Tor
21	XC6224B0917R	LVR-IC	LDO, 0.9V±20mV, 150mA, +CE, PDR	USPN-4B02	58vm	VR4	9e	Tor
21	XC6229H12B1R-G	LVR-IC	LDO, 1.25V±20mV, 300mA, +CE, ICP	BGA-4	63ba*	VR4	9a	Tor
21	XC6420AB217R-G	LVR-IC	LDO, Dual out, Vout1/Vout2=2.50/2.80V±2%, 150mA, +CE	USPN-6	52xv	VR19	9a	Tor
21	XC6420AB21DR-G	LVR-IC	LDO, Dual out, Vout1/Vout2=2.50/2.80V±2%, 150mA, +CE	USP-6B04	73x4	VR19	9a	Tor
21	XC6221C09B7R	LVR-IC	LDO, 0.95V±20mV, 200mA, +CE, PDR	USPN-4	58vm	VR4	9a	Tor
210	XC6216B312ER	LVR-IC	3.1V±2%, 150mA, +CE	USP-6C	49hu	VR4	9a	Tor
211	XC6216B322ER	LVR-IC	3.2V±2%, 150mA, +CE	USP-6C	49hu	VR4	9a	Tor
212	XC6216B332ER	LVR-IC	3.3V±2%, 150mA, +CE	USP-6C	49hu	VR4	9a	Tor
213	XC6216B342ER	LVR-IC	3.4V±2%, 150mA, +CE	USP-6C	49hu	VR4	9a	Tor



SMD code	Type	Function	Short description	Case	Pinout	Sch.	St.Mnf.
2131	TA2131FLG	LIN-IC	AF PA, 1.5..4.5V, 2x8mW(3V/32Ω)	QFN-24	38	-	9m Tos
214	XC6216B352ER	LVR-IC	3.5V±2%, 150mA, +CE	USP-6C	49hu	VR4	9a Tor
215	XC6216B362ER	LVR-IC	3.6V±2%, 150mA, +CE	USP-6C	49hu	VR4	9a Tor
216	XC6216B372ER	LVR-IC	3.7V±2%, 150mA, +CE	USP-6C	49hu	VR4	9a Tor
217	XC6216B382ER	LVR-IC	3.8V±2%, 150mA, +CE	USP-6C	49hu	VR4	9a Tor
218	XC6216B392ER	LVR-IC	3.9V±2%, 150mA, +CE	USP-6C	49hu	VR4	9a Tor
219	XC6216B402ER	LVR-IC	4.0V±2%, 150mA, +CE	USP-6C	49hu	VR4	9a Tor
21A	XC6216B412ER	LVR-IC	4.1V±2%, 150mA, +CE	USP-6C	49hu	VR4	9a Tor
21B	XC6216B422ER	LVR-IC	4.2V±2%, 150mA, +CE	USP-6C	49hu	VR4	9a Tor
21C	XC6216B432ER	LVR-IC	4.3V±2%, 150mA, +CE	USP-6C	49hu	VR4	9a Tor
21D	XC6216B442ER	LVR-IC	4.4V±2%, 150mA, +CE	USP-6C	49hu	VR4	9a Tor
21E	XC6216B452ER	LVR-IC	4.5V±2%, 150mA, +CE	USP-6C	49hu	VR4	9a Tor
21F	XC6216B462ER	LVR-IC	4.6V±2%, 150mA, +CE	USP-6C	49hu	VR4	9a Tor
21H	XC6216B472ER	LVR-IC	4.7V±2%, 150mA, +CE	USP-6C	49hu	VR4	9a Tor
21K	XC6216B482ER	LVR-IC	4.8V±2%, 150mA, +CE	USP-6C	49hu	VR4	9a Tor
21L	XC6216B492ER	LVR-IC	4.9V±2%, 150mA, +CE	USP-6C	49hu	VR4	9a Tor
21M	XC6216B502ER	LVR-IC	5.0V±2%, 150mA, +CE	USP-6C	49hu	VR4	9a Tor
21N	XC6216B512ER	LVR-IC	5.1V±2%, 150mA, +CE	USP-6C	49hu	VR4	9a Tor
21P	XC6216B522ER	LVR-IC	5.2V±2%, 150mA, +CE	USP-6C	49hu	VR4	9a Tor
21R	XC6216B532ER	LVR-IC	5.3V±2%, 150mA, +CE	USP-6C	49hu	VR4	9a Tor
21S	XC6216B542ER	LVR-IC	5.4V±2%, 150mA, +CE	USP-6C	49hu	VR4	9a Tor
21T	XC6216B552ER	LVR-IC	5.5V±2%, 150mA, +CE	USP-6C	49hu	VR4	9a Tor
21U	XC6216B562ER	LVR-IC	5.6V±2%, 150mA, +CE	USP-6C	49hu	VR4	9a Tor
21V	XC6216B572ER	LVR-IC	5.7V±2%, 150mA, +CE	USP-6C	49hu	VR4	9a Tor
21X	XC6216B582ER	LVR-IC	5.8V±2%, 150mA, +CE	USP-6C	49hu	VR4	9a Tor
21Y	XC6216B592ER	LVR-IC	5.9V±2%, 150mA, +CE	USP-6C	49hu	VR4	9a Tor
21Z	XC6216B602ER	LVR-IC	6.0V±2%, 150mA, +CE	USP-6C	49hu	VR4	9a Tor
22	RP110L281B	LVR-IC	LDO, 2.8V±1%, 150mA, +CE	DFN1010-4	48vm	VR4	9a Ric
22	XC6217C3327R-G	LVR-IC	LDO, 3.3V±2%, 200mA, +CE	USPN-4	58vm	VR4	9a Tor
22	XC6223C1219R-G	LVR-IC	LDO, 1.2V±20mV, 300mA, +CE, PDR	USPQ-4B03	48vm	VR4	9a Tor
22	XC6224B1017R	LVR-IC	LDO, 1.0V±20mV, 150mA, +CE, PDR	USPN-4B02	58vm	VR4	9e Tor
22	XC6229H1311R-G	LVR-IC	LDO, 1.3V±20mV, 300mA, +CE, ICP	BGA-4	63ba*	VR4	9a Tor
22	XC6420AB227R-G	LVR-IC	LDO, Dual out, Vout1/Vout2=2.50/2.85V±2%, 150mA, +CE	USPN-6	52xv	VR19	9a Tor
22	XC6420AB22DR-G	LVR-IC	LDO, Dual out, Vout1/Vout2=2.50/2.85V±2%, 150mA, +CE	USP-6B04	73x4	VR19	9a Tor
22	XC6221C10B7R	LVR-IC	LDO, 1.05V±20mV, 200mA, +CE, PDR	USPN-4	58vm	VR4	9a Tor
220	XC6216B612ER	LVR-IC	6.1V±2%, 150mA, +CE	USP-6C	49hu	VR4	9a Tor
221	XC6216B622ER	LVR-IC	6.2V±2%, 150mA, +CE	USP-6C	49hu	VR4	9a Tor
222	XC6216B632ER	LVR-IC	6.3V±2%, 150mA, +CE	USP-6C	49hu	VR4	9a Tor
223	XC6216B642ER	LVR-IC	6.4V±2%, 150mA, +CE	USP-6C	49hu	VR4	9a Tor
224	XC6216B652ER	LVR-IC	6.5V±2%, 150mA, +CE	USP-6C	49hu	VR4	9a Tor
225	XC6216B662ER	LVR-IC	6.6V±2%, 150mA, +CE	USP-6C	49hu	VR4	9a Tor
226	XC6216B672ER	LVR-IC	6.7V±2%, 150mA, +CE	USP-6C	49hu	VR4	9a Tor
227	XC6216B682ER	LVR-IC	6.8V±2%, 150mA, +CE	USP-6C	49hu	VR4	9a Tor
228	XC6216B692ER	LVR-IC	6.9V±2%, 150mA, +CE	USP-6C	49hu	VR4	9a Tor
229	XC6216B702ER	LVR-IC	7.0V±2%, 150mA, +CE	USP-6C	49hu	VR4	9a Tor
22A	XC6216B712ER	LVR-IC	7.1V±2%, 150mA, +CE	USP-6C	49hu	VR4	9a Tor
22B	XC6216B722ER	LVR-IC	7.2V±2%, 150mA, +CE	USP-6C	49hu	VR4	9a Tor
22C	XC6216B732ER	LVR-IC	7.3V±2%, 150mA, +CE	USP-6C	49hu	VR4	9a Tor
22D	XC6216B742ER	LVR-IC	7.4V±2%, 150mA, +CE	USP-6C	49hu	VR4	9a Tor
22E	XC6216B752ER	LVR-IC	7.5V±2%, 150mA, +CE	USP-6C	49hu	VR4	9a Tor
22F	XC6216B762ER	LVR-IC	7.6V±2%, 150mA, +CE	USP-6C	49hu	VR4	9a Tor
22H	XC6216B772ER	LVR-IC	7.7V±2%, 150mA, +CE	USP-6C	49hu	VR4	9a Tor
22K	XC6216B782ER	LVR-IC	7.8V±2%, 150mA, +CE	USP-6C	49hu	VR4	9a Tor
22L	XC6216B792ER	LVR-IC	7.9V±2%, 150mA, +CE	USP-6C	49hu	VR4	9a Tor
22M	XC6216B802ER	LVR-IC	8.0V±2%, 150mA, +CE	USP-6C	49hu	VR4	9a Tor
22N	XC6216B812ER	LVR-IC	8.1V±2%, 150mA, +CE	USP-6C	49hu	VR4	9a Tor
22P	XC6216B822ER	LVR-IC	8.2V±2%, 150mA, +CE	USP-6C	49hu	VR4	9a Tor
22R	XC6216B832ER	LVR-IC	8.3V±2%, 150mA, +CE	USP-6C	49hu	VR4	9a Tor
22S	XC6216B842ER	LVR-IC	8.4V±2%, 150mA, +CE	USP-6C	49hu	VR4	9a Tor
22T	XC6216B852ER	LVR-IC	8.5V±2%, 150mA, +CE	USP-6C	49hu	VR4	9a Tor
22U	XC6216B862ER	LVR-IC	8.6V±2%, 150mA, +CE	USP-6C	49hu	VR4	9a Tor
22V	XC6216B872ER	LVR-IC	8.7V±2%, 150mA, +CE	USP-6C	49hu	VR4	9a Tor
22X	XC6216B882ER	LVR-IC	8.8V±2%, 150mA, +CE	USP-6C	49hu	VR4	9a Tor
22Y	XC6216B892ER	LVR-IC	8.9V±2%, 150mA, +CE	USP-6C	49hu	VR4	9a Tor
22Z	XC6216B902ER	LVR-IC	9.0V±2%, 150mA, +CE	USP-6C	49hu	VR4	9a Tor
23	RP110L281B5	LVR-IC	LDO, 2.85V±1%, 150mA, +CE	DFN1010-4	48vm	VR4	9a Ric
23	XC6217C3427R-G	LVR-IC	LDO, 3.4V±2%, 200mA, +CE	USPN-4	58vm	VR4	9a Tor
23	XC6223C1319R-G	LVR-IC	LDO, 1.3V±20mV, 300mA, +CE, PDR	USPQ-4B03	48vm	VR4	9a Tor
23	XC6224B1117R	LVR-IC	LDO, 1.1V±20mV, 150mA, +CE, PDR	USPN-4B02	58vm	VR4	9e Tor
23	XC6229H13B1R-G	LVR-IC	LDO, 1.35V±20mV, 300mA, +CE, ICP	BGA-4	63ba*	VR4	9a Tor



SMD code	Type	Function	Short description	Case	Pinout	Sch.	St.	Mnf.
23	XC6420AB237R-G	LVR-IC	LDO, Dual out, Vout1/Vout2=3.30/1.50V±2%, 150mA, +CE	USPN-6	52xv	VR19	9a	Tor
23	XC6420AB23DR-G	LVR-IC	LDO, Dual out, Vout1/Vout2=3.30/1.50V±2%, 150mA, +CE	USP-6B04	73x4	VR19	9a	Tor
23	XC6222C11B7R	LVR-IC	LDO, 1.15V±20mV, 200mA, +CE, PDR	USPN-4	58vm	VR4	9a	Tor
230	XC6216B912ER	LVR-IC	9.1V±2%, 150mA, +CE	USP-6C	49hu	VR4	9a	Tor
231	XC6216B922ER	LVR-IC	9.2V±2%, 150mA, +CE	USP-6C	49hu	VR4	9a	Tor
232	XC6216B932ER	LVR-IC	9.3V±2%, 150mA, +CE	USP-6C	49hu	VR4	9a	Tor
233	XC6216B942ER	LVR-IC	9.4V±2%, 150mA, +CE	USP-6C	49hu	VR4	9a	Tor
2333	PT2333	LIN-IC	AF PA, BTL, class-D, 2.5. 5.5V, 2.5W(5V/4Ω), shutdown	BGA-9	39	AFP45	-	Pct
234	XC6216B952ER	LVR-IC	9.5V±2%, 150mA, +CE	USP-6C	49hu	VR4	9a	Tor
235	XC6216B962ER	LVR-IC	9.6V±2%, 150mA, +CE	USP-6C	49hu	VR4	9a	Tor
236	XC6216B972ER	LVR-IC	9.7V±2%, 150mA, +CE	USP-6C	49hu	VR4	9a	Tor
2367	PT2367	LIN-IC	AF PA, BTL, 2.2. 5.5V, 1W(5V/8Ω), 1/2S/LJ/RJ, mute, shutdown	BGA-8	39	AFP44	-	Pct
237	XC6216B982ER	LVR-IC	9.8V±2%, 150mA, +CE	USP-6C	49hu	VR4	9a	Tor
238	XC6216B992ER	LVR-IC	9.9V±2%, 150mA, +CE	USP-6C	49hu	VR4	9a	Tor
239	XC6216BA02ER	LVR-IC	10.0V±2%, 150mA, +CE	USP-6C	49hu	VR4	9a	Tor
23A	XC6216BA12ER	LVR-IC	10.1V±2%, 150mA, +CE	USP-6C	49hu	VR4	9a	Tor
23B	XC6216BA22ER	LVR-IC	10.2V±2%, 150mA, +CE	USP-6C	49hu	VR4	9a	Tor
23C	XC6216BA32ER	LVR-IC	10.3V±2%, 150mA, +CE	USP-6C	49hu	VR4	9a	Tor
23D	XC6216BA42ER	LVR-IC	10.4V±2%, 150mA, +CE	USP-6C	49hu	VR4	9a	Tor
23E	XC6216BA52ER	LVR-IC	10.5V±2%, 150mA, +CE	USP-6C	49hu	VR4	9a	Tor
23F	XC6216BA62ER	LVR-IC	10.6V±2%, 150mA, +CE	USP-6C	49hu	VR4	9a	Tor
23H	XC6216BA72ER	LVR-IC	10.7V±2%, 150mA, +CE	USP-6C	49hu	VR4	9a	Tor
23K	XC6216BA82ER	LVR-IC	10.8V±2%, 150mA, +CE	USP-6C	49hu	VR4	9a	Tor
23L	XC6216BA92ER	LVR-IC	10.9V±2%, 150mA, +CE	USP-6C	49hu	VR4	9a	Tor
23M	XC6216BB02ER	LVR-IC	11.0V±2%, 150mA, +CE	USP-6C	49hu	VR4	9a	Tor
23N	XC6216BB12ER	LVR-IC	11.1V±2%, 150mA, +CE	USP-6C	49hu	VR4	9a	Tor
23P	XC6216BB22ER	LVR-IC	11.2V±2%, 150mA, +CE	USP-6C	49hu	VR4	9a	Tor
23R	XC6216BB32ER	LVR-IC	11.3V±2%, 150mA, +CE	USP-6C	49hu	VR4	9a	Tor
23S	XC6216BB42ER	LVR-IC	11.4V±2%, 150mA, +CE	USP-6C	49hu	VR4	9a	Tor
23T	XC6216BB52ER	LVR-IC	11.5V±2%, 150mA, +CE	USP-6C	49hu	VR4	9a	Tor
23U	XC6216BB62ER	LVR-IC	11.6V±2%, 150mA, +CE	USP-6C	49hu	VR4	9a	Tor
23V	XC6216BB72ER	LVR-IC	11.7V±2%, 150mA, +CE	USP-6C	49hu	VR4	9a	Tor
23X	XC6216BB82ER	LVR-IC	11.8V±2%, 150mA, +CE	USP-6C	49hu	VR4	9a	Tor
23Y	XC6216BB92ER	LVR-IC	11.9V±2%, 150mA, +CE	USP-6C	49hu	VR4	9a	Tor
23Z	XC6216BC02ER	LVR-IC	12.0V±2%, 150mA, +CE	USP-6C	49hu	VR4	9a	Tor
24	RP110L291B	LVR-IC	LDO, 2.9V±1%, 150mA, +CE	DFN1010-4	48vm	VR4	9a	Ric
24	XC6217C3527R-G	LVR-IC	LDO, 3.5V±2%, 200mA, +CE	USPN-4	58vm	VR4	9a	Tor
24	XC6223C1419R-G	LVR-IC	LDO, 1.4V±20mV, 300mA, +CE, PDR	USPQ-4B03	48vm	VR4	9a	Tor
24	XC6224B1217R	LVR-IC	LDO, 1.2V±20mV, 150mA, +CE, PDR	USPN-4B02	58vm	VR4	9e	Tor
24	XC6229H1411R-G	LVR-IC	LDO, 1.4V±20mV, 300mA, +CE, ICP	BGA-4	63ba*	VR4	9a	Tor
24	XC6420AB247R-G	LVR-IC	LDO, Dual out, Vout1/Vout2=2.50/3.00V±2%, 150mA, +CE	USPN-6	52xv	VR19	9a	Tor
24	XC6420AB24DR-G	LVR-IC	LDO, Dual out, Vout1/Vout2=2.50/3.00V±2%, 150mA, +CE	USP-6B04	73x4	VR19	9a	Tor
24	XC6222C12B7R	LVR-IC	LDO, 1.25V±20mV, 200mA, +CE, PDR	USPN-4	58vm	VR4	9a	Tor
24A2	MAS9124A2CA11	LVR-IC	LDO, 2.8V, 150mA, +CE	WLCSP-5	64be*	VR7	9c	Mas
24A4	MAS9124A4CA11	LVR-IC	LDO, 1.8V, 150mA, +CE	WLCSP-5	64be*	VR7	9c	Mas
24A6	MAS9124A6CA11	LVR-IC	LDO, 3V, 150mA, +CE	WLCSP-5	64be*	VR7	9c	Mas
24A8	MAS9124A8CA11	LVR-IC	LDO, 2.86V, 150mA, +CE	WLCSP-5	64be*	VR7	9c	Mas
24AC	MAS9124ACCA11	LVR-IC	LDO, 2.6V, 150mA, +CE	WLCSP-5	64be*	VR7	9c	Mas
24Z2	MAS9124A2CA12	LVR-IC	LDO, 2.8V, 150mA, +CE	WLCSP-5	64bh*	VR7	9c	Mas
24Z8	MAS9124A8CA12	LVR-IC	LDO, 2.86V, 150mA, +CE	WLCSP-5	64bh*	VR7	9c	Mas
24Z9	MAS9124A9CA12	LVR-IC	LDO, 2.7V, 150mA, +CE	WLCSP-5	64bh*	VR7	9c	Mas
24ZF	MAS9124AFCA12	LVR-IC	LDO, 4V, 150mA, +CE	WLCSP-5	64bh*	VR7	9c	Mas
24ZG	MAS9124AGCA12	LVR-IC	LDO, 5V, 150mA, +CE	WLCSP-5	64bh*	VR7	9c	Mas
25	RP110L301B	LVR-IC	LDO, 3.0V±1%, 150mA, +CE	DFN1010-4	48vm	VR4	9a	Ric
25	XC6217C3627R-G	LVR-IC	LDO, 3.6V±2%, 200mA, +CE	USPN-4	58vm	VR4	9a	Tor
25	XC6223C1519R-G	LVR-IC	LDO, 1.5V±20mV, 300mA, +CE, PDR	USPQ-4B03	48vm	VR4	9a	Tor
25	XC6224B1317R	LVR-IC	LDO, 1.3V±1.5%, 150mA, +CE, PDR	USPN-4B02	58vm	VR4	9e	Tor
25	XC6229H14B1R-G	LVR-IC	LDO, 1.45V±20mV, 300mA, +CE, ICP	BGA-4	63ba*	VR4	9a	Tor
25	XC6420AB257R-G	LVR-IC	LDO, Dual out, Vout1/Vout2=2.50/3.30V±2%, 150mA, +CE	USPN-6	52xv	VR19	9a	Tor
25	XC6420AB25DR-G	LVR-IC	LDO, Dual out, Vout1/Vout2=2.50/3.30V±2%, 150mA, +CE	USP-6B04	73x4	VR19	9a	Tor
25	XC6222C13B7R	LVR-IC	LDO, 1.35V±20mV, 200mA, +CE, PDR	USPN-4	58vm	VR4	9a	Tor
26	RP110L311B	LVR-IC	LDO, 3.1V±1%, 150mA, +CE	DFN1010-4	48vm	VR4	9a	Ric
26	XC6217C3727R-G	LVR-IC	LDO, 3.7V±2%, 200mA, +CE	USPN-4	58vm	VR4	9a	Tor
26	XC6223C1619R-G	LVR-IC	LDO, 1.6V±20mV, 300mA, +CE, PDR	USPQ-4B03	48vm	VR4	9a	Tor
26	XC6224B1417R	LVR-IC	LDO, 1.4V±1.5%, 150mA, +CE, PDR	USPN-4B02	58vm	VR4	9e	Tor
26	XC6229H1511R-G	LVR-IC	LDO, 1.5V±20mV, 300mA, +CE, ICP	BGA-4	63ba*	VR4	9a	Tor
26	XC6420AB267R-G	LVR-IC	LDO, Dual out, Vout1/Vout2=2.85/3.00V±2%, 150mA, +CE	USPN-6	52xv	VR19	9a	Tor
26	XC6420AB26DR-G	LVR-IC	LDO, Dual out, Vout1/Vout2=2.85/3.00V±2%, 150mA, +CE	USP-6B04	73x4	VR19	9a	Tor
26	XC6222C14B7R	LVR-IC	LDO, 1.45V±20mV, 200mA, +CE, PDR	USPN-4	58vm	VR4	9a	Tor
27	RP110L321B	LVR-IC	LDO, 3.2V±1%, 150mA, +CE	DFN1010-4	48vm	VR4	9a	Ric



SMD code	Type	Function	Short description	Case	Pinout	Sch.	St.	Mnf.
27	XC6217C3827R-G	LVR-IC	LDO, 3.8V±2%, 200mA, +CE	USPN-4	58vm	VR4	9a	Tor
27	XC6223C1719R-G	LVR-IC	LDO, 1.7V±20mV, 300mA, +CE, PDR	USPQ-4B03	48vm	VR4	9a	Tor
27	XC6224B1517R	LVR-IC	LDO, 1.5V±1.5%, 150mA, +CE, PDR	USPN-4B02	58vm	VR4	9e	Tor
27	XC6229H15B1R-G	LVR-IC	LDO, 1.55V±20mV, 300mA, +CE, ICP	BGA-4	63ba*	VR4	9a	Tor
27	XC6420AB277R-G	LVR-IC	LDO, Dual out, Vout1/Vout2=2.85/3.30V±2%, 150mA, +CE	USPN-6	52xv	VR19	9a	Tor
27	XC6420AB27DR-G	LVR-IC	LDO, Dual out, Vout1/Vout2=2.85/3.30V±2%, 150mA, +CE	USP-6B04	73x4	VR19	9a	Tor
27	XC6221C15B7R	LVR-IC	LDO, 1.55V±20mV, 200mA, +CE, PDR	USPN-4	58vm	VR4	9a	Tor
28	RP110L331B	LVR-IC	LDO, 3.3V±1%, 150mA, +CE	DFN1010-4	48vm	VR4	9a	Ric
28	XC6217C3927R-G	LVR-IC	LDO, 3.9V±2%, 200mA, +CE	USPN-4	58vm	VR4	9a	Tor
28	XC6223C1819R-G	LVR-IC	LDO, 1.8V±20mV, 300mA, +CE, PDR	USPQ-4B03	48vm	VR4	9a	Tor
28	XC6224B1617R	LVR-IC	LDO, 1.6V±1.5%, 150mA, +CE, PDR	USPN-4B02	58vm	VR4	9e	Tor
28	XC6229H1611R-G	LVR-IC	LDO, 1.65V±20mV, 300mA, +CE, ICP	BGA-4	63ba*	VR4	9a	Tor
28	XC6420AB287R-G	LVR-IC	LDO, Dual out, Vout1/Vout2=3.00/3.00V±2%, 150mA, +CE	USPN-6	52xv	VR19	9a	Tor
28	XC6420AB28DR-G	LVR-IC	LDO, Dual out, Vout1/Vout2=3.00/3.00V±2%, 150mA, +CE	USP-6B04	73x4	VR19	9a	Tor
28	XC6221C16B7R	LVR-IC	LDO, 1.65V±20mV, 200mA, +CE, PDR	USPN-4	58vm	VR4	9a	Tor
2811A	NCP2811AFC	LIN-IC	AF PA, 2.7.5V, 2x27mW(5V/32Q), shutdown	BGA-12	39	-	9e	Ons
2811A	NCP2811AMT	LIN-IC	AF PA, 2.2.5.5V, 2x27mW(5V/32Q), shutdown	QFN-12	38	-	-	Ons
2811B	NCP2811BFC	LIN-IC	AF PA, 2.7.5V, 2x27mW(5V/32Q), shutdown	BGA-12	39	-	9e	Ons
2811B	NCP2811BMT	LIN-IC	AF PA, 2.2.5.5V, 2x27mW(5V/32Q), shutdown	QFN-12	38	-	-	Ons
29	LEE-29+	MMIC	RF amplifier, DC, 8GHz, 13.3dB (50Q)	FG873	36aa	A1	9b	Mc
29	RP110L341B	LVR-IC	LDO, 3.4V±1%, 150mA, +CE	DFN1010-4	48vm	VR4	9a	Ric
29	XC6217C4027R-G	LVR-IC	LDO, 4V±2%, 200mA, +CE	USPN-4	58vm	VR4	9a	Tor
29	XC6223C1919R-G	LVR-IC	LDO, 1.9V±20mV, 300mA, +CE, PDR	USPQ-4B03	48vm	VR4	9a	Tor
29	XC6224B1717R	LVR-IC	LDO, 1.7V±1.5%, 150mA, +CE, PDR	USPN-4B02	58vm	VR4	9e	Tor
29	XC6229H16B1R-G	LVR-IC	LDO, 1.65V±20mV, 300mA, +CE, ICP	BGA-4	63ba*	VR4	9a	Tor
29	XC6420AB297R-G	LVR-IC	LDO, Dual out, Vout1/Vout2=1.20/1.80V±2%, 150mA, +CE	USPN-6	52xv	VR19	9a	Tor
29	XC6420AB29DR-G	LVR-IC	LDO, Dual out, Vout1/Vout2=1.20/1.80V±2%, 150mA, +CE	USP-6B04	73x4	VR19	9a	Tor
29	XC6221C17B7R	LVR-IC	LDO, 1.75V±20mV, 200mA, +CE, PDR	USPN-4	58vm	VR4	9a	Tor
2990	AUD2990CS09	LIN-IC	AF PA, BTL, 2.7.5.5V, 2W(5V/4Q), select shutdown	BGA-9	39	-	-	Axp
2A	R3117K311A	Vdel-IC	3.1V±1%, -Reset ODO, Sense	DFN1010-4	48rq	VD11	9a	Ric
2A	RP100K121D	LVR-IC	LDO, LN, +CE, CL, 1.2V±0.8%, 200mA	PLP1612-4	45vm	VR4	9a	Ric
2A	XC6223C2019R-G	LVR-IC	LDO, 2.0V±1%, 300mA, +CE, PDR	USPQ-4B03	48vm	VR4	9a	Tor
2A	XC6224B1817R	LVR-IC	LDO, 1.8V±1.5%, 150mA, +CE, PDR	USPN-4B02	58vm	VR4	9e	Tor
2A	XC6229H1711R-G	LVR-IC	LDO, 1.7V±20mV, 300mA, +CE, ICP	BGA-4	63ba*	VR4	9a	Tor
2A	XC6221C18B7R	LVR-IC	LDO, 1.85V±20mV, 200mA, +CE, PDR	USPN-4	58vm	VR4	9a	Tor
2A151	XC6365A151ER	DC/DC-IC	PWM st-down, 100kHz, 1.5V±2.5%, 1A, +CE	USP-6C	49zo	DC7	9b	Tor
2A152	XC6365A152ER	DC/DC-IC	PWM st-down, 180kHz, 1.5V±2.5%, 1A, +CE	USP-6C	49zo	DC7	9b	Tor
2A153	XC6365A153ER	DC/DC-IC	PWM st-down, 300kHz, 1.5V±2.5%, 1A, +CE	USP-6C	49zo	DC7	9b	Tor
2A155	XC6365A155ER	DC/DC-IC	PWM st-down, 500kHz, 1.5V±2.5%, 1A, +CE	USP-6C	49zo	DC7	9b	Tor
2A161	XC6365A161ER	DC/DC-IC	PWM st-down, 100kHz, 1.6V±2.5%, 1A, +CE	USP-6C	49zo	DC7	9b	Tor
2A162	XC6365A162ER	DC/DC-IC	PWM st-down, 180kHz, 1.6V±2.5%, 1A, +CE	USP-6C	49zo	DC7	9b	Tor
2A163	XC6365A163ER	DC/DC-IC	PWM st-down, 300kHz, 1.6V±2.5%, 1A, +CE	USP-6C	49zo	DC7	9b	Tor
2A165	XC6365A165ER	DC/DC-IC	PWM st-down, 500kHz, 1.6V±2.5%, 1A, +CE	USP-6C	49zo	DC7	9b	Tor
2A171	XC6365A171ER	DC/DC-IC	PWM st-down, 100kHz, 1.7V±2.5%, 1A, +CE	USP-6C	49zo	DC7	9b	Tor
2A172	XC6365A172ER	DC/DC-IC	PWM st-down, 180kHz, 1.7V±2.5%, 1A, +CE	USP-6C	49zo	DC7	9b	Tor
2A173	XC6365A173ER	DC/DC-IC	PWM st-down, 300kHz, 1.7V±2.5%, 1A, +CE	USP-6C	49zo	DC7	9b	Tor
2A175	XC6365A175ER	DC/DC-IC	PWM st-down, 500kHz, 1.7V±2.5%, 1A, +CE	USP-6C	49zo	DC7	9b	Tor
2A181	XC6365A181ER	DC/DC-IC	PWM st-down, 100kHz, 1.8V±2.5%, 1A, +CE	USP-6C	49zo	DC7	9b	Tor
2A182	XC6365A182ER	DC/DC-IC	PWM st-down, 180kHz, 1.8V±2.5%, 1A, +CE	USP-6C	49zo	DC7	9b	Tor
2A183	XC6365A183ER	DC/DC-IC	PWM st-down, 300kHz, 1.8V±2.5%, 1A, +CE	USP-6C	49zo	DC7	9b	Tor
2A185	XC6365A185ER	DC/DC-IC	PWM st-down, 500kHz, 1.8V±2.5%, 1A, +CE	USP-6C	49zo	DC7	9b	Tor
2A191	XC6365A191ER	DC/DC-IC	PWM st-down, 100kHz, 1.9V±2.5%, 1A, +CE	USP-6C	49zo	DC7	9b	Tor
2A192	XC6365A192ER	DC/DC-IC	PWM st-down, 180kHz, 1.9V±2.5%, 1A, +CE	USP-6C	49zo	DC7	9b	Tor
2A193	XC6365A193ER	DC/DC-IC	PWM st-down, 300kHz, 1.9V±2.5%, 1A, +CE	USP-6C	49zo	DC7	9b	Tor
2A195	XC6365A195ER	DC/DC-IC	PWM st-down, 500kHz, 1.9V±2.5%, 1A, +CE	USP-6C	49zo	DC7	9b	Tor
2A200	XC6372A200D	DC/DC-IC	PWM/PFM step-up, 50kHz, 2.0V±2.5%, 100mA	USP-6B	49ga	DC2	9b	Tor
2A201	XC6365A201ER	DC/DC-IC	PWM st-down, 100kHz, 2.0V±2.5%, 1A, +CE	USP-6C	49zo	DC7	9b	Tor
2A201	XC6372A201D	DC/DC-IC	PWM/PFM step-up, 100kHz, 2.0V±2.5%, 100mA	USP-6B	49ga	DC2	9b	Tor
2A202	XC6365A202ER	DC/DC-IC	PWM st-down, 180kHz, 2.0V±2.5%, 1A, +CE	USP-6C	49zo	DC7	9b	Tor
2A202	XC6372A202D	DC/DC-IC	PWM/PFM step-up, 180kHz, 2.0V±2.5%, 100mA	USP-6B	49ga	DC2	9b	Tor
2A203	XC6365A203ER	DC/DC-IC	PWM st-down, 300kHz, 2.0V±2.5%, 1A, +CE	USP-6C	49zo	DC7	9b	Tor
2A205	XC6365A205ER	DC/DC-IC	PWM st-down, 500kHz, 2.0V±2.5%, 1A, +CE	USP-6C	49zo	DC7	9b	Tor
2A210	XC6372A210D	DC/DC-IC	PWM/PFM step-up, 50kHz, 2.1V±2.5%, 100mA	USP-6B	49ga	DC2	9b	Tor
2A211	XC6365A211ER	DC/DC-IC	PWM st-down, 100kHz, 2.1V±2.5%, 1A, +CE	USP-6C	49zo	DC7	9b	Tor
2A211	XC6372A211D	DC/DC-IC	PWM/PFM step-up, 100kHz, 2.1V±2.5%, 100mA	USP-6B	49ga	DC2	9b	Tor
2A212	XC6365A212ER	DC/DC-IC	PWM st-down, 180kHz, 2.1V±2.5%, 1A, +CE	USP-6C	49zo	DC7	9b	Tor
2A212	XC6372A212D	DC/DC-IC	PWM/PFM step-up, 180kHz, 2.1V±2.5%, 100mA	USP-6B	49ga	DC2	9b	Tor
2A213	XC6365A213ER	DC/DC-IC	PWM st-down, 300kHz, 2.1V±2.5%, 1A, +CE	USP-6C	49zo	DC7	9b	Tor
2A215	XC6365A215ER	DC/DC-IC	PWM st-down, 500kHz, 2.1V±2.5%, 1A, +CE	USP-6C	49zo	DC7	9b	Tor
2A220	XC6372A220D	DC/DC-IC	PWM/PFM step-up, 50kHz, 2.2V±2.5%, 100mA	USP-6B	49ga	DC2	9b	Tor



SMD code	Type	Function	Short description	Case	Pinout	Sch.	St.	Mnf.
2A632	XC6372A632D	DC/DC-IC	PWM/PFM step-up, 180kHz, 6.3V±2.5%, 100mA	USP-6B	49ga	DC2	9b	Tor
2A640	XC6372A640D	DC/DC-IC	PWM/PFM step-up, 50kHz, 6.4V±2.5%, 100mA	USP-6B	49ga	DC2	9b	Tor
2A641	XC6372A641D	DC/DC-IC	PWM/PFM step-up, 100kHz, 6.4V±2.5%, 100mA	USP-6B	49ga	DC2	9b	Tor
2A642	XC6372A642D	DC/DC-IC	PWM/PFM step-up, 180kHz, 6.4V±2.5%, 100mA	USP-6B	49ga	DC2	9b	Tor
2A650	XC6372A650D	DC/DC-IC	PWM/PFM step-up, 50kHz, 6.5V±2.5%, 100mA	USP-6B	49ga	DC2	9b	Tor
2A651	XC6372A651D	DC/DC-IC	PWM/PFM step-up, 100kHz, 6.5V±2.5%, 100mA	USP-6B	49ga	DC2	9b	Tor
2A652	XC6372A652D	DC/DC-IC	PWM/PFM step-up, 180kHz, 6.5V±2.5%, 100mA	USP-6B	49ga	DC2	9b	Tor
2A660	XC6372A660D	DC/DC-IC	PWM/PFM step-up, 50kHz, 6.6V±2.5%, 100mA	USP-6B	49ga	DC2	9b	Tor
2A661	XC6372A661D	DC/DC-IC	PWM/PFM step-up, 100kHz, 6.6V±2.5%, 100mA	USP-6B	49ga	DC2	9b	Tor
2A662	XC6372A662D	DC/DC-IC	PWM/PFM step-up, 180kHz, 6.6V±2.5%, 100mA	USP-6B	49ga	DC2	9b	Tor
2A670	XC6372A670D	DC/DC-IC	PWM/PFM step-up, 50kHz, 6.7V±2.5%, 100mA	USP-6B	49ga	DC2	9b	Tor
2A671	XC6372A671D	DC/DC-IC	PWM/PFM step-up, 100kHz, 6.7V±2.5%, 100mA	USP-6B	49ga	DC2	9b	Tor
2A672	XC6372A672D	DC/DC-IC	PWM/PFM step-up, 180kHz, 6.7V±2.5%, 100mA	USP-6B	49ga	DC2	9b	Tor
2A680	XC6372A680D	DC/DC-IC	PWM/PFM step-up, 50kHz, 6.8V±2.5%, 100mA	USP-6B	49ga	DC2	9b	Tor
2A681	XC6372A681D	DC/DC-IC	PWM/PFM step-up, 100kHz, 6.8V±2.5%, 100mA	USP-6B	49ga	DC2	9b	Tor
2A682	XC6372A682D	DC/DC-IC	PWM/PFM step-up, 180kHz, 6.8V±2.5%, 100mA	USP-6B	49ga	DC2	9b	Tor
2A690	XC6372A690D	DC/DC-IC	PWM/PFM step-up, 50kHz, 6.9V±2.5%, 100mA	USP-6B	49ga	DC2	9b	Tor
2A691	XC6372A691D	DC/DC-IC	PWM/PFM step-up, 100kHz, 6.9V±2.5%, 100mA	USP-6B	49ga	DC2	9b	Tor
2A692	XC6372A692D	DC/DC-IC	PWM/PFM step-up, 180kHz, 6.9V±2.5%, 100mA	USP-6B	49ga	DC2	9b	Tor
2A700	XC6372A700D	DC/DC-IC	PWM/PFM step-up, 50kHz, 7.0V±2.5%, 100mA	USP-6B	49ga	DC2	9b	Tor
2A701	XC6372A701D	DC/DC-IC	PWM/PFM step-up, 100kHz, 7.0V±2.5%, 100mA	USP-6B	49ga	DC2	9b	Tor
2A702	XC6372A702D	DC/DC-IC	PWM/PFM step-up, 180kHz, 7.0V±2.5%, 100mA	USP-6B	49ga	DC2	9b	Tor
2A8	XC9235F08CER	DC-DC-IC	PWM, st-dwn, 0.8V±2%, 600mA, 1.2MHz, Vin>1.8V, HSST, CL	USP-6C	49da	DC16	9a	Tor
2A9	XC9235F09CER	DC-DC-IC	PWM, st-dwn, 0.9V±2%, 600mA, 1.2MHz, Vin>1.8V, HSST, CL	USP-6C	49da	DC16	9a	Tor
2AA03	XC6403AA03D	LVRVdet-IC	LDO, 1.6V±2%, 300mA, Vdi=1.8V, -Reset ODO, +CE, PDR	USP-6B	49zx	VR15	9b	Tor
2AA07	XC6403AA07D	LVRVdet-IC	LDO, 1.8V±2%, 300mA, Vdi=2.9V, -Reset ODO, +CE, PDR	USP-6B	49zx	VR15	9b	Tor
2AA11	XC6403AA11D	LVRVdet-IC	LDO, 1.8V±2%, 300mA, Vdi=1.7V, -Reset ODO, +CE, PDR	USP-6B	49zx	VR15	9b	Tor
2AA12	XC6403AA12D	LVRVdet-IC	LDO, 3.0V±2%, 300mA, Vdi=4.2V, -Reset ODO, +CE, PDR	USP-6B	49zx	VR15	9b	Tor
2AA14	XC6403AA14D	LVRVdet-IC	LDO, 1.8V±2%, 300mA, Vdi=3.0V, -Reset ODO, +CE, PDR	USP-6B	49zx	VR15	9b	Tor
2AA16	XC6403AA16D	LVRVdet-IC	LDO, 2.5V±2%, 300mA, Vdi=2.9V, -Reset ODO, +CE, PDR	USP-6B	49zx	VR15	9b	Tor
2AA17	XC6403AA17D	LVRVdet-IC	LDO, 1.8V±2%, 300mA, Vdi=2.3V, -Reset ODO, +CE, PDR	USP-6B	49zx	VR15	9b	Tor
2AA18	XC6403AA18D	LVRVdet-IC	LDO, 2.8V±2%, 300mA, Vdi=3.4V, -Reset ODO, +CE, PDR	USP-6B	49zx	VR15	9b	Tor
2AA20	XC6403AA20D	LVRVdet-IC	LDO, 3.3V±2%, 300mA, Vdi=3.0V, -Reset ODO, +CE, PDR	USP-6B	49zx	VR15	9b	Tor
2AA21	XC6403AA21D	LVRVdet-IC	LDO, 3.3V±2%, 300mA, Vdi=3.1V, -Reset ODO, +CE, PDR	USP-6B	49zx	VR15	9b	Tor
2AA24	XC6403AA24D	LVRVdet-IC	LDO, 1.8V±2%, 300mA, Vdi=2.4V, -Reset ODO, +CE, PDR	USP-6B	49zx	VR15	9b	Tor
2AA25	XC6403AA25D	LVRVdet-IC	LDO, 3.2V±2%, 300mA, Vdi=2.8V, -Reset ODO, +CE, PDR	USP-6B	49zx	VR15	9b	Tor
2AA30	XC6403AA30D	LVRVdet-IC	LDO, 4.0V±2%, 300mA, Vdi=4.3V, -Reset ODO, +CE, PDR	USP-6B	49zx	VR15	9b	Tor
2AA31	XC6403AA31D	LVRVdet-IC	LDO, 2.85V±2%, 300mA, Vdi=2.7V, -Reset ODO, +CE, PDR	USP-6B	49zx	VR15	9b	Tor
2AA32	XC6403AA32D	LVRVdet-IC	LDO, 2.6V±2%, 300mA, Vdi=2.4V, -Reset ODO, +CE, PDR	USP-6B	49zx	VR15	9b	Tor
2AA33	XC6403AA33D	LVRVdet-IC	LDO, 2.7V±2%, 300mA, Vdi=2.8V, -Reset ODO, +CE, PDR	USP-6B	49zx	VR15	9b	Tor
2AA34	XC6403AA34D	LVRVdet-IC	LDO, 2.85V±2%, 300mA, Vdi=2.55V, -Reset ODO, +CE, PDR	USP-6B	49zx	VR15	9b	Tor
2AA80	XC6403AA80D	LVRVdet-IC	LDO, 1.8V±2%, 300mA, Vdi=1.6V, -Reset ODO, +CE, PDR	USP-6B	49zx	VR15	9b	Tor
2AA81	XC6403AA81D	LVRVdet-IC	LDO, 2.8V±2%, 300mA, Vdi=3.1V, -Reset ODO, +CE, PDR	USP-6B	49zx	VR15	9b	Tor
2AA82	XC6403AA82D	LVRVdet-IC	LDO, 1.8V±2%, 300mA, Vdi=2.0V, -Reset ODO, +CE, PDR	USP-6B	49zx	VR15	9b	Tor
2AA83	XC6403AA83D	LVRVdet-IC	LDO, 2.5V±2%, 300mA, Vdi=2.8V, -Reset ODO, +CE, PDR	USP-6B	49zx	VR15	9b	Tor
2AA84	XC6403AA84D	LVRVdet-IC	LDO, 2.85V±2%, 300mA, Vdi=3.2V, -Reset ODO, +CE, PDR	USP-6B	49zx	VR15	9b	Tor
2AA85	XC6403AA85D	LVRVdet-IC	LDO, 3.0V±2%, 300mA, Vdi=3.3V, -Reset ODO, +CE, PDR	USP-6B	49zx	VR15	9b	Tor
2AA86	XC6403AA86D	LVRVdet-IC	LDO, 3.5V±2%, 300mA, Vdi=3.8V, -Reset ODO, +CE, PDR	USP-6B	49zx	VR15	9b	Tor
2AA87	XC6403AA87D	LVRVdet-IC	LDO, 3.0V±2%, 300mA, Vdi= 4.2V, -Reset ODO, +CE, PDR	USP-6B	49zx	VR15	9b	Tor
2AA88	XC6403AA88D	LVRVdet-IC	LDO, 3.3V±2%, 300mA, Vdi= 4.0V, -Reset ODO, +CE, PDR	USP-6B	49zx	VR15	9b	Tor
2AB03	XC6403AB03D	LVRVdet-IC	LDO, 1.6V±2%, 300mA, Vdi=1.8V, +Reset ODO, +CE, PDR	USP-6B	49zx	VR15	9b	Tor
2AB07	XC6403AB07D	LVRVdet-IC	LDO, 1.8V±2%, 300mA, Vdi=2.9V, +Reset ODO, +CE, PDR	USP-6B	49zx	VR15	9b	Tor
2AB11	XC6403AB11D	LVRVdet-IC	LDO, 1.8V±2%, 300mA, Vdi=1.7V, +Reset ODO, +CE, PDR	USP-6B	49zx	VR15	9b	Tor
2AB12	XC6403AB12D	LVRVdet-IC	LDO, 3.0V±2%, 300mA, Vdi=4.2V, +Reset ODO, +CE, PDR	USP-6B	49zx	VR15	9b	Tor
2AB14	XC6403AB14D	LVRVdet-IC	LDO, 1.8V±2%, 300mA, Vdi=3.0V, +Reset ODO, +CE, PDR	USP-6B	49zx	VR15	9b	Tor
2AB16	XC6403AB16D	LVRVdet-IC	LDO, 2.5V±2%, 300mA, Vdi=2.9V, +Reset ODO, +CE, PDR	USP-6B	49zx	VR15	9b	Tor
2AB17	XC6403AB17D	LVRVdet-IC	LDO, 1.8V±2%, 300mA, Vdi=2.3V, +Reset ODO, +CE, PDR	USP-6B	49zx	VR15	9b	Tor
2AB18	XC6403AB18D	LVRVdet-IC	LDO, 2.8V±2%, 300mA, Vdi=3.4V, +Reset ODO, +CE, PDR	USP-6B	49zx	VR15	9b	Tor
2AB20	XC6403AB20D	LVRVdet-IC	LDO, 3.3V±2%, 300mA, Vdi=3.0V, +Reset ODO, +CE, PDR	USP-6B	49zx	VR15	9b	Tor
2AB21	XC6403AB21D	LVRVdet-IC	LDO, 3.3V±2%, 300mA, Vdi=3.1V, +Reset ODO, +CE, PDR	USP-6B	49zx	VR15	9b	Tor
2AB24	XC6403AB24D	LVRVdet-IC	LDO, 1.8V±2%, 300mA, Vdi=2.4V, +Reset ODO, +CE, PDR	USP-6B	49zx	VR15	9b	Tor
2AB25	XC6403AB25D	LVRVdet-IC	LDO, 3.2V±2%, 300mA, Vdi=2.8V, +Reset ODO, +CE, PDR	USP-6B	49zx	VR15	9b	Tor
2AB30	XC6403AB30D	LVRVdet-IC	LDO, 4.0V±2%, 300mA, Vdi=4.3V, +Reset ODO, +CE, PDR	USP-6B	49zx	VR15	9b	Tor
2AB31	XC6403AB31D	LVRVdet-IC	LDO, 2.85V±2%, 300mA, Vdi=2.7V, +Reset ODO, +CE, PDR	USP-6B	49zx	VR15	9b	Tor
2AB32	XC6403AB32D	LVRVdet-IC	LDO, 2.6V±2%, 300mA, Vdi=2.4V, +Reset ODO, +CE, PDR	USP-6B	49zx	VR15	9b	Tor
2AB33	XC6403AB33D	LVRVdet-IC	LDO, 2.7V±2%, 300mA, Vdi=2.8V, +Reset ODO, +CE, PDR	USP-6B	49zx	VR15	9b	Tor
2AB34	XC6403AB34D	LVRVdet-IC	LDO, 2.85V±2%, 300mA, Vdi=2.55V, +Reset ODO, +CE, PDR	USP-6B	49zx	VR15	9b	Tor
2AB80	XC6403AB80D	LVRVdet-IC	LDO, 1.8V±2%, 300mA, Vdi=1.6V, +Reset ODO, +CE, PDR	USP-6B	49zx	VR15	9b	Tor
2AB81	XC6403AB81D	LVRVdet-IC	LDO, 2.8V±2%, 300mA, Vdi=3.1V, +Reset ODO, +CE, PDR	USP-6B	49zx	VR15	9b	Tor
2AB82	XC6403AB82D	LVRVdet-IC	LDO, 1.8V±2%, 300mA, Vdi=2.0V, +Reset ODO, +CE, PDR	USP-6B	49zx	VR15	9b	Tor



SMD code	Type	Function	Short description	Case	Pinout	Sch.	St.	Mnf.
2AK14	XC6403AK14D	LVR/Vdet-IC	LDO, 1.8V±2%, 300mA, Vdo=3.0V, +Reset ODO, +CE	USP-6B	49zx	VR15	9b	Tor
2AK16	XC6403AK16D	LVR/Vdet-IC	LDO, 2.5V±2%, 300mA, Vdo=3.0V, +Reset ODO, +CE	USP-6B	49zx	VR15	9b	Tor
2AK17	XC6403AK17D	LVR/Vdet-IC	LDO, 1.8V±2%, 300mA, Vdo=2.3V, +Reset ODO, +CE	USP-6B	49zx	VR15	9b	Tor
2AK18	XC6403AK18D	LVR/Vdet-IC	LDO, 2.8V±2%, 300mA, Vdo=3.4V, +Reset ODO, +CE	USP-6B	49zx	VR15	9b	Tor
2AK20	XC6403AK20D	LVR/Vdet-IC	LDO, 3.3V±2%, 300mA, Vdo=3.0V, +Reset ODO, +CE	USP-6B	49zx	VR15	9b	Tor
2AK21	XC6403AK21D	LVR/Vdet-IC	LDO, 3.3V±2%, 300mA, Vdo=3.1V, +Reset ODO, +CE	USP-6B	49zx	VR15	9b	Tor
2AK24	XC6403AK24D	LVR/Vdet-IC	LDO, 1.8V±2%, 300mA, Vdo=2.4V, +Reset ODO, +CE	USP-6B	49zx	VR15	9b	Tor
2AK25	XC6403AK25D	LVR/Vdet-IC	LDO, 3.2V±2%, 300mA, Vdo=2.8V, +Reset ODO, +CE	USP-6B	49zx	VR15	9b	Tor
2AK30	XC6403AK30D	LVR/Vdet-IC	LDO, 4.0V±2%, 300mA, Vdo=4.3V, +Reset ODO, +CE	USP-6B	49zx	VR15	9b	Tor
2AK31	XC6403AK31D	LVR/Vdet-IC	LDO, 2.85V±2%, 300mA, Vdo=2.7V, +Reset ODO, +CE	USP-6B	49zx	VR15	9b	Tor
2AK32	XC6403AK32D	LVR/Vdet-IC	LDO, 2.6V±2%, 300mA, Vdo=2.4V, +Reset ODO, +CE	USP-6B	49zx	VR15	9b	Tor
2AK33	XC6403AK33D	LVR/Vdet-IC	LDO, 2.7V±2%, 300mA, Vdo=2.8V, +Reset ODO, +CE	USP-6B	49zx	VR15	9b	Tor
2AK34	XC6403AK34D	LVR/Vdet-IC	LDO, 2.85V±2%, 300mA, Vdo=2.55V, +Reset ODO, +CE	USP-6B	49zx	VR15	9b	Tor
2AK80	XC6403AK80D	LVR/Vdet-IC	LDO, 1.8V±2%, 300mA, Vdo=1.6V, +Reset ODO, +CE	USP-6B	49zx	VR15	9b	Tor
2AK81	XC6403AK81D	LVR/Vdet-IC	LDO, 2.8V±2%, 300mA, Vdo=3.1V, +Reset ODO, +CE	USP-6B	49zx	VR15	9b	Tor
2AK82	XC6403AK82D	LVR/Vdet-IC	LDO, 1.8V±2%, 300mA, Vdo=2.0V, +Reset ODO, +CE	USP-6B	49zx	VR15	9b	Tor
2AK83	XC6403AK83D	LVR/Vdet-IC	LDO, 2.5V±2%, 300mA, Vdo=2.8V, +Reset ODO, +CE	USP-6B	49zx	VR15	9b	Tor
2AK84	XC6403AK84D	LVR/Vdet-IC	LDO, 2.85V±2%, 300mA, Vdo=3.2V, +Reset ODO, +CE	USP-6B	49zx	VR15	9b	Tor
2AK85	XC6403AK85D	LVR/Vdet-IC	LDO, 3.0V±2%, 300mA, Vdo=3.1V, +Reset ODO, +CE	USP-6B	49zx	VR15	9b	Tor
2AK86	XC6403AK86D	LVR/Vdet-IC	LDO, 3.5V±2%, 300mA, Vdo=3.8V, +Reset ODO, +CE	USP-6B	49zx	VR15	9b	Tor
2AK87	XC6403AK87D	LVR/Vdet-IC	LDO, 3.0V±2%, 300mA, Vdo=4.2V, +Reset ODO, +CE	USP-6B	49zx	VR15	9b	Tor
2AK88	XC6403AK88D	LVR/Vdet-IC	LDO, 3.3V±2%, 300mA, Vdo=4.0V, +Reset ODO, +CE	USP-6B	49zx	VR15	9b	Tor
2AL	XC9235FOLCER	DC-DC-IC	PWM, st-dwn, 0.85V±2%, 600mA, 1.2MHz, Vin>1.8V, HSST, CL	USP-6C	49da	DC16	9a	Tor
2AL03	XC6403AL03D	LVR/Vdet-IC	LDO, 1.6V±2%, 300mA, Vdi=1.8V, -Reset ODO, -CE, PUR	USP-6B	49zx	VR15	9b	Tor
2AL07	XC6403AL07D	LVR/Vdet-IC	LDO, 1.8V±2%, 300mA, Vdi=2.9V, -Reset ODO, -CE, PUR	USP-6B	49zx	VR15	9b	Tor
2AL11	XC6403AL11D	LVR/Vdet-IC	LDO, 1.8V±2%, 300mA, Vdi=1.7V, -Reset ODO, -CE, PUR	USP-6B	49zx	VR15	9b	Tor
2AL12	XC6403AL12D	LVR/Vdet-IC	LDO, 3.0V±2%, 300mA, Vdi=4.2V, -Reset ODO, -CE, PUR	USP-6B	49zx	VR15	9b	Tor
2AL14	XC6403AL14D	LVR/Vdet-IC	LDO, 1.8V±2%, 300mA, Vdi=3.0V, -Reset ODO, -CE, PUR	USP-6B	49zx	VR15	9b	Tor
2AL16	XC6403AL16D	LVR/Vdet-IC	LDO, 2.5V±2%, 300mA, Vdi=2.9V, -Reset ODO, -CE, PUR	USP-6B	49zx	VR15	9b	Tor
2AL17	XC6403AL17D	LVR/Vdet-IC	LDO, 1.8V±2%, 300mA, Vdi=2.3V, -Reset ODO, -CE, PUR	USP-6B	49zx	VR15	9b	Tor
2AL18	XC6403AL18D	LVR/Vdet-IC	LDO, 2.8V±2%, 300mA, Vdi=3.4V, -Reset ODO, -CE, PUR	USP-6B	49zx	VR15	9b	Tor
2AL20	XC6403AL20D	LVR/Vdet-IC	LDO, 3.3V±2%, 300mA, Vdi=3.0V, -Reset ODO, -CE, PUR	USP-6B	49zx	VR15	9b	Tor
2AL21	XC6403AL21D	LVR/Vdet-IC	LDO, 3.3V±2%, 300mA, Vdi=3.1V, -Reset ODO, -CE, PUR	USP-6B	49zx	VR15	9b	Tor
2AL24	XC6403AL24D	LVR/Vdet-IC	LDO, 1.8V±2%, 300mA, Vdi=2.4V, -Reset ODO, -CE, PUR	USP-6B	49zx	VR15	9b	Tor
2AL25	XC6403AL25D	LVR/Vdet-IC	LDO, 3.2V±2%, 300mA, Vdi=2.8V, -Reset ODO, -CE, PUR	USP-6B	49zx	VR15	9b	Tor
2AL30	XC6403AL30D	LVR/Vdet-IC	LDO, 4.0V±2%, 300mA, Vdi=4.3V, -Reset ODO, -CE, PUR	USP-6B	49zx	VR15	9b	Tor
2AL31	XC6403AL31D	LVR/Vdet-IC	LDO, 2.85V±2%, 300mA, Vdi=2.7V, -Reset ODO, -CE, PUR	USP-6B	49zx	VR15	9b	Tor
2AL32	XC6403AL32D	LVR/Vdet-IC	LDO, 2.6V±2%, 300mA, Vdi=2.4V, -Reset ODO, -CE, PUR	USP-6B	49zx	VR15	9b	Tor
2AL33	XC6403AL33D	LVR/Vdet-IC	LDO, 2.7V±2%, 300mA, Vdi=2.8V, -Reset ODO, -CE, PUR	USP-6B	49zx	VR15	9b	Tor
2AL34	XC6403AL34D	LVR/Vdet-IC	LDO, 2.85V±2%, 300mA, Vdi=2.55V, -Reset ODO, -CE, PUR	USP-6B	49zx	VR15	9b	Tor
2AL80	XC6403AL80D	LVR/Vdet-IC	LDO, 1.8V±2%, 300mA, Vdi=1.6V, -Reset ODO, -CE, PUR	USP-6B	49zx	VR15	9b	Tor
2AL81	XC6403AL81D	LVR/Vdet-IC	LDO, 2.8V±2%, 300mA, Vdi=3.1V, -Reset ODO, -CE, PUR	USP-6B	49zx	VR15	9b	Tor
2AL82	XC6403AL82D	LVR/Vdet-IC	LDO, 1.8V±2%, 300mA, Vdi=2.0V, -Reset ODO, -CE, PUR	USP-6B	49zx	VR15	9b	Tor
2AL83	XC6403AL83D	LVR/Vdet-IC	LDO, 2.5V±2%, 300mA, Vdi=2.8V, -Reset ODO, -CE, PUR	USP-6B	49zx	VR15	9b	Tor
2AL84	XC6403AL84D	LVR/Vdet-IC	LDO, 2.85V±2%, 300mA, Vdi=3.2V, -Reset ODO, -CE, PUR	USP-6B	49zx	VR15	9b	Tor
2AL85	XC6403AL85D	LVR/Vdet-IC	LDO, 3.0V±2%, 300mA, Vdi=3.3V, -Reset ODO, -CE, PUR	USP-6B	49zx	VR15	9b	Tor
2AL86	XC6403AL86D	LVR/Vdet-IC	LDO, 3.5V±2%, 300mA, Vdi=3.8V, -Reset ODO, -CE, PUR	USP-6B	49zx	VR15	9b	Tor
2AL87	XC6403AL87D	LVR/Vdet-IC	LDO, 3.0V±2%, 300mA, Vdi=4.2V, -Reset ODO, -CE, PUR	USP-6B	49zx	VR15	9b	Tor
2AL88	XC6403AL88D	LVR/Vdet-IC	LDO, 3.3V±2%, 300mA, Vdi=4.0V, -Reset ODO, -CE, PUR	USP-6B	49zx	VR15	9b	Tor
2AM	XC9235F0MCER	DC-DC-IC	PWM, st-dwn, 0.95V±2%, 600mA, 1.2MHz, Vin>1.8V, HSST, CL	USP-6C	49da	DC16	9a	Tor
2AM03	XC6403AM03D	LVR/Vdet-IC	LDO, 1.6V±2%, 300mA, Vdi=1.8V, -Reset ODO, -CE, PUR	USP-6B	49zx	VR15	9b	Tor
2AM07	XC6403AM07D	LVR/Vdet-IC	LDO, 1.8V±2%, 300mA, Vdi=2.9V, -Reset ODO, -CE, PUR	USP-6B	49zx	VR15	9b	Tor
2AM11	XC6403AM11D	LVR/Vdet-IC	LDO, 1.8V±2%, 300mA, Vdi=1.7V, -Reset ODO, -CE, PUR	USP-6B	49zx	VR15	9b	Tor
2AM12	XC6403AM12D	LVR/Vdet-IC	LDO, 3.0V±2%, 300mA, Vdi=4.2V, -Reset ODO, -CE, PUR	USP-6B	49zx	VR15	9b	Tor
2AM14	XC6403AM14D	LVR/Vdet-IC	LDO, 1.8V±2%, 300mA, Vdi=3.0V, +Reset ODO, -CE, PUR	USP-6B	49zx	VR15	9b	Tor
2AM16	XC6403AM16D	LVR/Vdet-IC	LDO, 2.5V±2%, 300mA, Vdi=2.9V, -Reset ODO, -CE, PUR	USP-6B	49zx	VR15	9b	Tor
2AM17	XC6403AM17D	LVR/Vdet-IC	LDO, 1.8V±2%, 300mA, Vdi=2.3V, +Reset ODO, -CE, PUR	USP-6B	49zx	VR15	9b	Tor
2AM18	XC6403AM18D	LVR/Vdet-IC	LDO, 2.8V±2%, 300mA, Vdi=3.4V, +Reset ODO, -CE, PUR	USP-6B	49zx	VR15	9b	Tor
2AM20	XC6403AM20D	LVR/Vdet-IC	LDO, 3.3V±2%, 300mA, Vdi=3.0V, +Reset ODO, -CE, PUR	USP-6B	49zx	VR15	9b	Tor
2AM21	XC6403AM21D	LVR/Vdet-IC	LDO, 3.3V±2%, 300mA, Vdi=3.1V, +Reset ODO, -CE, PUR	USP-6B	49zx	VR15	9b	Tor
2AM24	XC6403AM24D	LVR/Vdet-IC	LDO, 1.8V±2%, 300mA, Vdi=2.4V, +Reset ODO, -CE, PUR	USP-6B	49zx	VR15	9b	Tor
2AM25	XC6403AM25D	LVR/Vdet-IC	LDO, 3.2V±2%, 300mA, Vdi=2.8V, +Reset ODO, -CE, PUR	USP-6B	49zx	VR15	9b	Tor
2AM30	XC6403AM30D	LVR/Vdet-IC	LDO, 4.0V±2%, 300mA, Vdi=4.3V, +Reset ODO, -CE, PUR	USP-6B	49zx	VR15	9b	Tor
2AM31	XC6403AM31D	LVR/Vdet-IC	LDO, 2.85V±2%, 300mA, Vdi=2.7V, +Reset ODO, -CE, PUR	USP-6B	49zx	VR15	9b	Tor
2AM32	XC6403AM32D	LVR/Vdet-IC	LDO, 2.6V±2%, 300mA, Vdi=2.4V, +Reset ODO, -CE, PUR	USP-6B	49zx	VR15	9b	Tor
2AM33	XC6403AM33D	LVR/Vdet-IC	LDO, 2.7V±2%, 300mA, Vdi=2.8V, +Reset ODO, -CE, PUR	USP-6B	49zx	VR15	9b	Tor
2AM34	XC6403AM34D	LVR/Vdet-IC	LDO, 2.85V±2%, 300mA, Vdi=2.55V, +Reset ODO, -CE, PUR	USP-6B	49zx	VR15	9b	Tor
2AM80	XC6403AM80D	LVR/Vdet-IC	LDO, 1.8V±2%, 300mA, Vdi=1.6V, +Reset ODO, -CE, PUR	USP-6B	49zx	VR15	9b	Tor
2AM81	XC6403AM81D	LVR/Vdet-IC	LDO, 2.8V±2%, 300mA, Vdi=3.1V, +Reset ODO, -CE, PUR	USP-6B	49zx	VR15	9b	Tor
2AM82	XC6403AM82D	LVR/Vdet-IC	LDO, 1.8V±2%, 300mA, Vdi=2.0V, +Reset ODO, -CE, PUR	USP-6B	49zx	VR15	9b	Tor



SMD code	Type	Function	Short description	Case	Pinout	Sch.	St.	Mnf.
2AU14	XC6403AU14D	LVR/Vdet-IC	LDO, 1.8V±2%, 300mA, Vdo=3.0V, +Reset ODO, -CE	USP-6B	49zx	VR15	9b	Tor
2AU16	XC6403AU16D	LVR/Vdet-IC	LDO, 2.5V±2%, 300mA, Vdo=3.0V, +Reset ODO, -CE	USP-6B	49zx	VR15	9b	Tor
2AU17	XC6403AU17D	LVR/Vdet-IC	LDO, 1.8V±2%, 300mA, Vdo=2.3V, +Reset ODO, -CE	USP-6B	49zx	VR15	9b	Tor
2AU18	XC6403AU18D	LVR/Vdet-IC	LDO, 2.8V±2%, 300mA, Vdo=3.4V, +Reset ODO, -CE	USP-6B	49zx	VR15	9b	Tor
2AU20	XC6403AU20D	LVR/Vdet-IC	LDO, 3.3V±2%, 300mA, Vdo=3.0V, +Reset ODO, -CE	USP-6B	49zx	VR15	9b	Tor
2AU21	XC6403AU21D	LVR/Vdet-IC	LDO, 3.3V±2%, 300mA, Vdo=3.1V, +Reset ODO, -CE	USP-6B	49zx	VR15	9b	Tor
2AU24	XC6403AU24D	LVR/Vdet-IC	LDO, 1.8V±2%, 300mA, Vdo=2.4V, +Reset ODO, -CE	USP-6B	49zx	VR15	9b	Tor
2AU25	XC6403AU25D	LVR/Vdet-IC	LDO, 3.2V±2%, 300mA, Vdo=2.8V, +Reset ODO, -CE	USP-6B	49zx	VR15	9b	Tor
2AU30	XC6403AU30D	LVR/Vdet-IC	LDO, 4.0V±2%, 300mA, Vdo=4.3V, +Reset ODO, -CE	USP-6B	49zx	VR15	9b	Tor
2AU31	XC6403AU31D	LVR/Vdet-IC	LDO, 2.85V±2%, 300mA, Vdo=2.7V, +Reset ODO, -CE	USP-6B	49zx	VR15	9b	Tor
2AU32	XC6403AU32D	LVR/Vdet-IC	LDO, 2.6V±2%, 300mA, Vdo=2.4V, +Reset ODO, -CE	USP-6B	49zx	VR15	9b	Tor
2AU33	XC6403AU33D	LVR/Vdet-IC	LDO, 2.7V±2%, 300mA, Vdo=2.8V, +Reset ODO, -CE	USP-6B	49zx	VR15	9b	Tor
2AU34	XC6403AU34D	LVR/Vdet-IC	LDO, 2.85V±2%, 300mA, Vdo=2.55V, +Reset ODO, -CE	USP-6B	49zx	VR15	9b	Tor
2AU80	XC6403AU80D	LVR/Vdet-IC	LDO, 1.8V±2%, 300mA, Vdo=1.6V, +Reset ODO, -CE	USP-6B	49zx	VR15	9b	Tor
2AU81	XC6403AU81D	LVR/Vdet-IC	LDO, 2.8V±2%, 300mA, Vdo=3.1V, +Reset ODO, -CE	USP-6B	49zx	VR15	9b	Tor
2AU82	XC6403AU82D	LVR/Vdet-IC	LDO, 1.8V±2%, 300mA, Vdo=2.0V, +Reset ODO, -CE	USP-6B	49zx	VR15	9b	Tor
2AU83	XC6403AU83D	LVR/Vdet-IC	LDO, 2.5V±2%, 300mA, Vdo=2.8V, +Reset ODO, -CE	USP-6B	49zx	VR15	9b	Tor
2AU84	XC6403AU84D	LVR/Vdet-IC	LDO, 2.85V±2%, 300mA, Vdo=3.2V, +Reset ODO, -CE	USP-6B	49zx	VR15	9b	Tor
2AU85	XC6403AU85D	LVR/Vdet-IC	LDO, 3.0V±2%, 300mA, Vdo=3.3V, +Reset ODO, -CE	USP-6B	49zx	VR15	9b	Tor
2AU86	XC6403AU86D	LVR/Vdet-IC	LDO, 3.5V±2%, 300mA, Vdo=3.8V, +Reset ODO, -CE	USP-6B	49zx	VR15	9b	Tor
2AU87	XC6403AU87D	LVR/Vdet-IC	LDO, 3.0V±2%, 300mA, Vdo=4.2V, +Reset ODO, -CE	USP-6B	49zx	VR15	9b	Tor
2AU88	XC6403AU88D	LVR/Vdet-IC	LDO, 3.3V±2%, 300mA, Vdo=4.0V, +Reset ODO, -CE	USP-6B	49zx	VR15	9b	Tor
2B	R3117K321A	Vdet-IC	3.2V±1%, -Reset ODO, Sense	DFM1010-4	48rq	VD11	9a	Ric
2B	RP100K131D	LVR-IC	LDO, LN, +CE, CL, 1.3V±0.8%, 200mA	PLP1612-4	45vm	VR4	9a	Ric
2B	XC6223C2119R-G	LVR-IC	LDO, 2.1V±1%, 300mA, +CE, PDR	USPQ-4B03	48vm	VR4	9a	Tor
2B	XC6224B1917R	LVR-IC	LDO, 1.9V±1.5%, 150mA, +CE, PDR	USPN-4B02	58vm	VR4	9e	Tor
2B	XC6229H17B1R-G	LVR-IC	LDO, 1.75V±20mV, 300mA, +CE, ICP	BGA-4	63ba*	VR4	9a	Tor
2B	XC6221C19B7R	LVR-IC	LDO, 1.95V±20mV, 200mA, +CE, PDR	USPN-4	58vm	VR4	9a	Tor
2B0	XC9235F10CER	DC-DC-IC	PWM, st-dwn, 1.0V±2%, 600mA, 1.2MHz, Vin>1.8V, HSST, CL	USP-6C	49da	DC16	9a	Tor
2B1	XC9235F11CER	DC-DC-IC	PWM, st-dwn, 1.1V±2%, 600mA, 1.2MHz, Vin>1.8V, HSST, CL	USP-6C	49da	DC16	9a	Tor
2B101	XC6365B101ER	DC/DC-IC	PWM st-down, 100kHz, Adj. 1.5..6V±2.5%, 1A, +CE	USP-6C	49zp	DC18	9b	Tor
2B102	XC6365B102ER	DC/DC-IC	PWM st-down, 180kHz, Adj. 1.5..6V±2.5%, 1A, +CE	USP-6C	49zp	DC18	9b	Tor
2B103	XC6365B103ER	DC/DC-IC	PWM st-down, 300kHz, Adj. 1.5..6V±2.5%, 1A, +CE	USP-6C	49zp	DC18	9b	Tor
2B104	XC6365B105ER	DC/DC-IC	PWM st-down, 500kHz, Adj. 1.5..6V±2.5%, 1A, +CE	USP-6C	49zp	DC18	9b	Tor
2B2	XC9235F12CER	DC-DC-IC	PWM, st-dwn, 1.2V±2%, 600mA, 1.2MHz, Vin>1.8V, HSST, CL	USP-6C	49da	DC16	9a	Tor
2B3	XC9235F13CER	DC-DC-IC	PWM, st-dwn, 1.3V±2%, 600mA, 1.2MHz, Vin>1.8V, HSST, CL	USP-6C	49da	DC16	9a	Tor
2B4	XC9235F14CER	DC-DC-IC	PWM, st-dwn, 1.4V±2%, 600mA, 1.2MHz, Vin>1.8V, HSST, CL	USP-6C	49da	DC16	9a	Tor
2B5	XC9235F15CER	DC-DC-IC	PWM, st-dwn, 1.5V±2%, 600mA, 1.2MHz, Vin>1.8V, HSST, CL	USP-6C	49da	DC16	9a	Tor
2B6	XC9235F16CER	DC-DC-IC	PWM, st-dwn, 1.6V±2%, 600mA, 1.2MHz, Vin>1.8V, HSST, CL	USP-6C	49da	DC16	9a	Tor
2B7	XC9235F17CER	DC-DC-IC	PWM, st-dwn, 1.7V±2%, 600mA, 1.2MHz, Vin>1.8V, HSST, CL	USP-6C	49da	DC16	9a	Tor
2B8	XC9235F18CER	DC-DC-IC	PWM, st-dwn, 1.8V±2%, 600mA, 1.2MHz, Vin>1.8V, HSST, CL	USP-6C	49da	DC16	9a	Tor
2B9	XC9235F19CER	DC-DC-IC	PWM, st-dwn, 1.9V±2%, 600mA, 1.2MHz, Vin>1.8V, HSST, CL	USP-6C	49da	DC16	9a	Tor
2BA	XC9235F1ACER	DC-DC-IC	PWM, st-dwn, 1.05V±2%, 600mA, 1.2MHz, Vin>1.8V, HSST, CL	USP-6C	49da	DC16	9a	Tor
2BA03	XC6403BA03D	LVR/Vdet-IC	LDO, 1.6V±2%, 300mA, Vdi=1.8V, -Reset ODO, +CE, PDR	USP-6B	49zx	VR15	9b	Tor
2BA07	XC6403BA07D	LVR/Vdet-IC	LDO, 1.8V±2%, 300mA, Vdi=2.9V, -Reset ODO, +CE, PDR	USP-6B	49zx	VR15	9b	Tor
2BA11	XC6403BA11D	LVR/Vdet-IC	LDO, 1.8V±2%, 300mA, Vdi=1.7V, -Reset ODO, +CE, PDR	USP-6B	49zx	VR15	9b	Tor
2BA12	XC6403BA12D	LVR/Vdet-IC	LDO, 3.0V±2%, 300mA, Vdi=4.2V, -Reset ODO, +CE, PDR	USP-6B	49zx	VR15	9b	Tor
2BA14	XC6403BA14D	LVR/Vdet-IC	LDO, 1.8V±2%, 300mA, Vdi=3.0V, -Reset ODO, +CE, PDR	USP-6B	49zx	VR15	9b	Tor
2BA16	XC6403BA16D	LVR/Vdet-IC	LDO, 2.5V±2%, 300mA, Vdi=2.9V, -Reset ODO, +CE, PDR	USP-6B	49zx	VR15	9b	Tor
2BA17	XC6403BA17D	LVR/Vdet-IC	LDO, 1.8V±2%, 300mA, Vdi=2.3V, -Reset ODO, +CE, PDR	USP-6B	49zx	VR15	9b	Tor
2BA18	XC6403BA18D	LVR/Vdet-IC	LDO, 2.8V±2%, 300mA, Vdi=3.4V, -Reset ODO, +CE, PDR	USP-6B	49zx	VR15	9b	Tor
2BA20	XC6403BA20D	LVR/Vdet-IC	LDO, 3.3V±2%, 300mA, Vdi=3.0V, -Reset ODO, +CE, PDR	USP-6B	49zx	VR15	9b	Tor
2BA21	XC6403BA21D	LVR/Vdet-IC	LDO, 3.3V±2%, 300mA, Vdi=3.1V, -Reset ODO, +CE, PDR	USP-6B	49zx	VR15	9b	Tor
2BA24	XC6403BA24D	LVR/Vdet-IC	LDO, 1.8V±2%, 300mA, Vdi=2.9V, -Reset ODO, +CE, PDR	USP-6B	49zx	VR15	9b	Tor
2BA25	XC6403BA25D	LVR/Vdet-IC	LDO, 3.2V±2%, 300mA, Vdi=2.8V, -Reset ODO, +CE, PDR	USP-6B	49zx	VR15	9b	Tor
2BA30	XC6403BA30D	LVR/Vdet-IC	LDO, 4.0V±2%, 300mA, Vdi=4.3V, -Reset ODO, +CE, PDR	USP-6B	49zx	VR15	9b	Tor
2BA31	XC6403BA31D	LVR/Vdet-IC	LDO, 2.85V±2%, 300mA, Vdi=2.7V, -Reset ODO, +CE, PDR	USP-6B	49zx	VR15	9b	Tor
2BA32	XC6403BA32D	LVR/Vdet-IC	LDO, 2.6V±2%, 300mA, Vdi=2.4V, -Reset ODO, +CE, PDR	USP-6B	49zx	VR15	9b	Tor
2BA33	XC6403BA33D	LVR/Vdet-IC	LDO, 2.7V±2%, 300mA, Vdi=2.8V, -Reset ODO, +CE, PDR	USP-6B	49zx	VR15	9b	Tor
2BA34	XC6403BA34D	LVR/Vdet-IC	LDO, 2.85V±2%, 300mA, Vdi=2.55V, -Reset ODO, +CE, PDR	USP-6B	49zx	VR15	9b	Tor
2BA80	XC6403BA80D	LVR/Vdet-IC	LDO, 1.8V±2%, 300mA, Vdi=1.6V, -Reset ODO, +CE, PDR	USP-6B	49zx	VR15	9b	Tor
2BA81	XC6403BA81D	LVR/Vdet-IC	LDO, 2.8V±2%, 300mA, Vdi=3.1V, -Reset ODO, +CE, PDR	USP-6B	49zx	VR15	9b	Tor
2BA82	XC6403BA82D	LVR/Vdet-IC	LDO, 1.8V±2%, 300mA, Vdi=2.0V, -Reset ODO, +CE, PDR	USP-6B	49zx	VR15	9b	Tor
2BA83	XC6403BA83D	LVR/Vdet-IC	LDO, 2.5V±2%, 300mA, Vdi=2.8V, -Reset ODO, +CE, PDR	USP-6B	49zx	VR15	9b	Tor
2BA84	XC6403BA84D	LVR/Vdet-IC	LDO, 2.85V±2%, 300mA, Vdi=3.2V, -Reset ODO, +CE, PDR	USP-6B	49zx	VR15	9b	Tor
2BA85	XC6403BA85D	LVR/Vdet-IC	LDO, 3.0V±2%, 300mA, Vdi=3.3V, -Reset ODO, +CE, PDR	USP-6B	49zx	VR15	9b	Tor
2BA86	XC6403BA86D	LVR/Vdet-IC	LDO, 3.5V±2%, 300mA, Vdi=3.8V, -Reset ODO, +CE, PDR	USP-6B	49zx	VR15	9b	Tor
2BA87	XC6403BA87D	LVR/Vdet-IC	LDO, 3.0V±2%, 300mA, Vdi=4.2V, -Reset ODO, +CE, PDR	USP-6B	49zx	VR15	9b	Tor
2BA88	XC6403BA88D	LVR/Vdet-IC	LDO, 3.3V±2%, 300mA, Vdi=4.0V, -Reset ODO, +CE, PDR	USP-6B	49zx	VR15	9b	Tor
2BB	XC9235F1BCER	DC-DC-IC	PWM, st-dwn, 1.15V±2%, 600mA, 1.2MHz, Vin>1.8V, HSST, CL	USP-6C	49da	DC16	9a	Tor



SMD code	Type	Function	Short description	Case	Pinout	Sch.	St.Mnf.
2BD34	XC6403BD34D	LVR/Vdet-IC	LDO, 2.85V±2%, 300mA, Vdo=2.55V, +Reset ODO, +CE, PDR	USP-6B	49zx	VR15	9b Tor
2BD80	XC6403BD80D	LVR/Vdet-IC	LDO, 1.8V±2%, 300mA, Vdo=1.6V, +Reset ODO, +CE, PDR	USP-6B	49zx	VR15	9b Tor
2BD81	XC6403BD81D	LVR/Vdet-IC	LDO, 2.8V±2%, 300mA, Vdo=3.1V, +Reset ODO, +CE, PDR	USP-6B	49zx	VR15	9b Tor
2BD82	XC6403BD82D	LVR/Vdet-IC	LDO, 1.8V±2%, 300mA, Vdo=2.0V, +Reset ODO, +CE, PDR	USP-6B	49zx	VR15	9b Tor
2BD83	XC6403BD83D	LVR/Vdet-IC	LDO, 2.5V±2%, 300mA, Vdo=2.8V, +Reset ODO, +CE, PDR	USP-6B	49zx	VR15	9b Tor
2BD84	XC6403BD84D	LVR/Vdet-IC	LDO, 2.85V±2%, 300mA, Vdo=3.2V, +Reset ODO, +CE, PDR	USP-6B	49zx	VR15	9b Tor
2BD85	XC6403BD85D	LVR/Vdet-IC	LDO, 3.0V±2%, 300mA, Vdo=3.3V, +Reset ODO, +CE, PDR	USP-6B	49zx	VR15	9b Tor
2BD86	XC6403BD86D	LVR/Vdet-IC	LDO, 3.5V±2%, 300mA, Vdo=3.8V, +Reset ODO, +CE, PDR	USP-6B	49zx	VR15	9b Tor
2BD87	XC6403BD87D	LVR/Vdet-IC	LDO, 3.0V±2%, 300mA, Vdo=4.2V, +Reset ODO, +CE, PDR	USP-6B	49zx	VR15	9b Tor
2BD88	XC6403BD88D	LVR/Vdet-IC	LDO, 3.3V±2%, 300mA, Vdo=4.0V, +Reset ODO, +CE, PDR	USP-6B	49zx	VR15	9b Tor
2BE	XC9235F1ECER	DC-DC-IC	PWM, st-dwn, 1.45V±2%, 600mA, 1.2MHz, Vin>1.8V, HSST, CL	USP-6C	49da	DC16	9a Tor
2BE03	XC6403BE03D	LVR/Vdet-IC	LDO, 1.6V±2%, 300mA, Vdi=1.8V, -Reset ODO, +CE	USP-6B	49zx	VR15	9b Tor
2BE07	XC6403BE07D	LVR/Vdet-IC	LDO, 1.8V±2%, 300mA, Vdi=2.9V, -Reset ODO, +CE	USP-6B	49zx	VR15	9b Tor
2BE11	XC6403BE11D	LVR/Vdet-IC	LDO, 1.8V±2%, 300mA, Vdi=1.7V, -Reset ODO, +CE	USP-6B	49zx	VR15	9b Tor
2BE12	XC6403BE12D	LVR/Vdet-IC	LDO, 3.0V±2%, 300mA, Vdi=4.2V, -Reset ODO, +CE	USP-6B	49zx	VR15	9b Tor
2BE14	XC6403BE14D	LVR/Vdet-IC	LDO, 1.8V±2%, 300mA, Vdi=3.0V, -Reset ODO, +CE	USP-6B	49zx	VR15	9b Tor
2BE16	XC6403BE16D	LVR/Vdet-IC	LDO, 2.5V±2%, 300mA, Vdi=2.9V, -Reset ODO, +CE	USP-6B	49zx	VR15	9b Tor
2BE17	XC6403BE17D	LVR/Vdet-IC	LDO, 1.8V±2%, 300mA, Vdi=2.3V, -Reset ODO, +CE	USP-6B	49zx	VR15	9b Tor
2BE18	XC6403BE18D	LVR/Vdet-IC	LDO, 2.8V±2%, 300mA, Vdi=3.4V, -Reset ODO, +CE	USP-6B	49zx	VR15	9b Tor
2BE20	XC6403BE20D	LVR/Vdet-IC	LDO, 3.3V±2%, 300mA, Vdi=3.0V, -Reset ODO, +CE	USP-6B	49zx	VR15	9b Tor
2BE21	XC6403BE21D	LVR/Vdet-IC	LDO, 3.3V±2%, 300mA, Vdi=3.1V, -Reset ODO, +CE	USP-6B	49zx	VR15	9b Tor
2BE24	XC6403BE24D	LVR/Vdet-IC	LDO, 1.8V±2%, 300mA, Vdi=4.2V, -Reset ODO, +CE	USP-6B	49zx	VR15	9b Tor
2BE25	XC6403BE25D	LVR/Vdet-IC	LDO, 3.2V±2%, 300mA, Vdi=2.8V, -Reset ODO, +CE	USP-6B	49zx	VR15	9b Tor
2BE30	XC6403BE30D	LVR/Vdet-IC	LDO, 4.0V±2%, 300mA, Vdi=4.3V, -Reset ODO, +CE	USP-6B	49zx	VR15	9b Tor
2BE31	XC6403BE31D	LVR/Vdet-IC	LDO, 2.85V±2%, 300mA, Vdi=2.5V, -Reset ODO, +CE	USP-6B	49zx	VR15	9b Tor
2BE32	XC6403BE32D	LVR/Vdet-IC	LDO, 2.6V±2%, 300mA, Vdi=2.4V, -Reset ODO, +CE	USP-6B	49zx	VR15	9b Tor
2BE33	XC6403BE33D	LVR/Vdet-IC	LDO, 2.7V±2%, 300mA, Vdi=2.8V, -Reset ODO, +CE	USP-6B	49zx	VR15	9b Tor
2BE34	XC6403BE34D	LVR/Vdet-IC	LDO, 2.85V±2%, 300mA, Vdi=2.55V, -Reset ODO, +CE	USP-6B	49zx	VR15	9b Tor
2BE80	XC6403BE80D	LVR/Vdet-IC	LDO, 1.8V±2%, 300mA, Vdi=1.6V, -Reset ODO, +CE	USP-6B	49zx	VR15	9b Tor
2BE81	XC6403BE81D	LVR/Vdet-IC	LDO, 2.8V±2%, 300mA, Vdi=3.1V, -Reset ODO, +CE	USP-6B	49zx	VR15	9b Tor
2BE82	XC6403BE82D	LVR/Vdet-IC	LDO, 1.8V±2%, 300mA, Vdi=2.0V, -Reset ODO, +CE	USP-6B	49zx	VR15	9b Tor
2BE83	XC6403BE83D	LVR/Vdet-IC	LDO, 2.5V±2%, 300mA, Vdi=2.8V, -Reset ODO, +CE	USP-6B	49zx	VR15	9b Tor
2BE84	XC6403BE84D	LVR/Vdet-IC	LDO, 2.85V±2%, 300mA, Vdi=3.2V, -Reset ODO, +CE	USP-6B	49zx	VR15	9b Tor
2BE85	XC6403BE85D	LVR/Vdet-IC	LDO, 3.0V±2%, 300mA, Vdi=3.3V, -Reset ODO, +CE	USP-6B	49zx	VR15	9b Tor
2BE86	XC6403BE86D	LVR/Vdet-IC	LDO, 3.5V±2%, 300mA, Vdi=3.8V, -Reset ODO, +CE	USP-6B	49zx	VR15	9b Tor
2BE87	XC6403BE87D	LVR/Vdet-IC	LDO, 3.0V±2%, 300mA, Vdi=4.2V, -Reset ODO, +CE	USP-6B	49zx	VR15	9b Tor
2BE88	XC6403BE88D	LVR/Vdet-IC	LDO, 3.3V±2%, 300mA, Vdi=4.0V, -Reset ODO, +CE	USP-6B	49zx	VR15	9b Tor
2BF	XC9235F1FCER	DC-DC-IC	PWM, st-dwn, 1.55V±2%, 600mA, 1.2MHz, Vin>1.8V, HSST, CL	USP-6C	49da	DC16	9a Tor
2BF03	XC6403BF03D	LVR/Vdet-IC	LDO, 1.6V±2%, 300mA, Vdi=1.8V, +Reset ODO, +CE	USP-6B	49zx	VR15	9b Tor
2BF07	XC6403BF07D	LVR/Vdet-IC	LDO, 1.8V±2%, 300mA, Vdi=2.9V, +Reset ODO, +CE	USP-6B	49zx	VR15	9b Tor
2BF11	XC6403BF11D	LVR/Vdet-IC	LDO, 1.8V±2%, 300mA, Vdi=1.7V, +Reset ODO, +CE	USP-6B	49zx	VR15	9b Tor
2BF12	XC6403BF12D	LVR/Vdet-IC	LDO, 3.0V±2%, 300mA, Vdi=4.2V, +Reset ODO, +CE	USP-6B	49zx	VR15	9b Tor
2BF14	XC6403BF14D	LVR/Vdet-IC	LDO, 1.8V±2%, 300mA, Vdi=3.0V, +Reset ODO, +CE	USP-6B	49zx	VR15	9b Tor
2BF16	XC6403BF16D	LVR/Vdet-IC	LDO, 2.5V±2%, 300mA, Vdi=2.9V, +Reset ODO, +CE	USP-6B	49zx	VR15	9b Tor
2BF17	XC6403BF17D	LVR/Vdet-IC	LDO, 1.8V±2%, 300mA, Vdi=2.3V, +Reset ODO, +CE	USP-6B	49zx	VR15	9b Tor
2BF18	XC6403BF18D	LVR/Vdet-IC	LDO, 2.8V±2%, 300mA, Vdi=3.4V, +Reset ODO, +CE	USP-6B	49zx	VR15	9b Tor
2BF20	XC6403BF20D	LVR/Vdet-IC	LDO, 3.3V±2%, 300mA, Vdi=3.0V, +Reset ODO, +CE	USP-6B	49zx	VR15	9b Tor
2BF21	XC6403BF21D	LVR/Vdet-IC	LDO, 3.3V±2%, 300mA, Vdi=3.1V, +Reset ODO, +CE	USP-6B	49zx	VR15	9b Tor
2BF24	XC6403BF24D	LVR/Vdet-IC	LDO, 1.8V±2%, 300mA, Vdi=2.4V, +Reset ODO, +CE	USP-6B	49zx	VR15	9b Tor
2BF25	XC6403BF25D	LVR/Vdet-IC	LDO, 3.2V±2%, 300mA, Vdi=2.8V, +Reset ODO, +CE	USP-6B	49zx	VR15	9b Tor
2BF30	XC6403BF30D	LVR/Vdet-IC	LDO, 4.0V±2%, 300mA, Vdi=4.3V, +Reset ODO, +CE	USP-6B	49zx	VR15	9b Tor
2BF31	XC6403BF31D	LVR/Vdet-IC	LDO, 2.85V±2%, 300mA, Vdi=2.7V, +Reset ODO, +CE	USP-6B	49zx	VR15	9b Tor
2BF32	XC6403BF32D	LVR/Vdet-IC	LDO, 2.6V±2%, 300mA, Vdi=2.4V, +Reset ODO, +CE	USP-6B	49zx	VR15	9b Tor
2BF33	XC6403BF33D	LVR/Vdet-IC	LDO, 2.7V±2%, 300mA, Vdi=2.8V, +Reset ODO, +CE	USP-6B	49zx	VR15	9b Tor
2BF34	XC6403BF34D	LVR/Vdet-IC	LDO, 2.85V±2%, 300mA, Vdi=2.55V, +Reset ODO, +CE	USP-6B	49zx	VR15	9b Tor
2BF80	XC6403BF80D	LVR/Vdet-IC	LDO, 1.8V±2%, 300mA, Vdi=1.6V, +Reset ODO, +CE	USP-6B	49zx	VR15	9b Tor
2BF81	XC6403BF81D	LVR/Vdet-IC	LDO, 2.8V±2%, 300mA, Vdi=3.1V, +Reset ODO, +CE	USP-6B	49zx	VR15	9b Tor
2BF82	XC6403BF82D	LVR/Vdet-IC	LDO, 1.8V±2%, 300mA, Vdi=2.0V, +Reset ODO, +CE	USP-6B	49zx	VR15	9b Tor
2BF83	XC6403BF83D	LVR/Vdet-IC	LDO, 2.5V±2%, 300mA, Vdi=2.8V, +Reset ODO, +CE	USP-6B	49zx	VR15	9b Tor
2BF84	XC6403BF84D	LVR/Vdet-IC	LDO, 2.85V±2%, 300mA, Vdi=3.2V, +Reset ODO, +CE	USP-6B	49zx	VR15	9b Tor
2BF85	XC6403BF85D	LVR/Vdet-IC	LDO, 3.0V±2%, 300mA, Vdi=3.3V, +Reset ODO, +CE	USP-6B	49zx	VR15	9b Tor
2BF86	XC6403BF86D	LVR/Vdet-IC	LDO, 3.5V±2%, 300mA, Vdi=3.8V, +Reset ODO, +CE	USP-6B	49zx	VR15	9b Tor
2BF87	XC6403BF87D	LVR/Vdet-IC	LDO, 3.0V±2%, 300mA, Vdi=4.2V, +Reset ODO, +CE	USP-6B	49zx	VR15	9b Tor
2BF88	XC6403BF88D	LVR/Vdet-IC	LDO, 3.3V±2%, 300mA, Vdi=4.0V, +Reset ODO, +CE	USP-6B	49zx	VR15	9b Tor
2BH	XC9235F1HCER	DC-DC-IC	PWM, st-dwn, 1.65V±2%, 600mA, 1.2MHz, Vin>1.8V, HSST, CL	USP-6C	49da	DC16	9a Tor
2BH03	XC6403BH03D	LVR/Vdet-IC	LDO, 1.6V±2%, 300mA, Vdo=1.8V, -Reset ODO, +CE	USP-6B	49zx	VR15	9b Tor
2BH07	XC6403BH07D	LVR/Vdet-IC	LDO, 1.8V±2%, 300mA, Vdo=2.9V, -Reset ODO, +CE	USP-6B	49zx	VR15	9b Tor
2BH11	XC6403BH11D	LVR/Vdet-IC	LDO, 1.8V±2%, 300mA, Vdo=1.7V, -Reset ODO, +CE	USP-6B	49zx	VR15	9b Tor
2BH12	XC6403BH12D	LVR/Vdet-IC	LDO, 3.0V±2%, 300mA, Vdo=4.2V, -Reset ODO, +CE	USP-6B	49zx	VR15	9b Tor
2BH14	XC6403BH14D	LVR/Vdet-IC	LDO, 1.8V±2%, 300mA, Vdo=3.0V, -Reset ODO, +CE	USP-6B	49zx	VR15	9b Tor



SMD code	Type	Function	Short description	Case	Pinout	Sch.	St.	Mnf.
2BH16	XC6403BH16D	LVR/Vdet-IC	LDO, 2.5V±2%, 300mA, Vdo=2.9V, -Reset ODO, +CE	USP-6B	49zx	VR15	9b	Tor
2BH17	XC6403BH17D	LVR/Vdet-IC	LDO, 1.8V±2%, 300mA, Vdo=3.3V, -Reset ODO, +CE	USP-6B	49zx	VR15	9b	Tor
2BH18	XC6403BH18D	LVR/Vdet-IC	LDO, 2.8V±2%, 300mA, Vdo=3.4V, -Reset ODO, +CE	USP-6B	49zx	VR15	9b	Tor
2BH20	XC6403BH20D	LVR/Vdet-IC	LDO, 3.3V±2%, 300mA, Vdo=3.0V, -Reset ODO, +CE	USP-6B	49zx	VR15	9b	Tor
2BH21	XC6403BH21D	LVR/Vdet-IC	LDO, 3.3V±2%, 300mA, Vdo=3.1V, -Reset ODO, +CE	USP-6B	49zx	VR15	9b	Tor
2BH24	XC6403BH24D	LVR/Vdet-IC	LDO, 1.8V±2%, 300mA, Vdo=2.4V, -Reset ODO, +CE	USP-6B	49zx	VR15	9b	Tor
2BH25	XC6403BH25D	LVR/Vdet-IC	LDO, 3.2V±2%, 300mA, Vdo=2.8V, -Reset ODO, +CE	USP-6B	49zx	VR15	9b	Tor
2BH30	XC6403BH30D	LVR/Vdet-IC	LDO, 4.0V±2%, 300mA, Vdo=4.3V, -Reset ODO, +CE	USP-6B	49zx	VR15	9b	Tor
2BH31	XC6403BH31D	LVR/Vdet-IC	LDO, 2.85V±2%, 300mA, Vdo=2.7V, -Reset ODO, +CE	USP-6B	49zx	VR15	9b	Tor
2BH32	XC6403BH32D	LVR/Vdet-IC	LDO, 2.6V±2%, 300mA, Vdo=2.4V, -Reset ODO, +CE	USP-6B	49zx	VR15	9b	Tor
2BH33	XC6403BH33D	LVR/Vdet-IC	LDO, 2.7V±2%, 300mA, Vdo=2.8V, -Reset ODO, +CE	USP-6B	49zx	VR15	9b	Tor
2BH34	XC6403BH34D	LVR/Vdet-IC	LDO, 2.85V±2%, 300mA, Vdo=2.55V, -Reset ODO, +CE	USP-6B	49zx	VR15	9b	Tor
2BH80	XC6403BH80D	LVR/Vdet-IC	LDO, 1.8V±2%, 300mA, Vdo=1.6V, -Reset ODO, +CE	USP-6B	49zx	VR15	9b	Tor
2BH81	XC6403BH81D	LVR/Vdet-IC	LDO, 2.8V±2%, 300mA, Vdo=3.1V, -Reset ODO, +CE	USP-6B	49zx	VR15	9b	Tor
2BH82	XC6403BH82D	LVR/Vdet-IC	LDO, 1.8V±2%, 300mA, Vdo=1.9V, -Reset ODO, +CE	USP-6B	49zx	VR15	9b	Tor
2BH83	XC6403BH83D	LVR/Vdet-IC	LDO, 2.5V±2%, 300mA, Vdo=2.8V, -Reset ODO, +CE	USP-6B	49zx	VR15	9b	Tor
2BH84	XC6403BH84D	LVR/Vdet-IC	LDO, 2.85V±2%, 300mA, Vdo=3.2V, -Reset ODO, +CE	USP-6B	49zx	VR15	9b	Tor
2BH85	XC6403BH85D	LVR/Vdet-IC	LDO, 3.0V±2%, 300mA, Vdo=3.3V, -Reset ODO, +CE	USP-6B	49zx	VR15	9b	Tor
2BH86	XC6403BH86D	LVR/Vdet-IC	LDO, 3.5V±2%, 300mA, Vdo=3.8V, -Reset ODO, +CE	USP-6B	49zx	VR15	9b	Tor
2BH87	XC6403BH87D	LVR/Vdet-IC	LDO, 3.0V±2%, 300mA, Vdo=4.2V, -Reset ODO, +CE	USP-6B	49zx	VR15	9b	Tor
2BH88	XC6403BH88D	LVR/Vdet-IC	LDO, 3.3V±2%, 300mA, Vdo=4.0V, -Reset ODO, +CE	USP-6B	49zx	VR15	9b	Tor
2BK	XC9235F1KCER	DC-DC-IC	PWM, st-down, 1.75V±2%, 600mA, 1.2MHz, Vin>1.8V, HSST, CL	USP-6C	49da	DC16	9a	Tor
2BK03	XC6403BK03D	LVR/Vdet-IC	LDO, 1.6V±2%, 300mA, Vdo=1.8V, +Reset ODO, +CE	USP-6B	49zx	VR15	9b	Tor
2BK07	XC6403BK07D	LVR/Vdet-IC	LDO, 1.8V±2%, 300mA, Vdo=2.9V, +Reset ODO, +CE	USP-6B	49zx	VR15	9b	Tor
2BK11	XC6403BK11D	LVR/Vdet-IC	LDO, 1.8V±2%, 300mA, Vdo=1.7V, +Reset ODO, +CE	USP-6B	49zx	VR15	9b	Tor
2BK12	XC6403BK12D	LVR/Vdet-IC	LDO, 3.0V±2%, 300mA, Vdo=4.2V, +Reset ODO, +CE	USP-6B	49zx	VR15	9b	Tor
2BK14	XC6403BK14D	LVR/Vdet-IC	LDO, 1.8V±2%, 300mA, Vdo=3.0V, +Reset ODO, +CE	USP-6B	49zx	VR15	9b	Tor
2BK16	XC6403BK16D	LVR/Vdet-IC	LDO, 2.5V±2%, 300mA, Vdo=2.9V, +Reset ODO, +CE	USP-6B	49zx	VR15	9b	Tor
2BK17	XC6403BK17D	LVR/Vdet-IC	LDO, 1.8V±2%, 300mA, Vdo=2.3V, +Reset ODO, +CE	USP-6B	49zx	VR15	9b	Tor
2BK18	XC6403BK18D	LVR/Vdet-IC	LDO, 2.8V±2%, 300mA, Vdo=3.4V, +Reset ODO, +CE	USP-6B	49zx	VR15	9b	Tor
2BK20	XC6403BK20D	LVR/Vdet-IC	LDO, 3.3V±2%, 300mA, Vdo=3.0V, +Reset ODO, +CE	USP-6B	49zx	VR15	9b	Tor
2BK21	XC6403BK21D	LVR/Vdet-IC	LDO, 3.3V±2%, 300mA, Vdo=3.1V, +Reset ODO, +CE	USP-6B	49zx	VR15	9b	Tor
2BK24	XC6403BK24D	LVR/Vdet-IC	LDO, 1.8V±2%, 300mA, Vdo=2.4V, +Reset ODO, +CE	USP-6B	49zx	VR15	9b	Tor
2BK25	XC6403BK25D	LVR/Vdet-IC	LDO, 3.2V±2%, 300mA, Vdo=2.8V, +Reset ODO, +CE	USP-6B	49zx	VR15	9b	Tor
2BK30	XC6403BK30D	LVR/Vdet-IC	LDO, 4.0V±2%, 300mA, Vdo=4.3V, +Reset ODO, +CE	USP-6B	49zx	VR15	9b	Tor
2BK31	XC6403BK31D	LVR/Vdet-IC	LDO, 2.85V±2%, 300mA, Vdo=2.7V, +Reset ODO, +CE	USP-6B	49zx	VR15	9b	Tor
2BK32	XC6403BK32D	LVR/Vdet-IC	LDO, 2.6V±2%, 300mA, Vdo=2.4V, +Reset ODO, +CE	USP-6B	49zx	VR15	9b	Tor
2BK33	XC6403BK33D	LVR/Vdet-IC	LDO, 2.7V±2%, 300mA, Vdo=2.8V, +Reset ODO, +CE	USP-6B	49zx	VR15	9b	Tor
2BK34	XC6403BK34D	LVR/Vdet-IC	LDO, 2.85V±2%, 300mA, Vdo=2.55V, +Reset ODO, +CE	USP-6B	49zx	VR15	9b	Tor
2BK80	XC6403BK80D	LVR/Vdet-IC	LDO, 1.8V±2%, 300mA, Vdo=1.6V, +Reset ODO, +CE	USP-6B	49zx	VR15	9b	Tor
2BK81	XC6403BK81D	LVR/Vdet-IC	LDO, 2.8V±2%, 300mA, Vdo=3.1V, +Reset ODO, +CE	USP-6B	49zx	VR15	9b	Tor
2BK82	XC6403BK82D	LVR/Vdet-IC	LDO, 1.8V±2%, 300mA, Vdo=2.0V, +Reset ODO, +CE	USP-6B	49zx	VR15	9b	Tor
2BK83	XC6403BK83D	LVR/Vdet-IC	LDO, 2.5V±2%, 300mA, Vdo=2.8V, +Reset ODO, +CE	USP-6B	49zx	VR15	9b	Tor
2BK84	XC6403BK84D	LVR/Vdet-IC	LDO, 2.85V±2%, 300mA, Vdo=3.2V, +Reset ODO, +CE	USP-6B	49zx	VR15	9b	Tor
2BK85	XC6403BK85D	LVR/Vdet-IC	LDO, 3.0V±2%, 300mA, Vdo=3.3V, +Reset ODO, +CE	USP-6B	49zx	VR15	9b	Tor
2BK86	XC6403BK86D	LVR/Vdet-IC	LDO, 3.5V±2%, 300mA, Vdo=3.8V, +Reset ODO, +CE	USP-6B	49zx	VR15	9b	Tor
2BK87	XC6403BK87D	LVR/Vdet-IC	LDO, 3.0V±2%, 300mA, Vdo=4.2V, +Reset ODO, +CE	USP-6B	49zx	VR15	9b	Tor
2BK88	XC6403BK88D	LVR/Vdet-IC	LDO, 3.3V±2%, 300mA, Vdo=4.0V, +Reset ODO, +CE	USP-6B	49zx	VR15	9b	Tor
2BL	XC9235F1LCER	DC-DC-IC	PWM, st-down, 1.85V±2%, 600mA, 1.2MHz, Vin>1.8V, HSST, CL	USP-6C	49da	DC16	9a	Tor
2BL03	XC6403BL03D	LVR/Vdet-IC	LDO, 1.6V±2%, 300mA, Vdi=1.8V, -Reset ODO, -CE, PUR	USP-6B	49zx	VR15	9b	Tor
2BL07	XC6403BL07D	LVR/Vdet-IC	LDO, 1.8V±2%, 300mA, Vdi=2.9V, -Reset ODO, -CE, PUR	USP-6B	49zx	VR15	9b	Tor
2BL11	XC6403BL11D	LVR/Vdet-IC	LDO, 1.8V±2%, 300mA, Vdi=1.7V, -Reset ODO, -CE, PUR	USP-6B	49zx	VR15	9b	Tor
2BL12	XC6403BL12D	LVR/Vdet-IC	LDO, 3.0V±2%, 300mA, Vdi=4.2V, -Reset ODO, -CE, PUR	USP-6B	49zx	VR15	9b	Tor
2BL14	XC6403BL14D	LVR/Vdet-IC	LDO, 1.8V±2%, 300mA, Vdi=3.0V, -Reset ODO, -CE, PUR	USP-6B	49zx	VR15	9b	Tor
2BL16	XC6403BL16D	LVR/Vdet-IC	LDO, 2.5V±2%, 300mA, Vdi=2.9V, -Reset ODO, -CE, PUR	USP-6B	49zx	VR15	9b	Tor
2BL17	XC6403BL17D	LVR/Vdet-IC	LDO, 1.8V±2%, 300mA, Vdi=2.3V, -Reset ODO, -CE, PUR	USP-6B	49zx	VR15	9b	Tor
2BL18	XC6403BL18D	LVR/Vdet-IC	LDO, 2.8V±2%, 300mA, Vdi=3.4V, -Reset ODO, -CE, PUR	USP-6B	49zx	VR15	9b	Tor
2BL20	XC6403BL20D	LVR/Vdet-IC	LDO, 3.3V±2%, 300mA, Vdi=3.0V, -Reset ODO, -CE, PUR	USP-6B	49zx	VR15	9b	Tor
2BL21	XC6403BL21D	LVR/Vdet-IC	LDO, 3.3V±2%, 300mA, Vdi=3.1V, -Reset ODO, -CE, PUR	USP-6B	49zx	VR15	9b	Tor
2BL24	XC6403BL24D	LVR/Vdet-IC	LDO, 1.8V±2%, 300mA, Vdi=2.4V, -Reset ODO, -CE, PUR	USP-6B	49zx	VR15	9b	Tor
2BL25	XC6403BL25D	LVR/Vdet-IC	LDO, 3.2V±2%, 300mA, Vdi=2.8V, -Reset ODO, -CE, PUR	USP-6B	49zx	VR15	9b	Tor
2BL30	XC6403BL30D	LVR/Vdet-IC	LDO, 4.0V±2%, 300mA, Vdi=4.3V, -Reset ODO, -CE, PUR	USP-6B	49zx	VR15	9b	Tor
2BL31	XC6403BL31D	LVR/Vdet-IC	LDO, 2.85V±2%, 300mA, Vdi=2.7V, -Reset ODO, -CE, PUR	USP-6B	49zx	VR15	9b	Tor
2BL32	XC6403BL32D	LVR/Vdet-IC	LDO, 2.6V±2%, 300mA, Vdi=2.4V, -Reset ODO, -CE, PUR	USP-6B	49zx	VR15	9b	Tor
2BL33	XC6403BL33D	LVR/Vdet-IC	LDO, 2.7V±2%, 300mA, Vdi=2.8V, -Reset ODO, -CE, PUR	USP-6B	49zx	VR15	9b	Tor
2BL34	XC6403BL34D	LVR/Vdet-IC	LDO, 2.85V±2%, 300mA, Vdi=2.55V, -Reset ODO, -CE, PUR	USP-6B	49zx	VR15	9b	Tor
2BL80	XC6403BL80D	LVR/Vdet-IC	LDO, 1.8V±2%, 300mA, Vdi=1.6V, -Reset ODO, -CE, PUR	USP-6B	49zx	VR15	9b	Tor
2BL81	XC6403BL81D	LVR/Vdet-IC	LDO, 2.8V±2%, 300mA, Vdi=3.1V, -Reset ODO, -CE, PUR	USP-6B	49zx	VR15	9b	Tor
2BL82	XC6403BL82D	LVR/Vdet-IC	LDO, 1.8V±2%, 300mA, Vdi=2.0V, -Reset ODO, -CE, PUR	USP-6B	49zx	VR15	9b	Tor
2BL83	XC6403BL83D	LVR/Vdet-IC	LDO, 2.5V±2%, 300mA, Vdi=2.8V, -Reset ODO, -CE, PUR	USP-6B	49zx	VR15	9b	Tor



SMD code	Type	Function	Short description	Case	Pinout	Sch.	St.Mnf.
2BT14	XC6403BT14D	LVR/Vdet-IC	LDO, 1.8V±2%, 300mA, Vdo=3.0V, -Reset ODO, -CE	USP-6B	49zx	VR15	9b Tor
2BT16	XC6403BT16D	LVR/Vdet-IC	LDO, 2.5V±2%, 300mA, Vdo=2.9V, -Reset ODO, -CE	USP-6B	49zx	VR15	9b Tor
2BT17	XC6403BT17D	LVR/Vdet-IC	LDO, 1.8V±2%, 300mA, Vdo=2.3V, -Reset ODO, -CE	USP-6B	49zx	VR15	9b Tor
2BT18	XC6403BT18D	LVR/Vdet-IC	LDO, 2.8V±2%, 300mA, Vdo=3.4V, -Reset ODO, -CE	USP-6B	49zx	VR15	9b Tor
2BT20	XC6403BT20D	LVR/Vdet-IC	LDO, 3.3V±2%, 300mA, Vdo=3.0V, -Reset ODO, -CE	USP-6B	49zx	VR15	9b Tor
2BT21	XC6403BT21D	LVR/Vdet-IC	LDO, 3.3V±2%, 300mA, Vdo=3.1V, -Reset ODO, -CE	USP-6B	49zx	VR15	9b Tor
2BT24	XC6403BT24D	LVR/Vdet-IC	LDO, 1.8V±2%, 300mA, Vdo=2.4V, -Reset ODO, -CE	USP-6B	49zx	VR15	9b Tor
2BT25	XC6403BT25D	LVR/Vdet-IC	LDO, 3.2V±2%, 300mA, Vdo=2.8V, -Reset ODO, -CE	USP-6B	49zx	VR15	9b Tor
2BT30	XC6403BT30D	LVR/Vdet-IC	LDO, 4.0V±2%, 300mA, Vdo=4.3V, -Reset ODO, -CE	USP-6B	49zx	VR15	9b Tor
2BT31	XC6403BT31D	LVR/Vdet-IC	LDO, 2.85V±2%, 300mA, Vdo=2.7V, -Reset ODO, -CE	USP-6B	49zx	VR15	9b Tor
2BT32	XC6403BT32D	LVR/Vdet-IC	LDO, 2.6V±2%, 300mA, Vdo=2.4V, -Reset ODO, -CE	USP-6B	49zx	VR15	9b Tor
2BT33	XC6403BT33D	LVR/Vdet-IC	LDO, 2.7V±2%, 300mA, Vdo=2.8V, -Reset ODO, -CE	USP-6B	49zx	VR15	9b Tor
2BT34	XC6403BT34D	LVR/Vdet-IC	LDO, 2.85V±2%, 300mA, Vdo=2.55V, -Reset ODO, -CE	USP-6B	49zx	VR15	9b Tor
2BT80	XC6403BT80D	LVR/Vdet-IC	LDO, 1.8V±2%, 300mA, Vdo=1.6V, -Reset ODO, -CE	USP-6B	49zx	VR15	9b Tor
2BT81	XC6403BT81D	LVR/Vdet-IC	LDO, 2.8V±2%, 300mA, Vdo=3.1V, -Reset ODO, -CE	USP-6B	49zx	VR15	9b Tor
2BT82	XC6403BT82D	LVR/Vdet-IC	LDO, 1.8V±2%, 300mA, Vdo=2.0V, -Reset ODO, -CE	USP-6B	49zx	VR15	9b Tor
2BT83	XC6403BT83D	LVR/Vdet-IC	LDO, 2.5V±2%, 300mA, Vdo=2.8V, -Reset ODO, -CE	USP-6B	49zx	VR15	9b Tor
2BT84	XC6403BT84D	LVR/Vdet-IC	LDO, 2.85V±2%, 300mA, Vdo=3.2V, -Reset ODO, -CE	USP-6B	49zx	VR15	9b Tor
2BT85	XC6403BT85D	LVR/Vdet-IC	LDO, 3.0V±2%, 300mA, Vdo=3.3V, -Reset ODO, -CE	USP-6B	49zx	VR15	9b Tor
2BT86	XC6403BT86D	LVR/Vdet-IC	LDO, 3.5V±2%, 300mA, Vdo=3.8V, -Reset ODO, -CE	USP-6B	49zx	VR15	9b Tor
2BT87	XC6403BT87D	LVR/Vdet-IC	LDO, 3.0V±2%, 300mA, Vdo=4.2V, -Reset ODO, -CE	USP-6B	49zx	VR15	9b Tor
2BT88	XC6403BT88D	LVR/Vdet-IC	LDO, 3.3V±2%, 300mA, Vdo=4.0V, -Reset ODO, -CE	USP-6B	49zx	VR15	9b Tor
2BU03	XC6403BU03D	LVR/Vdet-IC	LDO, 1.6V±2%, 300mA, Vdo=1.8V, +Reset ODO, -CE	USP-6B	49zx	VR15	9b Tor
2BU07	XC6403BU07D	LVR/Vdet-IC	LDO, 1.8V±2%, 300mA, Vdo=2.9V, +Reset ODO, -CE	USP-6B	49zx	VR15	9b Tor
2BU11	XC6403BU11D	LVR/Vdet-IC	LDO, 1.8V±2%, 300mA, Vdo=1.7V, +Reset ODO, -CE	USP-6B	49zx	VR15	9b Tor
2BU12	XC6403BU12D	LVR/Vdet-IC	LDO, 3.0V±2%, 300mA, Vdo=4.2V, +Reset ODO, -CE	USP-6B	49zx	VR15	9b Tor
2BU14	XC6403BU14D	LVR/Vdet-IC	LDO, 1.8V±2%, 300mA, Vdo=3.0V, +Reset ODO, -CE	USP-6B	49zx	VR15	9b Tor
2BU16	XC6403BU16D	LVR/Vdet-IC	LDO, 2.5V±2%, 300mA, Vdo=2.9V, +Reset ODO, -CE	USP-6B	49zx	VR15	9b Tor
2BU17	XC6403BU17D	LVR/Vdet-IC	LDO, 1.8V±2%, 300mA, Vdo=2.3V, +Reset ODO, -CE	USP-6B	49zx	VR15	9b Tor
2BU18	XC6403BU18D	LVR/Vdet-IC	LDO, 2.8V±2%, 300mA, Vdo=3.4V, +Reset ODO, -CE	USP-6B	49zx	VR15	9b Tor
2BU20	XC6403BU20D	LVR/Vdet-IC	LDO, 3.3V±2%, 300mA, Vdo=3.0V, +Reset ODO, -CE	USP-6B	49zx	VR15	9b Tor
2BU21	XC6403BU21D	LVR/Vdet-IC	LDO, 3.3V±2%, 300mA, Vdo=3.1V, +Reset ODO, -CE	USP-6B	49zx	VR15	9b Tor
2BU24	XC6403BU24D	LVR/Vdet-IC	LDO, 1.8V±2%, 300mA, Vdo=2.4V, +Reset ODO, -CE	USP-6B	49zx	VR15	9b Tor
2BU25	XC6403BU25D	LVR/Vdet-IC	LDO, 3.2V±2%, 300mA, Vdo=2.8V, +Reset ODO, -CE	USP-6B	49zx	VR15	9b Tor
2BU30	XC6403BU30D	LVR/Vdet-IC	LDO, 4.0V±2%, 300mA, Vdo=4.3V, +Reset ODO, -CE	USP-6B	49zx	VR15	9b Tor
2BU31	XC6403BU31D	LVR/Vdet-IC	LDO, 2.85V±2%, 300mA, Vdo=2.7V, +Reset ODO, -CE	USP-6B	49zx	VR15	9b Tor
2BU32	XC6403BU32D	LVR/Vdet-IC	LDO, 2.6V±2%, 300mA, Vdo=2.4V, +Reset ODO, -CE	USP-6B	49zx	VR15	9b Tor
2BU33	XC6403BU33D	LVR/Vdet-IC	LDO, 2.7V±2%, 300mA, Vdo=2.8V, +Reset ODO, -CE	USP-6B	49zx	VR15	9b Tor
2BU34	XC6403BU34D	LVR/Vdet-IC	LDO, 2.85V±2%, 300mA, Vdo=2.55V, +Reset ODO, -CE	USP-6B	49zx	VR15	9b Tor
2BU80	XC6403BU80D	LVR/Vdet-IC	LDO, 1.8V±2%, 300mA, Vdo=1.6V, +Reset ODO, -CE	USP-6B	49zx	VR15	9b Tor
2BU81	XC6403BU81D	LVR/Vdet-IC	LDO, 2.8V±2%, 300mA, Vdo=3.1V, +Reset ODO, -CE	USP-6B	49zx	VR15	9b Tor
2BU82	XC6403BU82D	LVR/Vdet-IC	LDO, 1.8V±2%, 300mA, Vdo=2.0V, +Reset ODO, -CE	USP-6B	49zx	VR15	9b Tor
2BU83	XC6403BU83D	LVR/Vdet-IC	LDO, 2.5V±2%, 300mA, Vdo=2.8V, +Reset ODO, -CE	USP-6B	49zx	VR15	9b Tor
2BU84	XC6403BU84D	LVR/Vdet-IC	LDO, 2.85V±2%, 300mA, Vdo=3.2V, +Reset ODO, -CE	USP-6B	49zx	VR15	9b Tor
2BU85	XC6403BU85D	LVR/Vdet-IC	LDO, 3.0V±2%, 300mA, Vdo=3.3V, +Reset ODO, -CE	USP-6B	49zx	VR15	9b Tor
2BU86	XC6403BU86D	LVR/Vdet-IC	LDO, 3.5V±2%, 300mA, Vdo=3.8V, +Reset ODO, -CE	USP-6B	49zx	VR15	9b Tor
2BU87	XC6403BU87D	LVR/Vdet-IC	LDO, 3.0V±2%, 300mA, Vdo=4.2V, +Reset ODO, -CE	USP-6B	49zx	VR15	9b Tor
2BU88	XC6403BU88D	LVR/Vdet-IC	LDO, 3.3V±2%, 300mA, Vdo=4.0V, +Reset ODO, -CE	USP-6B	49zx	VR15	9b Tor
2C	R3117K331A	Vdet-IC	3.3V±1%, -Reset ODO, Sense	DFM1010-4	48rq	VD11	9a Ric
2C	RP100K151D	LVR-IC	LDO, LN, +CE, CL, 1.5V±0.8%, 200mA	PLP1612-4	45vm	VR4	9a Ric
2C	XC6223C2219R-G	LVR-IC	LDO, 2.2V±1%, 300mA, +CE, PDR	USPQ-4B03	48vm	VR4	9a Tor
2C	XC6224B2017R	LVR-IC	LDO, 2.0V±1.5%, 150mA, +CE, PDR	USPN-4B02	58vm	VR4	9e Tor
2C	XC6229H1811R-G	LVR-IC	LDO, 1.8V±20mV, 300mA, +CE, ICP	BGA-4	63ba*	VR4	9a Tor
2C	XC6221C20B7R	LVR-IC	LDO, 2.05V±1%, 200mA, +CE, PDR	USPN-4	58vm	VR4	9a Tor
2C0	XC9235F20CER	DC-DC-IC	PWM, st-dwn, 2.0V±2%, 600mA, 1.2MHz, Vin>1.8V, HSST, CL	USP-6C	49da	DC16	9a Tor
2C1	XC9235F21CER	DC-DC-IC	PWM, st-dwn, 2.1V±2%, 600mA, 1.2MHz, Vin>1.8V, HSST, CL	USP-6C	49da	DC16	9a Tor
2C151	XC6365C151ER	DC/DC-IC	PWM st-down, 100kHz, 1.5V±2.5%, 1A, +CE, soft start	USP-6C	49zo	DC7	9b Tor
2C152	XC6365C152ER	DC/DC-IC	PWM st-down, 180kHz, 1.5V±2.5%, 1A, +CE, soft start	USP-6C	49zo	DC7	9b Tor
2C153	XC6365C153ER	DC/DC-IC	PWM st-down, 300kHz, 1.5V±2.5%, 1A, +CE, soft start	USP-6C	49zo	DC7	9b Tor
2C155	XC6365C155ER	DC/DC-IC	PWM st-down, 500kHz, 1.5V±2.5%, 1A, +CE, soft start	USP-6C	49zo	DC7	9b Tor
2C161	XC6365C161ER	DC/DC-IC	PWM st-down, 100kHz, 1.6V±2.5%, 1A, +CE, soft start	USP-6C	49zo	DC7	9b Tor
2C162	XC6365C162ER	DC/DC-IC	PWM st-down, 180kHz, 1.6V±2.5%, 1A, +CE, soft start	USP-6C	49zo	DC7	9b Tor
2C163	XC6365C163ER	DC/DC-IC	PWM st-down, 300kHz, 1.6V±2.5%, 1A, +CE, soft start	USP-6C	49zo	DC7	9b Tor
2C165	XC6365C165ER	DC/DC-IC	PWM st-down, 500kHz, 1.6V±2.5%, 1A, +CE, soft start	USP-6C	49zo	DC7	9b Tor
2C171	XC6365C171ER	DC/DC-IC	PWM st-down, 100kHz, 1.7V±2.5%, 1A, +CE, soft start	USP-6C	49zo	DC7	9b Tor
2C172	XC6365C172ER	DC/DC-IC	PWM st-down, 180kHz, 1.7V±2.5%, 1A, +CE, soft start	USP-6C	49zo	DC7	9b Tor
2C173	XC6365C173ER	DC/DC-IC	PWM st-down, 300kHz, 1.7V±2.5%, 1A, +CE, soft start	USP-6C	49zo	DC7	9b Tor
2C175	XC6365C175ER	DC/DC-IC	PWM st-down, 500kHz, 1.7V±2.5%, 1A, +CE, soft start	USP-6C	49zo	DC7	9b Tor
2C181	XC6365C181ER	DC/DC-IC	PWM st-down, 100kHz, 1.8V±2.5%, 1A, +CE, soft start	USP-6C	49zo	DC7	9b Tor
2C182	XC6365C182ER	DC/DC-IC	PWM st-down, 180kHz, 1.8V±2.5%, 1A, +CE, soft start	USP-6C	49zo	DC7	9b Tor



SMD code	Type	Function	Short description	Case	Pinout	Sch.	St.	Mnf.
2C582	XC6372C582D	DC/DC-IC	PWM/PFM step-up, 180kHz, +CE, 5.8V±2.5%, 100mA	USP-6B	49gd	DC3	9b	Tor
2C583	XC6365C583ER	DC/DC-IC	PWM st-down, 300kHz, 5.8V±2.5%, 1A, +CE, soft start	USP-6C	49zo	DC7	9b	Tor
2C585	XC6365C585ER	DC/DC-IC	PWM st-down, 500kHz, 5.8V±2.5%, 1A, +CE, soft start	USP-6C	49zo	DC7	9b	Tor
2C590	XC6372C590D	DC/DC-IC	PWM/PFM step-up, 50kHz, +CE, 5.9V±2.5%, 100mA	USP-6B	49gd	DC3	9b	Tor
2C591	XC6365C591ER	DC/DC-IC	PWM st-down, 100kHz, 5.9V±2.5%, 1A, +CE, soft start	USP-6C	49zo	DC7	9b	Tor
2C591	XC6372C591D	DC/DC-IC	PWM/PFM step-up, 100kHz, +CE, 5.9V±2.5%, 100mA	USP-6B	49gd	DC3	9b	Tor
2C592	XC6365C592ER	DC/DC-IC	PWM st-down, 180kHz, 5.9V±2.5%, 1A, +CE, soft start	USP-6C	49zo	DC7	9b	Tor
2C592	XC6372C592D	DC/DC-IC	PWM/PFM step-up, 180kHz, +CE, 5.9V±2.5%, 100mA	USP-6B	49gd	DC3	9b	Tor
2C593	XC6365C593ER	DC/DC-IC	PWM st-down, 300kHz, 5.9V±2.5%, 1A, +CE, soft start	USP-6C	49zo	DC7	9b	Tor
2C595	XC6365C595ER	DC/DC-IC	PWM st-down, 500kHz, 5.9V±2.5%, 1A, +CE, soft start	USP-6C	49zo	DC7	9b	Tor
2C6	XC9235F26CER	DC-DC-IC	PWM, st-dwn, 2.6V±2%, 600mA, 1.2MHz, Vin>1.8V, HSST, CL	USP-6C	49da	DC16	9a	Tor
2C600	XC6372C600D	DC/DC-IC	PWM/PFM step-up, 50kHz, +CE, 6.0V±2.5%, 100mA	USP-6B	49gd	DC3	9b	Tor
2C601	XC6365C601ER	DC/DC-IC	PWM st-down, 100kHz, 6.0V±2.5%, 1A, +CE, soft start	USP-6C	49zo	DC7	9b	Tor
2C601	XC6372C601D	DC/DC-IC	PWM/PFM step-up, 100kHz, +CE, 6.0V±2.5%, 100mA	USP-6B	49gd	DC3	9b	Tor
2C602	XC6365C602ER	DC/DC-IC	PWM st-down, 180kHz, 6.0V±2.5%, 1A, +CE, soft start	USP-6C	49zo	DC7	9b	Tor
2C602	XC6372C602D	DC/DC-IC	PWM/PFM step-up, 180kHz, +CE, 6.0V±2.5%, 100mA	USP-6B	49gd	DC3	9b	Tor
2C603	XC6365C603ER	DC/DC-IC	PWM st-down, 300kHz, 6.0V±2.5%, 1A, +CE, soft start	USP-6C	49zo	DC7	9b	Tor
2C605	XC6365C605ER	DC/DC-IC	PWM st-down, 500kHz, 6.0V±2.5%, 1A, +CE, soft start	USP-6C	49zo	DC7	9b	Tor
2C610	XC6372C610D	DC/DC-IC	PWM/PFM step-up, 50kHz, +CE, 6.1V±2.5%, 100mA	USP-6B	49gd	DC3	9b	Tor
2C611	XC6372C611D	DC/DC-IC	PWM/PFM step-up, 100kHz, +CE, 6.1V±2.5%, 100mA	USP-6B	49gd	DC3	9b	Tor
2C612	XC6372C612D	DC/DC-IC	PWM/PFM step-up, 180kHz, +CE, 6.1V±2.5%, 100mA	USP-6B	49gd	DC3	9b	Tor
2C620	XC6372C620D	DC/DC-IC	PWM/PFM step-up, 50kHz, +CE, 6.2V±2.5%, 100mA	USP-6B	49gd	DC3	9b	Tor
2C621	XC6372C621D	DC/DC-IC	PWM/PFM step-up, 100kHz, +CE, 6.2V±2.5%, 100mA	USP-6B	49gd	DC3	9b	Tor
2C622	XC6372C622D	DC/DC-IC	PWM/PFM step-up, 180kHz, +CE, 6.2V±2.5%, 100mA	USP-6B	49gd	DC3	9b	Tor
2C630	XC6372C630D	DC/DC-IC	PWM/PFM step-up, 50kHz, +CE, 6.3V±2.5%, 100mA	USP-6B	49gd	DC3	9b	Tor
2C631	XC6372C631D	DC/DC-IC	PWM/PFM step-up, 100kHz, +CE, 6.3V±2.5%, 100mA	USP-6B	49gd	DC3	9b	Tor
2C632	XC6372C632D	DC/DC-IC	PWM/PFM step-up, 180kHz, +CE, 6.3V±2.5%, 100mA	USP-6B	49gd	DC3	9b	Tor
2C640	XC6372C640D	DC/DC-IC	PWM/PFM step-up, 50kHz, +CE, 6.4V±2.5%, 100mA	USP-6B	49gd	DC3	9b	Tor
2C641	XC6372C641D	DC/DC-IC	PWM/PFM step-up, 100kHz, +CE, 6.4V±2.5%, 100mA	USP-6B	49gd	DC3	9b	Tor
2C642	XC6372C642D	DC/DC-IC	PWM/PFM step-up, 180kHz, +CE, 6.4V±2.5%, 100mA	USP-6B	49gd	DC3	9b	Tor
2C650	XC6372C650D	DC/DC-IC	PWM/PFM step-up, 50kHz, +CE, 6.5V±2.5%, 100mA	USP-6B	49gd	DC3	9b	Tor
2C651	XC6372C651D	DC/DC-IC	PWM/PFM step-up, 100kHz, +CE, 6.5V±2.5%, 100mA	USP-6B	49gd	DC3	9b	Tor
2C652	XC6372C652D	DC/DC-IC	PWM/PFM step-up, 180kHz, +CE, 6.5V±2.5%, 100mA	USP-6B	49gd	DC3	9b	Tor
2C660	XC6372C660D	DC/DC-IC	PWM/PFM step-up, 50kHz, +CE, 6.6V±2.5%, 100mA	USP-6B	49gd	DC3	9b	Tor
2C661	XC6372C661D	DC/DC-IC	PWM/PFM step-up, 100kHz, +CE, 6.6V±2.5%, 100mA	USP-6B	49gd	DC3	9b	Tor
2C662	XC6372C662D	DC/DC-IC	PWM/PFM step-up, 180kHz, +CE, 6.6V±2.5%, 100mA	USP-6B	49gd	DC3	9b	Tor
2C670	XC6372C670D	DC/DC-IC	PWM/PFM step-up, 50kHz, +CE, 6.7V±2.5%, 100mA	USP-6B	49gd	DC3	9b	Tor
2C671	XC6372C671D	DC/DC-IC	PWM/PFM step-up, 100kHz, +CE, 6.7V±2.5%, 100mA	USP-6B	49gd	DC3	9b	Tor
2C672	XC6372C672D	DC/DC-IC	PWM/PFM step-up, 180kHz, +CE, 6.7V±2.5%, 100mA	USP-6B	49gd	DC3	9b	Tor
2C680	XC6372C680D	DC/DC-IC	PWM/PFM step-up, 50kHz, +CE, 6.8V±2.5%, 100mA	USP-6B	49gd	DC3	9b	Tor
2C681	XC6372C681D	DC/DC-IC	PWM/PFM step-up, 100kHz, +CE, 6.8V±2.5%, 100mA	USP-6B	49gd	DC3	9b	Tor
2C682	XC6372C682D	DC/DC-IC	PWM/PFM step-up, 180kHz, +CE, 6.8V±2.5%, 100mA	USP-6B	49gd	DC3	9b	Tor
2C690	XC6372C690D	DC/DC-IC	PWM/PFM step-up, 50kHz, +CE, 6.9V±2.5%, 100mA	USP-6B	49gd	DC3	9b	Tor
2C691	XC6372C691D	DC/DC-IC	PWM/PFM step-up, 100kHz, +CE, 6.9V±2.5%, 100mA	USP-6B	49gd	DC3	9b	Tor
2C692	XC6372C692D	DC/DC-IC	PWM/PFM step-up, 180kHz, +CE, 6.9V±2.5%, 100mA	USP-6B	49gd	DC3	9b	Tor
2C7	XC9235F27CER	DC-DC-IC	PWM, st-dwn, 2.7V±2%, 600mA, 1.2MHz, Vin>1.8V, HSST, CL	USP-6C	49da	DC16	9a	Tor
2C700	XC6372C700D	DC/DC-IC	PWM/PFM step-up, 50kHz, +CE, 7.0V±2.5%, 100mA	USP-6B	49gd	DC3	9b	Tor
2C701	XC6372C701D	DC/DC-IC	PWM/PFM step-up, 100kHz, +CE, 7.0V±2.5%, 100mA	USP-6B	49gd	DC3	9b	Tor
2C702	XC6372C702D	DC/DC-IC	PWM/PFM step-up, 180kHz, +CE, 7.0V±2.5%, 100mA	USP-6B	49gd	DC3	9b	Tor
2C8	XC9235F28CER	DC-DC-IC	PWM, st-dwn, 2.8V±2%, 600mA, 1.2MHz, Vin>1.8V, HSST, CL	USP-6C	49da	DC16	9a	Tor
2C9	XC9235F29CER	DC-DC-IC	PWM, st-dwn, 2.9V±2%, 600mA, 1.2MHz, Vin>1.8V, HSST, CL	USP-6C	49da	DC16	9a	Tor
2CA	XC9235F2ACER	DC-DC-IC	PWM, st-dwn, 2.05V±2%, 600mA, 1.2MHz, Vin>1.8V, HSST, CL	USP-6C	49da	DC16	9a	Tor
2CA03	XC6403CA03D	LVR/Vdet-IC	LDO, 1.6V±2%, 300mA, Vdi=1.8V, -Reset ODO, +CE, PDR	USP-6B	49zx	VR15	9b	Tor
2CA07	XC6403CA07D	LVR/Vdet-IC	LDO, 1.8V±2%, 300mA, Vdi=2.0V, -Reset ODO, +CE, PDR	USP-6B	49zx	VR15	9b	Tor
2CA11	XC6403CA11D	LVR/Vdet-IC	LDO, 1.8V±2%, 300mA, Vdi=1.7V, -Reset ODO, +CE, PDR	USP-6B	49zx	VR15	9b	Tor
2CA12	XC6403CA12D	LVR/Vdet-IC	LDO, 3.0V±2%, 300mA, Vdi=4.2V, -Reset ODO, +CE, PDR	USP-6B	49zx	VR15	9b	Tor
2CA14	XC6403CA14D	LVR/Vdet-IC	LDO, 1.8V±2%, 300mA, Vdi=3.0V, -Reset ODO, +CE, PDR	USP-6B	49zx	VR15	9b	Tor
2CA16	XC6403CA16D	LVR/Vdet-IC	LDO, 2.5V±2%, 300mA, Vdi=2.9V, -Reset ODO, +CE, PDR	USP-6B	49zx	VR15	9b	Tor
2CA17	XC6403CA17D	LVR/Vdet-IC	LDO, 1.8V±2%, 300mA, Vdi=2.3V, -Reset ODO, +CE, PDR	USP-6B	49zx	VR15	9b	Tor
2CA18	XC6403CA18D	LVR/Vdet-IC	LDO, 2.8V±2%, 300mA, Vdi=3.4V, -Reset ODO, +CE, PDR	USP-6B	49zx	VR15	9b	Tor
2CA20	XC6403CA20D	LVR/Vdet-IC	LDO, 3.3V±2%, 300mA, Vdi=3.0V, -Reset ODO, +CE, PDR	USP-6B	49zx	VR15	9b	Tor
2CA21	XC6403CA21D	LVR/Vdet-IC	LDO, 3.3V±2%, 300mA, Vdi=3.1V, -Reset ODO, +CE, PDR	USP-6B	49zx	VR15	9b	Tor
2CA24	XC6403CA24D	LVR/Vdet-IC	LDO, 1.8V±2%, 300mA, Vdi=2.4V, -Reset ODO, +CE, PDR	USP-6B	49zx	VR15	9b	Tor
2CA25	XC6403CA25D	LVR/Vdet-IC	LDO, 3.2V±2%, 300mA, Vdi=2.8V, -Reset ODO, +CE, PDR	USP-6B	49zx	VR15	9b	Tor
2CA30	XC6403CA30D	LVR/Vdet-IC	LDO, 4.0V±2%, 300mA, Vdi=4.3V, -Reset ODO, +CE, PDR	USP-6B	49zx	VR15	9b	Tor
2CA31	XC6403CA31D	LVR/Vdet-IC	LDO, 2.85V±2%, 300mA, Vdi=2.7V, -Reset ODO, +CE, PDR	USP-6B	49zx	VR15	9b	Tor
2CA32	XC6403CA32D	LVR/Vdet-IC	LDO, 2.6V±2%, 300mA, Vdi=2.9V, -Reset ODO, +CE, PDR	USP-6B	49zx	VR15	9b	Tor
2CA33	XC6403CA33D	LVR/Vdet-IC	LDO, 2.7V±2%, 300mA, Vdi=2.8V, -Reset ODO, +CE, PDR	USP-6B	49zx	VR15	9b	Tor
2CA34	XC6403CA34D	LVR/Vdet-IC	LDO, 2.85V±2%, 300mA, Vdi=2.55V, -Reset ODO, +CE, PDR	USP-6B	49zx	VR15	9b	Tor
2CA80	XC6403CA80D	LVR/Vdet-IC	LDO, 1.8V±2%, 300mA, Vdi=1.6V, -Reset ODO, +CE, PDR	USP-6B	49zx	VR15	9b	Tor



SMD code	Type	Function	Short description	Case	Pinout	Sch.	St.Mnf.
2CD18	XC6403CD18D	LVR/Vdet-IC	LDO, 2.8V±2%, 300mA, Vdo=3.4V, +Reset ODO, +CE, PDR	USP-6B	49zx	VR15	9b Tor
2CD20	XC6403CD20D	LVR/Vdet-IC	LDO, 3.3V±2%, 300mA, Vdo=3.0V, +Reset ODO, +CE, PDR	USP-6B	49zx	VR15	9b Tor
2CD21	XC6403CD21D	LVR/Vdet-IC	LDO, 3.3V±2%, 300mA, Vdo=3.1V, +Reset ODO, +CE, PDR	USP-6B	49zx	VR15	9b Tor
2CD24	XC6403CD24D	LVR/Vdet-IC	LDO, 1.8V±2%, 300mA, Vdo=2.4V, +Reset ODO, +CE, PDR	USP-6B	49zx	VR15	9b Tor
2CD25	XC6403CD25D	LVR/Vdet-IC	LDO, 3.2V±2%, 300mA, Vdo=2.8V, +Reset ODO, +CE, PDR	USP-6B	49zx	VR15	9b Tor
2CD30	XC6403CD30D	LVR/Vdet-IC	LDO, 4.0V±2%, 300mA, Vdo=4.3V, +Reset ODO, +CE, PDR	USP-6B	49zx	VR15	9b Tor
2CD31	XC6403CD31D	LVR/Vdet-IC	LDO, 2.85V±2%, 300mA, Vdo=2.7V, +Reset ODO, +CE, PDR	USP-6B	49zx	VR15	9b Tor
2CD32	XC6403CD32D	LVR/Vdet-IC	LDO, 2.6V±2%, 300mA, Vdo=2.4V, +Reset ODO, +CE, PDR	USP-6B	49zx	VR15	9b Tor
2CD33	XC6403CD33D	LVR/Vdet-IC	LDO, 2.7V±2%, 300mA, Vdo=2.8V, +Reset ODO, +CE, PDR	USP-6B	49zx	VR15	9b Tor
2CD34	XC6403CD34D	LVR/Vdet-IC	LDO, 2.85V±2%, 300mA, Vdo=2.55V, +Reset ODO, +CE, PDR	USP-6B	49zx	VR15	9b Tor
2CD80	XC6403CD80D	LVR/Vdet-IC	LDO, 1.8V±2%, 300mA, Vdo=1.6V, +Reset ODO, +CE, PDR	USP-6B	49zx	VR15	9b Tor
2CD81	XC6403CD81D	LVR/Vdet-IC	LDO, 2.8V±2%, 300mA, Vdo=3.0V, +Reset ODO, +CE, PDR	USP-6B	49zx	VR15	9b Tor
2CD82	XC6403CD82D	LVR/Vdet-IC	LDO, 1.8V±2%, 300mA, Vdo=2.0V, +Reset ODO, +CE, PDR	USP-6B	49zx	VR15	9b Tor
2CD83	XC6403CD83D	LVR/Vdet-IC	LDO, 2.5V±2%, 300mA, Vdo=2.8V, +Reset ODO, +CE, PDR	USP-6B	49zx	VR15	9b Tor
2CD84	XC6403CD84D	LVR/Vdet-IC	LDO, 2.85V±2%, 300mA, Vdo=3.2V, +Reset ODO, +CE, PDR	USP-6B	49zx	VR15	9b Tor
2CD85	XC6403CD85D	LVR/Vdet-IC	LDO, 3.0V±2%, 300mA, Vdo=3.3V, +Reset ODO, +CE, PDR	USP-6B	49zx	VR15	9b Tor
2CD86	XC6403CD86D	LVR/Vdet-IC	LDO, 3.5V±2%, 300mA, Vdo=3.8V, +Reset ODO, +CE, PDR	USP-6B	49zx	VR15	9b Tor
2CD87	XC6403CD87D	LVR/Vdet-IC	LDO, 3.0V±2%, 300mA, Vdo=4.2V, +Reset ODO, +CE, PDR	USP-6B	49zx	VR15	9b Tor
2CD88	XC6403CD88D	LVR/Vdet-IC	LDO, 3.3V±2%, 300mA, Vdo=4.0V, +Reset ODO, +CE, PDR	USP-6B	49zx	VR15	9b Tor
2CE	XC9235F2CECER	DC-DC-IC	PWM, st-dwn, 2.45V±2%, 600mA, 1.2MHz, Vin>1.8V, HSST, CL	USP-6C	49da	DC16	9a Tor
2CE03	XC6403CE03D	LVR/Vdet-IC	LDO, 1.6V±2%, 300mA, Vdi=1.8V, -Reset ODO, +CE	USP-6B	49zx	VR15	9b Tor
2CE07	XC6403CE07D	LVR/Vdet-IC	LDO, 1.8V±2%, 300mA, Vdi=2.9V, -Reset ODO, +CE	USP-6B	49zx	VR15	9b Tor
2CE11	XC6403CE11D	LVR/Vdet-IC	LDO, 1.8V±2%, 300mA, Vdi=1.7V, -Reset ODO, +CE	USP-6B	49zx	VR15	9b Tor
2CE12	XC6403CE12D	LVR/Vdet-IC	LDO, 3.0V±2%, 300mA, Vdi=4.2V, -Reset ODO, +CE	USP-6B	49zx	VR15	9b Tor
2CE14	XC6403CE14D	LVR/Vdet-IC	LDO, 1.8V±2%, 300mA, Vdi=3.0V, -Reset ODO, +CE	USP-6B	49zx	VR15	9b Tor
2CE16	XC6403CE16D	LVR/Vdet-IC	LDO, 2.5V±2%, 300mA, Vdi=2.9V, -Reset ODO, +CE	USP-6B	49zx	VR15	9b Tor
2CE17	XC6403CE17D	LVR/Vdet-IC	LDO, 1.8V±2%, 300mA, Vdi=2.3V, -Reset ODO, +CE	USP-6B	49zx	VR15	9b Tor
2CE18	XC6403CE18D	LVR/Vdet-IC	LDO, 2.8V±2%, 300mA, Vdi=3.0V, -Reset ODO, +CE	USP-6B	49zx	VR15	9b Tor
2CE20	XC6403CE20D	LVR/Vdet-IC	LDO, 3.3V±2%, 300mA, Vdi=3.0V, -Reset ODO, +CE	USP-6B	49zx	VR15	9b Tor
2CE21	XC6403CE21D	LVR/Vdet-IC	LDO, 3.3V±2%, 300mA, Vdi=3.1V, -Reset ODO, +CE	USP-6B	49zx	VR15	9b Tor
2CE24	XC6403CE24D	LVR/Vdet-IC	LDO, 1.8V±2%, 300mA, Vdi=2.4V, -Reset ODO, +CE	USP-6B	49zx	VR15	9b Tor
2CE25	XC6403CE25D	LVR/Vdet-IC	LDO, 3.2V±2%, 300mA, Vdi=2.8V, -Reset ODO, +CE	USP-6B	49zx	VR15	9b Tor
2CE30	XC6403CE30D	LVR/Vdet-IC	LDO, 4.0V±2%, 300mA, Vdi=4.3V, -Reset ODO, +CE	USP-6B	49zx	VR15	9b Tor
2CE31	XC6403CE31D	LVR/Vdet-IC	LDO, 2.85V±2%, 300mA, Vdi=2.7V, -Reset ODO, +CE	USP-6B	49zx	VR15	9b Tor
2CE32	XC6403CE32D	LVR/Vdet-IC	LDO, 2.6V±2%, 300mA, Vdi=2.4V, -Reset ODO, +CE	USP-6B	49zx	VR15	9b Tor
2CE33	XC6403CE33D	LVR/Vdet-IC	LDO, 2.7V±2%, 300mA, Vdi=2.8V, -Reset ODO, +CE	USP-6B	49zx	VR15	9b Tor
2CE34	XC6403CE34D	LVR/Vdet-IC	LDO, 2.85V±2%, 300mA, Vdi=2.55V, -Reset ODO, +CE	USP-6B	49zx	VR15	9b Tor
2CE80	XC6403CE80D	LVR/Vdet-IC	LDO, 1.8V±2%, 300mA, Vdi=1.6V, -Reset ODO, +CE	USP-6B	49zx	VR15	9b Tor
2CE81	XC6403CE81D	LVR/Vdet-IC	LDO, 2.8V±2%, 300mA, Vdi=3.1V, -Reset ODO, +CE	USP-6B	49zx	VR15	9b Tor
2CE82	XC6403CE82D	LVR/Vdet-IC	LDO, 1.8V±2%, 300mA, Vdi=2.0V, -Reset ODO, +CE	USP-6B	49zx	VR15	9b Tor
2CE83	XC6403CE83D	LVR/Vdet-IC	LDO, 2.5V±2%, 300mA, Vdi=2.8V, -Reset ODO, +CE	USP-6B	49zx	VR15	9b Tor
2CE84	XC6403CE84D	LVR/Vdet-IC	LDO, 2.85V±2%, 300mA, Vdi=3.2V, -Reset ODO, +CE	USP-6B	49zx	VR15	9b Tor
2CE85	XC6403CE85D	LVR/Vdet-IC	LDO, 3.0V±2%, 300mA, Vdi=3.3V, -Reset ODO, +CE	USP-6B	49zx	VR15	9b Tor
2CE86	XC6403CE86D	LVR/Vdet-IC	LDO, 3.5V±2%, 300mA, Vdi=3.8V, -Reset ODO, +CE	USP-6B	49zx	VR15	9b Tor
2CE87	XC6403CE87D	LVR/Vdet-IC	LDO, 3.0V±2%, 300mA, Vdi=4.2V, -Reset ODO, +CE	USP-6B	49zx	VR15	9b Tor
2CE88	XC6403CE88D	LVR/Vdet-IC	LDO, 3.3V±2%, 300mA, Vdi=4.0V, -Reset ODO, +CE	USP-6B	49zx	VR15	9b Tor
2CF	XC9235F2FCER	DC-DC-IC	PWM, st-dwn, 2.55V±2%, 600mA, 1.2MHz, Vin>1.8V, HSST, CL	USP-6C	49da	DC16	9a Tor
2CF03	XC6403CF03D	LVR/Vdet-IC	LDO, 1.6V±2%, 300mA, Vdi=1.8V, -Reset ODO, +CE	USP-6B	49zx	VR15	9b Tor
2CF07	XC6403CF07D	LVR/Vdet-IC	LDO, 1.8V±2%, 300mA, Vdi=2.9V, +Reset ODO, +CE	USP-6B	49zx	VR15	9b Tor
2CF11	XC6403CF11D	LVR/Vdet-IC	LDO, 1.8V±2%, 300mA, Vdi=1.7V, +Reset ODO, +CE	USP-6B	49zx	VR15	9b Tor
2CF12	XC6403CF12D	LVR/Vdet-IC	LDO, 3.0V±2%, 300mA, Vdi=4.2V, +Reset ODO, +CE	USP-6B	49zx	VR15	9b Tor
2CF14	XC6403CF14D	LVR/Vdet-IC	LDO, 1.8V±2%, 300mA, Vdi=3.0V, +Reset ODO, +CE	USP-6B	49zx	VR15	9b Tor
2CF16	XC6403CF16D	LVR/Vdet-IC	LDO, 2.5V±2%, 300mA, Vdi=2.9V, +Reset ODO, +CE	USP-6B	49zx	VR15	9b Tor
2CF17	XC6403CF17D	LVR/Vdet-IC	LDO, 1.8V±2%, 300mA, Vdi=2.3V, +Reset ODO, +CE	USP-6B	49zx	VR15	9b Tor
2CF18	XC6403CF18D	LVR/Vdet-IC	LDO, 2.8V±2%, 300mA, Vdi=3.4V, +Reset ODO, +CE	USP-6B	49zx	VR15	9b Tor
2CF20	XC6403CF20D	LVR/Vdet-IC	LDO, 3.3V±2%, 300mA, Vdi=3.0V, +Reset ODO, +CE	USP-6B	49zx	VR15	9b Tor
2CF21	XC6403CF21D	LVR/Vdet-IC	LDO, 3.3V±2%, 300mA, Vdi=3.1V, +Reset ODO, +CE	USP-6B	49zx	VR15	9b Tor
2CF24	XC6403CF24D	LVR/Vdet-IC	LDO, 1.8V±2%, 300mA, Vdi=2.7V, +Reset ODO, +CE	USP-6B	49zx	VR15	9b Tor
2CF25	XC6403CF25D	LVR/Vdet-IC	LDO, 3.2V±2%, 300mA, Vdi=2.8V, +Reset ODO, +CE	USP-6B	49zx	VR15	9b Tor
2CF30	XC6403CF30D	LVR/Vdet-IC	LDO, 4.0V±2%, 300mA, Vdi=4.3V, +Reset ODO, +CE	USP-6B	49zx	VR15	9b Tor
2CF31	XC6403CF31D	LVR/Vdet-IC	LDO, 2.85V±2%, 300mA, Vdi=2.7V, +Reset ODO, +CE	USP-6B	49zx	VR15	9b Tor
2CF32	XC6403CF32D	LVR/Vdet-IC	LDO, 2.6V±2%, 300mA, Vdi=2.4V, +Reset ODO, +CE	USP-6B	49zx	VR15	9b Tor
2CF33	XC6403CF33D	LVR/Vdet-IC	LDO, 2.7V±2%, 300mA, Vdi=2.8V, +Reset ODO, +CE	USP-6B	49zx	VR15	9b Tor
2CF34	XC6403CF34D	LVR/Vdet-IC	LDO, 2.85V±2%, 300mA, Vdi=3.2V, +Reset ODO, +CE	USP-6B	49zx	VR15	9b Tor
2CF80	XC6403CF80D	LVR/Vdet-IC	LDO, 1.8V±2%, 300mA, Vdi=1.6V, +Reset ODO, +CE	USP-6B	49zx	VR15	9b Tor
2CF81	XC6403CF81D	LVR/Vdet-IC	LDO, 2.8V±2%, 300mA, Vdi=3.1V, +Reset ODO, +CE	USP-6B	49zx	VR15	9b Tor
2CF82	XC6403CF82D	LVR/Vdet-IC	LDO, 1.8V±2%, 300mA, Vdi=2.0V, +Reset ODO, +CE	USP-6B	49zx	VR15	9b Tor
2CF83	XC6403CF83D	LVR/Vdet-IC	LDO, 2.5V±2%, 300mA, Vdi=2.8V, +Reset ODO, +CE	USP-6B	49zx	VR15	9b Tor
2CF84	XC6403CF84D	LVR/Vdet-IC	LDO, 2.85V±2%, 300mA, Vdi=3.2V, +Reset ODO, +CE	USP-6B	49zx	VR15	9b Tor
2CF85	XC6403CF85D	LVR/Vdet-IC	LDO, 3.0V±2%, 300mA, Vdi=3.3V, +Reset ODO, +CE	USP-6B	49zx	VR15	9b Tor



SMD code	Type	Function	Short description	Case	Pinout	Sch.	St.Mnf.
2CF86	XC6403CF86D	LVR/Vdet-IC	LDO, 3.5V±2%, 300mA, Vdi=3.8V, +Reset ODO, +CE	USP-6B	49zx	VR15	9b Tor
2CF87	XC6403CF87D	LVR/Vdet-IC	LDO, 3.0V±2%, 300mA, Vdi=4.2V, +Reset ODO, +CE	USP-6B	49zx	VR15	9b Tor
2CF88	XC6403CF88D	LVR/Vdet-IC	LDO, 3.3V±2%, 300mA, Vdi=4.0V, +Reset ODO, +CE	USP-6B	49zx	VR15	9b Tor
2CH	XC9235F2HCER	DC-DC-IC	PWM, st-dwn, 2.65V±2%, 600mA, 1.2MHz, Vin>1.8V, HSST, CL	USP-6C	49da	DC16	9a Tor
2CH03	XC6403CH03D	LVR/Vdet-IC	LDO, 1.6V±2%, 300mA, Vdo=1.8V, -Reset ODO, +CE	USP-6B	49zx	VR15	9b Tor
2CH07	XC6403CH07D	LVR/Vdet-IC	LDO, 1.8V±2%, 300mA, Vdo=3.0V, -Reset ODO, +CE	USP-6B	49zx	VR15	9b Tor
2CH11	XC6403CH11D	LVR/Vdet-IC	LDO, 1.8V±2%, 300mA, Vdo=1.7V, -Reset ODO, +CE	USP-6B	49zx	VR15	9b Tor
2CH12	XC6403CH12D	LVR/Vdet-IC	LDO, 3.0V±2%, 300mA, Vdo=4.2V, -Reset ODO, +CE	USP-6B	49zx	VR15	9b Tor
2CH14	XC6403CH14D	LVR/Vdet-IC	LDO, 1.8V±2%, 300mA, Vdo=3.0V, -Reset ODO, +CE	USP-6B	49zx	VR15	9b Tor
2CH16	XC6403CH16D	LVR/Vdet-IC	LDO, 2.5V±2%, 300mA, Vdo=2.9V, -Reset ODO, +CE	USP-6B	49zx	VR15	9b Tor
2CH17	XC6403CH17D	LVR/Vdet-IC	LDO, 1.8V±2%, 300mA, Vdo=2.3V, -Reset ODO, +CE	USP-6B	49zx	VR15	9b Tor
2CH18	XC6403CH18D	LVR/Vdet-IC	LDO, 2.8V±2%, 300mA, Vdo=3.0V, -Reset ODO, +CE	USP-6B	49zx	VR15	9b Tor
2CH20	XC6403CH20D	LVR/Vdet-IC	LDO, 3.3V±2%, 300mA, Vdo=3.0V, -Reset ODO, +CE	USP-6B	49zx	VR15	9b Tor
2CH21	XC6403CH21D	LVR/Vdet-IC	LDO, 3.3V±2%, 300mA, Vdo=3.1V, -Reset ODO, +CE	USP-6B	49zx	VR15	9b Tor
2CH24	XC6403CH24D	LVR/Vdet-IC	LDO, 1.8V±2%, 300mA, Vdo=2.4V, -Reset ODO, +CE	USP-6B	49zx	VR15	9b Tor
2CH25	XC6403CH25D	LVR/Vdet-IC	LDO, 3.2V±2%, 300mA, Vdo=2.8V, -Reset ODO, +CE	USP-6B	49zx	VR15	9b Tor
2CH30	XC6403CH30D	LVR/Vdet-IC	LDO, 4.0V±2%, 300mA, Vdo=4.3V, -Reset ODO, +CE	USP-6B	49zx	VR15	9b Tor
2CH31	XC6403CH31D	LVR/Vdet-IC	LDO, 2.85V±2%, 300mA, Vdo=2.7V, -Reset ODO, +CE	USP-6B	49zx	VR15	9b Tor
2CH32	XC6403CH32D	LVR/Vdet-IC	LDO, 2.6V±2%, 300mA, Vdo=2.4V, -Reset ODO, +CE	USP-6B	49zx	VR15	9b Tor
2CH33	XC6403CH33D	LVR/Vdet-IC	LDO, 2.7V±2%, 300mA, Vdo=2.8V, -Reset ODO, +CE	USP-6B	49zx	VR15	9b Tor
2CH34	XC6403CH34D	LVR/Vdet-IC	LDO, 2.85V±2%, 300mA, Vdo=2.55V, -Reset ODO, +CE	USP-6B	49zx	VR15	9b Tor
2CH80	XC6403CH80D	LVR/Vdet-IC	LDO, 1.8V±2%, 300mA, Vdo=1.6V, -Reset ODO, +CE	USP-6B	49zx	VR15	9b Tor
2CH81	XC6403CH81D	LVR/Vdet-IC	LDO, 2.8V±2%, 300mA, Vdo=3.1V, -Reset ODO, +CE	USP-6B	49zx	VR15	9b Tor
2CH82	XC6403CH82D	LVR/Vdet-IC	LDO, 1.8V±2%, 300mA, Vdo=2.0V, -Reset ODO, +CE	USP-6B	49zx	VR15	9b Tor
2CH83	XC6403CH83D	LVR/Vdet-IC	LDO, 2.5V±2%, 300mA, Vdo=2.8V, -Reset ODO, +CE	USP-6B	49zx	VR15	9b Tor
2CH84	XC6403CH84D	LVR/Vdet-IC	LDO, 2.85V±2%, 300mA, Vdo=3.2V, -Reset ODO, +CE	USP-6B	49zx	VR15	9b Tor
2CH85	XC6403CH85D	LVR/Vdet-IC	LDO, 3.0V±2%, 300mA, Vdo=3.3V, -Reset ODO, +CE	USP-6B	49zx	VR15	9b Tor
2CH86	XC6403CH86D	LVR/Vdet-IC	LDO, 3.5V±2%, 300mA, Vdo=3.8V, -Reset ODO, +CE	USP-6B	49zx	VR15	9b Tor
2CH87	XC6403CH87D	LVR/Vdet-IC	LDO, 3.0V±2%, 300mA, Vdo=4.2V, -Reset ODO, +CE	USP-6B	49zx	VR15	9b Tor
2CH88	XC6403CH88D	LVR/Vdet-IC	LDO, 3.3V±2%, 300mA, Vdo=4.0V, -Reset ODO, +CE	USP-6B	49zx	VR15	9b Tor
2CK	XC9235F2KCER	DC-DC-IC	PWM, st-dwn, 2.75V±2%, 600mA, 1.2MHz, Vin>1.8V, HSST, CL	USP-6C	49da	DC16	9a Tor
2CK03	XC6403CK03D	LVR/Vdet-IC	LDO, 1.6V±2%, 300mA, Vdo=1.8V, -Reset ODO, +CE	USP-6B	49zx	VR15	9b Tor
2CK07	XC6403CK07D	LVR/Vdet-IC	LDO, 1.8V±2%, 300mA, Vdo=2.9V, +Reset ODO, +CE	USP-6B	49zx	VR15	9b Tor
2CK11	XC6403CK11D	LVR/Vdet-IC	LDO, 1.8V±2%, 300mA, Vdo=1.7V, +Reset ODO, +CE	USP-6B	49zx	VR15	9b Tor
2CK12	XC6403CK12D	LVR/Vdet-IC	LDO, 3.0V±2%, 300mA, Vdo=4.2V, +Reset ODO, +CE	USP-6B	49zx	VR15	9b Tor
2CK14	XC6403CK14D	LVR/Vdet-IC	LDO, 1.8V±2%, 300mA, Vdo=3.0V, +Reset ODO, +CE	USP-6B	49zx	VR15	9b Tor
2CK16	XC6403CK16D	LVR/Vdet-IC	LDO, 2.5V±2%, 300mA, Vdo=2.9V, -Reset ODO, +CE	USP-6B	49zx	VR15	9b Tor
2CK17	XC6403CK17D	LVR/Vdet-IC	LDO, 1.8V±2%, 300mA, Vdo=2.3V, -Reset ODO, +CE	USP-6B	49zx	VR15	9b Tor
2CK18	XC6403CK18D	LVR/Vdet-IC	LDO, 2.8V±2%, 300mA, Vdo=3.4V, +Reset ODO, +CE	USP-6B	49zx	VR15	9b Tor
2CK20	XC6403CK20D	LVR/Vdet-IC	LDO, 3.3V±2%, 300mA, Vdo=3.0V, -Reset ODO, +CE	USP-6B	49zx	VR15	9b Tor
2CK21	XC6403CK21D	LVR/Vdet-IC	LDO, 3.3V±2%, 300mA, Vdo=3.1V, +Reset ODO, +CE	USP-6B	49zx	VR15	9b Tor
2CK24	XC6403CK24D	LVR/Vdet-IC	LDO, 1.8V±2%, 300mA, Vdo=2.4V, +Reset ODO, +CE	USP-6B	49zx	VR15	9b Tor
2CK25	XC6403CK25D	LVR/Vdet-IC	LDO, 3.2V±2%, 300mA, Vdo=2.8V, +Reset ODO, +CE	USP-6B	49zx	VR15	9b Tor
2CK30	XC6403CK30D	LVR/Vdet-IC	LDO, 4.0V±2%, 300mA, Vdo=4.3V, +Reset ODO, +CE	USP-6B	49zx	VR15	9b Tor
2CK31	XC6403CK31D	LVR/Vdet-IC	LDO, 2.85V±2%, 300mA, Vdo=2.7V, +Reset ODO, +CE	USP-6B	49zx	VR15	9b Tor
2CK32	XC6403CK32D	LVR/Vdet-IC	LDO, 2.6V±2%, 300mA, Vdo=2.4V, +Reset ODO, +CE	USP-6B	49zx	VR15	9b Tor
2CK33	XC6403CK33D	LVR/Vdet-IC	LDO, 2.7V±2%, 300mA, Vdo=2.8V, +Reset ODO, +CE	USP-6B	49zx	VR15	9b Tor
2CK34	XC6403CK34D	LVR/Vdet-IC	LDO, 2.85V±2%, 300mA, Vdo=2.55V, +Reset ODO, +CE	USP-6B	49zx	VR15	9b Tor
2CK80	XC6403CK80D	LVR/Vdet-IC	LDO, 1.8V±2%, 300mA, Vdo=1.6V, +Reset ODO, +CE	USP-6B	49zx	VR15	9b Tor
2CK81	XC6403CK81D	LVR/Vdet-IC	LDO, 2.8V±2%, 300mA, Vdo=3.1V, +Reset ODO, +CE	USP-6B	49zx	VR15	9b Tor
2CK82	XC6403CK82D	LVR/Vdet-IC	LDO, 1.8V±2%, 300mA, Vdo=2.0V, +Reset ODO, +CE	USP-6B	49zx	VR15	9b Tor
2CK83	XC6403CK83D	LVR/Vdet-IC	LDO, 2.5V±2%, 300mA, Vdo=2.8V, +Reset ODO, +CE	USP-6B	49zx	VR15	9b Tor
2CK84	XC6403CK84D	LVR/Vdet-IC	LDO, 2.85V±2%, 300mA, Vdo=3.2V, +Reset ODO, +CE	USP-6B	49zx	VR15	9b Tor
2CK85	XC6403CK85D	LVR/Vdet-IC	LDO, 3.0V±2%, 300mA, Vdo=3.3V, +Reset ODO, +CE	USP-6B	49zx	VR15	9b Tor
2CK86	XC6403CK86D	LVR/Vdet-IC	LDO, 3.5V±2%, 300mA, Vdo=3.8V, +Reset ODO, +CE	USP-6B	49zx	VR15	9b Tor
2CK87	XC6403CK87D	LVR/Vdet-IC	LDO, 3.0V±2%, 300mA, Vdo=4.2V, +Reset ODO, +CE	USP-6B	49zx	VR15	9b Tor
2CK88	XC6403CK88D	LVR/Vdet-IC	LDO, 3.3V±2%, 300mA, Vdo=4.0V, +Reset ODO, +CE	USP-6B	49zx	VR15	9b Tor
2CL	XC9235F2LCER	DC-DC-IC	PWM, st-dwn, 2.85V±2%, 600mA, 1.2MHz, Vin>1.8V, HSST, CL	USP-6C	49da	DC16	9a Tor
2CL03	XC6403CL03D	LVR/Vdet-IC	LDO, 1.6V±2%, 300mA, Vdi=1.8V, -Reset ODO, -CE, PUR	USP-6B	49zx	VR15	9b Tor
2CL07	XC6403CL07D	LVR/Vdet-IC	LDO, 1.8V±2%, 300mA, Vdi=2.9V, -Reset ODO, -CE, PUR	USP-6B	49zx	VR15	9b Tor
2CL11	XC6403CL11D	LVR/Vdet-IC	LDO, 1.8V±2%, 300mA, Vdi=1.7V, -Reset ODO, -CE, PUR	USP-6B	49zx	VR15	9b Tor
2CL12	XC6403CL12D	LVR/Vdet-IC	LDO, 3.0V±2%, 300mA, Vdi=4.2V, -Reset ODO, -CE, PUR	USP-6B	49zx	VR15	9b Tor
2CL14	XC6403CL14D	LVR/Vdet-IC	LDO, 1.8V±2%, 300mA, Vdi=3.0V, -Reset ODO, -CE, PUR	USP-6B	49zx	VR15	9b Tor
2CL16	XC6403CL16D	LVR/Vdet-IC	LDO, 2.5V±2%, 300mA, Vdi=2.9V, -Reset ODO, -CE, PUR	USP-6B	49zx	VR15	9b Tor
2CL17	XC6403CL17D	LVR/Vdet-IC	LDO, 1.8V±2%, 300mA, Vdi=2.3V, -Reset ODO, -CE, PUR	USP-6B	49zx	VR15	9b Tor
2CL18	XC6403CL18D	LVR/Vdet-IC	LDO, 2.8V±2%, 300mA, Vdi=3.4V, -Reset ODO, -CE, PUR	USP-6B	49zx	VR15	9b Tor
2CL20	XC6403CL20D	LVR/Vdet-IC	LDO, 3.3V±2%, 300mA, Vdi=3.0V, -Reset ODO, -CE, PUR	USP-6B	49zx	VR15	9b Tor
2CL21	XC6403CL21D	LVR/Vdet-IC	LDO, 3.3V±2%, 300mA, Vdi=3.1V, -Reset ODO, -CE, PUR	USP-6B	49zx	VR15	9b Tor
2CL24	XC6403CL24D	LVR/Vdet-IC	LDO, 1.8V±2%, 300mA, Vdi=2.4V, -Reset ODO, -CE, PUR	USP-6B	49zx	VR15	9b Tor
2CL25	XC6403CL25D	LVR/Vdet-IC	LDO, 3.2V±2%, 300mA, Vdi=2.8V, -Reset ODO, -CE, PUR	USP-6B	49zx	VR15	9b Tor



SMD code	Type	Function	Short description	Case	Pinout	Sch.	St.Mnf.
2CS84	XC6403CS84D	LVR/Vdet-IC	LDO, 2.85V±2%, 300mA, Vdi=3.2V, +Reset ODO, -CE	USP-6B	49zx	VR15	9b Tor
2CS85	XC6403CS85D	LVR/Vdet-IC	LDO, 3.0V±2%, 300mA, Vdi=3.3V, +Reset ODO, -CE	USP-6B	49zx	VR15	9b Tor
2CS86	XC6403CS86D	LVR/Vdet-IC	LDO, 3.5V±2%, 300mA, Vdi=3.8V, +Reset ODO, -CE	USP-6B	49zx	VR15	9b Tor
2CS87	XC6403CS87D	LVR/Vdet-IC	LDO, 3.0V±2%, 300mA, Vdi= 4.2V, +Reset ODO, -CE	USP-6B	49zx	VR15	9b Tor
2CS88	XC6403CS88D	LVR/Vdet-IC	LDO, 3.3V±2%, 300mA, Vdi= 4.0V, +Reset ODO, -CE	USP-6B	49zx	VR15	9b Tor
2CT03	XC6403CT03D	LVR/Vdet-IC	LDO, 1.6V±2%, 300mA, Vdo=1.8V, -Reset ODO, -CE	USP-6B	49zx	VR15	9b Tor
2CT07	XC6403CT07D	LVR/Vdet-IC	LDO, 1.8V±2%, 300mA, Vdo=2.9V, -Reset ODO, -CE	USP-6B	49zx	VR15	9b Tor
2CT11	XC6403CT11D	LVR/Vdet-IC	LDO, 1.8V±2%, 300mA, Vdo=1.7V, -Reset ODO, -CE	USP-6B	49zx	VR15	9b Tor
2CT12	XC6403CT12D	LVR/Vdet-IC	LDO, 3.0V±2%, 300mA, Vdo=2.5V, -Reset ODO, -CE	USP-6B	49zx	VR15	9b Tor
2CT14	XC6403CT14D	LVR/Vdet-IC	LDO, 1.8V±2%, 300mA, Vdo=3.0V, -Reset ODO, -CE	USP-6B	49zx	VR15	9b Tor
2CT16	XC6403CT16D	LVR/Vdet-IC	LDO, 2.5V±2%, 300mA, Vdo=2.9V, -Reset ODO, -CE	USP-6B	49zx	VR15	9b Tor
2CT17	XC6403CT17D	LVR/Vdet-IC	LDO, 1.8V±2%, 300mA, Vdo=2.3V, -Reset ODO, -CE	USP-6B	49zx	VR15	9b Tor
2CT18	XC6403CT18D	LVR/Vdet-IC	LDO, 2.8V±2%, 300mA, Vdo=3.4V, -Reset ODO, -CE	USP-6B	49zx	VR15	9b Tor
2CT20	XC6403CT20D	LVR/Vdet-IC	LDO, 3.3V±2%, 300mA, Vdo=3.0V, -Reset ODO, -CE	USP-6B	49zx	VR15	9b Tor
2CT21	XC6403CT21D	LVR/Vdet-IC	LDO, 3.3V±2%, 300mA, Vdo=3.3V, -Reset ODO, -CE	USP-6B	49zx	VR15	9b Tor
2CT24	XC6403CT24D	LVR/Vdet-IC	LDO, 1.8V±2%, 300mA, Vdo=2.4V, -Reset ODO, -CE	USP-6B	49zx	VR15	9b Tor
2CT25	XC6403CT25D	LVR/Vdet-IC	LDO, 3.2V±2%, 300mA, Vdo=2.8V, -Reset ODO, -CE	USP-6B	49zx	VR15	9b Tor
2CT30	XC6403CT30D	LVR/Vdet-IC	LDO, 4.0V±2%, 300mA, Vdo=4.3V, -Reset ODO, -CE	USP-6B	49zx	VR15	9b Tor
2CT31	XC6403CT31D	LVR/Vdet-IC	LDO, 2.85V±2%, 300mA, Vdo=2.7V, -Reset ODO, -CE	USP-6B	49zx	VR15	9b Tor
2CT32	XC6403CT32D	LVR/Vdet-IC	LDO, 2.6V±2%, 300mA, Vdo=2.4V, -Reset ODO, -CE	USP-6B	49zx	VR15	9b Tor
2CT33	XC6403CT33D	LVR/Vdet-IC	LDO, 2.7V±2%, 300mA, Vdo=2.8V, -Reset ODO, -CE	USP-6B	49zx	VR15	9b Tor
2CT34	XC6403CT34D	LVR/Vdet-IC	LDO, 2.85V±2%, 300mA, Vdo=2.55V, -Reset ODO, -CE	USP-6B	49zx	VR15	9b Tor
2CT80	XC6403CT80D	LVR/Vdet-IC	LDO, 1.8V±2%, 300mA, Vdo=1.6V, -Reset ODO, -CE	USP-6B	49zx	VR15	9b Tor
2CT81	XC6403CT81D	LVR/Vdet-IC	LDO, 2.8V±2%, 300mA, Vdo=3.1V, -Reset ODO, -CE	USP-6B	49zx	VR15	9b Tor
2CT82	XC6403CT82D	LVR/Vdet-IC	LDO, 1.8V±2%, 300mA, Vdo=2.3V, -Reset ODO, -CE	USP-6B	49zx	VR15	9b Tor
2CT83	XC6403CT83D	LVR/Vdet-IC	LDO, 2.5V±2%, 300mA, Vdo=2.8V, -Reset ODO, -CE	USP-6B	49zx	VR15	9b Tor
2CT84	XC6403CT84D	LVR/Vdet-IC	LDO, 2.85V±2%, 300mA, Vdo=3.2V, -Reset ODO, -CE	USP-6B	49zx	VR15	9b Tor
2CT85	XC6403CT85D	LVR/Vdet-IC	LDO, 3.0V±2%, 300mA, Vdo=3.1V, -Reset ODO, -CE	USP-6B	49zx	VR15	9b Tor
2CT86	XC6403CT86D	LVR/Vdet-IC	LDO, 3.5V±2%, 300mA, Vdo=3.8V, -Reset ODO, -CE	USP-6B	49zx	VR15	9b Tor
2CT87	XC6403CT87D	LVR/Vdet-IC	LDO, 3.0V±2%, 300mA, Vdo= 4.2V, -Reset ODO, -CE	USP-6B	49zx	VR15	9b Tor
2CT88	XC6403CT88D	LVR/Vdet-IC	LDO, 3.3V±2%, 300mA, Vdo= 4.0V, -Reset ODO, -CE	USP-6B	49zx	VR15	9b Tor
2CU03	XC6403CU03D	LVR/Vdet-IC	LDO, 1.6V±2%, 300mA, Vdo=1.8V, -Reset ODO, -CE	USP-6B	49zx	VR15	9b Tor
2CU07	XC6403CU07D	LVR/Vdet-IC	LDO, 1.8V±2%, 300mA, Vdo=2.9V, +Reset ODO, -CE	USP-6B	49zx	VR15	9b Tor
2CU11	XC6403CU11D	LVR/Vdet-IC	LDO, 1.8V±2%, 300mA, Vdo=1.7V, +Reset ODO, -CE	USP-6B	49zx	VR15	9b Tor
2CU12	XC6403CU12D	LVR/Vdet-IC	LDO, 3.0V±2%, 300mA, Vdo=4.2V, +Reset ODO, -CE	USP-6B	49zx	VR15	9b Tor
2CU14	XC6403CU14D	LVR/Vdet-IC	LDO, 1.8V±2%, 300mA, Vdo=3.0V, +Reset ODO, -CE	USP-6B	49zx	VR15	9b Tor
2CU16	XC6403CU16D	LVR/Vdet-IC	LDO, 2.5V±2%, 300mA, Vdo=2.9V, -Reset ODO, -CE	USP-6B	49zx	VR15	9b Tor
2CU17	XC6403CU17D	LVR/Vdet-IC	LDO, 1.8V±2%, 300mA, Vdo=2.3V, +Reset ODO, -CE	USP-6B	49zx	VR15	9b Tor
2CU18	XC6403CU18D	LVR/Vdet-IC	LDO, 2.8V±2%, 300mA, Vdo=3.4V, +Reset ODO, -CE	USP-6B	49zx	VR15	9b Tor
2CU20	XC6403CU20D	LVR/Vdet-IC	LDO, 3.3V±2%, 300mA, Vdo=3.0V, -Reset ODO, -CE	USP-6B	49zx	VR15	9b Tor
2CU21	XC6403CU21D	LVR/Vdet-IC	LDO, 3.3V±2%, 300mA, Vdo=3.1V, +Reset ODO, -CE	USP-6B	49zx	VR15	9b Tor
2CU24	XC6403CU24D	LVR/Vdet-IC	LDO, 1.8V±2%, 300mA, Vdo=2.4V, +Reset ODO, -CE	USP-6B	49zx	VR15	9b Tor
2CU25	XC6403CU25D	LVR/Vdet-IC	LDO, 3.2V±2%, 300mA, Vdo=2.8V, +Reset ODO, -CE	USP-6B	49zx	VR15	9b Tor
2CU30	XC6403CU30D	LVR/Vdet-IC	LDO, 4.0V±2%, 300mA, Vdo=4.3V, +Reset ODO, -CE	USP-6B	49zx	VR15	9b Tor
2CU31	XC6403CU31D	LVR/Vdet-IC	LDO, 2.85V±2%, 300mA, Vdo=2.7V, +Reset ODO, -CE	USP-6B	49zx	VR15	9b Tor
2CU32	XC6403CU32D	LVR/Vdet-IC	LDO, 2.6V±2%, 300mA, Vdo=2.4V, +Reset ODO, -CE	USP-6B	49zx	VR15	9b Tor
2CU33	XC6403CU33D	LVR/Vdet-IC	LDO, 2.7V±2%, 300mA, Vdo=2.8V, +Reset ODO, -CE	USP-6B	49zx	VR15	9b Tor
2CU34	XC6403CU34D	LVR/Vdet-IC	LDO, 2.85V±2%, 300mA, Vdo=2.55V, +Reset ODO, -CE	USP-6B	49zx	VR15	9b Tor
2CU80	XC6403CU80D	LVR/Vdet-IC	LDO, 1.8V±2%, 300mA, Vdo=1.6V, +Reset ODO, -CE	USP-6B	49zx	VR15	9b Tor
2CU81	XC6403CU81D	LVR/Vdet-IC	LDO, 2.8V±2%, 300mA, Vdo=3.1V, +Reset ODO, -CE	USP-6B	49zx	VR15	9b Tor
2CU82	XC6403CU82D	LVR/Vdet-IC	LDO, 1.8V±2%, 300mA, Vdo=2.0V, +Reset ODO, -CE	USP-6B	49zx	VR15	9b Tor
2CU83	XC6403CU83D	LVR/Vdet-IC	LDO, 2.5V±2%, 300mA, Vdo=2.8V, +Reset ODO, -CE	USP-6B	49zx	VR15	9b Tor
2CU84	XC6403CU84D	LVR/Vdet-IC	LDO, 2.85V±2%, 300mA, Vdo=3.2V, +Reset ODO, -CE	USP-6B	49zx	VR15	9b Tor
2CU85	XC6403CU85D	LVR/Vdet-IC	LDO, 3.0V±2%, 300mA, Vdo=3.1V, +Reset ODO, -CE	USP-6B	49zx	VR15	9b Tor
2CU86	XC6403CU86D	LVR/Vdet-IC	LDO, 3.5V±2%, 300mA, Vdo=3.8V, +Reset ODO, -CE	USP-6B	49zx	VR15	9b Tor
2CU87	XC6403CU87D	LVR/Vdet-IC	LDO, 3.0V±2%, 300mA, Vdo= 4.2V, +Reset ODO, -CE	USP-6B	49zx	VR15	9b Tor
2CU88	XC6403CU88D	LVR/Vdet-IC	LDO, 3.3V±2%, 300mA, Vdo= 4.0V, +Reset ODO, -CE	USP-6B	49zx	VR15	9b Tor
2D	R3117K341A	Vdet-IC	3.4V±1%, -Reset ODO, Sense	DFN1010-4	48rq	VD11	9a Ric
2D	RP100K181D	LVR-IC	LDO, LN, +CE, CL, 1.8V±0.8%, 200mA	PLP1612-4	45vm	VR4	9a Ric
2D	XC6223C2319R-G	LVR-IC	LDO, 2.3V±1%, 300mA, +CE, PDR	USPQ-4B03	48vm	VR4	9a Tor
2D	XC6224B2117R	LVR-IC	LDO, 2.1V±1.5%, 150mA, +CE, PDR	USPN-4B02	58vm	VR4	9a Tor
2D	XC6229H18B1R-G	LVR-IC	LDO, 1.85V±20mV, 300mA, +CE, ICP	BGA-4	63ba*	VR4	9a Tor
2D	XC6221C21B7R	LVR-IC	LDO, 2.15V±1%, 200mA, +CE, PDR	USPN-4	58vm	VR4	9a Tor
2D0	XC9235F30CER	DC-DC-IC	PWM, st-dwn, 3.0V±2%, 600mA, 1.2MHz, Vin>1.8V, HSST, CL	USP-6C	49da	DC16	9a Tor
2D1	XC9235F31CER	DC-DC-IC	PWM, st-dwn, 3.1V±2%, 600mA, 1.2MHz, Vin>1.8V, HSST, CL	USP-6C	49da	DC16	9a Tor
2D101	XC6365D101ER	DC/DC-IC	PWM st-down, 100kHz, Adj. 1.5..6V±2.5%, 1A, +CE, soft start	USP-6C	49zp	DC18	9b Tor
2D102	XC6365D102ER	DC/DC-IC	PWM st-down, 180kHz, Adj. 1.5..6V±2.5%, 1A, +CE, soft start	USP-6C	49zp	DC18	9b Tor
2D103	XC6365D103ER	DC/DC-IC	PWM st-down, 300kHz, Adj. 1.5..6V±2.5%, 1A, +CE, soft start	USP-6C	49zp	DC18	9b Tor
2D104	XC6365D105ER	DC/DC-IC	PWM st-down, 500kHz, Adj. 1.5..6V±2.5%, 1A, +CE, soft start	USP-6C	49zp	DC18	9b Tor
2D2	XC9235F32CER	DC-DC-IC	PWM, st-dwn, 3.2V±2%, 600mA, 1.2MHz, Vin>1.8V, HSST, CL	USP-6C	49da	DC16	9a Tor



SMD code	Type	Function	Short description	Case	Pinout	Sch.	St.Mnf.
2DC20	XC6403DC20D	LVR/Vdet-IC	LDO, 3.3V±2%, 300mA, Vdo=3.0V, -Reset ODO, +CE, PDR	USP-6B	49zx	VR15	9b Tor
2DC21	XC6403DC21D	LVR/Vdet-IC	LDO, 3.3V±2%, 300mA, Vdo=3.1V, -Reset ODO, +CE, PDR	USP-6B	49zx	VR15	9b Tor
2DC24	XC6403DC24D	LVR/Vdet-IC	LDO, 1.8V±2%, 300mA, Vdo=2.4V, -Reset ODO, +CE, PDR	USP-6B	49zx	VR15	9b Tor
2DC25	XC6403DC25D	LVR/Vdet-IC	LDO, 3.2V±2%, 300mA, Vdo=2.8V, -Reset ODO, +CE, PDR	USP-6B	49zx	VR15	9b Tor
2DC30	XC6403DC30D	LVR/Vdet-IC	LDO, 4.0V±2%, 300mA, Vdo=4.3V, -Reset ODO, +CE, PDR	USP-6B	49zx	VR15	9b Tor
2DC31	XC6403DC31D	LVR/Vdet-IC	LDO, 2.85V±2%, 300mA, Vdo=2.7V, -Reset ODO, +CE, PDR	USP-6B	49zx	VR15	9b Tor
2DC32	XC6403DC32D	LVR/Vdet-IC	LDO, 2.6V±2%, 300mA, Vdo=2.4V, -Reset ODO, +CE, PDR	USP-6B	49zx	VR15	9b Tor
2DC33	XC6403DC33D	LVR/Vdet-IC	LDO, 2.7V±2%, 300mA, Vdo=2.8V, -Reset ODO, +CE, PDR	USP-6B	49zx	VR15	9b Tor
2DC34	XC6403DC34D	LVR/Vdet-IC	LDO, 2.85V±2%, 300mA, Vdo=2.55V, -Reset ODO, +CE, PDR	USP-6B	49zx	VR15	9b Tor
2DC80	XC6403DC80D	LVR/Vdet-IC	LDO, 1.8V±2%, 300mA, Vdo=1.6V, -Reset ODO, +CE, PDR	USP-6B	49zx	VR15	9b Tor
2DC81	XC6403DC81D	LVR/Vdet-IC	LDO, 2.8V±2%, 300mA, Vdo=3.1V, -Reset ODO, +CE, PDR	USP-6B	49zx	VR15	9b Tor
2DC82	XC6403DC82D	LVR/Vdet-IC	LDO, 1.8V±2%, 300mA, Vdo=2.0V, -Reset ODO, +CE, PDR	USP-6B	49zx	VR15	9b Tor
2DC83	XC6403DC83D	LVR/Vdet-IC	LDO, 2.5V±2%, 300mA, Vdo=2.8V, -Reset ODO, +CE, PDR	USP-6B	49zx	VR15	9b Tor
2DC84	XC6403DC84D	LVR/Vdet-IC	LDO, 2.85V±2%, 300mA, Vdo=3.2V, -Reset ODO, +CE, PDR	USP-6B	49zx	VR15	9b Tor
2DC85	XC6403DC85D	LVR/Vdet-IC	LDO, 3.0V±2%, 300mA, Vdo=3.0V, -Reset ODO, +CE, PDR	USP-6B	49zx	VR15	9b Tor
2DC86	XC6403DC86D	LVR/Vdet-IC	LDO, 3.5V±2%, 300mA, Vdo=3.8V, -Reset ODO, +CE, PDR	USP-6B	49zx	VR15	9b Tor
2DC87	XC6403DC87D	LVR/Vdet-IC	LDO, 3.0V±2%, 300mA, Vdo=4.2V, -Reset ODO, +CE, PDR	USP-6B	49zx	VR15	9b Tor
2DC88	XC6403DC88D	LVR/Vdet-IC	LDO, 3.3V±2%, 300mA, Vdo=4.0V, -Reset ODO, +CE, PDR	USP-6B	49zx	VR15	9b Tor
2DD	XC9235F3DCER	DC-DC-IC	PWM, st-dwn, 3.35V±2%, 600mA, 1.2MHz, Vin>1.8V, HSST, CL	USP-6C	49da	DC16	9a Tor
2DD03	XC6403DD03D	LVR/Vdet-IC	LDO, 1.6V±2%, 300mA, Vdo=1.8V, -Reset ODO, +CE, PDR	USP-6B	49zx	VR15	9b Tor
2DD07	XC6403DD07D	LVR/Vdet-IC	LDO, 1.8V±2%, 300mA, Vdo=2.9V, +Reset ODO, +CE, PDR	USP-6B	49zx	VR15	9b Tor
2DD11	XC6403DD11D	LVR/Vdet-IC	LDO, 1.8V±2%, 300mA, Vdo=1.7V, +Reset ODO, +CE, PDR	USP-6B	49zx	VR15	9b Tor
2DD12	XC6403DD12D	LVR/Vdet-IC	LDO, 3.0V±2%, 300mA, Vdo=4.2V, +Reset ODO, +CE, PDR	USP-6B	49zx	VR15	9b Tor
2DD14	XC6403DD14D	LVR/Vdet-IC	LDO, 1.8V±2%, 300mA, Vdo=3.0V, +Reset ODO, +CE, PDR	USP-6B	49zx	VR15	9b Tor
2DD16	XC6403DD16D	LVR/Vdet-IC	LDO, 2.5V±2%, 300mA, Vdo=2.9V, +Reset ODO, +CE, PDR	USP-6B	49zx	VR15	9b Tor
2DD17	XC6403DD17D	LVR/Vdet-IC	LDO, 1.8V±2%, 300mA, Vdo=2.3V, +Reset ODO, +CE, PDR	USP-6B	49zx	VR15	9b Tor
2DD18	XC6403DD18D	LVR/Vdet-IC	LDO, 2.8V±2%, 300mA, Vdo=3.4V, +Reset ODO, +CE, PDR	USP-6B	49zx	VR15	9b Tor
2DD20	XC6403DD20D	LVR/Vdet-IC	LDO, 3.3V±2%, 300mA, Vdo=3.0V, +Reset ODO, +CE, PDR	USP-6B	49zx	VR15	9b Tor
2DD21	XC6403DD21D	LVR/Vdet-IC	LDO, 3.3V±2%, 300mA, Vdo=3.1V, +Reset ODO, +CE, PDR	USP-6B	49zx	VR15	9b Tor
2DD24	XC6403DD24D	LVR/Vdet-IC	LDO, 1.8V±2%, 300mA, Vdo=2.4V, +Reset ODO, +CE, PDR	USP-6B	49zx	VR15	9b Tor
2DD25	XC6403DD25D	LVR/Vdet-IC	LDO, 3.2V±2%, 300mA, Vdo=2.8V, +Reset ODO, +CE, PDR	USP-6B	49zx	VR15	9b Tor
2DD30	XC6403DD30D	LVR/Vdet-IC	LDO, 4.0V±2%, 300mA, Vdo=4.3V, -Reset ODO, +CE, PDR	USP-6B	49zx	VR15	9b Tor
2DD31	XC6403DD31D	LVR/Vdet-IC	LDO, 2.85V±2%, 300mA, Vdo=2.7V, +Reset ODO, +CE, PDR	USP-6B	49zx	VR15	9b Tor
2DD32	XC6403DD32D	LVR/Vdet-IC	LDO, 2.6V±2%, 300mA, Vdo=2.4V, +Reset ODO, +CE, PDR	USP-6B	49zx	VR15	9b Tor
2DD33	XC6403DD33D	LVR/Vdet-IC	LDO, 2.7V±2%, 300mA, Vdo=2.8V, -Reset ODO, +CE, PDR	USP-6B	49zx	VR15	9b Tor
2DD34	XC6403DD34D	LVR/Vdet-IC	LDO, 2.85V±2%, 300mA, Vdo=2.55V, +Reset ODO, +CE, PDR	USP-6B	49zx	VR15	9b Tor
2DD80	XC6403DD80D	LVR/Vdet-IC	LDO, 1.8V±2%, 300mA, Vdo=1.6V, -Reset ODO, +CE, PDR	USP-6B	49zx	VR15	9b Tor
2DD81	XC6403DD81D	LVR/Vdet-IC	LDO, 2.8V±2%, 300mA, Vdo=3.0V, +Reset ODO, +CE, PDR	USP-6B	49zx	VR15	9b Tor
2DD82	XC6403DD82D	LVR/Vdet-IC	LDO, 1.8V±2%, 300mA, Vdo=2.0V, +Reset ODO, +CE, PDR	USP-6B	49zx	VR15	9b Tor
2DD83	XC6403DD83D	LVR/Vdet-IC	LDO, 2.5V±2%, 300mA, Vdo=2.8V, -Reset ODO, +CE, PDR	USP-6B	49zx	VR15	9b Tor
2DD84	XC6403DD84D	LVR/Vdet-IC	LDO, 2.85V±2%, 300mA, Vdo=3.2V, +Reset ODO, +CE, PDR	USP-6B	49zx	VR15	9b Tor
2DD85	XC6403DD85D	LVR/Vdet-IC	LDO, 3.0V±2%, 300mA, Vdo=3.3V, +Reset ODO, +CE, PDR	USP-6B	49zx	VR15	9b Tor
2DD86	XC6403DD86D	LVR/Vdet-IC	LDO, 3.5V±2%, 300mA, Vdo=3.8V, +Reset ODO, +CE, PDR	USP-6B	49zx	VR15	9b Tor
2DD87	XC6403DD87D	LVR/Vdet-IC	LDO, 3.0V±2%, 300mA, Vdo=4.2V, +Reset ODO, +CE, PDR	USP-6B	49zx	VR15	9b Tor
2DD88	XC6403DD88D	LVR/Vdet-IC	LDO, 3.3V±2%, 300mA, Vdo=4.0V, +Reset ODO, +CE, PDR	USP-6B	49zx	VR15	9b Tor
2DE	XC9235F3CECER	DC-DC-IC	PWM, st-dwn, 3.45V±2%, 600mA, 1.2MHz, Vin>1.8V, HSST, CL	USP-6C	49da	DC16	9a Tor
2DE03	XC6403DE03D	LVR/Vdet-IC	LDO, 1.6V±2%, 300mA, Vdi=1.8V, -Reset ODO, +CE	USP-6B	49zx	VR15	9b Tor
2DE07	XC6403DE07D	LVR/Vdet-IC	LDO, 1.8V±2%, 300mA, Vdi=2.9V, -Reset ODO, +CE	USP-6B	49zx	VR15	9b Tor
2DE11	XC6403DE11D	LVR/Vdet-IC	LDO, 1.8V±2%, 300mA, Vdi=1.7V, -Reset ODO, +CE	USP-6B	49zx	VR15	9b Tor
2DE12	XC6403DE12D	LVR/Vdet-IC	LDO, 3.0V±2%, 300mA, Vdi=4.2V, -Reset ODO, +CE	USP-6B	49zx	VR15	9b Tor
2DE14	XC6403DE14D	LVR/Vdet-IC	LDO, 1.8V±2%, 300mA, Vdi=3.0V, -Reset ODO, +CE	USP-6B	49zx	VR15	9b Tor
2DE16	XC6403DE16D	LVR/Vdet-IC	LDO, 2.5V±2%, 300mA, Vdi=2.9V, -Reset ODO, +CE	USP-6B	49zx	VR15	9b Tor
2DE17	XC6403DE17D	LVR/Vdet-IC	LDO, 1.8V±2%, 300mA, Vdi=2.3V, -Reset ODO, +CE	USP-6B	49zx	VR15	9b Tor
2DE18	XC6403DE18D	LVR/Vdet-IC	LDO, 2.8V±2%, 300mA, Vdi=3.2V, -Reset ODO, +CE	USP-6B	49zx	VR15	9b Tor
2DE20	XC6403DE20D	LVR/Vdet-IC	LDO, 3.3V±2%, 300mA, Vdi=3.0V, -Reset ODO, +CE	USP-6B	49zx	VR15	9b Tor
2DE21	XC6403DE21D	LVR/Vdet-IC	LDO, 3.3V±2%, 300mA, Vdi=3.1V, -Reset ODO, +CE	USP-6B	49zx	VR15	9b Tor
2DE24	XC6403DE24D	LVR/Vdet-IC	LDO, 1.8V±2%, 300mA, Vdi=2.4V, -Reset ODO, +CE	USP-6B	49zx	VR15	9b Tor
2DE25	XC6403DE25D	LVR/Vdet-IC	LDO, 3.2V±2%, 300mA, Vdi=2.8V, -Reset ODO, +CE	USP-6B	49zx	VR15	9b Tor
2DE30	XC6403DE30D	LVR/Vdet-IC	LDO, 4.0V±2%, 300mA, Vdi=4.3V, -Reset ODO, +CE	USP-6B	49zx	VR15	9b Tor
2DE31	XC6403DE31D	LVR/Vdet-IC	LDO, 2.85V±2%, 300mA, Vdi=2.7V, -Reset ODO, +CE	USP-6B	49zx	VR15	9b Tor
2DE32	XC6403DE32D	LVR/Vdet-IC	LDO, 2.6V±2%, 300mA, Vdi=2.4V, -Reset ODO, +CE	USP-6B	49zx	VR15	9b Tor
2DE33	XC6403DE33D	LVR/Vdet-IC	LDO, 2.7V±2%, 300mA, Vdi=2.8V, -Reset ODO, +CE	USP-6B	49zx	VR15	9b Tor
2DE34	XC6403DE34D	LVR/Vdet-IC	LDO, 2.85V±2%, 300mA, Vdi=2.55V, -Reset ODO, +CE	USP-6B	49zx	VR15	9b Tor
2DE80	XC6403DE80D	LVR/Vdet-IC	LDO, 1.8V±2%, 300mA, Vdi=1.6V, -Reset ODO, +CE	USP-6B	49zx	VR15	9b Tor
2DE81	XC6403DE81D	LVR/Vdet-IC	LDO, 2.8V±2%, 300mA, Vdi=3.1V, -Reset ODO, +CE	USP-6B	49zx	VR15	9b Tor
2DE82	XC6403DE82D	LVR/Vdet-IC	LDO, 1.8V±2%, 300mA, Vdi=2.0V, -Reset ODO, +CE	USP-6B	49zx	VR15	9b Tor
2DE83	XC6403DE83D	LVR/Vdet-IC	LDO, 2.5V±2%, 300mA, Vdi=2.8V, -Reset ODO, +CE	USP-6B	49zx	VR15	9b Tor
2DE84	XC6403DE84D	LVR/Vdet-IC	LDO, 2.85V±2%, 300mA, Vdi=3.2V, -Reset ODO, +CE	USP-6B	49zx	VR15	9b Tor
2DE85	XC6403DE85D	LVR/Vdet-IC	LDO, 3.0V±2%, 300mA, Vdi=3.3V, -Reset ODO, +CE	USP-6B	49zx	VR15	9b Tor
2DE86	XC6403DE86D	LVR/Vdet-IC	LDO, 3.5V±2%, 300mA, Vdi=3.8V, -Reset ODO, +CE	USP-6B	49zx	VR15	9b Tor



SMD code	Type	Function	Short description	Case	Pinout	Sch.	St.	Mnf.
2DE87	XC6403DE87D	LVR/Vdet-IC	LDO, 3.0V±2%, 300mA, Vdi= 4.2V, -Reset ODO, +CE	USP-6B	49zx	VR15	9b	Tor
2DE88	XC6403DE88D	LVR/Vdet-IC	LDO, 3.3V±2%, 300mA, Vdi= 4.0V, -Reset ODO, +CE	USP-6B	49zx	VR15	9b	Tor
2DF	XC9235F3FCER	DC-DC-IC	PWM, st-dwn, 3.55V±2%, 600mA, 1.2MHz, Vin>1.8V, HSST, CL	USP-6C	49da	DC16	9a	Tor
2DF03	XC6403DF03D	LVR/Vdet-IC	LDO, 1.6V±2%, 300mA, Vdi=1.8V, +Reset ODO, +CE	USP-6B	49zx	VR15	9b	Tor
2DF07	XC6403DF07D	LVR/Vdet-IC	LDO, 1.8V±2%, 300mA, Vdi=2.9V, +Reset ODO, +CE	USP-6B	49zx	VR15	9b	Tor
2DF11	XC6403DF11D	LVR/Vdet-IC	LDO, 1.8V±2%, 300mA, Vdi=1.7V, +Reset ODO, +CE	USP-6B	49zx	VR15	9b	Tor
2DF12	XC6403DF12D	LVR/Vdet-IC	LDO, 3.0V±2%, 300mA, Vdi=4.2V, +Reset ODO, +CE	USP-6B	49zx	VR15	9b	Tor
2DF14	XC6403DF14D	LVR/Vdet-IC	LDO, 1.8V±2%, 300mA, Vdi=3.0V, +Reset ODO, +CE	USP-6B	49zx	VR15	9b	Tor
2DF16	XC6403DF16D	LVR/Vdet-IC	LDO, 2.5V±2%, 300mA, Vdi=2.9V, +Reset ODO, +CE	USP-6B	49zx	VR15	9b	Tor
2DF17	XC6403DF17D	LVR/Vdet-IC	LDO, 1.8V±2%, 300mA, Vdi=2.3V, +Reset ODO, +CE	USP-6B	49zx	VR15	9b	Tor
2DF18	XC6403DF18D	LVR/Vdet-IC	LDO, 2.8V±2%, 300mA, Vdi=3.4V, +Reset ODO, +CE	USP-6B	49zx	VR15	9b	Tor
2DF20	XC6403DF20D	LVR/Vdet-IC	LDO, 3.3V±2%, 300mA, Vdi=3.0V, +Reset ODO, +CE	USP-6B	49zx	VR15	9b	Tor
2DF21	XC6403DF21D	LVR/Vdet-IC	LDO, 3.3V±2%, 300mA, Vdi=3.1V, +Reset ODO, +CE	USP-6B	49zx	VR15	9b	Tor
2DF24	XC6403DF24D	LVR/Vdet-IC	LDO, 1.8V±2%, 300mA, Vdi=2.4V, +Reset ODO, +CE	USP-6B	49zx	VR15	9b	Tor
2DF25	XC6403DF25D	LVR/Vdet-IC	LDO, 3.2V±2%, 300mA, Vdi=2.8V, +Reset ODO, +CE	USP-6B	49zx	VR15	9b	Tor
2DF30	XC6403DF30D	LVR/Vdet-IC	LDO, 4.0V±2%, 300mA, Vdi=4.3V, +Reset ODO, +CE	USP-6B	49zx	VR15	9b	Tor
2DF31	XC6403DF31D	LVR/Vdet-IC	LDO, 2.85V±2%, 300mA, Vdi=2.7V, +Reset ODO, +CE	USP-6B	49zx	VR15	9b	Tor
2DF32	XC6403DF32D	LVR/Vdet-IC	LDO, 2.6V±2%, 300mA, Vdi=2.4V, +Reset ODO, +CE	USP-6B	49zx	VR15	9b	Tor
2DF33	XC6403DF33D	LVR/Vdet-IC	LDO, 2.7V±2%, 300mA, Vdi=2.8V, +Reset ODO, +CE	USP-6B	49zx	VR15	9b	Tor
2DF34	XC6403DF34D	LVR/Vdet-IC	LDO, 2.85V±2%, 300mA, Vdi=2.55V, +Reset ODO, +CE	USP-6B	49zx	VR15	9b	Tor
2DF80	XC6403DF80D	LVR/Vdet-IC	LDO, 1.8V±2%, 300mA, Vdi=1.6V, +Reset ODO, +CE	USP-6B	49zx	VR15	9b	Tor
2DF81	XC6403DF81D	LVR/Vdet-IC	LDO, 2.8V±2%, 300mA, Vdi=3.1V, +Reset ODO, +CE	USP-6B	49zx	VR15	9b	Tor
2DF82	XC6403DF82D	LVR/Vdet-IC	LDO, 1.8V±2%, 300mA, Vdi=2.0V, +Reset ODO, +CE	USP-6B	49zx	VR15	9b	Tor
2DF83	XC6403DF83D	LVR/Vdet-IC	LDO, 2.5V±2%, 300mA, Vdi=2.8V, +Reset ODO, +CE	USP-6B	49zx	VR15	9b	Tor
2DF84	XC6403DF84D	LVR/Vdet-IC	LDO, 2.85V±2%, 300mA, Vdi=3.0V, +Reset ODO, +CE	USP-6B	49zx	VR15	9b	Tor
2DF85	XC6403DF85D	LVR/Vdet-IC	LDO, 3.0V±2%, 300mA, Vdi=3.3V, +Reset ODO, +CE	USP-6B	49zx	VR15	9b	Tor
2DF86	XC6403DF86D	LVR/Vdet-IC	LDO, 3.5V±2%, 300mA, Vdi=3.8V, +Reset ODO, +CE	USP-6B	49zx	VR15	9b	Tor
2DF87	XC6403DF87D	LVR/Vdet-IC	LDO, 3.0V±2%, 300mA, Vdi= 4.2V, +Reset ODO, +CE	USP-6B	49zx	VR15	9b	Tor
2DF88	XC6403DF88D	LVR/Vdet-IC	LDO, 3.3V±2%, 300mA, Vdi= 4.0V, +Reset ODO, +CE	USP-6B	49zx	VR15	9b	Tor
2DH	XC9235F3FCER	DC-DC-IC	PWM, st-dwn, 3.65V±2%, 600mA, 1.2MHz, Vin>1.8V, HSST, CL	USP-6C	49da	DC16	9a	Tor
2DH03	XC6403DH03D	LVR/Vdet-IC	LDO, 1.6V±2%, 300mA, Vdo=1.8V, -Reset ODO, +CE	USP-6B	49zx	VR15	9b	Tor
2DH07	XC6403DH07D	LVR/Vdet-IC	LDO, 1.8V±2%, 300mA, Vdo=2.9V, -Reset ODO, +CE	USP-6B	49zx	VR15	9b	Tor
2DH11	XC6403DH11D	LVR/Vdet-IC	LDO, 1.8V±2%, 300mA, Vdo=1.7V, -Reset ODO, +CE	USP-6B	49zx	VR15	9b	Tor
2DH12	XC6403DH12D	LVR/Vdet-IC	LDO, 3.0V±2%, 300mA, Vdo=4.2V, -Reset ODO, +CE	USP-6B	49zx	VR15	9b	Tor
2DH14	XC6403DH14D	LVR/Vdet-IC	LDO, 1.8V±2%, 300mA, Vdo=3.0V, -Reset ODO, +CE	USP-6B	49zx	VR15	9b	Tor
2DH16	XC6403DH16D	LVR/Vdet-IC	LDO, 2.5V±2%, 300mA, Vdo=2.9V, -Reset ODO, +CE	USP-6B	49zx	VR15	9b	Tor
2DH17	XC6403DH17D	LVR/Vdet-IC	LDO, 1.8V±2%, 300mA, Vdo=2.3V, -Reset ODO, +CE	USP-6B	49zx	VR15	9b	Tor
2DH18	XC6403DH18D	LVR/Vdet-IC	LDO, 2.8V±2%, 300mA, Vdo=3.4V, +Reset ODO, +CE	USP-6B	49zx	VR15	9b	Tor
2DH20	XC6403DH20D	LVR/Vdet-IC	LDO, 3.3V±2%, 300mA, Vdo=3.0V, -Reset ODO, +CE	USP-6B	49zx	VR15	9b	Tor
2DH21	XC6403DH21D	LVR/Vdet-IC	LDO, 3.3V±2%, 300mA, Vdo=3.1V, -Reset ODO, +CE	USP-6B	49zx	VR15	9b	Tor
2DH24	XC6403DH24D	LVR/Vdet-IC	LDO, 1.8V±2%, 300mA, Vdo=2.4V, -Reset ODO, +CE	USP-6B	49zx	VR15	9b	Tor
2DH25	XC6403DH25D	LVR/Vdet-IC	LDO, 3.2V±2%, 300mA, Vdo=2.8V, -Reset ODO, +CE	USP-6B	49zx	VR15	9b	Tor
2DH30	XC6403DH30D	LVR/Vdet-IC	LDO, 4.0V±2%, 300mA, Vdo=4.3V, -Reset ODO, +CE	USP-6B	49zx	VR15	9b	Tor
2DH31	XC6403DH31D	LVR/Vdet-IC	LDO, 2.85V±2%, 300mA, Vdo=2.7V, -Reset ODO, +CE	USP-6B	49zx	VR15	9b	Tor
2DH32	XC6403DH32D	LVR/Vdet-IC	LDO, 2.6V±2%, 300mA, Vdo=2.4V, -Reset ODO, +CE	USP-6B	49zx	VR15	9b	Tor
2DH33	XC6403DH33D	LVR/Vdet-IC	LDO, 2.7V±2%, 300mA, Vdo=2.8V, -Reset ODO, +CE	USP-6B	49zx	VR15	9b	Tor
2DH34	XC6403DH34D	LVR/Vdet-IC	LDO, 2.85V±2%, 300mA, Vdo=2.55V, -Reset ODO, +CE	USP-6B	49zx	VR15	9b	Tor
2DH80	XC6403DH80D	LVR/Vdet-IC	LDO, 1.8V±2%, 300mA, Vdo=1.6V, -Reset ODO, +CE	USP-6B	49zx	VR15	9b	Tor
2DH81	XC6403DH81D	LVR/Vdet-IC	LDO, 2.8V±2%, 300mA, Vdo=3.1V, -Reset ODO, +CE	USP-6B	49zx	VR15	9b	Tor
2DH82	XC6403DH82D	LVR/Vdet-IC	LDO, 1.8V±2%, 300mA, Vdo=2.0V, -Reset ODO, +CE	USP-6B	49zx	VR15	9b	Tor
2DH83	XC6403DH83D	LVR/Vdet-IC	LDO, 2.5V±2%, 300mA, Vdo=2.8V, -Reset ODO, +CE	USP-6B	49zx	VR15	9b	Tor
2DH84	XC6403DH84D	LVR/Vdet-IC	LDO, 2.85V±2%, 300mA, Vdo=3.2V, -Reset ODO, +CE	USP-6B	49zx	VR15	9b	Tor
2DH85	XC6403DH85D	LVR/Vdet-IC	LDO, 3.0V±2%, 300mA, Vdo=3.3V, -Reset ODO, +CE	USP-6B	49zx	VR15	9b	Tor
2DH86	XC6403DH86D	LVR/Vdet-IC	LDO, 3.5V±2%, 300mA, Vdo=3.8V, -Reset ODO, +CE	USP-6B	49zx	VR15	9b	Tor
2DH87	XC6403DH87D	LVR/Vdet-IC	LDO, 3.0V±2%, 300mA, Vdo= 4.2V, -Reset ODO, +CE	USP-6B	49zx	VR15	9b	Tor
2DH88	XC6403DH88D	LVR/Vdet-IC	LDO, 3.3V±2%, 300mA, Vdo= 4.0V, -Reset ODO, +CE	USP-6B	49zx	VR15	9b	Tor
2DK	XC9235F3K3KER	DC-DC-IC	PWM, st-dwn, 3.75V±2%, 600mA, 1.2MHz, Vin>1.8V, HSST, CL	USP-6C	49da	DC16	9a	Tor
2DK03	XC6403DK03D	LVR/Vdet-IC	LDO, 1.6V±2%, 300mA, Vdo=1.8V, +Reset ODO, +CE	USP-6B	49zx	VR15	9b	Tor
2DK07	XC6403DK07D	LVR/Vdet-IC	LDO, 1.8V±2%, 300mA, Vdo=2.9V, +Reset ODO, +CE	USP-6B	49zx	VR15	9b	Tor
2DK11	XC6403DK11D	LVR/Vdet-IC	LDO, 1.8V±2%, 300mA, Vdo=1.7V, +Reset ODO, +CE	USP-6B	49zx	VR15	9b	Tor
2DK12	XC6403DK12D	LVR/Vdet-IC	LDO, 3.0V±2%, 300mA, Vdo=4.2V, +Reset ODO, +CE	USP-6B	49zx	VR15	9b	Tor
2DK14	XC6403DK14D	LVR/Vdet-IC	LDO, 1.8V±2%, 300mA, Vdo=3.0V, +Reset ODO, +CE	USP-6B	49zx	VR15	9b	Tor
2DK16	XC6403DK16D	LVR/Vdet-IC	LDO, 2.5V±2%, 300mA, Vdo=2.9V, +Reset ODO, +CE	USP-6B	49zx	VR15	9b	Tor
2DK17	XC6403DK17D	LVR/Vdet-IC	LDO, 1.8V±2%, 300mA, Vdo=3.0V, +Reset ODO, +CE	USP-6B	49zx	VR15	9b	Tor
2DK18	XC6403DK18D	LVR/Vdet-IC	LDO, 2.8V±2%, 300mA, Vdo=3.4V, +Reset ODO, +CE	USP-6B	49zx	VR15	9b	Tor
2DK20	XC6403DK20D	LVR/Vdet-IC	LDO, 3.3V±2%, 300mA, Vdo=3.0V, +Reset ODO, +CE	USP-6B	49zx	VR15	9b	Tor
2DK21	XC6403DK21D	LVR/Vdet-IC	LDO, 3.3V±2%, 300mA, Vdo=3.1V, +Reset ODO, +CE	USP-6B	49zx	VR15	9b	Tor
2DK24	XC6403DK24D	LVR/Vdet-IC	LDO, 1.8V±2%, 300mA, Vdo=2.4V, +Reset ODO, +CE	USP-6B	49zx	VR15	9b	Tor
2DK25	XC6403DK25D	LVR/Vdet-IC	LDO, 3.2V±2%, 300mA, Vdo=2.8V, +Reset ODO, +CE	USP-6B	49zx	VR15	9b	Tor
2DK30	XC6403DK30D	LVR/Vdet-IC	LDO, 4.0V±2%, 300mA, Vdo=4.3V, +Reset ODO, +CE	USP-6B	49zx	VR15	9b	Tor



SMD code	Type	Function	Short description	Case	Pinout	Sch.	St.	Mnf.
2DK31	XC6403DK31D	LVR/Vdet-IC	LDO, 2.85V±2%, 300mA, Vdo=2.7V, +Reset ODO, +CE	USP-6B	49zx	VR15	9b	Tor
2DK32	XC6403DK32D	LVR/Vdet-IC	LDO, 2.6V±2%, 300mA, Vdo=2.4V, +Reset ODO, +CE	USP-6B	49zx	VR15	9b	Tor
2DK33	XC6403DK33D	LVR/Vdet-IC	LDO, 2.7V±2%, 300mA, Vdo=2.8V, +Reset ODO, +CE	USP-6B	49zx	VR15	9b	Tor
2DK34	XC6403DK34D	LVR/Vdet-IC	LDO, 2.85V±2%, 300mA, Vdo=2.55V, +Reset ODO, +CE	USP-6B	49zx	VR15	9b	Tor
2DK80	XC6403DK80D	LVR/Vdet-IC	LDO, 1.8V±2%, 300mA, Vdo=1.6V, +Reset ODO, +CE	USP-6B	49zx	VR15	9b	Tor
2DK81	XC6403DK81D	LVR/Vdet-IC	LDO, 2.8V±2%, 300mA, Vdo=3.1V, +Reset ODO, +CE	USP-6B	49zx	VR15	9b	Tor
2DK82	XC6403DK82D	LVR/Vdet-IC	LDO, 1.8V±2%, 300mA, Vdo=2.0V, +Reset ODO, +CE	USP-6B	49zx	VR15	9b	Tor
2DK83	XC6403DK83D	LVR/Vdet-IC	LDO, 2.5V±2%, 300mA, Vdo=2.8V, +Reset ODO, +CE	USP-6B	49zx	VR15	9b	Tor
2DK84	XC6403DK84D	LVR/Vdet-IC	LDO, 2.85V±2%, 300mA, Vdo=3.2V, +Reset ODO, +CE	USP-6B	49zx	VR15	9b	Tor
2DK85	XC6403DK85D	LVR/Vdet-IC	LDO, 3.0V±2%, 300mA, Vdo=3.3V, +Reset ODO, +CE	USP-6B	49zx	VR15	9b	Tor
2DK86	XC6403DK86D	LVR/Vdet-IC	LDO, 3.5V±2%, 300mA, Vdo=3.8V, +Reset ODO, +CE	USP-6B	49zx	VR15	9b	Tor
2DK87	XC6403DK87D	LVR/Vdet-IC	LDO, 3.0V±2%, 300mA, Vdo=4.2V, +Reset ODO, +CE	USP-6B	49zx	VR15	9b	Tor
2DK88	XC6403DK88D	LVR/Vdet-IC	LDO, 3.3V±2%, 300mA, Vdo=4.0V, +Reset ODO, +CE	USP-6B	49zx	VR15	9b	Tor
2DL	XC9235F3LCEER	DC-DC-IC	PWM, st-dwn, 3.85V±2%, 600mA, 1.2MHz, Vin>1.8V, HSST, CL	USP-6C	49da	DC16	9a	Tor
2DL03	XC6403DL03D	LVR/Vdet-IC	LDO, 1.6V±2%, 300mA, Vdi=1.8V, +Reset ODO, -CE, PUR	USP-6B	49zx	VR15	9b	Tor
2DL07	XC6403DL07D	LVR/Vdet-IC	LDO, 1.8V±2%, 300mA, Vdi=2.9V, -Reset ODO, -CE, PUR	USP-6B	49zx	VR15	9b	Tor
2DL11	XC6403DL11D	LVR/Vdet-IC	LDO, 1.8V±2%, 300mA, Vdi=1.7V, -Reset ODO, -CE, PUR	USP-6B	49zx	VR15	9b	Tor
2DL12	XC6403DL12D	LVR/Vdet-IC	LDO, 3.0V±2%, 300mA, Vdi=4.2V, -Reset ODO, -CE, PUR	USP-6B	49zx	VR15	9b	Tor
2DL14	XC6403DL14D	LVR/Vdet-IC	LDO, 1.8V±2%, 300mA, Vdi=3.0V, -Reset ODO, -CE, PUR	USP-6B	49zx	VR15	9b	Tor
2DL16	XC6403DL16D	LVR/Vdet-IC	LDO, 2.5V±2%, 300mA, Vdi=2.9V, -Reset ODO, -CE, PUR	USP-6B	49zx	VR15	9b	Tor
2DL17	XC6403DL17D	LVR/Vdet-IC	LDO, 1.8V±2%, 300mA, Vdi=2.3V, -Reset ODO, -CE, PUR	USP-6B	49zx	VR15	9b	Tor
2DL18	XC6403DL18D	LVR/Vdet-IC	LDO, 2.8V±2%, 300mA, Vdi=3.4V, -Reset ODO, -CE, PUR	USP-6B	49zx	VR15	9b	Tor
2DL20	XC6403DL20D	LVR/Vdet-IC	LDO, 3.3V±2%, 300mA, Vdi=3.0V, -Reset ODO, -CE, PUR	USP-6B	49zx	VR15	9b	Tor
2DL21	XC6403DL21D	LVR/Vdet-IC	LDO, 3.3V±2%, 300mA, Vdi=3.1V, -Reset ODO, -CE, PUR	USP-6B	49zx	VR15	9b	Tor
2DL24	XC6403DL24D	LVR/Vdet-IC	LDO, 1.8V±2%, 300mA, Vdi=2.9V, -Reset ODO, -CE, PUR	USP-6B	49zx	VR15	9b	Tor
2DL25	XC6403DL25D	LVR/Vdet-IC	LDO, 3.2V±2%, 300mA, Vdi=2.8V, -Reset ODO, -CE, PUR	USP-6B	49zx	VR15	9b	Tor
2DL30	XC6403DL30D	LVR/Vdet-IC	LDO, 4.0V±2%, 300mA, Vdi=4.3V, -Reset ODO, -CE, PUR	USP-6B	49zx	VR15	9b	Tor
2DL31	XC6403DL31D	LVR/Vdet-IC	LDO, 2.85V±2%, 300mA, Vdi=2.7V, -Reset ODO, -CE, PUR	USP-6B	49zx	VR15	9b	Tor
2DL32	XC6403DL32D	LVR/Vdet-IC	LDO, 2.6V±2%, 300mA, Vdi=2.4V, -Reset ODO, -CE, PUR	USP-6B	49zx	VR15	9b	Tor
2DL33	XC6403DL33D	LVR/Vdet-IC	LDO, 2.7V±2%, 300mA, Vdi=2.8V, -Reset ODO, -CE, PUR	USP-6B	49zx	VR15	9b	Tor
2DL34	XC6403DL34D	LVR/Vdet-IC	LDO, 2.85V±2%, 300mA, Vdi=2.55V, -Reset ODO, -CE, PUR	USP-6B	49zx	VR15	9b	Tor
2DL80	XC6403DL80D	LVR/Vdet-IC	LDO, 1.8V±2%, 300mA, Vdi=1.6V, -Reset ODO, -CE, PUR	USP-6B	49zx	VR15	9b	Tor
2DL81	XC6403DL81D	LVR/Vdet-IC	LDO, 2.8V±2%, 300mA, Vdi=3.1V, -Reset ODO, -CE, PUR	USP-6B	49zx	VR15	9b	Tor
2DL82	XC6403DL82D	LVR/Vdet-IC	LDO, 1.8V±2%, 300mA, Vdi=2.0V, -Reset ODO, -CE, PUR	USP-6B	49zx	VR15	9b	Tor
2DL83	XC6403DL83D	LVR/Vdet-IC	LDO, 2.5V±2%, 300mA, Vdi=2.8V, -Reset ODO, -CE, PUR	USP-6B	49zx	VR15	9b	Tor
2DL84	XC6403DL84D	LVR/Vdet-IC	LDO, 2.85V±2%, 300mA, Vdi=3.2V, -Reset ODO, -CE, PUR	USP-6B	49zx	VR15	9b	Tor
2DL85	XC6403DL85D	LVR/Vdet-IC	LDO, 3.0V±2%, 300mA, Vdi=3.3V, -Reset ODO, -CE, PUR	USP-6B	49zx	VR15	9b	Tor
2DL86	XC6403DL86D	LVR/Vdet-IC	LDO, 3.5V±2%, 300mA, Vdi=3.8V, -Reset ODO, -CE, PUR	USP-6B	49zx	VR15	9b	Tor
2DL87	XC6403DL87D	LVR/Vdet-IC	LDO, 3.0V±2%, 300mA, Vdi=4.2V, -Reset ODO, -CE, PUR	USP-6B	49zx	VR15	9b	Tor
2DL88	XC6403DL88D	LVR/Vdet-IC	LDO, 3.3V±2%, 300mA, Vdi=4.0V, -Reset ODO, -CE, PUR	USP-6B	49zx	VR15	9b	Tor
2DM	XC9235F3MCEER	DC-DC-IC	PWM, st-dwn, 3.95V±2%, 600mA, 1.2MHz, Vin>1.8V, HSST, CL	USP-6C	49da	DC16	9a	Tor
2DM03	XC6403DM03D	LVR/Vdet-IC	LDO, 1.6V±2%, 300mA, Vdi=1.8V, +Reset ODO, -CE, PUR	USP-6B	49zx	VR15	9b	Tor
2DM07	XC6403DM07D	LVR/Vdet-IC	LDO, 1.8V±2%, 300mA, Vdi=2.9V, +Reset ODO, -CE, PUR	USP-6B	49zx	VR15	9b	Tor
2DM11	XC6403DM11D	LVR/Vdet-IC	LDO, 1.8V±2%, 300mA, Vdi=1.7V, +Reset ODO, -CE, PUR	USP-6B	49zx	VR15	9b	Tor
2DM12	XC6403DM12D	LVR/Vdet-IC	LDO, 3.0V±2%, 300mA, Vdi=4.2V, +Reset ODO, -CE, PUR	USP-6B	49zx	VR15	9b	Tor
2DM14	XC6403DM14D	LVR/Vdet-IC	LDO, 1.8V±2%, 300mA, Vdi=3.0V, +Reset ODO, -CE, PUR	USP-6B	49zx	VR15	9b	Tor
2DM16	XC6403DM16D	LVR/Vdet-IC	LDO, 2.5V±2%, 300mA, Vdi=2.9V, +Reset ODO, -CE, PUR	USP-6B	49zx	VR15	9b	Tor
2DM17	XC6403DM17D	LVR/Vdet-IC	LDO, 1.8V±2%, 300mA, Vdi=2.3V, +Reset ODO, -CE, PUR	USP-6B	49zx	VR15	9b	Tor
2DM18	XC6403DM18D	LVR/Vdet-IC	LDO, 2.8V±2%, 300mA, Vdi=3.4V, +Reset ODO, -CE, PUR	USP-6B	49zx	VR15	9b	Tor
2DM20	XC6403DM20D	LVR/Vdet-IC	LDO, 3.3V±2%, 300mA, Vdi=3.0V, +Reset ODO, -CE, PUR	USP-6B	49zx	VR15	9b	Tor
2DM21	XC6403DM21D	LVR/Vdet-IC	LDO, 3.3V±2%, 300mA, Vdi=3.1V, +Reset ODO, -CE, PUR	USP-6B	49zx	VR15	9b	Tor
2DM24	XC6403DM24D	LVR/Vdet-IC	LDO, 1.8V±2%, 300mA, Vdi=2.4V, +Reset ODO, -CE, PUR	USP-6B	49zx	VR15	9b	Tor
2DM25	XC6403DM25D	LVR/Vdet-IC	LDO, 3.2V±2%, 300mA, Vdi=2.8V, +Reset ODO, -CE, PUR	USP-6B	49zx	VR15	9b	Tor
2DM30	XC6403DM30D	LVR/Vdet-IC	LDO, 4.0V±2%, 300mA, Vdi=4.3V, +Reset ODO, -CE, PUR	USP-6B	49zx	VR15	9b	Tor
2DM31	XC6403DM31D	LVR/Vdet-IC	LDO, 2.85V±2%, 300mA, Vdi=2.7V, +Reset ODO, -CE, PUR	USP-6B	49zx	VR15	9b	Tor
2DM32	XC6403DM32D	LVR/Vdet-IC	LDO, 2.6V±2%, 300mA, Vdi=2.4V, +Reset ODO, -CE, PUR	USP-6B	49zx	VR15	9b	Tor
2DM33	XC6403DM33D	LVR/Vdet-IC	LDO, 2.7V±2%, 300mA, Vdi=2.8V, +Reset ODO, -CE, PUR	USP-6B	49zx	VR15	9b	Tor
2DM34	XC6403DM34D	LVR/Vdet-IC	LDO, 2.85V±2%, 300mA, Vdi=2.55V, +Reset ODO, -CE, PUR	USP-6B	49zx	VR15	9b	Tor
2DM80	XC6403DM80D	LVR/Vdet-IC	LDO, 1.8V±2%, 300mA, Vdi=1.6V, +Reset ODO, -CE, PUR	USP-6B	49zx	VR15	9b	Tor
2DM81	XC6403DM81D	LVR/Vdet-IC	LDO, 2.8V±2%, 300mA, Vdi=3.1V, +Reset ODO, -CE, PUR	USP-6B	49zx	VR15	9b	Tor
2DM82	XC6403DM82D	LVR/Vdet-IC	LDO, 1.8V±2%, 300mA, Vdi=2.0V, +Reset ODO, -CE, PUR	USP-6B	49zx	VR15	9b	Tor
2DM83	XC6403DM83D	LVR/Vdet-IC	LDO, 2.5V±2%, 300mA, Vdi=2.8V, +Reset ODO, -CE, PUR	USP-6B	49zx	VR15	9b	Tor
2DM84	XC6403DM84D	LVR/Vdet-IC	LDO, 2.85V±2%, 300mA, Vdi=3.2V, +Reset ODO, -CE, PUR	USP-6B	49zx	VR15	9b	Tor
2DM85	XC6403DM85D	LVR/Vdet-IC	LDO, 3.0V±2%, 300mA, Vdi=3.3V, +Reset ODO, -CE, PUR	USP-6B	49zx	VR15	9b	Tor
2DM86	XC6403DM86D	LVR/Vdet-IC	LDO, 3.5V±2%, 300mA, Vdi=3.8V, +Reset ODO, -CE, PUR	USP-6B	49zx	VR15	9b	Tor
2DM87	XC6403DM87D	LVR/Vdet-IC	LDO, 3.0V±2%, 300mA, Vdi=4.2V, +Reset ODO, -CE, PUR	USP-6B	49zx	VR15	9b	Tor
2DM88	XC6403DM88D	LVR/Vdet-IC	LDO, 3.3V±2%, 300mA, Vdi=4.0V, +Reset ODO, -CE, PUR	USP-6B	49zx	VR15	9b	Tor
2DN03	XC6403DN03D	LVR/Vdet-IC	LDO, 1.6V±2%, 300mA, Vdo=1.8V, -Reset ODO, -CE, PUR	USP-6B	49zx	VR15	9b	Tor
2DN07	XC6403DN07D	LVR/Vdet-IC	LDO, 1.8V±2%, 300mA, Vdo=2.9V, -Reset ODO, -CE, PUR	USP-6B	49zx	VR15	9b	Tor
2DN11	XC6403DN11D	LVR/Vdet-IC	LDO, 1.8V±2%, 300mA, Vdo=1.7V, -Reset ODO, -CE, PUR	USP-6B	49zx	VR15	9b	Tor



SMD code	Type	Function	Short description	Case	Pinout	Sch.	St.	Mnf.
2DU31	XC6403DU31D	LVR/Vdet-IC	LDO, 2.85V±2%, 300mA, Vdo=2.7V, +Reset ODO, -CE	USP-6B	49zx	VR15	9b	Tor
2DU32	XC6403DU32D	LVR/Vdet-IC	LDO, 2.6V±2%, 300mA, Vdo=2.4V, +Reset ODO, -CE	USP-6B	49zx	VR15	9b	Tor
2DU33	XC6403DU33D	LVR/Vdet-IC	LDO, 2.7V±2%, 300mA, Vdo=2.8V, +Reset ODO, -CE	USP-6B	49zx	VR15	9b	Tor
2DU34	XC6403DU34D	LVR/Vdet-IC	LDO, 2.85V±2%, 300mA, Vdo=2.55V, +Reset ODO, -CE	USP-6B	49zx	VR15	9b	Tor
2DU80	XC6403DU80D	LVR/Vdet-IC	LDO, 1.8V±2%, 300mA, Vdo=1.6V, +Reset ODO, -CE	USP-6B	49zx	VR15	9b	Tor
2DU81	XC6403DU81D	LVR/Vdet-IC	LDO, 2.8V±2%, 300mA, Vdo=3.1V, +Reset ODO, -CE	USP-6B	49zx	VR15	9b	Tor
2DU82	XC6403DU82D	LVR/Vdet-IC	LDO, 1.8V±2%, 300mA, Vdo=2.0V, +Reset ODO, -CE	USP-6B	49zx	VR15	9b	Tor
2DU83	XC6403DU83D	LVR/Vdet-IC	LDO, 2.5V±2%, 300mA, Vdo=2.8V, +Reset ODO, -CE	USP-6B	49zx	VR15	9b	Tor
2DU84	XC6403DU84D	LVR/Vdet-IC	LDO, 2.85V±2%, 300mA, Vdo=3.2V, +Reset ODO, -CE	USP-6B	49zx	VR15	9b	Tor
2DU85	XC6403DU85D	LVR/Vdet-IC	LDO, 3.0V±2%, 300mA, Vdo=3.3V, +Reset ODO, -CE	USP-6B	49zx	VR15	9b	Tor
2DU86	XC6403DU86D	LVR/Vdet-IC	LDO, 3.5V±2%, 300mA, Vdo=3.8V, +Reset ODO, -CE	USP-6B	49zx	VR15	9b	Tor
2DU87	XC6403DU87D	LVR/Vdet-IC	LDO, 3.0V±2%, 300mA, Vdo=4.2V, +Reset ODO, -CE	USP-6B	49zx	VR15	9b	Tor
2DU88	XC6403DU88D	LVR/Vdet-IC	LDO, 3.3V±2%, 300mA, Vdo=4.0V, +Reset ODO, -CE	USP-6B	49zx	VR15	9b	Tor
2E	R3117K351A	Vdet-IC	3.5V±1%, -Reset ODO, Sense	DFN1010-4	48rq	VD11	9a	Ric
2E	RP100K181D5	LVR-IC	LDO, LN, +CE, CL, 1.85V±0.8%, 200mA	PLP1612-4	45vm	VR4	9a	Ric
2E	XC6223C2419R-G	LVR-IC	LDO, 2.4V±1%, 300mA, +CE, PDR	USPQ-4B03	48vm	VR4	9a	Tor
2E	XC6224B2217R	LVR-IC	LDO, 2.2V±1.5%, 150mA, +CE, PDR	USPN-4B02	58vm	VR4	9e	Tor
2E	XC6229H1911R-G	LVR-IC	LDO, 1.9V±20mV, 300mA, +CE, ICP	BGA-4	63ba*	VR4	9a	Tor
2E	XC6221C22B7R	LVR-IC	LDO, 2.25V±1%, 200mA, +CE, PDR	USPN-4	58vm	VR4	9a	Tor
2E0	XC9235F40CER	DC/DC-IC	PWM, st-dwn, 4.0V±2%, 600mA, 1.2MHz, Vin>1.8V, HSSST, CL	USP-6C	49da	DC16	9a	Tor
2E200	XC6372E200D	DC/DC-IC	PWM/PFM step-up, 50kHz, int. Vdd, 2.0V±2.5%, 100mA	USP-6B	49ge	DC4	9b	Tor
2E201	XC6372E201D	DC/DC-IC	PWM/PFM step-up, 100kHz, int. Vdd, 2.0V±2.5%, 100mA	USP-6B	49ge	DC4	9b	Tor
2E202	XC6372E202D	DC/DC-IC	PWM/PFM step-up, 180kHz, int. Vdd, 2.0V±2.5%, 100mA	USP-6B	49ge	DC4	9b	Tor
2E210	XC6372E210D	DC/DC-IC	PWM/PFM step-up, 50kHz, int. Vdd, 2.1V±2.5%, 100mA	USP-6B	49ge	DC4	9b	Tor
2E211	XC6372E211D	DC/DC-IC	PWM/PFM step-up, 100kHz, int. Vdd, 2.1V±2.5%, 100mA	USP-6B	49ge	DC4	9b	Tor
2E212	XC6372E212D	DC/DC-IC	PWM/PFM step-up, 180kHz, int. Vdd, 2.1V±2.5%, 100mA	USP-6B	49ge	DC4	9b	Tor
2E220	XC6372E220D	DC/DC-IC	PWM/PFM step-up, 50kHz, int. Vdd, 2.2V±2.5%, 100mA	USP-6B	49ge	DC4	9b	Tor
2E221	XC6372E221D	DC/DC-IC	PWM/PFM step-up, 100kHz, int. Vdd, 2.2V±2.5%, 100mA	USP-6B	49ge	DC4	9b	Tor
2E222	XC6372E222D	DC/DC-IC	PWM/PFM step-up, 180kHz, int. Vdd, 2.2V±2.5%, 100mA	USP-6B	49ge	DC4	9b	Tor
2E230	XC6372E230D	DC/DC-IC	PWM/PFM step-up, 50kHz, int. Vdd, 2.3V±2.5%, 100mA	USP-6B	49ge	DC4	9b	Tor
2E231	XC6372E231D	DC/DC-IC	PWM/PFM step-up, 100kHz, int. Vdd, 2.3V±2.5%, 100mA	USP-6B	49ge	DC4	9b	Tor
2E232	XC6372E232D	DC/DC-IC	PWM/PFM step-up, 180kHz, int. Vdd, 2.3V±2.5%, 100mA	USP-6B	49ge	DC4	9b	Tor
2E240	XC6372E240D	DC/DC-IC	PWM/PFM step-up, 50kHz, int. Vdd, 2.4V±2.5%, 100mA	USP-6B	49ge	DC4	9b	Tor
2E241	XC6372E241D	DC/DC-IC	PWM/PFM step-up, 100kHz, int. Vdd, 2.4V±2.5%, 100mA	USP-6B	49ge	DC4	9b	Tor
2E242	XC6372E242D	DC/DC-IC	PWM/PFM step-up, 180kHz, int. Vdd, 2.4V±2.5%, 100mA	USP-6B	49ge	DC4	9b	Tor
2E250	XC6372E250D	DC/DC-IC	PWM/PFM step-up, 50kHz, int. Vdd, 2.5V±2.5%, 100mA	USP-6B	49ge	DC4	9b	Tor
2E251	XC6372E251D	DC/DC-IC	PWM/PFM step-up, 100kHz, int. Vdd, 2.5V±2.5%, 100mA	USP-6B	49ge	DC4	9b	Tor
2E252	XC6372E252D	DC/DC-IC	PWM/PFM step-up, 180kHz, int. Vdd, 2.5V±2.5%, 100mA	USP-6B	49ge	DC4	9b	Tor
2E260	XC6372E260D	DC/DC-IC	PWM/PFM step-up, 50kHz, int. Vdd, 2.6V±2.5%, 100mA	USP-6B	49ge	DC4	9b	Tor
2E261	XC6372E261D	DC/DC-IC	PWM/PFM step-up, 100kHz, int. Vdd, 2.6V±2.5%, 100mA	USP-6B	49ge	DC4	9b	Tor
2E262	XC6372E262D	DC/DC-IC	PWM/PFM step-up, 180kHz, int. Vdd, 2.6V±2.5%, 100mA	USP-6B	49ge	DC4	9b	Tor
2E270	XC6372E270D	DC/DC-IC	PWM/PFM step-up, 50kHz, int. Vdd, 2.7V±2.5%, 100mA	USP-6B	49ge	DC4	9b	Tor
2E271	XC6372E271D	DC/DC-IC	PWM/PFM step-up, 100kHz, int. Vdd, 2.7V±2.5%, 100mA	USP-6B	49ge	DC4	9b	Tor
2E272	XC6372E272D	DC/DC-IC	PWM/PFM step-up, 180kHz, int. Vdd, 2.7V±2.5%, 100mA	USP-6B	49ge	DC4	9b	Tor
2E280	XC6372E280D	DC/DC-IC	PWM/PFM step-up, 50kHz, int. Vdd, 2.8V±2.5%, 100mA	USP-6B	49ge	DC4	9b	Tor
2E281	XC6372E281D	DC/DC-IC	PWM/PFM step-up, 100kHz, int. Vdd, 2.8V±2.5%, 100mA	USP-6B	49ge	DC4	9b	Tor
2E282	XC6372E282D	DC/DC-IC	PWM/PFM step-up, 180kHz, int. Vdd, 2.8V±2.5%, 100mA	USP-6B	49ge	DC4	9b	Tor
2E290	XC6372E290D	DC/DC-IC	PWM/PFM step-up, 50kHz, int. Vdd, 2.9V±2.5%, 100mA	USP-6B	49ge	DC4	9b	Tor
2E291	XC6372E291D	DC/DC-IC	PWM/PFM step-up, 100kHz, int. Vdd, 2.9V±2.5%, 100mA	USP-6B	49ge	DC4	9b	Tor
2E292	XC6372E292D	DC/DC-IC	PWM/PFM step-up, 180kHz, int. Vdd, 2.9V±2.5%, 100mA	USP-6B	49ge	DC4	9b	Tor
2E300	XC6372E300D	DC/DC-IC	PWM/PFM step-up, 50kHz, int. Vdd, 3.0V±2.5%, 100mA	USP-6B	49ge	DC4	9b	Tor
2E301	XC6372E301D	DC/DC-IC	PWM/PFM step-up, 100kHz, int. Vdd, 3.0V±2.5%, 100mA	USP-6B	49ge	DC4	9b	Tor
2E302	XC6372E302D	DC/DC-IC	PWM/PFM step-up, 180kHz, int. Vdd, 3.0V±2.5%, 100mA	USP-6B	49ge	DC4	9b	Tor
2E310	XC6372E310D	DC/DC-IC	PWM/PFM step-up, 50kHz, int. Vdd, 3.1V±2.5%, 100mA	USP-6B	49ge	DC4	9b	Tor
2E311	XC6372E311D	DC/DC-IC	PWM/PFM step-up, 100kHz, int. Vdd, 3.1V±2.5%, 100mA	USP-6B	49ge	DC4	9b	Tor
2E312	XC6372E312D	DC/DC-IC	PWM/PFM step-up, 180kHz, int. Vdd, 3.1V±2.5%, 100mA	USP-6B	49ge	DC4	9b	Tor
2E320	XC6372E320D	DC/DC-IC	PWM/PFM step-up, 50kHz, int. Vdd, 3.2V±2.5%, 100mA	USP-6B	49ge	DC4	9b	Tor
2E321	XC6372E321D	DC/DC-IC	PWM/PFM step-up, 100kHz, int. Vdd, 3.2V±2.5%, 100mA	USP-6B	49ge	DC4	9b	Tor
2E322	XC6372E322D	DC/DC-IC	PWM/PFM step-up, 180kHz, int. Vdd, 3.2V±2.5%, 100mA	USP-6B	49ge	DC4	9b	Tor
2E330	XC6372E330D	DC/DC-IC	PWM/PFM step-up, 50kHz, int. Vdd, 3.3V±2.5%, 100mA	USP-6B	49ge	DC4	9b	Tor
2E331	XC6372E331D	DC/DC-IC	PWM/PFM step-up, 100kHz, int. Vdd, 3.3V±2.5%, 100mA	USP-6B	49ge	DC4	9b	Tor
2E332	XC6372E332D	DC/DC-IC	PWM/PFM step-up, 180kHz, int. Vdd, 3.3V±2.5%, 100mA	USP-6B	49ge	DC4	9b	Tor
2E340	XC6372E340D	DC/DC-IC	PWM/PFM step-up, 50kHz, int. Vdd, 3.4V±2.5%, 100mA	USP-6B	49ge	DC4	9b	Tor
2E341	XC6372E341D	DC/DC-IC	PWM/PFM step-up, 100kHz, int. Vdd, 3.4V±2.5%, 100mA	USP-6B	49ge	DC4	9b	Tor
2E342	XC6372E342D	DC/DC-IC	PWM/PFM step-up, 180kHz, int. Vdd, 3.4V±2.5%, 100mA	USP-6B	49ge	DC4	9b	Tor
2E350	XC6372E350D	DC/DC-IC	PWM/PFM step-up, 50kHz, int. Vdd, 3.5V±2.5%, 100mA	USP-6B	49ge	DC4	9b	Tor
2E351	XC6372E351D	DC/DC-IC	PWM/PFM step-up, 100kHz, int. Vdd, 3.5V±2.5%, 100mA	USP-6B	49ge	DC4	9b	Tor
2E352	XC6372E352D	DC/DC-IC	PWM/PFM step-up, 180kHz, int. Vdd, 3.5V±2.5%, 100mA	USP-6B	49ge	DC4	9b	Tor
2E360	XC6372E360D	DC/DC-IC	PWM/PFM step-up, 50kHz, int. Vdd, 3.6V±2.5%, 100mA	USP-6B	49ge	DC4	9b	Tor
2E361	XC6372E361D	DC/DC-IC	PWM/PFM step-up, 100kHz, int. Vdd, 3.6V±2.5%, 100mA	USP-6B	49ge	DC4	9b	Tor



SMD code	Type	Function	Short description	Case	Pinout	Sch.	St.	Mnf.
2E600	XC6372E600D	DC/DC-IC	PWM/PFM step-up, 50kHz, int. Vdd, 6.0V±2.5%, 100mA	USP-6B	49ge	DC4	9b	Tor
2E601	XC6372E601D	DC/DC-IC	PWM/PFM step-up, 100kHz, int. Vdd, 6.0V±2.5%, 100mA	USP-6B	49ge	DC4	9b	Tor
2E602	XC6372E602D	DC/DC-IC	PWM/PFM step-up, 180kHz, int. Vdd, 6.0V±2.5%, 100mA	USP-6B	49ge	DC4	9b	Tor
2E610	XC6372E610D	DC/DC-IC	PWM/PFM step-up, 50kHz, int. Vdd, 6.1V±2.5%, 100mA	USP-6B	49ge	DC4	9b	Tor
2E611	XC6372E611D	DC/DC-IC	PWM/PFM step-up, 100kHz, int. Vdd, 6.1V±2.5%, 100mA	USP-6B	49ge	DC4	9b	Tor
2E612	XC6372E612D	DC/DC-IC	PWM/PFM step-up, 180kHz, int. Vdd, 6.1V±2.5%, 100mA	USP-6B	49ge	DC4	9b	Tor
2E620	XC6372E620D	DC/DC-IC	PWM/PFM step-up, 50kHz, int. Vdd, 6.2V±2.5%, 100mA	USP-6B	49ge	DC4	9b	Tor
2E621	XC6372E621D	DC/DC-IC	PWM/PFM step-up, 100kHz, int. Vdd, 6.2V±2.5%, 100mA	USP-6B	49ge	DC4	9b	Tor
2E622	XC6372E622D	DC/DC-IC	PWM/PFM step-up, 180kHz, int. Vdd, 6.2V±2.5%, 100mA	USP-6B	49ge	DC4	9b	Tor
2E630	XC6372E630D	DC/DC-IC	PWM/PFM step-up, 50kHz, int. Vdd, 6.3V±2.5%, 100mA	USP-6B	49ge	DC4	9b	Tor
2E631	XC6372E631D	DC/DC-IC	PWM/PFM step-up, 100kHz, int. Vdd, 6.3V±2.5%, 100mA	USP-6B	49ge	DC4	9b	Tor
2E632	XC6372E632D	DC/DC-IC	PWM/PFM step-up, 180kHz, int. Vdd, 6.3V±2.5%, 100mA	USP-6B	49ge	DC4	9b	Tor
2E640	XC6372E640D	DC/DC-IC	PWM/PFM step-up, 50kHz, int. Vdd, 6.4V±2.5%, 100mA	USP-6B	49ge	DC4	9b	Tor
2E641	XC6372E641D	DC/DC-IC	PWM/PFM step-up, 100kHz, int. Vdd, 6.4V±2.5%, 100mA	USP-6B	49ge	DC4	9b	Tor
2E642	XC6372E642D	DC/DC-IC	PWM/PFM step-up, 180kHz, int. Vdd, 6.4V±2.5%, 100mA	USP-6B	49ge	DC4	9b	Tor
2E650	XC6372E650D	DC/DC-IC	PWM/PFM step-up, 50kHz, int. Vdd, 6.5V±2.5%, 100mA	USP-6B	49ge	DC4	9b	Tor
2E651	XC6372E651D	DC/DC-IC	PWM/PFM step-up, 100kHz, int. Vdd, 6.5V±2.5%, 100mA	USP-6B	49ge	DC4	9b	Tor
2E652	XC6372E652D	DC/DC-IC	PWM/PFM step-up, 180kHz, int. Vdd, 6.5V±2.5%, 100mA	USP-6B	49ge	DC4	9b	Tor
2E660	XC6372E660D	DC/DC-IC	PWM/PFM step-up, 50kHz, int. Vdd, 6.6V±2.5%, 100mA	USP-6B	49ge	DC4	9b	Tor
2E661	XC6372E661D	DC/DC-IC	PWM/PFM step-up, 100kHz, int. Vdd, 6.6V±2.5%, 100mA	USP-6B	49ge	DC4	9b	Tor
2E662	XC6372E662D	DC/DC-IC	PWM/PFM step-up, 180kHz, int. Vdd, 6.6V±2.5%, 100mA	USP-6B	49ge	DC4	9b	Tor
2E670	XC6372E670D	DC/DC-IC	PWM/PFM step-up, 50kHz, int. Vdd, 6.7V±2.5%, 100mA	USP-6B	49ge	DC4	9b	Tor
2E671	XC6372E671D	DC/DC-IC	PWM/PFM step-up, 100kHz, int. Vdd, 6.7V±2.5%, 100mA	USP-6B	49ge	DC4	9b	Tor
2E672	XC6372E672D	DC/DC-IC	PWM/PFM step-up, 180kHz, int. Vdd, 6.7V±2.5%, 100mA	USP-6B	49ge	DC4	9b	Tor
2E680	XC6372E680D	DC/DC-IC	PWM/PFM step-up, 50kHz, int. Vdd, 6.8V±2.5%, 100mA	USP-6B	49ge	DC4	9b	Tor
2E681	XC6372E681D	DC/DC-IC	PWM/PFM step-up, 100kHz, int. Vdd, 6.8V±2.5%, 100mA	USP-6B	49ge	DC4	9b	Tor
2E682	XC6372E682D	DC/DC-IC	PWM/PFM step-up, 180kHz, int. Vdd, 6.8V±2.5%, 100mA	USP-6B	49ge	DC4	9b	Tor
2E690	XC6372E690D	DC/DC-IC	PWM/PFM step-up, 50kHz, int. Vdd, 6.9V±2.5%, 100mA	USP-6B	49ge	DC4	9b	Tor
2E691	XC6372E691D	DC/DC-IC	PWM/PFM step-up, 100kHz, int. Vdd, 6.9V±2.5%, 100mA	USP-6B	49ge	DC4	9b	Tor
2E692	XC6372E692D	DC/DC-IC	PWM/PFM step-up, 180kHz, int. Vdd, 6.9V±2.5%, 100mA	USP-6B	49ge	DC4	9b	Tor
2E700	XC6372E700D	DC/DC-IC	PWM/PFM step-up, 50kHz, int. Vdd, 7.0V±2.5%, 100mA	USP-6B	49ge	DC4	9b	Tor
2E701	XC6372E701D	DC/DC-IC	PWM/PFM step-up, 100kHz, int. Vdd, 7.0V±2.5%, 100mA	USP-6B	49ge	DC4	9b	Tor
2E702	XC6372E702D	DC/DC-IC	PWM/PFM step-up, 180kHz, int. Vdd, 7.0V±2.5%, 100mA	USP-6B	49ge	DC4	9b	Tor
2E703	XC6403EV03D	LVRVdet-IC	LDO, 1.6V±2%, 300mA, Vd=1.8V, -Reset ODO, Vdet/Sense	USP-6B	49zy	VR14	9b	Tor
2E707	XC6403EV07D	LVRVdet-IC	LDO, 1.8V±2%, 300mA, Vd=2.9V, -Reset ODO, Vdet/Sense	USP-6B	49zy	VR14	9b	Tor
2E711	XC6403EV11D	LVRVdet-IC	LDO, 1.8V±2%, 300mA, Vd=1.7V, -Reset ODO, Vdet/Sense	USP-6B	49zy	VR14	9b	Tor
2E712	XC6403EV12D	LVRVdet-IC	LDO, 3.0V±2%, 300mA, Vd=4.2V, -Reset ODO, Vdet/Sense	USP-6B	49zy	VR14	9b	Tor
2E714	XC6403EV14D	LVRVdet-IC	LDO, 1.8V±2%, 300mA, Vd=3.0V, -Reset ODO, Vdet/Sense	USP-6B	49zy	VR14	9b	Tor
2E716	XC6403EV16D	LVRVdet-IC	LDO, 2.5V±2%, 300mA, Vd=2.9V, -Reset ODO, Vdet/Sense	USP-6B	49zy	VR14	9b	Tor
2E717	XC6403EV17D	LVRVdet-IC	LDO, 1.8V±2%, 300mA, Vd=2.3V, -Reset ODO, Vdet/Sense	USP-6B	49zy	VR14	9b	Tor
2E718	XC6403EV18D	LVRVdet-IC	LDO, 2.8V±2%, 300mA, Vd=3.0V, -Reset ODO, Vdet/Sense	USP-6B	49zy	VR14	9b	Tor
2E720	XC6403EV20D	LVRVdet-IC	LDO, 3.3V±2%, 300mA, Vd=3.0V, -Reset ODO, Vdet/Sense	USP-6B	49zy	VR14	9b	Tor
2E721	XC6403EV21D	LVRVdet-IC	LDO, 3.3V±2%, 300mA, Vd=3.1V, -Reset ODO, Vdet/Sense	USP-6B	49zy	VR14	9b	Tor
2E724	XC6403EV24D	LVRVdet-IC	LDO, 1.8V±2%, 300mA, Vd=2.4V, -Reset ODO, Vdet/Sense	USP-6B	49zy	VR14	9b	Tor
2E725	XC6403EV25D	LVRVdet-IC	LDO, 3.2V±2%, 300mA, Vd=2.4V, -Reset ODO, Vdet/Sense	USP-6B	49zy	VR14	9b	Tor
2E730	XC6403EV30D	LVRVdet-IC	LDO, 4.0V±2%, 300mA, Vd=4.3V, -Reset ODO, Vdet/Sense	USP-6B	49zy	VR14	9b	Tor
2E731	XC6403EV31D	LVRVdet-IC	LDO, 2.85V±2%, 300mA, Vd=2.7V, -Reset ODO, Vdet/Sense	USP-6B	49zy	VR14	9b	Tor
2E732	XC6403EV32D	LVRVdet-IC	LDO, 2.6V±2%, 300mA, Vd=4.2V, -Reset ODO, Vdet/Sense	USP-6B	49zy	VR14	9b	Tor
2E733	XC6403EV33D	LVRVdet-IC	LDO, 2.7V±2%, 300mA, Vd=2.8V, -Reset ODO, Vdet/Sense	USP-6B	49zy	VR14	9b	Tor
2E734	XC6403EV34D	LVRVdet-IC	LDO, 2.85V±2%, 300mA, Vd=2.55V, -Reset ODO, Vdet/Sense	USP-6B	49zy	VR14	9b	Tor
2E780	XC6403EV80D	LVRVdet-IC	LDO, 1.8V±2%, 300mA, Vd=1.6V, -Reset ODO, Vdet/Sense	USP-6B	49zy	VR14	9b	Tor
2E781	XC6403EV81D	LVRVdet-IC	LDO, 2.8V±2%, 300mA, Vd=3.1V, -Reset ODO, Vdet/Sense	USP-6B	49zy	VR14	9b	Tor
2E782	XC6403EV82D	LVRVdet-IC	LDO, 1.8V±2%, 300mA, Vd=2.0V, -Reset ODO, Vdet/Sense	USP-6B	49zy	VR14	9b	Tor
2E783	XC6403EV83D	LVRVdet-IC	LDO, 2.5V±2%, 300mA, Vd=2.4V, -Reset ODO, Vdet/Sense	USP-6B	49zy	VR14	9b	Tor
2E784	XC6403EV84D	LVRVdet-IC	LDO, 2.85V±2%, 300mA, Vd=3.2V, -Reset ODO, Vdet/Sense	USP-6B	49zy	VR14	9b	Tor
2E785	XC6403EV85D	LVRVdet-IC	LDO, 3.0V±2%, 300mA, Vd=3.3V, -Reset ODO, Vdet/Sense	USP-6B	49zy	VR14	9b	Tor
2E786	XC6403EV86D	LVRVdet-IC	LDO, 3.5V±2%, 300mA, Vd=3.8V, -Reset ODO, Vdet/Sense	USP-6B	49zy	VR14	9b	Tor
2E787	XC6403EV87D	LVRVdet-IC	LDO, 3.0V±2%, 300mA, Vd=4.2V, -Reset ODO, Vdet/Sense	USP-6B	49zy	VR14	9b	Tor
2E788	XC6403EV88D	LVRVdet-IC	LDO, 3.3V±2%, 300mA, Vd=4.0V, -Reset ODO, Vdet/Sense	USP-6B	49zy	VR14	9b	Tor
2EX03	XC6403EX03D	LVRVdet-IC	LDO, 1.6V±2%, 300mA, Vd=1.8V, +Reset ODO, Vdet/Sense	USP-6B	49zy	VR14	9b	Tor
2EX07	XC6403EX07D	LVRVdet-IC	LDO, 1.8V±2%, 300mA, Vd=2.9V, +Reset ODO, Vdet/Sense	USP-6B	49zy	VR14	9b	Tor
2EX11	XC6403EX11D	LVRVdet-IC	LDO, 1.8V±2%, 300mA, Vd=1.7V, +Reset ODO, Vdet/Sense	USP-6B	49zy	VR14	9b	Tor
2EX12	XC6403EX12D	LVRVdet-IC	LDO, 3.0V±2%, 300mA, Vd=4.2V, +Reset ODO, Vdet/Sense	USP-6B	49zy	VR14	9b	Tor
2EX14	XC6403EX14D	LVRVdet-IC	LDO, 1.8V±2%, 300mA, Vd=3.0V, +Reset ODO, Vdet/Sense	USP-6B	49zy	VR14	9b	Tor
2EX16	XC6403EX16D	LVRVdet-IC	LDO, 2.5V±2%, 300mA, Vd=2.9V, +Reset ODO, Vdet/Sense	USP-6B	49zy	VR14	9b	Tor
2EX17	XC6403EX17D	LVRVdet-IC	LDO, 1.8V±2%, 300mA, Vd=2.3V, +Reset ODO, Vdet/Sense	USP-6B	49zy	VR14	9b	Tor
2EX18	XC6403EX18D	LVRVdet-IC	LDO, 2.8V±2%, 300mA, Vd=3.4V, +Reset ODO, Vdet/Sense	USP-6B	49zy	VR14	9b	Tor
2EX20	XC6403EX20D	LVRVdet-IC	LDO, 3.3V±2%, 300mA, Vd=3.0V, +Reset ODO, Vdet/Sense	USP-6B	49zy	VR14	9b	Tor
2EX21	XC6403EX21D	LVRVdet-IC	LDO, 3.3V±2%, 300mA, Vd=3.1V, +Reset ODO, Vdet/Sense	USP-6B	49zy	VR14	9b	Tor
2EX24	XC6403EX24D	LVRVdet-IC	LDO, 1.8V±2%, 300mA, Vd=2.4V, +Reset ODO, Vdet/Sense	USP-6B	49zy	VR14	9b	Tor



SMD code	Type	Function	Short description	Case	Pinout	Sch.	St.Mnf.
2EX25	XC6403EX25D	LVR/Vdet-IC	LDO, 3.2V±2%, 300mA, Vd=2.8V, +Reset ODO, Vdet/Sense	USP-6B	49zy	VR14	9b Tor
2EX30	XC6403EX30D	LVR/Vdet-IC	LDO, 4.0V±2%, 300mA, Vd=4.3V, +Reset ODO, Vdet/Sense	USP-6B	49zy	VR14	9b Tor
2EX31	XC6403EX31D	LVR/Vdet-IC	LDO, 2.85V±2%, 300mA, Vd=2.7V, +Reset ODO, Vdet/Sense	USP-6B	49zy	VR14	9b Tor
2EX32	XC6403EX32D	LVR/Vdet-IC	LDO, 2.6V±2%, 300mA, Vd=2.4V, +Reset ODO, Vdet/Sense	USP-6B	49zy	VR14	9b Tor
2EX33	XC6403EX33D	LVR/Vdet-IC	LDO, 2.7V±2%, 300mA, Vd=2.8V, +Reset ODO, Vdet/Sense	USP-6B	49zy	VR14	9b Tor
2EX34	XC6403EX34D	LVR/Vdet-IC	LDO, 2.85V±2%, 300mA, Vd=2.55V, +Reset ODO, Vdet/Sense	USP-6B	49zy	VR14	9b Tor
2EX80	XC6403EX80D	LVR/Vdet-IC	LDO, 1.8V±2%, 300mA, Vd=1.6V, +Reset ODO, Vdet/Sense	USP-6B	49zy	VR14	9b Tor
2EX81	XC6403EX81D	LVR/Vdet-IC	LDO, 2.8V±2%, 300mA, Vd=3.1V, +Reset ODO, Vdet/Sense	USP-6B	49zy	VR14	9b Tor
2EX82	XC6403EX82D	LVR/Vdet-IC	LDO, 1.8V±2%, 300mA, Vd=2.0V, +Reset ODO, Vdet/Sense	USP-6B	49zy	VR14	9b Tor
2EX83	XC6403EX83D	LVR/Vdet-IC	LDO, 2.5V±2%, 300mA, Vd=2.8V, +Reset ODO, Vdet/Sense	USP-6B	49zy	VR14	9b Tor
2EX84	XC6403EX84D	LVR/Vdet-IC	LDO, 2.85V±2%, 300mA, Vd=3.2V, +Reset ODO, Vdet/Sense	USP-6B	49zy	VR14	9b Tor
2EX85	XC6403EX85D	LVR/Vdet-IC	LDO, 3.0V±2%, 300mA, Vd=3.3V, +Reset ODO, Vdet/Sense	USP-6B	49zy	VR14	9b Tor
2EX86	XC6403EX86D	LVR/Vdet-IC	LDO, 3.5V±2%, 300mA, Vd=3.8V, +Reset ODO, Vdet/Sense	USP-6B	49zy	VR14	9b Tor
2EX87	XC6403EX87D	LVR/Vdet-IC	LDO, 3.0V±2%, 300mA, Vd=4.2V, +Reset ODO, Vdet/Sense	USP-6B	49zy	VR14	9b Tor
2EX88	XC6403EX88D	LVR/Vdet-IC	LDO, 3.3V±2%, 300mA, Vd=4.0V, +Reset ODO, Vdet/Sense	USP-6B	49zy	VR14	9b Tor
2EY03	XC6403EY03D	LVR/Vdet-IC	LDO, 1.6V±2%, 300mA, Vd=1.8V, -Reset ODO, Vr/Sense	USP-6B	49zy	VR14	9b Tor
2EY07	XC6403EY07D	LVR/Vdet-IC	LDO, 1.8V±2%, 300mA, Vd=2.9V, -Reset ODO, Vr/Sense	USP-6B	49zy	VR14	9b Tor
2EY11	XC6403EY11D	LVR/Vdet-IC	LDO, 1.8V±2%, 300mA, Vd=1.7V, -Reset ODO, Vr/Sense	USP-6B	49zy	VR14	9b Tor
2EY12	XC6403EY12D	LVR/Vdet-IC	LDO, 3.0V±2%, 300mA, Vd=4.2V, -Reset ODO, Vr/Sense	USP-6B	49zy	VR14	9b Tor
2EY14	XC6403EY14D	LVR/Vdet-IC	LDO, 1.8V±2%, 300mA, Vd=3.0V, -Reset ODO, Vr/Sense	USP-6B	49zy	VR14	9b Tor
2EY16	XC6403EY16D	LVR/Vdet-IC	LDO, 2.5V±2%, 300mA, Vd=2.9V, -Reset ODO, Vr/Sense	USP-6B	49zy	VR14	9b Tor
2EY17	XC6403EY17D	LVR/Vdet-IC	LDO, 1.8V±2%, 300mA, Vd=2.3V, -Reset ODO, Vr/Sense	USP-6B	49zy	VR14	9b Tor
2EY18	XC6403EY18D	LVR/Vdet-IC	LDO, 2.8V±2%, 300mA, Vd=3.4V, -Reset ODO, Vr/Sense	USP-6B	49zy	VR14	9b Tor
2EY20	XC6403EY20D	LVR/Vdet-IC	LDO, 3.3V±2%, 300mA, Vd=3.0V, -Reset ODO, Vr/Sense	USP-6B	49zy	VR14	9b Tor
2EY21	XC6403EY21D	LVR/Vdet-IC	LDO, 3.3V±2%, 300mA, Vd=3.1V, -Reset ODO, Vr/Sense	USP-6B	49zy	VR14	9b Tor
2EY24	XC6403EY24D	LVR/Vdet-IC	LDO, 1.8V±2%, 300mA, Vd=2.4V, -Reset ODO, Vr/Sense	USP-6B	49zy	VR14	9b Tor
2EY25	XC6403EY25D	LVR/Vdet-IC	LDO, 3.2V±2%, 300mA, Vd=2.8V, -Reset ODO, Vr/Sense	USP-6B	49zy	VR14	9b Tor
2EY30	XC6403EY30D	LVR/Vdet-IC	LDO, 4.0V±2%, 300mA, Vd=4.3V, -Reset ODO, Vr/Sense	USP-6B	49zy	VR14	9b Tor
2EY31	XC6403EY31D	LVR/Vdet-IC	LDO, 2.85V±2%, 300mA, Vd=2.7V, -Reset ODO, Vr/Sense	USP-6B	49zy	VR14	9b Tor
2EY32	XC6403EY32D	LVR/Vdet-IC	LDO, 2.6V±2%, 300mA, Vd=2.4V, -Reset ODO, Vr/Sense	USP-6B	49zy	VR14	9b Tor
2EY33	XC6403EY33D	LVR/Vdet-IC	LDO, 2.7V±2%, 300mA, Vd=2.8V, -Reset ODO, Vr/Sense	USP-6B	49zy	VR14	9b Tor
2EY34	XC6403EY34D	LVR/Vdet-IC	LDO, 2.85V±2%, 300mA, Vd=2.55V, -Reset ODO, Vr/Sense	USP-6B	49zy	VR14	9b Tor
2EY80	XC6403EY80D	LVR/Vdet-IC	LDO, 1.8V±2%, 300mA, Vd=1.6V, -Reset ODO, Vr/Sense	USP-6B	49zy	VR14	9b Tor
2EY81	XC6403EY81D	LVR/Vdet-IC	LDO, 2.8V±2%, 300mA, Vd=3.1V, -Reset ODO, Vr/Sense	USP-6B	49zy	VR14	9b Tor
2EY82	XC6403EY82D	LVR/Vdet-IC	LDO, 1.8V±2%, 300mA, Vd=2.0V, -Reset ODO, Vr/Sense	USP-6B	49zy	VR14	9b Tor
2EY83	XC6403EY83D	LVR/Vdet-IC	LDO, 2.5V±2%, 300mA, Vd=2.8V, -Reset ODO, Vr/Sense	USP-6B	49zy	VR14	9b Tor
2EY84	XC6403EY84D	LVR/Vdet-IC	LDO, 2.85V±2%, 300mA, Vd=3.2V, -Reset ODO, Vr/Sense	USP-6B	49zy	VR14	9b Tor
2EY85	XC6403EY85D	LVR/Vdet-IC	LDO, 3.0V±2%, 300mA, Vd=3.3V, -Reset ODO, Vr/Sense	USP-6B	49zy	VR14	9b Tor
2EY86	XC6403EY86D	LVR/Vdet-IC	LDO, 3.5V±2%, 300mA, Vd=3.8V, -Reset ODO, Vr/Sense	USP-6B	49zy	VR14	9b Tor
2EY87	XC6403EY87D	LVR/Vdet-IC	LDO, 3.0V±2%, 300mA, Vd=4.2V, -Reset ODO, Vr/Sense	USP-6B	49zy	VR14	9b Tor
2EY88	XC6403EY88D	LVR/Vdet-IC	LDO, 3.3V±2%, 300mA, Vd=4.0V, -Reset ODO, Vr/Sense	USP-6B	49zy	VR14	9b Tor
2EZ03	XC6403EZ03D	LVR/Vdet-IC	LDO, 1.6V±2%, 300mA, Vd=1.8V, +Reset ODO, Vr/Sense	USP-6B	49zy	VR14	9b Tor
2EZ07	XC6403EZ07D	LVR/Vdet-IC	LDO, 1.8V±2%, 300mA, Vd=2.9V, +Reset ODO, Vr/Sense	USP-6B	49zy	VR14	9b Tor
2EZ11	XC6403EZ11D	LVR/Vdet-IC	LDO, 1.8V±2%, 300mA, Vd=1.7V, +Reset ODO, Vr/Sense	USP-6B	49zy	VR14	9b Tor
2EZ12	XC6403EZ12D	LVR/Vdet-IC	LDO, 3.0V±2%, 300mA, Vd=4.2V, +Reset ODO, Vr/Sense	USP-6B	49zy	VR14	9b Tor
2EZ14	XC6403EZ14D	LVR/Vdet-IC	LDO, 1.8V±2%, 300mA, Vd=3.0V, +Reset ODO, Vr/Sense	USP-6B	49zy	VR14	9b Tor
2EZ16	XC6403EZ16D	LVR/Vdet-IC	LDO, 2.5V±2%, 300mA, Vd=2.9V, +Reset ODO, Vr/Sense	USP-6B	49zy	VR14	9b Tor
2EZ17	XC6403EZ17D	LVR/Vdet-IC	LDO, 1.8V±2%, 300mA, Vd=2.3V, +Reset ODO, Vr/Sense	USP-6B	49zy	VR14	9b Tor
2EZ18	XC6403EZ18D	LVR/Vdet-IC	LDO, 2.8V±2%, 300mA, Vd=3.4V, +Reset ODO, Vr/Sense	USP-6B	49zy	VR14	9b Tor
2EZ20	XC6403EZ20D	LVR/Vdet-IC	LDO, 3.3V±2%, 300mA, Vd=3.0V, +Reset ODO, Vr/Sense	USP-6B	49zy	VR14	9b Tor
2EZ21	XC6403EZ21D	LVR/Vdet-IC	LDO, 3.3V±2%, 300mA, Vd=3.1V, +Reset ODO, Vr/Sense	USP-6B	49zy	VR14	9b Tor
2EZ24	XC6403EZ24D	LVR/Vdet-IC	LDO, 1.8V±2%, 300mA, Vd=2.4V, +Reset ODO, Vr/Sense	USP-6B	49zy	VR14	9b Tor
2EZ25	XC6403EZ25D	LVR/Vdet-IC	LDO, 3.2V±2%, 300mA, Vd=2.8V, +Reset ODO, Vr/Sense	USP-6B	49zy	VR14	9b Tor
2EZ30	XC6403EZ30D	LVR/Vdet-IC	LDO, 4.0V±2%, 300mA, Vd=4.3V, +Reset ODO, Vr/Sense	USP-6B	49zy	VR14	9b Tor
2EZ31	XC6403EZ31D	LVR/Vdet-IC	LDO, 2.85V±2%, 300mA, Vd=2.7V, +Reset ODO, Vr/Sense	USP-6B	49zy	VR14	9b Tor
2EZ32	XC6403EZ32D	LVR/Vdet-IC	LDO, 2.6V±2%, 300mA, Vd=2.4V, +Reset ODO, Vr/Sense	USP-6B	49zy	VR14	9b Tor
2EZ33	XC6403EZ33D	LVR/Vdet-IC	LDO, 2.7V±2%, 300mA, Vd=2.8V, +Reset ODO, Vr/Sense	USP-6B	49zy	VR14	9b Tor
2EZ34	XC6403EZ34D	LVR/Vdet-IC	LDO, 2.85V±2%, 300mA, Vd=2.55V, +Reset ODO, Vr/Sense	USP-6B	49zy	VR14	9b Tor
2EZ80	XC6403EZ80D	LVR/Vdet-IC	LDO, 1.8V±2%, 300mA, Vd=1.6V, +Reset ODO, Vr/Sense	USP-6B	49zy	VR14	9b Tor
2EZ81	XC6403EZ81D	LVR/Vdet-IC	LDO, 2.8V±2%, 300mA, Vd=3.1V, +Reset ODO, Vr/Sense	USP-6B	49zy	VR14	9b Tor
2EZ82	XC6403EZ82D	LVR/Vdet-IC	LDO, 1.8V±2%, 300mA, Vd=2.0V, +Reset ODO, Vr/Sense	USP-6B	49zy	VR14	9b Tor
2EZ83	XC6403EZ83D	LVR/Vdet-IC	LDO, 2.5V±2%, 300mA, Vd=2.8V, +Reset ODO, Vr/Sense	USP-6B	49zy	VR14	9b Tor
2EZ84	XC6403EZ84D	LVR/Vdet-IC	LDO, 2.85V±2%, 300mA, Vd=3.2V, +Reset ODO, Vr/Sense	USP-6B	49zy	VR14	9b Tor
2EZ85	XC6403EZ85D	LVR/Vdet-IC	LDO, 3.0V±2%, 300mA, Vd=3.3V, +Reset ODO, Vr/Sense	USP-6B	49zy	VR14	9b Tor
2EZ86	XC6403EZ86D	LVR/Vdet-IC	LDO, 3.5V±2%, 300mA, Vd=3.8V, +Reset ODO, Vr/Sense	USP-6B	49zy	VR14	9b Tor
2EZ87	XC6403EZ87D	LVR/Vdet-IC	LDO, 3.0V±2%, 300mA, Vd=4.2V, +Reset ODO, Vr/Sense	USP-6B	49zy	VR14	9b Tor
2EZ88	XC6403EZ88D	LVR/Vdet-IC	LDO, 3.3V±2%, 300mA, Vd=4.0V, +Reset ODO, Vr/Sense	USP-6B	49zy	VR14	9b Tor
2F	R3117K361A	Vdet-IC	3.6V±1%, -Reset ODO, Sense	DFN1010-4	48rq	VD11	9a Ric
2F	RP100K191D	LVR-IC	LDO, LN, +CE, CL, 1.9V±0.8%, 200mA	PLP1612-4	45vm	VR4	9a Ric
2F	XC6223C2519R-G	LVR-IC	LDO, 2.5V±1%, 300mA, +CE, PDR	USPQ-4B03	48vm	VR4	9a Tor



SMD code	Type	Function	Short description	Case	Pinout	Sch.	St.	Mnf.
2F	XC6224B2317R	LVR-IC	LDO, 2.3V±1.5%, 150mA, +CE, PDR	USPN-4B02	58vm	VR4	9e	Tor
2F	XC6229H19B1R-G	LVR-IC	LDO, 1.95V±20mV, 300mA, +CE, ICP	BGA-4	63ba*	VR4	9a	Tor
2F	XC6221C23B7R	LVR-IC	LDO, 2.35V±1%, 200mA, +CE, PDR	USPN-4	58vm	VR4	9a	Tor
2F8	XC9235F08DER	DC-DC-IC	PWM, st-dwn, 0.8V±2%, 600mA, 3MHz, Vin>1.8V, HSST, CL	USP-6C	49da	DC16	9a	Tor
2F9	XC9235F09DER	DC-DC-IC	PWM, st-dwn, 0.9V±2%, 600mA, 3MHz, Vin>1.8V, HSST, CL	USP-6C	49da	DC16	9a	Tor
2FL	XC9235F0LDER	DC-DC-IC	PWM, st-dwn, 0.85V±2%, 600mA, 3MHz, Vin>1.8V, HSST, CL	USP-6C	49da	DC16	9a	Tor
2FM	XC9235F0MDER	DC-DC-IC	PWM, st-dwn, 0.95V±2%, 600mA, 3MHz, Vin>1.8V, HSST, CL	USP-6C	49da	DC16	9a	Tor
2FY03	XC6403FY03D	LVRVdet-IC	LDO, 1.6V±2%, 300mA, Vd=1.8V, -Reset ODO	USP-6B	49zz	VR13	9b	Tor
2FY07	XC6403FY07D	LVRVdet-IC	LDO, 1.8V±2%, 300mA, Vd=2.9V, -Reset ODO	USP-6B	49zz	VR13	9b	Tor
2FY11	XC6403FY11D	LVRVdet-IC	LDO, 1.8V±2%, 300mA, Vd=1.7V, -Reset ODO	USP-6B	49zz	VR13	9b	Tor
2FY12	XC6403FY12D	LVRVdet-IC	LDO, 3.0V±2%, 300mA, Vd=4.2V, -Reset ODO	USP-6B	49zz	VR13	9b	Tor
2FY14	XC6403FY14D	LVRVdet-IC	LDO, 1.8V±2%, 300mA, Vd=3.0V, -Reset ODO	USP-6B	49zz	VR13	9b	Tor
2FY16	XC6403FY16D	LVRVdet-IC	LDO, 2.5V±2%, 300mA, Vd=2.9V, -Reset ODO	USP-6B	49zz	VR13	9b	Tor
2FY17	XC6403FY17D	LVRVdet-IC	LDO, 1.8V±2%, 300mA, Vd=2.3V, -Reset ODO	USP-6B	49zz	VR13	9b	Tor
2FY18	XC6403FY18D	LVRVdet-IC	LDO, 2.8V±2%, 300mA, Vd=3.4V, -Reset ODO	USP-6B	49zz	VR13	9b	Tor
2FY20	XC6403FY20D	LVRVdet-IC	LDO, 3.3V±2%, 300mA, Vd=3.0V, -Reset ODO	USP-6B	49zz	VR13	9b	Tor
2FY21	XC6403FY21D	LVRVdet-IC	LDO, 3.3V±2%, 300mA, Vd=3.1V, -Reset ODO	USP-6B	49zz	VR13	9b	Tor
2FY24	XC6403FY24D	LVRVdet-IC	LDO, 1.8V±2%, 300mA, Vd=2.4V, -Reset ODO	USP-6B	49zz	VR13	9b	Tor
2FY25	XC6403FY25D	LVRVdet-IC	LDO, 3.2V±2%, 300mA, Vd=2.8V, -Reset ODO	USP-6B	49zz	VR13	9b	Tor
2FY30	XC6403FY30D	LVRVdet-IC	LDO, 4.0V±2%, 300mA, Vd=4.3V, -Reset ODO	USP-6B	49zz	VR13	9b	Tor
2FY31	XC6403FY31D	LVRVdet-IC	LDO, 2.85V±2%, 300mA, Vd=2.7V, -Reset ODO	USP-6B	49zz	VR13	9b	Tor
2FY32	XC6403FY32D	LVRVdet-IC	LDO, 2.6V±2%, 300mA, Vd=2.4V, -Reset ODO	USP-6B	49zz	VR13	9b	Tor
2FY33	XC6403FY33D	LVRVdet-IC	LDO, 2.7V±2%, 300mA, Vd=2.8V, -Reset ODO	USP-6B	49zz	VR13	9b	Tor
2FY34	XC6403FY34D	LVRVdet-IC	LDO, 2.85V±2%, 300mA, Vd=2.55V, -Reset ODO	USP-6B	49zz	VR13	9b	Tor
2FY80	XC6403FY80D	LVRVdet-IC	LDO, 1.8V±2%, 300mA, Vd=1.6V, -Reset ODO	USP-6B	49zz	VR13	9b	Tor
2FY81	XC6403FY81D	LVRVdet-IC	LDO, 2.8V±2%, 300mA, Vd=3.1V, -Reset ODO	USP-6B	49zz	VR13	9b	Tor
2FY82	XC6403FY82D	LVRVdet-IC	LDO, 1.8V±2%, 300mA, Vd=2.0V, -Reset ODO	USP-6B	49zz	VR13	9b	Tor
2FY83	XC6403FY83D	LVRVdet-IC	LDO, 2.5V±2%, 300mA, Vd=3.4V, -Reset ODO	USP-6B	49zz	VR13	9b	Tor
2FY84	XC6403FY84D	LVRVdet-IC	LDO, 2.85V±2%, 300mA, Vd=3.2V, -Reset ODO	USP-6B	49zz	VR13	9b	Tor
2FY85	XC6403FY85D	LVRVdet-IC	LDO, 3.0V±2%, 300mA, Vd=3.3V, -Reset ODO	USP-6B	49zz	VR13	9b	Tor
2FY86	XC6403FY86D	LVRVdet-IC	LDO, 3.5V±2%, 300mA, Vd=3.8V, -Reset ODO	USP-6B	49zz	VR13	9b	Tor
2FY87	XC6403FY87D	LVRVdet-IC	LDO, 3.0V±2%, 300mA, Vd=2.4V, -Reset ODO	USP-6B	49zz	VR13	9b	Tor
2FY88	XC6403FY88D	LVRVdet-IC	LDO, 3.3V±2%, 300mA, Vd=4.0V, -Reset ODO	USP-6B	49zz	VR13	9b	Tor
2FZ03	XC6403FZ03D	LVRVdet-IC	LDO, 1.6V±2%, 300mA, Vd=1.8V, +Reset ODO	USP-6B	49zz	VR13	9b	Tor
2FZ07	XC6403FZ07D	LVRVdet-IC	LDO, 1.8V±2%, 300mA, Vd=2.9V, +Reset ODO	USP-6B	49zz	VR13	9b	Tor
2FZ11	XC6403FZ11D	LVRVdet-IC	LDO, 1.8V±2%, 300mA, Vd=1.7V, +Reset ODO	USP-6B	49zz	VR13	9b	Tor
2FZ12	XC6403FZ12D	LVRVdet-IC	LDO, 3.0V±2%, 300mA, Vd=4.2V, +Reset ODO	USP-6B	49zz	VR13	9b	Tor
2FZ14	XC6403FZ14D	LVRVdet-IC	LDO, 1.8V±2%, 300mA, Vd=3.0V, +Reset ODO	USP-6B	49zz	VR13	9b	Tor
2FZ16	XC6403FZ16D	LVRVdet-IC	LDO, 2.5V±2%, 300mA, Vd=2.9V, +Reset ODO	USP-6B	49zz	VR13	9b	Tor
2FZ17	XC6403FZ17D	LVRVdet-IC	LDO, 1.8V±2%, 300mA, Vd=2.3V, +Reset ODO	USP-6B	49zz	VR13	9b	Tor
2FZ18	XC6403FZ18D	LVRVdet-IC	LDO, 2.8V±2%, 300mA, Vd=3.4V, +Reset ODO	USP-6B	49zz	VR13	9b	Tor
2FZ20	XC6403FZ20D	LVRVdet-IC	LDO, 3.3V±2%, 300mA, Vd=3.0V, +Reset ODO	USP-6B	49zz	VR13	9b	Tor
2FZ21	XC6403FZ21D	LVRVdet-IC	LDO, 3.3V±2%, 300mA, Vd=3.1V, +Reset ODO	USP-6B	49zz	VR13	9b	Tor
2FZ24	XC6403FZ24D	LVRVdet-IC	LDO, 1.8V±2%, 300mA, Vd=2.4V, +Reset ODO	USP-6B	49zz	VR13	9b	Tor
2FZ25	XC6403FZ25D	LVRVdet-IC	LDO, 3.2V±2%, 300mA, Vd=2.8V, +Reset ODO	USP-6B	49zz	VR13	9b	Tor
2FZ30	XC6403FZ30D	LVRVdet-IC	LDO, 4.0V±2%, 300mA, Vd=4.3V, +Reset ODO	USP-6B	49zz	VR13	9b	Tor
2FZ31	XC6403FZ31D	LVRVdet-IC	LDO, 2.85V±2%, 300mA, Vd=2.7V, +Reset ODO	USP-6B	49zz	VR13	9b	Tor
2FZ32	XC6403FZ32D	LVRVdet-IC	LDO, 2.6V±2%, 300mA, Vd=2.4V, +Reset ODO	USP-6B	49zz	VR13	9b	Tor
2FZ33	XC6403FZ33D	LVRVdet-IC	LDO, 2.7V±2%, 300mA, Vd=2.8V, +Reset ODO	USP-6B	49zz	VR13	9b	Tor
2FZ34	XC6403FZ34D	LVRVdet-IC	LDO, 2.85V±2%, 300mA, Vd=2.55V, +Reset ODO	USP-6B	49zz	VR13	9b	Tor
2FZ80	XC6403FZ80D	LVRVdet-IC	LDO, 1.8V±2%, 300mA, Vd=1.6V, +Reset ODO	USP-6B	49zz	VR13	9b	Tor
2FZ81	XC6403FZ81D	LVRVdet-IC	LDO, 2.8V±2%, 300mA, Vd=3.1V, +Reset ODO	USP-6B	49zz	VR13	9b	Tor
2FZ82	XC6403FZ82D	LVRVdet-IC	LDO, 1.8V±2%, 300mA, Vd=2.0V, +Reset ODO	USP-6B	49zz	VR13	9b	Tor
2FZ83	XC6403FZ83D	LVRVdet-IC	LDO, 2.5V±2%, 300mA, Vd=3.4V, +Reset ODO	USP-6B	49zz	VR13	9b	Tor
2FZ84	XC6403FZ84D	LVRVdet-IC	LDO, 2.85V±2%, 300mA, Vd=3.2V, +Reset ODO	USP-6B	49zz	VR13	9b	Tor
2FZ85	XC6403FZ85D	LVRVdet-IC	LDO, 3.0V±2%, 300mA, Vd=3.3V, +Reset ODO	USP-6B	49zz	VR13	9b	Tor
2FZ86	XC6403FZ86D	LVRVdet-IC	LDO, 3.5V±2%, 300mA, Vd=3.8V, +Reset ODO	USP-6B	49zz	VR13	9b	Tor
2FZ87	XC6403FZ87D	LVRVdet-IC	LDO, 3.0V±2%, 300mA, Vd=2.4V, +Reset ODO	USP-6B	49zz	VR13	9b	Tor
2FZ88	XC6403FZ88D	LVRVdet-IC	LDO, 3.3V±2%, 300mA, Vd=4.0V, +Reset ODO	USP-6B	49zz	VR13	9b	Tor
2G	R3117K371A	Vdet-IC	3.7V±1%, -Reset ODO, Sense	DFN1010-4	48rq	VD11	9a	Ric
2G	RP100K201D	LVR-IC	LDO, LN, +CE, CL, 2V±0.8%, 200mA	PLP1612-4	45vm	VR4	9a	Ric
2H	R3117K381A	Vdet-IC	3.8V±1%, -Reset ODO, Sense	DFN1010-4	48rq	VD11	9a	Ric
2H	RP100K251D	LVR-IC	LDO, LN, +CE, CL, 2.5V±0.8%, 200mA	PLP1612-4	45vm	VR4	9a	Ric
2H	XC6223C2619R-G	LVR-IC	LDO, 2.6V±1%, 300mA, +CE, PDR	USPQ-4B03	48vm	VR4	9a	Tor
2H	XC6224B2417R	LVR-IC	LDO, 2.4V±1.5%, 150mA, +CE, PDR	USPN-4B02	58vm	VR4	9e	Tor
2H	XC6229H2011R-G	LVR-IC	LDO, 2.0V±1%, 300mA, +CE, ICP	BGA-4	63ba*	VR4	9a	Tor
2H	XC6221C24B7R	LVR-IC	LDO, 2.45V±1%, 200mA, +CE, PDR	USPN-4	58vm	VR4	9a	Tor
2H0	XC9235F10DER	DC-DC-IC	PWM, st-dwn, 1.0V±2%, 600mA, 3MHz, Vin>1.8V, HSST, CL	USP-6C	49da	DC16	9a	Tor
2H1	XC9235F11DER	DC-DC-IC	PWM, st-dwn, 1.1V±2%, 600mA, 3MHz, Vin>1.8V, HSST, CL	USP-6C	49da	DC16	9a	Tor
2H2	XC9235F12DER	DC-DC-IC	PWM, st-dwn, 1.2V±2%, 600mA, 3MHz, Vin>1.8V, HSST, CL	USP-6C	49da	DC16	9a	Tor



SMD code	Type	Function	Short description	Case	Pinout	Sch.	St.	Mnf.
2H3	XC9235F13DER	DC-DC-IC	PWM, st-dwn, 1.3V±2%, 600mA, 3MHz, Vin>1.8V, HSST, CL	USP-6C	49da	DC16	9a	Tor
2H4	XC9235F14DER	DC-DC-IC	PWM, st-dwn, 1.4V±2%, 600mA, 3MHz, Vin>1.8V, HSST, CL	USP-6C	49da	DC16	9a	Tor
2H5	XC9235F15DER	DC-DC-IC	PWM, st-dwn, 1.5V±2%, 600mA, 3MHz, Vin>1.8V, HSST, CL	USP-6C	49da	DC16	9a	Tor
2H6	XC9235F16DER	DC-DC-IC	PWM, st-dwn, 1.6V±2%, 600mA, 3MHz, Vin>1.8V, HSST, CL	USP-6C	49da	DC16	9a	Tor
2H7	XC9235F17DER	DC-DC-IC	PWM, st-dwn, 1.7V±2%, 600mA, 3MHz, Vin>1.8V, HSST, CL	USP-6C	49da	DC16	9a	Tor
2H8	XC9235F18DER	DC-DC-IC	PWM, st-dwn, 1.8V±2%, 600mA, 3MHz, Vin>1.8V, HSST, CL	USP-6C	49da	DC16	9a	Tor
2H9	XC9235F19DER	DC-DC-IC	PWM, st-dwn, 1.9V±2%, 600mA, 3MHz, Vin>1.8V, HSST, CL	USP-6C	49da	DC16	9a	Tor
2HA	XC9235F1ADER	DC-DC-IC	PWM, st-dwn, 1.05V±2%, 600mA, 3MHz, Vin>1.8V, HSST, CL	USP-6C	49da	DC16	9a	Tor
2HB	XC9235F1BDER	DC-DC-IC	PWM, st-dwn, 1.15V±2%, 600mA, 3MHz, Vin>1.8V, HSST, CL	USP-6C	49da	DC16	9a	Tor
2HC	XC9235F1CDER	DC-DC-IC	PWM, st-dwn, 1.25V±2%, 600mA, 3MHz, Vin>1.8V, HSST, CL	USP-6C	49da	DC16	9a	Tor
2HD	XC9235F1DDER	DC-DC-IC	PWM, st-dwn, 1.35V±2%, 600mA, 3MHz, Vin>1.8V, HSST, CL	USP-6C	49da	DC16	9a	Tor
2HE	XC9235F1EDER	DC-DC-IC	PWM, st-dwn, 1.45V±2%, 600mA, 3MHz, Vin>1.8V, HSST, CL	USP-6C	49da	DC16	9a	Tor
2HF	XC9235F1FDER	DC-DC-IC	PWM, st-dwn, 1.55V±2%, 600mA, 3MHz, Vin>1.8V, HSST, CL	USP-6C	49da	DC16	9a	Tor
2HH	XC9235F1HDER	DC-DC-IC	PWM, st-dwn, 1.65V±2%, 600mA, 3MHz, Vin>1.8V, HSST, CL	USP-6C	49da	DC16	9a	Tor
2HK	XC9235F1KDER	DC-DC-IC	PWM, st-dwn, 1.75V±2%, 600mA, 3MHz, Vin>1.8V, HSST, CL	USP-6C	49da	DC16	9a	Tor
2HL	XC9235F1LDER	DC-DC-IC	PWM, st-dwn, 1.85V±2%, 600mA, 3MHz, Vin>1.8V, HSST, CL	USP-6C	49da	DC16	9a	Tor
2HM	XC9235F1MDER	DC-DC-IC	PWM, st-dwn, 1.95V±2%, 600mA, 3MHz, Vin>1.8V, HSST, CL	USP-6C	49da	DC16	9a	Tor
2J	R3117K391A	Vdet-IC	3.9V±1%, -Reset ODO, Sense	DFN1010-4	48rq	VD11	9a	Ric
2J	RP100K261D	LVR-IC	LDO, LN, +CE, CL, 2.6V±0.8%, 200mA	PLP1612-4	45vm	VR4	9a	Ric
2K	R3117K401A	Vdet-IC	4.0V±1%, -Reset ODO, Sense	DFN1010-4	48rq	VD11	9a	Ric
2K	RP100K271D	LVR-IC	LDO, LN, +CE, CL, 2.7V±0.8%, 200mA	PLP1612-4	45vm	VR4	9a	Ric
2K	XC6223C2719R-G	LVR-IC	LDO, 2.7V±1%, 300mA, +CE, PDR	USPQ-4B03	48vm	VR4	9a	Tor
2K	XC6224B2517R	LVR-IC	LDO, 2.5V±1.5%, 150mA, +CE, PDR	USPN-4B02	58vm	VR4	9e	Tor
2K	XC6229H20B1R-G	LVR-IC	LDO, 2.05V±1%, 300mA, +CE, ICP	BGA-4	63ba*	VR4	9a	Tor
2K	XC6221C25B7R	LVR-IC	LDO, 2.55V±1%, 200mA, +CE, PDR	USPN-4	58vm	VR4	9a	Tor
2K0	XC9235F20DER	DC-DC-IC	PWM, st-dwn, 2.0V±2%, 600mA, 3MHz, Vin>1.8V, HSST, CL	USP-6C	49da	DC16	9a	Tor
2K1	XC9235F21DER	DC-DC-IC	PWM, st-dwn, 2.1V±2%, 600mA, 3MHz, Vin>1.8V, HSST, CL	USP-6C	49da	DC16	9a	Tor
2K2	XC9235F22DER	DC-DC-IC	PWM, st-dwn, 2.2V±2%, 600mA, 3MHz, Vin>1.8V, HSST, CL	USP-6C	49da	DC16	9a	Tor
2K3	XC9235F23DER	DC-DC-IC	PWM, st-dwn, 2.3V±2%, 600mA, 3MHz, Vin>1.8V, HSST, CL	USP-6C	49da	DC16	9a	Tor
2K4	XC9235F24DER	DC-DC-IC	PWM, st-dwn, 2.4V±2%, 600mA, 3MHz, Vin>1.8V, HSST, CL	USP-6C	49da	DC16	9a	Tor
2K5	XC9235F25DER	DC-DC-IC	PWM, st-dwn, 2.5V±2%, 600mA, 3MHz, Vin>1.8V, HSST, CL	USP-6C	49da	DC16	9a	Tor
2K6	XC9235F26DER	DC-DC-IC	PWM, st-dwn, 2.6V±2%, 600mA, 3MHz, Vin>1.8V, HSST, CL	USP-6C	49da	DC16	9a	Tor
2K7	XC9235F27DER	DC-DC-IC	PWM, st-dwn, 2.7V±2%, 600mA, 3MHz, Vin>1.8V, HSST, CL	USP-6C	49da	DC16	9a	Tor
2K8	XC9235F28DER	DC-DC-IC	PWM, st-dwn, 2.8V±2%, 600mA, 3MHz, Vin>1.8V, HSST, CL	USP-6C	49da	DC16	9a	Tor
2K9	XC9235F29DER	DC-DC-IC	PWM, st-dwn, 2.9V±2%, 600mA, 3MHz, Vin>1.8V, HSST, CL	USP-6C	49da	DC16	9a	Tor
2KA	XC9235F2ADER	DC-DC-IC	PWM, st-dwn, 2.05V±2%, 600mA, 3MHz, Vin>1.8V, HSST, CL	USP-6C	49da	DC16	9a	Tor
2KB	XC9235F2BDER	DC-DC-IC	PWM, st-dwn, 2.15V±2%, 600mA, 3MHz, Vin>1.8V, HSST, CL	USP-6C	49da	DC16	9a	Tor
2KC	XC9235F2CDER	DC-DC-IC	PWM, st-dwn, 2.25V±2%, 600mA, 3MHz, Vin>1.8V, HSST, CL	USP-6C	49da	DC16	9a	Tor
2KD	XC9235F2DDER	DC-DC-IC	PWM, st-dwn, 2.35V±2%, 600mA, 3MHz, Vin>1.8V, HSST, CL	USP-6C	49da	DC16	9a	Tor
2KE	XC9235F2EDER	DC-DC-IC	PWM, st-dwn, 2.45V±2%, 600mA, 3MHz, Vin>1.8V, HSST, CL	USP-6C	49da	DC16	9a	Tor
2KF	XC9235F2FDER	DC-DC-IC	PWM, st-dwn, 2.55V±2%, 600mA, 3MHz, Vin>1.8V, HSST, CL	USP-6C	49da	DC16	9a	Tor
2KH	XC9235F2HDER	DC-DC-IC	PWM, st-dwn, 2.65V±2%, 600mA, 3MHz, Vin>1.8V, HSST, CL	USP-6C	49da	DC16	9a	Tor
2KL	XC9235F2KDER	DC-DC-IC	PWM, st-dwn, 2.75V±2%, 600mA, 3MHz, Vin>1.8V, HSST, CL	USP-6C	49da	DC16	9a	Tor
2KL	XC9235F2LDER	DC-DC-IC	PWM, st-dwn, 2.85V±2%, 600mA, 3MHz, Vin>1.8V, HSST, CL	USP-6C	49da	DC16	9a	Tor
2KM	XC9235F2MDER	DC-DC-IC	PWM, st-dwn, 2.95V±2%, 600mA, 3MHz, Vin>1.8V, HSST, CL	USP-6C	49da	DC16	9a	Tor
2L	R3117K411A	Vdet-IC	4.1V±1%, -Reset ODO, Sense	DFN1010-4	48rq	VD11	9a	Ric
2L	RP100K281D	LVR-IC	LDO, LN, +CE, CL, 2.8V±0.8%, 200mA	PLP1612-4	45vm	VR4	9a	Ric
2L	XC6223C2819R-G	LVR-IC	LDO, 2.8V±1%, 300mA, +CE, PDR	USPQ-4B03	48vm	VR4	9a	Tor
2L	XC6224B2617R	LVR-IC	LDO, 2.6V±1.5%, 150mA, +CE, PDR	USPN-4B02	58vm	VR4	9e	Tor
2L	XC6229H2111R-G	LVR-IC	LDO, 2.1V±1%, 300mA, +CE, ICP	BGA-4	63ba*	VR4	9a	Tor
2L	XC6221C26B7R	LVR-IC	LDO, 2.65V±1%, 200mA, +CE, PDR	USPN-4	58vm	VR4	9a	Tor
2L0	XC9235F30DER	DC-DC-IC	PWM, st-dwn, 3.0V±2%, 600mA, 3MHz, Vin>1.8V, HSST, CL	USP-6C	49da	DC16	9a	Tor
2L1	XC9235F31DER	DC-DC-IC	PWM, st-dwn, 3.1V±2%, 600mA, 3MHz, Vin>1.8V, HSST, CL	USP-6C	49da	DC16	9a	Tor
2L2	XC9235F32DER	DC-DC-IC	PWM, st-dwn, 3.2V±2%, 600mA, 3MHz, Vin>1.8V, HSST, CL	USP-6C	49da	DC16	9a	Tor
2L3	XC9235F33DER	DC-DC-IC	PWM, st-dwn, 3.3V±2%, 600mA, 3MHz, Vin>1.8V, HSST, CL	USP-6C	49da	DC16	9a	Tor
2L4	XC9235F34DER	DC-DC-IC	PWM, st-dwn, 3.4V±2%, 600mA, 3MHz, Vin>1.8V, HSST, CL	USP-6C	49da	DC16	9a	Tor
2L5	XC9235F35DER	DC-DC-IC	PWM, st-dwn, 3.5V±2%, 600mA, 3MHz, Vin>1.8V, HSST, CL	USP-6C	49da	DC16	9a	Tor
2L6	XC9235F36DER	DC-DC-IC	PWM, st-dwn, 3.6V±2%, 600mA, 3MHz, Vin>1.8V, HSST, CL	USP-6C	49da	DC16	9a	Tor
2L7	XC9235F37DER	DC-DC-IC	PWM, st-dwn, 3.7V±2%, 600mA, 3MHz, Vin>1.8V, HSST, CL	USP-6C	49da	DC16	9a	Tor
2L8	XC9235F38DER	DC-DC-IC	PWM, st-dwn, 3.8V±2%, 600mA, 3MHz, Vin>1.8V, HSST, CL	USP-6C	49da	DC16	9a	Tor
2L9	XC9235F39DER	DC-DC-IC	PWM, st-dwn, 3.9V±2%, 600mA, 3MHz, Vin>1.8V, HSST, CL	USP-6C	49da	DC16	9a	Tor
2LA	XC9235F3ADER	DC-DC-IC	PWM, st-dwn, 3.05V±2%, 600mA, 3MHz, Vin>1.8V, HSST, CL	USP-6C	49da	DC16	9a	Tor
2LB	XC9235F3BDER	DC-DC-IC	PWM, st-dwn, 3.15V±2%, 600mA, 3MHz, Vin>1.8V, HSST, CL	USP-6C	49da	DC16	9a	Tor
2LC	XC9235F3CDER	DC-DC-IC	PWM, st-dwn, 3.25V±2%, 600mA, 3MHz, Vin>1.8V, HSST, CL	USP-6C	49da	DC16	9a	Tor
2LD	XC9235F3DDER	DC-DC-IC	PWM, st-dwn, 3.35V±2%, 600mA, 3MHz, Vin>1.8V, HSST, CL	USP-6C	49da	DC16	9a	Tor
2LE	XC9235F3EDER	DC-DC-IC	PWM, st-dwn, 3.45V±2%, 600mA, 3MHz, Vin>1.8V, HSST, CL	USP-6C	49da	DC16	9a	Tor
2LF	XC9235F3FDER	DC-DC-IC	PWM, st-dwn, 3.55V±2%, 600mA, 3MHz, Vin>1.8V, HSST, CL	USP-6C	49da	DC16	9a	Tor
2LH	XC9235F3HDER	DC-DC-IC	PWM, st-dwn, 3.65V±2%, 600mA, 3MHz, Vin>1.8V, HSST, CL	USP-6C	49da	DC16	9a	Tor
2LK	XC9235F3KDER	DC-DC-IC	PWM, st-dwn, 3.75V±2%, 600mA, 3MHz, Vin>1.8V, HSST, CL	USP-6C	49da	DC16	9a	Tor
2LL	XC9235F3LDER	DC-DC-IC	PWM, st-dwn, 3.85V±2%, 600mA, 3MHz, Vin>1.8V, HSST, CL	USP-6C	49da	DC16	9a	Tor



SMD code	Type	Function	Short description	Case	Pinout	Sch.	St.	Mnf.
2LM	XC9235F3MDER	DC-DC-IC	PWM, st-dwn, 3.95V±2%, 600mA, 3MHz, Vin>1.8V, HSST, CL	USP-6C	49da	DC16	9a	Tor
2M	R3117K421A	Vdet-IC	4.2V±1%, -Reset ODO, Sense	DFN1010-4	48rq	VD11	9a	Ric
2M	RP100K281D5	LVR-IC	LDO, LN, +CE, CL, 2.85V±0.8%, 200mA	PLP1612-4	45vm	VR4	9a	Ric
2M	XC6223C2919R-G	LVR-IC	LDO, 2.9V±1%, 300mA, +CE, PDR	USPQ-4B03	48vm	VR4	9a	Tor
2M	XC6224B2717R	LVR-IC	LDO, 2.7V±1.5%, 150mA, +CE, PDR	USPN-4B02	58vm	VR4	9e	Tor
2M	XC6229H21B1R-G	LVR-IC	LDO, 2.15V±1%, 300mA, +CE, ICP	BGA-4	63ba*	VR4	9a	Tor
2M	XC6221C27B7R	LVR-IC	LDO, 2.75V±1%, 200mA, +CE, PDR	USPN-4	58vm	VR4	9a	Tor
2M0	XC9235F40DER	DC-DC-IC	PWM, st-dwn, 4.0V±2%, 600mA, 3MHz, Vin>1.8V, HSST, CL	USP-6C	49da	DC16	9a	Tor
2N	R3117K431A	Vdet-IC	4.3V±1%, -Reset ODO, Sense	DFN1010-4	48rq	VD11	9a	Ric
2N	RP100K291D	LVR-IC	LDO, LN, +CE, CL, 2.9V±0.8%, 200mA	PLP1612-4	45vm	VR4	9a	Ric
2N	XC6223C3019R-G	LVR-IC	LDO, 3.0V±1%, 300mA, +CE, PDR	USPQ-4B03	48vm	VR4	9a	Tor
2N	XC6224B2817R	LVR-IC	LDO, 2.8V±1.5%, 150mA, +CE, PDR	USPN-4B02	58vm	VR4	9e	Tor
2N	XC6229H2211R-G	LVR-IC	LDO, 2.2V±1%, 300mA, +CE, ICP	BGA-4	63ba*	VR4	9a	Tor
2N	XC6221C28B7R	LVR-IC	LDO, 2.85V±1%, 200mA, +CE, PDR	USPN-4	58vm	VR4	9a	Tor
2P	R3117K441A	Vdet-IC	4.4V±1%, -Reset ODO, Sense	DFN1010-4	48rq	VD11	9a	Ric
2P	RP100K301D	LVR-IC	LDO, LN, +CE, CL, 3V±0.8%, 200mA	PLP1612-4	45vm	VR4	9a	Ric
2P	XC6223C3119R-G	LVR-IC	LDO, 3.1V±1%, 300mA, +CE, PDR	USPQ-4B03	48vm	VR4	9a	Tor
2P	XC6224B2917R	LVR-IC	LDO, 2.9V±1.5%, 150mA, +CE, PDR	USPN-4B02	58vm	VR4	9e	Tor
2P	XC6229H22B1R-G	LVR-IC	LDO, 2.25V±1%, 300mA, +CE, ICP	BGA-4	63ba*	VR4	9a	Tor
2P	XC6221C29B7R	LVR-IC	LDO, 2.95V±1%, 200mA, +CE, PDR	USPN-4	58vm	VR4	9a	Tor
2Q	R3117K451A	Vdet-IC	4.5V±1%, -Reset ODO, Sense	DFN1010-4	48rq	VD11	9a	Ric
2Q	RP100K311D	LVR-IC	LDO, LN, +CE, CL, 3.1V±0.8%, 200mA	PLP1612-4	45vm	VR4	9a	Ric
2R	R3117K461A	Vdet-IC	4.6V±1%, -Reset ODO, Sense	DFN1010-4	48rq	VD11	9a	Ric
2R	RP100K331D	LVR-IC	LDO, LN, +CE, CL, 3.3V±0.8%, 200mA	PLP1612-4	45vm	VR4	9a	Ric
2R	XC6223C3219R-G	LVR-IC	LDO, 3.2V±1%, 300mA, +CE, PDR	USPQ-4B03	48vm	VR4	9a	Tor
2R	XC6224B3017R	LVR-IC	LDO, 3.0V±1.5%, 150mA, +CE, PDR	USPN-4B02	58vm	VR4	9e	Tor
2R	XC6229H2311R-G	LVR-IC	LDO, 2.3V±1%, 300mA, +CE, ICP	BGA-4	63ba*	VR4	9a	Tor
2R	XC6221C30B7R	LVR-IC	LDO, 3.05V±1%, 200mA, +CE, PDR	USPN-4	58vm	VR4	9a	Tor
2S	R3117K471A	Vdet-IC	4.7V±1%, -Reset ODO, Sense	DFN1010-4	48rq	VD11	9a	Ric
2S	XC6223C3319R-G	LVR-IC	LDO, 3.3V±1%, 300mA, +CE, PDR	USPQ-4B03	48vm	VR4	9a	Tor
2S	XC6229H23B1R-G	LVR-IC	LDO, 2.35V±1%, 300mA, +CE, ICP	BGA-4	63ba*	VR4	9a	Tor
2S	XC6221C31B7R	LVR-IC	LDO, 3.15V±1%, 200mA, +CE, PDR	USPN-4	58vm	VR4	9a	Tor
2T	R3117K481A	Vdet-IC	4.8V±1%, -Reset ODO, Sense	DFN1010-4	48rq	VD11	9a	Ric
2T	XC6223C3419R-G	LVR-IC	LDO, 3.4V±1%, 300mA, +CE, PDR	USPQ-4B03	48vm	VR4	9a	Tor
2T	XC6229H2411R-G	LVR-IC	LDO, 2.4V±1%, 300mA, +CE, ICP	BGA-4	63ba*	VR4	9a	Tor
2T	XC6221C32B7R	LVR-IC	LDO, 3.25V±1%, 200mA, +CE, PDR	USPN-4	58vm	VR4	9a	Tor
2U	R3117K491A	Vdet-IC	4.9V±1%, -Reset ODO, Sense	DFN1010-4	48rq	VD11	9a	Ric
2U	XC6223C3519R-G	LVR-IC	LDO, 3.5V±1%, 300mA, +CE, PDR	USPQ-4B03	48vm	VR4	9a	Tor
2U	XC6229H24B1R-G	LVR-IC	LDO, 2.45V±1%, 300mA, +CE, ICP	BGA-4	63ba*	VR4	9a	Tor
2U	XC6221C33B7R	LVR-IC	LDO, 3.35V±1%, 200mA, +CE, PDR	USPN-4	58vm	VR4	9a	Tor
2V	R3117K501A	Vdet-IC	5.0V±1%, -Reset ODO, Sense	DFN1010-4	48rq	VD11	9a	Ric
2V	XC6223C3619R-G	LVR-IC	LDO, 3.6V±1%, 300mA, +CE, PDR	USPQ-4B03	48vm	VR4	9a	Tor
2V	XC6229H2511R-G	LVR-IC	LDO, 2.5V±1%, 300mA, +CE, ICP	BGA-4	63ba*	VR4	9a	Tor
2V	XC6221C34B7R	LVR-IC	LDO, 3.45V±1%, 200mA, +CE, PDR	USPN-4	58vm	VR4	9a	Tor
2X	XC6223C3719R-G	LVR-IC	LDO, 3.7V±1%, 300mA, +CE, PDR	USPQ-4B03	48vm	VR4	9a	Tor
2X	XC6229H25B1R-G	LVR-IC	LDO, 2.55V±1%, 300mA, +CE, ICP	BGA-4	63ba*	VR4	9a	Tor
2X	XC6221C35B7R	LVR-IC	LDO, 3.55V±1%, 200mA, +CE, PDR	USPN-4	58vm	VR4	9a	Tor
2Y	XC6223C3819R-G	LVR-IC	LDO, 3.8V±1%, 300mA, +CE, PDR	USPQ-4B03	48vm	VR4	9a	Tor
2Y	XC6229H2611R-G	LVR-IC	LDO, 2.6V±1%, 300mA, +CE, ICP	BGA-4	63ba*	VR4	9a	Tor
2Y	XC6221C36B7R	LVR-IC	LDO, 3.65V±1%, 200mA, +CE, PDR	USPN-4	58vm	VR4	9a	Tor
2Z	XC6223C3919R-G	LVR-IC	LDO, 3.9V±1%, 300mA, +CE, PDR	USPQ-4B03	48vm	VR4	9a	Tor
2Z	XC6221C37B7R	LVR-IC	LDO, 3.75V±1%, 200mA, +CE, PDR	USPN-4	58vm	VR4	9a	Tor
3	NLU1G32MU	CMOS-Logic	2-input OR gate	UDFN-6	57Log4	-	9d	Ons
30	RP110L351B	LVR-IC	LDO, 3.5V±1%, 150mA, +CE	DFN1010-4	48vm	VR4	9a	Ric
30	XC6224B08B7R	LVR-IC	LDO, 0.85V±20mV, 150mA, +CE, PDR	USPN-4B02	58vm	VR4	9e	Tor
30	XC6229H26B1R-G	LVR-IC	LDO, 2.65V±1%, 300mA, +CE, ICP	BGA-4	63ba*	VR4	9a	Tor
30	XC6420AB307R-G	LVR-IC	LDO, Dual out, Vout1/Vout2=1.30/2.80V±2%, 150mA, +CE	USPN-6	52xv	VR19	9a	Tor
30	XC6420AB30DR-G	LVR-IC	LDO, Dual out, Vout1/Vout2=1.30/2.80V±2%, 150mA, +CE	USP-6B04	73x4	VR19	9a	Tor
30	XC6221C38B7R	LVR-IC	LDO, 3.85V±1%, 200mA, +CE, PDR	USPN-4	58vm	VR4	9a	Tor
30E	XC6505A151ER	LVR-IC	LDO, 1.5V±20mV, 200mA, +CE	USP-6C	49hq	VR4	9a	Tor
30F	XC6505A161ER	LVR-IC	LDO, 1.6V±20mV, 200mA, +CE	USP-6C	49hq	VR4	9a	Tor
30H	XC6505A171ER	LVR-IC	LDO, 1.7V±20mV, 200mA, +CE	USP-6C	49hq	VR4	9a	Tor
30K	XC6505A181ER	LVR-IC	LDO, 1.8V±20mV, 200mA, +CE	USP-6C	49hq	VR4	9a	Tor
30L	XC6505A191ER	LVR-IC	LDO, 1.9V±20mV, 200mA, +CE	USP-6C	49hq	VR4	9a	Tor
30M	XC6505A201ER	LVR-IC	LDO, 2.0V±1%, 200mA, +CE	USP-6C	49hq	VR4	9a	Tor
30N	XC6505A211ER	LVR-IC	LDO, 2.1V±1%, 200mA, +CE	USP-6C	49hq	VR4	9a	Tor
30P	XC6505A221ER	LVR-IC	LDO, 2.2V±1%, 200mA, +CE	USP-6C	49hq	VR4	9a	Tor
30R	XC6505A231ER	LVR-IC	LDO, 2.3V±1%, 200mA, +CE	USP-6C	49hq	VR4	9a	Tor
30S	XC6505A241ER	LVR-IC	LDO, 2.4V±1%, 200mA, +CE	USP-6C	49hq	VR4	9a	Tor
30T	XC6505A251ER	LVR-IC	LDO, 2.5V±1%, 200mA, +CE	USP-6C	49hq	VR4	9a	Tor



SMD code	Type	Function	Short description	Case	Pinout	Sch.	St.	Mnf.
30U	XC6505A261ER	LVR-IC	LDO, 2.6V±1%, 200mA, +CE	USP-6C	49hq	VR4	9a	Tor
30V	XC6505A271ER	LVR-IC	LDO, 2.7V±1%, 200mA, +CE	USP-6C	49hq	VR4	9a	Tor
30X	XC6505A281ER	LVR-IC	LDO, 2.8V±1%, 200mA, +CE	USP-6C	49hq	VR4	9a	Tor
30Y	XC6505A291ER	LVR-IC	LDO, 2.9V±1%, 200mA, +CE	USP-6C	49hq	VR4	9a	Tor
30Z	XC6505A301ER	LVR-IC	LDO, 3.0V±1%, 200mA, +CE	USP-6C	49hq	VR4	9a	Tor
31	RP110L361B	LVR-IC	LDO, 3.6V±1%, 150mA, +CE	DFN1010-4	48vm	VR4	9a	Ric
31	XC6224B09B7R	LVR-IC	LDO, 0.95V±20mV, 150mA, +CE, PDR	USPN-4B02	58vm	VR4	9e	Tor
31	XC6229H2711R-G	LVR-IC	LDO, 2.7V±1%, 300mA, +CE, ICP	BGA-4	63ba*	VR4	9a	Tor
31	XC6420AB317R-G	LVR-IC	LDO, Dual out, Vout1/Vout2=1.50/2.80V±2%, 150mA, +CE	USPN-6	52xv	VR19	9a	Tor
31	XC6420AB31DR-G	LVR-IC	LDO, Dual out, Vout1/Vout2=1.50/2.80V±2%, 150mA, +CE	USP-6B04	73x4	VR19	9a	Tor
31	XC6221C39B7R	LVR-IC	LDO, 3.95V±1%, 200mA, +CE, PDR	USPN-4	58vm	VR4	9a	Tor
310	XC6505A311ER	LVR-IC	LDO, 3.1V±1%, 200mA, +CE	USP-6C	49hq	VR4	9a	Tor
311	XC6505A321ER	LVR-IC	LDO, 3.2V±1%, 200mA, +CE	USP-6C	49hq	VR4	9a	Tor
312	XC6505A331ER	LVR-IC	LDO, 3.3V±1%, 200mA, +CE	USP-6C	49hq	VR4	9a	Tor
313	XC6505A341ER	LVR-IC	LDO, 3.4V±1%, 200mA, +CE	USP-6C	49hq	VR4	9a	Tor
314	XC6505A351ER	LVR-IC	LDO, 3.5V±1%, 200mA, +CE	USP-6C	49hq	VR4	9a	Tor
315	XC6505A361ER	LVR-IC	LDO, 3.6V±1%, 200mA, +CE	USP-6C	49hq	VR4	9a	Tor
316	XC6505A371ER	LVR-IC	LDO, 3.7V±1%, 200mA, +CE	USP-6C	49hq	VR4	9a	Tor
317	XC6505A381ER	LVR-IC	LDO, 3.8V±1%, 200mA, +CE	USP-6C	49hq	VR4	9a	Tor
318	XC6505A391ER	LVR-IC	LDO, 3.9V±1%, 200mA, +CE	USP-6C	49hq	VR4	9a	Tor
319	XC6505A401ER	LVR-IC	LDO, 4.0V±1%, 200mA, +CE	USP-6C	49hq	VR4	9a	Tor
31A	XC6505A411ER	LVR-IC	LDO, 4.1V±1%, 200mA, +CE	USP-6C	49hq	VR4	9a	Tor
31B	XC6505A421ER	LVR-IC	LDO, 4.2V±1%, 200mA, +CE	USP-6C	49hq	VR4	9a	Tor
31C	XC6505A431ER	LVR-IC	LDO, 4.3V±1%, 200mA, +CE	USP-6C	49hq	VR4	9a	Tor
31D	XC6505A441ER	LVR-IC	LDO, 4.4V±1%, 200mA, +CE	USP-6C	49hq	VR4	9a	Tor
31E	XC6505A451ER	LVR-IC	LDO, 4.5V±1%, 200mA, +CE	USP-6C	49hq	VR4	9a	Tor
31F	XC6505A461ER	LVR-IC	LDO, 4.6V±1%, 200mA, +CE	USP-6C	49hq	VR4	9a	Tor
31H	XC6505A471ER	LVR-IC	LDO, 4.7V±1%, 200mA, +CE	USP-6C	49hq	VR4	9a	Tor
31K	XC6505A481ER	LVR-IC	LDO, 4.8V±1%, 200mA, +CE	USP-6C	49hq	VR4	9a	Tor
31L	XC6505A491ER	LVR-IC	LDO, 4.9V±1%, 200mA, +CE	USP-6C	49hq	VR4	9a	Tor
31M	XC6505A501ER	LVR-IC	LDO, 5.0V±1%, 200mA, +CE	USP-6C	49hq	VR4	9a	Tor
32	RP110L081C	LVR-IC	LDO, 0.8V±1%, 150mA	DFN1010-4	48y1	VR1	9a	Ric
32	XC6223D1219R-G	LVR-IC	LDO, 1.2V±20mV, 300mA, +CE, CL, PDR	USPQ-4B03	48vm	VR4	9a	Tor
32	XC6224B10B7R	LVR-IC	LDO, 1.05V±20mV, 150mA, +CE, PDR	USPN-4B02	58vm	VR4	9e	Tor
32	XC6229H27B1R-G	LVR-IC	LDO, 2.75V±1%, 300mA, +CE, ICP	BGA-4	63ba*	VR4	9a	Tor
32	XC6420AB327R-G	LVR-IC	LDO, Dual out, Vout1/Vout2=1.80/2.80V±2%, 150mA, +CE	USPN-6	52xv	VR19	9a	Tor
32	XC6420AB32DR-G	LVR-IC	LDO, Dual out, Vout1/Vout2=1.80/2.80V±2%, 150mA, +CE	USP-6B04	73x4	VR19	9a	Tor
32	XC6221C40B7R	LVR-IC	LDO, 4.05V±1%, 200mA, +CE, PDR	USPN-4	58vm	VR4	9a	Tor
320	XC6505A611ER	LVR-IC	LDO, 6.1V±1%, 200mA, +CE	USP-6C	49hq	VR4	9a	Tor
321	XC6505A621ER	LVR-IC	LDO, 6.2V±1%, 200mA, +CE	USP-6C	49hq	VR4	9a	Tor
322	XC6505A631ER	LVR-IC	LDO, 6.3V±1%, 200mA, +CE	USP-6C	49hq	VR4	9a	Tor
323	XC6505A641ER	LVR-IC	LDO, 6.4V±1%, 200mA, +CE	USP-6C	49hq	VR4	9a	Tor
324	XC6505A651ER	LVR-IC	LDO, 6.5V±1%, 200mA, +CE	USP-6C	49hq	VR4	9a	Tor
325	XC6505A661ER	LVR-IC	LDO, 6.6V±1%, 200mA, +CE	USP-6C	49hq	VR4	9a	Tor
326	XC6505A671ER	LVR-IC	LDO, 6.7V±1%, 200mA, +CE	USP-6C	49hq	VR4	9a	Tor
327	XC6505A681ER	LVR-IC	LDO, 6.8V±1%, 200mA, +CE	USP-6C	49hq	VR4	9a	Tor
328	XC6505A691ER	LVR-IC	LDO, 6.9V±1%, 200mA, +CE	USP-6C	49hq	VR4	9a	Tor
329	XC6505A701ER	LVR-IC	LDO, 7.0V±1%, 200mA, +CE	USP-6C	49hq	VR4	9a	Tor
32N	XC6505A511ER	LVR-IC	LDO, 5.1V±1%, 200mA, +CE	USP-6C	49hq	VR4	9a	Tor
32P	XC6505A521ER	LVR-IC	LDO, 5.2V±1%, 200mA, +CE	USP-6C	49hq	VR4	9a	Tor
32R	XC6505A531ER	LVR-IC	LDO, 5.3V±1%, 200mA, +CE	USP-6C	49hq	VR4	9a	Tor
32S	XC6505A541ER	LVR-IC	LDO, 5.4V±1%, 200mA, +CE	USP-6C	49hq	VR4	9a	Tor
32T	XC6505A551ER	LVR-IC	LDO, 5.5V±1%, 200mA, +CE	USP-6C	49hq	VR4	9a	Tor
32U	XC6505A561ER	LVR-IC	LDO, 5.6V±1%, 200mA, +CE	USP-6C	49hq	VR4	9a	Tor
32V	XC6505A571ER	LVR-IC	LDO, 5.7V±1%, 200mA, +CE	USP-6C	49hq	VR4	9a	Tor
32X	XC6505A581ER	LVR-IC	LDO, 5.8V±1%, 200mA, +CE	USP-6C	49hq	VR4	9a	Tor
32Y	XC6505A591ER	LVR-IC	LDO, 5.9V±1%, 200mA, +CE	USP-6C	49hq	VR4	9a	Tor
32Z	XC6505A601ER	LVR-IC	LDO, 6.0V±1%, 200mA, +CE	USP-6C	49hq	VR4	9a	Tor
33	RP110L091C	LVR-IC	LDO, 0.9V±1%, 150mA	DFN1010-4	48y1	VR1	9a	Ric
33	XC6223D1319R-G	LVR-IC	LDO, 1.3V±20mV, 300mA, +CE, CL, PDR	USPQ-4B03	48vm	VR4	9a	Tor
33	XC6224B11B7R	LVR-IC	LDO, 1.15V±20mV, 150mA, +CE, PDR	USPN-4B02	58vm	VR4	9e	Tor
33	XC6229H2811R-G	LVR-IC	LDO, 2.8V±1%, 300mA, +CE, ICP	BGA-4	63ba*	VR4	9a	Tor
33	XC6420AB337R-G	LVR-IC	LDO, Dual out, Vout1/Vout2=2.80/2.80V±2%, 150mA, +CE	USPN-6	52xv	VR19	9a	Tor
33	XC6420AB33DR-G	LVR-IC	LDO, Dual out, Vout1/Vout2=2.80/2.80V±2%, 150mA, +CE	USP-6B04	73x4	VR19	9a	Tor
33	XC6221C41B7R	LVR-IC	LDO, 4.15V±1%, 200mA, +CE, PDR	USPN-4	58vm	VR4	9a	Tor
33A	XC6505A711ER	LVR-IC	LDO, 7.1V±1%, 200mA, +CE	USP-6C	49hq	VR4	9a	Tor
33B	XC6505A721ER	LVR-IC	LDO, 7.2V±1%, 200mA, +CE	USP-6C	49hq	VR4	9a	Tor
33C	XC6505A731ER	LVR-IC	LDO, 7.3V±1%, 200mA, +CE	USP-6C	49hq	VR4	9a	Tor
33D	XC6505A741ER	LVR-IC	LDO, 7.4V±1%, 200mA, +CE	USP-6C	49hq	VR4	9a	Tor
33E	XC6505A751ER	LVR-IC	LDO, 7.5V±1%, 200mA, +CE	USP-6C	49hq	VR4	9a	Tor



SMD code	Type	Function	Short description	Case	Pinout	Sch.	St.	Mnf.
33F	XC6505A761ER	LVR-IC	LDO, 7.6V±1%, 200mA, +CE	USP-6C	49hq	VR4	9a	Tor
33H	XC6505A771ER	LVR-IC	LDO, 7.7V±1%, 200mA, +CE	USP-6C	49hq	VR4	9a	Tor
33K	XC6505A781ER	LVR-IC	LDO, 7.8V±1%, 200mA, +CE	USP-6C	49hq	VR4	9a	Tor
33L	XC6505A791ER	LVR-IC	LDO, 7.9V±1%, 200mA, +CE	USP-6C	49hq	VR4	9a	Tor
33M	XC6505A801ER	LVR-IC	LDO, 8.0V±1%, 200mA, +CE	USP-6C	49hq	VR4	9a	Tor
34	RP110L101C	LVR-IC	LDO, 1.0V±1%, 150mA	DFN1010-4	48y1	VR1	9a	Ric
34	XC6223D1419R-G	LVR-IC	LDO, 1.4V±20mV, 300mA, +CE, CL, PDR	USPQ-4B03	48vm	VR4	9a	Tor
34	XC6224B12B7R	LVR-IC	LDO, 1.25V±1.5%, 150mA, +CE, PDR	USPN-4B02	58vm	VR4	9e	Tor
34	XC6229H28B1R-G	LVR-IC	LDO, 2.85V±1%, 300mA, +CE, ICP	BGA-4	63ba*	VR4	9a	Tor
34	XC6420AB347R-G	LVR-IC	LDO, Dual out, Vout1/Vout2=2.80/3.00V±2%, 150mA, +CE	USPN-6	52xv	VR19	9a	Tor
34	XC6420AB34DR-G	LVR-IC	LDO, Dual out, Vout1/Vout2=2.80/3.00V±2%, 150mA, +CE	USP-6B04	73x4	VR19	9a	Tor
34	XC6221C42B7R	LVR-IC	LDO, 4.25V±1%, 200mA, +CE, PDR	USPN-4	58vm	VR4	9a	Tor
34E	XC6505C151ER	LVR-IC	LDO, 1.5V±20mV, 200mA, +CE, CL	USP-6C	49hq	VR4	9a	Tor
34F	XC6505C161ER	LVR-IC	LDO, 1.6V±20mV, 200mA, +CE, CL	USP-6C	49hq	VR4	9a	Tor
34H	XC6505C171ER	LVR-IC	LDO, 1.7V±20mV, 200mA, +CE, CL	USP-6C	49hq	VR4	9a	Tor
34K	XC6505C181ER	LVR-IC	LDO, 1.8V±20mV, 200mA, +CE, CL	USP-6C	49hq	VR4	9a	Tor
34L	XC6505C191ER	LVR-IC	LDO, 1.9V±20mV, 200mA, +CE, CL	USP-6C	49hq	VR4	9a	Tor
34M	XC6505C201ER	LVR-IC	LDO, 2.0V±1%, 200mA, +CE, CL	USP-6C	49hq	VR4	9a	Tor
34N	XC6505C211ER	LVR-IC	LDO, 2.1V±1%, 200mA, +CE, CL	USP-6C	49hq	VR4	9a	Tor
34P	XC6505C221ER	LVR-IC	LDO, 2.2V±1%, 200mA, +CE, CL	USP-6C	49hq	VR4	9a	Tor
34R	XC6505C231ER	LVR-IC	LDO, 2.3V±1%, 200mA, +CE, CL	USP-6C	49hq	VR4	9a	Tor
34S	XC6505C241ER	LVR-IC	LDO, 2.4V±1%, 200mA, +CE, CL	USP-6C	49hq	VR4	9a	Tor
34T	XC6505C251ER	LVR-IC	LDO, 2.5V±1%, 200mA, +CE, CL	USP-6C	49hq	VR4	9a	Tor
34U	XC6505C261ER	LVR-IC	LDO, 2.6V±1%, 200mA, +CE, CL	USP-6C	49hq	VR4	9a	Tor
34V	XC6505C271ER	LVR-IC	LDO, 2.7V±1%, 200mA, +CE, CL	USP-6C	49hq	VR4	9a	Tor
34X	XC6505C281ER	LVR-IC	LDO, 2.8V±1%, 200mA, +CE, CL	USP-6C	49hq	VR4	9a	Tor
34Y	XC6505C291ER	LVR-IC	LDO, 2.9V±1%, 200mA, +CE, CL	USP-6C	49hq	VR4	9a	Tor
34Z	XC6505C301ER	LVR-IC	LDO, 3.0V±1%, 200mA, +CE, CL	USP-6C	49hq	VR4	9a	Tor
35	RP110L111C	LVR-IC	LDO, 1.1V±1%, 150mA	DFN1010-4	48y1	VR1	9a	Ric
35	XC6223D1519R-G	LVR-IC	LDO, 1.5V±20mV, 300mA, +CE, CL, PDR	USPQ-4B03	48vm	VR4	9a	Tor
35	XC6224B13B7R	LVR-IC	LDO, 1.25V±1.5%, 150mA, +CE, PDR	USPN-4B02	58vm	VR4	9e	Tor
35	XC6229H2911R-G	LVR-IC	LDO, 2.9V±1%, 300mA, +CE, ICP	BGA-4	63ba*	VR4	9a	Tor
35	XC6420AB357R-G	LVR-IC	LDO, Dual out, Vout1/Vout2=2.80/3.30V±2%, 150mA, +CE	USPN-6	52xv	VR19	9a	Tor
35	XC6420AB35DR-G	LVR-IC	LDO, Dual out, Vout1/Vout2=2.80/3.30V±2%, 150mA, +CE	USP-6B04	73x4	VR19	9a	Tor
35	XC6221C43B7R	LVR-IC	LDO, 4.35V±1%, 200mA, +CE, PDR	USPN-4	58vm	VR4	9a	Tor
350	XC6505C311ER	LVR-IC	LDO, 3.1V±1%, 200mA, +CE, CL	USP-6C	49hq	VR4	9a	Tor
351	XC6505C321ER	LVR-IC	LDO, 3.2V±1%, 200mA, +CE, CL	USP-6C	49hq	VR4	9a	Tor
352	XC6505C331ER	LVR-IC	LDO, 3.3V±1%, 200mA, +CE, CL	USP-6C	49hq	VR4	9a	Tor
353	XC6505C341ER	LVR-IC	LDO, 3.4V±1%, 200mA, +CE, CL	USP-6C	49hq	VR4	9a	Tor
354	XC6505C351ER	LVR-IC	LDO, 3.5V±1%, 200mA, +CE, CL	USP-6C	49hq	VR4	9a	Tor
355	XC6505C361ER	LVR-IC	LDO, 3.6V±1%, 200mA, +CE, CL	USP-6C	49hq	VR4	9a	Tor
356	XC6505C371ER	LVR-IC	LDO, 3.7V±1%, 200mA, +CE, CL	USP-6C	49hq	VR4	9a	Tor
357	XC6505C381ER	LVR-IC	LDO, 3.8V±1%, 200mA, +CE, CL	USP-6C	49hq	VR4	9a	Tor
358	XC6505C391ER	LVR-IC	LDO, 3.9V±1%, 200mA, +CE, CL	USP-6C	49hq	VR4	9a	Tor
359	XC6505C401ER	LVR-IC	LDO, 4.0V±1%, 200mA, +CE, CL	USP-6C	49hq	VR4	9a	Tor
35A	XC6505C411ER	LVR-IC	LDO, 4.1V±1%, 200mA, +CE, CL	USP-6C	49hq	VR4	9a	Tor
35B	XC6505C421ER	LVR-IC	LDO, 4.2V±1%, 200mA, +CE, CL	USP-6C	49hq	VR4	9a	Tor
35C	XC6505C431ER	LVR-IC	LDO, 4.3V±1%, 200mA, +CE, CL	USP-6C	49hq	VR4	9a	Tor
35D	XC6505C441ER	LVR-IC	LDO, 4.4V±1%, 200mA, +CE, CL	USP-6C	49hq	VR4	9a	Tor
35E	XC6505C451ER	LVR-IC	LDO, 4.5V±1%, 200mA, +CE, CL	USP-6C	49hq	VR4	9a	Tor
35F	XC6505C461ER	LVR-IC	LDO, 4.6V±1%, 200mA, +CE, CL	USP-6C	49hq	VR4	9a	Tor
35H	XC6505C471ER	LVR-IC	LDO, 4.7V±1%, 200mA, +CE, CL	USP-6C	49hq	VR4	9a	Tor
35K	XC6505C481ER	LVR-IC	LDO, 4.8V±1%, 200mA, +CE, CL	USP-6C	49hq	VR4	9a	Tor
35L	XC6505C491ER	LVR-IC	LDO, 4.9V±1%, 200mA, +CE, CL	USP-6C	49hq	VR4	9a	Tor
35M	XC6505C501ER	LVR-IC	LDO, 5.0V±1%, 200mA, +CE, CL	USP-6C	49hq	VR4	9a	Tor
36	RP110L121C	LVR-IC	LDO, 1.2V±1%, 150mA	DFN1010-4	48y1	VR1	9a	Ric
36	XC6223D1619R-G	LVR-IC	LDO, 1.6V±20mV, 300mA, +CE, CL, PDR	USPQ-4B03	48vm	VR4	9a	Tor
36	XC6224B14B7R	LVR-IC	LDO, 1.45V±1.5%, 150mA, +CE, PDR	USPN-4B02	58vm	VR4	9e	Tor
36	XC6229H29B1R-G	LVR-IC	LDO, 2.95V±1%, 300mA, +CE, ICP	BGA-4	63ba*	VR4	9a	Tor
36	XC6420AB367R-G	LVR-IC	LDO, Dual out, Vout1/Vout2=1.20/3.60V±2%, 150mA, +CE	USPN-6	52xv	VR19	9a	Tor
36	XC6420AB36DR-G	LVR-IC	LDO, Dual out, Vout1/Vout2=1.20/3.60V±2%, 150mA, +CE	USP-6B04	73x4	VR19	9a	Tor
36	XC6221C44B7R	LVR-IC	LDO, 4.45V±1%, 200mA, +CE, PDR	USPN-4	58vm	VR4	9a	Tor
360	XC6505C611ER	LVR-IC	LDO, 6.1V±1%, 200mA, +CE, CL	USP-6C	49hq	VR4	9a	Tor
361	XC6505C621ER	LVR-IC	LDO, 6.2V±1%, 200mA, +CE, CL	USP-6C	49hq	VR4	9a	Tor
362	XC6505C631ER	LVR-IC	LDO, 6.3V±1%, 200mA, +CE, CL	USP-6C	49hq	VR4	9a	Tor
363	XC6505C641ER	LVR-IC	LDO, 6.4V±1%, 200mA, +CE, CL	USP-6C	49hq	VR4	9a	Tor
364	XC6505C651ER	LVR-IC	LDO, 6.5V±1%, 200mA, +CE, CL	USP-6C	49hq	VR4	9a	Tor
365	XC6505C661ER	LVR-IC	LDO, 6.6V±1%, 200mA, +CE, CL	USP-6C	49hq	VR4	9a	Tor
366	XC6505C671ER	LVR-IC	LDO, 6.7V±1%, 200mA, +CE, CL	USP-6C	49hq	VR4	9a	Tor
367	XC6505C681ER	LVR-IC	LDO, 6.8V±1%, 200mA, +CE, CL	USP-6C	49hq	VR4	9a	Tor



SMD code	Type	Function	Short description	Case	Pinout	Sch.	St.	Mnf.
368	XC6505C691ER	LVR-IC	LDO, 6.9V±1%, 200mA, +CE, CL	USP-6C	49hq	VR4	9a	Tor
369	XC6505C701ER	LVR-IC	LDO, 7.0V±1%, 200mA, +CE, CL	USP-6C	49hq	VR4	9a	Tor
36N	XC6505C511ER	LVR-IC	LDO, 5.1V±1%, 200mA, +CE, CL	USP-6C	49hq	VR4	9a	Tor
36P	XC6505C521ER	LVR-IC	LDO, 5.2V±1%, 200mA, +CE, CL	USP-6C	49hq	VR4	9a	Tor
36R	XC6505C531ER	LVR-IC	LDO, 5.3V±1%, 200mA, +CE, CL	USP-6C	49hq	VR4	9a	Tor
36S	XC6505C541ER	LVR-IC	LDO, 5.4V±1%, 200mA, +CE, CL	USP-6C	49hq	VR4	9a	Tor
36T	XC6505C551ER	LVR-IC	LDO, 5.5V±1%, 200mA, +CE, CL	USP-6C	49hq	VR4	9a	Tor
36U	XC6505C561ER	LVR-IC	LDO, 5.6V±1%, 200mA, +CE, CL	USP-6C	49hq	VR4	9a	Tor
36V	XC6505C571ER	LVR-IC	LDO, 5.7V±1%, 200mA, +CE, CL	USP-6C	49hq	VR4	9a	Tor
36X	XC6505C581ER	LVR-IC	LDO, 5.8V±1%, 200mA, +CE, CL	USP-6C	49hq	VR4	9a	Tor
36Y	XC6505C591ER	LVR-IC	LDO, 5.9V±1%, 200mA, +CE, CL	USP-6C	49hq	VR4	9a	Tor
36Z	XC6505C601ER	LVR-IC	LDO, 6.0V±1%, 200mA, +CE, CL	USP-6C	49hq	VR4	9a	Tor
37	RP110L121C5	LVR-IC	LDO, 1.25V±1%, 150mA	DFN1010-4	48y1	VR1	9a	Ric
37	XC6217D0827R-G	LVR-IC	LDO, 0.8V±2%, 200mA, +CE, CL	USPN-4	58vm	VR4	9a	Tor
37	XC6223D1719R-G	LVR-IC	LDO, 1.7V±20mV, 300mA, +CE, CL, PDR	USPQ-4B03	48vm	VR4	9a	Tor
37	XC6224B15B7R	LVR-IC	LDO, 1.55V±1.5%, 150mA, +CE, PDR	USPN-4B02	58vm	VR4	9e	Tor
37	XC6229H3011R-G	LVR-IC	LDO, 3.0V±1%, 300mA, +CE, ICP	BGA-4	63ba*	VR4	9a	Tor
37	XC6420AB377R-G	LVR-IC	LDO, Dual out, Vout1/Vout2=3.60/1.20V±2%, 150mA, +CE	USPN-6	52xv	VR19	9a	Tor
37	XC6420AB37DR-G	LVR-IC	LDO, Dual out, Vout1/Vout2=3.60/1.20V±2%, 150mA, +CE	USP-6B04	73x4	VR19	9a	Tor
37	XC6221C45B7R	LVR-IC	LDO, 4.55V±1%, 200mA, +CE, PDR	USPN-4	58vm	VR4	9a	Tor
37A	XC6505C711ER	LVR-IC	LDO, 7.1V±1%, 200mA, +CE, CL	USP-6C	49hq	VR4	9a	Tor
37B	XC6505C721ER	LVR-IC	LDO, 7.2V±1%, 200mA, +CE, CL	USP-6C	49hq	VR4	9a	Tor
37C	XC6505C731ER	LVR-IC	LDO, 7.3V±1%, 200mA, +CE, CL	USP-6C	49hq	VR4	9a	Tor
37D	XC6505C741ER	LVR-IC	LDO, 7.4V±1%, 200mA, +CE, CL	USP-6C	49hq	VR4	9a	Tor
37E	XC6505C751ER	LVR-IC	LDO, 7.5V±1%, 200mA, +CE, CL	USP-6C	49hq	VR4	9a	Tor
37F	XC6505C761ER	LVR-IC	LDO, 7.6V±1%, 200mA, +CE, CL	USP-6C	49hq	VR4	9a	Tor
37H	XC6505C771ER	LVR-IC	LDO, 7.7V±1%, 200mA, +CE, CL	USP-6C	49hq	VR4	9a	Tor
37K	XC6505C781ER	LVR-IC	LDO, 7.8V±1%, 200mA, +CE, CL	USP-6C	49hq	VR4	9a	Tor
37L	XC6505C791ER	LVR-IC	LDO, 7.9V±1%, 200mA, +CE, CL	USP-6C	49hq	VR4	9a	Tor
37M	XC6505C801ER	LVR-IC	LDO, 8.0V±1%, 200mA, +CE, CL	USP-6C	49hq	VR4	9a	Tor
38	RP110L131C	LVR-IC	LDO, 1.3V±1%, 150mA	DFN1010-4	48y1	VR1	9a	Ric
38	XC6217D0927R-G	LVR-IC	LDO, 0.9V±2%, 200mA, +CE, CL	USPN-4	58vm	VR4	9a	Tor
38	XC6223D1819R-G	LVR-IC	LDO, 1.8V±20mV, 300mA, +CE, CL, PDR	USPQ-4B03	48vm	VR4	9a	Tor
38	XC6224B16B7R	LVR-IC	LDO, 1.65V±1.5%, 150mA, +CE, PDR	USPN-4B02	58vm	VR4	9e	Tor
38	XC6229H30B1R-G	LVR-IC	LDO, 3.05V±1%, 300mA, +CE, ICP	BGA-4	63ba*	VR4	9a	Tor
38	XC6420AB387R-G	LVR-IC	LDO, Dual out, Vout1/Vout2=1.20/2.80V±2%, 150mA, +CE	USPN-6	52xv	VR19	9a	Tor
38	XC6420AB38DR-G	LVR-IC	LDO, Dual out, Vout1/Vout2=1.20/2.80V±2%, 150mA, +CE	USP-6B04	73x4	VR19	9a	Tor
38	XC6221C46B7R	LVR-IC	LDO, 4.65V±1%, 200mA, +CE, PDR	USPN-4	58vm	VR4	9a	Tor
39	LEE-39+	MMIC	RF amplifier, DC..8GHz, 18.5dB (50Ω)	FG873	36aa	A1	9b	Mc
39	RP110L141C	LVR-IC	LDO, 1.4V±1%, 150mA	DFN1010-4	48y1	VR1	9a	Ric
39	XC6217D1027R-G	LVR-IC	LDO, 1V±2%, 200mA, +CE, CL	USPN-4	58vm	VR4	9a	Tor
39	XC6223D1919R-G	LVR-IC	LDO, 1.9V±20mV, 300mA, +CE, CL, PDR	USPQ-4B03	48vm	VR4	9a	Tor
39	XC6224B17B7R	LVR-IC	LDO, 1.75V±1.5%, 150mA, +CE, PDR	USPN-4B02	58vm	VR4	9e	Tor
39	XC6229H3111R-G	LVR-IC	LDO, 3.1V±1%, 300mA, +CE, ICP	BGA-4	63ba*	VR4	9a	Tor
39	XC6420AB397R-G	LVR-IC	LDO, Dual out, Vout1/Vout2=3.30/2.00V±2%, 150mA, +CE	USPN-6	52xv	VR19	9a	Tor
39	XC6420AB39DR-G	LVR-IC	LDO, Dual out, Vout1/Vout2=3.30/2.00V±2%, 150mA, +CE	USP-6B04	73x4	VR19	9a	Tor
39	XC6221C47B7R	LVR-IC	LDO, 4.75V±1%, 200mA, +CE, PDR	USPN-4	58vm	VR4	9a	Tor
3A	R3117K071C	Vdet-IC	0.7V±15mV, -Reset PPO, Sense	DFN1010-4	48rq	VD12	9a	Ric
3A	RP101K121B	LVR-IC	LDO, LN, +CE, 1.1V±0.8%, 300mA	DFN1612-4	45vm	VR4	9a	Ric
3A	XC6217D1127R-G	LVR-IC	LDO, 1.1V±2%, 200mA, +CE, CL	USPN-4	58vm	VR4	9a	Tor
3A	XC6223D2019R-G	LVR-IC	LDO, 2.0V±1%, 300mA, +CE, CL, PDR	USPQ-4B03	48vm	VR4	9a	Tor
3A	XC6224B18B7R	LVR-IC	LDO, 1.85V±1.5%, 150mA, +CE, PDR	USPN-4B02	58vm	VR4	9e	Tor
3A	XC6229H31B1R-G	LVR-IC	LDO, 3.15V±1%, 300mA, +CE, ICP	BGA-4	63ba*	VR4	9a	Tor
3A	XC6221C48B7R	LVR-IC	LDO, 4.85V±1%, 200mA, +CE, PDR	USPN-4	58vm	VR4	9a	Tor
3A0	XC6221A311GR	LVR-IC	LDO, 3.1V±1%, 200mA, +CE	USP-4	45vm	VR4	9a	Tor
3A016	XC6106A016ER	Vdet-IC	1.6V±2%, Hst, -MR, ±Reset PPO, Rt=3.13ms	USP-6C	49xs	VD21	9b	Tor
3A017	XC6106A017ER	Vdet-IC	1.7V±2%, Hst, -MR, ±Reset PPO, Rt=3.13ms	USP-6C	49xs	VD21	9b	Tor
3A018	XC6106A018ER	Vdet-IC	1.8V±2%, Hst, -MR, ±Reset PPO, Rt=3.13ms	USP-6C	49xs	VD21	9b	Tor
3A019	XC6106A019ER	Vdet-IC	1.9V±2%, Hst, -MR, ±Reset PPO, Rt=3.13ms	USP-6C	49xs	VD21	9b	Tor
3A020	XC6106A020ER	Vdet-IC	2.0V±2%, Hst, -MR, ±Reset PPO, Rt=3.13ms	USP-6C	49xs	VD21	9b	Tor
3A021	XC6106A021ER	Vdet-IC	2.1V±2%, Hst, -MR, ±Reset PPO, Rt=3.13ms	USP-6C	49xs	VD21	9b	Tor
3A022	XC6106A022ER	Vdet-IC	2.2V±2%, Hst, -MR, ±Reset PPO, Rt=3.13ms	USP-6C	49xs	VD21	9b	Tor
3A023	XC6106A023ER	Vdet-IC	2.3V±2%, Hst, -MR, ±Reset PPO, Rt=3.13ms	USP-6C	49xs	VD21	9b	Tor
3A024	XC6106A024ER	Vdet-IC	2.4V±2%, Hst, -MR, ±Reset PPO, Rt=3.13ms	USP-6C	49xs	VD21	9b	Tor
3A025	XC6106A025ER	Vdet-IC	2.5V±2%, Hst, -MR, ±Reset PPO, Rt=3.13ms	USP-6C	49xs	VD21	9b	Tor
3A026	XC6106A026ER	Vdet-IC	2.6V±2%, Hst, -MR, ±Reset PPO, Rt=3.13ms	USP-6C	49xs	VD21	9b	Tor
3A027	XC6106A027ER	Vdet-IC	2.7V±2%, Hst, -MR, ±Reset PPO, Rt=3.13ms	USP-6C	49xs	VD21	9b	Tor
3A028	XC6106A028ER	Vdet-IC	2.8V±2%, Hst, -MR, ±Reset PPO, Rt=3.13ms	USP-6C	49xs	VD21	9b	Tor
3A029	XC6106A029ER	Vdet-IC	2.9V±2%, Hst, -MR, ±Reset PPO, Rt=3.13ms	USP-6C	49xs	VD21	9b	Tor
3A030	XC6106A030ER	Vdet-IC	3.0V±2%, Hst, -MR, ±Reset PPO, Rt=3.13ms	USP-6C	49xs	VD21	9b	Tor



SMD code	Type	Function	Short description	Case	Pinout	Sch.	St.	Mnf.
3A626	XC6101A626ER	Vdet-IC	2.6V±2%, Hst, -MR, -Reset PPO, Wt=1.6s, Rt=3.13ms	USP-6C	49xh	VD17	9b	Tor
3A627	XC6101A627ER	Vdet-IC	2.7V±2%, Hst, -MR, -Reset PPO, Wt=1.6s, Rt=3.13ms	USP-6C	49xh	VD17	9b	Tor
3A628	XC6101A628ER	Vdet-IC	2.8V±2%, Hst, -MR, -Reset PPO, Wt=1.6s, Rt=3.13ms	USP-6C	49xh	VD17	9b	Tor
3A629	XC6101A629ER	Vdet-IC	2.9V±2%, Hst, -MR, -Reset PPO, Wt=1.6s, Rt=3.13ms	USP-6C	49xh	VD17	9b	Tor
3A630	XC6101A630ER	Vdet-IC	3.0V±2%, Hst, -MR, -Reset PPO, Wt=1.6s, Rt=3.13ms	USP-6C	49xh	VD17	9b	Tor
3A631	XC6101A631ER	Vdet-IC	3.1V±2%, Hst, -MR, -Reset PPO, Wt=1.6s, Rt=3.13ms	USP-6C	49xh	VD17	9b	Tor
3A632	XC6101A632ER	Vdet-IC	3.2V±2%, Hst, -MR, -Reset PPO, Wt=1.6s, Rt=3.13ms	USP-6C	49xh	VD17	9b	Tor
3A633	XC6101A633ER	Vdet-IC	3.3V±2%, Hst, -MR, -Reset PPO, Wt=1.6s, Rt=3.13ms	USP-6C	49xh	VD17	9b	Tor
3A634	XC6101A634ER	Vdet-IC	3.4V±2%, Hst, -MR, -Reset PPO, Wt=1.6s, Rt=3.13ms	USP-6C	49xh	VD17	9b	Tor
3A635	XC6101A635ER	Vdet-IC	3.5V±2%, Hst, -MR, -Reset PPO, Wt=1.6s, Rt=3.13ms	USP-6C	49xh	VD17	9b	Tor
3A636	XC6101A636ER	Vdet-IC	3.6V±2%, Hst, -MR, -Reset PPO, Wt=1.6s, Rt=3.13ms	USP-6C	49xh	VD17	9b	Tor
3A637	XC6101A637ER	Vdet-IC	3.7V±2%, Hst, -MR, -Reset PPO, Wt=1.6s, Rt=3.13ms	USP-6C	49xh	VD17	9b	Tor
3A638	XC6101A638ER	Vdet-IC	3.8V±2%, Hst, -MR, -Reset PPO, Wt=1.6s, Rt=3.13ms	USP-6C	49xh	VD17	9b	Tor
3A639	XC6101A639ER	Vdet-IC	3.9V±2%, Hst, -MR, -Reset PPO, Wt=1.6s, Rt=3.13ms	USP-6C	49xh	VD17	9b	Tor
3A640	XC6101A640ER	Vdet-IC	4.0V±2%, Hst, -MR, -Reset PPO, Wt=1.6s, Rt=3.13ms	USP-6C	49xh	VD17	9b	Tor
3A641	XC6101A641ER	Vdet-IC	4.1V±2%, Hst, -MR, -Reset PPO, Wt=1.6s, Rt=3.13ms	USP-6C	49xh	VD17	9b	Tor
3A642	XC6101A642ER	Vdet-IC	4.2V±2%, Hst, -MR, -Reset PPO, Wt=1.6s, Rt=3.13ms	USP-6C	49xh	VD17	9b	Tor
3A643	XC6101A643ER	Vdet-IC	4.3V±2%, Hst, -MR, -Reset PPO, Wt=1.6s, Rt=3.13ms	USP-6C	49xh	VD17	9b	Tor
3A644	XC6101A644ER	Vdet-IC	4.4V±2%, Hst, -MR, -Reset PPO, Wt=1.6s, Rt=3.13ms	USP-6C	49xh	VD17	9b	Tor
3A645	XC6101A645ER	Vdet-IC	4.5V±2%, Hst, -MR, -Reset PPO, Wt=1.6s, Rt=3.13ms	USP-6C	49xh	VD17	9b	Tor
3A646	XC6101A646ER	Vdet-IC	4.6V±2%, Hst, -MR, -Reset PPO, Wt=1.6s, Rt=3.13ms	USP-6C	49xh	VD17	9b	Tor
3A647	XC6101A647ER	Vdet-IC	4.7V±2%, Hst, -MR, -Reset PPO, Wt=1.6s, Rt=3.13ms	USP-6C	49xh	VD17	9b	Tor
3A648	XC6101A648ER	Vdet-IC	4.8V±2%, Hst, -MR, -Reset PPO, Wt=1.6s, Rt=3.13ms	USP-6C	49xh	VD17	9b	Tor
3A649	XC6101A649ER	Vdet-IC	4.9V±2%, Hst, -MR, -Reset PPO, Wt=1.6s, Rt=3.13ms	USP-6C	49xh	VD17	9b	Tor
3A650	XC6101A650ER	Vdet-IC	5.0V±2%, Hst, -MR, -Reset PPO, Wt=1.6s, Rt=3.13ms	USP-6C	49xh	VD17	9b	Tor
3A7	XC6221A381GR	LVR-IC	LDO, 3.8V±1%, 200mA, +CE	USP-4	45vm	VR4	9a	Tor
3A8	XC6221A391GR	LVR-IC	LDO, 3.9V±1%, 200mA, +CE	USP-4	45vm	VR4	9a	Tor
3A8	XC6227A081ER	LVR-IC	LDO, 0.8V±20mV, 700mA, +CE	USP-6C	49hq	VR4	9a	Tor
3A9	XC6221A401GR	LVR-IC	LDO, 4V±1%, 200mA, +CE	USP-4	45vm	VR4	9a	Tor
3A9	XC6227A091ER	LVR-IC	LDO, 0.9V±20mV, 700mA, +CE	USP-6C	49hq	VR4	9a	Tor
3AA	XC6221A411GR	LVR-IC	LDO, 4.1±1%, 200mA, +CE	USP-4	45vm	VR4	9a	Tor
3AA	XC6227A101ER	LVR-IC	LDO, 1.0V±20mV, 700mA, +CE	USP-6C	49hq	VR4	9a	Tor
3AA02	XC6404AA02D	LVR/det-IC	LDO, 2.7V±2%, 500mA, Vdi=4.2V, -Reset ODO, +CE, PDR	USP-6B	49zx	VR15	9b	Tor
3AA03	XC6404AA03D	LVR/det-IC	LDO, 2.5V±2%, 500mA, Vdi=2.6V, -Reset ODO, +CE, PDR	USP-6B	49zx	VR15	9b	Tor
3AA04	XC6404AA04D	LVR/det-IC	LDO, 3.3V±2%, 500mA, Vdi=4.3V, -Reset ODO, +CE, PDR	USP-6B	49zx	VR15	9b	Tor
3AA05	XC6404AA05D	LVR/det-IC	LDO, 3.3V±2%, 500mA, Vdi=4.4V, -Reset ODO, +CE, PDR	USP-6B	49zx	VR15	9b	Tor
3AA07	XC6404AA07D	LVR/det-IC	LDO, 3.3V±2%, 500mA, Vdi=5.2V, -Reset ODO, +CE, PDR	USP-6B	49zx	VR15	9b	Tor
3AA08	XC6404AA08D	LVR/det-IC	LDO, 2.8V±2%, 500mA, Vdi= 4.3V, -Reset ODO, +CE, PDR	USP-6B	49zx	VR15	9b	Tor
3AA09	XC6404AA09D	LVR/det-IC	LDO, 4.3V±2%, 500mA, Vdi=2.8V, -Reset ODO, +CE, PDR	USP-6B	49zx	VR15	9b	Tor
3AA11	XC6404AA11D	LVR/det-IC	LDO, 2.8V±2%, 500mA, Vdi=2.1V, -Reset ODO, +CE, PDR	USP-6B	49zx	VR15	9b	Tor
3AA12	XC6404AA12D	LVR/det-IC	LDO, 2.8V±2%, 500mA, Vdi=2.8V, -Reset ODO, +CE, PDR	USP-6B	49zx	VR15	9b	Tor
3AA15	XC6404AA15D	LVR/det-IC	LDO, 3.3V±2%, 500mA, Vdi=3.6V, -Reset ODO, +CE, PDR	USP-6B	49zx	VR15	9b	Tor
3AA18	XC6404AA18D	LVR/det-IC	LDO, 3.0V±2%, 500mA, Vdi=2.7V, -Reset ODO, +CE, PDR	USP-6B	49zx	VR15	9b	Tor
3AA19	XC6404AA19D	LVR/det-IC	LDO, 2.8V±2%, 500mA, Vdi=2.5V, -Reset ODO, +CE, PDR	USP-6B	49zx	VR15	9b	Tor
3AA20	XC6404AA20D	LVR/det-IC	LDO, 1.8V±2%, 500mA, Vdi=2.9V, -Reset ODO, +CE, PDR	USP-6B	49zx	VR15	9b	Tor
3AA21	XC6404AA21D	LVR/det-IC	LDO, 1.8V±2%, 500mA, Vdi=3.6V, -Reset ODO, +CE, PDR	USP-6B	49zx	VR15	9b	Tor
3AA22	XC6404AA22D	LVR/det-IC	LDO, 1.8V±2%, 500mA, Vdi=4.2V, -Reset ODO, +CE, PDR	USP-6B	49zx	VR15	9b	Tor
3AA23	XC6404AA23D	LVR/det-IC	LDO, 2.5V±2%, 500mA, Vdi=2.9V, -Reset ODO, +CE, PDR	USP-6B	49zx	VR15	9b	Tor
3AA24	XC6404AA24D	LVR/det-IC	LDO, 2.5V±2%, 500mA, Vdi=3.6V, -Reset ODO, +CE, PDR	USP-6B	49zx	VR15	9b	Tor
3AA25	XC6404AA25D	LVR/det-IC	LDO, 2.5V±2%, 500mA, Vdi=4.2V, -Reset ODO, +CE, PDR	USP-6B	49zx	VR15	9b	Tor
3AA26	XC6404AA26D	LVR/det-IC	LDO, 4.3V±2%, 500mA, Vdi=4.0V, -Reset ODO, +CE, PDR	USP-6B	49zx	VR15	9b	Tor
3AA27	XC6404AA27D	LVR/det-IC	LDO, 2.5V±2%, 500mA, Vdi=3.9V, -Reset ODO, +CE, PDR	USP-6B	49zx	VR15	9b	Tor
3AA28	XC6404AA28D	LVR/det-IC	LDO, 3.3V±2%, 500mA, Vdi=3.7V, -Reset ODO, +CE, PDR	USP-6B	49zx	VR15	9b	Tor
3AA29	XC6404AA29D	LVR/det-IC	LDO, 2.6V±2%, 500mA, Vdi=3.9V, -Reset ODO, +CE, PDR	USP-6B	49zx	VR15	9b	Tor
3AA30	XC6404AA30D	LVR/det-IC	LDO, 3.3V±2%, 500mA, Vdi=4.2V, -Reset ODO, +CE, PDR	USP-6B	49zx	VR15	9b	Tor
3AA31	XC6404AA31D	LVR/det-IC	LDO, 3.3V±2%, 500mA, Vdi=4.5V, -Reset ODO, +CE, PDR	USP-6B	49zx	VR15	9b	Tor
3AA32	XC6404AA32D	LVR/det-IC	LDO, 2.85V±2%, 500mA, Vdi=2.6V, -Reset ODO, +CE, PDR	USP-6B	49zx	VR15	9b	Tor
3AA33	XC6404AA33D	LVR/det-IC	LDO, 3.3V±2%, 500mA, Vdi=2.3V, -Reset ODO, +CE, PDR	USP-6B	49zx	VR15	9b	Tor
3AA34	XC6404AA34D	LVR/det-IC	LDO, 3.4V±2%, 500mA, Vdi=4.2V, -Reset ODO, +CE, PDR	USP-6B	49zx	VR15	9b	Tor
3AA80	XC6404AA80D	LVR/det-IC	LDO, 1.8V±2%, 500mA, Vdi=1.6V, -Reset ODO, +CE, PDR	USP-6B	49zx	VR15	9b	Tor
3A81	XC6404AA81D	LVR/det-IC	LDO, 2.8V±2%, 500mA, Vdi=3.1V, -Reset ODO, +CE, PDR	USP-6B	49zx	VR15	9b	Tor
3A82	XC6404AA82D	LVR/det-IC	LDO, 1.8V±2%, 500mA, Vdi=2.0V, -Reset ODO, +CE, PDR	USP-6B	49zx	VR15	9b	Tor
3A83	XC6404AA83D	LVR/det-IC	LDO, 2.5V±2%, 500mA, Vdi=2.8V, -Reset ODO, +CE, PDR	USP-6B	49zx	VR15	9b	Tor
3A84	XC6404AA84D	LVR/det-IC	LDO, 2.85V±2%, 500mA, Vdi=3.0V, -Reset ODO, +CE, PDR	USP-6B	49zx	VR15	9b	Tor
3A85	XC6404AA85D	LVR/det-IC	LDO, 3.0V±2%, 500mA, Vdi=3.3V, -Reset ODO, +CE, PDR	USP-6B	49zx	VR15	9b	Tor
3A86	XC6404AA86D	LVR/det-IC	LDO, 3.5V±2%, 500mA, Vdi=3.8V, -Reset ODO, +CE, PDR	USP-6B	49zx	VR15	9b	Tor
3A87	XC6404AA87D	LVR/det-IC	LDO, 3.0V±2%, 500mA, Vdi=4.2V, -Reset ODO, +CE, PDR	USP-6B	49zx	VR15	9b	Tor
3A88	XC6404AA88D	LVR/det-IC	LDO, 3.3V±2%, 500mA, Vdi=4.0V, -Reset ODO, +CE, PDR	USP-6B	49zx	VR15	9b	Tor
3AB	XC6221A421GR	LVR-IC	LDO, 4.2±1%, 200mA, +CE	USP-4	45vm	VR4	9a	Tor
3AB	XC6227A111ER	LVR-IC	LDO, 1.1V±20mV, 700mA, +CE	USP-6C	49hq	VR4	9a	Tor



SMD code	Type	Function	Short description	Case	Pinout	Sch.	St.Mnf.
3AC85	XC6404AC85D	LVR/Vdet-IC	LDO, 3.0V±2%, 500mA, Vdo=3.3V, -Reset ODO, +CE, PDR	USP-6B	49zx	VR15	9b Tor
3AC86	XC6404AC86D	LVR/Vdet-IC	LDO, 3.5V±2%, 500mA, Vdo=3.8V, -Reset ODO, +CE, PDR	USP-6B	49zx	VR15	9b Tor
3AC87	XC6404AC87D	LVR/Vdet-IC	LDO, 3.0V±2%, 500mA, Vdo=4.2V, -Reset ODO, +CE, PDR	USP-6B	49zx	VR15	9b Tor
3AC88	XC6404AC88D	LVR/Vdet-IC	LDO, 3.3V±2%, 500mA, Vdo=4.0V, -Reset ODO, +CE, PDR	USP-6B	49zx	VR15	9b Tor
3AD	XC6221A441GR	LVR-IC	LDO, 4.4±1%, 200mA, +CE	USP-4	45vm	VR4	9a Tor
3AD	XC6227A131ER	LVR-IC	LDO, 1.3V±20mV, 700mA, +CE	USP-6C	49hq	VR4	9a Tor
3AD02	XC6404AD02D	LVR/Vdet-IC	LDO, 2.7V±2%, 500mA, Vdo=4.2V, +Reset ODO, +CE, PDR	USP-6B	49zx	VR15	9b Tor
3AD03	XC6404AD03D	LVR/Vdet-IC	LDO, 2.5V±2%, 500mA, Vdo=2.6V, +Reset ODO, +CE, PDR	USP-6B	49zx	VR15	9b Tor
3AD04	XC6404AD04D	LVR/Vdet-IC	LDO, 3.3V±2%, 500mA, Vdo=4.3V, +Reset ODO, +CE, PDR	USP-6B	49zx	VR15	9b Tor
3AD05	XC6404AD05D	LVR/Vdet-IC	LDO, 3.3V±2%, 500mA, Vdo=4.4V, +Reset ODO, +CE, PDR	USP-6B	49zx	VR15	9b Tor
3AD07	XC6404AD07D	LVR/Vdet-IC	LDO, 3.3V±2%, 500mA, Vdo=5.2V, +Reset ODO, +CE, PDR	USP-6B	49zx	VR15	9b Tor
3AD08	XC6404AD08D	LVR/Vdet-IC	LDO, 2.8V±2%, 500mA, Vdo=4.3V, +Reset ODO, +CE, PDR	USP-6B	49zx	VR15	9b Tor
3AD09	XC6404AD09D	LVR/Vdet-IC	LDO, 4.3V±2%, 500mA, Vdo=2.8V, +Reset ODO, +CE, PDR	USP-6B	49zx	VR15	9b Tor
3AD11	XC6404AD11D	LVR/Vdet-IC	LDO, 2.8V±2%, 500mA, Vdo=2.1V, +Reset ODO, +CE, PDR	USP-6B	49zx	VR15	9b Tor
3AD12	XC6404AD12D	LVR/Vdet-IC	LDO, 2.8V±2%, 500mA, Vdo=2.9V, +Reset ODO, +CE, PDR	USP-6B	49zx	VR15	9b Tor
3AD15	XC6404AD15D	LVR/Vdet-IC	LDO, 3.3V±2%, 500mA, Vdo=3.6V, +Reset ODO, +CE, PDR	USP-6B	49zx	VR15	9b Tor
3AD18	XC6404AD18D	LVR/Vdet-IC	LDO, 3.0V±2%, 500mA, Vdo=2.7V, +Reset ODO, +CE, PDR	USP-6B	49zx	VR15	9b Tor
3AD19	XC6404AD19D	LVR/Vdet-IC	LDO, 2.8V±2%, 500mA, Vdo=2.5V, +Reset ODO, +CE, PDR	USP-6B	49zx	VR15	9b Tor
3AD20	XC6404AD20D	LVR/Vdet-IC	LDO, 1.8V±2%, 500mA, Vdo=2.9V, +Reset ODO, +CE, PDR	USP-6B	49zx	VR15	9b Tor
3AD21	XC6404AD21D	LVR/Vdet-IC	LDO, 1.8V±2%, 500mA, Vdo=3.6V, +Reset ODO, +CE, PDR	USP-6B	49zx	VR15	9b Tor
3AD22	XC6404AD22D	LVR/Vdet-IC	LDO, 1.8V±2%, 500mA, Vdo=4.2V, +Reset ODO, +CE, PDR	USP-6B	49zx	VR15	9b Tor
3AD23	XC6404AD23D	LVR/Vdet-IC	LDO, 2.5V±2%, 500mA, Vdo=2.9V, +Reset ODO, +CE, PDR	USP-6B	49zx	VR15	9b Tor
3AD24	XC6404AD24D	LVR/Vdet-IC	LDO, 2.5V±2%, 500mA, Vdo=3.6V, +Reset ODO, +CE, PDR	USP-6B	49zx	VR15	9b Tor
3AD25	XC6404AD25D	LVR/Vdet-IC	LDO, 2.5V±2%, 500mA, Vdo=4.2V, +Reset ODO, +CE, PDR	USP-6B	49zx	VR15	9b Tor
3AD26	XC6404AD26D	LVR/Vdet-IC	LDO, 4.3V±2%, 500mA, Vdo=4.0V, +Reset ODO, +CE, PDR	USP-6B	49zx	VR15	9b Tor
3AD27	XC6404AD27D	LVR/Vdet-IC	LDO, 2.5V±2%, 500mA, Vdo=3.9V, +Reset ODO, +CE, PDR	USP-6B	49zx	VR15	9b Tor
3AD28	XC6404AD28D	LVR/Vdet-IC	LDO, 3.3V±2%, 500mA, Vdo=3.7V, +Reset ODO, +CE, PDR	USP-6B	49zx	VR15	9b Tor
3AD29	XC6404AD29D	LVR/Vdet-IC	LDO, 2.6V±2%, 500mA, Vdo=3.9V, +Reset ODO, +CE, PDR	USP-6B	49zx	VR15	9b Tor
3AD30	XC6404AD30D	LVR/Vdet-IC	LDO, 3.3V±2%, 500mA, Vdo=4.2V, +Reset ODO, +CE, PDR	USP-6B	49zx	VR15	9b Tor
3AD31	XC6404AD31D	LVR/Vdet-IC	LDO, 3.3V±2%, 500mA, Vdo=4.5V, +Reset ODO, +CE, PDR	USP-6B	49zx	VR15	9b Tor
3AD32	XC6404AD32D	LVR/Vdet-IC	LDO, 2.85V±2%, 500mA, Vdo=2.6V, +Reset ODO, +CE, PDR	USP-6B	49zx	VR15	9b Tor
3AD33	XC6404AD33D	LVR/Vdet-IC	LDO, 3.3V±2%, 500mA, Vdo=3.1V, +Reset ODO, +CE, PDR	USP-6B	49zx	VR15	9b Tor
3AD34	XC6404AD34D	LVR/Vdet-IC	LDO, 3.4V±2%, 500mA, Vdo=4.2V, +Reset ODO, +CE, PDR	USP-6B	49zx	VR15	9b Tor
3AD80	XC6404AD80D	LVR/Vdet-IC	LDO, 1.8V±2%, 500mA, Vdo=1.6V, +Reset ODO, +CE, PDR	USP-6B	49zx	VR15	9b Tor
3AD81	XC6404AD81D	LVR/Vdet-IC	LDO, 2.8V±2%, 500mA, Vdo=3.1V, +Reset ODO, +CE, PDR	USP-6B	49zx	VR15	9b Tor
3AD82	XC6404AD82D	LVR/Vdet-IC	LDO, 1.8V±2%, 500mA, Vdo=2.0V, +Reset ODO, +CE, PDR	USP-6B	49zx	VR15	9b Tor
3AD83	XC6404AD83D	LVR/Vdet-IC	LDO, 2.5V±2%, 500mA, Vdo=2.8V, +Reset ODO, +CE, PDR	USP-6B	49zx	VR15	9b Tor
3AD84	XC6404AD84D	LVR/Vdet-IC	LDO, 2.85V±2%, 500mA, Vdo=3.2V, +Reset ODO, +CE, PDR	USP-6B	49zx	VR15	9b Tor
3AD85	XC6404AD85D	LVR/Vdet-IC	LDO, 3.0V±2%, 500mA, Vdo=3.3V, +Reset ODO, +CE, PDR	USP-6B	49zx	VR15	9b Tor
3AD86	XC6404AD86D	LVR/Vdet-IC	LDO, 3.5V±2%, 500mA, Vdo=3.8V, +Reset ODO, +CE, PDR	USP-6B	49zx	VR15	9b Tor
3AD87	XC6404AD87D	LVR/Vdet-IC	LDO, 3.0V±2%, 500mA, Vdo=3.9V, +Reset ODO, +CE, PDR	USP-6B	49zx	VR15	9b Tor
3AD88	XC6404AD88D	LVR/Vdet-IC	LDO, 3.3V±2%, 500mA, Vdo=4.0V, +Reset ODO, +CE, PDR	USP-6B	49zx	VR15	9b Tor
3AE	XC6221A451GR	LVR-IC	LDO, 4.5±1%, 200mA, +CE	USP-4	45vm	VR4	9a Tor
3AE	XC6227A141ER	LVR-IC	LDO, 1.4V±20mV, 700mA, +CE	USP-6C	49hq	VR4	9a Tor
3AE02	XC6404AE02D	LVR/Vdet-IC	LDO, 2.7V±2%, 500mA, Vdi=4.2V, -Reset ODO, +CE	USP-6B	49zx	VR15	9b Tor
3AE03	XC6404AE03D	LVR/Vdet-IC	LDO, 2.5V±2%, 500mA, Vdi=2.6V, -Reset ODO, +CE	USP-6B	49zx	VR15	9b Tor
3AE04	XC6404AE04D	LVR/Vdet-IC	LDO, 3.3V±2%, 500mA, Vdi=4.3V, -Reset ODO, +CE	USP-6B	49zx	VR15	9b Tor
3AE05	XC6404AE05D	LVR/Vdet-IC	LDO, 3.3V±2%, 500mA, Vdi=4.4V, -Reset ODO, +CE	USP-6B	49zx	VR15	9b Tor
3AE07	XC6404AE07D	LVR/Vdet-IC	LDO, 3.3V±2%, 500mA, Vdi=5.2V, -Reset ODO, +CE	USP-6B	49zx	VR15	9b Tor
3AE08	XC6404AE08D	LVR/Vdet-IC	LDO, 2.8V±2%, 500mA, Vdi=4.3V, -Reset ODO, +CE	USP-6B	49zx	VR15	9b Tor
3AE09	XC6404AE09D	LVR/Vdet-IC	LDO, 4.3V±2%, 500mA, Vdi=2.8V, +Reset ODO, +CE	USP-6B	49zx	VR15	9b Tor
3AE11	XC6404AE11D	LVR/Vdet-IC	LDO, 2.8V±2%, 500mA, Vdi=2.1V, -Reset ODO, +CE	USP-6B	49zx	VR15	9b Tor
3AE12	XC6404AE12D	LVR/Vdet-IC	LDO, 2.8V±2%, 500mA, Vdi=2.8V, -Reset ODO, +CE	USP-6B	49zx	VR15	9b Tor
3AE15	XC6404AE15D	LVR/Vdet-IC	LDO, 3.3V±2%, 500mA, Vdi=3.6V, -Reset ODO, +CE	USP-6B	49zx	VR15	9b Tor
3AE18	XC6404AE18D	LVR/Vdet-IC	LDO, 3.0V±2%, 500mA, Vdi=2.7V, -Reset ODO, +CE	USP-6B	49zx	VR15	9b Tor
3AE19	XC6404AE19D	LVR/Vdet-IC	LDO, 2.8V±2%, 500mA, Vdi=2.5V, -Reset ODO, +CE	USP-6B	49zx	VR15	9b Tor
3AE20	XC6404AE20D	LVR/Vdet-IC	LDO, 1.8V±2%, 500mA, Vdi=2.9V, -Reset ODO, +CE	USP-6B	49zx	VR15	9b Tor
3AE21	XC6404AE21D	LVR/Vdet-IC	LDO, 1.8V±2%, 500mA, Vdi=3.6V, -Reset ODO, +CE	USP-6B	49zx	VR15	9b Tor
3AE22	XC6404AE22D	LVR/Vdet-IC	LDO, 1.8V±2%, 500mA, Vdi=4.2V, -Reset ODO, +CE	USP-6B	49zx	VR15	9b Tor
3AE23	XC6404AE23D	LVR/Vdet-IC	LDO, 2.5V±2%, 500mA, Vdi=2.9V, -Reset ODO, +CE	USP-6B	49zx	VR15	9b Tor
3AE24	XC6404AE24D	LVR/Vdet-IC	LDO, 2.5V±2%, 500mA, Vdi=3.6V, -Reset ODO, +CE	USP-6B	49zx	VR15	9b Tor
3AE25	XC6404AE25D	LVR/Vdet-IC	LDO, 2.5V±2%, 500mA, Vdi=4.2V, -Reset ODO, +CE	USP-6B	49zx	VR15	9b Tor
3AE26	XC6404AE26D	LVR/Vdet-IC	LDO, 4.3V±2%, 500mA, Vdi=4.0V, -Reset ODO, +CE	USP-6B	49zx	VR15	9b Tor
3AE27	XC6404AE27D	LVR/Vdet-IC	LDO, 2.5V±2%, 500mA, Vdi=3.9V, -Reset ODO, +CE	USP-6B	49zx	VR15	9b Tor
3AE28	XC6404AE28D	LVR/Vdet-IC	LDO, 3.3V±2%, 500mA, Vdi=3.7V, -Reset ODO, +CE	USP-6B	49zx	VR15	9b Tor
3AE29	XC6404AE29D	LVR/Vdet-IC	LDO, 2.6V±2%, 500mA, Vdi=3.9V, -Reset ODO, +CE	USP-6B	49zx	VR15	9b Tor
3AE30	XC6404AE30D	LVR/Vdet-IC	LDO, 3.3V±2%, 500mA, Vdi=4.2V, -Reset ODO, +CE	USP-6B	49zx	VR15	9b Tor
3AE31	XC6404AE31D	LVR/Vdet-IC	LDO, 3.3V±2%, 500mA, Vdi=4.5V, -Reset ODO, +CE	USP-6B	49zx	VR15	9b Tor
3AE32	XC6404AE32D	LVR/Vdet-IC	LDO, 2.85V±2%, 500mA, Vdi=2.6V, -Reset ODO, +CE	USP-6B	49zx	VR15	9b Tor
3AE33	XC6404AE33D	LVR/Vdet-IC	LDO, 3.3V±2%, 500mA, Vdi=2.8V, -Reset ODO, +CE	USP-6B	49zx	VR15	9b Tor



SMD code	Type	Function	Short description	Case	Pinout	Sch.	St.	Mnf.
3AE34	XC6404AE34D	LVR/Vdet-IC	LDO, 3.4V±2%, 500mA, Vdi=4.2V, -Reset ODO, +CE	USP-6B	49zx	VR15	9b	Tor
3AE80	XC6404AE80D	LVR/Vdet-IC	LDO, 1.8V±2%, 500mA, Vdi=1.6V, -Reset ODO, +CE	USP-6B	49zx	VR15	9b	Tor
3AE81	XC6404AE81D	LVR/Vdet-IC	LDO, 2.8V±2%, 500mA, Vdi=3.1V, -Reset ODO, +CE	USP-6B	49zx	VR15	9b	Tor
3AE82	XC6404AE82D	LVR/Vdet-IC	LDO, 1.8V±2%, 500mA, Vdi=2.0V, -Reset ODO, +CE	USP-6B	49zx	VR15	9b	Tor
3AE83	XC6404AE83D	LVR/Vdet-IC	LDO, 2.5V±2%, 500mA, Vdi=2.8V, -Reset ODO, +CE	USP-6B	49zx	VR15	9b	Tor
3AE84	XC6404AE84D	LVR/Vdet-IC	LDO, 2.85V±2%, 500mA, Vdi=3.2V, -Reset ODO, +CE	USP-6B	49zx	VR15	9b	Tor
3AE85	XC6404AE85D	LVR/Vdet-IC	LDO, 3.0V±2%, 500mA, Vdi=3.3V, -Reset ODO, +CE	USP-6B	49zx	VR15	9b	Tor
3AE86	XC6404AE86D	LVR/Vdet-IC	LDO, 3.5V±2%, 500mA, Vdi=3.8V, -Reset ODO, +CE	USP-6B	49zx	VR15	9b	Tor
3AE87	XC6404AE87D	LVR/Vdet-IC	LDO, 3.0V±2%, 500mA, Vdi=4.2V, -Reset ODO, +CE	USP-6B	49zx	VR15	9b	Tor
3AE88	XC6404AE88D	LVR/Vdet-IC	LDO, 3.3V±2%, 500mA, Vdi=4.0V, -Reset ODO, +CE	USP-6B	49zx	VR15	9b	Tor
3AF	XC6221A461GR	LVR-IC	LDO, 4.6±1%, 200mA, +CE	USP-4	45vm	VR4	9a	Tor
3AF	XC6227A151ER	LVR-IC	LDO, 1.5V±20mV, 700mA, +CE	USP-6C	49hq	VR4	9a	Tor
3AF02	XC6404AF02D	LVR/Vdet-IC	LDO, 2.7V±2%, 500mA, Vdi=4.2V, +Reset ODO, +CE	USP-6B	49zx	VR15	9b	Tor
3AF03	XC6404AF03D	LVR/Vdet-IC	LDO, 2.5V±2%, 500mA, Vdi=2.6V, +Reset ODO, +CE	USP-6B	49zx	VR15	9b	Tor
3AF04	XC6404AF04D	LVR/Vdet-IC	LDO, 3.3V±2%, 500mA, Vdi=4.3V, +Reset ODO, +CE	USP-6B	49zx	VR15	9b	Tor
3AF05	XC6404AF05D	LVR/Vdet-IC	LDO, 3.3V±2%, 500mA, Vdi=4.4V, +Reset ODO, +CE	USP-6B	49zx	VR15	9b	Tor
3AF07	XC6404AF07D	LVR/Vdet-IC	LDO, 3.3V±2%, 500mA, Vdi=5.2V, +Reset ODO, +CE	USP-6B	49zx	VR15	9b	Tor
3AF08	XC6404AF08D	LVR/Vdet-IC	LDO, 2.8V±2%, 500mA, Vdi=4.3V, +Reset ODO, +CE	USP-6B	49zx	VR15	9b	Tor
3AF09	XC6404AF09D	LVR/Vdet-IC	LDO, 4.3V±2%, 500mA, Vdi=2.8V, +Reset ODO, +CE	USP-6B	49zx	VR15	9b	Tor
3AF11	XC6404AF11D	LVR/Vdet-IC	LDO, 2.8V±2%, 500mA, Vdi=2.1V, +Reset ODO, +CE	USP-6B	49zx	VR15	9b	Tor
3AF12	XC6404AF12D	LVR/Vdet-IC	LDO, 2.8V±2%, 500mA, Vdi=2.8V, +Reset ODO, +CE	USP-6B	49zx	VR15	9b	Tor
3AF15	XC6404AF15D	LVR/Vdet-IC	LDO, 3.3V±2%, 500mA, Vdi=3.6V, +Reset ODO, +CE	USP-6B	49zx	VR15	9b	Tor
3AF18	XC6404AF18D	LVR/Vdet-IC	LDO, 3.0V±2%, 500mA, Vdi=2.7V, +Reset ODO, +CE	USP-6B	49zx	VR15	9b	Tor
3AF19	XC6404AF19D	LVR/Vdet-IC	LDO, 2.8V±2%, 500mA, Vdi=2.5V, +Reset ODO, +CE	USP-6B	49zx	VR15	9b	Tor
3AF20	XC6404AF20D	LVR/Vdet-IC	LDO, 1.8V±2%, 500mA, Vdi=2.9V, +Reset ODO, +CE	USP-6B	49zx	VR15	9b	Tor
3AF21	XC6404AF21D	LVR/Vdet-IC	LDO, 1.8V±2%, 500mA, Vdi=3.6V, +Reset ODO, +CE	USP-6B	49zx	VR15	9b	Tor
3AF22	XC6404AF22D	LVR/Vdet-IC	LDO, 1.8V±2%, 500mA, Vdi=4.2V, +Reset ODO, +CE	USP-6B	49zx	VR15	9b	Tor
3AF23	XC6404AF23D	LVR/Vdet-IC	LDO, 2.5V±2%, 500mA, Vdi=2.9V, +Reset ODO, +CE	USP-6B	49zx	VR15	9b	Tor
3AF24	XC6404AF24D	LVR/Vdet-IC	LDO, 2.5V±2%, 500mA, Vdi=3.6V, +Reset ODO, +CE	USP-6B	49zx	VR15	9b	Tor
3AF25	XC6404AF25D	LVR/Vdet-IC	LDO, 2.5V±2%, 500mA, Vdi=4.2V, +Reset ODO, +CE	USP-6B	49zx	VR15	9b	Tor
3AF26	XC6404AF26D	LVR/Vdet-IC	LDO, 4.3V±2%, 500mA, Vdi=4.0V, +Reset ODO, +CE	USP-6B	49zx	VR15	9b	Tor
3AF27	XC6404AF27D	LVR/Vdet-IC	LDO, 2.5V±2%, 500mA, Vdi=3.9V, +Reset ODO, +CE	USP-6B	49zx	VR15	9b	Tor
3AF28	XC6404AF28D	LVR/Vdet-IC	LDO, 3.3V±2%, 500mA, Vdi=3.7V, +Reset ODO, +CE	USP-6B	49zx	VR15	9b	Tor
3AF29	XC6404AF29D	LVR/Vdet-IC	LDO, 2.6V±2%, 500mA, Vdi=3.9V, +Reset ODO, +CE	USP-6B	49zx	VR15	9b	Tor
3AF30	XC6404AF30D	LVR/Vdet-IC	LDO, 3.3V±2%, 500mA, Vdi=4.2V, +Reset ODO, +CE	USP-6B	49zx	VR15	9b	Tor
3AF31	XC6404AF31D	LVR/Vdet-IC	LDO, 3.3V±2%, 500mA, Vdi=4.5V, +Reset ODO, +CE	USP-6B	49zx	VR15	9b	Tor
3AF32	XC6404AF32D	LVR/Vdet-IC	LDO, 2.85V±2%, 500mA, Vdi=2.6V, +Reset ODO, +CE	USP-6B	49zx	VR15	9b	Tor
3AF33	XC6404AF33D	LVR/Vdet-IC	LDO, 3.3V±2%, 500mA, Vdi=2.8V, +Reset ODO, +CE	USP-6B	49zx	VR15	9b	Tor
3AF34	XC6404AF34D	LVR/Vdet-IC	LDO, 3.4V±2%, 500mA, Vdi=4.2V, +Reset ODO, +CE	USP-6B	49zx	VR15	9b	Tor
3AF80	XC6404AF80D	LVR/Vdet-IC	LDO, 1.8V±2%, 500mA, Vdi=1.6V, +Reset ODO, +CE	USP-6B	49zx	VR15	9b	Tor
3AF81	XC6404AF81D	LVR/Vdet-IC	LDO, 2.8V±2%, 500mA, Vdi=3.1V, +Reset ODO, +CE	USP-6B	49zx	VR15	9b	Tor
3AF82	XC6404AF82D	LVR/Vdet-IC	LDO, 1.8V±2%, 500mA, Vdi=2.0V, +Reset ODO, +CE	USP-6B	49zx	VR15	9b	Tor
3AF83	XC6404AF83D	LVR/Vdet-IC	LDO, 2.5V±2%, 500mA, Vdi=2.8V, +Reset ODO, +CE	USP-6B	49zx	VR15	9b	Tor
3AF84	XC6404AF84D	LVR/Vdet-IC	LDO, 2.85V±2%, 500mA, Vdi=3.2V, +Reset ODO, +CE	USP-6B	49zx	VR15	9b	Tor
3AF85	XC6404AF85D	LVR/Vdet-IC	LDO, 3.0V±2%, 500mA, Vdi=3.3V, +Reset ODO, +CE	USP-6B	49zx	VR15	9b	Tor
3AF86	XC6404AF86D	LVR/Vdet-IC	LDO, 3.5V±2%, 500mA, Vdi=3.8V, +Reset ODO, +CE	USP-6B	49zx	VR15	9b	Tor
3AF87	XC6404AF87D	LVR/Vdet-IC	LDO, 3.0V±2%, 500mA, Vdi=4.2V, +Reset ODO, +CE	USP-6B	49zx	VR15	9b	Tor
3AF88	XC6404AF88D	LVR/Vdet-IC	LDO, 3.3V±2%, 500mA, Vdi=4.0V, +Reset ODO, +CE	USP-6B	49zx	VR15	9b	Tor
3AH	XC6221A471GR	LVR-IC	LDO, 4.7±1%, 200mA, +CE	USP-4	45vm	VR4	9a	Tor
3AH	XC6227A161ER	LVR-IC	LDO, 1.6V±20mV, 700mA, +CE	USP-6C	49hq	VR4	9a	Tor
3AH02	XC6404AH02D	LVR/Vdet-IC	LDO, 2.7V±2%, 500mA, Vdo=4.2V, -Reset ODO, +CE	USP-6B	49zx	VR15	9b	Tor
3AH03	XC6404AH03D	LVR/Vdet-IC	LDO, 2.5V±2%, 500mA, Vdo=2.6V, -Reset ODO, +CE	USP-6B	49zx	VR15	9b	Tor
3AH04	XC6404AH04D	LVR/Vdet-IC	LDO, 3.3V±2%, 500mA, Vdo=4.3V, -Reset ODO, +CE	USP-6B	49zx	VR15	9b	Tor
3AH05	XC6404AH05D	LVR/Vdet-IC	LDO, 3.3V±2%, 500mA, Vdo=4.1V, -Reset ODO, +CE	USP-6B	49zx	VR15	9b	Tor
3AH07	XC6404AH07D	LVR/Vdet-IC	LDO, 3.3V±2%, 500mA, Vdo=5.2V, -Reset ODO, +CE	USP-6B	49zx	VR15	9b	Tor
3AH08	XC6404AH08D	LVR/Vdet-IC	LDO, 2.8V±2%, 500mA, Vdo=4.3V, -Reset ODO, +CE	USP-6B	49zx	VR15	9b	Tor
3AH09	XC6404AH09D	LVR/Vdet-IC	LDO, 4.3V±2%, 500mA, Vdo=2.8V, -Reset ODO, +CE	USP-6B	49zx	VR15	9b	Tor
3AH11	XC6404AH11D	LVR/Vdet-IC	LDO, 2.8V±2%, 500mA, Vdo=2.1V, -Reset ODO, +CE	USP-6B	49zx	VR15	9b	Tor
3AH12	XC6404AH12D	LVR/Vdet-IC	LDO, 2.8V±2%, 500mA, Vdo=2.8V, -Reset ODO, +CE	USP-6B	49zx	VR15	9b	Tor
3AH15	XC6404AH15D	LVR/Vdet-IC	LDO, 3.3V±2%, 500mA, Vdo=3.6V, -Reset ODO, +CE	USP-6B	49zx	VR15	9b	Tor
3AH18	XC6404AH18D	LVR/Vdet-IC	LDO, 3.0V±2%, 500mA, Vdo=2.7V, -Reset ODO, +CE	USP-6B	49zx	VR15	9b	Tor
3AH19	XC6404AH19D	LVR/Vdet-IC	LDO, 2.8V±2%, 500mA, Vdo=2.5V, -Reset ODO, +CE	USP-6B	49zx	VR15	9b	Tor
3AH20	XC6404AH20D	LVR/Vdet-IC	LDO, 1.8V±2%, 500mA, Vdo=2.9V, -Reset ODO, +CE	USP-6B	49zx	VR15	9b	Tor
3AH21	XC6404AH21D	LVR/Vdet-IC	LDO, 1.8V±2%, 500mA, Vdo=3.6V, -Reset ODO, +CE	USP-6B	49zx	VR15	9b	Tor
3AH22	XC6404AH22D	LVR/Vdet-IC	LDO, 1.8V±2%, 500mA, Vdo=4.2V, -Reset ODO, +CE	USP-6B	49zx	VR15	9b	Tor
3AH23	XC6404AH23D	LVR/Vdet-IC	LDO, 2.5V±2%, 500mA, Vdo=2.9V, -Reset ODO, +CE	USP-6B	49zx	VR15	9b	Tor
3AH24	XC6404AH24D	LVR/Vdet-IC	LDO, 2.5V±2%, 500mA, Vdo=3.6V, -Reset ODO, +CE	USP-6B	49zx	VR15	9b	Tor
3AH25	XC6404AH25D	LVR/Vdet-IC	LDO, 2.5V±2%, 500mA, Vdo=4.2V, -Reset ODO, +CE	USP-6B	49zx	VR15	9b	Tor
3AH26	XC6404AH26D	LVR/Vdet-IC	LDO, 4.3V±2%, 500mA, Vdo=4.0V, -Reset ODO, +CE	USP-6B	49zx	VR15	9b	Tor
3AH27	XC6404AH27D	LVR/Vdet-IC	LDO, 2.5V±2%, 500mA, Vdo=3.9V, -Reset ODO, +CE	USP-6B	49zx	VR15	9b	Tor



SMD code	Type	Function	Short description	Case	Pinout	Sch.	St.	Mnf.
3AH28	XC6404AH28D	LVR/Vdet-IC	LDO, 3.3V±2%, 500mA, Vdo=3.7V, -Reset ODO, +CE	USP-6B	49zx	VR15	9b	Tor
3AH29	XC6404AH29D	LVR/Vdet-IC	LDO, 2.6V±2%, 500mA, Vdo=3.9V, -Reset ODO, +CE	USP-6B	49zx	VR15	9b	Tor
3AH30	XC6404AH30D	LVR/Vdet-IC	LDO, 3.3V±2%, 500mA, Vdo=4.2V, -Reset ODO, +CE	USP-6B	49zx	VR15	9b	Tor
3AH31	XC6404AH31D	LVR/Vdet-IC	LDO, 3.3V±2%, 500mA, Vdo=4.5V, -Reset ODO, +CE	USP-6B	49zx	VR15	9b	Tor
3AH32	XC6404AH32D	LVR/Vdet-IC	LDO, 2.85V±2%, 500mA, Vdo=2.6V, -Reset ODO, +CE	USP-6B	49zx	VR15	9b	Tor
3AH33	XC6404AH33D	LVR/Vdet-IC	LDO, 3.3V±2%, 500mA, Vdo=2.8V, -Reset ODO, +CE	USP-6B	49zx	VR15	9b	Tor
3AH34	XC6404AH34D	LVR/Vdet-IC	LDO, 3.4V±2%, 500mA, Vdo=4.2V, -Reset ODO, +CE	USP-6B	49zx	VR15	9b	Tor
3AH80	XC6404AH80D	LVR/Vdet-IC	LDO, 1.8V±2%, 500mA, Vdo=1.6V, -Reset ODO, +CE	USP-6B	49zx	VR15	9b	Tor
3AH81	XC6404AH81D	LVR/Vdet-IC	LDO, 2.8V±2%, 500mA, Vdo=3.1V, -Reset ODO, +CE	USP-6B	49zx	VR15	9b	Tor
3AH82	XC6404AH82D	LVR/Vdet-IC	LDO, 1.8V±2%, 500mA, Vdo=2.0V, -Reset ODO, +CE	USP-6B	49zx	VR15	9b	Tor
3AH83	XC6404AH83D	LVR/Vdet-IC	LDO, 2.5V±2%, 500mA, Vdo=2.8V, -Reset ODO, +CE	USP-6B	49zx	VR15	9b	Tor
3AH84	XC6404AH84D	LVR/Vdet-IC	LDO, 2.85V±2%, 500mA, Vdo=3.1V, -Reset ODO, +CE	USP-6B	49zx	VR15	9b	Tor
3AH85	XC6404AH85D	LVR/Vdet-IC	LDO, 3.0V±2%, 500mA, Vdo=3.3V, -Reset ODO, +CE	USP-6B	49zx	VR15	9b	Tor
3AH86	XC6404AH86D	LVR/Vdet-IC	LDO, 3.5V±2%, 500mA, Vdo=3.8V, -Reset ODO, +CE	USP-6B	49zx	VR15	9b	Tor
3AH87	XC6404AH87D	LVR/Vdet-IC	LDO, 3.0V±2%, 500mA, Vdo=4.2V, -Reset ODO, +CE	USP-6B	49zx	VR15	9b	Tor
3AH88	XC6404AH88D	LVR/Vdet-IC	LDO, 3.3V±2%, 500mA, Vdo=4.0V, -Reset ODO, +CE	USP-6B	49zx	VR15	9b	Tor
3AK	XC6221A481GR	LVR-IC	LDO, 4.8±1%, 200mA, +CE	USP-4	45vm	VR4	9a	Tor
3AK	XC6227A171ER	LVR-IC	LDO, 1.7V±20mV, 700mA, +CE	USP-6C	49hq	VR4	9a	Tor
3AK02	XC6404AK02D	LVR/Vdet-IC	LDO, 2.7V±2%, 500mA, Vdo=4.2V, +Reset ODO, +CE	USP-6B	49zx	VR15	9b	Tor
3AK03	XC6404AK03D	LVR/Vdet-IC	LDO, 2.5V±2%, 500mA, Vdo=2.6V, -Reset ODO, +CE	USP-6B	49zx	VR15	9b	Tor
3AK04	XC6404AK04D	LVR/Vdet-IC	LDO, 3.3V±2%, 500mA, Vdo=4.3V, +Reset ODO, +CE	USP-6B	49zx	VR15	9b	Tor
3AK05	XC6404AK05D	LVR/Vdet-IC	LDO, 3.3V±2%, 500mA, Vdo=4.4V, +Reset ODO, +CE	USP-6B	49zx	VR15	9b	Tor
3AK07	XC6404AK07D	LVR/Vdet-IC	LDO, 3.3V±2%, 500mA, Vdo=5.2V, +Reset ODO, +CE	USP-6B	49zx	VR15	9b	Tor
3AK08	XC6404AK08D	LVR/Vdet-IC	LDO, 2.8V±2%, 500mA, Vdo=4.3V, +Reset ODO, +CE	USP-6B	49zx	VR15	9b	Tor
3AK09	XC6404AK09D	LVR/Vdet-IC	LDO, 4.3V±2%, 500mA, Vdo=3.6V, +Reset ODO, +CE	USP-6B	49zx	VR15	9b	Tor
3AK11	XC6404AK11D	LVR/Vdet-IC	LDO, 2.8V±2%, 500mA, Vdo=2.1V, +Reset ODO, +CE	USP-6B	49zx	VR15	9b	Tor
3AK12	XC6404AK12D	LVR/Vdet-IC	LDO, 2.8V±2%, 500mA, Vdo=2.8V, +Reset ODO, +CE	USP-6B	49zx	VR15	9b	Tor
3AK15	XC6404AK15D	LVR/Vdet-IC	LDO, 3.3V±2%, 500mA, Vdo=3.6V, -Reset ODO, +CE	USP-6B	49zx	VR15	9b	Tor
3AK18	XC6404AK18D	LVR/Vdet-IC	LDO, 3.0V±2%, 500mA, Vdo=2.7V, +Reset ODO, +CE	USP-6B	49zx	VR15	9b	Tor
3AK19	XC6404AK19D	LVR/Vdet-IC	LDO, 2.8V±2%, 500mA, Vdo=2.5V, +Reset ODO, +CE	USP-6B	49zx	VR15	9b	Tor
3AK20	XC6404AK20D	LVR/Vdet-IC	LDO, 1.8V±2%, 500mA, Vdo=2.9V, +Reset ODO, +CE	USP-6B	49zx	VR15	9b	Tor
3AK21	XC6404AK21D	LVR/Vdet-IC	LDO, 1.8V±2%, 500mA, Vdo=3.6V, -Reset ODO, +CE	USP-6B	49zx	VR15	9b	Tor
3AK22	XC6404AK22D	LVR/Vdet-IC	LDO, 1.8V±2%, 500mA, Vdo=4.2V, +Reset ODO, +CE	USP-6B	49zx	VR15	9b	Tor
3AK23	XC6404AK23D	LVR/Vdet-IC	LDO, 2.5V±2%, 500mA, Vdo=2.9V, +Reset ODO, +CE	USP-6B	49zx	VR15	9b	Tor
3AK24	XC6404AK24D	LVR/Vdet-IC	LDO, 2.5V±2%, 500mA, Vdo=3.6V, -Reset ODO, +CE	USP-6B	49zx	VR15	9b	Tor
3AK25	XC6404AK25D	LVR/Vdet-IC	LDO, 2.5V±2%, 500mA, Vdo=4.2V, +Reset ODO, +CE	USP-6B	49zx	VR15	9b	Tor
3AK26	XC6404AK26D	LVR/Vdet-IC	LDO, 4.3V±2%, 500mA, Vdo=4.0V, +Reset ODO, +CE	USP-6B	49zx	VR15	9b	Tor
3AK27	XC6404AK27D	LVR/Vdet-IC	LDO, 2.5V±2%, 500mA, Vdo=3.9V, +Reset ODO, +CE	USP-6B	49zx	VR15	9b	Tor
3AK28	XC6404AK28D	LVR/Vdet-IC	LDO, 3.3V±2%, 500mA, Vdo=3.7V, +Reset ODO, +CE	USP-6B	49zx	VR15	9b	Tor
3AK29	XC6404AK29D	LVR/Vdet-IC	LDO, 2.6V±2%, 500mA, Vdo=3.9V, +Reset ODO, +CE	USP-6B	49zx	VR15	9b	Tor
3AK30	XC6404AK30D	LVR/Vdet-IC	LDO, 3.3V±2%, 500mA, Vdo=4.2V, +Reset ODO, +CE	USP-6B	49zx	VR15	9b	Tor
3AK31	XC6404AK31D	LVR/Vdet-IC	LDO, 3.3V±2%, 500mA, Vdo=4.5V, +Reset ODO, +CE	USP-6B	49zx	VR15	9b	Tor
3AK32	XC6404AK32D	LVR/Vdet-IC	LDO, 2.85V±2%, 500mA, Vdo=2.6V, +Reset ODO, +CE	USP-6B	49zx	VR15	9b	Tor
3AK33	XC6404AK33D	LVR/Vdet-IC	LDO, 3.3V±2%, 500mA, Vdo=2.8V, +Reset ODO, +CE	USP-6B	49zx	VR15	9b	Tor
3AK34	XC6404AK34D	LVR/Vdet-IC	LDO, 3.4V±2%, 500mA, Vdo=4.2V, -Reset ODO, +CE	USP-6B	49zx	VR15	9b	Tor
3AK80	XC6404AK80D	LVR/Vdet-IC	LDO, 1.8V±2%, 500mA, Vdo=1.6V, -Reset ODO, +CE	USP-6B	49zx	VR15	9b	Tor
3AK81	XC6404AK81D	LVR/Vdet-IC	LDO, 2.8V±2%, 500mA, Vdo=3.1V, +Reset ODO, +CE	USP-6B	49zx	VR15	9b	Tor
3AK82	XC6404AK82D	LVR/Vdet-IC	LDO, 1.8V±2%, 500mA, Vdo=2.0V, +Reset ODO, +CE	USP-6B	49zx	VR15	9b	Tor
3AK83	XC6404AK83D	LVR/Vdet-IC	LDO, 2.5V±2%, 500mA, Vdo=2.8V, +Reset ODO, +CE	USP-6B	49zx	VR15	9b	Tor
3AK84	XC6404AK84D	LVR/Vdet-IC	LDO, 2.85V±2%, 500mA, Vdo=3.2V, +Reset ODO, +CE	USP-6B	49zx	VR15	9b	Tor
3AK85	XC6404AK85D	LVR/Vdet-IC	LDO, 3.0V±2%, 500mA, Vdo=3.3V, +Reset ODO, +CE	USP-6B	49zx	VR15	9b	Tor
3AK86	XC6404AK86D	LVR/Vdet-IC	LDO, 3.5V±2%, 500mA, Vdo=3.8V, +Reset ODO, +CE	USP-6B	49zx	VR15	9b	Tor
3AK87	XC6404AK87D	LVR/Vdet-IC	LDO, 3.0V±2%, 500mA, Vdo=4.2V, +Reset ODO, +CE	USP-6B	49zx	VR15	9b	Tor
3AK88	XC6404AK88D	LVR/Vdet-IC	LDO, 3.3V±2%, 500mA, Vdo=4.0V, +Reset ODO, +CE	USP-6B	49zx	VR15	9b	Tor
3AL	XC6221A491GR	LVR-IC	LDO, 4.9±1%, 200mA, +CE	USP-4	45vm	VR4	9a	Tor
3AL	XC6227A181ER	LVR-IC	LDO, 1.8V±20mV, 700mA, +CE	USP-6C	49hq	VR4	9a	Tor
3AL02	XC6404AL02D	LVR/Vdet-IC	LDO, 2.7V±2%, 500mA, Vdi=4.2V, -Reset ODO, -CE, PUR	USP-6B	49zx	VR15	9b	Tor
3AL03	XC6404AL03D	LVR/Vdet-IC	LDO, 2.5V±2%, 500mA, Vdi=2.6V, -Reset ODO, -CE, PUR	USP-6B	49zx	VR15	9b	Tor
3AL04	XC6404AL04D	LVR/Vdet-IC	LDO, 3.3V±2%, 500mA, Vdi=4.3V, -Reset ODO, -CE, PUR	USP-6B	49zx	VR15	9b	Tor
3AL05	XC6404AL05D	LVR/Vdet-IC	LDO, 3.3V±2%, 500mA, Vdi=4.4V, -Reset ODO, -CE, PUR	USP-6B	49zx	VR15	9b	Tor
3AL07	XC6404AL07D	LVR/Vdet-IC	LDO, 3.3V±2%, 500mA, Vdi=5.2V, -Reset ODO, -CE, PUR	USP-6B	49zx	VR15	9b	Tor
3AL08	XC6404AL08D	LVR/Vdet-IC	LDO, 2.8V±2%, 500mA, Vdi=4.3V, -Reset ODO, -CE, PUR	USP-6B	49zx	VR15	9b	Tor
3AL09	XC6404AL09D	LVR/Vdet-IC	LDO, 4.3V±2%, 500mA, Vdi=2.8V, -Reset ODO, -CE, PUR	USP-6B	49zx	VR15	9b	Tor
3AL11	XC6404AL11D	LVR/Vdet-IC	LDO, 2.8V±2%, 500mA, Vdi=2.1V, -Reset ODO, -CE, PUR	USP-6B	49zx	VR15	9b	Tor
3AL12	XC6404AL12D	LVR/Vdet-IC	LDO, 2.8V±2%, 500mA, Vdi=2.8V, -Reset ODO, -CE, PUR	USP-6B	49zx	VR15	9b	Tor
3AL15	XC6404AL15D	LVR/Vdet-IC	LDO, 3.3V±2%, 500mA, Vdi=3.6V, -Reset ODO, -CE, PUR	USP-6B	49zx	VR15	9b	Tor
3AL18	XC6404AL18D	LVR/Vdet-IC	LDO, 3.0V±2%, 500mA, Vdi=2.7V, -Reset ODO, -CE, PUR	USP-6B	49zx	VR15	9b	Tor
3AL19	XC6404AL19D	LVR/Vdet-IC	LDO, 2.8V±2%, 500mA, Vdi=2.5V, -Reset ODO, -CE, PUR	USP-6B	49zx	VR15	9b	Tor
3AL20	XC6404AL20D	LVR/Vdet-IC	LDO, 1.8V±2%, 500mA, Vdi=2.9V, -Reset ODO, -CE, PUR	USP-6B	49zx	VR15	9b	Tor
3AL21	XC6404AL21D	LVR/Vdet-IC	LDO, 1.8V±2%, 500mA, Vdi=3.6V, -Reset ODO, -CE, PUR	USP-6B	49zx	VR15	9b	Tor



SMD code	Type	Function	Short description	Case	Pinout	Sch.	St.	Mnf.
3AL22	XC6404AL22D	LVR/Vdet-IC	LDO, 1.8V±2%, 500mA, Vdi=4.2V, -Reset ODO, -CE, PUR	USP-6B	49zx	VR15	9b	Tor
3AL23	XC6404AL23D	LVR/Vdet-IC	LDO, 2.5V±2%, 500mA, Vdi=2.9V, -Reset ODO, -CE, PUR	USP-6B	49zx	VR15	9b	Tor
3AL24	XC6404AL24D	LVR/Vdet-IC	LDO, 2.5V±2%, 500mA, Vdi=3.6V, -Reset ODO, -CE, PUR	USP-6B	49zx	VR15	9b	Tor
3AL25	XC6404AL25D	LVR/Vdet-IC	LDO, 2.5V±2%, 500mA, Vdi=4.2V, -Reset ODO, -CE, PUR	USP-6B	49zx	VR15	9b	Tor
3AL26	XC6404AL26D	LVR/Vdet-IC	LDO, 4.3V±2%, 500mA, Vdi=4.0V, -Reset ODO, -CE, PUR	USP-6B	49zx	VR15	9b	Tor
3AL27	XC6404AL27D	LVR/Vdet-IC	LDO, 2.5V±2%, 500mA, Vdi=3.9V, -Reset ODO, -CE, PUR	USP-6B	49zx	VR15	9b	Tor
3AL28	XC6404AL28D	LVR/Vdet-IC	LDO, 3.3V±2%, 500mA, Vdi=3.7V, -Reset ODO, -CE, PUR	USP-6B	49zx	VR15	9b	Tor
3AL29	XC6404AL29D	LVR/Vdet-IC	LDO, 2.6V±2%, 500mA, Vdi=3.9V, -Reset ODO, -CE, PUR	USP-6B	49zx	VR15	9b	Tor
3AL30	XC6404AL30D	LVR/Vdet-IC	LDO, 3.3V±2%, 500mA, Vdi=4.2V, -Reset ODO, -CE, PUR	USP-6B	49zx	VR15	9b	Tor
3AL31	XC6404AL31D	LVR/Vdet-IC	LDO, 3.3V±2%, 500mA, Vdi=4.5V, -Reset ODO, -CE, PUR	USP-6B	49zx	VR15	9b	Tor
3AL32	XC6404AL32D	LVR/Vdet-IC	LDO, 2.85V±2%, 500mA, Vdi=2.6V, -Reset ODO, -CE, PUR	USP-6B	49zx	VR15	9b	Tor
3AL33	XC6404AL33D	LVR/Vdet-IC	LDO, 3.3V±2%, 500mA, Vdi=2.8V, -Reset ODO, -CE, PUR	USP-6B	49zx	VR15	9b	Tor
3AL34	XC6404AL34D	LVR/Vdet-IC	LDO, 3.4V±2%, 500mA, Vdi=4.2V, -Reset ODO, -CE, PUR	USP-6B	49zx	VR15	9b	Tor
3AL80	XC6404AL80D	LVR/Vdet-IC	LDO, 1.8V±2%, 500mA, Vdi=1.6V, -Reset ODO, -CE, PUR	USP-6B	49zx	VR15	9b	Tor
3AL81	XC6404AL81D	LVR/Vdet-IC	LDO, 2.8V±2%, 500mA, Vdi=3.1V, -Reset ODO, -CE, PUR	USP-6B	49zx	VR15	9b	Tor
3AL82	XC6404AL82D	LVR/Vdet-IC	LDO, 1.8V±2%, 500mA, Vdi=2.0V, -Reset ODO, -CE, PUR	USP-6B	49zx	VR15	9b	Tor
3AL83	XC6404AL83D	LVR/Vdet-IC	LDO, 2.5V±2%, 500mA, Vdi=2.8V, -Reset ODO, -CE, PUR	USP-6B	49zx	VR15	9b	Tor
3AL84	XC6404AL84D	LVR/Vdet-IC	LDO, 2.85V±2%, 500mA, Vdi=3.2V, -Reset ODO, -CE, PUR	USP-6B	49zx	VR15	9b	Tor
3AL85	XC6404AL85D	LVR/Vdet-IC	LDO, 3.0V±2%, 500mA, Vdi=3.3V, -Reset ODO, -CE, PUR	USP-6B	49zx	VR15	9b	Tor
3AL86	XC6404AL86D	LVR/Vdet-IC	LDO, 3.5V±2%, 500mA, Vdi=3.8V, -Reset ODO, -CE, PUR	USP-6B	49zx	VR15	9b	Tor
3AL87	XC6404AL87D	LVR/Vdet-IC	LDO, 3.0V±2%, 500mA, Vdi=4.2V, -Reset ODO, -CE, PUR	USP-6B	49zx	VR15	9b	Tor
3AL88	XC6404AL88D	LVR/Vdet-IC	LDO, 3.3V±2%, 500mA, Vdi=4.0V, -Reset ODO, -CE, PUR	USP-6B	49zx	VR15	9b	Tor
3AM	XC6221A501GR	LVR-IC	LDO, 5.0±1%, 200mA, +CE	USP-4	45vm	VR4	9a	Tor
3AM	XC6227A191ER	LVR-IC	LDO, 1.9V±20mV, 700mA, +CE	USP-6C	49hq	VR4	9a	Tor
3AM02	XC6404AM02D	LVR/Vdet-IC	LDO, 2.7V±2%, 500mA, Vdi=4.2V, +Reset ODO, -CE, PUR	USP-6B	49zx	VR15	9b	Tor
3AM03	XC6404AM03D	LVR/Vdet-IC	LDO, 2.5V±2%, 500mA, Vdi=2.6V, +Reset ODO, -CE, PUR	USP-6B	49zx	VR15	9b	Tor
3AM04	XC6404AM04D	LVR/Vdet-IC	LDO, 3.3V±2%, 500mA, Vdi=4.3V, +Reset ODO, -CE, PUR	USP-6B	49zx	VR15	9b	Tor
3AM05	XC6404AM05D	LVR/Vdet-IC	LDO, 3.3V±2%, 500mA, Vdi=4.1V, +Reset ODO, -CE, PUR	USP-6B	49zx	VR15	9b	Tor
3AM07	XC6404AM07D	LVR/Vdet-IC	LDO, 3.3V±2%, 500mA, Vdi=5.2V, +Reset ODO, -CE, PUR	USP-6B	49zx	VR15	9b	Tor
3AM08	XC6404AM08D	LVR/Vdet-IC	LDO, 2.8V±2%, 500mA, Vdi=4.3V, +Reset ODO, -CE, PUR	USP-6B	49zx	VR15	9b	Tor
3AM09	XC6404AM09D	LVR/Vdet-IC	LDO, 4.3V±2%, 500mA, Vdi=2.8V, +Reset ODO, -CE, PUR	USP-6B	49zx	VR15	9b	Tor
3AM11	XC6404AM11D	LVR/Vdet-IC	LDO, 2.8V±2%, 500mA, Vdi=2.1V, +Reset ODO, -CE, PUR	USP-6B	49zx	VR15	9b	Tor
3AM12	XC6404AM12D	LVR/Vdet-IC	LDO, 2.8V±2%, 500mA, Vdi=2.8V, +Reset ODO, -CE, PUR	USP-6B	49zx	VR15	9b	Tor
3AM15	XC6404AM15D	LVR/Vdet-IC	LDO, 3.3V±2%, 500mA, Vdi=3.6V, +Reset ODO, -CE, PUR	USP-6B	49zx	VR15	9b	Tor
3AM18	XC6404AM18D	LVR/Vdet-IC	LDO, 3.0V±2%, 500mA, Vdi=2.7V, +Reset ODO, -CE, PUR	USP-6B	49zx	VR15	9b	Tor
3AM19	XC6404AM19D	LVR/Vdet-IC	LDO, 2.8V±2%, 500mA, Vdi=2.5V, +Reset ODO, -CE, PUR	USP-6B	49zx	VR15	9b	Tor
3AM20	XC6404AM20D	LVR/Vdet-IC	LDO, 1.8V±2%, 500mA, Vdi=2.9V, +Reset ODO, -CE, PUR	USP-6B	49zx	VR15	9b	Tor
3AM21	XC6404AM21D	LVR/Vdet-IC	LDO, 1.8V±2%, 500mA, Vdi=3.6V, +Reset ODO, -CE, PUR	USP-6B	49zx	VR15	9b	Tor
3AM22	XC6404AM22D	LVR/Vdet-IC	LDO, 1.8V±2%, 500mA, Vdi=4.2V, +Reset ODO, -CE, PUR	USP-6B	49zx	VR15	9b	Tor
3AM23	XC6404AM23D	LVR/Vdet-IC	LDO, 2.5V±2%, 500mA, Vdi=2.9V, +Reset ODO, -CE, PUR	USP-6B	49zx	VR15	9b	Tor
3AM24	XC6404AM24D	LVR/Vdet-IC	LDO, 2.5V±2%, 500mA, Vdi=3.6V, +Reset ODO, -CE, PUR	USP-6B	49zx	VR15	9b	Tor
3AM25	XC6404AM25D	LVR/Vdet-IC	LDO, 2.5V±2%, 500mA, Vdi=4.2V, +Reset ODO, -CE, PUR	USP-6B	49zx	VR15	9b	Tor
3AM26	XC6404AM26D	LVR/Vdet-IC	LDO, 4.3V±2%, 500mA, Vdi=4.0V, +Reset ODO, -CE, PUR	USP-6B	49zx	VR15	9b	Tor
3AM27	XC6404AM27D	LVR/Vdet-IC	LDO, 2.5V±2%, 500mA, Vdi=3.9V, +Reset ODO, -CE, PUR	USP-6B	49zx	VR15	9b	Tor
3AM28	XC6404AM28D	LVR/Vdet-IC	LDO, 3.3V±2%, 500mA, Vdi=3.7V, +Reset ODO, -CE, PUR	USP-6B	49zx	VR15	9b	Tor
3AM29	XC6404AM29D	LVR/Vdet-IC	LDO, 2.6V±2%, 500mA, Vdi=3.9V, +Reset ODO, -CE, PUR	USP-6B	49zx	VR15	9b	Tor
3AM30	XC6404AM30D	LVR/Vdet-IC	LDO, 3.3V±2%, 500mA, Vdi=4.2V, +Reset ODO, -CE, PUR	USP-6B	49zx	VR15	9b	Tor
3AM31	XC6404AM31D	LVR/Vdet-IC	LDO, 3.3V±2%, 500mA, Vdi=4.5V, +Reset ODO, -CE, PUR	USP-6B	49zx	VR15	9b	Tor
3AM32	XC6404AM32D	LVR/Vdet-IC	LDO, 2.85V±2%, 500mA, Vdi=2.6V, +Reset ODO, -CE, PUR	USP-6B	49zx	VR15	9b	Tor
3AM33	XC6404AM33D	LVR/Vdet-IC	LDO, 3.3V±2%, 500mA, Vdi=2.8V, +Reset ODO, -CE, PUR	USP-6B	49zx	VR15	9b	Tor
3AM34	XC6404AM34D	LVR/Vdet-IC	LDO, 3.4V±2%, 500mA, Vdi=4.2V, +Reset ODO, -CE, PUR	USP-6B	49zx	VR15	9b	Tor
3AM80	XC6404AM80D	LVR/Vdet-IC	LDO, 1.8V±2%, 500mA, Vdi=1.6V, +Reset ODO, -CE, PUR	USP-6B	49zx	VR15	9b	Tor
3AM81	XC6404AM81D	LVR/Vdet-IC	LDO, 2.8V±2%, 500mA, Vdi=3.1V, +Reset ODO, -CE, PUR	USP-6B	49zx	VR15	9b	Tor
3AM82	XC6404AM82D	LVR/Vdet-IC	LDO, 1.8V±2%, 500mA, Vdi=2.0V, +Reset ODO, -CE, PUR	USP-6B	49zx	VR15	9b	Tor
3AM83	XC6404AM83D	LVR/Vdet-IC	LDO, 2.5V±2%, 500mA, Vdi=2.8V, +Reset ODO, -CE, PUR	USP-6B	49zx	VR15	9b	Tor
3AM84	XC6404AM84D	LVR/Vdet-IC	LDO, 2.85V±2%, 500mA, Vdi=3.2V, +Reset ODO, -CE, PUR	USP-6B	49zx	VR15	9b	Tor
3AM85	XC6404AM85D	LVR/Vdet-IC	LDO, 3.0V±2%, 500mA, Vdi=3.3V, +Reset ODO, -CE, PUR	USP-6B	49zx	VR15	9b	Tor
3AM86	XC6404AM86D	LVR/Vdet-IC	LDO, 3.5V±2%, 500mA, Vdi=3.8V, +Reset ODO, -CE, PUR	USP-6B	49zx	VR15	9b	Tor
3AM87	XC6404AM87D	LVR/Vdet-IC	LDO, 3.0V±2%, 500mA, Vdi=4.2V, +Reset ODO, -CE, PUR	USP-6B	49zx	VR15	9b	Tor
3AM88	XC6404AM88D	LVR/Vdet-IC	LDO, 3.3V±2%, 500mA, Vdi=4.0V, +Reset ODO, -CE, PUR	USP-6B	49zx	VR15	9b	Tor
3AN	XC6227A201ER	LVR-IC	LDO, 2.0V±20mV, 700mA, +CE	USP-6C	49hq	VR4	9a	Tor
3AN02	XC6404AN02D	LVR/Vdet-IC	LDO, 2.7V±2%, 500mA, Vdo=4.2V, -Reset ODO, -CE, PUR	USP-6B	49zx	VR15	9b	Tor
3AN03	XC6404AN03D	LVR/Vdet-IC	LDO, 2.5V±2%, 500mA, Vdo=2.6V, -Reset ODO, -CE, PUR	USP-6B	49zx	VR15	9b	Tor
3AN04	XC6404AN04D	LVR/Vdet-IC	LDO, 3.3V±2%, 500mA, Vdo=4.3V, -Reset ODO, -CE, PUR	USP-6B	49zx	VR15	9b	Tor
3AN05	XC6404AN05D	LVR/Vdet-IC	LDO, 3.3V±2%, 500mA, Vdo=4.4V, -Reset ODO, -CE, PUR	USP-6B	49zx	VR15	9b	Tor
3AN07	XC6404AN07D	LVR/Vdet-IC	LDO, 3.3V±2%, 500mA, Vdo=5.2V, -Reset ODO, -CE, PUR	USP-6B	49zx	VR15	9b	Tor
3AN08	XC6404AN08D	LVR/Vdet-IC	LDO, 2.8V±2%, 500mA, Vdo=4.3V, -Reset ODO, -CE, PUR	USP-6B	49zx	VR15	9b	Tor
3AN09	XC6404AN09D	LVR/Vdet-IC	LDO, 4.3V±2%, 500mA, Vdo=2.8V, -Reset ODO, -CE, PUR	USP-6B	49zx	VR15	9b	Tor
3AN11	XC6404AN11D	LVR/Vdet-IC	LDO, 2.8V±2%, 500mA, Vdo=2.1V, -Reset ODO, -CE, PUR	USP-6B	49zx	VR15	9b	Tor
3AN12	XC6404AN12D	LVR/Vdet-IC	LDO, 2.8V±2%, 500mA, Vdo=2.8V, -Reset ODO, -CE, PUR	USP-6B	49zx	VR15	9b	Tor



SMD code	Type	Function	Short description	Case	Pinout	Sch.	St.	Mnf.
3AU87	XC6404AU87D	LVR/det-IC	LDO, 3.0V±2%, 500mA, Vdo=4.2V, +Reset ODO, -CE	USP-6B	49zx	VR15	9b	Tor
3AU88	XC6404AU88D	LVR/det-IC	LDO, 3.3V±2%, 500mA, Vdo=4.0V, +Reset ODO, -CE	USP-6B	49zx	VR15	9b	Tor
3AV	XC6227A261ER	LVR-IC	LDO, 2.6V±1%, 700mA, +CE	USP-6C	49hq	VR4	9a	Tor
3AX	XC6227A271ER	LVR-IC	LDO, 2.7V±1%, 700mA, +CE	USP-6C	49hq	VR4	9a	Tor
3AY	XC6227A281ER	LVR-IC	LDO, 2.8V±1%, 700mA, +CE	USP-6C	49hq	VR4	9a	Tor
3AZ	XC6227A291ER	LVR-IC	LDO, 2.9V±1%, 700mA, +CE	USP-6C	49hq	VR4	9a	Tor
3B	R3117K081C	Vdet-IC	0.8V±15mV, -Reset PPO, Sense	DFN11010-4	48rq	VD12	9a	Ric
3B	RP101K131B	LVR-IC	LDO, LN, +CE, 1.3V±0.8%, 300mA	DFN1612-4	45vm	VR4	9a	Ric
3B	XC6217D1227R-G	LVR-IC	LDO, 1.2V±2%, 200mA, +CE, CL	USPN-4	58vm	VR4	9a	Tor
3B	XC6223D2119R-G	LVR-IC	LDO, 2.1V±1%, 300mA, +CE, CL, PDR	USPQ-4B03	48vm	VR4	9a	Tor
3B	XC6224B19B7R	LVR-IC	LDO, 1.95V±1.5%, 150mA, +CE, PDR	USPN-4B02	58vm	VR4	9e	Tor
3B	XC6229H3211R-G	LVR-IC	LDO, 3.2V±1%, 300mA, +CE, ICP	BGA-4	63ba*	VR4	9a	Tor
3B	XC6221C49B7R	LVR-IC	LDO, 4.95V±1%, 200mA, +CE, PDR	USPN-4	58vm	VR4	9a	Tor
3B016	XC6106B016ER	Vdet-IC	1.6V±2%, Hst, -MR, ±Reset PPO, Rt=25ms	USP-6C	49xs	VD21	9b	Tor
3B017	XC6106B017ER	Vdet-IC	1.7V±2%, Hst, -MR, ±Reset PPO, Rt=25ms	USP-6C	49xs	VD21	9b	Tor
3B018	XC6106B018ER	Vdet-IC	1.8V±2%, Hst, -MR, ±Reset PPO, Rt=25ms	USP-6C	49xs	VD21	9b	Tor
3B019	XC6106B019ER	Vdet-IC	1.9V±2%, Hst, -MR, ±Reset PPO, Rt=25ms	USP-6C	49xs	VD21	9b	Tor
3B020	XC6106B020ER	Vdet-IC	2.0V±2%, Hst, -MR, ±Reset PPO, Rt=25ms	USP-6C	49xs	VD21	9b	Tor
3B021	XC6106B021ER	Vdet-IC	2.1V±2%, Hst, -MR, ±Reset PPO, Rt=25ms	USP-6C	49xs	VD21	9b	Tor
3B022	XC6106B022ER	Vdet-IC	2.2V±2%, Hst, -MR, ±Reset PPO, Rt=25ms	USP-6C	49xs	VD21	9b	Tor
3B023	XC6106B023ER	Vdet-IC	2.3V±2%, Hst, -MR, ±Reset PPO, Rt=25ms	USP-6C	49xs	VD21	9b	Tor
3B024	XC6106B024ER	Vdet-IC	2.4V±2%, Hst, -MR, ±Reset PPO, Rt=25ms	USP-6C	49xs	VD21	9b	Tor
3B025	XC6106B025ER	Vdet-IC	2.5V±2%, Hst, -MR, ±Reset PPO, Rt=25ms	USP-6C	49xs	VD21	9b	Tor
3B026	XC6106B026ER	Vdet-IC	2.6V±2%, Hst, -MR, ±Reset PPO, Rt=25ms	USP-6C	49xs	VD21	9b	Tor
3B027	XC6106B027ER	Vdet-IC	2.7V±2%, Hst, -MR, ±Reset PPO, Rt=25ms	USP-6C	49xs	VD21	9b	Tor
3B028	XC6106B028ER	Vdet-IC	2.8V±2%, Hst, -MR, ±Reset PPO, Rt=25ms	USP-6C	49xs	VD21	9b	Tor
3B029	XC6106B029ER	Vdet-IC	2.9V±2%, Hst, -MR, ±Reset PPO, Rt=25ms	USP-6C	49xs	VD21	9b	Tor
3B030	XC6106B030ER	Vdet-IC	3.0V±2%, Hst, -MR, ±Reset PPO, Rt=25ms	USP-6C	49xs	VD21	9b	Tor
3B031	XC6106B031ER	Vdet-IC	3.1V±2%, Hst, -MR, ±Reset PPO, Rt=25ms	USP-6C	49xs	VD21	9b	Tor
3B032	XC6106B032ER	Vdet-IC	3.2V±2%, Hst, -MR, ±Reset PPO, Rt=25ms	USP-6C	49xs	VD21	9b	Tor
3B033	XC6106B033ER	Vdet-IC	3.3V±2%, Hst, -MR, ±Reset PPO, Rt=25ms	USP-6C	49xs	VD21	9b	Tor
3B034	XC6106B034ER	Vdet-IC	3.4V±2%, Hst, -MR, ±Reset PPO, Rt=25ms	USP-6C	49xs	VD21	9b	Tor
3B035	XC6106B035ER	Vdet-IC	3.5V±2%, Hst, -MR, ±Reset PPO, Rt=25ms	USP-6C	49xs	VD21	9b	Tor
3B036	XC6106B036ER	Vdet-IC	3.6V±2%, Hst, -MR, ±Reset PPO, Rt=25ms	USP-6C	49xs	VD21	9b	Tor
3B037	XC6106B037ER	Vdet-IC	3.7V±2%, Hst, -MR, ±Reset PPO, Rt=25ms	USP-6C	49xs	VD21	9b	Tor
3B038	XC6106B038ER	Vdet-IC	3.8V±2%, Hst, -MR, ±Reset PPO, Rt=25ms	USP-6C	49xs	VD21	9b	Tor
3B039	XC6106B039ER	Vdet-IC	3.9V±2%, Hst, -MR, ±Reset PPO, Rt=25ms	USP-6C	49xs	VD21	9b	Tor
3B040	XC6106B040ER	Vdet-IC	4.0V±2%, Hst, -MR, ±Reset PPO, Rt=25ms	USP-6C	49xs	VD21	9b	Tor
3B041	XC6106B041ER	Vdet-IC	4.1V±2%, Hst, -MR, ±Reset PPO, Rt=25ms	USP-6C	49xs	VD21	9b	Tor
3B042	XC6106B042ER	Vdet-IC	4.2V±2%, Hst, -MR, ±Reset PPO, Rt=25ms	USP-6C	49xs	VD21	9b	Tor
3B043	XC6106B043ER	Vdet-IC	4.3V±2%, Hst, -MR, ±Reset PPO, Rt=25ms	USP-6C	49xs	VD21	9b	Tor
3B044	XC6106B044ER	Vdet-IC	4.4V±2%, Hst, -MR, ±Reset PPO, Rt=25ms	USP-6C	49xs	VD21	9b	Tor
3B045	XC6106B045ER	Vdet-IC	4.5V±2%, Hst, -MR, ±Reset PPO, Rt=25ms	USP-6C	49xs	VD21	9b	Tor
3B046	XC6106B046ER	Vdet-IC	4.6V±2%, Hst, -MR, ±Reset PPO, Rt=25ms	USP-6C	49xs	VD21	9b	Tor
3B047	XC6106B047ER	Vdet-IC	4.7V±2%, Hst, -MR, ±Reset PPO, Rt=25ms	USP-6C	49xs	VD21	9b	Tor
3B048	XC6106B048ER	Vdet-IC	4.8V±2%, Hst, -MR, ±Reset PPO, Rt=25ms	USP-6C	49xs	VD21	9b	Tor
3B049	XC6106B049ER	Vdet-IC	4.9V±2%, Hst, -MR, ±Reset PPO, Rt=25ms	USP-6C	49xs	VD21	9b	Tor
3B050	XC6106B050ER	Vdet-IC	5.0V±2%, Hst, -MR, ±Reset PPO, Rt=25ms	USP-6C	49xs	VD21	9b	Tor
3B1	XC6221B321GR	LVR-IC	LDO, 3.2V±1%, 200mA, +CE, CL	USP-4	45vm	VR4	9a	Tor
3B2	XC6221B331GR	LVR-IC	LDO, 3.3V±1%, 200mA, +CE, CL	USP-4	45vm	VR4	9a	Tor
3B216	XC6101B216ER	Vdet-IC	1.6V±2%, Hst, -MR, -Reset PPO, Wt=50ms, Rt=25ms	USP-6C	49xh	VD17	9b	Tor
3B217	XC6101B217ER	Vdet-IC	1.7V±2%, Hst, -MR, -Reset PPO, Wt=50ms, Rt=25ms	USP-6C	49xh	VD17	9b	Tor
3B218	XC6101B218ER	Vdet-IC	1.8V±2%, Hst, -MR, -Reset PPO, Wt=50ms, Rt=25ms	USP-6C	49xh	VD17	9b	Tor
3B219	XC6101B219ER	Vdet-IC	1.9V±2%, Hst, -MR, -Reset PPO, Wt=50ms, Rt=25ms	USP-6C	49xh	VD17	9b	Tor
3B220	XC6101B220ER	Vdet-IC	2.0V±2%, Hst, -MR, -Reset PPO, Wt=50ms, Rt=25ms	USP-6C	49xh	VD17	9b	Tor
3B221	XC6101B221ER	Vdet-IC	2.1V±2%, Hst, -MR, -Reset PPO, Wt=50ms, Rt=25ms	USP-6C	49xh	VD17	9b	Tor
3B222	XC6101B222ER	Vdet-IC	2.2V±2%, Hst, -MR, -Reset PPO, Wt=50ms, Rt=25ms	USP-6C	49xh	VD17	9b	Tor
3B223	XC6101B223ER	Vdet-IC	2.3V±2%, Hst, -MR, -Reset PPO, Wt=50ms, Rt=25ms	USP-6C	49xh	VD17	9b	Tor
3B224	XC6101B224ER	Vdet-IC	2.4V±2%, Hst, -MR, -Reset PPO, Wt=50ms, Rt=25ms	USP-6C	49xh	VD17	9b	Tor
3B225	XC6101B225ER	Vdet-IC	2.5V±2%, Hst, -MR, -Reset PPO, Wt=50ms, Rt=25ms	USP-6C	49xh	VD17	9b	Tor
3B226	XC6101B226ER	Vdet-IC	2.6V±2%, Hst, -MR, -Reset PPO, Wt=50ms, Rt=25ms	USP-6C	49xh	VD17	9b	Tor
3B227	XC6101B227ER	Vdet-IC	2.7V±2%, Hst, -MR, -Reset PPO, Wt=50ms, Rt=25ms	USP-6C	49xh	VD17	9b	Tor
3B228	XC6101B228ER	Vdet-IC	2.8V±2%, Hst, -MR, -Reset PPO, Wt=50ms, Rt=25ms	USP-6C	49xh	VD17	9b	Tor
3B229	XC6101B229ER	Vdet-IC	2.9V±2%, Hst, -MR, -Reset PPO, Wt=50ms, Rt=25ms	USP-6C	49xh	VD17	9b	Tor
3B230	XC6101B230ER	Vdet-IC	3.0V±2%, Hst, -MR, -Reset PPO, Wt=50ms, Rt=25ms	USP-6C	49xh	VD17	9b	Tor
3B231	XC6101B231ER	Vdet-IC	3.1V±2%, Hst, -MR, -Reset PPO, Wt=50ms, Rt=25ms	USP-6C	49xh	VD17	9b	Tor
3B232	XC6101B232ER	Vdet-IC	3.2V±2%, Hst, -MR, -Reset PPO, Wt=50ms, Rt=25ms	USP-6C	49xh	VD17	9b	Tor
3B233	XC6101B233ER	Vdet-IC	3.3V±2%, Hst, -MR, -Reset PPO, Wt=50ms, Rt=25ms	USP-6C	49xh	VD17	9b	Tor
3B234	XC6101B234ER	Vdet-IC	3.4V±2%, Hst, -MR, -Reset PPO, Wt=50ms, Rt=25ms	USP-6C	49xh	VD17	9b	Tor
3B235	XC6101B235ER	Vdet-IC	3.5V±2%, Hst, -MR, -Reset PPO, Wt=50ms, Rt=25ms	USP-6C	49xh	VD17	9b	Tor



SMD code	Type	Function	Short description	Case	Pinout	Sch.	St.	Mnf.
3B632	XC6101B632ER	Vdet-IC	3.2V±2%, Hst, -MR, -Reset PPO, Wt=1.6s, Rt=25ms	USP-6C	49xh	VD17	9b	Tor
3B633	XC6101B633ER	Vdet-IC	3.3V±2%, Hst, -MR, -Reset PPO, Wt=1.6s, Rt=25ms	USP-6C	49xh	VD17	9b	Tor
3B634	XC6101B634ER	Vdet-IC	3.4V±2%, Hst, -MR, -Reset PPO, Wt=1.6s, Rt=25ms	USP-6C	49xh	VD17	9b	Tor
3B635	XC6101B635ER	Vdet-IC	3.5V±2%, Hst, -MR, -Reset PPO, Wt=1.6s, Rt=25ms	USP-6C	49xh	VD17	9b	Tor
3B636	XC6101B636ER	Vdet-IC	3.6V±2%, Hst, -MR, -Reset PPO, Wt=1.6s, Rt=25ms	USP-6C	49xh	VD17	9b	Tor
3B637	XC6101B637ER	Vdet-IC	3.7V±2%, Hst, -MR, -Reset PPO, Wt=1.6s, Rt=25ms	USP-6C	49xh	VD17	9b	Tor
3B638	XC6101B638ER	Vdet-IC	3.8V±2%, Hst, -MR, -Reset PPO, Wt=1.6s, Rt=25ms	USP-6C	49xh	VD17	9b	Tor
3B639	XC6101B639ER	Vdet-IC	3.9V±2%, Hst, -MR, -Reset PPO, Wt=1.6s, Rt=25ms	USP-6C	49xh	VD17	9b	Tor
3B640	XC6101B640ER	Vdet-IC	4.0V±2%, Hst, -MR, -Reset PPO, Wt=1.6s, Rt=25ms	USP-6C	49xh	VD17	9b	Tor
3B641	XC6101B641ER	Vdet-IC	4.1V±2%, Hst, -MR, -Reset PPO, Wt=1.6s, Rt=25ms	USP-6C	49xh	VD17	9b	Tor
3B642	XC6101B642ER	Vdet-IC	4.2V±2%, Hst, -MR, -Reset PPO, Wt=1.6s, Rt=25ms	USP-6C	49xh	VD17	9b	Tor
3B643	XC6101B643ER	Vdet-IC	4.3V±2%, Hst, -MR, -Reset PPO, Wt=1.6s, Rt=25ms	USP-6C	49xh	VD17	9b	Tor
3B644	XC6101B644ER	Vdet-IC	4.4V±2%, Hst, -MR, -Reset PPO, Wt=1.6s, Rt=25ms	USP-6C	49xh	VD17	9b	Tor
3B645	XC6101B645ER	Vdet-IC	4.5V±2%, Hst, -MR, -Reset PPO, Wt=1.6s, Rt=25ms	USP-6C	49xh	VD17	9b	Tor
3B646	XC6101B646ER	Vdet-IC	4.6V±2%, Hst, -MR, -Reset PPO, Wt=1.6s, Rt=25ms	USP-6C	49xh	VD17	9b	Tor
3B647	XC6101B647ER	Vdet-IC	4.7V±2%, Hst, -MR, -Reset PPO, Wt=1.6s, Rt=25ms	USP-6C	49xh	VD17	9b	Tor
3B648	XC6101B648ER	Vdet-IC	4.8V±2%, Hst, -MR, -Reset PPO, Wt=1.6s, Rt=25ms	USP-6C	49xh	VD17	9b	Tor
3B649	XC6101B649ER	Vdet-IC	4.9V±2%, Hst, -MR, -Reset PPO, Wt=1.6s, Rt=25ms	USP-6C	49xh	VD17	9b	Tor
3B650	XC6101B650ER	Vdet-IC	5.0V±2%, Hst, -MR, -Reset PPO, Wt=1.6s, Rt=25ms	USP-6C	49xh	VD17	9b	Tor
3B7	XC6221B381GR	LVR-IC	LDO, 3.8V±1%, 200mA, +CE, CL	USP-4	45vm	VR4	9a	Tor
3B8	XC6221B391GR	LVR-IC	LDO, 3.9V±1%, 200mA, +CE, CL	USP-4	45vm	VR4	9a	Tor
3B8	XC6227A08BER	LVR-IC	LDO, 0.85V±20mV, 700mA, +CE	USP-6C	49hq	VR4	9a	Tor
3B9	XC6221B401GR	LVR-IC	LDO, 4V±1%, 200mA, +CE, CL	USP-4	45vm	VR4	9a	Tor
3B9	XC6227A09BER	LVR-IC	LDO, 1.95V±20mV, 700mA, +CE	USP-6C	49hq	VR4	9a	Tor
3BA	XC6221B411GR	LVR-IC	LDO, 4.1V±1%, 200mA, +CE, CL	USP-4	45vm	VR4	9a	Tor
3BA	XC6227A10BER	LVR-IC	LDO, 1.05V±20mV, 700mA, +CE	USP-6C	49hq	VR4	9a	Tor
3BA02	XC6404BA02D	LVR/Vdet-IC	LDO, 2.7V±2%, 500mA, Vdi=4.2V, -Reset ODO, +CE, PDR	USP-6B	49zx	VR15	9b	Tor
3BA03	XC6404BA03D	LVR/Vdet-IC	LDO, 2.5V±2%, 500mA, Vdi=2.6V, -Reset ODO, +CE, PDR	USP-6B	49zx	VR15	9b	Tor
3BA04	XC6404BA04D	LVR/Vdet-IC	LDO, 3.3V±2%, 500mA, Vdi=4.3V, -Reset ODO, +CE, PDR	USP-6B	49zx	VR15	9b	Tor
3BA05	XC6404BA05D	LVR/Vdet-IC	LDO, 3.3V±2%, 500mA, Vdi=4.4V, -Reset ODO, +CE, PDR	USP-6B	49zx	VR15	9b	Tor
3BA07	XC6404BA07D	LVR/Vdet-IC	LDO, 3.3V±2%, 500mA, Vdi=5.2V, -Reset ODO, +CE, PDR	USP-6B	49zx	VR15	9b	Tor
3BA08	XC6404BA08D	LVR/Vdet-IC	LDO, 2.8V±2%, 500mA, Vdi= 4.3V, -Reset ODO, +CE, PDR	USP-6B	49zx	VR15	9b	Tor
3BA09	XC6404BA09D	LVR/Vdet-IC	LDO, 4.3V±2%, 500mA, Vdi=2.8V, -Reset ODO, +CE, PDR	USP-6B	49zx	VR15	9b	Tor
3BA11	XC6404BA11D	LVR/Vdet-IC	LDO, 2.8V±2%, 500mA, Vdi=2.1V, -Reset ODO, +CE, PDR	USP-6B	49zx	VR15	9b	Tor
3BA12	XC6404BA12D	LVR/Vdet-IC	LDO, 2.8V±2%, 500mA, Vdi=2.8V, -Reset ODO, +CE, PDR	USP-6B	49zx	VR15	9b	Tor
3BA15	XC6404BA15D	LVR/Vdet-IC	LDO, 3.3V±2%, 500mA, Vdi=3.6V, -Reset ODO, +CE, PDR	USP-6B	49zx	VR15	9b	Tor
3BA18	XC6404BA18D	LVR/Vdet-IC	LDO, 3.0V±2%, 500mA, Vdi=2.7V, -Reset ODO, +CE, PDR	USP-6B	49zx	VR15	9b	Tor
3BA19	XC6404BA19D	LVR/Vdet-IC	LDO, 2.8V±2%, 500mA, Vdi=2.5V, -Reset ODO, +CE, PDR	USP-6B	49zx	VR15	9b	Tor
3BA20	XC6404BA20D	LVR/Vdet-IC	LDO, 1.8V±2%, 500mA, Vdi=2.9V, -Reset ODO, +CE, PDR	USP-6B	49zx	VR15	9b	Tor
3BA21	XC6404BA21D	LVR/Vdet-IC	LDO, 1.8V±2%, 500mA, Vdi=3.6V, -Reset ODO, +CE, PDR	USP-6B	49zx	VR15	9b	Tor
3BA22	XC6404BA22D	LVR/Vdet-IC	LDO, 1.8V±2%, 500mA, Vdi=4.2V, -Reset ODO, +CE, PDR	USP-6B	49zx	VR15	9b	Tor
3BA23	XC6404BA23D	LVR/Vdet-IC	LDO, 2.5V±2%, 500mA, Vdi=2.9V, -Reset ODO, +CE, PDR	USP-6B	49zx	VR15	9b	Tor
3BA24	XC6404BA24D	LVR/Vdet-IC	LDO, 2.5V±2%, 500mA, Vdi=3.6V, -Reset ODO, +CE, PDR	USP-6B	49zx	VR15	9b	Tor
3BA25	XC6404BA25D	LVR/Vdet-IC	LDO, 2.5V±2%, 500mA, Vdi=4.2V, -Reset ODO, +CE, PDR	USP-6B	49zx	VR15	9b	Tor
3BA26	XC6404BA26D	LVR/Vdet-IC	LDO, 4.3V±2%, 500mA, Vdi=4.0V, -Reset ODO, +CE, PDR	USP-6B	49zx	VR15	9b	Tor
3BA27	XC6404BA27D	LVR/Vdet-IC	LDO, 2.5V±2%, 500mA, Vdi=3.9V, -Reset ODO, +CE, PDR	USP-6B	49zx	VR15	9b	Tor
3BA28	XC6404BA28D	LVR/Vdet-IC	LDO, 3.3V±2%, 500mA, Vdi=3.7V, -Reset ODO, +CE, PDR	USP-6B	49zx	VR15	9b	Tor
3BA29	XC6404BA29D	LVR/Vdet-IC	LDO, 2.6V±2%, 500mA, Vdi=3.9V, -Reset ODO, +CE, PDR	USP-6B	49zx	VR15	9b	Tor
3BA30	XC6404BA30D	LVR/Vdet-IC	LDO, 3.3V±2%, 500mA, Vdi=4.2V, -Reset ODO, +CE, PDR	USP-6B	49zx	VR15	9b	Tor
3BA31	XC6404BA31D	LVR/Vdet-IC	LDO, 3.3V±2%, 500mA, Vdi=4.5V, -Reset ODO, +CE, PDR	USP-6B	49zx	VR15	9b	Tor
3BA32	XC6404BA32D	LVR/Vdet-IC	LDO, 2.85V±2%, 500mA, Vdi=2.6V, -Reset ODO, +CE, PDR	USP-6B	49zx	VR15	9b	Tor
3BA33	XC6404BA33D	LVR/Vdet-IC	LDO, 3.3V±2%, 500mA, Vdi=2.8V, -Reset ODO, +CE, PDR	USP-6B	49zx	VR15	9b	Tor
3BA34	XC6404BA34D	LVR/Vdet-IC	LDO, 3.4V±2%, 500mA, Vdi=4.2V, -Reset ODO, +CE, PDR	USP-6B	49zx	VR15	9b	Tor
3BA80	XC6404BA80D	LVR/Vdet-IC	LDO, 1.8V±2%, 500mA, Vdi=1.6V, -Reset ODO, +CE, PDR	USP-6B	49zx	VR15	9b	Tor
3BA81	XC6404BA81D	LVR/Vdet-IC	LDO, 2.8V±2%, 500mA, Vdi=3.1V, -Reset ODO, +CE, PDR	USP-6B	49zx	VR15	9b	Tor
3BA82	XC6404BA82D	LVR/Vdet-IC	LDO, 1.8V±2%, 500mA, Vdi=2.0V, -Reset ODO, +CE, PDR	USP-6B	49zx	VR15	9b	Tor
3BA83	XC6404BA83D	LVR/Vdet-IC	LDO, 2.5V±2%, 500mA, Vdi=2.8V, -Reset ODO, +CE, PDR	USP-6B	49zx	VR15	9b	Tor
3BA84	XC6404BA84D	LVR/Vdet-IC	LDO, 2.85V±2%, 500mA, Vdi=3.2V, -Reset ODO, +CE, PDR	USP-6B	49zx	VR15	9b	Tor
3BA85	XC6404BA85D	LVR/Vdet-IC	LDO, 3.0V±2%, 500mA, Vdi=3.3V, -Reset ODO, +CE, PDR	USP-6B	49zx	VR15	9b	Tor
3BA86	XC6404BA86D	LVR/Vdet-IC	LDO, 3.5V±2%, 500mA, Vdi=3.8V, -Reset ODO, +CE, PDR	USP-6B	49zx	VR15	9b	Tor
3BA87	XC6404BA87D	LVR/Vdet-IC	LDO, 3.0V±2%, 500mA, Vdi=4.2V, -Reset ODO, +CE, PDR	USP-6B	49zx	VR15	9b	Tor
3BA88	XC6404BA88D	LVR/Vdet-IC	LDO, 3.3V±2%, 500mA, Vdi=4.0V, -Reset ODO, +CE, PDR	USP-6B	49zx	VR15	9b	Tor
3BB	XC6221B421GR	LVR-IC	LDO, 4.2V±1%, 200mA, +CE, CL	USP-4	45vm	VR4	9a	Tor
3BB	XC6227A11BER	LVR-IC	LDO, 1.15V±20mV, 700mA, +CE	USP-6C	49hq	VR4	9a	Tor
3BB02	XC6404BB02D	LVR/Vdet-IC	LDO, 2.7V±2%, 500mA, Vdi=4.2V, +Reset ODO, +CE, PDR	USP-6B	49zx	VR15	9b	Tor
3BB03	XC6404BB03D	LVR/Vdet-IC	LDO, 2.5V±2%, 500mA, Vdi=2.6V, +Reset ODO, +CE, PDR	USP-6B	49zx	VR15	9b	Tor
3BB04	XC6404BB04D	LVR/Vdet-IC	LDO, 3.3V±2%, 500mA, Vdi=4.3V, +Reset ODO, +CE, PDR	USP-6B	49zx	VR15	9b	Tor
3BB05	XC6404BB05D	LVR/Vdet-IC	LDO, 3.3V±2%, 500mA, Vdi=4.4V, +Reset ODO, +CE, PDR	USP-6B	49zx	VR15	9b	Tor
3BB07	XC6404BB07D	LVR/Vdet-IC	LDO, 3.3V±2%, 500mA, Vdi=5.2V, +Reset ODO, +CE, PDR	USP-6B	49zx	VR15	9b	Tor
3BB08	XC6404BB08D	LVR/Vdet-IC	LDO, 2.8V±2%, 500mA, Vdi= 4.3V, +Reset ODO, +CE, PDR	USP-6B	49zx	VR15	9b	Tor



SMD code	Type	Function	Short description	Case	Pinout	Sch.	St.Mnf.
3BD02	XC6404BD02D	LVR/Vdet-IC	LDO, 2.7V±2%, 500mA, Vdo=4.2V, +Reset ODO, +CE, PDR	USP-6B	49zx	VR15	9b Tor
3BD03	XC6404BD03D	LVR/Vdet-IC	LDO, 2.5V±2%, 500mA, Vdo=2.6V, +Reset ODO, +CE, PDR	USP-6B	49zx	VR15	9b Tor
3BD04	XC6404BD04D	LVR/Vdet-IC	LDO, 3.3V±2%, 500mA, Vdo=4.3V, +Reset ODO, +CE, PDR	USP-6B	49zx	VR15	9b Tor
3BD05	XC6404BD05D	LVR/Vdet-IC	LDO, 3.3V±2%, 500mA, Vdo=4.4V, +Reset ODO, +CE, PDR	USP-6B	49zx	VR15	9b Tor
3BD07	XC6404BD07D	LVR/Vdet-IC	LDO, 3.3V±2%, 500mA, Vdo=5.2V, +Reset ODO, +CE, PDR	USP-6B	49zx	VR15	9b Tor
3BD08	XC6404BD08D	LVR/Vdet-IC	LDO, 2.8V±2%, 500mA, Vdo=2.8V, +Reset ODO, +CE, PDR	USP-6B	49zx	VR15	9b Tor
3BD09	XC6404BD09D	LVR/Vdet-IC	LDO, 4.3V±2%, 500mA, Vdo=2.8V, +Reset ODO, +CE, PDR	USP-6B	49zx	VR15	9b Tor
3BD11	XC6404BD11D	LVR/Vdet-IC	LDO, 2.8V±2%, 500mA, Vdo=2.1V, +Reset ODO, +CE, PDR	USP-6B	49zx	VR15	9b Tor
3BD12	XC6404BD12D	LVR/Vdet-IC	LDO, 2.8V±2%, 500mA, Vdo=2.8V, +Reset ODO, +CE, PDR	USP-6B	49zx	VR15	9b Tor
3BD15	XC6404BD15D	LVR/Vdet-IC	LDO, 3.3V±2%, 500mA, Vdo=3.6V, +Reset ODO, +CE, PDR	USP-6B	49zx	VR15	9b Tor
3BD18	XC6404BD18D	LVR/Vdet-IC	LDO, 3.0V±2%, 500mA, Vdo=2.7V, +Reset ODO, +CE, PDR	USP-6B	49zx	VR15	9b Tor
3BD19	XC6404BD19D	LVR/Vdet-IC	LDO, 2.8V±2%, 500mA, Vdo=2.5V, +Reset ODO, +CE, PDR	USP-6B	49zx	VR15	9b Tor
3BD20	XC6404BD20D	LVR/Vdet-IC	LDO, 1.8V±2%, 500mA, Vdo=2.9V, +Reset ODO, +CE, PDR	USP-6B	49zx	VR15	9b Tor
3BD21	XC6404BD21D	LVR/Vdet-IC	LDO, 1.8V±2%, 500mA, Vdo=3.6V, +Reset ODO, +CE, PDR	USP-6B	49zx	VR15	9b Tor
3BD22	XC6404BD22D	LVR/Vdet-IC	LDO, 1.8V±2%, 500mA, Vdo=4.2V, +Reset ODO, +CE, PDR	USP-6B	49zx	VR15	9b Tor
3BD23	XC6404BD23D	LVR/Vdet-IC	LDO, 2.5V±2%, 500mA, Vdo=2.9V, +Reset ODO, +CE, PDR	USP-6B	49zx	VR15	9b Tor
3BD24	XC6404BD24D	LVR/Vdet-IC	LDO, 2.5V±2%, 500mA, Vdo=3.6V, +Reset ODO, +CE, PDR	USP-6B	49zx	VR15	9b Tor
3BD25	XC6404BD25D	LVR/Vdet-IC	LDO, 2.5V±2%, 500mA, Vdo=4.2V, +Reset ODO, +CE, PDR	USP-6B	49zx	VR15	9b Tor
3BD26	XC6404BD26D	LVR/Vdet-IC	LDO, 4.3V±2%, 500mA, Vdo=3.0V, +Reset ODO, +CE, PDR	USP-6B	49zx	VR15	9b Tor
3BD27	XC6404BD27D	LVR/Vdet-IC	LDO, 2.5V±2%, 500mA, Vdo=3.9V, +Reset ODO, +CE, PDR	USP-6B	49zx	VR15	9b Tor
3BD28	XC6404BD28D	LVR/Vdet-IC	LDO, 3.3V±2%, 500mA, Vdo=3.7V, +Reset ODO, +CE, PDR	USP-6B	49zx	VR15	9b Tor
3BD29	XC6404BD29D	LVR/Vdet-IC	LDO, 2.6V±2%, 500mA, Vdo=3.9V, +Reset ODO, +CE, PDR	USP-6B	49zx	VR15	9b Tor
3BD30	XC6404BD30D	LVR/Vdet-IC	LDO, 3.3V±2%, 500mA, Vdo=4.2V, +Reset ODO, +CE, PDR	USP-6B	49zx	VR15	9b Tor
3BD31	XC6404BD31D	LVR/Vdet-IC	LDO, 3.3V±2%, 500mA, Vdo=4.5V, +Reset ODO, +CE, PDR	USP-6B	49zx	VR15	9b Tor
3BD32	XC6404BD32D	LVR/Vdet-IC	LDO, 2.85V±2%, 500mA, Vdo=2.6V, +Reset ODO, +CE, PDR	USP-6B	49zx	VR15	9b Tor
3BD33	XC6404BD33D	LVR/Vdet-IC	LDO, 3.3V±2%, 500mA, Vdo=2.8V, +Reset ODO, +CE, PDR	USP-6B	49zx	VR15	9b Tor
3BD34	XC6404BD34D	LVR/Vdet-IC	LDO, 3.4V±2%, 500mA, Vdo=4.2V, +Reset ODO, +CE, PDR	USP-6B	49zx	VR15	9b Tor
3BD80	XC6404BD80D	LVR/Vdet-IC	LDO, 1.8V±2%, 500mA, Vdo=1.6V, +Reset ODO, +CE, PDR	USP-6B	49zx	VR15	9b Tor
3BD81	XC6404BD81D	LVR/Vdet-IC	LDO, 2.8V±2%, 500mA, Vdo=3.1V, +Reset ODO, +CE, PDR	USP-6B	49zx	VR15	9b Tor
3BD82	XC6404BD82D	LVR/Vdet-IC	LDO, 1.8V±2%, 500mA, Vdo=2.0V, +Reset ODO, +CE, PDR	USP-6B	49zx	VR15	9b Tor
3BD83	XC6404BD83D	LVR/Vdet-IC	LDO, 2.5V±2%, 500mA, Vdo=2.8V, +Reset ODO, +CE, PDR	USP-6B	49zx	VR15	9b Tor
3BD84	XC6404BD84D	LVR/Vdet-IC	LDO, 2.85V±2%, 500mA, Vdo=3.2V, +Reset ODO, +CE, PDR	USP-6B	49zx	VR15	9b Tor
3BD85	XC6404BD85D	LVR/Vdet-IC	LDO, 3.0V±2%, 500mA, Vdo=3.3V, +Reset ODO, +CE, PDR	USP-6B	49zx	VR15	9b Tor
3BD86	XC6404BD86D	LVR/Vdet-IC	LDO, 3.5V±2%, 500mA, Vdo=3.8V, +Reset ODO, +CE, PDR	USP-6B	49zx	VR15	9b Tor
3BD87	XC6404BD87D	LVR/Vdet-IC	LDO, 3.0V±2%, 500mA, Vdo=4.2V, +Reset ODO, +CE, PDR	USP-6B	49zx	VR15	9b Tor
3BD88	XC6404BD88D	LVR/Vdet-IC	LDO, 3.3V±2%, 500mA, Vdo=4.0V, +Reset ODO, +CE, PDR	USP-6B	49zx	VR15	9b Tor
3BE	XC6221B451GR	LVR-IC	LDO, 4.5V±1%, 200mA, +CE, CL	USP-4	45vm	VR4	9a Tor
3BE	XC6227A14BER	LVR-IC	LDO, 1.45V±20mV, 700mA, +CE	USP-6C	49hq	VR4	9a Tor
3BE02	XC6404BE02D	LVR/Vdet-IC	LDO, 2.7V±2%, 500mA, Vdi=4.2V, -Reset ODO, +CE	USP-6B	49zx	VR15	9b Tor
3BE03	XC6404BE03D	LVR/Vdet-IC	LDO, 2.5V±2%, 500mA, Vdi=2.6V, -Reset ODO, +CE	USP-6B	49zx	VR15	9b Tor
3BE04	XC6404BE04D	LVR/Vdet-IC	LDO, 3.3V±2%, 500mA, Vdi=4.3V, -Reset ODO, +CE	USP-6B	49zx	VR15	9b Tor
3BE05	XC6404BE05D	LVR/Vdet-IC	LDO, 3.3V±2%, 500mA, Vdi=4.4V, -Reset ODO, +CE	USP-6B	49zx	VR15	9b Tor
3BE07	XC6404BE07D	LVR/Vdet-IC	LDO, 3.3V±2%, 500mA, Vdi=5.2V, -Reset ODO, +CE	USP-6B	49zx	VR15	9b Tor
3BE08	XC6404BE08D	LVR/Vdet-IC	LDO, 2.8V±2%, 500mA, Vdi=4.3V, -Reset ODO, +CE	USP-6B	49zx	VR15	9b Tor
3BE09	XC6404BE09D	LVR/Vdet-IC	LDO, 4.3V±2%, 500mA, Vdi=2.8V, -Reset ODO, +CE	USP-6B	49zx	VR15	9b Tor
3BE11	XC6404BE11D	LVR/Vdet-IC	LDO, 2.8V±2%, 500mA, Vdi=2.1V, -Reset ODO, +CE	USP-6B	49zx	VR15	9b Tor
3BE12	XC6404BE12D	LVR/Vdet-IC	LDO, 2.8V±2%, 500mA, Vdi=2.8V, -Reset ODO, +CE	USP-6B	49zx	VR15	9b Tor
3BE15	XC6404BE15D	LVR/Vdet-IC	LDO, 3.3V±2%, 500mA, Vdi=3.6V, -Reset ODO, +CE	USP-6B	49zx	VR15	9b Tor
3BE18	XC6404BE18D	LVR/Vdet-IC	LDO, 3.0V±2%, 500mA, Vdi=2.7V, -Reset ODO, +CE	USP-6B	49zx	VR15	9b Tor
3BE19	XC6404BE19D	LVR/Vdet-IC	LDO, 2.8V±2%, 500mA, Vdi=2.5V, -Reset ODO, +CE	USP-6B	49zx	VR15	9b Tor
3BE20	XC6404BE20D	LVR/Vdet-IC	LDO, 1.8V±2%, 500mA, Vdi=2.9V, -Reset ODO, +CE	USP-6B	49zx	VR15	9b Tor
3BE21	XC6404BE21D	LVR/Vdet-IC	LDO, 1.8V±2%, 500mA, Vdi=3.6V, -Reset ODO, +CE	USP-6B	49zx	VR15	9b Tor
3BE22	XC6404BE22D	LVR/Vdet-IC	LDO, 1.8V±2%, 500mA, Vdi=4.2V, -Reset ODO, +CE	USP-6B	49zx	VR15	9b Tor
3BE23	XC6404BE23D	LVR/Vdet-IC	LDO, 2.5V±2%, 500mA, Vdi=2.9V, -Reset ODO, +CE	USP-6B	49zx	VR15	9b Tor
3BE24	XC6404BE24D	LVR/Vdet-IC	LDO, 2.5V±2%, 500mA, Vdi=3.6V, -Reset ODO, +CE	USP-6B	49zx	VR15	9b Tor
3BE25	XC6404BE25D	LVR/Vdet-IC	LDO, 2.5V±2%, 500mA, Vdi=4.2V, -Reset ODO, +CE	USP-6B	49zx	VR15	9b Tor
3BE26	XC6404BE26D	LVR/Vdet-IC	LDO, 4.3V±2%, 500mA, Vdi=4.0V, -Reset ODO, +CE	USP-6B	49zx	VR15	9b Tor
3BE27	XC6404BE27D	LVR/Vdet-IC	LDO, 2.5V±2%, 500mA, Vdi=3.9V, -Reset ODO, +CE	USP-6B	49zx	VR15	9b Tor
3BE28	XC6404BE28D	LVR/Vdet-IC	LDO, 3.3V±2%, 500mA, Vdi=3.7V, -Reset ODO, +CE	USP-6B	49zx	VR15	9b Tor
3BE29	XC6404BE29D	LVR/Vdet-IC	LDO, 2.6V±2%, 500mA, Vdi=3.9V, -Reset ODO, +CE	USP-6B	49zx	VR15	9b Tor
3BE30	XC6404BE30D	LVR/Vdet-IC	LDO, 3.3V±2%, 500mA, Vdi=4.2V, -Reset ODO, +CE	USP-6B	49zx	VR15	9b Tor
3BE31	XC6404BE31D	LVR/Vdet-IC	LDO, 3.3V±2%, 500mA, Vdi=4.5V, -Reset ODO, +CE	USP-6B	49zx	VR15	9b Tor
3BE32	XC6404BE32D	LVR/Vdet-IC	LDO, 2.85V±2%, 500mA, Vdi=2.6V, -Reset ODO, +CE	USP-6B	49zx	VR15	9b Tor
3BE33	XC6404BE33D	LVR/Vdet-IC	LDO, 3.3V±2%, 500mA, Vdi=2.9V, -Reset ODO, +CE	USP-6B	49zx	VR15	9b Tor
3BE34	XC6404BE34D	LVR/Vdet-IC	LDO, 3.4V±2%, 500mA, Vdi=4.2V, -Reset ODO, +CE	USP-6B	49zx	VR15	9b Tor
3BE80	XC6404BE80D	LVR/Vdet-IC	LDO, 1.8V±2%, 500mA, Vdi=1.6V, -Reset ODO, +CE	USP-6B	49zx	VR15	9b Tor
3BE81	XC6404BE81D	LVR/Vdet-IC	LDO, 2.8V±2%, 500mA, Vdi=3.1V, -Reset ODO, +CE	USP-6B	49zx	VR15	9b Tor
3BE82	XC6404BE82D	LVR/Vdet-IC	LDO, 1.8V±2%, 500mA, Vdi=2.0V, -Reset ODO, +CE	USP-6B	49zx	VR15	9b Tor
3BE83	XC6404BE83D	LVR/Vdet-IC	LDO, 2.5V±2%, 500mA, Vdi=2.8V, -Reset ODO, +CE	USP-6B	49zx	VR15	9b Tor
3BE84	XC6404BE84D	LVR/Vdet-IC	LDO, 2.85V±2%, 500mA, Vdi=3.2V, -Reset ODO, +CE	USP-6B	49zx	VR15	9b Tor



SMD code	Type	Function	Short description	Case	Pinout	Sch.	St.Mnf.
3BE85	XC6404BE85D	LVR/Vdet-IC	LDO, 3.0V±2%, 500mA, Vdi=3.3V, -Reset ODO, +CE	USP-6B	49zx	VR15	9b Tor
3BE86	XC6404BE86D	LVR/Vdet-IC	LDO, 3.5V±2%, 500mA, Vdi=3.8V, -Reset ODO, +CE	USP-6B	49zx	VR15	9b Tor
3BE87	XC6404BE87D	LVR/Vdet-IC	LDO, 3.0V±2%, 500mA, Vdi=4.2V, -Reset ODO, +CE	USP-6B	49zx	VR15	9b Tor
3BE88	XC6404BE88D	LVR/Vdet-IC	LDO, 3.3V±2%, 500mA, Vdi=4.0V, -Reset ODO, +CE	USP-6B	49zx	VR15	9b Tor
3BF	XC6221B461GR	LVR-IC	LDO, 4.6V±1%, 200mA, +CE, CL	USP-4	45vm	VR4	9a Tor
3BF	XC6227A15BER	LVR-IC	LDO, 1.55V±20mV, 700mA, +CE	USP-6C	49hq	VR4	9a Tor
3BF02	XC6404BF02D	LVR/Vdet-IC	LDO, 2.7V±2%, 500mA, Vdi=4.2V, +Reset ODO, +CE	USP-6B	49zx	VR15	9b Tor
3BF03	XC6404BF03D	LVR/Vdet-IC	LDO, 2.5V±2%, 500mA, Vdi=2.6V, +Reset ODO, +CE	USP-6B	49zx	VR15	9b Tor
3BF04	XC6404BF04D	LVR/Vdet-IC	LDO, 3.3V±2%, 500mA, Vdi=4.3V, +Reset ODO, +CE	USP-6B	49zx	VR15	9b Tor
3BF05	XC6404BF05D	LVR/Vdet-IC	LDO, 3.3V±2%, 500mA, Vdi=4.4V, +Reset ODO, +CE	USP-6B	49zx	VR15	9b Tor
3BF07	XC6404BF07D	LVR/Vdet-IC	LDO, 3.3V±2%, 500mA, Vdi=5.2V, +Reset ODO, +CE	USP-6B	49zx	VR15	9b Tor
3BF08	XC6404BF08D	LVR/Vdet-IC	LDO, 2.8V±2%, 500mA, Vdi=4.3V, +Reset ODO, +CE	USP-6B	49zx	VR15	9b Tor
3BF09	XC6404BF09D	LVR/Vdet-IC	LDO, 4.3V±2%, 500mA, Vdi=2.8V, +Reset ODO, +CE	USP-6B	49zx	VR15	9b Tor
3BF11	XC6404BF11D	LVR/Vdet-IC	LDO, 2.8V±2%, 500mA, Vdi=2.1V, +Reset ODO, +CE	USP-6B	49zx	VR15	9b Tor
3BF12	XC6404BF12D	LVR/Vdet-IC	LDO, 2.8V±2%, 500mA, Vdi=2.9V, +Reset ODO, +CE	USP-6B	49zx	VR15	9b Tor
3BF15	XC6404BF15D	LVR/Vdet-IC	LDO, 3.3V±2%, 500mA, Vdi=3.6V, +Reset ODO, +CE	USP-6B	49zx	VR15	9b Tor
3BF18	XC6404BF18D	LVR/Vdet-IC	LDO, 3.0V±2%, 500mA, Vdi=2.7V, +Reset ODO, +CE	USP-6B	49zx	VR15	9b Tor
3BF19	XC6404BF19D	LVR/Vdet-IC	LDO, 2.8V±2%, 500mA, Vdi=2.5V, +Reset ODO, +CE	USP-6B	49zx	VR15	9b Tor
3BF20	XC6404BF20D	LVR/Vdet-IC	LDO, 1.8V±2%, 500mA, Vdi=2.9V, +Reset ODO, +CE	USP-6B	49zx	VR15	9b Tor
3BF21	XC6404BF21D	LVR/Vdet-IC	LDO, 1.8V±2%, 500mA, Vdi=3.6V, +Reset ODO, +CE	USP-6B	49zx	VR15	9b Tor
3BF22	XC6404BF22D	LVR/Vdet-IC	LDO, 1.8V±2%, 500mA, Vdi=4.2V, +Reset ODO, +CE	USP-6B	49zx	VR15	9b Tor
3BF23	XC6404BF23D	LVR/Vdet-IC	LDO, 2.5V±2%, 500mA, Vdi=2.9V, +Reset ODO, +CE	USP-6B	49zx	VR15	9b Tor
3BF24	XC6404BF24D	LVR/Vdet-IC	LDO, 2.5V±2%, 500mA, Vdi=3.6V, +Reset ODO, +CE	USP-6B	49zx	VR15	9b Tor
3BF25	XC6404BF25D	LVR/Vdet-IC	LDO, 2.5V±2%, 500mA, Vdi=4.2V, +Reset ODO, +CE	USP-6B	49zx	VR15	9b Tor
3BF26	XC6404BF26D	LVR/Vdet-IC	LDO, 4.3V±2%, 500mA, Vdi=4.0V, +Reset ODO, +CE	USP-6B	49zx	VR15	9b Tor
3BF27	XC6404BF27D	LVR/Vdet-IC	LDO, 2.5V±2%, 500mA, Vdi=3.9V, +Reset ODO, +CE	USP-6B	49zx	VR15	9b Tor
3BF28	XC6404BF28D	LVR/Vdet-IC	LDO, 3.3V±2%, 500mA, Vdi=3.7V, +Reset ODO, +CE	USP-6B	49zx	VR15	9b Tor
3BF29	XC6404BF29D	LVR/Vdet-IC	LDO, 2.6V±2%, 500mA, Vdi=3.9V, +Reset ODO, +CE	USP-6B	49zx	VR15	9b Tor
3BF30	XC6404BF30D	LVR/Vdet-IC	LDO, 3.3V±2%, 500mA, Vdi=4.2V, +Reset ODO, +CE	USP-6B	49zx	VR15	9b Tor
3BF31	XC6404BF31D	LVR/Vdet-IC	LDO, 3.3V±2%, 500mA, Vdi=4.5V, +Reset ODO, +CE	USP-6B	49zx	VR15	9b Tor
3BF32	XC6404BF32D	LVR/Vdet-IC	LDO, 2.85V±2%, 500mA, Vdi=2.6V, +Reset ODO, +CE	USP-6B	49zx	VR15	9b Tor
3BF33	XC6404BF33D	LVR/Vdet-IC	LDO, 3.3V±2%, 500mA, Vdi=3.1V, +Reset ODO, +CE	USP-6B	49zx	VR15	9b Tor
3BF34	XC6404BF34D	LVR/Vdet-IC	LDO, 3.4V±2%, 500mA, Vdi=4.2V, +Reset ODO, +CE	USP-6B	49zx	VR15	9b Tor
3BF80	XC6404BF80D	LVR/Vdet-IC	LDO, 1.8V±2%, 500mA, Vdi=1.6V, +Reset ODO, +CE	USP-6B	49zx	VR15	9b Tor
3BF81	XC6404BF81D	LVR/Vdet-IC	LDO, 2.8V±2%, 500mA, Vdi=3.1V, +Reset ODO, +CE	USP-6B	49zx	VR15	9b Tor
3BF82	XC6404BF82D	LVR/Vdet-IC	LDO, 1.8V±2%, 500mA, Vdi=2.0V, +Reset ODO, +CE	USP-6B	49zx	VR15	9b Tor
3BF83	XC6404BF83D	LVR/Vdet-IC	LDO, 2.5V±2%, 500mA, Vdi=2.8V, +Reset ODO, +CE	USP-6B	49zx	VR15	9b Tor
3BF84	XC6404BF84D	LVR/Vdet-IC	LDO, 2.85V±2%, 500mA, Vdi=3.0V, +Reset ODO, +CE	USP-6B	49zx	VR15	9b Tor
3BF85	XC6404BF85D	LVR/Vdet-IC	LDO, 3.0V±2%, 500mA, Vdi=3.3V, +Reset ODO, +CE	USP-6B	49zx	VR15	9b Tor
3BF86	XC6404BF86D	LVR/Vdet-IC	LDO, 3.5V±2%, 500mA, Vdi=3.8V, +Reset ODO, +CE	USP-6B	49zx	VR15	9b Tor
3BF87	XC6404BF87D	LVR/Vdet-IC	LDO, 3.0V±2%, 500mA, Vdi=4.2V, +Reset ODO, +CE	USP-6B	49zx	VR15	9b Tor
3BF88	XC6404BF88D	LVR/Vdet-IC	LDO, 3.3V±2%, 500mA, Vdi=4.0V, +Reset ODO, +CE	USP-6B	49zx	VR15	9b Tor
3BH	XC6221B471GR	LVR-IC	LDO, 4.7V±1%, 200mA, +CE, CL	USP-4	45vm	VR4	9a Tor
3BH	XC6227A16BER	LVR-IC	LDO, 1.65V±20mV, 700mA, +CE	USP-6C	49hq	VR4	9a Tor
3BH02	XC6404BH02D	LVR/Vdet-IC	LDO, 2.7V±2%, 500mA, Vdo=4.2V, -Reset ODO, +CE	USP-6B	49zx	VR15	9b Tor
3BH03	XC6404BH03D	LVR/Vdet-IC	LDO, 2.5V±2%, 500mA, Vdo=2.6V, -Reset ODO, +CE	USP-6B	49zx	VR15	9b Tor
3BH04	XC6404BH04D	LVR/Vdet-IC	LDO, 3.3V±2%, 500mA, Vdo=4.3V, -Reset ODO, +CE	USP-6B	49zx	VR15	9b Tor
3BH05	XC6404BH05D	LVR/Vdet-IC	LDO, 3.3V±2%, 500mA, Vdo=4.4V, -Reset ODO, +CE	USP-6B	49zx	VR15	9b Tor
3BH07	XC6404BH07D	LVR/Vdet-IC	LDO, 3.3V±2%, 500mA, Vdo=5.2V, -Reset ODO, +CE	USP-6B	49zx	VR15	9b Tor
3BH08	XC6404BH08D	LVR/Vdet-IC	LDO, 2.8V±2%, 500mA, Vdo=4.3V, -Reset ODO, +CE	USP-6B	49zx	VR15	9b Tor
3BH09	XC6404BH09D	LVR/Vdet-IC	LDO, 4.3V±2%, 500mA, Vdo=3.2V, -Reset ODO, +CE	USP-6B	49zx	VR15	9b Tor
3BH11	XC6404BH11D	LVR/Vdet-IC	LDO, 2.8V±2%, 500mA, Vdo=2.1V, -Reset ODO, +CE	USP-6B	49zx	VR15	9b Tor
3BH12	XC6404BH12D	LVR/Vdet-IC	LDO, 2.8V±2%, 500mA, Vdo=2.8V, -Reset ODO, +CE	USP-6B	49zx	VR15	9b Tor
3BH15	XC6404BH15D	LVR/Vdet-IC	LDO, 3.3V±2%, 500mA, Vdo=3.6V, -Reset ODO, +CE	USP-6B	49zx	VR15	9b Tor
3BH18	XC6404BH18D	LVR/Vdet-IC	LDO, 3.0V±2%, 500mA, Vdo=2.7V, -Reset ODO, +CE	USP-6B	49zx	VR15	9b Tor
3BH19	XC6404BH19D	LVR/Vdet-IC	LDO, 2.8V±2%, 500mA, Vdo=2.5V, -Reset ODO, +CE	USP-6B	49zx	VR15	9b Tor
3BH20	XC6404BH20D	LVR/Vdet-IC	LDO, 1.8V±2%, 500mA, Vdo=2.9V, -Reset ODO, +CE	USP-6B	49zx	VR15	9b Tor
3BH21	XC6404BH21D	LVR/Vdet-IC	LDO, 1.8V±2%, 500mA, Vdo=3.6V, -Reset ODO, +CE	USP-6B	49zx	VR15	9b Tor
3BH22	XC6404BH22D	LVR/Vdet-IC	LDO, 1.8V±2%, 500mA, Vdo=4.2V, -Reset ODO, +CE	USP-6B	49zx	VR15	9b Tor
3BH23	XC6404BH23D	LVR/Vdet-IC	LDO, 2.5V±2%, 500mA, Vdo=2.9V, -Reset ODO, +CE	USP-6B	49zx	VR15	9b Tor
3BH24	XC6404BH24D	LVR/Vdet-IC	LDO, 2.5V±2%, 500mA, Vdo=3.6V, -Reset ODO, +CE	USP-6B	49zx	VR15	9b Tor
3BH25	XC6404BH25D	LVR/Vdet-IC	LDO, 2.5V±2%, 500mA, Vdo=4.2V, -Reset ODO, +CE	USP-6B	49zx	VR15	9b Tor
3BH26	XC6404BH26D	LVR/Vdet-IC	LDO, 4.3V±2%, 500mA, Vdo=4.0V, -Reset ODO, +CE	USP-6B	49zx	VR15	9b Tor
3BH27	XC6404BH27D	LVR/Vdet-IC	LDO, 2.5V±2%, 500mA, Vdo=3.9V, -Reset ODO, +CE	USP-6B	49zx	VR15	9b Tor
3BH28	XC6404BH28D	LVR/Vdet-IC	LDO, 3.3V±2%, 500mA, Vdo=3.7V, -Reset ODO, +CE	USP-6B	49zx	VR15	9b Tor
3BH29	XC6404BH29D	LVR/Vdet-IC	LDO, 2.6V±2%, 500mA, Vdo=3.9V, -Reset ODO, +CE	USP-6B	49zx	VR15	9b Tor
3BH30	XC6404BH30D	LVR/Vdet-IC	LDO, 3.3V±2%, 500mA, Vdo=4.2V, -Reset ODO, +CE	USP-6B	49zx	VR15	9b Tor
3BH31	XC6404BH31D	LVR/Vdet-IC	LDO, 3.3V±2%, 500mA, Vdo=4.5V, -Reset ODO, +CE	USP-6B	49zx	VR15	9b Tor
3BH32	XC6404BH32D	LVR/Vdet-IC	LDO, 2.85V±2%, 500mA, Vdo=2.6V, -Reset ODO, +CE	USP-6B	49zx	VR15	9b Tor
3BH33	XC6404BH33D	LVR/Vdet-IC	LDO, 3.3V±2%, 500mA, Vdo=2.8V, -Reset ODO, +CE	USP-6B	49zx	VR15	9b Tor



SMD code	Type	Function	Short description	Case	Pinout	Sch.	St.	Mnf.
3BH34	XC6404BH34D	LVR/Vdet-IC	LDO, 3.4V±2%, 500mA, Vdo=4.2V, -Reset ODO, +CE	USP-6B	49zx	VR15	9b	Tor
3BH80	XC6404BH80D	LVR/Vdet-IC	LDO, 1.8V±2%, 500mA, Vdo=1.6V, -Reset ODO, +CE	USP-6B	49zx	VR15	9b	Tor
3BH81	XC6404BH81D	LVR/Vdet-IC	LDO, 2.8V±2%, 500mA, Vdo=3.1V, -Reset ODO, +CE	USP-6B	49zx	VR15	9b	Tor
3BH82	XC6404BH82D	LVR/Vdet-IC	LDO, 1.8V±2%, 500mA, Vdo=2.0V, -Reset ODO, +CE	USP-6B	49zx	VR15	9b	Tor
3BH83	XC6404BH83D	LVR/Vdet-IC	LDO, 2.5V±2%, 500mA, Vdo=2.8V, -Reset ODO, +CE	USP-6B	49zx	VR15	9b	Tor
3BH84	XC6404BH84D	LVR/Vdet-IC	LDO, 2.85V±2%, 500mA, Vdo=3.2V, -Reset ODO, +CE	USP-6B	49zx	VR15	9b	Tor
3BH85	XC6404BH85D	LVR/Vdet-IC	LDO, 3.0V±2%, 500mA, Vdo=3.3V, -Reset ODO, +CE	USP-6B	49zx	VR15	9b	Tor
3BH86	XC6404BH86D	LVR/Vdet-IC	LDO, 3.5V±2%, 500mA, Vdo=3.8V, -Reset ODO, +CE	USP-6B	49zx	VR15	9b	Tor
3BH87	XC6404BH87D	LVR/Vdet-IC	LDO, 3.0V±2%, 500mA, Vdo=4.2V, -Reset ODO, +CE	USP-6B	49zx	VR15	9b	Tor
3BH88	XC6404BH88D	LVR/Vdet-IC	LDO, 3.3V±2%, 500mA, Vdo=4.0V, -Reset ODO, +CE	USP-6B	49zx	VR15	9b	Tor
3BK	XC6221B481GR	LVR-IC	LDO, 4.8V±1%, 200mA, +CE, CL	USP-4	45vm	VR4	9a	Tor
3BK	XC6227A17BER	LVR-IC	LDO, 1.75V±20mV, 700mA, +CE	USP-6C	49hq	VR4	9a	Tor
3BK02	XC6404BK02D	LVR/Vdet-IC	LDO, 2.7V±2%, 500mA, Vdo=4.2V, +Reset ODO, +CE	USP-6B	49zx	VR15	9b	Tor
3BK03	XC6404BK03D	LVR/Vdet-IC	LDO, 2.5V±2%, 500mA, Vdo=2.6V, +Reset ODO, +CE	USP-6B	49zx	VR15	9b	Tor
3BK04	XC6404BK04D	LVR/Vdet-IC	LDO, 3.3V±2%, 500mA, Vdo=4.3V, +Reset ODO, +CE	USP-6B	49zx	VR15	9b	Tor
3BK05	XC6404BK05D	LVR/Vdet-IC	LDO, 3.3V±2%, 500mA, Vdo=4.4V, +Reset ODO, +CE	USP-6B	49zx	VR15	9b	Tor
3BK07	XC6404BK07D	LVR/Vdet-IC	LDO, 3.3V±2%, 500mA, Vdo=5.2V, +Reset ODO, +CE	USP-6B	49zx	VR15	9b	Tor
3BK08	XC6404BK08D	LVR/Vdet-IC	LDO, 2.8V±2%, 500mA, Vdo= 4.3V, +Reset ODO, +CE	USP-6B	49zx	VR15	9b	Tor
3BK09	XC6404BK09D	LVR/Vdet-IC	LDO, 4.3V±2%, 500mA, Vdo=3.2V, +Reset ODO, +CE	USP-6B	49zx	VR15	9b	Tor
3BK11	XC6404BK11D	LVR/Vdet-IC	LDO, 2.8V±2%, 500mA, Vdo=2.1V, +Reset ODO, +CE	USP-6B	49zx	VR15	9b	Tor
3BK12	XC6404BK12D	LVR/Vdet-IC	LDO, 2.8V±2%, 500mA, Vdo=2.8V, +Reset ODO, +CE	USP-6B	49zx	VR15	9b	Tor
3BK15	XC6404BK15D	LVR/Vdet-IC	LDO, 3.3V±2%, 500mA, Vdo=3.6V, +Reset ODO, +CE	USP-6B	49zx	VR15	9b	Tor
3BK18	XC6404BK18D	LVR/Vdet-IC	LDO, 3.0V±2%, 500mA, Vdo=2.7V, +Reset ODO, +CE	USP-6B	49zx	VR15	9b	Tor
3BK19	XC6404BK19D	LVR/Vdet-IC	LDO, 2.8V±2%, 500mA, Vdo=2.5V, +Reset ODO, +CE	USP-6B	49zx	VR15	9b	Tor
3BK20	XC6404BK20D	LVR/Vdet-IC	LDO, 1.8V±2%, 500mA, Vdo=2.9V, +Reset ODO, +CE	USP-6B	49zx	VR15	9b	Tor
3BK21	XC6404BK21D	LVR/Vdet-IC	LDO, 1.8V±2%, 500mA, Vdo=3.6V, +Reset ODO, +CE	USP-6B	49zx	VR15	9b	Tor
3BK22	XC6404BK22D	LVR/Vdet-IC	LDO, 1.8V±2%, 500mA, Vdo=4.2V, +Reset ODO, +CE	USP-6B	49zx	VR15	9b	Tor
3BK23	XC6404BK23D	LVR/Vdet-IC	LDO, 2.5V±2%, 500mA, Vdo=2.9V, +Reset ODO, +CE	USP-6B	49zx	VR15	9b	Tor
3BK24	XC6404BK24D	LVR/Vdet-IC	LDO, 2.5V±2%, 500mA, Vdo=3.6V, +Reset ODO, +CE	USP-6B	49zx	VR15	9b	Tor
3BK25	XC6404BK25D	LVR/Vdet-IC	LDO, 2.5V±2%, 500mA, Vdo=4.2V, +Reset ODO, +CE	USP-6B	49zx	VR15	9b	Tor
3BK26	XC6404BK26D	LVR/Vdet-IC	LDO, 4.3V±2%, 500mA, Vdo=4.0V, +Reset ODO, +CE	USP-6B	49zx	VR15	9b	Tor
3BK27	XC6404BK27D	LVR/Vdet-IC	LDO, 2.5V±2%, 500mA, Vdo=3.9V, +Reset ODO, +CE	USP-6B	49zx	VR15	9b	Tor
3BK28	XC6404BK28D	LVR/Vdet-IC	LDO, 3.3V±2%, 500mA, Vdo=3.7V, +Reset ODO, +CE	USP-6B	49zx	VR15	9b	Tor
3BK29	XC6404BK29D	LVR/Vdet-IC	LDO, 2.6V±2%, 500mA, Vdo=3.9V, +Reset ODO, +CE	USP-6B	49zx	VR15	9b	Tor
3BK30	XC6404BK30D	LVR/Vdet-IC	LDO, 3.3V±2%, 500mA, Vdo=4.2V, +Reset ODO, +CE	USP-6B	49zx	VR15	9b	Tor
3BK31	XC6404BK31D	LVR/Vdet-IC	LDO, 3.3V±2%, 500mA, Vdo=4.5V, +Reset ODO, +CE	USP-6B	49zx	VR15	9b	Tor
3BK32	XC6404BK32D	LVR/Vdet-IC	LDO, 2.85V±2%, 500mA, Vdo=2.6V, +Reset ODO, +CE	USP-6B	49zx	VR15	9b	Tor
3BK33	XC6404BK33D	LVR/Vdet-IC	LDO, 3.3V±2%, 500mA, Vdo=2.9V, +Reset ODO, +CE	USP-6B	49zx	VR15	9b	Tor
3BK34	XC6404BK34D	LVR/Vdet-IC	LDO, 3.4V±2%, 500mA, Vdo=4.2V, +Reset ODO, +CE	USP-6B	49zx	VR15	9b	Tor
3BK80	XC6404BK80D	LVR/Vdet-IC	LDO, 1.8V±2%, 500mA, Vdo=1.6V, +Reset ODO, +CE	USP-6B	49zx	VR15	9b	Tor
3BK81	XC6404BK81D	LVR/Vdet-IC	LDO, 2.8V±2%, 500mA, Vdo=3.1V, +Reset ODO, +CE	USP-6B	49zx	VR15	9b	Tor
3BK82	XC6404BK82D	LVR/Vdet-IC	LDO, 1.8V±2%, 500mA, Vdo=2.0V, +Reset ODO, +CE	USP-6B	49zx	VR15	9b	Tor
3BK83	XC6404BK83D	LVR/Vdet-IC	LDO, 2.5V±2%, 500mA, Vdo=2.8V, +Reset ODO, +CE	USP-6B	49zx	VR15	9b	Tor
3BK84	XC6404BK84D	LVR/Vdet-IC	LDO, 2.85V±2%, 500mA, Vdo=3.2V, +Reset ODO, +CE	USP-6B	49zx	VR15	9b	Tor
3BK85	XC6404BK85D	LVR/Vdet-IC	LDO, 3.0V±2%, 500mA, Vdo=3.3V, +Reset ODO, +CE	USP-6B	49zx	VR15	9b	Tor
3BK86	XC6404BK86D	LVR/Vdet-IC	LDO, 3.5V±2%, 500mA, Vdo=3.8V, +Reset ODO, +CE	USP-6B	49zx	VR15	9b	Tor
3BK87	XC6404BK87D	LVR/Vdet-IC	LDO, 3.0V±2%, 500mA, Vdo=4.2V, +Reset ODO, +CE	USP-6B	49zx	VR15	9b	Tor
3BK88	XC6404BK88D	LVR/Vdet-IC	LDO, 3.3V±2%, 500mA, Vdo=4.0V, +Reset ODO, +CE	USP-6B	49zx	VR15	9b	Tor
3BL	XC6221B491GR	LVR-IC	LDO, 4.9V±1%, 200mA, +CE, CL	USP-4	45vm	VR4	9a	Tor
3BL	XC6227A18BER	LVR-IC	LDO, 1.85V±20mV, 700mA, +CE	USP-6C	49hq	VR4	9a	Tor
3BL02	XC6404BL02D	LVR/Vdet-IC	LDO, 2.7V±2%, 500mA, Vdi=4.2V, -Reset ODO, -CE, PUR	USP-6B	49zx	VR15	9b	Tor
3BL03	XC6404BL03D	LVR/Vdet-IC	LDO, 2.5V±2%, 500mA, Vdi=2.6V, -Reset ODO, -CE, PUR	USP-6B	49zx	VR15	9b	Tor
3BL04	XC6404BL04D	LVR/Vdet-IC	LDO, 3.3V±2%, 500mA, Vdi=4.3V, -Reset ODO, -CE, PUR	USP-6B	49zx	VR15	9b	Tor
3BL05	XC6404BL05D	LVR/Vdet-IC	LDO, 3.3V±2%, 500mA, Vdi=4.4V, -Reset ODO, -CE, PUR	USP-6B	49zx	VR15	9b	Tor
3BL07	XC6404BL07D	LVR/Vdet-IC	LDO, 3.3V±2%, 500mA, Vdi=5.2V, -Reset ODO, -CE, PUR	USP-6B	49zx	VR15	9b	Tor
3BL08	XC6404BL08D	LVR/Vdet-IC	LDO, 2.8V±2%, 500mA, Vdi= 4.3V, -Reset ODO, -CE, PUR	USP-6B	49zx	VR15	9b	Tor
3BL09	XC6404BL09D	LVR/Vdet-IC	LDO, 4.3V±2%, 500mA, Vdi=2.8V, -Reset ODO, -CE, PUR	USP-6B	49zx	VR15	9b	Tor
3BL11	XC6404BL11D	LVR/Vdet-IC	LDO, 2.8V±2%, 500mA, Vdi=2.1V, -Reset ODO, -CE, PUR	USP-6B	49zx	VR15	9b	Tor
3BL12	XC6404BL12D	LVR/Vdet-IC	LDO, 2.8V±2%, 500mA, Vdi=2.8V, -Reset ODO, -CE, PUR	USP-6B	49zx	VR15	9b	Tor
3BL15	XC6404BL15D	LVR/Vdet-IC	LDO, 3.3V±2%, 500mA, Vdi=3.6V, -Reset ODO, -CE, PUR	USP-6B	49zx	VR15	9b	Tor
3BL18	XC6404BL18D	LVR/Vdet-IC	LDO, 3.0V±2%, 500mA, Vdi=2.7V, -Reset ODO, -CE, PUR	USP-6B	49zx	VR15	9b	Tor
3BL19	XC6404BL19D	LVR/Vdet-IC	LDO, 2.8V±2%, 500mA, Vdi=2.5V, -Reset ODO, -CE, PUR	USP-6B	49zx	VR15	9b	Tor
3BL20	XC6404BL20D	LVR/Vdet-IC	LDO, 1.8V±2%, 500mA, Vdi=2.9V, -Reset ODO, -CE, PUR	USP-6B	49zx	VR15	9b	Tor
3BL21	XC6404BL21D	LVR/Vdet-IC	LDO, 1.8V±2%, 500mA, Vdi=3.6V, -Reset ODO, -CE, PUR	USP-6B	49zx	VR15	9b	Tor
3BL22	XC6404BL22D	LVR/Vdet-IC	LDO, 1.8V±2%, 500mA, Vdi=4.2V, -Reset ODO, -CE, PUR	USP-6B	49zx	VR15	9b	Tor
3BL23	XC6404BL23D	LVR/Vdet-IC	LDO, 2.5V±2%, 500mA, Vdi=2.9V, -Reset ODO, -CE, PUR	USP-6B	49zx	VR15	9b	Tor
3BL24	XC6404BL24D	LVR/Vdet-IC	LDO, 2.5V±2%, 500mA, Vdi=3.6V, -Reset ODO, -CE, PUR	USP-6B	49zx	VR15	9b	Tor
3BL25	XC6404BL25D	LVR/Vdet-IC	LDO, 2.5V±2%, 500mA, Vdi=4.2V, -Reset ODO, -CE, PUR	USP-6B	49zx	VR15	9b	Tor
3BL26	XC6404BL26D	LVR/Vdet-IC	LDO, 4.3V±2%, 500mA, Vdi=4.0V, -Reset ODO, -CE, PUR	USP-6B	49zx	VR15	9b	Tor
3BL27	XC6404BL27D	LVR/Vdet-IC	LDO, 2.5V±2%, 500mA, Vdi=3.9V, -Reset ODO, -CE, PUR	USP-6B	49zx	VR15	9b	Tor



SMD code	Type	Function	Short description	Case	Pinout	Sch.	St.Mnf.
3BL28	XC6404BL28D	LVR/Vdet-IC	LDO, 3.3V±2%, 500mA, Vdi=3.7V, -Reset ODO, -CE, PUR	USP-6B	49zx	VR15	9b Tor
3BL29	XC6404BL29D	LVR/Vdet-IC	LDO, 2.6V±2%, 500mA, Vdi=3.9V, -Reset ODO, -CE, PUR	USP-6B	49zx	VR15	9b Tor
3BL30	XC6404BL30D	LVR/Vdet-IC	LDO, 3.3V±2%, 500mA, Vdi=4.2V, -Reset ODO, -CE, PUR	USP-6B	49zx	VR15	9b Tor
3BL31	XC6404BL31D	LVR/Vdet-IC	LDO, 3.3V±2%, 500mA, Vdi=4.5V, -Reset ODO, -CE, PUR	USP-6B	49zx	VR15	9b Tor
3BL32	XC6404BL32D	LVR/Vdet-IC	LDO, 2.85V±2%, 500mA, Vdi=2.6V, -Reset ODO, -CE, PUR	USP-6B	49zx	VR15	9b Tor
3BL33	XC6404BL33D	LVR/Vdet-IC	LDO, 3.3V±2%, 500mA, Vdi=2.8V, -Reset ODO, -CE, PUR	USP-6B	49zx	VR15	9b Tor
3BL34	XC6404BL34D	LVR/Vdet-IC	LDO, 3.4V±2%, 500mA, Vdi=4.2V, -Reset ODO, -CE, PUR	USP-6B	49zx	VR15	9b Tor
3BL80	XC6404BL80D	LVR/Vdet-IC	LDO, 1.8V±2%, 500mA, Vdi=1.6V, -Reset ODO, -CE, PUR	USP-6B	49zx	VR15	9b Tor
3BL81	XC6404BL81D	LVR/Vdet-IC	LDO, 2.8V±2%, 500mA, Vdi=3.1V, -Reset ODO, -CE, PUR	USP-6B	49zx	VR15	9b Tor
3BL82	XC6404BL82D	LVR/Vdet-IC	LDO, 1.8V±2%, 500mA, Vdi=2.0V, -Reset ODO, -CE, PUR	USP-6B	49zx	VR15	9b Tor
3BL83	XC6404BL83D	LVR/Vdet-IC	LDO, 2.5V±2%, 500mA, Vdi=2.8V, -Reset ODO, -CE, PUR	USP-6B	49zx	VR15	9b Tor
3BL84	XC6404BL84D	LVR/Vdet-IC	LDO, 2.85V±2%, 500mA, Vdi=3.2V, -Reset ODO, -CE, PUR	USP-6B	49zx	VR15	9b Tor
3BL85	XC6404BL85D	LVR/Vdet-IC	LDO, 3.0V±2%, 500mA, Vdi=3.3V, -Reset ODO, -CE, PUR	USP-6B	49zx	VR15	9b Tor
3BL86	XC6404BL86D	LVR/Vdet-IC	LDO, 3.5V±2%, 500mA, Vdi=3.8V, -Reset ODO, -CE, PUR	USP-6B	49zx	VR15	9b Tor
3BL87	XC6404BL87D	LVR/Vdet-IC	LDO, 3.0V±2%, 500mA, Vdi=4.2V, -Reset ODO, -CE, PUR	USP-6B	49zx	VR15	9b Tor
3BL88	XC6404BL88D	LVR/Vdet-IC	LDO, 3.3V±2%, 500mA, Vdi=4.0V, -Reset ODO, -CE, PUR	USP-6B	49zx	VR15	9b Tor
3BM	XC6221B501GR	LVR-IC	LDO, 5.0V±1%, 200mA, +CE, CL	USP-4	45wm	VR4	9a Tor
3BM	XC6227A19BER	LVR-IC	LDO, 1.95V±20mV, 700mA, +CE	USP-6C	49hq	VR4	9a Tor
3BM02	XC6404BM02D	LVR/Vdet-IC	LDO, 2.7V±2%, 500mA, Vdi=4.2V, +Reset ODO, -CE, PUR	USP-6B	49zx	VR15	9b Tor
3BM03	XC6404BM03D	LVR/Vdet-IC	LDO, 2.5V±2%, 500mA, Vdi=2.6V, +Reset ODO, -CE, PUR	USP-6B	49zx	VR15	9b Tor
3BM04	XC6404BM04D	LVR/Vdet-IC	LDO, 3.3V±2%, 500mA, Vdi=4.3V, +Reset ODO, -CE, PUR	USP-6B	49zx	VR15	9b Tor
3BM05	XC6404BM05D	LVR/Vdet-IC	LDO, 3.3V±2%, 500mA, Vdi=4.4V, +Reset ODO, -CE, PUR	USP-6B	49zx	VR15	9b Tor
3BM07	XC6404BM07D	LVR/Vdet-IC	LDO, 3.3V±2%, 500mA, Vdi=5.2V, +Reset ODO, -CE, PUR	USP-6B	49zx	VR15	9b Tor
3BM08	XC6404BM08D	LVR/Vdet-IC	LDO, 2.8V±2%, 500mA, Vdi=4.3V, +Reset ODO, -CE, PUR	USP-6B	49zx	VR15	9b Tor
3BM09	XC6404BM09D	LVR/Vdet-IC	LDO, 4.3V±2%, 500mA, Vdi=2.8V, +Reset ODO, -CE, PUR	USP-6B	49zx	VR15	9b Tor
3BM11	XC6404BM11D	LVR/Vdet-IC	LDO, 2.8V±2%, 500mA, Vdi=2.1V, +Reset ODO, -CE, PUR	USP-6B	49zx	VR15	9b Tor
3BM12	XC6404BM12D	LVR/Vdet-IC	LDO, 2.8V±2%, 500mA, Vdi=2.8V, +Reset ODO, -CE, PUR	USP-6B	49zx	VR15	9b Tor
3BM15	XC6404BM15D	LVR/Vdet-IC	LDO, 3.3V±2%, 500mA, Vdi=3.6V, +Reset ODO, -CE, PUR	USP-6B	49zx	VR15	9b Tor
3BM18	XC6404BM18D	LVR/Vdet-IC	LDO, 3.0V±2%, 500mA, Vdi=2.7V, +Reset ODO, -CE, PUR	USP-6B	49zx	VR15	9b Tor
3BM19	XC6404BM19D	LVR/Vdet-IC	LDO, 2.8V±2%, 500mA, Vdi=2.5V, +Reset ODO, -CE, PUR	USP-6B	49zx	VR15	9b Tor
3BM20	XC6404BM20D	LVR/Vdet-IC	LDO, 1.8V±2%, 500mA, Vdi=2.9V, +Reset ODO, -CE, PUR	USP-6B	49zx	VR15	9b Tor
3BM21	XC6404BM21D	LVR/Vdet-IC	LDO, 1.8V±2%, 500mA, Vdi=3.6V, +Reset ODO, -CE, PUR	USP-6B	49zx	VR15	9b Tor
3BM22	XC6404BM22D	LVR/Vdet-IC	LDO, 1.8V±2%, 500mA, Vdi=4.2V, +Reset ODO, -CE, PUR	USP-6B	49zx	VR15	9b Tor
3BM23	XC6404BM23D	LVR/Vdet-IC	LDO, 2.5V±2%, 500mA, Vdi=2.9V, +Reset ODO, -CE, PUR	USP-6B	49zx	VR15	9b Tor
3BM24	XC6404BM24D	LVR/Vdet-IC	LDO, 2.5V±2%, 500mA, Vdi=3.6V, +Reset ODO, -CE, PUR	USP-6B	49zx	VR15	9b Tor
3BM25	XC6404BM25D	LVR/Vdet-IC	LDO, 2.5V±2%, 500mA, Vdi=4.2V, +Reset ODO, -CE, PUR	USP-6B	49zx	VR15	9b Tor
3BM26	XC6404BM26D	LVR/Vdet-IC	LDO, 4.3V±2%, 500mA, Vdi=4.0V, +Reset ODO, -CE, PUR	USP-6B	49zx	VR15	9b Tor
3BM27	XC6404BM27D	LVR/Vdet-IC	LDO, 2.5V±2%, 500mA, Vdi=3.9V, +Reset ODO, -CE, PUR	USP-6B	49zx	VR15	9b Tor
3BM28	XC6404BM28D	LVR/Vdet-IC	LDO, 3.3V±2%, 500mA, Vdi=3.7V, +Reset ODO, -CE, PUR	USP-6B	49zx	VR15	9b Tor
3BM29	XC6404BM29D	LVR/Vdet-IC	LDO, 2.6V±2%, 500mA, Vdi=3.9V, +Reset ODO, -CE, PUR	USP-6B	49zx	VR15	9b Tor
3BM30	XC6404BM30D	LVR/Vdet-IC	LDO, 3.3V±2%, 500mA, Vdi=4.2V, +Reset ODO, -CE, PUR	USP-6B	49zx	VR15	9b Tor
3BM31	XC6404BM31D	LVR/Vdet-IC	LDO, 3.3V±2%, 500mA, Vdi=4.5V, +Reset ODO, -CE, PUR	USP-6B	49zx	VR15	9b Tor
3BM32	XC6404BM32D	LVR/Vdet-IC	LDO, 2.85V±2%, 500mA, Vdi=2.6V, +Reset ODO, -CE, PUR	USP-6B	49zx	VR15	9b Tor
3BM33	XC6404BM33D	LVR/Vdet-IC	LDO, 3.3V±2%, 500mA, Vdi=2.8V, +Reset ODO, -CE, PUR	USP-6B	49zx	VR15	9b Tor
3BM34	XC6404BM34D	LVR/Vdet-IC	LDO, 3.4V±2%, 500mA, Vdi=4.2V, +Reset ODO, -CE, PUR	USP-6B	49zx	VR15	9b Tor
3BM80	XC6404BM80D	LVR/Vdet-IC	LDO, 1.8V±2%, 500mA, Vdi=1.6V, +Reset ODO, -CE, PUR	USP-6B	49zx	VR15	9b Tor
3BM81	XC6404BM81D	LVR/Vdet-IC	LDO, 2.8V±2%, 500mA, Vdi=3.1V, +Reset ODO, -CE, PUR	USP-6B	49zx	VR15	9b Tor
3BM82	XC6404BM82D	LVR/Vdet-IC	LDO, 1.8V±2%, 500mA, Vdi=2.0V, +Reset ODO, -CE, PUR	USP-6B	49zx	VR15	9b Tor
3BM83	XC6404BM83D	LVR/Vdet-IC	LDO, 2.5V±2%, 500mA, Vdi=2.8V, +Reset ODO, -CE, PUR	USP-6B	49zx	VR15	9b Tor
3BM84	XC6404BM84D	LVR/Vdet-IC	LDO, 2.85V±2%, 500mA, Vdi=3.2V, +Reset ODO, -CE, PUR	USP-6B	49zx	VR15	9b Tor
3BM85	XC6404BM85D	LVR/Vdet-IC	LDO, 3.0V±2%, 500mA, Vdi=3.3V, +Reset ODO, -CE, PUR	USP-6B	49zx	VR15	9b Tor
3BM86	XC6404BM86D	LVR/Vdet-IC	LDO, 3.5V±2%, 500mA, Vdi=3.8V, +Reset ODO, -CE, PUR	USP-6B	49zx	VR15	9b Tor
3BM87	XC6404BM87D	LVR/Vdet-IC	LDO, 3.0V±2%, 500mA, Vdi=4.2V, +Reset ODO, -CE, PUR	USP-6B	49zx	VR15	9b Tor
3BM88	XC6404BM88D	LVR/Vdet-IC	LDO, 3.3V±2%, 500mA, Vdi=4.0V, +Reset ODO, -CE, PUR	USP-6B	49zx	VR15	9b Tor
3BN	XC6227A20BER	LVR-IC	LDO, 2.05V±1%, 700mA, +CE	USP-6C	49hq	VR4	9a Tor
3BN02	XC6404BN02D	LVR/Vdet-IC	LDO, 2.7V±2%, 500mA, Vdo=4.2V, -Reset ODO, -CE, PUR	USP-6B	49zx	VR15	9b Tor
3BN03	XC6404BN03D	LVR/Vdet-IC	LDO, 2.5V±2%, 500mA, Vdo=2.6V, -Reset ODO, -CE, PUR	USP-6B	49zx	VR15	9b Tor
3BN04	XC6404BN04D	LVR/Vdet-IC	LDO, 3.3V±2%, 500mA, Vdo=4.3V, -Reset ODO, -CE, PUR	USP-6B	49zx	VR15	9b Tor
3BN05	XC6404BN05D	LVR/Vdet-IC	LDO, 3.3V±2%, 500mA, Vdo=4.4V, -Reset ODO, -CE, PUR	USP-6B	49zx	VR15	9b Tor
3BN07	XC6404BN07D	LVR/Vdet-IC	LDO, 3.3V±2%, 500mA, Vdo=5.2V, -Reset ODO, -CE, PUR	USP-6B	49zx	VR15	9b Tor
3BN08	XC6404BN08D	LVR/Vdet-IC	LDO, 2.8V±2%, 500mA, Vdo=4.3V, -Reset ODO, -CE, PUR	USP-6B	49zx	VR15	9b Tor
3BN09	XC6404BN09D	LVR/Vdet-IC	LDO, 4.3V±2%, 500mA, Vdo=2.8V, -Reset ODO, -CE, PUR	USP-6B	49zx	VR15	9b Tor
3BN11	XC6404BN11D	LVR/Vdet-IC	LDO, 2.8V±2%, 500mA, Vdo=2.1V, -Reset ODO, -CE, PUR	USP-6B	49zx	VR15	9b Tor
3BN12	XC6404BN12D	LVR/Vdet-IC	LDO, 2.8V±2%, 500mA, Vdo=3.3V, -Reset ODO, -CE, PUR	USP-6B	49zx	VR15	9b Tor
3BN15	XC6404BN15D	LVR/Vdet-IC	LDO, 3.3V±2%, 500mA, Vdo=3.6V, -Reset ODO, -CE, PUR	USP-6B	49zx	VR15	9b Tor
3BN18	XC6404BN18D	LVR/Vdet-IC	LDO, 3.0V±2%, 500mA, Vdo=2.7V, -Reset ODO, -CE, PUR	USP-6B	49zx	VR15	9b Tor
3BN19	XC6404BN19D	LVR/Vdet-IC	LDO, 2.8V±2%, 500mA, Vdo=2.5V, -Reset ODO, -CE, PUR	USP-6B	49zx	VR15	9b Tor
3BN20	XC6404BN20D	LVR/Vdet-IC	LDO, 1.8V±2%, 500mA, Vdo=2.9V, -Reset ODO, -CE, PUR	USP-6B	49zx	VR15	9b Tor
3BN21	XC6404BN21D	LVR/Vdet-IC	LDO, 1.8V±2%, 500mA, Vdo=3.6V, -Reset ODO, -CE, PUR	USP-6B	49zx	VR15	9b Tor
3BN22	XC6404BN22D	LVR/Vdet-IC	LDO, 1.8V±2%, 500mA, Vdo=4.2V, -Reset ODO, -CE, PUR	USP-6B	49zx	VR15	9b Tor



SMD code	Type	Function	Short description	Case	Pinout	Sch.	St.	Mnf.
3BR19	XC6404BR19D	LVR/Vdet-IC	LDO, 2.8V±2%, 500mA, Vdi=2.5V, -Reset ODO, -CE	USP-6B	49zx	VR15	9b	Tor
3BR20	XC6404BR20D	LVR/Vdet-IC	LDO, 1.8V±2%, 500mA, Vdi=2.9V, -Reset ODO, -CE	USP-6B	49zx	VR15	9b	Tor
3BR21	XC6404BR21D	LVR/Vdet-IC	LDO, 1.8V±2%, 500mA, Vdi=3.6V, -Reset ODO, -CE	USP-6B	49zx	VR15	9b	Tor
3BR22	XC6404BR22D	LVR/Vdet-IC	LDO, 1.8V±2%, 500mA, Vdi=4.2V, -Reset ODO, -CE	USP-6B	49zx	VR15	9b	Tor
3BR23	XC6404BR23D	LVR/Vdet-IC	LDO, 2.5V±2%, 500mA, Vdi=2.9V, -Reset ODO, -CE	USP-6B	49zx	VR15	9b	Tor
3BR24	XC6404BR24D	LVR/Vdet-IC	LDO, 2.5V±2%, 500mA, Vdi=3.6V, -Reset ODO, -CE	USP-6B	49zx	VR15	9b	Tor
3BR25	XC6404BR25D	LVR/Vdet-IC	LDO, 2.5V±2%, 500mA, Vdi=4.2V, -Reset ODO, -CE	USP-6B	49zx	VR15	9b	Tor
3BR26	XC6404BR26D	LVR/Vdet-IC	LDO, 4.3V±2%, 500mA, Vdi=4.0V, -Reset ODO, -CE	USP-6B	49zx	VR15	9b	Tor
3BR27	XC6404BR27D	LVR/Vdet-IC	LDO, 2.5V±2%, 500mA, Vdi=3.9V, -Reset ODO, -CE	USP-6B	49zx	VR15	9b	Tor
3BR28	XC6404BR28D	LVR/Vdet-IC	LDO, 3.3V±2%, 500mA, Vdi=3.7V, -Reset ODO, -CE	USP-6B	49zx	VR15	9b	Tor
3BR29	XC6404BR29D	LVR/Vdet-IC	LDO, 2.6V±2%, 500mA, Vdi=3.9V, -Reset ODO, -CE	USP-6B	49zx	VR15	9b	Tor
3BR30	XC6404BR30D	LVR/Vdet-IC	LDO, 3.3V±2%, 500mA, Vdi=4.2V, -Reset ODO, -CE	USP-6B	49zx	VR15	9b	Tor
3BR31	XC6404BR31D	LVR/Vdet-IC	LDO, 3.3V±2%, 500mA, Vdi=4.5V, -Reset ODO, -CE	USP-6B	49zx	VR15	9b	Tor
3BR32	XC6404BR32D	LVR/Vdet-IC	LDO, 2.85V±2%, 500mA, Vdi=2.6V, -Reset ODO, -CE	USP-6B	49zx	VR15	9b	Tor
3BR33	XC6404BR33D	LVR/Vdet-IC	LDO, 3.3V±2%, 500mA, Vdi=2.8V, -Reset ODO, -CE	USP-6B	49zx	VR15	9b	Tor
3BR34	XC6404BR34D	LVR/Vdet-IC	LDO, 3.4V±2%, 500mA, Vdi=4.2V, -Reset ODO, -CE	USP-6B	49zx	VR15	9b	Tor
3BR80	XC6404BR80D	LVR/Vdet-IC	LDO, 1.8V±2%, 500mA, Vdi=1.6V, -Reset ODO, -CE	USP-6B	49zx	VR15	9b	Tor
3BR81	XC6404BR81D	LVR/Vdet-IC	LDO, 2.8V±2%, 500mA, Vdi=3.1V, -Reset ODO, -CE	USP-6B	49zx	VR15	9b	Tor
3BR82	XC6404BR82D	LVR/Vdet-IC	LDO, 1.8V±2%, 500mA, Vdi=2.0V, -Reset ODO, -CE	USP-6B	49zx	VR15	9b	Tor
3BR83	XC6404BR83D	LVR/Vdet-IC	LDO, 2.5V±2%, 500mA, Vdi=2.8V, -Reset ODO, -CE	USP-6B	49zx	VR15	9b	Tor
3BR84	XC6404BR84D	LVR/Vdet-IC	LDO, 2.85V±2%, 500mA, Vdi=3.2V, -Reset ODO, -CE	USP-6B	49zx	VR15	9b	Tor
3BR85	XC6404BR85D	LVR/Vdet-IC	LDO, 3.0V±2%, 500mA, Vdi=3.3V, -Reset ODO, -CE	USP-6B	49zx	VR15	9b	Tor
3BR86	XC6404BR86D	LVR/Vdet-IC	LDO, 3.5V±2%, 500mA, Vdi=3.8V, -Reset ODO, -CE	USP-6B	49zx	VR15	9b	Tor
3BR87	XC6404BR87D	LVR/Vdet-IC	LDO, 3.0V±2%, 500mA, Vdi=4.2V, -Reset ODO, -CE	USP-6B	49zx	VR15	9b	Tor
3BR88	XC6404BR88D	LVR/Vdet-IC	LDO, 3.3V±2%, 500mA, Vdi=4.0V, -Reset ODO, -CE	USP-6B	49zx	VR15	9b	Tor
3BS	XC6227A23BER	LVR-IC	LDO, 2.35V±1%, 700mA, +CE	USP-6C	49hq	VR4	9a	Tor
3BS02	XC6404BS02D	LVR/Vdet-IC	LDO, 2.7V±2%, 500mA, Vdi=4.2V, +Reset ODO, -CE	USP-6B	49zx	VR15	9b	Tor
3BS03	XC6404BS03D	LVR/Vdet-IC	LDO, 2.5V±2%, 500mA, Vdi=2.8V, +Reset ODO, -CE	USP-6B	49zx	VR15	9b	Tor
3BS04	XC6404BS04D	LVR/Vdet-IC	LDO, 3.3V±2%, 500mA, Vdi=4.3V, +Reset ODO, -CE	USP-6B	49zx	VR15	9b	Tor
3BS05	XC6404BS05D	LVR/Vdet-IC	LDO, 3.3V±2%, 500mA, Vdi=4.4V, +Reset ODO, -CE	USP-6B	49zx	VR15	9b	Tor
3BS07	XC6404BS07D	LVR/Vdet-IC	LDO, 3.3V±2%, 500mA, Vdi=5.2V, +Reset ODO, -CE	USP-6B	49zx	VR15	9b	Tor
3BS08	XC6404BS08D	LVR/Vdet-IC	LDO, 2.8V±2%, 500mA, Vdi=4.3V, +Reset ODO, -CE	USP-6B	49zx	VR15	9b	Tor
3BS09	XC6404BS09D	LVR/Vdet-IC	LDO, 4.3V±2%, 500mA, Vdi=2.8V, +Reset ODO, -CE	USP-6B	49zx	VR15	9b	Tor
3BS11	XC6404BS11D	LVR/Vdet-IC	LDO, 2.8V±2%, 500mA, Vdi=2.1V, +Reset ODO, -CE	USP-6B	49zx	VR15	9b	Tor
3BS12	XC6404BS12D	LVR/Vdet-IC	LDO, 2.8V±2%, 500mA, Vdi=2.8V, +Reset ODO, -CE	USP-6B	49zx	VR15	9b	Tor
3BS15	XC6404BS15D	LVR/Vdet-IC	LDO, 3.3V±2%, 500mA, Vdi=3.6V, +Reset ODO, -CE	USP-6B	49zx	VR15	9b	Tor
3BS18	XC6404BS18D	LVR/Vdet-IC	LDO, 3.0V±2%, 500mA, Vdi=2.7V, +Reset ODO, -CE	USP-6B	49zx	VR15	9b	Tor
3BS19	XC6404BS19D	LVR/Vdet-IC	LDO, 2.8V±2%, 500mA, Vdi=2.5V, +Reset ODO, -CE	USP-6B	49zx	VR15	9b	Tor
3BS20	XC6404BS20D	LVR/Vdet-IC	LDO, 1.8V±2%, 500mA, Vdi=2.9V, +Reset ODO, -CE	USP-6B	49zx	VR15	9b	Tor
3BS21	XC6404BS21D	LVR/Vdet-IC	LDO, 1.8V±2%, 500mA, Vdi=3.6V, +Reset ODO, -CE	USP-6B	49zx	VR15	9b	Tor
3BS22	XC6404BS22D	LVR/Vdet-IC	LDO, 1.8V±2%, 500mA, Vdi=4.2V, +Reset ODO, -CE	USP-6B	49zx	VR15	9b	Tor
3BS23	XC6404BS23D	LVR/Vdet-IC	LDO, 2.5V±2%, 500mA, Vdi=2.9V, +Reset ODO, -CE	USP-6B	49zx	VR15	9b	Tor
3BS24	XC6404BS24D	LVR/Vdet-IC	LDO, 2.5V±2%, 500mA, Vdi=3.6V, +Reset ODO, -CE	USP-6B	49zx	VR15	9b	Tor
3BS25	XC6404BS25D	LVR/Vdet-IC	LDO, 2.5V±2%, 500mA, Vdi=4.2V, +Reset ODO, -CE	USP-6B	49zx	VR15	9b	Tor
3BS26	XC6404BS26D	LVR/Vdet-IC	LDO, 4.3V±2%, 500mA, Vdi=4.0V, +Reset ODO, -CE	USP-6B	49zx	VR15	9b	Tor
3BS27	XC6404BS27D	LVR/Vdet-IC	LDO, 2.5V±2%, 500mA, Vdi=3.9V, +Reset ODO, -CE	USP-6B	49zx	VR15	9b	Tor
3BS28	XC6404BS28D	LVR/Vdet-IC	LDO, 3.3V±2%, 500mA, Vdi=3.7V, +Reset ODO, -CE	USP-6B	49zx	VR15	9b	Tor
3BS29	XC6404BS29D	LVR/Vdet-IC	LDO, 2.6V±2%, 500mA, Vdi=3.9V, +Reset ODO, -CE	USP-6B	49zx	VR15	9b	Tor
3BS30	XC6404BS30D	LVR/Vdet-IC	LDO, 3.3V±2%, 500mA, Vdi=4.2V, +Reset ODO, -CE	USP-6B	49zx	VR15	9b	Tor
3BS31	XC6404BS31D	LVR/Vdet-IC	LDO, 3.3V±2%, 500mA, Vdi=4.5V, +Reset ODO, -CE	USP-6B	49zx	VR15	9b	Tor
3BS32	XC6404BS32D	LVR/Vdet-IC	LDO, 2.85V±2%, 500mA, Vdi=2.6V, +Reset ODO, -CE	USP-6B	49zx	VR15	9b	Tor
3BS33	XC6404BS33D	LVR/Vdet-IC	LDO, 3.3V±2%, 500mA, Vdi=2.8V, +Reset ODO, -CE	USP-6B	49zx	VR15	9b	Tor
3BS34	XC6404BS34D	LVR/Vdet-IC	LDO, 3.4V±2%, 500mA, Vdi=4.2V, +Reset ODO, -CE	USP-6B	49zx	VR15	9b	Tor
3BS80	XC6404BS80D	LVR/Vdet-IC	LDO, 1.8V±2%, 500mA, Vdi=1.6V, +Reset ODO, -CE	USP-6B	49zx	VR15	9b	Tor
3BS81	XC6404BS81D	LVR/Vdet-IC	LDO, 2.8V±2%, 500mA, Vdi=3.1V, +Reset ODO, -CE	USP-6B	49zx	VR15	9b	Tor
3BS82	XC6404BS82D	LVR/Vdet-IC	LDO, 1.8V±2%, 500mA, Vdi=2.0V, +Reset ODO, -CE	USP-6B	49zx	VR15	9b	Tor
3BS83	XC6404BS83D	LVR/Vdet-IC	LDO, 2.5V±2%, 500mA, Vdi=2.8V, +Reset ODO, -CE	USP-6B	49zx	VR15	9b	Tor
3BS84	XC6404BS84D	LVR/Vdet-IC	LDO, 2.85V±2%, 500mA, Vdi=3.2V, +Reset ODO, -CE	USP-6B	49zx	VR15	9b	Tor
3BS85	XC6404BS85D	LVR/Vdet-IC	LDO, 3.0V±2%, 500mA, Vdi=3.3V, +Reset ODO, -CE	USP-6B	49zx	VR15	9b	Tor
3BS86	XC6404BS86D	LVR/Vdet-IC	LDO, 3.5V±2%, 500mA, Vdi=3.8V, +Reset ODO, -CE	USP-6B	49zx	VR15	9b	Tor
3BS87	XC6404BS87D	LVR/Vdet-IC	LDO, 3.0V±2%, 500mA, Vdi=4.2V, +Reset ODO, -CE	USP-6B	49zx	VR15	9b	Tor
3BS88	XC6404BS88D	LVR/Vdet-IC	LDO, 3.3V±2%, 500mA, Vdi=4.0V, +Reset ODO, -CE	USP-6B	49zx	VR15	9b	Tor
3BT	XC6227A24BER	LVR-IC	LDO, 2.45V±1%, 700mA, +CE	USP-6C	49hq	VR4	9a	Tor
3BT02	XC6404BT02D	LVR/Vdet-IC	LDO, 2.7V±2%, 500mA, Vdo=4.2V, -Reset ODO, -CE	USP-6B	49zx	VR15	9b	Tor
3BT03	XC6404BT03D	LVR/Vdet-IC	LDO, 2.5V±2%, 500mA, Vdo=2.6V, -Reset ODO, -CE	USP-6B	49zx	VR15	9b	Tor
3BT04	XC6404BT04D	LVR/Vdet-IC	LDO, 3.3V±2%, 500mA, Vdo=4.3V, -Reset ODO, -CE	USP-6B	49zx	VR15	9b	Tor
3BT05	XC6404BT05D	LVR/Vdet-IC	LDO, 3.3V±2%, 500mA, Vdo=4.4V, -Reset ODO, -CE	USP-6B	49zx	VR15	9b	Tor
3BT07	XC6404BT07D	LVR/Vdet-IC	LDO, 3.3V±2%, 500mA, Vdo=5.2V, -Reset ODO, -CE	USP-6B	49zx	VR15	9b	Tor
3BT08	XC6404BT08D	LVR/Vdet-IC	LDO, 2.8V±2%, 500mA, Vdo=4.3V, -Reset ODO, -CE	USP-6B	49zx	VR15	9b	Tor
3BT09	XC6404BT09D	LVR/Vdet-IC	LDO, 4.3V±2%, 500mA, Vdo=2.8V, -Reset ODO, -CE	USP-6B	49zx	VR15	9b	Tor



SMD code	Type	Function	Short description	Case	Pinout	Sch.	St.Mnf.
3C	R3117K091C	Vdet-IC	0.9V±15mV, -Reset PPO, Sense	DFN1010-4	48rq	VD12	9a Ric
3C	RP101K151B	LVR-IC	LDO, LN, +CE, 1.5V±0.8%, 300mA	DFN1612-4	45vm	VR4	9a Ric
3C	XC6217D1327R-G	LVR-IC	LDO, 1.3V±2%, 200mA, +CE, CL	USPN-4	58vm	VR4	9a Tor
3C	XC6223D2219R-G	LVR-IC	LDO, 2.2V±1%, 300mA, +CE, CL, PDR	USPQ-4B03	48vm	VR4	9a Tor
3C	XC6224B20B7R	LVR-IC	LDO, 2.05V±1.5%, 150mA, +CE, PDR	USPN-4B02	58vm	VR4	9e Tor
3C	XC6229H32B1R-G	LVR-IC	LDO, 3.25V±1%, 300mA, +CE, ICP	BGA-4	63ba*	VR4	9a Tor
3C0	XC6227A301ER	LVR-IC	LDO, 3.0V±1%, 700mA, +CE	USP-6C	49hq	VR4	9a Tor
3C016	XC6106C016ER	Vdet-IC	1.6V±2%, Hst, -MR, ±Reset PPO, Rt=50ms	USP-6C	49xs	VD21	9b Tor
3C017	XC6106C017ER	Vdet-IC	1.7V±2%, Hst, -MR, ±Reset PPO, Rt=50ms	USP-6C	49xs	VD21	9b Tor
3C018	XC6106C018ER	Vdet-IC	1.8V±2%, Hst, -MR, ±Reset PPO, Rt=50ms	USP-6C	49xs	VD21	9b Tor
3C019	XC6106C019ER	Vdet-IC	1.9V±2%, Hst, -MR, ±Reset PPO, Rt=50ms	USP-6C	49xs	VD21	9b Tor
3C020	XC6106C020ER	Vdet-IC	2.0V±2%, Hst, -MR, ±Reset PPO, Rt=50ms	USP-6C	49xs	VD21	9b Tor
3C021	XC6106C021ER	Vdet-IC	2.1V±2%, Hst, -MR, ±Reset PPO, Rt=50ms	USP-6C	49xs	VD21	9b Tor
3C022	XC6106C022ER	Vdet-IC	2.2V±2%, Hst, -MR, ±Reset PPO, Rt=50ms	USP-6C	49xs	VD21	9b Tor
3C023	XC6106C023ER	Vdet-IC	2.3V±2%, Hst, -MR, ±Reset PPO, Rt=50ms	USP-6C	49xs	VD21	9b Tor
3C024	XC6106C024ER	Vdet-IC	2.4V±2%, Hst, -MR, ±Reset PPO, Rt=50ms	USP-6C	49xs	VD21	9b Tor
3C025	XC6106C025ER	Vdet-IC	2.5V±2%, Hst, -MR, ±Reset PPO, Rt=50ms	USP-6C	49xs	VD21	9b Tor
3C026	XC6106C026ER	Vdet-IC	2.6V±2%, Hst, -MR, ±Reset PPO, Rt=50ms	USP-6C	49xs	VD21	9b Tor
3C027	XC6106C027ER	Vdet-IC	2.7V±2%, Hst, -MR, ±Reset PPO, Rt=50ms	USP-6C	49xs	VD21	9b Tor
3C028	XC6106C028ER	Vdet-IC	2.8V±2%, Hst, -MR, ±Reset PPO, Rt=50ms	USP-6C	49xs	VD21	9b Tor
3C029	XC6106C029ER	Vdet-IC	2.9V±2%, Hst, -MR, ±Reset PPO, Rt=50ms	USP-6C	49xs	VD21	9b Tor
3C030	XC6106C030ER	Vdet-IC	3.0V±2%, Hst, -MR, ±Reset PPO, Rt=50ms	USP-6C	49xs	VD21	9b Tor
3C031	XC6106C031ER	Vdet-IC	3.1V±2%, Hst, -MR, ±Reset PPO, Rt=50ms	USP-6C	49xs	VD21	9b Tor
3C032	XC6106C032ER	Vdet-IC	3.2V±2%, Hst, -MR, ±Reset PPO, Rt=50ms	USP-6C	49xs	VD21	9b Tor
3C033	XC6106C033ER	Vdet-IC	3.3V±2%, Hst, -MR, ±Reset PPO, Rt=50ms	USP-6C	49xs	VD21	9b Tor
3C034	XC6106C034ER	Vdet-IC	3.4V±2%, Hst, -MR, ±Reset PPO, Rt=50ms	USP-6C	49xs	VD21	9b Tor
3C035	XC6106C035ER	Vdet-IC	3.5V±2%, Hst, -MR, ±Reset PPO, Rt=50ms	USP-6C	49xs	VD21	9b Tor
3C036	XC6106C036ER	Vdet-IC	3.6V±2%, Hst, -MR, ±Reset PPO, Rt=50ms	USP-6C	49xs	VD21	9b Tor
3C037	XC6106C037ER	Vdet-IC	3.7V±2%, Hst, -MR, ±Reset PPO, Rt=50ms	USP-6C	49xs	VD21	9b Tor
3C038	XC6106C038ER	Vdet-IC	3.8V±2%, Hst, -MR, ±Reset PPO, Rt=50ms	USP-6C	49xs	VD21	9b Tor
3C039	XC6106C039ER	Vdet-IC	3.9V±2%, Hst, -MR, ±Reset PPO, Rt=50ms	USP-6C	49xs	VD21	9b Tor
3C040	XC6106C040ER	Vdet-IC	4.0V±2%, Hst, -MR, ±Reset PPO, Rt=50ms	USP-6C	49xs	VD21	9b Tor
3C041	XC6106C041ER	Vdet-IC	4.1V±2%, Hst, -MR, ±Reset PPO, Rt=50ms	USP-6C	49xs	VD21	9b Tor
3C042	XC6106C042ER	Vdet-IC	4.2V±2%, Hst, -MR, ±Reset PPO, Rt=50ms	USP-6C	49xs	VD21	9b Tor
3C043	XC6106C043ER	Vdet-IC	4.3V±2%, Hst, -MR, ±Reset PPO, Rt=50ms	USP-6C	49xs	VD21	9b Tor
3C044	XC6106C044ER	Vdet-IC	4.4V±2%, Hst, -MR, ±Reset PPO, Rt=50ms	USP-6C	49xs	VD21	9b Tor
3C045	XC6106C045ER	Vdet-IC	4.5V±2%, Hst, -MR, ±Reset PPO, Rt=50ms	USP-6C	49xs	VD21	9b Tor
3C046	XC6106C046ER	Vdet-IC	4.6V±2%, Hst, -MR, ±Reset PPO, Rt=50ms	USP-6C	49xs	VD21	9b Tor
3C047	XC6106C047ER	Vdet-IC	4.7V±2%, Hst, -MR, ±Reset PPO, Rt=50ms	USP-6C	49xs	VD21	9b Tor
3C048	XC6106C048ER	Vdet-IC	4.8V±2%, Hst, -MR, ±Reset PPO, Rt=50ms	USP-6C	49xs	VD21	9b Tor
3C049	XC6106C049ER	Vdet-IC	4.9V±2%, Hst, -MR, ±Reset PPO, Rt=50ms	USP-6C	49xs	VD21	9b Tor
3C050	XC6106C050ER	Vdet-IC	5.0V±2%, Hst, -MR, ±Reset PPO, Rt=50ms	USP-6C	49xs	VD21	9b Tor
3C1	XC6227A311ER	LVR-IC	LDO, 3.1V±1%, 700mA, +CE	USP-6C	49hq	VR4	9a Tor
3C2	XC6227A321ER	LVR-IC	LDO, 3.2V±1%, 700mA, +CE	USP-6C	49hq	VR4	9a Tor
3C216	XC6101C216ER	Vdet-IC	1.6V±2%, Hst, -MR, -Reset PPO, Wt=50ms, Rt=50ms	USP-6C	49xh	VD17	9b Tor
3C217	XC6101C217ER	Vdet-IC	1.7V±2%, Hst, -MR, -Reset PPO, Wt=50ms, Rt=50ms	USP-6C	49xh	VD17	9b Tor
3C218	XC6101C218ER	Vdet-IC	1.8V±2%, Hst, -MR, -Reset PPO, Wt=50ms, Rt=50ms	USP-6C	49xh	VD17	9b Tor
3C219	XC6101C219ER	Vdet-IC	1.9V±2%, Hst, -MR, -Reset PPO, Wt=50ms, Rt=50ms	USP-6C	49xh	VD17	9b Tor
3C220	XC6101C220ER	Vdet-IC	2.0V±2%, Hst, -MR, -Reset PPO, Wt=50ms, Rt=50ms	USP-6C	49xh	VD17	9b Tor
3C221	XC6101C221ER	Vdet-IC	2.1V±2%, Hst, -MR, -Reset PPO, Wt=50ms, Rt=50ms	USP-6C	49xh	VD17	9b Tor
3C222	XC6101C222ER	Vdet-IC	2.2V±2%, Hst, -MR, -Reset PPO, Wt=50ms, Rt=50ms	USP-6C	49xh	VD17	9b Tor
3C223	XC6101C223ER	Vdet-IC	2.3V±2%, Hst, -MR, -Reset PPO, Wt=50ms, Rt=50ms	USP-6C	49xh	VD17	9b Tor
3C224	XC6101C224ER	Vdet-IC	2.4V±2%, Hst, -MR, -Reset PPO, Wt=50ms, Rt=50ms	USP-6C	49xh	VD17	9b Tor
3C225	XC6101C225ER	Vdet-IC	2.5V±2%, Hst, -MR, -Reset PPO, Wt=50ms, Rt=50ms	USP-6C	49xh	VD17	9b Tor
3C226	XC6101C226ER	Vdet-IC	2.6V±2%, Hst, -MR, -Reset PPO, Wt=50ms, Rt=50ms	USP-6C	49xh	VD17	9b Tor
3C227	XC6101C227ER	Vdet-IC	2.7V±2%, Hst, -MR, -Reset PPO, Wt=50ms, Rt=50ms	USP-6C	49xh	VD17	9b Tor
3C228	XC6101C228ER	Vdet-IC	2.8V±2%, Hst, -MR, -Reset PPO, Wt=50ms, Rt=50ms	USP-6C	49xh	VD17	9b Tor
3C229	XC6101C229ER	Vdet-IC	2.9V±2%, Hst, -MR, -Reset PPO, Wt=50ms, Rt=50ms	USP-6C	49xh	VD17	9b Tor
3C230	XC6101C230ER	Vdet-IC	3.0V±2%, Hst, -MR, -Reset PPO, Wt=50ms, Rt=50ms	USP-6C	49xh	VD17	9b Tor
3C231	XC6101C231ER	Vdet-IC	3.1V±2%, Hst, -MR, -Reset PPO, Wt=50ms, Rt=50ms	USP-6C	49xh	VD17	9b Tor
3C232	XC6101C232ER	Vdet-IC	3.2V±2%, Hst, -MR, -Reset PPO, Wt=50ms, Rt=50ms	USP-6C	49xh	VD17	9b Tor
3C233	XC6101C233ER	Vdet-IC	3.3V±2%, Hst, -MR, -Reset PPO, Wt=50ms, Rt=50ms	USP-6C	49xh	VD17	9b Tor
3C234	XC6101C234ER	Vdet-IC	3.4V±2%, Hst, -MR, -Reset PPO, Wt=50ms, Rt=50ms	USP-6C	49xh	VD17	9b Tor
3C235	XC6101C235ER	Vdet-IC	3.5V±2%, Hst, -MR, -Reset PPO, Wt=50ms, Rt=50ms	USP-6C	49xh	VD17	9b Tor
3C236	XC6101C236ER	Vdet-IC	3.6V±2%, Hst, -MR, -Reset PPO, Wt=50ms, Rt=50ms	USP-6C	49xh	VD17	9b Tor
3C237	XC6101C237ER	Vdet-IC	3.7V±2%, Hst, -MR, -Reset PPO, Wt=50ms, Rt=50ms	USP-6C	49xh	VD17	9b Tor
3C238	XC6101C238ER	Vdet-IC	3.8V±2%, Hst, -MR, -Reset PPO, Wt=50ms, Rt=50ms	USP-6C	49xh	VD17	9b Tor
3C239	XC6101C239ER	Vdet-IC	3.9V±2%, Hst, -MR, -Reset PPO, Wt=50ms, Rt=50ms	USP-6C	49xh	VD17	9b Tor
3C240	XC6101C240ER	Vdet-IC	4.0V±2%, Hst, -MR, -Reset PPO, Wt=50ms, Rt=50ms	USP-6C	49xh	VD17	9b Tor
3C241	XC6101C241ER	Vdet-IC	4.1V±2%, Hst, -MR, -Reset PPO, Wt=50ms, Rt=50ms	USP-6C	49xh	VD17	9b Tor



SMD code	Type	Function	Short description	Case	Pinout	Sch.	St.	Mnf.
3C638	XC6101C638ER	Vdet-IC	3.8V±2%, Hst. -MR, -Reset PPO, Wt=1.6s, Rt=50ms	USP-6C	49xh	VD17	9b	Tor
3C639	XC6101C639ER	Vdet-IC	3.9V±2%, Hst. -MR, -Reset PPO, Wt=1.6s, Rt=50ms	USP-6C	49xh	VD17	9b	Tor
3C640	XC6101C640ER	Vdet-IC	4.0V±2%, Hst. -MR, -Reset PPO, Wt=1.6s, Rt=50ms	USP-6C	49xh	VD17	9b	Tor
3C641	XC6101C641ER	Vdet-IC	4.1V±2%, Hst. -MR, -Reset PPO, Wt=1.6s, Rt=50ms	USP-6C	49xh	VD17	9b	Tor
3C642	XC6101C642ER	Vdet-IC	4.2V±2%, Hst. -MR, -Reset PPO, Wt=1.6s, Rt=50ms	USP-6C	49xh	VD17	9b	Tor
3C643	XC6101C643ER	Vdet-IC	4.3V±2%, Hst. -MR, -Reset PPO, Wt=1.6s, Rt=50ms	USP-6C	49xh	VD17	9b	Tor
3C644	XC6101C644ER	Vdet-IC	4.4V±2%, Hst. -MR, -Reset PPO, Wt=1.6s, Rt=50ms	USP-6C	49xh	VD17	9b	Tor
3C645	XC6101C645ER	Vdet-IC	4.5V±2%, Hst. -MR, -Reset PPO, Wt=1.6s, Rt=50ms	USP-6C	49xh	VD17	9b	Tor
3C646	XC6101C646ER	Vdet-IC	4.6V±2%, Hst. -MR, -Reset PPO, Wt=1.6s, Rt=50ms	USP-6C	49xh	VD17	9b	Tor
3C647	XC6101C647ER	Vdet-IC	4.7V±2%, Hst. -MR, -Reset PPO, Wt=1.6s, Rt=50ms	USP-6C	49xh	VD17	9b	Tor
3C648	XC6101C648ER	Vdet-IC	4.8V±2%, Hst. -MR, -Reset PPO, Wt=1.6s, Rt=50ms	USP-6C	49xh	VD17	9b	Tor
3C649	XC6101C649ER	Vdet-IC	4.9V±2%, Hst. -MR, -Reset PPO, Wt=1.6s, Rt=50ms	USP-6C	49xh	VD17	9b	Tor
3C650	XC6101C650ER	Vdet-IC	5.0V±2%, Hst. -MR, -Reset PPO, Wt=1.6s, Rt=50ms	USP-6C	49xh	VD17	9b	Tor
3C7	XC6227A371ER	LVR-IC	LDO, 3.7V±1%, 700mA, +CE	USP-6C	49hq	VR4	9a	Tor
3C8	XC6227A381ER	LVR-IC	LDO, 3.8V±1%, 700mA, +CE	USP-6C	49hq	VR4	9a	Tor
3C9	XC6227A391ER	LVR-IC	LDO, 3.9V±1%, 700mA, +CE	USP-6C	49hq	VR4	9a	Tor
3CA	XC6227A401ER	LVR-IC	LDO, 4.0V±1%, 700mA, +CE	USP-6C	49hq	VR4	9a	Tor
3CA02	XC6404CA02D	LVR/Vdet-IC	LDO, 2.7V±2%, 500mA, Vdi=4.2V, -Reset ODO, +CE, PDR	USP-6B	49zx	VR15	9b	Tor
3CA03	XC6404CA03D	LVR/Vdet-IC	LDO, 2.5V±2%, 500mA, Vdi=2.6V, -Reset ODO, +CE, PDR	USP-6B	49zx	VR15	9b	Tor
3CA04	XC6404CA04D	LVR/Vdet-IC	LDO, 3.3V±2%, 500mA, Vdi=4.3V, -Reset ODO, +CE, PDR	USP-6B	49zx	VR15	9b	Tor
3CA05	XC6404CA05D	LVR/Vdet-IC	LDO, 3.3V±2%, 500mA, Vdi=4.4V, -Reset ODO, +CE, PDR	USP-6B	49zx	VR15	9b	Tor
3CA07	XC6404CA07D	LVR/Vdet-IC	LDO, 3.3V±2%, 500mA, Vdi=5.2V, -Reset ODO, +CE, PDR	USP-6B	49zx	VR15	9b	Tor
3CA08	XC6404CA08D	LVR/Vdet-IC	LDO, 2.8V±2%, 500mA, Vdi= 4.3V, -Reset ODO, +CE, PDR	USP-6B	49zx	VR15	9b	Tor
3CA09	XC6404CA09D	LVR/Vdet-IC	LDO, 4.3V±2%, 500mA, Vdi=2.8V, -Reset ODO, +CE, PDR	USP-6B	49zx	VR15	9b	Tor
3CA11	XC6404CA11D	LVR/Vdet-IC	LDO, 2.8V±2%, 500mA, Vdi=2.1V, -Reset ODO, +CE, PDR	USP-6B	49zx	VR15	9b	Tor
3CA12	XC6404CA12D	LVR/Vdet-IC	LDO, 2.8V±2%, 500mA, Vdi=2.8V, -Reset ODO, +CE, PDR	USP-6B	49zx	VR15	9b	Tor
3CA15	XC6404CA15D	LVR/Vdet-IC	LDO, 3.3V±2%, 500mA, Vdi=3.6V, -Reset ODO, +CE, PDR	USP-6B	49zx	VR15	9b	Tor
3CA18	XC6404CA18D	LVR/Vdet-IC	LDO, 3.0V±2%, 500mA, Vdi=2.7V, -Reset ODO, +CE, PDR	USP-6B	49zx	VR15	9b	Tor
3CA19	XC6404CA19D	LVR/Vdet-IC	LDO, 2.8V±2%, 500mA, Vdi=2.5V, -Reset ODO, +CE, PDR	USP-6B	49zx	VR15	9b	Tor
3CA20	XC6404CA20D	LVR/Vdet-IC	LDO, 1.8V±2%, 500mA, Vdi=2.9V, -Reset ODO, +CE, PDR	USP-6B	49zx	VR15	9b	Tor
3CA21	XC6404CA21D	LVR/Vdet-IC	LDO, 1.8V±2%, 500mA, Vdi=3.6V, -Reset ODO, +CE, PDR	USP-6B	49zx	VR15	9b	Tor
3CA22	XC6404CA22D	LVR/Vdet-IC	LDO, 1.8V±2%, 500mA, Vdi=4.2V, -Reset ODO, +CE, PDR	USP-6B	49zx	VR15	9b	Tor
3CA23	XC6404CA23D	LVR/Vdet-IC	LDO, 2.5V±2%, 500mA, Vdi=2.9V, -Reset ODO, +CE, PDR	USP-6B	49zx	VR15	9b	Tor
3CA24	XC6404CA24D	LVR/Vdet-IC	LDO, 2.5V±2%, 500mA, Vdi=3.6V, -Reset ODO, +CE, PDR	USP-6B	49zx	VR15	9b	Tor
3CA25	XC6404CA25D	LVR/Vdet-IC	LDO, 2.5V±2%, 500mA, Vdi=4.2V, -Reset ODO, +CE, PDR	USP-6B	49zx	VR15	9b	Tor
3CA26	XC6404CA26D	LVR/Vdet-IC	LDO, 4.3V±2%, 500mA, Vdi=4.0V, -Reset ODO, +CE, PDR	USP-6B	49zx	VR15	9b	Tor
3CA27	XC6404CA27D	LVR/Vdet-IC	LDO, 2.5V±2%, 500mA, Vdi=3.9V, -Reset ODO, +CE, PDR	USP-6B	49zx	VR15	9b	Tor
3CA28	XC6404CA28D	LVR/Vdet-IC	LDO, 3.3V±2%, 500mA, Vdi=3.7V, -Reset ODO, +CE, PDR	USP-6B	49zx	VR15	9b	Tor
3CA29	XC6404CA29D	LVR/Vdet-IC	LDO, 2.6V±2%, 500mA, Vdi=3.9V, -Reset ODO, +CE, PDR	USP-6B	49zx	VR15	9b	Tor
3CA30	XC6404CA30D	LVR/Vdet-IC	LDO, 3.3V±2%, 500mA, Vdi=4.2V, -Reset ODO, +CE, PDR	USP-6B	49zx	VR15	9b	Tor
3CA31	XC6404CA31D	LVR/Vdet-IC	LDO, 3.3V±2%, 500mA, Vdi=4.5V, -Reset ODO, +CE, PDR	USP-6B	49zx	VR15	9b	Tor
3CA32	XC6404CA32D	LVR/Vdet-IC	LDO, 2.85V±2%, 500mA, Vdi=2.6V, -Reset ODO, +CE, PDR	USP-6B	49zx	VR15	9b	Tor
3CA33	XC6404CA33D	LVR/Vdet-IC	LDO, 3.3V±2%, 500mA, Vdi=2.8V, -Reset ODO, +CE, PDR	USP-6B	49zx	VR15	9b	Tor
3CA34	XC6404CA34D	LVR/Vdet-IC	LDO, 3.4V±2%, 500mA, Vdi=4.2V, -Reset ODO, +CE, PDR	USP-6B	49zx	VR15	9b	Tor
3CA80	XC6404CA80D	LVR/Vdet-IC	LDO, 1.8V±2%, 500mA, Vdi=1.6V, -Reset ODO, +CE, PDR	USP-6B	49zx	VR15	9b	Tor
3CA81	XC6404CA81D	LVR/Vdet-IC	LDO, 2.8V±2%, 500mA, Vdi=3.1V, -Reset ODO, +CE, PDR	USP-6B	49zx	VR15	9b	Tor
3CA82	XC6404CA82D	LVR/Vdet-IC	LDO, 1.8V±2%, 500mA, Vdi=2.0V, -Reset ODO, +CE, PDR	USP-6B	49zx	VR15	9b	Tor
3CA83	XC6404CA83D	LVR/Vdet-IC	LDO, 2.5V±2%, 500mA, Vdi=2.8V, -Reset ODO, +CE, PDR	USP-6B	49zx	VR15	9b	Tor
3CA84	XC6404CA84D	LVR/Vdet-IC	LDO, 2.85V±2%, 500mA, Vdi=3.2V, -Reset ODO, +CE, PDR	USP-6B	49zx	VR15	9b	Tor
3CA85	XC6404CA85D	LVR/Vdet-IC	LDO, 3.0V±2%, 500mA, Vdi=3.3V, -Reset ODO, +CE, PDR	USP-6B	49zx	VR15	9b	Tor
3CA86	XC6404CA86D	LVR/Vdet-IC	LDO, 3.5V±2%, 500mA, Vdi=3.8V, -Reset ODO, +CE, PDR	USP-6B	49zx	VR15	9b	Tor
3CA87	XC6404CA87D	LVR/Vdet-IC	LDO, 3.0V±2%, 500mA, Vdi=4.2V, -Reset ODO, +CE, PDR	USP-6B	49zx	VR15	9b	Tor
3CA88	XC6404CA88D	LVR/Vdet-IC	LDO, 3.3V±2%, 500mA, Vdi=4.0V, -Reset ODO, +CE, PDR	USP-6B	49zx	VR15	9b	Tor
3CB	XC6227A411ER	LVR-IC	LDO, 4.1V±1%, 700mA, +CE	USP-6C	49hq	VR4	9a	Tor
3CB02	XC6404CB02D	LVR/Vdet-IC	LDO, 2.7V±2%, 500mA, Vdi=4.2V, +Reset ODO, +CE, PDR	USP-6B	49zx	VR15	9b	Tor
3CB03	XC6404CB03D	LVR/Vdet-IC	LDO, 2.5V±2%, 500mA, Vdi=2.6V, +Reset ODO, +CE, PDR	USP-6B	49zx	VR15	9b	Tor
3CB04	XC6404CB04D	LVR/Vdet-IC	LDO, 3.3V±2%, 500mA, Vdi=4.3V, +Reset ODO, +CE, PDR	USP-6B	49zx	VR15	9b	Tor
3CB05	XC6404CB05D	LVR/Vdet-IC	LDO, 3.3V±2%, 500mA, Vdi=4.4V, +Reset ODO, +CE, PDR	USP-6B	49zx	VR15	9b	Tor
3CB07	XC6404CB07D	LVR/Vdet-IC	LDO, 3.3V±2%, 500mA, Vdi=5.2V, +Reset ODO, +CE, PDR	USP-6B	49zx	VR15	9b	Tor
3CB08	XC6404CB08D	LVR/Vdet-IC	LDO, 2.8V±2%, 500mA, Vdi= 4.3V, +Reset ODO, +CE, PDR	USP-6B	49zx	VR15	9b	Tor
3CB09	XC6404CB09D	LVR/Vdet-IC	LDO, 4.3V±2%, 500mA, Vdi=2.8V, +Reset ODO, +CE, PDR	USP-6B	49zx	VR15	9b	Tor
3CB11	XC6404CB11D	LVR/Vdet-IC	LDO, 2.8V±2%, 500mA, Vdi=2.1V, +Reset ODO, +CE, PDR	USP-6B	49zx	VR15	9b	Tor
3CB12	XC6404CB12D	LVR/Vdet-IC	LDO, 2.8V±2%, 500mA, Vdi=2.8V, +Reset ODO, +CE, PDR	USP-6B	49zx	VR15	9b	Tor
3CB15	XC6404CB15D	LVR/Vdet-IC	LDO, 3.3V±2%, 500mA, Vdi=3.6V, +Reset ODO, +CE, PDR	USP-6B	49zx	VR15	9b	Tor
3CB18	XC6404CB18D	LVR/Vdet-IC	LDO, 3.0V±2%, 500mA, Vdi=2.7V, +Reset ODO, +CE, PDR	USP-6B	49zx	VR15	9b	Tor
3CB19	XC6404CB19D	LVR/Vdet-IC	LDO, 2.8V±2%, 500mA, Vdi=2.5V, +Reset ODO, +CE, PDR	USP-6B	49zx	VR15	9b	Tor
3CB20	XC6404CB20D	LVR/Vdet-IC	LDO, 1.8V±2%, 500mA, Vdi=2.9V, +Reset ODO, +CE, PDR	USP-6B	49zx	VR15	9b	Tor
3CB21	XC6404CB21D	LVR/Vdet-IC	LDO, 1.8V±2%, 500mA, Vdi=3.6V, +Reset ODO, +CE, PDR	USP-6B	49zx	VR15	9b	Tor
3CB22	XC6404CB22D	LVR/Vdet-IC	LDO, 1.8V±2%, 500mA, Vdi=4.2V, +Reset ODO, +CE, PDR	USP-6B	49zx	VR15	9b	Tor
3CB23	XC6404CB23D	LVR/Vdet-IC	LDO, 2.5V±2%, 500mA, Vdi=2.9V, +Reset ODO, +CE, PDR	USP-6B	49zx	VR15	9b	Tor



SMD code	Type	Function	Short description	Case	Pinout	Sch.	St.	Mnf.
3CB24	XC6404CB24D	LVR/Vdet-IC	LDO, 2.5V±2%, 500mA, Vdi=3.6V, +Reset ODO, +CE, PDR	USP-6B	49zx	VR15	9b	Tor
3CB25	XC6404CB25D	LVR/Vdet-IC	LDO, 2.5V±2%, 500mA, Vdi=4.2V, +Reset ODO, +CE, PDR	USP-6B	49zx	VR15	9b	Tor
3CB26	XC6404CB26D	LVR/Vdet-IC	LDO, 4.3V±2%, 500mA, Vdi=4.0V, +Reset ODO, +CE, PDR	USP-6B	49zx	VR15	9b	Tor
3CB27	XC6404CB27D	LVR/Vdet-IC	LDO, 2.5V±2%, 500mA, Vdi=3.9V, +Reset ODO, +CE, PDR	USP-6B	49zx	VR15	9b	Tor
3CB28	XC6404CB28D	LVR/Vdet-IC	LDO, 3.3V±2%, 500mA, Vdi=3.7V, +Reset ODO, +CE, PDR	USP-6B	49zx	VR15	9b	Tor
3CB29	XC6404CB29D	LVR/Vdet-IC	LDO, 2.6V±2%, 500mA, Vdi=3.9V, +Reset ODO, +CE, PDR	USP-6B	49zx	VR15	9b	Tor
3CB30	XC6404CB30D	LVR/Vdet-IC	LDO, 3.3V±2%, 500mA, Vdi=4.2V, +Reset ODO, +CE, PDR	USP-6B	49zx	VR15	9b	Tor
3CB31	XC6404CB31D	LVR/Vdet-IC	LDO, 3.3V±2%, 500mA, Vdi=4.5V, +Reset ODO, +CE, PDR	USP-6B	49zx	VR15	9b	Tor
3CB32	XC6404CB32D	LVR/Vdet-IC	LDO, 2.85V±2%, 500mA, Vdi=2.6V, +Reset ODO, +CE, PDR	USP-6B	49zx	VR15	9b	Tor
3CB33	XC6404CB33D	LVR/Vdet-IC	LDO, 3.3V±2%, 500mA, Vdi=2.8V, +Reset ODO, +CE, PDR	USP-6B	49zx	VR15	9b	Tor
3CB34	XC6404CB34D	LVR/Vdet-IC	LDO, 3.4V±2%, 500mA, Vdi=4.2V, +Reset ODO, +CE, PDR	USP-6B	49zx	VR15	9b	Tor
3CB80	XC6404CB80D	LVR/Vdet-IC	LDO, 1.8V±2%, 500mA, Vdi=1.6V, +Reset ODO, +CE, PDR	USP-6B	49zx	VR15	9b	Tor
3CB81	XC6404CB81D	LVR/Vdet-IC	LDO, 2.8V±2%, 500mA, Vdi=3.1V, +Reset ODO, +CE, PDR	USP-6B	49zx	VR15	9b	Tor
3CB82	XC6404CB82D	LVR/Vdet-IC	LDO, 1.8V±2%, 500mA, Vdi=2.0V, +Reset ODO, +CE, PDR	USP-6B	49zx	VR15	9b	Tor
3CB83	XC6404CB83D	LVR/Vdet-IC	LDO, 2.5V±2%, 500mA, Vdi=2.8V, +Reset ODO, +CE, PDR	USP-6B	49zx	VR15	9b	Tor
3CB84	XC6404CB84D	LVR/Vdet-IC	LDO, 2.85V±2%, 500mA, Vdi=3.2V, +Reset ODO, +CE, PDR	USP-6B	49zx	VR15	9b	Tor
3CB85	XC6404CB85D	LVR/Vdet-IC	LDO, 3.0V±2%, 500mA, Vdi=3.3V, +Reset ODO, +CE, PDR	USP-6B	49zx	VR15	9b	Tor
3CB86	XC6404CB86D	LVR/Vdet-IC	LDO, 3.5V±2%, 500mA, Vdi=3.8V, +Reset ODO, +CE, PDR	USP-6B	49zx	VR15	9b	Tor
3CB87	XC6404CB87D	LVR/Vdet-IC	LDO, 3.0V±2%, 500mA, Vdi=4.2V, +Reset ODO, +CE, PDR	USP-6B	49zx	VR15	9b	Tor
3CB88	XC6404CB88D	LVR/Vdet-IC	LDO, 3.3V±2%, 500mA, Vdi=4.0V, +Reset ODO, +CE, PDR	USP-6B	49zx	VR15	9b	Tor
3CC	XC6227A421ER	LVR-IC	LDO, 4.2V±1%, 700mA, +CE	USP-6C	49hq	VR4	9a	Tor
3CC02	XC6404CC02D	LVR/Vdet-IC	LDO, 2.7V±2%, 500mA, Vdo=4.2V, -Reset ODO, +CE, PDR	USP-6B	49zx	VR15	9b	Tor
3CC03	XC6404CC03D	LVR/Vdet-IC	LDO, 2.5V±2%, 500mA, Vdo=2.6V, -Reset ODO, +CE, PDR	USP-6B	49zx	VR15	9b	Tor
3CC04	XC6404CC04D	LVR/Vdet-IC	LDO, 3.3V±2%, 500mA, Vdo=4.3V, -Reset ODO, +CE, PDR	USP-6B	49zx	VR15	9b	Tor
3CC05	XC6404CC05D	LVR/Vdet-IC	LDO, 3.3V±2%, 500mA, Vdo=4.4V, -Reset ODO, +CE, PDR	USP-6B	49zx	VR15	9b	Tor
3CC07	XC6404CC07D	LVR/Vdet-IC	LDO, 3.3V±2%, 500mA, Vdo=5.2V, -Reset ODO, +CE, PDR	USP-6B	49zx	VR15	9b	Tor
3CC08	XC6404CC08D	LVR/Vdet-IC	LDO, 2.8V±2%, 500mA, Vdo=4.3V, -Reset ODO, +CE, PDR	USP-6B	49zx	VR15	9b	Tor
3CC09	XC6404CC09D	LVR/Vdet-IC	LDO, 4.3V±2%, 500mA, Vdo=2.8V, -Reset ODO, +CE, PDR	USP-6B	49zx	VR15	9b	Tor
3CC11	XC6404CC11D	LVR/Vdet-IC	LDO, 2.8V±2%, 500mA, Vdo=2.1V, -Reset ODO, +CE, PDR	USP-6B	49zx	VR15	9b	Tor
3CC12	XC6404CC12D	LVR/Vdet-IC	LDO, 2.8V±2%, 500mA, Vdo=2.8V, -Reset ODO, +CE, PDR	USP-6B	49zx	VR15	9b	Tor
3CC15	XC6404CC15D	LVR/Vdet-IC	LDO, 3.3V±2%, 500mA, Vdo=3.6V, -Reset ODO, +CE, PDR	USP-6B	49zx	VR15	9b	Tor
3CC18	XC6404CC18D	LVR/Vdet-IC	LDO, 3.0V±2%, 500mA, Vdo=3.6V, -Reset ODO, +CE, PDR	USP-6B	49zx	VR15	9b	Tor
3CC19	XC6404CC19D	LVR/Vdet-IC	LDO, 2.8V±2%, 500mA, Vdo=2.5V, -Reset ODO, +CE, PDR	USP-6B	49zx	VR15	9b	Tor
3CC20	XC6404CC20D	LVR/Vdet-IC	LDO, 1.8V±2%, 500mA, Vdo=2.9V, -Reset ODO, +CE, PDR	USP-6B	49zx	VR15	9b	Tor
3CC21	XC6404CC21D	LVR/Vdet-IC	LDO, 1.8V±2%, 500mA, Vdo=3.6V, -Reset ODO, +CE, PDR	USP-6B	49zx	VR15	9b	Tor
3CC22	XC6404CC22D	LVR/Vdet-IC	LDO, 1.8V±2%, 500mA, Vdo=4.2V, -Reset ODO, +CE, PDR	USP-6B	49zx	VR15	9b	Tor
3CC23	XC6404CC23D	LVR/Vdet-IC	LDO, 2.5V±2%, 500mA, Vdo=2.9V, -Reset ODO, +CE, PDR	USP-6B	49zx	VR15	9b	Tor
3CC24	XC6404CC24D	LVR/Vdet-IC	LDO, 2.5V±2%, 500mA, Vdo=3.4V, -Reset ODO, +CE, PDR	USP-6B	49zx	VR15	9b	Tor
3CC25	XC6404CC25D	LVR/Vdet-IC	LDO, 2.5V±2%, 500mA, Vdo=4.2V, -Reset ODO, +CE, PDR	USP-6B	49zx	VR15	9b	Tor
3CC26	XC6404CC26D	LVR/Vdet-IC	LDO, 4.3V±2%, 500mA, Vdo=4.0V, -Reset ODO, +CE, PDR	USP-6B	49zx	VR15	9b	Tor
3CC27	XC6404CC27D	LVR/Vdet-IC	LDO, 2.5V±2%, 500mA, Vdo=3.9V, -Reset ODO, +CE, PDR	USP-6B	49zx	VR15	9b	Tor
3CC28	XC6404CC28D	LVR/Vdet-IC	LDO, 3.3V±2%, 500mA, Vdo=3.7V, -Reset ODO, +CE, PDR	USP-6B	49zx	VR15	9b	Tor
3CC29	XC6404CC29D	LVR/Vdet-IC	LDO, 2.6V±2%, 500mA, Vdo=3.9V, -Reset ODO, +CE, PDR	USP-6B	49zx	VR15	9b	Tor
3CC30	XC6404CC30D	LVR/Vdet-IC	LDO, 3.3V±2%, 500mA, Vdo=4.2V, -Reset ODO, +CE, PDR	USP-6B	49zx	VR15	9b	Tor
3CC31	XC6404CC31D	LVR/Vdet-IC	LDO, 3.3V±2%, 500mA, Vdo=4.5V, -Reset ODO, +CE, PDR	USP-6B	49zx	VR15	9b	Tor
3CC32	XC6404CC32D	LVR/Vdet-IC	LDO, 2.85V±2%, 500mA, Vdo=2.6V, -Reset ODO, +CE, PDR	USP-6B	49zx	VR15	9b	Tor
3CC33	XC6404CC33D	LVR/Vdet-IC	LDO, 3.3V±2%, 500mA, Vdo=2.8V, -Reset ODO, +CE, PDR	USP-6B	49zx	VR15	9b	Tor
3CC34	XC6404CC34D	LVR/Vdet-IC	LDO, 3.4V±2%, 500mA, Vdo=4.2V, -Reset ODO, +CE, PDR	USP-6B	49zx	VR15	9b	Tor
3CC80	XC6404CC80D	LVR/Vdet-IC	LDO, 1.8V±2%, 500mA, Vdo=1.6V, -Reset ODO, +CE, PDR	USP-6B	49zx	VR15	9b	Tor
3CC81	XC6404CC81D	LVR/Vdet-IC	LDO, 2.8V±2%, 500mA, Vdo=3.1V, -Reset ODO, +CE, PDR	USP-6B	49zx	VR15	9b	Tor
3CC82	XC6404CC82D	LVR/Vdet-IC	LDO, 1.8V±2%, 500mA, Vdo=2.8V, -Reset ODO, +CE, PDR	USP-6B	49zx	VR15	9b	Tor
3CC83	XC6404CC83D	LVR/Vdet-IC	LDO, 2.5V±2%, 500mA, Vdo=2.8V, -Reset ODO, +CE, PDR	USP-6B	49zx	VR15	9b	Tor
3CC84	XC6404CC84D	LVR/Vdet-IC	LDO, 2.85V±2%, 500mA, Vdo=3.2V, -Reset ODO, +CE, PDR	USP-6B	49zx	VR15	9b	Tor
3CC85	XC6404CC85D	LVR/Vdet-IC	LDO, 3.0V±2%, 500mA, Vdo=3.3V, -Reset ODO, +CE, PDR	USP-6B	49zx	VR15	9b	Tor
3CC86	XC6404CC86D	LVR/Vdet-IC	LDO, 3.5V±2%, 500mA, Vdo=3.8V, -Reset ODO, +CE, PDR	USP-6B	49zx	VR15	9b	Tor
3CC87	XC6404CC87D	LVR/Vdet-IC	LDO, 3.0V±2%, 500mA, Vdo=4.2V, -Reset ODO, +CE, PDR	USP-6B	49zx	VR15	9b	Tor
3CC88	XC6404CC88D	LVR/Vdet-IC	LDO, 3.3V±2%, 500mA, Vdo=4.0V, -Reset ODO, +CE, PDR	USP-6B	49zx	VR15	9b	Tor
3CD	XC6227A431ER	LVR-IC	LDO, 4.3V±1%, 700mA, +CE	USP-6C	49hq	VR4	9a	Tor
3CD02	XC6404CD02D	LVR/Vdet-IC	LDO, 2.7V±2%, 500mA, Vdo=4.2V, +Reset ODO, +CE, PDR	USP-6B	49zx	VR15	9b	Tor
3CD03	XC6404CD03D	LVR/Vdet-IC	LDO, 2.5V±2%, 500mA, Vdo=2.6V, +Reset ODO, +CE, PDR	USP-6B	49zx	VR15	9b	Tor
3CD04	XC6404CD04D	LVR/Vdet-IC	LDO, 3.3V±2%, 500mA, Vdo=4.3V, +Reset ODO, +CE, PDR	USP-6B	49zx	VR15	9b	Tor
3CD05	XC6404CD05D	LVR/Vdet-IC	LDO, 3.3V±2%, 500mA, Vdo=4.4V, +Reset ODO, +CE, PDR	USP-6B	49zx	VR15	9b	Tor
3CD07	XC6404CD07D	LVR/Vdet-IC	LDO, 3.3V±2%, 500mA, Vdo=5.2V, +Reset ODO, +CE, PDR	USP-6B	49zx	VR15	9b	Tor
3CD08	XC6404CD08D	LVR/Vdet-IC	LDO, 2.8V±2%, 500mA, Vdo=4.3V, +Reset ODO, +CE, PDR	USP-6B	49zx	VR15	9b	Tor
3CD09	XC6404CD09D	LVR/Vdet-IC	LDO, 4.3V±2%, 500mA, Vdo=2.8V, +Reset ODO, +CE, PDR	USP-6B	49zx	VR15	9b	Tor
3CD11	XC6404CD11D	LVR/Vdet-IC	LDO, 2.8V±2%, 500mA, Vdo=2.1V, +Reset ODO, +CE, PDR	USP-6B	49zx	VR15	9b	Tor
3CD12	XC6404CD12D	LVR/Vdet-IC	LDO, 2.8V±2%, 500mA, Vdo=2.8V, +Reset ODO, +CE, PDR	USP-6B	49zx	VR15	9b	Tor
3CD15	XC6404CD15D	LVR/Vdet-IC	LDO, 3.3V±2%, 500mA, Vdo=3.6V, +Reset ODO, +CE, PDR	USP-6B	49zx	VR15	9b	Tor
3CD18	XC6404CD18D	LVR/Vdet-IC	LDO, 3.0V±2%, 500mA, Vdo=2.7V, +Reset ODO, +CE, PDR	USP-6B	49zx	VR15	9b	Tor
3CD19	XC6404CD19D	LVR/Vdet-IC	LDO, 2.8V±2%, 500mA, Vdo=2.5V, +Reset ODO, +CE, PDR	USP-6B	49zx	VR15	9b	Tor



SMD code	Type	Function	Short description	Case	Pinout	Sch.	St.	Mnf.
3CD20	XC6404CD20D	LVR/Vdet-IC	LDO, 1.8V±2%, 500mA, Vdo=2.9V, +Reset ODO, +CE, PDR	USP-6B	49zx	VR15	9b	Tor
3CD21	XC6404CD21D	LVR/Vdet-IC	LDO, 1.8V±2%, 500mA, Vdo=3.6V, +Reset ODO, +CE, PDR	USP-6B	49zx	VR15	9b	Tor
3CD22	XC6404CD22D	LVR/Vdet-IC	LDO, 1.8V±2%, 500mA, Vdo=4.2V, +Reset ODO, +CE, PDR	USP-6B	49zx	VR15	9b	Tor
3CD23	XC6404CD23D	LVR/Vdet-IC	LDO, 2.5V±2%, 500mA, Vdo=2.9V, +Reset ODO, +CE, PDR	USP-6B	49zx	VR15	9b	Tor
3CD24	XC6404CD24D	LVR/Vdet-IC	LDO, 2.5V±2%, 500mA, Vdo=3.6V, +Reset ODO, +CE, PDR	USP-6B	49zx	VR15	9b	Tor
3CD25	XC6404CD25D	LVR/Vdet-IC	LDO, 2.5V±2%, 500mA, Vdo=4.2V, +Reset ODO, +CE, PDR	USP-6B	49zx	VR15	9b	Tor
3CD26	XC6404CD26D	LVR/Vdet-IC	LDO, 4.3V±2%, 500mA, Vdo=4.0V, +Reset ODO, +CE, PDR	USP-6B	49zx	VR15	9b	Tor
3CD27	XC6404CD27D	LVR/Vdet-IC	LDO, 2.5V±2%, 500mA, Vdo=3.9V, +Reset ODO, +CE, PDR	USP-6B	49zx	VR15	9b	Tor
3CD28	XC6404CD28D	LVR/Vdet-IC	LDO, 3.3V±2%, 500mA, Vdo=3.7V, +Reset ODO, +CE, PDR	USP-6B	49zx	VR15	9b	Tor
3CD29	XC6404CD29D	LVR/Vdet-IC	LDO, 2.6V±2%, 500mA, Vdo=3.9V, +Reset ODO, +CE, PDR	USP-6B	49zx	VR15	9b	Tor
3CD30	XC6404CD30D	LVR/Vdet-IC	LDO, 3.3V±2%, 500mA, Vdo=4.5V, +Reset ODO, +CE, PDR	USP-6B	49zx	VR15	9b	Tor
3CD31	XC6404CD31D	LVR/Vdet-IC	LDO, 3.3V±2%, 500mA, Vdo=4.5V, +Reset ODO, +CE, PDR	USP-6B	49zx	VR15	9b	Tor
3CD32	XC6404CD32D	LVR/Vdet-IC	LDO, 2.85V±2%, 500mA, Vdo=2.6V, +Reset ODO, +CE, PDR	USP-6B	49zx	VR15	9b	Tor
3CD33	XC6404CD33D	LVR/Vdet-IC	LDO, 3.3V±2%, 500mA, Vdo=2.8V, +Reset ODO, +CE, PDR	USP-6B	49zx	VR15	9b	Tor
3CD34	XC6404CD34D	LVR/Vdet-IC	LDO, 3.4V±2%, 500mA, Vdo=4.2V, +Reset ODO, +CE, PDR	USP-6B	49zx	VR15	9b	Tor
3CD80	XC6404CD80D	LVR/Vdet-IC	LDO, 1.8V±2%, 500mA, Vdo=1.6V, +Reset ODO, +CE, PDR	USP-6B	49zx	VR15	9b	Tor
3CD81	XC6404CD81D	LVR/Vdet-IC	LDO, 2.8V±2%, 500mA, Vdo=3.1V, +Reset ODO, +CE, PDR	USP-6B	49zx	VR15	9b	Tor
3CD82	XC6404CD82D	LVR/Vdet-IC	LDO, 1.8V±2%, 500mA, Vdo=2.0V, +Reset ODO, +CE, PDR	USP-6B	49zx	VR15	9b	Tor
3CD83	XC6404CD83D	LVR/Vdet-IC	LDO, 2.5V±2%, 500mA, Vdo=2.8V, +Reset ODO, +CE, PDR	USP-6B	49zx	VR15	9b	Tor
3CD84	XC6404CD84D	LVR/Vdet-IC	LDO, 2.85V±2%, 500mA, Vdo=3.2V, +Reset ODO, +CE, PDR	USP-6B	49zx	VR15	9b	Tor
3CD85	XC6404CD85D	LVR/Vdet-IC	LDO, 3.0V±2%, 500mA, Vdo=3.3V, +Reset ODO, +CE, PDR	USP-6B	49zx	VR15	9b	Tor
3CD86	XC6404CD86D	LVR/Vdet-IC	LDO, 3.5V±2%, 500mA, Vdo=3.8V, +Reset ODO, +CE, PDR	USP-6B	49zx	VR15	9b	Tor
3CD87	XC6404CD87D	LVR/Vdet-IC	LDO, 3.0V±2%, 500mA, Vdo=4.2V, +Reset ODO, +CE, PDR	USP-6B	49zx	VR15	9b	Tor
3CD88	XC6404CD88D	LVR/Vdet-IC	LDO, 3.3V±2%, 500mA, Vdo=4.0V, +Reset ODO, +CE, PDR	USP-6B	49zx	VR15	9b	Tor
3CE	XC6227A441ER	LVR-IC	LDO, 4.4V±1%, 700mA, +CE	USP-6C	49hq	VR4	9a	Tor
3CE02	XC6404CE02D	LVR/Vdet-IC	LDO, 2.7V±2%, 500mA, Vdi=4.2V, -Reset ODO, +CE	USP-6B	49zx	VR15	9b	Tor
3CE03	XC6404CE03D	LVR/Vdet-IC	LDO, 2.5V±2%, 500mA, Vdi=2.6V, -Reset ODO, +CE	USP-6B	49zx	VR15	9b	Tor
3CE04	XC6404CE04D	LVR/Vdet-IC	LDO, 3.3V±2%, 500mA, Vdi=4.3V, -Reset ODO, +CE	USP-6B	49zx	VR15	9b	Tor
3CE05	XC6404CE05D	LVR/Vdet-IC	LDO, 3.3V±2%, 500mA, Vdi=4.4V, -Reset ODO, +CE	USP-6B	49zx	VR15	9b	Tor
3CE07	XC6404CE07D	LVR/Vdet-IC	LDO, 3.3V±2%, 500mA, Vdi=5.2V, -Reset ODO, +CE	USP-6B	49zx	VR15	9b	Tor
3CE08	XC6404CE08D	LVR/Vdet-IC	LDO, 2.8V±2%, 500mA, Vdi=4.3V, -Reset ODO, +CE	USP-6B	49zx	VR15	9b	Tor
3CE09	XC6404CE09D	LVR/Vdet-IC	LDO, 4.3V±2%, 500mA, Vdi=2.8V, -Reset ODO, +CE	USP-6B	49zx	VR15	9b	Tor
3CE11	XC6404CE11D	LVR/Vdet-IC	LDO, 2.8V±2%, 500mA, Vdi=2.1V, -Reset ODO, +CE	USP-6B	49zx	VR15	9b	Tor
3CE12	XC6404CE12D	LVR/Vdet-IC	LDO, 2.8V±2%, 500mA, Vdi=2.8V, -Reset ODO, +CE	USP-6B	49zx	VR15	9b	Tor
3CE15	XC6404CE15D	LVR/Vdet-IC	LDO, 3.3V±2%, 500mA, Vdi=3.6V, -Reset ODO, +CE	USP-6B	49zx	VR15	9b	Tor
3CE18	XC6404CE18D	LVR/Vdet-IC	LDO, 3.0V±2%, 500mA, Vdi=2.7V, -Reset ODO, +CE	USP-6B	49zx	VR15	9b	Tor
3CE19	XC6404CE19D	LVR/Vdet-IC	LDO, 2.8V±2%, 500mA, Vdi=2.5V, -Reset ODO, +CE	USP-6B	49zx	VR15	9b	Tor
3CE20	XC6404CE20D	LVR/Vdet-IC	LDO, 1.8V±2%, 500mA, Vdi=2.9V, -Reset ODO, +CE	USP-6B	49zx	VR15	9b	Tor
3CE21	XC6404CE21D	LVR/Vdet-IC	LDO, 1.8V±2%, 500mA, Vdi=3.6V, -Reset ODO, +CE	USP-6B	49zx	VR15	9b	Tor
3CE22	XC6404CE22D	LVR/Vdet-IC	LDO, 1.8V±2%, 500mA, Vdi=4.2V, -Reset ODO, +CE	USP-6B	49zx	VR15	9b	Tor
3CE23	XC6404CE23D	LVR/Vdet-IC	LDO, 2.5V±2%, 500mA, Vdi=2.9V, -Reset ODO, +CE	USP-6B	49zx	VR15	9b	Tor
3CE24	XC6404CE24D	LVR/Vdet-IC	LDO, 2.5V±2%, 500mA, Vdi=3.6V, -Reset ODO, +CE	USP-6B	49zx	VR15	9b	Tor
3CE25	XC6404CE25D	LVR/Vdet-IC	LDO, 2.5V±2%, 500mA, Vdi=4.2V, -Reset ODO, +CE	USP-6B	49zx	VR15	9b	Tor
3CE26	XC6404CE26D	LVR/Vdet-IC	LDO, 4.3V±2%, 500mA, Vdi=4.0V, -Reset ODO, +CE	USP-6B	49zx	VR15	9b	Tor
3CE27	XC6404CE27D	LVR/Vdet-IC	LDO, 2.5V±2%, 500mA, Vdi=3.9V, -Reset ODO, +CE	USP-6B	49zx	VR15	9b	Tor
3CE28	XC6404CE28D	LVR/Vdet-IC	LDO, 3.3V±2%, 500mA, Vdi=3.7V, -Reset ODO, +CE	USP-6B	49zx	VR15	9b	Tor
3CE29	XC6404CE29D	LVR/Vdet-IC	LDO, 2.6V±2%, 500mA, Vdi=3.9V, -Reset ODO, +CE	USP-6B	49zx	VR15	9b	Tor
3CE30	XC6404CE30D	LVR/Vdet-IC	LDO, 3.3V±2%, 500mA, Vdi=4.2V, -Reset ODO, +CE	USP-6B	49zx	VR15	9b	Tor
3CE31	XC6404CE31D	LVR/Vdet-IC	LDO, 3.3V±2%, 500mA, Vdi=4.5V, -Reset ODO, +CE	USP-6B	49zx	VR15	9b	Tor
3CE32	XC6404CE32D	LVR/Vdet-IC	LDO, 2.85V±2%, 500mA, Vdi=2.6V, -Reset ODO, +CE	USP-6B	49zx	VR15	9b	Tor
3CE33	XC6404CE33D	LVR/Vdet-IC	LDO, 3.3V±2%, 500mA, Vdi=2.8V, -Reset ODO, +CE	USP-6B	49zx	VR15	9b	Tor
3CE34	XC6404CE34D	LVR/Vdet-IC	LDO, 3.4V±2%, 500mA, Vdi=4.2V, -Reset ODO, +CE	USP-6B	49zx	VR15	9b	Tor
3CE80	XC6404CE80D	LVR/Vdet-IC	LDO, 1.8V±2%, 500mA, Vdi=1.6V, -Reset ODO, +CE	USP-6B	49zx	VR15	9b	Tor
3CE81	XC6404CE81D	LVR/Vdet-IC	LDO, 2.8V±2%, 500mA, Vdi=3.1V, -Reset ODO, +CE	USP-6B	49zx	VR15	9b	Tor
3CE82	XC6404CE82D	LVR/Vdet-IC	LDO, 1.8V±2%, 500mA, Vdi=2.0V, -Reset ODO, +CE	USP-6B	49zx	VR15	9b	Tor
3CE83	XC6404CE83D	LVR/Vdet-IC	LDO, 2.5V±2%, 500mA, Vdi=2.8V, -Reset ODO, +CE	USP-6B	49zx	VR15	9b	Tor
3CE84	XC6404CE84D	LVR/Vdet-IC	LDO, 2.85V±2%, 500mA, Vdi=3.2V, -Reset ODO, +CE	USP-6B	49zx	VR15	9b	Tor
3CE85	XC6404CE85D	LVR/Vdet-IC	LDO, 3.0V±2%, 500mA, Vdi=3.3V, -Reset ODO, +CE	USP-6B	49zx	VR15	9b	Tor
3CE86	XC6404CE86D	LVR/Vdet-IC	LDO, 3.5V±2%, 500mA, Vdi=3.8V, -Reset ODO, +CE	USP-6B	49zx	VR15	9b	Tor
3CE87	XC6404CE87D	LVR/Vdet-IC	LDO, 3.0V±2%, 500mA, Vdi=4.2V, -Reset ODO, +CE	USP-6B	49zx	VR15	9b	Tor
3CE88	XC6404CE88D	LVR/Vdet-IC	LDO, 3.3V±2%, 500mA, Vdi=4.0V, -Reset ODO, +CE	USP-6B	49zx	VR15	9b	Tor
3CF	XC6227A451ER	LVR-IC	LDO, 4.5V±1%, 700mA, +CE	USP-6C	49hq	VR4	9a	Tor
3CF02	XC6404CF02D	LVR/Vdet-IC	LDO, 2.7V±2%, 500mA, Vdi=4.2V, +Reset ODO, +CE	USP-6B	49zx	VR15	9b	Tor
3CF03	XC6404CF03D	LVR/Vdet-IC	LDO, 2.5V±2%, 500mA, Vdi=2.6V, +Reset ODO, +CE	USP-6B	49zx	VR15	9b	Tor
3CF04	XC6404CF04D	LVR/Vdet-IC	LDO, 3.3V±2%, 500mA, Vdi=4.3V, +Reset ODO, +CE	USP-6B	49zx	VR15	9b	Tor
3CF05	XC6404CF05D	LVR/Vdet-IC	LDO, 3.3V±2%, 500mA, Vdi=4.4V, +Reset ODO, +CE	USP-6B	49zx	VR15	9b	Tor
3CF07	XC6404CF07D	LVR/Vdet-IC	LDO, 3.3V±2%, 500mA, Vdi=5.2V, +Reset ODO, +CE	USP-6B	49zx	VR15	9b	Tor
3CF08	XC6404CF08D	LVR/Vdet-IC	LDO, 2.8V±2%, 500mA, Vdi=4.3V, +Reset ODO, +CE	USP-6B	49zx	VR15	9b	Tor
3CF09	XC6404CF09D	LVR/Vdet-IC	LDO, 4.3V±2%, 500mA, Vdi=2.8V, +Reset ODO, +CE	USP-6B	49zx	VR15	9b	Tor
3CF11	XC6404CF11D	LVR/Vdet-IC	LDO, 2.8V±2%, 500mA, Vdi=2.1V, +Reset ODO, +CE	USP-6B	49zx	VR15	9b	Tor



SMD code	Type	Function	Short description	Case	Pinout	Sch.	St.Mnf.
3CF12	XC6404CF12D	LVR/Vdet-IC	LDO, 2.8V±2%, 500mA, Vdi=2.8V, +Reset ODO, +CE	USP-6B	49zx	VR15	9b Tor
3CF15	XC6404CF15D	LVR/Vdet-IC	LDO, 3.3V±2%, 500mA, Vdi=3.6V, +Reset ODO, +CE	USP-6B	49zx	VR15	9b Tor
3CF18	XC6404CF18D	LVR/Vdet-IC	LDO, 3.0V±2%, 500mA, Vdi=2.7V, +Reset ODO, +CE	USP-6B	49zx	VR15	9b Tor
3CF19	XC6404CF19D	LVR/Vdet-IC	LDO, 2.8V±2%, 500mA, Vdi=2.5V, +Reset ODO, +CE	USP-6B	49zx	VR15	9b Tor
3CF20	XC6404CF20D	LVR/Vdet-IC	LDO, 1.8V±2%, 500mA, Vdi=2.9V, +Reset ODO, +CE	USP-6B	49zx	VR15	9b Tor
3CF21	XC6404CF21D	LVR/Vdet-IC	LDO, 1.8V±2%, 500mA, Vdi=3.6V, +Reset ODO, +CE	USP-6B	49zx	VR15	9b Tor
3CF22	XC6404CF22D	LVR/Vdet-IC	LDO, 1.8V±2%, 500mA, Vdi=4.2V, +Reset ODO, +CE	USP-6B	49zx	VR15	9b Tor
3CF23	XC6404CF23D	LVR/Vdet-IC	LDO, 2.5V±2%, 500mA, Vdi=2.9V, +Reset ODO, +CE	USP-6B	49zx	VR15	9b Tor
3CF24	XC6404CF24D	LVR/Vdet-IC	LDO, 2.5V±2%, 500mA, Vdi=3.6V, +Reset ODO, +CE	USP-6B	49zx	VR15	9b Tor
3CF25	XC6404CF25D	LVR/Vdet-IC	LDO, 2.5V±2%, 500mA, Vdi=4.2V, +Reset ODO, +CE	USP-6B	49zx	VR15	9b Tor
3CF26	XC6404CF26D	LVR/Vdet-IC	LDO, 4.3V±2%, 500mA, Vdi=4.0V, +Reset ODO, +CE	USP-6B	49zx	VR15	9b Tor
3CF27	XC6404CF27D	LVR/Vdet-IC	LDO, 2.5V±2%, 500mA, Vdi=3.9V, +Reset ODO, +CE	USP-6B	49zx	VR15	9b Tor
3CF28	XC6404CF28D	LVR/Vdet-IC	LDO, 3.3V±2%, 500mA, Vdi=3.7V, +Reset ODO, +CE	USP-6B	49zx	VR15	9b Tor
3CF29	XC6404CF29D	LVR/Vdet-IC	LDO, 2.6V±2%, 500mA, Vdi=3.9V, +Reset ODO, +CE	USP-6B	49zx	VR15	9b Tor
3CF30	XC6404CF30D	LVR/Vdet-IC	LDO, 3.3V±2%, 500mA, Vdi=4.2V, +Reset ODO, +CE	USP-6B	49zx	VR15	9b Tor
3CF31	XC6404CF31D	LVR/Vdet-IC	LDO, 3.3V±2%, 500mA, Vdi=4.5V, +Reset ODO, +CE	USP-6B	49zx	VR15	9b Tor
3CF32	XC6404CF32D	LVR/Vdet-IC	LDO, 2.85V±2%, 500mA, Vdi=2.6V, +Reset ODO, +CE	USP-6B	49zx	VR15	9b Tor
3CF33	XC6404CF33D	LVR/Vdet-IC	LDO, 3.3V±2%, 500mA, Vdi=2.8V, +Reset ODO, +CE	USP-6B	49zx	VR15	9b Tor
3CF34	XC6404CF34D	LVR/Vdet-IC	LDO, 3.4V±2%, 500mA, Vdi=4.2V, +Reset ODO, +CE	USP-6B	49zx	VR15	9b Tor
3CF80	XC6404CF80D	LVR/Vdet-IC	LDO, 1.8V±2%, 500mA, Vdi=1.6V, +Reset ODO, +CE	USP-6B	49zx	VR15	9b Tor
3CF81	XC6404CF81D	LVR/Vdet-IC	LDO, 2.8V±2%, 500mA, Vdi=3.1V, +Reset ODO, +CE	USP-6B	49zx	VR15	9b Tor
3CF82	XC6404CF82D	LVR/Vdet-IC	LDO, 1.8V±2%, 500mA, Vdi=2.9V, +Reset ODO, +CE	USP-6B	49zx	VR15	9b Tor
3CF83	XC6404CF83D	LVR/Vdet-IC	LDO, 2.5V±2%, 500mA, Vdi=2.8V, +Reset ODO, +CE	USP-6B	49zx	VR15	9b Tor
3CF84	XC6404CF84D	LVR/Vdet-IC	LDO, 2.85V±2%, 500mA, Vdi=3.2V, +Reset ODO, +CE	USP-6B	49zx	VR15	9b Tor
3CF85	XC6404CF85D	LVR/Vdet-IC	LDO, 3.0V±2%, 500mA, Vdi=3.9V, +Reset ODO, +CE	USP-6B	49zx	VR15	9b Tor
3CF86	XC6404CF86D	LVR/Vdet-IC	LDO, 3.5V±2%, 500mA, Vdi=3.8V, +Reset ODO, +CE	USP-6B	49zx	VR15	9b Tor
3CF87	XC6404CF87D	LVR/Vdet-IC	LDO, 3.0V±2%, 500mA, Vdi=4.2V, +Reset ODO, +CE	USP-6B	49zx	VR15	9b Tor
3CF88	XC6404CF88D	LVR/Vdet-IC	LDO, 3.3V±2%, 500mA, Vdi=4.0V, +Reset ODO, +CE	USP-6B	49zx	VR15	9b Tor
3CH	XC6227A461ER	LVR-IC	LDO, 4.6V±1%, 700mA, +CE	USP-6C	49hq	VR4	9a Tor
3CH02	XC6404CH02D	LVR/Vdet-IC	LDO, 2.7V±2%, 500mA, Vdo=4.2V, -Reset ODO, +CE	USP-6B	49zx	VR15	9b Tor
3CH03	XC6404CH03D	LVR/Vdet-IC	LDO, 2.5V±2%, 500mA, Vdo=2.6V, -Reset ODO, +CE	USP-6B	49zx	VR15	9b Tor
3CH04	XC6404CH04D	LVR/Vdet-IC	LDO, 3.3V±2%, 500mA, Vdo=3.3V, -Reset ODO, +CE	USP-6B	49zx	VR15	9b Tor
3CH05	XC6404CH05D	LVR/Vdet-IC	LDO, 3.3V±2%, 500mA, Vdo=4.4V, -Reset ODO, +CE	USP-6B	49zx	VR15	9b Tor
3CH07	XC6404CH07D	LVR/Vdet-IC	LDO, 3.3V±2%, 500mA, Vdo=5.2V, -Reset ODO, +CE	USP-6B	49zx	VR15	9b Tor
3CH08	XC6404CH08D	LVR/Vdet-IC	LDO, 2.8V±2%, 500mA, Vdo=4.3V, -Reset ODO, +CE	USP-6B	49zx	VR15	9b Tor
3CH09	XC6404CH09D	LVR/Vdet-IC	LDO, 4.3V±2%, 500mA, Vdo=2.8V, -Reset ODO, +CE	USP-6B	49zx	VR15	9b Tor
3CH11	XC6404CH11D	LVR/Vdet-IC	LDO, 2.8V±2%, 500mA, Vdo=2.1V, -Reset ODO, +CE	USP-6B	49zx	VR15	9b Tor
3CH12	XC6404CH12D	LVR/Vdet-IC	LDO, 2.8V±2%, 500mA, Vdo=2.3V, -Reset ODO, +CE	USP-6B	49zx	VR15	9b Tor
3CH15	XC6404CH15D	LVR/Vdet-IC	LDO, 3.3V±2%, 500mA, Vdo=3.6V, -Reset ODO, +CE	USP-6B	49zx	VR15	9b Tor
3CH18	XC6404CH18D	LVR/Vdet-IC	LDO, 3.0V±2%, 500mA, Vdo=2.7V, -Reset ODO, +CE	USP-6B	49zx	VR15	9b Tor
3CH19	XC6404CH19D	LVR/Vdet-IC	LDO, 2.8V±2%, 500mA, Vdo=2.5V, -Reset ODO, +CE	USP-6B	49zx	VR15	9b Tor
3CH20	XC6404CH20D	LVR/Vdet-IC	LDO, 1.8V±2%, 500mA, Vdo=2.9V, -Reset ODO, +CE	USP-6B	49zx	VR15	9b Tor
3CH21	XC6404CH21D	LVR/Vdet-IC	LDO, 1.8V±2%, 500mA, Vdo=3.6V, -Reset ODO, +CE	USP-6B	49zx	VR15	9b Tor
3CH22	XC6404CH22D	LVR/Vdet-IC	LDO, 1.8V±2%, 500mA, Vdo=4.2V, -Reset ODO, +CE	USP-6B	49zx	VR15	9b Tor
3CH23	XC6404CH23D	LVR/Vdet-IC	LDO, 2.5V±2%, 500mA, Vdo=2.9V, -Reset ODO, +CE	USP-6B	49zx	VR15	9b Tor
3CH24	XC6404CH24D	LVR/Vdet-IC	LDO, 2.5V±2%, 500mA, Vdo=3.6V, -Reset ODO, +CE	USP-6B	49zx	VR15	9b Tor
3CH25	XC6404CH25D	LVR/Vdet-IC	LDO, 2.5V±2%, 500mA, Vdo=4.2V, -Reset ODO, +CE	USP-6B	49zx	VR15	9b Tor
3CH26	XC6404CH26D	LVR/Vdet-IC	LDO, 4.3V±2%, 500mA, Vdo=4.0V, -Reset ODO, +CE	USP-6B	49zx	VR15	9b Tor
3CH27	XC6404CH27D	LVR/Vdet-IC	LDO, 2.5V±2%, 500mA, Vdo=3.9V, -Reset ODO, +CE	USP-6B	49zx	VR15	9b Tor
3CH28	XC6404CH28D	LVR/Vdet-IC	LDO, 3.3V±2%, 500mA, Vdo=3.7V, -Reset ODO, +CE	USP-6B	49zx	VR15	9b Tor
3CH29	XC6404CH29D	LVR/Vdet-IC	LDO, 2.6V±2%, 500mA, Vdo=3.9V, -Reset ODO, +CE	USP-6B	49zx	VR15	9b Tor
3CH30	XC6404CH30D	LVR/Vdet-IC	LDO, 3.3V±2%, 500mA, Vdo=4.2V, -Reset ODO, +CE	USP-6B	49zx	VR15	9b Tor
3CH31	XC6404CH31D	LVR/Vdet-IC	LDO, 3.3V±2%, 500mA, Vdo=4.5V, -Reset ODO, +CE	USP-6B	49zx	VR15	9b Tor
3CH32	XC6404CH32D	LVR/Vdet-IC	LDO, 2.85V±2%, 500mA, Vdo=2.6V, -Reset ODO, +CE	USP-6B	49zx	VR15	9b Tor
3CH33	XC6404CH33D	LVR/Vdet-IC	LDO, 3.3V±2%, 500mA, Vdo=2.8V, -Reset ODO, +CE	USP-6B	49zx	VR15	9b Tor
3CH34	XC6404CH34D	LVR/Vdet-IC	LDO, 3.4V±2%, 500mA, Vdo=4.2V, -Reset ODO, +CE	USP-6B	49zx	VR15	9b Tor
3CH80	XC6404CH80D	LVR/Vdet-IC	LDO, 1.8V±2%, 500mA, Vdo=1.6V, -Reset ODO, +CE	USP-6B	49zx	VR15	9b Tor
3CH81	XC6404CH81D	LVR/Vdet-IC	LDO, 2.8V±2%, 500mA, Vdo=3.1V, -Reset ODO, +CE	USP-6B	49zx	VR15	9b Tor
3CH82	XC6404CH82D	LVR/Vdet-IC	LDO, 1.8V±2%, 500mA, Vdo=2.0V, -Reset ODO, +CE	USP-6B	49zx	VR15	9b Tor
3CH83	XC6404CH83D	LVR/Vdet-IC	LDO, 2.5V±2%, 500mA, Vdo=2.8V, -Reset ODO, +CE	USP-6B	49zx	VR15	9b Tor
3CH84	XC6404CH84D	LVR/Vdet-IC	LDO, 2.85V±2%, 500mA, Vdo=3.2V, -Reset ODO, +CE	USP-6B	49zx	VR15	9b Tor
3CH85	XC6404CH85D	LVR/Vdet-IC	LDO, 3.0V±2%, 500mA, Vdo=3.3V, -Reset ODO, +CE	USP-6B	49zx	VR15	9b Tor
3CH86	XC6404CH86D	LVR/Vdet-IC	LDO, 3.5V±2%, 500mA, Vdo=3.8V, -Reset ODO, +CE	USP-6B	49zx	VR15	9b Tor
3CH87	XC6404CH87D	LVR/Vdet-IC	LDO, 3.0V±2%, 500mA, Vdo=4.2V, -Reset ODO, +CE	USP-6B	49zx	VR15	9b Tor
3CH88	XC6404CH88D	LVR/Vdet-IC	LDO, 3.3V±2%, 500mA, Vdo=4.0V, -Reset ODO, +CE	USP-6B	49zx	VR15	9b Tor
3CK	XC6227A471ER	LVR-IC	LDO, 4.7V±1%, 700mA, +CE	USP-6C	49hq	VR4	9a Tor
3CK02	XC6404CK02D	LVR/Vdet-IC	LDO, 2.7V±2%, 500mA, Vdo=4.2V, +Reset ODO, +CE	USP-6B	49zx	VR15	9b Tor
3CK03	XC6404CK03D	LVR/Vdet-IC	LDO, 2.5V±2%, 500mA, Vdo=2.6V, +Reset ODO, +CE	USP-6B	49zx	VR15	9b Tor
3CK04	XC6404CK04D	LVR/Vdet-IC	LDO, 3.3V±2%, 500mA, Vdo=4.3V, +Reset ODO, +CE	USP-6B	49zx	VR15	9b Tor
3CK05	XC6404CK05D	LVR/Vdet-IC	LDO, 3.3V±2%, 500mA, Vdo=4.4V, +Reset ODO, +CE	USP-6B	49zx	VR15	9b Tor



SMD code	Type	Function	Short description	Case	Pinout	Sch.	St.	Mnf.
3CK07	XC6404CK07D	LVR/Vdet-IC	LDO, 3.3V±2%, 500mA, Vdo=5.2V, +Reset ODO, +CE	USP-6B	49zx	VR15	9b	Tor
3CK08	XC6404CK08D	LVR/Vdet-IC	LDO, 2.8V±2%, 500mA, Vdo=5.4V, +Reset ODO, +CE	USP-6B	49zx	VR15	9b	Tor
3CK09	XC6404CK09D	LVR/Vdet-IC	LDO, 4.3V±2%, 500mA, Vdo=2.8V, +Reset ODO, +CE	USP-6B	49zx	VR15	9b	Tor
3CK11	XC6404CK11D	LVR/Vdet-IC	LDO, 2.8V±2%, 500mA, Vdo=2.1V, +Reset ODO, +CE	USP-6B	49zx	VR15	9b	Tor
3CK12	XC6404CK12D	LVR/Vdet-IC	LDO, 2.8V±2%, 500mA, Vdo=2.8V, +Reset ODO, +CE	USP-6B	49zx	VR15	9b	Tor
3CK15	XC6404CK15D	LVR/Vdet-IC	LDO, 3.3V±2%, 500mA, Vdo=3.6V, +Reset ODO, +CE	USP-6B	49zx	VR15	9b	Tor
3CK18	XC6404CK18D	LVR/Vdet-IC	LDO, 3.0V±2%, 500mA, Vdo=2.7V, +Reset ODO, +CE	USP-6B	49zx	VR15	9b	Tor
3CK19	XC6404CK19D	LVR/Vdet-IC	LDO, 2.8V±2%, 500mA, Vdo=2.5V, +Reset ODO, +CE	USP-6B	49zx	VR15	9b	Tor
3CK20	XC6404CK20D	LVR/Vdet-IC	LDO, 1.8V±2%, 500mA, Vdo=2.9V, +Reset ODO, +CE	USP-6B	49zx	VR15	9b	Tor
3CK21	XC6404CK21D	LVR/Vdet-IC	LDO, 1.8V±2%, 500mA, Vdo=3.6V, +Reset ODO, +CE	USP-6B	49zx	VR15	9b	Tor
3CK22	XC6404CK22D	LVR/Vdet-IC	LDO, 1.8V±2%, 500mA, Vdo=4.2V, +Reset ODO, +CE	USP-6B	49zx	VR15	9b	Tor
3CK23	XC6404CK23D	LVR/Vdet-IC	LDO, 2.5V±2%, 500mA, Vdo=2.9V, +Reset ODO, +CE	USP-6B	49zx	VR15	9b	Tor
3CK24	XC6404CK24D	LVR/Vdet-IC	LDO, 2.5V±2%, 500mA, Vdo=3.6V, +Reset ODO, +CE	USP-6B	49zx	VR15	9b	Tor
3CK25	XC6404CK25D	LVR/Vdet-IC	LDO, 2.5V±2%, 500mA, Vdo=4.2V, +Reset ODO, +CE	USP-6B	49zx	VR15	9b	Tor
3CK26	XC6404CK26D	LVR/Vdet-IC	LDO, 4.3V±2%, 500mA, Vdo=4.0V, +Reset ODO, +CE	USP-6B	49zx	VR15	9b	Tor
3CK27	XC6404CK27D	LVR/Vdet-IC	LDO, 2.5V±2%, 500mA, Vdo=3.9V, +Reset ODO, +CE	USP-6B	49zx	VR15	9b	Tor
3CK28	XC6404CK28D	LVR/Vdet-IC	LDO, 3.3V±2%, 500mA, Vdo=3.7V, +Reset ODO, +CE	USP-6B	49zx	VR15	9b	Tor
3CK29	XC6404CK29D	LVR/Vdet-IC	LDO, 2.6V±2%, 500mA, Vdo=3.9V, +Reset ODO, +CE	USP-6B	49zx	VR15	9b	Tor
3CK30	XC6404CK30D	LVR/Vdet-IC	LDO, 3.3V±2%, 500mA, Vdo=4.2V, +Reset ODO, +CE	USP-6B	49zx	VR15	9b	Tor
3CK31	XC6404CK31D	LVR/Vdet-IC	LDO, 3.3V±2%, 500mA, Vdo=4.5V, +Reset ODO, +CE	USP-6B	49zx	VR15	9b	Tor
3CK32	XC6404CK32D	LVR/Vdet-IC	LDO, 2.85V±2%, 500mA, Vdo=2.6V, +Reset ODO, +CE	USP-6B	49zx	VR15	9b	Tor
3CK33	XC6404CK33D	LVR/Vdet-IC	LDO, 3.3V±2%, 500mA, Vdo=2.8V, +Reset ODO, +CE	USP-6B	49zx	VR15	9b	Tor
3CK34	XC6404CK34D	LVR/Vdet-IC	LDO, 3.4V±2%, 500mA, Vdo=4.2V, +Reset ODO, +CE	USP-6B	49zx	VR15	9b	Tor
3CK80	XC6404CK80D	LVR/Vdet-IC	LDO, 1.8V±2%, 500mA, Vdo=1.6V, +Reset ODO, +CE	USP-6B	49zx	VR15	9b	Tor
3CK81	XC6404CK81D	LVR/Vdet-IC	LDO, 2.8V±2%, 500mA, Vdo=3.1V, +Reset ODO, +CE	USP-6B	49zx	VR15	9b	Tor
3CK82	XC6404CK82D	LVR/Vdet-IC	LDO, 1.8V±2%, 500mA, Vdo=2.0V, +Reset ODO, +CE	USP-6B	49zx	VR15	9b	Tor
3CK83	XC6404CK83D	LVR/Vdet-IC	LDO, 2.5V±2%, 500mA, Vdo=2.8V, +Reset ODO, +CE	USP-6B	49zx	VR15	9b	Tor
3CK84	XC6404CK84D	LVR/Vdet-IC	LDO, 2.85V±2%, 500mA, Vdo=3.2V, +Reset ODO, +CE	USP-6B	49zx	VR15	9b	Tor
3CK85	XC6404CK85D	LVR/Vdet-IC	LDO, 3.0V±2%, 500mA, Vdo=3.3V, +Reset ODO, +CE	USP-6B	49zx	VR15	9b	Tor
3CK86	XC6404CK86D	LVR/Vdet-IC	LDO, 3.5V±2%, 500mA, Vdo=3.8V, +Reset ODO, +CE	USP-6B	49zx	VR15	9b	Tor
3CK87	XC6404CK87D	LVR/Vdet-IC	LDO, 3.0V±2%, 500mA, Vdo=4.2V, +Reset ODO, +CE	USP-6B	49zx	VR15	9b	Tor
3CK88	XC6404CK88D	LVR/Vdet-IC	LDO, 3.3V±2%, 500mA, Vdo=4.0V, +Reset ODO, +CE	USP-6B	49zx	VR15	9b	Tor
3CL	XC6227A481ER	LVR-IC	LDO, 4.8V±1%, 700mA, +CE	USP-6C	49hq	VR4	9a	Tor
3CL02	XC6404CL02D	LVR/Vdet-IC	LDO, 2.7V±2%, 500mA, Vdi=4.2V, -Reset ODO, -CE, PUR	USP-6B	49zx	VR15	9b	Tor
3CL03	XC6404CL03D	LVR/Vdet-IC	LDO, 2.5V±2%, 500mA, Vdi=2.6V, -Reset ODO, -CE, PUR	USP-6B	49zx	VR15	9b	Tor
3CL04	XC6404CL04D	LVR/Vdet-IC	LDO, 3.3V±2%, 500mA, Vdi=4.3V, -Reset ODO, -CE, PUR	USP-6B	49zx	VR15	9b	Tor
3CL05	XC6404CL05D	LVR/Vdet-IC	LDO, 3.3V±2%, 500mA, Vdi=4.4V, -Reset ODO, -CE, PUR	USP-6B	49zx	VR15	9b	Tor
3CL07	XC6404CL07D	LVR/Vdet-IC	LDO, 3.3V±2%, 500mA, Vdi=5.2V, -Reset ODO, -CE, PUR	USP-6B	49zx	VR15	9b	Tor
3CL08	XC6404CL08D	LVR/Vdet-IC	LDO, 2.8V±2%, 500mA, Vdi= 4.3V, -Reset ODO, -CE, PUR	USP-6B	49zx	VR15	9b	Tor
3CL09	XC6404CL09D	LVR/Vdet-IC	LDO, 4.3V±2%, 500mA, Vdi=2.8V, -Reset ODO, -CE, PUR	USP-6B	49zx	VR15	9b	Tor
3CL11	XC6404CL11D	LVR/Vdet-IC	LDO, 2.8V±2%, 500mA, Vdi=2.1V, -Reset ODO, -CE, PUR	USP-6B	49zx	VR15	9b	Tor
3CL12	XC6404CL12D	LVR/Vdet-IC	LDO, 2.8V±2%, 500mA, Vdi=2.8V, -Reset ODO, -CE, PUR	USP-6B	49zx	VR15	9b	Tor
3CL15	XC6404CL15D	LVR/Vdet-IC	LDO, 3.3V±2%, 500mA, Vdi=3.6V, -Reset ODO, -CE, PUR	USP-6B	49zx	VR15	9b	Tor
3CL18	XC6404CL18D	LVR/Vdet-IC	LDO, 3.0V±2%, 500mA, Vdi=2.7V, -Reset ODO, -CE, PUR	USP-6B	49zx	VR15	9b	Tor
3CL19	XC6404CL19D	LVR/Vdet-IC	LDO, 2.8V±2%, 500mA, Vdi=2.5V, -Reset ODO, -CE, PUR	USP-6B	49zx	VR15	9b	Tor
3CL20	XC6404CL20D	LVR/Vdet-IC	LDO, 1.8V±2%, 500mA, Vdi=2.9V, -Reset ODO, -CE, PUR	USP-6B	49zx	VR15	9b	Tor
3CL21	XC6404CL21D	LVR/Vdet-IC	LDO, 1.8V±2%, 500mA, Vdi=3.6V, -Reset ODO, -CE, PUR	USP-6B	49zx	VR15	9b	Tor
3CL22	XC6404CL22D	LVR/Vdet-IC	LDO, 1.8V±2%, 500mA, Vdi=4.2V, -Reset ODO, -CE, PUR	USP-6B	49zx	VR15	9b	Tor
3CL23	XC6404CL23D	LVR/Vdet-IC	LDO, 2.5V±2%, 500mA, Vdi=2.9V, -Reset ODO, -CE, PUR	USP-6B	49zx	VR15	9b	Tor
3CL24	XC6404CL24D	LVR/Vdet-IC	LDO, 2.5V±2%, 500mA, Vdi=3.6V, -Reset ODO, -CE, PUR	USP-6B	49zx	VR15	9b	Tor
3CL25	XC6404CL25D	LVR/Vdet-IC	LDO, 2.5V±2%, 500mA, Vdi=4.2V, -Reset ODO, -CE, PUR	USP-6B	49zx	VR15	9b	Tor
3CL26	XC6404CL26D	LVR/Vdet-IC	LDO, 4.3V±2%, 500mA, Vdi=4.0V, -Reset ODO, -CE, PUR	USP-6B	49zx	VR15	9b	Tor
3CL27	XC6404CL27D	LVR/Vdet-IC	LDO, 2.5V±2%, 500mA, Vdi=3.9V, -Reset ODO, -CE, PUR	USP-6B	49zx	VR15	9b	Tor
3CL28	XC6404CL28D	LVR/Vdet-IC	LDO, 3.3V±2%, 500mA, Vdi=3.7V, -Reset ODO, -CE, PUR	USP-6B	49zx	VR15	9b	Tor
3CL29	XC6404CL29D	LVR/Vdet-IC	LDO, 2.6V±2%, 500mA, Vdi=3.9V, -Reset ODO, -CE, PUR	USP-6B	49zx	VR15	9b	Tor
3CL30	XC6404CL30D	LVR/Vdet-IC	LDO, 3.3V±2%, 500mA, Vdi=4.2V, -Reset ODO, -CE, PUR	USP-6B	49zx	VR15	9b	Tor
3CL31	XC6404CL31D	LVR/Vdet-IC	LDO, 3.3V±2%, 500mA, Vdi=4.5V, -Reset ODO, -CE, PUR	USP-6B	49zx	VR15	9b	Tor
3CL32	XC6404CL32D	LVR/Vdet-IC	LDO, 2.85V±2%, 500mA, Vdi=2.6V, -Reset ODO, -CE, PUR	USP-6B	49zx	VR15	9b	Tor
3CL33	XC6404CL33D	LVR/Vdet-IC	LDO, 3.3V±2%, 500mA, Vdi=2.8V, -Reset ODO, -CE, PUR	USP-6B	49zx	VR15	9b	Tor
3CL34	XC6404CL34D	LVR/Vdet-IC	LDO, 3.4V±2%, 500mA, Vdi=4.2V, -Reset ODO, -CE, PUR	USP-6B	49zx	VR15	9b	Tor
3CL80	XC6404CL80D	LVR/Vdet-IC	LDO, 1.8V±2%, 500mA, Vdi=1.6V, -Reset ODO, -CE, PUR	USP-6B	49zx	VR15	9b	Tor
3CL81	XC6404CL81D	LVR/Vdet-IC	LDO, 2.8V±2%, 500mA, Vdi=3.1V, -Reset ODO, -CE, PUR	USP-6B	49zx	VR15	9b	Tor
3CL82	XC6404CL82D	LVR/Vdet-IC	LDO, 1.8V±2%, 500mA, Vdi=2.0V, -Reset ODO, -CE, PUR	USP-6B	49zx	VR15	9b	Tor
3CL83	XC6404CL83D	LVR/Vdet-IC	LDO, 2.5V±2%, 500mA, Vdi=2.8V, -Reset ODO, -CE, PUR	USP-6B	49zx	VR15	9b	Tor
3CL84	XC6404CL84D	LVR/Vdet-IC	LDO, 2.85V±2%, 500mA, Vdi=3.2V, -Reset ODO, -CE, PUR	USP-6B	49zx	VR15	9b	Tor
3CL85	XC6404CL85D	LVR/Vdet-IC	LDO, 3.0V±2%, 500mA, Vdi=3.3V, -Reset ODO, -CE, PUR	USP-6B	49zx	VR15	9b	Tor
3CL86	XC6404CL86D	LVR/Vdet-IC	LDO, 3.5V±2%, 500mA, Vdi=3.8V, -Reset ODO, -CE, PUR	USP-6B	49zx	VR15	9b	Tor
3CL87	XC6404CL87D	LVR/Vdet-IC	LDO, 3.0V±2%, 500mA, Vdi=4.2V, -Reset ODO, -CE, PUR	USP-6B	49zx	VR15	9b	Tor
3CL88	XC6404CL88D	LVR/Vdet-IC	LDO, 3.3V±2%, 500mA, Vdi=4.0V, -Reset ODO, -CE, PUR	USP-6B	49zx	VR15	9b	Tor
3CM	XC6227A491ER	LVR-IC	LDO, 4.9V±1%, 700mA, +CE	USP-6C	49hq	VR4	9a	Tor



SMD code	Type	Function	Short description	Case	Pinout	Sch.	St.Mnf.
3CM02	XC6404CM02D	LVR/Vdet-IC	LDO, 2.7V±2%, 500mA, Vdi=4.2V, +Reset ODO, -CE, PUR	USP-6B	49zx	VR15	9b Tor
3CM03	XC6404CM03D	LVR/Vdet-IC	LDO, 2.5V±2%, 500mA, Vdi=2.6V, +Reset ODO, -CE, PUR	USP-6B	49zx	VR15	9b Tor
3CM04	XC6404CM04D	LVR/Vdet-IC	LDO, 3.3V±2%, 500mA, Vdi=4.3V, +Reset ODO, -CE, PUR	USP-6B	49zx	VR15	9b Tor
3CM05	XC6404CM05D	LVR/Vdet-IC	LDO, 3.3V±2%, 500mA, Vdi=4.4V, +Reset ODO, -CE, PUR	USP-6B	49zx	VR15	9b Tor
3CM07	XC6404CM07D	LVR/Vdet-IC	LDO, 3.3V±2%, 500mA, Vdi=5.2V, +Reset ODO, -CE, PUR	USP-6B	49zx	VR15	9b Tor
3CM08	XC6404CM08D	LVR/Vdet-IC	LDO, 2.8V±2%, 500mA, Vdi=4.3V, +Reset ODO, -CE, PUR	USP-6B	49zx	VR15	9b Tor
3CM09	XC6404CM09D	LVR/Vdet-IC	LDO, 4.3V±2%, 500mA, Vdi=2.8V, +Reset ODO, -CE, PUR	USP-6B	49zx	VR15	9b Tor
3CM11	XC6404CM11D	LVR/Vdet-IC	LDO, 2.8V±2%, 500mA, Vdi=2.1V, +Reset ODO, -CE, PUR	USP-6B	49zx	VR15	9b Tor
3CM12	XC6404CM12D	LVR/Vdet-IC	LDO, 2.8V±2%, 500mA, Vdi=2.8V, +Reset ODO, -CE, PUR	USP-6B	49zx	VR15	9b Tor
3CM15	XC6404CM15D	LVR/Vdet-IC	LDO, 3.3V±2%, 500mA, Vdi=3.6V, +Reset ODO, -CE, PUR	USP-6B	49zx	VR15	9b Tor
3CM18	XC6404CM18D	LVR/Vdet-IC	LDO, 3.0V±2%, 500mA, Vdi=2.7V, +Reset ODO, -CE, PUR	USP-6B	49zx	VR15	9b Tor
3CM19	XC6404CM19D	LVR/Vdet-IC	LDO, 2.8V±2%, 500mA, Vdi=2.5V, +Reset ODO, -CE, PUR	USP-6B	49zx	VR15	9b Tor
3CM20	XC6404CM20D	LVR/Vdet-IC	LDO, 1.8V±2%, 500mA, Vdi=2.9V, +Reset ODO, -CE, PUR	USP-6B	49zx	VR15	9b Tor
3CM21	XC6404CM21D	LVR/Vdet-IC	LDO, 1.8V±2%, 500mA, Vdi=3.6V, +Reset ODO, -CE, PUR	USP-6B	49zx	VR15	9b Tor
3CM22	XC6404CM22D	LVR/Vdet-IC	LDO, 1.8V±2%, 500mA, Vdi=4.2V, +Reset ODO, -CE, PUR	USP-6B	49zx	VR15	9b Tor
3CM23	XC6404CM23D	LVR/Vdet-IC	LDO, 2.5V±2%, 500mA, Vdi=2.9V, +Reset ODO, -CE, PUR	USP-6B	49zx	VR15	9b Tor
3CM24	XC6404CM24D	LVR/Vdet-IC	LDO, 2.5V±2%, 500mA, Vdi=3.6V, +Reset ODO, -CE, PUR	USP-6B	49zx	VR15	9b Tor
3CM25	XC6404CM25D	LVR/Vdet-IC	LDO, 2.5V±2%, 500mA, Vdi=4.2V, +Reset ODO, -CE, PUR	USP-6B	49zx	VR15	9b Tor
3CM26	XC6404CM26D	LVR/Vdet-IC	LDO, 4.3V±2%, 500mA, Vdi=4.0V, +Reset ODO, -CE, PUR	USP-6B	49zx	VR15	9b Tor
3CM27	XC6404CM27D	LVR/Vdet-IC	LDO, 2.5V±2%, 500mA, Vdi=3.9V, +Reset ODO, -CE, PUR	USP-6B	49zx	VR15	9b Tor
3CM28	XC6404CM28D	LVR/Vdet-IC	LDO, 3.3V±2%, 500mA, Vdi=3.7V, +Reset ODO, -CE, PUR	USP-6B	49zx	VR15	9b Tor
3CM29	XC6404CM29D	LVR/Vdet-IC	LDO, 2.6V±2%, 500mA, Vdi=3.9V, +Reset ODO, -CE, PUR	USP-6B	49zx	VR15	9b Tor
3CM30	XC6404CM30D	LVR/Vdet-IC	LDO, 3.3V±2%, 500mA, Vdi=4.2V, +Reset ODO, -CE, PUR	USP-6B	49zx	VR15	9b Tor
3CM31	XC6404CM31D	LVR/Vdet-IC	LDO, 3.3V±2%, 500mA, Vdi=4.5V, +Reset ODO, -CE, PUR	USP-6B	49zx	VR15	9b Tor
3CM32	XC6404CM32D	LVR/Vdet-IC	LDO, 2.85V±2%, 500mA, Vdi=2.5V, +Reset ODO, -CE, PUR	USP-6B	49zx	VR15	9b Tor
3CM33	XC6404CM33D	LVR/Vdet-IC	LDO, 3.3V±2%, 500mA, Vdi=2.8V, +Reset ODO, -CE, PUR	USP-6B	49zx	VR15	9b Tor
3CM34	XC6404CM34D	LVR/Vdet-IC	LDO, 3.4V±2%, 500mA, Vdi=4.2V, +Reset ODO, -CE, PUR	USP-6B	49zx	VR15	9b Tor
3CM80	XC6404CM80D	LVR/Vdet-IC	LDO, 1.8V±2%, 500mA, Vdi=1.6V, +Reset ODO, -CE, PUR	USP-6B	49zx	VR15	9b Tor
3CM81	XC6404CM81D	LVR/Vdet-IC	LDO, 2.8V±2%, 500mA, Vdi=3.1V, +Reset ODO, -CE, PUR	USP-6B	49zx	VR15	9b Tor
3CM82	XC6404CM82D	LVR/Vdet-IC	LDO, 1.8V±2%, 500mA, Vdi=2.0V, +Reset ODO, -CE, PUR	USP-6B	49zx	VR15	9b Tor
3CM83	XC6404CM83D	LVR/Vdet-IC	LDO, 2.5V±2%, 500mA, Vdi=2.8V, +Reset ODO, -CE, PUR	USP-6B	49zx	VR15	9b Tor
3CM84	XC6404CM84D	LVR/Vdet-IC	LDO, 2.85V±2%, 500mA, Vdi=2.7V, +Reset ODO, -CE, PUR	USP-6B	49zx	VR15	9b Tor
3CM85	XC6404CM85D	LVR/Vdet-IC	LDO, 3.0V±2%, 500mA, Vdi=3.3V, +Reset ODO, -CE, PUR	USP-6B	49zx	VR15	9b Tor
3CM86	XC6404CM86D	LVR/Vdet-IC	LDO, 3.5V±2%, 500mA, Vdi=3.8V, +Reset ODO, -CE, PUR	USP-6B	49zx	VR15	9b Tor
3CM87	XC6404CM87D	LVR/Vdet-IC	LDO, 3.0V±2%, 500mA, Vdi=4.2V, +Reset ODO, -CE, PUR	USP-6B	49zx	VR15	9b Tor
3CM88	XC6404CM88D	LVR/Vdet-IC	LDO, 3.3V±2%, 500mA, Vdi=4.0V, +Reset ODO, -CE, PUR	USP-6B	49zx	VR15	9b Tor
3CN	XC6227A501ER	LVR-IC	LDO, 5.0V±1%, 700mA, +CE	USP-6C	49hq	VR4	9a Tor
3CN02	XC6404CN02D	LVR/Vdet-IC	LDO, 2.7V±2%, 500mA, Vdo=4.2V, -Reset ODO, -CE, PUR	USP-6B	49zx	VR15	9b Tor
3CN03	XC6404CN03D	LVR/Vdet-IC	LDO, 2.5V±2%, 500mA, Vdo=2.6V, -Reset ODO, -CE, PUR	USP-6B	49zx	VR15	9b Tor
3CN04	XC6404CN04D	LVR/Vdet-IC	LDO, 3.3V±2%, 500mA, Vdo=4.3V, -Reset ODO, -CE, PUR	USP-6B	49zx	VR15	9b Tor
3CN05	XC6404CN05D	LVR/Vdet-IC	LDO, 3.3V±2%, 500mA, Vdo=4.4V, -Reset ODO, -CE, PUR	USP-6B	49zx	VR15	9b Tor
3CN07	XC6404CN07D	LVR/Vdet-IC	LDO, 3.3V±2%, 500mA, Vdo=5.2V, -Reset ODO, -CE, PUR	USP-6B	49zx	VR15	9b Tor
3CN08	XC6404CN08D	LVR/Vdet-IC	LDO, 2.8V±2%, 500mA, Vdo=4.3V, -Reset ODO, -CE, PUR	USP-6B	49zx	VR15	9b Tor
3CN09	XC6404CN09D	LVR/Vdet-IC	LDO, 4.3V±2%, 500mA, Vdo=2.8V, -Reset ODO, -CE, PUR	USP-6B	49zx	VR15	9b Tor
3CN11	XC6404CN11D	LVR/Vdet-IC	LDO, 2.8V±2%, 500mA, Vdo=2.1V, -Reset ODO, -CE, PUR	USP-6B	49zx	VR15	9b Tor
3CN12	XC6404CN12D	LVR/Vdet-IC	LDO, 2.8V±2%, 500mA, Vdo=2.8V, -Reset ODO, -CE, PUR	USP-6B	49zx	VR15	9b Tor
3CN15	XC6404CN15D	LVR/Vdet-IC	LDO, 3.3V±2%, 500mA, Vdo=3.6V, -Reset ODO, -CE, PUR	USP-6B	49zx	VR15	9b Tor
3CN18	XC6404CN18D	LVR/Vdet-IC	LDO, 3.0V±2%, 500mA, Vdo=2.7V, -Reset ODO, -CE, PUR	USP-6B	49zx	VR15	9b Tor
3CN19	XC6404CN19D	LVR/Vdet-IC	LDO, 2.8V±2%, 500mA, Vdo=2.5V, -Reset ODO, -CE, PUR	USP-6B	49zx	VR15	9b Tor
3CN20	XC6404CN20D	LVR/Vdet-IC	LDO, 1.8V±2%, 500mA, Vdo=2.9V, -Reset ODO, -CE, PUR	USP-6B	49zx	VR15	9b Tor
3CN21	XC6404CN21D	LVR/Vdet-IC	LDO, 1.8V±2%, 500mA, Vdo=3.6V, -Reset ODO, -CE, PUR	USP-6B	49zx	VR15	9b Tor
3CN22	XC6404CN22D	LVR/Vdet-IC	LDO, 1.8V±2%, 500mA, Vdo=4.2V, -Reset ODO, -CE, PUR	USP-6B	49zx	VR15	9b Tor
3CN23	XC6404CN23D	LVR/Vdet-IC	LDO, 2.5V±2%, 500mA, Vdo=2.9V, -Reset ODO, -CE, PUR	USP-6B	49zx	VR15	9b Tor
3CN24	XC6404CN24D	LVR/Vdet-IC	LDO, 2.5V±2%, 500mA, Vdo=3.6V, -Reset ODO, -CE, PUR	USP-6B	49zx	VR15	9b Tor
3CN25	XC6404CN25D	LVR/Vdet-IC	LDO, 2.5V±2%, 500mA, Vdo=4.2V, -Reset ODO, -CE, PUR	USP-6B	49zx	VR15	9b Tor
3CN26	XC6404CN26D	LVR/Vdet-IC	LDO, 4.3V±2%, 500mA, Vdo=4.0V, -Reset ODO, -CE, PUR	USP-6B	49zx	VR15	9b Tor
3CN27	XC6404CN27D	LVR/Vdet-IC	LDO, 2.5V±2%, 500mA, Vdo=3.9V, -Reset ODO, -CE, PUR	USP-6B	49zx	VR15	9b Tor
3CN28	XC6404CN28D	LVR/Vdet-IC	LDO, 3.3V±2%, 500mA, Vdo=3.7V, -Reset ODO, -CE, PUR	USP-6B	49zx	VR15	9b Tor
3CN29	XC6404CN29D	LVR/Vdet-IC	LDO, 2.6V±2%, 500mA, Vdo=3.9V, -Reset ODO, -CE, PUR	USP-6B	49zx	VR15	9b Tor
3CN30	XC6404CN30D	LVR/Vdet-IC	LDO, 3.3V±2%, 500mA, Vdo=4.2V, -Reset ODO, -CE, PUR	USP-6B	49zx	VR15	9b Tor
3CN31	XC6404CN31D	LVR/Vdet-IC	LDO, 3.3V±2%, 500mA, Vdo=4.5V, -Reset ODO, -CE, PUR	USP-6B	49zx	VR15	9b Tor
3CN32	XC6404CN32D	LVR/Vdet-IC	LDO, 2.85V±2%, 500mA, Vdo=2.6V, -Reset ODO, -CE, PUR	USP-6B	49zx	VR15	9b Tor
3CN33	XC6404CN33D	LVR/Vdet-IC	LDO, 3.3V±2%, 500mA, Vdo=2.8V, -Reset ODO, -CE, PUR	USP-6B	49zx	VR15	9b Tor
3CN34	XC6404CN34D	LVR/Vdet-IC	LDO, 3.4V±2%, 500mA, Vdo=4.2V, -Reset ODO, -CE, PUR	USP-6B	49zx	VR15	9b Tor
3CN80	XC6404CN80D	LVR/Vdet-IC	LDO, 1.8V±2%, 500mA, Vdo=1.6V, -Reset ODO, -CE, PUR	USP-6B	49zx	VR15	9b Tor
3CN81	XC6404CN81D	LVR/Vdet-IC	LDO, 2.8V±2%, 500mA, Vdo=3.1V, -Reset ODO, -CE, PUR	USP-6B	49zx	VR15	9b Tor
3CN82	XC6404CN82D	LVR/Vdet-IC	LDO, 1.8V±2%, 500mA, Vdo=2.0V, -Reset ODO, -CE, PUR	USP-6B	49zx	VR15	9b Tor
3CN83	XC6404CN83D	LVR/Vdet-IC	LDO, 2.5V±2%, 500mA, Vdo=2.8V, -Reset ODO, -CE, PUR	USP-6B	49zx	VR15	9b Tor
3CN84	XC6404CN84D	LVR/Vdet-IC	LDO, 2.85V±2%, 500mA, Vdo=3.2V, -Reset ODO, -CE, PUR	USP-6B	49zx	VR15	9b Tor
3CN85	XC6404CN85D	LVR/Vdet-IC	LDO, 3.0V±2%, 500mA, Vdo=3.3V, -Reset ODO, -CE, PUR	USP-6B	49zx	VR15	9b Tor



SMD code	Type	Function	Short description	Case	Pinout	Sch.	St.Mnf.
3CN86	XC6404CN86D	LVR/Vdet-IC	LDO, 3.5V±2%, 500mA, Vdo=3.8V, -Reset ODO, -CE, PUR	USP-6B	49zx	VR15	9b Tor
3CN87	XC6404CN87D	LVR/Vdet-IC	LDO, 3.0V±2%, 500mA, Vdo=4.2V, -Reset ODO, -CE, PUR	USP-6B	49zx	VR15	9b Tor
3CN88	XC6404CN88D	LVR/Vdet-IC	LDO, 3.3V±2%, 500mA, Vdo=4.0V, -Reset ODO, -CE, PUR	USP-6B	49zx	VR15	9b Tor
3CP02	XC6404CP02D	LVR/Vdet-IC	LDO, 2.7V±2%, 500mA, Vdo=4.2V, +Reset ODO, -CE, PUR	USP-6B	49zx	VR15	9b Tor
3CP03	XC6404CP03D	LVR/Vdet-IC	LDO, 2.5V±2%, 500mA, Vdo=2.6V, +Reset ODO, -CE, PUR	USP-6B	49zx	VR15	9b Tor
3CP04	XC6404CP04D	LVR/Vdet-IC	LDO, 3.3V±2%, 500mA, Vdo=4.3V, +Reset ODO, -CE, PUR	USP-6B	49zx	VR15	9b Tor
3CP05	XC6404CP05D	LVR/Vdet-IC	LDO, 3.3V±2%, 500mA, Vdo=4.4V, +Reset ODO, -CE, PUR	USP-6B	49zx	VR15	9b Tor
3CP07	XC6404CP07D	LVR/Vdet-IC	LDO, 3.3V±2%, 500mA, Vdo=5.2V, +Reset ODO, -CE, PUR	USP-6B	49zx	VR15	9b Tor
3CP08	XC6404CP08D	LVR/Vdet-IC	LDO, 2.8V±2%, 500mA, Vdo=4.5V, +Reset ODO, -CE, PUR	USP-6B	49zx	VR15	9b Tor
3CP09	XC6404CP09D	LVR/Vdet-IC	LDO, 4.3V±2%, 500mA, Vdo=2.8V, +Reset ODO, -CE, PUR	USP-6B	49zx	VR15	9b Tor
3CP11	XC6404CP11D	LVR/Vdet-IC	LDO, 2.8V±2%, 500mA, Vdo=2.1V, +Reset ODO, -CE, PUR	USP-6B	49zx	VR15	9b Tor
3CP12	XC6404CP12D	LVR/Vdet-IC	LDO, 2.8V±2%, 500mA, Vdo=2.8V, +Reset ODO, -CE, PUR	USP-6B	49zx	VR15	9b Tor
3CP15	XC6404CP15D	LVR/Vdet-IC	LDO, 3.3V±2%, 500mA, Vdo=3.6V, +Reset ODO, -CE, PUR	USP-6B	49zx	VR15	9b Tor
3CP18	XC6404CP18D	LVR/Vdet-IC	LDO, 3.0V±2%, 500mA, Vdo=2.7V, +Reset ODO, -CE, PUR	USP-6B	49zx	VR15	9b Tor
3CP19	XC6404CP19D	LVR/Vdet-IC	LDO, 2.8V±2%, 500mA, Vdo=2.5V, +Reset ODO, -CE, PUR	USP-6B	49zx	VR15	9b Tor
3CP20	XC6404CP20D	LVR/Vdet-IC	LDO, 1.8V±2%, 500mA, Vdo=2.9V, +Reset ODO, -CE, PUR	USP-6B	49zx	VR15	9b Tor
3CP21	XC6404CP21D	LVR/Vdet-IC	LDO, 1.8V±2%, 500mA, Vdo=3.6V, +Reset ODO, -CE, PUR	USP-6B	49zx	VR15	9b Tor
3CP22	XC6404CP22D	LVR/Vdet-IC	LDO, 1.8V±2%, 500mA, Vdo=4.2V, +Reset ODO, -CE, PUR	USP-6B	49zx	VR15	9b Tor
3CP23	XC6404CP23D	LVR/Vdet-IC	LDO, 2.5V±2%, 500mA, Vdo=2.9V, +Reset ODO, -CE, PUR	USP-6B	49zx	VR15	9b Tor
3CP24	XC6404CP24D	LVR/Vdet-IC	LDO, 2.5V±2%, 500mA, Vdo=3.6V, +Reset ODO, -CE, PUR	USP-6B	49zx	VR15	9b Tor
3CP25	XC6404CP25D	LVR/Vdet-IC	LDO, 2.5V±2%, 500mA, Vdo=4.2V, +Reset ODO, -CE, PUR	USP-6B	49zx	VR15	9b Tor
3CP26	XC6404CP26D	LVR/Vdet-IC	LDO, 4.3V±2%, 500mA, Vdo=4.0V, +Reset ODO, -CE, PUR	USP-6B	49zx	VR15	9b Tor
3CP27	XC6404CP27D	LVR/Vdet-IC	LDO, 2.5V±2%, 500mA, Vdo=3.9V, +Reset ODO, -CE, PUR	USP-6B	49zx	VR15	9b Tor
3CP28	XC6404CP28D	LVR/Vdet-IC	LDO, 3.3V±2%, 500mA, Vdo=3.7V, +Reset ODO, -CE, PUR	USP-6B	49zx	VR15	9b Tor
3CP29	XC6404CP29D	LVR/Vdet-IC	LDO, 2.6V±2%, 500mA, Vdo=3.9V, +Reset ODO, -CE, PUR	USP-6B	49zx	VR15	9b Tor
3CP30	XC6404CP30D	LVR/Vdet-IC	LDO, 3.3V±2%, 500mA, Vdo=4.2V, +Reset ODO, -CE, PUR	USP-6B	49zx	VR15	9b Tor
3CP31	XC6404CP31D	LVR/Vdet-IC	LDO, 3.3V±2%, 500mA, Vdo=4.5V, +Reset ODO, -CE, PUR	USP-6B	49zx	VR15	9b Tor
3CP32	XC6404CP32D	LVR/Vdet-IC	LDO, 2.85V±2%, 500mA, Vdo=2.6V, +Reset ODO, -CE, PUR	USP-6B	49zx	VR15	9b Tor
3CP33	XC6404CP33D	LVR/Vdet-IC	LDO, 3.3V±2%, 500mA, Vdo=2.8V, +Reset ODO, -CE, PUR	USP-6B	49zx	VR15	9b Tor
3CP34	XC6404CP34D	LVR/Vdet-IC	LDO, 3.4V±2%, 500mA, Vdo=4.2V, +Reset ODO, -CE, PUR	USP-6B	49zx	VR15	9b Tor
3CP80	XC6404CP80D	LVR/Vdet-IC	LDO, 1.8V±2%, 500mA, Vdo=1.6V, +Reset ODO, -CE, PUR	USP-6B	49zx	VR15	9b Tor
3CP81	XC6404CP81D	LVR/Vdet-IC	LDO, 2.8V±2%, 500mA, Vdo=3.1V, +Reset ODO, -CE, PUR	USP-6B	49zx	VR15	9b Tor
3CP82	XC6404CP82D	LVR/Vdet-IC	LDO, 1.8V±2%, 500mA, Vdo=2.0V, +Reset ODO, -CE, PUR	USP-6B	49zx	VR15	9b Tor
3CP83	XC6404CP83D	LVR/Vdet-IC	LDO, 2.5V±2%, 500mA, Vdo=2.8V, +Reset ODO, -CE, PUR	USP-6B	49zx	VR15	9b Tor
3CP84	XC6404CP84D	LVR/Vdet-IC	LDO, 2.85V±2%, 500mA, Vdo=3.2V, +Reset ODO, -CE, PUR	USP-6B	49zx	VR15	9b Tor
3CP85	XC6404CP85D	LVR/Vdet-IC	LDO, 3.0V±2%, 500mA, Vdo=3.3V, +Reset ODO, -CE, PUR	USP-6B	49zx	VR15	9b Tor
3CP86	XC6404CP86D	LVR/Vdet-IC	LDO, 3.5V±2%, 500mA, Vdo=3.8V, +Reset ODO, -CE, PUR	USP-6B	49zx	VR15	9b Tor
3CP87	XC6404CP87D	LVR/Vdet-IC	LDO, 3.0V±2%, 500mA, Vdo=4.2V, +Reset ODO, -CE, PUR	USP-6B	49zx	VR15	9b Tor
3CP88	XC6404CP88D	LVR/Vdet-IC	LDO, 3.3V±2%, 500mA, Vdo=4.0V, +Reset ODO, -CE, PUR	USP-6B	49zx	VR15	9b Tor
3CR02	XC6404CR02D	LVR/Vdet-IC	LDO, 2.7V±2%, 500mA, Vdi=4.2V, -Reset ODO, -CE	USP-6B	49zx	VR15	9b Tor
3CR03	XC6404CR03D	LVR/Vdet-IC	LDO, 2.5V±2%, 500mA, Vdi=2.6V, -Reset ODO, -CE	USP-6B	49zx	VR15	9b Tor
3CR04	XC6404CR04D	LVR/Vdet-IC	LDO, 3.3V±2%, 500mA, Vdi=4.3V, -Reset ODO, -CE	USP-6B	49zx	VR15	9b Tor
3CR05	XC6404CR05D	LVR/Vdet-IC	LDO, 3.3V±2%, 500mA, Vdi=4.4V, -Reset ODO, -CE	USP-6B	49zx	VR15	9b Tor
3CR07	XC6404CR07D	LVR/Vdet-IC	LDO, 3.3V±2%, 500mA, Vdi=5.2V, -Reset ODO, -CE	USP-6B	49zx	VR15	9b Tor
3CR08	XC6404CR08D	LVR/Vdet-IC	LDO, 2.8V±2%, 500mA, Vdi=4.3V, -Reset ODO, -CE	USP-6B	49zx	VR15	9b Tor
3CR09	XC6404CR09D	LVR/Vdet-IC	LDO, 4.3V±2%, 500mA, Vdi=2.8V, -Reset ODO, -CE	USP-6B	49zx	VR15	9b Tor
3CR11	XC6404CR11D	LVR/Vdet-IC	LDO, 2.8V±2%, 500mA, Vdi=2.1V, -Reset ODO, -CE	USP-6B	49zx	VR15	9b Tor
3CR12	XC6404CR12D	LVR/Vdet-IC	LDO, 2.8V±2%, 500mA, Vdi=2.8V, -Reset ODO, -CE	USP-6B	49zx	VR15	9b Tor
3CR15	XC6404CR15D	LVR/Vdet-IC	LDO, 3.3V±2%, 500mA, Vdi=3.6V, -Reset ODO, -CE	USP-6B	49zx	VR15	9b Tor
3CR18	XC6404CR18D	LVR/Vdet-IC	LDO, 3.0V±2%, 500mA, Vdi=2.7V, -Reset ODO, -CE	USP-6B	49zx	VR15	9b Tor
3CR19	XC6404CR19D	LVR/Vdet-IC	LDO, 2.8V±2%, 500mA, Vdi=2.5V, -Reset ODO, -CE	USP-6B	49zx	VR15	9b Tor
3CR20	XC6404CR20D	LVR/Vdet-IC	LDO, 1.8V±2%, 500mA, Vdi=2.9V, -Reset ODO, -CE	USP-6B	49zx	VR15	9b Tor
3CR21	XC6404CR21D	LVR/Vdet-IC	LDO, 1.8V±2%, 500mA, Vdi=3.6V, -Reset ODO, -CE	USP-6B	49zx	VR15	9b Tor
3CR22	XC6404CR22D	LVR/Vdet-IC	LDO, 1.8V±2%, 500mA, Vdi=4.2V, -Reset ODO, -CE	USP-6B	49zx	VR15	9b Tor
3CR23	XC6404CR23D	LVR/Vdet-IC	LDO, 2.5V±2%, 500mA, Vdi=2.9V, -Reset ODO, -CE	USP-6B	49zx	VR15	9b Tor
3CR24	XC6404CR24D	LVR/Vdet-IC	LDO, 2.5V±2%, 500mA, Vdi=3.6V, -Reset ODO, -CE	USP-6B	49zx	VR15	9b Tor
3CR25	XC6404CR25D	LVR/Vdet-IC	LDO, 2.5V±2%, 500mA, Vdi=4.2V, -Reset ODO, -CE	USP-6B	49zx	VR15	9b Tor
3CR26	XC6404CR26D	LVR/Vdet-IC	LDO, 4.3V±2%, 500mA, Vdi=4.0V, -Reset ODO, -CE	USP-6B	49zx	VR15	9b Tor
3CR27	XC6404CR27D	LVR/Vdet-IC	LDO, 2.5V±2%, 500mA, Vdi=3.9V, -Reset ODO, -CE	USP-6B	49zx	VR15	9b Tor
3CR28	XC6404CR28D	LVR/Vdet-IC	LDO, 3.3V±2%, 500mA, Vdi=3.7V, -Reset ODO, -CE	USP-6B	49zx	VR15	9b Tor
3CR29	XC6404CR29D	LVR/Vdet-IC	LDO, 2.6V±2%, 500mA, Vdi=3.9V, -Reset ODO, -CE	USP-6B	49zx	VR15	9b Tor
3CR30	XC6404CR30D	LVR/Vdet-IC	LDO, 3.3V±2%, 500mA, Vdi=4.2V, -Reset ODO, -CE	USP-6B	49zx	VR15	9b Tor
3CR31	XC6404CR31D	LVR/Vdet-IC	LDO, 3.3V±2%, 500mA, Vdi=4.5V, -Reset ODO, -CE	USP-6B	49zx	VR15	9b Tor
3CR32	XC6404CR32D	LVR/Vdet-IC	LDO, 2.85V±2%, 500mA, Vdi=2.6V, -Reset ODO, -CE	USP-6B	49zx	VR15	9b Tor
3CR33	XC6404CR33D	LVR/Vdet-IC	LDO, 3.3V±2%, 500mA, Vdi=2.8V, -Reset ODO, -CE	USP-6B	49zx	VR15	9b Tor
3CR34	XC6404CR34D	LVR/Vdet-IC	LDO, 3.4V±2%, 500mA, Vdi=4.2V, -Reset ODO, -CE	USP-6B	49zx	VR15	9b Tor
3CR80	XC6404CR80D	LVR/Vdet-IC	LDO, 1.8V±2%, 500mA, Vdi=1.6V, -Reset ODO, -CE	USP-6B	49zx	VR15	9b Tor
3CR81	XC6404CR81D	LVR/Vdet-IC	LDO, 2.8V±2%, 500mA, Vdi=3.1V, -Reset ODO, -CE	USP-6B	49zx	VR15	9b Tor
3CR82	XC6404CR82D	LVR/Vdet-IC	LDO, 1.8V±2%, 500mA, Vdi=2.0V, -Reset ODO, -CE	USP-6B	49zx	VR15	9b Tor
3CR83	XC6404CR83D	LVR/Vdet-IC	LDO, 2.5V±2%, 500mA, Vdi=2.8V, -Reset ODO, -CE	USP-6B	49zx	VR15	9b Tor



SMD code	Type	Function	Short description	Case	Pinout	Sch.	St.	Mnf.
3CT82	XC6404CT82D	LVR/Vdet-IC	LDO, 1.8V±2%, 500mA, Vdo=2.0V, -Reset ODO, -CE	USP-6B	49zx	VR15	9b	Tor
3CT83	XC6404CT83D	LVR/Vdet-IC	LDO, 2.5V±2%, 500mA, Vdo=2.8V, -Reset ODO, -CE	USP-6B	49zx	VR15	9b	Tor
3CT84	XC6404CT84D	LVR/Vdet-IC	LDO, 2.85V±2%, 500mA, Vdo=3.2V, -Reset ODO, -CE	USP-6B	49zx	VR15	9b	Tor
3CT85	XC6404CT85D	LVR/Vdet-IC	LDO, 3.0V±2%, 500mA, Vdo=3.3V, -Reset ODO, -CE	USP-6B	49zx	VR15	9b	Tor
3CT86	XC6404CT86D	LVR/Vdet-IC	LDO, 3.5V±2%, 500mA, Vdo=3.8V, -Reset ODO, -CE	USP-6B	49zx	VR15	9b	Tor
3CT87	XC6404CT87D	LVR/Vdet-IC	LDO, 3.0V±2%, 500mA, Vdo=4.2V, -Reset ODO, -CE	USP-6B	49zx	VR15	9b	Tor
3CT88	XC6404CT88D	LVR/Vdet-IC	LDO, 3.3V±2%, 500mA, Vdo=4.0V, -Reset ODO, -CE	USP-6B	49zx	VR15	9b	Tor
3CU02	XC6404CU02D	LVR/Vdet-IC	LDO, 2.7V±2%, 500mA, Vdo=4.2V, +Reset ODO, -CE	USP-6B	49zx	VR15	9b	Tor
3CU03	XC6404CU03D	LVR/Vdet-IC	LDO, 2.5V±2%, 500mA, Vdo=2.6V, +Reset ODO, -CE	USP-6B	49zx	VR15	9b	Tor
3CU04	XC6404CU04D	LVR/Vdet-IC	LDO, 3.3V±2%, 500mA, Vdo=4.3V, +Reset ODO, -CE	USP-6B	49zx	VR15	9b	Tor
3CU05	XC6404CU05D	LVR/Vdet-IC	LDO, 3.3V±2%, 500mA, Vdo=4.4V, +Reset ODO, -CE	USP-6B	49zx	VR15	9b	Tor
3CU07	XC6404CU07D	LVR/Vdet-IC	LDO, 3.3V±2%, 500mA, Vdo=5.2V, +Reset ODO, -CE	USP-6B	49zx	VR15	9b	Tor
3CU08	XC6404CU08D	LVR/Vdet-IC	LDO, 2.8V±2%, 500mA, Vdo= 4.3V, +Reset ODO, -CE	USP-6B	49zx	VR15	9b	Tor
3CU09	XC6404CU09D	LVR/Vdet-IC	LDO, 4.3V±2%, 500mA, Vdo=2.8V, +Reset ODO, -CE	USP-6B	49zx	VR15	9b	Tor
3CU11	XC6404CU11D	LVR/Vdet-IC	LDO, 2.8V±2%, 500mA, Vdo=1.7V, +Reset ODO, -CE	USP-6B	49zx	VR15	9b	Tor
3CU12	XC6404CU12D	LVR/Vdet-IC	LDO, 2.8V±2%, 500mA, Vdo=2.8V, +Reset ODO, -CE	USP-6B	49zx	VR15	9b	Tor
3CU15	XC6404CU15D	LVR/Vdet-IC	LDO, 3.3V±2%, 500mA, Vdo=3.6V, +Reset ODO, -CE	USP-6B	49zx	VR15	9b	Tor
3CU18	XC6404CU18D	LVR/Vdet-IC	LDO, 3.0V±2%, 500mA, Vdo=2.7V, +Reset ODO, -CE	USP-6B	49zx	VR15	9b	Tor
3CU19	XC6404CU19D	LVR/Vdet-IC	LDO, 2.8V±2%, 500mA, Vdo=2.5V, +Reset ODO, -CE	USP-6B	49zx	VR15	9b	Tor
3CU20	XC6404CU20D	LVR/Vdet-IC	LDO, 1.8V±2%, 500mA, Vdo=2.9V, +Reset ODO, -CE	USP-6B	49zx	VR15	9b	Tor
3CU21	XC6404CU21D	LVR/Vdet-IC	LDO, 1.8V±2%, 500mA, Vdo=3.6V, +Reset ODO, -CE	USP-6B	49zx	VR15	9b	Tor
3CU22	XC6404CU22D	LVR/Vdet-IC	LDO, 1.8V±2%, 500mA, Vdo=4.2V, +Reset ODO, -CE	USP-6B	49zx	VR15	9b	Tor
3CU23	XC6404CU23D	LVR/Vdet-IC	LDO, 2.5V±2%, 500mA, Vdo=2.9V, +Reset ODO, -CE	USP-6B	49zx	VR15	9b	Tor
3CU24	XC6404CU24D	LVR/Vdet-IC	LDO, 2.5V±2%, 500mA, Vdo=3.6V, +Reset ODO, -CE	USP-6B	49zx	VR15	9b	Tor
3CU25	XC6404CU25D	LVR/Vdet-IC	LDO, 2.5V±2%, 500mA, Vdo=4.2V, +Reset ODO, -CE	USP-6B	49zx	VR15	9b	Tor
3CU26	XC6404CU26D	LVR/Vdet-IC	LDO, 4.3V±2%, 500mA, Vdo=4.0V, +Reset ODO, -CE	USP-6B	49zx	VR15	9b	Tor
3CU27	XC6404CU27D	LVR/Vdet-IC	LDO, 2.5V±2%, 500mA, Vdo=3.9V, +Reset ODO, -CE	USP-6B	49zx	VR15	9b	Tor
3CU28	XC6404CU28D	LVR/Vdet-IC	LDO, 3.3V±2%, 500mA, Vdo=3.7V, +Reset ODO, -CE	USP-6B	49zx	VR15	9b	Tor
3CU29	XC6404CU29D	LVR/Vdet-IC	LDO, 2.6V±2%, 500mA, Vdo=3.9V, +Reset ODO, -CE	USP-6B	49zx	VR15	9b	Tor
3CU30	XC6404CU30D	LVR/Vdet-IC	LDO, 3.3V±2%, 500mA, Vdo=4.2V, +Reset ODO, -CE	USP-6B	49zx	VR15	9b	Tor
3CU31	XC6404CU31D	LVR/Vdet-IC	LDO, 3.3V±2%, 500mA, Vdo=4.5V, +Reset ODO, -CE	USP-6B	49zx	VR15	9b	Tor
3CU32	XC6404CU32D	LVR/Vdet-IC	LDO, 2.85V±2%, 500mA, Vdo=2.6V, +Reset ODO, -CE	USP-6B	49zx	VR15	9b	Tor
3CU33	XC6404CU33D	LVR/Vdet-IC	LDO, 3.3V±2%, 500mA, Vdo=2.8V, +Reset ODO, -CE	USP-6B	49zx	VR15	9b	Tor
3CU34	XC6404CU34D	LVR/Vdet-IC	LDO, 3.4V±2%, 500mA, Vdo=4.2V, +Reset ODO, -CE	USP-6B	49zx	VR15	9b	Tor
3CU80	XC6404CU80D	LVR/Vdet-IC	LDO, 1.8V±2%, 500mA, Vdo=1.6V, +Reset ODO, -CE	USP-6B	49zx	VR15	9b	Tor
3CU81	XC6404CU81D	LVR/Vdet-IC	LDO, 2.8V±2%, 500mA, Vdo=3.1V, +Reset ODO, -CE	USP-6B	49zx	VR15	9b	Tor
3CU82	XC6404CU82D	LVR/Vdet-IC	LDO, 1.8V±2%, 500mA, Vdo=2.0V, +Reset ODO, -CE	USP-6B	49zx	VR15	9b	Tor
3CU83	XC6404CU83D	LVR/Vdet-IC	LDO, 2.5V±2%, 500mA, Vdo=2.8V, +Reset ODO, -CE	USP-6B	49zx	VR15	9b	Tor
3CU84	XC6404CU84D	LVR/Vdet-IC	LDO, 2.85V±2%, 500mA, Vdo=3.2V, +Reset ODO, -CE	USP-6B	49zx	VR15	9b	Tor
3CU85	XC6404CU85D	LVR/Vdet-IC	LDO, 3.0V±2%, 500mA, Vdo=3.3V, +Reset ODO, -CE	USP-6B	49zx	VR15	9b	Tor
3CU86	XC6404CU86D	LVR/Vdet-IC	LDO, 3.5V±2%, 500mA, Vdo=3.8V, +Reset ODO, -CE	USP-6B	49zx	VR15	9b	Tor
3CU87	XC6404CU87D	LVR/Vdet-IC	LDO, 3.0V±2%, 500mA, Vdo=4.2V, +Reset ODO, -CE	USP-6B	49zx	VR15	9b	Tor
3CU88	XC6404CU88D	LVR/Vdet-IC	LDO, 3.3V±2%, 500mA, Vdo=4.0V, +Reset ODO, -CE	USP-6B	49zx	VR15	9b	Tor
3D	R3117K101C	Vdet-IC	1.0V±15mV, -Reset PPO, Sense	DFN11010-4	48rq	VD12	9a	Ric
3D	RP101K181B	LVR-IC	LDO, LN, +CE, 1.8V±0.8%, 300mA	DFN11612-4	45vm	VR4	9a	Ric
3D	XC6217D1427R-G	LVR-IC	LDO, 1.4V±2%, 200mA, +CE, CL	USPN-4	58vm	VR4	9a	Tor
3D	XC6223D2319R-G	LVR-IC	LDO, 2.3V±1%, 300mA, +CE, CL, PDR	USPQ-4B03	48vm	VR4	9a	Tor
3D	XC6224B21B7R	LVR-IC	LDO, 2.15V±1.5%, 150mA, +CE, PDR	USPN-4B02	58vm	VR4	9a	Tor
3D	XC6229H3311R-G	LVR-IC	LDO, 3.3V±1%, 300mA, +CE, ICP	BGA-4	63ba*	VR4	9a	Tor
3D0	XC6227A30BER	LVR-IC	LDO, 3.05V±1%, 700mA, +CE	USP-6C	49hq	VR4	9a	Tor
3D016	XC6106D016ER	Vdet-IC	1.6V±2%, Hst, -MR, ±Reset PPO, Rt=100ms	USP-6C	49xs	VD21	9b	Tor
3D017	XC6106D017ER	Vdet-IC	1.7V±2%, Hst, -MR, ±Reset PPO, Rt=100ms	USP-6C	49xs	VD21	9b	Tor
3D018	XC6106D018ER	Vdet-IC	1.8V±2%, Hst, -MR, ±Reset PPO, Rt=100ms	USP-6C	49xs	VD21	9b	Tor
3D019	XC6106D019ER	Vdet-IC	1.9V±2%, Hst, -MR, ±Reset PPO, Rt=100ms	USP-6C	49xs	VD21	9b	Tor
3D020	XC6106D020ER	Vdet-IC	2.0V±2%, Hst, -MR, ±Reset PPO, Rt=100ms	USP-6C	49xs	VD21	9b	Tor
3D021	XC6106D021ER	Vdet-IC	2.1V±2%, Hst, -MR, ±Reset PPO, Rt=100ms	USP-6C	49xs	VD21	9b	Tor
3D022	XC6106D022ER	Vdet-IC	2.2V±2%, Hst, -MR, ±Reset PPO, Rt=100ms	USP-6C	49xs	VD21	9b	Tor
3D023	XC6106D023ER	Vdet-IC	2.3V±2%, Hst, -MR, ±Reset PPO, Rt=100ms	USP-6C	49xs	VD21	9b	Tor
3D024	XC6106D024ER	Vdet-IC	2.4V±2%, Hst, -MR, ±Reset PPO, Rt=100ms	USP-6C	49xs	VD21	9b	Tor
3D025	XC6106D025ER	Vdet-IC	2.5V±2%, Hst, -MR, ±Reset PPO, Rt=100ms	USP-6C	49xs	VD21	9b	Tor
3D026	XC6106D026ER	Vdet-IC	2.6V±2%, Hst, -MR, ±Reset PPO, Rt=100ms	USP-6C	49xs	VD21	9b	Tor
3D027	XC6106D027ER	Vdet-IC	2.7V±2%, Hst, -MR, ±Reset PPO, Rt=100ms	USP-6C	49xs	VD21	9b	Tor
3D028	XC6106D028ER	Vdet-IC	2.8V±2%, Hst, -MR, ±Reset PPO, Rt=100ms	USP-6C	49xs	VD21	9b	Tor
3D029	XC6106D029ER	Vdet-IC	2.9V±2%, Hst, -MR, ±Reset PPO, Rt=100ms	USP-6C	49xs	VD21	9b	Tor
3D030	XC6106D030ER	Vdet-IC	3.0V±2%, Hst, -MR, ±Reset PPO, Rt=100ms	USP-6C	49xs	VD21	9b	Tor
3D031	XC6106D031ER	Vdet-IC	3.1V±2%, Hst, -MR, ±Reset PPO, Rt=100ms	USP-6C	49xs	VD21	9b	Tor
3D032	XC6106D032ER	Vdet-IC	3.2V±2%, Hst, -MR, ±Reset PPO, Rt=100ms	USP-6C	49xs	VD21	9b	Tor
3D033	XC6106D033ER	Vdet-IC	3.3V±2%, Hst, -MR, ±Reset PPO, Rt=100ms	USP-6C	49xs	VD21	9b	Tor
3D034	XC6106D034ER	Vdet-IC	3.4V±2%, Hst, -MR, ±Reset PPO, Rt=100ms	USP-6C	49xs	VD21	9b	Tor
3D035	XC6106D035ER	Vdet-IC	3.5V±2%, Hst, -MR, ±Reset PPO, Rt=100ms	USP-6C	49xs	VD21	9b	Tor



SMD code	Type	Function	Short description	Case	Pinout	Sch.	St.	Mnf.
3D630	XC6101D630ER	Vdet-IC	3.0V±2%, Hst, -MR, -Reset PPO, Wt=1.6s, Rt=100ms	USP-6C	49xh	VD17	9b	Tor
3D631	XC6101D631ER	Vdet-IC	3.1V±2%, Hst, -MR, -Reset PPO, Wt=1.6s, Rt=100ms	USP-6C	49xh	VD17	9b	Tor
3D632	XC6101D632ER	Vdet-IC	3.2V±2%, Hst, -MR, -Reset PPO, Wt=1.6s, Rt=100ms	USP-6C	49xh	VD17	9b	Tor
3D633	XC6101D633ER	Vdet-IC	3.3V±2%, Hst, -MR, -Reset PPO, Wt=1.6s, Rt=100ms	USP-6C	49xh	VD17	9b	Tor
3D634	XC6101D634ER	Vdet-IC	3.4V±2%, Hst, -MR, -Reset PPO, Wt=1.6s, Rt=100ms	USP-6C	49xh	VD17	9b	Tor
3D635	XC6101D635ER	Vdet-IC	3.5V±2%, Hst, -MR, -Reset PPO, Wt=1.6s, Rt=100ms	USP-6C	49xh	VD17	9b	Tor
3D636	XC6101D636ER	Vdet-IC	3.6V±2%, Hst, -MR, -Reset PPO, Wt=1.6s, Rt=100ms	USP-6C	49xh	VD17	9b	Tor
3D637	XC6101D637ER	Vdet-IC	3.7V±2%, Hst, -MR, -Reset PPO, Wt=1.6s, Rt=100ms	USP-6C	49xh	VD17	9b	Tor
3D638	XC6101D638ER	Vdet-IC	3.8V±2%, Hst, -MR, -Reset PPO, Wt=1.6s, Rt=100ms	USP-6C	49xh	VD17	9b	Tor
3D639	XC6101D639ER	Vdet-IC	3.9V±2%, Hst, -MR, -Reset PPO, Wt=1.6s, Rt=100ms	USP-6C	49xh	VD17	9b	Tor
3D640	XC6101D640ER	Vdet-IC	4.0V±2%, Hst, -MR, -Reset PPO, Wt=1.6s, Rt=100ms	USP-6C	49xh	VD17	9b	Tor
3D641	XC6101D641ER	Vdet-IC	4.1V±2%, Hst, -MR, -Reset PPO, Wt=1.6s, Rt=100ms	USP-6C	49xh	VD17	9b	Tor
3D642	XC6101D642ER	Vdet-IC	4.2V±2%, Hst, -MR, -Reset PPO, Wt=1.6s, Rt=100ms	USP-6C	49xh	VD17	9b	Tor
3D643	XC6101D643ER	Vdet-IC	4.3V±2%, Hst, -MR, -Reset PPO, Wt=1.6s, Rt=100ms	USP-6C	49xh	VD17	9b	Tor
3D644	XC6101D644ER	Vdet-IC	4.4V±2%, Hst, -MR, -Reset PPO, Wt=1.6s, Rt=100ms	USP-6C	49xh	VD17	9b	Tor
3D645	XC6101D645ER	Vdet-IC	4.5V±2%, Hst, -MR, -Reset PPO, Wt=1.6s, Rt=100ms	USP-6C	49xh	VD17	9b	Tor
3D646	XC6101D646ER	Vdet-IC	4.6V±2%, Hst, -MR, -Reset PPO, Wt=1.6s, Rt=100ms	USP-6C	49xh	VD17	9b	Tor
3D647	XC6101D647ER	Vdet-IC	4.7V±2%, Hst, -MR, -Reset PPO, Wt=1.6s, Rt=100ms	USP-6C	49xh	VD17	9b	Tor
3D648	XC6101D648ER	Vdet-IC	4.8V±2%, Hst, -MR, -Reset PPO, Wt=1.6s, Rt=100ms	USP-6C	49xh	VD17	9b	Tor
3D649	XC6101D649ER	Vdet-IC	4.9V±2%, Hst, -MR, -Reset PPO, Wt=1.6s, Rt=100ms	USP-6C	49xh	VD17	9b	Tor
3D650	XC6101D650ER	Vdet-IC	5.0V±2%, Hst, -MR, -Reset PPO, Wt=1.6s, Rt=100ms	USP-6C	49xh	VD17	9b	Tor
3D7	XC6227A37BER	LVR-IC	LDO, 3.75V±1%, 700mA, +CE	USP-6C	49hq	VR4	9a	Tor
3D8	XC6227A38BER	LVR-IC	LDO, 3.85V±1%, 700mA, +CE	USP-6C	49hq	VR4	9a	Tor
3D9	XC6227A39BER	LVR-IC	LDO, 3.95V±1%, 700mA, +CE	USP-6C	49hq	VR4	9a	Tor
3DA	XC6227A40BER	LVR-IC	LDO, 4.05V±1%, 700mA, +CE	USP-6C	49hq	VR4	9a	Tor
3DA02	XC6404DA02D	LVR/Vdet-IC	LDO, 2.7V±2%, 500mA, Vdi=4.2V, -Reset ODO, +CE, PDR	USP-6B	49zx	VR15	9b	Tor
3DA03	XC6404DA03D	LVR/Vdet-IC	LDO, 2.5V±2%, 500mA, Vdi=2.6V, -Reset ODO, +CE, PDR	USP-6B	49zx	VR15	9b	Tor
3DA04	XC6404DA04D	LVR/Vdet-IC	LDO, 3.3V±2%, 500mA, Vdi=3.3V, -Reset ODO, +CE, PDR	USP-6B	49zx	VR15	9b	Tor
3DA05	XC6404DA05D	LVR/Vdet-IC	LDO, 3.3V±2%, 500mA, Vdi=4.4V, -Reset ODO, +CE, PDR	USP-6B	49zx	VR15	9b	Tor
3DA07	XC6404DA07D	LVR/Vdet-IC	LDO, 3.3V±2%, 500mA, Vdi=5.2V, -Reset ODO, +CE, PDR	USP-6B	49zx	VR15	9b	Tor
3DA08	XC6404DA08D	LVR/Vdet-IC	LDO, 2.8V±2%, 500mA, Vdi= 4.3V, -Reset ODO, +CE, PDR	USP-6B	49zx	VR15	9b	Tor
3DA09	XC6404DA09D	LVR/Vdet-IC	LDO, 4.3V±2%, 500mA, Vdi=2.8V, -Reset ODO, +CE, PDR	USP-6B	49zx	VR15	9b	Tor
3DA11	XC6404DA11D	LVR/Vdet-IC	LDO, 2.8V±2%, 500mA, Vdi=2.1V, -Reset ODO, +CE, PDR	USP-6B	49zx	VR15	9b	Tor
3DA12	XC6404DA12D	LVR/Vdet-IC	LDO, 2.8V±2%, 500mA, Vdi=2.8V, -Reset ODO, +CE, PDR	USP-6B	49zx	VR15	9b	Tor
3DA15	XC6404DA15D	LVR/Vdet-IC	LDO, 3.3V±2%, 500mA, Vdi=4.3V, -Reset ODO, +CE, PDR	USP-6B	49zx	VR15	9b	Tor
3DA18	XC6404DA18D	LVR/Vdet-IC	LDO, 3.0V±2%, 500mA, Vdi=2.7V, -Reset ODO, +CE, PDR	USP-6B	49zx	VR15	9b	Tor
3DA19	XC6404DA19D	LVR/Vdet-IC	LDO, 2.8V±2%, 500mA, Vdi=2.5V, -Reset ODO, +CE, PDR	USP-6B	49zx	VR15	9b	Tor
3DA20	XC6404DA20D	LVR/Vdet-IC	LDO, 1.8V±2%, 500mA, Vdi=2.9V, -Reset ODO, +CE, PDR	USP-6B	49zx	VR15	9b	Tor
3DA21	XC6404DA21D	LVR/Vdet-IC	LDO, 1.8V±2%, 500mA, Vdi=3.6V, -Reset ODO, +CE, PDR	USP-6B	49zx	VR15	9b	Tor
3DA22	XC6404DA22D	LVR/Vdet-IC	LDO, 1.8V±2%, 500mA, Vdi=4.2V, -Reset ODO, +CE, PDR	USP-6B	49zx	VR15	9b	Tor
3DA23	XC6404DA23D	LVR/Vdet-IC	LDO, 2.5V±2%, 500mA, Vdi=2.9V, -Reset ODO, +CE, PDR	USP-6B	49zx	VR15	9b	Tor
3DA24	XC6404DA24D	LVR/Vdet-IC	LDO, 2.5V±2%, 500mA, Vdi=3.6V, -Reset ODO, +CE, PDR	USP-6B	49zx	VR15	9b	Tor
3DA25	XC6404DA25D	LVR/Vdet-IC	LDO, 2.5V±2%, 500mA, Vdi=4.2V, -Reset ODO, +CE, PDR	USP-6B	49zx	VR15	9b	Tor
3DA26	XC6404DA26D	LVR/Vdet-IC	LDO, 4.3V±2%, 500mA, Vdi=4.0V, -Reset ODO, +CE, PDR	USP-6B	49zx	VR15	9b	Tor
3DA27	XC6404DA27D	LVR/Vdet-IC	LDO, 2.5V±2%, 500mA, Vdi=3.9V, -Reset ODO, +CE, PDR	USP-6B	49zx	VR15	9b	Tor
3DA28	XC6404DA28D	LVR/Vdet-IC	LDO, 3.3V±2%, 500mA, Vdi=3.7V, -Reset ODO, +CE, PDR	USP-6B	49zx	VR15	9b	Tor
3DA29	XC6404DA29D	LVR/Vdet-IC	LDO, 2.6V±2%, 500mA, Vdi=3.9V, -Reset ODO, +CE, PDR	USP-6B	49zx	VR15	9b	Tor
3DA30	XC6404DA30D	LVR/Vdet-IC	LDO, 3.3V±2%, 500mA, Vdi=4.2V, -Reset ODO, +CE, PDR	USP-6B	49zx	VR15	9b	Tor
3DA31	XC6404DA31D	LVR/Vdet-IC	LDO, 3.3V±2%, 500mA, Vdi=4.5V, -Reset ODO, +CE, PDR	USP-6B	49zx	VR15	9b	Tor
3DA32	XC6404DA32D	LVR/Vdet-IC	LDO, 2.85V±2%, 500mA, Vdi=2.6V, -Reset ODO, +CE, PDR	USP-6B	49zx	VR15	9b	Tor
3DA33	XC6404DA33D	LVR/Vdet-IC	LDO, 3.3V±2%, 500mA, Vdi=2.8V, -Reset ODO, +CE, PDR	USP-6B	49zx	VR15	9b	Tor
3DA34	XC6404DA34D	LVR/Vdet-IC	LDO, 3.4V±2%, 500mA, Vdi=4.2V, -Reset ODO, +CE, PDR	USP-6B	49zx	VR15	9b	Tor
3DA80	XC6404DA80D	LVR/Vdet-IC	LDO, 1.8V±2%, 500mA, Vdi=1.6V, -Reset ODO, +CE, PDR	USP-6B	49zx	VR15	9b	Tor
3DA81	XC6404DA81D	LVR/Vdet-IC	LDO, 2.8V±2%, 500mA, Vdi=3.1V, -Reset ODO, +CE, PDR	USP-6B	49zx	VR15	9b	Tor
3DA82	XC6404DA82D	LVR/Vdet-IC	LDO, 1.8V±2%, 500mA, Vdi=2.0V, -Reset ODO, +CE, PDR	USP-6B	49zx	VR15	9b	Tor
3DA83	XC6404DA83D	LVR/Vdet-IC	LDO, 2.5V±2%, 500mA, Vdi=2.8V, -Reset ODO, +CE, PDR	USP-6B	49zx	VR15	9b	Tor
3DA84	XC6404DA84D	LVR/Vdet-IC	LDO, 2.85V±2%, 500mA, Vdi=3.2V, -Reset ODO, +CE, PDR	USP-6B	49zx	VR15	9b	Tor
3DA85	XC6404DA85D	LVR/Vdet-IC	LDO, 3.0V±2%, 500mA, Vdi=3.3V, -Reset ODO, +CE, PDR	USP-6B	49zx	VR15	9b	Tor
3DA86	XC6404DA86D	LVR/Vdet-IC	LDO, 3.5V±2%, 500mA, Vdi=3.8V, -Reset ODO, +CE, PDR	USP-6B	49zx	VR15	9b	Tor
3DA87	XC6404DA87D	LVR/Vdet-IC	LDO, 3.0V±2%, 500mA, Vdi=4.2V, -Reset ODO, +CE, PDR	USP-6B	49zx	VR15	9b	Tor
3DA88	XC6404DA88D	LVR/Vdet-IC	LDO, 3.3V±2%, 500mA, Vdi=4.0V, -Reset ODO, +CE, PDR	USP-6B	49zx	VR15	9b	Tor
3DB	XC6227A41BER	LVR-IC	LDO, 4.15V±1%, 700mA, +CE	USP-6C	49hq	VR4	9a	Tor
3DB02	XC6404DB02D	LVR/Vdet-IC	LDO, 2.7V±2%, 500mA, Vdi=4.2V, +Reset ODO, -CE, PDR	USP-6B	49zx	VR15	9b	Tor
3DB03	XC6404DB03D	LVR/Vdet-IC	LDO, 2.5V±2%, 500mA, Vdi=2.6V, +Reset ODO, -CE, PDR	USP-6B	49zx	VR15	9b	Tor
3DB04	XC6404DB04D	LVR/Vdet-IC	LDO, 3.3V±2%, 500mA, Vdi=4.3V, +Reset ODO, -CE, PDR	USP-6B	49zx	VR15	9b	Tor
3DB05	XC6404DB05D	LVR/Vdet-IC	LDO, 3.3V±2%, 500mA, Vdi=4.4V, +Reset ODO, -CE, PDR	USP-6B	49zx	VR15	9b	Tor
3DB07	XC6404DB07D	LVR/Vdet-IC	LDO, 3.3V±2%, 500mA, Vdi=5.2V, +Reset ODO, -CE, PDR	USP-6B	49zx	VR15	9b	Tor
3DB08	XC6404DB08D	LVR/Vdet-IC	LDO, 2.8V±2%, 500mA, Vdi= 4.3V, +Reset ODO, -CE, PDR	USP-6B	49zx	VR15	9b	Tor
3DB09	XC6404DB09D	LVR/Vdet-IC	LDO, 4.3V±2%, 500mA, Vdi=2.8V, +Reset ODO, -CE, PDR	USP-6B	49zx	VR15	9b	Tor
3DB11	XC6404DB11D	LVR/Vdet-IC	LDO, 2.8V±2%, 500mA, Vdi=2.1V, +Reset ODO, -CE, PDR	USP-6B	49zx	VR15	9b	Tor



SMD code	Type	Function	Short description	Case	Pinout	Sch.	St.	Mnf.
3DD07	XC6404DD07D	LVR/Vdet-IC	LDO, 3.3V±2%, 500mA, Vdo=5.2V, +Reset ODO, +CE, PDR	USP-6B	49zx	VR15	9b	Tor
3DD08	XC6404DD08D	LVR/Vdet-IC	LDO, 2.8V±2%, 500mA, Vdo=5.4V, +Reset ODO, +CE, PDR	USP-6B	49zx	VR15	9b	Tor
3DD09	XC6404DD09D	LVR/Vdet-IC	LDO, 4.3V±2%, 500mA, Vdo=2.8V, +Reset ODO, +CE, PDR	USP-6B	49zx	VR15	9b	Tor
3DD11	XC6404DD11D	LVR/Vdet-IC	LDO, 2.8V±2%, 500mA, Vdo=2.1V, +Reset ODO, +CE, PDR	USP-6B	49zx	VR15	9b	Tor
3DD12	XC6404DD12D	LVR/Vdet-IC	LDO, 2.8V±2%, 500mA, Vdo=2.8V, +Reset ODO, +CE, PDR	USP-6B	49zx	VR15	9b	Tor
3DD15	XC6404DD15D	LVR/Vdet-IC	LDO, 3.3V±2%, 500mA, Vdo=3.6V, +Reset ODO, +CE, PDR	USP-6B	49zx	VR15	9b	Tor
3DD18	XC6404DD18D	LVR/Vdet-IC	LDO, 3.0V±2%, 500mA, Vdo=2.7V, +Reset ODO, +CE, PDR	USP-6B	49zx	VR15	9b	Tor
3DD19	XC6404DD19D	LVR/Vdet-IC	LDO, 2.8V±2%, 500mA, Vdo=2.5V, +Reset ODO, +CE, PDR	USP-6B	49zx	VR15	9b	Tor
3DD20	XC6404DD20D	LVR/Vdet-IC	LDO, 1.8V±2%, 500mA, Vdo=2.9V, +Reset ODO, +CE, PDR	USP-6B	49zx	VR15	9b	Tor
3DD21	XC6404DD21D	LVR/Vdet-IC	LDO, 1.8V±2%, 500mA, Vdo=3.6V, +Reset ODO, +CE, PDR	USP-6B	49zx	VR15	9b	Tor
3DD22	XC6404DD22D	LVR/Vdet-IC	LDO, 1.8V±2%, 500mA, Vdo=4.2V, +Reset ODO, +CE, PDR	USP-6B	49zx	VR15	9b	Tor
3DD23	XC6404DD23D	LVR/Vdet-IC	LDO, 2.5V±2%, 500mA, Vdo=2.9V, +Reset ODO, +CE, PDR	USP-6B	49zx	VR15	9b	Tor
3DD24	XC6404DD24D	LVR/Vdet-IC	LDO, 2.5V±2%, 500mA, Vdo=3.6V, +Reset ODO, +CE, PDR	USP-6B	49zx	VR15	9b	Tor
3DD25	XC6404DD25D	LVR/Vdet-IC	LDO, 2.5V±2%, 500mA, Vdo=4.2V, +Reset ODO, +CE, PDR	USP-6B	49zx	VR15	9b	Tor
3DD26	XC6404DD26D	LVR/Vdet-IC	LDO, 4.3V±2%, 500mA, Vdo=4.0V, +Reset ODO, +CE, PDR	USP-6B	49zx	VR15	9b	Tor
3DD27	XC6404DD27D	LVR/Vdet-IC	LDO, 2.5V±2%, 500mA, Vdo=3.9V, +Reset ODO, +CE, PDR	USP-6B	49zx	VR15	9b	Tor
3DD28	XC6404DD28D	LVR/Vdet-IC	LDO, 3.3V±2%, 500mA, Vdo=3.7V, +Reset ODO, +CE, PDR	USP-6B	49zx	VR15	9b	Tor
3DD29	XC6404DD29D	LVR/Vdet-IC	LDO, 2.6V±2%, 500mA, Vdo=3.9V, +Reset ODO, +CE, PDR	USP-6B	49zx	VR15	9b	Tor
3DD30	XC6404DD30D	LVR/Vdet-IC	LDO, 3.3V±2%, 500mA, Vdo=4.2V, +Reset ODO, +CE, PDR	USP-6B	49zx	VR15	9b	Tor
3DD31	XC6404DD31D	LVR/Vdet-IC	LDO, 3.3V±2%, 500mA, Vdo=4.5V, +Reset ODO, +CE, PDR	USP-6B	49zx	VR15	9b	Tor
3DD32	XC6404DD32D	LVR/Vdet-IC	LDO, 2.85V±2%, 500mA, Vdo=2.6V, +Reset ODO, +CE, PDR	USP-6B	49zx	VR15	9b	Tor
3DD33	XC6404DD33D	LVR/Vdet-IC	LDO, 3.3V±2%, 500mA, Vdo=2.8V, +Reset ODO, +CE, PDR	USP-6B	49zx	VR15	9b	Tor
3DD34	XC6404DD34D	LVR/Vdet-IC	LDO, 3.4V±2%, 500mA, Vdo=4.2V, +Reset ODO, +CE, PDR	USP-6B	49zx	VR15	9b	Tor
3DD80	XC6404DD80D	LVR/Vdet-IC	LDO, 1.8V±2%, 500mA, Vdo=1.6V, +Reset ODO, +CE, PDR	USP-6B	49zx	VR15	9b	Tor
3DD81	XC6404DD81D	LVR/Vdet-IC	LDO, 2.8V±2%, 500mA, Vdo=3.1V, +Reset ODO, +CE, PDR	USP-6B	49zx	VR15	9b	Tor
3DD82	XC6404DD82D	LVR/Vdet-IC	LDO, 1.8V±2%, 500mA, Vdo=2.0V, +Reset ODO, +CE, PDR	USP-6B	49zx	VR15	9b	Tor
3DD83	XC6404DD83D	LVR/Vdet-IC	LDO, 2.5V±2%, 500mA, Vdo=2.8V, +Reset ODO, +CE, PDR	USP-6B	49zx	VR15	9b	Tor
3DD84	XC6404DD84D	LVR/Vdet-IC	LDO, 2.85V±2%, 500mA, Vdo=3.2V, +Reset ODO, +CE, PDR	USP-6B	49zx	VR15	9b	Tor
3DD85	XC6404DD85D	LVR/Vdet-IC	LDO, 3.0V±2%, 500mA, Vdo=3.3V, +Reset ODO, +CE, PDR	USP-6B	49zx	VR15	9b	Tor
3DD86	XC6404DD86D	LVR/Vdet-IC	LDO, 3.5V±2%, 500mA, Vdo=3.8V, +Reset ODO, +CE, PDR	USP-6B	49zx	VR15	9b	Tor
3DD87	XC6404DD87D	LVR/Vdet-IC	LDO, 3.0V±2%, 500mA, Vdo=4.2V, +Reset ODO, +CE, PDR	USP-6B	49zx	VR15	9b	Tor
3DD88	XC6404DD88D	LVR/Vdet-IC	LDO, 3.3V±2%, 500mA, Vdo=4.0V, +Reset ODO, +CE, PDR	USP-6B	49zx	VR15	9b	Tor
3DE	XC6227A4BER	LVR-IC	LDO, 4.45V±1%, 700mA, +CE	USP-6C	49hq	VR4	9a	Tor
3DE02	XC6404DE02D	LVR/Vdet-IC	LDO, 2.7V±2%, 500mA, Vdi=4.2V, -Reset ODO, +CE	USP-6B	49zx	VR15	9b	Tor
3DE03	XC6404DE03D	LVR/Vdet-IC	LDO, 2.5V±2%, 500mA, Vdi=2.6V, -Reset ODO, +CE	USP-6B	49zx	VR15	9b	Tor
3DE04	XC6404DE04D	LVR/Vdet-IC	LDO, 3.3V±2%, 500mA, Vdi=4.3V, -Reset ODO, +CE	USP-6B	49zx	VR15	9b	Tor
3DE05	XC6404DE05D	LVR/Vdet-IC	LDO, 3.3V±2%, 500mA, Vdi=4.4V, -Reset ODO, +CE	USP-6B	49zx	VR15	9b	Tor
3DE07	XC6404DE07D	LVR/Vdet-IC	LDO, 3.3V±2%, 500mA, Vdi=5.2V, -Reset ODO, +CE	USP-6B	49zx	VR15	9b	Tor
3DE08	XC6404DE08D	LVR/Vdet-IC	LDO, 2.8V±2%, 500mA, Vdi= 4.3V, -Reset ODO, +CE	USP-6B	49zx	VR15	9b	Tor
3DE09	XC6404DE09D	LVR/Vdet-IC	LDO, 4.3V±2%, 500mA, Vdi=2.8V, -Reset ODO, +CE	USP-6B	49zx	VR15	9b	Tor
3DE11	XC6404DE11D	LVR/Vdet-IC	LDO, 2.8V±2%, 500mA, Vdi=2.1V, -Reset ODO, +CE	USP-6B	49zx	VR15	9b	Tor
3DE12	XC6404DE12D	LVR/Vdet-IC	LDO, 2.8V±2%, 500mA, Vdi=2.8V, -Reset ODO, +CE	USP-6B	49zx	VR15	9b	Tor
3DE15	XC6404DE15D	LVR/Vdet-IC	LDO, 3.3V±2%, 500mA, Vdi=3.6V, -Reset ODO, +CE	USP-6B	49zx	VR15	9b	Tor
3DE18	XC6404DE18D	LVR/Vdet-IC	LDO, 3.0V±2%, 500mA, Vdi=2.7V, -Reset ODO, +CE	USP-6B	49zx	VR15	9b	Tor
3DE19	XC6404DE19D	LVR/Vdet-IC	LDO, 2.8V±2%, 500mA, Vdi=2.5V, -Reset ODO, +CE	USP-6B	49zx	VR15	9b	Tor
3DE20	XC6404DE20D	LVR/Vdet-IC	LDO, 1.8V±2%, 500mA, Vdi=2.9V, -Reset ODO, +CE	USP-6B	49zx	VR15	9b	Tor
3DE21	XC6404DE21D	LVR/Vdet-IC	LDO, 1.8V±2%, 500mA, Vdi=3.6V, -Reset ODO, +CE	USP-6B	49zx	VR15	9b	Tor
3DE22	XC6404DE22D	LVR/Vdet-IC	LDO, 1.8V±2%, 500mA, Vdi=4.2V, -Reset ODO, +CE	USP-6B	49zx	VR15	9b	Tor
3DE23	XC6404DE23D	LVR/Vdet-IC	LDO, 2.5V±2%, 500mA, Vdi=2.9V, -Reset ODO, +CE	USP-6B	49zx	VR15	9b	Tor
3DE24	XC6404DE24D	LVR/Vdet-IC	LDO, 2.5V±2%, 500mA, Vdi=3.6V, -Reset ODO, +CE	USP-6B	49zx	VR15	9b	Tor
3DE25	XC6404DE25D	LVR/Vdet-IC	LDO, 2.5V±2%, 500mA, Vdi=4.2V, -Reset ODO, +CE	USP-6B	49zx	VR15	9b	Tor
3DE26	XC6404DE26D	LVR/Vdet-IC	LDO, 4.3V±2%, 500mA, Vdi=4.0V, -Reset ODO, +CE	USP-6B	49zx	VR15	9b	Tor
3DE27	XC6404DE27D	LVR/Vdet-IC	LDO, 2.5V±2%, 500mA, Vdi=3.9V, -Reset ODO, +CE	USP-6B	49zx	VR15	9b	Tor
3DE28	XC6404DE28D	LVR/Vdet-IC	LDO, 3.3V±2%, 500mA, Vdi=3.7V, -Reset ODO, +CE	USP-6B	49zx	VR15	9b	Tor
3DE29	XC6404DE29D	LVR/Vdet-IC	LDO, 2.6V±2%, 500mA, Vdi=3.9V, -Reset ODO, +CE	USP-6B	49zx	VR15	9b	Tor
3DE30	XC6404DE30D	LVR/Vdet-IC	LDO, 3.3V±2%, 500mA, Vdi=4.2V, -Reset ODO, +CE	USP-6B	49zx	VR15	9b	Tor
3DE31	XC6404DE31D	LVR/Vdet-IC	LDO, 3.3V±2%, 500mA, Vdi=4.5V, -Reset ODO, +CE	USP-6B	49zx	VR15	9b	Tor
3DE32	XC6404DE32D	LVR/Vdet-IC	LDO, 2.85V±2%, 500mA, Vdi=2.6V, -Reset ODO, +CE	USP-6B	49zx	VR15	9b	Tor
3DE33	XC6404DE33D	LVR/Vdet-IC	LDO, 3.3V±2%, 500mA, Vdi=2.8V, -Reset ODO, +CE	USP-6B	49zx	VR15	9b	Tor
3DE34	XC6404DE34D	LVR/Vdet-IC	LDO, 3.4V±2%, 500mA, Vdi=4.2V, -Reset ODO, +CE	USP-6B	49zx	VR15	9b	Tor
3DE80	XC6404DE80D	LVR/Vdet-IC	LDO, 1.8V±2%, 500mA, Vdi=1.6V, -Reset ODO, +CE	USP-6B	49zx	VR15	9b	Tor
3DE81	XC6404DE81D	LVR/Vdet-IC	LDO, 2.8V±2%, 500mA, Vdi=3.1V, -Reset ODO, +CE	USP-6B	49zx	VR15	9b	Tor
3DE82	XC6404DE82D	LVR/Vdet-IC	LDO, 1.8V±2%, 500mA, Vdi=2.0V, -Reset ODO, +CE	USP-6B	49zx	VR15	9b	Tor
3DE83	XC6404DE83D	LVR/Vdet-IC	LDO, 2.5V±2%, 500mA, Vdi=2.8V, -Reset ODO, +CE	USP-6B	49zx	VR15	9b	Tor
3DE84	XC6404DE84D	LVR/Vdet-IC	LDO, 2.85V±2%, 500mA, Vdi=3.2V, -Reset ODO, +CE	USP-6B	49zx	VR15	9b	Tor
3DE85	XC6404DE85D	LVR/Vdet-IC	LDO, 3.0V±2%, 500mA, Vdi=3.3V, -Reset ODO, +CE	USP-6B	49zx	VR15	9b	Tor
3DE86	XC6404DE86D	LVR/Vdet-IC	LDO, 3.5V±2%, 500mA, Vdi=3.8V, -Reset ODO, +CE	USP-6B	49zx	VR15	9b	Tor
3DE87	XC6404DE87D	LVR/Vdet-IC	LDO, 3.0V±2%, 500mA, Vdi=4.2V, -Reset ODO, +CE	USP-6B	49zx	VR15	9b	Tor
3DE88	XC6404DE88D	LVR/Vdet-IC	LDO, 3.3V±2%, 500mA, Vdi=4.0V, -Reset ODO, +CE	USP-6B	49zx	VR15	9b	Tor
3DF	XC6227A45BER	LVR-IC	LDO, 4.55V±1%, 700mA, +CE	USP-6C	49hq	VR4	9a	Tor



SMD code	Type	Function	Short description	Case	Pinout	Sch.	St.	Mnf.
3DH86	XC6404DH86D	LVR/Vdet-IC	LDO, 3.5V±2%, 500mA, Vdo=3.8V, -Reset ODO, +CE	USP-6B	49zx	VR15	9b	Tor
3DH87	XC6404DH87D	LVR/Vdet-IC	LDO, 3.0V±2%, 500mA, Vdo=4.2V, -Reset ODO, +CE	USP-6B	49zx	VR15	9b	Tor
3DH88	XC6404DH88D	LVR/Vdet-IC	LDO, 3.3V±2%, 500mA, Vdo=4.0V, -Reset ODO, +CE	USP-6B	49zx	VR15	9b	Tor
3DK	XC6227A47BER	LVR-IC	LDO, 4.75V±1%, 700mA, +CE	USP-6C	49hq	VR4	9a	Tor
3DK02	XC6404DK02D	LVR/Vdet-IC	LDO, 2.7V±2%, 500mA, Vdo=4.2V, +Reset ODO, +CE	USP-6B	49zx	VR15	9b	Tor
3DK03	XC6404DK03D	LVR/Vdet-IC	LDO, 2.5V±2%, 500mA, Vdo=2.6V, +Reset ODO, +CE	USP-6B	49zx	VR15	9b	Tor
3DK04	XC6404DK04D	LVR/Vdet-IC	LDO, 3.3V±2%, 500mA, Vdo=4.3V, +Reset ODO, +CE	USP-6B	49zx	VR15	9b	Tor
3DK05	XC6404DK05D	LVR/Vdet-IC	LDO, 3.3V±2%, 500mA, Vdo=4.4V, +Reset ODO, +CE	USP-6B	49zx	VR15	9b	Tor
3DK07	XC6404DK07D	LVR/Vdet-IC	LDO, 3.3V±2%, 500mA, Vdo=5.2V, +Reset ODO, +CE	USP-6B	49zx	VR15	9b	Tor
3DK08	XC6404DK08D	LVR/Vdet-IC	LDO, 2.8V±2%, 500mA, Vdo= 4.3V, +Reset ODO, +CE	USP-6B	49zx	VR15	9b	Tor
3DK09	XC6404DK09D	LVR/Vdet-IC	LDO, 4.3V±2%, 500mA, Vdo=2.8V, +Reset ODO, +CE	USP-6B	49zx	VR15	9b	Tor
3DK11	XC6404DK11D	LVR/Vdet-IC	LDO, 2.8V±2%, 500mA, Vdo=2.8V, +Reset ODO, +CE	USP-6B	49zx	VR15	9b	Tor
3DK12	XC6404DK12D	LVR/Vdet-IC	LDO, 2.8V±2%, 500mA, Vdo=2.8V, +Reset ODO, +CE	USP-6B	49zx	VR15	9b	Tor
3DK15	XC6404DK15D	LVR/Vdet-IC	LDO, 3.3V±2%, 500mA, Vdo=3.6V, +Reset ODO, +CE	USP-6B	49zx	VR15	9b	Tor
3DK18	XC6404DK18D	LVR/Vdet-IC	LDO, 3.0V±2%, 500mA, Vdo=3.7V, +Reset ODO, +CE	USP-6B	49zx	VR15	9b	Tor
3DK19	XC6404DK19D	LVR/Vdet-IC	LDO, 2.8V±2%, 500mA, Vdo=2.5V, +Reset ODO, +CE	USP-6B	49zx	VR15	9b	Tor
3DK20	XC6404DK20D	LVR/Vdet-IC	LDO, 1.8V±2%, 500mA, Vdo=2.9V, +Reset ODO, +CE	USP-6B	49zx	VR15	9b	Tor
3DK21	XC6404DK21D	LVR/Vdet-IC	LDO, 1.8V±2%, 500mA, Vdo=3.6V, +Reset ODO, +CE	USP-6B	49zx	VR15	9b	Tor
3DK22	XC6404DK22D	LVR/Vdet-IC	LDO, 1.8V±2%, 500mA, Vdo=1.6V, +Reset ODO, +CE	USP-6B	49zx	VR15	9b	Tor
3DK23	XC6404DK23D	LVR/Vdet-IC	LDO, 2.5V±2%, 500mA, Vdo=2.9V, +Reset ODO, +CE	USP-6B	49zx	VR15	9b	Tor
3DK24	XC6404DK24D	LVR/Vdet-IC	LDO, 2.5V±2%, 500mA, Vdo=3.6V, +Reset ODO, +CE	USP-6B	49zx	VR15	9b	Tor
3DK25	XC6404DK25D	LVR/Vdet-IC	LDO, 2.5V±2%, 500mA, Vdo=4.2V, +Reset ODO, +CE	USP-6B	49zx	VR15	9b	Tor
3DK26	XC6404DK26D	LVR/Vdet-IC	LDO, 4.3V±2%, 500mA, Vdo=4.0V, +Reset ODO, +CE	USP-6B	49zx	VR15	9b	Tor
3DK27	XC6404DK27D	LVR/Vdet-IC	LDO, 2.5V±2%, 500mA, Vdo=3.9V, +Reset ODO, +CE	USP-6B	49zx	VR15	9b	Tor
3DK28	XC6404DK28D	LVR/Vdet-IC	LDO, 3.3V±2%, 500mA, Vdo=3.7V, +Reset ODO, +CE	USP-6B	49zx	VR15	9b	Tor
3DK29	XC6404DK29D	LVR/Vdet-IC	LDO, 2.6V±2%, 500mA, Vdo=3.9V, +Reset ODO, +CE	USP-6B	49zx	VR15	9b	Tor
3DK30	XC6404DK30D	LVR/Vdet-IC	LDO, 3.3V±2%, 500mA, Vdo=4.2V, +Reset ODO, +CE	USP-6B	49zx	VR15	9b	Tor
3DK31	XC6404DK31D	LVR/Vdet-IC	LDO, 3.3V±2%, 500mA, Vdo=4.5V, +Reset ODO, +CE	USP-6B	49zx	VR15	9b	Tor
3DK32	XC6404DK32D	LVR/Vdet-IC	LDO, 2.85V±2%, 500mA, Vdo=2.6V, +Reset ODO, +CE	USP-6B	49zx	VR15	9b	Tor
3DK33	XC6404DK33D	LVR/Vdet-IC	LDO, 3.3V±2%, 500mA, Vdo=2.8V, +Reset ODO, +CE	USP-6B	49zx	VR15	9b	Tor
3DK34	XC6404DK34D	LVR/Vdet-IC	LDO, 3.4V±2%, 500mA, Vdo=4.2V, +Reset ODO, +CE	USP-6B	49zx	VR15	9b	Tor
3DK80	XC6404DK80D	LVR/Vdet-IC	LDO, 1.8V±2%, 500mA, Vdo=1.6V, +Reset ODO, +CE	USP-6B	49zx	VR15	9b	Tor
3DK81	XC6404DK81D	LVR/Vdet-IC	LDO, 2.8V±2%, 500mA, Vdo=3.1V, +Reset ODO, +CE	USP-6B	49zx	VR15	9b	Tor
3DK82	XC6404DK82D	LVR/Vdet-IC	LDO, 1.8V±2%, 500mA, Vdo=2.0V, +Reset ODO, +CE	USP-6B	49zx	VR15	9b	Tor
3DK83	XC6404DK83D	LVR/Vdet-IC	LDO, 2.5V±2%, 500mA, Vdo=2.8V, +Reset ODO, +CE	USP-6B	49zx	VR15	9b	Tor
3DK84	XC6404DK84D	LVR/Vdet-IC	LDO, 2.85V±2%, 500mA, Vdo=3.2V, +Reset ODO, +CE	USP-6B	49zx	VR15	9b	Tor
3DK85	XC6404DK85D	LVR/Vdet-IC	LDO, 3.0V±2%, 500mA, Vdo=3.3V, +Reset ODO, +CE	USP-6B	49zx	VR15	9b	Tor
3DK86	XC6404DK86D	LVR/Vdet-IC	LDO, 3.5V±2%, 500mA, Vdo=3.7V, +Reset ODO, +CE	USP-6B	49zx	VR15	9b	Tor
3DK87	XC6404DK87D	LVR/Vdet-IC	LDO, 3.0V±2%, 500mA, Vdo=4.2V, +Reset ODO, +CE	USP-6B	49zx	VR15	9b	Tor
3DK88	XC6404DK88D	LVR/Vdet-IC	LDO, 3.3V±2%, 500mA, Vdo=4.0V, +Reset ODO, +CE	USP-6B	49zx	VR15	9b	Tor
3DL	XC6227A48BER	LVR-IC	LDO, 4.65V±1%, 700mA, +CE	USP-6C	49hq	VR4	9a	Tor
3DL02	XC6404DL02D	LVR/Vdet-IC	LDO, 2.7V±2%, 500mA, Vdi=4.2V, -Reset ODO, -CE, PUR	USP-6B	49zx	VR15	9b	Tor
3DL03	XC6404DL03D	LVR/Vdet-IC	LDO, 2.5V±2%, 500mA, Vdi=2.6V, -Reset ODO, -CE, PUR	USP-6B	49zx	VR15	9b	Tor
3DL04	XC6404DL04D	LVR/Vdet-IC	LDO, 3.3V±2%, 500mA, Vdi=4.3V, -Reset ODO, -CE, PUR	USP-6B	49zx	VR15	9b	Tor
3DL05	XC6404DL05D	LVR/Vdet-IC	LDO, 3.3V±2%, 500mA, Vdi=4.4V, -Reset ODO, -CE, PUR	USP-6B	49zx	VR15	9b	Tor
3DL07	XC6404DL07D	LVR/Vdet-IC	LDO, 3.3V±2%, 500mA, Vdi=5.2V, -Reset ODO, -CE, PUR	USP-6B	49zx	VR15	9b	Tor
3DL08	XC6404DL08D	LVR/Vdet-IC	LDO, 2.8V±2%, 500mA, Vdi= 4.3V, -Reset ODO, -CE, PUR	USP-6B	49zx	VR15	9b	Tor
3DL09	XC6404DL09D	LVR/Vdet-IC	LDO, 4.3V±2%, 500mA, Vdi=2.8V, -Reset ODO, -CE, PUR	USP-6B	49zx	VR15	9b	Tor
3DL11	XC6404DL11D	LVR/Vdet-IC	LDO, 2.8V±2%, 500mA, Vdi=2.1V, -Reset ODO, -CE, PUR	USP-6B	49zx	VR15	9b	Tor
3DL12	XC6404DL12D	LVR/Vdet-IC	LDO, 2.8V±2%, 500mA, Vdi=2.8V, -Reset ODO, -CE, PUR	USP-6B	49zx	VR15	9b	Tor
3DL15	XC6404DL15D	LVR/Vdet-IC	LDO, 3.3V±2%, 500mA, Vdi=3.6V, -Reset ODO, -CE, PUR	USP-6B	49zx	VR15	9b	Tor
3DL18	XC6404DL18D	LVR/Vdet-IC	LDO, 3.0V±2%, 500mA, Vdi=2.7V, -Reset ODO, -CE, PUR	USP-6B	49zx	VR15	9b	Tor
3DL19	XC6404DL19D	LVR/Vdet-IC	LDO, 2.8V±2%, 500mA, Vdi=2.5V, -Reset ODO, -CE, PUR	USP-6B	49zx	VR15	9b	Tor
3DL20	XC6404DL20D	LVR/Vdet-IC	LDO, 1.8V±2%, 500mA, Vdi=2.9V, -Reset ODO, -CE, PUR	USP-6B	49zx	VR15	9b	Tor
3DL21	XC6404DL21D	LVR/Vdet-IC	LDO, 1.8V±2%, 500mA, Vdi=3.6V, -Reset ODO, -CE, PUR	USP-6B	49zx	VR15	9b	Tor
3DL22	XC6404DL22D	LVR/Vdet-IC	LDO, 1.8V±2%, 500mA, Vdi=4.2V, -Reset ODO, -CE, PUR	USP-6B	49zx	VR15	9b	Tor
3DL23	XC6404DL23D	LVR/Vdet-IC	LDO, 2.5V±2%, 500mA, Vdi=2.9V, -Reset ODO, -CE, PUR	USP-6B	49zx	VR15	9b	Tor
3DL24	XC6404DL24D	LVR/Vdet-IC	LDO, 2.5V±2%, 500mA, Vdi=3.6V, -Reset ODO, -CE, PUR	USP-6B	49zx	VR15	9b	Tor
3DL25	XC6404DL25D	LVR/Vdet-IC	LDO, 2.5V±2%, 500mA, Vdi=4.2V, -Reset ODO, -CE, PUR	USP-6B	49zx	VR15	9b	Tor
3DL26	XC6404DL26D	LVR/Vdet-IC	LDO, 4.3V±2%, 500mA, Vdi=4.0V, -Reset ODO, -CE, PUR	USP-6B	49zx	VR15	9b	Tor
3DL27	XC6404DL27D	LVR/Vdet-IC	LDO, 2.5V±2%, 500mA, Vdi=3.9V, -Reset ODO, -CE, PUR	USP-6B	49zx	VR15	9b	Tor
3DL28	XC6404DL28D	LVR/Vdet-IC	LDO, 3.3V±2%, 500mA, Vdi=3.7V, -Reset ODO, -CE, PUR	USP-6B	49zx	VR15	9b	Tor
3DL29	XC6404DL29D	LVR/Vdet-IC	LDO, 2.6V±2%, 500mA, Vdi=3.9V, -Reset ODO, -CE, PUR	USP-6B	49zx	VR15	9b	Tor
3DL30	XC6404DL30D	LVR/Vdet-IC	LDO, 3.3V±2%, 500mA, Vdi=4.2V, -Reset ODO, -CE, PUR	USP-6B	49zx	VR15	9b	Tor
3DL31	XC6404DL31D	LVR/Vdet-IC	LDO, 3.3V±2%, 500mA, Vdi=4.5V, -Reset ODO, -CE, PUR	USP-6B	49zx	VR15	9b	Tor
3DL32	XC6404DL32D	LVR/Vdet-IC	LDO, 2.85V±2%, 500mA, Vdi=2.6V, -Reset ODO, -CE, PUR	USP-6B	49zx	VR15	9b	Tor
3DL33	XC6404DL33D	LVR/Vdet-IC	LDO, 3.3V±2%, 500mA, Vdi=2.9V, -Reset ODO, -CE, PUR	USP-6B	49zx	VR15	9b	Tor
3DL34	XC6404DL34D	LVR/Vdet-IC	LDO, 3.4V±2%, 500mA, Vdi=4.2V, -Reset ODO, -CE, PUR	USP-6B	49zx	VR15	9b	Tor
3DL80	XC6404DL80D	LVR/Vdet-IC	LDO, 1.8V±2%, 500mA, Vdi=1.6V, -Reset ODO, -CE, PUR	USP-6B	49zx	VR15	9b	Tor
3DL81	XC6404DL81D	LVR/Vdet-IC	LDO, 2.8V±2%, 500mA, Vdi=3.1V, -Reset ODO, -CE, PUR	USP-6B	49zx	VR15	9b	Tor



SMD code	Type	Function	Short description	Case	Pinout	Sch.	St.	Mnf.
3DT30	XC6404DT30D	LVR/Vdet-IC	LDO, 3.3V±2%, 500mA, Vdo=4.2V, -Reset ODO, -CE	USP-6B	49zx	VR15	9b	Tor
3DT31	XC6404DT31D	LVR/Vdet-IC	LDO, 3.3V±2%, 500mA, Vdo=4.5V, -Reset ODO, -CE	USP-6B	49zx	VR15	9b	Tor
3DT32	XC6404DT32D	LVR/Vdet-IC	LDO, 2.85V±2%, 500mA, Vdo=2.6V, -Reset ODO, -CE	USP-6B	49zx	VR15	9b	Tor
3DT33	XC6404DT33D	LVR/Vdet-IC	LDO, 3.3V±2%, 500mA, Vdo=2.8V, -Reset ODO, -CE	USP-6B	49zx	VR15	9b	Tor
3DT34	XC6404DT34D	LVR/Vdet-IC	LDO, 3.4V±2%, 500mA, Vdo=4.2V, -Reset ODO, -CE	USP-6B	49zx	VR15	9b	Tor
3DT80	XC6404DT80D	LVR/Vdet-IC	LDO, 1.8V±2%, 500mA, Vdo=1.6V, -Reset ODO, -CE	USP-6B	49zx	VR15	9b	Tor
3DT81	XC6404DT81D	LVR/Vdet-IC	LDO, 2.8V±2%, 500mA, Vdo=3.1V, -Reset ODO, -CE	USP-6B	49zx	VR15	9b	Tor
3DT82	XC6404DT82D	LVR/Vdet-IC	LDO, 1.8V±2%, 500mA, Vdo=2.0V, -Reset ODO, -CE	USP-6B	49zx	VR15	9b	Tor
3DT83	XC6404DT83D	LVR/Vdet-IC	LDO, 2.5V±2%, 500mA, Vdo=2.8V, -Reset ODO, -CE	USP-6B	49zx	VR15	9b	Tor
3DT84	XC6404DT84D	LVR/Vdet-IC	LDO, 2.85V±2%, 500mA, Vdo=3.2V, -Reset ODO, -CE	USP-6B	49zx	VR15	9b	Tor
3DT85	XC6404DT85D	LVR/Vdet-IC	LDO, 3.0V±2%, 500mA, Vdo=3.3V, -Reset ODO, -CE	USP-6B	49zx	VR15	9b	Tor
3DT86	XC6404DT86D	LVR/Vdet-IC	LDO, 3.5V±2%, 500mA, Vdo=3.8V, -Reset ODO, -CE	USP-6B	49zx	VR15	9b	Tor
3DT87	XC6404DT87D	LVR/Vdet-IC	LDO, 3.0V±2%, 500mA, Vdo=4.2V, -Reset ODO, -CE	USP-6B	49zx	VR15	9b	Tor
3DT88	XC6404DT88D	LVR/Vdet-IC	LDO, 3.3V±2%, 500mA, Vdo=4.0V, -Reset ODO, -CE	USP-6B	49zx	VR15	9b	Tor
3DU02	XC6404DU02D	LVR/Vdet-IC	LDO, 2.7V±2%, 500mA, Vdo=4.2V, +Reset ODO, -CE	USP-6B	49zx	VR15	9b	Tor
3DU03	XC6404DU03D	LVR/Vdet-IC	LDO, 2.5V±2%, 500mA, Vdo=2.6V, +Reset ODO, -CE	USP-6B	49zx	VR15	9b	Tor
3DU04	XC6404DU04D	LVR/Vdet-IC	LDO, 3.3V±2%, 500mA, Vdo=4.3V, +Reset ODO, -CE	USP-6B	49zx	VR15	9b	Tor
3DU05	XC6404DU05D	LVR/Vdet-IC	LDO, 3.3V±2%, 500mA, Vdo=4.4V, +Reset ODO, -CE	USP-6B	49zx	VR15	9b	Tor
3DU07	XC6404DU07D	LVR/Vdet-IC	LDO, 3.3V±2%, 500mA, Vdo=5.2V, +Reset ODO, -CE	USP-6B	49zx	VR15	9b	Tor
3DU08	XC6404DU08D	LVR/Vdet-IC	LDO, 2.8V±2%, 500mA, Vdo=4.3V, +Reset ODO, -CE	USP-6B	49zx	VR15	9b	Tor
3DU09	XC6404DU09D	LVR/Vdet-IC	LDO, 4.3V±2%, 500mA, Vdo=2.8V, +Reset ODO, -CE	USP-6B	49zx	VR15	9b	Tor
3DU11	XC6404DU11D	LVR/Vdet-IC	LDO, 2.8V±2%, 500mA, Vdo=2.1V, +Reset ODO, -CE	USP-6B	49zx	VR15	9b	Tor
3DU12	XC6404DU12D	LVR/Vdet-IC	LDO, 2.8V±2%, 500mA, Vdo=2.8V, +Reset ODO, -CE	USP-6B	49zx	VR15	9b	Tor
3DU15	XC6404DU15D	LVR/Vdet-IC	LDO, 3.3V±2%, 500mA, Vdo=3.6V, +Reset ODO, -CE	USP-6B	49zx	VR15	9b	Tor
3DU18	XC6404DU18D	LVR/Vdet-IC	LDO, 3.0V±2%, 500mA, Vdo=2.7V, +Reset ODO, -CE	USP-6B	49zx	VR15	9b	Tor
3DU19	XC6404DU19D	LVR/Vdet-IC	LDO, 2.8V±2%, 500mA, Vdo=2.5V, +Reset ODO, -CE	USP-6B	49zx	VR15	9b	Tor
3DU20	XC6404DU20D	LVR/Vdet-IC	LDO, 1.8V±2%, 500mA, Vdo=2.9V, +Reset ODO, -CE	USP-6B	49zx	VR15	9b	Tor
3DU21	XC6404DU21D	LVR/Vdet-IC	LDO, 1.8V±2%, 500mA, Vdo=3.6V, +Reset ODO, -CE	USP-6B	49zx	VR15	9b	Tor
3DU22	XC6404DU22D	LVR/Vdet-IC	LDO, 1.8V±2%, 500mA, Vdo=4.2V, +Reset ODO, -CE	USP-6B	49zx	VR15	9b	Tor
3DU23	XC6404DU23D	LVR/Vdet-IC	LDO, 2.5V±2%, 500mA, Vdo=2.9V, +Reset ODO, -CE	USP-6B	49zx	VR15	9b	Tor
3DU24	XC6404DU24D	LVR/Vdet-IC	LDO, 2.5V±2%, 500mA, Vdo=3.6V, +Reset ODO, -CE	USP-6B	49zx	VR15	9b	Tor
3DU25	XC6404DU25D	LVR/Vdet-IC	LDO, 2.5V±2%, 500mA, Vdo=4.2V, +Reset ODO, -CE	USP-6B	49zx	VR15	9b	Tor
3DU26	XC6404DU26D	LVR/Vdet-IC	LDO, 4.3V±2%, 500mA, Vdo=4.0V, +Reset ODO, -CE	USP-6B	49zx	VR15	9b	Tor
3DU27	XC6404DU27D	LVR/Vdet-IC	LDO, 2.5V±2%, 500mA, Vdo=3.9V, +Reset ODO, -CE	USP-6B	49zx	VR15	9b	Tor
3DU28	XC6404DU28D	LVR/Vdet-IC	LDO, 3.3V±2%, 500mA, Vdo=3.7V, +Reset ODO, -CE	USP-6B	49zx	VR15	9b	Tor
3DU29	XC6404DU29D	LVR/Vdet-IC	LDO, 2.6V±2%, 500mA, Vdo=3.9V, +Reset ODO, -CE	USP-6B	49zx	VR15	9b	Tor
3DU30	XC6404DU30D	LVR/Vdet-IC	LDO, 3.3V±2%, 500mA, Vdo=4.2V, +Reset ODO, -CE	USP-6B	49zx	VR15	9b	Tor
3DU31	XC6404DU31D	LVR/Vdet-IC	LDO, 3.3V±2%, 500mA, Vdo=4.5V, +Reset ODO, -CE	USP-6B	49zx	VR15	9b	Tor
3DU32	XC6404DU32D	LVR/Vdet-IC	LDO, 2.85V±2%, 500mA, Vdo=2.6V, +Reset ODO, -CE	USP-6B	49zx	VR15	9b	Tor
3DU33	XC6404DU33D	LVR/Vdet-IC	LDO, 3.3V±2%, 500mA, Vdo=2.8V, +Reset ODO, -CE	USP-6B	49zx	VR15	9b	Tor
3DU34	XC6404DU34D	LVR/Vdet-IC	LDO, 3.4V±2%, 500mA, Vdo=4.2V, +Reset ODO, -CE	USP-6B	49zx	VR15	9b	Tor
3DU80	XC6404DU80D	LVR/Vdet-IC	LDO, 1.8V±2%, 500mA, Vdo=1.6V, +Reset ODO, -CE	USP-6B	49zx	VR15	9b	Tor
3DU81	XC6404DU81D	LVR/Vdet-IC	LDO, 2.8V±2%, 500mA, Vdo=3.1V, +Reset ODO, -CE	USP-6B	49zx	VR15	9b	Tor
3DU82	XC6404DU82D	LVR/Vdet-IC	LDO, 1.8V±2%, 500mA, Vdo=2.0V, +Reset ODO, -CE	USP-6B	49zx	VR15	9b	Tor
3DU83	XC6404DU83D	LVR/Vdet-IC	LDO, 2.5V±2%, 500mA, Vdo=3.8V, +Reset ODO, -CE	USP-6B	49zx	VR15	9b	Tor
3DU84	XC6404DU84D	LVR/Vdet-IC	LDO, 2.85V±2%, 500mA, Vdo=3.2V, +Reset ODO, -CE	USP-6B	49zx	VR15	9b	Tor
3DU85	XC6404DU85D	LVR/Vdet-IC	LDO, 3.0V±2%, 500mA, Vdo=3.3V, +Reset ODO, -CE	USP-6B	49zx	VR15	9b	Tor
3DU86	XC6404DU86D	LVR/Vdet-IC	LDO, 3.5V±2%, 500mA, Vdo=3.8V, +Reset ODO, -CE	USP-6B	49zx	VR15	9b	Tor
3DU87	XC6404DU87D	LVR/Vdet-IC	LDO, 3.0V±2%, 500mA, Vdo=4.2V, +Reset ODO, -CE	USP-6B	49zx	VR15	9b	Tor
3DU88	XC6404DU88D	LVR/Vdet-IC	LDO, 3.3V±2%, 500mA, Vdo=4.0V, +Reset ODO, -CE	USP-6B	49zx	VR15	9b	Tor
3E	R3117K111C	Vdet-IC	1.1V±15mV, -Reset PPO, Sense	DFN1010-4	48rq	VD12	9a	Ric
3E	RP101K181B5	LVR-IC	LDO, LN, +CE, 1.85V±0.8%, 300mA	DFN11612-4	45vm	VR4	9a	Ric
3E	XC6217D1527R-G	LVR-IC	LDO, 1.5V±2%, 200mA, +CE, CL	USPN-4	58vm	VR4	9a	Tor
3E	XC6223D2419R-G	LVR-IC	LDO, 2.4V±1%, 300mA, +CE, CL, PDR	USPQ-4B03	48vm	VR4	9a	Tor
3E	XC6224B22B7R	LVR-IC	LDO, 2.25V±1.5%, 150mA, +CE, PDR	USPN-4B02	58vm	VR4	9e	Tor
3E	XC6229H33B1R-G	LVR-IC	LDO, 3.35V±1%, 300mA, +CE, ICP	BGA-4	63ba*	VR4	9a	Tor
3E016	XC6106E016ER	Vdet-IC	1.6V±2%, Hst, -MR, ±Reset PPO, Rt=200ms	USP-6C	49xs	VD21	9b	Tor
3E017	XC6106E017ER	Vdet-IC	1.7V±2%, Hst, -MR, ±Reset PPO, Rt=200ms	USP-6C	49xs	VD21	9b	Tor
3E018	XC6106E018ER	Vdet-IC	1.8V±2%, Hst, -MR, ±Reset PPO, Rt=200ms	USP-6C	49xs	VD21	9b	Tor
3E019	XC6106E019ER	Vdet-IC	1.9V±2%, Hst, -MR, ±Reset PPO, Rt=200ms	USP-6C	49xs	VD21	9b	Tor
3E020	XC6106E020ER	Vdet-IC	2.0V±2%, Hst, -MR, ±Reset PPO, Rt=200ms	USP-6C	49xs	VD21	9b	Tor
3E021	XC6106E021ER	Vdet-IC	2.1V±2%, Hst, -MR, ±Reset PPO, Rt=200ms	USP-6C	49xs	VD21	9b	Tor
3E022	XC6106E022ER	Vdet-IC	2.2V±2%, Hst, -MR, ±Reset PPO, Rt=200ms	USP-6C	49xs	VD21	9b	Tor
3E023	XC6106E023ER	Vdet-IC	2.3V±2%, Hst, -MR, ±Reset PPO, Rt=200ms	USP-6C	49xs	VD21	9b	Tor
3E024	XC6106E024ER	Vdet-IC	2.4V±2%, Hst, -MR, ±Reset PPO, Rt=200ms	USP-6C	49xs	VD21	9b	Tor
3E025	XC6106E025ER	Vdet-IC	2.5V±2%, Hst, -MR, ±Reset PPO, Rt=200ms	USP-6C	49xs	VD21	9b	Tor
3E026	XC6106E026ER	Vdet-IC	2.6V±2%, Hst, -MR, ±Reset PPO, Rt=200ms	USP-6C	49xs	VD21	9b	Tor
3E027	XC6106E027ER	Vdet-IC	2.7V±2%, Hst, -MR, ±Reset PPO, Rt=200ms	USP-6C	49xs	VD21	9b	Tor
3E028	XC6106E028ER	Vdet-IC	2.8V±2%, Hst, -MR, ±Reset PPO, Rt=200ms	USP-6C	49xs	VD21	9b	Tor
3E029	XC6106E029ER	Vdet-IC	2.9V±2%, Hst, -MR, ±Reset PPO, Rt=200ms	USP-6C	49xs	VD21	9b	Tor



SMD code	Type	Function	Short description	Case	Pinout	Sch.	St.	Mnf.
3EE	XC6227C141ER	LVR-IC	LDO, 1.4V±20mV, 700mA, +CE, PDR	USP-6C	49hq	VR4	9a	Tor
3EF	XC6221A16BGR	LVR-IC	LDO, 1.65V±20mV, 200mA, +CE	USP-4	45vm	VR4	9a	Tor
3EF	XC6227C151ER	LVR-IC	LDO, 1.5V±20mV, 700mA, +CE, PDR	USP-6C	49hq	VR4	9a	Tor
3EH	XC6221A17BGR	LVR-IC	LDO, 1.75V±20mV, 200mA, +CE	USP-4	45vm	VR4	9a	Tor
3EH	XC6227C161ER	LVR-IC	LDO, 1.6V±20mV, 700mA, +CE, PDR	USP-6C	49hq	VR4	9a	Tor
3EK	XC6221A18BGR	LVR-IC	LDO, 1.85V±20mV, 200mA, +CE	USP-4	45vm	VR4	9a	Tor
3EK	XC6227C171ER	LVR-IC	LDO, 1.7V±20mV, 700mA, +CE, PDR	USP-6C	49hq	VR4	9a	Tor
3EL	XC6221A19BGR	LVR-IC	LDO, 1.95V±20mV, 200mA, +CE	USP-4	45vm	VR4	9a	Tor
3EL	XC6227C181ER	LVR-IC	LDO, 1.8V±20mV, 700mA, +CE, PDR	USP-6C	49hq	VR4	9a	Tor
3EM	XC6221A20BGR	LVR-IC	LDO, 2.05V±1%, 200mA, +CE	USP-4	45vm	VR4	9a	Tor
3EM	XC6227C191ER	LVR-IC	LDO, 1.9V±20mV, 700mA, +CE, PDR	USP-6C	49hq	VR4	9a	Tor
3EN	XC6221A21BGR	LVR-IC	LDO, 2.15V±1%, 200mA, +CE	USP-4	45vm	VR4	9a	Tor
3EN	XC6227C201ER	LVR-IC	LDO, 2.0V±20mV, 700mA, +CE, PDR	USP-6C	49hq	VR4	9a	Tor
3EP	XC6221A22BGR	LVR-IC	LDO, 2.25V±1%, 200mA, +CE	USP-4	45vm	VR4	9a	Tor
3EP	XC6227C211ER	LVR-IC	LDO, 2.1V±1%, 700mA, +CE, PDR	USP-6C	49hq	VR4	9a	Tor
3ER	XC6221A23BGR	LVR-IC	LDO, 2.35V±1%, 200mA, +CE	USP-4	45vm	VR4	9a	Tor
3ER	XC6227C221ER	LVR-IC	LDO, 2.2V±1%, 700mA, +CE, PDR	USP-6C	49hq	VR4	9a	Tor
3ES	XC6221A24BGR	LVR-IC	LDO, 2.45V±1%, 200mA, +CE	USP-4	45vm	VR4	9a	Tor
3ES	XC6227C231ER	LVR-IC	LDO, 2.3V±1%, 700mA, +CE, PDR	USP-6C	49hq	VR4	9a	Tor
3ET	XC6221A25BGR	LVR-IC	LDO, 2.55V±1%, 200mA, +CE	USP-4	45vm	VR4	9a	Tor
3ET	XC6227C241ER	LVR-IC	LDO, 2.4V±1%, 700mA, +CE, PDR	USP-6C	49hq	VR4	9a	Tor
3EU	XC6221A26BGR	LVR-IC	LDO, 2.65V±1%, 200mA, +CE	USP-4	45vm	VR4	9a	Tor
3EU	XC6227C251ER	LVR-IC	LDO, 2.5V±1%, 700mA, +CE, PDR	USP-6C	49hq	VR4	9a	Tor
3EV	XC6221A27BGR	LVR-IC	LDO, 2.75V±1%, 200mA, +CE	USP-4	45vm	VR4	9a	Tor
3EV	XC6227C261ER	LVR-IC	LDO, 2.6V±1%, 700mA, +CE, PDR	USP-6C	49hq	VR4	9a	Tor
3EV02	XC6404EV02D	LVR/Vdet-IC	LDO, 2.7V±2%, 500mA, Vd=4.2V, -Reset ODO, Vdet/Sense	USP-6B	49zy	VR14	9b	Tor
3EV03	XC6404EV03D	LVR/Vdet-IC	LDO, 2.5V±2%, 500mA, Vd=2.6V, -Reset ODO, Vdet/Sense	USP-6B	49zy	VR14	9b	Tor
3EV04	XC6404EV04D	LVR/Vdet-IC	LDO, 3.3V±2%, 500mA, Vd=4.3V, -Reset ODO, Vdet/Sense	USP-6B	49zy	VR14	9b	Tor
3EV05	XC6404EV05D	LVR/Vdet-IC	LDO, 3.3V±2%, 500mA, Vd=4.4V, -Reset ODO, Vdet/Sense	USP-6B	49zy	VR14	9b	Tor
3EV07	XC6404EV07D	LVR/Vdet-IC	LDO, 3.3V±2%, 500mA, Vd=5.2V, -Reset ODO, Vdet/Sense	USP-6B	49zy	VR14	9b	Tor
3EV08	XC6404EV08D	LVR/Vdet-IC	LDO, 2.8V±2%, 500mA, Vd=4.3V, -Reset ODO, Vdet/Sense	USP-6B	49zy	VR14	9b	Tor
3EV09	XC6404EV09D	LVR/Vdet-IC	LDO, 4.3V±2%, 500mA, Vd=2.8V, -Reset ODO, Vdet/Sense	USP-6B	49zy	VR14	9b	Tor
3EV11	XC6404EV11D	LVR/Vdet-IC	LDO, 2.8V±2%, 500mA, Vd=2.1V, -Reset ODO, Vdet/Sense	USP-6B	49zy	VR14	9b	Tor
3EV12	XC6404EV12D	LVR/Vdet-IC	LDO, 2.8V±2%, 500mA, Vd=2.8V, -Reset ODO, Vdet/Sense	USP-6B	49zy	VR14	9b	Tor
3EV15	XC6404EV15D	LVR/Vdet-IC	LDO, 3.3V±2%, 500mA, Vd=3.6V, -Reset ODO, Vdet/Sense	USP-6B	49zy	VR14	9b	Tor
3EV18	XC6404EV18D	LVR/Vdet-IC	LDO, 3.0V±2%, 500mA, Vd=2.7V, -Reset ODO, Vdet/Sense	USP-6B	49zy	VR14	9b	Tor
3EV19	XC6404EV19D	LVR/Vdet-IC	LDO, 2.8V±2%, 500mA, Vd=2.5V, -Reset ODO, Vdet/Sense	USP-6B	49zy	VR14	9b	Tor
3EV20	XC6404EV20D	LVR/Vdet-IC	LDO, 1.8V±2%, 500mA, Vd=2.9V, -Reset ODO, Vdet/Sense	USP-6B	49zy	VR14	9b	Tor
3EV21	XC6404EV21D	LVR/Vdet-IC	LDO, 1.8V±2%, 500mA, Vd=3.6V, -Reset ODO, Vdet/Sense	USP-6B	49zy	VR14	9b	Tor
3EV22	XC6404EV22D	LVR/Vdet-IC	LDO, 1.8V±2%, 500mA, Vd=4.2V, -Reset ODO, Vdet/Sense	USP-6B	49zy	VR14	9b	Tor
3EV23	XC6404EV23D	LVR/Vdet-IC	LDO, 2.5V±2%, 500mA, Vd=2.9V, -Reset ODO, Vdet/Sense	USP-6B	49zy	VR14	9b	Tor
3EV24	XC6404EV24D	LVR/Vdet-IC	LDO, 2.5V±2%, 500mA, Vd=3.6V, -Reset ODO, Vdet/Sense	USP-6B	49zy	VR14	9b	Tor
3EV25	XC6404EV25D	LVR/Vdet-IC	LDO, 2.5V±2%, 500mA, Vd=4.2V, -Reset ODO, Vdet/Sense	USP-6B	49zy	VR14	9b	Tor
3EV26	XC6404EV26D	LVR/Vdet-IC	LDO, 4.3V±2%, 500mA, Vd=4.0V, -Reset ODO, Vdet/Sense	USP-6B	49zy	VR14	9b	Tor
3EV27	XC6404EV27D	LVR/Vdet-IC	LDO, 2.5V±2%, 500mA, Vd=3.3V, -Reset ODO, Vdet/Sense	USP-6B	49zy	VR14	9b	Tor
3EV28	XC6404EV28D	LVR/Vdet-IC	LDO, 3.3V±2%, 500mA, Vd=3.7V, -Reset ODO, Vdet/Sense	USP-6B	49zy	VR14	9b	Tor
3EV29	XC6404EV29D	LVR/Vdet-IC	LDO, 2.6V±2%, 500mA, Vd=3.9V, -Reset ODO, Vdet/Sense	USP-6B	49zy	VR14	9b	Tor
3EV30	XC6404EV30D	LVR/Vdet-IC	LDO, 3.3V±2%, 500mA, Vd=4.2V, -Reset ODO, Vdet/Sense	USP-6B	49zy	VR14	9b	Tor
3EV31	XC6404EV31D	LVR/Vdet-IC	LDO, 3.3V±2%, 500mA, Vd=4.5V, -Reset ODO, Vdet/Sense	USP-6B	49zy	VR14	9b	Tor
3EV32	XC6404EV32D	LVR/Vdet-IC	LDO, 2.85V±2%, 500mA, Vd=2.6V, -Reset ODO, Vdet/Sense	USP-6B	49zy	VR14	9b	Tor
3EV33	XC6404EV33D	LVR/Vdet-IC	LDO, 3.3V±2%, 500mA, Vd=2.8V, -Reset ODO, Vdet/Sense	USP-6B	49zy	VR14	9b	Tor
3EV34	XC6404EV34D	LVR/Vdet-IC	LDO, 3.4V±2%, 500mA, Vd=4.2V, -Reset ODO, Vdet/Sense	USP-6B	49zy	VR14	9b	Tor
3EV80	XC6404EV80D	LVR/Vdet-IC	LDO, 1.8V±2%, 500mA, Vd=1.6V, -Reset ODO, Vdet/Sense	USP-6B	49zy	VR14	9b	Tor
3EV81	XC6404EV81D	LVR/Vdet-IC	LDO, 2.8V±2%, 500mA, Vd=3.1V, -Reset ODO, Vdet/Sense	USP-6B	49zy	VR14	9b	Tor
3EV82	XC6404EV82D	LVR/Vdet-IC	LDO, 1.8V±2%, 500mA, Vd=2.0V, -Reset ODO, Vdet/Sense	USP-6B	49zy	VR14	9b	Tor
3EV83	XC6404EV83D	LVR/Vdet-IC	LDO, 2.5V±2%, 500mA, Vd=2.8V, -Reset ODO, Vdet/Sense	USP-6B	49zy	VR14	9b	Tor
3EV84	XC6404EV84D	LVR/Vdet-IC	LDO, 2.85V±2%, 500mA, Vd=3.2V, -Reset ODO, Vdet/Sense	USP-6B	49zy	VR14	9b	Tor
3EV85	XC6404EV85D	LVR/Vdet-IC	LDO, 3.0V±2%, 500mA, Vd=3.3V, -Reset ODO, Vdet/Sense	USP-6B	49zy	VR14	9b	Tor
3EV86	XC6404EV86D	LVR/Vdet-IC	LDO, 3.5V±2%, 500mA, Vd=3.8V, -Reset ODO, Vdet/Sense	USP-6B	49zy	VR14	9b	Tor
3EV87	XC6404EV87D	LVR/Vdet-IC	LDO, 3.0V±2%, 500mA, Vd=4.2V, -Reset ODO, Vdet/Sense	USP-6B	49zy	VR14	9b	Tor
3EV88	XC6404EV88D	LVR/Vdet-IC	LDO, 3.3V±2%, 500mA, Vd=4.0V, -Reset ODO, Vdet/Sense	USP-6B	49zy	VR14	9b	Tor
3EX	XC6221A28BGR	LVR-IC	LDO, 2.85V±1%, 200mA, +CE	USP-4	45vm	VR4	9a	Tor
3EX	XC6227C271ER	LVR-IC	LDO, 2.7V±1%, 700mA, +CE, PDR	USP-6C	49hq	VR4	9a	Tor
3EX02	XC6404EX02D	LVR/Vdet-IC	LDO, 2.7V±2%, 500mA, Vd=4.2V, +Reset ODO, Vdet/Sense	USP-6B	49zy	VR14	9b	Tor
3EX03	XC6404EX03D	LVR/Vdet-IC	LDO, 2.5V±2%, 500mA, Vd=2.6V, +Reset ODO, Vdet/Sense	USP-6B	49zy	VR14	9b	Tor
3EX04	XC6404EX04D	LVR/Vdet-IC	LDO, 3.3V±2%, 500mA, Vd=4.3V, +Reset ODO, Vdet/Sense	USP-6B	49zy	VR14	9b	Tor
3EX05	XC6404EX05D	LVR/Vdet-IC	LDO, 3.3V±2%, 500mA, Vd=4.4V, +Reset ODO, Vdet/Sense	USP-6B	49zy	VR14	9b	Tor
3EX07	XC6404EX07D	LVR/Vdet-IC	LDO, 3.3V±2%, 500mA, Vd=5.2V, +Reset ODO, Vdet/Sense	USP-6B	49zy	VR14	9b	Tor
3EX08	XC6404EX08D	LVR/Vdet-IC	LDO, 2.8V±2%, 500mA, Vd=4.3V, +Reset ODO, Vdet/Sense	USP-6B	49zy	VR14	9b	Tor
3EX09	XC6404EX09D	LVR/Vdet-IC	LDO, 4.3V±2%, 500mA, Vd=2.8V, +Reset ODO, Vdet/Sense	USP-6B	49zy	VR14	9b	Tor



SMD code	Type	Function	Short description	Case	Pinout	Sch.	St.	Mnf.
3EX11	XC6404EX11D	LVR/Vdet-IC	LDO, 2.8V±2%, 500mA, Vd=2.1V, +Reset ODO, Vdet/Sense	USP-6B	49zy	VR14	9b	Tor
3EX12	XC6404EX12D	LVR/Vdet-IC	LDO, 2.8V±2%, 500mA, Vd=2.8V, +Reset ODO, Vdet/Sense	USP-6B	49zy	VR14	9b	Tor
3EX15	XC6404EX15D	LVR/Vdet-IC	LDO, 3.3V±2%, 500mA, Vd=3.6V, +Reset ODO, Vdet/Sense	USP-6B	49zy	VR14	9b	Tor
3EX18	XC6404EX18D	LVR/Vdet-IC	LDO, 3.0V±2%, 500mA, Vd=2.7V, +Reset ODO, Vdet/Sense	USP-6B	49zy	VR14	9b	Tor
3EX19	XC6404EX19D	LVR/Vdet-IC	LDO, 2.8V±2%, 500mA, Vd=2.5V, +Reset ODO, Vdet/Sense	USP-6B	49zy	VR14	9b	Tor
3EX20	XC6404EX20D	LVR/Vdet-IC	LDO, 1.8V±2%, 500mA, Vd=2.9V, +Reset ODO, Vdet/Sense	USP-6B	49zy	VR14	9b	Tor
3EX21	XC6404EX21D	LVR/Vdet-IC	LDO, 1.8V±2%, 500mA, Vd=3.6V, +Reset ODO, Vdet/Sense	USP-6B	49zy	VR14	9b	Tor
3EX22	XC6404EX22D	LVR/Vdet-IC	LDO, 1.8V±2%, 500mA, Vd=4.2V, +Reset ODO, Vdet/Sense	USP-6B	49zy	VR14	9b	Tor
3EX23	XC6404EX23D	LVR/Vdet-IC	LDO, 2.5V±2%, 500mA, Vd=2.9V, +Reset ODO, Vdet/Sense	USP-6B	49zy	VR14	9b	Tor
3EX24	XC6404EX24D	LVR/Vdet-IC	LDO, 2.5V±2%, 500mA, Vd=3.6V, +Reset ODO, Vdet/Sense	USP-6B	49zy	VR14	9b	Tor
3EX25	XC6404EX25D	LVR/Vdet-IC	LDO, 2.5V±2%, 500mA, Vd=4.2V, +Reset ODO, Vdet/Sense	USP-6B	49zy	VR14	9b	Tor
3EX26	XC6404EX26D	LVR/Vdet-IC	LDO, 4.3V±2%, 500mA, Vd=4.0V, +Reset ODO, Vdet/Sense	USP-6B	49zy	VR14	9b	Tor
3EX27	XC6404EX27D	LVR/Vdet-IC	LDO, 2.5V±2%, 500mA, Vd=3.9V, +Reset ODO, Vdet/Sense	USP-6B	49zy	VR14	9b	Tor
3EX28	XC6404EX28D	LVR/Vdet-IC	LDO, 3.3V±2%, 500mA, Vd=3.7V, +Reset ODO, Vdet/Sense	USP-6B	49zy	VR14	9b	Tor
3EX29	XC6404EX29D	LVR/Vdet-IC	LDO, 2.6V±2%, 500mA, Vd=3.9V, +Reset ODO, Vdet/Sense	USP-6B	49zy	VR14	9b	Tor
3EX30	XC6404EX30D	LVR/Vdet-IC	LDO, 3.3V±2%, 500mA, Vd=4.2V, +Reset ODO, Vdet/Sense	USP-6B	49zy	VR14	9b	Tor
3EX31	XC6404EX31D	LVR/Vdet-IC	LDO, 3.3V±2%, 500mA, Vd=4.5V, +Reset ODO, Vdet/Sense	USP-6B	49zy	VR14	9b	Tor
3EX32	XC6404EX32D	LVR/Vdet-IC	LDO, 2.85V±2%, 500mA, Vd=2.6V, +Reset ODO, Vdet/Sense	USP-6B	49zy	VR14	9b	Tor
3EX33	XC6404EX33D	LVR/Vdet-IC	LDO, 3.3V±2%, 500mA, Vd=2.8V, +Reset ODO, Vdet/Sense	USP-6B	49zy	VR14	9b	Tor
3EX34	XC6404EX34D	LVR/Vdet-IC	LDO, 3.4V±2%, 500mA, Vd=4.2V, +Reset ODO, Vdet/Sense	USP-6B	49zy	VR14	9b	Tor
3EX80	XC6404EX80D	LVR/Vdet-IC	LDO, 1.8V±2%, 500mA, Vd=1.6V, +Reset ODO, Vdet/Sense	USP-6B	49zy	VR14	9b	Tor
3EX81	XC6404EX81D	LVR/Vdet-IC	LDO, 2.8V±2%, 500mA, Vd=3.1V, +Reset ODO, Vdet/Sense	USP-6B	49zy	VR14	9b	Tor
3EX82	XC6404EX82D	LVR/Vdet-IC	LDO, 1.8V±2%, 500mA, Vd=2.0V, +Reset ODO, Vdet/Sense	USP-6B	49zy	VR14	9b	Tor
3EX83	XC6404EX83D	LVR/Vdet-IC	LDO, 2.5V±2%, 500mA, Vd=2.8V, +Reset ODO, Vdet/Sense	USP-6B	49zy	VR14	9b	Tor
3EX84	XC6404EX84D	LVR/Vdet-IC	LDO, 2.85V±2%, 500mA, Vd=3.2V, +Reset ODO, Vdet/Sense	USP-6B	49zy	VR14	9b	Tor
3EX85	XC6404EX85D	LVR/Vdet-IC	LDO, 3.0V±2%, 500mA, Vd=3.3V, +Reset ODO, Vdet/Sense	USP-6B	49zy	VR14	9b	Tor
3EX86	XC6404EX86D	LVR/Vdet-IC	LDO, 3.5V±2%, 500mA, Vd=3.8V, +Reset ODO, Vdet/Sense	USP-6B	49zy	VR14	9b	Tor
3EX87	XC6404EX87D	LVR/Vdet-IC	LDO, 3.0V±2%, 500mA, Vd=4.2V, +Reset ODO, Vdet/Sense	USP-6B	49zy	VR14	9b	Tor
3EX88	XC6404EX88D	LVR/Vdet-IC	LDO, 3.3V±2%, 500mA, Vd=4.0V, +Reset ODO, Vdet/Sense	USP-6B	49zy	VR14	9b	Tor
3EY	XC6221A29BGR	LVR-IC	LDO, 2.95V±1%, 200mA, +CE	USP-4	45wm	VR4	9a	Tor
3EY	XC6227C281ER	LVR-IC	LDO, 2.8V±1%, 700mA, +CE, PDR	USP-6C	49hq	VR4	9a	Tor
3EY02	XC6404EY02D	LVR/Vdet-IC	LDO, 2.7V±2%, 500mA, Vd=4.2V, -Reset ODO, Vr/Sense	USP-6B	49zy	VR14	9b	Tor
3EY03	XC6404EY03D	LVR/Vdet-IC	LDO, 2.5V±2%, 500mA, Vd=2.6V, -Reset ODO, Vr/Sense	USP-6B	49zy	VR14	9b	Tor
3EY04	XC6404EY04D	LVR/Vdet-IC	LDO, 3.3V±2%, 500mA, Vd=4.3V, -Reset ODO, Vr/Sense	USP-6B	49zy	VR14	9b	Tor
3EY05	XC6404EY05D	LVR/Vdet-IC	LDO, 3.3V±2%, 500mA, Vd=4.1V, -Reset ODO, Vr/Sense	USP-6B	49zy	VR14	9b	Tor
3EY07	XC6404EY07D	LVR/Vdet-IC	LDO, 3.3V±2%, 500mA, Vd=5.2V, -Reset ODO, Vr/Sense	USP-6B	49zy	VR14	9b	Tor
3EY08	XC6404EY08D	LVR/Vdet-IC	LDO, 2.8V±2%, 500mA, Vd=4.3V, -Reset ODO, Vr/Sense	USP-6B	49zy	VR14	9b	Tor
3EY09	XC6404EY09D	LVR/Vdet-IC	LDO, 4.3V±2%, 500mA, Vd=2.8V, -Reset ODO, Vr/Sense	USP-6B	49zy	VR14	9b	Tor
3EY11	XC6404EY11D	LVR/Vdet-IC	LDO, 2.8V±2%, 500mA, Vd=2.1V, -Reset ODO, Vr/Sense	USP-6B	49zy	VR14	9b	Tor
3EY12	XC6404EY12D	LVR/Vdet-IC	LDO, 2.8V±2%, 500mA, Vd=2.8V, -Reset ODO, Vr/Sense	USP-6B	49zy	VR14	9b	Tor
3EY15	XC6404EY15D	LVR/Vdet-IC	LDO, 3.3V±2%, 500mA, Vd=3.2V, -Reset ODO, Vr/Sense	USP-6B	49zy	VR14	9b	Tor
3EY18	XC6404EY18D	LVR/Vdet-IC	LDO, 3.0V±2%, 500mA, Vd=2.7V, -Reset ODO, Vr/Sense	USP-6B	49zy	VR14	9b	Tor
3EY19	XC6404EY19D	LVR/Vdet-IC	LDO, 2.8V±2%, 500mA, Vd=2.5V, -Reset ODO, Vr/Sense	USP-6B	49zy	VR14	9b	Tor
3EY20	XC6404EY20D	LVR/Vdet-IC	LDO, 1.8V±2%, 500mA, Vd=2.9V, -Reset ODO, Vr/Sense	USP-6B	49zy	VR14	9b	Tor
3EY21	XC6404EY21D	LVR/Vdet-IC	LDO, 1.8V±2%, 500mA, Vd=3.6V, -Reset ODO, Vr/Sense	USP-6B	49zy	VR14	9b	Tor
3EY22	XC6404EY22D	LVR/Vdet-IC	LDO, 1.8V±2%, 500mA, Vd=4.2V, -Reset ODO, Vr/Sense	USP-6B	49zy	VR14	9b	Tor
3EY23	XC6404EY23D	LVR/Vdet-IC	LDO, 2.5V±2%, 500mA, Vd=2.9V, -Reset ODO, Vr/Sense	USP-6B	49zy	VR14	9b	Tor
3EY24	XC6404EY24D	LVR/Vdet-IC	LDO, 2.5V±2%, 500mA, Vd=3.6V, -Reset ODO, Vr/Sense	USP-6B	49zy	VR14	9b	Tor
3EY25	XC6404EY25D	LVR/Vdet-IC	LDO, 2.5V±2%, 500mA, Vd=4.2V, -Reset ODO, Vr/Sense	USP-6B	49zy	VR14	9b	Tor
3EY26	XC6404EY26D	LVR/Vdet-IC	LDO, 4.3V±2%, 500mA, Vd=4.0V, -Reset ODO, Vr/Sense	USP-6B	49zy	VR14	9b	Tor
3EY27	XC6404EY27D	LVR/Vdet-IC	LDO, 2.5V±2%, 500mA, Vd=3.9V, -Reset ODO, Vr/Sense	USP-6B	49zy	VR14	9b	Tor
3EY28	XC6404EY28D	LVR/Vdet-IC	LDO, 3.3V±2%, 500mA, Vd=3.7V, -Reset ODO, Vr/Sense	USP-6B	49zy	VR14	9b	Tor
3EY29	XC6404EY29D	LVR/Vdet-IC	LDO, 2.6V±2%, 500mA, Vd=3.9V, -Reset ODO, Vr/Sense	USP-6B	49zy	VR14	9b	Tor
3EY30	XC6404EY30D	LVR/Vdet-IC	LDO, 3.3V±2%, 500mA, Vd=4.2V, -Reset ODO, Vr/Sense	USP-6B	49zy	VR14	9b	Tor
3EY31	XC6404EY31D	LVR/Vdet-IC	LDO, 3.3V±2%, 500mA, Vd=4.5V, -Reset ODO, Vr/Sense	USP-6B	49zy	VR14	9b	Tor
3EY32	XC6404EY32D	LVR/Vdet-IC	LDO, 2.85V±2%, 500mA, Vd=2.6V, -Reset ODO, Vr/Sense	USP-6B	49zy	VR14	9b	Tor
3EY33	XC6404EY33D	LVR/Vdet-IC	LDO, 3.3V±2%, 500mA, Vd=2.8V, -Reset ODO, Vr/Sense	USP-6B	49zy	VR14	9b	Tor
3EY34	XC6404EY34D	LVR/Vdet-IC	LDO, 3.4V±2%, 500mA, Vd=4.2V, -Reset ODO, Vr/Sense	USP-6B	49zy	VR14	9b	Tor
3EY80	XC6404EY80D	LVR/Vdet-IC	LDO, 1.8V±2%, 500mA, Vd=1.6V, -Reset ODO, Vr/Sense	USP-6B	49zy	VR14	9b	Tor
3EY81	XC6404EY81D	LVR/Vdet-IC	LDO, 2.8V±2%, 500mA, Vd=3.1V, -Reset ODO, Vr/Sense	USP-6B	49zy	VR14	9b	Tor
3EY82	XC6404EY82D	LVR/Vdet-IC	LDO, 1.8V±2%, 500mA, Vd=2.0V, -Reset ODO, Vr/Sense	USP-6B	49zy	VR14	9b	Tor
3EY83	XC6404EY83D	LVR/Vdet-IC	LDO, 2.5V±2%, 500mA, Vd=2.8V, -Reset ODO, Vr/Sense	USP-6B	49zy	VR14	9b	Tor
3EY84	XC6404EY84D	LVR/Vdet-IC	LDO, 2.85V±2%, 500mA, Vd=3.2V, -Reset ODO, Vr/Sense	USP-6B	49zy	VR14	9b	Tor
3EY85	XC6404EY85D	LVR/Vdet-IC	LDO, 3.0V±2%, 500mA, Vd=3.3V, -Reset ODO, Vr/Sense	USP-6B	49zy	VR14	9b	Tor
3EY86	XC6404EY86D	LVR/Vdet-IC	LDO, 3.5V±2%, 500mA, Vd=3.8V, -Reset ODO, Vr/Sense	USP-6B	49zy	VR14	9b	Tor
3EY87	XC6404EY87D	LVR/Vdet-IC	LDO, 3.0V±2%, 500mA, Vd=4.2V, -Reset ODO, Vr/Sense	USP-6B	49zy	VR14	9b	Tor
3EY88	XC6404EY88D	LVR/Vdet-IC	LDO, 3.3V±2%, 500mA, Vd=4.0V, -Reset ODO, Vr/Sense	USP-6B	49zy	VR14	9b	Tor
3EZ	XC6221A30BGR	LVR-IC	LDO, 3.05V±1%, 200mA, +CE	USP-4	45wm	VR4	9a	Tor
3EZ	XC6227C291ER	LVR-IC	LDO, 2.9V±1%, 700mA, +CE, PDR	USP-6C	49hq	VR4	9a	Tor
3EZ02	XC6404EZ02D	LVR/Vdet-IC	LDO, 2.7V±2%, 500mA, Vd=4.2V, +Reset ODO, Vr/Sense	USP-6B	49zy	VR14	9b	Tor



SMD code	Type	Function	Short description	Case	Pinout	Sch.	St.Mnf.
3E203	XC6404EZ03D	LVR/Vdet-IC	LDO, 2.5V±2%, 500mA, Vd=2.6V, +Reset ODO, Vr/Sense	USP-6B	49zy	VR14	9b Tor
3E204	XC6404EZ04D	LVR/Vdet-IC	LDO, 3.3V±2%, 500mA, Vd=4.3V, +Reset ODO, Vr/Sense	USP-6B	49zy	VR14	9b Tor
3E205	XC6404EZ05D	LVR/Vdet-IC	LDO, 3.3V±2%, 500mA, Vd=4.4V, +Reset ODO, Vr/Sense	USP-6B	49zy	VR14	9b Tor
3E207	XC6404EZ07D	LVR/Vdet-IC	LDO, 3.3V±2%, 500mA, Vd=5.2V, +Reset ODO, Vr/Sense	USP-6B	49zy	VR14	9b Tor
3E208	XC6404EZ08D	LVR/Vdet-IC	LDO, 2.8V±2%, 500mA, Vd=4.3V, +Reset ODO, Vr/Sense	USP-6B	49zy	VR14	9b Tor
3E209	XC6404EZ09D	LVR/Vdet-IC	LDO, 4.3V±2%, 500mA, Vd=3.6V, +Reset ODO, Vr/Sense	USP-6B	49zy	VR14	9b Tor
3E211	XC6404EZ11D	LVR/Vdet-IC	LDO, 2.8V±2%, 500mA, Vd=2.1V, +Reset ODO, Vr/Sense	USP-6B	49zy	VR14	9b Tor
3E212	XC6404EZ12D	LVR/Vdet-IC	LDO, 2.8V±2%, 500mA, Vd=2.8V, +Reset ODO, Vr/Sense	USP-6B	49zy	VR14	9b Tor
3E215	XC6404EZ15D	LVR/Vdet-IC	LDO, 3.3V±2%, 500mA, Vd=3.6V, +Reset ODO, Vr/Sense	USP-6B	49zy	VR14	9b Tor
3E218	XC6404EZ18D	LVR/Vdet-IC	LDO, 3.0V±2%, 500mA, Vd=2.7V, +Reset ODO, Vr/Sense	USP-6B	49zy	VR14	9b Tor
3E219	XC6404EZ19D	LVR/Vdet-IC	LDO, 2.8V±2%, 500mA, Vd=2.5V, +Reset ODO, Vr/Sense	USP-6B	49zy	VR14	9b Tor
3E220	XC6404EZ20D	LVR/Vdet-IC	LDO, 1.8V±2%, 500mA, Vd=3.6V, +Reset ODO, Vr/Sense	USP-6B	49zy	VR14	9b Tor
3E221	XC6404EZ21D	LVR/Vdet-IC	LDO, 1.8V±2%, 500mA, Vd=3.6V, +Reset ODO, Vr/Sense	USP-6B	49zy	VR14	9b Tor
3E222	XC6404EZ22D	LVR/Vdet-IC	LDO, 1.8V±2%, 500mA, Vd=4.2V, +Reset ODO, Vr/Sense	USP-6B	49zy	VR14	9b Tor
3E223	XC6404EZ23D	LVR/Vdet-IC	LDO, 2.5V±2%, 500mA, Vd=2.8V, +Reset ODO, Vr/Sense	USP-6B	49zy	VR14	9b Tor
3E224	XC6404EZ24D	LVR/Vdet-IC	LDO, 2.5V±2%, 500mA, Vd=3.6V, +Reset ODO, Vr/Sense	USP-6B	49zy	VR14	9b Tor
3E225	XC6404EZ25D	LVR/Vdet-IC	LDO, 2.5V±2%, 500mA, Vd=4.2V, +Reset ODO, Vr/Sense	USP-6B	49zy	VR14	9b Tor
3E226	XC6404EZ26D	LVR/Vdet-IC	LDO, 4.3V±2%, 500mA, Vd=4.0V, +Reset ODO, Vr/Sense	USP-6B	49zy	VR14	9b Tor
3E227	XC6404EZ27D	LVR/Vdet-IC	LDO, 2.5V±2%, 500mA, Vd=3.9V, +Reset ODO, Vr/Sense	USP-6B	49zy	VR14	9b Tor
3E228	XC6404EZ28D	LVR/Vdet-IC	LDO, 3.3V±2%, 500mA, Vd=3.7V, +Reset ODO, Vr/Sense	USP-6B	49zy	VR14	9b Tor
3E229	XC6404EZ29D	LVR/Vdet-IC	LDO, 2.6V±2%, 500mA, Vd=3.9V, +Reset ODO, Vr/Sense	USP-6B	49zy	VR14	9b Tor
3E230	XC6404EZ30D	LVR/Vdet-IC	LDO, 3.3V±2%, 500mA, Vd=4.2V, +Reset ODO, Vr/Sense	USP-6B	49zy	VR14	9b Tor
3E231	XC6404EZ31D	LVR/Vdet-IC	LDO, 3.3V±2%, 500mA, Vd=4.5V, +Reset ODO, Vr/Sense	USP-6B	49zy	VR14	9b Tor
3E232	XC6404EZ32D	LVR/Vdet-IC	LDO, 2.85V±2%, 500mA, Vd=2.6V, +Reset ODO, Vr/Sense	USP-6B	49zy	VR14	9b Tor
3E233	XC6404EZ33D	LVR/Vdet-IC	LDO, 3.3V±2%, 500mA, Vd=2.8V, +Reset ODO, Vr/Sense	USP-6B	49zy	VR14	9b Tor
3E234	XC6404EZ34D	LVR/Vdet-IC	LDO, 3.4V±2%, 500mA, Vd=4.2V, +Reset ODO, Vr/Sense	USP-6B	49zy	VR14	9b Tor
3E280	XC6404EZ80D	LVR/Vdet-IC	LDO, 1.8V±2%, 500mA, Vd=1.6V, +Reset ODO, Vr/Sense	USP-6B	49zy	VR14	9b Tor
3E281	XC6404EZ81D	LVR/Vdet-IC	LDO, 2.8V±2%, 500mA, Vd=3.1V, +Reset ODO, Vr/Sense	USP-6B	49zy	VR14	9b Tor
3E282	XC6404EZ82D	LVR/Vdet-IC	LDO, 1.8V±2%, 500mA, Vd=2.0V, +Reset ODO, Vr/Sense	USP-6B	49zy	VR14	9b Tor
3E283	XC6404EZ83D	LVR/Vdet-IC	LDO, 2.5V±2%, 500mA, Vd=2.8V, +Reset ODO, Vr/Sense	USP-6B	49zy	VR14	9b Tor
3E284	XC6404EZ84D	LVR/Vdet-IC	LDO, 2.85V±2%, 500mA, Vd=3.2V, +Reset ODO, Vr/Sense	USP-6B	49zy	VR14	9b Tor
3E285	XC6404EZ85D	LVR/Vdet-IC	LDO, 3.0V±2%, 500mA, Vd=3.9V, +Reset ODO, Vr/Sense	USP-6B	49zy	VR14	9b Tor
3E286	XC6404EZ86D	LVR/Vdet-IC	LDO, 3.5V±2%, 500mA, Vd=3.8V, +Reset ODO, Vr/Sense	USP-6B	49zy	VR14	9b Tor
3E287	XC6404EZ87D	LVR/Vdet-IC	LDO, 3.0V±2%, 500mA, Vd=4.2V, +Reset ODO, Vr/Sense	USP-6B	49zy	VR14	9b Tor
3E288	XC6404EZ88D	LVR/Vdet-IC	LDO, 3.3V±2%, 500mA, Vd=4.0V, +Reset ODO, Vr/Sense	USP-6B	49zy	VR14	9b Tor
3F	R3117K121C	Vdet-IC	1.2V±15mV, -Reset PPO, Sense	DFN1010-4	48rq	VD12	9a Ric
3F	RP101K191B	LVR-IC	LDO, LN, +CE, 1.9V±0.8%, 300mA	DFN1612-4	45vm	VR4	9a Ric
3F	XC6217D1627R-G	LVR-IC	LDO, 1.6V±2%, 200mA, +CE, CL	USPN-4	58vm	VR4	9a Tor
3F	XC6223D2519R-G	LVR-IC	LDO, 2.5V±1%, 300mA, +CE, CL, PDR	USPQ-4B03	48vm	VR4	9a Tor
3F	XC6224B23B7R	LVR-IC	LDO, 2.25V±1.5%, 150mA, +CE, PDR	USPN-4B02	58vm	VR4	9e Tor
3F	XC6229H3411R-G	LVR-IC	LDO, 3.4V±1%, 300mA, +CE, ICP	BGA-4	63ba*	VR4	9a Tor
3F016	XC6106F016ER	Vdet-IC	1.6V±2%, Hst, -MR, ±Reset PPO, Rt=400ms	USP-6C	49xs	VD21	9b Tor
3F017	XC6106F017ER	Vdet-IC	1.7V±2%, Hst, -MR, ±Reset PPO, Rt=400ms	USP-6C	49xs	VD21	9b Tor
3F018	XC6106F018ER	Vdet-IC	1.8V±2%, Hst, -MR, ±Reset PPO, Rt=400ms	USP-6C	49xs	VD21	9b Tor
3F019	XC6106F019ER	Vdet-IC	1.9V±2%, Hst, -MR, ±Reset PPO, Rt=400ms	USP-6C	49xs	VD21	9b Tor
3F020	XC6106F020ER	Vdet-IC	2.0V±2%, Hst, -MR, ±Reset PPO, Rt=400ms	USP-6C	49xs	VD21	9b Tor
3F021	XC6106F021ER	Vdet-IC	2.1V±2%, Hst, -MR, ±Reset PPO, Rt=400ms	USP-6C	49xs	VD21	9b Tor
3F022	XC6106F022ER	Vdet-IC	2.2V±2%, Hst, -MR, ±Reset PPO, Rt=400ms	USP-6C	49xs	VD21	9b Tor
3F023	XC6106F023ER	Vdet-IC	2.3V±2%, Hst, -MR, ±Reset PPO, Rt=400ms	USP-6C	49xs	VD21	9b Tor
3F024	XC6106F024ER	Vdet-IC	2.4V±2%, Hst, -MR, ±Reset PPO, Rt=400ms	USP-6C	49xs	VD21	9b Tor
3F025	XC6106F025ER	Vdet-IC	2.5V±2%, Hst, -MR, ±Reset PPO, Rt=400ms	USP-6C	49xs	VD21	9b Tor
3F026	XC6106F026ER	Vdet-IC	2.6V±2%, Hst, -MR, ±Reset PPO, Rt=400ms	USP-6C	49xs	VD21	9b Tor
3F027	XC6106F027ER	Vdet-IC	2.7V±2%, Hst, -MR, ±Reset PPO, Rt=400ms	USP-6C	49xs	VD21	9b Tor
3F028	XC6106F028ER	Vdet-IC	2.8V±2%, Hst, -MR, ±Reset PPO, Rt=400ms	USP-6C	49xs	VD21	9b Tor
3F029	XC6106F029ER	Vdet-IC	2.9V±2%, Hst, -MR, ±Reset PPO, Rt=400ms	USP-6C	49xs	VD21	9b Tor
3F030	XC6106F030ER	Vdet-IC	3.0V±2%, Hst, -MR, ±Reset PPO, Rt=400ms	USP-6C	49xs	VD21	9b Tor
3F031	XC6106F031ER	Vdet-IC	3.1V±2%, Hst, -MR, ±Reset PPO, Rt=400ms	USP-6C	49xs	VD21	9b Tor
3F032	XC6106F032ER	Vdet-IC	3.2V±2%, Hst, -MR, ±Reset PPO, Rt=400ms	USP-6C	49xs	VD21	9b Tor
3F033	XC6106F033ER	Vdet-IC	3.3V±2%, Hst, -MR, ±Reset PPO, Rt=400ms	USP-6C	49xs	VD21	9b Tor
3F034	XC6106F034ER	Vdet-IC	3.4V±2%, Hst, -MR, ±Reset PPO, Rt=400ms	USP-6C	49xs	VD21	9b Tor
3F035	XC6106F035ER	Vdet-IC	3.5V±2%, Hst, -MR, ±Reset PPO, Rt=400ms	USP-6C	49xs	VD21	9b Tor
3F036	XC6106F036ER	Vdet-IC	3.6V±2%, Hst, -MR, ±Reset PPO, Rt=400ms	USP-6C	49xs	VD21	9b Tor
3F037	XC6106F037ER	Vdet-IC	3.7V±2%, Hst, -MR, ±Reset PPO, Rt=400ms	USP-6C	49xs	VD21	9b Tor
3F038	XC6106F038ER	Vdet-IC	3.8V±2%, Hst, -MR, ±Reset PPO, Rt=400ms	USP-6C	49xs	VD21	9b Tor
3F039	XC6106F039ER	Vdet-IC	3.9V±2%, Hst, -MR, ±Reset PPO, Rt=400ms	USP-6C	49xs	VD21	9b Tor
3F040	XC6106F040ER	Vdet-IC	4.0V±2%, Hst, -MR, ±Reset PPO, Rt=400ms	USP-6C	49xs	VD21	9b Tor
3F041	XC6106F041ER	Vdet-IC	4.1V±2%, Hst, -MR, ±Reset PPO, Rt=400ms	USP-6C	49xs	VD21	9b Tor
3F042	XC6106F042ER	Vdet-IC	4.2V±2%, Hst, -MR, ±Reset PPO, Rt=400ms	USP-6C	49xs	VD21	9b Tor
3F043	XC6106F043ER	Vdet-IC	4.3V±2%, Hst, -MR, ±Reset PPO, Rt=400ms	USP-6C	49xs	VD21	9b Tor
3F044	XC6106F044ER	Vdet-IC	4.4V±2%, Hst, -MR, ±Reset PPO, Rt=400ms	USP-6C	49xs	VD21	9b Tor



SMD code	Type	Function	Short description	Case	Pinout	Sch.	St.Mnf.
3F645	XC6101F645ER	Vdet-IC	4.5V±2%, Hst, -MR, -Reset PPO, Wt=1.6s, Rt=400ms	USP-6C	49xh	VD17	9b Tor
3F646	XC6101F646ER	Vdet-IC	4.6V±2%, Hst, -MR, -Reset PPO, Wt=1.6s, Rt=400ms	USP-6C	49xh	VD17	9b Tor
3F647	XC6101F647ER	Vdet-IC	4.7V±2%, Hst, -MR, -Reset PPO, Wt=1.6s, Rt=400ms	USP-6C	49xh	VD17	9b Tor
3F648	XC6101F648ER	Vdet-IC	4.8V±2%, Hst, -MR, -Reset PPO, Wt=1.6s, Rt=400ms	USP-6C	49xh	VD17	9b Tor
3F649	XC6101F649ER	Vdet-IC	4.9V±2%, Hst, -MR, -Reset PPO, Wt=1.6s, Rt=400ms	USP-6C	49xh	VD17	9b Tor
3F650	XC6101F650ER	Vdet-IC	5.0V±2%, Hst, -MR, -Reset PPO, Wt=1.6s, Rt=400ms	USP-6C	49xh	VD17	9b Tor
3F7	XC6221B08BGR	LVR-IC	LDO, 0.85V±20mV, 200mA, +CE, CL	USP-4	45vm	VR4	9a Tor
3F8	XC6221B09BGR	LVR-IC	LDO, 0.95V±20mV, 200mA, +CE, CL	USP-4	45vm	VR4	9a Tor
3F8	XC6227C08BER	LVR-IC	LDO, 0.85V±20mV, 700mA, +CE, PDR	USP-6C	49hq	VR4	9a Tor
3F9	XC6221B10BGR	LVR-IC	LDO, 1.05V±20mV, 200mA, +CE, CL	USP-4	45vm	VR4	9a Tor
3F9	XC6227C09BER	LVR-IC	LDO, 1.95V±20mV, 700mA, +CE, PDR	USP-6C	49hq	VR4	9a Tor
3FA	XC6221B11BGR	LVR-IC	LDO, 1.15V±20mV, 200mA, +CE, CL	USP-4	45vm	VR4	9a Tor
3FA	XC6227C10BER	LVR-IC	LDO, 1.05V±20mV, 700mA, +CE, PDR	USP-6C	49hq	VR4	9a Tor
3FB	XC6221B12BGR	LVR-IC	LDO, 1.25V±20mV, 200mA, +CE, CL	USP-4	45vm	VR4	9a Tor
3FB	XC6227C11BER	LVR-IC	LDO, 1.15V±20mV, 700mA, +CE, PDR	USP-6C	49hq	VR4	9a Tor
3FC	XC6221B13BGR	LVR-IC	LDO, 1.35V±20mV, 200mA, +CE, CL	USP-4	45vm	VR4	9a Tor
3FC	XC6227C12BER	LVR-IC	LDO, 1.25V±20mV, 700mA, +CE, PDR	USP-6C	49hq	VR4	9a Tor
3FD	XC6221B14BGR	LVR-IC	LDO, 1.45V±20mV, 200mA, +CE, CL	USP-4	45vm	VR4	9a Tor
3FD	XC6227C13BER	LVR-IC	LDO, 1.35V±20mV, 700mA, +CE, PDR	USP-6C	49hq	VR4	9a Tor
3FE	XC6221B15BGR	LVR-IC	LDO, 1.55V±20mV, 200mA, +CE, CL	USP-4	45vm	VR4	9a Tor
3FE	XC6227C14BER	LVR-IC	LDO, 1.45V±20mV, 700mA, +CE, PDR	USP-6C	49hq	VR4	9a Tor
3FF	XC6221B16BGR	LVR-IC	LDO, 1.65V±20mV, 200mA, +CE, CL	USP-4	45vm	VR4	9a Tor
3FF	XC6227C15BER	LVR-IC	LDO, 1.55V±20mV, 700mA, +CE, PDR	USP-6C	49hq	VR4	9a Tor
3FH	XC6221B17BGR	LVR-IC	LDO, 1.75V±20mV, 200mA, +CE, CL	USP-4	45vm	VR4	9a Tor
3FH	XC6227C16BER	LVR-IC	LDO, 1.65V±20mV, 700mA, +CE, PDR	USP-6C	49hq	VR4	9a Tor
3FK	XC6221B18BGR	LVR-IC	LDO, 1.85V±20mV, 200mA, +CE, CL	USP-4	45vm	VR4	9a Tor
3FK	XC6227C17BER	LVR-IC	LDO, 1.75V±20mV, 700mA, +CE, PDR	USP-6C	49hq	VR4	9a Tor
3FL	XC6221B19BGR	LVR-IC	LDO, 1.95V±20mV, 200mA, +CE, CL	USP-4	45vm	VR4	9a Tor
3FL	XC6227C18BER	LVR-IC	LDO, 1.85V±20mV, 700mA, +CE, PDR	USP-6C	49hq	VR4	9a Tor
3FM	XC6221B20BGR	LVR-IC	LDO, 2.05V±1%, 200mA, +CE, CL	USP-4	45vm	VR4	9a Tor
3FM	XC6227C19BER	LVR-IC	LDO, 1.95V±20mV, 700mA, +CE, PDR	USP-6C	49hq	VR4	9a Tor
3FN	XC6221B21BGR	LVR-IC	LDO, 2.15V±1%, 200mA, +CE, CL	USP-4	45vm	VR4	9a Tor
3FN	XC6227C20BER	LVR-IC	LDO, 2.05V±1%, 700mA, +CE, PDR	USP-6C	49hq	VR4	9a Tor
3FP	XC6221B22BGR	LVR-IC	LDO, 2.25V±1%, 200mA, +CE, CL	USP-4	45vm	VR4	9a Tor
3FP	XC6227C21BER	LVR-IC	LDO, 2.15V±1%, 700mA, +CE, PDR	USP-6C	49hq	VR4	9a Tor
3FR	XC6221B23BGR	LVR-IC	LDO, 2.35V±1%, 200mA, +CE, CL	USP-4	45vm	VR4	9a Tor
3FR	XC6227C22BER	LVR-IC	LDO, 2.25V±1%, 700mA, +CE, PDR	USP-6C	49hq	VR4	9a Tor
3FS	XC6221B24BGR	LVR-IC	LDO, 2.45V±1%, 200mA, +CE, CL	USP-4	45vm	VR4	9a Tor
3FS	XC6227C23BER	LVR-IC	LDO, 2.35V±1%, 700mA, +CE, PDR	USP-6C	49hq	VR4	9a Tor
3FT	XC6221B25BGR	LVR-IC	LDO, 2.55V±1%, 200mA, +CE, CL	USP-4	45vm	VR4	9a Tor
3FT	XC6227C24BER	LVR-IC	LDO, 2.45V±1%, 700mA, +CE, PDR	USP-6C	49hq	VR4	9a Tor
3FU	XC6221B26BGR	LVR-IC	LDO, 2.65V±1%, 200mA, +CE, CL	USP-4	45vm	VR4	9a Tor
3FU	XC6227C25BER	LVR-IC	LDO, 2.55V±1%, 700mA, +CE, PDR	USP-6C	49hq	VR4	9a Tor
3FV	XC6221B27BGR	LVR-IC	LDO, 2.75V±1%, 200mA, +CE, CL	USP-4	45vm	VR4	9a Tor
3FV	XC6227C26BER	LVR-IC	LDO, 2.65V±1%, 700mA, +CE, PDR	USP-6C	49hq	VR4	9a Tor
3FX	XC6221B28BGR	LVR-IC	LDO, 2.85V±1%, 200mA, +CE, CL	USP-4	45vm	VR4	9a Tor
3FX	XC6227C27BER	LVR-IC	LDO, 2.75V±1%, 700mA, +CE, PDR	USP-6C	49hq	VR4	9a Tor
3FY	XC6221B29BGR	LVR-IC	LDO, 2.95V±1%, 200mA, +CE, CL	USP-4	45vm	VR4	9a Tor
3FY	XC6227C28BER	LVR-IC	LDO, 2.85V±1%, 700mA, +CE, PDR	USP-6C	49hq	VR4	9a Tor
3FY02	XC6404FY02D	LVR/Vdet-IC	LDO, 2.7V±2%, 500mA, Vd=4.2V, -Reset ODO	USP-6B	49zz	VR13	9b Tor
3FY03	XC6404FY03D	LVR/Vdet-IC	LDO, 2.5V±2%, 500mA, Vd=2.6V, -Reset ODO	USP-6B	49zz	VR13	9b Tor
3FY04	XC6404FY04D	LVR/Vdet-IC	LDO, 3.3V±2%, 500mA, Vd=4.3V, -Reset ODO	USP-6B	49zz	VR13	9b Tor
3FY05	XC6404FY05D	LVR/Vdet-IC	LDO, 3.3V±2%, 500mA, Vd=4.4V, -Reset ODO	USP-6B	49zz	VR13	9b Tor
3FY07	XC6404FY07D	LVR/Vdet-IC	LDO, 3.3V±2%, 500mA, Vd=5.2V, -Reset ODO	USP-6B	49zz	VR13	9b Tor
3FY08	XC6404FY08D	LVR/Vdet-IC	LDO, 2.8V±2%, 500mA, Vd=4.3V, -Reset ODO	USP-6B	49zz	VR13	9b Tor
3FY09	XC6404FY09D	LVR/Vdet-IC	LDO, 4.3V±2%, 500mA, Vd=2.8V, -Reset ODO	USP-6B	49zz	VR13	9b Tor
3FY11	XC6404FY11D	LVR/Vdet-IC	LDO, 2.8V±2%, 500mA, Vd=2.1V, -Reset ODO	USP-6B	49zz	VR13	9b Tor
3FY12	XC6404FY12D	LVR/Vdet-IC	LDO, 2.8V±2%, 500mA, Vd=2.8V, -Reset ODO	USP-6B	49zz	VR13	9b Tor
3FY15	XC6404FY15D	LVR/Vdet-IC	LDO, 3.3V±2%, 500mA, Vd=3.6V, -Reset ODO	USP-6B	49zz	VR13	9b Tor
3FY18	XC6404FY18D	LVR/Vdet-IC	LDO, 3.0V±2%, 500mA, Vd=2.7V, -Reset ODO	USP-6B	49zz	VR13	9b Tor
3FY19	XC6404FY19D	LVR/Vdet-IC	LDO, 2.8V±2%, 500mA, Vd=2.5V, -Reset ODO	USP-6B	49zz	VR13	9b Tor
3FY20	XC6404FY20D	LVR/Vdet-IC	LDO, 1.8V±2%, 500mA, Vd=2.9V, -Reset ODO	USP-6B	49zz	VR13	9b Tor
3FY21	XC6404FY21D	LVR/Vdet-IC	LDO, 1.8V±2%, 500mA, Vd=3.6V, -Reset ODO	USP-6B	49zz	VR13	9b Tor
3FY22	XC6404FY22D	LVR/Vdet-IC	LDO, 1.8V±2%, 500mA, Vd=4.2V, -Reset ODO	USP-6B	49zz	VR13	9b Tor
3FY23	XC6404FY23D	LVR/Vdet-IC	LDO, 2.5V±2%, 500mA, Vd=2.9V, -Reset ODO	USP-6B	49zz	VR13	9b Tor
3FY24	XC6404FY24D	LVR/Vdet-IC	LDO, 2.5V±2%, 500mA, Vd=3.6V, -Reset ODO	USP-6B	49zz	VR13	9b Tor
3FY25	XC6404FY25D	LVR/Vdet-IC	LDO, 2.5V±2%, 500mA, Vd=4.2V, -Reset ODO	USP-6B	49zz	VR13	9b Tor
3FY26	XC6404FY26D	LVR/Vdet-IC	LDO, 4.3V±2%, 500mA, Vd=4.0V, -Reset ODO	USP-6B	49zz	VR13	9b Tor
3FY27	XC6404FY27D	LVR/Vdet-IC	LDO, 2.5V±2%, 500mA, Vd=3.9V, -Reset ODO	USP-6B	49zz	VR13	9b Tor
3FY28	XC6404FY28D	LVR/Vdet-IC	LDO, 3.3V±2%, 500mA, Vd=3.7V, -Reset ODO	USP-6B	49zz	VR13	9b Tor



SMD code	Type	Function	Short description	Case	Pinout	Sch.	St.Mnf.
3FY29	XC6404FY29D	LVR/Vdet-IC	LDO, 2.6V±2%, 500mA, Vd=3.9V, -Reset ODO	USP-6B	49zz	VR13	9b Tor
3FY30	XC6404FY30D	LVR/Vdet-IC	LDO, 3.3V±2%, 500mA, Vd=4.2V, -Reset ODO	USP-6B	49zz	VR13	9b Tor
3FY31	XC6404FY31D	LVR/Vdet-IC	LDO, 3.3V±2%, 500mA, Vd=4.5V, -Reset ODO	USP-6B	49zz	VR13	9b Tor
3FY32	XC6404FY32D	LVR/Vdet-IC	LDO, 2.85V±2%, 500mA, Vd=2.6V, -Reset ODO	USP-6B	49zz	VR13	9b Tor
3FY33	XC6404FY33D	LVR/Vdet-IC	LDO, 3.3V±2%, 500mA, Vd=2.8V, -Reset ODO	USP-6B	49zz	VR13	9b Tor
3FY34	XC6404FY34D	LVR/Vdet-IC	LDO, 3.4V±2%, 500mA, Vd=4.2V, -Reset ODO	USP-6B	49zz	VR13	9b Tor
3FY80	XC6404FY80D	LVR/Vdet-IC	LDO, 1.8V±2%, 500mA, Vd=1.6V, -Reset ODO	USP-6B	49zz	VR13	9b Tor
3FY81	XC6404FY81D	LVR/Vdet-IC	LDO, 2.8V±2%, 500mA, Vd=3.1V, -Reset ODO	USP-6B	49zz	VR13	9b Tor
3FY82	XC6404FY82D	LVR/Vdet-IC	LDO, 1.8V±2%, 500mA, Vd=2.0V, -Reset ODO	USP-6B	49zz	VR13	9b Tor
3FY83	XC6404FY83D	LVR/Vdet-IC	LDO, 2.5V±2%, 500mA, Vd=2.8V, -Reset ODO	USP-6B	49zz	VR13	9b Tor
3FY84	XC6404FY84D	LVR/Vdet-IC	LDO, 2.85V±2%, 500mA, Vd=3.2V, -Reset ODO	USP-6B	49zz	VR13	9b Tor
3FY85	XC6404FY85D	LVR/Vdet-IC	LDO, 3.0V±2%, 500mA, Vd=3.0V, -Reset ODO	USP-6B	49zz	VR13	9b Tor
3FY86	XC6404FY86D	LVR/Vdet-IC	LDO, 3.5V±2%, 500mA, Vd=3.8V, -Reset ODO	USP-6B	49zz	VR13	9b Tor
3FY87	XC6404FY87D	LVR/Vdet-IC	LDO, 3.0V±2%, 500mA, Vd=4.2V, -Reset ODO	USP-6B	49zz	VR13	9b Tor
3FY88	XC6404FY88D	LVR/Vdet-IC	LDO, 3.3V±2%, 500mA, Vd=4.0V, -Reset ODO	USP-6B	49zz	VR13	9b Tor
3FZ	XC6221B30BGR	LVR-IC	LDO, 3.05V±1%, 200mA, +CE, CL	USP-4	45vm	VR4	9a Tor
3FZ	XC6227C29BER	LVR-IC	LDO, 2.95V±1%, 700mA, +CE, PDR	USP-6C	49hq	VR4	9a Tor
3FZ02	XC6404FZ02D	LVR/Vdet-IC	LDO, 2.7V±2%, 500mA, Vd=4.2V, +Reset ODO	USP-6B	49zz	VR13	9b Tor
3FZ03	XC6404FZ03D	LVR/Vdet-IC	LDO, 2.5V±2%, 500mA, Vd=2.6V, +Reset ODO	USP-6B	49zz	VR13	9b Tor
3FZ04	XC6404FZ04D	LVR/Vdet-IC	LDO, 3.3V±2%, 500mA, Vd=4.3V, +Reset ODO	USP-6B	49zz	VR13	9b Tor
3FZ05	XC6404FZ05D	LVR/Vdet-IC	LDO, 3.3V±2%, 500mA, Vd=4.4V, +Reset ODO	USP-6B	49zz	VR13	9b Tor
3FZ07	XC6404FZ07D	LVR/Vdet-IC	LDO, 3.3V±2%, 500mA, Vd=5.2V, +Reset ODO	USP-6B	49zz	VR13	9b Tor
3FZ08	XC6404FZ08D	LVR/Vdet-IC	LDO, 2.8V±2%, 500mA, Vd= 4.3V, +Reset ODO	USP-6B	49zz	VR13	9b Tor
3FZ09	XC6404FZ09D	LVR/Vdet-IC	LDO, 4.3V±2%, 500mA, Vd=2.8V, +Reset ODO	USP-6B	49zz	VR13	9b Tor
3FZ11	XC6404FZ11D	LVR/Vdet-IC	LDO, 2.8V±2%, 500mA, Vd=2.1V, +Reset ODO	USP-6B	49zz	VR13	9b Tor
3FZ12	XC6404FZ12D	LVR/Vdet-IC	LDO, 2.8V±2%, 500mA, Vd=2.8V, +Reset ODO	USP-6B	49zz	VR13	9b Tor
3FZ15	XC6404FZ15D	LVR/Vdet-IC	LDO, 3.3V±2%, 500mA, Vd=3.6V, +Reset ODO	USP-6B	49zz	VR13	9b Tor
3FZ18	XC6404FZ18D	LVR/Vdet-IC	LDO, 3.0V±2%, 500mA, Vd=2.7V, +Reset ODO	USP-6B	49zz	VR13	9b Tor
3FZ19	XC6404FZ19D	LVR/Vdet-IC	LDO, 2.8V±2%, 500mA, Vd=2.5V, +Reset ODO	USP-6B	49zz	VR13	9b Tor
3FZ20	XC6404FZ20D	LVR/Vdet-IC	LDO, 1.8V±2%, 500mA, Vd=2.9V, +Reset ODO	USP-6B	49zz	VR13	9b Tor
3FZ21	XC6404FZ21D	LVR/Vdet-IC	LDO, 1.8V±2%, 500mA, Vd=3.6V, +Reset ODO	USP-6B	49zz	VR13	9b Tor
3FZ22	XC6404FZ22D	LVR/Vdet-IC	LDO, 1.8V±2%, 500mA, Vd=4.2V, +Reset ODO	USP-6B	49zz	VR13	9b Tor
3FZ23	XC6404FZ23D	LVR/Vdet-IC	LDO, 2.5V±2%, 500mA, Vd=2.9V, +Reset ODO	USP-6B	49zz	VR13	9b Tor
3FZ24	XC6404FZ24D	LVR/Vdet-IC	LDO, 2.5V±2%, 500mA, Vd=3.6V, +Reset ODO	USP-6B	49zz	VR13	9b Tor
3FZ25	XC6404FZ25D	LVR/Vdet-IC	LDO, 2.5V±2%, 500mA, Vd=4.2V, +Reset ODO	USP-6B	49zz	VR13	9b Tor
3FZ26	XC6404FZ26D	LVR/Vdet-IC	LDO, 4.3V±2%, 500mA, Vd=4.0V, +Reset ODO	USP-6B	49zz	VR13	9b Tor
3FZ27	XC6404FZ27D	LVR/Vdet-IC	LDO, 2.5V±2%, 500mA, Vd=3.9V, +Reset ODO	USP-6B	49zz	VR13	9b Tor
3FZ28	XC6404FZ28D	LVR/Vdet-IC	LDO, 3.3V±2%, 500mA, Vd=3.7V, +Reset ODO	USP-6B	49zz	VR13	9b Tor
3FZ29	XC6404FZ29D	LVR/Vdet-IC	LDO, 2.6V±2%, 500mA, Vd=3.9V, +Reset ODO	USP-6B	49zz	VR13	9b Tor
3FZ30	XC6404FZ30D	LVR/Vdet-IC	LDO, 3.3V±2%, 500mA, Vd=4.2V, +Reset ODO	USP-6B	49zz	VR13	9b Tor
3FZ31	XC6404FZ31D	LVR/Vdet-IC	LDO, 3.3V±2%, 500mA, Vd=4.5V, +Reset ODO	USP-6B	49zz	VR13	9b Tor
3FZ32	XC6404FZ32D	LVR/Vdet-IC	LDO, 2.85V±2%, 500mA, Vd=2.6V, +Reset ODO	USP-6B	49zz	VR13	9b Tor
3FZ33	XC6404FZ33D	LVR/Vdet-IC	LDO, 3.3V±2%, 500mA, Vd=2.8V, +Reset ODO	USP-6B	49zz	VR13	9b Tor
3FZ34	XC6404FZ34D	LVR/Vdet-IC	LDO, 3.4V±2%, 500mA, Vd=4.2V, +Reset ODO	USP-6B	49zz	VR13	9b Tor
3FZ80	XC6404FZ80D	LVR/Vdet-IC	LDO, 1.8V±2%, 500mA, Vd=1.6V, +Reset ODO	USP-6B	49zz	VR13	9b Tor
3FZ81	XC6404FZ81D	LVR/Vdet-IC	LDO, 2.8V±2%, 500mA, Vd=3.1V, +Reset ODO	USP-6B	49zz	VR13	9b Tor
3FZ82	XC6404FZ82D	LVR/Vdet-IC	LDO, 1.8V±2%, 500mA, Vd=2.0V, +Reset ODO	USP-6B	49zz	VR13	9b Tor
3FZ83	XC6404FZ83D	LVR/Vdet-IC	LDO, 2.5V±2%, 500mA, Vd=2.8V, +Reset ODO	USP-6B	49zz	VR13	9b Tor
3FZ84	XC6404FZ84D	LVR/Vdet-IC	LDO, 2.85V±2%, 500mA, Vd=3.2V, +Reset ODO	USP-6B	49zz	VR13	9b Tor
3FZ85	XC6404FZ85D	LVR/Vdet-IC	LDO, 3.0V±2%, 500mA, Vd=3.3V, +Reset ODO	USP-6B	49zz	VR13	9b Tor
3FZ86	XC6404FZ86D	LVR/Vdet-IC	LDO, 3.5V±2%, 500mA, Vd=3.8V, +Reset ODO	USP-6B	49zz	VR13	9b Tor
3FZ87	XC6404FZ87D	LVR/Vdet-IC	LDO, 3.0V±2%, 500mA, Vd=4.2V, +Reset ODO	USP-6B	49zz	VR13	9b Tor
3FZ88	XC6404FZ88D	LVR/Vdet-IC	LDO, 3.3V±2%, 500mA, Vd=4.0V, +Reset ODO	USP-6B	49zz	VR13	9b Tor
3G	R3117K131C	Vdet-IC	1.3V±15mV, -Reset PPO, Sense	DFN11010-4	48rq	VD12	9a Ric
3G	RP101K201B	LVR-IC	LDO, LN, +CE, 2V±0.8%, 300mA	DFN1612-4	45vm	VR4	9a Ric
3H	R3117K141C	Vdet-IC	1.4V±15mV, -Reset PPO, Sense	DFN11010-4	48rq	VD12	9a Ric
3H	RP101K251B	LVR-IC	LDO, LN, +CE, 2.5V±0.8%, 300mA	DFN1612-4	45vm	VR4	9a Ric
3H	XC6217D1727R-G	LVR-IC	LDO, 1.7V±2%, 200mA, +CE, CL	USPN-4	58vm	VR4	9a Tor
3H	XC6223D2619R-G	LVR-IC	LDO, 2.6V±1%, 300mA, +CE, CL, PDR	USPQ-4B03	48vm	VR4	9a Tor
3H	XC6224B24B7R	LVR-IC	LDO, 2.45V±1.5%, 150mA, +CE, PDR	USPN-4B02	58vm	VR4	9e Tor
3H	XC6229H34B1R-G	LVR-IC	LDO, 3.45V±1%, 300mA, +CE, ICP	BGA-4	63ba*	VR4	9a Tor
3H0	XC6227C301ER	LVR-IC	LDO, 3.0V±1%, 700mA, +CE, PDR	USP-6C	49hq	VR4	9a Tor
3H016	XC6106H016ER	Vdet-IC	1.6V±2%, Hst, -MR, ±Reset PPO, Rt=1.6s	USP-6C	49xs	VD21	9b Tor
3H017	XC6106H017ER	Vdet-IC	1.7V±2%, Hst, -MR, ±Reset PPO, Rt=1.6s	USP-6C	49xs	VD21	9b Tor
3H018	XC6106H018ER	Vdet-IC	1.8V±2%, Hst, -MR, ±Reset PPO, Rt=1.6s	USP-6C	49xs	VD21	9b Tor
3H019	XC6106H019ER	Vdet-IC	1.9V±2%, Hst, -MR, ±Reset PPO, Rt=1.6s	USP-6C	49xs	VD21	9b Tor
3H020	XC6106H020ER	Vdet-IC	2.0V±2%, Hst, -MR, ±Reset PPO, Rt=1.6s	USP-6C	49xs	VD21	9b Tor
3H021	XC6106H021ER	Vdet-IC	2.1V±2%, Hst, -MR, ±Reset PPO, Rt=1.6s	USP-6C	49xs	VD21	9b Tor
3H022	XC6106H022ER	Vdet-IC	2.2V±2%, Hst, -MR, ±Reset PPO, Rt=1.6s	USP-6C	49xs	VD21	9b Tor
3H023	XC6106H023ER	Vdet-IC	2.3V±2%, Hst, -MR, ±Reset PPO, Rt=1.6s	USP-6C	49xs	VD21	9b Tor



SMD code	Type	Function	Short description	Case	Pinout	Sch.	St.	Mnf.
3H9	XC6227C391ER	LVR-IC	LDO, 3.9V±1%, 700mA, +CE, PDR	USP-6C	49hq	VR4	9a	Tor
3HA	XC6227C401ER	LVR-IC	LDO, 4.0V±1%, 700mA, +CE, PDR	USP-6C	49hq	VR4	9a	Tor
3HB	XC6227C411ER	LVR-IC	LDO, 4.1V±1%, 700mA, +CE, PDR	USP-6C	49hq	VR4	9a	Tor
3HC	XC6227C421ER	LVR-IC	LDO, 4.2V±1%, 700mA, +CE, PDR	USP-6C	49hq	VR4	9a	Tor
3HD	XC6227C431ER	LVR-IC	LDO, 4.3V±1%, 700mA, +CE, PDR	USP-6C	49hq	VR4	9a	Tor
3HE	XC6227C441ER	LVR-IC	LDO, 4.4V±1%, 700mA, +CE, PDR	USP-6C	49hq	VR4	9a	Tor
3HF	XC6227C451ER	LVR-IC	LDO, 4.5V±1%, 700mA, +CE, PDR	USP-6C	49hq	VR4	9a	Tor
3HH	XC6227C461ER	LVR-IC	LDO, 4.6V±1%, 700mA, +CE, PDR	USP-6C	49hq	VR4	9a	Tor
3HK	XC6227C471ER	LVR-IC	LDO, 4.7V±1%, 700mA, +CE, PDR	USP-6C	49hq	VR4	9a	Tor
3HL	XC6227C481ER	LVR-IC	LDO, 4.8V±1%, 700mA, +CE, PDR	USP-6C	49hq	VR4	9a	Tor
3HM	XC6227C491ER	LVR-IC	LDO, 9V±1%, 700mA, +CE, PDR	USP-6C	49hq	VR4	9a	Tor
3HN	XC6227C501ER	LVR-IC	LDO, 5.0V±1%, 700mA, +CE, PDR	USP-6C	49hq	VR4	9a	Tor
3J	R3117K151C	Vdet-IC	1.5V±15mV, -Reset PPO, Sense	DFN1010-4	48rq	VD12	9a	Ric
3J	RP101K261B	LVR-IC	LDO, LN, +CE, 2.6V±0.8%, 300mA	DFN1612-4	45vm	VR4	9a	Ric
3K	R3117K161C	Vdet-IC	1.6V±1%, -Reset PPO, Sense	DFN1010-4	48rq	VD12	9a	Ric
3K	RP101K271B	LVR-IC	LDO, LN, +CE, 2.7V±0.8%, 300mA	DFN1612-4	45vm	VR4	9a	Ric
3K	XC6217D1827R-G	LVR-IC	LDO, 1.8V±2%, 200mA, +CE, CL	USPN-4	58vm	VR4	9a	Tor
3K	XC6223D2719R-G	LVR-IC	LDO, 2.7V±1%, 300mA, +CE, CL, PDR	USPQ-4B03	48vm	VR4	9a	Tor
3K	XC6224B25B7R	LVR-IC	LDO, 2.55V±1.5%, 150mA, +CE, PDR	USPN-4B02	58vm	VR4	9e	Tor
3K	XC6229H3511R-G	LVR-IC	LDO, 3.5V±1%, 300mA, +CE, ICP	BGA-4	63ba*	VR4	9a	Tor
3K0	XC6227C30BER	LVR-IC	LDO, 3.05V±1%, 700mA, +CE, PDR	USP-6C	49hq	VR4	9a	Tor
3K1	XC6227C31BER	LVR-IC	LDO, 3.15V±1%, 700mA, +CE, PDR	USP-6C	49hq	VR4	9a	Tor
3K2	XC6227C32BER	LVR-IC	LDO, 3.25V±1%, 700mA, +CE, PDR	USP-6C	49hq	VR4	9a	Tor
3K3	XC6227C33BER	LVR-IC	LDO, 3.35V±1%, 700mA, +CE, PDR	USP-6C	49hq	VR4	9a	Tor
3K4	XC6227C34BER	LVR-IC	LDO, 3.45V±1%, 700mA, +CE, PDR	USP-6C	49hq	VR4	9a	Tor
3K5	XC6227C35BER	LVR-IC	LDO, 3.55V±1%, 700mA, +CE, PDR	USP-6C	49hq	VR4	9a	Tor
3K6	XC6227C36BER	LVR-IC	LDO, 3.65V±1%, 700mA, +CE, PDR	USP-6C	49hq	VR4	9a	Tor
3K7	XC6227C37BER	LVR-IC	LDO, 3.75V±1%, 700mA, +CE, PDR	USP-6C	49hq	VR4	9a	Tor
3K8	XC6227C38BER	LVR-IC	LDO, 3.85V±1%, 700mA, +CE, PDR	USP-6C	49hq	VR4	9a	Tor
3K9	XC6227C39BER	LVR-IC	LDO, 3.95V±1%, 700mA, +CE, PDR	USP-6C	49hq	VR4	9a	Tor
3KA	XC6227C40BER	LVR-IC	LDO, 4.05V±1%, 700mA, +CE, PDR	USP-6C	49hq	VR4	9a	Tor
3KB	XC6227C41BER	LVR-IC	LDO, 4.15V±1%, 700mA, +CE, PDR	USP-6C	49hq	VR4	9a	Tor
3KC	XC6227C42BER	LVR-IC	LDO, 4.25V±1%, 700mA, +CE, PDR	USP-6C	49hq	VR4	9a	Tor
3KD	XC6227C43BER	LVR-IC	LDO, 4.35V±1%, 700mA, +CE, PDR	USP-6C	49hq	VR4	9a	Tor
3KE	XC6227C44BER	LVR-IC	LDO, 4.45V±1%, 700mA, +CE, PDR	USP-6C	49hq	VR4	9a	Tor
3KF	XC6227C45BER	LVR-IC	LDO, 4.55V±1%, 700mA, +CE, PDR	USP-6C	49hq	VR4	9a	Tor
3KH	XC6227C46BER	LVR-IC	LDO, 4.65V±1%, 700mA, +CE, PDR	USP-6C	49hq	VR4	9a	Tor
3KK	XC6227C47BER	LVR-IC	LDO, 4.75V±1%, 700mA, +CE, PDR	USP-6C	49hq	VR4	9a	Tor
3KL	XC6227C48BER	LVR-IC	LDO, 4.85V±1%, 700mA, +CE, PDR	USP-6C	49hq	VR4	9a	Tor
3KM	XC6227C49BER	LVR-IC	LDO, 4.95V±1%, 700mA, +CE, PDR	USP-6C	49hq	VR4	9a	Tor
3L	R3117K171C	Vdet-IC	1.7V±1%, -Reset PPO, Sense	DFN1010-4	48rq	VD12	9a	Ric
3L	RP101K281B	LVR-IC	LDO, LN, +CE, 2.8V±0.8%, 300mA	DFN1612-4	45vm	VR4	9a	Ric
3L	XC6217D1927R-G	LVR-IC	LDO, 1.9V±2%, 200mA, +CE, CL	USPN-4	58vm	VR4	9a	Tor
3L	XC6223D2819R-G	LVR-IC	LDO, 2.8V±1%, 300mA, +CE, CL, PDR	USPQ-4B03	48vm	VR4	9a	Tor
3L	XC6224B26B7R	LVR-IC	LDO, 2.65V±1.5%, 150mA, +CE, PDR	USPN-4B02	58vm	VR4	9e	Tor
3L	XC6229H35B1R-G	LVR-IC	LDO, 3.55V±1%, 300mA, +CE, ICP	BGA-4	63ba*	VR4	9a	Tor
3L0	XC6221A31BGR	LVR-IC	LDO, 3.15V±1%, 200mA, +CE	USP-4	45vm	VR4	9a	Tor
3L1	XC6221A32BGR	LVR-IC	LDO, 3.25V±1%, 200mA, +CE	USP-4	45vm	VR4	9a	Tor
3L2	XC6221A33BGR	LVR-IC	LDO, 3.35V±1%, 200mA, +CE	USP-4	45vm	VR4	9a	Tor
3L3	XC6221A34BGR	LVR-IC	LDO, 3.45V±1%, 200mA, +CE	USP-4	45vm	VR4	9a	Tor
3L4	XC6221A35BGR	LVR-IC	LDO, 3.55V±1%, 200mA, +CE	USP-4	45vm	VR4	9a	Tor
3L5	XC6221A36BGR	LVR-IC	LDO, 3.65V±1%, 200mA, +CE	USP-4	45vm	VR4	9a	Tor
3L6	XC6221A37BGR	LVR-IC	LDO, 3.75V±1%, 200mA, +CE	USP-4	45vm	VR4	9a	Tor
3L7	XC6221A38BGR	LVR-IC	LDO, 3.85V±1%, 200mA, +CE	USP-4	45vm	VR4	9a	Tor
3L8	XC6221A39BGR	LVR-IC	LDO, 3.95V±1%, 200mA, +CE	USP-4	45vm	VR4	9a	Tor
3L9	XC6221A40BGR	LVR-IC	LDO, 4.05±1%, 200mA, +CE	USP-4	45vm	VR4	9a	Tor
3LA	XC6221A41BGR	LVR-IC	LDO, 4.15±1%, 200mA, +CE	USP-4	45vm	VR4	9a	Tor
3LB	XC6221A42BGR	LVR-IC	LDO, 4.25±1%, 200mA, +CE	USP-4	45vm	VR4	9a	Tor
3LC	XC6221A43BGR	LVR-IC	LDO, 4.35±1%, 200mA, +CE	USP-4	45vm	VR4	9a	Tor
3LD	XC6221A44BGR	LVR-IC	LDO, 4.45±1%, 200mA, +CE	USP-4	45vm	VR4	9a	Tor
3LE	XC6221A45BGR	LVR-IC	LDO, 4.55±1%, 200mA, +CE	USP-4	45vm	VR4	9a	Tor
3LF	XC6221A46BGR	LVR-IC	LDO, 4.65±1%, 200mA, +CE	USP-4	45vm	VR4	9a	Tor
3LH	XC6221A47BGR	LVR-IC	LDO, 4.75±1%, 200mA, +CE	USP-4	45vm	VR4	9a	Tor
3LK	XC6221A48BGR	LVR-IC	LDO, 4.85±1%, 200mA, +CE	USP-4	45vm	VR4	9a	Tor
3LL	XC6221A49BGR	LVR-IC	LDO, 4.95±1%, 200mA, +CE	USP-4	45vm	VR4	9a	Tor
3M	R3117K181C	Vdet-IC	1.8V±1%, -Reset PPO, Sense	DFN1010-4	48rq	VD12	9a	Ric
3M	RP101K281B5	LVR-IC	LDO, LN, +CE, 2.85V±0.8%, 300mA	DFN1612-4	45vm	VR4	9a	Ric
3M	XC6217D2027R-G	LVR-IC	LDO, 2V±2%, 200mA, +CE, CL	USPN-4	58vm	VR4	9a	Tor
3M	XC6223D2919R-G	LVR-IC	LDO, 2.9V±1%, 300mA, +CE, CL, PDR	USPQ-4B03	48vm	VR4	9a	Tor
3M	XC6224B27B7R	LVR-IC	LDO, 2.75V±1.5%, 150mA, +CE, PDR	USPN-4B02	58vm	VR4	9e	Tor



SMD code	Type	Function	Short description	Case	Pinout	Sch.	St.	Mnf.
3M	XC6229H3611R-G	LVR-IC	LDO, 3.6V±1%, 300mA, +CE, ICP	BGA-4	63ba*	VR4	9a	Tor
3M0	XC6221B31BGR	LVR-IC	LDO, 3.15V±1%, 200mA, +CE, CL	USP-4	45vm	VR4	9a	Tor
3M1	XC6221B32BGR	LVR-IC	LDO, 3.25V±1%, 200mA, +CE, CL	USP-4	45vm	VR4	9a	Tor
3M2	XC6221B33BGR	LVR-IC	LDO, 3.35V±1%, 200mA, +CE, CL	USP-4	45vm	VR4	9a	Tor
3M3	XC6221B34BGR	LVR-IC	LDO, 3.45V±1%, 200mA, +CE, CL	USP-4	45vm	VR4	9a	Tor
3M4	XC6221B35BGR	LVR-IC	LDO, 3.55V±1%, 200mA, +CE, CL	USP-4	45vm	VR4	9a	Tor
3M5	XC6221B36BGR	LVR-IC	LDO, 3.65V±1%, 200mA, +CE, CL	USP-4	45vm	VR4	9a	Tor
3M6	XC6221B37BGR	LVR-IC	LDO, 3.75V±1%, 200mA, +CE, CL	USP-4	45vm	VR4	9a	Tor
3M7	XC6221B38BGR	LVR-IC	LDO, 3.85V±1%, 200mA, +CE, CL	USP-4	45vm	VR4	9a	Tor
3M8	XC6221B39BGR	LVR-IC	LDO, 3.95V±1%, 200mA, +CE, CL	USP-4	45vm	VR4	9a	Tor
3M9	XC6221B40BGR	LVR-IC	LDO, 4.05V±1%, 200mA, +CE, CL	USP-4	45vm	VR4	9a	Tor
3MA	XC6221B41BGR	LVR-IC	LDO, 4.15V±1%, 200mA, +CE, CL	USP-4	45vm	VR4	9a	Tor
3MB	XC6221B42BGR	LVR-IC	LDO, 4.25V±1%, 200mA, +CE, CL	USP-4	45vm	VR4	9a	Tor
3MC	XC6221B43BGR	LVR-IC	LDO, 4.35V±1%, 200mA, +CE, CL	USP-4	45vm	VR4	9a	Tor
3MD	XC6221B44BGR	LVR-IC	LDO, 4.45V±1%, 200mA, +CE, CL	USP-4	45vm	VR4	9a	Tor
3ME	XC6221B45BGR	LVR-IC	LDO, 4.55V±1%, 200mA, +CE, CL	USP-4	45vm	VR4	9a	Tor
3MF	XC6221B46BGR	LVR-IC	LDO, 4.65V±1%, 200mA, +CE, CL	USP-4	45vm	VR4	9a	Tor
3MH	XC6221B47BGR	LVR-IC	LDO, 4.75V±1%, 200mA, +CE, CL	USP-4	45vm	VR4	9a	Tor
3MK	XC6221B48BGR	LVR-IC	LDO, 4.85V±1%, 200mA, +CE, CL	USP-4	45vm	VR4	9a	Tor
3ML	XC6221B49BGR	LVR-IC	LDO, 4.95V±1%, 200mA, +CE, CL	USP-4	45vm	VR4	9a	Tor
3N	R3117K191C	Vdet-IC	1.9V±1%, -Reset PPO, Sense	DFN1010-4	48rq	VD12	9a	Ric
3N	RP101K291B	LVR-IC	LDO, LN, +CE, 2.9V±0.8%, 300mA	DFN1612-4	45vm	VR4	9a	Ric
3N	XC6217D2127R-G	LVR-IC	LDO, 2.1V±2%, 200mA, +CE, CL	USPN-4	58vm	VR4	9a	Tor
3N	XC6223D3019R-G	LVR-IC	LDO, 3.0V±1%, 300mA, +CE, CL, PDR	USPQ-4B03	48vm	VR4	9a	Tor
3N	XC6224B28B7R	LVR-IC	LDO, 2.85V±1.5%, 150mA, +CE, PDR	USPN-4B02	58vm	VR4	9e	Tor
3N	XC6229H36B1R-G	LVR-IC	LDO, 3.65V±1%, 300mA, +CE, ICP	BGA-4	63ba*	VR4	9a	Tor
3P	R3117K201C	Vdet-IC	2V±1%, -Reset PPO, Sense	DFN1010-4	48rq	VD12	9a	Ric
3P	RP101K301B	LVR-IC	LDO, LN, +CE, 3V±0.8%, 300mA	DFN1612-4	45vm	VR4	9a	Ric
3P	XC6217D2227R-G	LVR-IC	LDO, 2.2V±2%, 200mA, +CE, CL	USPN-4	58vm	VR4	9a	Tor
3P	XC6223D3119R-G	LVR-IC	LDO, 3.1V±1%, 300mA, +CE, CL, PDR	USPQ-4B03	48vm	VR4	9a	Tor
3P	XC6224B29B7R	LVR-IC	LDO, 2.95V±1.5%, 150mA, +CE, PDR	USPN-4B02	58vm	VR4	9e	Tor
3P	XC6229H3711R-G	LVR-IC	LDO, 3.7V±1%, 300mA, +CE, ICP	BGA-4	63ba*	VR4	9a	Tor
3Q	R3117K211C	Vdet-IC	2.1V±1%, -Reset PPO, Sense	DFN1010-4	48rq	VD12	9a	Ric
3Q	RP101K311B	LVR-IC	LDO, LN, +CE, 3.1V±0.8%, 300mA	DFN1612-4	45vm	VR4	9a	Ric
3R	R3117K221C	Vdet-IC	2.2V±1%, -Reset PPO, Sense	DFN1010-4	48rq	VD12	9a	Ric
3R	RP101K331B	LVR-IC	LDO, LN, +CE, 3.3V±0.8%, 300mA	DFN1612-4	45vm	VR4	9a	Ric
3R	XC6217D2327R-G	LVR-IC	LDO, 2.3V±2%, 200mA, +CE, CL	USPN-4	58vm	VR4	9a	Tor
3R	XC6223D3219R-G	LVR-IC	LDO, 3.2V±1%, 300mA, +CE, CL, PDR	USPQ-4B03	48vm	VR4	9a	Tor
3R	XC6229H37B1R-G	LVR-IC	LDO, 3.75V±1%, 300mA, +CE, ICP	BGA-4	63ba*	VR4	9a	Tor
3S	R3117K231C	Vdet-IC	2.3V±1%, -Reset PPO, Sense	DFN1010-4	48rq	VD12	9a	Ric
3S	RP101K211B	LVR-IC	LDO, LN, +CE, 2.1V±0.8%, 300mA	DFN1612-4	45vm	VR4	9a	Ric
3S	XC6217D2427R-G	LVR-IC	LDO, 2.4V±2%, 200mA, +CE, CL	USPN-4	58vm	VR4	9a	Tor
3S	XC6223D3319R-G	LVR-IC	LDO, 3.3V±1%, 300mA, +CE, CL, PDR	USPQ-4B03	48vm	VR4	9a	Tor
3S	XC6229H3811R-G	LVR-IC	LDO, 3.8V±1%, 300mA, +CE, ICP	BGA-4	63ba*	VR4	9a	Tor
3T	R3117K241C	Vdet-IC	2.4V±1%, -Reset PPO, Sense	DFN1010-4	48rq	VD12	9a	Ric
3T	XC6217D2527R-G	LVR-IC	LDO, 2.5V±2%, 200mA, +CE, CL	USPN-4	58vm	VR4	9a	Tor
3T	XC6223D3419R-G	LVR-IC	LDO, 3.4V±1%, 300mA, +CE, CL, PDR	USPQ-4B03	48vm	VR4	9a	Tor
3T	XC6229H38B1R-G	LVR-IC	LDO, 3.85V±1%, 300mA, +CE, ICP	BGA-4	63ba*	VR4	9a	Tor
3U	R3117K251C	Vdet-IC	2.5V±1%, -Reset PPO, Sense	DFN1010-4	48rq	VD12	9a	Ric
3U	XC6217D2627R-G	LVR-IC	LDO, 2.6V±2%, 200mA, +CE, CL	USPN-4	58vm	VR4	9a	Tor
3U	XC6223D3519R-G	LVR-IC	LDO, 3.5V±1%, 300mA, +CE, CL, PDR	USPQ-4B03	48vm	VR4	9a	Tor
3U	XC6229H3911R-G	LVR-IC	LDO, 3.9V±1%, 300mA, +CE, ICP	BGA-4	63ba*	VR4	9a	Tor
3V	R3117K261C	Vdet-IC	2.6V±1%, -Reset PPO, Sense	DFN1010-4	48rq	VD12	9a	Ric
3V	XC6217D2727R-G	LVR-IC	LDO, 2.7V±2%, 200mA, +CE, CL	USPN-4	58vm	VR4	9a	Tor
3V	XC6223D3619R-G	LVR-IC	LDO, 3.6V±1%, 300mA, +CE, CL, PDR	USPQ-4B03	48vm	VR4	9a	Tor
3V	XC6229H39B1R-G	LVR-IC	LDO, 3.95V±1%, 300mA, +CE, ICP	BGA-4	63ba*	VR4	9a	Tor
3V7	XC6221A081GR	LVR-IC	LDO, 0.8V±20mV, 200mA, +CE	USP-4	45vm	VR4	9a	Tor
3V8	XC6221A091GR	LVR-IC	LDO, 0.9V±20mV, 200mA, +CE	USP-4	45vm	VR4	9a	Tor
3V9	XC6221A101GR	LVR-IC	LDO, 1V±20mV, 200mA, +CE	USP-4	45vm	VR4	9a	Tor
3VA	XC6221A111GR	LVR-IC	LDO, 1.1V±20mV, 200mA, +CE	USP-4	45vm	VR4	9a	Tor
3VB	XC6221A121GR	LVR-IC	LDO, 1.2V±20mV, 200mA, +CE	USP-4	45vm	VR4	9a	Tor
3VC	XC6221A131GR	LVR-IC	LDO, 1.3V±20mV, 200mA, +CE	USP-4	45vm	VR4	9a	Tor
3VD	XC6221A141GR	LVR-IC	LDO, 1.4V±20mV, 200mA, +CE	USP-4	45vm	VR4	9a	Tor
3VE	XC6221A151GR	LVR-IC	LDO, 1.5V±20mV, 200mA, +CE	USP-4	45vm	VR4	9a	Tor
3VF	XC6221A161GR	LVR-IC	LDO, 1.6V±20mV, 200mA, +CE	USP-4	45vm	VR4	9a	Tor
3VH	XC6221A171GR	LVR-IC	LDO, 1.7V±20mV, 200mA, +CE	USP-4	45vm	VR4	9a	Tor
3VK	XC6221A181GR	LVR-IC	LDO, 1.8V±20mV, 200mA, +CE	USP-4	45vm	VR4	9a	Tor
3VL	XC6221A191GR	LVR-IC	LDO, 1.9V±20mV, 200mA, +CE	USP-4	45vm	VR4	9a	Tor
3VM	XC6221A201GR	LVR-IC	LDO, 2V±1%, 200mA, +CE	USP-4	45vm	VR4	9a	Tor
3VN	XC6221A211GR	LVR-IC	LDO, 2.1V±1%, 200mA, +CE	USP-4	45vm	VR4	9a	Tor



SMD code	Type	Function	Short description	Case	Pinout	Sch.	St.	Mnf.
3VP	XC6221A221GR	LVR-IC	LDO, 2.2V±1%, 200mA, +CE	USP-4	45vm	VR4	9a	Tor
3VR	XC6221A231GR	LVR-IC	LDO, 2.3V±1%, 200mA, +CE	USP-4	45vm	VR4	9a	Tor
3VS	XC6221A241GR	LVR-IC	LDO, 2.4V±1%, 200mA, +CE	USP-4	45vm	VR4	9a	Tor
3VT	XC6221A251GR	LVR-IC	LDO, 2.5V±1%, 200mA, +CE	USP-4	45vm	VR4	9a	Tor
3VU	XC6221A261GR	LVR-IC	LDO, 2.6V±1%, 200mA, +CE	USP-4	45vm	VR4	9a	Tor
3VV	XC6221A271GR	LVR-IC	LDO, 2.7V±1%, 200mA, +CE	USP-4	45vm	VR4	9a	Tor
3VX	XC6221A281GR	LVR-IC	LDO, 2.8V±1%, 200mA, +CE	USP-4	45vm	VR4	9a	Tor
3VY	XC6221A291GR	LVR-IC	LDO, 2.9V±1%, 200mA, +CE	USP-4	45vm	VR4	9a	Tor
3VZ	XC6221A301GR	LVR-IC	LDO, 3V±1%, 200mA, +CE	USP-4	45vm	VR4	9a	Tor
3W	R3117K271C	Vdet-IC	2.7V±1%, -Reset PPO, Sense	DFN1010-4	48rq	VD12	9a	Ric
3X	R3117K281C	Vdet-IC	2.8V±1%, -Reset PPO, Sense	DFN1010-4	48rq	VD12	9a	Ric
3X	XC6217D2827R-G	LVR-IC	LDO, 2.8V±2%, 200mA, +CE, CL	USPN-4	58vm	VR4	9a	Tor
3X	XC6223D3719R-G	LVR-IC	LDO, 3.7V±1%, 300mA, +CE, CL, PDR	USPQ-4B03	48vm	VR4	9a	Tor
3X	XC6229H4011R-G	LVR-IC	LDO, 4.0V±1%, 300mA, +CE, ICP	BGA-4	63ba*	VR4	9a	Tor
3X0	XC6221B311GR	LVR-IC	LDO, 3.1V±1%, 200mA, +CE, CL	USP-4	45vm	VR4	9a	Tor
3X7	XC6221B081GR	LVR-IC	LDO, 0.8V±20mV, 200mA, +CE, CL	USP-4	45vm	VR4	9a	Tor
3X8	XC6221B091GR	LVR-IC	LDO, 0.9V±20mV, 200mA, +CE, CL	USP-4	45vm	VR4	9a	Tor
3X9	XC6221B101GR	LVR-IC	LDO, 1V±20mV, 200mA, +CE, CL	USP-4	45vm	VR4	9a	Tor
3XA	XC6221B111GR	LVR-IC	LDO, 1.1V±20mV, 200mA, +CE, CL	USP-4	45vm	VR4	9a	Tor
3XB	XC6221B121GR	LVR-IC	LDO, 1.2V±20mV, 200mA, +CE, CL	USP-4	45vm	VR4	9a	Tor
3XC	XC6221B131GR	LVR-IC	LDO, 1.3V±20mV, 200mA, +CE, CL	USP-4	45vm	VR4	9a	Tor
3XD	XC6221B141GR	LVR-IC	LDO, 1.4V±20mV, 200mA, +CE, CL	USP-4	45vm	VR4	9a	Tor
3XE	XC6221B151GR	LVR-IC	LDO, 1.5V±20mV, 200mA, +CE, CL	USP-4	45vm	VR4	9a	Tor
3XF	XC6221B161GR	LVR-IC	LDO, 1.6V±20mV, 200mA, +CE, CL	USP-4	45vm	VR4	9a	Tor
3XH	XC6221B171GR	LVR-IC	LDO, 1.7V±20mV, 200mA, +CE, CL	USP-4	45vm	VR4	9a	Tor
3XK	XC6221B181GR	LVR-IC	LDO, 1.8V±20mV, 200mA, +CE, CL	USP-4	45vm	VR4	9a	Tor
3XL	XC6221B191GR	LVR-IC	LDO, 1.9V±20mV, 200mA, +CE, CL	USP-4	45vm	VR4	9a	Tor
3XM	XC6221B201GR	LVR-IC	LDO, 2V±1%, 200mA, +CE, CL	USP-4	45vm	VR4	9a	Tor
3XN	XC6221B211GR	LVR-IC	LDO, 2.1V±1%, 200mA, +CE, CL	USP-4	45vm	VR4	9a	Tor
3XP	XC6221B221GR	LVR-IC	LDO, 2.2V±1%, 200mA, +CE, CL	USP-4	45vm	VR4	9a	Tor
3XR	XC6221B231GR	LVR-IC	LDO, 2.3V±1%, 200mA, +CE, CL	USP-4	45vm	VR4	9a	Tor
3XS	XC6221B241GR	LVR-IC	LDO, 2.4V±1%, 200mA, +CE, CL	USP-4	45vm	VR4	9a	Tor
3XT	XC6221B251GR	LVR-IC	LDO, 2.5V±1%, 200mA, +CE, CL	USP-4	45vm	VR4	9a	Tor
3XU	XC6221B261GR	LVR-IC	LDO, 2.6V±1%, 200mA, +CE, CL	USP-4	45vm	VR4	9a	Tor
3XV	XC6221B271GR	LVR-IC	LDO, 2.7V±1%, 200mA, +CE, CL	USP-4	45vm	VR4	9a	Tor
3XX	XC6221B281GR	LVR-IC	LDO, 2.8V±1%, 200mA, +CE, CL	USP-4	45vm	VR4	9a	Tor
3XY	XC6221B291GR	LVR-IC	LDO, 2.9V±1%, 200mA, +CE, CL	USP-4	45vm	VR4	9a	Tor
3XZ	XC6221B301GR	LVR-IC	LDO, 3V±1%, 200mA, +CE, CL	USP-4	45vm	VR4	9a	Tor
3Y	R3117K291C	Vdet-IC	2.9V±1%, -Reset PPO, Sense	DFN1010-4	48rq	VD12	9a	Ric
3Y	XC6217D2927R-G	LVR-IC	LDO, 2.9V±2%, 200mA, +CE, CL	USPN-4	58vm	VR4	9a	Tor
3Y	XC6223D3819R-G	LVR-IC	LDO, 3.8V±1%, 300mA, +CE, CL, PDR	USPQ-4B03	48vm	VR4	9a	Tor
3Z	R3117K301C	Vdet-IC	3.0V±1%, -Reset PPO, Sense	DFN1010-4	48rq	VD12	9a	Ric
3Z	XC6217D3027R-G	LVR-IC	LDO, 3V±2%, 200mA, +CE, CL	USPN-4	58vm	VR4	9a	Tor
3Z	XC6223D3919R-G	LVR-IC	LDO, 3.9V±1%, 300mA, +CE, CL, PDR	USPQ-4B03	48vm	VR4	9a	Tor
40	RP110L151C	LVR-IC	LDO, 1.5V±1%, 150mA	DFN1010-4	48y1	VR1	9a	Ric
40	XC6217D3127R-G	LVR-IC	LDO, 3.1V±2%, 200mA, +CE, CL	USPN-4	58vm	VR4	9a	Tor
40	XC6420AB407R-G	LVR-IC	LDO, Dual out, Vout1/Vout2=3.00/3.30V±2%, 150mA, +CE	USPN-6	52xv	VR19	9a	Tor
40	XC6420AB40DR-G	LVR-IC	LDO, Dual out, Vout1/Vout2=3.00/3.30V±2%, 150mA, +CE	USP-6B04	73x4	VR19	9a	Tor
40	XC6221D0817R	LVR-IC	LDO, 0.8V±20mV, 200mA, +CE, CL, PDR	USPN-4	58vm	VR4	9a	Tor
41	RP110L161C	LVR-IC	LDO, 1.6V±1%, 150mA	DFN1010-4	48y1	VR1	9a	Ric
41	XC6217D3227R-G	LVR-IC	LDO, 3.2V±2%, 200mA, +CE, CL	USPN-4	58vm	VR4	9a	Tor
41	XC6420AB417R-G	LVR-IC	LDO, Dual out, Vout1/Vout2=3.30/3.30V±2%, 150mA, +CE	USPN-6	52xv	VR19	9a	Tor
41	XC6420AB41DR-G	LVR-IC	LDO, Dual out, Vout1/Vout2=3.30/3.30V±2%, 150mA, +CE	USP-6B04	73x4	VR19	9a	Tor
41	XC6221D0917R	LVR-IC	LDO, 0.9V±20mV, 200mA, +CE, CL, PDR	USPN-4	58vm	VR4	9a	Tor
42	RP110L171C	LVR-IC	LDO, 1.7V±1%, 150mA	DFN1010-4	48y1	VR1	9a	Ric
42	XC6217D3327R-G	LVR-IC	LDO, 3.3V±2%, 200mA, +CE, CL	USPN-4	58vm	VR4	9a	Tor
42	XC6223E1219R-G	LVR-IC	LDO, 1.2V±20mV, 300mA, +CE, ICP	USPQ-4B03	48vm	VR4	9a	Tor
42	XC6420AB427R-G	LVR-IC	LDO, Dual out, Vout1/Vout2=1.30/1.50V±2%, 150mA, +CE	USPN-6	52xv	VR19	9a	Tor
42	XC6420AB42DR-G	LVR-IC	LDO, Dual out, Vout1/Vout2=1.30/1.50V±2%, 150mA, +CE	USP-6B04	73x4	VR19	9a	Tor
42	XC6221D1017R	LVR-IC	LDO, 1V±20mV, 200mA, +CE, CL, PDR	USPN-4	58vm	VR4	9a	Tor
4201	AK4201EU	LIN-IC	AF PA, 2.6..5.5V, 2x65mW(5V/16C), shutdown	DFN-12	37	-	-	Ask
4213	AK4213EC	LIN-IC	AF PA, BTL, class-D, 2.6..5.5V, 1.6W+2x64mW(5V/4(16)C), 12C	BGA-29	39	-	-	Ask
43	RP110L181C	LVR-IC	LDO, 1.8V±1%, 150mA	DFN1010-4	48y1	VR1	9a	Ric
43	XC6217D3427R-G	LVR-IC	LDO, 3.4V±2%, 200mA, +CE, CL	USPN-4	58vm	VR4	9a	Tor
43	XC6223E1319R-G	LVR-IC	LDO, 1.3V±20mV, 300mA, +CE, ICP	USPQ-4B03	48vm	VR4	9a	Tor
43	XC6420AB437R-G	LVR-IC	LDO, Dual out, Vout1/Vout2=2.60/2.80V±2%, 150mA, +CE	USPN-6	52xv	VR19	9a	Tor
43	XC6420AB43DR-G	LVR-IC	LDO, Dual out, Vout1/Vout2=2.60/2.80V±2%, 150mA, +CE	USP-6B04	73x4	VR19	9a	Tor
43	XC6221D1117R	LVR-IC	LDO, 1.1V±20mV, 200mA, +CE, CL, PDR	USPN-4	58vm	VR4	9a	Tor
44	RP110L181C5	LVR-IC	LDO, 1.85V±1%, 150mA	DFN1010-4	48y1	VR1	9a	Ric
44	XC6217D3527R-G	LVR-IC	LDO, 3.5V±2%, 200mA, +CE, CL	USPN-4	58vm	VR4	9a	Tor



SMD code	Type	Function	Short description	Case	Pinout	Sch.	St.Mnf.
44	XC6223E1419R-G	LVR-IC	LDO, 1.4V±20mV, 300mA, +CE, ICP	USPQ-4B03	48vm	VR4	9a Tor
44	XC6420AB447R-G	LVR-IC	LDO, Dual out, Vout1/Vout2=3.10/3.30V±2%, 150mA, +CE	USPN-6	52xv	VR19	9a Tor
44	XC6420AB44DR-G	LVR-IC	LDO, Dual out, Vout1/Vout2=3.10/3.30V±2%, 150mA, +CE	USP-6B04	73x4	VR19	9a Tor
44	XC6221D1217R	LVR-IC	LDO, 1.2V±20mV, 200mA, +CE, CL, PDR	USPN-4	58vm	VR4	9a Tor
45	RP110L191C	LVR-IC	LDO, 1.9V±1%, 150mA	DFN1010-4	48y1	VR1	9a Ric
45	XC6217D3627R-G	LVR-IC	LDO, 3.6V±2%, 200mA, +CE, CL	USPN-4	58vm	VR4	9a Tor
45	XC6223E1519R-G	LVR-IC	LDO, 1.5V±20mV, 300mA, +CE, ICP	USPQ-4B03	48vm	VR4	9a Tor
45	XC6420AB457R-G	LVR-IC	LDO, Dual out, Vout1/Vout2=1.50/2.60V±2%, 150mA, +CE	USPN-6	52xv	VR19	9a Tor
45	XC6420AB45DR-G	LVR-IC	LDO, Dual out, Vout1/Vout2=1.50/2.60V±2%, 150mA, +CE	USP-6B04	73x4	VR19	9a Tor
45	XC6221D1317R	LVR-IC	LDO, 1.3V±20mV, 200mA, +CE, CL, PDR	USPN-4	58vm	VR4	9a Tor
46	RP110L201C	LVR-IC	LDO, 2.0V±1%, 150mA	DFN1010-4	48y1	VR1	9a Ric
46	XC6217D3727R-G	LVR-IC	LDO, 3.7V±2%, 200mA, +CE, CL	USPN-4	58vm	VR4	9a Tor
46	XC6223E1619R-G	LVR-IC	LDO, 1.6V±20mV, 300mA, +CE, ICP	USPQ-4B03	48vm	VR4	9a Tor
46	XC6420AB467R-G	LVR-IC	LDO, Dual out, Vout1/Vout2=2.60/3.30V±2%, 150mA, +CE	USPN-6	52xv	VR19	9a Tor
46	XC6420AB46DR-G	LVR-IC	LDO, Dual out, Vout1/Vout2=2.60/3.30V±2%, 150mA, +CE	USP-6B04	73x4	VR19	9a Tor
46	XC6221D1417R	LVR-IC	LDO, 1.4V±20mV, 200mA, +CE, CL, PDR	USPN-4	58vm	VR4	9a Tor
47	RP110L211C	LVR-IC	LDO, 2.1V±1%, 150mA	DFN1010-4	48y1	VR1	9a Ric
47	XC6217D3827R-G	LVR-IC	LDO, 3.8V±2%, 200mA, +CE, CL	USPN-4	58vm	VR4	9a Tor
47	XC6223E1719R-G	LVR-IC	LDO, 1.7V±20mV, 300mA, +CE, ICP	USPQ-4B03	48vm	VR4	9a Tor
47	XC6420AB477R-G	LVR-IC	LDO, Dual out, Vout1/Vout2=3.40/3.40V±2%, 150mA, +CE	USPN-6	52xv	VR19	9a Tor
47	XC6420AB47DR-G	LVR-IC	LDO, Dual out, Vout1/Vout2=3.40/3.40V±2%, 150mA, +CE	USP-6B04	73x4	VR19	9a Tor
47	XC6221D1517R	LVR-IC	LDO, 1.5V±20mV, 200mA, +CE, CL, PDR	USPN-4	58vm	VR4	9a Tor
48	RP110L221C	LVR-IC	LDO, 2.2V±1%, 150mA	DFN1010-4	48y1	VR1	9a Ric
48	XC6217D3927R-G	LVR-IC	LDO, 3.9V±2%, 200mA, +CE, CL	USPN-4	58vm	VR4	9a Tor
48	XC6223E1819R-G	LVR-IC	LDO, 1.8V±20mV, 300mA, +CE, ICP	USPQ-4B03	48vm	VR4	9a Tor
48	XC6420AB487R-G	LVR-IC	LDO, Dual out, Vout1/Vout2=2.85/2.60V±2%, 150mA, +CE	USPN-6	52xv	VR19	9a Tor
48	XC6420AB48DR-G	LVR-IC	LDO, Dual out, Vout1/Vout2=2.85/2.60V±2%, 150mA, +CE	USP-6B04	73x4	VR19	9a Tor
48	XC6221D1617R	LVR-IC	LDO, 1.6V±20mV, 200mA, +CE, CL, PDR	USPN-4	58vm	VR4	9a Tor
4821	TS4821QT	LIN-IC	AF PA, 2.5.5V, 2x100mW(5V/160)	DFN-8	37	AFP6	- Ste
48511S	LM48511S	LIN-IC	AF PA, BTL, class-D, 2.5.5.5V, 3W(5V/40), shutdown	LQFN-24	38	-	- Nsc
4866TQ	SGM4866YQ16G	LIN-IC	AF PA, BTL, 2.6.5.5V, 2x1.28W(5V/80)	QFN-16	38	-	9m Sgm
4871	TS4871QT	LIN-IC	AF PA, BTL, 2.5.5.5V, 1W(5V/80), shutdown	DFN-8	37	AFP12	- Ste
4872	TS48721JT	LIN-IC	AF PA, BTL, 2.5.5.5V, 1W(5V/80), shutdown	BGA-9	39	AFP44	- Ste
4890	MC4890D	LIN-IC	AF PA, BTL, 2.5.5.5V, 1.5W(5V/80), shutdown	DFN-8	37	AFP12	- Mep
4890	TS48901QT	LIN-IC	AF PA, BTL, 2.5.5.5V, 1W(5V/80), shutdown	DFN-8	37	AFP12	- Ste
4890YG	SGM4890YG	LIN-IC	AF PA, BTL, 2.5.5.5V, 1.1W(5V/80), shutdown	BGA-9	39	AFP44	9k Sgm
4891	SGM4891YDEBG	LIN-IC	AF PA, BTL, 2.2.5.5V, 1.2W(5V/80)	DFN-8	37	AFP12	9m Sgm
4894	NCP4894MNR2	LIN-IC	AF PA, BTL, 2.2.5.5V, 1.8W(5V/80), shutdown	DFN-10	37	AFP19	- Ons
4894YG	SGM4894YDB8	LIN-IC	AF PA, BTL, 2.5.5.5V, 1.1W(5V/80), shutdown	BGA-9	39	AFP51	- Sgm
4896YG	SGM4896YG	LIN-IC	AF PA, BTL, 2.5.5.5V, 1.15W(5V/80), shutdown	BGA-8	39	AFP47	9m Sgm
49	LEE-49+	MMIC	RF amplifier, DC, 5GHz, 12dB (50Ω)	FG873	36aa	A1	9b Mc
49	RP110L231C	LVR-IC	LDO, 2.3V±1%, 150mA	DFN1010-4	48y1	VR1	9a Ric
49	XC6217D4027R-G	LVR-IC	LDO, 4V±2%, 200mA, +CE, CL	USPN-4	58vm	VR4	9a Tor
49	XC6223E1919R-G	LVR-IC	LDO, 1.9V±20mV, 300mA, +CE, ICP	USPQ-4B03	48vm	VR4	9a Tor
49	XC6420AB497R-G	LVR-IC	LDO, Dual out, Vout1/Vout2=3.30/1.80V±2%, 150mA, +CE	USPN-6	52xv	VR19	9a Tor
49	XC6420AB49DR-G	LVR-IC	LDO, Dual out, Vout1/Vout2=3.30/1.80V±2%, 150mA, +CE	USP-6B04	73x4	VR19	9a Tor
49	XC6221D1717R	LVR-IC	LDO, 1.7V±20mV, 200mA, +CE, CL, PDR	USPN-4	58vm	VR4	9a Tor
4972	TS49721JT	LIN-IC	AF PA, BTL, 2.5.5.5V, 1.2W(5V/80), shutdown	BGA-9	39	AFP44	- Ste
4990	AUD4990CS09	LIN-IC	AF PA, BTL, 2.7.5.5V, 2W(5V/40), select shutdown	BGA-9	39	-	- Axp
4992A	EUA4992AJ	LIN-IC	AF PA, BTL, 2.2.5.5V, 2x2.5W(5V/40), shutdown	TQFN-16	38	-	- Eut
4996	MC4996	LIN-IC	AF PA, BTL, 2.5.5.5V, 2W(5V/40), shutdown	DFN-8	37	AFP12	- Eut
4A	R3117K311C	Vdet-IC	3.1V±1%, -Reset PPO, Sense	DFN1010-4	48rq	VD12	9a Ric
4A	RP101K121D	LVR-IC	LDO, LIN, +CE, CL, 1.1V±0.8%, 300mA	DFN1612-4	45vm	VR4	9a Ric
4A	XC6223E2019R-G	LVR-IC	LDO, 2.0V±1%, 300mA, +CE, ICP	USPQ-4B03	48vm	VR4	9a Tor
4A	XC6221D1817R	LVR-IC	LDO, 1.8V±20mV, 200mA, +CE, CL, PDR	USPN-4	58vm	VR4	9a Tor
4A016	XC6107A016ER	Vdet-IC	1.6V±2%, Hst, -MR, +Rst PPO, -Rst ODO, Rt=3.13ms	USP-6C	49xs	VD22	9b Tor
4A017	XC6107A017ER	Vdet-IC	1.7V±2%, Hst, -MR, +Rst PPO, -Rst ODO, Rt=3.13ms	USP-6C	49xs	VD22	9b Tor
4A018	XC6107A018ER	Vdet-IC	1.8V±2%, Hst, -MR, +Rst PPO, -Rst ODO, Rt=3.13ms	USP-6C	49xs	VD22	9b Tor
4A019	XC6107A019ER	Vdet-IC	1.9V±2%, Hst, -MR, +Rst PPO, -Rst ODO, Rt=3.13ms	USP-6C	49xs	VD22	9b Tor
4A020	XC6107A020ER	Vdet-IC	2.0V±2%, Hst, -MR, +Rst PPO, -Rst ODO, Rt=3.13ms	USP-6C	49xs	VD22	9b Tor
4A021	XC6107A021ER	Vdet-IC	2.1V±2%, Hst, -MR, +Rst PPO, -Rst ODO, Rt=3.13ms	USP-6C	49xs	VD22	9b Tor
4A022	XC6107A022ER	Vdet-IC	2.2V±2%, Hst, -MR, +Rst PPO, -Rst ODO, Rt=3.13ms	USP-6C	49xs	VD22	9b Tor
4A023	XC6107A023ER	Vdet-IC	2.3V±2%, Hst, -MR, +Rst PPO, -Rst ODO, Rt=3.13ms	USP-6C	49xs	VD22	9b Tor
4A024	XC6107A024ER	Vdet-IC	2.4V±2%, Hst, -MR, +Rst PPO, -Rst ODO, Rt=3.13ms	USP-6C	49xs	VD22	9b Tor
4A025	XC6107A025ER	Vdet-IC	2.5V±2%, Hst, -MR, +Rst PPO, -Rst ODO, Rt=3.13ms	USP-6C	49xs	VD22	9b Tor
4A026	XC6107A026ER	Vdet-IC	2.6V±2%, Hst, -MR, +Rst PPO, -Rst ODO, Rt=3.13ms	USP-6C	49xs	VD22	9b Tor
4A027	XC6107A027ER	Vdet-IC	2.7V±2%, Hst, -MR, +Rst PPO, -Rst ODO, Rt=3.13ms	USP-6C	49xs	VD22	9b Tor
4A028	XC6107A028ER	Vdet-IC	2.8V±2%, Hst, -MR, +Rst PPO, -Rst ODO, Rt=3.13ms	USP-6C	49xs	VD22	9b Tor
4A029	XC6107A029ER	Vdet-IC	2.9V±2%, Hst, -MR, +Rst PPO, -Rst ODO, Rt=3.13ms	USP-6C	49xs	VD22	9b Tor
4A030	XC6107A030ER	Vdet-IC	3.0V±2%, Hst, -MR, +Rst PPO, -Rst ODO, Rt=3.13ms	USP-6C	49xs	VD22	9b Tor



SMD code	Type	Function	Short description	Case	Pinout	Sch.	St.Mnf.
4A631	XC6102A631ER	Vdet-IC	3.1V±2%, Hst, -MR, -Reset ODO, Wt=1.6s, Rt=3.13ms	USP-6C	49xh	VD16	9b Tor
4A632	XC6102A632ER	Vdet-IC	3.2V±2%, Hst, -MR, -Reset ODO, Wt=1.6s, Rt=3.13ms	USP-6C	49xh	VD16	9b Tor
4A633	XC6102A633ER	Vdet-IC	3.3V±2%, Hst, -MR, -Reset ODO, Wt=1.6s, Rt=3.13ms	USP-6C	49xh	VD16	9b Tor
4A634	XC6102A634ER	Vdet-IC	3.4V±2%, Hst, -MR, -Reset ODO, Wt=1.6s, Rt=3.13ms	USP-6C	49xh	VD16	9b Tor
4A635	XC6102A635ER	Vdet-IC	3.5V±2%, Hst, -MR, -Reset ODO, Wt=1.6s, Rt=3.13ms	USP-6C	49xh	VD16	9b Tor
4A636	XC6102A636ER	Vdet-IC	3.6V±2%, Hst, -MR, -Reset ODO, Wt=1.6s, Rt=3.13ms	USP-6C	49xh	VD16	9b Tor
4A637	XC6102A637ER	Vdet-IC	3.7V±2%, Hst, -MR, -Reset ODO, Wt=1.6s, Rt=3.13ms	USP-6C	49xh	VD16	9b Tor
4A638	XC6102A638ER	Vdet-IC	3.8V±2%, Hst, -MR, -Reset ODO, Wt=1.6s, Rt=3.13ms	USP-6C	49xh	VD16	9b Tor
4A639	XC6102A639ER	Vdet-IC	3.9V±2%, Hst, -MR, -Reset ODO, Wt=1.6s, Rt=3.13ms	USP-6C	49xh	VD16	9b Tor
4A640	XC6102A640ER	Vdet-IC	4.0V±2%, Hst, -MR, -Reset ODO, Wt=1.6s, Rt=3.13ms	USP-6C	49xh	VD16	9b Tor
4A641	XC6102A641ER	Vdet-IC	4.1V±2%, Hst, -MR, -Reset ODO, Wt=1.6s, Rt=3.13ms	USP-6C	49xh	VD16	9b Tor
4A642	XC6102A642ER	Vdet-IC	4.2V±2%, Hst, -MR, -Reset ODO, Wt=1.6s, Rt=3.13ms	USP-6C	49xh	VD16	9b Tor
4A643	XC6102A643ER	Vdet-IC	4.3V±2%, Hst, -MR, -Reset ODO, Wt=1.6s, Rt=3.13ms	USP-6C	49xh	VD16	9b Tor
4A644	XC6102A644ER	Vdet-IC	4.4V±2%, Hst, -MR, -Reset ODO, Wt=1.6s, Rt=3.13ms	USP-6C	49xh	VD16	9b Tor
4A645	XC6102A645ER	Vdet-IC	4.5V±2%, Hst, -MR, -Reset ODO, Wt=1.6s, Rt=3.13ms	USP-6C	49xh	VD16	9b Tor
4A646	XC6102A646ER	Vdet-IC	4.6V±2%, Hst, -MR, -Reset ODO, Wt=1.6s, Rt=3.13ms	USP-6C	49xh	VD16	9b Tor
4A647	XC6102A647ER	Vdet-IC	4.7V±2%, Hst, -MR, -Reset ODO, Wt=1.6s, Rt=3.13ms	USP-6C	49xh	VD16	9b Tor
4A648	XC6102A648ER	Vdet-IC	4.8V±2%, Hst, -MR, -Reset ODO, Wt=1.6s, Rt=3.13ms	USP-6C	49xh	VD16	9b Tor
4A649	XC6102A649ER	Vdet-IC	4.9V±2%, Hst, -MR, -Reset ODO, Wt=1.6s, Rt=3.13ms	USP-6C	49xh	VD16	9b Tor
4A650	XC6102A650ER	Vdet-IC	5.0V±2%, Hst, -MR, -Reset ODO, Wt=1.6s, Rt=3.13ms	USP-6C	49xh	VD16	9b Tor
4A8	XC9235A08C4R-G	DC-DC-IC	PWM, st-dwn, 0.8V±2%, 600mA, 1.2MHz, Vin>2V, LSST	USP-6EL	56dc5	DC1	9a Tor
4A8	XC9235A08CER	DC-DC-IC	PWM, st-dwn, 0.8V±2%, 600mA, 1.2MHz, Vin>2V, LSST	USP-6C	49dc5	DC1	9a Tor
4A9	XC9235A09C4R-G	DC-DC-IC	PWM, st-dwn, 0.9V±2%, 600mA, 1.2MHz, Vin>2V, LSST	USP-6EL	56dc5	DC1	9a Tor
4A9	XC9235A09CER	DC-DC-IC	PWM, st-dwn, 0.9V±2%, 600mA, 1.2MHz, Vin>2V, LSST	USP-6C	49dc5	DC1	9a Tor
4AL	XC9235A0LC4R-G	DC-DC-IC	PWM, st-dwn, 0.85V±2%, 600mA, 1.2MHz, Vin>2V, LSST	USP-6EL	56dc5	DC1	9a Tor
4AL	XC9235A0LCER	DC-DC-IC	PWM, st-dwn, 0.85V±2%, 600mA, 1.2MHz, Vin>2V, LSST	USP-6C	49dc5	DC1	9a Tor
4AM	XC9235A0MC4R-G	DC-DC-IC	PWM, st-dwn, 0.95V±2%, 600mA, 1.2MHz, Vin>2V, LSST	USP-6EL	56dc5	DC1	9a Tor
4AM	XC9235A0MCEER	DC-DC-IC	PWM, st-dwn, 0.95V±2%, 600mA, 1.2MHz, Vin>2V, LSST	USP-6C	49dc5	DC1	9a Tor
4B	R3117K321C	Vdet-IC	3.2V±1%, -Reset PPO, Sense	DFN1010-4	48rq	VD12	9a Ric
4B	RP101K131D	LVR-IC	LDO, LN, +CE, CL, 1.3V±0.8%, 300mA	DFN1612-4	45vm	VR4	9a Ric
4B	XC622E2119R-G	LVR-IC	LDO, 2.1V±1%, 300mA, +CE, ICP	USPQ-4B03	48vm	VR4	9a Tor
4B	XC6221D1917R	LVR-IC	LDO, 1.9V±20mV, 200mA, +CE, CL, PDR	USPN-4	58vm	VR4	9a Tor
4B0	XC9235A10C4R-G	DC-DC-IC	PWM, st-dwn, 1.0V±2%, 600mA, 1.2MHz, Vin>2V, LSST	USP-6EL	56dc5	DC1	9a Tor
4B0	XC9235A10CER	DC-DC-IC	PWM, st-dwn, 1.0V±2%, 600mA, 1.2MHz, Vin>2V, LSST	USP-6C	49dc5	DC1	9a Tor
4B016	XC6107B016ER	Vdet-IC	1.6V±2%, Hst, -MR, +Rst PPO, -Rst ODO, Rt=25ms	USP-6C	49xs	VD22	9b Tor
4B017	XC6107B017ER	Vdet-IC	1.7V±2%, Hst, -MR, +Rst PPO, -Rst ODO, Rt=25ms	USP-6C	49xs	VD22	9b Tor
4B018	XC6107B018ER	Vdet-IC	1.8V±2%, Hst, -MR, +Rst PPO, -Rst ODO, Rt=25ms	USP-6C	49xs	VD22	9b Tor
4B019	XC6107B019ER	Vdet-IC	1.9V±2%, Hst, -MR, +Rst PPO, -Rst ODO, Rt=25ms	USP-6C	49xs	VD22	9b Tor
4B020	XC6107B020ER	Vdet-IC	2.0V±2%, Hst, -MR, +Rst PPO, -Rst ODO, Rt=25ms	USP-6C	49xs	VD22	9b Tor
4B021	XC6107B021ER	Vdet-IC	2.1V±2%, Hst, -MR, +Rst PPO, -Rst ODO, Rt=25ms	USP-6C	49xs	VD22	9b Tor
4B022	XC6107B022ER	Vdet-IC	2.2V±2%, Hst, -MR, +Rst PPO, -Rst ODO, Rt=25ms	USP-6C	49xs	VD22	9b Tor
4B023	XC6107B023ER	Vdet-IC	2.3V±2%, Hst, -MR, +Rst PPO, -Rst ODO, Rt=25ms	USP-6C	49xs	VD22	9b Tor
4B024	XC6107B024ER	Vdet-IC	2.4V±2%, Hst, -MR, +Rst PPO, -Rst ODO, Rt=25ms	USP-6C	49xs	VD22	9b Tor
4B025	XC6107B025ER	Vdet-IC	2.5V±2%, Hst, -MR, +Rst PPO, -Rst ODO, Rt=25ms	USP-6C	49xs	VD22	9b Tor
4B026	XC6107B026ER	Vdet-IC	2.6V±2%, Hst, -MR, +Rst PPO, -Rst ODO, Rt=25ms	USP-6C	49xs	VD22	9b Tor
4B027	XC6107B027ER	Vdet-IC	2.7V±2%, Hst, -MR, +Rst PPO, -Rst ODO, Rt=25ms	USP-6C	49xs	VD22	9b Tor
4B028	XC6107B028ER	Vdet-IC	2.8V±2%, Hst, -MR, +Rst PPO, -Rst ODO, Rt=25ms	USP-6C	49xs	VD22	9b Tor
4B029	XC6107B029ER	Vdet-IC	2.9V±2%, Hst, -MR, +Rst PPO, -Rst ODO, Rt=25ms	USP-6C	49xs	VD22	9b Tor
4B030	XC6107B030ER	Vdet-IC	3.0V±2%, Hst, -MR, +Rst PPO, -Rst ODO, Rt=25ms	USP-6C	49xs	VD22	9b Tor
4B031	XC6107B031ER	Vdet-IC	3.1V±2%, Hst, -MR, +Rst PPO, -Rst ODO, Rt=25ms	USP-6C	49xs	VD22	9b Tor
4B032	XC6107B032ER	Vdet-IC	3.2V±2%, Hst, -MR, +Rst PPO, -Rst ODO, Rt=25ms	USP-6C	49xs	VD22	9b Tor
4B033	XC6107B033ER	Vdet-IC	3.3V±2%, Hst, -MR, +Rst PPO, -Rst ODO, Rt=25ms	USP-6C	49xs	VD22	9b Tor
4B034	XC6107B034ER	Vdet-IC	3.4V±2%, Hst, -MR, +Rst PPO, -Rst ODO, Rt=25ms	USP-6C	49xs	VD22	9b Tor
4B035	XC6107B035ER	Vdet-IC	3.5V±2%, Hst, -MR, +Rst PPO, -Rst ODO, Rt=25ms	USP-6C	49xs	VD22	9b Tor
4B036	XC6107B036ER	Vdet-IC	3.6V±2%, Hst, -MR, +Rst PPO, -Rst ODO, Rt=25ms	USP-6C	49xs	VD22	9b Tor
4B037	XC6107B037ER	Vdet-IC	3.7V±2%, Hst, -MR, +Rst PPO, -Rst ODO, Rt=25ms	USP-6C	49xs	VD22	9b Tor
4B038	XC6107B038ER	Vdet-IC	3.8V±2%, Hst, -MR, +Rst PPO, -Rst ODO, Rt=25ms	USP-6C	49xs	VD22	9b Tor
4B039	XC6107B039ER	Vdet-IC	3.9V±2%, Hst, -MR, +Rst PPO, -Rst ODO, Rt=25ms	USP-6C	49xs	VD22	9b Tor
4B040	XC6107B040ER	Vdet-IC	4.0V±2%, Hst, -MR, +Rst PPO, -Rst ODO, Rt=25ms	USP-6C	49xs	VD22	9b Tor
4B041	XC6107B041ER	Vdet-IC	4.1V±2%, Hst, -MR, +Rst PPO, -Rst ODO, Rt=25ms	USP-6C	49xs	VD22	9b Tor
4B042	XC6107B042ER	Vdet-IC	4.2V±2%, Hst, -MR, +Rst PPO, -Rst ODO, Rt=25ms	USP-6C	49xs	VD22	9b Tor
4B043	XC6107B043ER	Vdet-IC	4.3V±2%, Hst, -MR, +Rst PPO, -Rst ODO, Rt=25ms	USP-6C	49xs	VD22	9b Tor
4B044	XC6107B044ER	Vdet-IC	4.4V±2%, Hst, -MR, +Rst PPO, -Rst ODO, Rt=25ms	USP-6C	49xs	VD22	9b Tor
4B045	XC6107B045ER	Vdet-IC	4.5V±2%, Hst, -MR, +Rst PPO, -Rst ODO, Rt=25ms	USP-6C	49xs	VD22	9b Tor
4B046	XC6107B046ER	Vdet-IC	4.6V±2%, Hst, -MR, +Rst PPO, -Rst ODO, Rt=25ms	USP-6C	49xs	VD22	9b Tor
4B047	XC6107B047ER	Vdet-IC	4.7V±2%, Hst, -MR, +Rst PPO, -Rst ODO, Rt=25ms	USP-6C	49xs	VD22	9b Tor
4B048	XC6107B048ER	Vdet-IC	4.8V±2%, Hst, -MR, +Rst PPO, -Rst ODO, Rt=25ms	USP-6C	49xs	VD22	9b Tor
4B049	XC6107B049ER	Vdet-IC	4.9V±2%, Hst, -MR, +Rst PPO, -Rst ODO, Rt=25ms	USP-6C	49xs	VD22	9b Tor
4B050	XC6107B050ER	Vdet-IC	5.0V±2%, Hst, -MR, +Rst PPO, -Rst ODO, Rt=25ms	USP-6C	49xs	VD22	9b Tor
4B1	XC9235A11C4R-G	DC-DC-IC	PWM, st-dwn, 1.1V±2%, 600mA, 1.2MHz, Vin>2V, LSST	USP-6EL	56dc5	DC1	9a Tor



SMD code	Type	Function	Short description	Case	Pinout	Sch.	St.	Mnf.
4BM	XC9235A1MC4R-G	DC-DC-IC	PWM, st-dwn, 1.95V±2%, 600mA, 1.2MHz, Vin>2V, LSST	USP-6EL	56dc5	DC1	9a	Tor
4BM	XC9235A1MCKER	DC-DC-IC	PWM, st-dwn, 1.95V±2%, 600mA, 1.2MHz, Vin>2V, LSST	USP-6C	49dc5	DC1	9a	Tor
4C	R3117K331C	Vdet-IC	3.3V±1%, -Reset PPO, Sense	DFN1010-4	48rq	VD12	9a	Ric
4C	RP101K151D	LVR-IC	LDO, LN, +CE, CL, 1.5V±0.8%, 300mA	DFN1612-4	45vm	VR4	9a	Ric
4C	XC6223E2219R-G	LVR-IC	LDO, 2.2V±1%, 300mA, +CE, ICP	USPQ-4B03	48vm	VR4	9a	Tor
4C	XC6221D2017R	LVR-IC	LDO, 2V±1%, 200mA, +CE, CL, PDR	USPN-4	58vm	VR4	9a	Tor
4C0	XC9235A20C4R-G	DC-DC-IC	PWM, st-dwn, 2.0V±2%, 600mA, 1.2MHz, Vin>2V, LSST	USP-6EL	56dc5	DC1	9a	Tor
4C0	XC9235A20CER	DC-DC-IC	PWM, st-dwn, 2.0V±2%, 600mA, 1.2MHz, Vin>2V, LSST	USP-6C	49dc5	DC1	9a	Tor
4C016	XC6107C016ER	Vdet-IC	1.6V±2%, Hst, -MR, +Rst PPO, -Rst ODO, Rt=50ms	USP-6C	49xs	VD22	9b	Tor
4C017	XC6107C017ER	Vdet-IC	1.7V±2%, Hst, -MR, +Rst PPO, -Rst ODO, Rt=50ms	USP-6C	49xs	VD22	9b	Tor
4C018	XC6107C018ER	Vdet-IC	1.8V±2%, Hst, -MR, +Rst PPO, -Rst ODO, Rt=50ms	USP-6C	49xs	VD22	9b	Tor
4C019	XC6107C019ER	Vdet-IC	1.9V±2%, Hst, -MR, +Rst PPO, -Rst ODO, Rt=50ms	USP-6C	49xs	VD22	9b	Tor
4C020	XC6107C020ER	Vdet-IC	2.0V±2%, Hst, -MR, +Rst PPO, -Rst ODO, Rt=50ms	USP-6C	49xs	VD22	9b	Tor
4C021	XC6107C021ER	Vdet-IC	2.1V±2%, Hst, -MR, +Rst PPO, -Rst ODO, Rt=50ms	USP-6C	49xs	VD22	9b	Tor
4C022	XC6107C022ER	Vdet-IC	2.2V±2%, Hst, -MR, +Rst PPO, -Rst ODO, Rt=50ms	USP-6C	49xs	VD22	9b	Tor
4C023	XC6107C023ER	Vdet-IC	2.3V±2%, Hst, -MR, +Rst PPO, -Rst ODO, Rt=50ms	USP-6C	49xs	VD22	9b	Tor
4C024	XC6107C024ER	Vdet-IC	2.4V±2%, Hst, -MR, +Rst PPO, -Rst ODO, Rt=50ms	USP-6C	49xs	VD22	9b	Tor
4C025	XC6107C025ER	Vdet-IC	2.5V±2%, Hst, -MR, +Rst PPO, -Rst ODO, Rt=50ms	USP-6C	49xs	VD22	9b	Tor
4C026	XC6107C026ER	Vdet-IC	2.6V±2%, Hst, -MR, +Rst PPO, -Rst ODO, Rt=50ms	USP-6C	49xs	VD22	9b	Tor
4C027	XC6107C027ER	Vdet-IC	2.7V±2%, Hst, -MR, +Rst PPO, -Rst ODO, Rt=50ms	USP-6C	49xs	VD22	9b	Tor
4C028	XC6107C028ER	Vdet-IC	2.8V±2%, Hst, -MR, +Rst PPO, -Rst ODO, Rt=50ms	USP-6C	49xs	VD22	9b	Tor
4C029	XC6107C029ER	Vdet-IC	2.9V±2%, Hst, -MR, +Rst PPO, -Rst ODO, Rt=50ms	USP-6C	49xs	VD22	9b	Tor
4C030	XC6107C030ER	Vdet-IC	3.0V±2%, Hst, -MR, +Rst PPO, -Rst ODO, Rt=50ms	USP-6C	49xs	VD22	9b	Tor
4C031	XC6107C031ER	Vdet-IC	3.1V±2%, Hst, -MR, +Rst PPO, -Rst ODO, Rt=50ms	USP-6C	49xs	VD22	9b	Tor
4C032	XC6107C032ER	Vdet-IC	3.2V±2%, Hst, -MR, +Rst PPO, -Rst ODO, Rt=50ms	USP-6C	49xs	VD22	9b	Tor
4C033	XC6107C033ER	Vdet-IC	3.3V±2%, Hst, -MR, +Rst PPO, -Rst ODO, Rt=50ms	USP-6C	49xs	VD22	9b	Tor
4C034	XC6107C034ER	Vdet-IC	3.4V±2%, Hst, -MR, +Rst PPO, -Rst ODO, Rt=50ms	USP-6C	49xs	VD22	9b	Tor
4C035	XC6107C035ER	Vdet-IC	3.5V±2%, Hst, -MR, +Rst PPO, -Rst ODO, Rt=50ms	USP-6C	49xs	VD22	9b	Tor
4C036	XC6107C036ER	Vdet-IC	3.6V±2%, Hst, -MR, +Rst PPO, -Rst ODO, Rt=50ms	USP-6C	49xs	VD22	9b	Tor
4C037	XC6107C037ER	Vdet-IC	3.7V±2%, Hst, -MR, +Rst PPO, -Rst ODO, Rt=50ms	USP-6C	49xs	VD22	9b	Tor
4C038	XC6107C038ER	Vdet-IC	3.8V±2%, Hst, -MR, +Rst PPO, -Rst ODO, Rt=50ms	USP-6C	49xs	VD22	9b	Tor
4C039	XC6107C039ER	Vdet-IC	3.9V±2%, Hst, -MR, +Rst PPO, -Rst ODO, Rt=50ms	USP-6C	49xs	VD22	9b	Tor
4C040	XC6107C040ER	Vdet-IC	4.0V±2%, Hst, -MR, +Rst PPO, -Rst ODO, Rt=50ms	USP-6C	49xs	VD22	9b	Tor
4C041	XC6107C041ER	Vdet-IC	4.1V±2%, Hst, -MR, +Rst PPO, -Rst ODO, Rt=50ms	USP-6C	49xs	VD22	9b	Tor
4C042	XC6107C042ER	Vdet-IC	4.2V±2%, Hst, -MR, +Rst PPO, -Rst ODO, Rt=50ms	USP-6C	49xs	VD22	9b	Tor
4C043	XC6107C043ER	Vdet-IC	4.3V±2%, Hst, -MR, +Rst PPO, -Rst ODO, Rt=50ms	USP-6C	49xs	VD22	9b	Tor
4C044	XC6107C044ER	Vdet-IC	4.4V±2%, Hst, -MR, +Rst PPO, -Rst ODO, Rt=50ms	USP-6C	49xs	VD22	9b	Tor
4C045	XC6107C045ER	Vdet-IC	4.5V±2%, Hst, -MR, +Rst PPO, -Rst ODO, Rt=50ms	USP-6C	49xs	VD22	9b	Tor
4C046	XC6107C046ER	Vdet-IC	4.6V±2%, Hst, -MR, +Rst PPO, -Rst ODO, Rt=50ms	USP-6C	49xs	VD22	9b	Tor
4C047	XC6107C047ER	Vdet-IC	4.7V±2%, Hst, -MR, +Rst PPO, -Rst ODO, Rt=50ms	USP-6C	49xs	VD22	9b	Tor
4C048	XC6107C048ER	Vdet-IC	4.8V±2%, Hst, -MR, +Rst PPO, -Rst ODO, Rt=50ms	USP-6C	49xs	VD22	9b	Tor
4C049	XC6107C049ER	Vdet-IC	4.9V±2%, Hst, -MR, +Rst PPO, -Rst ODO, Rt=50ms	USP-6C	49xs	VD22	9b	Tor
4C050	XC6107C050ER	Vdet-IC	5.0V±2%, Hst, -MR, +Rst PPO, -Rst ODO, Rt=50ms	USP-6C	49xs	VD22	9b	Tor
4C1	XC9235A21C4R-G	DC-DC-IC	PWM, st-dwn, 2.1V±2%, 600mA, 1.2MHz, Vin>2V, LSST	USP-6EL	56dc5	DC1	9a	Tor
4C1	XC9235A21CER	DC-DC-IC	PWM, st-dwn, 2.1V±2%, 600mA, 1.2MHz, Vin>2V, LSST	USP-6C	49dc5	DC1	9a	Tor
4C2	XC9235A22C4R-G	DC-DC-IC	PWM, st-dwn, 2.2V±2%, 600mA, 1.2MHz, Vin>2V, LSST	USP-6EL	56dc5	DC1	9a	Tor
4C2	XC9235A22CER	DC-DC-IC	PWM, st-dwn, 2.2V±2%, 600mA, 1.2MHz, Vin>2V, LSST	USP-6C	49dc5	DC1	9a	Tor
4C216	XC6102C216ER	Vdet-IC	1.6V±2%, Hst, -MR, -Reset ODO, Wt=50ms, Rt=50ms	USP-6C	49xh	VD16	9b	Tor
4C217	XC6102C217ER	Vdet-IC	1.7V±2%, Hst, -MR, -Reset ODO, Wt=50ms, Rt=50ms	USP-6C	49xh	VD16	9b	Tor
4C218	XC6102C218ER	Vdet-IC	1.8V±2%, Hst, -MR, -Reset ODO, Wt=50ms, Rt=50ms	USP-6C	49xh	VD16	9b	Tor
4C219	XC6102C219ER	Vdet-IC	1.9V±2%, Hst, -MR, -Reset ODO, Wt=50ms, Rt=50ms	USP-6C	49xh	VD16	9b	Tor
4C220	XC6102C220ER	Vdet-IC	2.0V±2%, Hst, -MR, -Reset ODO, Wt=50ms, Rt=50ms	USP-6C	49xh	VD16	9b	Tor
4C221	XC6102C221ER	Vdet-IC	2.1V±2%, Hst, -MR, -Reset ODO, Wt=50ms, Rt=50ms	USP-6C	49xh	VD16	9b	Tor
4C222	XC6102C222ER	Vdet-IC	2.2V±2%, Hst, -MR, -Reset ODO, Wt=50ms, Rt=50ms	USP-6C	49xh	VD16	9b	Tor
4C223	XC6102C223ER	Vdet-IC	2.3V±2%, Hst, -MR, -Reset ODO, Wt=50ms, Rt=50ms	USP-6C	49xh	VD16	9b	Tor
4C224	XC6102C224ER	Vdet-IC	2.4V±2%, Hst, -MR, -Reset ODO, Wt=50ms, Rt=50ms	USP-6C	49xh	VD16	9b	Tor
4C225	XC6102C225ER	Vdet-IC	2.5V±2%, Hst, -MR, -Reset ODO, Wt=50ms, Rt=50ms	USP-6C	49xh	VD16	9b	Tor
4C226	XC6102C226ER	Vdet-IC	2.6V±2%, Hst, -MR, -Reset ODO, Wt=50ms, Rt=50ms	USP-6C	49xh	VD16	9b	Tor
4C227	XC6102C227ER	Vdet-IC	2.7V±2%, Hst, -MR, -Reset ODO, Wt=50ms, Rt=50ms	USP-6C	49xh	VD16	9b	Tor
4C228	XC6102C228ER	Vdet-IC	2.8V±2%, Hst, -MR, -Reset ODO, Wt=50ms, Rt=50ms	USP-6C	49xh	VD16	9b	Tor
4C229	XC6102C229ER	Vdet-IC	2.9V±2%, Hst, -MR, -Reset ODO, Wt=50ms, Rt=50ms	USP-6C	49xh	VD16	9b	Tor
4C230	XC6102C230ER	Vdet-IC	3.0V±2%, Hst, -MR, -Reset ODO, Wt=50ms, Rt=50ms	USP-6C	49xh	VD16	9b	Tor
4C231	XC6102C231ER	Vdet-IC	3.1V±2%, Hst, -MR, -Reset ODO, Wt=50ms, Rt=50ms	USP-6C	49xh	VD16	9b	Tor
4C232	XC6102C232ER	Vdet-IC	3.2V±2%, Hst, -MR, -Reset ODO, Wt=50ms, Rt=50ms	USP-6C	49xh	VD16	9b	Tor
4C233	XC6102C233ER	Vdet-IC	3.3V±2%, Hst, -MR, -Reset ODO, Wt=50ms, Rt=50ms	USP-6C	49xh	VD16	9b	Tor
4C234	XC6102C234ER	Vdet-IC	3.4V±2%, Hst, -MR, -Reset ODO, Wt=50ms, Rt=50ms	USP-6C	49xh	VD16	9b	Tor
4C235	XC6102C235ER	Vdet-IC	3.5V±2%, Hst, -MR, -Reset ODO, Wt=50ms, Rt=50ms	USP-6C	49xh	VD16	9b	Tor
4C236	XC6102C236ER	Vdet-IC	3.6V±2%, Hst, -MR, -Reset ODO, Wt=50ms, Rt=50ms	USP-6C	49xh	VD16	9b	Tor
4C237	XC6102C237ER	Vdet-IC	3.7V±2%, Hst, -MR, -Reset ODO, Wt=50ms, Rt=50ms	USP-6C	49xh	VD16	9b	Tor
4C238	XC6102C238ER	Vdet-IC	3.8V±2%, Hst, -MR, -Reset ODO, Wt=50ms, Rt=50ms	USP-6C	49xh	VD16	9b	Tor



SMD code	Type	Function	Short description	Case	Pinout	Sch.	St.	Mnf.
4C631	XC6102C631ER	Vdet-IC	3.1V±2%, Hst, -MR, -Reset ODO, Wt=1.6s, Rt=50ms	USP-6C	49xh	VD16	9b	Tor
4C632	XC6102C632ER	Vdet-IC	3.2V±2%, Hst, -MR, -Reset ODO, Wt=1.6s, Rt=50ms	USP-6C	49xh	VD16	9b	Tor
4C633	XC6102C633ER	Vdet-IC	3.3V±2%, Hst, -MR, -Reset ODO, Wt=1.6s, Rt=50ms	USP-6C	49xh	VD16	9b	Tor
4C634	XC6102C634ER	Vdet-IC	3.4V±2%, Hst, -MR, -Reset ODO, Wt=1.6s, Rt=50ms	USP-6C	49xh	VD16	9b	Tor
4C635	XC6102C635ER	Vdet-IC	3.5V±2%, Hst, -MR, -Reset ODO, Wt=1.6s, Rt=50ms	USP-6C	49xh	VD16	9b	Tor
4C636	XC6102C636ER	Vdet-IC	3.6V±2%, Hst, -MR, -Reset ODO, Wt=1.6s, Rt=50ms	USP-6C	49xh	VD16	9b	Tor
4C637	XC6102C637ER	Vdet-IC	3.7V±2%, Hst, -MR, -Reset ODO, Wt=1.6s, Rt=50ms	USP-6C	49xh	VD16	9b	Tor
4C638	XC6102C638ER	Vdet-IC	3.8V±2%, Hst, -MR, -Reset ODO, Wt=1.6s, Rt=50ms	USP-6C	49xh	VD16	9b	Tor
4C639	XC6102C639ER	Vdet-IC	3.9V±2%, Hst, -MR, -Reset ODO, Wt=1.6s, Rt=50ms	USP-6C	49xh	VD16	9b	Tor
4C640	XC6102C640ER	Vdet-IC	4.0V±2%, Hst, -MR, -Reset ODO, Wt=1.6s, Rt=50ms	USP-6C	49xh	VD16	9b	Tor
4C641	XC6102C641ER	Vdet-IC	4.1V±2%, Hst, -MR, -Reset ODO, Wt=1.6s, Rt=50ms	USP-6C	49xh	VD16	9b	Tor
4C642	XC6102C642ER	Vdet-IC	4.2V±2%, Hst, -MR, -Reset ODO, Wt=1.6s, Rt=50ms	USP-6C	49xh	VD16	9b	Tor
4C643	XC6102C643ER	Vdet-IC	4.3V±2%, Hst, -MR, -Reset ODO, Wt=1.6s, Rt=50ms	USP-6C	49xh	VD16	9b	Tor
4C644	XC6102C644ER	Vdet-IC	4.4V±2%, Hst, -MR, -Reset ODO, Wt=1.6s, Rt=50ms	USP-6C	49xh	VD16	9b	Tor
4C645	XC6102C645ER	Vdet-IC	4.5V±2%, Hst, -MR, -Reset ODO, Wt=1.6s, Rt=50ms	USP-6C	49xh	VD16	9b	Tor
4C646	XC6102C646ER	Vdet-IC	4.6V±2%, Hst, -MR, -Reset ODO, Wt=1.6s, Rt=50ms	USP-6C	49xh	VD16	9b	Tor
4C647	XC6102C647ER	Vdet-IC	4.7V±2%, Hst, -MR, -Reset ODO, Wt=1.6s, Rt=50ms	USP-6C	49xh	VD16	9b	Tor
4C648	XC6102C648ER	Vdet-IC	4.8V±2%, Hst, -MR, -Reset ODO, Wt=1.6s, Rt=50ms	USP-6C	49xh	VD16	9b	Tor
4C649	XC6102C649ER	Vdet-IC	4.9V±2%, Hst, -MR, -Reset ODO, Wt=1.6s, Rt=50ms	USP-6C	49xh	VD16	9b	Tor
4C650	XC6102C650ER	Vdet-IC	5.0V±2%, Hst, -MR, -Reset ODO, Wt=1.6s, Rt=50ms	USP-6C	49xh	VD16	9b	Tor
4C7	XC9235A27C4R-G	DC-DC-IC	PWM, st-dwn, 2.7V±2%, 600mA, 1.2MHz, Vin>2V, LSST	USP-6EL	56dc5	DC1	9a	Tor
4C7	XC9235A27CER	DC-DC-IC	PWM, st-dwn, 2.7V±2%, 600mA, 1.2MHz, Vin>2V, LSST	USP-6C	49dc5	DC1	9a	Tor
4C8	XC9235A28C4R-G	DC-DC-IC	PWM, st-dwn, 2.8V±2%, 600mA, 1.2MHz, Vin>2V, LSST	USP-6EL	56dc5	DC1	9a	Tor
4C8	XC9235A28CER	DC-DC-IC	PWM, st-dwn, 2.8V±2%, 600mA, 1.2MHz, Vin>2V, LSST	USP-6C	49dc5	DC1	9a	Tor
4C9	XC9235A29C4R-G	DC-DC-IC	PWM, st-dwn, 2.9V±2%, 600mA, 1.2MHz, Vin>2V, LSST	USP-6EL	56dc5	DC1	9a	Tor
4C9	XC9235A29CER	DC-DC-IC	PWM, st-dwn, 2.9V±2%, 600mA, 1.2MHz, Vin>2V, LSST	USP-6C	49dc5	DC1	9a	Tor
4CA	XC9235A2AC4R-G	DC-DC-IC	PWM, st-dwn, 2.05V±2%, 600mA, 1.2MHz, Vin>2V, LSST	USP-6EL	56dc5	DC1	9a	Tor
4CA	XC9235A2ACER	DC-DC-IC	PWM, st-dwn, 2.05V±2%, 600mA, 1.2MHz, Vin>2V, LSST	USP-6C	49dc5	DC1	9a	Tor
4CB	XC9235A2BC4R-G	DC-DC-IC	PWM, st-dwn, 2.15V±2%, 600mA, 1.2MHz, Vin>2V, LSST	USP-6EL	56dc5	DC1	9a	Tor
4CB	XC9235A2BCER	DC-DC-IC	PWM, st-dwn, 2.15V±2%, 600mA, 1.2MHz, Vin>2V, LSST	USP-6C	49dc5	DC1	9a	Tor
4CC	XC9235A2CC4R-G	DC-DC-IC	PWM, st-dwn, 2.25V±2%, 600mA, 1.2MHz, Vin>2V, LSST	USP-6EL	56dc5	DC1	9a	Tor
4CC	XC9235A2CCER	DC-DC-IC	PWM, st-dwn, 2.25V±2%, 600mA, 1.2MHz, Vin>2V, LSST	USP-6C	49dc5	DC1	9a	Tor
4CD	XC9235A2DC4R-G	DC-DC-IC	PWM, st-dwn, 2.35V±2%, 600mA, 1.2MHz, Vin>2V, LSST	USP-6EL	56dc5	DC1	9a	Tor
4CD	XC9235A2DCER	DC-DC-IC	PWM, st-dwn, 2.35V±2%, 600mA, 1.2MHz, Vin>2V, LSST	USP-6C	49dc5	DC1	9a	Tor
4CE	XC9235A2EC4R-G	DC-DC-IC	PWM, st-dwn, 2.45V±2%, 600mA, 1.2MHz, Vin>2V, LSST	USP-6EL	56dc5	DC1	9a	Tor
4CE	XC9235A2ECER	DC-DC-IC	PWM, st-dwn, 2.45V±2%, 600mA, 1.2MHz, Vin>2V, LSST	USP-6C	49dc5	DC1	9a	Tor
4CF	XC9235A2FC4R-G	DC-DC-IC	PWM, st-dwn, 2.55V±2%, 600mA, 1.2MHz, Vin>2V, LSST	USP-6EL	56dc5	DC1	9a	Tor
4CF	XC9235A2FCER	DC-DC-IC	PWM, st-dwn, 2.55V±2%, 600mA, 1.2MHz, Vin>2V, LSST	USP-6C	49dc5	DC1	9a	Tor
4CH	XC9235A2HC4R-G	DC-DC-IC	PWM, st-dwn, 2.65V±2%, 600mA, 1.2MHz, Vin>2V, LSST	USP-6EL	56dc5	DC1	9a	Tor
4CH	XC9235A2HCER	DC-DC-IC	PWM, st-dwn, 2.65V±2%, 600mA, 1.2MHz, Vin>2V, LSST	USP-6C	49dc5	DC1	9a	Tor
4CK	XC9235A2KC4R-G	DC-DC-IC	PWM, st-dwn, 2.75V±2%, 600mA, 1.2MHz, Vin>2V, LSST	USP-6EL	56dc5	DC1	9a	Tor
4CK	XC9235A2KCER	DC-DC-IC	PWM, st-dwn, 2.75V±2%, 600mA, 1.2MHz, Vin>2V, LSST	USP-6C	49dc5	DC1	9a	Tor
4CL	XC9235A2LC4R-G	DC-DC-IC	PWM, st-dwn, 2.85V±2%, 600mA, 1.2MHz, Vin>2V, LSST	USP-6EL	56dc5	DC1	9a	Tor
4CL	XC9235A2LCER	DC-DC-IC	PWM, st-dwn, 2.85V±2%, 600mA, 1.2MHz, Vin>2V, LSST	USP-6C	49dc5	DC1	9a	Tor
4CM	XC9235A2MC4R-G	DC-DC-IC	PWM, st-dwn, 2.95V±2%, 600mA, 1.2MHz, Vin>2V, LSST	USP-6EL	56dc5	DC1	9a	Tor
4CM	XC9235A2MCER	DC-DC-IC	PWM, st-dwn, 2.95V±2%, 600mA, 1.2MHz, Vin>2V, LSST	USP-6C	49dc5	DC1	9a	Tor
4D	R3117K341C	Vdet-IC	3.4V±1%, -Reset PPO, Sense	DFN1010-4	48rq	VD12	9a	Ric
4D	RP101K181D	LVR-IC	LDO, LN, +CE, CL, 1.8V±0.8%, 300mA	DFN1612-4	45vm	VR4	9a	Ric
4D	XC622E2319R-G	LVR-IC	LDO, 2.3V±1%, 300mA, +CE, ICP	USPQ-4B03	48vm	VR4	9a	Tor
4D	XC622D12117R	LVR-IC	LDO, 2.1V±1%, 200mA, +CE, CL, PDR	USPN-4	58vm	VR4	9a	Tor
4D0	XC9235A30C4R-G	DC-DC-IC	PWM, st-dwn, 3.0V±2%, 600mA, 1.2MHz, Vin>2V, LSST	USP-6EL	56dc5	DC1	9a	Tor
4D0	XC9235A30CER	DC-DC-IC	PWM, st-dwn, 3.0V±2%, 600mA, 1.2MHz, Vin>2V, LSST	USP-6C	49dc5	DC1	9a	Tor
4D016	XC6107D016ER	Vdet-IC	1.6V±2%, Hst, -MR, +Rst PPO, -Rst ODO, Rt=100ms	USP-6C	49xs	VD22	9b	Tor
4D017	XC6107D017ER	Vdet-IC	1.7V±2%, Hst, -MR, +Rst PPO, -Rst ODO, Rt=100ms	USP-6C	49xs	VD22	9b	Tor
4D018	XC6107D018ER	Vdet-IC	1.8V±2%, Hst, -MR, +Rst PPO, -Rst ODO, Rt=100ms	USP-6C	49xs	VD22	9b	Tor
4D019	XC6107D019ER	Vdet-IC	1.9V±2%, Hst, -MR, +Rst PPO, -Rst ODO, Rt=100ms	USP-6C	49xs	VD22	9b	Tor
4D020	XC6107D020ER	Vdet-IC	2.0V±2%, Hst, -MR, +Rst PPO, -Rst ODO, Rt=100ms	USP-6C	49xs	VD22	9b	Tor
4D021	XC6107D021ER	Vdet-IC	2.1V±2%, Hst, -MR, +Rst PPO, -Rst ODO, Rt=100ms	USP-6C	49xs	VD22	9b	Tor
4D022	XC6107D022ER	Vdet-IC	2.2V±2%, Hst, -MR, +Rst PPO, -Rst ODO, Rt=100ms	USP-6C	49xs	VD22	9b	Tor
4D023	XC6107D023ER	Vdet-IC	2.3V±2%, Hst, -MR, +Rst PPO, -Rst ODO, Rt=100ms	USP-6C	49xs	VD22	9b	Tor
4D024	XC6107D024ER	Vdet-IC	2.4V±2%, Hst, -MR, +Rst PPO, -Rst ODO, Rt=100ms	USP-6C	49xs	VD22	9b	Tor
4D025	XC6107D025ER	Vdet-IC	2.5V±2%, Hst, -MR, +Rst PPO, -Rst ODO, Rt=100ms	USP-6C	49xs	VD22	9b	Tor
4D026	XC6107D026ER	Vdet-IC	2.6V±2%, Hst, -MR, +Rst PPO, -Rst ODO, Rt=100ms	USP-6C	49xs	VD22	9b	Tor
4D027	XC6107D027ER	Vdet-IC	2.7V±2%, Hst, -MR, +Rst PPO, -Rst ODO, Rt=100ms	USP-6C	49xs	VD22	9b	Tor
4D028	XC6107D028ER	Vdet-IC	2.8V±2%, Hst, -MR, +Rst PPO, -Rst ODO, Rt=100ms	USP-6C	49xs	VD22	9b	Tor
4D029	XC6107D029ER	Vdet-IC	2.9V±2%, Hst, -MR, +Rst PPO, -Rst ODO, Rt=100ms	USP-6C	49xs	VD22	9b	Tor
4D030	XC6107D030ER	Vdet-IC	3.0V±2%, Hst, -MR, +Rst PPO, -Rst ODO, Rt=100ms	USP-6C	49xs	VD22	9b	Tor
4D031	XC6107D031ER	Vdet-IC	3.1V±2%, Hst, -MR, +Rst PPO, -Rst ODO, Rt=100ms	USP-6C	49xs	VD22	9b	Tor
4D032	XC6107D032ER	Vdet-IC	3.2V±2%, Hst, -MR, +Rst PPO, -Rst ODO, Rt=100ms	USP-6C	49xs	VD22	9b	Tor
4D033	XC6107D033ER	Vdet-IC	3.3V±2%, Hst, -MR, +Rst PPO, -Rst ODO, Rt=100ms	USP-6C	49xs	VD22	9b	Tor



SMD code	Type	Function	Short description	Case	Pinout	Sch.	St.	Mnf.
4D622	XC6102D622ER	Vdet-IC	2.2V±2%, Hst, -MR, -Reset ODO, Wt=1.6s, Rt=100ms	USP-6C	49xh	VD16	9b	Tor
4D623	XC6102D623ER	Vdet-IC	2.3V±2%, Hst, -MR, -Reset ODO, Wt=1.6s, Rt=100ms	USP-6C	49xh	VD16	9b	Tor
4D624	XC6102D624ER	Vdet-IC	2.4V±2%, Hst, -MR, -Reset ODO, Wt=1.6s, Rt=100ms	USP-6C	49xh	VD16	9b	Tor
4D625	XC6102D625ER	Vdet-IC	2.5V±2%, Hst, -MR, -Reset ODO, Wt=1.6s, Rt=100ms	USP-6C	49xh	VD16	9b	Tor
4D626	XC6102D626ER	Vdet-IC	2.6V±2%, Hst, -MR, -Reset ODO, Wt=1.6s, Rt=100ms	USP-6C	49xh	VD16	9b	Tor
4D627	XC6102D627ER	Vdet-IC	2.7V±2%, Hst, -MR, -Reset ODO, Wt=1.6s, Rt=100ms	USP-6C	49xh	VD16	9b	Tor
4D628	XC6102D628ER	Vdet-IC	2.8V±2%, Hst, -MR, -Reset ODO, Wt=1.6s, Rt=100ms	USP-6C	49xh	VD16	9b	Tor
4D629	XC6102D629ER	Vdet-IC	2.9V±2%, Hst, -MR, -Reset ODO, Wt=1.6s, Rt=100ms	USP-6C	49xh	VD16	9b	Tor
4D630	XC6102D630ER	Vdet-IC	3.0V±2%, Hst, -MR, -Reset ODO, Wt=1.6s, Rt=100ms	USP-6C	49xh	VD16	9b	Tor
4D631	XC6102D631ER	Vdet-IC	3.1V±2%, Hst, -MR, -Reset ODO, Wt=1.6s, Rt=100ms	USP-6C	49xh	VD16	9b	Tor
4D632	XC6102D632ER	Vdet-IC	3.2V±2%, Hst, -MR, -Reset ODO, Wt=1.6s, Rt=100ms	USP-6C	49xh	VD16	9b	Tor
4D633	XC6102D633ER	Vdet-IC	3.3V±2%, Hst, -MR, -Reset ODO, Wt=1.6s, Rt=100ms	USP-6C	49xh	VD16	9b	Tor
4D634	XC6102D634ER	Vdet-IC	3.4V±2%, Hst, -MR, -Reset ODO, Wt=1.6s, Rt=100ms	USP-6C	49xh	VD16	9b	Tor
4D635	XC6102D635ER	Vdet-IC	3.5V±2%, Hst, -MR, -Reset ODO, Wt=1.6s, Rt=100ms	USP-6C	49xh	VD16	9b	Tor
4D636	XC6102D636ER	Vdet-IC	3.6V±2%, Hst, -MR, -Reset ODO, Wt=1.6s, Rt=100ms	USP-6C	49xh	VD16	9b	Tor
4D637	XC6102D637ER	Vdet-IC	3.7V±2%, Hst, -MR, -Reset ODO, Wt=1.6s, Rt=100ms	USP-6C	49xh	VD16	9b	Tor
4D638	XC6102D638ER	Vdet-IC	3.8V±2%, Hst, -MR, -Reset ODO, Wt=1.6s, Rt=100ms	USP-6C	49xh	VD16	9b	Tor
4D639	XC6102D639ER	Vdet-IC	3.9V±2%, Hst, -MR, -Reset ODO, Wt=1.6s, Rt=100ms	USP-6C	49xh	VD16	9b	Tor
4D640	XC6102D640ER	Vdet-IC	4.0V±2%, Hst, -MR, -Reset ODO, Wt=1.6s, Rt=100ms	USP-6C	49xh	VD16	9b	Tor
4D641	XC6102D641ER	Vdet-IC	4.1V±2%, Hst, -MR, -Reset ODO, Wt=1.6s, Rt=100ms	USP-6C	49xh	VD16	9b	Tor
4D642	XC6102D642ER	Vdet-IC	4.2V±2%, Hst, -MR, -Reset ODO, Wt=1.6s, Rt=100ms	USP-6C	49xh	VD16	9b	Tor
4D643	XC6102D643ER	Vdet-IC	4.3V±2%, Hst, -MR, -Reset ODO, Wt=1.6s, Rt=100ms	USP-6C	49xh	VD16	9b	Tor
4D644	XC6102D644ER	Vdet-IC	4.4V±2%, Hst, -MR, -Reset ODO, Wt=1.6s, Rt=100ms	USP-6C	49xh	VD16	9b	Tor
4D645	XC6102D645ER	Vdet-IC	4.5V±2%, Hst, -MR, -Reset ODO, Wt=1.6s, Rt=100ms	USP-6C	49xh	VD16	9b	Tor
4D646	XC6102D646ER	Vdet-IC	4.6V±2%, Hst, -MR, -Reset ODO, Wt=1.6s, Rt=100ms	USP-6C	49xh	VD16	9b	Tor
4D647	XC6102D647ER	Vdet-IC	4.7V±2%, Hst, -MR, -Reset ODO, Wt=1.6s, Rt=100ms	USP-6C	49xh	VD16	9b	Tor
4D648	XC6102D648ER	Vdet-IC	4.8V±2%, Hst, -MR, -Reset ODO, Wt=1.6s, Rt=100ms	USP-6C	49xh	VD16	9b	Tor
4D649	XC6102D649ER	Vdet-IC	4.9V±2%, Hst, -MR, -Reset ODO, Wt=1.6s, Rt=100ms	USP-6C	49xh	VD16	9b	Tor
4D650	XC6102D650ER	Vdet-IC	5.0V±2%, Hst, -MR, -Reset ODO, Wt=1.6s, Rt=100ms	USP-6C	49xh	VD16	9b	Tor
4D7	XC9235A37C4R-G	DC-DC-IC	PWM, st-dwn, 3.7V±2%, 600mA, 1.2MHz, Vin>2V, LSST	USP-6EL	56dc5	DC1	9a	Tor
4D7	XC9235A37CER	DC-DC-IC	PWM, st-dwn, 3.7V±2%, 600mA, 1.2MHz, Vin>2V, LSST	USP-6C	49dc5	DC1	9a	Tor
4D8	XC9235A38C4R-G	DC-DC-IC	PWM, st-dwn, 3.8V±2%, 600mA, 1.2MHz, Vin>2V, LSST	USP-6EL	56dc5	DC1	9a	Tor
4D8	XC9235A38CER	DC-DC-IC	PWM, st-dwn, 3.8V±2%, 600mA, 1.2MHz, Vin>2V, LSST	USP-6C	49dc5	DC1	9a	Tor
4D9	XC9235A39C4R-G	DC-DC-IC	PWM, st-dwn, 3.9V±2%, 600mA, 1.2MHz, Vin>2V, LSST	USP-6EL	56dc5	DC1	9a	Tor
4D9	XC9235A39CER	DC-DC-IC	PWM, st-dwn, 3.9V±2%, 600mA, 1.2MHz, Vin>2V, LSST	USP-6C	49dc5	DC1	9a	Tor
4DA	XC9235A3AC4R-G	DC-DC-IC	PWM, st-dwn, 3.05V±2%, 600mA, 1.2MHz, Vin>2V, LSST	USP-6EL	56dc5	DC1	9a	Tor
4DA	XC9235A3ACER	DC-DC-IC	PWM, st-dwn, 3.05V±2%, 600mA, 1.2MHz, Vin>2V, LSST	USP-6C	49dc5	DC1	9a	Tor
4DB	XC9235A3BC4R-G	DC-DC-IC	PWM, st-dwn, 3.15V±2%, 600mA, 1.2MHz, Vin>2V, LSST	USP-6EL	56dc5	DC1	9a	Tor
4DB	XC9235A3BCER	DC-DC-IC	PWM, st-dwn, 3.15V±2%, 600mA, 1.2MHz, Vin>2V, LSST	USP-6C	49dc5	DC1	9a	Tor
4DC	XC9235A3CC4R-G	DC-DC-IC	PWM, st-dwn, 3.25V±2%, 600mA, 1.2MHz, Vin>2V, LSST	USP-6EL	56dc5	DC1	9a	Tor
4DC	XC9235A3CCER	DC-DC-IC	PWM, st-dwn, 3.25V±2%, 600mA, 1.2MHz, Vin>2V, LSST	USP-6C	49dc5	DC1	9a	Tor
4DD	XC9235A3DC4R-G	DC-DC-IC	PWM, st-dwn, 3.35V±2%, 600mA, 1.2MHz, Vin>2V, LSST	USP-6EL	56dc5	DC1	9a	Tor
4DD	XC9235A3DCER	DC-DC-IC	PWM, st-dwn, 3.35V±2%, 600mA, 1.2MHz, Vin>2V, LSST	USP-6C	49dc5	DC1	9a	Tor
4DE	XC9235A3EC4R-G	DC-DC-IC	PWM, st-dwn, 3.45V±2%, 600mA, 1.2MHz, Vin>2V, LSST	USP-6EL	56dc5	DC1	9a	Tor
4DE	XC9235A3ECER	DC-DC-IC	PWM, st-dwn, 3.45V±2%, 600mA, 1.2MHz, Vin>2V, LSST	USP-6C	49dc5	DC1	9a	Tor
4DF	XC9235A3FC4R-G	DC-DC-IC	PWM, st-dwn, 3.55V±2%, 600mA, 1.2MHz, Vin>2V, LSST	USP-6EL	56dc5	DC1	9a	Tor
4DF	XC9235A3FCER	DC-DC-IC	PWM, st-dwn, 3.55V±2%, 600mA, 1.2MHz, Vin>2V, LSST	USP-6C	49dc5	DC1	9a	Tor
4DH	XC9235A3HC4R-G	DC-DC-IC	PWM, st-dwn, 3.65V±2%, 600mA, 1.2MHz, Vin>2V, LSST	USP-6EL	56dc5	DC1	9a	Tor
4DH	XC9235A3HCER	DC-DC-IC	PWM, st-dwn, 3.65V±2%, 600mA, 1.2MHz, Vin>2V, LSST	USP-6C	49dc5	DC1	9a	Tor
4DK	XC9235A3KC4R-G	DC-DC-IC	PWM, st-dwn, 3.75V±2%, 600mA, 1.2MHz, Vin>2V, LSST	USP-6EL	56dc5	DC1	9a	Tor
4DK	XC9235A3KCER	DC-DC-IC	PWM, st-dwn, 3.75V±2%, 600mA, 1.2MHz, Vin>2V, LSST	USP-6C	49dc5	DC1	9a	Tor
4DL	XC9235A3LC4R-G	DC-DC-IC	PWM, st-dwn, 3.85V±2%, 600mA, 1.2MHz, Vin>2V, LSST	USP-6EL	56dc5	DC1	9a	Tor
4DL	XC9235A3LCER	DC-DC-IC	PWM, st-dwn, 3.85V±2%, 600mA, 1.2MHz, Vin>2V, LSST	USP-6C	49dc5	DC1	9a	Tor
4DM	XC9235A3MC4R-G	DC-DC-IC	PWM, st-dwn, 3.95V±2%, 600mA, 1.2MHz, Vin>2V, LSST	USP-6EL	56dc5	DC1	9a	Tor
4DM	XC9235A3MCER	DC-DC-IC	PWM, st-dwn, 3.95V±2%, 600mA, 1.2MHz, Vin>2V, LSST	USP-6C	49dc5	DC1	9a	Tor
4E	R3117K351C	Vdet-IC	3.5V±1%, -Reset PPO, Sense	DFN1010-4	48rq	VD12	9a	Ric
4E	RP101K181D5	LVR-IC	LDO, LN, +CE, CL, 1.85V±0.8%, 300mA	DFN1612-4	45vm	VR4	9a	Ric
4E	XG6223E2419R-G	LVR-IC	LDO, 2.4V±1%, 300mA, +CE, ICP	USPQ-4B03	48vm	VR4	9a	Tor
4E	XG6221D2217R	LVR-IC	LDO, 2.2V±1%, 200mA, +CE, CL, PDR	USPN-4	58vm	VR4	9a	Tor
4E0	XC9235A40C4R-G	DC-DC-IC	PWM, st-dwn, 4.0V±2%, 600mA, 1.2MHz, Vin>2V, LSST	USP-6EL	56dc5	DC1	9a	Tor
4E0	XC9235A40CER	DC-DC-IC	PWM, st-dwn, 4.0V±2%, 600mA, 1.2MHz, Vin>2V, LSST	USP-6C	49dc5	DC1	9a	Tor
4E016	XC6107E016ER	Vdet-IC	1.6V±2%, Hst, -MR, +Rst PPO, -Rst ODO, Rt=200ms	USP-6C	49xs	VD22	9b	Tor
4E017	XC6107E017ER	Vdet-IC	1.7V±2%, Hst, -MR, +Rst PPO, -Rst ODO, Rt=200ms	USP-6C	49xs	VD22	9b	Tor
4E018	XC6107E018ER	Vdet-IC	1.8V±2%, Hst, -MR, +Rst PPO, -Rst ODO, Rt=200ms	USP-6C	49xs	VD22	9b	Tor
4E019	XC6107E019ER	Vdet-IC	1.9V±2%, Hst, -MR, +Rst PPO, -Rst ODO, Rt=200ms	USP-6C	49xs	VD22	9b	Tor
4E020	XC6107E020ER	Vdet-IC	2.0V±2%, Hst, -MR, +Rst PPO, -Rst ODO, Rt=200ms	USP-6C	49xs	VD22	9b	Tor
4E021	XC6107E021ER	Vdet-IC	2.1V±2%, Hst, -MR, +Rst PPO, -Rst ODO, Rt=200ms	USP-6C	49xs	VD22	9b	Tor
4E022	XC6107E022ER	Vdet-IC	2.2V±2%, Hst, -MR, +Rst PPO, -Rst ODO, Rt=200ms	USP-6C	49xs	VD22	9b	Tor
4E023	XC6107E023ER	Vdet-IC	2.3V±2%, Hst, -MR, +Rst PPO, -Rst ODO, Rt=200ms	USP-6C	49xs	VD22	9b	Tor
4E024	XC6107E024ER	Vdet-IC	2.4V±2%, Hst, -MR, +Rst PPO, -Rst ODO, Rt=200ms	USP-6C	49xs	VD22	9b	Tor



SMD code	Type	Function	Short description	Case	Pinout	Sch.	St.Mnf.
4E525	XC6102E525ER	Vdet-IC	2.5V±2%, Hst, -MR, -Reset ODO, Wt=400ms, Rt=200ms	USP-6C	49xh	VD16	9b Tor
4E526	XC6102E526ER	Vdet-IC	2.6V±2%, Hst, -MR, -Reset ODO, Wt=400ms, Rt=200ms	USP-6C	49xh	VD16	9b Tor
4E527	XC6102E527ER	Vdet-IC	2.7V±2%, Hst, -MR, -Reset ODO, Wt=400ms, Rt=200ms	USP-6C	49xh	VD16	9b Tor
4E528	XC6102E528ER	Vdet-IC	2.8V±2%, Hst, -MR, -Reset ODO, Wt=400ms, Rt=200ms	USP-6C	49xh	VD16	9b Tor
4E529	XC6102E529ER	Vdet-IC	2.9V±2%, Hst, -MR, -Reset ODO, Wt=400ms, Rt=200ms	USP-6C	49xh	VD16	9b Tor
4E530	XC6102E530ER	Vdet-IC	3.0V±2%, Hst, -MR, -Reset ODO, Wt=400ms, Rt=200ms	USP-6C	49xh	VD16	9b Tor
4E531	XC6102E531ER	Vdet-IC	3.1V±2%, Hst, -MR, -Reset ODO, Wt=400ms, Rt=200ms	USP-6C	49xh	VD16	9b Tor
4E532	XC6102E532ER	Vdet-IC	3.2V±2%, Hst, -MR, -Reset ODO, Wt=400ms, Rt=200ms	USP-6C	49xh	VD16	9b Tor
4E533	XC6102E533ER	Vdet-IC	3.3V±2%, Hst, -MR, -Reset ODO, Wt=400ms, Rt=200ms	USP-6C	49xh	VD16	9b Tor
4E534	XC6102E534ER	Vdet-IC	3.4V±2%, Hst, -MR, -Reset ODO, Wt=400ms, Rt=200ms	USP-6C	49xh	VD16	9b Tor
4E535	XC6102E535ER	Vdet-IC	3.5V±2%, Hst, -MR, -Reset ODO, Wt=400ms, Rt=200ms	USP-6C	49xh	VD16	9b Tor
4E536	XC6102E536ER	Vdet-IC	3.6V±2%, Hst, -MR, -Reset ODO, Wt=400ms, Rt=200ms	USP-6C	49xh	VD16	9b Tor
4E537	XC6102E537ER	Vdet-IC	3.7V±2%, Hst, -MR, -Reset ODO, Wt=400ms, Rt=200ms	USP-6C	49xh	VD16	9b Tor
4E538	XC6102E538ER	Vdet-IC	3.8V±2%, Hst, -MR, -Reset ODO, Wt=400ms, Rt=200ms	USP-6C	49xh	VD16	9b Tor
4E539	XC6102E539ER	Vdet-IC	3.9V±2%, Hst, -MR, -Reset ODO, Wt=400ms, Rt=200ms	USP-6C	49xh	VD16	9b Tor
4E540	XC6102E540ER	Vdet-IC	4.0V±2%, Hst, -MR, -Reset ODO, Wt=400ms, Rt=200ms	USP-6C	49xh	VD16	9b Tor
4E541	XC6102E541ER	Vdet-IC	4.1V±2%, Hst, -MR, -Reset ODO, Wt=400ms, Rt=200ms	USP-6C	49xh	VD16	9b Tor
4E542	XC6102E542ER	Vdet-IC	4.2V±2%, Hst, -MR, -Reset ODO, Wt=400ms, Rt=200ms	USP-6C	49xh	VD16	9b Tor
4E543	XC6102E543ER	Vdet-IC	4.3V±2%, Hst, -MR, -Reset ODO, Wt=400ms, Rt=200ms	USP-6C	49xh	VD16	9b Tor
4E544	XC6102E544ER	Vdet-IC	4.4V±2%, Hst, -MR, -Reset ODO, Wt=400ms, Rt=200ms	USP-6C	49xh	VD16	9b Tor
4E545	XC6102E545ER	Vdet-IC	4.5V±2%, Hst, -MR, -Reset ODO, Wt=400ms, Rt=200ms	USP-6C	49xh	VD16	9b Tor
4E546	XC6102E546ER	Vdet-IC	4.6V±2%, Hst, -MR, -Reset ODO, Wt=400ms, Rt=200ms	USP-6C	49xh	VD16	9b Tor
4E547	XC6102E547ER	Vdet-IC	4.7V±2%, Hst, -MR, -Reset ODO, Wt=400ms, Rt=200ms	USP-6C	49xh	VD16	9b Tor
4E548	XC6102E548ER	Vdet-IC	4.8V±2%, Hst, -MR, -Reset ODO, Wt=400ms, Rt=200ms	USP-6C	49xh	VD16	9b Tor
4E549	XC6102E549ER	Vdet-IC	4.9V±2%, Hst, -MR, -Reset ODO, Wt=400ms, Rt=200ms	USP-6C	49xh	VD16	9b Tor
4E550	XC6102E550ER	Vdet-IC	5.0V±2%, Hst, -MR, -Reset ODO, Wt=400ms, Rt=200ms	USP-6C	49xh	VD16	9b Tor
4E616	XC6102E616ER	Vdet-IC	1.6V±2%, Hst, -MR, -Reset ODO, Wt=1.6s, Rt=200ms	USP-6C	49xh	VD16	9b Tor
4E617	XC6102E617ER	Vdet-IC	1.7V±2%, Hst, -MR, -Reset ODO, Wt=1.6s, Rt=200ms	USP-6C	49xh	VD16	9b Tor
4E618	XC6102E618ER	Vdet-IC	1.8V±2%, Hst, -MR, -Reset ODO, Wt=1.6s, Rt=200ms	USP-6C	49xh	VD16	9b Tor
4E619	XC6102E619ER	Vdet-IC	1.9V±2%, Hst, -MR, -Reset ODO, Wt=1.6s, Rt=200ms	USP-6C	49xh	VD16	9b Tor
4E620	XC6102E620ER	Vdet-IC	2.0V±2%, Hst, -MR, -Reset ODO, Wt=1.6s, Rt=200ms	USP-6C	49xh	VD16	9b Tor
4E621	XC6102E621ER	Vdet-IC	2.1V±2%, Hst, -MR, -Reset ODO, Wt=1.6s, Rt=200ms	USP-6C	49xh	VD16	9b Tor
4E622	XC6102E622ER	Vdet-IC	2.2V±2%, Hst, -MR, -Reset ODO, Wt=1.6s, Rt=200ms	USP-6C	49xh	VD16	9b Tor
4E623	XC6102E623ER	Vdet-IC	2.3V±2%, Hst, -MR, -Reset ODO, Wt=1.6s, Rt=200ms	USP-6C	49xh	VD16	9b Tor
4E624	XC6102E624ER	Vdet-IC	2.4V±2%, Hst, -MR, -Reset ODO, Wt=1.6s, Rt=200ms	USP-6C	49xh	VD16	9b Tor
4E625	XC6102E625ER	Vdet-IC	2.5V±2%, Hst, -MR, -Reset ODO, Wt=1.6s, Rt=200ms	USP-6C	49xh	VD16	9b Tor
4E626	XC6102E626ER	Vdet-IC	2.6V±2%, Hst, -MR, -Reset ODO, Wt=1.6s, Rt=200ms	USP-6C	49xh	VD16	9b Tor
4E627	XC6102E627ER	Vdet-IC	2.7V±2%, Hst, -MR, -Reset ODO, Wt=1.6s, Rt=200ms	USP-6C	49xh	VD16	9b Tor
4E628	XC6102E628ER	Vdet-IC	2.8V±2%, Hst, -MR, -Reset ODO, Wt=1.6s, Rt=200ms	USP-6C	49xh	VD16	9b Tor
4E629	XC6102E629ER	Vdet-IC	2.9V±2%, Hst, -MR, -Reset ODO, Wt=1.6s, Rt=200ms	USP-6C	49xh	VD16	9b Tor
4E630	XC6102E630ER	Vdet-IC	3.0V±2%, Hst, -MR, -Reset ODO, Wt=1.6s, Rt=200ms	USP-6C	49xh	VD16	9b Tor
4E631	XC6102E631ER	Vdet-IC	3.1V±2%, Hst, -MR, -Reset ODO, Wt=1.6s, Rt=200ms	USP-6C	49xh	VD16	9b Tor
4E632	XC6102E632ER	Vdet-IC	3.2V±2%, Hst, -MR, -Reset ODO, Wt=1.6s, Rt=200ms	USP-6C	49xh	VD16	9b Tor
4E633	XC6102E633ER	Vdet-IC	3.3V±2%, Hst, -MR, -Reset ODO, Wt=1.6s, Rt=200ms	USP-6C	49xh	VD16	9b Tor
4E634	XC6102E634ER	Vdet-IC	3.4V±2%, Hst, -MR, -Reset ODO, Wt=1.6s, Rt=200ms	USP-6C	49xh	VD16	9b Tor
4E635	XC6102E635ER	Vdet-IC	3.5V±2%, Hst, -MR, -Reset ODO, Wt=1.6s, Rt=200ms	USP-6C	49xh	VD16	9b Tor
4E636	XC6102E636ER	Vdet-IC	3.6V±2%, Hst, -MR, -Reset ODO, Wt=1.6s, Rt=200ms	USP-6C	49xh	VD16	9b Tor
4E637	XC6102E637ER	Vdet-IC	3.7V±2%, Hst, -MR, -Reset ODO, Wt=1.6s, Rt=200ms	USP-6C	49xh	VD16	9b Tor
4E638	XC6102E638ER	Vdet-IC	3.8V±2%, Hst, -MR, -Reset ODO, Wt=1.6s, Rt=200ms	USP-6C	49xh	VD16	9b Tor
4E639	XC6102E639ER	Vdet-IC	3.9V±2%, Hst, -MR, -Reset ODO, Wt=1.6s, Rt=200ms	USP-6C	49xh	VD16	9b Tor
4E640	XC6102E640ER	Vdet-IC	4.0V±2%, Hst, -MR, -Reset ODO, Wt=1.6s, Rt=200ms	USP-6C	49xh	VD16	9b Tor
4E641	XC6102E641ER	Vdet-IC	4.1V±2%, Hst, -MR, -Reset ODO, Wt=1.6s, Rt=200ms	USP-6C	49xh	VD16	9b Tor
4E642	XC6102E642ER	Vdet-IC	4.2V±2%, Hst, -MR, -Reset ODO, Wt=1.6s, Rt=200ms	USP-6C	49xh	VD16	9b Tor
4E643	XC6102E643ER	Vdet-IC	4.3V±2%, Hst, -MR, -Reset ODO, Wt=1.6s, Rt=200ms	USP-6C	49xh	VD16	9b Tor
4E644	XC6102E644ER	Vdet-IC	4.4V±2%, Hst, -MR, -Reset ODO, Wt=1.6s, Rt=200ms	USP-6C	49xh	VD16	9b Tor
4E645	XC6102E645ER	Vdet-IC	4.5V±2%, Hst, -MR, -Reset ODO, Wt=1.6s, Rt=200ms	USP-6C	49xh	VD16	9b Tor
4E646	XC6102E646ER	Vdet-IC	4.6V±2%, Hst, -MR, -Reset ODO, Wt=1.6s, Rt=200ms	USP-6C	49xh	VD16	9b Tor
4E647	XC6102E647ER	Vdet-IC	4.7V±2%, Hst, -MR, -Reset ODO, Wt=1.6s, Rt=200ms	USP-6C	49xh	VD16	9b Tor
4E648	XC6102E648ER	Vdet-IC	4.8V±2%, Hst, -MR, -Reset ODO, Wt=1.6s, Rt=200ms	USP-6C	49xh	VD16	9b Tor
4E649	XC6102E649ER	Vdet-IC	4.9V±2%, Hst, -MR, -Reset ODO, Wt=1.6s, Rt=200ms	USP-6C	49xh	VD16	9b Tor
4E650	XC6102E650ER	Vdet-IC	5.0V±2%, Hst, -MR, -Reset ODO, Wt=1.6s, Rt=200ms	USP-6C	49xh	VD16	9b Tor
4F	R3117K361C	Vdet-IC	3.6V±1%, -Reset PPO, Sense	DFN11010-4	48rq	VD12	9a Ric
4F	RP101K191D	LVR-IC	LDO, LN, +CE, CL, 1.9V±0.8%, 300mA	DFN11612-4	45vm	VR4	9a Ric
4F	XC6223E2519R-G	LVR-IC	LDO, 2.5V±1%, 300mA, +CE, ICP	USPQ-4B03	48vm	VR4	9a Tor
4F	XC6221D2317R	LVR-IC	LDO, 2.3V±1%, 200mA, +CE, CL, PDR	USPN-4	58vm	VR4	9a Tor
4F016	XC6107F016ER	Vdet-IC	1.6V±2%, Hst, -MR, +Rst PPO, -Rst ODO, Rt=400ms	USP-6C	49xs	VD22	9b Tor
4F017	XC6107F017ER	Vdet-IC	1.7V±2%, Hst, -MR, +Rst PPO, -Rst ODO, Rt=400ms	USP-6C	49xs	VD22	9b Tor
4F018	XC6107F018ER	Vdet-IC	1.8V±2%, Hst, -MR, +Rst PPO, -Rst ODO, Rt=400ms	USP-6C	49xs	VD22	9b Tor
4F019	XC6107F019ER	Vdet-IC	1.9V±2%, Hst, -MR, +Rst PPO, -Rst ODO, Rt=400ms	USP-6C	49xs	VD22	9b Tor
4F020	XC6107F020ER	Vdet-IC	2.0V±2%, Hst, -MR, +Rst PPO, -Rst ODO, Rt=400ms	USP-6C	49xs	VD22	9b Tor



SMD code	Type	Function	Short description	Case	Pinout	Sch.	St.	Mnf.
4F621	XC6102F621ER	Vdet-IC	2.1V±2%, Hst, -MR, -Reset ODO, Wt=1.6s, Rt=400ms	USP-6C	49xh	VD16	9b	Tor
4F622	XC6102F622ER	Vdet-IC	2.2V±2%, Hst, -MR, -Reset ODO, Wt=1.6s, Rt=400ms	USP-6C	49xh	VD16	9b	Tor
4F623	XC6102F623ER	Vdet-IC	2.3V±2%, Hst, -MR, -Reset ODO, Wt=1.6s, Rt=400ms	USP-6C	49xh	VD16	9b	Tor
4F624	XC6102F624ER	Vdet-IC	2.4V±2%, Hst, -MR, -Reset ODO, Wt=1.6s, Rt=400ms	USP-6C	49xh	VD16	9b	Tor
4F625	XC6102F625ER	Vdet-IC	2.5V±2%, Hst, -MR, -Reset ODO, Wt=1.6s, Rt=400ms	USP-6C	49xh	VD16	9b	Tor
4F626	XC6102F626ER	Vdet-IC	2.6V±2%, Hst, -MR, -Reset ODO, Wt=1.6s, Rt=400ms	USP-6C	49xh	VD16	9b	Tor
4F627	XC6102F627ER	Vdet-IC	2.7V±2%, Hst, -MR, -Reset ODO, Wt=1.6s, Rt=400ms	USP-6C	49xh	VD16	9b	Tor
4F628	XC6102F628ER	Vdet-IC	2.8V±2%, Hst, -MR, -Reset ODO, Wt=1.6s, Rt=400ms	USP-6C	49xh	VD16	9b	Tor
4F629	XC6102F629ER	Vdet-IC	2.9V±2%, Hst, -MR, -Reset ODO, Wt=1.6s, Rt=400ms	USP-6C	49xh	VD16	9b	Tor
4F630	XC6102F630ER	Vdet-IC	3.0V±2%, Hst, -MR, -Reset ODO, Wt=1.6s, Rt=400ms	USP-6C	49xh	VD16	9b	Tor
4F631	XC6102F631ER	Vdet-IC	3.1V±2%, Hst, -MR, -Reset ODO, Wt=1.6s, Rt=400ms	USP-6C	49xh	VD16	9b	Tor
4F632	XC6102F632ER	Vdet-IC	3.2V±2%, Hst, -MR, -Reset ODO, Wt=1.6s, Rt=400ms	USP-6C	49xh	VD16	9b	Tor
4F633	XC6102F633ER	Vdet-IC	3.3V±2%, Hst, -MR, -Reset ODO, Wt=1.6s, Rt=400ms	USP-6C	49xh	VD16	9b	Tor
4F634	XC6102F634ER	Vdet-IC	3.4V±2%, Hst, -MR, -Reset ODO, Wt=1.6s, Rt=400ms	USP-6C	49xh	VD16	9b	Tor
4F635	XC6102F635ER	Vdet-IC	3.5V±2%, Hst, -MR, -Reset ODO, Wt=1.6s, Rt=400ms	USP-6C	49xh	VD16	9b	Tor
4F636	XC6102F636ER	Vdet-IC	3.6V±2%, Hst, -MR, -Reset ODO, Wt=1.6s, Rt=400ms	USP-6C	49xh	VD16	9b	Tor
4F637	XC6102F637ER	Vdet-IC	3.7V±2%, Hst, -MR, -Reset ODO, Wt=1.6s, Rt=400ms	USP-6C	49xh	VD16	9b	Tor
4F638	XC6102F638ER	Vdet-IC	3.8V±2%, Hst, -MR, -Reset ODO, Wt=1.6s, Rt=400ms	USP-6C	49xh	VD16	9b	Tor
4F639	XC6102F639ER	Vdet-IC	3.9V±2%, Hst, -MR, -Reset ODO, Wt=1.6s, Rt=400ms	USP-6C	49xh	VD16	9b	Tor
4F640	XC6102F640ER	Vdet-IC	4.0V±2%, Hst, -MR, -Reset ODO, Wt=1.6s, Rt=400ms	USP-6C	49xh	VD16	9b	Tor
4F641	XC6102F641ER	Vdet-IC	4.1V±2%, Hst, -MR, -Reset ODO, Wt=1.6s, Rt=400ms	USP-6C	49xh	VD16	9b	Tor
4F642	XC6102F642ER	Vdet-IC	4.2V±2%, Hst, -MR, -Reset ODO, Wt=1.6s, Rt=400ms	USP-6C	49xh	VD16	9b	Tor
4F643	XC6102F643ER	Vdet-IC	4.3V±2%, Hst, -MR, -Reset ODO, Wt=1.6s, Rt=400ms	USP-6C	49xh	VD16	9b	Tor
4F644	XC6102F644ER	Vdet-IC	4.4V±2%, Hst, -MR, -Reset ODO, Wt=1.6s, Rt=400ms	USP-6C	49xh	VD16	9b	Tor
4F645	XC6102F645ER	Vdet-IC	4.5V±2%, Hst, -MR, -Reset ODO, Wt=1.6s, Rt=400ms	USP-6C	49xh	VD16	9b	Tor
4F646	XC6102F646ER	Vdet-IC	4.6V±2%, Hst, -MR, -Reset ODO, Wt=1.6s, Rt=400ms	USP-6C	49xh	VD16	9b	Tor
4F647	XC6102F647ER	Vdet-IC	4.7V±2%, Hst, -MR, -Reset ODO, Wt=1.6s, Rt=400ms	USP-6C	49xh	VD16	9b	Tor
4F648	XC6102F648ER	Vdet-IC	4.8V±2%, Hst, -MR, -Reset ODO, Wt=1.6s, Rt=400ms	USP-6C	49xh	VD16	9b	Tor
4F649	XC6102F649ER	Vdet-IC	4.9V±2%, Hst, -MR, -Reset ODO, Wt=1.6s, Rt=400ms	USP-6C	49xh	VD16	9b	Tor
4F650	XC6102F650ER	Vdet-IC	5.0V±2%, Hst, -MR, -Reset ODO, Wt=1.6s, Rt=400ms	USP-6C	49xh	VD16	9b	Tor
4F8	XC9235A08D4R-G	DC-DC-IC	PWM, st-dwn, 0.8V±2%, 600mA, 3MHz, Vin>2V, LSST	USP-6EL	56dc5	DC1	9a	Tor
4F8	XC9235A08DER	DC-DC-IC	PWM, st-dwn, 0.8V±2%, 600mA, 3MHz, Vin>2V, LSST	USP-6C	49dc5	DC1	9a	Tor
4F8	XL205A084AR-G	DC/DC-IC	PWM st-dwn, 3MHz, 0.8V±2%, 600mA, -CE	CL-2025	67dc7	DC9	9a	Tor
4F9	XC9235A09D4R-G	DC-DC-IC	PWM, st-dwn, 0.9V±2%, 600mA, 3MHz, Vin>2V, LSST	USP-6EL	56dc5	DC1	9a	Tor
4F9	XC9235A09DER	DC-DC-IC	PWM, st-dwn, 0.9V±2%, 600mA, 3MHz, Vin>2V, LSST	USP-6C	49dc5	DC1	9a	Tor
4F9	XCL205A094AR-G	DC/DC-IC	PWM st-dwn, 3MHz, 0.9V±2%, 600mA, -CE	CL-2025	67dc7	DC9	9a	Tor
4FL	XC9235A0LD4R-G	DC-DC-IC	PWM, st-dwn, 0.85V±2%, 600mA, 3MHz, Vin>2V, LSST	USP-6EL	56dc5	DC1	9a	Tor
4FL	XC9235A0LDER	DC-DC-IC	PWM, st-dwn, 0.85V±2%, 600mA, 3MHz, Vin>2V, LSST	USP-6C	49dc5	DC1	9a	Tor
4FM	XC9235A0MD4R-G	DC-DC-IC	PWM, st-dwn, 0.95V±2%, 600mA, 3MHz, Vin>2V, LSST	USP-6EL	56dc5	DC1	9a	Tor
4FM	XC9235A0MDER	DC-DC-IC	PWM, st-dwn, 0.95V±2%, 600mA, 3MHz, Vin>2V, LSST	USP-6C	49dc5	DC1	9a	Tor
4G	R3117K371C	Vdet-IC	3.7V±1%, -Reset PPO, Sense	DFN1010-4	48rq	VD12	9a	Ric
4G	RP101K201D	LVR-IC	LDO, LN, +CE, CL, 2V±0.8%, 300mA	DFN1612-4	45vm	VR4	9a	Ric
4H	R3117K381C	Vdet-IC	3.8V±1%, -Reset PPO, Sense	DFN1010-4	48rq	VD12	9a	Ric
4H	RP101K251D	LVR-IC	LDO, LN, +CE, CL, 2.5V±0.8%, 300mA	DFN1612-4	45vm	VR4	9a	Ric
4H	XC6223E2619R-G	LVR-IC	LDO, 2.6V±1%, 300mA, +CE, ICP	USPQ-4B03	48vm	VR4	9a	Tor
4H	XC6221D2417R	LVR-IC	LDO, 2.4V±1%, 200mA, +CE, CL, PDR	USPN-4	58vm	VR4	9a	Tor
4H0	XC9235A10D4R-G	DC-DC-IC	PWM, st-dwn, 1.0V±2%, 600mA, 3MHz, Vin>2V, LSST	USP-6EL	56dc5	DC1	9a	Tor
4H0	XC9235A10DER	DC-DC-IC	PWM, st-dwn, 1.0V±2%, 600mA, 3MHz, Vin>2V, LSST	USP-6C	49dc5	DC1	9a	Tor
4H0	XCL205A104AR-G	DC/DC-IC	PWM st-dwn, 3MHz, 1.0V±2%, 600mA, -CE	CL-2025	67dc7	DC9	9a	Tor
4H016	XC6107H016ER	Vdet-IC	1.6V±2%, Hst, -MR, +Rst PPO, -Rst ODO, Rt=1.6s	USP-6C	49xs	VD22	9b	Tor
4H017	XC6107H017ER	Vdet-IC	1.7V±2%, Hst, -MR, +Rst PPO, -Rst ODO, Rt=1.6s	USP-6C	49xs	VD22	9b	Tor
4H018	XC6107H018ER	Vdet-IC	1.8V±2%, Hst, -MR, +Rst PPO, -Rst ODO, Rt=1.6s	USP-6C	49xs	VD22	9b	Tor
4H019	XC6107H019ER	Vdet-IC	1.9V±2%, Hst, -MR, +Rst PPO, -Rst ODO, Rt=1.6s	USP-6C	49xs	VD22	9b	Tor
4H020	XC6107H020ER	Vdet-IC	2.0V±2%, Hst, -MR, +Rst PPO, -Rst ODO, Rt=1.6s	USP-6C	49xs	VD22	9b	Tor
4H021	XC6107H021ER	Vdet-IC	2.1V±2%, Hst, -MR, +Rst PPO, -Rst ODO, Rt=1.6s	USP-6C	49xs	VD22	9b	Tor
4H022	XC6107H022ER	Vdet-IC	2.2V±2%, Hst, -MR, +Rst PPO, -Rst ODO, Rt=1.6s	USP-6C	49xs	VD22	9b	Tor
4H023	XC6107H023ER	Vdet-IC	2.3V±2%, Hst, -MR, +Rst PPO, -Rst ODO, Rt=1.6s	USP-6C	49xs	VD22	9b	Tor
4H024	XC6107H024ER	Vdet-IC	2.4V±2%, Hst, -MR, +Rst PPO, -Rst ODO, Rt=1.6s	USP-6C	49xs	VD22	9b	Tor
4H025	XC6107H025ER	Vdet-IC	2.5V±2%, Hst, -MR, +Rst PPO, -Rst ODO, Rt=1.6s	USP-6C	49xs	VD22	9b	Tor
4H026	XC6107H026ER	Vdet-IC	2.6V±2%, Hst, -MR, +Rst PPO, -Rst ODO, Rt=1.6s	USP-6C	49xs	VD22	9b	Tor
4H027	XC6107H027ER	Vdet-IC	2.7V±2%, Hst, -MR, +Rst PPO, -Rst ODO, Rt=1.6s	USP-6C	49xs	VD22	9b	Tor
4H028	XC6107H028ER	Vdet-IC	2.8V±2%, Hst, -MR, +Rst PPO, -Rst ODO, Rt=1.6s	USP-6C	49xs	VD22	9b	Tor
4H029	XC6107H029ER	Vdet-IC	2.9V±2%, Hst, -MR, +Rst PPO, -Rst ODO, Rt=1.6s	USP-6C	49xs	VD22	9b	Tor
4H030	XC6107H030ER	Vdet-IC	3.0V±2%, Hst, -MR, +Rst PPO, -Rst ODO, Rt=1.6s	USP-6C	49xs	VD22	9b	Tor
4H031	XC6107H031ER	Vdet-IC	3.1V±2%, Hst, -MR, +Rst PPO, -Rst ODO, Rt=1.6s	USP-6C	49xs	VD22	9b	Tor
4H032	XC6107H032ER	Vdet-IC	3.2V±2%, Hst, -MR, +Rst PPO, -Rst ODO, Rt=1.6s	USP-6C	49xs	VD22	9b	Tor
4H033	XC6107H033ER	Vdet-IC	3.3V±2%, Hst, -MR, +Rst PPO, -Rst ODO, Rt=1.6s	USP-6C	49xs	VD22	9b	Tor
4H034	XC6107H034ER	Vdet-IC	3.4V±2%, Hst, -MR, +Rst PPO, -Rst ODO, Rt=1.6s	USP-6C	49xs	VD22	9b	Tor
4H035	XC6107H035ER	Vdet-IC	3.5V±2%, Hst, -MR, +Rst PPO, -Rst ODO, Rt=1.6s	USP-6C	49xs	VD22	9b	Tor
4H036	XC6107H036ER	Vdet-IC	3.6V±2%, Hst, -MR, +Rst PPO, -Rst ODO, Rt=1.6s	USP-6C	49xs	VD22	9b	Tor



SMD code	Type	Function	Short description	Case	Pinout	Sch.	St.Mnf.
4H037	XC6107H037ER	Vdet-IC	3.7V±2%, Hst, -MR, +Rst PPO, -Rst ODO, Rt=1.6s	USP-6C	49xs	VD22	9b Tor
4H038	XC6107H038ER	Vdet-IC	3.8V±2%, Hst, -MR, +Rst PPO, -Rst ODO, Rt=1.6s	USP-6C	49xs	VD22	9b Tor
4H039	XC6107H039ER	Vdet-IC	3.9V±2%, Hst, -MR, +Rst PPO, -Rst ODO, Rt=1.6s	USP-6C	49xs	VD22	9b Tor
4H040	XC6107H040ER	Vdet-IC	4.0V±2%, Hst, -MR, +Rst PPO, -Rst ODO, Rt=1.6s	USP-6C	49xs	VD22	9b Tor
4H041	XC6107H041ER	Vdet-IC	4.1V±2%, Hst, -MR, +Rst PPO, -Rst ODO, Rt=1.6s	USP-6C	49xs	VD22	9b Tor
4H042	XC6107H042ER	Vdet-IC	4.2V±2%, Hst, -MR, +Rst PPO, -Rst ODO, Rt=1.6s	USP-6C	49xs	VD22	9b Tor
4H043	XC6107H043ER	Vdet-IC	4.3V±2%, Hst, -MR, +Rst PPO, -Rst ODO, Rt=1.6s	USP-6C	49xs	VD22	9b Tor
4H044	XC6107H044ER	Vdet-IC	4.4V±2%, Hst, -MR, +Rst PPO, -Rst ODO, Rt=1.6s	USP-6C	49xs	VD22	9b Tor
4H045	XC6107H045ER	Vdet-IC	4.5V±2%, Hst, -MR, +Rst PPO, -Rst ODO, Rt=1.6s	USP-6C	49xs	VD22	9b Tor
4H046	XC6107H046ER	Vdet-IC	4.6V±2%, Hst, -MR, +Rst PPO, -Rst ODO, Rt=1.6s	USP-6C	49xs	VD22	9b Tor
4H047	XC6107H047ER	Vdet-IC	4.7V±2%, Hst, -MR, +Rst PPO, -Rst ODO, Rt=1.6s	USP-6C	49xs	VD22	9b Tor
4H048	XC6107H048ER	Vdet-IC	4.8V±2%, Hst, -MR, +Rst PPO, -Rst ODO, Rt=1.6s	USP-6C	49xs	VD22	9b Tor
4H049	XC6107H049ER	Vdet-IC	4.9V±2%, Hst, -MR, +Rst PPO, -Rst ODO, Rt=1.6s	USP-6C	49xs	VD22	9b Tor
4H050	XC6107H050ER	Vdet-IC	5.0V±2%, Hst, -MR, +Rst PPO, -Rst ODO, Rt=1.6s	USP-6C	49xs	VD22	9b Tor
4H1	XC9235A11D4R-G	DC-DC-IC	PWM, st-dwn, 1.1V±2%, 600mA, 3MHz, Vin>2V, LSST	USP-6EL	56dc5	DC1	9a Tor
4H1	XC9235A11DER	DC-DC-IC	PWM, st-dwn, 1.1V±2%, 600mA, 3MHz, Vin>2V, LSST	USP-6C	49dc5	DC1	9a Tor
4H1	XCL205A114AR-G	DC/DC-IC	PWM st-dwn, 3MHz, 1.1V±2%, 600mA, -CE	CL-2025	67dc7	DC9	9a Tor
4H2	XC9235A12D4R-G	DC-DC-IC	PWM, st-dwn, 1.2V±2%, 600mA, 3MHz, Vin>2V, LSST	USP-6EL	56dc5	DC1	9a Tor
4H2	XC9235A12DER	DC-DC-IC	PWM, st-dwn, 1.2V±2%, 600mA, 3MHz, Vin>2V, LSST	USP-6C	49dc5	DC1	9a Tor
4H2	XCL205A124AR-G	DC/DC-IC	PWM st-dwn, 3MHz, 1.2V±2%, 600mA, -CE	CL-2025	67dc7	DC9	9a Tor
4H3	XC9235A13D4R-G	DC-DC-IC	PWM, st-dwn, 1.3V±2%, 600mA, 3MHz, Vin>2V, LSST	USP-6EL	56dc5	DC1	9a Tor
4H3	XC9235A13DER	DC-DC-IC	PWM, st-dwn, 1.3V±2%, 600mA, 3MHz, Vin>2V, LSST	USP-6C	49dc5	DC1	9a Tor
4H3	XCL205A134AR-G	DC/DC-IC	PWM st-dwn, 3MHz, 1.3V±2%, 600mA, -CE	CL-2025	67dc7	DC9	9a Tor
4H4	XC9235A14D4R-G	DC-DC-IC	PWM, st-dwn, 1.4V±2%, 600mA, 3MHz, Vin>2V, LSST	USP-6EL	56dc5	DC1	9a Tor
4H4	XC9235A14DER	DC-DC-IC	PWM, st-dwn, 1.4V±2%, 600mA, 3MHz, Vin>2V, LSST	USP-6C	49dc5	DC1	9a Tor
4H4	XCL205A144AR-G	DC/DC-IC	PWM st-dwn, 3MHz, 1.4V±2%, 600mA, -CE	CL-2025	67dc7	DC9	9a Tor
4H5	XC9235A15D4R-G	DC-DC-IC	PWM, st-dwn, 1.5V±2%, 600mA, 3MHz, Vin>2V, LSST	USP-6EL	56dc5	DC1	9a Tor
4H5	XC9235A15DER	DC-DC-IC	PWM, st-dwn, 1.5V±2%, 600mA, 3MHz, Vin>2V, LSST	USP-6C	49dc5	DC1	9a Tor
4H5	XCL205A154AR-G	DC/DC-IC	PWM st-dwn, 3MHz, 1.5V±2%, 600mA, -CE	CL-2025	67dc7	DC9	9a Tor
4H6	XC9235A16D4R-G	DC-DC-IC	PWM, st-dwn, 1.6V±2%, 600mA, 3MHz, Vin>2V, LSST	USP-6EL	56dc5	DC1	9a Tor
4H6	XC9235A16DER	DC-DC-IC	PWM, st-dwn, 1.6V±2%, 600mA, 3MHz, Vin>2V, LSST	USP-6C	49dc5	DC1	9a Tor
4H6	XCL205A164AR-G	DC/DC-IC	PWM st-dwn, 3MHz, 1.6V±2%, 600mA, -CE	CL-2025	67dc7	DC9	9a Tor
4H616	XC6102H616ER	Vdet-IC	1.6V±2%, Hst, -MR, -Reset ODO, Wt=1.6s, Rt=1.6s	USP-6C	49xh	VD16	9b Tor
4H617	XC6102H617ER	Vdet-IC	1.7V±2%, Hst, -MR, -Reset ODO, Wt=1.6s, Rt=1.6s	USP-6C	49xh	VD16	9b Tor
4H618	XC6102H618ER	Vdet-IC	1.8V±2%, Hst, -MR, -Reset ODO, Wt=1.6s, Rt=1.6s	USP-6C	49xh	VD16	9b Tor
4H619	XC6102H619ER	Vdet-IC	1.9V±2%, Hst, -MR, -Reset ODO, Wt=1.6s, Rt=1.6s	USP-6C	49xh	VD16	9b Tor
4H620	XC6102H620ER	Vdet-IC	2.0V±2%, Hst, -MR, -Reset ODO, Wt=1.6s, Rt=1.6s	USP-6C	49xh	VD16	9b Tor
4H621	XC6102H621ER	Vdet-IC	2.1V±2%, Hst, -MR, -Reset ODO, Wt=1.6s, Rt=1.6s	USP-6C	49xh	VD16	9b Tor
4H622	XC6102H622ER	Vdet-IC	2.2V±2%, Hst, -MR, -Reset ODO, Wt=1.6s, Rt=1.6s	USP-6C	49xh	VD16	9b Tor
4H623	XC6102H623ER	Vdet-IC	2.3V±2%, Hst, -MR, -Reset ODO, Wt=1.6s, Rt=1.6s	USP-6C	49xh	VD16	9b Tor
4H624	XC6102H624ER	Vdet-IC	2.4V±2%, Hst, -MR, -Reset ODO, Wt=1.6s, Rt=1.6s	USP-6C	49xh	VD16	9b Tor
4H625	XC6102H625ER	Vdet-IC	2.5V±2%, Hst, -MR, -Reset ODO, Wt=1.6s, Rt=1.6s	USP-6C	49xh	VD16	9b Tor
4H626	XC6102H626ER	Vdet-IC	2.6V±2%, Hst, -MR, -Reset ODO, Wt=1.6s, Rt=1.6s	USP-6C	49xh	VD16	9b Tor
4H627	XC6102H627ER	Vdet-IC	2.7V±2%, Hst, -MR, -Reset ODO, Wt=1.6s, Rt=1.6s	USP-6C	49xh	VD16	9b Tor
4H628	XC6102H628ER	Vdet-IC	2.8V±2%, Hst, -MR, -Reset ODO, Wt=1.6s, Rt=1.6s	USP-6C	49xh	VD16	9b Tor
4H629	XC6102H629ER	Vdet-IC	2.9V±2%, Hst, -MR, -Reset ODO, Wt=1.6s, Rt=1.6s	USP-6C	49xh	VD16	9b Tor
4H630	XC6102H630ER	Vdet-IC	3.0V±2%, Hst, -MR, -Reset ODO, Wt=1.6s, Rt=1.6s	USP-6C	49xh	VD16	9b Tor
4H631	XC6102H631ER	Vdet-IC	3.1V±2%, Hst, -MR, -Reset ODO, Wt=1.6s, Rt=1.6s	USP-6C	49xh	VD16	9b Tor
4H632	XC6102H632ER	Vdet-IC	3.2V±2%, Hst, -MR, -Reset ODO, Wt=1.6s, Rt=1.6s	USP-6C	49xh	VD16	9b Tor
4H633	XC6102H633ER	Vdet-IC	3.3V±2%, Hst, -MR, -Reset ODO, Wt=1.6s, Rt=1.6s	USP-6C	49xh	VD16	9b Tor
4H634	XC6102H634ER	Vdet-IC	3.4V±2%, Hst, -MR, -Reset ODO, Wt=1.6s, Rt=1.6s	USP-6C	49xh	VD16	9b Tor
4H635	XC6102H635ER	Vdet-IC	3.5V±2%, Hst, -MR, -Reset ODO, Wt=1.6s, Rt=1.6s	USP-6C	49xh	VD16	9b Tor
4H636	XC6102H636ER	Vdet-IC	3.6V±2%, Hst, -MR, -Reset ODO, Wt=1.6s, Rt=1.6s	USP-6C	49xh	VD16	9b Tor
4H637	XC6102H637ER	Vdet-IC	3.7V±2%, Hst, -MR, -Reset ODO, Wt=1.6s, Rt=1.6s	USP-6C	49xh	VD16	9b Tor
4H638	XC6102H638ER	Vdet-IC	3.8V±2%, Hst, -MR, -Reset ODO, Wt=1.6s, Rt=1.6s	USP-6C	49xh	VD16	9b Tor
4H639	XC6102H639ER	Vdet-IC	3.9V±2%, Hst, -MR, -Reset ODO, Wt=1.6s, Rt=1.6s	USP-6C	49xh	VD16	9b Tor
4H640	XC6102H640ER	Vdet-IC	4.0V±2%, Hst, -MR, -Reset ODO, Wt=1.6s, Rt=1.6s	USP-6C	49xh	VD16	9b Tor
4H641	XC6102H641ER	Vdet-IC	4.1V±2%, Hst, -MR, -Reset ODO, Wt=1.6s, Rt=1.6s	USP-6C	49xh	VD16	9b Tor
4H642	XC6102H642ER	Vdet-IC	4.2V±2%, Hst, -MR, -Reset ODO, Wt=1.6s, Rt=1.6s	USP-6C	49xh	VD16	9b Tor
4H643	XC6102H643ER	Vdet-IC	4.3V±2%, Hst, -MR, -Reset ODO, Wt=1.6s, Rt=1.6s	USP-6C	49xh	VD16	9b Tor
4H644	XC6102H644ER	Vdet-IC	4.4V±2%, Hst, -MR, -Reset ODO, Wt=1.6s, Rt=1.6s	USP-6C	49xh	VD16	9b Tor
4H645	XC6102H645ER	Vdet-IC	4.5V±2%, Hst, -MR, -Reset ODO, Wt=1.6s, Rt=1.6s	USP-6C	49xh	VD16	9b Tor
4H646	XC6102H646ER	Vdet-IC	4.6V±2%, Hst, -MR, -Reset ODO, Wt=1.6s, Rt=1.6s	USP-6C	49xh	VD16	9b Tor
4H647	XC6102H647ER	Vdet-IC	4.7V±2%, Hst, -MR, -Reset ODO, Wt=1.6s, Rt=1.6s	USP-6C	49xh	VD16	9b Tor
4H648	XC6102H648ER	Vdet-IC	4.8V±2%, Hst, -MR, -Reset ODO, Wt=1.6s, Rt=1.6s	USP-6C	49xh	VD16	9b Tor
4H649	XC6102H649ER	Vdet-IC	4.9V±2%, Hst, -MR, -Reset ODO, Wt=1.6s, Rt=1.6s	USP-6C	49xh	VD16	9b Tor
4H650	XC6102H650ER	Vdet-IC	5.0V±2%, Hst, -MR, -Reset ODO, Wt=1.6s, Rt=1.6s	USP-6C	49xh	VD16	9b Tor
4H7	XC9235A17D4R-G	DC-DC-IC	PWM, st-dwn, 1.7V±2%, 600mA, 3MHz, Vin>2V, LSST	USP-6EL	56dc5	DC1	9a Tor
4H7	XC9235A17DER	DC-DC-IC	PWM, st-dwn, 1.7V±2%, 600mA, 3MHz, Vin>2V, LSST	USP-6C	49dc5	DC1	9a Tor
4H7	XCL205A174AR-G	DC/DC-IC	PWM st-dwn, 3MHz, 1.7V±2%, 600mA, -CE	CL-2025	67dc7	DC9	9a Tor



SMD code	Type	Function	Short description	Case	Pinout	Sch.	St.	Mnf.
4H8	XC9235A18D4R-G	DC-DC-IC	PWM, st-dwn, 1.8V±2%, 600mA, 3MHz, Vin>2V, LSST	USP-6EL	56dc5	DC1	9a	Tor
4H8	XC9235A18DER	DC-DC-IC	PWM, st-dwn, 1.8V±2%, 600mA, 3MHz, Vin>2V, LSST	USP-6C	49dc5	DC1	9a	Tor
4H8	XCL205A184AR-G	DC/DC-IC	PWM st-dwn, 3MHz, 1.8V±2%, 600mA, -CE	CL-2025	67dc7	DC9	9a	Tor
4H9	XC9235A19D4R-G	DC-DC-IC	PWM, st-dwn, 1.9V±2%, 600mA, 3MHz, Vin>2V, LSST	USP-6EL	56dc5	DC1	9a	Tor
4H9	XC9235A19DER	DC-DC-IC	PWM, st-dwn, 1.9V±2%, 600mA, 3MHz, Vin>2V, LSST	USP-6C	49dc5	DC1	9a	Tor
4H9	XCL205A194AR-G	DC/DC-IC	PWM st-dwn, 3MHz, 1.9V±2%, 600mA, -CE	CL-2025	67dc7	DC9	9a	Tor
4HA	XC9235A1AD4R-G	DC-DC-IC	PWM, st-dwn, 1.05V±2%, 600mA, 3MHz, Vin>2V, LSST	USP-6EL	56dc5	DC1	9a	Tor
4HA	XC9235A1ADER	DC-DC-IC	PWM, st-dwn, 1.05V±2%, 600mA, 3MHz, Vin>2V, LSST	USP-6C	49dc5	DC1	9a	Tor
4HB	XC9235A1BD4R-G	DC-DC-IC	PWM, st-dwn, 1.15V±2%, 600mA, 3MHz, Vin>2V, LSST	USP-6EL	56dc5	DC1	9a	Tor
4HB	XC9235A1BDER	DC-DC-IC	PWM, st-dwn, 1.15V±2%, 600mA, 3MHz, Vin>2V, LSST	USP-6C	49dc5	DC1	9a	Tor
4HC	XC9235A1CD4R-G	DC-DC-IC	PWM, st-dwn, 1.25V±2%, 600mA, 3MHz, Vin>2V, LSST	USP-6EL	56dc5	DC1	9a	Tor
4HC	XC9235A1CDER	DC-DC-IC	PWM, st-dwn, 1.25V±2%, 600mA, 3MHz, Vin>2V, LSST	USP-6C	49dc5	DC1	9a	Tor
4HD	XC9235A1DD4R-G	DC-DC-IC	PWM, st-dwn, 1.35V±2%, 600mA, 3MHz, Vin>2V, LSST	USP-6EL	56dc5	DC1	9a	Tor
4HD	XC9235A1DDER	DC-DC-IC	PWM, st-dwn, 1.35V±2%, 600mA, 3MHz, Vin>2V, LSST	USP-6C	49dc5	DC1	9a	Tor
4HE	XC9235A1ED4R-G	DC-DC-IC	PWM, st-dwn, 1.45V±2%, 600mA, 3MHz, Vin>2V, LSST	USP-6EL	56dc5	DC1	9a	Tor
4HE	XC9235A1EDER	DC-DC-IC	PWM, st-dwn, 1.45V±2%, 600mA, 3MHz, Vin>2V, LSST	USP-6C	49dc5	DC1	9a	Tor
4HF	XC9235A1FD4R-G	DC-DC-IC	PWM, st-dwn, 1.55V±2%, 600mA, 3MHz, Vin>2V, LSST	USP-6EL	56dc5	DC1	9a	Tor
4HF	XC9235A1FDER	DC-DC-IC	PWM, st-dwn, 1.55V±2%, 600mA, 3MHz, Vin>2V, LSST	USP-6C	49dc5	DC1	9a	Tor
4HH	XC9235A1HD4R-G	DC-DC-IC	PWM, st-dwn, 1.65V±2%, 600mA, 3MHz, Vin>2V, LSST	USP-6EL	56dc5	DC1	9a	Tor
4HH	XC9235A1HDER	DC-DC-IC	PWM, st-dwn, 1.65V±2%, 600mA, 3MHz, Vin>2V, LSST	USP-6C	49dc5	DC1	9a	Tor
4HK	XC9235A1KD4R-G	DC-DC-IC	PWM, st-dwn, 1.75V±2%, 600mA, 3MHz, Vin>2V, LSST	USP-6EL	56dc5	DC1	9a	Tor
4HK	XC9235A1KDER	DC-DC-IC	PWM, st-dwn, 1.75V±2%, 600mA, 3MHz, Vin>2V, LSST	USP-6C	49dc5	DC1	9a	Tor
4HL	XC9235A1LD4R-G	DC-DC-IC	PWM, st-dwn, 1.85V±2%, 600mA, 3MHz, Vin>2V, LSST	USP-6EL	56dc5	DC1	9a	Tor
4HL	XC9235A1LDER	DC-DC-IC	PWM, st-dwn, 1.85V±2%, 600mA, 3MHz, Vin>2V, LSST	USP-6C	49dc5	DC1	9a	Tor
4HM	XC9235A1MD4R-G	DC-DC-IC	PWM, st-dwn, 1.95V±2%, 600mA, 3MHz, Vin>2V, LSST	USP-6EL	56dc5	DC1	9a	Tor
4HM	XC9235A1MDER	DC-DC-IC	PWM, st-dwn, 1.95V±2%, 600mA, 3MHz, Vin>2V, LSST	USP-6C	49dc5	DC1	9a	Tor
4J	R3117K391C	Vdet-IC	3.9V±1%, -Reset PPO, Sense	DFN1010-4	48rq	VD12	9a	Ric
4J	RP101K261D	LVR-IC	LDO, LN, +CE, CL, 2.6V±0.8%, 300mA	DFN1612-4	45vm	VR4	9a	Ric
4K	R3117K401C	Vdet-IC	4.0V±1%, -Reset PPO, Sense	DFN1010-4	48rq	VD12	9a	Ric
4K	RP101K271D	LVR-IC	LDO, LN, +CE, CL, 2.7V±0.8%, 300mA	DFN1612-4	45vm	VR4	9a	Ric
4K	XC6223E2719R-G	LVR-IC	LDO, 2.7V±1%, 300mA, +CE, ICP	USPQ-4B03	48vm	VR4	9a	Tor
4K	XC6221D2517R	LVR-IC	LDO, 2.5V±1%, 200mA, +CE, CL, PDR	USPN-4	58vm	VR4	9a	Tor
4K0	XC9235A20D4R-G	DC-DC-IC	PWM, st-dwn, 2.0V±2%, 600mA, 3MHz, Vin>2V, LSST	USP-6EL	56dc5	DC1	9a	Tor
4K0	XC9235A20DER	DC-DC-IC	PWM, st-dwn, 2.0V±2%, 600mA, 3MHz, Vin>2V, LSST	USP-6C	49dc5	DC1	9a	Tor
4K0	XCL205A204AR-G	DC/DC-IC	PWM st-dwn, 3MHz, 2.0V±2%, 600mA, -CE	CL-2025	67dc7	DC9	9a	Tor
4K1	XC9235A21D4R-G	DC-DC-IC	PWM, st-dwn, 2.1V±2%, 600mA, 3MHz, Vin>2V, LSST	USP-6EL	56dc5	DC1	9a	Tor
4K1	XC9235A21DER	DC-DC-IC	PWM, st-dwn, 2.1V±2%, 600mA, 3MHz, Vin>2V, LSST	USP-6C	49dc5	DC1	9a	Tor
4K1	XCL205A214AR-G	DC/DC-IC	PWM st-dwn, 3MHz, 2.1V±2%, 600mA, -CE	CL-2025	67dc7	DC9	9a	Tor
4K2	XC9235A22D4R-G	DC-DC-IC	PWM, st-dwn, 2.2V±2%, 600mA, 3MHz, Vin>2V, LSST	USP-6EL	56dc5	DC1	9a	Tor
4K2	XC9235A22DER	DC-DC-IC	PWM, st-dwn, 2.2V±2%, 600mA, 3MHz, Vin>2V, LSST	USP-6C	49dc5	DC1	9a	Tor
4K2	XCL205A224AR-G	DC/DC-IC	PWM st-dwn, 3MHz, 2.2V±2%, 600mA, -CE	CL-2025	67dc7	DC9	9a	Tor
4K3	XC9235A23D4R-G	DC-DC-IC	PWM, st-dwn, 2.3V±2%, 600mA, 3MHz, Vin>2V, LSST	USP-6EL	56dc5	DC1	9a	Tor
4K3	XC9235A23DER	DC-DC-IC	PWM, st-dwn, 2.3V±2%, 600mA, 3MHz, Vin>2V, LSST	USP-6C	49dc5	DC1	9a	Tor
4K3	XCL205A234AR-G	DC/DC-IC	PWM st-dwn, 3MHz, 2.3V±2%, 600mA, -CE	CL-2025	67dc7	DC9	9a	Tor
4K4	XC9235A24D4R-G	DC-DC-IC	PWM, st-dwn, 2.4V±2%, 600mA, 3MHz, Vin>2V, LSST	USP-6EL	56dc5	DC1	9a	Tor
4K4	XC9235A24DER	DC-DC-IC	PWM, st-dwn, 2.4V±2%, 600mA, 3MHz, Vin>2V, LSST	USP-6C	49dc5	DC1	9a	Tor
4K4	XCL205A244AR-G	DC/DC-IC	PWM st-dwn, 3MHz, 2.4V±2%, 600mA, -CE	CL-2025	67dc7	DC9	9a	Tor
4K5	XC9235A25D4R-G	DC-DC-IC	PWM, st-dwn, 2.5V±2%, 600mA, 3MHz, Vin>2V, LSST	USP-6EL	56dc5	DC1	9a	Tor
4K5	XC9235A25DER	DC-DC-IC	PWM, st-dwn, 2.5V±2%, 600mA, 3MHz, Vin>2V, LSST	USP-6C	49dc5	DC1	9a	Tor
4K5	XCL205A254AR-G	DC/DC-IC	PWM st-dwn, 3MHz, 2.5V±2%, 600mA, -CE	CL-2025	67dc7	DC9	9a	Tor
4K6	XC9235A26D4R-G	DC-DC-IC	PWM, st-dwn, 2.6V±2%, 600mA, 3MHz, Vin>2V, LSST	USP-6EL	56dc5	DC1	9a	Tor
4K6	XC9235A26DER	DC-DC-IC	PWM, st-dwn, 2.6V±2%, 600mA, 3MHz, Vin>2V, LSST	USP-6C	49dc5	DC1	9a	Tor
4K6	XCL205A264AR-G	DC/DC-IC	PWM st-dwn, 3MHz, 2.6V±2%, 600mA, -CE	CL-2025	67dc7	DC9	9a	Tor
4K7	XC9235A27D4R-G	DC-DC-IC	PWM, st-dwn, 2.7V±2%, 600mA, 3MHz, Vin>2V, LSST	USP-6EL	56dc5	DC1	9a	Tor
4K7	XC9235A27DER	DC-DC-IC	PWM, st-dwn, 2.7V±2%, 600mA, 3MHz, Vin>2V, LSST	USP-6C	49dc5	DC1	9a	Tor
4K7	XCL205A274AR-G	DC/DC-IC	PWM st-dwn, 3MHz, 2.7V±2%, 600mA, -CE	CL-2025	67dc7	DC9	9a	Tor
4K8	XC9235A28D4R-G	DC-DC-IC	PWM, st-dwn, 2.8V±2%, 600mA, 3MHz, Vin>2V, LSST	USP-6EL	56dc5	DC1	9a	Tor
4K8	XC9235A28DER	DC-DC-IC	PWM, st-dwn, 2.8V±2%, 600mA, 3MHz, Vin>2V, LSST	USP-6C	49dc5	DC1	9a	Tor
4K8	XCL205A284AR-G	DC/DC-IC	PWM st-dwn, 3MHz, 2.8V±2%, 600mA, -CE	CL-2025	67dc7	DC9	9a	Tor
4K9	XC9235A29D4R-G	DC-DC-IC	PWM, st-dwn, 2.9V±2%, 600mA, 3MHz, Vin>2V, LSST	USP-6EL	56dc5	DC1	9a	Tor
4K9	XC9235A29DER	DC-DC-IC	PWM, st-dwn, 2.9V±2%, 600mA, 3MHz, Vin>2V, LSST	USP-6C	49dc5	DC1	9a	Tor
4K9	XCL205A294AR-G	DC/DC-IC	PWM st-dwn, 3MHz, 2.9V±2%, 600mA, -CE	CL-2025	67dc7	DC9	9a	Tor
4KA	XC9235A2AD4R-G	DC-DC-IC	PWM, st-dwn, 2.05V±2%, 600mA, 3MHz, Vin>2V, LSST	USP-6EL	56dc5	DC1	9a	Tor
4KA	XC9235A2ADER	DC-DC-IC	PWM, st-dwn, 2.05V±2%, 600mA, 3MHz, Vin>2V, LSST	USP-6C	49dc5	DC1	9a	Tor
4KB	XC9235A2BD4R-G	DC-DC-IC	PWM, st-dwn, 2.15V±2%, 600mA, 3MHz, Vin>2V, LSST	USP-6EL	56dc5	DC1	9a	Tor
4KB	XC9235A2BDER	DC-DC-IC	PWM, st-dwn, 2.15V±2%, 600mA, 3MHz, Vin>2V, LSST	USP-6C	49dc5	DC1	9a	Tor
4KC	XC9235A2CD4R-G	DC-DC-IC	PWM, st-dwn, 2.25V±2%, 600mA, 3MHz, Vin>2V, LSST	USP-6EL	56dc5	DC1	9a	Tor
4KC	XC9235A2CDER	DC-DC-IC	PWM, st-dwn, 2.25V±2%, 600mA, 3MHz, Vin>2V, LSST	USP-6C	49dc5	DC1	9a	Tor
4KD	XC9235A2DD4R-G	DC-DC-IC	PWM, st-dwn, 2.35V±2%, 600mA, 3MHz, Vin>2V, LSST	USP-6EL	56dc5	DC1	9a	Tor
4KD	XC9235A2DDER	DC-DC-IC	PWM, st-dwn, 2.35V±2%, 600mA, 3MHz, Vin>2V, LSST	USP-6C	49dc5	DC1	9a	Tor



SMD code	Type	Function	Short description	Case	Pinout	Sch.	St.	Mnf.
4KE	XC9235A2ED4R-G	DC-DC-IC	PWM, st-dwn, 2.45V±2%, 600mA, 3MHz, Vin>2V, LSST	USP-6EL	56dc5	DC1	9a	Tor
4KE	XC9235A2EDER	DC-DC-IC	PWM, st-dwn, 2.45V±2%, 600mA, 3MHz, Vin>2V, LSST	USP-6C	49dc5	DC1	9a	Tor
4KF	XC9235A2FD4R-G	DC-DC-IC	PWM, st-dwn, 2.55V±2%, 600mA, 3MHz, Vin>2V, LSST	USP-6EL	56dc5	DC1	9a	Tor
4KF	XC9235A2FDER	DC-DC-IC	PWM, st-dwn, 2.55V±2%, 600mA, 3MHz, Vin>2V, LSST	USP-6C	49dc5	DC1	9a	Tor
4KH	XC9235A2HD4R-G	DC-DC-IC	PWM, st-dwn, 2.65V±2%, 600mA, 3MHz, Vin>2V, LSST	USP-6EL	56dc5	DC1	9a	Tor
4KH	XC9235A2HDER	DC-DC-IC	PWM, st-dwn, 2.65V±2%, 600mA, 3MHz, Vin>2V, LSST	USP-6C	49dc5	DC1	9a	Tor
4KK	XC9235A2KD4R-G	DC-DC-IC	PWM, st-dwn, 2.75V±2%, 600mA, 3MHz, Vin>2V, LSST	USP-6EL	56dc5	DC1	9a	Tor
4KK	XC9235A2KDER	DC-DC-IC	PWM, st-dwn, 2.75V±2%, 600mA, 3MHz, Vin>2V, LSST	USP-6C	49dc5	DC1	9a	Tor
4KL	XC9235A2LD4R-G	DC-DC-IC	PWM, st-dwn, 2.85V±2%, 600mA, 3MHz, Vin>2V, LSST	USP-6EL	56dc5	DC1	9a	Tor
4KL	XC9235A2LDER	DC-DC-IC	PWM, st-dwn, 2.85V±2%, 600mA, 3MHz, Vin>2V, LSST	USP-6C	49dc5	DC1	9a	Tor
4KM	XC9235A2MD4R-G	DC-DC-IC	PWM, st-dwn, 2.95V±2%, 600mA, 3MHz, Vin>2V, LSST	USP-6EL	56dc5	DC1	9a	Tor
4KM	XC9235A2MDER	DC-DC-IC	PWM, st-dwn, 2.95V±2%, 600mA, 3MHz, Vin>2V, LSST	USP-6C	49dc5	DC1	9a	Tor
4L	R3117K411C	Vdel-IC	4.1V±1%, -Reset PPO, Sense	DFN1010-4	48rq	VD12	9a	Ric
4L	RP101K281D	LVR-IC	LDO, LN, +CE, CL, 2.8V±0.8%, 300mA	DFN1612-4	45vm	VR4	9a	Ric
4L	XG6223E2819R-G	LVR-IC	LDO, 2.8V±1%, 300mA, +CE, ICP	USPQ-4B03	48vm	VR4	9a	Tor
4L	XG6221D2617R	LVR-IC	LDO, 2.6V±1%, 200mA, +CE, CL, PDR	USPN-4	58vm	VR4	9a	Tor
4L0	XC9235A30D4R-G	DC-DC-IC	PWM, st-dwn, 3.0V±2%, 600mA, 3MHz, Vin>2V, LSST	USP-6EL	56dc5	DC1	9a	Tor
4L0	XC9235A30DER	DC-DC-IC	PWM, st-dwn, 3.0V±2%, 600mA, 3MHz, Vin>2V, LSST	USP-6C	49dc5	DC1	9a	Tor
4L0	XCL205A304AR-G	DC/DC-IC	PWM st-dwn, 3MHz, 3.0V±2%, 600mA, -CE	CL-2025	67dc7	DC9	9a	Tor
4L1	XC9235A31D4R-G	DC-DC-IC	PWM, st-dwn, 3.1V±2%, 600mA, 3MHz, Vin>2V, LSST	USP-6EL	56dc5	DC1	9a	Tor
4L1	XC9235A31DER	DC-DC-IC	PWM, st-dwn, 3.1V±2%, 600mA, 3MHz, Vin>2V, LSST	USP-6C	49dc5	DC1	9a	Tor
4L1	XCL205A314AR-G	DC/DC-IC	PWM st-dwn, 3MHz, 3.1V±2%, 600mA, -CE	CL-2025	67dc7	DC9	9a	Tor
4L2	XC9235A32D4R-G	DC-DC-IC	PWM, st-dwn, 3.2V±2%, 600mA, 3MHz, Vin>2V, LSST	USP-6EL	56dc5	DC1	9a	Tor
4L2	XC9235A32DER	DC-DC-IC	PWM, st-dwn, 3.2V±2%, 600mA, 3MHz, Vin>2V, LSST	USP-6C	49dc5	DC1	9a	Tor
4L2	XCL205A324AR-G	DC/DC-IC	PWM st-dwn, 3MHz, 3.2V±2%, 600mA, -CE	CL-2025	67dc7	DC9	9a	Tor
4L3	XC9235A33D4R-G	DC-DC-IC	PWM, st-dwn, 3.3V±2%, 600mA, 3MHz, Vin>2V, LSST	USP-6EL	56dc5	DC1	9a	Tor
4L3	XC9235A33DER	DC-DC-IC	PWM, st-dwn, 3.3V±2%, 600mA, 3MHz, Vin>2V, LSST	USP-6C	49dc5	DC1	9a	Tor
4L3	XCL205A334AR-G	DC/DC-IC	PWM st-dwn, 3MHz, 3.3V±2%, 600mA, -CE	CL-2025	67dc7	DC9	9a	Tor
4L4	XC9235A34D4R-G	DC-DC-IC	PWM, st-dwn, 3.4V±2%, 600mA, 3MHz, Vin>2V, LSST	USP-6EL	56dc5	DC1	9a	Tor
4L4	XC9235A34DER	DC-DC-IC	PWM, st-dwn, 3.4V±2%, 600mA, 3MHz, Vin>2V, LSST	USP-6C	49dc5	DC1	9a	Tor
4L4	XCL205A344AR-G	DC/DC-IC	PWM st-dwn, 3MHz, 3.4V±2%, 600mA, -CE	CL-2025	67dc7	DC9	9a	Tor
4L5	XC9235A35D4R-G	DC-DC-IC	PWM, st-dwn, 3.5V±2%, 600mA, 3MHz, Vin>2V, LSST	USP-6EL	56dc5	DC1	9a	Tor
4L5	XC9235A35DER	DC-DC-IC	PWM, st-dwn, 3.5V±2%, 600mA, 3MHz, Vin>2V, LSST	USP-6C	49dc5	DC1	9a	Tor
4L5	XCL205A354AR-G	DC/DC-IC	PWM st-dwn, 3MHz, 3.5V±2%, 600mA, -CE	CL-2025	67dc7	DC9	9a	Tor
4L6	XC9235A36D4R-G	DC-DC-IC	PWM, st-dwn, 3.6V±2%, 600mA, 3MHz, Vin>2V, LSST	USP-6EL	56dc5	DC1	9a	Tor
4L6	XC9235A36DER	DC-DC-IC	PWM, st-dwn, 3.6V±2%, 600mA, 3MHz, Vin>2V, LSST	USP-6C	49dc5	DC1	9a	Tor
4L6	XCL205A364AR-G	DC/DC-IC	PWM st-dwn, 3MHz, 3.6V±2%, 600mA, -CE	CL-2025	67dc7	DC9	9a	Tor
4L7	XC9235A37D4R-G	DC-DC-IC	PWM, st-dwn, 3.7V±2%, 600mA, 3MHz, Vin>2V, LSST	USP-6EL	56dc5	DC1	9a	Tor
4L7	XC9235A37DER	DC-DC-IC	PWM, st-dwn, 3.7V±2%, 600mA, 3MHz, Vin>2V, LSST	USP-6C	49dc5	DC1	9a	Tor
4L7	XCL205A374AR-G	DC/DC-IC	PWM st-dwn, 3MHz, 3.7V±2%, 600mA, -CE	CL-2025	67dc7	DC9	9a	Tor
4L8	XC9235A38D4R-G	DC-DC-IC	PWM, st-dwn, 3.8V±2%, 600mA, 3MHz, Vin>2V, LSST	USP-6EL	56dc5	DC1	9a	Tor
4L8	XC9235A38DER	DC-DC-IC	PWM, st-dwn, 3.8V±2%, 600mA, 3MHz, Vin>2V, LSST	USP-6C	49dc5	DC1	9a	Tor
4L8	XCL205A384AR-G	DC/DC-IC	PWM st-dwn, 3MHz, 3.8V±2%, 600mA, -CE	CL-2025	67dc7	DC9	9a	Tor
4L9	XC9235A39D4R-G	DC-DC-IC	PWM, st-dwn, 3.9V±2%, 600mA, 3MHz, Vin>2V, LSST	USP-6EL	56dc5	DC1	9a	Tor
4L9	XC9235A39DER	DC-DC-IC	PWM, st-dwn, 3.9V±2%, 600mA, 3MHz, Vin>2V, LSST	USP-6C	49dc5	DC1	9a	Tor
4L9	XCL205A394AR-G	DC/DC-IC	PWM st-dwn, 3MHz, 3.9V±2%, 600mA, -CE	CL-2025	67dc7	DC9	9a	Tor
4LA	XC9235A3AD4R-G	DC-DC-IC	PWM, st-dwn, 3.05V±2%, 600mA, 3MHz, Vin>2V, LSST	USP-6EL	56dc5	DC1	9a	Tor
4LA	XC9235A3ADER	DC-DC-IC	PWM, st-dwn, 3.05V±2%, 600mA, 3MHz, Vin>2V, LSST	USP-6C	49dc5	DC1	9a	Tor
4LB	XC9235A3BD4R-G	DC-DC-IC	PWM, st-dwn, 3.15V±2%, 600mA, 3MHz, Vin>2V, LSST	USP-6EL	56dc5	DC1	9a	Tor
4LB	XC9235A3BDER	DC-DC-IC	PWM, st-dwn, 3.15V±2%, 600mA, 3MHz, Vin>2V, LSST	USP-6C	49dc5	DC1	9a	Tor
4LC	XC9235A3CD4R-G	DC-DC-IC	PWM, st-dwn, 3.25V±2%, 600mA, 3MHz, Vin>2V, LSST	USP-6EL	56dc5	DC1	9a	Tor
4LC	XC9235A3CDER	DC-DC-IC	PWM, st-dwn, 3.25V±2%, 600mA, 3MHz, Vin>2V, LSST	USP-6C	49dc5	DC1	9a	Tor
4LD	XC9235A3DD4R-G	DC-DC-IC	PWM, st-dwn, 3.35V±2%, 600mA, 3MHz, Vin>2V, LSST	USP-6EL	56dc5	DC1	9a	Tor
4LD	XC9235A3DDER	DC-DC-IC	PWM, st-dwn, 3.35V±2%, 600mA, 3MHz, Vin>2V, LSST	USP-6C	49dc5	DC1	9a	Tor
4LE	XC9235A3ED4R-G	DC-DC-IC	PWM, st-dwn, 3.45V±2%, 600mA, 3MHz, Vin>2V, LSST	USP-6EL	56dc5	DC1	9a	Tor
4LE	XC9235A3EDER	DC-DC-IC	PWM, st-dwn, 3.45V±2%, 600mA, 3MHz, Vin>2V, LSST	USP-6C	49dc5	DC1	9a	Tor
4LF	XC9235A3FD4R-G	DC-DC-IC	PWM, st-dwn, 3.55V±2%, 600mA, 3MHz, Vin>2V, LSST	USP-6EL	56dc5	DC1	9a	Tor
4LF	XC9235A3FDER	DC-DC-IC	PWM, st-dwn, 3.55V±2%, 600mA, 3MHz, Vin>2V, LSST	USP-6C	49dc5	DC1	9a	Tor
4LH	XC9235A3HD4R-G	DC-DC-IC	PWM, st-dwn, 3.65V±2%, 600mA, 3MHz, Vin>2V, LSST	USP-6EL	56dc5	DC1	9a	Tor
4LH	XC9235A3HDER	DC-DC-IC	PWM, st-dwn, 3.65V±2%, 600mA, 3MHz, Vin>2V, LSST	USP-6C	49dc5	DC1	9a	Tor
4LK	XC9235A3KD4R-G	DC-DC-IC	PWM, st-dwn, 3.75V±2%, 600mA, 3MHz, Vin>2V, LSST	USP-6EL	56dc5	DC1	9a	Tor
4LK	XC9235A3KDER	DC-DC-IC	PWM, st-dwn, 3.75V±2%, 600mA, 3MHz, Vin>2V, LSST	USP-6C	49dc5	DC1	9a	Tor
4LL	XC9235A3LD4R-G	DC-DC-IC	PWM, st-dwn, 3.85V±2%, 600mA, 3MHz, Vin>2V, LSST	USP-6EL	56dc5	DC1	9a	Tor
4LL	XC9235A3LDER	DC-DC-IC	PWM, st-dwn, 3.85V±2%, 600mA, 3MHz, Vin>2V, LSST	USP-6C	49dc5	DC1	9a	Tor
4LM	XC9235A3MD4R-G	DC-DC-IC	PWM, st-dwn, 3.95V±2%, 600mA, 3MHz, Vin>2V, LSST	USP-6EL	56dc5	DC1	9a	Tor
4LM	XC9235A3MDER	DC-DC-IC	PWM, st-dwn, 3.95V±2%, 600mA, 3MHz, Vin>2V, LSST	USP-6C	49dc5	DC1	9a	Tor
4M	R3117K421C	Vdel-IC	4.2V±1%, -Reset PPO, Sense	DFN1010-4	48rq	VD12	9a	Ric
4M	RP101K281D5	LVR-IC	LDO, LN, +CE, CL, 2.85V±0.8%, 300mA	DFN1612-4	45vm	VR4	9a	Ric
4M	XG6223E2919R-G	LVR-IC	LDO, 2.9V±1%, 300mA, +CE, ICP	USPQ-4B03	48vm	VR4	9a	Tor
4M	XG6221D2171R	LVR-IC	LDO, 2.7V±1%, 200mA, +CE, CL, PDR	USPN-4	58vm	VR4	9a	Tor



SMD code	Type	Function	Short description	Case	Pinout	Sch.	St.	Mnf.
4M0	XC9235A40D4R-G	DC-DC-IC	PWM, st-dwn, 4.0V±2%, 600mA, 3MHz, Vin>2V, LSST	USP-6EL	56dc5	DC1	9a	Tor
4M0	XC9235A40DER	DC-DC-IC	PWM, st-dwn, 4.0V±2%, 600mA, 3MHz, Vin>2V, LSST	USP-6C	49dc5	DC1	9a	Tor
4M0	XCL205A40A4R-G	DG/DC-IC	PWM st-dwn, 3MHz, 4.0V±2%, 600mA, -CE	CL-2025	67dc7	DC9	9a	Tor
4N	R3117K431C	Vdet-IC	4.3V±1%, -Reset PPO, Sense	DFN1010-4	48rq	VD12	9a	Ric
4N	RP101K291D	LVR-IC	LDO, LN, +CE, CL, 2.9V±0.8%, 300mA	DFN1612-4	45vm	VR4	9a	Ric
4N	XC6223E3019R-G	LVR-IC	LDO, 3.0V±1%, 300mA, +CE, ICP	USPQ-4B03	48vm	VR4	9a	Tor
4N	XC6221D2817R	LVR-IC	LDO, 2.8V±1%, 200mA, +CE, CL, PDR	USPN-4	58vm	VR4	9a	Tor
4N8	XC9235E08C4	DG/DC-IC	PWM step-down, 1.2MHz, 0.8V±2%, 600mA, CL, Vin>1.8V, LSST	USP-6EL	56dc5	DC1	9a	Tor
4N8	XC9235E08CER	DC-DC-IC	PWM, st-dwn, 0.8V±2%, 600mA, 1.2MHz, Vin>1.8V, LSST, CL	USP-6C	49dc5	DC1	9a	Tor
4N9	XC9235E09C4	DG/DC-IC	PWM step-down, 1.2MHz, 0.9V±2%, 600mA, CL, Vin>1.8V, LSST	USP-6EL	56dc5	DC1	9a	Tor
4N9	XC9235E09CER	DC-DC-IC	PWM, st-dwn, 0.9V±2%, 600mA, 1.2MHz, Vin>1.8V, LSST, CL	USP-6C	49dc5	DC1	9a	Tor
4NL	XC9235E0LC4	DG/DC-IC	PWM step-down, 1.2MHz, 0.85V±2%, 600mA, CL, Vin>1.8V, LSST	USP-6EL	56dc5	DC1	9a	Tor
4NL	XC9235E0LCER	DC-DC-IC	PWM, st-dwn, 0.85V±2%, 600mA, 1.2MHz, Vin>1.8V, LSST, CL	USP-6C	49dc5	DC1	9a	Tor
4NM	XC9235E0MC4	DG/DC-IC	PWM step-down, 1.2MHz, 0.95V±2%, 600mA, CL, Vin>1.8V, LSST	USP-6EL	56dc5	DC1	9a	Tor
4NM	XC9235E0MCER	DC-DC-IC	PWM, st-dwn, 0.95V±2%, 600mA, 1.2MHz, Vin>1.8V, LSST, CL	USP-6C	49dc5	DC1	9a	Tor
4P	R3117K441C	Vdet-IC	4.4V±1%, -Reset PPO, Sense	DFN1010-4	48rq	VD12	9a	Ric
4P	RP101K301D	LVR-IC	LDO, LN, +CE, CL, 3V±0.8%, 300mA	DFN1612-4	45vm	VR4	9a	Ric
4P	XC6223E3119R-G	LVR-IC	LDO, 3.1V±1%, 300mA, +CE, ICP	USPQ-4B03	48vm	VR4	9a	Tor
4P	XC6221D2917R	LVR-IC	LDO, 2.9V±1%, 200mA, +CE, CL, PDR	USPN-4	58vm	VR4	9a	Tor
4P0	XC9235E10C4	DG/DC-IC	PWM step-down, 1.2MHz, 1.0V±2%, 600mA, CL, Vin>1.8V, LSST	USP-6EL	56dc5	DC1	9a	Tor
4P0	XC9235E10CER	DC-DC-IC	PWM, st-dwn, 1.0V±2%, 600mA, 1.2MHz, Vin>1.8V, LSST, CL	USP-6C	49dc5	DC1	9a	Tor
4P1	XC9235E11C4	DG/DC-IC	PWM step-down, 1.2MHz, 1.1V±2%, 600mA, CL, Vin>1.8V, LSST	USP-6EL	56dc5	DC1	9a	Tor
4P1	XC9235E11CER	DC-DC-IC	PWM, st-dwn, 1.1V±2%, 600mA, 1.2MHz, Vin>1.8V, LSST, CL	USP-6C	49dc5	DC1	9a	Tor
4P2	XC9235E12C4	DG/DC-IC	PWM step-down, 1.2MHz, 1.2V±2%, 600mA, CL, Vin>1.8V, LSST	USP-6EL	56dc5	DC1	9a	Tor
4P2	XC9235E12CER	DC-DC-IC	PWM, st-dwn, 1.2V±2%, 600mA, 1.2MHz, Vin>1.8V, LSST, CL	USP-6C	49dc5	DC1	9a	Tor
4P3	XC9235E13C4	DG/DC-IC	PWM step-down, 1.2MHz, 1.3V±2%, 600mA, CL, Vin>1.8V, LSST	USP-6EL	56dc5	DC1	9a	Tor
4P3	XC9235E13CER	DC-DC-IC	PWM, st-dwn, 1.3V±2%, 600mA, 1.2MHz, Vin>1.8V, LSST, CL	USP-6C	49dc5	DC1	9a	Tor
4P4	XC9235E14C4	DG/DC-IC	PWM step-down, 1.2MHz, 1.4V±2%, 600mA, CL, Vin>1.8V, LSST	USP-6EL	56dc5	DC1	9a	Tor
4P4	XC9235E14CER	DC-DC-IC	PWM, st-dwn, 1.4V±2%, 600mA, 1.2MHz, Vin>1.8V, LSST, CL	USP-6C	49dc5	DC1	9a	Tor
4P5	XC9235E15C4	DG/DC-IC	PWM step-down, 1.2MHz, 1.5V±2%, 600mA, CL, Vin>1.8V, LSST	USP-6EL	56dc5	DC1	9a	Tor
4P5	XC9235E15CER	DC-DC-IC	PWM, st-dwn, 1.5V±2%, 600mA, 1.2MHz, Vin>1.8V, LSST, CL	USP-6C	49dc5	DC1	9a	Tor
4P6	XC9235E16C4	DG/DC-IC	PWM step-down, 1.2MHz, 1.6V±2%, 600mA, CL, Vin>1.8V, LSST	USP-6EL	56dc5	DC1	9a	Tor
4P6	XC9235E16CER	DC-DC-IC	PWM, st-dwn, 1.6V±2%, 600mA, 1.2MHz, Vin>1.8V, LSST, CL	USP-6C	49dc5	DC1	9a	Tor
4P7	XC9235E17C4	DG/DC-IC	PWM step-down, 1.2MHz, 1.7V±2%, 600mA, CL, Vin>1.8V, LSST	USP-6EL	56dc5	DC1	9a	Tor
4P7	XC9235E17CER	DC-DC-IC	PWM, st-dwn, 1.7V±2%, 600mA, 1.2MHz, Vin>1.8V, LSST, CL	USP-6C	49dc5	DC1	9a	Tor
4P8	XC9235E18C4	DG/DC-IC	PWM step-down, 1.2MHz, 1.8V±2%, 600mA, CL, Vin>1.8V, LSST	USP-6EL	56dc5	DC1	9a	Tor
4P8	XC9235E18CER	DC-DC-IC	PWM, st-dwn, 1.8V±2%, 600mA, 1.2MHz, Vin>1.8V, LSST, CL	USP-6C	49dc5	DC1	9a	Tor
4P9	XC9235E19C4	DG/DC-IC	PWM step-down, 1.2MHz, 1.9V±2%, 600mA, CL, Vin>1.8V, LSST	USP-6EL	56dc5	DC1	9a	Tor
4P9	XC9235E19CER	DC-DC-IC	PWM, st-dwn, 1.9V±2%, 600mA, 1.2MHz, Vin>1.8V, LSST, CL	USP-6C	49dc5	DC1	9a	Tor
4PA	XC9235E1AC4	DG/DC-IC	PWM step-down, 1.2MHz, 1.05V±2%, 600mA, CL, Vin>1.8V, LSST	USP-6EL	56dc5	DC1	9a	Tor
4PA	XC9235E1ACER	DC-DC-IC	PWM, st-dwn, 1.05V±2%, 600mA, 1.2MHz, Vin>1.8V, LSST, CL	USP-6C	49dc5	DC1	9a	Tor
4PB	XC9235E1BC4	DG/DC-IC	PWM step-down, 1.2MHz, 1.15V±2%, 600mA, CL, Vin>1.8V, LSST	USP-6EL	56dc5	DC1	9a	Tor
4PB	XC9235E1BCER	DC-DC-IC	PWM, st-dwn, 1.15V±2%, 600mA, 1.2MHz, Vin>1.8V, LSST, CL	USP-6C	49dc5	DC1	9a	Tor
4PC	XC9235E1CC4	DG/DC-IC	PWM step-down, 1.2MHz, 1.25V±2%, 600mA, CL, Vin>1.8V, LSST	USP-6EL	56dc5	DC1	9a	Tor
4PC	XC9235E1CCER	DC-DC-IC	PWM, st-dwn, 1.25V±2%, 600mA, 1.2MHz, Vin>1.8V, LSST, CL	USP-6C	49dc5	DC1	9a	Tor
4PD	XC9235E1DC4	DG/DC-IC	PWM step-down, 1.2MHz, 1.35V±2%, 600mA, CL, Vin>1.8V, LSST	USP-6EL	56dc5	DC1	9a	Tor
4PD	XC9235E1DCER	DC-DC-IC	PWM, st-dwn, 1.35V±2%, 600mA, 1.2MHz, Vin>1.8V, LSST, CL	USP-6C	49dc5	DC1	9a	Tor
4PE	XC9235E1EC4	DG/DC-IC	PWM step-down, 1.2MHz, 1.45V±2%, 600mA, CL, Vin>1.8V, LSST	USP-6EL	56dc5	DC1	9a	Tor
4PE	XC9235E1ECER	DC-DC-IC	PWM, st-dwn, 1.45V±2%, 600mA, 1.2MHz, Vin>1.8V, LSST, CL	USP-6C	49dc5	DC1	9a	Tor
4PF	XC9235E1FC4	DG/DC-IC	PWM step-down, 1.2MHz, 1.55V±2%, 600mA, CL, Vin>1.8V, LSST	USP-6EL	56dc5	DC1	9a	Tor
4PF	XC9235E1FCER	DC-DC-IC	PWM, st-dwn, 1.55V±2%, 600mA, 1.2MHz, Vin>1.8V, LSST, CL	USP-6C	49dc5	DC1	9a	Tor
4PH	XC9235E1HC4	DG/DC-IC	PWM step-down, 1.2MHz, 1.65V±2%, 600mA, CL, Vin>1.8V, LSST	USP-6EL	56dc5	DC1	9a	Tor
4PH	XC9235E1HCER	DC-DC-IC	PWM, st-dwn, 1.65V±2%, 600mA, 1.2MHz, Vin>1.8V, LSST, CL	USP-6C	49dc5	DC1	9a	Tor
4PK	XC9235E1KC4	DG/DC-IC	PWM step-down, 1.2MHz, 1.75V±2%, 600mA, CL, Vin>1.8V, LSST	USP-6EL	56dc5	DC1	9a	Tor
4PK	XC9235E1KCER	DC-DC-IC	PWM, st-dwn, 1.75V±2%, 600mA, 1.2MHz, Vin>1.8V, LSST, CL	USP-6C	49dc5	DC1	9a	Tor
4PL	XC9235E1LC4	DG/DC-IC	PWM step-down, 1.2MHz, 1.85V±2%, 600mA, CL, Vin>1.8V, LSST	USP-6EL	56dc5	DC1	9a	Tor
4PL	XC9235E1LCER	DC-DC-IC	PWM, st-dwn, 1.85V±2%, 600mA, 1.2MHz, Vin>1.8V, LSST, CL	USP-6C	49dc5	DC1	9a	Tor
4PM	XC9235E1MC4	DG/DC-IC	PWM step-down, 1.2MHz, 1.95V±2%, 600mA, CL, Vin>1.8V, LSST	USP-6EL	56dc5	DC1	9a	Tor
4PM	XC9235E1MCER	DC-DC-IC	PWM, st-dwn, 1.95V±2%, 600mA, 1.2MHz, Vin>1.8V, LSST, CL	USP-6C	49dc5	DC1	9a	Tor
4Q	R3117K451C	Vdet-IC	4.5V±1%, -Reset PPO, Sense	DFN1010-4	48rq	VD12	9a	Ric
4Q	RP101K311D	LVR-IC	LDO, LN, +CE, CL, 3.1V±0.8%, 300mA	DFN1612-4	45vm	VR4	9a	Ric
4R	R3117K461C	Vdet-IC	4.6V±1%, -Reset PPO, Sense	DFN1010-4	48rq	VD12	9a	Ric
4R	RP101K331D	LVR-IC	LDO, LN, +CE, CL, 3.3V±0.8%, 300mA	DFN1612-4	45vm	VR4	9a	Ric
4R	XC6223E3219R-G	LVR-IC	LDO, 3.2V±1%, 300mA, +CE, ICP	USPQ-4B03	48vm	VR4	9a	Tor
4R	XC6221D3017R	LVR-IC	LDO, 3V±1%, 200mA, +CE, CL, PDR	USPN-4	58vm	VR4	9a	Tor
4R0	XC9235E20C4	DG/DC-IC	PWM step-down, 1.2MHz, 2.0V±2%, 600mA, CL, Vin>1.8V, LSST	USP-6EL	56dc5	DC1	9a	Tor
4R0	XC9235E20CER	DC-DC-IC	PWM, st-dwn, 2.0V±2%, 600mA, 1.2MHz, Vin>1.8V, LSST, CL	USP-6C	49dc5	DC1	9a	Tor
4R1	XC9235E21C4	DG/DC-IC	PWM step-down, 1.2MHz, 2.1V±2%, 600mA, CL, Vin>1.8V, LSST	USP-6EL	56dc5	DC1	9a	Tor
4R1	XC9235E21CER	DC-DC-IC	PWM, st-dwn, 2.1V±2%, 600mA, 1.2MHz, Vin>1.8V, LSST, CL	USP-6C	49dc5	DC1	9a	Tor
4R2	XC9235E22C4	DG/DC-IC	PWM step-down, 1.2MHz, 2.2V±2%, 600mA, CL, Vin>1.8V, LSST	USP-6EL	56dc5	DC1	9a	Tor



SMD code	Type	Function	Short description	Case	Pinout	Sch.	St.	Mnf.
4SF	XC9235E3FCER	DC-DC-IC	PWM, st-dwn, 3.55V±2%, 600mA, 1.2MHz, Vin>1.8V, LSST, CL	USP-6C	49dc5	DC1	9a	Tor
4SH	XC9235E3HC4	DC/DC-IC	PWM step-down, 1.2MHz, 3.65V±2%, 600mA, CL, Vin>1.8V, LSST	USP-6EL	56dc5	DC1	9a	Tor
4SH	XC9235E3HCER	DC-DC-IC	PWM, st-dwn, 3.65V±2%, 600mA, 1.2MHz, Vin>1.8V, LSST, CL	USP-6C	49dc5	DC1	9a	Tor
4SK	XC9235E3KC4	DC/DC-IC	PWM step-down, 1.2MHz, 3.75V±2%, 600mA, CL, Vin>1.8V, LSST	USP-6EL	56dc5	DC1	9a	Tor
4SK	XC9235E3KCER	DC-DC-IC	PWM, st-dwn, 3.75V±2%, 600mA, 1.2MHz, Vin>1.8V, LSST, CL	USP-6C	49dc5	DC1	9a	Tor
4SL	XC9235E3LC4	DC/DC-IC	PWM step-down, 1.2MHz, 3.85V±2%, 600mA, CL, Vin>1.8V, LSST	USP-6EL	56dc5	DC1	9a	Tor
4SL	XC9235E3LCER	DC-DC-IC	PWM, st-dwn, 3.85V±2%, 600mA, 1.2MHz, Vin>1.8V, LSST, CL	USP-6C	49dc5	DC1	9a	Tor
4SM	XC9235E3MC4	DC/DC-IC	PWM step-down, 1.2MHz, 3.95V±2%, 600mA, CL, Vin>1.8V, LSST	USP-6EL	56dc5	DC1	9a	Tor
4SM	XC9235E3MCER	DC-DC-IC	PWM, st-dwn, 3.95V±2%, 600mA, 1.2MHz, Vin>1.8V, LSST, CL	USP-6C	49dc5	DC1	9a	Tor
4T	R3117K481C	Vdet-IC	4.8V±1%, -Reset PPO, Sense	DFN1010-4	48rq	VD12	9a	Ric
4T	XG6223E3419R-G	LVR-IC	LDO, 3.4V±1%, 300mA, +CE, ICP	USPQ-4B03	48vm	VR4	9a	Tor
4T	XG6221D3217R	LVR-IC	LDO, 3.2V±1%, 200mA, +CE, CL, PDR	USPN-4	58vm	VR4	9a	Tor
4T0	XC9235E40C4	DC/DC-IC	PWM step-down, 1.2MHz, 4.0V±2%, 600mA, CL, Vin>1.8V, LSST	USP-6EL	56dc5	DC1	9a	Tor
4T0	XC9235E40CER	DC-DC-IC	PWM, st-dwn, 4.0V±2%, 600mA, 1.2MHz, Vin>1.8V, LSST, CL	USP-6C	49dc5	DC1	9a	Tor
4U	R3117K491C	Vdet-IC	4.9V±1%, -Reset PPO, Sense	DFN1010-4	48rq	VD12	9a	Ric
4U	XG6223E3519R-G	LVR-IC	LDO, 3.5V±1%, 300mA, +CE, ICP	USPQ-4B03	48vm	VR4	9a	Tor
4U	XG6221D3317R	LVR-IC	LDO, 3.3V±1%, 200mA, +CE, CL, PDR	USPN-4	58vm	VR4	9a	Tor
4U8	XC9235E08D4	DC/DC-IC	PWM step-down, 3MHz, 0.8V±2%, 600mA, CL, Vin>1.8V, LSST	USP-6EL	56dc5	DC1	9a	Tor
4U8	XC9235E08DER	DC-DC-IC	PWM, st-dwn, 0.8V±2%, 600mA, 3MHz, Vin>1.8V, LSST, CL	USP-6C	49dc5	DC1	9a	Tor
4U9	XC9235E09D4	DC/DC-IC	PWM step-down, 3MHz, 0.9V±2%, 600mA, CL, Vin>1.8V, LSST	USP-6EL	56dc5	DC1	9a	Tor
4U9	XC9235E09DER	DC-DC-IC	PWM, st-dwn, 0.9V±2%, 600mA, 3MHz, Vin>1.8V, LSST, CL	USP-6C	49dc5	DC1	9a	Tor
4UL	XC9235E0LD4	DC/DC-IC	PWM step-down, 3MHz, 0.85V±2%, 600mA, CL, Vin>1.8V, LSST	USP-6EL	56dc5	DC1	9a	Tor
4UL	XC9235E0LDER	DC-DC-IC	PWM, st-dwn, 0.85V±2%, 600mA, 3MHz, Vin>1.8V, LSST, CL	USP-6C	49dc5	DC1	9a	Tor
4UM	XC9235E0MD4	DC/DC-IC	PWM step-down, 3MHz, 0.95V±2%, 600mA, CL, Vin>1.8V, LSST	USP-6EL	56dc5	DC1	9a	Tor
4UM	XC9235E0MDER	DC-DC-IC	PWM, st-dwn, 0.95V±2%, 600mA, 3MHz, Vin>1.8V, LSST, CL	USP-6C	49dc5	DC1	9a	Tor
4V	R3117K501C	Vdet-IC	5.0V±1%, -Reset PPO, Sense	DFN1010-4	48rq	VD12	9a	Ric
4V	XG6223E3619R-G	LVR-IC	LDO, 3.6V±1%, 300mA, +CE, ICP	USPQ-4B03	48vm	VR4	9a	Tor
4V	XG6221D3417R	LVR-IC	LDO, 3.4V±1%, 200mA, +CE, CL, PDR	USPN-4	58vm	VR4	9a	Tor
4V0	XC9235E10D4	DC/DC-IC	PWM step-down, 3MHz, 1.0V±2%, 600mA, CL, Vin>1.8V, LSST	USP-6EL	56dc5	DC1	9a	Tor
4V0	XC9235E10DER	DC-DC-IC	PWM, st-dwn, 1.0V±2%, 600mA, 3MHz, Vin>1.8V, LSST, CL	USP-6C	49dc5	DC1	9a	Tor
4V1	XC9235E11D4	DC/DC-IC	PWM step-down, 3MHz, 1.1V±2%, 600mA, CL, Vin>1.8V, LSST	USP-6EL	56dc5	DC1	9a	Tor
4V1	XC9235E11DER	DC-DC-IC	PWM, st-dwn, 1.1V±2%, 600mA, 3MHz, Vin>1.8V, LSST, CL	USP-6C	49dc5	DC1	9a	Tor
4V2	XC9235E12D4	DC/DC-IC	PWM step-down, 3MHz, 1.2V±2%, 600mA, CL, Vin>1.8V, LSST	USP-6EL	56dc5	DC1	9a	Tor
4V2	XC9235E12DER	DC-DC-IC	PWM, st-dwn, 1.2V±2%, 600mA, 3MHz, Vin>1.8V, LSST, CL	USP-6C	49dc5	DC1	9a	Tor
4V3	XC9235E13D4	DC/DC-IC	PWM step-down, 3MHz, 1.3V±2%, 600mA, CL, Vin>1.8V, LSST	USP-6EL	56dc5	DC1	9a	Tor
4V3	XC9235E13DER	DC-DC-IC	PWM, st-dwn, 1.3V±2%, 600mA, 3MHz, Vin>1.8V, LSST, CL	USP-6C	49dc5	DC1	9a	Tor
4V4	XC9235E14D4	DC/DC-IC	PWM step-down, 3MHz, 1.4V±2%, 600mA, CL, Vin>1.8V, LSST	USP-6EL	56dc5	DC1	9a	Tor
4V4	XC9235E14DER	DC-DC-IC	PWM, st-dwn, 1.4V±2%, 600mA, 3MHz, Vin>1.8V, LSST, CL	USP-6C	49dc5	DC1	9a	Tor
4V5	XC9235E15D4	DC/DC-IC	PWM step-down, 3MHz, 1.5V±2%, 600mA, CL, Vin>1.8V, LSST	USP-6EL	56dc5	DC1	9a	Tor
4V5	XC9235E15DER	DC-DC-IC	PWM, st-dwn, 1.5V±2%, 600mA, 3MHz, Vin>1.8V, LSST, CL	USP-6C	49dc5	DC1	9a	Tor
4V6	XC9235E16D4	DC/DC-IC	PWM step-down, 3MHz, 1.6V±2%, 600mA, CL, Vin>1.8V, LSST	USP-6EL	56dc5	DC1	9a	Tor
4V6	XC9235E16DER	DC-DC-IC	PWM, st-dwn, 1.6V±2%, 600mA, 3MHz, Vin>1.8V, LSST, CL	USP-6C	49dc5	DC1	9a	Tor
4V7	XC9235E17D4	DC/DC-IC	PWM step-down, 3MHz, 1.7V±2%, 600mA, CL, Vin>1.8V, LSST	USP-6EL	56dc5	DC1	9a	Tor
4V7	XC9235E17DER	DC-DC-IC	PWM, st-dwn, 1.7V±2%, 600mA, 3MHz, Vin>1.8V, LSST, CL	USP-6C	49dc5	DC1	9a	Tor
4V8	XC9235E18D4	DC/DC-IC	PWM step-down, 3MHz, 1.8V±2%, 600mA, CL, Vin>1.8V, LSST	USP-6EL	56dc5	DC1	9a	Tor
4V8	XC9235E18DER	DC-DC-IC	PWM, st-dwn, 1.8V±2%, 600mA, 3MHz, Vin>1.8V, LSST, CL	USP-6C	49dc5	DC1	9a	Tor
4V9	XC9235E19D4	DC/DC-IC	PWM step-down, 3MHz, 1.9V±2%, 600mA, CL, Vin>1.8V, LSST	USP-6EL	56dc5	DC1	9a	Tor
4V9	XC9235E19DER	DC-DC-IC	PWM, st-dwn, 1.9V±2%, 600mA, 3MHz, Vin>1.8V, LSST, CL	USP-6C	49dc5	DC1	9a	Tor
4VA	XC9235E1AD4	DC/DC-IC	PWM step-down, 3MHz, 1.05V±2%, 600mA, CL, Vin>1.8V, LSST	USP-6EL	56dc5	DC1	9a	Tor
4VA	XC9235E1ADER	DC-DC-IC	PWM, st-dwn, 1.05V±2%, 600mA, 3MHz, Vin>1.8V, LSST, CL	USP-6C	49dc5	DC1	9a	Tor
4VB	XC9235E1BD4	DC/DC-IC	PWM step-down, 3MHz, 1.15V±2%, 600mA, CL, Vin>1.8V, LSST	USP-6EL	56dc5	DC1	9a	Tor
4VB	XC9235E1BDER	DC-DC-IC	PWM, st-dwn, 1.15V±2%, 600mA, 3MHz, Vin>1.8V, LSST, CL	USP-6C	49dc5	DC1	9a	Tor
4VC	XC9235E1CD4	DC/DC-IC	PWM step-down, 3MHz, 1.25V±2%, 600mA, CL, Vin>1.8V, LSST	USP-6EL	56dc5	DC1	9a	Tor
4VC	XC9235E1CDER	DC-DC-IC	PWM, st-dwn, 1.25V±2%, 600mA, 3MHz, Vin>1.8V, LSST, CL	USP-6C	49dc5	DC1	9a	Tor
4VD	XC9235E1DD4	DC/DC-IC	PWM step-down, 3MHz, 1.35V±2%, 600mA, CL, Vin>1.8V, LSST	USP-6EL	56dc5	DC1	9a	Tor
4VD	XC9235E1DDER	DC-DC-IC	PWM, st-dwn, 1.35V±2%, 600mA, 3MHz, Vin>1.8V, LSST, CL	USP-6C	49dc5	DC1	9a	Tor
4VE	XC9235E1ED4	DC/DC-IC	PWM step-down, 3MHz, 1.45V±2%, 600mA, CL, Vin>1.8V, LSST	USP-6EL	56dc5	DC1	9a	Tor
4VE	XC9235E1EDER	DC-DC-IC	PWM, st-dwn, 1.45V±2%, 600mA, 3MHz, Vin>1.8V, LSST, CL	USP-6C	49dc5	DC1	9a	Tor
4VF	XC9235E1FD4	DC/DC-IC	PWM step-down, 3MHz, 1.55V±2%, 600mA, CL, Vin>1.8V, LSST	USP-6EL	56dc5	DC1	9a	Tor
4VF	XC9235E1FDER	DC-DC-IC	PWM, st-dwn, 1.55V±2%, 600mA, 3MHz, Vin>1.8V, LSST, CL	USP-6C	49dc5	DC1	9a	Tor
4VH	XC9235E1HD4	DC/DC-IC	PWM step-down, 3MHz, 1.65V±2%, 600mA, CL, Vin>1.8V, LSST	USP-6EL	56dc5	DC1	9a	Tor
4VH	XC9235E1HDER	DC-DC-IC	PWM, st-dwn, 1.65V±2%, 600mA, 3MHz, Vin>1.8V, LSST, CL	USP-6C	49dc5	DC1	9a	Tor
4VK	XC9235E1KD4	DC/DC-IC	PWM step-down, 3MHz, 1.75V±2%, 600mA, CL, Vin>1.8V, LSST	USP-6EL	56dc5	DC1	9a	Tor
4VK	XC9235E1KDER	DC-DC-IC	PWM, st-dwn, 1.75V±2%, 600mA, 3MHz, Vin>1.8V, LSST, CL	USP-6C	49dc5	DC1	9a	Tor
4VL	XC9235E1LD4	DC/DC-IC	PWM step-down, 3MHz, 1.85V±2%, 600mA, CL, Vin>1.8V, LSST	USP-6EL	56dc5	DC1	9a	Tor
4VL	XC9235E1LDER	DC-DC-IC	PWM, st-dwn, 1.85V±2%, 600mA, 3MHz, Vin>1.8V, LSST, CL	USP-6C	49dc5	DC1	9a	Tor
4VM	XC9235E1MD4	DC/DC-IC	PWM step-down, 3MHz, 1.95V±2%, 600mA, CL, Vin>1.8V, LSST	USP-6EL	56dc5	DC1	9a	Tor
4VM	XC9235E1MDER	DC-DC-IC	PWM, st-dwn, 1.95V±2%, 600mA, 3MHz, Vin>1.8V, LSST, CL	USP-6C	49dc5	DC1	9a	Tor
4X	XG6223E3719R-G	LVR-IC	LDO, 3.7V±1%, 300mA, +CE, ICP	USPQ-4B03	48vm	VR4	9a	Tor
4X	XG6221D3517R	LVR-IC	LDO, 3.5V±1%, 200mA, +CE, CL, PDR	USPN-4	58vm	VR4	9a	Tor



SMD code	Type	Function	Short description	Case	Pinout	Sch.	St.	Mnf.
4YE	XC9235E3ED4	DC/DC-IC	PWM step-down, 3MHz, 3.45V±2%, 600mA, CL, Vin>1.8V, LSST	USP-6EL	56dc5	DC1	9a	Tor
4YE	XC9235E3EDER	DC-DC-IC	PWM, st-dwn, 3.45V±2%, 600mA, 3MHz, Vin>1.8V, LSST, CL	USP-6C	49dc5	DC1	9a	Tor
4YF	XC9235E3FD4	DC/DC-IC	PWM step-down, 3MHz, 3.55V±2%, 600mA, CL, Vin>1.8V, LSST	USP-6EL	56dc5	DC1	9a	Tor
4YF	XC9235E3FDER	DC-DC-IC	PWM, st-dwn, 3.55V±2%, 600mA, 3MHz, Vin>1.8V, LSST, CL	USP-6C	49dc5	DC1	9a	Tor
4YH	XC9235E3HD4	DC/DC-IC	PWM step-down, 3MHz, 3.65V±2%, 600mA, CL, Vin>1.8V, LSST	USP-6EL	56dc5	DC1	9a	Tor
4YH	XC9235E3HDER	DC-DC-IC	PWM, st-dwn, 3.65V±2%, 600mA, 3MHz, Vin>1.8V, LSST, CL	USP-6C	49dc5	DC1	9a	Tor
4YK	XC9235E3KD4	DC/DC-IC	PWM step-down, 3MHz, 3.75V±2%, 600mA, CL, Vin>1.8V, LSST	USP-6EL	56dc5	DC1	9a	Tor
4YK	XC9235E3KDER	DC-DC-IC	PWM, st-dwn, 3.75V±2%, 600mA, 3MHz, Vin>1.8V, LSST, CL	USP-6C	49dc5	DC1	9a	Tor
4YL	XC9235E3LD4	DC/DC-IC	PWM step-down, 3MHz, 3.85V±2%, 600mA, CL, Vin>1.8V, LSST	USP-6EL	56dc5	DC1	9a	Tor
4YL	XC9235E3LDER	DC-DC-IC	PWM, st-dwn, 3.85V±2%, 600mA, 3MHz, Vin>1.8V, LSST, CL	USP-6C	49dc5	DC1	9a	Tor
4YM	XC9235E3MD4	DC/DC-IC	PWM step-down, 3MHz, 3.95V±2%, 600mA, CL, Vin>1.8V, LSST	USP-6EL	56dc5	DC1	9a	Tor
4YM	XC9235E3MDER	DC-DC-IC	PWM, st-dwn, 3.95V±2%, 600mA, 3MHz, Vin>1.8V, LSST, CL	USP-6C	49dc5	DC1	9a	Tor
4Z	XC6223E3919R-G	LVR-IC	LDO, 3.9V±1%, 300mA, +CE, ICP	USPQ-4B03	48vm	VR4	9a	Tor
4Z	XC6221D3171R	LVR-IC	LDO, 3.7V±1%, 200mA, +CE, CL, PDR	USPN-4	58vm	VR4	9a	Tor
4Z0	XC9235E40D4	DC/DC-IC	PWM step-down, 3MHz, 4.0V±2%, 600mA, CL, Vin>1.8V, LSST	USP-6EL	56dc5	DC1	9a	Tor
4Z0	XC9235E40DER	DC-DC-IC	PWM, st-dwn, 4.0V±2%, 600mA, 3MHz, Vin>1.8V, LSST, CL	USP-6C	49dc5	DC1	9a	Tor
5	NLU1GT32MU	CMOS-Logic	2-input OR gate, TTL level	UDFN-6	57/Log4	-	9d	Ons
50	RP110L241C	LVR-IC	LDO, 2.4V±1%, 150mA	DFN1010-4	48y1	VR1	9a	Ric
50	XC6420AB507R-G	LVR-IC	LDO, Dual out, Vout1/Vout2=1.80/1.20V±2%, 150mA, +CE	USPN-6	52xv	VR19	9a	Tor
50	XC6420AB50DR-G	LVR-IC	LDO, Dual out, Vout1/Vout2=1.80/1.20V±2%, 150mA, +CE	USP-6B04	73x4	VR19	9a	Tor
50	XC6221D3817R	LVR-IC	LDO, 3.8V±1%, 200mA, +CE, CL, PDR	USPN-4	58vm	VR4	9a	Tor
5004	AUD5004CS09	LIN-IC	AF PA, BTL, 2.7..5.5V, 2W(5V/4Q), select shutdown	BGA-9	39	-	-	Axp
5015	AUD5015CS12	LIN-IC	AF PA, BTL, 2.7..5.5V, 2W(5V/4Q), select shutdown	BGA-12	39	-	-	Axp
5020	AUD5020CS09	LIN-IC	AF PA, BTL, class-D, 2.7..5.5V, 2.5W(5V/4Q), shutdown	BGA-9	39	AFP45	-	Axp
51	RP110L251C	LVR-IC	LDO, 2.5V±1%, 150mA	DFN1010-4	48y1	VR1	9a	Ric
51	XC6420AB517R-G	LVR-IC	LDO, Dual out, Vout1/Vout2=3.10/3.10V±2%, 150mA, +CE	USPN-6	52xv	VR19	9a	Tor
51	XC6420AB51DR-G	LVR-IC	LDO, Dual out, Vout1/Vout2=3.10/3.10V±2%, 150mA, +CE	USP-6B04	73x4	VR19	9a	Tor
51	XC6221D3917R	LVR-IC	LDO, 3.9V±1%, 200mA, +CE, CL, PDR	USPN-4	58vm	VR4	9a	Tor
52	RP110L261C	LVR-IC	LDO, 2.6V±1%, 150mA	DFN1010-4	48y1	VR1	9a	Ric
52	XC6223F1219R-G	LVR-IC	LDO, 1.2V±20mV, 300mA, +CE, CL, ICP	USPQ-4B03	48vm	VR4	9a	Tor
52	XC6420AB527R-G	LVR-IC	LDO, Dual out, Vout1/Vout2=1.50/3.10V±2%, 150mA, +CE	USPN-6	52xv	VR19	9a	Tor
52	XC6420AB52DR-G	LVR-IC	LDO, Dual out, Vout1/Vout2=1.50/3.10V±2%, 150mA, +CE	USP-6B04	73x4	VR19	9a	Tor
52	XC6221D4017R	LVR-IC	LDO, 4V±1%, 200mA, +CE, CL, PDR	USPN-4	58vm	VR4	9a	Tor
53	RP110L271C	LVR-IC	LDO, 2.7V±1%, 150mA	DFN1010-4	48y1	VR1	9a	Ric
53	XC6223F1319R-G	LVR-IC	LDO, 1.3V±20mV, 300mA, +CE, CL, ICP	USPQ-4B03	48vm	VR4	9a	Tor
53	XC6420AB537R-G	LVR-IC	LDO, Dual out, Vout1/Vout2=3.30/2.80V±2%, 150mA, +CE	USPN-6	52xv	VR19	9a	Tor
53	XC6420AB53DR-G	LVR-IC	LDO, Dual out, Vout1/Vout2=3.30/2.80V±2%, 150mA, +CE	USP-6B04	73x4	VR19	9a	Tor
53	XC6221D4117R	LVR-IC	LDO, 4.1V±1%, 200mA, +CE, CL, PDR	USPN-4	58vm	VR4	9a	Tor
54	LM4854BL	LIN-IC	AF PA, BTL, 2.7..5.5V, 1.9W(4Q)+2x85mW(8Q), shutdown	BGA-12	39	-	-	Nsc
54	RP110L281C	LVR-IC	LDO, 2.8V±1%, 150mA	DFN1010-4	48y1	VR1	9a	Ric
54	XC6223F1419R-G	LVR-IC	LDO, 1.4V±20mV, 300mA, +CE, CL, ICP	USPQ-4B03	48vm	VR4	9a	Tor
54	XC6420AB547R-G	LVR-IC	LDO, Dual out, Vout1/Vout2=3.00/2.80V±2%, 150mA, +CE	USPN-6	52xv	VR19	9a	Tor
54	XC6420AB54DR-G	LVR-IC	LDO, Dual out, Vout1/Vout2=3.00/2.80V±2%, 150mA, +CE	USP-6B04	73x4	VR19	9a	Tor
54	XC6221D4217R	LVR-IC	LDO, 4.2V±1%, 200mA, +CE, CL, PDR	USPN-4	58vm	VR4	9a	Tor
54000IRTZ	ISL54000IR	LIN-IC	AF PA, 2.7..5.5V, 2x950mW(5V/8Q), shutdown	TQFN-20	38	-	9m	Isl
54001IRTZ	ISL54001IR	LIN-IC	AF PA, 2.7..5.5V, 2x950mW(5V/8Q), shutdown	TQFN-20	38	-	9m	Isl
54002IRTZ	ISL54002IR	LIN-IC	AF PA, 2.7..5.5V, 2x950mW(5V/8Q), shutdown	TQFN-20	38	-	9m	Isl
54003IRTZ	ISL54003IR	LIN-IC	AF PA, BTL, 2.7..5.5V, 950mW(8Q)+2x50mW(32Q), shutdown	TQFN-20	38	-	9m	Isl
54004IRTZ	ISL54004IR	LIN-IC	AF PA, BTL, 2.7..5.5V, 950mW(8Q)+2x50mW(32Q), shutdown	TQFN-20	38	-	9m	Isl
54005IRTZ	ISL54005IR	LIN-IC	AF PA, BTL, 2.7..5.5V, 950mW(8Q)+2x50mW(32Q), shutdown	TQFN-20	38	-	9m	Isl
54006IRTZ	ISL54006IR	LIN-IC	AF PA, BTL, 2.7..5.5V, 950mW(8Q)+2x50mW(32Q), shutdown	TQFN-20	38	-	9m	Isl
5460	BD5460GUL	LIN-IC	AF PA, BTL, class-D, 2.5..5.5V, 850mW(5V/4Q), shutdown	BGA-9	39	AFP45	9g	Rhm
5461	BD5461GUL	LIN-IC	AF PA, BTL, class-D, 2.5..5.5V, 850mW(5V/4Q), shutdown	BGA-9	39	AFP45	9g	Rhm
5465	BD5465GUL	LIN-IC	AF PA, BTL, class-D, 2.5..5.5V, 650mW(5V/4Q), shutdown	BGA-9	39	AFP45	9g	Rhm
5466	BD5466GUL	LIN-IC	AF PA, BTL, class-D, 2.5..5.5V, 700mW(5V/4Q), shutdown	BGA-9	39	AFP45	9g	Rhm
5467	BD5467GUL	LIN-IC	AF PA, BTL, class-D, 2.5..5.5V, 700mW(5V/4Q), shutdown	BGA-9	39	AFP45	9g	Rhm
5468	BD5468GUL	LIN-IC	AF PA, BTL, class-D, 2.5..5.5V, 700mW(5V/4Q), shutdown	BGA-9	39	AFP45	9g	Rhm
55	74AUP1Z125GF	CMOS-Logic	X-tal driver with enable and internal resistor	SOT891	52/Log83	-	9c	Phi
55	74AUP1Z125GM	CMOS-Logic	X-tal driver with enable and internal resistor	SOT-886	57/Log83	-	9c	Phi
55	LM4855BL	LIN-IC	AF PA, BTL, 2.7..5.5V, 1.1W(8Q)+2x115mW(32Q), SPI	BGA-20	39	-	-	Nsc
55	RP110L281C5	LVR-IC	LDO, 2.85V±1%, 150mA	DFN1010-4	48y1	VR1	9a	Ric
55	XC6223F1519R-G	LVR-IC	LDO, 1.5V±20mV, 300mA, +CE, CL, ICP	USPQ-4B03	48vm	VR4	9a	Tor
55	XC6420AB557R-G	LVR-IC	LDO, Dual out, Vout1/Vout2=3.30/3.00V±2%, 150mA, +CE	USPN-6	52xv	VR19	9a	Tor
55	XC6420AB55DR-G	LVR-IC	LDO, Dual out, Vout1/Vout2=3.30/3.00V±2%, 150mA, +CE	USP-6B04	73x4	VR19	9a	Tor
55	XC6221D4317R	LVR-IC	LDO, 4.3V±1%, 200mA, +CE, CL, PDR	USPN-4	58vm	VR4	9a	Tor
56	RP110L291C	LVR-IC	LDO, 2.9V±1%, 150mA	DFN1010-4	48y1	VR1	9a	Ric
56	TS4956EJIT	LIN-IC	AF PA, BTL, 2.7..5.5V, 450mW(8Q)+2x32mW(32Q), +65mW, I2C	BGA-18	39	-	-	Stc
56	XC6223F1619R-G	LVR-IC	LDO, 1.6V±20mV, 300mA, +CE, CL, ICP	USPQ-4B03	48vm	VR4	9a	Tor
56	XC6221D4417R	LVR-IC	LDO, 4.4V±1%, 200mA, +CE, CL, PDR	USPN-4	58vm	VR4	9a	Tor
57	RP110L301C	LVR-IC	LDO, 3.0V±1%, 150mA	DFN1010-4	48y1	VR1	9a	Ric



SMD code	Type	Function	Short description	Case	Pinout	Sch.	St.	Mnf.
57	XC6217C08A7R-G	LVR-IC	LDO, 0.85V±2%, 200mA, +CE	USPN-4	58vm	VR4	9a	Tor
57	XC6223F1719R-G	LVR-IC	LDO, 1.7V±20mV, 300mA, +CE, CL, ICP	USPQ-4B03	48vm	VR4	9a	Tor
57	XC6221D4517R	LVR-IC	LDO, 4.5V±1%, 200mA, +CE, CL, PDR	USPN-4	58vm	VR4	9a	Tor
58	RP110L31C	LVR-IC	LDO, 3.1V±1%, 150mA	DFN1010-4	48y1	VR1	9a	Ric
58	XC6217C09A7R-G	LVR-IC	LDO, 0.95V±2%, 200mA, +CE	USPN-4	58vm	VR4	9a	Tor
58	XC6223F1819R-G	LVR-IC	LDO, 1.8V±20mV, 300mA, +CE, CL, ICP	USPQ-4B03	48vm	VR4	9a	Tor
58	XC6221D4617R	LVR-IC	LDO, 4.6V±1%, 200mA, +CE, CL, PDR	USPN-4	58vm	VR4	9a	Tor
59	74AUP1T97GF	CMOS-Logic	Configurable gate with voltage-level translator	SOT891	52/Log81	-	9c	Phi
59	74AUP1T97GM	CMOS-Logic	Configurable gate with voltage-level translator	SOT-886	57/Log81	-	9c	Phi
59	LEE-59+	MMIC	RF amplifier, DC, 5GHz, 17.8dB (50Ω)	FG873	36aa	A1	9b	Mc
59	RP110L321C	LVR-IC	LDO, 3.2V±1%, 150mA	DFN1010-4	48y1	VR1	9a	Ric
59	XC6217C10A7R-G	LVR-IC	LDO, 1.05V±2%, 200mA, +CE	USPN-4	58vm	VR4	9a	Tor
59	XC6223F1919R-G	LVR-IC	LDO, 1.9V±20mV, 300mA, +CE, CL, ICP	USPQ-4B03	48vm	VR4	9a	Tor
59	XC6221D4717R	LVR-IC	LDO, 4.7V±1%, 200mA, +CE, CL, PDR	USPN-4	58vm	VR4	9a	Tor
5A	RP101K122B	LVR-IC	LDO, LN, +CE, 1.2V±0.8%, 300mA	DFN1612-4B	45vm	VR4	9a	Ric
5A	RP200K081B	LVR-IC	LDO, 0.8V±1.0%, 300mA, +CE, AE(mode)	DFN1212-6	52ht	VR10	9a	Ric
5A	XC6217C11A7R-G	LVR-IC	LDO, 1.15V±2%, 200mA, +CE	USPN-4	58vm	VR4	9a	Tor
5A	XC6223F2019R-G	LVR-IC	LDO, 2.0V±1%, 300mA, +CE, CL, ICP	USPQ-4B03	48vm	VR4	9a	Tor
5A	XC6221D4817R	LVR-IC	LDO, 4.8V±1%, 200mA, +CE, CL, PDR	USPN-4	58vm	VR4	9a	Tor
5A116	XC6103A116ER	Vdel-IC	1.6V±2%, Hst, -MR, +Reset PPO, Wt=6.25ms, Rt=3.13ms	USP-6C	49xh	VD17	9b	Tor
5A117	XC6103A117ER	Vdel-IC	1.7V±2%, Hst, -MR, +Reset PPO, Wt=6.25ms, Rt=3.13ms	USP-6C	49xh	VD17	9b	Tor
5A118	XC6103A118ER	Vdel-IC	1.8V±2%, Hst, -MR, +Reset PPO, Wt=6.25ms, Rt=3.13ms	USP-6C	49xh	VD17	9b	Tor
5A119	XC6103A119ER	Vdel-IC	1.9V±2%, Hst, -MR, +Reset PPO, Wt=6.25ms, Rt=3.13ms	USP-6C	49xh	VD17	9b	Tor
5A120	XC6103A120ER	Vdel-IC	2.0V±2%, Hst, -MR, +Reset PPO, Wt=6.25ms, Rt=3.13ms	USP-6C	49xh	VD17	9b	Tor
5A121	XC6103A121ER	Vdel-IC	2.1V±2%, Hst, -MR, +Reset PPO, Wt=6.25ms, Rt=3.13ms	USP-6C	49xh	VD17	9b	Tor
5A122	XC6103A122ER	Vdel-IC	2.2V±2%, Hst, -MR, +Reset PPO, Wt=6.25ms, Rt=3.13ms	USP-6C	49xh	VD17	9b	Tor
5A123	XC6103A123ER	Vdel-IC	2.3V±2%, Hst, -MR, +Reset PPO, Wt=6.25ms, Rt=3.13ms	USP-6C	49xh	VD17	9b	Tor
5A124	XC6103A124ER	Vdel-IC	2.4V±2%, Hst, -MR, +Reset PPO, Wt=6.25ms, Rt=3.13ms	USP-6C	49xh	VD17	9b	Tor
5A125	XC6103A125ER	Vdel-IC	2.5V±2%, Hst, -MR, +Reset PPO, Wt=6.25ms, Rt=3.13ms	USP-6C	49xh	VD17	9b	Tor
5A126	XC6103A126ER	Vdel-IC	2.6V±2%, Hst, -MR, +Reset PPO, Wt=6.25ms, Rt=3.13ms	USP-6C	49xh	VD17	9b	Tor
5A127	XC6103A127ER	Vdel-IC	2.7V±2%, Hst, -MR, +Reset PPO, Wt=6.25ms, Rt=3.13ms	USP-6C	49xh	VD17	9b	Tor
5A128	XC6103A128ER	Vdel-IC	2.8V±2%, Hst, -MR, +Reset PPO, Wt=6.25ms, Rt=3.13ms	USP-6C	49xh	VD17	9b	Tor
5A129	XC6103A129ER	Vdel-IC	2.9V±2%, Hst, -MR, +Reset PPO, Wt=6.25ms, Rt=3.13ms	USP-6C	49xh	VD17	9b	Tor
5A130	XC6103A130ER	Vdel-IC	3.0V±2%, Hst, -MR, +Reset PPO, Wt=6.25ms, Rt=3.13ms	USP-6C	49xh	VD17	9b	Tor
5A131	XC6103A131ER	Vdel-IC	3.1V±2%, Hst, -MR, +Reset PPO, Wt=6.25ms, Rt=3.13ms	USP-6C	49xh	VD17	9b	Tor
5A132	XC6103A132ER	Vdel-IC	3.2V±2%, Hst, -MR, +Reset PPO, Wt=6.25ms, Rt=3.13ms	USP-6C	49xh	VD17	9b	Tor
5A133	XC6103A133ER	Vdel-IC	3.3V±2%, Hst, -MR, +Reset PPO, Wt=6.25ms, Rt=3.13ms	USP-6C	49xh	VD17	9b	Tor
5A134	XC6103A134ER	Vdel-IC	3.4V±2%, Hst, -MR, +Reset PPO, Wt=6.25ms, Rt=3.13ms	USP-6C	49xh	VD17	9b	Tor
5A135	XC6103A135ER	Vdel-IC	3.5V±2%, Hst, -MR, +Reset PPO, Wt=6.25ms, Rt=3.13ms	USP-6C	49xh	VD17	9b	Tor
5A136	XC6103A136ER	Vdel-IC	3.6V±2%, Hst, -MR, +Reset PPO, Wt=6.25ms, Rt=3.13ms	USP-6C	49xh	VD17	9b	Tor
5A137	XC6103A137ER	Vdel-IC	3.7V±2%, Hst, -MR, +Reset PPO, Wt=6.25ms, Rt=3.13ms	USP-6C	49xh	VD17	9b	Tor
5A138	XC6103A138ER	Vdel-IC	3.8V±2%, Hst, -MR, +Reset PPO, Wt=6.25ms, Rt=3.13ms	USP-6C	49xh	VD17	9b	Tor
5A139	XC6103A139ER	Vdel-IC	3.9V±2%, Hst, -MR, +Reset PPO, Wt=6.25ms, Rt=3.13ms	USP-6C	49xh	VD17	9b	Tor
5A140	XC6103A140ER	Vdel-IC	4.0V±2%, Hst, -MR, +Reset PPO, Wt=6.25ms, Rt=3.13ms	USP-6C	49xh	VD17	9b	Tor
5A141	XC6103A141ER	Vdel-IC	4.1V±2%, Hst, -MR, +Reset PPO, Wt=6.25ms, Rt=3.13ms	USP-6C	49xh	VD17	9b	Tor
5A142	XC6103A142ER	Vdel-IC	4.2V±2%, Hst, -MR, +Reset PPO, Wt=6.25ms, Rt=3.13ms	USP-6C	49xh	VD17	9b	Tor
5A143	XC6103A143ER	Vdel-IC	4.3V±2%, Hst, -MR, +Reset PPO, Wt=6.25ms, Rt=3.13ms	USP-6C	49xh	VD17	9b	Tor
5A144	XC6103A144ER	Vdel-IC	4.4V±2%, Hst, -MR, +Reset PPO, Wt=6.25ms, Rt=3.13ms	USP-6C	49xh	VD17	9b	Tor
5A145	XC6103A145ER	Vdel-IC	4.5V±2%, Hst, -MR, +Reset PPO, Wt=6.25ms, Rt=3.13ms	USP-6C	49xh	VD17	9b	Tor
5A146	XC6103A146ER	Vdel-IC	4.6V±2%, Hst, -MR, +Reset PPO, Wt=6.25ms, Rt=3.13ms	USP-6C	49xh	VD17	9b	Tor
5A147	XC6103A147ER	Vdel-IC	4.7V±2%, Hst, -MR, +Reset PPO, Wt=6.25ms, Rt=3.13ms	USP-6C	49xh	VD17	9b	Tor
5A148	XC6103A148ER	Vdel-IC	4.8V±2%, Hst, -MR, +Reset PPO, Wt=6.25ms, Rt=3.13ms	USP-6C	49xh	VD17	9b	Tor
5A149	XC6103A149ER	Vdel-IC	4.9V±2%, Hst, -MR, +Reset PPO, Wt=6.25ms, Rt=3.13ms	USP-6C	49xh	VD17	9b	Tor
5A150	XC6103A150ER	Vdel-IC	5.0V±2%, Hst, -MR, +Reset PPO, Wt=6.25ms, Rt=3.13ms	USP-6C	49xh	VD17	9b	Tor
5A200	XC6371A200D	DC/DC-IC	PWM step-up, 50kHz, 2.0V±2.5%, 100mA	USP-6B	49ga	DC2	9b	Tor
5A201	XC6371A201D	DC/DC-IC	PWM step-up, 100kHz, 2.0V±2.5%, 100mA	USP-6B	49ga	DC2	9b	Tor
5A202	XC6371A202D	DC/DC-IC	PWM step-up, 180kHz, 2.0V±2.5%, 100mA	USP-6B	49ga	DC2	9b	Tor
5A210	XC6371A210D	DC/DC-IC	PWM step-up, 50kHz, 2.1V±2.5%, 100mA	USP-6B	49ga	DC2	9b	Tor
5A211	XC6371A211D	DC/DC-IC	PWM step-up, 100kHz, 2.1V±2.5%, 100mA	USP-6B	49ga	DC2	9b	Tor
5A212	XC6371A212D	DC/DC-IC	PWM step-up, 180kHz, 2.1V±2.5%, 100mA	USP-6B	49ga	DC2	9b	Tor
5A216	XC6103A216ER	Vdel-IC	1.6V±2%, Hst, -MR, +Reset PPO, Wt=50ms, Rt=3.13ms	USP-6C	49xh	VD17	9b	Tor
5A217	XC6103A217ER	Vdel-IC	1.7V±2%, Hst, -MR, +Reset PPO, Wt=50ms, Rt=3.13ms	USP-6C	49xh	VD17	9b	Tor
5A218	XC6103A218ER	Vdel-IC	1.8V±2%, Hst, -MR, +Reset PPO, Wt=50ms, Rt=3.13ms	USP-6C	49xh	VD17	9b	Tor
5A219	XC6103A219ER	Vdel-IC	1.9V±2%, Hst, -MR, +Reset PPO, Wt=50ms, Rt=3.13ms	USP-6C	49xh	VD17	9b	Tor
5A220	XC6103A220ER	Vdel-IC	2.0V±2%, Hst, -MR, +Reset PPO, Wt=50ms, Rt=3.13ms	USP-6C	49xh	VD17	9b	Tor
5A220	XC6371A220D	DC/DC-IC	PWM step-up, 50kHz, 2.2V±2.5%, 100mA	USP-6B	49ga	DC2	9b	Tor
5A221	XC6103A221ER	Vdel-IC	2.1V±2%, Hst, -MR, +Reset PPO, Wt=50ms, Rt=3.13ms	USP-6C	49xh	VD17	9b	Tor
5A221	XC6371A221D	DC/DC-IC	PWM step-up, 100kHz, 2.2V±2.5%, 100mA	USP-6B	49ga	DC2	9b	Tor
5A222	XC6103A222ER	Vdel-IC	2.2V±2%, Hst, -MR, +Reset PPO, Wt=50ms, Rt=3.13ms	USP-6C	49xh	VD17	9b	Tor
5A222	XC6371A222D	DC/DC-IC	PWM step-up, 180kHz, 2.2V±2.5%, 100mA	USP-6B	49ga	DC2	9b	Tor



SMD code	Type	Function	Short description	Case	Pinout	Sch.	St.	Mnf.
5A640	XC6103A640ER	Vdet-IC	4.0V±2%, Hst, -MR, +Reset PPO, Wt=1.6s, Rt=3.13ms	USP-6C	49xh	VD17	9b	Tor
5A640	XC6371A640D	DC/DC-IC	PWM step-up, 50kHz, 6.4V±2.5%, 100mA	USP-6B	49ga	DC2	9b	Tor
5A641	XC6103A641ER	Vdet-IC	4.1V±2%, Hst, -MR, +Reset PPO, Wt=1.6s, Rt=3.13ms	USP-6C	49xh	VD17	9b	Tor
5A641	XC6371A641D	DC/DC-IC	PWM step-up, 100kHz, 6.4V±2.5%, 100mA	USP-6B	49ga	DC2	9b	Tor
5A642	XC6103A642ER	Vdet-IC	4.2V±2%, Hst, -MR, +Reset PPO, Wt=1.6s, Rt=3.13ms	USP-6C	49xh	VD17	9b	Tor
5A642	XC6371A642D	DC/DC-IC	PWM step-up, 180kHz, 6.4V±2.5%, 100mA	USP-6B	49ga	DC2	9b	Tor
5A643	XC6103A643ER	Vdet-IC	4.3V±2%, Hst, -MR, +Reset PPO, Wt=1.6s, Rt=3.13ms	USP-6C	49xh	VD17	9b	Tor
5A644	XC6103A644ER	Vdet-IC	4.4V±2%, Hst, -MR, +Reset PPO, Wt=1.6s, Rt=3.13ms	USP-6C	49xh	VD17	9b	Tor
5A645	XC6103A645ER	Vdet-IC	4.5V±2%, Hst, -MR, +Reset PPO, Wt=1.6s, Rt=3.13ms	USP-6C	49xh	VD17	9b	Tor
5A646	XC6103A646ER	Vdet-IC	4.6V±2%, Hst, -MR, +Reset PPO, Wt=1.6s, Rt=3.13ms	USP-6C	49xh	VD17	9b	Tor
5A647	XC6103A647ER	Vdet-IC	4.7V±2%, Hst, -MR, +Reset PPO, Wt=1.6s, Rt=3.13ms	USP-6C	49xh	VD17	9b	Tor
5A648	XC6103A648ER	Vdet-IC	4.8V±2%, Hst, -MR, +Reset PPO, Wt=1.6s, Rt=3.13ms	USP-6C	49xh	VD17	9b	Tor
5A649	XC6103A649ER	Vdet-IC	4.9V±2%, Hst, -MR, +Reset PPO, Wt=1.6s, Rt=3.13ms	USP-6C	49xh	VD17	9b	Tor
5A650	XC6103A650ER	Vdet-IC	5.0V±2%, Hst, -MR, +Reset PPO, Wt=1.6s, Rt=3.13ms	USP-6C	49xh	VD17	9b	Tor
5A650	XC6371A650D	DC/DC-IC	PWM step-up, 50kHz, 6.5V±2.5%, 100mA	USP-6B	49ga	DC2	9b	Tor
5A651	XC6371A651D	DC/DC-IC	PWM step-up, 100kHz, 6.5V±2.5%, 100mA	USP-6B	49ga	DC2	9b	Tor
5A652	XC6371A652D	DC/DC-IC	PWM step-up, 180kHz, 6.5V±2.5%, 100mA	USP-6B	49ga	DC2	9b	Tor
5A660	XC6371A660D	DC/DC-IC	PWM step-up, 50kHz, 6.6V±2.5%, 100mA	USP-6B	49ga	DC2	9b	Tor
5A661	XC6371A661D	DC/DC-IC	PWM step-up, 100kHz, 6.6V±2.5%, 100mA	USP-6B	49ga	DC2	9b	Tor
5A662	XC6371A662D	DC/DC-IC	PWM step-up, 180kHz, 6.6V±2.5%, 100mA	USP-6B	49ga	DC2	9b	Tor
5A670	XC6371A670D	DC/DC-IC	PWM step-up, 50kHz, 6.7V±2.5%, 100mA	USP-6B	49ga	DC2	9b	Tor
5A671	XC6371A671D	DC/DC-IC	PWM step-up, 100kHz, 6.7V±2.5%, 100mA	USP-6B	49ga	DC2	9b	Tor
5A672	XC6371A672D	DC/DC-IC	PWM step-up, 180kHz, 6.7V±2.5%, 100mA	USP-6B	49ga	DC2	9b	Tor
5A680	XC6371A680D	DC/DC-IC	PWM step-up, 50kHz, 6.8V±2.5%, 100mA	USP-6B	49ga	DC2	9b	Tor
5A681	XC6371A681D	DC/DC-IC	PWM step-up, 100kHz, 6.8V±2.5%, 100mA	USP-6B	49ga	DC2	9b	Tor
5A682	XC6371A682D	DC/DC-IC	PWM step-up, 180kHz, 6.8V±2.5%, 100mA	USP-6B	49ga	DC2	9b	Tor
5A690	XC6371A690D	DC/DC-IC	PWM step-up, 50kHz, 6.9V±2.5%, 100mA	USP-6B	49ga	DC2	9b	Tor
5A691	XC6371A691D	DC/DC-IC	PWM step-up, 100kHz, 6.9V±2.5%, 100mA	USP-6B	49ga	DC2	9b	Tor
5A692	XC6371A692D	DC/DC-IC	PWM step-up, 180kHz, 6.9V±2.5%, 100mA	USP-6B	49ga	DC2	9b	Tor
5A700	XC6371A700D	DC/DC-IC	PWM step-up, 50kHz, 7.0V±2.5%, 100mA	USP-6B	49ga	DC2	9b	Tor
5A701	XC6371A701D	DC/DC-IC	PWM step-up, 100kHz, 7.0V±2.5%, 100mA	USP-6B	49ga	DC2	9b	Tor
5A702	XC6371A702D	DC/DC-IC	PWM step-up, 180kHz, 7.0V±2.5%, 100mA	USP-6B	49ga	DC2	9b	Tor
5A8	XC9236A08C4R-G	DC-DC-IC	PWM/PFM, st-dwn, 0.8V±2%, 600mA, 1.2MHz, Vin>2V, LSST	USP-6EL	56dc5	DC1	9a	Tor
5A8	XC9236A08CER	DC-DC-IC	PWM/PFM, st-dwn, 0.8V±2%, 600mA, 1.2MHz, Vin>2V, LSST	USP-6C	49dc5	DC1	9a	Tor
5A9	XC9236A09C4R-G	DC-DC-IC	PWM/PFM, st-dwn, 0.9V±2%, 600mA, 1.2MHz, Vin>2V, LSST	USP-6EL	56dc5	DC1	9a	Tor
5A9	XC9236A09CER	DC-DC-IC	PWM/PFM, st-dwn, 0.9V±2%, 600mA, 1.2MHz, Vin>2V, LSST	USP-6C	49dc5	DC1	9a	Tor
5AL	XC9236A0LC4R-G	DC-DC-IC	PWM/PFM, st-dwn, 0.85V±2%, 600mA, 1.2MHz, Vin>2V, LSST	USP-6EL	56dc5	DC1	9a	Tor
5AL	XC9236A0LCER	DC-DC-IC	PWM/PFM, st-dwn, 0.85V±2%, 600mA, 1.2MHz, Vin>2V, LSST	USP-6C	49dc5	DC1	9a	Tor
5AM	XC9236A0MC4R-G	DC-DC-IC	PWM/PFM, st-dwn, 0.95V±2%, 600mA, 1.2MHz, Vin>2V, LSST	USP-6EL	56dc5	DC1	9a	Tor
5AM	XC9236A0MCER	DC-DC-IC	PWM/PFM, st-dwn, 0.95V±2%, 600mA, 1.2MHz, Vin>2V, LSST	USP-6C	49dc5	DC1	9a	Tor
5B	RP101K132B	LVR-IC	LDO, 1.3V±0.8%, 300mA	DFN1612-4B	45vm	VR4	9a	Ric
5B	RP200K091B	LVR-IC	LDO, 0.9V±1.0%, 300mA, +CE, AE(mode)	DFN1212-6	52ht	VR10	9a	Ric
5B	XC6217C12A7R-G	LVR-IC	LDO, 1.25V±2%, 200mA, +CE	USPN-4	58vm	VR4	9a	Tor
5B	XC6223F2119R-G	LVR-IC	LDO, 2.1V±1%, 300mA, +CE, CL, ICP	USPQ-4B03	48vm	VR4	9a	Tor
5B	XC6221D14917R	LVR-IC	LDO, 4.9V±1%, 200mA, +CE, CL, PDR	USPN-4	58vm	VR4	9a	Tor
5B0	XC9236A10C4R-G	DC-DC-IC	PWM/PFM, st-dwn, 1.0V±2%, 600mA, 1.2MHz, Vin>2V, LSST	USP-6EL	56dc5	DC1	9a	Tor
5B0	XC9236A10CER	DC-DC-IC	PWM/PFM, st-dwn, 1.0V±2%, 600mA, 1.2MHz, Vin>2V, LSST	USP-6C	49dc5	DC1	9a	Tor
5B1	XC9236A11C4R-G	DC-DC-IC	PWM/PFM, st-dwn, 1.1V±2%, 600mA, 1.2MHz, Vin>2V, LSST	USP-6EL	56dc5	DC1	9a	Tor
5B1	XC9236A11CER	DC-DC-IC	PWM/PFM, st-dwn, 1.1V±2%, 600mA, 1.2MHz, Vin>2V, LSST	USP-6C	49dc5	DC1	9a	Tor
5B2	XC9236A12C4R-G	DC-DC-IC	PWM/PFM, st-dwn, 1.2V±2%, 600mA, 1.2MHz, Vin>2V, LSST	USP-6EL	56dc5	DC1	9a	Tor
5B2	XC9236A12CER	DC-DC-IC	PWM/PFM, st-dwn, 1.2V±2%, 600mA, 1.2MHz, Vin>2V, LSST	USP-6C	49dc5	DC1	9a	Tor
5B216	XC6103B216ER	Vdet-IC	1.6V±2%, Hst, -MR, +Reset PPO, Wt=50ms, Rt=25ms	USP-6C	49xh	VD17	9b	Tor
5B217	XC6103B217ER	Vdet-IC	1.7V±2%, Hst, -MR, +Reset PPO, Wt=50ms, Rt=25ms	USP-6C	49xh	VD17	9b	Tor
5B218	XC6103B218ER	Vdet-IC	1.8V±2%, Hst, -MR, +Reset PPO, Wt=50ms, Rt=25ms	USP-6C	49xh	VD17	9b	Tor
5B219	XC6103B219ER	Vdet-IC	1.9V±2%, Hst, -MR, +Reset PPO, Wt=50ms, Rt=25ms	USP-6C	49xh	VD17	9b	Tor
5B220	XC6103B220ER	Vdet-IC	2.0V±2%, Hst, -MR, +Reset PPO, Wt=50ms, Rt=25ms	USP-6C	49xh	VD17	9b	Tor
5B221	XC6103B221ER	Vdet-IC	2.1V±2%, Hst, -MR, +Reset PPO, Wt=50ms, Rt=25ms	USP-6C	49xh	VD17	9b	Tor
5B222	XC6103B222ER	Vdet-IC	2.2V±2%, Hst, -MR, +Reset PPO, Wt=50ms, Rt=25ms	USP-6C	49xh	VD17	9b	Tor
5B223	XC6103B223ER	Vdet-IC	2.3V±2%, Hst, -MR, +Reset PPO, Wt=50ms, Rt=25ms	USP-6C	49xh	VD17	9b	Tor
5B224	XC6103B224ER	Vdet-IC	2.4V±2%, Hst, -MR, +Reset PPO, Wt=50ms, Rt=25ms	USP-6C	49xh	VD17	9b	Tor
5B225	XC6103B225ER	Vdet-IC	2.5V±2%, Hst, -MR, +Reset PPO, Wt=50ms, Rt=25ms	USP-6C	49xh	VD17	9b	Tor
5B226	XC6103B226ER	Vdet-IC	2.6V±2%, Hst, -MR, +Reset PPO, Wt=50ms, Rt=25ms	USP-6C	49xh	VD17	9b	Tor
5B227	XC6103B227ER	Vdet-IC	2.7V±2%, Hst, -MR, +Reset PPO, Wt=50ms, Rt=25ms	USP-6C	49xh	VD17	9b	Tor
5B228	XC6103B228ER	Vdet-IC	2.8V±2%, Hst, -MR, +Reset PPO, Wt=50ms, Rt=25ms	USP-6C	49xh	VD17	9b	Tor
5B229	XC6103B229ER	Vdet-IC	2.9V±2%, Hst, -MR, +Reset PPO, Wt=50ms, Rt=25ms	USP-6C	49xh	VD17	9b	Tor
5B230	XC6103B230ER	Vdet-IC	3.0V±2%, Hst, -MR, +Reset PPO, Wt=50ms, Rt=25ms	USP-6C	49xh	VD17	9b	Tor
5B231	XC6103B231ER	Vdet-IC	3.1V±2%, Hst, -MR, +Reset PPO, Wt=50ms, Rt=25ms	USP-6C	49xh	VD17	9b	Tor
5B232	XC6103B232ER	Vdet-IC	3.2V±2%, Hst, -MR, +Reset PPO, Wt=50ms, Rt=25ms	USP-6C	49xh	VD17	9b	Tor
5B233	XC6103B233ER	Vdet-IC	3.3V±2%, Hst, -MR, +Reset PPO, Wt=50ms, Rt=25ms	USP-6C	49xh	VD17	9b	Tor
5B234	XC6103B234ER	Vdet-IC	3.4V±2%, Hst, -MR, +Reset PPO, Wt=50ms, Rt=25ms	USP-6C	49xh	VD17	9b	Tor



SMD code	Type	Function	Short description	Case	Pinout	Sch.	St.	Mnf.
5B627	XC6103B627ER	Vdet-IC	2.7V±2%, Hst, -MR, +Reset PPO, Wt=1.6s, Rt=25ms	USP-6C	49xh	VD17	9b	Tor
5B628	XC6103B628ER	Vdet-IC	2.8V±2%, Hst, -MR, +Reset PPO, Wt=1.6s, Rt=25ms	USP-6C	49xh	VD17	9b	Tor
5B629	XC6103B629ER	Vdet-IC	2.9V±2%, Hst, -MR, +Reset PPO, Wt=1.6s, Rt=25ms	USP-6C	49xh	VD17	9b	Tor
5B630	XC6103B630ER	Vdet-IC	3.0V±2%, Hst, -MR, +Reset PPO, Wt=1.6s, Rt=25ms	USP-6C	49xh	VD17	9b	Tor
5B631	XC6103B631ER	Vdet-IC	3.1V±2%, Hst, -MR, +Reset PPO, Wt=1.6s, Rt=25ms	USP-6C	49xh	VD17	9b	Tor
5B632	XC6103B632ER	Vdet-IC	3.2V±2%, Hst, -MR, +Reset PPO, Wt=1.6s, Rt=25ms	USP-6C	49xh	VD17	9b	Tor
5B633	XC6103B633ER	Vdet-IC	3.3V±2%, Hst, -MR, +Reset PPO, Wt=1.6s, Rt=25ms	USP-6C	49xh	VD17	9b	Tor
5B634	XC6103B634ER	Vdet-IC	3.4V±2%, Hst, -MR, +Reset PPO, Wt=1.6s, Rt=25ms	USP-6C	49xh	VD17	9b	Tor
5B635	XC6103B635ER	Vdet-IC	3.5V±2%, Hst, -MR, +Reset PPO, Wt=1.6s, Rt=25ms	USP-6C	49xh	VD17	9b	Tor
5B636	XC6103B636ER	Vdet-IC	3.6V±2%, Hst, -MR, +Reset PPO, Wt=1.6s, Rt=25ms	USP-6C	49xh	VD17	9b	Tor
5B637	XC6103B637ER	Vdet-IC	3.7V±2%, Hst, -MR, +Reset PPO, Wt=1.6s, Rt=25ms	USP-6C	49xh	VD17	9b	Tor
5B638	XC6103B638ER	Vdet-IC	3.8V±2%, Hst, -MR, +Reset PPO, Wt=1.6s, Rt=25ms	USP-6C	49xh	VD17	9b	Tor
5B639	XC6103B639ER	Vdet-IC	3.9V±2%, Hst, -MR, +Reset PPO, Wt=1.6s, Rt=25ms	USP-6C	49xh	VD17	9b	Tor
5B640	XC6103B640ER	Vdet-IC	4.0V±2%, Hst, -MR, +Reset PPO, Wt=1.6s, Rt=25ms	USP-6C	49xh	VD17	9b	Tor
5B641	XC6103B641ER	Vdet-IC	4.1V±2%, Hst, -MR, +Reset PPO, Wt=1.6s, Rt=25ms	USP-6C	49xh	VD17	9b	Tor
5B642	XC6103B642ER	Vdet-IC	4.2V±2%, Hst, -MR, +Reset PPO, Wt=1.6s, Rt=25ms	USP-6C	49xh	VD17	9b	Tor
5B643	XC6103B643ER	Vdet-IC	4.3V±2%, Hst, -MR, +Reset PPO, Wt=1.6s, Rt=25ms	USP-6C	49xh	VD17	9b	Tor
5B644	XC6103B644ER	Vdet-IC	4.4V±2%, Hst, -MR, +Reset PPO, Wt=1.6s, Rt=25ms	USP-6C	49xh	VD17	9b	Tor
5B645	XC6103B645ER	Vdet-IC	4.5V±2%, Hst, -MR, +Reset PPO, Wt=1.6s, Rt=25ms	USP-6C	49xh	VD17	9b	Tor
5B646	XC6103B646ER	Vdet-IC	4.6V±2%, Hst, -MR, +Reset PPO, Wt=1.6s, Rt=25ms	USP-6C	49xh	VD17	9b	Tor
5B647	XC6103B647ER	Vdet-IC	4.7V±2%, Hst, -MR, +Reset PPO, Wt=1.6s, Rt=25ms	USP-6C	49xh	VD17	9b	Tor
5B648	XC6103B648ER	Vdet-IC	4.8V±2%, Hst, -MR, +Reset PPO, Wt=1.6s, Rt=25ms	USP-6C	49xh	VD17	9b	Tor
5B649	XC6103B649ER	Vdet-IC	4.9V±2%, Hst, -MR, +Reset PPO, Wt=1.6s, Rt=25ms	USP-6C	49xh	VD17	9b	Tor
5B650	XC6103B650ER	Vdet-IC	5.0V±2%, Hst, -MR, +Reset PPO, Wt=1.6s, Rt=25ms	USP-6C	49xh	VD17	9b	Tor
5B7	XC9236A17C4R-G	DC-DC-IC	PWM/PPM, st-dwn, 1.7V±2%, 600mA, 1.2MHz, Vin>2V, LSST	USP-6EL	56dc5	DC1	9a	Tor
5B7	XC9236A17CER	DC-DC-IC	PWM/PPM, st-dwn, 1.7V±2%, 600mA, 1.2MHz, Vin>2V, LSST	USP-6C	49dc5	DC1	9a	Tor
5B8	XC9236A18C4R-G	DC-DC-IC	PWM/PPM, st-dwn, 1.8V±2%, 600mA, 1.2MHz, Vin>2V, LSST	USP-6EL	56dc5	DC1	9a	Tor
5B8	XC9236A18CER	DC-DC-IC	PWM/PPM, st-dwn, 1.8V±2%, 600mA, 1.2MHz, Vin>2V, LSST	USP-6C	49dc5	DC1	9a	Tor
5B9	XC9236A19C4R-G	DC-DC-IC	PWM/PPM, st-dwn, 1.9V±2%, 600mA, 1.2MHz, Vin>2V, LSST	USP-6EL	56dc5	DC1	9a	Tor
5B9	XC9236A19CER	DC-DC-IC	PWM/PPM, st-dwn, 1.9V±2%, 600mA, 1.2MHz, Vin>2V, LSST	USP-6C	49dc5	DC1	9a	Tor
5BA	XC9236A1AC4R-G	DC-DC-IC	PWM/PPM, st-dwn, 1.05V±2%, 600mA, 1.2MHz, Vin>2V, LSST	USP-6EL	56dc5	DC1	9a	Tor
5BA	XC9236A1ACER	DC-DC-IC	PWM/PPM, st-dwn, 1.05V±2%, 600mA, 1.2MHz, Vin>2V, LSST	USP-6C	49dc5	DC1	9a	Tor
5BB	XC9236A1BC4R-G	DC-DC-IC	PWM/PPM, st-dwn, 1.15V±2%, 600mA, 1.2MHz, Vin>2V, LSST	USP-6EL	56dc5	DC1	9a	Tor
5BB	XC9236A1BCER	DC-DC-IC	PWM/PPM, st-dwn, 1.15V±2%, 600mA, 1.2MHz, Vin>2V, LSST	USP-6C	49dc5	DC1	9a	Tor
5BC	XC9236A1CC4R-G	DC-DC-IC	PWM/PPM, st-dwn, 1.25V±2%, 600mA, 1.2MHz, Vin>2V, LSST	USP-6EL	56dc5	DC1	9a	Tor
5BC	XC9236A1CCER	DC-DC-IC	PWM/PPM, st-dwn, 1.25V±2%, 600mA, 1.2MHz, Vin>2V, LSST	USP-6C	49dc5	DC1	9a	Tor
5BD	XC9236A1DC4R-G	DC-DC-IC	PWM/PPM, st-dwn, 1.35V±2%, 600mA, 1.2MHz, Vin>2V, LSST	USP-6EL	56dc5	DC1	9a	Tor
5BD	XC9236A1DCER	DC-DC-IC	PWM/PPM, st-dwn, 1.35V±2%, 600mA, 1.2MHz, Vin>2V, LSST	USP-6C	49dc5	DC1	9a	Tor
5BE	XC9236A1EC4R-G	DC-DC-IC	PWM/PPM, st-dwn, 1.45V±2%, 600mA, 1.2MHz, Vin>2V, LSST	USP-6EL	56dc5	DC1	9a	Tor
5BE	XC9236A1ECER	DC-DC-IC	PWM/PPM, st-dwn, 1.45V±2%, 600mA, 1.2MHz, Vin>2V, LSST	USP-6C	49dc5	DC1	9a	Tor
5BF	XC9236A1FC4R-G	DC-DC-IC	PWM/PPM, st-dwn, 1.55V±2%, 600mA, 1.2MHz, Vin>2V, LSST	USP-6EL	56dc5	DC1	9a	Tor
5BF	XC9236A1FCER	DC-DC-IC	PWM/PPM, st-dwn, 1.55V±2%, 600mA, 1.2MHz, Vin>2V, LSST	USP-6C	49dc5	DC1	9a	Tor
5BH	XC9236A1HC4R-G	DC-DC-IC	PWM/PPM, st-dwn, 1.65V±2%, 600mA, 1.2MHz, Vin>2V, LSST	USP-6EL	56dc5	DC1	9a	Tor
5BH	XC9236A1HCER	DC-DC-IC	PWM/PPM, st-dwn, 1.65V±2%, 600mA, 1.2MHz, Vin>2V, LSST	USP-6C	49dc5	DC1	9a	Tor
5BK	XC9236A1KC4R-G	DC-DC-IC	PWM/PPM, st-dwn, 1.75V±2%, 600mA, 1.2MHz, Vin>2V, LSST	USP-6EL	56dc5	DC1	9a	Tor
5BK	XC9236A1KCER	DC-DC-IC	PWM/PPM, st-dwn, 1.75V±2%, 600mA, 1.2MHz, Vin>2V, LSST	USP-6C	49dc5	DC1	9a	Tor
5BL	XC9236A1LC4R-G	DC-DC-IC	PWM/PPM, st-dwn, 1.85V±2%, 600mA, 1.2MHz, Vin>2V, LSST	USP-6EL	56dc5	DC1	9a	Tor
5BL	XC9236A1LCER	DC-DC-IC	PWM/PPM, st-dwn, 1.85V±2%, 600mA, 1.2MHz, Vin>2V, LSST	USP-6C	49dc5	DC1	9a	Tor
5BM	XC9236A1MC4R-G	DC-DC-IC	PWM/PPM, st-dwn, 1.95V±2%, 600mA, 1.2MHz, Vin>2V, LSST	USP-6EL	56dc5	DC1	9a	Tor
5BM	XC9236A1MCER	DC-DC-IC	PWM/PPM, st-dwn, 1.95V±2%, 600mA, 1.2MHz, Vin>2V, LSST	USP-6C	49dc5	DC1	9a	Tor
5C	RP101K152B	LVR-IC	LDO, LN, +CE, 1.5V±0.8%, 300mA	DFN1612-4B	45vm	VR4	9a	Ric
5C	RP200K101B	LVR-IC	LDO, 1V±1.0%, 300mA, +CE, AE(mode)	DFN1212-6	52ht	VR10	9a	Ric
5C	XC6217C13A7R-G	LVR-IC	LDO, 1.35V±2%, 200mA, +CE	USPN-4	58vm	VR4	9a	Tor
5C	XC6223F2219R-G	LVR-IC	LDO, 2.2V±1%, 300mA, +CE, CL, ICP	USPQ-4B03	48vm	VR4	9a	Tor
5C	XC6221D5017R	LVR-IC	LDO, 5.0V±1%, 200mA, +CE, CLL, PDR	USPN-4	58vm	VR4	9a	Tor
5C0	XC9236A20C4R-G	DC-DC-IC	PWM/PPM, st-dwn, 2.0V±2%, 600mA, 1.2MHz, Vin>2V, LSST	USP-6EL	56dc5	DC1	9a	Tor
5C0	XC9236A20CER	DC-DC-IC	PWM/PPM, st-dwn, 2.0V±2%, 600mA, 1.2MHz, Vin>2V, LSST	USP-6C	49dc5	DC1	9a	Tor
5C1	XC9236A21C4R-G	DC-DC-IC	PWM/PPM, st-dwn, 2.1V±2%, 600mA, 1.2MHz, Vin>2V, LSST	USP-6EL	56dc5	DC1	9a	Tor
5C1	XC9236A21CER	DC-DC-IC	PWM/PPM, st-dwn, 2.1V±2%, 600mA, 1.2MHz, Vin>2V, LSST	USP-6C	49dc5	DC1	9a	Tor
5C2	XC9236A22C4R-G	DC-DC-IC	PWM/PPM, st-dwn, 2.2V±2%, 600mA, 1.2MHz, Vin>2V, LSST	USP-6EL	56dc5	DC1	9a	Tor
5C2	XC9236A22CER	DC-DC-IC	PWM/PPM, st-dwn, 2.2V±2%, 600mA, 1.2MHz, Vin>2V, LSST	USP-6C	49dc5	DC1	9a	Tor
5C200	XC6371C200D	DC/DC-IC	PWM step-up, 50kHz, +CE, 2.0V±2.5%, 100mA	USP-6B	49gd	DC3	9b	Tor
5C201	XC6371C201D	DC/DC-IC	PWM step-up, 100kHz, +CE, 2.0V±2.5%, 100mA	USP-6B	49gd	DC3	9b	Tor
5C202	XC6371C202D	DC/DC-IC	PWM step-up, 180kHz, +CE, 2.0V±2.5%, 100mA	USP-6B	49gd	DC3	9b	Tor
5C210	XC6371C210D	DC/DC-IC	PWM step-up, 50kHz, +CE, 2.1V±2.5%, 100mA	USP-6B	49gd	DC3	9b	Tor
5C211	XC6371C211D	DC/DC-IC	PWM step-up, 100kHz, +CE, 2.1V±2.5%, 100mA	USP-6B	49gd	DC3	9b	Tor
5C212	XC6371C212D	DC/DC-IC	PWM step-up, 180kHz, +CE, 2.1V±2.5%, 100mA	USP-6B	49gd	DC3	9b	Tor
5C216	XC6103C216ER	Vdet-IC	1.6V±2%, Hst, -MR, +Reset PPO, Wt=50ms, Rt=50ms	USP-6C	49xh	VD17	9b	Tor
5C217	XC6103C217ER	Vdet-IC	1.7V±2%, Hst, -MR, +Reset PPO, Wt=50ms, Rt=50ms	USP-6C	49xh	VD17	9b	Tor
5C218	XC6103C218ER	Vdet-IC	1.8V±2%, Hst, -MR, +Reset PPO, Wt=50ms, Rt=50ms	USP-6C	49xh	VD17	9b	Tor



SMD code	Type	Function	Short description	Case	Pinout	Sch.	St.Mnf.
5C525	XC6103C525ER	Vdet-IC	2.5V±2%, Hst, -MR, +Reset PPO, Wt=400ms, Rt=50ms	USP-6C	49xh	VD17	9b Tor
5C526	XC6103C526ER	Vdet-IC	2.6V±2%, Hst, -MR, +Reset PPO, Wt=400ms, Rt=50ms	USP-6C	49xh	VD17	9b Tor
5C527	XC6103C527ER	Vdet-IC	2.7V±2%, Hst, -MR, +Reset PPO, Wt=400ms, Rt=50ms	USP-6C	49xh	VD17	9b Tor
5C528	XC6103C528ER	Vdet-IC	2.8V±2%, Hst, -MR, +Reset PPO, Wt=400ms, Rt=50ms	USP-6C	49xh	VD17	9b Tor
5C529	XC6103C529ER	Vdet-IC	2.9V±2%, Hst, -MR, +Reset PPO, Wt=400ms, Rt=50ms	USP-6C	49xh	VD17	9b Tor
5C530	XC6103C530ER	Vdet-IC	3.0V±2%, Hst, -MR, +Reset PPO, Wt=400ms, Rt=50ms	USP-6C	49xh	VD17	9b Tor
5C530	XC6371C530D	DC/DC-IC	PWM step-up, 50kHz, +CE, 5.3V±2.5%, 100mA	USP-6B	49gd	DC3	9b Tor
5C531	XC6103C531ER	Vdet-IC	3.1V±2%, Hst, -MR, +Reset PPO, Wt=400ms, Rt=50ms	USP-6C	49xh	VD17	9b Tor
5C531	XC6371C531D	DC/DC-IC	PWM step-up, 100kHz, +CE, 5.3V±2.5%, 100mA	USP-6B	49gd	DC3	9b Tor
5C532	XC6103C532ER	Vdet-IC	3.2V±2%, Hst, -MR, +Reset PPO, Wt=400ms, Rt=50ms	USP-6C	49xh	VD17	9b Tor
5C532	XC6371C532D	DC/DC-IC	PWM step-up, 180kHz, +CE, 5.3V±2.5%, 100mA	USP-6B	49gd	DC3	9b Tor
5C533	XC6103C533ER	Vdet-IC	3.3V±2%, Hst, -MR, +Reset PPO, Wt=400ms, Rt=50ms	USP-6C	49xh	VD17	9b Tor
5C534	XC6103C534ER	Vdet-IC	3.4V±2%, Hst, -MR, +Reset PPO, Wt=400ms, Rt=50ms	USP-6C	49xh	VD17	9b Tor
5C535	XC6103C535ER	Vdet-IC	3.5V±2%, Hst, -MR, +Reset PPO, Wt=400ms, Rt=50ms	USP-6C	49xh	VD17	9b Tor
5C536	XC6103C536ER	Vdet-IC	3.6V±2%, Hst, -MR, +Reset PPO, Wt=400ms, Rt=50ms	USP-6C	49xh	VD17	9b Tor
5C537	XC6103C537ER	Vdet-IC	3.7V±2%, Hst, -MR, +Reset PPO, Wt=400ms, Rt=50ms	USP-6C	49xh	VD17	9b Tor
5C538	XC6103C538ER	Vdet-IC	3.8V±2%, Hst, -MR, +Reset PPO, Wt=400ms, Rt=50ms	USP-6C	49xh	VD17	9b Tor
5C539	XC6103C539ER	Vdet-IC	3.9V±2%, Hst, -MR, +Reset PPO, Wt=400ms, Rt=50ms	USP-6C	49xh	VD17	9b Tor
5C540	XC6103C540ER	Vdet-IC	4.0V±2%, Hst, -MR, +Reset PPO, Wt=400ms, Rt=50ms	USP-6C	49xh	VD17	9b Tor
5C540	XC6371C540D	DC/DC-IC	PWM step-up, 50kHz, +CE, 5.4V±2.5%, 100mA	USP-6B	49gd	DC3	9b Tor
5C541	XC6103C541ER	Vdet-IC	4.1V±2%, Hst, -MR, +Reset PPO, Wt=400ms, Rt=50ms	USP-6C	49xh	VD17	9b Tor
5C541	XC6371C541D	DC/DC-IC	PWM step-up, 100kHz, +CE, 5.4V±2.5%, 100mA	USP-6B	49gd	DC3	9b Tor
5C542	XC6103C542ER	Vdet-IC	4.2V±2%, Hst, -MR, +Reset PPO, Wt=400ms, Rt=50ms	USP-6C	49xh	VD17	9b Tor
5C542	XC6371C542D	DC/DC-IC	PWM step-up, 180kHz, +CE, 5.4V±2.5%, 100mA	USP-6B	49gd	DC3	9b Tor
5C543	XC6103C543ER	Vdet-IC	4.3V±2%, Hst, -MR, +Reset PPO, Wt=400ms, Rt=50ms	USP-6C	49xh	VD17	9b Tor
5C544	XC6103C544ER	Vdet-IC	4.4V±2%, Hst, -MR, +Reset PPO, Wt=400ms, Rt=50ms	USP-6C	49xh	VD17	9b Tor
5C545	XC6103C545ER	Vdet-IC	4.5V±2%, Hst, -MR, +Reset PPO, Wt=400ms, Rt=50ms	USP-6C	49xh	VD17	9b Tor
5C546	XC6103C546ER	Vdet-IC	4.6V±2%, Hst, -MR, +Reset PPO, Wt=400ms, Rt=50ms	USP-6C	49xh	VD17	9b Tor
5C547	XC6103C547ER	Vdet-IC	4.7V±2%, Hst, -MR, +Reset PPO, Wt=400ms, Rt=50ms	USP-6C	49xh	VD17	9b Tor
5C548	XC6103C548ER	Vdet-IC	4.8V±2%, Hst, -MR, +Reset PPO, Wt=400ms, Rt=50ms	USP-6C	49xh	VD17	9b Tor
5C549	XC6103C549ER	Vdet-IC	4.9V±2%, Hst, -MR, +Reset PPO, Wt=400ms, Rt=50ms	USP-6C	49xh	VD17	9b Tor
5C550	XC6103C550ER	Vdet-IC	5.0V±2%, Hst, -MR, +Reset PPO, Wt=400ms, Rt=50ms	USP-6C	49xh	VD17	9b Tor
5C550	XC6371C550D	DC/DC-IC	PWM step-up, 50kHz, +CE, 5.5V±2.5%, 100mA	USP-6B	49gd	DC3	9b Tor
5C551	XC6371C551D	DC/DC-IC	PWM step-up, 100kHz, +CE, 5.5V±2.5%, 100mA	USP-6B	49gd	DC3	9b Tor
5C552	XC6371C552D	DC/DC-IC	PWM step-up, 180kHz, +CE, 5.5V±2.5%, 100mA	USP-6B	49gd	DC3	9b Tor
5C560	XC6371C560D	DC/DC-IC	PWM step-up, 50kHz, +CE, 5.6V±2.5%, 100mA	USP-6B	49gd	DC3	9b Tor
5C561	XC6371C561D	DC/DC-IC	PWM step-up, 100kHz, +CE, 5.6V±2.5%, 100mA	USP-6B	49gd	DC3	9b Tor
5C562	XC6371C562D	DC/DC-IC	PWM step-up, 180kHz, +CE, 5.6V±2.5%, 100mA	USP-6B	49gd	DC3	9b Tor
5C570	XC6371C570D	DC/DC-IC	PWM step-up, 50kHz, +CE, 5.7V±2.5%, 100mA	USP-6B	49gd	DC3	9b Tor
5C571	XC6371C571D	DC/DC-IC	PWM step-up, 100kHz, +CE, 5.7V±2.5%, 100mA	USP-6B	49gd	DC3	9b Tor
5C572	XC6371C572D	DC/DC-IC	PWM step-up, 180kHz, +CE, 5.7V±2.5%, 100mA	USP-6B	49gd	DC3	9b Tor
5C580	XC6371C580D	DC/DC-IC	PWM step-up, 50kHz, +CE, 5.8V±2.5%, 100mA	USP-6B	49gd	DC3	9b Tor
5C581	XC6371C581D	DC/DC-IC	PWM step-up, 100kHz, +CE, 5.8V±2.5%, 100mA	USP-6B	49gd	DC3	9b Tor
5C582	XC6371C582D	DC/DC-IC	PWM step-up, 180kHz, +CE, 5.8V±2.5%, 100mA	USP-6B	49gd	DC3	9b Tor
5C590	XC6371C590D	DC/DC-IC	PWM step-up, 50kHz, +CE, 5.9V±2.5%, 100mA	USP-6B	49gd	DC3	9b Tor
5C591	XC6371C591D	DC/DC-IC	PWM step-up, 100kHz, +CE, 5.9V±2.5%, 100mA	USP-6B	49gd	DC3	9b Tor
5C592	XC6371C592D	DC/DC-IC	PWM step-up, 180kHz, +CE, 5.9V±2.5%, 100mA	USP-6B	49gd	DC3	9b Tor
5C6	XC9236A26C4R-G	DC-DC-IC	PWM/PFM, st-dwn, 2.6V±2%, 600mA, 1.2MHz, Vin>2V, LLSST	USP-6EL	56dc5	DC1	9a Tor
5C6	XC9236A26CER	DC-DC-IC	PWM/PFM, st-dwn, 2.6V±2%, 600mA, 1.2MHz, Vin>2V, LLSST	USP-6C	49dc5	DC1	9a Tor
5C600	XC6371C600D	DC/DC-IC	PWM step-up, 50kHz, +CE, 6.0V±2.5%, 100mA	USP-6B	49gd	DC3	9b Tor
5C601	XC6371C601D	DC/DC-IC	PWM step-up, 100kHz, +CE, 6.0V±2.5%, 100mA	USP-6B	49gd	DC3	9b Tor
5C602	XC6371C602D	DC/DC-IC	PWM step-up, 180kHz, +CE, 6.0V±2.5%, 100mA	USP-6B	49gd	DC3	9b Tor
5C610	XC6371C610D	DC/DC-IC	PWM step-up, 50kHz, +CE, 6.1V±2.5%, 100mA	USP-6B	49gd	DC3	9b Tor
5C611	XC6371C611D	DC/DC-IC	PWM step-up, 100kHz, +CE, 6.1V±2.5%, 100mA	USP-6B	49gd	DC3	9b Tor
5C612	XC6371C612D	DC/DC-IC	PWM step-up, 180kHz, +CE, 6.1V±2.5%, 100mA	USP-6B	49gd	DC3	9b Tor
5C616	XC6103C616ER	Vdet-IC	1.6V±2%, Hst, -MR, +Reset PPO, Wt=1.6s, Rt=50ms	USP-6C	49xh	VD17	9b Tor
5C617	XC6103C617ER	Vdet-IC	1.7V±2%, Hst, -MR, +Reset PPO, Wt=1.6s, Rt=50ms	USP-6C	49xh	VD17	9b Tor
5C618	XC6103C618ER	Vdet-IC	1.8V±2%, Hst, -MR, +Reset PPO, Wt=1.6s, Rt=50ms	USP-6C	49xh	VD17	9b Tor
5C619	XC6103C619ER	Vdet-IC	1.9V±2%, Hst, -MR, +Reset PPO, Wt=1.6s, Rt=50ms	USP-6C	49xh	VD17	9b Tor
5C620	XC6103C620ER	Vdet-IC	2.0V±2%, Hst, -MR, +Reset PPO, Wt=1.6s, Rt=50ms	USP-6C	49xh	VD17	9b Tor
5C620	XC6371C620D	DC/DC-IC	PWM step-up, 50kHz, +CE, 6.2V±2.5%, 100mA	USP-6B	49gd	DC3	9b Tor
5C621	XC6103C621ER	Vdet-IC	2.1V±2%, Hst, -MR, +Reset PPO, Wt=1.6s, Rt=50ms	USP-6C	49xh	VD17	9b Tor
5C621	XC6371C621D	DC/DC-IC	PWM step-up, 100kHz, +CE, 6.2V±2.5%, 100mA	USP-6B	49gd	DC3	9b Tor
5C622	XC6103C622ER	Vdet-IC	2.2V±2%, Hst, -MR, +Reset PPO, Wt=1.6s, Rt=50ms	USP-6C	49xh	VD17	9b Tor
5C622	XC6371C622D	DC/DC-IC	PWM step-up, 180kHz, +CE, 6.2V±2.5%, 100mA	USP-6B	49gd	DC3	9b Tor
5C623	XC6103C623ER	Vdet-IC	2.3V±2%, Hst, -MR, +Reset PPO, Wt=1.6s, Rt=50ms	USP-6C	49xh	VD17	9b Tor
5C624	XC6103C624ER	Vdet-IC	2.4V±2%, Hst, -MR, +Reset PPO, Wt=1.6s, Rt=50ms	USP-6C	49xh	VD17	9b Tor
5C625	XC6103C625ER	Vdet-IC	2.5V±2%, Hst, -MR, +Reset PPO, Wt=1.6s, Rt=50ms	USP-6C	49xh	VD17	9b Tor
5C626	XC6103C626ER	Vdet-IC	2.6V±2%, Hst, -MR, +Reset PPO, Wt=1.6s, Rt=50ms	USP-6C	49xh	VD17	9b Tor
5C627	XC6103C627ER	Vdet-IC	2.7V±2%, Hst, -MR, +Reset PPO, Wt=1.6s, Rt=50ms	USP-6C	49xh	VD17	9b Tor



SMD code	Type	Function	Short description	Case	Pinout	Sch.	St.	Mnf.
5C628	XC6103C628ER	Vdet-IC	2.8V±2%, Hst, -MR, +Reset PPO, Wt=1.6s, Rt=50ms	USP-6C	49xh	VD17	9b	Tor
5C629	XC6103C629ER	Vdet-IC	2.9V±2%, Hst, -MR, +Reset PPO, Wt=1.6s, Rt=50ms	USP-6C	49xh	VD17	9b	Tor
5C630	XC6103C630ER	Vdet-IC	3.0V±2%, Hst, -MR, +Reset PPO, Wt=1.6s, Rt=50ms	USP-6C	49xh	VD17	9b	Tor
5C630	XC6371C630D	DC/DC-IC	PWM step-up, 50kHz, +CE, 6.3V±2.5%, 100mA	USP-6B	49gd	DC3	9b	Tor
5C631	XC6103C631ER	Vdet-IC	3.1V±2%, Hst, -MR, +Reset PPO, Wt=1.6s, Rt=50ms	USP-6C	49xh	VD17	9b	Tor
5C631	XC6371C631D	DC/DC-IC	PWM step-up, 100kHz, +CE, 6.3V±2.5%, 100mA	USP-6B	49gd	DC3	9b	Tor
5C632	XC6103C632ER	Vdet-IC	3.2V±2%, Hst, -MR, +Reset PPO, Wt=1.6s, Rt=50ms	USP-6C	49xh	VD17	9b	Tor
5C632	XC6371C632D	DC/DC-IC	PWM step-up, 180kHz, +CE, 6.3V±2.5%, 100mA	USP-6B	49gd	DC3	9b	Tor
5C633	XC6103C633ER	Vdet-IC	3.3V±2%, Hst, -MR, +Reset PPO, Wt=1.6s, Rt=50ms	USP-6C	49xh	VD17	9b	Tor
5C634	XC6103C634ER	Vdet-IC	3.4V±2%, Hst, -MR, +Reset PPO, Wt=1.6s, Rt=50ms	USP-6C	49xh	VD17	9b	Tor
5C635	XC6103C635ER	Vdet-IC	3.5V±2%, Hst, -MR, +Reset PPO, Wt=1.6s, Rt=50ms	USP-6C	49xh	VD17	9b	Tor
5C636	XC6103C636ER	Vdet-IC	3.6V±2%, Hst, -MR, +Reset PPO, Wt=1.6s, Rt=50ms	USP-6C	49xh	VD17	9b	Tor
5C637	XC6103C637ER	Vdet-IC	3.7V±2%, Hst, -MR, +Reset PPO, Wt=1.6s, Rt=50ms	USP-6C	49xh	VD17	9b	Tor
5C638	XC6103C638ER	Vdet-IC	3.8V±2%, Hst, -MR, +Reset PPO, Wt=1.6s, Rt=50ms	USP-6C	49xh	VD17	9b	Tor
5C639	XC6103C639ER	Vdet-IC	3.9V±2%, Hst, -MR, +Reset PPO, Wt=1.6s, Rt=50ms	USP-6C	49xh	VD17	9b	Tor
5C640	XC6103C640ER	Vdet-IC	4.0V±2%, Hst, -MR, +Reset PPO, Wt=1.6s, Rt=50ms	USP-6C	49xh	VD17	9b	Tor
5C640	XC6371C640D	DC/DC-IC	PWM step-up, 50kHz, +CE, 6.4V±2.5%, 100mA	USP-6B	49gd	DC3	9b	Tor
5C641	XC6103C641ER	Vdet-IC	4.1V±2%, Hst, -MR, +Reset PPO, Wt=1.6s, Rt=50ms	USP-6C	49xh	VD17	9b	Tor
5C641	XC6371C641D	DC/DC-IC	PWM step-up, 100kHz, +CE, 6.4V±2.5%, 100mA	USP-6B	49gd	DC3	9b	Tor
5C642	XC6103C642ER	Vdet-IC	4.2V±2%, Hst, -MR, +Reset PPO, Wt=1.6s, Rt=50ms	USP-6C	49xh	VD17	9b	Tor
5C642	XC6371C642D	DC/DC-IC	PWM step-up, 180kHz, +CE, 6.4V±2.5%, 100mA	USP-6B	49gd	DC3	9b	Tor
5C643	XC6103C643ER	Vdet-IC	4.3V±2%, Hst, -MR, +Reset PPO, Wt=1.6s, Rt=50ms	USP-6C	49xh	VD17	9b	Tor
5C644	XC6103C644ER	Vdet-IC	4.4V±2%, Hst, -MR, +Reset PPO, Wt=1.6s, Rt=50ms	USP-6C	49xh	VD17	9b	Tor
5C645	XC6103C645ER	Vdet-IC	4.5V±2%, Hst, -MR, +Reset PPO, Wt=1.6s, Rt=50ms	USP-6C	49xh	VD17	9b	Tor
5C646	XC6103C646ER	Vdet-IC	4.6V±2%, Hst, -MR, +Reset PPO, Wt=1.6s, Rt=50ms	USP-6C	49xh	VD17	9b	Tor
5C647	XC6103C647ER	Vdet-IC	4.7V±2%, Hst, -MR, +Reset PPO, Wt=1.6s, Rt=50ms	USP-6C	49xh	VD17	9b	Tor
5C648	XC6103C648ER	Vdet-IC	4.8V±2%, Hst, -MR, +Reset PPO, Wt=1.6s, Rt=50ms	USP-6C	49xh	VD17	9b	Tor
5C649	XC6103C649ER	Vdet-IC	4.9V±2%, Hst, -MR, +Reset PPO, Wt=1.6s, Rt=50ms	USP-6C	49xh	VD17	9b	Tor
5C650	XC6103C650ER	Vdet-IC	5.0V±2%, Hst, -MR, +Reset PPO, Wt=1.6s, Rt=50ms	USP-6C	49xh	VD17	9b	Tor
5C650	XC6371C650D	DC/DC-IC	PWM step-up, 50kHz, +CE, 6.5V±2.5%, 100mA	USP-6B	49gd	DC3	9b	Tor
5C651	XC6371C651D	DC/DC-IC	PWM step-up, 100kHz, +CE, 6.5V±2.5%, 100mA	USP-6B	49gd	DC3	9b	Tor
5C652	XC6371C652D	DC/DC-IC	PWM step-up, 180kHz, +CE, 6.5V±2.5%, 100mA	USP-6B	49gd	DC3	9b	Tor
5C660	XC6371C660D	DC/DC-IC	PWM step-up, 50kHz, +CE, 6.6V±2.5%, 100mA	USP-6B	49gd	DC3	9b	Tor
5C661	XC6371C661D	DC/DC-IC	PWM step-up, 100kHz, +CE, 6.6V±2.5%, 100mA	USP-6B	49gd	DC3	9b	Tor
5C662	XC6371C662D	DC/DC-IC	PWM step-up, 180kHz, +CE, 6.6V±2.5%, 100mA	USP-6B	49gd	DC3	9b	Tor
5C670	XC6371C670D	DC/DC-IC	PWM step-up, 50kHz, +CE, 6.7V±2.5%, 100mA	USP-6B	49gd	DC3	9b	Tor
5C671	XC6371C671D	DC/DC-IC	PWM step-up, 100kHz, +CE, 6.7V±2.5%, 100mA	USP-6B	49gd	DC3	9b	Tor
5C672	XC6371C672D	DC/DC-IC	PWM step-up, 180kHz, +CE, 6.7V±2.5%, 100mA	USP-6B	49gd	DC3	9b	Tor
5C680	XC6371C680D	DC/DC-IC	PWM step-up, 50kHz, +CE, 6.8V±2.5%, 100mA	USP-6B	49gd	DC3	9b	Tor
5C681	XC6371C681D	DC/DC-IC	PWM step-up, 100kHz, +CE, 6.8V±2.5%, 100mA	USP-6B	49gd	DC3	9b	Tor
5C682	XC6371C682D	DC/DC-IC	PWM step-up, 180kHz, +CE, 6.8V±2.5%, 100mA	USP-6B	49gd	DC3	9b	Tor
5C690	XC6371C690D	DC/DC-IC	PWM step-up, 50kHz, +CE, 6.9V±2.5%, 100mA	USP-6B	49gd	DC3	9b	Tor
5C691	XC6371C691D	DC/DC-IC	PWM step-up, 100kHz, +CE, 6.9V±2.5%, 100mA	USP-6B	49gd	DC3	9b	Tor
5C692	XC6371C692D	DC/DC-IC	PWM step-up, 180kHz, +CE, 6.9V±2.5%, 100mA	USP-6B	49gd	DC3	9b	Tor
5C7	XC9236A27C4R-G	DC-DC-IC	PWM/PFM, st-dwn, 2.7V±2%, 600mA, 1.2MHz, Vin>2V, LSST	USP-6EL	56dc5	DC1	9a	Tor
5C7	XC9236A27CER	DC-DC-IC	PWM/PFM, st-dwn, 2.7V±2%, 600mA, 1.2MHz, Vin>2V, LSST	USP-6C	49dc5	DC1	9a	Tor
5C700	XC6371C700D	DC/DC-IC	PWM step-up, 50kHz, +CE, 7.0V±2.5%, 100mA	USP-6B	49gd	DC3	9b	Tor
5C701	XC6371C701D	DC/DC-IC	PWM step-up, 100kHz, +CE, 7.0V±2.5%, 100mA	USP-6B	49gd	DC3	9b	Tor
5C702	XC6371C702D	DC/DC-IC	PWM step-up, 180kHz, +CE, 7.0V±2.5%, 100mA	USP-6B	49gd	DC3	9b	Tor
5C8	XC9236A28C4R-G	DC-DC-IC	PWM/PFM, st-dwn, 2.8V±2%, 600mA, 1.2MHz, Vin>2V, LSST	USP-6EL	56dc5	DC1	9a	Tor
5C8	XC9236A28CER	DC-DC-IC	PWM/PFM, st-dwn, 2.8V±2%, 600mA, 1.2MHz, Vin>2V, LSST	USP-6C	49dc5	DC1	9a	Tor
5C9	XC9236A29C4R-G	DC-DC-IC	PWM/PFM, st-dwn, 2.9V±2%, 600mA, 1.2MHz, Vin>2V, LSST	USP-6EL	56dc5	DC1	9a	Tor
5C9	XC9236A29CER	DC-DC-IC	PWM/PFM, st-dwn, 2.9V±2%, 600mA, 1.2MHz, Vin>2V, LSST	USP-6C	49dc5	DC1	9a	Tor
5CA	XC9236A2AC4R-G	DC-DC-IC	PWM/PFM, st-dwn, 2.05V±2%, 600mA, 1.2MHz, Vin>2V, LSST	USP-6EL	56dc5	DC1	9a	Tor
5CA	XC9236A2ACER	DC-DC-IC	PWM/PFM, st-dwn, 2.05V±2%, 600mA, 1.2MHz, Vin>2V, LSST	USP-6C	49dc5	DC1	9a	Tor
5CB	XC9236A2BC4R-G	DC-DC-IC	PWM/PFM, st-dwn, 2.15V±2%, 600mA, 1.2MHz, Vin>2V, LSST	USP-6EL	56dc5	DC1	9a	Tor
5CB	XC9236A2BCER	DC-DC-IC	PWM/PFM, st-dwn, 2.15V±2%, 600mA, 1.2MHz, Vin>2V, LSST	USP-6C	49dc5	DC1	9a	Tor
5CC	XC9236A2CC4R-G	DC-DC-IC	PWM/PFM, st-dwn, 2.25V±2%, 600mA, 1.2MHz, Vin>2V, LSST	USP-6EL	56dc5	DC1	9a	Tor
5CC	XC9236A2CCER	DC-DC-IC	PWM/PFM, st-dwn, 2.25V±2%, 600mA, 1.2MHz, Vin>2V, LSST	USP-6C	49dc5	DC1	9a	Tor
5CD	XC9236A2DC4R-G	DC-DC-IC	PWM/PFM, st-dwn, 2.35V±2%, 600mA, 1.2MHz, Vin>2V, LSST	USP-6EL	56dc5	DC1	9a	Tor
5CD	XC9236A2DCER	DC-DC-IC	PWM/PFM, st-dwn, 2.35V±2%, 600mA, 1.2MHz, Vin>2V, LSST	USP-6C	49dc5	DC1	9a	Tor
5CE	XC9236A2EC4R-G	DC-DC-IC	PWM/PFM, st-dwn, 2.45V±2%, 600mA, 1.2MHz, Vin>2V, LSST	USP-6EL	56dc5	DC1	9a	Tor
5CE	XC9236A2ECER	DC-DC-IC	PWM/PFM, st-dwn, 2.45V±2%, 600mA, 1.2MHz, Vin>2V, LSST	USP-6C	49dc5	DC1	9a	Tor
5CF	XC9236A2FC4R-G	DC-DC-IC	PWM/PFM, st-dwn, 2.55V±2%, 600mA, 1.2MHz, Vin>2V, LSST	USP-6EL	56dc5	DC1	9a	Tor
5CF	XC9236A2FCER	DC-DC-IC	PWM/PFM, st-dwn, 2.55V±2%, 600mA, 1.2MHz, Vin>2V, LSST	USP-6C	49dc5	DC1	9a	Tor
5CH	XC9236A2HC4R-G	DC-DC-IC	PWM/PFM, st-dwn, 2.65V±2%, 600mA, 1.2MHz, Vin>2V, LSST	USP-6EL	56dc5	DC1	9a	Tor
5CH	XC9236A2HCER	DC-DC-IC	PWM/PFM, st-dwn, 2.65V±2%, 600mA, 1.2MHz, Vin>2V, LSST	USP-6C	49dc5	DC1	9a	Tor
5CK	XC9236A2KC4R-G	DC-DC-IC	PWM/PFM, st-dwn, 2.75V±2%, 600mA, 1.2MHz, Vin>2V, LSST	USP-6EL	56dc5	DC1	9a	Tor
5CK	XC9236A2KCER	DC-DC-IC	PWM/PFM, st-dwn, 2.75V±2%, 600mA, 1.2MHz, Vin>2V, LSST	USP-6C	49dc5	DC1	9a	Tor
5CL	XC9236A2LC4R-G	DC-DC-IC	PWM/PFM, st-dwn, 2.85V±2%, 600mA, 1.2MHz, Vin>2V, LSST	USP-6EL	56dc5	DC1	9a	Tor



SMD code	Type	Function	Short description	Case	Pinout	Sch.	St.	Mnf.
5CL	XC9236A2LCER	DC-DC-IC	PWM/PFM, st-dwn, 2.85V±2%, 600mA, 1.2MHz, Vin>2V, LSST	USP-6C	49dc5	DC1	9a	Tor
5CM	XC9236A2MC4R-G	DC-DC-IC	PWM/PFM, st-dwn, 2.95V±2%, 600mA, 1.2MHz, Vin>2V, LSST	USP-6EL	56dc5	DC1	9a	Tor
5CM	XC9236A2MCER	DC-DC-IC	PWM/PFM, st-dwn, 2.95V±2%, 600mA, 1.2MHz, Vin>2V, LSST	USP-6C	49dc5	DC1	9a	Tor
5D	RP101K182B	LVR-IC	LDO, LN, +CE, 1.8V±0.8%, 300mA	DFN1612-4B	45vm	VR4	9a	Ric
5D	RP200K111B	LVR-IC	LDO, 1.1V±1.0%, 300mA, +CE, AE(mode)	DFN1212-6	52ht	VR10	9a	Ric
5D	XG6217C14A7R-G	LVR-IC	LDO, 1.45V±2%, 200mA, +CE	USPN-4	58vm	VR4	9a	Tor
5D	XG6223F2319R-G	LVR-IC	LDO, 2.3V±1%, 300mA, +CE, CL, ICP	USPQ-4B03	48vm	VR4	9a	Tor
5D0	XC9236A30C4R-G	DC-DC-IC	PWM/PFM, st-dwn, 3.0V±2%, 600mA, 1.2MHz, Vin>2V, LSST	USP-6EL	56dc5	DC1	9a	Tor
5D0	XC9236A30CER	DC-DC-IC	PWM/PFM, st-dwn, 3.0V±2%, 600mA, 1.2MHz, Vin>2V, LSST	USP-6C	49dc5	DC1	9a	Tor
5D1	XC9236A31C4R-G	DC-DC-IC	PWM/PFM, st-dwn, 3.1V±2%, 600mA, 1.2MHz, Vin>2V, LSST	USP-6EL	56dc5	DC1	9a	Tor
5D1	XC9236A31CER	DC-DC-IC	PWM/PFM, st-dwn, 3.1V±2%, 600mA, 1.2MHz, Vin>2V, LSST	USP-6C	49dc5	DC1	9a	Tor
5D2	XC9236A32C4R-G	DC-DC-IC	PWM/PFM, st-dwn, 3.2V±2%, 600mA, 1.2MHz, Vin>2V, LSST	USP-6EL	56dc5	DC1	9a	Tor
5D2	XC9236A32CER	DC-DC-IC	PWM/PFM, st-dwn, 3.2V±2%, 600mA, 1.2MHz, Vin>2V, LSST	USP-6C	49dc5	DC1	9a	Tor
5D3	XC9236A33C4R-G	DC-DC-IC	PWM/PFM, st-dwn, 3.3V±2%, 600mA, 1.2MHz, Vin>2V, LSST	USP-6EL	56dc5	DC1	9a	Tor
5D3	XC9236A33CER	DC-DC-IC	PWM/PFM, st-dwn, 3.3V±2%, 600mA, 1.2MHz, Vin>2V, LSST	USP-6C	49dc5	DC1	9a	Tor
5D316	XG6103D316ER	Vdet-IC	1.6V±2%, Hst, -MR, +Reset PPO, Wt=100ms, Rt=100ms	USP-6C	49xh	VD17	9b	Tor
5D317	XG6103D317ER	Vdet-IC	1.7V±2%, Hst, -MR, +Reset PPO, Wt=100ms, Rt=100ms	USP-6C	49xh	VD17	9b	Tor
5D318	XG6103D318ER	Vdet-IC	1.8V±2%, Hst, -MR, +Reset PPO, Wt=100ms, Rt=100ms	USP-6C	49xh	VD17	9b	Tor
5D319	XG6103D319ER	Vdet-IC	1.9V±2%, Hst, -MR, +Reset PPO, Wt=100ms, Rt=100ms	USP-6C	49xh	VD17	9b	Tor
5D320	XG6103D320ER	Vdet-IC	2.0V±2%, Hst, -MR, +Reset PPO, Wt=100ms, Rt=100ms	USP-6C	49xh	VD17	9b	Tor
5D321	XG6103D321ER	Vdet-IC	2.1V±2%, Hst, -MR, +Reset PPO, Wt=100ms, Rt=100ms	USP-6C	49xh	VD17	9b	Tor
5D322	XG6103D322ER	Vdet-IC	2.2V±2%, Hst, -MR, +Reset PPO, Wt=100ms, Rt=100ms	USP-6C	49xh	VD17	9b	Tor
5D323	XG6103D323ER	Vdet-IC	2.3V±2%, Hst, -MR, +Reset PPO, Wt=100ms, Rt=100ms	USP-6C	49xh	VD17	9b	Tor
5D324	XG6103D324ER	Vdet-IC	2.4V±2%, Hst, -MR, +Reset PPO, Wt=100ms, Rt=100ms	USP-6C	49xh	VD17	9b	Tor
5D325	XG6103D325ER	Vdet-IC	2.5V±2%, Hst, -MR, +Reset PPO, Wt=100ms, Rt=100ms	USP-6C	49xh	VD17	9b	Tor
5D326	XG6103D326ER	Vdet-IC	2.6V±2%, Hst, -MR, +Reset PPO, Wt=100ms, Rt=100ms	USP-6C	49xh	VD17	9b	Tor
5D327	XG6103D327ER	Vdet-IC	2.7V±2%, Hst, -MR, +Reset PPO, Wt=100ms, Rt=100ms	USP-6C	49xh	VD17	9b	Tor
5D328	XG6103D328ER	Vdet-IC	2.8V±2%, Hst, -MR, +Reset PPO, Wt=100ms, Rt=100ms	USP-6C	49xh	VD17	9b	Tor
5D329	XG6103D329ER	Vdet-IC	2.9V±2%, Hst, -MR, +Reset PPO, Wt=100ms, Rt=100ms	USP-6C	49xh	VD17	9b	Tor
5D330	XG6103D330ER	Vdet-IC	3.0V±2%, Hst, -MR, +Reset PPO, Wt=100ms, Rt=100ms	USP-6C	49xh	VD17	9b	Tor
5D331	XG6103D331ER	Vdet-IC	3.1V±2%, Hst, -MR, +Reset PPO, Wt=100ms, Rt=100ms	USP-6C	49xh	VD17	9b	Tor
5D332	XG6103D332ER	Vdet-IC	3.2V±2%, Hst, -MR, +Reset PPO, Wt=100ms, Rt=100ms	USP-6C	49xh	VD17	9b	Tor
5D333	XG6103D333ER	Vdet-IC	3.3V±2%, Hst, -MR, +Reset PPO, Wt=100ms, Rt=100ms	USP-6C	49xh	VD17	9b	Tor
5D334	XG6103D334ER	Vdet-IC	3.4V±2%, Hst, -MR, +Reset PPO, Wt=100ms, Rt=100ms	USP-6C	49xh	VD17	9b	Tor
5D335	XG6103D335ER	Vdet-IC	3.5V±2%, Hst, -MR, +Reset PPO, Wt=100ms, Rt=100ms	USP-6C	49xh	VD17	9b	Tor
5D336	XG6103D336ER	Vdet-IC	3.6V±2%, Hst, -MR, +Reset PPO, Wt=100ms, Rt=100ms	USP-6C	49xh	VD17	9b	Tor
5D337	XG6103D337ER	Vdet-IC	3.7V±2%, Hst, -MR, +Reset PPO, Wt=100ms, Rt=100ms	USP-6C	49xh	VD17	9b	Tor
5D338	XG6103D338ER	Vdet-IC	3.8V±2%, Hst, -MR, +Reset PPO, Wt=100ms, Rt=100ms	USP-6C	49xh	VD17	9b	Tor
5D339	XG6103D339ER	Vdet-IC	3.9V±2%, Hst, -MR, +Reset PPO, Wt=100ms, Rt=100ms	USP-6C	49xh	VD17	9b	Tor
5D340	XG6103D340ER	Vdet-IC	4.0V±2%, Hst, -MR, +Reset PPO, Wt=100ms, Rt=100ms	USP-6C	49xh	VD17	9b	Tor
5D341	XG6103D341ER	Vdet-IC	4.1V±2%, Hst, -MR, +Reset PPO, Wt=100ms, Rt=100ms	USP-6C	49xh	VD17	9b	Tor
5D342	XG6103D342ER	Vdet-IC	4.2V±2%, Hst, -MR, +Reset PPO, Wt=100ms, Rt=100ms	USP-6C	49xh	VD17	9b	Tor
5D343	XG6103D343ER	Vdet-IC	4.3V±2%, Hst, -MR, +Reset PPO, Wt=100ms, Rt=100ms	USP-6C	49xh	VD17	9b	Tor
5D344	XG6103D344ER	Vdet-IC	4.4V±2%, Hst, -MR, +Reset PPO, Wt=100ms, Rt=100ms	USP-6C	49xh	VD17	9b	Tor
5D345	XG6103D345ER	Vdet-IC	4.5V±2%, Hst, -MR, +Reset PPO, Wt=100ms, Rt=100ms	USP-6C	49xh	VD17	9b	Tor
5D346	XG6103D346ER	Vdet-IC	4.6V±2%, Hst, -MR, +Reset PPO, Wt=100ms, Rt=100ms	USP-6C	49xh	VD17	9b	Tor
5D347	XG6103D347ER	Vdet-IC	4.7V±2%, Hst, -MR, +Reset PPO, Wt=100ms, Rt=100ms	USP-6C	49xh	VD17	9b	Tor
5D348	XG6103D348ER	Vdet-IC	4.8V±2%, Hst, -MR, +Reset PPO, Wt=100ms, Rt=100ms	USP-6C	49xh	VD17	9b	Tor
5D349	XG6103D349ER	Vdet-IC	4.9V±2%, Hst, -MR, +Reset PPO, Wt=100ms, Rt=100ms	USP-6C	49xh	VD17	9b	Tor
5D350	XG6103D350ER	Vdet-IC	5.0V±2%, Hst, -MR, +Reset PPO, Wt=100ms, Rt=100ms	USP-6C	49xh	VD17	9b	Tor
5D4	XC9236A34C4R-G	DC-DC-IC	PWM/PFM, st-dwn, 3.4V±2%, 600mA, 1.2MHz, Vin>2V, LSST	USP-6EL	56dc5	DC1	9a	Tor
5D4	XC9236A34CER	DC-DC-IC	PWM/PFM, st-dwn, 3.4V±2%, 600mA, 1.2MHz, Vin>2V, LSST	USP-6C	49dc5	DC1	9a	Tor
5D416	XG6103D416ER	Vdet-IC	1.6V±2%, Hst, -MR, +Reset PPO, Wt=200ms, Rt=100ms	USP-6C	49xh	VD17	9b	Tor
5D417	XG6103D417ER	Vdet-IC	1.7V±2%, Hst, -MR, +Reset PPO, Wt=200ms, Rt=100ms	USP-6C	49xh	VD17	9b	Tor
5D418	XG6103D418ER	Vdet-IC	1.8V±2%, Hst, -MR, +Reset PPO, Wt=200ms, Rt=100ms	USP-6C	49xh	VD17	9b	Tor
5D419	XG6103D419ER	Vdet-IC	1.9V±2%, Hst, -MR, +Reset PPO, Wt=200ms, Rt=100ms	USP-6C	49xh	VD17	9b	Tor
5D420	XG6103D420ER	Vdet-IC	2.0V±2%, Hst, -MR, +Reset PPO, Wt=200ms, Rt=100ms	USP-6C	49xh	VD17	9b	Tor
5D421	XG6103D421ER	Vdet-IC	2.1V±2%, Hst, -MR, +Reset PPO, Wt=200ms, Rt=100ms	USP-6C	49xh	VD17	9b	Tor
5D422	XG6103D422ER	Vdet-IC	2.2V±2%, Hst, -MR, +Reset PPO, Wt=200ms, Rt=100ms	USP-6C	49xh	VD17	9b	Tor
5D423	XG6103D423ER	Vdet-IC	2.3V±2%, Hst, -MR, +Reset PPO, Wt=200ms, Rt=100ms	USP-6C	49xh	VD17	9b	Tor
5D424	XG6103D424ER	Vdet-IC	2.4V±2%, Hst, -MR, +Reset PPO, Wt=200ms, Rt=100ms	USP-6C	49xh	VD17	9b	Tor
5D425	XG6103D425ER	Vdet-IC	2.5V±2%, Hst, -MR, +Reset PPO, Wt=200ms, Rt=100ms	USP-6C	49xh	VD17	9b	Tor
5D426	XG6103D426ER	Vdet-IC	2.6V±2%, Hst, -MR, +Reset PPO, Wt=200ms, Rt=100ms	USP-6C	49xh	VD17	9b	Tor
5D427	XG6103D427ER	Vdet-IC	2.7V±2%, Hst, -MR, +Reset PPO, Wt=200ms, Rt=100ms	USP-6C	49xh	VD17	9b	Tor
5D428	XG6103D428ER	Vdet-IC	2.8V±2%, Hst, -MR, +Reset PPO, Wt=200ms, Rt=100ms	USP-6C	49xh	VD17	9b	Tor
5D429	XG6103D429ER	Vdet-IC	2.9V±2%, Hst, -MR, +Reset PPO, Wt=200ms, Rt=100ms	USP-6C	49xh	VD17	9b	Tor
5D430	XG6103D430ER	Vdet-IC	3.0V±2%, Hst, -MR, +Reset PPO, Wt=200ms, Rt=100ms	USP-6C	49xh	VD17	9b	Tor
5D431	XG6103D431ER	Vdet-IC	3.1V±2%, Hst, -MR, +Reset PPO, Wt=200ms, Rt=100ms	USP-6C	49xh	VD17	9b	Tor
5D432	XG6103D432ER	Vdet-IC	3.2V±2%, Hst, -MR, +Reset PPO, Wt=200ms, Rt=100ms	USP-6C	49xh	VD17	9b	Tor
5D433	XG6103D433ER	Vdet-IC	3.3V±2%, Hst, -MR, +Reset PPO, Wt=200ms, Rt=100ms	USP-6C	49xh	VD17	9b	Tor



SMD code	Type	Function	Short description	Case	Pinout	Sch.	St.Mnf.
5D630	XC6103D630ER	Vdet-IC	3.0V±2%, Hst, -MR, +Reset PPO, Wt=1.6s, Rt=100ms	USP-6C	49xh	VD17	9b Tor
5D631	XC6103D631ER	Vdet-IC	3.1V±2%, Hst, -MR, +Reset PPO, Wt=1.6s, Rt=100ms	USP-6C	49xh	VD17	9b Tor
5D632	XC6103D632ER	Vdet-IC	3.2V±2%, Hst, -MR, +Reset PPO, Wt=1.6s, Rt=100ms	USP-6C	49xh	VD17	9b Tor
5D633	XC6103D633ER	Vdet-IC	3.3V±2%, Hst, -MR, +Reset PPO, Wt=1.6s, Rt=100ms	USP-6C	49xh	VD17	9b Tor
5D634	XC6103D634ER	Vdet-IC	3.4V±2%, Hst, -MR, +Reset PPO, Wt=1.6s, Rt=100ms	USP-6C	49xh	VD17	9b Tor
5D635	XC6103D635ER	Vdet-IC	3.5V±2%, Hst, -MR, +Reset PPO, Wt=1.6s, Rt=100ms	USP-6C	49xh	VD17	9b Tor
5D636	XC6103D636ER	Vdet-IC	3.6V±2%, Hst, -MR, +Reset PPO, Wt=1.6s, Rt=100ms	USP-6C	49xh	VD17	9b Tor
5D637	XC6103D637ER	Vdet-IC	3.7V±2%, Hst, -MR, +Reset PPO, Wt=1.6s, Rt=100ms	USP-6C	49xh	VD17	9b Tor
5D638	XC6103D638ER	Vdet-IC	3.8V±2%, Hst, -MR, +Reset PPO, Wt=1.6s, Rt=100ms	USP-6C	49xh	VD17	9b Tor
5D639	XC6103D639ER	Vdet-IC	3.9V±2%, Hst, -MR, +Reset PPO, Wt=1.6s, Rt=100ms	USP-6C	49xh	VD17	9b Tor
5D640	XC6103D640ER	Vdet-IC	4.0V±2%, Hst, -MR, +Reset PPO, Wt=1.6s, Rt=100ms	USP-6C	49xh	VD17	9b Tor
5D641	XC6103D641ER	Vdet-IC	4.1V±2%, Hst, -MR, +Reset PPO, Wt=1.6s, Rt=100ms	USP-6C	49xh	VD17	9b Tor
5D642	XC6103D642ER	Vdet-IC	4.2V±2%, Hst, -MR, +Reset PPO, Wt=1.6s, Rt=100ms	USP-6C	49xh	VD17	9b Tor
5D643	XC6103D643ER	Vdet-IC	4.3V±2%, Hst, -MR, +Reset PPO, Wt=1.6s, Rt=100ms	USP-6C	49xh	VD17	9b Tor
5D644	XC6103D644ER	Vdet-IC	4.4V±2%, Hst, -MR, +Reset PPO, Wt=1.6s, Rt=100ms	USP-6C	49xh	VD17	9b Tor
5D645	XC6103D645ER	Vdet-IC	4.5V±2%, Hst, -MR, +Reset PPO, Wt=1.6s, Rt=100ms	USP-6C	49xh	VD17	9b Tor
5D646	XC6103D646ER	Vdet-IC	4.6V±2%, Hst, -MR, +Reset PPO, Wt=1.6s, Rt=100ms	USP-6C	49xh	VD17	9b Tor
5D647	XC6103D647ER	Vdet-IC	4.7V±2%, Hst, -MR, +Reset PPO, Wt=1.6s, Rt=100ms	USP-6C	49xh	VD17	9b Tor
5D648	XC6103D648ER	Vdet-IC	4.8V±2%, Hst, -MR, +Reset PPO, Wt=1.6s, Rt=100ms	USP-6C	49xh	VD17	9b Tor
5D649	XC6103D649ER	Vdet-IC	4.9V±2%, Hst, -MR, +Reset PPO, Wt=1.6s, Rt=100ms	USP-6C	49xh	VD17	9b Tor
5D650	XC6103D650ER	Vdet-IC	5.0V±2%, Hst, -MR, +Reset PPO, Wt=1.6s, Rt=100ms	USP-6C	49xh	VD17	9b Tor
5D7	XC9236A37C4R-G	DC-DC-IC	PWM/PFM, st-dwn, 3.7V±2%, 600mA, 1.2MHz, Vin>2V, LSST	USP-6EL	56dc5	DC1	9a Tor
5D7	XC9236A37CER	DC-DC-IC	PWM/PFM, st-dwn, 3.7V±2%, 600mA, 1.2MHz, Vin>2V, LSST	USP-6C	49dc5	DC1	9a Tor
5D8	XC9236A38C4R-G	DC-DC-IC	PWM/PFM, st-dwn, 3.8V±2%, 600mA, 1.2MHz, Vin>2V, LSST	USP-6EL	56dc5	DC1	9a Tor
5D8	XC9236A38CER	DC-DC-IC	PWM/PFM, st-dwn, 3.8V±2%, 600mA, 1.2MHz, Vin>2V, LSST	USP-6C	49dc5	DC1	9a Tor
5D9	XC9236A39C4R-G	DC-DC-IC	PWM/PFM, st-dwn, 3.9V±2%, 600mA, 1.2MHz, Vin>2V, LSST	USP-6EL	56dc5	DC1	9a Tor
5D9	XC9236A39CER	DC-DC-IC	PWM/PFM, st-dwn, 3.9V±2%, 600mA, 1.2MHz, Vin>2V, LSST	USP-6C	49dc5	DC1	9a Tor
5DA	XC9236A3AC4R-G	DC-DC-IC	PWM/PFM, st-dwn, 3.05V±2%, 600mA, 1.2MHz, Vin>2V, LSST	USP-6EL	56dc5	DC1	9a Tor
5DA	XC9236A3ACER	DC-DC-IC	PWM/PFM, st-dwn, 3.05V±2%, 600mA, 1.2MHz, Vin>2V, LSST	USP-6C	49dc5	DC1	9a Tor
5DB	XC9236A3BC4R-G	DC-DC-IC	PWM/PFM, st-dwn, 3.15V±2%, 600mA, 1.2MHz, Vin>2V, LSST	USP-6EL	56dc5	DC1	9a Tor
5DB	XC9236A3BCER	DC-DC-IC	PWM/PFM, st-dwn, 3.15V±2%, 600mA, 1.2MHz, Vin>2V, LSST	USP-6C	49dc5	DC1	9a Tor
5DC	XC9236A3CC4R-G	DC-DC-IC	PWM/PFM, st-dwn, 3.25V±2%, 600mA, 1.2MHz, Vin>2V, LSST	USP-6EL	56dc5	DC1	9a Tor
5DC	XC9236A3CCER	DC-DC-IC	PWM/PFM, st-dwn, 3.25V±2%, 600mA, 1.2MHz, Vin>2V, LSST	USP-6C	49dc5	DC1	9a Tor
5DD	XC9236A3DC4R-G	DC-DC-IC	PWM/PFM, st-dwn, 3.35V±2%, 600mA, 1.2MHz, Vin>2V, LSST	USP-6EL	56dc5	DC1	9a Tor
5DD	XC9236A3DCER	DC-DC-IC	PWM/PFM, st-dwn, 3.35V±2%, 600mA, 1.2MHz, Vin>2V, LSST	USP-6C	49dc5	DC1	9a Tor
5DE	XC9236A3EC4R-G	DC-DC-IC	PWM/PFM, st-dwn, 3.45V±2%, 600mA, 1.2MHz, Vin>2V, LSST	USP-6EL	56dc5	DC1	9a Tor
5DE	XC9236A3ECER	DC-DC-IC	PWM/PFM, st-dwn, 3.45V±2%, 600mA, 1.2MHz, Vin>2V, LSST	USP-6C	49dc5	DC1	9a Tor
5DF	XC9236A3FC4R-G	DC-DC-IC	PWM/PFM, st-dwn, 3.55V±2%, 600mA, 1.2MHz, Vin>2V, LSST	USP-6EL	56dc5	DC1	9a Tor
5DF	XC9236A3FCER	DC-DC-IC	PWM/PFM, st-dwn, 3.55V±2%, 600mA, 1.2MHz, Vin>2V, LSST	USP-6C	49dc5	DC1	9a Tor
5DH	XC9236A3HC4R-G	DC-DC-IC	PWM/PFM, st-dwn, 3.65V±2%, 600mA, 1.2MHz, Vin>2V, LSST	USP-6EL	56dc5	DC1	9a Tor
5DH	XC9236A3HCER	DC-DC-IC	PWM/PFM, st-dwn, 3.65V±2%, 600mA, 1.2MHz, Vin>2V, LSST	USP-6C	49dc5	DC1	9a Tor
5DK	XC9236A3KC4R-G	DC-DC-IC	PWM/PFM, st-dwn, 3.75V±2%, 600mA, 1.2MHz, Vin>2V, LSST	USP-6EL	56dc5	DC1	9a Tor
5DK	XC9236A3KCER	DC-DC-IC	PWM/PFM, st-dwn, 3.75V±2%, 600mA, 1.2MHz, Vin>2V, LSST	USP-6C	49dc5	DC1	9a Tor
5DL	XC9236A3LC4R-G	DC-DC-IC	PWM/PFM, st-dwn, 3.85V±2%, 600mA, 1.2MHz, Vin>2V, LSST	USP-6EL	56dc5	DC1	9a Tor
5DL	XC9236A3LCER	DC-DC-IC	PWM/PFM, st-dwn, 3.85V±2%, 600mA, 1.2MHz, Vin>2V, LSST	USP-6C	49dc5	DC1	9a Tor
5DM	XC9236A3MC4R-G	DC-DC-IC	PWM/PFM, st-dwn, 3.95V±2%, 600mA, 1.2MHz, Vin>2V, LSST	USP-6EL	56dc5	DC1	9a Tor
5DM	XC9236A3MCER	DC-DC-IC	PWM/PFM, st-dwn, 3.95V±2%, 600mA, 1.2MHz, Vin>2V, LSST	USP-6C	49dc5	DC1	9a Tor
5E	RP101K182B5	LVR-IC	LDO, LN, +CE, 1.85V±0.8%, 300mA	DFN1612-4B	45vm	VR4	9a Ric
5E	RP200K121B	LVR-IC	LDO, 1.2V±1.0%, 300mA, +CE, AE(mode)	DFN1212-6	52ht	VR10	9a Ric
5E	XC6217C15A7R-G	LVR-IC	LDO, 1.55V±2%, 200mA, +CE	USPN-4	58vm	VR4	9a Tor
5E	XC6223F2419R-G	LVR-IC	LDO, 2.4V±1%, 300mA, +CE, CL, ICP	USPQ-4B03	48vm	VR4	9a Tor
5E0	XC9236A40C4R-G	DC-DC-IC	PWM/PFM, st-dwn, 4.0V±2%, 600mA, 1.2MHz, Vin>2V, LSST	USP-6EL	56dc5	DC1	9a Tor
5E0	XC9236A40CER	DC-DC-IC	PWM/PFM, st-dwn, 4.0V±2%, 600mA, 1.2MHz, Vin>2V, LSST	USP-6C	49dc5	DC1	9a Tor
5E200	XC6371E200D	DC/DC-IC	PWM step-up, 50kHz, int. Vdd, 2.0V±2.5%, 100mA	USP-6B	49ge	DC4	9b Tor
5E201	XC6371E201D	DC/DC-IC	PWM step-up, 100kHz, int. Vdd, 2.0V±2.5%, 100mA	USP-6B	49ge	DC4	9b Tor
5E202	XC6371E202D	DC/DC-IC	PWM step-up, 180kHz, int. Vdd, 2.0V±2.5%, 100mA	USP-6B	49ge	DC4	9b Tor
5E210	XC6371E210D	DC/DC-IC	PWM step-up, 50kHz, int. Vdd, 2.1V±2.5%, 100mA	USP-6B	49ge	DC4	9b Tor
5E211	XC6371E211D	DC/DC-IC	PWM step-up, 100kHz, int. Vdd, 2.1V±2.5%, 100mA	USP-6B	49ge	DC4	9b Tor
5E212	XC6371E212D	DC/DC-IC	PWM step-up, 180kHz, int. Vdd, 2.1V±2.5%, 100mA	USP-6B	49ge	DC4	9b Tor
5E220	XC6371E220D	DC/DC-IC	PWM step-up, 50kHz, int. Vdd, 2.2V±2.5%, 100mA	USP-6B	49ge	DC4	9b Tor
5E221	XC6371E221D	DC/DC-IC	PWM step-up, 100kHz, int. Vdd, 2.2V±2.5%, 100mA	USP-6B	49ge	DC4	9b Tor
5E222	XC6371E222D	DC/DC-IC	PWM step-up, 180kHz, int. Vdd, 2.2V±2.5%, 100mA	USP-6B	49ge	DC4	9b Tor
5E230	XC6371E230D	DC/DC-IC	PWM step-up, 50kHz, int. Vdd, 2.3V±2.5%, 100mA	USP-6B	49ge	DC4	9b Tor
5E231	XC6371E231D	DC/DC-IC	PWM step-up, 100kHz, int. Vdd, 2.3V±2.5%, 100mA	USP-6B	49ge	DC4	9b Tor
5E232	XC6371E232D	DC/DC-IC	PWM step-up, 180kHz, int. Vdd, 2.3V±2.5%, 100mA	USP-6B	49ge	DC4	9b Tor
5E240	XC6371E240D	DC/DC-IC	PWM step-up, 50kHz, int. Vdd, 2.4V±2.5%, 100mA	USP-6B	49ge	DC4	9b Tor
5E241	XC6371E241D	DC/DC-IC	PWM step-up, 100kHz, int. Vdd, 2.4V±2.5%, 100mA	USP-6B	49ge	DC4	9b Tor
5E242	XC6371E242D	DC/DC-IC	PWM step-up, 180kHz, int. Vdd, 2.4V±2.5%, 100mA	USP-6B	49ge	DC4	9b Tor
5E250	XC6371E250D	DC/DC-IC	PWM step-up, 50kHz, int. Vdd, 2.5V±2.5%, 100mA	USP-6B	49ge	DC4	9b Tor
5E251	XC6371E251D	DC/DC-IC	PWM step-up, 100kHz, int. Vdd, 2.5V±2.5%, 100mA	USP-6B	49ge	DC4	9b Tor



SMD code	Type	Function	Short description	Case	Pinout	Sch.	St.	Mnf.
5E640	XC6371E640D	DC/DC-IC	PWM step-up, 50kHz, int. Vdd, 6.4V±2.5%, 100mA	USP-6B	49ge	DC4	9b	Tor
5E641	XC6103E641ER	Vdet-IC	4.1V±2%, Hst. -MR, +Reset PPO, Wt=1.6s, Rt=200ms	USP-6C	49xh	VD17	9b	Tor
5E641	XC6371E641D	DC/DC-IC	PWM step-up, 100kHz, int. Vdd, 6.4V±2.5%, 100mA	USP-6B	49ge	DC4	9b	Tor
5E642	XC6103E642ER	Vdet-IC	4.2V±2%, Hst. -MR, +Reset PPO, Wt=1.6s, Rt=200ms	USP-6C	49xh	VD17	9b	Tor
5E642	XC6371E642D	DC/DC-IC	PWM step-up, 180kHz, int. Vdd, 6.4V±2.5%, 100mA	USP-6B	49ge	DC4	9b	Tor
5E643	XC6103E643ER	Vdet-IC	4.3V±2%, Hst. -MR, +Reset PPO, Wt=1.6s, Rt=200ms	USP-6C	49xh	VD17	9b	Tor
5E644	XC6103E644ER	Vdet-IC	4.4V±2%, Hst. -MR, +Reset PPO, Wt=1.6s, Rt=200ms	USP-6C	49xh	VD17	9b	Tor
5E645	XC6103E645ER	Vdet-IC	4.5V±2%, Hst. -MR, +Reset PPO, Wt=1.6s, Rt=200ms	USP-6C	49xh	VD17	9b	Tor
5E646	XC6103E646ER	Vdet-IC	4.6V±2%, Hst. -MR, +Reset PPO, Wt=1.6s, Rt=200ms	USP-6C	49xh	VD17	9b	Tor
5E647	XC6103E647ER	Vdet-IC	4.7V±2%, Hst. -MR, +Reset PPO, Wt=1.6s, Rt=200ms	USP-6C	49xh	VD17	9b	Tor
5E648	XC6103E648ER	Vdet-IC	4.8V±2%, Hst. -MR, +Reset PPO, Wt=1.6s, Rt=200ms	USP-6C	49xh	VD17	9b	Tor
5E649	XC6103E649ER	Vdet-IC	4.9V±2%, Hst. -MR, +Reset PPO, Wt=1.6s, Rt=200ms	USP-6C	49xh	VD17	9b	Tor
5E650	XC6103E650ER	Vdet-IC	5.0V±2%, Hst. -MR, +Reset PPO, Wt=1.6s, Rt=200ms	USP-6C	49xh	VD17	9b	Tor
5E650	XC6371E650D	DC/DC-IC	PWM step-up, 50kHz, int. Vdd, 6.5V±2.5%, 100mA	USP-6B	49ge	DC4	9b	Tor
5E651	XC6371E651D	DC/DC-IC	PWM step-up, 100kHz, int. Vdd, 6.5V±2.5%, 100mA	USP-6B	49ge	DC4	9b	Tor
5E652	XC6371E652D	DC/DC-IC	PWM step-up, 180kHz, int. Vdd, 6.5V±2.5%, 100mA	USP-6B	49ge	DC4	9b	Tor
5E660	XC6371E660D	DC/DC-IC	PWM step-up, 50kHz, int. Vdd, 6.6V±2.5%, 100mA	USP-6B	49ge	DC4	9b	Tor
5E661	XC6371E661D	DC/DC-IC	PWM step-up, 100kHz, int. Vdd, 6.6V±2.5%, 100mA	USP-6B	49ge	DC4	9b	Tor
5E662	XC6371E662D	DC/DC-IC	PWM step-up, 180kHz, int. Vdd, 6.6V±2.5%, 100mA	USP-6B	49ge	DC4	9b	Tor
5E670	XC6371E670D	DC/DC-IC	PWM step-up, 50kHz, int. Vdd, 6.7V±2.5%, 100mA	USP-6B	49ge	DC4	9b	Tor
5E671	XC6371E671D	DC/DC-IC	PWM step-up, 100kHz, int. Vdd, 6.7V±2.5%, 100mA	USP-6B	49ge	DC4	9b	Tor
5E672	XC6371E672D	DC/DC-IC	PWM step-up, 180kHz, int. Vdd, 6.7V±2.5%, 100mA	USP-6B	49ge	DC4	9b	Tor
5E680	XC6371E680D	DC/DC-IC	PWM step-up, 50kHz, int. Vdd, 6.8V±2.5%, 100mA	USP-6B	49ge	DC4	9b	Tor
5E681	XC6371E681D	DC/DC-IC	PWM step-up, 100kHz, int. Vdd, 6.8V±2.5%, 100mA	USP-6B	49ge	DC4	9b	Tor
5E682	XC6371E682D	DC/DC-IC	PWM step-up, 180kHz, int. Vdd, 6.8V±2.5%, 100mA	USP-6B	49ge	DC4	9b	Tor
5E690	XC6371E690D	DC/DC-IC	PWM step-up, 50kHz, int. Vdd, 6.9V±2.5%, 100mA	USP-6B	49ge	DC4	9b	Tor
5E691	XC6371E691D	DC/DC-IC	PWM step-up, 100kHz, int. Vdd, 6.9V±2.5%, 100mA	USP-6B	49ge	DC4	9b	Tor
5E692	XC6371E692D	DC/DC-IC	PWM step-up, 180kHz, int. Vdd, 6.9V±2.5%, 100mA	USP-6B	49ge	DC4	9b	Tor
5E700	XC6371E700D	DC/DC-IC	PWM step-up, 50kHz, int. Vdd, 7.0V±2.5%, 100mA	USP-6B	49ge	DC4	9b	Tor
5E701	XC6371E701D	DC/DC-IC	PWM step-up, 100kHz, int. Vdd, 7.0V±2.5%, 100mA	USP-6B	49ge	DC4	9b	Tor
5E702	XC6371E702D	DC/DC-IC	PWM step-up, 180kHz, int. Vdd, 7.0V±2.5%, 100mA	USP-6B	49ge	DC4	9b	Tor
5F	RP101K192B	LVR-IC	LDO, LN, +CE, 1.9V±0.8%, 300mA	DFN1612-4B	45vm	VR4	9a	Ric
5F	RP200K131B	LVR-IC	LDO, 1.3V±1.0%, 300mA, +CE, AE(mode)	DFN1212-6	52ht	VR10	9a	Ric
5F	XC6217C16A7R-G	LVR-IC	LDO, 1.65V±2%, 200mA, +CE	USPN-4	58vm	VR4	9a	Tor
5F	XC6223F2519R-G	LVR-IC	LDO, 2.5V±1%, 300mA, +CE, CL, ICP	USPQ-4B03	48vm	VR4	9a	Tor
5F516	XC6103F516ER	Vdet-IC	1.6V±2%, Hst. -MR, +Reset PPO, Wt=400ms, Rt=400ms	USP-6C	49xh	VD17	9b	Tor
5F517	XC6103F517ER	Vdet-IC	1.7V±2%, Hst. -MR, +Reset PPO, Wt=400ms, Rt=400ms	USP-6C	49xh	VD17	9b	Tor
5F518	XC6103F518ER	Vdet-IC	1.8V±2%, Hst. -MR, +Reset PPO, Wt=400ms, Rt=400ms	USP-6C	49xh	VD17	9b	Tor
5F519	XC6103F519ER	Vdet-IC	1.9V±2%, Hst. -MR, +Reset PPO, Wt=400ms, Rt=400ms	USP-6C	49xh	VD17	9b	Tor
5F520	XC6103F520ER	Vdet-IC	2.0V±2%, Hst. -MR, +Reset PPO, Wt=400ms, Rt=400ms	USP-6C	49xh	VD17	9b	Tor
5F521	XC6103F521ER	Vdet-IC	2.1V±2%, Hst. -MR, +Reset PPO, Wt=400ms, Rt=400ms	USP-6C	49xh	VD17	9b	Tor
5F522	XC6103F522ER	Vdet-IC	2.2V±2%, Hst. -MR, +Reset PPO, Wt=400ms, Rt=400ms	USP-6C	49xh	VD17	9b	Tor
5F523	XC6103F523ER	Vdet-IC	2.3V±2%, Hst. -MR, +Reset PPO, Wt=400ms, Rt=400ms	USP-6C	49xh	VD17	9b	Tor
5F524	XC6103F524ER	Vdet-IC	2.4V±2%, Hst. -MR, +Reset PPO, Wt=400ms, Rt=400ms	USP-6C	49xh	VD17	9b	Tor
5F525	XC6103F525ER	Vdet-IC	2.5V±2%, Hst. -MR, +Reset PPO, Wt=400ms, Rt=400ms	USP-6C	49xh	VD17	9b	Tor
5F526	XC6103F526ER	Vdet-IC	2.6V±2%, Hst. -MR, +Reset PPO, Wt=400ms, Rt=400ms	USP-6C	49xh	VD17	9b	Tor
5F527	XC6103F527ER	Vdet-IC	2.7V±2%, Hst. -MR, +Reset PPO, Wt=400ms, Rt=400ms	USP-6C	49xh	VD17	9b	Tor
5F528	XC6103F528ER	Vdet-IC	2.8V±2%, Hst. -MR, +Reset PPO, Wt=400ms, Rt=400ms	USP-6C	49xh	VD17	9b	Tor
5F529	XC6103F529ER	Vdet-IC	2.9V±2%, Hst. -MR, +Reset PPO, Wt=400ms, Rt=400ms	USP-6C	49xh	VD17	9b	Tor
5F530	XC6103F530ER	Vdet-IC	3.0V±2%, Hst. -MR, +Reset PPO, Wt=400ms, Rt=400ms	USP-6C	49xh	VD17	9b	Tor
5F531	XC6103F531ER	Vdet-IC	3.1V±2%, Hst. -MR, +Reset PPO, Wt=400ms, Rt=400ms	USP-6C	49xh	VD17	9b	Tor
5F532	XC6103F532ER	Vdet-IC	3.2V±2%, Hst. -MR, +Reset PPO, Wt=400ms, Rt=400ms	USP-6C	49xh	VD17	9b	Tor
5F533	XC6103F533ER	Vdet-IC	3.3V±2%, Hst. -MR, +Reset PPO, Wt=400ms, Rt=400ms	USP-6C	49xh	VD17	9b	Tor
5F534	XC6103F534ER	Vdet-IC	3.4V±2%, Hst. -MR, +Reset PPO, Wt=400ms, Rt=400ms	USP-6C	49xh	VD17	9b	Tor
5F535	XC6103F535ER	Vdet-IC	3.5V±2%, Hst. -MR, +Reset PPO, Wt=400ms, Rt=400ms	USP-6C	49xh	VD17	9b	Tor
5F536	XC6103F536ER	Vdet-IC	3.6V±2%, Hst. -MR, +Reset PPO, Wt=400ms, Rt=400ms	USP-6C	49xh	VD17	9b	Tor
5F537	XC6103F537ER	Vdet-IC	3.7V±2%, Hst. -MR, +Reset PPO, Wt=400ms, Rt=400ms	USP-6C	49xh	VD17	9b	Tor
5F538	XC6103F538ER	Vdet-IC	3.8V±2%, Hst. -MR, +Reset PPO, Wt=400ms, Rt=400ms	USP-6C	49xh	VD17	9b	Tor
5F539	XC6103F539ER	Vdet-IC	3.9V±2%, Hst. -MR, +Reset PPO, Wt=400ms, Rt=400ms	USP-6C	49xh	VD17	9b	Tor
5F540	XC6103F540ER	Vdet-IC	4.0V±2%, Hst. -MR, +Reset PPO, Wt=400ms, Rt=400ms	USP-6C	49xh	VD17	9b	Tor
5F541	XC6103F541ER	Vdet-IC	4.1V±2%, Hst. -MR, +Reset PPO, Wt=400ms, Rt=400ms	USP-6C	49xh	VD17	9b	Tor
5F542	XC6103F542ER	Vdet-IC	4.2V±2%, Hst. -MR, +Reset PPO, Wt=400ms, Rt=400ms	USP-6C	49xh	VD17	9b	Tor
5F543	XC6103F543ER	Vdet-IC	4.3V±2%, Hst. -MR, +Reset PPO, Wt=400ms, Rt=400ms	USP-6C	49xh	VD17	9b	Tor
5F544	XC6103F544ER	Vdet-IC	4.4V±2%, Hst. -MR, +Reset PPO, Wt=400ms, Rt=400ms	USP-6C	49xh	VD17	9b	Tor
5F545	XC6103F545ER	Vdet-IC	4.5V±2%, Hst. -MR, +Reset PPO, Wt=400ms, Rt=400ms	USP-6C	49xh	VD17	9b	Tor
5F546	XC6103F546ER	Vdet-IC	4.6V±2%, Hst. -MR, +Reset PPO, Wt=400ms, Rt=400ms	USP-6C	49xh	VD17	9b	Tor
5F547	XC6103F547ER	Vdet-IC	4.7V±2%, Hst. -MR, +Reset PPO, Wt=400ms, Rt=400ms	USP-6C	49xh	VD17	9b	Tor
5F548	XC6103F548ER	Vdet-IC	4.8V±2%, Hst. -MR, +Reset PPO, Wt=400ms, Rt=400ms	USP-6C	49xh	VD17	9b	Tor
5F549	XC6103F549ER	Vdet-IC	4.9V±2%, Hst. -MR, +Reset PPO, Wt=400ms, Rt=400ms	USP-6C	49xh	VD17	9b	Tor
5F550	XC6103F550ER	Vdet-IC	5.0V±2%, Hst. -MR, +Reset PPO, Wt=400ms, Rt=400ms	USP-6C	49xh	VD17	9b	Tor



SMD code	Type	Function	Short description	Case	Pinout	Sch.	St.	Mnf.
5F616	XC6103F616ER	Vdet-IC	1.6V±2%, Hst, -MR, +Reset PPO, Wt=1.6s, Rt=400ms	USP-6C	49xh	VD17	9b	Tor
5F617	XC6103F617ER	Vdet-IC	1.7V±2%, Hst, -MR, +Reset PPO, Wt=1.6s, Rt=400ms	USP-6C	49xh	VD17	9b	Tor
5F618	XC6103F618ER	Vdet-IC	1.8V±2%, Hst, -MR, +Reset PPO, Wt=1.6s, Rt=400ms	USP-6C	49xh	VD17	9b	Tor
5F619	XC6103F619ER	Vdet-IC	1.9V±2%, Hst, -MR, +Reset PPO, Wt=1.6s, Rt=400ms	USP-6C	49xh	VD17	9b	Tor
5F620	XC6103F620ER	Vdet-IC	2.0V±2%, Hst, -MR, +Reset PPO, Wt=1.6s, Rt=400ms	USP-6C	49xh	VD17	9b	Tor
5F621	XC6103F621ER	Vdet-IC	2.1V±2%, Hst, -MR, +Reset PPO, Wt=1.6s, Rt=400ms	USP-6C	49xh	VD17	9b	Tor
5F622	XC6103F622ER	Vdet-IC	2.2V±2%, Hst, -MR, +Reset PPO, Wt=1.6s, Rt=400ms	USP-6C	49xh	VD17	9b	Tor
5F623	XC6103F623ER	Vdet-IC	2.3V±2%, Hst, -MR, +Reset PPO, Wt=1.6s, Rt=400ms	USP-6C	49xh	VD17	9b	Tor
5F624	XC6103F624ER	Vdet-IC	2.4V±2%, Hst, -MR, +Reset PPO, Wt=1.6s, Rt=400ms	USP-6C	49xh	VD17	9b	Tor
5F625	XC6103F625ER	Vdet-IC	2.5V±2%, Hst, -MR, +Reset PPO, Wt=1.6s, Rt=400ms	USP-6C	49xh	VD17	9b	Tor
5F626	XC6103F626ER	Vdet-IC	2.6V±2%, Hst, -MR, +Reset PPO, Wt=1.6s, Rt=400ms	USP-6C	49xh	VD17	9b	Tor
5F627	XC6103F627ER	Vdet-IC	2.7V±2%, Hst, -MR, +Reset PPO, Wt=1.6s, Rt=400ms	USP-6C	49xh	VD17	9b	Tor
5F628	XC6103F628ER	Vdet-IC	2.8V±2%, Hst, -MR, +Reset PPO, Wt=1.6s, Rt=400ms	USP-6C	49xh	VD17	9b	Tor
5F629	XC6103F629ER	Vdet-IC	2.9V±2%, Hst, -MR, +Reset PPO, Wt=1.6s, Rt=400ms	USP-6C	49xh	VD17	9b	Tor
5F630	XC6103F630ER	Vdet-IC	3.0V±2%, Hst, -MR, +Reset PPO, Wt=1.6s, Rt=400ms	USP-6C	49xh	VD17	9b	Tor
5F631	XC6103F631ER	Vdet-IC	3.1V±2%, Hst, -MR, +Reset PPO, Wt=1.6s, Rt=400ms	USP-6C	49xh	VD17	9b	Tor
5F632	XC6103F632ER	Vdet-IC	3.2V±2%, Hst, -MR, +Reset PPO, Wt=1.6s, Rt=400ms	USP-6C	49xh	VD17	9b	Tor
5F633	XC6103F633ER	Vdet-IC	3.3V±2%, Hst, -MR, +Reset PPO, Wt=1.6s, Rt=400ms	USP-6C	49xh	VD17	9b	Tor
5F634	XC6103F634ER	Vdet-IC	3.4V±2%, Hst, -MR, +Reset PPO, Wt=1.6s, Rt=400ms	USP-6C	49xh	VD17	9b	Tor
5F635	XC6103F635ER	Vdet-IC	3.5V±2%, Hst, -MR, +Reset PPO, Wt=1.6s, Rt=400ms	USP-6C	49xh	VD17	9b	Tor
5F636	XC6103F636ER	Vdet-IC	3.6V±2%, Hst, -MR, +Reset PPO, Wt=1.6s, Rt=400ms	USP-6C	49xh	VD17	9b	Tor
5F637	XC6103F637ER	Vdet-IC	3.7V±2%, Hst, -MR, +Reset PPO, Wt=1.6s, Rt=400ms	USP-6C	49xh	VD17	9b	Tor
5F638	XC6103F638ER	Vdet-IC	3.8V±2%, Hst, -MR, +Reset PPO, Wt=1.6s, Rt=400ms	USP-6C	49xh	VD17	9b	Tor
5F639	XC6103F639ER	Vdet-IC	3.9V±2%, Hst, -MR, +Reset PPO, Wt=1.6s, Rt=400ms	USP-6C	49xh	VD17	9b	Tor
5F640	XC6103F640ER	Vdet-IC	4.0V±2%, Hst, -MR, +Reset PPO, Wt=1.6s, Rt=400ms	USP-6C	49xh	VD17	9b	Tor
5F641	XC6103F641ER	Vdet-IC	4.1V±2%, Hst, -MR, +Reset PPO, Wt=1.6s, Rt=400ms	USP-6C	49xh	VD17	9b	Tor
5F642	XC6103F642ER	Vdet-IC	4.2V±2%, Hst, -MR, +Reset PPO, Wt=1.6s, Rt=400ms	USP-6C	49xh	VD17	9b	Tor
5F643	XC6103F643ER	Vdet-IC	4.3V±2%, Hst, -MR, +Reset PPO, Wt=1.6s, Rt=400ms	USP-6C	49xh	VD17	9b	Tor
5F644	XC6103F644ER	Vdet-IC	4.4V±2%, Hst, -MR, +Reset PPO, Wt=1.6s, Rt=400ms	USP-6C	49xh	VD17	9b	Tor
5F645	XC6103F645ER	Vdet-IC	4.5V±2%, Hst, -MR, +Reset PPO, Wt=1.6s, Rt=400ms	USP-6C	49xh	VD17	9b	Tor
5F646	XC6103F646ER	Vdet-IC	4.6V±2%, Hst, -MR, +Reset PPO, Wt=1.6s, Rt=400ms	USP-6C	49xh	VD17	9b	Tor
5F647	XC6103F647ER	Vdet-IC	4.7V±2%, Hst, -MR, +Reset PPO, Wt=1.6s, Rt=400ms	USP-6C	49xh	VD17	9b	Tor
5F648	XC6103F648ER	Vdet-IC	4.8V±2%, Hst, -MR, +Reset PPO, Wt=1.6s, Rt=400ms	USP-6C	49xh	VD17	9b	Tor
5F649	XC6103F649ER	Vdet-IC	4.9V±2%, Hst, -MR, +Reset PPO, Wt=1.6s, Rt=400ms	USP-6C	49xh	VD17	9b	Tor
5F650	XC6103F650ER	Vdet-IC	5.0V±2%, Hst, -MR, +Reset PPO, Wt=1.6s, Rt=400ms	USP-6C	49xh	VD17	9b	Tor
5F8	XC9236A08D4R-G	DC-DC-IC	PWM/PFM, st-dwn, 0.8V±2%, 600mA, 3MHz, Vin>2V, LSST	USP-6EL	56dc5	DC1	9a	Tor
5F8	XC9236A08DER	DC-DC-IC	PWM/PFM, st-dwn, 0.8V±2%, 600mA, 3MHz, Vin>2V, LSST	USP-6C	49dc5	DC1	9a	Tor
5F8	XCL206A084AR-G	DC/DC-IC	PWM/PFM st-dwn, 3MHz, 0.8V±2%, 600mA	CL-2025	67dc7	DC9	9a	Tor
5F9	XC9236A09D4R-G	DC-DC-IC	PWM/PFM, st-dwn, 0.9V±2%, 600mA, 3MHz, Vin>2V, LSST	USP-6EL	56dc5	DC1	9a	Tor
5F9	XC9236A09DER	DC-DC-IC	PWM/PFM, st-dwn, 0.9V±2%, 600mA, 3MHz, Vin>2V, LSST	USP-6C	49dc5	DC1	9a	Tor
5F9	XCL206A094AR-G	DC/DC-IC	PWM/PFM st-dwn, 3MHz, 0.9V±2%, 600mA	CL-2025	67dc7	DC9	9a	Tor
5FL	XC9236A0LD4R-G	DC-DC-IC	PWM/PFM, st-dwn, 0.85V±2%, 600mA, 3MHz, Vin>2V, LSST	USP-6EL	56dc5	DC1	9a	Tor
5FL	XC9236A0LDER	DC-DC-IC	PWM/PFM, st-dwn, 0.85V±2%, 600mA, 3MHz, Vin>2V, LSST	USP-6C	49dc5	DC1	9a	Tor
5FM	XC9236A0MD4R-G	DC-DC-IC	PWM/PFM, st-dwn, 0.95V±2%, 600mA, 3MHz, Vin>2V, LSST	USP-6EL	56dc5	DC1	9a	Tor
5FM	XC9236A0MDER	DC-DC-IC	PWM/PFM, st-dwn, 0.95V±2%, 600mA, 3MHz, Vin>2V, LSST	USP-6C	49dc5	DC1	9a	Tor
5G	RP101K202B	LVR-IC	LDO, LN, +CE, 2V±0.8%, 300mA	DFN1612-4B	45vm	VR4	9a	Ric
5G	RP200K141B	LVR-IC	LDO, 1.4V±1.0%, 300mA, +CE, AE(mode)	DFN1212-6	52ht	VR10	9a	Ric
5H	RP101K252B	LVR-IC	LDO, LN, +CE, 2.5V±0.8%, 300mA	DFN1612-4B	45vm	VR4	9a	Ric
5H	RP200K151B	LVR-IC	LDO, 1.5V±1.0%, 300mA, +CE, AE(mode)	DFN1212-6	52ht	VR10	9a	Ric
5H	XC6217C17A7R-G	LVR-IC	LDO, 1.75V±2%, 200mA, +CE	USPN-4	58vm	VR4	9a	Tor
5H	XC6223F2619R-G	LVR-IC	LDO, 2.6V±1%, 300mA, +CE, CL, ICP	USPQ-4B03	48vm	VR4	9a	Tor
5H0	XC9236A10D4R-G	DC-DC-IC	PWM/PFM, st-dwn, 1.0V±2%, 600mA, 3MHz, Vin>2V, LSST	USP-6EL	56dc5	DC1	9a	Tor
5H0	XC9236A10DER	DC-DC-IC	PWM/PFM, st-dwn, 1.0V±2%, 600mA, 3MHz, Vin>2V, LSST	USP-6C	49dc5	DC1	9a	Tor
5H0	XCL206A104AR-G	DC/DC-IC	PWM/PFM st-dwn, 3MHz, 1.0V±2%, 600mA	CL-2025	67dc7	DC9	9a	Tor
5H1	XC9236A11D4R-G	DC-DC-IC	PWM/PFM, st-dwn, 1.1V±2%, 600mA, 3MHz, Vin>2V, LSST	USP-6EL	56dc5	DC1	9a	Tor
5H1	XC9236A11DER	DC-DC-IC	PWM/PFM, st-dwn, 1.1V±2%, 600mA, 3MHz, Vin>2V, LSST	USP-6C	49dc5	DC1	9a	Tor
5H1	XCL206A114AR-G	DC/DC-IC	PWM/PFM st-dwn, 3MHz, 1.1V±2%, 600mA	CL-2025	67dc7	DC9	9a	Tor
5H2	XC9236A12D4R-G	DC-DC-IC	PWM/PFM, st-dwn, 1.2V±2%, 600mA, 3MHz, Vin>2V, LSST	USP-6EL	56dc5	DC1	9a	Tor
5H2	XC9236A12DER	DC-DC-IC	PWM/PFM, st-dwn, 1.2V±2%, 600mA, 3MHz, Vin>2V, LSST	USP-6C	49dc5	DC1	9a	Tor
5H2	XCL206A124AR-G	DC/DC-IC	PWM/PFM st-dwn, 3MHz, 1.2V±2%, 600mA	CL-2025	67dc7	DC9	9a	Tor
5H3	XC9236A13D4R-G	DC-DC-IC	PWM/PFM, st-dwn, 1.3V±2%, 600mA, 3MHz, Vin>2V, LSST	USP-6EL	56dc5	DC1	9a	Tor
5H3	XC9236A13DER	DC-DC-IC	PWM/PFM, st-dwn, 1.3V±2%, 600mA, 3MHz, Vin>2V, LSST	USP-6C	49dc5	DC1	9a	Tor
5H3	XCL206A134AR-G	DC/DC-IC	PWM/PFM st-dwn, 3MHz, 1.3V±2%, 600mA	CL-2025	67dc7	DC9	9a	Tor
5H4	XC9236A14D4R-G	DC-DC-IC	PWM/PFM, st-dwn, 1.4V±2%, 600mA, 3MHz, Vin>2V, LSST	USP-6EL	56dc5	DC1	9a	Tor
5H4	XC9236A14DER	DC-DC-IC	PWM/PFM, st-dwn, 1.4V±2%, 600mA, 3MHz, Vin>2V, LSST	USP-6C	49dc5	DC1	9a	Tor
5H4	XCL206A144AR-G	DC/DC-IC	PWM/PFM st-dwn, 3MHz, 1.4V±2%, 600mA	CL-2025	67dc7	DC9	9a	Tor
5H5	XC9236A15D4R-G	DC-DC-IC	PWM/PFM, st-dwn, 1.5V±2%, 600mA, 3MHz, Vin>2V, LSST	USP-6EL	56dc5	DC1	9a	Tor
5H5	XC9236A15DER	DC-DC-IC	PWM/PFM, st-dwn, 1.5V±2%, 600mA, 3MHz, Vin>2V, LSST	USP-6C	49dc5	DC1	9a	Tor
5H5	XCL206A154AR-G	DC/DC-IC	PWM/PFM st-dwn, 3MHz, 1.5V±2%, 600mA	CL-2025	67dc7	DC9	9a	Tor
5H6	XC9236A16D4R-G	DC-DC-IC	PWM/PFM, st-dwn, 1.6V±2%, 600mA, 3MHz, Vin>2V, LSST	USP-6EL	56dc5	DC1	9a	Tor



SMD code	Type	Function	Short description	Case	Pinout	Sch.	St.	Mnf.
5H6	XC9236A16DER	DC-DC-IC	PWM/PFM, st-dwn, 1.6V±2%, 600mA, 3MHz, Vin>2V, LSST	USP-6C	49dc5	DC1	9a	Tor
5H6	XCL206A164AR-G	DC/DC-IC	PWM/PFM st-dwn, 3MHz, 1.6V±2%, 600mA	CL-2025	67dc7	DC9	9a	Tor
5H616	XC6103H616ER	Vdet-IC	1.6V±2%, Hst, -MR, +Reset PPO, Wt=1.6s, Rt=1.6s	USP-6C	49xh	VD17	9b	Tor
5H617	XC6103H617ER	Vdet-IC	1.7V±2%, Hst, -MR, +Reset PPO, Wt=1.6s, Rt=1.6s	USP-6C	49xh	VD17	9b	Tor
5H618	XC6103H618ER	Vdet-IC	1.8V±2%, Hst, -MR, +Reset PPO, Wt=1.6s, Rt=1.6s	USP-6C	49xh	VD17	9b	Tor
5H619	XC6103H619ER	Vdet-IC	1.9V±2%, Hst, -MR, +Reset PPO, Wt=1.6s, Rt=1.6s	USP-6C	49xh	VD17	9b	Tor
5H620	XC6103H620ER	Vdet-IC	2.0V±2%, Hst, -MR, +Reset PPO, Wt=1.6s, Rt=1.6s	USP-6C	49xh	VD17	9b	Tor
5H621	XC6103H621ER	Vdet-IC	2.1V±2%, Hst, -MR, +Reset PPO, Wt=1.6s, Rt=1.6s	USP-6C	49xh	VD17	9b	Tor
5H622	XC6103H622ER	Vdet-IC	2.2V±2%, Hst, -MR, +Reset PPO, Wt=1.6s, Rt=1.6s	USP-6C	49xh	VD17	9b	Tor
5H623	XC6103H623ER	Vdet-IC	2.3V±2%, Hst, -MR, +Reset PPO, Wt=1.6s, Rt=1.6s	USP-6C	49xh	VD17	9b	Tor
5H624	XC6103H624ER	Vdet-IC	2.4V±2%, Hst, -MR, +Reset PPO, Wt=1.6s, Rt=1.6s	USP-6C	49xh	VD17	9b	Tor
5H625	XC6103H625ER	Vdet-IC	2.5V±2%, Hst, -MR, +Reset PPO, Wt=1.6s, Rt=1.6s	USP-6C	49xh	VD17	9b	Tor
5H626	XC6103H626ER	Vdet-IC	2.6V±2%, Hst, -MR, +Reset PPO, Wt=1.6s, Rt=1.6s	USP-6C	49xh	VD17	9b	Tor
5H627	XC6103H627ER	Vdet-IC	2.7V±2%, Hst, -MR, +Reset PPO, Wt=1.6s, Rt=1.6s	USP-6C	49xh	VD17	9b	Tor
5H628	XC6103H628ER	Vdet-IC	2.8V±2%, Hst, -MR, +Reset PPO, Wt=1.6s, Rt=1.6s	USP-6C	49xh	VD17	9b	Tor
5H629	XC6103H629ER	Vdet-IC	2.9V±2%, Hst, -MR, +Reset PPO, Wt=1.6s, Rt=1.6s	USP-6C	49xh	VD17	9b	Tor
5H630	XC6103H630ER	Vdet-IC	3.0V±2%, Hst, -MR, +Reset PPO, Wt=1.6s, Rt=1.6s	USP-6C	49xh	VD17	9b	Tor
5H631	XC6103H631ER	Vdet-IC	3.1V±2%, Hst, -MR, +Reset PPO, Wt=1.6s, Rt=1.6s	USP-6C	49xh	VD17	9b	Tor
5H632	XC6103H632ER	Vdet-IC	3.2V±2%, Hst, -MR, +Reset PPO, Wt=1.6s, Rt=1.6s	USP-6C	49xh	VD17	9b	Tor
5H633	XC6103H633ER	Vdet-IC	3.3V±2%, Hst, -MR, +Reset PPO, Wt=1.6s, Rt=1.6s	USP-6C	49xh	VD17	9b	Tor
5H634	XC6103H634ER	Vdet-IC	3.4V±2%, Hst, -MR, +Reset PPO, Wt=1.6s, Rt=1.6s	USP-6C	49xh	VD17	9b	Tor
5H635	XC6103H635ER	Vdet-IC	3.5V±2%, Hst, -MR, +Reset PPO, Wt=1.6s, Rt=1.6s	USP-6C	49xh	VD17	9b	Tor
5H636	XC6103H636ER	Vdet-IC	3.6V±2%, Hst, -MR, +Reset PPO, Wt=1.6s, Rt=1.6s	USP-6C	49xh	VD17	9b	Tor
5H637	XC6103H637ER	Vdet-IC	3.7V±2%, Hst, -MR, +Reset PPO, Wt=1.6s, Rt=1.6s	USP-6C	49xh	VD17	9b	Tor
5H638	XC6103H638ER	Vdet-IC	3.8V±2%, Hst, -MR, +Reset PPO, Wt=1.6s, Rt=1.6s	USP-6C	49xh	VD17	9b	Tor
5H639	XC6103H639ER	Vdet-IC	3.9V±2%, Hst, -MR, +Reset PPO, Wt=1.6s, Rt=1.6s	USP-6C	49xh	VD17	9b	Tor
5H640	XC6103H640ER	Vdet-IC	4.0V±2%, Hst, -MR, +Reset PPO, Wt=1.6s, Rt=1.6s	USP-6C	49xh	VD17	9b	Tor
5H641	XC6103H641ER	Vdet-IC	4.1V±2%, Hst, -MR, +Reset PPO, Wt=1.6s, Rt=1.6s	USP-6C	49xh	VD17	9b	Tor
5H642	XC6103H642ER	Vdet-IC	4.2V±2%, Hst, -MR, +Reset PPO, Wt=1.6s, Rt=1.6s	USP-6C	49xh	VD17	9b	Tor
5H643	XC6103H643ER	Vdet-IC	4.3V±2%, Hst, -MR, +Reset PPO, Wt=1.6s, Rt=1.6s	USP-6C	49xh	VD17	9b	Tor
5H644	XC6103H644ER	Vdet-IC	4.4V±2%, Hst, -MR, +Reset PPO, Wt=1.6s, Rt=1.6s	USP-6C	49xh	VD17	9b	Tor
5H645	XC6103H645ER	Vdet-IC	4.5V±2%, Hst, -MR, +Reset PPO, Wt=1.6s, Rt=1.6s	USP-6C	49xh	VD17	9b	Tor
5H646	XC6103H646ER	Vdet-IC	4.6V±2%, Hst, -MR, +Reset PPO, Wt=1.6s, Rt=1.6s	USP-6C	49xh	VD17	9b	Tor
5H647	XC6103H647ER	Vdet-IC	4.7V±2%, Hst, -MR, +Reset PPO, Wt=1.6s, Rt=1.6s	USP-6C	49xh	VD17	9b	Tor
5H648	XC6103H648ER	Vdet-IC	4.8V±2%, Hst, -MR, +Reset PPO, Wt=1.6s, Rt=1.6s	USP-6C	49xh	VD17	9b	Tor
5H649	XC6103H649ER	Vdet-IC	4.9V±2%, Hst, -MR, +Reset PPO, Wt=1.6s, Rt=1.6s	USP-6C	49xh	VD17	9b	Tor
5H650	XC6103H650ER	Vdet-IC	5.0V±2%, Hst, -MR, +Reset PPO, Wt=1.6s, Rt=1.6s	USP-6C	49xh	VD17	9b	Tor
5H7	XC9236A17D4R-G	DC-DC-IC	PWM/PFM, st-dwn, 1.7V±2%, 600mA, 3MHz, Vin>2V, LSST	USP-6EL	56dc5	DC1	9a	Tor
5H7	XC9236A17DER	DC-DC-IC	PWM/PFM, st-dwn, 1.7V±2%, 600mA, 3MHz, Vin>2V, LSST	USP-6C	49dc5	DC1	9a	Tor
5H7	XCL206A174AR-G	DC/DC-IC	PWM/PFM st-dwn, 3MHz, 1.7V±2%, 600mA	CL-2025	67dc7	DC9	9a	Tor
5H8	XC9236A18D4R-G	DC-DC-IC	PWM/PFM, st-dwn, 1.8V±2%, 600mA, 3MHz, Vin>2V, LSST	USP-6EL	56dc5	DC1	9a	Tor
5H8	XC9236A18DER	DC-DC-IC	PWM/PFM, st-dwn, 1.8V±2%, 600mA, 3MHz, Vin>2V, LSST	USP-6C	49dc5	DC1	9a	Tor
5H8	XCL206A184AR-G	DC/DC-IC	PWM/PFM st-dwn, 3MHz, 1.8V±2%, 600mA	CL-2025	67dc7	DC9	9a	Tor
5H9	XC9236A19D4R-G	DC-DC-IC	PWM/PFM, st-dwn, 1.9V±2%, 600mA, 3MHz, Vin>2V, LSST	USP-6EL	56dc5	DC1	9a	Tor
5H9	XC9236A19DER	DC-DC-IC	PWM/PFM, st-dwn, 1.9V±2%, 600mA, 3MHz, Vin>2V, LSST	USP-6C	49dc5	DC1	9a	Tor
5H9	XCL206A194AR-G	DC/DC-IC	PWM/PFM st-dwn, 3MHz, 1.9V±2%, 600mA	CL-2025	67dc7	DC9	9a	Tor
5HA	XC9236A1AD4R-G	DC-DC-IC	PWM/PFM, st-dwn, 1.05V±2%, 600mA, 3MHz, Vin>2V, LSST	USP-6EL	56dc5	DC1	9a	Tor
5HA	XC9236A1ADER	DC-DC-IC	PWM/PFM, st-dwn, 1.05V±2%, 600mA, 3MHz, Vin>2V, LSST	USP-6C	49dc5	DC1	9a	Tor
5HB	XC9236A1BD4R-G	DC-DC-IC	PWM/PFM, st-dwn, 1.15V±2%, 600mA, 3MHz, Vin>2V, LSST	USP-6EL	56dc5	DC1	9a	Tor
5HB	XC9236A1BDER	DC-DC-IC	PWM/PFM, st-dwn, 1.15V±2%, 600mA, 3MHz, Vin>2V, LSST	USP-6C	49dc5	DC1	9a	Tor
5HC	XC9236A1CD4R-G	DC-DC-IC	PWM/PFM, st-dwn, 1.25V±2%, 600mA, 3MHz, Vin>2V, LSST	USP-6EL	56dc5	DC1	9a	Tor
5HC	XC9236A1CDER	DC-DC-IC	PWM/PFM, st-dwn, 1.25V±2%, 600mA, 3MHz, Vin>2V, LSST	USP-6C	49dc5	DC1	9a	Tor
5HD	XC9236A1DD4R-G	DC-DC-IC	PWM/PFM, st-dwn, 1.35V±2%, 600mA, 3MHz, Vin>2V, LSST	USP-6EL	56dc5	DC1	9a	Tor
5HD	XC9236A1DDER	DC-DC-IC	PWM/PFM, st-dwn, 1.35V±2%, 600mA, 3MHz, Vin>2V, LSST	USP-6C	49dc5	DC1	9a	Tor
5HE	XC9236A1ED4R-G	DC-DC-IC	PWM/PFM, st-dwn, 1.45V±2%, 600mA, 3MHz, Vin>2V, LSST	USP-6EL	56dc5	DC1	9a	Tor
5HE	XC9236A1EDER	DC-DC-IC	PWM/PFM, st-dwn, 1.45V±2%, 600mA, 3MHz, Vin>2V, LSST	USP-6C	49dc5	DC1	9a	Tor
5HF	XC9236A1FD4R-G	DC-DC-IC	PWM/PFM, st-dwn, 1.55V±2%, 600mA, 3MHz, Vin>2V, LSST	USP-6EL	56dc5	DC1	9a	Tor
5HF	XC9236A1FDER	DC-DC-IC	PWM/PFM, st-dwn, 1.55V±2%, 600mA, 3MHz, Vin>2V, LSST	USP-6C	49dc5	DC1	9a	Tor
5HH	XC9236A1HD4R-G	DC-DC-IC	PWM/PFM, st-dwn, 1.65V±2%, 600mA, 3MHz, Vin>2V, LSST	USP-6EL	56dc5	DC1	9a	Tor
5HH	XC9236A1HDER	DC-DC-IC	PWM/PFM, st-dwn, 1.65V±2%, 600mA, 3MHz, Vin>2V, LSST	USP-6C	49dc5	DC1	9a	Tor
5HK	XC9236A1KD4R-G	DC-DC-IC	PWM/PFM, st-dwn, 1.75V±2%, 600mA, 3MHz, Vin>2V, LSST	USP-6EL	56dc5	DC1	9a	Tor
5HK	XC9236A1KDER	DC-DC-IC	PWM/PFM, st-dwn, 1.75V±2%, 600mA, 3MHz, Vin>2V, LSST	USP-6C	49dc5	DC1	9a	Tor
5HL	XC9236A1LD4R-G	DC-DC-IC	PWM/PFM, st-dwn, 1.85V±2%, 600mA, 3MHz, Vin>2V, LSST	USP-6EL	56dc5	DC1	9a	Tor
5HL	XC9236A1LDER	DC-DC-IC	PWM/PFM, st-dwn, 1.85V±2%, 600mA, 3MHz, Vin>2V, LSST	USP-6C	49dc5	DC1	9a	Tor
5HM	XC9236A1MD4R-G	DC-DC-IC	PWM/PFM, st-dwn, 1.95V±2%, 600mA, 3MHz, Vin>2V, LSST	USP-6EL	56dc5	DC1	9a	Tor
5HM	XC9236A1MDER	DC-DC-IC	PWM/PFM, st-dwn, 1.95V±2%, 600mA, 3MHz, Vin>2V, LSST	USP-6C	49dc5	DC1	9a	Tor
5J	RP101K262B	LVR-IC	LDO, LN, +CE, 2.6V±0.8%, 300mA	DFN1612-4B	45vm	VR4	9a	Ric
5J	RP200K161B	LVR-IC	LDO, 1.6V±1.0%, 300mA, +CE, AE(mode)	DFN1212-6	52ht	VR10	9a	Ric
5K	RP101K272B	LVR-IC	LDO, LN, +CE, 2.7V±0.8%, 300mA	DFN1612-4B	45vm	VR4	9a	Ric
5K	RP200K171B	LVR-IC	LDO, 1.7V±1.0%, 300mA, +CE, AE(mode)	DFN1212-6	52ht	VR10	9a	Ric



SMD code	Type	Function	Short description	Case	Pinout	Sch.	St.	Mnf.
5K	XC6217C18A7R-G	LVR-IC	LDO, 1.85V±2%, 200mA, +CE	USPN-4	58vm	VR4	9a	Tor
5K	XC6223F2719R-G	LVR-IC	LDO, 2.7V±1%, 300mA, +CE, CL, ICP	USPQ-4B03	48vm	VR4	9a	Tor
5K0	XC9236A20D4R-G	DC-DC-IC	PWM/PFM, st-dwn, 2.0V±2%, 600mA, 3MHz, Vin>2V, LSST	USP-6EL	56dc5	DC1	9a	Tor
5K0	XC9236A20DER	DC-DC-IC	PWM/PFM, st-dwn, 2.0V±2%, 600mA, 3MHz, Vin>2V, LSST	USP-6C	49dc5	DC1	9a	Tor
5K0	XCL206A204AR-G	DC/DC-IC	PWM/PFM st-dwn, 3MHz, 2.0V±2%, 600mA	CL-2025	67dc7	DC9	9a	Tor
5K1	XC9236A21D4R-G	DC-DC-IC	PWM/PFM, st-dwn, 2.1V±2%, 600mA, 3MHz, Vin>2V, LSST	USP-6EL	56dc5	DC1	9a	Tor
5K1	XC9236A21DER	DC-DC-IC	PWM/PFM, st-dwn, 2.1V±2%, 600mA, 3MHz, Vin>2V, LSST	USP-6C	49dc5	DC1	9a	Tor
5K1	XCL206A214AR-G	DC/DC-IC	PWM/PFM st-dwn, 3MHz, 2.1V±2%, 600mA	CL-2025	67dc7	DC9	9a	Tor
5K2	XC9236A22D4R-G	DC-DC-IC	PWM/PFM, st-dwn, 2.2V±2%, 600mA, 3MHz, Vin>2V, LSST	USP-6EL	56dc5	DC1	9a	Tor
5K2	XC9236A22DER	DC-DC-IC	PWM/PFM, st-dwn, 2.2V±2%, 600mA, 3MHz, Vin>2V, LSST	USP-6C	49dc5	DC1	9a	Tor
5K2	XCL206A224AR-G	DC/DC-IC	PWM/PFM st-dwn, 3MHz, 2.2V±2%, 600mA	CL-2025	67dc7	DC9	9a	Tor
5K3	XC9236A23D4R-G	DC-DC-IC	PWM/PFM, st-dwn, 2.3V±2%, 600mA, 3MHz, Vin>2V, LSST	USP-6EL	56dc5	DC1	9a	Tor
5K3	XC9236A23DER	DC-DC-IC	PWM/PFM, st-dwn, 2.3V±2%, 600mA, 3MHz, Vin>2V, LSST	USP-6C	49dc5	DC1	9a	Tor
5K3	XCL206A234AR-G	DC/DC-IC	PWM/PFM st-dwn, 3MHz, 2.3V±2%, 600mA	CL-2025	67dc7	DC9	9a	Tor
5K4	XC9236A24D4R-G	DC-DC-IC	PWM/PFM, st-dwn, 2.4V±2%, 600mA, 3MHz, Vin>2V, LSST	USP-6EL	56dc5	DC1	9a	Tor
5K4	XC9236A24DER	DC-DC-IC	PWM/PFM, st-dwn, 2.4V±2%, 600mA, 3MHz, Vin>2V, LSST	USP-6C	49dc5	DC1	9a	Tor
5K4	XCL206A244AR-G	DC/DC-IC	PWM/PFM st-dwn, 3MHz, 2.4V±2%, 600mA	CL-2025	67dc7	DC9	9a	Tor
5K5	XC9236A25D4R-G	DC-DC-IC	PWM/PFM, st-dwn, 2.5V±2%, 600mA, 3MHz, Vin>2V, LSST	USP-6EL	56dc5	DC1	9a	Tor
5K5	XC9236A25DER	DC-DC-IC	PWM/PFM, st-dwn, 2.5V±2%, 600mA, 3MHz, Vin>2V, LSST	USP-6C	49dc5	DC1	9a	Tor
5K5	XCL206A254AR-G	DC/DC-IC	PWM/PFM st-dwn, 3MHz, 2.5V±2%, 600mA	CL-2025	67dc7	DC9	9a	Tor
5K6	XC9236A26D4R-G	DC-DC-IC	PWM/PFM, st-dwn, 2.6V±2%, 600mA, 3MHz, Vin>2V, LSST	USP-6EL	56dc5	DC1	9a	Tor
5K6	XC9236A26DER	DC-DC-IC	PWM/PFM, st-dwn, 2.6V±2%, 600mA, 3MHz, Vin>2V, LSST	USP-6C	49dc5	DC1	9a	Tor
5K6	XCL206A264AR-G	DC/DC-IC	PWM/PFM st-dwn, 3MHz, 2.6V±2%, 600mA	CL-2025	67dc7	DC9	9a	Tor
5K7	XC9236A27D4R-G	DC-DC-IC	PWM/PFM, st-dwn, 2.7V±2%, 600mA, 3MHz, Vin>2V, LSST	USP-6EL	56dc5	DC1	9a	Tor
5K7	XC9236A27DER	DC-DC-IC	PWM/PFM, st-dwn, 2.7V±2%, 600mA, 3MHz, Vin>2V, LSST	USP-6C	49dc5	DC1	9a	Tor
5K7	XCL206A274AR-G	DC/DC-IC	PWM/PFM st-dwn, 3MHz, 2.7V±2%, 600mA	CL-2025	67dc7	DC9	9a	Tor
5K8	XC9236A28D4R-G	DC-DC-IC	PWM/PFM, st-dwn, 2.8V±2%, 600mA, 3MHz, Vin>2V, LSST	USP-6EL	56dc5	DC1	9a	Tor
5K8	XC9236A28DER	DC-DC-IC	PWM/PFM, st-dwn, 2.8V±2%, 600mA, 3MHz, Vin>2V, LSST	USP-6C	49dc5	DC1	9a	Tor
5K8	XCL206A284AR-G	DC/DC-IC	PWM/PFM st-dwn, 3MHz, 2.8V±2%, 600mA	CL-2025	67dc7	DC9	9a	Tor
5K9	XC9236A29D4R-G	DC-DC-IC	PWM/PFM, st-dwn, 2.9V±2%, 600mA, 3MHz, Vin>2V, LSST	USP-6EL	56dc5	DC1	9a	Tor
5K9	XC9236A29DER	DC-DC-IC	PWM/PFM, st-dwn, 2.9V±2%, 600mA, 3MHz, Vin>2V, LSST	USP-6C	49dc5	DC1	9a	Tor
5K9	XCL206A294AR-G	DC/DC-IC	PWM/PFM st-dwn, 3MHz, 2.9V±2%, 600mA	CL-2025	67dc7	DC9	9a	Tor
5KA	XC9236A2AD4R-G	DC-DC-IC	PWM/PFM, st-dwn, 2.05V±2%, 600mA, 3MHz, Vin>2V, LSST	USP-6EL	56dc5	DC1	9a	Tor
5KA	XC9236A2ADER	DC-DC-IC	PWM/PFM, st-dwn, 2.05V±2%, 600mA, 3MHz, Vin>2V, LSST	USP-6C	49dc5	DC1	9a	Tor
5KB	XC9236A2BD4R-G	DC-DC-IC	PWM/PFM, st-dwn, 2.10V±2%, 600mA, 3MHz, Vin>2V, LSST	USP-6EL	56dc5	DC1	9a	Tor
5KB	XC9236A2BDER	DC-DC-IC	PWM/PFM, st-dwn, 2.15V±2%, 600mA, 3MHz, Vin>2V, LSST	USP-6C	49dc5	DC1	9a	Tor
5KC	XC9236A2CD4R-G	DC-DC-IC	PWM/PFM, st-dwn, 2.25V±2%, 600mA, 3MHz, Vin>2V, LSST	USP-6EL	56dc5	DC1	9a	Tor
5KC	XC9236A2CDER	DC-DC-IC	PWM/PFM, st-dwn, 2.25V±2%, 600mA, 3MHz, Vin>2V, LSST	USP-6C	49dc5	DC1	9a	Tor
5KD	XC9236A2DD4R-G	DC-DC-IC	PWM/PFM, st-dwn, 2.35V±2%, 600mA, 3MHz, Vin>2V, LSST	USP-6EL	56dc5	DC1	9a	Tor
5KD	XC9236A2DDER	DC-DC-IC	PWM/PFM, st-dwn, 2.35V±2%, 600mA, 3MHz, Vin>2V, LSST	USP-6C	49dc5	DC1	9a	Tor
5KE	XC9236A2ED4R-G	DC-DC-IC	PWM/PFM, st-dwn, 2.45V±2%, 600mA, 3MHz, Vin>2V, LSST	USP-6EL	56dc5	DC1	9a	Tor
5KE	XC9236A2EDER	DC-DC-IC	PWM/PFM, st-dwn, 2.45V±2%, 600mA, 3MHz, Vin>2V, LSST	USP-6C	49dc5	DC1	9a	Tor
5KF	XC9236A2FD4R-G	DC-DC-IC	PWM/PFM, st-dwn, 2.55V±2%, 600mA, 3MHz, Vin>2V, LSST	USP-6EL	56dc5	DC1	9a	Tor
5KF	XC9236A2FDER	DC-DC-IC	PWM/PFM, st-dwn, 2.55V±2%, 600mA, 3MHz, Vin>2V, LSST	USP-6C	49dc5	DC1	9a	Tor
5KH	XC9236A2HD4R-G	DC-DC-IC	PWM/PFM, st-dwn, 2.65V±2%, 600mA, 3MHz, Vin>2V, LSST	USP-6EL	56dc5	DC1	9a	Tor
5KH	XC9236A2HDER	DC-DC-IC	PWM/PFM, st-dwn, 2.65V±2%, 600mA, 3MHz, Vin>2V, LSST	USP-6C	49dc5	DC1	9a	Tor
5KK	XC9236A2KD4R-G	DC-DC-IC	PWM/PFM, st-dwn, 2.75V±2%, 600mA, 3MHz, Vin>2V, LSST	USP-6EL	56dc5	DC1	9a	Tor
5KK	XC9236A2KDER	DC-DC-IC	PWM/PFM, st-dwn, 2.75V±2%, 600mA, 3MHz, Vin>2V, LSST	USP-6C	49dc5	DC1	9a	Tor
5KL	XC9236A2LD4R-G	DC-DC-IC	PWM/PFM, st-dwn, 2.85V±2%, 600mA, 3MHz, Vin>2V, LSST	USP-6EL	56dc5	DC1	9a	Tor
5KL	XC9236A2LDER	DC-DC-IC	PWM/PFM, st-dwn, 2.85V±2%, 600mA, 3MHz, Vin>2V, LSST	USP-6C	49dc5	DC1	9a	Tor
5KM	XC9236A2MD4R-G	DC-DC-IC	PWM/PFM, st-dwn, 2.95V±2%, 600mA, 3MHz, Vin>2V, LSST	USP-6EL	56dc5	DC1	9a	Tor
5KM	XC9236A2MDER	DC-DC-IC	PWM/PFM, st-dwn, 2.95V±2%, 600mA, 3MHz, Vin>2V, LSST	USP-6C	49dc5	DC1	9a	Tor
5L	RP101K282B	LVR-IC	LDO, LN, +CE, 2.8V±0.8%, 300mA	DFN1612-4B	45vm	VR4	9a	Ric
5L	RP200K181B	LVR-IC	LDO, 1.8V±1.0%, 300mA, +CE, AE(mode)	DFN1212-6	52ht	VR10	9a	Ric
5L	XC6217C19A7R-G	LVR-IC	LDO, 1.95V±2%, 200mA, +CE	USPN-4	58vm	VR4	9a	Tor
5L	XC6223F2819R-G	LVR-IC	LDO, 2.8V±1%, 300mA, +CE, CL, ICP	USPQ-4B03	48vm	VR4	9a	Tor
5L0	XC9236A30D4R-G	DC-DC-IC	PWM/PFM, st-dwn, 3.0V±2%, 600mA, 3MHz, Vin>2V, LSST	USP-6EL	56dc5	DC1	9a	Tor
5L0	XC9236A30DER	DC-DC-IC	PWM/PFM, st-dwn, 3.0V±2%, 600mA, 3MHz, Vin>2V, LSST	USP-6C	49dc5	DC1	9a	Tor
5L0	XCL206A304AR-G	DC/DC-IC	PWM/PFM st-dwn, 3MHz, 3.0V±2%, 600mA	CL-2025	67dc7	DC9	9a	Tor
5L1	XC9236A31D4R-G	DC-DC-IC	PWM/PFM, st-dwn, 3.1V±2%, 600mA, 3MHz, Vin>2V, LSST	USP-6EL	56dc5	DC1	9a	Tor
5L1	XC9236A31DER	DC-DC-IC	PWM/PFM, st-dwn, 3.1V±2%, 600mA, 3MHz, Vin>2V, LSST	USP-6C	49dc5	DC1	9a	Tor
5L1	XCL206A314AR-G	DC/DC-IC	PWM/PFM st-dwn, 3MHz, 3.1V±2%, 600mA	CL-2025	67dc7	DC9	9a	Tor
5L2	XC9236A32D4R-G	DC-DC-IC	PWM/PFM, st-dwn, 3.2V±2%, 600mA, 3MHz, Vin>2V, LSST	USP-6EL	56dc5	DC1	9a	Tor
5L2	XC9236A32DER	DC-DC-IC	PWM/PFM, st-dwn, 3.2V±2%, 600mA, 3MHz, Vin>2V, LSST	USP-6C	49dc5	DC1	9a	Tor
5L2	XCL206A324AR-G	DC/DC-IC	PWM/PFM st-dwn, 3MHz, 3.2V±2%, 600mA	CL-2025	67dc7	DC9	9a	Tor
5L3	XC9236A33D4R-G	DC-DC-IC	PWM/PFM, st-dwn, 3.3V±2%, 600mA, 3MHz, Vin>2V, LSST	USP-6EL	56dc5	DC1	9a	Tor
5L3	XC9236A33DER	DC-DC-IC	PWM/PFM, st-dwn, 3.3V±2%, 600mA, 3MHz, Vin>2V, LSST	USP-6C	49dc5	DC1	9a	Tor
5L3	XCL206A334AR-G	DC/DC-IC	PWM/PFM st-dwn, 3MHz, 3.3V±2%, 600mA	CL-2025	67dc7	DC9	9a	Tor
5L4	XC9236A34D4R-G	DC-DC-IC	PWM/PFM, st-dwn, 3.4V±2%, 600mA, 3MHz, Vin>2V, LSST	USP-6EL	56dc5	DC1	9a	Tor
5L4	XC9236A34DER	DC-DC-IC	PWM/PFM, st-dwn, 3.4V±2%, 600mA, 3MHz, Vin>2V, LSST	USP-6C	49dc5	DC1	9a	Tor



SMD code	Type	Function	Short description	Case	Pinout	Sch.	St.	Mnf.
5L4	XCL206A344AR-G	DC/DC-IC	PWM/PFM st-dwn, 3MHz, 3.4V±2%, 600mA	CL-2025	67dc7	DC9	9a	Tor
5L5	XC9236A35DAR-G	DC-DC-IC	PWM/PFM, st-dwn, 3.5V±2%, 600mA, 3MHz, Vin>2V, LSST	USP-6EL	56dc5	DC1	9a	Tor
5L5	XC9236A35DER	DC-DC-IC	PWM/PFM, st-dwn, 3.5V±2%, 600mA, 3MHz, Vin>2V, LSST	USP-6C	49dc5	DC1	9a	Tor
5L5	XCL206A354AR-G	DC/DC-IC	PWM/PFM st-dwn, 3MHz, 3.5V±2%, 600mA	CL-2025	67dc7	DC9	9a	Tor
5L6	XC9236A36D4R-G	DC-DC-IC	PWM/PFM, st-dwn, 3.6V±2%, 600mA, 3MHz, Vin>2V, LSST	USP-6EL	56dc5	DC1	9a	Tor
5L6	XC9236A36DER	DC-DC-IC	PWM/PFM, st-dwn, 3.6V±2%, 600mA, 3MHz, Vin>2V, LSST	USP-6C	49dc5	DC1	9a	Tor
5L6	XCL206A364AR-G	DC/DC-IC	PWM/PFM st-dwn, 3MHz, 3.6V±2%, 600mA	CL-2025	67dc7	DC9	9a	Tor
5L7	XC9236A37D4R-G	DC-DC-IC	PWM/PFM, st-dwn, 3.7V±2%, 600mA, 3MHz, Vin>2V, LSST	USP-6EL	56dc5	DC1	9a	Tor
5L7	XC9236A37DER	DC-DC-IC	PWM/PFM, st-dwn, 3.7V±2%, 600mA, 3MHz, Vin>2V, LSST	USP-6C	49dc5	DC1	9a	Tor
5L7	XCL206A374AR-G	DC/DC-IC	PWM/PFM st-dwn, 3MHz, 3.7V±2%, 600mA	CL-2025	67dc7	DC9	9a	Tor
5L8	XC9236A38D4R-G	DC-DC-IC	PWM/PFM, st-dwn, 3.8V±2%, 600mA, 3MHz, Vin>2V, LSST	USP-6EL	56dc5	DC1	9a	Tor
5L8	XC9236A38DER	DC-DC-IC	PWM/PFM, st-dwn, 3.8V±2%, 600mA, 3MHz, Vin>2V, LSST	USP-6C	49dc5	DC1	9a	Tor
5L8	XCL206A384AR-G	DC/DC-IC	PWM/PFM st-dwn, 3MHz, 3.8V±2%, 600mA	CL-2025	67dc7	DC9	9a	Tor
5L9	XC9236A39D4R-G	DC-DC-IC	PWM/PFM, st-dwn, 3.9V±2%, 600mA, 3MHz, Vin>2V, LSST	USP-6EL	56dc5	DC1	9a	Tor
5L9	XC9236A39DER	DC-DC-IC	PWM/PFM, st-dwn, 3.9V±2%, 600mA, 3MHz, Vin>2V, LSST	USP-6C	49dc5	DC1	9a	Tor
5L9	XCL206A394AR-G	DC/DC-IC	PWM/PFM st-dwn, 3MHz, 3.9V±2%, 600mA	CL-2025	67dc7	DC9	9a	Tor
5LA	XC9236A3AD4R-G	DC-DC-IC	PWM/PFM, st-dwn, 3.05V±2%, 600mA, 3MHz, Vin>2V, LSST	USP-6EL	56dc5	DC1	9a	Tor
5LA	XC9236A3ADER	DC-DC-IC	PWM/PFM, st-dwn, 3.05V±2%, 600mA, 3MHz, Vin>2V, LSST	USP-6C	49dc5	DC1	9a	Tor
5LB	XC9236A3BD4R-G	DC-DC-IC	PWM/PFM, st-dwn, 3.15V±2%, 600mA, 3MHz, Vin>2V, LSST	USP-6EL	56dc5	DC1	9a	Tor
5LB	XC9236A3BDER	DC-DC-IC	PWM/PFM, st-dwn, 3.15V±2%, 600mA, 3MHz, Vin>2V, LSST	USP-6C	49dc5	DC1	9a	Tor
5LB	XC9236A3BDER	DC-DC-IC	PWM/PFM, st-dwn, 3.15V±2%, 600mA, 3MHz, Vin>2V, LSST	USP-6C	49dc5	DC1	9a	Tor
5LC	XC9236A3CD4R-G	DC-DC-IC	PWM/PFM, st-dwn, 3.25V±2%, 600mA, 3MHz, Vin>2V, LSST	USP-6EL	56dc5	DC1	9a	Tor
5LC	XC9236A3CDER	DC-DC-IC	PWM/PFM, st-dwn, 3.25V±2%, 600mA, 3MHz, Vin>2V, LSST	USP-6C	49dc5	DC1	9a	Tor
5LD	XC9236A3DD4R-G	DC-DC-IC	PWM/PFM, st-dwn, 3.35V±2%, 600mA, 3MHz, Vin>2V, LSST	USP-6EL	56dc5	DC1	9a	Tor
5LD	XC9236A3DDER	DC-DC-IC	PWM/PFM, st-dwn, 3.35V±2%, 600mA, 3MHz, Vin>2V, LSST	USP-6C	49dc5	DC1	9a	Tor
5LE	XC9236A3ED4R-G	DC-DC-IC	PWM/PFM, st-dwn, 3.45V±2%, 600mA, 3MHz, Vin>2V, LSST	USP-6EL	56dc5	DC1	9a	Tor
5LE	XC9236A3EDER	DC-DC-IC	PWM/PFM, st-dwn, 3.45V±2%, 600mA, 3MHz, Vin>2V, LSST	USP-6C	49dc5	DC1	9a	Tor
5LF	XC9236A3FD4R-G	DC-DC-IC	PWM/PFM, st-dwn, 3.55V±2%, 600mA, 3MHz, Vin>2V, LSST	USP-6EL	56dc5	DC1	9a	Tor
5LF	XC9236A3FDER	DC-DC-IC	PWM/PFM, st-dwn, 3.55V±2%, 600mA, 3MHz, Vin>2V, LSST	USP-6C	49dc5	DC1	9a	Tor
5LH	XC9236A3HD4R-G	DC-DC-IC	PWM/PFM, st-dwn, 3.65V±2%, 600mA, 3MHz, Vin>2V, LSST	USP-6EL	56dc5	DC1	9a	Tor
5LH	XC9236A3HDER	DC-DC-IC	PWM/PFM, st-dwn, 3.65V±2%, 600mA, 3MHz, Vin>2V, LSST	USP-6C	49dc5	DC1	9a	Tor
5LK	XC9236A3KD4R-G	DC-DC-IC	PWM/PFM, st-dwn, 3.75V±2%, 600mA, 3MHz, Vin>2V, LSST	USP-6EL	56dc5	DC1	9a	Tor
5LK	XC9236A3KDER	DC-DC-IC	PWM/PFM, st-dwn, 3.75V±2%, 600mA, 3MHz, Vin>2V, LSST	USP-6C	49dc5	DC1	9a	Tor
5LL	XC9236A3LD4R-G	DC-DC-IC	PWM/PFM, st-dwn, 3.85V±2%, 600mA, 3MHz, Vin>2V, LSST	USP-6EL	56dc5	DC1	9a	Tor
5LL	XC9236A3LDER	DC-DC-IC	PWM/PFM, st-dwn, 3.85V±2%, 600mA, 3MHz, Vin>2V, LSST	USP-6C	49dc5	DC1	9a	Tor
5LM	XC9236A3MD4R-G	DC-DC-IC	PWM/PFM, st-dwn, 3.95V±2%, 600mA, 3MHz, Vin>2V, LSST	USP-6EL	56dc5	DC1	9a	Tor
5LM	XC9236A3MDER	DC-DC-IC	PWM/PFM, st-dwn, 3.95V±2%, 600mA, 3MHz, Vin>2V, LSST	USP-6C	49dc5	DC1	9a	Tor
5M	RP101K282B5	LVR-IC	LDO, LN, +CE, 2.85V±0.8%, 300mA	DFN1612-4B	45vm	VR4	9a	Ric
5M	RP200K191B	LVR-IC	LDO, 1.9V±1.0%, 300mA, +CE, AE(mode)	DFN1212-6	52ht	VR10	9a	Ric
5M	XC6217C20A7R-G	LVR-IC	LDO, 2.05V±2%, 200mA, +CE	USPN-4	58vm	VR4	9a	Tor
5M	XC6223F2919R-G	LVR-IC	LDO, 2.9V±1%, 300mA, +CE, CL, ICP	USPQ-4B03	48vm	VR4	9a	Tor
5M0	XC9236A40D4R-G	DC-DC-IC	PWM/PFM, st-dwn, 4.0V±2%, 600mA, 3MHz, Vin>2V, LSST	USP-6EL	56dc5	DC1	9a	Tor
5M0	XC9236A40DER	DC-DC-IC	PWM/PFM, st-dwn, 4.0V±2%, 600mA, 3MHz, Vin>2V, LSST	USP-6C	49dc5	DC1	9a	Tor
5M0	XCL206A404AR-G	DC/DC-IC	PWM/PFM st-dwn, 3MHz, 4.0V±2%, 600mA	CL-2025	67dc7	DC9	9a	Tor
5N	RP101K292B	LVR-IC	LDO, LN, +CE, 2.9V±0.8%, 300mA	DFN1612-4B	45vm	VR4	9a	Ric
5N	RP200K201B	LVR-IC	LDO, 2V±1.0%, 300mA, +CE, AE(mode)	DFN1212-6	52ht	VR10	9a	Ric
5N	XC6217C21A7R-G	LVR-IC	LDO, 2.15V±2%, 200mA, +CE	USPN-4	58vm	VR4	9a	Tor
5N	XC6223F3019R-G	LVR-IC	LDO, 3.0V±1%, 300mA, +CE, CL, ICP	USPQ-4B03	48vm	VR4	9a	Tor
5N8	XC9236E08C4	DC-DC-IC	PWM/PFM st-dwn, 1.2MHz, 0.8V±2%, 600mA, CL, Vin>1.8V, LSST	USP-6EL	56dc5	DC1	9a	Tor
5N8	XC9236E08CER	DC-DC-IC	PWM/PFM, st-dwn, 0.8V±2%, 600mA, 1.2MHz, Vin>1.8V, LSST, CL	USP-6C	49dc5	DC1	9a	Tor
5N9	XC9236E09C4	DC/DC-IC	PWM/PFM st-dwn, 1.2MHz, 0.9V±2%, 600mA, CL, Vin>1.8V, LSST	USP-6EL	56dc5	DC1	9a	Tor
5N9	XC9236E09CER	DC-DC-IC	PWM/PFM, st-dwn, 0.9V±2%, 600mA, 1.2MHz, Vin>1.8V, LSST, CL	USP-6C	49dc5	DC1	9a	Tor
5NL	XC9236E0LC4	DC/DC-IC	PWM/PFM st-dwn, 1.2MHz, 0.85V±2%, 600mA, CL, Vin>1.8V, LSST	USP-6EL	56dc5	DC1	9a	Tor
5NL	XC9236E0LCER	DC-DC-IC	PWM/PFM, st-dwn, 0.85V±2%, 600mA, 1.2MHz, Vin>1.8V, LSST, CL	USP-6C	49dc5	DC1	9a	Tor
5NM	XC9236E0MC4	DC/DC-IC	PWM/PFM st-dwn, 1.2MHz, 0.95V±2%, 600mA, CL, Vin>1.8V, LSST	USP-6EL	56dc5	DC1	9a	Tor
5NM	XC9236E0MCER	DC-DC-IC	PWM/PFM, st-dwn, 0.95V±2%, 600mA, 1.2MHz, Vin>1.8V, LSST, CL	USP-6C	49dc5	DC1	9a	Tor
5P	RP101K302B	LVR-IC	LDO, LN, +CE, 3V±0.8%, 300mA	DFN1612-4B	45vm	VR4	9a	Ric
5P	RP200K211B	LVR-IC	LDO, 2.1V±1.0%, 300mA, +CE, AE(mode)	DFN1212-6	52ht	VR10	9a	Ric
5P	XC6217C22A7R-G	LVR-IC	LDO, 2.25V±2%, 200mA, +CE	USPN-4	58vm	VR4	9a	Tor
5P	XC6223F3119R-G	LVR-IC	LDO, 3.1V±1%, 300mA, +CE, CL, ICP	USPQ-4B03	48vm	VR4	9a	Tor
5P0	XC9236E10C4	DC/DC-IC	PWM/PFM st-dwn, 1.2MHz, 1.0V±2%, 600mA, CL, Vin>1.8V, LSST	USP-6EL	56dc5	DC1	9a	Tor
5P0	XC9236E10CER	DC-DC-IC	PWM/PFM, st-dwn, 1.0V±2%, 600mA, 1.2MHz, Vin>1.8V, LSST, CL	USP-6C	49dc5	DC1	9a	Tor
5P1	XC9236E11C4	DC/DC-IC	PWM/PFM st-dwn, 1.2MHz, 1.1V±2%, 600mA, CL, Vin>1.8V, LSST	USP-6EL	56dc5	DC1	9a	Tor
5P1	XC9236E11CER	DC-DC-IC	PWM/PFM, st-dwn, 1.1V±2%, 600mA, 1.2MHz, Vin>1.8V, LSST, CL	USP-6C	49dc5	DC1	9a	Tor
5P2	XC9236E12C4	DC/DC-IC	PWM/PFM st-dwn, 1.2MHz, 1.2V±2%, 600mA, CL, Vin>1.8V, LSST	USP-6EL	56dc5	DC1	9a	Tor
5P2	XC9236E12CER	DC-DC-IC	PWM/PFM, st-dwn, 1.2V±2%, 600mA, 1.2MHz, Vin>1.8V, LSST, CL	USP-6C	49dc5	DC1	9a	Tor
5P3	XC9236E13C4	DC/DC-IC	PWM/PFM st-dwn, 1.2MHz, 1.3V±2%, 600mA, CL, Vin>1.8V, LSST	USP-6EL	56dc5	DC1	9a	Tor
5P3	XC9236E13CER	DC-DC-IC	PWM/PFM, st-dwn, 1.3V±2%, 600mA, 1.2MHz, Vin>1.8V, LSST, CL	USP-6C	49dc5	DC1	9a	Tor
5P4	XC9236E14C4	DC/DC-IC	PWM/PFM st-dwn, 1.2MHz, 1.4V±2%, 600mA, CL, Vin>1.8V, LSST	USP-6EL	56dc5	DC1	9a	Tor
5P4	XC9236E14CER	DC-DC-IC	PWM/PFM, st-dwn, 1.4V±2%, 600mA, 1.2MHz, Vin>1.8V, LSST, CL	USP-6C	49dc5	DC1	9a	Tor
5P5	XC9236E15C4	DC/DC-IC	PWM/PFM st-dwn, 1.2MHz, 1.5V±2%, 600mA, CL, Vin>1.8V, LSST	USP-6EL	56dc5	DC1	9a	Tor



SMD code	Type	Function	Short description	Case	Pinout	Sch.	St.	Mnf.
5RK	XC9236E2KCER	DC-DC-IC	PWM/PFM, st-dwn, 2.75V±2%, 600mA, 1.2MHz, Vin>1.8V, LSST, CL	USP-6C	49dc5	DC1	9a	Tor
5RL	XC9236E2L2C	DC/DC-IC	PWM/PFM st-dwn, 1.2MHz, 2.85V±2%, 600mA, CL, Vin>1.8V, LSST	USP-6EL	56dc5	DC1	9a	Tor
5RL	XC9236E2LCER	DC-DC-IC	PWM/PFM, st-dwn, 2.85V±2%, 600mA, 1.2MHz, Vin>1.8V, LSST, CL	USP-6C	49dc5	DC1	9a	Tor
5RM	XC9236E2MC4	DC/DC-IC	PWM/PFM st-dwn, 1.2MHz, 2.95V±2%, 600mA, CL, Vin>1.8V, LSST	USP-6EL	56dc5	DC1	9a	Tor
5RM	XC9236E2MCER	DC-DC-IC	PWM/PFM, st-dwn, 2.95V±2%, 600mA, 1.2MHz, Vin>1.8V, LSST, CL	USP-6C	49dc5	DC1	9a	Tor
5S	RP101K212B	LVR-IC	LDO, 3.3V±1%, 300mA, +CE, AE(mode)	DFN1612-4B	45vm	VR4	9a	Ric
5S	RP200K241B	LVR-IC	LDO, 2.4V±1.0%, 300mA, +CE, AE(mode)	DFN1212-6	52ht	VR10	9a	Ric
5S	XC6217C24A7R-G	LVR-IC	LDO, 2.45V±2%, 200mA, +CE	USPN-4	58vm	VR4	9a	Tor
5S	XC6223F3319R-G	LVR-IC	LDO, 3.3V±1%, 300mA, +CE, CL, ICP	USPQ-4B03	48vm	VR4	9a	Tor
5S0	XC9236E30C4	DC/DC-IC	PWM/PFM st-dwn, 1.2MHz, 3.0V±2%, 600mA, CL, Vin>1.8V, LSST	USP-6EL	56dc5	DC1	9a	Tor
5S0	XC9236E30CER	DC-DC-IC	PWM/PFM, st-dwn, 3.0V±2%, 600mA, 1.2MHz, Vin>1.8V, LSST, CL	USP-6C	49dc5	DC1	9a	Tor
5S1	XC9236E31C4	DC/DC-IC	PWM/PFM st-dwn, 1.2MHz, 3.1V±2%, 600mA, CL, Vin>1.8V, LSST	USP-6EL	56dc5	DC1	9a	Tor
5S1	XC9236E31CER	DC-DC-IC	PWM/PFM, st-dwn, 3.1V±2%, 600mA, 1.2MHz, Vin>1.8V, LSST, CL	USP-6C	49dc5	DC1	9a	Tor
5S2	XC9236E32C4	DC/DC-IC	PWM/PFM st-dwn, 1.2MHz, 3.2V±2%, 600mA, CL, Vin>1.8V, LSST	USP-6EL	56dc5	DC1	9a	Tor
5S2	XC9236E32CER	DC-DC-IC	PWM/PFM, st-dwn, 3.2V±2%, 600mA, 1.2MHz, Vin>1.8V, LSST, CL	USP-6C	49dc5	DC1	9a	Tor
5S3	XC9236E33C4	DC/DC-IC	PWM/PFM st-dwn, 1.2MHz, 3.3V±2%, 600mA, CL, Vin>1.8V, LSST	USP-6EL	56dc5	DC1	9a	Tor
5S3	XC9236E33CER	DC-DC-IC	PWM/PFM, st-dwn, 3.3V±2%, 600mA, 1.2MHz, Vin>1.8V, LSST, CL	USP-6C	49dc5	DC1	9a	Tor
5S4	XC9236E34C4	DC/DC-IC	PWM/PFM st-dwn, 1.2MHz, 3.4V±2%, 600mA, CL, Vin>1.8V, LSST	USP-6EL	56dc5	DC1	9a	Tor
5S4	XC9236E34CER	DC-DC-IC	PWM/PFM, st-dwn, 3.4V±2%, 600mA, 1.2MHz, Vin>1.8V, LSST, CL	USP-6C	49dc5	DC1	9a	Tor
5S5	XC9236E35C4	DC/DC-IC	PWM/PFM st-dwn, 1.2MHz, 3.5V±2%, 600mA, CL, Vin>1.8V, LSST	USP-6EL	56dc5	DC1	9a	Tor
5S5	XC9236E35CER	DC-DC-IC	PWM/PFM, st-dwn, 3.5V±2%, 600mA, 1.2MHz, Vin>1.8V, LSST, CL	USP-6C	49dc5	DC1	9a	Tor
5S6	XC9236E36C4	DC/DC-IC	PWM/PFM st-dwn, 1.2MHz, 3.6V±2%, 600mA, CL, Vin>1.8V, LSST	USP-6EL	56dc5	DC1	9a	Tor
5S6	XC9236E36CER	DC-DC-IC	PWM/PFM, st-dwn, 3.6V±2%, 600mA, 1.2MHz, Vin>1.8V, LSST, CL	USP-6C	49dc5	DC1	9a	Tor
5S7	XC9236E37C4	DC/DC-IC	PWM/PFM st-dwn, 1.2MHz, 3.7V±2%, 600mA, CL, Vin>1.8V, LSST	USP-6EL	56dc5	DC1	9a	Tor
5S7	XC9236E37CER	DC-DC-IC	PWM/PFM, st-dwn, 3.7V±2%, 600mA, 1.2MHz, Vin>1.8V, LSST, CL	USP-6C	49dc5	DC1	9a	Tor
5S8	XC9236E38C4	DC/DC-IC	PWM/PFM st-dwn, 1.2MHz, 3.8V±2%, 600mA, CL, Vin>1.8V, LSST	USP-6EL	56dc5	DC1	9a	Tor
5S8	XC9236E38CER	DC-DC-IC	PWM/PFM, st-dwn, 3.8V±2%, 600mA, 1.2MHz, Vin>1.8V, LSST, CL	USP-6C	49dc5	DC1	9a	Tor
5S9	XC9236E39C4	DC/DC-IC	PWM/PFM st-dwn, 1.2MHz, 3.9V±2%, 600mA, CL, Vin>1.8V, LSST	USP-6EL	56dc5	DC1	9a	Tor
5S9	XC9236E39CER	DC-DC-IC	PWM/PFM, st-dwn, 3.9V±2%, 600mA, 1.2MHz, Vin>1.8V, LSST, CL	USP-6C	49dc5	DC1	9a	Tor
5SA	XC9236E3AC4	DC/DC-IC	PWM/PFM st-dwn, 1.2MHz, 3.05V±2%, 600mA, CL, Vin>1.8V, LSST	USP-6EL	56dc5	DC1	9a	Tor
5SA	XC9236E3ACER	DC-DC-IC	PWM/PFM, st-dwn, 3.05V±2%, 600mA, 1.2MHz, Vin>1.8V, LSST, CL	USP-6C	49dc5	DC1	9a	Tor
5SB	XC9236E3BC4	DC/DC-IC	PWM/PFM st-dwn, 1.2MHz, 3.15V±2%, 600mA, CL, Vin>1.8V, LSST	USP-6EL	56dc5	DC1	9a	Tor
5SB	XC9236E3BCER	DC-DC-IC	PWM/PFM, st-dwn, 3.15V±2%, 600mA, 1.2MHz, Vin>1.8V, LSST, CL	USP-6C	49dc5	DC1	9a	Tor
5SC	XC9236E3CC4	DC/DC-IC	PWM/PFM st-dwn, 1.2MHz, 3.25V±2%, 600mA, CL, Vin>1.8V, LSST	USP-6EL	56dc5	DC1	9a	Tor
5SC	XC9236E3CCER	DC-DC-IC	PWM/PFM, st-dwn, 3.25V±2%, 600mA, 1.2MHz, Vin>1.8V, LSST, CL	USP-6C	49dc5	DC1	9a	Tor
5SD	XC9236E3DC4	DC/DC-IC	PWM/PFM st-dwn, 1.2MHz, 3.35V±2%, 600mA, CL, Vin>1.8V, LSST	USP-6EL	56dc5	DC1	9a	Tor
5SD	XC9236E3DCER	DC-DC-IC	PWM/PFM, st-dwn, 3.35V±2%, 600mA, 1.2MHz, Vin>1.8V, LSST, CL	USP-6C	49dc5	DC1	9a	Tor
5SE	XC9236E3EC4	DC/DC-IC	PWM/PFM st-dwn, 1.2MHz, 3.45V±2%, 600mA, CL, Vin>1.8V, LSST	USP-6EL	56dc5	DC1	9a	Tor
5SE	XC9236E3ECER	DC-DC-IC	PWM/PFM, st-dwn, 3.45V±2%, 600mA, 1.2MHz, Vin>1.8V, LSST, CL	USP-6C	49dc5	DC1	9a	Tor
5SF	XC9236E3FC4	DC/DC-IC	PWM/PFM st-dwn, 1.2MHz, 3.55V±2%, 600mA, CL, Vin>1.8V, LSST	USP-6EL	56dc5	DC1	9a	Tor
5SF	XC9236E3FCER	DC-DC-IC	PWM/PFM, st-dwn, 3.55V±2%, 600mA, 1.2MHz, Vin>1.8V, LSST, CL	USP-6C	49dc5	DC1	9a	Tor
5SH	XC9236E3HC4	DC/DC-IC	PWM/PFM st-dwn, 1.2MHz, 3.65V±2%, 600mA, CL, Vin>1.8V, LSST	USP-6EL	56dc5	DC1	9a	Tor
5SH	XC9236E3HCER	DC-DC-IC	PWM/PFM, st-dwn, 3.65V±2%, 600mA, 1.2MHz, Vin>1.8V, LSST, CL	USP-6C	49dc5	DC1	9a	Tor
5SK	XC9236E3KC4	DC/DC-IC	PWM/PFM st-dwn, 1.2MHz, 3.75V±2%, 600mA, CL, Vin>1.8V, LSST	USP-6EL	56dc5	DC1	9a	Tor
5SK	XC9236E3KCER	DC-DC-IC	PWM/PFM, st-dwn, 3.75V±2%, 600mA, 1.2MHz, Vin>1.8V, LSST, CL	USP-6C	49dc5	DC1	9a	Tor
5SL	XC9236E3LC4	DC/DC-IC	PWM/PFM st-dwn, 1.2MHz, 3.85V±2%, 600mA, CL, Vin>1.8V, LSST	USP-6EL	56dc5	DC1	9a	Tor
5SL	XC9236E3LCER	DC-DC-IC	PWM/PFM, st-dwn, 3.85V±2%, 600mA, 1.2MHz, Vin>1.8V, LSST, CL	USP-6C	49dc5	DC1	9a	Tor
5SM	XC9236E3MC4	DC/DC-IC	PWM/PFM st-dwn, 1.2MHz, 3.95V±2%, 600mA, CL, Vin>1.8V, LSST	USP-6EL	56dc5	DC1	9a	Tor
5SM	XC9236E3MCER	DC-DC-IC	PWM/PFM, st-dwn, 3.95V±2%, 600mA, 1.2MHz, Vin>1.8V, LSST, CL	USP-6C	49dc5	DC1	9a	Tor
5T	RP200K251B	LVR-IC	LDO, 2.5V±1.0%, 300mA, +CE, AE(mode)	DFN1212-6	52ht	VR10	9a	Ric
5T	XC6217C25A7R-G	LVR-IC	LDO, 2.55V±2%, 200mA, +CE	USPN-4	58vm	VR4	9a	Tor
5T	XC6223F3419R-G	LVR-IC	LDO, 3.4V±1%, 300mA, +CE, CL, ICP	USPQ-4B03	48vm	VR4	9a	Tor
5T0	XC9236E40C4	DC/DC-IC	PWM/PFM st-dwn, 1.2MHz, 4.0V±2%, 600mA, CL, Vin>1.8V, LSST	USP-6EL	56dc5	DC1	9a	Tor
5T0	XC9236E40CER	DC-DC-IC	PWM/PFM, st-dwn, 4.0V±2%, 600mA, 1.2MHz, Vin>1.8V, LSST, CL	USP-6C	49dc5	DC1	9a	Tor
5U	RP200K261B	LVR-IC	LDO, 2.6V±1.0%, 300mA, +CE, AE(mode)	DFN1212-6	52ht	VR10	9a	Ric
5U	XC6217C26A7R-G	LVR-IC	LDO, 2.65V±2%, 200mA, +CE	USPN-4	58vm	VR4	9a	Tor
5U	XC6223F3519R-G	LVR-IC	LDO, 3.5V±1%, 300mA, +CE, CL, ICP	USPQ-4B03	48vm	VR4	9a	Tor
5U8	XC9236E08D4	DC/DC-IC	PWM/PFM st-dwn, 3MHz, 0.8V±2%, 600mA, CL, Vin>1.8V, LSST	USP-6EL	56dc5	DC1	9a	Tor
5U8	XC9236E08DER	DC-DC-IC	PWM/PFM, st-dwn, 0.8V±2%, 600mA, 3MHz, Vin>1.8V, LSST, CL	USP-6C	49dc5	DC1	9a	Tor
5U9	XC9236E09D4	DC/DC-IC	PWM/PFM st-dwn, 3MHz, 0.9V±2%, 600mA, CL, Vin>1.8V, LSST	USP-6EL	56dc5	DC1	9a	Tor
5U9	XC9236E09DER	DC-DC-IC	PWM/PFM, st-dwn, 0.9V±2%, 600mA, 3MHz, Vin>1.8V, LSST, CL	USP-6C	49dc5	DC1	9a	Tor
5UL	XC9236E0LD4	DC/DC-IC	PWM/PFM st-dwn, 3MHz, 0.85V±2%, 600mA, CL, Vin>1.8V, LSST	USP-6EL	56dc5	DC1	9a	Tor
5UL	XC9236E0LDER	DC-DC-IC	PWM/PFM, st-dwn, 0.85V±2%, 600mA, 3MHz, Vin>1.8V, LSST, CL	USP-6C	49dc5	DC1	9a	Tor
5UM	XC9236E0MD4	DC/DC-IC	PWM/PFM st-dwn, 3MHz, 0.95V±2%, 600mA, CL, Vin>1.8V, LSST	USP-6EL	56dc5	DC1	9a	Tor
5UM	XC9236E0MDER	DC-DC-IC	PWM/PFM, st-dwn, 0.95V±2%, 600mA, 3MHz, Vin>1.8V, LSST, CL	USP-6C	49dc5	DC1	9a	Tor
5V	RP200K271B	LVR-IC	LDO, 2.7V±1.0%, 300mA, +CE, AE(mode)	DFN1212-6	52ht	VR10	9a	Ric
5V	XC6217C27A7R-G	LVR-IC	LDO, 2.75V±2%, 200mA, +CE	USPN-4	58vm	VR4	9a	Tor
5V	XC6223F3619R-G	LVR-IC	LDO, 3.6V±1%, 300mA, +CE, CL, ICP	USPQ-4B03	48vm	VR4	9a	Tor
5V0	XC9236E10D4	DC/DC-IC	PWM/PFM st-dwn, 3MHz, 1.0V±2%, 600mA, CL, Vin>1.8V, LSST	USP-6EL	56dc5	DC1	9a	Tor
5V0	XC9236E10DER	DC-DC-IC	PWM/PFM, st-dwn, 1.0V±2%, 600mA, 3MHz, Vin>1.8V, LSST, CL	USP-6C	49dc5	DC1	9a	Tor



SMD code	Type	Function	Short description	Case	Pinout	Sch.	St.	Mnf.
5XE	XC9236E2ED4	DC/DC-IC	PWM/PFM st-dwn, 3MHz, 2.45V±2%, 600mA, CL, Vin>1.8V, LSST	USP-6EL	56dc5	DC1	9a	Tor
5XE	XC9236E2EDER	DC-DC-IC	PWM/PFM st-dwn, 2.45V±2%, 600mA, 3MHz, Vin>1.8V, LSST, CL	USP-6CF	49dc5	DC1	9a	Tor
5XF	XC9236E2FD4	DC/DC-IC	PWM/PFM st-dwn, 3MHz, 2.55V±2%, 600mA, CL, Vin>1.8V, LSST	USP-6EL	56dc5	DC1	9a	Tor
5XF	XC9236E2FDER	DC-DC-IC	PWM/PFM st-dwn, 2.55V±2%, 600mA, 3MHz, Vin>1.8V, LSST, CL	USP-6CF	49dc5	DC1	9a	Tor
5XH	XC9236E2HD4	DC/DC-IC	PWM/PFM st-dwn, 3MHz, 2.65V±2%, 600mA, CL, Vin>1.8V, LSST	USP-6EL	56dc5	DC1	9a	Tor
5XH	XC9236E2HDER	DC-DC-IC	PWM/PFM st-dwn, 2.65V±2%, 600mA, 3MHz, Vin>1.8V, LSST, CL	USP-6CF	49dc5	DC1	9a	Tor
5XK	XC9236E2KD4	DC/DC-IC	PWM/PFM st-dwn, 3MHz, 2.75V±2%, 600mA, CL, Vin>1.8V, LSST	USP-6EL	56dc5	DC1	9a	Tor
5XK	XC9236E2KDER	DC-DC-IC	PWM/PFM st-dwn, 2.75V±2%, 600mA, 3MHz, Vin>1.8V, LSST, CL	USP-6CF	49dc5	DC1	9a	Tor
5XL	XC9236E2LD4	DC/DC-IC	PWM/PFM st-dwn, 3MHz, 2.85V±2%, 600mA, CL, Vin>1.8V, LSST	USP-6EL	56dc5	DC1	9a	Tor
5XL	XC9236E2LDER	DC-DC-IC	PWM/PFM st-dwn, 2.85V±2%, 600mA, 3MHz, Vin>1.8V, LSST, CL	USP-6CF	49dc5	DC1	9a	Tor
5XM	XC9236E2MD4	DC/DC-IC	PWM/PFM st-dwn, 3MHz, 2.95V±2%, 600mA, CL, Vin>1.8V, LSST	USP-6EL	56dc5	DC1	9a	Tor
5XM	XC9236E2MDER	DC-DC-IC	PWM/PFM st-dwn, 2.95V±2%, 600mA, 3MHz, Vin>1.8V, LSST, CL	USP-6CF	49dc5	DC1	9a	Tor
5Y	RP200K301B	LVR-IC	LDO, 3V±1.0%, 300mA, +CE, AE(mode)	DFN1212-6	52ht	VR10	9a	Ric
5Y	XC6217C29A7R-G	LVR-IC	LDO, 2.95V±2%, 200mA, +CE	USPN-4	58vm	VR4	9a	Tor
5Y	XC6223F3819R-G	LVR-IC	LDO, 3.8V±1%, 300mA, +CE, CL, ICP	USPQ-4B03	48vm	VR4	9a	Tor
5Y0	XC9236E30D4	DC/DC-IC	PWM/PFM st-dwn, 3MHz, 3.0V±2%, 600mA, CL, Vin>1.8V, LSST	USP-6EL	56dc5	DC1	9a	Tor
5Y0	XC9236E30DER	DC-DC-IC	PWM/PFM st-dwn, 3.0V±2%, 600mA, 3MHz, Vin>1.8V, LSST, CL	USP-6CF	49dc5	DC1	9a	Tor
5Y1	XC9236E31D4	DC/DC-IC	PWM/PFM st-dwn, 3MHz, 3.1V±2%, 600mA, CL, Vin>1.8V, LSST	USP-6EL	56dc5	DC1	9a	Tor
5Y1	XC9236E31DER	DC-DC-IC	PWM/PFM st-dwn, 3.1V±2%, 600mA, 3MHz, Vin>1.8V, LSST, CL	USP-6CF	49dc5	DC1	9a	Tor
5Y2	XC9236E32D4	DC/DC-IC	PWM/PFM st-dwn, 3MHz, 3.2V±2%, 600mA, CL, Vin>1.8V, LSST	USP-6EL	56dc5	DC1	9a	Tor
5Y2	XC9236E32DER	DC-DC-IC	PWM/PFM st-dwn, 3.2V±2%, 600mA, 3MHz, Vin>1.8V, LSST, CL	USP-6CF	49dc5	DC1	9a	Tor
5Y3	XC9236E33D4	DC/DC-IC	PWM/PFM st-dwn, 3MHz, 3.3V±2%, 600mA, CL, Vin>1.8V, LSST	USP-6EL	56dc5	DC1	9a	Tor
5Y3	XC9236E33DER	DC-DC-IC	PWM/PFM st-dwn, 3.3V±2%, 600mA, 3MHz, Vin>1.8V, LSST, CL	USP-6CF	49dc5	DC1	9a	Tor
5Y4	XC9236E34D4	DC/DC-IC	PWM/PFM st-dwn, 3MHz, 3.4V±2%, 600mA, CL, Vin>1.8V, LSST	USP-6EL	56dc5	DC1	9a	Tor
5Y4	XC9236E34DER	DC-DC-IC	PWM/PFM st-dwn, 3.4V±2%, 600mA, 3MHz, Vin>1.8V, LSST, CL	USP-6CF	49dc5	DC1	9a	Tor
5Y5	XC9236E35D4	DC/DC-IC	PWM/PFM st-dwn, 3MHz, 3.5V±2%, 600mA, CL, Vin>1.8V, LSST	USP-6EL	56dc5	DC1	9a	Tor
5Y5	XC9236E35DER	DC-DC-IC	PWM/PFM st-dwn, 3.5V±2%, 600mA, 3MHz, Vin>1.8V, LSST, CL	USP-6CF	49dc5	DC1	9a	Tor
5Y6	XC9236E36D4	DC/DC-IC	PWM/PFM st-dwn, 3MHz, 3.6V±2%, 600mA, CL, Vin>1.8V, LSST	USP-6EL	56dc5	DC1	9a	Tor
5Y6	XC9236E36DER	DC-DC-IC	PWM/PFM st-dwn, 3.6V±2%, 600mA, 3MHz, Vin>1.8V, LSST, CL	USP-6CF	49dc5	DC1	9a	Tor
5Y7	XC9236E37D4	DC/DC-IC	PWM/PFM st-dwn, 3MHz, 3.7V±2%, 600mA, CL, Vin>1.8V, LSST	USP-6EL	56dc5	DC1	9a	Tor
5Y7	XC9236E37DER	DC-DC-IC	PWM/PFM st-dwn, 3.7V±2%, 600mA, 3MHz, Vin>1.8V, LSST, CL	USP-6CF	49dc5	DC1	9a	Tor
5Y8	XC9236E38D4	DC/DC-IC	PWM/PFM st-dwn, 3MHz, 3.8V±2%, 600mA, CL, Vin>1.8V, LSST	USP-6EL	56dc5	DC1	9a	Tor
5Y8	XC9236E38DER	DC-DC-IC	PWM/PFM st-dwn, 3.8V±2%, 600mA, 3MHz, Vin>1.8V, LSST, CL	USP-6CF	49dc5	DC1	9a	Tor
5Y9	XC9236E39D4	DC/DC-IC	PWM/PFM st-dwn, 3MHz, 3.9V±2%, 600mA, CL, Vin>1.8V, LSST	USP-6EL	56dc5	DC1	9a	Tor
5Y9	XC9236E39DER	DC-DC-IC	PWM/PFM st-dwn, 3.9V±2%, 600mA, 3MHz, Vin>1.8V, LSST, CL	USP-6CF	49dc5	DC1	9a	Tor
5YA	XC9236E3AD4	DC/DC-IC	PWM/PFM st-dwn, 3MHz, 3.05V±2%, 600mA, CL, Vin>1.8V, LSST	USP-6EL	56dc5	DC1	9a	Tor
5YA	XC9236E3ADER	DC-DC-IC	PWM/PFM st-dwn, 3.05V±2%, 600mA, 3MHz, Vin>1.8V, LSST, CL	USP-6CF	49dc5	DC1	9a	Tor
5YB	XC9236E3BD4	DC/DC-IC	PWM/PFM st-dwn, 3MHz, 3.15V±2%, 600mA, CL, Vin>1.8V, LSST	USP-6EL	56dc5	DC1	9a	Tor
5YB	XC9236E3BDER	DC-DC-IC	PWM/PFM st-dwn, 3.15V±2%, 600mA, 3MHz, Vin>1.8V, LSST, CL	USP-6CF	49dc5	DC1	9a	Tor
5YC	XC9236E3CD4	DC/DC-IC	PWM/PFM st-dwn, 3MHz, 3.25V±2%, 600mA, CL, Vin>1.8V, LSST	USP-6EL	56dc5	DC1	9a	Tor
5YC	XC9236E3CDER	DC-DC-IC	PWM/PFM st-dwn, 3.25V±2%, 600mA, 3MHz, Vin>1.8V, LSST, CL	USP-6CF	49dc5	DC1	9a	Tor
5YD	XC9236E3DD4	DC/DC-IC	PWM/PFM st-dwn, 3MHz, 3.35V±2%, 600mA, CL, Vin>1.8V, LSST	USP-6EL	56dc5	DC1	9a	Tor
5YD	XC9236E3DDER	DC-DC-IC	PWM/PFM st-dwn, 3.35V±2%, 600mA, 3MHz, Vin>1.8V, LSST, CL	USP-6CF	49dc5	DC1	9a	Tor
5YE	XC9236E3ED4	DC/DC-IC	PWM/PFM st-dwn, 3MHz, 3.45V±2%, 600mA, CL, Vin>1.8V, LSST	USP-6EL	56dc5	DC1	9a	Tor
5YE	XC9236E3EDER	DC-DC-IC	PWM/PFM st-dwn, 3.45V±2%, 600mA, 3MHz, Vin>1.8V, LSST, CL	USP-6CF	49dc5	DC1	9a	Tor
5YF	XC9236E3FD4	DC/DC-IC	PWM/PFM st-dwn, 3MHz, 3.55V±2%, 600mA, CL, Vin>1.8V, LSST	USP-6EL	56dc5	DC1	9a	Tor
5YF	XC9236E3FDER	DC-DC-IC	PWM/PFM st-dwn, 3.55V±2%, 600mA, 3MHz, Vin>1.8V, LSST, CL	USP-6CF	49dc5	DC1	9a	Tor
5YH	XC9236E3HD4	DC/DC-IC	PWM/PFM st-dwn, 3MHz, 3.65V±2%, 600mA, CL, Vin>1.8V, LSST	USP-6EL	56dc5	DC1	9a	Tor
5YH	XC9236E3HDER	DC-DC-IC	PWM/PFM st-dwn, 3.65V±2%, 600mA, 3MHz, Vin>1.8V, LSST, CL	USP-6CF	49dc5	DC1	9a	Tor
5YK	XC9236E3KD4	DC/DC-IC	PWM/PFM st-dwn, 3MHz, 3.75V±2%, 600mA, CL, Vin>1.8V, LSST	USP-6EL	56dc5	DC1	9a	Tor
5YK	XC9236E3KDER	DC-DC-IC	PWM/PFM st-dwn, 3.75V±2%, 600mA, 3MHz, Vin>1.8V, LSST, CL	USP-6CF	49dc5	DC1	9a	Tor
5YL	XC9236E3LD4	DC/DC-IC	PWM/PFM st-dwn, 3MHz, 3.85V±2%, 600mA, CL, Vin>1.8V, LSST	USP-6EL	56dc5	DC1	9a	Tor
5YL	XC9236E3LDER	DC-DC-IC	PWM/PFM st-dwn, 3.85V±2%, 600mA, 3MHz, Vin>1.8V, LSST, CL	USP-6CF	49dc5	DC1	9a	Tor
5YM	XC9236E3MD4	DC/DC-IC	PWM/PFM st-dwn, 3MHz, 3.95V±2%, 600mA, CL, Vin>1.8V, LSST	USP-6EL	56dc5	DC1	9a	Tor
5YM	XC9236E3MDER	DC-DC-IC	PWM/PFM st-dwn, 3.95V±2%, 600mA, 3MHz, Vin>1.8V, LSST, CL	USP-6CF	49dc5	DC1	9a	Tor
5Z	RP200K311B	LVR-IC	LDO, 3.1V±1.0%, 300mA, +CE, AE(mode)	DFN1212-6	52ht	VR10	9a	Ric
5Z	XC6217C30A7R-G	LVR-IC	LDO, 3.05V±2%, 200mA, +CE	USPN-4	58vm	VR4	9a	Tor
5Z	XC6223F3919R-G	LVR-IC	LDO, 3.9V±1%, 300mA, +CE, CL, ICP	USPQ-4B03	48vm	VR4	9a	Tor
5Z0	XC9236E40D4	DC/DC-IC	PWM/PFM st-dwn, 3MHz, 4.0V±2%, 600mA, CL, Vin>1.8V, LSST	USP-6EL	56dc5	DC1	9a	Tor
5Z0	XC9236E40DER	DC-DC-IC	PWM/PFM st-dwn, 4.0V±2%, 600mA, 3MHz, Vin>1.8V, LSST, CL	USP-6CF	49dc5	DC1	9a	Tor
60	RP110L331C	LVR-IC	LDO, 3.3V±1%, 150mA	DFN1010-4	48y1	VR1	9a	Ric
60	XC6217C31A7R-G	LVR-IC	LDO, 3.15V±2%, 200mA, +CE	USPN-4	58vm	VR4	9a	Tor
60	XC6221D08B7R	LVR-IC	LDO, 0.85V±20mV, 200mA, +CE, CL, PDR	USPN-4	58vm	VR4	9a	Tor
6020A2	TPA6020A2RGW	LIN-IC	AF PA, BTL, 2.5..5.5V, 2x2.8W(5V/4Q), shutdown	QFN-20	38	-	-	Ti
61	RP110L341C	LVR-IC	LDO, 3.4V±1%, 150mA	DFN1010-4	48y1	VR1	9a	Ric
61	XC6217C32A7R-G	LVR-IC	LDO, 3.25V±2%, 200mA, +CE	USPN-4	58vm	VR4	9a	Tor
61	XC6221D09B7R	LVR-IC	LDO, 0.95V±20mV, 200mA, +CE, CL, PDR	USPN-4	58vm	VR4	9a	Tor
6105	BL6105LQ	LIN-IC	AF PA, BTL, class-D, 2.5..5.5V, 1.4W(5V/4Q), shutdown	DFN-8	37	AFP24	-	Shb
6110	BL6110TLX	LIN-IC	AF PA, BTL, class-D, 2.5..5.5V, 2.8W(5V/4Q), shutdown	BGA-9	39	AFP45	-	Shb
6112	BL6112LQ	LIN-IC	AF PA, BTL, class-D, 2.5..5.5V, 2x2.1W(5V/4Q), shutdown	QFN-20	38	-	-	Shb



SMD code	Type	Function	Short description	Case	Pinout	Sch.	St.	Mnf.
6112	BL6112TLX	LIN-IC	AF PA, BTL, class-D, 2.5..5.5V, 2x2.1W(5V/4Q), shutdown	BGA-16	39	AFP46	-	Shb
618	MIC5252-1.8BML	LVR-IC	LDO, LN, +CE, 1.8V±1%, 150mA	LLP-6	56ub	VR7	9a	Mcr
62	RP110L351C	LVR-IC	LDO, 3.5V±1%, 150mA	DFN1010-4	48y1	VR1	9a	Ric
62	TS4962MEJIT	LIN-IC	AF PA, BTL, class-D, 2.4..5.5V, 3W(5V/4Q), shutdown	BGA-9	39	AFP45	-	Ste
62	XC6217C33A7R-G	LVR-IC	LDO, 3.35V±2%, 200mA, +CE	USPN-4	58vm	VR4	9a	Tor
62	XC6223G1219R-G	LVR-IC	LDO, 1.2V±20mV, 300mA, +CE, PDR, ICP	USPQ-4B03	48vm	VR4	9a	Tor
62	XC6221D10B7R	LVR-IC	LDO, 1.05V±20mV, 200mA, +CE, CL, PDR	USPN-4	58vm	VR4	9a	Tor
6205	EUA6205J	LIN-IC	AF PA, BTL, 2.5..5.5V, 1.25W(5V/8Q), shutdown	TDFN-8	37	AFP22	-	Eut
6214A	EUA6214AJ	LIN-IC	AF PA, BTL, 2.5..5.5V, 1.7W(5V/8Q), shutdown	TDFN-8	37	AFP22	-	Eut
625	MIC5252-2.5BML	LVR-IC	LDO, LN, +CE, 2.5V±1%, 150mA	LLP-6	56ub	VR7	9a	Mcr
628	MIC5252-2.8BML	LVR-IC	LDO, LN, +CE, 2.8V±1%, 150mA	LLP-6	56ub	VR7	9a	Mcr
62J	MIC5252-2.85BML	LVR-IC	LDO, LN, +CE, 2.85V±1%, 150mA	LLP-6	56ub	VR7	9a	Mcr
63	RP110L361C	LVR-IC	LDO, 3.6V±1%, 150mA	DFN1010-4	48y1	VR1	9a	Ric
63	XC6217C34A7R-G	LVR-IC	LDO, 3.45V±2%, 200mA, +CE	USPN-4	58vm	VR4	9a	Tor
63	XC6223G1319R-G	LVR-IC	LDO, 1.3V±20mV, 300mA, +CE, PDR, ICP	USPQ-4B03	48vm	VR4	9a	Tor
63	XC6221D11B7R	LVR-IC	LDO, 1.15V±20mV, 200mA, +CE, CL, PDR	USPN-4	58vm	VR4	9a	Tor
630	MIC5252-3.0BML	LVR-IC	LDO, LN, +CE, 3V±1%, 150mA	LLP-6	56ub	VR7	9a	Mcr
6335	MS6335Q	LIN-IC	16-bit DAC, AF PA 2x52mW(5V/32Q), mute, I2C	QFN-16	38	-	-	Mos
6337	MS6337Q	LIN-IC	16-bit DAC, AF PA 1.8W(5V/4Q), mute, I2C	QFN-24	38	-	-	Mos
64	RP110L081D	LVR-IC	LDO, 0.8V±1%, 150mA, +CE, CL	DFN1010-4	48vm	VR4	9a	Ric
64	XC6217C35A7R-G	LVR-IC	LDO, 3.55V±2%, 200mA, +CE	USPN-4	58vm	VR4	9a	Tor
64	XC6223G1419R-G	LVR-IC	LDO, 1.4V±20mV, 300mA, +CE, PDR, ICP	USPQ-4B03	48vm	VR4	9a	Tor
64	XC6221D12B7R	LVR-IC	LDO, 1.25V±20mV, 200mA, +CE, CL, PDR	USPN-4	58vm	VR4	9a	Tor
65	RP110L091D	LVR-IC	LDO, 0.9V±1%, 150mA, +CE, CL	DFN1010-4	48vm	VR4	9a	Ric
65	XC6217C36A7R-G	LVR-IC	LDO, 3.65V±2%, 200mA, +CE	USPN-4	58vm	VR4	9a	Tor
65	XC6223G1519R-G	LVR-IC	LDO, 1.5V±20mV, 300mA, +CE, PDR, ICP	USPQ-4B03	48vm	VR4	9a	Tor
65	XC6221D13B7R	LVR-IC	LDO, 1.35V±20mV, 200mA, +CE, CL, PDR	USPN-4	58vm	VR4	9a	Tor
654	MIC5365-1.2YC5	LVR-IC	LDO, 1.2V±2%, 150mA, +CE	MLF-4	48vm	VR4	9a	Mcr
655	MIC5365-1.3YC5	LVR-IC	LDO, 1.3V±2%, 150mA, +CE	MLF-4	48vm	VR4	9a	Mcr
65C	MIC5365-1.0YC5	LVR-IC	LDO, 1.0V±2%, 150mA, +CE	MLF-4	48vm	VR4	9a	Mcr
65F	MIC5365-1.5YC5	LVR-IC	LDO, 1.5V±2%, 150mA, +CE	MLF-4	48vm	VR4	9a	Mcr
65G	MIC5365-1.8YC5	LVR-IC	LDO, 1.8V±2%, 150mA, +CE	MLF-4	48vm	VR4	9a	Mcr
65H	MIC5365-2.0YC5	LVR-IC	LDO, 2.0V±2%, 150mA, +CE	MLF-4	48vm	VR4	9a	Mcr
65J	MIC5365-2.5YC5	LVR-IC	LDO, 2.5V±2%, 150mA, +CE	MLF-4	48vm	VR4	9a	Mcr
65K	MIC5365-2.6YC5	LVR-IC	LDO, 2.6V±2%, 150mA, +CE	MLF-4	48vm	VR4	9a	Mcr
65L	MIC5365-2.7YC5	LVR-IC	LDO, 2.7V±2%, 150mA, +CE	MLF-4	48vm	VR4	9a	Mcr
65M	MIC5365-2.8YC5	LVR-IC	LDO, 2.8V±2%, 150mA, +CE	MLF-4	48vm	VR4	9a	Mcr
65N	MIC5365-2.85YC5	LVR-IC	LDO, 2.85V±2%, 150mA, +CE	MLF-4	48vm	VR4	9a	Mcr
65O	MIC5365-2.9YC5	LVR-IC	LDO, 2.9V±2%, 150mA, +CE	MLF-4	48vm	VR4	9a	Mcr
65P	MIC5365-3.0YC5	LVR-IC	LDO, 3.0V±2%, 150mA, +CE	MLF-4	48vm	VR4	9a	Mcr
65S	MIC5365-3.3YC5	LVR-IC	LDO, 3.3V±2%, 150mA, +CE	MLF-4	48vm	VR4	9a	Mcr
66	RP110L101D	LVR-IC	LDO, 1.0V±1%, 150mA, +CE, CL	DFN1010-4	48vm	VR4	9a	Ric
66	XC6217C37A7R-G	LVR-IC	LDO, 3.75V±2%, 200mA, +CE	USPN-4	58vm	VR4	9a	Tor
66	XC6223G1619R-G	LVR-IC	LDO, 1.6V±20mV, 300mA, +CE, PDR, ICP	USPQ-4B03	48vm	VR4	9a	Tor
66	XC6221D14B7R	LVR-IC	LDO, 1.45V±20mV, 200mA, +CE, CL, PDR	USPN-4	58vm	VR4	9a	Tor
664	MIC5366-1.2YC5	LVR-IC	LDO, 1.2V±2%, 150mA, +CE, CL	MLF-4	48vm	VR4	9a	Mcr
665	MIC5366-1.3YC5	LVR-IC	LDO, 1.3V±2%, 150mA, +CE, CL	MLF-4	48vm	VR4	9a	Mcr
66C	MIC5366-1.0YC5	LVR-IC	LDO, 1.0V±2%, 150mA, +CE, CL	MLF-4	48vm	VR4	9a	Mcr
66F	MIC5366-1.5YC5	LVR-IC	LDO, 1.5V±2%, 150mA, +CE, CL	MLF-4	48vm	VR4	9a	Mcr
66G	MIC5366-1.8YC5	LVR-IC	LDO, 1.8V±2%, 150mA, +CE, CL	MLF-4	48vm	VR4	9a	Mcr
66H	MIC5366-2.0YC5	LVR-IC	LDO, 2.0V±2%, 150mA, +CE, CL	MLF-4	48vm	VR4	9a	Mcr
66J	MIC5366-2.5YC5	LVR-IC	LDO, 2.5V±2%, 150mA, +CE, CL	MLF-4	48vm	VR4	9a	Mcr
66K	MIC5366-2.6YC5	LVR-IC	LDO, 2.6V±2%, 150mA, +CE, CL	MLF-4	48vm	VR4	9a	Mcr
66L	MIC5366-2.7YC5	LVR-IC	LDO, 2.7V±2%, 150mA, +CE, CL	MLF-4	48vm	VR4	9a	Mcr
66M	MIC5366-2.8YC5	LVR-IC	LDO, 2.8V±2%, 150mA, +CE, CL	MLF-4	48vm	VR4	9a	Mcr
66N	MIC5366-2.85YC5	LVR-IC	LDO, 2.85V±2%, 150mA, +CE, CL	MLF-4	48vm	VR4	9a	Mcr
66O	MIC5366-2.9YC5	LVR-IC	LDO, 2.9V±2%, 150mA, +CE, CL	MLF-4	48vm	VR4	9a	Mcr
66P	MIC5366-3.0YC5	LVR-IC	LDO, 3.0V±2%, 150mA, +CE, CL	MLF-4	48vm	VR4	9a	Mcr
66S	MIC5366-3.3YC5	LVR-IC	LDO, 3.3V±2%, 150mA, +CE, CL	MLF-4	48vm	VR4	9a	Mcr
67	RP110L111D	LVR-IC	LDO, 1.1V±1%, 150mA, +CE, CL	DFN1010-4	48vm	VR4	9a	Ric
67	XC6217C38A7R-G	LVR-IC	LDO, 3.85V±2%, 200mA, +CE	USPN-4	58vm	VR4	9a	Tor
67	XC6223G1719R-G	LVR-IC	LDO, 1.7V±20mV, 300mA, +CE, PDR, ICP	USPQ-4B03	48vm	VR4	9a	Tor
67	XC6221D15B7R	LVR-IC	LDO, 1.55V±20mV, 200mA, +CE, CL, PDR	USPN-4	58vm	VR4	9a	Tor
68	RP110L121D	LVR-IC	LDO, 1.2V±1%, 150mA, +CE, CL	DFN1010-4	48vm	VR4	9a	Ric
68	XC6217C39A7R-G	LVR-IC	LDO, 3.95V±2%, 200mA, +CE	USPN-4	58vm	VR4	9a	Tor
68	XC6223G1819R-G	LVR-IC	LDO, 1.8V±20mV, 300mA, +CE, PDR, ICP	USPQ-4B03	48vm	VR4	9a	Tor
68	XC6221D16B7R	LVR-IC	LDO, 1.65V±20mV, 200mA, +CE, CL, PDR	USPN-4	58vm	VR4	9a	Tor
6871	HT6871CR	LIN-IC	AF PA, BTL, class-D, 2.5..5.5V, 3W(5V/4Q), shutdown	BGA-9	39	-	-	Hrc
69	RP110L121D5	LVR-IC	LDO, 1.25V±1%, 150mA, +CE, CL	DFN1010-4	48vm	VR4	9a	Ric
69	XC6223G1919R-G	LVR-IC	LDO, 1.9V±20mV, 300mA, +CE, PDR, ICP	USPQ-4B03	48vm	VR4	9a	Tor



SMD code	Type	Function	Short description	Case	Pinout	Sch.	St.	Mnf.
6A645	XC6104A645ER	Vdel-IC	4.5V±2%, Hst, ±Reset PPO, Wt=1.6s, Rt=3.13ms	USP-6C	49xq	VD19	9b	Tor
6A646	XC6104A646ER	Vdel-IC	4.6V±2%, Hst, ±Reset PPO, Wt=1.6s, Rt=3.13ms	USP-6C	49xq	VD19	9b	Tor
6A647	XC6104A647ER	Vdel-IC	4.7V±2%, Hst, ±Reset PPO, Wt=1.6s, Rt=3.13ms	USP-6C	49xq	VD19	9b	Tor
6A648	XC6104A648ER	Vdel-IC	4.8V±2%, Hst, ±Reset PPO, Wt=1.6s, Rt=3.13ms	USP-6C	49xq	VD19	9b	Tor
6A649	XC6104A649ER	Vdel-IC	4.9V±2%, Hst, ±Reset PPO, Wt=1.6s, Rt=3.13ms	USP-6C	49xq	VD19	9b	Tor
6A650	XC6104A650ER	Vdel-IC	5.0V±2%, Hst, ±Reset PPO, Wt=1.6s, Rt=3.13ms	USP-6C	49xq	VD19	9b	Tor
6A8	XC9237A08C4R-G	DC-DC-IC	PWM-PWM/PFM, st-dwn, 0.8V±2%, 600mA, 1.2MHz, Vin>2V, LSST	USP-6EL	56dc5	DC1	9a	Tor
6A8	XC9237A08CER	DC-DC-IC	PWM-PWM/PFM, st-dwn, 0.8V±2%, 600mA, 1.2MHz, Vin>2V, LSST	USP-6C	49dc5	DC1	9a	Tor
6A9	XC9237A09C4R-G	DC-DC-IC	PWM-PWM/PFM, st-dwn, 0.9V±2%, 600mA, 1.2MHz, Vin>2V, LSST	USP-6EL	56dc5	DC1	9a	Tor
6A9	XC9237A09CER	DC-DC-IC	PWM-PWM/PFM, st-dwn, 0.9V±2%, 600mA, 1.2MHz, Vin>2V, LSST	USP-6C	49dc5	DC1	9a	Tor
6AL	XC9237A0LC4R-G	DC-DC-IC	PWM-PWM/PFM, st-dwn, 0.85V±2%, 600mA, 1.2MHz, Vin>2V, LSST	USP-6EL	56dc5	DC1	9a	Tor
6AL	XC9237A0LCER	DC-DC-IC	PWM-PWM/PFM, st-dwn, 0.85V±2%, 600mA, 1.2MHz, Vin>2V, LSST	USP-6C	49dc5	DC1	9a	Tor
6AM	XC9237A0MC4R-G	DC-DC-IC	PWM-PWM/PFM, st-dwn, 0.95V±2%, 600mA, 1.2MHz, Vin>2V, LSST	USP-6EL	56dc5	DC1	9a	Tor
6AM	XC9237A0MCER	DC-DC-IC	PWM-PWM/PFM, st-dwn, 0.95V±2%, 600mA, 1.2MHz, Vin>2V, LSST	USP-6C	49dc5	DC1	9a	Tor
6B	RP101K132D	LVR-IC	LDO, LN, +CE, CL, 1.3V±0.8%, 300mA	DFM1612-4B	45vm	VR4	9a	Ric
6B	RP200K331B	LVR-IC	LDO, 3.3V±1.0%, 300mA, +CE, AE(mode)	DFN1212-6	52ht	VR10	9a	Ric
6B	XC6223G2119R-G	LVR-IC	LDO, 2.1V±1%, 300mA, +CE, PDR, ICP	USPQ-4B03	48vm	VR4	9a	Tor
6B	XC6221D19B7R	LVR-IC	LDO, 1.95V±20mV, 200mA, +CE, CL, PDR	USPN-4	58vm	VR4	9a	Tor
6B0	XC9237A10C4R-G	DC-DC-IC	PWM-PWM/PFM, st-dwn, 1.0V±2%, 600mA, 1.2MHz, Vin>2V, LSST	USP-6EL	56dc5	DC1	9a	Tor
6B0	XC9237A10CER	DC-DC-IC	PWM-PWM/PFM, st-dwn, 1.0V±2%, 600mA, 1.2MHz, Vin>2V, LSST	USP-6C	49dc5	DC1	9a	Tor
6B1	XC9237A11C4R-G	DC-DC-IC	PWM-PWM/PFM, st-dwn, 1.1V±2%, 600mA, 1.2MHz, Vin>2V, LSST	USP-6EL	56dc5	DC1	9a	Tor
6B1	XC9237A11CER	DC-DC-IC	PWM-PWM/PFM, st-dwn, 1.1V±2%, 600mA, 1.2MHz, Vin>2V, LSST	USP-6C	49dc5	DC1	9a	Tor
6B2	XC9237A12C4R-G	DC-DC-IC	PWM-PWM/PFM, st-dwn, 1.2V±2%, 600mA, 1.2MHz, Vin>2V, LSST	USP-6EL	56dc5	DC1	9a	Tor
6B2	XC9237A12CER	DC-DC-IC	PWM-PWM/PFM, st-dwn, 1.2V±2%, 600mA, 1.2MHz, Vin>2V, LSST	USP-6C	49dc5	DC1	9a	Tor
6B216	XC6104B216ER	Vdel-IC	1.6V±2%, Hst, ±Reset PPO, Wt=50ms, Rt=25ms	USP-6C	49xq	VD19	9b	Tor
6B217	XC6104B217ER	Vdel-IC	1.7V±2%, Hst, ±Reset PPO, Wt=50ms, Rt=25ms	USP-6C	49xq	VD19	9b	Tor
6B218	XC6104B218ER	Vdel-IC	1.8V±2%, Hst, ±Reset PPO, Wt=50ms, Rt=25ms	USP-6C	49xq	VD19	9b	Tor
6B219	XC6104B219ER	Vdel-IC	1.9V±2%, Hst, ±Reset PPO, Wt=50ms, Rt=25ms	USP-6C	49xq	VD19	9b	Tor
6B220	XC6104B220ER	Vdel-IC	2.0V±2%, Hst, ±Reset PPO, Wt=50ms, Rt=25ms	USP-6C	49xq	VD19	9b	Tor
6B221	XC6104B221ER	Vdel-IC	2.1V±2%, Hst, ±Reset PPO, Wt=50ms, Rt=25ms	USP-6C	49xq	VD19	9b	Tor
6B222	XC6104B222ER	Vdel-IC	2.2V±2%, Hst, ±Reset PPO, Wt=50ms, Rt=25ms	USP-6C	49xq	VD19	9b	Tor
6B223	XC6104B223ER	Vdel-IC	2.3V±2%, Hst, ±Reset PPO, Wt=50ms, Rt=25ms	USP-6C	49xq	VD19	9b	Tor
6B224	XC6104B224ER	Vdel-IC	2.4V±2%, Hst, ±Reset PPO, Wt=50ms, Rt=25ms	USP-6C	49xq	VD19	9b	Tor
6B225	XC6104B225ER	Vdel-IC	2.5V±2%, Hst, ±Reset PPO, Wt=50ms, Rt=25ms	USP-6C	49xq	VD19	9b	Tor
6B226	XC6104B226ER	Vdel-IC	2.6V±2%, Hst, ±Reset PPO, Wt=50ms, Rt=25ms	USP-6C	49xq	VD19	9b	Tor
6B227	XC6104B227ER	Vdel-IC	2.7V±2%, Hst, ±Reset PPO, Wt=50ms, Rt=25ms	USP-6C	49xq	VD19	9b	Tor
6B228	XC6104B228ER	Vdel-IC	2.8V±2%, Hst, ±Reset PPO, Wt=50ms, Rt=25ms	USP-6C	49xq	VD19	9b	Tor
6B229	XC6104B229ER	Vdel-IC	2.9V±2%, Hst, ±Reset PPO, Wt=50ms, Rt=25ms	USP-6C	49xq	VD19	9b	Tor
6B230	XC6104B230ER	Vdel-IC	3.0V±2%, Hst, ±Reset PPO, Wt=50ms, Rt=25ms	USP-6C	49xq	VD19	9b	Tor
6B231	XC6104B231ER	Vdel-IC	3.1V±2%, Hst, ±Reset PPO, Wt=50ms, Rt=25ms	USP-6C	49xq	VD19	9b	Tor
6B232	XC6104B232ER	Vdel-IC	3.2V±2%, Hst, ±Reset PPO, Wt=50ms, Rt=25ms	USP-6C	49xq	VD19	9b	Tor
6B233	XC6104B233ER	Vdel-IC	3.3V±2%, Hst, ±Reset PPO, Wt=50ms, Rt=25ms	USP-6C	49xq	VD19	9b	Tor
6B234	XC6104B234ER	Vdel-IC	3.4V±2%, Hst, ±Reset PPO, Wt=50ms, Rt=25ms	USP-6C	49xq	VD19	9b	Tor
6B235	XC6104B235ER	Vdel-IC	3.5V±2%, Hst, ±Reset PPO, Wt=50ms, Rt=25ms	USP-6C	49xq	VD19	9b	Tor
6B236	XC6104B236ER	Vdel-IC	3.6V±2%, Hst, ±Reset PPO, Wt=50ms, Rt=25ms	USP-6C	49xq	VD19	9b	Tor
6B237	XC6104B237ER	Vdel-IC	3.7V±2%, Hst, ±Reset PPO, Wt=50ms, Rt=25ms	USP-6C	49xq	VD19	9b	Tor
6B238	XC6104B238ER	Vdel-IC	3.8V±2%, Hst, ±Reset PPO, Wt=50ms, Rt=25ms	USP-6C	49xq	VD19	9b	Tor
6B239	XC6104B239ER	Vdel-IC	3.9V±2%, Hst, ±Reset PPO, Wt=50ms, Rt=25ms	USP-6C	49xq	VD19	9b	Tor
6B240	XC6104B240ER	Vdel-IC	4.0V±2%, Hst, ±Reset PPO, Wt=50ms, Rt=25ms	USP-6C	49xq	VD19	9b	Tor
6B241	XC6104B241ER	Vdel-IC	4.1V±2%, Hst, ±Reset PPO, Wt=50ms, Rt=25ms	USP-6C	49xq	VD19	9b	Tor
6B242	XC6104B242ER	Vdel-IC	4.2V±2%, Hst, ±Reset PPO, Wt=50ms, Rt=25ms	USP-6C	49xq	VD19	9b	Tor
6B243	XC6104B243ER	Vdel-IC	4.3V±2%, Hst, ±Reset PPO, Wt=50ms, Rt=25ms	USP-6C	49xq	VD19	9b	Tor
6B244	XC6104B244ER	Vdel-IC	4.4V±2%, Hst, ±Reset PPO, Wt=50ms, Rt=25ms	USP-6C	49xq	VD19	9b	Tor
6B245	XC6104B245ER	Vdel-IC	4.5V±2%, Hst, ±Reset PPO, Wt=50ms, Rt=25ms	USP-6C	49xq	VD19	9b	Tor
6B246	XC6104B246ER	Vdel-IC	4.6V±2%, Hst, ±Reset PPO, Wt=50ms, Rt=25ms	USP-6C	49xq	VD19	9b	Tor
6B247	XC6104B247ER	Vdel-IC	4.7V±2%, Hst, ±Reset PPO, Wt=50ms, Rt=25ms	USP-6C	49xq	VD19	9b	Tor
6B248	XC6104B248ER	Vdel-IC	4.8V±2%, Hst, ±Reset PPO, Wt=50ms, Rt=25ms	USP-6C	49xq	VD19	9b	Tor
6B249	XC6104B249ER	Vdel-IC	4.9V±2%, Hst, ±Reset PPO, Wt=50ms, Rt=25ms	USP-6C	49xq	VD19	9b	Tor
6B250	XC6104B250ER	Vdel-IC	5.0V±2%, Hst, ±Reset PPO, Wt=50ms, Rt=25ms	USP-6C	49xq	VD19	9b	Tor
6B3	XC9237A13C4R-G	DC-DC-IC	PWM-PWM/PFM, st-dwn, 1.3V±2%, 600mA, 1.2MHz, Vin>2V, LSST	USP-6EL	56dc5	DC1	9a	Tor
6B3	XC9237A13CER	DC-DC-IC	PWM-PWM/PFM, st-dwn, 1.3V±2%, 600mA, 1.2MHz, Vin>2V, LSST	USP-6C	49dc5	DC1	9a	Tor
6B316	XC6104B316ER	Vdel-IC	1.6V±2%, Hst, ±Reset PPO, Wt=100ms, Rt=25ms	USP-6C	49xq	VD19	9b	Tor
6B317	XC6104B317ER	Vdel-IC	1.7V±2%, Hst, ±Reset PPO, Wt=100ms, Rt=25ms	USP-6C	49xq	VD19	9b	Tor
6B318	XC6104B318ER	Vdel-IC	1.8V±2%, Hst, ±Reset PPO, Wt=100ms, Rt=25ms	USP-6C	49xq	VD19	9b	Tor
6B319	XC6104B319ER	Vdel-IC	1.9V±2%, Hst, ±Reset PPO, Wt=100ms, Rt=25ms	USP-6C	49xq	VD19	9b	Tor
6B320	XC6104B320ER	Vdel-IC	2.0V±2%, Hst, ±Reset PPO, Wt=100ms, Rt=25ms	USP-6C	49xq	VD19	9b	Tor
6B321	XC6104B321ER	Vdel-IC	2.1V±2%, Hst, ±Reset PPO, Wt=100ms, Rt=25ms	USP-6C	49xq	VD19	9b	Tor
6B322	XC6104B322ER	Vdel-IC	2.2V±2%, Hst, ±Reset PPO, Wt=100ms, Rt=25ms	USP-6C	49xq	VD19	9b	Tor
6B323	XC6104B323ER	Vdel-IC	2.3V±2%, Hst, ±Reset PPO, Wt=100ms, Rt=25ms	USP-6C	49xq	VD19	9b	Tor
6B324	XC6104B324ER	Vdel-IC	2.4V±2%, Hst, ±Reset PPO, Wt=100ms, Rt=25ms	USP-6C	49xq	VD19	9b	Tor



SMD code	Type	Function	Short description	Case	Pinout	Sch.	St.	Mnf.
6B8	XC9237A18CER	DC-DC-IC	PWM-PWM/PPM, st-dwn, 1.8V±2%, 600mA, 1.2MHz, Vin>2V, LSST	USP-6C	49dc5	DC1	9a	Tor
6B9	XC9237A19C4R-G	DC-DC-IC	PWM-PWM/PPM, st-dwn, 1.9V±2%, 600mA, 1.2MHz, Vin>2V, LSST	USP-6EL	56dc5	DC1	9a	Tor
6B9	XC9237A19CER	DC-DC-IC	PWM-PWM/PPM, st-dwn, 1.9V±2%, 600mA, 1.2MHz, Vin>2V, LSST	USP-6C	49dc5	DC1	9a	Tor
6BA	XC9237A1AC4R-G	DC-DC-IC	PWM-PWM/PPM, st-dwn, 1.05V±2%, 600mA, 1.2MHz, Vin>2V, LSST	USP-6EL	56dc5	DC1	9a	Tor
6BA	XC9237A1ACER	DC-DC-IC	PWM-PWM/PPM, st-dwn, 1.05V±2%, 600mA, 1.2MHz, Vin>2V, LSST	USP-6C	49dc5	DC1	9a	Tor
6BB	XC9237A1BC4R-G	DC-DC-IC	PWM-PWM/PPM, st-dwn, 1.15V±2%, 600mA, 1.2MHz, Vin>2V, LSST	USP-6EL	56dc5	DC1	9a	Tor
6BB	XC9237A1BCER	DC-DC-IC	PWM-PWM/PPM, st-dwn, 1.15V±2%, 600mA, 1.2MHz, Vin>2V, LSST	USP-6C	49dc5	DC1	9a	Tor
6BC	XC9237A1CC4R-G	DC-DC-IC	PWM-PWM/PPM, st-dwn, 1.25V±2%, 600mA, 1.2MHz, Vin>2V, LSST	USP-6EL	56dc5	DC1	9a	Tor
6BC	XC9237A1CCER	DC-DC-IC	PWM-PWM/PPM, st-dwn, 1.25V±2%, 600mA, 1.2MHz, Vin>2V, LSST	USP-6C	49dc5	DC1	9a	Tor
6BD	XC9237A1DC4R-G	DC-DC-IC	PWM-PWM/PPM, st-dwn, 1.35V±2%, 600mA, 1.2MHz, Vin>2V, LSST	USP-6EL	56dc5	DC1	9a	Tor
6BD	XC9237A1DCER	DC-DC-IC	PWM-PWM/PPM, st-dwn, 1.35V±2%, 600mA, 1.2MHz, Vin>2V, LSST	USP-6C	49dc5	DC1	9a	Tor
6BE	XC9237A1EC4R-G	DC-DC-IC	PWM-PWM/PPM, st-dwn, 1.45V±2%, 600mA, 1.2MHz, Vin>2V, LSST	USP-6EL	56dc5	DC1	9a	Tor
6BE	XC9237A1ECER	DC-DC-IC	PWM-PWM/PPM, st-dwn, 1.45V±2%, 600mA, 1.2MHz, Vin>2V, LSST	USP-6C	49dc5	DC1	9a	Tor
6BF	XC9237A1FC4R-G	DC-DC-IC	PWM-PWM/PPM, st-dwn, 1.55V±2%, 600mA, 1.2MHz, Vin>2V, LSST	USP-6EL	56dc5	DC1	9a	Tor
6BF	XC9237A1FCER	DC-DC-IC	PWM-PWM/PPM, st-dwn, 1.55V±2%, 600mA, 1.2MHz, Vin>2V, LSST	USP-6C	49dc5	DC1	9a	Tor
6BH	XC9237A1HC4R-G	DC-DC-IC	PWM-PWM/PPM, st-dwn, 1.65V±2%, 600mA, 1.2MHz, Vin>2V, LSST	USP-6EL	56dc5	DC1	9a	Tor
6BH	XC9237A1HCER	DC-DC-IC	PWM-PWM/PPM, st-dwn, 1.65V±2%, 600mA, 1.2MHz, Vin>2V, LSST	USP-6C	49dc5	DC1	9a	Tor
6BK	XC9237A1KC4R-G	DC-DC-IC	PWM-PWM/PPM, st-dwn, 1.75V±2%, 600mA, 1.2MHz, Vin>2V, LSST	USP-6EL	56dc5	DC1	9a	Tor
6BK	XC9237A1KCER	DC-DC-IC	PWM-PWM/PPM, st-dwn, 1.75V±2%, 600mA, 1.2MHz, Vin>2V, LSST	USP-6C	49dc5	DC1	9a	Tor
6BL	XC9237A1LC4R-G	DC-DC-IC	PWM-PWM/PPM, st-dwn, 1.85V±2%, 600mA, 1.2MHz, Vin>2V, LSST	USP-6EL	56dc5	DC1	9a	Tor
6BL	XC9237A1LCER	DC-DC-IC	PWM-PWM/PPM, st-dwn, 1.85V±2%, 600mA, 1.2MHz, Vin>2V, LSST	USP-6C	49dc5	DC1	9a	Tor
6BM	XC9237A1MC4R-G	DC-DC-IC	PWM-PWM/PPM, st-dwn, 1.95V±2%, 600mA, 1.2MHz, Vin>2V, LSST	USP-6EL	56dc5	DC1	9a	Tor
6BM	XC9237A1MCER	DC-DC-IC	PWM-PWM/PPM, st-dwn, 1.95V±2%, 600mA, 1.2MHz, Vin>2V, LSST	USP-6C	49dc5	DC1	9a	Tor
6C	RP10K1152D	LVR-IC	LDO, LN, +CE, CL, 1.5V±0.8%, 300mA	DFN1612-4B	45vm	VR4	9a	Ric
6C	RP20K0341B	LVR-IC	LDO, 3.4V±1.0%, 300mA, +CE, AE(mode)	DFN1212-6	52ht	VR10	9a	Ric
6C	XC6223G2219R-G	LVR-IC	LDO, 2.2V±1%, 300mA, +CE, PDR, ICP	USPQ-4B03	48vm	VR4	9a	Tor
6C	XC6221D20B7R	LVR-IC	LDO, 2.05V±1%, 200mA, +CE, CL, PDR	USPN-4	58vm	VR4	9a	Tor
6C0	XC9237A20C4R-G	DC-DC-IC	PWM-PWM/PPM, st-dwn, 2.0V±2%, 600mA, 1.2MHz, Vin>2V, LSST	USP-6EL	56dc5	DC1	9a	Tor
6C0	XC9237A20CER	DC-DC-IC	PWM-PWM/PPM, st-dwn, 2.0V±2%, 600mA, 1.2MHz, Vin>2V, LSST	USP-6C	49dc5	DC1	9a	Tor
6C1	XC9237A21C4R-G	DC-DC-IC	PWM-PWM/PPM, st-dwn, 2.1V±2%, 600mA, 1.2MHz, Vin>2V, LSST	USP-6EL	56dc5	DC1	9a	Tor
6C1	XC9237A21CER	DC-DC-IC	PWM-PWM/PPM, st-dwn, 2.1V±2%, 600mA, 1.2MHz, Vin>2V, LSST	USP-6C	49dc5	DC1	9a	Tor
6C2	XC9237A22C4R-G	DC-DC-IC	PWM-PWM/PPM, st-dwn, 2.2V±2%, 600mA, 1.2MHz, Vin>2V, LSST	USP-6EL	56dc5	DC1	9a	Tor
6C2	XC9237A22CER	DC-DC-IC	PWM-PWM/PPM, st-dwn, 2.2V±2%, 600mA, 1.2MHz, Vin>2V, LSST	USP-6C	49dc5	DC1	9a	Tor
6C216	XC6104C216ER	Vdet-IC	1.6V±2%, Hst, ±Reset PPO, Wt=50ms, Rt=50ms	USP-6C	49xq	VD19	9b	Tor
6C217	XC6104C217ER	Vdet-IC	1.7V±2%, Hst, ±Reset PPO, Wt=50ms, Rt=50ms	USP-6C	49xq	VD19	9b	Tor
6C218	XC6104C218ER	Vdet-IC	1.8V±2%, Hst, ±Reset PPO, Wt=50ms, Rt=50ms	USP-6C	49xq	VD19	9b	Tor
6C219	XC6104C219ER	Vdet-IC	1.9V±2%, Hst, ±Reset PPO, Wt=50ms, Rt=50ms	USP-6C	49xq	VD19	9b	Tor
6C220	XC6104C220ER	Vdet-IC	2.0V±2%, Hst, ±Reset PPO, Wt=50ms, Rt=50ms	USP-6C	49xq	VD19	9b	Tor
6C221	XC6104C221ER	Vdet-IC	2.1V±2%, Hst, ±Reset PPO, Wt=50ms, Rt=50ms	USP-6C	49xq	VD19	9b	Tor
6C222	XC6104C222ER	Vdet-IC	2.2V±2%, Hst, ±Reset PPO, Wt=50ms, Rt=50ms	USP-6C	49xq	VD19	9b	Tor
6C223	XC6104C223ER	Vdet-IC	2.3V±2%, Hst, ±Reset PPO, Wt=50ms, Rt=50ms	USP-6C	49xq	VD19	9b	Tor
6C224	XC6104C224ER	Vdet-IC	2.4V±2%, Hst, ±Reset PPO, Wt=50ms, Rt=50ms	USP-6C	49xq	VD19	9b	Tor
6C225	XC6104C225ER	Vdet-IC	2.5V±2%, Hst, ±Reset PPO, Wt=50ms, Rt=50ms	USP-6C	49xq	VD19	9b	Tor
6C226	XC6104C226ER	Vdet-IC	2.6V±2%, Hst, ±Reset PPO, Wt=50ms, Rt=50ms	USP-6C	49xq	VD19	9b	Tor
6C227	XC6104C227ER	Vdet-IC	2.7V±2%, Hst, ±Reset PPO, Wt=50ms, Rt=50ms	USP-6C	49xq	VD19	9b	Tor
6C228	XC6104C228ER	Vdet-IC	2.8V±2%, Hst, ±Reset PPO, Wt=50ms, Rt=50ms	USP-6C	49xq	VD19	9b	Tor
6C229	XC6104C229ER	Vdet-IC	2.9V±2%, Hst, ±Reset PPO, Wt=50ms, Rt=50ms	USP-6C	49xq	VD19	9b	Tor
6C230	XC6104C230ER	Vdet-IC	3.0V±2%, Hst, ±Reset PPO, Wt=50ms, Rt=50ms	USP-6C	49xq	VD19	9b	Tor
6C231	XC6104C231ER	Vdet-IC	3.1V±2%, Hst, ±Reset PPO, Wt=50ms, Rt=50ms	USP-6C	49xq	VD19	9b	Tor
6C232	XC6104C232ER	Vdet-IC	3.2V±2%, Hst, ±Reset PPO, Wt=50ms, Rt=50ms	USP-6C	49xq	VD19	9b	Tor
6C233	XC6104C233ER	Vdet-IC	3.3V±2%, Hst, ±Reset PPO, Wt=50ms, Rt=50ms	USP-6C	49xq	VD19	9b	Tor
6C234	XC6104C234ER	Vdet-IC	3.4V±2%, Hst, ±Reset PPO, Wt=50ms, Rt=50ms	USP-6C	49xq	VD19	9b	Tor
6C235	XC6104C235ER	Vdet-IC	3.5V±2%, Hst, ±Reset PPO, Wt=50ms, Rt=50ms	USP-6C	49xq	VD19	9b	Tor
6C236	XC6104C236ER	Vdet-IC	3.6V±2%, Hst, ±Reset PPO, Wt=50ms, Rt=50ms	USP-6C	49xq	VD19	9b	Tor
6C237	XC6104C237ER	Vdet-IC	3.7V±2%, Hst, ±Reset PPO, Wt=50ms, Rt=50ms	USP-6C	49xq	VD19	9b	Tor
6C238	XC6104C238ER	Vdet-IC	3.8V±2%, Hst, ±Reset PPO, Wt=50ms, Rt=50ms	USP-6C	49xq	VD19	9b	Tor
6C239	XC6104C239ER	Vdet-IC	3.9V±2%, Hst, ±Reset PPO, Wt=50ms, Rt=50ms	USP-6C	49xq	VD19	9b	Tor
6C240	XC6104C240ER	Vdet-IC	4.0V±2%, Hst, ±Reset PPO, Wt=50ms, Rt=50ms	USP-6C	49xq	VD19	9b	Tor
6C241	XC6104C241ER	Vdet-IC	4.1V±2%, Hst, ±Reset PPO, Wt=50ms, Rt=50ms	USP-6C	49xq	VD19	9b	Tor
6C242	XC6104C242ER	Vdet-IC	4.2V±2%, Hst, ±Reset PPO, Wt=50ms, Rt=50ms	USP-6C	49xq	VD19	9b	Tor
6C243	XC6104C243ER	Vdet-IC	4.3V±2%, Hst, ±Reset PPO, Wt=50ms, Rt=50ms	USP-6C	49xq	VD19	9b	Tor
6C244	XC6104C244ER	Vdet-IC	4.4V±2%, Hst, ±Reset PPO, Wt=50ms, Rt=50ms	USP-6C	49xq	VD19	9b	Tor
6C245	XC6104C245ER	Vdet-IC	4.5V±2%, Hst, ±Reset PPO, Wt=50ms, Rt=50ms	USP-6C	49xq	VD19	9b	Tor
6C246	XC6104C246ER	Vdet-IC	4.6V±2%, Hst, ±Reset PPO, Wt=50ms, Rt=50ms	USP-6C	49xq	VD19	9b	Tor
6C247	XC6104C247ER	Vdet-IC	4.7V±2%, Hst, ±Reset PPO, Wt=50ms, Rt=50ms	USP-6C	49xq	VD19	9b	Tor
6C248	XC6104C248ER	Vdet-IC	4.8V±2%, Hst, ±Reset PPO, Wt=50ms, Rt=50ms	USP-6C	49xq	VD19	9b	Tor
6C249	XC6104C249ER	Vdet-IC	4.9V±2%, Hst, ±Reset PPO, Wt=50ms, Rt=50ms	USP-6C	49xq	VD19	9b	Tor
6C250	XC6104C250ER	Vdet-IC	5.0V±2%, Hst, ±Reset PPO, Wt=50ms, Rt=50ms	USP-6C	49xq	VD19	9b	Tor
6C3	XC9237A23C4R-G	DC-DC-IC	PWM-PWM/PPM, st-dwn, 2.3V±2%, 600mA, 1.2MHz, Vin>2V, LSST	USP-6EL	56dc5	DC1	9a	Tor
6C3	XC9237A23CER	DC-DC-IC	PWM-PWM/PPM, st-dwn, 2.3V±2%, 600mA, 1.2MHz, Vin>2V, LSST	USP-6C	49dc5	DC1	9a	Tor



SMD code	Type	Function	Short description	Case	Pinout	Sch.	St.Mnf.
6C645	XC6104C645ER	Vdet-IC	4.5V±2%, Hst, ±Reset PPO, Wt=1.6s, Rt=50ms	USP-6C	49xq	VD19	9b Tor
6C646	XC6104C646ER	Vdet-IC	4.6V±2%, Hst, ±Reset PPO, Wt=1.6s, Rt=50ms	USP-6C	49xq	VD19	9b Tor
6C647	XC6104C647ER	Vdet-IC	4.7V±2%, Hst, ±Reset PPO, Wt=1.6s, Rt=50ms	USP-6C	49xq	VD19	9b Tor
6C648	XC6104C648ER	Vdet-IC	4.8V±2%, Hst, ±Reset PPO, Wt=1.6s, Rt=50ms	USP-6C	49xq	VD19	9b Tor
6C649	XC6104C649ER	Vdet-IC	4.9V±2%, Hst, ±Reset PPO, Wt=1.6s, Rt=50ms	USP-6C	49xq	VD19	9b Tor
6C650	XC6104C650ER	Vdet-IC	5.0V±2%, Hst, ±Reset PPO, Wt=1.6s, Rt=50ms	USP-6C	49xq	VD19	9b Tor
6C7	XC9237A274R-G	DC-DC-IC	PWM-PWM/PPM, st-dwn, 2.7V±2%, 600mA, 1.2MHz, Vin>2V, LSST	USP-6EL	56dc5	DC1	9a Tor
6C7	XC9237A27CER	DC-DC-IC	PWM-PWM/PPM, st-dwn, 2.7V±2%, 600mA, 1.2MHz, Vin>2V, LSST	USP-6C	49dc5	DC1	9a Tor
6C8	XC9237A28C4R-G	DC-DC-IC	PWM-PWM/PPM, st-dwn, 2.8V±2%, 600mA, 1.2MHz, Vin>2V, LSST	USP-6EL	56dc5	DC1	9a Tor
6C8	XC9237A28CER	DC-DC-IC	PWM-PWM/PPM, st-dwn, 2.8V±2%, 600mA, 1.2MHz, Vin>2V, LSST	USP-6C	49dc5	DC1	9a Tor
6C9	XC9237A29C4R-G	DC-DC-IC	PWM-PWM/PPM, st-dwn, 2.9V±2%, 600mA, 1.2MHz, Vin>2V, LSST	USP-6EL	56dc5	DC1	9a Tor
6C9	XC9237A29CER	DC-DC-IC	PWM-PWM/PPM, st-dwn, 2.9V±2%, 600mA, 1.2MHz, Vin>2V, LSST	USP-6C	49dc5	DC1	9a Tor
6CA	XC9237A2AC4R-G	DC-DC-IC	PWM-PWM/PPM, st-dwn, 2.05V±2%, 600mA, 1.2MHz, Vin>2V, LSST	USP-6EL	56dc5	DC1	9a Tor
6CA	XC9237A2ACER	DC-DC-IC	PWM-PWM/PPM, st-dwn, 2.05V±2%, 600mA, 1.2MHz, Vin>2V, LSST	USP-6C	49dc5	DC1	9a Tor
6CB	XC9237A2BC4R-G	DC-DC-IC	PWM-PWM/PPM, st-dwn, 2.15V±2%, 600mA, 1.2MHz, Vin>2V, LSST	USP-6EL	56dc5	DC1	9a Tor
6CB	XC9237A2BCER	DC-DC-IC	PWM-PWM/PPM, st-dwn, 2.15V±2%, 600mA, 1.2MHz, Vin>2V, LSST	USP-6C	49dc5	DC1	9a Tor
6CC	XC9237A2CC4R-G	DC-DC-IC	PWM-PWM/PPM, st-dwn, 2.25V±2%, 600mA, 1.2MHz, Vin>2V, LSST	USP-6EL	56dc5	DC1	9a Tor
6CC	XC9237A2CCER	DC-DC-IC	PWM-PWM/PPM, st-dwn, 2.25V±2%, 600mA, 1.2MHz, Vin>2V, LSST	USP-6C	49dc5	DC1	9a Tor
6CD	XC9237A2DC4R-G	DC-DC-IC	PWM-PWM/PPM, st-dwn, 2.35V±2%, 600mA, 1.2MHz, Vin>2V, LSST	USP-6EL	56dc5	DC1	9a Tor
6CD	XC9237A2DCER	DC-DC-IC	PWM-PWM/PPM, st-dwn, 2.35V±2%, 600mA, 1.2MHz, Vin>2V, LSST	USP-6C	49dc5	DC1	9a Tor
6CE	XC9237A2EC4R-G	DC-DC-IC	PWM-PWM/PPM, st-dwn, 2.45V±2%, 600mA, 1.2MHz, Vin>2V, LSST	USP-6EL	56dc5	DC1	9a Tor
6CE	XC9237A2ECER	DC-DC-IC	PWM-PWM/PPM, st-dwn, 2.45V±2%, 600mA, 1.2MHz, Vin>2V, LSST	USP-6C	49dc5	DC1	9a Tor
6CF	XC9237A2FC4R-G	DC-DC-IC	PWM-PWM/PPM, st-dwn, 2.55V±2%, 600mA, 1.2MHz, Vin>2V, LSST	USP-6EL	56dc5	DC1	9a Tor
6CF	XC9237A2FCER	DC-DC-IC	PWM-PWM/PPM, st-dwn, 2.55V±2%, 600mA, 1.2MHz, Vin>2V, LSST	USP-6C	49dc5	DC1	9a Tor
6CH	XC9237A2HC4R-G	DC-DC-IC	PWM-PWM/PPM, st-dwn, 2.65V±2%, 600mA, 1.2MHz, Vin>2V, LSST	USP-6EL	56dc5	DC1	9a Tor
6CH	XC9237A2HCER	DC-DC-IC	PWM-PWM/PPM, st-dwn, 2.65V±2%, 600mA, 1.2MHz, Vin>2V, LSST	USP-6C	49dc5	DC1	9a Tor
6CK	XC9237A2KC4R-G	DC-DC-IC	PWM-PWM/PPM, st-dwn, 2.75V±2%, 600mA, 1.2MHz, Vin>2V, LSST	USP-6EL	56dc5	DC1	9a Tor
6CK	XC9237A2KCER	DC-DC-IC	PWM-PWM/PPM, st-dwn, 2.75V±2%, 600mA, 1.2MHz, Vin>2V, LSST	USP-6C	49dc5	DC1	9a Tor
6CL	XC9237A2LC4R-G	DC-DC-IC	PWM-PWM/PPM, st-dwn, 2.85V±2%, 600mA, 1.2MHz, Vin>2V, LSST	USP-6EL	56dc5	DC1	9a Tor
6CL	XC9237A2LCER	DC-DC-IC	PWM-PWM/PPM, st-dwn, 2.85V±2%, 600mA, 1.2MHz, Vin>2V, LSST	USP-6C	49dc5	DC1	9a Tor
6CM	XC9237A2MC4R-G	DC-DC-IC	PWM-PWM/PPM, st-dwn, 2.95V±2%, 600mA, 1.2MHz, Vin>2V, LSST	USP-6EL	56dc5	DC1	9a Tor
6CM	XC9237A2MCER	DC-DC-IC	PWM-PWM/PPM, st-dwn, 2.95V±2%, 600mA, 1.2MHz, Vin>2V, LSST	USP-6C	49dc5	DC1	9a Tor
6D	RP101K182D	LVR-IC	LDO, LN, +CE, CL, 1.8V±0.8%, 300mA	DFN1612-4B	45um	VR4	9a Ric
6D	RP200K351B	LVR-IC	LDO, 3.5V±1.0%, 300mA, +CE, AE(mode)	DFN1212-6	52ht	VR10	9a Ric
6D	XC6223G2319R-G	LVR-IC	LDO, 2.3V±1%, 300mA, +CE, PDR, ICP	USPQ-4B03	48vm	VR4	9a Tor
6D	XC6221D21B7R	LVR-IC	LDO, 2.15V±1%, 200mA, +CE, CL, PDR	USPN-4	58vm	VR4	9a Tor
6D0	XC9237A30C4R-G	DC-DC-IC	PWM-PWM/PPM, st-dwn, 3.0V±2%, 600mA, 1.2MHz, Vin>2V, LSST	USP-6EL	56dc5	DC1	9a Tor
6D0	XC9237A30CER	DC-DC-IC	PWM-PWM/PPM, st-dwn, 3.0V±2%, 600mA, 1.2MHz, Vin>2V, LSST	USP-6C	49dc5	DC1	9a Tor
6D1	XC9237A31C4R-G	DC-DC-IC	PWM-PWM/PPM, st-dwn, 3.1V±2%, 600mA, 1.2MHz, Vin>2V, LSST	USP-6EL	56dc5	DC1	9a Tor
6D1	XC9237A31CER	DC-DC-IC	PWM-PWM/PPM, st-dwn, 3.1V±2%, 600mA, 1.2MHz, Vin>2V, LSST	USP-6C	49dc5	DC1	9a Tor
6D2	XC9237A32C4R-G	DC-DC-IC	PWM-PWM/PPM, st-dwn, 3.2V±2%, 600mA, 1.2MHz, Vin>2V, LSST	USP-6EL	56dc5	DC1	9a Tor
6D2	XC9237A32CER	DC-DC-IC	PWM-PWM/PPM, st-dwn, 3.2V±2%, 600mA, 1.2MHz, Vin>2V, LSST	USP-6C	49dc5	DC1	9a Tor
6D3	XC9237A33C4R-G	DC-DC-IC	PWM-PWM/PPM, st-dwn, 3.3V±2%, 600mA, 1.2MHz, Vin>2V, LSST	USP-6EL	56dc5	DC1	9a Tor
6D3	XC9237A33CER	DC-DC-IC	PWM-PWM/PPM, st-dwn, 3.3V±2%, 600mA, 1.2MHz, Vin>2V, LSST	USP-6C	49dc5	DC1	9a Tor
6D316	XC6104D316ER	Vdet-IC	1.6V±2%, Hst, ±Reset PPO, Wt=100ms, Rt=100ms	USP-6C	49xq	VD19	9b Tor
6D317	XC6104D317ER	Vdet-IC	1.7V±2%, Hst, ±Reset PPO, Wt=100ms, Rt=100ms	USP-6C	49xq	VD19	9b Tor
6D318	XC6104D318ER	Vdet-IC	1.8V±2%, Hst, ±Reset PPO, Wt=100ms, Rt=100ms	USP-6C	49xq	VD19	9b Tor
6D319	XC6104D319ER	Vdet-IC	1.9V±2%, Hst, ±Reset PPO, Wt=100ms, Rt=100ms	USP-6C	49xq	VD19	9b Tor
6D320	XC6104D320ER	Vdet-IC	2.0V±2%, Hst, ±Reset PPO, Wt=100ms, Rt=100ms	USP-6C	49xq	VD19	9b Tor
6D321	XC6104D321ER	Vdet-IC	2.1V±2%, Hst, ±Reset PPO, Wt=100ms, Rt=100ms	USP-6C	49xq	VD19	9b Tor
6D322	XC6104D322ER	Vdet-IC	2.2V±2%, Hst, ±Reset PPO, Wt=100ms, Rt=100ms	USP-6C	49xq	VD19	9b Tor
6D323	XC6104D323ER	Vdet-IC	2.3V±2%, Hst, ±Reset PPO, Wt=100ms, Rt=100ms	USP-6C	49xq	VD19	9b Tor
6D324	XC6104D324ER	Vdet-IC	2.4V±2%, Hst, ±Reset PPO, Wt=100ms, Rt=100ms	USP-6C	49xq	VD19	9b Tor
6D325	XC6104D325ER	Vdet-IC	2.5V±2%, Hst, ±Reset PPO, Wt=100ms, Rt=100ms	USP-6C	49xq	VD19	9b Tor
6D326	XC6104D326ER	Vdet-IC	2.6V±2%, Hst, ±Reset PPO, Wt=100ms, Rt=100ms	USP-6C	49xq	VD19	9b Tor
6D327	XC6104D327ER	Vdet-IC	2.7V±2%, Hst, ±Reset PPO, Wt=100ms, Rt=100ms	USP-6C	49xq	VD19	9b Tor
6D328	XC6104D328ER	Vdet-IC	2.8V±2%, Hst, ±Reset PPO, Wt=100ms, Rt=100ms	USP-6C	49xq	VD19	9b Tor
6D329	XC6104D329ER	Vdet-IC	2.9V±2%, Hst, ±Reset PPO, Wt=100ms, Rt=100ms	USP-6C	49xq	VD19	9b Tor
6D330	XC6104D330ER	Vdet-IC	3.0V±2%, Hst, ±Reset PPO, Wt=100ms, Rt=100ms	USP-6C	49xq	VD19	9b Tor
6D331	XC6104D331ER	Vdet-IC	3.1V±2%, Hst, ±Reset PPO, Wt=100ms, Rt=100ms	USP-6C	49xq	VD19	9b Tor
6D332	XC6104D332ER	Vdet-IC	3.2V±2%, Hst, ±Reset PPO, Wt=100ms, Rt=100ms	USP-6C	49xq	VD19	9b Tor
6D333	XC6104D333ER	Vdet-IC	3.3V±2%, Hst, ±Reset PPO, Wt=100ms, Rt=100ms	USP-6C	49xq	VD19	9b Tor
6D334	XC6104D334ER	Vdet-IC	3.4V±2%, Hst, ±Reset PPO, Wt=100ms, Rt=100ms	USP-6C	49xq	VD19	9b Tor
6D335	XC6104D335ER	Vdet-IC	3.5V±2%, Hst, ±Reset PPO, Wt=100ms, Rt=100ms	USP-6C	49xq	VD19	9b Tor
6D336	XC6104D336ER	Vdet-IC	3.6V±2%, Hst, ±Reset PPO, Wt=100ms, Rt=100ms	USP-6C	49xq	VD19	9b Tor
6D337	XC6104D337ER	Vdet-IC	3.7V±2%, Hst, ±Reset PPO, Wt=100ms, Rt=100ms	USP-6C	49xq	VD19	9b Tor
6D338	XC6104D338ER	Vdet-IC	3.8V±2%, Hst, ±Reset PPO, Wt=100ms, Rt=100ms	USP-6C	49xq	VD19	9b Tor
6D339	XC6104D339ER	Vdet-IC	3.9V±2%, Hst, ±Reset PPO, Wt=100ms, Rt=100ms	USP-6C	49xq	VD19	9b Tor
6D340	XC6104D340ER	Vdet-IC	4.0V±2%, Hst, ±Reset PPO, Wt=100ms, Rt=100ms	USP-6C	49xq	VD19	9b Tor
6D341	XC6104D341ER	Vdet-IC	4.1V±2%, Hst, ±Reset PPO, Wt=100ms, Rt=100ms	USP-6C	49xq	VD19	9b Tor



SMD code	Type	Function	Short description	Case	Pinout	Sch.	St.	Mnf.
6DK	XC9237A3KC4R-G	DC-DC-IC	PWM-PWM/PPM, st-dwn, 3.75V±2%, 600mA, 1.2MHz, Vin>2V, LSST	USP-6EL	56dc5	DC1	9a	Tor
6DK	XC9237A3KCER	DC-DC-IC	PWM-PWM/PPM, st-dwn, 3.75V±2%, 600mA, 1.2MHz, Vin>2V, LSST	USP-6C	49dc5	DC1	9a	Tor
6DL	XC9237A3LC4R-G	DC-DC-IC	PWM-PWM/PPM, st-dwn, 3.85V±2%, 600mA, 1.2MHz, Vin>2V, LSST	USP-6EL	56dc5	DC1	9a	Tor
6DL	XC9237A3LCER	DC-DC-IC	PWM-PWM/PPM, st-dwn, 3.85V±2%, 600mA, 1.2MHz, Vin>2V, LSST	USP-6C	49dc5	DC1	9a	Tor
6DM	XC9237A3MC4R-G	DC-DC-IC	PWM-PWM/PPM, st-dwn, 3.95V±2%, 600mA, 1.2MHz, Vin>2V, LSST	USP-6EL	56dc5	DC1	9a	Tor
6DM	XC9237A3MCER	DC-DC-IC	PWM-PWM/PPM, st-dwn, 3.95V±2%, 600mA, 1.2MHz, Vin>2V, LSST	USP-6C	49dc5	DC1	9a	Tor
6E	RP101K182D5	LVR-IC	LDO, L _N , +CE, CL, 1.85V±0.8%, 300mA	DFN1612-4B	45vm	VR4	9a	Ric
6E	RP200K361B	LVR-IC	LDO, 3.6V±1.0%, 300mA, +CE, AE(mode)	DFN1212-6	52ht	VR10	9a	Ric
6E	XC6223G2419R-G	LVR-IC	LDO, 2.4V±1%, 300mA, +CE, PDR, ICP	USPQ-4B03	48vm	VR4	9a	Tor
6E	XC6221D22B7R	LVR-IC	LDO, 2.25V±1%, 200mA, +CE, CL, PDR	USPN-4	58vm	VR4	9a	Tor
6E0	XC9237A40C4R-G	DC-DC-IC	PWM-PWM/PPM, st-dwn, 4.0V±2%, 600mA, 1.2MHz, Vin>2V, LSST	USP-6EL	56dc5	DC1	9a	Tor
6E0	XC9237A40CER	DC-DC-IC	PWM-PWM/PPM, st-dwn, 4.0V±2%, 600mA, 1.2MHz, Vin>2V, LSST	USP-6C	49dc5	DC1	9a	Tor
6E416	XC6104E416ER	Vdet-IC	1.6V±2%, Hst, ±Reset PPO, Wt=200ms, Rt=200ms	USP-6C	49xq	VD19	9b	Tor
6E417	XC6104E417ER	Vdet-IC	1.7V±2%, Hst, ±Reset PPO, Wt=200ms, Rt=200ms	USP-6C	49xq	VD19	9b	Tor
6E418	XC6104E418ER	Vdet-IC	1.8V±2%, Hst, ±Reset PPO, Wt=200ms, Rt=200ms	USP-6C	49xq	VD19	9b	Tor
6E419	XC6104E419ER	Vdet-IC	1.9V±2%, Hst, ±Reset PPO, Wt=200ms, Rt=200ms	USP-6C	49xq	VD19	9b	Tor
6E420	XC6104E420ER	Vdet-IC	2.0V±2%, Hst, ±Reset PPO, Wt=200ms, Rt=200ms	USP-6C	49xq	VD19	9b	Tor
6E421	XC6104E421ER	Vdet-IC	2.1V±2%, Hst, ±Reset PPO, Wt=200ms, Rt=200ms	USP-6C	49xq	VD19	9b	Tor
6E422	XC6104E422ER	Vdet-IC	2.2V±2%, Hst, ±Reset PPO, Wt=200ms, Rt=200ms	USP-6C	49xq	VD19	9b	Tor
6E423	XC6104E423ER	Vdet-IC	2.3V±2%, Hst, ±Reset PPO, Wt=200ms, Rt=200ms	USP-6C	49xq	VD19	9b	Tor
6E424	XC6104E424ER	Vdet-IC	2.4V±2%, Hst, ±Reset PPO, Wt=200ms, Rt=200ms	USP-6C	49xq	VD19	9b	Tor
6E425	XC6104E425ER	Vdet-IC	2.5V±2%, Hst, ±Reset PPO, Wt=200ms, Rt=200ms	USP-6C	49xq	VD19	9b	Tor
6E426	XC6104E426ER	Vdet-IC	2.6V±2%, Hst, ±Reset PPO, Wt=200ms, Rt=200ms	USP-6C	49xq	VD19	9b	Tor
6E427	XC6104E427ER	Vdet-IC	2.7V±2%, Hst, ±Reset PPO, Wt=200ms, Rt=200ms	USP-6C	49xq	VD19	9b	Tor
6E428	XC6104E428ER	Vdet-IC	2.8V±2%, Hst, ±Reset PPO, Wt=200ms, Rt=200ms	USP-6C	49xq	VD19	9b	Tor
6E429	XC6104E429ER	Vdet-IC	2.9V±2%, Hst, ±Reset PPO, Wt=200ms, Rt=200ms	USP-6C	49xq	VD19	9b	Tor
6E430	XC6104E430ER	Vdet-IC	3.0V±2%, Hst, ±Reset PPO, Wt=200ms, Rt=200ms	USP-6C	49xq	VD19	9b	Tor
6E431	XC6104E431ER	Vdet-IC	3.1V±2%, Hst, ±Reset PPO, Wt=200ms, Rt=200ms	USP-6C	49xq	VD19	9b	Tor
6E432	XC6104E432ER	Vdet-IC	3.2V±2%, Hst, ±Reset PPO, Wt=200ms, Rt=200ms	USP-6C	49xq	VD19	9b	Tor
6E433	XC6104E433ER	Vdet-IC	3.3V±2%, Hst, ±Reset PPO, Wt=200ms, Rt=200ms	USP-6C	49xq	VD19	9b	Tor
6E434	XC6104E434ER	Vdet-IC	3.4V±2%, Hst, ±Reset PPO, Wt=200ms, Rt=200ms	USP-6C	49xq	VD19	9b	Tor
6E435	XC6104E435ER	Vdet-IC	3.5V±2%, Hst, ±Reset PPO, Wt=200ms, Rt=200ms	USP-6C	49xq	VD19	9b	Tor
6E436	XC6104E436ER	Vdet-IC	3.6V±2%, Hst, ±Reset PPO, Wt=200ms, Rt=200ms	USP-6C	49xq	VD19	9b	Tor
6E437	XC6104E437ER	Vdet-IC	3.7V±2%, Hst, ±Reset PPO, Wt=200ms, Rt=200ms	USP-6C	49xq	VD19	9b	Tor
6E438	XC6104E438ER	Vdet-IC	3.8V±2%, Hst, ±Reset PPO, Wt=200ms, Rt=200ms	USP-6C	49xq	VD19	9b	Tor
6E439	XC6104E439ER	Vdet-IC	3.9V±2%, Hst, ±Reset PPO, Wt=200ms, Rt=200ms	USP-6C	49xq	VD19	9b	Tor
6E440	XC6104E440ER	Vdet-IC	4.0V±2%, Hst, ±Reset PPO, Wt=200ms, Rt=200ms	USP-6C	49xq	VD19	9b	Tor
6E441	XC6104E441ER	Vdet-IC	4.1V±2%, Hst, ±Reset PPO, Wt=200ms, Rt=200ms	USP-6C	49xq	VD19	9b	Tor
6E442	XC6104E442ER	Vdet-IC	4.2V±2%, Hst, ±Reset PPO, Wt=200ms, Rt=200ms	USP-6C	49xq	VD19	9b	Tor
6E443	XC6104E443ER	Vdet-IC	4.3V±2%, Hst, ±Reset PPO, Wt=200ms, Rt=200ms	USP-6C	49xq	VD19	9b	Tor
6E444	XC6104E444ER	Vdet-IC	4.4V±2%, Hst, ±Reset PPO, Wt=200ms, Rt=200ms	USP-6C	49xq	VD19	9b	Tor
6E445	XC6104E445ER	Vdet-IC	4.5V±2%, Hst, ±Reset PPO, Wt=200ms, Rt=200ms	USP-6C	49xq	VD19	9b	Tor
6E446	XC6104E446ER	Vdet-IC	4.6V±2%, Hst, ±Reset PPO, Wt=200ms, Rt=200ms	USP-6C	49xq	VD19	9b	Tor
6E447	XC6104E447ER	Vdet-IC	4.7V±2%, Hst, ±Reset PPO, Wt=200ms, Rt=200ms	USP-6C	49xq	VD19	9b	Tor
6E448	XC6104E448ER	Vdet-IC	4.8V±2%, Hst, ±Reset PPO, Wt=200ms, Rt=200ms	USP-6C	49xq	VD19	9b	Tor
6E449	XC6104E449ER	Vdet-IC	4.9V±2%, Hst, ±Reset PPO, Wt=200ms, Rt=200ms	USP-6C	49xq	VD19	9b	Tor
6E450	XC6104E450ER	Vdet-IC	5.0V±2%, Hst, ±Reset PPO, Wt=200ms, Rt=200ms	USP-6C	49xq	VD19	9b	Tor
6E516	XC6104E516ER	Vdet-IC	1.6V±2%, Hst, ±Reset PPO, Wt=400ms, Rt=200ms	USP-6C	49xq	VD19	9b	Tor
6E517	XC6104E517ER	Vdet-IC	1.7V±2%, Hst, ±Reset PPO, Wt=400ms, Rt=200ms	USP-6C	49xq	VD19	9b	Tor
6E518	XC6104E518ER	Vdet-IC	1.8V±2%, Hst, ±Reset PPO, Wt=400ms, Rt=200ms	USP-6C	49xq	VD19	9b	Tor
6E519	XC6104E519ER	Vdet-IC	1.9V±2%, Hst, ±Reset PPO, Wt=400ms, Rt=200ms	USP-6C	49xq	VD19	9b	Tor
6E520	XC6104E520ER	Vdet-IC	2.0V±2%, Hst, ±Reset PPO, Wt=400ms, Rt=200ms	USP-6C	49xq	VD19	9b	Tor
6E521	XC6104E521ER	Vdet-IC	2.1V±2%, Hst, ±Reset PPO, Wt=400ms, Rt=200ms	USP-6C	49xq	VD19	9b	Tor
6E522	XC6104E522ER	Vdet-IC	2.2V±2%, Hst, ±Reset PPO, Wt=400ms, Rt=200ms	USP-6C	49xq	VD19	9b	Tor
6E523	XC6104E523ER	Vdet-IC	2.3V±2%, Hst, ±Reset PPO, Wt=400ms, Rt=200ms	USP-6C	49xq	VD19	9b	Tor
6E524	XC6104E524ER	Vdet-IC	2.4V±2%, Hst, ±Reset PPO, Wt=400ms, Rt=200ms	USP-6C	49xq	VD19	9b	Tor
6E525	XC6104E525ER	Vdet-IC	2.5V±2%, Hst, ±Reset PPO, Wt=400ms, Rt=200ms	USP-6C	49xq	VD19	9b	Tor
6E526	XC6104E526ER	Vdet-IC	2.6V±2%, Hst, ±Reset PPO, Wt=400ms, Rt=200ms	USP-6C	49xq	VD19	9b	Tor
6E527	XC6104E527ER	Vdet-IC	2.7V±2%, Hst, ±Reset PPO, Wt=400ms, Rt=200ms	USP-6C	49xq	VD19	9b	Tor
6E528	XC6104E528ER	Vdet-IC	2.8V±2%, Hst, ±Reset PPO, Wt=400ms, Rt=200ms	USP-6C	49xq	VD19	9b	Tor
6E529	XC6104E529ER	Vdet-IC	2.9V±2%, Hst, ±Reset PPO, Wt=400ms, Rt=200ms	USP-6C	49xq	VD19	9b	Tor
6E530	XC6104E530ER	Vdet-IC	3.0V±2%, Hst, ±Reset PPO, Wt=400ms, Rt=200ms	USP-6C	49xq	VD19	9b	Tor
6E531	XC6104E531ER	Vdet-IC	3.1V±2%, Hst, ±Reset PPO, Wt=400ms, Rt=200ms	USP-6C	49xq	VD19	9b	Tor
6E532	XC6104E532ER	Vdet-IC	3.2V±2%, Hst, ±Reset PPO, Wt=400ms, Rt=200ms	USP-6C	49xq	VD19	9b	Tor
6E533	XC6104E533ER	Vdet-IC	3.3V±2%, Hst, ±Reset PPO, Wt=400ms, Rt=200ms	USP-6C	49xq	VD19	9b	Tor
6E534	XC6104E534ER	Vdet-IC	3.4V±2%, Hst, ±Reset PPO, Wt=400ms, Rt=200ms	USP-6C	49xq	VD19	9b	Tor
6E535	XC6104E535ER	Vdet-IC	3.5V±2%, Hst, ±Reset PPO, Wt=400ms, Rt=200ms	USP-6C	49xq	VD19	9b	Tor
6E536	XC6104E536ER	Vdet-IC	3.6V±2%, Hst, ±Reset PPO, Wt=400ms, Rt=200ms	USP-6C	49xq	VD19	9b	Tor
6E537	XC6104E537ER	Vdet-IC	3.7V±2%, Hst, ±Reset PPO, Wt=400ms, Rt=200ms	USP-6C	49xq	VD19	9b	Tor
6E538	XC6104E538ER	Vdet-IC	3.8V±2%, Hst, ±Reset PPO, Wt=400ms, Rt=200ms	USP-6C	49xq	VD19	9b	Tor



SMD code	Type	Function	Short description	Case	Pinout	Sch.	St.Mnf.
6F535	XC6104F535ER	Vdet-IC	3.5V±2%, Hst, ±Reset PPO, Wt=400ms, Rt=400ms	USP-6C	49xq	VD19	9b Tor
6F536	XC6104F536ER	Vdet-IC	3.6V±2%, Hst, ±Reset PPO, Wt=400ms, Rt=400ms	USP-6C	49xq	VD19	9b Tor
6F537	XC6104F537ER	Vdet-IC	3.7V±2%, Hst, ±Reset PPO, Wt=400ms, Rt=400ms	USP-6C	49xq	VD19	9b Tor
6F538	XC6104F538ER	Vdet-IC	3.8V±2%, Hst, ±Reset PPO, Wt=400ms, Rt=400ms	USP-6C	49xq	VD19	9b Tor
6F539	XC6104F539ER	Vdet-IC	3.9V±2%, Hst, ±Reset PPO, Wt=400ms, Rt=400ms	USP-6C	49xq	VD19	9b Tor
6F540	XC6104F540ER	Vdet-IC	4.0V±2%, Hst, ±Reset PPO, Wt=400ms, Rt=400ms	USP-6C	49xq	VD19	9b Tor
6F541	XC6104F541ER	Vdet-IC	4.1V±2%, Hst, ±Reset PPO, Wt=400ms, Rt=400ms	USP-6C	49xq	VD19	9b Tor
6F542	XC6104F542ER	Vdet-IC	4.2V±2%, Hst, ±Reset PPO, Wt=400ms, Rt=400ms	USP-6C	49xq	VD19	9b Tor
6F543	XC6104F543ER	Vdet-IC	4.3V±2%, Hst, ±Reset PPO, Wt=400ms, Rt=400ms	USP-6C	49xq	VD19	9b Tor
6F544	XC6104F544ER	Vdet-IC	4.4V±2%, Hst, ±Reset PPO, Wt=400ms, Rt=400ms	USP-6C	49xq	VD19	9b Tor
6F545	XC6104F545ER	Vdet-IC	4.5V±2%, Hst, ±Reset PPO, Wt=400ms, Rt=400ms	USP-6C	49xq	VD19	9b Tor
6F546	XC6104F546ER	Vdet-IC	4.6V±2%, Hst, ±Reset PPO, Wt=400ms, Rt=400ms	USP-6C	49xq	VD19	9b Tor
6F547	XC6104F547ER	Vdet-IC	4.7V±2%, Hst, ±Reset PPO, Wt=400ms, Rt=400ms	USP-6C	49xq	VD19	9b Tor
6F548	XC6104F548ER	Vdet-IC	4.8V±2%, Hst, ±Reset PPO, Wt=400ms, Rt=400ms	USP-6C	49xq	VD19	9b Tor
6F549	XC6104F549ER	Vdet-IC	4.9V±2%, Hst, ±Reset PPO, Wt=400ms, Rt=400ms	USP-6C	49xq	VD19	9b Tor
6F550	XC6104F550ER	Vdet-IC	5.0V±2%, Hst, ±Reset PPO, Wt=400ms, Rt=400ms	USP-6C	49xq	VD19	9b Tor
6F616	XC6104F616ER	Vdet-IC	1.6V±2%, Hst, ±Reset PPO, Wt=1.6s, Rt=400ms	USP-6C	49xq	VD19	9b Tor
6F617	XC6104F617ER	Vdet-IC	1.7V±2%, Hst, ±Reset PPO, Wt=1.6s, Rt=400ms	USP-6C	49xq	VD19	9b Tor
6F618	XC6104F618ER	Vdet-IC	1.8V±2%, Hst, ±Reset PPO, Wt=1.6s, Rt=400ms	USP-6C	49xq	VD19	9b Tor
6F619	XC6104F619ER	Vdet-IC	1.9V±2%, Hst, ±Reset PPO, Wt=1.6s, Rt=400ms	USP-6C	49xq	VD19	9b Tor
6F620	XC6104F620ER	Vdet-IC	2.0V±2%, Hst, ±Reset PPO, Wt=1.6s, Rt=400ms	USP-6C	49xq	VD19	9b Tor
6F621	XC6104F621ER	Vdet-IC	2.1V±2%, Hst, ±Reset PPO, Wt=1.6s, Rt=400ms	USP-6C	49xq	VD19	9b Tor
6F622	XC6104F622ER	Vdet-IC	2.2V±2%, Hst, ±Reset PPO, Wt=1.6s, Rt=400ms	USP-6C	49xq	VD19	9b Tor
6F623	XC6104F623ER	Vdet-IC	2.3V±2%, Hst, ±Reset PPO, Wt=1.6s, Rt=400ms	USP-6C	49xq	VD19	9b Tor
6F624	XC6104F624ER	Vdet-IC	2.4V±2%, Hst, ±Reset PPO, Wt=1.6s, Rt=400ms	USP-6C	49xq	VD19	9b Tor
6F625	XC6104F625ER	Vdet-IC	2.5V±2%, Hst, ±Reset PPO, Wt=1.6s, Rt=400ms	USP-6C	49xq	VD19	9b Tor
6F626	XC6104F626ER	Vdet-IC	2.6V±2%, Hst, ±Reset PPO, Wt=1.6s, Rt=400ms	USP-6C	49xq	VD19	9b Tor
6F627	XC6104F627ER	Vdet-IC	2.7V±2%, Hst, ±Reset PPO, Wt=1.6s, Rt=400ms	USP-6C	49xq	VD19	9b Tor
6F628	XC6104F628ER	Vdet-IC	2.8V±2%, Hst, ±Reset PPO, Wt=1.6s, Rt=400ms	USP-6C	49xq	VD19	9b Tor
6F629	XC6104F629ER	Vdet-IC	2.9V±2%, Hst, ±Reset PPO, Wt=1.6s, Rt=400ms	USP-6C	49xq	VD19	9b Tor
6F630	XC6104F630ER	Vdet-IC	3.0V±2%, Hst, ±Reset PPO, Wt=1.6s, Rt=400ms	USP-6C	49xq	VD19	9b Tor
6F631	XC6104F631ER	Vdet-IC	3.1V±2%, Hst, ±Reset PPO, Wt=1.6s, Rt=400ms	USP-6C	49xq	VD19	9b Tor
6F632	XC6104F632ER	Vdet-IC	3.2V±2%, Hst, ±Reset PPO, Wt=1.6s, Rt=400ms	USP-6C	49xq	VD19	9b Tor
6F633	XC6104F633ER	Vdet-IC	3.3V±2%, Hst, ±Reset PPO, Wt=1.6s, Rt=400ms	USP-6C	49xq	VD19	9b Tor
6F634	XC6104F634ER	Vdet-IC	3.4V±2%, Hst, ±Reset PPO, Wt=1.6s, Rt=400ms	USP-6C	49xq	VD19	9b Tor
6F635	XC6104F635ER	Vdet-IC	3.5V±2%, Hst, ±Reset PPO, Wt=1.6s, Rt=400ms	USP-6C	49xq	VD19	9b Tor
6F636	XC6104F636ER	Vdet-IC	3.6V±2%, Hst, ±Reset PPO, Wt=1.6s, Rt=400ms	USP-6C	49xq	VD19	9b Tor
6F637	XC6104F637ER	Vdet-IC	3.7V±2%, Hst, ±Reset PPO, Wt=1.6s, Rt=400ms	USP-6C	49xq	VD19	9b Tor
6F638	XC6104F638ER	Vdet-IC	3.8V±2%, Hst, ±Reset PPO, Wt=1.6s, Rt=400ms	USP-6C	49xq	VD19	9b Tor
6F639	XC6104F639ER	Vdet-IC	3.9V±2%, Hst, ±Reset PPO, Wt=1.6s, Rt=400ms	USP-6C	49xq	VD19	9b Tor
6F640	XC6104F640ER	Vdet-IC	4.0V±2%, Hst, ±Reset PPO, Wt=1.6s, Rt=400ms	USP-6C	49xq	VD19	9b Tor
6F641	XC6104F641ER	Vdet-IC	4.1V±2%, Hst, ±Reset PPO, Wt=1.6s, Rt=400ms	USP-6C	49xq	VD19	9b Tor
6F642	XC6104F642ER	Vdet-IC	4.2V±2%, Hst, ±Reset PPO, Wt=1.6s, Rt=400ms	USP-6C	49xq	VD19	9b Tor
6F643	XC6104F643ER	Vdet-IC	4.3V±2%, Hst, ±Reset PPO, Wt=1.6s, Rt=400ms	USP-6C	49xq	VD19	9b Tor
6F644	XC6104F644ER	Vdet-IC	4.4V±2%, Hst, ±Reset PPO, Wt=1.6s, Rt=400ms	USP-6C	49xq	VD19	9b Tor
6F645	XC6104F645ER	Vdet-IC	4.5V±2%, Hst, ±Reset PPO, Wt=1.6s, Rt=400ms	USP-6C	49xq	VD19	9b Tor
6F646	XC6104F646ER	Vdet-IC	4.6V±2%, Hst, ±Reset PPO, Wt=1.6s, Rt=400ms	USP-6C	49xq	VD19	9b Tor
6F647	XC6104F647ER	Vdet-IC	4.7V±2%, Hst, ±Reset PPO, Wt=1.6s, Rt=400ms	USP-6C	49xq	VD19	9b Tor
6F648	XC6104F648ER	Vdet-IC	4.8V±2%, Hst, ±Reset PPO, Wt=1.6s, Rt=400ms	USP-6C	49xq	VD19	9b Tor
6F649	XC6104F649ER	Vdet-IC	4.9V±2%, Hst, ±Reset PPO, Wt=1.6s, Rt=400ms	USP-6C	49xq	VD19	9b Tor
6F650	XC6104F650ER	Vdet-IC	5.0V±2%, Hst, ±Reset PPO, Wt=1.6s, Rt=400ms	USP-6C	49xq	VD19	9b Tor
6F8	XC9237A08D4R-G	DC-DC-IC	PWM-PWM/PFM, st-dwn, 0.8V±2%, 600mA, 3MHz, Vin>2V, LSST	USP-6EL	56dc5	DC1	9a Tor
6F8	XC9237A08DER	DC-DC-IC	PWM-PWM/PFM, st-dwn, 0.8V±2%, 600mA, 3MHz, Vin>2V, LSST	USP-6C	49dc5	DC1	9a Tor
6F8	XCL207A084AR-G	DC/DC-IC	PWM-PWM/PFM st-dwn, 3MHz, 0.8V±2%, 600mA	CL-2025	67dc7	DC9	9a Tor
6F9	XC9237A09D4R-G	DC-DC-IC	PWM-PWM/PFM, st-dwn, 0.9V±2%, 600mA, 3MHz, Vin>2V, LSST	USP-6EL	56dc5	DC1	9a Tor
6F9	XC9237A09DER	DC-DC-IC	PWM-PWM/PFM, st-dwn, 0.9V±2%, 600mA, 3MHz, Vin>2V, LSST	USP-6C	49dc5	DC1	9a Tor
6F9	XCL207A094AR-G	DC/DC-IC	PWM-PWM/PFM st-dwn, 3MHz, 0.9V±2%, 600mA	CL-2025	67dc7	DC9	9a Tor
6FL	XC9237A0LD4R-G	DC-DC-IC	PWM-PWM/PFM, st-dwn, 0.85V±2%, 600mA, 3MHz, Vin>2V, LSST	USP-6EL	56dc5	DC1	9a Tor
6FL	XC9237A0LDER	DC-DC-IC	PWM-PWM/PFM, st-dwn, 0.85V±2%, 600mA, 3MHz, Vin>2V, LSST	USP-6C	49dc5	DC1	9a Tor
6FM	XC9237A0MD4R-G	DC-DC-IC	PWM-PWM/PFM, st-dwn, 0.95V±2%, 600mA, 3MHz, Vin>2V, LSST	USP-6EL	56dc5	DC1	9a Tor
6FM	XC9237A0MDER	DC-DC-IC	PWM-PWM/PFM, st-dwn, 0.95V±2%, 600mA, 3MHz, Vin>2V, LSST	USP-6C	49dc5	DC1	9a Tor
6G	RP101K202D	LVR-IC	LDO, LN, +CE, CL, 2V±0.8%, 300mA	DFN1612-4B	45vm	VR4	9a Ric
6G	RP200K381B	LVR-IC	LDO, 3.8V±1.0%, 300mA, +CE, AE(mode)	DFN1212-6	52ht	VR10	9a Ric
6H	RP101K252D	LVR-IC	LDO, LN, +CE, CL, 2.5V±0.8%, 300mA	DFN1612-4B	45vm	VR4	9a Ric
6H	RP200K391B	LVR-IC	LDO, 3.9V±1.0%, 300mA, +CE, AE(mode)	DFN1212-6	52ht	VR10	9a Ric
6H	XC6223G2619R-G	LVR-IC	LDO, 2.6V±1%, 300mA, +CE, PDR, ICP	USPQ-4B03	48vm	VR4	9a Tor
6H	XC6221D24B7R	LVR-IC	LDO, 2.45V±1%, 200mA, +CE, CL, PDR	USPN-4	58vm	VR4	9a Tor
6H0	XC9237A10D4R-G	DC-DC-IC	PWM-PWM/PFM, st-dwn, 1.0V±2%, 600mA, 3MHz, Vin>2V, LSST	USP-6EL	56dc5	DC1	9a Tor
6H0	XC9237A10DER	DC-DC-IC	PWM-PWM/PFM, st-dwn, 1.0V±2%, 600mA, 3MHz, Vin>2V, LSST	USP-6C	49dc5	DC1	9a Tor
6H0	XCL207A104AR-G	DC/DC-IC	PWM-PWM/PFM st-dwn, 3MHz, 1.0V±2%, 600mA	CL-2025	67dc7	DC9	9a Tor



SMD code	Type	Function	Short description	Case	Pinout	Sch.	St.	Mnf.
6HE	XC9237A1ED4R-G	DC-DC-IC	PWM-PWM/PPM, st-dwn, 1.45V±2%, 600mA, 3MHz, Vin>2V, LSST	USP-6EL	56dc5	DC1	9a	Tor
6HE	XC9237A1EDER	DC-DC-IC	PWM-PWM/PPM, st-dwn, 1.45V±2%, 600mA, 3MHz, Vin>2V, LSST	USP-6C	49dc5	DC1	9a	Tor
6HF	XC9237A1FD4R-G	DC-DC-IC	PWM-PWM/PPM, st-dwn, 1.55V±2%, 600mA, 3MHz, Vin>2V, LSST	USP-6EL	56dc5	DC1	9a	Tor
6HF	XC9237A1FDER	DC-DC-IC	PWM-PWM/PPM, st-dwn, 1.55V±2%, 600mA, 3MHz, Vin>2V, LSST	USP-6C	49dc5	DC1	9a	Tor
6HH	XC9237A1HD4R-G	DC-DC-IC	PWM-PWM/PPM, st-dwn, 1.65V±2%, 600mA, 3MHz, Vin>2V, LSST	USP-6EL	56dc5	DC1	9a	Tor
6HH	XC9237A1HDER	DC-DC-IC	PWM-PWM/PPM, st-dwn, 1.65V±2%, 600mA, 3MHz, Vin>2V, LSST	USP-6C	49dc5	DC1	9a	Tor
6HK	XC9237A1KD4R-G	DC-DC-IC	PWM-PWM/PPM, st-dwn, 1.75V±2%, 600mA, 3MHz, Vin>2V, LSST	USP-6EL	56dc5	DC1	9a	Tor
6HK	XC9237A1KDER	DC-DC-IC	PWM-PWM/PPM, st-dwn, 1.75V±2%, 600mA, 3MHz, Vin>2V, LSST	USP-6C	49dc5	DC1	9a	Tor
6HL	XC9237A1LD4R-G	DC-DC-IC	PWM-PWM/PPM, st-dwn, 1.85V±2%, 600mA, 3MHz, Vin>2V, LSST	USP-6EL	56dc5	DC1	9a	Tor
6HL	XC9237A1LDER	DC-DC-IC	PWM-PWM/PPM, st-dwn, 1.85V±2%, 600mA, 3MHz, Vin>2V, LSST	USP-6C	49dc5	DC1	9a	Tor
6HM	XC9237A1MD4R-G	DC-DC-IC	PWM-PWM/PPM, st-dwn, 1.95V±2%, 600mA, 3MHz, Vin>2V, LSST	USP-6EL	56dc5	DC1	9a	Tor
6HM	XC9237A1MDER	DC-DC-IC	PWM-PWM/PPM, st-dwn, 1.95V±2%, 600mA, 3MHz, Vin>2V, LSST	USP-6C	49dc5	DC1	9a	Tor
6J	RP101K262D	LVR-IC	LDO, LN, +CE, CL, 2.6V±0.8%, 300mA	DFN1612-4B	45vm	VR4	9a	Ric
6J	RP200K040B	LVR-IC	LDO, 4V±1.0%, 300mA, +CE, AE(mode)	DFM1212-6	52ht	VR10	9a	Ric
6K	RP101K272D	LVR-IC	LDO, LN, +CE, CL, 2.7V±0.8%, 300mA	DFM1612-4B	45vm	VR4	9a	Ric
6K	XG6223G2719R-G	LVR-IC	LDO, 2.7V±1%, 300mA, +CE, PDR, ICP	USPQ-4B03	48vm	VR4	9a	Tor
6K	XG6221D25B7R	LVR-IC	LDO, 2.55V±1%, 200mA, +CE, CL, PDR	USPN-4	58vm	VR4	9a	Tor
6KO	XC9237A20D4R-G	DC-DC-IC	PWM-PWM/PPM, st-dwn, 2.0V±2%, 600mA, 3MHz, Vin>2V, LSST	USP-6EL	56dc5	DC1	9a	Tor
6KO	XC9237A20DER	DC-DC-IC	PWM-PWM/PPM, st-dwn, 2.0V±2%, 600mA, 3MHz, Vin>2V, LSST	USP-6C	49dc5	DC1	9a	Tor
6KQ	XCL207A204AR-G	DC/DC-IC	PWM-PWM/PPM st-dwn, 3MHz, 2.0V±2%, 600mA	CL-2025	67dc7	DC9	9a	Tor
6K1	XC9237A21D4R-G	DC-DC-IC	PWM-PWM/PPM, st-dwn, 2.1V±2%, 600mA, 3MHz, Vin>2V, LSST	USP-6EL	56dc5	DC1	9a	Tor
6K1	XC9237A21DER	DC-DC-IC	PWM-PWM/PPM, st-dwn, 2.1V±2%, 600mA, 3MHz, Vin>2V, LSST	USP-6C	49dc5	DC1	9a	Tor
6K1	XCL207A214AR-G	DC/DC-IC	PWM-PWM/PPM st-dwn, 3MHz, 2.1V±2%, 600mA	CL-2025	67dc7	DC9	9a	Tor
6K2	XC9237A22D4R-G	DC-DC-IC	PWM-PWM/PPM, st-dwn, 2.2V±2%, 600mA, 3MHz, Vin>2V, LSST	USP-6EL	56dc5	DC1	9a	Tor
6K2	XC9237A22DER	DC-DC-IC	PWM-PWM/PPM, st-dwn, 2.2V±2%, 600mA, 3MHz, Vin>2V, LSST	USP-6C	49dc5	DC1	9a	Tor
6K2	XCL207A224AR-G	DC/DC-IC	PWM-PWM/PPM st-dwn, 3MHz, 2.2V±2%, 600mA	CL-2025	67dc7	DC9	9a	Tor
6K3	XC9237A23D4R-G	DC-DC-IC	PWM-PWM/PPM, st-dwn, 2.3V±2%, 600mA, 3MHz, Vin>2V, LSST	USP-6EL	56dc5	DC1	9a	Tor
6K3	XC9237A23DER	DC-DC-IC	PWM-PWM/PPM, st-dwn, 2.3V±2%, 600mA, 3MHz, Vin>2V, LSST	USP-6C	49dc5	DC1	9a	Tor
6K3	XCL207A234AR-G	DC/DC-IC	PWM-PWM/PPM st-dwn, 3MHz, 2.3V±2%, 600mA	CL-2025	67dc7	DC9	9a	Tor
6K4	XC9237A24D4R-G	DC-DC-IC	PWM-PWM/PPM, st-dwn, 2.4V±2%, 600mA, 3MHz, Vin>2V, LSST	USP-6EL	56dc5	DC1	9a	Tor
6K4	XC9237A24DER	DC-DC-IC	PWM-PWM/PPM, st-dwn, 2.4V±2%, 600mA, 3MHz, Vin>2V, LSST	USP-6C	49dc5	DC1	9a	Tor
6K4	XCL207A244AR-G	DC/DC-IC	PWM-PWM/PPM st-dwn, 3MHz, 2.4V±2%, 600mA	CL-2025	67dc7	DC9	9a	Tor
6K5	XC9237A25D4R-G	DC-DC-IC	PWM-PWM/PPM, st-dwn, 2.5V±2%, 600mA, 3MHz, Vin>2V, LSST	USP-6EL	56dc5	DC1	9a	Tor
6K5	XC9237A25DER	DC-DC-IC	PWM-PWM/PPM, st-dwn, 2.5V±2%, 600mA, 3MHz, Vin>2V, LSST	USP-6C	49dc5	DC1	9a	Tor
6K5	XCL207A254AR-G	DC/DC-IC	PWM-PWM/PPM st-dwn, 3MHz, 2.5V±2%, 600mA	CL-2025	67dc7	DC9	9a	Tor
6K6	XC9237A26D4R-G	DC-DC-IC	PWM-PWM/PPM, st-dwn, 2.6V±2%, 600mA, 3MHz, Vin>2V, LSST	USP-6EL	56dc5	DC1	9a	Tor
6K6	XC9237A26DER	DC-DC-IC	PWM-PWM/PPM, st-dwn, 2.6V±2%, 600mA, 3MHz, Vin>2V, LSST	USP-6C	49dc5	DC1	9a	Tor
6K6	XCL207A264AR-G	DC/DC-IC	PWM-PWM/PPM st-dwn, 3MHz, 2.6V±2%, 600mA	CL-2025	67dc7	DC9	9a	Tor
6K7	XC9237A27D4R-G	DC-DC-IC	PWM-PWM/PPM, st-dwn, 2.7V±2%, 600mA, 3MHz, Vin>2V, LSST	USP-6EL	56dc5	DC1	9a	Tor
6K7	XC9237A27DER	DC-DC-IC	PWM-PWM/PPM, st-dwn, 2.7V±2%, 600mA, 3MHz, Vin>2V, LSST	USP-6C	49dc5	DC1	9a	Tor
6K7	XCL207A274AR-G	DC/DC-IC	PWM-PWM/PPM st-dwn, 3MHz, 2.7V±2%, 600mA	CL-2025	67dc7	DC9	9a	Tor
6K8	XC9237A28D4R-G	DC-DC-IC	PWM-PWM/PPM, st-dwn, 2.8V±2%, 600mA, 3MHz, Vin>2V, LSST	USP-6EL	56dc5	DC1	9a	Tor
6K8	XC9237A28DER	DC-DC-IC	PWM-PWM/PPM, st-dwn, 2.8V±2%, 600mA, 3MHz, Vin>2V, LSST	USP-6C	49dc5	DC1	9a	Tor
6K8	XCL207A284AR-G	DC/DC-IC	PWM-PWM/PPM st-dwn, 3MHz, 2.8V±2%, 600mA	CL-2025	67dc7	DC9	9a	Tor
6K9	XC9237A29D4R-G	DC-DC-IC	PWM-PWM/PPM, st-dwn, 2.9V±2%, 600mA, 3MHz, Vin>2V, LSST	USP-6EL	56dc5	DC1	9a	Tor
6K9	XC9237A29DER	DC-DC-IC	PWM-PWM/PPM, st-dwn, 2.9V±2%, 600mA, 3MHz, Vin>2V, LSST	USP-6C	49dc5	DC1	9a	Tor
6K9	XCL207A294AR-G	DC/DC-IC	PWM-PWM/PPM st-dwn, 3MHz, 2.9V±2%, 600mA	CL-2025	67dc7	DC9	9a	Tor
6KA	XC9237A2AD4R-G	DC-DC-IC	PWM-PWM/PPM, st-dwn, 2.05V±2%, 600mA, 3MHz, Vin>2V, LSST	USP-6EL	56dc5	DC1	9a	Tor
6KA	XC9237A2ADER	DC-DC-IC	PWM-PWM/PPM, st-dwn, 2.05V±2%, 600mA, 3MHz, Vin>2V, LSST	USP-6C	49dc5	DC1	9a	Tor
6KA	XC9237A2BD4R-G	DC-DC-IC	PWM-PWM/PPM, st-dwn, 2.15V±2%, 600mA, 3MHz, Vin>2V, LSST	USP-6EL	56dc5	DC1	9a	Tor
6KB	XC9237A2BDER	DC-DC-IC	PWM-PWM/PPM, st-dwn, 2.15V±2%, 600mA, 3MHz, Vin>2V, LSST	USP-6C	49dc5	DC1	9a	Tor
6KC	XC9237A2CD4R-G	DC-DC-IC	PWM-PWM/PPM, st-dwn, 2.25V±2%, 600mA, 3MHz, Vin>2V, LSST	USP-6EL	56dc5	DC1	9a	Tor
6KC	XC9237A2CDER	DC-DC-IC	PWM-PWM/PPM, st-dwn, 2.25V±2%, 600mA, 3MHz, Vin>2V, LSST	USP-6C	49dc5	DC1	9a	Tor
6KD	XC9237A2DD4R-G	DC-DC-IC	PWM-PWM/PPM, st-dwn, 2.35V±2%, 600mA, 3MHz, Vin>2V, LSST	USP-6EL	56dc5	DC1	9a	Tor
6KD	XC9237A2DDER	DC-DC-IC	PWM-PWM/PPM, st-dwn, 2.35V±2%, 600mA, 3MHz, Vin>2V, LSST	USP-6C	49dc5	DC1	9a	Tor
6KE	XC9237A2ED4R-G	DC-DC-IC	PWM-PWM/PPM, st-dwn, 2.45V±2%, 600mA, 3MHz, Vin>2V, LSST	USP-6EL	56dc5	DC1	9a	Tor
6KE	XC9237A2EDER	DC-DC-IC	PWM-PWM/PPM, st-dwn, 2.45V±2%, 600mA, 3MHz, Vin>2V, LSST	USP-6C	49dc5	DC1	9a	Tor
6KF	XC9237A2FD4R-G	DC-DC-IC	PWM-PWM/PPM, st-dwn, 2.55V±2%, 600mA, 3MHz, Vin>2V, LSST	USP-6EL	56dc5	DC1	9a	Tor
6KF	XC9237A2FDER	DC-DC-IC	PWM-PWM/PPM, st-dwn, 2.55V±2%, 600mA, 3MHz, Vin>2V, LSST	USP-6C	49dc5	DC1	9a	Tor
6KH	XC9237A2HD4R-G	DC-DC-IC	PWM-PWM/PPM, st-dwn, 2.65V±2%, 600mA, 3MHz, Vin>2V, LSST	USP-6EL	56dc5	DC1	9a	Tor
6KH	XC9237A2HDER	DC-DC-IC	PWM-PWM/PPM, st-dwn, 2.65V±2%, 600mA, 3MHz, Vin>2V, LSST	USP-6C	49dc5	DC1	9a	Tor
6KK	XC9237A2KD4R-G	DC-DC-IC	PWM-PWM/PPM, st-dwn, 2.75V±2%, 600mA, 3MHz, Vin>2V, LSST	USP-6EL	56dc5	DC1	9a	Tor
6KK	XC9237A2KDER	DC-DC-IC	PWM-PWM/PPM, st-dwn, 2.75V±2%, 600mA, 3MHz, Vin>2V, LSST	USP-6C	49dc5	DC1	9a	Tor
6KL	XC9237A2LD4R-G	DC-DC-IC	PWM-PWM/PPM, st-dwn, 2.85V±2%, 600mA, 3MHz, Vin>2V, LSST	USP-6EL	56dc5	DC1	9a	Tor
6KL	XC9237A2LDER	DC-DC-IC	PWM-PWM/PPM, st-dwn, 2.85V±2%, 600mA, 3MHz, Vin>2V, LSST	USP-6C	49dc5	DC1	9a	Tor
6KM	XC9237A2MD4R-G	DC-DC-IC	PWM-PWM/PPM, st-dwn, 2.95V±2%, 600mA, 3MHz, Vin>2V, LSST	USP-6EL	56dc5	DC1	9a	Tor
6KM	XC9237A2MDER	DC-DC-IC	PWM-PWM/PPM, st-dwn, 2.95V±2%, 600mA, 3MHz, Vin>2V, LSST	USP-6C	49dc5	DC1	9a	Tor
6L	RP101K282D	LVR-IC	LDO, LN, +CE, CL, 2.8V±0.8%, 300mA	DFN1612-4B	45vm	VR4	9a	Ric
6L	XG6223G2819R-G	LVR-IC	LDO, 2.8V±1%, 300mA, +CE, PDR, ICP	USPQ-4B03	48vm	VR4	9a	Tor
6L	XG6221D26B7R	LVR-IC	LDO, 2.65V±1%, 200mA, +CE, CL, PDR	USPN-4	58vm	VR4	9a	Tor



SMD code	Type	Function	Short description	Case	Pinout	Sch.	St.	Mnf.
6L0	XC9237A30D4R-G	DC-DC-IC	PWM-PWM/PPM, st-dwn, 3.0V±2%, 600mA, 3MHz, Vin>2V, LSST	USP-6EL	56dc5	DC1	9a	Tor
6L0	XC9237A30DER	DC-DC-IC	PWM-PWM/PPM, st-dwn, 3.0V±2%, 600mA, 3MHz, Vin>2V, LSST	USP-6C	49dc5	DC1	9a	Tor
6L0	XCL207A304AR-G	DC/DC-IC	PWM-PWM/PPM st-dwn, 3MHz, 3.0V±2%, 600mA	CL-2025	67dc7	DC9	9a	Tor
6L1	XC9237A31D4R-G	DC-DC-IC	PWM-PWM/PPM, st-dwn, 3.1V±2%, 600mA, 3MHz, Vin>2V, LSST	USP-6EL	56dc5	DC1	9a	Tor
6L1	XC9237A31DER	DC-DC-IC	PWM-PWM/PPM, st-dwn, 3.1V±2%, 600mA, 3MHz, Vin>2V, LSST	USP-6C	49dc5	DC1	9a	Tor
6L1	XCL207A314AR-G	DC/DC-IC	PWM-PWM/PPM st-dwn, 3MHz, 3.1V±2%, 600mA	CL-2025	67dc7	DC9	9a	Tor
6L2	XC9237A32D4R-G	DC-DC-IC	PWM-PWM/PPM, st-dwn, 3.2V±2%, 600mA, 3MHz, Vin>2V, LSST	USP-6EL	56dc5	DC1	9a	Tor
6L2	XC9237A32DER	DC-DC-IC	PWM-PWM/PPM, st-dwn, 3.2V±2%, 600mA, 3MHz, Vin>2V, LSST	USP-6C	49dc5	DC1	9a	Tor
6L2	XCL207A324AR-G	DC/DC-IC	PWM-PWM/PPM st-dwn, 3MHz, 3.2V±2%, 600mA	CL-2025	67dc7	DC9	9a	Tor
6L3	XC9237A33D4R-G	DC-DC-IC	PWM-PWM/PPM, st-dwn, 3.3V±2%, 600mA, 3MHz, Vin>2V, LSST	USP-6EL	56dc5	DC1	9a	Tor
6L3	XC9237A33DER	DC-DC-IC	PWM-PWM/PPM, st-dwn, 3.3V±2%, 600mA, 3MHz, Vin>2V, LSST	USP-6C	49dc5	DC1	9a	Tor
6L3	XCL207A334AR-G	DC/DC-IC	PWM-PWM/PPM st-dwn, 3MHz, 3.3V±2%, 600mA	CL-2025	67dc7	DC9	9a	Tor
6L4	XC9237A34D4R-G	DC-DC-IC	PWM-PWM/PPM, st-dwn, 3.4V±2%, 600mA, 3MHz, Vin>2V, LSST	USP-6EL	56dc5	DC1	9a	Tor
6L4	XC9237A34DER	DC-DC-IC	PWM-PWM/PPM, st-dwn, 3.4V±2%, 600mA, 3MHz, Vin>2V, LSST	USP-6C	49dc5	DC1	9a	Tor
6L4	XCL207A344AR-G	DC/DC-IC	PWM-PWM/PPM st-dwn, 3MHz, 3.4V±2%, 600mA	CL-2025	67dc7	DC9	9a	Tor
6L5	XC9237A35D4R-G	DC-DC-IC	PWM-PWM/PPM, st-dwn, 3.5V±2%, 600mA, 3MHz, Vin>2V, LSST	USP-6EL	56dc5	DC1	9a	Tor
6L5	XC9237A35DER	DC-DC-IC	PWM-PWM/PPM, st-dwn, 3.5V±2%, 600mA, 3MHz, Vin>2V, LSST	USP-6C	49dc5	DC1	9a	Tor
6L5	XCL207A354AR-G	DC/DC-IC	PWM-PWM/PPM st-dwn, 3MHz, 3.5V±2%, 600mA	CL-2025	67dc7	DC9	9a	Tor
6L6	XC9237A36D4R-G	DC-DC-IC	PWM-PWM/PPM, st-dwn, 3.6V±2%, 600mA, 3MHz, Vin>2V, LSST	USP-6EL	56dc5	DC1	9a	Tor
6L6	XC9237A36DER	DC-DC-IC	PWM-PWM/PPM, st-dwn, 3.6V±2%, 600mA, 3MHz, Vin>2V, LSST	USP-6C	49dc5	DC1	9a	Tor
6L6	XCL207A364AR-G	DC/DC-IC	PWM-PWM/PPM st-dwn, 3MHz, 3.6V±2%, 600mA	CL-2025	67dc7	DC9	9a	Tor
6L7	XC9237A37D4R-G	DC-DC-IC	PWM-PWM/PPM, st-dwn, 3.7V±2%, 600mA, 3MHz, Vin>2V, LSST	USP-6EL	56dc5	DC1	9a	Tor
6L7	XC9237A37DER	DC-DC-IC	PWM-PWM/PPM, st-dwn, 3.7V±2%, 600mA, 3MHz, Vin>2V, LSST	USP-6C	49dc5	DC1	9a	Tor
6L7	XCL207A374AR-G	DC/DC-IC	PWM-PWM/PPM st-dwn, 3MHz, 3.7V±2%, 600mA	CL-2025	67dc7	DC9	9a	Tor
6L8	XC9237A38D4R-G	DC-DC-IC	PWM-PWM/PPM, st-dwn, 3.8V±2%, 600mA, 3MHz, Vin>2V, LSST	USP-6EL	56dc5	DC1	9a	Tor
6L8	XC9237A38DER	DC-DC-IC	PWM-PWM/PPM, st-dwn, 3.8V±2%, 600mA, 3MHz, Vin>2V, LSST	USP-6C	49dc5	DC1	9a	Tor
6L8	XCL207A384AR-G	DC/DC-IC	PWM-PWM/PPM st-dwn, 3MHz, 3.8V±2%, 600mA	CL-2025	67dc7	DC9	9a	Tor
6L9	XC9237A39D4R-G	DC-DC-IC	PWM-PWM/PPM, st-dwn, 3.9V±2%, 600mA, 3MHz, Vin>2V, LSST	USP-6EL	56dc5	DC1	9a	Tor
6L9	XC9237A39DER	DC-DC-IC	PWM-PWM/PPM, st-dwn, 3.9V±2%, 600mA, 3MHz, Vin>2V, LSST	USP-6C	49dc5	DC1	9a	Tor
6L9	XCL207A394AR-G	DC/DC-IC	PWM-PWM/PPM st-dwn, 3MHz, 3.9V±2%, 600mA	CL-2025	67dc7	DC9	9a	Tor
6LA	XC9237A3AD4R-G	DC-DC-IC	PWM-PWM/PPM, st-dwn, 3.05V±2%, 600mA, 3MHz, Vin>2V, LSST	USP-6EL	56dc5	DC1	9a	Tor
6LA	XC9237A3ADER	DC-DC-IC	PWM-PWM/PPM, st-dwn, 3.05V±2%, 600mA, 3MHz, Vin>2V, LSST	USP-6C	49dc5	DC1	9a	Tor
6LB	XC9237A3BD4R-G	DC-DC-IC	PWM-PWM/PPM, st-dwn, 3.15V±2%, 600mA, 3MHz, Vin>2V, LSST	USP-6EL	56dc5	DC1	9a	Tor
6LB	XC9237A3BDER	DC-DC-IC	PWM-PWM/PPM, st-dwn, 3.15V±2%, 600mA, 3MHz, Vin>2V, LSST	USP-6C	49dc5	DC1	9a	Tor
6LC	XC9237A3CD4R-G	DC-DC-IC	PWM-PWM/PPM, st-dwn, 3.25V±2%, 600mA, 3MHz, Vin>2V, LSST	USP-6EL	56dc5	DC1	9a	Tor
6LC	XC9237A3CDER	DC-DC-IC	PWM-PWM/PPM, st-dwn, 3.25V±2%, 600mA, 3MHz, Vin>2V, LSST	USP-6C	49dc5	DC1	9a	Tor
6LD	XC9237A3DD4R-G	DC-DC-IC	PWM-PWM/PPM, st-dwn, 3.35V±2%, 600mA, 3MHz, Vin>2V, LSST	USP-6EL	56dc5	DC1	9a	Tor
6LD	XC9237A3DDER	DC-DC-IC	PWM-PWM/PPM, st-dwn, 3.35V±2%, 600mA, 3MHz, Vin>2V, LSST	USP-6C	49dc5	DC1	9a	Tor
6LE	XC9237A3ED4R-G	DC-DC-IC	PWM-PWM/PPM, st-dwn, 3.45V±2%, 600mA, 3MHz, Vin>2V, LSST	USP-6EL	56dc5	DC1	9a	Tor
6LE	XC9237A3EDER	DC-DC-IC	PWM-PWM/PPM, st-dwn, 3.45V±2%, 600mA, 3MHz, Vin>2V, LSST	USP-6C	49dc5	DC1	9a	Tor
6LF	XC9237A3FD4R-G	DC-DC-IC	PWM-PWM/PPM, st-dwn, 3.55V±2%, 600mA, 3MHz, Vin>2V, LSST	USP-6EL	56dc5	DC1	9a	Tor
6LF	XC9237A3FDER	DC-DC-IC	PWM-PWM/PPM, st-dwn, 3.55V±2%, 600mA, 3MHz, Vin>2V, LSST	USP-6C	49dc5	DC1	9a	Tor
6LH	XC9237A3HD4R-G	DC-DC-IC	PWM-PWM/PPM, st-dwn, 3.65V±2%, 600mA, 3MHz, Vin>2V, LSST	USP-6EL	56dc5	DC1	9a	Tor
6LH	XC9237A3HDER	DC-DC-IC	PWM-PWM/PPM, st-dwn, 3.65V±2%, 600mA, 3MHz, Vin>2V, LSST	USP-6C	49dc5	DC1	9a	Tor
6LK	XC9237A3KD4R-G	DC-DC-IC	PWM-PWM/PPM, st-dwn, 3.75V±2%, 600mA, 3MHz, Vin>2V, LSST	USP-6EL	56dc5	DC1	9a	Tor
6LK	XC9237A3KDER	DC-DC-IC	PWM-PWM/PPM, st-dwn, 3.75V±2%, 600mA, 3MHz, Vin>2V, LSST	USP-6C	49dc5	DC1	9a	Tor
6LL	XC9237A3LD4R-G	DC-DC-IC	PWM-PWM/PPM, st-dwn, 3.85V±2%, 600mA, 3MHz, Vin>2V, LSST	USP-6EL	56dc5	DC1	9a	Tor
6LL	XC9237A3LDER	DC-DC-IC	PWM-PWM/PPM, st-dwn, 3.85V±2%, 600mA, 3MHz, Vin>2V, LSST	USP-6C	49dc5	DC1	9a	Tor
6LM	XC9237A3MD4R-G	DC-DC-IC	PWM-PWM/PPM, st-dwn, 3.95V±2%, 600mA, 3MHz, Vin>2V, LSST	USP-6EL	56dc5	DC1	9a	Tor
6LM	XC9237A3MDER	DC-DC-IC	PWM-PWM/PPM, st-dwn, 3.95V±2%, 600mA, 3MHz, Vin>2V, LSST	USP-6C	49dc5	DC1	9a	Tor
6M	RP101K282D5	LVR-IC	LDO, LN, +CE, CL, 2.85V±0.8%, 300mA	DFN1612-4B	45vm	VR4	9a	Ric
6M	XC6223G2919R-G	LVR-IC	LDO, 2.9V±1%, 300mA, +CE, PDR, ICP	USPQ-4B03	48vm	VR4	9a	Tor
6M	XC6221D27B7R	LVR-IC	LDO, 2.75V±1%, 200mA, +CE, CL, PDR	USPN-4	58vm	VR4	9a	Tor
6M0	XC9237A40D4R-G	DC-DC-IC	PWM-PWM/PPM, st-dwn, 4.0V±2%, 600mA, 3MHz, Vin>2V, LSST	USP-6EL	56dc5	DC1	9a	Tor
6M0	XC9237A40DER	DC-DC-IC	PWM-PWM/PPM, st-dwn, 4.0V±2%, 600mA, 3MHz, Vin>2V, LSST	USP-6C	49dc5	DC1	9a	Tor
6M0	XCL207A404AR-G	DC/DC-IC	PWM-PWM/PPM st-dwn, 3MHz, 4.0V±2%, 600mA	CL-2025	67dc7	DC9	9a	Tor
6N	RP101K292D	LVR-IC	LDO, LN, +CE, CL, 2.9V±0.8%, 300mA	DFN1612-4B	45vm	VR4	9a	Ric
6N	XC6223G3019R-G	LVR-IC	LDO, 3.0V±1%, 300mA, +CE, PDR, ICP	USPQ-4B03	48vm	VR4	9a	Tor
6N	XC6221D28B7R	LVR-IC	LDO, 2.85V±1%, 200mA, +CE, CL, PDR	USPN-4	58vm	VR4	9a	Tor
6N8	XC9237E08C4	DC/DC-IC	PWM/PPM st-dwn, 1.2MHz, 0.8V±2%, 600mA, CL, Vin>1.8V, LSST	USP-6EL	56dc5	DC1	9a	Tor
6N8	XC9237E08CER	DC-DC-IC	PWM-PWM/PPM, st-dwn, 0.8V±2%, 600mA, 1.2MHz, Vin>1.8V, LSST, CL	USP-6C	49dc5	DC1	9a	Tor
6N9	XC9237E09C4	DC/DC-IC	PWM/PPM st-dwn, 1.2MHz, 0.9V±2%, 600mA, CL, Vin>1.8V, LSST	USP-6EL	56dc5	DC1	9a	Tor
6N9	XC9237E09CER	DC-DC-IC	PWM-PWM/PPM, st-dwn, 0.9V±2%, 600mA, 1.2MHz, Vin>1.8V, LSST, CL	USP-6C	49dc5	DC1	9a	Tor
6NL	XC9237E0LC4	DC/DC-IC	PWM-PWM/PPM, st-dwn, 1.2MHz, 0.85V±2%, 600mA, CL, Vin>1.8V, LSST	USP-6EL	56dc5	DC1	9a	Tor
6NL	XC9237E0LCER	DC-DC-IC	PWM-PWM/PPM, st-dwn, 0.85V±2%, 600mA, 1.2MHz, Vin>1.8V, LSST, CL	USP-6C	49dc5	DC1	9a	Tor
6NM	XC9237E0MC4	DC/DC-IC	PWM/PPM st-dwn, 1.2MHz, 0.95V±2%, 600mA, CL, Vin>1.8V, LSST	USP-6EL	56dc5	DC1	9a	Tor
6NM	XC9237E0MCER	DC-DC-IC	PWM-PWM/PPM, st-dwn, 0.95V±2%, 600mA, 1.2MHz, Vin>1.8V, LSST, CL	USP-6C	49dc5	DC1	9a	Tor
6P	RP101K302D	LVR-IC	LDO, LN, +CE, CL, 3V±0.8%, 300mA	DFN1612-4B	45vm	VR4	9a	Ric
6P	XC6223G3119R-G	LVR-IC	LDO, 3.1V±1%, 300mA, +CE, PDR, ICP	USPQ-4B03	48vm	VR4	9a	Tor
6P	XC6221D29B7R	LVR-IC	LDO, 2.95V±1%, 200mA, +CE, CL, PDR	USPN-4	58vm	VR4	9a	Tor



SMD code	Type	Function	Short description	Case	Pinout	Sch.	St.	Mnf.
6XC	XC9237E2CDER	DC-DC-IC	PWM-PWM/PPM, st-dwn, 2.25V±2%, 600mA, 3MHz, Vin>1.8V, LSST, CL	USP-6C	49dc5	DC1	9a	Tor
6XD	XC9237E2DD4	DC/DC-IC	PWM/PPM st-dwn, 3MHz, 2.35V±2%, 600mA, CL, Vin>1.8V, LSST	USP-6EL	56dc5	DC1	9a	Tor
6XD	XC9237E2DDER	DC-DC-IC	PWM-PWM/PPM, st-dwn, 2.35V±2%, 600mA, 3MHz, Vin>1.8V, LSST, CL	USP-6C	49dc5	DC1	9a	Tor
6XE	XC9237E2ED4	DC/DC-IC	PWM/PPM st-dwn, 3MHz, 2.45V±2%, 600mA, CL, Vin>1.8V, LSST	USP-6EL	56dc5	DC1	9a	Tor
6XE	XC9237E2EDER	DC-DC-IC	PWM-PWM/PPM, st-dwn, 2.45V±2%, 600mA, 3MHz, Vin>1.8V, LSST, CL	USP-6C	49dc5	DC1	9a	Tor
6XF	XC9237E2FPD4	DC/DC-IC	PWM/PPM st-dwn, 3MHz, 2.55V±2%, 600mA, CL, Vin>1.8V, LSST	USP-6EL	56dc5	DC1	9a	Tor
6XF	XC9237E2FDER	DC-DC-IC	PWM-PWM/PPM, st-dwn, 2.55V±2%, 600mA, 3MHz, Vin>1.8V, LSST, CL	USP-6C	49dc5	DC1	9a	Tor
6XH	XC9237E2HD4	DC/DC-IC	PWM/PPM st-dwn, 3MHz, 2.65V±2%, 600mA, CL, Vin>1.8V, LSST	USP-6EL	56dc5	DC1	9a	Tor
6XH	XC9237E2HDER	DC-DC-IC	PWM-PWM/PPM, st-dwn, 2.65V±2%, 600mA, 3MHz, Vin>1.8V, LSST, CL	USP-6C	49dc5	DC1	9a	Tor
6XK	XC9237E2KD4	DC/DC-IC	PWM/PPM st-dwn, 3MHz, 2.75V±2%, 600mA, CL, Vin>1.8V, LSST	USP-6EL	56dc5	DC1	9a	Tor
6XK	XC9237E2KDER	DC-DC-IC	PWM-PWM/PPM, st-dwn, 2.75V±2%, 600mA, 3MHz, Vin>1.8V, LSST, CL	USP-6C	49dc5	DC1	9a	Tor
6XL	XC9237E2LD4	DC/DC-IC	PWM/PPM st-dwn, 3MHz, 2.85V±2%, 600mA, CL, Vin>1.8V, LSST	USP-6EL	56dc5	DC1	9a	Tor
6XL	XC9237E2LDER	DC-DC-IC	PWM-PWM/PPM, st-dwn, 2.85V±2%, 600mA, 3MHz, Vin>1.8V, LSST, CL	USP-6C	49dc5	DC1	9a	Tor
6XM	XC9237E2MD4	DC/DC-IC	PWM/PPM st-dwn, 3MHz, 2.95V±2%, 600mA, CL, Vin>1.8V, LSST	USP-6EL	56dc5	DC1	9a	Tor
6XM	XC9237E2MDER	DC-DC-IC	PWM-PWM/PPM, st-dwn, 2.95V±2%, 600mA, 3MHz, Vin>1.8V, LSST, CL	USP-6C	49dc5	DC1	9a	Tor
6Y	XC6223G3819R-G	LVR-IC	LDO, 3.8V±1%, 300mA, +CE, PDR, ICP	USPQ-4B03	48vm	VR4	9a	Tor
6Y	XC6221D36B7R	LVR-IC	LDO, 3.65V±1%, 200mA, +CE, CL, PDR	USPN-4	58vm	VR4	9a	Tor
6Y0	XC9237E30D4	DC/DC-IC	PWM/PPM st-dwn, 3MHz, 3.0V±2%, 600mA, CL, Vin>1.8V, LSST	USP-6EL	56dc5	DC1	9a	Tor
6Y0	XC9237E30DER	DC-DC-IC	PWM-PWM/PPM, st-dwn, 3.0V±2%, 600mA, 3MHz, Vin>1.8V, LSST, CL	USP-6C	49dc5	DC1	9a	Tor
6Y1	XC9237E31D4	DC/DC-IC	PWM/PPM st-dwn, 3MHz, 3.1V±2%, 600mA, CL, Vin>1.8V, LSST	USP-6EL	56dc5	DC1	9a	Tor
6Y1	XC9237E31DER	DC-DC-IC	PWM-PWM/PPM, st-dwn, 3.1V±2%, 600mA, 3MHz, Vin>1.8V, LSST, CL	USP-6C	49dc5	DC1	9a	Tor
6Y2	XC9237E32D4	DC/DC-IC	PWM/PPM st-dwn, 3MHz, 3.2V±2%, 600mA, CL, Vin>1.8V, LSST	USP-6EL	56dc5	DC1	9a	Tor
6Y2	XC9237E32DER	DC-DC-IC	PWM-PWM/PPM, st-dwn, 3.2V±2%, 600mA, 3MHz, Vin>1.8V, LSST, CL	USP-6C	49dc5	DC1	9a	Tor
6Y3	XC9237E33D4	DC/DC-IC	PWM/PPM st-dwn, 3MHz, 3.3V±2%, 600mA, CL, Vin>1.8V, LSST	USP-6EL	56dc5	DC1	9a	Tor
6Y3	XC9237E33DER	DC-DC-IC	PWM-PWM/PPM, st-dwn, 3.3V±2%, 600mA, 3MHz, Vin>1.8V, LSST, CL	USP-6C	49dc5	DC1	9a	Tor
6Y4	XC9237E34D4	DC/DC-IC	PWM/PPM st-dwn, 3MHz, 3.4V±2%, 600mA, CL, Vin>1.8V, LSST	USP-6EL	56dc5	DC1	9a	Tor
6Y4	XC9237E34DER	DC-DC-IC	PWM-PWM/PPM, st-dwn, 3.4V±2%, 600mA, 3MHz, Vin>1.8V, LSST, CL	USP-6C	49dc5	DC1	9a	Tor
6Y5	XC9237E35D4	DC/DC-IC	PWM/PPM st-dwn, 3MHz, 3.5V±2%, 600mA, CL, Vin>1.8V, LSST	USP-6EL	56dc5	DC1	9a	Tor
6Y5	XC9237E35DER	DC-DC-IC	PWM-PWM/PPM, st-dwn, 3.5V±2%, 600mA, 3MHz, Vin>1.8V, LSST, CL	USP-6C	49dc5	DC1	9a	Tor
6Y6	XC9237E36D4	DC/DC-IC	PWM/PPM st-dwn, 3MHz, 3.6V±2%, 600mA, CL, Vin>1.8V, LSST	USP-6EL	56dc5	DC1	9a	Tor
6Y6	XC9237E36DER	DC-DC-IC	PWM-PWM/PPM, st-dwn, 3.6V±2%, 600mA, 3MHz, Vin>1.8V, LSST, CL	USP-6C	49dc5	DC1	9a	Tor
6Y7	XC9237E37D4	DC/DC-IC	PWM/PPM st-dwn, 3MHz, 3.7V±2%, 600mA, CL, Vin>1.8V, LSST	USP-6EL	56dc5	DC1	9a	Tor
6Y7	XC9237E37DER	DC-DC-IC	PWM-PWM/PPM, st-dwn, 3.7V±2%, 600mA, 3MHz, Vin>1.8V, LSST, CL	USP-6C	49dc5	DC1	9a	Tor
6Y8	XC9237E38D4	DC/DC-IC	PWM/PPM st-dwn, 3MHz, 3.8V±2%, 600mA, CL, Vin>1.8V, LSST	USP-6EL	56dc5	DC1	9a	Tor
6Y8	XC9237E38DER	DC-DC-IC	PWM-PWM/PPM, st-dwn, 3.8V±2%, 600mA, 3MHz, Vin>1.8V, LSST, CL	USP-6C	49dc5	DC1	9a	Tor
6Y9	XC9237E39D4	DC/DC-IC	PWM/PPM st-dwn, 3MHz, 3.9V±2%, 600mA, CL, Vin>1.8V, LSST	USP-6EL	56dc5	DC1	9a	Tor
6Y9	XC9237E39DER	DC-DC-IC	PWM-PWM/PPM, st-dwn, 3.9V±2%, 600mA, 3MHz, Vin>1.8V, LSST, CL	USP-6C	49dc5	DC1	9a	Tor
6YA	XC9237E3AD4	DC/DC-IC	PWM/PPM st-dwn, 3MHz, 3.05V±2%, 600mA, CL, Vin>1.8V, LSST	USP-6EL	56dc5	DC1	9a	Tor
6YA	XC9237E3ADER	DC-DC-IC	PWM-PWM/PPM, st-dwn, 3.05V±2%, 600mA, 3MHz, Vin>1.8V, LSST, CL	USP-6C	49dc5	DC1	9a	Tor
6YB	XC9237E3BD4	DC/DC-IC	PWM/PPM st-dwn, 3MHz, 3.15V±2%, 600mA, CL, Vin>1.8V, LSST	USP-6EL	56dc5	DC1	9a	Tor
6YB	XC9237E3BDER	DC-DC-IC	PWM-PWM/PPM, st-dwn, 3.15V±2%, 600mA, 3MHz, Vin>1.8V, LSST, CL	USP-6C	49dc5	DC1	9a	Tor
6YC	XC9237E3CD4	DC/DC-IC	PWM/PPM st-dwn, 3MHz, 3.25V±2%, 600mA, CL, Vin>1.8V, LSST	USP-6EL	56dc5	DC1	9a	Tor
6YC	XC9237E3CDER	DC-DC-IC	PWM-PWM/PPM, st-dwn, 3.25V±2%, 600mA, 3MHz, Vin>1.8V, LSST, CL	USP-6C	49dc5	DC1	9a	Tor
6YD	XC9237E3DD4	DC/DC-IC	PWM/PPM st-dwn, 3MHz, 3.35V±2%, 600mA, CL, Vin>1.8V, LSST	USP-6EL	56dc5	DC1	9a	Tor
6YD	XC9237E3DDER	DC-DC-IC	PWM-PWM/PPM, st-dwn, 3.35V±2%, 600mA, 3MHz, Vin>1.8V, LSST, CL	USP-6C	49dc5	DC1	9a	Tor
6YE	XC9237E3ED4	DC/DC-IC	PWM/PPM st-dwn, 3MHz, 3.45V±2%, 600mA, CL, Vin>1.8V, LSST	USP-6EL	56dc5	DC1	9a	Tor
6YE	XC9237E3EDER	DC-DC-IC	PWM-PWM/PPM, st-dwn, 3.45V±2%, 600mA, 3MHz, Vin>1.8V, LSST, CL	USP-6C	49dc5	DC1	9a	Tor
6YF	XC9237E3FD4	DC/DC-IC	PWM/PPM st-dwn, 3MHz, 3.55V±2%, 600mA, CL, Vin>1.8V, LSST	USP-6EL	56dc5	DC1	9a	Tor
6YF	XC9237E3FDER	DC-DC-IC	PWM-PWM/PPM, st-dwn, 3.55V±2%, 600mA, 3MHz, Vin>1.8V, LSST, CL	USP-6C	49dc5	DC1	9a	Tor
6YH	XC9237E3HD4	DC/DC-IC	PWM/PPM st-dwn, 3MHz, 3.65V±2%, 600mA, CL, Vin>1.8V, LSST	USP-6EL	56dc5	DC1	9a	Tor
6YH	XC9237E3HDER	DC-DC-IC	PWM-PWM/PPM, st-dwn, 3.65V±2%, 600mA, 3MHz, Vin>1.8V, LSST, CL	USP-6C	49dc5	DC1	9a	Tor
6YK	XC9237E3KD4	DC/DC-IC	PWM/PPM st-dwn, 3MHz, 3.75V±2%, 600mA, CL, Vin>1.8V, LSST	USP-6EL	56dc5	DC1	9a	Tor
6YK	XC9237E3KDER	DC-DC-IC	PWM-PWM/PPM, st-dwn, 3.75V±2%, 600mA, 3MHz, Vin>1.8V, LSST, CL	USP-6C	49dc5	DC1	9a	Tor
6YL	XC9237E3LD4	DC/DC-IC	PWM/PPM st-dwn, 3MHz, 3.85V±2%, 600mA, CL, Vin>1.8V, LSST	USP-6EL	56dc5	DC1	9a	Tor
6YL	XC9237E3LDER	DC-DC-IC	PWM-PWM/PPM, st-dwn, 3.85V±2%, 600mA, 3MHz, Vin>1.8V, LSST, CL	USP-6C	49dc5	DC1	9a	Tor
6YM	XC9237E3MD4	DC/DC-IC	PWM/PPM st-dwn, 3MHz, 3.95V±2%, 600mA, CL, Vin>1.8V, LSST	USP-6EL	56dc5	DC1	9a	Tor
6YM	XC9237E3MDER	DC-DC-IC	PWM-PWM/PPM, st-dwn, 3.95V±2%, 600mA, 3MHz, Vin>1.8V, LSST, CL	USP-6C	49dc5	DC1	9a	Tor
6Z	XC6223G3919R-G	LVR-IC	LDO, 3.9V±1%, 300mA, +CE, PDR, ICP	USPQ-4B03	48vm	VR4	9a	Tor
6Z	XC6221D37B7R	LVR-IC	LDO, 3.75V±1%, 200mA, +CE, CL, PDR	USPN-4	58vm	VR4	9a	Tor
6Z0	XC9237E40D4	DC/DC-IC	PWM/PPM st-dwn, 3MHz, 4.0V±2%, 600mA, CL, Vin>1.8V, LSST	USP-6EL	56dc5	DC1	9a	Tor
6Z0	XC9237E40DER	DC-DC-IC	PWM-PWM/PPM, st-dwn, 4.0V±2%, 600mA, 3MHz, Vin>1.8V, LSST, CL	USP-6C	49dc5	DC1	9a	Tor
70	EUA2011AH	LIN-IC	AF PA, BTL, class-D, 2.4-5.5V, 2.5W(5V/4Q), shutdown	BGA-9	39	AFP45	-	Eut
70	RP110L131D	LVR-IC	LDO, 1.3V±1%, 150mA, +CE, CL	DFN1010-4	48vm	VR4	9a	Ric
70	XC6221D38B7R	LVR-IC	LDO, 3.85V±1%, 200mA, +CE, CL, PDR	USPN-4	58vm	VR4	9a	Tor
71	RP110L141D	LVR-IC	LDO, 1.4V±1%, 150mA, +CE, CL	DFN1010-4	48vm	VR4	9a	Ric
71	XC6221D39B7R	LVR-IC	LDO, 3.95V±1%, 200mA, +CE, CL, PDR	USPN-4	58vm	VR4	9a	Tor
7112	Si91871DMP-12-T1	LVR-IC	LDO, 1.2V±1.5%, 400mA, +CE	MLP35	62we	VR7	8d	Vs
7115	Si91871DMP-15-T1	LVR-IC	LDO, 1.5V±1.5%, 400mA, +CE	MLP35	62we	VR7	8d	Vs
7118	Si91871DMP-18-T1	LVR-IC	LDO, 1.8V±1.5%, 400mA, +CE	MLP35	62we	VR7	8d	Vs
7120	Si91871DMP-20-T1	LVR-IC	LDO, 2.0V±1.5%, 400mA, +CE	MLP35	62we	VR7	8d	Vs



SMD code	Type	Function	Short description	Case	Pinout	Sch.	St.	Mnf.
7122	SI91871DMP-22-T1	LVR-IC	LDO, 2.2V±1.5%, 400mA, +CE	MLP35	62we	VR7	8d	Vs
7125	SI91871DMP-25-T1	LVR-IC	LDO, 2.5V±1.5%, 400mA, +CE	MLP35	62we	VR7	8d	Vs
7126	SI91871DMP-26-T1	LVR-IC	LDO, 2.6V±1.5%, 400mA, +CE	MLP35	62we	VR7	8d	Vs
7127	SI91871DMP-27-T1	LVR-IC	LDO, 2.7V±1.5%, 400mA, +CE	MLP35	62we	VR7	8d	Vs
7128	SI91871DMP-28-T1	LVR-IC	LDO, 2.8V±1.5%, 400mA, +CE	MLP35	62we	VR7	8d	Vs
71285	SI91871DMP-285-T1	LVR-IC	LDO, 2.85V±1.5%, 400mA, +CE	MLP35	62we	VR7	8d	Vs
7129	SI91871DMP-29-T1	LVR-IC	LDO, 2.9V±1.5%, 400mA, +CE	MLP35	62we	VR7	8d	Vs
7130	SI91871DMP-30-T1	LVR-IC	LDO, 3.0V±1.5%, 400mA, +CE	MLP35	62we	VR7	8d	Vs
7133	SI91871DMP-33-T1	LVR-IC	LDO, 3.3V±1.5%, 400mA, +CE	MLP35	62we	VR7	8d	Vs
7135	SI91871DMP-35-T1	LVR-IC	LDO, 3.5V±1.5%, 400mA, +CE	MLP35	62we	VR7	8d	Vs
7136	SI91871DMP-36-T1	LVR-IC	LDO, 3.6V±1.5%, 400mA, +CE	MLP35	62we	VR7	8d	Vs
7150	SI91871DMP-50-T1	LVR-IC	LDO, 5.0V±1.5%, 400mA, +CE	MLP35	62we	VR7	8d	Vs
72	RP110L151D	LVR-IC	LDO, 1.5V±1%, 150mA, +CE, CL	DFN1010-4	48vm	VR4	9a	Ric
72	XC6223H1219R-G	LVR-IC	LDO, 1.2V±20mV, 300mA, +CE, CL, PDR, ICP	USPQ-4B03	48vm	VR4	9a	Tor
72	XC6221D40B7R	LVR-IC	LDO, 4.05V±1%, 200mA, +CE, CL, PDR	USPN-4	58vm	VR4	9a	Tor
7201A	EUP7201-1 8/2.8J	LVR-IC	LDO, Dual out, Vout1/Vout2=1.8V/2.8V±2%, 150mA, +CE	DFN-6	56xv	VR19	9m	Eut
73	RP110L161D	LVR-IC	LDO, 1.6V±1%, 150mA, +CE, CL	DFN1010-4	48vm	VR4	9a	Ric
73	XC6223H1319R-G	LVR-IC	LDO, 1.3V±20mV, 300mA, +CE, CL, PDR, ICP	USPQ-4B03	48vm	VR4	9a	Tor
73	XC6221D41B7R	LVR-IC	LDO, 4.15V±1%, 200mA, +CE, CL, PDR	USPN-4	58vm	VR4	9a	Tor
74	RP110L171D	LVR-IC	LDO, 1.7V±1%, 150mA, +CE, CL	DFN1010-4	48vm	VR4	9a	Ric
74	XC6223H1419R-G	LVR-IC	LDO, 1.4V±20mV, 300mA, +CE, CL, PDR, ICP	USPQ-4B03	48vm	VR4	9a	Tor
74	XC6221D42B7R	LVR-IC	LDO, 4.25V±1%, 200mA, +CE, CL, PDR	USPN-4	58vm	VR4	9a	Tor
75	RP110L181D	LVR-IC	LDO, 1.8V±1%, 150mA, +CE, CL	DFN1010-4	48vm	VR4	9a	Ric
75	XC6223H1519R-G	LVR-IC	LDO, 1.5V±20mV, 300mA, +CE, CL, PDR, ICP	USPQ-4B03	48vm	VR4	9a	Tor
75	XC6221D43B7R	LVR-IC	LDO, 4.35V±1%, 200mA, +CE, CL, PDR	USPN-4	58vm	VR4	9a	Tor
76	RP110L181D5	LVR-IC	LDO, 1.85V±1%, 150mA, +CE, CL	DFN1010-4	48vm	VR4	9a	Ric
76	XC6223H1619R-G	LVR-IC	LDO, 1.6V±20mV, 300mA, +CE, CL, PDR, ICP	USPQ-4B03	48vm	VR4	9a	Tor
76	XC6221D44B7R	LVR-IC	LDO, 4.45V±1%, 200mA, +CE, CL, PDR	USPN-4	58vm	VR4	9a	Tor
77	RP110L191D	LVR-IC	LDO, 1.9V±1%, 150mA, +CE, CL	DFN1010-4	48vm	VR4	9a	Ric
77	XC6217D08A7R-G	LVR-IC	LDO, 0.85V±2%, 200mA, +CE, CL	USPN-4	58vm	VR4	9a	Tor
77	XC6223H1719R-G	LVR-IC	LDO, 1.7V±20mV, 300mA, +CE, CL, PDR, ICP	USPQ-4B03	48vm	VR4	9a	Tor
77	XC6221D45B7R	LVR-IC	LDO, 4.55V±1%, 200mA, +CE, CL, PDR	USPN-4	58vm	VR4	9a	Tor
78	RP110L201D	LVR-IC	LDO, 2.0V±1%, 150mA, +CE, CL	DFN1010-4	48vm	VR4	9a	Ric
78	XC6217D09A7R-G	LVR-IC	LDO, 0.95V±2%, 200mA, +CE, CL	USPN-4	58vm	VR4	9a	Tor
78	XC6223H1819R-G	LVR-IC	LDO, 1.8V±20mV, 300mA, +CE, CL, PDR, ICP	USPQ-4B03	48vm	VR4	9a	Tor
78	XC6221D46B7R	LVR-IC	LDO, 4.65V±1%, 200mA, +CE, CL, PDR	USPN-4	58vm	VR4	9a	Tor
7832A	AK7832AB	LIN-IC	AF PA, BTL, class-D, 2.5..5.5V, 2W(5V/8Q), I2C, ALC	BGA-24	39	-	-	Ask
7839	BU7839GVW	LIN-IC	16-bit DAC, AF PA 2x12mW(5V/32Q), mute, I2C	BGA-24	39	-	-	9g Rhm
78A0	GS18890AW	LIN-IC	AF PA, BTL, class-D, 2.5..5.5V, 2.5W(5V/8Q), shutdown	BGA-9	39	-	-	Go2
79	RP110L211D	LVR-IC	LDO, 2.1V±1%, 150mA, +CE, CL	DFN1010-4	48vm	VR4	9a	Ric
79	XC6217D10A7R-G	LVR-IC	LDO, 1.05V±2%, 200mA, +CE, CL	USPN-4	58vm	VR4	9a	Tor
79	XC6223H1919R-G	LVR-IC	LDO, 1.9V±20mV, 300mA, +CE, CL, PDR, ICP	USPQ-4B03	48vm	VR4	9a	Tor
79	XC6221D47B7R	LVR-IC	LDO, 4.75V±1%, 200mA, +CE, CL, PDR	USPN-4	58vm	VR4	9a	Tor
7A	RP103K121B	LVR-IC	LDO, 1.2V±1%, 150mA, +CE	DFN1010-4	48vm	VR4	9a	Ric
7A	RP200K081D	LVR-IC	LDO, 0.8V±1.0%, 300mA, +CE, CL, AE(mode)	DFN1212-6	52ht	VR10	9a	Ric
7A	XC6217D11A7R-G	LVR-IC	LDO, 1.15V±2%, 200mA, +CE, CL	USPN-4	58vm	VR4	9a	Tor
7A	XC6223H2019R-G	LVR-IC	LDO, 2.0V±1%, 300mA, +CE, CL, PDR, ICP	USPQ-4B03	48vm	VR4	9a	Tor
7A	XC6221D48B7R	LVR-IC	LDO, 4.85V±1%, 200mA, +CE, CL, PDR	USPN-4	58vm	VR4	9a	Tor
7A116	XC6105A116ER	Vdet-IC	1.6V±2%, Hst, +Rst PPO, -Rst ODO, Wt=6.25ms, Rt=3.13ms	USP-6C	49xq	VD20	9b	Tor
7A117	XC6105A117ER	Vdet-IC	1.7V±2%, Hst, +Rst PPO, -Rst ODO, Wt=6.25ms, Rt=3.13ms	USP-6C	49xq	VD20	9b	Tor
7A118	XC6105A118ER	Vdet-IC	1.8V±2%, Hst, +Rst PPO, -Rst ODO, Wt=6.25ms, Rt=3.13ms	USP-6C	49xq	VD20	9b	Tor
7A119	XC6105A119ER	Vdet-IC	1.9V±2%, Hst, +Rst PPO, -Rst ODO, Wt=6.25ms, Rt=3.13ms	USP-6C	49xq	VD20	9b	Tor
7A120	XC6105A120ER	Vdet-IC	2.0V±2%, Hst, +Rst PPO, -Rst ODO, Wt=6.25ms, Rt=3.13ms	USP-6C	49xq	VD20	9b	Tor
7A121	XC6105A121ER	Vdet-IC	2.1V±2%, Hst, +Rst PPO, -Rst ODO, Wt=6.25ms, Rt=3.13ms	USP-6C	49xq	VD20	9b	Tor
7A122	XC6105A122ER	Vdet-IC	2.2V±2%, Hst, +Rst PPO, -Rst ODO, Wt=6.25ms, Rt=3.13ms	USP-6C	49xq	VD20	9b	Tor
7A123	XC6105A123ER	Vdet-IC	2.3V±2%, Hst, +Rst PPO, -Rst ODO, Wt=6.25ms, Rt=3.13ms	USP-6C	49xq	VD20	9b	Tor
7A124	XC6105A124ER	Vdet-IC	2.4V±2%, Hst, +Rst PPO, -Rst ODO, Wt=6.25ms, Rt=3.13ms	USP-6C	49xq	VD20	9b	Tor
7A125	XC6105A125ER	Vdet-IC	2.5V±2%, Hst, +Rst PPO, -Rst ODO, Wt=6.25ms, Rt=3.13ms	USP-6C	49xq	VD20	9b	Tor
7A126	XC6105A126ER	Vdet-IC	2.6V±2%, Hst, +Rst PPO, -Rst ODO, Wt=6.25ms, Rt=3.13ms	USP-6C	49xq	VD20	9b	Tor
7A127	XC6105A127ER	Vdet-IC	2.7V±2%, Hst, +Rst PPO, -Rst ODO, Wt=6.25ms, Rt=3.13ms	USP-6C	49xq	VD20	9b	Tor
7A128	XC6105A128ER	Vdet-IC	2.8V±2%, Hst, +Rst PPO, -Rst ODO, Wt=6.25ms, Rt=3.13ms	USP-6C	49xq	VD20	9b	Tor
7A129	XC6105A129ER	Vdet-IC	2.9V±2%, Hst, +Rst PPO, -Rst ODO, Wt=6.25ms, Rt=3.13ms	USP-6C	49xq	VD20	9b	Tor
7A130	XC6105A130ER	Vdet-IC	3.0V±2%, Hst, +Rst PPO, -Rst ODO, Wt=6.25ms, Rt=3.13ms	USP-6C	49xq	VD20	9b	Tor
7A131	XC6105A131ER	Vdet-IC	3.1V±2%, Hst, +Rst PPO, -Rst ODO, Wt=6.25ms, Rt=3.13ms	USP-6C	49xq	VD20	9b	Tor
7A132	XC6105A132ER	Vdet-IC	3.2V±2%, Hst, +Rst PPO, -Rst ODO, Wt=6.25ms, Rt=3.13ms	USP-6C	49xq	VD20	9b	Tor
7A133	XC6105A133ER	Vdet-IC	3.3V±2%, Hst, +Rst PPO, -Rst ODO, Wt=6.25ms, Rt=3.13ms	USP-6C	49xq	VD20	9b	Tor
7A134	XC6105A134ER	Vdet-IC	3.4V±2%, Hst, +Rst PPO, -Rst ODO, Wt=6.25ms, Rt=3.13ms	USP-6C	49xq	VD20	9b	Tor
7A135	XC6105A135ER	Vdet-IC	3.5V±2%, Hst, +Rst PPO, -Rst ODO, Wt=6.25ms, Rt=3.13ms	USP-6C	49xq	VD20	9b	Tor
7A136	XC6105A136ER	Vdet-IC	3.6V±2%, Hst, +Rst PPO, -Rst ODO, Wt=6.25ms, Rt=3.13ms	USP-6C	49xq	VD20	9b	Tor
7A137	XC6105A137ER	Vdet-IC	3.7V±2%, Hst, +Rst PPO, -Rst ODO, Wt=6.25ms, Rt=3.13ms	USP-6C	49xq	VD20	9b	Tor



SMD code	Type	Function	Short description	Case	Pinout	Sch.	St.Mnf.
7A538	XC6105A538ER	Vdet-IC	3.8V±2%, Hst, +Rst PPO, -Rst ODO, Wt=400ms, Rt=3.13ms	USP-6C	49xq	VD20	9b Tor
7A539	XC6105A539ER	Vdet-IC	3.9V±2%, Hst, +Rst PPO, -Rst ODO, Wt=400ms, Rt=3.13ms	USP-6C	49xq	VD20	9b Tor
7A540	XC6105A540ER	Vdet-IC	4.0V±2%, Hst, +Rst PPO, -Rst ODO, Wt=400ms, Rt=3.13ms	USP-6C	49xq	VD20	9b Tor
7A541	XC6105A541ER	Vdet-IC	4.1V±2%, Hst, +Rst PPO, -Rst ODO, Wt=400ms, Rt=3.13ms	USP-6C	49xq	VD20	9b Tor
7A542	XC6105A542ER	Vdet-IC	4.2V±2%, Hst, +Rst PPO, -Rst ODO, Wt=400ms, Rt=3.13ms	USP-6C	49xq	VD20	9b Tor
7A543	XC6105A543ER	Vdet-IC	4.3V±2%, Hst, +Rst PPO, -Rst ODO, Wt=400ms, Rt=3.13ms	USP-6C	49xq	VD20	9b Tor
7A544	XC6105A544ER	Vdet-IC	4.4V±2%, Hst, +Rst PPO, -Rst ODO, Wt=400ms, Rt=3.13ms	USP-6C	49xq	VD20	9b Tor
7A545	XC6105A545ER	Vdet-IC	4.5V±2%, Hst, +Rst PPO, -Rst ODO, Wt=400ms, Rt=3.13ms	USP-6C	49xq	VD20	9b Tor
7A546	XC6105A546ER	Vdet-IC	4.6V±2%, Hst, +Rst PPO, -Rst ODO, Wt=400ms, Rt=3.13ms	USP-6C	49xq	VD20	9b Tor
7A547	XC6105A547ER	Vdet-IC	4.7V±2%, Hst, +Rst PPO, -Rst ODO, Wt=400ms, Rt=3.13ms	USP-6C	49xq	VD20	9b Tor
7A548	XC6105A548ER	Vdet-IC	4.8V±2%, Hst, +Rst PPO, -Rst ODO, Wt=400ms, Rt=3.13ms	USP-6C	49xq	VD20	9b Tor
7A549	XC6105A549ER	Vdet-IC	4.9V±2%, Hst, +Rst PPO, -Rst ODO, Wt=400ms, Rt=3.13ms	USP-6C	49xq	VD20	9b Tor
7A550	XC6105A550ER	Vdet-IC	5.0V±2%, Hst, +Rst PPO, -Rst ODO, Wt=400ms, Rt=3.13ms	USP-6C	49xq	VD20	9b Tor
7A616	XC6105A616ER	Vdet-IC	1.6V±2%, Hst, +Rst PPO, -Rst ODO, Wt=1.6s, Rt=3.13ms	USP-6C	49xq	VD20	9b Tor
7A617	XC6105A617ER	Vdet-IC	1.7V±2%, Hst, +Rst PPO, -Rst ODO, Wt=1.6s, Rt=3.13ms	USP-6C	49xq	VD20	9b Tor
7A618	XC6105A618ER	Vdet-IC	1.8V±2%, Hst, +Rst PPO, -Rst ODO, Wt=1.6s, Rt=3.13ms	USP-6C	49xq	VD20	9b Tor
7A619	XC6105A619ER	Vdet-IC	1.9V±2%, Hst, +Rst PPO, -Rst ODO, Wt=1.6s, Rt=3.13ms	USP-6C	49xq	VD20	9b Tor
7A620	XC6105A620ER	Vdet-IC	2.0V±2%, Hst, +Rst PPO, -Rst ODO, Wt=1.6s, Rt=3.13ms	USP-6C	49xq	VD20	9b Tor
7A621	XC6105A621ER	Vdet-IC	2.1V±2%, Hst, +Rst PPO, -Rst ODO, Wt=1.6s, Rt=3.13ms	USP-6C	49xq	VD20	9b Tor
7A622	XC6105A622ER	Vdet-IC	2.2V±2%, Hst, +Rst PPO, -Rst ODO, Wt=1.6s, Rt=3.13ms	USP-6C	49xq	VD20	9b Tor
7A623	XC6105A623ER	Vdet-IC	2.3V±2%, Hst, +Rst PPO, -Rst ODO, Wt=1.6s, Rt=3.13ms	USP-6C	49xq	VD20	9b Tor
7A624	XC6105A624ER	Vdet-IC	2.4V±2%, Hst, +Rst PPO, -Rst ODO, Wt=1.6s, Rt=3.13ms	USP-6C	49xq	VD20	9b Tor
7A625	XC6105A625ER	Vdet-IC	2.5V±2%, Hst, +Rst PPO, -Rst ODO, Wt=1.6s, Rt=3.13ms	USP-6C	49xq	VD20	9b Tor
7A626	XC6105A626ER	Vdet-IC	2.6V±2%, Hst, +Rst PPO, -Rst ODO, Wt=1.6s, Rt=3.13ms	USP-6C	49xq	VD20	9b Tor
7A627	XC6105A627ER	Vdet-IC	2.7V±2%, Hst, +Rst PPO, -Rst ODO, Wt=1.6s, Rt=3.13ms	USP-6C	49xq	VD20	9b Tor
7A628	XC6105A628ER	Vdet-IC	2.8V±2%, Hst, +Rst PPO, -Rst ODO, Wt=1.6s, Rt=3.13ms	USP-6C	49xq	VD20	9b Tor
7A629	XC6105A629ER	Vdet-IC	2.9V±2%, Hst, +Rst PPO, -Rst ODO, Wt=1.6s, Rt=3.13ms	USP-6C	49xq	VD20	9b Tor
7A630	XC6105A630ER	Vdet-IC	3.0V±2%, Hst, +Rst PPO, -Rst ODO, Wt=1.6s, Rt=3.13ms	USP-6C	49xq	VD20	9b Tor
7A631	XC6105A631ER	Vdet-IC	3.1V±2%, Hst, +Rst PPO, -Rst ODO, Wt=1.6s, Rt=3.13ms	USP-6C	49xq	VD20	9b Tor
7A632	XC6105A632ER	Vdet-IC	3.2V±2%, Hst, +Rst PPO, -Rst ODO, Wt=1.6s, Rt=3.13ms	USP-6C	49xq	VD20	9b Tor
7A633	XC6105A633ER	Vdet-IC	3.3V±2%, Hst, +Rst PPO, -Rst ODO, Wt=1.6s, Rt=3.13ms	USP-6C	49xq	VD20	9b Tor
7A634	XC6105A634ER	Vdet-IC	3.4V±2%, Hst, +Rst PPO, -Rst ODO, Wt=1.6s, Rt=3.13ms	USP-6C	49xq	VD20	9b Tor
7A635	XC6105A635ER	Vdet-IC	3.5V±2%, Hst, +Rst PPO, -Rst ODO, Wt=1.6s, Rt=3.13ms	USP-6C	49xq	VD20	9b Tor
7A636	XC6105A636ER	Vdet-IC	3.6V±2%, Hst, +Rst PPO, -Rst ODO, Wt=1.6s, Rt=3.13ms	USP-6C	49xq	VD20	9b Tor
7A637	XC6105A637ER	Vdet-IC	3.7V±2%, Hst, +Rst PPO, -Rst ODO, Wt=1.6s, Rt=3.13ms	USP-6C	49xq	VD20	9b Tor
7A638	XC6105A638ER	Vdet-IC	3.8V±2%, Hst, +Rst PPO, -Rst ODO, Wt=1.6s, Rt=3.13ms	USP-6C	49xq	VD20	9b Tor
7A639	XC6105A639ER	Vdet-IC	3.9V±2%, Hst, +Rst PPO, -Rst ODO, Wt=1.6s, Rt=3.13ms	USP-6C	49xq	VD20	9b Tor
7A640	XC6105A640ER	Vdet-IC	4.0V±2%, Hst, +Rst PPO, -Rst ODO, Wt=1.6s, Rt=3.13ms	USP-6C	49xq	VD20	9b Tor
7A641	XC6105A641ER	Vdet-IC	4.1V±2%, Hst, +Rst PPO, -Rst ODO, Wt=1.6s, Rt=3.13ms	USP-6C	49xq	VD20	9b Tor
7A642	XC6105A642ER	Vdet-IC	4.2V±2%, Hst, +Rst PPO, -Rst ODO, Wt=1.6s, Rt=3.13ms	USP-6C	49xq	VD20	9b Tor
7A643	XC6105A643ER	Vdet-IC	4.3V±2%, Hst, +Rst PPO, -Rst ODO, Wt=1.6s, Rt=3.13ms	USP-6C	49xq	VD20	9b Tor
7A644	XC6105A644ER	Vdet-IC	4.4V±2%, Hst, +Rst PPO, -Rst ODO, Wt=1.6s, Rt=3.13ms	USP-6C	49xq	VD20	9b Tor
7A645	XC6105A645ER	Vdet-IC	4.5V±2%, Hst, +Rst PPO, -Rst ODO, Wt=1.6s, Rt=3.13ms	USP-6C	49xq	VD20	9b Tor
7A646	XC6105A646ER	Vdet-IC	4.6V±2%, Hst, +Rst PPO, -Rst ODO, Wt=1.6s, Rt=3.13ms	USP-6C	49xq	VD20	9b Tor
7A647	XC6105A647ER	Vdet-IC	4.7V±2%, Hst, +Rst PPO, -Rst ODO, Wt=1.6s, Rt=3.13ms	USP-6C	49xq	VD20	9b Tor
7A648	XC6105A648ER	Vdet-IC	4.8V±2%, Hst, +Rst PPO, -Rst ODO, Wt=1.6s, Rt=3.13ms	USP-6C	49xq	VD20	9b Tor
7A649	XC6105A649ER	Vdet-IC	4.9V±2%, Hst, +Rst PPO, -Rst ODO, Wt=1.6s, Rt=3.13ms	USP-6C	49xq	VD20	9b Tor
7A650	XC6105A650ER	Vdet-IC	5.0V±2%, Hst, +Rst PPO, -Rst ODO, Wt=1.6s, Rt=3.13ms	USP-6C	49xq	VD20	9b Tor
7A8	XC9236F08CER	DC-DC-IC	PWM/PFM, st-dwn, 0.8V±2%, 600mA, 1.2MHz, Vin>1.8V, HSST, CL	USP-6C	49da	DC16	9a Tor
7A9	XC9236F09CER	DC-DC-IC	PWM/PFM, st-dwn, 0.9V±2%, 600mA, 1.2MHz, Vin>1.8V, HSST, CL	USP-6C	49da	DC16	9a Tor
7AA	XC6602A051ER-G	LVR-IC	LDO, 0.5V±15mV, 1A, +CE, soft start	USP-6C	49gm	VR11	9a Tor
7AB	XC6602A061ER-G	LVR-IC	LDO, 0.6V±15mV, 1A, +CE, soft start	USP-6C	49gm	VR11	9a Tor
7AC	XC6602A071ER-G	LVR-IC	LDO, 0.7V±15mV, 1A, +CE, soft start	USP-6C	49gm	VR11	9a Tor
7AD	XC6602A081ER-G	LVR-IC	LDO, 0.8V±15mV, 1A, +CE, soft start	USP-6C	49gm	VR11	9a Tor
7AE	XC6602A091ER-G	LVR-IC	LDO, 0.9V±15mV, 1A, +CE, soft start	USP-6C	49gm	VR11	9a Tor
7AF	XC6602A101ER-G	LVR-IC	LDO, 1.0V±15mV, 1A, +CE, soft start	USP-6C	49gm	VR11	9a Tor
7AL	XC9236F0LCER	DC-DC-IC	PWM/PFM, st-dwn, 0.85V±2%, 600mA, 1.2MHz, Vin>1.8V, HSST, CL	USP-6C	49da	DC16	9a Tor
7AM	XC6602A141ER-G	LVR-IC	LDO, 1.4V±20mV, 1A, +CE, soft start	USP-6C	49gm	VR11	9a Tor
7AN	XC9236F0MCER	DC-DC-IC	PWM/PFM, st-dwn, 0.95V±2%, 600mA, 1.2MHz, Vin>1.8V, HSST, CL	USP-6C	49da	DC16	9a Tor
7AN	XC6602A151ER-G	LVR-IC	LDO, 1.5V±20mV, 1A, +CE, soft start	USP-6C	49gm	VR11	9a Tor
7AP	XC6602A161ER-G	LVR-IC	LDO, 1.6V±20mV, 1A, +CE, soft start	USP-6C	49gm	VR11	9a Tor
7AR	XC6602A171ER-G	LVR-IC	LDO, 1.7V±20mV, 1A, +CE, soft start	USP-6C	49gm	VR11	9a Tor
7AS	XC6602A181ER-G	LVR-IC	LDO, 1.8V±20mV, 1A, +CE, soft start	USP-6C	49gm	VR11	9a Tor
7B	RP103K131B	LVR-IC	LDO, 1.3V±1%, 150mA, +CE	DFN1010-4	48vm	VR4	9a Ric
7B	RP200K091D	LVR-IC	LDO, 0.9V±1.0%, 300mA, +CE, CL, AE(mode)	DFN1212-6	52ht	VR10	9a Ric
7B	XC6217D12A7R-G	LVR-IC	LDO, 1.25V±2%, 200mA, +CE, CL	USPN-4	58vm	VR4	9a Tor
7B	XC6223H2119R-G	LVR-IC	LDO, 2.1V±1%, 300mA, +CE, CL, PDR, ICP	USPQ-4B03	48vm	VR4	9a Tor
7B	XC6221D49B7R	LVR-IC	LDO, 4.95V±1%, 200mA, +CE, CL, PDR	USPN-4	58vm	VR4	9a Tor
7B0	XC9236F10CER	DC-DC-IC	PWM/PFM, st-dwn, 1.0V±2%, 600mA, 1.2MHz, Vin>1.8V, HSST, CL	USP-6C	49da	DC16	9a Tor
7B1	XC9236F11CER	DC-DC-IC	PWM/PFM, st-dwn, 1.1V±2%, 600mA, 1.2MHz, Vin>1.8V, HSST, CL	USP-6C	49da	DC16	9a Tor



SMD code	Type	Function	Short description	Case	Pinout	Sch.	St.Mnf.
7B547	XC6105B547ER	Vdet-IC	4.7V±2%, Hst, +Rst PPO, -Rst ODO, Wt=400ms, Rt=25ms	USP-6C	49xq	VD20	9b Tor
7B548	XC6105B548ER	Vdet-IC	4.8V±2%, Hst, +Rst PPO, -Rst ODO, Wt=400ms, Rt=25ms	USP-6C	49xq	VD20	9b Tor
7B549	XC6105B549ER	Vdet-IC	4.9V±2%, Hst, +Rst PPO, -Rst ODO, Wt=400ms, Rt=25ms	USP-6C	49xq	VD20	9b Tor
7B550	XC6105B550ER	Vdet-IC	5.0V±2%, Hst, +Rst PPO, -Rst ODO, Wt=400ms, Rt=25ms	USP-6C	49xq	VD20	9b Tor
7B6	XC9236F16CER	DC-DC-IC	PWM/PFM, st-dwn, 1.6V±2%, 600mA, 1.2MHz, Vin>1.8V, HSST, CL	USP-6C	49da	DC16	9a Tor
7B616	XC6105B616ER	Vdet-IC	1.6V±2%, Hst, +Rst PPO, -Rst ODO, Wt=1.6s, Rt=25ms	USP-6C	49xq	VD20	9b Tor
7B617	XC6105B617ER	Vdet-IC	1.7V±2%, Hst, +Rst PPO, -Rst ODO, Wt=1.6s, Rt=25ms	USP-6C	49xq	VD20	9b Tor
7B618	XC6105B618ER	Vdet-IC	1.8V±2%, Hst, +Rst PPO, -Rst ODO, Wt=1.6s, Rt=25ms	USP-6C	49xq	VD20	9b Tor
7B619	XC6105B619ER	Vdet-IC	1.9V±2%, Hst, +Rst PPO, -Rst ODO, Wt=1.6s, Rt=25ms	USP-6C	49xq	VD20	9b Tor
7B620	XC6105B620ER	Vdet-IC	2.0V±2%, Hst, +Rst PPO, -Rst ODO, Wt=1.6s, Rt=25ms	USP-6C	49xq	VD20	9b Tor
7B621	XC6105B621ER	Vdet-IC	2.1V±2%, Hst, +Rst PPO, -Rst ODO, Wt=1.6s, Rt=25ms	USP-6C	49xq	VD20	9b Tor
7B622	XC6105B622ER	Vdet-IC	2.2V±2%, Hst, +Rst PPO, -Rst ODO, Wt=1.6s, Rt=25ms	USP-6C	49xq	VD20	9b Tor
7B623	XC6105B623ER	Vdet-IC	2.3V±2%, Hst, +Rst PPO, -Rst ODO, Wt=1.6s, Rt=25ms	USP-6C	49xq	VD20	9b Tor
7B624	XC6105B624ER	Vdet-IC	2.4V±2%, Hst, +Rst PPO, -Rst ODO, Wt=1.6s, Rt=25ms	USP-6C	49xq	VD20	9b Tor
7B625	XC6105B625ER	Vdet-IC	2.5V±2%, Hst, +Rst PPO, -Rst ODO, Wt=1.6s, Rt=25ms	USP-6C	49xq	VD20	9b Tor
7B626	XC6105B626ER	Vdet-IC	2.6V±2%, Hst, +Rst PPO, -Rst ODO, Wt=1.6s, Rt=25ms	USP-6C	49xq	VD20	9b Tor
7B627	XC6105B627ER	Vdet-IC	2.7V±2%, Hst, +Rst PPO, -Rst ODO, Wt=1.6s, Rt=25ms	USP-6C	49xq	VD20	9b Tor
7B628	XC6105B628ER	Vdet-IC	2.8V±2%, Hst, +Rst PPO, -Rst ODO, Wt=1.6s, Rt=25ms	USP-6C	49xq	VD20	9b Tor
7B629	XC6105B629ER	Vdet-IC	2.9V±2%, Hst, +Rst PPO, -Rst ODO, Wt=1.6s, Rt=25ms	USP-6C	49xq	VD20	9b Tor
7B630	XC6105B630ER	Vdet-IC	3.0V±2%, Hst, +Rst PPO, -Rst ODO, Wt=1.6s, Rt=25ms	USP-6C	49xq	VD20	9b Tor
7B631	XC6105B631ER	Vdet-IC	3.1V±2%, Hst, +Rst PPO, -Rst ODO, Wt=1.6s, Rt=25ms	USP-6C	49xq	VD20	9b Tor
7B632	XC6105B632ER	Vdet-IC	3.2V±2%, Hst, +Rst PPO, -Rst ODO, Wt=1.6s, Rt=25ms	USP-6C	49xq	VD20	9b Tor
7B633	XC6105B633ER	Vdet-IC	3.3V±2%, Hst, +Rst PPO, -Rst ODO, Wt=1.6s, Rt=25ms	USP-6C	49xq	VD20	9b Tor
7B634	XC6105B634ER	Vdet-IC	3.4V±2%, Hst, +Rst PPO, -Rst ODO, Wt=1.6s, Rt=25ms	USP-6C	49xq	VD20	9b Tor
7B635	XC6105B635ER	Vdet-IC	3.5V±2%, Hst, +Rst PPO, -Rst ODO, Wt=1.6s, Rt=25ms	USP-6C	49xq	VD20	9b Tor
7B636	XC6105B636ER	Vdet-IC	3.6V±2%, Hst, +Rst PPO, -Rst ODO, Wt=1.6s, Rt=25ms	USP-6C	49xq	VD20	9b Tor
7B637	XC6105B637ER	Vdet-IC	3.7V±2%, Hst, +Rst PPO, -Rst ODO, Wt=1.6s, Rt=25ms	USP-6C	49xq	VD20	9b Tor
7B638	XC6105B638ER	Vdet-IC	3.8V±2%, Hst, +Rst PPO, -Rst ODO, Wt=1.6s, Rt=25ms	USP-6C	49xq	VD20	9b Tor
7B639	XC6105B639ER	Vdet-IC	3.9V±2%, Hst, +Rst PPO, -Rst ODO, Wt=1.6s, Rt=25ms	USP-6C	49xq	VD20	9b Tor
7B640	XC6105B640ER	Vdet-IC	4.0V±2%, Hst, +Rst PPO, -Rst ODO, Wt=1.6s, Rt=25ms	USP-6C	49xq	VD20	9b Tor
7B641	XC6105B641ER	Vdet-IC	4.1V±2%, Hst, +Rst PPO, -Rst ODO, Wt=1.6s, Rt=25ms	USP-6C	49xq	VD20	9b Tor
7B642	XC6105B642ER	Vdet-IC	4.2V±2%, Hst, +Rst PPO, -Rst ODO, Wt=1.6s, Rt=25ms	USP-6C	49xq	VD20	9b Tor
7B643	XC6105B643ER	Vdet-IC	4.3V±2%, Hst, +Rst PPO, -Rst ODO, Wt=1.6s, Rt=25ms	USP-6C	49xq	VD20	9b Tor
7B644	XC6105B644ER	Vdet-IC	4.4V±2%, Hst, +Rst PPO, -Rst ODO, Wt=1.6s, Rt=25ms	USP-6C	49xq	VD20	9b Tor
7B645	XC6105B645ER	Vdet-IC	4.5V±2%, Hst, +Rst PPO, -Rst ODO, Wt=1.6s, Rt=25ms	USP-6C	49xq	VD20	9b Tor
7B646	XC6105B646ER	Vdet-IC	4.6V±2%, Hst, +Rst PPO, -Rst ODO, Wt=1.6s, Rt=25ms	USP-6C	49xq	VD20	9b Tor
7B647	XC6105B647ER	Vdet-IC	4.7V±2%, Hst, +Rst PPO, -Rst ODO, Wt=1.6s, Rt=25ms	USP-6C	49xq	VD20	9b Tor
7B648	XC6105B648ER	Vdet-IC	4.8V±2%, Hst, +Rst PPO, -Rst ODO, Wt=1.6s, Rt=25ms	USP-6C	49xq	VD20	9b Tor
7B649	XC6105B649ER	Vdet-IC	4.9V±2%, Hst, +Rst PPO, -Rst ODO, Wt=1.6s, Rt=25ms	USP-6C	49xq	VD20	9b Tor
7B650	XC6105B650ER	Vdet-IC	5.0V±2%, Hst, +Rst PPO, -Rst ODO, Wt=1.6s, Rt=25ms	USP-6C	49xq	VD20	9b Tor
7B7	XC9236F17CER	DC-DC-IC	PWM/PFM, st-dwn, 1.7V±2%, 600mA, 1.2MHz, Vin>1.8V, HSST, CL	USP-6C	49da	DC16	9a Tor
7B8	XC9236F18CER	DC-DC-IC	PWM/PFM, st-dwn, 1.8V±2%, 600mA, 1.2MHz, Vin>1.8V, HSST, CL	USP-6C	49da	DC16	9a Tor
7B9	XC9236F19CER	DC-DC-IC	PWM/PFM, st-dwn, 1.9V±2%, 600mA, 1.2MHz, Vin>1.8V, HSST, CL	USP-6C	49da	DC16	9a Tor
7BA	XC6602B051ER-G	LVR-IC	LDO, 0.5V±15mV, 1A, +CE	USP-6C	49gm	VR11	9a Tor
7BA	XC9236F1ACER	DC-DC-IC	PWM/PFM, st-dwn, 1.05V±2%, 600mA, 1.2MHz, Vin>1.8V, HSST, CL	USP-6C	49da	DC16	9a Tor
7BB	XC6602B061ER-G	LVR-IC	LDO, 0.6V±15mV, 1A, +CE	USP-6C	49gm	VR11	9a Tor
7BB	XC9236F1BCER	DC-DC-IC	PWM/PFM, st-dwn, 1.15V±2%, 600mA, 1.2MHz, Vin>1.8V, HSST, CL	USP-6C	49da	DC16	9a Tor
7BC	XC6602B071ER-G	LVR-IC	LDO, 0.7V±15mV, 1A, +CE	USP-6C	49gm	VR11	9a Tor
7BC	XC9236F1CCER	DC-DC-IC	PWM/PFM, st-dwn, 1.25V±2%, 600mA, 1.2MHz, Vin>1.8V, HSST, CL	USP-6C	49da	DC16	9a Tor
7BD	XC6602B081ER-G	LVR-IC	LDO, 0.8V±15mV, 1A, +CE	USP-6C	49gm	VR11	9a Tor
7BD	XC9236F1DCER	DC-DC-IC	PWM/PFM, st-dwn, 1.35V±2%, 600mA, 1.2MHz, Vin>1.8V, HSST, CL	USP-6C	49da	DC16	9a Tor
7BE	XC6602B091ER-G	LVR-IC	LDO, 0.9V±15mV, 1A, +CE	USP-6C	49gm	VR11	9a Tor
7BE	XC9236F1ECER	DC-DC-IC	PWM/PFM, st-dwn, 1.45V±2%, 600mA, 1.2MHz, Vin>1.8V, HSST, CL	USP-6C	49da	DC16	9a Tor
7BF	XC6602B101ER-G	LVR-IC	LDO, 1.0V±15mV, 1A, +CE	USP-6C	49gm	VR11	9a Tor
7BF	XC9236F1FCER	DC-DC-IC	PWM/PFM, st-dwn, 1.55V±2%, 600mA, 1.2MHz, Vin>1.8V, HSST, CL	USP-6C	49da	DC16	9a Tor
7BH	XC6602B111ER-G	LVR-IC	LDO, 1.1V±15mV, 1A, +CE	USP-6C	49gm	VR11	9a Tor
7BH	XC9236F1HCER	DC-DC-IC	PWM/PFM, st-dwn, 1.65V±2%, 600mA, 1.2MHz, Vin>1.8V, HSST, CL	USP-6C	49da	DC16	9a Tor
7BK	XC6602B121ER-G	LVR-IC	LDO, 1.2V±20mV, 1A, +CE	USP-6C	49gm	VR11	9a Tor
7BK	XC9236F1KCER	DC-DC-IC	PWM/PFM, st-dwn, 1.75V±2%, 600mA, 1.2MHz, Vin>1.8V, HSST, CL	USP-6C	49da	DC16	9a Tor
7BL	XC6602B131ER-G	LVR-IC	LDO, 1.3V±20mV, 1A, +CE	USP-6C	49gm	VR11	9a Tor
7BL	XC9236F1LCER	DC-DC-IC	PWM/PFM, st-dwn, 1.85V±2%, 600mA, 1.2MHz, Vin>1.8V, HSST, CL	USP-6C	49da	DC16	9a Tor
7BM	XC6602B141ER-G	LVR-IC	LDO, 1.4V±20mV, 1A, +CE	USP-6C	49gm	VR11	9a Tor
7BM	XC9236F1MCER	DC-DC-IC	PWM/PFM, st-dwn, 1.95V±2%, 600mA, 1.2MHz, Vin>1.8V, HSST, CL	USP-6C	49da	DC16	9a Tor
7BN	XC6602B151ER-G	LVR-IC	LDO, 1.5V±20mV, 1A, +CE	USP-6C	49gm	VR11	9a Tor
7BP	XC6602B161ER-G	LVR-IC	LDO, 1.6V±20mV, 1A, +CE	USP-6C	49gm	VR11	9a Tor
7BR	XC6602B171ER-G	LVR-IC	LDO, 1.7V±20mV, 1A, +CE	USP-6C	49gm	VR11	9a Tor
7BS	XC6602B181ER-G	LVR-IC	LDO, 1.8V±20mV, 1A, +CE	USP-6C	49gm	VR11	9a Tor
7C	RP103K151B	LVR-IC	LDO, 1.5V±1%, 150mA, +CE	DFN1010-4	48vm	VR4	9a Ric
7C	RP200K101D	LVR-IC	LDO, 1V±1.0%, 300mA, +CE, CL, AE(mode)	DFN1212-6	52ht	VR10	9a Ric
7C	XC6217D13A7R-G	LVR-IC	LDO, 1.35V±2%, 200mA, +CE, CL	USPN-4	58vm	VR4	9a Tor



SMD code	Type	Function	Short description	Case	Pinout	Sch.	St.Mnf.
7C544	XC6105C544ER	Vdet-IC	4.4V±2%, Hst, +Rst PPO, -Rst ODO, Wt=400ms, Rt=50ms	USP-6C	49xq	VD20	9b Tor
7C545	XC6105C545ER	Vdet-IC	4.5V±2%, Hst, +Rst PPO, -Rst ODO, Wt=400ms, Rt=50ms	USP-6C	49xq	VD20	9b Tor
7C546	XC6105C546ER	Vdet-IC	4.6V±2%, Hst, +Rst PPO, -Rst ODO, Wt=400ms, Rt=50ms	USP-6C	49xq	VD20	9b Tor
7C547	XC6105C547ER	Vdet-IC	4.7V±2%, Hst, +Rst PPO, -Rst ODO, Wt=400ms, Rt=50ms	USP-6C	49xq	VD20	9b Tor
7C548	XC6105C548ER	Vdet-IC	4.8V±2%, Hst, +Rst PPO, -Rst ODO, Wt=400ms, Rt=50ms	USP-6C	49xq	VD20	9b Tor
7C549	XC6105C549ER	Vdet-IC	4.9V±2%, Hst, +Rst PPO, -Rst ODO, Wt=400ms, Rt=50ms	USP-6C	49xq	VD20	9b Tor
7C550	XC6105C550ER	Vdet-IC	5.0V±2%, Hst, +Rst PPO, -Rst ODO, Wt=400ms, Rt=50ms	USP-6C	49xq	VD20	9b Tor
7C6	XC9236F26CER	DC-DC-IC	PWM/PFM, st-dwn, 2.6V±2%, 600mA, 1.2MHz, Vin>1.8V, HSST, CL	USP-6C	49da	DC16	9a Tor
7C616	XC6105C616ER	Vdet-IC	1.6V±2%, Hst, +Rst PPO, -Rst ODO, Wt=1.6s, Rt=50ms	USP-6C	49xq	VD20	9b Tor
7C617	XC6105C617ER	Vdet-IC	1.7V±2%, Hst, +Rst PPO, -Rst ODO, Wt=1.6s, Rt=50ms	USP-6C	49xq	VD20	9b Tor
7C618	XC6105C618ER	Vdet-IC	1.8V±2%, Hst, +Rst PPO, -Rst ODO, Wt=1.6s, Rt=50ms	USP-6C	49xq	VD20	9b Tor
7C619	XC6105C619ER	Vdet-IC	1.9V±2%, Hst, +Rst PPO, -Rst ODO, Wt=1.6s, Rt=50ms	USP-6C	49xq	VD20	9b Tor
7C620	XC6105C620ER	Vdet-IC	2.0V±2%, Hst, +Rst PPO, -Rst ODO, Wt=1.6s, Rt=50ms	USP-6C	49xq	VD20	9b Tor
7C621	XC6105C621ER	Vdet-IC	2.1V±2%, Hst, +Rst PPO, -Rst ODO, Wt=1.6s, Rt=50ms	USP-6C	49xq	VD20	9b Tor
7C622	XC6105C622ER	Vdet-IC	2.2V±2%, Hst, +Rst PPO, -Rst ODO, Wt=1.6s, Rt=50ms	USP-6C	49xq	VD20	9b Tor
7C623	XC6105C623ER	Vdet-IC	2.3V±2%, Hst, +Rst PPO, -Rst ODO, Wt=1.6s, Rt=50ms	USP-6C	49xq	VD20	9b Tor
7C624	XC6105C624ER	Vdet-IC	2.4V±2%, Hst, +Rst PPO, -Rst ODO, Wt=1.6s, Rt=50ms	USP-6C	49xq	VD20	9b Tor
7C625	XC6105C625ER	Vdet-IC	2.5V±2%, Hst, +Rst PPO, -Rst ODO, Wt=1.6s, Rt=50ms	USP-6C	49xq	VD20	9b Tor
7C626	XC6105C626ER	Vdet-IC	2.6V±2%, Hst, +Rst PPO, -Rst ODO, Wt=1.6s, Rt=50ms	USP-6C	49xq	VD20	9b Tor
7C627	XC6105C627ER	Vdet-IC	2.7V±2%, Hst, +Rst PPO, -Rst ODO, Wt=1.6s, Rt=50ms	USP-6C	49xq	VD20	9b Tor
7C628	XC6105C628ER	Vdet-IC	2.8V±2%, Hst, +Rst PPO, -Rst ODO, Wt=1.6s, Rt=50ms	USP-6C	49xq	VD20	9b Tor
7C629	XC6105C629ER	Vdet-IC	2.9V±2%, Hst, +Rst PPO, -Rst ODO, Wt=1.6s, Rt=50ms	USP-6C	49xq	VD20	9b Tor
7C630	XC6105C630ER	Vdet-IC	3.0V±2%, Hst, +Rst PPO, -Rst ODO, Wt=1.6s, Rt=50ms	USP-6C	49xq	VD20	9b Tor
7C631	XC6105C631ER	Vdet-IC	3.1V±2%, Hst, +Rst PPO, -Rst ODO, Wt=1.6s, Rt=50ms	USP-6C	49xq	VD20	9b Tor
7C632	XC6105C632ER	Vdet-IC	3.2V±2%, Hst, +Rst PPO, -Rst ODO, Wt=1.6s, Rt=50ms	USP-6C	49xq	VD20	9b Tor
7C633	XC6105C633ER	Vdet-IC	3.3V±2%, Hst, +Rst PPO, -Rst ODO, Wt=1.6s, Rt=50ms	USP-6C	49xq	VD20	9b Tor
7C634	XC6105C634ER	Vdet-IC	3.4V±2%, Hst, +Rst PPO, -Rst ODO, Wt=1.6s, Rt=50ms	USP-6C	49xq	VD20	9b Tor
7C635	XC6105C635ER	Vdet-IC	3.5V±2%, Hst, +Rst PPO, -Rst ODO, Wt=1.6s, Rt=50ms	USP-6C	49xq	VD20	9b Tor
7C636	XC6105C636ER	Vdet-IC	3.6V±2%, Hst, +Rst PPO, -Rst ODO, Wt=1.6s, Rt=50ms	USP-6C	49xq	VD20	9b Tor
7C637	XC6105C637ER	Vdet-IC	3.7V±2%, Hst, +Rst PPO, -Rst ODO, Wt=1.6s, Rt=50ms	USP-6C	49xq	VD20	9b Tor
7C638	XC6105C638ER	Vdet-IC	3.8V±2%, Hst, +Rst PPO, -Rst ODO, Wt=1.6s, Rt=50ms	USP-6C	49xq	VD20	9b Tor
7C639	XC6105C639ER	Vdet-IC	3.9V±2%, Hst, +Rst PPO, -Rst ODO, Wt=1.6s, Rt=50ms	USP-6C	49xq	VD20	9b Tor
7C640	XC6105C640ER	Vdet-IC	4.0V±2%, Hst, +Rst PPO, -Rst ODO, Wt=1.6s, Rt=50ms	USP-6C	49xq	VD20	9b Tor
7C641	XC6105C641ER	Vdet-IC	4.1V±2%, Hst, +Rst PPO, -Rst ODO, Wt=1.6s, Rt=50ms	USP-6C	49xq	VD20	9b Tor
7C642	XC6105C642ER	Vdet-IC	4.2V±2%, Hst, +Rst PPO, -Rst ODO, Wt=1.6s, Rt=50ms	USP-6C	49xq	VD20	9b Tor
7C643	XC6105C643ER	Vdet-IC	4.3V±2%, Hst, +Rst PPO, -Rst ODO, Wt=1.6s, Rt=50ms	USP-6C	49xq	VD20	9b Tor
7C644	XC6105C644ER	Vdet-IC	4.4V±2%, Hst, +Rst PPO, -Rst ODO, Wt=1.6s, Rt=50ms	USP-6C	49xq	VD20	9b Tor
7C645	XC6105C645ER	Vdet-IC	4.5V±2%, Hst, +Rst PPO, -Rst ODO, Wt=1.6s, Rt=50ms	USP-6C	49xq	VD20	9b Tor
7C646	XC6105C646ER	Vdet-IC	4.6V±2%, Hst, +Rst PPO, -Rst ODO, Wt=1.6s, Rt=50ms	USP-6C	49xq	VD20	9b Tor
7C647	XC6105C647ER	Vdet-IC	4.7V±2%, Hst, +Rst PPO, -Rst ODO, Wt=1.6s, Rt=50ms	USP-6C	49xq	VD20	9b Tor
7C648	XC6105C648ER	Vdet-IC	4.8V±2%, Hst, +Rst PPO, -Rst ODO, Wt=1.6s, Rt=50ms	USP-6C	49xq	VD20	9b Tor
7C649	XC6105C649ER	Vdet-IC	4.9V±2%, Hst, +Rst PPO, -Rst ODO, Wt=1.6s, Rt=50ms	USP-6C	49xq	VD20	9b Tor
7C650	XC6105C650ER	Vdet-IC	5.0V±2%, Hst, +Rst PPO, -Rst ODO, Wt=1.6s, Rt=50ms	USP-6C	49xq	VD20	9b Tor
7C7	XC9236F27CER	DC-DC-IC	PWM/PFM, st-dwn, 2.7V±2%, 600mA, 1.2MHz, Vin>1.8V, HSST, CL	USP-6C	49da	DC16	9a Tor
7C8	XC9236F28CER	DC-DC-IC	PWM/PFM, st-dwn, 2.8V±2%, 600mA, 1.2MHz, Vin>1.8V, HSST, CL	USP-6C	49da	DC16	9a Tor
7C9	XC9236F29CER	DC-DC-IC	PWM/PFM, st-dwn, 2.9V±2%, 600mA, 1.2MHz, Vin>1.8V, HSST, CL	USP-6C	49da	DC16	9a Tor
7CA	XC9236F2ACER	DC-DC-IC	PWM/PFM, st-dwn, 2.05V±2%, 600mA, 1.2MHz, Vin>1.8V, HSST, CL	USP-6C	49da	DC16	9a Tor
7CB	XC9236F2BCER	DC-DC-IC	PWM/PFM, st-dwn, 2.15V±2%, 600mA, 1.2MHz, Vin>1.8V, HSST, CL	USP-6C	49da	DC16	9a Tor
7CC	XC9236F2CCER	DC-DC-IC	PWM/PFM, st-dwn, 2.25V±2%, 600mA, 1.2MHz, Vin>1.8V, HSST, CL	USP-6C	49da	DC16	9a Tor
7CD	XC9236F2DCER	DC-DC-IC	PWM/PFM, st-dwn, 2.35V±2%, 600mA, 1.2MHz, Vin>1.8V, HSST, CL	USP-6C	49da	DC16	9a Tor
7CE	XC9236F2ECER	DC-DC-IC	PWM/PFM, st-dwn, 2.45V±2%, 600mA, 1.2MHz, Vin>1.8V, HSST, CL	USP-6C	49da	DC16	9a Tor
7CF	XC9236F2FCER	DC-DC-IC	PWM/PFM, st-dwn, 2.55V±2%, 600mA, 1.2MHz, Vin>1.8V, HSST, CL	USP-6C	49da	DC16	9a Tor
7CH	XC9236F2HCER	DC-DC-IC	PWM/PFM, st-dwn, 2.65V±2%, 600mA, 1.2MHz, Vin>1.8V, HSST, CL	USP-6C	49da	DC16	9a Tor
7CK	XC9236F2KCER	DC-DC-IC	PWM/PFM, st-dwn, 2.75V±2%, 600mA, 1.2MHz, Vin>1.8V, HSST, CL	USP-6C	49da	DC16	9a Tor
7CL	XC9236F2LCER	DC-DC-IC	PWM/PFM, st-dwn, 2.85V±2%, 600mA, 1.2MHz, Vin>1.8V, HSST, CL	USP-6C	49da	DC16	9a Tor
7CM	XC9236F2MCER	DC-DC-IC	PWM/PFM, st-dwn, 2.95V±2%, 600mA, 1.2MHz, Vin>1.8V, HSST, CL	USP-6C	49da	DC16	9a Tor
7D	RP103K181B	LVR-IC	LDO, 1.8V±1%, 150mA, +CE	DFN1010-4	48vm	VR4	9a Ric
7D	RP200K111D	LVR-IC	LDO, 1.1V±1.0%, 300mA, +CE, CL, AE(mode)	DFN1212-6	52ht	VR10	9a Ric
7D	XC6217D14A7R-G	LVR-IC	LDO, 1.45V±2%, 200mA, +CE, CL	USPN-4	58vm	VR4	9a Tor
7D	XC6223H2319R-G	LVR-IC	LDO, 2.3V±1%, 300mA, +CE, CL, PDR, ICP	USPQ-4B03	48vm	VR4	9a Tor
7D0	XC9236F30CER	DC-DC-IC	PWM/PFM, st-dwn, 3.0V±2%, 600mA, 1.2MHz, Vin>1.8V, HSST, CL	USP-6C	49da	DC16	9a Tor
7D1	XC9236F31CER	DC-DC-IC	PWM/PFM, st-dwn, 3.1V±2%, 600mA, 1.2MHz, Vin>1.8V, HSST, CL	USP-6C	49da	DC16	9a Tor
7D2	XC9236F32CER	DC-DC-IC	PWM/PFM, st-dwn, 3.2V±2%, 600mA, 1.2MHz, Vin>1.8V, HSST, CL	USP-6C	49da	DC16	9a Tor
7D3	XC9236F33CER	DC-DC-IC	PWM/PFM, st-dwn, 3.3V±2%, 600mA, 1.2MHz, Vin>1.8V, HSST, CL	USP-6C	49da	DC16	9a Tor
7D316	XC6105D316ER	Vdet-IC	1.6V±2%, Hst, +Rst PPO, -Rst ODO, Wt=100ms, Rt=100ms	USP-6C	49xq	VD20	9b Tor
7D317	XC6105D317ER	Vdet-IC	1.7V±2%, Hst, +Rst PPO, -Rst ODO, Wt=100ms, Rt=100ms	USP-6C	49xq	VD20	9b Tor
7D318	XC6105D318ER	Vdet-IC	1.8V±2%, Hst, +Rst PPO, -Rst ODO, Wt=100ms, Rt=100ms	USP-6C	49xq	VD20	9b Tor
7D319	XC6105D319ER	Vdet-IC	1.9V±2%, Hst, +Rst PPO, -Rst ODO, Wt=100ms, Rt=100ms	USP-6C	49xq	VD20	9b Tor
7D320	XC6105D320ER	Vdet-IC	2.0V±2%, Hst, +Rst PPO, -Rst ODO, Wt=100ms, Rt=100ms	USP-6C	49xq	VD20	9b Tor
7D321	XC6105D321ER	Vdet-IC	2.1V±2%, Hst, +Rst PPO, -Rst ODO, Wt=100ms, Rt=100ms	USP-6C	49xq	VD20	9b Tor



SMD code	Type	Function	Short description	Case	Pinout	Sch.	St.Mnf.
7F532	XC6105F532ER	Vdet-IC	3.2V±2%, Hst, +Rst PPO, -Rst ODO, Wt=400ms, Rt=400ms	USP-6C	49xq	VD20	9b Tor
7F533	XC6105F533ER	Vdet-IC	3.3V±2%, Hst, +Rst PPO, -Rst ODO, Wt=400ms, Rt=400ms	USP-6C	49xq	VD20	9b Tor
7F534	XC6105F534ER	Vdet-IC	3.4V±2%, Hst, +Rst PPO, -Rst ODO, Wt=400ms, Rt=400ms	USP-6C	49xq	VD20	9b Tor
7F535	XC6105F535ER	Vdet-IC	3.5V±2%, Hst, +Rst PPO, -Rst ODO, Wt=400ms, Rt=400ms	USP-6C	49xq	VD20	9b Tor
7F536	XC6105F536ER	Vdet-IC	3.6V±2%, Hst, +Rst PPO, -Rst ODO, Wt=400ms, Rt=400ms	USP-6C	49xq	VD20	9b Tor
7F537	XC6105F537ER	Vdet-IC	3.7V±2%, Hst, +Rst PPO, -Rst ODO, Wt=400ms, Rt=400ms	USP-6C	49xq	VD20	9b Tor
7F538	XC6105F538ER	Vdet-IC	3.8V±2%, Hst, +Rst PPO, -Rst ODO, Wt=400ms, Rt=400ms	USP-6C	49xq	VD20	9b Tor
7F539	XC6105F539ER	Vdet-IC	3.9V±2%, Hst, +Rst PPO, -Rst ODO, Wt=400ms, Rt=400ms	USP-6C	49xq	VD20	9b Tor
7F540	XC6105F540ER	Vdet-IC	4.0V±2%, Hst, +Rst PPO, -Rst ODO, Wt=400ms, Rt=400ms	USP-6C	49xq	VD20	9b Tor
7F541	XC6105F541ER	Vdet-IC	4.1V±2%, Hst, +Rst PPO, -Rst ODO, Wt=400ms, Rt=400ms	USP-6C	49xq	VD20	9b Tor
7F542	XC6105F542ER	Vdet-IC	4.2V±2%, Hst, +Rst PPO, -Rst ODO, Wt=400ms, Rt=400ms	USP-6C	49xq	VD20	9b Tor
7F543	XC6105F543ER	Vdet-IC	4.3V±2%, Hst, +Rst PPO, -Rst ODO, Wt=400ms, Rt=400ms	USP-6C	49xq	VD20	9b Tor
7F544	XC6105F544ER	Vdet-IC	4.4V±2%, Hst, +Rst PPO, -Rst ODO, Wt=400ms, Rt=400ms	USP-6C	49xq	VD20	9b Tor
7F545	XC6105F545ER	Vdet-IC	4.5V±2%, Hst, +Rst PPO, -Rst ODO, Wt=400ms, Rt=400ms	USP-6C	49xq	VD20	9b Tor
7F546	XC6105F546ER	Vdet-IC	4.6V±2%, Hst, +Rst PPO, -Rst ODO, Wt=400ms, Rt=400ms	USP-6C	49xq	VD20	9b Tor
7F547	XC6105F547ER	Vdet-IC	4.7V±2%, Hst, +Rst PPO, -Rst ODO, Wt=400ms, Rt=400ms	USP-6C	49xq	VD20	9b Tor
7F548	XC6105F548ER	Vdet-IC	4.8V±2%, Hst, +Rst PPO, -Rst ODO, Wt=400ms, Rt=400ms	USP-6C	49xq	VD20	9b Tor
7F549	XC6105F549ER	Vdet-IC	4.9V±2%, Hst, +Rst PPO, -Rst ODO, Wt=400ms, Rt=400ms	USP-6C	49xq	VD20	9b Tor
7F550	XC6105F550ER	Vdet-IC	5.0V±2%, Hst, +Rst PPO, -Rst ODO, Wt=400ms, Rt=400ms	USP-6C	49xq	VD20	9b Tor
7F616	XC6105F616ER	Vdet-IC	1.6V±2%, Hst, +Rst PPO, -Rst ODO, Wt=1.6s, Rt=400ms	USP-6C	49xq	VD20	9b Tor
7F617	XC6105F617ER	Vdet-IC	1.7V±2%, Hst, +Rst PPO, -Rst ODO, Wt=1.6s, Rt=400ms	USP-6C	49xq	VD20	9b Tor
7F618	XC6105F618ER	Vdet-IC	1.8V±2%, Hst, +Rst PPO, -Rst ODO, Wt=1.6s, Rt=400ms	USP-6C	49xq	VD20	9b Tor
7F619	XC6105F619ER	Vdet-IC	1.9V±2%, Hst, +Rst PPO, -Rst ODO, Wt=1.6s, Rt=400ms	USP-6C	49xq	VD20	9b Tor
7F620	XC6105F620ER	Vdet-IC	2.0V±2%, Hst, +Rst PPO, -Rst ODO, Wt=1.6s, Rt=400ms	USP-6C	49xq	VD20	9b Tor
7F621	XC6105F621ER	Vdet-IC	2.1V±2%, Hst, +Rst PPO, -Rst ODO, Wt=1.6s, Rt=400ms	USP-6C	49xq	VD20	9b Tor
7F622	XC6105F622ER	Vdet-IC	2.2V±2%, Hst, +Rst PPO, -Rst ODO, Wt=1.6s, Rt=400ms	USP-6C	49xq	VD20	9b Tor
7F623	XC6105F623ER	Vdet-IC	2.3V±2%, Hst, +Rst PPO, -Rst ODO, Wt=1.6s, Rt=400ms	USP-6C	49xq	VD20	9b Tor
7F624	XC6105F624ER	Vdet-IC	2.4V±2%, Hst, +Rst PPO, -Rst ODO, Wt=1.6s, Rt=400ms	USP-6C	49xq	VD20	9b Tor
7F625	XC6105F625ER	Vdet-IC	2.5V±2%, Hst, +Rst PPO, -Rst ODO, Wt=1.6s, Rt=400ms	USP-6C	49xq	VD20	9b Tor
7F626	XC6105F626ER	Vdet-IC	2.6V±2%, Hst, +Rst PPO, -Rst ODO, Wt=1.6s, Rt=400ms	USP-6C	49xq	VD20	9b Tor
7F627	XC6105F627ER	Vdet-IC	2.7V±2%, Hst, +Rst PPO, -Rst ODO, Wt=1.6s, Rt=400ms	USP-6C	49xq	VD20	9b Tor
7F628	XC6105F628ER	Vdet-IC	2.8V±2%, Hst, +Rst PPO, -Rst ODO, Wt=1.6s, Rt=400ms	USP-6C	49xq	VD20	9b Tor
7F629	XC6105F629ER	Vdet-IC	2.9V±2%, Hst, +Rst PPO, -Rst ODO, Wt=1.6s, Rt=400ms	USP-6C	49xq	VD20	9b Tor
7F630	XC6105F630ER	Vdet-IC	3.0V±2%, Hst, +Rst PPO, -Rst ODO, Wt=1.6s, Rt=400ms	USP-6C	49xq	VD20	9b Tor
7F631	XC6105F631ER	Vdet-IC	3.1V±2%, Hst, +Rst PPO, -Rst ODO, Wt=1.6s, Rt=400ms	USP-6C	49xq	VD20	9b Tor
7F632	XC6105F632ER	Vdet-IC	3.2V±2%, Hst, +Rst PPO, -Rst ODO, Wt=1.6s, Rt=400ms	USP-6C	49xq	VD20	9b Tor
7F633	XC6105F633ER	Vdet-IC	3.3V±2%, Hst, +Rst PPO, -Rst ODO, Wt=1.6s, Rt=400ms	USP-6C	49xq	VD20	9b Tor
7F634	XC6105F634ER	Vdet-IC	3.4V±2%, Hst, +Rst PPO, -Rst ODO, Wt=1.6s, Rt=400ms	USP-6C	49xq	VD20	9b Tor
7F635	XC6105F635ER	Vdet-IC	3.5V±2%, Hst, +Rst PPO, -Rst ODO, Wt=1.6s, Rt=400ms	USP-6C	49xq	VD20	9b Tor
7F636	XC6105F636ER	Vdet-IC	3.6V±2%, Hst, +Rst PPO, -Rst ODO, Wt=1.6s, Rt=400ms	USP-6C	49xq	VD20	9b Tor
7F637	XC6105F637ER	Vdet-IC	3.7V±2%, Hst, +Rst PPO, -Rst ODO, Wt=1.6s, Rt=400ms	USP-6C	49xq	VD20	9b Tor
7F638	XC6105F638ER	Vdet-IC	3.8V±2%, Hst, +Rst PPO, -Rst ODO, Wt=1.6s, Rt=400ms	USP-6C	49xq	VD20	9b Tor
7F639	XC6105F639ER	Vdet-IC	3.9V±2%, Hst, +Rst PPO, -Rst ODO, Wt=1.6s, Rt=400ms	USP-6C	49xq	VD20	9b Tor
7F640	XC6105F640ER	Vdet-IC	4.0V±2%, Hst, +Rst PPO, -Rst ODO, Wt=1.6s, Rt=400ms	USP-6C	49xq	VD20	9b Tor
7F641	XC6105F641ER	Vdet-IC	4.1V±2%, Hst, +Rst PPO, -Rst ODO, Wt=1.6s, Rt=400ms	USP-6C	49xq	VD20	9b Tor
7F642	XC6105F642ER	Vdet-IC	4.2V±2%, Hst, +Rst PPO, -Rst ODO, Wt=1.6s, Rt=400ms	USP-6C	49xq	VD20	9b Tor
7F643	XC6105F643ER	Vdet-IC	4.3V±2%, Hst, +Rst PPO, -Rst ODO, Wt=1.6s, Rt=400ms	USP-6C	49xq	VD20	9b Tor
7F644	XC6105F644ER	Vdet-IC	4.4V±2%, Hst, +Rst PPO, -Rst ODO, Wt=1.6s, Rt=400ms	USP-6C	49xq	VD20	9b Tor
7F645	XC6105F645ER	Vdet-IC	4.5V±2%, Hst, +Rst PPO, -Rst ODO, Wt=1.6s, Rt=400ms	USP-6C	49xq	VD20	9b Tor
7F646	XC6105F646ER	Vdet-IC	4.6V±2%, Hst, +Rst PPO, -Rst ODO, Wt=1.6s, Rt=400ms	USP-6C	49xq	VD20	9b Tor
7F647	XC6105F647ER	Vdet-IC	4.7V±2%, Hst, +Rst PPO, -Rst ODO, Wt=1.6s, Rt=400ms	USP-6C	49xq	VD20	9b Tor
7F648	XC6105F648ER	Vdet-IC	4.8V±2%, Hst, +Rst PPO, -Rst ODO, Wt=1.6s, Rt=400ms	USP-6C	49xq	VD20	9b Tor
7F649	XC6105F649ER	Vdet-IC	4.9V±2%, Hst, +Rst PPO, -Rst ODO, Wt=1.6s, Rt=400ms	USP-6C	49xq	VD20	9b Tor
7F650	XC6105F650ER	Vdet-IC	5.0V±2%, Hst, +Rst PPO, -Rst ODO, Wt=1.6s, Rt=400ms	USP-6C	49xq	VD20	9b Tor
7F8	XC9236F08DER	DC-DC-IC	PWM/PFM, st-dwn, 0.8V±2%, 600mA, 3MHz, Vin>1.8V, HSST, CL	USP-6C	49da	DC16	9a Tor
7F9	XC9236F09DER	DC-DC-IC	PWM/PFM, st-dwn, 0.9V±2%, 600mA, 3MHz, Vin>1.8V, HSST, CL	USP-6C	49da	DC16	9a Tor
7F9L	XC9236F0LDER	DC-DC-IC	PWM/PFM, st-dwn, 0.85V±2%, 600mA, 3MHz, Vin>1.8V, HSST, CL	USP-6C	49da	DC16	9a Tor
7FM	XC9236F0MDER	DC-DC-IC	PWM/PFM, st-dwn, 0.95V±2%, 600mA, 3MHz, Vin>1.8V, HSST, CL	USP-6C	49da	DC16	9a Tor
7G	RP103K201B	LVR-IC	LDO, 2V±1%, 150mA, +CE	DFN1010-4	48ym	VR4	9a Ric
7G	RP200K141B	LVR-IC	LDO, 1.4V±1.0%, 300mA, +CE, CL, AE(mode)	DFN1212-6	52ht	VR10	9a Ric
7H	RP103K251B	LVR-IC	LDO, 2.5V±1%, 150mA, +CE	DFN1010-4	48ym	VR4	9a Ric
7H	RP200K151D	LVR-IC	LDO, 1.5V±1.0%, 300mA, +CE, CL, AE(mode)	DFN1212-6	52ht	VR10	9a Ric
7H	XC6217D17A7R-G	LVR-IC	LDO, 1.75V±2%, 200mA, +CE, CL	USPN-4	58vm	VR4	9a Tor
7H	XC6223H2619R-G	LVR-IC	LDO, 2.6V±1%, 300mA, +CE, CL, PDR, ICP	USPQ-4B03	48vm	VR4	9a Tor
7H0	XC9236F10DER	DC-DC-IC	PWM/PFM, st-dwn, 1.0V±2%, 600mA, 3MHz, Vin>1.8V, HSST, CL	USP-6C	49da	DC16	9a Tor
7H1	XC9236F11DER	DC-DC-IC	PWM/PFM, st-dwn, 1.1V±2%, 600mA, 3MHz, Vin>1.8V, HSST, CL	USP-6C	49da	DC16	9a Tor
7H2	XC9236F12DER	DC-DC-IC	PWM/PFM, st-dwn, 1.2V±2%, 600mA, 3MHz, Vin>1.8V, HSST, CL	USP-6C	49da	DC16	9a Tor
7H3	XC9236F13DER	DC-DC-IC	PWM/PFM, st-dwn, 1.3V±2%, 600mA, 3MHz, Vin>1.8V, HSST, CL	USP-6C	49da	DC16	9a Tor
7H4	XC9236F14DER	DC-DC-IC	PWM/PFM, st-dwn, 1.4V±2%, 600mA, 3MHz, Vin>1.8V, HSST, CL	USP-6C	49da	DC16	9a Tor
7H5	XC9236F15DER	DC-DC-IC	PWM/PFM, st-dwn, 1.5V±2%, 600mA, 3MHz, Vin>1.8V, HSST, CL	USP-6C	49da	DC16	9a Tor



SMD code	Type	Function	Short description	Case	Pinout	Sch.	St.Mnf.
7H6	XC9236F16DER	DC-DC-IC	PWM/PFM, st-dwn, 1.6V±2%, 600mA, 3MHz, Vin>1.8V, HSST, CL	USP-6C	49da	DC16	9a Tor
7H616	XC6105H616ER	Vdet-IC	1.6V±2%, Hst, +Rst PPO, -Rst ODO, Wt=1.6s, Rt=1.6s	USP-6C	49xq	VD20	9b Tor
7H617	XC6105H617ER	Vdet-IC	1.7V±2%, Hst, +Rst PPO, -Rst ODO, Wt=1.6s, Rt=1.6s	USP-6C	49xq	VD20	9b Tor
7H618	XC6105H618ER	Vdet-IC	1.8V±2%, Hst, +Rst PPO, -Rst ODO, Wt=1.6s, Rt=1.6s	USP-6C	49xq	VD20	9b Tor
7H619	XC6105H619ER	Vdet-IC	1.9V±2%, Hst, +Rst PPO, -Rst ODO, Wt=1.6s, Rt=1.6s	USP-6C	49xq	VD20	9b Tor
7H620	XC6105H620ER	Vdet-IC	2.0V±2%, Hst, +Rst PPO, -Rst ODO, Wt=1.6s, Rt=1.6s	USP-6C	49xq	VD20	9b Tor
7H621	XC6105H621ER	Vdet-IC	2.1V±2%, Hst, +Rst PPO, -Rst ODO, Wt=1.6s, Rt=1.6s	USP-6C	49xq	VD20	9b Tor
7H622	XC6105H622ER	Vdet-IC	2.2V±2%, Hst, +Rst PPO, -Rst ODO, Wt=1.6s, Rt=1.6s	USP-6C	49xq	VD20	9b Tor
7H623	XC6105H623ER	Vdet-IC	2.3V±2%, Hst, +Rst PPO, -Rst ODO, Wt=1.6s, Rt=1.6s	USP-6C	49xq	VD20	9b Tor
7H624	XC6105H624ER	Vdet-IC	2.4V±2%, Hst, +Rst PPO, -Rst ODO, Wt=1.6s, Rt=1.6s	USP-6C	49xq	VD20	9b Tor
7H625	XC6105H625ER	Vdet-IC	2.5V±2%, Hst, +Rst PPO, -Rst ODO, Wt=1.6s, Rt=1.6s	USP-6C	49xq	VD20	9b Tor
7H626	XC6105H626ER	Vdet-IC	2.6V±2%, Hst, +Rst PPO, -Rst ODO, Wt=1.6s, Rt=1.6s	USP-6C	49xq	VD20	9b Tor
7H627	XC6105H627ER	Vdet-IC	2.7V±2%, Hst, +Rst PPO, -Rst ODO, Wt=1.6s, Rt=1.6s	USP-6C	49xq	VD20	9b Tor
7H628	XC6105H628ER	Vdet-IC	2.8V±2%, Hst, +Rst PPO, -Rst ODO, Wt=1.6s, Rt=1.6s	USP-6C	49xq	VD20	9b Tor
7H629	XC6105H629ER	Vdet-IC	2.9V±2%, Hst, +Rst PPO, -Rst ODO, Wt=1.6s, Rt=1.6s	USP-6C	49xq	VD20	9b Tor
7H630	XC6105H630ER	Vdet-IC	3.0V±2%, Hst, +Rst PPO, -Rst ODO, Wt=1.6s, Rt=1.6s	USP-6C	49xq	VD20	9b Tor
7H631	XC6105H631ER	Vdet-IC	3.1V±2%, Hst, +Rst PPO, -Rst ODO, Wt=1.6s, Rt=1.6s	USP-6C	49xq	VD20	9b Tor
7H632	XC6105H632ER	Vdet-IC	3.2V±2%, Hst, +Rst PPO, -Rst ODO, Wt=1.6s, Rt=1.6s	USP-6C	49xq	VD20	9b Tor
7H633	XC6105H633ER	Vdet-IC	3.3V±2%, Hst, +Rst PPO, -Rst ODO, Wt=1.6s, Rt=1.6s	USP-6C	49xq	VD20	9b Tor
7H634	XC6105H634ER	Vdet-IC	3.4V±2%, Hst, +Rst PPO, -Rst ODO, Wt=1.6s, Rt=1.6s	USP-6C	49xq	VD20	9b Tor
7H635	XC6105H635ER	Vdet-IC	3.5V±2%, Hst, +Rst PPO, -Rst ODO, Wt=1.6s, Rt=1.6s	USP-6C	49xq	VD20	9b Tor
7H636	XC6105H636ER	Vdet-IC	3.6V±2%, Hst, +Rst PPO, -Rst ODO, Wt=1.6s, Rt=1.6s	USP-6C	49xq	VD20	9b Tor
7H637	XC6105H637ER	Vdet-IC	3.7V±2%, Hst, +Rst PPO, -Rst ODO, Wt=1.6s, Rt=1.6s	USP-6C	49xq	VD20	9b Tor
7H638	XC6105H638ER	Vdet-IC	3.8V±2%, Hst, +Rst PPO, -Rst ODO, Wt=1.6s, Rt=1.6s	USP-6C	49xq	VD20	9b Tor
7H639	XC6105H639ER	Vdet-IC	3.9V±2%, Hst, +Rst PPO, -Rst ODO, Wt=1.6s, Rt=1.6s	USP-6C	49xq	VD20	9b Tor
7H640	XC6105H640ER	Vdet-IC	4.0V±2%, Hst, +Rst PPO, -Rst ODO, Wt=1.6s, Rt=1.6s	USP-6C	49xq	VD20	9b Tor
7H641	XC6105H641ER	Vdet-IC	4.1V±2%, Hst, +Rst PPO, -Rst ODO, Wt=1.6s, Rt=1.6s	USP-6C	49xq	VD20	9b Tor
7H642	XC6105H642ER	Vdet-IC	4.2V±2%, Hst, +Rst PPO, -Rst ODO, Wt=1.6s, Rt=1.6s	USP-6C	49xq	VD20	9b Tor
7H643	XC6105H643ER	Vdet-IC	4.3V±2%, Hst, +Rst PPO, -Rst ODO, Wt=1.6s, Rt=1.6s	USP-6C	49xq	VD20	9b Tor
7H644	XC6105H644ER	Vdet-IC	4.4V±2%, Hst, +Rst PPO, -Rst ODO, Wt=1.6s, Rt=1.6s	USP-6C	49xq	VD20	9b Tor
7H645	XC6105H645ER	Vdet-IC	4.5V±2%, Hst, +Rst PPO, -Rst ODO, Wt=1.6s, Rt=1.6s	USP-6C	49xq	VD20	9b Tor
7H646	XC6105H646ER	Vdet-IC	4.6V±2%, Hst, +Rst PPO, -Rst ODO, Wt=1.6s, Rt=1.6s	USP-6C	49xq	VD20	9b Tor
7H647	XC6105H647ER	Vdet-IC	4.7V±2%, Hst, +Rst PPO, -Rst ODO, Wt=1.6s, Rt=1.6s	USP-6C	49xq	VD20	9b Tor
7H648	XC6105H648ER	Vdet-IC	4.8V±2%, Hst, +Rst PPO, -Rst ODO, Wt=1.6s, Rt=1.6s	USP-6C	49xq	VD20	9b Tor
7H649	XC6105H649ER	Vdet-IC	4.9V±2%, Hst, +Rst PPO, -Rst ODO, Wt=1.6s, Rt=1.6s	USP-6C	49xq	VD20	9b Tor
7H650	XC6105H650ER	Vdet-IC	5.0V±2%, Hst, +Rst PPO, -Rst ODO, Wt=1.6s, Rt=1.6s	USP-6C	49xq	VD20	9b Tor
7H7	XC9236F17DER	DC-DC-IC	PWM/PFM, st-dwn, 1.7V±2%, 600mA, 3MHz, Vin>1.8V, HSST, CL	USP-6C	49da	DC16	9a Tor
7H8	XC9236F18DER	DC-DC-IC	PWM/PFM, st-dwn, 1.8V±2%, 600mA, 3MHz, Vin>1.8V, HSST, CL	USP-6C	49da	DC16	9a Tor
7H9	XC9236F19DER	DC-DC-IC	PWM/PFM, st-dwn, 1.9V±2%, 600mA, 3MHz, Vin>1.8V, HSST, CL	USP-6C	49da	DC16	9a Tor
7HA	XC9236F1ADER	DC-DC-IC	PWM/PFM, st-dwn, 1.05V±2%, 600mA, 3MHz, Vin>1.8V, HSST, CL	USP-6C	49da	DC16	9a Tor
7HB	XC9236F1BDER	DC-DC-IC	PWM/PFM, st-dwn, 1.15V±2%, 600mA, 3MHz, Vin>1.8V, HSST, CL	USP-6C	49da	DC16	9a Tor
7HC	XC9236F1CDER	DC-DC-IC	PWM/PFM, st-dwn, 1.25V±2%, 600mA, 3MHz, Vin>1.8V, HSST, CL	USP-6C	49da	DC16	9a Tor
7HD	XC9236F1DDER	DC-DC-IC	PWM/PFM, st-dwn, 1.35V±2%, 600mA, 3MHz, Vin>1.8V, HSST, CL	USP-6C	49da	DC16	9a Tor
7HE	XC9236F1EDER	DC-DC-IC	PWM/PFM, st-dwn, 1.45V±2%, 600mA, 3MHz, Vin>1.8V, HSST, CL	USP-6C	49da	DC16	9a Tor
7HF	XC9236F1FDER	DC-DC-IC	PWM/PFM, st-dwn, 1.55V±2%, 600mA, 3MHz, Vin>1.8V, HSST, CL	USP-6C	49da	DC16	9a Tor
7HH	XC9236F1HDER	DC-DC-IC	PWM/PFM, st-dwn, 1.65V±2%, 600mA, 3MHz, Vin>1.8V, HSST, CL	USP-6C	49da	DC16	9a Tor
7HK	XC9236F1KDER	DC-DC-IC	PWM/PFM, st-dwn, 1.75V±2%, 600mA, 3MHz, Vin>1.8V, HSST, CL	USP-6C	49da	DC16	9a Tor
7HL	XC9236F1LDER	DC-DC-IC	PWM/PFM, st-dwn, 1.85V±2%, 600mA, 3MHz, Vin>1.8V, HSST, CL	USP-6C	49da	DC16	9a Tor
7HM	XC9236F1MDER	DC-DC-IC	PWM/PFM, st-dwn, 1.95V±2%, 600mA, 3MHz, Vin>1.8V, HSST, CL	USP-6C	49da	DC16	9a Tor
7J	RP103K261B	LVR-IC	LDO, 2.6V±1%, 150mA, +CE	DFN1010-4	48vm	VR4	9a Ric
7J	RP200K161D	LVR-IC	LDO, 1.6V±1.0%, 300mA, +CE, CL, AE(mode)	DFN1212-6	52ht	VR10	9a Ric
7K	RP103K271B	LVR-IC	LDO, 2.7V±1%, 150mA, +CE	DFN1010-4	48vm	VR4	9a Ric
7K	RP200K171D	LVR-IC	LDO, 1.7V±1.0%, 300mA, +CE, CL, AE(mode)	DFN1212-6	52ht	VR10	9a Ric
7K	XC6217D18A7R-G	LVR-IC	LDO, 1.85V±2%, 200mA, +CE, CL	USP-4	58vm	VR4	9a Tor
7K	XC6223H2719R-G	LVR-IC	LDO, 2.7V±1%, 300mA, +CE, CL, PDR, ICP	USPQ-4B03	48vm	VR4	9a Tor
7K0	XC9236F20DER	DC-DC-IC	PWM/PFM, st-dwn, 2.0V±2%, 600mA, 3MHz, Vin>1.8V, HSST, CL	USP-6C	49da	DC16	9a Tor
7K1	XC9236F21DER	DC-DC-IC	PWM/PFM, st-dwn, 2.1V±2%, 600mA, 3MHz, Vin>1.8V, HSST, CL	USP-6C	49da	DC16	9a Tor
7K2	XC9236F22DER	DC-DC-IC	PWM/PFM, st-dwn, 2.2V±2%, 600mA, 3MHz, Vin>1.8V, HSST, CL	USP-6C	49da	DC16	9a Tor
7K3	XC9236F23DER	DC-DC-IC	PWM/PFM, st-dwn, 2.3V±2%, 600mA, 3MHz, Vin>1.8V, HSST, CL	USP-6C	49da	DC16	9a Tor
7K4	XC9236F24DER	DC-DC-IC	PWM/PFM, st-dwn, 2.4V±2%, 600mA, 3MHz, Vin>1.8V, HSST, CL	USP-6C	49da	DC16	9a Tor
7K5	XC9236F25DER	DC-DC-IC	PWM/PFM, st-dwn, 2.5V±2%, 600mA, 3MHz, Vin>1.8V, HSST, CL	USP-6C	49da	DC16	9a Tor
7K6	XC9236F26DER	DC-DC-IC	PWM/PFM, st-dwn, 2.6V±2%, 600mA, 3MHz, Vin>1.8V, HSST, CL	USP-6C	49da	DC16	9a Tor
7K7	XC9236F27DER	DC-DC-IC	PWM/PFM, st-dwn, 2.7V±2%, 600mA, 3MHz, Vin>1.8V, HSST, CL	USP-6C	49da	DC16	9a Tor
7K8	XC9236F28DER	DC-DC-IC	PWM/PFM, st-dwn, 2.8V±2%, 600mA, 3MHz, Vin>1.8V, HSST, CL	USP-6C	49da	DC16	9a Tor
7K9	XC9236F29DER	DC-DC-IC	PWM/PFM, st-dwn, 2.9V±2%, 600mA, 3MHz, Vin>1.8V, HSST, CL	USP-6C	49da	DC16	9a Tor
7KA	XC9236F2ADER	DC-DC-IC	PWM/PFM, st-dwn, 2.05V±2%, 600mA, 3MHz, Vin>1.8V, HSST, CL	USP-6C	49da	DC16	9a Tor
7KB	XC9236F2BDER	DC-DC-IC	PWM/PFM, st-dwn, 2.15V±2%, 600mA, 3MHz, Vin>1.8V, HSST, CL	USP-6C	49da	DC16	9a Tor
7KC	XC9236F2CDER	DC-DC-IC	PWM/PFM, st-dwn, 2.25V±2%, 600mA, 3MHz, Vin>1.8V, HSST, CL	USP-6C	49da	DC16	9a Tor
7KD	XC9236F2DDER	DC-DC-IC	PWM/PFM, st-dwn, 2.35V±2%, 600mA, 3MHz, Vin>1.8V, HSST, CL	USP-6C	49da	DC16	9a Tor
7KE	XC9236F2EDER	DC-DC-IC	PWM/PFM, st-dwn, 2.45V±2%, 600mA, 3MHz, Vin>1.8V, HSST, CL	USP-6C	49da	DC16	9a Tor



SMD code	Type	Function	Short description	Case	Pinout	Sch.	St.	Mnf.
7KF	XC9236F2FDER	DC-DC-IC	PWM/PFM, st-dwn, 2.55V±2%, 600mA, 3MHz, Vin>1.8V, HSST, CL	USP-6C	49da	DC16	9a	Tor
7KH	XC9236F2HDER	DC-DC-IC	PWM/PFM, st-dwn, 2.65V±2%, 600mA, 3MHz, Vin>1.8V, HSST, CL	USP-6C	49da	DC16	9a	Tor
7KK	XC9236F2KDER	DC-DC-IC	PWM/PFM, st-dwn, 2.75V±2%, 600mA, 3MHz, Vin>1.8V, HSST, CL	USP-6C	49da	DC16	9a	Tor
7KL	XC9236F2LDER	DC-DC-IC	PWM/PFM, st-dwn, 2.85V±2%, 600mA, 3MHz, Vin>1.8V, HSST, CL	USP-6C	49da	DC16	9a	Tor
7KM	XC9236F2MDER	DC-DC-IC	PWM/PFM, st-dwn, 2.95V±2%, 600mA, 3MHz, Vin>1.8V, HSST, CL	USP-6C	49da	DC16	9a	Tor
7L	RP103K281B	LVR-IC	LDO, 2.8V±1%, 150mA, +CE	DFN1010-4	48vm	VR4	9a	Ric
7L	RP200K181D	LVR-IC	LDO, 1.8V±1.0%, 300mA, +CE, CL, AE(mode)	DFN1212-6	52ht	VR10	9a	Ric
7L	XG6217D19A7R-G	LVR-IC	LDO, 1.95V±2%, 200mA, +CE, CL	USPN-4	58vm	VR4	9a	Tor
7L	XG6223H2819R-G	LVR-IC	LDO, 2.8V±1%, 300mA, +CE, CL, PDR, ICP	USPQ-4B03	48vm	VR4	9a	Tor
7L0	XC9236F30DER	DC-DC-IC	PWM/PFM, st-dwn, 3.0V±2%, 600mA, 3MHz, Vin>1.8V, HSST, CL	USP-6C	49da	DC16	9a	Tor
7L1	XC9236F31DER	DC-DC-IC	PWM/PFM, st-dwn, 3.1V±2%, 600mA, 3MHz, Vin>1.8V, HSST, CL	USP-6C	49da	DC16	9a	Tor
7L2	XC9236F32DER	DC-DC-IC	PWM/PFM, st-dwn, 3.2V±2%, 600mA, 3MHz, Vin>1.8V, HSST, CL	USP-6C	49da	DC16	9a	Tor
7L3	XC9236F33DER	DC-DC-IC	PWM/PFM, st-dwn, 3.3V±2%, 600mA, 3MHz, Vin>1.8V, HSST, CL	USP-6C	49da	DC16	9a	Tor
7L4	XC9236F34DER	DC-DC-IC	PWM/PFM, st-dwn, 3.4V±2%, 600mA, 3MHz, Vin>1.8V, HSST, CL	USP-6C	49da	DC16	9a	Tor
7L5	XC9236F35DER	DC-DC-IC	PWM/PFM, st-dwn, 3.5V±2%, 600mA, 3MHz, Vin>1.8V, HSST, CL	USP-6C	49da	DC16	9a	Tor
7L6	XC9236F36DER	DC-DC-IC	PWM/PFM, st-dwn, 3.6V±2%, 600mA, 3MHz, Vin>1.8V, HSST, CL	USP-6C	49da	DC16	9a	Tor
7L7	XC9236F37DER	DC-DC-IC	PWM/PFM, st-dwn, 3.7V±2%, 600mA, 3MHz, Vin>1.8V, HSST, CL	USP-6C	49da	DC16	9a	Tor
7L8	XC9236F38DER	DC-DC-IC	PWM/PFM, st-dwn, 3.8V±2%, 600mA, 3MHz, Vin>1.8V, HSST, CL	USP-6C	49da	DC16	9a	Tor
7L9	XC9236F39DER	DC-DC-IC	PWM/PFM, st-dwn, 3.9V±2%, 600mA, 3MHz, Vin>1.8V, HSST, CL	USP-6C	49da	DC16	9a	Tor
7LA	XC9236F3ADER	DC-DC-IC	PWM/PFM, st-dwn, 3.05V±2%, 600mA, 3MHz, Vin>1.8V, HSST, CL	USP-6C	49da	DC16	9a	Tor
7LB	XC9236F3BDER	DC-DC-IC	PWM/PFM, st-dwn, 3.15V±2%, 600mA, 3MHz, Vin>1.8V, HSST, CL	USP-6C	49da	DC16	9a	Tor
7LC	XC9236F3CDER	DC-DC-IC	PWM/PFM, st-dwn, 3.25V±2%, 600mA, 3MHz, Vin>1.8V, HSST, CL	USP-6C	49da	DC16	9a	Tor
7LD	XC9236F3DDER	DC-DC-IC	PWM/PFM, st-dwn, 3.35V±2%, 600mA, 3MHz, Vin>1.8V, HSST, CL	USP-6C	49da	DC16	9a	Tor
7LE	XC9236F3EDER	DC-DC-IC	PWM/PFM, st-dwn, 3.45V±2%, 600mA, 3MHz, Vin>1.8V, HSST, CL	USP-6C	49da	DC16	9a	Tor
7LF	XC9236F3FDER	DC-DC-IC	PWM/PFM, st-dwn, 3.55V±2%, 600mA, 3MHz, Vin>1.8V, HSST, CL	USP-6C	49da	DC16	9a	Tor
7LH	XC9236F3HDER	DC-DC-IC	PWM/PFM, st-dwn, 3.65V±2%, 600mA, 3MHz, Vin>1.8V, HSST, CL	USP-6C	49da	DC16	9a	Tor
7LK	XC9236F3KDER	DC-DC-IC	PWM/PFM, st-dwn, 3.75V±2%, 600mA, 3MHz, Vin>1.8V, HSST, CL	USP-6C	49da	DC16	9a	Tor
7LL	XC9236F3LDER	DC-DC-IC	PWM/PFM, st-dwn, 3.85V±2%, 600mA, 3MHz, Vin>1.8V, HSST, CL	USP-6C	49da	DC16	9a	Tor
7LM	XC9236F3MDER	DC-DC-IC	PWM/PFM, st-dwn, 3.95V±2%, 600mA, 3MHz, Vin>1.8V, HSST, CL	USP-6C	49da	DC16	9a	Tor
7M	RP103K281B5	LVR-IC	LDO, 2.85V±1%, 150mA, +CE	DFN1010-4	48vm	VR4	9a	Ric
7M	RP200K191D	LVR-IC	LDO, 1.9V±1.0%, 300mA, +CE, CL, AE(mode)	DFN1212-6	52ht	VR10	9a	Ric
7M	XG6217D20A7R-G	LVR-IC	LDO, 2.05V±2%, 200mA, +CE, CL	USPN-4	58vm	VR4	9a	Tor
7M	XG6223H2919R-G	LVR-IC	LDO, 2.9V±1%, 300mA, +CE, CL, PDR, ICP	USPQ-4B03	48vm	VR4	9a	Tor
7M0	XC9236F40DER	DC-DC-IC	PWM/PFM, st-dwn, 4.0V±2%, 600mA, 3MHz, Vin>1.8V, HSST, CL	USP-6C	49da	DC16	9a	Tor
7N	RP103K291B	LVR-IC	LDO, 2.9V±1%, 150mA, +CE	DFN1010-4	48vm	VR4	9a	Ric
7N	RP200K201D	LVR-IC	LDO, 2V±1.0%, 300mA, +CE, CL, AE(mode)	DFN1212-6	52ht	VR10	9a	Ric
7N	XG6217D21A7R-G	LVR-IC	LDO, 2.15V±2%, 200mA, +CE, CL	USPN-4	58vm	VR4	9a	Tor
7N	XG6223H3019R-G	LVR-IC	LDO, 3.0V±1%, 300mA, +CE, CL, PDR, ICP	USPQ-4B03	48vm	VR4	9a	Tor
7P	RP103K301B	LVR-IC	LDO, 3V±1%, 150mA, +CE	DFN1010-4	48vm	VR4	9a	Ric
7P	RP200K211D	LVR-IC	LDO, 2.1V±1.0%, 300mA, +CE, CL, AE(mode)	DFN1212-6	52ht	VR10	9a	Ric
7P	XG6217D22A7R-G	LVR-IC	LDO, 2.25V±2%, 200mA, +CE, CL	USPN-4	58vm	VR4	9a	Tor
7P	XG6223H3119R-G	LVR-IC	LDO, 3.1V±1%, 300mA, +CE, CL, PDR, ICP	USPQ-4B03	48vm	VR4	9a	Tor
7Q	RP103K311B	LVR-IC	LDO, 3.1V±1%, 150mA, +CE	DFN1010-4	48vm	VR4	9a	Ric
7Q	RP200K221D	LVR-IC	LDO, 2.2V±1.0%, 300mA, +CE, CL, AE(mode)	DFN1212-6	52ht	VR10	9a	Ric
7R	RP103K331B	LVR-IC	LDO, 3.3V±1%, 150mA, +CE	DFN1010-4	48vm	VR4	9a	Ric
7R	RP200K231D	LVR-IC	LDO, 2.3V±1.0%, 300mA, +CE, CL, AE(mode)	DFN1212-6	52ht	VR10	9a	Ric
7R	XG6217D23A7R-G	LVR-IC	LDO, 2.35V±2%, 200mA, +CE, CL	USPN-4	58vm	VR4	9a	Tor
7R	XG6223H3219R-G	LVR-IC	LDO, 3.2V±1%, 300mA, +CE, CL, PDR, ICP	USPQ-4B03	48vm	VR4	9a	Tor
7S	RP200K241D	LVR-IC	LDO, 2.4V±1.0%, 300mA, +CE, CL, AE(mode)	DFN1212-6	52ht	VR10	9a	Ric
7S	XG6217D24A7R-G	LVR-IC	LDO, 2.45V±2%, 200mA, +CE, CL	USPN-4	58vm	VR4	9a	Tor
7S	XG6223H3319R-G	LVR-IC	LDO, 3.3V±1%, 300mA, +CE, CL, PDR, ICP	USPQ-4B03	48vm	VR4	9a	Tor
7T	RP103K211B	LVR-IC	LDO, 2.1V±1%, 150mA, +CE	DFN1010-4	48vm	VR4	9a	Ric
7T	RP200K251D	LVR-IC	LDO, 2.5V±1.0%, 300mA, +CE, CL, AE(mode)	DFN1212-6	52ht	VR10	9a	Ric
7T	XG6217D25A7R-G	LVR-IC	LDO, 2.55V±2%, 200mA, +CE, CL	USPN-4	58vm	VR4	9a	Tor
7T	XG6223H3419R-G	LVR-IC	LDO, 3.4V±1%, 300mA, +CE, CL, PDR, ICP	USPQ-4B03	48vm	VR4	9a	Tor
7U	RP103K321B	LVR-IC	LDO, 3.2V±1%, 150mA, +CE	DFN1010-4	48vm	VR4	9a	Ric
7U	RP200K261D	LVR-IC	LDO, 2.6V±1.0%, 300mA, +CE, CL, AE(mode)	DFN1212-6	52ht	VR10	9a	Ric
7U	XG6217D26A7R-G	LVR-IC	LDO, 2.65V±2%, 200mA, +CE, CL	USPN-4	58vm	VR4	9a	Tor
7U	XG6223H3519R-G	LVR-IC	LDO, 3.5V±1%, 300mA, +CE, CL, PDR, ICP	USPQ-4B03	48vm	VR4	9a	Tor
7V	RP103K291B5	LVR-IC	LDO, 2.95V±1%, 150mA, +CE	DFN1010-4	48vm	VR4	9a	Ric
7V	RP200K271D	LVR-IC	LDO, 2.7V±1.0%, 300mA, +CE, CL, AE(mode)	DFN1212-6	52ht	VR10	9a	Ric
7V	XG6217D27A7R-G	LVR-IC	LDO, 2.75V±2%, 200mA, +CE, CL	USPN-4	58vm	VR4	9a	Tor
7V	XG6223H3619R-G	LVR-IC	LDO, 3.6V±1%, 300mA, +CE, CL, PDR, ICP	USPQ-4B03	48vm	VR4	9a	Tor
7W	RP103K221B	LVR-IC	LDO, 2.2V±1%, 150mA, +CE	DFN1010-4	48vm	VR4	9a	Ric
7W	RP200K281D	LVR-IC	LDO, 2.8V±1.0%, 300mA, +CE, CL, AE(mode)	DFN1212-6	52ht	VR10	9a	Ric
7X	RP103K161B	LVR-IC	LDO, 1.6V±1%, 150mA, +CE	DFN1010-4	48vm	VR4	9a	Ric
7X	RP200K291D	LVR-IC	LDO, 2.9V±1.0%, 300mA, +CE, CL, AE(mode)	DFN1212-6	52ht	VR10	9a	Ric
7X	XG6217D28A7R-G	LVR-IC	LDO, 2.85V±2%, 200mA, +CE, CL	USPN-4	58vm	VR4	9a	Tor
7X	XG6223H3719R-G	LVR-IC	LDO, 3.7V±1%, 300mA, +CE, CL, PDR, ICP	USPQ-4B03	48vm	VR4	9a	Tor
7Y	RP103K141B	LVR-IC	LDO, 1.4V±1%, 150mA, +CE	DFN1010-4	48vm	VR4	9a	Ric



SMD
code

Type

Function

Short description

Case

Pinout Sch.

St.Mnf.

SMD code	Type	Function	Short description	Case	Pinout Sch.	St.Mnf.
7Y	RP200K301D	LVR-IC	LDO, 3V±1.0%, 300mA, +CE, CL, AE(mode)	DFN1212-6	52ht	VR10 9a Ric
7Y	XC6217D29A7R-G	LVR-IC	LDO, 2.95V±2%, 200mA, +CE, CL	USPN-4	58vm	VR4 9a Tor
7Y	XC6223H3819R-G	LVR-IC	LDO, 3.8V±1%, 300mA, +CE, CL, PDR, ICP	USPQ-4B03	48vm	VR4 9a Tor
7Z	RP103K171B	LVR-IC	LDO, 1.7V±1%, 150mA, +CE	DFN1010-4	48vm	VR4 9a Ric
7Z	RP200K311D	LVR-IC	LDO, 3.1V±1.0%, 300mA, +CE, CL, AE(mode)	DFN1212-6	52ht	VR10 9a Ric
7Z	XC6217D30A7R-G	LVR-IC	LDO, 3.15V±2%, 200mA, +CE, CL	USPN-4	58vm	VR4 9a Tor
7Z	XC6223H3919R-G	LVR-IC	LDO, 3.9V±1%, 300mA, +CE, CL, PDR, ICP	USPQ-4B03	48vm	VR4 9a Tor
80	RP110L221D	LVR-IC	LDO, 2.2V±1%, 150mA, +CE, CL	DFN1010-4	48vm	VR4 9a Ric
80	XC6217D31A7R-G	LVR-IC	LDO, 3.15V±2%, 200mA, +CE, CL	USPN-4	58vm	VR4 9a Tor
81	RP110L231D	LVR-IC	LDO, 2.3V±1%, 150mA, +CE, CL	DFN1010-4	48vm	VR4 9a Ric
81	XC6217D32A7R-G	LVR-IC	LDO, 3.25V±2%, 200mA, +CE, CL	USPN-4	58vm	VR4 9a Tor
815	MIC5305-1.5BML	LVR-IC	LDO, LN, +CE, 1.5V±1%, 150mA	LLP-6	56ub	VR7 - Mcr
818	MIC5305-1.8BML	LVR-IC	LDO, LN, +CE, 1.8V±1%, 150mA	LLP-6	56ub	VR7 - Mcr
81K	XC6701B18ER	LVR-IC	1.8V±2%, 150mA, +CE	USP-6C	49hu	VR4 9a Tor
81L	XC6701B19ER	LVR-IC	1.9V±2%, 150mA, +CE	USP-6C	49hu	VR4 9a Tor
81M	XC6701B20ER	LVR-IC	2.0V±2%, 150mA, +CE	USP-6C	49hu	VR4 9a Tor
81N	XC6701B21ER	LVR-IC	2.1V±2%, 150mA, +CE	USP-6C	49hu	VR4 9a Tor
81P	XC6701B22ER	LVR-IC	2.2V±2%, 150mA, +CE	USP-6C	49hu	VR4 9a Tor
81R	XC6701B23ER	LVR-IC	2.3V±2%, 150mA, +CE	USP-6C	49hu	VR4 9a Tor
81S	XC6701B24ER	LVR-IC	2.4V±2%, 150mA, +CE	USP-6C	49hu	VR4 9a Tor
81T	XC6701B25ER	LVR-IC	2.5V±2%, 150mA, +CE	USP-6C	49hu	VR4 9a Tor
81U	XC6701B26ER	LVR-IC	2.6V±2%, 150mA, +CE	USP-6C	49hu	VR4 9a Tor
81V	XC6701B27ER	LVR-IC	2.7V±2%, 150mA, +CE	USP-6C	49hu	VR4 9a Tor
81X	XC6701B28ER	LVR-IC	2.8V±2%, 150mA, +CE	USP-6C	49hu	VR4 9a Tor
81Y	XC6701B29ER	LVR-IC	2.9V±2%, 150mA, +CE	USP-6C	49hu	VR4 9a Tor
81Z	XC6701B30ER	LVR-IC	3.0V±2%, 150mA, +CE	USP-6C	49hu	VR4 9a Tor
82	RP110L241D	LVR-IC	LDO, 2.4V±1%, 150mA, +CE, CL	DFN1010-4	48vm	VR4 9a Ric
82	XC6217D33A7R-G	LVR-IC	LDO, 3.35V±2%, 200mA, +CE, CL	USPN-4	58vm	VR4 9a Tor
82	XC6223A12B9R-G	LVR-IC	LDO, 1.25V±20mV, 300mA, +CE	USPQ-4B03	48vm	VR4 9a Tor
820	XC6701B31ER	LVR-IC	3.1V±2%, 150mA, +CE	USP-6C	49hu	VR4 9a Tor
821	XC6701B32ER	LVR-IC	3.2V±2%, 150mA, +CE	USP-6C	49hu	VR4 9a Tor
822	XC6701B33ER	LVR-IC	3.3V±2%, 150mA, +CE	USP-6C	49hu	VR4 9a Tor
823	XC6701B34ER	LVR-IC	3.4V±2%, 150mA, +CE	USP-6C	49hu	VR4 9a Tor
824	XC6701B35ER	LVR-IC	3.5V±2%, 150mA, +CE	USP-6C	49hu	VR4 9a Tor
825	MIC5305-2.5BML	LVR-IC	LDO, LN, +CE, 2.5V±1%, 150mA	LLP-6	56ub	VR7 - Mcr
825	XC6701B36ER	LVR-IC	3.6V±2%, 150mA, +CE	USP-6C	49hu	VR4 9a Tor
826	MIC5305-2.6BML	LVR-IC	LDO, LN, +CE, 2.6V±1%, 150mA	LLP-6	56ub	VR7 - Mcr
826	XC6701B37ER	LVR-IC	3.7V±2%, 150mA, +CE	USP-6C	49hu	VR4 9a Tor
827	MIC5305-2.7BML	LVR-IC	LDO, LN, +CE, 2.7V±1%, 150mA	LLP-6	56ub	VR7 - Mcr
827	XC6701B38ER	LVR-IC	3.8V±2%, 150mA, +CE	USP-6C	49hu	VR4 9a Tor
828	MIC5305-2.8BML	LVR-IC	LDO, LN, +CE, 2.8V±1%, 150mA	LLP-6	56ub	VR7 - Mcr
828	XC6701B39ER	LVR-IC	3.9V±2%, 150mA, +CE	USP-6C	49hu	VR4 9a Tor
829	MIC5305-2.9BML	LVR-IC	LDO, LN, +CE, 2.9V±1%, 150mA	LLP-6	56ub	VR7 - Mcr
829	XC6701B40ER	LVR-IC	4.0V±2%, 150mA, +CE	USP-6C	49hu	VR4 9a Tor
82A	XC6701B41ER	LVR-IC	4.1V±2%, 150mA, +CE	USP-6C	49hu	VR4 9a Tor
82B	XC6701B42ER	LVR-IC	4.2V±2%, 150mA, +CE	USP-6C	49hu	VR4 9a Tor
82C	XC6701B43ER	LVR-IC	4.3V±2%, 150mA, +CE	USP-6C	49hu	VR4 9a Tor
82D	XC6701B44ER	LVR-IC	4.4V±2%, 150mA, +CE	USP-6C	49hu	VR4 9a Tor
82E	XC6701B45ER	LVR-IC	4.5V±2%, 150mA, +CE	USP-6C	49hu	VR4 9a Tor
82F	XC6701B46ER	LVR-IC	4.6V±2%, 150mA, +CE	USP-6C	49hu	VR4 9a Tor
82H	XC6701B47ER	LVR-IC	4.7V±2%, 150mA, +CE	USP-6C	49hu	VR4 9a Tor
82K	XC6701B48ER	LVR-IC	4.8V±2%, 150mA, +CE	USP-6C	49hu	VR4 9a Tor
82L	XC6701B49ER	LVR-IC	4.9V±2%, 150mA, +CE	USP-6C	49hu	VR4 9a Tor
82M	XC6701B50ER	LVR-IC	5.0V±2%, 150mA, +CE	USP-6C	49hu	VR4 9a Tor
82N	XC6701B51ER	LVR-IC	5.1V±2%, 150mA, +CE	USP-6C	49hu	VR4 9a Tor
82P	XC6701B52ER	LVR-IC	5.2V±2%, 150mA, +CE	USP-6C	49hu	VR4 9a Tor
82R	XC6701B53ER	LVR-IC	5.3V±2%, 150mA, +CE	USP-6C	49hu	VR4 9a Tor
82S	XC6701B54ER	LVR-IC	5.4V±2%, 150mA, +CE	USP-6C	49hu	VR4 9a Tor
82T	XC6701B55ER	LVR-IC	5.5V±2%, 150mA, +CE	USP-6C	49hu	VR4 9a Tor
82U	XC6701B56ER	LVR-IC	5.6V±2%, 150mA, +CE	USP-6C	49hu	VR4 9a Tor
82V	XC6701B57ER	LVR-IC	5.7V±2%, 150mA, +CE	USP-6C	49hu	VR4 9a Tor
82X	XC6701B58ER	LVR-IC	5.8V±2%, 150mA, +CE	USP-6C	49hu	VR4 9a Tor
82Y	XC6701B59ER	LVR-IC	5.9V±2%, 150mA, +CE	USP-6C	49hu	VR4 9a Tor
82Z	XC6701B60ER	LVR-IC	6.0V±2%, 150mA, +CE	USP-6C	49hu	VR4 9a Tor
83	RP110L251D	LVR-IC	LDO, 2.5V±1%, 150mA, +CE, CL	DFN1010-4	48vm	VR4 9a Ric
83	XC6217D34A7R-G	LVR-IC	LDO, 3.45V±2%, 200mA, +CE, CL	USPN-4	58vm	VR4 9a Tor
83	XC6223A13B9R-G	LVR-IC	LDO, 1.35V±20mV, 300mA, +CE	USPQ-4B03	48vm	VR4 9a Tor
830	MIC5305-3.0BML	LVR-IC	LDO, LN, +CE, 3V±1%, 150mA	LLP-6	56ub	VR7 - Mcr
830	XC6701B61ER	LVR-IC	6.1V±2%, 150mA, +CE	USP-6C	49hu	VR4 9a Tor
831	XC6701B62ER	LVR-IC	6.2V±2%, 150mA, +CE	USP-6C	49hu	VR4 9a Tor



SMD code	Type	Function	Short description	Case	Pinout	Sch.	St.	Mnf.
832	XC6701B63ER	LVR-IC	6.3V±2%, 150mA, +CE	USP-6C	49hu	VR4	9a	Tor
833	MIC5305-3.3BML	LVR-IC	LDO, LN, +CE, 3.3V±1%, 150mA	LLP-6	56ub	VR7	-	Mcr
833	XC6701B64ER	LVR-IC	6.4V±2%, 150mA, +CE	USP-6C	49hu	VR4	9a	Tor
834	XC6701B65ER	LVR-IC	6.5V±2%, 150mA, +CE	USP-6C	49hu	VR4	9a	Tor
835	XC6701B66ER	LVR-IC	6.6V±2%, 150mA, +CE	USP-6C	49hu	VR4	9a	Tor
836	XC6701B67ER	LVR-IC	6.7V±2%, 150mA, +CE	USP-6C	49hu	VR4	9a	Tor
837	XC6701B68ER	LVR-IC	6.8V±2%, 150mA, +CE	USP-6C	49hu	VR4	9a	Tor
838	XC6701B69ER	LVR-IC	6.9V±2%, 150mA, +CE	USP-6C	49hu	VR4	9a	Tor
839	XC6701B70ER	LVR-IC	7.0V±2%, 150mA, +CE	USP-6C	49hu	VR4	9a	Tor
83A	XC6701B71ER	LVR-IC	7.1V±2%, 150mA, +CE	USP-6C	49hu	VR4	9a	Tor
83B	XC6701B72ER	LVR-IC	7.2V±2%, 150mA, +CE	USP-6C	49hu	VR4	9a	Tor
83C	XC6701B73ER	LVR-IC	7.3V±2%, 150mA, +CE	USP-6C	49hu	VR4	9a	Tor
83D	XC6701B74ER	LVR-IC	7.4V±2%, 150mA, +CE	USP-6C	49hu	VR4	9a	Tor
83E	XC6701B75ER	LVR-IC	7.5V±2%, 150mA, +CE	USP-6C	49hu	VR4	9a	Tor
83F	XC6701B76ER	LVR-IC	7.6V±2%, 150mA, +CE	USP-6C	49hu	VR4	9a	Tor
83H	XC6701B77ER	LVR-IC	7.7V±2%, 150mA, +CE	USP-6C	49hu	VR4	9a	Tor
83K	XC6701B78ER	LVR-IC	7.8V±2%, 150mA, +CE	USP-6C	49hu	VR4	9a	Tor
83L	XC6701B79ER	LVR-IC	7.9V±2%, 150mA, +CE	USP-6C	49hu	VR4	9a	Tor
83M	XC6701B80ER	LVR-IC	8.0V±2%, 150mA, +CE	USP-6C	49hu	VR4	9a	Tor
83N	XC6701B81ER	LVR-IC	8.1V±2%, 150mA, +CE	USP-6C	49hu	VR4	9a	Tor
83P	XC6701B82ER	LVR-IC	8.2V±2%, 150mA, +CE	USP-6C	49hu	VR4	9a	Tor
83R	XC6701B83ER	LVR-IC	8.3V±2%, 150mA, +CE	USP-6C	49hu	VR4	9a	Tor
83S	XC6701B84ER	LVR-IC	8.4V±2%, 150mA, +CE	USP-6C	49hu	VR4	9a	Tor
83T	XC6701B85ER	LVR-IC	8.5V±2%, 150mA, +CE	USP-6C	49hu	VR4	9a	Tor
83U	XC6701B86ER	LVR-IC	8.6V±2%, 150mA, +CE	USP-6C	49hu	VR4	9a	Tor
83V	XC6701B87ER	LVR-IC	8.7V±2%, 150mA, +CE	USP-6C	49hu	VR4	9a	Tor
83X	XC6701B88ER	LVR-IC	8.8V±2%, 150mA, +CE	USP-6C	49hu	VR4	9a	Tor
83Y	XC6701B89ER	LVR-IC	8.9V±2%, 150mA, +CE	USP-6C	49hu	VR4	9a	Tor
83Z	XC6701B90ER	LVR-IC	9.0V±2%, 150mA, +CE	USP-6C	49hu	VR4	9a	Tor
84	RP110L261D	LVR-IC	LDO, 2.6V±1%, 150mA, +CE, CL	DFN11010-4	48vm	VR4	9a	Ric
84	XC6217D35A7R-G	LVR-IC	LDO, 3.55V±2%, 200mA, +CE, CL	USPN-4	58vm	VR4	9a	Tor
84	XC6223A14B9R-G	LVR-IC	LDO, 1.45V±20mV, 300mA, +CE	USPQ-4B03	48vm	VR4	9a	Tor
840	XC6701B91ER	LVR-IC	9.1V±2%, 150mA, +CE	USP-6C	49hu	VR4	9a	Tor
841	XC6701B92ER	LVR-IC	9.2V±2%, 150mA, +CE	USP-6C	49hu	VR4	9a	Tor
8415	BD88415GUL	LIN-IC	AF PA, 2.5..5.5V, 2x60mW(3V/16Ω), shutdown	BGA-14	39	-	9g	Rhm
842	XC6701B93ER	LVR-IC	9.3V±2%, 150mA, +CE	USP-6C	49hu	VR4	9a	Tor
843	XC6701B94ER	LVR-IC	9.4V±2%, 150mA, +CE	USP-6C	49hu	VR4	9a	Tor
844	XC6701B95ER	LVR-IC	9.5V±2%, 150mA, +CE	USP-6C	49hu	VR4	9a	Tor
845	XC6701B96ER	LVR-IC	9.6V±2%, 150mA, +CE	USP-6C	49hu	VR4	9a	Tor
846	XC6701B97ER	LVR-IC	9.7V±2%, 150mA, +CE	USP-6C	49hu	VR4	9a	Tor
847	XC6701B98ER	LVR-IC	9.8V±2%, 150mA, +CE	USP-6C	49hu	VR4	9a	Tor
848	XC6701B99ER	LVR-IC	9.9V±2%, 150mA, +CE	USP-6C	49hu	VR4	9a	Tor
849	XC6701BA0ER	LVR-IC	10.0V±2%, 150mA, +CE	USP-6C	49hu	VR4	9a	Tor
84A	XC6701BA1ER	LVR-IC	10.1V±2%, 150mA, +CE	USP-6C	49hu	VR4	9a	Tor
84B	XC6701BA2ER	LVR-IC	10.2V±2%, 150mA, +CE	USP-6C	49hu	VR4	9a	Tor
84C	XC6701BA3ER	LVR-IC	10.3V±2%, 150mA, +CE	USP-6C	49hu	VR4	9a	Tor
84D	XC6701BA4ER	LVR-IC	10.4V±2%, 150mA, +CE	USP-6C	49hu	VR4	9a	Tor
84E	XC6701BA5ER	LVR-IC	10.5V±2%, 150mA, +CE	USP-6C	49hu	VR4	9a	Tor
84F	XC6701BA6ER	LVR-IC	10.6V±2%, 150mA, +CE	USP-6C	49hu	VR4	9a	Tor
84H	MIC5305-4.75BML	LVR-IC	LDO, LN, +CE, 4.75V±1%, 150mA	LLP-6	56ub	VR7	-	Mcr
84H	XC6701BA7ER	LVR-IC	10.7V±2%, 150mA, +CE	USP-6C	49hu	VR4	9a	Tor
84K	XC6701BA8ER	LVR-IC	10.8V±2%, 150mA, +CE	USP-6C	49hu	VR4	9a	Tor
84L	XC6701BA9ER	LVR-IC	10.9V±2%, 150mA, +CE	USP-6C	49hu	VR4	9a	Tor
84M	XC6701BB0ER	LVR-IC	11.0V±2%, 150mA, +CE	USP-6C	49hu	VR4	9a	Tor
84N	XC6701BB1ER	LVR-IC	11.1V±2%, 150mA, +CE	USP-6C	49hu	VR4	9a	Tor
84P	XC6701BB2ER	LVR-IC	11.2V±2%, 150mA, +CE	USP-6C	49hu	VR4	9a	Tor
84R	XC6701BB3ER	LVR-IC	11.3V±2%, 150mA, +CE	USP-6C	49hu	VR4	9a	Tor
84S	XC6701BB4ER	LVR-IC	11.4V±2%, 150mA, +CE	USP-6C	49hu	VR4	9a	Tor
84T	XC6701BB5ER	LVR-IC	11.5V±2%, 150mA, +CE	USP-6C	49hu	VR4	9a	Tor
84U	XC6701BB6ER	LVR-IC	11.6V±2%, 150mA, +CE	USP-6C	49hu	VR4	9a	Tor
84V	XC6701BB7ER	LVR-IC	11.7V±2%, 150mA, +CE	USP-6C	49hu	VR4	9a	Tor
84X	XC6701BB8ER	LVR-IC	11.8V±2%, 150mA, +CE	USP-6C	49hu	VR4	9a	Tor
84Y	XC6701BB9ER	LVR-IC	11.9V±2%, 150mA, +CE	USP-6C	49hu	VR4	9a	Tor
84Z	XC6701BC0ER	LVR-IC	12.0V±2%, 150mA, +CE	USP-6C	49hu	VR4	9a	Tor
85	RP110L271D	LVR-IC	LDO, 2.7V±1%, 150mA, +CE, CL	DFN11010-4	48vm	VR4	9a	Ric
85	XC6217D36A7R-G	LVR-IC	LDO, 3.65V±2%, 200mA, +CE, CL	USPN-4	58vm	VR4	9a	Tor
85	XC6223A15B9R-G	LVR-IC	LDO, 1.55V±20mV, 300mA, +CE	USPQ-4B03	48vm	VR4	9a	Tor
8512	SI9185DMP-12-T1	LVR-IC	LDO, 1.2V±1.5%, 500mA, +CE, Error	MLP33	61v7	VR25	8d	Vs
8515	SI9185DMP-15-T1	LVR-IC	LDO, 1.5V±1.5%, 500mA, +CE, Error	MLP33	61v7	VR25	8d	Vs
8518	SI9185DMP-18-T1	LVR-IC	LDO, 1.8V±1.5%, 500mA, +CE, Error	MLP33	61v7	VR25	8d	Vs



SMD code	Type	Function	Short description	Case	Pinout	Sch.	St.	Mnf.
8520	SI9185DMP-20-T1	LVR-IC	LDO, 2.0V±1.5%, 500mA, +CE, Error	MLP33	61vr7	VR25	8d	Vs
8525	SI9185DMP-25-T1	LVR-IC	LDO, 2.5V±1.5%, 500mA, +CE, Error	MLP33	61vr7	VR25	8d	Vs
8528	SI9185DMP-28-T1	LVR-IC	LDO, 2.8V±1.5%, 500mA, +CE, Error	MLP33	61vr7	VR25	8d	Vs
8529	SI9185DMP-29-T1	LVR-IC	LDO, 2.9V±1.5%, 500mA, +CE, Error	MLP33	61vr7	VR25	8d	Vs
8530	SI9185DMP-30-T1	LVR-IC	LDO, 3.0V±1.5%, 500mA, +CE, Error	MLP33	61vr7	VR25	8d	Vs
8533	SI9185DMP-33-T1	LVR-IC	LDO, 3.3V±1.5%, 500mA, +CE, Error	MLP33	61vr7	VR25	8d	Vs
8550	SI9185DMP-50-T1	LVR-IC	LDO, 5.0V±1.5%, 500mA, +CE, Error	MLP33	61vr7	VR25	8d	Vs
85AD	SI9185DMP-AD-T1	LVR-IC	LDO, Adj, 1.2..5V, 150mA, +CE, Error	MLP33	61vr8	VR25	8d	Vs
85BBA1	KBA2338-WCSP	LIN-IC	AF PA, BTL, class-D, 2.5..5.5V, 3W(5V/3Q), shutdown	BGA-9	39	AFP45	-	Ktc
86	RP110L281D	LVR-IC	LDO, 2.8V±1%, 150mA, +CE, CL	DFN1010-4	48vm	VR4	9a	Ric
86	XC6217D37A7R-G	LVR-IC	LDO, 3.75V±2%, 200mA, +CE, CL	USPN-4	58vm	VR4	9a	Tor
86	XC6223A16B9R-G	LVR-IC	LDO, 1.65V±20mV, 300mA, +CE	USPQ-4B03	48vm	VR4	9a	Tor
87	RP110L281D5	LVR-IC	LDO, 2.85V±1%, 150mA, +CE, CL	DFN1010-4	48vm	VR4	9a	Ric
87	XC6217D38A7R-G	LVR-IC	LDO, 3.85V±2%, 200mA, +CE, CL	USPN-4	58vm	VR4	9a	Tor
87	XC6223A17B9R-G	LVR-IC	LDO, 1.75V±20mV, 300mA, +CE	USPQ-4B03	48vm	VR4	9a	Tor
88	RP110L291D	LVR-IC	LDO, 2.9V±1%, 150mA, +CE, CL	DFN1010-4	48vm	VR4	9a	Ric
88	XC6217D39A7R-G	LVR-IC	LDO, 3.95V±2%, 200mA, +CE, CL	USPN-4	58vm	VR4	9a	Tor
88	XC6223A18B9R-G	LVR-IC	LDO, 1.85V±20mV, 300mA, +CE	USPQ-4B03	48vm	VR4	9a	Tor
89	RP110L301D	LVR-IC	LDO, 3.0V±1%, 150mA, +CE, CL	DFN1010-4	48vm	VR4	9a	Ric
89	XC6221B40B7R	LVR-IC	LDO, 4.05V±1%, 200mA, +CE, CL	USPN-4	58vm	VR4	9a	Tor
89	XC6223A19B9R-G	LVR-IC	LDO, 1.95V±20mV, 300mA, +CE	USPQ-4B03	48vm	VR4	9a	Tor
8A	RP103K121D	LVR-IC	LDO, 1.2V±1%, 150mA, +CE, CL	DFN1010-4	48vm	VR4	9a	Ric
8A	RP200K321D	LVR-IC	LDO, 3.2V±1.0%, 300mA, +CE, CL, AE(mode)	DFN1212-6	52ht	VR10	9a	Ric
8A	XC6223A20B9R-G	LVR-IC	LDO, 2.05V±1%, 300mA, +CE	USPQ-4B03	48vm	VR4	9a	Tor
8A0	XC6701BC1ER	LVR-IC	12.1V±2%, 150mA, +CE	USP-6C	49hu	VR4	9a	Tor
8A016	XC6116A016ER	Vdet-IC	1.6V±2%, -MR, ±Reset PPO, Rt=3.13ms	USP-6C	49xs	VD21	9b	Tor
8A017	XC6116A017ER	Vdet-IC	1.7V±2%, -MR, ±Reset PPO, Rt=3.13ms	USP-6C	49xs	VD21	9b	Tor
8A018	XC6116A018ER	Vdet-IC	1.8V±2%, -MR, ±Reset PPO, Rt=3.13ms	USP-6C	49xs	VD21	9b	Tor
8A019	XC6116A019ER	Vdet-IC	1.9V±2%, -MR, ±Reset PPO, Rt=3.13ms	USP-6C	49xs	VD21	9b	Tor
8A020	XC6116A020ER	Vdet-IC	2.0V±2%, -MR, ±Reset PPO, Rt=3.13ms	USP-6C	49xs	VD21	9b	Tor
8A021	XC6116A021ER	Vdet-IC	2.1V±2%, -MR, ±Reset PPO, Rt=3.13ms	USP-6C	49xs	VD21	9b	Tor
8A022	XC6116A022ER	Vdet-IC	2.2V±2%, -MR, ±Reset PPO, Rt=3.13ms	USP-6C	49xs	VD21	9b	Tor
8A023	XC6116A023ER	Vdet-IC	2.3V±2%, -MR, ±Reset PPO, Rt=3.13ms	USP-6C	49xs	VD21	9b	Tor
8A024	XC6116A024ER	Vdet-IC	2.4V±2%, -MR, ±Reset PPO, Rt=3.13ms	USP-6C	49xs	VD21	9b	Tor
8A025	XC6116A025ER	Vdet-IC	2.5V±2%, -MR, ±Reset PPO, Rt=3.13ms	USP-6C	49xs	VD21	9b	Tor
8A026	XC6116A026ER	Vdet-IC	2.6V±2%, -MR, ±Reset PPO, Rt=3.13ms	USP-6C	49xs	VD21	9b	Tor
8A027	XC6116A027ER	Vdet-IC	2.7V±2%, -MR, ±Reset PPO, Rt=3.13ms	USP-6C	49xs	VD21	9b	Tor
8A028	XC6116A028ER	Vdet-IC	2.8V±2%, -MR, ±Reset PPO, Rt=3.13ms	USP-6C	49xs	VD21	9b	Tor
8A029	XC6116A029ER	Vdet-IC	2.9V±2%, -MR, ±Reset PPO, Rt=3.13ms	USP-6C	49xs	VD21	9b	Tor
8A030	XC6116A030ER	Vdet-IC	3.0V±2%, -MR, ±Reset PPO, Rt=3.13ms	USP-6C	49xs	VD21	9b	Tor
8A031	XC6116A031ER	Vdet-IC	3.1V±2%, -MR, ±Reset PPO, Rt=3.13ms	USP-6C	49xs	VD21	9b	Tor
8A032	XC6116A032ER	Vdet-IC	3.2V±2%, -MR, ±Reset PPO, Rt=3.13ms	USP-6C	49xs	VD21	9b	Tor
8A033	XC6116A033ER	Vdet-IC	3.3V±2%, -MR, ±Reset PPO, Rt=3.13ms	USP-6C	49xs	VD21	9b	Tor
8A034	XC6116A034ER	Vdet-IC	3.4V±2%, -MR, ±Reset PPO, Rt=3.13ms	USP-6C	49xs	VD21	9b	Tor
8A035	XC6116A035ER	Vdet-IC	3.5V±2%, -MR, ±Reset PPO, Rt=3.13ms	USP-6C	49xs	VD21	9b	Tor
8A036	XC6116A036ER	Vdet-IC	3.6V±2%, -MR, ±Reset PPO, Rt=3.13ms	USP-6C	49xs	VD21	9b	Tor
8A037	XC6116A037ER	Vdet-IC	3.7V±2%, -MR, ±Reset PPO, Rt=3.13ms	USP-6C	49xs	VD21	9b	Tor
8A038	XC6116A038ER	Vdet-IC	3.8V±2%, -MR, ±Reset PPO, Rt=3.13ms	USP-6C	49xs	VD21	9b	Tor
8A039	XC6116A039ER	Vdet-IC	3.9V±2%, -MR, ±Reset PPO, Rt=3.13ms	USP-6C	49xs	VD21	9b	Tor
8A040	XC6116A040ER	Vdet-IC	4.0V±2%, -MR, ±Reset PPO, Rt=3.13ms	USP-6C	49xs	VD21	9b	Tor
8A041	XC6116A041ER	Vdet-IC	4.1V±2%, -MR, ±Reset PPO, Rt=3.13ms	USP-6C	49xs	VD21	9b	Tor
8A042	XC6116A042ER	Vdet-IC	4.2V±2%, -MR, ±Reset PPO, Rt=3.13ms	USP-6C	49xs	VD21	9b	Tor
8A043	XC6116A043ER	Vdet-IC	4.3V±2%, -MR, ±Reset PPO, Rt=3.13ms	USP-6C	49xs	VD21	9b	Tor
8A044	XC6116A044ER	Vdet-IC	4.4V±2%, -MR, ±Reset PPO, Rt=3.13ms	USP-6C	49xs	VD21	9b	Tor
8A045	XC6116A045ER	Vdet-IC	4.5V±2%, -MR, ±Reset PPO, Rt=3.13ms	USP-6C	49xs	VD21	9b	Tor
8A046	XC6116A046ER	Vdet-IC	4.6V±2%, -MR, ±Reset PPO, Rt=3.13ms	USP-6C	49xs	VD21	9b	Tor
8A047	XC6116A047ER	Vdet-IC	4.7V±2%, -MR, ±Reset PPO, Rt=3.13ms	USP-6C	49xs	VD21	9b	Tor
8A048	XC6116A048ER	Vdet-IC	4.8V±2%, -MR, ±Reset PPO, Rt=3.13ms	USP-6C	49xs	VD21	9b	Tor
8A049	XC6116A049ER	Vdet-IC	4.9V±2%, -MR, ±Reset PPO, Rt=3.13ms	USP-6C	49xs	VD21	9b	Tor
8A050	XC6116A050ER	Vdet-IC	5.0V±2%, -MR, ±Reset PPO, Rt=3.13ms	USP-6C	49xs	VD21	9b	Tor
8A1	XC6701BC2ER	LVR-IC	12.2V±2%, 150mA, +CE	USP-6C	49hu	VR4	9a	Tor
8A116	XC6111A116ER	Vdet-IC	1.6V±2%, -MR, -Reset PPO, Wt=6.25ms, Rt=3.13ms	USP-6C	49xh	VD17	9b	Tor
8A117	XC6111A117ER	Vdet-IC	1.7V±2%, -MR, -Reset PPO, Wt=6.25ms, Rt=3.13ms	USP-6C	49xh	VD17	9b	Tor
8A118	XC6111A118ER	Vdet-IC	1.8V±2%, -MR, -Reset PPO, Wt=6.25ms, Rt=3.13ms	USP-6C	49xh	VD17	9b	Tor
8A119	XC6111A119ER	Vdet-IC	1.9V±2%, -MR, -Reset PPO, Wt=6.25ms, Rt=3.13ms	USP-6C	49xh	VD17	9b	Tor
8A120	XC6111A120ER	Vdet-IC	2.0V±2%, -MR, -Reset PPO, Wt=6.25ms, Rt=3.13ms	USP-6C	49xh	VD17	9b	Tor
8A121	XC6111A121ER	Vdet-IC	2.1V±2%, -MR, -Reset PPO, Wt=6.25ms, Rt=3.13ms	USP-6C	49xh	VD17	9b	Tor
8A122	XC6111A122ER	Vdet-IC	2.2V±2%, -MR, -Reset PPO, Wt=6.25ms, Rt=3.13ms	USP-6C	49xh	VD17	9b	Tor
8A123	XC6111A123ER	Vdet-IC	2.3V±2%, -MR, -Reset PPO, Wt=6.25ms, Rt=3.13ms	USP-6C	49xh	VD17	9b	Tor
8A124	XC6111A124ER	Vdet-IC	2.4V±2%, -MR, -Reset PPO, Wt=6.25ms, Rt=3.13ms	USP-6C	49xh	VD17	9b	Tor



SMD code	Type	Function	Short description	Case	Pinout	Sch.	St.	Mnf.
8AB	XC6701BD2ER	LVR-IC	13.2V±2%, 150mA, +CE	USP-6C	49hu	VR4	9a	Tor
8AC	XC6701BD3ER	LVR-IC	13.3V±2%, 150mA, +CE	USP-6C	49hu	VR4	9a	Tor
8AD	XC6701BD4ER	LVR-IC	13.4V±2%, 150mA, +CE	USP-6C	49hu	VR4	9a	Tor
8AE	XC6701BD5ER	LVR-IC	13.5V±2%, 150mA, +CE	USP-6C	49hu	VR4	9a	Tor
8AF	XC6701BD6ER	LVR-IC	13.6V±2%, 150mA, +CE	USP-6C	49hu	VR4	9a	Tor
8AH	XC6701BD7ER	LVR-IC	13.7V±2%, 150mA, +CE	USP-6C	49hu	VR4	9a	Tor
8AK	XC6701BD8ER	LVR-IC	13.8V±2%, 150mA, +CE	USP-6C	49hu	VR4	9a	Tor
8AL	XC6701BD9ER	LVR-IC	13.9V±2%, 150mA, +CE	USP-6C	49hu	VR4	9a	Tor
8AM	XC6701BE0ER	LVR-IC	14.0V±2%, 150mA, +CE	USP-6C	49hu	VR4	9a	Tor
8AN	XC6701BE1ER	LVR-IC	14.1V±2%, 150mA, +CE	USP-6C	49hu	VR4	9a	Tor
8AP	XC6701BE2ER	LVR-IC	14.2V±2%, 150mA, +CE	USP-6C	49hu	VR4	9a	Tor
8AR	XC6701BE3ER	LVR-IC	14.3V±2%, 150mA, +CE	USP-6C	49hu	VR4	9a	Tor
8AS	XC6701BE4ER	LVR-IC	14.4V±2%, 150mA, +CE	USP-6C	49hu	VR4	9a	Tor
8AT	XC6701BE5ER	LVR-IC	14.5V±2%, 150mA, +CE	USP-6C	49hu	VR4	9a	Tor
8AU	XC6701BE6ER	LVR-IC	14.6V±2%, 150mA, +CE	USP-6C	49hu	VR4	9a	Tor
8AV	XC6701BE7ER	LVR-IC	14.7V±2%, 150mA, +CE	USP-6C	49hu	VR4	9a	Tor
8AX	XC6701BE8ER	LVR-IC	14.8V±2%, 150mA, +CE	USP-6C	49hu	VR4	9a	Tor
8AY	XC6701BE9ER	LVR-IC	14.9V±2%, 150mA, +CE	USP-6C	49hu	VR4	9a	Tor
8AZ	XC6701BF0ER	LVR-IC	15.0V±2%, 150mA, +CE	USP-6C	49hu	VR4	9a	Tor
8B	RP103K131D	LVR-IC	LDO, 1.3V±1%, 150mA, +CE, CL	DFN1010-4	48ym	VR4	9a	Ric
8B	RP200K331D	LVR-IC	LDO, 3.3V±1.0%, 300mA, +CE, CL, AE(mode)	DFN1212-6	52ht	VR10	9a	Ric
8B	XC6223A21B9R-G	LVR-IC	LDO, 2.15V±1%, 300mA, +CE	USP-QB-4B03	48ym	VR4	9a	Tor
8B0	XC6701BF1ER	LVR-IC	15.1V±2%, 150mA, +CE	USP-6C	49hu	VR4	9a	Tor
8B016	XC6116B016ER	Vdet-IC	1.6V±2%, -MR, ±Reset PPO, Rt=25ms	USP-6C	49xs	VD21	9b	Tor
8B017	XC6116B017ER	Vdet-IC	1.7V±2%, -MR, ±Reset PPO, Rt=25ms	USP-6C	49xs	VD21	9b	Tor
8B018	XC6116B018ER	Vdet-IC	1.8V±2%, -MR, ±Reset PPO, Rt=25ms	USP-6C	49xs	VD21	9b	Tor
8B019	XC6116B019ER	Vdet-IC	1.9V±2%, -MR, ±Reset PPO, Rt=25ms	USP-6C	49xs	VD21	9b	Tor
8B020	XC6116B020ER	Vdet-IC	2.0V±2%, -MR, ±Reset PPO, Rt=25ms	USP-6C	49xs	VD21	9b	Tor
8B021	XC6116B021ER	Vdet-IC	2.1V±2%, -MR, ±Reset PPO, Rt=25ms	USP-6C	49xs	VD21	9b	Tor
8B022	XC6116B022ER	Vdet-IC	2.2V±2%, -MR, ±Reset PPO, Rt=25ms	USP-6C	49xs	VD21	9b	Tor
8B023	XC6116B023ER	Vdet-IC	2.3V±2%, -MR, ±Reset PPO, Rt=25ms	USP-6C	49xs	VD21	9b	Tor
8B024	XC6116B024ER	Vdet-IC	2.4V±2%, -MR, ±Reset PPO, Rt=25ms	USP-6C	49xs	VD21	9b	Tor
8B025	XC6116B025ER	Vdet-IC	2.5V±2%, -MR, ±Reset PPO, Rt=25ms	USP-6C	49xs	VD21	9b	Tor
8B026	XC6116B026ER	Vdet-IC	2.6V±2%, -MR, ±Reset PPO, Rt=25ms	USP-6C	49xs	VD21	9b	Tor
8B027	XC6116B027ER	Vdet-IC	2.7V±2%, -MR, ±Reset PPO, Rt=25ms	USP-6C	49xs	VD21	9b	Tor
8B028	XC6116B028ER	Vdet-IC	2.8V±2%, -MR, ±Reset PPO, Rt=25ms	USP-6C	49xs	VD21	9b	Tor
8B029	XC6116B029ER	Vdet-IC	2.9V±2%, -MR, ±Reset PPO, Rt=25ms	USP-6C	49xs	VD21	9b	Tor
8B030	XC6116B030ER	Vdet-IC	3.0V±2%, -MR, ±Reset PPO, Rt=25ms	USP-6C	49xs	VD21	9b	Tor
8B031	XC6116B031ER	Vdet-IC	3.1V±2%, -MR, ±Reset PPO, Rt=25ms	USP-6C	49xs	VD21	9b	Tor
8B032	XC6116B032ER	Vdet-IC	3.2V±2%, -MR, ±Reset PPO, Rt=25ms	USP-6C	49xs	VD21	9b	Tor
8B033	XC6116B033ER	Vdet-IC	3.3V±2%, -MR, ±Reset PPO, Rt=25ms	USP-6C	49xs	VD21	9b	Tor
8B034	XC6116B034ER	Vdet-IC	3.4V±2%, -MR, ±Reset PPO, Rt=25ms	USP-6C	49xs	VD21	9b	Tor
8B035	XC6116B035ER	Vdet-IC	3.5V±2%, -MR, ±Reset PPO, Rt=25ms	USP-6C	49xs	VD21	9b	Tor
8B036	XC6116B036ER	Vdet-IC	3.6V±2%, -MR, ±Reset PPO, Rt=25ms	USP-6C	49xs	VD21	9b	Tor
8B037	XC6116B037ER	Vdet-IC	3.7V±2%, -MR, ±Reset PPO, Rt=25ms	USP-6C	49xs	VD21	9b	Tor
8B038	XC6116B038ER	Vdet-IC	3.8V±2%, -MR, ±Reset PPO, Rt=25ms	USP-6C	49xs	VD21	9b	Tor
8B039	XC6116B039ER	Vdet-IC	3.9V±2%, -MR, ±Reset PPO, Rt=25ms	USP-6C	49xs	VD21	9b	Tor
8B040	XC6116B040ER	Vdet-IC	4.0V±2%, -MR, ±Reset PPO, Rt=25ms	USP-6C	49xs	VD21	9b	Tor
8B041	XC6116B041ER	Vdet-IC	4.1V±2%, -MR, ±Reset PPO, Rt=25ms	USP-6C	49xs	VD21	9b	Tor
8B042	XC6116B042ER	Vdet-IC	4.2V±2%, -MR, ±Reset PPO, Rt=25ms	USP-6C	49xs	VD21	9b	Tor
8B043	XC6116B043ER	Vdet-IC	4.3V±2%, -MR, ±Reset PPO, Rt=25ms	USP-6C	49xs	VD21	9b	Tor
8B044	XC6116B044ER	Vdet-IC	4.4V±2%, -MR, ±Reset PPO, Rt=25ms	USP-6C	49xs	VD21	9b	Tor
8B045	XC6116B045ER	Vdet-IC	4.5V±2%, -MR, ±Reset PPO, Rt=25ms	USP-6C	49xs	VD21	9b	Tor
8B046	XC6116B046ER	Vdet-IC	4.6V±2%, -MR, ±Reset PPO, Rt=25ms	USP-6C	49xs	VD21	9b	Tor
8B047	XC6116B047ER	Vdet-IC	4.7V±2%, -MR, ±Reset PPO, Rt=25ms	USP-6C	49xs	VD21	9b	Tor
8B048	XC6116B048ER	Vdet-IC	4.8V±2%, -MR, ±Reset PPO, Rt=25ms	USP-6C	49xs	VD21	9b	Tor
8B049	XC6116B049ER	Vdet-IC	4.9V±2%, -MR, ±Reset PPO, Rt=25ms	USP-6C	49xs	VD21	9b	Tor
8B050	XC6116B050ER	Vdet-IC	5.0V±2%, -MR, ±Reset PPO, Rt=25ms	USP-6C	49xs	VD21	9b	Tor
8B1	XC6701BF2ER	LVR-IC	15.2V±2%, 150mA, +CE	USP-6C	49hu	VR4	9a	Tor
8B2	XC6701BF3ER	LVR-IC	15.3V±2%, 150mA, +CE	USP-6C	49hu	VR4	9a	Tor
8B216	XC6111B216ER	Vdet-IC	1.6V±2%, -MR, -Reset PPO, Wt=50ms, Rt=25ms	USP-6C	49xh	VD17	9b	Tor
8B217	XC6111B217ER	Vdet-IC	1.7V±2%, -MR, -Reset PPO, Wt=50ms, Rt=25ms	USP-6C	49xh	VD17	9b	Tor
8B218	XC6111B218ER	Vdet-IC	1.8V±2%, -MR, -Reset PPO, Wt=50ms, Rt=25ms	USP-6C	49xh	VD17	9b	Tor
8B219	XC6111B219ER	Vdet-IC	1.9V±2%, -MR, -Reset PPO, Wt=50ms, Rt=25ms	USP-6C	49xh	VD17	9b	Tor
8B220	XC6111B220ER	Vdet-IC	2.0V±2%, -MR, -Reset PPO, Wt=50ms, Rt=25ms	USP-6C	49xh	VD17	9b	Tor
8B221	XC6111B221ER	Vdet-IC	2.1V±2%, -MR, -Reset PPO, Wt=50ms, Rt=25ms	USP-6C	49xh	VD17	9b	Tor
8B222	XC6111B222ER	Vdet-IC	2.2V±2%, -MR, -Reset PPO, Wt=50ms, Rt=25ms	USP-6C	49xh	VD17	9b	Tor
8B223	XC6111B223ER	Vdet-IC	2.3V±2%, -MR, -Reset PPO, Wt=50ms, Rt=25ms	USP-6C	49xh	VD17	9b	Tor
8B224	XC6111B224ER	Vdet-IC	2.4V±2%, -MR, -Reset PPO, Wt=50ms, Rt=25ms	USP-6C	49xh	VD17	9b	Tor
8B225	XC6111B225ER	Vdet-IC	2.5V±2%, -MR, -Reset PPO, Wt=50ms, Rt=25ms	USP-6C	49xh	VD17	9b	Tor



SMD code	Type	Function	Short description	Case	Pinout	Sch.	St.Mnf.
8B622	XC6111B622ER	Vdet-IC	2.2V±2%, -MR, -Reset PPO, Wt=1.6s, Rt=25ms	USP-6C	49xh	VD17	9b Tor
8B623	XC6111B623ER	Vdet-IC	2.3V±2%, -MR, -Reset PPO, Wt=1.6s, Rt=25ms	USP-6C	49xh	VD17	9b Tor
8B624	XC6111B624ER	Vdet-IC	2.4V±2%, -MR, -Reset PPO, Wt=1.6s, Rt=25ms	USP-6C	49xh	VD17	9b Tor
8B625	XC6111B625ER	Vdet-IC	2.5V±2%, -MR, -Reset PPO, Wt=1.6s, Rt=25ms	USP-6C	49xh	VD17	9b Tor
8B626	XC6111B626ER	Vdet-IC	2.6V±2%, -MR, -Reset PPO, Wt=1.6s, Rt=25ms	USP-6C	49xh	VD17	9b Tor
8B627	XC6111B627ER	Vdet-IC	2.7V±2%, -MR, -Reset PPO, Wt=1.6s, Rt=25ms	USP-6C	49xh	VD17	9b Tor
8B628	XC6111B628ER	Vdet-IC	2.8V±2%, -MR, -Reset PPO, Wt=1.6s, Rt=25ms	USP-6C	49xh	VD17	9b Tor
8B629	XC6111B629ER	Vdet-IC	2.9V±2%, -MR, -Reset PPO, Wt=1.6s, Rt=25ms	USP-6C	49xh	VD17	9b Tor
8B630	XC6111B630ER	Vdet-IC	3.0V±2%, -MR, -Reset PPO, Wt=1.6s, Rt=25ms	USP-6C	49xh	VD17	9b Tor
8B631	XC6111B631ER	Vdet-IC	3.1V±2%, -MR, -Reset PPO, Wt=1.6s, Rt=25ms	USP-6C	49xh	VD17	9b Tor
8B632	XC6111B632ER	Vdet-IC	3.2V±2%, -MR, -Reset PPO, Wt=1.6s, Rt=25ms	USP-6C	49xh	VD17	9b Tor
8B633	XC6111B633ER	Vdet-IC	3.3V±2%, -MR, -Reset PPO, Wt=1.6s, Rt=25ms	USP-6C	49xh	VD17	9b Tor
8B634	XC6111B634ER	Vdet-IC	3.4V±2%, -MR, -Reset PPO, Wt=1.6s, Rt=25ms	USP-6C	49xh	VD17	9b Tor
8B635	XC6111B635ER	Vdet-IC	3.5V±2%, -MR, -Reset PPO, Wt=1.6s, Rt=25ms	USP-6C	49xh	VD17	9b Tor
8B636	XC6111B636ER	Vdet-IC	3.6V±2%, -MR, -Reset PPO, Wt=1.6s, Rt=25ms	USP-6C	49xh	VD17	9b Tor
8B637	XC6111B637ER	Vdet-IC	3.7V±2%, -MR, -Reset PPO, Wt=1.6s, Rt=25ms	USP-6C	49xh	VD17	9b Tor
8B638	XC6111B638ER	Vdet-IC	3.8V±2%, -MR, -Reset PPO, Wt=1.6s, Rt=25ms	USP-6C	49xh	VD17	9b Tor
8B639	XC6111B639ER	Vdet-IC	3.9V±2%, -MR, -Reset PPO, Wt=1.6s, Rt=25ms	USP-6C	49xh	VD17	9b Tor
8B640	XC6111B640ER	Vdet-IC	4.0V±2%, -MR, -Reset PPO, Wt=1.6s, Rt=25ms	USP-6C	49xh	VD17	9b Tor
8B641	XC6111B641ER	Vdet-IC	4.1V±2%, -MR, -Reset PPO, Wt=1.6s, Rt=25ms	USP-6C	49xh	VD17	9b Tor
8B642	XC6111B642ER	Vdet-IC	4.2V±2%, -MR, -Reset PPO, Wt=1.6s, Rt=25ms	USP-6C	49xh	VD17	9b Tor
8B643	XC6111B643ER	Vdet-IC	4.3V±2%, -MR, -Reset PPO, Wt=1.6s, Rt=25ms	USP-6C	49xh	VD17	9b Tor
8B644	XC6111B644ER	Vdet-IC	4.4V±2%, -MR, -Reset PPO, Wt=1.6s, Rt=25ms	USP-6C	49xh	VD17	9b Tor
8B645	XC6111B645ER	Vdet-IC	4.5V±2%, -MR, -Reset PPO, Wt=1.6s, Rt=25ms	USP-6C	49xh	VD17	9b Tor
8B646	XC6111B646ER	Vdet-IC	4.6V±2%, -MR, -Reset PPO, Wt=1.6s, Rt=25ms	USP-6C	49xh	VD17	9b Tor
8B647	XC6111B647ER	Vdet-IC	4.7V±2%, -MR, -Reset PPO, Wt=1.6s, Rt=25ms	USP-6C	49xh	VD17	9b Tor
8B648	XC6111B648ER	Vdet-IC	4.8V±2%, -MR, -Reset PPO, Wt=1.6s, Rt=25ms	USP-6C	49xh	VD17	9b Tor
8B649	XC6111B649ER	Vdet-IC	4.9V±2%, -MR, -Reset PPO, Wt=1.6s, Rt=25ms	USP-6C	49xh	VD17	9b Tor
8B650	XC6111B650ER	Vdet-IC	5.0V±2%, -MR, -Reset PPO, Wt=1.6s, Rt=25ms	USP-6C	49xh	VD17	9b Tor
8B7	XC6701BF8ER	LVR-IC	15.8V±2%, 150mA, +CE	USP-6C	49hu	VR4	9a Tor
8B8	XC6701BF9ER	LVR-IC	15.9V±2%, 150mA, +CE	USP-6C	49hu	VR4	9a Tor
8B9	XC6701BG0ER	LVR-IC	16.0V±2%, 150mA, +CE	USP-6C	49hu	VR4	9a Tor
8BA	XC6701BG1ER	LVR-IC	16.1V±2%, 150mA, +CE	USP-6C	49hu	VR4	9a Tor
8BB	XC6701BG2ER	LVR-IC	16.2V±2%, 150mA, +CE	USP-6C	49hu	VR4	9a Tor
8BC	XC6701BG3ER	LVR-IC	16.3V±2%, 150mA, +CE	USP-6C	49hu	VR4	9a Tor
8BD	XC6701BG4ER	LVR-IC	16.4V±2%, 150mA, +CE	USP-6C	49hu	VR4	9a Tor
8BE	XC6701BG5ER	LVR-IC	16.5V±2%, 150mA, +CE	USP-6C	49hu	VR4	9a Tor
8BF	XC6701BG6ER	LVR-IC	16.6V±2%, 150mA, +CE	USP-6C	49hu	VR4	9a Tor
8BH	XC6701BG7ER	LVR-IC	16.7V±2%, 150mA, +CE	USP-6C	49hu	VR4	9a Tor
8BK	XC6701BG8ER	LVR-IC	16.8V±2%, 150mA, +CE	USP-6C	49hu	VR4	9a Tor
8BL	XC6701BG9ER	LVR-IC	16.9V±2%, 150mA, +CE	USP-6C	49hu	VR4	9a Tor
8BM	XC6701BH0ER	LVR-IC	17.0V±2%, 150mA, +CE	USP-6C	49hu	VR4	9a Tor
8BN	XC6701BH1ER	LVR-IC	17.1V±2%, 150mA, +CE	USP-6C	49hu	VR4	9a Tor
8BP	XC6701BH2ER	LVR-IC	17.2V±2%, 150mA, +CE	USP-6C	49hu	VR4	9a Tor
8BR	XC6701BH3ER	LVR-IC	17.3V±2%, 150mA, +CE	USP-6C	49hu	VR4	9a Tor
8BS	XC6701BH4ER	LVR-IC	17.4V±2%, 150mA, +CE	USP-6C	49hu	VR4	9a Tor
8BT	XC6701BH5ER	LVR-IC	17.5V±2%, 150mA, +CE	USP-6C	49hu	VR4	9a Tor
8BU	XC6701BH6ER	LVR-IC	17.6V±2%, 150mA, +CE	USP-6C	49hu	VR4	9a Tor
8BV	XC6701BH7ER	LVR-IC	17.7V±2%, 150mA, +CE	USP-6C	49hu	VR4	9a Tor
8BX	XC6701BH8ER	LVR-IC	17.8V±2%, 150mA, +CE	USP-6C	49hu	VR4	9a Tor
8BY	XC6701BH9ER	LVR-IC	17.9V±2%, 150mA, +CE	USP-6C	49hu	VR4	9a Tor
8BZ	XC6701BJ0ER	LVR-IC	18.0V±2%, 150mA, +CE	USP-6C	49hu	VR4	9a Tor
8C	RP103K151D	LVR-IC	LDO, 1.5V±1%, 150mA, +CE, CL	DFM1010-4	48hm	VR4	9a Ric
8C	RP200K341D	LVR-IC	LDO, 3.4V±1.0%, 300mA, +CE, CL, AE(mode)	DFM1212-6	52ht	VR10	9a Ric
8C	XC6223A22B9R-G	LVR-IC	LDO, 2.25V±1%, 300mA, +CE	USPQ-4B03	48vm	VR4	9a Tor
8C016	XC6116C016ER	Vdet-IC	1.6V±2%, -MR, ±Reset PPO, Rt=50ms	USP-6C	49xs	VD21	9b Tor
8C017	XC6116C017ER	Vdet-IC	1.7V±2%, -MR, ±Reset PPO, Rt=50ms	USP-6C	49xs	VD21	9b Tor
8C018	XC6116C018ER	Vdet-IC	1.8V±2%, -MR, ±Reset PPO, Rt=50ms	USP-6C	49xs	VD21	9b Tor
8C019	XC6116C019ER	Vdet-IC	1.9V±2%, -MR, ±Reset PPO, Rt=50ms	USP-6C	49xs	VD21	9b Tor
8C020	XC6116C020ER	Vdet-IC	2.0V±2%, -MR, ±Reset PPO, Rt=50ms	USP-6C	49xs	VD21	9b Tor
8C021	XC6116C021ER	Vdet-IC	2.1V±2%, -MR, ±Reset PPO, Rt=50ms	USP-6C	49xs	VD21	9b Tor
8C022	XC6116C022ER	Vdet-IC	2.2V±2%, -MR, ±Reset PPO, Rt=50ms	USP-6C	49xs	VD21	9b Tor
8C023	XC6116C023ER	Vdet-IC	2.3V±2%, -MR, ±Reset PPO, Rt=50ms	USP-6C	49xs	VD21	9b Tor
8C024	XC6116C024ER	Vdet-IC	2.4V±2%, -MR, ±Reset PPO, Rt=50ms	USP-6C	49xs	VD21	9b Tor
8C025	XC6116C025ER	Vdet-IC	2.5V±2%, -MR, ±Reset PPO, Rt=50ms	USP-6C	49xs	VD21	9b Tor
8C026	XC6116C026ER	Vdet-IC	2.6V±2%, -MR, ±Reset PPO, Rt=50ms	USP-6C	49xs	VD21	9b Tor
8C027	XC6116C027ER	Vdet-IC	2.7V±2%, -MR, ±Reset PPO, Rt=50ms	USP-6C	49xs	VD21	9b Tor
8C028	XC6116C028ER	Vdet-IC	2.8V±2%, -MR, ±Reset PPO, Rt=50ms	USP-6C	49xs	VD21	9b Tor
8C029	XC6116C029ER	Vdet-IC	2.9V±2%, -MR, ±Reset PPO, Rt=50ms	USP-6C	49xs	VD21	9b Tor
8C030	XC6116C030ER	Vdet-IC	3.0V±2%, -MR, ±Reset PPO, Rt=50ms	USP-6C	49xs	VD21	9b Tor



SMD code	Type	Function	Short description	Case	Pinout	Sch.	St.	Mnf.
8D628	XC6111D628ER	Vdet-IC	2.8V±2%, -MR, -Reset PPO, Wt=1.6s, Rt=100ms	USP-6C	49xh	VD17	9b	Tor
8D629	XC6111D629ER	Vdet-IC	2.9V±2%, -MR, -Reset PPO, Wt=1.6s, Rt=100ms	USP-6C	49xh	VD17	9b	Tor
8D630	XC6111D630ER	Vdet-IC	3.0V±2%, -MR, -Reset PPO, Wt=1.6s, Rt=100ms	USP-6C	49xh	VD17	9b	Tor
8D631	XC6111D631ER	Vdet-IC	3.1V±2%, -MR, -Reset PPO, Wt=1.6s, Rt=100ms	USP-6C	49xh	VD17	9b	Tor
8D632	XC6111D632ER	Vdet-IC	3.2V±2%, -MR, -Reset PPO, Wt=1.6s, Rt=100ms	USP-6C	49xh	VD17	9b	Tor
8D633	XC6111D633ER	Vdet-IC	3.3V±2%, -MR, -Reset PPO, Wt=1.6s, Rt=100ms	USP-6C	49xh	VD17	9b	Tor
8D634	XC6111D634ER	Vdet-IC	3.4V±2%, -MR, -Reset PPO, Wt=1.6s, Rt=100ms	USP-6C	49xh	VD17	9b	Tor
8D635	XC6111D635ER	Vdet-IC	3.5V±2%, -MR, -Reset PPO, Wt=1.6s, Rt=100ms	USP-6C	49xh	VD17	9b	Tor
8D636	XC6111D636ER	Vdet-IC	3.6V±2%, -MR, -Reset PPO, Wt=1.6s, Rt=100ms	USP-6C	49xh	VD17	9b	Tor
8D637	XC6111D637ER	Vdet-IC	3.7V±2%, -MR, -Reset PPO, Wt=1.6s, Rt=100ms	USP-6C	49xh	VD17	9b	Tor
8D638	XC6111D638ER	Vdet-IC	3.8V±2%, -MR, -Reset PPO, Wt=1.6s, Rt=100ms	USP-6C	49xh	VD17	9b	Tor
8D639	XC6111D639ER	Vdet-IC	3.9V±2%, -MR, -Reset PPO, Wt=1.6s, Rt=100ms	USP-6C	49xh	VD17	9b	Tor
8D640	XC6111D640ER	Vdet-IC	4.0V±2%, -MR, -Reset PPO, Wt=1.6s, Rt=100ms	USP-6C	49xh	VD17	9b	Tor
8D641	XC6111D641ER	Vdet-IC	4.1V±2%, -MR, -Reset PPO, Wt=1.6s, Rt=100ms	USP-6C	49xh	VD17	9b	Tor
8D642	XC6111D642ER	Vdet-IC	4.2V±2%, -MR, -Reset PPO, Wt=1.6s, Rt=100ms	USP-6C	49xh	VD17	9b	Tor
8D643	XC6111D643ER	Vdet-IC	4.3V±2%, -MR, -Reset PPO, Wt=1.6s, Rt=100ms	USP-6C	49xh	VD17	9b	Tor
8D644	XC6111D644ER	Vdet-IC	4.4V±2%, -MR, -Reset PPO, Wt=1.6s, Rt=100ms	USP-6C	49xh	VD17	9b	Tor
8D645	XC6111D645ER	Vdet-IC	4.5V±2%, -MR, -Reset PPO, Wt=1.6s, Rt=100ms	USP-6C	49xh	VD17	9b	Tor
8D646	XC6111D646ER	Vdet-IC	4.6V±2%, -MR, -Reset PPO, Wt=1.6s, Rt=100ms	USP-6C	49xh	VD17	9b	Tor
8D647	XC6111D647ER	Vdet-IC	4.7V±2%, -MR, -Reset PPO, Wt=1.6s, Rt=100ms	USP-6C	49xh	VD17	9b	Tor
8D648	XC6111D648ER	Vdet-IC	4.8V±2%, -MR, -Reset PPO, Wt=1.6s, Rt=100ms	USP-6C	49xh	VD17	9b	Tor
8D649	XC6111D649ER	Vdet-IC	4.9V±2%, -MR, -Reset PPO, Wt=1.6s, Rt=100ms	USP-6C	49xh	VD17	9b	Tor
8D650	XC6111D650ER	Vdet-IC	5.0V±2%, -MR, -Reset PPO, Wt=1.6s, Rt=100ms	USP-6C	49xh	VD17	9b	Tor
8E	RP103K181D5	LVR-IC	LDO, 1.85V±1%, 150mA, +CE, CL	DFN1010-4	48vm	VR4	9a	Ric
8E	RP200K361D	LVR-IC	LDO, 3.6V±1.0%, 300mA, +CE, CL, AE(mode)	DFN1212-6	52ht	VR10	9a	Ric
8E	XC6223A24B9R-G	LVR-IC	LDO, 2.45V±1%, 300mA, +CE	USPQ-4B03	48vm	VR4	9a	Tor
8E016	XC6116E016ER	Vdet-IC	1.6V±2%, -MR, ±Reset PPO, Rt=200ms	USP-6C	49xs	VD21	9b	Tor
8E017	XC6116E017ER	Vdet-IC	1.7V±2%, -MR, ±Reset PPO, Rt=200ms	USP-6C	49xs	VD21	9b	Tor
8E018	XC6116E018ER	Vdet-IC	1.8V±2%, -MR, ±Reset PPO, Rt=200ms	USP-6C	49xs	VD21	9b	Tor
8E019	XC6116E019ER	Vdet-IC	1.9V±2%, -MR, ±Reset PPO, Rt=200ms	USP-6C	49xs	VD21	9b	Tor
8E020	XC6116E020ER	Vdet-IC	2.0V±2%, -MR, ±Reset PPO, Rt=200ms	USP-6C	49xs	VD21	9b	Tor
8E021	XC6116E021ER	Vdet-IC	2.1V±2%, -MR, ±Reset PPO, Rt=200ms	USP-6C	49xs	VD21	9b	Tor
8E022	XC6116E022ER	Vdet-IC	2.2V±2%, -MR, ±Reset PPO, Rt=200ms	USP-6C	49xs	VD21	9b	Tor
8E023	XC6116E023ER	Vdet-IC	2.3V±2%, -MR, ±Reset PPO, Rt=200ms	USP-6C	49xs	VD21	9b	Tor
8E024	XC6116E024ER	Vdet-IC	2.4V±2%, -MR, ±Reset PPO, Rt=200ms	USP-6C	49xs	VD21	9b	Tor
8E025	XC6116E025ER	Vdet-IC	2.5V±2%, -MR, ±Reset PPO, Rt=200ms	USP-6C	49xs	VD21	9b	Tor
8E026	XC6116E026ER	Vdet-IC	2.6V±2%, -MR, ±Reset PPO, Rt=200ms	USP-6C	49xs	VD21	9b	Tor
8E027	XC6116E027ER	Vdet-IC	2.7V±2%, -MR, ±Reset PPO, Rt=200ms	USP-6C	49xs	VD21	9b	Tor
8E028	XC6116E028ER	Vdet-IC	2.8V±2%, -MR, ±Reset PPO, Rt=200ms	USP-6C	49xs	VD21	9b	Tor
8E029	XC6116E029ER	Vdet-IC	2.9V±2%, -MR, ±Reset PPO, Rt=200ms	USP-6C	49xs	VD21	9b	Tor
8E030	XC6116E030ER	Vdet-IC	3.0V±2%, -MR, ±Reset PPO, Rt=200ms	USP-6C	49xs	VD21	9b	Tor
8E031	XC6116E031ER	Vdet-IC	3.1V±2%, -MR, ±Reset PPO, Rt=200ms	USP-6C	49xs	VD21	9b	Tor
8E032	XC6116E032ER	Vdet-IC	3.2V±2%, -MR, ±Reset PPO, Rt=200ms	USP-6C	49xs	VD21	9b	Tor
8E033	XC6116E033ER	Vdet-IC	3.3V±2%, -MR, ±Reset PPO, Rt=200ms	USP-6C	49xs	VD21	9b	Tor
8E034	XC6116E034ER	Vdet-IC	3.4V±2%, -MR, ±Reset PPO, Rt=200ms	USP-6C	49xs	VD21	9b	Tor
8E035	XC6116E035ER	Vdet-IC	3.5V±2%, -MR, ±Reset PPO, Rt=200ms	USP-6C	49xs	VD21	9b	Tor
8E036	XC6116E036ER	Vdet-IC	3.6V±2%, -MR, ±Reset PPO, Rt=200ms	USP-6C	49xs	VD21	9b	Tor
8E037	XC6116E037ER	Vdet-IC	3.7V±2%, -MR, ±Reset PPO, Rt=200ms	USP-6C	49xs	VD21	9b	Tor
8E038	XC6116E038ER	Vdet-IC	3.8V±2%, -MR, ±Reset PPO, Rt=200ms	USP-6C	49xs	VD21	9b	Tor
8E039	XC6116E039ER	Vdet-IC	3.9V±2%, -MR, ±Reset PPO, Rt=200ms	USP-6C	49xs	VD21	9b	Tor
8E040	XC6116E040ER	Vdet-IC	4.0V±2%, -MR, ±Reset PPO, Rt=200ms	USP-6C	49xs	VD21	9b	Tor
8E041	XC6116E041ER	Vdet-IC	4.1V±2%, -MR, ±Reset PPO, Rt=200ms	USP-6C	49xs	VD21	9b	Tor
8E042	XC6116E042ER	Vdet-IC	4.2V±2%, -MR, ±Reset PPO, Rt=200ms	USP-6C	49xs	VD21	9b	Tor
8E043	XC6116E043ER	Vdet-IC	4.3V±2%, -MR, ±Reset PPO, Rt=200ms	USP-6C	49xs	VD21	9b	Tor
8E044	XC6116E044ER	Vdet-IC	4.4V±2%, -MR, ±Reset PPO, Rt=200ms	USP-6C	49xs	VD21	9b	Tor
8E045	XC6116E045ER	Vdet-IC	4.5V±2%, -MR, ±Reset PPO, Rt=200ms	USP-6C	49xs	VD21	9b	Tor
8E046	XC6116E046ER	Vdet-IC	4.6V±2%, -MR, ±Reset PPO, Rt=200ms	USP-6C	49xs	VD21	9b	Tor
8E047	XC6116E047ER	Vdet-IC	4.7V±2%, -MR, ±Reset PPO, Rt=200ms	USP-6C	49xs	VD21	9b	Tor
8E048	XC6116E048ER	Vdet-IC	4.8V±2%, -MR, ±Reset PPO, Rt=200ms	USP-6C	49xs	VD21	9b	Tor
8E049	XC6116E049ER	Vdet-IC	4.9V±2%, -MR, ±Reset PPO, Rt=200ms	USP-6C	49xs	VD21	9b	Tor
8E050	XC6116E050ER	Vdet-IC	5.0V±2%, -MR, ±Reset PPO, Rt=200ms	USP-6C	49xs	VD21	9b	Tor
8E416	XC6111E416ER	Vdet-IC	1.6V±2%, -MR, -Reset PPO, Wt=200ms, Rt=200ms	USP-6C	49xh	VD17	9b	Tor
8E417	XC6111E417ER	Vdet-IC	1.7V±2%, -MR, -Reset PPO, Wt=200ms, Rt=200ms	USP-6C	49xh	VD17	9b	Tor
8E418	XC6111E418ER	Vdet-IC	1.8V±2%, -MR, -Reset PPO, Wt=200ms, Rt=200ms	USP-6C	49xh	VD17	9b	Tor
8E419	XC6111E419ER	Vdet-IC	1.9V±2%, -MR, -Reset PPO, Wt=200ms, Rt=200ms	USP-6C	49xh	VD17	9b	Tor
8E420	XC6111E420ER	Vdet-IC	2.0V±2%, -MR, -Reset PPO, Wt=200ms, Rt=200ms	USP-6C	49xh	VD17	9b	Tor
8E421	XC6111E421ER	Vdet-IC	2.1V±2%, -MR, -Reset PPO, Wt=200ms, Rt=200ms	USP-6C	49xh	VD17	9b	Tor
8E422	XC6111E422ER	Vdet-IC	2.2V±2%, -MR, -Reset PPO, Wt=200ms, Rt=200ms	USP-6C	49xh	VD17	9b	Tor
8E423	XC6111E423ER	Vdet-IC	2.3V±2%, -MR, -Reset PPO, Wt=200ms, Rt=200ms	USP-6C	49xh	VD17	9b	Tor
8E424	XC6111E424ER	Vdet-IC	2.4V±2%, -MR, -Reset PPO, Wt=200ms, Rt=200ms	USP-6C	49xh	VD17	9b	Tor



SMD code	Type	Function	Short description	Case	Pinout	Sch.	St.	Mnf.
8E625	XC6111E625ER	Vdet-IC	2.5V±2%, -MR, -Reset PPO, Wt=1.6s, Rt=200ms	USP-6C	49xh	VD17	9b	Tor
8E626	XC6111E626ER	Vdet-IC	2.6V±2%, -MR, -Reset PPO, Wt=1.6s, Rt=200ms	USP-6C	49xh	VD17	9b	Tor
8E627	XC6111E627ER	Vdet-IC	2.7V±2%, -MR, -Reset PPO, Wt=1.6s, Rt=200ms	USP-6C	49xh	VD17	9b	Tor
8E628	XC6111E628ER	Vdet-IC	2.8V±2%, -MR, -Reset PPO, Wt=1.6s, Rt=200ms	USP-6C	49xh	VD17	9b	Tor
8E629	XC6111E629ER	Vdet-IC	2.9V±2%, -MR, -Reset PPO, Wt=1.6s, Rt=200ms	USP-6C	49xh	VD17	9b	Tor
8E630	XC6111E630ER	Vdet-IC	3.0V±2%, -MR, -Reset PPO, Wt=1.6s, Rt=200ms	USP-6C	49xh	VD17	9b	Tor
8E631	XC6111E631ER	Vdet-IC	3.1V±2%, -MR, -Reset PPO, Wt=1.6s, Rt=200ms	USP-6C	49xh	VD17	9b	Tor
8E632	XC6111E632ER	Vdet-IC	3.2V±2%, -MR, -Reset PPO, Wt=1.6s, Rt=200ms	USP-6C	49xh	VD17	9b	Tor
8E633	XC6111E633ER	Vdet-IC	3.3V±2%, -MR, -Reset PPO, Wt=1.6s, Rt=200ms	USP-6C	49xh	VD17	9b	Tor
8E634	XC6111E634ER	Vdet-IC	3.4V±2%, -MR, -Reset PPO, Wt=1.6s, Rt=200ms	USP-6C	49xh	VD17	9b	Tor
8E635	XC6111E635ER	Vdet-IC	3.5V±2%, -MR, -Reset PPO, Wt=1.6s, Rt=200ms	USP-6C	49xh	VD17	9b	Tor
8E636	XC6111E636ER	Vdet-IC	3.6V±2%, -MR, -Reset PPO, Wt=1.6s, Rt=200ms	USP-6C	49xh	VD17	9b	Tor
8E637	XC6111E637ER	Vdet-IC	3.7V±2%, -MR, -Reset PPO, Wt=1.6s, Rt=200ms	USP-6C	49xh	VD17	9b	Tor
8E638	XC6111E638ER	Vdet-IC	3.8V±2%, -MR, -Reset PPO, Wt=1.6s, Rt=200ms	USP-6C	49xh	VD17	9b	Tor
8E639	XC6111E639ER	Vdet-IC	3.9V±2%, -MR, -Reset PPO, Wt=1.6s, Rt=200ms	USP-6C	49xh	VD17	9b	Tor
8E640	XC6111E640ER	Vdet-IC	4.0V±2%, -MR, -Reset PPO, Wt=1.6s, Rt=200ms	USP-6C	49xh	VD17	9b	Tor
8E641	XC6111E641ER	Vdet-IC	4.1V±2%, -MR, -Reset PPO, Wt=1.6s, Rt=200ms	USP-6C	49xh	VD17	9b	Tor
8E642	XC6111E642ER	Vdet-IC	4.2V±2%, -MR, -Reset PPO, Wt=1.6s, Rt=200ms	USP-6C	49xh	VD17	9b	Tor
8E643	XC6111E643ER	Vdet-IC	4.3V±2%, -MR, -Reset PPO, Wt=1.6s, Rt=200ms	USP-6C	49xh	VD17	9b	Tor
8E644	XC6111E644ER	Vdet-IC	4.4V±2%, -MR, -Reset PPO, Wt=1.6s, Rt=200ms	USP-6C	49xh	VD17	9b	Tor
8E645	XC6111E645ER	Vdet-IC	4.5V±2%, -MR, -Reset PPO, Wt=1.6s, Rt=200ms	USP-6C	49xh	VD17	9b	Tor
8E646	XC6111E646ER	Vdet-IC	4.6V±2%, -MR, -Reset PPO, Wt=1.6s, Rt=200ms	USP-6C	49xh	VD17	9b	Tor
8E647	XC6111E647ER	Vdet-IC	4.7V±2%, -MR, -Reset PPO, Wt=1.6s, Rt=200ms	USP-6C	49xh	VD17	9b	Tor
8E648	XC6111E648ER	Vdet-IC	4.8V±2%, -MR, -Reset PPO, Wt=1.6s, Rt=200ms	USP-6C	49xh	VD17	9b	Tor
8E649	XC6111E649ER	Vdet-IC	4.9V±2%, -MR, -Reset PPO, Wt=1.6s, Rt=200ms	USP-6C	49xh	VD17	9b	Tor
8E650	XC6111E650ER	Vdet-IC	5.0V±2%, -MR, -Reset PPO, Wt=1.6s, Rt=200ms	USP-6C	49xh	VD17	9b	Tor
8F	RP103K191D	LVR-IC	LDO, 1.9V±1%, 150mA, +CE, CL	DFN11010-4	48vm	VR4	9a	Ric
8F	RP200K371D	LVR-IC	LDO, 3.7V±1.0%, 300mA, +CE, CL, AE(mode)	DFM1212-6	52ht	VR10	9a	Ric
8F	XC6223A25B9R-G	LVR-IC	LDO, 2.55V±1%, 300mA, +CE	USPQ-4B03	48vm	VR4	9a	Tor
8F016	XC6116F016ER	Vdet-IC	1.6V±2%, -MR, ±Reset PPO, Rt=400ms	USP-6C	49xs	VD21	9b	Tor
8F017	XC6116F017ER	Vdet-IC	1.7V±2%, -MR, ±Reset PPO, Rt=400ms	USP-6C	49xs	VD21	9b	Tor
8F018	XC6116F018ER	Vdet-IC	1.8V±2%, -MR, ±Reset PPO, Rt=400ms	USP-6C	49xs	VD21	9b	Tor
8F019	XC6116F019ER	Vdet-IC	1.9V±2%, -MR, ±Reset PPO, Rt=400ms	USP-6C	49xs	VD21	9b	Tor
8F020	XC6116F020ER	Vdet-IC	2.0V±2%, -MR, ±Reset PPO, Rt=400ms	USP-6C	49xs	VD21	9b	Tor
8F021	XC6116F021ER	Vdet-IC	2.1V±2%, -MR, ±Reset PPO, Rt=400ms	USP-6C	49xs	VD21	9b	Tor
8F022	XC6116F022ER	Vdet-IC	2.2V±2%, -MR, ±Reset PPO, Rt=400ms	USP-6C	49xs	VD21	9b	Tor
8F023	XC6116F023ER	Vdet-IC	2.3V±2%, -MR, ±Reset PPO, Rt=400ms	USP-6C	49xs	VD21	9b	Tor
8F024	XC6116F024ER	Vdet-IC	2.4V±2%, -MR, ±Reset PPO, Rt=400ms	USP-6C	49xs	VD21	9b	Tor
8F025	XC6116F025ER	Vdet-IC	2.5V±2%, -MR, ±Reset PPO, Rt=400ms	USP-6C	49xs	VD21	9b	Tor
8F026	XC6116F026ER	Vdet-IC	2.6V±2%, -MR, ±Reset PPO, Rt=400ms	USP-6C	49xs	VD21	9b	Tor
8F027	XC6116F027ER	Vdet-IC	2.7V±2%, -MR, ±Reset PPO, Rt=400ms	USP-6C	49xs	VD21	9b	Tor
8F028	XC6116F028ER	Vdet-IC	2.8V±2%, -MR, ±Reset PPO, Rt=400ms	USP-6C	49xs	VD21	9b	Tor
8F029	XC6116F029ER	Vdet-IC	2.9V±2%, -MR, ±Reset PPO, Rt=400ms	USP-6C	49xs	VD21	9b	Tor
8F030	XC6116F030ER	Vdet-IC	3.0V±2%, -MR, ±Reset PPO, Rt=400ms	USP-6C	49xs	VD21	9b	Tor
8F031	XC6116F031ER	Vdet-IC	3.1V±2%, -MR, ±Reset PPO, Rt=400ms	USP-6C	49xs	VD21	9b	Tor
8F032	XC6116F032ER	Vdet-IC	3.2V±2%, -MR, ±Reset PPO, Rt=400ms	USP-6C	49xs	VD21	9b	Tor
8F033	XC6116F033ER	Vdet-IC	3.3V±2%, -MR, ±Reset PPO, Rt=400ms	USP-6C	49xs	VD21	9b	Tor
8F034	XC6116F034ER	Vdet-IC	3.4V±2%, -MR, ±Reset PPO, Rt=400ms	USP-6C	49xs	VD21	9b	Tor
8F035	XC6116F035ER	Vdet-IC	3.5V±2%, -MR, ±Reset PPO, Rt=400ms	USP-6C	49xs	VD21	9b	Tor
8F036	XC6116F036ER	Vdet-IC	3.6V±2%, -MR, ±Reset PPO, Rt=400ms	USP-6C	49xs	VD21	9b	Tor
8F037	XC6116F037ER	Vdet-IC	3.7V±2%, -MR, ±Reset PPO, Rt=400ms	USP-6C	49xs	VD21	9b	Tor
8F038	XC6116F038ER	Vdet-IC	3.8V±2%, -MR, ±Reset PPO, Rt=400ms	USP-6C	49xs	VD21	9b	Tor
8F039	XC6116F039ER	Vdet-IC	3.9V±2%, -MR, ±Reset PPO, Rt=400ms	USP-6C	49xs	VD21	9b	Tor
8F040	XC6116F040ER	Vdet-IC	4.0V±2%, -MR, ±Reset PPO, Rt=400ms	USP-6C	49xs	VD21	9b	Tor
8F041	XC6116F041ER	Vdet-IC	4.1V±2%, -MR, ±Reset PPO, Rt=400ms	USP-6C	49xs	VD21	9b	Tor
8F042	XC6116F042ER	Vdet-IC	4.2V±2%, -MR, ±Reset PPO, Rt=400ms	USP-6C	49xs	VD21	9b	Tor
8F043	XC6116F043ER	Vdet-IC	4.3V±2%, -MR, ±Reset PPO, Rt=400ms	USP-6C	49xs	VD21	9b	Tor
8F044	XC6116F044ER	Vdet-IC	4.4V±2%, -MR, ±Reset PPO, Rt=400ms	USP-6C	49xs	VD21	9b	Tor
8F045	XC6116F045ER	Vdet-IC	4.5V±2%, -MR, ±Reset PPO, Rt=400ms	USP-6C	49xs	VD21	9b	Tor
8F046	XC6116F046ER	Vdet-IC	4.6V±2%, -MR, ±Reset PPO, Rt=400ms	USP-6C	49xs	VD21	9b	Tor
8F047	XC6116F047ER	Vdet-IC	4.7V±2%, -MR, ±Reset PPO, Rt=400ms	USP-6C	49xs	VD21	9b	Tor
8F048	XC6116F048ER	Vdet-IC	4.8V±2%, -MR, ±Reset PPO, Rt=400ms	USP-6C	49xs	VD21	9b	Tor
8F049	XC6116F049ER	Vdet-IC	4.9V±2%, -MR, ±Reset PPO, Rt=400ms	USP-6C	49xs	VD21	9b	Tor
8F050	XC6116F050ER	Vdet-IC	5.0V±2%, -MR, ±Reset PPO, Rt=400ms	USP-6C	49xs	VD21	9b	Tor
8F516	XC6111F516ER	Vdet-IC	1.6V±2%, -MR, -Reset PPO, Wt=400ms, Rt=400ms	USP-6C	49xh	VD17	9b	Tor
8F517	XC6111F517ER	Vdet-IC	1.7V±2%, -MR, -Reset PPO, Wt=400ms, Rt=400ms	USP-6C	49xh	VD17	9b	Tor
8F518	XC6111F518ER	Vdet-IC	1.8V±2%, -MR, -Reset PPO, Wt=400ms, Rt=400ms	USP-6C	49xh	VD17	9b	Tor
8F519	XC6111F519ER	Vdet-IC	1.9V±2%, -MR, -Reset PPO, Wt=400ms, Rt=400ms	USP-6C	49xh	VD17	9b	Tor
8F520	XC6111F520ER	Vdet-IC	2.0V±2%, -MR, -Reset PPO, Wt=400ms, Rt=400ms	USP-6C	49xh	VD17	9b	Tor
8F521	XC6111F521ER	Vdet-IC	2.1V±2%, -MR, -Reset PPO, Wt=400ms, Rt=400ms	USP-6C	49xh	VD17	9b	Tor



SMD code	Type	Function	Short description	Case	Pinout	Sch.	St.Mnf.
8H017	XC6116H017ER	Vdet-IC	1.7V±2%, -MR, ±Reset PPO, Rt=1.6s	USP-6C	49xs	VD21	9b Tor
8H018	XC6116H018ER	Vdet-IC	1.8V±2%, -MR, ±Reset PPO, Rt=1.6s	USP-6C	49xs	VD21	9b Tor
8H019	XC6116H019ER	Vdet-IC	1.9V±2%, -MR, ±Reset PPO, Rt=1.6s	USP-6C	49xs	VD21	9b Tor
8H020	XC6116H020ER	Vdet-IC	2.0V±2%, -MR, ±Reset PPO, Rt=1.6s	USP-6C	49xs	VD21	9b Tor
8H021	XC6116H021ER	Vdet-IC	2.1V±2%, -MR, ±Reset PPO, Rt=1.6s	USP-6C	49xs	VD21	9b Tor
8H022	XC6116H022ER	Vdet-IC	2.2V±2%, -MR, ±Reset PPO, Rt=1.6s	USP-6C	49xs	VD21	9b Tor
8H023	XC6116H023ER	Vdet-IC	2.3V±2%, -MR, ±Reset PPO, Rt=1.6s	USP-6C	49xs	VD21	9b Tor
8H024	XC6116H024ER	Vdet-IC	2.4V±2%, -MR, ±Reset PPO, Rt=1.6s	USP-6C	49xs	VD21	9b Tor
8H025	XC6116H025ER	Vdet-IC	2.5V±2%, -MR, ±Reset PPO, Rt=1.6s	USP-6C	49xs	VD21	9b Tor
8H026	XC6116H026ER	Vdet-IC	2.6V±2%, -MR, ±Reset PPO, Rt=1.6s	USP-6C	49xs	VD21	9b Tor
8H027	XC6116H027ER	Vdet-IC	2.7V±2%, -MR, ±Reset PPO, Rt=1.6s	USP-6C	49xs	VD21	9b Tor
8H028	XC6116H028ER	Vdet-IC	2.8V±2%, -MR, ±Reset PPO, Rt=1.6s	USP-6C	49xs	VD21	9b Tor
8H029	XC6116H029ER	Vdet-IC	2.9V±2%, -MR, ±Reset PPO, Rt=1.6s	USP-6C	49xs	VD21	9b Tor
8H030	XC6116H030ER	Vdet-IC	3.0V±2%, -MR, ±Reset PPO, Rt=1.6s	USP-6C	49xs	VD21	9b Tor
8H031	XC6116H031ER	Vdet-IC	3.1V±2%, -MR, ±Reset PPO, Rt=1.6s	USP-6C	49xs	VD21	9b Tor
8H032	XC6116H032ER	Vdet-IC	3.2V±2%, -MR, ±Reset PPO, Rt=1.6s	USP-6C	49xs	VD21	9b Tor
8H033	XC6116H033ER	Vdet-IC	3.3V±2%, -MR, ±Reset PPO, Rt=1.6s	USP-6C	49xs	VD21	9b Tor
8H034	XC6116H034ER	Vdet-IC	3.4V±2%, -MR, ±Reset PPO, Rt=1.6s	USP-6C	49xs	VD21	9b Tor
8H035	XC6116H035ER	Vdet-IC	3.5V±2%, -MR, ±Reset PPO, Rt=1.6s	USP-6C	49xs	VD21	9b Tor
8H036	XC6116H036ER	Vdet-IC	3.6V±2%, -MR, ±Reset PPO, Rt=1.6s	USP-6C	49xs	VD21	9b Tor
8H037	XC6116H037ER	Vdet-IC	3.7V±2%, -MR, ±Reset PPO, Rt=1.6s	USP-6C	49xs	VD21	9b Tor
8H038	XC6116H038ER	Vdet-IC	3.8V±2%, -MR, ±Reset PPO, Rt=1.6s	USP-6C	49xs	VD21	9b Tor
8H039	XC6116H039ER	Vdet-IC	3.9V±2%, -MR, ±Reset PPO, Rt=1.6s	USP-6C	49xs	VD21	9b Tor
8H040	XC6116H040ER	Vdet-IC	4.0V±2%, -MR, ±Reset PPO, Rt=1.6s	USP-6C	49xs	VD21	9b Tor
8H041	XC6116H041ER	Vdet-IC	4.1V±2%, -MR, ±Reset PPO, Rt=1.6s	USP-6C	49xs	VD21	9b Tor
8H042	XC6116H042ER	Vdet-IC	4.2V±2%, -MR, ±Reset PPO, Rt=1.6s	USP-6C	49xs	VD21	9b Tor
8H043	XC6116H043ER	Vdet-IC	4.3V±2%, -MR, ±Reset PPO, Rt=1.6s	USP-6C	49xs	VD21	9b Tor
8H044	XC6116H044ER	Vdet-IC	4.4V±2%, -MR, ±Reset PPO, Rt=1.6s	USP-6C	49xs	VD21	9b Tor
8H045	XC6116H045ER	Vdet-IC	4.5V±2%, -MR, ±Reset PPO, Rt=1.6s	USP-6C	49xs	VD21	9b Tor
8H046	XC6116H046ER	Vdet-IC	4.6V±2%, -MR, ±Reset PPO, Rt=1.6s	USP-6C	49xs	VD21	9b Tor
8H047	XC6116H047ER	Vdet-IC	4.7V±2%, -MR, ±Reset PPO, Rt=1.6s	USP-6C	49xs	VD21	9b Tor
8H048	XC6116H048ER	Vdet-IC	4.8V±2%, -MR, ±Reset PPO, Rt=1.6s	USP-6C	49xs	VD21	9b Tor
8H049	XC6116H049ER	Vdet-IC	4.9V±2%, -MR, ±Reset PPO, Rt=1.6s	USP-6C	49xs	VD21	9b Tor
8H050	XC6116H050ER	Vdet-IC	5.0V±2%, -MR, ±Reset PPO, Rt=1.6s	USP-6C	49xs	VD21	9b Tor
8H166	XC6111H616ER	Vdet-IC	1.6V±2%, -MR, -Reset PPO, Wt=1.6s, Rt=1.6s	USP-6C	49xh	VD17	9b Tor
8H167	XC6111H617ER	Vdet-IC	1.7V±2%, -MR, -Reset PPO, Wt=1.6s, Rt=1.6s	USP-6C	49xh	VD17	9b Tor
8H168	XC6111H618ER	Vdet-IC	1.8V±2%, -MR, -Reset PPO, Wt=1.6s, Rt=1.6s	USP-6C	49xh	VD17	9b Tor
8H169	XC6111H619ER	Vdet-IC	1.9V±2%, -MR, -Reset PPO, Wt=1.6s, Rt=1.6s	USP-6C	49xh	VD17	9b Tor
8H620	XC6111H620ER	Vdet-IC	2.0V±2%, -MR, -Reset PPO, Wt=1.6s, Rt=1.6s	USP-6C	49xh	VD17	9b Tor
8H621	XC6111H621ER	Vdet-IC	2.1V±2%, -MR, -Reset PPO, Wt=1.6s, Rt=1.6s	USP-6C	49xh	VD17	9b Tor
8H622	XC6111H622ER	Vdet-IC	2.2V±2%, -MR, -Reset PPO, Wt=1.6s, Rt=1.6s	USP-6C	49xh	VD17	9b Tor
8H623	XC6111H623ER	Vdet-IC	2.3V±2%, -MR, -Reset PPO, Wt=1.6s, Rt=1.6s	USP-6C	49xh	VD17	9b Tor
8H624	XC6111H624ER	Vdet-IC	2.4V±2%, -MR, -Reset PPO, Wt=1.6s, Rt=1.6s	USP-6C	49xh	VD17	9b Tor
8H625	XC6111H625ER	Vdet-IC	2.5V±2%, -MR, -Reset PPO, Wt=1.6s, Rt=1.6s	USP-6C	49xh	VD17	9b Tor
8H626	XC6111H626ER	Vdet-IC	2.6V±2%, -MR, -Reset PPO, Wt=1.6s, Rt=1.6s	USP-6C	49xh	VD17	9b Tor
8H627	XC6111H627ER	Vdet-IC	2.7V±2%, -MR, -Reset PPO, Wt=1.6s, Rt=1.6s	USP-6C	49xh	VD17	9b Tor
8H628	XC6111H628ER	Vdet-IC	2.8V±2%, -MR, -Reset PPO, Wt=1.6s, Rt=1.6s	USP-6C	49xh	VD17	9b Tor
8H629	XC6111H629ER	Vdet-IC	2.9V±2%, -MR, -Reset PPO, Wt=1.6s, Rt=1.6s	USP-6C	49xh	VD17	9b Tor
8H630	XC6111H630ER	Vdet-IC	3.0V±2%, -MR, -Reset PPO, Wt=1.6s, Rt=1.6s	USP-6C	49xh	VD17	9b Tor
8H631	XC6111H631ER	Vdet-IC	3.1V±2%, -MR, -Reset PPO, Wt=1.6s, Rt=1.6s	USP-6C	49xh	VD17	9b Tor
8H632	XC6111H632ER	Vdet-IC	3.2V±2%, -MR, -Reset PPO, Wt=1.6s, Rt=1.6s	USP-6C	49xh	VD17	9b Tor
8H633	XC6111H633ER	Vdet-IC	3.3V±2%, -MR, -Reset PPO, Wt=1.6s, Rt=1.6s	USP-6C	49xh	VD17	9b Tor
8H634	XC6111H634ER	Vdet-IC	3.4V±2%, -MR, -Reset PPO, Wt=1.6s, Rt=1.6s	USP-6C	49xh	VD17	9b Tor
8H635	XC6111H635ER	Vdet-IC	3.5V±2%, -MR, -Reset PPO, Wt=1.6s, Rt=1.6s	USP-6C	49xh	VD17	9b Tor
8H636	XC6111H636ER	Vdet-IC	3.6V±2%, -MR, -Reset PPO, Wt=1.6s, Rt=1.6s	USP-6C	49xh	VD17	9b Tor
8H637	XC6111H637ER	Vdet-IC	3.7V±2%, -MR, -Reset PPO, Wt=1.6s, Rt=1.6s	USP-6C	49xh	VD17	9b Tor
8H638	XC6111H638ER	Vdet-IC	3.8V±2%, -MR, -Reset PPO, Wt=1.6s, Rt=1.6s	USP-6C	49xh	VD17	9b Tor
8H639	XC6111H639ER	Vdet-IC	3.9V±2%, -MR, -Reset PPO, Wt=1.6s, Rt=1.6s	USP-6C	49xh	VD17	9b Tor
8H640	XC6111H640ER	Vdet-IC	4.0V±2%, -MR, -Reset PPO, Wt=1.6s, Rt=1.6s	USP-6C	49xh	VD17	9b Tor
8H641	XC6111H641ER	Vdet-IC	4.1V±2%, -MR, -Reset PPO, Wt=1.6s, Rt=1.6s	USP-6C	49xh	VD17	9b Tor
8H642	XC6111H642ER	Vdet-IC	4.2V±2%, -MR, -Reset PPO, Wt=1.6s, Rt=1.6s	USP-6C	49xh	VD17	9b Tor
8H643	XC6111H643ER	Vdet-IC	4.3V±2%, -MR, -Reset PPO, Wt=1.6s, Rt=1.6s	USP-6C	49xh	VD17	9b Tor
8H644	XC6111H644ER	Vdet-IC	4.4V±2%, -MR, -Reset PPO, Wt=1.6s, Rt=1.6s	USP-6C	49xh	VD17	9b Tor
8H645	XC6111H645ER	Vdet-IC	4.5V±2%, -MR, -Reset PPO, Wt=1.6s, Rt=1.6s	USP-6C	49xh	VD17	9b Tor
8H646	XC6111H646ER	Vdet-IC	4.6V±2%, -MR, -Reset PPO, Wt=1.6s, Rt=1.6s	USP-6C	49xh	VD17	9b Tor
8H647	XC6111H647ER	Vdet-IC	4.7V±2%, -MR, -Reset PPO, Wt=1.6s, Rt=1.6s	USP-6C	49xh	VD17	9b Tor
8H648	XC6111H648ER	Vdet-IC	4.8V±2%, -MR, -Reset PPO, Wt=1.6s, Rt=1.6s	USP-6C	49xh	VD17	9b Tor
8H649	XC6111H649ER	Vdet-IC	4.9V±2%, -MR, -Reset PPO, Wt=1.6s, Rt=1.6s	USP-6C	49xh	VD17	9b Tor
8H650	XC6111H650ER	Vdet-IC	5.0V±2%, -MR, -Reset PPO, Wt=1.6s, Rt=1.6s	USP-6C	49xh	VD17	9b Tor
8J	RP103K261D	LVR-IC	LDO, 2.6V±1%, 150mA, +CE, CL	DFM1010-4	48vm	VR4	9a Ric



SMD code	Type	Function	Short description	Case	Pinout	Sch.	St.	Mnf.
8J	RP200K401D	LVR-IC	LDO, 4V±1.0%, 300mA, +CE, CL, AE(mode)	DFN1212-6	52ht	VR10	9a	Ric
8K	RP103K271D	LVR-IC	LDO, 2.7V±1%, 150mA, +CE, CL	DFN1010-4	48vm	VR4	9a	Ric
8K	XC6223A27B9R-G	LVR-IC	LDO, 2.75V±1%, 300mA, +CE	USPQ-4B03	48vm	VR4	9a	Tor
8L	RP103K281D	LVR-IC	LDO, 2.8V±1%, 150mA, +CE, CL	DFN1010-4	48vm	VR4	9a	Ric
8L	XC6223A28B9R-G	LVR-IC	LDO, 2.85V±1%, 300mA, +CE	USPQ-4B03	48vm	VR4	9a	Tor
8M	RP103K281D5	LVR-IC	LDO, 2.85V±1%, 150mA, +CE, CL	DFN1010-4	48vm	VR4	9a	Ric
8M	XC6223A28B9R-G	LVR-IC	LDO, 2.95V±1%, 300mA, +CE	USPQ-4B03	48vm	VR4	9a	Tor
8N	RP103K291D	LVR-IC	LDO, 2.9V±1%, 150mA, +CE, CL	DFN1010-4	48vm	VR4	9a	Ric
8N	XC6223A30B9R-G	LVR-IC	LDO, 3.05V±1%, 300mA, +CE	USPQ-4B03	48vm	VR4	9a	Tor
8P	RP103K301D	LVR-IC	LDO, 3V±1%, 150mA, +CE, CL	DFN1010-4	48vm	VR4	9a	Ric
8P	XC6223A31B9R-G	LVR-IC	LDO, 3.15V±1%, 300mA, +CE	USPQ-4B03	48vm	VR4	9a	Tor
8Q	RP103K311D	LVR-IC	LDO, 3.1V±1%, 150mA, +CE, CL	DFN1010-4	48vm	VR4	9a	Ric
8R	RP103K331D	LVR-IC	LDO, 3.3V±1%, 150mA, +CE, CL	DFN1010-4	48vm	VR4	9a	Ric
8R	XC6223A32B9R-G	LVR-IC	LDO, 3.25V±1%, 300mA, +CE	USPQ-4B03	48vm	VR4	9a	Tor
8S	RP103K231B	LVR-IC	LDO, 2.3V±1%, 150mA, +CE	DFN1010-4	48vm	VR4	9a	Ric
8S	XC6223A33B9R-G	LVR-IC	LDO, 3.35V±1%, 300mA, +CE	USPQ-4B03	48vm	VR4	9a	Tor
8T	RP103K211D	LVR-IC	LDO, 2.1V±1%, 150mA, +CE, CL	DFN1010-4	48vm	VR4	9a	Ric
8T	XC6223A34B9R-G	LVR-IC	LDO, 3.45V±1%, 300mA, +CE	USPQ-4B03	48vm	VR4	9a	Tor
8U	RP103K321D	LVR-IC	LDO, 3.2V±1%, 150mA, +CE, CL	DFN1010-4	48vm	VR4	9a	Ric
8U	XC6223A35B9R-G	LVR-IC	LDO, 3.55V±1%, 300mA, +CE	USPQ-4B03	48vm	VR4	9a	Tor
8V	RP103K291D5	LVR-IC	LDO, 2.95V±1%, 150mA, +CE, CL	DFN1010-4	48vm	VR4	9a	Ric
8V	XC6223A36B9R-G	LVR-IC	LDO, 3.65V±1%, 300mA, +CE	USPQ-4B03	48vm	VR4	9a	Tor
8W	RP103K221D	LVR-IC	LDO, 2.2V±1%, 150mA, +CE, CL	DFN1010-4	48vm	VR4	9a	Ric
8X	RP103K161D	LVR-IC	LDO, 1.6V±1%, 150mA, +CE, CL	DFN1010-4	48vm	VR4	9a	Ric
8X	XC6221B41B7R	LVR-IC	LDO, 4.15V±1%, 200mA, +CE, CL	USPN-4	58vm	VR4	9a	Tor
8X	XC6223A37B9R-G	LVR-IC	LDO, 3.75V±1%, 300mA, +CE	USPQ-4B03	48vm	VR4	9a	Tor
8Y	RP103K141D	LVR-IC	LDO, 1.4V±1%, 150mA, +CE, CL	DFN1010-4	48vm	VR4	9a	Ric
8Y	XC6221B42B7R	LVR-IC	LDO, 4.25V±1%, 200mA, +CE, CL	USPN-4	58vm	VR4	9a	Tor
8Y	XC6223A38B9R-G	LVR-IC	LDO, 3.85V±1%, 300mA, +CE	USPQ-4B03	48vm	VR4	9a	Tor
8Z	RP103K171D	LVR-IC	LDO, 1.7V±1%, 150mA, +CE, CL	DFN1010-4	48vm	VR4	9a	Ric
8Z	XC6221B43B7R	LVR-IC	LDO, 4.35V±1%, 200mA, +CE, CL	USPN-4	58vm	VR4	9a	Tor
8Z	XC6223A39B9R-G	LVR-IC	LDO, 3.95V±1%, 300mA, +CE	USPQ-4B03	48vm	VR4	9a	Tor
90	RP110L311D	LVR-IC	LDO, 3.1V±1%, 150mA, +CE, CL	DFN1010-4	48vm	VR4	9a	Ric
902	XC6223G121GR-G	LVR-IC	LDO, 1.2V±20mV, 300mA, +CE, PDR, ICP	USP-4	45vm	VR4	9a	Tor
903	XC6223G131GR-G	LVR-IC	LDO, 1.3V±20mV, 300mA, +CE, PDR, ICP	USP-4	45vm	VR4	9a	Tor
904	XC6223G141GR-G	LVR-IC	LDO, 1.4V±20mV, 300mA, +CE, PDR, ICP	USP-4	45vm	VR4	9a	Tor
905	XC6223G151GR-G	LVR-IC	LDO, 1.5V±20mV, 300mA, +CE, PDR, ICP	USP-4	45vm	VR4	9a	Tor
906	XC6223G161GR-G	LVR-IC	LDO, 1.6V±20mV, 300mA, +CE, PDR, ICP	USP-4	45vm	VR4	9a	Tor
907	XC6223G171GR-G	LVR-IC	LDO, 1.7V±20mV, 300mA, +CE, PDR, ICP	USP-4	45vm	VR4	9a	Tor
908	XC6223G181GR-G	LVR-IC	LDO, 1.8V±20mV, 300mA, +CE, PDR, ICP	USP-4	45vm	VR4	9a	Tor
909	XC6223G191GR-G	LVR-IC	LDO, 1.9V±20mV, 300mA, +CE, PDR, ICP	USP-4	45vm	VR4	9a	Tor
90A	XC6223G201GR-G	LVR-IC	LDO, 2.0V±1%, 300mA, +CE, PDR, ICP	USP-4	45vm	VR4	9a	Tor
90B	XC6223G211GR-G	LVR-IC	LDO, 2.1V±1%, 300mA, +CE, PDR, ICP	USP-4	45vm	VR4	9a	Tor
90C	XC6223G221GR-G	LVR-IC	LDO, 2.2V±1%, 300mA, +CE, PDR, ICP	USP-4	45vm	VR4	9a	Tor
90D	XC6223G231GR-G	LVR-IC	LDO, 2.3V±1%, 300mA, +CE, PDR, ICP	USP-4	45vm	VR4	9a	Tor
90E	XC6223G241GR-G	LVR-IC	LDO, 2.4V±1%, 300mA, +CE, PDR, ICP	USP-4	45vm	VR4	9a	Tor
90F	XC6223G251GR-G	LVR-IC	LDO, 2.5V±1%, 300mA, +CE, PDR, ICP	USP-4	45vm	VR4	9a	Tor
90H	XC6223G261GR-G	LVR-IC	LDO, 2.6V±1%, 300mA, +CE, PDR, ICP	USP-4	45vm	VR4	9a	Tor
90K	XC6223G271GR-G	LVR-IC	LDO, 2.7V±1%, 300mA, +CE, PDR, ICP	USP-4	45vm	VR4	9a	Tor
90L	XC6223G281GR-G	LVR-IC	LDO, 2.8V±1%, 300mA, +CE, PDR, ICP	USP-4	45vm	VR4	9a	Tor
90M	XC6223G291GR-G	LVR-IC	LDO, 2.9V±1%, 300mA, +CE, PDR, ICP	USP-4	45vm	VR4	9a	Tor
90N	XC6223G301GR-G	LVR-IC	LDO, 3.0V±1%, 300mA, +CE, PDR, ICP	USP-4	45vm	VR4	9a	Tor
90P	XC6223G311GR-G	LVR-IC	LDO, 3.1V±1%, 300mA, +CE, PDR, ICP	USP-4	45vm	VR4	9a	Tor
90R	XC6223G321GR-G	LVR-IC	LDO, 3.2V±1%, 300mA, +CE, PDR, ICP	USP-4	45vm	VR4	9a	Tor
90S	XC6223G331GR-G	LVR-IC	LDO, 3.3V±1%, 300mA, +CE, PDR, ICP	USP-4	45vm	VR4	9a	Tor
90T	XC6223G341GR-G	LVR-IC	LDO, 3.4V±1%, 300mA, +CE, PDR, ICP	USP-4	45vm	VR4	9a	Tor
90U	XC6223G351GR-G	LVR-IC	LDO, 3.5V±1%, 300mA, +CE, PDR, ICP	USP-4	45vm	VR4	9a	Tor
90V	XC6223G361GR-G	LVR-IC	LDO, 3.6V±1%, 300mA, +CE, PDR, ICP	USP-4	45vm	VR4	9a	Tor
90X	XC6223G371GR-G	LVR-IC	LDO, 3.7V±1%, 300mA, +CE, PDR, ICP	USP-4	45vm	VR4	9a	Tor
90Y	XC6223G381GR-G	LVR-IC	LDO, 3.8V±1%, 300mA, +CE, PDR, ICP	USP-4	45vm	VR4	9a	Tor
90Z	XC6223G391GR-G	LVR-IC	LDO, 3.9V±1%, 300mA, +CE, PDR, ICP	USP-4	45vm	VR4	9a	Tor
91	RP110L321D	LVR-IC	LDO, 3.2V±1%, 150mA, +CE, CL	DFN1010-4	48vm	VR4	9a	Ric
910	XC6223G401GR-G	LVR-IC	LDO, 4.0V±1%, 300mA, +CE, PDR, ICP	USP-4	45vm	VR4	9a	Tor
92	RP110L331D	LVR-IC	LDO, 3.3V±1%, 150mA, +CE, CL	DFN1010-4	48vm	VR4	9a	Ric
92	XC6223B12B9R-G	LVR-IC	LDO, 1.25V±20mV, 300mA, +CE, CL	USPQ-4B03	48vm	VR4	9a	Tor
922	XC6223G12BGR-G	LVR-IC	LDO, 1.25V±20mV, 300mA, +CE, PDR, ICP	USP-4	45vm	VR4	9a	Tor
923	XC6223G13BGR-G	LVR-IC	LDO, 1.35V±20mV, 300mA, +CE, PDR, ICP	USP-4	45vm	VR4	9a	Tor
924	XC6223G14BGR-G	LVR-IC	LDO, 1.45V±20mV, 300mA, +CE, PDR, ICP	USP-4	45vm	VR4	9a	Tor
925	XC6223G15BGR-G	LVR-IC	LDO, 1.55V±20mV, 300mA, +CE, PDR, ICP	USP-4	45vm	VR4	9a	Tor
926	XC6223G16BGR-G	LVR-IC	LDO, 1.65V±20mV, 300mA, +CE, PDR, ICP	USP-4	45vm	VR4	9a	Tor



SMD code	Type	Function	Short description	Case	Pinout	Sch.	St.	Mnf.
927	XC6223G17BGR-G	LVR-IC	LDO, 1.75V±20mV, 300mA, +CE, PDR, ICP	USP-4	45vm	VR4	9a	Tor
928	XC6223G18BGR-G	LVR-IC	LDO, 1.85V±20mV, 300mA, +CE, PDR, ICP	USP-4	45vm	VR4	9a	Tor
929	XC6223G19BGR-G	LVR-IC	LDO, 1.95V±20mV, 300mA, +CE, PDR, ICP	USP-4	45vm	VR4	9a	Tor
92A	XC6223G20BGR-G	LVR-IC	LDO, 2.05V±1%, 300mA, +CE, PDR, ICP	USP-4	45vm	VR4	9a	Tor
92B	XC6223G21BGR-G	LVR-IC	LDO, 2.15V±1%, 300mA, +CE, PDR, ICP	USP-4	45vm	VR4	9a	Tor
92C	XC6223G22BGR-G	LVR-IC	LDO, 2.25V±1%, 300mA, +CE, PDR, ICP	USP-4	45vm	VR4	9a	Tor
92D	XC6223G23BGR-G	LVR-IC	LDO, 2.35V±1%, 300mA, +CE, PDR, ICP	USP-4	45vm	VR4	9a	Tor
92E	XC6223G24BGR-G	LVR-IC	LDO, 2.45V±1%, 300mA, +CE, PDR, ICP	USP-4	45vm	VR4	9a	Tor
92F	XC6223G25BGR-G	LVR-IC	LDO, 2.55V±1%, 300mA, +CE, PDR, ICP	USP-4	45vm	VR4	9a	Tor
92H	XC6223G26BGR-G	LVR-IC	LDO, 2.65V±1%, 300mA, +CE, PDR, ICP	USP-4	45vm	VR4	9a	Tor
92K	XC6223G27BGR-G	LVR-IC	LDO, 2.75V±1%, 300mA, +CE, PDR, ICP	USP-4	45vm	VR4	9a	Tor
92L	XC6223G28BGR-G	LVR-IC	LDO, 2.85V±1%, 300mA, +CE, PDR, ICP	USP-4	45vm	VR4	9a	Tor
92M	XC6223G29BGR-G	LVR-IC	LDO, 2.95V±1%, 300mA, +CE, PDR, ICP	USP-4	45vm	VR4	9a	Tor
92N	XC6223G30BGR-G	LVR-IC	LDO, 3.05V±1%, 300mA, +CE, PDR, ICP	USP-4	45vm	VR4	9a	Tor
92P	XC6223G31BGR-G	LVR-IC	LDO, 3.15V±1%, 300mA, +CE, PDR, ICP	USP-4	45vm	VR4	9a	Tor
92R	XC6223G32BGR-G	LVR-IC	LDO, 3.25V±1%, 300mA, +CE, PDR, ICP	USP-4	45vm	VR4	9a	Tor
92S	XC6223G33BGR-G	LVR-IC	LDO, 3.35V±1%, 300mA, +CE, PDR, ICP	USP-4	45vm	VR4	9a	Tor
92T	XC6223G34BGR-G	LVR-IC	LDO, 3.45V±1%, 300mA, +CE, PDR, ICP	USP-4	45vm	VR4	9a	Tor
92U	XC6223G35BGR-G	LVR-IC	LDO, 3.55V±1%, 300mA, +CE, PDR, ICP	USP-4	45vm	VR4	9a	Tor
92V	XC6223G36BGR-G	LVR-IC	LDO, 3.65V±1%, 300mA, +CE, PDR, ICP	USP-4	45vm	VR4	9a	Tor
92X	XC6223G37BGR-G	LVR-IC	LDO, 3.75V±1%, 300mA, +CE, PDR, ICP	USP-4	45vm	VR4	9a	Tor
92Y	XC6223G38BGR-G	LVR-IC	LDO, 3.85V±1%, 300mA, +CE, PDR, ICP	USP-4	45vm	VR4	9a	Tor
92Z	XC6223G39BGR-G	LVR-IC	LDO, 3.95V±1%, 300mA, +CE, PDR, ICP	USP-4	45vm	VR4	9a	Tor
93	RP110L341D	LVR-IC	LDO, 3.4V±1%, 150mA, +CE, CL	DFN1010-4	48vm	VR4	9a	Ric
93	XC6223B13B9R-G	LVR-IC	LDO, 1.35V±20mV, 300mA, +CE, CL	USPQ-4B03	48vm	VR4	9a	Tor
932	XC6223H121GR-G	LVR-IC	LDO, 1.2V±20mV, 300mA, +CE, CL, PDR, ICP	USP-4	45vm	VR4	9a	Tor
933	XC6223H131GR-G	LVR-IC	LDO, 1.3V±20mV, 300mA, +CE, CL, PDR, ICP	USP-4	45vm	VR4	9a	Tor
934	XC6223H141GR-G	LVR-IC	LDO, 1.4V±20mV, 300mA, +CE, CL, PDR, ICP	USP-4	45vm	VR4	9a	Tor
935	XC6223H151GR-G	LVR-IC	LDO, 1.5V±20mV, 300mA, +CE, CL, PDR, ICP	USP-4	45vm	VR4	9a	Tor
936	XC6223H161GR-G	LVR-IC	LDO, 1.6V±20mV, 300mA, +CE, CL, PDR, ICP	USP-4	45vm	VR4	9a	Tor
937	XC6223H171GR-G	LVR-IC	LDO, 1.7V±20mV, 300mA, +CE, CL, PDR, ICP	USP-4	45vm	VR4	9a	Tor
938	XC6223H181GR-G	LVR-IC	LDO, 1.8V±20mV, 300mA, +CE, CL, PDR, ICP	USP-4	45vm	VR4	9a	Tor
939	XC6223H191GR-G	LVR-IC	LDO, 1.9V±20mV, 300mA, +CE, CL, PDR, ICP	USP-4	45vm	VR4	9a	Tor
93A	XC6223H201GR-G	LVR-IC	LDO, 2.0V±1%, 300mA, +CE, CL, PDR, ICP	USP-4	45vm	VR4	9a	Tor
93B	XC6223H211GR-G	LVR-IC	LDO, 2.1V±1%, 300mA, +CE, CL, PDR, ICP	USP-4	45vm	VR4	9a	Tor
93C	XC6223H221GR-G	LVR-IC	LDO, 2.2V±1%, 300mA, +CE, CL, PDR, ICP	USP-4	45vm	VR4	9a	Tor
93D	XC6223H231GR-G	LVR-IC	LDO, 2.3V±1%, 300mA, +CE, CL, PDR, ICP	USP-4	45vm	VR4	9a	Tor
93E	XC6223H241GR-G	LVR-IC	LDO, 2.4V±1%, 300mA, +CE, CL, PDR, ICP	USP-4	45vm	VR4	9a	Tor
93F	XC6223H251GR-G	LVR-IC	LDO, 2.5V±1%, 300mA, +CE, CL, PDR, ICP	USP-4	45vm	VR4	9a	Tor
93H	XC6223H261GR-G	LVR-IC	LDO, 2.6V±1%, 300mA, +CE, CL, PDR, ICP	USP-4	45vm	VR4	9a	Tor
93K	XC6223H271GR-G	LVR-IC	LDO, 2.7V±1%, 300mA, +CE, CL, PDR, ICP	USP-4	45vm	VR4	9a	Tor
93L	XC6223H281GR-G	LVR-IC	LDO, 2.8V±1%, 300mA, +CE, CL, PDR, ICP	USP-4	45vm	VR4	9a	Tor
93M	XC6223H291GR-G	LVR-IC	LDO, 2.9V±1%, 300mA, +CE, CL, PDR, ICP	USP-4	45vm	VR4	9a	Tor
93N	XC6223H301GR-G	LVR-IC	LDO, 3.0V±1%, 300mA, +CE, CL, PDR, ICP	USP-4	45vm	VR4	9a	Tor
93P	XC6223H311GR-G	LVR-IC	LDO, 3.1V±1%, 300mA, +CE, CL, PDR, ICP	USP-4	45vm	VR4	9a	Tor
93R	XC6223H321GR-G	LVR-IC	LDO, 3.2V±1%, 300mA, +CE, CL, PDR, ICP	USP-4	45vm	VR4	9a	Tor
93S	XC6223H331GR-G	LVR-IC	LDO, 3.3V±1%, 300mA, +CE, CL, PDR, ICP	USP-4	45vm	VR4	9a	Tor
93T	XC6223H341GR-G	LVR-IC	LDO, 3.4V±1%, 300mA, +CE, CL, PDR, ICP	USP-4	45vm	VR4	9a	Tor
93U	XC6223H351GR-G	LVR-IC	LDO, 3.5V±1%, 300mA, +CE, CL, PDR, ICP	USP-4	45vm	VR4	9a	Tor
93V	XC6223H361GR-G	LVR-IC	LDO, 3.6V±1%, 300mA, +CE, CL, PDR, ICP	USP-4	45vm	VR4	9a	Tor
93X	XC6223H371GR-G	LVR-IC	LDO, 3.7V±1%, 300mA, +CE, CL, PDR, ICP	USP-4	45vm	VR4	9a	Tor
93Y	XC6223H381GR-G	LVR-IC	LDO, 3.8V±1%, 300mA, +CE, CL, PDR, ICP	USP-4	45vm	VR4	9a	Tor
93Z	XC6223H391GR-G	LVR-IC	LDO, 3.9V±1%, 300mA, +CE, CL, PDR, ICP	USP-4	45vm	VR4	9a	Tor
94	RP110L351D	LVR-IC	LDO, 3.5V±1%, 150mA, +CE, CL	DFN1010-4	48vm	VR4	9a	Ric
94	XC6223B14B9R-G	LVR-IC	LDO, 1.45V±20mV, 300mA, +CE, CL	USPQ-4B03	48vm	VR4	9a	Tor
940	XC6223H401GR-G	LVR-IC	LDO, 4.0V±1%, 300mA, +CE, CL, PDR, ICP	USP-4	45vm	VR4	9a	Tor
95	RP110L361D	LVR-IC	LDO, 3.6V±1%, 150mA, +CE, CL	DFN1010-4	48vm	VR4	9a	Ric
95	TS4995EJIT	LIN-IC	AF PA, BTL, 2.5-5.5V, 1.2W(5V/8Q), select shutdown	BGA-9	39	-	-	Ste
95	XC6223B15B9R-G	LVR-IC	LDO, 1.55V±20mV, 300mA, +CE, CL	USPQ-4B03	48vm	VR4	9a	Tor
952	XC6223H12BGR-G	LVR-IC	LDO, 1.25V±20mV, 300mA, +CE, CL, PDR, ICP	USP-4	45vm	VR4	9a	Tor
953	XC6223H13BGR-G	LVR-IC	LDO, 1.35V±20mV, 300mA, +CE, CL, PDR, ICP	USP-4	45vm	VR4	9a	Tor
954	XC6223H14BGR-G	LVR-IC	LDO, 1.45V±20mV, 300mA, +CE, CL, PDR, ICP	USP-4	45vm	VR4	9a	Tor
955	XC6223H15BGR-G	LVR-IC	LDO, 1.55V±20mV, 300mA, +CE, CL, PDR, ICP	USP-4	45vm	VR4	9a	Tor
956	XC6223H16BGR-G	LVR-IC	LDO, 1.65V±20mV, 300mA, +CE, CL, PDR, ICP	USP-4	45vm	VR4	9a	Tor
957	XC6223H17BGR-G	LVR-IC	LDO, 1.75V±20mV, 300mA, +CE, CL, PDR, ICP	USP-4	45vm	VR4	9a	Tor
958	XC6223H18BGR-G	LVR-IC	LDO, 1.85V±20mV, 300mA, +CE, CL, PDR, ICP	USP-4	45vm	VR4	9a	Tor
959	XC6223H19BGR-G	LVR-IC	LDO, 1.95V±20mV, 300mA, +CE, CL, PDR, ICP	USP-4	45vm	VR4	9a	Tor
95A	XC6223H20BGR-G	LVR-IC	LDO, 2.05V±1%, 300mA, +CE, CL, PDR, ICP	USP-4	45vm	VR4	9a	Tor
95B	XC6223H21BGR-G	LVR-IC	LDO, 2.15V±1%, 300mA, +CE, CL, PDR, ICP	USP-4	45vm	VR4	9a	Tor
95C	XC6223H22BGR-G	LVR-IC	LDO, 2.25V±1%, 300mA, +CE, CL, PDR, ICP	USP-4	45vm	VR4	9a	Tor



SMD code	Type	Function	Short description	Case	Pinout	Sch.	St.	Mnf.
95D	XC6223H23BGR-G	LVR-IC	LDO, 2.35V±1%, 300mA, +CE, CL, PDR, ICP	USP-4	45vm	VR4	9a	Tor
95E	XC6223H24BGR-G	LVR-IC	LDO, 2.45V±1%, 300mA, +CE, CL, PDR, ICP	USP-4	45vm	VR4	9a	Tor
95F	XC6223H25BGR-G	LVR-IC	LDO, 2.55V±1%, 300mA, +CE, CL, PDR, ICP	USP-4	45vm	VR4	9a	Tor
95H	XC6223H26BGR-G	LVR-IC	LDO, 2.65V±1%, 300mA, +CE, CL, PDR, ICP	USP-4	45vm	VR4	9a	Tor
95K	XC6223H27BGR-G	LVR-IC	LDO, 2.75V±1%, 300mA, +CE, CL, PDR, ICP	USP-4	45vm	VR4	9a	Tor
95L	XC6223H28BGR-G	LVR-IC	LDO, 2.85V±1%, 300mA, +CE, CL, PDR, ICP	USP-4	45vm	VR4	9a	Tor
95M	XC6223H29BGR-G	LVR-IC	LDO, 2.95V±1%, 300mA, +CE, CL, PDR, ICP	USP-4	45vm	VR4	9a	Tor
95N	XC6223H30BGR-G	LVR-IC	LDO, 3.05V±1%, 300mA, +CE, CL, PDR, ICP	USP-4	45vm	VR4	9a	Tor
95P	XC6223H31BGR-G	LVR-IC	LDO, 3.15V±1%, 300mA, +CE, CL, PDR, ICP	USP-4	45vm	VR4	9a	Tor
95R	XC6223H32BGR-G	LVR-IC	LDO, 3.25V±1%, 300mA, +CE, CL, PDR, ICP	USP-4	45vm	VR4	9a	Tor
95S	XC6223H33BGR-G	LVR-IC	LDO, 3.35V±1%, 300mA, +CE, CL, PDR, ICP	USP-4	45vm	VR4	9a	Tor
95T	XC6223H34BGR-G	LVR-IC	LDO, 3.45V±1%, 300mA, +CE, CL, PDR, ICP	USP-4	45vm	VR4	9a	Tor
95U	XC6223H35BGR-G	LVR-IC	LDO, 3.55V±1%, 300mA, +CE, CL, PDR, ICP	USP-4	45vm	VR4	9a	Tor
95V	XC6223H36BGR-G	LVR-IC	LDO, 3.65V±1%, 300mA, +CE, CL, PDR, ICP	USP-4	45vm	VR4	9a	Tor
95X	XC6223H37BGR-G	LVR-IC	LDO, 3.75V±1%, 300mA, +CE, CL, PDR, ICP	USP-4	45vm	VR4	9a	Tor
95Y	XC6223H38BGR-G	LVR-IC	LDO, 3.85V±1%, 300mA, +CE, CL, PDR, ICP	USP-4	45vm	VR4	9a	Tor
95Z	XC6223H39BGR-G	LVR-IC	LDO, 3.95V±1%, 300mA, +CE, CL, PDR, ICP	USP-4	45vm	VR4	9a	Tor
96	XC6223B16B9R-G	LVR-IC	LDO, 1.65V±20mV, 300mA, +CE, CL	USPQ-4B03	48vm	VR4	9a	Tor
97	XC6221A0817R	LVR-IC	LDO, 0.8V±20mV, 200mA, +CE	USPN-4	58vm	VR4	9a	Tor
97	XC6223B17B9R-G	LVR-IC	LDO, 1.75V±20mV, 300mA, +CE, CL	USPQ-4B03	48vm	VR4	9a	Tor
98	XC6221A0917R	LVR-IC	LDO, 0.9V±20mV, 200mA, +CE	USPN-4	58vm	VR4	9a	Tor
98	XC6223B18B9R-G	LVR-IC	LDO, 1.85V±20mV, 300mA, +CE, CL	USPQ-4B03	48vm	VR4	9a	Tor
99	XC6221A1017R	LVR-IC	LDO, 1V±20mV, 200mA, +CE	USPN-4	58vm	VR4	9a	Tor
99	XC6223B19B9R-G	LVR-IC	LDO, 1.95V±20mV, 300mA, +CE, CL	USPQ-4B03	48vm	VR4	9a	Tor
9A	RP103K241B	LVR-IC	LDO, 2.4V±1%, 150mA, +CE	DFN1010-4	48vm	VR4	9a	Ric
9A	XC6221A1117R	LVR-IC	LDO, 1.1V±20mV, 200mA, +CE	USPN-4	58vm	VR4	9a	Tor
9A	XC6223B20B9R-G	LVR-IC	LDO, 2.05V±1%, 300mA, +CE, CL	USPQ-4B03	48vm	VR4	9a	Tor
9A0	XC6601A071ER	LVR-IC	0.7V±20mV, 400mA, +CE, PDR, UVLO	USP-6C	49gm	VR11	9a	Tor
9A016	XC6117A016ER	Vdet-IC	1.6V±2%, -MR, +Rst PPO, -Rst ODO, Rt=3.13ms	USP-6C	49xs	VD22	9b	Tor
9A017	XC6117A017ER	Vdet-IC	1.7V±2%, -MR, +Rst PPO, -Rst ODO, Rt=3.13ms	USP-6C	49xs	VD22	9b	Tor
9A018	XC6117A018ER	Vdet-IC	1.8V±2%, -MR, +Rst PPO, -Rst ODO, Rt=3.13ms	USP-6C	49xs	VD22	9b	Tor
9A019	XC6117A019ER	Vdet-IC	1.9V±2%, -MR, +Rst PPO, -Rst ODO, Rt=3.13ms	USP-6C	49xs	VD22	9b	Tor
9A020	XC6117A020ER	Vdet-IC	2.0V±2%, -MR, +Rst PPO, -Rst ODO, Rt=3.13ms	USP-6C	49xs	VD22	9b	Tor
9A021	XC6117A021ER	Vdet-IC	2.1V±2%, -MR, +Rst PPO, -Rst ODO, Rt=3.13ms	USP-6C	49xs	VD22	9b	Tor
9A022	XC6117A022ER	Vdet-IC	2.2V±2%, -MR, +Rst PPO, -Rst ODO, Rt=3.13ms	USP-6C	49xs	VD22	9b	Tor
9A023	XC6117A023ER	Vdet-IC	2.3V±2%, -MR, +Rst PPO, -Rst ODO, Rt=3.13ms	USP-6C	49xs	VD22	9b	Tor
9A024	XC6117A024ER	Vdet-IC	2.4V±2%, -MR, +Rst PPO, -Rst ODO, Rt=3.13ms	USP-6C	49xs	VD22	9b	Tor
9A025	XC6117A025ER	Vdet-IC	2.5V±2%, -MR, +Rst PPO, -Rst ODO, Rt=3.13ms	USP-6C	49xs	VD22	9b	Tor
9A026	XC6117A026ER	Vdet-IC	2.6V±2%, -MR, +Rst PPO, -Rst ODO, Rt=3.13ms	USP-6C	49xs	VD22	9b	Tor
9A027	XC6117A027ER	Vdet-IC	2.7V±2%, -MR, +Rst PPO, -Rst ODO, Rt=3.13ms	USP-6C	49xs	VD22	9b	Tor
9A028	XC6117A028ER	Vdet-IC	2.8V±2%, -MR, +Rst PPO, -Rst ODO, Rt=3.13ms	USP-6C	49xs	VD22	9b	Tor
9A029	XC6117A029ER	Vdet-IC	2.9V±2%, -MR, +Rst PPO, -Rst ODO, Rt=3.13ms	USP-6C	49xs	VD22	9b	Tor
9A030	XC6117A030ER	Vdet-IC	3.0V±2%, -MR, +Rst PPO, -Rst ODO, Rt=3.13ms	USP-6C	49xs	VD22	9b	Tor
9A031	XC6117A031ER	Vdet-IC	3.1V±2%, -MR, +Rst PPO, -Rst ODO, Rt=3.13ms	USP-6C	49xs	VD22	9b	Tor
9A032	XC6117A032ER	Vdet-IC	3.2V±2%, -MR, +Rst PPO, -Rst ODO, Rt=3.13ms	USP-6C	49xs	VD22	9b	Tor
9A033	XC6117A033ER	Vdet-IC	3.3V±2%, -MR, +Rst PPO, -Rst ODO, Rt=3.13ms	USP-6C	49xs	VD22	9b	Tor
9A034	XC6117A034ER	Vdet-IC	3.4V±2%, -MR, +Rst PPO, -Rst ODO, Rt=3.13ms	USP-6C	49xs	VD22	9b	Tor
9A035	XC6117A035ER	Vdet-IC	3.5V±2%, -MR, +Rst PPO, -Rst ODO, Rt=3.13ms	USP-6C	49xs	VD22	9b	Tor
9A036	XC6117A036ER	Vdet-IC	3.6V±2%, -MR, +Rst PPO, -Rst ODO, Rt=3.13ms	USP-6C	49xs	VD22	9b	Tor
9A037	XC6117A037ER	Vdet-IC	3.7V±2%, -MR, +Rst PPO, -Rst ODO, Rt=3.13ms	USP-6C	49xs	VD22	9b	Tor
9A038	XC6117A038ER	Vdet-IC	3.8V±2%, -MR, +Rst PPO, -Rst ODO, Rt=3.13ms	USP-6C	49xs	VD22	9b	Tor
9A039	XC6117A039ER	Vdet-IC	3.9V±2%, -MR, +Rst PPO, -Rst ODO, Rt=3.13ms	USP-6C	49xs	VD22	9b	Tor
9A040	XC6117A040ER	Vdet-IC	4.0V±2%, -MR, +Rst PPO, -Rst ODO, Rt=3.13ms	USP-6C	49xs	VD22	9b	Tor
9A041	XC6117A041ER	Vdet-IC	4.1V±2%, -MR, +Rst PPO, -Rst ODO, Rt=3.13ms	USP-6C	49xs	VD22	9b	Tor
9A042	XC6117A042ER	Vdet-IC	4.2V±2%, -MR, +Rst PPO, -Rst ODO, Rt=3.13ms	USP-6C	49xs	VD22	9b	Tor
9A043	XC6117A043ER	Vdet-IC	4.3V±2%, -MR, +Rst PPO, -Rst ODO, Rt=3.13ms	USP-6C	49xs	VD22	9b	Tor
9A044	XC6117A044ER	Vdet-IC	4.4V±2%, -MR, +Rst PPO, -Rst ODO, Rt=3.13ms	USP-6C	49xs	VD22	9b	Tor
9A045	XC6117A045ER	Vdet-IC	4.5V±2%, -MR, +Rst PPO, -Rst ODO, Rt=3.13ms	USP-6C	49xs	VD22	9b	Tor
9A046	XC6117A046ER	Vdet-IC	4.6V±2%, -MR, +Rst PPO, -Rst ODO, Rt=3.13ms	USP-6C	49xs	VD22	9b	Tor
9A047	XC6117A047ER	Vdet-IC	4.7V±2%, -MR, +Rst PPO, -Rst ODO, Rt=3.13ms	USP-6C	49xs	VD22	9b	Tor
9A048	XC6117A048ER	Vdet-IC	4.8V±2%, -MR, +Rst PPO, -Rst ODO, Rt=3.13ms	USP-6C	49xs	VD22	9b	Tor
9A049	XC6117A049ER	Vdet-IC	4.9V±2%, -MR, +Rst PPO, -Rst ODO, Rt=3.13ms	USP-6C	49xs	VD22	9b	Tor
9A050	XC6117A050ER	Vdet-IC	5.0V±2%, -MR, +Rst PPO, -Rst ODO, Rt=3.13ms	USP-6C	49xs	VD22	9b	Tor
9A1	XC6601A07BER	LVR-IC	0.7V±20mV, 400mA, +CE, PDR, UVLO	USP-6C	49gm	VR11	9a	Tor
9A116	XC6112A116ER	Vdet-IC	1.6V±2%, -MR, -Reset ODO, Wt=6.25ms, Rt=3.13ms	USP-6C	49xh	VD16	9b	Tor
9A117	XC6112A117ER	Vdet-IC	1.7V±2%, -MR, -Reset ODO, Wt=6.25ms, Rt=3.13ms	USP-6C	49xh	VD16	9b	Tor
9A118	XC6112A118ER	Vdet-IC	1.8V±2%, -MR, -Reset ODO, Wt=6.25ms, Rt=3.13ms	USP-6C	49xh	VD16	9b	Tor
9A119	XC6112A119ER	Vdet-IC	1.9V±2%, -MR, -Reset ODO, Wt=6.25ms, Rt=3.13ms	USP-6C	49xh	VD16	9b	Tor
9A120	XC6112A120ER	Vdet-IC	2.0V±2%, -MR, -Reset ODO, Wt=6.25ms, Rt=3.13ms	USP-6C	49xh	VD16	9b	Tor
9A121	XC6112A121ER	Vdet-IC	2.1V±2%, -MR, -Reset ODO, Wt=6.25ms, Rt=3.13ms	USP-6C	49xh	VD16	9b	Tor



SMD code	Type	Function	Short description	Case	Pinout	Sch.	St.	Mnf.
9A8	XC6601A111ER	LVR-IC	1.1V±20mV, 400mA, +CE, PDR, UVLO	USP-6C	49gm	VR11	9a	Tor
9A9	XC6601A11BER	LVR-IC	1.15V±20mV, 400mA, +CE, PDR, UVLO	USP-6C	49gm	VR11	9a	Tor
9AA	XC6601A121ER	LVR-IC	1.2V±20mV, 400mA, +CE, PDR, UVLO	USP-6C	49gm	VR11	9a	Tor
9AB	XC6601A12BER	LVR-IC	1.25V±20mV, 400mA, +CE, PDR, UVLO	USP-6C	49gm	VR11	9a	Tor
9AC	XC6601A131ER	LVR-IC	1.3V±20mV, 400mA, +CE, PDR, UVLO	USP-6C	49gm	VR11	9a	Tor
9AD	XC6601A13BER	LVR-IC	1.35V±20mV, 400mA, +CE, PDR, UVLO	USP-6C	49gm	VR11	9a	Tor
9AE	XC6601A141ER	LVR-IC	1.4V±20mV, 400mA, +CE, PDR, UVLO	USP-6C	49gm	VR11	9a	Tor
9AF	XC6601A14BER	LVR-IC	1.45V±20mV, 400mA, +CE, PDR, UVLO	USP-6C	49gm	VR11	9a	Tor
9AH	XC6601A151ER	LVR-IC	1.5V±20mV, 400mA, +CE, PDR, UVLO	USP-6C	49gm	VR11	9a	Tor
9AK	XC6601A15BER	LVR-IC	1.55V±20mV, 400mA, +CE, PDR, UVLO	USP-6C	49gm	VR11	9a	Tor
9AL	XC6601A161ER	LVR-IC	1.6V±20mV, 400mA, +CE, PDR, UVLO	USP-6C	49gm	VR11	9a	Tor
9AM	XC6601A16BER	LVR-IC	1.65V±20mV, 400mA, +CE, PDR, UVLO	USP-6C	49gm	VR11	9a	Tor
9AN	XC6601A171ER	LVR-IC	1.7V±20mV, 400mA, +CE, PDR, UVLO	USP-6C	49gm	VR11	9a	Tor
9AP	XC6601A17BER	LVR-IC	1.75V±20mV, 400mA, +CE, PDR, UVLO	USP-6C	49gm	VR11	9a	Tor
9AR	XC6601A181ER	LVR-IC	1.8V±20mV, 400mA, +CE, PDR, UVLO	USP-6C	49gm	VR11	9a	Tor
9B	XC6221A1217R	LVR-IC	LDO, 1.2V±20mV, 200mA, +CE	USPN-4	58vm	VR4	9a	Tor
9B	XC6223B21B9R-G	LVR-IC	LDO, 2.15V±1%, 300mA, +CE, CL	USPQ-4B03	48vm	VR4	9a	Tor
9B0	XC6601B071ER	LVR-IC	0.7V±20mV, 400mA, +CE, UVLO	USP-6C	49gm	VR11	9a	Tor
9B016	XC6117B016ER	Vdet-IC	1.6V±2%, -MR, +Rst PPO, -Rst ODO, Rt=25ms	USP-6C	49xs	VD22	9b	Tor
9B017	XC6117B017ER	Vdet-IC	1.7V±2%, -MR, +Rst PPO, -Rst ODO, Rt=25ms	USP-6C	49xs	VD22	9b	Tor
9B018	XC6117B018ER	Vdet-IC	1.8V±2%, -MR, +Rst PPO, -Rst ODO, Rt=25ms	USP-6C	49xs	VD22	9b	Tor
9B019	XC6117B019ER	Vdet-IC	1.9V±2%, -MR, +Rst PPO, -Rst ODO, Rt=25ms	USP-6C	49xs	VD22	9b	Tor
9B020	XC6117B020ER	Vdet-IC	2.0V±2%, -MR, +Rst PPO, -Rst ODO, Rt=25ms	USP-6C	49xs	VD22	9b	Tor
9B021	XC6117B021ER	Vdet-IC	2.1V±2%, -MR, +Rst PPO, -Rst ODO, Rt=25ms	USP-6C	49xs	VD22	9b	Tor
9B022	XC6117B022ER	Vdet-IC	2.2V±2%, -MR, +Rst PPO, -Rst ODO, Rt=25ms	USP-6C	49xs	VD22	9b	Tor
9B023	XC6117B023ER	Vdet-IC	2.3V±2%, -MR, +Rst PPO, -Rst ODO, Rt=25ms	USP-6C	49xs	VD22	9b	Tor
9B024	XC6117B024ER	Vdet-IC	2.4V±2%, -MR, +Rst PPO, -Rst ODO, Rt=25ms	USP-6C	49xs	VD22	9b	Tor
9B025	XC6117B025ER	Vdet-IC	2.5V±2%, -MR, +Rst PPO, -Rst ODO, Rt=25ms	USP-6C	49xs	VD22	9b	Tor
9B026	XC6117B026ER	Vdet-IC	2.6V±2%, -MR, +Rst PPO, -Rst ODO, Rt=25ms	USP-6C	49xs	VD22	9b	Tor
9B027	XC6117B027ER	Vdet-IC	2.7V±2%, -MR, +Rst PPO, -Rst ODO, Rt=25ms	USP-6C	49xs	VD22	9b	Tor
9B028	XC6117B028ER	Vdet-IC	2.8V±2%, -MR, +Rst PPO, -Rst ODO, Rt=25ms	USP-6C	49xs	VD22	9b	Tor
9B029	XC6117B029ER	Vdet-IC	2.9V±2%, -MR, +Rst PPO, -Rst ODO, Rt=25ms	USP-6C	49xs	VD22	9b	Tor
9B030	XC6117B030ER	Vdet-IC	3.0V±2%, -MR, +Rst PPO, -Rst ODO, Rt=25ms	USP-6C	49xs	VD22	9b	Tor
9B031	XC6117B031ER	Vdet-IC	3.1V±2%, -MR, +Rst PPO, -Rst ODO, Rt=25ms	USP-6C	49xs	VD22	9b	Tor
9B032	XC6117B032ER	Vdet-IC	3.2V±2%, -MR, +Rst PPO, -Rst ODO, Rt=25ms	USP-6C	49xs	VD22	9b	Tor
9B033	XC6117B033ER	Vdet-IC	3.3V±2%, -MR, +Rst PPO, -Rst ODO, Rt=25ms	USP-6C	49xs	VD22	9b	Tor
9B034	XC6117B034ER	Vdet-IC	3.4V±2%, -MR, +Rst PPO, -Rst ODO, Rt=25ms	USP-6C	49xs	VD22	9b	Tor
9B035	XC6117B035ER	Vdet-IC	3.5V±2%, -MR, +Rst PPO, -Rst ODO, Rt=25ms	USP-6C	49xs	VD22	9b	Tor
9B036	XC6117B036ER	Vdet-IC	3.6V±2%, -MR, +Rst PPO, -Rst ODO, Rt=25ms	USP-6C	49xs	VD22	9b	Tor
9B037	XC6117B037ER	Vdet-IC	3.7V±2%, -MR, +Rst PPO, -Rst ODO, Rt=25ms	USP-6C	49xs	VD22	9b	Tor
9B038	XC6117B038ER	Vdet-IC	3.8V±2%, -MR, +Rst PPO, -Rst ODO, Rt=25ms	USP-6C	49xs	VD22	9b	Tor
9B039	XC6117B039ER	Vdet-IC	3.9V±2%, -MR, +Rst PPO, -Rst ODO, Rt=25ms	USP-6C	49xs	VD22	9b	Tor
9B040	XC6117B040ER	Vdet-IC	4.0V±2%, -MR, +Rst PPO, -Rst ODO, Rt=25ms	USP-6C	49xs	VD22	9b	Tor
9B041	XC6117B041ER	Vdet-IC	4.1V±2%, -MR, +Rst PPO, -Rst ODO, Rt=25ms	USP-6C	49xs	VD22	9b	Tor
9B042	XC6117B042ER	Vdet-IC	4.2V±2%, -MR, +Rst PPO, -Rst ODO, Rt=25ms	USP-6C	49xs	VD22	9b	Tor
9B043	XC6117B043ER	Vdet-IC	4.3V±2%, -MR, +Rst PPO, -Rst ODO, Rt=25ms	USP-6C	49xs	VD22	9b	Tor
9B044	XC6117B044ER	Vdet-IC	4.4V±2%, -MR, +Rst PPO, -Rst ODO, Rt=25ms	USP-6C	49xs	VD22	9b	Tor
9B045	XC6117B045ER	Vdet-IC	4.5V±2%, -MR, +Rst PPO, -Rst ODO, Rt=25ms	USP-6C	49xs	VD22	9b	Tor
9B046	XC6117B046ER	Vdet-IC	4.6V±2%, -MR, +Rst PPO, -Rst ODO, Rt=25ms	USP-6C	49xs	VD22	9b	Tor
9B047	XC6117B047ER	Vdet-IC	4.7V±2%, -MR, +Rst PPO, -Rst ODO, Rt=25ms	USP-6C	49xs	VD22	9b	Tor
9B048	XC6117B048ER	Vdet-IC	4.8V±2%, -MR, +Rst PPO, -Rst ODO, Rt=25ms	USP-6C	49xs	VD22	9b	Tor
9B049	XC6117B049ER	Vdet-IC	4.9V±2%, -MR, +Rst PPO, -Rst ODO, Rt=25ms	USP-6C	49xs	VD22	9b	Tor
9B050	XC6117B050ER	Vdet-IC	5.0V±2%, -MR, +Rst PPO, -Rst ODO, Rt=25ms	USP-6C	49xs	VD22	9b	Tor
9B1	XC6601B07BER	LVR-IC	0.75V±20mV, 400mA, +CE, UVLO	USP-6C	49gm	VR11	9a	Tor
9B2	XC6601B081ER	LVR-IC	0.8V±20mV, 400mA, +CE, UVLO	USP-6C	49gm	VR11	9a	Tor
9B216	XC6112B216ER	Vdet-IC	1.6V±2%, -MR, -Reset ODO, Wt=50ms, Rt=25ms	USP-6C	49xh	VD16	9b	Tor
9B217	XC6112B217ER	Vdet-IC	1.7V±2%, -MR, -Reset ODO, Wt=50ms, Rt=25ms	USP-6C	49xh	VD16	9b	Tor
9B218	XC6112B218ER	Vdet-IC	1.8V±2%, -MR, -Reset ODO, Wt=50ms, Rt=25ms	USP-6C	49xh	VD16	9b	Tor
9B219	XC6112B219ER	Vdet-IC	1.9V±2%, -MR, -Reset ODO, Wt=50ms, Rt=25ms	USP-6C	49xh	VD16	9b	Tor
9B220	XC6112B220ER	Vdet-IC	2.0V±2%, -MR, -Reset ODO, Wt=50ms, Rt=25ms	USP-6C	49xh	VD16	9b	Tor
9B221	XC6112B221ER	Vdet-IC	2.1V±2%, -MR, -Reset ODO, Wt=50ms, Rt=25ms	USP-6C	49xh	VD16	9b	Tor
9B222	XC6112B222ER	Vdet-IC	2.2V±2%, -MR, -Reset ODO, Wt=50ms, Rt=25ms	USP-6C	49xh	VD16	9b	Tor
9B223	XC6112B223ER	Vdet-IC	2.3V±2%, -MR, -Reset ODO, Wt=50ms, Rt=25ms	USP-6C	49xh	VD16	9b	Tor
9B224	XC6112B224ER	Vdet-IC	2.4V±2%, -MR, -Reset ODO, Wt=50ms, Rt=25ms	USP-6C	49xh	VD16	9b	Tor
9B225	XC6112B225ER	Vdet-IC	2.5V±2%, -MR, -Reset ODO, Wt=50ms, Rt=25ms	USP-6C	49xh	VD16	9b	Tor
9B226	XC6112B226ER	Vdet-IC	2.6V±2%, -MR, -Reset ODO, Wt=50ms, Rt=25ms	USP-6C	49xh	VD16	9b	Tor
9B227	XC6112B227ER	Vdet-IC	2.7V±2%, -MR, -Reset ODO, Wt=50ms, Rt=25ms	USP-6C	49xh	VD16	9b	Tor
9B228	XC6112B228ER	Vdet-IC	2.8V±2%, -MR, -Reset ODO, Wt=50ms, Rt=25ms	USP-6C	49xh	VD16	9b	Tor
9B229	XC6112B229ER	Vdet-IC	2.9V±2%, -MR, -Reset ODO, Wt=50ms, Rt=25ms	USP-6C	49xh	VD16	9b	Tor
9B230	XC6112B230ER	Vdet-IC	3.0V±2%, -MR, -Reset ODO, Wt=50ms, Rt=25ms	USP-6C	49xh	VD16	9b	Tor



SMD code	Type	Function	Short description	Case	Pinout	Sch.	St.	Mnf.
9B627	XC6112B627ER	Vdet-IC	2.7V±2%, -MR, -Reset ODO, Wt=1.6s, Rt=25ms	USP-6C	49xh	VD16	9b	Tor
9B628	XC6112B628ER	Vdet-IC	2.8V±2%, -MR, -Reset ODO, Wt=1.6s, Rt=25ms	USP-6C	49xh	VD16	9b	Tor
9B629	XC6112B629ER	Vdet-IC	2.9V±2%, -MR, -Reset ODO, Wt=1.6s, Rt=25ms	USP-6C	49xh	VD16	9b	Tor
9B630	XC6112B630ER	Vdet-IC	3.0V±2%, -MR, -Reset ODO, Wt=1.6s, Rt=25ms	USP-6C	49xh	VD16	9b	Tor
9B631	XC6112B631ER	Vdet-IC	3.1V±2%, -MR, -Reset ODO, Wt=1.6s, Rt=25ms	USP-6C	49xh	VD16	9b	Tor
9B632	XC6112B632ER	Vdet-IC	3.2V±2%, -MR, -Reset ODO, Wt=1.6s, Rt=25ms	USP-6C	49xh	VD16	9b	Tor
9B633	XC6112B633ER	Vdet-IC	3.3V±2%, -MR, -Reset ODO, Wt=1.6s, Rt=25ms	USP-6C	49xh	VD16	9b	Tor
9B634	XC6112B634ER	Vdet-IC	3.4V±2%, -MR, -Reset ODO, Wt=1.6s, Rt=25ms	USP-6C	49xh	VD16	9b	Tor
9B635	XC6112B635ER	Vdet-IC	3.5V±2%, -MR, -Reset ODO, Wt=1.6s, Rt=25ms	USP-6C	49xh	VD16	9b	Tor
9B636	XC6112B636ER	Vdet-IC	3.6V±2%, -MR, -Reset ODO, Wt=1.6s, Rt=25ms	USP-6C	49xh	VD16	9b	Tor
9B637	XC6112B637ER	Vdet-IC	3.7V±2%, -MR, -Reset ODO, Wt=1.6s, Rt=25ms	USP-6C	49xh	VD16	9b	Tor
9B638	XC6112B638ER	Vdet-IC	3.8V±2%, -MR, -Reset ODO, Wt=1.6s, Rt=25ms	USP-6C	49xh	VD16	9b	Tor
9B639	XC6112B639ER	Vdet-IC	3.9V±2%, -MR, -Reset ODO, Wt=1.6s, Rt=25ms	USP-6C	49xh	VD16	9b	Tor
9B640	XC6112B640ER	Vdet-IC	4.0V±2%, -MR, -Reset ODO, Wt=1.6s, Rt=25ms	USP-6C	49xh	VD16	9b	Tor
9B641	XC6112B641ER	Vdet-IC	4.1V±2%, -MR, -Reset ODO, Wt=1.6s, Rt=25ms	USP-6C	49xh	VD16	9b	Tor
9B642	XC6112B642ER	Vdet-IC	4.2V±2%, -MR, -Reset ODO, Wt=1.6s, Rt=25ms	USP-6C	49xh	VD16	9b	Tor
9B643	XC6112B643ER	Vdet-IC	4.3V±2%, -MR, -Reset ODO, Wt=1.6s, Rt=25ms	USP-6C	49xh	VD16	9b	Tor
9B644	XC6112B644ER	Vdet-IC	4.4V±2%, -MR, -Reset ODO, Wt=1.6s, Rt=25ms	USP-6C	49xh	VD16	9b	Tor
9B645	XC6112B645ER	Vdet-IC	4.5V±2%, -MR, -Reset ODO, Wt=1.6s, Rt=25ms	USP-6C	49xh	VD16	9b	Tor
9B646	XC6112B646ER	Vdet-IC	4.6V±2%, -MR, -Reset ODO, Wt=1.6s, Rt=25ms	USP-6C	49xh	VD16	9b	Tor
9B647	XC6112B647ER	Vdet-IC	4.7V±2%, -MR, -Reset ODO, Wt=1.6s, Rt=25ms	USP-6C	49xh	VD16	9b	Tor
9B648	XC6112B648ER	Vdet-IC	4.8V±2%, -MR, -Reset ODO, Wt=1.6s, Rt=25ms	USP-6C	49xh	VD16	9b	Tor
9B649	XC6112B649ER	Vdet-IC	4.9V±2%, -MR, -Reset ODO, Wt=1.6s, Rt=25ms	USP-6C	49xh	VD16	9b	Tor
9B650	XC6112B650ER	Vdet-IC	5.0V±2%, -MR, -Reset ODO, Wt=1.6s, Rt=25ms	USP-6C	49xh	VD16	9b	Tor
9B7	XC6601B10BER	LVR-IC	1.05V±20mV, 400mA, +CE, UVLO	USP-6C	49gm	VR11	9a	Tor
9B8	XC6601B111ER	LVR-IC	1.1V±20mV, 400mA, +CE, UVLO	USP-6C	49gm	VR11	9a	Tor
9B9	XC6601B11BER	LVR-IC	1.15V±20mV, 400mA, +CE, UVLO	USP-6C	49gm	VR11	9a	Tor
9BA	XC6601B121ER	LVR-IC	1.2V±20mV, 400mA, +CE, UVLO	USP-6C	49gm	VR11	9a	Tor
9BB	XC6601B12BER	LVR-IC	1.25V±20mV, 400mA, +CE, UVLO	USP-6C	49gm	VR11	9a	Tor
9BC	XC6601B131ER	LVR-IC	1.3V±20mV, 400mA, +CE, UVLO	USP-6C	49gm	VR11	9a	Tor
9BD	XC6601B13BER	LVR-IC	1.35V±20mV, 400mA, +CE, UVLO	USP-6C	49gm	VR11	9a	Tor
9BE	XC6601B141ER	LVR-IC	1.4V±20mV, 400mA, +CE, UVLO	USP-6C	49gm	VR11	9a	Tor
9BF	XC6601B14BER	LVR-IC	1.45V±20mV, 400mA, +CE, UVLO	USP-6C	49gm	VR11	9a	Tor
9BH	XC6601B151ER	LVR-IC	1.5V±20mV, 400mA, +CE, UVLO	USP-6C	49gm	VR11	9a	Tor
9BK	XC6601B15BER	LVR-IC	1.55V±20mV, 400mA, +CE, UVLO	USP-6C	49gm	VR11	9a	Tor
9BL	XC6601B161ER	LVR-IC	1.6V±20mV, 400mA, +CE, UVLO	USP-6C	49gm	VR11	9a	Tor
9BM	XC6601B16BER	LVR-IC	1.65V±20mV, 400mA, +CE, UVLO	USP-6C	49gm	VR11	9a	Tor
9BN	XC6601B171ER	LVR-IC	1.7V±20mV, 400mA, +CE, UVLO	USP-6C	49gm	VR11	9a	Tor
9BP	XC6601B17BER	LVR-IC	1.75V±20mV, 400mA, +CE, UVLO	USP-6C	49gm	VR11	9a	Tor
9BR	XC6601B181ER	LVR-IC	1.8V±20mV, 400mA, +CE, UVLO	USP-6C	49gm	VR11	9a	Tor
9C	XC6222A1317R	LVR-IC	LDO, 1.3V±20mV, 200mA, +CE	USPN-4	58vm	VR4	9a	Tor
9C	XC6223B22B9R-G	LVR-IC	LDO, 2.25V±1%, 300mA, +CE, CL	USPQ-4B03	48vm	VR4	9a	Tor
9C016	XC6117C016ER	Vdet-IC	1.6V±2%, -MR, +Rst PPO, -Rst ODO, Rt=50ms	USP-6C	49xs	VD22	9b	Tor
9C017	XC6117C017ER	Vdet-IC	1.7V±2%, -MR, +Rst PPO, -Rst ODO, Rt=50ms	USP-6C	49xs	VD22	9b	Tor
9C018	XC6117C018ER	Vdet-IC	1.8V±2%, -MR, +Rst PPO, -Rst ODO, Rt=50ms	USP-6C	49xs	VD22	9b	Tor
9C019	XC6117C019ER	Vdet-IC	1.9V±2%, -MR, +Rst PPO, -Rst ODO, Rt=50ms	USP-6C	49xs	VD22	9b	Tor
9C020	XC6117C020ER	Vdet-IC	2.0V±2%, -MR, +Rst PPO, -Rst ODO, Rt=50ms	USP-6C	49xs	VD22	9b	Tor
9C021	XC6117C021ER	Vdet-IC	2.1V±2%, -MR, +Rst PPO, -Rst ODO, Rt=50ms	USP-6C	49xs	VD22	9b	Tor
9C022	XC6117C022ER	Vdet-IC	2.2V±2%, -MR, +Rst PPO, -Rst ODO, Rt=50ms	USP-6C	49xs	VD22	9b	Tor
9C023	XC6117C023ER	Vdet-IC	2.3V±2%, -MR, +Rst PPO, -Rst ODO, Rt=50ms	USP-6C	49xs	VD22	9b	Tor
9C024	XC6117C024ER	Vdet-IC	2.4V±2%, -MR, +Rst PPO, -Rst ODO, Rt=50ms	USP-6C	49xs	VD22	9b	Tor
9C025	XC6117C025ER	Vdet-IC	2.5V±2%, -MR, +Rst PPO, -Rst ODO, Rt=50ms	USP-6C	49xs	VD22	9b	Tor
9C026	XC6117C026ER	Vdet-IC	2.6V±2%, -MR, +Rst PPO, -Rst ODO, Rt=50ms	USP-6C	49xs	VD22	9b	Tor
9C027	XC6117C027ER	Vdet-IC	2.7V±2%, -MR, +Rst PPO, -Rst ODO, Rt=50ms	USP-6C	49xs	VD22	9b	Tor
9C028	XC6117C028ER	Vdet-IC	2.8V±2%, -MR, +Rst PPO, -Rst ODO, Rt=50ms	USP-6C	49xs	VD22	9b	Tor
9C029	XC6117C029ER	Vdet-IC	2.9V±2%, -MR, +Rst PPO, -Rst ODO, Rt=50ms	USP-6C	49xs	VD22	9b	Tor
9C030	XC6117C030ER	Vdet-IC	3.0V±2%, -MR, +Rst PPO, -Rst ODO, Rt=50ms	USP-6C	49xs	VD22	9b	Tor
9C031	XC6117C031ER	Vdet-IC	3.1V±2%, -MR, +Rst PPO, -Rst ODO, Rt=50ms	USP-6C	49xs	VD22	9b	Tor
9C032	XC6117C032ER	Vdet-IC	3.2V±2%, -MR, +Rst PPO, -Rst ODO, Rt=50ms	USP-6C	49xs	VD22	9b	Tor
9C033	XC6117C033ER	Vdet-IC	3.3V±2%, -MR, +Rst PPO, -Rst ODO, Rt=50ms	USP-6C	49xs	VD22	9b	Tor
9C034	XC6117C034ER	Vdet-IC	3.4V±2%, -MR, +Rst PPO, -Rst ODO, Rt=50ms	USP-6C	49xs	VD22	9b	Tor
9C035	XC6117C035ER	Vdet-IC	3.5V±2%, -MR, +Rst PPO, -Rst ODO, Rt=50ms	USP-6C	49xs	VD22	9b	Tor
9C036	XC6117C036ER	Vdet-IC	3.6V±2%, -MR, +Rst PPO, -Rst ODO, Rt=50ms	USP-6C	49xs	VD22	9b	Tor
9C037	XC6117C037ER	Vdet-IC	3.7V±2%, -MR, +Rst PPO, -Rst ODO, Rt=50ms	USP-6C	49xs	VD22	9b	Tor
9C038	XC6117C038ER	Vdet-IC	3.8V±2%, -MR, +Rst PPO, -Rst ODO, Rt=50ms	USP-6C	49xs	VD22	9b	Tor
9C039	XC6117C039ER	Vdet-IC	3.9V±2%, -MR, +Rst PPO, -Rst ODO, Rt=50ms	USP-6C	49xs	VD22	9b	Tor
9C040	XC6117C040ER	Vdet-IC	4.0V±2%, -MR, +Rst PPO, -Rst ODO, Rt=50ms	USP-6C	49xs	VD22	9b	Tor
9C041	XC6117C041ER	Vdet-IC	4.1V±2%, -MR, +Rst PPO, -Rst ODO, Rt=50ms	USP-6C	49xs	VD22	9b	Tor
9C042	XC6117C042ER	Vdet-IC	4.2V±2%, -MR, +Rst PPO, -Rst ODO, Rt=50ms	USP-6C	49xs	VD22	9b	Tor
9C043	XC6117C043ER	Vdet-IC	4.3V±2%, -MR, +Rst PPO, -Rst ODO, Rt=50ms	USP-6C	49xs	VD22	9b	Tor



SMD code	Type	Function	Short description	Case	Pinout	Sch.	St.	Mnf.
9E542	XC6112E542ER	Vdet-IC	4.2V±2%, -MR, -Reset ODO, Wt=400ms, Rt=200ms	USP-6C	49xh	VD16	9b	Tor
9E543	XC6112E543ER	Vdet-IC	4.3V±2%, -MR, -Reset ODO, Wt=400ms, Rt=200ms	USP-6C	49xh	VD16	9b	Tor
9E544	XC6112E544ER	Vdet-IC	4.4V±2%, -MR, -Reset ODO, Wt=400ms, Rt=200ms	USP-6C	49xh	VD16	9b	Tor
9E545	XC6112E545ER	Vdet-IC	4.5V±2%, -MR, -Reset ODO, Wt=400ms, Rt=200ms	USP-6C	49xh	VD16	9b	Tor
9E546	XC6112E546ER	Vdet-IC	4.6V±2%, -MR, -Reset ODO, Wt=400ms, Rt=200ms	USP-6C	49xh	VD16	9b	Tor
9E547	XC6112E547ER	Vdet-IC	4.7V±2%, -MR, -Reset ODO, Wt=400ms, Rt=200ms	USP-6C	49xh	VD16	9b	Tor
9E548	XC6112E548ER	Vdet-IC	4.8V±2%, -MR, -Reset ODO, Wt=400ms, Rt=200ms	USP-6C	49xh	VD16	9b	Tor
9E549	XC6112E549ER	Vdet-IC	4.9V±2%, -MR, -Reset ODO, Wt=400ms, Rt=200ms	USP-6C	49xh	VD16	9b	Tor
9E550	XC6112E550ER	Vdet-IC	5.0V±2%, -MR, -Reset ODO, Wt=400ms, Rt=200ms	USP-6C	49xh	VD16	9b	Tor
9E6	XC6223A16BGR-G	LVR-IC	LDO, 1.65V±20mV, 300mA, +CE	USP-4	45vm	VR4	9a	Tor
9E616	XC6112E616ER	Vdet-IC	1.6V±2%, -MR, -Reset ODO, Wt=1.6s, Rt=200ms	USP-6C	49xh	VD16	9b	Tor
9E617	XC6112E617ER	Vdet-IC	1.7V±2%, -MR, -Reset ODO, Wt=1.6s, Rt=200ms	USP-6C	49xh	VD16	9b	Tor
9E618	XC6112E618ER	Vdet-IC	1.8V±2%, -MR, -Reset ODO, Wt=1.6s, Rt=200ms	USP-6C	49xh	VD16	9b	Tor
9E619	XC6112E619ER	Vdet-IC	1.9V±2%, -MR, -Reset ODO, Wt=1.6s, Rt=200ms	USP-6C	49xh	VD16	9b	Tor
9E620	XC6112E620ER	Vdet-IC	2.0V±2%, -MR, -Reset ODO, Wt=1.6s, Rt=200ms	USP-6C	49xh	VD16	9b	Tor
9E621	XC6112E621ER	Vdet-IC	2.1V±2%, -MR, -Reset ODO, Wt=1.6s, Rt=200ms	USP-6C	49xh	VD16	9b	Tor
9E622	XC6112E622ER	Vdet-IC	2.2V±2%, -MR, -Reset ODO, Wt=1.6s, Rt=200ms	USP-6C	49xh	VD16	9b	Tor
9E623	XC6112E623ER	Vdet-IC	2.3V±2%, -MR, -Reset ODO, Wt=1.6s, Rt=200ms	USP-6C	49xh	VD16	9b	Tor
9E624	XC6112E624ER	Vdet-IC	2.4V±2%, -MR, -Reset ODO, Wt=1.6s, Rt=200ms	USP-6C	49xh	VD16	9b	Tor
9E625	XC6112E625ER	Vdet-IC	2.5V±2%, -MR, -Reset ODO, Wt=1.6s, Rt=200ms	USP-6C	49xh	VD16	9b	Tor
9E626	XC6112E626ER	Vdet-IC	2.6V±2%, -MR, -Reset ODO, Wt=1.6s, Rt=200ms	USP-6C	49xh	VD16	9b	Tor
9E627	XC6112E627ER	Vdet-IC	2.7V±2%, -MR, -Reset ODO, Wt=1.6s, Rt=200ms	USP-6C	49xh	VD16	9b	Tor
9E628	XC6112E628ER	Vdet-IC	2.8V±2%, -MR, -Reset ODO, Wt=1.6s, Rt=200ms	USP-6C	49xh	VD16	9b	Tor
9E629	XC6112E629ER	Vdet-IC	2.9V±2%, -MR, -Reset ODO, Wt=1.6s, Rt=200ms	USP-6C	49xh	VD16	9b	Tor
9E630	XC6112E630ER	Vdet-IC	3.0V±2%, -MR, -Reset ODO, Wt=1.6s, Rt=200ms	USP-6C	49xh	VD16	9b	Tor
9E631	XC6112E631ER	Vdet-IC	3.1V±2%, -MR, -Reset ODO, Wt=1.6s, Rt=200ms	USP-6C	49xh	VD16	9b	Tor
9E632	XC6112E632ER	Vdet-IC	3.2V±2%, -MR, -Reset ODO, Wt=1.6s, Rt=200ms	USP-6C	49xh	VD16	9b	Tor
9E633	XC6112E633ER	Vdet-IC	3.3V±2%, -MR, -Reset ODO, Wt=1.6s, Rt=200ms	USP-6C	49xh	VD16	9b	Tor
9E634	XC6112E634ER	Vdet-IC	3.4V±2%, -MR, -Reset ODO, Wt=1.6s, Rt=200ms	USP-6C	49xh	VD16	9b	Tor
9E635	XC6112E635ER	Vdet-IC	3.5V±2%, -MR, -Reset ODO, Wt=1.6s, Rt=200ms	USP-6C	49xh	VD16	9b	Tor
9E636	XC6112E636ER	Vdet-IC	3.6V±2%, -MR, -Reset ODO, Wt=1.6s, Rt=200ms	USP-6C	49xh	VD16	9b	Tor
9E637	XC6112E637ER	Vdet-IC	3.7V±2%, -MR, -Reset ODO, Wt=1.6s, Rt=200ms	USP-6C	49xh	VD16	9b	Tor
9E638	XC6112E638ER	Vdet-IC	3.8V±2%, -MR, -Reset ODO, Wt=1.6s, Rt=200ms	USP-6C	49xh	VD16	9b	Tor
9E639	XC6112E639ER	Vdet-IC	3.9V±2%, -MR, -Reset ODO, Wt=1.6s, Rt=200ms	USP-6C	49xh	VD16	9b	Tor
9E640	XC6112E640ER	Vdet-IC	4.0V±2%, -MR, -Reset ODO, Wt=1.6s, Rt=200ms	USP-6C	49xh	VD16	9b	Tor
9E641	XC6112E641ER	Vdet-IC	4.1V±2%, -MR, -Reset ODO, Wt=1.6s, Rt=200ms	USP-6C	49xh	VD16	9b	Tor
9E642	XC6112E642ER	Vdet-IC	4.2V±2%, -MR, -Reset ODO, Wt=1.6s, Rt=200ms	USP-6C	49xh	VD16	9b	Tor
9E643	XC6112E643ER	Vdet-IC	4.3V±2%, -MR, -Reset ODO, Wt=1.6s, Rt=200ms	USP-6C	49xh	VD16	9b	Tor
9E644	XC6112E644ER	Vdet-IC	4.4V±2%, -MR, -Reset ODO, Wt=1.6s, Rt=200ms	USP-6C	49xh	VD16	9b	Tor
9E645	XC6112E645ER	Vdet-IC	4.5V±2%, -MR, -Reset ODO, Wt=1.6s, Rt=200ms	USP-6C	49xh	VD16	9b	Tor
9E646	XC6112E646ER	Vdet-IC	4.6V±2%, -MR, -Reset ODO, Wt=1.6s, Rt=200ms	USP-6C	49xh	VD16	9b	Tor
9E647	XC6112E647ER	Vdet-IC	4.7V±2%, -MR, -Reset ODO, Wt=1.6s, Rt=200ms	USP-6C	49xh	VD16	9b	Tor
9E648	XC6112E648ER	Vdet-IC	4.8V±2%, -MR, -Reset ODO, Wt=1.6s, Rt=200ms	USP-6C	49xh	VD16	9b	Tor
9E649	XC6112E649ER	Vdet-IC	4.9V±2%, -MR, -Reset ODO, Wt=1.6s, Rt=200ms	USP-6C	49xh	VD16	9b	Tor
9E650	XC6112E650ER	Vdet-IC	5.0V±2%, -MR, -Reset ODO, Wt=1.6s, Rt=200ms	USP-6C	49xh	VD16	9b	Tor
9E7	XC6223A17BGR-G	LVR-IC	LDO, 1.75V±20mV, 300mA, +CE	USP-4	45vm	VR4	9a	Tor
9E8	XC6223A18BGR-G	LVR-IC	LDO, 1.85V±20mV, 300mA, +CE	USP-4	45vm	VR4	9a	Tor
9E9	XC6223A19BGR-G	LVR-IC	LDO, 1.95V±20mV, 300mA, +CE	USP-4	45vm	VR4	9a	Tor
9EA	XC6223A20BGR-G	LVR-IC	LDO, 2.05V±1%, 300mA, +CE	USP-4	45vm	VR4	9a	Tor
9EB	XC6223A21BGR-G	LVR-IC	LDO, 2.15V±1%, 300mA, +CE	USP-4	45vm	VR4	9a	Tor
9EC	XC6223A22BGR-G	LVR-IC	LDO, 2.25V±1%, 300mA, +CE	USP-4	45vm	VR4	9a	Tor
9ED	XC6223A23BGR-G	LVR-IC	LDO, 2.35V±1%, 300mA, +CE	USP-4	45vm	VR4	9a	Tor
9EE	XC6223A24BGR-G	LVR-IC	LDO, 2.45V±1%, 300mA, +CE	USP-4	45vm	VR4	9a	Tor
9EF	XC6223A25BGR-G	LVR-IC	LDO, 2.55V±1%, 300mA, +CE	USP-4	45vm	VR4	9a	Tor
9EH	XC6223A26BGR-G	LVR-IC	LDO, 2.65V±1%, 300mA, +CE	USP-4	45vm	VR4	9a	Tor
9EK	XC6223A27BGR-G	LVR-IC	LDO, 2.75V±1%, 300mA, +CE	USP-4	45vm	VR4	9a	Tor
9EL	XC6223A28BGR-G	LVR-IC	LDO, 2.85V±1%, 300mA, +CE	USP-4	45vm	VR4	9a	Tor
9EM	XC6223A29BGR-G	LVR-IC	LDO, 2.95V±1%, 300mA, +CE	USP-4	45vm	VR4	9a	Tor
9EN	XC6223A30BGR-G	LVR-IC	LDO, 3.05V±1%, 300mA, +CE	USP-4	45vm	VR4	9a	Tor
9EP	XC6223A31BGR-G	LVR-IC	LDO, 3.15V±1%, 300mA, +CE	USP-4	45vm	VR4	9a	Tor
9ER	XC6223A32BGR-G	LVR-IC	LDO, 3.25V±1%, 300mA, +CE	USP-4	45vm	VR4	9a	Tor
9ES	XC6223A33BGR-G	LVR-IC	LDO, 3.35V±1%, 300mA, +CE	USP-4	45vm	VR4	9a	Tor
9ET	XC6223A34BGR-G	LVR-IC	LDO, 3.45V±1%, 300mA, +CE	USP-4	45vm	VR4	9a	Tor
9EU	XC6223A35BGR-G	LVR-IC	LDO, 3.55V±1%, 300mA, +CE	USP-4	45vm	VR4	9a	Tor
9EV	XC6223A36BGR-G	LVR-IC	LDO, 3.65V±1%, 300mA, +CE	USP-4	45vm	VR4	9a	Tor
9EX	XC6223A37BGR-G	LVR-IC	LDO, 3.75V±1%, 300mA, +CE	USP-4	45vm	VR4	9a	Tor
9EY	XC6223A38BGR-G	LVR-IC	LDO, 3.85V±1%, 300mA, +CE	USP-4	45vm	VR4	9a	Tor
9EZ	XC6223A39BGR-G	LVR-IC	LDO, 3.95V±1%, 300mA, +CE	USP-4	45vm	VR4	9a	Tor
9F	XC6221A1617R	LVR-IC	LDO, 1.6V±20mV, 200mA, +CE	USPN-4	58vm	VR4	9a	Tor
9F	XC6223B25B9R-G	LVR-IC	LDO, 2.55V±1%, 300mA, +CE, CL	USPQ-4B03	48vm	VR4	9a	Tor



SMD code	Type	Function	Short description	Case	Pinout	Sch.	St.	Mnf.
9F547	XC6112F547ER	Vdet-IC	4.7V±2%, -MR, -Reset ODO, Wt=400ms, Rt=400ms	USP-6C	49xh	VD16	9b	Tor
9F548	XC6112F548ER	Vdet-IC	4.8V±2%, -MR, -Reset ODO, Wt=400ms, Rt=400ms	USP-6C	49xh	VD16	9b	Tor
9F549	XC6112F549ER	Vdet-IC	4.9V±2%, -MR, -Reset ODO, Wt=400ms, Rt=400ms	USP-6C	49xh	VD16	9b	Tor
9F550	XC6112F550ER	Vdet-IC	5.0V±2%, -MR, -Reset ODO, Wt=400ms, Rt=400ms	USP-6C	49xh	VD16	9b	Tor
9F6	XC6223B161GR-G	LVR-IC	LDO, 1.6V±20mV, 300mA, +CE, CL	USP-4	45vm	VR4	9a	Tor
9F616	XC6112F616ER	Vdet-IC	1.6V±2%, -MR, -Reset ODO, Wt=1.6s, Rt=400ms	USP-6C	49xh	VD16	9b	Tor
9F617	XC6112F617ER	Vdet-IC	1.7V±2%, -MR, -Reset ODO, Wt=1.6s, Rt=400ms	USP-6C	49xh	VD16	9b	Tor
9F618	XC6112F618ER	Vdet-IC	1.8V±2%, -MR, -Reset ODO, Wt=1.6s, Rt=400ms	USP-6C	49xh	VD16	9b	Tor
9F619	XC6112F619ER	Vdet-IC	1.9V±2%, -MR, -Reset ODO, Wt=1.6s, Rt=400ms	USP-6C	49xh	VD16	9b	Tor
9F620	XC6112F620ER	Vdet-IC	2.0V±2%, -MR, -Reset ODO, Wt=1.6s, Rt=400ms	USP-6C	49xh	VD16	9b	Tor
9F621	XC6112F621ER	Vdet-IC	2.1V±2%, -MR, -Reset ODO, Wt=1.6s, Rt=400ms	USP-6C	49xh	VD16	9b	Tor
9F622	XC6112F622ER	Vdet-IC	2.2V±2%, -MR, -Reset ODO, Wt=1.6s, Rt=400ms	USP-6C	49xh	VD16	9b	Tor
9F623	XC6112F623ER	Vdet-IC	2.3V±2%, -MR, -Reset ODO, Wt=1.6s, Rt=400ms	USP-6C	49xh	VD16	9b	Tor
9F624	XC6112F624ER	Vdet-IC	2.4V±2%, -MR, -Reset ODO, Wt=1.6s, Rt=400ms	USP-6C	49xh	VD16	9b	Tor
9F625	XC6112F625ER	Vdet-IC	2.5V±2%, -MR, -Reset ODO, Wt=1.6s, Rt=400ms	USP-6C	49xh	VD16	9b	Tor
9F626	XC6112F626ER	Vdet-IC	2.6V±2%, -MR, -Reset ODO, Wt=1.6s, Rt=400ms	USP-6C	49xh	VD16	9b	Tor
9F627	XC6112F627ER	Vdet-IC	2.7V±2%, -MR, -Reset ODO, Wt=1.6s, Rt=400ms	USP-6C	49xh	VD16	9b	Tor
9F628	XC6112F628ER	Vdet-IC	2.8V±2%, -MR, -Reset ODO, Wt=1.6s, Rt=400ms	USP-6C	49xh	VD16	9b	Tor
9F629	XC6112F629ER	Vdet-IC	2.9V±2%, -MR, -Reset ODO, Wt=1.6s, Rt=400ms	USP-6C	49xh	VD16	9b	Tor
9F630	XC6112F630ER	Vdet-IC	3.0V±2%, -MR, -Reset ODO, Wt=1.6s, Rt=400ms	USP-6C	49xh	VD16	9b	Tor
9F631	XC6112F631ER	Vdet-IC	3.1V±2%, -MR, -Reset ODO, Wt=1.6s, Rt=400ms	USP-6C	49xh	VD16	9b	Tor
9F632	XC6112F632ER	Vdet-IC	3.2V±2%, -MR, -Reset ODO, Wt=1.6s, Rt=400ms	USP-6C	49xh	VD16	9b	Tor
9F633	XC6112F633ER	Vdet-IC	3.3V±2%, -MR, -Reset ODO, Wt=1.6s, Rt=400ms	USP-6C	49xh	VD16	9b	Tor
9F634	XC6112F634ER	Vdet-IC	3.4V±2%, -MR, -Reset ODO, Wt=1.6s, Rt=400ms	USP-6C	49xh	VD16	9b	Tor
9F635	XC6112F635ER	Vdet-IC	3.5V±2%, -MR, -Reset ODO, Wt=1.6s, Rt=400ms	USP-6C	49xh	VD16	9b	Tor
9F636	XC6112F636ER	Vdet-IC	3.6V±2%, -MR, -Reset ODO, Wt=1.6s, Rt=400ms	USP-6C	49xh	VD16	9b	Tor
9F637	XC6112F637ER	Vdet-IC	3.7V±2%, -MR, -Reset ODO, Wt=1.6s, Rt=400ms	USP-6C	49xh	VD16	9b	Tor
9F638	XC6112F638ER	Vdet-IC	3.8V±2%, -MR, -Reset ODO, Wt=1.6s, Rt=400ms	USP-6C	49xh	VD16	9b	Tor
9F639	XC6112F639ER	Vdet-IC	3.9V±2%, -MR, -Reset ODO, Wt=1.6s, Rt=400ms	USP-6C	49xh	VD16	9b	Tor
9F640	XC6112F640ER	Vdet-IC	4.0V±2%, -MR, -Reset ODO, Wt=1.6s, Rt=400ms	USP-6C	49xh	VD16	9b	Tor
9F641	XC6112F641ER	Vdet-IC	4.1V±2%, -MR, -Reset ODO, Wt=1.6s, Rt=400ms	USP-6C	49xh	VD16	9b	Tor
9F642	XC6112F642ER	Vdet-IC	4.2V±2%, -MR, -Reset ODO, Wt=1.6s, Rt=400ms	USP-6C	49xh	VD16	9b	Tor
9F643	XC6112F643ER	Vdet-IC	4.3V±2%, -MR, -Reset ODO, Wt=1.6s, Rt=400ms	USP-6C	49xh	VD16	9b	Tor
9F644	XC6112F644ER	Vdet-IC	4.4V±2%, -MR, -Reset ODO, Wt=1.6s, Rt=400ms	USP-6C	49xh	VD16	9b	Tor
9F645	XC6112F645ER	Vdet-IC	4.5V±2%, -MR, -Reset ODO, Wt=1.6s, Rt=400ms	USP-6C	49xh	VD16	9b	Tor
9F646	XC6112F646ER	Vdet-IC	4.6V±2%, -MR, -Reset ODO, Wt=1.6s, Rt=400ms	USP-6C	49xh	VD16	9b	Tor
9F647	XC6112F647ER	Vdet-IC	4.7V±2%, -MR, -Reset ODO, Wt=1.6s, Rt=400ms	USP-6C	49xh	VD16	9b	Tor
9F648	XC6112F648ER	Vdet-IC	4.8V±2%, -MR, -Reset ODO, Wt=1.6s, Rt=400ms	USP-6C	49xh	VD16	9b	Tor
9F649	XC6112F649ER	Vdet-IC	4.9V±2%, -MR, -Reset ODO, Wt=1.6s, Rt=400ms	USP-6C	49xh	VD16	9b	Tor
9F650	XC6112F650ER	Vdet-IC	5.0V±2%, -MR, -Reset ODO, Wt=1.6s, Rt=400ms	USP-6C	49xh	VD16	9b	Tor
9F7	XC6223B171GR-G	LVR-IC	LDO, 1.7V±20mV, 300mA, +CE, CL	USP-4	45vm	VR4	9a	Tor
9F8	XC6223B181GR-G	LVR-IC	LDO, 1.8V±20mV, 300mA, +CE, CL	USP-4	45vm	VR4	9a	Tor
9F9	XC6223B191GR-G	LVR-IC	LDO, 1.9V±20mV, 300mA, +CE, CL	USP-4	45vm	VR4	9a	Tor
9FA	XC6223B201GR-G	LVR-IC	LDO, 2.0V±1%, 300mA, +CE, CL	USP-4	45vm	VR4	9a	Tor
9FB	XC6223B211GR-G	LVR-IC	LDO, 2.1V±1%, 300mA, +CE, CL	USP-4	45vm	VR4	9a	Tor
9FC	XC6223B221GR-G	LVR-IC	LDO, 2.2V±1%, 300mA, +CE, CL	USP-4	45vm	VR4	9a	Tor
9FD	XC6223B231GR-G	LVR-IC	LDO, 2.3V±1%, 300mA, +CE, CL	USP-4	45vm	VR4	9a	Tor
9FE	XC6223B241GR-G	LVR-IC	LDO, 2.4V±1%, 300mA, +CE, CL	USP-4	45vm	VR4	9a	Tor
9FF	XC6223B251GR-G	LVR-IC	LDO, 2.5V±1%, 300mA, +CE, CL	USP-4	45vm	VR4	9a	Tor
9FH	XC6223B261GR-G	LVR-IC	LDO, 2.6V±1%, 300mA, +CE, CL	USP-4	45vm	VR4	9a	Tor
9FK	XC6223B271GR-G	LVR-IC	LDO, 2.7V±1%, 300mA, +CE, CL	USP-4	45vm	VR4	9a	Tor
9FL	XC6223B281GR-G	LVR-IC	LDO, 2.8V±1%, 300mA, +CE, CL	USP-4	45vm	VR4	9a	Tor
9FM	XC6223B291GR-G	LVR-IC	LDO, 2.9V±1%, 300mA, +CE, CL	USP-4	45vm	VR4	9a	Tor
9FN	XC6223B301GR-G	LVR-IC	LDO, 3.0V±1%, 300mA, +CE, CL	USP-4	45vm	VR4	9a	Tor
9FP	XC6223B311GR-G	LVR-IC	LDO, 3.1V±1%, 300mA, +CE, CL	USP-4	45vm	VR4	9a	Tor
9FR	XC6223B321GR-G	LVR-IC	LDO, 3.2V±1%, 300mA, +CE, CL	USP-4	45vm	VR4	9a	Tor
9FS	XC6223B331GR-G	LVR-IC	LDO, 3.3V±1%, 300mA, +CE, CL	USP-4	45vm	VR4	9a	Tor
9FT	XC6223B341GR-G	LVR-IC	LDO, 3.4V±1%, 300mA, +CE, CL	USP-4	45vm	VR4	9a	Tor
9FU	XC6223B351GR-G	LVR-IC	LDO, 3.5V±1%, 300mA, +CE, CL	USP-4	45vm	VR4	9a	Tor
9FV	XC6223B361GR-G	LVR-IC	LDO, 3.6V±1%, 300mA, +CE, CL	USP-4	45vm	VR4	9a	Tor
9FX	XC6223B371GR-G	LVR-IC	LDO, 3.7V±1%, 300mA, +CE, CL	USP-4	45vm	VR4	9a	Tor
9FY	XC6223B381GR-G	LVR-IC	LDO, 3.8V±1%, 300mA, +CE, CL	USP-4	45vm	VR4	9a	Tor
9FZ	XC6223B391GR-G	LVR-IC	LDO, 3.9V±1%, 300mA, +CE, CL	USP-4	45vm	VR4	9a	Tor
9H	XC6221A1717R	LVR-IC	LDO, 1.7V±20mV, 200mA, +CE	USPN-4	58vm	VR4	9a	Tor
9H	XC6223B26B9R-G	LVR-IC	LDO, 2.65V±1%, 300mA, +CE, CL	USPQ-4B03	48vm	VR4	9a	Tor
9H0	XC6223B401GR-G	LVR-IC	LDO, 4.0V±1%, 300mA, +CE, CL	USP-4	45vm	VR4	9a	Tor
9H016	XC6117H016ER	Vdet-IC	1.6V±2%, -MR, +Rst PPO, -Rst ODO, Rt=1.6s	USP-6C	49xs	VD22	9b	Tor
9H017	XC6117H017ER	Vdet-IC	1.7V±2%, -MR, +Rst PPO, -Rst ODO, Rt=1.6s	USP-6C	49xs	VD22	9b	Tor
9H018	XC6117H018ER	Vdet-IC	1.8V±2%, -MR, +Rst PPO, -Rst ODO, Rt=1.6s	USP-6C	49xs	VD22	9b	Tor
9H019	XC6117H019ER	Vdet-IC	1.9V±2%, -MR, +Rst PPO, -Rst ODO, Rt=1.6s	USP-6C	49xs	VD22	9b	Tor



SMD code	Type	Function	Short description	Case	Pinout	Sch.	St.	Mnf.
9K4	XC6223B14BGR-G	LVR-IC	LDO, 1.45V±20mV, 300mA, +CE, CL	USP-4	45vm	VR4	9a	Tor
9K5	XC6223B15BGR-G	LVR-IC	LDO, 1.55V±20mV, 300mA, +CE, CL	USP-4	45vm	VR4	9a	Tor
9K6	XC6223B16BGR-G	LVR-IC	LDO, 1.65V±20mV, 300mA, +CE, CL	USP-4	45vm	VR4	9a	Tor
9K7	XC6223B17BGR-G	LVR-IC	LDO, 1.75V±20mV, 300mA, +CE, CL	USP-4	45vm	VR4	9a	Tor
9K8	XC6223B18BGR-G	LVR-IC	LDO, 1.85V±20mV, 300mA, +CE, CL	USP-4	45vm	VR4	9a	Tor
9K9	XC6223B19BGR-G	LVR-IC	LDO, 1.95V±20mV, 300mA, +CE, CL	USP-4	45vm	VR4	9a	Tor
9KA	XC6223B20BGR-G	LVR-IC	LDO, 2.05V±1%, 300mA, +CE, CL	USP-4	45vm	VR4	9a	Tor
9KB	XC6223B21BGR-G	LVR-IC	LDO, 2.15V±1%, 300mA, +CE, CL	USP-4	45vm	VR4	9a	Tor
9KC	XC6223B22BGR-G	LVR-IC	LDO, 2.25V±1%, 300mA, +CE, CL	USP-4	45vm	VR4	9a	Tor
9KD	XC6223B23BGR-G	LVR-IC	LDO, 2.35V±1%, 300mA, +CE, CL	USP-4	45vm	VR4	9a	Tor
9KE	XC6223B24BGR-G	LVR-IC	LDO, 2.45V±1%, 300mA, +CE, CL	USP-4	45vm	VR4	9a	Tor
9KF	XC6223B25BGR-G	LVR-IC	LDO, 2.55V±1%, 300mA, +CE, CL	USP-4	45vm	VR4	9a	Tor
9KH	XC6223B26BGR-G	LVR-IC	LDO, 2.65V±1%, 300mA, +CE, CL	USP-4	45vm	VR4	9a	Tor
9KK	XC6223B27BGR-G	LVR-IC	LDO, 2.75V±1%, 300mA, +CE, CL	USP-4	45vm	VR4	9a	Tor
9KL	XC6223B28BGR-G	LVR-IC	LDO, 2.85V±1%, 300mA, +CE, CL	USP-4	45vm	VR4	9a	Tor
9KM	XC6223B29BGR-G	LVR-IC	LDO, 2.95V±1%, 300mA, +CE, CL	USP-4	45vm	VR4	9a	Tor
9KN	XC6223B30BGR-G	LVR-IC	LDO, 3.05V±1%, 300mA, +CE, CL	USP-4	45vm	VR4	9a	Tor
9KP	XC6223B31BGR-G	LVR-IC	LDO, 3.15V±1%, 300mA, +CE, CL	USP-4	45vm	VR4	9a	Tor
9KR	XC6223B32BGR-G	LVR-IC	LDO, 3.25V±1%, 300mA, +CE, CL	USP-4	45vm	VR4	9a	Tor
9KS	XC6223B33BGR-G	LVR-IC	LDO, 3.35V±1%, 300mA, +CE, CL	USP-4	45vm	VR4	9a	Tor
9KT	XC6223B34BGR-G	LVR-IC	LDO, 3.45V±1%, 300mA, +CE, CL	USP-4	45vm	VR4	9a	Tor
9KU	XC6223B35BGR-G	LVR-IC	LDO, 3.55V±1%, 300mA, +CE, CL	USP-4	45vm	VR4	9a	Tor
9KV	XC6223B36BGR-G	LVR-IC	LDO, 3.65V±1%, 300mA, +CE, CL	USP-4	45vm	VR4	9a	Tor
9KX	XC6223B37BGR-G	LVR-IC	LDO, 3.75V±1%, 300mA, +CE, CL	USP-4	45vm	VR4	9a	Tor
9KY	XC6223B38BGR-G	LVR-IC	LDO, 3.85V±1%, 300mA, +CE, CL	USP-4	45vm	VR4	9a	Tor
9KZ	XC6223B39BGR-G	LVR-IC	LDO, 3.95V±1%, 300mA, +CE, CL	USP-4	45vm	VR4	9a	Tor
9L	XC6221A1917R	LVR-IC	LDO, 1.9V±20mV, 200mA, +CE	USPN-4	58vm	VR4	9a	Tor
9L	XC6223B28B9R-G	LVR-IC	LDO, 2.85V±1%, 300mA, +CE, CL	USPQ-4B03	48vm	VR4	9a	Tor
9L2	XC6223C121GR-G	LVR-IC	LDO, 1.2V±20mV, 300mA, +CE, PDR	USP-4	45vm	VR4	9a	Tor
9L3	XC6223C131GR-G	LVR-IC	LDO, 1.3V±20mV, 300mA, +CE, PDR	USP-4	45vm	VR4	9a	Tor
9L4	XC6223C141GR-G	LVR-IC	LDO, 1.4V±20mV, 300mA, +CE, PDR	USP-4	45vm	VR4	9a	Tor
9L5	XC6223C151GR-G	LVR-IC	LDO, 1.5V±20mV, 300mA, +CE, PDR	USP-4	45vm	VR4	9a	Tor
9L6	XC6223C161GR-G	LVR-IC	LDO, 1.6V±20mV, 300mA, +CE, PDR	USP-4	45vm	VR4	9a	Tor
9L7	XC6223C171GR-G	LVR-IC	LDO, 1.7V±20mV, 300mA, +CE, PDR	USP-4	45vm	VR4	9a	Tor
9L8	XC6223C181GR-G	LVR-IC	LDO, 1.8V±20mV, 300mA, +CE, PDR	USP-4	45vm	VR4	9a	Tor
9L9	XC6223C191GR-G	LVR-IC	LDO, 1.9V±20mV, 300mA, +CE, PDR	USP-4	45vm	VR4	9a	Tor
9LA	XC6223C201GR-G	LVR-IC	LDO, 2.0V±1%, 300mA, +CE, PDR	USP-4	45vm	VR4	9a	Tor
9LB	XC6223C211GR-G	LVR-IC	LDO, 2.1V±1%, 300mA, +CE, PDR	USP-4	45vm	VR4	9a	Tor
9LC	XC6223C221GR-G	LVR-IC	LDO, 2.2V±1%, 300mA, +CE, PDR	USP-4	45vm	VR4	9a	Tor
9LD	XC6223C231GR-G	LVR-IC	LDO, 2.3V±1%, 300mA, +CE, PDR	USP-4	45vm	VR4	9a	Tor
9LE	XC6223C241GR-G	LVR-IC	LDO, 2.4V±1%, 300mA, +CE, PDR	USP-4	45vm	VR4	9a	Tor
9LF	XC6223C251GR-G	LVR-IC	LDO, 2.5V±1%, 300mA, +CE, PDR	USP-4	45vm	VR4	9a	Tor
9LH	XC6223C261GR-G	LVR-IC	LDO, 2.6V±1%, 300mA, +CE, PDR	USP-4	45vm	VR4	9a	Tor
9LH	XC6223C271GR-G	LVR-IC	LDO, 2.7V±1%, 300mA, +CE, PDR	USP-4	45vm	VR4	9a	Tor
9LL	XC6223C281GR-G	LVR-IC	LDO, 2.8V±1%, 300mA, +CE, PDR	USP-4	45vm	VR4	9a	Tor
9LM	XC6223C291GR-G	LVR-IC	LDO, 2.9V±1%, 300mA, +CE, PDR	USP-4	45vm	VR4	9a	Tor
9LN	XC6223C301GR-G	LVR-IC	LDO, 3.0V±1%, 300mA, +CE, PDR	USP-4	45vm	VR4	9a	Tor
9LP	XC6223C311GR-G	LVR-IC	LDO, 3.1V±1%, 300mA, +CE, PDR	USP-4	45vm	VR4	9a	Tor
9LR	XC6223C321GR-G	LVR-IC	LDO, 3.2V±1%, 300mA, +CE, PDR	USP-4	45vm	VR4	9a	Tor
9LS	XC6223C331GR-G	LVR-IC	LDO, 3.3V±1%, 300mA, +CE, PDR	USP-4	45vm	VR4	9a	Tor
9LT	XC6223C341GR-G	LVR-IC	LDO, 3.4V±1%, 300mA, +CE, PDR	USP-4	45vm	VR4	9a	Tor
9LU	XC6223C351GR-G	LVR-IC	LDO, 3.5V±1%, 300mA, +CE, PDR	USP-4	45vm	VR4	9a	Tor
9LV	XC6223C361GR-G	LVR-IC	LDO, 3.6V±1%, 300mA, +CE, PDR	USP-4	45vm	VR4	9a	Tor
9LX	XC6223C371GR-G	LVR-IC	LDO, 3.7V±1%, 300mA, +CE, PDR	USP-4	45vm	VR4	9a	Tor
9LY	XC6223C381GR-G	LVR-IC	LDO, 3.8V±1%, 300mA, +CE, PDR	USP-4	45vm	VR4	9a	Tor
9LZ	XC6223C391GR-G	LVR-IC	LDO, 3.9V±1%, 300mA, +CE, PDR	USP-4	45vm	VR4	9a	Tor
9M	XC6221A2017R	LVR-IC	LDO, 2V±1%, 200mA, +CE	USPN-4	58vm	VR4	9a	Tor
9M	XC6223B29B9R-G	LVR-IC	LDO, 2.95V±1%, 300mA, +CE, CL	USPQ-4B03	48vm	VR4	9a	Tor
9M0	XC6223C401GR-G	LVR-IC	LDO, 4.0V±1%, 300mA, +CE, PDR	USP-4	45vm	VR4	9a	Tor
9N	XC6221A2117R	LVR-IC	LDO, 2.1V±1%, 200mA, +CE	USPN-4	58vm	VR4	9a	Tor
9N	XC6223B30B9R-G	LVR-IC	LDO, 3.05V±1%, 300mA, +CE, CL	USPQ-4B03	48vm	VR4	9a	Tor
9N2	XC6223C12BGR-G	LVR-IC	LDO, 1.25V±20mV, 300mA, +CE, PDR	USP-4	45vm	VR4	9a	Tor
9N3	XC6223C13BGR-G	LVR-IC	LDO, 1.35V±20mV, 300mA, +CE, PDR	USP-4	45vm	VR4	9a	Tor
9N4	XC6223C14BGR-G	LVR-IC	LDO, 1.45V±20mV, 300mA, +CE, PDR	USP-4	45vm	VR4	9a	Tor
9N5	XC6223C15BGR-G	LVR-IC	LDO, 1.55V±20mV, 300mA, +CE, PDR	USP-4	45vm	VR4	9a	Tor
9N6	XC6223C16BGR-G	LVR-IC	LDO, 1.65V±20mV, 300mA, +CE, PDR	USP-4	45vm	VR4	9a	Tor
9N7	XC6223C17BGR-G	LVR-IC	LDO, 1.75V±20mV, 300mA, +CE, PDR	USP-4	45vm	VR4	9a	Tor
9N8	XC6223C18BGR-G	LVR-IC	LDO, 1.85V±20mV, 300mA, +CE, PDR	USP-4	45vm	VR4	9a	Tor
9N9	XC6223C19BGR-G	LVR-IC	LDO, 1.95V±20mV, 300mA, +CE, PDR	USP-4	45vm	VR4	9a	Tor
9NA	XC6223C20BGR-G	LVR-IC	LDO, 2.05V±1%, 300mA, +CE, PDR	USP-4	45vm	VR4	9a	Tor



SMD code	Type	Function	Short description	Case	Pinout	Sch.	St.	Mnf.
9NB	XC6223C21BGR-G	LVR-IC	LDO, 2.15V±1%, 300mA, +CE, PDR	USP-4	45vm	VR4	9a	Tor
9NC	XC6223C22BGR-G	LVR-IC	LDO, 2.25V±1%, 300mA, +CE, PDR	USP-4	45vm	VR4	9a	Tor
9ND	XC6223C23BGR-G	LVR-IC	LDO, 2.35V±1%, 300mA, +CE, PDR	USP-4	45vm	VR4	9a	Tor
9NE	XC6223C24BGR-G	LVR-IC	LDO, 2.45V±1%, 300mA, +CE, PDR	USP-4	45vm	VR4	9a	Tor
9NF	XC6223C25BGR-G	LVR-IC	LDO, 2.55V±1%, 300mA, +CE, PDR	USP-4	45vm	VR4	9a	Tor
9NH	XC6223C26BGR-G	LVR-IC	LDO, 2.65V±1%, 300mA, +CE, PDR	USP-4	45vm	VR4	9a	Tor
9NK	XC6223C27BGR-G	LVR-IC	LDO, 2.75V±1%, 300mA, +CE, PDR	USP-4	45vm	VR4	9a	Tor
9NL	XC6223C28BGR-G	LVR-IC	LDO, 2.85V±1%, 300mA, +CE, PDR	USP-4	45vm	VR4	9a	Tor
9NM	XC6223C29BGR-G	LVR-IC	LDO, 2.95V±1%, 300mA, +CE, PDR	USP-4	45vm	VR4	9a	Tor
9NN	XC6223C30BGR-G	LVR-IC	LDO, 3.05V±1%, 300mA, +CE, PDR	USP-4	45vm	VR4	9a	Tor
9NP	XC6223C31BGR-G	LVR-IC	LDO, 3.15V±1%, 300mA, +CE, PDR	USP-4	45vm	VR4	9a	Tor
9NR	XC6223C32BGR-G	LVR-IC	LDO, 3.25V±1%, 300mA, +CE, PDR	USP-4	45vm	VR4	9a	Tor
9NS	XC6223C33BGR-G	LVR-IC	LDO, 3.35V±1%, 300mA, +CE, PDR	USP-4	45vm	VR4	9a	Tor
9NT	XC6223C34BGR-G	LVR-IC	LDO, 3.45V±1%, 300mA, +CE, PDR	USP-4	45vm	VR4	9a	Tor
9NU	XC6223C35BGR-G	LVR-IC	LDO, 3.55V±1%, 300mA, +CE, PDR	USP-4	45vm	VR4	9a	Tor
9NV	XC6223C36BGR-G	LVR-IC	LDO, 3.65V±1%, 300mA, +CE, PDR	USP-4	45vm	VR4	9a	Tor
9NX	XC6223C37BGR-G	LVR-IC	LDO, 3.75V±1%, 300mA, +CE, PDR	USP-4	45vm	VR4	9a	Tor
9NY	XC6223C38BGR-G	LVR-IC	LDO, 3.85V±1%, 300mA, +CE, PDR	USP-4	45vm	VR4	9a	Tor
9NZ	XC6223C39BGR-G	LVR-IC	LDO, 3.95V±1%, 300mA, +CE, PDR	USP-4	45vm	VR4	9a	Tor
9P	XC6221A217R	LVR-IC	LDO, 2.2V±1%, 200mA, +CE	USPN-4	58vm	VR4	9a	Tor
9P	XC6223B31B9R-G	LVR-IC	LDO, 3.15V±1%, 300mA, +CE, CL	USPQ-4B03	48vm	VR4	9a	Tor
9P2	XC6223D121GR-G	LVR-IC	LDO, 1.2V±20mV, 300mA, +CE, CL, PDR	USP-4	45vm	VR4	9a	Tor
9P3	XC6223D131GR-G	LVR-IC	LDO, 1.3V±20mV, 300mA, +CE, CL, PDR	USP-4	45vm	VR4	9a	Tor
9P4	XC6223D141GR-G	LVR-IC	LDO, 1.4V±20mV, 300mA, +CE, CL, PDR	USP-4	45vm	VR4	9a	Tor
9P5	XC6223D151GR-G	LVR-IC	LDO, 1.5V±20mV, 300mA, +CE, CL, PDR	USP-4	45vm	VR4	9a	Tor
9P6	XC6223D161GR-G	LVR-IC	LDO, 1.6V±20mV, 300mA, +CE, CL, PDR	USP-4	45vm	VR4	9a	Tor
9P7	XC6223D171GR-G	LVR-IC	LDO, 1.7V±20mV, 300mA, +CE, CL, PDR	USP-4	45vm	VR4	9a	Tor
9P8	XC6223D181GR-G	LVR-IC	LDO, 1.8V±20mV, 300mA, +CE, CL, PDR	USP-4	45vm	VR4	9a	Tor
9P9	XC6223D191GR-G	LVR-IC	LDO, 1.9V±20mV, 300mA, +CE, CL, PDR	USP-4	45vm	VR4	9a	Tor
9PA	XC6223D201GR-G	LVR-IC	LDO, 2.0V±1%, 300mA, +CE, CL, PDR	USP-4	45vm	VR4	9a	Tor
9PB	XC6223D211GR-G	LVR-IC	LDO, 2.1V±1%, 300mA, +CE, CL, PDR	USP-4	45vm	VR4	9a	Tor
9PC	XC6223D221GR-G	LVR-IC	LDO, 2.2V±1%, 300mA, +CE, CL, PDR	USP-4	45vm	VR4	9a	Tor
9PD	XC6223D231GR-G	LVR-IC	LDO, 2.3V±1%, 300mA, +CE, CL, PDR	USP-4	45vm	VR4	9a	Tor
9PE	XC6223D241GR-G	LVR-IC	LDO, 2.4V±1%, 300mA, +CE, CL, PDR	USP-4	45vm	VR4	9a	Tor
9PF	XC6223D251GR-G	LVR-IC	LDO, 2.5V±1%, 300mA, +CE, CL, PDR	USP-4	45vm	VR4	9a	Tor
9PH	XC6223D261GR-G	LVR-IC	LDO, 2.6V±1%, 300mA, +CE, CL, PDR	USP-4	45vm	VR4	9a	Tor
9PK	XC6223D271GR-G	LVR-IC	LDO, 2.7V±1%, 300mA, +CE, CL, PDR	USP-4	45vm	VR4	9a	Tor
9PL	XC6223D281GR-G	LVR-IC	LDO, 2.8V±1%, 300mA, +CE, CL, PDR	USP-4	45vm	VR4	9a	Tor
9PM	XC6223D291GR-G	LVR-IC	LDO, 2.9V±1%, 300mA, +CE, CL, PDR	USP-4	45vm	VR4	9a	Tor
9PN	XC6223D301GR-G	LVR-IC	LDO, 3.0V±1%, 300mA, +CE, CL, PDR	USP-4	45vm	VR4	9a	Tor
9PP	XC6223D311GR-G	LVR-IC	LDO, 3.1V±1%, 300mA, +CE, CL, PDR	USP-4	45vm	VR4	9a	Tor
9PR	XC6223D321GR-G	LVR-IC	LDO, 3.2V±1%, 300mA, +CE, CL, PDR	USP-4	45vm	VR4	9a	Tor
9PS	XC6223D331GR-G	LVR-IC	LDO, 3.3V±1%, 300mA, +CE, CL, PDR	USP-4	45vm	VR4	9a	Tor
9PT	XC6223D341GR-G	LVR-IC	LDO, 3.4V±1%, 300mA, +CE, CL, PDR	USP-4	45vm	VR4	9a	Tor
9PU	XC6223D351GR-G	LVR-IC	LDO, 3.5V±1%, 300mA, +CE, CL, PDR	USP-4	45vm	VR4	9a	Tor
9PV	XC6223D361GR-G	LVR-IC	LDO, 3.6V±1%, 300mA, +CE, CL, PDR	USP-4	45vm	VR4	9a	Tor
9PX	XC6223D371GR-G	LVR-IC	LDO, 3.7V±1%, 300mA, +CE, CL, PDR	USP-4	45vm	VR4	9a	Tor
9PY	XC6223D381GR-G	LVR-IC	LDO, 3.8V±1%, 300mA, +CE, CL, PDR	USP-4	45vm	VR4	9a	Tor
9PZ	XC6223D391GR-G	LVR-IC	LDO, 3.9V±1%, 300mA, +CE, CL, PDR	USP-4	45vm	VR4	9a	Tor
9R	XC6221A2317R	LVR-IC	LDO, 2.3V±1%, 200mA, +CE	USPN-4	58vm	VR4	9a	Tor
9R	XC6223B32B9R-G	LVR-IC	LDO, 3.25V±1%, 300mA, +CE, CL	USPQ-4B03	48vm	VR4	9a	Tor
9R0	XC6223D401GR-G	LVR-IC	LDO, 4.0V±1%, 300mA, +CE, CL, PDR	USP-4	45vm	VR4	9a	Tor
9S	XC6221A2417R	LVR-IC	LDO, 2.4V±1%, 200mA, +CE	USPN-4	58vm	VR4	9a	Tor
9S	XC6223B33B9R-G	LVR-IC	LDO, 3.35V±1%, 300mA, +CE, CL	USPQ-4B03	48vm	VR4	9a	Tor
9S2	XC6223D12BGR-G	LVR-IC	LDO, 1.25V±20mV, 300mA, +CE, CL, PDR	USP-4	45vm	VR4	9a	Tor
9S3	XC6223D13BGR-G	LVR-IC	LDO, 1.35V±20mV, 300mA, +CE, CL, PDR	USP-4	45vm	VR4	9a	Tor
9S4	XC6223D14BGR-G	LVR-IC	LDO, 1.45V±20mV, 300mA, +CE, CL, PDR	USP-4	45vm	VR4	9a	Tor
9S5	XC6223D15BGR-G	LVR-IC	LDO, 1.55V±20mV, 300mA, +CE, CL, PDR	USP-4	45vm	VR4	9a	Tor
9S6	XC6223D16BGR-G	LVR-IC	LDO, 1.65V±20mV, 300mA, +CE, CL, PDR	USP-4	45vm	VR4	9a	Tor
9S7	XC6223D17BGR-G	LVR-IC	LDO, 1.75V±20mV, 300mA, +CE, CL, PDR	USP-4	45vm	VR4	9a	Tor
9S8	XC6223D18BGR-G	LVR-IC	LDO, 1.85V±20mV, 300mA, +CE, CL, PDR	USP-4	45vm	VR4	9a	Tor
9S9	XC6223D19BGR-G	LVR-IC	LDO, 1.95V±20mV, 300mA, +CE, CL, PDR	USP-4	45vm	VR4	9a	Tor
9SA	XC6223D20BGR-G	LVR-IC	LDO, 2.05V±1%, 300mA, +CE, CL, PDR	USP-4	45vm	VR4	9a	Tor
9SB	XC6223D21BGR-G	LVR-IC	LDO, 2.15V±1%, 300mA, +CE, CL, PDR	USP-4	45vm	VR4	9a	Tor
9SC	XC6223D22BGR-G	LVR-IC	LDO, 2.25V±1%, 300mA, +CE, CL, PDR	USP-4	45vm	VR4	9a	Tor
9SD	XC6223D23BGR-G	LVR-IC	LDO, 2.35V±1%, 300mA, +CE, CL, PDR	USP-4	45vm	VR4	9a	Tor
9SE	XC6223D24BGR-G	LVR-IC	LDO, 2.45V±1%, 300mA, +CE, CL, PDR	USP-4	45vm	VR4	9a	Tor
9SF	XC6223D25BGR-G	LVR-IC	LDO, 2.55V±1%, 300mA, +CE, CL, PDR	USP-4	45vm	VR4	9a	Tor
9SH	XC6223D26BGR-G	LVR-IC	LDO, 2.65V±1%, 300mA, +CE, CL, PDR	USP-4	45vm	VR4	9a	Tor
9SK	XC6223D27BGR-G	LVR-IC	LDO, 2.75V±1%, 300mA, +CE, CL, PDR	USP-4	45vm	VR4	9a	Tor



SMD code	Type	Function	Short description	Case	Pinout	Sch.	St.	Mnf.
9SL	XC6223D28BGR-G	LVR-IC	LDO, 2.85V±1%, 300mA, +CE, CL, PDR	USP-4	45vm	VR4	9a	Tor
9SM	XC6223D29BGR-G	LVR-IC	LDO, 2.95V±1%, 300mA, +CE, CL, PDR	USP-4	45vm	VR4	9a	Tor
9SN	XC6223D30BGR-G	LVR-IC	LDO, 3.05V±1%, 300mA, +CE, CL, PDR	USP-4	45vm	VR4	9a	Tor
9SP	XC6223D31BGR-G	LVR-IC	LDO, 3.15V±1%, 300mA, +CE, CL, PDR	USP-4	45vm	VR4	9a	Tor
9SR	XC6223D32BGR-G	LVR-IC	LDO, 3.25V±1%, 300mA, +CE, CL, PDR	USP-4	45vm	VR4	9a	Tor
9SS	XC6223D33BGR-G	LVR-IC	LDO, 3.35V±1%, 300mA, +CE, CL, PDR	USP-4	45vm	VR4	9a	Tor
9ST	XC6223D34BGR-G	LVR-IC	LDO, 3.45V±1%, 300mA, +CE, CL, PDR	USP-4	45vm	VR4	9a	Tor
9SU	XC6223D35BGR-G	LVR-IC	LDO, 3.55V±1%, 300mA, +CE, CL, PDR	USP-4	45vm	VR4	9a	Tor
9SV	XC6223D36BGR-G	LVR-IC	LDO, 3.65V±1%, 300mA, +CE, CL, PDR	USP-4	45vm	VR4	9a	Tor
9SX	XC6223D37BGR-G	LVR-IC	LDO, 3.75V±1%, 300mA, +CE, CL, PDR	USP-4	45vm	VR4	9a	Tor
9SY	XC6223D38BGR-G	LVR-IC	LDO, 3.85V±1%, 300mA, +CE, CL, PDR	USP-4	45vm	VR4	9a	Tor
9SZ	XC6223D39BGR-G	LVR-IC	LDO, 3.95V±1%, 300mA, +CE, CL, PDR	USP-4	45vm	VR4	9a	Tor
9T	XC6221A2517R	LVR-IC	LDO, 2.5V±1%, 200mA, +CE	USPN-4	58vm	VR4	9a	Tor
9T	XC6223B34B9R-G	LVR-IC	LDO, 3.45V±1%, 300mA, +CE, CL	USPQ-4B03	48vm	VR4	9a	Tor
9T2	XC6223E121GR-G	LVR-IC	LDO, 1.2V±20mV, 300mA, +CE, ICP	USP-4	45vm	VR4	9a	Tor
9T3	XC6223E131GR-G	LVR-IC	LDO, 1.3V±20mV, 300mA, +CE, ICP	USP-4	45vm	VR4	9a	Tor
9T4	XC6223E141GR-G	LVR-IC	LDO, 1.4V±20mV, 300mA, +CE, ICP	USP-4	45vm	VR4	9a	Tor
9T5	XC6223E151GR-G	LVR-IC	LDO, 1.5V±20mV, 300mA, +CE, ICP	USP-4	45vm	VR4	9a	Tor
9T6	XC6223E161GR-G	LVR-IC	LDO, 1.6V±20mV, 300mA, +CE, ICP	USP-4	45vm	VR4	9a	Tor
9T7	XC6223E171GR-G	LVR-IC	LDO, 1.7V±20mV, 300mA, +CE, ICP	USP-4	45vm	VR4	9a	Tor
9T8	XC6223E181GR-G	LVR-IC	LDO, 1.8V±20mV, 300mA, +CE, ICP	USP-4	45vm	VR4	9a	Tor
9T9	XC6223E191GR-G	LVR-IC	LDO, 1.9V±20mV, 300mA, +CE, ICP	USP-4	45vm	VR4	9a	Tor
9TA	XC6223E201GR-G	LVR-IC	LDO, 2.0V±1%, 300mA, +CE, ICP	USP-4	45vm	VR4	9a	Tor
9TB	XC6223E211GR-G	LVR-IC	LDO, 2.1V±1%, 300mA, +CE, ICP	USP-4	45vm	VR4	9a	Tor
9TC	XC6223E221GR-G	LVR-IC	LDO, 2.2V±1%, 300mA, +CE, ICP	USP-4	45vm	VR4	9a	Tor
9TD	XC6223E231GR-G	LVR-IC	LDO, 2.3V±1%, 300mA, +CE, ICP	USP-4	45vm	VR4	9a	Tor
9TE	XC6223E241GR-G	LVR-IC	LDO, 2.4V±1%, 300mA, +CE, ICP	USP-4	45vm	VR4	9a	Tor
9TF	XC6223E251GR-G	LVR-IC	LDO, 2.5V±1%, 300mA, +CE, ICP	USP-4	45vm	VR4	9a	Tor
9TH	XC6223E261GR-G	LVR-IC	LDO, 2.6V±1%, 300mA, +CE, ICP	USP-4	45vm	VR4	9a	Tor
9TK	XC6223E271GR-G	LVR-IC	LDO, 2.7V±1%, 300mA, +CE, ICP	USP-4	45vm	VR4	9a	Tor
9TL	XC6223E281GR-G	LVR-IC	LDO, 2.8V±1%, 300mA, +CE, ICP	USP-4	45vm	VR4	9a	Tor
9TM	XC6223E291GR-G	LVR-IC	LDO, 2.9V±1%, 300mA, +CE, ICP	USP-4	45vm	VR4	9a	Tor
9TN	XC6223E301GR-G	LVR-IC	LDO, 3.0V±1%, 300mA, +CE, ICP	USP-4	45vm	VR4	9a	Tor
9TP	XC6223E311GR-G	LVR-IC	LDO, 3.1V±1%, 300mA, +CE, ICP	USP-4	45vm	VR4	9a	Tor
9TR	XC6223E321GR-G	LVR-IC	LDO, 3.2V±1%, 300mA, +CE, ICP	USP-4	45vm	VR4	9a	Tor
9TS	XC6223E331GR-G	LVR-IC	LDO, 3.3V±1%, 300mA, +CE, ICP	USP-4	45vm	VR4	9a	Tor
9TT	XC6223E341GR-G	LVR-IC	LDO, 3.4V±1%, 300mA, +CE, ICP	USP-4	45vm	VR4	9a	Tor
9TU	XC6223E351GR-G	LVR-IC	LDO, 3.5V±1%, 300mA, +CE, ICP	USP-4	45vm	VR4	9a	Tor
9TV	XC6223E361GR-G	LVR-IC	LDO, 3.6V±1%, 300mA, +CE, ICP	USP-4	45vm	VR4	9a	Tor
9TX	XC6223E371GR-G	LVR-IC	LDO, 3.7V±1%, 300mA, +CE, ICP	USP-4	45vm	VR4	9a	Tor
9TY	XC6223E381GR-G	LVR-IC	LDO, 3.8V±1%, 300mA, +CE, ICP	USP-4	45vm	VR4	9a	Tor
9TZ	XC6223E391GR-G	LVR-IC	LDO, 3.9V±1%, 300mA, +CE, ICP	USP-4	45vm	VR4	9a	Tor
9U	XC6221A2617R	LVR-IC	LDO, 2.6V±1%, 200mA, +CE	USPN-4	58vm	VR4	9a	Tor
9U	XC6223B35B9R-G	LVR-IC	LDO, 3.55V±1%, 300mA, +CE, CL	USPQ-4B03	48vm	VR4	9a	Tor
9U0	XC6223E401GR-G	LVR-IC	LDO, 4.0V±1%, 300mA, +CE, ICP	USP-4	45vm	VR4	9a	Tor
9V	XC6221A2717R	LVR-IC	LDO, 2.7V±1%, 200mA, +CE	USPN-4	58vm	VR4	9a	Tor
9V	XC6223B36B9R-G	LVR-IC	LDO, 3.65V±1%, 300mA, +CE, CL	USPQ-4B03	48vm	VR4	9a	Tor
9V2	XC6223E12BGR-G	LVR-IC	LDO, 1.25V±20mV, 300mA, +CE, ICP	USP-4	45vm	VR4	9a	Tor
9V3	XC6223E13BGR-G	LVR-IC	LDO, 1.35V±20mV, 300mA, +CE, ICP	USP-4	45vm	VR4	9a	Tor
9V4	XC6223E14BGR-G	LVR-IC	LDO, 1.45V±20mV, 300mA, +CE, ICP	USP-4	45vm	VR4	9a	Tor
9V5	XC6223E15BGR-G	LVR-IC	LDO, 1.55V±20mV, 300mA, +CE, ICP	USP-4	45vm	VR4	9a	Tor
9V6	XC6223E16BGR-G	LVR-IC	LDO, 1.65V±20mV, 300mA, +CE, ICP	USP-4	45vm	VR4	9a	Tor
9V7	XC6223E17BGR-G	LVR-IC	LDO, 1.75V±20mV, 300mA, +CE, ICP	USP-4	45vm	VR4	9a	Tor
9V8	XC6223E18BGR-G	LVR-IC	LDO, 1.85V±20mV, 300mA, +CE, ICP	USP-4	45vm	VR4	9a	Tor
9V9	XC6223E19BGR-G	LVR-IC	LDO, 1.95V±20mV, 300mA, +CE, ICP	USP-4	45vm	VR4	9a	Tor
9VA	XC6223E20BGR-G	LVR-IC	LDO, 2.05V±1%, 300mA, +CE, ICP	USP-4	45vm	VR4	9a	Tor
9VB	XC6223E21BGR-G	LVR-IC	LDO, 2.15V±1%, 300mA, +CE, ICP	USP-4	45vm	VR4	9a	Tor
9VC	XC6223E22BGR-G	LVR-IC	LDO, 2.25V±1%, 300mA, +CE, ICP	USP-4	45vm	VR4	9a	Tor
9VD	XC6223E23BGR-G	LVR-IC	LDO, 2.35V±1%, 300mA, +CE, ICP	USP-4	45vm	VR4	9a	Tor
9VE	XC6223E24BGR-G	LVR-IC	LDO, 2.45V±1%, 300mA, +CE, ICP	USP-4	45vm	VR4	9a	Tor
9VF	XC6223E25BGR-G	LVR-IC	LDO, 2.55V±1%, 300mA, +CE, ICP	USP-4	45vm	VR4	9a	Tor
9VH	XC6223E26BGR-G	LVR-IC	LDO, 2.65V±1%, 300mA, +CE, ICP	USP-4	45vm	VR4	9a	Tor
9VK	XC6223E27BGR-G	LVR-IC	LDO, 2.75V±1%, 300mA, +CE, ICP	USP-4	45vm	VR4	9a	Tor
9VL	XC6223E28BGR-G	LVR-IC	LDO, 2.85V±1%, 300mA, +CE, ICP	USP-4	45vm	VR4	9a	Tor
9VM	XC6223E29BGR-G	LVR-IC	LDO, 2.95V±1%, 300mA, +CE, ICP	USP-4	45vm	VR4	9a	Tor
9VN	XC6223E30BGR-G	LVR-IC	LDO, 3.05V±1%, 300mA, +CE, ICP	USP-4	45vm	VR4	9a	Tor
9VP	XC6223E31BGR-G	LVR-IC	LDO, 3.15V±1%, 300mA, +CE, ICP	USP-4	45vm	VR4	9a	Tor
9VR	XC6223E32BGR-G	LVR-IC	LDO, 3.25V±1%, 300mA, +CE, ICP	USP-4	45vm	VR4	9a	Tor
9VS	XC6223E33BGR-G	LVR-IC	LDO, 3.35V±1%, 300mA, +CE, ICP	USP-4	45vm	VR4	9a	Tor
9VT	XC6223E34BGR-G	LVR-IC	LDO, 3.45V±1%, 300mA, +CE, ICP	USP-4	45vm	VR4	9a	Tor



SMD code	Type	Function	Short description	Case	Pinout	Sch.	St.	Mnf.
9VU	XC6223E35BGR-G	LVR-IC	LDO, 3.55V±1%, 300mA, +CE, ICP	USP-4	45vm	VR4	9a	Tor
9VV	XC6223E36BGR-G	LVR-IC	LDO, 3.65V±1%, 300mA, +CE, ICP	USP-4	45vm	VR4	9a	Tor
9VX	XC6223E37BGR-G	LVR-IC	LDO, 3.75V±1%, 300mA, +CE, ICP	USP-4	45vm	VR4	9a	Tor
9VY	XC6223E38BGR-G	LVR-IC	LDO, 3.85V±1%, 300mA, +CE, ICP	USP-4	45vm	VR4	9a	Tor
9VZ	XC6223E39BGR-G	LVR-IC	LDO, 3.95V±1%, 300mA, +CE, ICP	USP-4	45vm	VR4	9a	Tor
9X	XC6221A2817R	LVR-IC	LDO, 2.8V±1%, 200mA, +CE	USPN-4	58vm	VR4	9a	Tor
9X	XC6223B37B9R-G	LVR-IC	LDO, 3.75V±1%, 300mA, +CE, CL	USPQ-4B03	48vm	VR4	9a	Tor
9X2	XC6223F121GR-G	LVR-IC	LDO, 1.2V±20mV, 300mA, +CE, CL, ICP	USP-4	45vm	VR4	9a	Tor
9X3	XC6223F131GR-G	LVR-IC	LDO, 1.3V±20mV, 300mA, +CE, CL, ICP	USP-4	45vm	VR4	9a	Tor
9X4	XC6223F141GR-G	LVR-IC	LDO, 1.4V±20mV, 300mA, +CE, CL, ICP	USP-4	45vm	VR4	9a	Tor
9X5	XC6223F151GR-G	LVR-IC	LDO, 1.5V±20mV, 300mA, +CE, CL, ICP	USP-4	45vm	VR4	9a	Tor
9X6	XC6223F161GR-G	LVR-IC	LDO, 1.6V±20mV, 300mA, +CE, CL, ICP	USP-4	45vm	VR4	9a	Tor
9X7	XC6223F171GR-G	LVR-IC	LDO, 1.7V±20mV, 300mA, +CE, CL, ICP	USP-4	45vm	VR4	9a	Tor
9X8	XC6223F181GR-G	LVR-IC	LDO, 1.8V±20mV, 300mA, +CE, CL, ICP	USP-4	45vm	VR4	9a	Tor
9X9	XC6223F191GR-G	LVR-IC	LDO, 1.9V±20mV, 300mA, +CE, CL, ICP	USP-4	45vm	VR4	9a	Tor
9XA	XC6223F201GR-G	LVR-IC	LDO, 2.0V±1%, 300mA, +CE, CL, ICP	USP-4	45vm	VR4	9a	Tor
9XB	XC6223F211GR-G	LVR-IC	LDO, 2.1V±1%, 300mA, +CE, CL, ICP	USP-4	45vm	VR4	9a	Tor
9XC	XC6223F221GR-G	LVR-IC	LDO, 2.2V±1%, 300mA, +CE, CL, ICP	USP-4	45vm	VR4	9a	Tor
9XD	XC6223F231GR-G	LVR-IC	LDO, 2.3V±1%, 300mA, +CE, CL, ICP	USP-4	45vm	VR4	9a	Tor
9XE	XC6223F241GR-G	LVR-IC	LDO, 2.4V±1%, 300mA, +CE, CL, ICP	USP-4	45vm	VR4	9a	Tor
9XF	XC6223F251GR-G	LVR-IC	LDO, 2.5V±1%, 300mA, +CE, CL, ICP	USP-4	45vm	VR4	9a	Tor
9XH	XC6223F261GR-G	LVR-IC	LDO, 2.6V±1%, 300mA, +CE, CL, ICP	USP-4	45vm	VR4	9a	Tor
9XK	XC6223F271GR-G	LVR-IC	LDO, 2.7V±1%, 300mA, +CE, CL, ICP	USP-4	45vm	VR4	9a	Tor
9XL	XC6223F281GR-G	LVR-IC	LDO, 2.8V±1%, 300mA, +CE, CL, ICP	USP-4	45vm	VR4	9a	Tor
9XM	XC6223F291GR-G	LVR-IC	LDO, 2.9V±1%, 300mA, +CE, CL, ICP	USP-4	45vm	VR4	9a	Tor
9XN	XC6223F301GR-G	LVR-IC	LDO, 3.0V±1%, 300mA, +CE, CL, ICP	USP-4	45vm	VR4	9a	Tor
9XP	XC6223F311GR-G	LVR-IC	LDO, 3.1V±1%, 300mA, +CE, CL, ICP	USP-4	45vm	VR4	9a	Tor
9XR	XC6223F321GR-G	LVR-IC	LDO, 3.2V±1%, 300mA, +CE, CL, ICP	USP-4	45vm	VR4	9a	Tor
9XS	XC6223F331GR-G	LVR-IC	LDO, 3.3V±1%, 300mA, +CE, CL, ICP	USP-4	45vm	VR4	9a	Tor
9XT	XC6223F341GR-G	LVR-IC	LDO, 3.4V±1%, 300mA, +CE, CL, ICP	USP-4	45vm	VR4	9a	Tor
9XU	XC6223F351GR-G	LVR-IC	LDO, 3.5V±1%, 300mA, +CE, CL, ICP	USP-4	45vm	VR4	9a	Tor
9XV	XC6223F361GR-G	LVR-IC	LDO, 3.6V±1%, 300mA, +CE, CL, ICP	USP-4	45vm	VR4	9a	Tor
9XX	XC6223F371GR-G	LVR-IC	LDO, 3.7V±1%, 300mA, +CE, CL, ICP	USP-4	45vm	VR4	9a	Tor
9XY	XC6223F381GR-G	LVR-IC	LDO, 3.8V±1%, 300mA, +CE, CL, ICP	USP-4	45vm	VR4	9a	Tor
9XZ	XC6223F391GR-G	LVR-IC	LDO, 3.9V±1%, 300mA, +CE, CL, ICP	USP-4	45vm	VR4	9a	Tor
9Y	XC6221A2917R	LVR-IC	LDO, 2.9V±1%, 200mA, +CE	USPN-4	58vm	VR4	9a	Tor
9Y	XC6223B38B9R-G	LVR-IC	LDO, 3.85V±1%, 300mA, +CE, CL	USPQ-4B03	48vm	VR4	9a	Tor
9Y0	XC6223F401GR-G	LVR-IC	LDO, 4.0V±1%, 300mA, +CE, CL, ICP	USP-4	45vm	VR4	9a	Tor
9Z	XC6221A3017R	LVR-IC	LDO, 3V±1%, 200mA, +CE	USPN-4	58vm	VR4	9a	Tor
9Z	XC6223B39B9R-G	LVR-IC	LDO, 3.95V±1%, 300mA, +CE, CL	USPQ-4B03	48vm	VR4	9a	Tor
9Z2	XC6223F12BGR-G	LVR-IC	LDO, 1.25V±20mV, 300mA, +CE, CL, ICP	USP-4	45vm	VR4	9a	Tor
9Z3	XC6223F13BGR-G	LVR-IC	LDO, 1.35V±20mV, 300mA, +CE, CL, ICP	USP-4	45vm	VR4	9a	Tor
9Z4	XC6223F14BGR-G	LVR-IC	LDO, 1.45V±20mV, 300mA, +CE, CL, ICP	USP-4	45vm	VR4	9a	Tor
9Z5	XC6223F15BGR-G	LVR-IC	LDO, 1.55V±20mV, 300mA, +CE, CL, ICP	USP-4	45vm	VR4	9a	Tor
9Z6	XC6223F16BGR-G	LVR-IC	LDO, 1.65V±20mV, 300mA, +CE, CL, ICP	USP-4	45vm	VR4	9a	Tor
9Z7	XC6223F17BGR-G	LVR-IC	LDO, 1.75V±20mV, 300mA, +CE, CL, ICP	USP-4	45vm	VR4	9a	Tor
9Z8	XC6223F18BGR-G	LVR-IC	LDO, 1.85V±20mV, 300mA, +CE, CL, ICP	USP-4	45vm	VR4	9a	Tor
9Z9	XC6223F19BGR-G	LVR-IC	LDO, 1.95V±20mV, 300mA, +CE, CL, ICP	USP-4	45vm	VR4	9a	Tor
9ZA	XC6223F20BGR-G	LVR-IC	LDO, 2.05V±1%, 300mA, +CE, CL, ICP	USP-4	45vm	VR4	9a	Tor
9ZB	XC6223F21BGR-G	LVR-IC	LDO, 2.15V±1%, 300mA, +CE, CL, ICP	USP-4	45vm	VR4	9a	Tor
9ZC	XC6223F22BGR-G	LVR-IC	LDO, 2.25V±1%, 300mA, +CE, CL, ICP	USP-4	45vm	VR4	9a	Tor
9ZD	XC6223F23BGR-G	LVR-IC	LDO, 2.35V±1%, 300mA, +CE, CL, ICP	USP-4	45vm	VR4	9a	Tor
9ZE	XC6223F24BGR-G	LVR-IC	LDO, 2.45V±1%, 300mA, +CE, CL, ICP	USP-4	45vm	VR4	9a	Tor
9ZF	XC6223F25BGR-G	LVR-IC	LDO, 2.55V±1%, 300mA, +CE, CL, ICP	USP-4	45vm	VR4	9a	Tor
9ZH	XC6223F26BGR-G	LVR-IC	LDO, 2.65V±1%, 300mA, +CE, CL, ICP	USP-4	45vm	VR4	9a	Tor
9ZK	XC6223F27BGR-G	LVR-IC	LDO, 2.75V±1%, 300mA, +CE, CL, ICP	USP-4	45vm	VR4	9a	Tor
9ZL	XC6223F28BGR-G	LVR-IC	LDO, 2.85V±1%, 300mA, +CE, CL, ICP	USP-4	45vm	VR4	9a	Tor
9ZM	XC6223F29BGR-G	LVR-IC	LDO, 2.95V±1%, 300mA, +CE, CL, ICP	USP-4	45vm	VR4	9a	Tor
9ZN	XC6223F30BGR-G	LVR-IC	LDO, 3.05V±1%, 300mA, +CE, CL, ICP	USP-4	45vm	VR4	9a	Tor
9ZP	XC6223F31BGR-G	LVR-IC	LDO, 3.15V±1%, 300mA, +CE, CL, ICP	USP-4	45vm	VR4	9a	Tor
9ZR	XC6223F32BGR-G	LVR-IC	LDO, 3.25V±1%, 300mA, +CE, CL, ICP	USP-4	45vm	VR4	9a	Tor
9ZS	XC6223F33BGR-G	LVR-IC	LDO, 3.35V±1%, 300mA, +CE, CL, ICP	USP-4	45vm	VR4	9a	Tor
9ZT	XC6223F34BGR-G	LVR-IC	LDO, 3.45V±1%, 300mA, +CE, CL, ICP	USP-4	45vm	VR4	9a	Tor
9ZU	XC6223F35BGR-G	LVR-IC	LDO, 3.55V±1%, 300mA, +CE, CL, ICP	USP-4	45vm	VR4	9a	Tor
9ZV	XC6223F36BGR-G	LVR-IC	LDO, 3.65V±1%, 300mA, +CE, CL, ICP	USP-4	45vm	VR4	9a	Tor
9ZX	XC6223F37BGR-G	LVR-IC	LDO, 3.75V±1%, 300mA, +CE, CL, ICP	USP-4	45vm	VR4	9a	Tor
9ZY	XC6223F38BGR-G	LVR-IC	LDO, 3.85V±1%, 300mA, +CE, CL, ICP	USP-4	45vm	VR4	9a	Tor
9ZZ	XC6223F39BGR-G	LVR-IC	LDO, 3.95V±1%, 300mA, +CE, CL, ICP	USP-4	45vm	VR4	9a	Tor
A	MAV-11SM	MMIC	RF amplifier, 50MHz..8GHz, 9dB (50Ω)	LLP-X	36aa	A1	9a	Mc
A0	R3118K061A	Vdet-IC	0.6V±22.5mV, -Reset ODO, Sense	DFM1212-6	52z3	VD14	9a	Ric



SMD code	Type	Function	Short description	Case	Pinout	Sch.	St.	Mnf.
A00	74AHC2G00GD	CMOS-Logic	Dual 2-input NAND gates	SOT996-2	54Log50	-	9a	Phi
A04	74AHC3G04GD	CMOS-Logic	Triple inverters	SOT996-2	54Log56	-	9a	Phi
A08	74AHC2G08GD	CMOS-Logic	Dual 2-input AND gates	SOT996-2	54Log51	-	9a	Phi
A1	R3118K071A	Vdet-IC	0.7V±22.5mV, -Reset ODO, Sense	DFN1212-6	52z3	VD14	9a	Ric
A10	CP2210LC	LIN-IC	AF PA, BTL, class-D, 2.5..5.5V, 3W(5V/3Ω), shutdown	BGA-9	39	AFP45	-	Cpm
A10LD	CP2210LQ	LIN-IC	AF PA, BTL, class-D, 2.5..5.5V, 3W(5V/4Ω), shutdown	DFN-8	37	AFP24	-	Cpm
A12	CP2212LC	LIN-IC	AF PA, BTL, class-D, 2.5..5.5V, 2x3W(5V/4Ω), shutdown	BGA-16	39	AFP46	-	Cpm
A12LQ20	CP2212LQ	LIN-IC	AF PA, BTL, class-D, 2.5..5.5V, 2x3W(5V/4Ω), shutdown	QFN-20	38	-	-	Cpm
A15	CP2215LC	LIN-IC	AF PA, BTL, class-D, 2.5..5.5V, 3W(5V/3Ω), shutdown	BGA-9	39	AFP45	-	Cpm
A15	SSM2302CPZ	LIN-IC	AF PA, BTL, class-D, 2.5..5.5V, 2x1.4W(5V/4Ω), shutdown	CP-16	37	-	-	Ad
A15LD	CP2215LQ	LIN-IC	AF PA, BTL, class-D, 2.5..5.5V, 3W(5V/4Ω), shutdown	DFN-8	37	AFP48	-	Cpm
A18	TK71818CB	LVR-IC	LDO, 1.8V±1.5%, 200mA, +CE	FC-5	64be*	VR7	9c	Tok
A1C	SSM2301CPZ	LIN-IC	AF PA, BTL, class-D, 2.5..5.5V, 1.4W(5V/8Ω), shutdown	CP-8-2	37	-	-	Ad
A1G	SSM2311CBZ	LIN-IC	AF PA, BTL, class-D, 2.5..5.5V, 3W(5V/3Ω), shutdown	BGA-9	39	AFP45	-	Ad
a2	74AUP1G3208GF	CMOS-Logic	3-input OR-AND gate	SOT891	52Log46	-	9c	Phi
a2	74AUP1G3208GM	CMOS-Logic	3-input OR-AND gate	SOT-886	57Log46	-	9c	Phi
A2	AUD5999QF08	LIN-IC	AF PA, BTL, 2.7..5.5V, 2W(5V/4Ω), shutdown	LQ-8	77	-	-	Axp
A2	LM4665ITL	LIN-IC	AF PA, BTL, class-D, 2.7..5.5V, 1W(5V/8Ω), shutdown	BGA-9	39	-	-	Nsc
A2	R3118K081A	Vdet-IC	0.8V±22.5mV, -Reset ODO, Sense	DFN1212-6	52z3	VD14	9a	Ric
A2	XC6223C12B9R-G	LVR-IC	LDO, 1.25V±20mV, 300mA, +CE, PDR	USPQ-4B03	48vm	VR4	9a	Tor
A20	APA2010HA	LIN-IC	AF PA, BTL, class-D, 2.7..5.5V, 3W(5V/4Ω), shutdown	BGA-9	39	AFP45	-	Anp
A20	TK71820CB	LVR-IC	LDO, 2V±1.5%, 200mA, +CE	FC-5	64be*	VR7	9c	Tok
A2011	EUA2011J	LIN-IC	AF PA, BTL, class-D, 2.5..5.5V, 3W(5V/4Ω), shutdown	DFN-8	37	AFP24	-	Eut
A2012	EUA2012J	LIN-IC	AF PA, BTL, class-D, 2.7..5.5V, 2.7W(5V/4Ω), shutdown	TQFN-20	38	-	-	Eut
A2014	EUA2014J	LIN-IC	AF PA, BTL, class-D, 2.7..5.5V, 2.5W(5V/4Ω), 3D, shutdown	TQFN-24	38	-	-	Eut
A21	APA2010AHA	LIN-IC	AF PA, BTL, class-D, 2.7..5.5V, 3W(5V/4Ω), shutdown	BGA-9	39	AFP45	-	Anp
A25	74AHC2G125GD	CMOS-Logic	Dual bus buffer with 3-state output	SOT996-2	54Log54	-	9a	Phi
A25	TK71825CB	LVR-IC	LDO, 2.5V±1.5%, 200mA, +CE	FC-5	64be*	VR7	9c	Tok
A2510	EUA2510J	LIN-IC	AF PA, BTL, class-D, 2.7..5.5V, 2.7W(5V/4Ω), shutdown	TDFN-14	37	-	-	Eut
A26	74AHC2G126GD	CMOS-Logic	Dual bus buffer with 3-state output	SOT996-2	54Log55	-	9a	Phi
A27	TK71827CB	LVR-IC	LDO, 2.7V±1.5%, 200mA, +CE	FC-5	64be*	VR7	9c	Tok
A28	TK71828CB	LVR-IC	LDO, 2.8V±1.5%, 200mA, +CE	FC-5	64be*	VR7	9c	Tok
A29	TK71829CB	LVR-IC	LDO, 2.9V±1.5%, 200mA, +CE	FC-5	64be*	VR7	9c	Tok
A2A	NLMD5820M	LIN-IC	AF PA, BTL, class-D, 2.7..5.5V, 2.65W(5V/4Ω), shutdown	DFN-16	37	-	-	Ons
a2P	74AUP2G157GM	CMOS-Logic	2-input multiplexer	SOT902-1	51Log66	-	9a	Phi
a2P	74AUP2G157GT	CMOS-Logic	2-input multiplexer	SOT833-1	53Log66	-	9c	Phi
A3	R3118K091A	Vdet-IC	0.9V±22.5mV, -Reset ODO, Sense	DFN1212-6	52z3	VD14	9a	Ric
A3	XC6223C13B9R-G	LVR-IC	LDO, 1.35V±20mV, 300mA, +CE, PDR	USPQ-4B03	48vm	VR4	9a	Tor
A30	TK71830CB	LVR-IC	LDO, 3V±1.5%, 200mA, +CE	FC-5	64be*	VR7	9c	Tok
A31	TK71831CB	LVR-IC	LDO, 3.1V±1.5%, 200mA, +CE	FC-5	64be*	VR7	9c	Tok
A32	74AHC2G32GD	CMOS-Logic	Dual 2-input OR gates	SOT996-2	54Log52	-	9a	Phi
A33	TK71833CB	LVR-IC	LDO, 3.3V±1.5%, 200mA, +CE	FC-5	64be*	VR7	9c	Tok
a38	74AUP2G38GM	CMOS-Logic	Dual 2-input NAND gate (ODO)	SOT902-1	51Log62	-	9a	Phi
A488AD	AUD4988AD14-4	LIN-IC	AF PA, BTL, 2.7..5.5V, 2x2W(5V/4Ω), shutdown	SOT833-1	53Log62	-	9c	Phi
A488BD	AUD4988BD14-4	LIN-IC	AF PA, BTL, 2.7..5.5V, 2x2W(5V/4Ω), shutdown	SOT891	52Log76	-	9c	Phi
A488CD	AUD4988CD14-4	LIN-IC	AF PA, BTL, 2.7..5.5V, 2x2W(5V/4Ω), shutdown	SOT-886	57Log76	-	9c	Phi
A488DD	AUD4988DD14-4	LIN-IC	AF PA, BTL, 2.7..5.5V, 2x2W(5V/4Ω), shutdown	BGA-36	39	-	-	Nsc
A488ED	AUD4988ED14-4	LIN-IC	AF PA, BTL, 2.7..5.5V, 2x2W(5V/4Ω), shutdown	DFN1212-6	52z3	VD14	9a	Ric
A4980D	AUD4990D10-3	LIN-IC	AF PA, BTL, 2.7..5.5V, 2V(5V/4Ω), select shutdown	USPQ-4B03	48vm	VR4	9a	Tor
A4990D	AUD4990D10-4	LIN-IC	AF PA, BTL, 2.7..5.5V, 2V(5V/4Ω), select shutdown	SOT996-2	54Log60	-	9a	Phi
A4990D	LY8892BB	LIN-IC	AF PA, BTL, 2.7..5.5V, 2W(5V/4Ω), shutdown	DFN-14	37	-	-	Axp
A4991D	AUD4991D10-3	LIN-IC	AF PA, BTL, 2.7..5.5V, 2V(5V/4Ω), select shutdown	DFN-14	37	AFP49	-	Axp
A4992	EUA4992J	LIN-IC	AF PA, BTL, 2.2..5.5V, 2x2.5W(5V/4Ω), shutdown	DFN-10	37	AFP50	-	Axp
A4992D	AUD4992D14-4	LIN-IC	AF PA, BTL, 2.7..5.5V, 2x2W(5V/4Ω), shutdown	TQFN-16	38	-	-	Eut
A4995	EUA4995J	LIN-IC	AF PA, BTL, 2.5..5.5V, 1.36W(5V/4Ω), shutdown	DFN-14	37	-	-	Axp
A4996	EUA4996J	LIN-IC	AF PA, BTL, 2.5..5.5V, 2x2.5W(5V/4Ω), shutdown	TDFN-8	37	AFP22	-	Eut
A5	R3118K111A	Vdet-IC	1.1V±22.5mV, -Reset ODO, Sense	TQFN-16	38	-	-	Eut
A5	XC6223C15B9R-G	LVR-IC	LDO, 1.55V±20mV, 300mA, +CE, PDR	DFN1212-6	52z3	VD14	9a	Ric
A5004	AUD5004D10-3	LIN-IC	AF PA, BTL, 2.7..5.5V, 2W(5V/4Ω), select shutdown	USPQ-4B03	48vm	VR4	9a	Tor
A5006D	AUD5006D14-4	LIN-IC	AF PA, BTL, 2.7..5.5V, 2x2W(5V/4Ω), mute, shutdown	DFN-10	37	-	-	Axp
A5011D	AUD5011D14-4	LIN-IC	AF PA, BTL, 2.7..5.5V, 2x2W(5V/4Ω), shutdown	DFN-14	37	-	-	Axp



SMD code	Type	Function	Short description	Case	Pinout	Sch.	St.Mnf.
A5012Q	AUD5012QF24	LIN-IC	AF PA, BTL, 4.5..5.5V, 2x2W(5V/3Q), shutdown, Up/Dwn volume	QFN-24	38	-	- Axp
A5013	AUD5013D14-4	LIN-IC	AF PA, BTL, 2.7..5.5V, 2x2W(5V/4Q), shutdown	DFN-14	37	-	- Axp
A5020Q	AUD5020QF16	LIN-IC	AF PA, BTL, class-D, 2.7..5.5V, 2.5W(5V/4Q), shutdown	QFN-16	38	-	- Axp
A51	TS4851JT	LIN-IC	AF PA, BTL, 3..5.5V, 1W(5V/8Q)+2x80mW(5V/32Q)	BGA-18	39	-	- Ste
A5980D	AUD5980D14-4	LIN-IC	AF PA, BTL, 2.7..5.5V, 2x2W(5V/4Q), shutdown	DFN-14	37	AFP49	- Axp
A5982Q	AUD5982QF24	LIN-IC	AF PA, BTL, 2.7..5.5V, 2x2W(5V/4Q), shutdown	QFN-24	38	-	- Axp
A5992D	AUD5992D14-4	LIN-IC	AF PA, BTL, 2.7..5.5V, 2x2W(5V/4Q), shutdown	DFN-14	37	-	- Axp
A6	BL6203ITL	LIN-IC	AF PA, BTL, 2.5..5.5V, 1.25W(5V/8Q), shutdown	BGA-8	39	AFP47	- Shb
A6	R3118K121A	Vdet-IC	1.2V±22.5mV, -Reset ODO, Sense	DFN1212-6	52z3	VD14	9a Ric
A6	XC6223C16B9R-G	LVR-IC	LDO, 1.65V±20mV, 300mA, +CE, PDR	USPQ-4B03	48vm	VR4	9a Tor
A6	XPT4990ITL	LIN-IC	AF PA, BTL, 2.5..5.5V, 1.2W(5V/8Q), shutdown	BGA-8	39	AFP44	9m Xpt
A61LQ	CP2261LQ	LIN-IC	AF PA, BTL, 2.5..5.5V, 2x2.8W(5V/3Q), shutdown	QFN-16	38	-	- Cpm
A6201	EUA6201J	LIN-IC	AF PA, BTL, 2.5..5.5V, 1.36W(5V/8Q), shutdown	TDFN-8	37	AFP22	- Eut
A6204	EUA6204J	LIN-IC	AF PA, BTL, 2.5..5.5V, 1.6W(5V/8Q), shutdown	DFN-8	37	AFP22	- Eut
A6G	BL6203GITL	LIN-IC	AF PA, BTL, 2.5..5.5V, 1.25W(5V/8Q), shutdown	BGA-8	39	AFP47	- Shb
A6G	CP2203GITL	LIN-IC	AF PA, BTL, 2.5..5.5V, 1.25W(5V/8Q), shutdown	BGA-8	39	AFP47	- Cpm
a7	74AUP1T57GF	CMOS-Logic	Configurable gate with voltage-level translator	SOT891	52/Log79	-	9c Phi
a7	74AUP1T57GM	CMOS-Logic	Configurable gate with voltage-level translator	SOT-886	57/Log79	-	9c Phi
A7	R3118K131A	Vdet-IC	1.3V±22.5mV, -Reset ODO, Sense	DFN1212-6	52z3	VD14	9a Ric
A7	XC6221A08B7R	LVR-IC	LDO, 0.85V±20mV, 200mA, +CE	USPN-4	58vm	VR4	9a Tor
A7	XC6223C17B9R-G	LVR-IC	LDO, 1.75V±20mV, 300mA, +CE, PDR	USPQ-4B03	48vm	VR4	9a Tor
A72	APA0712HA	LIN-IC	AF PA, BTL, 2.6..5.5V, 1.4W(5V/8Q), shutdown	BGA-9	39	AFP44	- Anp
A73	TS4973JT	LIN-IC	AF PA, BTL, 2.8..5.5V, 1.2W(5V/8Q), shutdown	BGA-9	39	-	- Ste
A74	TS4974IQT	LIN-IC	AF PA, BTL, 2.5..5.5V, 1W(5V/8Q), shutdown	DFN-10	37	-	- Ste
A75	TS4975EJUT	LIN-IC	AF PA, 2.5..5.5V, 2x102mW(5V/16Q), shutdown	BGA-16	39	-	- Ste
a8	74AUP1T58GF	CMOS-Logic	Configurable gate with voltage-level translator	SOT891	52/Log80	-	9c Phi
a8	74AUP1T58GM	CMOS-Logic	Configurable gate with voltage-level translator	SOT-886	57/Log80	-	9c Phi
A8	R3118K141A	Vdet-IC	1.4V±22.5mV, -Reset ODO, Sense	DFN1212-6	52z3	VD14	9a Ric
A8	SH4890ITL	LIN-IC	AF PA, BTL, 2.2..5.5V, 1W(5V/8Q), shutdown	BGA-9	39	AFP44	- Sit
A8	XC6221A09B7R	LVR-IC	LDO, 0.95V±20mV, 200mA, +CE	USPN-4	58vm	VR4	9a Tor
A8	XC6223C18B9R-G	LVR-IC	LDO, 1.85V±20mV, 300mA, +CE, PDR	USPQ-4B03	48vm	VR4	9a Tor
A84	TS4984EJUT	LIN-IC	AF PA, BTL, 2.2..5.5V, 2x1.2W(5V/4Q), shutdown	BGA-15	39	-	- Ste
A84	TS4984FC	LIN-IC	AF PA, BTL, 2.2..5.5V, 2x1.2W(5V/4Q), shutdown	BGA-15	39	-	- Ste
A85	TS4985EJUT	LIN-IC	AF PA, BTL, 2.5..5.5V, 2x1.2W(5V/8Q), shutdown	BGA-15	39	-	- Ste
A8A	XC6108C08AGR	Vdet-IC	0.8V±2%, Hysteresis, -Reset PPO	USP-4	45ro	VD15	9b Tor
A8B	XC6108C08BGR	Vdet-IC	0.8V±2%, -Reset PPO	USP-4	45ro	VD15	9b Tor
A8C	XC6108C08CGR	Vdet-IC	0.8V±2%, Hysteresis, -Reset PPO	USP-4	45m	VD15	9b Tor
A8D	XC6108C08DGR	Vdet-IC	0.8V±2%, -Reset PPO	USP-4	45m	VD15	9b Tor
A8G	CP2290GITL	LIN-IC	AF PA, BTL, 2.5..5.5V, 1.25W(5V/8Q), shutdown	BGA-9	39	AFP44	- Cpm
a9	74AUP1G98GF	CMOS-Logic	Configurable multiple function gate	SOT891	52/Log82	-	9c Phi
a9	74AUP1G98GM	CMOS-Logic	Configurable multiple function gate	SOT-886	57/Log82	-	9c Phi
A9	LM4855ITL	LIN-IC	AF PA, BTL, 2.5..5.5V, 1.1W(4Q)+2x115mW(8Q), SPI	BGA-20	39	-	- Nsc
A9	R3118K151A	Vdet-IC	1.5V±22.5mV, -Reset ODO, Sense	DFN1212-6	52z3	VD14	9a Ric
A9	XC6221A10B7R	LVR-IC	LDO, 1.05V±20mV, 200mA, +CE	USPN-4	58vm	VR4	9a Tor
A9	XC6223C19B9R-G	LVR-IC	LDO, 1.95V±20mV, 300mA, +CE, PDR	USPQ-4B03	48vm	VR4	9a Tor
A90	TS4990IJT	LIN-IC	AF PA, BTL, 2.5..5.5V, 1.2W(5V/8Q), shutdown	BGA-9	39	AFP44	- Ste
A94	TS4994EJUT	LIN-IC	AF PA, BTL, 2.5..5.5V, 1.2W(5V/8Q), select shutdown	BGA-9	39	AFP53	- Ste
A94	TS4994FC	LIN-IC	AF PA, BTL, 2.5..5.5V, 1.2W(5V/8Q), select shutdown	BGA-9	39	AFP53	- Ste
A94	TS4994IJT	LIN-IC	AF PA, BTL, 2.5..5.5V, 1.2W(5V/8Q), select shutdown	BGA-9	39	AFP53	- Ste
A9A	XC6108C09AGR	Vdet-IC	0.9V±2%, Hysteresis, -Reset PPO	USP-4	45ro	VD15	9b Tor
A9B	XC6108C09BGR	Vdet-IC	0.9V±2%, -Reset PPO	USP-4	45ro	VD15	9b Tor
A9C	XC6108C09CGR	Vdet-IC	0.9V±2%, Hysteresis, -Reset PPO	USP-4	45m	VD15	9b Tor
A9D	XC6108C09DGR	Vdet-IC	0.9V±2%, -Reset PPO	USP-4	45m	VD15	9b Tor
aA	74AUP2G34GF	CMOS-Logic	Dual non-inverter buffers	SOT891	52/Log23	-	9c Phi
aA	74AUP2G34GM	CMOS-Logic	Dual non-inverter buffers	SOT-886	57/Log23	-	9c Phi
AA	LY8010CL	LIN-IC	AF PA, BTL, class-D, 2.7..5.5V, 3W(5V/4Q), shutdown	BGA-9	39	AFP45	- Ltk
AA	LY8210CL	LIN-IC	AF PA, BTL, class-D, 2.7..5.5V, 2x2.5W(5V/4Q), separate shutdown	BGA-18	39	-	- Ltk
AA	RP104K121B	LVR-IC	LDO, 1.2V±0.8%, 150mA, +CE	DFN1010-4	48vm	VR4	9a Ric
AA	RP105K061B	LVR-IC	LDO, 0.6V±15mV, 400mA, +CE	DFN1212-6	52zd	VR11	9a Ric
AA	XC6221A11B7R	LVR-IC	LDO, 1.15V±20mV, 200mA, +CE	USPN-4	58vm	VR4	9a Tor
AA	XC6223C20B9R-G	LVR-IC	LDO, 2.05V±1%, 300mA, +CE, PDR	USPQ-4B03	48vm	VR4	9a Tor
AA-	RT9013-12PQV	LVR-IC	LDO, 1.2V±2%, 500mA, +CE	WDFN-8	49	VR4	9a Rct
AA01	RP150K001B	LVR-IC	LDO, LN, Dual out, Vout1/Vout2=2.85V/2.85V±1%, 300mA, +CE, CL	PLP2020-8	37yv	VR19	9b Ric
AA02	RP150K002B	LVR-IC	LDO, LN, Dual out, Vout1/Vout2=3V/3V±1%, 300mA, +CE, CL	PLP2020-8	37yv	VR19	9b Ric
AA03	RP150K003B	LVR-IC	LDO, LN, Dual out, Vout1/Vout2=3.3V/3.3V±1%, 300mA, +CE, CL	PLP2020-8	37yv	VR19	9b Ric
AA04	RP150K004B	LVR-IC	LDO, LN, Dual out, Vout1/Vout2=2.5V/1.8V±1%, 300mA, +CE, CL	PLP2020-8	37yv	VR19	9b Ric
AA05	RP150K005B	LVR-IC	LDO, LN, Dual out, Vout1/Vout2=2.8V/2.6V±1%, 300mA, +CE, CL	PLP2020-8	37yv	VR19	9b Ric
AA06	RP150K006B	LVR-IC	LDO, LN, Dual out, Vout1/Vout2=1.5V/2.6V±1%, 300mA, +CE, CL	PLP2020-8	37yv	VR19	9b Ric
AA07	RP150K007B	LVR-IC	LDO, LN, Dual out, Vout1/Vout2=3.3V/1.8V±1%, 300mA, +CE, CL	PLP2020-8	37yv	VR19	9b Ric
AA08	RP150K008B	LVR-IC	LDO, LN, Dual out, Vout1/Vout2=1.8V/2.8V±1%, 300mA, +CE, CL	PLP2020-8	37yv	VR19	9b Ric



SMD code	Type	Function	Short description	Case	Pinout	Sch.	St.Mnf.
AA642	XC6113A642ER	Vdet-IC	4.2V±2%, -MR, +Reset PPO, Wt=1.6s, Rt=3.13ms	USP-6C	49xh	VD17	9b Tor
AA643	XC6113A643ER	Vdet-IC	4.3V±2%, -MR, +Reset PPO, Wt=1.6s, Rt=3.13ms	USP-6C	49xh	VD17	9b Tor
AA644	XC6113A644ER	Vdet-IC	4.4V±2%, -MR, +Reset PPO, Wt=1.6s, Rt=3.13ms	USP-6C	49xh	VD17	9b Tor
AA645	XC6113A645ER	Vdet-IC	4.5V±2%, -MR, +Reset PPO, Wt=1.6s, Rt=3.13ms	USP-6C	49xh	VD17	9b Tor
AA646	XC6113A646ER	Vdet-IC	4.6V±2%, -MR, +Reset PPO, Wt=1.6s, Rt=3.13ms	USP-6C	49xh	VD17	9b Tor
AA647	XC6113A647ER	Vdet-IC	4.7V±2%, -MR, +Reset PPO, Wt=1.6s, Rt=3.13ms	USP-6C	49xh	VD17	9b Tor
AA648	XC6113A648ER	Vdet-IC	4.8V±2%, -MR, +Reset PPO, Wt=1.6s, Rt=3.13ms	USP-6C	49xh	VD17	9b Tor
AA649	XC6113A649ER	Vdet-IC	4.9V±2%, -MR, +Reset PPO, Wt=1.6s, Rt=3.13ms	USP-6C	49xh	VD17	9b Tor
AA650	XC6113A650ER	Vdet-IC	5.0V±2%, -MR, +Reset PPO, Wt=1.6s, Rt=3.13ms	USP-6C	49xh	VD17	9b Tor
AAA	MAX4368ETA	LIN-IC	AF PA, BTL, 2.3..5.5V, 330mW(5V/32Q), shutdown	DFN-8	37	AFP27	9m Max
AAA	MAX98303EWE+	LIN-IC	AF PA, BTL, class-D, 2.7..5.5V, 2x3.1W(5V/4Q), shutdown	BGA-16	39	-	9m Max
AAB	MAX4367ETA	LIN-IC	AF PA, BTL, 2.3..5.5V, 330mW(5V/32Q), shutdown	DFN-8	37	AFP27	9m Max
AAC	MAX4366ETA	LIN-IC	AF PA, BTL, 2.3..5.5V, 330mW(5V/32Q), shutdown	DFN-8	37	AFP12	9m Max
AACB	MAX9711ETC	LIN-IC	AF PA, BTL, 4.5..5.5V, 3W(5V/4Q), shutdown	QFN-12	38	-	9m Max
AADI	TPA6203A1GQV	LIN-IC	AF PA, BTL, 2.5..5.5V, 1.25W(5V/8Q), shutdown	BGA-8	39	AFP47	- Ti
AADZ	MAX9721AETC	LIN-IC	AF PA, 0.9..1.8V, 2x20mW(1.9V/32Q), shutdown	QFN-12	38	AFP58	9m Max
AAEA	MAX9721BETC	LIN-IC	AF PA, 0.9..1.8V, 2x20mW(1.9V/32Q), shutdown	QFN-12	38	AFP58	9m Max
AAEB	MAX9721CETC	LIN-IC	AF PA, 0.9..1.8V, 2x20mW(1.9V/32Q), shutdown	QFN-12	38	AFP58	9m Max
AAEI	TPA6203A1ZQV	LIN-IC	AF PA, BTL, 2.5..5.5V, 1.25W(5V/8Q), shutdown	BGA-8	39	AFP47	- Ti
AAEW	MAX9725AETC	LIN-IC	AF PA, 0.9..1.8V, 2x20mW(1.9V/32Q), shutdown	QFN-12	38	AFP58	9m Max
AAEX	MAX9725BETC	LIN-IC	AF PA, 0.9..1.8V, 2x20mW(1.9V/32Q), shutdown	QFN-12	38	AFP58	9m Max
AAEY	MAX9725CETC	LIN-IC	AF PA, 0.9..1.8V, 2x20mW(1.9V/32Q), shutdown	QFN-12	38	AFP58	9m Max
AAEZ	MAX9725DET	LIN-IC	AF PA, 0.9..1.8V, 2x20mW(1.9V/32Q), shutdown	QFN-12	38	AFP58	9m Max
AAFI	TPA2005D1ZQY	LIN-IC	AF PA, BTL, class-D, 2.5..5.5V, 1.4W(5V/8Q), shutdown	BGA-15	39	-	- Ti
AAG	BL6211TLX	LIN-IC	AF PA, BTL, 2.5..5.5V, 1.25W(5V/8Q), shutdown	BGA-9	39	AFP51	- Shb
AAG	CP2296GITL	LIN-IC	AF PA, BTL, 2.5..5.5V, 1.25W(5V/8Q), shutdown	BGA-9	39	AFP51	- Cpm
AAGW	MAX9711ETC/V	LIN-IC	AF PA, BTL, 4.5..5.5V, 3W(5V/4Q), shutdown	QFN-12	38	-	9m Max
AAI	MAX9712ETB	LIN-IC	AF PA, BTL, class-D, 2.2..5.5V, 500mW(5V/8Q), shutdown	DFN-10	37	AFP55	9m Max
AAK	MAX4368EBL-T	LIN-IC	AF PA, BTL, 2.3..5.5V, 330mW(5V/32Q), shutdown	BGA-8	39	AFP44	9m Max
AAK	MAX6410BS33-T	Vdet-IC	3.3V±1.5%, -MR, +Reset PPO	UCSP-4	63bd*	VD5	9a Max
AAL	MAX4367EBL-T	LIN-IC	AF PA, BTL, 2.3..5.5V, 330mW(5V/32Q), shutdown	BGA-8	39	-	9m Max
AAL	MAX6410BS34-T	Vdet-IC	3.4V±1.5%, -MR, +Reset PPO	UCSP-4	63bd*	VD5	9a Max
AAM	MAX4368EBL-T	LIN-IC	AF PA, BTL, 2.3..5.5V, 330mW(5V/32Q), shutdown	BGA-8	39	-	9m Max
AAM	MAX6410BS35-T	Vdet-IC	3.5V±1.5%, -MR, +Reset PPO	UCSP-4	63bd*	VD5	9a Max
AAN	MAX4369EBL-T	LIN-IC	AF PA, BTL, 2.3..5.5V 2x120mW(5V/16Q)	BGA-9	39	-	9m Max
AAN	MAX6410BS36-T	Vdet-IC	3.6V±1.5%, -MR, +Reset PPO	UCSP-4	63bd*	VD5	9a Max
AAI	TPA6205A1ZQV	LIN-IC	AF PA, BTL, 2.5..5.5V, 1.25W(5V/8Q), shutdown	BGA-8	39	AFP47	- Ti
AAO	MAX6410BS37-T	Vdet-IC	3.7V±1.5%, -MR, +Reset PPO	UCSP-4	63bd*	VD5	9a Max
AAOI	TPA6205A1DRB	LIN-IC	AF PA, BTL, 2.5..5.5V, 1.25W(5V/8Q), shutdown	DFN-8	37	-	- Ti
AAI	MAX6410BS38-T	Vdet-IC	3.8V±1.5%, -MR, +Reset PPO	UCSP-4	63bd*	VD5	9a Max
AAQ	MAX6410BS39-T	Vdet-IC	3.9V±1.5%, -MR, +Reset PPO	UCSP-4	63bd*	VD5	9a Max
AAR	MAX6410BS40-T	Vdet-IC	4.0V±1.5%, -MR, +Reset PPO	UCSP-4	63bd*	VD5	9a Max
AAS	MAX6410BS41-T	Vdet-IC	4.1V±1.5%, -MR, +Reset PPO	UCSP-4	63bd*	VD5	9a Max
AAT	MAX6410BS42-T	Vdet-IC	4.2V±1.5%, -MR, +Reset PPO	UCSP-4	63bd*	VD5	9a Max
AAT	MAX9728AETC+	LIN-IC	AF PA, 4.5..5.5V, 2x60mW(5V/32Q), shutdown	QFN-12	38	-	9m Max
AAU	MAX6410BS43-T	Vdet-IC	4.3V±1.5%, -MR, +Reset PPO	UCSP-4	63bd*	VD5	9a Max
AAU	MAX9728BETC+	LIN-IC	AF PA, 4.5..5.5V, 2x60mW(5V/32Q), shutdown	QFN-12	38	-	9m Max
AAV	MAX6410BS44-T	Vdet-IC	4.4V±1.5%, -MR, +Reset PPO	UCSP-4	63bd*	VD5	9a Max
AAV	MAX9718AETB	LIN-IC	AF PA, BTL, 2.2..5.5V, 1.1W(5V/8Q), select shutdown	DFN-10	37	AFP19	9m Max
AAW	MAX6410BS45-T	Vdet-IC	4.5V±1.5%, -MR, +Reset PPO	UCSP-4	63bd*	VD5	9a Max
AAW	MAX9718BETB	LIN-IC	AF PA, BTL, 2.7..5.5V 1.4W(5V/4Q), select shutdown	DFN-10	37	AFP20	9m Max
AAX	MAX6410BS46-T	Vdet-IC	4.6V±1.5%, -MR, +Reset PPO	UCSP-4	63bd*	VD5	9a Max
AAX	MAX9718CETB	LIN-IC	AF PA, BTL, 2.7..5.5V 1.4W(5V/4Q), select shutdown	DFN-10	37	AFP20	9m Max
AAX	MAX9722AETE	LIN-IC	AF PA, 2.4..5.5V, 2x125mW(3V/32Q), shutdown	QFN-16	38	-	9m Max
AAZ	MAX6411BS33-T	Vdet-IC	3.3V±1.5%, -MR, -Reset ODO	UCSP-4	63bd*	VD4	9a Max
AAZ	MAX9718DET	LIN-IC	AF PA, BTL, 2.7..5.5V 1.4W(5V/4Q), select shutdown	DFN-10	37	AFP20	9m Max
AAZ	MAX9722BETE	LIN-IC	AF PA, 2.4..5.5V, 2x125mW(3V/32Q), shutdown	QFN-16	38	-	9m Max
AAZ	MAX6411BS34-T	Vdet-IC	3.4V±1.5%, -MR, -Reset ODO	UCSP-4	63bd*	VD4	9a Max
aB	74AUP1G38GF	CMOS-Logic	2-input NAND gate (ODO)	SOT891	52L	Log17	- 9c Phi
aB	74AUP1G38GM	CMOS-Logic	2-input NAND gate (ODO)	SOT-886	57L	Log17	- 9c Phi
AB	RP104K131B	LVR-IC	LDO, 1.3V±0.8%, 150mA, +CE	DFN1010-4	48vm	VR4	9a Ric
AB	RP105K071B	LVR-IC	LDO, 0.7V±15mV, 400mA, +CE	DFN1212-6	52zd	VR11	9a Ric
AB	XC6221A12B7R	LVR-IC	LDO, 1.25V±20mV, 200mA, +CE	USPN-4	58vm	VR4	9a Tor
AB	XC6223C21B9R-G	LVR-IC	LDO, 2.15V±1%, 300mA, +CE, PDR	USPQ-4B03	48vm	VR4	9a Tor
AB01	RP151K001B	LVR/Vdet-IC	LDO, Dual out, Vout1/Vout2=2.8V/2.8V±1%, 300mA, +CE, Vdet	DFN2020-8	75	-	9b Ric
AB02	RP151K002B	LVR/Vdet-IC	LDO, Dual out, Vout1/Vout2=2.8V/1.8V±1%, 300mA, +CE, Vdet	DFN2020-8	75	-	9b Ric
AB05	RP151K005B	LVR/Vdet-IC	LDO, Dual out, Vout1/Vout2=3.0V/2.8V±1%, 300mA, +CE, Vdet	DFN2020-8	75	-	9b Ric
AB06	RP151K006B	LVR/Vdet-IC	LDO, Dual out, Vout1/Vout2=1.5V/3.3V±1%, 300mA, +CE, Vdet	DFN2020-8	75	-	9b Ric
AB216	XC6113B216ER	Vdet-IC	1.6V±2%, -MR, +Reset PPO, Wt=50ms, Rt=25ms	USP-6C	49xh	VD17	9b Tor
AB217	XC6113B217ER	Vdet-IC	1.7V±2%, -MR, +Reset PPO, Wt=50ms, Rt=25ms	USP-6C	49xh	VD17	9b Tor



SMD code	Type	Function	Short description	Case	Pinout	Sch.	St.	Mnf.
AB618	XC6113B618ER	Vdet-IC	1.8V±2%, -MR, +Reset PPO, Wt=1.6s, Rt=25ms	USP-6C	49xh	VD17	9b	Tor
AB619	XC6113B619ER	Vdet-IC	1.9V±2%, -MR, +Reset PPO, Wt=1.6s, Rt=25ms	USP-6C	49xh	VD17	9b	Tor
AB620	XC6113B620ER	Vdet-IC	2.0V±2%, -MR, +Reset PPO, Wt=1.6s, Rt=25ms	USP-6C	49xh	VD17	9b	Tor
AB621	XC6113B621ER	Vdet-IC	2.1V±2%, -MR, +Reset PPO, Wt=1.6s, Rt=25ms	USP-6C	49xh	VD17	9b	Tor
AB622	XC6113B622ER	Vdet-IC	2.2V±2%, -MR, +Reset PPO, Wt=1.6s, Rt=25ms	USP-6C	49xh	VD17	9b	Tor
AB623	XC6113B623ER	Vdet-IC	2.3V±2%, -MR, +Reset PPO, Wt=1.6s, Rt=25ms	USP-6C	49xh	VD17	9b	Tor
AB624	XC6113B624ER	Vdet-IC	2.4V±2%, -MR, +Reset PPO, Wt=1.6s, Rt=25ms	USP-6C	49xh	VD17	9b	Tor
AB625	XC6113B625ER	Vdet-IC	2.5V±2%, -MR, +Reset PPO, Wt=1.6s, Rt=25ms	USP-6C	49xh	VD17	9b	Tor
AB626	XC6113B626ER	Vdet-IC	2.6V±2%, -MR, +Reset PPO, Wt=1.6s, Rt=25ms	USP-6C	49xh	VD17	9b	Tor
AB627	XC6113B627ER	Vdet-IC	2.7V±2%, -MR, +Reset PPO, Wt=1.6s, Rt=25ms	USP-6C	49xh	VD17	9b	Tor
AB628	XC6113B628ER	Vdet-IC	2.8V±2%, -MR, +Reset PPO, Wt=1.6s, Rt=25ms	USP-6C	49xh	VD17	9b	Tor
AB629	XC6113B629ER	Vdet-IC	2.9V±2%, -MR, +Reset PPO, Wt=1.6s, Rt=25ms	USP-6C	49xh	VD17	9b	Tor
AB630	XC6113B630ER	Vdet-IC	3.0V±2%, -MR, +Reset PPO, Wt=1.6s, Rt=25ms	USP-6C	49xh	VD17	9b	Tor
AB631	XC6113B631ER	Vdet-IC	3.1V±2%, -MR, +Reset PPO, Wt=1.6s, Rt=25ms	USP-6C	49xh	VD17	9b	Tor
AB632	XC6113B632ER	Vdet-IC	3.2V±2%, -MR, +Reset PPO, Wt=1.6s, Rt=25ms	USP-6C	49xh	VD17	9b	Tor
AB633	XC6113B633ER	Vdet-IC	3.3V±2%, -MR, +Reset PPO, Wt=1.6s, Rt=25ms	USP-6C	49xh	VD17	9b	Tor
AB634	XC6113B634ER	Vdet-IC	3.4V±2%, -MR, +Reset PPO, Wt=1.6s, Rt=25ms	USP-6C	49xh	VD17	9b	Tor
AB635	XC6113B635ER	Vdet-IC	3.5V±2%, -MR, +Reset PPO, Wt=1.6s, Rt=25ms	USP-6C	49xh	VD17	9b	Tor
AB636	XC6113B636ER	Vdet-IC	3.6V±2%, -MR, +Reset PPO, Wt=1.6s, Rt=25ms	USP-6C	49xh	VD17	9b	Tor
AB637	XC6113B637ER	Vdet-IC	3.7V±2%, -MR, +Reset PPO, Wt=1.6s, Rt=25ms	USP-6C	49xh	VD17	9b	Tor
AB638	XC6113B638ER	Vdet-IC	3.8V±2%, -MR, +Reset PPO, Wt=1.6s, Rt=25ms	USP-6C	49xh	VD17	9b	Tor
AB639	XC6113B639ER	Vdet-IC	3.9V±2%, -MR, +Reset PPO, Wt=1.6s, Rt=25ms	USP-6C	49xh	VD17	9b	Tor
AB640	XC6113B640ER	Vdet-IC	4.0V±2%, -MR, +Reset PPO, Wt=1.6s, Rt=25ms	USP-6C	49xh	VD17	9b	Tor
AB641	XC6113B641ER	Vdet-IC	4.1V±2%, -MR, +Reset PPO, Wt=1.6s, Rt=25ms	USP-6C	49xh	VD17	9b	Tor
AB642	XC6113B642ER	Vdet-IC	4.2V±2%, -MR, +Reset PPO, Wt=1.6s, Rt=25ms	USP-6C	49xh	VD17	9b	Tor
AB643	XC6113B643ER	Vdet-IC	4.3V±2%, -MR, +Reset PPO, Wt=1.6s, Rt=25ms	USP-6C	49xh	VD17	9b	Tor
AB644	XC6113B644ER	Vdet-IC	4.4V±2%, -MR, +Reset PPO, Wt=1.6s, Rt=25ms	USP-6C	49xh	VD17	9b	Tor
AB645	XC6113B645ER	Vdet-IC	4.5V±2%, -MR, +Reset PPO, Wt=1.6s, Rt=25ms	USP-6C	49xh	VD17	9b	Tor
AB646	XC6113B646ER	Vdet-IC	4.6V±2%, -MR, +Reset PPO, Wt=1.6s, Rt=25ms	USP-6C	49xh	VD17	9b	Tor
AB647	XC6113B647ER	Vdet-IC	4.7V±2%, -MR, +Reset PPO, Wt=1.6s, Rt=25ms	USP-6C	49xh	VD17	9b	Tor
AB648	XC6113B648ER	Vdet-IC	4.8V±2%, -MR, +Reset PPO, Wt=1.6s, Rt=25ms	USP-6C	49xh	VD17	9b	Tor
AB649	XC6113B649ER	Vdet-IC	4.9V±2%, -MR, +Reset PPO, Wt=1.6s, Rt=25ms	USP-6C	49xh	VD17	9b	Tor
AB650	XC6113B650ER	Vdet-IC	5.0V±2%, -MR, +Reset PPO, Wt=1.6s, Rt=25ms	USP-6C	49xh	VD17	9b	Tor
ABA	MAX6411BS35-T	Vdet-IC	3.5V±1.5%, -MR, -Reset ODO	UCSP-4	63bd*	VD4	9a	Max
ABB	MAX6411BS36-T	Vdet-IC	3.6V±1.5%, -MR, -Reset ODO	UCSP-4	63bd*	VD4	9a	Max
ABC	MAX6411BS37-T	Vdet-IC	3.7V±1.5%, -MR, -Reset ODO	UCSP-4	63bd*	VD4	9a	Max
ABD	MAX6411BS38-T	Vdet-IC	3.8V±1.5%, -MR, -Reset ODO	UCSP-4	63bd*	VD4	9a	Max
ABE	MAX6411BS39-T	Vdet-IC	3.9V±1.5%, -MR, -Reset ODO	UCSP-4	63bd*	VD4	9a	Max
ABF	MAX6411BS40-T	Vdet-IC	4.0V±1.5%, -MR, -Reset ODO	UCSP-4	63bd*	VD4	9a	Max
ABF	MAX97200AEWC+	LIN-IC	AF PA, 1.6 2V, 2x45mW(16Q), shutdown	BGA-12	39	-	9m	Max
ABG	MAX6411BS41-T	Vdet-IC	4.1V±1.5%, -MR, -Reset ODO	UCSP-4	63bd*	VD4	9a	Max
ABG	MAX6477BL18AD3	LVR/Vdet-IC	LDO, 1.8V±1.3%, 300mA, -Reset PPO, Set, +CE	BGA-6	40	-	9m	Max
ABG	MAX97200BEWC+	LIN-IC	AF PA, 1.6 2V, 2x45mW(16Q), shutdown	BGA-12	39	-	9m	Max
ABH	MAX6411BS42-T	Vdet-IC	4.2V±1.5%, -MR, -Reset ODO	UCSP-4	63bd*	VD4	9a	Max
ABH	MAX6478BL28BD3	LVR/Vdet-IC	LDO, 2.8V±1.3%, 300mA, -Reset ODO, Set, +CE	BGA-6	40	-	9m	Max
ABI	MAX6411BS43-T	Vdet-IC	4.3V±1.5%, -MR, -Reset ODO	UCSP-4	63bd*	VD4	9a	Max
ABI	MAX6479BL15BD2	LVR/Vdet-IC	LDO, 1.5V±1.3%, 300mA, -Reset PPO, Set, -MR	BGA-6	40	-	9m	Max
ABJ	MAX6411BS44-T	Vdet-IC	4.4V±1.5%, -MR, -Reset ODO	UCSP-4	63bd*	VD4	9a	Max
ABJ	MAX6480BL33AD3	LVR/Vdet-IC	LDO, 3.3V±1.3%, 300mA, -Reset ODO, Set, -MR	BGA-6	40	-	9m	Max
ABK	MAX6411BS45-T	Vdet-IC	4.5V±1.5%, -MR, -Reset ODO	UCSP-4	63bd*	VD4	9a	Max
ABK	MAX6481BL30BD4	LVR/Vdet-IC	LDO, 3.0V±1.3%, 300mA, -Reset PPO, -MR, +CE	BGA-6	40	-	9m	Max
ABL	MAX6411BS46-T	Vdet-IC	4.6V±1.5%, -MR, -Reset ODO	UCSP-4	63bd*	VD4	9a	Max
ABL	MAX6482BL18BD3	LVR/Vdet-IC	LDO, 1.8V±1.3%, 300mA, -Reset ODO, -MR, +CE	BGA-6	40	-	9m	Max
ABM	MAX6483BL25AD1	LVR/Vdet-IC	LDO, 2.5V±1.3%, 300mA, -Reset PPO, FB, +CE	BGA-6	40	-	9m	Max
ABN	MAX6484BL33BD3	LVR/Vdet-IC	LDO, 3.3V±1.3%, 300mA, -Reset ODO, FB, +CE	BGA-6	40	-	9m	Max
ABN	MAX9712EBC-T	LIN-IC	AF PA, BTL, class-D, 2.2 5.5V, 500mW(5V/8Q), shutdown	BGA-10	39	AFP56	9m	Max
ABP	MAX9721AEBC+T	LIN-IC	AF PA, 0.9 1.8V, 2x20mW(1.9V/32Q), shutdown	BGA-12	39	AFP57	9m	Max
ABQ	MAX9721BEBC+T	LIN-IC	AF PA, 0.9 1.8V, 2x20mW(1.5V/32Q), shutdown	BGA-12	39	AFP57	9m	Max
ABR	MAX9721CEBC+T	LIN-IC	AF PA, 0.9 1.8V, 2x20mW(1.5V/32Q), shutdown	BGA-12	39	AFP57	9m	Max
ABW	MAX6477BL15BD3	LVR/Vdet-IC	LDO, 1.5V±1.3%, 300mA, -Reset PPO, Set, +CE	BGA-6	40	-	9m	Max
ABX	MAX6477BL25BD3	LVR/Vdet-IC	LDO, 2.5V±1.3%, 300mA, -Reset PPO, Set, +CE	BGA-6	40	-	9m	Max
ABY	MAX6477BL28AD3	LVR/Vdet-IC	LDO, 2.8V±1.3%, 300mA, -Reset PPO, Set, +CE	BGA-6	40	-	9m	Max
ABZ	MAX6477BL30BD3	LVR/Vdet-IC	LDO, 3.0V±1.3%, 300mA, -Reset PPO, Set, +CE	BGA-6	40	-	9m	Max
aC	74AUP1G57GF	CMOS-Logic	Configurable multiple-function gate	SOT891	52LLog36	-	9c	Phi
aC	74AUP1G57GM	CMOS-Logic	Configurable multiple-function gate	SOT-886	57LLog36	-	9c	Phi
AC	RP104K151B	LVR-IC	LDO, 1.5V±0.8%, 150mA, +CE	DFN10101-4	48vm	VR4	9a	Ric
AC	RP105K081B	LVR-IC	LDO, 0.8V±15mV, 400mA, +CE	DFN1212-6	52zd	VR11	9a	Ric
AC	RT9013B-18PQWA	LVR-IC	LDO, 1.8V±2%, 500mA, +CE	WDFN-6	49xu	VR4	9a	Rct
AC	XC6221A13B7R	LVR-IC	LDO, 1.35V±20mV, 200mA, +CE	USPN-4	58vm	VR4	9a	Tor
AC	XC6223C22B9R-G	LVR-IC	LDO, 2.25V±1%, 300mA, +CE, PDR	USPQ-4B03	48vm	VR4	9a	Tor



SMD code	Type	Function	Short description	Case	Pinout	Sch.	St.	Mnf.
AC540	XC6113C540ER	Vdet-IC	4.0V±2%, -MR, +Reset PPO, Wt=400ms, Rt=50ms	USP-6C	49xh	VD17	9b	Tor
AC541	XC6113C541ER	Vdet-IC	4.1V±2%, -MR, +Reset PPO, Wt=400ms, Rt=50ms	USP-6C	49xh	VD17	9b	Tor
AC542	XC6113C542ER	Vdet-IC	4.2V±2%, -MR, +Reset PPO, Wt=400ms, Rt=50ms	USP-6C	49xh	VD17	9b	Tor
AC543	XC6113C543ER	Vdet-IC	4.3V±2%, -MR, +Reset PPO, Wt=400ms, Rt=50ms	USP-6C	49xh	VD17	9b	Tor
AC544	XC6113C544ER	Vdet-IC	4.4V±2%, -MR, +Reset PPO, Wt=400ms, Rt=50ms	USP-6C	49xh	VD17	9b	Tor
AC545	XC6113C545ER	Vdet-IC	4.5V±2%, -MR, +Reset PPO, Wt=400ms, Rt=50ms	USP-6C	49xh	VD17	9b	Tor
AC546	XC6113C546ER	Vdet-IC	4.6V±2%, -MR, +Reset PPO, Wt=400ms, Rt=50ms	USP-6C	49xh	VD17	9b	Tor
AC547	XC6113C547ER	Vdet-IC	4.7V±2%, -MR, +Reset PPO, Wt=400ms, Rt=50ms	USP-6C	49xh	VD17	9b	Tor
AC548	XC6113C548ER	Vdet-IC	4.8V±2%, -MR, +Reset PPO, Wt=400ms, Rt=50ms	USP-6C	49xh	VD17	9b	Tor
AC549	XC6113C549ER	Vdet-IC	4.9V±2%, -MR, +Reset PPO, Wt=400ms, Rt=50ms	USP-6C	49xh	VD17	9b	Tor
AC550	XC6113C550ER	Vdet-IC	5.0V±2%, -MR, +Reset PPO, Wt=400ms, Rt=50ms	USP-6C	49xh	VD17	9b	Tor
AC616	XC6113C616ER	Vdet-IC	1.6V±2%, -MR, +Reset PPO, Wt=1.6s, Rt=50ms	USP-6C	49xh	VD17	9b	Tor
AC617	XC6113C617ER	Vdet-IC	1.7V±2%, -MR, +Reset PPO, Wt=1.6s, Rt=50ms	USP-6C	49xh	VD17	9b	Tor
AC618	XC6113C618ER	Vdet-IC	1.8V±2%, -MR, +Reset PPO, Wt=1.6s, Rt=50ms	USP-6C	49xh	VD17	9b	Tor
AC619	XC6113C619ER	Vdet-IC	1.9V±2%, -MR, +Reset PPO, Wt=1.6s, Rt=50ms	USP-6C	49xh	VD17	9b	Tor
AC620	XC6113C620ER	Vdet-IC	2.0V±2%, -MR, +Reset PPO, Wt=1.6s, Rt=50ms	USP-6C	49xh	VD17	9b	Tor
AC621	XC6113C621ER	Vdet-IC	2.1V±2%, -MR, +Reset PPO, Wt=1.6s, Rt=50ms	USP-6C	49xh	VD17	9b	Tor
AC622	XC6113C622ER	Vdet-IC	2.2V±2%, -MR, +Reset PPO, Wt=1.6s, Rt=50ms	USP-6C	49xh	VD17	9b	Tor
AC623	XC6113C623ER	Vdet-IC	2.3V±2%, -MR, +Reset PPO, Wt=1.6s, Rt=50ms	USP-6C	49xh	VD17	9b	Tor
AC624	XC6113C624ER	Vdet-IC	2.4V±2%, -MR, +Reset PPO, Wt=1.6s, Rt=50ms	USP-6C	49xh	VD17	9b	Tor
AC625	XC6113C625ER	Vdet-IC	2.5V±2%, -MR, +Reset PPO, Wt=1.6s, Rt=50ms	USP-6C	49xh	VD17	9b	Tor
AC626	XC6113C626ER	Vdet-IC	2.6V±2%, -MR, +Reset PPO, Wt=1.6s, Rt=50ms	USP-6C	49xh	VD17	9b	Tor
AC627	XC6113C627ER	Vdet-IC	2.7V±2%, -MR, +Reset PPO, Wt=1.6s, Rt=50ms	USP-6C	49xh	VD17	9b	Tor
AC628	XC6113C628ER	Vdet-IC	2.8V±2%, -MR, +Reset PPO, Wt=1.6s, Rt=50ms	USP-6C	49xh	VD17	9b	Tor
AC629	XC6113C629ER	Vdet-IC	2.9V±2%, -MR, +Reset PPO, Wt=1.6s, Rt=50ms	USP-6C	49xh	VD17	9b	Tor
AC630	XC6113C630ER	Vdet-IC	3.0V±2%, -MR, +Reset PPO, Wt=1.6s, Rt=50ms	USP-6C	49xh	VD17	9b	Tor
AC631	XC6113C631ER	Vdet-IC	3.1V±2%, -MR, +Reset PPO, Wt=1.6s, Rt=50ms	USP-6C	49xh	VD17	9b	Tor
AC632	XC6113C632ER	Vdet-IC	3.2V±2%, -MR, +Reset PPO, Wt=1.6s, Rt=50ms	USP-6C	49xh	VD17	9b	Tor
AC633	XC6113C633ER	Vdet-IC	3.3V±2%, -MR, +Reset PPO, Wt=1.6s, Rt=50ms	USP-6C	49xh	VD17	9b	Tor
AC634	XC6113C634ER	Vdet-IC	3.4V±2%, -MR, +Reset PPO, Wt=1.6s, Rt=50ms	USP-6C	49xh	VD17	9b	Tor
AC635	XC6113C635ER	Vdet-IC	3.5V±2%, -MR, +Reset PPO, Wt=1.6s, Rt=50ms	USP-6C	49xh	VD17	9b	Tor
AC636	XC6113C636ER	Vdet-IC	3.6V±2%, -MR, +Reset PPO, Wt=1.6s, Rt=50ms	USP-6C	49xh	VD17	9b	Tor
AC637	XC6113C637ER	Vdet-IC	3.7V±2%, -MR, +Reset PPO, Wt=1.6s, Rt=50ms	USP-6C	49xh	VD17	9b	Tor
AC638	XC6113C638ER	Vdet-IC	3.8V±2%, -MR, +Reset PPO, Wt=1.6s, Rt=50ms	USP-6C	49xh	VD17	9b	Tor
AC639	XC6113C639ER	Vdet-IC	3.9V±2%, -MR, +Reset PPO, Wt=1.6s, Rt=50ms	USP-6C	49xh	VD17	9b	Tor
AC640	XC6113C640ER	Vdet-IC	4.0V±2%, -MR, +Reset PPO, Wt=1.6s, Rt=50ms	USP-6C	49xh	VD17	9b	Tor
AC641	XC6113C641ER	Vdet-IC	4.1V±2%, -MR, +Reset PPO, Wt=1.6s, Rt=50ms	USP-6C	49xh	VD17	9b	Tor
AC642	XC6113C642ER	Vdet-IC	4.2V±2%, -MR, +Reset PPO, Wt=1.6s, Rt=50ms	USP-6C	49xh	VD17	9b	Tor
AC643	XC6113C643ER	Vdet-IC	4.3V±2%, -MR, +Reset PPO, Wt=1.6s, Rt=50ms	USP-6C	49xh	VD17	9b	Tor
AC644	XC6113C644ER	Vdet-IC	4.4V±2%, -MR, +Reset PPO, Wt=1.6s, Rt=50ms	USP-6C	49xh	VD17	9b	Tor
AC645	XC6113C645ER	Vdet-IC	4.5V±2%, -MR, +Reset PPO, Wt=1.6s, Rt=50ms	USP-6C	49xh	VD17	9b	Tor
AC646	XC6113C646ER	Vdet-IC	4.6V±2%, -MR, +Reset PPO, Wt=1.6s, Rt=50ms	USP-6C	49xh	VD17	9b	Tor
AC647	XC6113C647ER	Vdet-IC	4.7V±2%, -MR, +Reset PPO, Wt=1.6s, Rt=50ms	USP-6C	49xh	VD17	9b	Tor
AC648	XC6113C648ER	Vdet-IC	4.8V±2%, -MR, +Reset PPO, Wt=1.6s, Rt=50ms	USP-6C	49xh	VD17	9b	Tor
AC649	XC6113C649ER	Vdet-IC	4.9V±2%, -MR, +Reset PPO, Wt=1.6s, Rt=50ms	USP-6C	49xh	VD17	9b	Tor
AC650	XC6113C650ER	Vdet-IC	5.0V±2%, -MR, +Reset PPO, Wt=1.6s, Rt=50ms	USP-6C	49xh	VD17	9b	Tor
ACA	MAX6477BL33AD3	LVR/Vdet-IC	LDO, 3.3V±1.3%, 300mA, -Reset PPO, Set, +CE	BGA-6	40	-	9m	Max
ACB	MAX6478BL15BD3	LVR/Vdet-IC	LDO, 1.5V±1.3%, 300mA, -Reset ODO, Set, +CE	BGA-6	40	-	9m	Max
ACC	MAX6478BL18AD3	LVR/Vdet-IC	LDO, 1.8V±1.3%, 300mA, -Reset ODO, Set, +CE	BGA-6	40	-	9m	Max
ACC	MAX9700BEBC-T	LIN-IC	AF PA, BTL, class-D, 2.2.5.5V, 12W(5V/8Ω), shutdown	BGA-10	39	AFP56	9m	Max
ACD	MAX4365ETA	LIN-IC	AF PA, BTL, 2.7.5.5V, 1W(5V/8Ω), shutdown	DFN-8	37	-	9m	Max
ACD	MAX6478BL25BD3	LVR/Vdet-IC	LDO, 2.5V±1.3%, 300mA, -Reset ODO, Set, +CE	BGA-6	40	-	9m	Max
ACD	MAX9700AEB-C	LIN-IC	AF PA, BTL, class-D, 2.2.5.5V, 12W(5V/8Ω), shutdown	BGA-10	39	AFP56	9m	Max
ACE	MAX6478BL28AD3	LVR/Vdet-IC	LDO, 2.8V±1.3%, 300mA, -Reset ODO, Set, +CE	BGA-6	40	-	9m	Max
ACE	MAX9700CEBC-T	LIN-IC	AF PA, BTL, class-D, 2.2.5.5V, 12W(5V/8Ω), shutdown	BGA-10	39	AFP56	9m	Max
ACF	MAX6478BL30BD3	LVR/Vdet-IC	LDO, 3.0V±1.3%, 300mA, -Reset ODO, Set, +CE	BGA-6	40	-	9m	Max
ACF	MAX9700DEBC-T	LIN-IC	AF PA, BTL, class-D, 2.2.5.5V, 12W(5V/8Ω), shutdown	BGA-10	39	AFP56	9m	Max
ACG	MAX6478BL33AD3	LVR/Vdet-IC	LDO, 3.3V±1.3%, 300mA, -Reset ODO, Set, +CE	BGA-6	40	-	9m	Max
ACG	MAX9705BEBC-T	LIN-IC	AF PA, BTL, class-D, 2.2.5.5V, 2.3W(5V/4Ω), shutdown	BGA-10	39	AFP60	9m	Max
ACH	MAX6479BL15AD3	LVR/Vdet-IC	LDO, 1.5V±1.3%, 300mA, -Reset PPO, Set, -MR	BGA-6	40	-	9m	Max
ACH	MAX9705AEB-C	LIN-IC	AF PA, BTL, class-D, 2.2.5.5V, 2.3W(5V/4Ω), shutdown	BGA-10	39	AFP60	9m	Max
ACI	MAX6479BL18BD3	LVR/Vdet-IC	LDO, 1.8V±1.3%, 300mA, -Reset PPO, Set, -MR	BGA-6	40	-	9m	Max
ACI	MAX9700BETB	LIN-IC	AF PA, BTL, class-D, 2.2.5.5V, 12W(5V/8Ω), shutdown	DFN-10	37	AFP55	9m	Max
ACI	MAX9705CEBC-T	LIN-IC	AF PA, BTL, class-D, 2.2.5.5V, 2.3W(5V/4Ω), shutdown	BGA-10	39	AFP60	9m	Max
ACJ	MAX6479BL25AD3	LVR/Vdet-IC	LDO, 2.5V±1.3%, 300mA, -Reset PPO, Set, -MR	BGA-6	40	-	9m	Max
ACJ	MAX9705DEBC-T	LIN-IC	AF PA, BTL, class-D, 2.2.5.5V, 2.3W(5V/4Ω), shutdown	BGA-10	39	AFP60	9m	Max
ACK	MAX6479BL28BD3	LVR/Vdet-IC	LDO, 2.8V±1.3%, 300mA, -Reset PPO, Set, -MR	BGA-6	40	-	9m	Max
ACK	MAX9725AEB-C	LIN-IC	AF PA, 0.9.1.8V, 2x20mW(1.9V/32Ω), shutdown	BGA-12	39	AFP57	9m	Max
ACL	MAX6479BL30AD3	LVR/Vdet-IC	LDO, 3.0V±1.3%, 300mA, -Reset PPO, Set, -MR	BGA-6	40	-	9m	Max
ACL	MAX9725BEBC-T	LIN-IC	AF PA, 0.9.1.8V, 2x20mW(1.9V/32Ω), shutdown	BGA-12	39	AFP57	9m	Max



SMD code	Type	Function	Short description	Case	Pinout	Sch.	St.Mnf.
ACM	MAX6479BL33BD3	LVR/Vdet-IC	LDO, 3.3V±1.3%, 300mA, -Reset PPO, Set, -MR	BGA-6	40	-	9m Max
ACM	MAX9700AETB	LIN-IC	AF PA, BTL, class-D, 2.2.5.5V, 1.2W(5V/8Ω), shutdown	DFN-10	37	AFP55	9m Max
ACM	MAX9725CEBC-T	LIN-IC	AF PA, 0.9.1.8V, 2x20mW(1.9V/32Ω), shutdown	BGA-12	39	AFP57	9m Max
ACN	MAX6480BL15BD3	LVR/Vdet-IC	LDO, 1.5V±1.3%, 300mA, -Reset ODO, Set, -MR	BGA-6	40	-	9m Max
ACN	MAX9700CETB	LIN-IC	AF PA, BTL, class-D, 2.2.5.5V, 1.2W(5V/8Ω), shutdown	DFN-10	37	AFP55	9m Max
ACN	MAX9725DEBC-T	LIN-IC	AF PA, 0.9.1.8V, 2x20mW(1.9V/32Ω), shutdown	BGA-12	39	AFP57	9m Max
ACO	MAX6480BL18AD3	LVR/Vdet-IC	LDO, 1.8V±1.3%, 300mA, -Reset ODO, Set, -MR	BGA-6	40	-	9m Max
ACO	MAX9700DETB	LIN-IC	AF PA, BTL, class-D, 2.2.5.5V, 1.2W(5V/8Ω), shutdown	DFN-10	37	AFP55	9m Max
ACP	MAX6480BL25BD3	LVR/Vdet-IC	LDO, 2.5V±1.3%, 300mA, -Reset ODO, Set, -MR	BGA-6	40	-	9m Max
ACP	MAX9830ETA+	LIN-IC	AF PA, BTL, class-D, 2.5.5.5V, 2W(5V/4Ω), shutdown	DFN-8	37	-	9m Max
ACQ	MAX6480BL28AD3	LVR/Vdet-IC	LDO, 2.8V±1.3%, 300mA, -Reset ODO, Set, -MR	BGA-6	40	-	9m Max
ACR	MAX6480BL30BD3	LVR/Vdet-IC	LDO, 3.0V±1.3%, 300mA, -Reset ODO, Set, -MR	BGA-6	40	-	9m Max
ACS	MAX6481BL15BD3	LVR/Vdet-IC	LDO, 1.5V±1.3%, 300mA, -Reset PPO, -MR, +CE	BGA-6	40	-	9m Max
ACT	MAX64697A28AD3	LVR/Vdet-IC	LDO, 2.8V±1.3%, 300mA, -Reset PPO, Set, +CE	DFN-8	37	-	9m Max
ACT	MAX6481BL18AD3	LVR/Vdet-IC	LDO, 1.8V±1.3%, 300mA, -Reset PPO, -MR, +CE	BGA-6	40	-	9m Max
ACU	MAX6470TA33AD3	LVR/Vdet-IC	LDO, 3.3V±1.3%, 300mA, -Reset ODO, Set, +CE	DFN-8	37	-	9m Max
ACU	MAX6481BL25BD3	LVR/Vdet-IC	LDO, 2.5V±1.3%, 300mA, -Reset PPO, -MR, +CE	BGA-6	40	-	9m Max
ACV	MAX6471TA30BD4	LVR/Vdet-IC	LDO, 3.0V±1.3%, 300mA, -Reset PPO, Set, -MR	DFN-8	37	-	9m Max
ACV	MAX6481BL28AD3	LVR/Vdet-IC	LDO, 2.8V±1.3%, 300mA, -Reset PPO, -MR, +CE	BGA-6	40	-	9m Max
ACW	MAX6472TA18BD3	LVR/Vdet-IC	LDO, 1.8V±1.3%, 300mA, -Reset ODO, Set, -MR	DFN-8	37	-	9m Max
ACW	MAX6481BL30BD3	LVR/Vdet-IC	LDO, 3.0V±1.3%, 300mA, -Reset PPO, -MR, +CE	BGA-6	40	-	9m Max
ACX	MAX6473TA25AD1	LVR/Vdet-IC	LDO, 2.5V±1.3%, 300mA, -Reset PPO, -MR, +CE	DFN-8	37	-	9m Max
ACX	MAX6481BL33AD3	LVR/Vdet-IC	LDO, 3.3V±1.3%, 300mA, -Reset PPO, -MR, +CE	BGA-6	40	-	9m Max
ACX	MAX9705BETB+T	LIN-IC	AF PA, BTL, class-D, 2.5.5.5V, 2.3W(5V/4Ω), shutdown	TDFN-10	37	AFP55	9m Max
ACY	MAX6474TA15BD2	LVR/Vdet-IC	LDO, 1.5V±1.3%, 300mA, -Reset ODO, -MR, +CE	DFN-8	37	-	9m Max
ACY	MAX6482BL15BD3	LVR/Vdet-IC	LDO, 1.5V±1.3%, 300mA, -Reset ODO, -MR, +CE	BGA-6	40	-	9m Max
ACY	MAX9705AETB+T	LIN-IC	AF PA, BTL, class-D, 2.5.5.5V, 2.3W(5V/4Ω), shutdown	TDFN-10	37	AFP55	9m Max
ACZ	MAX6475TA33AD3	LVR/Vdet-IC	LDO, 3.3V±1.3%, 300mA, -Reset PPO, FB, +CE	DFN-8	37	-	9m Max
ACZ	MAX6482BL18AD3	LVR/Vdet-IC	LDO, 1.8V±1.3%, 300mA, -Reset ODO, -MR, +CE	BGA-6	40	-	9m Max
ACZ	MAX9705CETB+T	LIN-IC	AF PA, BTL, class-D, 2.5.5.5V, 2.3W(5V/4Ω), shutdown	TDFN-10	37	AFP55	9m Max
aD	74AUP2GU04GM	CMOS-Logic	Dual inverters	SOT-886	57/Log24	-	9c Phi
AD	RP104K181B	LVR-IC	LDO, 1.8V±0.8%, 150mA, +CE	DFN1010-4	48vm	VR4	9a Ric
AD	RP105K091B	LVR-IC	LDO, 0.9V±15mV, 400mA, +CE	DFN1212-6	52zd	VR11	9a Ric
AD	RT9013B-25PQWA	LVR-IC	LDO, 2.5V±2%, 500mA, +CE	WDFN-6	49xu	VR4	9a Ret
AD	XC6221A14B7R	LVR-IC	LDO, 1.45V±20mV, 200mA, +CE	USPN-4	58vm	VR4	9a Rot
AD	XC6223C23B9R-G	LVR-IC	LDO, 2.35V±1%, 300mA, +CE, PDR	USPQ-4B03	48vm	VR4	9a Tor
AD-	RT9013-15PQV	LVR-IC	LDO, 1.5V±2%, 500mA, +CE	WDFN-8	49	VR4	9a Ret
AD01	RP102K121D	LVR-IC	LDO, LN, +CE, CL, 1.2V±1%, 300mA	PLP1820-6	49wf	VR4	9b Ric
AD02	RP102K131D	LVR-IC	LDO, LN, +CE, CL, 1.3V±1%, 300mA	PLP1820-6	49wf	VR4	9b Ric
AD03	RP102K151D	LVR-IC	LDO, LN, +CE, CL, 1.5V±1%, 300mA	PLP1820-6	49wf	VR4	9b Ric
AD04	RP102K181D	LVR-IC	LDO, LN, +CE, CL, 1.8V±1%, 300mA	PLP1820-6	49wf	VR4	9b Ric
AD05	RP102K251D	LVR-IC	LDO, LN, +CE, CL, 2.5V±1%, 300mA	PLP1820-6	49wf	VR4	9b Ric
AD06	RP102K261D	LVR-IC	LDO, LN, +CE, CL, 2.6V±1%, 300mA	PLP1820-6	49wf	VR4	9b Ric
AD07	RP102K281D	LVR-IC	LDO, LN, +CE, CL, 2.8V±1%, 300mA	PLP1820-6	49wf	VR4	9b Ric
AD08	RP102K281D5	LVR-IC	LDO, LN, +CE, CL, 2.85V±1%, 300mA	PLP1820-6	49wf	VR4	9b Ric
AD09	RP102K291D	LVR-IC	LDO, LN, +CE, CL, 2.9V±1%, 300mA	PLP1820-6	49wf	VR4	9b Ric
AD10	RP102K301D	LVR-IC	LDO, LN, +CE, CL, 3V±1%, 300mA	PLP1820-6	49wf	VR4	9b Ric
AD11	RP102K331D	LVR-IC	LDO, LN, +CE, CL, 3.3V±1%, 300mA	PLP1820-6	49wf	VR4	9b Ric
AD316	XC6113D316ER	Vdet-IC	1.6V±2%, -MR, +Reset PPO, Wt=100ms, Rt=100ms	USP-6C	49xh	VD17	9b Tor
AD317	XC6113D317ER	Vdet-IC	1.7V±2%, -MR, +Reset PPO, Wt=100ms, Rt=100ms	USP-6C	49xh	VD17	9b Tor
AD318	XC6113D318ER	Vdet-IC	1.8V±2%, -MR, +Reset PPO, Wt=100ms, Rt=100ms	USP-6C	49xh	VD17	9b Tor
AD319	XC6113D319ER	Vdet-IC	1.9V±2%, -MR, +Reset PPO, Wt=100ms, Rt=100ms	USP-6C	49xh	VD17	9b Tor
AD320	XC6113D320ER	Vdet-IC	2.0V±2%, -MR, +Reset PPO, Wt=100ms, Rt=100ms	USP-6C	49xh	VD17	9b Tor
AD321	XC6113D321ER	Vdet-IC	2.1V±2%, -MR, +Reset PPO, Wt=100ms, Rt=100ms	USP-6C	49xh	VD17	9b Tor
AD322	XC6113D322ER	Vdet-IC	2.2V±2%, -MR, +Reset PPO, Wt=100ms, Rt=100ms	USP-6C	49xh	VD17	9b Tor
AD323	XC6113D323ER	Vdet-IC	2.3V±2%, -MR, +Reset PPO, Wt=100ms, Rt=100ms	USP-6C	49xh	VD17	9b Tor
AD324	XC6113D324ER	Vdet-IC	2.4V±2%, -MR, +Reset PPO, Wt=100ms, Rt=100ms	USP-6C	49xh	VD17	9b Tor
AD325	XC6113D325ER	Vdet-IC	2.5V±2%, -MR, +Reset PPO, Wt=100ms, Rt=100ms	USP-6C	49xh	VD17	9b Tor
AD326	XC6113D326ER	Vdet-IC	2.6V±2%, -MR, +Reset PPO, Wt=100ms, Rt=100ms	USP-6C	49xh	VD17	9b Tor
AD327	XC6113D327ER	Vdet-IC	2.7V±2%, -MR, +Reset PPO, Wt=100ms, Rt=100ms	USP-6C	49xh	VD17	9b Tor
AD328	XC6113D328ER	Vdet-IC	2.8V±2%, -MR, +Reset PPO, Wt=100ms, Rt=100ms	USP-6C	49xh	VD17	9b Tor
AD329	XC6113D329ER	Vdet-IC	2.9V±2%, -MR, +Reset PPO, Wt=100ms, Rt=100ms	USP-6C	49xh	VD17	9b Tor
AD330	XC6113D330ER	Vdet-IC	3.0V±2%, -MR, +Reset PPO, Wt=100ms, Rt=100ms	USP-6C	49xh	VD17	9b Tor
AD331	XC6113D331ER	Vdet-IC	3.1V±2%, -MR, +Reset PPO, Wt=100ms, Rt=100ms	USP-6C	49xh	VD17	9b Tor
AD332	XC6113D332ER	Vdet-IC	3.2V±2%, -MR, +Reset PPO, Wt=100ms, Rt=100ms	USP-6C	49xh	VD17	9b Tor
AD333	XC6113D333ER	Vdet-IC	3.3V±2%, -MR, +Reset PPO, Wt=100ms, Rt=100ms	USP-6C	49xh	VD17	9b Tor
AD334	XC6113D334ER	Vdet-IC	3.4V±2%, -MR, +Reset PPO, Wt=100ms, Rt=100ms	USP-6C	49xh	VD17	9b Tor
AD335	XC6113D335ER	Vdet-IC	3.5V±2%, -MR, +Reset PPO, Wt=100ms, Rt=100ms	USP-6C	49xh	VD17	9b Tor
AD336	XC6113D336ER	Vdet-IC	3.6V±2%, -MR, +Reset PPO, Wt=100ms, Rt=100ms	USP-6C	49xh	VD17	9b Tor
AD337	XC6113D337ER	Vdet-IC	3.7V±2%, -MR, +Reset PPO, Wt=100ms, Rt=100ms	USP-6C	49xh	VD17	9b Tor



SMD code	Type	Function	Short description	Case	Pinout	Sch.	St.	Mnf.
AD538	XC6113D538ER	Vdet-IC	3.8V±2%, -MR, +Reset PPO, Wt=400ms, Rt=100ms	USP-6C	49xh	VD17	9b	Tor
AD539	XC6113D539ER	Vdet-IC	3.9V±2%, -MR, +Reset PPO, Wt=400ms, Rt=100ms	USP-6C	49xh	VD17	9b	Tor
AD540	XC6113D540ER	Vdet-IC	4.0V±2%, -MR, +Reset PPO, Wt=400ms, Rt=100ms	USP-6C	49xh	VD17	9b	Tor
AD541	XC6113D541ER	Vdet-IC	4.1V±2%, -MR, +Reset PPO, Wt=400ms, Rt=100ms	USP-6C	49xh	VD17	9b	Tor
AD542	XC6113D542ER	Vdet-IC	4.2V±2%, -MR, +Reset PPO, Wt=400ms, Rt=100ms	USP-6C	49xh	VD17	9b	Tor
AD543	XC6113D543ER	Vdet-IC	4.3V±2%, -MR, +Reset PPO, Wt=400ms, Rt=100ms	USP-6C	49xh	VD17	9b	Tor
AD544	XC6113D544ER	Vdet-IC	4.4V±2%, -MR, +Reset PPO, Wt=400ms, Rt=100ms	USP-6C	49xh	VD17	9b	Tor
AD545	XC6113D545ER	Vdet-IC	4.5V±2%, -MR, +Reset PPO, Wt=400ms, Rt=100ms	USP-6C	49xh	VD17	9b	Tor
AD546	XC6113D546ER	Vdet-IC	4.6V±2%, -MR, +Reset PPO, Wt=400ms, Rt=100ms	USP-6C	49xh	VD17	9b	Tor
AD547	XC6113D547ER	Vdet-IC	4.7V±2%, -MR, +Reset PPO, Wt=400ms, Rt=100ms	USP-6C	49xh	VD17	9b	Tor
AD548	XC6113D548ER	Vdet-IC	4.8V±2%, -MR, +Reset PPO, Wt=400ms, Rt=100ms	USP-6C	49xh	VD17	9b	Tor
AD549	XC6113D549ER	Vdet-IC	4.9V±2%, -MR, +Reset PPO, Wt=400ms, Rt=100ms	USP-6C	49xh	VD17	9b	Tor
AD550	XC6113D550ER	Vdet-IC	5.0V±2%, -MR, +Reset PPO, Wt=400ms, Rt=100ms	USP-6C	49xh	VD17	9b	Tor
AD616	XC6113D616ER	Vdet-IC	1.6V±2%, -MR, +Reset PPO, Wt=1.6s, Rt=100ms	USP-6C	49xh	VD17	9b	Tor
AD617	XC6113D617ER	Vdet-IC	1.7V±2%, -MR, +Reset PPO, Wt=1.6s, Rt=100ms	USP-6C	49xh	VD17	9b	Tor
AD618	XC6113D618ER	Vdet-IC	1.8V±2%, -MR, +Reset PPO, Wt=1.6s, Rt=100ms	USP-6C	49xh	VD17	9b	Tor
AD619	XC6113D619ER	Vdet-IC	1.9V±2%, -MR, +Reset PPO, Wt=1.6s, Rt=100ms	USP-6C	49xh	VD17	9b	Tor
AD620	XC6113D620ER	Vdet-IC	2.0V±2%, -MR, +Reset PPO, Wt=1.6s, Rt=100ms	USP-6C	49xh	VD17	9b	Tor
AD621	XC6113D621ER	Vdet-IC	2.1V±2%, -MR, +Reset PPO, Wt=1.6s, Rt=100ms	USP-6C	49xh	VD17	9b	Tor
AD622	XC6113D622ER	Vdet-IC	2.2V±2%, -MR, +Reset PPO, Wt=1.6s, Rt=100ms	USP-6C	49xh	VD17	9b	Tor
AD623	XC6113D623ER	Vdet-IC	2.3V±2%, -MR, +Reset PPO, Wt=1.6s, Rt=100ms	USP-6C	49xh	VD17	9b	Tor
AD624	XC6113D624ER	Vdet-IC	2.4V±2%, -MR, +Reset PPO, Wt=1.6s, Rt=100ms	USP-6C	49xh	VD17	9b	Tor
AD625	XC6113D625ER	Vdet-IC	2.5V±2%, -MR, +Reset PPO, Wt=1.6s, Rt=100ms	USP-6C	49xh	VD17	9b	Tor
AD626	XC6113D626ER	Vdet-IC	2.6V±2%, -MR, +Reset PPO, Wt=1.6s, Rt=100ms	USP-6C	49xh	VD17	9b	Tor
AD627	XC6113D627ER	Vdet-IC	2.7V±2%, -MR, +Reset PPO, Wt=1.6s, Rt=100ms	USP-6C	49xh	VD17	9b	Tor
AD628	XC6113D628ER	Vdet-IC	2.8V±2%, -MR, +Reset PPO, Wt=1.6s, Rt=100ms	USP-6C	49xh	VD17	9b	Tor
AD629	XC6113D629ER	Vdet-IC	2.9V±2%, -MR, +Reset PPO, Wt=1.6s, Rt=100ms	USP-6C	49xh	VD17	9b	Tor
AD630	XC6113D630ER	Vdet-IC	3.0V±2%, -MR, +Reset PPO, Wt=1.6s, Rt=100ms	USP-6C	49xh	VD17	9b	Tor
AD631	XC6113D631ER	Vdet-IC	3.1V±2%, -MR, +Reset PPO, Wt=1.6s, Rt=100ms	USP-6C	49xh	VD17	9b	Tor
AD632	XC6113D632ER	Vdet-IC	3.2V±2%, -MR, +Reset PPO, Wt=1.6s, Rt=100ms	USP-6C	49xh	VD17	9b	Tor
AD633	XC6113D633ER	Vdet-IC	3.3V±2%, -MR, +Reset PPO, Wt=1.6s, Rt=100ms	USP-6C	49xh	VD17	9b	Tor
AD634	XC6113D634ER	Vdet-IC	3.4V±2%, -MR, +Reset PPO, Wt=1.6s, Rt=100ms	USP-6C	49xh	VD17	9b	Tor
AD635	XC6113D635ER	Vdet-IC	3.5V±2%, -MR, +Reset PPO, Wt=1.6s, Rt=100ms	USP-6C	49xh	VD17	9b	Tor
AD636	XC6113D636ER	Vdet-IC	3.6V±2%, -MR, +Reset PPO, Wt=1.6s, Rt=100ms	USP-6C	49xh	VD17	9b	Tor
AD637	XC6113D637ER	Vdet-IC	3.7V±2%, -MR, +Reset PPO, Wt=1.6s, Rt=100ms	USP-6C	49xh	VD17	9b	Tor
AD638	XC6113D638ER	Vdet-IC	3.8V±2%, -MR, +Reset PPO, Wt=1.6s, Rt=100ms	USP-6C	49xh	VD17	9b	Tor
AD639	XC6113D639ER	Vdet-IC	3.9V±2%, -MR, +Reset PPO, Wt=1.6s, Rt=100ms	USP-6C	49xh	VD17	9b	Tor
AD640	XC6113D640ER	Vdet-IC	4.0V±2%, -MR, +Reset PPO, Wt=1.6s, Rt=100ms	USP-6C	49xh	VD17	9b	Tor
AD641	XC6113D641ER	Vdet-IC	4.1V±2%, -MR, +Reset PPO, Wt=1.6s, Rt=100ms	USP-6C	49xh	VD17	9b	Tor
AD642	XC6113D642ER	Vdet-IC	4.2V±2%, -MR, +Reset PPO, Wt=1.6s, Rt=100ms	USP-6C	49xh	VD17	9b	Tor
AD643	XC6113D643ER	Vdet-IC	4.3V±2%, -MR, +Reset PPO, Wt=1.6s, Rt=100ms	USP-6C	49xh	VD17	9b	Tor
AD644	XC6113D644ER	Vdet-IC	4.4V±2%, -MR, +Reset PPO, Wt=1.6s, Rt=100ms	USP-6C	49xh	VD17	9b	Tor
AD645	XC6113D645ER	Vdet-IC	4.5V±2%, -MR, +Reset PPO, Wt=1.6s, Rt=100ms	USP-6C	49xh	VD17	9b	Tor
AD646	XC6113D646ER	Vdet-IC	4.6V±2%, -MR, +Reset PPO, Wt=1.6s, Rt=100ms	USP-6C	49xh	VD17	9b	Tor
AD647	XC6113D647ER	Vdet-IC	4.7V±2%, -MR, +Reset PPO, Wt=1.6s, Rt=100ms	USP-6C	49xh	VD17	9b	Tor
AD648	XC6113D648ER	Vdet-IC	4.8V±2%, -MR, +Reset PPO, Wt=1.6s, Rt=100ms	USP-6C	49xh	VD17	9b	Tor
AD649	XC6113D649ER	Vdet-IC	4.9V±2%, -MR, +Reset PPO, Wt=1.6s, Rt=100ms	USP-6C	49xh	VD17	9b	Tor
AD650	XC6113D650ER	Vdet-IC	5.0V±2%, -MR, +Reset PPO, Wt=1.6s, Rt=100ms	USP-6C	49xh	VD17	9b	Tor
ADA	MAX6476TA15AD1	LVR/Vdet-IC	LDO, 1.5V±1.3%, 300mA, -Reset ODO, FB, +CE	DFN-8	37	-	9m	Max
ADA	MAX6482BL25BD3	LVR/Vdet-IC	LDO, 2.5V±1.3%, 300mA, -Reset ODO, -MR, +CE	BGA-6	40	-	9m	Max
ADA	MAX9705DETBT	LIN-IC	AF PA, BTL, class-D, 2.5..5.5V, 2.3W(5V/4Ω), shutdown	TDFN-10	37	AFP55	9m	Max
ADB	MAX6482BL28AD3	LVR/Vdet-IC	LDO, 2.8V±1.3%, 300mA, -Reset ODO, -MR, +CE	BGA-6	40	-	9m	Max
ADC	MAX6482BL30BD3	LVR/Vdet-IC	LDO, 3.0V±1.3%, 300mA, -Reset ODO, -MR, +CE	BGA-6	40	-	9m	Max
ADD	MAX6482BL33AD3	LVR/Vdet-IC	LDO, 3.3V±1.3%, 300mA, -Reset ODO, -MR, +CE	BGA-6	40	-	9m	Max
ADE	MAX6483BL15BD3	LVR/Vdet-IC	LDO, 1.5V±1.3%, 300mA, -Reset PPO, FB, +CE	BGA-6	40	-	9m	Max
ADF	MAX6483BL18AD3	LVR/Vdet-IC	LDO, 1.8V±1.3%, 300mA, -Reset PPO, FB, +CE	BGA-6	40	-	9m	Max
ADG	MAX6483BL25BD3	LVR/Vdet-IC	LDO, 2.8V±1.3%, 300mA, -Reset PPO, FB, +CE	BGA-6	40	-	9m	Max
ADH	MAX6483BL28AD3	LVR/Vdet-IC	LDO, 2.8V±1.3%, 300mA, -Reset PPO, FB, +CE	BGA-6	40	-	9m	Max
ADI	MAX6483BL30BD3	LVR/Vdet-IC	LDO, 3.0V±1.3%, 300mA, -Reset PPO, FB, +CE	BGA-6	40	-	9m	Max
ADJ	MAX6483BL33AD3	LVR/Vdet-IC	LDO, 3.3V±1.3%, 300mA, -Reset PPO, FB, +CE	BGA-6	40	-	9m	Max
ADK	MAX6484BL15BD3	LVR/Vdet-IC	LDO, 1.5V±1.3%, 300mA, -Reset ODO, FB, +CE	BGA-6	40	-	9m	Max
ADL	MAX6484BL18AD3	LVR/Vdet-IC	LDO, 1.8V±1.3%, 300mA, -Reset ODO, FB, +CE	BGA-6	40	-	9m	Max
ADM	MAX6484BL25BD3	LVR/Vdet-IC	LDO, 2.5V±1.3%, 300mA, -Reset ODO, FB, +CE	BGA-6	40	-	9m	Max
ADN	MAX6484BL28AD3	LVR/Vdet-IC	LDO, 2.8V±1.3%, 300mA, -Reset ODO, FB, +CE	BGA-6	40	-	9m	Max
ADO	MAX6469TA15BD3	LVR/Vdet-IC	LDO, 1.5V±1.3%, 300mA, -Reset PPO, Set, +CE	DFN-8	37	-	9m	Max
ADO	MAX6484BL30BD3	LVR/Vdet-IC	LDO, 3.0V±1.3%, 300mA, -Reset ODO, FB, +CE	BGA-6	40	-	9m	Max
ADP	MAX6469TA18AD3	LVR/Vdet-IC	LDO, 1.8V±1.3%, 300mA, -Reset PPO, Set, +CE	DFN-8	37	-	9m	Max
ADP	MAX6484BL33AD3	LVR/Vdet-IC	LDO, 3.3V±1.3%, 300mA, -Reset ODO, FB, +CE	BGA-6	40	-	9m	Max
ADQ	MAX6469TA25BD3	LVR/Vdet-IC	LDO, 2.5V±1.3%, 300mA, -Reset PPO, Set, +CE	DFN-8	37	-	9m	Max
ADQ	MAX6477BL285AD3	LVR/Vdet-IC	LDO, 2.85V±1.3%, 300mA, -Reset PPO, Set, +CE	BGA-6	40	-	9m	Max



SMD code	Type	Function	Short description	Case	Pinout	Sch.	St.	Mnf.
ADR	MAX6469TA30BD3	LVR/Vdet-IC	LDO, 3.0V±1.3%, 300mA, -Reset PPO, Set, +CE	DFN-8	37	-	9m	Max
ADR	MAX6477BL285BD3	LVR/Vdet-IC	LDO, 2.85V±1.3%, 300mA, -Reset PPO, Set, +CE	BGA-6	40	-	9m	Max
ADS	MAX6469TA33AD3	LVR/Vdet-IC	LDO, 3.3V±1.3%, 300mA, -Reset PPO, Set, +CE	DFN-8	37	-	9m	Max
ADS	MAX6478BL285AD3	LVR/Vdet-IC	LDO, 2.85V±1.3%, 300mA, -Reset ODO, Set, +CE	BGA-6	40	-	9m	Max
ADT	MAX6470TA15BD3	LVR/Vdet-IC	LDO, 1.5V±1.3%, 300mA, -Reset ODO, Set, +CE	DFN-8	37	-	9m	Max
ADT	MAX6478BL285BD3	LVR/Vdet-IC	LDO, 2.85V±1.3%, 300mA, -Reset ODO, Set, +CE	BGA-6	40	-	9m	Max
ADU	MAX6470TA18AD3	LVR/Vdet-IC	LDO, 1.8V±1.3%, 300mA, -Reset ODO, Set, +CE	DFN-8	37	-	9m	Max
ADV	MAX6470TA25BD3	LVR/Vdet-IC	LDO, 2.5V±1.3%, 300mA, -Reset ODO, Set, +CE	DFN-8	37	-	9m	Max
ADV	MAX9890AEBL-T	LIN-IC	Audio click-pop suppress, (36dB), 2.7..5.5V, THD<0.03%(32Q)	BGA-9	39bF*	-	9a	Max
ADW	MAX6406BS22-T	Vdet-IC	2.2V±1.5%, -MR, -Reset PPO	UCSP-4	63bd*	VD5	9a	Max
ADW	MAX6470TA28AD3	LVR/Vdet-IC	LDO, 2.8V±1.3%, 300mA, -Reset ODO, Set, +CE	DFN-8	37	-	9m	Max
ADW	MAX9890BEBL-T	LIN-IC	Audio click-pop suppress, (36dB), 2.7..5.5V, THD<0.03%(32Q)	BGA-9	39bF*	-	9a	Max
ADX	MAX6406BS23-T	Vdet-IC	2.3V±1.5%, -MR, -Reset PPO	UCSP-4	63bd*	VD5	9a	Max
ADX	MAX9718AEBL-T	LIN-IC	AF PA, BTL, 2.7..5.5V, 1.4W(5V/4Q), select shutdown	BGA-9	39	AFP53	9m	Max
ADY	MAX6406BS24-T	Vdet-IC	2.4V±1.5%, -MR, -Reset PPO	UCSP-4	63bd*	VD5	9a	Max
ADY	MAX6470TA30BD3	LVR/Vdet-IC	LDO, 3.0V±1.3%, 300mA, -Reset ODO, Set, +CE	DFN-8	37	-	9m	Max
ADY	MAX9718BEBL-T	LIN-IC	AF PA, BTL, 2.7..5.5V, 1.4W(5V/4Q), select shutdown	BGA-9	39	AFP54	9m	Max
ADZ	MAX6406BS25-T	Vdet-IC	2.5V±1.5%, -MR, -Reset PPO	UCSP-4	63bd*	VD5	9a	Max
ADZ	MAX6471TA15AD3	LVR/Vdet-IC	LDO, 1.5V±1.3%, 300mA, -Reset PPO, Set, -MR	DFN-8	37	-	9m	Max
ADZ	MAX9718CEBL-T	LIN-IC	AF PA, BTL, 2.7..5.5V, 1.4W(5V/4Q), select shutdown	BGA-9	39	AFP54	9m	Max
AE	RP104K181B5	LVR-IC	LDO, 1.85V±0.8%, 150mA, +CE	DFN1010-4	48vm	VR4	9a	Ric
AE	RP105K101B	LVR-IC	LDO, 1.0V±15mV, 400mA, +CE	DFN1212-6	52zd	VR11	9a	Ric
AE	RT9013B-33PQWA	LVR-IC	LDO, 3.3V±2%, 500mA, +CE	WDFN-6	49xu	VR4	9a	Ret
AE	XC6221A15B7R	LVR-IC	LDO, 1.55V±20mV, 200mA, +CE	USPN-4	58vm	VR4	9a	Tor
AE	XC6223C24B9R-G	LVR-IC	LDO, 2.45V±1%, 300mA, +CE, PDR	USPQ-4B03	48vm	VR4	9a	Tor
AE-	RT9013-25PQV	LVR-IC	LDO, 2.5V±2%, 500mA, +CE	WDFN-8	49	VR4	9a	Ret
AE416	XC6113E416ER	Vdet-IC	1.6V±2%, -MR, +Reset PPO, Wt=200ms, Rt=200ms	USP-6C	49xh	VD17	9b	Tor
AE417	XC6113E417ER	Vdet-IC	1.7V±2%, -MR, +Reset PPO, Wt=200ms, Rt=200ms	USP-6C	49xh	VD17	9b	Tor
AE418	XC6113E418ER	Vdet-IC	1.8V±2%, -MR, +Reset PPO, Wt=200ms, Rt=200ms	USP-6C	49xh	VD17	9b	Tor
AE419	XC6113E419ER	Vdet-IC	1.9V±2%, -MR, +Reset PPO, Wt=200ms, Rt=200ms	USP-6C	49xh	VD17	9b	Tor
AE420	XC6113E420ER	Vdet-IC	2.0V±2%, -MR, +Reset PPO, Wt=200ms, Rt=200ms	USP-6C	49xh	VD17	9b	Tor
AE421	XC6113E421ER	Vdet-IC	2.1V±2%, -MR, +Reset PPO, Wt=200ms, Rt=200ms	USP-6C	49xh	VD17	9b	Tor
AE422	XC6113E422ER	Vdet-IC	2.2V±2%, -MR, +Reset PPO, Wt=200ms, Rt=200ms	USP-6C	49xh	VD17	9b	Tor
AE423	XC6113E423ER	Vdet-IC	2.3V±2%, -MR, +Reset PPO, Wt=200ms, Rt=200ms	USP-6C	49xh	VD17	9b	Tor
AE424	XC6113E424ER	Vdet-IC	2.4V±2%, -MR, +Reset PPO, Wt=200ms, Rt=200ms	USP-6C	49xh	VD17	9b	Tor
AE425	XC6113E425ER	Vdet-IC	2.5V±2%, -MR, +Reset PPO, Wt=200ms, Rt=200ms	USP-6C	49xh	VD17	9b	Tor
AE426	XC6113E426ER	Vdet-IC	2.6V±2%, -MR, +Reset PPO, Wt=200ms, Rt=200ms	USP-6C	49xh	VD17	9b	Tor
AE427	XC6113E427ER	Vdet-IC	2.7V±2%, -MR, +Reset PPO, Wt=200ms, Rt=200ms	USP-6C	49xh	VD17	9b	Tor
AE428	XC6113E428ER	Vdet-IC	2.8V±2%, -MR, +Reset PPO, Wt=200ms, Rt=200ms	USP-6C	49xh	VD17	9b	Tor
AE429	XC6113E429ER	Vdet-IC	2.9V±2%, -MR, +Reset PPO, Wt=200ms, Rt=200ms	USP-6C	49xh	VD17	9b	Tor
AE430	XC6113E430ER	Vdet-IC	3.0V±2%, -MR, +Reset PPO, Wt=200ms, Rt=200ms	USP-6C	49xh	VD17	9b	Tor
AE431	XC6113E431ER	Vdet-IC	3.1V±2%, -MR, +Reset PPO, Wt=200ms, Rt=200ms	USP-6C	49xh	VD17	9b	Tor
AE432	XC6113E432ER	Vdet-IC	3.2V±2%, -MR, +Reset PPO, Wt=200ms, Rt=200ms	USP-6C	49xh	VD17	9b	Tor
AE433	XC6113E433ER	Vdet-IC	3.3V±2%, -MR, +Reset PPO, Wt=200ms, Rt=200ms	USP-6C	49xh	VD17	9b	Tor
AE434	XC6113E434ER	Vdet-IC	3.4V±2%, -MR, +Reset PPO, Wt=200ms, Rt=200ms	USP-6C	49xh	VD17	9b	Tor
AE435	XC6113E435ER	Vdet-IC	3.5V±2%, -MR, +Reset PPO, Wt=200ms, Rt=200ms	USP-6C	49xh	VD17	9b	Tor
AE436	XC6113E436ER	Vdet-IC	3.6V±2%, -MR, +Reset PPO, Wt=200ms, Rt=200ms	USP-6C	49xh	VD17	9b	Tor
AE437	XC6113E437ER	Vdet-IC	3.7V±2%, -MR, +Reset PPO, Wt=200ms, Rt=200ms	USP-6C	49xh	VD17	9b	Tor
AE438	XC6113E438ER	Vdet-IC	3.8V±2%, -MR, +Reset PPO, Wt=200ms, Rt=200ms	USP-6C	49xh	VD17	9b	Tor
AE439	XC6113E439ER	Vdet-IC	3.9V±2%, -MR, +Reset PPO, Wt=200ms, Rt=200ms	USP-6C	49xh	VD17	9b	Tor
AE440	XC6113E440ER	Vdet-IC	4.0V±2%, -MR, +Reset PPO, Wt=200ms, Rt=200ms	USP-6C	49xh	VD17	9b	Tor
AE441	XC6113E441ER	Vdet-IC	4.1V±2%, -MR, +Reset PPO, Wt=200ms, Rt=200ms	USP-6C	49xh	VD17	9b	Tor
AE442	XC6113E442ER	Vdet-IC	4.2V±2%, -MR, +Reset PPO, Wt=200ms, Rt=200ms	USP-6C	49xh	VD17	9b	Tor
AE443	XC6113E443ER	Vdet-IC	4.3V±2%, -MR, +Reset PPO, Wt=200ms, Rt=200ms	USP-6C	49xh	VD17	9b	Tor
AE444	XC6113E444ER	Vdet-IC	4.4V±2%, -MR, +Reset PPO, Wt=200ms, Rt=200ms	USP-6C	49xh	VD17	9b	Tor
AE445	XC6113E445ER	Vdet-IC	4.5V±2%, -MR, +Reset PPO, Wt=200ms, Rt=200ms	USP-6C	49xh	VD17	9b	Tor
AE446	XC6113E446ER	Vdet-IC	4.6V±2%, -MR, +Reset PPO, Wt=200ms, Rt=200ms	USP-6C	49xh	VD17	9b	Tor
AE447	XC6113E447ER	Vdet-IC	4.7V±2%, -MR, +Reset PPO, Wt=200ms, Rt=200ms	USP-6C	49xh	VD17	9b	Tor
AE448	XC6113E448ER	Vdet-IC	4.8V±2%, -MR, +Reset PPO, Wt=200ms, Rt=200ms	USP-6C	49xh	VD17	9b	Tor
AE449	XC6113E449ER	Vdet-IC	4.9V±2%, -MR, +Reset PPO, Wt=200ms, Rt=200ms	USP-6C	49xh	VD17	9b	Tor
AE450	XC6113E450ER	Vdet-IC	5.0V±2%, -MR, +Reset PPO, Wt=200ms, Rt=200ms	USP-6C	49xh	VD17	9b	Tor
AE516	XC6113E516ER	Vdet-IC	1.6V±2%, -MR, +Reset PPO, Wt=400ms, Rt=200ms	USP-6C	49xh	VD17	9b	Tor
AE517	XC6113E517ER	Vdet-IC	1.7V±2%, -MR, +Reset PPO, Wt=400ms, Rt=200ms	USP-6C	49xh	VD17	9b	Tor
AE518	XC6113E518ER	Vdet-IC	1.8V±2%, -MR, +Reset PPO, Wt=400ms, Rt=200ms	USP-6C	49xh	VD17	9b	Tor
AE519	XC6113E519ER	Vdet-IC	1.9V±2%, -MR, +Reset PPO, Wt=400ms, Rt=200ms	USP-6C	49xh	VD17	9b	Tor
AE520	XC6113E520ER	Vdet-IC	2.0V±2%, -MR, +Reset PPO, Wt=400ms, Rt=200ms	USP-6C	49xh	VD17	9b	Tor
AE521	XC6113E521ER	Vdet-IC	2.1V±2%, -MR, +Reset PPO, Wt=400ms, Rt=200ms	USP-6C	49xh	VD17	9b	Tor
AE522	XC6113E522ER	Vdet-IC	2.2V±2%, -MR, +Reset PPO, Wt=400ms, Rt=200ms	USP-6C	49xh	VD17	9b	Tor
AE523	XC6113E523ER	Vdet-IC	2.3V±2%, -MR, +Reset PPO, Wt=400ms, Rt=200ms	USP-6C	49xh	VD17	9b	Tor
AE524	XC6113E524ER	Vdet-IC	2.4V±2%, -MR, +Reset PPO, Wt=400ms, Rt=200ms	USP-6C	49xh	VD17	9b	Tor



SMD code	Type	Function	Short description	Case	Pinout	Sch.	St.Mnf.
AED	MAX6406BS29-T	Vdet-IC	2.9V±1.5%, -MR, -Reset PPO	UCSP-4	63bd*	VD5	9a Max
AED	MAX6471TA30AD3	LVR/det-IC	LDO, 3.0V±1.3%, 300mA, -Reset PPO, Set, -MR	DFN-8	37	-	9m Max
AED	MAX9717BEBL-T	LIN-IC	AF PA, BTL, 2.7..5.5V, 1.4W(5V/4Q), shutdown	BGA-9	39	-	9m Max
AEE	MAX6406BS30-T	Vdet-IC	3.0V±1.5%, -MR, -Reset PPO	UCSP-4	63bd*	VD5	9a Max
AEE	MAX6471TA33BD3	LVR/Vdet-IC	LDO, 3.3V±1.3%, 300mA, -Reset PPO, Set, -MR	DFN-8	37	-	9m Max
AEE	MAX9717CEBL-T	LIN-IC	AF PA, BTL, 2.7..5.5V, 1.4W(5V/4Q), shutdown	BGA-9	39	-	9m Max
AEF	MAX6406BS31-T	Vdet-IC	3.1V±1.5%, -MR, -Reset PPO	UCSP-4	63bd*	VD5	9a Max
AEF	MAX6472TA15AD3	LVR/Vdet-IC	LDO, 1.5V±1.3%, 300mA, -Reset ODO, Set, -MR	DFN-8	37	-	9m Max
AEF	MAX9717DEBL-T	LIN-IC	AF PA, BTL, 2.7..5.5V, 1.4W(5V/4Q), shutdown	BGA-9	39	-	9m Max
AEF	MAX6407BS22-T	Vdet-IC	2.2V±1.5%, -MR, +Reset PPO	UCSP-4	63bd*	VD5	9a Max
AEF	MAX6472TA25AD3	LVR/Vdet-IC	LDO, 2.5V±1.3%, 300mA, -Reset ODO, Set, -MR	DFN-8	37	-	9m Max
AEG	MAX6407BS23-T	Vdet-IC	2.3V±1.5%, -MR, +Reset PPO	UCSP-4	63bd*	VD5	9a Max
AEG	MAX6472TA28BD3	LVR/Vdet-IC	LDO, 2.8V±1.3%, 300mA, -Reset ODO, Set, -MR	DFN-8	37	-	9m Max
AEI	MAX6407BS24-T	Vdet-IC	2.4V±1.5%, -MR, +Reset PPO	UCSP-4	63bd*	VD5	9a Max
AEI	MAX6472TA30AD3	LVR/det-IC	LDO, 3.0V±1.3%, 300mA, -Reset ODO, Set, -MR	DFN-8	37	-	9m Max
AEI	MAX6478BL33BD3	LVR/Vdet-IC	LDO, 3.3V±1.3%, 300mA, -Reset ODO, Set, +CE	BGA-6	40	-	9m Max
AEJ	MAX6407BS25-T	Vdet-IC	2.5V±1.5%, -MR, +Reset PPO	UCSP-4	63bd*	VD5	9a Max
AEJ	MAX6472TA33BD3	LVR/Vdet-IC	LDO, 3.3V±1.3%, 300mA, -Reset ODO, Set, -MR	DFN-8	37	-	9m Max
AEJ	MAX6479BL30BD3	LVR/Vdet-IC	LDO, 3.0V±1.3%, 300mA, -Reset PPO, Set, -MR	BGA-6	40	-	9m Max
AEK	MAX6407BS26-T	Vdet-IC	2.6V±1.5%, -MR, +Reset PPO	UCSP-4	63bd*	VD5	9a Max
AEK	MAX6473TA15AD3	LVR/Vdet-IC	LDO, 1.5V±1.3%, 300mA, -Reset PPO, -MR, +CE	DFN-8	37	-	9m Max
AEK	MAX6480BL25AD3	LVR/Vdet-IC	LDO, 2.5V±1.3%, 300mA, -Reset ODO, Set, -MR	BGA-6	40	-	9m Max
AEL	MAX6407BS27-T	Vdet-IC	2.7V±1.5%, -MR, +Reset PPO	UCSP-4	63bd*	VD5	9a Max
AEL	MAX6473TA18BD3	LVR/Vdet-IC	LDO, 1.8V±1.3%, 300mA, -Reset PPO, -MR, +CE	DFN-8	37	-	9m Max
AEL	MAX6482BL33BD3	LVR/Vdet-IC	LDO, 3.3V±1.3%, 300mA, -Reset ODO, -MR, +CE	BGA-6	40	-	9m Max
AEM	MAX6407BS28-T	Vdet-IC	2.8V±1.5%, -MR, +Reset PPO	UCSP-4	63bd*	VD5	9a Max
AEM	MAX6473TA25AD3	LVR/Vdet-IC	LDO, 2.8V±1.3%, 300mA, -Reset PPO, -MR, +CE	DFN-8	37	-	9m Max
AEM	MAX6484BL18BD3	LVR/det-IC	LDO, 1.8V±1.3%, 300mA, -Reset ODO, FB, +CE	BGA-6	40	-	9m Max
AEN	MAX6407BS29-T	Vdet-IC	2.9V±1.5%, -MR, +Reset PPO	UCSP-4	63bd*	VD5	9a Max
AEN	MAX6473TA28BD3	LVR/Vdet-IC	LDO, 2.8V±1.3%, 300mA, -Reset PPO, -MR, +CE	DFN-8	37	-	9m Max
AEO	MAX6407BS30-T	Vdet-IC	3.0V±1.5%, -MR, +Reset PPO	UCSP-4	63bd*	VD5	9a Max
AEO	MAX6473TA30AD3	LVR/Vdet-IC	LDO, 3.0V±1.3%, 300mA, -Reset PPO, -MR, +CE	DFN-8	37	-	9m Max
AEP	MAX6407BS31-T	Vdet-IC	3.1V±1.5%, -MR, +Reset PPO	UCSP-4	63bd*	VD5	9a Max
AEP	MAX6473TA33BD3	LVR/Vdet-IC	LDO, 3.3V±1.3%, 300mA, -Reset PPO, -MR, +CE	DFN-8	37	-	9m Max
AEQ	MAX6408BS22-T	Vdet-IC	2.2V±1.5%, -MR, -Reset ODO	UCSP-4	63bd*	VD4	9a Max
AEQ	MAX6474TA15AD3	LVR/Vdet-IC	LDO, 1.5V±1.3%, 300mA, -Reset ODO, -MR, +CE	DFN-8	37	-	9m Max
AER	MAX6408BS23-T	Vdet-IC	2.3V±1.5%, -MR, -Reset ODO	UCSP-4	63bd*	VD4	9a Max
AER	MAX6474TA18BD3	LVR/Vdet-IC	LDO, 1.8V±1.3%, 300mA, -Reset ODO, -MR, +CE	DFN-8	37	-	9m Max
AER	MAX6477BL22BD3	LVR/Vdet-IC	LDO, 2.2V±1.3%, 300mA, -Reset PPO, Set, +CE	BGA-6	40	-	9m Max
AER	MAX98302ETD+	LIN-IC	AF PA, BTL, class-D, 2.7..5.5V, 2x2.4W(5V/4Q), shutdown	TDFN-14	37	-	9m Max
AES	MAX6408BS24-T	Vdet-IC	2.4V±1.5%, -MR, -Reset ODO	UCSP-4	63bd*	VD4	9a Max
AES	MAX6474TA25AD3	LVR/Vdet-IC	LDO, 2.5V±1.3%, 300mA, -Reset ODO, -MR, +CE	DFN-8	37	-	9m Max
AET	MAX6408BS25-T	Vdet-IC	2.5V±1.5%, -MR, -Reset ODO	UCSP-4	63bd*	VD4	9a Max
AET	MAX6474TA28BD3	LVR/Vdet-IC	LDO, 2.8V±1.3%, 300mA, -Reset ODO, -MR, +CE	DFN-8	37	-	9m Max
AEU	MAX6408BS26-T	Vdet-IC	2.6V±1.5%, -MR, -Reset ODO	UCSP-4	63bd*	VD4	9a Max
AEU	MAX6474TA30AD3	LVR/Vdet-IC	LDO, 3.0V±1.3%, 300mA, -Reset ODO, -MR, +CE	DFN-8	37	-	9m Max
AEV	MAX6408BS27-T	Vdet-IC	2.7V±1.5%, -MR, -Reset ODO	UCSP-4	63bd*	VD4	9a Max
AEV	MAX6474TA33BD3	LVR/Vdet-IC	LDO, 3.3V±1.3%, 300mA, -Reset ODO, -MR, +CE	DFN-8	37	-	9m Max
AEW	MAX6408BS28-T	Vdet-IC	2.8V±1.5%, -MR, -Reset ODO	UCSP-4	63bd*	VD4	9a Max
AEW	MAX6475TA15BD3	LVR/Vdet-IC	LDO, 1.5V±1.3%, 300mA, -Reset PPO, FB, +CE	DFN-8	37	-	9m Max
AEX	MAX6408BS29-T	Vdet-IC	2.9V±1.5%, -MR, -Reset ODO	UCSP-4	63bd*	VD4	9a Max
AEX	MAX6475TA18AD3	LVR/Vdet-IC	LDO, 1.8V±1.3%, 300mA, -Reset PPO, FB, +CE	DFN-8	37	-	9m Max
AEY	MAX6408BS30-T	Vdet-IC	3.0V±1.5%, -MR, -Reset ODO	UCSP-4	63bd*	VD4	9a Max
AEY	MAX6475TA25BD3	LVR/Vdet-IC	LDO, 2.5V±1.3%, 300mA, -Reset PPO, FB, +CE	DFN-8	37	-	9m Max
AEZ	MAX6408BS31-T	Vdet-IC	3.1V±1.5%, -MR, -Reset ODO	UCSP-4	63bd*	VD4	9a Max
AEZ	MAX6475TA28AD3	LVR/Vdet-IC	LDO, 2.8V±1.3%, 300mA, -Reset PPO, FB, +CE	DFN-8	37	-	9m Max
AF	RP104K191B	LVR-IC	LDO, 1.9V±0.8%, 150mA, +CE	DFN1010-4	48vm	VR4	9a Ric
AF	RP105K121B	LVR-IC	LDO, 1.2V±15mV, 400mA, +CE	DFN1212-6	52zd	VR11	9a Ric
AF	XG6221A16B7R	LVR-IC	LDO, 1.65V±20mV, 200mA, +CE	USPN-4	58vm	VR4	9a Tor
AF	XG6223C25B9R-G	LVR-IC	LDO, 2.55V±1%, 300mA, +CE, PDR	USPQ-4B03	48vm	VR4	9a Tor
AF01	RP500K111A	DC/DC-IC	PWMVFM st-dwn, 1.1V±24mV, 600mA, +CE	DFN1820-6	74ee	DC20	9b Ric
AF02	RP500K121A	DC/DC-IC	PWMVFM st-dwn, 1.2V±24mV, 600mA, +CE	DFN1820-6	74ee	DC20	9b Ric
AF03	RP500K121A5	DC/DC-IC	PWMVFM st-dwn, 1.2V±24mV, 600mA, +CE	DFN1820-6	74ee	DC20	9b Ric
AF04	RP500K131A	DC/DC-IC	PWMVFM st-dwn, 1.3V±24mV, 600mA, +CE	DFN1820-6	74ee	DC20	9b Ric
AF05	RP500K151A	DC/DC-IC	PWMVFM st-dwn, 1.5V±24mV, 600mA, +CE	DFN1820-6	74ee	DC20	9b Ric
AF06	RP500K181A	DC/DC-IC	PWMVFM st-dwn, 1.8V±1.5%, 600mA, +CE	DFN1820-6	74ee	DC20	9b Ric
AF07	RP500K251A	DC/DC-IC	PWMVFM st-dwn, 2.5V±1.5%, 600mA, +CE	DFN1820-6	74ee	DC20	9b Ric
AF08	RP500K331A	DC/DC-IC	PWMVFM st-dwn, 3.3V±1.5%, 600mA, +CE	DFN1820-6	74ee	DC20	9b Ric
AF09	RP500K112A	DC/DC-IC	PWM st-dwn, 1.1V±24mV, 600mA, +CE	DFN1820-6	74ee	DC20	9b Ric
AF10	RP500K122A	DC/DC-IC	PWM st-dwn, 1.2V±24mV, 600mA, +CE	DFN1820-6	74ee	DC20	9b Ric



SMD code	Type	Function	Short description	Case	Pinout	Sch.	St.	Mnf.
AF11	RP500K122A5	DC/DC-IC	PWM st-dwn, 1.25V±24mV, 600mA, +CE	DFN1820-6	74ee	DC20	9b	Ric
AF12	RP500K132A	DC/DC-IC	PWM st-dwn, 1.3V±24mV, 600mA, +CE	DFN1820-6	74ee	DC20	9b	Ric
AF13	RP500K152A	DC/DC-IC	PWM st-dwn, 1.5V±24mV, 600mA, +CE	DFN1820-6	74ee	DC20	9b	Ric
AF14	RP500K182A	DC/DC-IC	PWM st-dwn, 1.8V±1.5%, 600mA, +CE	DFN1820-6	74ee	DC20	9b	Ric
AF15	RP500K252A	DC/DC-IC	PWM st-dwn, 2.5V±1.5%, 600mA, +CE	DFN1820-6	74ee	DC20	9b	Ric
AF16	RP500K332A	DC/DC-IC	PWM st-dwn, 3.3V±1.5%, 600mA, +CE	DFN1820-6	74ee	DC20	9b	Ric
AF17	RP500K161A	DC/DC-IC	PWM/FM st-dwn, 1.6V±24mV, 600mA, +CE	DFN1820-6	74ee	DC20	9b	Ric
AF18	RP500K281A	DC/DC-IC	PWM/FM st-dwn, 2.8V±1.5%, 600mA, +CE	DFN1820-6	74ee	DC20	9b	Ric
AF19	RP500K114A	DC/DC-IC	PWM st-dwn, 1.1V±24mV, 600mA, +CE, CL	DFN1820-6	74ee	DC20	9b	Ric
AF20	RP500K124A	DC/DC-IC	PWM st-dwn, 1.2V±24mV, 600mA, +CE, CL	DFN1820-6	74ee	DC20	9b	Ric
AF21	RP500K154A	DC/DC-IC	PWM st-dwn, 1.5V±24mV, 600mA, +CE, CL	DFN1820-6	74ee	DC20	9b	Ric
AF22	RP500K184A	DC/DC-IC	PWM st-dwn, 1.8V±1.5%, 600mA, +CE, CL	DFN1820-6	74ee	DC20	9b	Ric
AF23	RP500K254A	DC/DC-IC	PWM st-dwn, 2.5V±1.5%, 600mA, +CE, CL	DFN1820-6	74ee	DC20	9b	Ric
AF24	RP500K284A	DC/DC-IC	PWM st-dwn, 2.8V±1.5%, 600mA, +CE, CL	DFN1820-6	74ee	DC20	9b	Ric
AF25	RP500K334A	DC/DC-IC	PWM st-dwn, 3.3V±1.5%, 600mA, +CE, CL	DFN1820-6	74ee	DC20	9b	Ric
AF26	RP500K124A5	DC/DC-IC	PWM st-dwn, 1.25V±24mV, 600mA, +CE, CL	DFN1820-6	74ee	DC20	9b	Ric
AF27	RP500K134A	DC/DC-IC	PWM st-dwn, 1.3V±24mV, 600mA, +CE, CL	DFN1820-6	74ee	DC20	9b	Ric
AF28	RP500K162A	DC/DC-IC	PWM st-dwn, 1.6V±24mV, 600mA, +CE	DFN1820-6	74ee	DC20	9b	Ric
AF29	RP500K164A	DC/DC-IC	PWM st-dwn, 1.6V±24mV, 600mA, +CE, CL	DFN1820-6	74ee	DC20	9b	Ric
AF30	RP500K282A	DC/DC-IC	PWM st-dwn, 2.8V±1.5%, 600mA, +CE	DFN1820-6	74ee	DC20	9b	Ric
AF31	RP500K301A	DC/DC-IC	PWM/FM st-dwn, 3.0V±1.5%, 600mA, +CE	DFN1820-6	74ee	DC20	9b	Ric
AF32	RP500K302A	DC/DC-IC	PWM st-dwn, 3.0V±1.5%, 600mA, +CE	DFN1820-6	74ee	DC20	9b	Ric
AF33	RP500K304A	DC/DC-IC	PWM st-dwn, 3.0V±1.5%, 600mA, +CE, CL	DFN1820-6	74ee	DC20	9b	Ric
AF34	RP500K221A	DC/DC-IC	PWM/FM st-dwn, 2.2V±1.5%, 600mA, +CE	DFN1820-6	74ee	DC20	9b	Ric
AF35	RP500K311A	DC/DC-IC	PWM/FM st-dwn, 3.1V±1.5%, 600mA, +CE	DFN1820-6	74ee	DC20	9b	Ric
AF36	RP500K141A	DC/DC-IC	PWM/FM st-dwn, 1.4V±24mV, 600mA, +CE	DFN1820-6	74ee	DC20	9b	Ric
AF37	RP500K201A	DC/DC-IC	PWM/FM st-dwn, 2.0V±1.5%, 600mA, +CE	DFN1820-6	74ee	DC20	9b	Ric
AF38	RP500K231A	DC/DC-IC	PWM/FM st-dwn, 2.3V±1.5%, 600mA, +CE	DFN1820-6	74ee	DC20	9b	Ric
AF39	RP500K142A	DC/DC-IC	PWM st-dwn, 1.4V±24mV, 600mA, +CE	DFN1820-6	74ee	DC20	9b	Ric
AF40	RP500K144A	DC/DC-IC	PWM st-dwn, 1.4V±24mV, 600mA, +CE, CL	DFN1820-6	74ee	DC20	9b	Ric
AF41	RP500K171A	DC/DC-IC	PWM/FM st-dwn, 1.7V±1.5%, 600mA, +CE	DFN1820-6	74ee	DC20	9b	Ric
AF42	RP500K172A	DC/DC-IC	PWM st-dwn, 1.7V±1.5%, 600mA, +CE	DFN1820-6	74ee	DC20	9b	Ric
AF43	RP500K174A	DC/DC-IC	PWM st-dwn, 1.7V±1.5%, 600mA, +CE, CL	DFN1820-6	74ee	DC20	9b	Ric
AF44	RP500K191A	DC/DC-IC	PWM/FM st-dwn, 1.9V±1.5%, 600mA, +CE	DFN1820-6	74ee	DC20	9b	Ric
AF45	RP500K192A	DC/DC-IC	PWM st-dwn, 1.9V±1.5%, 600mA, +CE	DFN1820-6	74ee	DC20	9b	Ric
AF46	RP500K194A	DC/DC-IC	PWM st-dwn, 1.9V±1.5%, 600mA, +CE, CL	DFN1820-6	74ee	DC20	9b	Ric
AF47	RP500K202A	DC/DC-IC	PWM st-dwn, 2.0V±1.5%, 600mA, +CE	DFN1820-6	74ee	DC20	9b	Ric
AF48	RP500K204A	DC/DC-IC	PWM st-dwn, 2.0V±1.5%, 600mA, +CE, CL	DFN1820-6	74ee	DC20	9b	Ric
AF49	RP500K211A	DC/DC-IC	PWM/FM st-dwn, 2.1V±1.5%, 600mA, +CE	DFN1820-6	74ee	DC20	9b	Ric
AF50	RP500K212A	DC/DC-IC	PWM st-dwn, 2.1V±1.5%, 600mA, +CE	DFN1820-6	74ee	DC20	9b	Ric
AF51	RP500K214A	DC/DC-IC	PWM st-dwn, 2.1V±1.5%, 600mA, +CE, CL	DFN1820-6	74ee	DC20	9b	Ric
AF516	XC6113F516ER	Vdet-IC	1.6V±2%, -MR, +Reset PPO, Wt=400ms, Rt=400ms	USP-6C	49xh	VD17	9b	Tor
AF517	XC6113F517ER	Vdet-IC	1.7V±2%, -MR, +Reset PPO, Wt=400ms, Rt=400ms	USP-6C	49xh	VD17	9b	Tor
AF518	XC6113F518ER	Vdet-IC	1.8V±2%, -MR, +Reset PPO, Wt=400ms, Rt=400ms	USP-6C	49xh	VD17	9b	Tor
AF519	XC6113F519ER	Vdet-IC	1.9V±2%, -MR, +Reset PPO, Wt=400ms, Rt=400ms	USP-6C	49xh	VD17	9b	Tor
AF52	RP500K222A	DC/DC-IC	PWM st-dwn, 2.2V±1.5%, 600mA, +CE	DFN1820-6	74ee	DC20	9b	Ric
AF520	XC6113F520ER	Vdet-IC	2.0V±2%, -MR, +Reset PPO, Wt=400ms, Rt=400ms	USP-6C	49xh	VD17	9b	Tor
AF521	XC6113F521ER	Vdet-IC	2.1V±2%, -MR, +Reset PPO, Wt=400ms, Rt=400ms	USP-6C	49xh	VD17	9b	Tor
AF522	XC6113F522ER	Vdet-IC	2.2V±2%, -MR, +Reset PPO, Wt=400ms, Rt=400ms	USP-6C	49xh	VD17	9b	Tor
AF523	XC6113F523ER	Vdet-IC	2.3V±2%, -MR, +Reset PPO, Wt=400ms, Rt=400ms	USP-6C	49xh	VD17	9b	Tor
AF524	XC6113F524ER	Vdet-IC	2.4V±2%, -MR, +Reset PPO, Wt=400ms, Rt=400ms	USP-6C	49xh	VD17	9b	Tor
AF525	XC6113F525ER	Vdet-IC	2.5V±2%, -MR, +Reset PPO, Wt=400ms, Rt=400ms	USP-6C	49xh	VD17	9b	Tor
AF526	XC6113F526ER	Vdet-IC	2.6V±2%, -MR, +Reset PPO, Wt=400ms, Rt=400ms	USP-6C	49xh	VD17	9b	Tor
AF527	XC6113F527ER	Vdet-IC	2.7V±2%, -MR, +Reset PPO, Wt=400ms, Rt=400ms	USP-6C	49xh	VD17	9b	Tor
AF528	XC6113F528ER	Vdet-IC	2.8V±2%, -MR, +Reset PPO, Wt=400ms, Rt=400ms	USP-6C	49xh	VD17	9b	Tor
AF529	XC6113F529ER	Vdet-IC	2.9V±2%, -MR, +Reset PPO, Wt=400ms, Rt=400ms	USP-6C	49xh	VD17	9b	Tor
AF53	RP500K224A	DC/DC-IC	PWM st-dwn, 2.2V±1.5%, 600mA, +CE, CL	DFN1820-6	74ee	DC20	9b	Ric
AF530	XC6113F530ER	Vdet-IC	3.0V±2%, -MR, +Reset PPO, Wt=400ms, Rt=400ms	USP-6C	49xh	VD17	9b	Tor
AF531	XC6113F531ER	Vdet-IC	3.1V±2%, -MR, +Reset PPO, Wt=400ms, Rt=400ms	USP-6C	49xh	VD17	9b	Tor
AF532	XC6113F532ER	Vdet-IC	3.2V±2%, -MR, +Reset PPO, Wt=400ms, Rt=400ms	USP-6C	49xh	VD17	9b	Tor
AF533	XC6113F533ER	Vdet-IC	3.3V±2%, -MR, +Reset PPO, Wt=400ms, Rt=400ms	USP-6C	49xh	VD17	9b	Tor
AF534	XC6113F534ER	Vdet-IC	3.4V±2%, -MR, +Reset PPO, Wt=400ms, Rt=400ms	USP-6C	49xh	VD17	9b	Tor
AF535	XC6113F535ER	Vdet-IC	3.5V±2%, -MR, +Reset PPO, Wt=400ms, Rt=400ms	USP-6C	49xh	VD17	9b	Tor
AF536	XC6113F536ER	Vdet-IC	3.6V±2%, -MR, +Reset PPO, Wt=400ms, Rt=400ms	USP-6C	49xh	VD17	9b	Tor
AF537	XC6113F537ER	Vdet-IC	3.7V±2%, -MR, +Reset PPO, Wt=400ms, Rt=400ms	USP-6C	49xh	VD17	9b	Tor
AF538	XC6113F538ER	Vdet-IC	3.8V±2%, -MR, +Reset PPO, Wt=400ms, Rt=400ms	USP-6C	49xh	VD17	9b	Tor
AF539	XC6113F539ER	Vdet-IC	3.9V±2%, -MR, +Reset PPO, Wt=400ms, Rt=400ms	USP-6C	49xh	VD17	9b	Tor
AF54	RP500K232A	DC/DC-IC	PWM st-dwn, 2.3V±1.5%, 600mA, +CE	DFN1820-6	74ee	DC20	9b	Ric
AF540	XC6113F540ER	Vdet-IC	4.0V±2%, -MR, +Reset PPO, Wt=400ms, Rt=400ms	USP-6C	49xh	VD17	9b	Tor
AF541	XC6113F541ER	Vdet-IC	4.1V±2%, -MR, +Reset PPO, Wt=400ms, Rt=400ms	USP-6C	49xh	VD17	9b	Tor



SMD code	Type	Function	Short description	Case	Pinout	Sch.	St.	Mnf.
AF542	XC6113F542ER	Vdet-IC	4.2V±2%, -MR, +Reset PPO, Wt=400ms, Rt=400ms	USP-6C	49xh	VD17	9b	Tor
AF543	XC6113F543ER	Vdet-IC	4.3V±2%, -MR, +Reset PPO, Wt=400ms, Rt=400ms	USP-6C	49xh	VD17	9b	Tor
AF544	XC6113F544ER	Vdet-IC	4.4V±2%, -MR, +Reset PPO, Wt=400ms, Rt=400ms	USP-6C	49xh	VD17	9b	Tor
AF545	XC6113F545ER	Vdet-IC	4.5V±2%, -MR, +Reset PPO, Wt=400ms, Rt=400ms	USP-6C	49xh	VD17	9b	Tor
AF546	XC6113F546ER	Vdet-IC	4.6V±2%, -MR, +Reset PPO, Wt=400ms, Rt=400ms	USP-6C	49xh	VD17	9b	Tor
AF547	XC6113F547ER	Vdet-IC	4.7V±2%, -MR, +Reset PPO, Wt=400ms, Rt=400ms	USP-6C	49xh	VD17	9b	Tor
AF548	XC6113F548ER	Vdet-IC	4.8V±2%, -MR, +Reset PPO, Wt=400ms, Rt=400ms	USP-6C	49xh	VD17	9b	Tor
AF549	XC6113F549ER	Vdet-IC	4.9V±2%, -MR, +Reset PPO, Wt=400ms, Rt=400ms	USP-6C	49xh	VD17	9b	Tor
AF55	RP500K234A	DC/DC-IC	PWM st-dwn, 2.3V±1.5%, 600mA, +CE, CL	DFN1820-6	74ee	DC20	9b	Ric
AF550	XC6113F550ER	Vdet-IC	5.0V±2%, -MR, +Reset PPO, Wt=400ms, Rt=400ms	USP-6C	49xh	VD17	9b	Tor
AF56	RP500K241A	DC/DC-IC	PWM/VFM st-dwn, 2.4V±1.5%, 600mA, +CE	DFN1820-6	74ee	DC20	9b	Ric
AF57	RP500K242A	DC/DC-IC	PWM st-dwn, 2.4V±1.5%, 600mA, +CE	DFN1820-6	74ee	DC20	9b	Ric
AF58	RP500K244A	DC/DC-IC	PWM st-dwn, 2.4V±1.5%, 600mA, +CE, CL	DFN1820-6	74ee	DC20	9b	Ric
AF59	RP500K261A	DC/DC-IC	PWM/VFM st-dwn, 2.6V±1.5%, 600mA, +CE	DFN1820-6	74ee	DC20	9b	Ric
AF60	RP500K262A	DC/DC-IC	PWM st-dwn, 2.6V±1.5%, 600mA, +CE	DFN1820-6	74ee	DC20	9b	Ric
AF61	RP500K264A	DC/DC-IC	PWM st-dwn, 2.6V±1.5%, 600mA, +CE, CL	DFN1820-6	74ee	DC20	9b	Ric
AF616	XC6113F616ER	Vdet-IC	1.6V±2%, -MR, +Reset PPO, Wt=1.6s, Rt=400ms	USP-6C	49xh	VD17	9b	Tor
AF617	XC6113F617ER	Vdet-IC	1.7V±2%, -MR, +Reset PPO, Wt=1.6s, Rt=400ms	USP-6C	49xh	VD17	9b	Tor
AF618	XC6113F618ER	Vdet-IC	1.8V±2%, -MR, +Reset PPO, Wt=1.6s, Rt=400ms	USP-6C	49xh	VD17	9b	Tor
AF619	XC6113F619ER	Vdet-IC	1.9V±2%, -MR, +Reset PPO, Wt=1.6s, Rt=400ms	USP-6C	49xh	VD17	9b	Tor
AF62	RP500K271A	DC/DC-IC	PWM/VFM st-dwn, 2.7V±1.5%, 600mA, +CE	DFN1820-6	74ee	DC20	9b	Ric
AF620	XC6113F620ER	Vdet-IC	2.0V±2%, -MR, +Reset PPO, Wt=1.6s, Rt=400ms	USP-6C	49xh	VD17	9b	Tor
AF621	XC6113F621ER	Vdet-IC	2.1V±2%, -MR, +Reset PPO, Wt=1.6s, Rt=400ms	USP-6C	49xh	VD17	9b	Tor
AF622	XC6113F622ER	Vdet-IC	2.2V±2%, -MR, +Reset PPO, Wt=1.6s, Rt=400ms	USP-6C	49xh	VD17	9b	Tor
AF623	XC6113F623ER	Vdet-IC	2.3V±2%, -MR, +Reset PPO, Wt=1.6s, Rt=400ms	USP-6C	49xh	VD17	9b	Tor
AF624	XC6113F624ER	Vdet-IC	2.4V±2%, -MR, +Reset PPO, Wt=1.6s, Rt=400ms	USP-6C	49xh	VD17	9b	Tor
AF625	XC6113F625ER	Vdet-IC	2.5V±2%, -MR, +Reset PPO, Wt=1.6s, Rt=400ms	USP-6C	49xh	VD17	9b	Tor
AF626	XC6113F626ER	Vdet-IC	2.6V±2%, -MR, +Reset PPO, Wt=1.6s, Rt=400ms	USP-6C	49xh	VD17	9b	Tor
AF627	XC6113F627ER	Vdet-IC	2.7V±2%, -MR, +Reset PPO, Wt=1.6s, Rt=400ms	USP-6C	49xh	VD17	9b	Tor
AF628	XC6113F628ER	Vdet-IC	2.8V±2%, -MR, +Reset PPO, Wt=1.6s, Rt=400ms	USP-6C	49xh	VD17	9b	Tor
AF629	XC6113F629ER	Vdet-IC	2.9V±2%, -MR, +Reset PPO, Wt=1.6s, Rt=400ms	USP-6C	49xh	VD17	9b	Tor
AF63	RP500K272A	DC/DC-IC	PWM st-dwn, 2.7V±1.5%, 600mA, +CE	DFN1820-6	74ee	DC20	9b	Ric
AF630	XC6113F630ER	Vdet-IC	3.0V±2%, -MR, +Reset PPO, Wt=1.6s, Rt=400ms	USP-6C	49xh	VD17	9b	Tor
AF631	XC6113F631ER	Vdet-IC	3.1V±2%, -MR, +Reset PPO, Wt=1.6s, Rt=400ms	USP-6C	49xh	VD17	9b	Tor
AF632	XC6113F632ER	Vdet-IC	3.2V±2%, -MR, +Reset PPO, Wt=1.6s, Rt=400ms	USP-6C	49xh	VD17	9b	Tor
AF633	XC6113F633ER	Vdet-IC	3.3V±2%, -MR, +Reset PPO, Wt=1.6s, Rt=400ms	USP-6C	49xh	VD17	9b	Tor
AF634	XC6113F634ER	Vdet-IC	3.4V±2%, -MR, +Reset PPO, Wt=1.6s, Rt=400ms	USP-6C	49xh	VD17	9b	Tor
AF635	XC6113F635ER	Vdet-IC	3.5V±2%, -MR, +Reset PPO, Wt=1.6s, Rt=400ms	USP-6C	49xh	VD17	9b	Tor
AF636	XC6113F636ER	Vdet-IC	3.6V±2%, -MR, +Reset PPO, Wt=1.6s, Rt=400ms	USP-6C	49xh	VD17	9b	Tor
AF637	XC6113F637ER	Vdet-IC	3.7V±2%, -MR, +Reset PPO, Wt=1.6s, Rt=400ms	USP-6C	49xh	VD17	9b	Tor
AF638	XC6113F638ER	Vdet-IC	3.8V±2%, -MR, +Reset PPO, Wt=1.6s, Rt=400ms	USP-6C	49xh	VD17	9b	Tor
AF639	XC6113F639ER	Vdet-IC	3.9V±2%, -MR, +Reset PPO, Wt=1.6s, Rt=400ms	USP-6C	49xh	VD17	9b	Tor
AF64	RP500K274A	DC/DC-IC	PWM st-dwn, 2.7V±1.5%, 600mA, +CE, CL	DFN1820-6	74ee	DC20	9b	Ric
AF640	XC6113F640ER	Vdet-IC	4.0V±2%, -MR, +Reset PPO, Wt=1.6s, Rt=400ms	USP-6C	49xh	VD17	9b	Tor
AF641	XC6113F641ER	Vdet-IC	4.1V±2%, -MR, +Reset PPO, Wt=1.6s, Rt=400ms	USP-6C	49xh	VD17	9b	Tor
AF642	XC6113F642ER	Vdet-IC	4.2V±2%, -MR, +Reset PPO, Wt=1.6s, Rt=400ms	USP-6C	49xh	VD17	9b	Tor
AF643	XC6113F643ER	Vdet-IC	4.3V±2%, -MR, +Reset PPO, Wt=1.6s, Rt=400ms	USP-6C	49xh	VD17	9b	Tor
AF644	XC6113F644ER	Vdet-IC	4.4V±2%, -MR, +Reset PPO, Wt=1.6s, Rt=400ms	USP-6C	49xh	VD17	9b	Tor
AF645	XC6113F645ER	Vdet-IC	4.5V±2%, -MR, +Reset PPO, Wt=1.6s, Rt=400ms	USP-6C	49xh	VD17	9b	Tor
AF646	XC6113F646ER	Vdet-IC	4.6V±2%, -MR, +Reset PPO, Wt=1.6s, Rt=400ms	USP-6C	49xh	VD17	9b	Tor
AF647	XC6113F647ER	Vdet-IC	4.7V±2%, -MR, +Reset PPO, Wt=1.6s, Rt=400ms	USP-6C	49xh	VD17	9b	Tor
AF648	XC6113F648ER	Vdet-IC	4.8V±2%, -MR, +Reset PPO, Wt=1.6s, Rt=400ms	USP-6C	49xh	VD17	9b	Tor
AF649	XC6113F649ER	Vdet-IC	4.9V±2%, -MR, +Reset PPO, Wt=1.6s, Rt=400ms	USP-6C	49xh	VD17	9b	Tor
AF65	RP500K291A	DC/DC-IC	PWM/VFM st-dwn, 2.9V±1.5%, 600mA, +CE	DFN1820-6	74ee	DC20	9b	Ric
AF650	XC6113F650ER	Vdet-IC	5.0V±2%, -MR, +Reset PPO, Wt=1.6s, Rt=400ms	USP-6C	49xh	VD17	9b	Tor
AF66	RP500K292A	DC/DC-IC	PWM st-dwn, 2.9V±1.5%, 600mA, +CE	DFN1820-6	74ee	DC20	9b	Ric
AF67	RP500K294A	DC/DC-IC	PWM st-dwn, 2.9V±1.5%, 600mA, +CE, CL	DFN1820-6	74ee	DC20	9b	Ric
AF68	RP500K312A	DC/DC-IC	PWM st-dwn, 3.1V±1.5%, 600mA, +CE	DFN1820-6	74ee	DC20	9b	Ric
AF69	RP500K314A	DC/DC-IC	PWM st-dwn, 3.1V±1.5%, 600mA, +CE, CL	DFN1820-6	74ee	DC20	9b	Ric
AF70	RP500K321A	DC/DC-IC	PWM/VFM st-dwn, 3.2V±1.5%, 600mA, +CE	DFN1820-6	74ee	DC20	9b	Ric
AF71	RP500K322A	DC/DC-IC	PWM st-dwn, 3.2V±1.5%, 600mA, +CE	DFN1820-6	74ee	DC20	9b	Ric
AF72	RP500K324A	DC/DC-IC	PWM st-dwn, 3.2V±1.5%, 600mA, +CE, CL	DFN1820-6	74ee	DC20	9b	Ric
AFA	MAX6409BS33-T	Vdet-IC	3.3V±1.5%, -MR, -Reset PPO	UCSP-4	63bd*	VD5	9a	Max
AFA	MAX6475TA30BD3	LVR/Vdet-IC	LDO, 3.0V±1.3%, 300mA, -Reset PPO, FB, +CE	DFN-8	37	-	9m	Max
AFB	MAX6409BS34-T	Vdet-IC	3.4V±1.5%, -MR, -Reset PPO	UCSP-4	63bd*	VD5	9a	Max
AFB	MAX6476TA15BD3	LVR/Vdet-IC	LDO, 1.5V±1.3%, 300mA, -Reset ODO, FB, +CE	DFN-8	37	-	9m	Max
AFC	MAX6409BS35-T	Vdet-IC	3.5V±1.5%, -MR, -Reset PPO	UCSP-4	63bd*	VD5	9a	Max
AFC	MAX6476TA18AD3	LVR/Vdet-IC	LDO, 1.8V±1.3%, 300mA, -Reset ODO, FB, +CE	DFN-8	37	-	9m	Max
AFD	MAX6409BS36-T	Vdet-IC	3.6V±1.5%, -MR, -Reset PPO	UCSP-4	63bd*	VD5	9a	Max
AFD	MAX6476TA25BD3	LVR/Vdet-IC	LDO, 2.5V±1.3%, 300mA, -Reset ODO, FB, +CE	DFN-8	37	-	9m	Max



SMD code	Type	Function	Short description	Case	Pinout	Sch.	St.	Mnf.
AFE	MAX6409BS37-T	Vdet-IC	3.7V±1.5%, -MR, -Reset PPO	UCSP-4	63bd*	VD5	9a	Max
AFE	MAX6476TA28AD3	LVR/det-IC	LDO, 2.8V±1.3%, 300mA, -Reset ODO, FB, +CE	DFN-8	37	-	9m	Max
AFF	MAX6409BS38-T	Vdet-IC	3.8V±1.5%, -MR, -Reset PPO	UCSP-4	63bd*	VD5	9a	Max
AFF	MAX6476TA30BD3	LVR/det-IC	LDO, 3.0V±1.3%, 300mA, -Reset ODO, FB, +CE	DFN-8	37	-	9m	Max
AFF	MAX8678BETE+	LIN-IC	AF PA, BTL, 2.7..5.5V, 1.1W(5V/8Q), shutdown	QFN-16	38	-	9m	Max
AFG	MAX6409BS39-T	Vdet-IC	3.9V±1.5%, -MR, -Reset PPO	UCSP-4	63bd*	VD5	9a	Max
AFG	MAX6476TA33AD3	LVR/det-IC	LDO, 3.3V±1.3%, 300mA, -Reset ODO, FB, +CE	DFN-8	37	-	9m	Max
AFH	MAX4365-TA	LIN-IC	AF PA, BTL, 2.7..5.5V, 1W(5V/8Q), shutdown	DFN-8	37	-	9m	Max
AFH	MAX6409BS40-T	Vdet-IC	4.0V±1.5%, -MR, -Reset PPO	UCSP-4	63bd*	VD5	9a	Max
AFH	MAX6479BL28AD3	LVR/det-IC	LDO, 2.8V±1.3%, 300mA, -Reset PPO, Set, -MR	BGA-6	40	-	9m	Max
AFI	MAX6409BS41-T	Vdet-IC	4.1V±1.5%, -MR, -Reset PPO	UCSP-4	63bd*	VD5	9a	Max
AFJ	MAX6409BS42-T	Vdet-IC	4.2V±1.5%, -MR, -Reset PPO	UCSP-4	63bd*	VD5	9a	Max
AFK	MAX6409BS43-T	Vdet-IC	4.3V±1.5%, -MR, -Reset PPO	UCSP-4	63bd*	VD5	9a	Max
AFL	MAX6409BS44-T	Vdet-IC	4.4V±1.5%, -MR, -Reset PPO	UCSP-4	63bd*	VD5	9a	Max
AFM	MAX6409BS45-T	Vdet-IC	4.5V±1.5%, -MR, -Reset PPO	UCSP-4	63bd*	VD5	9a	Max
AFN	MAX6409BS46-T	Vdet-IC	4.6V±1.5%, -MR, -Reset PPO	UCSP-4	63bd*	VD5	9a	Max
aG	74AUP1G332GF	CMOS-Logic	3-input OR gate	SOT891	52Log32	-	9c	Phi
aG	74AUP1G332GM	CMOS-Logic	3-input OR gate	SOT-886	57Log32	-	9c	Phi
AG	RP104K201B	LVR-IC	LDO, 2.0V±0.8%, 150mA, +CE	DFN1010-4	48vm	VR4	9a	Ric
AG	RP105K131B	LVR-IC	LDO, 1.3V±15mV, 400mA, +CE	DFN1212-6	52zd	VR14	9a	Ric
AG	RT9013B-35PQWA	LVR-IC	LDO, 3.5V±2%, 500mA, +CE	WDFN-6	49xu	VR4	9a	Rct
AG	SN2010W	LIN-IC	AF PA, BTL, class-D, 2.5..5.5V, 2.6W(5V/4Q), shutdown	BGA-9	39	AFP45	-	Se
aH	74AUP1G386GF	CMOS-Logic	3-input EXCLUSIVE-OR gate	SOT891	52Log33	-	9c	Phi
aH	74AUP1G386GM	CMOS-Logic	3-input EXCLUSIVE-OR gate	SOT-886	57Log33	-	9c	Phi
aH	74LVC1G386GF	CMOS-Logic	3-input EXCLUSIVE-OR gate	SOT891	52Log33	-	9c	Phi
AH	CP2297LD	LIN-IC	AF PA, BTL, 2.5..5.5V, 3.1W(5V/8Q), shutdown	DFN-8	37	AFP22	-	Cpm
AH	RP104K251B	LVR-IC	LDO, 2.5V±0.8%, 150mA, +CE	DFN1010-4	48vm	VR4	9a	Ric
AH	RP105K141B	LVR-IC	LDO, 1.4V±15mV, 400mA, +CE	DFN1212-6	52zd	VR11	9a	Ric
AH	RT9013B-15PQWA	LVR-IC	LDO, 1.5V±2%, 500mA, +CE	WDFN-6	49xu	VR4	9a	Rct
AH	XC6221A17B7R	LVR-IC	LDO, 1.75V±20mV, 200mA, +CE	USPN-4	58vm	VR4	9a	Tor
AH	XC6223C26B9R-G	LVR-IC	LDO, 2.65V±1%, 300mA, +CE, PDR	USPQ-4B03	48vm	VR4	9a	Tor
AH-	RT9013-33PQV	LVR-IC	LDO, 3.3V±2%, 500mA, +CE	WDFN-8	49	VR4	9a	Rct
AH616	XC6113H616ER	Vdet-IC	1.6V±2%, -MR, +Reset PPO, Wlt=1.6s, Rt=1.6s	USP-6C	49xh	VD17	9b	Tor
AH617	XC6113H617ER	Vdet-IC	1.7V±2%, -MR, +Reset PPO, Wlt=1.6s, Rt=1.6s	USP-6C	49xh	VD17	9b	Tor
AH618	XC6113H618ER	Vdet-IC	1.8V±2%, -MR, +Reset PPO, Wlt=1.6s, Rt=1.6s	USP-6C	49xh	VD17	9b	Tor
AH619	XC6113H619ER	Vdet-IC	1.9V±2%, -MR, +Reset PPO, Wlt=1.6s, Rt=1.6s	USP-6C	49xh	VD17	9b	Tor
AH620	XC6113H620ER	Vdet-IC	2.0V±2%, -MR, +Reset PPO, Wlt=1.6s, Rt=1.6s	USP-6C	49xh	VD17	9b	Tor
AH621	XC6113H621ER	Vdet-IC	2.1V±2%, -MR, +Reset PPO, Wlt=1.6s, Rt=1.6s	USP-6C	49xh	VD17	9b	Tor
AH622	XC6113H622ER	Vdet-IC	2.2V±2%, -MR, +Reset PPO, Wlt=1.6s, Rt=1.6s	USP-6C	49xh	VD17	9b	Tor
AH623	XC6113H623ER	Vdet-IC	2.3V±2%, -MR, +Reset PPO, Wlt=1.6s, Rt=1.6s	USP-6C	49xh	VD17	9b	Tor
AH624	XC6113H624ER	Vdet-IC	2.4V±2%, -MR, +Reset PPO, Wlt=1.6s, Rt=1.6s	USP-6C	49xh	VD17	9b	Tor
AH625	XC6113H625ER	Vdet-IC	2.5V±2%, -MR, +Reset PPO, Wlt=1.6s, Rt=1.6s	USP-6C	49xh	VD17	9b	Tor
AH626	XC6113H626ER	Vdet-IC	2.6V±2%, -MR, +Reset PPO, Wlt=1.6s, Rt=1.6s	USP-6C	49xh	VD17	9b	Tor
AH627	XC6113H627ER	Vdet-IC	2.7V±2%, -MR, +Reset PPO, Wlt=1.6s, Rt=1.6s	USP-6C	49xh	VD17	9b	Tor
AH628	XC6113H628ER	Vdet-IC	2.8V±2%, -MR, +Reset PPO, Wlt=1.6s, Rt=1.6s	USP-6C	49xh	VD17	9b	Tor
AH629	XC6113H629ER	Vdet-IC	2.9V±2%, -MR, +Reset PPO, Wlt=1.6s, Rt=1.6s	USP-6C	49xh	VD17	9b	Tor
AH630	XC6113H630ER	Vdet-IC	3.0V±2%, -MR, +Reset PPO, Wlt=1.6s, Rt=1.6s	USP-6C	49xh	VD17	9b	Tor
AH631	XC6113H631ER	Vdet-IC	3.1V±2%, -MR, +Reset PPO, Wlt=1.6s, Rt=1.6s	USP-6C	49xh	VD17	9b	Tor
AH632	XC6113H632ER	Vdet-IC	3.2V±2%, -MR, +Reset PPO, Wlt=1.6s, Rt=1.6s	USP-6C	49xh	VD17	9b	Tor
AH633	XC6113H633ER	Vdet-IC	3.3V±2%, -MR, +Reset PPO, Wlt=1.6s, Rt=1.6s	USP-6C	49xh	VD17	9b	Tor
AH634	XC6113H634ER	Vdet-IC	3.4V±2%, -MR, +Reset PPO, Wlt=1.6s, Rt=1.6s	USP-6C	49xh	VD17	9b	Tor
AH635	XC6113H635ER	Vdet-IC	3.5V±2%, -MR, +Reset PPO, Wlt=1.6s, Rt=1.6s	USP-6C	49xh	VD17	9b	Tor
AH636	XC6113H636ER	Vdet-IC	3.6V±2%, -MR, +Reset PPO, Wlt=1.6s, Rt=1.6s	USP-6C	49xh	VD17	9b	Tor
AH637	XC6113H637ER	Vdet-IC	3.7V±2%, -MR, +Reset PPO, Wlt=1.6s, Rt=1.6s	USP-6C	49xh	VD17	9b	Tor
AH638	XC6113H638ER	Vdet-IC	3.8V±2%, -MR, +Reset PPO, Wlt=1.6s, Rt=1.6s	USP-6C	49xh	VD17	9b	Tor
AH639	XC6113H639ER	Vdet-IC	3.9V±2%, -MR, +Reset PPO, Wlt=1.6s, Rt=1.6s	USP-6C	49xh	VD17	9b	Tor
AH640	XC6113H640ER	Vdet-IC	4.0V±2%, -MR, +Reset PPO, Wlt=1.6s, Rt=1.6s	USP-6C	49xh	VD17	9b	Tor
AH641	XC6113H641ER	Vdet-IC	4.1V±2%, -MR, +Reset PPO, Wlt=1.6s, Rt=1.6s	USP-6C	49xh	VD17	9b	Tor
AH642	XC6113H642ER	Vdet-IC	4.2V±2%, -MR, +Reset PPO, Wlt=1.6s, Rt=1.6s	USP-6C	49xh	VD17	9b	Tor
AH643	XC6113H643ER	Vdet-IC	4.3V±2%, -MR, +Reset PPO, Wlt=1.6s, Rt=1.6s	USP-6C	49xh	VD17	9b	Tor
AH644	XC6113H644ER	Vdet-IC	4.4V±2%, -MR, +Reset PPO, Wlt=1.6s, Rt=1.6s	USP-6C	49xh	VD17	9b	Tor
AH645	XC6113H645ER	Vdet-IC	4.5V±2%, -MR, +Reset PPO, Wlt=1.6s, Rt=1.6s	USP-6C	49xh	VD17	9b	Tor
AH646	XC6113H646ER	Vdet-IC	4.6V±2%, -MR, +Reset PPO, Wlt=1.6s, Rt=1.6s	USP-6C	49xh	VD17	9b	Tor
AH647	XC6113H647ER	Vdet-IC	4.7V±2%, -MR, +Reset PPO, Wlt=1.6s, Rt=1.6s	USP-6C	49xh	VD17	9b	Tor
AH648	XC6113H648ER	Vdet-IC	4.8V±2%, -MR, +Reset PPO, Wlt=1.6s, Rt=1.6s	USP-6C	49xh	VD17	9b	Tor
AH649	XC6113H649ER	Vdet-IC	4.9V±2%, -MR, +Reset PPO, Wlt=1.6s, Rt=1.6s	USP-6C	49xh	VD17	9b	Tor
AH650	XC6113H650ER	Vdet-IC	5.0V±2%, -MR, +Reset PPO, Wlt=1.6s, Rt=1.6s	USP-6C	49xh	VD17	9b	Tor
AHA	MAX9890AETA	LIN-IC	Audio click-pop suppress, (36dB), 2.7..5.5V, THD<0.03%(32Q)	DFN-8	37cb	-	-	Max
AHB	MAX9890BETA	LIN-IC	Audio click-pop suppress, (36dB), 2.7..5.5V, THD<0.03%(32Q)	DFN-8	37cb	-	-	Max
AHI	MAX6760TALAD3	Vdet-IC	5.0V±1.5%/ADJ, -MR, -UV PPO, -OV ODO	TDFN-8	37	-	9a	Max



SMD code	Type	Function	Short description	Case	Pinout	Sch.	St.	Mnf.
AHJ	MAX6760TATWD3	Vdet-IC	3.3/1.8V±1.5%, -MR, -UV PPO, -OV ODO	TDFN-8	37	-	9a	Max
AHL	MAX6760TAWAD3	Vdet-IC	1.8V±1.5%/ADJ, -MR, -UV PPO, -OV ODO	TDFN-8	37	-	9a	Max
AHN	MAX6761TALAD3	Vdet-IC	5.0V±1.5%/ADJ, -MR, +UV PPO, -OV ODO	TDFN-8	37	-	9a	Max
AHO	MAX6761TATWD3	Vdet-IC	3.3/1.8V±1.5%, -MR, +UV PPO, -OV ODO	TDFN-8	37	-	9a	Max
AHQ	MAX6761TAWAD3	Vdet-IC	1.8V±1.5%/ADJ, -MR, -UV ODO, -OV ODO	TDFN-8	37	-	9a	Max
AHR	MAX6762TALAD3	Vdet-IC	5.0V±1.5%/ADJ, -MR, -UV ODO, -OV ODO	TDFN-8	37	-	9a	Max
AHT	MAX6762TAZWD3	Vdet-IC	2.5/1.8V±1.5%, -MR, -UV ODO, -OV ODO	TDFN-8	37	-	9a	Max
AHW	MAX9716ETA	LIN-IC	AF PA, BTL, 2.7..5.5V 1.4W(5V/4Q), shutdown	DFN-8	37	AFP12	9m	Max
AHX	MAX9717AETA	LIN-IC	AF PA, BTL, 2.7..5.5V 1.4W(5V/4Q), shutdown	DFN-8	37	AFP23	9m	Max
AHY	MAX9717BETA	LIN-IC	AF PA, BTL, 2.7..5.5V, 1.4W(5V/4Q), shutdown	DFN-8	37	AFP36	9m	Max
AHZ	MAX9717CETA	LIN-IC	AF PA, BTL, 2.7..5.5V, 1.4W(5V/4Q), shutdown	DFN-8	37	AFP36	9m	Max
AI	CP2297ITL	LIN-IC	AF PA, BTL, 2.5..5.5V, 3.1W(5V/4Q), shutdown	BGA-9	39	AFP51	-	Cpm
AIA	MAX9717DETA	LIN-IC	AF PA, BTL, 2.7..5.5V, 1.4W(5V/4Q), shutdown	DFN-8	37	AFP36	9m	Max
AIF	MAX97220AETE+	LIN-IC	AF PA, 2.4..5.5V, 2x125mW(3V/32Q), shutdown	QFN-16	38	-	9m	Max
AIFI	TPA6140AYF	LIN-IC	AF PA, 2.5..5.5V, 2x32mW(5V/16Q), I2C	BGA-16	39	-	-	Ti
AIG	MAX97220BETE+	LIN-IC	AF PA, 2.4..5.5V, 2x125mW(3V/32Q), shutdown	QFN-16	38	-	9m	Max
AIH	MAX97220CETE+	LIN-IC	AF PA, 2.4..5.5V, 2x125mW(3V/32Q), shutdown	QFN-16	38	-	9m	Max
AIH	MAX98300EWL+	LIN-IC	AF PA, BTL, class-D, 2.7..5.5V, 2.6W(5V/4Q), shutdown	BGA-9	39	-	9m	Max
AII	MAX97220DETE+	LIN-IC	AF PA, 2.4..5.5V, 2x125mW(3V/32Q), shutdown	QFN-16	38	-	9m	Max
AIO	MAX6760TALTD3	Vdet-IC	5.0/3.3V±1.5%, -MR, -UV PPO, -OV ODO	TDFN-8	37	-	9a	Max
AIR	MAX6760TATZD3	Vdet-IC	3.3/2.5V±1.5%, -MR, -UV PPO, -OV ODO	TDFN-8	37	-	9a	Max
AIR	MAX98304EWL+	LIN-IC	AF PA, BTL, class-D, 2.7..5.5V, 3.1W(5V/4Q), shutdown	BGA-9	39	-	9m	Max
AIT	MAX6760TATAD3	Vdet-IC	3.3V±1.5%/ADJ, -MR, -UV PPO, -OV ODO	TDFN-8	37	-	9a	Max
AIV	MAX6760TARAD3	Vdet-IC	3.0V±1.5%/ADJ, -MR, -UV PPO, -OV ODO	TDFN-8	37	-	9a	Max
AIWI	TPA6132ART	LIN-IC	AF PA, 2.5..5.5V, 2x25mW(5V/16Q), enable	QFN-16	38	-	-	Ti
AIX	MAX6760TAZWD3	Vdet-IC	2.5/1.8V±1.5%, -MR, -UV PPO, -OV ODO	TDFN-8	37	-	9a	Max
AIZ	MAX6760TAZAD3	Vdet-IC	2.5V±1.5%/ADJ, -MR, -UV PPO, -OV ODO	TDFN-8	37	-	9a	Max
AJ	RP104K261B	LVR-IC	LDO, 2.6V±0.8%, 150mA, +CE	DFN1010-4	48vm	VR4	9a	Ric
AJ	RP105K151B	LVR-IC	LDO, 1.5V±15mV, 400mA, +CE	DFN1212-6	52zd	VR11	9a	Ric
AJ-	RT9013-1BPQV	LVR-IC	LDO, 1.25V±2%, 500mA, +CE	WDFN-8	49	VR4	9a	Rct
AJB	MAX6760TAWED3	Vdet-IC	1.8/0.9V±1.5%, -MR, -UV PPO, -OV ODO	TDFN-8	37	-	9a	Max
AJD	MAX6761TALTD3	Vdet-IC	5.0/3.3±1.5%/V, -MR, +UV PPO, -OV ODO	TDFN-8	37	-	9a	Max
AJG	MAX6761TATZD3	Vdet-IC	3.3/2.5V±1.5%, -MR, +UV PPO, -OV ODO	TDFN-8	37	-	9a	Max
AJI	MAX6761TATAD3	Vdet-IC	3.3V±1.5%/ADJ, -MR, +UV PPO, -OV ODO	TDFN-8	37	-	9a	Max
AJK	MAX6761TARAD3	Vdet-IC	3.0V±1.5%/ADJ, -MR, +UV PPO, -OV ODO	TDFN-8	37	-	9a	Max
AJM	MAX6761TAZWD3	Vdet-IC	2.5/1.8V±1.5%, -MR, +UV PPO, -OV ODO	TDFN-8	37	-	9a	Max
AJO	MAX6761TAZAD3	Vdet-IC	2.5V±1.5%/ADJ, -MR, +UV PPO, -OV ODO	TDFN-8	37	-	9a	Max
AJQ	MAX6761TAWED3	Vdet-IC	1.8/0.9V±1.5%, -MR, +UV PPO, -OV ODO	TDFN-8	37	-	9a	Max
AJT	MAX6762TALTD3	Vdet-IC	5.0/3.3V±1.5%, -MR, -UV ODO, -OV ODO	TDFN-8	37	-	9a	Max
AJW	MAX6762TATZD3	Vdet-IC	3.3/2.5V±1.5%, -MR, -UV ODO, -OV ODO	TDFN-8	37	-	9a	Max
AJY	MAX6762TATWD3	Vdet-IC	3.3/1.8V±1.5%, -MR, -UV ODO, -OV ODO	TDFN-8	37	-	9a	Max
AJZ	STH4010YEF	LIN-IC	AF PA, BTL, class-D, 2.5..5.5V, 2.5W(5V/4Q), shutdown	BGA-9	39	AFP45	-	Sit
AJZ	TPA2010D1YEF	LIN-IC	AF PA, BTL, class-D, 2.5..5.5V, 2.5W(5V/8Q), shutdown	BGA-9	39	AFP45	-	Ti
aK	74AUP1G58GF	CMOS-Logic	Configurable multiple-function gate	SOT891	52Log37	-	9c	Phi
aK	74AUP1G58GM	CMOS-Logic	Configurable multiple-function gate	SOT-886	57Log37	-	9c	Phi
AK	CP2293LD	LIN-IC	AF PA, BTL, 2.5..5.5V, 3W(5V/8Q), shutdown	DFN-8	37	AFP22	-	Cpm
AK	RP104K271B	LVR-IC	LDO, 2.7V±0.8%, 150mA, +CE	DFN1010-4	48vm	VR4	9a	Ric
AK	RP105K111B	LVR-IC	LDO, 1.1V±15mV, 400mA, +CE	DFN1212-6	52zd	VR11	9a	Ric
AK	XC6221A18B7R	LVR-IC	LDO, 1.85V±20mV, 200mA, +CE	USPN-4	58vm	VR4	9a	Tor
AK	XC6223C27B9R-G	LVR-IC	LDO, 2.75V±1%, 300mA, +CE, PDR	USPQ-4B03	48vm	VR4	9a	Tor
AKA	MAX6762TATAD3	Vdet-IC	3.3V±1.5%/ADJ, -MR, -UV ODO, -OV ODO	TDFN-8	37	-	9a	Max
AKB	MAX6762TARAD3	Vdet-IC	3.0V±1.5%/ADJ, -MR, -UV ODO, -OV ODO	TDFN-8	37	-	9a	Max
AKE	MAX6762TAZAD3	Vdet-IC	2.5V±1.5%/ADJ, -MR, -UV ODO, -OV ODO	TDFN-8	37	-	9a	Max
AKF	MAX6762TAWED3	Vdet-IC	1.8/0.9V±1.5%, -MR, -UV ODO, -OV ODO	TDFN-8	37	-	9a	Max
AKH	MAX6762TAWAD3	Vdet-IC	1.8V±1.5%/ADJ, -MR, -UV ODO, -OV ODO	TDFN-8	37	-	9a	Max
AKO	STH4010YZF	LIN-IC	AF PA, BTL, class-D, 2.5..5.5V, 2.5W(5V/4Q), shutdown	BGA-9	39	AFP45	-	Sit
AKO	TPA2010D1YZF	LIN-IC	AF PA, BTL, class-D, 2.5..5.5V, 2.5W(5V/8Q), shutdown	BGA-9	39	AFP45	-	Ti
AKQ	TPA4411RTJ	LIN-IC	AF PA, 1.8..4.5V, 2x80mW(4V/16Q), shutdown	QFN-20	38	-	-	Ti
AKR	TPA2012D2Y2H	LIN-IC	AF PA, BTL, class-D, 2.5..5.5V, 2x2.1W(5V/4Q), shutdown	BGA-16	39	AFP46	-	Ti
AKS	TPA2012D2RTJ	LIN-IC	AF PA, BTL, class-D, 2.5..5.5V, 2x2.1W(5V/4Q), shutdown	QFN-20	38	-	-	Ti
AKT	TPA4411Y2H	LIN-IC	AF PA, 1.8..4.5V, 2x80mW(4V/16Q), shutdown	BGA-16	39	-	-	Ti
AL	CP2293ITL	LIN-IC	AF PA, BTL, 2.5..5.5V, 3W(5V/8Q), shutdown	BGA-8	39	AFP47	-	Cpm
AL	MAX8840EY27+T	LVR-IC	LDO, 2.7V±2%, 150mA, +CE	DFN-6	52	VR7a	9t	Max
AL	RP104K281B	LVR-IC	LDO, 2.8V±0.8%, 150mA, +CE	DFN1010-4	48vm	VR4	9a	Ric
AL	XC6221A19B7R	LVR-IC	LDO, 1.95V±20mV, 200mA, +CE	USPN-4	58vm	VR4	9a	Tor
AL	XC6223C28B9R-G	LVR-IC	LDO, 2.85V±1%, 300mA, +CE, PDR	USPQ-4B03	48vm	VR4	9a	Tor
AM	RP104K281B5	LVR-IC	LDO, 2.85V±0.8%, 150mA, +CE	DFN1010-4	48vm	VR4	9a	Ric
AM	XC6221A20B7R	LVR-IC	LDO, 2.05V±1%, 200mA, +CE	USPN-4	58vm	VR4	9a	Tor
AM	XC6223C29B9R-G	LVR-IC	LDO, 2.95V±1%, 300mA, +CE, PDR	USPQ-4B03	48vm	VR4	9a	Tor
AM01	RP131K081B	LVR-IC	LDO, 0.8V±1%, 1A, +CE	DFN1820-6	74wf	VR4	9b	Ric



SMD code	Type	Function	Short description	Case	Pinout	Sch.	St.	Mnf.
AM02	RP131K091B	LVR-IC	LDO, 0.9V±1%, 1A, +CE	DFN1820-6	74wf	VR4	9b	Ric
AM03	RP131K101B	LVR-IC	LDO, 1V±1%, 1A, +CE	DFN1820-6	74wf	VR4	9b	Ric
AM04	RP131K111B	LVR-IC	LDO, 1.1V±1%, 1A	DFN1820-6	74wf	VR4	9b	Ric
AM05	RP131K121B	LVR-IC	LDO, 1.2V±1%, 1A, +CE	DFN1820-6	74wf	VR4	9b	Ric
AM06	RP131K121B5	LVR-IC	LDO, 1.25V±1%, 1A, +CE	DFN1820-6	74wf	VR4	9b	Ric
AM07	RP131K131B	LVR-IC	LDO, 1.3V±1%, 1A, +CE	DFN1820-6	74wf	VR4	9b	Ric
AM08	RP131K141B	LVR-IC	LDO, 1.4V±1%, 1A, +CE	DFN1820-6	74wf	VR4	9b	Ric
AM09	RP131K151B	LVR-IC	LDO, 1.5V±1%, 1A, +CE	DFN1820-6	74wf	VR4	9b	Ric
AM10	RP131K161B	LVR-IC	LDO, 1.6V±1%, 1A, +CE	DFN1820-6	74wf	VR4	9b	Ric
AM11	RP131K171B	LVR-IC	LDO, 1.7V±1%, 1A, +CE	DFN1820-6	74wf	VR4	9b	Ric
AM12	RP131K181B	LVR-IC	LDO, 1.8V±1%, 1A, +CE	DFN1820-6	74wf	VR4	9b	Ric
AM13	RP131K181B5	LVR-IC	LDO, 1.85V±1%, 1A, +CE	DFN1820-6	74wf	VR4	9b	Ric
AM14	RP131K191B	LVR-IC	LDO, 1.9V±1%, 1A, +CE	DFN1820-6	74wf	VR4	9b	Ric
AM15	RP131K201B	LVR-IC	LDO, 2V±1%, 1A, +CE	DFN1820-6	74wf	VR4	9b	Ric
AM16	RP131K211B	LVR-IC	LDO, 2.1V±1%, 1A, +CE	DFN1820-6	74wf	VR4	9b	Ric
AM17	RP131K221B	LVR-IC	LDO, 2.2V±1%, 1A, +CE	DFN1820-6	74wf	VR4	9b	Ric
AM18	RP131K231B	LVR-IC	LDO, 2.3V±1%, 1A, +CE	DFN1820-6	74wf	VR4	9b	Ric
AM19	RP131K241B	LVR-IC	LDO, 2.4V±1%, 1A, +CE	DFN1820-6	74wf	VR4	9b	Ric
AM20	RP131K251B	LVR-IC	LDO, 2.5V±1%, 1A, +CE	DFN1820-6	74wf	VR4	9b	Ric
AM21	RP131K261B	LVR-IC	LDO, 2.6V±1%, 1A, +CE	DFN1820-6	74wf	VR4	9b	Ric
AM22	RP131K271B	LVR-IC	LDO, 2.7V±1%, 1A, +CE	DFN1820-6	74wf	VR4	9b	Ric
AM23	RP131K281B	LVR-IC	LDO, 2.8V±1%, 1A, +CE	DFN1820-6	74wf	VR4	9b	Ric
AM24	RP131K281B5	LVR-IC	LDO, 2.85V±1%, 1A, +CE	DFN1820-6	74wf	VR4	9b	Ric
AM25	RP131K291B	LVR-IC	LDO, 2.9V±1%, 1A, +CE	DFN1820-6	74wf	VR4	9b	Ric
AM26	RP131K301B	LVR-IC	LDO, 3V±1%, 1A, +CE	DFN1820-6	74wf	VR4	9b	Ric
AM27	RP131K311B	LVR-IC	LDO, 3.1V±1%, 1A, +CE	DFN1820-6	74wf	VR4	9b	Ric
AM28	RP131K321B	LVR-IC	LDO, 3.2V±1%, 1A, +CE	DFN1820-6	74wf	VR4	9b	Ric
AM29	RP131K331B	LVR-IC	LDO, 3.3V±1%, 1A, +CE	DFN1820-6	74wf	VR4	9b	Ric
AM30	RP131K341B	LVR-IC	LDO, 3.4V±1%, 1A, +CE	DFN1820-6	74wf	VR4	9b	Ric
AM31	RP131K351B	LVR-IC	LDO, 3.5V±1%, 1A, +CE	DFN1820-6	74wf	VR4	9b	Ric
AM32	RP131K361B	LVR-IC	LDO, 3.6V±1%, 1A, +CE	DFN1820-6	74wf	VR4	9b	Ric
AM33	RP131K371B	LVR-IC	LDO, 3.7V±1%, 1A, +CE	DFN1820-6	74wf	VR4	9b	Ric
AM34	RP131K381B	LVR-IC	LDO, 3.8V±1%, 1A, +CE	DFN1820-6	74wf	VR4	9b	Ric
AM35	RP131K391B	LVR-IC	LDO, 3.9V±1%, 1A, +CE	DFN1820-6	74wf	VR4	9b	Ric
AM36	RP131K401B	LVR-IC	LDO, 4V±1%, 1A, +CE	DFN1820-6	74wf	VR4	9b	Ric
AM37	RP131K411B	LVR-IC	LDO, 4.1V±1%, 1A, +CE	DFN1820-6	74wf	VR4	9b	Ric
AM38	RP131K421B	LVR-IC	LDO, 4.2V±1%, 1A, +CE	DFN1820-6	74wf	VR4	9b	Ric
AM39	RP131K431B	LVR-IC	LDO, 4.3V±1%, 1A, +CE	DFN1820-6	74wf	VR4	9b	Ric
AM40	RP131K441B	LVR-IC	LDO, 4.4V±1%, 1A, +CE	DFN1820-6	74wf	VR4	9b	Ric
AM41	RP131K451B	LVR-IC	LDO, 4.5V±1%, 1A, +CE	DFN1820-6	74wf	VR4	9b	Ric
AM42	RP131K461B	LVR-IC	LDO, 4.6V±1%, 1A, +CE	DFN1820-6	74wf	VR4	9b	Ric
AM43	RP131K471B	LVR-IC	LDO, 4.7V±1%, 1A, +CE	DFN1820-6	74wf	VR4	9b	Ric
AM44	RP131K481B	LVR-IC	LDO, 4.8V±1%, 1A, +CE	DFN1820-6	74wf	VR4	9b	Ric
AM45	RP131K491B	LVR-IC	LDO, 4.9V±1%, 1A, +CE	DFN1820-6	74wf	VR4	9b	Ric
AM46	RP131K501B	LVR-IC	LDO, 5V±1%, 1A, +CE	DFN1820-6	74wf	VR4	9b	Ric
AM47	RP131K101B5	LVR-IC	LDO, 1.05V±1%, 1A, +CE	DFN1820-6	74wf	VR4	9b	Ric
aN	74AUP1G34GF	CMOS-Logic	Noninverting buffer	SOT891	52LLog10	-	9c	Phi
aN	74AUP1G34GM	CMOS-Logic	Noninverting buffer	SOT-886	57LLog10	-	9c	Phi
AN	RP104K291B	LVR-IC	LDO, 2.9V±0.8%, 150mA, +CE	DFN1010-4	48vm	VR4	9a	Ric
AN	XC6221A21B7R	LVR-IC	LDO, 2.15V±1%, 200mA, +CE	USPN-4	58vm	VR4	9a	Tor
AN	XC6223C30B9R-G	LVR-IC	LDO, 3.05V±1%, 300mA, +CE, PDR	USPQ-4B03	48vm	VR4	9a	Tor
AN01	RP131K081D	LVR-IC	LDO, 0.8V±1%, 1A, +CE, CL	DFN1820-6	74wf	VR4	9b	Ric
AN02	RP131K091D	LVR-IC	LDO, 0.9V±1%, 1A, +CE, CL	DFN1820-6	74wf	VR4	9b	Ric
AN03	RP131K101D	LVR-IC	LDO, 1V±1%, 1A, +CE, CL	DFN1820-6	74wf	VR4	9b	Ric
AN04	RP131K111D	LVR-IC	LDO, 1.1V±1%, 1A, +CE, CL	DFN1820-6	74wf	VR4	9b	Ric
AN05	RP131K121D	LVR-IC	LDO, 1.2V±1%, 1A, +CE, CL	DFN1820-6	74wf	VR4	9b	Ric
AN06	RP131K121D5	LVR-IC	LDO, 1.25V±1%, 1A, +CE, CL	DFN1820-6	74wf	VR4	9b	Ric
AN07	RP131K131D	LVR-IC	LDO, 1.3V±1%, 1A, +CE, CL	DFN1820-6	74wf	VR4	9b	Ric
AN08	RP131K141D	LVR-IC	LDO, 1.4V±1%, 1A, +CE, CL	DFN1820-6	74wf	VR4	9b	Ric
AN09	RP131K151D	LVR-IC	LDO, 1.5V±1%, 1A, +CE, CL	DFN1820-6	74wf	VR4	9b	Ric
AN10	RP131K161D	LVR-IC	LDO, 1.6V±1%, 1A, +CE, CL	DFN1820-6	74wf	VR4	9b	Ric
AN11	RP131K171D	LVR-IC	LDO, 1.7V±1%, 1A, +CE, CL	DFN1820-6	74wf	VR4	9b	Ric
AN12	RP131K181D	LVR-IC	LDO, 1.8V±1%, 1A, +CE, CL	DFN1820-6	74wf	VR4	9b	Ric
AN13	RP131K181D5	LVR-IC	LDO, 1.85V±1%, 1A, +CE, CL	DFN1820-6	74wf	VR4	9b	Ric
AN14	RP131K191D	LVR-IC	LDO, 1.9V±1%, 1A, +CE, CL	DFN1820-6	74wf	VR4	9b	Ric
AN15	RP131K201D	LVR-IC	LDO, 2V±1%, 1A, +CE, CL	DFN1820-6	74wf	VR4	9b	Ric
AN16	RP131K211D	LVR-IC	LDO, 2.1V±1%, 1A, +CE, CL	DFN1820-6	74wf	VR4	9b	Ric
AN17	RP131K221D	LVR-IC	LDO, 2.2V±1%, 1A, +CE, CL	DFN1820-6	74wf	VR4	9b	Ric
AN18	RP131K231D	LVR-IC	LDO, 2.3V±1%, 1A, +CE, CL	DFN1820-6	74wf	VR4	9b	Ric
AN19	RP131K241D	LVR-IC	LDO, 2.4V±1%, 1A, +CE, CL	DFN1820-6	74wf	VR4	9b	Ric



SMD code	Type	Function	Short description	Case	Pinout	Sch.	St.	Mnf.
AN20	RP131K251D	LVR-IC	LDO, 2.5V±1%, 1A, +CE, CL	DFN1820-6	74wf	VR4	9b	Ric
AN21	RP131K261D	LVR-IC	LDO, 2.6V±1%, 1A, +CE, CL	DFN1820-6	74wf	VR4	9b	Ric
AN22	RP131K271D	LVR-IC	LDO, 2.7V±1%, 1A, +CE, CL	DFN1820-6	74wf	VR4	9b	Ric
AN23	RP131K281D	LVR-IC	LDO, 2.8V±1%, 1A, +CE, CL	DFN1820-6	74wf	VR4	9b	Ric
AN24	RP131K281D5	LVR-IC	LDO, 2.85V±1%, 1A, +CE, CL	DFN1820-6	74wf	VR4	9b	Ric
AN25	RP131K291D	LVR-IC	LDO, 2.9V±1%, 1A, +CE, CL	DFN1820-6	74wf	VR4	9b	Ric
AN26	RP131K301D	LVR-IC	LDO, 3V±1%, 1A, +CE, CL	DFN1820-6	74wf	VR4	9b	Ric
AN27	RP131K311D	LVR-IC	LDO, 3.1V±1%, 1A, +CE, CL	DFN1820-6	74wf	VR4	9b	Ric
AN28	RP131K321D	LVR-IC	LDO, 3.2V±1%, 1A, +CE, CL	DFN1820-6	74wf	VR4	9b	Ric
AN29	RP131K331D	LVR-IC	LDO, 3.3V±1%, 1A, +CE, CL	DFN1820-6	74wf	VR4	9b	Ric
AN30	RP131K341D	LVR-IC	LDO, 3.4V±1%, 1A, +CE, CL	DFN1820-6	74wf	VR4	9b	Ric
AN31	RP131K351D	LVR-IC	LDO, 3.5V±1%, 1A, +CE, CL	DFN1820-6	74wf	VR4	9b	Ric
AN32	RP131K361D	LVR-IC	LDO, 3.6V±1%, 1A, +CE, CL	DFN1820-6	74wf	VR4	9b	Ric
AN33	RP131K371D	LVR-IC	LDO, 3.7V±1%, 1A, +CE, CL	DFN1820-6	74wf	VR4	9b	Ric
AN34	RP131K381D	LVR-IC	LDO, 3.8V±1%, 1A, +CE, CL	DFN1820-6	74wf	VR4	9b	Ric
AN35	RP131K391D	LVR-IC	LDO, 3.9V±1%, 1A, +CE, CL	DFN1820-6	74wf	VR4	9b	Ric
AN36	RP131K401D	LVR-IC	LDO, 4V±1%, 1A, +CE, CL	DFN1820-6	74wf	VR4	9b	Ric
AN37	RP131K411D	LVR-IC	LDO, 4.1V±1%, 1A, +CE, CL	DFN1820-6	74wf	VR4	9b	Ric
AN38	RP131K421D	LVR-IC	LDO, 4.2V±1%, 1A, +CE, CL	DFN1820-6	74wf	VR4	9b	Ric
AN39	RP131K431D	LVR-IC	LDO, 4.3V±1%, 1A, +CE, CL	DFN1820-6	74wf	VR4	9b	Ric
AN40	RP131K441D	LVR-IC	LDO, 4.4V±1%, 1A, +CE, CL	DFN1820-6	74wf	VR4	9b	Ric
AN41	RP131K451D	LVR-IC	LDO, 4.5V±1%, 1A, +CE, CL	DFN1820-6	74wf	VR4	9b	Ric
AN42	RP131K461D	LVR-IC	LDO, 4.6V±1%, 1A, +CE, CL	DFN1820-6	74wf	VR4	9b	Ric
AN43	RP131K471D	LVR-IC	LDO, 4.7V±1%, 1A, +CE, CL	DFN1820-6	74wf	VR4	9b	Ric
AN44	RP131K481D	LVR-IC	LDO, 4.8V±1%, 1A, +CE, CL	DFN1820-6	74wf	VR4	9b	Ric
AN45	RP131K491D	LVR-IC	LDO, 4.9V±1%, 1A, +CE, CL	DFN1820-6	74wf	VR4	9b	Ric
AN46	RP131K501D	LVR-IC	LDO, 5V±1%, 1A, +CE, CL	DFN1820-6	74wf	VR4	9b	Ric
AN47	RP131K101D5	LVR-IC	LDO, 1.05V±1%, 1A, +CE, CL	DFN1820-6	74wf	VR4	9b	Ric
AOTI	TPA6135A2RT	LIN-IC	AF PA, 1.8..4.5V, 2x25mW(3V/16Ω), enable	QFN-16	38	-	-	Ti
AOWI	TPA6136A2YFF	LIN-IC	AF PA, 1.8..4.5V, 2x25mW(3V/16Ω), shutdown	BGA-16	39	-	-	Ti
aP	74AUP1G157GF	CMOS-Logic	2-input multiplexer	SOT891	52Log42	-	9c	Phi
aP	74AUP1G157GM	CMOS-Logic	2-input multiplexer	SOT-886	52Log42	-	9c	Chi
AP	RP104K301B	LVR-IC	LDO, 3.0V±0.8%, 150mA, +CE	DFN1010-4	48vm	VR4	9a	Ric
AP	XC6221A22B7R	LVR-IC	LDO, 2.25V±1%, 200mA, +CE	USPN-4	58vm	VR4	9a	Tor
AP	XC6223C31B9R-G	LVR-IC	LDO, 3.15V±1%, 300mA, +CE, PDR	USPQ-4B03	48vm	VR4	9a	Tor
AP01	R5324K001A	LVR-IC	LDO, Triple out, V1/V2/V3=2.8V/2.8V/2.8V±1%, 200mA, +CE, CL	DFN-10	37	VR21	9b	Ric
AP02	R5324K001B	LVR-IC	LDO, Triple out, V1/V2/V3=2.8V/2.8V/2.8V±1%, 200mA, +CE	DFN-10	37	VR21	9b	Ric
AP03	R5324K002A	LVR-IC	LDO, Triple out, V1/V2/V3=2.9V/2.9V/2.9V±1%, 200mA, +CE, CL	DFN-10	37	VR21	9b	Ric
AP04	R5324K002B	LVR-IC	LDO, Triple out, V1/V2/V3=2.9V/2.9V/2.9V±1%, 200mA, +CE	DFN-10	37	VR21	9b	Ric
AP05	R5324K003A	LVR-IC	LDO, Triple out, V1/V2/V3=3.0V/3.0V/3.0V±1%, 200mA, +CE, CL	DFN-10	37	VR21	9b	Ric
AP06	R5324K003B	LVR-IC	LDO, Triple out, V1/V2/V3=3.0V/3.0V/3.0V±1%, 200mA, +CE	DFN-10	37	VR21	9b	Ric
AP07	R5324K004A	LVR-IC	LDO, Triple out, V1/V2/V3=3.3V/3.3V/3.3V±1%, 200mA, +CE, CL	DFN-10	37	VR21	9b	Ric
AP08	R5324K004B	LVR-IC	LDO, Triple out, V1/V2/V3=3.3V/3.3V/3.3V±1%, 200mA, +CE	DFN-10	37	VR21	9b	Ric
AP09	R5324K005B	LVR-IC	LDO, Triple out, V1/V2/V3=3.5V/3.5V/3.5V±1%, 200mA, +CE	DFN-10	37	VR21	9b	Ric
AP10	R5324K006B	LVR-IC	LDO, Triple out, V1/V2/V3=2.8V/2.8V/2.8V±1%, 200mA, +CE	DFN-10	37	VR21	9b	Ric
AP11	R5324K007B	LVR-IC	LDO, Triple out, V1/V2/V3=3.3V/3.3V/3.3V±1%, 200mA, +CE	DFN-10	37	VR21	9b	Ric
AP12	R5324K008B	LVR-IC	LDO, Triple out, V1/V2/V3=3.3V/2.8V/2.7V±1%, 200mA, +CE	DFN-10	37	VR21	9b	Ric
AP13	R5324K009B	LVR-IC	LDO, Triple out, V1/V2/V3=3.1V/2.8V/2.8V±1%, 200mA, +CE	DFN-10	37	VR21	9b	Ric
AP14	R5324K010B	LVR-IC	LDO, Triple out, V1/V2/V3=1.8V/3.1V/3.1V±1%, 200mA, +CE	DFN-10	37	VR21	9b	Ric
AP15	R5324K011B	LVR-IC	LDO, Triple out, V1/V2/V3=3.0V/2.5V/1.8V±1%, 200mA, +CE	DFN-10	37	VR21	9b	Ric
AP16	R5324K012B	LVR-IC	LDO, Triple out, V1/V2/V3=3.3V/3.0V/1.8V±1%, 200mA, +CE	DFN-10	37	VR21	9b	Ric
AP17	R5324K013B	LVR-IC	LDO, Triple out, V1/V2/V3=3.0V/1.8V/1.8V±1%, 200mA, +CE	DFN-10	37	VR21	9b	Ric
AP18	R5324K014B	LVR-IC	LDO, Triple out, V1/V2/V3=3.3V/3.0V/3.5V±1%, 200mA, +CE	DFN-10	37	VR21	9b	Ric
AP19	R5324K015B	LVR-IC	LDO, Triple out, V1/V2/V3=3.3V/1.8V/1.8V±1%, 200mA, +CE	DFN-10	37	VR21	9b	Ric
AP20	R5324K016B	LVR-IC	LDO, Triple out, V1/V2/V3=3.0V/2.8V/1.8V±1%, 200mA, +CE	DFN-10	37	VR21	9b	Ric
AP21	R5324K017B	LVR-IC	LDO, Triple out, V1/V2/V3=2.9V/1.5V/2.9V±1%, 200mA, +CE	DFN-10	37	VR21	9b	Ric
AP22	R5324K018B	LVR-IC	LDO, Triple out, V1/V2/V3=3.3V/3.3V/3.3V±1%, 200mA, +CE	DFN-10	37	VR21	9b	Ric
AP23	R5324K019B	LVR-IC	LDO, Triple out, V1/V2/V3=1.5V/1.85V/2.85V±1%, 200mA, +CE	DFN-10	37	VR21	9b	Ric
AP24	R5324K020B	LVR-IC	LDO, Triple out, V1/V2/V3=3.0V/2.8V/1.5V±1%, 200mA, +CE	DFN-10	37	VR21	9b	Ric
AP25	R5324K021B	LVR-IC	LDO, Triple out, V1/V2/V3=2.5V/3.0V/3.3V±1%, 200mA, +CE	DFN-10	37	VR21	9b	Ric
AP26	R5324K022B	LVR-IC	LDO, Triple out, V1/V2/V3=1.8V/2.5V/2.8V±1%, 200mA, +CE	DFN-10	37	VR21	9b	Ric
AP27	R5324K023B	LVR-IC	LDO, Triple out, V1/V2/V3=2.8V/1.8V/1.8V±1%, 200mA, +CE	DFN-10	37	VR21	9b	Ric
AP28	R5324K024B	LVR-IC	LDO, Triple out, V1/V2/V3=2.8V/1.8V/2.85V±1%, 200mA, +CE	DFN-10	37	VR21	9b	Ric
AP29	R5324K025B	LVR-IC	LDO, Triple out, V1/V2/V3=2.8V/2.6V/1.8V±1%, 200mA, +CE	DFN-10	37	VR21	9b	Ric
AP30	R5324K026B	LVR-IC	LDO, Triple out, V1/V2/V3=2.8V/2.8V/1.8V±1%, 200mA, +CE	DFN-10	37	VR21	9b	Ric
APO	MAX6471TA15BD3	LVR/Vdet-IC	LDO, 1.5V±1.3%, 300mA, -Reset PPO, Set, -MR	DFN-8	37	-	9m	Max
APP	MAX6471TA25BD3	LVR/Vdet-IC	LDO, 2.5V±1.3%, 300mA, -Reset PPO, Set, -MR	DFN-8	37	-	9m	Max
APQ	MAX6471TA28AD3	LVR/Vdet-IC	LDO, 2.8V±1.3%, 300mA, -Reset PPO, Set, -MR	DFN-8	37	-	9m	Max
APR	MAX6471TA30BD3	LVR/Vdet-IC	LDO, 3.0V±1.3%, 300mA, -Reset PPO, Set, -MR	DFN-8	37	-	9m	Max
APS	MAX6471TA18AD3	LVR/Vdet-IC	LDO, 1.8V±1.3%, 300mA, -Reset PPO, Set, -MR	DFN-8	37	-	9m	Max



SMD code	Type	Function	Short description	Case	Pinout	Sch.	St.Mnf.
APT	MAX6471TA33AD3	LVR/det-IC	LDO, 3.3V±1.3%, 300mA, -Reset PPO, Set, -MR	DFN-8	37	-	9a Max
AQ	RP104K321B	LVR-IC	LDO, 3.2V±0.8%, 150mA, +CE	DFN1010-4	48vm	VR4	9a Ric
aR	74AUP1T98GF	CMOS-Logic	Configurable gate with voltage-level translator	SOT891	52Log82	-	9c Phi
aR	74AUP1T98GM	CMOS-Logic	Configurable gate with voltage-level translator	SOT-886	57Log82	-	9c Phi
AR	RP104K331B	LVR-IC	LDO, 3.3V±0.8%, 150mA, +CE	DFN1010-4	48vm	VR4	9a Ric
AR	XC6221A23B7R	LVR-IC	LDO, 2.35V±1%, 200mA, +CE	USPN-4	58vm	VR4	9a Tor
AR	XC6223C32B9R-G	LVR-IC	LDO, 3.25V±1%, 300mA, +CE, PDR	USPQ-4B03	48vm	VR4	9a Tor
AS	RP104K311B	LVR-IC	LDO, 3.1V±0.8%, 150mA, +CE	DFN1010-4	48vm	VR4	9a Ric
AS	XC6221A24B7R	LVR-IC	LDO, 2.45V±1%, 200mA, +CE	USPN-4	58vm	VR4	9a Tor
AS	XC6223C33B9R-G	LVR-IC	LDO, 3.35V±1%, 300mA, +CE, PDR	USPQ-4B03	48vm	VR4	9a Tor
AS01	RP400K001A	DC/DC-IC	PWM st-up, 700kHz, Adj. 1.8..5V, 200mA, +CE	DFN1820-6	74	-	9b Ric
AS02	RP400K181A	DC/DC-IC	PWM st-up, 700kHz, 1.8V±2%, 200mA, +CE	DFN1820-6	74gn	DC19	9b Ric
AS03	RP400K191A	DC/DC-IC	PWM st-up, 700kHz, 1.9V±2%, 200mA, +CE	DFN1820-6	74gn	DC19	9b Ric
AS04	RP400K201A	DC/DC-IC	PWM st-up, 700kHz, 2.0V±2%, 200mA, +CE	DFN1820-6	74gn	DC19	9b Ric
AS05	RP400K211A	DC/DC-IC	PWM st-up, 700kHz, 2.1V±2%, 200mA, +CE	DFN1820-6	74gn	DC19	9b Ric
AS06	RP400K221A	DC/DC-IC	PWM st-up, 700kHz, 2.2V±2%, 200mA, +CE	DFN1820-6	74gn	DC19	9b Ric
AS07	RP400K231A	DC/DC-IC	PWM st-up, 700kHz, 2.3V±2%, 200mA, +CE	DFN1820-6	74gn	DC19	9b Ric
AS08	RP400K241A	DC/DC-IC	PWM st-up, 700kHz, 2.4V±2%, 200mA, +CE	DFN1820-6	74gn	DC19	9b Ric
AS09	RP400K251A	DC/DC-IC	PWM st-up, 700kHz, 2.5V±2%, 200mA, +CE	DFN1820-6	74gn	DC19	9b Ric
AS10	RP400K261A	DC/DC-IC	PWM st-up, 700kHz, 2.6V±2%, 200mA, +CE	DFN1820-6	74gn	DC19	9b Ric
AS11	RP400K271A	DC/DC-IC	PWM st-up, 700kHz, 2.7V±2%, 200mA, +CE	DFN1820-6	74gn	DC19	9b Ric
AS12	RP400K281A	DC/DC-IC	PWM st-up, 700kHz, 2.8V±2%, 200mA, +CE	DFN1820-6	74gn	DC19	9b Ric
AS13	RP400K291A	DC/DC-IC	PWM st-up, 700kHz, 2.9V±2%, 200mA, +CE	DFN1820-6	74gn	DC19	9b Ric
AS14	RP400K301A	DC/DC-IC	PWM st-up, 700kHz, 3.0V±2%, 200mA, +CE	DFN1820-6	74gn	DC19	9b Ric
AS15	RP400K311A	DC/DC-IC	PWM st-up, 700kHz, 3.1V±2%, 200mA, +CE	DFN1820-6	74gn	DC19	9b Ric
AS16	RP400K321A	DC/DC-IC	PWM st-up, 700kHz, 3.2V±2%, 200mA, +CE	DFN1820-6	74gn	DC19	9b Ric
AS17	RP400K331A	DC/DC-IC	PWM st-up, 700kHz, 3.3V±2%, 200mA, +CE	DFN1820-6	74gn	DC19	9b Ric
AS18	RP400K341A	DC/DC-IC	PWM st-up, 700kHz, 3.4V±2%, 200mA, +CE	DFN1820-6	74gn	DC19	9b Ric
AS19	RP400K351A	DC/DC-IC	PWM st-up, 700kHz, 3.5V±2%, 200mA, +CE	DFN1820-6	74gn	DC19	9b Ric
AS20	RP400K361A	DC/DC-IC	PWM st-up, 700kHz, 3.6V±2%, 200mA, +CE	DFN1820-6	74gn	DC19	9b Ric
AS21	RP400K371A	DC/DC-IC	PWM st-up, 700kHz, 3.7V±2%, 200mA, +CE	DFN1820-6	74gn	DC19	9b Ric
AS22	RP400K381A	DC/DC-IC	PWM st-up, 700kHz, 3.8V±2%, 200mA, +CE	DFN1820-6	74gn	DC19	9b Ric
AS23	RP400K391A	DC/DC-IC	PWM st-up, 700kHz, 3.9V±2%, 200mA, +CE	DFN1820-6	74gn	DC19	9b Ric
AS24	RP400K401A	DC/DC-IC	PWM st-up, 700kHz, 4.0V±2%, 200mA, +CE	DFN1820-6	74gn	DC19	9b Ric
AS25	RP400K411A	DC/DC-IC	PWM st-up, 700kHz, 4.1V±2%, 200mA, +CE	DFN1820-6	74gn	DC19	9b Ric
AS26	RP400K421A	DC/DC-IC	PWM st-up, 700kHz, 4.2V±2%, 200mA, +CE	DFN1820-6	74gn	DC19	9b Ric
AS27	RP400K431A	DC/DC-IC	PWM st-up, 700kHz, 4.3V±2%, 200mA, +CE	DFN1820-6	74gn	DC19	9b Ric
AS28	RP400K441A	DC/DC-IC	PWM st-up, 700kHz, 4.4V±2%, 200mA, +CE	DFN1820-6	74gn	DC19	9b Ric
AS29	RP400K451A	DC/DC-IC	PWM st-up, 700kHz, 4.5V±2%, 200mA, +CE	DFN1820-6	74gn	DC19	9b Ric
AS30	RP400K461A	DC/DC-IC	PWM st-up, 700kHz, 4.6V±2%, 200mA, +CE	DFN1820-6	74gn	DC19	9b Ric
AS31	RP400K471A	DC/DC-IC	PWM st-up, 700kHz, 4.7V±2%, 200mA, +CE	DFN1820-6	74gn	DC19	9b Ric
AS32	RP400K481A	DC/DC-IC	PWM st-up, 700kHz, 4.8V±2%, 200mA, +CE	DFN1820-6	74gn	DC19	9b Ric
AS33	RP400K491A	DC/DC-IC	PWM st-up, 700kHz, 4.9V±2%, 200mA, +CE	DFN1820-6	74gn	DC19	9b Ric
AS34	RP400K501A	DC/DC-IC	PWM st-up, 700kHz, 5.0V±2%, 200mA, +CE	DFN1820-6	74gn	DC19	9b Ric
ASBI	TPA6141AY2F	LIN-IC	AF PA, 2.5..5.5V, 2x32mW(3V/32C), shutdown	BGA-16	39	-	Ti
aT	74AUP1G175GF	CMOS-Logic	Positive edge-triggered D-type flip-flop with reset	SOT891	52Log40	-	9c Phi
aT	74AUP1G175GM	CMOS-Logic	Positive edge-triggered D-type flip-flop with reset	SOT-886	57Log40	-	9c Phi
AT	RP104K241B	LVR-IC	LDO, 2.4V±0.8%, 150mA, +CE	DFN1010-4	48vm	VR4	9a Ric
AT	XC6221A25B7R	LVR-IC	LDO, 2.55V±1%, 200mA, +CE	USPN-4	58vm	VR4	9a Tor
AT	XC6223C34B9R-G	LVR-IC	LDO, 3.45V±1%, 300mA, +CE, PDR	USPQ-4B03	48vm	VR4	9a Tor
AT01	RP400K001C	DC/DC-IC	PWM st-up, 700kHz, Adj. 1.8..5V, 200mA, +CE	DFN1820-6	74	-	9b Ric
AT02	RP400K181C	DC/DC-IC	PWM st-up, 700kHz, 1.8V±2%, 200mA, +CE	DFN1820-6	74gn	DC19	9b Ric
AT03	RP400K191C	DC/DC-IC	PWM st-up, 700kHz, 1.9V±2%, 200mA, +CE	DFN1820-6	74gn	DC19	9b Ric
AT04	RP400K201C	DC/DC-IC	PWM st-up, 700kHz, 2.0V±2%, 200mA, +CE	DFN1820-6	74gn	DC19	9b Ric
AT05	RP400K211C	DC/DC-IC	PWM st-up, 700kHz, 2.1V±2%, 200mA, +CE	DFN1820-6	74gn	DC19	9b Ric
AT06	RP400K221C	DC/DC-IC	PWM st-up, 700kHz, 2.2V±2%, 200mA, +CE	DFN1820-6	74gn	DC19	9b Ric
AT07	RP400K231C	DC/DC-IC	PWM st-up, 700kHz, 2.3V±2%, 200mA, +CE	DFN1820-6	74gn	DC19	9b Ric
AT08	RP400K241C	DC/DC-IC	PWM st-up, 700kHz, 2.4V±2%, 200mA, +CE	DFN1820-6	74gn	DC19	9b Ric
AT09	RP400K251C	DC/DC-IC	PWM st-up, 700kHz, 2.5V±2%, 200mA, +CE	DFN1820-6	74gn	DC19	9b Ric
AT10	RP400K261C	DC/DC-IC	PWM st-up, 700kHz, 2.6V±2%, 200mA, +CE	DFN1820-6	74gn	DC19	9b Ric
AT11	RP400K271C	DC/DC-IC	PWM st-up, 700kHz, 2.7V±2%, 200mA, +CE	DFN1820-6	74gn	DC19	9b Ric
AT12	RP400K281C	DC/DC-IC	PWM st-up, 700kHz, 2.8V±2%, 200mA, +CE	DFN1820-6	74gn	DC19	9b Ric
AT13	RP400K291C	DC/DC-IC	PWM st-up, 700kHz, 2.9V±2%, 200mA, +CE	DFN1820-6	74gn	DC19	9b Ric
AT14	RP400K301C	DC/DC-IC	PWM st-up, 700kHz, 3.0V±2%, 200mA, +CE	DFN1820-6	74gn	DC19	9b Ric
AT15	RP400K311C	DC/DC-IC	PWM st-up, 700kHz, 3.1V±2%, 200mA, +CE	DFN1820-6	74gn	DC19	9b Ric
AT16	RP400K321C	DC/DC-IC	PWM st-up, 700kHz, 3.2V±2%, 200mA, +CE	DFN1820-6	74gn	DC19	9b Ric
AT17	RP400K331C	DC/DC-IC	PWM st-up, 700kHz, 3.3V±2%, 200mA, +CE	DFN1820-6	74gn	DC19	9b Ric
AT18	RP400K341C	DC/DC-IC	PWM st-up, 700kHz, 3.4V±2%, 200mA, +CE	DFN1820-6	74gn	DC19	9b Ric
AT19	RP400K351C	DC/DC-IC	PWM st-up, 700kHz, 3.5V±2%, 200mA, +CE	DFN1820-6	74gn	DC19	9b Ric
AT20	RP400K361C	DC/DC-IC	PWM st-up, 700kHz, 3.6V±2%, 200mA, +CE	DFN1820-6	74gn	DC19	9b Ric



SMD code	Type	Function	Short description	Case	Pinout	Sch.	St.	Mnf.
AT21	RP400K371C	DC/DC-IC	PWM st-up, 700kHz, 3.7V±2%, 200mA, +CE	DFN1820-6	74gn	DC19	9b	Ric
AT22	RP400K381C	DC/DC-IC	PWM st-up, 700kHz, 3.8V±2%, 200mA, +CE	DFN1820-6	74gn	DC19	9b	Ric
AT23	RP400K391C	DC/DC-IC	PWM st-up, 700kHz, 3.9V±2%, 200mA, +CE	DFN1820-6	74gn	DC19	9b	Ric
AT24	RP400K401C	DC/DC-IC	PWM st-up, 700kHz, 4.0V±2%, 200mA, +CE	DFN1820-6	74gn	DC19	9b	Ric
AT25	RP400K411C	DC/DC-IC	PWM st-up, 700kHz, 4.1V±2%, 200mA, +CE	DFN1820-6	74gn	DC19	9b	Ric
AT26	RP400K421C	DC/DC-IC	PWM st-up, 700kHz, 4.2V±2%, 200mA, +CE	DFN1820-6	74gn	DC19	9b	Ric
AT27	RP400K431C	DC/DC-IC	PWM st-up, 700kHz, 4.3V±2%, 200mA, +CE	DFN1820-6	74gn	DC19	9b	Ric
AT28	RP400K441C	DC/DC-IC	PWM st-up, 700kHz, 4.4V±2%, 200mA, +CE	DFN1820-6	74gn	DC19	9b	Ric
AT29	RP400K451C	DC/DC-IC	PWM st-up, 700kHz, 4.5V±2%, 200mA, +CE	DFN1820-6	74gn	DC19	9b	Ric
AT30	RP400K461C	DC/DC-IC	PWM st-up, 700kHz, 4.6V±2%, 200mA, +CE	DFN1820-6	74gn	DC19	9b	Ric
AT31	RP400K471C	DC/DC-IC	PWM st-up, 700kHz, 4.7V±2%, 200mA, +CE	DFN1820-6	74gn	DC19	9b	Ric
AT32	RP400K481C	DC/DC-IC	PWM st-up, 700kHz, 4.8V±2%, 200mA, +CE	DFN1820-6	74gn	DC19	9b	Ric
AT33	RP400K491C	DC/DC-IC	PWM st-up, 700kHz, 4.9V±2%, 200mA, +CE	DFN1820-6	74gn	DC19	9b	Ric
AT34	RP400K501C	DC/DC-IC	PWM st-up, 700kHz, 5.0V±2%, 200mA, +CE	DFN1820-6	74gn	DC19	9b	Ric
ATQ	MAX16057ATT17+	Vdet-IC	1.7V±2%, -MR, -Reset PPO	TDFN-8	37	-	9a	Max
ATR	MAX16057ATT23+	Vdet-IC	2.3V±2%, -MR, -Reset PPO	TDFN-8	37	-	9a	Max
ATS	MAX16057ATT26+	Vdet-IC	2.6V±2%, -MR, -Reset PPO	TDFN-8	37	-	9a	Max
ATT	MAX16057ATT29+	Vdet-IC	2.9V±2%, -MR, -Reset PPO	TDFN-8	37	-	9a	Max
ATW	MAX16059ATT16+	Vdet-IC	1.6V±2%, -MR, -Reset ODO	TDFN-8	37	-	9a	Max
ATX	MAX16059ATT22+	Vdet-IC	2.2V±2%, -MR, -Reset ODO	TDFN-8	37	-	9a	Max
ATY	MAX16059ATT26+	Vdet-IC	2.6V±2%, -MR, -Reset ODO	TDFN-8	37	-	9a	Max
ATZ	MAX16059ATT29+	Vdet-IC	2.9V±2%, -MR, -Reset ODO	TDFN-8	37	-	9a	Max
aU	74AUP1G158GF	CMOS-Logic	2-input inverting multiplexer	SOT891	52Log48	-	9c	Phi
au	74AUP1G158GM	CMOS-Logic	2-input inverting multiplexer	SOT-886	57Log48	-	9c	Phi
AU	RP104K221B	LVR-IC	LDO, 2.2V±0.8%, 150mA, +CE	DFN1010-4	48vm	VR4	9a	Ric
AU	XC6221A26B7R	LVR-IC	LDO, 2.65V±1%, 200mA, +CE	USPN-4	58vm	VR4	9a	Tor
AU	XC6223C35B9R-G	LVR-IC	LDO, 3.55V±1%, 300mA, +CE, PDR	USPQ-4B03	48vm	VR4	9a	Tor
AUA	MAX16059ATT31+	Vdet-IC	3.1V±2%, -MR, -Reset ODO	TDFN-8	37	-	9a	Max
AUB	MAX16059ATT44+	Vdet-IC	4.4V±2%, -MR, -Reset ODO	TDFN-8	37	-	9a	Max
AUC	MAX16057ATT36+	Vdet-IC	3.6V±2%, -MR, -Reset PPO	TDFN-8	37	-	9a	Max
AUD	MAX16057ATT41+	Vdet-IC	4.1V±2%, -MR, -Reset PPO	TDFN-8	37	-	9a	Max
AJU	MAX9820ETB+	LIN-IC	AF PA, 4.5.5V, 2x95mW(5V/32Q), shutdown	DFN-10	37	-	9m	Max
aV	74AUP1G97GF	CMOS-Logic	Configurable multiple-function gate	SOT891	52Log41	-	9c	Phi
aV	74AUP1G97GM	CMOS-Logic	Configurable multiple-function gate	SOT-886	57Log41	-	9c	Phi
AV	RP104K231B	LVR-IC	LDO, 2.3V±0.8%, 150mA, +CE	DFN1010-4	48vm	VR4	9a	Ric
AV	XC6221A27B7R	LVR-IC	LDO, 2.75V±1%, 200mA, +CE	USPN-4	58vm	VR4	9a	Tor
AV	XC6223C36B9R-G	LVR-IC	LDO, 3.65V±1%, 300mA, +CE, PDR	USPQ-4B03	48vm	VR4	9a	Tor
aW	74AUP1G373GF	CMOS-Logic	D-type transparent latch with 3-state output	SOT891	52Log35	-	9c	Phi
aW	74AUP1G373GM	CMOS-Logic	D-type transparent latch with 3-state output	SOT-886	57Log35	-	9c	Phi
AW	RP104K271B5	LVR-IC	LDO, 2.75V±0.8%, 150mA, +CE	DFN1010-4	48vm	VR4	9a	Ric
aX	74AUP1G374GF	CMOS-Logic	Positive edge-triggered D-type flip-flop with 3-state output	SOT891	52Log28	-	9c	Phi
aX	74AUP1G374GM	CMOS-Logic	Positive edge-triggered D-type flip-flop with 3-state output	SOT-886	57Log28	-	9c	Phi
AX	RP104K211B	LVR-IC	LDO, 2.1V±0.8%, 150mA, +CE	DFN1010-4	48vm	VR4	9a	Ric
AX	XC6221A28B7R	LVR-IC	LDO, 2.85V±1%, 200mA, +CE	USPN-4	58vm	VR4	9a	Tor
AX	XC6223C37B9R-G	LVR-IC	LDO, 3.75V±1%, 300mA, +CE, PDR	USPQ-4B03	48vm	VR4	9a	Tor
aY	74AUP1G0832GF	CMOS-Logic	3-input AND-OR gate	SOT891	52Log45	-	9c	Phi
aY	74AUP1G0832GM	CMOS-Logic	3-input AND-OR gate	SOT-886	57Log45	-	9c	Phi
AY	XC6221A29B7R	LVR-IC	LDO, 2.95V±1%, 200mA, +CE	USPN-4	58vm	VR4	9a	Tor
AY	XC6223C38B9R-G	LVR-IC	LDO, 3.85V±1%, 300mA, +CE, PDR	USPQ-4B03	48vm	VR4	9a	Tor
AYJ	TPA6204A1DRB	LIN-IC	AF PA, BTL, 2.5.5.5V, 1.7W(5V/8Q), shutdown	DFN-8	37	AFF22	-	Ti
AYN	TPA6211A1DRB	LIN-IC	AF PA, BTL, 2.5.5.5V, 3.2W(5V/3Q), shutdown	DFN-8	37	AFF22	-	Ti
AZ	XC6221A30B7R	LVR-IC	LDO, 3.05V±1%, 200mA, +CE	USPN-4	58vm	VR4	9a	Tor
AZ	XC6223C39B9R-G	LVR-IC	LDO, 3.95V±1%, 300mA, +CE, PDR	USPQ-4B03	48vm	VR4	9a	Tor
B0	EUA4990B	LIN-IC	AF PA, BTL, 3.5.5V, 1.36W(5V/8Q), shutdown	BGA-9	39	AFP44	-	Eut
B0	R3118K161A	Vdet-IC	1.6V±1.5%, -Reset ODO, Sense	DFN1212-6	52z3	VD14	9a	Ric
B0A	XC6108C10AGR	Vdet-IC	1.0V±2%, Hysteresis, -Reset PPO	USP-4	45ro	VD15	9b	Tor
B0B	XC6108C10BGR	Vdet-IC	1.0V±2%, -Reset PPO	USP-4	45ro	VD15	9b	Tor
B0C	XC6108C10CGR	Vdet-IC	1.0V±2%, Hysteresis, -Reset PPO	USP-4	45m	VD15	9b	Tor
B0D	XC6108C10DGR	Vdet-IC	1.0V±2%, -Reset PPO	USP-4	45m	VD15	9b	Tor
B1	R3118K171A	Vdet-IC	1.7V±1.5%, -Reset ODO, Sense	DFN1212-6	52z3	VD14	9a	Ric
B1	TS4601BE1JT	LIN-IC	AF PA, 1.8.4.5V, 2x75mW(4V/16Q), stand-by, I2C	BGA-16	39	-	9p	Ste
B1A	XC6108C11AGR	Vdet-IC	1.1V±2%, Hysteresis, -Reset PPO	USP-4	45ro	VD15	9b	Tor
B1B	XC6108C11BGR	Vdet-IC	1.1V±2%, -Reset PPO	USP-4	45ro	VD15	9b	Tor
B1C	XC6108C11CGR	Vdet-IC	1.1V±2%, Hysteresis, -Reset PPO	USP-4	45m	VD15	9b	Tor
B1D	XC6108C11DGR	Vdet-IC	1.1V±2%, -Reset PPO	USP-4	45m	VD15	9b	Tor
B2	LM4923LQ	LIN-IC	AF PA, BTL, 2.4.5.5V, 1.1W(5V/8Q), shutdown	LQ-8	77	-	-	Nsc
B2	R3118K181A	Vdet-IC	1.8V±1.5%, -Reset ODO, Sense	DFN1212-6	52z3	VD14	9a	Ric
B2	RT9013-12PQW	LVR-IC	LDO, 1.2V±2%, 500mA, +CE	WDFN-6	49xu	VR4	9a	Rct
B2	XC6223D12B9R-G	LVR-IC	LDO, 1.25V±20mV, 300mA, +CE, CL, PDR	USPQ-4B03	48vm	VR4	9a	Tor
B2173G	TB2173FTG	LIN-IC	AF PA, 2.5.5.5V, 2x9.5mW(3V/32Q)	QFN-44	38	-	9m	Tos



SMD code	Type	Function	Short description	Case	Pinout	Sch.	St.	Mnf.
B26	TB2140FTG	LIN-IC	AF PA, 1.8.5.3.6V, 2x30mW(5V/32Ω), shutdown	QFN-16	38	-	9m	Tos
B2A	XC6108C12AGR	Vdet-IC	1.2V±2%, Hysteresis, -Reset PPO	USP-4	45ro	VD15	9b	Tor
B2B	XC6108C12BGR	Vdet-IC	1.2V±2%, -Reset PPO	USP-4	45ro	VD15	9b	Tor
B2C	XC6108C12CGR	Vdet-IC	1.2V±2%, Hysteresis, -Reset PPO	USP-4	45m	VD15	9b	Tor
B2D	XC6108C12DGR	Vdet-IC	1.2V±2%, -Reset PPO	USP-4	45m	VD15	9b	Tor
B3	R3118K191A	Vdet-IC	1.9V±1.5%, -Reset ODO, Sense	DFN1212-6	52z3	VD14	9a	Ric
B3	RT9013-15PQW	LVR-IC	LDO, 1.5V±2%, 500mA, +CE	WDFN-6	49xu	VR4	9a	Rct
B3	XC6223D13B9R-G	LVR-IC	LDO, 1.35V±20mV, 300mA, +CE, CL, PDR	USPQ-4B03	48vm	VR4	9a	Tor
B3A	XC6108C13AGR	Vdet-IC	1.3V±2%, Hysteresis, -Reset PPO	USP-4	45ro	VD15	9b	Tor
B3B	XC6108C13BGR	Vdet-IC	1.3V±2%, -Reset PPO	USP-4	45ro	VD15	9b	Tor
B3C	XC6108C13CGR	Vdet-IC	1.3V±2%, Hysteresis, -Reset PPO	USP-4	45m	VD15	9b	Tor
B3D	XC6108C13DGR	Vdet-IC	1.3V±2%, -Reset PPO	USP-4	45m	VD15	9b	Tor
B4	LM4667ITL	LIN-IC	AF PA, BTL, class-D, 2.2.5.5V, 1.3W(5V/8Ω), shutdown	BGA-9	39	AFP52	-	Nsc
B4	R3118K201A	Vdet-IC	2.0V±1.5%, -Reset ODO, Sense	DFN1212-6	52z3	VD14	9a	Ric
B4	RT9013-18PQW	LVR-IC	LDO, 1.8V±2%, 500mA, +CE	WDFN-6	49xu	VR4	9a	Rct
B4	RT9013B-30GQW/C	LVR-IC	LDO, 3.0V±2%, 500mA, +CE	WDFN-6	49xu	VR4	9a	Rct
B4	XC6223D14B9R-G	LVR-IC	LDO, 1.45V±20mV, 300mA, +CE, CL, PDR	USPQ-4B03	48vm	VR4	9a	Tor
B4A	XC6108C14AGR	Vdet-IC	1.4V±2%, Hysteresis, -Reset PPO	USP-4	45ro	VD15	9b	Tor
B4B	XC6108C14BGR	Vdet-IC	1.4V±2%, -Reset PPO	USP-4	45ro	VD15	9b	Tor
B4C	XC6108C14CGR	Vdet-IC	1.4V±2%, Hysteresis, -Reset PPO	USP-4	45m	VD15	9b	Tor
B4D	XC6108C14DGR	Vdet-IC	1.4V±2%, -Reset PPO	USP-4	45m	VD15	9b	Tor
B5	74AVC1T45GM	CMOS-Logic	Dual supply translating transceiver with 3-state output	SOT-886	57/Log70	-	9c	Phi
B5	R3118K211A	Vdet-IC	2.1V±1.5%, -Reset ODO, Sense	DFN1212-6	52z3	VD14	9a	Ric
B5	RT9013-1HPQW	LVR-IC	LDO, 1.85V±2%, 500mA, +CE	WDFN-6	49xu	VR4	9a	Rct
B5	XC6223D15B9R-G	LVR-IC	LDO, 1.55V±20mV, 300mA, +CE, CL, PDR	USPQ-4B03	48vm	VR4	9a	Tor
B55	TS4855IJT	LIN-IC	AF PA, BTL, 3.5.5V, 1W(8Ω)+2x25mW(32Ω), digital volume	BGA-18	39	-	-	Ste
B5A	XC6108C15AGR	Vdet-IC	1.5V±2%, Hysteresis, -Reset PPO	USP-4	45ro	VD15	9b	Tor
B5B	XC6108C15BGR	Vdet-IC	1.5V±2%, -Reset PPO	USP-4	45ro	VD15	9b	Tor
B5C	XC6108C15CGR	Vdet-IC	1.5V±2%, Hysteresis, -Reset PPO	USP-4	45m	VD15	9b	Tor
B5D	XC6108C15DGR	Vdet-IC	1.5V±2%, -Reset PPO	USP-4	45m	VD15	9b	Tor
B6	R3118K221A	Vdet-IC	2.2V±1.5%, -Reset ODO, Sense	DFN1212-6	52z3	VD14	9a	Ric
B6	RT9013-25PQW	LVR-IC	LDO, 2.5V±2%, 500mA, +CE	WDFN-6	49xu	VR4	9a	Rct
B6	XC6223D16B9R-G	LVR-IC	LDO, 1.65V±20mV, 300mA, +CE, CL, PDR	USPQ-4B03	48vm	VR4	9a	Tor
B6A	XC6108C16AGR	Vdet-IC	1.6V±2%, Hysteresis, -Reset PPO	USP-4	45ro	VD15	9b	Tor
B6B	XC6108C16BGR	Vdet-IC	1.6V±2%, -Reset PPO	USP-4	45ro	VD15	9b	Tor
B6C	XC6108C16CGR	Vdet-IC	1.6V±2%, Hysteresis, -Reset PPO	USP-4	45m	VD15	9b	Tor
B6D	XC6108C16DGR	Vdet-IC	1.6V±2%, -Reset PPO	USP-4	45m	VD15	9b	Tor
B7	LM4856ITL	LIN-IC	AF PA, BTL, 2.6.5.5V, 1.1W(8Ω)+2x60mW(32Ω), I2C	BGA-18	39	-	-	Nsc
B7	R3118K231A	Vdet-IC	2.3V±1.5%, -Reset ODO, Sense	DFN1212-6	52z3	VD14	9a	Ric
B7	RT9013-28PQW	LVR-IC	LDO, 2.8V±2%, 500mA, +CE	WDFN-6	49xu	VR4	9a	Rct
B7	XC6221B0817R	LVR-IC	LDO, 0.8V±20mV, 200mA, +CE, CL	USPN-4	58vm	VR4	9a	Tor
B7	XC6223D17B9R-G	LVR-IC	LDO, 1.75V±20mV, 300mA, +CE, CL, PDR	USPQ-4B03	48vm	VR4	9a	Tor
B7A	XC6108C17AGR	Vdet-IC	1.7V±2%, Hysteresis, -Reset PPO	USP-4	45ro	VD15	9b	Tor
B7B	XC6108C17BGR	Vdet-IC	1.7V±2%, -Reset PPO	USP-4	45ro	VD15	9b	Tor
B7C	XC6108C17CGR	Vdet-IC	1.7V±2%, Hysteresis, -Reset PPO	USP-4	45m	VD15	9b	Tor
B7D	XC6108C17DGR	Vdet-IC	1.7V±2%, -Reset PPO	USP-4	45m	VD15	9b	Tor
B8	LM4852ITL	LIN-IC	AF PA, BTL, 2.6.5.5V, 1.1W(8Ω)+2x60mW(32Ω), I2C	BGA-18	39	-	-	Nsc
B8	R3118K241A	Vdet-IC	2.4V±1.5%, -Reset ODO, Sense	DFN1212-6	52z3	VD14	9a	Ric
B8	RT9013-2HPQW	LVR-IC	LDO, 2.85V±2%, 500mA, +CE	WDFN-6	49xu	VR4	9a	Rct
B8	XC6221B0917R	LVR-IC	LDO, 0.9V±20mV, 200mA, +CE, CL	USPN-4	58vm	VR4	9a	Tor
B8	XC6223D18B9R-G	LVR-IC	LDO, 1.85V±20mV, 300mA, +CE, CL, PDR	USPQ-4B03	48vm	VR4	9a	Tor
B8A	XC6108C18AGR	Vdet-IC	1.8V±2%, Hysteresis, -Reset PPO	USP-4	45ro	VD15	9b	Tor
B8B	XC6108C18BGR	Vdet-IC	1.8V±2%, -Reset PPO	USP-4	45ro	VD15	9b	Tor
B8C	XC6108C18CGR	Vdet-IC	1.8V±2%, Hysteresis, -Reset PPO	USP-4	45m	VD15	9b	Tor
B8D	XC6108C18DGR	Vdet-IC	1.8V±2%, -Reset PPO	USP-4	45m	VD15	9b	Tor
B9	LM4921ITL	LIN-IC	Dual 16-bit stereo DAC, AF PA, 2.6.5.5V, 2x60mW(32Ω), I2C	BGA-20	39	-	-	Nsc
B9	R3118K251A	Vdet-IC	2.5V±1.5%, -Reset ODO, Sense	DFN1212-6	52z3	VD14	9a	Ric
B9	RT9013-30PQW	LVR-IC	LDO, 3.0V±2%, 500mA, +CE	WDFN-6	49xu	VR4	9a	Rct
B9	XC6221B1017R	LVR-IC	LDO, 1V±20mV, 200mA, +CE, CL	USPN-4	58vm	VR4	9a	Tor
B9	XC6223D19B9R-G	LVR-IC	LDO, 1.95V±20mV, 300mA, +CE, CL, PDR	USPQ-4B03	48vm	VR4	9a	Tor
B9A	XC6108C19AGR	Vdet-IC	1.9V±2%, Hysteresis, -Reset PPO	USP-4	45ro	VD15	9b	Tor
B9B	XC6108C19BGR	Vdet-IC	1.9V±2%, -Reset PPO	USP-4	45ro	VD15	9b	Tor
B9C	XC6108C19CGR	Vdet-IC	1.9V±2%, Hysteresis, -Reset PPO	USP-4	45m	VD15	9b	Tor
B9D	XC6108C19DGR	Vdet-IC	1.9V±2%, -Reset PPO	USP-4	45m	VD15	9b	Tor
BA	RP104K121C	LVR-IC	LDO, 1.2V±0.8%, 150mA	DFN1010-4	48y1	VR1	9a	Ric
BA	RP105K061D	LVR-IC	LDO, 0.6V±15mV, 400mA, +CE, CL	DFN1212-6	52z2	VR11	9a	Ric
BA	RT9013-33PQW	LVR-IC	LDO, 3.3V±2%, 500mA, +CE	WDFN-6	49xu	VR4	9a	Rct
BA	XC6221B1117R	LVR-IC	LDO, 1.1V±20mV, 200mA, +CE, CL	USPN-4	58vm	VR4	9a	Tor
BA	XC6223D20B9R-G	LVR-IC	LDO, 2.05V±1%, 300mA, +CE, CL, PDR	USPQ-4B03	48vm	VR4	9a	Tor
BA01	RP153L001A	LVR-IC	LDO, Dual out, Vout1/Vout2=2.8V/2.8V±1%, 150mA, +CE	DFN1216-8	37x6	VR26	9b	Ric



SMD code	Type	Function	Short description	Case	Pinout	Sch.	St.	Mnf.
BA535	XC6114A535ER	Vdel-IC	3.5V±2%, ±Reset PPO, Wt=400ms, Rt=3.13ms	USP-6C	49xq	VD19	9b	Tor
BA536	XC6114A536ER	Vdel-IC	3.6V±2%, ±Reset PPO, Wt=400ms, Rt=3.13ms	USP-6C	49xq	VD19	9b	Tor
BA537	XC6114A537ER	Vdel-IC	3.7V±2%, ±Reset PPO, Wt=400ms, Rt=3.13ms	USP-6C	49xq	VD19	9b	Tor
BA538	XC6114A538ER	Vdel-IC	3.8V±2%, ±Reset PPO, Wt=400ms, Rt=3.13ms	USP-6C	49xq	VD19	9b	Tor
BA539	XC6114A539ER	Vdel-IC	3.9V±2%, ±Reset PPO, Wt=400ms, Rt=3.13ms	USP-6C	49xq	VD19	9b	Tor
BA540	XC6114A540ER	Vdel-IC	4.0V±2%, ±Reset PPO, Wt=400ms, Rt=3.13ms	USP-6C	49xq	VD19	9b	Tor
BA541	XC6114A541ER	Vdel-IC	4.1V±2%, ±Reset PPO, Wt=400ms, Rt=3.13ms	USP-6C	49xq	VD19	9b	Tor
BA542	XC6114A542ER	Vdel-IC	4.2V±2%, ±Reset PPO, Wt=400ms, Rt=3.13ms	USP-6C	49xq	VD19	9b	Tor
BA543	XC6114A543ER	Vdel-IC	4.3V±2%, ±Reset PPO, Wt=400ms, Rt=3.13ms	USP-6C	49xq	VD19	9b	Tor
BA544	XC6114A544ER	Vdel-IC	4.4V±2%, ±Reset PPO, Wt=400ms, Rt=3.13ms	USP-6C	49xq	VD19	9b	Tor
BA545	XC6114A545ER	Vdel-IC	4.5V±2%, ±Reset PPO, Wt=400ms, Rt=3.13ms	USP-6C	49xq	VD19	9b	Tor
BA546	XC6114A546ER	Vdel-IC	4.6V±2%, ±Reset PPO, Wt=400ms, Rt=3.13ms	USP-6C	49xq	VD19	9b	Tor
BA547	XC6114A547ER	Vdel-IC	4.7V±2%, ±Reset PPO, Wt=400ms, Rt=3.13ms	USP-6C	49xq	VD19	9b	Tor
BA548	XC6114A548ER	Vdel-IC	4.8V±2%, ±Reset PPO, Wt=400ms, Rt=3.13ms	USP-6C	49xq	VD19	9b	Tor
BA549	XC6114A549ER	Vdel-IC	4.9V±2%, ±Reset PPO, Wt=400ms, Rt=3.13ms	USP-6C	49xq	VD19	9b	Tor
BA550	XC6114A550ER	Vdel-IC	5.0V±2%, ±Reset PPO, Wt=400ms, Rt=3.13ms	USP-6C	49xq	VD19	9b	Tor
BA616	XC6114A616ER	Vdel-IC	1.6V±2%, ±Reset PPO, Wt=1.6s, Rt=3.13ms	USP-6C	49xq	VD19	9b	Tor
BA617	XC6114A617ER	Vdel-IC	1.7V±2%, ±Reset PPO, Wt=1.6s, Rt=3.13ms	USP-6C	49xq	VD19	9b	Tor
BA618	XC6114A618ER	Vdel-IC	1.8V±2%, ±Reset PPO, Wt=1.6s, Rt=3.13ms	USP-6C	49xq	VD19	9b	Tor
BA619	XC6114A619ER	Vdel-IC	1.9V±2%, ±Reset PPO, Wt=1.6s, Rt=3.13ms	USP-6C	49xq	VD19	9b	Tor
BA620	XC6114A620ER	Vdel-IC	2.0V±2%, ±Reset PPO, Wt=1.6s, Rt=3.13ms	USP-6C	49xq	VD19	9b	Tor
BA621	XC6114A621ER	Vdel-IC	2.1V±2%, ±Reset PPO, Wt=1.6s, Rt=3.13ms	USP-6C	49xq	VD19	9b	Tor
BA622	XC6114A622ER	Vdel-IC	2.2V±2%, ±Reset PPO, Wt=1.6s, Rt=3.13ms	USP-6C	49xq	VD19	9b	Tor
BA623	XC6114A623ER	Vdel-IC	2.3V±2%, ±Reset PPO, Wt=1.6s, Rt=3.13ms	USP-6C	49xq	VD19	9b	Tor
BA624	XC6114A624ER	Vdel-IC	2.4V±2%, ±Reset PPO, Wt=1.6s, Rt=3.13ms	USP-6C	49xq	VD19	9b	Tor
BA625	XC6114A625ER	Vdel-IC	2.5V±2%, ±Reset PPO, Wt=1.6s, Rt=3.13ms	USP-6C	49xq	VD19	9b	Tor
BA626	XC6114A626ER	Vdel-IC	2.6V±2%, ±Reset PPO, Wt=1.6s, Rt=3.13ms	USP-6C	49xq	VD19	9b	Tor
BA627	XC6114A627ER	Vdel-IC	2.7V±2%, ±Reset PPO, Wt=1.6s, Rt=3.13ms	USP-6C	49xq	VD19	9b	Tor
BA628	XC6114A628ER	Vdel-IC	2.8V±2%, ±Reset PPO, Wt=1.6s, Rt=3.13ms	USP-6C	49xq	VD19	9b	Tor
BA629	XC6114A629ER	Vdel-IC	2.9V±2%, ±Reset PPO, Wt=1.6s, Rt=3.13ms	USP-6C	49xq	VD19	9b	Tor
BA630	XC6114A630ER	Vdel-IC	3.0V±2%, ±Reset PPO, Wt=1.6s, Rt=3.13ms	USP-6C	49xq	VD19	9b	Tor
BA631	XC6114A631ER	Vdel-IC	3.1V±2%, ±Reset PPO, Wt=1.6s, Rt=3.13ms	USP-6C	49xq	VD19	9b	Tor
BA632	XC6114A632ER	Vdel-IC	3.2V±2%, ±Reset PPO, Wt=1.6s, Rt=3.13ms	USP-6C	49xq	VD19	9b	Tor
BA633	XC6114A633ER	Vdel-IC	3.3V±2%, ±Reset PPO, Wt=1.6s, Rt=3.13ms	USP-6C	49xq	VD19	9b	Tor
BA634	XC6114A634ER	Vdel-IC	3.4V±2%, ±Reset PPO, Wt=1.6s, Rt=3.13ms	USP-6C	49xq	VD19	9b	Tor
BA635	XC6114A635ER	Vdel-IC	3.5V±2%, ±Reset PPO, Wt=1.6s, Rt=3.13ms	USP-6C	49xq	VD19	9b	Tor
BA636	XC6114A636ER	Vdel-IC	3.6V±2%, ±Reset PPO, Wt=1.6s, Rt=3.13ms	USP-6C	49xq	VD19	9b	Tor
BA637	XC6114A637ER	Vdel-IC	3.7V±2%, ±Reset PPO, Wt=1.6s, Rt=3.13ms	USP-6C	49xq	VD19	9b	Tor
BA638	XC6114A638ER	Vdel-IC	3.8V±2%, ±Reset PPO, Wt=1.6s, Rt=3.13ms	USP-6C	49xq	VD19	9b	Tor
BA639	XC6114A639ER	Vdel-IC	3.9V±2%, ±Reset PPO, Wt=1.6s, Rt=3.13ms	USP-6C	49xq	VD19	9b	Tor
BA640	XC6114A640ER	Vdel-IC	4.0V±2%, ±Reset PPO, Wt=1.6s, Rt=3.13ms	USP-6C	49xq	VD19	9b	Tor
BA641	XC6114A641ER	Vdel-IC	4.1V±2%, ±Reset PPO, Wt=1.6s, Rt=3.13ms	USP-6C	49xq	VD19	9b	Tor
BA642	XC6114A642ER	Vdel-IC	4.2V±2%, ±Reset PPO, Wt=1.6s, Rt=3.13ms	USP-6C	49xq	VD19	9b	Tor
BA643	XC6114A643ER	Vdel-IC	4.3V±2%, ±Reset PPO, Wt=1.6s, Rt=3.13ms	USP-6C	49xq	VD19	9b	Tor
BA644	XC6114A644ER	Vdel-IC	4.4V±2%, ±Reset PPO, Wt=1.6s, Rt=3.13ms	USP-6C	49xq	VD19	9b	Tor
BA645	XC6114A645ER	Vdel-IC	4.5V±2%, ±Reset PPO, Wt=1.6s, Rt=3.13ms	USP-6C	49xq	VD19	9b	Tor
BA646	XC6114A646ER	Vdel-IC	4.6V±2%, ±Reset PPO, Wt=1.6s, Rt=3.13ms	USP-6C	49xq	VD19	9b	Tor
BA647	XC6114A647ER	Vdel-IC	4.7V±2%, ±Reset PPO, Wt=1.6s, Rt=3.13ms	USP-6C	49xq	VD19	9b	Tor
BA648	XC6114A648ER	Vdel-IC	4.8V±2%, ±Reset PPO, Wt=1.6s, Rt=3.13ms	USP-6C	49xq	VD19	9b	Tor
BA649	XC6114A649ER	Vdel-IC	4.9V±2%, ±Reset PPO, Wt=1.6s, Rt=3.13ms	USP-6C	49xq	VD19	9b	Tor
BA650	XC6114A650ER	Vdel-IC	5.0V±2%, ±Reset PPO, Wt=1.6s, Rt=3.13ms	USP-6C	49xq	VD19	9b	Tor
BA8	XC9237F08CER	DC-DC-IC	PWM-PWM/PFM, st-dwn, 0.8V±2%, 600mA, 1.2MHz, Vin>1.8V, HSST, CL	USP-6C	49da	DC16	9a	Tor
BA9	XC9237F09CER	DC-DC-IC	PWM-PWM/PFM, st-dwn, 0.9V±2%, 600mA, 1.2MHz, Vin>1.8V, HSST, CL	USP-6C	49da	DC16	9a	Tor
BAG	A2190ITL	LIN-IC	AF PA, BTL, 2.5..5.5V, 1.25W(5V/8Ω), shutdown	BGA-9	39	AFF44	9s	Aot
BAG	BL6212TLX	LIN-IC	AF PA, BTL, 2.5..5.5V, 1.28W(5V/8Ω), shutdown	BGA-9	39	AFF44	-	Shb
BAG	MC4990C	LIN-IC	AF PA, BTL, 2.5..5.5V, 1.25W(5V/8Ω), shutdown	BGA-9	39	AFF44	-	Mep
BAL	XC9237F0LCER	DC-DC-IC	PWM-PWM/PFM, st-dwn, 0.85V±2%, 600mA, 1.2MHz, Vin>1.8V, HSST, CL	USP-6C	49da	DC16	9a	Tor
BAM	XC9237F0MCER	DC-DC-IC	PWM-PWM/PFM, st-dwn, 0.95V±2%, 600mA, 1.2MHz, Vin>1.8V, HSST, CL	USP-6C	49da	DC16	9a	Tor
BAY	XC6119C08A7R	Vdel-IC	0.8V±30mV, -Reset PPO	USPN-4	58lj	VD3	9th	Tor
BAZ	XC6119C09A7R	Vdel-IC	0.9V±30mV, -Reset PPO	USPN-4	58lj	VD3	9th	Tor
BB	RP104K131C	LVR-IC	LDO, 1.3V±0.8%, 150mA	DFN1010-4	48y1	VR1	9a	Ric
BB	RP105K071D	LVR-IC	LDO, 0.7V±15mV, 400mA, +CE, CL	DFN1212-6	52zd	VR11	9a	Ric
BB	RT919-18PQW	LVR-IC	LDO, 1.8V±1%, 300mA, +CE	WDFN-6L	49ub	VR7	9a	Rct
BB	XC6221B1217R	LVR-IC	LDO, 1.2V±20mV, 200mA, +CE, CL	USPN-4	58vm	VR4	9a	Tor
BB	XC6223D21B9R-G	LVR-IC	LDO, 2.15V±1%, 300mA, +CE, CL, PDR	USPQ-4B03	48vm	VR4	9a	Tor
BB0	XC9237F10CER	DC-DC-IC	PWM-PWM/PFM, st-dwn, 1.0V±2%, 600mA, 1.2MHz, Vin>1.8V, HSST, CL	USP-6C	49da	DC16	9a	Tor
BB02	RP153L002B	LVR-IC	LDO, Dual out, Vout1/Vout2=1.8V/2.8V±1%, 150mA, +CE	DFN1216-8	37x6	VR26	9b	Ric
BB03	RP153L003B	LVR-IC	LDO, Dual out, Vout1/Vout2=1.5V/2.8V±1%, 150mA, +CE	DFN1216-8	37x6	VR26	9b	Ric
BB04	RP153L004B	LVR-IC	LDO, Dual out, Vout1/Vout2=1.2V/1.8V±1%, 150mA, +CE	DFN1216-8	37x6	VR26	9b	Ric
BB05	RP153L005B	LVR-IC	LDO, Dual out, Vout1/Vout2=3.3V/1.2V±1%, 150mA, +CE	DFN1216-8	37x6	VR26	9b	Ric



SMD code	Type	Function	Short description	Case	Pinout	Sch.	St.	Mnf.
BB06	RP153L006B	LVR-IC	LDO, Dual out, Vout1/Vout2=3.3V/1.8V±1%, 150mA, +CE	DFN1216-8	37x6	VR26	9b	Ric
BB07	RP153L007B	LVR-IC	LDO, Dual out, Vout1/Vout2=2.85V/2.85V±1%, 150mA, +CE	DFN1216-8	37x6	VR26	9b	Ric
BB08	RP153L008B	LVR-IC	LDO, Dual out, Vout1/Vout2=2.85V/2.6V±1%, 150mA, +CE	DFN1216-8	37x6	VR26	9b	Ric
BB09	RP153L009B	LVR-IC	LDO, Dual out, Vout1/Vout2=3.0V/2.8V±1%, 150mA, +CE	DFN1216-8	37x6	VR26	9b	Ric
BB1	XC9237F11CE	DC-DC-IC	PWM-PWM/PPM, st-dwn, 1.1V±2%, 600mA, 1.2MHz, Vin>1.8V, HSST, CL	USP-6C	49da	DC16	9a	Tor
BB10	RP153L010B	LVR-IC	LDO, Dual out, Vout1/Vout2=3.0V/1.8V±1%, 150mA, +CE	DFN1216-8	37x6	VR26	9b	Ric
BB11	RP153L011B	LVR-IC	LDO, Dual out, Vout1/Vout2=1.8V/1.5V±1%, 150mA, +CE	DFN1216-8	37x6	VR26	9b	Ric
BB12	RP153L012B	LVR-IC	LDO, Dual out, Vout1/Vout2=2.8V/2.6V±1%, 150mA, +CE	DFN1216-8	37x6	VR26	9b	Ric
BB13	RP153L013B	LVR-IC	LDO, Dual out, Vout1/Vout2=3.3V/2.8V±1%, 150mA, +CE	DFN1216-8	37x6	VR26	9b	Ric
BB14	RP153L014B	LVR-IC	LDO, Dual out, Vout1/Vout2=3.3V/3.3V±1%, 150mA, +CE	DFN1216-8	37x6	VR26	9b	Ric
BB15	RP153L015B	LVR-IC	LDO, Dual out, Vout1/Vout2=1.5V/2.5V±1%, 150mA, +CE	DFN1216-8	37x6	VR26	9b	Ric
BB16	RP153L016B	LVR-IC	LDO, Dual out, Vout1/Vout2=1.5V/3.0V±1%, 150mA, +CE	DFN1216-8	37x6	VR26	9b	Ric
BB17	RP153L017B	LVR-IC	LDO, Dual out, Vout1/Vout2=2.5V/3.0V±1%, 150mA, +CE	DFN1216-8	37x6	VR26	9b	Ric
BB18	RP153L018B	LVR-IC	LDO, Dual out, Vout1/Vout2=1.8V/1.8V±1%, 150mA, +CE	DFN1216-8	37x6	VR26	9b	Ric
BB19	RP153L019B	LVR-IC	LDO, Dual out, Vout1/Vout2=1.5V/2.6V±1%, 150mA, +CE	DFN1216-8	37x6	VR26	9b	Ric
BB2	XC9237F12CE	DC-DC-IC	PWM-PWM/PPM, st-dwn, 1.2V±2%, 600mA, 1.2MHz, Vin>1.8V, HSST, CL	USP-6C	49da	DC16	9a	Tor
BB20	RP153L020B	LVR-IC	LDO, Dual out, Vout1/Vout2=2.8V/1.8V±1%, 150mA, +CE	DFN1216-8	37x6	VR26	9b	Ric
BB21	RP153L021B	LVR-IC	LDO, Dual out, Vout1/Vout2=1.2V/2.8V±1%, 150mA, +CE	DFN1216-8	37x6	VR26	9b	Ric
BB216	XC6114B216ER	Vdel-IC	1.6V±2%, ±Reset PPO, Wt=50ms, Rt=25ms	USP-6C	49xq	VD19	9b	Tor
BB217	XC6114B217ER	Vdel-IC	1.7V±2%, ±Reset PPO, Wt=50ms, Rt=25ms	USP-6C	49xq	VD19	9b	Tor
BB218	XC6114B218ER	Vdel-IC	1.8V±2%, ±Reset PPO, Wt=50ms, Rt=25ms	USP-6C	49xq	VD19	9b	Tor
BB219	XC6114B219ER	Vdel-IC	1.9V±2%, ±Reset PPO, Wt=50ms, Rt=25ms	USP-6C	49xq	VD19	9b	Tor
BB22	RP153L022B	LVR-IC	LDO, Dual out, Vout1/Vout2=2.8V/1.2V±1%, 150mA, +CE	DFN1216-8	37x6	VR26	9b	Ric
BB220	XC6114B220ER	Vdel-IC	2.0V±2%, ±Reset PPO, Wt=50ms, Rt=25ms	USP-6C	49xq	VD19	9b	Tor
BB221	XC6114B221ER	Vdel-IC	2.1V±2%, ±Reset PPO, Wt=50ms, Rt=25ms	USP-6C	49xq	VD19	9b	Tor
BB222	XC6114B222ER	Vdel-IC	2.2V±2%, ±Reset PPO, Wt=50ms, Rt=25ms	USP-6C	49xq	VD19	9b	Tor
BB223	XC6114B223ER	Vdel-IC	2.3V±2%, ±Reset PPO, Wt=50ms, Rt=25ms	USP-6C	49xq	VD19	9b	Tor
BB224	XC6114B224ER	Vdel-IC	2.4V±2%, ±Reset PPO, Wt=50ms, Rt=25ms	USP-6C	49xq	VD19	9b	Tor
BB225	XC6114B225ER	Vdel-IC	2.5V±2%, ±Reset PPO, Wt=50ms, Rt=25ms	USP-6C	49xq	VD19	9b	Tor
BB226	XC6114B226ER	Vdel-IC	2.6V±2%, ±Reset PPO, Wt=50ms, Rt=25ms	USP-6C	49xq	VD19	9b	Tor
BB227	XC6114B227ER	Vdel-IC	2.7V±2%, ±Reset PPO, Wt=50ms, Rt=25ms	USP-6C	49xq	VD19	9b	Tor
BB228	XC6114B228ER	Vdel-IC	2.8V±2%, ±Reset PPO, Wt=50ms, Rt=25ms	USP-6C	49xq	VD19	9b	Tor
BB229	XC6114B229ER	Vdel-IC	2.9V±2%, ±Reset PPO, Wt=50ms, Rt=25ms	USP-6C	49xq	VD19	9b	Tor
BB23	RP153L023B	LVR-IC	LDO, Dual out, Vout1/Vout2=2.5V/2.5V±1%, 150mA, +CE	DFN1216-8	37x6	VR26	9b	Ric
BB230	XC6114B230ER	Vdel-IC	3.0V±2%, ±Reset PPO, Wt=50ms, Rt=25ms	USP-6C	49xq	VD19	9b	Tor
BB231	XC6114B231ER	Vdel-IC	3.1V±2%, ±Reset PPO, Wt=50ms, Rt=25ms	USP-6C	49xq	VD19	9b	Tor
BB232	XC6114B232ER	Vdel-IC	3.2V±2%, ±Reset PPO, Wt=50ms, Rt=25ms	USP-6C	49xq	VD19	9b	Tor
BB233	XC6114B233ER	Vdel-IC	3.3V±2%, ±Reset PPO, Wt=50ms, Rt=25ms	USP-6C	49xq	VD19	9b	Tor
BB234	XC6114B234ER	Vdel-IC	3.4V±2%, ±Reset PPO, Wt=50ms, Rt=25ms	USP-6C	49xq	VD19	9b	Tor
BB235	XC6114B235ER	Vdel-IC	3.5V±2%, ±Reset PPO, Wt=50ms, Rt=25ms	USP-6C	49xq	VD19	9b	Tor
BB236	XC6114B236ER	Vdel-IC	3.6V±2%, ±Reset PPO, Wt=50ms, Rt=25ms	USP-6C	49xq	VD19	9b	Tor
BB237	XC6114B237ER	Vdel-IC	3.7V±2%, ±Reset PPO, Wt=50ms, Rt=25ms	USP-6C	49xq	VD19	9b	Tor
BB238	XC6114B238ER	Vdel-IC	3.8V±2%, ±Reset PPO, Wt=50ms, Rt=25ms	USP-6C	49xq	VD19	9b	Tor
BB239	XC6114B239ER	Vdel-IC	3.9V±2%, ±Reset PPO, Wt=50ms, Rt=25ms	USP-6C	49xq	VD19	9b	Tor
BB24	RP153L024B	LVR-IC	LDO, Dual out, Vout1/Vout2=3.3V/3.0V±1%, 150mA, +CE	DFN1216-8	37x6	VR26	9b	Ric
BB240	XC6114B240ER	Vdel-IC	4.0V±2%, ±Reset PPO, Wt=50ms, Rt=25ms	USP-6C	49xq	VD19	9b	Tor
BB241	XC6114B241ER	Vdel-IC	4.1V±2%, ±Reset PPO, Wt=50ms, Rt=25ms	USP-6C	49xq	VD19	9b	Tor
BB242	XC6114B242ER	Vdel-IC	4.2V±2%, ±Reset PPO, Wt=50ms, Rt=25ms	USP-6C	49xq	VD19	9b	Tor
BB243	XC6114B243ER	Vdel-IC	4.3V±2%, ±Reset PPO, Wt=50ms, Rt=25ms	USP-6C	49xq	VD19	9b	Tor
BB244	XC6114B244ER	Vdel-IC	4.4V±2%, ±Reset PPO, Wt=50ms, Rt=25ms	USP-6C	49xq	VD19	9b	Tor
BB245	XC6114B245ER	Vdel-IC	4.5V±2%, ±Reset PPO, Wt=50ms, Rt=25ms	USP-6C	49xq	VD19	9b	Tor
BB246	XC6114B246ER	Vdel-IC	4.6V±2%, ±Reset PPO, Wt=50ms, Rt=25ms	USP-6C	49xq	VD19	9b	Tor
BB247	XC6114B247ER	Vdel-IC	4.7V±2%, ±Reset PPO, Wt=50ms, Rt=25ms	USP-6C	49xq	VD19	9b	Tor
BB248	XC6114B248ER	Vdel-IC	4.8V±2%, ±Reset PPO, Wt=50ms, Rt=25ms	USP-6C	49xq	VD19	9b	Tor
BB249	XC6114B249ER	Vdel-IC	4.9V±2%, ±Reset PPO, Wt=50ms, Rt=25ms	USP-6C	49xq	VD19	9b	Tor
BB25	RP153L025B	LVR-IC	LDO, Dual out, Vout1/Vout2=3.0V/3.0V±1%, 150mA, +CE	DFN1216-8	37x6	VR26	9b	Ric
BB250	XC6114B250ER	Vdel-IC	5.0V±2%, ±Reset PPO, Wt=50ms, Rt=25ms	USP-6C	49xq	VD19	9b	Tor
BB26	RP153L026B	LVR-IC	LDO, Dual out, Vout1/Vout2=2.8V/3.1V±1%, 150mA, +CE	DFN1216-8	37x6	VR26	9b	Ric
BB27	RP153L027B	LVR-IC	LDO, Dual out, Vout1/Vout2=2.3V/2.8V±1%, 150mA, +CE	DFN1216-8	37x6	VR26	9b	Ric
BB28	RP153L028B	LVR-IC	LDO, Dual out, Vout1/Vout2=2.8V/1.0V±1%, 150mA, +CE	DFN1216-8	37x6	VR26	9b	Ric
BB29	RP153L029B	LVR-IC	LDO, Dual out, Vout1/Vout2=1.5V/1.5V±1%, 150mA, +CE	DFN1216-8	37x6	VR26	9b	Ric
BB3	XC9237F13CE	DC-DC-IC	PWM-PWM/PPM, st-dwn, 1.3V±2%, 600mA, 1.2MHz, Vin>1.8V, HSST, CL	USP-6C	49da	DC16	9a	Tor
BB30	RP153L030B	LVR-IC	LDO, Dual out, Vout1/Vout2=1.5V/3.3V±1%, 150mA, +CE	DFN1216-8	37x6	VR26	9b	Ric
BB31	RP153L031B	LVR-IC	LDO, Dual out, Vout1/Vout2=1.8V/2.7V±1%, 150mA, +CE	DFN1216-8	37x6	VR26	9b	Ric
BB316	XC6114B316ER	Vdel-IC	1.6V±2%, ±Reset PPO, Wt=100ms, Rt=25ms	USP-6C	49xq	VD19	9b	Tor
BB317	XC6114B317ER	Vdel-IC	1.7V±2%, ±Reset PPO, Wt=100ms, Rt=25ms	USP-6C	49xq	VD19	9b	Tor
BB318	XC6114B318ER	Vdel-IC	1.8V±2%, ±Reset PPO, Wt=100ms, Rt=25ms	USP-6C	49xq	VD19	9b	Tor
BB319	XC6114B319ER	Vdel-IC	1.9V±2%, ±Reset PPO, Wt=100ms, Rt=25ms	USP-6C	49xq	VD19	9b	Tor
BB32	RP153L032B	LVR-IC	LDO, Dual out, Vout1/Vout2=1.2V/3.0V±1%, 150mA, +CE	DFN1216-8	37x6	VR26	9b	Ric
BB320	XC6114B320ER	Vdel-IC	2.0V±2%, ±Reset PPO, Wt=100ms, Rt=25ms	USP-6C	49xq	VD19	9b	Tor



SMD code	Type	Function	Short description	Case	Pinout	Sch.	St.	Mnf.
BB321	XC6114B321ER	Vdel-IC	2.1V±2%, ±Reset PPO, Wt=100ms, Rt=25ms	USP-6C	49xq	VD19	9b	Tor
BB322	XC6114B322ER	Vdel-IC	2.1V±2%, ±Reset PPO, Wt=100ms, Rt=25ms	USP-6C	49xq	VD19	9b	Tor
BB323	XC6114B323ER	Vdel-IC	2.3V±2%, ±Reset PPO, Wt=100ms, Rt=25ms	USP-6C	49xq	VD19	9b	Tor
BB324	XC6114B324ER	Vdel-IC	2.4V±2%, ±Reset PPO, Wt=100ms, Rt=25ms	USP-6C	49xq	VD19	9b	Tor
BB325	XC6114B325ER	Vdel-IC	2.5V±2%, ±Reset PPO, Wt=100ms, Rt=25ms	USP-6C	49xq	VD19	9b	Tor
BB326	XC6114B326ER	Vdel-IC	2.6V±2%, ±Reset PPO, Wt=100ms, Rt=25ms	USP-6C	49xq	VD19	9b	Tor
BB327	XC6114B327ER	Vdel-IC	2.7V±2%, ±Reset PPO, Wt=100ms, Rt=25ms	USP-6C	49xq	VD19	9b	Tor
BB328	XC6114B328ER	Vdel-IC	2.8V±2%, ±Reset PPO, Wt=100ms, Rt=25ms	USP-6C	49xq	VD19	9b	Tor
BB329	XC6114B329ER	Vdel-IC	2.9V±2%, ±Reset PPO, Wt=100ms, Rt=25ms	USP-6C	49xq	VD19	9b	Tor
BB33	RP153L033B	LVR-IC	LDO, Dual out, Vout1/Vout2=3.1V/3.1V±1%, 150mA, +CE	DFM1216-8	37x6	VR26	9b	Ric
BB330	XC6114B330ER	Vdel-IC	3.0V±2%, ±Reset PPO, Wt=100ms, Rt=25ms	USP-6C	49xq	VD19	9b	Tor
BB331	XC6114B331ER	Vdel-IC	3.1V±2%, ±Reset PPO, Wt=100ms, Rt=25ms	USP-6C	49xq	VD19	9b	Tor
BB332	XC6114B332ER	Vdel-IC	3.2V±2%, ±Reset PPO, Wt=100ms, Rt=25ms	USP-6C	49xq	VD19	9b	Tor
BB333	XC6114B333ER	Vdel-IC	3.3V±2%, ±Reset PPO, Wt=100ms, Rt=25ms	USP-6C	49xq	VD19	9b	Tor
BB334	XC6114B334ER	Vdel-IC	3.4V±2%, ±Reset PPO, Wt=100ms, Rt=25ms	USP-6C	49xq	VD19	9b	Tor
BB335	XC6114B335ER	Vdel-IC	3.5V±2%, ±Reset PPO, Wt=100ms, Rt=25ms	USP-6C	49xq	VD19	9b	Tor
BB336	XC6114B336ER	Vdel-IC	3.6V±2%, ±Reset PPO, Wt=100ms, Rt=25ms	USP-6C	49xq	VD19	9b	Tor
BB337	XC6114B337ER	Vdel-IC	3.7V±2%, ±Reset PPO, Wt=100ms, Rt=25ms	USP-6C	49xq	VD19	9b	Tor
BB338	XC6114B338ER	Vdel-IC	3.8V±2%, ±Reset PPO, Wt=100ms, Rt=25ms	USP-6C	49xq	VD19	9b	Tor
BB339	XC6114B339ER	Vdel-IC	3.9V±2%, ±Reset PPO, Wt=100ms, Rt=25ms	USP-6C	49xq	VD19	9b	Tor
BB34	RP153L034B	LVR-IC	LDO, Dual out, Vout1/Vout2=1.8V/2.6V±1%, 150mA, +CE	DFM1216-8	37x6	VR26	9b	Ric
BB340	XC6114B340ER	Vdel-IC	4.0V±2%, ±Reset PPO, Wt=100ms, Rt=25ms	USP-6C	49xq	VD19	9b	Tor
BB341	XC6114B341ER	Vdel-IC	4.1V±2%, ±Reset PPO, Wt=100ms, Rt=25ms	USP-6C	49xq	VD19	9b	Tor
BB342	XC6114B342ER	Vdel-IC	4.2V±2%, ±Reset PPO, Wt=100ms, Rt=25ms	USP-6C	49xq	VD19	9b	Tor
BB343	XC6114B343ER	Vdel-IC	4.3V±2%, ±Reset PPO, Wt=100ms, Rt=25ms	USP-6C	49xq	VD19	9b	Tor
BB344	XC6114B344ER	Vdel-IC	4.4V±2%, ±Reset PPO, Wt=100ms, Rt=25ms	USP-6C	49xq	VD19	9b	Tor
BB345	XC6114B345ER	Vdel-IC	4.5V±2%, ±Reset PPO, Wt=100ms, Rt=25ms	USP-6C	49xq	VD19	9b	Tor
BB346	XC6114B346ER	Vdel-IC	4.6V±2%, ±Reset PPO, Wt=100ms, Rt=25ms	USP-6C	49xq	VD19	9b	Tor
BB347	XC6114B347ER	Vdel-IC	4.7V±2%, ±Reset PPO, Wt=100ms, Rt=25ms	USP-6C	49xq	VD19	9b	Tor
BB348	XC6114B348ER	Vdel-IC	4.8V±2%, ±Reset PPO, Wt=100ms, Rt=25ms	USP-6C	49xq	VD19	9b	Tor
BB349	XC6114B349ER	Vdel-IC	4.9V±2%, ±Reset PPO, Wt=100ms, Rt=25ms	USP-6C	49xq	VD19	9b	Tor
BB35	RP153L035B	LVR-IC	LDO, Dual out, Vout1/Vout2=2.5V/1.2V±1%, 150mA, +CE	DFM1216-8	37x6	VR26	9b	Ric
BB350	XC6114B350ER	Vdel-IC	5.0V±2%, ±Reset PPO, Wt=100ms, Rt=25ms	USP-6C	49xq	VD19	9b	Tor
BB36	RP153L036B	LVR-IC	LDO, Dual out, Vout1/Vout2=1.2V/2.9V±1%, 150mA, +CE	DFM1216-8	37x6	VR26	9b	Ric
BB37	RP153L037B	LVR-IC	LDO, Dual out, Vout1/Vout2=3.3V/2.0V±1%, 150mA, +CE	DFM1216-8	37x6	VR26	9b	Ric
BB38	RP153L038B	LVR-IC	LDO, Dual out, Vout1/Vout2=1.2V/2.85V±1%, 150mA, +CE	DFM1216-8	37x6	VR26	9b	Ric
BB39	RP153L039B	LVR-IC	LDO, Dual out, Vout1/Vout2=2.1V/3.2V±1%, 150mA, +CE	DFM1216-8	37x6	VR26	9b	Ric
BB4	XC9237F14CER	DC-DC-IC	PWM-PWMPFM, st-dwn, 1.4V±2%, 600mA, 1.2MHz, Vin>1.8V, HSST, CL	USP-6C	49da	DC16	9a	Tor
BB40	RP153L040B	LVR-IC	LDO, Dual out, Vout1/Vout2=2.8V/2.85V±1%, 150mA, +CE	DFM1216-8	37x6	VR26	9b	Ric
BB41	RP153L041B	LVR-IC	LDO, Dual out, Vout1/Vout2=1.8V/3.0V±1%, 150mA, +CE	DFM1216-8	37x6	VR26	9b	Ric
BB416	XC6114B416ER	Vdel-IC	1.6V±2%, ±Reset PPO, Wt=200ms, Rt=25ms	USP-6C	49xq	VD19	9b	Tor
BB417	XC6114B417ER	Vdel-IC	1.7V±2%, ±Reset PPO, Wt=200ms, Rt=25ms	USP-6C	49xq	VD19	9b	Tor
BB418	XC6114B418ER	Vdel-IC	1.8V±2%, ±Reset PPO, Wt=200ms, Rt=25ms	USP-6C	49xq	VD19	9b	Tor
BB419	XC6114B419ER	Vdel-IC	1.9V±2%, ±Reset PPO, Wt=200ms, Rt=25ms	USP-6C	49xq	VD19	9b	Tor
BB42	RP153L042B	LVR-IC	LDO, Dual out, Vout1/Vout2=1.2V/2.6V±1%, 150mA, +CE	DFM1216-8	37x6	VR26	9b	Ric
BB420	XC6114B420ER	Vdel-IC	2.0V±2%, ±Reset PPO, Wt=200ms, Rt=25ms	USP-6C	49xq	VD19	9b	Tor
BB421	XC6114B421ER	Vdel-IC	2.1V±2%, ±Reset PPO, Wt=200ms, Rt=25ms	USP-6C	49xq	VD19	9b	Tor
BB422	XC6114B422ER	Vdel-IC	2.2V±2%, ±Reset PPO, Wt=200ms, Rt=25ms	USP-6C	49xq	VD19	9b	Tor
BB423	XC6114B423ER	Vdel-IC	2.3V±2%, ±Reset PPO, Wt=200ms, Rt=25ms	USP-6C	49xq	VD19	9b	Tor
BB424	XC6114B424ER	Vdel-IC	2.4V±2%, ±Reset PPO, Wt=200ms, Rt=25ms	USP-6C	49xq	VD19	9b	Tor
BB425	XC6114B425ER	Vdel-IC	2.5V±2%, ±Reset PPO, Wt=200ms, Rt=25ms	USP-6C	49xq	VD19	9b	Tor
BB426	XC6114B426ER	Vdel-IC	2.6V±2%, ±Reset PPO, Wt=200ms, Rt=25ms	USP-6C	49xq	VD19	9b	Tor
BB427	XC6114B427ER	Vdel-IC	2.7V±2%, ±Reset PPO, Wt=200ms, Rt=25ms	USP-6C	49xq	VD19	9b	Tor
BB428	XC6114B428ER	Vdel-IC	2.8V±2%, ±Reset PPO, Wt=200ms, Rt=25ms	USP-6C	49xq	VD19	9b	Tor
BB429	XC6114B429ER	Vdel-IC	2.9V±2%, ±Reset PPO, Wt=200ms, Rt=25ms	USP-6C	49xq	VD19	9b	Tor
BB43	RP153L043B	LVR-IC	LDO, Dual out, Vout1/Vout2=1.3V/2.8V±1%, 150mA, +CE	DFM1216-8	37x6	VR26	9b	Ric
BB430	XC6114B430ER	Vdel-IC	3.0V±2%, ±Reset PPO, Wt=200ms, Rt=25ms	USP-6C	49xq	VD19	9b	Tor
BB431	XC6114B431ER	Vdel-IC	3.1V±2%, ±Reset PPO, Wt=200ms, Rt=25ms	USP-6C	49xq	VD19	9b	Tor
BB432	XC6114B432ER	Vdel-IC	3.2V±2%, ±Reset PPO, Wt=200ms, Rt=25ms	USP-6C	49xq	VD19	9b	Tor
BB433	XC6114B433ER	Vdel-IC	3.3V±2%, ±Reset PPO, Wt=200ms, Rt=25ms	USP-6C	49xq	VD19	9b	Tor
BB434	XC6114B434ER	Vdel-IC	3.4V±2%, ±Reset PPO, Wt=200ms, Rt=25ms	USP-6C	49xq	VD19	9b	Tor
BB435	XC6114B435ER	Vdel-IC	3.5V±2%, ±Reset PPO, Wt=200ms, Rt=25ms	USP-6C	49xq	VD19	9b	Tor
BB436	XC6114B436ER	Vdel-IC	3.6V±2%, ±Reset PPO, Wt=200ms, Rt=25ms	USP-6C	49xq	VD19	9b	Tor
BB437	XC6114B437ER	Vdel-IC	3.7V±2%, ±Reset PPO, Wt=200ms, Rt=25ms	USP-6C	49xq	VD19	9b	Tor
BB438	XC6114B438ER	Vdel-IC	3.8V±2%, ±Reset PPO, Wt=200ms, Rt=25ms	USP-6C	49xq	VD19	9b	Tor
BB439	XC6114B439ER	Vdel-IC	3.9V±2%, ±Reset PPO, Wt=200ms, Rt=25ms	USP-6C	49xq	VD19	9b	Tor
BB44	RP153L044B	LVR-IC	LDO, Dual out, Vout1/Vout2=1.1V/1.5V±1%, 150mA, +CE	DFM1216-8	37x6	VR26	9b	Ric
BB440	XC6114B440ER	Vdel-IC	4.0V±2%, ±Reset PPO, Wt=200ms, Rt=25ms	USP-6C	49xq	VD19	9b	Tor
BB441	XC6114B441ER	Vdel-IC	4.1V±2%, ±Reset PPO, Wt=200ms, Rt=25ms	USP-6C	49xq	VD19	9b	Tor
BB442	XC6114B442ER	Vdel-IC	4.2V±2%, ±Reset PPO, Wt=200ms, Rt=25ms	USP-6C	49xq	VD19	9b	Tor



SMD code	Type	Function	Short description	Case	Pinout	Sch.	St.	Mnf.
BB443	XC6114B443ER	Vdet-IC	4.3V±2%, ±Reset PPO, Wt=200ms, Rt=25ms	USP-6C	49xq	VD19	9b	Tor
BB444	XC6114B444ER	Vdet-IC	4.4V±2%, ±Reset PPO, Wt=200ms, Rt=25ms	USP-6C	49xq	VD19	9b	Tor
BB445	XC6114B445ER	Vdet-IC	4.5V±2%, ±Reset PPO, Wt=200ms, Rt=25ms	USP-6C	49xq	VD19	9b	Tor
BB446	XC6114B446ER	Vdet-IC	4.6V±2%, ±Reset PPO, Wt=200ms, Rt=25ms	USP-6C	49xq	VD19	9b	Tor
BB447	XC6114B447ER	Vdet-IC	4.7V±2%, ±Reset PPO, Wt=200ms, Rt=25ms	USP-6C	49xq	VD19	9b	Tor
BB448	XC6114B448ER	Vdet-IC	4.8V±2%, ±Reset PPO, Wt=200ms, Rt=25ms	USP-6C	49xq	VD19	9b	Tor
BB449	XC6114B449ER	Vdet-IC	4.9V±2%, ±Reset PPO, Wt=200ms, Rt=25ms	USP-6C	49xq	VD19	9b	Tor
BB45	RP153L045B	LVR-IC	LDO, Dual out, Vout1/Vout2=2.8V/3.3V±1%, 150mA, +CE	DFN1216-8	37x6	VR26	9b	Ric
BB450	XC6114B450ER	Vdet-IC	5.0V±2%, ±Reset PPO, Wt=200ms, Rt=25ms	USP-6C	49xq	VD19	9b	Tor
BB46	RP153L046B	LVR-IC	LDO, Dual out, Vout1/Vout2=2.8V/3.0V±1%, 150mA, +CE	DFN1216-8	37x6	VR26	9b	Ric
BB47	RP153L047B	LVR-IC	LDO, Dual out, Vout1/Vout2=2.5V/2.8V±1%, 150mA, +CE	DFN1216-8	37x6	VR26	9b	Ric
BB48	RP153L048B	LVR-IC	LDO, Dual out, Vout1/Vout2=2.5V/3.2V±1%, 150mA, +CE	DFN1216-8	37x6	VR26	9b	Ric
BB49	RP153L049B	LVR-IC	LDO, Dual out, Vout1/Vout2=1.5V/2.85V±1%, 150mA, +CE	DFN1216-8	37x6	VR26	9b	Ric
BB5	XC9237F15CER	DC-DC-IC	PWM-PWM/PPM, st-dwn, 1.5V±2%, 600mA, 1.2MHz, Vin>1.8V, HSST, CL	USP-6C	49da	DC16	9a	Tor
BB50	RP153L050B	LVR-IC	LDO, Dual out, Vout1/Vout2=2.4V/2.9V±1%, 150mA, +CE	DFN1216-8	37x6	VR26	9b	Ric
BB51	RP153L051B	LVR-IC	LDO, Dual out, Vout1/Vout2=1.0V/1.8V±1%, 150mA, +CE	DFN1216-8	37x6	VR26	9b	Ric
BB516	XC6114B516ER	Vdet-IC	1.6V±2%, ±Reset PPO, Wt=400ms, Rt=25ms	USP-6C	49xq	VD19	9b	Tor
BB517	XC6114B517ER	Vdet-IC	1.7V±2%, ±Reset PPO, Wt=400ms, Rt=25ms	USP-6C	49xq	VD19	9b	Tor
BB518	XC6114B518ER	Vdet-IC	1.8V±2%, ±Reset PPO, Wt=400ms, Rt=25ms	USP-6C	49xq	VD19	9b	Tor
BB519	XC6114B519ER	Vdet-IC	1.9V±2%, ±Reset PPO, Wt=400ms, Rt=25ms	USP-6C	49xq	VD19	9b	Tor
BB52	RP153L052B	LVR-IC	LDO, Dual out, Vout1/Vout2=1.8V/2.85V±1%, 150mA, +CE	DFN1216-8	37x6	VR26	9b	Ric
BB520	XC6114B520ER	Vdet-IC	2.0V±2%, ±Reset PPO, Wt=400ms, Rt=25ms	USP-6C	49xq	VD19	9b	Tor
BB521	XC6114B521ER	Vdet-IC	2.1V±2%, ±Reset PPO, Wt=400ms, Rt=25ms	USP-6C	49xq	VD19	9b	Tor
BB522	XC6114B522ER	Vdet-IC	2.2V±2%, ±Reset PPO, Wt=400ms, Rt=25ms	USP-6C	49xq	VD19	9b	Tor
BB523	XC6114B523ER	Vdet-IC	2.3V±2%, ±Reset PPO, Wt=400ms, Rt=25ms	USP-6C	49xq	VD19	9b	Tor
BB524	XC6114B524ER	Vdet-IC	2.4V±2%, ±Reset PPO, Wt=400ms, Rt=25ms	USP-6C	49xq	VD19	9b	Tor
BB525	XC6114B525ER	Vdet-IC	2.5V±2%, ±Reset PPO, Wt=400ms, Rt=25ms	USP-6C	49xq	VD19	9b	Tor
BB526	XC6114B526ER	Vdet-IC	2.6V±2%, ±Reset PPO, Wt=400ms, Rt=25ms	USP-6C	49xq	VD19	9b	Tor
BB527	XC6114B527ER	Vdet-IC	2.7V±2%, ±Reset PPO, Wt=400ms, Rt=25ms	USP-6C	49xq	VD19	9b	Tor
BB528	XC6114B528ER	Vdet-IC	2.8V±2%, ±Reset PPO, Wt=400ms, Rt=25ms	USP-6C	49xq	VD19	9b	Tor
BB529	XC6114B529ER	Vdet-IC	2.9V±2%, ±Reset PPO, Wt=400ms, Rt=25ms	USP-6C	49xq	VD19	9b	Tor
BB530	XC6114B530ER	Vdet-IC	3.0V±2%, ±Reset PPO, Wt=400ms, Rt=25ms	USP-6C	49xq	VD19	9b	Tor
BB531	XC6114B531ER	Vdet-IC	3.1V±2%, ±Reset PPO, Wt=400ms, Rt=25ms	USP-6C	49xq	VD19	9b	Tor
BB532	XC6114B532ER	Vdet-IC	3.2V±2%, ±Reset PPO, Wt=400ms, Rt=25ms	USP-6C	49xq	VD19	9b	Tor
BB533	XC6114B533ER	Vdet-IC	3.3V±2%, ±Reset PPO, Wt=400ms, Rt=25ms	USP-6C	49xq	VD19	9b	Tor
BB534	XC6114B534ER	Vdet-IC	3.4V±2%, ±Reset PPO, Wt=400ms, Rt=25ms	USP-6C	49xq	VD19	9b	Tor
BB535	XC6114B535ER	Vdet-IC	3.5V±2%, ±Reset PPO, Wt=400ms, Rt=25ms	USP-6C	49xq	VD19	9b	Tor
BB536	XC6114B536ER	Vdet-IC	3.6V±2%, ±Reset PPO, Wt=400ms, Rt=25ms	USP-6C	49xq	VD19	9b	Tor
BB537	XC6114B537ER	Vdet-IC	3.7V±2%, ±Reset PPO, Wt=400ms, Rt=25ms	USP-6C	49xq	VD19	9b	Tor
BB538	XC6114B538ER	Vdet-IC	3.8V±2%, ±Reset PPO, Wt=400ms, Rt=25ms	USP-6C	49xq	VD19	9b	Tor
BB539	XC6114B539ER	Vdet-IC	3.9V±2%, ±Reset PPO, Wt=400ms, Rt=25ms	USP-6C	49xq	VD19	9b	Tor
BB540	XC6114B540ER	Vdet-IC	4.0V±2%, ±Reset PPO, Wt=400ms, Rt=25ms	USP-6C	49xq	VD19	9b	Tor
BB541	XC6114B541ER	Vdet-IC	4.1V±2%, ±Reset PPO, Wt=400ms, Rt=25ms	USP-6C	49xq	VD19	9b	Tor
BB542	XC6114B542ER	Vdet-IC	4.2V±2%, ±Reset PPO, Wt=400ms, Rt=25ms	USP-6C	49xq	VD19	9b	Tor
BB543	XC6114B543ER	Vdet-IC	4.3V±2%, ±Reset PPO, Wt=400ms, Rt=25ms	USP-6C	49xq	VD19	9b	Tor
BB544	XC6114B544ER	Vdet-IC	4.4V±2%, ±Reset PPO, Wt=400ms, Rt=25ms	USP-6C	49xq	VD19	9b	Tor
BB545	XC6114B545ER	Vdet-IC	4.5V±2%, ±Reset PPO, Wt=400ms, Rt=25ms	USP-6C	49xq	VD19	9b	Tor
BB546	XC6114B546ER	Vdet-IC	4.6V±2%, ±Reset PPO, Wt=400ms, Rt=25ms	USP-6C	49xq	VD19	9b	Tor
BB547	XC6114B547ER	Vdet-IC	4.7V±2%, ±Reset PPO, Wt=400ms, Rt=25ms	USP-6C	49xq	VD19	9b	Tor
BB548	XC6114B548ER	Vdet-IC	4.8V±2%, ±Reset PPO, Wt=400ms, Rt=25ms	USP-6C	49xq	VD19	9b	Tor
BB549	XC6114B549ER	Vdet-IC	4.9V±2%, ±Reset PPO, Wt=400ms, Rt=25ms	USP-6C	49xq	VD19	9b	Tor
BB550	XC6114B550ER	Vdet-IC	5.0V±2%, ±Reset PPO, Wt=400ms, Rt=25ms	USP-6C	49xq	VD19	9b	Tor
BB6	XC9237F16CER	DC-DC-IC	PWM-PWM/PPM, st-dwn, 1.6V±2%, 600mA, 1.2MHz, Vin>1.8V, HSST, CL	USP-6C	49da	DC16	9a	Tor
BB616	XC6114B616ER	Vdet-IC	1.6V±2%, ±Reset PPO, Wt=1.6s, Rt=25ms	USP-6C	49xq	VD19	9b	Tor
BB617	XC6114B617ER	Vdet-IC	1.7V±2%, ±Reset PPO, Wt=1.6s, Rt=25ms	USP-6C	49xq	VD19	9b	Tor
BB618	XC6114B618ER	Vdet-IC	1.8V±2%, ±Reset PPO, Wt=1.6s, Rt=25ms	USP-6C	49xq	VD19	9b	Tor
BB619	XC6114B619ER	Vdet-IC	1.9V±2%, ±Reset PPO, Wt=1.6s, Rt=25ms	USP-6C	49xq	VD19	9b	Tor
BB620	XC6114B620ER	Vdet-IC	2.0V±2%, ±Reset PPO, Wt=1.6s, Rt=25ms	USP-6C	49xq	VD19	9b	Tor
BB621	XC6114B621ER	Vdet-IC	2.1V±2%, ±Reset PPO, Wt=1.6s, Rt=25ms	USP-6C	49xq	VD19	9b	Tor
BB622	XC6114B622ER	Vdet-IC	2.2V±2%, ±Reset PPO, Wt=1.6s, Rt=25ms	USP-6C	49xq	VD19	9b	Tor
BB623	XC6114B623ER	Vdet-IC	2.3V±2%, ±Reset PPO, Wt=1.6s, Rt=25ms	USP-6C	49xq	VD19	9b	Tor
BB624	XC6114B624ER	Vdet-IC	2.4V±2%, ±Reset PPO, Wt=1.6s, Rt=25ms	USP-6C	49xq	VD19	9b	Tor
BB625	XC6114B625ER	Vdet-IC	2.5V±2%, ±Reset PPO, Wt=1.6s, Rt=25ms	USP-6C	49xq	VD19	9b	Tor
BB626	XC6114B626ER	Vdet-IC	2.6V±2%, ±Reset PPO, Wt=1.6s, Rt=25ms	USP-6C	49xq	VD19	9b	Tor
BB627	XC6114B627ER	Vdet-IC	2.7V±2%, ±Reset PPO, Wt=1.6s, Rt=25ms	USP-6C	49xq	VD19	9b	Tor
BB628	XC6114B628ER	Vdet-IC	2.8V±2%, ±Reset PPO, Wt=1.6s, Rt=25ms	USP-6C	49xq	VD19	9b	Tor
BB629	XC6114B629ER	Vdet-IC	2.9V±2%, ±Reset PPO, Wt=1.6s, Rt=25ms	USP-6C	49xq	VD19	9b	Tor
BB630	XC6114B630ER	Vdet-IC	3.0V±2%, ±Reset PPO, Wt=1.6s, Rt=25ms	USP-6C	49xq	VD19	9b	Tor
BB631	XC6114B631ER	Vdet-IC	3.1V±2%, ±Reset PPO, Wt=1.6s, Rt=25ms	USP-6C	49xq	VD19	9b	Tor
BB632	XC6114B632ER	Vdet-IC	3.2V±2%, ±Reset PPO, Wt=1.6s, Rt=25ms	USP-6C	49xq	VD19	9b	Tor



SMD code	Type	Function	Short description	Case	Pinout	Sch.	St.Mnf.
BB633	XC6114B633ER	Vdet-IC	3.3V±2%, ±Reset PPO, Wlt=1.6s, Rt=25ms	USP-6C	49xq	VD19	9b Tor
BB634	XC6114B634ER	Vdet-IC	3.4V±2%, ±Reset PPO, Wlt=1.6s, Rt=25ms	USP-6C	49xq	VD19	9b Tor
BB635	XC6114B635ER	Vdet-IC	3.5V±2%, ±Reset PPO, Wlt=1.6s, Rt=25ms	USP-6C	49xq	VD19	9b Tor
BB636	XC6114B636ER	Vdet-IC	3.6V±2%, ±Reset PPO, Wlt=1.6s, Rt=25ms	USP-6C	49xq	VD19	9b Tor
BB637	XC6114B637ER	Vdet-IC	3.7V±2%, ±Reset PPO, Wlt=1.6s, Rt=25ms	USP-6C	49xq	VD19	9b Tor
BB638	XC6114B638ER	Vdet-IC	3.8V±2%, ±Reset PPO, Wlt=1.6s, Rt=25ms	USP-6C	49xq	VD19	9b Tor
BB639	XC6114B639ER	Vdet-IC	3.9V±2%, ±Reset PPO, Wlt=1.6s, Rt=25ms	USP-6C	49xq	VD19	9b Tor
BB640	XC6114B640ER	Vdet-IC	4.0V±2%, ±Reset PPO, Wlt=1.6s, Rt=25ms	USP-6C	49xq	VD19	9b Tor
BB641	XC6114B641ER	Vdet-IC	4.1V±2%, ±Reset PPO, Wlt=1.6s, Rt=25ms	USP-6C	49xq	VD19	9b Tor
BB642	XC6114B642ER	Vdet-IC	4.2V±2%, ±Reset PPO, Wlt=1.6s, Rt=25ms	USP-6C	49xq	VD19	9b Tor
BB643	XC6114B643ER	Vdet-IC	4.3V±2%, ±Reset PPO, Wlt=1.6s, Rt=25ms	USP-6C	49xq	VD19	9b Tor
BB644	XC6114B644ER	Vdet-IC	4.4V±2%, ±Reset PPO, Wlt=1.6s, Rt=25ms	USP-6C	49xq	VD19	9b Tor
BB645	XC6114B645ER	Vdet-IC	4.5V±2%, ±Reset PPO, Wlt=1.6s, Rt=25ms	USP-6C	49xq	VD19	9b Tor
BB646	XC6114B646ER	Vdet-IC	4.6V±2%, ±Reset PPO, Wlt=1.6s, Rt=25ms	USP-6C	49xq	VD19	9b Tor
BB647	XC6114B647ER	Vdet-IC	4.7V±2%, ±Reset PPO, Wlt=1.6s, Rt=25ms	USP-6C	49xq	VD19	9b Tor
BB648	XC6114B648ER	Vdet-IC	4.8V±2%, ±Reset PPO, Wlt=1.6s, Rt=25ms	USP-6C	49xq	VD19	9b Tor
BB649	XC6114B649ER	Vdet-IC	4.9V±2%, ±Reset PPO, Wlt=1.6s, Rt=25ms	USP-6C	49xq	VD19	9b Tor
BB650	XC6114B650ER	Vdet-IC	5.0V±2%, ±Reset PPO, Wlt=1.6s, Rt=25ms	USP-6C	49xq	VD19	9b Tor
BB7	XC9237F17CER	DC-DC-IC	PWM-PWM/PPM, st-dwn, 1.7V±2%, 600mA, 1.2MHz, Vin>1.8V, HSST, CL	USP-6C	49da	DC16	9a Tor
BB8	XC9237F18CER	DC-DC-IC	PWM-PWM/PPM, st-dwn, 1.8V±2%, 600mA, 1.2MHz, Vin>1.8V, HSST, CL	USP-6C	49da	DC16	9a Tor
BB9	XC9237F19CER	DC-DC-IC	PWM-PWM/PPM, st-dwn, 1.9V±2%, 600mA, 1.2MHz, Vin>1.8V, HSST, CL	USP-6C	49da	DC16	9a Tor
BBA	XC9237F1ACER	DC-DC-IC	PWM-PWM/PPM, st-dwn, 1.05V±2%, 600mA, 1.2MHz, Vin>1.8V, HSST, CL	USP-6C	49da	DC16	9a Tor
BBB	XC9237F1BCER	DC-DC-IC	PWM-PWM/PPM, st-dwn, 1.15V±2%, 600mA, 1.2MHz, Vin>1.8V, HSST, CL	USP-6C	49da	DC16	9a Tor
BBC	XC9237F1CCER	DC-DC-IC	PWM-PWM/PPM, st-dwn, 1.25V±2%, 600mA, 1.2MHz, Vin>1.8V, HSST, CL	USP-6C	49da	DC16	9a Tor
BBD	XC9237F1DCER	DC-DC-IC	PWM-PWM/PPM, st-dwn, 1.35V±2%, 600mA, 1.2MHz, Vin>1.8V, HSST, CL	USP-6C	49da	DC16	9a Tor
BBE	XC9237F1ECER	DC-DC-IC	PWM-PWM/PPM, st-dwn, 1.45V±2%, 600mA, 1.2MHz, Vin>1.8V, HSST, CL	USP-6C	49da	DC16	9a Tor
BBF	XC9237F1FCER	DC-DC-IC	PWM-PWM/PPM, st-dwn, 1.55V±2%, 600mA, 1.2MHz, Vin>1.8V, HSST, CL	USP-6C	49da	DC16	9a Tor
BBH	XC9237F1HCER	DC-DC-IC	PWM-PWM/PPM, st-dwn, 1.65V±2%, 600mA, 1.2MHz, Vin>1.8V, HSST, CL	USP-6C	49da	DC16	9a Tor
BBK	XC9237F1KCER	DC-DC-IC	PWM-PWM/PPM, st-dwn, 1.75V±2%, 600mA, 1.2MHz, Vin>1.8V, HSST, CL	USP-6C	49da	DC16	9a Tor
BBL	XC9237F1LCER	DC-DC-IC	PWM-PWM/PPM, st-dwn, 1.85V±2%, 600mA, 1.2MHz, Vin>1.8V, HSST, CL	USP-6C	49da	DC16	9a Tor
BBM	XC9237F1MCER	DC-DC-IC	PWM-PWM/PPM, st-dwn, 1.95V±2%, 600mA, 1.2MHz, Vin>1.8V, HSST, CL	USP-6C	49da	DC16	9a Tor
BBN	XC6119C10A7R	Vdet-IC	1.0V±30mV, -Reset PPO	USPN-4	58j	VD3	9h Tor
BBP	XC6119C11A7R	Vdet-IC	1.1V±30mV, -Reset PPO	USPN-4	58j	VD3	9h Tor
BBR	XC6119C12A7R	Vdet-IC	1.2V±30mV, -Reset PPO	USPN-4	58j	VD3	9h Tor
BBS	XC6119C13A7R	Vdet-IC	1.3V±30mV, -Reset PPO	USPN-4	58j	VD3	9h Tor
BBT	XC6119C14A7R	Vdet-IC	1.4V±30mV, -Reset PPO	USPN-4	58j	VD3	9h Tor
BBU	XC6119C15A7R	Vdet-IC	1.5V±2%, -Reset PPO	USPN-4	58j	VD3	9h Tor
BBV	XC6119C16A7R	Vdet-IC	1.6V±2%, -Reset PPO	USPN-4	58j	VD3	9h Tor
BBX	XC6119C17A7R	Vdet-IC	1.7V±2%, -Reset PPO	USPN-4	58j	VD3	9h Tor
BBY	XC6119C18A7R	Vdet-IC	1.8V±2%, -Reset PPO	USPN-4	58j	VD3	9h Tor
BBZ	XC6119C19A7R	Vdet-IC	1.9V±2%, -Reset PPO	USPN-4	58j	VD3	9h Tor
BC	PAM8303DAZN	LIN-IC	AF PA, BTL, class-D, 2.7..5.5V, 3W(5V/4Q), shutdown	BGA-9	39	AFF45	- Pam
BC	RP104K151C	LVR-IC	LDO, 1.5V±0.8%, 150mA	DFN1010-4	48y1	VR1	9a Ric
BC	RP105K081D	LVR-IC	LDO, 0.8V±15mV, 400mA, +CE, CL	DFN1212-6	52zd	VR11	9a Ric
BC	RT9193-1HPQW	LVR-IC	LDO, 1.85V±1%, 300mA, +CE	WDFN-6L	49ub	VR7	9a Rct
BC	XC6221B1317R	LVR-IC	LDO, 1.3V±20mV, 200mA, +CE, CL	USPN-4	58vm	VR4	9a Tor
BC	XC6223D22B9R-G	LVR-IC	LDO, 2.25V±1%, 300mA, +CE, CL, PDR	USPQ-4B03	48vm	VR4	9a Tor
BC0	XC9237F20CER	DC-DC-IC	PWM-PWM/PPM, st-dwn, 2.0V±2%, 600mA, 1.2MHz, Vin>1.8V, HSST, CL	USP-6C	49da	DC16	9a Tor
BC01	RP153L001D	LVR-IC	LDO, Dual out, Vout1/Vout2=2.8V/2.8V±1%, 150mA, +CE	DFN1216-8	37x6	VR26	9b Ric
BC02	RP153L002D	LVR-IC	LDO, Dual out, Vout1/Vout2=1.8V/2.8V±1%, 150mA, +CE	DFN1216-8	37x6	VR26	9b Ric
BC03	RP153L003D	LVR-IC	LDO, Dual out, Vout1/Vout2=1.5V/2.8V±1%, 150mA, +CE	DFN1216-8	37x6	VR26	9b Ric
BC04	RP153L004D	LVR-IC	LDO, Dual out, Vout1/Vout2=1.2V/1.8V±1%, 150mA, +CE	DFN1216-8	37x6	VR26	9b Ric
BC05	RP153L005D	LVR-IC	LDO, Dual out, Vout1/Vout2=3.3V/1.2V±1%, 150mA, +CE	DFN1216-8	37x6	VR26	9b Ric
BC06	RP153L006D	LVR-IC	LDO, Dual out, Vout1/Vout2=3.3V/1.8V±1%, 150mA, +CE	DFN1216-8	37x6	VR26	9b Ric
BC07	RP153L007D	LVR-IC	LDO, Dual out, Vout1/Vout2=2.85V/2.85V±1%, 150mA, +CE	DFN1216-8	37x6	VR26	9b Ric
BC08	RP153L008D	LVR-IC	LDO, Dual out, Vout1/Vout2=2.85V/2.6V±1%, 150mA, +CE	DFN1216-8	37x6	VR26	9b Ric
BC09	RP153L009D	LVR-IC	LDO, Dual out, Vout1/Vout2=3.0V/2.8V±1%, 150mA, +CE	DFN1216-8	37x6	VR26	9b Ric
BC1	XC9237F21CER	DC-DC-IC	PWM-PWM/PPM, st-dwn, 2.1V±2%, 600mA, 1.2MHz, Vin>1.8V, HSST, CL	USP-6C	49da	DC16	9a Tor
BC10	RP153L010D	LVR-IC	LDO, Dual out, Vout1/Vout2=3.0V/1.8V±1%, 150mA, +CE	DFN1216-8	37x6	VR26	9b Ric
BC11	RP153L011D	LVR-IC	LDO, Dual out, Vout1/Vout2=1.8V/1.5V±1%, 150mA, +CE	DFN1216-8	37x6	VR26	9b Ric
BC12	RP153L012D	LVR-IC	LDO, Dual out, Vout1/Vout2=2.8V/2.6V±1%, 150mA, +CE	DFN1216-8	37x6	VR26	9b Ric
BC13	RP153L013D	LVR-IC	LDO, Dual out, Vout1/Vout2=3.3V/2.8V±1%, 150mA, +CE	DFN1216-8	37x6	VR26	9b Ric
BC14	RP153L014D	LVR-IC	LDO, Dual out, Vout1/Vout2=3.3V/3.3V±1%, 150mA, +CE	DFN1216-8	37x6	VR26	9b Ric
BC15	RP153L015D	LVR-IC	LDO, Dual out, Vout1/Vout2=1.5V/2.5V±1%, 150mA, +CE	DFN1216-8	37x6	VR26	9b Ric
BC16	RP153L016D	LVR-IC	LDO, Dual out, Vout1/Vout2=1.5V/3.0V±1%, 150mA, +CE	DFN1216-8	37x6	VR26	9b Ric
BC17	RP153L017D	LVR-IC	LDO, Dual out, Vout1/Vout2=2.5V/3.0V±1%, 150mA, +CE	DFN1216-8	37x6	VR26	9b Ric
BC18	RP153L018D	LVR-IC	LDO, Dual out, Vout1/Vout2=1.8V/1.8V±1%, 150mA, +CE	DFN1216-8	37x6	VR26	9b Ric
BC19	RP153L019D	LVR-IC	LDO, Dual out, Vout1/Vout2=1.5V/2.6V±1%, 150mA, +CE	DFN1216-8	37x6	VR26	9b Ric
BC2	XC9237F22CER	DC-DC-IC	PWM-PWM/PPM, st-dwn, 2.2V±2%, 600mA, 1.2MHz, Vin>1.8V, HSST, CL	USP-6C	49da	DC16	9a Tor
BC20	RP153L020D	LVR-IC	LDO, Dual out, Vout1/Vout2=2.8V/1.8V±1%, 150mA, +CE	DFN1216-8	37x6	VR26	9b Ric



SMD code	Type	Function	Short description	Case	Pinout	Sch.	St.Mnf.
BC21	RP153L021D	LVR-IC	LDO, Dual out, Vout1/Vout2=1.2V/2.8V±1%, 150mA, +CE	DFN1216-8	37x6	VR26	9b Ric
BC216	XC6114C216ER	Vdet-IC	1.6V±2%, ±Reset PPO, Wt=50ms, Rt=50ms	USP-6C	49xq	VD19	9b Tor
BC217	XC6114C217ER	Vdet-IC	1.7V±2%, ±Reset PPO, Wt=50ms, Rt=50ms	USP-6C	49xq	VD19	9b Tor
BC218	XC6114C218ER	Vdet-IC	1.8V±2%, ±Reset PPO, Wt=50ms, Rt=50ms	USP-6C	49xq	VD19	9b Tor
BC219	XC6114C219ER	Vdet-IC	1.9V±2%, ±Reset PPO, Wt=50ms, Rt=50ms	USP-6C	49xq	VD19	9b Tor
BC22	RP153L022D	LVR-IC	LDO, Dual out, Vout1/Vout2=2.8V/1.2V±1%, 150mA, +CE	DFN1216-8	37x6	VR26	9b Ric
BC220	XC6114C220ER	Vdet-IC	2.0V±2%, ±Reset PPO, Wt=50ms, Rt=50ms	USP-6C	49xq	VD19	9b Tor
BC221	XC6114C221ER	Vdet-IC	2.1V±2%, ±Reset PPO, Wt=50ms, Rt=50ms	USP-6C	49xq	VD19	9b Tor
BC222	XC6114C222ER	Vdet-IC	2.2V±2%, ±Reset PPO, Wt=50ms, Rt=50ms	USP-6C	49xq	VD19	9b Tor
BC223	XC6114C223ER	Vdet-IC	2.3V±2%, ±Reset PPO, Wt=50ms, Rt=50ms	USP-6C	49xq	VD19	9b Tor
BC224	XC6114C224ER	Vdet-IC	2.4V±2%, ±Reset PPO, Wt=50ms, Rt=50ms	USP-6C	49xq	VD19	9b Tor
BC225	XC6114C225ER	Vdet-IC	2.5V±2%, ±Reset PPO, Wt=50ms, Rt=50ms	USP-6C	49xq	VD19	9b Tor
BC226	XC6114C226ER	Vdet-IC	2.6V±2%, ±Reset PPO, Wt=50ms, Rt=50ms	USP-6C	49xq	VD19	9b Tor
BC227	XC6114C227ER	Vdet-IC	2.7V±2%, ±Reset PPO, Wt=50ms, Rt=50ms	USP-6C	49xq	VD19	9b Tor
BC228	XC6114C228ER	Vdet-IC	2.8V±2%, ±Reset PPO, Wt=50ms, Rt=50ms	USP-6C	49xq	VD19	9b Tor
BC229	XC6114C229ER	Vdet-IC	2.9V±2%, ±Reset PPO, Wt=50ms, Rt=50ms	USP-6C	49xq	VD19	9b Tor
BC23	RP153L023D	LVR-IC	LDO, Dual out, Vout1/Vout2=2.5V/2.5V±1%, 150mA, +CE	DFN1216-8	37x6	VR26	9b Ric
BC230	XC6114C230ER	Vdet-IC	3.0V±2%, ±Reset PPO, Wt=50ms, Rt=50ms	USP-6C	49xq	VD19	9b Tor
BC231	XC6114C231ER	Vdet-IC	3.1V±2%, ±Reset PPO, Wt=50ms, Rt=50ms	USP-6C	49xq	VD19	9b Tor
BC232	XC6114C232ER	Vdet-IC	3.2V±2%, ±Reset PPO, Wt=50ms, Rt=50ms	USP-6C	49xq	VD19	9b Tor
BC233	XC6114C233ER	Vdet-IC	3.3V±2%, ±Reset PPO, Wt=50ms, Rt=50ms	USP-6C	49xq	VD19	9b Tor
BC234	XC6114C234ER	Vdet-IC	3.4V±2%, ±Reset PPO, Wt=50ms, Rt=50ms	USP-6C	49xq	VD19	9b Tor
BC235	XC6114C235ER	Vdet-IC	3.5V±2%, ±Reset PPO, Wt=50ms, Rt=50ms	USP-6C	49xq	VD19	9b Tor
BC236	XC6114C236ER	Vdet-IC	3.6V±2%, ±Reset PPO, Wt=50ms, Rt=50ms	USP-6C	49xq	VD19	9b Tor
BC237	XC6114C237ER	Vdet-IC	3.7V±2%, ±Reset PPO, Wt=50ms, Rt=50ms	USP-6C	49xq	VD19	9b Tor
BC238	XC6114C238ER	Vdet-IC	3.8V±2%, ±Reset PPO, Wt=50ms, Rt=50ms	USP-6C	49xq	VD19	9b Tor
BC239	XC6114C239ER	Vdet-IC	3.9V±2%, ±Reset PPO, Wt=50ms, Rt=50ms	USP-6C	49xq	VD19	9b Tor
BC24	RP153L024D	LVR-IC	LDO, Dual out, Vout1/Vout2=3.3V/3.0V±1%, 150mA, +CE	DFN1216-8	37x6	VR26	9b Ric
BC240	XC6114C240ER	Vdet-IC	4.0V±2%, ±Reset PPO, Wt=50ms, Rt=50ms	USP-6C	49xq	VD19	9b Tor
BC241	XC6114C241ER	Vdet-IC	4.1V±2%, ±Reset PPO, Wt=50ms, Rt=50ms	USP-6C	49xq	VD19	9b Tor
BC242	XC6114C242ER	Vdet-IC	4.2V±2%, ±Reset PPO, Wt=50ms, Rt=50ms	USP-6C	49xq	VD19	9b Tor
BC243	XC6114C243ER	Vdet-IC	4.3V±2%, ±Reset PPO, Wt=50ms, Rt=50ms	USP-6C	49xq	VD19	9b Tor
BC244	XC6114C244ER	Vdet-IC	4.4V±2%, ±Reset PPO, Wt=50ms, Rt=50ms	USP-6C	49xq	VD19	9b Tor
BC245	XC6114C245ER	Vdet-IC	4.5V±2%, ±Reset PPO, Wt=50ms, Rt=50ms	USP-6C	49xq	VD19	9b Tor
BC246	XC6114C246ER	Vdet-IC	4.6V±2%, ±Reset PPO, Wt=50ms, Rt=50ms	USP-6C	49xq	VD19	9b Tor
BC247	XC6114C247ER	Vdet-IC	4.7V±2%, ±Reset PPO, Wt=50ms, Rt=50ms	USP-6C	49xq	VD19	9b Tor
BC248	XC6114C248ER	Vdet-IC	4.8V±2%, ±Reset PPO, Wt=50ms, Rt=50ms	USP-6C	49xq	VD19	9b Tor
BC249	XC6114C249ER	Vdet-IC	4.9V±2%, ±Reset PPO, Wt=50ms, Rt=50ms	USP-6C	49xq	VD19	9b Tor
BC25	RP153L025D	LVR-IC	LDO, Dual out, Vout1/Vout2=3.0V/3.0V±1%, 150mA, +CE	DFN1216-8	37x6	VR26	9b Ric
BC250	XC6114C250ER	Vdet-IC	5.0V±2%, ±Reset PPO, Wt=50ms, Rt=50ms	USP-6C	49xq	VD19	9b Tor
BC26	RP153L026D	LVR-IC	LDO, Dual out, Vout1/Vout2=2.8V/3.1V±1%, 150mA, +CE	DFN1216-8	37x6	VR26	9b Ric
BC27	RP153L027D	LVR-IC	LDO, Dual out, Vout1/Vout2=2.3V/2.8V±1%, 150mA, +CE	DFN1216-8	37x6	VR26	9b Ric
BC28	RP153L028D	LVR-IC	LDO, Dual out, Vout1/Vout2=2.8V/1.0V±1%, 150mA, +CE	DFN1216-8	37x6	VR26	9b Ric
BC29	RP153L029D	LVR-IC	LDO, Dual out, Vout1/Vout2=1.5V/1.5V±1%, 150mA, +CE	DFN1216-8	37x6	VR26	9b Ric
BC3	XC9237F23CER	DC-DC-IC	PWM-PWM/PPM, st-dwn, 2.3V±2%, 600mA, 1.2MHz, Vin>1.8V, HSST, CL	USP-6C	49da	DC16	9a Tor
BC30	RP153L030D	LVR-IC	LDO, Dual out, Vout1/Vout2=1.5V/3.3V±1%, 150mA, +CE	DFN1216-8	37x6	VR26	9b Ric
BC31	RP153L031D	LVR-IC	LDO, Dual out, Vout1/Vout2=1.8V/2.7V±1%, 150mA, +CE	DFN1216-8	37x6	VR26	9b Ric
BC316	XC6114C316ER	Vdet-IC	1.6V±2%, ±Reset PPO, Wt=100ms, Rt=50ms	USP-6C	49xq	VD19	9b Tor
BC317	XC6114C317ER	Vdet-IC	1.7V±2%, ±Reset PPO, Wt=100ms, Rt=50ms	USP-6C	49xq	VD19	9b Tor
BC318	XC6114C318ER	Vdet-IC	1.8V±2%, ±Reset PPO, Wt=100ms, Rt=50ms	USP-6C	49xq	VD19	9b Tor
BC319	XC6114C319ER	Vdet-IC	1.9V±2%, ±Reset PPO, Wt=100ms, Rt=50ms	USP-6C	49xq	VD19	9b Tor
BC32	RP153L032D	LVR-IC	LDO, Dual out, Vout1/Vout2=1.2V/3.0V±1%, 150mA, +CE	DFN1216-8	37x6	VR26	9b Ric
BC320	XC6114C320ER	Vdet-IC	2.0V±2%, ±Reset PPO, Wt=100ms, Rt=50ms	USP-6C	49xq	VD19	9b Tor
BC321	XC6114C321ER	Vdet-IC	2.1V±2%, ±Reset PPO, Wt=100ms, Rt=50ms	USP-6C	49xq	VD19	9b Tor
BC322	XC6114C322ER	Vdet-IC	2.2V±2%, ±Reset PPO, Wt=100ms, Rt=50ms	USP-6C	49xq	VD19	9b Tor
BC323	XC6114C323ER	Vdet-IC	2.3V±2%, ±Reset PPO, Wt=100ms, Rt=50ms	USP-6C	49xq	VD19	9b Tor
BC324	XC6114C324ER	Vdet-IC	2.4V±2%, ±Reset PPO, Wt=100ms, Rt=50ms	USP-6C	49xq	VD19	9b Tor
BC325	XC6114C325ER	Vdet-IC	2.5V±2%, ±Reset PPO, Wt=100ms, Rt=50ms	USP-6C	49xq	VD19	9b Tor
BC326	XC6114C326ER	Vdet-IC	2.6V±2%, ±Reset PPO, Wt=100ms, Rt=50ms	USP-6C	49xq	VD19	9b Tor
BC327	XC6114C327ER	Vdet-IC	2.7V±2%, ±Reset PPO, Wt=100ms, Rt=50ms	USP-6C	49xq	VD19	9b Tor
BC328	XC6114C328ER	Vdet-IC	2.8V±2%, ±Reset PPO, Wt=100ms, Rt=50ms	USP-6C	49xq	VD19	9b Tor
BC329	XC6114C329ER	Vdet-IC	2.9V±2%, ±Reset PPO, Wt=100ms, Rt=50ms	USP-6C	49xq	VD19	9b Tor
BC33	RP153L033D	LVR-IC	LDO, Dual out, Vout1/Vout2=3.1V/3.1V±1%, 150mA, +CE	DFN1216-8	37x6	VR26	9b Ric
BC330	XC6114C330ER	Vdet-IC	3.0V±2%, ±Reset PPO, Wt=100ms, Rt=50ms	USP-6C	49xq	VD19	9b Tor
BC331	XC6114C331ER	Vdet-IC	3.1V±2%, ±Reset PPO, Wt=100ms, Rt=50ms	USP-6C	49xq	VD19	9b Tor
BC332	XC6114C332ER	Vdet-IC	3.2V±2%, ±Reset PPO, Wt=100ms, Rt=50ms	USP-6C	49xq	VD19	9b Tor
BC333	XC6114C333ER	Vdet-IC	3.3V±2%, ±Reset PPO, Wt=100ms, Rt=50ms	USP-6C	49xq	VD19	9b Tor
BC334	XC6114C334ER	Vdet-IC	3.4V±2%, ±Reset PPO, Wt=100ms, Rt=50ms	USP-6C	49xq	VD19	9b Tor
BC335	XC6114C335ER	Vdet-IC	3.5V±2%, ±Reset PPO, Wt=100ms, Rt=50ms	USP-6C	49xq	VD19	9b Tor
BC336	XC6114C336ER	Vdet-IC	3.6V±2%, ±Reset PPO, Wt=100ms, Rt=50ms	USP-6C	49xq	VD19	9b Tor



SMD code	Type	Function	Short description	Case	Pinout	Sch.	St.	Mnf.
BC337	XC6114C337ER	Vdet-IC	3.7V±2%, ±Reset PPO, Wt=100ms, Rt=50ms	USP-6C	49xq	VD19	9b	Tor
BC338	XC6114C338ER	Vdet-IC	3.8V±2%, ±Reset PPO, Wt=100ms, Rt=50ms	USP-6C	49xq	VD19	9b	Tor
BC339	XC6114C339ER	Vdet-IC	3.9V±2%, ±Reset PPO, Wt=100ms, Rt=50ms	USP-6C	49xq	VD19	9b	Tor
BC34	RP153L034D	LVR-IC	LDO, Dual out, Vout1/Vout2=1.8V/2.6V±1%, 150mA, +CE	DFN1216-8	37x6	VR26	9b	Ric
BC340	XC6114C340ER	Vdet-IC	4.0V±2%, ±Reset PPO, Wt=100ms, Rt=50ms	USP-6C	49xq	VD19	9b	Tor
BC341	XC6114C341ER	Vdet-IC	4.1V±2%, ±Reset PPO, Wt=100ms, Rt=50ms	USP-6C	49xq	VD19	9b	Tor
BC342	XC6114C342ER	Vdet-IC	4.2V±2%, ±Reset PPO, Wt=100ms, Rt=50ms	USP-6C	49xq	VD19	9b	Tor
BC343	XC6114C343ER	Vdet-IC	4.3V±2%, ±Reset PPO, Wt=100ms, Rt=50ms	USP-6C	49xq	VD19	9b	Tor
BC344	XC6114C344ER	Vdet-IC	4.4V±2%, ±Reset PPO, Wt=100ms, Rt=50ms	USP-6C	49xq	VD19	9b	Tor
BC345	XC6114C345ER	Vdet-IC	4.5V±2%, ±Reset PPO, Wt=100ms, Rt=50ms	USP-6C	49xq	VD19	9b	Tor
BC346	XC6114C346ER	Vdet-IC	4.6V±2%, ±Reset PPO, Wt=100ms, Rt=50ms	USP-6C	49xq	VD19	9b	Tor
BC347	XC6114C347ER	Vdet-IC	4.7V±2%, ±Reset PPO, Wt=100ms, Rt=50ms	USP-6C	49xq	VD19	9b	Tor
BC348	XC6114C348ER	Vdet-IC	4.8V±2%, ±Reset PPO, Wt=100ms, Rt=50ms	USP-6C	49xq	VD19	9b	Tor
BC349	XC6114C349ER	Vdet-IC	4.9V±2%, ±Reset PPO, Wt=100ms, Rt=50ms	USP-6C	49xq	VD19	9b	Tor
BC35	RP153L035D	LVR-IC	LDO, Dual out, Vout1/Vout2=2.5V/1.2V±1%, 150mA, +CE	DFN1216-8	37x6	VR26	9b	Ric
BC350	XC6114C350ER	Vdet-IC	5.0V±2%, ±Reset PPO, Wt=100ms, Rt=50ms	USP-6C	49xq	VD19	9b	Tor
BC36	RP153L036D	LVR-IC	LDO, Dual out, Vout1/Vout2=1.2V/2.9V±1%, 150mA, +CE	DFN1216-8	37x6	VR26	9b	Ric
BC37	RP153L037D	LVR-IC	LDO, Dual out, Vout1/Vout2=3.3V/2.0V±1%, 150mA, +CE	DFN1216-8	37x6	VR26	9b	Ric
BC38	RP153L038D	LVR-IC	LDO, Dual out, Vout1/Vout2=1.2V/2.85V±1%, 150mA, +CE	DFN1216-8	37x6	VR26	9b	Ric
BC39	RP153L039D	LVR-IC	LDO, Dual out, Vout1/Vout2=2.1V/3.3V±1%, 150mA, +CE	DFN1216-8	37x6	VR26	9b	Ric
BC4	XC9237F24CER	DC-DC-IC	PWM-PWM/PPM, st-dwn, 2.4V±2%, 600mA, 1.2MHz, Vin>1.8V, HSST, CL	USP-6C	49da	DC16	9a	Tor
BC40	RP153L040D	LVR-IC	LDO, Dual out, Vout1/Vout2=2.8V/2.85V±1%, 150mA, +CE	DFN1216-8	37x6	VR26	9b	Ric
BC41	RP153L041D	LVR-IC	LDO, Dual out, Vout1/Vout2=1.8V/3.0V±1%, 150mA, +CE	DFN1216-8	37x6	VR26	9b	Ric
BC416	XC6114C416ER	Vdet-IC	1.6V±2%, ±Reset PPO, Wt=200ms, Rt=50ms	USP-6C	49xq	VD19	9b	Tor
BC417	XC6114C417ER	Vdet-IC	1.7V±2%, ±Reset PPO, Wt=200ms, Rt=50ms	USP-6C	49xq	VD19	9b	Tor
BC418	XC6114C418ER	Vdet-IC	1.8V±2%, ±Reset PPO, Wt=200ms, Rt=50ms	USP-6C	49xq	VD19	9b	Tor
BC419	XC6114C419ER	Vdet-IC	1.9V±2%, ±Reset PPO, Wt=200ms, Rt=50ms	USP-6C	49xq	VD19	9b	Tor
BC42	RP153L042D	LVR-IC	LDO, Dual out, Vout1/Vout2=1.2V/2.6V±1%, 150mA, +CE	DFN1216-8	37x6	VR26	9b	Ric
BC420	XC6114C420ER	Vdet-IC	2.0V±2%, ±Reset PPO, Wt=200ms, Rt=50ms	USP-6C	49xq	VD19	9b	Tor
BC421	XC6114C421ER	Vdet-IC	2.1V±2%, ±Reset PPO, Wt=200ms, Rt=50ms	USP-6C	49xq	VD19	9b	Tor
BC422	XC6114C422ER	Vdet-IC	2.2V±2%, ±Reset PPO, Wt=200ms, Rt=50ms	USP-6C	49xq	VD19	9b	Tor
BC423	XC6114C423ER	Vdet-IC	2.3V±2%, ±Reset PPO, Wt=200ms, Rt=50ms	USP-6C	49xq	VD19	9b	Tor
BC424	XC6114C424ER	Vdet-IC	2.4V±2%, ±Reset PPO, Wt=200ms, Rt=50ms	USP-6C	49xq	VD19	9b	Tor
BC425	XC6114C425ER	Vdet-IC	2.5V±2%, ±Reset PPO, Wt=200ms, Rt=50ms	USP-6C	49xq	VD19	9b	Tor
BC426	XC6114C426ER	Vdet-IC	2.6V±2%, ±Reset PPO, Wt=200ms, Rt=50ms	USP-6C	49xq	VD19	9b	Tor
BC427	XC6114C427ER	Vdet-IC	2.7V±2%, ±Reset PPO, Wt=200ms, Rt=50ms	USP-6C	49xq	VD19	9b	Tor
BC428	XC6114C428ER	Vdet-IC	2.8V±2%, ±Reset PPO, Wt=200ms, Rt=50ms	USP-6C	49xq	VD19	9b	Tor
BC429	XC6114C429ER	Vdet-IC	2.9V±2%, ±Reset PPO, Wt=200ms, Rt=50ms	USP-6C	49xq	VD19	9b	Tor
BC43	RP153L043D	LVR-IC	LDO, Dual out, Vout1/Vout2=1.3V/2.8V±1%, 150mA, +CE	DFN1216-8	37x6	VR26	9b	Ric
BC430	XC6114C430ER	Vdet-IC	3.0V±2%, ±Reset PPO, Wt=200ms, Rt=50ms	USP-6C	49xq	VD19	9b	Tor
BC431	XC6114C431ER	Vdet-IC	3.1V±2%, ±Reset PPO, Wt=200ms, Rt=50ms	USP-6C	49xq	VD19	9b	Tor
BC432	XC6114C432ER	Vdet-IC	3.2V±2%, ±Reset PPO, Wt=200ms, Rt=50ms	USP-6C	49xq	VD19	9b	Tor
BC433	XC6114C433ER	Vdet-IC	3.3V±2%, ±Reset PPO, Wt=200ms, Rt=50ms	USP-6C	49xq	VD19	9b	Tor
BC434	XC6114C434ER	Vdet-IC	3.4V±2%, ±Reset PPO, Wt=200ms, Rt=50ms	USP-6C	49xq	VD19	9b	Tor
BC435	XC6114C435ER	Vdet-IC	3.5V±2%, ±Reset PPO, Wt=200ms, Rt=50ms	USP-6C	49xq	VD19	9b	Tor
BC436	XC6114C436ER	Vdet-IC	3.6V±2%, ±Reset PPO, Wt=200ms, Rt=50ms	USP-6C	49xq	VD19	9b	Tor
BC437	XC6114C437ER	Vdet-IC	3.7V±2%, ±Reset PPO, Wt=200ms, Rt=50ms	USP-6C	49xq	VD19	9b	Tor
BC438	XC6114C438ER	Vdet-IC	3.8V±2%, ±Reset PPO, Wt=200ms, Rt=50ms	USP-6C	49xq	VD19	9b	Tor
BC439	XC6114C439ER	Vdet-IC	3.9V±2%, ±Reset PPO, Wt=200ms, Rt=50ms	USP-6C	49xq	VD19	9b	Tor
BC44	RP153L044D	LVR-IC	LDO, Dual out, Vout1/Vout2=1.1V/1.5V±1%, 150mA, +CE	DFN1216-8	37x6	VR26	9b	Ric
BC440	XC6114C440ER	Vdet-IC	4.0V±2%, ±Reset PPO, Wt=200ms, Rt=50ms	USP-6C	49xq	VD19	9b	Tor
BC441	XC6114C441ER	Vdet-IC	4.1V±2%, ±Reset PPO, Wt=200ms, Rt=50ms	USP-6C	49xq	VD19	9b	Tor
BC442	XC6114C442ER	Vdet-IC	4.2V±2%, ±Reset PPO, Wt=200ms, Rt=50ms	USP-6C	49xq	VD19	9b	Tor
BC443	XC6114C443ER	Vdet-IC	4.3V±2%, ±Reset PPO, Wt=200ms, Rt=50ms	USP-6C	49xq	VD19	9b	Tor
BC444	XC6114C444ER	Vdet-IC	4.4V±2%, ±Reset PPO, Wt=200ms, Rt=50ms	USP-6C	49xq	VD19	9b	Tor
BC445	XC6114C445ER	Vdet-IC	4.5V±2%, ±Reset PPO, Wt=200ms, Rt=50ms	USP-6C	49xq	VD19	9b	Tor
BC446	XC6114C446ER	Vdet-IC	4.6V±2%, ±Reset PPO, Wt=200ms, Rt=50ms	USP-6C	49xq	VD19	9b	Tor
BC447	XC6114C447ER	Vdet-IC	4.7V±2%, ±Reset PPO, Wt=200ms, Rt=50ms	USP-6C	49xq	VD19	9b	Tor
BC448	XC6114C448ER	Vdet-IC	4.8V±2%, ±Reset PPO, Wt=200ms, Rt=50ms	USP-6C	49xq	VD19	9b	Tor
BC449	XC6114C449ER	Vdet-IC	4.9V±2%, ±Reset PPO, Wt=200ms, Rt=50ms	USP-6C	49xq	VD19	9b	Tor
BC45	RP153L045D	LVR-IC	LDO, Dual out, Vout1/Vout2=2.8V/3.8V±1%, 150mA, +CE	DFN1216-8	37x6	VR26	9b	Ric
BC450	XC6114C450ER	Vdet-IC	5.0V±2%, ±Reset PPO, Wt=200ms, Rt=50ms	USP-6C	49xq	VD19	9b	Tor
BC46	RP153L046D	LVR-IC	LDO, Dual out, Vout1/Vout2=2.8V/3.0V±1%, 150mA, +CE	DFN1216-8	37x6	VR26	9b	Ric
BC47	RP153L047D	LVR-IC	LDO, Dual out, Vout1/Vout2=2.5V/2.8V±1%, 150mA, +CE	DFN1216-8	37x6	VR26	9b	Ric
BC48	RP153L048D	LVR-IC	LDO, Dual out, Vout1/Vout2=2.5V/3.2V±1%, 150mA, +CE	DFN1216-8	37x6	VR26	9b	Ric
BC49	RP153L049D	LVR-IC	LDO, Dual out, Vout1/Vout2=1.5V/2.85V±1%, 150mA, +CE	DFN1216-8	37x6	VR26	9b	Ric
BC5	XC9237F25CER	DC-DC-IC	PWM-PWM/PPM, st-dwn, 2.5V±2%, 600mA, 1.2MHz, Vin>1.8V, HSST, CL	USP-6C	49da	DC16	9a	Tor
BC50	RP153L050D	LVR-IC	LDO, Dual out, Vout1/Vout2=2.4V/2.9V±1%, 150mA, +CE	DFN1216-8	37x6	VR26	9b	Ric
BC51	RP153L051D	LVR-IC	LDO, Dual out, Vout1/Vout2=1.0V/1.8V±1%, 150mA, +CE	DFN1216-8	37x6	VR26	9b	Ric
BC516	XC6114C516ER	Vdet-IC	1.6V±2%, ±Reset PPO, Wt=400ms, Rt=50ms	USP-6C	49xq	VD19	9b	Tor



SMD code	Type	Function	Short description	Case	Pinout	Sch.	St.	Mnf.
BC650	XC6114C650ER	Vdet-IC	5.0V±2%, ±Reset PPO, Wt=1.6s, Rt=50ms	USP-6C	49xq	VD19	9b	Tor
BC7	XC9237F27CER	DC-DC-IC	PWM-PWM/PPM, st-dwn, 2.7V±2%, 600mA, 1.2MHz, Vin>1.8V, HSST, CL	USP-6C	49da	DC16	9a	Tor
BC8	XC9237F28CER	DC-DC-IC	PWM-PWM/PPM, st-dwn, 2.8V±2%, 600mA, 1.2MHz, Vin>1.8V, HSST, CL	USP-6C	49da	DC16	9a	Tor
BC9	XC9237F29CER	DC-DC-IC	PWM-PWM/PPM, st-dwn, 2.9V±2%, 600mA, 1.2MHz, Vin>1.8V, HSST, CL	USP-6C	49da	DC16	9a	Tor
BCA	XC9237F2ACER	DC-DC-IC	PWM-PWM/PPM, st-dwn, 2.05V±2%, 600mA, 1.2MHz, Vin>1.8V, HSST, CL	USP-6C	49da	DC16	9a	Tor
BCB	XC9237F2BCER	DC-DC-IC	PWM-PWM/PPM, st-dwn, 2.15V±2%, 600mA, 1.2MHz, Vin>1.8V, HSST, CL	USP-6C	49da	DC16	9a	Tor
BCC	XC9237F2CCER	DC-DC-IC	PWM-PWM/PPM, st-dwn, 2.25V±2%, 600mA, 1.2MHz, Vin>1.8V, HSST, CL	USP-6C	49da	DC16	9a	Tor
BCD	XC9237F2DCER	DC-DC-IC	PWM-PWM/PPM, st-dwn, 2.35V±2%, 600mA, 1.2MHz, Vin>1.8V, HSST, CL	USP-6C	49da	DC16	9a	Tor
BCE	XC9237F2ECER	DC-DC-IC	PWM-PWM/PPM, st-dwn, 2.45V±2%, 600mA, 1.2MHz, Vin>1.8V, HSST, CL	USP-6C	49da	DC16	9a	Tor
BCF	XC9237F2FCER	DC-DC-IC	PWM-PWM/PPM, st-dwn, 2.55V±2%, 600mA, 1.2MHz, Vin>1.8V, HSST, CL	USP-6C	49da	DC16	9a	Tor
BCH	XC9237F2HCER	DC-DC-IC	PWM-PWM/PPM, st-dwn, 2.65V±2%, 600mA, 1.2MHz, Vin>1.8V, HSST, CL	USP-6C	49da	DC16	9a	Tor
BCK	XC9237F2KCER	DC-DC-IC	PWM-PWM/PPM, st-dwn, 2.75V±2%, 600mA, 1.2MHz, Vin>1.8V, HSST, CL	USP-6C	49da	DC16	9a	Tor
BCL	XC9237F2LCER	DC-DC-IC	PWM-PWM/PPM, st-dwn, 2.85V±2%, 600mA, 1.2MHz, Vin>1.8V, HSST, CL	USP-6C	49da	DC16	9a	Tor
BCM	XC9237F2MCER	DC-DC-IC	PWM-PWM/PPM, st-dwn, 2.95V±2%, 600mA, 1.2MHz, Vin>1.8V, HSST, CL	USP-6C	49da	DC16	9a	Tor
BCN	XC6119C20A7R	Vdet-IC	2.0V±2%, -Reset PPO	USPN-4	58dj	VD3	9h	Tor
BCP	XC6119C21A7R	Vdet-IC	2.1V±2%, -Reset PPO	USPN-4	58j	VD3	9h	Tor
BCR	XC6119C22A7R	Vdet-IC	2.2V±2%, -Reset PPO	USPN-4	58j	VD3	9h	Tor
BCS	XC6119C23A7R	Vdet-IC	2.3V±2%, -Reset PPO	USPN-4	58j	VD3	9h	Tor
BCT	XC6119C24A7R	Vdet-IC	2.4V±2%, -Reset PPO	USPN-4	58j	VD3	9h	Tor
BCU	XC6119C25A7R	Vdet-IC	2.5V±2%, -Reset PPO	USPN-4	58j	VD3	9h	Tor
BCV	XC6119C26A7R	Vdet-IC	2.6V±2%, -Reset PPO	USPN-4	58j	VD3	9h	Tor
BCX	XC6119C27A7R	Vdet-IC	2.7V±2%, -Reset PPO	USPN-4	58j	VD3	9h	Tor
BCY	XC6119C28A7R	Vdet-IC	2.8V±2%, -Reset PPO	USPN-4	58j	VD3	9h	Tor
BCZ	XC6119C29A7R	Vdet-IC	2.9V±2%, -Reset PPO	USPN-4	58j	VD3	9h	Tor
BD	RP104K181C	LVR-IC	LDO, 1.8V±0.8%, 150mA	DFN1010-4	48y1	VR1	9a	Ric
BD	RP105K091D	LVR-IC	LDO, 0.9V±15mV, 400mA, +CE, CL	DFN1212-6	52zd	VR11	9a	Ric
BD	RT193-28PQW	LVR-IC	LDO, 2.8V±1%, 300mA, +CE	WDFN-6L	49ub	VR7	9a	Rct
BD	XC6221B1417R	LVR-IC	LDO, 1.4V±20mV, 200mA, +CE, CL	USPN-4	58vm	VR4	9a	Tor
BD	XC6223D23B9R-G	LVR-IC	LDO, 2.35V±1%, 300mA, +CE, CL, PDR	USPQ-4B03	48vm	VR4	9a	Tor
BD0	XC9237F30CER	DC-DC-IC	PWM-PWM/PPM, st-dwn, 3.0V±2%, 600mA, 1.2MHz, Vin>1.8V, HSST, CL	USP-6C	49da	DC16	9a	Tor
BD01	RP153L001E	LVR-IC	LDO, Dual out, Vout1/Vout2=2.8V/2.8V±1%, 150mA, +CE	DFN1216-8	37x6	VR26	9b	Ric
BD02	RP153L002E	LVR-IC	LDO, Dual out, Vout1/Vout2=1.8V/2.8V±1%, 150mA, +CE	DFN1216-8	37x6	VR26	9b	Ric
BD03	RP153L003E	LVR-IC	LDO, Dual out, Vout1/Vout2=1.5V/2.8V±1%, 150mA, +CE	DFN1216-8	37x6	VR26	9b	Ric
BD04	RP153L004E	LVR-IC	LDO, Dual out, Vout1/Vout2=1.2V/1.8V±1%, 150mA, +CE	DFN1216-8	37x6	VR26	9b	Ric
BD05	RP153L005E	LVR-IC	LDO, Dual out, Vout1/Vout2=3.3V/1.2V±1%, 150mA, +CE	DFN1216-8	37x6	VR26	9b	Ric
BD06	RP153L006E	LVR-IC	LDO, Dual out, Vout1/Vout2=3.3V/1.8V±1%, 150mA, +CE	DFN1216-8	37x6	VR26	9b	Ric
BD07	RP153L007E	LVR-IC	LDO, Dual out, Vout1/Vout2=2.85V/2.85V±1%, 150mA, +CE	DFN1216-8	37x6	VR26	9b	Ric
BD08	RP153L008E	LVR-IC	LDO, Dual out, Vout1/Vout2=2.85V/2.6V±1%, 150mA, +CE	DFN1216-8	37x6	VR26	9b	Ric
BD09	RP153L009E	LVR-IC	LDO, Dual out, Vout1/Vout2=3.0V/2.8V±1%, 150mA, +CE	DFN1216-8	37x6	VR26	9b	Ric
BD1	XC9237F31CER	DC-DC-IC	PWM-PWM/PPM, st-dwn, 3.1V±2%, 600mA, 1.2MHz, Vin>1.8V, HSST, CL	USP-6C	49da	DC16	9a	Tor
BD10	RP153L010E	LVR-IC	LDO, Dual out, Vout1/Vout2=3.0V/1.8V±1%, 150mA, +CE	DFN1216-8	37x6	VR26	9b	Ric
BD11	RP153L011E	LVR-IC	LDO, Dual out, Vout1/Vout2=1.8V/1.5V±1%, 150mA, +CE	DFN1216-8	37x6	VR26	9b	Ric
BD12	RP153L012E	LVR-IC	LDO, Dual out, Vout1/Vout2=2.8V/2.6V±1%, 150mA, +CE	DFN1216-8	37x6	VR26	9b	Ric
BD13	RP153L013E	LVR-IC	LDO, Dual out, Vout1/Vout2=3.3V/2.8V±1%, 150mA, +CE	DFN1216-8	37x6	VR26	9b	Ric
BD14	RP153L014E	LVR-IC	LDO, Dual out, Vout1/Vout2=3.3V/3.3V±1%, 150mA, +CE	DFN1216-8	37x6	VR26	9b	Ric
BD15	RP153L015E	LVR-IC	LDO, Dual out, Vout1/Vout2=1.5V/2.5V±1%, 150mA, +CE	DFN1216-8	37x6	VR26	9b	Ric
BD16	RP153L016E	LVR-IC	LDO, Dual out, Vout1/Vout2=1.5V/3.0V±1%, 150mA, +CE	DFN1216-8	37x6	VR26	9b	Ric
BD17	RP153L017E	LVR-IC	LDO, Dual out, Vout1/Vout2=2.5V/3.0V±1%, 150mA, +CE	DFN1216-8	37x6	VR26	9b	Ric
BD18	RP153L018E	LVR-IC	LDO, Dual out, Vout1/Vout2=1.8V/1.8V±1%, 150mA, +CE	DFN1216-8	37x6	VR26	9b	Ric
BD19	RP153L019E	LVR-IC	LDO, Dual out, Vout1/Vout2=1.5V/2.6V±1%, 150mA, +CE	DFN1216-8	37x6	VR26	9b	Ric
BD2	XC9237F32CER	DC-DC-IC	PWM-PWM/PPM, st-dwn, 3.2V±2%, 600mA, 1.2MHz, Vin>1.8V, HSST, CL	USP-6C	49da	DC16	9a	Tor
BD20	RP153L020E	LVR-IC	LDO, Dual out, Vout1/Vout2=2.8V/1.8V±1%, 150mA, +CE	DFN1216-8	37x6	VR26	9b	Ric
BD21	RP153L021E	LVR-IC	LDO, Dual out, Vout1/Vout2=1.2V/2.8V±1%, 150mA, +CE	DFN1216-8	37x6	VR26	9b	Ric
BD22	RP153L022E	LVR-IC	LDO, Dual out, Vout1/Vout2=2.8V/1.2V±1%, 150mA, +CE	DFN1216-8	37x6	VR26	9b	Ric
BD23	RP153L023E	LVR-IC	LDO, Dual out, Vout1/Vout2=2.5V/2.5V±1%, 150mA, +CE	DFN1216-8	37x6	VR26	9b	Ric
BD24	RP153L024E	LVR-IC	LDO, Dual out, Vout1/Vout2=3.3V/3.0V±1%, 150mA, +CE	DFN1216-8	37x6	VR26	9b	Ric
BD25	RP153L025E	LVR-IC	LDO, Dual out, Vout1/Vout2=3.0V/3.0V±1%, 150mA, +CE	DFN1216-8	37x6	VR26	9b	Ric
BD26	RP153L026E	LVR-IC	LDO, Dual out, Vout1/Vout2=2.8V/3.1V±1%, 150mA, +CE	DFN1216-8	37x6	VR26	9b	Ric
BD27	RP153L027E	LVR-IC	LDO, Dual out, Vout1/Vout2=2.3V/2.8V±1%, 150mA, +CE	DFN1216-8	37x6	VR26	9b	Ric
BD28	RP153L028E	LVR-IC	LDO, Dual out, Vout1/Vout2=2.8V/1.0V±1%, 150mA, +CE	DFN1216-8	37x6	VR26	9b	Ric
BD29	RP153L029E	LVR-IC	LDO, Dual out, Vout1/Vout2=1.5V/1.5V±1%, 150mA, +CE	DFN1216-8	37x6	VR26	9b	Ric
BD3	XC9237F33CER	DC-DC-IC	PWM-PWM/PPM, st-dwn, 3.3V±2%, 600mA, 1.2MHz, Vin>1.8V, HSST, CL	USP-6C	49da	DC16	9a	Tor
BD30	RP153L030E	LVR-IC	LDO, Dual out, Vout1/Vout2=1.5V/3.3V±1%, 150mA, +CE	DFN1216-8	37x6	VR26	9b	Ric
BD31	RP153L031E	LVR-IC	LDO, Dual out, Vout1/Vout2=1.8V/2.7V±1%, 150mA, +CE	DFN1216-8	37x6	VR26	9b	Ric
BD316	XC6114D316ER	Vdet-IC	1.6V±2%, ±Reset PPO, Wt=100ms, Rt=100ms	USP-6C	49xq	VD19	9b	Tor
BD317	XC6114D317ER	Vdet-IC	1.7V±2%, ±Reset PPO, Wt=100ms, Rt=100ms	USP-6C	49xq	VD19	9b	Tor
BD318	XC6114D318ER	Vdet-IC	1.8V±2%, ±Reset PPO, Wt=100ms, Rt=100ms	USP-6C	49xq	VD19	9b	Tor
BD319	XC6114D319ER	Vdet-IC	1.9V±2%, ±Reset PPO, Wt=100ms, Rt=100ms	USP-6C	49xq	VD19	9b	Tor
BD32	RP153L032E	LVR-IC	LDO, Dual out, Vout1/Vout2=1.2V/3.0V±1%, 150mA, +CE	DFN1216-8	37x6	VR26	9b	Ric
BD320	XC6114D320ER	Vdet-IC	2.0V±2%, ±Reset PPO, Wt=100ms, Rt=100ms	USP-6C	49xq	VD19	9b	Tor



SMD code	Type	Function	Short description	Case	Pinout	Sch.	St.	Mnf.
BD321	XC6114D321ER	Vdet-IC	2.1V±2%, ±Reset PPO, Wt=100ms, Rt=100ms	USP-6C	49xq	VD19	9b	Tor
BD322	XC6114D322ER	Vdet-IC	2.1V±2%, ±Reset PPO, Wt=100ms, Rt=100ms	USP-6C	49xq	VD19	9b	Tor
BD323	XC6114D323ER	Vdet-IC	2.3V±2%, ±Reset PPO, Wt=100ms, Rt=100ms	USP-6C	49xq	VD19	9b	Tor
BD324	XC6114D324ER	Vdet-IC	2.4V±2%, ±Reset PPO, Wt=100ms, Rt=100ms	USP-6C	49xq	VD19	9b	Tor
BD325	XC6114D325ER	Vdet-IC	2.5V±2%, ±Reset PPO, Wt=100ms, Rt=100ms	USP-6C	49xq	VD19	9b	Tor
BD326	XC6114D326ER	Vdet-IC	2.6V±2%, ±Reset PPO, Wt=100ms, Rt=100ms	USP-6C	49xq	VD19	9b	Tor
BD327	XC6114D327ER	Vdet-IC	2.7V±2%, ±Reset PPO, Wt=100ms, Rt=100ms	USP-6C	49xq	VD19	9b	Tor
BD328	XC6114D328ER	Vdet-IC	2.8V±2%, ±Reset PPO, Wt=100ms, Rt=100ms	USP-6C	49xq	VD19	9b	Tor
BD329	XC6114D329ER	Vdet-IC	2.9V±2%, ±Reset PPO, Wt=100ms, Rt=100ms	USP-6C	49xq	VD19	9b	Tor
BD33	RP153L033E	LVR-IC	LDO, Dual out, Vout1/Vout2=3.1V/3.1V±1%, 150mA, +CE	DFM1216-8	37x6	VR26	9b	Ric
BD330	XC6114D330ER	Vdet-IC	3.0V±2%, ±Reset PPO, Wt=100ms, Rt=100ms	USP-6C	49xq	VD19	9b	Tor
BD331	XC6114D331ER	Vdet-IC	3.1V±2%, ±Reset PPO, Wt=100ms, Rt=100ms	USP-6C	49xq	VD19	9b	Tor
BD332	XC6114D332ER	Vdet-IC	3.2V±2%, ±Reset PPO, Wt=100ms, Rt=100ms	USP-6C	49xq	VD19	9b	Tor
BD333	XC6114D333ER	Vdet-IC	3.3V±2%, ±Reset PPO, Wt=100ms, Rt=100ms	USP-6C	49xq	VD19	9b	Tor
BD334	XC6114D334ER	Vdet-IC	3.4V±2%, ±Reset PPO, Wt=100ms, Rt=100ms	USP-6C	49xq	VD19	9b	Tor
BD335	XC6114D335ER	Vdet-IC	3.5V±2%, ±Reset PPO, Wt=100ms, Rt=100ms	USP-6C	49xq	VD19	9b	Tor
BD336	XC6114D336ER	Vdet-IC	3.6V±2%, ±Reset PPO, Wt=100ms, Rt=100ms	USP-6C	49xq	VD19	9b	Tor
BD337	XC6114D337ER	Vdet-IC	3.7V±2%, ±Reset PPO, Wt=100ms, Rt=100ms	USP-6C	49xq	VD19	9b	Tor
BD338	XC6114D338ER	Vdet-IC	3.8V±2%, ±Reset PPO, Wt=100ms, Rt=100ms	USP-6C	49xq	VD19	9b	Tor
BD339	XC6114D339ER	Vdet-IC	3.9V±2%, ±Reset PPO, Wt=100ms, Rt=100ms	USP-6C	49xq	VD19	9b	Tor
BD34	RP153L034E	LVR-IC	LDO, Dual out, Vout1/Vout2=1.8V/2.6V±1%, 150mA, +CE	DFM1216-8	37x6	VR26	9b	Ric
BD340	XC6114D340ER	Vdet-IC	4.0V±2%, ±Reset PPO, Wt=100ms, Rt=100ms	USP-6C	49xq	VD19	9b	Tor
BD341	XC6114D341ER	Vdet-IC	4.1V±2%, ±Reset PPO, Wt=100ms, Rt=100ms	USP-6C	49xq	VD19	9b	Tor
BD342	XC6114D342ER	Vdet-IC	4.2V±2%, ±Reset PPO, Wt=100ms, Rt=100ms	USP-6C	49xq	VD19	9b	Tor
BD343	XC6114D343ER	Vdet-IC	4.3V±2%, ±Reset PPO, Wt=100ms, Rt=100ms	USP-6C	49xq	VD19	9b	Tor
BD344	XC6114D344ER	Vdet-IC	4.4V±2%, ±Reset PPO, Wt=100ms, Rt=100ms	USP-6C	49xq	VD19	9b	Tor
BD345	XC6114D345ER	Vdet-IC	4.5V±2%, ±Reset PPO, Wt=100ms, Rt=100ms	USP-6C	49xq	VD19	9b	Tor
BD346	XC6114D346ER	Vdet-IC	4.6V±2%, ±Reset PPO, Wt=100ms, Rt=100ms	USP-6C	49xq	VD19	9b	Tor
BD347	XC6114D347ER	Vdet-IC	4.7V±2%, ±Reset PPO, Wt=100ms, Rt=100ms	USP-6C	49xq	VD19	9b	Tor
BD348	XC6114D348ER	Vdet-IC	4.8V±2%, ±Reset PPO, Wt=100ms, Rt=100ms	USP-6C	49xq	VD19	9b	Tor
BD349	XC6114D349ER	Vdet-IC	4.9V±2%, ±Reset PPO, Wt=100ms, Rt=100ms	USP-6C	49xq	VD19	9b	Tor
BD35	RP153L035E	LVR-IC	LDO, Dual out, Vout1/Vout2=2.5V/1.2V±1%, 150mA, +CE	DFM1216-8	37x6	VR26	9b	Ric
BD350	XC6114D350ER	Vdet-IC	5.0V±2%, ±Reset PPO, Wt=100ms, Rt=100ms	USP-6C	49xq	VD19	9b	Tor
BD36	RP153L036E	LVR-IC	LDO, Dual out, Vout1/Vout2=1.2V/2.9V±1%, 150mA, +CE	DFM1216-8	37x6	VR26	9b	Ric
BD37	RP153L037E	LVR-IC	LDO, Dual out, Vout1/Vout2=3.3V/2.0V±1%, 150mA, +CE	DFM1216-8	37x6	VR26	9b	Ric
BD38	RP153L038E	LVR-IC	LDO, Dual out, Vout1/Vout2=1.2V/2.85V±1%, 150mA, +CE	DFM1216-8	37x6	VR26	9b	Ric
BD39	RP153L039E	LVR-IC	LDO, Dual out, Vout1/Vout2=2.1V/3.3V±1%, 150mA, +CE	DFM1216-8	37x6	VR26	9b	Ric
BD4	XC9237F34CER	DC-DC-IC	PWM-PWMPFM, st-dwn, 3.4V±2%, 600mA, 1.2MHz, Vin>1.8V, HSST, CL	USP-6C	49da	DC16	9a	Tor
BD40	RP153L040E	LVR-IC	LDO, Dual out, Vout1/Vout2=2.8V/2.85V±1%, 150mA, +CE	DFM1216-8	37x6	VR26	9b	Ric
BD41	RP153L041E	LVR-IC	LDO, Dual out, Vout1/Vout2=1.8V/3.0V±1%, 150mA, +CE	DFM1216-8	37x6	VR26	9b	Ric
BD416	XC6114D416ER	Vdet-IC	1.6V±2%, ±Reset PPO, Wt=200ms, Rt=100ms	USP-6C	49xq	VD19	9b	Tor
BD417	XC6114D417ER	Vdet-IC	1.7V±2%, ±Reset PPO, Wt=200ms, Rt=100ms	USP-6C	49xq	VD19	9b	Tor
BD418	XC6114D418ER	Vdet-IC	1.8V±2%, ±Reset PPO, Wt=200ms, Rt=100ms	USP-6C	49xq	VD19	9b	Tor
BD419	XC6114D419ER	Vdet-IC	1.9V±2%, ±Reset PPO, Wt=200ms, Rt=100ms	USP-6C	49xq	VD19	9b	Tor
BD42	RP153L042E	LVR-IC	LDO, Dual out, Vout1/Vout2=1.2V/2.8V±1%, 150mA, +CE	DFM1216-8	37x6	VR26	9b	Ric
BD420	XC6114D420ER	Vdet-IC	2.0V±2%, ±Reset PPO, Wt=200ms, Rt=100ms	USP-6C	49xq	VD19	9b	Tor
BD421	XC6114D421ER	Vdet-IC	2.1V±2%, ±Reset PPO, Wt=200ms, Rt=100ms	USP-6C	49xq	VD19	9b	Tor
BD422	XC6114D422ER	Vdet-IC	2.2V±2%, ±Reset PPO, Wt=200ms, Rt=100ms	USP-6C	49xq	VD19	9b	Tor
BD423	XC6114D423ER	Vdet-IC	2.3V±2%, ±Reset PPO, Wt=200ms, Rt=100ms	USP-6C	49xq	VD19	9b	Tor
BD424	XC6114D424ER	Vdet-IC	2.4V±2%, ±Reset PPO, Wt=200ms, Rt=100ms	USP-6C	49xq	VD19	9b	Tor
BD425	XC6114D425ER	Vdet-IC	2.5V±2%, ±Reset PPO, Wt=200ms, Rt=100ms	USP-6C	49xq	VD19	9b	Tor
BD426	XC6114D426ER	Vdet-IC	2.6V±2%, ±Reset PPO, Wt=200ms, Rt=100ms	USP-6C	49xq	VD19	9b	Tor
BD427	XC6114D427ER	Vdet-IC	2.7V±2%, ±Reset PPO, Wt=200ms, Rt=100ms	USP-6C	49xq	VD19	9b	Tor
BD428	XC6114D428ER	Vdet-IC	2.8V±2%, ±Reset PPO, Wt=200ms, Rt=100ms	USP-6C	49xq	VD19	9b	Tor
BD429	XC6114D429ER	Vdet-IC	2.9V±2%, ±Reset PPO, Wt=200ms, Rt=100ms	USP-6C	49xq	VD19	9b	Tor
BD43	RP153L043E	LVR-IC	LDO, Dual out, Vout1/Vout2=1.3V/2.8V±1%, 150mA, +CE	DFM1216-8	37x6	VR26	9b	Ric
BD430	XC6114D430ER	Vdet-IC	3.0V±2%, ±Reset PPO, Wt=200ms, Rt=100ms	USP-6C	49xq	VD19	9b	Tor
BD431	XC6114D431ER	Vdet-IC	3.1V±2%, ±Reset PPO, Wt=200ms, Rt=100ms	USP-6C	49xq	VD19	9b	Tor
BD432	XC6114D432ER	Vdet-IC	3.2V±2%, ±Reset PPO, Wt=200ms, Rt=100ms	USP-6C	49xq	VD19	9b	Tor
BD433	XC6114D433ER	Vdet-IC	3.3V±2%, ±Reset PPO, Wt=200ms, Rt=100ms	USP-6C	49xq	VD19	9b	Tor
BD434	XC6114D434ER	Vdet-IC	3.4V±2%, ±Reset PPO, Wt=200ms, Rt=100ms	USP-6C	49xq	VD19	9b	Tor
BD435	XC6114D435ER	Vdet-IC	3.5V±2%, ±Reset PPO, Wt=200ms, Rt=100ms	USP-6C	49xq	VD19	9b	Tor
BD436	XC6114D436ER	Vdet-IC	3.6V±2%, ±Reset PPO, Wt=200ms, Rt=100ms	USP-6C	49xq	VD19	9b	Tor
BD437	XC6114D437ER	Vdet-IC	3.7V±2%, ±Reset PPO, Wt=200ms, Rt=100ms	USP-6C	49xq	VD19	9b	Tor
BD438	XC6114D438ER	Vdet-IC	3.8V±2%, ±Reset PPO, Wt=200ms, Rt=100ms	USP-6C	49xq	VD19	9b	Tor
BD439	XC6114D439ER	Vdet-IC	3.9V±2%, ±Reset PPO, Wt=200ms, Rt=100ms	USP-6C	49xq	VD19	9b	Tor
BD44	RP153L044E	LVR-IC	LDO, Dual out, Vout1/Vout2=1.1V/1.5V±1%, 150mA, +CE	DFM1216-8	37x6	VR26	9b	Ric
BD440	XC6114D440ER	Vdet-IC	4.0V±2%, ±Reset PPO, Wt=200ms, Rt=100ms	USP-6C	49xq	VD19	9b	Tor
BD441	XC6114D441ER	Vdet-IC	4.1V±2%, ±Reset PPO, Wt=200ms, Rt=100ms	USP-6C	49xq	VD19	9b	Tor
BD442	XC6114D442ER	Vdet-IC	4.2V±2%, ±Reset PPO, Wt=200ms, Rt=100ms	USP-6C	49xq	VD19	9b	Tor



SMD code	Type	Function	Short description	Case	Pinout	Sch.	St.Mnf.
BD443	XC6114D443ER	Vdet-IC	4.3V±2%, ±Reset PPO, Wt=200ms, Rt=100ms	USP-6C	49xq	VD19	9b Tor
BD444	XC6114D444ER	Vdet-IC	4.4V±2%, ±Reset PPO, Wt=200ms, Rt=100ms	USP-6C	49xq	VD19	9b Tor
BD445	XC6114D445ER	Vdet-IC	4.5V±2%, ±Reset PPO, Wt=200ms, Rt=100ms	USP-6C	49xq	VD19	9b Tor
BD446	XC6114D446ER	Vdet-IC	4.6V±2%, ±Reset PPO, Wt=200ms, Rt=100ms	USP-6C	49xq	VD19	9b Tor
BD447	XC6114D447ER	Vdet-IC	4.7V±2%, ±Reset PPO, Wt=200ms, Rt=100ms	USP-6C	49xq	VD19	9b Tor
BD448	XC6114D448ER	Vdet-IC	4.8V±2%, ±Reset PPO, Wt=200ms, Rt=100ms	USP-6C	49xq	VD19	9b Tor
BD449	XC6114D449ER	Vdet-IC	4.9V±2%, ±Reset PPO, Wt=200ms, Rt=100ms	USP-6C	49xq	VD19	9b Tor
BD45	RP153L045E	LVR-IC	LDO, Dual out, Vout1/Vout2=2.8V/3.3V±1%, 150mA, +CE	DFN1216-8	37x6	VR26	9b Ric
BD450	XC6114D450ER	Vdet-IC	5.0V±2%, ±Reset PPO, Wt=200ms, Rt=100ms	USP-6C	49xq	VD19	9b Tor
BD46	RP153L046E	LVR-IC	LDO, Dual out, Vout1/Vout2=2.8V/3.0V±1%, 150mA, +CE	DFN1216-8	37x6	VR26	9b Ric
BD47	RP153L047E	LVR-IC	LDO, Dual out, Vout1/Vout2=2.5V/2.8V±1%, 150mA, +CE	DFN1216-8	37x6	VR26	9b Ric
BD48	RP153L048E	LVR-IC	LDO, Dual out, Vout1/Vout2=2.5V/3.2V±1%, 150mA, +CE	DFN1216-8	37x6	VR26	9b Ric
BD49	RP153L049E	LVR-IC	LDO, Dual out, Vout1/Vout2=1.5V/2.85V±1%, 150mA, +CE	DFN1216-8	37x6	VR26	9b Ric
BD5	XC9237F36CE	DC-DC-IC	PWM-PWM/PPM, st-dwn, 3.5V±2%, 600mA, 1.2MHz, Vin>1.8V, HSST, CL	USP-6C	49da	DC16	9a Tor
BD50	RP153L050E	LVR-IC	LDO, Dual out, Vout1/Vout2=2.4V/2.9V±1%, 150mA, +CE	DFN1216-8	37x6	VR26	9b Ric
BD51	RP153L051E	LVR-IC	LDO, Dual out, Vout1/Vout2=1.0V/1.8V±1%, 150mA, +CE	DFN1216-8	37x6	VR26	9b Ric
BD516	XC6114D516ER	Vdet-IC	1.6V±2%, ±Reset PPO, Wt=400ms, Rt=100ms	USP-6C	49xq	VD19	9b Tor
BD517	XC6114D517ER	Vdet-IC	1.7V±2%, ±Reset PPO, Wt=400ms, Rt=100ms	USP-6C	49xq	VD19	9b Tor
BD518	XC6114D518ER	Vdet-IC	1.8V±2%, ±Reset PPO, Wt=400ms, Rt=100ms	USP-6C	49xq	VD19	9b Tor
BD519	XC6114D519ER	Vdet-IC	1.9V±2%, ±Reset PPO, Wt=400ms, Rt=100ms	USP-6C	49xq	VD19	9b Tor
BD52	RP153L052E	LVR-IC	LDO, Dual out, Vout1/Vout2=1.8V/2.85V±1%, 150mA, +CE	DFN1216-8	37x6	VR26	9b Ric
BD520	XC6114D520ER	Vdet-IC	2.0V±2%, ±Reset PPO, Wt=400ms, Rt=100ms	USP-6C	49xq	VD19	9b Tor
BD521	XC6114D521ER	Vdet-IC	2.1V±2%, ±Reset PPO, Wt=400ms, Rt=100ms	USP-6C	49xq	VD19	9b Tor
BD522	XC6114D522ER	Vdet-IC	2.2V±2%, ±Reset PPO, Wt=400ms, Rt=100ms	USP-6C	49xq	VD19	9b Tor
BD523	XC6114D523ER	Vdet-IC	2.3V±2%, ±Reset PPO, Wt=400ms, Rt=100ms	USP-6C	49xq	VD19	9b Tor
BD524	XC6114D524ER	Vdet-IC	2.4V±2%, ±Reset PPO, Wt=400ms, Rt=100ms	USP-6C	49xq	VD19	9b Tor
BD525	XC6114D525ER	Vdet-IC	2.5V±2%, ±Reset PPO, Wt=400ms, Rt=100ms	USP-6C	49xq	VD19	9b Tor
BD526	XC6114D526ER	Vdet-IC	2.6V±2%, ±Reset PPO, Wt=400ms, Rt=100ms	USP-6C	49xq	VD19	9b Tor
BD527	XC6114D527ER	Vdet-IC	2.7V±2%, ±Reset PPO, Wt=400ms, Rt=100ms	USP-6C	49xq	VD19	9b Tor
BD528	XC6114D528ER	Vdet-IC	2.8V±2%, ±Reset PPO, Wt=400ms, Rt=100ms	USP-6C	49xq	VD19	9b Tor
BD529	XC6114D529ER	Vdet-IC	2.9V±2%, ±Reset PPO, Wt=400ms, Rt=100ms	USP-6C	49xq	VD19	9b Tor
BD530	XC6114D530ER	Vdet-IC	3.0V±2%, ±Reset PPO, Wt=400ms, Rt=100ms	USP-6C	49xq	VD19	9b Tor
BD531	XC6114D531ER	Vdet-IC	3.1V±2%, ±Reset PPO, Wt=400ms, Rt=100ms	USP-6C	49xq	VD19	9b Tor
BD532	XC6114D532ER	Vdet-IC	3.2V±2%, ±Reset PPO, Wt=400ms, Rt=100ms	USP-6C	49xq	VD19	9b Tor
BD533	XC6114D533ER	Vdet-IC	3.3V±2%, ±Reset PPO, Wt=400ms, Rt=100ms	USP-6C	49xq	VD19	9b Tor
BD534	XC6114D534ER	Vdet-IC	3.4V±2%, ±Reset PPO, Wt=400ms, Rt=100ms	USP-6C	49xq	VD19	9b Tor
BD535	XC6114D535ER	Vdet-IC	3.5V±2%, ±Reset PPO, Wt=400ms, Rt=100ms	USP-6C	49xq	VD19	9b Tor
BD536	XC6114D536ER	Vdet-IC	3.6V±2%, ±Reset PPO, Wt=400ms, Rt=100ms	USP-6C	49xq	VD19	9b Tor
BD537	XC6114D537ER	Vdet-IC	3.7V±2%, ±Reset PPO, Wt=400ms, Rt=100ms	USP-6C	49xq	VD19	9b Tor
BD538	XC6114D538ER	Vdet-IC	3.8V±2%, ±Reset PPO, Wt=400ms, Rt=100ms	USP-6C	49xq	VD19	9b Tor
BD539	XC6114D539ER	Vdet-IC	3.9V±2%, ±Reset PPO, Wt=400ms, Rt=100ms	USP-6C	49xq	VD19	9b Tor
BD540	XC6114D540ER	Vdet-IC	4.0V±2%, ±Reset PPO, Wt=400ms, Rt=100ms	USP-6C	49xq	VD19	9b Tor
BD541	XC6114D541ER	Vdet-IC	4.1V±2%, ±Reset PPO, Wt=400ms, Rt=100ms	USP-6C	49xq	VD19	9b Tor
BD542	XC6114D542ER	Vdet-IC	4.2V±2%, ±Reset PPO, Wt=400ms, Rt=100ms	USP-6C	49xq	VD19	9b Tor
BD543	XC6114D543ER	Vdet-IC	4.3V±2%, ±Reset PPO, Wt=400ms, Rt=100ms	USP-6C	49xq	VD19	9b Tor
BD544	XC6114D544ER	Vdet-IC	4.4V±2%, ±Reset PPO, Wt=400ms, Rt=100ms	USP-6C	49xq	VD19	9b Tor
BD545	XC6114D545ER	Vdet-IC	4.5V±2%, ±Reset PPO, Wt=400ms, Rt=100ms	USP-6C	49xq	VD19	9b Tor
BD546	XC6114D546ER	Vdet-IC	4.6V±2%, ±Reset PPO, Wt=400ms, Rt=100ms	USP-6C	49xq	VD19	9b Tor
BD547	XC6114D547ER	Vdet-IC	4.7V±2%, ±Reset PPO, Wt=400ms, Rt=100ms	USP-6C	49xq	VD19	9b Tor
BD548	XC6114D548ER	Vdet-IC	4.8V±2%, ±Reset PPO, Wt=400ms, Rt=100ms	USP-6C	49xq	VD19	9b Tor
BD549	XC6114D549ER	Vdet-IC	4.9V±2%, ±Reset PPO, Wt=400ms, Rt=100ms	USP-6C	49xq	VD19	9b Tor
BD550	XC6114D550ER	Vdet-IC	5.0V±2%, ±Reset PPO, Wt=400ms, Rt=100ms	USP-6C	49xq	VD19	9b Tor
BD6	XC9237F36CE	DC-DC-IC	PWM-PWM/PPM, st-dwn, 3.6V±2%, 600mA, 1.2MHz, Vin>1.8V, HSST, CL	USP-6C	49da	DC16	9a Tor
BD616	XC6114D616ER	Vdet-IC	1.6V±2%, ±Reset PPO, Wt=1.6s, Rt=100ms	USP-6C	49xq	VD19	9b Tor
BD617	XC6114D617ER	Vdet-IC	1.7V±2%, ±Reset PPO, Wt=1.6s, Rt=100ms	USP-6C	49xq	VD19	9b Tor
BD618	XC6114D618ER	Vdet-IC	1.8V±2%, ±Reset PPO, Wt=1.6s, Rt=100ms	USP-6C	49xq	VD19	9b Tor
BD619	XC6114D619ER	Vdet-IC	1.9V±2%, ±Reset PPO, Wt=1.6s, Rt=100ms	USP-6C	49xq	VD19	9b Tor
BD620	XC6114D620ER	Vdet-IC	2.0V±2%, ±Reset PPO, Wt=1.6s, Rt=100ms	USP-6C	49xq	VD19	9b Tor
BD621	XC6114D621ER	Vdet-IC	2.1V±2%, ±Reset PPO, Wt=1.6s, Rt=100ms	USP-6C	49xq	VD19	9b Tor
BD622	XC6114D622ER	Vdet-IC	2.2V±2%, ±Reset PPO, Wt=1.6s, Rt=100ms	USP-6C	49xq	VD19	9b Tor
BD623	XC6114D623ER	Vdet-IC	2.3V±2%, ±Reset PPO, Wt=1.6s, Rt=100ms	USP-6C	49xq	VD19	9b Tor
BD624	XC6114D624ER	Vdet-IC	2.4V±2%, ±Reset PPO, Wt=1.6s, Rt=100ms	USP-6C	49xq	VD19	9b Tor
BD625	XC6114D625ER	Vdet-IC	2.5V±2%, ±Reset PPO, Wt=1.6s, Rt=100ms	USP-6C	49xq	VD19	9b Tor
BD626	XC6114D626ER	Vdet-IC	2.6V±2%, ±Reset PPO, Wt=1.6s, Rt=100ms	USP-6C	49xq	VD19	9b Tor
BD627	XC6114D627ER	Vdet-IC	2.7V±2%, ±Reset PPO, Wt=1.6s, Rt=100ms	USP-6C	49xq	VD19	9b Tor
BD628	XC6114D628ER	Vdet-IC	2.8V±2%, ±Reset PPO, Wt=1.6s, Rt=100ms	USP-6C	49xq	VD19	9b Tor
BD629	XC6114D629ER	Vdet-IC	2.9V±2%, ±Reset PPO, Wt=1.6s, Rt=100ms	USP-6C	49xq	VD19	9b Tor
BD630	XC6114D630ER	Vdet-IC	3.0V±2%, ±Reset PPO, Wt=1.6s, Rt=100ms	USP-6C	49xq	VD19	9b Tor
BD631	XC6114D631ER	Vdet-IC	3.1V±2%, ±Reset PPO, Wt=1.6s, Rt=100ms	USP-6C	49xq	VD19	9b Tor
BD632	XC6114D632ER	Vdet-IC	3.2V±2%, ±Reset PPO, Wt=1.6s, Rt=100ms	USP-6C	49xq	VD19	9b Tor



SMD code	Type	Function	Short description	Case	Pinout	Sch.	St.	Mnf.
BE639	XC6114E639ER	Vdet-IC	3.9V±2%, ±Reset PPO, Wt=1.6s, Rt=200ms	USP-6C	49xq	VD19	9b	Tor
BE640	XC6114E640ER	Vdet-IC	4.0V±2%, ±Reset PPO, Wt=1.6s, Rt=200ms	USP-6C	49xq	VD19	9b	Tor
BE641	XC6114E641ER	Vdet-IC	4.1V±2%, ±Reset PPO, Wt=1.6s, Rt=200ms	USP-6C	49xq	VD19	9b	Tor
BE642	XC6114E642ER	Vdet-IC	4.2V±2%, ±Reset PPO, Wt=1.6s, Rt=200ms	USP-6C	49xq	VD19	9b	Tor
BE643	XC6114E643ER	Vdet-IC	4.3V±2%, ±Reset PPO, Wt=1.6s, Rt=200ms	USP-6C	49xq	VD19	9b	Tor
BE644	XC6114E644ER	Vdet-IC	4.4V±2%, ±Reset PPO, Wt=1.6s, Rt=200ms	USP-6C	49xq	VD19	9b	Tor
BE645	XC6114E645ER	Vdet-IC	4.5V±2%, ±Reset PPO, Wt=1.6s, Rt=200ms	USP-6C	49xq	VD19	9b	Tor
BE646	XC6114E646ER	Vdet-IC	4.6V±2%, ±Reset PPO, Wt=1.6s, Rt=200ms	USP-6C	49xq	VD19	9b	Tor
BE647	XC6114E647ER	Vdet-IC	4.7V±2%, ±Reset PPO, Wt=1.6s, Rt=200ms	USP-6C	49xq	VD19	9b	Tor
BE648	XC6114E648ER	Vdet-IC	4.8V±2%, ±Reset PPO, Wt=1.6s, Rt=200ms	USP-6C	49xq	VD19	9b	Tor
BE649	XC6114E649ER	Vdet-IC	4.9V±2%, ±Reset PPO, Wt=1.6s, Rt=200ms	USP-6C	49xq	VD19	9b	Tor
BE650	XC6114E650ER	Vdet-IC	5.0V±2%, ±Reset PPO, Wt=1.6s, Rt=200ms	USP-6C	49xq	VD19	9b	Tor
BEN	XC6119C40A7R	Vdet-IC	4.0V±2%, -Reset PPO	USPN-4	58ij	VD3	9h	Tor
BEP	XC6119C41A7R	Vdet-IC	4.1V±2%, -Reset PPO	USPN-4	58ij	VD3	9h	Tor
BER	XC6119C42A7R	Vdet-IC	4.2V±2%, -Reset PPO	USPN-4	58ij	VD3	9h	Tor
BES	XC6119C43A7R	Vdet-IC	4.3V±2%, -Reset PPO	USPN-4	58ij	VD3	9h	Tor
BET	XC6119C44A7R	Vdet-IC	4.4V±2%, -Reset PPO	USPN-4	58ij	VD3	9h	Tor
BEU	XC6119C45A7R	Vdet-IC	4.5V±2%, -Reset PPO	USPN-4	58ij	VD3	9h	Tor
BEV	XC6119C46A7R	Vdet-IC	4.6V±2%, -Reset PPO	USPN-4	58ij	VD3	9h	Tor
BEX	XC6119C47A7R	Vdet-IC	4.7V±2%, -Reset PPO	USPN-4	58ij	VD3	9h	Tor
BEY	XC6119C48A7R	Vdet-IC	4.8V±2%, -Reset PPO	USPN-4	58ij	VD3	9h	Tor
BEZ	XC6119C49A7R	Vdet-IC	4.9V±2%, -Reset PPO	USPN-4	58ij	VD3	9h	Tor
BF	RP104K191C	LVR-IC	LDO, 1.9V±0.8%, 150mA	DFN1010-4	48y1	VR1	9a	Ric
BF	RP105K121D	LVR-IC	LDO, 1.2V±15mV, 400mA, +CE, CL	DFN1212-6	52zd	VR11	9a	Ric
BF	RT9193-33PQW	LVR-IC	LDO, 3.3V±1%, 300mA, +CE	WDFN-6L	49ub	VR7	9a	Tor
BF	XC6221B1617R	LVR-IC	LDO, 1.6V±20mV, 200mA, +CE, CL	USPN-4	58vm	VR4	9a	Tor
BF	XC6223D25B9R-G	LVR-IC	LDO, 2.55±1%, 300mA, +CE, CL, PDR	USPQ-4B03	48vm	VR4	9a	Tor
BF516	XC6114F516ER	Vdet-IC	1.6V±2%, ±Reset PPO, Wt=400ms, Rt=400ms	USP-6C	49xq	VD19	9b	Tor
BF517	XC6114F517ER	Vdet-IC	1.7V±2%, ±Reset PPO, Wt=400ms, Rt=400ms	USP-6C	49xq	VD19	9b	Tor
BF518	XC6114F518ER	Vdet-IC	1.8V±2%, ±Reset PPO, Wt=400ms, Rt=400ms	USP-6C	49xq	VD19	9b	Tor
BF519	XC6114F519ER	Vdet-IC	1.9V±2%, ±Reset PPO, Wt=400ms, Rt=400ms	USP-6C	49xq	VD19	9b	Tor
BF520	XC6114F520ER	Vdet-IC	2.0V±2%, ±Reset PPO, Wt=400ms, Rt=400ms	USP-6C	49xq	VD19	9b	Tor
BF521	XC6114F521ER	Vdet-IC	2.1V±2%, ±Reset PPO, Wt=400ms, Rt=400ms	USP-6C	49xq	VD19	9b	Tor
BF522	XC6114F522ER	Vdet-IC	2.2V±2%, ±Reset PPO, Wt=400ms, Rt=400ms	USP-6C	49xq	VD19	9b	Tor
BF523	XC6114F523ER	Vdet-IC	2.3V±2%, ±Reset PPO, Wt=400ms, Rt=400ms	USP-6C	49xq	VD19	9b	Tor
BF524	XC6114F524ER	Vdet-IC	2.4V±2%, ±Reset PPO, Wt=400ms, Rt=400ms	USP-6C	49xq	VD19	9b	Tor
BF525	XC6114F525ER	Vdet-IC	2.5V±2%, ±Reset PPO, Wt=400ms, Rt=400ms	USP-6C	49xq	VD19	9b	Tor
BF526	XC6114F526ER	Vdet-IC	2.6V±2%, ±Reset PPO, Wt=400ms, Rt=400ms	USP-6C	49xq	VD19	9b	Tor
BF527	XC6114F527ER	Vdet-IC	2.7V±2%, ±Reset PPO, Wt=400ms, Rt=400ms	USP-6C	49xq	VD19	9b	Tor
BF528	XC6114F528ER	Vdet-IC	2.8V±2%, ±Reset PPO, Wt=400ms, Rt=400ms	USP-6C	49xq	VD19	9b	Tor
BF529	XC6114F529ER	Vdet-IC	2.9V±2%, ±Reset PPO, Wt=400ms, Rt=400ms	USP-6C	49xq	VD19	9b	Tor
BF530	XC6114F530ER	Vdet-IC	3.0V±2%, ±Reset PPO, Wt=400ms, Rt=400ms	USP-6C	49xq	VD19	9b	Tor
BF531	XC6114F531ER	Vdet-IC	3.1V±2%, ±Reset PPO, Wt=400ms, Rt=400ms	USP-6C	49xq	VD19	9b	Tor
BF532	XC6114F532ER	Vdet-IC	3.2V±2%, ±Reset PPO, Wt=400ms, Rt=400ms	USP-6C	49xq	VD19	9b	Tor
BF533	XC6114F533ER	Vdet-IC	3.3V±2%, ±Reset PPO, Wt=400ms, Rt=400ms	USP-6C	49xq	VD19	9b	Tor
BF534	XC6114F534ER	Vdet-IC	3.4V±2%, ±Reset PPO, Wt=400ms, Rt=400ms	USP-6C	49xq	VD19	9b	Tor
BF535	XC6114F535ER	Vdet-IC	3.5V±2%, ±Reset PPO, Wt=400ms, Rt=400ms	USP-6C	49xq	VD19	9b	Tor
BF536	XC6114F536ER	Vdet-IC	3.6V±2%, ±Reset PPO, Wt=400ms, Rt=400ms	USP-6C	49xq	VD19	9b	Tor
BF537	XC6114F537ER	Vdet-IC	3.7V±2%, ±Reset PPO, Wt=400ms, Rt=400ms	USP-6C	49xq	VD19	9b	Tor
BF538	XC6114F538ER	Vdet-IC	3.8V±2%, ±Reset PPO, Wt=400ms, Rt=400ms	USP-6C	49xq	VD19	9b	Tor
BF539	XC6114F539ER	Vdet-IC	3.9V±2%, ±Reset PPO, Wt=400ms, Rt=400ms	USP-6C	49xq	VD19	9b	Tor
BF540	XC6114F540ER	Vdet-IC	4.0V±2%, ±Reset PPO, Wt=400ms, Rt=400ms	USP-6C	49xq	VD19	9b	Tor
BF541	XC6114F541ER	Vdet-IC	4.1V±2%, ±Reset PPO, Wt=400ms, Rt=400ms	USP-6C	49xq	VD19	9b	Tor
BF542	XC6114F542ER	Vdet-IC	4.2V±2%, ±Reset PPO, Wt=400ms, Rt=400ms	USP-6C	49xq	VD19	9b	Tor
BF543	XC6114F543ER	Vdet-IC	4.3V±2%, ±Reset PPO, Wt=400ms, Rt=400ms	USP-6C	49xq	VD19	9b	Tor
BF544	XC6114F544ER	Vdet-IC	4.4V±2%, ±Reset PPO, Wt=400ms, Rt=400ms	USP-6C	49xq	VD19	9b	Tor
BF545	XC6114F545ER	Vdet-IC	4.5V±2%, ±Reset PPO, Wt=400ms, Rt=400ms	USP-6C	49xq	VD19	9b	Tor
BF546	XC6114F546ER	Vdet-IC	4.6V±2%, ±Reset PPO, Wt=400ms, Rt=400ms	USP-6C	49xq	VD19	9b	Tor
BF547	XC6114F547ER	Vdet-IC	4.7V±2%, ±Reset PPO, Wt=400ms, Rt=400ms	USP-6C	49xq	VD19	9b	Tor
BF548	XC6114F548ER	Vdet-IC	4.8V±2%, ±Reset PPO, Wt=400ms, Rt=400ms	USP-6C	49xq	VD19	9b	Tor
BF549	XC6114F549ER	Vdet-IC	4.9V±2%, ±Reset PPO, Wt=400ms, Rt=400ms	USP-6C	49xq	VD19	9b	Tor
BF550	XC6114F550ER	Vdet-IC	5.0V±2%, ±Reset PPO, Wt=400ms, Rt=400ms	USP-6C	49xq	VD19	9b	Tor
BF616	XC6114F616ER	Vdet-IC	1.6V±2%, ±Reset PPO, Wt=1.6s, Rt=400ms	USP-6C	49xq	VD19	9b	Tor
BF617	XC6114F617ER	Vdet-IC	1.7V±2%, ±Reset PPO, Wt=1.6s, Rt=400ms	USP-6C	49xq	VD19	9b	Tor
BF618	XC6114F618ER	Vdet-IC	1.8V±2%, ±Reset PPO, Wt=1.6s, Rt=400ms	USP-6C	49xq	VD19	9b	Tor
BF619	XC6114F619ER	Vdet-IC	1.9V±2%, ±Reset PPO, Wt=1.6s, Rt=400ms	USP-6C	49xq	VD19	9b	Tor
BF620	XC6114F620ER	Vdet-IC	2.0V±2%, ±Reset PPO, Wt=1.6s, Rt=400ms	USP-6C	49xq	VD19	9b	Tor
BF621	XC6114F621ER	Vdet-IC	2.1V±2%, ±Reset PPO, Wt=1.6s, Rt=400ms	USP-6C	49xq	VD19	9b	Tor
BF622	XC6114F622ER	Vdet-IC	2.2V±2%, ±Reset PPO, Wt=1.6s, Rt=400ms	USP-6C	49xq	VD19	9b	Tor
BF623	XC6114F623ER	Vdet-IC	2.3V±2%, ±Reset PPO, Wt=1.6s, Rt=400ms	USP-6C	49xq	VD19	9b	Tor



SMD code	Type	Function	Short description	Case	Pinout	Sch.	St.	Mnf.
BF624	XC6114F624ER	Vdet-IC	2.4V±2%, ±Reset PPO, Wt=1.6s, Rt=400ms	USP-6C	49xq	VD19	9b	Tor
BF625	XC6114F625ER	Vdet-IC	2.5V±2%, ±Reset PPO, Wt=1.6s, Rt=400ms	USP-6C	49xq	VD19	9b	Tor
BF626	XC6114F626ER	Vdet-IC	2.6V±2%, ±Reset PPO, Wt=1.6s, Rt=400ms	USP-6C	49xq	VD19	9b	Tor
BF627	XC6114F627ER	Vdet-IC	2.7V±2%, ±Reset PPO, Wt=1.6s, Rt=400ms	USP-6C	49xq	VD19	9b	Tor
BF628	XC6114F628ER	Vdet-IC	2.8V±2%, ±Reset PPO, Wt=1.6s, Rt=400ms	USP-6C	49xq	VD19	9b	Tor
BF629	XC6114F629ER	Vdet-IC	2.9V±2%, ±Reset PPO, Wt=1.6s, Rt=400ms	USP-6C	49xq	VD19	9b	Tor
BF630	XC6114F630ER	Vdet-IC	3.0V±2%, ±Reset PPO, Wt=1.6s, Rt=400ms	USP-6C	49xq	VD19	9b	Tor
BF631	XC6114F631ER	Vdet-IC	3.1V±2%, ±Reset PPO, Wt=1.6s, Rt=400ms	USP-6C	49xq	VD19	9b	Tor
BF632	XC6114F632ER	Vdet-IC	3.2V±2%, ±Reset PPO, Wt=1.6s, Rt=400ms	USP-6C	49xq	VD19	9b	Tor
BF633	XC6114F633ER	Vdet-IC	3.3V±2%, ±Reset PPO, Wt=1.6s, Rt=400ms	USP-6C	49xq	VD19	9b	Tor
BF634	XC6114F634ER	Vdet-IC	3.4V±2%, ±Reset PPO, Wt=1.6s, Rt=400ms	USP-6C	49xq	VD19	9b	Tor
BF635	XC6114F635ER	Vdet-IC	3.5V±2%, ±Reset PPO, Wt=1.6s, Rt=400ms	USP-6C	49xq	VD19	9b	Tor
BF636	XC6114F636ER	Vdet-IC	3.6V±2%, ±Reset PPO, Wt=1.6s, Rt=400ms	USP-6C	49xq	VD19	9b	Tor
BF637	XC6114F637ER	Vdet-IC	3.7V±2%, ±Reset PPO, Wt=1.6s, Rt=400ms	USP-6C	49xq	VD19	9b	Tor
BF638	XC6114F638ER	Vdet-IC	3.8V±2%, ±Reset PPO, Wt=1.6s, Rt=400ms	USP-6C	49xq	VD19	9b	Tor
BF639	XC6114F639ER	Vdet-IC	3.9V±2%, ±Reset PPO, Wt=1.6s, Rt=400ms	USP-6C	49xq	VD19	9b	Tor
BF640	XC6114F640ER	Vdet-IC	4.0V±2%, ±Reset PPO, Wt=1.6s, Rt=400ms	USP-6C	49xq	VD19	9b	Tor
BF641	XC6114F641ER	Vdet-IC	4.1V±2%, ±Reset PPO, Wt=1.6s, Rt=400ms	USP-6C	49xq	VD19	9b	Tor
BF642	XC6114F642ER	Vdet-IC	4.2V±2%, ±Reset PPO, Wt=1.6s, Rt=400ms	USP-6C	49xq	VD19	9b	Tor
BF643	XC6114F643ER	Vdet-IC	4.3V±2%, ±Reset PPO, Wt=1.6s, Rt=400ms	USP-6C	49xq	VD19	9b	Tor
BF644	XC6114F644ER	Vdet-IC	4.4V±2%, ±Reset PPO, Wt=1.6s, Rt=400ms	USP-6C	49xq	VD19	9b	Tor
BF645	XC6114F645ER	Vdet-IC	4.5V±2%, ±Reset PPO, Wt=1.6s, Rt=400ms	USP-6C	49xq	VD19	9b	Tor
BF646	XC6114F646ER	Vdet-IC	4.6V±2%, ±Reset PPO, Wt=1.6s, Rt=400ms	USP-6C	49xq	VD19	9b	Tor
BF647	XC6114F647ER	Vdet-IC	4.7V±2%, ±Reset PPO, Wt=1.6s, Rt=400ms	USP-6C	49xq	VD19	9b	Tor
BF648	XC6114F648ER	Vdet-IC	4.8V±2%, ±Reset PPO, Wt=1.6s, Rt=400ms	USP-6C	49xq	VD19	9b	Tor
BF649	XC6114F649ER	Vdet-IC	4.9V±2%, ±Reset PPO, Wt=1.6s, Rt=400ms	USP-6C	49xq	VD19	9b	Tor
BF650	XC6114F650ER	Vdet-IC	5.0V±2%, ±Reset PPO, Wt=1.6s, Rt=400ms	USP-6C	49xq	VD19	9b	Tor
BF8	XC9237F08DER	DC-DC-IC	PWM-PWM/PPM, st-dwn, 0.8V±2%, 600mA, 3MHz, Vin>1.8V, HSST, CL	USP-6C	49da	DC16	9a	Tor
BF9	XC9237F09DER	DC-DC-IC	PWM-PWM/PPM, st-dwn, 0.9V±2%, 600mA, 3MHz, Vin>1.8V, HSST, CL	USP-6C	49da	DC16	9a	Tor
BFL	XC9237F0LDER	DC-DC-IC	PWM-PWM/PPM, st-dwn, 0.85V±2%, 600mA, 3MHz, Vin>1.8V, HSST, CL	USP-6C	49da	DC16	9a	Tor
BFM	XC9237F0MDER	DC-DC-IC	PWM-PWM/PPM, st-dwn, 0.95V±2%, 600mA, 3MHz, Vin>1.8V, HSST, CL	USP-6C	49da	DC16	9a	Tor
BFN	XC6119C50A7R	Vdet-IC	5.0V±2%, -Reset PPO	USPN-4	58ij	VD3	9h	Tor
BG	RP104K201C	LVR-IC	LDO, 2.0V±0.8%, 150mA	DFN1010-4	48y1	VR1	9a	Ric
BG	RP105K131D	LVR-IC	LDO, 1.3V±15mV, 400mA, +CE, CL	DFN1212-6	52zd	VR11	9a	Ric
BH	RP104K251C	LVR-IC	LDO, 2.5V±0.8%, 150mA	DFN1010-4	48y1	VR1	9a	Ric
BH	RP105K141D	LVR-IC	LDO, 1.4V±15mV, 400mA, +CE, CL	DFN1212-6	52zd	VR11	9a	Ric
BH	XC6221B1717R	LVR-IC	LDO, 1.7V±20mV, 200mA, +CE, CL	USPN-4	58um	VR4	9a	Tor
BH	XC6223D26B9R-G	LVR-IC	LDO, 2.65V±1%, 300mA, +CE, CL, PDR	USPQ-4B03	48vm	VR4	9a	Tor
BH0	XC9237F10DER	DC-DC-IC	PWM-PWM/PPM, st-dwn, 1.0V±2%, 600mA, 3MHz, Vin>1.8V, HSST, CL	USP-6C	49da	DC16	9a	Tor
BH01	RP153L001B	LVR-IC	LDO, Dual out, Vout1/Vout2=2.8V/2.8V±1%, 150mA, +CE	DFN1216-8	37x6	VR26	9b	Ric
BH1	XC9237F11DER	DC-DC-IC	PWM-PWM/PPM, st-dwn, 1.1V±2%, 600mA, 3MHz, Vin>1.8V, HSST, CL	USP-6C	49da	DC16	9a	Tor
BH2	XC9237F12DER	DC-DC-IC	PWM-PWM/PPM, st-dwn, 1.2V±2%, 600mA, 3MHz, Vin>1.8V, HSST, CL	USP-6C	49da	DC16	9a	Tor
BH3	XC9237F13DER	DC-DC-IC	PWM-PWM/PPM, st-dwn, 1.3V±2%, 600mA, 3MHz, Vin>1.8V, HSST, CL	USP-6C	49da	DC16	9a	Tor
BH4	XC9237F14DER	DC-DC-IC	PWM-PWM/PPM, st-dwn, 1.4V±2%, 600mA, 3MHz, Vin>1.8V, HSST, CL	USP-6C	49da	DC16	9a	Tor
BH5	XC9237F15DER	DC-DC-IC	PWM-PWM/PPM, st-dwn, 1.5V±2%, 600mA, 3MHz, Vin>1.8V, HSST, CL	USP-6C	49da	DC16	9a	Tor
BH6	XC9237F16DER	DC-DC-IC	PWM-PWM/PPM, st-dwn, 1.6V±2%, 600mA, 3MHz, Vin>1.8V, HSST, CL	USP-6C	49da	DC16	9a	Tor
BH616	XC6114H616ER	Vdet-IC	1.6V±2%, ±Reset PPO, Wt=1.6s, Rt=1.6s	USP-6C	49xq	VD19	9b	Tor
BH617	XC6114H617ER	Vdet-IC	1.7V±2%, ±Reset PPO, Wt=1.6s, Rt=1.6s	USP-6C	49xq	VD19	9b	Tor
BH618	XC6114H618ER	Vdet-IC	1.8V±2%, ±Reset PPO, Wt=1.6s, Rt=1.6s	USP-6C	49xq	VD19	9b	Tor
BH619	XC6114H619ER	Vdet-IC	1.9V±2%, ±Reset PPO, Wt=1.6s, Rt=1.6s	USP-6C	49xq	VD19	9b	Tor
BH620	XC6114H620ER	Vdet-IC	2.0V±2%, ±Reset PPO, Wt=1.6s, Rt=1.6s	USP-6C	49xq	VD19	9b	Tor
BH621	XC6114H621ER	Vdet-IC	2.1V±2%, ±Reset PPO, Wt=1.6s, Rt=1.6s	USP-6C	49xq	VD19	9b	Tor
BH622	XC6114H622ER	Vdet-IC	2.2V±2%, ±Reset PPO, Wt=1.6s, Rt=1.6s	USP-6C	49xq	VD19	9b	Tor
BH623	XC6114H623ER	Vdet-IC	2.3V±2%, ±Reset PPO, Wt=1.6s, Rt=1.6s	USP-6C	49xq	VD19	9b	Tor
BH624	XC6114H624ER	Vdet-IC	2.4V±2%, ±Reset PPO, Wt=1.6s, Rt=1.6s	USP-6C	49xq	VD19	9b	Tor
BH625	XC6114H625ER	Vdet-IC	2.5V±2%, ±Reset PPO, Wt=1.6s, Rt=1.6s	USP-6C	49xq	VD19	9b	Tor
BH626	XC6114H626ER	Vdet-IC	2.6V±2%, ±Reset PPO, Wt=1.6s, Rt=1.6s	USP-6C	49xq	VD19	9b	Tor
BH627	XC6114H627ER	Vdet-IC	2.7V±2%, ±Reset PPO, Wt=1.6s, Rt=1.6s	USP-6C	49xq	VD19	9b	Tor
BH628	XC6114H628ER	Vdet-IC	2.8V±2%, ±Reset PPO, Wt=1.6s, Rt=1.6s	USP-6C	49xq	VD19	9b	Tor
BH629	XC6114H629ER	Vdet-IC	2.9V±2%, ±Reset PPO, Wt=1.6s, Rt=1.6s	USP-6C	49xq	VD19	9b	Tor
BH630	XC6114H630ER	Vdet-IC	3.0V±2%, ±Reset PPO, Wt=1.6s, Rt=1.6s	USP-6C	49xq	VD19	9b	Tor
BH631	XC6114H631ER	Vdet-IC	3.1V±2%, ±Reset PPO, Wt=1.6s, Rt=1.6s	USP-6C	49xq	VD19	9b	Tor
BH632	XC6114H632ER	Vdet-IC	3.2V±2%, ±Reset PPO, Wt=1.6s, Rt=1.6s	USP-6C	49xq	VD19	9b	Tor
BH633	XC6114H633ER	Vdet-IC	3.3V±2%, ±Reset PPO, Wt=1.6s, Rt=1.6s	USP-6C	49xq	VD19	9b	Tor
BH634	XC6114H634ER	Vdet-IC	3.4V±2%, ±Reset PPO, Wt=1.6s, Rt=1.6s	USP-6C	49xq	VD19	9b	Tor
BH635	XC6114H635ER	Vdet-IC	3.5V±2%, ±Reset PPO, Wt=1.6s, Rt=1.6s	USP-6C	49xq	VD19	9b	Tor
BH636	XC6114H636ER	Vdet-IC	3.6V±2%, ±Reset PPO, Wt=1.6s, Rt=1.6s	USP-6C	49xq	VD19	9b	Tor
BH637	XC6114H637ER	Vdet-IC	3.7V±2%, ±Reset PPO, Wt=1.6s, Rt=1.6s	USP-6C	49xq	VD19	9b	Tor
BH638	XC6114H638ER	Vdet-IC	3.8V±2%, ±Reset PPO, Wt=1.6s, Rt=1.6s	USP-6C	49xq	VD19	9b	Tor
BH639	XC6114H639ER	Vdet-IC	3.9V±2%, ±Reset PPO, Wt=1.6s, Rt=1.6s	USP-6C	49xq	VD19	9b	Tor



SMD code	Type	Function	Short description	Case	Pinout	Sch.	St.	Mnf.
BH640	XC6114H640ER	Vdet-IC	4.0V±2%, ±Reset PPO, Wlt=1.6s, Rt=1.6s	USP-6C	49xq	VD19	9b	Tor
BH641	XC6114H641ER	Vdet-IC	4.1V±2%, ±Reset PPO, Wlt=1.6s, Rt=1.6s	USP-6C	49xq	VD19	9b	Tor
BH642	XC6114H642ER	Vdet-IC	4.2V±2%, ±Reset PPO, Wlt=1.6s, Rt=1.6s	USP-6C	49xq	VD19	9b	Tor
BH643	XC6114H643ER	Vdet-IC	4.3V±2%, ±Reset PPO, Wlt=1.6s, Rt=1.6s	USP-6C	49xq	VD19	9b	Tor
BH644	XC6114H644ER	Vdet-IC	4.4V±2%, ±Reset PPO, Wlt=1.6s, Rt=1.6s	USP-6C	49xq	VD19	9b	Tor
BH645	XC6114H645ER	Vdet-IC	4.5V±2%, ±Reset PPO, Wlt=1.6s, Rt=1.6s	USP-6C	49xq	VD19	9b	Tor
BH646	XC6114H646ER	Vdet-IC	4.6V±2%, ±Reset PPO, Wlt=1.6s, Rt=1.6s	USP-6C	49xq	VD19	9b	Tor
BH647	XC6114H647ER	Vdet-IC	4.7V±2%, ±Reset PPO, Wlt=1.6s, Rt=1.6s	USP-6C	49xq	VD19	9b	Tor
BH648	XC6114H648ER	Vdet-IC	4.8V±2%, ±Reset PPO, Wlt=1.6s, Rt=1.6s	USP-6C	49xq	VD19	9b	Tor
BH649	XC6114H649ER	Vdet-IC	4.9V±2%, ±Reset PPO, Wlt=1.6s, Rt=1.6s	USP-6C	49xq	VD19	9b	Tor
BH650	XC6114H650ER	Vdet-IC	5.0V±2%, ±Reset PPO, Wlt=1.6s, Rt=1.6s	USP-6C	49xq	VD19	9b	Tor
BH7	XC9237F17DER	DC-DC-IC	PWM-PWM/PPM, st-dwn, 1.7V±2%, 600mA, 3MHz, Vin>1.8V, HSST, CL	USP-6C	49da	DC16	9a	Tor
BH8	XC9237F18DER	DC-DC-IC	PWM-PWM/PPM, st-dwn, 1.8V±2%, 600mA, 3MHz, Vin>1.8V, HSST, CL	USP-6C	49da	DC16	9a	Tor
BH9	XC9237F19DER	DC-DC-IC	PWM-PWM/PPM, st-dwn, 1.9V±2%, 600mA, 3MHz, Vin>1.8V, HSST, CL	USP-6C	49da	DC16	9a	Tor
BHA	XC9237F1ADER	DC-DC-IC	PWM-PWM/PPM, st-dwn, 1.05V±2%, 600mA, 3MHz, Vin>1.8V, HSST, CL	USP-6C	49da	DC16	9a	Tor
BHB	XC9237F1BDER	DC-DC-IC	PWM-PWM/PPM, st-dwn, 1.15V±2%, 600mA, 3MHz, Vin>1.8V, HSST, CL	USP-6C	49da	DC16	9a	Tor
BHC	XC9237F1CDER	DC-DC-IC	PWM-PWM/PPM, st-dwn, 1.25V±2%, 600mA, 3MHz, Vin>1.8V, HSST, CL	USP-6C	49da	DC16	9a	Tor
BHD	XC9237F1DDER	DC-DC-IC	PWM-PWM/PPM, st-dwn, 1.35V±2%, 600mA, 3MHz, Vin>1.8V, HSST, CL	USP-6C	49da	DC16	9a	Tor
BHE	XC9237F1EDER	DC-DC-IC	PWM-PWM/PPM, st-dwn, 1.45V±2%, 600mA, 3MHz, Vin>1.8V, HSST, CL	USP-6C	49da	DC16	9a	Tor
BHF	XC9237F1FDER	DC-DC-IC	PWM-PWM/PPM, st-dwn, 1.55V±2%, 600mA, 3MHz, Vin>1.8V, HSST, CL	USP-6C	49da	DC16	9a	Tor
BHH	XC9237F1HDER	DC-DC-IC	PWM-PWM/PPM, st-dwn, 1.65V±2%, 600mA, 3MHz, Vin>1.8V, HSST, CL	USP-6C	49da	DC16	9a	Tor
BHK	XC9237F1KDER	DC-DC-IC	PWM-PWM/PPM, st-dwn, 1.75V±2%, 600mA, 3MHz, Vin>1.8V, HSST, CL	USP-6C	49da	DC16	9a	Tor
BHL	XC9237F1LDER	DC-DC-IC	PWM-PWM/PPM, st-dwn, 1.85V±2%, 600mA, 3MHz, Vin>1.8V, HSST, CL	USP-6C	49da	DC16	9a	Tor
BHM	XC9237F1MDER	DC-DC-IC	PWM-PWM/PPM, st-dwn, 1.95V±2%, 600mA, 3MHz, Vin>1.8V, HSST, CL	USP-6C	49da	DC16	9a	Tor
BHY	XC6119N08A7R	Vdet-IC	0.8V±30mV, -Reset ODO	USPN-4	58j	VD1	9h	Tor
BHZ	XC6119N09A7R	Vdet-IC	0.9V±30mV, -Reset ODO	USPN-4	58j	VD1	9h	Tor
BIQ	TPA2005D1DRB	LIN-IC	ADF PA, BTL, class-D, 2.5-5.5V, 1.4W(5W/8Ω), shutdown	DFN1-8	37	AFF24	-	Ti
BJ	RP104K261C	LVR-IC	LDO, 2.6V±0.8%, 150mA	DFN1010-4	48y1	VR1	9a	Ric
BJ	RP105K151D	LVR-IC	LDO, 1.5V±15mV, 400mA, +CE, CL	DFN1212-6	52zd	VR11	9a	Ric
BK	RP104K271C	LVR-IC	LDO, 2.7V±0.8%, 150mA	DFN1010-4	48y1	VR1	9a	Ric
BK	RP105K111D	LVR-IC	LDO, 1.1V±15mV, 400mA, +CE, CL	DFN1212-6	52zd	VR11	9a	Ric
BK	XC6221B1817R	LVR-IC	LDO, 1.8V±20mV, 200mA, +CE, CL	USPN-4	58vm	VR4	9a	Tor
BK	XC6223D27B9R-G	LVR-IC	LDO, 2.75V±1%, 300mA, +CE, CL, PDR	USPQ-4B03	48vm	VR4	9a	Tor
BK0	XC9237F20DER	DC-DC-IC	PWM-PWM/PPM, st-dwn, 2.0V±2%, 600mA, 3MHz, Vin>1.8V, HSST, CL	USP-6C	49da	DC16	9a	Tor
BK1	XC9237F21DER	DC-DC-IC	PWM-PWM/PPM, st-dwn, 2.1V±2%, 600mA, 3MHz, Vin>1.8V, HSST, CL	USP-6C	49da	DC16	9a	Tor
BK2	XC9237F22DER	DC-DC-IC	PWM-PWM/PPM, st-dwn, 2.2V±2%, 600mA, 3MHz, Vin>1.8V, HSST, CL	USP-6C	49da	DC16	9a	Tor
BK3	XC9237F23DER	DC-DC-IC	PWM-PWM/PPM, st-dwn, 2.3V±2%, 600mA, 3MHz, Vin>1.8V, HSST, CL	USP-6C	49da	DC16	9a	Tor
BK4	XC9237F24DER	DC-DC-IC	PWM-PWM/PPM, st-dwn, 2.4V±2%, 600mA, 3MHz, Vin>1.8V, HSST, CL	USP-6C	49da	DC16	9a	Tor
BK5	XC9237F25DER	DC-DC-IC	PWM-PWM/PPM, st-dwn, 2.5V±2%, 600mA, 3MHz, Vin>1.8V, HSST, CL	USP-6C	49da	DC16	9a	Tor
BK6	XC9237F26DER	DC-DC-IC	PWM-PWM/PPM, st-dwn, 2.6V±2%, 600mA, 3MHz, Vin>1.8V, HSST, CL	USP-6C	49da	DC16	9a	Tor
BK7	XC9237F27DER	DC-DC-IC	PWM-PWM/PPM, st-dwn, 2.7V±2%, 600mA, 3MHz, Vin>1.8V, HSST, CL	USP-6C	49da	DC16	9a	Tor
BK8	XC9237F28DER	DC-DC-IC	PWM-PWM/PPM, st-dwn, 2.8V±2%, 600mA, 3MHz, Vin>1.8V, HSST, CL	USP-6C	49da	DC16	9a	Tor
BK9	XC9237F29DER	DC-DC-IC	PWM-PWM/PPM, st-dwn, 2.9V±2%, 600mA, 3MHz, Vin>1.8V, HSST, CL	USP-6C	49da	DC16	9a	Tor
BKA	XC9237F2ADER	DC-DC-IC	PWM-PWM/PPM, st-dwn, 2.05V±2%, 600mA, 3MHz, Vin>1.8V, HSST, CL	USP-6C	49da	DC16	9a	Tor
BKB	XC9237F2BDER	DC-DC-IC	PWM-PWM/PPM, st-dwn, 2.15V±2%, 600mA, 3MHz, Vin>1.8V, HSST, CL	USP-6C	49da	DC16	9a	Tor
BKC	XC9237F2CDER	DC-DC-IC	PWM-PWM/PPM, st-dwn, 2.25V±2%, 600mA, 3MHz, Vin>1.8V, HSST, CL	USP-6C	49da	DC16	9a	Tor
BKD	XC9237F2DDER	DC-DC-IC	PWM-PWM/PPM, st-dwn, 2.35V±2%, 600mA, 3MHz, Vin>1.8V, HSST, CL	USP-6C	49da	DC16	9a	Tor
BKE	XC9237F2EDER	DC-DC-IC	PWM-PWM/PPM, st-dwn, 2.45V±2%, 600mA, 3MHz, Vin>1.8V, HSST, CL	USP-6C	49da	DC16	9a	Tor
BKF	XC9237F2FDER	DC-DC-IC	PWM-PWM/PPM, st-dwn, 2.55V±2%, 600mA, 3MHz, Vin>1.8V, HSST, CL	USP-6C	49da	DC16	9a	Tor
BKH	XC9237F2HDER	DC-DC-IC	PWM-PWM/PPM, st-dwn, 2.65V±2%, 600mA, 3MHz, Vin>1.8V, HSST, CL	USP-6C	49da	DC16	9a	Tor
BKK	XC9237F2KDER	DC-DC-IC	PWM-PWM/PPM, st-dwn, 2.75V±2%, 600mA, 3MHz, Vin>1.8V, HSST, CL	USP-6C	49da	DC16	9a	Tor
BKL	XC9237F2LDER	DC-DC-IC	PWM-PWM/PPM, st-dwn, 2.85V±2%, 600mA, 3MHz, Vin>1.8V, HSST, CL	USP-6C	49da	DC16	9a	Tor
BKM	XC9237F2MDER	DC-DC-IC	PWM-PWM/PPM, st-dwn, 2.95V±2%, 600mA, 3MHz, Vin>1.8V, HSST, CL	USP-6C	49da	DC16	9a	Tor
BKN	XC6119N10A7R	Vdet-IC	1.0V±30mV, -Reset ODO	USPN-4	58j	VD1	9h	Tor
BKP	XC6119N11A7R	Vdet-IC	1.1V±30mV, -Reset ODO	USPN-4	58j	VD1	9h	Tor
BKR	XC6119N12A7R	Vdet-IC	1.2V±30mV, -Reset ODO	USPN-4	58j	VD1	9h	Tor
BKS	XC6119N13A7R	Vdet-IC	1.3V±30mV, -Reset ODO	USPN-4	58j	VD1	9h	Tor
BKT	XC6119N14A7R	Vdet-IC	1.4V±30mV, -Reset ODO	USPN-4	58j	VD1	9h	Tor
BKU	XC6119N15A7R	Vdet-IC	1.5V±2%, -Reset ODO	USPN-4	58j	VD1	9h	Tor
BKV	XC6119N16A7R	Vdet-IC	1.6V±2%, -Reset ODO	USPN-4	58j	VD1	9h	Tor
BKX	XC6119N17A7R	Vdet-IC	1.7V±2%, -Reset ODO	USPN-4	58j	VD1	9h	Tor
BKY	XC6119N18A7R	Vdet-IC	1.8V±2%, -Reset ODO	USPN-4	58j	VD1	9h	Tor
BKZ	MAX16056ATA17+	Vdet-IC	1.7V±2%, -MR, -Reset PPO, WDT	TDFN-8	37	-	9a	Max
BKZ	XC6119N19A7R	Vdet-IC	1.9V±2%, -Reset ODO	USPN-4	58j	VD1	9h	Tor
BL	RP104K281C	LVR-IC	LDO, 2.8V±0.8%, 150mA	DFN1010-4	48y1	VR1	9a	Ric
BL	XC6221B1917R	LVR-IC	LDO, 1.9V±20mV, 200mA, +CE, CL	USPN-4	58vm	VR4	9a	Tor
BL	XC6223D28B9R-G	LVR-IC	LDO, 2.85V±1%, 300mA, +CE, CL, PDR	USPQ-4B03	48vm	VR4	9a	Tor
BL0	XC9237F30DER	DC-DC-IC	PWM-PWM/PPM, st-dwn, 3.0V±2%, 600mA, 3MHz, Vin>1.8V, HSST, CL	USP-6C	49da	DC16	9a	Tor
BL1	XC9237F31DER	DC-DC-IC	PWM-PWM/PPM, st-dwn, 3.1V±2%, 600mA, 3MHz, Vin>1.8V, HSST, CL	USP-6C	49da	DC16	9a	Tor
BL2	XC9237F32DER	DC-DC-IC	PWM-PWM/PPM, st-dwn, 3.2V±2%, 600mA, 3MHz, Vin>1.8V, HSST, CL	USP-6C	49da	DC16	9a	Tor



SMD code	Type	Function	Short description	Case	Pinout	Sch.	St.	Mnf.	
BL3	XC9237F33DER	DC-DC-IC	PWM-PWM/PPFM, st-dwn, 3.3V±2%, 600mA, 3MHz, Vin>1.8V, HSST, CL	USP-6C	49da	DC16	9a	Tor	
BL4	XC9237F34DER	DC-DC-IC	PWM-PWM/PPFM, st-dwn, 3.4V±2%, 600mA, 3MHz, Vin>1.8V, HSST, CL	USP-6C	49da	DC16	9a	Tor	
BL5	XC9237F35DER	DC-DC-IC	PWM-PWM/PPFM, st-dwn, 3.5V±2%, 600mA, 3MHz, Vin>1.8V, HSST, CL	USP-6C	49da	DC16	9a	Tor	
BL6	XC9237F36DER	DC-DC-IC	PWM-PWM/PPFM, st-dwn, 3.6V±2%, 600mA, 3MHz, Vin>1.8V, HSST, CL	USP-6C	49da	DC16	9a	Tor	
BL7	XC9237F37DER	DC-DC-IC	PWM-PWM/PPFM, st-dwn, 3.7V±2%, 600mA, 3MHz, Vin>1.8V, HSST, CL	USP-6C	49da	DC16	9a	Tor	
BL8	XC9237F38DER	DC-DC-IC	PWM-PWM/PPFM, st-dwn, 3.8V±2%, 600mA, 3MHz, Vin>1.8V, HSST, CL	USP-6C	49da	DC16	9a	Tor	
BL9	XC9237F39DER	DC-DC-IC	PWM-PWM/PPFM, st-dwn, 3.9V±2%, 600mA, 3MHz, Vin>1.8V, HSST, CL	USP-6C	49da	DC16	9a	Tor	
BLA	MAX16056ATA23+	Vdet-IC	2.3V±2%, -MR, -Reset PPO, WDT	TDFN-8	37	-	9a	Max	
BLA	XC9237F34DER	DC-DC-IC	PWM-PWM/PPFM, st-dwn, 3.05V±2%, 600mA, 3MHz, Vin>1.8V, HSST, CL	USP-6C	49da	DC16	9a	Tor	
BLB	MAX16056ATA26+	Vdet-IC	2.6V±2%, -MR, -Reset PPO, WDT	TDFN-8	37	-	9a	Max	
BLB	XC9237F3BDER	DC-DC-IC	PWM-PWM/PPFM, st-dwn, 3.15V±2%, 600mA, 3MHz, Vin>1.8V, HSST, CL	USP-6C	49da	DC16	9a	Tor	
BLC	MAX16056ATA29+	Vdet-IC	2.9V±2%, -MR, -Reset PPO, WDT	TDFN-8	37	-	9a	Max	
BLC	XC9237F3CDER	DC-DC-IC	PWM-PWM/PPFM, st-dwn, 3.25V±2%, 600mA, 3MHz, Vin>1.8V, HSST, CL	USP-6C	49da	DC16	9a	Tor	
BLD	MAX16056ATA31+	Vdet-IC	3.1V±2%, -MR, -Reset PPO, WDT	TDFN-8	37	-	9a	Max	
BLD	XC9237F3DDER	DC-DC-IC	PWM-PWM/PPFM, st-dwn, 3.35V±2%, 600mA, 3MHz, Vin>1.8V, HSST, CL	USP-6C	49da	DC16	9a	Tor	
BLE	MAX16056ATA46+	Vdet-IC	4.6V±2%, -MR, -Reset PPO, WDT	TDFN-8	37	-	9a	Max	
BLE	XC9237F3EDER	DC-DC-IC	PWM-PWM/PPFM, st-dwn, 3.45V±2%, 600mA, 3MHz, Vin>1.8V, HSST, CL	USP-6C	49da	DC16	9a	Tor	
BLF	MAX16058ATA16+	Vdet-IC	1.6V±2%, -MR, -Reset ODO, WDT	TDFN-8	37	-	9a	Max	
BLF	XC9237F3FDER	DC-DC-IC	PWM-PWM/PPFM, st-dwn, 3.55V±2%, 600mA, 3MHz, Vin>1.8V, HSST, CL	USP-6C	49da	DC16	9a	Tor	
BLG	MAX16058ATA22+	Vdet-IC	2.2V±2%, -MR, -Reset ODO, WDT	TDFN-8	37	-	9a	Max	
BLH	MAX16058ATA26+	Vdet-IC	2.6V±2%, -MR, -Reset ODO, WDT	TDFN-8	37	-	9a	Max	
BLH	XC9237F3HDER	DC-DC-IC	PWM-PWM/PPFM, st-dwn, 3.65V±2%, 600mA, 3MHz, Vin>1.8V, HSST, CL	USP-6C	49da	DC16	9a	Tor	
BLI	MAX16058ATA29+	Vdet-IC	2.9V±2%, -MR, -Reset ODO, WDT	TDFN-8	37	-	9a	Max	
BLJ	MAX16058ATA31+	Vdet-IC	3.1V±2%, -MR, -Reset ODO, WDT	TDFN-8	37	-	9a	Max	
BLK	MAX16058ATA44+	Vdet-IC	4.4V±2%, -MR, -Reset ODO, WDT	TDFN-8	37	-	9a	Max	
BLK	XC9237F3KDER	DC-DC-IC	PWM-PWM/PPFM, st-dwn, 3.75V±2%, 600mA, 3MHz, Vin>1.8V, HSST, CL	USP-6C	49da	DC16	9a	Tor	
BLL	XC9237F3LDER	DC-DC-IC	PWM-PWM/PPFM, st-dwn, 3.85V±2%, 600mA, 3MHz, Vin>1.8V, HSST, CL	USP-6C	49da	DC16	9a	Tor	
BLM	XC9237F3MDER	DC-DC-IC	PWM-PWM/PPFM, st-dwn, 3.95V±2%, 600mA, 3MHz, Vin>1.8V, HSST, CL	USP-6C	49da	DC16	9a	Tor	
BLN	XC6119N20A7R	Vdet-IC	2.0V±2%, -Reset ODO	USPN-4	58rj	VD1	9h	Tor	
BLP	XC6119N21A7R	Vdet-IC	2.1V±2%, -Reset ODO	USPN-4	58rj	VD1	9h	Tor	
BLR	XC6119N22A7R	Vdet-IC	2.2V±2%, -Reset ODO	USPN-4	58rj	VD1	9h	Tor	
BLS	XC6119N23A7R	Vdet-IC	2.3V±2%, -Reset ODO	USPN-4	58rj	VD1	9h	Tor	
BLT	XC6119N24A7R	Vdet-IC	2.4V±2%, -Reset ODO	USPN-4	58rj	VD1	9h	Tor	
BLU	XC6119N25A7R	Vdet-IC	2.5V±2%, -Reset ODO	USPN-4	58rj	VD1	9h	Tor	
BLV	XC6119N26A7R	Vdet-IC	2.6V±2%, -Reset ODO	USPN-4	58rj	VD1	9h	Tor	
BLX	XC6119N27A7R	Vdet-IC	2.7V±2%, -Reset ODO	USPN-4	58rj	VD1	9h	Tor	
BLY	XC6119N28A7R	Vdet-IC	2.8V±2%, -Reset ODO	USPN-4	58rj	VD1	9h	Tor	
BLZ	XC6119N29A7R	Vdet-IC	2.9V±2%, -Reset ODO	USPN-4	58rj	VD1	9h	Tor	
bM	74CBTLV1G125GM	CMOS-Logic	Bus buffer gate with 3-state output	SOT-886	57L	Log14	-	9c	Phi
BM	RP104K281C5	LVR-IC	LDO, 2.85V±0.8%, 150mA	DFN1010-4	48y1	VR1	9a	Ric	
BM	XC6221B2017R	LVR-IC	LDO, 2V±1%, 200mA, +CE, CL	USPN-4	58vm	VR4	9a	Tor	
BM	XC6223D29B9R-G	LVR-IC	LDO, 2.95V±1%, 300mA, +CE, CL, PDR	USPQ-4B03	48vm	VR4	9a	Tor	
BM0	XC9237F40DER	DC-DC-IC	PWM-PWM/PPFM, st-dwn, 4.0V±2%, 600mA, 3MHz, Vin>1.8V, HSST, CL	USP-6C	49da	DC16	9a	Tor	
BM01	RP154L001A	LVR-IC	LDO, Dual out, Vout1/Vout2=2.8V/2.8V±1%, 300mA, +CE	DFN1216-8	37x6	VR26	9b	Ric	
BM02	RP154L002A	LVR-IC	LDO, Dual out, Vout1/Vout2=1.8V/2.8V±1%, 300mA, +CE	DFN1216-8	37x6	VR26	9b	Ric	
BM03	RP154L003A	LVR-IC	LDO, Dual out, Vout1/Vout2=1.5V/2.8V±1%, 300mA, +CE	DFN1216-8	37x6	VR26	9b	Ric	
BM04	RP154L004A	LVR-IC	LDO, Dual out, Vout1/Vout2=1.2V/1.8V±1%, 300mA, +CE	DFN1216-8	37x6	VR26	9b	Ric	
BM05	RP154L005A	LVR-IC	LDO, Dual out, Vout1/Vout2=3.3V/1.2V±1%, 300mA, +CE	DFN1216-8	37x6	VR26	9b	Ric	
BM06	RP154L006A	LVR-IC	LDO, Dual out, Vout1/Vout2=3.3V/1.8V±1%, 300mA, +CE	DFN1216-8	37x6	VR26	9b	Ric	
BM07	RP154L007A	LVR-IC	LDO, Dual out, Vout1/Vout2=2.85V/2.85V±1%, 300mA, +CE	DFN1216-8	37x6	VR26	9b	Ric	
BM08	RP154L008A	LVR-IC	LDO, Dual out, Vout1/Vout2=2.85V/2.6V±1%, 300mA, +CE	DFN1216-8	37x6	VR26	9b	Ric	
BM09	RP154L009A	LVR-IC	LDO, Dual out, Vout1/Vout2=3.0V/2.8V±1%, 300mA, +CE	DFN1216-8	37x6	VR26	9b	Ric	
BM10	RP154L010A	LVR-IC	LDO, Dual out, Vout1/Vout2=3.0V/1.8V±1%, 300mA, +CE	DFN1216-8	37x6	VR26	9b	Ric	
BM11	RP154L011A	LVR-IC	LDO, Dual out, Vout1/Vout2=1.8V/1.5V±1%, 300mA, +CE	DFN1216-8	37x6	VR26	9b	Ric	
BM12	RP154L012A	LVR-IC	LDO, Dual out, Vout1/Vout2=2.8V/2.6V±1%, 300mA, +CE	DFN1216-8	37x6	VR26	9b	Ric	
BM13	RP154L013A	LVR-IC	LDO, Dual out, Vout1/Vout2=3.3V/2.8V±1%, 300mA, +CE	DFN1216-8	37x6	VR26	9b	Ric	
BM14	RP154L014A	LVR-IC	LDO, Dual out, Vout1/Vout2=3.3V/3.3V±1%, 300mA, +CE	DFN1216-8	37x6	VR26	9b	Ric	
BM15	RP154L015A	LVR-IC	LDO, Dual out, Vout1/Vout2=1.5V/2.5V±1%, 300mA, +CE	DFN1216-8	37x6	VR26	9b	Ric	
BM16	RP154L016A	LVR-IC	LDO, Dual out, Vout1/Vout2=1.5V/3.0V±1%, 300mA, +CE	DFN1216-8	37x6	VR26	9b	Ric	
BM17	RP154L017A	LVR-IC	LDO, Dual out, Vout1/Vout2=2.5V/3.0V±1%, 300mA, +CE	DFN1216-8	37x6	VR26	9b	Ric	
BM18	RP154L018A	LVR-IC	LDO, Dual out, Vout1/Vout2=1.8V/1.8V±1%, 300mA, +CE	DFN1216-8	37x6	VR26	9b	Ric	
BM19	RP154L019A	LVR-IC	LDO, Dual out, Vout1/Vout2=1.5V/2.6V±1%, 300mA, +CE	DFN1216-8	37x6	VR26	9b	Ric	
BM20	RP154L020A	LVR-IC	LDO, Dual out, Vout1/Vout2=2.8V/1.8V±1%, 300mA, +CE	DFN1216-8	37x6	VR26	9b	Ric	
BM21	RP154L021A	LVR-IC	LDO, Dual out, Vout1/Vout2=1.2V/2.8V±1%, 300mA, +CE	DFN1216-8	37x6	VR26	9b	Ric	
BM22	RP154L022A	LVR-IC	LDO, Dual out, Vout1/Vout2=2.8V/1.2V±1%, 300mA, +CE	DFN1216-8	37x6	VR26	9b	Ric	
BM23	RP154L023A	LVR-IC	LDO, Dual out, Vout1/Vout2=2.5V/2.5V±1%, 300mA, +CE	DFN1216-8	37x6	VR26	9b	Ric	
BM24	RP154L024A	LVR-IC	LDO, Dual out, Vout1/Vout2=3.3V/3.0V±1%, 300mA, +CE	DFN1216-8	37x6	VR26	9b	Ric	
BM25	RP154L025A	LVR-IC	LDO, Dual out, Vout1/Vout2=3.0V/3.0V±1%, 300mA, +CE	DFN1216-8	37x6	VR26	9b	Ric	
BM26	RP154L026A	LVR-IC	LDO, Dual out, Vout1/Vout2=2.8V/3.1V±1%, 300mA, +CE	DFN1216-8	37x6	VR26	9b	Ric	
BM27	RP154L027A	LVR-IC	LDO, Dual out, Vout1/Vout2=2.3V/2.8V±1%, 300mA, +CE	DFN1216-8	37x6	VR26	9b	Ric	



SMD code	Type	Function	Short description	Case	Pinout	Sch.	St.	Mnf.
BM28	RP154L028A	LVR-IC	LDO, Dual out, Vout1/Vout2=2.8V/1.0V±1%, 300mA, +CE	DFN1216-8	37x6	VR26	9b	Ric
BM29	RP154L029A	LVR-IC	LDO, Dual out, Vout1/Vout2=1.5V/1.5V±1%, 300mA, +CE	DFN1216-8	37x6	VR26	9b	Ric
BM30	RP154L030A	LVR-IC	LDO, Dual out, Vout1/Vout2=1.2V/2.9V±1%, 300mA, +CE	DFN1216-8	37x6	VR26	9b	Ric
BM31	RP154L031A	LVR-IC	LDO, Dual out, Vout1/Vout2=2.65V/2.85V±1%, 300mA, +CE	DFN1216-8	37x6	VR26	9b	Ric
BM32	RP154L032A	LVR-IC	LDO, Dual out, Vout1/Vout2=3.3V/2.85V±1%, 300mA, +CE	DFN1216-8	37x6	VR26	9b	Ric
BM33	RP154L033A	LVR-IC	LDO, Dual out, Vout1/Vout2=1.8V/2.9V±1%, 300mA, +CE	DFN1216-8	37x6	VR26	9b	Ric
BM34	RP154L034A	LVR-IC	LDO, Dual out, Vout1/Vout2=3.1V/3.1V±1%, 300mA, +CE	DFN1216-8	37x6	VR26	9b	Ric
BM35	RP154L035A	LVR-IC	LDO, Dual out, Vout1/Vout2=2.8V/2.7V±1%, 300mA, +CE	DFN1216-8	37x6	VR26	9b	Ric
BM36	RP154L036A	LVR-IC	LDO, Dual out, Vout1/Vout2=1.0V/1.8V±1%, 300mA, +CE	DFN1216-8	37x6	VR26	9b	Ric
BMN	XC6119N30A7R	Vdet-IC	3.0V±2%, -Reset ODO	USPN-4	58j	VD1	9h	Tor
BMP	XC6119N31A7R	Vdet-IC	3.1V±2%, -Reset ODO	USPN-4	58j	VD1	9h	Tor
BMR	XC6119N32A7R	Vdet-IC	3.2V±2%, -Reset ODO	USPN-4	58j	VD1	9h	Tor
BMS	XC6119N33A7R	Vdet-IC	3.3V±2%, -Reset ODO	USPN-4	58j	VD1	9h	Tor
BMT	XC6119N34A7R	Vdet-IC	3.4V±2%, -Reset ODO	USPN-4	58j	VD1	9h	Tor
BMU	XC6119N35A7R	Vdet-IC	3.5V±2%, -Reset ODO	USPN-4	58j	VD1	9h	Tor
BMV	XC6119N36A7R	Vdet-IC	3.6V±2%, -Reset ODO	USPN-4	58j	VD1	9h	Tor
BMX	XC6119N37A7R	Vdet-IC	3.7V±2%, -Reset ODO	USPN-4	58j	VD1	9h	Tor
BMY	XC6119N38A7R	Vdet-IC	3.8V±2%, -Reset ODO	USPN-4	58j	VD1	9h	Tor
BMZ	XC6119N39A7R	Vdet-IC	3.9V±2%, -Reset ODO	USPN-4	58j	VD1	9h	Tor
BN	RP104K291C	LVR-IC	LDO, 2.9V±0.8%, 150mA	DFN1010-4	48y1	VR1	9a	Ric
BN	XC6221B2117R	LVR-IC	LDO, 2.1V±1%, 200mA, +CE, CL	USPN-4	58vm	VR4	9a	Tor
BN	XC6223D30B9R-G	LVR-IC	LDO, 3.05V±1%, 300mA, +CE, CL, PDR	USPQ-4B03	48vm	VR4	9a	Tor
BN01	RP154L001B	LVR-IC	LDO, Dual out, Vout1/Vout2=2.8V/2.8V±1%, 300mA, +CE	DFN1216-8	37x6	VR26	9b	Ric
BN02	RP154L002B	LVR-IC	LDO, Dual out, Vout1/Vout2=1.8V/2.8V±1%, 300mA, +CE	DFN1216-8	37x6	VR26	9b	Ric
BN03	RP154L003B	LVR-IC	LDO, Dual out, Vout1/Vout2=1.5V/2.8V±1%, 300mA, +CE	DFN1216-8	37x6	VR26	9b	Ric
BN04	RP154L004B	LVR-IC	LDO, Dual out, Vout1/Vout2=1.2V/1.8V±1%, 300mA, +CE	DFN1216-8	37x6	VR26	9b	Ric
BN05	RP154L005B	LVR-IC	LDO, Dual out, Vout1/Vout2=3.3V/1.2V±1%, 300mA, +CE	DFN1216-8	37x6	VR26	9b	Ric
BN06	RP154L006B	LVR-IC	LDO, Dual out, Vout1/Vout2=3.3V/1.8V±1%, 300mA, +CE	DFN1216-8	37x6	VR26	9b	Ric
BN07	RP154L007B	LVR-IC	LDO, Dual out, Vout1/Vout2=2.85V/2.85V±1%, 300mA, +CE	DFN1216-8	37x6	VR26	9b	Ric
BN08	RP154L008B	LVR-IC	LDO, Dual out, Vout1/Vout2=2.85V/2.6V±1%, 300mA, +CE	DFN1216-8	37x6	VR26	9b	Ric
BN09	RP154L009B	LVR-IC	LDO, Dual out, Vout1/Vout2=3.0V/2.8V±1%, 300mA, +CE	DFN1216-8	37x6	VR26	9b	Ric
BN10	RP154L010B	LVR-IC	LDO, Dual out, Vout1/Vout2=3.0V/1.8V±1%, 300mA, +CE	DFN1216-8	37x6	VR26	9b	Ric
BN11	RP154L011B	LVR-IC	LDO, Dual out, Vout1/Vout2=1.8V/1.5V±1%, 300mA, +CE	DFN1216-8	37x6	VR26	9b	Ric
BN12	RP154L012B	LVR-IC	LDO, Dual out, Vout1/Vout2=2.8V/2.6V±1%, 300mA, +CE	DFN1216-8	37x6	VR26	9b	Ric
BN13	RP154L013B	LVR-IC	LDO, Dual out, Vout1/Vout2=3.3V/2.8V±1%, 300mA, +CE	DFN1216-8	37x6	VR26	9b	Ric
BN14	RP154L014B	LVR-IC	LDO, Dual out, Vout1/Vout2=3.3V/3.3V±1%, 300mA, +CE	DFN1216-8	37x6	VR26	9b	Ric
BN15	RP154L015B	LVR-IC	LDO, Dual out, Vout1/Vout2=1.5V/2.5V±1%, 300mA, +CE	DFN1216-8	37x6	VR26	9b	Ric
BN16	RP154L016B	LVR-IC	LDO, Dual out, Vout1/Vout2=1.5V/3.0V±1%, 300mA, +CE	DFN1216-8	37x6	VR26	9b	Ric
BN17	RP154L017B	LVR-IC	LDO, Dual out, Vout1/Vout2=2.5V/3.0V±1%, 300mA, +CE	DFN1216-8	37x6	VR26	9b	Ric
BN18	RP154L018B	LVR-IC	LDO, Dual out, Vout1/Vout2=1.8V/1.8V±1%, 300mA, +CE	DFN1216-8	37x6	VR26	9b	Ric
BN19	RP154L019B	LVR-IC	LDO, Dual out, Vout1/Vout2=1.5V/2.6V±1%, 300mA, +CE	DFN1216-8	37x6	VR26	9b	Ric
BN20	RP154L020B	LVR-IC	LDO, Dual out, Vout1/Vout2=2.8V/1.8V±1%, 300mA, +CE	DFN1216-8	37x6	VR26	9b	Ric
BN21	RP154L021B	LVR-IC	LDO, Dual out, Vout1/Vout2=1.2V/2.8V±1%, 300mA, +CE	DFN1216-8	37x6	VR26	9b	Ric
BN22	RP154L022B	LVR-IC	LDO, Dual out, Vout1/Vout2=2.8V/1.2V±1%, 300mA, +CE	DFN1216-8	37x6	VR26	9b	Ric
BN23	RP154L023B	LVR-IC	LDO, Dual out, Vout1/Vout2=2.5V/2.5V±1%, 300mA, +CE	DFN1216-8	37x6	VR26	9b	Ric
BN24	RP154L024B	LVR-IC	LDO, Dual out, Vout1/Vout2=3.3V/3.0V±1%, 300mA, +CE	DFN1216-8	37x6	VR26	9b	Ric
BN25	RP154L025B	LVR-IC	LDO, Dual out, Vout1/Vout2=3.0V/3.0V±1%, 300mA, +CE	DFN1216-8	37x6	VR26	9b	Ric
BN26	RP154L026B	LVR-IC	LDO, Dual out, Vout1/Vout2=2.8V/3.1V±1%, 300mA, +CE	DFN1216-8	37x6	VR26	9b	Ric
BN27	RP154L027B	LVR-IC	LDO, Dual out, Vout1/Vout2=2.3V/2.8V±1%, 300mA, +CE	DFN1216-8	37x6	VR26	9b	Ric
BN28	RP154L028B	LVR-IC	LDO, Dual out, Vout1/Vout2=2.8V/1.0V±1%, 300mA, +CE	DFN1216-8	37x6	VR26	9b	Ric
BN29	RP154L029B	LVR-IC	LDO, Dual out, Vout1/Vout2=1.5V/1.5V±1%, 300mA, +CE	DFN1216-8	37x6	VR26	9b	Ric
BN30	RP154L030B	LVR-IC	LDO, Dual out, Vout1/Vout2=1.2V/2.9V±1%, 300mA, +CE	DFN1216-8	37x6	VR26	9b	Ric
BN31	RP154L031B	LVR-IC	LDO, Dual out, Vout1/Vout2=2.65V/2.85V±1%, 300mA, +CE	DFN1216-8	37x6	VR26	9b	Ric
BN32	RP154L032B	LVR-IC	LDO, Dual out, Vout1/Vout2=3.3V/2.85V±1%, 300mA, +CE	DFN1216-8	37x6	VR26	9b	Ric
BN33	RP154L033B	LVR-IC	LDO, Dual out, Vout1/Vout2=1.8V/2.9V±1%, 300mA, +CE	DFN1216-8	37x6	VR26	9b	Ric
BN34	RP154L034B	LVR-IC	LDO, Dual out, Vout1/Vout2=3.1V/3.1V±1%, 300mA, +CE	DFN1216-8	37x6	VR26	9b	Ric
BN35	RP154L035B	LVR-IC	LDO, Dual out, Vout1/Vout2=2.8V/2.7V±1%, 300mA, +CE	DFN1216-8	37x6	VR26	9b	Ric
BN36	RP154L036B	LVR-IC	LDO, Dual out, Vout1/Vout2=1.0V/1.8V±1%, 300mA, +CE	DFN1216-8	37x6	VR26	9b	Ric
BMN	XC6119N40A7R	Vdet-IC	4.0V±2%, -Reset ODO	USPN-4	58j	VD1	9h	Tor
BNP	XC6119N41A7R	Vdet-IC	4.1V±2%, -Reset ODO	USPN-4	58j	VD1	9h	Tor
BNR	XC6119N42A7R	Vdet-IC	4.2V±2%, -Reset ODO	USPN-4	58j	VD1	9h	Tor
BNS	XC6119N43A7R	Vdet-IC	4.3V±2%, -Reset ODO	USPN-4	58j	VD1	9h	Tor
BNT	XC6119N44A7R	Vdet-IC	4.4V±2%, -Reset ODO	USPN-4	58j	VD1	9h	Tor
BNU	XC6119N45A7R	Vdet-IC	4.5V±2%, -Reset ODO	USPN-4	58j	VD1	9h	Tor
BNV	XC6119N46A7R	Vdet-IC	4.6V±2%, -Reset ODO	USPN-4	58j	VD1	9h	Tor
BNX	XC6119N47A7R	Vdet-IC	4.7V±2%, -Reset ODO	USPN-4	58j	VD1	9h	Tor
BNY	XC6119N48A7R	Vdet-IC	4.8V±2%, -Reset ODO	USPN-4	58j	VD1	9h	Tor
BNZ	XC6119N49A7R	Vdet-IC	4.9V±2%, -Reset ODO	USPN-4	58j	VD1	9h	Tor
BP	RP104K301C	LVR-IC	LDO, 3.0V±0.8%, 150mA	DFN1010-4	48y1	VR1	9a	Ric
BP	XC6221B2217R	LVR-IC	LDO, 2.2V±1%, 200mA, +CE, CL	USPN-4	58vm	VR4	9a	Tor



SMD code	Type	Function	Short description	Case	Pinout	Sch.	St.	Mnf.
BP70	RP500L333A	DC/DC-IC	PWM/VFM st-dwn, 3.1V±1.5%, 600mA, +CE, CL	DFN1616-6	79ee	DC20	9b	Ric
BP71	RP500L323A	DC/DC-IC	PWM/VFM st-dwn, 3.2V±1.5%, 600mA, +CE, CL	DFN1616-6	79ee	DC20	9b	Ric
BP72	RP500L333A	DC/DC-IC	PWM/VFM st-dwn, 3.3V±1.5%, 600mA, +CE, CL	DFN1616-6	79ee	DC20	9b	Ric
BP73	RP500L114A	DC/DC-IC	PWM st-dwn, 1.1V±24mV, 600mA, +CE, CL	DFN1616-6	79ee	DC20	9b	Ric
BP74	RP500L124A	DC/DC-IC	PWM st-dwn, 1.2V±24mV, 600mA, +CE, CL	DFN1616-6	79ee	DC20	9b	Ric
BP75	RP500L124A5	DC/DC-IC	PWM st-dwn, 1.25V±24mV, 600mA, +CE, CL	DFN1616-6	79ee	DC20	9b	Ric
BP76	RP500L134A	DC/DC-IC	PWM st-dwn, 1.4V±24mV, 600mA, +CE, CL	DFN1616-6	79ee	DC20	9b	Ric
BP77	RP500L144A	DC/DC-IC	PWM st-dwn, 1.4V±24mV, 600mA, +CE, CL	DFN1616-6	79ee	DC20	9b	Ric
BP78	RP500L154A	DC/DC-IC	PWM st-dwn, 1.5V±24mV, 600mA, +CE, CL	DFN1616-6	79ee	DC20	9b	Ric
BP79	RP500L164A	DC/DC-IC	PWM st-dwn, 1.6V±1.5%, 600mA, +CE, CL	DFN1616-6	79ee	DC20	9b	Ric
BP80	RP500L174A	DC/DC-IC	PWM st-dwn, 1.7V±1.5%, 600mA, +CE, CL	DFN1616-6	79ee	DC20	9b	Ric
BP81	RP500L184A	DC/DC-IC	PWM st-dwn, 1.8V±1.5%, 600mA, +CE, CL	DFN1616-6	79ee	DC20	9b	Ric
BP82	RP500L194A	DC/DC-IC	PWM st-dwn, 1.9V±1.5%, 600mA, +CE, CL	DFN1616-6	79ee	DC20	9b	Ric
BP83	RP500L204A	DC/DC-IC	PWM st-dwn, 2.0V±1.5%, 600mA, +CE, CL	DFN1616-6	79ee	DC20	9b	Ric
BP84	RP500L214A	DC/DC-IC	PWM st-dwn, 2.1V±1.5%, 600mA, +CE, CL	DFN1616-6	79ee	DC20	9b	Ric
BP85	RP500L224A	DC/DC-IC	PWM st-dwn, 2.2V±1.5%, 600mA, +CE, CL	DFN1616-6	79ee	DC20	9b	Ric
BP86	RP500L234A	DC/DC-IC	PWM st-dwn, 2.3V±1.5%, 600mA, +CE, CL	DFN1616-6	79ee	DC20	9b	Ric
BP87	RP500L244A	DC/DC-IC	PWM st-dwn, 2.4V±1.5%, 600mA, +CE, CL	DFN1616-6	79ee	DC20	9b	Ric
BP88	RP500L254A	DC/DC-IC	PWM st-dwn, 2.5V±1.5%, 600mA, +CE, CL	DFN1616-6	79ee	DC20	9b	Ric
BP89	RP500L264A	DC/DC-IC	PWM st-dwn, 2.6V±1.5%, 600mA, +CE, CL	DFN1616-6	79ee	DC20	9b	Ric
BP90	RP500L274A	DC/DC-IC	PWM st-dwn, 2.7V±1.5%, 600mA, +CE, CL	DFN1616-6	79ee	DC20	9b	Ric
BP91	RP500L284A	DC/DC-IC	PWM st-dwn, 2.8V±1.5%, 600mA, +CE, CL	DFN1616-6	79ee	DC20	9b	Ric
BP92	RP500L294A	DC/DC-IC	PWM st-dwn, 2.9V±1.5%, 600mA, +CE, CL	DFN1616-6	79ee	DC20	9b	Ric
BP93	RP500L304A	DC/DC-IC	PWM st-dwn, 3.0V±1.5%, 600mA, +CE, CL	DFN1616-6	79ee	DC20	9b	Ric
BP94	RP500L314A	DC/DC-IC	PWM st-dwn, 3.1V±1.5%, 600mA, +CE, CL	DFN1616-6	79ee	DC20	9b	Ric
BP95	RP500L324A	DC/DC-IC	PWM st-dwn, 3.2V±1.5%, 600mA, +CE, CL	DFN1616-6	79ee	DC20	9b	Ric
BP96	RP500L334A	DC/DC-IC	PWM st-dwn, 3.3V±1.5%, 600mA, +CE, CL	DFN1616-6	79ee	DC20	9b	Ric
BPB	TPA4411MRTJ	LIN-IC	AF PA, 1.8..4.5V, 2x80mW(4W/16Q), shutdown	QFN-20	38C	-	-	Ti
BPN	XG6119N50A7R	VdeI-IC	5.0V±2%, -Reset ODO	USPN-4	58rj	VD1	9h	Tor
BPX	TPA2032D1YZF	LIN-IC	AF PA, BTL, class-D, 2.5..5.5V, 2.75W(5V/4Q), shutdown	BGA-9	39	AFP45	-	Ti
BPY	TPA2033D1YZF	LIN-IC	AF PA, BTL, class-D, 2.5..5.5V, 2.75W(5V/4Q), shutdown	BGA-9	39	AFP45	-	Ti
BPZ	TPA2034D1YZF	LIN-IC	AF PA, BTL, class-D, 2.5..5.5V, 2.75W(5V/4Q), shutdown	BGA-9	39	AFP45	-	Ti
BQ	RP104K321C	LVR-IC	LDO, 3.2V±0.8%, 150mA	DFN1010-4	48y1	VR1	9a	Ric
BR	RP104K331C	LVR-IC	LDO, 3.3V±0.8%, 150mA	DFN1010-4	48y1	VR1	9a	Ric
BR	XG6221B2317R	LVR-IC	LDO, 2.3V±1%, 200mA, +CE, CL	USPN-4	58vm	VR4	9a	Tor
BR	XG6223D32B9R-G	LVR-IC	LDO, 3.25V±1%, 300mA, +CE, CL, PDR	USPQ-4B03	48vm	VR4	9a	Tor
BR01	RP400K001B	DC/DC-IC	PWM st-up, 700kHz, Adj. 1.8..5V, 200mA	DFN1820-6	74	-	9b	Ric
BR02	RP400K181B	DC/DC-IC	PWM st-up, 700kHz, 1.8V±2%, 200mA	DFN1820-6	74gp	DC4	9b	Ric
BR03	RP400K191B	DC/DC-IC	PWM st-up, 700kHz, 1.9V±2%, 200mA	DFN1820-6	74gp	DC4	9b	Ric
BR04	RP400K201B	DC/DC-IC	PWM st-up, 700kHz, 2.0V±2%, 200mA	DFN1820-6	74gp	DC4	9b	Ric
BR05	RP400K211B	DC/DC-IC	PWM st-up, 700kHz, 2.1V±2%, 200mA	DFN1820-6	74gp	DC4	9b	Ric
BR06	RP400K221B	DC/DC-IC	PWM st-up, 700kHz, 2.2V±2%, 200mA	DFN1820-6	74gp	DC4	9b	Ric
BR07	RP400K231B	DC/DC-IC	PWM st-up, 700kHz, 2.3V±2%, 200mA	DFN1820-6	74gp	DC4	9b	Ric
BR08	RP400K241B	DC/DC-IC	PWM st-up, 700kHz, 2.4V±2%, 200mA	DFN1820-6	74gp	DC4	9b	Ric
BR09	RP400K251B	DC/DC-IC	PWM st-up, 700kHz, 2.5V±2%, 200mA	DFN1820-6	74gp	DC4	9b	Ric
BR10	RP400K261B	DC/DC-IC	PWM st-up, 700kHz, 2.6V±2%, 200mA	DFN1820-6	74gp	DC4	9b	Ric
BR11	RP400K271B	DC/DC-IC	PWM st-up, 700kHz, 2.7V±2%, 200mA	DFN1820-6	74gp	DC4	9b	Ric
BR12	RP400K281B	DC/DC-IC	PWM st-up, 700kHz, 2.8V±2%, 200mA	DFN1820-6	74gp	DC4	9b	Ric
BR13	RP400K291B	DC/DC-IC	PWM st-up, 700kHz, 2.9V±2%, 200mA	DFN1820-6	74gp	DC4	9b	Ric
BR14	RP400K301B	DC/DC-IC	PWM st-up, 700kHz, 3.0V±2%, 200mA	DFN1820-6	74gp	DC4	9b	Ric
BR15	RP400K311B	DC/DC-IC	PWM st-up, 700kHz, 3.1V±2%, 200mA	DFN1820-6	74gp	DC4	9b	Ric
BR16	RP400K321B	DC/DC-IC	PWM st-up, 700kHz, 3.2V±2%, 200mA	DFN1820-6	74gp	DC4	9b	Ric
BR17	RP400K331B	DC/DC-IC	PWM st-up, 700kHz, 3.3V±2%, 200mA	DFN1820-6	74gp	DC4	9b	Ric
BR18	RP400K341B	DC/DC-IC	PWM st-up, 700kHz, 3.4V±2%, 200mA	DFN1820-6	74gp	DC4	9b	Ric
BR19	RP400K351B	DC/DC-IC	PWM st-up, 700kHz, 3.5V±2%, 200mA	DFN1820-6	74gp	DC4	9b	Ric
BR20	RP400K361B	DC/DC-IC	PWM st-up, 700kHz, 3.6V±2%, 200mA	DFN1820-6	74gp	DC4	9b	Ric
BR21	RP400K371B	DC/DC-IC	PWM st-up, 700kHz, 3.7V±2%, 200mA	DFN1820-6	74gp	DC4	9b	Ric
BR22	RP400K381B	DC/DC-IC	PWM st-up, 700kHz, 3.8V±2%, 200mA	DFN1820-6	74gp	DC4	9b	Ric
BR23	RP400K391B	DC/DC-IC	PWM st-up, 700kHz, 3.9V±2%, 200mA	DFN1820-6	74gp	DC4	9b	Ric
BR24	RP400K401B	DC/DC-IC	PWM st-up, 700kHz, 4.0V±2%, 200mA	DFN1820-6	74gp	DC4	9b	Ric
BR25	RP400K411B	DC/DC-IC	PWM st-up, 700kHz, 4.1V±2%, 200mA	DFN1820-6	74gp	DC4	9b	Ric
BR26	RP400K421B	DC/DC-IC	PWM st-up, 700kHz, 4.2V±2%, 200mA	DFN1820-6	74gp	DC4	9b	Ric
BR27	RP400K431B	DC/DC-IC	PWM st-up, 700kHz, 4.3V±2%, 200mA	DFN1820-6	74gp	DC4	9b	Ric
BR28	RP400K441B	DC/DC-IC	PWM st-up, 700kHz, 4.4V±2%, 200mA	DFN1820-6	74gp	DC4	9b	Ric
BR29	RP400K451B	DC/DC-IC	PWM st-up, 700kHz, 4.5V±2%, 200mA	DFN1820-6	74gp	DC4	9b	Ric
BR30	RP400K461B	DC/DC-IC	PWM st-up, 700kHz, 4.6V±2%, 200mA	DFN1820-6	74gp	DC4	9b	Ric
BR31	RP400K471B	DC/DC-IC	PWM st-up, 700kHz, 4.7V±2%, 200mA	DFN1820-6	74gp	DC4	9b	Ric
BR32	RP400K481B	DC/DC-IC	PWM st-up, 700kHz, 4.8V±2%, 200mA	DFN1820-6	74gp	DC4	9b	Ric
BR33	RP400K491B	DC/DC-IC	PWM st-up, 700kHz, 4.9V±2%, 200mA	DFN1820-6	74gp	DC4	9b	Ric
BR34	RP400K501B	DC/DC-IC	PWM st-up, 700kHz, 5.0V±2%, 200mA	DFN1820-6	74gp	DC4	9b	Ric



SMD code	Type	Function	Short description	Case	Pinout	Sch.	St.	Mnf.
BRU	TPA6130A2YZH	LIN-IC	AF PA, 2.5..5.5V, 2x130mW(4V/16Q), shutdown	BGA-16	39	-	-	Ti
BS	RP104K311C	LVR-IC	LDO, 3.1V±0.8%, 150mA	DFN1010-4	48y1	VR1	9a	Ric
BS	RT9193T-18PQW	LVR-IC	LDO, 1.8V±1%, 300mA, +CE	WDFN-6L	49ub	VR7	9a	Rct
BS	XG6221B2417R	LVR-IC	LDO, 2.4V±1%, 200mA, +CE, CL	USPN-4	58vm	VR4	9a	Tor
BS	XG6223D33B9R-G	LVR-IC	LDO, 3.35V±1%, 300mA, +CE, CL, PDR	USPQ-4B03	48vm	VR4	9a	Tor
BSG	TPA6130A2RTJ	LIN-IC	AF PA, 2.5..5.5V, 2x130mW(4V/16Q), shutdown	QFN-20	38	-	-	Ti
BT	RP104K241C	LVR-IC	LDO, 2.4V±0.8%, 150mA	DFN1010-4	48y1	VR1	9a	Ric
BT	XG6221B2517R	LVR-IC	LDO, 2.5V±1%, 200mA, +CE, CL	USPN-4	58vm	VR4	9a	Tor
BT	XG6223D34B9R-G	LVR-IC	LDO, 3.45V±1%, 300mA, +CE, CL, PDR	USPQ-4B03	48vm	VR4	9a	Tor
BT08	RP503L081A	DC/DC-IC	PWMVFM st-down, 0.8V±18mV, 600mA, +CE	DFN1616-6	79ee	DC20	9b	Ric
BT09	RP503L091A	DC/DC-IC	PWMVFM st-down, 0.9V±18mV, 600mA, +CE	DFN1616-6	79ee	DC20	9b	Ric
BT10	RP503L101A	DC/DC-IC	PWMVFM st-down, 1.0V±18mV, 600mA, +CE	DFN1616-6	79ee	DC20	9b	Ric
BT11	RP503L111A	DC/DC-IC	PWMVFM st-down, 1.1V±18mV, 600mA, +CE	DFN1616-6	79ee	DC20	9b	Ric
BT12	RP503L121A	DC/DC-IC	PWMVFM st-down, 1.2V±1.5%, 600mA, +CE	DFN1616-6	79ee	DC20	9b	Ric
BT13	RP503L131A	DC/DC-IC	PWMVFM st-down, 1.3V±1.5%, 600mA, +CE	DFN1616-6	79ee	DC20	9b	Ric
BT14	RP503L141A	DC/DC-IC	PWMVFM st-down, 1.4V±1.5%, 600mA, +CE	DFN1616-6	79ee	DC20	9b	Ric
BT15	RP503L151A	DC/DC-IC	PWMVFM st-down, 1.5V±1.5%, 600mA, +CE	DFN1616-6	79ee	DC20	9b	Ric
BT16	RP503L161A	DC/DC-IC	PWMVFM st-down, 1.6V±1.5%, 600mA, +CE	DFN1616-6	79ee	DC20	9b	Ric
BT17	RP503L171A	DC/DC-IC	PWMVFM st-down, 1.7V±1.5%, 600mA, +CE	DFN1616-6	79ee	DC20	9b	Ric
BT18	RP503L181A	DC/DC-IC	PWMVFM st-down, 1.8V±1.5%, 600mA, +CE	DFN1616-6	79ee	DC20	9b	Ric
BT19	RP503L191A	DC/DC-IC	PWMVFM st-down, 1.9V±1.5%, 600mA, +CE	DFN1616-6	79ee	DC20	9b	Ric
BT20	RP503L201A	DC/DC-IC	PWMVFM st-down, 2.0V±1.5%, 600mA, +CE	DFN1616-6	79ee	DC20	9b	Ric
BT21	RP503L211A	DC/DC-IC	PWMVFM st-down, 2.1V±1.5%, 600mA, +CE	DFN1616-6	79ee	DC20	9b	Ric
BT22	RP503L221A	DC/DC-IC	PWMVFM st-down, 2.2V±1.5%, 600mA, +CE	DFN1616-6	79ee	DC20	9b	Ric
BT23	RP503L231A	DC/DC-IC	PWMVFM st-down, 2.3V±1.5%, 600mA, +CE	DFN1616-6	79ee	DC20	9b	Ric
BT24	RP503L241A	DC/DC-IC	PWMVFM st-down, 2.4V±1.5%, 600mA, +CE	DFN1616-6	79ee	DC20	9b	Ric
BT25	RP503L251A	DC/DC-IC	PWMVFM st-down, 2.5V±1.5%, 600mA, +CE	DFN1616-6	79ee	DC20	9b	Ric
BT26	RP503L121A5	DC/DC-IC	PWMVFM st-down, 1.25V±1.5%, 600mA, +CE	DFN1616-6	79ee	DC20	9b	Ric
BTH	TPA2013D1YZH	LIN-IC	AF PA, BTL, class-D, 3..5.5V, 2.7W(5V/4Q), shutdown	BGA-16	39	-	-	Ti
BTI	TPA2013D1RGP	LIN-IC	AF PA, BTL, class-D, 3..5.5V, 2.7W(5V/4Q), shutdown	QFN-20	38	-	-	Ti
BTQ	TPA2006D1DRB	LIN-IC	AF PA, BTL, class-D, 2.5..5.5V, 1.45W(5V/8Q), shutdown	DFN-8	37	AFP24	-	Ti
BU	RP104K221C	LVR-IC	LDO, 2.2V±0.8%, 150mA	DFN1010-4	48y1	VR1	9a	Ric
BU	XG6221B2617R	LVR-IC	LDO, 2.6V±1%, 200mA, +CE, CL	USPN-4	58vm	VR4	9a	Tor
BU	XG6223D35B9R-G	LVR-IC	LDO, 3.55V±1%, 300mA, +CE, CL, PDR	USPQ-4B03	48vm	VR4	9a	Tor
BU08	RP503L082A	DC/DC-IC	PWMVFM st-down, 0.8V±18mV, 600mA, +CE, CL	DFN1616-6	79ee	DC20	9b	Ric
BU09	RP503L092A	DC/DC-IC	PWMVFM st-down, 0.9V±18mV, 600mA, +CE, CL	DFN1616-6	79ee	DC20	9b	Ric
BU10	RP503L102A	DC/DC-IC	PWMVFM st-down, 1.0V±18mV, 600mA, +CE, CL	DFN1616-6	79ee	DC20	9b	Ric
BU11	RP503L112A	DC/DC-IC	PWMVFM st-down, 1.1V±18mV, 600mA, +CE, CL	DFN1616-6	79ee	DC20	9b	Ric
BU12	RP503L122A	DC/DC-IC	PWMVFM st-down, 1.2V±1.5%, 600mA, +CE, CL	DFN1616-6	79ee	DC20	9b	Ric
BU13	RP503L132A	DC/DC-IC	PWMVFM st-down, 1.3V±1.5%, 600mA, +CE, CL	DFN1616-6	79ee	DC20	9b	Ric
BU14	RP503L142A	DC/DC-IC	PWMVFM st-down, 1.4V±1.5%, 600mA, +CE, CL	DFN1616-6	79ee	DC20	9b	Ric
BU15	RP503L152A	DC/DC-IC	PWMVFM st-down, 1.5V±1.5%, 600mA, +CE, CL	DFN1616-6	79ee	DC20	9b	Ric
BU16	RP503L162A	DC/DC-IC	PWMVFM st-down, 1.6V±1.5%, 600mA, +CE, CL	DFN1616-6	79ee	DC20	9b	Ric
BU17	RP503L172A	DC/DC-IC	PWMVFM st-down, 1.7V±1.5%, 600mA, +CE, CL	DFN1616-6	79ee	DC20	9b	Ric
BU18	RP503L182A	DC/DC-IC	PWMVFM st-down, 1.8V±1.5%, 600mA, +CE, CL	DFN1616-6	79ee	DC20	9b	Ric
BU19	RP503L192A	DC/DC-IC	PWMVFM st-down, 1.9V±1.5%, 600mA, +CE, CL	DFN1616-6	79ee	DC20	9b	Ric
BU20	RP503L202A	DC/DC-IC	PWMVFM st-down, 2.0V±1.5%, 600mA, +CE, CL	DFN1616-6	79ee	DC20	9b	Ric
BU21	RP503L212A	DC/DC-IC	PWMVFM st-down, 2.1V±1.5%, 600mA, +CE, CL	DFN1616-6	79ee	DC20	9b	Ric
BU22	RP503L222A	DC/DC-IC	PWMVFM st-down, 2.2V±1.5%, 600mA, +CE, CL	DFN1616-6	79ee	DC20	9b	Ric
BU23	RP503L232A	DC/DC-IC	PWMVFM st-down, 2.3V±1.5%, 600mA, +CE, CL	DFN1616-6	79ee	DC20	9b	Ric
BU24	RP503L242A	DC/DC-IC	PWMVFM st-down, 2.4V±1.5%, 600mA, +CE, CL	DFN1616-6	79ee	DC20	9b	Ric
BU25	RP503L252A	DC/DC-IC	PWMVFM st-down, 2.5V±1.5%, 600mA, +CE, CL	DFN1616-6	79ee	DC20	9b	Ric
BU26	RP503L122A5	DC/DC-IC	PWMVFM st-down, 1.25V±1.5%, 600mA, +CE, CL	DFN1616-6	79ee	DC20	9b	Ric
BV	RP104K231C	LVR-IC	LDO, 2.3V±0.8%, 150mA	DFN1010-4	48y1	VR1	9a	Ric
BV	XG6221B2717R	LVR-IC	LDO, 2.7V±1%, 200mA, +CE, CL	USPN-4	58vm	VR4	9a	Tor
BV	XG6223D36B9R-G	LVR-IC	LDO, 3.65V±1%, 300mA, +CE, CL, PDR	USPQ-4B03	48vm	VR4	9a	Tor
BV10	RP501K101A	DC/DC-IC	PWMVFM-PWM st-down, 1.0V±24mA, 1A, +CE, Mode	DFN2527-10	37	DC8	9b	Ric
BV11	RP501K111A	DC/DC-IC	PWMVFM-PWM st-down, 1.1V±24mA, 1A, +CE, Mode	DFN2527-10	37	DC8	9b	Ric
BV12	RP501K121A	DC/DC-IC	PWMVFM-PWM st-down, 1.2V±24mA, 1A, +CE, Mode	DFN2527-10	37	DC8	9b	Ric
BV13	RP501K131A	DC/DC-IC	PWMVFM-PWM st-down, 1.3V±24mA, 1A, +CE, Mode	DFN2527-10	37	DC8	9b	Ric
BV14	RP501K141A	DC/DC-IC	PWMVFM-PWM st-down, 1.4V±24mA, 1A, +CE, Mode	DFN2527-10	37	DC8	9b	Ric
BV15	RP501K151A	DC/DC-IC	PWMVFM-PWM st-down, 1.5V±24mA, 1A, +CE, Mode	DFN2527-10	37	DC8	9b	Ric
BV16	RP501K161A	DC/DC-IC	PWMVFM-PWM st-down, 1.6V±1.5%, 1A, +CE, Mode	DFN2527-10	37	DC8	9b	Ric
BV17	RP501K171A	DC/DC-IC	PWMVFM-PWM st-down, 1.7V±1.5%, 1A, +CE, Mode	DFN2527-10	37	DC8	9b	Ric
BV18	RP501K181A	DC/DC-IC	PWMVFM-PWM st-down, 1.8V±1.5%, 1A, +CE, Mode	DFN2527-10	37	DC8	9b	Ric
BV19	RP501K191A	DC/DC-IC	PWMVFM-PWM st-down, 1.9V±1.5%, 1A, +CE, Mode	DFN2527-10	37	DC8	9b	Ric
BV20	RP501K201A	DC/DC-IC	PWMVFM-PWM st-down, 2.0V±1.5%, 1A, +CE, Mode	DFN2527-10	37	DC8	9b	Ric
BV21	RP501K211A	DC/DC-IC	PWMVFM-PWM st-down, 2.1V±1.5%, 1A, +CE, Mode	DFN2527-10	37	DC8	9b	Ric
BV22	RP501K221A	DC/DC-IC	PWMVFM-PWM st-down, 2.2V±1.5%, 1A, +CE, Mode	DFN2527-10	37	DC8	9b	Ric
BV23	RP501K231A	DC/DC-IC	PWMVFM-PWM st-down, 2.3V±1.5%, 1A, +CE, Mode	DFN2527-10	37	DC8	9b	Ric



SMD code	Type	Function	Short description	Case	Pinout	Sch.	St.Mnf.
BV24	RP501K241A	DC/DC-IC	PWMVFM-PWM st-down, 2.4V±1.5%, 1A, +CE, Mode	DFN2527-10	37	DC8	9b Ric
BV25	RP501K251A	DC/DC-IC	PWMVFM-PWM st-down, 2.5V±1.5%, 1A, +CE, Mode	DFN2527-10	37	DC8	9b Ric
BV26	RP501K261A	DC/DC-IC	PWMVFM-PWM st-down, 2.6V±1.5%, 1A, +CE, Mode	DFN2527-10	37	DC8	9b Ric
BV27	RP501K271A	DC/DC-IC	PWMVFM-PWM st-down, 2.7V±1.5%, 1A, +CE, Mode	DFN2527-10	37	DC8	9b Ric
BV28	RP501K281A	DC/DC-IC	PWMVFM-PWM st-down, 2.8V±1.5%, 1A, +CE, Mode	DFN2527-10	37	DC8	9b Ric
BV29	RP501K291A	DC/DC-IC	PWMVFM-PWM st-down, 2.9V±1.5%, 1A, +CE, Mode	DFN2527-10	37	DC8	9b Ric
BV30	RP501K301A	DC/DC-IC	PWMVFM-PWM st-down, 3.0V±1.5%, 1A, +CE, Mode	DFN2527-10	37	DC8	9b Ric
BV31	RP501K311A	DC/DC-IC	PWMVFM-PWM st-down, 3.1V±1.5%, 1A, +CE, Mode	DFN2527-10	37	DC8	9b Ric
BV32	RP501K321A	DC/DC-IC	PWMVFM-PWM st-down, 3.2V±1.5%, 1A, +CE, Mode	DFN2527-10	37	DC8	9b Ric
BV33	RP501K331A	DC/DC-IC	PWMVFM-PWM st-down, 3.3V±1.5%, 1A, +CE, Mode	DFN2527-10	37	DC8	9b Ric
BV34	RP501K121A5	DC/DC-IC	PWMVFM-PWM st-down, 1.25V±24mA, 1A, +CE, Mode	DFN2527-10	37	DC8	9b Ric
BV35	RP501K131A5	DC/DC-IC	PWMVFM-PWM st-down, 1.35V±24mA, 1A, +CE, Mode	DFN2527-10	37	DC8	9b Ric
BW	RP104K271C5	LVR-IC	LDO, 2.75V±0.8%, 150mA	DFN1010-4	48y1	VR1	9a Ric
BW	RT9198-33PQW	LVR-IC	LDO, 3.3V±1%, 300mA, +CE	WDFN-6	49	VR4	9a Rct
BW10	RP501K101B	DC/DC-IC	PWMVFM-PWM st-down, 1.0V±24mA, 1A, +CE, CL, Mode	DFN2527-10	37	DC8	9b Ric
BW11	RP501K111B	DC/DC-IC	PWMVFM-PWM st-down, 1.1V±24mA, 1A, +CE, CL, Mode	DFN2527-10	37	DC8	9b Ric
BW12	RP501K121B	DC/DC-IC	PWMVFM-PWM st-down, 1.2V±24mA, 1A, +CE, CL, Mode	DFN2527-10	37	DC8	9b Ric
BW13	RP501K131B	DC/DC-IC	PWMVFM-PWM st-down, 1.3V±24mA, 1A, +CE, CL, Mode	DFN2527-10	37	DC8	9b Ric
BW14	RP501K141B	DC/DC-IC	PWMVFM-PWM st-down, 1.4V±24mA, 1A, +CE, CL, Mode	DFN2527-10	37	DC8	9b Ric
BW15	RP501K151B	DC/DC-IC	PWMVFM-PWM st-down, 1.5V±24mA, 1A, +CE, CL, Mode	DFN2527-10	37	DC8	9b Ric
BW16	RP501K161B	DC/DC-IC	PWMVFM-PWM st-down, 1.6V±1.5%, 1A, +CE, CL, Mode	DFN2527-10	37	DC8	9b Ric
BW17	RP501K171B	DC/DC-IC	PWMVFM-PWM st-down, 1.7V±1.5%, 1A, +CE, CL, Mode	DFN2527-10	37	DC8	9b Ric
BW18	RP501K181B	DC/DC-IC	PWMVFM-PWM st-down, 1.8V±1.5%, 1A, +CE, CL, Mode	DFN2527-10	37	DC8	9b Ric
BW19	RP501K191B	DC/DC-IC	PWMVFM-PWM st-down, 1.9V±1.5%, 1A, +CE, CL, Mode	DFN2527-10	37	DC8	9b Ric
BW20	RP501K201B	DC/DC-IC	PWMVFM-PWM st-down, 2.0V±1.5%, 1A, +CE, CL, Mode	DFN2527-10	37	DC8	9b Ric
BW21	RP501K211B	DC/DC-IC	PWMVFM-PWM st-down, 2.1V±1.5%, 1A, +CE, CL, Mode	DFN2527-10	37	DC8	9b Ric
BW22	RP501K221B	DC/DC-IC	PWMVFM-PWM st-down, 2.2V±1.5%, 1A, +CE, CL, Mode	DFN2527-10	37	DC8	9b Ric
BW23	RP501K231B	DC/DC-IC	PWMVFM-PWM st-down, 2.3V±1.5%, 1A, +CE, CL, Mode	DFN2527-10	37	DC8	9b Ric
BW24	RP501K241B	DC/DC-IC	PWMVFM-PWM st-down, 2.4V±1.5%, 1A, +CE, CL, Mode	DFN2527-10	37	DC8	9b Ric
BW25	RP501K251B	DC/DC-IC	PWMVFM-PWM st-down, 2.5V±1.5%, 1A, +CE, CL, Mode	DFN2527-10	37	DC8	9b Ric
BW26	RP501K261B	DC/DC-IC	PWMVFM-PWM st-down, 2.6V±1.5%, 1A, +CE, CL, Mode	DFN2527-10	37	DC8	9b Ric
BW27	RP501K271B	DC/DC-IC	PWMVFM-PWM st-down, 2.7V±1.5%, 1A, +CE, CL, Mode	DFN2527-10	37	DC8	9b Ric
BW28	RP501K281B	DC/DC-IC	PWMVFM-PWM st-down, 2.8V±1.5%, 1A, +CE, CL, Mode	DFN2527-10	37	DC8	9b Ric
BW29	RP501K291B	DC/DC-IC	PWMVFM-PWM st-down, 2.9V±1.5%, 1A, +CE, CL, Mode	DFN2527-10	37	DC8	9b Ric
BW30	RP501K301B	DC/DC-IC	PWMVFM-PWM st-down, 3.0V±1.5%, 1A, +CE, CL, Mode	DFN2527-10	37	DC8	9b Ric
BW31	RP501K311B	DC/DC-IC	PWMVFM-PWM st-down, 3.1V±1.5%, 1A, +CE, CL, Mode	DFN2527-10	37	DC8	9b Ric
BW32	RP501K321B	DC/DC-IC	PWMVFM-PWM st-down, 3.2V±1.5%, 1A, +CE, CL, Mode	DFN2527-10	37	DC8	9b Ric
BW33	RP501K331B	DC/DC-IC	PWMVFM-PWM st-down, 3.3V±1.5%, 1A, +CE, CL, Mode	DFN2527-10	37	DC8	9b Ric
BW34	RP501K121B5	DC/DC-IC	PWMVFM-PWM st-down, 1.25V±24mA, 1A, +CE, CL, Mode	DFN2527-10	37	DC8	9b Ric
BW35	RP501K131B5	DC/DC-IC	PWMVFM-PWM st-down, 1.35V±24mA, 1A, +CE, CL, Mode	DFN2527-10	37	DC8	9b Ric
BX	RP104K211C	LVR-IC	LDO, 2.1V±0.8%, 150mA	DFN1010-4	48y1	VR1	9a Ric
BX	XC6221B2817R	LVR-IC	LDO, 2.8V±1%, 200mA, +CE, CL	USPN-4	58vm	VR4	9a Tor
BX	XC6223D37B9R-G	LVR-IC	LDO, 3.75V±1%, 300mA, +CE, CL, PDR	USPQ-4B03	48vm	VR4	9a Tor
BX08	RP502L081B	DC/DC-IC	PWM st-down, 0.8V±24mV, 800mA, +CE	DFN1616-6	79ee	DC20	9b Ric
BX09	RP502L091B	DC/DC-IC	PWM st-down, 0.9V±24mV, 800mA, +CE	DFN1616-6	79ee	DC20	9b Ric
BX10	RP502L101B	DC/DC-IC	PWM st-down, 1.0V±24mV, 800mA, +CE	DFN1616-6	79ee	DC20	9b Ric
BX11	RP502L111B	DC/DC-IC	PWM st-down, 1.1V±24mV, 800mA, +CE	DFN1616-6	79ee	DC20	9b Ric
BX12	RP502L121B	DC/DC-IC	PWM st-down, 1.2V±24mV, 900mA, +CE	DFN1616-6	79ee	DC20	9b Ric
BX13	RP502L131B	DC/DC-IC	PWM st-down, 1.3V±24mV, 900mA, +CE	DFN1616-6	79ee	DC20	9b Ric
BX14	RP502L141B	DC/DC-IC	PWM st-down, 1.4V±24mV, 900mA, +CE	DFN1616-6	79ee	DC20	9b Ric
BX15	RP502L151B	DC/DC-IC	PWM st-down, 1.5V±24mV, 900mA, +CE	DFN1616-6	79ee	DC20	9b Ric
BX16	RP502L161B	DC/DC-IC	PWM st-down, 1.6V±1.5%, 900mA, +CE	DFN1616-6	79ee	DC20	9b Ric
BX17	RP502L171B	DC/DC-IC	PWM st-down, 1.7V±1.5%, 900mA, +CE	DFN1616-6	79ee	DC20	9b Ric
BX18	RP502L181B	DC/DC-IC	PWM st-down, 1.8V±1.5%, 900mA, +CE	DFN1616-6	79ee	DC20	9b Ric
BX19	RP502L191B	DC/DC-IC	PWM st-down, 1.9V±1.5%, 900mA, +CE	DFN1616-6	79ee	DC20	9b Ric
BX20	RP502L201B	DC/DC-IC	PWM st-down, 2.0V±1.5%, 900mA, +CE	DFN1616-6	79ee	DC20	9b Ric
BX21	RP502L211B	DC/DC-IC	PWM st-down, 2.1V±1.5%, 900mA, +CE	DFN1616-6	79ee	DC20	9b Ric
BX22	RP502L221B	DC/DC-IC	PWM st-down, 2.2V±1.5%, 900mA, +CE	DFN1616-6	79ee	DC20	9b Ric
BX23	RP502L231B	DC/DC-IC	PWM st-down, 2.3V±1.5%, 900mA, +CE	DFN1616-6	79ee	DC20	9b Ric
BX24	RP502L241B	DC/DC-IC	PWM st-down, 2.4V±1.5%, 900mA, +CE	DFN1616-6	79ee	DC20	9b Ric
BX25	RP502L251B	DC/DC-IC	PWM st-down, 2.5V±1.5%, 900mA, +CE	DFN1616-6	79ee	DC20	9b Ric
BX26	RP502L261B	DC/DC-IC	PWM st-down, 2.6V±1.5%, 900mA, +CE	DFN1616-6	79ee	DC20	9b Ric
BX27	RP502L271B	DC/DC-IC	PWM st-down, 2.7V±1.5%, 900mA, +CE	DFN1616-6	79ee	DC20	9b Ric
BX28	RP502L281B	DC/DC-IC	PWM st-down, 2.8V±1.5%, 900mA, +CE	DFN1616-6	79ee	DC20	9b Ric
BX29	RP502L291B	DC/DC-IC	PWM st-down, 2.9V±1.5%, 900mA, +CE	DFN1616-6	79ee	DC20	9b Ric
BX30	RP502L301B	DC/DC-IC	PWM st-down, 3.0V±1.5%, 900mA, +CE	DFN1616-6	79ee	DC20	9b Ric
BX31	RP502L311B	DC/DC-IC	PWM st-down, 3.1V±1.5%, 900mA, +CE	DFN1616-6	79ee	DC20	9b Ric
BX32	RP502L321B	DC/DC-IC	PWM st-down, 3.2V±1.5%, 900mA, +CE	DFN1616-6	79ee	DC20	9b Ric
BX33	RP502L331B	DC/DC-IC	PWM st-down, 3.3V±1.5%, 900mA, +CE	DFN1616-6	79ee	DC20	9b Ric
BX34	RP502L121B5	DC/DC-IC	PWM st-down, 1.25V±24mV, 900mA, +CE	DFN1616-6	79ee	DC20	9b Ric



SMD code	Type	Function	Short description	Case	Pinout	Sch.	St.	Mnf.
BY	XC6221B2917R	LVR-IC	LDO, 2.9V±1%, 200mA, +CE, CL	USPN-4	58vm	VR4	9a	Tor
BY	XC6223D38B9R-G	LVR-IC	LDO, 3.85V±1%, 300mA, +CE, CL, PDR	USPQ-4B03	48vm	VR4	9a	Tor
BY08	RP502L082B	DC/DC-IC	PWM/VFM st-down, 0.8V±24mV, 800mA, +CE	DFN1616-6	79ee	DC20	9b	Ric
BY09	RP502L092B	DC/DC-IC	PWM/VFM st-down, 0.9V±24mV, 800mA, +CE	DFN1616-6	79ee	DC20	9b	Ric
BY10	RP502L102B	DC/DC-IC	PWM/VFM st-down, 1.0V±24mV, 800mA, +CE	DFN1616-6	79ee	DC20	9b	Ric
BY11	RP502L112B	DC/DC-IC	PWM/VFM st-down, 1.1V±24mV, 800mA, +CE	DFN1616-6	79ee	DC20	9b	Ric
BY12	RP502L122B	DC/DC-IC	PWM/VFM st-down, 1.2V±24mV, 900mA, +CE	DFN1616-6	79ee	DC20	9b	Ric
BY13	RP502L132B	DC/DC-IC	PWM/VFM st-down, 1.3V±24mV, 900mA, +CE	DFN1616-6	79ee	DC20	9b	Ric
BY14	RP502L142B	DC/DC-IC	PWM/VFM st-down, 1.4V±24mV, 900mA, +CE	DFN1616-6	79ee	DC20	9b	Ric
BY15	RP502L152B	DC/DC-IC	PWM/VFM st-down, 1.5V±24mV, 900mA, +CE	DFN1616-6	79ee	DC20	9b	Ric
BY16	RP502L162B	DC/DC-IC	PWM/VFM st-down, 1.6V±1.5%, 900mA, +CE	DFN1616-6	79ee	DC20	9b	Ric
BY17	RP502L172B	DC/DC-IC	PWM/VFM st-down, 1.7V±1.5%, 900mA, +CE	DFN1616-6	79ee	DC20	9b	Ric
BY18	RP502L182B	DC/DC-IC	PWM/VFM st-down, 1.8V±1.5%, 900mA, +CE	DFN1616-6	79ee	DC20	9b	Ric
BY19	RP502L192B	DC/DC-IC	PWM/VFM st-down, 1.9V±1.5%, 900mA, +CE	DFN1616-6	79ee	DC20	9b	Ric
BY20	RP502L202B	DC/DC-IC	PWM/VFM st-down, 2.0V±1.5%, 900mA, +CE	DFN1616-6	79ee	DC20	9b	Ric
BY21	RP502L212B	DC/DC-IC	PWM/VFM st-down, 2.1V±1.5%, 900mA, +CE	DFN1616-6	79ee	DC20	9b	Ric
BY22	RP502L222B	DC/DC-IC	PWM/VFM st-down, 2.2V±1.5%, 900mA, +CE	DFN1616-6	79ee	DC20	9b	Ric
BY23	RP502L232B	DC/DC-IC	PWM/VFM st-down, 2.3V±1.5%, 900mA, +CE	DFN1616-6	79ee	DC20	9b	Ric
BY24	RP502L242B	DC/DC-IC	PWM/VFM st-down, 2.4V±1.5%, 900mA, +CE	DFN1616-6	79ee	DC20	9b	Ric
BY25	RP502L252B	DC/DC-IC	PWM/VFM st-down, 2.5V±1.5%, 900mA, +CE	DFN1616-6	79ee	DC20	9b	Ric
BY26	RP502L262B	DC/DC-IC	PWM/VFM st-down, 2.6V±1.5%, 900mA, +CE	DFN1616-6	79ee	DC20	9b	Ric
BY27	RP502L272B	DC/DC-IC	PWM/VFM st-down, 2.7V±1.5%, 900mA, +CE	DFN1616-6	79ee	DC20	9b	Ric
BY28	RP502L282B	DC/DC-IC	PWM/VFM st-down, 2.8V±1.5%, 900mA, +CE	DFN1616-6	79ee	DC20	9b	Ric
BY29	RP502L292B	DC/DC-IC	PWM/VFM st-down, 2.9V±1.5%, 900mA, +CE	DFN1616-6	79ee	DC20	9b	Ric
BY30	RP502L302B	DC/DC-IC	PWM/VFM st-down, 3.0V±1.5%, 900mA, +CE	DFN1616-6	79ee	DC20	9b	Ric
BY31	RP502L312B	DC/DC-IC	PWM/VFM st-down, 3.1V±1.5%, 900mA, +CE	DFN1616-6	79ee	DC20	9b	Ric
BY32	RP502L322B	DC/DC-IC	PWM/VFM st-down, 3.2V±1.5%, 900mA, +CE	DFN1616-6	79ee	DC20	9b	Ric
BY33	RP502L332B	DC/DC-IC	PWM/VFM st-down, 3.3V±1.5%, 900mA, +CE	DFN1616-6	79ee	DC20	9b	Ric
BY34	RP502L122B5	DC/DC-IC	PWM/VFM st-down, 1.25V±24mV, 900mA, +CE	DFN1616-6	79ee	DC20	9b	Ric
BZ	XC6221B3017R	LVR-IC	LDO, 3V±1%, 200mA, +CE, CL	USPN-4	58vm	VR4	9a	Tor
BZ	XC6223D39B9R-G	LVR-IC	LDO, 3.95V±1%, 300mA, +CE, CL, PDR	USPQ-4B03	48vm	VR4	9a	Tor
BZ08	RP502L083B	DC/DC-IC	PWM st-down, 0.8V±24mV, 800mA, +CE, CL	DFN1616-6	79ee	DC20	9b	Ric
BZ09	RP502L093B	DC/DC-IC	PWM st-down, 0.9V±24mV, 800mA, +CE, CL	DFN1616-6	79ee	DC20	9b	Ric
BZ10	RP502L103B	DC/DC-IC	PWM st-down, 1.0V±24mV, 800mA, +CE, CL	DFN1616-6	79ee	DC20	9b	Ric
BZ11	RP502L113B	DC/DC-IC	PWM st-down, 1.1V±24mV, 800mA, +CE, CL	DFN1616-6	79ee	DC20	9b	Ric
BZ12	RP502L123B	DC/DC-IC	PWM st-down, 1.2V±24mV, 900mA, +CE, CL	DFN1616-6	79ee	DC20	9b	Ric
BZ13	RP502L133B	DC/DC-IC	PWM st-down, 1.3V±24mV, 900mA, +CE, CL	DFN1616-6	79ee	DC20	9b	Ric
BZ14	RP502L143B	DC/DC-IC	PWM st-down, 1.4V±24mV, 900mA, +CE, CL	DFN1616-6	79ee	DC20	9b	Ric
BZ15	RP502L153B	DC/DC-IC	PWM st-down, 1.5V±24mV, 900mA, +CE, CL	DFN1616-6	79ee	DC20	9b	Ric
BZ16	RP502L163B	DC/DC-IC	PWM st-down, 1.6V±1.5%, 900mA, +CE, CL	DFN1616-6	79ee	DC20	9b	Ric
BZ17	RP502L173B	DC/DC-IC	PWM st-down, 1.7V±1.5%, 900mA, +CE, CL	DFN1616-6	79ee	DC20	9b	Ric
BZ18	RP502L183B	DC/DC-IC	PWM st-down, 1.8V±1.5%, 900mA, +CE, CL	DFN1616-6	79ee	DC20	9b	Ric
BZ19	RP502L193B	DC/DC-IC	PWM st-down, 1.9V±1.5%, 900mA, +CE, CL	DFN1616-6	79ee	DC20	9b	Ric
BZ20	RP502L203B	DC/DC-IC	PWM st-down, 2.0V±1.5%, 900mA, +CE, CL	DFN1616-6	79ee	DC20	9b	Ric
BZ21	RP502L213B	DC/DC-IC	PWM st-down, 2.1V±1.5%, 900mA, +CE, CL	DFN1616-6	79ee	DC20	9b	Ric
BZ22	RP502L223B	DC/DC-IC	PWM st-down, 2.2V±1.5%, 900mA, +CE, CL	DFN1616-6	79ee	DC20	9b	Ric
BZ23	RP502L233B	DC/DC-IC	PWM st-down, 2.3V±1.5%, 900mA, +CE, CL	DFN1616-6	79ee	DC20	9b	Ric
BZ24	RP502L243B	DC/DC-IC	PWM st-down, 2.4V±1.5%, 900mA, +CE, CL	DFN1616-6	79ee	DC20	9b	Ric
BZ25	RP502L253B	DC/DC-IC	PWM st-down, 2.5V±1.5%, 900mA, +CE, CL	DFN1616-6	79ee	DC20	9b	Ric
BZ26	RP502L263B	DC/DC-IC	PWM st-down, 2.6V±1.5%, 900mA, +CE, CL	DFN1616-6	79ee	DC20	9b	Ric
BZ27	RP502L273B	DC/DC-IC	PWM st-down, 2.7V±1.5%, 900mA, +CE, CL	DFN1616-6	79ee	DC20	9b	Ric
BZ28	RP502L283B	DC/DC-IC	PWM st-down, 2.8V±1.5%, 900mA, +CE, CL	DFN1616-6	79ee	DC20	9b	Ric
BZ29	RP502L293B	DC/DC-IC	PWM st-down, 2.9V±1.5%, 900mA, +CE, CL	DFN1616-6	79ee	DC20	9b	Ric
BZ30	RP502L303B	DC/DC-IC	PWM st-down, 3.0V±1.5%, 900mA, +CE, CL	DFN1616-6	79ee	DC20	9b	Ric
BZ31	RP502L313B	DC/DC-IC	PWM st-down, 3.1V±1.5%, 900mA, +CE, CL	DFN1616-6	79ee	DC20	9b	Ric
BZ32	RP502L323B	DC/DC-IC	PWM st-down, 3.2V±1.5%, 900mA, +CE, CL	DFN1616-6	79ee	DC20	9b	Ric
BZ33	RP502L333B	DC/DC-IC	PWM st-down, 3.3V±1.5%, 900mA, +CE, CL	DFN1616-6	79ee	DC20	9b	Ric
BZ34	RP502L123B5	DC/DC-IC	PWM st-down, 1.25V±24mV, 900mA, +CE, CL	DFN1616-6	79ee	DC20	9b	Ric
c0	EUA2011H	LIN-IC	AF PA, BTL, class-D, 2.5..5.5V, 3W(5V/3D), shutdown	BGA-9	39	AFP45	-	Eut
C0	R3118K261A	Vde-IC	2.6V±1.5%, -Reset ODO, Sense	DFN1212-6	52z3	VD14	9a	Ric
C0	RP109L081B	LVR-IC	LDO, 0.8V±1%, 150mA, +CE	DFN1010-4	48vm	VR4	9a	Ric
C0	RT9193-1HPQV	LVR-IC	LDO, 1.85V±1%, 300mA, +CE	WDFN-6L	49ub	VR7	9a	Rct
C00	74AHCT2G00GD	CMOS-Logic	Dual 2-input NAND gates	SOT996-2	54Log50	-	9a	Phi
C001	R5323K001B	LVR-IC	LDO, Dual out, V1=2.8V±1%, V2=2.8V±1%, 150mA, +CE, CL	DFN1820-6	74rh	VR19	9b	Ric
C002	R5323K002B	LVR-IC	LDO, Dual out, V1=2.9V±1%, V2=2.9V±1%, 150mA, +CE, CL	DFN1820-6	74rh	VR19	9b	Ric
C003	R5323K003B	LVR-IC	LDO, Dual out, V1=3V±1%, V2=3V±1%, 150mA, +CE, CL	DFN1820-6	74rh	VR19	9b	Ric
C004	R5323K004B	LVR-IC	LDO, Dual out, V1=1.8V±1%, V2=1.8V±1%, 150mA, +CE, CL	DFN1820-6	74rh	VR19	9b	Ric
C005	R5323K005B	LVR-IC	LDO, Dual out, V1=2.7V±1%, V2=2.7V±1%, 150mA, +CE, CL	DFN1820-6	74rh	VR19	9b	Ric
C006	R5323K006B	LVR-IC	LDO, Dual out, V1=2.5V±1%, V2=2.5V±1%, 150mA, +CE, CL	DFN1820-6	74rh	VR19	9b	Ric
C007	R5323K007B	LVR-IC	LDO, Dual out, V1=1.5V±1%, V2=1.5V±1%, 150mA, +CE, CL	DFN1820-6	74rh	VR19	9b	Ric



SMD code	Type	Function	Short description	Case	Pinout	Sch.	St.	Mnf.
C008	R5323K008B	LVR-IC	LDO, Dual out, V1=2.8V±1%, V2=4V±1%, 150mA, +CE, CL	DFN1820-6	74rh	VR19	9b	Ric
C009	R5323K009B	LVR-IC	LDO, Dual out, V1=2.5V±1%, V2=2.7V±1%, 150mA, +CE, CL	DFN1820-6	74rh	VR19	9b	Ric
C010	R5323K002A	LVR-IC	LDO, Dual out, V1=2.9V±1%, V2=2.9V±1%, 150mA, +CE	DFN1820-6	74rh	VR19	9b	Ric
C011	R5323K003A	LVR-IC	LDO, Dual out, V1=3V±1%, V2=3V±1%, 150mA, +CE	DFN1820-6	74rh	VR19	9b	Ric
C012	R5323K010B	LVR-IC	LDO, Dual out, V1=2.6V±1%, V2=2.6V±1%, 150mA, +CE, CL	DFN1820-6	74rh	VR19	9b	Ric
C013	R5323K013A	LVR-IC	LDO, Dual out, V1=1.8V±1%, V2=3.3V±1%, 150mA, +CE	DFN1820-6	74rh	VR19	9b	Ric
C014	R5323K014B	LVR-IC	LDO, Dual out, V1=2.8V±1%, V2=2.9V±1%, 150mA, +CE, CL	DFN1820-6	74rh	VR19	9b	Ric
C015	R5323K015B	LVR-IC	LDO, Dual out, V1=1.5V±1%, V2=3.3V±1%, 150mA, +CE, CL	DFN1820-6	74rh	VR19	9b	Ric
C016	R5323K016B	LVR-IC	LDO, Dual out, V1=1.5V±1%, V2=2.5V±1%, 150mA, +CE, CL	DFN1820-6	74rh	VR19	9b	Ric
C017	R5323K017B	LVR-IC	LDO, Dual out, V1=1.5V±1%, V2=2.5V±1%, 150mA, +CE, CL	DFN1820-6	74rh	VR19	9b	Ric
C018	R5323K018A	LVR-IC	LDO, Dual out, V1=3.2V±1%, V2=3V±1%, 150mA, +CE, CL	DFN1820-6	74rh	VR19	9b	Ric
C019	R5323K019A	LVR-IC	LDO, Dual out, V1=2.8V±1%, V2=3V±1%, 150mA, +CE, CL	DFN1820-6	74rh	VR19	9b	Ric
C020	R5323K019B	LVR-IC	LDO, Dual out, V1=2.8V±1%, V2=3V±1%, 150mA, +CE, CL	DFN1820-6	74rh	VR19	9b	Ric
C021	R5323K020A	LVR-IC	LDO, Dual out, V1=1.5V±1%, V2=2.9V±1%, 150mA, +CE	DFN1820-6	74rh	VR19	9b	Ric
C022	R5323K020B	LVR-IC	LDO, Dual out, V1=1.5V±1%, V2=2.9V±1%, 150mA, +CE, CL	DFN1820-6	74rh	VR19	9b	Ric
C023	R5323K021B	LVR-IC	LDO, Dual out, V1=2.9V±1%, V2=1.8V±1%, 150mA, +CE, CL	DFN1820-6	74rh	VR19	9b	Ric
C024	R5323K022B	LVR-IC	LDO, Dual out, V1=2.8V±1%, V2=1.8V±1%, 150mA, +CE, CL	DFN1820-6	74rh	VR19	9b	Ric
C025	R5323K023A	LVR-IC	LDO, Dual out, V1=2.8V±1%, V2=3.3V±1%, 150mA, +CE	DFN1820-6	74rh	VR19	9b	Ric
C026	R5323K023B	LVR-IC	LDO, Dual out, V1=2.8V±1%, V2=3.3V±1%, 150mA, +CE, CL	DFN1820-6	74rh	VR19	9b	Ric
C027	R5323K024A	LVR-IC	LDO, Dual out, V1=3V±1%, V2=3.1V±1%, 150mA, +CE	DFN1820-6	74rh	VR19	9b	Ric
C028	R5323K013B	LVR-IC	LDO, Dual out, V1=1.8V±1%, V2=3.3V±1%, 150mA, +CE, CL	DFN1820-6	74rh	VR19	9b	Ric
C029	R5323K027B	LVR-IC	LDO, Dual out, V1=1.8V±1%, V2=2.5V±1%, 150mA, +CE, CL	DFN1820-6	74rh	VR19	9b	Ric
C030	R5323K029B	LVR-IC	LDO, Dual out, V1=2.85V±1%, V2=2.85V±1%, 150mA, +CE, CL	DFN1820-6	74rh	VR19	9b	Ric
C031	R5323K012B	LVR-IC	LDO, Dual out, V1=3.3V±1%, V2=2.5V±1%, 150mA, +CE, CL	DFN1820-6	74rh	VR19	9b	Ric
C032	R5323K026B	LVR-IC	LDO, Dual out, V1=3.3V±1%, V2=3.1V±1%, 150mA, +CE, CL	DFN1820-6	74rh	VR19	9b	Ric
C033	R5323K030A	LVR-IC	LDO, Dual out, V1=2.7V±1%, V2=3V±1%, 150mA, +CE	DFN1820-6	74rh	VR19	9b	Ric
C034	R5323K030B	LVR-IC	LDO, Dual out, V1=2.7V±1%, V2=3V±1%, 150mA, +CE, CL	DFN1820-6	74rh	VR19	9b	Ric
C035	R5323K031B	LVR-IC	LDO, Dual out, V1=1.9V±1%, V2=2.8V±1%, 150mA, +CE, CL	DFN1820-6	74rh	VR19	9b	Ric
C036	R5323K032B	LVR-IC	LDO, Dual out, V1=2.5V±1%, V2=2.8V±1%, 150mA, +CE, CL	DFN1820-6	74rh	VR19	9b	Ric
C037	R5323K033B	LVR-IC	LDO, Dual out, V1=2.4V±1%, V2=3V±1%, 150mA, +CE, CL	DFN1820-6	74rh	VR19	9b	Ric
C038	R5323K034B	LVR-IC	LDO, Dual out, V1=2.5V±1%, V2=2.9V±1%, 150mA, +CE, CL	DFN1820-6	74rh	VR19	9b	Ric
C039	R5323K035B	LVR-IC	LDO, Dual out, V1=1.5V±1%, V2=2.7V±1%, 150mA, +CE, CL	DFN1820-6	74rh	VR19	9b	Ric
C04	74AHCT3G04GD	CMOS-Logic	Triple inverters	SOT996-2	54LLog56	-	9a	Phi
C040	R5323K036B	LVR-IC	LDO, Dual out, V1=2.6V±1%, V2=2.9V±1%, 150mA, +CE, CL	DFN1820-6	74rh	VR19	9b	Ric
C041	R5323K011B	LVR-IC	LDO, Dual out, V1=3.3V±1%, V2=3V±1%, 150mA, +CE, CL	DFN1820-6	74rh	VR19	9b	Ric
C042	R5323K037B	LVR-IC	LDO, Dual out, V1=1.8V±1%, V2=2.6V±1%, 150mA, +CE, CL	DFN1820-6	74rh	VR19	9b	Ric
C043	R5323K038B	LVR-IC	LDO, Dual out, V1=1.7V±1%, V2=2.8V±1%, 150mA, +CE, CL	DFN1820-6	74rh	VR19	9b	Ric
C044	R5323K039B	LVR-IC	LDO, Dual out, V1=1.8V±1%, V2=3.1V±1%, 150mA, +CE, CL	DFN1820-6	74rh	VR19	9b	Ric
C045	R5323K040B	LVR-IC	LDO, Dual out, V1=1.8V±1%, V2=3V±1%, 150mA, +CE, CL	DFN1820-6	74rh	VR19	9b	Ric
C046	R5323K041B	LVR-IC	LDO, Dual out, V1=2.7V±1%, V2=1.8V±1%, 150mA, +CE, CL	DFN1820-6	74rh	VR19	9b	Ric
C047	R5323K042B	LVR-IC	LDO, Dual out, V1=3.3V±1%, V2=3.3V±1%, 150mA, +CE, CL	DFN1820-6	74rh	VR19	9b	Ric
C048	R5323K024B	LVR-IC	LDO, Dual out, V1=3V±1%, V2=3.1V±1%, 150mA, +CE, CL	DFN1820-6	74rh	VR19	9b	Ric
C049	R5323K025B	LVR-IC	LDO, Dual out, V1=2.9V±1%, V2=3V±1%, 150mA, +CE, CL	DFN1820-6	74rh	VR19	9b	Ric
C050	R5323K028B	LVR-IC	LDO, Dual out, V1=3.1V±1%, V2=3.1V±1%, 150mA, +CE, CL	DFN1820-6	74rh	VR19	9b	Ric
C051	R5323K001A	LVR-IC	LDO, Dual out, V1=2.8V±1%, V2=2.8V±1%, 150mA, +CE	DFN1820-6	74rh	VR19	9b	Ric
C052	R5323K043B	LVR-IC	LDO, Dual out, V1=2.7V±1%, V2=2.85V±1%, 150mA, +CE, CL	DFN1820-6	74rh	VR19	9b	Ric
C053	R5323K044B	LVR-IC	LDO, Dual out, V1=2.6V±1%, V2=3.3V±1%, 150mA, +CE, CL	DFN1820-6	74rh	VR19	9b	Ric
C054	R5323K045B	LVR-IC	LDO, Dual out, V1=1.5V±1%, V2=2.85V±1%, 150mA, +CE, CL	DFN1820-6	74rh	VR19	9b	Ric
C055	R5323K046B	LVR-IC	LDO, Dual out, V1=1.5V±1%, V2=3.0V±1%, 150mA, +CE, CL	DFN1820-6	74rh	VR19	9b	Ric
C056	R5323K047B	LVR-IC	LDO, Dual out, V1=2.6V±1%, V2=2.8V±1%, 150mA, +CE, CL	DFN1820-6	74rh	VR19	9b	Ric
C057	R5323K011A	LVR-IC	LDO, Dual out, V1=3.3V±1%, V2=3.0V±1%, 150mA, +CE	DFN1820-6	74rh	VR19	9b	Ric
C058	R5323K048B	LVR-IC	LDO, Dual out, V1=1.5V±1%, V2=2.6V±1%, 150mA, +CE, CL	DFN1820-6	74rh	VR19	9b	Ric
C059	R5323K049B	LVR-IC	LDO, Dual out, V1=1.5V±1%, V2=1.8V±1%, 150mA, +CE, CL	DFN1820-6	74rh	VR19	9b	Ric
C060	R5323K050B	LVR-IC	LDO, Dual out, V1=2.1V±1%, V2=2.1V±1%, 150mA, +CE, CL	DFN1820-6	74rh	VR19	9b	Ric
C061	R5323K051B	LVR-IC	LDO, Dual out, V1=2.7V±1%, V2=2.8V±1%, 150mA, +CE, CL	DFN1820-6	74rh	VR19	9b	Ric
C062	R5323K052B	LVR-IC	LDO, Dual out, V1=1.5V±1%, V2=3.1V±1%, 150mA, +CE, CL	DFN1820-6	74rh	VR19	9b	Ric
C063	R5323K053B	LVR-IC	LDO, Dual out, V1=2.5V±1%, V2=3.0V±1%, 150mA, +CE, CL	DFN1820-6	74rh	VR19	9b	Ric
C064	R5323K054A	LVR-IC	LDO, Dual out, V1=2.8V±1%, V2=2.85V±1%, 150mA, +CE	DFN1820-6	74rh	VR19	9b	Ric
C065	R5323K054B	LVR-IC	LDO, Dual out, V1=2.8V±1%, V2=2.85V±1%, 150mA, +CE, CL	DFN1820-6	74rh	VR19	9b	Ric
C08	74AHCT2G08GD	CMOS-Logic	Dual 2-input AND gates	SOT996-2	54LLog51	-	9a	Phi
C0A	XC6108C20AGR	Vdet-IC	2.0V±2%, Hysteresis, -Reset PPO	USP-4	45ro	VD15	9b	Tor
C0B	XC6108C20BGR	Vdet-IC	2.0V±2%, -Reset PPO	USP-4	45ro	VD15	9b	Tor
C0C	XC6108C20CGR	Vdet-IC	2.0V±2%, Hysteresis, -Reset PPO	USP-4	45rn	VD15	9b	Tor
C0D	XC6108C20DGR	Vdet-IC	2.0V±2%, -Reset PPO	USP-4	45rn	VD15	9b	Tor
C1	R3118K271A	Vdet-IC	2.7V±1.5%, -Reset ODO, Sense	DFN1212-6	52z3	VD14	9a	Ric
C1	RP109L091B	LVR-IC	LDO, 0.9V±1%, 150mA, +CE	DFN1010-4	48um	VR4	9a	Ric
C1	RT9193-18POV	LVR-IC	LDO, 1.8V±1%, 300mA, +CE	WDFN-6L	49ub	VR7	9a	Rct
C1A	XC6108C21AGR	Vdet-IC	2.1V±2%, Hysteresis, -Reset PPO	USP-4	45ro	VD15	9b	Tor
C1B	XC6108C21BGR	Vdet-IC	2.1V±2%, -Reset PPO	USP-4	45ro	VD15	9b	Tor
C1C	XC6108C21CGR	Vdet-IC	2.1V±2%, Hysteresis, -Reset PPO	USP-4	45rn	VD15	9b	Tor



SMD code	Type	Function	Short description	Case	Pinout	Sch.	St.	Mnf.
C1D	XC6108C21DGR	Vdet-IC	2.1V±2%, -Reset PPO	USP-4	45rn	VD15	9b	Tor
C2	LM4857TIL	LIN-IC	AF PA, BTL, 2.7..5.5V, 2x1.2W(4Q)+2x75+100mW(32Q), 12C	BGA-30	39	-	9n	Nsc
C2	LM4859TIL	LIN-IC	AF PA, BTL, 2.7..5.5V, 2x1.2W(4Q)+2x75mW(32Q), 12C	BGA-30	39	-	9n	Nsc
C2	R3118K281A	Vdet-IC	2.8V±1.5%, -Reset ODO, Sense	DFN1212-6	52z3	VD14	9a	Ric
C2	RP109L101B	LVR-IC	LDO, 1.0V±1%, 150mA, +CE	DFN1010-4	48vm	VR4	9a	Ric
C2	XC6223E12B9R-G	LVR-IC	LDO, 1.25V±20mV, 300mA, +CE, ICP	USPQ-4B03	48vm	VR4	9a	Tor
C25	74AHCT2G125GD	CMOS-Logic	Dual bus buffer with 3-state output	SOT996-2	54Log54	-	9a	Phi
C26	74AHCT2G126GD	CMOS-Logic	Dual bus buffer with 3-state output	SOT996-2	54Log55	-	9a	Phi
C2A	XC6108C22AGR	Vdet-IC	2.2V±2%, Hysteresis, -Reset PPO	USP-4	45ro	VD15	9b	Tor
C2B	XC6108C22BGR	Vdet-IC	2.2V±2%, -Reset PPO	USP-4	45ro	VD15	9b	Tor
C2C	XC6108C22CGR	Vdet-IC	2.2V±2%, Hysteresis, -Reset PPO	USP-4	45rn	VD15	9b	Tor
C2D	XC6108C22DGR	Vdet-IC	2.2V±2%, -Reset PPO	USP-4	45rn	VD15	9b	Tor
C3	R3118K291A	Vdet-IC	2.9V±1.5%, -Reset ODO, Sense	DFN1212-6	52z3	VD14	9a	Ric
C3	RP109L111B	LVR-IC	LDO, 1.1V±1%, 150mA, +CE	DFN1010-4	48vm	VR4	9a	Ric
C3	XC6223E13B9R-G	LVR-IC	LDO, 1.35V±20mV, 300mA, +CE, ICP	USPQ-4B03	48vm	VR4	9a	Tor
C32	74AHCT2G32GD	CMOS-Logic	Dual 2-input OR gates	SOT996-2	54Log52	-	9a	Phi
C3A	XC6108C23AGR	Vdet-IC	2.3V±2%, Hysteresis, -Reset PPO	USP-4	45ro	VD15	9b	Tor
C3B	XC6108C23BGR	Vdet-IC	2.3V±2%, -Reset PPO	USP-4	45ro	VD15	9b	Tor
C3C	XC6108C23CGR	Vdet-IC	2.3V±2%, Hysteresis, -Reset PPO	USP-4	45rn	VD15	9b	Tor
C3D	XC6108C23DGR	Vdet-IC	2.3V±2%, -Reset PPO	USP-4	45rn	VD15	9b	Tor
C4	R3118K301A	Vdet-IC	3.0V±1.5%, -Reset ODO, Sense	DFN1212-6	52z3	VD14	9a	Ric
C4	RP109L121B	LVR-IC	LDO, 1.2V±1%, 150mA, +CE	DFN1010-4	48vm	VR4	9a	Ric
C4	XC6223E14B9R-G	LVR-IC	LDO, 1.45V±20mV, 300mA, +CE, ICP	USPQ-4B03	48vm	VR4	9a	Tor
C41	74AHCT2G241GD	CMOS-Logic	Dual bus buffer non-inverted with 3-state output	SOT996-2	54Log60	-	9a	Phi
C4A	XC6108C24AGR	Vdet-IC	2.4V±2%, Hysteresis, -Reset PPO	USP-4	45ro	VD15	9b	Tor
C4B	XC6108C24BGR	Vdet-IC	2.4V±2%, -Reset PPO	USP-4	45ro	VD15	9b	Tor
C4C	XC6108C24CGR	Vdet-IC	2.4V±2%, Hysteresis, -Reset PPO	USP-4	45rn	VD15	9b	Tor
C4D	XC6108C24DGR	Vdet-IC	2.4V±2%, -Reset PPO	USP-4	45rn	VD15	9b	Tor
C5	R3118K311A	Vdet-IC	3.1V±1.5%, -Reset ODO, Sense	DFN1212-6	52z3	VD14	9a	Ric
C5	RP109L131B	LVR-IC	LDO, 1.3V±1%, 150mA, +CE	DFN1010-4	48vm	VR4	9a	Ric
C5	XC6223E15B9R-G	LVR-IC	LDO, 1.55V±20mV, 300mA, +CE, ICP	USPQ-4B03	48vm	VR4	9a	Tor
C5A	XC6108C25AGR	Vdet-IC	2.5V±2%, Hysteresis, -Reset PPO	USP-4	45ro	VD15	9b	Tor
C5B	XC6108C25BGR	Vdet-IC	2.5V±2%, -Reset PPO	USP-4	45ro	VD15	9b	Tor
C5C	XC6108C25CGR	Vdet-IC	2.5V±2%, Hysteresis, -Reset PPO	USP-4	45rn	VD15	9b	Tor
C5D	XC6108C25DGR	Vdet-IC	2.5V±2%, -Reset PPO	USP-4	45rn	VD15	9b	Tor
C6	R3118K321A	Vdet-IC	3.2V±1.5%, -Reset ODO, Sense	DFN1212-6	52z3	VD14	9a	Ric
C6	RP109L141B	LVR-IC	LDO, 1.4V±1%, 150mA, +CE	DFN1010-4	48vm	VR4	9a	Ric
C6	XC6223E16B9R-G	LVR-IC	LDO, 1.65V±20mV, 300mA, +CE, ICP	USPQ-4B03	48vm	VR4	9a	Tor
C6A	XC6108C26AGR	Vdet-IC	2.6V±2%, Hysteresis, -Reset PPO	USP-4	45ro	VD15	9b	Tor
C6B	XC6108C26BGR	Vdet-IC	2.6V±2%, -Reset PPO	USP-4	45ro	VD15	9b	Tor
C6C	XC6108C26CGR	Vdet-IC	2.6V±2%, Hysteresis, -Reset PPO	USP-4	45rn	VD15	9b	Tor
C6D	XC6108C26DGR	Vdet-IC	2.6V±2%, -Reset PPO	USP-4	45rn	VD15	9b	Tor
C7	R3118K331A	Vdet-IC	3.3V±1.5%, -Reset ODO, Sense	DFN1212-6	52z3	VD14	9a	Ric
C7	RP109L151B	LVR-IC	LDO, 1.5V±1%, 150mA, +CE	DFN1010-4	48vm	VR4	9a	Ric
C7	RT9193-28PQV	LVR-IC	LDO, 2.8V±1%, 300mA, +CE	WDFN-6L	49ub	VR7	9a	Rct
C7	XC6221B08B7R	LVR-IC	LDO, 0.85V±20mV, 200mA, +CE, CL	USPN-4	58vm	VR4	9a	Tor
C7	XC6223E17B9R-G	LVR-IC	LDO, 1.75V±20mV, 300mA, +CE, ICP	USPQ-4B03	48vm	VR4	9a	Tor
C7A	XC6108C27AGR	Vdet-IC	2.7V±2%, Hysteresis, -Reset PPO	USP-4	45ro	VD15	9b	Tor
C7B	XC6108C27BGR	Vdet-IC	2.7V±2%, -Reset PPO	USP-4	45ro	VD15	9b	Tor
C7C	XC6108C27CGR	Vdet-IC	2.7V±2%, Hysteresis, -Reset PPO	USP-4	45rn	VD15	9b	Tor
C7D	XC6108C27DGR	Vdet-IC	2.7V±2%, -Reset PPO	USP-4	45rn	VD15	9b	Tor
C8	R3118K341A	Vdet-IC	3.4V±1.5%, -Reset ODO, Sense	DFN1212-6	52z3	VD14	9a	Ric
C8	RP109L161B	LVR-IC	LDO, 1.6V±1%, 150mA, +CE	DFN1010-4	48vm	VR4	9a	Ric
C8	RT9193-30PQV	LVR-IC	LDO, 3.0V±1%, 300mA, +CE	WDFN-6L	49ub	VR7	9a	Rct
C8	XC6221B09B7R	LVR-IC	LDO, 0.95V±20mV, 200mA, +CE, CL	USPN-4	58vm	VR4	9a	Tor
C8	XC6223E18B9R-G	LVR-IC	LDO, 1.85V±20mV, 300mA, +CE, ICP	USPQ-4B03	48vm	VR4	9a	Tor
C8A	XC6108C28AGR	Vdet-IC	2.8V±2%, Hysteresis, -Reset PPO	USP-4	45ro	VD15	9b	Tor
C8B	XC6108C28BGR	Vdet-IC	2.8V±2%, -Reset PPO	USP-4	45ro	VD15	9b	Tor
C8C	XC6108C28CGR	Vdet-IC	2.8V±2%, Hysteresis, -Reset PPO	USP-4	45rn	VD15	9b	Tor
C8D	XC6108C28DGR	Vdet-IC	2.8V±2%, -Reset PPO	USP-4	45rn	VD15	9b	Tor
C9	R3118K351A	Vdet-IC	3.5V±1.5%, -Reset ODO, Sense	DFN1212-6	52z3	VD14	9a	Ric
C9	RP109L171B	LVR-IC	LDO, 1.7V±1%, 150mA, +CE	DFN1010-4	48vm	VR4	9a	Ric
C9	RT9193-33PQV	LVR-IC	LDO, 3.3V±1%, 300mA, +CE	WDFN-6L	49ub	VR7	9a	Rct
C9	XC6221B10B7R	LVR-IC	LDO, 1.05V±20mV, 200mA, +CE, CL	USPN-4	58vm	VR4	9a	Tor
C9	XC6223E19B9R-G	LVR-IC	LDO, 1.95V±20mV, 300mA, +CE, ICP	USPQ-4B03	48vm	VR4	9a	Tor
C9A	XC6108C29AGR	Vdet-IC	2.9V±2%, Hysteresis, -Reset PPO	USP-4	45ro	VD15	9b	Tor
C9B	XC6108C29BGR	Vdet-IC	2.9V±2%, -Reset PPO	USP-4	45ro	VD15	9b	Tor
C9C	XC6108C29CGR	Vdet-IC	2.9V±2%, Hysteresis, -Reset PPO	USP-4	45rn	VD15	9b	Tor
C9D	XC6108C29DGR	Vdet-IC	2.9V±2%, -Reset PPO	USP-4	45rn	VD15	9b	Tor
CA	R3134K10EA	Vdet-IC	1.0V±1.8%, -Reset ODO, -MR	DFN1212-6	52z6	VD4	9a	Ric



SMD code	Type	Function	Short description	Case	Pinout	Sch.	St.	Mnf.
CA232	XC6115A232ER	Vdet-IC	3.2V±2%, +Rst PPO, -Rst ODO, Wt=50ms, Rt=3.13ms	USP-6C	49xq	VD20	9b	Tor
CA233	XC6115A233ER	Vdet-IC	3.3V±2%, +Rst PPO, -Rst ODO, Wt=50ms, Rt=3.13ms	USP-6C	49xq	VD20	9b	Tor
CA234	XC6115A234ER	Vdet-IC	3.4V±2%, +Rst PPO, -Rst ODO, Wt=50ms, Rt=3.13ms	USP-6C	49xq	VD20	9b	Tor
CA235	XC6115A235ER	Vdet-IC	3.5V±2%, +Rst PPO, -Rst ODO, Wt=50ms, Rt=3.13ms	USP-6C	49xq	VD20	9b	Tor
CA236	XC6115A236ER	Vdet-IC	3.6V±2%, +Rst PPO, -Rst ODO, Wt=50ms, Rt=3.13ms	USP-6C	49xq	VD20	9b	Tor
CA237	XC6115A237ER	Vdet-IC	3.7V±2%, +Rst PPO, -Rst ODO, Wt=50ms, Rt=3.13ms	USP-6C	49xq	VD20	9b	Tor
CA238	XC6115A238ER	Vdet-IC	3.8V±2%, +Rst PPO, -Rst ODO, Wt=50ms, Rt=3.13ms	USP-6C	49xq	VD20	9b	Tor
CA239	XC6115A239ER	Vdet-IC	3.9V±2%, +Rst PPO, -Rst ODO, Wt=50ms, Rt=3.13ms	USP-6C	49xq	VD20	9b	Tor
CA24	RP502L244B	DC/DC-IC	PWMVFM st-down, 2.4V±1.5%, 900mA, +CE, CL	DFN1616-6	79ee	DC20	9b	Ric
CA240	XC6115A240ER	Vdet-IC	4.0V±2%, +Rst PPO, -Rst ODO, Wt=50ms, Rt=3.13ms	USP-6C	49xq	VD20	9b	Tor
CA241	XC6115A241ER	Vdet-IC	4.1V±2%, +Rst PPO, -Rst ODO, Wt=50ms, Rt=3.13ms	USP-6C	49xq	VD20	9b	Tor
CA242	XC6115A242ER	Vdet-IC	4.2V±2%, +Rst PPO, -Rst ODO, Wt=50ms, Rt=3.13ms	USP-6C	49xq	VD20	9b	Tor
CA243	XC6115A243ER	Vdet-IC	4.3V±2%, +Rst PPO, -Rst ODO, Wt=50ms, Rt=3.13ms	USP-6C	49xq	VD20	9b	Tor
CA244	XC6115A244ER	Vdet-IC	4.4V±2%, +Rst PPO, -Rst ODO, Wt=50ms, Rt=3.13ms	USP-6C	49xq	VD20	9b	Tor
CA245	XC6115A245ER	Vdet-IC	4.5V±2%, +Rst PPO, -Rst ODO, Wt=50ms, Rt=3.13ms	USP-6C	49xq	VD20	9b	Tor
CA246	XC6115A246ER	Vdet-IC	4.6V±2%, +Rst PPO, -Rst ODO, Wt=50ms, Rt=3.13ms	USP-6C	49xq	VD20	9b	Tor
CA247	XC6115A247ER	Vdet-IC	4.7V±2%, +Rst PPO, -Rst ODO, Wt=50ms, Rt=3.13ms	USP-6C	49xq	VD20	9b	Tor
CA248	XC6115A248ER	Vdet-IC	4.8V±2%, +Rst PPO, -Rst ODO, Wt=50ms, Rt=3.13ms	USP-6C	49xq	VD20	9b	Tor
CA249	XC6115A249ER	Vdet-IC	4.9V±2%, +Rst PPO, -Rst ODO, Wt=50ms, Rt=3.13ms	USP-6C	49xq	VD20	9b	Tor
CA25	RP502L254B	DC/DC-IC	PWMVFM st-down, 2.5V±1.5%, 900mA, +CE, CL	DFN1616-6	79ee	DC20	9b	Ric
CA250	XC6115A250ER	Vdet-IC	5.0V±2%, +Rst PPO, -Rst ODO, Wt=50ms, Rt=3.13ms	USP-6C	49xq	VD20	9b	Tor
CA26	RP502L264B	DC/DC-IC	PWMVFM st-down, 2.6V±1.5%, 900mA, +CE, CL	DFN1616-6	79ee	DC20	9b	Ric
CA27	RP502L274B	DC/DC-IC	PWMVFM st-down, 2.7V±1.5%, 900mA, +CE, CL	DFN1616-6	79ee	DC20	9b	Ric
CA28	RP502L284B	DC/DC-IC	PWMVFM st-down, 2.8V±1.5%, 900mA, +CE, CL	DFN1616-6	79ee	DC20	9b	Ric
CA29	RP502L294B	DC/DC-IC	PWMVFM st-down, 2.9V±1.5%, 900mA, +CE, CL	DFN1616-6	79ee	DC20	9b	Ric
CA30	RP502L304B	DC/DC-IC	PWMVFM st-down, 3.0V±1.5%, 900mA, +CE, CL	DFN1616-6	79ee	DC20	9b	Ric
CA31	RP502L314B	DC/DC-IC	PWMVFM st-down, 3.1V±1.5%, 900mA, +CE, CL	DFN1616-6	79ee	DC20	9b	Ric
CA316	XC6115A316ER	Vdet-IC	1.6V±2%, +Rst PPO, -Rst ODO, Wt=100ms, Rt=3.13ms	USP-6C	49xq	VD20	9b	Tor
CA317	XC6115A317ER	Vdet-IC	1.7V±2%, +Rst PPO, -Rst ODO, Wt=100ms, Rt=3.13ms	USP-6C	49xq	VD20	9b	Tor
CA318	XC6115A318ER	Vdet-IC	1.8V±2%, +Rst PPO, -Rst ODO, Wt=100ms, Rt=3.13ms	USP-6C	49xq	VD20	9b	Tor
CA319	XC6115A319ER	Vdet-IC	1.9V±2%, +Rst PPO, -Rst ODO, Wt=100ms, Rt=3.13ms	USP-6C	49xq	VD20	9b	Tor
CA32	RP502L324B	DC/DC-IC	PWMVFM st-down, 3.2V±1.5%, 900mA, +CE, CL	DFN1616-6	79ee	DC20	9b	Ric
CA320	XC6115A320ER	Vdet-IC	2.0V±2%, +Rst PPO, -Rst ODO, Wt=100ms, Rt=3.13ms	USP-6C	49xq	VD20	9b	Tor
CA321	XC6115A321ER	Vdet-IC	2.1V±2%, +Rst PPO, -Rst ODO, Wt=100ms, Rt=3.13ms	USP-6C	49xq	VD20	9b	Tor
CA322	XC6115A322ER	Vdet-IC	2.2V±2%, +Rst PPO, -Rst ODO, Wt=100ms, Rt=3.13ms	USP-6C	49xq	VD20	9b	Tor
CA323	XC6115A323ER	Vdet-IC	2.3V±2%, +Rst PPO, -Rst ODO, Wt=100ms, Rt=3.13ms	USP-6C	49xq	VD20	9b	Tor
CA324	XC6115A324ER	Vdet-IC	2.4V±2%, +Rst PPO, -Rst ODO, Wt=100ms, Rt=3.13ms	USP-6C	49xq	VD20	9b	Tor
CA325	XC6115A325ER	Vdet-IC	2.5V±2%, +Rst PPO, -Rst ODO, Wt=100ms, Rt=3.13ms	USP-6C	49xq	VD20	9b	Tor
CA326	XC6115A326ER	Vdet-IC	2.6V±2%, +Rst PPO, -Rst ODO, Wt=100ms, Rt=3.13ms	USP-6C	49xq	VD20	9b	Tor
CA327	XC6115A327ER	Vdet-IC	2.7V±2%, +Rst PPO, -Rst ODO, Wt=100ms, Rt=3.13ms	USP-6C	49xq	VD20	9b	Tor
CA328	XC6115A328ER	Vdet-IC	2.8V±2%, +Rst PPO, -Rst ODO, Wt=100ms, Rt=3.13ms	USP-6C	49xq	VD20	9b	Tor
CA329	XC6115A329ER	Vdet-IC	2.9V±2%, +Rst PPO, -Rst ODO, Wt=100ms, Rt=3.13ms	USP-6C	49xq	VD20	9b	Tor
CA33	RP502L334B	DC/DC-IC	PWMVFM st-down, 3.3V±1.5%, 900mA, +CE, CL	DFN1616-6	79ee	DC20	9b	Ric
CA330	XC6115A330ER	Vdet-IC	3.0V±2%, +Rst PPO, -Rst ODO, Wt=100ms, Rt=3.13ms	USP-6C	49xq	VD20	9b	Tor
CA331	XC6115A331ER	Vdet-IC	3.1V±2%, +Rst PPO, -Rst ODO, Wt=100ms, Rt=3.13ms	USP-6C	49xq	VD20	9b	Tor
CA332	XC6115A332ER	Vdet-IC	3.2V±2%, +Rst PPO, -Rst ODO, Wt=100ms, Rt=3.13ms	USP-6C	49xq	VD20	9b	Tor
CA333	XC6115A333ER	Vdet-IC	3.3V±2%, +Rst PPO, -Rst ODO, Wt=100ms, Rt=3.13ms	USP-6C	49xq	VD20	9b	Tor
CA334	XC6115A334ER	Vdet-IC	3.4V±2%, +Rst PPO, -Rst ODO, Wt=100ms, Rt=3.13ms	USP-6C	49xq	VD20	9b	Tor
CA335	XC6115A335ER	Vdet-IC	3.5V±2%, +Rst PPO, -Rst ODO, Wt=100ms, Rt=3.13ms	USP-6C	49xq	VD20	9b	Tor
CA336	XC6115A336ER	Vdet-IC	3.6V±2%, +Rst PPO, -Rst ODO, Wt=100ms, Rt=3.13ms	USP-6C	49xq	VD20	9b	Tor
CA337	XC6115A337ER	Vdet-IC	3.7V±2%, +Rst PPO, -Rst ODO, Wt=100ms, Rt=3.13ms	USP-6C	49xq	VD20	9b	Tor
CA338	XC6115A338ER	Vdet-IC	3.8V±2%, +Rst PPO, -Rst ODO, Wt=100ms, Rt=3.13ms	USP-6C	49xq	VD20	9b	Tor
CA339	XC6115A339ER	Vdet-IC	3.9V±2%, +Rst PPO, -Rst ODO, Wt=100ms, Rt=3.13ms	USP-6C	49xq	VD20	9b	Tor
CA34	RP502L124B5	DC/DC-IC	PWMVFM st-down, 1.25V±24mV, 900mA, +CE, CL	DFN1616-6	79ee	DC20	9b	Ric
CA340	XC6115A340ER	Vdet-IC	4.0V±2%, +Rst PPO, -Rst ODO, Wt=100ms, Rt=3.13ms	USP-6C	49xq	VD20	9b	Tor
CA341	XC6115A341ER	Vdet-IC	4.1V±2%, +Rst PPO, -Rst ODO, Wt=100ms, Rt=3.13ms	USP-6C	49xq	VD20	9b	Tor
CA342	XC6115A342ER	Vdet-IC	4.2V±2%, +Rst PPO, -Rst ODO, Wt=100ms, Rt=3.13ms	USP-6C	49xq	VD20	9b	Tor
CA343	XC6115A343ER	Vdet-IC	4.3V±2%, +Rst PPO, -Rst ODO, Wt=100ms, Rt=3.13ms	USP-6C	49xq	VD20	9b	Tor
CA344	XC6115A344ER	Vdet-IC	4.4V±2%, +Rst PPO, -Rst ODO, Wt=100ms, Rt=3.13ms	USP-6C	49xq	VD20	9b	Tor
CA345	XC6115A345ER	Vdet-IC	4.5V±2%, +Rst PPO, -Rst ODO, Wt=100ms, Rt=3.13ms	USP-6C	49xq	VD20	9b	Tor
CA346	XC6115A346ER	Vdet-IC	4.6V±2%, +Rst PPO, -Rst ODO, Wt=100ms, Rt=3.13ms	USP-6C	49xq	VD20	9b	Tor
CA347	XC6115A347ER	Vdet-IC	4.7V±2%, +Rst PPO, -Rst ODO, Wt=100ms, Rt=3.13ms	USP-6C	49xq	VD20	9b	Tor
CA348	XC6115A348ER	Vdet-IC	4.8V±2%, +Rst PPO, -Rst ODO, Wt=100ms, Rt=3.13ms	USP-6C	49xq	VD20	9b	Tor
CA349	XC6115A349ER	Vdet-IC	4.9V±2%, +Rst PPO, -Rst ODO, Wt=100ms, Rt=3.13ms	USP-6C	49xq	VD20	9b	Tor
CA350	XC6115A350ER	Vdet-IC	5.0V±2%, +Rst PPO, -Rst ODO, Wt=100ms, Rt=3.13ms	USP-6C	49xq	VD20	9b	Tor
CA416	XC6115A416ER	Vdet-IC	1.6V±2%, +Rst PPO, -Rst ODO, Wt=200ms, Rt=3.13ms	USP-6C	49xq	VD20	9b	Tor
CA417	XC6115A417ER	Vdet-IC	1.7V±2%, +Rst PPO, -Rst ODO, Wt=200ms, Rt=3.13ms	USP-6C	49xq	VD20	9b	Tor
CA418	XC6115A418ER	Vdet-IC	1.8V±2%, +Rst PPO, -Rst ODO, Wt=200ms, Rt=3.13ms	USP-6C	49xq	VD20	9b	Tor
CA419	XC6115A419ER	Vdet-IC	1.9V±2%, +Rst PPO, -Rst ODO, Wt=200ms, Rt=3.13ms	USP-6C	49xq	VD20	9b	Tor
CA420	XC6115A420ER	Vdet-IC	2.0V±2%, +Rst PPO, -Rst ODO, Wt=200ms, Rt=3.13ms	USP-6C	49xq	VD20	9b	Tor



SMD code	Type	Function	Short description	Case	Pinout	Sch.	St.Mnf.
CA621	XC6115A621ER	Vdel-IC	2.1V±2%, +Rst PPO, -Rst ODO, Wt=1.6s, Rt=3.13ms	USP-6C	49xq	VD20	9b Tor
CA622	XC6115A622ER	Vdel-IC	2.2V±2%, +Rst PPO, -Rst ODO, Wt=1.6s, Rt=3.13ms	USP-6C	49xq	VD20	9b Tor
CA623	XC6115A623ER	Vdel-IC	2.3V±2%, +Rst PPO, -Rst ODO, Wt=1.6s, Rt=3.13ms	USP-6C	49xq	VD20	9b Tor
CA624	XC6115A624ER	Vdel-IC	2.4V±2%, +Rst PPO, -Rst ODO, Wt=1.6s, Rt=3.13ms	USP-6C	49xq	VD20	9b Tor
CA625	XC6115A625ER	Vdel-IC	2.5V±2%, +Rst PPO, -Rst ODO, Wt=1.6s, Rt=3.13ms	USP-6C	49xq	VD20	9b Tor
CA626	XC6115A626ER	Vdel-IC	2.6V±2%, +Rst PPO, -Rst ODO, Wt=1.6s, Rt=3.13ms	USP-6C	49xq	VD20	9b Tor
CA627	XC6115A627ER	Vdel-IC	2.7V±2%, +Rst PPO, -Rst ODO, Wt=1.6s, Rt=3.13ms	USP-6C	49xq	VD20	9b Tor
CA628	XC6115A628ER	Vdel-IC	2.8V±2%, +Rst PPO, -Rst ODO, Wt=1.6s, Rt=3.13ms	USP-6C	49xq	VD20	9b Tor
CA629	XC6115A629ER	Vdel-IC	2.9V±2%, +Rst PPO, -Rst ODO, Wt=1.6s, Rt=3.13ms	USP-6C	49xq	VD20	9b Tor
CA630	XC6115A630ER	Vdel-IC	3.0V±2%, +Rst PPO, -Rst ODO, Wt=1.6s, Rt=3.13ms	USP-6C	49xq	VD20	9b Tor
CA631	XC6115A631ER	Vdel-IC	3.1V±2%, +Rst PPO, -Rst ODO, Wt=1.6s, Rt=3.13ms	USP-6C	49xq	VD20	9b Tor
CA632	XC6115A632ER	Vdel-IC	3.2V±2%, +Rst PPO, -Rst ODO, Wt=1.6s, Rt=3.13ms	USP-6C	49xq	VD20	9b Tor
CA633	XC6115A633ER	Vdel-IC	3.3V±2%, +Rst PPO, -Rst ODO, Wt=1.6s, Rt=3.13ms	USP-6C	49xq	VD20	9b Tor
CA634	XC6115A634ER	Vdel-IC	3.4V±2%, +Rst PPO, -Rst ODO, Wt=1.6s, Rt=3.13ms	USP-6C	49xq	VD20	9b Tor
CA635	XC6115A635ER	Vdel-IC	3.5V±2%, +Rst PPO, -Rst ODO, Wt=1.6s, Rt=3.13ms	USP-6C	49xq	VD20	9b Tor
CA636	XC6115A636ER	Vdel-IC	3.6V±2%, +Rst PPO, -Rst ODO, Wt=1.6s, Rt=3.13ms	USP-6C	49xq	VD20	9b Tor
CA637	XC6115A637ER	Vdel-IC	3.7V±2%, +Rst PPO, -Rst ODO, Wt=1.6s, Rt=3.13ms	USP-6C	49xq	VD20	9b Tor
CA638	XC6115A638ER	Vdel-IC	3.8V±2%, +Rst PPO, -Rst ODO, Wt=1.6s, Rt=3.13ms	USP-6C	49xq	VD20	9b Tor
CA639	XC6115A639ER	Vdel-IC	3.9V±2%, +Rst PPO, -Rst ODO, Wt=1.6s, Rt=3.13ms	USP-6C	49xq	VD20	9b Tor
CA640	XC6115A640ER	Vdel-IC	4.0V±2%, +Rst PPO, -Rst ODO, Wt=1.6s, Rt=3.13ms	USP-6C	49xq	VD20	9b Tor
CA641	XC6115A641ER	Vdel-IC	4.1V±2%, +Rst PPO, -Rst ODO, Wt=1.6s, Rt=3.13ms	USP-6C	49xq	VD20	9b Tor
CA642	XC6115A642ER	Vdel-IC	4.2V±2%, +Rst PPO, -Rst ODO, Wt=1.6s, Rt=3.13ms	USP-6C	49xq	VD20	9b Tor
CA643	XC6115A643ER	Vdel-IC	4.3V±2%, +Rst PPO, -Rst ODO, Wt=1.6s, Rt=3.13ms	USP-6C	49xq	VD20	9b Tor
CA644	XC6115A644ER	Vdel-IC	4.4V±2%, +Rst PPO, -Rst ODO, Wt=1.6s, Rt=3.13ms	USP-6C	49xq	VD20	9b Tor
CA645	XC6115A645ER	Vdel-IC	4.5V±2%, +Rst PPO, -Rst ODO, Wt=1.6s, Rt=3.13ms	USP-6C	49xq	VD20	9b Tor
CA646	XC6115A646ER	Vdel-IC	4.6V±2%, +Rst PPO, -Rst ODO, Wt=1.6s, Rt=3.13ms	USP-6C	49xq	VD20	9b Tor
CA647	XC6115A647ER	Vdel-IC	4.7V±2%, +Rst PPO, -Rst ODO, Wt=1.6s, Rt=3.13ms	USP-6C	49xq	VD20	9b Tor
CA648	XC6115A648ER	Vdel-IC	4.8V±2%, +Rst PPO, -Rst ODO, Wt=1.6s, Rt=3.13ms	USP-6C	49xq	VD20	9b Tor
CA649	XC6115A649ER	Vdel-IC	4.9V±2%, +Rst PPO, -Rst ODO, Wt=1.6s, Rt=3.13ms	USP-6C	49xq	VD20	9b Tor
CA650	XC6115A650ER	Vdel-IC	5.0V±2%, +Rst PPO, -Rst ODO, Wt=1.6s, Rt=3.13ms	USP-6C	49xq	VD20	9b Tor
CA8	XC9235B08C4R-G	DC-DC-IC	PWM, st-dwn, 0.8V±2%, 600mA, 1.2MHz, Vin>2V, HSST, CL	USP-6EL	56dc5	DC1	9a Tor
CA8	XC9235B08CER	DC-DC-IC	PWM, st-dwn, 0.8V±2%, 600mA, 1.2MHz, Vin>2V, HSST, CL	USP-6C	49dc5	DC1	9a Tor
CA9	XC9235B09C4R-G	DC-DC-IC	PWM, st-dwn, 0.9V±2%, 600mA, 1.2MHz, Vin>2V, HSST, CL	USP-6EL	56dc5	DC1	9a Tor
CA9	XC9235B09CER	DC-DC-IC	PWM, st-dwn, 0.9V±2%, 600mA, 1.2MHz, Vin>2V, HSST, CL	USP-6C	49dc5	DC1	9a Tor
CAL	XC9235B0LC4R-G	DC-DC-IC	PWM, st-dwn, 0.85V±2%, 600mA, 1.2MHz, Vin>2V, HSST, CL	USP-6EL	56dc5	DC1	9a Tor
CAL	XC9235B0LCER	DC-DC-IC	PWM, st-dwn, 0.85V±2%, 600mA, 1.2MHz, Vin>2V, HSST, CL	USP-6C	49dc5	DC1	9a Tor
CAM	XC9235B0MC4R-G	DC-DC-IC	PWM, st-dwn, 0.95V±2%, 600mA, 1.2MHz, Vin>2V, HSST, CL	USP-6EL	56dc5	DC1	9a Tor
CAM	XC9235B0MCER	DC-DC-IC	PWM, st-dwn, 0.95V±2%, 600mA, 1.2MHz, Vin>2V, HSST, CL	USP-6C	49dc5	DC1	9a Tor
CB	BH15RB1WGUT	LVR-IC	LDO, 1.5V, 150mA, +CE	BGA-4	63bg*	VR4	9a Rhm
CB	R3134K11EA	Vdel-IC	1.1V±1.8%, -Reset ODO, -MR	DFN1212-6	52z6	VD4	9a Ric
CB	RP104K131D	LVR-IC	LDO, 1.3V±0.8%, 150mA, +CE, CL	DFN1010-4	48vm	VR4	9a Ric
CB	XC6221B12B7R	LVR-IC	LDO, 1.25V±20mV, 200mA, +CE, CL	USPN-4	58vm	VR4	9a Tor
CB	XC6223E21B9R-G	LVR-IC	LDO, 2.15V±1%, 300mA, +CE, ICP	USPQ-4B03	48vm	VR4	9a Tor
CB0	XC6213B312GR	LVR-IC	LDO, 3.1V±2%, 150mA, +CE	USP-4	45vm	VR4	9b Tor
CB0	XC9235B10C4R-G	DC-DC-IC	PWM, st-dwn, 1.0V±2%, 600mA, 1.2MHz, Vin>2V, HSST, CL	USP-6EL	56dc5	DC1	9a Tor
CB0	XC9235B10CER	DC-DC-IC	PWM, st-dwn, 1.0V±2%, 600mA, 1.2MHz, Vin>2V, HSST, CL	USP-6C	49dc5	DC1	9a Tor
CB1	XC6213B322GR	LVR-IC	LDO, 3.2V±2%, 150mA, +CE	USP-4	45vm	VR4	9b Tor
CB1	XC9235B11C4R-G	DC-DC-IC	PWM, st-dwn, 1.1V±2%, 600mA, 1.2MHz, Vin>2V, HSST, CL	USP-6EL	56dc5	DC1	9a Tor
CB1	XC9235B11CER	DC-DC-IC	PWM, st-dwn, 1.1V±2%, 600mA, 1.2MHz, Vin>2V, HSST, CL	USP-6C	49dc5	DC1	9a Tor
CB2	XC6213B332GR	LVR-IC	LDO, 3.3V±2%, 150mA, +CE	USP-4	45vm	VR4	9b Tor
CB2	XC9235B12C4R-G	DC-DC-IC	PWM, st-dwn, 1.2V±2%, 600mA, 1.2MHz, Vin>2V, HSST, CL	USP-6EL	56dc5	DC1	9a Tor
CB2	XC9235B12CER	DC-DC-IC	PWM, st-dwn, 1.2V±2%, 600mA, 1.2MHz, Vin>2V, HSST, CL	USP-6C	49dc5	DC1	9a Tor
CB216	XC6115B216ER	Vdel-IC	1.6V±2%, +Rst PPO, -Rst ODO, Wt=50ms, Rt=25ms	USP-6C	49xq	VD20	9b Tor
CB217	XC6115B217ER	Vdel-IC	1.7V±2%, +Rst PPO, -Rst ODO, Wt=50ms, Rt=25ms	USP-6C	49xq	VD20	9b Tor
CB218	XC6115B218ER	Vdel-IC	1.8V±2%, +Rst PPO, -Rst ODO, Wt=50ms, Rt=25ms	USP-6C	49xq	VD20	9b Tor
CB219	XC6115B219ER	Vdel-IC	1.9V±2%, +Rst PPO, -Rst ODO, Wt=50ms, Rt=25ms	USP-6C	49xq	VD20	9b Tor
CB220	XC6115B220ER	Vdel-IC	2.0V±2%, +Rst PPO, -Rst ODO, Wt=50ms, Rt=25ms	USP-6C	49xq	VD20	9b Tor
CB221	XC6115B221ER	Vdel-IC	2.1V±2%, +Rst PPO, -Rst ODO, Wt=50ms, Rt=25ms	USP-6C	49xq	VD20	9b Tor
CB222	XC6115B222ER	Vdel-IC	2.2V±2%, +Rst PPO, -Rst ODO, Wt=50ms, Rt=25ms	USP-6C	49xq	VD20	9b Tor
CB223	XC6115B223ER	Vdel-IC	2.3V±2%, +Rst PPO, -Rst ODO, Wt=50ms, Rt=25ms	USP-6C	49xq	VD20	9b Tor
CB224	XC6115B224ER	Vdel-IC	2.4V±2%, +Rst PPO, -Rst ODO, Wt=50ms, Rt=25ms	USP-6C	49xq	VD20	9b Tor
CB225	XC6115B225ER	Vdel-IC	2.5V±2%, +Rst PPO, -Rst ODO, Wt=50ms, Rt=25ms	USP-6C	49xq	VD20	9b Tor
CB226	XC6115B226ER	Vdel-IC	2.6V±2%, +Rst PPO, -Rst ODO, Wt=50ms, Rt=25ms	USP-6C	49xq	VD20	9b Tor
CB227	XC6115B227ER	Vdel-IC	2.7V±2%, +Rst PPO, -Rst ODO, Wt=50ms, Rt=25ms	USP-6C	49xq	VD20	9b Tor
CB228	XC6115B228ER	Vdel-IC	2.8V±2%, +Rst PPO, -Rst ODO, Wt=50ms, Rt=25ms	USP-6C	49xq	VD20	9b Tor
CB229	XC6115B229ER	Vdel-IC	2.9V±2%, +Rst PPO, -Rst ODO, Wt=50ms, Rt=25ms	USP-6C	49xq	VD20	9b Tor
CB230	XC6115B230ER	Vdel-IC	3.0V±2%, +Rst PPO, -Rst ODO, Wt=50ms, Rt=25ms	USP-6C	49xq	VD20	9b Tor
CB231	XC6115B231ER	Vdel-IC	3.1V±2%, +Rst PPO, -Rst ODO, Wt=50ms, Rt=25ms	USP-6C	49xq	VD20	9b Tor
CB232	XC6115B232ER	Vdel-IC	3.2V±2%, +Rst PPO, -Rst ODO, Wt=50ms, Rt=25ms	USP-6C	49xq	VD20	9b Tor
CB233	XC6115B233ER	Vdel-IC	3.3V±2%, +Rst PPO, -Rst ODO, Wt=50ms, Rt=25ms	USP-6C	49xq	VD20	9b Tor



SMD code	Type	Function	Short description	Case	Pinout	Sch.	St.	Mnf.
CB234	XC6115B234ER	Vdet-IC	3.4V±2%, +Rst PPO, -Rst ODO, Wt=50ms, Rt=25ms	USP-6C	49xq	VD20	9b	Tor
CB235	XC6115B235ER	Vdet-IC	3.5V±2%, +Rst PPO, -Rst ODO, Wt=50ms, Rt=25ms	USP-6C	49xq	VD20	9b	Tor
CB236	XC6115B236ER	Vdet-IC	3.6V±2%, +Rst PPO, -Rst ODO, Wt=50ms, Rt=25ms	USP-6C	49xq	VD20	9b	Tor
CB237	XC6115B237ER	Vdet-IC	3.7V±2%, +Rst PPO, -Rst ODO, Wt=50ms, Rt=25ms	USP-6C	49xq	VD20	9b	Tor
CB238	XC6115B238ER	Vdet-IC	3.8V±2%, +Rst PPO, -Rst ODO, Wt=50ms, Rt=25ms	USP-6C	49xq	VD20	9b	Tor
CB239	XC6115B239ER	Vdet-IC	3.9V±2%, +Rst PPO, -Rst ODO, Wt=50ms, Rt=25ms	USP-6C	49xq	VD20	9b	Tor
CB240	XC6115B240ER	Vdet-IC	4.0V±2%, +Rst PPO, -Rst ODO, Wt=50ms, Rt=25ms	USP-6C	49xq	VD20	9b	Tor
CB241	XC6115B241ER	Vdet-IC	4.1V±2%, +Rst PPO, -Rst ODO, Wt=50ms, Rt=25ms	USP-6C	49xq	VD20	9b	Tor
CB242	XC6115B242ER	Vdet-IC	4.2V±2%, +Rst PPO, -Rst ODO, Wt=50ms, Rt=25ms	USP-6C	49xq	VD20	9b	Tor
CB243	XC6115B243ER	Vdet-IC	4.3V±2%, +Rst PPO, -Rst ODO, Wt=50ms, Rt=25ms	USP-6C	49xq	VD20	9b	Tor
CB244	XC6115B244ER	Vdet-IC	4.4V±2%, +Rst PPO, -Rst ODO, Wt=50ms, Rt=25ms	USP-6C	49xq	VD20	9b	Tor
CB245	XC6115B245ER	Vdet-IC	4.5V±2%, +Rst PPO, -Rst ODO, Wt=50ms, Rt=25ms	USP-6C	49xq	VD20	9b	Tor
CB246	XC6115B246ER	Vdet-IC	4.6V±2%, +Rst PPO, -Rst ODO, Wt=50ms, Rt=25ms	USP-6C	49xq	VD20	9b	Tor
CB247	XC6115B247ER	Vdet-IC	4.7V±2%, +Rst PPO, -Rst ODO, Wt=50ms, Rt=25ms	USP-6C	49xq	VD20	9b	Tor
CB248	XC6115B248ER	Vdet-IC	4.8V±2%, +Rst PPO, -Rst ODO, Wt=50ms, Rt=25ms	USP-6C	49xq	VD20	9b	Tor
CB249	XC6115B249ER	Vdet-IC	4.9V±2%, +Rst PPO, -Rst ODO, Wt=50ms, Rt=25ms	USP-6C	49xq	VD20	9b	Tor
CB250	XC6115B250ER	Vdet-IC	5.0V±2%, +Rst PPO, -Rst ODO, Wt=50ms, Rt=25ms	USP-6C	49xq	VD20	9b	Tor
CB3	XC6213B342GR	LVR-IC	LDO, 3.4V±2%, 150mA, +CE	USP-4	45vm	VR4	9b	Tor
CB3	XC9235B13C4R-G	DC-DC-IC	PWM, st-down, 1.3V±2%, 600mA, 1.2MHz, Vin>2V, HSST, CL	USP-6EL	56dc5	DC1	9a	Tor
CB3	XC9235B13CER	DC-DC-IC	PWM, st-down, 1.3V±2%, 600mA, 1.2MHz, Vin>2V, HSST, CL	USP-6C	49dc5	DC1	9a	Tor
CB316	XC6115B316ER	Vdet-IC	1.6V±2%, +Rst PPO, -Rst ODO, Wt=100ms, Rt=25ms	USP-6C	49xq	VD20	9b	Tor
CB317	XC6115B317ER	Vdet-IC	1.7V±2%, +Rst PPO, -Rst ODO, Wt=100ms, Rt=25ms	USP-6C	49xq	VD20	9b	Tor
CB318	XC6115B318ER	Vdet-IC	1.8V±2%, +Rst PPO, -Rst ODO, Wt=100ms, Rt=25ms	USP-6C	49xq	VD20	9b	Tor
CB319	XC6115B319ER	Vdet-IC	1.9V±2%, +Rst PPO, -Rst ODO, Wt=100ms, Rt=25ms	USP-6C	49xq	VD20	9b	Tor
CB320	XC6115B320ER	Vdet-IC	2.0V±2%, +Rst PPO, -Rst ODO, Wt=100ms, Rt=25ms	USP-6C	49xq	VD20	9b	Tor
CB321	XC6115B321ER	Vdet-IC	2.1V±2%, +Rst PPO, -Rst ODO, Wt=100ms, Rt=25ms	USP-6C	49xq	VD20	9b	Tor
CB322	XC6115B322ER	Vdet-IC	2.2V±2%, +Rst PPO, -Rst ODO, Wt=100ms, Rt=25ms	USP-6C	49xq	VD20	9b	Tor
CB323	XC6115B323ER	Vdet-IC	2.3V±2%, +Rst PPO, -Rst ODO, Wt=100ms, Rt=25ms	USP-6C	49xq	VD20	9b	Tor
CB324	XC6115B324ER	Vdet-IC	2.4V±2%, +Rst PPO, -Rst ODO, Wt=100ms, Rt=25ms	USP-6C	49xq	VD20	9b	Tor
CB325	XC6115B325ER	Vdet-IC	2.5V±2%, +Rst PPO, -Rst ODO, Wt=100ms, Rt=25ms	USP-6C	49xq	VD20	9b	Tor
CB326	XC6115B326ER	Vdet-IC	2.6V±2%, +Rst PPO, -Rst ODO, Wt=100ms, Rt=25ms	USP-6C	49xq	VD20	9b	Tor
CB327	XC6115B327ER	Vdet-IC	2.7V±2%, +Rst PPO, -Rst ODO, Wt=100ms, Rt=25ms	USP-6C	49xq	VD20	9b	Tor
CB328	XC6115B328ER	Vdet-IC	2.8V±2%, +Rst PPO, -Rst ODO, Wt=100ms, Rt=25ms	USP-6C	49xq	VD20	9b	Tor
CB329	XC6115B329ER	Vdet-IC	2.9V±2%, +Rst PPO, -Rst ODO, Wt=100ms, Rt=25ms	USP-6C	49xq	VD20	9b	Tor
CB330	XC6115B330ER	Vdet-IC	3.0V±2%, +Rst PPO, -Rst ODO, Wt=100ms, Rt=25ms	USP-6C	49xq	VD20	9b	Tor
CB331	XC6115B331ER	Vdet-IC	3.1V±2%, +Rst PPO, -Rst ODO, Wt=100ms, Rt=25ms	USP-6C	49xq	VD20	9b	Tor
CB332	XC6115B332ER	Vdet-IC	3.2V±2%, +Rst PPO, -Rst ODO, Wt=100ms, Rt=25ms	USP-6C	49xq	VD20	9b	Tor
CB333	XC6115B333ER	Vdet-IC	3.3V±2%, +Rst PPO, -Rst ODO, Wt=100ms, Rt=25ms	USP-6C	49xq	VD20	9b	Tor
CB334	XC6115B334ER	Vdet-IC	3.4V±2%, +Rst PPO, -Rst ODO, Wt=100ms, Rt=25ms	USP-6C	49xq	VD20	9b	Tor
CB335	XC6115B335ER	Vdet-IC	3.5V±2%, +Rst PPO, -Rst ODO, Wt=100ms, Rt=25ms	USP-6C	49xq	VD20	9b	Tor
CB336	XC6115B336ER	Vdet-IC	3.6V±2%, +Rst PPO, -Rst ODO, Wt=100ms, Rt=25ms	USP-6C	49xq	VD20	9b	Tor
CB337	XC6115B337ER	Vdet-IC	3.7V±2%, +Rst PPO, -Rst ODO, Wt=100ms, Rt=25ms	USP-6C	49xq	VD20	9b	Tor
CB338	XC6115B338ER	Vdet-IC	3.8V±2%, +Rst PPO, -Rst ODO, Wt=100ms, Rt=25ms	USP-6C	49xq	VD20	9b	Tor
CB339	XC6115B339ER	Vdet-IC	3.9V±2%, +Rst PPO, -Rst ODO, Wt=100ms, Rt=25ms	USP-6C	49xq	VD20	9b	Tor
CB340	XC6115B340ER	Vdet-IC	4.0V±2%, +Rst PPO, -Rst ODO, Wt=100ms, Rt=25ms	USP-6C	49xq	VD20	9b	Tor
CB341	XC6115B341ER	Vdet-IC	4.1V±2%, +Rst PPO, -Rst ODO, Wt=100ms, Rt=25ms	USP-6C	49xq	VD20	9b	Tor
CB342	XC6115B342ER	Vdet-IC	4.2V±2%, +Rst PPO, -Rst ODO, Wt=100ms, Rt=25ms	USP-6C	49xq	VD20	9b	Tor
CB343	XC6115B343ER	Vdet-IC	4.3V±2%, +Rst PPO, -Rst ODO, Wt=100ms, Rt=25ms	USP-6C	49xq	VD20	9b	Tor
CB344	XC6115B344ER	Vdet-IC	4.4V±2%, +Rst PPO, -Rst ODO, Wt=100ms, Rt=25ms	USP-6C	49xq	VD20	9b	Tor
CB345	XC6115B345ER	Vdet-IC	4.5V±2%, +Rst PPO, -Rst ODO, Wt=100ms, Rt=25ms	USP-6C	49xq	VD20	9b	Tor
CB346	XC6115B346ER	Vdet-IC	4.6V±2%, +Rst PPO, -Rst ODO, Wt=100ms, Rt=25ms	USP-6C	49xq	VD20	9b	Tor
CB347	XC6115B347ER	Vdet-IC	4.7V±2%, +Rst PPO, -Rst ODO, Wt=100ms, Rt=25ms	USP-6C	49xq	VD20	9b	Tor
CB348	XC6115B348ER	Vdet-IC	4.8V±2%, +Rst PPO, -Rst ODO, Wt=100ms, Rt=25ms	USP-6C	49xq	VD20	9b	Tor
CB349	XC6115B349ER	Vdet-IC	4.9V±2%, +Rst PPO, -Rst ODO, Wt=100ms, Rt=25ms	USP-6C	49xq	VD20	9b	Tor
CB350	XC6115B350ER	Vdet-IC	5.0V±2%, +Rst PPO, -Rst ODO, Wt=100ms, Rt=25ms	USP-6C	49xq	VD20	9b	Tor
CB4	XC6213B352GR	LVR-IC	LDO, 3.5V±2%, 150mA, +CE	USP-4	45vm	VR4	9b	Tor
CB4	XC9235B14C4R-G	DC-DC-IC	PWM, st-down, 1.4V±2%, 600mA, 1.2MHz, Vin>2V, HSST, CL	USP-6EL	56dc5	DC1	9a	Tor
CB4	XC9235B14CER	DC-DC-IC	PWM, st-down, 1.4V±2%, 600mA, 1.2MHz, Vin>2V, HSST, CL	USP-6C	49dc5	DC1	9a	Tor
CB416	XC6115B416ER	Vdet-IC	1.6V±2%, +Rst PPO, -Rst ODO, Wt=200ms, Rt=25ms	USP-6C	49xq	VD20	9b	Tor
CB417	XC6115B417ER	Vdet-IC	1.7V±2%, +Rst PPO, -Rst ODO, Wt=200ms, Rt=25ms	USP-6C	49xq	VD20	9b	Tor
CB418	XC6115B418ER	Vdet-IC	1.8V±2%, +Rst PPO, -Rst ODO, Wt=200ms, Rt=25ms	USP-6C	49xq	VD20	9b	Tor
CB419	XC6115B419ER	Vdet-IC	1.9V±2%, +Rst PPO, -Rst ODO, Wt=200ms, Rt=25ms	USP-6C	49xq	VD20	9b	Tor
CB420	XC6115B420ER	Vdet-IC	2.0V±2%, +Rst PPO, -Rst ODO, Wt=200ms, Rt=25ms	USP-6C	49xq	VD20	9b	Tor
CB421	XC6115B421ER	Vdet-IC	2.1V±2%, +Rst PPO, -Rst ODO, Wt=200ms, Rt=25ms	USP-6C	49xq	VD20	9b	Tor
CB422	XC6115B422ER	Vdet-IC	2.2V±2%, +Rst PPO, -Rst ODO, Wt=200ms, Rt=25ms	USP-6C	49xq	VD20	9b	Tor
CB423	XC6115B423ER	Vdet-IC	2.3V±2%, +Rst PPO, -Rst ODO, Wt=200ms, Rt=25ms	USP-6C	49xq	VD20	9b	Tor
CB424	XC6115B424ER	Vdet-IC	2.4V±2%, +Rst PPO, -Rst ODO, Wt=200ms, Rt=25ms	USP-6C	49xq	VD20	9b	Tor
CB425	XC6115B425ER	Vdet-IC	2.5V±2%, +Rst PPO, -Rst ODO, Wt=200ms, Rt=25ms	USP-6C	49xq	VD20	9b	Tor
CB426	XC6115B426ER	Vdet-IC	2.6V±2%, +Rst PPO, -Rst ODO, Wt=200ms, Rt=25ms	USP-6C	49xq	VD20	9b	Tor
CB427	XC6115B427ER	Vdet-IC	2.7V±2%, +Rst PPO, -Rst ODO, Wt=200ms, Rt=25ms	USP-6C	49xq	VD20	9b	Tor



SMD code	Type	Function	Short description	Case	Pinout	Sch.	St.Mnf.
CB622	XC6115B622ER	Vdet-IC	2.2V±2%, +Rst PPO, -Rst ODO, Wt=1.6s, Rt=25ms	USP-6C	49xq	VD20	9b Tor
CB623	XC6115B623ER	Vdet-IC	2.3V±2%, +Rst PPO, -Rst ODO, Wt=1.6s, Rt=25ms	USP-6C	49xq	VD20	9b Tor
CB624	XC6115B624ER	Vdet-IC	2.4V±2%, +Rst PPO, -Rst ODO, Wt=1.6s, Rt=25ms	USP-6C	49xq	VD20	9b Tor
CB625	XC6115B625ER	Vdet-IC	2.5V±2%, +Rst PPO, -Rst ODO, Wt=1.6s, Rt=25ms	USP-6C	49xq	VD20	9b Tor
CB626	XC6115B626ER	Vdet-IC	2.6V±2%, +Rst PPO, -Rst ODO, Wt=1.6s, Rt=25ms	USP-6C	49xq	VD20	9b Tor
CB627	XC6115B627ER	Vdet-IC	2.7V±2%, +Rst PPO, -Rst ODO, Wt=1.6s, Rt=25ms	USP-6C	49xq	VD20	9b Tor
CB628	XC6115B628ER	Vdet-IC	2.8V±2%, +Rst PPO, -Rst ODO, Wt=1.6s, Rt=25ms	USP-6C	49xq	VD20	9b Tor
CB629	XC6115B629ER	Vdet-IC	2.9V±2%, +Rst PPO, -Rst ODO, Wt=1.6s, Rt=25ms	USP-6C	49xq	VD20	9b Tor
CB630	XC6115B630ER	Vdet-IC	3.0V±2%, +Rst PPO, -Rst ODO, Wt=1.6s, Rt=25ms	USP-6C	49xq	VD20	9b Tor
CB631	XC6115B631ER	Vdet-IC	3.1V±2%, +Rst PPO, -Rst ODO, Wt=1.6s, Rt=25ms	USP-6C	49xq	VD20	9b Tor
CB632	XC6115B632ER	Vdet-IC	3.2V±2%, +Rst PPO, -Rst ODO, Wt=1.6s, Rt=25ms	USP-6C	49xq	VD20	9b Tor
CB633	XC6115B633ER	Vdet-IC	3.3V±2%, +Rst PPO, -Rst ODO, Wt=1.6s, Rt=25ms	USP-6C	49xq	VD20	9b Tor
CB634	XC6115B634ER	Vdet-IC	3.4V±2%, +Rst PPO, -Rst ODO, Wt=1.6s, Rt=25ms	USP-6C	49xq	VD20	9b Tor
CB635	XC6115B635ER	Vdet-IC	3.5V±2%, +Rst PPO, -Rst ODO, Wt=1.6s, Rt=25ms	USP-6C	49xq	VD20	9b Tor
CB636	XC6115B636ER	Vdet-IC	3.6V±2%, +Rst PPO, -Rst ODO, Wt=1.6s, Rt=25ms	USP-6C	49xq	VD20	9b Tor
CB637	XC6115B637ER	Vdet-IC	3.7V±2%, +Rst PPO, -Rst ODO, Wt=1.6s, Rt=25ms	USP-6C	49xq	VD20	9b Tor
CB638	XC6115B638ER	Vdet-IC	3.8V±2%, +Rst PPO, -Rst ODO, Wt=1.6s, Rt=25ms	USP-6C	49xq	VD20	9b Tor
CB639	XC6115B639ER	Vdet-IC	3.9V±2%, +Rst PPO, -Rst ODO, Wt=1.6s, Rt=25ms	USP-6C	49xq	VD20	9b Tor
CB640	XC6115B640ER	Vdet-IC	4.0V±2%, +Rst PPO, -Rst ODO, Wt=1.6s, Rt=25ms	USP-6C	49xq	VD20	9b Tor
CB641	XC6115B641ER	Vdet-IC	4.1V±2%, +Rst PPO, -Rst ODO, Wt=1.6s, Rt=25ms	USP-6C	49xq	VD20	9b Tor
CB642	XC6115B642ER	Vdet-IC	4.2V±2%, +Rst PPO, -Rst ODO, Wt=1.6s, Rt=25ms	USP-6C	49xq	VD20	9b Tor
CB643	XC6115B643ER	Vdet-IC	4.3V±2%, +Rst PPO, -Rst ODO, Wt=1.6s, Rt=25ms	USP-6C	49xq	VD20	9b Tor
CB644	XC6115B644ER	Vdet-IC	4.4V±2%, +Rst PPO, -Rst ODO, Wt=1.6s, Rt=25ms	USP-6C	49xq	VD20	9b Tor
CB645	XC6115B645ER	Vdet-IC	4.5V±2%, +Rst PPO, -Rst ODO, Wt=1.6s, Rt=25ms	USP-6C	49xq	VD20	9b Tor
CB646	XC6115B646ER	Vdet-IC	4.6V±2%, +Rst PPO, -Rst ODO, Wt=1.6s, Rt=25ms	USP-6C	49xq	VD20	9b Tor
CB647	XC6115B647ER	Vdet-IC	4.7V±2%, +Rst PPO, -Rst ODO, Wt=1.6s, Rt=25ms	USP-6C	49xq	VD20	9b Tor
CB648	XC6115B648ER	Vdet-IC	4.8V±2%, +Rst PPO, -Rst ODO, Wt=1.6s, Rt=25ms	USP-6C	49xq	VD20	9b Tor
CB649	XC6115B649ER	Vdet-IC	4.9V±2%, +Rst PPO, -Rst ODO, Wt=1.6s, Rt=25ms	USP-6C	49xq	VD20	9b Tor
CB650	XC6115B650ER	Vdet-IC	5.0V±2%, +Rst PPO, -Rst ODO, Wt=1.6s, Rt=25ms	USP-6C	49xq	VD20	9b Tor
CB7	XC6213B382GR	LVR-IC	LDO, 3.8V±2%, 150mA, +CE	USP-4	45vm	VR4	9b Tor
CB7	XC9235B17C4R-G	DC-DC-IC	PWM, st-dwn, 1.7V±2%, 600mA, 1.2MHz, Vin>2V, HSST, CL	USP-6EL	56dc5	DC1	9a Tor
CB7	XC9235B17CER	DC-DC-IC	PWM, st-dwn, 1.7V±2%, 600mA, 1.2MHz, Vin>2V, HSST, CL	USP-6C	49dc5	DC1	9a Tor
CB8	XC6213B392GR	LVR-IC	LDO, 3.9V±2%, 150mA, +CE	USP-4	45vm	VR4	9b Tor
CB8	XC9235B18C4R-G	DC-DC-IC	PWM, st-dwn, 1.8V±2%, 600mA, 1.2MHz, Vin>2V, HSST, CL	USP-6EL	56dc5	DC1	9a Tor
CB8	XC9235B18CER	DC-DC-IC	PWM, st-dwn, 1.8V±2%, 600mA, 1.2MHz, Vin>2V, HSST, CL	USP-6C	49dc5	DC1	9a Tor
CB9	XC6213B402GR	LVR-IC	LDO, 4V±2%, 150mA, +CE	USP-4	45vm	VR4	9b Tor
CB9	XC9235B19C4R-G	DC-DC-IC	PWM, st-dwn, 1.9V±2%, 600mA, 1.2MHz, Vin>2V, HSST, CL	USP-6EL	56dc5	DC1	9a Tor
CB9	XC9235B19CER	DC-DC-IC	PWM, st-dwn, 1.9V±2%, 600mA, 1.2MHz, Vin>2V, HSST, CL	USP-6C	49dc5	DC1	9a Tor
CBA	XC6213B412GR	LVR-IC	LDO, 4.1V±2%, 150mA, +CE	USP-4	45vm	VR4	9b Tor
CBA	XC9235B1AC4R-G	DC-DC-IC	PWM, st-dwn, 1.05V±2%, 600mA, 1.2MHz, Vin>2V, HSST, CL	USP-6EL	56dc5	DC1	9a Tor
CBA	XC9235B1ACER	DC-DC-IC	PWM, st-dwn, 1.05V±2%, 600mA, 1.2MHz, Vin>2V, HSST, CL	USP-6C	49dc5	DC1	9a Tor
CBB	XC6213B422GR	LVR-IC	LDO, 4.2V±2%, 150mA, +CE	USP-4	45vm	VR4	9b Tor
CBB	XC9235B1BC4R-G	DC-DC-IC	PWM, st-dwn, 1.15V±2%, 600mA, 1.2MHz, Vin>2V, HSST, CL	USP-6EL	56dc5	DC1	9a Tor
CBB	XC9235B1BCER	DC-DC-IC	PWM, st-dwn, 1.15V±2%, 600mA, 1.2MHz, Vin>2V, HSST, CL	USP-6C	49dc5	DC1	9a Tor
CBBC	XC6213B432GR	LVR-IC	LDO, 4.3V±2%, 150mA, +CE	USP-4	45vm	VR4	9b Tor
CBBC	XC9235B1CC4R-G	DC-DC-IC	PWM, st-dwn, 1.25V±2%, 600mA, 1.2MHz, Vin>2V, HSST, CL	USP-6EL	56dc5	DC1	9a Tor
CBBC	XC9235B1CCER	DC-DC-IC	PWM, st-dwn, 1.25V±2%, 600mA, 1.2MHz, Vin>2V, HSST, CL	USP-6C	49dc5	DC1	9a Tor
CBD	XC6213B442GR	LVR-IC	LDO, 4.4V±2%, 150mA, +CE	USP-4	45vm	VR4	9b Tor
CBD	XC9235B1DC4R-G	DC-DC-IC	PWM, st-dwn, 1.35V±2%, 600mA, 1.2MHz, Vin>2V, HSST, CL	USP-6EL	56dc5	DC1	9a Tor
CBD	XC9235B1DCER	DC-DC-IC	PWM, st-dwn, 1.35V±2%, 600mA, 1.2MHz, Vin>2V, HSST, CL	USP-6C	49dc5	DC1	9a Tor
CBE	XC6213B452GR	LVR-IC	LDO, 4.5V±2%, 150mA, +CE	USP-4	45vm	VR4	9b Tor
CBE	XC9235B1EC4R-G	DC-DC-IC	PWM, st-dwn, 1.45V±2%, 600mA, 1.2MHz, Vin>2V, HSST, CL	USP-6EL	56dc5	DC1	9a Tor
CBE	XC9235B1ECER	DC-DC-IC	PWM, st-dwn, 1.45V±2%, 600mA, 1.2MHz, Vin>2V, HSST, CL	USP-6C	49dc5	DC1	9a Tor
CBF	XC6213B462GR	LVR-IC	LDO, 4.6V±2%, 150mA, +CE	USP-4	45vm	VR4	9b Tor
CBF	XC9235B1FC4R-G	DC-DC-IC	PWM, st-dwn, 1.55V±2%, 600mA, 1.2MHz, Vin>2V, HSST, CL	USP-6EL	56dc5	DC1	9a Tor
CBF	XC9235B1FCER	DC-DC-IC	PWM, st-dwn, 1.55V±2%, 600mA, 1.2MHz, Vin>2V, HSST, CL	USP-6C	49dc5	DC1	9a Tor
CBH	XC6213B472GR	LVR-IC	LDO, 4.7V±2%, 150mA, +CE	USP-4	45vm	VR4	9b Tor
CBH	XC9235B1HC4R-G	DC-DC-IC	PWM, st-dwn, 1.65V±2%, 600mA, 1.2MHz, Vin>2V, HSST, CL	USP-6EL	56dc5	DC1	9a Tor
CBH	XC9235B1HCER	DC-DC-IC	PWM, st-dwn, 1.65V±2%, 600mA, 1.2MHz, Vin>2V, HSST, CL	USP-6C	49dc5	DC1	9a Tor
CBK	XC6213B482GR	LVR-IC	LDO, 4.8V±2%, 150mA, +CE	USP-4	45vm	VR4	9b Tor
CBK	XC9235B1KC4R-G	DC-DC-IC	PWM, st-dwn, 1.75V±2%, 600mA, 1.2MHz, Vin>2V, HSST, CL	USP-6EL	56dc5	DC1	9a Tor
CBK	XC9235B1KCER	DC-DC-IC	PWM, st-dwn, 1.75V±2%, 600mA, 1.2MHz, Vin>2V, HSST, CL	USP-6C	49dc5	DC1	9a Tor
CBL	XC6213B492GR	LVR-IC	LDO, 4.9V±2%, 150mA, +CE	USP-4	45vm	VR4	9b Tor
CBL	XC9235B1LC4R-G	DC-DC-IC	PWM, st-dwn, 1.85V±2%, 600mA, 1.2MHz, Vin>2V, HSST, CL	USP-6EL	56dc5	DC1	9a Tor
CBL	XC9235B1LCER	DC-DC-IC	PWM, st-dwn, 1.85V±2%, 600mA, 1.2MHz, Vin>2V, HSST, CL	USP-6C	49dc5	DC1	9a Tor
CBM	XC6213B502GR	LVR-IC	LDO, 5V±2%, 150mA, +CE	USP-4	45vm	VR4	9b Tor
CBM	XC9235B1MC4R-G	DC-DC-IC	PWM, st-dwn, 1.95V±2%, 600mA, 1.2MHz, Vin>2V, HSST, CL	USP-6EL	56dc5	DC1	9a Tor
CBM	XC9235B1MCER	DC-DC-IC	PWM, st-dwn, 1.95V±2%, 600mA, 1.2MHz, Vin>2V, HSST, CL	USP-6C	49dc5	DC1	9a Tor
CC	BH18RB1WGUT	LVR-IC	LDO, 1.8V, 150mA, +CE	BGA-4	63bg*	VR4	9a Rhm
CC	R313AK12EA	Vdet-IC	1.2V±1.8%, -Reset ODO, -MR	DFM1212-6	52z6	VD4	9a Ric



SMD code	Type	Function	Short description	Case	Pinout	Sch.	St.	Mnf.
COH	XC9235B2HC4R-G	DC-DC-IC	PWM, st-dwn, 2.65V±2%, 600mA, 1.2MHz, Vin>2V, HSST, CL	USP-6EL	56dc5	DC1	9a	Tor
COH	XC9235B2HCER	DC-DC-IC	PWM, st-dwn, 2.65V±2%, 600mA, 1.2MHz, Vin>2V, HSST, CL	USP-6C	49dc5	DC1	9a	Tor
COJ	TPA2016D2YZH	LIN-IC	AF PA, BTL, class-D, 2.5..5.5V, 2x1.7W(5V/4Q), shutdown	BGA-16	39	-	-	Ti
COK	XC9235B2KC4R-G	DC-DC-IC	PWM, st-dwn, 2.75V±2%, 600mA, 1.2MHz, Vin>2V, HSST, CL	USP-6EL	56dc5	DC1	9a	Tor
COK	XC9235B2KCER	DC-DC-IC	PWM, st-dwn, 2.75V±2%, 600mA, 1.2MHz, Vin>2V, HSST, CL	USP-6C	49dc5	DC1	9a	Tor
CCL	XC9235B2LC4R-G	DC-DC-IC	PWM, st-dwn, 2.85V±2%, 600mA, 1.2MHz, Vin>2V, HSST, CL	USP-6EL	56dc5	DC1	9a	Tor
CCL	XC9235B2LCER	DC-DC-IC	PWM, st-dwn, 2.85V±2%, 600mA, 1.2MHz, Vin>2V, HSST, CL	USP-6C	49dc5	DC1	9a	Tor
CCM	XC9235B2MC4R-G	DC-DC-IC	PWM, st-dwn, 2.95V±2%, 600mA, 1.2MHz, Vin>2V, HSST, CL	USP-6EL	56dc5	DC1	9a	Tor
CCM	XC9235B2MCER	DC-DC-IC	PWM, st-dwn, 2.95V±2%, 600mA, 1.2MHz, Vin>2V, HSST, CL	USP-6C	49dc5	DC1	9a	Tor
CD	BH25RB1WGUT	LVR-IC	LDO, 2.5V, 150mA, +CE	BGA-4	63bg*	VR4	9a	Rhm
CD	R3134K13EA	Vdet-IC	1.3V±1.8%, -Reset ODO, -MR	DFM1212-6	52z6	VD4	9a	Ric
CD	RP104K181D	LVR-IC	LDO, 1.8V±0.8%, 150mA, +CE, CL	DFM1010-4	48vm	VR4	9a	Tor
CD	XC6221B14B7R	LVR-IC	LDO, 1.45V±20mV, 200mA, +CE, CL	USPN-4	58vm	VR4	9a	Tor
CD	XC6223E23B9R-G	LVR-IC	LDO, 2.35V±1%, 300mA, +CE, ICP	USPQ-4B03	48vm	VR4	9a	Tor
CD0	XC9235B30C4R-G	DC-DC-IC	PWM, st-dwn, 3.0V±2%, 600mA, 1.2MHz, Vin>2V, HSST, CL	USP-6EL	56dc5	DC1	9a	Tor
CD0	XC9235B30CER	DC-DC-IC	PWM, st-dwn, 3.0V±2%, 600mA, 1.2MHz, Vin>2V, HSST, CL	USP-6C	49dc5	DC1	9a	Tor
CD1	XC9235B31C4R-G	DC-DC-IC	PWM, st-dwn, 3.1V±2%, 600mA, 1.2MHz, Vin>2V, HSST, CL	USP-6EL	56dc5	DC1	9a	Tor
CD1	XC9235B31CER	DC-DC-IC	PWM, st-dwn, 3.1V±2%, 600mA, 1.2MHz, Vin>2V, HSST, CL	USP-6C	49dc5	DC1	9a	Tor
CD2	XC9235B32C4R-G	DC-DC-IC	PWM, st-dwn, 3.2V±2%, 600mA, 1.2MHz, Vin>2V, HSST, CL	USP-6EL	56dc5	DC1	9a	Tor
CD2	XC9235B32CER	DC-DC-IC	PWM, st-dwn, 3.2V±2%, 600mA, 1.2MHz, Vin>2V, HSST, CL	USP-6C	49dc5	DC1	9a	Tor
CD3	XC9235B33C4R-G	DC-DC-IC	PWM, st-dwn, 3.3V±2%, 600mA, 1.2MHz, Vin>2V, HSST, CL	USP-6EL	56dc5	DC1	9a	Tor
CD3	XC9235B33CER	DC-DC-IC	PWM, st-dwn, 3.3V±2%, 600mA, 1.2MHz, Vin>2V, HSST, CL	USP-6C	49dc5	DC1	9a	Tor
CD316	XC6115D316ER	Vdet-IC	1.6V±2%, +Rst PPO, -Rst ODO, Wt=100ms, Rt=100ms	USP-6C	49xq	VD20	9b	Tor
CD317	XC6115D317ER	Vdet-IC	1.7V±2%, +Rst PPO, -Rst ODO, Wt=100ms, Rt=100ms	USP-6C	49xq	VD20	9b	Tor
CD318	XC6115D318ER	Vdet-IC	1.8V±2%, +Rst PPO, -Rst ODO, Wt=100ms, Rt=100ms	USP-6C	49xq	VD20	9b	Tor
CD319	XC6115D319ER	Vdet-IC	1.9V±2%, +Rst PPO, -Rst ODO, Wt=100ms, Rt=100ms	USP-6C	49xq	VD20	9b	Tor
CD320	XC6115D320ER	Vdet-IC	2.0V±2%, +Rst PPO, -Rst ODO, Wt=100ms, Rt=100ms	USP-6C	49xq	VD20	9b	Tor
CD321	XC6115D321ER	Vdet-IC	2.1V±2%, +Rst PPO, -Rst ODO, Wt=100ms, Rt=100ms	USP-6C	49xq	VD20	9b	Tor
CD322	XC6115D322ER	Vdet-IC	2.2V±2%, +Rst PPO, -Rst ODO, Wt=100ms, Rt=100ms	USP-6C	49xq	VD20	9b	Tor
CD323	XC6115D323ER	Vdet-IC	2.3V±2%, +Rst PPO, -Rst ODO, Wt=100ms, Rt=100ms	USP-6C	49xq	VD20	9b	Tor
CD324	XC6115D324ER	Vdet-IC	2.4V±2%, +Rst PPO, -Rst ODO, Wt=100ms, Rt=100ms	USP-6C	49xq	VD20	9b	Tor
CD325	XC6115D325ER	Vdet-IC	2.5V±2%, +Rst PPO, -Rst ODO, Wt=100ms, Rt=100ms	USP-6C	49xq	VD20	9b	Tor
CD326	XC6115D326ER	Vdet-IC	2.6V±2%, +Rst PPO, -Rst ODO, Wt=100ms, Rt=100ms	USP-6C	49xq	VD20	9b	Tor
CD327	XC6115D327ER	Vdet-IC	2.7V±2%, +Rst PPO, -Rst ODO, Wt=100ms, Rt=100ms	USP-6C	49xq	VD20	9b	Tor
CD328	XC6115D328ER	Vdet-IC	2.8V±2%, +Rst PPO, -Rst ODO, Wt=100ms, Rt=100ms	USP-6C	49xq	VD20	9b	Tor
CD329	XC6115D329ER	Vdet-IC	2.9V±2%, +Rst PPO, -Rst ODO, Wt=100ms, Rt=100ms	USP-6C	49xq	VD20	9b	Tor
CD330	XC6115D330ER	Vdet-IC	3.0V±2%, +Rst PPO, -Rst ODO, Wt=100ms, Rt=100ms	USP-6C	49xq	VD20	9b	Tor
CD331	XC6115D331ER	Vdet-IC	3.1V±2%, +Rst PPO, -Rst ODO, Wt=100ms, Rt=100ms	USP-6C	49xq	VD20	9b	Tor
CD332	XC6115D332ER	Vdet-IC	3.2V±2%, +Rst PPO, -Rst ODO, Wt=100ms, Rt=100ms	USP-6C	49xq	VD20	9b	Tor
CD333	XC6115D333ER	Vdet-IC	3.3V±2%, +Rst PPO, -Rst ODO, Wt=100ms, Rt=100ms	USP-6C	49xq	VD20	9b	Tor
CD334	XC6115D334ER	Vdet-IC	3.4V±2%, +Rst PPO, -Rst ODO, Wt=100ms, Rt=100ms	USP-6C	49xq	VD20	9b	Tor
CD335	XC6115D335ER	Vdet-IC	3.5V±2%, +Rst PPO, -Rst ODO, Wt=100ms, Rt=100ms	USP-6C	49xq	VD20	9b	Tor
CD336	XC6115D336ER	Vdet-IC	3.6V±2%, +Rst PPO, -Rst ODO, Wt=100ms, Rt=100ms	USP-6C	49xq	VD20	9b	Tor
CD337	XC6115D337ER	Vdet-IC	3.7V±2%, +Rst PPO, -Rst ODO, Wt=100ms, Rt=100ms	USP-6C	49xq	VD20	9b	Tor
CD338	XC6115D338ER	Vdet-IC	3.8V±2%, +Rst PPO, -Rst ODO, Wt=100ms, Rt=100ms	USP-6C	49xq	VD20	9b	Tor
CD339	XC6115D339ER	Vdet-IC	3.9V±2%, +Rst PPO, -Rst ODO, Wt=100ms, Rt=100ms	USP-6C	49xq	VD20	9b	Tor
CD340	XC6115D340ER	Vdet-IC	4.0V±2%, +Rst PPO, -Rst ODO, Wt=100ms, Rt=100ms	USP-6C	49xq	VD20	9b	Tor
CD341	XC6115D341ER	Vdet-IC	4.1V±2%, +Rst PPO, -Rst ODO, Wt=100ms, Rt=100ms	USP-6C	49xq	VD20	9b	Tor
CD342	XC6115D342ER	Vdet-IC	4.2V±2%, +Rst PPO, -Rst ODO, Wt=100ms, Rt=100ms	USP-6C	49xq	VD20	9b	Tor
CD343	XC6115D343ER	Vdet-IC	4.3V±2%, +Rst PPO, -Rst ODO, Wt=100ms, Rt=100ms	USP-6C	49xq	VD20	9b	Tor
CD344	XC6115D344ER	Vdet-IC	4.4V±2%, +Rst PPO, -Rst ODO, Wt=100ms, Rt=100ms	USP-6C	49xq	VD20	9b	Tor
CD345	XC6115D345ER	Vdet-IC	4.5V±2%, +Rst PPO, -Rst ODO, Wt=100ms, Rt=100ms	USP-6C	49xq	VD20	9b	Tor
CD346	XC6115D346ER	Vdet-IC	4.6V±2%, +Rst PPO, -Rst ODO, Wt=100ms, Rt=100ms	USP-6C	49xq	VD20	9b	Tor
CD347	XC6115D347ER	Vdet-IC	4.7V±2%, +Rst PPO, -Rst ODO, Wt=100ms, Rt=100ms	USP-6C	49xq	VD20	9b	Tor
CD348	XC6115D348ER	Vdet-IC	4.8V±2%, +Rst PPO, -Rst ODO, Wt=100ms, Rt=100ms	USP-6C	49xq	VD20	9b	Tor
CD349	XC6115D349ER	Vdet-IC	4.9V±2%, +Rst PPO, -Rst ODO, Wt=100ms, Rt=100ms	USP-6C	49xq	VD20	9b	Tor
CD350	XC6115D350ER	Vdet-IC	5.0V±2%, +Rst PPO, -Rst ODO, Wt=100ms, Rt=100ms	USP-6C	49xq	VD20	9b	Tor
CD4	XC9235B34C4R-G	DC-DC-IC	PWM, st-dwn, 3.4V±2%, 600mA, 1.2MHz, Vin>2V, HSST, CL	USP-6EL	56dc5	DC1	9a	Tor
CD4	XC9235B34CER	DC-DC-IC	PWM, st-dwn, 3.4V±2%, 600mA, 1.2MHz, Vin>2V, HSST, CL	USP-6C	49dc5	DC1	9a	Tor
CD416	XC6115D416ER	Vdet-IC	1.6V±2%, +Rst PPO, -Rst ODO, Wt=200ms, Rt=100ms	USP-6C	49xq	VD20	9b	Tor
CD417	XC6115D417ER	Vdet-IC	1.7V±2%, +Rst PPO, -Rst ODO, Wt=200ms, Rt=100ms	USP-6C	49xq	VD20	9b	Tor
CD418	XC6115D418ER	Vdet-IC	1.8V±2%, +Rst PPO, -Rst ODO, Wt=200ms, Rt=100ms	USP-6C	49xq	VD20	9b	Tor
CD419	XC6115D419ER	Vdet-IC	1.9V±2%, +Rst PPO, -Rst ODO, Wt=200ms, Rt=100ms	USP-6C	49xq	VD20	9b	Tor
CD420	XC6115D420ER	Vdet-IC	2.0V±2%, +Rst PPO, -Rst ODO, Wt=200ms, Rt=100ms	USP-6C	49xq	VD20	9b	Tor
CD421	XC6115D421ER	Vdet-IC	2.1V±2%, +Rst PPO, -Rst ODO, Wt=200ms, Rt=100ms	USP-6C	49xq	VD20	9b	Tor
CD422	XC6115D422ER	Vdet-IC	2.2V±2%, +Rst PPO, -Rst ODO, Wt=200ms, Rt=100ms	USP-6C	49xq	VD20	9b	Tor
CD423	XC6115D423ER	Vdet-IC	2.3V±2%, +Rst PPO, -Rst ODO, Wt=200ms, Rt=100ms	USP-6C	49xq	VD20	9b	Tor
CD424	XC6115D424ER	Vdet-IC	2.4V±2%, +Rst PPO, -Rst ODO, Wt=200ms, Rt=100ms	USP-6C	49xq	VD20	9b	Tor
CD425	XC6115D425ER	Vdet-IC	2.5V±2%, +Rst PPO, -Rst ODO, Wt=200ms, Rt=100ms	USP-6C	49xq	VD20	9b	Tor
CD426	XC6115D426ER	Vdet-IC	2.6V±2%, +Rst PPO, -Rst ODO, Wt=200ms, Rt=100ms	USP-6C	49xq	VD20	9b	Tor



SMD code	Type	Function	Short description	Case	Pinout	Sch.	St.	Mnf.
CD623	XC6115D623ER	Vdel-IC	2.3V±2%, +Rst PPO, -Rst ODO, Wt=1.6s, Rt=100ms	USP-6C	49xq	VD20	9b	Tor
CD624	XC6115D624ER	Vdel-IC	2.4V±2%, +Rst PPO, -Rst ODO, Wt=1.6s, Rt=100ms	USP-6C	49xq	VD20	9b	Tor
CD625	XC6115D625ER	Vdel-IC	2.5V±2%, +Rst PPO, -Rst ODO, Wt=1.6s, Rt=100ms	USP-6C	49xq	VD20	9b	Tor
CD626	XC6115D626ER	Vdel-IC	2.6V±2%, +Rst PPO, -Rst ODO, Wt=1.6s, Rt=100ms	USP-6C	49xq	VD20	9b	Tor
CD627	XC6115D627ER	Vdel-IC	2.7V±2%, +Rst PPO, -Rst ODO, Wt=1.6s, Rt=100ms	USP-6C	49xq	VD20	9b	Tor
CD628	XC6115D628ER	Vdel-IC	2.8V±2%, +Rst PPO, -Rst ODO, Wt=1.6s, Rt=100ms	USP-6C	49xq	VD20	9b	Tor
CD629	XC6115D629ER	Vdel-IC	2.9V±2%, +Rst PPO, -Rst ODO, Wt=1.6s, Rt=100ms	USP-6C	49xq	VD20	9b	Tor
CD630	XC6115D630ER	Vdel-IC	3.0V±2%, +Rst PPO, -Rst ODO, Wt=1.6s, Rt=100ms	USP-6C	49xq	VD20	9b	Tor
CD631	XC6115D631ER	Vdel-IC	3.1V±2%, +Rst PPO, -Rst ODO, Wt=1.6s, Rt=100ms	USP-6C	49xq	VD20	9b	Tor
CD632	XC6115D632ER	Vdel-IC	3.2V±2%, +Rst PPO, -Rst ODO, Wt=1.6s, Rt=100ms	USP-6C	49xq	VD20	9b	Tor
CD633	XC6115D633ER	Vdel-IC	3.3V±2%, +Rst PPO, -Rst ODO, Wt=1.6s, Rt=100ms	USP-6C	49xq	VD20	9b	Tor
CD634	XC6115D634ER	Vdel-IC	3.4V±2%, +Rst PPO, -Rst ODO, Wt=1.6s, Rt=100ms	USP-6C	49xq	VD20	9b	Tor
CD635	XC6115D635ER	Vdel-IC	3.5V±2%, +Rst PPO, -Rst ODO, Wt=1.6s, Rt=100ms	USP-6C	49xq	VD20	9b	Tor
CD636	XC6115D636ER	Vdel-IC	3.6V±2%, +Rst PPO, -Rst ODO, Wt=1.6s, Rt=100ms	USP-6C	49xq	VD20	9b	Tor
CD637	XC6115D637ER	Vdel-IC	3.7V±2%, +Rst PPO, -Rst ODO, Wt=1.6s, Rt=100ms	USP-6C	49xq	VD20	9b	Tor
CD638	XC6115D638ER	Vdel-IC	3.8V±2%, +Rst PPO, -Rst ODO, Wt=1.6s, Rt=100ms	USP-6C	49xq	VD20	9b	Tor
CD639	XC6115D639ER	Vdel-IC	3.9V±2%, +Rst PPO, -Rst ODO, Wt=1.6s, Rt=100ms	USP-6C	49xq	VD20	9b	Tor
CD640	XC6115D640ER	Vdel-IC	4.0V±2%, +Rst PPO, -Rst ODO, Wt=1.6s, Rt=100ms	USP-6C	49xq	VD20	9b	Tor
CD641	XC6115D641ER	Vdel-IC	4.1V±2%, +Rst PPO, -Rst ODO, Wt=1.6s, Rt=100ms	USP-6C	49xq	VD20	9b	Tor
CD642	XC6115D642ER	Vdel-IC	4.2V±2%, +Rst PPO, -Rst ODO, Wt=1.6s, Rt=100ms	USP-6C	49xq	VD20	9b	Tor
CD643	XC6115D643ER	Vdel-IC	4.3V±2%, +Rst PPO, -Rst ODO, Wt=1.6s, Rt=100ms	USP-6C	49xq	VD20	9b	Tor
CD644	XC6115D644ER	Vdel-IC	4.4V±2%, +Rst PPO, -Rst ODO, Wt=1.6s, Rt=100ms	USP-6C	49xq	VD20	9b	Tor
CD645	XC6115D645ER	Vdel-IC	4.5V±2%, +Rst PPO, -Rst ODO, Wt=1.6s, Rt=100ms	USP-6C	49xq	VD20	9b	Tor
CD646	XC6115D646ER	Vdel-IC	4.6V±2%, +Rst PPO, -Rst ODO, Wt=1.6s, Rt=100ms	USP-6C	49xq	VD20	9b	Tor
CD647	XC6115D647ER	Vdel-IC	4.7V±2%, +Rst PPO, -Rst ODO, Wt=1.6s, Rt=100ms	USP-6C	49xq	VD20	9b	Tor
CD648	XC6115D648ER	Vdel-IC	4.8V±2%, +Rst PPO, -Rst ODO, Wt=1.6s, Rt=100ms	USP-6C	49xq	VD20	9b	Tor
CD649	XC6115D649ER	Vdel-IC	4.9V±2%, +Rst PPO, -Rst ODO, Wt=1.6s, Rt=100ms	USP-6C	49xq	VD20	9b	Tor
CD650	XC6115D650ER	Vdel-IC	5.0V±2%, +Rst PPO, -Rst ODO, Wt=1.6s, Rt=100ms	USP-6C	49xq	VD20	9b	Tor
CD7	XC9235B37C4R-G	DC-DC-IC	PWM, st-dwn, 3.7V±2%, 600mA, 1.2MHz, Vin>2V, HSST, CL	USP-6EL	56dc5	DC1	9a	Tor
CD7	XC9235B37CER	DC-DC-IC	PWM, st-dwn, 3.7V±2%, 600mA, 1.2MHz, Vin>2V, HSST, CL	USP-6C	49dc5	DC1	9a	Tor
CD8	XC9235B38C4R-G	DC-DC-IC	PWM, st-dwn, 3.8V±2%, 600mA, 1.2MHz, Vin>2V, HSST, CL	USP-6EL	56dc5	DC1	9a	Tor
CD8	XC9235B38CER	DC-DC-IC	PWM, st-dwn, 3.8V±2%, 600mA, 1.2MHz, Vin>2V, HSST, CL	USP-6C	49dc5	DC1	9a	Tor
CD9	XC9235B39C4R-G	DC-DC-IC	PWM, st-dwn, 3.9V±2%, 600mA, 1.2MHz, Vin>2V, HSST, CL	USP-6EL	56dc5	DC1	9a	Tor
CD9	XC9235B39CER	DC-DC-IC	PWM, st-dwn, 3.9V±2%, 600mA, 1.2MHz, Vin>2V, HSST, CL	USP-6C	49dc5	DC1	9a	Tor
CDA	XC9235B3AC4R-G	DC-DC-IC	PWM, st-dwn, 3.05V±2%, 600mA, 1.2MHz, Vin>2V, HSST, CL	USP-6EL	56dc5	DC1	9a	Tor
CDA	XC9235B3ACER	DC-DC-IC	PWM, st-dwn, 3.05V±2%, 600mA, 1.2MHz, Vin>2V, HSST, CL	USP-6C	49dc5	DC1	9a	Tor
CDB	XC9235B3BC4R-G	DC-DC-IC	PWM, st-dwn, 3.15V±2%, 600mA, 1.2MHz, Vin>2V, HSST, CL	USP-6EL	56dc5	DC1	9a	Tor
CDB	XC9235B3BCER	DC-DC-IC	PWM, st-dwn, 3.15V±2%, 600mA, 1.2MHz, Vin>2V, HSST, CL	USP-6C	49dc5	DC1	9a	Tor
CDC	XC9235B3CC4R-G	DC-DC-IC	PWM, st-dwn, 3.25V±2%, 600mA, 1.2MHz, Vin>2V, HSST, CL	USP-6EL	56dc5	DC1	9a	Tor
CDC	XC9235B3CCER	DC-DC-IC	PWM, st-dwn, 3.25V±2%, 600mA, 1.2MHz, Vin>2V, HSST, CL	USP-6C	49dc5	DC1	9a	Tor
CDD	XC9235B3DC4R-G	DC-DC-IC	PWM, st-dwn, 3.35V±2%, 600mA, 1.2MHz, Vin>2V, HSST, CL	USP-6EL	56dc5	DC1	9a	Tor
CDD	XC9235B3DCER	DC-DC-IC	PWM, st-dwn, 3.35V±2%, 600mA, 1.2MHz, Vin>2V, HSST, CL	USP-6C	49dc5	DC1	9a	Tor
CDE	XC9235B3EC4R-G	DC-DC-IC	PWM, st-dwn, 3.45V±2%, 600mA, 1.2MHz, Vin>2V, HSST, CL	USP-6EL	56dc5	DC1	9a	Tor
CDE	XC9235B3ECER	DC-DC-IC	PWM, st-dwn, 3.45V±2%, 600mA, 1.2MHz, Vin>2V, HSST, CL	USP-6C	49dc5	DC1	9a	Tor
CDF	XC9235B3FC4R-G	DC-DC-IC	PWM, st-dwn, 3.55V±2%, 600mA, 1.2MHz, Vin>2V, HSST, CL	USP-6EL	56dc5	DC1	9a	Tor
CDF	XC9235B3FCER	DC-DC-IC	PWM, st-dwn, 3.55V±2%, 600mA, 1.2MHz, Vin>2V, HSST, CL	USP-6C	49dc5	DC1	9a	Tor
CDH	XC9235B3HC4R-G	DC-DC-IC	PWM, st-dwn, 3.65V±2%, 600mA, 1.2MHz, Vin>2V, HSST, CL	USP-6EL	56dc5	DC1	9a	Tor
CDH	XC9235B3HCE	DC-DC-IC	PWM, st-dwn, 3.65V±2%, 600mA, 1.2MHz, Vin>2V, HSST, CL	USP-6C	49dc5	DC1	9a	Tor
CDK	XC9235B3KC4R-G	DC-DC-IC	PWM, st-dwn, 3.75V±2%, 600mA, 1.2MHz, Vin>2V, HSST, CL	USP-6EL	56dc5	DC1	9a	Tor
CDK	XC9235B3KCE	DC-DC-IC	PWM, st-dwn, 3.75V±2%, 600mA, 1.2MHz, Vin>2V, HSST, CL	USP-6C	49dc5	DC1	9a	Tor
CDL	XC9235B3LC4R-G	DC-DC-IC	PWM, st-dwn, 3.85V±2%, 600mA, 1.2MHz, Vin>2V, HSST, CL	USP-6EL	56dc5	DC1	9a	Tor
CDL	XC9235B3LCE	DC-DC-IC	PWM, st-dwn, 3.85V±2%, 600mA, 1.2MHz, Vin>2V, HSST, CL	USP-6C	49dc5	DC1	9a	Tor
CDM	XC9235B3MC4R-G	DC-DC-IC	PWM, st-dwn, 3.95V±2%, 600mA, 1.2MHz, Vin>2V, HSST, CL	USP-6EL	56dc5	DC1	9a	Tor
CDM	XC9235B3MCE	DC-DC-IC	PWM, st-dwn, 3.95V±2%, 600mA, 1.2MHz, Vin>2V, HSST, CL	USP-6C	49dc5	DC1	9a	Tor
CE	BH28RB1WGUT	LVR-IC	LDO, 2.8V, 150mA, +CE	BGA-4	63bg*	VR4	9a	Rhm
CE	R3134K14EA	Vdel-IC	1.4V±1.8%, -Reset ODO, -MR	DFN1212-6	52z6	VD4	9a	Ric
CE	RP104K181D5	LVR-IC	LDO, 1.85V±0.8%, 150mA, +CE, CL	DFN1010-4	48vm	VR4	9a	Ric
CE	XC6221B15B7R	LVR-IC	LDO, 1.55V±20mV, 200mA, +CE, CL	USPN-4	58vm	VR4	9a	Tor
CE	XC6223E24B9R-G	LVR-IC	LDO, 2.45V±1%, 300mA, +CE, ICP	USPQ-4B03	48vm	VR4	9a	Tor
CE0	XC9235B40C4R-G	DC-DC-IC	PWM, st-dwn, 4.0V±2%, 600mA, 1.2MHz, Vin>2V, HSST, CL	USP-6EL	56dc5	DC1	9a	Tor
CE0	XC9235B40CER	DC-DC-IC	PWM, st-dwn, 4.0V±2%, 600mA, 1.2MHz, Vin>2V, HSST, CL	USP-6C	49dc5	DC1	9a	Tor
CE416	XC6115E416ER	Vdel-IC	1.6V±2%, +Rst PPO, -Rst ODO, Wt=200ms, Rt=200ms	USP-6C	49xq	VD20	9b	Tor
CE417	XC6115E417ER	Vdel-IC	1.7V±2%, +Rst PPO, -Rst ODO, Wt=200ms, Rt=200ms	USP-6C	49xq	VD20	9b	Tor
CE418	XC6115E418ER	Vdel-IC	1.8V±2%, +Rst PPO, -Rst ODO, Wt=200ms, Rt=200ms	USP-6C	49xq	VD20	9b	Tor
CE419	XC6115E419ER	Vdel-IC	1.9V±2%, +Rst PPO, -Rst ODO, Wt=200ms, Rt=200ms	USP-6C	49xq	VD20	9b	Tor
CE420	XC6115E420ER	Vdel-IC	2.0V±2%, +Rst PPO, -Rst ODO, Wt=200ms, Rt=200ms	USP-6C	49xq	VD20	9b	Tor
CE421	XC6115E421ER	Vdel-IC	2.1V±2%, +Rst PPO, -Rst ODO, Wt=200ms, Rt=200ms	USP-6C	49xq	VD20	9b	Tor
CE422	XC6115E422ER	Vdel-IC	2.2V±2%, +Rst PPO, -Rst ODO, Wt=200ms, Rt=200ms	USP-6C	49xq	VD20	9b	Tor
CE423	XC6115E423ER	Vdel-IC	2.3V±2%, +Rst PPO, -Rst ODO, Wt=200ms, Rt=200ms	USP-6C	49xq	VD20	9b	Tor
CE424	XC6115E424ER	Vdel-IC	2.4V±2%, +Rst PPO, -Rst ODO, Wt=200ms, Rt=200ms	USP-6C	49xq	VD20	9b	Tor



SMD code	Type	Function	Short description	Case	Pinout	Sch.	St.Mnf.
CE625	XC6115E625ER	Vdet-IC	2.5V±2%, +Rst PPO, -Rst ODO, Wt=1.6s, Rt=200ms	USP-6C	49xq	VD20	9b Tor
CE626	XC6115E626ER	Vdet-IC	2.6V±2%, +Rst PPO, -Rst ODO, Wt=1.6s, Rt=200ms	USP-6C	49xq	VD20	9b Tor
CE627	XC6115E627ER	Vdet-IC	2.7V±2%, +Rst PPO, -Rst ODO, Wt=1.6s, Rt=200ms	USP-6C	49xq	VD20	9b Tor
CE628	XC6115E628ER	Vdet-IC	2.8V±2%, +Rst PPO, -Rst ODO, Wt=1.6s, Rt=200ms	USP-6C	49xq	VD20	9b Tor
CE629	XC6115E629ER	Vdet-IC	2.9V±2%, +Rst PPO, -Rst ODO, Wt=1.6s, Rt=200ms	USP-6C	49xq	VD20	9b Tor
CE630	XC6115E630ER	Vdet-IC	3.0V±2%, +Rst PPO, -Rst ODO, Wt=1.6s, Rt=200ms	USP-6C	49xq	VD20	9b Tor
CE631	XC6115E631ER	Vdet-IC	3.1V±2%, +Rst PPO, -Rst ODO, Wt=1.6s, Rt=200ms	USP-6C	49xq	VD20	9b Tor
CE632	XC6115E632ER	Vdet-IC	3.2V±2%, +Rst PPO, -Rst ODO, Wt=1.6s, Rt=200ms	USP-6C	49xq	VD20	9b Tor
CE633	XC6115E633ER	Vdet-IC	3.3V±2%, +Rst PPO, -Rst ODO, Wt=1.6s, Rt=200ms	USP-6C	49xq	VD20	9b Tor
CE634	XC6115E634ER	Vdet-IC	3.4V±2%, +Rst PPO, -Rst ODO, Wt=1.6s, Rt=200ms	USP-6C	49xq	VD20	9b Tor
CE635	XC6115E635ER	Vdet-IC	3.5V±2%, +Rst PPO, -Rst ODO, Wt=1.6s, Rt=200ms	USP-6C	49xq	VD20	9b Tor
CE636	XC6115E636ER	Vdet-IC	3.6V±2%, +Rst PPO, -Rst ODO, Wt=1.6s, Rt=200ms	USP-6C	49xq	VD20	9b Tor
CE637	XC6115E637ER	Vdet-IC	3.7V±2%, +Rst PPO, -Rst ODO, Wt=1.6s, Rt=200ms	USP-6C	49xq	VD20	9b Tor
CE638	XC6115E638ER	Vdet-IC	3.8V±2%, +Rst PPO, -Rst ODO, Wt=1.6s, Rt=200ms	USP-6C	49xq	VD20	9b Tor
CE639	XC6115E639ER	Vdet-IC	3.9V±2%, +Rst PPO, -Rst ODO, Wt=1.6s, Rt=200ms	USP-6C	49xq	VD20	9b Tor
CE640	XC6115E640ER	Vdet-IC	4.0V±2%, +Rst PPO, -Rst ODO, Wt=1.6s, Rt=200ms	USP-6C	49xq	VD20	9b Tor
CE641	XC6115E641ER	Vdet-IC	4.1V±2%, +Rst PPO, -Rst ODO, Wt=1.6s, Rt=200ms	USP-6C	49xq	VD20	9b Tor
CE642	XC6115E642ER	Vdet-IC	4.2V±2%, +Rst PPO, -Rst ODO, Wt=1.6s, Rt=200ms	USP-6C	49xq	VD20	9b Tor
CE643	XC6115E643ER	Vdet-IC	4.3V±2%, +Rst PPO, -Rst ODO, Wt=1.6s, Rt=200ms	USP-6C	49xq	VD20	9b Tor
CE644	XC6115E644ER	Vdet-IC	4.4V±2%, +Rst PPO, -Rst ODO, Wt=1.6s, Rt=200ms	USP-6C	49xq	VD20	9b Tor
CE645	XC6115E645ER	Vdet-IC	4.5V±2%, +Rst PPO, -Rst ODO, Wt=1.6s, Rt=200ms	USP-6C	49xq	VD20	9b Tor
CE646	XC6115E646ER	Vdet-IC	4.6V±2%, +Rst PPO, -Rst ODO, Wt=1.6s, Rt=200ms	USP-6C	49xq	VD20	9b Tor
CE647	XC6115E647ER	Vdet-IC	4.7V±2%, +Rst PPO, -Rst ODO, Wt=1.6s, Rt=200ms	USP-6C	49xq	VD20	9b Tor
CE648	XC6115E648ER	Vdet-IC	4.8V±2%, +Rst PPO, -Rst ODO, Wt=1.6s, Rt=200ms	USP-6C	49xq	VD20	9b Tor
CE649	XC6115E649ER	Vdet-IC	4.9V±2%, +Rst PPO, -Rst ODO, Wt=1.6s, Rt=200ms	USP-6C	49xq	VD20	9b Tor
CE650	XC6115E650ER	Vdet-IC	5.0V±2%, +Rst PPO, -Rst ODO, Wt=1.6s, Rt=200ms	USP-6C	49xq	VD20	9b Tor
CEH	TPA2100P1YZH	LIN-IC	AF PA, BTL, class-D, 19Vp-p, piezo speaker, shutdown	BGA-16	39	-	Ti
CEI	TPA2031D1YZF	LIN-IC	AF PA, BTL, class-D, 2.5..5.5V, 2.5W(5V/4Ω), shutdown	BGA-9	39	AFP45	-
CF	BH29RB1WGUT	LVR-IC	LDO, 2.9V, 150mA, +CE	BGA-4	63b*	VR4	9a Rhm
CF	R3134K15EA	Vdet-IC	1.5V±1.8%, -Reset ODO, -MR	DFN1212-6	52z6	VD4	9a Ric
CF	RP104K191D	LVR-IC	LDO, 1.9V±0.8%, 150mA, +CE, CL	DFN1010-4	48vm	VR4	9a Ric
CF	XC6221B16B7R	LVR-IC	LDO, 1.65V±20mV, 200mA, +CE, CL	USPN-4	58vm	VR4	9a Tor
CF	XC6223E25B9R-G	LVR-IC	LDO, 2.55V±1%, 300mA, +CE, ICP	USPQ-4B03	48vm	VR4	9a Tor
CF516	XC6115F516ER	Vdet-IC	1.6V±2%, +Rst PPO, -Rst ODO, Wt=400ms, Rt=400ms	USP-6C	49xq	VD20	9b Tor
CF517	XC6115F517ER	Vdet-IC	1.7V±2%, +Rst PPO, -Rst ODO, Wt=400ms, Rt=400ms	USP-6C	49xq	VD20	9b Tor
CF518	XC6115F518ER	Vdet-IC	1.8V±2%, +Rst PPO, -Rst ODO, Wt=400ms, Rt=400ms	USP-6C	49xq	VD20	9b Tor
CF519	XC6115F519ER	Vdet-IC	1.9V±2%, +Rst PPO, -Rst ODO, Wt=400ms, Rt=400ms	USP-6C	49xq	VD20	9b Tor
CF520	XC6115F520ER	Vdet-IC	2.0V±2%, +Rst PPO, -Rst ODO, Wt=400ms, Rt=400ms	USP-6C	49xq	VD20	9b Tor
CF521	XC6115F521ER	Vdet-IC	2.1V±2%, +Rst PPO, -Rst ODO, Wt=400ms, Rt=400ms	USP-6C	49xq	VD20	9b Tor
CF522	XC6115F522ER	Vdet-IC	2.2V±2%, +Rst PPO, -Rst ODO, Wt=400ms, Rt=400ms	USP-6C	49xq	VD20	9b Tor
CF523	XC6115F523ER	Vdet-IC	2.3V±2%, +Rst PPO, -Rst ODO, Wt=400ms, Rt=400ms	USP-6C	49xq	VD20	9b Tor
CF524	XC6115F524ER	Vdet-IC	2.4V±2%, +Rst PPO, -Rst ODO, Wt=400ms, Rt=400ms	USP-6C	49xq	VD20	9b Tor
CF525	XC6115F525ER	Vdet-IC	2.5V±2%, +Rst PPO, -Rst ODO, Wt=400ms, Rt=400ms	USP-6C	49xq	VD20	9b Tor
CF526	XC6115F526ER	Vdet-IC	2.6V±2%, +Rst PPO, -Rst ODO, Wt=400ms, Rt=400ms	USP-6C	49xq	VD20	9b Tor
CF527	XC6115F527ER	Vdet-IC	2.7V±2%, +Rst PPO, -Rst ODO, Wt=400ms, Rt=400ms	USP-6C	49xq	VD20	9b Tor
CF528	XC6115F528ER	Vdet-IC	2.8V±2%, +Rst PPO, -Rst ODO, Wt=400ms, Rt=400ms	USP-6C	49xq	VD20	9b Tor
CF529	XC6115F529ER	Vdet-IC	2.9V±2%, +Rst PPO, -Rst ODO, Wt=400ms, Rt=400ms	USP-6C	49xq	VD20	9b Tor
CF530	XC6115F530ER	Vdet-IC	3.0V±2%, +Rst PPO, -Rst ODO, Wt=400ms, Rt=400ms	USP-6C	49xq	VD20	9b Tor
CF531	XC6115F531ER	Vdet-IC	3.1V±2%, +Rst PPO, -Rst ODO, Wt=400ms, Rt=400ms	USP-6C	49xq	VD20	9b Tor
CF532	XC6115F532ER	Vdet-IC	3.2V±2%, +Rst PPO, -Rst ODO, Wt=400ms, Rt=400ms	USP-6C	49xq	VD20	9b Tor
CF533	XC6115F533ER	Vdet-IC	3.3V±2%, +Rst PPO, -Rst ODO, Wt=400ms, Rt=400ms	USP-6C	49xq	VD20	9b Tor
CF534	XC6115F534ER	Vdet-IC	3.4V±2%, +Rst PPO, -Rst ODO, Wt=400ms, Rt=400ms	USP-6C	49xq	VD20	9b Tor
CF535	XC6115F535ER	Vdet-IC	3.5V±2%, +Rst PPO, -Rst ODO, Wt=400ms, Rt=400ms	USP-6C	49xq	VD20	9b Tor
CF536	XC6115F536ER	Vdet-IC	3.6V±2%, +Rst PPO, -Rst ODO, Wt=400ms, Rt=400ms	USP-6C	49xq	VD20	9b Tor
CF537	XC6115F537ER	Vdet-IC	3.7V±2%, +Rst PPO, -Rst ODO, Wt=400ms, Rt=400ms	USP-6C	49xq	VD20	9b Tor
CF538	XC6115F538ER	Vdet-IC	3.8V±2%, +Rst PPO, -Rst ODO, Wt=400ms, Rt=400ms	USP-6C	49xq	VD20	9b Tor
CF539	XC6115F539ER	Vdet-IC	3.9V±2%, +Rst PPO, -Rst ODO, Wt=400ms, Rt=400ms	USP-6C	49xq	VD20	9b Tor
CF540	XC6115F540ER	Vdet-IC	4.0V±2%, +Rst PPO, -Rst ODO, Wt=400ms, Rt=400ms	USP-6C	49xq	VD20	9b Tor
CF541	XC6115F541ER	Vdet-IC	4.1V±2%, +Rst PPO, -Rst ODO, Wt=400ms, Rt=400ms	USP-6C	49xq	VD20	9b Tor
CF542	XC6115F542ER	Vdet-IC	4.2V±2%, +Rst PPO, -Rst ODO, Wt=400ms, Rt=400ms	USP-6C	49xq	VD20	9b Tor
CF543	XC6115F543ER	Vdet-IC	4.3V±2%, +Rst PPO, -Rst ODO, Wt=400ms, Rt=400ms	USP-6C	49xq	VD20	9b Tor
CF544	XC6115F544ER	Vdet-IC	4.4V±2%, +Rst PPO, -Rst ODO, Wt=400ms, Rt=400ms	USP-6C	49xq	VD20	9b Tor
CF545	XC6115F545ER	Vdet-IC	4.5V±2%, +Rst PPO, -Rst ODO, Wt=400ms, Rt=400ms	USP-6C	49xq	VD20	9b Tor
CF546	XC6115F546ER	Vdet-IC	4.6V±2%, +Rst PPO, -Rst ODO, Wt=400ms, Rt=400ms	USP-6C	49xq	VD20	9b Tor
CF547	XC6115F547ER	Vdet-IC	4.7V±2%, +Rst PPO, -Rst ODO, Wt=400ms, Rt=400ms	USP-6C	49xq	VD20	9b Tor
CF548	XC6115F548ER	Vdet-IC	4.8V±2%, +Rst PPO, -Rst ODO, Wt=400ms, Rt=400ms	USP-6C	49xq	VD20	9b Tor
CF549	XC6115F549ER	Vdet-IC	4.9V±2%, +Rst PPO, -Rst ODO, Wt=400ms, Rt=400ms	USP-6C	49xq	VD20	9b Tor
CF550	XC6115F550ER	Vdet-IC	5.0V±2%, +Rst PPO, -Rst ODO, Wt=400ms, Rt=400ms	USP-6C	49xq	VD20	9b Tor
CF616	XC6115F616ER	Vdet-IC	1.6V±2%, +Rst PPO, -Rst ODO, Wt=1.6s, Rt=400ms	USP-6C	49xq	VD20	9b Tor
CF617	XC6115F617ER	Vdet-IC	1.7V±2%, +Rst PPO, -Rst ODO, Wt=1.6s, Rt=400ms	USP-6C	49xq	VD20	9b Tor



SMD code	Type	Function	Short description	Case	Pinout	Sch.	St.Mnf.
CH	XC6221B17B7R	LVR-IC	LDO, 1.75V±20mV, 200mA, +CE, CL	USPN-4	58vm	VR4	9a Tor
CH	XC6223E26B9R-G	LVR-IC	LDO, 2.65V±1%, 300mA, +CE, ICP	USPQ-4B03	48vm	VR4	9a Tor
CH0	XC9235B10D4R-G	DC-DC-IC	PWM, st-dwn, 1.0V±2%, 600mA, 3MHz, Vin>2V, HSST, CL	USP-6EL	56dc5	DC1	9a Tor
CH0	XC9235B10DER	DC-DC-IC	PWM, st-dwn, 1.0V±2%, 600mA, 3MHz, Vin>2V, HSST, CL	USP-6C	49dc5	DC1	9a Tor
CH0	XCL205B104AR-G	DC/DC-IC	PWM st-dwn, 3MHz, 1.0V±2%, 600mA, -CE, auto discharge	CL-2025	67dc7	DC9	9a Tor
CH1	XC9235B11D4R-G	DC-DC-IC	PWM, st-dwn, 1.1V±2%, 600mA, 3MHz, Vin>2V, HSST, CL	USP-6EL	56dc5	DC1	9a Tor
CH1	XC9235B11DER	DC-DC-IC	PWM, st-dwn, 1.1V±2%, 600mA, 3MHz, Vin>2V, HSST, CL	USP-6C	49dc5	DC1	9a Tor
CH1	XCL205B114AR-G	DC/DC-IC	PWM st-dwn, 3MHz, 1.1V±2%, 600mA, -CE, auto discharge	CL-2025	67dc7	DC9	9a Tor
CH2	XC9235B12D4R-G	DC-DC-IC	PWM, st-dwn, 1.2V±2%, 600mA, 3MHz, Vin>2V, HSST, CL	USP-6EL	56dc5	DC1	9a Tor
CH2	XC9235B12DER	DC-DC-IC	PWM, st-dwn, 1.2V±2%, 600mA, 3MHz, Vin>2V, HSST, CL	USP-6C	49dc5	DC1	9a Tor
CH2	XCL205B124AR-G	DC/DC-IC	PWM st-dwn, 3MHz, 1.2V±2%, 600mA, -CE, auto discharge	CL-2025	67dc7	DC9	9a Tor
CH3	XC9235B13D4R-G	DC-DC-IC	PWM, st-dwn, 1.3V±2%, 600mA, 3MHz, Vin>2V, HSST, CL	USP-6EL	56dc5	DC1	9a Tor
CH3	XC9235B13DER	DC-DC-IC	PWM, st-dwn, 1.3V±2%, 600mA, 3MHz, Vin>2V, HSST, CL	USP-6C	49dc5	DC1	9a Tor
CH3	XCL205B134AR-G	DC/DC-IC	PWM st-dwn, 3MHz, 1.3V±2%, 600mA, -CE, auto discharge	CL-2025	67dc7	DC9	9a Tor
CH4	XC9235B14D4R-G	DC-DC-IC	PWM, st-dwn, 1.4V±2%, 600mA, 3MHz, Vin>2V, HSST, CL	USP-6EL	56dc5	DC1	9a Tor
CH4	XC9235B14DER	DC-DC-IC	PWM, st-dwn, 1.4V±2%, 600mA, 3MHz, Vin>2V, HSST, CL	USP-6C	49dc5	DC1	9a Tor
CH4	XCL205B144AR-G	DC/DC-IC	PWM st-dwn, 3MHz, 1.4V±2%, 600mA, -CE, auto discharge	CL-2025	67dc7	DC9	9a Tor
CH5	XC9235B15D4R-G	DC-DC-IC	PWM, st-dwn, 1.5V±2%, 600mA, 3MHz, Vin>2V, HSST, CL	USP-6EL	56dc5	DC1	9a Tor
CH5	XC9235B15DER	DC-DC-IC	PWM, st-dwn, 1.5V±2%, 600mA, 3MHz, Vin>2V, HSST, CL	USP-6C	49dc5	DC1	9a Tor
CH5	XCL205B154AR-G	DC/DC-IC	PWM st-dwn, 3MHz, 1.5V±2%, 600mA, -CE, auto discharge	CL-2025	67dc7	DC9	9a Tor
CH6	XC9235B16D4R-G	DC-DC-IC	PWM, st-dwn, 1.6V±2%, 600mA, 3MHz, Vin>2V, HSST, CL	USP-6EL	56dc5	DC1	9a Tor
CH6	XC9235B16DER	DC-DC-IC	PWM, st-dwn, 1.6V±2%, 600mA, 3MHz, Vin>2V, HSST, CL	USP-6C	49dc5	DC1	9a Tor
CH6	XCL205B164AR-G	DC/DC-IC	PWM st-dwn, 3MHz, 1.6V±2%, 600mA, -CE, auto discharge	CL-2025	67dc7	DC9	9a Tor
CH616	XC6115H616ER	Vdel-IC	1.6V±2%, +Rst PPO, -Rst ODO, Wt=1.6s, Rt=1.6s	USP-6C	49xq	VD20	9b Tor
CH617	XC6115H617ER	Vdel-IC	1.7V±2%, +Rst PPO, -Rst ODO, Wt=1.6s, Rt=1.6s	USP-6C	49xq	VD20	9b Tor
CH618	XC6115H618ER	Vdel-IC	1.8V±2%, +Rst PPO, -Rst ODO, Wt=1.6s, Rt=1.6s	USP-6C	49xq	VD20	9b Tor
CH619	XC6115H619ER	Vdel-IC	1.9V±2%, +Rst PPO, -Rst ODO, Wt=1.6s, Rt=1.6s	USP-6C	49xq	VD20	9b Tor
CH620	XC6115H620ER	Vdel-IC	2.0V±2%, +Rst PPO, -Rst ODO, Wt=1.6s, Rt=1.6s	USP-6C	49xq	VD20	9b Tor
CH621	XC6115H621ER	Vdel-IC	2.1V±2%, +Rst PPO, -Rst ODO, Wt=1.6s, Rt=1.6s	USP-6C	49xq	VD20	9b Tor
CH622	XC6115H622ER	Vdel-IC	2.2V±2%, +Rst PPO, -Rst ODO, Wt=1.6s, Rt=1.6s	USP-6C	49xq	VD20	9b Tor
CH623	XC6115H623ER	Vdel-IC	2.3V±2%, +Rst PPO, -Rst ODO, Wt=1.6s, Rt=1.6s	USP-6C	49xq	VD20	9b Tor
CH624	XC6115H624ER	Vdel-IC	2.4V±2%, +Rst PPO, -Rst ODO, Wt=1.6s, Rt=1.6s	USP-6C	49xq	VD20	9b Tor
CH625	XC6115H625ER	Vdel-IC	2.5V±2%, +Rst PPO, -Rst ODO, Wt=1.6s, Rt=1.6s	USP-6C	49xq	VD20	9b Tor
CH626	XC6115H626ER	Vdel-IC	2.6V±2%, +Rst PPO, -Rst ODO, Wt=1.6s, Rt=1.6s	USP-6C	49xq	VD20	9b Tor
CH627	XC6115H627ER	Vdel-IC	2.7V±2%, +Rst PPO, -Rst ODO, Wt=1.6s, Rt=1.6s	USP-6C	49xq	VD20	9b Tor
CH628	XC6115H628ER	Vdel-IC	2.8V±2%, +Rst PPO, -Rst ODO, Wt=1.6s, Rt=1.6s	USP-6C	49xq	VD20	9b Tor
CH629	XC6115H629ER	Vdel-IC	2.9V±2%, +Rst PPO, -Rst ODO, Wt=1.6s, Rt=1.6s	USP-6C	49xq	VD20	9b Tor
CH630	XC6115H630ER	Vdel-IC	3.0V±2%, +Rst PPO, -Rst ODO, Wt=1.6s, Rt=1.6s	USP-6C	49xq	VD20	9b Tor
CH631	XC6115H631ER	Vdel-IC	3.1V±2%, +Rst PPO, -Rst ODO, Wt=1.6s, Rt=1.6s	USP-6C	49xq	VD20	9b Tor
CH632	XC6115H632ER	Vdel-IC	3.2V±2%, +Rst PPO, -Rst ODO, Wt=1.6s, Rt=1.6s	USP-6C	49xq	VD20	9b Tor
CH633	XC6115H633ER	Vdel-IC	3.3V±2%, +Rst PPO, -Rst ODO, Wt=1.6s, Rt=1.6s	USP-6C	49xq	VD20	9b Tor
CH634	XC6115H634ER	Vdel-IC	3.4V±2%, +Rst PPO, -Rst ODO, Wt=1.6s, Rt=1.6s	USP-6C	49xq	VD20	9b Tor
CH635	XC6115H635ER	Vdel-IC	3.5V±2%, +Rst PPO, -Rst ODO, Wt=1.6s, Rt=1.6s	USP-6C	49xq	VD20	9b Tor
CH636	XC6115H636ER	Vdel-IC	3.6V±2%, +Rst PPO, -Rst ODO, Wt=1.6s, Rt=1.6s	USP-6C	49xq	VD20	9b Tor
CH637	XC6115H637ER	Vdel-IC	3.7V±2%, +Rst PPO, -Rst ODO, Wt=1.6s, Rt=1.6s	USP-6C	49xq	VD20	9b Tor
CH638	XC6115H638ER	Vdel-IC	3.8V±2%, +Rst PPO, -Rst ODO, Wt=1.6s, Rt=1.6s	USP-6C	49xq	VD20	9b Tor
CH639	XC6115H639ER	Vdel-IC	3.9V±2%, +Rst PPO, -Rst ODO, Wt=1.6s, Rt=1.6s	USP-6C	49xq	VD20	9b Tor
CH640	XC6115H640ER	Vdel-IC	4.0V±2%, +Rst PPO, -Rst ODO, Wt=1.6s, Rt=1.6s	USP-6C	49xq	VD20	9b Tor
CH641	XC6115H641ER	Vdel-IC	4.1V±2%, +Rst PPO, -Rst ODO, Wt=1.6s, Rt=1.6s	USP-6C	49xq	VD20	9b Tor
CH642	XC6115H642ER	Vdel-IC	4.2V±2%, +Rst PPO, -Rst ODO, Wt=1.6s, Rt=1.6s	USP-6C	49xq	VD20	9b Tor
CH643	XC6115H643ER	Vdel-IC	4.3V±2%, +Rst PPO, -Rst ODO, Wt=1.6s, Rt=1.6s	USP-6C	49xq	VD20	9b Tor
CH644	XC6115H644ER	Vdel-IC	4.4V±2%, +Rst PPO, -Rst ODO, Wt=1.6s, Rt=1.6s	USP-6C	49xq	VD20	9b Tor
CH645	XC6115H645ER	Vdel-IC	4.5V±2%, +Rst PPO, -Rst ODO, Wt=1.6s, Rt=1.6s	USP-6C	49xq	VD20	9b Tor
CH646	XC6115H646ER	Vdel-IC	4.6V±2%, +Rst PPO, -Rst ODO, Wt=1.6s, Rt=1.6s	USP-6C	49xq	VD20	9b Tor
CH647	XC6115H647ER	Vdel-IC	4.7V±2%, +Rst PPO, -Rst ODO, Wt=1.6s, Rt=1.6s	USP-6C	49xq	VD20	9b Tor
CH648	XC6115H648ER	Vdel-IC	4.8V±2%, +Rst PPO, -Rst ODO, Wt=1.6s, Rt=1.6s	USP-6C	49xq	VD20	9b Tor
CH649	XC6115H649ER	Vdel-IC	4.9V±2%, +Rst PPO, -Rst ODO, Wt=1.6s, Rt=1.6s	USP-6C	49xq	VD20	9b Tor
CH650	XC6115H650ER	Vdel-IC	5.0V±2%, +Rst PPO, -Rst ODO, Wt=1.6s, Rt=1.6s	USP-6C	49xq	VD20	9b Tor
CH7	XC9235B17D4R-G	DC-DC-IC	PWM, st-dwn, 1.7V±2%, 600mA, 3MHz, Vin>2V, HSST, CL	USP-6EL	56dc5	DC1	9a Tor
CH7	XC9235B17DER	DC-DC-IC	PWM, st-dwn, 1.7V±2%, 600mA, 3MHz, Vin>2V, HSST, CL	USP-6C	49dc5	DC1	9a Tor
CH7	XCL205B174AR-G	DC/DC-IC	PWM st-dwn, 3MHz, 1.7V±2%, 600mA, -CE, auto discharge	CL-2025	67dc7	DC9	9a Tor
CH8	XC9235B18D4R-G	DC-DC-IC	PWM, st-dwn, 1.8V±2%, 600mA, 3MHz, Vin>2V, HSST, CL	USP-6EL	56dc5	DC1	9a Tor
CH8	XC9235B18DER	DC-DC-IC	PWM, st-dwn, 1.8V±2%, 600mA, 3MHz, Vin>2V, HSST, CL	USP-6C	49dc5	DC1	9a Tor
CH8	XCL205B184AR-G	DC/DC-IC	PWM st-dwn, 3MHz, 1.8V±2%, 600mA, -CE, auto discharge	CL-2025	67dc7	DC9	9a Tor
CH9	XC9235B19D4R-G	DC-DC-IC	PWM, st-dwn, 1.9V±2%, 600mA, 3MHz, Vin>2V, HSST, CL	USP-6EL	56dc5	DC1	9a Tor
CH9	XC9235B19DER	DC-DC-IC	PWM, st-dwn, 1.9V±2%, 600mA, 3MHz, Vin>2V, HSST, CL	USP-6C	49dc5	DC1	9a Tor
CH9	XCL205B194AR-G	DC/DC-IC	PWM st-dwn, 3MHz, 1.9V±2%, 600mA, -CE, auto discharge	CL-2025	67dc7	DC9	9a Tor
CHA	XC9235B1AD4R-G	DC-DC-IC	PWM, st-dwn, 1.05V±2%, 600mA, 3MHz, Vin>2V, HSST, CL	USP-6EL	56dc5	DC1	9a Tor
CHA	XC9235B1ADER	DC-DC-IC	PWM, st-dwn, 1.05V±2%, 600mA, 3MHz, Vin>2V, HSST, CL	USP-6C	49dc5	DC1	9a Tor
CHB	XC9235B1BD4R-G	DC-DC-IC	PWM, st-dwn, 1.15V±2%, 600mA, 3MHz, Vin>2V, HSST, CL	USP-6EL	56dc5	DC1	9a Tor



SMD code	Type	Function	Short description	Case	Pinout	Sch.	St.	Mnf.
CHB	XC9235B1BDER	DC-DC-IC	PWM, st-dwn, 1.15V±2%, 600mA, 3MHz, Vin>2V, HSST, CL	USP-6C	49dc5	DC1	9a	Tor
CHC	XC9235B1CD4R-G	DC-DC-IC	PWM, st-dwn, 1.25V±2%, 600mA, 3MHz, Vin>2V, HSST, CL	USP-6EL	56dc5	DC1	9a	Tor
CHC	XC9235B1CDER	DC-DC-IC	PWM, st-dwn, 1.25V±2%, 600mA, 3MHz, Vin>2V, HSST, CL	USP-6C	49dc5	DC1	9a	Tor
CHD	XC9235B1DD4R-G	DC-DC-IC	PWM, st-dwn, 1.35V±2%, 600mA, 3MHz, Vin>2V, HSST, CL	USP-6EL	56dc5	DC1	9a	Tor
CHD	XC9235B1DDER	DC-DC-IC	PWM, st-dwn, 1.35V±2%, 600mA, 3MHz, Vin>2V, HSST, CL	USP-6C	49dc5	DC1	9a	Tor
CHE	XC9235B1ED4R-G	DC-DC-IC	PWM, st-dwn, 1.45V±2%, 600mA, 3MHz, Vin>2V, HSST, CL	USP-6EL	56dc5	DC1	9a	Tor
CHE	XC9235B1EDER	DC-DC-IC	PWM, st-dwn, 1.45V±2%, 600mA, 3MHz, Vin>2V, HSST, CL	USP-6C	49dc5	DC1	9a	Tor
CHF	XC9235B1FD4R-G	DC-DC-IC	PWM, st-dwn, 1.55V±2%, 600mA, 3MHz, Vin>2V, HSST, CL	USP-6EL	56dc5	DC1	9a	Tor
CHF	XC9235B1FDER	DC-DC-IC	PWM, st-dwn, 1.55V±2%, 600mA, 3MHz, Vin>2V, HSST, CL	USP-6C	49dc5	DC1	9a	Tor
CHH	XC9235B1HD4R-G	DC-DC-IC	PWM, st-dwn, 1.65V±2%, 600mA, 3MHz, Vin>2V, HSST, CL	USP-6EL	56dc5	DC1	9a	Tor
CHH	XC9235B1HDER	DC-DC-IC	PWM, st-dwn, 1.65V±2%, 600mA, 3MHz, Vin>2V, HSST, CL	USP-6C	49dc5	DC1	9a	Tor
CHK	XC9235B1KD4R-G	DC-DC-IC	PWM, st-dwn, 1.75V±2%, 600mA, 3MHz, Vin>2V, HSST, CL	USP-6EL	56dc5	DC1	9a	Tor
CHK	XC9235B1KDER	DC-DC-IC	PWM, st-dwn, 1.75V±2%, 600mA, 3MHz, Vin>2V, HSST, CL	USP-6C	49dc5	DC1	9a	Tor
CHL	XC9235B1LD4R-G	DC-DC-IC	PWM, st-dwn, 1.85V±2%, 600mA, 3MHz, Vin>2V, HSST, CL	USP-6EL	56dc5	DC1	9a	Tor
CHL	XC9235B1LDER	DC-DC-IC	PWM, st-dwn, 1.85V±2%, 600mA, 3MHz, Vin>2V, HSST, CL	USP-6C	49dc5	DC1	9a	Tor
CHM	XC9235B1MD4R-G	DC-DC-IC	PWM, st-dwn, 1.95V±2%, 600mA, 3MHz, Vin>2V, HSST, CL	USP-6EL	56dc5	DC1	9a	Tor
CHM	XC9235B1MDER	DC-DC-IC	PWM, st-dwn, 1.95V±2%, 600mA, 3MHz, Vin>2V, HSST, CL	USP-6C	49dc5	DC1	9a	Tor
CJ	BH33RB1WGUT	LVR-IC	LDO, 3.3V, 150mA, +CE	BGA-4	63bg*	VR4	9a	Rhm
CJ	R3134K18EA	Vdef-IC	1.8V±1.8%, -Reset ODO, -MR	DFN1212-6	52z6	VD4	9a	Ric
CJ	RP104K261D	LVR-IC	LDO, 2.6V±0.8%, 150mA, +CE, CL	DFN1010-4	48ym	VR4	9a	Ric
CK	R3134K19EA	Vdef-IC	1.9V±1.8%, -Reset ODO, -MR	DFN1212-6	52z6	VD4	9a	Ric
CK	RP104K271D	LVR-IC	LDO, 2.7V±0.8%, 150mA, +CE, CL	DFN1010-4	48ym	VR4	9a	Ric
CK	RT9193-2HPQV	LVR-IC	LDO, 2.85V±1%, 300mA, +CE	WDFN-6L	49ub	VR7	9a	Ret
CK	XG6221B18B7R	LVR-IC	LDO, 1.85V±20mV, 200mA, +CE, CL	USPN-4	58vm	VR4	9a	Tor
CK	XG6223E27B9R-G	LVR-IC	LDO, 2.75V±1%, 300mA, +CE, ICP	USPQ-4B03	48ym	VR4	9a	Tor
CK0	XC9235B20D4R-G	DC-DC-IC	PWM, st-dwn, 2.0V±2%, 600mA, 3MHz, Vin>2V, HSST, CL	USP-6EL	56dc5	DC1	9a	Tor
CK0	XC9235B20DER	DC-DC-IC	PWM, st-dwn, 2.0V±2%, 600mA, 3MHz, Vin>2V, HSST, CL	USP-6C	49dc5	DC1	9a	Tor
CK0	XCL205B204AR-G	DC/DC-IC	PWM st-dwn, 3MHz, 2.0V±2%, 600mA, -CE, auto discharge	CL-2025	67dc7	DC9	9a	Tor
CK1	XC9235B21D4R-G	DC-DC-IC	PWM, st-dwn, 2.1V±2%, 600mA, 3MHz, Vin>2V, HSST, CL	USP-6EL	56dc5	DC1	9a	Tor
CK1	XC9235B21DER	DC-DC-IC	PWM, st-dwn, 2.1V±2%, 600mA, 3MHz, Vin>2V, HSST, CL	USP-6C	49dc5	DC1	9a	Tor
CK1	XCL205B214AR-G	DC/DC-IC	PWM st-dwn, 3MHz, 2.1V±2%, 600mA, -CE, auto discharge	CL-2025	67dc7	DC9	9a	Tor
CK2	XC9235B22D4R-G	DC-DC-IC	PWM, st-dwn, 2.2V±2%, 600mA, 3MHz, Vin>2V, HSST, CL	USP-6EL	56dc5	DC1	9a	Tor
CK2	XC9235B22DER	DC-DC-IC	PWM, st-dwn, 2.2V±2%, 600mA, 3MHz, Vin>2V, HSST, CL	USP-6C	49dc5	DC1	9a	Tor
CK2	XCL205B224AR-G	DC/DC-IC	PWM st-dwn, 3MHz, 2.2V±2%, 600mA, -CE, auto discharge	CL-2025	67dc7	DC9	9a	Tor
CK3	XC9235B23D4R-G	DC-DC-IC	PWM, st-dwn, 2.3V±2%, 600mA, 3MHz, Vin>2V, HSST, CL	USP-6EL	56dc5	DC1	9a	Tor
CK3	XC9235B23DER	DC-DC-IC	PWM, st-dwn, 2.3V±2%, 600mA, 3MHz, Vin>2V, HSST, CL	USP-6C	49dc5	DC1	9a	Tor
CK3	XCL205B234AR-G	DC/DC-IC	PWM st-dwn, 3MHz, 2.3V±2%, 600mA, -CE, auto discharge	CL-2025	67dc7	DC9	9a	Tor
CK4	XC9235B24D4R-G	DC-DC-IC	PWM, st-dwn, 2.4V±2%, 600mA, 3MHz, Vin>2V, HSST, CL	USP-6EL	56dc5	DC1	9a	Tor
CK4	XC9235B24DER	DC-DC-IC	PWM, st-dwn, 2.4V±2%, 600mA, 3MHz, Vin>2V, HSST, CL	USP-6C	49dc5	DC1	9a	Tor
CK4	XCL205B244AR-G	DC/DC-IC	PWM st-dwn, 3MHz, 2.4V±2%, 600mA, -CE, auto discharge	CL-2025	67dc7	DC9	9a	Tor
CK5	XC9235B25D4R-G	DC-DC-IC	PWM, st-dwn, 2.5V±2%, 600mA, 3MHz, Vin>2V, HSST, CL	USP-6EL	56dc5	DC1	9a	Tor
CK5	XC9235B25DER	DC-DC-IC	PWM, st-dwn, 2.5V±2%, 600mA, 3MHz, Vin>2V, HSST, CL	USP-6C	49dc5	DC1	9a	Tor
CK5	XCL205B254AR-G	DC/DC-IC	PWM st-dwn, 3MHz, 2.5V±2%, 600mA, -CE, auto discharge	CL-2025	67dc7	DC9	9a	Tor
CK6	XC9235B26D4R-G	DC-DC-IC	PWM, st-dwn, 2.6V±2%, 600mA, 3MHz, Vin>2V, HSST, CL	USP-6EL	56dc5	DC1	9a	Tor
CK6	XC9235B26DER	DC-DC-IC	PWM, st-dwn, 2.6V±2%, 600mA, 3MHz, Vin>2V, HSST, CL	USP-6C	49dc5	DC1	9a	Tor
CK6	XCL205B264AR-G	DC/DC-IC	PWM st-dwn, 3MHz, 2.6V±2%, 600mA, -CE, auto discharge	CL-2025	67dc7	DC9	9a	Tor
CK7	XC9235B27D4R-G	DC-DC-IC	PWM, st-dwn, 2.7V±2%, 600mA, 3MHz, Vin>2V, HSST, CL	USP-6EL	56dc5	DC1	9a	Tor
CK7	XC9235B27DER	DC-DC-IC	PWM, st-dwn, 2.7V±2%, 600mA, 3MHz, Vin>2V, HSST, CL	USP-6C	49dc5	DC1	9a	Tor
CK7	XCL205B274AR-G	DC/DC-IC	PWM st-dwn, 3MHz, 2.7V±2%, 600mA, -CE, auto discharge	CL-2025	67dc7	DC9	9a	Tor
CK8	XC9235B28D4R-G	DC-DC-IC	PWM, st-dwn, 2.8V±2%, 600mA, 3MHz, Vin>2V, HSST, CL	USP-6EL	56dc5	DC1	9a	Tor
CK8	XC9235B28DER	DC-DC-IC	PWM, st-dwn, 2.8V±2%, 600mA, 3MHz, Vin>2V, HSST, CL	USP-6C	49dc5	DC1	9a	Tor
CK8	XCL205B284AR-G	DC/DC-IC	PWM st-dwn, 3MHz, 2.8V±2%, 600mA, -CE, auto discharge	CL-2025	67dc7	DC9	9a	Tor
CK9	XC9235B29D4R-G	DC-DC-IC	PWM, st-dwn, 2.9V±2%, 600mA, 3MHz, Vin>2V, HSST, CL	USP-6EL	56dc5	DC1	9a	Tor
CK9	XC9235B29DER	DC-DC-IC	PWM, st-dwn, 2.9V±2%, 600mA, 3MHz, Vin>2V, HSST, CL	USP-6C	49dc5	DC1	9a	Tor
CK9	XCL205B294AR-G	DC/DC-IC	PWM st-dwn, 3MHz, 2.9V±2%, 600mA, -CE, auto discharge	CL-2025	67dc7	DC9	9a	Tor
CKA	XC9235B2AD4R-G	DC-DC-IC	PWM, st-dwn, 2.05V±2%, 600mA, 3MHz, Vin>2V, HSST, CL	USP-6EL	56dc5	DC1	9a	Tor
CKA	XC9235B2ADER	DC-DC-IC	PWM, st-dwn, 2.05V±2%, 600mA, 3MHz, Vin>2V, HSST, CL	USP-6C	49dc5	DC1	9a	Tor
CKB	XC9235B2BD4R-G	DC-DC-IC	PWM, st-dwn, 2.15V±2%, 600mA, 3MHz, Vin>2V, HSST, CL	USP-6EL	56dc5	DC1	9a	Tor
CKB	XC9235B2BDER	DC-DC-IC	PWM, st-dwn, 2.15V±2%, 600mA, 3MHz, Vin>2V, HSST, CL	USP-6C	49dc5	DC1	9a	Tor
CKC	XC9235B2CD4R-G	DC-DC-IC	PWM, st-dwn, 2.25V±2%, 600mA, 3MHz, Vin>2V, HSST, CL	USP-6EL	56dc5	DC1	9a	Tor
CKC	XC9235B2CDER	DC-DC-IC	PWM, st-dwn, 2.25V±2%, 600mA, 3MHz, Vin>2V, HSST, CL	USP-6C	49dc5	DC1	9a	Tor
CKD	XC9235B2DD4R-G	DC-DC-IC	PWM, st-dwn, 2.35V±2%, 600mA, 3MHz, Vin>2V, HSST, CL	USP-6EL	56dc5	DC1	9a	Tor
CKD	XC9235B2DDER	DC-DC-IC	PWM, st-dwn, 2.35V±2%, 600mA, 3MHz, Vin>2V, HSST, CL	USP-6C	49dc5	DC1	9a	Tor
CKE	XC9235B2ED4R-G	DC-DC-IC	PWM, st-dwn, 2.45V±2%, 600mA, 3MHz, Vin>2V, HSST, CL	USP-6EL	56dc5	DC1	9a	Tor
CKE	XC9235B2EDER	DC-DC-IC	PWM, st-dwn, 2.45V±2%, 600mA, 3MHz, Vin>2V, HSST, CL	USP-6C	49dc5	DC1	9a	Tor
CKF	XC9235B2FD4R-G	DC-DC-IC	PWM, st-dwn, 2.55V±2%, 600mA, 3MHz, Vin>2V, HSST, CL	USP-6EL	56dc5	DC1	9a	Tor
CKF	XC9235B2FDER	DC-DC-IC	PWM, st-dwn, 2.55V±2%, 600mA, 3MHz, Vin>2V, HSST, CL	USP-6C	49dc5	DC1	9a	Tor
CKH	XC9235B2HD4R-G	DC-DC-IC	PWM, st-dwn, 2.65V±2%, 600mA, 3MHz, Vin>2V, HSST, CL	USP-6EL	56dc5	DC1	9a	Tor
CKH	XC9235B2HDER	DC-DC-IC	PWM, st-dwn, 2.65V±2%, 600mA, 3MHz, Vin>2V, HSST, CL	USP-6C	49dc5	DC1	9a	Tor
CKK	XC9235B2KD4R-G	DC-DC-IC	PWM, st-dwn, 2.75V±2%, 600mA, 3MHz, Vin>2V, HSST, CL	USP-6EL	56dc5	DC1	9a	Tor



SMD code	Type	Function	Short description	Case	Pinout	Sch.	St.	Mnf.
CKK	XC9235B2KDER	DC-DC-IC	PWM, st-dwn, 2.75V±2%, 600mA, 3MHz, Vin>2V, HSST, CL	USP-6C	49dc5	DC1	9a	Tor
CKL	XC9235B2LD4R-G	DC-DC-IC	PWM, st-dwn, 2.85V±2%, 600mA, 3MHz, Vin>2V, HSST, CL	USP-6EL	56dc5	DC1	9a	Tor
CKL	XC9235B2LDER	DC-DC-IC	PWM, st-dwn, 2.85V±2%, 600mA, 3MHz, Vin>2V, HSST, CL	USP-6C	49dc5	DC1	9a	Tor
CKM	XC9235B2MD4R-G	DC-DC-IC	PWM, st-dwn, 2.95V±2%, 600mA, 3MHz, Vin>2V, HSST, CL	USP-6EL	56dc5	DC1	9a	Tor
CKM	XC9235B2MDER	DC-DC-IC	PWM, st-dwn, 2.95V±2%, 600mA, 3MHz, Vin>2V, HSST, CL	USP-6C	49dc5	DC1	9a	Tor
CL	R3134K20EA	VdeI-IC	2.0V±1.8%, -Reset ODO, -MR	DFN1212-6	52z6	VD4	9a	Ric
CL	RP104K281D	LVR-IC	LDO, 2.8V±0.8%, 150mA, +CE, CL	DFN1010-4	48vm	VR4	9a	Ric
CL	XC6221B19B7R	LVR-IC	LDO, 1.95V±20mV, 200mA, +CE, CL	USPN-4	58vm	VR4	9a	Tor
CL	XC6223E28B9R-G	LVR-IC	LDO, 2.85V±1%, 300mA, +CE, ICP	USPQ-4B03	48vm	VR4	9a	Tor
CL0	XC9235B30D4R-G	DC-DC-IC	PWM, st-dwn, 3.0V±2%, 600mA, 3MHz, Vin>2V, HSST, CL	USP-6EL	56dc5	DC1	9a	Tor
CL0	XC9235B30DER	DC-DC-IC	PWM, st-dwn, 3.0V±2%, 600mA, 3MHz, Vin>2V, HSST, CL	USP-6C	49dc5	DC1	9a	Tor
CL0	XCL205B304AR-G	DC/DC-IC	PWM st-dwn, 3MHz, 3.0V±2%, 600mA, -CE, auto discharge	CL-2025	67dc7	DC9	9a	Tor
CL1	XC9235B31D4R-G	DC-DC-IC	PWM, st-dwn, 3.1V±2%, 600mA, 3MHz, Vin>2V, HSST, CL	USP-6EL	56dc5	DC1	9a	Tor
CL1	XC9235B31DER	DC-DC-IC	PWM, st-dwn, 3.1V±2%, 600mA, 3MHz, Vin>2V, HSST, CL	USP-6C	49dc5	DC1	9a	Tor
CL1	XCL205B314AR-G	DC/DC-IC	PWM st-dwn, 3MHz, 3.1V±2%, 600mA, -CE, auto discharge	CL-2025	67dc7	DC9	9a	Tor
CL2	XC9235B32D4R-G	DC-DC-IC	PWM, st-dwn, 3.2V±2%, 600mA, 3MHz, Vin>2V, HSST, CL	USP-6EL	56dc5	DC1	9a	Tor
CL2	XC9235B32DER	DC-DC-IC	PWM, st-dwn, 3.2V±2%, 600mA, 3MHz, Vin>2V, HSST, CL	USP-6C	49dc5	DC1	9a	Tor
CL2	XCL205B324AR-G	DC/DC-IC	PWM st-dwn, 3MHz, 3.2V±2%, 600mA, -CE, auto discharge	CL-2025	67dc7	DC9	9a	Tor
CL3	XC9235B33D4R-G	DC-DC-IC	PWM, st-dwn, 3.3V±2%, 600mA, 3MHz, Vin>2V, HSST, CL	USP-6EL	56dc5	DC1	9a	Tor
CL3	XC9235B33DER	DC-DC-IC	PWM, st-dwn, 3.3V±2%, 600mA, 3MHz, Vin>2V, HSST, CL	USP-6C	49dc5	DC1	9a	Tor
CL3	XCL205B334AR-G	DC/DC-IC	PWM st-dwn, 3MHz, 3.3V±2%, 600mA, -CE, auto discharge	CL-2025	67dc7	DC9	9a	Tor
CL4	XC9235B34D4R-G	DC-DC-IC	PWM, st-dwn, 3.4V±2%, 600mA, 3MHz, Vin>2V, HSST, CL	USP-6EL	56dc5	DC1	9a	Tor
CL4	XC9235B34DER	DC-DC-IC	PWM, st-dwn, 3.4V±2%, 600mA, 3MHz, Vin>2V, HSST, CL	USP-6C	49dc5	DC1	9a	Tor
CL4	XCL205B344AR-G	DC/DC-IC	PWM st-dwn, 3MHz, 3.4V±2%, 600mA, -CE, auto discharge	CL-2025	67dc7	DC9	9a	Tor
CL5	XC9235B35D4R-G	DC-DC-IC	PWM, st-dwn, 3.5V±2%, 600mA, 3MHz, Vin>2V, HSST, CL	USP-6EL	56dc5	DC1	9a	Tor
CL5	XC9235B35DER	DC-DC-IC	PWM, st-dwn, 3.5V±2%, 600mA, 3MHz, Vin>2V, HSST, CL	USP-6C	49dc5	DC1	9a	Tor
CL5	XCL205B354AR-G	DC/DC-IC	PWM st-dwn, 3MHz, 3.5V±2%, 600mA, -CE, auto discharge	CL-2025	67dc7	DC9	9a	Tor
CL6	XC9235B36D4R-G	DC-DC-IC	PWM, st-dwn, 3.6V±2%, 600mA, 3MHz, Vin>2V, HSST, CL	USP-6EL	56dc5	DC1	9a	Tor
CL6	XC9235B36DER	DC-DC-IC	PWM, st-dwn, 3.6V±2%, 600mA, 3MHz, Vin>2V, HSST, CL	USP-6C	49dc5	DC1	9a	Tor
CL6	XCL205B364AR-G	DC/DC-IC	PWM st-dwn, 3MHz, 3.6V±2%, 600mA, -CE, auto discharge	CL-2025	67dc7	DC9	9a	Tor
CL7	XC9235B37D4R-G	DC-DC-IC	PWM, st-dwn, 3.7V±2%, 600mA, 3MHz, Vin>2V, HSST, CL	USP-6EL	56dc5	DC1	9a	Tor
CL7	XC9235B37DER	DC-DC-IC	PWM, st-dwn, 3.7V±2%, 600mA, 3MHz, Vin>2V, HSST, CL	USP-6C	49dc5	DC1	9a	Tor
CL7	XCL205B374AR-G	DC/DC-IC	PWM st-dwn, 3MHz, 3.7V±2%, 600mA, -CE, auto discharge	CL-2025	67dc7	DC9	9a	Tor
CL8	XC9235B38D4R-G	DC-DC-IC	PWM, st-dwn, 3.8V±2%, 600mA, 3MHz, Vin>2V, HSST, CL	USP-6EL	56dc5	DC1	9a	Tor
CL8	XC9235B38DER	DC-DC-IC	PWM, st-dwn, 3.8V±2%, 600mA, 3MHz, Vin>2V, HSST, CL	USP-6C	49dc5	DC1	9a	Tor
CL8	XCL205B384AR-G	DC/DC-IC	PWM st-dwn, 3MHz, 3.8V±2%, 600mA, -CE, auto discharge	CL-2025	67dc7	DC9	9a	Tor
CL9	XC9235B39D4R-G	DC-DC-IC	PWM, st-dwn, 3.9V±2%, 600mA, 3MHz, Vin>2V, HSST, CL	USP-6EL	56dc5	DC1	9a	Tor
CL9	XC9235B39DER	DC-DC-IC	PWM, st-dwn, 3.9V±2%, 600mA, 3MHz, Vin>2V, HSST, CL	USP-6C	49dc5	DC1	9a	Tor
CL9	XCL205B394AR-G	DC/DC-IC	PWM st-dwn, 3MHz, 3.9V±2%, 600mA, -CE, auto discharge	CL-2025	67dc7	DC9	9a	Tor
CLA	XC9235B3AD4R-G	DC-DC-IC	PWM, st-dwn, 3.05V±2%, 600mA, 3MHz, Vin>2V, HSST, CL	USP-6EL	56dc5	DC1	9a	Tor
CLA	XC9235B3ADER	DC-DC-IC	PWM, st-dwn, 3.05V±2%, 600mA, 3MHz, Vin>2V, HSST, CL	USP-6C	49dc5	DC1	9a	Tor
CLB	XC9235B3BD4R-G	DC-DC-IC	PWM, st-dwn, 3.15V±2%, 600mA, 3MHz, Vin>2V, HSST, CL	USP-6EL	56dc5	DC1	9a	Tor
CLB	XC9235B3BDER	DC-DC-IC	PWM, st-dwn, 3.15V±2%, 600mA, 3MHz, Vin>2V, HSST, CL	USP-6C	49dc5	DC1	9a	Tor
CLC	XC9235B3CD4R-G	DC-DC-IC	PWM, st-dwn, 3.25V±2%, 600mA, 3MHz, Vin>2V, HSST, CL	USP-6EL	56dc5	DC1	9a	Tor
CLC	XC9235B3CDER	DC-DC-IC	PWM, st-dwn, 3.25V±2%, 600mA, 3MHz, Vin>2V, HSST, CL	USP-6C	49dc5	DC1	9a	Tor
CLD	XC9235B3DD4R-G	DC-DC-IC	PWM, st-dwn, 3.35V±2%, 600mA, 3MHz, Vin>2V, HSST, CL	USP-6EL	56dc5	DC1	9a	Tor
CLD	XC9235B3DDER	DC-DC-IC	PWM, st-dwn, 3.35V±2%, 600mA, 3MHz, Vin>2V, HSST, CL	USP-6C	49dc5	DC1	9a	Tor
CLE	XC9235B3ED4R-G	DC-DC-IC	PWM, st-dwn, 3.45V±2%, 600mA, 3MHz, Vin>2V, HSST, CL	USP-6EL	56dc5	DC1	9a	Tor
CLE	XC9235B3EDER	DC-DC-IC	PWM, st-dwn, 3.45V±2%, 600mA, 3MHz, Vin>2V, HSST, CL	USP-6C	49dc5	DC1	9a	Tor
CLF	XC9235B3FD4R-G	DC-DC-IC	PWM, st-dwn, 3.55V±2%, 600mA, 3MHz, Vin>2V, HSST, CL	USP-6EL	56dc5	DC1	9a	Tor
CLF	XC9235B3FDER	DC-DC-IC	PWM, st-dwn, 3.55V±2%, 600mA, 3MHz, Vin>2V, HSST, CL	USP-6C	49dc5	DC1	9a	Tor
CLH	XC9235B3HD4R-G	DC-DC-IC	PWM, st-dwn, 3.65V±2%, 600mA, 3MHz, Vin>2V, HSST, CL	USP-6EL	56dc5	DC1	9a	Tor
CLH	XC9235B3HDER	DC-DC-IC	PWM, st-dwn, 3.65V±2%, 600mA, 3MHz, Vin>2V, HSST, CL	USP-6C	49dc5	DC1	9a	Tor
CLK	XC9235B3KD4R-G	DC-DC-IC	PWM, st-dwn, 3.75V±2%, 600mA, 3MHz, Vin>2V, HSST, CL	USP-6EL	56dc5	DC1	9a	Tor
CLK	XC9235B3KDER	DC-DC-IC	PWM, st-dwn, 3.75V±2%, 600mA, 3MHz, Vin>2V, HSST, CL	USP-6C	49dc5	DC1	9a	Tor
CLL	XC9235B3LD4R-G	DC-DC-IC	PWM, st-dwn, 3.85V±2%, 600mA, 3MHz, Vin>2V, HSST, CL	USP-6EL	56dc5	DC1	9a	Tor
CLL	XC9235B3LDER	DC-DC-IC	PWM, st-dwn, 3.85V±2%, 600mA, 3MHz, Vin>2V, HSST, CL	USP-6C	49dc5	DC1	9a	Tor
CLM	XC9235B3MD4R-G	DC-DC-IC	PWM, st-dwn, 3.95V±2%, 600mA, 3MHz, Vin>2V, HSST, CL	USP-6EL	56dc5	DC1	9a	Tor
CLM	XC9235B3MDER	DC-DC-IC	PWM, st-dwn, 3.95V±2%, 600mA, 3MHz, Vin>2V, HSST, CL	USP-6C	49dc5	DC1	9a	Tor
CM	R3134K21EA	VdeI-IC	2.1V±1.8%, -Reset ODO, -MR	DFN1212-6	52z6	VD4	9a	Ric
CM	RP104K281D5	LVR-IC	LDO, 2.85V±0.8%, 150mA, +CE, CL	DFN1010-4	48vm	VR4	9a	Ric
CM	XC6221B20B7R	LVR-IC	LDO, 2.05V±1%, 200mA, +CE, CL	USPN-4	58vm	VR4	9a	Tor
CM	XC6223E29B9R-G	LVR-IC	LDO, 2.95V±1%, 300mA, +CE, ICP	USPQ-4B03	48vm	VR4	9a	Tor
CM0	XC6213B31AGR	LVR-IC	LDO, 3.15V±2%, 150mA, +CE	USP-4	45vm	VR4	9b	Tor
CM0	XC9235B40D4R-G	DC-DC-IC	PWM, st-dwn, 4.0V±2%, 600mA, 3MHz, Vin>2V, HSST, CL	USP-6EL	56dc5	DC1	9a	Tor
CM0	XC9235B40DER	DC-DC-IC	PWM, st-dwn, 4.0V±2%, 600mA, 3MHz, Vin>2V, HSST, CL	USP-6C	49dc5	DC1	9a	Tor
CM0	XCL205B404AR-G	DC/DC-IC	PWM st-dwn, 3MHz, 4.0V±2%, 600mA, -CE, auto discharge	CL-2025	67dc7	DC9	9a	Tor
CM1	XC6213B32AGR	LVR-IC	LDO, 3.25V±2%, 150mA, +CE	USP-4	45vm	VR4	9b	Tor
CM2	XC6213B33AGR	LVR-IC	LDO, 3.35V±2%, 150mA, +CE	USP-4	45vm	VR4	9b	Tor
CM3	XC6213B34AGR	LVR-IC	LDO, 3.45V±2%, 150mA, +CE	USP-4	45vm	VR4	9b	Tor



SMD code	Type	Function	Short description	Case	Pinout	Sch.	St.	Mnf.
CM4	XC6213B35AGR	LVR-IC	LDO, 3.55V±2%, 150mA, +CE	USP-4	45vm	VR4	9b	Tor
CM5	XC6213B36AGR	LVR-IC	LDO, 3.65V±2%, 150mA, +CE	USP-4	45vm	VR4	9b	Tor
CM6	XC6213B37AGR	LVR-IC	LDO, 3.75V±2%, 150mA, +CE	USP-4	45vm	VR4	9b	Tor
CM7	XC6213B38AGR	LVR-IC	LDO, 3.85V±2%, 150mA, +CE	USP-4	45vm	VR4	9b	Tor
CM8	XC6213B39AGR	LVR-IC	LDO, 3.95V±2%, 150mA, +CE	USP-4	45vm	VR4	9b	Tor
CM9	XC6213B40AGR	LVR-IC	LDO, 4.05V±2%, 150mA, +CE	USP-4	45vm	VR4	9b	Tor
CMA	XC6213B41AGR	LVR-IC	LDO, 4.15V±2%, 150mA, +CE	USP-4	45vm	VR4	9b	Tor
CMB	XC6213B42AGR	LVR-IC	LDO, 4.25V±2%, 150mA, +CE	USP-4	45vm	VR4	9b	Tor
CMC	XC6213B43AGR	LVR-IC	LDO, 4.35V±2%, 150mA, +CE	USP-4	45vm	VR4	9b	Tor
CMD	XC6213B44AGR	LVR-IC	LDO, 4.45V±2%, 150mA, +CE	USP-4	45vm	VR4	9b	Tor
CME	XC6213B45AGR	LVR-IC	LDO, 4.55V±2%, 150mA, +CE	USP-4	45vm	VR4	9b	Tor
CMF	XC6213B46AGR	LVR-IC	LDO, 4.65V±2%, 150mA, +CE	USP-4	45vm	VR4	9b	Tor
CMH	XC6213B47AGR	LVR-IC	LDO, 4.75V±2%, 150mA, +CE	USP-4	45vm	VR4	9b	Tor
CMK	XC6213B48AGR	LVR-IC	LDO, 4.85V±2%, 150mA, +CE	USP-4	45vm	VR4	9b	Tor
CML	XC6213B49AGR	LVR-IC	LDO, 4.95V±2%, 150mA, +CE	USP-4	45vm	VR4	9b	Tor
CN	R3134K22EA	Vdet-IC	2.2V±1.8%, -Reset ODO, -MR	DFN1212-6	52z6	VD4	9a	Ric
CN	RP104K291D	LVR-IC	LDO, 2.9V±0.8%, 150mA, +CE, CL	DFN1010-4	48vm	VR4	9a	Ric
CN	XC6221B21B7R	LVR-IC	LDO, 2.15V±1%, 200mA, +CE, CL	USPN-4	58vm	VR4	9a	Tor
CN	XC6223E30B9R-G	LVR-IC	LDO, 3.05V±1%, 300mA, +CE, ICP	USPQ-4B03	48vm	VR4	9a	Tor
CN8	XC9235G08C4	DC/DC-IC	PWM step-down, 1.2MHz, 0.8V±2%, 600mA, CL, Vin>1.8V, HSST	USP-6EL	56dc5	DC1	9a	Tor
CN8	XC9235G08CER	DC-DC-IC	PWM, st-dwn, 0.8V±2%, 600mA, 1.2MHz, Vin>1.8V, HSST, CL	USP-6C	49dc5	DC1	9a	Tor
CN9	XC9235G09C4	DC/DC-IC	PWM step-down, 1.2MHz, 0.9V±2%, 600mA, CL, Vin>1.8V, HSST	USP-6EL	56dc5	DC1	9a	Tor
CN9	XC9235G09CER	DC-DC-IC	PWM, st-dwn, 0.9V±2%, 600mA, 1.2MHz, Vin>1.8V, HSST, CL	USP-6C	49dc5	DC1	9a	Tor
CNL	XC9235G0LC4	DC/DC-IC	PWM step-down, 1.2MHz, 0.85V±2%, 600mA, CL, Vin>1.8V, HSST	USP-6EL	56dc5	DC1	9a	Tor
CNL	XC9235G0LCER	DC-DC-IC	PWM, st-dwn, 0.85V±2%, 600mA, 1.2MHz, Vin>1.8V, HSST, CL	USP-6C	49dc5	DC1	9a	Tor
CNM	XC9235G0MC4	DC/DC-IC	PWM step-down, 1.2MHz, 0.95V±2%, 600mA, CL, Vin>1.8V, HSST	USP-6EL	56dc5	DC1	9a	Tor
CNM	XC9235G0MCER	DC-DC-IC	PWM, st-dwn, 0.95V±2%, 600mA, 1.2MHz, Vin>1.8V, HSST, CL	USP-6C	49dc5	DC1	9a	Tor
CP	R3134K23EA	Vdet-IC	2.3V±1.8%, -Reset ODO, -MR	DFN1212-6	52z6	VD4	9a	Ric
CP	RP104K301D	LVR-IC	LDO, 3.0V±0.8%, 150mA, +CE, CL	DFN1010-4	48vm	VR4	9a	Ric
CP	XC6221B22B7R	LVR-IC	LDO, 2.25V±1%, 200mA, +CE, CL	USPN-4	58vm	VR4	9a	Tor
CP	XC6223E31B9R-G	LVR-IC	LDO, 3.15V±1%, 300mA, +CE, ICP	USPQ-4B03	48vm	VR4	9a	Tor
CP0	XC9235G10C4	DC/DC-IC	PWM step-down, 1.2MHz, 1.0V±2%, 600mA, CL, Vin>1.8V, HSST	USP-6EL	56dc5	DC1	9a	Tor
CP0	XC9235G10CER	DC-DC-IC	PWM, st-dwn, 1.0V±2%, 600mA, 1.2MHz, Vin>1.8V, HSST, CL	USP-6C	49dc5	DC1	9a	Tor
CP1	XC9235G11C4	DC/DC-IC	PWM step-down, 1.2MHz, 1.1V±2%, 600mA, CL, Vin>1.8V, HSST	USP-6EL	56dc5	DC1	9a	Tor
CP1	XC9235G11CER	DC-DC-IC	PWM, st-dwn, 1.1V±2%, 600mA, 1.2MHz, Vin>1.8V, HSST, CL	USP-6C	49dc5	DC1	9a	Tor
CP2	XC9235G12C4	DC/DC-IC	PWM step-down, 1.2MHz, 1.2V±2%, 600mA, CL, Vin>1.8V, HSST	USP-6EL	56dc5	DC1	9a	Tor
CP2	XC9235G12CER	DC-DC-IC	PWM, st-dwn, 1.2V±2%, 600mA, 1.2MHz, Vin>1.8V, HSST, CL	USP-6C	49dc5	DC1	9a	Tor
CP3	XC9235G13C4	DC/DC-IC	PWM step-down, 1.2MHz, 1.3V±2%, 600mA, CL, Vin>1.8V, HSST	USP-6EL	56dc5	DC1	9a	Tor
CP3	XC9235G13CER	DC-DC-IC	PWM, st-dwn, 1.3V±2%, 600mA, 1.2MHz, Vin>1.8V, HSST, CL	USP-6C	49dc5	DC1	9a	Tor
CP4	XC9235G14C4	DC/DC-IC	PWM step-down, 1.2MHz, 1.4V±2%, 600mA, CL, Vin>1.8V, HSST	USP-6EL	56dc5	DC1	9a	Tor
CP4	XC9235G14CER	DC-DC-IC	PWM, st-dwn, 1.4V±2%, 600mA, 1.2MHz, Vin>1.8V, HSST, CL	USP-6C	49dc5	DC1	9a	Tor
CP5	XC9235G15C4	DC/DC-IC	PWM step-down, 1.2MHz, 1.5V±2%, 600mA, CL, Vin>1.8V, HSST	USP-6EL	56dc5	DC1	9a	Tor
CP5	XC9235G15CER	DC-DC-IC	PWM, st-dwn, 1.5V±2%, 600mA, 1.2MHz, Vin>1.8V, HSST, CL	USP-6C	49dc5	DC1	9a	Tor
CP6	XC9235G16C4	DC/DC-IC	PWM step-down, 1.2MHz, 1.6V±2%, 600mA, CL, Vin>1.8V, HSST	USP-6EL	56dc5	DC1	9a	Tor
CP6	XC9235G16CER	DC-DC-IC	PWM, st-dwn, 1.6V±2%, 600mA, 1.2MHz, Vin>1.8V, HSST, CL	USP-6C	49dc5	DC1	9a	Tor
CP7	XC9235G17C4	DC/DC-IC	PWM step-down, 1.2MHz, 1.7V±2%, 600mA, CL, Vin>1.8V, HSST	USP-6EL	56dc5	DC1	9a	Tor
CP7	XC9235G17CER	DC-DC-IC	PWM, st-dwn, 1.7V±2%, 600mA, 1.2MHz, Vin>1.8V, HSST, CL	USP-6C	49dc5	DC1	9a	Tor
CP8	XC9235G18C4	DC/DC-IC	PWM step-down, 1.2MHz, 1.8V±2%, 600mA, CL, Vin>1.8V, HSST	USP-6EL	56dc5	DC1	9a	Tor
CP8	XC9235G18CER	DC-DC-IC	PWM, st-dwn, 1.8V±2%, 600mA, 1.2MHz, Vin>1.8V, HSST, CL	USP-6C	49dc5	DC1	9a	Tor
CP9	XC9235G19C4	DC/DC-IC	PWM step-down, 1.2MHz, 1.9V±2%, 600mA, CL, Vin>1.8V, HSST	USP-6EL	56dc5	DC1	9a	Tor
CP9	XC9235G19CER	DC-DC-IC	PWM, st-dwn, 1.9V±2%, 600mA, 1.2MHz, Vin>1.8V, HSST, CL	USP-6C	49dc5	DC1	9a	Tor
CPA	XC9235G1AC4	DC/DC-IC	PWM step-down, 1.2MHz, 1.05V±2%, 600mA, CL, Vin>1.8V, HSST	USP-6EL	56dc5	DC1	9a	Tor
CPA	XC9235G1ACER	DC-DC-IC	PWM, st-dwn, 1.05V±2%, 600mA, 1.2MHz, Vin>1.8V, HSST, CL	USP-6C	49dc5	DC1	9a	Tor
CPB	XC9235G1BC4	DC/DC-IC	PWM step-down, 1.2MHz, 1.15V±2%, 600mA, CL, Vin>1.8V, HSST	USP-6EL	56dc5	DC1	9a	Tor
CPB	XC9235G1BCER	DC-DC-IC	PWM, st-dwn, 1.15V±2%, 600mA, 1.2MHz, Vin>1.8V, HSST, CL	USP-6C	49dc5	DC1	9a	Tor
CPC	XC9235G1CC4	DC/DC-IC	PWM step-down, 1.2MHz, 1.25V±2%, 600mA, CL, Vin>1.8V, HSST	USP-6EL	56dc5	DC1	9a	Tor
CPC	XC9235G1CCER	DC-DC-IC	PWM, st-dwn, 1.25V±2%, 600mA, 1.2MHz, Vin>1.8V, HSST, CL	USP-6C	49dc5	DC1	9a	Tor
CPD	XC9235G1DC4	DC/DC-IC	PWM step-down, 1.2MHz, 1.35V±2%, 600mA, CL, Vin>1.8V, HSST	USP-6EL	56dc5	DC1	9a	Tor
CPD	XC9235G1DCER	DC-DC-IC	PWM, st-dwn, 1.35V±2%, 600mA, 1.2MHz, Vin>1.8V, HSST, CL	USP-6C	49dc5	DC1	9a	Tor
CPE	XC9235G1EC4	DC/DC-IC	PWM step-down, 1.2MHz, 1.45V±2%, 600mA, CL, Vin>1.8V, HSST	USP-6EL	56dc5	DC1	9a	Tor
CPE	XC9235G1ECER	DC-DC-IC	PWM, st-dwn, 1.45V±2%, 600mA, 1.2MHz, Vin>1.8V, HSST, CL	USP-6C	49dc5	DC1	9a	Tor
CPF	XC9235G1FC4	DC/DC-IC	PWM step-down, 1.2MHz, 1.55V±2%, 600mA, CL, Vin>1.8V, HSST	USP-6EL	56dc5	DC1	9a	Tor
CPF	XC9235G1FCER	DC-DC-IC	PWM, st-dwn, 1.55V±2%, 600mA, 1.2MHz, Vin>1.8V, HSST, CL	USP-6C	49dc5	DC1	9a	Tor
CPH	XC9235G1HC4	DC/DC-IC	PWM step-down, 1.2MHz, 1.65V±2%, 600mA, CL, Vin>1.8V, HSST	USP-6EL	56dc5	DC1	9a	Tor
CPH	XC9235G1HCER	DC-DC-IC	PWM, st-dwn, 1.65V±2%, 600mA, 1.2MHz, Vin>1.8V, HSST, CL	USP-6C	49dc5	DC1	9a	Tor
CPK	XC9235G1KC4	DC/DC-IC	PWM step-down, 1.2MHz, 1.75V±2%, 600mA, CL, Vin>1.8V, HSST	USP-6EL	56dc5	DC1	9a	Tor
CPK	XC9235G1KCER	DC-DC-IC	PWM, st-dwn, 1.75V±2%, 600mA, 1.2MHz, Vin>1.8V, HSST, CL	USP-6C	49dc5	DC1	9a	Tor
CPL	XC9235G1LC4	DC/DC-IC	PWM step-down, 1.2MHz, 1.85V±2%, 600mA, CL, Vin>1.8V, HSST	USP-6EL	56dc5	DC1	9a	Tor
CPL	XC9235G1LCER	DC-DC-IC	PWM, st-dwn, 1.85V±2%, 600mA, 1.2MHz, Vin>1.8V, HSST, CL	USP-6C	49dc5	DC1	9a	Tor
CPM	XC9235G1MC4	DC/DC-IC	PWM step-down, 1.2MHz, 1.95V±2%, 600mA, CL, Vin>1.8V, HSST	USP-6EL	56dc5	DC1	9a	Tor



SMD code	Type	Function	Short description	Case	Pinout	Sch.	St.	Mnf.
CPM	XC9235G1MCCER	DC-DC-IC	PWM, st-dwn, 1.95V±2%, 600mA, 1.2MHz, Vin>1.8V, HSST, CL	USP-6C	49dc5	DC1	9a	Tor
CQ	RP104K321D	LVR-IC	LDO, 3.2V±0.8%, 150mA, +CE, CL	DFN1010-4	48vm	VR4	9a	Ric
CR	R3134K24EA	Vdet-IC	2.4V±1.2%, -Reset ODO, -MR	DFN1212-6	52z6	VD4	9a	Ric
CR	RP104K331D	LVR-IC	LDO, 3.3V±0.8%, 150mA, +CE, CL	DFN1010-4	48vm	VR4	9a	Ric
CR	XC6221B23B7R	LVR-IC	LDO, 2.35V±1%, 200mA, +CE, CL	USPN-4	58vm	VR4	9a	Tor
CR	XC6223E32B9R-G	LVR-IC	LDO, 3.25V±1%, 300mA, +CE, ICP	USPQ-4B03	48vm	VR4	9a	Tor
CR0	XC9235G20C4	DC/DC-IC	PWM step-down, 1.2MHz, 2.0V±2%, 600mA, CL, Vin>1.8V, HSST	USP-6EL	56dc5	DC1	9a	Tor
CR0	XC9235G20CER	DC-DC-IC	PWM, st-dwn, 2.0V±2%, 600mA, 1.2MHz, Vin>1.8V, HSST, CL	USP-6C	49dc5	DC1	9a	Tor
CR1	XC9235G21C4	DC/DC-IC	PWM step-down, 1.2MHz, 2.1V±2%, 600mA, CL, Vin>1.8V, HSST	USP-6EL	56dc5	DC1	9a	Tor
CR1	XC9235G21CER	DC-DC-IC	PWM, st-dwn, 2.1V±2%, 600mA, 1.2MHz, Vin>1.8V, HSST, CL	USP-6C	49dc5	DC1	9a	Tor
CR2	XC9235G22C4	DC/DC-IC	PWM step-down, 1.2MHz, 2.2V±2%, 600mA, CL, Vin>1.8V, HSST	USP-6EL	56dc5	DC1	9a	Tor
CR2	XC9235G22CER	DC-DC-IC	PWM, st-dwn, 2.2V±2%, 600mA, 1.2MHz, Vin>1.8V, HSST, CL	USP-6C	49dc5	DC1	9a	Tor
CR3	XC9235G23C4	DC/DC-IC	PWM step-down, 1.2MHz, 2.3V±2%, 600mA, CL, Vin>1.8V, HSST	USP-6EL	56dc5	DC1	9a	Tor
CR3	XC9235G23CER	DC-DC-IC	PWM, st-dwn, 2.3V±2%, 600mA, 1.2MHz, Vin>1.8V, HSST, CL	USP-6C	49dc5	DC1	9a	Tor
CR4	XC9235G24C4	DC/DC-IC	PWM step-down, 1.2MHz, 2.4V±2%, 600mA, CL, Vin>1.8V, HSST	USP-6EL	56dc5	DC1	9a	Tor
CR4	XC9235G24CER	DC-DC-IC	PWM, st-dwn, 2.4V±2%, 600mA, 1.2MHz, Vin>1.8V, HSST, CL	USP-6C	49dc5	DC1	9a	Tor
CR5	XC9235G25C4	DC/DC-IC	PWM step-down, 1.2MHz, 2.5V±2%, 600mA, CL, Vin>1.8V, HSST	USP-6EL	56dc5	DC1	9a	Tor
CR5	XC9235G25CER	DC-DC-IC	PWM, st-dwn, 2.5V±2%, 600mA, 1.2MHz, Vin>1.8V, HSST, CL	USP-6C	49dc5	DC1	9a	Tor
CR6	XC9235G26C4	DC/DC-IC	PWM step-down, 1.2MHz, 2.6V±2%, 600mA, CL, Vin>1.8V, HSST	USP-6EL	56dc5	DC1	9a	Tor
CR6	XC9235G26CER	DC-DC-IC	PWM, st-dwn, 2.6V±2%, 600mA, 1.2MHz, Vin>1.8V, HSST, CL	USP-6C	49dc5	DC1	9a	Tor
CR7	XC9235G27C4	DC/DC-IC	PWM step-down, 1.2MHz, 2.7V±2%, 600mA, CL, Vin>1.8V, HSST	USP-6EL	56dc5	DC1	9a	Tor
CR7	XC9235G27CER	DC-DC-IC	PWM, st-dwn, 2.7V±2%, 600mA, 1.2MHz, Vin>1.8V, HSST, CL	USP-6C	49dc5	DC1	9a	Tor
CR8	XC9235G28C4	DC/DC-IC	PWM step-down, 1.2MHz, 2.8V±2%, 600mA, CL, Vin>1.8V, HSST	USP-6EL	56dc5	DC1	9a	Tor
CR8	XC9235G28CER	DC-DC-IC	PWM, st-dwn, 2.8V±2%, 600mA, 1.2MHz, Vin>1.8V, HSST, CL	USP-6C	49dc5	DC1	9a	Tor
CR9	XC9235G29C4	DC/DC-IC	PWM step-down, 1.2MHz, 2.9V±2%, 600mA, CL, Vin>1.8V, HSST	USP-6EL	56dc5	DC1	9a	Tor
CR9	XC9235G29CER	DC-DC-IC	PWM, st-dwn, 2.9V±2%, 600mA, 1.2MHz, Vin>1.8V, HSST, CL	USP-6C	49dc5	DC1	9a	Tor
CRA	XC9235G2AC4	DC/DC-IC	PWM step-down, 1.2MHz, 2.05V±2%, 600mA, CL, Vin>1.8V, HSST	USP-6EL	56dc5	DC1	9a	Tor
CRA	XC9235G2ACER	DC-DC-IC	PWM, st-dwn, 2.05V±2%, 600mA, 1.2MHz, Vin>1.8V, HSST, CL	USP-6C	49dc5	DC1	9a	Tor
CRB	XC9235G2BC4	DC/DC-IC	PWM step-down, 1.2MHz, 2.15V±2%, 600mA, CL, Vin>1.8V, HSST	USP-6EL	56dc5	DC1	9a	Tor
CRB	XC9235G2BCER	DC-DC-IC	PWM, st-dwn, 2.15V±2%, 600mA, 1.2MHz, Vin>1.8V, HSST, CL	USP-6C	49dc5	DC1	9a	Tor
CRC	XC9235G2CC4	DC/DC-IC	PWM step-down, 1.2MHz, 2.25V±2%, 600mA, CL, Vin>1.8V, HSST	USP-6EL	56dc5	DC1	9a	Tor
CRC	XC9235G2CCER	DC-DC-IC	PWM, st-dwn, 2.25V±2%, 600mA, 1.2MHz, Vin>1.8V, HSST, CL	USP-6C	49dc5	DC1	9a	Tor
CRD	XC9235G2DC4	DC/DC-IC	PWM step-down, 1.2MHz, 2.35V±2%, 600mA, CL, Vin>1.8V, HSST	USP-6EL	56dc5	DC1	9a	Tor
CRD	XC9235G2DCER	DC-DC-IC	PWM, st-dwn, 2.35V±2%, 600mA, 1.2MHz, Vin>1.8V, HSST, CL	USP-6C	49dc5	DC1	9a	Tor
CRE	XC9235G2EC4	DC/DC-IC	PWM step-down, 1.2MHz, 2.45V±2%, 600mA, CL, Vin>1.8V, HSST	USP-6EL	56dc5	DC1	9a	Tor
CRE	XC9235G2ECER	DC-DC-IC	PWM, st-dwn, 2.45V±2%, 600mA, 1.2MHz, Vin>1.8V, HSST, CL	USP-6C	49dc5	DC1	9a	Tor
CRF	XC9235G2FC4	DC/DC-IC	PWM step-down, 1.2MHz, 2.55V±2%, 600mA, CL, Vin>1.8V, HSST	USP-6EL	56dc5	DC1	9a	Tor
CRF	XC9235G2FCER	DC-DC-IC	PWM, st-dwn, 2.55V±2%, 600mA, 1.2MHz, Vin>1.8V, HSST, CL	USP-6C	49dc5	DC1	9a	Tor
CRH	XC9235G2HC4	DC/DC-IC	PWM step-down, 1.2MHz, 2.65V±2%, 600mA, CL, Vin>1.8V, HSST	USP-6EL	56dc5	DC1	9a	Tor
CRH	XC9235G2HCER	DC-DC-IC	PWM, st-dwn, 2.65V±2%, 600mA, 1.2MHz, Vin>1.8V, HSST, CL	USP-6C	49dc5	DC1	9a	Tor
CRK	XC9235G2KC4	DC/DC-IC	PWM step-down, 1.2MHz, 2.75V±2%, 600mA, CL, Vin>1.8V, HSST	USP-6EL	56dc5	DC1	9a	Tor
CRK	XC9235G2KCER	DC-DC-IC	PWM, st-dwn, 2.75V±2%, 600mA, 1.2MHz, Vin>1.8V, HSST, CL	USP-6C	49dc5	DC1	9a	Tor
CRL	XC9235G2LC4	DC/DC-IC	PWM step-down, 1.2MHz, 2.85V±2%, 600mA, CL, Vin>1.8V, HSST	USP-6EL	56dc5	DC1	9a	Tor
CRL	XC9235G2LCER	DC-DC-IC	PWM, st-dwn, 2.85V±2%, 600mA, 1.2MHz, Vin>1.8V, HSST, CL	USP-6C	49dc5	DC1	9a	Tor
CRM	XC9235G2MC4	DC/DC-IC	PWM step-down, 1.2MHz, 2.95V±2%, 600mA, CL, Vin>1.8V, HSST	USP-6EL	56dc5	DC1	9a	Tor
CRM	XC9235G2MCER	DC-DC-IC	PWM, st-dwn, 2.95V±2%, 600mA, 1.2MHz, Vin>1.8V, HSST, CL	USP-6C	49dc5	DC1	9a	Tor
CS	R3134K25EA	Vdet-IC	2.5V±1.8%, -Reset ODO, -MR	DFN1212-6	52z6	VD4	9a	Ric
CS	RP104K311D	LVR-IC	LDO, 3.1V±0.8%, 150mA, +CE, CL	DFN1010-4	48vm	VR4	9a	Ric
CS	XC6221B24B7R	LVR-IC	LDO, 2.45V±1%, 200mA, +CE, CL	USPN-4	58vm	VR4	9a	Tor
CS	XC6223E33B9R-G	LVR-IC	LDO, 3.35V±1%, 300mA, +CE, ICP	USPQ-4B03	48vm	VR4	9a	Tor
CS0	XC9235G30C4	DC/DC-IC	PWM step-down, 1.2MHz, 3.0V±2%, 600mA, CL, Vin>1.8V, HSST	USP-6EL	56dc5	DC1	9a	Tor
CS0	XC9235G30CER	DC-DC-IC	PWM, st-dwn, 3.0V±2%, 600mA, 1.2MHz, Vin>1.8V, HSST, CL	USP-6C	49dc5	DC1	9a	Tor
CS1	GS6202UQR	LVR-IC	LDO, Dual out, Vout1/Vout2=3.0V/3.3V±2%, 250mA, +CE	UFN-6	49xv	VR19	9m	Glo
CS1	XC9235G31C4	DC/DC-IC	PWM step-down, 1.2MHz, 3.1V±2%, 600mA, CL, Vin>1.8V, HSST	USP-6EL	56dc5	DC1	9a	Tor
CS1	XC9235G31CER	DC-DC-IC	PWM, st-dwn, 3.1V±2%, 600mA, 1.2MHz, Vin>1.8V, HSST, CL	USP-6C	49dc5	DC1	9a	Tor
CS2	GS6202UFQ	LVR-IC	LDO, Dual out, Vout1/Vout2=1.8V/3.0V±2%, 250mA, +CE	UFN-6	49xv	VR19	9m	Glo
CS2	XC9235G32C4	DC/DC-IC	PWM step-down, 1.2MHz, 3.2V±2%, 600mA, CL, Vin>1.8V, HSST	USP-6EL	56dc5	DC1	9a	Tor
CS2	XC9235G32CER	DC-DC-IC	PWM, st-dwn, 3.2V±2%, 600mA, 1.2MHz, Vin>1.8V, HSST, CL	USP-6C	49dc5	DC1	9a	Tor
CS3	GS6202UQQ	LVR-IC	LDO, Dual out, Vout1/Vout2=3.0V/3.0V±2%, 250mA, +CE	UFN-6	49xv	VR19	9m	Glo
CS3	XC9235G33C4	DC/DC-IC	PWM step-down, 1.2MHz, 3.3V±2%, 600mA, CL, Vin>1.8V, HSST	USP-6EL	56dc5	DC1	9a	Tor
CS3	XC9235G33CER	DC-DC-IC	PWM, st-dwn, 3.3V±2%, 600mA, 1.2MHz, Vin>1.8V, HSST, CL	USP-6C	49dc5	DC1	9a	Tor
CS4	XC9235G34C4	DC/DC-IC	PWM step-down, 1.2MHz, 3.4V±2%, 600mA, CL, Vin>1.8V, HSST	USP-6EL	56dc5	DC1	9a	Tor
CS4	XC9235G34CER	DC-DC-IC	PWM, st-dwn, 3.4V±2%, 600mA, 1.2MHz, Vin>1.8V, HSST, CL	USP-6C	49dc5	DC1	9a	Tor
CS5	XC9235G35C4	DC/DC-IC	PWM step-down, 1.2MHz, 3.5V±2%, 600mA, CL, Vin>1.8V, HSST	USP-6EL	56dc5	DC1	9a	Tor
CS5	XC9235G35CER	DC-DC-IC	PWM, st-dwn, 3.5V±2%, 600mA, 1.2MHz, Vin>1.8V, HSST, CL	USP-6C	49dc5	DC1	9a	Tor
CS6	XC9235G36C4	DC/DC-IC	PWM step-down, 1.2MHz, 3.6V±2%, 600mA, CL, Vin>1.8V, HSST	USP-6EL	56dc5	DC1	9a	Tor
CS6	XC9235G36CER	DC-DC-IC	PWM, st-dwn, 3.6V±2%, 600mA, 1.2MHz, Vin>1.8V, HSST, CL	USP-6C	49dc5	DC1	9a	Tor
CS7	XC9235G37C4	DC/DC-IC	PWM step-down, 1.2MHz, 3.7V±2%, 600mA, CL, Vin>1.8V, HSST	USP-6EL	56dc5	DC1	9a	Tor
CS7	XC9235G37CER	DC-DC-IC	PWM, st-dwn, 3.7V±2%, 600mA, 1.2MHz, Vin>1.8V, HSST, CL	USP-6C	49dc5	DC1	9a	Tor
CS8	XC9235G38C4	DC/DC-IC	PWM step-down, 1.2MHz, 3.8V±2%, 600mA, CL, Vin>1.8V, HSST	USP-6EL	56dc5	DC1	9a	Tor



SMD code	Type	Function	Short description	Case	Pinout	Sch.	St.	Mnf.
CS8	XC9235G38CER	DC-DC-IC	PWM, st-dwn, 3.8V±2%, 600mA, 1.2MHz, Vin>1.8V, HSST, CL	USP-6C	49dc5	DC1	9a	Tor
CS9	XC9235G39C4	DC/DC-IC	PWM step-down, 1.2MHz, 3.9V±2%, 600mA, CL, Vin>1.8V, HSST	USP-6EL	56dc5	DC1	9a	Tor
CS9	XC9235G39CER	DC-DC-IC	PWM, st-dwn, 3.9V±2%, 600mA, 1.2MHz, Vin>1.8V, HSST, CL	USP-6C	49dc5	DC1	9a	Tor
CSA	GS6202URRF	LVR-IC	LDO, Dual out, Vout1/Vout2=3.3V/3.3V±2%, 250mA, +CE	UFN-6	49xv	VR19	9m	Glo
CSA	XC9235G3AC4	DC/DC-IC	PWM step-down, 1.2MHz, 3.05V±2%, 600mA, CL, Vin>1.8V, HSST	USP-6EL	56dc5	DC1	9a	Tor
CSA	XC9235G3ACER	DC-DC-IC	PWM, st-dwn, 3.05V±2%, 600mA, 1.2MHz, Vin>1.8V, HSST, CL	USP-6C	49dc5	DC1	9a	Tor
CSB	GS6202UJRF	LVR-IC	LDO, Dual out, Vout1/Vout2=2.8V/3.3V±2%, 250mA, +CE	UFN-6	49xv	VR19	9m	Glo
CSB	XC9235G3BC4	DC/DC-IC	PWM step-down, 1.2MHz, 3.15V±2%, 600mA, CL, Vin>1.8V, HSST	USP-6EL	56dc5	DC1	9a	Tor
CSB	XC9235G3BCER	DC-DC-IC	PWM, st-dwn, 3.15V±2%, 600mA, 1.2MHz, Vin>1.8V, HSST, CL	USP-6C	49dc5	DC1	9a	Tor
CSC	GS6202UHRF	LVR-IC	LDO, Dual out, Vout1/Vout2=2.5V/3.3V±2%, 250mA, +CE	UFN-6	49xv	VR19	9m	Glo
CSC	XC9235G3CC4	DC/DC-IC	PWM step-down, 1.2MHz, 3.25V±2%, 600mA, CL, Vin>1.8V, HSST	USP-6EL	56dc5	DC1	9a	Tor
CSC	XC9235G3CCER	DC-DC-IC	PWM, st-dwn, 3.25V±2%, 600mA, 1.2MHz, Vin>1.8V, HSST, CL	USP-6C	49dc5	DC1	9a	Tor
CSD	GS6202URFF	LVR-IC	LDO, Dual out, Vout1/Vout2=1.8V/3.3V±2%, 250mA, +CE	UFN-6	49xv	VR19	9m	Glo
CSD	XC9235G3DC4	DC/DC-IC	PWM step-down, 1.2MHz, 3.35V±2%, 600mA, CL, Vin>1.8V, HSST	USP-6EL	56dc5	DC1	9a	Tor
CSD	XC9235G3DCER	DC-DC-IC	PWM, st-dwn, 3.35V±2%, 600mA, 1.2MHz, Vin>1.8V, HSST, CL	USP-6C	49dc5	DC1	9a	Tor
CSE	GS6202UGRF	LVR-IC	LDO, Dual out, Vout1/Vout2=1.5V/3.3V±2%, 250mA, +CE	UFN-6	49xv	VR19	9m	Glo
CSE	XC9235G3EC4	DC/DC-IC	PWM step-down, 1.2MHz, 3.45V±2%, 600mA, CL, Vin>1.8V, HSST	USP-6EL	56dc5	DC1	9a	Tor
CSE	XC9235G3ECER	DC-DC-IC	PWM, st-dwn, 3.45V±2%, 600mA, 1.2MHz, Vin>1.8V, HSST, CL	USP-6C	49dc5	DC1	9a	Tor
CSF	GS6202UDRF	LVR-IC	LDO, Dual out, Vout1/Vout2=2.3V/3.3V±2%, 250mA, +CE	UFN-6	49xv	VR19	9m	Glo
CSF	XC9235G3FC4	DC/DC-IC	PWM step-down, 1.2MHz, 3.55V±2%, 600mA, CL, Vin>1.8V, HSST	USP-6EL	56dc5	DC1	9a	Tor
CSF	XC9235G3FCER	DC-DC-IC	PWM, st-dwn, 3.55V±2%, 600mA, 1.2MHz, Vin>1.8V, HSST, CL	USP-6C	49dc5	DC1	9a	Tor
CSG	GS6202UJF	LVR-IC	LDO, Dual out, Vout1/Vout2=2.8V/2.8V±2%, 250mA, +CE	UFN-6	49xv	VR19	9m	Glo
CSH	GS6202UJHF	LVR-IC	LDO, Dual out, Vout1/Vout2=2.5V/2.8V±2%, 250mA, +CE	UFN-6	49xv	VR19	9m	Glo
CSH	XC9235G3HC4	DC/DC-IC	PWM step-down, 1.2MHz, 3.65V±2%, 600mA, CL, Vin>1.8V, HSST	USP-6EL	56dc5	DC1	9a	Tor
CSH	XC9235G3HCER	DC-DC-IC	PWM, st-dwn, 3.65V±2%, 600mA, 1.2MHz, Vin>1.8V, HSST, CL	USP-6C	49dc5	DC1	9a	Tor
CSJ	GS6202UFJF	LVR-IC	LDO, Dual out, Vout1/Vout2=1.8V/2.8V±2%, 250mA, +CE	UFN-6	49xv	VR19	9m	Glo
CSK	GS6202UGJF	LVR-IC	LDO, Dual out, Vout1/Vout2=1.5V/2.8V±2%, 250mA, +CE	UFN-6	49xv	VR19	9m	Glo
CSK	XC9235G3KC4	DC/DC-IC	PWM step-down, 1.2MHz, 3.75V±2%, 600mA, CL, Vin>1.8V, HSST	USP-6EL	56dc5	DC1	9a	Tor
CSK	XC9235G3KCER	DC-DC-IC	PWM, st-dwn, 3.75V±2%, 600mA, 1.2MHz, Vin>1.8V, HSST, CL	USP-6C	49dc5	DC1	9a	Tor
CSL	GS6202UDJF	LVR-IC	LDO, Dual out, Vout1/Vout2=1.2V/2.8V±2%, 250mA, +CE	UFN-6	49xv	VR19	9m	Glo
CSL	XC9235G3LC4	DC/DC-IC	PWM step-down, 1.2MHz, 3.85V±2%, 600mA, CL, Vin>1.8V, HSST	USP-6EL	56dc5	DC1	9a	Tor
CSL	XC9235G3LCER	DC-DC-IC	PWM, st-dwn, 3.85V±2%, 600mA, 1.2MHz, Vin>1.8V, HSST, CL	USP-6C	49dc5	DC1	9a	Tor
CSM	GS6202UHHF	LVR-IC	LDO, Dual out, Vout1/Vout2=2.5V/2.5V±2%, 250mA, +CE	UFN-6	49xv	VR19	9m	Glo
CSM	XC9235G3MC4	DC/DC-IC	PWM step-down, 1.2MHz, 3.95V±2%, 600mA, CL, Vin>1.8V, HSST	USP-6EL	56dc5	DC1	9a	Tor
CSM	XC9235G3MCER	DC-DC-IC	PWM, st-dwn, 3.95V±2%, 600mA, 1.2MHz, Vin>1.8V, HSST, CL	USP-6C	49dc5	DC1	9a	Tor
CSN	GS6202UHFH	LVR-IC	LDO, Dual out, Vout1/Vout2=1.8V/2.5V±2%, 250mA, +CE	UFN-6	49xv	VR19	9m	Glo
CSQ	GS6202UGHF	LVR-IC	LDO, Dual out, Vout1/Vout2=1.5V/2.5V±2%, 250mA, +CE	UFN-6	49xv	VR19	9m	Glo
CSQ	GS6202UDHF	LVR-IC	LDO, Dual out, Vout1/Vout2=1.2V/2.5V±2%, 250mA, +CE	UFN-6	49xv	VR19	9m	Glo
CSR	GS6202UFFF	LVR-IC	LDO, Dual out, Vout1/Vout2=1.8V/1.8V±2%, 250mA, +CE	UFN-6	49xv	VR19	9m	Glo
CSS	GS6202UGFF	LVR-IC	LDO, Dual out, Vout1/Vout2=1.5V/1.8V±2%, 250mA, +CE	UFN-6	49xv	VR19	9m	Glo
CSST	GS6202UDFF	LVR-IC	LDO, Dual out, Vout1/Vout2=1.2V/1.8V±2%, 250mA, +CE	UFN-6	49xv	VR19	9m	Glo
CSU	GS6202UGGF	LVR-IC	LDO, Dual out, Vout1/Vout2=1.5V/1.5V±2%, 250mA, +CE	UFN-6	49xv	VR19	9m	Glo
CSV	GS6202UDGF	LVR-IC	LDO, Dual out, Vout1/Vout2=1.2V/1.5V±2%, 250mA, +CE	UFN-6	49xv	VR19	9m	Glo
CSW	GS6202U11F	LVR-IC	LDO, Dual out, Vout1/Vout2=2.85V/2.85V±2%, 250mA, +CE	UFN-6	49xv	VR19	9m	Glo
CT	R3134K26EA	Vdet-IC	2.6V±1.8%, -Reset ODO, -MR	DFN1212-6	52z6	VD4	9a	Ric
CT	RP104K241D	LVR-IC	LDO, 2.4V±0.8%, 150mA, +CE, CL	DFN1010-4	48vm	VR4	9a	Ric
CT	XC6221B25B7R	LVR-IC	LDO, 2.55V±1%, 200mA, +CE, CL	USPN-4	58vm	VR4	9a	Tor
CT	XC6223E35B9R-G	LVR-IC	LDO, 3.45V±1%, 300mA, +CE, ICP	USPQ-4B03	48vm	VR4	9a	Tor
CT0	XC9235G40C4	DC/DC-IC	PWM step-down, 1.2MHz, 4.0V±2%, 600mA, CL, Vin>1.8V, HSST	USP-6EL	56dc5	DC1	9a	Tor
CT0	XC9235G40CER	DC-DC-IC	PWM, st-dwn, 4.0V±2%, 600mA, 1.2MHz, Vin>1.8V, HSST, CL	USP-6C	49dc5	DC1	9a	Tor
CJ	R3134K27EA	Vdet-IC	2.7V±1.8%, -Reset ODO, -MR	DFN1212-6	52z6	VD4	9a	Ric
CJ	RP104K221D	LVR-IC	LDO, 2.2V±0.8%, 150mA, +CE, CL	DFN1010-4	48vm	VR4	9a	Ric
CJ	XC6221B26B7R	LVR-IC	LDO, 2.65V±1%, 200mA, +CE, CL	USPN-4	58vm	VR4	9a	Tor
CJ	XC6223E35B9R-G	LVR-IC	LDO, 3.55V±1%, 300mA, +CE, ICP	USPQ-4B03	48vm	VR4	9a	Tor
CJ8	XC9235G08D4	DC/DC-IC	PWM step-down, 3MHz, 0.8V±2%, 600mA, CL, Vin>1.8V, HSST	USP-6EL	56dc5	DC1	9a	Tor
CJ8	XC9235G08DER	DC-DC-IC	PWM, st-dwn, 0.8V±2%, 600mA, 3MHz, Vin>1.8V, HSST, CL	USP-6C	49dc5	DC1	9a	Tor
CJ9	XC9235G09D4	DC/DC-IC	PWM step-down, 3MHz, 0.9V±2%, 600mA, CL, Vin>1.8V, HSST	USP-6EL	56dc5	DC1	9a	Tor
CJ9	XC9235G09DER	DC-DC-IC	PWM, st-dwn, 0.9V±2%, 600mA, 3MHz, Vin>1.8V, HSST, CL	USP-6C	49dc5	DC1	9a	Tor
CJL	XC9235G0LD4	DC/DC-IC	PWM step-down, 3MHz, 0.85V±2%, 600mA, CL, Vin>1.8V, HSST	USP-6EL	56dc5	DC1	9a	Tor
CJL	XC9235G0LDER	DC-DC-IC	PWM, st-dwn, 0.85V±2%, 600mA, 3MHz, Vin>1.8V, HSST, CL	USP-6C	49dc5	DC1	9a	Tor
CJM	XC9235G0MD4	DC/DC-IC	PWM step-down, 3MHz, 0.95V±2%, 600mA, CL, Vin>1.8V, HSST	USP-6EL	56dc5	DC1	9a	Tor
CJM	XC9235G0MDER	DC-DC-IC	PWM, st-dwn, 0.95V±2%, 600mA, 3MHz, Vin>1.8V, HSST, CL	USP-6C	49dc5	DC1	9a	Tor
CV	R3134K28EA	Vdet-IC	2.8V±1.8%, -Reset ODO, -MR	DFN1212-6	52z6	VD4	9a	Ric
CV	RP104K231D	LVR-IC	LDO, 2.3V±0.8%, 150mA, +CE, CL	DFN1010-4	48vm	VR4	9a	Ric
CV	XC6221B27B7R	LVR-IC	LDO, 2.75V±1%, 200mA, +CE, CL	USPN-4	58vm	VR4	9a	Tor
CV	XC6223E36B9R-G	LVR-IC	LDO, 3.65V±1%, 300mA, +CE, ICP	USPQ-4B03	48vm	VR4	9a	Tor
CV0	XC9235G10D4	DC/DC-IC	PWM step-down, 3MHz, 1.0V±2%, 600mA, CL, Vin>1.8V, HSST	USP-6EL	56dc5	DC1	9a	Tor
CV0	XC9235G10DER	DC-DC-IC	PWM, st-dwn, 1.0V±2%, 600mA, 3MHz, Vin>1.8V, HSST, CL	USP-6C	49dc5	DC1	9a	Tor
CV1	XC9235G11D4	DC/DC-IC	PWM step-down, 3MHz, 1.1V±2%, 600mA, CL, Vin>1.8V, HSST	USP-6EL	56dc5	DC1	9a	Tor
CV1	XC9235G11DER	DC-DC-IC	PWM, st-dwn, 1.1V±2%, 600mA, 3MHz, Vin>1.8V, HSST, CL	USP-6C	49dc5	DC1	9a	Tor



SMD code	Type	Function	Short description	Case	Pinout	Sch.	St.	Mnf.
CV2	XC9235G12D4	DC/DC-IC	PWM step-down, 3MHz, 1.2V±2%, 600mA, CL, Vin>1.8V, HSST	USP-6EL	56dc5	DC1	9a	Tor
CV2	XC9235G12DER	DC-DC-IC	PWM, st-dwn, 1.2V±2%, 600mA, 3MHz, Vin>1.8V, HSST, CL	USP-6C	49dc5	DC1	9a	Tor
CV3	XC9235G13D4	DC/DC-IC	PWM step-down, 3MHz, 1.3V±2%, 600mA, CL, Vin>1.8V, HSST	USP-6EL	56dc5	DC1	9a	Tor
CV3	XC9235G13DER	DC-DC-IC	PWM, st-dwn, 1.3V±2%, 600mA, 3MHz, Vin>1.8V, HSST, CL	USP-6C	49dc5	DC1	9a	Tor
CV4	XC9235G14D4	DC/DC-IC	PWM step-down, 3MHz, 1.4V±2%, 600mA, CL, Vin>1.8V, HSST	USP-6EL	56dc5	DC1	9a	Tor
CV4	XC9235G14DER	DC-DC-IC	PWM, st-dwn, 1.4V±2%, 600mA, 3MHz, Vin>1.8V, HSST, CL	USP-6C	49dc5	DC1	9a	Tor
CV5	XC9235G15D4	DC/DC-IC	PWM step-down, 3MHz, 1.5V±2%, 600mA, CL, Vin>1.8V, HSST	USP-6EL	56dc5	DC1	9a	Tor
CV5	XC9235G15DER	DC-DC-IC	PWM, st-dwn, 1.5V±2%, 600mA, 3MHz, Vin>1.8V, HSST, CL	USP-6C	49dc5	DC1	9a	Tor
CV6	XC9235G16D4	DC/DC-IC	PWM step-down, 3MHz, 1.6V±2%, 600mA, CL, Vin>1.8V, HSST	USP-6EL	56dc5	DC1	9a	Tor
CV6	XC9235G16DER	DC-DC-IC	PWM, st-dwn, 1.6V±2%, 600mA, 3MHz, Vin>1.8V, HSST, CL	USP-6C	49dc5	DC1	9a	Tor
CV7	XC9235G17D4	DC/DC-IC	PWM step-down, 3MHz, 1.7V±2%, 600mA, CL, Vin>1.8V, HSST	USP-6EL	56dc5	DC1	9a	Tor
CV7	XC9235G17DER	DC-DC-IC	PWM, st-dwn, 1.7V±2%, 600mA, 3MHz, Vin>1.8V, HSST, CL	USP-6C	49dc5	DC1	9a	Tor
CV8	XC9235G18D4	DC/DC-IC	PWM step-down, 3MHz, 1.8V±2%, 600mA, CL, Vin>1.8V, HSST	USP-6EL	56dc5	DC1	9a	Tor
CV8	XC9235G18DER	DC-DC-IC	PWM, st-dwn, 1.8V±2%, 600mA, 3MHz, Vin>1.8V, HSST, CL	USP-6C	49dc5	DC1	9a	Tor
CV9	XC9235G19D4	DC/DC-IC	PWM step-down, 3MHz, 1.9V±2%, 600mA, CL, Vin>1.8V, HSST	USP-6EL	56dc5	DC1	9a	Tor
CV9	XC9235G19DER	DC-DC-IC	PWM, st-dwn, 1.9V±2%, 600mA, 3MHz, Vin>1.8V, HSST, CL	USP-6C	49dc5	DC1	9a	Tor
CVA	XC9235G1AD4	DC/DC-IC	PWM step-down, 3MHz, 1.05V±2%, 600mA, CL, Vin>1.8V, HSST	USP-6EL	56dc5	DC1	9a	Tor
CVA	XC9235G1ADER	DC-DC-IC	PWM, st-dwn, 1.05V±2%, 600mA, 3MHz, Vin>1.8V, HSST, CL	USP-6C	49dc5	DC1	9a	Tor
CVB	XC9235G1BD4	DC/DC-IC	PWM step-down, 3MHz, 1.15V±2%, 600mA, CL, Vin>1.8V, HSST	USP-6EL	56dc5	DC1	9a	Tor
CVB	XC9235G1BDER	DC-DC-IC	PWM, st-dwn, 1.15V±2%, 600mA, 3MHz, Vin>1.8V, HSST, CL	USP-6C	49dc5	DC1	9a	Tor
CVC	XC9235G1CD4	DC/DC-IC	PWM step-down, 3MHz, 1.25V±2%, 600mA, CL, Vin>1.8V, HSST	USP-6EL	56dc5	DC1	9a	Tor
CVC	XC9235G1CDER	DC-DC-IC	PWM, st-dwn, 1.25V±2%, 600mA, 3MHz, Vin>1.8V, HSST, CL	USP-6C	49dc5	DC1	9a	Tor
CVD	XC9235G1DD4	DC/DC-IC	PWM step-down, 3MHz, 1.35V±2%, 600mA, CL, Vin>1.8V, HSST	USP-6EL	56dc5	DC1	9a	Tor
CVD	XC9235G1DDER	DC-DC-IC	PWM, st-dwn, 1.35V±2%, 600mA, 3MHz, Vin>1.8V, HSST, CL	USP-6C	49dc5	DC1	9a	Tor
CVE	XC9235G1ED4	DC/DC-IC	PWM step-down, 3MHz, 1.45V±2%, 600mA, CL, Vin>1.8V, HSST	USP-6EL	56dc5	DC1	9a	Tor
CVE	XC9235G1EDER	DC-DC-IC	PWM, st-dwn, 1.45V±2%, 600mA, 3MHz, Vin>1.8V, HSST, CL	USP-6C	49dc5	DC1	9a	Tor
CVF	XC9235G1FD4	DC/DC-IC	PWM step-down, 3MHz, 1.55V±2%, 600mA, CL, Vin>1.8V, HSST	USP-6EL	56dc5	DC1	9a	Tor
CVF	XC9235G1FDER	DC-DC-IC	PWM, st-dwn, 1.55V±2%, 600mA, 3MHz, Vin>1.8V, HSST, CL	USP-6C	49dc5	DC1	9a	Tor
CVH	XC9235G1HD4	DC/DC-IC	PWM step-down, 3MHz, 1.65V±2%, 600mA, CL, Vin>1.8V, HSST	USP-6EL	56dc5	DC1	9a	Tor
CVH	XC9235G1HDER	DC-DC-IC	PWM, st-dwn, 1.65V±2%, 600mA, 3MHz, Vin>1.8V, HSST, CL	USP-6C	49dc5	DC1	9a	Tor
CVK	XC9235G1KD4	DC/DC-IC	PWM step-down, 3MHz, 1.75V±2%, 600mA, CL, Vin>1.8V, HSST	USP-6EL	56dc5	DC1	9a	Tor
CVK	XC9235G1KDER	DC-DC-IC	PWM, st-dwn, 1.75V±2%, 600mA, 3MHz, Vin>1.8V, HSST, CL	USP-6C	49dc5	DC1	9a	Tor
CVL	XC9235G1LD4	DC/DC-IC	PWM step-down, 3MHz, 1.85V±2%, 600mA, CL, Vin>1.8V, HSST	USP-6EL	56dc5	DC1	9a	Tor
CVL	XC9235G1LDER	DC-DC-IC	PWM, st-dwn, 1.85V±2%, 600mA, 3MHz, Vin>1.8V, HSST, CL	USP-6C	49dc5	DC1	9a	Tor
CVM	XC9235G1MD4	DC/DC-IC	PWM step-down, 3MHz, 1.95V±2%, 600mA, CL, Vin>1.8V, HSST	USP-6EL	56dc5	DC1	9a	Tor
CVM	XC9235G1MDER	DC-DC-IC	PWM, st-dwn, 1.95V±2%, 600mA, 3MHz, Vin>1.8V, HSST, CL	USP-6C	49dc5	DC1	9a	Tor
CVV	TPA2036D1YZF	LIN-IC	AF PA, BTL, class-D, 2.5..5.5V, 2.75W(5V/4Q), shutdown	BGA-9	39	AFP45	-	Ti
CW	R3134K29EA	Vdet-IC	2.9V±1.8%, -Reset ODO, -MR	DFN1212-6	52z6	VD4	9a	Ric
CW	RP104K271D5	LVR-IC	LDO, 2.75V±0.8%, 150mA, +CE, CL	DFN1010-4	48vm	VR4	9a	Ric
CX	R3134K30EA	Vdet-IC	3.0V±1.8%, -Reset ODO, -MR	DFN1212-6	52z6	VD4	9a	Ric
CX	RP104K211D	LVR-IC	LDO, 2.1V±0.8%, 150mA, +CE, CL	DFN1010-4	48vm	VR4	9a	Ric
CX	XC6221B28B7R	LVR-IC	LDO, 2.85V±1%, 200mA, +CE, CL	USPN-4	58vm	VR4	9a	Tor
CX	XC6223E37B9R-G	LVR-IC	LDO, 3.75V±1%, 300mA, +CE, ICP	USPQ-4B03	48vm	VR4	9a	Tor
CX0	XC9235G20D4	DC/DC-IC	PWM step-down, 3MHz, 2.0V±2%, 600mA, CL, Vin>1.8V, HSST	USP-6EL	56dc5	DC1	9a	Tor
CX0	XC9235G20DER	DC-DC-IC	PWM, st-dwn, 2.0V±2%, 600mA, 3MHz, Vin>1.8V, HSST, CL	USP-6C	49dc5	DC1	9a	Tor
CX1	XC9235G21D4	DC/DC-IC	PWM step-down, 3MHz, 2.1V±2%, 600mA, CL, Vin>1.8V, HSST	USP-6EL	56dc5	DC1	9a	Tor
CX1	XC9235G21DER	DC-DC-IC	PWM, st-dwn, 2.1V±2%, 600mA, 3MHz, Vin>1.8V, HSST, CL	USP-6C	49dc5	DC1	9a	Tor
CX2	XC9235G22D4	DC/DC-IC	PWM step-down, 3MHz, 2.2V±2%, 600mA, CL, Vin>1.8V, HSST	USP-6EL	56dc5	DC1	9a	Tor
CX2	XC9235G22DER	DC-DC-IC	PWM, st-dwn, 2.2V±2%, 600mA, 3MHz, Vin>1.8V, HSST, CL	USP-6C	49dc5	DC1	9a	Tor
CX3	XC9235G23D4	DC/DC-IC	PWM step-down, 3MHz, 2.3V±2%, 600mA, CL, Vin>1.8V, HSST	USP-6EL	56dc5	DC1	9a	Tor
CX3	XC9235G23DER	DC-DC-IC	PWM, st-dwn, 2.3V±2%, 600mA, 3MHz, Vin>1.8V, HSST, CL	USP-6C	49dc5	DC1	9a	Tor
CX4	XC9235G24D4	DC/DC-IC	PWM step-down, 3MHz, 2.4V±2%, 600mA, CL, Vin>1.8V, HSST	USP-6EL	56dc5	DC1	9a	Tor
CX4	XC9235G24DER	DC-DC-IC	PWM, st-dwn, 2.4V±2%, 600mA, 3MHz, Vin>1.8V, HSST, CL	USP-6C	49dc5	DC1	9a	Tor
CX5	XC9235G25D4	DC/DC-IC	PWM step-down, 3MHz, 2.5V±2%, 600mA, CL, Vin>1.8V, HSST	USP-6EL	56dc5	DC1	9a	Tor
CX5	XC9235G25DER	DC-DC-IC	PWM, st-dwn, 2.5V±2%, 600mA, 3MHz, Vin>1.8V, HSST, CL	USP-6C	49dc5	DC1	9a	Tor
CX6	XC9235G26D4	DC/DC-IC	PWM step-down, 3MHz, 2.6V±2%, 600mA, CL, Vin>1.8V, HSST	USP-6EL	56dc5	DC1	9a	Tor
CX6	XC9235G26DER	DC-DC-IC	PWM, st-dwn, 2.6V±2%, 600mA, 3MHz, Vin>1.8V, HSST, CL	USP-6C	49dc5	DC1	9a	Tor
CX7	XC9235G27D4	DC/DC-IC	PWM step-down, 3MHz, 2.7V±2%, 600mA, CL, Vin>1.8V, HSST	USP-6EL	56dc5	DC1	9a	Tor
CX7	XC9235G27DER	DC-DC-IC	PWM, st-dwn, 2.7V±2%, 600mA, 3MHz, Vin>1.8V, HSST, CL	USP-6C	49dc5	DC1	9a	Tor
CX8	XC9235G28D4	DC/DC-IC	PWM step-down, 3MHz, 2.8V±2%, 600mA, CL, Vin>1.8V, HSST	USP-6EL	56dc5	DC1	9a	Tor
CX8	XC9235G28DER	DC-DC-IC	PWM, st-dwn, 2.8V±2%, 600mA, 3MHz, Vin>1.8V, HSST, CL	USP-6C	49dc5	DC1	9a	Tor
CX9	XC9235G29D4	DC/DC-IC	PWM step-down, 3MHz, 2.9V±2%, 600mA, CL, Vin>1.8V, HSST	USP-6EL	56dc5	DC1	9a	Tor
CX9	XC9235G29DER	DC-DC-IC	PWM, st-dwn, 2.9V±2%, 600mA, 3MHz, Vin>1.8V, HSST, CL	USP-6C	49dc5	DC1	9a	Tor
CXA	XC9235G2AD4	DC/DC-IC	PWM step-down, 3MHz, 2.05V±2%, 600mA, CL, Vin>1.8V, HSST	USP-6EL	56dc5	DC1	9a	Tor
CXA	XC9235G2ADER	DC-DC-IC	PWM, st-dwn, 2.05V±2%, 600mA, 3MHz, Vin>1.8V, HSST, CL	USP-6C	49dc5	DC1	9a	Tor
CXB	XC6213B122GR	LVR-IC	LDO, 1.2V±2%, 150mA, +CE	USP-4	45vm	VR4	9b	Tor
CXB	XC9235G2BD4	DC/DC-IC	PWM step-down, 3MHz, 2.15V±2%, 600mA, CL, Vin>1.8V, HSST	USP-6EL	56dc5	DC1	9a	Tor
CXB	XC9235G2BDER	DC-DC-IC	PWM, st-dwn, 2.15V±2%, 600mA, 3MHz, Vin>1.8V, HSST, CL	USP-6C	49dc5	DC1	9a	Tor
CXC	XC6213B132GR	LVR-IC	LDO, 1.3V±2%, 150mA, +CE	USP-4	45vm	VR4	9b	Tor
CXC	XC9235G2CD4	DC/DC-IC	PWM step-down, 3MHz, 2.25V±2%, 600mA, CL, Vin>1.8V, HSST	USP-6EL	56dc5	DC1	9a	Tor



SMD code	Type	Function	Short description	Case	Pinout	Sch.	St.	Mnf.
CXC	XC9235G2CDER	DC-DC-IC	PWM, st-dwn, 2.25V±2%, 600mA, 3MHz, Vin>1.8V, HSST, CL	USP-6C	49dc5	DC1	9a	Tor
CXD	XC6213B142GR	LVR-IC	LDO, 1.4V±2%, 150mA, +CE	USP-4	45vm	VR4	9b	Tor
CXD	XC9235G2DD4	DC/DC-IC	PWM step-down, 3MHz, 2.35V±2%, 600mA, CL, Vin>1.8V, HSST	USP-6EL	56dc5	DC1	9a	Tor
CXD	XC9235G2DDER	DC-DC-IC	PWM, st-dwn, 2.35V±2%, 600mA, 3MHz, Vin>1.8V, HSST, CL	USP-6C	49dc5	DC1	9a	Tor
CXE	XC6213B152GR	LVR-IC	LDO, 1.5V±2%, 150mA, +CE	USP-4	45vm	VR4	9b	Tor
CXE	XC9235G2ED4	DC/DC-IC	PWM step-down, 3MHz, 2.45V±2%, 600mA, CL, Vin>1.8V, HSST	USP-6EL	56dc5	DC1	9a	Tor
CXE	XC9235G2EDER	DC-DC-IC	PWM, st-dwn, 2.45V±2%, 600mA, 3MHz, Vin>1.8V, HSST, CL	USP-6C	49dc5	DC1	9a	Tor
CXF	XC6213B162GR	LVR-IC	LDO, 1.6V±2%, 150mA, +CE	USP-4	45vm	VR4	9b	Tor
CXF	XC9235G2FD4	DC/DC-IC	PWM step-down, 3MHz, 2.55V±2%, 600mA, CL, Vin>1.8V, HSST	USP-6EL	56dc5	DC1	9a	Tor
CXF	XC9235G2FDER	DC-DC-IC	PWM, st-dwn, 2.55V±2%, 600mA, 3MHz, Vin>1.8V, HSST, CL	USP-6C	49dc5	DC1	9a	Tor
CXH	XC6213B172GR	LVR-IC	LDO, 1.7V±2%, 150mA, +CE	USP-4	45vm	VR4	9b	Tor
CXH	XC9235G2HD4	DC/DC-IC	PWM step-down, 3MHz, 2.65V±2%, 600mA, CL, Vin>1.8V, HSST	USP-6EL	56dc5	DC1	9a	Tor
CXH	XC9235G2HDER	DC-DC-IC	PWM, st-dwn, 2.65V±2%, 600mA, 3MHz, Vin>1.8V, HSST, CL	USP-6C	49dc5	DC1	9a	Tor
CXK	XC6213B182GR	LVR-IC	LDO, 1.8V±2%, 150mA, +CE	USP-4	45vm	VR4	9b	Tor
CXK	XC9235G2KD4	DC/DC-IC	PWM step-down, 3MHz, 2.75V±2%, 600mA, CL, Vin>1.8V, HSST	USP-6EL	56dc5	DC1	9a	Tor
CXK	XC9235G2KDER	DC-DC-IC	PWM, st-dwn, 2.75V±2%, 600mA, 3MHz, Vin>1.8V, HSST, CL	USP-6C	49dc5	DC1	9a	Tor
CXL	XC6213B192GR	LVR-IC	LDO, 1.9V±2%, 150mA, +CE	USP-4	45vm	VR4	9b	Tor
CXL	XC9235G2LD4	DC/DC-IC	PWM step-down, 3MHz, 2.85V±2%, 600mA, CL, Vin>1.8V, HSST	USP-6EL	56dc5	DC1	9a	Tor
CXL	XC9235G2LDER	DC-DC-IC	PWM, st-dwn, 2.85V±2%, 600mA, 3MHz, Vin>1.8V, HSST, CL	USP-6C	49dc5	DC1	9a	Tor
CXM	XC6213B202GR	LVR-IC	LDO, 2V±2%, 150mA, +CE	USP-4	45vm	VR4	9b	Tor
CXM	XC9235G2MD4	DC/DC-IC	PWM step-down, 3MHz, 2.95V±2%, 600mA, CL, Vin>1.8V, HSST	USP-6EL	56dc5	DC1	9a	Tor
CXM	XC9235G2MDER	DC-DC-IC	PWM, st-dwn, 2.95V±2%, 600mA, 3MHz, Vin>1.8V, HSST, CL	USP-6C	49dc5	DC1	9a	Tor
CXN	XC6213B212GR	LVR-IC	LDO, 2.1V±2%, 150mA, +CE	USP-4	45vm	VR4	9b	Tor
CXP	XC6213B222GR	LVR-IC	LDO, 2.2V±2%, 150mA, +CE	USP-4	45vm	VR4	9b	Tor
CXR	XC6213B232GR	LVR-IC	LDO, 2.3V±2%, 150mA, +CE	USP-4	45vm	VR4	9b	Tor
CXS	XC6213B242GR	LVR-IC	LDO, 2.4V±2%, 150mA, +CE	USP-4	45vm	VR4	9b	Tor
CXT	XC6213B252GR	LVR-IC	LDO, 2.5V±2%, 150mA, +CE	USP-4	45vm	VR4	9b	Tor
CXU	XC6213B262GR	LVR-IC	LDO, 2.6V±2%, 150mA, +CE	USP-4	45vm	VR4	9b	Tor
CXV	XC6213B272GR	LVR-IC	LDO, 2.7V±2%, 150mA, +CE	USP-4	45vm	VR4	9b	Tor
CXX	XC6213B282GR	LVR-IC	LDO, 2.8V±2%, 150mA, +CE	USP-4	45vm	VR4	9b	Tor
CXY	XC6213B292GR	LVR-IC	LDO, 2.9V±2%, 150mA, +CE	USP-4	45vm	VR4	9b	Tor
CXZ	XC6213B302GR	LVR-IC	LDO, 3V±2%, 150mA, +CE	USP-4	45vm	VR4	9b	Tor
CY	R3134K31EA	Vdel-IC	3.1V±1.8%, -Reset ODO, -MR	DFN1212-6	52z6	VD4	9a	Ric
CY	XC6221B29B7R	LVR-IC	LDO, 2.95V±1%, 200mA, +CE, CL	USPN-4	58vm	VR4	9a	Tor
CY	XC6223E38B9R-G	LVR-IC	LDO, 3.85V±1%, 300mA, +CE, ICP	USPQ-4B03	48vm	VR4	9a	Tor
CY0	XC9235G30D4	DC/DC-IC	PWM step-down, 3MHz, 3.0V±2%, 600mA, CL, Vin>1.8V, HSST	USP-6EL	56dc5	DC1	9a	Tor
CY0	XC9235G30DER	DC-DC-IC	PWM, st-dwn, 3.0V±2%, 600mA, 3MHz, Vin>1.8V, HSST, CL	USP-6C	49dc5	DC1	9a	Tor
CY1	XC9235G31D4	DC/DC-IC	PWM step-down, 3MHz, 3.1V±2%, 600mA, CL, Vin>1.8V, HSST	USP-6EL	56dc5	DC1	9a	Tor
CY1	XC9235G31DER	DC-DC-IC	PWM, st-dwn, 3.1V±2%, 600mA, 3MHz, Vin>1.8V, HSST, CL	USP-6C	49dc5	DC1	9a	Tor
CY2	XC9235G32D4	DC/DC-IC	PWM step-down, 3MHz, 3.2V±2%, 600mA, CL, Vin>1.8V, HSST	USP-6EL	56dc5	DC1	9a	Tor
CY2	XC9235G32DER	DC-DC-IC	PWM, st-dwn, 3.2V±2%, 600mA, 3MHz, Vin>1.8V, HSST, CL	USP-6C	49dc5	DC1	9a	Tor
CY3	XC9235G33D4	DC/DC-IC	PWM step-down, 3MHz, 3.3V±2%, 600mA, CL, Vin>1.8V, HSST	USP-6EL	56dc5	DC1	9a	Tor
CY3	XC9235G33DER	DC-DC-IC	PWM, st-dwn, 3.3V±2%, 600mA, 3MHz, Vin>1.8V, HSST, CL	USP-6C	49dc5	DC1	9a	Tor
CY4	XC9235G34D4	DC/DC-IC	PWM step-down, 3MHz, 3.4V±2%, 600mA, CL, Vin>1.8V, HSST	USP-6EL	56dc5	DC1	9a	Tor
CY4	XC9235G34DER	DC-DC-IC	PWM, st-dwn, 3.4V±2%, 600mA, 3MHz, Vin>1.8V, HSST, CL	USP-6C	49dc5	DC1	9a	Tor
CY5	XC9235G35D4	DC/DC-IC	PWM step-down, 3MHz, 3.5V±2%, 600mA, CL, Vin>1.8V, HSST	USP-6EL	56dc5	DC1	9a	Tor
CY5	XC9235G35DER	DC-DC-IC	PWM, st-dwn, 3.5V±2%, 600mA, 3MHz, Vin>1.8V, HSST, CL	USP-6C	49dc5	DC1	9a	Tor
CY6	XC9235G36D4	DC/DC-IC	PWM step-down, 3MHz, 3.6V±2%, 600mA, CL, Vin>1.8V, HSST	USP-6EL	56dc5	DC1	9a	Tor
CY6	XC9235G36DER	DC-DC-IC	PWM, st-dwn, 3.6V±2%, 600mA, 3MHz, Vin>1.8V, HSST, CL	USP-6C	49dc5	DC1	9a	Tor
CY7	XC9235G37D4	DC/DC-IC	PWM step-down, 3MHz, 3.7V±2%, 600mA, CL, Vin>1.8V, HSST	USP-6EL	56dc5	DC1	9a	Tor
CY7	XC9235G37DER	DC-DC-IC	PWM, st-dwn, 3.7V±2%, 600mA, 3MHz, Vin>1.8V, HSST, CL	USP-6C	49dc5	DC1	9a	Tor
CY8	XC9235G38D4	DC/DC-IC	PWM step-down, 3MHz, 3.8V±2%, 600mA, CL, Vin>1.8V, HSST	USP-6EL	56dc5	DC1	9a	Tor
CY8	XC9235G38DER	DC-DC-IC	PWM, st-dwn, 3.8V±2%, 600mA, 3MHz, Vin>1.8V, HSST, CL	USP-6C	49dc5	DC1	9a	Tor
CY9	XC9235G39D4	DC/DC-IC	PWM step-down, 3MHz, 3.9V±2%, 600mA, CL, Vin>1.8V, HSST	USP-6EL	56dc5	DC1	9a	Tor
CY9	XC9235G39DER	DC-DC-IC	PWM, st-dwn, 3.9V±2%, 600mA, 3MHz, Vin>1.8V, HSST, CL	USP-6C	49dc5	DC1	9a	Tor
CYA	XC9235G3AD4	DC/DC-IC	PWM step-down, 3MHz, 3.05V±2%, 600mA, CL, Vin>1.8V, HSST	USP-6EL	56dc5	DC1	9a	Tor
CYA	XC9235G3ADER	DC-DC-IC	PWM, st-dwn, 3.05V±2%, 600mA, 3MHz, Vin>1.8V, HSST, CL	USP-6C	49dc5	DC1	9a	Tor
CYAAG	AIC1750-AAAGDA	LVR-IC	LDO, Dual out, Vout1=1.1V, Vout2=1.1V, 150mA, +CE	DFN-6L	52xv	VR19	9c	Aic
CYABG	AIC1750-ABGDA	LVR-IC	LDO, Dual out, Vout1=1.1V, Vout2=1.2V, 150mA, +CE	DFN-6L	52xv	VR19	9c	Aic
CYACG	AIC1750-ACGDA	LVR-IC	LDO, Dual out, Vout1=1.1V, Vout2=1.3V, 150mA, +CE	DFN-6L	52xv	VR19	9c	Aic
CYADG	AIC1750-ADGDA	LVR-IC	LDO, Dual out, Vout1=1.1V, Vout2=1.4V, 150mA, +CE	DFN-6L	52xv	VR19	9c	Aic
CYAEG	AIC1750-AEGDA	LVR-IC	LDO, Dual out, Vout1=1.1V, Vout2=1.5V, 150mA, +CE	DFN-6L	52xv	VR19	9c	Aic
CYAFG	AIC1750-AFGDA	LVR-IC	LDO, Dual out, Vout1=1.1V, Vout2=1.6V, 150mA, +CE	DFN-6L	52xv	VR19	9c	Aic
CYAGG	AIC1750-AGGDA	LVR-IC	LDO, Dual out, Vout1=1.1V, Vout2=1.7V, 150mA, +CE	DFN-6L	52xv	VR19	9c	Aic
CYAHG	AIC1750-AHGDA	LVR-IC	LDO, Dual out, Vout1=1.1V, Vout2=1.8V, 150mA, +CE	DFN-6L	52xv	VR19	9c	Aic
CYAIG	AIC1750-AIGDA	LVR-IC	LDO, Dual out, Vout1=1.1V, Vout2=1.9V, 150mA, +CE	DFN-6L	52xv	VR19	9c	Aic
CYAJG	AIC1750-AJGDA	LVR-IC	LDO, Dual out, Vout1=1.1V, Vout2=2.0V, 150mA, +CE	DFN-6L	52xv	VR19	9c	Aic
CYAKG	AIC1750-AKGDA	LVR-IC	LDO, Dual out, Vout1=1.1V, Vout2=2.1V, 150mA, +CE	DFN-6L	52xv	VR19	9c	Aic
CYALG	AIC1750-ALGDA	LVR-IC	LDO, Dual out, Vout1=1.1V, Vout2=2.2V, 150mA, +CE	DFN-6L	52xv	VR19	9c	Aic
CYAMG	AIC1750-AMGDA	LVR-IC	LDO, Dual out, Vout1=1.1V, Vout2=2.3V, 150mA, +CE	DFN-6L	52xv	VR19	9c	Aic



SMD code	Type	Function	Short description	Case	Pinout	Sch.	St.	Mnf.
CYANG	AIC1750-ANGDA	LVR-IC	LDO, Dual out, Vout1=1.1V, Vout2=2.4V, 150mA, +CE	DFN-6L	52xv	VR19	9c	Aic
CYAOG	AIC1750-AOGBDA	LVR-IC	LDO, Dual out, Vout1=1.1V, Vout2=2.5V, 150mA, +CE	DFN-6L	52xv	VR19	9c	Aic
CYAPG	AIC1750-APGDA	LVR-IC	LDO, Dual out, Vout1=1.1V, Vout2=2.6V, 150mA, +CE	DFN-6L	52xv	VR19	9c	Aic
CYAQG	AIC1750-AQGBDA	LVR-IC	LDO, Dual out, Vout1=1.1V, Vout2=2.7V, 150mA, +CE	DFN-6L	52xv	VR19	9c	Aic
CYARG	AIC1750-ARGDA	LVR-IC	LDO, Dual out, Vout1=1.1V, Vout2=2.8V, 150mA, +CE	DFN-6L	52xv	VR19	9c	Aic
CYASG	AIC1750-ASGDA	LVR-IC	LDO, Dual out, Vout1=1.1V, Vout2=2.9V, 150mA, +CE	DFN-6L	52xv	VR19	9c	Aic
CYATG	AIC1750-ATGDA	LVR-IC	LDO, Dual out, Vout1=1.1V, Vout2=3.0V, 150mA, +CE	DFN-6L	52xv	VR19	9c	Aic
CYAUG	AIC1750-AUGDA	LVR-IC	LDO, Dual out, Vout1=1.1V, Vout2=3.1V, 150mA, +CE	DFN-6L	52xv	VR19	9c	Aic
CYAVG	AIC1750-AVGBDA	LVR-IC	LDO, Dual out, Vout1=1.1V, Vout2=3.2V, 150mA, +CE	DFN-6L	52xv	VR19	9c	Aic
CYAWG	AIC1750-AWGBDA	LVR-IC	LDO, Dual out, Vout1=1.1V, Vout2=3.3V, 150mA, +CE	DFN-6L	52xv	VR19	9c	Aic
CYAXG	AIC1750-AXGDA	LVR-IC	LDO, Dual out, Vout1=1.1V, Vout2=2.85V, 150mA, +CE	DFN-6L	52xv	VR19	9c	Aic
CYB	XC9235G3BD4	DC/DC-IC	PWM step-down, 3MHz, 3.15V±2%, 600mA, CL, Vin>1.8V, HSST	USP-6EL	56dc5	DC1	9a	Tor
CYB	XC9235G3BDDER	DC-DC-IC	PWM, st-dwn, 3.15V±2%, 600mA, 3MHz, Vin>1.8V, HSST, CL	USP-6C	49dc5	DC1	9a	Tor
CYBAG	AIC1750-BAGDA	LVR-IC	LDO, Dual out, Vout1=1.2V, Vout2=1.1V, 150mA, +CE	DFN-6L	52xv	VR19	9c	Aic
CYBBG	AIC1750-BBGBDA	LVR-IC	LDO, Dual out, Vout1=1.2V, Vout2=1.2V, 150mA, +CE	DFN-6L	52xv	VR19	9c	Aic
CYBCG	AIC1750-BCGBDA	LVR-IC	LDO, Dual out, Vout1=1.2V, Vout2=1.3V, 150mA, +CE	DFN-6L	52xv	VR19	9c	Aic
CYBDG	AIC1750-BDGBDA	LVR-IC	LDO, Dual out, Vout1=1.2V, Vout2=1.4V, 150mA, +CE	DFN-6L	52xv	VR19	9c	Aic
CYBEG	AIC1750-BEGDA	LVR-IC	LDO, Dual out, Vout1=1.2V, Vout2=1.5V, 150mA, +CE	DFN-6L	52xv	VR19	9c	Aic
CYBFG	AIC1750-BFGBDA	LVR-IC	LDO, Dual out, Vout1=1.2V, Vout2=1.6V, 150mA, +CE	DFN-6L	52xv	VR19	9c	Aic
CYBGG	AIC1750-BGGDA	LVR-IC	LDO, Dual out, Vout1=1.2V, Vout2=1.7V, 150mA, +CE	DFN-6L	52xv	VR19	9c	Aic
CYBHG	AIC1750-BHGBDA	LVR-IC	LDO, Dual out, Vout1=1.2V, Vout2=1.8V, 150mA, +CE	DFN-6L	52xv	VR19	9c	Aic
CYBIG	AIC1750-BIGDA	LVR-IC	LDO, Dual out, Vout1=1.2V, Vout2=1.9V, 150mA, +CE	DFN-6L	52xv	VR19	9c	Aic
CYBJG	AIC1750-BJGBDA	LVR-IC	LDO, Dual out, Vout1=1.2V, Vout2=2.0V, 150mA, +CE	DFN-6L	52xv	VR19	9c	Aic
CYBKJ	AIC1750-BKGBDA	LVR-IC	LDO, Dual out, Vout1=1.2V, Vout2=2.1V, 150mA, +CE	DFN-6L	52xv	VR19	9c	Aic
CYBLG	AIC1750-BLGBDA	LVR-IC	LDO, Dual out, Vout1=1.2V, Vout2=2.2V, 150mA, +CE	DFN-6L	52xv	VR19	9c	Aic
CYBMG	AIC1750-BMGBDA	LVR-IC	LDO, Dual out, Vout1=1.2V, Vout2=2.3V, 150mA, +CE	DFN-6L	52xv	VR19	9c	Aic
CYBNG	AIC1750-BNGBDA	LVR-IC	LDO, Dual out, Vout1=1.2V, Vout2=2.4V, 150mA, +CE	DFN-6L	52xv	VR19	9c	Aic
CYBOG	AIC1750-BOGBDA	LVR-IC	LDO, Dual out, Vout1=1.2V, Vout2=2.5V, 150mA, +CE	DFN-6L	52xv	VR19	9c	Aic
CYBPG	AIC1750-BPGBDA	LVR-IC	LDO, Dual out, Vout1=1.2V, Vout2=2.6V, 150mA, +CE	DFN-6L	52xv	VR19	9c	Aic
CYBQG	AIC1750-BQGBDA	LVR-IC	LDO, Dual out, Vout1=1.2V, Vout2=2.7V, 150mA, +CE	DFN-6L	52xv	VR19	9c	Aic
CYBRG	AIC1750-BRGBDA	LVR-IC	LDO, Dual out, Vout1=1.2V, Vout2=2.8V, 150mA, +CE	DFN-6L	52xv	VR19	9c	Aic
CYBSG	AIC1750-BSGDA	LVR-IC	LDO, Dual out, Vout1=1.2V, Vout2=2.9V, 150mA, +CE	DFN-6L	52xv	VR19	9c	Aic
CYBTG	AIC1750-BTGBDA	LVR-IC	LDO, Dual out, Vout1=1.2V, Vout2=3.0V, 150mA, +CE	DFN-6L	52xv	VR19	9c	Aic
CYBUG	AIC1750-BUGDA	LVR-IC	LDO, Dual out, Vout1=1.2V, Vout2=3.1V, 150mA, +CE	DFN-6L	52xv	VR19	9c	Aic
CYBVG	AIC1750-BVGBDA	LVR-IC	LDO, Dual out, Vout1=1.2V, Vout2=3.2V, 150mA, +CE	DFN-6L	52xv	VR19	9c	Aic
CYBWG	AIC1750-BWGBDA	LVR-IC	LDO, Dual out, Vout1=1.2V, Vout2=3.3V, 150mA, +CE	DFN-6L	52xv	VR19	9c	Aic
CYBXG	AIC1750-BXGDA	LVR-IC	LDO, Dual out, Vout1=1.2V, Vout2=2.85V, 150mA, +CE	DFN-6L	52xv	VR19	9c	Aic
CYC	XC9235G3CD4	DC/DC-IC	PWM step-down, 3MHz, 3.25V±2%, 600mA, CL, Vin>1.8V, HSST	USP-6EL	56dc5	DC1	9a	Tor
CYC	XC9235G3CDDER	DC-DC-IC	PWM, st-dwn, 3.25V±2%, 600mA, 3MHz, Vin>1.8V, HSST, CL	USP-6C	49dc5	DC1	9a	Tor
CYCAC	AIC1750-CAGDA	LVR-IC	LDO, Dual out, Vout1=1.3V, Vout2=1.1V, 150mA, +CE	DFN-6L	52xv	VR19	9c	Aic
CYCBG	AIC1750-CBGBDA	LVR-IC	LDO, Dual out, Vout1=1.3V, Vout2=1.2V, 150mA, +CE	DFN-6L	52xv	VR19	9c	Aic
CYCCG	AIC1750-CCGDA	LVR-IC	LDO, Dual out, Vout1=1.3V, Vout2=1.3V, 150mA, +CE	DFN-6L	52xv	VR19	9c	Aic
CYCDG	AIC1750-CDGDA	LVR-IC	LDO, Dual out, Vout1=1.3V, Vout2=1.4V, 150mA, +CE	DFN-6L	52xv	VR19	9c	Aic
CYCEG	AIC1750-CEGDA	LVR-IC	LDO, Dual out, Vout1=1.3V, Vout2=1.5V, 150mA, +CE	DFN-6L	52xv	VR19	9c	Aic
CYCFG	AIC1750-CFGBDA	LVR-IC	LDO, Dual out, Vout1=1.3V, Vout2=1.6V, 150mA, +CE	DFN-6L	52xv	VR19	9c	Aic
CYCGG	AIC1750-CGGDA	LVR-IC	LDO, Dual out, Vout1=1.3V, Vout2=1.7V, 150mA, +CE	DFN-6L	52xv	VR19	9c	Aic
CYCHG	AIC1750-CHGDA	LVR-IC	LDO, Dual out, Vout1=1.3V, Vout2=1.8V, 150mA, +CE	DFN-6L	52xv	VR19	9c	Aic
CYCIJ	AIC1750-CIGDA	LVR-IC	LDO, Dual out, Vout1=1.3V, Vout2=1.9V, 150mA, +CE	DFN-6L	52xv	VR19	9c	Aic
CYCIJ	AIC1750-CJGDA	LVR-IC	LDO, Dual out, Vout1=1.3V, Vout2=2.0V, 150mA, +CE	DFN-6L	52xv	VR19	9c	Aic
CYCKG	AIC1750-CKGDA	LVR-IC	LDO, Dual out, Vout1=1.3V, Vout2=2.1V, 150mA, +CE	DFN-6L	52xv	VR19	9c	Aic
CYCLG	AIC1750-CLGDA	LVR-IC	LDO, Dual out, Vout1=1.3V, Vout2=2.2V, 150mA, +CE	DFN-6L	52xv	VR19	9c	Aic
CYCMG	AIC1750-CMGDA	LVR-IC	LDO, Dual out, Vout1=1.3V, Vout2=2.3V, 150mA, +CE	DFN-6L	52xv	VR19	9c	Aic
CYCNJ	AIC1750-CNGDA	LVR-IC	LDO, Dual out, Vout1=1.3V, Vout2=2.4V, 150mA, +CE	DFN-6L	52xv	VR19	9c	Aic
CYCOG	AIC1750-COGBDA	LVR-IC	LDO, Dual out, Vout1=1.3V, Vout2=2.5V, 150mA, +CE	DFN-6L	52xv	VR19	9c	Aic
CYCPG	AIC1750-CPGDA	LVR-IC	LDO, Dual out, Vout1=1.3V, Vout2=2.6V, 150mA, +CE	DFN-6L	52xv	VR19	9c	Aic
CYCQG	AIC1750-CQGBDA	LVR-IC	LDO, Dual out, Vout1=1.3V, Vout2=2.7V, 150mA, +CE	DFN-6L	52xv	VR19	9c	Aic
CYCRG	AIC1750-CRGBDA	LVR-IC	LDO, Dual out, Vout1=1.3V, Vout2=2.8V, 150mA, +CE	DFN-6L	52xv	VR19	9c	Aic
CYCSG	AIC1750-CSGDA	LVR-IC	LDO, Dual out, Vout1=1.3V, Vout2=2.9V, 150mA, +CE	DFN-6L	52xv	VR19	9c	Aic
CYCTG	AIC1750-CYGDA	LVR-IC	LDO, Dual out, Vout1=1.3V, Vout2=3.0V, 150mA, +CE	DFN-6L	52xv	VR19	9c	Aic
CYCUG	AIC1750-CUGDA	LVR-IC	LDO, Dual out, Vout1=1.3V, Vout2=3.1V, 150mA, +CE	DFN-6L	52xv	VR19	9c	Aic
CYCVG	AIC1750-CVGBDA	LVR-IC	LDO, Dual out, Vout1=1.3V, Vout2=3.2V, 150mA, +CE	DFN-6L	52xv	VR19	9c	Aic
CYCWG	AIC1750-CWGBDA	LVR-IC	LDO, Dual out, Vout1=1.3V, Vout2=3.3V, 150mA, +CE	DFN-6L	52xv	VR19	9c	Aic
CYCXG	AIC1750-CXGDA	LVR-IC	LDO, Dual out, Vout1=1.3V, Vout2=2.85V, 150mA, +CE	DFN-6L	52xv	VR19	9c	Aic
CYD	XC9235G3DD4	DC/DC-IC	PWM step-down, 3MHz, 3.35V±2%, 600mA, CL, Vin>1.8V, HSST	USP-6EL	56dc5	DC1	9a	Tor
CYD	XC9235G3DDER	DC-DC-IC	PWM, st-dwn, 3.35V±2%, 600mA, 3MHz, Vin>1.8V, HSST, CL	USP-6C	49dc5	DC1	9a	Tor
CYDAG	AIC1750-DAGDA	LVR-IC	LDO, Dual out, Vout1=1.4V, Vout2=1.1V, 150mA, +CE	DFN-6L	52xv	VR19	9c	Aic
CYDBG	AIC1750-DBGDA	LVR-IC	LDO, Dual out, Vout1=1.4V, Vout2=1.2V, 150mA, +CE	DFN-6L	52xv	VR19	9c	Aic
CYDCG	AIC1750-DCGDA	LVR-IC	LDO, Dual out, Vout1=1.4V, Vout2=1.3V, 150mA, +CE	DFN-6L	52xv	VR19	9c	Aic
CYDDG	AIC1750-DDGDA	LVR-IC	LDO, Dual out, Vout1=1.4V, Vout2=1.4V, 150mA, +CE	DFN-6L	52xv	VR19	9c	Aic
CYDEG	AIC1750-DEGDA	LVR-IC	LDO, Dual out, Vout1=1.4V, Vout2=1.5V, 150mA, +CE	DFN-6L	52xv	VR19	9c	Aic



SMD code	Type	Function	Short description	Case	Pinout	Sch.	St.	Mnf.
CYDFG	AIC1750-DFGDA	LVR-IC	LDO, Dual out, Vout1=1.4V, Vout2=1.6V, 150mA, +CE	DFN-6L	52xv	VR19	9c	Aic
CYDGG	AIC1750-DGGDA	LVR-IC	LDO, Dual out, Vout1=1.4V, Vout2=1.7V, 150mA, +CE	DFN-6L	52xv	VR19	9c	Aic
CYDHG	AIC1750-DHGDA	LVR-IC	LDO, Dual out, Vout1=1.4V, Vout2=1.8V, 150mA, +CE	DFN-6L	52xv	VR19	9c	Aic
CYDIG	AIC1750-DIGDA	LVR-IC	LDO, Dual out, Vout1=1.4V, Vout2=1.9V, 150mA, +CE	DFN-6L	52xv	VR19	9c	Aic
CYDJG	AIC1750-DJGDA	LVR-IC	LDO, Dual out, Vout1=1.4V, Vout2=2.0V, 150mA, +CE	DFN-6L	52xv	VR19	9c	Aic
CYDKG	AIC1750-DKGDA	LVR-IC	LDO, Dual out, Vout1=1.4V, Vout2=2.1V, 150mA, +CE	DFN-6L	52xv	VR19	9c	Aic
CYDLG	AIC1750-DLGD	LVR-IC	LDO, Dual out, Vout1=1.4V, Vout2=2.2V, 150mA, +CE	DFN-6L	52xv	VR19	9c	Aic
CYDMG	AIC1750-DMGDA	LVR-IC	LDO, Dual out, Vout1=1.4V, Vout2=2.3V, 150mA, +CE	DFN-6L	52xv	VR19	9c	Aic
CYDNG	AIC1750-DNGDA	LVR-IC	LDO, Dual out, Vout1=1.4V, Vout2=2.4V, 150mA, +CE	DFN-6L	52xv	VR19	9c	Aic
CYDOG	AIC1750-DOGDA	LVR-IC	LDO, Dual out, Vout1=1.4V, Vout2=2.5V, 150mA, +CE	DFN-6L	52xv	VR19	9c	Aic
CYDPG	AIC1750-DPGDA	LVR-IC	LDO, Dual out, Vout1=1.4V, Vout2=2.6V, 150mA, +CE	DFN-6L	52xv	VR19	9c	Aic
CYDQG	AIC1750-DQGDA	LVR-IC	LDO, Dual out, Vout1=1.4V, Vout2=2.7V, 150mA, +CE	DFN-6L	52xv	VR19	9c	Aic
CYDRG	AIC1750-DRGDA	LVR-IC	LDO, Dual out, Vout1=1.4V, Vout2=2.8V, 150mA, +CE	DFN-6L	52xv	VR19	9c	Aic
CYDSG	AIC1750-DSGDA	LVR-IC	LDO, Dual out, Vout1=1.4V, Vout2=2.9V, 150mA, +CE	DFN-6L	52xv	VR19	9c	Aic
CYDTG	AIC1750-DTGDA	LVR-IC	LDO, Dual out, Vout1=1.4V, Vout2=3.0V, 150mA, +CE	DFN-6L	52xv	VR19	9c	Aic
CYDUG	AIC1750-DUGDA	LVR-IC	LDO, Dual out, Vout1=1.4V, Vout2=3.1V, 150mA, +CE	DFN-6L	52xv	VR19	9c	Aic
CYDVG	AIC1750-DVGDA	LVR-IC	LDO, Dual out, Vout1=1.4V, Vout2=3.2V, 150mA, +CE	DFN-6L	52xv	VR19	9c	Aic
CYDWG	AIC1750-DWGDA	LVR-IC	LDO, Dual out, Vout1=1.4V, Vout2=3.3V, 150mA, +CE	DFN-6L	52xv	VR19	9c	Aic
CYDXG	AIC1750-DXGDA	LVR-IC	LDO, Dual out, Vout1=1.4V, Vout2=2.85V, 150mA, +CE	DFN-6L	52xv	VR19	9c	Aic
CYE	XC9235G3E04	DC/DC-IC	PWM step-down, 3MHz, 3.45V±2%, 600mA, CL, Vin>1.8V, HSST	USP-6EL	56dc5	DC1	9a	Tor
CYE	XC9235G3EDER	DC-DC-IC	PWM, st-dwn, 3.45V±2%, 600mA, 3MHz, Vin>1.8V, HSST, CL	USP-6C	49dc5	DC1	9a	Tor
CYEG	AIC1750-EAGDA	LVR-IC	LDO, Dual out, Vout1=1.5V, Vout2=1.1V, 150mA, +CE	DFN-6L	52xv	VR19	9c	Aic
CYEBG	AIC1750-EBGDA	LVR-IC	LDO, Dual out, Vout1=1.5V, Vout2=1.2V, 150mA, +CE	DFN-6L	52xv	VR19	9c	Aic
CYECG	AIC1750-ECGDA	LVR-IC	LDO, Dual out, Vout1=1.5V, Vout2=1.3V, 150mA, +CE	DFN-6L	52xv	VR19	9c	Aic
CYEDG	AIC1750-EDGDA	LVR-IC	LDO, Dual out, Vout1=1.5V, Vout2=1.4V, 150mA, +CE	DFN-6L	52xv	VR19	9c	Aic
CYEEG	AIC1750-EEGDA	LVR-IC	LDO, Dual out, Vout1=1.5V, Vout2=1.5V, 150mA, +CE	DFN-6L	52xv	VR19	9c	Aic
CYEFG	AIC1750-EFGDA	LVR-IC	LDO, Dual out, Vout1=1.5V, Vout2=1.6V, 150mA, +CE	DFN-6L	52xv	VR19	9c	Aic
CYEGG	AIC1750-EGGDA	LVR-IC	LDO, Dual out, Vout1=1.5V, Vout2=1.7V, 150mA, +CE	DFN-6L	52xv	VR19	9c	Aic
CYEHG	AIC1750-EHGDA	LVR-IC	LDO, Dual out, Vout1=1.5V, Vout2=1.8V, 150mA, +CE	DFN-6L	52xv	VR19	9c	Aic
CYEIG	AIC1750-EIGDA	LVR-IC	LDO, Dual out, Vout1=1.5V, Vout2=1.9V, 150mA, +CE	DFN-6L	52xv	VR19	9c	Aic
CYEJG	AIC1750-EJGDA	LVR-IC	LDO, Dual out, Vout1=1.5V, Vout2=2.0V, 150mA, +CE	DFN-6L	52xv	VR19	9c	Aic
CYKGG	AIC1750-EKGDA	LVR-IC	LDO, Dual out, Vout1=1.5V, Vout2=2.1V, 150mA, +CE	DFN-6L	52xv	VR19	9c	Aic
CYELG	AIC1750-ELGDA	LVR-IC	LDO, Dual out, Vout1=1.5V, Vout2=2.2V, 150mA, +CE	DFN-6L	52xv	VR19	9c	Aic
CYEMG	AIC1750-EMGDA	LVR-IC	LDO, Dual out, Vout1=1.5V, Vout2=2.3V, 150mA, +CE	DFN-6L	52xv	VR19	9c	Aic
CYENG	AIC1750-ENGDA	LVR-IC	LDO, Dual out, Vout1=1.5V, Vout2=2.4V, 150mA, +CE	DFN-6L	52xv	VR19	9c	Aic
CYEOG	AIC1750-EOGDA	LVR-IC	LDO, Dual out, Vout1=1.5V, Vout2=2.5V, 150mA, +CE	DFN-6L	52xv	VR19	9c	Aic
CYEPG	AIC1750-EPGDA	LVR-IC	LDO, Dual out, Vout1=1.5V, Vout2=2.6V, 150mA, +CE	DFN-6L	52xv	VR19	9c	Aic
CYEQG	AIC1750-EQGDA	LVR-IC	LDO, Dual out, Vout1=1.5V, Vout2=2.7V, 150mA, +CE	DFN-6L	52xv	VR19	9c	Aic
CYERG	AIC1750-ERGDA	LVR-IC	LDO, Dual out, Vout1=1.5V, Vout2=2.8V, 150mA, +CE	DFN-6L	52xv	VR19	9c	Aic
CYESG	AIC1750-ESGDA	LVR-IC	LDO, Dual out, Vout1=1.5V, Vout2=2.9V, 150mA, +CE	DFN-6L	52xv	VR19	9c	Aic
CYETG	AIC1750-ETGDA	LVR-IC	LDO, Dual out, Vout1=1.5V, Vout2=3.0V, 150mA, +CE	DFN-6L	52xv	VR19	9c	Aic
CYEUG	AIC1750-EUGDA	LVR-IC	LDO, Dual out, Vout1=1.5V, Vout2=3.1V, 150mA, +CE	DFN-6L	52xv	VR19	9c	Aic
CYEVG	AIC1750-EVGDA	LVR-IC	LDO, Dual out, Vout1=1.5V, Vout2=3.2V, 150mA, +CE	DFN-6L	52xv	VR19	9c	Aic
CYEWG	AIC1750-EWGDA	LVR-IC	LDO, Dual out, Vout1=1.5V, Vout2=3.3V, 150mA, +CE	DFN-6L	52xv	VR19	9c	Aic
CYEXG	AIC1750-EXGDA	LVR-IC	LDO, Dual out, Vout1=1.5V, Vout2=2.85V, 150mA, +CE	DFN-6L	52xv	VR19	9c	Aic
CYF	XC9235G3F04	DC/DC-IC	PWM step-down, 3MHz, 3.55V±2%, 600mA, CL, Vin>1.8V, HSST	USP-6EL	56dc5	DC1	9a	Tor
CYF	XC9235G3FDER	DC-DC-IC	PWM, st-dwn, 3.55V±2%, 600mA, 3MHz, Vin>1.8V, HSST, CL	USP-6C	49dc5	DC1	9a	Tor
CYFAG	AIC1750-FAGDA	LVR-IC	LDO, Dual out, Vout1=1.6V, Vout2=1.1V, 150mA, +CE	DFN-6L	52xv	VR19	9c	Aic
CYFBG	AIC1750-FBGDA	LVR-IC	LDO, Dual out, Vout1=1.6V, Vout2=1.2V, 150mA, +CE	DFN-6L	52xv	VR19	9c	Aic
CYFCG	AIC1750-FCGDA	LVR-IC	LDO, Dual out, Vout1=1.6V, Vout2=1.3V, 150mA, +CE	DFN-6L	52xv	VR19	9c	Aic
CYFDG	AIC1750-FDGDA	LVR-IC	LDO, Dual out, Vout1=1.6V, Vout2=1.4V, 150mA, +CE	DFN-6L	52xv	VR19	9c	Aic
CYFEG	AIC1750-FEGDA	LVR-IC	LDO, Dual out, Vout1=1.6V, Vout2=1.5V, 150mA, +CE	DFN-6L	52xv	VR19	9c	Aic
CYFFG	AIC1750-FFGDA	LVR-IC	LDO, Dual out, Vout1=1.6V, Vout2=1.6V, 150mA, +CE	DFN-6L	52xv	VR19	9c	Aic
CYFGG	AIC1750-FGGDA	LVR-IC	LDO, Dual out, Vout1=1.6V, Vout2=1.7V, 150mA, +CE	DFN-6L	52xv	VR19	9c	Aic
CYFHG	AIC1750-FHGDA	LVR-IC	LDO, Dual out, Vout1=1.6V, Vout2=1.8V, 150mA, +CE	DFN-6L	52xv	VR19	9c	Aic
CYFIG	AIC1750-FIGDA	LVR-IC	LDO, Dual out, Vout1=1.6V, Vout2=1.9V, 150mA, +CE	DFN-6L	52xv	VR19	9c	Aic
CYFJG	AIC1750-FJGDA	LVR-IC	LDO, Dual out, Vout1=1.6V, Vout2=2.0V, 150mA, +CE	DFN-6L	52xv	VR19	9c	Aic
CYFKG	AIC1750-FKGDA	LVR-IC	LDO, Dual out, Vout1=1.6V, Vout2=2.1V, 150mA, +CE	DFN-6L	52xv	VR19	9c	Aic
CYFLG	AIC1750-FLGDA	LVR-IC	LDO, Dual out, Vout1=1.6V, Vout2=2.2V, 150mA, +CE	DFN-6L	52xv	VR19	9c	Aic
CYFMG	AIC1750-FMGDA	LVR-IC	LDO, Dual out, Vout1=1.6V, Vout2=2.3V, 150mA, +CE	DFN-6L	52xv	VR19	9c	Aic
CYFNG	AIC1750-FNGDA	LVR-IC	LDO, Dual out, Vout1=1.6V, Vout2=2.4V, 150mA, +CE	DFN-6L	52xv	VR19	9c	Aic
CYFOG	AIC1750-FOGDA	LVR-IC	LDO, Dual out, Vout1=1.6V, Vout2=2.5V, 150mA, +CE	DFN-6L	52xv	VR19	9c	Aic
CYFPG	AIC1750-FPGDA	LVR-IC	LDO, Dual out, Vout1=1.6V, Vout2=2.6V, 150mA, +CE	DFN-6L	52xv	VR19	9c	Aic
CYFQG	AIC1750-FQGDA	LVR-IC	LDO, Dual out, Vout1=1.6V, Vout2=2.7V, 150mA, +CE	DFN-6L	52xv	VR19	9c	Aic
CYFRG	AIC1750-FRGDA	LVR-IC	LDO, Dual out, Vout1=1.6V, Vout2=2.8V, 150mA, +CE	DFN-6L	52xv	VR19	9c	Aic
CYFSG	AIC1750-FSGDA	LVR-IC	LDO, Dual out, Vout1=1.6V, Vout2=2.9V, 150mA, +CE	DFN-6L	52xv	VR19	9c	Aic
CYFTG	AIC1750-FTGDA	LVR-IC	LDO, Dual out, Vout1=1.6V, Vout2=3.0V, 150mA, +CE	DFN-6L	52xv	VR19	9c	Aic
CYFUG	AIC1750-FUGDA	LVR-IC	LDO, Dual out, Vout1=1.6V, Vout2=3.1V, 150mA, +CE	DFN-6L	52xv	VR19	9c	Aic
CYFVG	AIC1750-FVGDA	LVR-IC	LDO, Dual out, Vout1=1.6V, Vout2=3.2V, 150mA, +CE	DFN-6L	52xv	VR19	9c	Aic
CYFWG	AIC1750-FWGDA	LVR-IC	LDO, Dual out, Vout1=1.6V, Vout2=3.3V, 150mA, +CE	DFN-6L	52xv	VR19	9c	Aic



SMD code	Type	Function	Short description	Case	Pinout	Sch.	St.	Mnf.
CYFXG	AIC1750-FXGDA	LVR-IC	LDO, Dual out, Vout1=1.6V, Vout2=2.85V, 150mA, +CE	DFN-6L	52xv	VR19	9c	Aic
CYGAG	AIC1750-GAGDA	LVR-IC	LDO, Dual out, Vout1=1.7V, Vout2=1.1V, 150mA, +CE	DFN-6L	52xv	VR19	9c	Aic
CYGBG	AIC1750-GBGDA	LVR-IC	LDO, Dual out, Vout1=1.7V, Vout2=1.2V, 150mA, +CE	DFN-6L	52xv	VR19	9c	Aic
CYGGC	AIC1750-GCGDA	LVR-IC	LDO, Dual out, Vout1=1.7V, Vout2=1.3V, 150mA, +CE	DFN-6L	52xv	VR19	9c	Aic
CYGDG	AIC1750-GDGD	LVR-IC	LDO, Dual out, Vout1=1.7V, Vout2=1.4V, 150mA, +CE	DFN-6L	52xv	VR19	9c	Aic
CYGEG	AIC1750-GEGDA	LVR-IC	LDO, Dual out, Vout1=1.7V, Vout2=1.5V, 150mA, +CE	DFN-6L	52xv	VR19	9c	Aic
CYGFG	AIC1750-GFGDA	LVR-IC	LDO, Dual out, Vout1=1.7V, Vout2=1.6V, 150mA, +CE	DFN-6L	52xv	VR19	9c	Aic
CYGGG	AIC1750-GGGDA	LVR-IC	LDO, Dual out, Vout1=1.7V, Vout2=1.7V, 150mA, +CE	DFN-6L	52xv	VR19	9c	Aic
CYGHG	AIC1750-GHGDA	LVR-IC	LDO, Dual out, Vout1=1.7V, Vout2=1.8V, 150mA, +CE	DFN-6L	52xv	VR19	9c	Aic
CYGIG	AIC1750-GIGDA	LVR-IC	LDO, Dual out, Vout1=1.7V, Vout2=1.9V, 150mA, +CE	DFN-6L	52xv	VR19	9c	Aic
CYGJG	AIC1750-GJGDA	LVR-IC	LDO, Dual out, Vout1=1.7V, Vout2=2.0V, 150mA, +CE	DFN-6L	52xv	VR19	9c	Aic
CYKKG	AIC1750-GKGD	LVR-IC	LDO, Dual out, Vout1=1.7V, Vout2=2.1V, 150mA, +CE	DFN-6L	52xv	VR19	9c	Aic
CYGLG	AIC1750-GLGDA	LVR-IC	LDO, Dual out, Vout1=1.7V, Vout2=2.2V, 150mA, +CE	DFN-6L	52xv	VR19	9c	Aic
CYIMG	AIC1750-GMGDA	LVR-IC	LDO, Dual out, Vout1=1.7V, Vout2=2.3V, 150mA, +CE	DFN-6L	52xv	VR19	9c	Aic
CYNGG	AIC1750-GNGDA	LVR-IC	LDO, Dual out, Vout1=1.7V, Vout2=2.4V, 150mA, +CE	DFN-6L	52xv	VR19	9c	Aic
CYGOG	AIC1750-GOGDA	LVR-IC	LDO, Dual out, Vout1=1.7V, Vout2=2.5V, 150mA, +CE	DFN-6L	52xv	VR19	9c	Aic
CYGP	AIC1750-GPGDA	LVR-IC	LDO, Dual out, Vout1=1.7V, Vout2=2.6V, 150mA, +CE	DFN-6L	52xv	VR19	9c	Aic
CYQG	AIC1750-GQGDA	LVR-IC	LDO, Dual out, Vout1=1.7V, Vout2=2.7V, 150mA, +CE	DFN-6L	52xv	VR19	9c	Aic
CYRGR	AIC1750-GRGDA	LVR-IC	LDO, Dual out, Vout1=1.7V, Vout2=2.8V, 150mA, +CE	DFN-6L	52xv	VR19	9c	Aic
CYSGG	AIC1750-GSGDA	LVR-IC	LDO, Dual out, Vout1=1.7V, Vout2=2.9V, 150mA, +CE	DFN-6L	52xv	VR19	9c	Aic
CYGTG	AIC1750-GTGD	LVR-IC	LDO, Dual out, Vout1=1.7V, Vout2=3.0V, 150mA, +CE	DFN-6L	52xv	VR19	9c	Aic
CYUGG	AIC1750-GUGDA	LVR-IC	LDO, Dual out, Vout1=1.7V, Vout2=3.1V, 150mA, +CE	DFN-6L	52xv	VR19	9c	Aic
CYVGG	AIC1750-GVGD	LVR-IC	LDO, Dual out, Vout1=1.7V, Vout2=3.2V, 150mA, +CE	DFN-6L	52xv	VR19	9c	Aic
CYWG	AIC1750-GWGD	LVR-IC	LDO, Dual out, Vout1=1.7V, Vout2=3.3V, 150mA, +CE	DFN-6L	52xv	VR19	9c	Aic
CYXG	AIC1750-GXGDA	LVR-IC	LDO, Dual out, Vout1=1.7V, Vout2=2.85V, 150mA, +CE	DFN-6L	52xv	VR19	9c	Aic
CYH	XC9235G3HD4	DC/DC-IC	PWM step-down, 3MHz, 3.65V±2%, 600mA, CL, Vin>1.8V, HSST	USP-6EL	56dc5	DC1	9a	Tor
CYH	XC9235G3HDER	DC-DC-IC	PWM, st-dwn, 3.65V±2%, 600mA, 3MHz, Vin>1.8V, HSST, CL	USP-6C	49dc5	DC1	9a	Tor
CYHAG	AIC1750-HAGDA	LVR-IC	LDO, Dual out, Vout1=1.8V, Vout2=1.1V, 150mA, +CE	DFN-6L	52xv	VR19	9c	Aic
CYHBG	AIC1750-HBGDA	LVR-IC	LDO, Dual out, Vout1=1.8V, Vout2=1.2V, 150mA, +CE	DFN-6L	52xv	VR19	9c	Aic
CYHCG	AIC1750-HCGDA	LVR-IC	LDO, Dual out, Vout1=1.8V, Vout2=1.3V, 150mA, +CE	DFN-6L	52xv	VR19	9c	Aic
CYHDG	AIC1750-HDGD	LVR-IC	LDO, Dual out, Vout1=1.8V, Vout2=1.4V, 150mA, +CE	DFN-6L	52xv	VR19	9c	Aic
CYHEG	AIC1750-HEGDA	LVR-IC	LDO, Dual out, Vout1=1.8V, Vout2=1.5V, 150mA, +CE	DFN-6L	52xv	VR19	9c	Aic
CYHFG	AIC1750-HFGDA	LVR-IC	LDO, Dual out, Vout1=1.8V, Vout2=1.6V, 150mA, +CE	DFN-6L	52xv	VR19	9c	Aic
CYHGG	AIC1750-HGGDA	LVR-IC	LDO, Dual out, Vout1=1.8V, Vout2=1.7V, 150mA, +CE	DFN-6L	52xv	VR19	9c	Aic
CYHHG	AIC1750-HHGDA	LVR-IC	LDO, Dual out, Vout1=1.8V, Vout2=1.8V, 150mA, +CE	DFN-6L	52xv	VR19	9c	Aic
CYHIG	AIC1750-HIGDA	LVR-IC	LDO, Dual out, Vout1=1.8V, Vout2=1.9V, 150mA, +CE	DFN-6L	52xv	VR19	9c	Aic
CYHJG	AIC1750-HJGDA	LVR-IC	LDO, Dual out, Vout1=1.8V, Vout2=2.0V, 150mA, +CE	DFN-6L	52xv	VR19	9c	Aic
CYHKG	AIC1750-HKGD	LVR-IC	LDO, Dual out, Vout1=1.8V, Vout2=2.1V, 150mA, +CE	DFN-6L	52xv	VR19	9c	Aic
CYHLG	AIC1750-HLGD	LVR-IC	LDO, Dual out, Vout1=1.8V, Vout2=2.2V, 150mA, +CE	DFN-6L	52xv	VR19	9c	Aic
CYHMG	AIC1750-HMGDA	LVR-IC	LDO, Dual out, Vout1=1.8V, Vout2=2.3V, 150mA, +CE	DFN-6L	52xv	VR19	9c	Aic
CYHNG	AIC1750-HNGDA	LVR-IC	LDO, Dual out, Vout1=1.8V, Vout2=2.4V, 150mA, +CE	DFN-6L	52xv	VR19	9c	Aic
CYHOG	AIC1750-HOGDA	LVR-IC	LDO, Dual out, Vout1=1.8V, Vout2=2.5V, 150mA, +CE	DFN-6L	52xv	VR19	9c	Aic
CYHPG	AIC1750-HPGD	LVR-IC	LDO, Dual out, Vout1=1.8V, Vout2=2.6V, 150mA, +CE	DFN-6L	52xv	VR19	9c	Aic
CYHQG	AIC1750-HQGD	LVR-IC	LDO, Dual out, Vout1=1.8V, Vout2=2.7V, 150mA, +CE	DFN-6L	52xv	VR19	9c	Aic
CYHRG	AIC1750-HRGDA	LVR-IC	LDO, Dual out, Vout1=1.8V, Vout2=2.8V, 150mA, +CE	DFN-6L	52xv	VR19	9c	Aic
CYHSG	AIC1750-HSGDA	LVR-IC	LDO, Dual out, Vout1=1.8V, Vout2=2.9V, 150mA, +CE	DFN-6L	52xv	VR19	9c	Aic
CYHTG	AIC1750-HTGD	LVR-IC	LDO, Dual out, Vout1=1.8V, Vout2=3.0V, 150mA, +CE	DFN-6L	52xv	VR19	9c	Aic
CYHUG	AIC1750-HUGDA	LVR-IC	LDO, Dual out, Vout1=1.8V, Vout2=3.1V, 150mA, +CE	DFN-6L	52xv	VR19	9c	Aic
CYHVG	AIC1750-HVGD	LVR-IC	LDO, Dual out, Vout1=1.8V, Vout2=3.2V, 150mA, +CE	DFN-6L	52xv	VR19	9c	Aic
CYHWG	AIC1750-HWGD	LVR-IC	LDO, Dual out, Vout1=1.8V, Vout2=3.3V, 150mA, +CE	DFN-6L	52xv	VR19	9c	Aic
CYHXG	AIC1750-HXGDA	LVR-IC	LDO, Dual out, Vout1=1.8V, Vout2=2.85V, 150mA, +CE	DFN-6L	52xv	VR19	9c	Aic
CYIAG	AIC1750-IAGDA	LVR-IC	LDO, Dual out, Vout1=1.9V, Vout2=1.1V, 150mA, +CE	DFN-6L	52xv	VR19	9c	Aic
CYIBG	AIC1750-IBGDA	LVR-IC	LDO, Dual out, Vout1=1.9V, Vout2=1.2V, 150mA, +CE	DFN-6L	52xv	VR19	9c	Aic
CYICG	AIC1750-ICGDA	LVR-IC	LDO, Dual out, Vout1=1.9V, Vout2=1.3V, 150mA, +CE	DFN-6L	52xv	VR19	9c	Aic
CYIDG	AIC1750-IDGDA	LVR-IC	LDO, Dual out, Vout1=1.9V, Vout2=1.4V, 150mA, +CE	DFN-6L	52xv	VR19	9c	Aic
CYIEG	AIC1750-IEGDA	LVR-IC	LDO, Dual out, Vout1=1.9V, Vout2=1.5V, 150mA, +CE	DFN-6L	52xv	VR19	9c	Aic
CYIFG	AIC1750-IFGD	LVR-IC	LDO, Dual out, Vout1=1.9V, Vout2=1.6V, 150mA, +CE	DFN-6L	52xv	VR19	9c	Aic
CYIGG	AIC1750-IGGDA	LVR-IC	LDO, Dual out, Vout1=1.9V, Vout2=1.7V, 150mA, +CE	DFN-6L	52xv	VR19	9c	Aic
CYIHG	AIC1750-IHGDA	LVR-IC	LDO, Dual out, Vout1=1.9V, Vout2=1.8V, 150mA, +CE	DFN-6L	52xv	VR19	9c	Aic
CYIIG	AIC1750-IIGDA	LVR-IC	LDO, Dual out, Vout1=1.9V, Vout2=1.9V, 150mA, +CE	DFN-6L	52xv	VR19	9c	Aic
CYIJG	AIC1750-IJGDA	LVR-IC	LDO, Dual out, Vout1=1.9V, Vout2=2.0V, 150mA, +CE	DFN-6L	52xv	VR19	9c	Aic
CYIKG	AIC1750-IKGDA	LVR-IC	LDO, Dual out, Vout1=1.9V, Vout2=2.1V, 150mA, +CE	DFN-6L	52xv	VR19	9c	Aic
CYILG	AIC1750-ILGD	LVR-IC	LDO, Dual out, Vout1=1.9V, Vout2=2.2V, 150mA, +CE	DFN-6L	52xv	VR19	9c	Aic
CYIMG	AIC1750-IMGDA	LVR-IC	LDO, Dual out, Vout1=1.9V, Vout2=2.3V, 150mA, +CE	DFN-6L	52xv	VR19	9c	Aic
CYING	AIC1750-INGDA	LVR-IC	LDO, Dual out, Vout1=1.9V, Vout2=2.4V, 150mA, +CE	DFN-6L	52xv	VR19	9c	Aic
CYIOG	AIC1750-IOGDA	LVR-IC	LDO, Dual out, Vout1=1.9V, Vout2=2.5V, 150mA, +CE	DFN-6L	52xv	VR19	9c	Aic
CYIPG	AIC1750-IPGD	LVR-IC	LDO, Dual out, Vout1=1.9V, Vout2=2.6V, 150mA, +CE	DFN-6L	52xv	VR19	9c	Aic
CYIQG	AIC1750-IQGD	LVR-IC	LDO, Dual out, Vout1=1.9V, Vout2=2.7V, 150mA, +CE	DFN-6L	52xv	VR19	9c	Aic
CYIRG	AIC1750-IRGDA	LVR-IC	LDO, Dual out, Vout1=1.9V, Vout2=2.8V, 150mA, +CE	DFN-6L	52xv	VR19	9c	Aic
CYISG	AIC1750-ISGDA	LVR-IC	LDO, Dual out, Vout1=1.9V, Vout2=2.9V, 150mA, +CE	DFN-6L	52xv	VR19	9c	Aic



SMD code	Type	Function	Short description	Case	Pinout	Sch.	St.	Mnf.
CYITG	AIC1750-ITGDA	LVR-IC	LDO, Dual out, Vout1=1.9V, Vout2=3.0V, 150mA, +CE	DFN-6L	52xv	VR19	9c	Aic
CYIUG	AIC1750-IUGDA	LVR-IC	LDO, Dual out, Vout1=1.9V, Vout2=3.1V, 150mA, +CE	DFN-6L	52xv	VR19	9c	Aic
CYIVG	AIC1750-IVGDA	LVR-IC	LDO, Dual out, Vout1=1.9V, Vout2=3.2V, 150mA, +CE	DFN-6L	52xv	VR19	9c	Aic
CYIWG	AIC1750-IVGDA	LVR-IC	LDO, Dual out, Vout1=1.9V, Vout2=3.3V, 150mA, +CE	DFN-6L	52xv	VR19	9c	Aic
CYIXG	AIC1750-IXGDA	LVR-IC	LDO, Dual out, Vout1=1.9V, Vout2=2.85V, 150mA, +CE	DFN-6L	52xv	VR19	9c	Aic
CYJAG	AIC1750-JAGDA	LVR-IC	LDO, Dual out, Vout1=2.0V, Vout2=1.1V, 150mA, +CE	DFN-6L	52xv	VR19	9c	Aic
CYJBG	AIC1750-JBGDA	LVR-IC	LDO, Dual out, Vout1=2.0V, Vout2=1.2V, 150mA, +CE	DFN-6L	52xv	VR19	9c	Aic
CYJCG	AIC1750-JCGDA	LVR-IC	LDO, Dual out, Vout1=2.0V, Vout2=1.3V, 150mA, +CE	DFN-6L	52xv	VR19	9c	Aic
CYJDG	AIC1750-JDGDA	LVR-IC	LDO, Dual out, Vout1=2.0V, Vout2=1.4V, 150mA, +CE	DFN-6L	52xv	VR19	9c	Aic
CYJEG	AIC1750-JEGDA	LVR-IC	LDO, Dual out, Vout1=2.0V, Vout2=1.5V, 150mA, +CE	DFN-6L	52xv	VR19	9c	Aic
CYJFG	AIC1750-JFGDA	LVR-IC	LDO, Dual out, Vout1=2.0V, Vout2=1.6V, 150mA, +CE	DFN-6L	52xv	VR19	9c	Aic
CYJGG	AIC1750-JGGDA	LVR-IC	LDO, Dual out, Vout1=2.0V, Vout2=1.7V, 150mA, +CE	DFN-6L	52xv	VR19	9c	Aic
CYJHG	AIC1750-JHGDA	LVR-IC	LDO, Dual out, Vout1=2.0V, Vout2=1.8V, 150mA, +CE	DFN-6L	52xv	VR19	9c	Aic
CYJIG	AIC1750-JIGDA	LVR-IC	LDO, Dual out, Vout1=2.0V, Vout2=1.9V, 150mA, +CE	DFN-6L	52xv	VR19	9c	Aic
CYJJG	AIC1750-JJGDA	LVR-IC	LDO, Dual out, Vout1=2.0V, Vout2=2.0V, 150mA, +CE	DFN-6L	52xv	VR19	9c	Aic
CYJKG	AIC1750-JKGDA	LVR-IC	LDO, Dual out, Vout1=2.0V, Vout2=2.1V, 150mA, +CE	DFN-6L	52xv	VR19	9c	Aic
CYJLG	AIC1750-JLGDA	LVR-IC	LDO, Dual out, Vout1=2.0V, Vout2=2.2V, 150mA, +CE	DFN-6L	52xv	VR19	9c	Aic
CYJMG	AIC1750-JMGDA	LVR-IC	LDO, Dual out, Vout1=2.0V, Vout2=2.3V, 150mA, +CE	DFN-6L	52xv	VR19	9c	Aic
CYJNG	AIC1750-JNGDA	LVR-IC	LDO, Dual out, Vout1=2.0V, Vout2=2.4V, 150mA, +CE	DFN-6L	52xv	VR19	9c	Aic
CYJOG	AIC1750-JOGDA	LVR-IC	LDO, Dual out, Vout1=2.0V, Vout2=2.5V, 150mA, +CE	DFN-6L	52xv	VR19	9c	Aic
CYJPG	AIC1750-JPGDA	LVR-IC	LDO, Dual out, Vout1=2.0V, Vout2=2.6V, 150mA, +CE	DFN-6L	52xv	VR19	9c	Aic
CYJQG	AIC1750-JQGDA	LVR-IC	LDO, Dual out, Vout1=2.0V, Vout2=2.7V, 150mA, +CE	DFN-6L	52xv	VR19	9c	Aic
CYJRG	AIC1750-JRGDA	LVR-IC	LDO, Dual out, Vout1=2.0V, Vout2=2.8V, 150mA, +CE	DFN-6L	52xv	VR19	9c	Aic
CYJSG	AIC1750-JSGDA	LVR-IC	LDO, Dual out, Vout1=2.0V, Vout2=2.9V, 150mA, +CE	DFN-6L	52xv	VR19	9c	Aic
CYJTG	AIC1750-JTGDA	LVR-IC	LDO, Dual out, Vout1=2.0V, Vout2=3.0V, 150mA, +CE	DFN-6L	52xv	VR19	9c	Aic
CYJUG	AIC1750-JUGDA	LVR-IC	LDO, Dual out, Vout1=2.0V, Vout2=3.1V, 150mA, +CE	DFN-6L	52xv	VR19	9c	Aic
CYJVG	AIC1750-JVGDA	LVR-IC	LDO, Dual out, Vout1=2.0V, Vout2=3.2V, 150mA, +CE	DFN-6L	52xv	VR19	9c	Aic
CYJWG	AIC1750-JWGDA	LVR-IC	LDO, Dual out, Vout1=2.0V, Vout2=3.3V, 150mA, +CE	DFN-6L	52xv	VR19	9c	Aic
CYJXG	AIC1750-JXGDA	LVR-IC	LDO, Dual out, Vout1=2.0V, Vout2=2.85V, 150mA, +CE	DFN-6L	52xv	VR19	9c	Aic
CYK	XC9235G3KD4	DC/DC-IC	PWM step-down, 3MHz, 3.75V±2%, 600mA, CL, Vin>1.8V, HSST	USP-6EL	56dc5	DC1	9a	Tor
CYK	XC9235G3KDER	DC-DC-IC	PWM, st-dwn, 3.75V±2%, 600mA, 3MHz, Vin>1.8V, HSST, CL	USP-6C	49dc5	DC1	9a	Tor
CYKAG	AIC1750-KAGDA	LVR-IC	LDO, Dual out, Vout1=2.1V, Vout2=1.1V, 150mA, +CE	DFN-6L	52xv	VR19	9c	Aic
CYKBG	AIC1750-KBGDA	LVR-IC	LDO, Dual out, Vout1=2.1V, Vout2=1.2V, 150mA, +CE	DFN-6L	52xv	VR19	9c	Aic
CYKCG	AIC1750-KCGDA	LVR-IC	LDO, Dual out, Vout1=2.1V, Vout2=1.3V, 150mA, +CE	DFN-6L	52xv	VR19	9c	Aic
CYKDG	AIC1750-KDGDA	LVR-IC	LDO, Dual out, Vout1=2.1V, Vout2=1.4V, 150mA, +CE	DFN-6L	52xv	VR19	9c	Aic
CYKEG	AIC1750-KEGDA	LVR-IC	LDO, Dual out, Vout1=2.1V, Vout2=1.5V, 150mA, +CE	DFN-6L	52xv	VR19	9c	Aic
CYKFG	AIC1750-KFGDA	LVR-IC	LDO, Dual out, Vout1=2.1V, Vout2=1.6V, 150mA, +CE	DFN-6L	52xv	VR19	9c	Aic
CYKGG	AIC1750-KGGDA	LVR-IC	LDO, Dual out, Vout1=2.1V, Vout2=1.7V, 150mA, +CE	DFN-6L	52xv	VR19	9c	Aic
CYKHG	AIC1750-KHGDA	LVR-IC	LDO, Dual out, Vout1=2.1V, Vout2=1.8V, 150mA, +CE	DFN-6L	52xv	VR19	9c	Aic
CYKIG	AIC1750-KIGDA	LVR-IC	LDO, Dual out, Vout1=2.1V, Vout2=1.9V, 150mA, +CE	DFN-6L	52xv	VR19	9c	Aic
CYKJG	AIC1750-KJGDA	LVR-IC	LDO, Dual out, Vout1=2.1V, Vout2=2.0V, 150mA, +CE	DFN-6L	52xv	VR19	9c	Aic
CYKKG	AIC1750-KKGDA	LVR-IC	LDO, Dual out, Vout1=2.1V, Vout2=2.1V, 150mA, +CE	DFN-6L	52xv	VR19	9c	Aic
CYKLG	AIC1750-KLGDA	LVR-IC	LDO, Dual out, Vout1=2.1V, Vout2=2.2V, 150mA, +CE	DFN-6L	52xv	VR19	9c	Aic
CYKMG	AIC1750-KMGDA	LVR-IC	LDO, Dual out, Vout1=2.1V, Vout2=2.3V, 150mA, +CE	DFN-6L	52xv	VR19	9c	Aic
CYKNG	AIC1750-KNGDA	LVR-IC	LDO, Dual out, Vout1=2.1V, Vout2=2.4V, 150mA, +CE	DFN-6L	52xv	VR19	9c	Aic
CYKOG	AIC1750-KOGDA	LVR-IC	LDO, Dual out, Vout1=2.1V, Vout2=2.5V, 150mA, +CE	DFN-6L	52xv	VR19	9c	Aic
CYKPG	AIC1750-KPGDA	LVR-IC	LDO, Dual out, Vout1=2.1V, Vout2=2.6V, 150mA, +CE	DFN-6L	52xv	VR19	9c	Aic
CYKQG	AIC1750-KQGDA	LVR-IC	LDO, Dual out, Vout1=2.1V, Vout2=2.7V, 150mA, +CE	DFN-6L	52xv	VR19	9c	Aic
CYKRG	AIC1750-KRGDA	LVR-IC	LDO, Dual out, Vout1=2.1V, Vout2=2.8V, 150mA, +CE	DFN-6L	52xv	VR19	9c	Aic
CYKSG	AIC1750-KSGDA	LVR-IC	LDO, Dual out, Vout1=2.1V, Vout2=2.9V, 150mA, +CE	DFN-6L	52xv	VR19	9c	Aic
CYKTG	AIC1750-KTGDA	LVR-IC	LDO, Dual out, Vout1=2.1V, Vout2=3.0V, 150mA, +CE	DFN-6L	52xv	VR19	9c	Aic
CYKUG	AIC1750-KUGDA	LVR-IC	LDO, Dual out, Vout1=2.1V, Vout2=3.1V, 150mA, +CE	DFN-6L	52xv	VR19	9c	Aic
CYKVG	AIC1750-KVGDA	LVR-IC	LDO, Dual out, Vout1=2.1V, Vout2=3.2V, 150mA, +CE	DFN-6L	52xv	VR19	9c	Aic
CYKWG	AIC1750-KWGDA	LVR-IC	LDO, Dual out, Vout1=2.1V, Vout2=3.3V, 150mA, +CE	DFN-6L	52xv	VR19	9c	Aic
CYKXG	AIC1750-KXGDA	LVR-IC	LDO, Dual out, Vout1=2.1V, Vout2=2.85V, 150mA, +CE	DFN-6L	52xv	VR19	9c	Aic
CYL	XC9235G3LD4	DC/DC-IC	PWM step-down, 3MHz, 3.85V±2%, 600mA, CL, Vin>1.8V, HSST	USP-6EL	56dc5	DC1	9a	Tor
CYL	XC9235G3LDER	DC-DC-IC	PWM, st-dwn, 3.85V±2%, 600mA, 3MHz, Vin>1.8V, HSST, CL	USP-6C	49dc5	DC1	9a	Tor
CYLAG	AIC1750-LAGDA	LVR-IC	LDO, Dual out, Vout1=2.2V, Vout2=1.1V, 150mA, +CE	DFN-6L	52xv	VR19	9c	Aic
CYLBG	AIC1750-LBGDA	LVR-IC	LDO, Dual out, Vout1=2.2V, Vout2=1.2V, 150mA, +CE	DFN-6L	52xv	VR19	9c	Aic
CYLCG	AIC1750-LCGDA	LVR-IC	LDO, Dual out, Vout1=2.2V, Vout2=1.3V, 150mA, +CE	DFN-6L	52xv	VR19	9c	Aic
CYLDG	AIC1750-LDGDA	LVR-IC	LDO, Dual out, Vout1=2.2V, Vout2=1.4V, 150mA, +CE	DFN-6L	52xv	VR19	9c	Aic
CYLEG	AIC1750-LEGDA	LVR-IC	LDO, Dual out, Vout1=2.2V, Vout2=1.5V, 150mA, +CE	DFN-6L	52xv	VR19	9c	Aic
CYLFG	AIC1750-LFGDA	LVR-IC	LDO, Dual out, Vout1=2.2V, Vout2=1.6V, 150mA, +CE	DFN-6L	52xv	VR19	9c	Aic
CYLGG	AIC1750-LGGDA	LVR-IC	LDO, Dual out, Vout1=2.2V, Vout2=1.7V, 150mA, +CE	DFN-6L	52xv	VR19	9c	Aic
CYLHG	AIC1750-LHGDA	LVR-IC	LDO, Dual out, Vout1=2.2V, Vout2=1.8V, 150mA, +CE	DFN-6L	52xv	VR19	9c	Aic
CYLIG	AIC1750-LIGDA	LVR-IC	LDO, Dual out, Vout1=2.2V, Vout2=1.9V, 150mA, +CE	DFN-6L	52xv	VR19	9c	Aic
CYLJG	AIC1750-LJGDA	LVR-IC	LDO, Dual out, Vout1=2.2V, Vout2=2.0V, 150mA, +CE	DFN-6L	52xv	VR19	9c	Aic
CYLKG	AIC1750-LKGDA	LVR-IC	LDO, Dual out, Vout1=2.2V, Vout2=2.1V, 150mA, +CE	DFN-6L	52xv	VR19	9c	Aic
CYLLG	AIC1750-LLGDA	LVR-IC	LDO, Dual out, Vout1=2.2V, Vout2=2.2V, 150mA, +CE	DFN-6L	52xv	VR19	9c	Aic
CYLMG	AIC1750-LMGDA	LVR-IC	LDO, Dual out, Vout1=2.2V, Vout2=2.3V, 150mA, +CE	DFN-6L	52xv	VR19	9c	Aic



SMD code	Type	Function	Short description	Case	Pinout	Sch.	St.	Mnf.
CYXDG	AIC1750-XDGDA	LVR-IC	LDO, Dual out, Vout1=2.85V, Vout2=1.4V, 150mA, +CE	DFN-6L	52xv	VR19	9c	Aic
CYXEG	AIC1750-XEGDA	LVR-IC	LDO, Dual out, Vout1=2.85V, Vout2=1.5V, 150mA, +CE	DFN-6L	52xv	VR19	9c	Aic
CYXFG	AIC1750-XFGDA	LVR-IC	LDO, Dual out, Vout1=2.85V, Vout2=1.6V, 150mA, +CE	DFN-6L	52xv	VR19	9c	Aic
CYXGG	AIC1750-XGGDA	LVR-IC	LDO, Dual out, Vout1=2.85V, Vout2=1.7V, 150mA, +CE	DFN-6L	52xv	VR19	9c	Aic
CYXHG	AIC1750-XHGDA	LVR-IC	LDO, Dual out, Vout1=2.85V, Vout2=1.8V, 150mA, +CE	DFN-6L	52xv	VR19	9c	Aic
CYXIG	AIC1750-XIGDA	LVR-IC	LDO, Dual out, Vout1=2.85V, Vout2=1.9V, 150mA, +CE	DFN-6L	52xv	VR19	9c	Aic
CYXJG	AIC1750-XJGDA	LVR-IC	LDO, Dual out, Vout1=2.85V, Vout2=2.0V, 150mA, +CE	DFN-6L	52xv	VR19	9c	Aic
CYXKG	AIC1750-XKGD	LVR-IC	LDO, Dual out, Vout1=2.85V, Vout2=2.1V, 150mA, +CE	DFN-6L	52xv	VR19	9c	Aic
CYXLG	AIC1750-XLGD	LVR-IC	LDO, Dual out, Vout1=2.85V, Vout2=2.2V, 150mA, +CE	DFN-6L	52xv	VR19	9c	Aic
CYXMG	AIC1750-XMGDA	LVR-IC	LDO, Dual out, Vout1=2.85V, Vout2=2.3V, 150mA, +CE	DFN-6L	52xv	VR19	9c	Aic
CYXNG	AIC1750-XNGDA	LVR-IC	LDO, Dual out, Vout1=2.85V, Vout2=2.4V, 150mA, +CE	DFN-6L	52xv	VR19	9c	Aic
CYXOG	AIC1750-XOGDA	LVR-IC	LDO, Dual out, Vout1=2.85V, Vout2=2.5V, 150mA, +CE	DFN-6L	52xv	VR19	9c	Aic
CYXPG	AIC1750-XPGDA	LVR-IC	LDO, Dual out, Vout1=2.85V, Vout2=2.6V, 150mA, +CE	DFN-6L	52xv	VR19	9c	Aic
CYXQG	AIC1750-XQGDA	LVR-IC	LDO, Dual out, Vout1=2.85V, Vout2=2.7V, 150mA, +CE	DFN-6L	52xv	VR19	9c	Aic
CYXRG	AIC1750-XRQDA	LVR-IC	LDO, Dual out, Vout1=2.85V, Vout2=2.8V, 150mA, +CE	DFN-6L	52xv	VR19	9c	Aic
CYXSG	AIC1750-XSGDA	LVR-IC	LDO, Dual out, Vout1=2.85V, Vout2=2.9V, 150mA, +CE	DFN-6L	52xv	VR19	9c	Aic
CYXTG	AIC1750-XTGDA	LVR-IC	LDO, Dual out, Vout1=2.85V, Vout2=3.0V, 150mA, +CE	DFN-6L	52xv	VR19	9c	Aic
CYXUG	AIC1750-XUGDA	LVR-IC	LDO, Dual out, Vout1=2.85V, Vout2=3.1V, 150mA, +CE	DFN-6L	52xv	VR19	9c	Aic
CYXVG	AIC1750-XVQDA	LVR-IC	LDO, Dual out, Vout1=2.85V, Vout2=3.2V, 150mA, +CE	DFN-6L	52xv	VR19	9c	Aic
CYXWG	AIC1750-XWQDA	LVR-IC	LDO, Dual out, Vout1=2.85V, Vout2=3.3V, 150mA, +CE	DFN-6L	52xv	VR19	9c	Aic
CYXXG	AIC1750-XXGDA	LVR-IC	LDO, Dual out, Vout1=2.85V, Vout2=2.85V, 150mA, +CE	DFN-6L	52xv	VR19	9c	Aic
CZ	R3134K32EA	Vdel-IC	3.2V±1.8%, -Reset ODO, -MR	DFN1212-6	52z6	VD4	9a	Ric
CZ	XC6221B30B7R	LVR-IC	LDO, 3.05V±1%, 200mA, +CE, CL	USPN-4	58vm	VR4	9a	Tor
CZ	XC6223E39B9R-G	LVR-IC	LDO, 3.95V±1%, 300mA, +CE, ICP	USPQ-4B03	48vm	VR4	9a	Tor
CZ0	XC9235G40D4	DC/DC-IC	PWM step-down, 3MHz, 4.0V±2%, 600mA, CL, Vin>1.8V, HSST	USP-6EL	56dc5	DC1	9a	Tor
CZ0	XC9235G40DER	DC-DC-IC	PWM, st-down, 4.0V±2%, 600mA, 3MHz, Vin>1.8V, HSST, CL	USP-6C	49dc5	DC1	9a	Tor
d0	EUA2012H	LIN-IC	AF PA, BTL, class-D, 2.5..5.5V, 2x2.7W(5V/4Q), shutdown	BGA-16	39	AFP46	-	Eut
D0	R3118K361A	Vdel-IC	3.6V±1.5%, -Reset ODO, Sense	DFN1212-6	52z3	VD14	9a	Ric
D0	RP109L181B	LVR-IC	LDO, 1.8V±1%, 150mA, +CE	DFN1010-4	48vm	VR4	9a	Ric
D0	XC6221A3117R	LVR-IC	LDO, 3.1V±1%, 200mA, +CE	USPN-4	58vm	VR4	9a	Tor
D001	R5325K001B	LVR-IC	LDO, Dual out, V1=2V±1%, V2=2V±1%, 150mA, +CE, CL	DFN1820-6	74i	VR19	9b	Ric
D002	R5325K002B	LVR-IC	LDO, Dual out, V1=2.8V±1%, V2=2.8V±1%, 150mA, +CE, CL	DFN1820-6	74i	VR19	9b	Ric
D003	R5325K003B	LVR-IC	LDO, Dual out, V1=1.8V±1%, V2=3V±1%, 150mA, +CE, CL	DFN1820-6	74i	VR19	9b	Ric
D004	R5325K004B	LVR-IC	LDO, Dual out, V1=2.5V±1%, V2=3V±1%, 150mA, +CE, CL	DFN1820-6	74i	VR19	9b	Ric
D005	R5325K005B	LVR-IC	LDO, Dual out, V1=1.8V±1%, V2=2.5V±1%, 150mA, +CE, CL	DFN1820-6	74i	VR19	9b	Ric
D006	R5325K006B	LVR-IC	LDO, Dual out, V1=1.8V±1%, V2=3.3V±1%, 150mA, +CE, CL	DFN1820-6	74i	VR19	9b	Ric
D007	R5325K007B	LVR-IC	LDO, Dual out, V1=2.5V±1%, V2=2.8V±1%, 150mA, +CE, CL	DFN1820-6	74i	VR19	9b	Ric
D008	R5325K008B	LVR-IC	LDO, Dual out, V1=1.2V±1%, V2=1.2V±1%, 150mA, +CE, CL	DFN1820-6	74i	VR19	9b	Ric
D009	R5325K009B	LVR-IC	LDO, Dual out, V1=1.5V±1%, V2=1.6V±1%, 150mA, +CE, CL	DFN1820-6	74i	VR19	9b	Ric
D010	R5325K010B	LVR-IC	LDO, Dual out, V1=1.5V±1%, V2=2.8V±1%, 150mA, +CE, CL	DFN1820-6	74i	VR19	9b	Ric
D011	R5325K011B	LVR-IC	LDO, Dual out, V1=3V±1%, V2=3V±1%, 150mA, +CE, CL	DFN1820-6	74i	VR19	9b	Ric
D012	R5325K012B	LVR-IC	LDO, Dual out, V1=3.1V±1%, V2=3.1V±1%, 150mA, +CE, CL	DFN1820-6	74i	VR19	9b	Ric
D013	R5325K013B	LVR-IC	LDO, Dual out, V1=2.7V±1%, V2=1.8V±1%, 150mA, +CE, CL	DFN1820-6	74i	VR19	9b	Ric
D014	R5325K014B	LVR-IC	LDO, Dual out, V1=1.8V±1%, V2=2.6V±1%, 150mA, +CE, CL	DFN1820-6	74i	VR19	9b	Ric
D015	R5325K015B	LVR-IC	LDO, Dual out, V1=3.3V±1%, V2=3.3V±1%, 150mA, +CE, CL	DFN1820-6	74i	VR19	9b	Ric
D016	R5325K016B	LVR-IC	LDO, Dual out, V1=2.85V±1%, V2=2.85V±1%, 150mA, +CE, CL	DFN1820-6	74i	VR19	9b	Ric
D017	R5325K017B	LVR-IC	LDO, Dual out, V1=2.9V±1%, V2=2.9V±1%, 150mA, +CE, CL	DFN1820-6	74i	VR19	9b	Ric
D018	R5325K018B	LVR-IC	LDO, Dual out, V1=1.2V±1%, V2=2.6V±1%, 150mA, +CE, CL	DFN1820-6	74i	VR19	9b	Ric
D019	R5325K019B	LVR-IC	LDO, Dual out, V1=2.8V±1%, V2=2.9V±1%, 150mA, +CE, CL	DFN1820-6	74i	VR19	9b	Ric
D020	R5325K020B	LVR-IC	LDO, Dual out, V1=1.2V±1%, V2=1.8V±1%, 150mA, +CE, CL	DFN1820-6	74i	VR19	9b	Ric
D021	R5325K021B	LVR-IC	LDO, Dual out, V1=2.5V±1%, V2=1.2V±1%, 150mA, +CE, CL	DFN1820-6	74i	VR19	9b	Ric
D022	R5325K022B	LVR-IC	LDO, Dual out, V1=2.7V±1%, V2=2.85V±1%, 150mA, +CE, CL	DFN1820-6	74i	VR19	9b	Ric
D023	R5325K023B	LVR-IC	LDO, Dual out, V1=1.2V±1%, V2=2.8V±1%, 150mA, +CE, CL	DFN1820-6	74i	VR19	9b	Ric
D024	R5325K024B	LVR-IC	LDO, Dual out, V1=1.2V±1%, V2=3V±1%, 150mA, +CE, CL	DFN1820-6	74i	VR19	9b	Ric
D025	R5325K025B	LVR-IC	LDO, Dual out, V1=2.5V±1%, V2=2.9V±1%, 150mA, +CE, CL	DFN1820-6	74i	VR19	9b	Ric
D026	R5325K026B	LVR-IC	LDO, Dual out, V1=1.2V±1%, V2=2.7V±1%, 150mA, +CE, CL	DFN1820-6	74i	VR19	9b	Ric
D027	R5325K027B	LVR-IC	LDO, Dual out, V1=2.9V±1%, V2=1.8V±1%, 150mA, +CE, CL	DFN1820-6	74i	VR19	9b	Ric
D028	R5325K028B	LVR-IC	LDO, Dual out, V1=1.5V±1%, V2=1.8V±1%, 150mA, +CE, CL	DFN1820-6	74i	VR19	9b	Ric
D029	R5325K029B	LVR-IC	LDO, Dual out, V1=3.3V±1%, V2=3.3V±1%, 150mA, +CE, CL	DFN1820-6	74i	VR19	9b	Ric
D03	MD4103C	LIN-IC	AF PA, BTL, class-D, 2.4..5.5V, 3W(5V/3Ω), shutdown	BGA-9	39	AFP45	-	Mep
D030	R5325K030B	LVR-IC	LDO, Dual out, V1=3.45V±1%, V2=2.3V±1%, 150mA, +CE, CL	DFN1820-6	74i	VR19	9b	Ric
D031	R5325K031B	LVR-IC	LDO, Dual out, V1=1.3V±1%, V2=1.8V±1%, 150mA, +CE, CL	DFN1820-6	74i	VR19	9b	Ric
D032	R5325K032B	LVR-IC	LDO, Dual out, V1=1.8V±1%, V2=1.8V±1%, 150mA, +CE, CL	DFN1820-6	74i	VR19	9b	Ric
D033	R5325K033B	LVR-IC	LDO, Dual out, V1=3.1V±1%, V2=3.0V±1%, 150mA, +CE, CL	DFN1820-6	74i	VR19	9b	Ric
D034	R5325K034B	LVR-IC	LDO, Dual out, V1=2.95V±1%, V2=2.75V±1%, 150mA, +CE, CL	DFN1820-6	74i	VR19	9b	Ric
D035	R5325K035B	LVR-IC	LDO, Dual out, V1=2.8V±1%, V2=2.85V±1%, 150mA, +CE, CL	DFN1820-6	74i	VR19	9b	Ric
DOA	XC6108C30AGR	Vdel-IC	3.0V±2%, Hysteresis, -Reset PPO	USP-4	45ro	VD15	9b	Tor
DOB	XC6108C30BGR	Vdel-IC	3.0V±2%, -Reset PPO	USP-4	45ro	VD15	9b	Tor
DOC	XC6108C30CGR	Vdel-IC	3.0V±2%, Hysteresis, -Reset PPO	USP-4	45rm	VD15	9b	Tor
DOD	XC6108C30DGR	Vdel-IC	3.0V±2%, -Reset PPO	USP-4	45m	VD15	9b	Tor



SMD code	Type	Function	Short description	Case	Pinout	Sch.	St.Mnf.
D1	R3118K371A	Vdet-IC	3.7V±1.5%, -Reset ODO, Sense	DFN1212-6	52z3	VD14	9a Ric
D1	RP109L191B	LVR-IC	LDO, 1.9V±1%, 150mA, +CE	DFN1010-4	48vm	VR4	9a Ric
D1	XC6221A3217R	LVR-IC	LDO, 3.2V±1%, 200mA, +CE	USPN-4	58vm	VR4	9a Tor
D1A	XC6108C31AGR	Vdet-IC	3.1V±2%, Hysteresis, -Reset PPO	USP-4	45ro	VD15	9b Tor
D1B	XC6108C31BGR	Vdet-IC	3.1V±2%, -Reset PPO	USP-4	45ro	VD15	9b Tor
D1C	XC6108C31CGR	Vdet-IC	3.1V±2%, Hysteresis, -Reset PPO	USP-4	45rm	VD15	9b Tor
D1D	XC6108C31DGR	Vdet-IC	3.1V±2%, -Reset PPO	USP-4	45m	VD15	9b Tor
D2	LM4990ITL	LIN-IC	AF PA, BTL, 2.5..5.5V, 1.25W(5V/8Ω), shutdown	BGA-9	39	AFP44	- Nsc
D2	R3118K381A	Vdet-IC	3.8V±1.5%, -Reset ODO, Sense	DFN1212-6	52z3	VD14	9a Ric
D2	RP109L201B	LVR-IC	LDO, 2.0V±1%, 150mA, +CE	DFN1010-4	48vm	VR4	9a Ric
D2	SH4990ITL	LIN-IC	AF PA, BTL, 2.2..5.5V, 2W(5V/8Ω), shutdown	BGA-9	39	AFP44	- Sit
D2	XC6221A3317R	LVR-IC	LDO, 3.3V±1%, 200mA, +CE	USPN-4	58vm	VR4	9a Tor
D2	XC6223F12B9R-G	LVR-IC	LDO, 1.25V±20mV, 300mA, +CE, CL, ICP	USPQ-4B03	48vm	VR4	9a Tor
D2	XPT4890ITL	LIN-IC	AF PA, BTL, 2.5..5.5V, 1.2W(5V/8Ω), shutdown	BGA-8	39	AFP44	9m Xpt
D2A	XC6108C32AGR	Vdet-IC	3.2V±2%, Hysteresis, -Reset PPO	USP-4	45ro	VD15	9b Tor
D2B	XC6108C32BGR	Vdet-IC	3.2V±2%, -Reset PPO	USP-4	45ro	VD15	9b Tor
D2C	XC6108C32CGR	Vdet-IC	3.2V±2%, Hysteresis, -Reset PPO	USP-4	45m	VD15	9b Tor
D2D	XC6108C32DGR	Vdet-IC	3.2V±2%, -Reset PPO	USP-4	45m	VD15	9b Tor
D3	R3118K391A	Vdet-IC	3.9V±1.5%, -Reset ODO, Sense	DFN1212-6	52z3	VD14	9a Ric
D3	RP109L211B	LVR-IC	LDO, 2.1V±1%, 150mA, +CE	DFN1010-4	48vm	VR4	9a Ric
D3	XC6221A3417R	LVR-IC	LDO, 3.4V±1%, 200mA, +CE	USPN-4	58vm	VR4	9a Tor
D3	XC6223F13B9R-G	LVR-IC	LDO, 1.35V±20mV, 300mA, +CE, CL, ICP	USPQ-4B03	48vm	VR4	9a Tor
D3A	XC6108C33AGR	Vdet-IC	3.3V±2%, Hysteresis, -Reset PPO	USP-4	45ro	VD15	9b Tor
D3B	XC6108C33BGR	Vdet-IC	3.3V±2%, -Reset PPO	USP-4	45ro	VD15	9b Tor
D3C	XC6108C33CGR	Vdet-IC	3.3V±2%, Hysteresis, -Reset PPO	USP-4	45m	VD15	9b Tor
D3D	XC6108C33DGR	Vdet-IC	3.3V±2%, -Reset PPO	USP-4	45m	VD15	9b Tor
D4	R3118K401A	Vdet-IC	4.0V±1.5%, -Reset ODO, Sense	DFN1212-6	52z3	VD14	9a Ric
D4	RP109L221B	LVR-IC	LDO, 2.2V±1%, 150mA, +CE	DFN1010-4	48vm	VR4	9a Ric
D4	XC6221A3517R	LVR-IC	LDO, 3.5V±1%, 200mA, +CE	USPN-4	58vm	VR4	9a Tor
D4	XC6223F14B9R-G	LVR-IC	LDO, 1.45V±20mV, 300mA, +CE, CL, ICP	USPQ-4B03	48vm	VR4	9a Tor
D4A	XC6108C34AGR	Vdet-IC	3.4V±2%, Hysteresis, -Reset PPO	USP-4	45ro	VD15	9b Tor
D4B	XC6108C34BGR	Vdet-IC	3.4V±2%, -Reset PPO	USP-4	45ro	VD15	9b Tor
D4C	XC6108C34CGR	Vdet-IC	3.4V±2%, Hysteresis, -Reset PPO	USP-4	45m	VD15	9b Tor
D4D	XC6108C34DGR	Vdet-IC	3.4V±2%, -Reset PPO	USP-4	45m	VD15	9b Tor
D5	R3118K411A	Vdet-IC	4.1V±1.5%, -Reset ODO, Sense	DFN1212-6	52z3	VD14	9a Ric
D5	RP109L231B	LVR-IC	LDO, 2.3V±1%, 150mA, +CE	DFN1010-4	48vm	VR4	9a Ric
D5	XC6221A3617R	LVR-IC	LDO, 3.6V±1%, 200mA, +CE	USPN-4	58vm	VR4	9a Tor
D5	XC6223F15B9R-G	LVR-IC	LDO, 1.55V±20mV, 300mA, +CE, CL, ICP	USPQ-4B03	48vm	VR4	9a Tor
D53	NX3L1G53GD	CMOS-Logic	Single-pole double-throw analog switch	SOT996-2	54Log58	-	9a Phi
D53	NX3L1G53GM	CMOS-Logic	Single-pole double-throw analog switch	SOT902-1	51Log58	-	9a Phi
D53	NX3L1G53GT	CMOS-Logic	Single-pole double-throw analog switch	SOT833-1	53Log58	-	9c Phi
D5A	XC6108C35AGR	Vdet-IC	3.5V±2%, Hysteresis, -Reset PPO	USP-4	45ro	VD15	9b Tor
D5B	XC6108C35BGR	Vdet-IC	3.5V±2%, -Reset PPO	USP-4	45ro	VD15	9b Tor
D5C	XC6108C35CGR	Vdet-IC	3.5V±2%, Hysteresis, -Reset PPO	USP-4	45m	VD15	9b Tor
D5D	XC6108C35DGR	Vdet-IC	3.5V±2%, -Reset PPO	USP-4	45m	VD15	9b Tor
D6	R3118K421A	Vdet-IC	4.2V±1.5%, -Reset ODO, Sense	DFN1212-6	52z3	VD14	9a Ric
D6	RP109L241B	LVR-IC	LDO, 2.4V±1%, 150mA, +CE	DFN1010-4	48vm	VR4	9a Ric
D6	XC6221A3717R	LVR-IC	LDO, 3.7V±1%, 200mA, +CE	USPN-4	58vm	VR4	9a Tor
D6	XC6223F16B9R-G	LVR-IC	LDO, 1.65V±20mV, 300mA, +CE, CL, ICP	USPQ-4B03	48vm	VR4	9a Tor
D66	NX3L2G66GD	CMOS-Logic	2-channel analog switch	SOT996-2	54Log68	-	9a Phi
D66	NX3L2G66GM	CMOS-Logic	2-channel analog switch	SOT902-1	51Log68	-	9a Phi
D66	NX3L2G66GT	CMOS-Logic	2-channel analog switch	SOT833-1	53Log68	-	9c Phi
D6A	XC6108C36AGR	Vdet-IC	3.6V±2%, Hysteresis, -Reset PPO	USP-4	45ro	VD15	9b Tor
D6B	XC6108C36BGR	Vdet-IC	3.6V±2%, -Reset PPO	USP-4	45ro	VD15	9b Tor
D6C	XC6108C36CGR	Vdet-IC	3.6V±2%, Hysteresis, -Reset PPO	USP-4	45m	VD15	9b Tor
D6D	XC6108C36DGR	Vdet-IC	3.6V±2%, -Reset PPO	USP-4	45m	VD15	9b Tor
D7	R3118K431A	Vdet-IC	4.3V±1.5%, -Reset ODO, Sense	DFN1212-6	52z3	VD14	9a Ric
D7	RP109L251B	LVR-IC	LDO, 2.5V±1%, 150mA, +CE	DFN1010-4	48vm	VR4	9a Ric
D7	XC6221A3817R	LVR-IC	LDO, 3.8V±1%, 200mA, +CE	USPN-4	58vm	VR4	9a Tor
D7	XC6223F17B9R-G	LVR-IC	LDO, 1.75V±20mV, 300mA, +CE, CL, ICP	USPQ-4B03	48vm	VR4	9a Tor
D7A	XC6108C37AGR	Vdet-IC	3.7V±2%, Hysteresis, -Reset PPO	USP-4	45ro	VD15	9b Tor
D7B	XC6108C37BGR	Vdet-IC	3.7V±2%, -Reset PPO	USP-4	45ro	VD15	9b Tor
D7C	XC6108C37CGR	Vdet-IC	3.7V±2%, Hysteresis, -Reset PPO	USP-4	45m	VD15	9b Tor
D7D	XC6108C37DGR	Vdet-IC	3.7V±2%, -Reset PPO	USP-4	45m	VD15	9b Tor
D8	R3118K441A	Vdet-IC	4.4V±1.5%, -Reset ODO, Sense	DFN1212-6	52z3	VD14	9a Ric
D8	RP109L261B	LVR-IC	LDO, 2.6V±1%, 150mA, +CE	DFN1010-4	48vm	VR4	9a Ric
D8	XC6221A3917R	LVR-IC	LDO, 3.9V±1%, 200mA, +CE	USPN-4	58vm	VR4	9a Tor
D8	XC6223F18B9R-G	LVR-IC	LDO, 1.85V±20mV, 300mA, +CE, CL, ICP	USPQ-4B03	48vm	VR4	9a Tor
D8A	XC6108C38AGR	Vdet-IC	3.8V±2%, Hysteresis, -Reset PPO	USP-4	45ro	VD15	9b Tor
D8B	XC6108C38BGR	Vdet-IC	3.8V±2%, -Reset PPO	USP-4	45ro	VD15	9b Tor



SMD code	Type	Function	Short description	Case	Pinout	Sch.	St.	Mnf.
D8C	XC6108C38CGR	Vdet-IC	3.8V±2%, Hysteresis, -Reset PPO	USP-4	45m	VD15	9b	Tor
D8D	XC6108C38DGR	Vdet-IC	3.8V±2%, -Reset PPO	USP-4	45m	VD15	9b	Tor
D9	R3118K451A	Vdet-IC	4.5V±1.5%, -Reset ODO, Sense	DFN1212-6	52z3	VD14	9a	Ric
D9	RP109L271B	LVR-IC	LDO, 2.7V±1%, 150mA, +CE	DFN1010-4	48vm	VR4	9a	Ric
D9	XC6221A4017R	LVR-IC	LDO, 4V±1%, 200mA, +CE	USPN-4	58vm	VR4	9a	Tor
D9	XC6223F19B9R-G	LVR-IC	LDO, 1.95V±20mV, 300mA, +CE, CL, ICP	USPQ-4B03	48vm	VR4	9a	Tor
D9A	XC6108C39AGR	Vdet-IC	3.9V±2%, Hysteresis, -Reset PPO	USP-4	45ro	VD15	9b	Tor
D9B	XC6108C39BGR	Vdet-IC	3.9V±2%, -Reset PPO	USP-4	45ro	VD15	9b	Tor
D9C	XC6108C39CGR	Vdet-IC	3.9V±2%, Hysteresis, -Reset PPO	USP-4	45m	VD15	9b	Tor
D9D	XC6108C39DGR	Vdet-IC	3.9V±2%, -Reset PPO	USP-4	45m	VD15	9b	Tor
DA	R3114K071A	Vdet-IC	0.7V±0.8%, -Reset ODO	DFN1010-4	48vd9	VD9	9a	Ric
DA	R3134K33EA	Vdet-IC	3.3V±1.8%, -Reset ODO, -MR	DFN1212-6	52z6	VD4	9a	Ric
DA	XC6223F20B9R-G	LVR-IC	LDO, 2.05V±1%, 300mA, +CE, CL, ICP	USPQ-4B03	48vm	VR4	9a	Tor
DA8	XC9236B08C4R-G	DC-DC-IC	PWM/PFM, st-dwn, 0.8V±2%, 600mA, 1.2MHz, Vin>2V, HSST, CL	USP-6EL	56dc5	DC1	9a	Tor
DA8	XC9236B08CER	DC-DC-IC	PWM/PFM, st-dwn, 0.8V±2%, 600mA, 1.2MHz, Vin>2V, HSST, CL	USP-6C	49dc5	DC1	9a	Tor
DA9	XC9236B09C4R-G	DC-DC-IC	PWM/PFM, st-dwn, 0.9V±2%, 600mA, 1.2MHz, Vin>2V, HSST, CL	USP-6EL	56dc5	DC1	9a	Tor
DA9	XC9236B09CER	DC-DC-IC	PWM/PFM, st-dwn, 0.9V±2%, 600mA, 1.2MHz, Vin>2V, HSST, CL	USP-6C	49dc5	DC1	9a	Tor
DAL	XC9236B0L4R-G	DC-DC-IC	PWM/PFM, st-dwn, 0.85V±2%, 600mA, 1.2MHz, Vin>2V, HSST, CL	USP-6EL	56dc5	DC1	9a	Tor
DAL	XC9236B0LCER	DC-DC-IC	PWM/PFM, st-dwn, 0.85V±2%, 600mA, 1.2MHz, Vin>2V, HSST, CL	USP-6C	49dc5	DC1	9a	Tor
DAM	XC9236B0MC4R-G	DC-DC-IC	PWM/PFM, st-dwn, 0.95V±2%, 600mA, 1.2MHz, Vin>2V, HSST, CL	USP-6EL	56dc5	DC1	9a	Tor
DAM	XC9236B0MCER	DC-DC-IC	PWM/PFM, st-dwn, 0.95V±2%, 600mA, 1.2MHz, Vin>2V, HSST, CL	USP-6C	49dc5	DC1	9a	Tor
DAR	TPA2039D1YFF	LIN-IC	AF PA, BTL, class-D, 2.5..5.5V, 3.25W(5V/4Q), shutdown	BGA-9	39	AFP45	-	Ti
DB	R3114K081A	Vdet-IC	0.8V±0.8%, -Reset ODO	DFN1010-4	48vd9	VD9	9a	Ric
DB	R3134K34EA	Vdet-IC	3.4V±1.8%, -Reset ODO, -MR	DFN1212-6	52z6	VD4	9a	Ric
DB	XC6223F21B9R-G	LVR-IC	LDO, 2.15V±1%, 300mA, +CE, CL, ICP	USPQ-4B03	48vm	VR4	9a	Tor
DB0	XC9236B10C4R-G	DC-DC-IC	PWM/PFM, st-dwn, 1.0V±2%, 600mA, 1.2MHz, Vin>2V, HSST, CL	USP-6EL	56dc5	DC1	9a	Tor
DB0	XC9236B10CER	DC-DC-IC	PWM/PFM, st-dwn, 1.0V±2%, 600mA, 1.2MHz, Vin>2V, HSST, CL	USP-6C	49dc5	DC1	9a	Tor
DB1	XC9236B11C4R-G	DC-DC-IC	PWM/PFM, st-dwn, 1.1V±2%, 600mA, 1.2MHz, Vin>2V, HSST, CL	USP-6EL	56dc5	DC1	9a	Tor
DB1	XC9236B11CER	DC-DC-IC	PWM/PFM, st-dwn, 1.1V±2%, 600mA, 1.2MHz, Vin>2V, HSST, CL	USP-6C	49dc5	DC1	9a	Tor
DB2	XC9236B12C4R-G	DC-DC-IC	PWM/PFM, st-dwn, 1.2V±2%, 600mA, 1.2MHz, Vin>2V, HSST, CL	USP-6EL	56dc5	DC1	9a	Tor
DB2	XC9236B12CER	DC-DC-IC	PWM/PFM, st-dwn, 1.2V±2%, 600mA, 1.2MHz, Vin>2V, HSST, CL	USP-6C	49dc5	DC1	9a	Tor
DB3	XC9236B13C4R-G	DC-DC-IC	PWM/PFM, st-dwn, 1.3V±2%, 600mA, 1.2MHz, Vin>2V, HSST, CL	USP-6EL	56dc5	DC1	9a	Tor
DB3	XC9236B13CER	DC-DC-IC	PWM/PFM, st-dwn, 1.3V±2%, 600mA, 1.2MHz, Vin>2V, HSST, CL	USP-6C	49dc5	DC1	9a	Tor
DB4	XC9236B14C4R-G	DC-DC-IC	PWM/PFM, st-dwn, 1.4V±2%, 600mA, 1.2MHz, Vin>2V, HSST, CL	USP-6EL	56dc5	DC1	9a	Tor
DB4	XC9236B14CER	DC-DC-IC	PWM/PFM, st-dwn, 1.4V±2%, 600mA, 1.2MHz, Vin>2V, HSST, CL	USP-6C	49dc5	DC1	9a	Tor
DB5	XC9236B15C4R-G	DC-DC-IC	PWM/PFM, st-dwn, 1.5V±2%, 600mA, 1.2MHz, Vin>2V, HSST, CL	USP-6EL	56dc5	DC1	9a	Tor
DB5	XC9236B15CER	DC-DC-IC	PWM/PFM, st-dwn, 1.5V±2%, 600mA, 1.2MHz, Vin>2V, HSST, CL	USP-6C	49dc5	DC1	9a	Tor
DB6	XC9236B16C4R-G	DC-DC-IC	PWM/PFM, st-dwn, 1.6V±2%, 600mA, 1.2MHz, Vin>2V, HSST, CL	USP-6EL	56dc5	DC1	9a	Tor
DB6	XC9236B16CER	DC-DC-IC	PWM/PFM, st-dwn, 1.6V±2%, 600mA, 1.2MHz, Vin>2V, HSST, CL	USP-6C	49dc5	DC1	9a	Tor
DB7	XC9236B17C4R-G	DC-DC-IC	PWM/PFM, st-dwn, 1.7V±2%, 600mA, 1.2MHz, Vin>2V, HSST, CL	USP-6EL	56dc5	DC1	9a	Tor
DB7	XC9236B17CER	DC-DC-IC	PWM/PFM, st-dwn, 1.7V±2%, 600mA, 1.2MHz, Vin>2V, HSST, CL	USP-6C	49dc5	DC1	9a	Tor
DB8	XC9236B18C4R-G	DC-DC-IC	PWM/PFM, st-dwn, 1.8V±2%, 600mA, 1.2MHz, Vin>2V, HSST, CL	USP-6EL	56dc5	DC1	9a	Tor
DB8	XC9236B18CER	DC-DC-IC	PWM/PFM, st-dwn, 1.8V±2%, 600mA, 1.2MHz, Vin>2V, HSST, CL	USP-6C	49dc5	DC1	9a	Tor
DB9	XC9236B19C4R-G	DC-DC-IC	PWM/PFM, st-dwn, 1.9V±2%, 600mA, 1.2MHz, Vin>2V, HSST, CL	USP-6EL	56dc5	DC1	9a	Tor
DB9	XC9236B19CER	DC-DC-IC	PWM/PFM, st-dwn, 1.9V±2%, 600mA, 1.2MHz, Vin>2V, HSST, CL	USP-6C	49dc5	DC1	9a	Tor
DBA	XC9236B1AC4R-G	DC-DC-IC	PWM/PFM, st-dwn, 1.05V±2%, 600mA, 1.2MHz, Vin>2V, HSST, CL	USP-6EL	56dc5	DC1	9a	Tor
DBA	XC9236B1ACER	DC-DC-IC	PWM/PFM, st-dwn, 1.05V±2%, 600mA, 1.2MHz, Vin>2V, HSST, CL	USP-6C	49dc5	DC1	9a	Tor
DBB	XC9236B1BC4R-G	DC-DC-IC	PWM/PFM, st-dwn, 1.15V±2%, 600mA, 1.2MHz, Vin>2V, HSST, CL	USP-6EL	56dc5	DC1	9a	Tor
DBB	XC9236B1BCER	DC-DC-IC	PWM/PFM, st-dwn, 1.15V±2%, 600mA, 1.2MHz, Vin>2V, HSST, CL	USP-6C	49dc5	DC1	9a	Tor
DBC	XC9236B1CC4R-G	DC-DC-IC	PWM/PFM, st-dwn, 1.25V±2%, 600mA, 1.2MHz, Vin>2V, HSST, CL	USP-6EL	56dc5	DC1	9a	Tor
DBC	XC9236B1CCER	DC-DC-IC	PWM/PFM, st-dwn, 1.25V±2%, 600mA, 1.2MHz, Vin>2V, HSST, CL	USP-6C	49dc5	DC1	9a	Tor
DBD	XC9236B1DC4R-G	DC-DC-IC	PWM/PFM, st-dwn, 1.35V±2%, 600mA, 1.2MHz, Vin>2V, HSST, CL	USP-6EL	56dc5	DC1	9a	Tor
DBD	XC9236B1DCER	DC-DC-IC	PWM/PFM, st-dwn, 1.35V±2%, 600mA, 1.2MHz, Vin>2V, HSST, CL	USP-6C	49dc5	DC1	9a	Tor
DBE	XC9236B1EC4R-G	DC-DC-IC	PWM/PFM, st-dwn, 1.45V±2%, 600mA, 1.2MHz, Vin>2V, HSST, CL	USP-6EL	56dc5	DC1	9a	Tor
DBE	XC9236B1ECER	DC-DC-IC	PWM/PFM, st-dwn, 1.45V±2%, 600mA, 1.2MHz, Vin>2V, HSST, CL	USP-6C	49dc5	DC1	9a	Tor
DBF	XC9236B1FC4R-G	DC-DC-IC	PWM/PFM, st-dwn, 1.55V±2%, 600mA, 1.2MHz, Vin>2V, HSST, CL	USP-6EL	56dc5	DC1	9a	Tor
DBF	XC9236B1FCER	DC-DC-IC	PWM/PFM, st-dwn, 1.55V±2%, 600mA, 1.2MHz, Vin>2V, HSST, CL	USP-6C	49dc5	DC1	9a	Tor
DBH	XC9236B1HC4R-G	DC-DC-IC	PWM/PFM, st-dwn, 1.65V±2%, 600mA, 1.2MHz, Vin>2V, HSST, CL	USP-6EL	56dc5	DC1	9a	Tor
DBH	XC9236B1HCER	DC-DC-IC	PWM/PFM, st-dwn, 1.65V±2%, 600mA, 1.2MHz, Vin>2V, HSST, CL	USP-6C	49dc5	DC1	9a	Tor
DBK	XC9236B1KC4R-G	DC-DC-IC	PWM/PFM, st-dwn, 1.75V±2%, 600mA, 1.2MHz, Vin>2V, HSST, CL	USP-6EL	56dc5	DC1	9a	Tor
DBK	XC9236B1KCER	DC-DC-IC	PWM/PFM, st-dwn, 1.75V±2%, 600mA, 1.2MHz, Vin>2V, HSST, CL	USP-6C	49dc5	DC1	9a	Tor
DBL	XC9236B1LC4R-G	DC-DC-IC	PWM/PFM, st-dwn, 1.85V±2%, 600mA, 1.2MHz, Vin>2V, HSST, CL	USP-6EL	56dc5	DC1	9a	Tor
DBL	XC9236B1LCER	DC-DC-IC	PWM/PFM, st-dwn, 1.85V±2%, 600mA, 1.2MHz, Vin>2V, HSST, CL	USP-6C	49dc5	DC1	9a	Tor
DBM	XC9236B1MC4R-G	DC-DC-IC	PWM/PFM, st-dwn, 1.95V±2%, 600mA, 1.2MHz, Vin>2V, HSST, CL	USP-6EL	56dc5	DC1	9a	Tor
DBM	XC9236B1MCER	DC-DC-IC	PWM/PFM, st-dwn, 1.95V±2%, 600mA, 1.2MHz, Vin>2V, HSST, CL	USP-6C	49dc5	DC1	9a	Tor
DC	R3114K091A	Vdet-IC	0.9V±0.8%, -Reset ODO	DFN1010-4	48vd9	VD9	9a	Ric
DC	R3134K35EA	Vdet-IC	3.5V±1.8%, -Reset ODO, -MR	DFN1212-6	52z6	VD4	9a	Ric
DC	XC6223F22B9R-G	LVR-IC	LDO, 2.25V±1%, 300mA, +CE, CL, ICP	USPQ-4B03	48vm	VR4	9a	Tor
DC0	XC9236B20C4R-G	DC-DC-IC	PWM/PFM, st-dwn, 2.0V±2%, 600mA, 1.2MHz, Vin>2V, HSST, CL	USP-6EL	56dc5	DC1	9a	Tor
DC0	XC9236B20CER	DC-DC-IC	PWM/PFM, st-dwn, 2.0V±2%, 600mA, 1.2MHz, Vin>2V, HSST, CL	USP-6C	49dc5	DC1	9a	Tor



SMD code	Type	Function	Short description	Case	Pinout	Sch.	St.	Mnf.
DC1	XC9236B21C4R-G	DC-DC-IC	PWM/PFM, st-dwn, 2.1V±2%, 600mA, 1.2MHz, Vin>2V, HSST, CL	USP-6EL	56dc5	DC1	9a	Tor
DC1	XC9236B21C4R	DC-DC-IC	PWM/PFM, st-dwn, 2.1V±2%, 600mA, 1.2MHz, Vin>2V, HSST, CL	USP-6C	49dc5	DC1	9a	Tor
DC2	XC9236B22C4R-G	DC-DC-IC	PWM/PFM, st-dwn, 2.2V±2%, 600mA, 1.2MHz, Vin>2V, HSST, CL	USP-6EL	56dc5	DC1	9a	Tor
DC2	XC9236B22CER	DC-DC-IC	PWM/PFM, st-dwn, 2.2V±2%, 600mA, 1.2MHz, Vin>2V, HSST, CL	USP-6C	49dc5	DC1	9a	Tor
DC3	TSDCO5JT	LIN-IC	AF PA, BTL, 2.5..5.5V, 1.2W(5V/8Ω), shutdown	BGA-9	39	AFP44	-	Ste
DC3	XC9236B23C4R-G	DC-DC-IC	PWM/PFM, st-dwn, 2.3V±2%, 600mA, 1.2MHz, Vin>2V, HSST, CL	USP-6EL	56dc5	DC1	9a	Tor
DC3	XC9236B23CER	DC-DC-IC	PWM/PFM, st-dwn, 2.3V±2%, 600mA, 1.2MHz, Vin>2V, HSST, CL	USP-6C	49dc5	DC1	9a	Tor
DC4	XC9236B24C4R-G	DC-DC-IC	PWM/PFM, st-dwn, 2.4V±2%, 600mA, 1.2MHz, Vin>2V, HSST, CL	USP-6EL	56dc5	DC1	9a	Tor
DC4	XC9236B24CER	DC-DC-IC	PWM/PFM, st-dwn, 2.4V±2%, 600mA, 1.2MHz, Vin>2V, HSST, CL	USP-6C	49dc5	DC1	9a	Tor
DC5	XC9236B25C4R-G	DC-DC-IC	PWM/PFM, st-dwn, 2.5V±2%, 600mA, 1.2MHz, Vin>2V, HSST, CL	USP-6EL	56dc5	DC1	9a	Tor
DC5	XC9236B25CER	DC-DC-IC	PWM/PFM, st-dwn, 2.5V±2%, 600mA, 1.2MHz, Vin>2V, HSST, CL	USP-6C	49dc5	DC1	9a	Tor
DC6	XC9236B26C4R-G	DC-DC-IC	PWM/PFM, st-dwn, 2.6V±2%, 600mA, 1.2MHz, Vin>2V, HSST, CL	USP-6EL	56dc5	DC1	9a	Tor
DC6	XC9236B26CER	DC-DC-IC	PWM/PFM, st-dwn, 2.6V±2%, 600mA, 1.2MHz, Vin>2V, HSST, CL	USP-6C	49dc5	DC1	9a	Tor
DC7	XC9236B27C4R-G	DC-DC-IC	PWM/PFM, st-dwn, 2.7V±2%, 600mA, 1.2MHz, Vin>2V, HSST, CL	USP-6EL	56dc5	DC1	9a	Tor
DC7	XC9236B27CER	DC-DC-IC	PWM/PFM, st-dwn, 2.7V±2%, 600mA, 1.2MHz, Vin>2V, HSST, CL	USP-6C	49dc5	DC1	9a	Tor
DC8	XC9236B28C4R-G	DC-DC-IC	PWM/PFM, st-dwn, 2.8V±2%, 600mA, 1.2MHz, Vin>2V, HSST, CL	USP-6EL	56dc5	DC1	9a	Tor
DC8	XC9236B28CER	DC-DC-IC	PWM/PFM, st-dwn, 2.8V±2%, 600mA, 1.2MHz, Vin>2V, HSST, CL	USP-6C	49dc5	DC1	9a	Tor
DC9	XC9236B29C4R-G	DC-DC-IC	PWM/PFM, st-dwn, 2.9V±2%, 600mA, 1.2MHz, Vin>2V, HSST, CL	USP-6EL	56dc5	DC1	9a	Tor
DC9	XC9236B29CER	DC-DC-IC	PWM/PFM, st-dwn, 2.9V±2%, 600mA, 1.2MHz, Vin>2V, HSST, CL	USP-6C	49dc5	DC1	9a	Tor
DCA	XC9236B2AC4R-G	DC-DC-IC	PWM/PFM, st-dwn, 2.05V±2%, 600mA, 1.2MHz, Vin>2V, HSST, CL	USP-6EL	56dc5	DC1	9a	Tor
DCA	XC9236B2ACER	DC-DC-IC	PWM/PFM, st-dwn, 2.05V±2%, 600mA, 1.2MHz, Vin>2V, HSST, CL	USP-6C	49dc5	DC1	9a	Tor
DCB	XC9236B2BC4R-G	DC-DC-IC	PWM/PFM, st-dwn, 2.15V±2%, 600mA, 1.2MHz, Vin>2V, HSST, CL	USP-6EL	56dc5	DC1	9a	Tor
DCB	XC9236B2BCER	DC-DC-IC	PWM/PFM, st-dwn, 2.15V±2%, 600mA, 1.2MHz, Vin>2V, HSST, CL	USP-6C	49dc5	DC1	9a	Tor
DCC	XC9236B2CC4R-G	DC-DC-IC	PWM/PFM, st-dwn, 2.25V±2%, 600mA, 1.2MHz, Vin>2V, HSST, CL	USP-6EL	56dc5	DC1	9a	Tor
DCC	XC9236B2CCER	DC-DC-IC	PWM/PFM, st-dwn, 2.25V±2%, 600mA, 1.2MHz, Vin>2V, HSST, CL	USP-6C	49dc5	DC1	9a	Tor
DCD	XC9236B2DC4R-G	DC-DC-IC	PWM/PFM, st-dwn, 2.35V±2%, 600mA, 1.2MHz, Vin>2V, HSST, CL	USP-6EL	56dc5	DC1	9a	Tor
DCD	XC9236B2DCER	DC-DC-IC	PWM/PFM, st-dwn, 2.35V±2%, 600mA, 1.2MHz, Vin>2V, HSST, CL	USP-6C	49dc5	DC1	9a	Tor
DCE	XC9236B2EC4R-G	DC-DC-IC	PWM/PFM, st-dwn, 2.45V±2%, 600mA, 1.2MHz, Vin>2V, HSST, CL	USP-6EL	56dc5	DC1	9a	Tor
DCE	XC9236B2ECER	DC-DC-IC	PWM/PFM, st-dwn, 2.45V±2%, 600mA, 1.2MHz, Vin>2V, HSST, CL	USP-6C	49dc5	DC1	9a	Tor
DCF	XC9236B2FC4R-G	DC-DC-IC	PWM/PFM, st-dwn, 2.55V±2%, 600mA, 1.2MHz, Vin>2V, HSST, CL	USP-6EL	56dc5	DC1	9a	Tor
DCF	XC9236B2FCER	DC-DC-IC	PWM/PFM, st-dwn, 2.55V±2%, 600mA, 1.2MHz, Vin>2V, HSST, CL	USP-6C	49dc5	DC1	9a	Tor
DCH	XC9236B2HC4R-G	DC-DC-IC	PWM/PFM, st-dwn, 2.65V±2%, 600mA, 1.2MHz, Vin>2V, HSST, CL	USP-6EL	56dc5	DC1	9a	Tor
DCH	XC9236B2HCER	DC-DC-IC	PWM/PFM, st-dwn, 2.65V±2%, 600mA, 1.2MHz, Vin>2V, HSST, CL	USP-6C	49dc5	DC1	9a	Tor
DCK	XC9236B2KC4R-G	DC-DC-IC	PWM/PFM, st-dwn, 2.75V±2%, 600mA, 1.2MHz, Vin>2V, HSST, CL	USP-6EL	56dc5	DC1	9a	Tor
DCK	XC9236B2KCER	DC-DC-IC	PWM/PFM, st-dwn, 2.75V±2%, 600mA, 1.2MHz, Vin>2V, HSST, CL	USP-6C	49dc5	DC1	9a	Tor
DCL	XC9236B2LC4R-G	DC-DC-IC	PWM/PFM, st-dwn, 2.85V±2%, 600mA, 1.2MHz, Vin>2V, HSST, CL	USP-6EL	56dc5	DC1	9a	Tor
DCL	XC9236B2LCER	DC-DC-IC	PWM/PFM, st-dwn, 2.85V±2%, 600mA, 1.2MHz, Vin>2V, HSST, CL	USP-6C	49dc5	DC1	9a	Tor
DCM	XC9236B2MC4R-G	DC-DC-IC	PWM/PFM, st-dwn, 2.95V±2%, 600mA, 1.2MHz, Vin>2V, HSST, CL	USP-6EL	56dc5	DC1	9a	Tor
DCM	XC9236B2MCER	DC-DC-IC	PWM/PFM, st-dwn, 2.95V±2%, 600mA, 1.2MHz, Vin>2V, HSST, CL	USP-6C	49dc5	DC1	9a	Tor
DD	R3114K101A	Vdel-IC	1.0V±0.8%, -Reset ODO	DFN1010-4	48vd9	VD9	9a	Ric
DD	R3134K36EA	Vdel-IC	3.6V±1.8%, -Reset ODO, -MR	DFN1212-6	52z6	VD4	9a	Ric
DD	XG6223F23B9R-G	LVR-IC	LDO, 2.35V±1%, 300mA, +CE, CL, ICP	USPQ-4B03	48vm	VR4	9a	Tor
DD0	XC9236B30C4R-G	DC-DC-IC	PWM/PFM, st-dwn, 3.0V±2%, 600mA, 1.2MHz, Vin>2V, HSST, CL	USP-6EL	56dc5	DC1	9a	Tor
DD0	XC9236B30CER	DC-DC-IC	PWM/PFM, st-dwn, 3.0V±2%, 600mA, 1.2MHz, Vin>2V, HSST, CL	USP-6C	49dc5	DC1	9a	Tor
DD1	XC9236B31C4R-G	DC-DC-IC	PWM/PFM, st-dwn, 3.1V±2%, 600mA, 1.2MHz, Vin>2V, HSST, CL	USP-6EL	56dc5	DC1	9a	Tor
DD1	XC9236B31CER	DC-DC-IC	PWM/PFM, st-dwn, 3.1V±2%, 600mA, 1.2MHz, Vin>2V, HSST, CL	USP-6C	49dc5	DC1	9a	Tor
DD2	XC9236B32C4R-G	DC-DC-IC	PWM/PFM, st-dwn, 3.2V±2%, 600mA, 1.2MHz, Vin>2V, HSST, CL	USP-6EL	56dc5	DC1	9a	Tor
DD2	XC9236B32CER	DC-DC-IC	PWM/PFM, st-dwn, 3.2V±2%, 600mA, 1.2MHz, Vin>2V, HSST, CL	USP-6C	49dc5	DC1	9a	Tor
DD3	XC9236B33C4R-G	DC-DC-IC	PWM/PFM, st-dwn, 3.3V±2%, 600mA, 1.2MHz, Vin>2V, HSST, CL	USP-6EL	56dc5	DC1	9a	Tor
DD3	XC9236B33CER	DC-DC-IC	PWM/PFM, st-dwn, 3.3V±2%, 600mA, 1.2MHz, Vin>2V, HSST, CL	USP-6C	49dc5	DC1	9a	Tor
DD4	XC9236B34C4R-G	DC-DC-IC	PWM/PFM, st-dwn, 3.4V±2%, 600mA, 1.2MHz, Vin>2V, HSST, CL	USP-6EL	56dc5	DC1	9a	Tor
DD4	XC9236B34CER	DC-DC-IC	PWM/PFM, st-dwn, 3.4V±2%, 600mA, 1.2MHz, Vin>2V, HSST, CL	USP-6C	49dc5	DC1	9a	Tor
DD5	XC9236B35C4R-G	DC-DC-IC	PWM/PFM, st-dwn, 3.5V±2%, 600mA, 1.2MHz, Vin>2V, HSST, CL	USP-6EL	56dc5	DC1	9a	Tor
DD5	XC9236B35CER	DC-DC-IC	PWM/PFM, st-dwn, 3.5V±2%, 600mA, 1.2MHz, Vin>2V, HSST, CL	USP-6C	49dc5	DC1	9a	Tor
DD6	XC9236B36C4R-G	DC-DC-IC	PWM/PFM, st-dwn, 3.6V±2%, 600mA, 1.2MHz, Vin>2V, HSST, CL	USP-6EL	56dc5	DC1	9a	Tor
DD6	XC9236B36CER	DC-DC-IC	PWM/PFM, st-dwn, 3.6V±2%, 600mA, 1.2MHz, Vin>2V, HSST, CL	USP-6C	49dc5	DC1	9a	Tor
DD7	XC9236B37C4R-G	DC-DC-IC	PWM/PFM, st-dwn, 3.7V±2%, 600mA, 1.2MHz, Vin>2V, HSST, CL	USP-6EL	56dc5	DC1	9a	Tor
DD7	XC9236B37CER	DC-DC-IC	PWM/PFM, st-dwn, 3.7V±2%, 600mA, 1.2MHz, Vin>2V, HSST, CL	USP-6C	49dc5	DC1	9a	Tor
DD8	XC9236B38C4R-G	DC-DC-IC	PWM/PFM, st-dwn, 3.8V±2%, 600mA, 1.2MHz, Vin>2V, HSST, CL	USP-6EL	56dc5	DC1	9a	Tor
DD8	XC9236B38CER	DC-DC-IC	PWM/PFM, st-dwn, 3.8V±2%, 600mA, 1.2MHz, Vin>2V, HSST, CL	USP-6C	49dc5	DC1	9a	Tor
DD9	XC9236B39C4R-G	DC-DC-IC	PWM/PFM, st-dwn, 3.9V±2%, 600mA, 1.2MHz, Vin>2V, HSST, CL	USP-6EL	56dc5	DC1	9a	Tor
DD9	XC9236B39CER	DC-DC-IC	PWM/PFM, st-dwn, 3.9V±2%, 600mA, 1.2MHz, Vin>2V, HSST, CL	USP-6C	49dc5	DC1	9a	Tor
DDA	XC9236B3AC4R-G	DC-DC-IC	PWM/PFM, st-dwn, 3.05V±2%, 600mA, 1.2MHz, Vin>2V, HSST, CL	USP-6EL	56dc5	DC1	9a	Tor
DDA	XC9236B3ACER	DC-DC-IC	PWM/PFM, st-dwn, 3.05V±2%, 600mA, 1.2MHz, Vin>2V, HSST, CL	USP-6C	49dc5	DC1	9a	Tor
DDB	XC9236B3BC4R-G	DC-DC-IC	PWM/PFM, st-dwn, 3.15V±2%, 600mA, 1.2MHz, Vin>2V, HSST, CL	USP-6EL	56dc5	DC1	9a	Tor
DDB	XC9236B3BCER	DC-DC-IC	PWM/PFM, st-dwn, 3.15V±2%, 600mA, 1.2MHz, Vin>2V, HSST, CL	USP-6C	49dc5	DC1	9a	Tor
DDC	XC9236B3CC4R-G	DC-DC-IC	PWM/PFM, st-dwn, 3.25V±2%, 600mA, 1.2MHz, Vin>2V, HSST, CL	USP-6EL	56dc5	DC1	9a	Tor
DDC	XC9236B3CCER	DC-DC-IC	PWM/PFM, st-dwn, 3.25V±2%, 600mA, 1.2MHz, Vin>2V, HSST, CL	USP-6C	49dc5	DC1	9a	Tor
DDD	XC9236B3DC4R-G	DC-DC-IC	PWM/PFM, st-dwn, 3.35V±2%, 600mA, 1.2MHz, Vin>2V, HSST, CL	USP-6EL	56dc5	DC1	9a	Tor
DDD	XC9236B3DCER	DC-DC-IC	PWM/PFM, st-dwn, 3.35V±2%, 600mA, 1.2MHz, Vin>2V, HSST, CL	USP-6C	49dc5	DC1	9a	Tor



SMD code	Type	Function	Short description	Case	Pinout	Sch.	St.	Mnf.
DDE	XC9236B3EC4R-G	DC-DC-IC	PWM/PFM, st-dwn, 3.45V±2%, 600mA, 1.2MHz, Vin>2V, HSST, CL	USP-6EL	56dc5	DC1	9a	Tor
DDE	XC9236B3ECER	DC-DC-IC	PWM/PFM, st-dwn, 3.45V±2%, 600mA, 1.2MHz, Vin>2V, HSST, CL	USP-6C	49dc5	DC1	9a	Tor
DDF	XC9236B3FC4R-G	DC-DC-IC	PWM/PFM, st-dwn, 3.55V±2%, 600mA, 1.2MHz, Vin>2V, HSST, CL	USP-6EL	56dc5	DC1	9a	Tor
DDF	XC9236B3FCER	DC-DC-IC	PWM/PFM, st-dwn, 3.55V±2%, 600mA, 1.2MHz, Vin>2V, HSST, CL	USP-6C	49dc5	DC1	9a	Tor
DDH	XC9236B3HC4R-G	DC-DC-IC	PWM/PFM, st-dwn, 3.65V±2%, 600mA, 1.2MHz, Vin>2V, HSST, CL	USP-6EL	56dc5	DC1	9a	Tor
DDH	XC9236B3HCER	DC-DC-IC	PWM/PFM, st-dwn, 3.65V±2%, 600mA, 1.2MHz, Vin>2V, HSST, CL	USP-6C	49dc5	DC1	9a	Tor
DDK	XC9236B3KC4R-G	DC-DC-IC	PWM/PFM, st-dwn, 3.75V±2%, 600mA, 1.2MHz, Vin>2V, HSST, CL	USP-6EL	56dc5	DC1	9a	Tor
DDK	XC9236B3KCEr	DC-DC-IC	PWM/PFM, st-dwn, 3.75V±2%, 600mA, 1.2MHz, Vin>2V, HSST, CL	USP-6C	49dc5	DC1	9a	Tor
DDL	XC9236B3LC4R-G	DC-DC-IC	PWM/PFM, st-dwn, 3.85V±2%, 600mA, 1.2MHz, Vin>2V, HSST, CL	USP-6EL	56dc5	DC1	9a	Tor
DDL	XC9236B3LCER	DC-DC-IC	PWM/PFM, st-dwn, 3.85V±2%, 600mA, 1.2MHz, Vin>2V, HSST, CL	USP-6C	49dc5	DC1	9a	Tor
DDM	XC9236B3MC4R-G	DC-DC-IC	PWM/PFM, st-dwn, 3.95V±2%, 600mA, 1.2MHz, Vin>2V, HSST, CL	USP-6EL	56dc5	DC1	9a	Tor
DDM	XC9236B3MCEr	DC-DC-IC	PWM/PFM, st-dwn, 3.95V±2%, 600mA, 1.2MHz, Vin>2V, HSST, CL	USP-6C	49dc5	DC1	9a	Tor
DE	R3114K111A	Vdel-IC	1.1V±0.8%, -Reset ODO	DFN1010-4	48vd9	VD9	9a	Ric
DE	R3134K37EA	Vdel-IC	3.7V±1.8%, -Reset ODO, -MR	DFN1212-6	52z6	VD4	9a	Ric
DE	RT9198-35PQW	LVR-IC	LDO, 3.5V±1%, 300mA, +CE	WDFN-6	49	VR4	9a	Ret
DE	XG6223F24B9R-G	LVR-IC	LDO, 2.45V±1%, 300mA, +CE, CL, ICP	USPQ-4B03	48vm	VR4	9a	Tor
DE0	XC9236B40C4R-G	DC-DC-IC	PWM/PFM, st-dwn, 4.0V±2%, 600mA, 1.2MHz, Vin>2V, HSST, CL	USP-6EL	56dc5	DC1	9a	Tor
DE0	XC9236B40CER	DC-DC-IC	PWM/PFM, st-dwn, 4.0V±2%, 600mA, 1.2MHz, Vin>2V, HSST, CL	USP-6C	49dc5	DC1	9a	Tor
DF	R3114K121A	Vdel-IC	1.2V±0.8%, -Reset ODO	DFN1010-4	48vd9	VD9	9a	Ric
DF	R3134K38EA	Vdel-IC	3.8V±1.8%, -Reset ODO, -MR	DFN1212-6	52z6	VD4	9a	Ric
DF	RT9193-35PQW	LVR-IC	LDO, 3.5V±1%, 300mA, +CE	WDFN-6L	49ub	VR7	9a	Ret
DF	XG6223F25B9R-G	LVR-IC	LDO, 2.55V±1%, 300mA, +CE, CL, ICP	USPQ-4B03	48vm	VR4	9a	Tor
DF8	XC9236B08D4R-G	DC-DC-IC	PWM/PFM, st-dwn, 0.8V±2%, 600mA, 3MHz, Vin>2V, HSST, CL	USP-6EL	56dc5	DC1	9a	Tor
DF8	XC9236B08DER	DC-DC-IC	PWM/PFM, st-dwn, 0.8V±2%, 600mA, 3MHz, Vin>2V, HSST, CL	USP-6C	49dc5	DC1	9a	Tor
DF8	XCL206B084AR-G	DC/DC-IC	PWM/PFM st-dwn, 3MHz, 0.8V±2%, 600mA, auto discharge	CL-2025	67dc7	DC9	9a	Tor
DF9	XC9236B09D4R-G	DC-DC-IC	PWM/PFM, st-dwn, 0.9V±2%, 600mA, 3MHz, Vin>2V, HSST, CL	USP-6EL	56dc5	DC1	9a	Tor
DF9	XC9236B09DER	DC-DC-IC	PWM/PFM, st-dwn, 0.9V±2%, 600mA, 3MHz, Vin>2V, HSST, CL	USP-6C	49dc5	DC1	9a	Tor
DF9	XCL206B094AR-G	DC/DC-IC	PWM/PFM st-dwn, 3MHz, 0.9V±2%, 600mA, auto discharge	CL-2025	67dc7	DC9	9a	Tor
DFL	XC9236B0LD4R-G	DC-DC-IC	PWM/PFM, st-dwn, 0.85V±2%, 600mA, 3MHz, Vin>2V, HSST, CL	USP-6EL	56dc5	DC1	9a	Tor
DFL	XC9236B0LDER	DC-DC-IC	PWM/PFM, st-dwn, 0.85V±2%, 600mA, 3MHz, Vin>2V, HSST, CL	USP-6C	49dc5	DC1	9a	Tor
DFM	XC9236B0MD4R-G	DC-DC-IC	PWM/PFM, st-dwn, 0.95V±2%, 600mA, 3MHz, Vin>2V, HSST, CL	USP-6EL	56dc5	DC1	9a	Tor
DFM	XC9236B0MDER	DC-DC-IC	PWM/PFM, st-dwn, 0.95V±2%, 600mA, 3MHz, Vin>2V, HSST, CL	USP-6C	49dc5	DC1	9a	Tor
DG	R3114K131A	Vdel-IC	1.3V±0.8%, -Reset ODO	DFN1010-4	48vd9	VD9	9a	Ric
DG	R3134K39EA	Vdel-IC	3.9V±1.8%, -Reset ODO, -MR	DFN1212-6	52z6	VD4	9a	Ric
DH	R3114K141A	Vdel-IC	1.4V±0.8%, -Reset ODO	DFN1010-4	48vd9	VD9	9a	Ric
DH	R3134K40EA	Vdel-IC	4.0V±1.8%, -Reset ODO, -MR	DFN1212-6	52z6	VD4	9a	Ric
DH	XG6223F26B9R-G	LVR-IC	LDO, 2.65V±1%, 300mA, +CE, CL, ICP	USPQ-4B03	48vm	VR4	9a	Tor
DH0	XC9236B10D4R-G	DC-DC-IC	PWM/PFM, st-dwn, 1.0V±2%, 600mA, 3MHz, Vin>2V, HSST, CL	USP-6EL	56dc5	DC1	9a	Tor
DH0	XC9236B10DER	DC-DC-IC	PWM/PFM, st-dwn, 1.0V±2%, 600mA, 3MHz, Vin>2V, HSST, CL	USP-6C	49dc5	DC1	9a	Tor
DH0	XCL206B104AR-G	DC/DC-IC	PWM/PFM st-dwn, 3MHz, 1.0V±2%, 600mA, auto discharge	CL-2025	67dc7	DC9	9a	Tor
DH1	XC9236B11D4R-G	DC-DC-IC	PWM/PFM, st-dwn, 1.1V±2%, 600mA, 3MHz, Vin>2V, HSST, CL	USP-6EL	56dc5	DC1	9a	Tor
DH1	XC9236B11DER	DC-DC-IC	PWM/PFM, st-dwn, 1.1V±2%, 600mA, 3MHz, Vin>2V, HSST, CL	USP-6C	49dc5	DC1	9a	Tor
DH1	XCL206B114AR-G	DC/DC-IC	PWM/PFM st-dwn, 3MHz, 1.1V±2%, 600mA, auto discharge	CL-2025	67dc7	DC9	9a	Tor
DH2	XC9236B12D4R-G	DC-DC-IC	PWM/PFM, st-dwn, 1.2V±2%, 600mA, 3MHz, Vin>2V, HSST, CL	USP-6EL	56dc5	DC1	9a	Tor
DH2	XC9236B12DER	DC-DC-IC	PWM/PFM, st-dwn, 1.2V±2%, 600mA, 3MHz, Vin>2V, HSST, CL	USP-6C	49dc5	DC1	9a	Tor
DH2	XCL206B124AR-G	DC/DC-IC	PWM/PFM st-dwn, 3MHz, 1.2V±2%, 600mA, auto discharge	CL-2025	67dc7	DC9	9a	Tor
DH3	XC9236B13D4R-G	DC-DC-IC	PWM/PFM, st-dwn, 1.3V±2%, 600mA, 3MHz, Vin>2V, HSST, CL	USP-6EL	56dc5	DC1	9a	Tor
DH3	XC9236B13DER	DC-DC-IC	PWM/PFM, st-dwn, 1.3V±2%, 600mA, 3MHz, Vin>2V, HSST, CL	USP-6C	49dc5	DC1	9a	Tor
DH3	XCL206B134AR-G	DC/DC-IC	PWM/PFM st-dwn, 3MHz, 1.3V±2%, 600mA, auto discharge	CL-2025	67dc7	DC9	9a	Tor
DH4	XC9236B14D4R-G	DC-DC-IC	PWM/PFM, st-dwn, 1.4V±2%, 600mA, 3MHz, Vin>2V, HSST, CL	USP-6EL	56dc5	DC1	9a	Tor
DH4	XC9236B14DER	DC-DC-IC	PWM/PFM, st-dwn, 1.4V±2%, 600mA, 3MHz, Vin>2V, HSST, CL	USP-6C	49dc5	DC1	9a	Tor
DH4	XCL206B144AR-G	DC/DC-IC	PWM/PFM st-dwn, 3MHz, 1.4V±2%, 600mA, auto discharge	CL-2025	67dc7	DC9	9a	Tor
DH5	XC9236B15D4R-G	DC-DC-IC	PWM/PFM, st-dwn, 1.5V±2%, 600mA, 3MHz, Vin>2V, HSST, CL	USP-6EL	56dc5	DC1	9a	Tor
DH5	XC9236B15DER	DC-DC-IC	PWM/PFM, st-dwn, 1.5V±2%, 600mA, 3MHz, Vin>2V, HSST, CL	USP-6C	49dc5	DC1	9a	Tor
DH5	XCL206B154AR-G	DC/DC-IC	PWM/PFM st-dwn, 3MHz, 1.5V±2%, 600mA, auto discharge	CL-2025	67dc7	DC9	9a	Tor
DH6	XC9236B16D4R-G	DC-DC-IC	PWM/PFM, st-dwn, 1.6V±2%, 600mA, 3MHz, Vin>2V, HSST, CL	USP-6EL	56dc5	DC1	9a	Tor
DH6	XC9236B16DER	DC-DC-IC	PWM/PFM, st-dwn, 1.6V±2%, 600mA, 3MHz, Vin>2V, HSST, CL	USP-6C	49dc5	DC1	9a	Tor
DH6	XCL206B164AR-G	DC/DC-IC	PWM/PFM st-dwn, 3MHz, 1.6V±2%, 600mA, auto discharge	CL-2025	67dc7	DC9	9a	Tor
DH7	XC9236B17D4R-G	DC-DC-IC	PWM/PFM, st-dwn, 1.7V±2%, 600mA, 3MHz, Vin>2V, HSST, CL	USP-6EL	56dc5	DC1	9a	Tor
DH7	XC9236B17DER	DC-DC-IC	PWM/PFM, st-dwn, 1.7V±2%, 600mA, 3MHz, Vin>2V, HSST, CL	USP-6C	49dc5	DC1	9a	Tor
DH7	XCL206B174AR-G	DC/DC-IC	PWM/PFM st-dwn, 3MHz, 1.7V±2%, 600mA, auto discharge	CL-2025	67dc7	DC9	9a	Tor
DH8	XC9236B18D4R-G	DC-DC-IC	PWM/PFM, st-dwn, 1.8V±2%, 600mA, 3MHz, Vin>2V, HSST, CL	USP-6EL	56dc5	DC1	9a	Tor
DH8	XC9236B18DER	DC-DC-IC	PWM/PFM, st-dwn, 1.8V±2%, 600mA, 3MHz, Vin>2V, HSST, CL	USP-6C	49dc5	DC1	9a	Tor
DH8	XCL206B184AR-G	DC/DC-IC	PWM/PFM st-dwn, 3MHz, 1.8V±2%, 600mA, auto discharge	CL-2025	67dc7	DC9	9a	Tor
DH9	XC9236B19D4R-G	DC-DC-IC	PWM/PFM, st-dwn, 1.9V±2%, 600mA, 3MHz, Vin>2V, HSST, CL	USP-6EL	56dc5	DC1	9a	Tor
DH9	XC9236B19DER	DC-DC-IC	PWM/PFM, st-dwn, 1.9V±2%, 600mA, 3MHz, Vin>2V, HSST, CL	USP-6C	49dc5	DC1	9a	Tor
DH9	XCL206B194AR-G	DC/DC-IC	PWM/PFM st-dwn, 3MHz, 1.9V±2%, 600mA, auto discharge	CL-2025	67dc7	DC9	9a	Tor
DHA	XC9236B1AD4R-G	DC-DC-IC	PWM/PFM, st-dwn, 1.05V±2%, 600mA, 3MHz, Vin>2V, HSST, CL	USP-6EL	56dc5	DC1	9a	Tor
DHA	XC9236B1ADER	DC-DC-IC	PWM/PFM, st-dwn, 1.05V±2%, 600mA, 3MHz, Vin>2V, HSST, CL	USP-6C	49dc5	DC1	9a	Tor
DHB	XC9236B1BD4R-G	DC-DC-IC	PWM/PFM, st-dwn, 1.15V±2%, 600mA, 3MHz, Vin>2V, HSST, CL	USP-6EL	56dc5	DC1	9a	Tor



SMD code	Type	Function	Short description	Case	Pinout	Sch.	St.	Mnf.
DHB	XC9236B1BDER	DC-DC-IC	PWM/PFM, st-dwn, 1.15V±2%, 600mA, 3MHz, Vin>2V, HSST, CL	USP-6C	49dc5	DC1	9a	Tor
DHC	XC9236B1CD4R-G	DC-DC-IC	PWM/PFM, st-dwn, 1.25V±2%, 600mA, 3MHz, Vin>2V, HSST, CL	USP-6EL	56dc5	DC1	9a	Tor
DHC	XC9236B1CDER	DC-DC-IC	PWM/PFM, st-dwn, 1.25V±2%, 600mA, 3MHz, Vin>2V, HSST, CL	USP-6C	49dc5	DC1	9a	Tor
DHD	XC9236B1DD4R-G	DC-DC-IC	PWM/PFM, st-dwn, 1.35V±2%, 600mA, 3MHz, Vin>2V, HSST, CL	USP-6EL	56dc5	DC1	9a	Tor
DHD	XC9236B1DDER	DC-DC-IC	PWM/PFM, st-dwn, 1.35V±2%, 600mA, 3MHz, Vin>2V, HSST, CL	USP-6C	49dc5	DC1	9a	Tor
DHE	XC9236B1ED4R-G	DC-DC-IC	PWM/PFM, st-dwn, 1.45V±2%, 600mA, 3MHz, Vin>2V, HSST, CL	USP-6EL	56dc5	DC1	9a	Tor
DHE	XC9236B1EDER	DC-DC-IC	PWM/PFM, st-dwn, 1.45V±2%, 600mA, 3MHz, Vin>2V, HSST, CL	USP-6C	49dc5	DC1	9a	Tor
DHF	XC9236B1FD4R-G	DC-DC-IC	PWM/PFM, st-dwn, 1.55V±2%, 600mA, 3MHz, Vin>2V, HSST, CL	USP-6EL	56dc5	DC1	9a	Tor
DHF	XC9236B1FDER	DC-DC-IC	PWM/PFM, st-dwn, 1.55V±2%, 600mA, 3MHz, Vin>2V, HSST, CL	USP-6C	49dc5	DC1	9a	Tor
DHH	XC9236B1HD4R-G	DC-DC-IC	PWM/PFM, st-dwn, 1.65V±2%, 600mA, 3MHz, Vin>2V, HSST, CL	USP-6EL	56dc5	DC1	9a	Tor
DHH	XC9236B1HDER	DC-DC-IC	PWM/PFM, st-dwn, 1.65V±2%, 600mA, 3MHz, Vin>2V, HSST, CL	USP-6C	49dc5	DC1	9a	Tor
DHK	XC9236B1KD4R-G	DC-DC-IC	PWM/PFM, st-dwn, 1.75V±2%, 600mA, 3MHz, Vin>2V, HSST, CL	USP-6EL	56dc5	DC1	9a	Tor
DHK	XC9236B1KDER	DC-DC-IC	PWM/PFM, st-dwn, 1.75V±2%, 600mA, 3MHz, Vin>2V, HSST, CL	USP-6C	49dc5	DC1	9a	Tor
DHL	XC9236B1LD4R-G	DC-DC-IC	PWM/PFM, st-dwn, 1.85V±2%, 600mA, 3MHz, Vin>2V, HSST, CL	USP-6EL	56dc5	DC1	9a	Tor
DHL	XC9236B1LDER	DC-DC-IC	PWM/PFM, st-dwn, 1.85V±2%, 600mA, 3MHz, Vin>2V, HSST, CL	USP-6C	49dc5	DC1	9a	Tor
DHM	XC9236B1MD4R-G	DC-DC-IC	PWM/PFM, st-dwn, 1.95V±2%, 600mA, 3MHz, Vin>2V, HSST, CL	USP-6EL	56dc5	DC1	9a	Tor
DHM	XC9236B1MDER	DC-DC-IC	PWM/PFM, st-dwn, 1.95V±2%, 600mA, 3MHz, Vin>2V, HSST, CL	USP-6C	49dc5	DC1	9a	Tor
DI	NX3L1T5157GM	CMOS-Logic	Single-pole double-throw analog switch	SOT-886	57LLog85	-	9c	Phi
DJ	R3114K151A	Vdel-IC	1.5V±0.8%, -Reset ODO	DFN1010-4	48vd9	VD9	9a	Ric
DJ	R3134K41EA	Vdel-IC	4.1V±1.8%, -Reset ODO, -MR	DFN1212-6	52z6	VD4	9a	Ric
DK	R3114K161A	Vdel-IC	1.6V±0.8%, -Reset ODO	DFN1010-4	48vd9	VD9	9a	Ric
DK	R3134K42EA	Vdel-IC	4.2V±1.8%, -Reset ODO, -MR	DFN1212-6	52z6	VD4	9a	Ric
DK	XC6223F27B9R-G	LVR-IC	LDO, 2.75V±1%, 300mA, +CE, CL, ICP	USPQ-4B03	48vm	VR4	9a	Tor
DK0	XC9236B20D4R-G	DC-DC-IC	PWM/PFM, st-dwn, 2.0V±2%, 600mA, 3MHz, Vin>2V, HSST, CL	USP-6EL	56dc5	DC1	9a	Tor
DK0	XC9236B20DER	DC-DC-IC	PWM/PFM, st-dwn, 2.0V±2%, 600mA, 3MHz, Vin>2V, HSST, CL	USP-6C	49dc5	DC1	9a	Tor
DK0	XCL206B204AR-G	DC/DC-IC	PWM/PFM st-dwn, 3MHz, 2.0V±2%, 600mA, auto discharge	CL-2025	67dc7	DC9	9a	Tor
DK1	XC9236B21D4R-G	DC-DC-IC	PWM/PFM, st-dwn, 2.1V±2%, 600mA, 3MHz, Vin>2V, HSST, CL	USP-6EL	56dc5	DC1	9a	Tor
DK1	XC9236B21DER	DC-DC-IC	PWM/PFM, st-dwn, 2.1V±2%, 600mA, 3MHz, Vin>2V, HSST, CL	USP-6C	49dc5	DC1	9a	Tor
DK1	XCL206B214AR-G	DC/DC-IC	PWM/PFM st-dwn, 3MHz, 2.1V±2%, 600mA, auto discharge	CL-2025	67dc7	DC9	9a	Tor
DK2	XC9236B22D4R-G	DC-DC-IC	PWM/PFM, st-dwn, 2.2V±2%, 600mA, 3MHz, Vin>2V, HSST, CL	USP-6EL	56dc5	DC1	9a	Tor
DK2	XC9236B22DER	DC-DC-IC	PWM/PFM, st-dwn, 2.2V±2%, 600mA, 3MHz, Vin>2V, HSST, CL	USP-6C	49dc5	DC1	9a	Tor
DK2	XCL206B224AR-G	DC/DC-IC	PWM/PFM st-dwn, 3MHz, 2.2V±2%, 600mA, auto discharge	CL-2025	67dc7	DC9	9a	Tor
DK3	XC9236B23D4R-G	DC-DC-IC	PWM/PFM, st-dwn, 2.3V±2%, 600mA, 3MHz, Vin>2V, HSST, CL	USP-6EL	56dc5	DC1	9a	Tor
DK3	XC9236B23DER	DC-DC-IC	PWM/PFM, st-dwn, 2.3V±2%, 600mA, 3MHz, Vin>2V, HSST, CL	USP-6C	49dc5	DC1	9a	Tor
DK3	XCL206B234AR-G	DC/DC-IC	PWM/PFM st-dwn, 3MHz, 2.3V±2%, 600mA, auto discharge	CL-2025	67dc7	DC9	9a	Tor
DK4	XC9236B24D4R-G	DC-DC-IC	PWM/PFM, st-dwn, 2.4V±2%, 600mA, 3MHz, Vin>2V, HSST, CL	USP-6EL	56dc5	DC1	9a	Tor
DK4	XC9236B24DER	DC-DC-IC	PWM/PFM, st-dwn, 2.4V±2%, 600mA, 3MHz, Vin>2V, HSST, CL	USP-6C	49dc5	DC1	9a	Tor
DK4	XCL206B244AR-G	DC/DC-IC	PWM/PFM st-dwn, 3MHz, 2.4V±2%, 600mA, auto discharge	CL-2025	67dc7	DC9	9a	Tor
DK5	XC9236B25D4R-G	DC-DC-IC	PWM/PFM, st-dwn, 2.5V±2%, 600mA, 3MHz, Vin>2V, HSST, CL	USP-6EL	56dc5	DC1	9a	Tor
DK5	XC9236B25DER	DC-DC-IC	PWM/PFM, st-dwn, 2.5V±2%, 600mA, 3MHz, Vin>2V, HSST, CL	USP-6C	49dc5	DC1	9a	Tor
DK5	XCL206B254AR-G	DC/DC-IC	PWM/PFM st-dwn, 3MHz, 2.5V±2%, 600mA, auto discharge	CL-2025	67dc7	DC9	9a	Tor
DK6	XC9236B26D4R-G	DC-DC-IC	PWM/PFM, st-dwn, 2.6V±2%, 600mA, 3MHz, Vin>2V, HSST, CL	USP-6EL	56dc5	DC1	9a	Tor
DK6	XC9236B26DER	DC-DC-IC	PWM/PFM, st-dwn, 2.6V±2%, 600mA, 3MHz, Vin>2V, HSST, CL	USP-6C	49dc5	DC1	9a	Tor
DK6	XCL206B264AR-G	DC/DC-IC	PWM/PFM st-dwn, 3MHz, 2.6V±2%, 600mA, auto discharge	CL-2025	67dc7	DC9	9a	Tor
DK7	XC9236B27D4R-G	DC-DC-IC	PWM/PFM, st-dwn, 2.7V±2%, 600mA, 3MHz, Vin>2V, HSST, CL	USP-6EL	56dc5	DC1	9a	Tor
DK7	XC9236B27DER	DC-DC-IC	PWM/PFM, st-dwn, 2.7V±2%, 600mA, 3MHz, Vin>2V, HSST, CL	USP-6C	49dc5	DC1	9a	Tor
DK7	XCL206B274AR-G	DC/DC-IC	PWM/PFM st-dwn, 3MHz, 2.7V±2%, 600mA, auto discharge	CL-2025	67dc7	DC9	9a	Tor
DK8	XC9236B28D4R-G	DC-DC-IC	PWM/PFM, st-dwn, 2.8V±2%, 600mA, 3MHz, Vin>2V, HSST, CL	USP-6EL	56dc5	DC1	9a	Tor
DK8	XC9236B28DER	DC-DC-IC	PWM/PFM, st-dwn, 2.8V±2%, 600mA, 3MHz, Vin>2V, HSST, CL	USP-6C	49dc5	DC1	9a	Tor
DK8	XCL206B284AR-G	DC/DC-IC	PWM/PFM st-dwn, 3MHz, 2.8V±2%, 600mA, auto discharge	CL-2025	67dc7	DC9	9a	Tor
DK9	XC9236B29D4R-G	DC-DC-IC	PWM/PFM, st-dwn, 2.9V±2%, 600mA, 3MHz, Vin>2V, HSST, CL	USP-6EL	56dc5	DC1	9a	Tor
DK9	XC9236B29DER	DC-DC-IC	PWM/PFM, st-dwn, 2.9V±2%, 600mA, 3MHz, Vin>2V, HSST, CL	USP-6C	49dc5	DC1	9a	Tor
DK9	XCL206B294AR-G	DC/DC-IC	PWM/PFM st-dwn, 3MHz, 2.9V±2%, 600mA, auto discharge	CL-2025	67dc7	DC9	9a	Tor
DKA	XC9236B2AD4R-G	DC-DC-IC	PWM/PFM, st-dwn, 2.05V±2%, 600mA, 3MHz, Vin>2V, HSST, CL	USP-6EL	56dc5	DC1	9a	Tor
DKA	XC9236B2ADER	DC-DC-IC	PWM/PFM, st-dwn, 2.05V±2%, 600mA, 3MHz, Vin>2V, HSST, CL	USP-6C	49dc5	DC1	9a	Tor
DKB	XC9236B2BD4R-G	DC-DC-IC	PWM/PFM, st-dwn, 2.15V±2%, 600mA, 3MHz, Vin>2V, HSST, CL	USP-6EL	56dc5	DC1	9a	Tor
DKB	XC9236B2BDER	DC-DC-IC	PWM/PFM, st-dwn, 2.15V±2%, 600mA, 3MHz, Vin>2V, HSST, CL	USP-6C	49dc5	DC1	9a	Tor
DKC	XC9236B2CD4R-G	DC-DC-IC	PWM/PFM, st-dwn, 2.25V±2%, 600mA, 3MHz, Vin>2V, HSST, CL	USP-6EL	56dc5	DC1	9a	Tor
DKC	XC9236B2CDER	DC-DC-IC	PWM/PFM, st-dwn, 2.25V±2%, 600mA, 3MHz, Vin>2V, HSST, CL	USP-6C	49dc5	DC1	9a	Tor
DKD	XC9236B2DD4R-G	DC-DC-IC	PWM/PFM, st-dwn, 2.35V±2%, 600mA, 3MHz, Vin>2V, HSST, CL	USP-6EL	56dc5	DC1	9a	Tor
DKD	XC9236B2DDER	DC-DC-IC	PWM/PFM, st-dwn, 2.35V±2%, 600mA, 3MHz, Vin>2V, HSST, CL	USP-6C	49dc5	DC1	9a	Tor
DKE	XC9236B2ED4R-G	DC-DC-IC	PWM/PFM, st-dwn, 2.45V±2%, 600mA, 3MHz, Vin>2V, HSST, CL	USP-6EL	56dc5	DC1	9a	Tor
DKE	XC9236B2EDER	DC-DC-IC	PWM/PFM, st-dwn, 2.45V±2%, 600mA, 3MHz, Vin>2V, HSST, CL	USP-6C	49dc5	DC1	9a	Tor
DKF	XC9236B2FD4R-G	DC-DC-IC	PWM/PFM, st-dwn, 2.55V±2%, 600mA, 3MHz, Vin>2V, HSST, CL	USP-6EL	56dc5	DC1	9a	Tor
DKF	XC9236B2FDER	DC-DC-IC	PWM/PFM, st-dwn, 2.55V±2%, 600mA, 3MHz, Vin>2V, HSST, CL	USP-6C	49dc5	DC1	9a	Tor
DKH	XC9236B2HD4R-G	DC-DC-IC	PWM/PFM, st-dwn, 2.65V±2%, 600mA, 3MHz, Vin>2V, HSST, CL	USP-6EL	56dc5	DC1	9a	Tor
DKH	XC9236B2HDER	DC-DC-IC	PWM/PFM, st-dwn, 2.65V±2%, 600mA, 3MHz, Vin>2V, HSST, CL	USP-6C	49dc5	DC1	9a	Tor
DKI	XC9236B2ID4R-G	DC-DC-IC	PWM/PFM, st-dwn, 2.75V±2%, 600mA, 3MHz, Vin>2V, HSST, CL	USP-6EL	56dc5	DC1	9a	Tor
DKI	XC9236B2IDER	DC-DC-IC	PWM/PFM, st-dwn, 2.75V±2%, 600mA, 3MHz, Vin>2V, HSST, CL	USP-6C	49dc5	DC1	9a	Tor
DKL	XC9236B2LD4R-G	DC-DC-IC	PWM/PFM, st-dwn, 2.85V±2%, 600mA, 3MHz, Vin>2V, HSST, CL	USP-6EL	56dc5	DC1	9a	Tor



SMD code	Type	Function	Short description	Case	Pinout	Sch.	St.	Mnf.
DKL	XC9236B2LDER	DC-DC-IC	PWM/PFM, st-dwn, 2.85V±2%, 600mA, 3MHz, Vin>2V, HSST, CL	USP-6C	49dc5	DC1	9a	Tor
DKM	XC9236B2MD4R-G	DC-DC-IC	PWM/PFM, st-dwn, 2.95V±2%, 600mA, 3MHz, Vin>2V, HSST, CL	USP-6EL	56dc5	DC1	9a	Tor
DKM	XC9236B2MDER	DC-DC-IC	PWM/PFM, st-dwn, 2.95V±2%, 600mA, 3MHz, Vin>2V, HSST, CL	USP-6C	49dc5	DC1	9a	Tor
dL	NX3V1G66GM	CMOS-Logic	Single-pole single-throw analog switch	SOT-886	57L0g16	-	9c	Phi
DL	NX3L1G66GM	CMOS-Logic	Single-pole single-throw analog switch	SOT-886	57L0g16	-	9c	Phi
DL	R3114K171A	Vdet-IC	1.7V±0.8%, -Reset ODO	DFN1010-4	48vd9	VD9	9a	Ric
DL	R3134K43EA	Vdet-IC	4.3V±1.8%, -Reset ODO, -MR	DFN1212-6	52z6	VD4	9a	Ric
DL	XC6223F28B9R-G	LVR-IC	LDO, 2.85V±1%, 300mA, +CE, CL, ICP	USPQ-4B03	48vm	VR4	9a	Tor
DL0	XC9236B30D4R-G	DC-DC-IC	PWM/PFM, st-dwn, 3.0V±2%, 600mA, 3MHz, Vin>2V, HSST, CL	USP-6EL	56dc5	DC1	9a	Tor
DL0	XC9236B30DER	DC-DC-IC	PWM/PFM, st-dwn, 3.0V±2%, 600mA, 3MHz, Vin>2V, HSST, CL	USP-6C	49dc5	DC1	9a	Tor
DL0	XCL206B304AR-G	DC/DC-IC	PWM/PFM st-dwn, 3MHz, 3.0V±2%, 600mA, auto discharge	CL-2025	67dc7	DC9	9a	Tor
DL1	XC9236B31D4R-G	DC-DC-IC	PWM/PFM, st-dwn, 3.1V±2%, 600mA, 3MHz, Vin>2V, HSST, CL	USP-6EL	56dc5	DC1	9a	Tor
DL1	XC9236B31DER	DC-DC-IC	PWM/PFM, st-dwn, 3.1V±2%, 600mA, 3MHz, Vin>2V, HSST, CL	USP-6C	49dc5	DC1	9a	Tor
DL1	XCL206B314AR-G	DC/DC-IC	PWM/PFM st-dwn, 3MHz, 3.1V±2%, 600mA, auto discharge	CL-2025	67dc7	DC9	9a	Tor
DL2	XC9236B32D4R-G	DC-DC-IC	PWM/PFM, st-dwn, 3.2V±2%, 600mA, 3MHz, Vin>2V, HSST, CL	USP-6EL	56dc5	DC1	9a	Tor
DL2	XC9236B32DER	DC-DC-IC	PWM/PFM, st-dwn, 3.2V±2%, 600mA, 3MHz, Vin>2V, HSST, CL	USP-6C	49dc5	DC1	9a	Tor
DL2	XCL206B324AR-G	DC/DC-IC	PWM/PFM st-dwn, 3MHz, 3.2V±2%, 600mA, auto discharge	CL-2025	67dc7	DC9	9a	Tor
DL3	XC9236B33D4R-G	DC-DC-IC	PWM/PFM, st-dwn, 3.3V±2%, 600mA, 3MHz, Vin>2V, HSST, CL	USP-6EL	56dc5	DC1	9a	Tor
DL3	XC9236B33DER	DC-DC-IC	PWM/PFM, st-dwn, 3.3V±2%, 600mA, 3MHz, Vin>2V, HSST, CL	USP-6C	49dc5	DC1	9a	Tor
DL3	XCL206B334AR-G	DC/DC-IC	PWM/PFM st-dwn, 3MHz, 3.3V±2%, 600mA, auto discharge	CL-2025	67dc7	DC9	9a	Tor
DL4	XC9236B34D4R-G	DC-DC-IC	PWM/PFM, st-dwn, 3.4V±2%, 600mA, 3MHz, Vin>2V, HSST, CL	USP-6EL	56dc5	DC1	9a	Tor
DL4	XC9236B34DER	DC-DC-IC	PWM/PFM, st-dwn, 3.4V±2%, 600mA, 3MHz, Vin>2V, HSST, CL	USP-6C	49dc5	DC1	9a	Tor
DL4	XCL206B344AR-G	DC/DC-IC	PWM/PFM st-dwn, 3MHz, 3.4V±2%, 600mA, auto discharge	CL-2025	67dc7	DC9	9a	Tor
DL5	XC9236B35D4R-G	DC-DC-IC	PWM/PFM, st-dwn, 3.5V±2%, 600mA, 3MHz, Vin>2V, HSST, CL	USP-6EL	56dc5	DC1	9a	Tor
DL5	XC9236B35DER	DC-DC-IC	PWM/PFM, st-dwn, 3.5V±2%, 600mA, 3MHz, Vin>2V, HSST, CL	USP-6C	49dc5	DC1	9a	Tor
DL5	XCL206B354AR-G	DC/DC-IC	PWM/PFM st-dwn, 3MHz, 3.5V±2%, 600mA, auto discharge	CL-2025	67dc7	DC9	9a	Tor
DL6	XC9236B36D4R-G	DC-DC-IC	PWM/PFM, st-dwn, 3.6V±2%, 600mA, 3MHz, Vin>2V, HSST, CL	USP-6EL	56dc5	DC1	9a	Tor
DL6	XC9236B36DER	DC-DC-IC	PWM/PFM, st-dwn, 3.6V±2%, 600mA, 3MHz, Vin>2V, HSST, CL	USP-6C	49dc5	DC1	9a	Tor
DL6	XCL206B364AR-G	DC/DC-IC	PWM/PFM st-dwn, 3MHz, 3.6V±2%, 600mA, auto discharge	CL-2025	67dc7	DC9	9a	Tor
DL7	XC9236B37D4R-G	DC-DC-IC	PWM/PFM, st-dwn, 3.7V±2%, 600mA, 3MHz, Vin>2V, HSST, CL	USP-6EL	56dc5	DC1	9a	Tor
DL7	XC9236B37DER	DC-DC-IC	PWM/PFM, st-dwn, 3.7V±2%, 600mA, 3MHz, Vin>2V, HSST, CL	USP-6C	49dc5	DC1	9a	Tor
DL7	XCL206B374AR-G	DC/DC-IC	PWM/PFM st-dwn, 3MHz, 3.7V±2%, 600mA, auto discharge	CL-2025	67dc7	DC9	9a	Tor
DL8	XC9236B38D4R-G	DC-DC-IC	PWM/PFM, st-dwn, 3.8V±2%, 600mA, 3MHz, Vin>2V, HSST, CL	USP-6EL	56dc5	DC1	9a	Tor
DL8	XC9236B38DER	DC-DC-IC	PWM/PFM, st-dwn, 3.8V±2%, 600mA, 3MHz, Vin>2V, HSST, CL	USP-6C	49dc5	DC1	9a	Tor
DL8	XCL206B384AR-G	DC/DC-IC	PWM/PFM st-dwn, 3MHz, 3.8V±2%, 600mA, auto discharge	CL-2025	67dc7	DC9	9a	Tor
DL9	XC9236B39D4R-G	DC-DC-IC	PWM/PFM, st-dwn, 3.9V±2%, 600mA, 3MHz, Vin>2V, HSST, CL	USP-6EL	56dc5	DC1	9a	Tor
DL9	XC9236B39DER	DC-DC-IC	PWM/PFM, st-dwn, 3.9V±2%, 600mA, 3MHz, Vin>2V, HSST, CL	USP-6C	49dc5	DC1	9a	Tor
DL9	XCL206B394AR-G	DC/DC-IC	PWM/PFM st-dwn, 3MHz, 3.9V±2%, 600mA, auto discharge	CL-2025	67dc7	DC9	9a	Tor
DLA	XC9236B3AD4R-G	DC-DC-IC	PWM/PFM, st-dwn, 3.05V±2%, 600mA, 3MHz, Vin>2V, HSST, CL	USP-6EL	56dc5	DC1	9a	Tor
DLA	XC9236B3ADER	DC-DC-IC	PWM/PFM, st-dwn, 3.05V±2%, 600mA, 3MHz, Vin>2V, HSST, CL	USP-6C	49dc5	DC1	9a	Tor
DLB	XC9236B3BD4R-G	DC-DC-IC	PWM/PFM, st-dwn, 3.15V±2%, 600mA, 3MHz, Vin>2V, HSST, CL	USP-6EL	56dc5	DC1	9a	Tor
DLB	XC9236B3BDER	DC-DC-IC	PWM/PFM, st-dwn, 3.15V±2%, 600mA, 3MHz, Vin>2V, HSST, CL	USP-6C	49dc5	DC1	9a	Tor
DLC	XC9236B3CD4R-G	DC-DC-IC	PWM/PFM, st-dwn, 3.25V±2%, 600mA, 3MHz, Vin>2V, HSST, CL	USP-6EL	56dc5	DC1	9a	Tor
DLC	XC9236B3CDER	DC-DC-IC	PWM/PFM, st-dwn, 3.25V±2%, 600mA, 3MHz, Vin>2V, HSST, CL	USP-6C	49dc5	DC1	9a	Tor
DLD	XC9236B3DD4R-G	DC-DC-IC	PWM/PFM, st-dwn, 3.35V±2%, 600mA, 3MHz, Vin>2V, HSST, CL	USP-6EL	56dc5	DC1	9a	Tor
DLD	XC9236B3DDER	DC-DC-IC	PWM/PFM, st-dwn, 3.35V±2%, 600mA, 3MHz, Vin>2V, HSST, CL	USP-6C	49dc5	DC1	9a	Tor
DLE	XC9236B3ED4R-G	DC-DC-IC	PWM/PFM, st-dwn, 3.45V±2%, 600mA, 3MHz, Vin>2V, HSST, CL	USP-6EL	56dc5	DC1	9a	Tor
DLE	XC9236B3EDER	DC-DC-IC	PWM/PFM, st-dwn, 3.45V±2%, 600mA, 3MHz, Vin>2V, HSST, CL	USP-6C	49dc5	DC1	9a	Tor
DLF	XC9236B3FD4R-G	DC-DC-IC	PWM/PFM, st-dwn, 3.55V±2%, 600mA, 3MHz, Vin>2V, HSST, CL	USP-6EL	56dc5	DC1	9a	Tor
DLF	XC9236B3FDER	DC-DC-IC	PWM/PFM, st-dwn, 3.55V±2%, 600mA, 3MHz, Vin>2V, HSST, CL	USP-6C	49dc5	DC1	9a	Tor
DLH	XC9236B3HD4R-G	DC-DC-IC	PWM/PFM, st-dwn, 3.65V±2%, 600mA, 3MHz, Vin>2V, HSST, CL	USP-6EL	56dc5	DC1	9a	Tor
DLH	XC9236B3HDER	DC-DC-IC	PWM/PFM, st-dwn, 3.65V±2%, 600mA, 3MHz, Vin>2V, HSST, CL	USP-6C	49dc5	DC1	9a	Tor
DLK	XC9236B3KD4R-G	DC-DC-IC	PWM/PFM, st-dwn, 3.75V±2%, 600mA, 3MHz, Vin>2V, HSST, CL	USP-6EL	56dc5	DC1	9a	Tor
DLK	XC9236B3KDER	DC-DC-IC	PWM/PFM, st-dwn, 3.75V±2%, 600mA, 3MHz, Vin>2V, HSST, CL	USP-6C	49dc5	DC1	9a	Tor
DLL	XC9236B3LD4R-G	DC-DC-IC	PWM/PFM, st-dwn, 3.85V±2%, 600mA, 3MHz, Vin>2V, HSST, CL	USP-6EL	56dc5	DC1	9a	Tor
DLL	XC9236B3LDER	DC-DC-IC	PWM/PFM, st-dwn, 3.85V±2%, 600mA, 3MHz, Vin>2V, HSST, CL	USP-6C	49dc5	DC1	9a	Tor
DLM	XC9236B3MD4R-G	DC-DC-IC	PWM/PFM, st-dwn, 3.95V±2%, 600mA, 3MHz, Vin>2V, HSST, CL	USP-6EL	56dc5	DC1	9a	Tor
DLM	XC9236B3MDER	DC-DC-IC	PWM/PFM, st-dwn, 3.95V±2%, 600mA, 3MHz, Vin>2V, HSST, CL	USP-6C	49dc5	DC1	9a	Tor
DM	R3114K181A	Vdet-IC	1.8V±0.8%, -Reset ODO	DFN1010-4	48vd9	VD9	9a	Ric
DM	R3134K44EA	Vdet-IC	4.4V±1.8%, -Reset ODO, -MR	DFN1212-6	52z6	VD4	9a	Ric
DM	XC6223F29B9R-G	LVR-IC	LDO, 2.95V±1%, 300mA, +CE, CL, ICP	USPQ-4B03	48vm	VR4	9a	Tor
DM0	XC9236B40D4R-G	DC-DC-IC	PWM/PFM, st-dwn, 4.0V±2%, 600mA, 3MHz, Vin>2V, HSST, CL	USP-6EL	56dc5	DC1	9a	Tor
DM0	XC9236B40DER	DC-DC-IC	PWM/PFM, st-dwn, 4.0V±2%, 600mA, 3MHz, Vin>2V, HSST, CL	USP-6C	49dc5	DC1	9a	Tor
DM0	XCL206B404AR-G	DC/DC-IC	PWM/PFM st-dwn, 3MHz, 4.0V±2%, 600mA, auto discharge	CL-2025	67dc7	DC9	9a	Tor
DN	R3114K191A	Vdet-IC	1.9V±0.8%, -Reset ODO	DFN1010-4	48vd9	VD9	9a	Ric
DN	R3134K45EA	Vdet-IC	4.5V±1.8%, -Reset ODO, -MR	DFN1212-6	52z6	VD4	9a	Ric
DN	XC6223F30B9R-G	LVR-IC	LDO, 3.05V±1%, 300mA, +CE, CL, ICP	USPQ-4B03	48vm	VR4	9a	Tor
DN8	XC9236G08C4	DC/DC-IC	PWM/PFM st-dwn, 1.2MHz, 0.8V±2%, 600mA, CL, Vin>1.8V, HSST	USP-6EL	56dc5	DC1	9a	Tor
DN8	XC9236G08CER	DC-DC-IC	PWM/PFM, st-dwn, 0.8V±2%, 600mA, 1.2MHz, Vin>1.8V, HSST, CL	USP-6C	49dc5	DC1	9a	Tor
DN9	XC9236G09C4	DC/DC-IC	PWM/PFM st-dwn, 1.2MHz, 0.9V±2%, 600mA, CL, Vin>1.8V, HSST	USP-6EL	56dc5	DC1	9a	Tor



SMD code	Type	Function	Short description	Case	Pinout	Sch.	St.	Mnf.
DN9	XC9236G09CER	DC-DC-IC	PWM/PFM, st-dwn, 0.9V±2%, 600mA, 1.2MHz, Vin>1.8V, HSST, CL	USP-6C	49dc5	DC1	9a	Tor
DNL	XC9236G0LC4	DC/DC-IC	PWM/PFM st-dwn, 1.2MHz, 0.85V±2%, 600mA, CL, Vin>1.8V, HSST	USP-6EL	56dc5	DC1	9a	Tor
DNL	XC9236G0LCER	DC-DC-IC	PWM/PFM, st-dwn, 0.85V±2%, 600mA, 1.2MHz, Vin>1.8V, HSST, CL	USP-6C	49dc5	DC1	9a	Tor
DNM	XC9236G0MC4	DC/DC-IC	PWM/PFM st-dwn, 1.2MHz, 0.95V±2%, 600mA, CL, Vin>1.8V, HSST	USP-6EL	56dc5	DC1	9a	Tor
DNM	XC9236G0MCER	DC-DC-IC	PWM/PFM, st-dwn, 0.95V±2%, 600mA, 1.2MHz, Vin>1.8V, HSST, CL	USP-6C	49dc5	DC1	9a	Tor
dO	NX3V1T66GM	CMOS-Logic	Single-pole single-throw analog switch	SOT-886	57L/Log16	-	9c	Phi
DO	NX3L1T66GM	CMOS-Logic	Single-pole single-throw analog switch	SOT-886	57L/Log16	-	9c	Phi
DOO	NX3L2T66GM	CMOS-Logic	2-channel analog switch	SOT902-1	51L/Log68	-	9a	Phi
DOO	NX3L2T66GT	CMOS-Logic	2-channel analog switch	SOT833-1	53L/Log68	-	9c	Phi
DP	R3114K201A	Vdet-IC	2.0V±0.8%, -Reset ODO	DFN1010-4	48vd9	VD9	9a	Ric
DP	R3134K46EA	Vdet-IC	4.6V±1.8%, -Reset ODO, -MR	DFN1212-6	52z6	VD4	9a	Ric
DP	XG6223F31B9R-G	LVR-IC	LDO, 3.15V±1%, 300mA, +CE, CL, ICP	USPQ-4B03	48vm	VR4	9a	Tor
DP0	XC9236G10C4	DC/DC-IC	PWM/PFM st-dwn, 1.2MHz, 1.0V±2%, 600mA, CL, Vin>1.8V, HSST	USP-6EL	56dc5	DC1	9a	Tor
DP0	XC9236G10CER	DC-DC-IC	PWM/PFM, st-dwn, 1.0V±2%, 600mA, 1.2MHz, Vin>1.8V, HSST, CL	USP-6C	49dc5	DC1	9a	Tor
DP1	XC9236G11C4	DC/DC-IC	PWM/PFM st-dwn, 1.2MHz, 1.1V±2%, 600mA, CL, Vin>1.8V, HSST	USP-6EL	56dc5	DC1	9a	Tor
DP1	XC9236G11CER	DC-DC-IC	PWM/PFM, st-dwn, 1.1V±2%, 600mA, 1.2MHz, Vin>1.8V, HSST, CL	USP-6C	49dc5	DC1	9a	Tor
DP2	XC9236G12C4	DC/DC-IC	PWM/PFM st-dwn, 1.2MHz, 1.2V±2%, 600mA, CL, Vin>1.8V, HSST	USP-6EL	56dc5	DC1	9a	Tor
DP2	XC9236G12CER	DC-DC-IC	PWM/PFM, st-dwn, 1.2V±2%, 600mA, 1.2MHz, Vin>1.8V, HSST, CL	USP-6C	49dc5	DC1	9a	Tor
DP3	XC9236G13C4	DC/DC-IC	PWM/PFM st-dwn, 1.2MHz, 1.3V±2%, 600mA, CL, Vin>1.8V, HSST	USP-6EL	56dc5	DC1	9a	Tor
DP3	XC9236G13CER	DC-DC-IC	PWM/PFM, st-dwn, 1.3V±2%, 600mA, 1.2MHz, Vin>1.8V, HSST, CL	USP-6C	49dc5	DC1	9a	Tor
DP4	XC9236G14C4	DC/DC-IC	PWM/PFM st-dwn, 1.2MHz, 1.4V±2%, 600mA, CL, Vin>1.8V, HSST	USP-6EL	56dc5	DC1	9a	Tor
DP4	XC9236G14CER	DC-DC-IC	PWM/PFM, st-dwn, 1.4V±2%, 600mA, 1.2MHz, Vin>1.8V, HSST, CL	USP-6C	49dc5	DC1	9a	Tor
DP5	XC9236G15C4	DC/DC-IC	PWM/PFM st-dwn, 1.2MHz, 1.5V±2%, 600mA, CL, Vin>1.8V, HSST	USP-6EL	56dc5	DC1	9a	Tor
DP5	XC9236G15CER	DC-DC-IC	PWM/PFM, st-dwn, 1.5V±2%, 600mA, 1.2MHz, Vin>1.8V, HSST, CL	USP-6C	49dc5	DC1	9a	Tor
DP6	XC9236G16C4	DC/DC-IC	PWM/PFM st-dwn, 1.2MHz, 1.6V±2%, 600mA, CL, Vin>1.8V, HSST	USP-6EL	56dc5	DC1	9a	Tor
DP6	XC9236G16CER	DC-DC-IC	PWM/PFM, st-dwn, 1.6V±2%, 600mA, 1.2MHz, Vin>1.8V, HSST, CL	USP-6C	49dc5	DC1	9a	Tor
DP7	XC9236G17C4	DC/DC-IC	PWM/PFM st-dwn, 1.2MHz, 1.7V±2%, 600mA, CL, Vin>1.8V, HSST	USP-6EL	56dc5	DC1	9a	Tor
DP7	XC9236G17CER	DC-DC-IC	PWM/PFM, st-dwn, 1.7V±2%, 600mA, 1.2MHz, Vin>1.8V, HSST, CL	USP-6C	49dc5	DC1	9a	Tor
DP8	XC9236G18C4	DC/DC-IC	PWM/PFM st-dwn, 1.2MHz, 1.8V±2%, 600mA, CL, Vin>1.8V, HSST	USP-6EL	56dc5	DC1	9a	Tor
DP8	XC9236G18CER	DC-DC-IC	PWM/PFM, st-dwn, 1.8V±2%, 600mA, 1.2MHz, Vin>1.8V, HSST, CL	USP-6C	49dc5	DC1	9a	Tor
DP9	XC9236G19C4	DC/DC-IC	PWM/PFM st-dwn, 1.2MHz, 1.9V±2%, 600mA, CL, Vin>1.8V, HSST	USP-6EL	56dc5	DC1	9a	Tor
DP9	XC9236G19CER	DC-DC-IC	PWM/PFM, st-dwn, 1.9V±2%, 600mA, 1.2MHz, Vin>1.8V, HSST, CL	USP-6C	49dc5	DC1	9a	Tor
DPA	XC9236G1AC4	DC/DC-IC	PWM/PFM st-dwn, 1.2MHz, 1.05V±2%, 600mA, CL, Vin>1.8V, HSST	USP-6EL	56dc5	DC1	9a	Tor
DPA	XC9236G1ACER	DC-DC-IC	PWM/PFM, st-dwn, 1.05V±2%, 600mA, 1.2MHz, Vin>1.8V, HSST, CL	USP-6C	49dc5	DC1	9a	Tor
DPB	XC9236G1BC4	DC/DC-IC	PWM/PFM st-dwn, 1.2MHz, 1.15V±2%, 600mA, CL, Vin>1.8V, HSST	USP-6EL	56dc5	DC1	9a	Tor
DPB	XC9236G1BCER	DC-DC-IC	PWM/PFM, st-dwn, 1.15V±2%, 600mA, 1.2MHz, Vin>1.8V, HSST, CL	USP-6C	49dc5	DC1	9a	Tor
DPC	XC9236G1CC4	DC/DC-IC	PWM/PFM st-dwn, 1.2MHz, 1.25V±2%, 600mA, CL, Vin>1.8V, HSST	USP-6EL	56dc5	DC1	9a	Tor
DPC	XC9236G1CCER	DC-DC-IC	PWM/PFM, st-dwn, 1.25V±2%, 600mA, 1.2MHz, Vin>1.8V, HSST, CL	USP-6C	49dc5	DC1	9a	Tor
DPD	XC9236G1DC4	DC/DC-IC	PWM/PFM st-dwn, 1.2MHz, 1.35V±2%, 600mA, CL, Vin>1.8V, HSST	USP-6EL	56dc5	DC1	9a	Tor
DPD	XC9236G1DCER	DC-DC-IC	PWM/PFM, st-dwn, 1.35V±2%, 600mA, 1.2MHz, Vin>1.8V, HSST, CL	USP-6C	49dc5	DC1	9a	Tor
DPE	XC9236G1EC4	DC/DC-IC	PWM/PFM st-dwn, 1.2MHz, 1.45V±2%, 600mA, CL, Vin>1.8V, HSST	USP-6EL	56dc5	DC1	9a	Tor
DPE	XC9236G1ECER	DC-DC-IC	PWM/PFM, st-dwn, 1.45V±2%, 600mA, 1.2MHz, Vin>1.8V, HSST, CL	USP-6C	49dc5	DC1	9a	Tor
DPF	XC9236G1FC4	DC/DC-IC	PWM/PFM st-dwn, 1.2MHz, 1.55V±2%, 600mA, CL, Vin>1.8V, HSST	USP-6EL	56dc5	DC1	9a	Tor
DPF	XC9236G1FCER	DC-DC-IC	PWM/PFM, st-dwn, 1.55V±2%, 600mA, 1.2MHz, Vin>1.8V, HSST, CL	USP-6C	49dc5	DC1	9a	Tor
DPH	XC9236G1HC4	DC/DC-IC	PWM/PFM st-dwn, 1.2MHz, 1.65V±2%, 600mA, CL, Vin>1.8V, HSST	USP-6EL	56dc5	DC1	9a	Tor
DPH	XC9236G1HCER	DC-DC-IC	PWM/PFM, st-dwn, 1.65V±2%, 600mA, 1.2MHz, Vin>1.8V, HSST, CL	USP-6C	49dc5	DC1	9a	Tor
DPK	XC9236G1KC4	DC/DC-IC	PWM/PFM st-dwn, 1.2MHz, 1.75V±2%, 600mA, CL, Vin>1.8V, HSST	USP-6EL	56dc5	DC1	9a	Tor
DPK	XC9236G1KCER	DC-DC-IC	PWM/PFM, st-dwn, 1.75V±2%, 600mA, 1.2MHz, Vin>1.8V, HSST, CL	USP-6C	49dc5	DC1	9a	Tor
DPL	XC9236G1LC4	DC/DC-IC	PWM/PFM st-dwn, 1.2MHz, 1.85V±2%, 600mA, CL, Vin>1.8V, HSST	USP-6EL	56dc5	DC1	9a	Tor
DPL	XC9236G1LCER	DC-DC-IC	PWM/PFM, st-dwn, 1.85V±2%, 600mA, 1.2MHz, Vin>1.8V, HSST, CL	USP-6C	49dc5	DC1	9a	Tor
DPM	XC9236G1MC4	DC/DC-IC	PWM/PFM st-dwn, 1.2MHz, 1.95V±2%, 600mA, CL, Vin>1.8V, HSST	USP-6EL	56dc5	DC1	9a	Tor
DPM	XC9236G1MCER	DC-DC-IC	PWM/PFM, st-dwn, 1.95V±2%, 600mA, 1.2MHz, Vin>1.8V, HSST, CL	USP-6C	49dc5	DC1	9a	Tor
DQ	R3114K211A	Vdet-IC	2.1V±0.8%, -Reset ODO	DFN1010-4	48vd9	VD9	9a	Ric
DQ	R3114K221A	Vdet-IC	2.2V±0.8%, -Reset ODO	DFN1010-4	48vd9	VD9	9a	Ric
DR	R3134K47EA	Vdet-IC	4.7V±1.8%, -Reset ODO, -MR	DFN1212-6	52z6	VD4	9a	Ric
DR	XG6223F32B9R-G	LVR-IC	LDO, 3.25V±1%, 300mA, +CE, CL, ICP	USPQ-4B03	48vm	VR4	9a	Tor
DR0	XC9236G20C4	DC/DC-IC	PWM/PFM st-dwn, 1.2MHz, 2.0V±2%, 600mA, CL, Vin>1.8V, HSST	USP-6EL	56dc5	DC1	9a	Tor
DR0	XC9236G20CER	DC-DC-IC	PWM/PFM, st-dwn, 2.0V±2%, 600mA, 1.2MHz, Vin>1.8V, HSST, CL	USP-6C	49dc5	DC1	9a	Tor
DR1	XC9236G21C4	DC/DC-IC	PWM/PFM st-dwn, 1.2MHz, 2.1V±2%, 600mA, CL, Vin>1.8V, HSST	USP-6EL	56dc5	DC1	9a	Tor
DR1	XC9236G21CER	DC-DC-IC	PWM/PFM, st-dwn, 2.1V±2%, 600mA, 1.2MHz, Vin>1.8V, HSST, CL	USP-6C	49dc5	DC1	9a	Tor
DR2	XC9236G22C4	DC/DC-IC	PWM/PFM st-dwn, 1.2MHz, 2.2V±2%, 600mA, CL, Vin>1.8V, HSST	USP-6EL	56dc5	DC1	9a	Tor
DR2	XC9236G22CER	DC-DC-IC	PWM/PFM, st-dwn, 2.2V±2%, 600mA, 1.2MHz, Vin>1.8V, HSST, CL	USP-6C	49dc5	DC1	9a	Tor
DR3	XC9236G23C4	DC/DC-IC	PWM/PFM st-dwn, 1.2MHz, 2.3V±2%, 600mA, CL, Vin>1.8V, HSST	USP-6EL	56dc5	DC1	9a	Tor
DR3	XC9236G23CER	DC-DC-IC	PWM/PFM, st-dwn, 2.3V±2%, 600mA, 1.2MHz, Vin>1.8V, HSST, CL	USP-6C	49dc5	DC1	9a	Tor
DR4	XC9236G24C4	DC/DC-IC	PWM/PFM st-dwn, 1.2MHz, 2.4V±2%, 600mA, CL, Vin>1.8V, HSST	USP-6EL	56dc5	DC1	9a	Tor
DR4	XC9236G24CER	DC-DC-IC	PWM/PFM, st-dwn, 2.4V±2%, 600mA, 1.2MHz, Vin>1.8V, HSST, CL	USP-6C	49dc5	DC1	9a	Tor
DR5	XC9236G25C4	DC/DC-IC	PWM/PFM st-dwn, 1.2MHz, 2.5V±2%, 600mA, CL, Vin>1.8V, HSST	USP-6EL	56dc5	DC1	9a	Tor
DR5	XC9236G25CER	DC-DC-IC	PWM/PFM, st-dwn, 2.5V±2%, 600mA, 1.2MHz, Vin>1.8V, HSST, CL	USP-6C	49dc5	DC1	9a	Tor
DR6	XC9236G26C4	DC/DC-IC	PWM/PFM st-dwn, 1.2MHz, 2.6V±2%, 600mA, CL, Vin>1.8V, HSST	USP-6EL	56dc5	DC1	9a	Tor
DR6	XC9236G26CER	DC-DC-IC	PWM/PFM, st-dwn, 2.6V±2%, 600mA, 1.2MHz, Vin>1.8V, HSST, CL	USP-6C	49dc5	DC1	9a	Tor



SMD code	Type	Function	Short description	Case	Pinout	Sch.	St.Mnf.
DT	R3134K49EA	Vdet-IC	4.9V±1.8%, -Reset ODO, -MR	DFN1212-6	52z6	VD4	9a Ric
DT	XC9236G34B9R-G	LVR-IC	LDO, 3.45V±1%, 300mA, +CE, CL, ICP	USPQ-4B03	48vm	VR4	9a Tor
DT0	XC9236G40C4	DC/DC-IC	PWM/PFM st-dwn, 1.2MHz, 4.0V±2%, 600mA, CL, Vin>1.8V, HSST	USP-6EL	56dc5	DC1	9a Tor
DT0	XC9236G40CER	DC-DC-IC	PWM/PFM, st-dwn, 4.0V±2%, 600mA, 1.2MHz, Vin>1.8V, HSST, CL	USP-6C	49dc5	DC1	9a Tor
DU	R3114K251A	Vdet-IC	2.5V±0.8%, -Reset ODO	DFN1010-4	48vd9	VD9	9a Ric
DU	R3134K50EA	Vdet-IC	5.0V±1.8%, -Reset ODO, -MR	DFN1212-6	52z6	VD4	9a Ric
DU	XC6223F35B9R-G	LVR-IC	LDO, 3.55V±1%, 300mA, +CE, CL, ICP	USPQ-4B03	48vm	VR4	9a Tor
DU8	XC9236G08D4	DC/DC-IC	PWM/PFM st-dwn, 3MHz, 0.8V±2%, 600mA, CL, Vin>1.8V, HSST	USP-6EL	56dc5	DC1	9a Tor
DU8	XC9236G08DER	DC-DC-IC	PWM/PFM, st-dwn, 0.8V±2%, 600mA, 3MHz, Vin>1.8V, HSST, CL	USP-6C	49dc5	DC1	9a Tor
DU9	XC9236G09D4	DC/DC-IC	PWM/PFM st-dwn, 3MHz, 0.9V±2%, 600mA, CL, Vin>1.8V, HSST	USP-6EL	56dc5	DC1	9a Tor
DU9	XC9236G09DER	DC-DC-IC	PWM/PFM, st-dwn, 0.9V±2%, 600mA, 3MHz, Vin>1.8V, HSST, CL	USP-6C	49dc5	DC1	9a Tor
DUL	XC9236G0LD4	DC/DC-IC	PWM/PFM st-dwn, 3MHz, 0.85V±2%, 600mA, CL, Vin>1.8V, HSST	USP-6EL	56dc5	DC1	9a Tor
DUL	XC9236G0LDER	DC-DC-IC	PWM/PFM, st-dwn, 0.85V±2%, 600mA, 3MHz, Vin>1.8V, HSST, CL	USP-6C	49dc5	DC1	9a Tor
DUM	XC9236G0MD4	DC/DC-IC	PWM/PFM st-dwn, 3MHz, 0.95V±2%, 600mA, CL, Vin>1.8V, HSST	USP-6EL	56dc5	DC1	9a Tor
DUM	XC9236G0MDER	DC-DC-IC	PWM/PFM, st-dwn, 0.95V±2%, 600mA, 3MHz, Vin>1.8V, HSST, CL	USP-6C	49dc5	DC1	9a Tor
DV	R3114K261A	Vdet-IC	2.6V±0.8%, -Reset ODO	DFN1010-4	48vd9	VD9	9a Ric
DV	R3134K23EA2	Vdet-IC	2.32V±1.8%, -Reset ODO, -MR	DFN1212-6	52z6	VD4	9a Ric
DV	XC6223F36B9R-G	LVR-IC	LDO, 3.65V±1%, 300mA, +CE, CL, ICP	USPQ-4B03	48vm	VR4	9a Tor
DV0	XC9236G10D4	DC/DC-IC	PWM/PFM st-dwn, 3MHz, 1.0V±2%, 600mA, CL, Vin>1.8V, HSST	USP-6EL	56dc5	DC1	9a Tor
DV0	XC9236G10DER	DC-DC-IC	PWM/PFM, st-dwn, 1.0V±2%, 600mA, 3MHz, Vin>1.8V, HSST, CL	USP-6C	49dc5	DC1	9a Tor
DV1	XC9236G11D4	DC/DC-IC	PWM/PFM st-dwn, 3MHz, 1.1V±2%, 600mA, CL, Vin>1.8V, HSST	USP-6EL	56dc5	DC1	9a Tor
DV1	XC9236G11DER	DC-DC-IC	PWM/PFM, st-dwn, 1.1V±2%, 600mA, 3MHz, Vin>1.8V, HSST, CL	USP-6C	49dc5	DC1	9a Tor
DV2	XC9236G12D4	DC/DC-IC	PWM/PFM st-dwn, 3MHz, 1.2V±2%, 600mA, CL, Vin>1.8V, HSST	USP-6EL	56dc5	DC1	9a Tor
DV2	XC9236G12DER	DC-DC-IC	PWM/PFM, st-dwn, 1.2V±2%, 600mA, 3MHz, Vin>1.8V, HSST, CL	USP-6C	49dc5	DC1	9a Tor
DV3	XC9236G13D4	DC/DC-IC	PWM/PFM st-dwn, 3MHz, 1.3V±2%, 600mA, CL, Vin>1.8V, HSST	USP-6EL	56dc5	DC1	9a Tor
DV3	XC9236G13DER	DC-DC-IC	PWM/PFM, st-dwn, 1.3V±2%, 600mA, 3MHz, Vin>1.8V, HSST, CL	USP-6C	49dc5	DC1	9a Tor
DV4	XC9236G14D4	DC/DC-IC	PWM/PFM st-dwn, 3MHz, 1.4V±2%, 600mA, CL, Vin>1.8V, HSST	USP-6EL	56dc5	DC1	9a Tor
DV4	XC9236G14DER	DC-DC-IC	PWM/PFM, st-dwn, 1.4V±2%, 600mA, 3MHz, Vin>1.8V, HSST, CL	USP-6C	49dc5	DC1	9a Tor
DV5	XC9236G15D4	DC/DC-IC	PWM/PFM st-dwn, 3MHz, 1.5V±2%, 600mA, CL, Vin>1.8V, HSST	USP-6EL	56dc5	DC1	9a Tor
DV5	XC9236G15DER	DC-DC-IC	PWM/PFM, st-dwn, 1.5V±2%, 600mA, 3MHz, Vin>1.8V, HSST, CL	USP-6C	49dc5	DC1	9a Tor
DV6	XC9236G16D4	DC/DC-IC	PWM/PFM st-dwn, 3MHz, 1.6V±2%, 600mA, CL, Vin>1.8V, HSST	USP-6EL	56dc5	DC1	9a Tor
DV6	XC9236G16DER	DC-DC-IC	PWM/PFM, st-dwn, 1.6V±2%, 600mA, 3MHz, Vin>1.8V, HSST, CL	USP-6C	49dc5	DC1	9a Tor
DV7	XC9236G17D4	DC/DC-IC	PWM/PFM st-dwn, 3MHz, 1.7V±2%, 600mA, CL, Vin>1.8V, HSST	USP-6EL	56dc5	DC1	9a Tor
DV7	XC9236G17DER	DC-DC-IC	PWM/PFM, st-dwn, 1.7V±2%, 600mA, 3MHz, Vin>1.8V, HSST, CL	USP-6C	49dc5	DC1	9a Tor
DV8	XC9236G18D4	DC/DC-IC	PWM/PFM st-dwn, 3MHz, 1.8V±2%, 600mA, CL, Vin>1.8V, HSST	USP-6EL	56dc5	DC1	9a Tor
DV8	XC9236G18DER	DC-DC-IC	PWM/PFM, st-dwn, 1.8V±2%, 600mA, 3MHz, Vin>1.8V, HSST, CL	USP-6C	49dc5	DC1	9a Tor
DV9	XC9236G19D4	DC/DC-IC	PWM/PFM st-dwn, 3MHz, 1.9V±2%, 600mA, CL, Vin>1.8V, HSST	USP-6EL	56dc5	DC1	9a Tor
DV9	XC9236G19DER	DC-DC-IC	PWM/PFM, st-dwn, 1.9V±2%, 600mA, 3MHz, Vin>1.8V, HSST, CL	USP-6C	49dc5	DC1	9a Tor
DVA	XC9236G1AD4	DC/DC-IC	PWM/PFM st-dwn, 3MHz, 1.05V±2%, 600mA, CL, Vin>1.8V, HSST	USP-6EL	56dc5	DC1	9a Tor
DVA	XC9236G1ADER	DC-DC-IC	PWM/PFM, st-dwn, 1.05V±2%, 600mA, 3MHz, Vin>1.8V, HSST, CL	USP-6C	49dc5	DC1	9a Tor
DVB	XC9236G1BD4	DC/DC-IC	PWM/PFM st-dwn, 3MHz, 1.15V±2%, 600mA, CL, Vin>1.8V, HSST	USP-6EL	56dc5	DC1	9a Tor
DVB	XC9236G1BDER	DC-DC-IC	PWM/PFM, st-dwn, 1.15V±2%, 600mA, 3MHz, Vin>1.8V, HSST, CL	USP-6C	49dc5	DC1	9a Tor
DVC	XC9236G1CD4	DC/DC-IC	PWM/PFM st-dwn, 3MHz, 1.25V±2%, 600mA, CL, Vin>1.8V, HSST	USP-6EL	56dc5	DC1	9a Tor
DVC	XC9236G1CDER	DC-DC-IC	PWM/PFM, st-dwn, 1.25V±2%, 600mA, 3MHz, Vin>1.8V, HSST, CL	USP-6C	49dc5	DC1	9a Tor
DVD	XC9236G1DD4	DC/DC-IC	PWM/PFM st-dwn, 3MHz, 1.35V±2%, 600mA, CL, Vin>1.8V, HSST	USP-6EL	56dc5	DC1	9a Tor
DVD	XC9236G1DDER	DC-DC-IC	PWM/PFM, st-dwn, 1.35V±2%, 600mA, 3MHz, Vin>1.8V, HSST, CL	USP-6C	49dc5	DC1	9a Tor
DVE	XC9236G1ED4	DC/DC-IC	PWM/PFM st-dwn, 3MHz, 1.45V±2%, 600mA, CL, Vin>1.8V, HSST	USP-6EL	56dc5	DC1	9a Tor
DVE	XC9236G1EDER	DC-DC-IC	PWM/PFM, st-dwn, 1.45V±2%, 600mA, 3MHz, Vin>1.8V, HSST, CL	USP-6C	49dc5	DC1	9a Tor
DVF	XC9236G1FD4	DC/DC-IC	PWM/PFM st-dwn, 3MHz, 1.55V±2%, 600mA, CL, Vin>1.8V, HSST	USP-6EL	56dc5	DC1	9a Tor
DVF	XC9236G1FDER	DC-DC-IC	PWM/PFM, st-dwn, 1.55V±2%, 600mA, 3MHz, Vin>1.8V, HSST, CL	USP-6C	49dc5	DC1	9a Tor
DVH	XC9236G1HD4	DC/DC-IC	PWM/PFM st-dwn, 3MHz, 1.65V±2%, 600mA, CL, Vin>1.8V, HSST	USP-6EL	56dc5	DC1	9a Tor
DVH	XC9236G1HDER	DC-DC-IC	PWM/PFM, st-dwn, 1.65V±2%, 600mA, 3MHz, Vin>1.8V, HSST, CL	USP-6C	49dc5	DC1	9a Tor
DVK	XC9236G1KD4	DC/DC-IC	PWM/PFM st-dwn, 3MHz, 1.75V±2%, 600mA, CL, Vin>1.8V, HSST	USP-6EL	56dc5	DC1	9a Tor
DVK	XC9236G1KDER	DC-DC-IC	PWM/PFM, st-dwn, 1.75V±2%, 600mA, 3MHz, Vin>1.8V, HSST, CL	USP-6C	49dc5	DC1	9a Tor
DVL	XC9236G1LD4	DC/DC-IC	PWM/PFM st-dwn, 3MHz, 1.85V±2%, 600mA, CL, Vin>1.8V, HSST	USP-6EL	56dc5	DC1	9a Tor
DVL	XC9236G1LDER	DC-DC-IC	PWM/PFM, st-dwn, 1.85V±2%, 600mA, 3MHz, Vin>1.8V, HSST, CL	USP-6C	49dc5	DC1	9a Tor
DVM	XC9236G1MD4	DC/DC-IC	PWM/PFM st-dwn, 3MHz, 1.95V±2%, 600mA, CL, Vin>1.8V, HSST	USP-6EL	56dc5	DC1	9a Tor
DVM	XC9236G1MDER	DC-DC-IC	PWM/PFM, st-dwn, 1.95V±2%, 600mA, 3MHz, Vin>1.8V, HSST, CL	USP-6C	49dc5	DC1	9a Tor
DW	R3114K271A	Vdet-IC	2.7V±0.8%, -Reset ODO	DFN1010-4	48vd9	VD9	9a Ric
DW	R3134K26EA3	Vdet-IC	2.63V±1.8%, -Reset ODO, -MR	DFN1212-6	52z6	VD4	9a Ric
DX	R3114K281A	Vdet-IC	2.8V±0.8%, -Reset ODO	DFN1010-4	48vd9	VD9	9a Ric
DX	R3134K29EA3	Vdet-IC	2.93V±1.8%, -Reset ODO, -MR	DFN1212-6	52z6	VD4	9a Ric
DX	XC6223F37B9R-G	LVR-IC	LDO, 3.75V±1%, 300mA, +CE, CL, ICP	USPQ-4B03	48vm	VR4	9a Tor
DX0	XC9236G20D4	DC/DC-IC	PWM/PFM st-dwn, 3MHz, 2.0V±2%, 600mA, CL, Vin>1.8V, HSST	USP-6EL	56dc5	DC1	9a Tor
DX0	XC9236G20DER	DC-DC-IC	PWM/PFM, st-dwn, 2.0V±2%, 600mA, 3MHz, Vin>1.8V, HSST, CL	USP-6C	49dc5	DC1	9a Tor
DX1	XC9236G21D4	DC/DC-IC	PWM/PFM st-dwn, 3MHz, 2.1V±2%, 600mA, CL, Vin>1.8V, HSST	USP-6EL	56dc5	DC1	9a Tor
DX1	XC9236G21DER	DC-DC-IC	PWM/PFM, st-dwn, 2.1V±2%, 600mA, 3MHz, Vin>1.8V, HSST, CL	USP-6C	49dc5	DC1	9a Tor
DX2	XC9236G22D4	DC/DC-IC	PWM/PFM st-dwn, 3MHz, 2.2V±2%, 600mA, CL, Vin>1.8V, HSST	USP-6EL	56dc5	DC1	9a Tor
DX2	XC9236G22DER	DC-DC-IC	PWM/PFM, st-dwn, 2.2V±2%, 600mA, 3MHz, Vin>1.8V, HSST, CL	USP-6C	49dc5	DC1	9a Tor
DX3	XC9236G23D4	DC/DC-IC	PWM/PFM st-dwn, 3MHz, 2.3V±2%, 600mA, CL, Vin>1.8V, HSST	USP-6EL	56dc5	DC1	9a Tor



SMD code	Type	Function	Short description	Case	Pinout	Sch.	St.	Mnf.
DYK	XC9236G3KD4	DC/DC-IC	PWM/PFM st-dwn, 3MHz, 3.75V±2%, 600mA, CL, Vin>1.8V, HSST	USP-6EL	56dc5	DC1	9a	Tor
DYK	XC9236G3KDER	DC-DC-IC	PWM/PFM, st-dwn, 3.75V±2%, 600mA, 3MHz, Vin-1.8V, HSST, CL	USP-6C	49dc5	DC1	9a	Tor
DYL	XC9236G3LD4	DC/DC-IC	PWM/PFM st-dwn, 3MHz, 3.85V±2%, 600mA, CL, Vin>1.8V, HSST	USP-6EL	56dc5	DC1	9a	Tor
DYL	XC9236G3LDER	DC-DC-IC	PWM/PFM, st-dwn, 3.85V±2%, 600mA, 3MHz, Vin-1.8V, HSST, CL	USP-6C	49dc5	DC1	9a	Tor
DYM	XC9236G3MD4	DC/DC-IC	PWM/PFM st-dwn, 3MHz, 3.95V±2%, 600mA, CL, Vin>1.8V, HSST	USP-6EL	56dc5	DC1	9a	Tor
DYM	XC9236G3MDER	DC-DC-IC	PWM/PFM, st-dwn, 3.95V±2%, 600mA, 3MHz, Vin-1.8V, HSST, CL	USP-6C	49dc5	DC1	9a	Tor
DZ	R3114K301A	Vdet-IC	3.0V±0.8%, -Reset ODO	DFN1010-4	48vd9	VD9	9a	Ric
DZ	R3134K43EA8	Vdet-IC	4.38V±1.8%, -Reset ODO, -MR	DFN1212-6	52z6	VD4	9a	Ric
DZ	XC6223F39B9R-G	LVR-IC	LDO, 3.95V±1%, 300mA, +CE, CL, ICP	USPQ-4B03	48vm	VR4	9a	Tor
DZ0	XC9236G40D4	DC/DC-IC	PWM/PFM st-dwn, 3MHz, 4.0V±2%, 600mA, CL, Vin>1.8V, HSST	USP-6EL	56dc5	DC1	9a	Tor
DZ0	XC9236G40DER	DC-DC-IC	PWM/PFM, st-dwn, 4.0V±2%, 600mA, 3MHz, Vin-1.8V, HSST, CL	USP-6C	49dc5	DC1	9a	Tor
E*	SH4890BP	LIN-IC	AF PA, BTL, 2.2.5.5V, 1W(5V/8C), shutdown	BGA-8	39	AFP44	-	Sit
E0	R3118K461A	Vdet-IC	4.6V±1.5%, -Reset ODO, Sense	DFN1212-6	52z3	VD14	9a	Ric
E0	RP109L281B	LVR-IC	LDO, 2.8V±1%, 150mA, +CE	DFN1010-4	48vm	VR4	9a	Tor
E0	XC6221A31B7R	LVR-IC	LDO, 3.15V±1%, 200mA, +CE	USPN-4	58vm	VR4	9a	Tor
E00	HD74LVC2G00CLE	CMOS-Logic	Dual 2-input NAND gates	WCSP-8	50Log50	-	9d	Ren
E02	RD74LVC2G02WPE	CMOS-Logic	Dual 2-input NOR gates	WCSP-8	50Log53	-	9d	Ren
E04	HD74LVC3G04CLE	CMOS-Logic	Triple inverters	WCSP-8	50Log56	-	9d	Ren
E08	RD74LVC2G08WPE	CMOS-Logic	Dual 2-input AND gates	WCSP-8	50Log51	-	9d	Ren
E0A	XC6108C40AGR	Vdet-IC	4.0V±2%, Hysteresis, -Reset PPO	USP-4	45ro	VD15	9b	Tor
E0B	XC6108C40BGR	Vdet-IC	4.0V±2%, -Reset PPO	USP-4	45ro	VD15	9b	Tor
E0C	XC6108C40CGR	Vdet-IC	4.0V±2%, Hysteresis, -Reset PPO	USP-4	45ro	VD15	9b	Tor
E0D	XC6108C40DGR	Vdet-IC	4.0V±2%, -Reset PPO	USP-4	45rm	VD15	9b	Tor
E1	R3118K471A	Vdet-IC	4.7V±1.5%, -Reset ODO, Sense	DFN1212-6	52z3	VD14	9a	Ric
E1	RD74LVC1G00WPE	CMOS-Logic	2-input NAND gate	WCSP-5	46Log1	-	9d	Ren
E1	RP109L291B	LVR-IC	LDO, 2.9V±1%, 150mA, +CE	DFN1010-4	48vm	VR4	9a	Ric
E1	XC6221A32B7R	LVR-IC	LDO, 3.25V±1%, 200mA, +CE	USPN-4	58vm	VR4	9a	Tor
E125	R1182K121B5	LVR-IC	LDO, 1.25V±2%, 150mA, +CE	PLP1616-6	66ys	VR4	9b	Ric
E12B	R1182K121B	LVR-IC	LDO, 1.2V±2%, 150mA, +CE	PLP1616-6	66ys	VR4	9b	Ric
E13B	R1182K131B	LVR-IC	LDO, 1.3V±2%, 150mA, +CE	PLP1616-6	66ys	VR4	9b	Ric
E14B	R1182K141B	LVR-IC	LDO, 1.4V±2%, 150mA, +CE	PLP1616-6	66ys	VR4	9b	Ric
E15B	R1182K151B	LVR-IC	LDO, 1.5V±2%, 150mA, +CE	PLP1616-6	66ys	VR4	9b	Ric
E16B	R1182K161B	LVR-IC	LDO, 1.6V±2%, 150mA, +CE	PLP1616-6	66ys	VR4	9b	Ric
E17B	R1182K171B	LVR-IC	LDO, 1.7V±2%, 150mA, +CE	PLP1616-6	66ys	VR4	9b	Ric
E185	R1182K181B5	LVR-IC	LDO, 1.85V±2%, 150mA, +CE	PLP1616-6	66ys	VR4	9b	Ric
E18B	R1182K181B	LVR-IC	LDO, 1.8V±2%, 150mA, +CE	PLP1616-6	66ys	VR4	9b	Ric
E19B	R1182K191B	LVR-IC	LDO, 1.9V±2%, 150mA, +CE	PLP1616-6	66ys	VR4	9b	Ric
E1A	XC6108C41AGR	Vdet-IC	4.1V±2%, Hysteresis, -Reset PPO	USP-4	45ro	VD15	9b	Tor
E1B	XC6108C41BGR	Vdet-IC	4.1V±2%, -Reset PPO	USP-4	45ro	VD15	9b	Tor
E1C	XC6108C41CGR	Vdet-IC	4.1V±2%, Hysteresis, -Reset PPO	USP-4	45rm	VD15	9b	Tor
E1D	XC6108C41DGR	Vdet-IC	4.1V±2%, -Reset PPO	USP-4	45rm	VD15	9b	Tor
E2	HD74LVC1G08CLE	CMOS-Logic	2-input AND gate	WCSP-5	46Log3	-	9d	Ren
E2	HD74LVC1G08CPE	CMOS-Logic	2-input AND gate	WCSP-5	46Log3	-	9d	Ren
E2	R3118K481A	Vdet-IC	4.8V±1.5%, -Reset ODO, Sense	DFN1212-6	52z3	VD14	9a	Ric
E2	RD74LVC1G08WPE	CMOS-Logic	2-input AND gate	WCSP-5	46Log3	-	9d	Ren
E2	RP109L301B	LVR-IC	LDO, 3.0V±1%, 150mA, +CE	DFN1010-4	48vm	VR4	9a	Ric
E2	XC6221A33B7R	LVR-IC	LDO, 3.35V±1%, 200mA, +CE	USPN-4	58vm	VR4	9a	Tor
E2	XC6223G12B9R-G	LVR-IC	LDO, 1.25V±20mV, 300mA, +CE, PDR, ICP	USPQ-4B03	48vm	VR4	9a	Tor
E20B	R1182K201B	LVR-IC	LDO, 2V±2%, 150mA, +CE	PLP1616-6	66ys	VR4	9b	Ric
E21B	R1182K211B	LVR-IC	LDO, 2.1V±2%, 150mA, +CE	PLP1616-6	66ys	VR4	9b	Ric
E22B	R1182K221B	LVR-IC	LDO, 2.2V±2%, 150mA, +CE	PLP1616-6	66ys	VR4	9b	Ric
E23B	R1182K231B	LVR-IC	LDO, 2.3V±2%, 150mA, +CE	PLP1616-6	66ys	VR4	9b	Ric
E24B	R1182K241B	LVR-IC	LDO, 2.4V±2%, 150mA, +CE	PLP1616-6	66ys	VR4	9b	Ric
E25	RD74LVC2G125WPE	CMOS-Logic	Dual bus buffer with 3-state output	WCSP-8	50Log54	-	9d	Ren
E25B	R1182K251B	LVR-IC	LDO, 2.5V±2%, 150mA, +CE	PLP1616-6	66ys	VR4	9b	Ric
E26	HD74LVC2G126CLE	CMOS-Logic	Dual bus buffer with 3-state output	WCSP-8	50Log55	-	9d	Ren
E26B	R1182K261B	LVR-IC	LDO, 2.6V±2%, 150mA, +CE	PLP1616-6	66ys	VR4	9b	Ric
E27B	R1182K271B	LVR-IC	LDO, 2.7V±2%, 150mA, +CE	PLP1616-6	66ys	VR4	9b	Ric
E285	R1182K281B5	LVR-IC	LDO, 2.85V±2%, 150mA, +CE	PLP1616-6	66ys	VR4	9b	Ric
E28B	R1182K281B	LVR-IC	LDO, 2.8V±2%, 150mA, +CE	PLP1616-6	66ys	VR4	9b	Ric
E29B	R1182K291B	LVR-IC	LDO, 2.9V±2%, 150mA, +CE	PLP1616-6	66ys	VR4	9b	Ric
E2A	XC6108C42AGR	Vdet-IC	4.2V±2%, Hysteresis, -Reset PPO	USP-4	45ro	VD15	9b	Tor
E2B	XC6108C42BGR	Vdet-IC	4.2V±2%, -Reset PPO	USP-4	45ro	VD15	9b	Tor
E2C	XC6108C42CGR	Vdet-IC	4.2V±2%, Hysteresis, -Reset PPO	USP-4	45rm	VD15	9b	Tor
E2D	XC6108C42DGR	Vdet-IC	4.2V±2%, -Reset PPO	USP-4	45rm	VD15	9b	Tor
e3	NX3V1T384GM	CMOS-Logic	Single-pole single-throw analog switch	SOT-886	57Log86	-	9c	Phi
E3	HD74LVC1G02CLE	CMOS-Logic	2-input NOR gate	WCSP-5	46Log2	-	9d	Ren
E3	HD74LVC1G02CPE	CMOS-Logic	2-input NOR gate	WCSP-5	46Log2	-	9d	Ren
E3	R3118K491A	Vdet-IC	4.9V±1.5%, -Reset ODO, Sense	DFN1212-6	52z3	VD14	9a	Ric
E3	RD74LVC1G02WPE	CMOS-Logic	2-input NOR gate	WCSP-5	46Log2	-	9d	Ren



SMD code	Type	Function	Short description	Case	Pinout	Sch.	St.	Mnf.
E3	RP109L311B	LVR-IC	LDO, 3.1V±1%, 150mA, +CE	DFN1010-4	48vm	VR4	9a	Ric
E3	XC6221A34B7R	LVR-IC	LDO, 3.45V±1%, 200mA, +CE	USPN-4	58vm	VR4	9a	Tor
E3	XC6223G13B9R-G	LVR-IC	LDO, 1.35V±20mV, 300mA, +CE, PDR, ICP	USPQ-4B03	48vm	VR4	9a	Tor
E30B	R1182K301B	LVR-IC	LDO, 3V±2%, 150mA, +CE	PLP1616-6	66ys	VR4	9b	Ric
E31B	R1182K311B	LVR-IC	LDO, 3.1V±2%, 150mA, +CE	PLP1616-6	66ys	VR4	9b	Ric
E32	RD74LVC2G32WPE	CMOS-Logic	Dual 2-input OR gates	WCSP-8	50/Log52	-	9d	Ren
E32B	R1182K321B	LVR-IC	LDO, 3.2V±2%, 150mA, +CE	PLP1616-6	66ys	VR4	9b	Ric
E33B	R1182K331B	LVR-IC	LDO, 3.3V±2%, 150mA, +CE	PLP1616-6	66ys	VR4	9b	Ric
E34B	R1182K341B	LVR-IC	LDO, 3.4V±2%, 150mA, +CE	PLP1616-6	66ys	VR4	9b	Ric
E35B	R1182K351B	LVR-IC	LDO, 3.5V±2%, 150mA, +CE	PLP1616-6	66ys	VR4	9b	Ric
E36B	R1182K361B	LVR-IC	LDO, 3.6V±2%, 150mA, +CE	PLP1616-6	66ys	VR4	9b	Ric
E37B	R1182K371B	LVR-IC	LDO, 3.7V±2%, 150mA, +CE	PLP1616-6	66ys	VR4	9b	Ric
E38B	R1182K381B	LVR-IC	LDO, 3.8V±2%, 150mA, +CE	PLP1616-6	66ys	VR4	9b	Ric
E39B	R1182K391B	LVR-IC	LDO, 3.9V±2%, 150mA, +CE	PLP1616-6	66ys	VR4	9b	Ric
E3A	XC6108C43AGR	Vdet-IC	4.3V±2%, Hysteresis, -Reset PPO	USP-4	45ro	VD15	9b	Tor
E3B	XC6108C43BGR	Vdet-IC	4.3V±2%, -Reset PPO	USP-4	45ro	VD15	9b	Tor
E3C	XC6108C43CGR	Vdet-IC	4.3V±2%, Hysteresis, -Reset PPO	USP-4	45m	VD15	9b	Tor
E3D	XC6108C43DGR	Vdet-IC	4.3V±2%, -Reset PPO	USP-4	45m	VD15	9b	Tor
E4	HD74LVC1G32CLE	CMOS-Logic	2-input OR gate	WCSP-5	46/Log4	-	9d	Ren
E4	HD74LVC1G32CPE	CMOS-Logic	2-input OR gate	WCSP-5	46/Log4	-	9d	Ren
E4	LM4664TL	LIN-IC	AF PA, BTL, class-D, 2.7..5.5V, 1.1W(5V/8Ω), shutdown	BGA-9	39	AFP52	-	Nsc
E4	R3118K501A	Vdet-IC	5.0V±1.5%, -Reset ODO, Sense	DFN1212-6	52z3	VD14	9a	Ric
E4	RD74LVC1G32WPE	CMOS-Logic	2-input OR gate	WCSP-5	46/Log4	-	9d	Ren
E4	RP109L321B	LVR-IC	LDO, 3.2V±1%, 150mA, +CE	DFN1010-4	48vm	VR4	9a	Ric
E4	XC6221A35B7R	LVR-IC	LDO, 3.55V±1%, 200mA, +CE	USPN-4	58vm	VR4	9a	Tor
E4	XC6223G14B9R-G	LVR-IC	LDO, 1.45V±20mV, 300mA, +CE, PDR, ICP	USPQ-4B03	48vm	VR4	9a	Tor
E40B	R1182K401B	LVR-IC	LDO, 4V±2%, 150mA, +CE	PLP1616-6	66ys	VR4	9b	Ric
E4A	XC6108C44AGR	Vdet-IC	4.4V±2%, Hysteresis, -Reset PPO	USP-4	45ro	VD15	9b	Tor
E4B	XC6108C44BGR	Vdet-IC	4.4V±2%, -Reset PPO	USP-4	45ro	VD15	9b	Tor
E4C	XC6108C44CGR	Vdet-IC	4.4V±2%, Hysteresis, -Reset PPO	USP-4	45m	VD15	9b	Tor
E4D	XC6108C44DGR	Vdet-IC	4.4V±2%, -Reset PPO	USP-4	45m	VD15	9b	Tor
E5	HD74LVC1G04CLE	CMOS-Logic	Inverter	WCSP-5	46/Log6	-	9d	Ren
E5	HD74LVC1G04CPE	CMOS-Logic	Inverter	WCSP-5	46/Log6	-	9d	Ren
E5	RD74LVC1G04WPE	CMOS-Logic	Inverter	WCSP-5	46/Log6	-	9d	Ren
E5	RP109L331B	LVR-IC	LDO, 3.3V±1%, 150mA, +CE	DFN1010-4	48vm	VR4	9a	Ric
E5	RT9013-1BPQW	LVR-IC	LDO, 1.25V±2%, 500mA, +CE	WDFN-6	49xu	VR4	9a	Rct
E5	XC6221A36B7R	LVR-IC	LDO, 3.65V±1%, 200mA, +CE	USPN-4	58vm	VR4	9a	Tor
E5	XC6223G15B9R-G	LVR-IC	LDO, 1.55V±20mV, 300mA, +CE, PDR, ICP	USPQ-4B03	48vm	VR4	9a	Tor
E53	HD74LVC2G53CLE	CMOS-Logic	2-channel analog multiplexer/demultiplexer	WCSP-8	50/Log58	-	9d	Ren
E5A	XC6108C45AGR	Vdet-IC	4.5V±2%, Hysteresis, -Reset PPO	USP-4	45ro	VD15	9b	Tor
E5B	XC6108C45BGR	Vdet-IC	4.5V±2%, -Reset PPO	USP-4	45ro	VD15	9b	Tor
E5C	XC6108C45CGR	Vdet-IC	4.5V±2%, Hysteresis, -Reset PPO	USP-4	45m	VD15	9b	Tor
E5D	XC6108C45DGR	Vdet-IC	4.5V±2%, -Reset PPO	USP-4	45m	VD15	9b	Tor
E6	LM4670TL	LIN-IC	AF PA, BTL, class-D, 2.4..5.5V, 3W(5V/3Ω), shutdown	BGA-9	39	AFP45	-	Nsc
E6	RP109L341B	LVR-IC	LDO, 3.4V±1%, 150mA, +CE	DFN1010-4	48vm	VR4	9a	Ric
E6	XC6221A37B7R	LVR-IC	LDO, 3.75V±1%, 200mA, +CE	USPN-4	58vm	VR4	9a	Tor
E6	XC6223G16B9R-G	LVR-IC	LDO, 1.65V±20mV, 300mA, +CE, PDR, ICP	USPQ-4B03	48vm	VR4	9a	Tor
E66	HD74LVC2G66CLE	CMOS-Logic	2-channel analog switch	WCSP-8	50/Log68	-	9d	Ren
E6A	XC6108C46AGR	Vdet-IC	4.6V±2%, Hysteresis, -Reset PPO	USP-4	45ro	VD15	9b	Tor
E6B	XC6108C46BGR	Vdet-IC	4.6V±2%, -Reset PPO	USP-4	45ro	VD15	9b	Tor
E6C	XC6108C46CGR	Vdet-IC	4.6V±2%, Hysteresis, -Reset PPO	USP-4	45m	VD15	9b	Tor
E6D	XC6108C46DGR	Vdet-IC	4.6V±2%, -Reset PPO	USP-4	45m	VD15	9b	Tor
E7	LM4671TL	LIN-IC	AF PA, BTL, class-D, 2.5..5.5V, 2.5W(5V/4Ω), shutdown	BGA-9	39	AFP45	-	Nsc
E7	RP109L351B	LVR-IC	LDO, 3.5V±1%, 150mA, +CE	DFN1010-4	48vm	VR4	9a	Ric
E7	XC6221A38B7R	LVR-IC	LDO, 3.85V±1%, 200mA, +CE	USPN-4	58vm	VR4	9a	Tor
E7	XC6223G17B9R-G	LVR-IC	LDO, 1.75V±20mV, 300mA, +CE, PDR, ICP	USPQ-4B03	48vm	VR4	9a	Tor
E7A	XC6108C47AGR	Vdet-IC	4.7V±2%, Hysteresis, -Reset PPO	USP-4	45ro	VD15	9b	Tor
E7B	XC6108C47BGR	Vdet-IC	4.7V±2%, -Reset PPO	USP-4	45ro	VD15	9b	Tor
E7C	XC6108C47CGR	Vdet-IC	4.7V±2%, Hysteresis, -Reset PPO	USP-4	45m	VD15	9b	Tor
E7D	XC6108C47DGR	Vdet-IC	4.7V±2%, -Reset PPO	USP-4	45m	VD15	9b	Tor
E8	RD74LVC1G86WPE	CMOS-Logic	2-input EXCLUSIVE-OR gate	WCSP-5	46/Log5	-	9d	Ren
E8	RP109L361B	LVR-IC	LDO, 3.6V±1%, 150mA, +CE	DFN1010-4	48vm	VR4	9a	Ric
E8	XC6221A39B7R	LVR-IC	LDO, 3.95V±1%, 200mA, +CE	USPN-4	58vm	VR4	9a	Tor
E8	XC6223G18B9R-G	LVR-IC	LDO, 1.85V±20mV, 300mA, +CE, PDR, ICP	USPQ-4B03	48vm	VR4	9a	Tor
E8A	XC6108C48AGR	Vdet-IC	4.8V±2%, Hysteresis, -Reset PPO	USP-4	45ro	VD15	9b	Tor
E8B	XC6108C48BGR	Vdet-IC	4.8V±2%, -Reset PPO	USP-4	45ro	VD15	9b	Tor
E8C	XC6108C48CGR	Vdet-IC	4.8V±2%, Hysteresis, -Reset PPO	USP-4	45m	VD15	9b	Tor
E8D	XC6108C48DGR	Vdet-IC	4.8V±2%, -Reset PPO	USP-4	45m	VD15	9b	Tor
E9	HD74LVC1G66CLE	CMOS-Logic	Bilateral analogic switch	WCSP-5	46/Log16	-	9d	Ren
E9	HD74LVC1G66CPE	CMOS-Logic	Bilateral analogic switch	WCSP-5	46/Log16	-	9d	Ren



SMD code	Type	Function	Short description	Case	Pinout	Sch.	St.	Mnf.
E9	RP109L121B5	LVR-IC	LDO, 1.25V±1%, 150mA, +CE	DFN1010-4	48vm	VR4	9a	Ric
E9	XC6223G19B9R-G	LVR-IC	LDO, 1.95V±20mV, 300mA, +CE, PDR, ICP	USPQ-4B03	48vm	VR4	9a	Tor
E9A	XC6108C49AGR	Vdet-IC	4.9V±2%, Hysteresis, -Reset PPO	USP-4	45ro	VD15	9b	Tor
E9B	XC6108C49BGR	Vdet-IC	4.9V±2%, -Reset PPO	USP-4	45ro	VD15	9b	Tor
E9C	XC6108C49CGR	Vdet-IC	4.9V±2%, Hysteresis, -Reset PPO	USP-4	45rn	VD15	9b	Tor
E9D	XC6108C49DGR	Vdet-IC	4.9V±2%, -Reset PPO	USP-4	45rn	VD15	9b	Tor
EA	R3114K311A	Vdet-IC	3.1V±0.8%, -Reset ODO	DFN1010-4	48vd9	VD9	9a	Ric
EA	R3134K46EA3	Vdet-IC	4.63V±1.8%, -Reset ODO, -MR	DFN1212-6	52z6	VD4	9a	Ric
EA	RD74LVC1G14WPE	CMOS-Logic	Inverting Schmitt-trigger	WCSP-5	46LLog7	-	9d	Ren
EA	XC6223G20B9R-G	LVR-IC	LDO, 2.05V±1%, 300mA, +CE, PDR, ICP	USPQ-4B03	48vm	VR4	9a	Tor
EA8	XC9237B08C4R-G	DC-DC-IC	PWM-PWM/PPM, st-dwn, 0.8V±2%, 600mA, 1.2MHz, Vin>2V, HSST, CL	USP-6EL	56dc5	DC1	9a	Tor
EA8	XC9237B08CER	DC-DC-IC	PWM-PWM/PPM, st-dwn, 0.8V±2%, 600mA, 1.2MHz, Vin>2V, HSST, CL	USP-6C	49dc5	DC1	9a	Tor
EA9	XC9237B09C4R-G	DC-DC-IC	PWM-PWM/PPM, st-dwn, 0.9V±2%, 600mA, 1.2MHz, Vin>2V, HSST, CL	USP-6EL	56dc5	DC1	9a	Tor
EA9	XC9237B09CER	DC-DC-IC	PWM-PWM/PPM, st-dwn, 0.9V±2%, 600mA, 1.2MHz, Vin>2V, HSST, CL	USP-6C	49dc5	DC1	9a	Tor
EAL	XC9237B0LC4R-G	DC-DC-IC	PWM-PWM/PPM, st-dwn, 0.85V±2%, 600mA, 1.2MHz, Vin>2V, HSST, CL	USP-6EL	56dc5	DC1	9a	Tor
EAL	XC9237B0LCER	DC-DC-IC	PWM-PWM/PPM, st-dwn, 0.85V±2%, 600mA, 1.2MHz, Vin>2V, HSST, CL	USP-6C	49dc5	DC1	9a	Tor
EAM	XC9237B0MC4R-G	DC-DC-IC	PWM-PWM/PPM, st-dwn, 0.95V±2%, 600mA, 1.2MHz, Vin>2V, HSST, CL	USP-6EL	56dc5	DC1	9a	Tor
EAM	XC9237B0MCER	DC-DC-IC	PWM-PWM/PPM, st-dwn, 0.95V±2%, 600mA, 1.2MHz, Vin>2V, HSST, CL	USP-6C	49dc5	DC1	9a	Tor
EB	R3114K321A	Vdet-IC	3.2V±0.8%, -Reset ODO	DFN1010-4	48vd9	VD9	9a	Ric
EB	RD74LVC1G125WPE	CMOS-Logic	Bus buffer gate with 3-state output	WCSP-5	46LLog14	-	9d	Ren
EB	XC6223G21B9R-G	LVR-IC	LDO, 2.15V±1%, 300mA, +CE, PDR, ICP	USPQ-4B03	48vm	VR4	9a	Tor
EB0	XC9237B10C4R-G	DC-DC-IC	PWM-PWM/PPM, st-dwn, 1.0V±2%, 600mA, 1.2MHz, Vin>2V, HSST, CL	USP-6EL	56dc5	DC1	9a	Tor
EB0	XC9237B10CER	DC-DC-IC	PWM-PWM/PPM, st-dwn, 1.0V±2%, 600mA, 1.2MHz, Vin>2V, HSST, CL	USP-6C	49dc5	DC1	9a	Tor
EB1	XC9237B11C4R-G	DC-DC-IC	PWM-PWM/PPM, st-dwn, 1.1V±2%, 600mA, 1.2MHz, Vin>2V, HSST, CL	USP-6EL	56dc5	DC1	9a	Tor
EB1	XC9237B11CER	DC-DC-IC	PWM-PWM/PPM, st-dwn, 1.1V±2%, 600mA, 1.2MHz, Vin>2V, HSST, CL	USP-6C	49dc5	DC1	9a	Tor
EB2	XC9237B12C4R-G	DC-DC-IC	PWM-PWM/PPM, st-dwn, 1.2V±2%, 600mA, 1.2MHz, Vin>2V, HSST, CL	USP-6EL	56dc5	DC1	9a	Tor
EB2	XC9237B12CER	DC-DC-IC	PWM-PWM/PPM, st-dwn, 1.2V±2%, 600mA, 1.2MHz, Vin>2V, HSST, CL	USP-6C	49dc5	DC1	9a	Tor
EB3	XC9237B13C4R-G	DC-DC-IC	PWM-PWM/PPM, st-dwn, 1.3V±2%, 600mA, 1.2MHz, Vin>2V, HSST, CL	USP-6EL	56dc5	DC1	9a	Tor
EB3	XC9237B13CER	DC-DC-IC	PWM-PWM/PPM, st-dwn, 1.3V±2%, 600mA, 1.2MHz, Vin>2V, HSST, CL	USP-6C	49dc5	DC1	9a	Tor
EB4	XC9237B14C4R-G	DC-DC-IC	PWM-PWM/PPM, st-dwn, 1.4V±2%, 600mA, 1.2MHz, Vin>2V, HSST, CL	USP-6EL	56dc5	DC1	9a	Tor
EB4	XC9237B14CER	DC-DC-IC	PWM-PWM/PPM, st-dwn, 1.4V±2%, 600mA, 1.2MHz, Vin>2V, HSST, CL	USP-6C	49dc5	DC1	9a	Tor
EB5	XC9237B15C4R-G	DC-DC-IC	PWM-PWM/PPM, st-dwn, 1.5V±2%, 600mA, 1.2MHz, Vin>2V, HSST, CL	USP-6EL	56dc5	DC1	9a	Tor
EB5	XC9237B15CER	DC-DC-IC	PWM-PWM/PPM, st-dwn, 1.5V±2%, 600mA, 1.2MHz, Vin>2V, HSST, CL	USP-6C	49dc5	DC1	9a	Tor
EB6	XC9237B16C4R-G	DC-DC-IC	PWM-PWM/PPM, st-dwn, 1.6V±2%, 600mA, 1.2MHz, Vin>2V, HSST, CL	USP-6EL	56dc5	DC1	9a	Tor
EB6	XC9237B16CER	DC-DC-IC	PWM-PWM/PPM, st-dwn, 1.6V±2%, 600mA, 1.2MHz, Vin>2V, HSST, CL	USP-6C	49dc5	DC1	9a	Tor
EB7	XC9237B17C4R-G	DC-DC-IC	PWM-PWM/PPM, st-dwn, 1.7V±2%, 600mA, 1.2MHz, Vin>2V, HSST, CL	USP-6EL	56dc5	DC1	9a	Tor
EB7	XC9237B17CER	DC-DC-IC	PWM-PWM/PPM, st-dwn, 1.7V±2%, 600mA, 1.2MHz, Vin>2V, HSST, CL	USP-6C	49dc5	DC1	9a	Tor
EB8	XC9237B18C4R-G	DC-DC-IC	PWM-PWM/PPM, st-dwn, 1.8V±2%, 600mA, 1.2MHz, Vin>2V, HSST, CL	USP-6EL	56dc5	DC1	9a	Tor
EB8	XC9237B18CER	DC-DC-IC	PWM-PWM/PPM, st-dwn, 1.8V±2%, 600mA, 1.2MHz, Vin>2V, HSST, CL	USP-6C	49dc5	DC1	9a	Tor
EB9	XC9237B19C4R-G	DC-DC-IC	PWM-PWM/PPM, st-dwn, 1.9V±2%, 600mA, 1.2MHz, Vin>2V, HSST, CL	USP-6EL	56dc5	DC1	9a	Tor
EB9	XC9237B19CER	DC-DC-IC	PWM-PWM/PPM, st-dwn, 1.9V±2%, 600mA, 1.2MHz, Vin>2V, HSST, CL	USP-6C	49dc5	DC1	9a	Tor
EBA	XC9237B1AC4R-G	DC-DC-IC	PWM-PWM/PPM, st-dwn, 1.05V±2%, 600mA, 1.2MHz, Vin>2V, HSST, CL	USP-6EL	56dc5	DC1	9a	Tor
EBA	XC9237B1ACER	DC-DC-IC	PWM-PWM/PPM, st-dwn, 1.05V±2%, 600mA, 1.2MHz, Vin>2V, HSST, CL	USP-6C	49dc5	DC1	9a	Tor
EBB	XC9237B1BC4R-G	DC-DC-IC	PWM-PWM/PPM, st-dwn, 1.15V±2%, 600mA, 1.2MHz, Vin>2V, HSST, CL	USP-6EL	56dc5	DC1	9a	Tor
EBB	XC9237B1BCER	DC-DC-IC	PWM-PWM/PPM, st-dwn, 1.15V±2%, 600mA, 1.2MHz, Vin>2V, HSST, CL	USP-6C	49dc5	DC1	9a	Tor
EBC	XC9237B1CC4R-G	DC-DC-IC	PWM-PWM/PPM, st-dwn, 1.25V±2%, 600mA, 1.2MHz, Vin>2V, HSST, CL	USP-6EL	56dc5	DC1	9a	Tor
EBC	XC9237B1CCER	DC-DC-IC	PWM-PWM/PPM, st-dwn, 1.25V±2%, 600mA, 1.2MHz, Vin>2V, HSST, CL	USP-6C	49dc5	DC1	9a	Tor
EBD	XC9237B1DC4R-G	DC-DC-IC	PWM-PWM/PPM, st-dwn, 1.35V±2%, 600mA, 1.2MHz, Vin>2V, HSST, CL	USP-6EL	56dc5	DC1	9a	Tor
EBD	XC9237B1DCER	DC-DC-IC	PWM-PWM/PPM, st-dwn, 1.35V±2%, 600mA, 1.2MHz, Vin>2V, HSST, CL	USP-6C	49dc5	DC1	9a	Tor
EBE	XC9237B1EC4R-G	DC-DC-IC	PWM-PWM/PPM, st-dwn, 1.45V±2%, 600mA, 1.2MHz, Vin>2V, HSST, CL	USP-6EL	56dc5	DC1	9a	Tor
EBE	XC9237B1ECER	DC-DC-IC	PWM-PWM/PPM, st-dwn, 1.45V±2%, 600mA, 1.2MHz, Vin>2V, HSST, CL	USP-6C	49dc5	DC1	9a	Tor
EBF	XC9237B1FC4R-G	DC-DC-IC	PWM-PWM/PPM, st-dwn, 1.55V±2%, 600mA, 1.2MHz, Vin>2V, HSST, CL	USP-6EL	56dc5	DC1	9a	Tor
EBF	XC9237B1FCER	DC-DC-IC	PWM-PWM/PPM, st-dwn, 1.55V±2%, 600mA, 1.2MHz, Vin>2V, HSST, CL	USP-6C	49dc5	DC1	9a	Tor
EBH	XC9237B1HC4R-G	DC-DC-IC	PWM-PWM/PPM, st-dwn, 1.65V±2%, 600mA, 1.2MHz, Vin>2V, HSST, CL	USP-6EL	56dc5	DC1	9a	Tor
EBH	XC9237B1HCER	DC-DC-IC	PWM-PWM/PPM, st-dwn, 1.65V±2%, 600mA, 1.2MHz, Vin>2V, HSST, CL	USP-6C	49dc5	DC1	9a	Tor
EBK	XC9237B1KC4R-G	DC-DC-IC	PWM-PWM/PPM, st-dwn, 1.75V±2%, 600mA, 1.2MHz, Vin>2V, HSST, CL	USP-6EL	56dc5	DC1	9a	Tor
EBK	XC9237B1KCER	DC-DC-IC	PWM-PWM/PPM, st-dwn, 1.75V±2%, 600mA, 1.2MHz, Vin>2V, HSST, CL	USP-6C	49dc5	DC1	9a	Tor
EBL	XC9237B1LC4R-G	DC-DC-IC	PWM-PWM/PPM, st-dwn, 1.85V±2%, 600mA, 1.2MHz, Vin>2V, HSST, CL	USP-6EL	56dc5	DC1	9a	Tor
EBL	XC9237B1LCER	DC-DC-IC	PWM-PWM/PPM, st-dwn, 1.85V±2%, 600mA, 1.2MHz, Vin>2V, HSST, CL	USP-6C	49dc5	DC1	9a	Tor
EBM	XC9237B1MC4R-G	DC-DC-IC	PWM-PWM/PPM, st-dwn, 1.95V±2%, 600mA, 1.2MHz, Vin>2V, HSST, CL	USP-6EL	56dc5	DC1	9a	Tor
EBM	XC9237B1MCER	DC-DC-IC	PWM-PWM/PPM, st-dwn, 1.95V±2%, 600mA, 1.2MHz, Vin>2V, HSST, CL	USP-6C	49dc5	DC1	9a	Tor
EC	R3114K331A	Vdet-IC	3.3V±0.8%, -Reset ODO	DFN1010-4	48vd9	VD9	9a	Ric
EC	RD74LVC1G126WPE	CMOS-Logic	Bus buffer gate with 3-state output	WCSP-5	46LLog13	-	9d	Ren
EC	RT9193-30PQW	LVR-IC	LDO, 3.0V±1%, 300mA, +CE	WDFN-6L	4ub	VR7	9a	Ret
EC	XC6223G22B9R-G	LVR-IC	LDO, 2.25V±1%, 300mA, +CE, PDR, ICP	USPQ-4B03	48vm	VR4	9a	Tor
EC0	XC9237B20C4R-G	DC-DC-IC	PWM-PWM/PPM, st-dwn, 2.0V±2%, 600mA, 1.2MHz, Vin>2V, HSST, CL	USP-6EL	56dc5	DC1	9a	Tor
EC0	XC9237B20CER	DC-DC-IC	PWM-PWM/PPM, st-dwn, 2.0V±2%, 600mA, 1.2MHz, Vin>2V, HSST, CL	USP-6C	49dc5	DC1	9a	Tor
EC1	XC9237B21C4R-G	DC-DC-IC	PWM-PWM/PPM, st-dwn, 2.1V±2%, 600mA, 1.2MHz, Vin>2V, HSST, CL	USP-6EL	56dc5	DC1	9a	Tor
EC1	XC9237B21CER	DC-DC-IC	PWM-PWM/PPM, st-dwn, 2.1V±2%, 600mA, 1.2MHz, Vin>2V, HSST, CL	USP-6C	49dc5	DC1	9a	Tor
EC2	XC9237B22C4R-G	DC-DC-IC	PWM-PWM/PPM, st-dwn, 2.2V±2%, 600mA, 1.2MHz, Vin>2V, HSST, CL	USP-6EL	56dc5	DC1	9a	Tor



SMD code	Type	Function	Short description	Case	Pinout	Sch.	St.	Mnf.
EDH	XC9237B3HCER	DC-DC-IC	PWM-PWM/PPM, st-dwn, 3.65V±2%, 600mA, 1.2MHz, Vin>2V, HSST, CL	USP-6C	49dc5	DC1	9a	Tor
EDK	XC9237B3KC4R-G	DC-DC-IC	PWM-PWM/PPM, st-dwn, 3.75V±2%, 600mA, 1.2MHz, Vin>2V, HSST, CL	USP-6EL	56dc5	DC1	9a	Tor
EDK	XC9237B3KCER	DC-DC-IC	PWM-PWM/PPM, st-dwn, 3.75V±2%, 600mA, 1.2MHz, Vin>2V, HSST, CL	USP-6C	49dc5	DC1	9a	Tor
EDL	XC9237B3LC4R-G	DC-DC-IC	PWM-PWM/PPM, st-dwn, 3.85V±2%, 600mA, 1.2MHz, Vin>2V, HSST, CL	USP-6EL	56dc5	DC1	9a	Tor
EDL	XC9237B3LCER	DC-DC-IC	PWM-PWM/PPM, st-dwn, 3.85V±2%, 600mA, 1.2MHz, Vin>2V, HSST, CL	USP-6C	49dc5	DC1	9a	Tor
EDM	XC9237B3MC4R-G	DC-DC-IC	PWM-PWM/PPM, st-dwn, 3.95V±2%, 600mA, 1.2MHz, Vin>2V, HSST, CL	USP-6EL	56dc5	DC1	9a	Tor
EDM	XC9237B3MCER	DC-DC-IC	PWM-PWM/PPM, st-dwn, 3.95V±2%, 600mA, 1.2MHz, Vin>2V, HSST, CL	USP-6C	49dc5	DC1	9a	Tor
EE	R3114K351A	Vdet-IC	3.5V±0.8%, -Reset ODO	DFN1010-4	48vd9	VD9	9a	Ric
EE	RD74LVC1G07WPE	CMOS-Logic	Noninverting buffer/driver (ODO)	WCSP-5	46LLog8	-	9d	Ren
EE	XG6223G24B9R-G	LVR-IC	LDO, 2.45V±1%, 300mA, +CE, PDR, ICP	USPQ-4B03	48vm	VR4	9a	Tor
EE0	XC9237B40C4R-G	DC-DC-IC	PWM-PWM/PPM, st-dwn, 4.0V±2%, 600mA, 1.2MHz, Vin>2V, HSST, CL	USP-6EL	56dc5	DC1	9a	Tor
EE0	XC9237B40CER	DC-DC-IC	PWM-PWM/PPM, st-dwn, 4.0V±2%, 600mA, 1.2MHz, Vin>2V, HSST, CL	USP-6C	49dc5	DC1	9a	Tor
EF	R3114K361A	Vdet-IC	3.6V±0.8%, -Reset ODO	DFN1010-4	48vd9	VD9	9a	Ric
EF	RD74LVC1G79WPE	CMOS-Logic	Positive edge-triggered D-type flip-flop	WCSP-5	46LLog20	-	9d	Ren
EF	XG6223G25B9R-G	LVR-IC	LDO, 2.55V±1%, 300mA, +CE, PDR, ICP	USPQ-4B03	48vm	VR4	9a	Tor
EF8	XC9237B08D4R-G	DC-DC-IC	PWM-PWM/PPM, st-dwn, 0.8V±2%, 600mA, 3MHz, Vin>2V, HSST, CL	USP-6EL	56dc5	DC1	9a	Tor
EF8	XC9237B08DER	DC-DC-IC	PWM-PWM/PPM, st-dwn, 0.8V±2%, 600mA, 3MHz, Vin>2V, HSST, CL	USP-6C	49dc5	DC1	9a	Tor
EF8	XCL207B084AR-G	DC/DC-IC	PWM-PWM/PPM st-dwn, 3MHz, 0.8V±2%, 600mA, auto discharge	CL-2025	67dc7	DC9	9a	Tor
EF9	XC9237B09D4R-G	DC-DC-IC	PWM-PWM/PPM, st-dwn, 0.9V±2%, 600mA, 3MHz, Vin>2V, HSST, CL	USP-6EL	56dc5	DC1	9a	Tor
EF9	XC9237B09DER	DC-DC-IC	PWM-PWM/PPM, st-dwn, 0.9V±2%, 600mA, 3MHz, Vin>2V, HSST, CL	USP-6C	49dc5	DC1	9a	Tor
EF9	XCL207B094AR-G	DC/DC-IC	PWM-PWM/PPM st-dwn, 3MHz, 0.9V±2%, 600mA, auto discharge	CL-2025	67dc7	DC9	9a	Tor
EFL	XC9237B0LD4R-G	DC-DC-IC	PWM-PWM/PPM, st-dwn, 0.85V±2%, 600mA, 3MHz, Vin>2V, HSST, CL	USP-6EL	56dc5	DC1	9a	Tor
EFL	XC9237B0LDER	DC-DC-IC	PWM-PWM/PPM, st-dwn, 0.85V±2%, 600mA, 3MHz, Vin>2V, HSST, CL	USP-6C	49dc5	DC1	9a	Tor
EFM	XC9237B0MD4R-G	DC-DC-IC	PWM-PWM/PPM, st-dwn, 0.95V±2%, 600mA, 3MHz, Vin>2V, HSST, CL	USP-6EL	56dc5	DC1	9a	Tor
EFM	XC9237B0MDER	DC-DC-IC	PWM-PWM/PPM, st-dwn, 0.95V±2%, 600mA, 3MHz, Vin>2V, HSST, CL	USP-6C	49dc5	DC1	9a	Tor
EG	R3114K371A	Vdet-IC	3.7V±0.8%, -Reset ODO	DFN1010-4	48vd9	VD9	9a	Ric
EH	R3114K381A	Vdet-IC	3.8V±0.8%, -Reset ODO	DFN1010-4	48vd9	VD9	9a	Ric
EH	RD74LVC1G240WPE	CMOS-Logic	Bus buffer inverted with 3-state output	WCSP-5	46LLog22	-	9d	Ren
EH	XG6223G26B9R-G	LVR-IC	LDO, 2.65V±1%, 300mA, +CE, PDR, ICP	USPQ-4B03	48vm	VR4	9a	Tor
EH0	XC9237B10D4R-G	DC-DC-IC	PWM-PWM/PPM, st-dwn, 1.0V±2%, 600mA, 3MHz, Vin>2V, HSST, CL	USP-6EL	56dc5	DC1	9a	Tor
EH0	XC9237B10DER	DC-DC-IC	PWM-PWM/PPM, st-dwn, 1.0V±2%, 600mA, 3MHz, Vin>2V, HSST, CL	USP-6C	49dc5	DC1	9a	Tor
EH0	XCL207B104AR-G	DC/DC-IC	PWM-PWM/PPM st-dwn, 3MHz, 1.0V±2%, 600mA, auto discharge	CL-2025	67dc7	DC9	9a	Tor
EH1	XC9237B11D4R-G	DC-DC-IC	PWM-PWM/PPM, st-dwn, 1.1V±2%, 600mA, 3MHz, Vin>2V, HSST, CL	USP-6EL	56dc5	DC1	9a	Tor
EH1	XC9237B11DER	DC-DC-IC	PWM-PWM/PPM, st-dwn, 1.1V±2%, 600mA, 3MHz, Vin>2V, HSST, CL	USP-6C	49dc5	DC1	9a	Tor
EH1	XCL207B114AR-G	DC/DC-IC	PWM-PWM/PPM st-dwn, 3MHz, 1.1V±2%, 600mA, auto discharge	CL-2025	67dc7	DC9	9a	Tor
EH2	XC9237B12D4R-G	DC-DC-IC	PWM-PWM/PPM, st-dwn, 1.2V±2%, 600mA, 3MHz, Vin>2V, HSST, CL	USP-6EL	56dc5	DC1	9a	Tor
EH2	XC9237B12DER	DC-DC-IC	PWM-PWM/PPM, st-dwn, 1.2V±2%, 600mA, 3MHz, Vin>2V, HSST, CL	USP-6C	49dc5	DC1	9a	Tor
EH2	XCL207B124AR-G	DC/DC-IC	PWM-PWM/PPM st-dwn, 3MHz, 1.2V±2%, 600mA, auto discharge	CL-2025	67dc7	DC9	9a	Tor
EH3	XC9237B13D4R-G	DC-DC-IC	PWM-PWM/PPM, st-dwn, 1.3V±2%, 600mA, 3MHz, Vin>2V, HSST, CL	USP-6EL	56dc5	DC1	9a	Tor
EH3	XC9237B13DER	DC-DC-IC	PWM-PWM/PPM, st-dwn, 1.3V±2%, 600mA, 3MHz, Vin>2V, HSST, CL	USP-6C	49dc5	DC1	9a	Tor
EH3	XCL207B134AR-G	DC/DC-IC	PWM-PWM/PPM st-dwn, 3MHz, 1.3V±2%, 600mA, auto discharge	CL-2025	67dc7	DC9	9a	Tor
EH4	XC9237B14D4R-G	DC-DC-IC	PWM-PWM/PPM, st-dwn, 1.4V±2%, 600mA, 3MHz, Vin>2V, HSST, CL	USP-6EL	56dc5	DC1	9a	Tor
EH4	XC9237B14DER	DC-DC-IC	PWM-PWM/PPM, st-dwn, 1.4V±2%, 600mA, 3MHz, Vin>2V, HSST, CL	USP-6C	49dc5	DC1	9a	Tor
EH4	XCL207B144AR-G	DC/DC-IC	PWM-PWM/PPM st-dwn, 3MHz, 1.4V±2%, 600mA, auto discharge	CL-2025	67dc7	DC9	9a	Tor
EH5	XC9237B15D4R-G	DC-DC-IC	PWM-PWM/PPM, st-dwn, 1.5V±2%, 600mA, 3MHz, Vin>2V, HSST, CL	USP-6EL	56dc5	DC1	9a	Tor
EH5	XC9237B15DER	DC-DC-IC	PWM-PWM/PPM, st-dwn, 1.5V±2%, 600mA, 3MHz, Vin>2V, HSST, CL	USP-6C	49dc5	DC1	9a	Tor
EH5	XCL207B154AR-G	DC/DC-IC	PWM-PWM/PPM st-dwn, 3MHz, 1.5V±2%, 600mA, auto discharge	CL-2025	67dc7	DC9	9a	Tor
EH6	XC9237B16D4R-G	DC-DC-IC	PWM-PWM/PPM, st-dwn, 1.6V±2%, 600mA, 3MHz, Vin>2V, HSST, CL	USP-6EL	56dc5	DC1	9a	Tor
EH6	XC9237B16DER	DC-DC-IC	PWM-PWM/PPM, st-dwn, 1.6V±2%, 600mA, 3MHz, Vin>2V, HSST, CL	USP-6C	49dc5	DC1	9a	Tor
EH6	XCL207B164AR-G	DC/DC-IC	PWM-PWM/PPM st-dwn, 3MHz, 1.6V±2%, 600mA, auto discharge	CL-2025	67dc7	DC9	9a	Tor
EH7	XC9237B17D4R-G	DC-DC-IC	PWM-PWM/PPM, st-dwn, 1.7V±2%, 600mA, 3MHz, Vin>2V, HSST, CL	USP-6EL	56dc5	DC1	9a	Tor
EH7	XC9237B17DER	DC-DC-IC	PWM-PWM/PPM, st-dwn, 1.7V±2%, 600mA, 3MHz, Vin>2V, HSST, CL	USP-6C	49dc5	DC1	9a	Tor
EH7	XCL207B174AR-G	DC/DC-IC	PWM-PWM/PPM st-dwn, 3MHz, 1.7V±2%, 600mA, auto discharge	CL-2025	67dc7	DC9	9a	Tor
EH8	XC9237B18D4R-G	DC-DC-IC	PWM-PWM/PPM, st-dwn, 1.8V±2%, 600mA, 3MHz, Vin>2V, HSST, CL	USP-6EL	56dc5	DC1	9a	Tor
EH8	XC9237B18DER	DC-DC-IC	PWM-PWM/PPM, st-dwn, 1.8V±2%, 600mA, 3MHz, Vin>2V, HSST, CL	USP-6C	49dc5	DC1	9a	Tor
EH8	XCL207B184AR-G	DC/DC-IC	PWM-PWM/PPM st-dwn, 3MHz, 1.8V±2%, 600mA, auto discharge	CL-2025	67dc7	DC9	9a	Tor
EH9	XC9237B19D4R-G	DC-DC-IC	PWM-PWM/PPM, st-dwn, 1.9V±2%, 600mA, 3MHz, Vin>2V, HSST, CL	USP-6EL	56dc5	DC1	9a	Tor
EH9	XC9237B19DER	DC-DC-IC	PWM-PWM/PPM, st-dwn, 1.9V±2%, 600mA, 3MHz, Vin>2V, HSST, CL	USP-6C	49dc5	DC1	9a	Tor
EH9	XCL207B194AR-G	DC/DC-IC	PWM-PWM/PPM st-dwn, 3MHz, 1.9V±2%, 600mA, auto discharge	CL-2025	67dc7	DC9	9a	Tor
EHA	XC9237B1AD4R-G	DC-DC-IC	PWM-PWM/PPM, st-dwn, 1.05V±2%, 600mA, 3MHz, Vin>2V, HSST, CL	USP-6EL	56dc5	DC1	9a	Tor
EHA	XC9237B1ADER	DC-DC-IC	PWM-PWM/PPM, st-dwn, 1.05V±2%, 600mA, 3MHz, Vin>2V, HSST, CL	USP-6C	49dc5	DC1	9a	Tor
EHA	XCL207B1AD4R-G	DC/DC-IC	PWM-PWM/PPM st-dwn, 3MHz, 1.05V±2%, 600mA, auto discharge	CL-2025	67dc7	DC9	9a	Tor
EHB	XC9237B1BD4R-G	DC-DC-IC	PWM-PWM/PPM, st-dwn, 1.15V±2%, 600mA, 3MHz, Vin>2V, HSST, CL	USP-6EL	56dc5	DC1	9a	Tor
EHB	XC9237B1BDER	DC-DC-IC	PWM-PWM/PPM, st-dwn, 1.15V±2%, 600mA, 3MHz, Vin>2V, HSST, CL	USP-6C	49dc5	DC1	9a	Tor
EHC	XC9237B1CD4R-G	DC-DC-IC	PWM-PWM/PPM, st-dwn, 1.25V±2%, 600mA, 3MHz, Vin>2V, HSST, CL	USP-6EL	56dc5	DC1	9a	Tor
EHC	XC9237B1CDER	DC-DC-IC	PWM-PWM/PPM, st-dwn, 1.25V±2%, 600mA, 3MHz, Vin>2V, HSST, CL	USP-6C	49dc5	DC1	9a	Tor
EHD	XC9237B1DD4R-G	DC-DC-IC	PWM-PWM/PPM, st-dwn, 1.35V±2%, 600mA, 3MHz, Vin>2V, HSST, CL	USP-6EL	56dc5	DC1	9a	Tor
EHD	XC9237B1DDER	DC-DC-IC	PWM-PWM/PPM, st-dwn, 1.35V±2%, 600mA, 3MHz, Vin>2V, HSST, CL	USP-6C	49dc5	DC1	9a	Tor
EHE	XC9237B1ED4R-G	DC-DC-IC	PWM-PWM/PPM, st-dwn, 1.45V±2%, 600mA, 3MHz, Vin>2V, HSST, CL	USP-6EL	56dc5	DC1	9a	Tor
EHE	XC9237B1EDER	DC-DC-IC	PWM-PWM/PPM, st-dwn, 1.45V±2%, 600mA, 3MHz, Vin>2V, HSST, CL	USP-6C	49dc5	DC1	9a	Tor
EHF	XC9237B1FD4R-G	DC-DC-IC	PWM-PWM/PPM, st-dwn, 1.55V±2%, 600mA, 3MHz, Vin>2V, HSST, CL	USP-6EL	56dc5	DC1	9a	Tor



SMD code	Type	Function	Short description	Case	Pinout	Sch.	St.	Mnf.
EHF	XC9237B1FDER	DC-DC-IC	PWM-PWM/PPM, st-dwn, 1.55V±2%, 600mA, 3MHz, Vin>2V, HSST, CL	USP-6C	49dc5	DC1	9a	Tor
EHH	XC9237B1HD4R-G	DC-DC-IC	PWM-PWM/PPM, st-dwn, 1.65V±2%, 600mA, 3MHz, Vin>2V, HSST, CL	USP-6EL	56dc5	DC1	9a	Tor
EHH	XC9237B1HDER	DC-DC-IC	PWM-PWM/PPM, st-dwn, 1.65V±2%, 600mA, 3MHz, Vin>2V, HSST, CL	USP-6C	49dc5	DC1	9a	Tor
EHK	XC9237B1KD4R-G	DC-DC-IC	PWM-PWM/PPM, st-dwn, 1.75V±2%, 600mA, 3MHz, Vin>2V, HSST, CL	USP-6EL	56dc5	DC1	9a	Tor
EHK	XC9237B1KDER	DC-DC-IC	PWM-PWM/PPM, st-dwn, 1.75V±2%, 600mA, 3MHz, Vin>2V, HSST, CL	USP-6C	49dc5	DC1	9a	Tor
EHL	XC9237B1LD4R-G	DC-DC-IC	PWM-PWM/PPM, st-dwn, 1.85V±2%, 600mA, 3MHz, Vin>2V, HSST, CL	USP-6EL	56dc5	DC1	9a	Tor
EHL	XC9237B1LDER	DC-DC-IC	PWM-PWM/PPM, st-dwn, 1.85V±2%, 600mA, 3MHz, Vin>2V, HSST, CL	USP-6C	49dc5	DC1	9a	Tor
EHM	XC9237B1MD4R-G	DC-DC-IC	PWM-PWM/PPM, st-dwn, 1.95V±2%, 600mA, 3MHz, Vin>2V, HSST, CL	USP-6EL	56dc5	DC1	9a	Tor
EHM	XC9237B1MDER	DC-DC-IC	PWM-PWM/PPM, st-dwn, 1.95V±2%, 600mA, 3MHz, Vin>2V, HSST, CL	USP-6C	49dc5	DC1	9a	Tor
EJ	R3114K391A	Vdet-IC	3.9V±0.8%, -Reset ODO	DFN1010-4	48vd9	VD9	9a	Ric
EJ	RT9013-13PQW	LVR-IC	LDO, 1.3V±2%, 500mA, +CE	WDFN-6	49xu	VR4	9a	Rct
EK	HD74LVC1G17CLE	CMOS-Logic	Schmitt-trigger	WCSP-5	46Lsg11	-	9d	Ren
EK	R3114K401A	Vdet-IC	4.0V±0.8%, -Reset ODO	DFN1010-4	48vd9	VD9	9a	Ric
EK	RD74LVC1G17WPE	CMOS-Logic	Schmitt-trigger	WCSP-5	46Lsg11	-	9d	Ren
EK	XG6223G27B9R-G	LVR-IC	LDO, 2.75V±1%, 300mA, +CE, PDR, ICP	USPQ-4B03	48vm	VR4	9a	Tor
EK0	XC9237B20D4R-G	DC-DC-IC	PWM-PWM/PPM, st-dwn, 2.0V±2%, 600mA, 3MHz, Vin>2V, HSST, CL	USP-6EL	56dc5	DC1	9a	Tor
EK0	XC9237B20DER	DC-DC-IC	PWM-PWM/PPM, st-dwn, 2.0V±2%, 600mA, 3MHz, Vin>2V, HSST, CL	USP-6C	49dc5	DC1	9a	Tor
EK0	XCL207B204AR-G	DC/DC-IC	PWM-PWM/PPM st-dwn, 3MHz, 2.0V±2%, 600mA, auto discharge	CL-2025	67dc7	DC9	9a	Tor
EK1	XC9237B21D4R-G	DC-DC-IC	PWM-PWM/PPM, st-dwn, 2.1V±2%, 600mA, 3MHz, Vin>2V, HSST, CL	USP-6EL	56dc5	DC1	9a	Tor
EK1	XC9237B21DER	DC-DC-IC	PWM-PWM/PPM, st-dwn, 2.1V±2%, 600mA, 3MHz, Vin>2V, HSST, CL	USP-6C	49dc5	DC1	9a	Tor
EK1	XCL207B214AR-G	DC/DC-IC	PWM-PWM/PPM st-dwn, 3MHz, 2.1V±2%, 600mA, auto discharge	CL-2025	67dc7	DC9	9a	Tor
EK2	XC9237B22D4R-G	DC-DC-IC	PWM-PWM/PPM, st-dwn, 2.2V±2%, 600mA, 3MHz, Vin>2V, HSST, CL	USP-6EL	56dc5	DC1	9a	Tor
EK2	XC9237B22DER	DC-DC-IC	PWM-PWM/PPM, st-dwn, 2.2V±2%, 600mA, 3MHz, Vin>2V, HSST, CL	USP-6C	49dc5	DC1	9a	Tor
EK2	XCL207B224AR-G	DC/DC-IC	PWM-PWM/PPM st-dwn, 3MHz, 2.2V±2%, 600mA, auto discharge	CL-2025	67dc7	DC9	9a	Tor
EK3	XC9237B23D4R-G	DC-DC-IC	PWM-PWM/PPM, st-dwn, 2.3V±2%, 600mA, 3MHz, Vin>2V, HSST, CL	USP-6EL	56dc5	DC1	9a	Tor
EK3	XC9237B23DER	DC-DC-IC	PWM-PWM/PPM, st-dwn, 2.3V±2%, 600mA, 3MHz, Vin>2V, HSST, CL	USP-6C	49dc5	DC1	9a	Tor
EK3	XCL207B234AR-G	DC/DC-IC	PWM-PWM/PPM st-dwn, 3MHz, 2.3V±2%, 600mA, auto discharge	CL-2025	67dc7	DC9	9a	Tor
EK4	XC9237B24D4R-G	DC-DC-IC	PWM-PWM/PPM, st-dwn, 2.4V±2%, 600mA, 3MHz, Vin>2V, HSST, CL	USP-6EL	56dc5	DC1	9a	Tor
EK4	XC9237B24DER	DC-DC-IC	PWM-PWM/PPM, st-dwn, 2.4V±2%, 600mA, 3MHz, Vin>2V, HSST, CL	USP-6C	49dc5	DC1	9a	Tor
EK4	XCL207B244AR-G	DC/DC-IC	PWM-PWM/PPM st-dwn, 3MHz, 2.4V±2%, 600mA, auto discharge	CL-2025	67dc7	DC9	9a	Tor
EK5	XC9237B25D4R-G	DC-DC-IC	PWM-PWM/PPM, st-dwn, 2.5V±2%, 600mA, 3MHz, Vin>2V, HSST, CL	USP-6EL	56dc5	DC1	9a	Tor
EK5	XC9237B25DER	DC-DC-IC	PWM-PWM/PPM, st-dwn, 2.5V±2%, 600mA, 3MHz, Vin>2V, HSST, CL	USP-6C	49dc5	DC1	9a	Tor
EK5	XCL207B254AR-G	DC/DC-IC	PWM-PWM/PPM st-dwn, 3MHz, 2.5V±2%, 600mA, auto discharge	CL-2025	67dc7	DC9	9a	Tor
EK6	XC9237B26D4R-G	DC-DC-IC	PWM-PWM/PPM, st-dwn, 2.6V±2%, 600mA, 3MHz, Vin>2V, HSST, CL	USP-6EL	56dc5	DC1	9a	Tor
EK6	XC9237B26DER	DC-DC-IC	PWM-PWM/PPM, st-dwn, 2.6V±2%, 600mA, 3MHz, Vin>2V, HSST, CL	USP-6C	49dc5	DC1	9a	Tor
EK6	XCL207B264AR-G	DC/DC-IC	PWM-PWM/PPM st-dwn, 3MHz, 2.6V±2%, 600mA, auto discharge	CL-2025	67dc7	DC9	9a	Tor
EK7	XC9237B27D4R-G	DC-DC-IC	PWM-PWM/PPM, st-dwn, 2.7V±2%, 600mA, 3MHz, Vin>2V, HSST, CL	USP-6EL	56dc5	DC1	9a	Tor
EK7	XC9237B27DER	DC-DC-IC	PWM-PWM/PPM, st-dwn, 2.7V±2%, 600mA, 3MHz, Vin>2V, HSST, CL	USP-6C	49dc5	DC1	9a	Tor
EK7	XCL207B274AR-G	DC/DC-IC	PWM-PWM/PPM st-dwn, 3MHz, 2.7V±2%, 600mA, auto discharge	CL-2025	67dc7	DC9	9a	Tor
EK8	XC9237B28D4R-G	DC-DC-IC	PWM-PWM/PPM, st-dwn, 2.8V±2%, 600mA, 3MHz, Vin>2V, HSST, CL	USP-6EL	56dc5	DC1	9a	Tor
EK8	XC9237B28DER	DC-DC-IC	PWM-PWM/PPM, st-dwn, 2.8V±2%, 600mA, 3MHz, Vin>2V, HSST, CL	USP-6C	49dc5	DC1	9a	Tor
EK8	XCL207B284AR-G	DC/DC-IC	PWM-PWM/PPM st-dwn, 3MHz, 2.8V±2%, 600mA, auto discharge	CL-2025	67dc7	DC9	9a	Tor
EK9	XC9237B29D4R-G	DC-DC-IC	PWM-PWM/PPM, st-dwn, 2.9V±2%, 600mA, 3MHz, Vin>2V, HSST, CL	USP-6EL	56dc5	DC1	9a	Tor
EK9	XC9237B29DER	DC-DC-IC	PWM-PWM/PPM, st-dwn, 2.9V±2%, 600mA, 3MHz, Vin>2V, HSST, CL	USP-6C	49dc5	DC1	9a	Tor
EK9	XCL207B294AR-G	DC/DC-IC	PWM-PWM/PPM st-dwn, 3MHz, 2.9V±2%, 600mA, auto discharge	CL-2025	67dc7	DC9	9a	Tor
EKA	XC9237B2AD4R-G	DC-DC-IC	PWM-PWM/PPM, st-dwn, 2.05V±2%, 600mA, 3MHz, Vin>2V, HSST, CL	USP-6EL	56dc5	DC1	9a	Tor
EKA	XC9237B2ADER	DC-DC-IC	PWM-PWM/PPM, st-dwn, 2.05V±2%, 600mA, 3MHz, Vin>2V, HSST, CL	USP-6C	49dc5	DC1	9a	Tor
EKB	XC9237B2BD4R-G	DC-DC-IC	PWM-PWM/PPM, st-dwn, 2.15V±2%, 600mA, 3MHz, Vin>2V, HSST, CL	USP-6EL	56dc5	DC1	9a	Tor
EKB	XC9237B2BDER	DC-DC-IC	PWM-PWM/PPM, st-dwn, 2.15V±2%, 600mA, 3MHz, Vin>2V, HSST, CL	USP-6C	49dc5	DC1	9a	Tor
EKC	XC9237B2CD4R-G	DC-DC-IC	PWM-PWM/PPM, st-dwn, 2.25V±2%, 600mA, 3MHz, Vin>2V, HSST, CL	USP-6EL	56dc5	DC1	9a	Tor
EKC	XC9237B2CDER	DC-DC-IC	PWM-PWM/PPM, st-dwn, 2.25V±2%, 600mA, 3MHz, Vin>2V, HSST, CL	USP-6C	49dc5	DC1	9a	Tor
EKD	XC9237B2DD4R-G	DC-DC-IC	PWM-PWM/PPM, st-dwn, 2.35V±2%, 600mA, 3MHz, Vin>2V, HSST, CL	USP-6EL	56dc5	DC1	9a	Tor
EKD	XC9237B2DDER	DC-DC-IC	PWM-PWM/PPM, st-dwn, 2.35V±2%, 600mA, 3MHz, Vin>2V, HSST, CL	USP-6C	49dc5	DC1	9a	Tor
EKE	XC9237B2ED4R-G	DC-DC-IC	PWM-PWM/PPM, st-dwn, 2.45V±2%, 600mA, 3MHz, Vin>2V, HSST, CL	USP-6EL	56dc5	DC1	9a	Tor
EKE	XC9237B2EDER	DC-DC-IC	PWM-PWM/PPM, st-dwn, 2.45V±2%, 600mA, 3MHz, Vin>2V, HSST, CL	USP-6C	49dc5	DC1	9a	Tor
EKF	XC9237B2FD4R-G	DC-DC-IC	PWM-PWM/PPM, st-dwn, 2.55V±2%, 600mA, 3MHz, Vin>2V, HSST, CL	USP-6EL	56dc5	DC1	9a	Tor
EKF	XC9237B2FDER	DC-DC-IC	PWM-PWM/PPM, st-dwn, 2.55V±2%, 600mA, 3MHz, Vin>2V, HSST, CL	USP-6C	49dc5	DC1	9a	Tor
EKH	XC9237B2HD4R-G	DC-DC-IC	PWM-PWM/PPM, st-dwn, 2.65V±2%, 600mA, 3MHz, Vin>2V, HSST, CL	USP-6EL	56dc5	DC1	9a	Tor
EKH	XC9237B2HDER	DC-DC-IC	PWM-PWM/PPM, st-dwn, 2.65V±2%, 600mA, 3MHz, Vin>2V, HSST, CL	USP-6C	49dc5	DC1	9a	Tor
EKK	XC9237B2KD4R-G	DC-DC-IC	PWM-PWM/PPM, st-dwn, 2.75V±2%, 600mA, 3MHz, Vin>2V, HSST, CL	USP-6EL	56dc5	DC1	9a	Tor
EKK	XC9237B2KDER	DC-DC-IC	PWM-PWM/PPM, st-dwn, 2.75V±2%, 600mA, 3MHz, Vin>2V, HSST, CL	USP-6C	49dc5	DC1	9a	Tor
EKL	XC9237B2LD4R-G	DC-DC-IC	PWM-PWM/PPM, st-dwn, 2.85V±2%, 600mA, 3MHz, Vin>2V, HSST, CL	USP-6EL	56dc5	DC1	9a	Tor
EKL	XC9237B2LDER	DC-DC-IC	PWM-PWM/PPM, st-dwn, 2.85V±2%, 600mA, 3MHz, Vin>2V, HSST, CL	USP-6C	49dc5	DC1	9a	Tor
EKM	XC9237B2MD4R-G	DC-DC-IC	PWM-PWM/PPM, st-dwn, 2.95V±2%, 600mA, 3MHz, Vin>2V, HSST, CL	USP-6EL	56dc5	DC1	9a	Tor
EKM	XC9237B2MDER	DC-DC-IC	PWM-PWM/PPM, st-dwn, 2.95V±2%, 600mA, 3MHz, Vin>2V, HSST, CL	USP-6C	49dc5	DC1	9a	Tor
eL	NX3V1G384GM	CMOS-Logic	Single-pole single-throw analog switch	SO8-886	57Lsg86	-	9c	Pic
EL	R3114K411A	Vdet-IC	4.1V±0.8%, -Reset ODO	DFN1010-4	48vd9	VD9	9a	Ric
EL	XG6223G28B9R-G	LVR-IC	LDO, 2.85V±1%, 300mA, +CE, PDR, ICP	USPQ-4B03	48vm	VR4	9a	Tor
EL0	XC9237B30D4R-G	DC-DC-IC	PWM-PWM/PPM, st-dwn, 3.0V±2%, 600mA, 3MHz, Vin>2V, HSST, CL	USP-6EL	56dc5	DC1	9a	Tor
EL0	XC9237B30DER	DC-DC-IC	PWM-PWM/PPM, st-dwn, 3.0V±2%, 600mA, 3MHz, Vin>2V, HSST, CL	USP-6C	49dc5	DC1	9a	Tor



SMD code	Type	Function	Short description	Case	Pinout	Sch.	St.	Mnf.
EL0	XCL207B304AR-G	DC/DC-IC	PWM-PWM/PPM st-dwn, 3MHz, 3.0V±2%, 600mA, auto discharge	CL-2025	67dc7	DC9	9a	Tor
EL1	XC9237B31D4R-G	DC-DC-IC	PWM-PWM/PPM, st-dwn, 3.1V±2%, 600mA, 3MHz, Vin>2V, HSST, CL	USP-6EL	56dc5	DC1	9a	Tor
EL1	XC9237B31DER	DC-DC-IC	PWM-PWM/PPM, st-dwn, 3.1V±2%, 600mA, 3MHz, Vin>2V, HSST, CL	USP-6C	49dc5	DC1	9a	Tor
EL1	XCL207B314AR-G	DC/DC-IC	PWM-PWM/PPM st-dwn, 3MHz, 3.1V±2%, 600mA, auto discharge	CL-2025	67dc7	DC9	9a	Tor
EL2	XC9237B32D4R-G	DC-DC-IC	PWM-PWM/PPM, st-dwn, 3.2V±2%, 600mA, 3MHz, Vin>2V, HSST, CL	USP-6EL	56dc5	DC1	9a	Tor
EL2	XC9237B32DER	DC-DC-IC	PWM-PWM/PPM, st-dwn, 3.2V±2%, 600mA, 3MHz, Vin>2V, HSST, CL	USP-6C	49dc5	DC1	9a	Tor
EL2	XCL207B324AR-G	DC/DC-IC	PWM-PWM/PPM st-dwn, 3MHz, 3.2V±2%, 600mA, auto discharge	CL-2025	67dc7	DC9	9a	Tor
EL3	XC9237B33D4R-G	DC-DC-IC	PWM-PWM/PPM, st-dwn, 3.3V±2%, 600mA, 3MHz, Vin>2V, HSST, CL	USP-6EL	56dc5	DC1	9a	Tor
EL3	XC9237B33DER	DC-DC-IC	PWM-PWM/PPM, st-dwn, 3.3V±2%, 600mA, 3MHz, Vin>2V, HSST, CL	USP-6C	49dc5	DC1	9a	Tor
EL3	XCL207B334AR-G	DC/DC-IC	PWM-PWM/PPM st-dwn, 3MHz, 3.3V±2%, 600mA, auto discharge	CL-2025	67dc7	DC9	9a	Tor
EL4	XC9237B34D4R-G	DC-DC-IC	PWM-PWM/PPM, st-dwn, 3.4V±2%, 600mA, 3MHz, Vin>2V, HSST, CL	USP-6EL	56dc5	DC1	9a	Tor
EL4	XC9237B34DER	DC-DC-IC	PWM-PWM/PPM, st-dwn, 3.4V±2%, 600mA, 3MHz, Vin>2V, HSST, CL	USP-6C	49dc5	DC1	9a	Tor
EL4	XCL207B344AR-G	DC/DC-IC	PWM-PWM/PPM st-dwn, 3MHz, 3.4V±2%, 600mA, auto discharge	CL-2025	67dc7	DC9	9a	Tor
EL5	XC9237B35D4R-G	DC-DC-IC	PWM-PWM/PPM, st-dwn, 3.5V±2%, 600mA, 3MHz, Vin>2V, HSST, CL	USP-6EL	56dc5	DC1	9a	Tor
EL5	XC9237B35DER	DC-DC-IC	PWM-PWM/PPM, st-dwn, 3.5V±2%, 600mA, 3MHz, Vin>2V, HSST, CL	USP-6C	49dc5	DC1	9a	Tor
EL5	XCL207B354AR-G	DC/DC-IC	PWM-PWM/PPM st-dwn, 3MHz, 3.5V±2%, 600mA, auto discharge	CL-2025	67dc7	DC9	9a	Tor
EL6	XC9237B36D4R-G	DC-DC-IC	PWM-PWM/PPM, st-dwn, 3.6V±2%, 600mA, 3MHz, Vin>2V, HSST, CL	USP-6EL	56dc5	DC1	9a	Tor
EL6	XC9237B36DER	DC-DC-IC	PWM-PWM/PPM, st-dwn, 3.6V±2%, 600mA, 3MHz, Vin>2V, HSST, CL	USP-6C	49dc5	DC1	9a	Tor
EL6	XCL207B364AR-G	DC/DC-IC	PWM-PWM/PPM st-dwn, 3MHz, 3.6V±2%, 600mA, auto discharge	CL-2025	67dc7	DC9	9a	Tor
EL7	XC9237B37D4R-G	DC-DC-IC	PWM-PWM/PPM, st-dwn, 3.7V±2%, 600mA, 3MHz, Vin>2V, HSST, CL	USP-6EL	56dc5	DC1	9a	Tor
EL7	XC9237B37DER	DC-DC-IC	PWM-PWM/PPM, st-dwn, 3.7V±2%, 600mA, 3MHz, Vin>2V, HSST, CL	USP-6C	49dc5	DC1	9a	Tor
EL7	XCL207B374AR-G	DC/DC-IC	PWM-PWM/PPM st-dwn, 3MHz, 3.7V±2%, 600mA, auto discharge	CL-2025	67dc7	DC9	9a	Tor
EL8	XC9237B38D4R-G	DC-DC-IC	PWM-PWM/PPM, st-dwn, 3.8V±2%, 600mA, 3MHz, Vin>2V, HSST, CL	USP-6EL	56dc5	DC1	9a	Tor
EL8	XC9237B38DER	DC-DC-IC	PWM-PWM/PPM, st-dwn, 3.8V±2%, 600mA, 3MHz, Vin>2V, HSST, CL	USP-6C	49dc5	DC1	9a	Tor
EL8	XCL207B384AR-G	DC/DC-IC	PWM-PWM/PPM st-dwn, 3MHz, 3.8V±2%, 600mA, auto discharge	CL-2025	67dc7	DC9	9a	Tor
EL9	XC9237B39D4R-G	DC-DC-IC	PWM-PWM/PPM, st-dwn, 3.9V±2%, 600mA, 3MHz, Vin>2V, HSST, CL	USP-6EL	56dc5	DC1	9a	Tor
EL9	XC9237B39DER	DC-DC-IC	PWM-PWM/PPM, st-dwn, 3.9V±2%, 600mA, 3MHz, Vin>2V, HSST, CL	USP-6C	49dc5	DC1	9a	Tor
EL9	XCL207B394AR-G	DC/DC-IC	PWM-PWM/PPM st-dwn, 3MHz, 3.9V±2%, 600mA, auto discharge	CL-2025	67dc7	DC9	9a	Tor
ELA	XC9237B3AD4R-G	DC-DC-IC	PWM-PWM/PPM, st-dwn, 3.05V±2%, 600mA, 3MHz, Vin>2V, HSST, CL	USP-6EL	56dc5	DC1	9a	Tor
ELA	XC9237B3ADER	DC-DC-IC	PWM-PWM/PPM, st-dwn, 3.05V±2%, 600mA, 3MHz, Vin>2V, HSST, CL	USP-6C	49dc5	DC1	9a	Tor
ELB	XC9237B3BD4R-G	DC-DC-IC	PWM-PWM/PPM, st-dwn, 3.15V±2%, 600mA, 3MHz, Vin>2V, HSST, CL	USP-6EL	56dc5	DC1	9a	Tor
ELB	XC9237B3BDER	DC-DC-IC	PWM-PWM/PPM, st-dwn, 3.15V±2%, 600mA, 3MHz, Vin>2V, HSST, CL	USP-6C	49dc5	DC1	9a	Tor
ELC	XC9237B3CD4R-G	DC-DC-IC	PWM-PWM/PPM, st-dwn, 3.25V±2%, 600mA, 3MHz, Vin>2V, HSST, CL	USP-6EL	56dc5	DC1	9a	Tor
ELC	XC9237B3CDER	DC-DC-IC	PWM-PWM/PPM, st-dwn, 3.25V±2%, 600mA, 3MHz, Vin>2V, HSST, CL	USP-6C	49dc5	DC1	9a	Tor
ELD	XC9237B3DD4R-G	DC-DC-IC	PWM-PWM/PPM, st-dwn, 3.35V±2%, 600mA, 3MHz, Vin>2V, HSST, CL	USP-6EL	56dc5	DC1	9a	Tor
ELD	XC9237B3DDER	DC-DC-IC	PWM-PWM/PPM, st-dwn, 3.35V±2%, 600mA, 3MHz, Vin>2V, HSST, CL	USP-6C	49dc5	DC1	9a	Tor
ELE	XC9237B3ED4R-G	DC-DC-IC	PWM-PWM/PPM, st-dwn, 3.45V±2%, 600mA, 3MHz, Vin>2V, HSST, CL	USP-6EL	56dc5	DC1	9a	Tor
ELE	XC9237B3EDER	DC-DC-IC	PWM-PWM/PPM, st-dwn, 3.45V±2%, 600mA, 3MHz, Vin>2V, HSST, CL	USP-6C	49dc5	DC1	9a	Tor
ELF	XC9237B3FD4R-G	DC-DC-IC	PWM-PWM/PPM, st-dwn, 3.55V±2%, 600mA, 3MHz, Vin>2V, HSST, CL	USP-6EL	56dc5	DC1	9a	Tor
ELF	XC9237B3FDER	DC-DC-IC	PWM-PWM/PPM, st-dwn, 3.55V±2%, 600mA, 3MHz, Vin>2V, HSST, CL	USP-6C	49dc5	DC1	9a	Tor
ELH	XC9237B3HD4R-G	DC-DC-IC	PWM-PWM/PPM, st-dwn, 3.65V±2%, 600mA, 3MHz, Vin>2V, HSST, CL	USP-6EL	56dc5	DC1	9a	Tor
ELH	XC9237B3HDER	DC-DC-IC	PWM-PWM/PPM, st-dwn, 3.65V±2%, 600mA, 3MHz, Vin>2V, HSST, CL	USP-6C	49dc5	DC1	9a	Tor
ELK	XC9237B3KD4R-G	DC-DC-IC	PWM-PWM/PPM, st-dwn, 3.75V±2%, 600mA, 3MHz, Vin>2V, HSST, CL	USP-6EL	56dc5	DC1	9a	Tor
ELK	XC9237B3KDER	DC-DC-IC	PWM-PWM/PPM, st-dwn, 3.75V±2%, 600mA, 3MHz, Vin>2V, HSST, CL	USP-6C	49dc5	DC1	9a	Tor
ELL	XC9237B3LD4R-G	DC-DC-IC	PWM-PWM/PPM, st-dwn, 3.85V±2%, 600mA, 3MHz, Vin>2V, HSST, CL	USP-6EL	56dc5	DC1	9a	Tor
ELL	XC9237B3LDER	DC-DC-IC	PWM-PWM/PPM, st-dwn, 3.85V±2%, 600mA, 3MHz, Vin>2V, HSST, CL	USP-6C	49dc5	DC1	9a	Tor
ELM	XC9237B3MD4R-G	DC-DC-IC	PWM-PWM/PPM, st-dwn, 3.95V±2%, 600mA, 3MHz, Vin>2V, HSST, CL	USP-6EL	56dc5	DC1	9a	Tor
ELM	XC9237B3MDER	DC-DC-IC	PWM-PWM/PPM, st-dwn, 3.95V±2%, 600mA, 3MHz, Vin>2V, HSST, CL	USP-6C	49dc5	DC1	9a	Tor
EM	R3114K421A	Vdet-IC	4.2V±0.8% -Reset ODO	DFN1010-4	48vd9	VD9	9a	Ric
EM	RT9193-29PQW	LVR-IC	LDO, 2.95V±1%, 300mA, +CE	WDFN-6L	49ub	VR7	9a	Rct
EM	XG6223G29B9R-G	LVR-IC	LDO, 2.95V±1%, 300mA, +CE, PDR, ICP	USPQ-4B03	48vm	VR4	9a	Tor
EM0	XC9237B40D4R-G	DC-DC-IC	PWM-PWM/PPM, st-dwn, 4.0V±2%, 600mA, 3MHz, Vin>2V, HSST, CL	USP-6EL	56dc5	DC1	9a	Tor
EM0	XC9237B40DER	DC-DC-IC	PWM-PWM/PPM, st-dwn, 4.0V±2%, 600mA, 3MHz, Vin>2V, HSST, CL	USP-6C	49dc5	DC1	9a	Tor
EM0	XCL207B404AR-G	DC/DC-IC	PWM-PWM/PPM st-dwn, 3MHz, 4.0V±2%, 600mA, auto discharge	CL-2025	67dc7	DC9	9a	Tor
EMP00	EMA1901-50WL09G	LIN-IC	AF PA, BTL, 2.5-5.5V, 1.25W(5V/8Ω), shutdown	BGA-9	39	AFF44	9k	Emp
EMP01	EMA2901-50WL09GR	LIN-IC	AF PA, BTL, 2.5-5.5V, 2.5W(5V/8Ω), shutdown	BGA-9	39	AFF44	9k	Emp
EMP02	EMA1903-50WL09G	LIN-IC	AF PA, BTL, 2.2-5.5V, 1W(5V/8Ω), shutdown	BGA-9	39	AFF53	9k	Emp
EN	R3114K431A	Vdet-IC	4.3V±0.8% -Reset ODO	DFN1010-4	48vd9	VD9	9a	Ric
EN	XG6223G30B9R-G	LVR-IC	LDO, 3.05V±1%, 300mA, +CE, PDR, ICP	USPQ-4B03	48vm	VR4	9a	Tor
EN8	XC9237G08C4	DC/DC-IC	PWM/PPM st-dwn, 1.2MHz, 0.8V±2%, 600mA, CL, Vin>1.8V, HSST	USP-6EL	56dc5	DC1	9a	Tor
EN8	XC9237G08CER	DC-DC-IC	PWM-PWM/PPM, st-dwn, 0.8V±2%, 600mA, 1.2MHz, Vin>1.8V, HSST, CL	USP-6C	49dc5	DC1	9a	Tor
EN9	XC9237G09C4	DC/DC-IC	PWM/PPM st-dwn, 1.2MHz, 0.9V±2%, 600mA, CL, Vin>1.8V, HSST	USP-6EL	56dc5	DC1	9a	Tor
EN9	XC9237G09CER	DC-DC-IC	PWM-PWM/PPM, st-dwn, 0.9V±2%, 600mA, 1.2MHz, Vin>1.8V, HSST, CL	USP-6C	49dc5	DC1	9a	Tor
ENL	XC9237G0LC4	DC/DC-IC	PWM-PWM/PPM st-dwn, 1.2MHz, 0.85V±2%, 600mA, CL, Vin>1.8V, HSST	USP-6EL	56dc5	DC1	9a	Tor
ENL	XC9237G0LCER	DC-DC-IC	PWM-PWM/PPM, st-dwn, 0.85V±2%, 600mA, 1.2MHz, Vin>1.8V, HSST, CL	USP-6C	49dc5	DC1	9a	Tor
ENM	XC9237G0MC4	DC/DC-IC	PWM/PPM st-dwn, 1.2MHz, 0.95V±2%, 600mA, CL, Vin>1.8V, HSST	USP-6EL	56dc5	DC1	9a	Tor
ENM	XC9237G0MCER	DC-DC-IC	PWM-PWM/PPM, st-dwn, 0.95V±2%, 600mA, 1.2MHz, Vin>1.8V, HSST, CL	USP-6C	49dc5	DC1	9a	Tor
EP	R3114K441A	Vdet-IC	4.4V±0.8% -Reset ODO	DFN1010-4	48vd9	VD9	9a	Ric
EP	XG6223G31B9R-G	LVR-IC	LDO, 3.15V±1%, 300mA, +CE, PDR, ICP	USPQ-4B03	48vm	VR4	9a	Tor
EP0	XC9237G10C4	DC/DC-IC	PWM/PPM st-dwn, 1.2MHz, 1.0V±2%, 600mA, CL, Vin>1.8V, HSST	USP-6EL	56dc5	DC1	9a	Tor



SMD code	Type	Function	Short description	Case	Pinout	Sch.	St.	Mnf.
ERE	XC9237G2EC4	DC/DC-IC	PWM/PFM st-dwn, 1.2MHz, 2.45V±2%, 600mA, CL, Vin>1.8V, HSST	USP-6EL	56dc5	DC1	9a	Tor
ERE	XC9237G2ECER	DC-DC-IC	PWM-PWM/PFM, st-dwn, 2.45V±2%, 600mA, 1.2MHz, Vin>1.8V, HSST, CL	USP-6C	49dc5	DC1	9a	Tor
ERF	XC9237G2FC4	DC/DC-IC	PWM/PFM st-dwn, 1.2MHz, 2.55V±2%, 600mA, CL, Vin>1.8V, HSST	USP-6EL	56dc5	DC1	9a	Tor
ERF	XC9237G2FCER	DC-DC-IC	PWM-PWM/PFM, st-dwn, 2.55V±2%, 600mA, 1.2MHz, Vin>1.8V, HSST, CL	USP-6C	49dc5	DC1	9a	Tor
ERH	XC9237G2HC4	DC/DC-IC	PWM/PFM st-dwn, 1.2MHz, 2.65V±2%, 600mA, CL, Vin>1.8V, HSST	USP-6EL	56dc5	DC1	9a	Tor
ERH	XC9237G2HCER	DC-DC-IC	PWM-PWM/PFM, st-dwn, 2.65V±2%, 600mA, 1.2MHz, Vin>1.8V, HSST, CL	USP-6C	49dc5	DC1	9a	Tor
ERK	XC9237G2KC4	DC/DC-IC	PWM/PFM st-dwn, 1.2MHz, 2.75V±2%, 600mA, CL, Vin>1.8V, HSST	USP-6EL	56dc5	DC1	9a	Tor
ERK	XC9237G2KCER	DC-DC-IC	PWM-PWM/PFM, st-dwn, 2.75V±2%, 600mA, 1.2MHz, Vin>1.8V, HSST, CL	USP-6C	49dc5	DC1	9a	Tor
ERL	XC9237G2LC4	DC/DC-IC	PWM/PFM st-dwn, 1.2MHz, 2.85V±2%, 600mA, CL, Vin>1.8V, HSST	USP-6EL	56dc5	DC1	9a	Tor
ERL	XC9237G2LCER	DC-DC-IC	PWM-PWM/PFM, st-dwn, 2.85V±2%, 600mA, 1.2MHz, Vin>1.8V, HSST, CL	USP-6C	49dc5	DC1	9a	Tor
ERM	XC9237G2MC4	DC/DC-IC	PWM/PFM st-dwn, 1.2MHz, 2.95V±2%, 600mA, CL, Vin>1.8V, HSST	USP-6EL	56dc5	DC1	9a	Tor
ERM	XC9237G2MCER	DC-DC-IC	PWM-PWM/PFM, st-dwn, 2.95V±2%, 600mA, 1.2MHz, Vin>1.8V, HSST, CL	USP-6C	49dc5	DC1	9a	Tor
ES	R3114K471A	Vdet-IC	4.7V±0.8%, -Reset ODO	DFN1010-4	48vd9	VD9	9a	Ric
ES	XG6223G3B9R-G	LVR-IC	LDO, 3.35V±1%, 300mA, +CE, PDR, ICP	USPQ-4B03	48vm	VR4	9a	Tor
ES0	XC9237G30C4	DC/DC-IC	PWM/PFM st-dwn, 1.2MHz, 3.0V±2%, 600mA, CL, Vin>1.8V, HSST	USP-6EL	56dc5	DC1	9a	Tor
ES0	XC9237G30CER	DC-DC-IC	PWM-PWM/PFM, st-dwn, 3.0V±2%, 600mA, 1.2MHz, Vin>1.8V, HSST, CL	USP-6C	49dc5	DC1	9a	Tor
ES1	XC9237G31C4	DC/DC-IC	PWM/PFM st-dwn, 1.2MHz, 3.1V±2%, 600mA, CL, Vin>1.8V, HSST	USP-6EL	56dc5	DC1	9a	Tor
ES1	XC9237G31CER	DC-DC-IC	PWM-PWM/PFM, st-dwn, 3.1V±2%, 600mA, 1.2MHz, Vin>1.8V, HSST, CL	USP-6C	49dc5	DC1	9a	Tor
ES2	XC9237G32C4	DC/DC-IC	PWM/PFM st-dwn, 1.2MHz, 3.2V±2%, 600mA, CL, Vin>1.8V, HSST	USP-6EL	56dc5	DC1	9a	Tor
ES2	XC9237G32CER	DC-DC-IC	PWM-PWM/PFM, st-dwn, 3.2V±2%, 600mA, 1.2MHz, Vin>1.8V, HSST, CL	USP-6C	49dc5	DC1	9a	Tor
ES3	XC9237G33C4	DC/DC-IC	PWM/PFM st-dwn, 1.2MHz, 3.3V±2%, 600mA, CL, Vin>1.8V, HSST	USP-6EL	56dc5	DC1	9a	Tor
ES3	XC9237G33CER	DC-DC-IC	PWM-PWM/PFM, st-dwn, 3.3V±2%, 600mA, 1.2MHz, Vin>1.8V, HSST, CL	USP-6C	49dc5	DC1	9a	Tor
ES4	XC9237G34C4	DC/DC-IC	PWM/PFM st-dwn, 1.2MHz, 3.4V±2%, 600mA, CL, Vin>1.8V, HSST	USP-6EL	56dc5	DC1	9a	Tor
ES4	XC9237G34CER	DC-DC-IC	PWM-PWM/PFM, st-dwn, 3.4V±2%, 600mA, 1.2MHz, Vin>1.8V, HSST, CL	USP-6C	49dc5	DC1	9a	Tor
ES5	XC9237G35C4	DC/DC-IC	PWM/PFM st-dwn, 1.2MHz, 3.5V±2%, 600mA, CL, Vin>1.8V, HSST	USP-6EL	56dc5	DC1	9a	Tor
ES5	XC9237G35CER	DC-DC-IC	PWM-PWM/PFM, st-dwn, 3.5V±2%, 600mA, 1.2MHz, Vin>1.8V, HSST, CL	USP-6C	49dc5	DC1	9a	Tor
ES6	XC9237G36C4	DC/DC-IC	PWM/PFM st-dwn, 1.2MHz, 3.6V±2%, 600mA, CL, Vin>1.8V, HSST	USP-6EL	56dc5	DC1	9a	Tor
ES6	XC9237G36CER	DC-DC-IC	PWM-PWM/PFM, st-dwn, 3.6V±2%, 600mA, 1.2MHz, Vin>1.8V, HSST, CL	USP-6C	49dc5	DC1	9a	Tor
ES7	XC9237G37C4	DC/DC-IC	PWM/PFM st-dwn, 1.2MHz, 3.7V±2%, 600mA, CL, Vin>1.8V, HSST	USP-6EL	56dc5	DC1	9a	Tor
ES7	XC9237G37CER	DC-DC-IC	PWM-PWM/PFM, st-dwn, 3.7V±2%, 600mA, 1.2MHz, Vin>1.8V, HSST, CL	USP-6C	49dc5	DC1	9a	Tor
ES8	XC9237G38C4	DC/DC-IC	PWM/PFM st-dwn, 1.2MHz, 3.8V±2%, 600mA, CL, Vin>1.8V, HSST	USP-6EL	56dc5	DC1	9a	Tor
ES8	XC9237G38CER	DC-DC-IC	PWM-PWM/PFM, st-dwn, 3.8V±2%, 600mA, 1.2MHz, Vin>1.8V, HSST, CL	USP-6C	49dc5	DC1	9a	Tor
ES9	XC9237G39C4	DC/DC-IC	PWM/PFM st-dwn, 1.2MHz, 3.9V±2%, 600mA, CL, Vin>1.8V, HSST	USP-6EL	56dc5	DC1	9a	Tor
ES9	XC9237G39CER	DC-DC-IC	PWM-PWM/PFM, st-dwn, 3.9V±2%, 600mA, 1.2MHz, Vin>1.8V, HSST, CL	USP-6C	49dc5	DC1	9a	Tor
ESA	XC9237G3AC4	DC/DC-IC	PWM/PFM st-dwn, 1.2MHz, 3.05V±2%, 600mA, CL, Vin>1.8V, HSST	USP-6EL	56dc5	DC1	9a	Tor
ESA	XC9237G3ACER	DC-DC-IC	PWM-PWM/PFM, st-dwn, 3.05V±2%, 600mA, 1.2MHz, Vin>1.8V, HSST, CL	USP-6C	49dc5	DC1	9a	Tor
ESB	XC9237G3BC4	DC/DC-IC	PWM/PFM st-dwn, 1.2MHz, 3.15V±2%, 600mA, CL, Vin>1.8V, HSST	USP-6EL	56dc5	DC1	9a	Tor
ESB	XC9237G3BCER	DC-DC-IC	PWM-PWM/PFM, st-dwn, 3.15V±2%, 600mA, 1.2MHz, Vin>1.8V, HSST, CL	USP-6C	49dc5	DC1	9a	Tor
ESC	XC9237G3CC4	DC/DC-IC	PWM/PFM st-dwn, 1.2MHz, 3.25V±2%, 600mA, CL, Vin>1.8V, HSST	USP-6EL	56dc5	DC1	9a	Tor
ESC	XC9237G3CCER	DC-DC-IC	PWM-PWM/PFM, st-dwn, 3.25V±2%, 600mA, 1.2MHz, Vin>1.8V, HSST, CL	USP-6C	49dc5	DC1	9a	Tor
ESD	XC9237G3DC4	DC/DC-IC	PWM/PFM st-dwn, 1.2MHz, 3.35V±2%, 600mA, CL, Vin>1.8V, HSST	USP-6EL	56dc5	DC1	9a	Tor
ESD	XC9237G3DCER	DC-DC-IC	PWM-PWM/PFM, st-dwn, 3.35V±2%, 600mA, 1.2MHz, Vin>1.8V, HSST, CL	USP-6C	49dc5	DC1	9a	Tor
ESE	XC9237G3EC4	DC/DC-IC	PWM/PFM st-dwn, 1.2MHz, 3.45V±2%, 600mA, CL, Vin>1.8V, HSST	USP-6EL	56dc5	DC1	9a	Tor
ESE	XC9237G3ECER	DC-DC-IC	PWM-PWM/PFM, st-dwn, 3.45V±2%, 600mA, 1.2MHz, Vin>1.8V, HSST, CL	USP-6C	49dc5	DC1	9a	Tor
ESF	XC9237G3FC4	DC/DC-IC	PWM/PFM st-dwn, 1.2MHz, 3.55V±2%, 600mA, CL, Vin>1.8V, HSST	USP-6EL	56dc5	DC1	9a	Tor
ESF	XC9237G3FCER	DC-DC-IC	PWM-PWM/PFM, st-dwn, 3.55V±2%, 600mA, 1.2MHz, Vin>1.8V, HSST, CL	USP-6C	49dc5	DC1	9a	Tor
ESH	XC9237G3HC4	DC/DC-IC	PWM/PFM st-dwn, 1.2MHz, 3.65V±2%, 600mA, CL, Vin>1.8V, HSST	USP-6EL	56dc5	DC1	9a	Tor
ESH	XC9237G3HCER	DC-DC-IC	PWM-PWM/PFM, st-dwn, 3.65V±2%, 600mA, 1.2MHz, Vin>1.8V, HSST, CL	USP-6C	49dc5	DC1	9a	Tor
ESK	XC9237G3KC4	DC/DC-IC	PWM/PFM st-dwn, 1.2MHz, 3.75V±2%, 600mA, CL, Vin>1.8V, HSST	USP-6EL	56dc5	DC1	9a	Tor
ESK	XC9237G3KCER	DC-DC-IC	PWM-PWM/PFM, st-dwn, 3.75V±2%, 600mA, 1.2MHz, Vin>1.8V, HSST, CL	USP-6C	49dc5	DC1	9a	Tor
ESL	XC9237G3LC4	DC/DC-IC	PWM/PFM st-dwn, 1.2MHz, 3.85V±2%, 600mA, CL, Vin>1.8V, HSST	USP-6EL	56dc5	DC1	9a	Tor
ESL	XC9237G3LCER	DC-DC-IC	PWM-PWM/PFM, st-dwn, 3.85V±2%, 600mA, 1.2MHz, Vin>1.8V, HSST, CL	USP-6C	49dc5	DC1	9a	Tor
ESM	XC9237G3MC4	DC/DC-IC	PWM/PFM st-dwn, 1.2MHz, 3.95V±2%, 600mA, CL, Vin>1.8V, HSST	USP-6EL	56dc5	DC1	9a	Tor
ESM	XC9237G3MCER	DC-DC-IC	PWM-PWM/PFM, st-dwn, 3.95V±2%, 600mA, 1.2MHz, Vin>1.8V, HSST, CL	USP-6C	49dc5	DC1	9a	Tor
ET	R3114K481A	Vdet-IC	4.8V±0.8%, -Reset ODO	DFN1010-4	48vd9	VD9	9a	Ric
ET	XG6223G3B9R-G	LVR-IC	LDO, 3.45V±1%, 300mA, +CE, PDR, ICP	USPQ-4B03	48vm	VR4	9a	Tor
ET0	XC9237G40C4	DC/DC-IC	PWM/PFM st-dwn, 1.2MHz, 4.0V±2%, 600mA, CL, Vin>1.8V, HSST	USP-6EL	56dc5	DC1	9a	Tor
ET0	XC9237G40CER	DC-DC-IC	PWM-PWM/PFM, st-dwn, 4.0V±2%, 600mA, 1.2MHz, Vin>1.8V, HSST, CL	USP-6C	49dc5	DC1	9a	Tor
ET8	XG6215B092GR	LVR-IC	LDO, 0.9V±2%, 200mA, +CE	USP-4	45vm	VR4	9b	Tor
ET9	XG6215B102GR	LVR-IC	LDO, 1V±2%, 200mA, +CE	USP-4	45vm	VR4	9b	Tor
ETA	XG6215B112GR	LVR-IC	LDO, 1.1V±2%, 200mA, +CE	USP-4	45vm	VR4	9b	Tor
ETB	XG6215B122GR	LVR-IC	LDO, 1.2V±2%, 200mA, +CE	USP-4	45vm	VR4	9b	Tor
ETC	XG6215B132GR	LVR-IC	LDO, 1.3V±2%, 200mA, +CE	USP-4	45vm	VR4	9b	Tor
ETD	XG6215B142GR	LVR-IC	LDO, 1.4V±2%, 200mA, +CE	USP-4	45vm	VR4	9b	Tor
ETE	XG6215B152GR	LVR-IC	LDO, 1.5V±2%, 200mA, +CE	USP-4	45vm	VR4	9b	Tor
ETF	XG6215B162GR	LVR-IC	LDO, 1.6V±2%, 200mA, +CE	USP-4	45vm	VR4	9b	Tor
ETH	XG6215B172GR	LVR-IC	LDO, 1.7V±2%, 200mA, +CE	USP-4	45vm	VR4	9b	Tor
ETK	XG6215B182GR	LVR-IC	LDO, 1.8V±2%, 200mA, +CE	USP-4	45vm	VR4	9b	Tor
ETL	XG6215B192GR	LVR-IC	LDO, 1.9V±2%, 200mA, +CE	USP-4	45vm	VR4	9b	Tor
ETM	XG6215B202GR	LVR-IC	LDO, 2V±2%, 200mA, +CE	USP-4	45vm	VR4	9b	Tor



SMD code	Type	Function	Short description	Case	Pinout	Sch.	St.	Mnf.
ETN	XC6215B212GR	LVR-IC	LDO, 2.1V±2%, 200mA, +CE	USP-4	45vm	VR4	9b	Tor
ETP	XC6215B222GR	LVR-IC	LDO, 2.2V±2%, 200mA, +CE	USP-4	45vm	VR4	9b	Tor
ETR	XC6215B232GR	LVR-IC	LDO, 2.3V±2%, 200mA, +CE	USP-4	45vm	VR4	9b	Tor
ETS	XC6215B242GR	LVR-IC	LDO, 2.4V±2%, 200mA, +CE	USP-4	45vm	VR4	9b	Tor
ETT	XC6215B252GR	LVR-IC	LDO, 2.5V±2%, 200mA, +CE	USP-4	45vm	VR4	9b	Tor
ETU	XC6215B262GR	LVR-IC	LDO, 2.6V±2%, 200mA, +CE	USP-4	45vm	VR4	9b	Tor
ETV	XC6215B272GR	LVR-IC	LDO, 2.7V±2%, 200mA, +CE	USP-4	45vm	VR4	9b	Tor
ETX	XC6215B282GR	LVR-IC	LDO, 2.8V±2%, 200mA, +CE	USP-4	45vm	VR4	9b	Tor
ETY	XC6215B292GR	LVR-IC	LDO, 2.9V±2%, 200mA, +CE	USP-4	45vm	VR4	9b	Tor
ETZ	XC6215B302GR	LVR-IC	LDO, 3V±2%, 200mA, +CE	USP-4	45vm	VR4	9b	Tor
EU	R3114K491A	Vdet-IC	4.9V±0.8%, -Reset ODO	DFN1010-4	48vd9	VD9	9a	Ric
EU	XC6223G35B9R-G	LVR-IC	LDO, 3.55V±1%, 300mA, +CE, PDR, ICP	USPQ-4B03	48vm	VR4	9a	Tor
EU0	XC6215B312GR	LVR-IC	LDO, 3.1V±2%, 200mA, +CE	USP-4	45vm	VR4	9b	Tor
EU1	XC6215B322GR	LVR-IC	LDO, 3.2V±2%, 200mA, +CE	USP-4	45vm	VR4	9b	Tor
EU2	XC6215B332GR	LVR-IC	LDO, 3.3V±2%, 200mA, +CE	USP-4	45vm	VR4	9b	Tor
EU3	XC6215B342GR	LVR-IC	LDO, 3.4V±2%, 200mA, +CE	USP-4	45vm	VR4	9b	Tor
EU4	XC6215B352GR	LVR-IC	LDO, 3.5V±2%, 200mA, +CE	USP-4	45vm	VR4	9b	Tor
EU5	XC6215B362GR	LVR-IC	LDO, 3.6V±2%, 200mA, +CE	USP-4	45vm	VR4	9b	Tor
EU6	XC6215B372GR	LVR-IC	LDO, 3.7V±2%, 200mA, +CE	USP-4	45vm	VR4	9b	Tor
EU7	XC6215B382GR	LVR-IC	LDO, 3.8V±2%, 200mA, +CE	USP-4	45vm	VR4	9b	Tor
EU8	XC6215B392GR	LVR-IC	LDO, 3.9V±2%, 200mA, +CE	USP-4	45vm	VR4	9b	Tor
EU8	XC9237G08D4	DC/DC-IC	PWM/PFM st-dwn, 3MHz, 0.8V±2%, 600mA, CL, Vin>1.8V, HSST	USP-6EL	56dc5	DC1	9a	Tor
EU8	XC9237G08DER	DC-DC-IC	PWM-PWM/PFM, st-dwn, 0.8V±2%, 600mA, 3MHz, Vin>1.8V, HSST, CL	USP-6C	49dc5	DC1	9a	Tor
EU9	XC6215B402GR	LVR-IC	LDO, 4V±2%, 200mA, +CE	USP-4	45vm	VR4	9b	Tor
EU9	XC9237G09D4	DC/DC-IC	PWM/PFM st-dwn, 3MHz, 0.9V±2%, 600mA, CL, Vin>1.8V, HSST	USP-6EL	56dc5	DC1	9a	Tor
EU9	XC9237G09DER	DC-DC-IC	PWM-PWM/PFM, st-dwn, 0.9V±2%, 600mA, 3MHz, Vin>1.8V, HSST, CL	USP-6C	49dc5	DC1	9a	Tor
EUA	XC6215B412GR	LVR-IC	LDO, 4.1V±2%, 200mA, +CE	USP-4	45vm	VR4	9b	Tor
EUB	XC6215B422GR	LVR-IC	LDO, 4.2V±2%, 200mA, +CE	USP-4	45vm	VR4	9b	Tor
EUC	XC6215B432GR	LVR-IC	LDO, 4.3V±2%, 200mA, +CE	USP-4	45vm	VR4	9b	Tor
EUD	XC6215B442GR	LVR-IC	LDO, 4.4V±2%, 200mA, +CE	USP-4	45vm	VR4	9b	Tor
EUE	XC6215B452GR	LVR-IC	LDO, 4.5V±2%, 200mA, +CE	USP-4	45vm	VR4	9b	Tor
EUF	XC6215B462GR	LVR-IC	LDO, 4.6V±2%, 200mA, +CE	USP-4	45vm	VR4	9b	Tor
EUH	XC6215B472GR	LVR-IC	LDO, 4.7V±2%, 200mA, +CE	USP-4	45vm	VR4	9b	Tor
EUK	XC6215B482GR	LVR-IC	LDO, 4.8V±2%, 200mA, +CE	USP-4	45vm	VR4	9b	Tor
EUL	XC6215B492GR	LVR-IC	LDO, 4.9V±2%, 200mA, +CE	USP-4	45vm	VR4	9b	Tor
EUL	XC9237G0LD4	DC/DC-IC	PWM/PFM st-dwn, 3MHz, 0.85V±2%, 600mA, CL, Vin>1.8V, HSST	USP-6EL	56dc5	DC1	9a	Tor
EUL	XC9237G0LDER	DC-DC-IC	PWM-PWM/PFM, st-dwn, 0.85V±2%, 600mA, 3MHz, Vin>1.8V, HSST, CL	USP-6C	49dc5	DC1	9a	Tor
EUM	XC6215B502GR	LVR-IC	LDO, 5V±2%, 200mA, +CE	USP-4	45vm	VR4	9b	Tor
EUM	XC9237G0MD4	DC/DC-IC	PWM/PFM st-dwn, 3MHz, 0.95V±2%, 600mA, CL, Vin>1.8V, HSST	USP-6EL	56dc5	DC1	9a	Tor
EUM	XC9237G0MDER	DC-DC-IC	PWM-PWM/PFM, st-dwn, 0.95V±2%, 600mA, 3MHz, Vin>1.8V, HSST, CL	USP-6C	49dc5	DC1	9a	Tor
EV	R3114K501A	Vdet-IC	5V±0.8%, -Reset ODO	DFN1010-4	48vd9	VD9	9a	Ric
EV	XC6223G36B9R-G	LVR-IC	LDO, 3.65V±1%, 300mA, +CE, PDR, ICP	USPQ-4B03	48vm	VR4	9a	Tor
EV0	XC9237G10D4	DC/DC-IC	PWM/PFM st-dwn, 3MHz, 1.0V±2%, 600mA, CL, Vin>1.8V, HSST	USP-6EL	56dc5	DC1	9a	Tor
EV0	XC9237G10DER	DC-DC-IC	PWM-PWM/PFM, st-dwn, 1.0V±2%, 600mA, 3MHz, Vin>1.8V, HSST, CL	USP-6C	49dc5	DC1	9a	Tor
EV1	XC9237G11D4	DC/DC-IC	PWM/PFM st-dwn, 3MHz, 1.1V±2%, 600mA, CL, Vin>1.8V, HSST	USP-6EL	56dc5	DC1	9a	Tor
EV1	XC9237G11DER	DC-DC-IC	PWM-PWM/PFM, st-dwn, 1.1V±2%, 600mA, 3MHz, Vin>1.8V, HSST, CL	USP-6C	49dc5	DC1	9a	Tor
EV2	XC9237G12D4	DC/DC-IC	PWM/PFM st-dwn, 3MHz, 1.2V±2%, 600mA, CL, Vin>1.8V, HSST	USP-6EL	56dc5	DC1	9a	Tor
EV2	XC9237G12DER	DC-DC-IC	PWM-PWM/PFM, st-dwn, 1.2V±2%, 600mA, 3MHz, Vin>1.8V, HSST, CL	USP-6C	49dc5	DC1	9a	Tor
EV3	XC9237G13D4	DC/DC-IC	PWM/PFM st-dwn, 3MHz, 1.3V±2%, 600mA, CL, Vin>1.8V, HSST	USP-6EL	56dc5	DC1	9a	Tor
EV3	XC9237G13DER	DC-DC-IC	PWM-PWM/PFM, st-dwn, 1.3V±2%, 600mA, 3MHz, Vin>1.8V, HSST, CL	USP-6C	49dc5	DC1	9a	Tor
EV4	XC9237G14D4	DC/DC-IC	PWM/PFM st-dwn, 3MHz, 1.4V±2%, 600mA, CL, Vin>1.8V, HSST	USP-6EL	56dc5	DC1	9a	Tor
EV4	XC9237G14DER	DC-DC-IC	PWM-PWM/PFM, st-dwn, 1.4V±2%, 600mA, 3MHz, Vin>1.8V, HSST, CL	USP-6C	49dc5	DC1	9a	Tor
EV5	XC9237G15D4	DC/DC-IC	PWM/PFM st-dwn, 3MHz, 1.5V±2%, 600mA, CL, Vin>1.8V, HSST	USP-6EL	56dc5	DC1	9a	Tor
EV5	XC9237G15DER	DC-DC-IC	PWM-PWM/PFM, st-dwn, 1.5V±2%, 600mA, 3MHz, Vin>1.8V, HSST, CL	USP-6C	49dc5	DC1	9a	Tor
EV6	XC9237G16D4	DC/DC-IC	PWM/PFM st-dwn, 3MHz, 1.6V±2%, 600mA, CL, Vin>1.8V, HSST	USP-6EL	56dc5	DC1	9a	Tor
EV6	XC9237G16DER	DC-DC-IC	PWM-PWM/PFM, st-dwn, 1.6V±2%, 600mA, 3MHz, Vin>1.8V, HSST, CL	USP-6C	49dc5	DC1	9a	Tor
EV7	XC9237G17D4	DC/DC-IC	PWM/PFM st-dwn, 3MHz, 1.7V±2%, 600mA, CL, Vin>1.8V, HSST	USP-6EL	56dc5	DC1	9a	Tor
EV7	XC9237G17DER	DC-DC-IC	PWM-PWM/PFM, st-dwn, 1.7V±2%, 600mA, 3MHz, Vin>1.8V, HSST, CL	USP-6C	49dc5	DC1	9a	Tor
EV8	XC9237G18D4	DC/DC-IC	PWM/PFM st-dwn, 3MHz, 1.8V±2%, 600mA, CL, Vin>1.8V, HSST	USP-6EL	56dc5	DC1	9a	Tor
EV8	XC9237G18DER	DC-DC-IC	PWM-PWM/PFM, st-dwn, 1.8V±2%, 600mA, 3MHz, Vin>1.8V, HSST, CL	USP-6C	49dc5	DC1	9a	Tor
EV9	XC9237G19D4	DC/DC-IC	PWM/PFM st-dwn, 3MHz, 1.9V±2%, 600mA, CL, Vin>1.8V, HSST	USP-6EL	56dc5	DC1	9a	Tor
EV9	XC9237G19DER	DC-DC-IC	PWM-PWM/PFM, st-dwn, 1.9V±2%, 600mA, 3MHz, Vin>1.8V, HSST, CL	USP-6C	49dc5	DC1	9a	Tor
EVA	XC9237G1AD4	DC/DC-IC	PWM/PFM st-dwn, 3MHz, 1.05V±2%, 600mA, CL, Vin>1.8V, HSST	USP-6EL	56dc5	DC1	9a	Tor
EVA	XC9237G1ADER	DC-DC-IC	PWM-PWM/PFM, st-dwn, 1.05V±2%, 600mA, 3MHz, Vin>1.8V, HSST, CL	USP-6C	49dc5	DC1	9a	Tor
EVB	XC9237G1BD4	DC/DC-IC	PWM/PFM st-dwn, 3MHz, 1.15V±2%, 600mA, CL, Vin>1.8V, HSST	USP-6EL	56dc5	DC1	9a	Tor
EVB	XC9237G1BDER	DC-DC-IC	PWM-PWM/PFM, st-dwn, 1.15V±2%, 600mA, 3MHz, Vin>1.8V, HSST, CL	USP-6C	49dc5	DC1	9a	Tor
EVC	XC9237G1CD4	DC/DC-IC	PWM/PFM st-dwn, 3MHz, 1.25V±2%, 600mA, CL, Vin>1.8V, HSST	USP-6EL	56dc5	DC1	9a	Tor
EVC	XC9237G1CDER	DC-DC-IC	PWM-PWM/PFM, st-dwn, 1.25V±2%, 600mA, 3MHz, Vin>1.8V, HSST, CL	USP-6C	49dc5	DC1	9a	Tor
EVD	XC9237G1DD4	DC/DC-IC	PWM/PFM st-dwn, 3MHz, 1.35V±2%, 600mA, CL, Vin>1.8V, HSST	USP-6EL	56dc5	DC1	9a	Tor
EVD	XC9237G1DDER	DC-DC-IC	PWM-PWM/PFM, st-dwn, 1.35V±2%, 600mA, 3MHz, Vin>1.8V, HSST, CL	USP-6C	49dc5	DC1	9a	Tor



SMD code	Type	Function	Short description	Case	Pinout	Sch.	St.	Mnf.
EY8	XC9237G38D4	DC/DC-IC	PWM/PFM st-dwn, 3MHz, 3.8V±2%, 600mA, CL, Vin>1.8V, HSST	USP-6EL	56dc5	DC1	9a	Tor
EY8	XC9237G38DER	DC-DC-IC	PWM-PWM/PFM, st-dwn, 3.8V±2%, 600mA, 3MHz, Vin>1.8V, HSST, CL	USP-6C	49dc5	DC1	9a	Tor
EY9	XC9237G39D4	DC/DC-IC	PWM/PFM st-dwn, 3MHz, 3.9V±2%, 600mA, CL, Vin>1.8V, HSST	USP-6EL	56dc5	DC1	9a	Tor
EY9	XC9237G39DER	DC-DC-IC	PWM-PWM/PFM, st-dwn, 3.9V±2%, 600mA, 3MHz, Vin>1.8V, HSST, CL	USP-6C	49dc5	DC1	9a	Tor
EYA	XC9237G3AD4	DC/DC-IC	PWM/PFM st-dwn, 3MHz, 3.05V±2%, 600mA, CL, Vin>1.8V, HSST	USP-6EL	56dc5	DC1	9a	Tor
EYA	XC9237G3ADER	DC-DC-IC	PWM-PWM/PFM, st-dwn, 3.05V±2%, 600mA, 3MHz, Vin>1.8V, HSST, CL	USP-6C	49dc5	DC1	9a	Tor
EYB	XC9237G3BD4	DC/DC-IC	PWM/PFM st-dwn, 3MHz, 3.15V±2%, 600mA, CL, Vin>1.8V, HSST	USP-6EL	56dc5	DC1	9a	Tor
EYB	XC9237G3BDER	DC-DC-IC	PWM-PWM/PFM, st-dwn, 3.15V±2%, 600mA, 3MHz, Vin>1.8V, HSST, CL	USP-6C	49dc5	DC1	9a	Tor
EYC	XC9237G3CD4	DC/DC-IC	PWM/PFM st-dwn, 3MHz, 3.25V±2%, 600mA, CL, Vin>1.8V, HSST	USP-6EL	56dc5	DC1	9a	Tor
EYC	XC9237G3CDER	DC-DC-IC	PWM-PWM/PFM, st-dwn, 3.25V±2%, 600mA, 3MHz, Vin>1.8V, HSST, CL	USP-6C	49dc5	DC1	9a	Tor
EYD	XC9237G3DD4	DC/DC-IC	PWM/PFM st-dwn, 3MHz, 3.35V±2%, 600mA, CL, Vin>1.8V, HSST	USP-6EL	56dc5	DC1	9a	Tor
EYD	XC9237G3DDER	DC-DC-IC	PWM-PWM/PFM, st-dwn, 3.35V±2%, 600mA, 3MHz, Vin>1.8V, HSST, CL	USP-6C	49dc5	DC1	9a	Tor
EYE	XC9237G3ED4	DC/DC-IC	PWM/PFM st-dwn, 3MHz, 3.45V±2%, 600mA, CL, Vin>1.8V, HSST	USP-6EL	56dc5	DC1	9a	Tor
EYE	XC9237G3EDER	DC-DC-IC	PWM-PWM/PFM, st-dwn, 3.45V±2%, 600mA, 3MHz, Vin>1.8V, HSST, CL	USP-6C	49dc5	DC1	9a	Tor
EYF	XC9237G3FD4	DC/DC-IC	PWM/PFM st-dwn, 3MHz, 3.55V±2%, 600mA, CL, Vin>1.8V, HSST	USP-6EL	56dc5	DC1	9a	Tor
EYF	XC9237G3FDER	DC-DC-IC	PWM-PWM/PFM, st-dwn, 3.55V±2%, 600mA, 3MHz, Vin>1.8V, HSST, CL	USP-6C	49dc5	DC1	9a	Tor
EYH	XC9237G3HD4	DC/DC-IC	PWM/PFM st-dwn, 3MHz, 3.65V±2%, 600mA, CL, Vin>1.8V, HSST	USP-6EL	56dc5	DC1	9a	Tor
EYH	XC9237G3HDER	DC-DC-IC	PWM-PWM/PFM, st-dwn, 3.65V±2%, 600mA, 3MHz, Vin>1.8V, HSST, CL	USP-6C	49dc5	DC1	9a	Tor
EYK	XC9237G3KD4	DC/DC-IC	PWM/PFM st-dwn, 3MHz, 3.75V±2%, 600mA, CL, Vin>1.8V, HSST	USP-6EL	56dc5	DC1	9a	Tor
EYK	XC9237G3KDER	DC-DC-IC	PWM-PWM/PFM, st-dwn, 3.75V±2%, 600mA, 3MHz, Vin>1.8V, HSST, CL	USP-6C	49dc5	DC1	9a	Tor
EYL	XC9237G3LD4	DC/DC-IC	PWM/PFM st-dwn, 3MHz, 3.85V±2%, 600mA, CL, Vin>1.8V, HSST	USP-6EL	56dc5	DC1	9a	Tor
EYL	XC9237G3LDER	DC-DC-IC	PWM-PWM/PFM, st-dwn, 3.85V±2%, 600mA, 3MHz, Vin>1.8V, HSST, CL	USP-6C	49dc5	DC1	9a	Tor
EYM	XC9237G3MD4	DC/DC-IC	PWM/PFM st-dwn, 3MHz, 3.95V±2%, 600mA, CL, Vin>1.8V, HSST	USP-6EL	56dc5	DC1	9a	Tor
EYM	XC9237G3MDER	DC-DC-IC	PWM-PWM/PFM, st-dwn, 3.95V±2%, 600mA, 3MHz, Vin>1.8V, HSST, CL	USP-6C	49dc5	DC1	9a	Tor
EZ	RT9013-27PQ	LVR-IC	LDO, 2.7V±2%, 500mA, +CE	WDFN-6	49xv	VR4	9a	Ret
EZ	XC6223G39B9R-G	LVR-IC	LDO, 3.95V±1%, 300mA, +CE, PDR, ICP	USPQ-4B03	48vm	VR4	9a	Tor
EZ0	XC9237G40D4	DC/DC-IC	PWM/PFM st-dwn, 3MHz, 4.0V±2%, 600mA, CL, Vin>1.8V, HSST	USP-6EL	56dc5	DC1	9a	Tor
EZ0	XC9237G40DER	DC-DC-IC	PWM-PWM/PFM, st-dwn, 4.0V±2%, 600mA, 3MHz, Vin>1.8V, HSST, CL	USP-6C	49dc5	DC1	9a	Tor
F	HMPP-3862	PIN-diode	Dual, RF, Att, 50V±2%, 1A(1µs), <0.2pF, 22Q(1mA), <80ns	MP	37cs	-	-	Agi
F	HMPP-3865	PIN-diode	Dual, RF, Att, 50V±2%, 1A(1µs), <0.2pF, 22Q(1mA), <80ns	MP	37ct	-	-	Agi
F0	FP6121-CVSP	LVR-IC	LDO, Dual out, Vout1/Vout2=2.8V/1.8V±2%, 150mA, +CE	VSON-6	56xv	VR19	9m	Fit
F0	R3118K061C	Vdet-IC	0.6V±22.5mV, -Reset PPO, Sense	DFN1212-6	52z3	VD15	9a	Ric
F0	RP109L081D	LVR-IC	LDO, 0.8V±1%, 150mA, +CE, CL	DFN1010-4	48vm	VR4	9a	Ric
F0	XC6221B3117R	LVR-IC	LDO, 3.1V±1%, 200mA, +CE, CL	USPN-4	58vm	VR4	9a	Tor
F0A	XC6108C50AGR	Vdet-IC	5.0V±2%, Hysteresis, -Reset PPO	USP-4	45ro	VD15	9b	Tor
F0A	XC6127C55A7R	Vdet-IC	5.5V±0.8%, -Reset PPO, -MR, Rt=50ms	USPN-4	58cc	VD5	9h	Tor
F0B	XC6108C50BGR	Vdet-IC	5.0V±2%, -Reset PPO	USP-4	45ro	VD15	9b	Tor
F0B	XC6127C55B7R	Vdet-IC	5.5V±0.8%, -Reset PPO, -MR, Rt=100ms	USPN-4	58cc	VD5	9h	Tor
F0C	XC6108C50CGR	Vdet-IC	5.0V±2%, Hysteresis, -Reset PPO	USP-4	45m	VD15	9b	Tor
F0C	XC6127C55C7R	Vdet-IC	5.5V±0.8%, -Reset PPO, -MR, Rt=200ms	USPN-4	58cc	VD5	9h	Tor
F0D	XC6108C50DGR	Vdet-IC	5.0V±2%, -Reset PPO	USP-4	45m	VD15	9b	Tor
F0D	XC6127C55D7R	Vdet-IC	5.5V±0.8%, -Reset PPO, -MR, Rt=400ms	USPN-4	58cc	VD5	9h	Tor
F0E	XC6127C55E7R	Vdet-IC	5.5V±0.8%, -Reset PPO, -MR, Rt=800ms	USPN-4	58cc	VD5	9h	Tor
F0F	XC6127C55F7R	Vdet-IC	5.5V±0.8%, +Reset PPO, -MR, Rt=50ms	USPN-4	58cc	VD5	9h	Tor
F0H	XC6127C55G7R	Vdet-IC	5.5V±0.8%, +Reset PPO, -MR, Rt=100ms	USPN-4	58cc	VD5	9h	Tor
F0K	XC6127C55H7R	Vdet-IC	5.5V±0.8%, +Reset PPO, -MR, Rt=200ms	USPN-4	58cc	VD5	9h	Tor
F0L	XC6127C55J7R	Vdet-IC	5.5V±0.8%, +Reset PPO, -MR, Rt=400ms	USPN-4	58cc	VD5	9h	Tor
F0M	XC6127C55K7R	Vdet-IC	5.5V±0.8%, +Reset PPO, -MR, Rt=800ms	USPN-4	58cc	VD5	9h	Tor
f1	FP6121-DVSP	LVR-IC	LDO, Dual out, Vout1/Vout2=2.5V/1.8V±2%, 150mA, +CE	VSON-6	56xv	VR19	9m	Fit
F1	R3118K071C	Vdet-IC	0.7V±22.5mV, -Reset PPO, Sense	DFN1212-6	52z3	VD15	9a	Ric
F1	RP109L091D	LVR-IC	LDO, 0.9V±1%, 150mA, +CE, CL	DFN1010-4	48vm	VR4	9a	Ric
F1	XC6221B3217R	LVR-IC	LDO, 3.2V±1%, 200mA, +CE, CL	USPN-4	58vm	VR4	9a	Tor
F125	R1182K121D5	LVR-IC	LDO, 1.25V±2%, 150mA, +CE, CL	PLP1616-6	66ys	VR4	9b	Ric
F12D	R1182K121D	LVR-IC	LDO, 1.2V±2%, 150mA, +CE, CL	PLP1616-6	66ys	VR4	9b	Ric
F13D	R1182K131D	LVR-IC	LDO, 1.3V±2%, 150mA, +CE, CL	PLP1616-6	66ys	VR4	9b	Ric
F14D	R1182K141D	LVR-IC	LDO, 1.4V±2%, 150mA, +CE, CL	PLP1616-6	66ys	VR4	9b	Ric
F15D	R1182K151D	LVR-IC	LDO, 1.5V±2%, 150mA, +CE, CL	PLP1616-6	66ys	VR4	9b	Ric
F16D	R1182K161D	LVR-IC	LDO, 1.6V±2%, 150mA, +CE, CL	PLP1616-6	66ys	VR4	9b	Ric
F17D	R1182K171D	LVR-IC	LDO, 1.7V±2%, 150mA, +CE, CL	PLP1616-6	66ys	VR4	9b	Ric
F185	R1182K181D5	LVR-IC	LDO, 1.85V±2%, 150mA, +CE, CL	PLP1616-6	66ys	VR4	9b	Ric
F18D	R1182K181D	LVR-IC	LDO, 1.8V±2%, 150mA, +CE, CL	PLP1616-6	66ys	VR4	9b	Ric
F19D	R1182K191D	LVR-IC	LDO, 1.9V±2%, 150mA, +CE, CL	PLP1616-6	66ys	VR4	9b	Ric
f2	FP6121-EVSP	LVR-IC	LDO, Dual out, Vout1/Vout2=3.0V/1.8V±2%, 150mA, +CE	VSON-6	56xv	VR19	9m	Fit
F2	LM4954TL	LIN-IC	AF PA, BTL, 2.7..9V, 3W(6V/80), shutdown	BGA-9	39	AFP44	-	Nsc
F2	R3118K081C	Vdet-IC	0.8V±22.5mV, -Reset PPO, Sense	DFN1212-6	52z3	VD15	9a	Ric
F2	RP109L101D	LVR-IC	LDO, 1.0V±1%, 150mA, +CE, CL	DFN1010-4	48vm	VR4	9a	Ric
F2	XC6221B3317R	LVR-IC	LDO, 3.3V±1%, 200mA, +CE, CL	USPN-4	58vm	VR4	9a	Tor
F2	XC6223H12B9R-G	LVR-IC	LDO, 1.25V±20mV, 300mA, +CE, CL, PDR, ICP	USPQ-4B03	48vm	VR4	9a	Tor
F20D	R1182K201D	LVR-IC	LDO, 2V±2%, 150mA, +CE, CL	PLP1616-6	66ys	VR4	9b	Ric
F21D	R1182K211D	LVR-IC	LDO, 2.1V±2%, 150mA, +CE, CL	PLP1616-6	66ys	VR4	9b	Ric



SMD code	Type	Function	Short description	Case	Pinout	Sch.	St.Mnf.
F22D	R1182K221D	LVR-IC	LDO, 2.2V±2%, 150mA, +CE, CL	PLP1616-6	66ys	VR4	9b Ric
F23D	R1182K231D	LVR-IC	LDO, 2.3V±2%, 150mA, +CE, CL	PLP1616-6	66ys	VR4	9b Ric
F24D	R1182K241D	LVR-IC	LDO, 2.4V±2%, 150mA, +CE, CL	PLP1616-6	66ys	VR4	9b Ric
F25D	R1182K251D	LVR-IC	LDO, 2.5V±2%, 150mA, +CE, CL	PLP1616-6	66ys	VR4	9b Ric
I26	XC7WH126GD	CMOS-Logic	Dual bus buffer with 3-state output	SOT996-2	54LLog54	-	9a Phi
F26D	R1182K261D	LVR-IC	LDO, 2.6V±2%, 150mA, +CE, CL	PLP1616-6	66ys	VR4	9b Ric
F27D	R1182K271D	LVR-IC	LDO, 2.7V±2%, 150mA, +CE, CL	PLP1616-6	66ys	VR4	9b Ric
F285	R1182K281D5	LVR-IC	LDO, 2.85V±2%, 150mA, +CE, CL	PLP1616-6	66ys	VR4	9b Ric
F28D	R1182K281D	LVR-IC	LDO, 2.8V±2%, 150mA, +CE, CL	PLP1616-6	66ys	VR4	9b Ric
F29D	R1182K291D	LVR-IC	LDO, 2.9V±2%, 150mA, +CE, CL	PLP1616-6	66ys	VR4	9b Ric
I3	FP6121-FVSP	LVR-IC	LDO, Dual out, Vout1/Vout2=1.8V/2.8V±2%, 150mA, +CE	VSON-6	56xv	VR19	9m Fit
F3	R3118K091C	Vdel-IC	0.9V±22.5mV, -Reset PPO, Sense	DFN1212-6	52z3	VD15	9a Ric
F3	RP109L111D	LVR-IC	LDO, 1.1V±1%, 150mA, +CE, CL	DFN1010-4	48vm	VR4	9a Ric
F3	XC6221B3417R	LVR-IC	LDO, 3.4V±1%, 200mA, +CE, CL	USPN-4	58vm	VR4	9a Tor
F3	XC6223H13B9R-G	LVR-IC	LDO, 1.35V±20mV, 300mA, +CE, CL, PDR, ICP	USPQ-4B03	48vm	VR4	9a Tor
F30D	R1182K301D	LVR-IC	LDO, 3V±2%, 150mA, +CE, CL	PLP1616-6	66ys	VR4	9b Ric
F31D	R1182K311D	LVR-IC	LDO, 3.1V±2%, 150mA, +CE, CL	PLP1616-6	66ys	VR4	9b Ric
F32D	R1182K321D	LVR-IC	LDO, 3.2V±2%, 150mA, +CE, CL	PLP1616-6	66ys	VR4	9b Ric
F33D	R1182K331D	LVR-IC	LDO, 3.3V±2%, 150mA, +CE, CL	PLP1616-6	66ys	VR4	9b Ric
F34D	R1182K341D	LVR-IC	LDO, 3.4V±2%, 150mA, +CE, CL	PLP1616-6	66ys	VR4	9b Ric
F35D	R1182K351D	LVR-IC	LDO, 3.5V±2%, 150mA, +CE, CL	PLP1616-6	66ys	VR4	9b Ric
F36D	R1182K361D	LVR-IC	LDO, 3.6V±2%, 150mA, +CE, CL	PLP1616-6	66ys	VR4	9b Ric
F37D	R1182K371D	LVR-IC	LDO, 3.7V±2%, 150mA, +CE, CL	PLP1616-6	66ys	VR4	9b Ric
F38D	R1182K381D	LVR-IC	LDO, 3.8V±2%, 150mA, +CE, CL	PLP1616-6	66ys	VR4	9b Ric
F39D	R1182K391D	LVR-IC	LDO, 3.9V±2%, 150mA, +CE, CL	PLP1616-6	66ys	VR4	9b Ric
I4	FP6121-GVSP	LVR-IC	LDO, Dual out, Vout1/Vout2=2.8V/2.8V±2%, 150mA, +CE	VSON-6	56xv	VR19	9m Fit
F4	R3118K101C	Vdel-IC	1.0V±22.5mV, -Reset PPO, Sense	DFN1212-6	52z3	VD15	9a Ric
F4	RP109L121D	LVR-IC	LDO, 1.2V±1%, 150mA, +CE, CL	DFN1010-4	48vm	VR4	9a Ric
F4	XC6221B3517R	LVR-IC	LDO, 3.5V±1%, 200mA, +CE, CL	USPN-4	58vm	VR4	9a Tor
F4	XC6223H14B9R-G	LVR-IC	LDO, 1.45V±20mV, 300mA, +CE, CL, PDR, ICP	USPQ-4B03	48vm	VR4	9a Tor
F40D	R1182K401D	LVR-IC	LDO, 4V±2%, 150mA, +CE, CL	PLP1616-6	66ys	VR4	9b Ric
I5	FP6121-HVSP	LVR-IC	LDO, Dual out, Vout1/Vout2=1.5V/2.8V±2%, 150mA, +CE	VSON-6	56xv	VR19	9m Fit
F5	R3118K111C	Vdel-IC	1.1V±22.5mV, -Reset PPO, Sense	DFN1212-6	52z3	VD15	9a Ric
F5	RP109L131D	LVR-IC	LDO, 1.3V±1%, 150mA, +CE, CL	DFN1010-4	48vm	VR4	9a Ric
F5	XC6221B3617R	LVR-IC	LDO, 3.6V±1%, 200mA, +CE, CL	USPN-4	58vm	VR4	9a Tor
F5	XC6223H15B9R-G	LVR-IC	LDO, 1.55V±20mV, 300mA, +CE, CL, PDR, ICP	USPQ-4B03	48vm	VR4	9a Tor
I6	FP6121-IVSP	LVR-IC	LDO, Dual out, Vout1/Vout2=1.8V/3.3V±2%, 150mA, +CE	VSON-6	56xv	VR19	9m Fit
F6	R3118K121C	Vdel-IC	1.2V±22.5mV, -Reset PPO, Sense	DFN1212-6	52z3	VD15	9a Ric
F6	RP109L141D	LVR-IC	LDO, 1.4V±1%, 150mA, +CE, CL	DFN1010-4	48vm	VR4	9a Ric
F6	XC6221B3717R	LVR-IC	LDO, 3.7V±1%, 200mA, +CE, CL	USPN-4	58vm	VR4	9a Tor
F6	XC6223H16B9R-G	LVR-IC	LDO, 1.65V±20mV, 300mA, +CE, CL, PDR, ICP	USPQ-4B03	48vm	VR4	9a Tor
I7	FP6121-JVSP	LVR-IC	LDO, Dual out, Vout1/Vout2=1.3V/2.8V±2%, 150mA, +CE	VSON-6	56xv	VR19	9m Fit
F7	R3118K131C	Vdel-IC	1.3V±22.5mV, -Reset PPO, Sense	DFN1212-6	52z3	VD15	9a Ric
F7	RP109L151D	LVR-IC	LDO, 1.5V±1%, 150mA, +CE, CL	DFN1010-4	48vm	VR4	9a Ric
F7	XC6221B3817R	LVR-IC	LDO, 3.8V±1%, 200mA, +CE, CL	USPN-4	58vm	VR4	9a Tor
F7	XC6223H17B9R-G	LVR-IC	LDO, 1.75V±20mV, 300mA, +CE, CL, PDR, ICP	USPQ-4B03	48vm	VR4	9a Tor
I8	FP6121-KVSP	LVR-IC	LDO, Dual out, Vout1/Vout2=1.2V/2.8V±2%, 150mA, +CE	VSON-6	56xv	VR19	9m Fit
F8	R3118K141C	Vdel-IC	1.4V±22.5mV, -Reset PPO, Sense	DFN1212-6	52z3	VD15	9a Ric
F8	RP109L161D	LVR-IC	LDO, 1.6V±1%, 150mA, +CE, CL	DFN1010-4	48vm	VR4	9a Ric
F8	XC6221B3917R	LVR-IC	LDO, 3.9V±1%, 200mA, +CE, CL	USPN-4	58vm	VR4	9a Tor
F8	XC6223H18B9R-G	LVR-IC	LDO, 1.85V±20mV, 300mA, +CE, CL, PDR, ICP	USPQ-4B03	48vm	VR4	9a Tor
I9	FP6121-MVSP	LVR-IC	LDO, Dual out, Vout1/Vout2=1.8V/3.0V±2%, 150mA, +CE	VSON-6	56xv	VR19	9m Fit
F9	LM4928TL	LIN-IC	AF PA, BTL, 2.4. 5.5V, 1.2W(5V/8Q), shutdown	BGA-16	39	-	- Nsc
F9	R3118K151C	Vdel-IC	1.5V±22.5mV, -Reset PPO, Sense	DFN1212-6	52z3	VD15	9a Ric
F9	RP109L171D	LVR-IC	LDO, 1.7V±1%, 150mA, +CE, CL	DFN1010-4	48vm	VR4	9a Ric
F9	XC6221B4017R	LVR-IC	LDO, 4V±1%, 200mA, +CE, CL	USPN-4	58vm	VR4	9a Tor
F9	XC6223H19B9R-G	LVR-IC	LDO, 1.95V±20mV, 300mA, +CE, CL, PDR, ICP	USPQ-4B03	48vm	VR4	9a Tor
FA	R3114K071C	Vdel-IC	0.7V±0.8%, -Reset PPO	DFN1010-4	48vd9	VD7	9a Ric
FA	R3134K101C	Vdel-IC	1.0V±1.8%, -Reset PPO, -MR	DFN1212-6	52z6	VD5	9a Ric
FA	XC6223H20B9R-G	LVR-IC	LDO, 2.05V±1%, 300mA, +CE, CL, PDR, ICP	USPQ-4B03	48vm	VR4	9a Tor
FA11G	AIC1747-11GDA	LVR-IC	LDO, 1.1V±2%, 300mA, +CE	DFN-6L	52ub	VR7	9c Aic
FA12G	AIC1747-12GDA	LVR-IC	LDO, 1.2V±2%, 300mA, +CE	DFN-6L	52ub	VR7	9c Aic
FA13G	AIC1747-13GDA	LVR-IC	LDO, 1.3V±2%, 300mA, +CE	DFN-6L	52ub	VR7	9c Aic
FA15G	AIC1747-15GDA	LVR-IC	LDO, 1.5V±2%, 300mA, +CE	DFN-6L	52ub	VR7	9c Aic
FA18G	AIC1747-18GDA	LVR-IC	LDO, 1.8V±2%, 300mA, +CE	DFN-6L	52ub	VR7	9c Aic
FA20G	AIC1747-20GDA	LVR-IC	LDO, 2.0V±2%, 300mA, +CE	DFN-6L	52ub	VR7	9c Aic
FA25G	AIC1747-25GDA	LVR-IC	LDO, 2.5V±2%, 300mA, +CE	DFN-6L	52ub	VR7	9c Aic
FA27G	AIC1747-27GDA	LVR-IC	LDO, 2.7V±2%, 300mA, +CE	DFN-6L	52ub	VR7	9c Aic
FA2JG	AIC1747-285GDA	LVR-IC	LDO, 2.85V±2%, 300mA, +CE	DFN-6L	52ub	VR7	9c Aic
FA30G	AIC1747-30GDA	LVR-IC	LDO, 3.0V±2%, 300mA, +CE	DFN-6L	52ub	VR7	9c Aic



SMD code	Type	Function	Short description	Case	Pinout	Sch.	St.	Mnf.
FA33G	AIC1747-33GDA	LVR-IC	LDO, 3.3V±2%, 300mA, +CE	DFN-6L	52ub	VR7	9c	Aic
FA35G	AIC1747-35GDA	LVR-IC	LDO, 3.5V±2%, 300mA, +CE	DFN-6L	52ub	VR7	9c	Aic
FA37G	AIC1747-37GDA	LVR-IC	LDO, 3.7V±2%, 300mA, +CE	DFN-6L	52ub	VR7	9c	Aic
FA38G	AIC1747-38GDA	LVR-IC	LDO, 3.8V±2%, 300mA, +CE	DFN-6L	52ub	VR7	9c	Aic
FAA	XC6127C15A7R	Vdet-IC	1.5V±0.8%, -Reset PPO, -MR, Rt=50ms	USPN-4	58cc	VD5	9th	Tor
FAB	XC6127C15B7R	Vdet-IC	1.5V±0.8%, -Reset PPO, -MR, Rt=100ms	USPN-4	58cc	VD5	9th	Tor
FAC	XC6127C15C7R	Vdet-IC	1.5V±0.8%, -Reset PPO, -MR, Rt=200ms	USPN-4	58cc	VD5	9th	Tor
FAD	XC6127C15D7R	Vdet-IC	1.5V±0.8%, -Reset PPO, -MR, Rt=400ms	USPN-4	58cc	VD5	9th	Tor
FAE	XC6127C15E7R	Vdet-IC	1.5V±0.8%, -Reset PPO, -MR, Rt=800ms	USPN-4	58cc	VD5	9th	Tor
FAF	XC6127C15F7R	Vdet-IC	1.5V±0.8%, +Reset PPO, -MR, Rt=50ms	USPN-4	58cc	VD5	9th	Tor
FAH	XC6127C15G7R	Vdet-IC	1.5V±0.8%, +Reset PPO, -MR, Rt=100ms	USPN-4	58cc	VD5	9th	Tor
FAK	XC6127C15H7R	Vdet-IC	1.5V±0.8%, +Reset PPO, -MR, Rt=200ms	USPN-4	58cc	VD5	9th	Tor
FAL	XC6127C15J7R	Vdet-IC	1.5V±0.8%, +Reset PPO, -MR, Rt=400ms	USPN-4	58cc	VD5	9th	Tor
FAM	XC6127C15K7R	Vdet-IC	1.5V±0.8%, +Reset PPO, -MR, Rt=800ms	USPN-4	58cc	VD5	9th	Tor
FAN	XC6127C16A7R	Vdet-IC	1.6V±0.8%, -Reset PPO, -MR, Rt=50ms	USPN-4	58cc	VD5	9th	Tor
FAP	XC6127C16B7R	Vdet-IC	1.6V±0.8%, -Reset PPO, -MR, Rt=100ms	USPN-4	58cc	VD5	9th	Tor
FAR	XC6127C16C7R	Vdet-IC	1.6V±0.8%, -Reset PPO, -MR, Rt=200ms	USPN-4	58cc	VD5	9th	Tor
FAS	XC6127C16D7R	Vdet-IC	1.6V±0.8%, -Reset PPO, -MR, Rt=400ms	USPN-4	58cc	VD5	9th	Tor
FAT	XC6127C16E7R	Vdet-IC	1.6V±0.8%, -Reset PPO, -MR, Rt=800ms	USPN-4	58cc	VD5	9th	Tor
FAU	XC6127C16F7R	Vdet-IC	1.6V±0.8%, +Reset PPO, -MR, Rt=50ms	USPN-4	58cc	VD5	9th	Tor
FAV	XC6127C16G7R	Vdet-IC	1.6V±0.8%, +Reset PPO, -MR, Rt=100ms	USPN-4	58cc	VD5	9th	Tor
FAX	XC6127C16H7R	Vdet-IC	1.6V±0.8%, +Reset PPO, -MR, Rt=200ms	USPN-4	58cc	VD5	9th	Tor
FAY	XC6127C16J7R	Vdet-IC	1.6V±0.8%, +Reset PPO, -MR, Rt=400ms	USPN-4	58cc	VD5	9th	Tor
FAZ	XC6127C16K7R	Vdet-IC	1.6V±0.8%, +Reset PPO, -MR, Rt=800ms	USPN-4	58cc	VD5	9th	Tor
FB	R3114K08IC	Vdet-IC	0.8V±0.8%, -Reset PPO	DFN1010-4	48vd9	VD7	9a	Ric
FB	R3134K11EC	Vdet-IC	1.1V±1.8%, -Reset PPO, -MR	DFN1212-6	52z6	VD5	9a	Ric
FB	XC6223H21B9R-G	LVR-IC	LDO, 2.15V±1%, 300mA, +CE, CL, PDR, ICP	USPQ-4B03	48vm	VR4	9a	Tor
FBA	XC6127C17A7R	Vdet-IC	1.7V±0.8%, -Reset PPO, -MR, Rt=50ms	USPN-4	58cc	VD5	9th	Tor
FBB	XC6127C17B7R	Vdet-IC	1.7V±0.8%, -Reset PPO, -MR, Rt=100ms	USPN-4	58cc	VD5	9th	Tor
FBC	XC6127C17C7R	Vdet-IC	1.7V±0.8%, -Reset PPO, -MR, Rt=200ms	USPN-4	58cc	VD5	9th	Tor
FBD	XC6127C17D7R	Vdet-IC	1.7V±0.8%, -Reset PPO, -MR, Rt=400ms	USPN-4	58cc	VD5	9th	Tor
FBE	XC6127C17E7R	Vdet-IC	1.7V±0.8%, -Reset PPO, -MR, Rt=800ms	USPN-4	58cc	VD5	9th	Tor
FBF	XC6127C17F7R	Vdet-IC	1.7V±0.8%, +Reset PPO, -MR, Rt=50ms	USPN-4	58cc	VD5	9th	Tor
FBH	XC6127C17G7R	Vdet-IC	1.7V±0.8%, +Reset PPO, -MR, Rt=100ms	USPN-4	58cc	VD5	9th	Tor
FBK	XC6127C17H7R	Vdet-IC	1.7V±0.8%, +Reset PPO, -MR, Rt=200ms	USPN-4	58cc	VD5	9th	Tor
FBL	XC6127C17J7R	Vdet-IC	1.7V±0.8%, +Reset PPO, -MR, Rt=400ms	USPN-4	58cc	VD5	9th	Tor
FBM	XC6127C17K7R	Vdet-IC	1.7V±0.8%, +Reset PPO, -MR, Rt=800ms	USPN-4	58cc	VD5	9th	Tor
FBN	XC6127C18A7R	Vdet-IC	1.8V±0.8%, -Reset PPO, -MR, Rt=50ms	USPN-4	58cc	VD5	9th	Tor
FBP	XC6127C18B7R	Vdet-IC	1.8V±0.8%, -Reset PPO, -MR, Rt=100ms	USPN-4	58cc	VD5	9th	Tor
FBR	XC6127C18C7R	Vdet-IC	1.8V±0.8%, -Reset PPO, -MR, Rt=200ms	USPN-4	58cc	VD5	9th	Tor
FBS	XC6127C18D7R	Vdet-IC	1.8V±0.8%, -Reset PPO, -MR, Rt=400ms	USPN-4	58cc	VD5	9th	Tor
FBT	XC6127C18E7R	Vdet-IC	1.8V±0.8%, -Reset PPO, -MR, Rt=800ms	USPN-4	58cc	VD5	9th	Tor
FBU	XC6127C18F7R	Vdet-IC	1.8V±0.8%, +Reset PPO, -MR, Rt=50ms	USPN-4	58cc	VD5	9th	Tor
FBV	XC6127C18G7R	Vdet-IC	1.8V±0.8%, +Reset PPO, -MR, Rt=100ms	USPN-4	58cc	VD5	9th	Tor
FBX	XC6127C18H7R	Vdet-IC	1.8V±0.8%, +Reset PPO, -MR, Rt=200ms	USPN-4	58cc	VD5	9th	Tor
FBY	XC6127C18J7R	Vdet-IC	1.8V±0.8%, +Reset PPO, -MR, Rt=400ms	USPN-4	58cc	VD5	9th	Tor
FBZ	XC6127C18K7R	Vdet-IC	1.8V±0.8%, +Reset PPO, -MR, Rt=800ms	USPN-4	58cc	VD5	9th	Tor
FC	R3114K09IC	Vdet-IC	0.9V±0.8%, -Reset PPO	DFN1010-4	48vd9	VD7	9a	Ric
FC	R3134K12EC	Vdet-IC	1.2V±1.8%, -Reset PPO, -MR	DFN1212-6	52z6	VD5	9a	Ric
FC	XC6223H22B9R-G	LVR-IC	LDO, 2.25V±1%, 300mA, +CE, CL, PDR, ICP	USPQ-4B03	48vm	VR4	9a	Tor
FCA	XC6127C19A7R	Vdet-IC	1.9V±0.8%, -Reset PPO, -MR, Rt=50ms	USPN-4	58cc	VD5	9th	Tor
FCB	XC6127C19B7R	Vdet-IC	1.9V±0.8%, -Reset PPO, -MR, Rt=100ms	USPN-4	58cc	VD5	9th	Tor
FCC	XC6127C19C7R	Vdet-IC	1.9V±0.8%, -Reset PPO, -MR, Rt=200ms	USPN-4	58cc	VD5	9th	Tor
FCD	XC6127C19D7R	Vdet-IC	1.9V±0.8%, -Reset PPO, -MR, Rt=400ms	USPN-4	58cc	VD5	9th	Tor
FCE	XC6127C19E7R	Vdet-IC	1.9V±0.8%, -Reset PPO, -MR, Rt=800ms	USPN-4	58cc	VD5	9th	Tor
FCF	XC6127C19F7R	Vdet-IC	1.9V±0.8%, +Reset PPO, -MR, Rt=50ms	USPN-4	58cc	VD5	9th	Tor
FCH	XC6127C19G7R	Vdet-IC	1.9V±0.8%, +Reset PPO, -MR, Rt=100ms	USPN-4	58cc	VD5	9th	Tor
FCK	XC6127C19H7R	Vdet-IC	1.9V±0.8%, +Reset PPO, -MR, Rt=200ms	USPN-4	58cc	VD5	9th	Tor
FCL	XC6127C19J7R	Vdet-IC	1.9V±0.8%, +Reset PPO, -MR, Rt=400ms	USPN-4	58cc	VD5	9th	Tor
FCM	XC6127C19K7R	Vdet-IC	1.9V±0.8%, +Reset PPO, -MR, Rt=800ms	USPN-4	58cc	VD5	9th	Tor
FCN	XC6127C20A7R	Vdet-IC	2.0V±0.8%, -Reset PPO, -MR, Rt=50ms	USPN-4	58cc	VD5	9th	Tor
FCP	XC6127C20B7R	Vdet-IC	2.0V±0.8%, -Reset PPO, -MR, Rt=100ms	USPN-4	58cc	VD5	9th	Tor
FCR	XC6127C20C7R	Vdet-IC	2.0V±0.8%, -Reset PPO, -MR, Rt=200ms	USPN-4	58cc	VD5	9th	Tor
FCS	XC6127C20D7R	Vdet-IC	2.0V±0.8%, -Reset PPO, -MR, Rt=400ms	USPN-4	58cc	VD5	9th	Tor
FCT	XC6127C20E7R	Vdet-IC	2.0V±0.8%, -Reset PPO, -MR, Rt=800ms	USPN-4	58cc	VD5	9th	Tor
FCU	XC6127C20F7R	Vdet-IC	2.0V±0.8%, +Reset PPO, -MR, Rt=50ms	USPN-4	58cc	VD5	9th	Tor
FCV	XC6127C20G7R	Vdet-IC	2.0V±0.8%, +Reset PPO, -MR, Rt=100ms	USPN-4	58cc	VD5	9th	Tor
FCX	XC6127C20H7R	Vdet-IC	2.0V±0.8%, +Reset PPO, -MR, Rt=200ms	USPN-4	58cc	VD5	9th	Tor
FCY	XC6127C20J7R	Vdet-IC	2.0V±0.8%, +Reset PPO, -MR, Rt=400ms	USPN-4	58cc	VD5	9th	Tor
FCZ	XC6127C20K7R	Vdet-IC	2.0V±0.8%, +Reset PPO, -MR, Rt=800ms	USPN-4	58cc	VD5	9th	Tor



SMD
code

Type

Function

Short description

Case

Pinout Sch. St.Mnf.

SMD code	Type	Function	Short description	Case	Pinout	Sch.	St.Mnf.
FD	R3114K101C	Vdet-IC	1.0V±0.8%, -Reset PPO	DFN1010-4	48vd9	VD7	9a Ric
FD	R3134K13EC	Vdet-IC	1.3V±1.8%, -Reset PPO, -MR	DFN1212-6	52z6	VD5	9a Ric
FD	RT9193-24GQW	LVR-IC	LDO, 2.4V±1%, 300mA, +CE	WDFN-6L	49ub	VR7	9a Ret
FD	XC6223H23B9R-G	LVR-IC	LDO, 2.35V±1%, 300mA, +CE, CL, PDR, ICP	USPQ-4B03	48vm	VR4	9a Tor
FDA	XC6127C21A7R	Vdet-IC	2.1V±0.8%, -Reset PPO, -MR, Rt=50ms	USPN-4	58cc	VD5	9th Tor
FDB	XC6127C21B7R	Vdet-IC	2.1V±0.8%, -Reset PPO, -MR, Rt=100ms	USPN-4	58cc	VD5	9th Tor
FDC	XC6127C21C7R	Vdet-IC	2.1V±0.8%, -Reset PPO, -MR, Rt=200ms	USPN-4	58cc	VD5	9th Tor
FDD	XC6127C21D7R	Vdet-IC	2.1V±0.8%, -Reset PPO, -MR, Rt=400ms	USPN-4	58cc	VD5	9th Tor
FDE	XC6127C21E7R	Vdet-IC	2.1V±0.8%, -Reset PPO, -MR, Rt=800ms	USPN-4	58cc	VD5	9th Tor
FDG	XC6127C21F7R	Vdet-IC	2.1V±0.8%, +Reset PPO, -MR, Rt=50ms	USPN-4	58cc	VD5	9th Tor
FDH	XC6127C21G7R	Vdet-IC	2.1V±0.8%, +Reset PPO, -MR, Rt=100ms	USPN-4	58cc	VD5	9th Tor
FDK	XC6127C21H7R	Vdet-IC	2.1V±0.8%, +Reset PPO, -MR, Rt=200ms	USPN-4	58cc	VD5	9th Tor
FDL	XC6127C21J7R	Vdet-IC	2.1V±0.8%, +Reset PPO, -MR, Rt=400ms	USPN-4	58cc	VD5	9th Tor
FDM	XC6127C21K7R	Vdet-IC	2.1V±0.8%, +Reset PPO, -MR, Rt=800ms	USPN-4	58cc	VD5	9th Tor
FDN	XC6127C22A7R	Vdet-IC	2.2V±0.8%, -Reset PPO, -MR, Rt=50ms	USPN-4	58cc	VD5	9th Tor
FDP	XC6127C22B7R	Vdet-IC	2.2V±0.8%, -Reset PPO, -MR, Rt=100ms	USPN-4	58cc	VD5	9th Tor
FDR	XC6127C22C7R	Vdet-IC	2.2V±0.8%, -Reset PPO, -MR, Rt=200ms	USPN-4	58cc	VD5	9th Tor
FDS	XC6127C22D7R	Vdet-IC	2.2V±0.8%, -Reset PPO, -MR, Rt=400ms	USPN-4	58cc	VD5	9th Tor
FDT	XC6127C22E7R	Vdet-IC	2.2V±0.8%, -Reset PPO, -MR, Rt=800ms	USPN-4	58cc	VD5	9th Tor
FDU	XC6127C22F7R	Vdet-IC	2.2V±0.8%, +Reset PPO, -MR, Rt=50ms	USPN-4	58cc	VD5	9th Tor
FDV	XC6127C22G7R	Vdet-IC	2.2V±0.8%, +Reset PPO, -MR, Rt=100ms	USPN-4	58cc	VD5	9th Tor
FDX	XC6127C22H7R	Vdet-IC	2.2V±0.8%, +Reset PPO, -MR, Rt=200ms	USPN-4	58cc	VD5	9th Tor
FDY	XC6127C22J7R	Vdet-IC	2.2V±0.8%, +Reset PPO, -MR, Rt=400ms	USPN-4	58cc	VD5	9th Tor
FDZ	XC6127C22K7R	Vdet-IC	2.2V±0.8%, +Reset PPO, -MR, Rt=800ms	USPN-4	58cc	VD5	9th Tor
FE	R3114K111C	Vdet-IC	1.1V±0.8%, -Reset PPO	DFN1010-4	48vd9	VD7	9a Ric
FE	R3134K14EC	Vdet-IC	1.4V±1.8%, -Reset PPO, -MR	DFN1212-6	52z6	VD5	9a Ric
FE	XC6223H24B9R-G	LVR-IC	LDO, 2.45V±1%, 300mA, +CE, CL, PDR, ICP	USPQ-4B03	48vm	VR4	9a Tor
FEA	XC6127C23A7R	Vdet-IC	2.3V±0.8%, -Reset PPO, -MR, Rt=50ms	USPN-4	58cc	VD5	9th Tor
FEB	XC6127C23B7R	Vdet-IC	2.3V±0.8%, -Reset PPO, -MR, Rt=100ms	USPN-4	58cc	VD5	9th Tor
FEC	XC6127C23C7R	Vdet-IC	2.3V±0.8%, -Reset PPO, -MR, Rt=200ms	USPN-4	58cc	VD5	9th Tor
FED	XC6127C23D7R	Vdet-IC	2.3V±0.8%, -Reset PPO, -MR, Rt=400ms	USPN-4	58cc	VD5	9th Tor
FEE	XC6127C23E7R	Vdet-IC	2.3V±0.8%, -Reset PPO, -MR, Rt=800ms	USPN-4	58cc	VD5	9th Tor
FEF	XC6127C23F7R	Vdet-IC	2.3V±0.8%, +Reset PPO, -MR, Rt=50ms	USPN-4	58cc	VD5	9th Tor
FEH	XC6127C23G7R	Vdet-IC	2.3V±0.8%, +Reset PPO, -MR, Rt=100ms	USPN-4	58cc	VD5	9th Tor
FEK	XC6127C23H7R	Vdet-IC	2.3V±0.8%, +Reset PPO, -MR, Rt=200ms	USPN-4	58cc	VD5	9th Tor
FEL	XC6127C23J7R	Vdet-IC	2.3V±0.8%, +Reset PPO, -MR, Rt=400ms	USPN-4	58cc	VD5	9th Tor
FEM	XC6127C23K7R	Vdet-IC	2.3V±0.8%, +Reset PPO, -MR, Rt=800ms	USPN-4	58cc	VD5	9th Tor
FEN	XC6127C24A7R	Vdet-IC	2.4V±0.8%, -Reset PPO, -MR, Rt=50ms	USPN-4	58cc	VD5	9th Tor
FEP	XC6127C24B7R	Vdet-IC	2.4V±0.8%, -Reset PPO, -MR, Rt=100ms	USPN-4	58cc	VD5	9th Tor
FER	XC6127C24C7R	Vdet-IC	2.4V±0.8%, -Reset PPO, -MR, Rt=200ms	USPN-4	58cc	VD5	9th Tor
FES	XC6127C24D7R	Vdet-IC	2.4V±0.8%, -Reset PPO, -MR, Rt=400ms	USPN-4	58cc	VD5	9th Tor
FET	XC6127C24E7R	Vdet-IC	2.4V±0.8%, -Reset PPO, -MR, Rt=800ms	USPN-4	58cc	VD5	9th Tor
FEU	XC6127C24F7R	Vdet-IC	2.4V±0.8%, +Reset PPO, -MR, Rt=50ms	USPN-4	58cc	VD5	9th Tor
FEV	XC6127C24G7R	Vdet-IC	2.4V±0.8%, +Reset PPO, -MR, Rt=100ms	USPN-4	58cc	VD5	9th Tor
FEX	XC6127C24H7R	Vdet-IC	2.4V±0.8%, +Reset PPO, -MR, Rt=200ms	USPN-4	58cc	VD5	9th Tor
FEY	XC6127C24J7R	Vdet-IC	2.4V±0.8%, +Reset PPO, -MR, Rt=400ms	USPN-4	58cc	VD5	9th Tor
FEZ	XC6127C24K7R	Vdet-IC	2.4V±0.8%, +Reset PPO, -MR, Rt=800ms	USPN-4	58cc	VD5	9th Tor
FF	R3114K121C	Vdet-IC	1.2V±0.8%, -Reset PPO	DFN1010-4	48vd9	VD7	9a Ric
FF	R3134K15EC	Vdet-IC	1.5V±1.8%, -Reset PPO, -MR	DFN1212-6	52z6	VD5	9a Ric
FF	XC6223H25B9R-G	LVR-IC	LDO, 2.55V±1%, 300mA, +CE, CL, PDR, ICP	USPQ-4B03	48vm	VR4	9a Tor
FFA	XC6127C25A7R	Vdet-IC	2.5V±0.8%, -Reset PPO, -MR, Rt=50ms	USPN-4	58cc	VD5	9th Tor
FFB	XC6127C25B7R	Vdet-IC	2.5V±0.8%, -Reset PPO, -MR, Rt=100ms	USPN-4	58cc	VD5	9th Tor
FFC	XC6127C25C7R	Vdet-IC	2.5V±0.8%, -Reset PPO, -MR, Rt=200ms	USPN-4	58cc	VD5	9th Tor
FFD	XC6127C25D7R	Vdet-IC	2.5V±0.8%, -Reset PPO, -MR, Rt=400ms	USPN-4	58cc	VD5	9th Tor
FFE	XC6127C25E7R	Vdet-IC	2.5V±0.8%, -Reset PPO, -MR, Rt=800ms	USPN-4	58cc	VD5	9th Tor
FFF	XC6127C25F7R	Vdet-IC	2.5V±0.8%, +Reset PPO, -MR, Rt=50ms	USPN-4	58cc	VD5	9th Tor
FFH	XC6127C25G7R	Vdet-IC	2.5V±0.8%, +Reset PPO, -MR, Rt=100ms	USPN-4	58cc	VD5	9th Tor
FFK	XC6127C25H7R	Vdet-IC	2.5V±0.8%, +Reset PPO, -MR, Rt=200ms	USPN-4	58cc	VD5	9th Tor
FFL	XC6127C25J7R	Vdet-IC	2.5V±0.8%, +Reset PPO, -MR, Rt=400ms	USPN-4	58cc	VD5	9th Tor
FFM	XC6127C25K7R	Vdet-IC	2.5V±0.8%, +Reset PPO, -MR, Rt=800ms	USPN-4	58cc	VD5	9th Tor
FFN	XC6127C26A7R	Vdet-IC	2.6V±0.8%, -Reset PPO, -MR, Rt=50ms	USPN-4	58cc	VD5	9th Tor
FFP	XC6127C26B7R	Vdet-IC	2.6V±0.8%, -Reset PPO, -MR, Rt=100ms	USPN-4	58cc	VD5	9th Tor
FFR	XC6127C26C7R	Vdet-IC	2.6V±0.8%, -Reset PPO, -MR, Rt=200ms	USPN-4	58cc	VD5	9th Tor
FFS	XC6127C26D7R	Vdet-IC	2.6V±0.8%, -Reset PPO, -MR, Rt=400ms	USPN-4	58cc	VD5	9th Tor
FFT	XC6127C26E7R	Vdet-IC	2.6V±0.8%, -Reset PPO, -MR, Rt=800ms	USPN-4	58cc	VD5	9th Tor
FFU	XC6127C26F7R	Vdet-IC	2.6V±0.8%, +Reset PPO, -MR, Rt=50ms	USPN-4	58cc	VD5	9th Tor
FFV	XC6127C26G7R	Vdet-IC	2.6V±0.8%, +Reset PPO, -MR, Rt=100ms	USPN-4	58cc	VD5	9th Tor
FFX	XC6127C26H7R	Vdet-IC	2.6V±0.8%, +Reset PPO, -MR, Rt=200ms	USPN-4	58cc	VD5	9th Tor
FFY	XC6127C26J7R	Vdet-IC	2.6V±0.8%, +Reset PPO, -MR, Rt=400ms	USPN-4	58cc	VD5	9th Tor
FFZ	XC6127C26K7R	Vdet-IC	2.6V±0.8%, +Reset PPO, -MR, Rt=800ms	USPN-4	58cc	VD5	9th Tor



SMD code	Type	Function	Short description	Case	Pinout	Sch.	St.Mnf.
FG	R3114K131C	Vdet-IC	1.3V±0.8%, -Reset PPO	DFN1010-4	48vd9	VD7	9a Ric
FG	R3134K16EC	Vdet-IC	1.6V±1.8%, -Reset PPO, -MR	DFN1212-6	52z6	VD5	9a Ric
FH	R3114K141C	Vdet-IC	1.4V±0.8%, -Reset PPO	DFN1010-4	48vd9	VD7	9a Ric
FH	R3134K17EC	Vdet-IC	1.7V±1.8%, -Reset PPO, -MR	DFN1212-6	52z6	VD5	9a Ric
FH	XC6223H26B9R-G	LVR-IC	LDO, 2.65V±1%, 300mA, +CE, CL, PDR, ICP	USPQ-4B03	48vm	VR4	9a Tor
FHA	XC6127C27A7R	Vdet-IC	2.7V±0.8%, -Reset PPO, -MR, Rt=50ms	USPN-4	58cc	VD5	9th Tor
FHB	XC6127C27B7R	Vdet-IC	2.7V±0.8%, -Reset PPO, -MR, Rt=100ms	USPN-4	58cc	VD5	9th Tor
FHC	XC6127C27C7R	Vdet-IC	2.7V±0.8%, -Reset PPO, -MR, Rt=200ms	USPN-4	58cc	VD5	9th Tor
FHD	XC6127C27D7R	Vdet-IC	2.7V±0.8%, -Reset PPO, -MR, Rt=400ms	USPN-4	58cc	VD5	9th Tor
FHE	XC6127C27E7R	Vdet-IC	2.7V±0.8%, -Reset PPO, -MR, Rt=800ms	USPN-4	58cc	VD5	9th Tor
FHF	XC6127C27F7R	Vdet-IC	2.7V±0.8%, +Reset PPO, -MR, Rt=50ms	USPN-4	58cc	VD5	9th Tor
FHH	XC6127C27G7R	Vdet-IC	2.7V±0.8%, +Reset PPO, -MR, Rt=100ms	USPN-4	58cc	VD5	9th Tor
FHK	XC6127C27H7R	Vdet-IC	2.7V±0.8%, +Reset PPO, -MR, Rt=200ms	USPN-4	58cc	VD5	9th Tor
FHL	XC6127C27J7R	Vdet-IC	2.7V±0.8%, +Reset PPO, -MR, Rt=400ms	USPN-4	58cc	VD5	9th Tor
FHM	XC6127C27K7R	Vdet-IC	2.7V±0.8%, +Reset PPO, -MR, Rt=800ms	USPN-4	58cc	VD5	9th Tor
FHN	XC6127C28A7R	Vdet-IC	2.8V±0.8%, -Reset PPO, -MR, Rt=50ms	USPN-4	58cc	VD5	9th Tor
FHP	XC6127C28B7R	Vdet-IC	2.8V±0.8%, -Reset PPO, -MR, Rt=100ms	USPN-4	58cc	VD5	9th Tor
FHR	XC6127C28C7R	Vdet-IC	2.8V±0.8%, -Reset PPO, -MR, Rt=200ms	USPN-4	58cc	VD5	9th Tor
FHS	XC6127C28D7R	Vdet-IC	2.8V±0.8%, -Reset PPO, -MR, Rt=400ms	USPN-4	58cc	VD5	9th Tor
FHT	XC6127C28E7R	Vdet-IC	2.8V±0.8%, -Reset PPO, -MR, Rt=800ms	USPN-4	58cc	VD5	9th Tor
FHU	XC6127C28F7R	Vdet-IC	2.8V±0.8%, +Reset PPO, -MR, Rt=50ms	USPN-4	58cc	VD5	9th Tor
FHV	XC6127C28G7R	Vdet-IC	2.8V±0.8%, +Reset PPO, -MR, Rt=100ms	USPN-4	58cc	VD5	9th Tor
FHX	XC6127C28H7R	Vdet-IC	2.8V±0.8%, +Reset PPO, -MR, Rt=200ms	USPN-4	58cc	VD5	9th Tor
FHY	XC6127C28J7R	Vdet-IC	2.8V±0.8%, +Reset PPO, -MR, Rt=400ms	USPN-4	58cc	VD5	9th Tor
FHZ	XC6127C28K7R	Vdet-IC	2.8V±0.8%, +Reset PPO, -MR, Rt=800ms	USPN-4	58cc	VD5	9th Tor
FJ	R3114K151C	Vdet-IC	1.5V±0.8%, -Reset PPO	DFN1010-4	48vd9	VD7	9a Ric
FJ	R3134K18EC	Vdet-IC	1.8V±1.8%, -Reset PPO, -MR	DFN1212-6	52z6	VD5	9a Ric
FJ	RT9193-2HGQW	LVR-IC	LDO, 2.85V±1%, 300mA, +CE	WDFN-6L	49ub	VR7	9a Ric
FJ11G	AIC1746-11GDA	LVR-IC	LDO, 1.1V±2%, 150mA, +CE	DFN-6L	52ub	VR7	9c Aic
FJ12G	AIC1746-12GDA	LVR-IC	LDO, 1.2V±2%, 150mA, +CE	DFN-6L	52ub	VR7	9c Aic
FJ13G	AIC1746-13GDA	LVR-IC	LDO, 1.3V±2%, 150mA, +CE	DFN-6L	52ub	VR7	9c Aic
FJ15G	AIC1746-15GDA	LVR-IC	LDO, 1.5V±2%, 150mA, +CE	DFN-6L	52ub	VR7	9c Aic
FJ18G	AIC1746-18GDA	LVR-IC	LDO, 1.8V±2%, 150mA, +CE	DFN-6L	52ub	VR7	9c Aic
FJ20G	AIC1746-20GDA	LVR-IC	LDO, 2.0V±2%, 150mA, +CE	DFN-6L	52ub	VR7	9c Aic
FJ25G	AIC1746-25GDA	LVR-IC	LDO, 2.5V±2%, 150mA, +CE	DFN-6L	52ub	VR7	9c Aic
FJ27G	AIC1746-27GDA	LVR-IC	LDO, 2.7V±2%, 150mA, +CE	DFN-6L	52ub	VR7	9c Aic
FJ2JG	AIC1746-285GDA	LVR-IC	LDO, 2.85V±2%, 150mA, +CE	DFN-6L	52ub	VR7	9c Aic
FJ30G	AIC1746-30GDA	LVR-IC	LDO, 3.0V±2%, 150mA, +CE	DFN-6L	52ub	VR7	9c Aic
FJ33G	AIC1746-33GDA	LVR-IC	LDO, 3.3V±2%, 150mA, +CE	DFN-6L	52ub	VR7	9c Aic
FJ35G	AIC1746-35GDA	LVR-IC	LDO, 3.5V±2%, 150mA, +CE	DFN-6L	52ub	VR7	9c Aic
FJ37G	AIC1746-37GDA	LVR-IC	LDO, 3.7V±2%, 150mA, +CE	DFN-6L	52ub	VR7	9c Aic
FJ38G	AIC1746-38GDA	LVR-IC	LDO, 3.8V±2%, 150mA, +CE	DFN-6L	52ub	VR7	9c Aic
FK	R3114K161C	Vdet-IC	1.6V±0.8%, -Reset PPO	DFN1010-4	48vd9	VD7	9a Ric
FK	R3134K19EC	Vdet-IC	1.9V±1.8%, -Reset PPO, -MR	DFN1212-6	52z6	VD5	9a Ric
FK	XC6223H27B9R-G	LVR-IC	LDO, 2.75V±1%, 300mA, +CE, CL, PDR, ICP	USPQ-4B03	48vm	VR4	9a Tor
FKA	XC6127C29A7R	Vdet-IC	2.9V±0.8%, -Reset PPO, -MR, Rt=50ms	USPN-4	58cc	VD5	9th Tor
FKB	XC6127C29B7R	Vdet-IC	2.9V±0.8%, -Reset PPO, -MR, Rt=100ms	USPN-4	58cc	VD5	9th Tor
FKC	XC6127C29C7R	Vdet-IC	2.9V±0.8%, -Reset PPO, -MR, Rt=200ms	USPN-4	58cc	VD5	9th Tor
FKD	XC6127C29D7R	Vdet-IC	2.9V±0.8%, -Reset PPO, -MR, Rt=400ms	USPN-4	58cc	VD5	9th Tor
FKE	XC6127C29E7R	Vdet-IC	2.9V±0.8%, -Reset PPO, -MR, Rt=800ms	USPN-4	58cc	VD5	9th Tor
FKF	XC6127C29F7R	Vdet-IC	2.9V±0.8%, +Reset PPO, -MR, Rt=50ms	USPN-4	58cc	VD5	9th Tor
FKH	XC6127C29G7R	Vdet-IC	2.9V±0.8%, +Reset PPO, -MR, Rt=100ms	USPN-4	58cc	VD5	9th Tor
FKK	XC6127C29H7R	Vdet-IC	2.9V±0.8%, +Reset PPO, -MR, Rt=200ms	USPN-4	58cc	VD5	9th Tor
FKL	XC6127C29J7R	Vdet-IC	2.9V±0.8%, +Reset PPO, -MR, Rt=400ms	USPN-4	58cc	VD5	9th Tor
FKM	XC6127C29K7R	Vdet-IC	2.9V±0.8%, +Reset PPO, -MR, Rt=800ms	USPN-4	58cc	VD5	9th Tor
FKN	XC6127C30A7R	Vdet-IC	3.0V±0.8%, -Reset PPO, -MR, Rt=50ms	USPN-4	58cc	VD5	9th Tor
FKP	XC6127C30B7R	Vdet-IC	3.0V±0.8%, -Reset PPO, -MR, Rt=100ms	USPN-4	58cc	VD5	9th Tor
FKR	XC6127C30C7R	Vdet-IC	3.0V±0.8%, -Reset PPO, -MR, Rt=200ms	USPN-4	58cc	VD5	9th Tor
FKS	XC6127C30D7R	Vdet-IC	3.0V±0.8%, -Reset PPO, -MR, Rt=400ms	USPN-4	58cc	VD5	9th Tor
FKT	XC6127C30E7R	Vdet-IC	3.0V±0.8%, -Reset PPO, -MR, Rt=800ms	USPN-4	58cc	VD5	9th Tor
FKU	XC6127C30F7R	Vdet-IC	3.0V±0.8%, +Reset PPO, -MR, Rt=50ms	USPN-4	58cc	VD5	9th Tor
FKV	XC6127C30G7R	Vdet-IC	3.0V±0.8%, +Reset PPO, -MR, Rt=100ms	USPN-4	58cc	VD5	9th Tor
FKX	XC6127C30H7R	Vdet-IC	3.0V±0.8%, +Reset PPO, -MR, Rt=200ms	USPN-4	58cc	VD5	9th Tor
FKY	XC6127C30J7R	Vdet-IC	3.0V±0.8%, +Reset PPO, -MR, Rt=400ms	USPN-4	58cc	VD5	9th Tor
FKZ	XC6127C30K7R	Vdet-IC	3.0V±0.8%, +Reset PPO, -MR, Rt=800ms	USPN-4	58cc	VD5	9th Tor
FL	R3114K171C	Vdet-IC	1.7V±0.8%, -Reset PPO	DFN1010-4	48vd9	VD7	9a Ric
FL	R3134K20EC	Vdet-IC	2.0V±1.8%, -Reset PPO, -MR	DFN1212-6	52z6	VD5	9a Ric
FL	XC6223H28B9R-G	LVR-IC	LDO, 2.85V±1%, 300mA, +CE, CL, PDR, ICP	USPQ-4B03	48vm	VR4	9a Tor
FLA	XC6127C31A7R	Vdet-IC	3.1V±0.8%, -Reset PPO, -MR, Rt=50ms	USPN-4	58cc	VD5	9th Tor
FLB	XC6127C31B7R	Vdet-IC	3.1V±0.8%, -Reset PPO, -MR, Rt=100ms	USPN-4	58cc	VD5	9th Tor



SMD code	Type	Function	Short description	Case	Pinout	Sch.	St.	Mnf.
FLC	XC6127C31C7R	Vdet-IC	3.1V±0.8%, -Reset PPO, -MR, Rt=200ms	USPN-4	58cc	VD5	9th	Tor
FLD	XC6127C31D7R	Vdet-IC	3.1V±0.8%, -Reset PPO, -MR, Rt=400ms	USPN-4	58cc	VD5	9th	Tor
FLE	XC6127C31E7R	Vdet-IC	3.1V±0.8%, -Reset PPO, -MR, Rt=800ms	USPN-4	58cc	VD5	9th	Tor
FLF	XC6127C31F7R	Vdet-IC	3.1V±0.8%, +Reset PPO, -MR, Rt=50ms	USPN-4	58cc	VD5	9th	Tor
FLH	XC6127C31G7R	Vdet-IC	3.1V±0.8%, +Reset PPO, -MR, Rt=100ms	USPN-4	58cc	VD5	9th	Tor
FLK	XC6127C31H7R	Vdet-IC	3.1V±0.8%, +Reset PPO, -MR, Rt=200ms	USPN-4	58cc	VD5	9th	Tor
FLL	XC6127C31J7R	Vdet-IC	3.1V±0.8%, +Reset PPO, -MR, Rt=400ms	USPN-4	58cc	VD5	9th	Tor
FLM	XC6127C31K7R	Vdet-IC	3.1V±0.8%, +Reset PPO, -MR, Rt=800ms	USPN-4	58cc	VD5	9th	Tor
FLN	XC6127C32A7R	Vdet-IC	3.2V±0.8%, -Reset PPO, -MR, Rt=50ms	USPN-4	58cc	VD5	9th	Tor
FLP	XC6127C32B7R	Vdet-IC	3.2V±0.8%, -Reset PPO, -MR, Rt=100ms	USPN-4	58cc	VD5	9th	Tor
FLR	XC6127C32C7R	Vdet-IC	3.2V±0.8%, -Reset PPO, -MR, Rt=200ms	USPN-4	58cc	VD5	9th	Tor
FLS	XC6127C32D7R	Vdet-IC	3.2V±0.8%, -Reset PPO, -MR, Rt=400ms	USPN-4	58cc	VD5	9th	Tor
FLT	XC6127C32E7R	Vdet-IC	3.2V±0.8%, -Reset PPO, -MR, Rt=800ms	USPN-4	58cc	VD5	9th	Tor
FLU	XC6127C32F7R	Vdet-IC	3.2V±0.8%, +Reset PPO, -MR, Rt=50ms	USPN-4	58cc	VD5	9th	Tor
FLV	XC6127C32G7R	Vdet-IC	3.2V±0.8%, +Reset PPO, -MR, Rt=100ms	USPN-4	58cc	VD5	9th	Tor
FLX	XC6127C32H7R	Vdet-IC	3.2V±0.8%, +Reset PPO, -MR, Rt=200ms	USPN-4	58cc	VD5	9th	Tor
FLY	XC6127C32J7R	Vdet-IC	3.2V±0.8%, +Reset PPO, -MR, Rt=400ms	USPN-4	58cc	VD5	9th	Tor
FLZ	XC6127C32K7R	Vdet-IC	3.2V±0.8%, +Reset PPO, -MR, Rt=800ms	USPN-4	58cc	VD5	9th	Tor
FM	XC75H125GF	CMOS-Logic	Bus buffer gate with 3-state output	SOT891	52/Log14	-	9a	Phi
FM	XC75H125GM	CMOS-Logic	Bus buffer gate with 3-state output	SOT-886	57/Log14	-	9a	Phi
FM	R3114K181C	Vdet-IC	1.8V±0.8%, -Reset PPO	DFN1010-4	48vd9	VD7	9a	Ric
FM	R3134K21EC	Vdet-IC	2.1V±1.8%, -Reset PPO, -MR	DFN1212-6	52z6	VD5	9a	Ric
FM	XC6223H29B9R-G	LVR-IC	LDO, 2.95V±1%, 300mA, +CE, CL, PDR, ICP	USPQ-4B03	48vm	VR4	9a	Tor
FMA	XC6127C33A7R	Vdet-IC	3.3V±0.8%, -Reset PPO, -MR, Rt=50ms	USPN-4	58cc	VD5	9th	Tor
FMB	XC6127C33B7R	Vdet-IC	3.3V±0.8%, -Reset PPO, -MR, Rt=100ms	USPN-4	58cc	VD5	9th	Tor
FMC	XC6127C33C7R	Vdet-IC	3.3V±0.8%, -Reset PPO, -MR, Rt=200ms	USPN-4	58cc	VD5	9th	Tor
FMD	XC6127C33D7R	Vdet-IC	3.3V±0.8%, -Reset PPO, -MR, Rt=400ms	USPN-4	58cc	VD5	9th	Tor
FME	XC6127C33E7R	Vdet-IC	3.3V±0.8%, -Reset PPO, -MR, Rt=800ms	USPN-4	58cc	VD5	9th	Tor
FMF	XC6127C33F7R	Vdet-IC	3.3V±0.8%, +Reset PPO, -MR, Rt=50ms	USPN-4	58cc	VD5	9th	Tor
FMH	XC6127C33G7R	Vdet-IC	3.3V±0.8%, +Reset PPO, -MR, Rt=100ms	USPN-4	58cc	VD5	9th	Tor
FMK	XC6127C33H7R	Vdet-IC	3.3V±0.8%, +Reset PPO, -MR, Rt=200ms	USPN-4	58cc	VD5	9th	Tor
FML	XC6127C33J7R	Vdet-IC	3.3V±0.8%, +Reset PPO, -MR, Rt=400ms	USPN-4	58cc	VD5	9th	Tor
FMM	XC6127C33K7R	Vdet-IC	3.3V±0.8%, +Reset PPO, -MR, Rt=800ms	USPN-4	58cc	VD5	9th	Tor
FMN	XC6127C34A7R	Vdet-IC	3.4V±0.8%, -Reset PPO, -MR, Rt=50ms	USPN-4	58cc	VD5	9th	Tor
FMP	XC6127C34B7R	Vdet-IC	3.4V±0.8%, -Reset PPO, -MR, Rt=100ms	USPN-4	58cc	VD5	9th	Tor
FMR	XC6127C34C7R	Vdet-IC	3.4V±0.8%, -Reset PPO, -MR, Rt=200ms	USPN-4	58cc	VD5	9th	Tor
FMS	XC6127C34D7R	Vdet-IC	3.4V±0.8%, -Reset PPO, -MR, Rt=400ms	USPN-4	58cc	VD5	9th	Tor
FMT	XC6127C34E7R	Vdet-IC	3.4V±0.8%, -Reset PPO, -MR, Rt=800ms	USPN-4	58cc	VD5	9th	Tor
FMU	XC6127C34F7R	Vdet-IC	3.4V±0.8%, +Reset PPO, -MR, Rt=50ms	USPN-4	58cc	VD5	9th	Tor
FMV	XC6127C34G7R	Vdet-IC	3.4V±0.8%, +Reset PPO, -MR, Rt=100ms	USPN-4	58cc	VD5	9th	Tor
FMX	XC6127C34H7R	Vdet-IC	3.4V±0.8%, +Reset PPO, -MR, Rt=200ms	USPN-4	58cc	VD5	9th	Tor
FMY	XC6127C34J7R	Vdet-IC	3.4V±0.8%, +Reset PPO, -MR, Rt=400ms	USPN-4	58cc	VD5	9th	Tor
FMZ	XC6127C34K7R	Vdet-IC	3.4V±0.8%, +Reset PPO, -MR, Rt=800ms	USPN-4	58cc	VD5	9th	Tor
FN	R3114K191C	Vdet-IC	1.9V±0.8%, -Reset PPO	DFN1010-4	48vd9	VD7	9a	Ric
FN	R3134K22EC	Vdet-IC	2.2V±1.8%, -Reset PPO, -MR	DFN1212-6	52z6	VD5	9a	Ric
FN	XC6223H30B9R-G	LVR-IC	LDO, 3.05V±1%, 300mA, +CE, CL, PDR, ICP	USPQ-4B03	48vm	VR4	9a	Tor
FNA	XC6127C35A7R	Vdet-IC	3.5V±0.8%, -Reset PPO, -MR, Rt=50ms	USPN-4	58cc	VD5	9th	Tor
FNB	XC6127C35B7R	Vdet-IC	3.5V±0.8%, -Reset PPO, -MR, Rt=100ms	USPN-4	58cc	VD5	9th	Tor
FNC	XC6127C35C7R	Vdet-IC	3.5V±0.8%, -Reset PPO, -MR, Rt=200ms	USPN-4	58cc	VD5	9th	Tor
FND	XC6127C35D7R	Vdet-IC	3.5V±0.8%, -Reset PPO, -MR, Rt=400ms	USPN-4	58cc	VD5	9th	Tor
FNE	XC6127C35E7R	Vdet-IC	3.5V±0.8%, -Reset PPO, -MR, Rt=800ms	USPN-4	58cc	VD5	9th	Tor
FNF	XC6127C35F7R	Vdet-IC	3.5V±0.8%, +Reset PPO, -MR, Rt=50ms	USPN-4	58cc	VD5	9th	Tor
FNH	XC6127C35G7R	Vdet-IC	3.5V±0.8%, +Reset PPO, -MR, Rt=100ms	USPN-4	58cc	VD5	9th	Tor
FNK	XC6127C35H7R	Vdet-IC	3.5V±0.8%, +Reset PPO, -MR, Rt=200ms	USPN-4	58cc	VD5	9th	Tor
FNL	XC6127C35J7R	Vdet-IC	3.5V±0.8%, +Reset PPO, -MR, Rt=400ms	USPN-4	58cc	VD5	9th	Tor
FNM	XC6127C35K7R	Vdet-IC	3.5V±0.8%, +Reset PPO, -MR, Rt=800ms	USPN-4	58cc	VD5	9th	Tor
FNN	XC6127C36A7R	Vdet-IC	3.6V±0.8%, -Reset PPO, -MR, Rt=50ms	USPN-4	58cc	VD5	9th	Tor
FNP	XC6127C36B7R	Vdet-IC	3.6V±0.8%, -Reset PPO, -MR, Rt=100ms	USPN-4	58cc	VD5	9th	Tor
FNR	XC6127C36C7R	Vdet-IC	3.6V±0.8%, -Reset PPO, -MR, Rt=200ms	USPN-4	58cc	VD5	9th	Tor
FNS	XC6127C36D7R	Vdet-IC	3.6V±0.8%, -Reset PPO, -MR, Rt=400ms	USPN-4	58cc	VD5	9th	Tor
FNT	XC6127C36E7R	Vdet-IC	3.6V±0.8%, -Reset PPO, -MR, Rt=800ms	USPN-4	58cc	VD5	9th	Tor
FNU	XC6127C36F7R	Vdet-IC	3.6V±0.8%, +Reset PPO, -MR, Rt=50ms	USPN-4	58cc	VD5	9th	Tor
FNV	XC6127C36G7R	Vdet-IC	3.6V±0.8%, +Reset PPO, -MR, Rt=100ms	USPN-4	58cc	VD5	9th	Tor
FNX	XC6127C36H7R	Vdet-IC	3.6V±0.8%, +Reset PPO, -MR, Rt=200ms	USPN-4	58cc	VD5	9th	Tor
FNY	XC6127C36J7R	Vdet-IC	3.6V±0.8%, +Reset PPO, -MR, Rt=400ms	USPN-4	58cc	VD5	9th	Tor
FNZ	XC6127C36K7R	Vdet-IC	3.6V±0.8%, +Reset PPO, -MR, Rt=800ms	USPN-4	58cc	VD5	9th	Tor
FP	FP6121-NVSP	LVR-IC	LDO, Dual out, Vout1/Vout2=2.8V/3.3V±2%, 150mA, +CE	VSON-6	56vx	VR19	9m	Fit
FP	R3114K201C	Vdet-IC	2.0V±0.8%, -Reset PPO	DFN1010-4	48vd9	VD7	9a	Ric
FP	R3134K23EC	Vdet-IC	2.3V±1.8%, -Reset PPO, -MR	DFN1212-6	52z6	VD5	9a	Ric
FP	XC6223H31B9R-G	LVR-IC	LDO, 3.15V±1%, 300mA, +CE, CL, PDR, ICP	USPQ-4B03	48vm	VR4	9a	Tor



SMD code	Type	Function	Short description	Case	Pinout	Sch.	St.	Mnf.
FPA	XC6127C37A7R	Vdet-IC	3.7V±0.8%, -Reset PPO, -MR, Rt=50ms	USPN-4	58cc	VD5	9h	Tor
FPB	XC6127C37B7R	Vdet-IC	3.7V±0.8%, -Reset PPO, -MR, Rt=100ms	USPN-4	58cc	VD5	9h	Tor
FPC	XC6127C37C7R	Vdet-IC	3.7V±0.8%, -Reset PPO, -MR, Rt=200ms	USPN-4	58cc	VD5	9h	Tor
FPD	XC6127C37D7R	Vdet-IC	3.7V±0.8%, -Reset PPO, -MR, Rt=400ms	USPN-4	58cc	VD5	9h	Tor
FPE	XC6127C37E7R	Vdet-IC	3.7V±0.8%, -Reset PPO, -MR, Rt=800ms	USPN-4	58cc	VD5	9h	Tor
FPF	XC6127C37F7R	Vdet-IC	3.7V±0.8%, +Reset PPO, -MR, Rt=50ms	USPN-4	58cc	VD5	9h	Tor
FPH	XC6127C37G7R	Vdet-IC	3.7V±0.8%, +Reset PPO, -MR, Rt=100ms	USPN-4	58cc	VD5	9h	Tor
FPK	XC6127C37H7R	Vdet-IC	3.7V±0.8%, +Reset PPO, -MR, Rt=200ms	USPN-4	58cc	VD5	9h	Tor
FFL	XC6127C37J7R	Vdet-IC	3.7V±0.8%, +Reset PPO, -MR, Rt=400ms	USPN-4	58cc	VD5	9h	Tor
FPM	XC6127C37K7R	Vdet-IC	3.7V±0.8%, +Reset PPO, -MR, Rt=800ms	USPN-4	58cc	VD5	9h	Tor
FPN	XC6127C38A7R	Vdet-IC	3.8V±0.8%, -Reset PPO, -MR, Rt=50ms	USPN-4	58cc	VD5	9h	Tor
FPQ	XC6127C38B7R	Vdet-IC	3.8V±0.8%, -Reset PPO, -MR, Rt=100ms	USPN-4	58cc	VD5	9h	Tor
FPR	XC6127C38C7R	Vdet-IC	3.8V±0.8%, -Reset PPO, -MR, Rt=200ms	USPN-4	58cc	VD5	9h	Tor
FPS	XC6127C38D7R	Vdet-IC	3.8V±0.8%, -Reset PPO, -MR, Rt=400ms	USPN-4	58cc	VD5	9h	Tor
FPT	XC6127C38E7R	Vdet-IC	3.8V±0.8%, -Reset PPO, -MR, Rt=800ms	USPN-4	58cc	VD5	9h	Tor
FPU	XC6127C38F7R	Vdet-IC	3.8V±0.8%, +Reset PPO, -MR, Rt=50ms	USPN-4	58cc	VD5	9h	Tor
FPV	XC6127C38G7R	Vdet-IC	3.8V±0.8%, +Reset PPO, -MR, Rt=100ms	USPN-4	58cc	VD5	9h	Tor
FPX	XC6127C38H7R	Vdet-IC	3.8V±0.8%, +Reset PPO, -MR, Rt=200ms	USPN-4	58cc	VD5	9h	Tor
FPY	XC6127C38J7R	Vdet-IC	3.8V±0.8%, +Reset PPO, -MR, Rt=400ms	USPN-4	58cc	VD5	9h	Tor
FPZ	XC6127C38K7R	Vdet-IC	3.8V±0.8%, +Reset PPO, -MR, Rt=800ms	USPN-4	58cc	VD5	9h	Tor
FQ	R3114K21C	Vdet-IC	2.1V±0.8%, -Reset PPO	DFN1010-4	48vd9	VD7	9a	Ric
FR	FP6121-OVSP	LVR-IC	LDO, Dual out, Vout1/Vout2=1.8V/1.8V±2%, 150mA, +CE	VSON-6	56xx	VR19	9m	Fit
FR	PAM8404ZE	LIN-IC	AF PA, BTL, class-D, 2.5..5.5V, 2x3W(5V/4Ω), shutdown	BGA-16	39	AFP46	-	Pam
FR	R3114K221C	Vdet-IC	2.2V±0.8%, -Reset PPO	DFN1010-4	48vd9	VD7	9a	Ric
FR	R3134K24EC	Vdet-IC	2.4V±1.8%, -Reset PPO, -MR	DFN1212-6	52z6	VD5	9a	Ric
FR	XC6223H32B9R-G	LVR-IC	LDO, 3.25V±1%, 300mA, +CE, CL, PDR, ICP	USPQ-4B03	48vm	VR4	9a	Tor
FR0	XC6901D091ER-G	LVR-IC	-0.9V±1.5%, 200mA, +CE, CL	USP-6C	49ey	VR7	9a	Tor
FR1	XC6901D101ER-G	LVR-IC	-1.0V±1.5%, 200mA, +CE, CL	USP-6C	49ey	VR7	9a	Tor
FR2	XC6901D111ER-G	LVR-IC	-1.1V±1.5%, 200mA, +CE, CL	USP-6C	49ey	VR7	9a	Tor
FR3	XC6901D121ER-G	LVR-IC	-1.2V±1.5%, 200mA, +CE, CL	USP-6C	49ey	VR7	9a	Tor
FR4	XC6901D131ER-G	LVR-IC	-1.3V±1.5%, 200mA, +CE, CL	USP-6C	49ey	VR7	9a	Tor
FR5	XC6901D141ER-G	LVR-IC	-1.4V±1.5%, 200mA, +CE, CL	USP-6C	49ey	VR7	9a	Tor
FR6	XC6901D151ER-G	LVR-IC	-1.5V±1.5%, 200mA, +CE, CL	USP-6C	49ey	VR7	9a	Tor
FR7	XC6901D161ER-G	LVR-IC	-1.6V±1.5%, 200mA, +CE, CL	USP-6C	49ey	VR7	9a	Tor
FR8	XC6901D171ER-G	LVR-IC	-1.7V±1.5%, 200mA, +CE, CL	USP-6C	49ey	VR7	9a	Tor
FR9	XC6901D181ER-G	LVR-IC	-1.8V±1.5%, 200mA, +CE, CL	USP-6C	49ey	VR7	9a	Tor
FRA	XC6127C39A7R	Vdet-IC	3.9V±0.8%, -Reset PPO, -MR, Rt=50ms	USPN-4	58cc	VD5	9h	Tor
FRA	XC6901D191ER-G	LVR-IC	-1.9V±1.5%, 200mA, +CE, CL	USP-6C	49ey	VR7	9a	Tor
FRB	XC6127C39B7R	Vdet-IC	3.9V±0.8%, -Reset PPO, -MR, Rt=100ms	USPN-4	58cc	VD5	9h	Tor
FRB	XC6901D201ER-G	LVR-IC	-2.0V±1.5%, 200mA, +CE, CL	USP-6C	49ey	VR7	9a	Tor
FRC	XC6127C39C7R	Vdet-IC	3.9V±0.8%, -Reset PPO, -MR, Rt=200ms	USPN-4	58cc	VD5	9h	Tor
FRC	XC6901D211ER-G	LVR-IC	-2.1V±1.5%, 200mA, +CE, CL	USP-6C	49ey	VR7	9a	Tor
FRD	XC6127C39D7R	Vdet-IC	3.9V±0.8%, -Reset PPO, -MR, Rt=400ms	USPN-4	58cc	VD5	9h	Tor
FRD	XC6901D221ER-G	LVR-IC	-2.2V±1.5%, 200mA, +CE, CL	USP-6C	49ey	VR7	9a	Tor
FRE	XC6127C39E7R	Vdet-IC	3.9V±0.8%, -Reset PPO, -MR, Rt=800ms	USPN-4	58cc	VD5	9h	Tor
FRE	XC6901D231ER-G	LVR-IC	-2.3V±1.5%, 200mA, +CE, CL	USP-6C	49ey	VR7	9a	Tor
FRF	XC6127C39F7R	Vdet-IC	3.9V±0.8%, +Reset PPO, -MR, Rt=50ms	USPN-4	58cc	VD5	9h	Tor
FRF	XC6901D241ER-G	LVR-IC	-2.4V±1.5%, 200mA, +CE, CL	USP-6C	49ey	VR7	9a	Tor
FRH	XC6127C39G7R	Vdet-IC	3.9V±0.8%, +Reset PPO, -MR, Rt=100ms	USPN-4	58cc	VD5	9h	Tor
FRH	XC6901D251ER-G	LVR-IC	-2.5V±1.5%, 200mA, +CE, CL	USP-6C	49ey	VR7	9a	Tor
FRJ	XC6901D261ER-G	LVR-IC	-2.6V±1.5%, 200mA, +CE, CL	USP-6C	49ey	VR7	9a	Tor
FRK	XC6127C39H7R	Vdet-IC	3.9V±0.8%, +Reset PPO, -MR, Rt=200ms	USPN-4	58cc	VD5	9h	Tor
FRL	XC6127C39J7R	Vdet-IC	3.9V±0.8%, +Reset PPO, -MR, Rt=400ms	USPN-4	58cc	VD5	9h	Tor
FRL	XC6901D271ER-G	LVR-IC	-2.7V±1.5%, 200mA, +CE, CL	USP-6C	49ey	VR7	9a	Tor
FRM	XC6127C39K7R	Vdet-IC	3.9V±0.8%, +Reset PPO, -MR, Rt=800ms	USPN-4	58cc	VD5	9h	Tor
FRM	XC6901D281ER-G	LVR-IC	-2.8V±1.5%, 200mA, +CE, CL	USP-6C	49ey	VR7	9a	Tor
FRN	XC6127C40A7R	Vdet-IC	4.0V±0.8%, -Reset PPO, -MR, Rt=50ms	USPN-4	58cc	VD5	9h	Tor
FRN	XC6901D291ER-G	LVR-IC	-2.9V±1.5%, 200mA, +CE, CL	USP-6C	49ey	VR7	9a	Tor
FRP	XC6127C40B7R	Vdet-IC	4.0V±0.8%, -Reset PPO, -MR, Rt=100ms	USPN-4	58cc	VD5	9h	Tor
FRP	XC6901D301ER-G	LVR-IC	-3.0V±1.5%, 200mA, +CE, CL	USP-6C	49ey	VR7	9a	Tor
FRR	XC6127C40C7R	Vdet-IC	4.0V±0.8%, -Reset PPO, -MR, Rt=200ms	USPN-4	58cc	VD5	9h	Tor
FRR	XC6901D311ER-G	LVR-IC	-3.1V±1.5%, 200mA, +CE, CL	USP-6C	49ey	VR7	9a	Tor
FRS	XC6127C40D7R	Vdet-IC	4.0V±0.8%, -Reset PPO, -MR, Rt=400ms	USPN-4	58cc	VD5	9h	Tor
FRS	XC6901D321ER-G	LVR-IC	-3.2V±1.5%, 200mA, +CE, CL	USP-6C	49ey	VR7	9a	Tor
FRT	XC6127C40E7R	Vdet-IC	4.0V±0.8%, -Reset PPO, -MR, Rt=800ms	USPN-4	58cc	VD5	9h	Tor
FRT	XC6901D331ER-G	LVR-IC	-3.3V±1.5%, 200mA, +CE, CL	USP-6C	49ey	VR7	9a	Tor
FRU	XC6127C40F7R	Vdet-IC	4.0V±0.8%, +Reset PPO, -MR, Rt=50ms	USPN-4	58cc	VD5	9h	Tor
FRU	XC6901D341ER-G	LVR-IC	-3.4V±1.5%, 200mA, +CE, CL	USP-6C	49ey	VR7	9a	Tor
FRV	XC6127C40G7R	Vdet-IC	4.0V±0.8%, +Reset PPO, -MR, Rt=100ms	USPN-4	58cc	VD5	9h	Tor
FRV	XC6901D351ER-G	LVR-IC	-3.5V±1.5%, 200mA, +CE, CL	USP-6C	49ey	VR7	9a	Tor



SMD code	Type	Function	Short description	Case	Pinout	Sch.	St.	Mnf.
FRX	XC6127C40H7R	Vdet-IC	4.0V±0.8%, +Reset PPO, -MR, Rt=200ms	USPN-4	58cc	VD5	9h	Tor
FRX	XC6901D361ER-G	LVR-IC	-3.6V±1.5%, 200mA, +CE, CL	USP-6C	49ey	VR7	9a	Tor
FRY	XC6127C40J7R	Vdet-IC	4.0V±0.8%, +Reset PPO, -MR, Rt=400ms	USPN-4	58cc	VD5	9h	Tor
FRY	XC6901D371ER-G	LVR-IC	-3.7V±1.5%, 200mA, +CE, CL	USP-6C	49ey	VR7	9a	Tor
FRZ	XC6127C40K7R	Vdet-IC	4.0V±0.8%, +Reset PPO, -MR, Rt=800ms	USPN-4	58cc	VD5	9h	Tor
FRZ	XC6901D381ER-G	LVR-IC	-3.8V±1.5%, 200mA, +CE, CL	USP-6C	49ey	VR7	9a	Tor
fs	FP6121-LVSP	LVR-IC	LDO, Dual out, Vout1/Vout2=1.8V/2.6V±2%, 150mA, +CE	VSON-6	56xv	VR19	9m	Fit
FS	R3114K231C	Vdet-IC	2.3V±0.8%, -Reset PPO	DFN1010-4	48vd9	VD7	9a	Ric
FS	R3134K25EC	Vdet-IC	2.5V±1.8%, -Reset PPO, -MR	DFN1212-6	52z6	VD5	9a	Ric
FS	RT9193-25GQW	LVR-IC	LDO, 2.5V±1%, 300mA, +CE	WDFN-6L	49ub	VR7	9a	Ret
FS	XC6223H33B9R-G	LVR-IC	LDO, 3.35V±1%, 300mA, +CE, CL, PDR, ICP	USPQ-4B03	48vm	VR4	9a	Tor
FS0	XC6901D391ER-G	LVR-IC	-3.9V±1.5%, 200mA, +CE, CL	USP-6C	49ey	VR7	9a	Tor
FS1	XC6901D401ER-G	LVR-IC	-4.0V±1.5%, 200mA, +CE, CL	USP-6C	49ey	VR7	9a	Tor
FS2	XC6901D411ER-G	LVR-IC	-4.1V±1.5%, 200mA, +CE, CL	USP-6C	49ey	VR7	9a	Tor
FS3	XC6901D421ER-G	LVR-IC	-4.2V±1.5%, 200mA, +CE, CL	USP-6C	49ey	VR7	9a	Tor
FS4	XC6901D431ER-G	LVR-IC	-4.3V±1.5%, 200mA, +CE, CL	USP-6C	49ey	VR7	9a	Tor
FS5	XC6901D441ER-G	LVR-IC	-4.4V±1.5%, 200mA, +CE, CL	USP-6C	49ey	VR7	9a	Tor
FS6	XC6901D451ER-G	LVR-IC	-4.5V±1.5%, 200mA, +CE, CL	USP-6C	49ey	VR7	9a	Tor
FS7	XC6901D461ER-G	LVR-IC	-4.6V±1.5%, 200mA, +CE, CL	USP-6C	49ey	VR7	9a	Tor
FS8	XC6901D471ER-G	LVR-IC	-4.7V±1.5%, 200mA, +CE, CL	USP-6C	49ey	VR7	9a	Tor
FS9	XC6901D481ER-G	LVR-IC	-4.8V±1.5%, 200mA, +CE, CL	USP-6C	49ey	VR7	9a	Tor
FSA	XC6127C41A7R	Vdet-IC	4.1V±0.8%, -Reset PPO, -MR, Rt=50ms	USPN-4	58cc	VD5	9h	Tor
FSA	XC6901D491ER-G	LVR-IC	-4.9V±1.5%, 200mA, +CE, CL	USP-6C	49ey	VR7	9a	Tor
FSB	XC6127C41B7R	Vdet-IC	4.1V±0.8%, -Reset PPO, -MR, Rt=100ms	USPN-4	58cc	VD5	9h	Tor
FSB	XC6901D501ER-G	LVR-IC	-5.0V±1.5%, 200mA, +CE, CL	USP-6C	49ey	VR7	9a	Tor
FSC	XC6127C41C7R	Vdet-IC	4.1V±0.8%, -Reset PPO, -MR, Rt=200ms	USPN-4	58cc	VD5	9h	Tor
FSC	XC6901D511ER-G	LVR-IC	-5.1V±1.5%, 200mA, +CE, CL	USP-6C	49ey	VR7	9a	Tor
FSD	XC6127C41D7R	Vdet-IC	4.1V±0.8%, -Reset PPO, -MR, Rt=400ms	USPN-4	58cc	VD5	9h	Tor
FSD	XC6901D521ER-G	LVR-IC	-5.2V±1.5%, 200mA, +CE, CL	USP-6C	49ey	VR7	9a	Tor
FSE	XC6127C41E7R	Vdet-IC	4.1V±0.8%, -Reset PPO, -MR, Rt=800ms	USPN-4	58cc	VD5	9h	Tor
FSE	XC6901D531ER-G	LVR-IC	-5.3V±1.5%, 200mA, +CE, CL	USP-6C	49ey	VR7	9a	Tor
FSF	XC6127C41F7R	Vdet-IC	4.1V±0.8%, +Reset PPO, -MR, Rt=50ms	USPN-4	58cc	VD5	9h	Tor
FSF	XC6901D541ER-G	LVR-IC	-5.4V±1.5%, 200mA, +CE, CL	USP-6C	49ey	VR7	9a	Tor
FSH	XC6127C41G7R	Vdet-IC	4.1V±0.8%, +Reset PPO, -MR, Rt=100ms	USPN-4	58cc	VD5	9h	Tor
FSH	XC6901D551ER-G	LVR-IC	-5.5V±1.5%, 200mA, +CE, CL	USP-6C	49ey	VR7	9a	Tor
FSJ	XC6901D561ER-G	LVR-IC	-5.6V±1.5%, 200mA, +CE, CL	USP-6C	49ey	VR7	9a	Tor
FSK	XC6127C41H7R	Vdet-IC	4.1V±0.8%, +Reset PPO, -MR, Rt=200ms	USPN-4	58cc	VD5	9h	Tor
FSL	XC6127C41J7R	Vdet-IC	4.1V±0.8%, +Reset PPO, -MR, Rt=400ms	USPN-4	58cc	VD5	9h	Tor
FSL	XC6901D571ER-G	LVR-IC	-5.7V±1.5%, 200mA, +CE, CL	USP-6C	49ey	VR7	9a	Tor
FSM	XC6127C41K7R	Vdet-IC	4.1V±0.8%, +Reset PPO, -MR, Rt=800ms	USPN-4	58cc	VD5	9h	Tor
FSM	XC6901D581ER-G	LVR-IC	-5.8V±1.5%, 200mA, +CE, CL	USP-6C	49ey	VR7	9a	Tor
FSN	XC6127C42A7R	Vdet-IC	4.2V±0.8%, -Reset PPO, -MR, Rt=50ms	USPN-4	58cc	VD5	9h	Tor
FSN	XC6901D591ER-G	LVR-IC	-5.9V±1.5%, 200mA, +CE, CL	USP-6C	49ey	VR7	9a	Tor
FSP	XC6127C42B7R	Vdet-IC	4.2V±0.8%, -Reset PPO, -MR, Rt=100ms	USPN-4	58cc	VD5	9h	Tor
FSP	XC6901D601ER-G	LVR-IC	-6.0V±1.5%, 200mA, +CE, CL	USP-6C	49ey	VR7	9a	Tor
FSR	XC6127C42C7R	Vdet-IC	4.2V±0.8%, -Reset PPO, -MR, Rt=200ms	USPN-4	58cc	VD5	9h	Tor
FSR	XC6901D611ER-G	LVR-IC	-6.1V±1.5%, 200mA, +CE, CL	USP-6C	49ey	VR7	9a	Tor
FSS	XC6127C42D7R	Vdet-IC	4.2V±0.8%, -Reset PPO, -MR, Rt=400ms	USPN-4	58cc	VD5	9h	Tor
FSS	XC6901D621ER-G	LVR-IC	-6.2V±1.5%, 200mA, +CE, CL	USP-6C	49ey	VR7	9a	Tor
FST	XC6127C42E7R	Vdet-IC	4.2V±0.8%, -Reset PPO, -MR, Rt=800ms	USPN-4	58cc	VD5	9h	Tor
FST	XC6901D631ER-G	LVR-IC	-6.3V±1.5%, 200mA, +CE, CL	USP-6C	49ey	VR7	9a	Tor
FSU	XC6127C42F7R	Vdet-IC	4.2V±0.8%, +Reset PPO, -MR, Rt=50ms	USPN-4	58cc	VD5	9h	Tor
FSU	XC6901D641ER-G	LVR-IC	-6.4V±1.5%, 200mA, +CE, CL	USP-6C	49ey	VR7	9a	Tor
FSV	XC6127C42G7R	Vdet-IC	4.2V±0.8%, +Reset PPO, -MR, Rt=100ms	USPN-4	58cc	VD5	9h	Tor
FSV	XC6901D651ER-G	LVR-IC	-6.5V±1.5%, 200mA, +CE, CL	USP-6C	49ey	VR7	9a	Tor
FSX	XC6127C42H7R	Vdet-IC	4.2V±0.8%, +Reset PPO, -MR, Rt=200ms	USPN-4	58cc	VD5	9h	Tor
FSX	XC6901D661ER-G	LVR-IC	-6.6V±1.5%, 200mA, +CE, CL	USP-6C	49ey	VR7	9a	Tor
FSY	XC6127C42J7R	Vdet-IC	4.2V±0.8%, +Reset PPO, -MR, Rt=400ms	USPN-4	58cc	VD5	9h	Tor
FSY	XC6901D671ER-G	LVR-IC	-6.7V±1.5%, 200mA, +CE, CL	USP-6C	49ey	VR7	9a	Tor
FSZ	XC6127C42K7R	Vdet-IC	4.2V±0.8%, +Reset PPO, -MR, Rt=800ms	USPN-4	58cc	VD5	9h	Tor
FSZ	XC6901D681ER-G	LVR-IC	-6.8V±1.5%, 200mA, +CE, CL	USP-6C	49ey	VR7	9a	Tor
FT	R3114K241C	Vdet-IC	2.4V±0.8%, -Reset PPO	DFN1010-4	48vd9	VD7	9a	Ric
FT	R3134K26EC	Vdet-IC	2.6V±1.8%, -Reset PPO, -MR	DFN1212-6	52z6	VD5	9a	Ric
FT	XC6223H34B9R-G	LVR-IC	LDO, 3.45V±1%, 300mA, +CE, CL, PDR, ICP	USPQ-4B03	48vm	VR4	9a	Tor
FT0	XC6901D691ER-G	LVR-IC	-6.9V±1.5%, 200mA, +CE, CL	USP-6C	49ey	VR7	9a	Tor
FT1	XC6901D701ER-G	LVR-IC	-7.0V±1.5%, 200mA, +CE, CL	USP-6C	49ey	VR7	9a	Tor
FT2	XC6901D711ER-G	LVR-IC	-7.1V±1.5%, 200mA, +CE, CL	USP-6C	49ey	VR7	9a	Tor
FT3	XC6901D721ER-G	LVR-IC	-7.2V±1.5%, 200mA, +CE, CL	USP-6C	49ey	VR7	9a	Tor
FT4	XC6901D731ER-G	LVR-IC	-7.3V±1.5%, 200mA, +CE, CL	USP-6C	49ey	VR7	9a	Tor
FT5	XC6901D741ER-G	LVR-IC	-7.4V±1.5%, 200mA, +CE, CL	USP-6C	49ey	VR7	9a	Tor



SMD code	Type	Function	Short description	Case	Pinout	Sch.	St.	Mnf.
FT6	XC6901D751ER-G	LVR-IC	-7.5V±1.5%, 200mA, +CE, CL	USP-6C	49ey	VR7	9a	Tor
FT7	XC6901D761ER-G	LVR-IC	-7.6V±1.5%, 200mA, +CE, CL	USP-6C	49ey	VR7	9a	Tor
FT8	XC6901D771ER-G	LVR-IC	-7.7V±1.5%, 200mA, +CE, CL	USP-6C	49ey	VR7	9a	Tor
FT9	XC6901D781ER-G	LVR-IC	-7.8V±1.5%, 200mA, +CE, CL	USP-6C	49ey	VR7	9a	Tor
FTA	XC6127C43A7R	Vdet-IC	4.3V±0.8%, -Reset PPO, -MR, Rt=50ms	USPN-4	58cc	VD5	9h	Tor
FTA	XC6901D791ER-G	LVR-IC	-7.9V±1.5%, 200mA, +CE, CL	USP-6C	49ey	VR7	9a	Tor
FTB	XC6127C43B7R	Vdet-IC	4.3V±0.8%, -Reset PPO, -MR, Rt=100ms	USPN-4	58cc	VD5	9h	Tor
FTB	XC6901D801ER-G	LVR-IC	-8.0V±1.5%, 200mA, +CE, CL	USP-6C	49ey	VR7	9a	Tor
FTC	XC6127C43C7R	Vdet-IC	4.3V±0.8%, -Reset PPO, -MR, Rt=200ms	USPN-4	58cc	VD5	9h	Tor
FTC	XC6901D811ER-G	LVR-IC	-8.1V±1.5%, 200mA, +CE, CL	USP-6C	49ey	VR7	9a	Tor
FTD	XC6127C43D7R	Vdet-IC	4.3V±0.8%, -Reset PPO, -MR, Rt=400ms	USPN-4	58cc	VD5	9h	Tor
FTD	XC6901D821ER-G	LVR-IC	-8.2V±1.5%, 200mA, +CE, CL	USP-6C	49ey	VR7	9a	Tor
FTE	XC6127C43E7R	Vdet-IC	4.3V±0.8%, -Reset PPO, -MR, Rt=800ms	USPN-4	58cc	VD5	9h	Tor
FTE	XC6901D831ER-G	LVR-IC	-8.3V±1.5%, 200mA, +CE, CL	USP-6C	49ey	VR7	9a	Tor
FTF	XC6127C43F7R	Vdet-IC	4.3V±0.8%, +Reset PPO, -MR, Rt=50ms	USPN-4	58cc	VD5	9h	Tor
FTF	XC6901D841ER-G	LVR-IC	-8.4V±1.5%, 200mA, +CE, CL	USP-6C	49ey	VR7	9a	Tor
FTH	XC6127C43G7R	Vdet-IC	4.3V±0.8%, +Reset PPO, -MR, Rt=100ms	USPN-4	58cc	VD5	9h	Tor
FTH	XC6901D851ER-G	LVR-IC	-8.5V±1.5%, 200mA, +CE, CL	USP-6C	49ey	VR7	9a	Tor
FTK	XC6127C43H7R	Vdet-IC	4.3V±0.8%, +Reset PPO, -MR, Rt=200ms	USPN-4	58cc	VD5	9h	Tor
FTK	XC6901D861ER-G	LVR-IC	-8.6V±1.5%, 200mA, +CE, CL	USP-6C	49ey	VR7	9a	Tor
FTL	XC6127C43J7R	Vdet-IC	4.3V±0.8%, +Reset PPO, -MR, Rt=400ms	USPN-4	58cc	VD5	9h	Tor
FTL	XC6901D871ER-G	LVR-IC	-8.7V±1.5%, 200mA, +CE, CL	USP-6C	49ey	VR7	9a	Tor
FTM	XC6127C43K7R	Vdet-IC	4.3V±0.8%, +Reset PPO, -MR, Rt=800ms	USPN-4	58cc	VD5	9h	Tor
FTM	XC6901D881ER-G	LVR-IC	-8.8V±1.5%, 200mA, +CE, CL	USP-6C	49ey	VR7	9a	Tor
FTN	XC6127C44A7R	Vdet-IC	4.4V±0.8%, -Reset PPO, -MR, Rt=50ms	USPN-4	58cc	VD5	9h	Tor
FTN	XC6901D891ER-G	LVR-IC	-8.9V±1.5%, 200mA, +CE, CL	USP-6C	49ey	VR7	9a	Tor
FTP	XC6127C44B7R	Vdet-IC	4.4V±0.8%, -Reset PPO, -MR, Rt=100ms	USPN-4	58cc	VD5	9h	Tor
FTP	XC6901D901ER-G	LVR-IC	-9.0V±1.5%, 200mA, +CE, CL	USP-6C	49ey	VR7	9a	Tor
FTR	XC6127C44C7R	Vdet-IC	4.4V±0.8%, -Reset PPO, -MR, Rt=200ms	USPN-4	58cc	VD5	9h	Tor
FTR	XC6901D911ER-G	LVR-IC	-9.1V±1.5%, 200mA, +CE, CL	USP-6C	49ey	VR7	9a	Tor
FTS	XC6127C44D7R	Vdet-IC	4.4V±0.8%, -Reset PPO, -MR, Rt=400ms	USPN-4	58cc	VD5	9h	Tor
FTS	XC6901D921ER-G	LVR-IC	-9.2V±1.5%, 200mA, +CE, CL	USP-6C	49ey	VR7	9a	Tor
FTT	XC6127C44E7R	Vdet-IC	4.4V±0.8%, -Reset PPO, -MR, Rt=800ms	USPN-4	58cc	VD5	9h	Tor
FTT	XC6901D931ER-G	LVR-IC	-9.3V±1.5%, 200mA, +CE, CL	USP-6C	49ey	VR7	9a	Tor
FTU	XC6127C44F7R	Vdet-IC	4.4V±0.8%, +Reset PPO, -MR, Rt=50ms	USPN-4	58cc	VD5	9h	Tor
FTU	XC6901D941ER-G	LVR-IC	-9.4V±1.5%, 200mA, +CE, CL	USP-6C	49ey	VR7	9a	Tor
FTV	XC6127C44G7R	Vdet-IC	4.4V±0.8%, +Reset PPO, -MR, Rt=100ms	USPN-4	58cc	VD5	9h	Tor
FTV	XC6901D951ER-G	LVR-IC	-9.5V±1.5%, 200mA, +CE, CL	USP-6C	49ey	VR7	9a	Tor
FTX	XC6127C44H7R	Vdet-IC	4.4V±0.8%, +Reset PPO, -MR, Rt=200ms	USPN-4	58cc	VD5	9h	Tor
FTX	XC6901D961ER-G	LVR-IC	-9.6V±1.5%, 200mA, +CE, CL	USP-6C	49ey	VR7	9a	Tor
FTY	XC6127C44J7R	Vdet-IC	4.4V±0.8%, +Reset PPO, -MR, Rt=400ms	USPN-4	58cc	VD5	9h	Tor
FTY	XC6901D971ER-G	LVR-IC	-9.7V±1.5%, 200mA, +CE, CL	USP-6C	49ey	VR7	9a	Tor
FTZ	XC6127C44K7R	Vdet-IC	4.4V±0.8%, +Reset PPO, -MR, Rt=800ms	USPN-4	58cc	VD5	9h	Tor
FTZ	XC6901D981ER-G	LVR-IC	-9.8V±1.5%, 200mA, +CE, CL	USP-6C	49ey	VR7	9a	Tor
FU	R3114K251C	Vdet-IC	2.5V±0.8%, -Reset PPO	DFN1010-4	48vd9	VD7	9a	Ric
FU	R3134K27EC	Vdet-IC	2.7V±1.8%, -Reset PPO, -MR	DFN1212-6	52z6	VD5	9a	Ric
FU	XC6223H35B9R-G	LVR-IC	LDO, 3.55V±1%, 300mA, +CE, CL, PDR, ICP	USPQ-4B03	48vm	VR4	9a	Tor
FU0	XC6901D991ER-G	LVR-IC	-9.9V±1.5%, 200mA, +CE, CL	USP-6C	49ey	VR7	9a	Tor
FU1	XC6901DA01ER-G	LVR-IC	-10.0V±1.5%, 200mA, +CE, CL	USP-6C	49ey	VR7	9a	Tor
FU2	XC6901DA11ER-G	LVR-IC	-10.1V±1.5%, 200mA, +CE, CL	USP-6C	49ey	VR7	9a	Tor
FU3	XC6901DA21ER-G	LVR-IC	-10.2V±1.5%, 200mA, +CE, CL	USP-6C	49ey	VR7	9a	Tor
FU4	XC6901DA31ER-G	LVR-IC	-10.3V±1.5%, 200mA, +CE, CL	USP-6C	49ey	VR7	9a	Tor
FU5	XC6901DA41ER-G	LVR-IC	-10.4V±1.5%, 200mA, +CE, CL	USP-6C	49ey	VR7	9a	Tor
FU6	XC6901DA51ER-G	LVR-IC	-10.5V±1.5%, 200mA, +CE, CL	USP-6C	49ey	VR7	9a	Tor
FU7	XC6901DA61ER-G	LVR-IC	-10.6V±1.5%, 200mA, +CE, CL	USP-6C	49ey	VR7	9a	Tor
FU8	XC6901DA71ER-G	LVR-IC	-10.7V±1.5%, 200mA, +CE, CL	USP-6C	49ey	VR7	9a	Tor
FU9	XC6901DA81ER-G	LVR-IC	-10.8V±1.5%, 200mA, +CE, CL	USP-6C	49ey	VR7	9a	Tor
FUA	XC6127C45A7R	Vdet-IC	4.5V±0.8%, -Reset PPO, -MR, Rt=50ms	USPN-4	58cc	VD5	9h	Tor
FUA	XC6901DA91ER-G	LVR-IC	-10.9V±1.5%, 200mA, +CE, CL	USP-6C	49ey	VR7	9a	Tor
FUB	XC6127C45B7R	Vdet-IC	4.5V±0.8%, -Reset PPO, -MR, Rt=100ms	USPN-4	58cc	VD5	9h	Tor
FUB	XC6901DB01ER-G	LVR-IC	-11.0V±1.5%, 200mA, +CE, CL	USP-6C	49ey	VR7	9a	Tor
FUC	XC6127C45C7R	Vdet-IC	4.5V±0.8%, -Reset PPO, -MR, Rt=200ms	USPN-4	58cc	VD5	9h	Tor
FUC	XC6901DB11ER-G	LVR-IC	-11.1V±1.5%, 200mA, +CE, CL	USP-6C	49ey	VR7	9a	Tor
FUD	XC6127C45D7R	Vdet-IC	4.5V±0.8%, -Reset PPO, -MR, Rt=400ms	USPN-4	58cc	VD5	9h	Tor
FUD	XC6901DB21ER-G	LVR-IC	-11.2V±1.5%, 200mA, +CE, CL	USP-6C	49ey	VR7	9a	Tor
FUE	XC6127C45E7R	Vdet-IC	4.5V±0.8%, -Reset PPO, -MR, Rt=800ms	USPN-4	58cc	VD5	9h	Tor
FUE	XC6901DB31ER-G	LVR-IC	-11.3V±1.5%, 200mA, +CE, CL	USP-6C	49ey	VR7	9a	Tor
FUF	XC6127C45F7R	Vdet-IC	4.5V±0.8%, +Reset PPO, -MR, Rt=50ms	USPN-4	58cc	VD5	9h	Tor
FUF	XC6901DB41ER-G	LVR-IC	-11.4V±1.5%, 200mA, +CE, CL	USP-6C	49ey	VR7	9a	Tor
FUH	XC6127C45G7R	Vdet-IC	4.5V±0.8%, +Reset PPO, -MR, Rt=100ms	USPN-4	58cc	VD5	9h	Tor



SMD code	Type	Function	Short description	Case	Pinout	Sch.	St.	Mnf.
FUH	XC6901DB51ER-G	LVR-IC	-11.5V±1.5%, 200mA, +CE, CL	USP-6C	49ey	VR7	9a	Tor
FUK	XC6127C45H7R	Vdet-IC	4.5V±0.8%, +Reset PPO, -MR, Rt=200ms	USPN-4	58cc	VD5	9h	Tor
FUK	XC6901DB61ER-G	LVR-IC	-11.6V±1.5%, 200mA, +CE, CL	USP-6C	49ey	VR7	9a	Tor
FUL	XC6127C45J7R	Vdet-IC	4.5V±0.8%, +Reset PPO, -MR, Rt=400ms	USPN-4	58cc	VD5	9h	Tor
FUL	XC6901DB71ER-G	LVR-IC	-11.7V±1.5%, 200mA, +CE, CL	USP-6C	49ey	VR7	9a	Tor
FUM	XC6127C45K7R	Vdet-IC	4.5V±0.8%, +Reset PPO, -MR, Rt=800ms	USPN-4	58cc	VD5	9h	Tor
FUM	XC6901DB81ER-G	LVR-IC	-11.8V±1.5%, 200mA, +CE, CL	USP-6C	49ey	VR7	9a	Tor
FUN	XC6127C46A7R	Vdet-IC	4.6V±0.8%, -Reset PPO, -MR, Rt=50ms	USPN-4	58cc	VD5	9h	Tor
FUN	XC6901DB91ER-G	LVR-IC	-11.9V±1.5%, 200mA, +CE, CL	USP-6C	49ey	VR7	9a	Tor
FUP	XC6127C46B7R	Vdet-IC	4.6V±0.8%, -Reset PPO, -MR, Rt=100ms	USPN-4	58cc	VD5	9h	Tor
FUP	XC6901DC01ER-G	LVR-IC	-12.0V±1.5%, 200mA, +CE, CL	USP-6C	49ey	VR7	9a	Tor
FUR	XC6127C46C7R	Vdet-IC	4.6V±0.8%, -Reset PPO, -MR, Rt=200ms	USPN-4	58cc	VD5	9h	Tor
FUS	XC6127C46D7R	Vdet-IC	4.6V±0.8%, -Reset PPO, -MR, Rt=400ms	USPN-4	58cc	VD5	9h	Tor
FUT	XC6127C46E7R	Vdet-IC	4.6V±0.8%, -Reset PPO, -MR, Rt=800ms	USPN-4	58cc	VD5	9h	Tor
FUU	XC6127C46F7R	Vdet-IC	4.6V±0.8%, +Reset PPO, -MR, Rt=50ms	USPN-4	58cc	VD5	9h	Tor
FUV	XC6127C46G7R	Vdet-IC	4.6V±0.8%, +Reset PPO, -MR, Rt=100ms	USPN-4	58cc	VD5	9h	Tor
FUX	XC6127C46H7R	Vdet-IC	4.6V±0.8%, +Reset PPO, -MR, Rt=200ms	USPN-4	58cc	VD5	9h	Tor
FUY	XC6127C46J7R	Vdet-IC	4.6V±0.8%, +Reset PPO, -MR, Rt=400ms	USPN-4	58cc	VD5	9h	Tor
FUZ	XC6127C46K7R	Vdet-IC	4.6V±0.8%, +Reset PPO, -MR, Rt=800ms	USPN-4	58cc	VD5	9h	Tor
FV	FP6121-PVSP	LVR-IC	LDO, Dual out, Vout1/Vout2=2.85V/2.85V±2%, 150mA, +CE	VSON-6	56xv	VR19	9m	Fit
FV	R3114K261C	Vdet-IC	2.6V±0.8%, -Reset PPO	DFN1010-4	48vd9	VD7	9a	Ric
FV	R3134K28EC	Vdet-IC	2.8V±1.8%, -Reset PPO, -MR	DFN1212-6	52z6	VD5	9a	Ric
FV	XC6223H36B9R-G	LVR-IC	LDO, 3.65V±1%, 300mA, +CE, CL, PDR, ICP	USPQ-4B03	48vm	VR4	9a	Tor
FVA	XC6127C47A7R	Vdet-IC	4.7V±0.8%, -Reset PPO, -MR, Rt=50ms	USPN-4	58cc	VD5	9h	Tor
FVB	XC6127C47B7R	Vdet-IC	4.7V±0.8%, -Reset PPO, -MR, Rt=100ms	USPN-4	58cc	VD5	9h	Tor
FVC	XC6127C47C7R	Vdet-IC	4.7V±0.8%, -Reset PPO, -MR, Rt=200ms	USPN-4	58cc	VD5	9h	Tor
FVD	XC6127C47D7R	Vdet-IC	4.7V±0.8%, -Reset PPO, -MR, Rt=400ms	USPN-4	58cc	VD5	9h	Tor
FVE	XC6127C47E7R	Vdet-IC	4.7V±0.8%, -Reset PPO, -MR, Rt=800ms	USPN-4	58cc	VD5	9h	Tor
FVF	XC6127C47F7R	Vdet-IC	4.7V±0.8%, +Reset PPO, -MR, Rt=50ms	USPN-4	58cc	VD5	9h	Tor
FVH	XC6127C47G7R	Vdet-IC	4.7V±0.8%, +Reset PPO, -MR, Rt=100ms	USPN-4	58cc	VD5	9h	Tor
FVK	XC6127C47H7R	Vdet-IC	4.7V±0.8%, +Reset PPO, -MR, Rt=200ms	USPN-4	58cc	VD5	9h	Tor
FVL	XC6127C47J7R	Vdet-IC	4.7V±0.8%, +Reset PPO, -MR, Rt=400ms	USPN-4	58cc	VD5	9h	Tor
FVM	XC6127C47K7R	Vdet-IC	4.7V±0.8%, +Reset PPO, -MR, Rt=800ms	USPN-4	58cc	VD5	9h	Tor
FVN	XC6127C48A7R	Vdet-IC	4.8V±0.8%, -Reset PPO, -MR, Rt=50ms	USPN-4	58cc	VD5	9h	Tor
FVP	XC6127C48B7R	Vdet-IC	4.8V±0.8%, -Reset PPO, -MR, Rt=100ms	USPN-4	58cc	VD5	9h	Tor
FVR	XC6127C48C7R	Vdet-IC	4.8V±0.8%, -Reset PPO, -MR, Rt=200ms	USPN-4	58cc	VD5	9h	Tor
FVS	XC6127C48D7R	Vdet-IC	4.8V±0.8%, -Reset PPO, -MR, Rt=400ms	USPN-4	58cc	VD5	9h	Tor
FVT	XC6127C48E7R	Vdet-IC	4.8V±0.8%, -Reset PPO, -MR, Rt=800ms	USPN-4	58cc	VD5	9h	Tor
FVU	XC6127C48F7R	Vdet-IC	4.8V±0.8%, +Reset PPO, -MR, Rt=50ms	USPN-4	58cc	VD5	9h	Tor
FVV	XC6127C48G7R	Vdet-IC	4.8V±0.8%, +Reset PPO, -MR, Rt=100ms	USPN-4	58cc	VD5	9h	Tor
FVX	XC6127C48H7R	Vdet-IC	4.8V±0.8%, +Reset PPO, -MR, Rt=200ms	USPN-4	58cc	VD5	9h	Tor
FVY	XC6127C48J7R	Vdet-IC	4.8V±0.8%, +Reset PPO, -MR, Rt=400ms	USPN-4	58cc	VD5	9h	Tor
FVZ	XC6127C48K7R	Vdet-IC	4.8V±0.8%, +Reset PPO, -MR, Rt=800ms	USPN-4	58cc	VD5	9h	Tor
FW	R3114K271C	Vdet-IC	2.7V±0.8%, -Reset PPO	DFN1010-4	48vd9	VD7	9a	Ric
FW	R3134K29EC	Vdet-IC	2.9V±1.8%, -Reset PPO, -MR	DFN1212-6	52z6	VD5	9a	Ric
fx	FP6121-AVSP	LVR-IC	LDO, Dual out, Vout1/Vout2=3.3V/2.8V±2%, 150mA, +CE	VSON-6	56xv	VR19	9m	Fit
FX	R3114K281C	Vdet-IC	2.8V±0.8%, -Reset PPO	DFN1010-4	48vd9	VD7	9a	Ric
FX	R3134K30EC	Vdet-IC	3.0V±1.8%, -Reset PPO, -MR	DFN1212-6	52z6	VD5	9a	Ric
FX	XC6223H37B9R-G	LVR-IC	LDO, 3.75V±1%, 300mA, +CE, CL, PDR, ICP	USPQ-4B03	48vm	VR4	9a	Tor
FXA	XC6127C49A7R	Vdet-IC	4.9V±0.8%, -Reset PPO, -MR, Rt=50ms	USPN-4	58cc	VD5	9h	Tor
FXB	XC6127C49B7R	Vdet-IC	4.9V±0.8%, -Reset PPO, -MR, Rt=100ms	USPN-4	58cc	VD5	9h	Tor
FXC	XC6127C49C7R	Vdet-IC	4.9V±0.8%, -Reset PPO, -MR, Rt=200ms	USPN-4	58cc	VD5	9h	Tor
FXD	XC6127C49D7R	Vdet-IC	4.9V±0.8%, -Reset PPO, -MR, Rt=400ms	USPN-4	58cc	VD5	9h	Tor
FXE	XC6127C49E7R	Vdet-IC	4.9V±0.8%, -Reset PPO, -MR, Rt=800ms	USPN-4	58cc	VD5	9h	Tor
FXF	XC6127C49F7R	Vdet-IC	4.9V±0.8%, +Reset PPO, -MR, Rt=50ms	USPN-4	58cc	VD5	9h	Tor
FXH	XC6127C49G7R	Vdet-IC	4.9V±0.8%, +Reset PPO, -MR, Rt=100ms	USPN-4	58cc	VD5	9h	Tor
FXK	XC6127C49H7R	Vdet-IC	4.9V±0.8%, +Reset PPO, -MR, Rt=200ms	USPN-4	58cc	VD5	9h	Tor
FXL	XC6127C49J7R	Vdet-IC	4.9V±0.8%, +Reset PPO, -MR, Rt=400ms	USPN-4	58cc	VD5	9h	Tor
FXM	XC6127C49K7R	Vdet-IC	4.9V±0.8%, +Reset PPO, -MR, Rt=800ms	USPN-4	58cc	VD5	9h	Tor
FXN	XC6127C50A7R	Vdet-IC	5.0V±0.8%, -Reset PPO, -MR, Rt=50ms	USPN-4	58cc	VD5	9h	Tor
FXP	XC6127C50B7R	Vdet-IC	5.0V±0.8%, -Reset PPO, -MR, Rt=100ms	USPN-4	58cc	VD5	9h	Tor
FXR	XC6127C50C7R	Vdet-IC	5.0V±0.8%, -Reset PPO, -MR, Rt=200ms	USPN-4	58cc	VD5	9h	Tor
FXS	XC6127C50D7R	Vdet-IC	5.0V±0.8%, -Reset PPO, -MR, Rt=400ms	USPN-4	58cc	VD5	9h	Tor
FXT	XC6127C50E7R	Vdet-IC	5.0V±0.8%, -Reset PPO, -MR, Rt=800ms	USPN-4	58cc	VD5	9h	Tor
FXU	XC6127C50F7R	Vdet-IC	5.0V±0.8%, +Reset PPO, -MR, Rt=50ms	USPN-4	58cc	VD5	9h	Tor
FXV	XC6127C50G7R	Vdet-IC	5.0V±0.8%, +Reset PPO, -MR, Rt=100ms	USPN-4	58cc	VD5	9h	Tor
FXX	XC6127C50H7R	Vdet-IC	5.0V±0.8%, +Reset PPO, -MR, Rt=200ms	USPN-4	58cc	VD5	9h	Tor
FXY	XC6127C50J7R	Vdet-IC	5.0V±0.8%, +Reset PPO, -MR, Rt=400ms	USPN-4	58cc	VD5	9h	Tor
FXZ	XC6127C50K7R	Vdet-IC	5.0V±0.8%, +Reset PPO, -MR, Rt=800ms	USPN-4	58cc	VD5	9h	Tor
FY	R3114K291C	Vdet-IC	2.9V±0.8%, -Reset PPO	DFN1010-4	48vd9	VD7	9a	Ric



SMD code	Type	Function	Short description	Case	Pinout	Sch.	St.Mnf.
FY	R3134K31EC	Vdet-IC	3.1V±1.8%, -Reset PPO, -MR	DFN1212-6	52z6	VD5	9a Ric
FY	XC6223H38B9R-G	LVR-IC	LDO, 3.85V±1%, 300mA, +CE, CL, PDR, ICP	USPQ-4B03	48vm	VR4	9a Tor
FYA	XC6127C51A7R	Vdet-IC	5.1V±0.8%, -Reset PPO, -MR, Rt=50ms	USPN-4	58cc	VD5	9h Tor
FYB	XC6127C51B7R	Vdet-IC	5.1V±0.8%, -Reset PPO, -MR, Rt=100ms	USPN-4	58cc	VD5	9h Tor
FYC	XC6127C51C7R	Vdet-IC	5.1V±0.8%, -Reset PPO, -MR, Rt=200ms	USPN-4	58cc	VD5	9h Tor
FYD	XC6127C51D7R	Vdet-IC	5.1V±0.8%, -Reset PPO, -MR, Rt=400ms	USPN-4	58cc	VD5	9h Tor
FYE	XC6127C51E7R	Vdet-IC	5.1V±0.8%, -Reset PPO, -MR, Rt=800ms	USPN-4	58cc	VD5	9h Tor
FYF	XC6127C51F7R	Vdet-IC	5.1V±0.8%, +Reset PPO, -MR, Rt=50ms	USPN-4	58cc	VD5	9h Tor
FYH	XC6127C51G7R	Vdet-IC	5.1V±0.8%, +Reset PPO, -MR, Rt=100ms	USPN-4	58cc	VD5	9h Tor
FYK	XC6127C51H7R	Vdet-IC	5.1V±0.8%, +Reset PPO, -MR, Rt=200ms	USPN-4	58cc	VD5	9h Tor
FYL	XC6127C51J7R	Vdet-IC	5.1V±0.8%, +Reset PPO, -MR, Rt=400ms	USPN-4	58cc	VD5	9h Tor
FYM	XC6127C51K7R	Vdet-IC	5.1V±0.8%, +Reset PPO, -MR, Rt=800ms	USPN-4	58cc	VD5	9h Tor
FYN	XC6127C52A7R	Vdet-IC	5.2V±0.8%, -Reset PPO, -MR, Rt=50ms	USPN-4	58cc	VD5	9h Tor
FYP	XC6127C52B7R	Vdet-IC	5.2V±0.8%, -Reset PPO, -MR, Rt=100ms	USPN-4	58cc	VD5	9h Tor
FYR	XC6127C52C7R	Vdet-IC	5.2V±0.8%, -Reset PPO, -MR, Rt=200ms	USPN-4	58cc	VD5	9h Tor
FYS	XC6127C52D7R	Vdet-IC	5.2V±0.8%, -Reset PPO, -MR, Rt=400ms	USPN-4	58cc	VD5	9h Tor
FYT	XC6127C52E7R	Vdet-IC	5.2V±0.8%, -Reset PPO, -MR, Rt=800ms	USPN-4	58cc	VD5	9h Tor
FYU	XC6127C52F7R	Vdet-IC	5.2V±0.8%, +Reset PPO, -MR, Rt=50ms	USPN-4	58cc	VD5	9h Tor
FYV	XC6127C52G7R	Vdet-IC	5.2V±0.8%, +Reset PPO, -MR, Rt=100ms	USPN-4	58cc	VD5	9h Tor
FYX	XC6127C52H7R	Vdet-IC	5.2V±0.8%, +Reset PPO, -MR, Rt=200ms	USPN-4	58cc	VD5	9h Tor
FYY	XC6127C52J7R	Vdet-IC	5.2V±0.8%, +Reset PPO, -MR, Rt=400ms	USPN-4	58cc	VD5	9h Tor
FYZ	XC6127C52K7R	Vdet-IC	5.2V±0.8%, +Reset PPO, -MR, Rt=800ms	USPN-4	58cc	VD5	9h Tor
fz	FP6121-BVSP	LVR-IC	LDO, Dual out, Vout1/Vout2=3.3V/2.5V±2%, 150mA, +CE	VSON-6	56xv	VR19	9m Fit
FZ	R3114K301C	Vdet-IC	3.0V±0.8%, -Reset PPO	DFN1010-4	48vd9	VD7	9a Ric
FZ	R3134K32EC	Vdet-IC	3.2V±1.8%, -Reset PPO, -MR	DFN1212-6	52z6	VD5	9a Ric
FZ	XC6223H39B9R-G	LVR-IC	LDO, 3.95V±1%, 300mA, +CE, CL, PDR, ICP	USPQ-4B03	48vm	VR4	9a Tor
FZA	XC6127C53A7R	Vdet-IC	5.3V±0.8%, -Reset PPO, -MR, Rt=50ms	USPN-4	58cc	VD5	9h Tor
FZB	XC6127C53B7R	Vdet-IC	5.3V±0.8%, -Reset PPO, -MR, Rt=100ms	USPN-4	58cc	VD5	9h Tor
FZC	XC6127C53C7R	Vdet-IC	5.3V±0.8%, -Reset PPO, -MR, Rt=200ms	USPN-4	58cc	VD5	9h Tor
FZD	XC6127C53D7R	Vdet-IC	5.3V±0.8%, -Reset PPO, -MR, Rt=400ms	USPN-4	58cc	VD5	9h Tor
FZE	XC6127C53E7R	Vdet-IC	5.3V±0.8%, -Reset PPO, -MR, Rt=800ms	USPN-4	58cc	VD5	9h Tor
FZF	XC6127C53F7R	Vdet-IC	5.3V±0.8%, +Reset PPO, -MR, Rt=50ms	USPN-4	58cc	VD5	9h Tor
FZH	XC6127C53G7R	Vdet-IC	5.3V±0.8%, +Reset PPO, -MR, Rt=100ms	USPN-4	58cc	VD5	9h Tor
FZK	XC6127C53H7R	Vdet-IC	5.3V±0.8%, +Reset PPO, -MR, Rt=200ms	USPN-4	58cc	VD5	9h Tor
FZL	XC6127C53J7R	Vdet-IC	5.3V±0.8%, +Reset PPO, -MR, Rt=400ms	USPN-4	58cc	VD5	9h Tor
FZM	XC6127C53K7R	Vdet-IC	5.3V±0.8%, +Reset PPO, -MR, Rt=800ms	USPN-4	58cc	VD5	9h Tor
FZN	XC6127C54A7R	Vdet-IC	5.4V±0.8%, -Reset PPO, -MR, Rt=50ms	USPN-4	58cc	VD5	9h Tor
FZP	XC6127C54B7R	Vdet-IC	5.4V±0.8%, -Reset PPO, -MR, Rt=100ms	USPN-4	58cc	VD5	9h Tor
FZR	XC6127C54C7R	Vdet-IC	5.4V±0.8%, -Reset PPO, -MR, Rt=200ms	USPN-4	58cc	VD5	9h Tor
FZS	XC6127C54D7R	Vdet-IC	5.4V±0.8%, -Reset PPO, -MR, Rt=400ms	USPN-4	58cc	VD5	9h Tor
FZT	XC6127C54E7R	Vdet-IC	5.4V±0.8%, -Reset PPO, -MR, Rt=800ms	USPN-4	58cc	VD5	9h Tor
FZU	XC6127C54F7R	Vdet-IC	5.4V±0.8%, +Reset PPO, -MR, Rt=50ms	USPN-4	58cc	VD5	9h Tor
FZV	XC6127C54G7R	Vdet-IC	5.4V±0.8%, +Reset PPO, -MR, Rt=100ms	USPN-4	58cc	VD5	9h Tor
FZX	XC6127C54H7R	Vdet-IC	5.4V±0.8%, +Reset PPO, -MR, Rt=200ms	USPN-4	58cc	VD5	9h Tor
FZY	XC6127C54J7R	Vdet-IC	5.4V±0.8%, +Reset PPO, -MR, Rt=400ms	USPN-4	58cc	VD5	9h Tor
FZZ	XC6127C54K7R	Vdet-IC	5.4V±0.8%, +Reset PPO, -MR, Rt=800ms	USPN-4	58cc	VD5	9h Tor
G0	R3118K161C	Vdet-IC	1.6V±1.5%, -Reset PPO, Sense	DFN1212-6	52z3	VD15	9a Ric
G0	RP109L181D	LVR-IC	LDO, 1.8V±1%, 150mA, +CE, CL	DFN1010-4	48vm	VR4	9a Ric
G08	LM4808LD	LIN-IC	AF PA, 2.5.5V, 2x105mW(4V/16Q)	DFN-8	37	AFP6	- Nsc
G09	LM4809LD	LIN-IC	AF PA, 2.5.5V, 2x105mW(4V/16Q), shutdown	DFN-8	37	AFP7	- Nsc
G1	LM4922TL	LIN-IC	AF PA, 2.2.5.5V, 2x80mW(5V/16Q), shutdown	BGA-16	39	-	- Nsc
G1	R3118K171C	Vdet-IC	1.7V±1.5%, -Reset PPO, Sense	DFN1212-6	52z3	VD15	9a Ric
G1	RP109L191D	LVR-IC	LDO, 1.9V±1%, 150mA, +CE, CL	DFN1010-4	48vm	VR4	9a Ric
G10	LM4810LD	LIN-IC	AF PA, 2.5.5V, 2x105mW(4V/16Q), shutdown	DFN-8	37	-	- Nsc
G10	LM4811LD	LIN-IC	AF PA, 2.5.5V, 2x105mW(4V/16Q), shutdown	DFN-10	37	-	- Nsc
G19	LM4819LD	LIN-IC	AF PA, BTL, 2.5.5V, 35mW(3.5V/8Q), shutdown	DFN-8	37	AFP11	- Nsc
G2	R3118K181C	Vdet-IC	1.8V±1.5%, -Reset PPO, Sense	DFN1212-6	52z3	VD15	9a Ric
G2	RP109L201D	LVR-IC	LDO, 2.0V±1%, 150mA, +CE, CL	DFN1010-4	48vm	VR4	9a Ric
G3	R3118K191C	Vdet-IC	1.9V±1.5%, -Reset PPO, Sense	DFN1212-6	52z3	VD15	9a Ric
G3	RP109L211D	LVR-IC	LDO, 2.1V±1%, 150mA, +CE, CL	DFN1010-4	48vm	VR4	9a Ric
G4	LM4673TM	LIN-IC	AF PA, BTL, class-D, 2.5.5.5V, 2.65W(5V/4Q), shutdown	BGA-9	39	AFP45	- Nsc
G4	R3118K201C	Vdet-IC	2.0V±1.5%, -Reset PPO, Sense	DFN1212-6	52z3	VD15	9a Ric
G4	RP109L221D	LVR-IC	LDO, 2.2V±1%, 150mA, +CE, CL	DFN1010-4	48vm	VR4	9a Ric
G5	LM4846TL	LIN-IC	AF PA, BTL, 2.7.5.5V, 500mW(4Q)+2x25mW(32Q), I2C	BGA-25	39	-	- Nsc
G5	R3118K211C	Vdet-IC	2.1V±1.5%, -Reset PPO, Sense	DFN1212-6	52z3	VD15	9a Ric
G5	RP109L231D	LVR-IC	LDO, 2.3V±1%, 150mA, +CE, CL	DFN1010-4	48vm	VR4	9a Ric
G52	LM4851BL	LIN-IC	AF PA, BTL, 2.7.5.5V, 1.1W(4Q)+2x115mW(8Q), volume	BGA-16	39	-	- Nsc
G6	R3118K221C	Vdet-IC	2.2V±1.5%, -Reset PPO, Sense	DFN1212-6	52z3	VD15	9a Ric
G6	RP109L241D	LVR-IC	LDO, 2.4V±1%, 150mA, +CE, CL	DFN1010-4	48vm	VR4	9a Ric
G64	LM4864LD	LIN-IC	AF PA, BTL, 2.7.5.5V, 725mW(5V/8Q), shutdown	DFN-10	37	AFP15	- Nsc



SMD code	Type	Function	Short description	Case	Pinout	Sch.	St.	Mnf.
G65	LM4865IBP	LIN-IC	AF PA, BTL, 2.7..5.5V, 750mW(5V/8Q), DC volume	BGA-9	39	-	-	Nsc
G7	R3118K231C	Vdet-IC	2.3V±1.5%, -Reset PPO, Sense	DFN1212-6	52z3	VD15	9a	Ric
G7	RP109L251D	LVR-IC	LDO, 2.5V±1%, 150mA, +CE, CL	DFN1010-4	48vm	VR4	9a	Ric
G79	LM4879IBL	LIN-IC	AF PA, BTL, 2.2..5V, 1.1W(5V/8Q), shutdown	BGA-9	39	AFP44	-	Nsc
G8	LM4995TM	LIN-IC	AF PA, BTL, 2.4..5.5V, 1.3W(5V/8Q), shutdown	BGA-9	39	AFP44	-	Nsc
G8	R3118K241C	Vdet-IC	2.4V±1.5%, -Reset PPO, Sense	DFN1212-6	52z3	VD15	9a	Ric
G8	RP109L261D	LVR-IC	LDO, 2.6V±1%, 150mA, +CE, CL	DFN1010-4	48vm	VR4	9a	Ric
G9	R3118K251C	Vdet-IC	2.5V±1.5%, -Reset PPO, Sense	DFN1212-6	52z3	VD15	9a	Ric
G9	RP109L271D	LVR-IC	LDO, 2.7V±1%, 150mA, +CE, CL	DFN1010-4	48vm	VR4	9a	Ric
G93	LM4893ITL	LIN-IC	AF PA, BTL, 2.2..5.5V, 1.1W(5V/8Q), shutdown	BGA-9	39	AFP44	-	Nsc
GA	LM4872IBP	LIN-IC	AF PA, BTL, 2..5.5V, 1W(5V/8Q), shutdown	BGA-8	39	AFP44	-	Nsc
GA	R3114K311C	Vdet-IC	3.1V±0.8%, -Reset PPO	DFN1010-4	48vd9	VD7	9a	Ric
GA	R3134K33EC	Vdet-IC	3.3V±1.8%, -Reset PPO, -MR	DFN1212-6	52z6	VD5	9a	Ric
GA3	LM4889ITL	LIN-IC	AF PA, BTL, 2.7..5.5V, 1W(5V/8Q), shutdown	BGA-8	39	AFP44	-	Nsc
GA3	LM4902LD	LIN-IC	AF PA, BTL, 2.2..5.5V, 265mW(5V/8Q), shutdown	DFN-8	37	AFP12	-	Nsc
GA4	LM4910LQ	LIN-IC	AF PA, BTL, 2.2..5.5V, 2x35mW(3V/32Q), shutdown	LQ-8	77	-	-	Nsc
GA5	LM4915LQ	LIN-IC	AF PA, BTL, 2.2..5.5V, 90mW(3V/32Q), shutdown	LQ-8	77	-	-	Nsc
GA6	LM4904ITL	LIN-IC	AF PA, BTL, 2.2..5.5V, 1W(5V/8Q), shutdown	BGA-8	39	AFP44	-	Nsc
GA6	LM4905LQ	LIN-IC	AF PA, BTL, 2.5..5.5V, 1W(5V/8Q), shutdown	LQ-8	77	-	-	Nsc
GA7	LM4894ITL	LIN-IC	AF PA, BTL, 2.2..5.5V, 1W(5V/8Q), shutdown	BGA-9	39	AFP53	-	Nsc
GA7	LM4908LQ	LIN-IC	AF PA, 2.2..5.5V, 2x100mW(5V/16Q)	LQ-8	77	AFP6	-	Nsc
GA8	LM4890ITL	LIN-IC	AF PA, BTL, 2.2..5.5V, 1.1W(5V/8Q), shutdown	BGA-9	39	AFP44	9k	Nsc
GB	LM4877IBP	LIN-IC	AF PA, BTL, 2..5.5V, 1W(5V/8Q), shutdown	BGA-8	39	AFP44	-	Nsc
GB	R3114K321C	Vdet-IC	3.2V±0.8%, -Reset PPO	DFN1010-4	48vd9	VD7	9a	Ric
GB	R3134K34EC	Vdet-IC	3.4V±1.8%, -Reset PPO, -MR	DFN1212-6	52z6	VD5	9a	Ric
GB1	LM4851ITL	LIN-IC	AF PA, BTL, 2.7..5.5V, 1.1W(5V/4Q)+2x115mW(8Q)	BGA-16	39	-	-	Nsc
GB3	LM4809LQ	LIN-IC	AF PA, 2..5.5V, 2x100mW(16Q), shutdown	LQ-8	77	AFP7	-	Nsc
GB3	XPT4809LQ	LIN-IC	AF PA, 1.8..6V, 2x105mW(5V/16Q), shutdown	LQ-8	77	AFP7	9m	Xpt
GB6	LM4930ITL	LIN-IC	16-bit DAC, AF PA, BTL, 2.7..5.5V, 300mW(4Q)+2x25mW(32Q), I2C	BGA-36	39	-	-	Nsc
GC	R3114K331C	Vdet-IC	3.3V±0.8%, -Reset PPO	DFN1010-4	48vd9	VD7	9a	Ric
GC	R3134K35EC	Vdet-IC	3.5V±1.8%, -Reset PPO, -MR	DFN1212-6	52z6	VD5	9a	Ric
GC0	LM4900LD	LIN-IC	AF PA, BTL, 2.2..5.5V, 265mW(5V/8Q), shutdown	DFN-8	37	AFP12	-	Nsc
GC1	LM4899ITL	LIN-IC	AF PA, BTL, 2.2..5.5V, 1W(5V/8Q), select shutdown	BGA-9	39	AFP54	-	Nsc
GC3	LM4898ITL	LIN-IC	AF PA, BTL, 2.2..5.5V, 1W(5V/8Q), shutdown	BGA-9	39	AFP53	-	Nsc
GC9	LM49100GR	LIN-IC	AF PA, BTL, 2.7..5.5V, 1.25W(5V/4Q)+2x50mW(32Q), I2C	BGA-25	39	-	-	Nsc
GC9	LM4931ITL	LIN-IC	AF PA, BTL, 2.7..5.5V, 1.1W(4Q)+2x26mW(32Q), I2C	BGA-42	39	-	-	Nsc
GD	LM4878IBP	LIN-IC	AF PA, BTL, 2..5.5V, 1W(5V/8Q), shutdown	BGA-8	39	AFP44	-	Nsc
GD	R3114K341C	Vdet-IC	3.4V±0.8%, -Reset PPO	DFN1010-4	48vd9	VD7	9a	Ric
GD	R3134K36EC	Vdet-IC	3.6V±1.8%, -Reset PPO, -MR	DFN1212-6	52z6	VD5	9a	Ric
GE	EMA1001IBP	LIN-IC	AF PA, BTL, 2..5.5V, 1W(5V/8Q), shutdown	BGA-8	39	AFP44	9k	Emp
GE	LM4890IBP	LIN-IC	AF PA, BTL, 2.2..5.5V, 1.1W(5V/8Q), shutdown	BGA-8	39	AFP44	9k	Nsc
GE	R3114K351C	Vdet-IC	3.5V±0.8%, -Reset PPO	DFN1010-4	48vd9	VD7	9a	Ric
GE	R3134K37EC	Vdet-IC	3.7V±1.8%, -Reset PPO, -MR	DFN1212-6	52z6	VD5	9a	Ric
GE2	LM4894ITP	LIN-IC	AF PA, BTL, 2.2..5.5V, 1W(5V/8Q), shutdown	BGA-9	39	AFP53	-	Nsc
GE3	LM4895ITP	LIN-IC	AF PA, BTL, 2.2..5.5V, 1W(5V/8Q), select shutdown	BGA-9	39	AFP54	-	Nsc
GE5	LM4845ITL	LIN-IC	AF PA, BTL, 2.7..5.5V, 500mW(5V/4Q)+2x25mW(32Q), I2C	BGA-25	39	-	-	Nsc
GF	LM4820IBP-6	LIN-IC	AF PA, BTL, 2..5.5V, 1W(5V/8Q), shutdown	BGA-8	39	AFP44	-	Nsc
GF	R3114K361C	Vdet-IC	3.6V±0.8%, -Reset PPO	DFN1010-4	48vd9	VD7	9a	Ric
GF	R3134K38EC	Vdet-IC	3.8V±1.8%, -Reset PPO, -MR	DFN1212-6	52z6	VD5	9a	Ric
GF3	LM4844TL	LIN-IC	AF PA, BTL, 2.7..5.5V, 2x1.2W(5V/4Q)+2x80mW(32Q), I2C	BGA-30	39	-	-	Nsc
GF7	LM4962TL	LIN-IC	AF PA, BTL, 2.7..5.5V, 15Vp-p, ceramic speaker, shutdown	BGA-20	39	-	-	Nsc
GG	LM4891IBP	LIN-IC	AF PA, BTL, 2.2..5.5V, 1.1W(5V/8Q), shutdown	BGA-8	39	AFP44	-	Nsc
GG	R3114K371C	Vdet-IC	3.7V±0.8%, -Reset PPO	DFN1010-4	48vd9	VD7	9a	Ric
GG	R3134K39EC	Vdet-IC	3.9V±1.8%, -Reset PPO, -MR	DFN1212-6	52z6	VD5	9a	Ric
GG3	LM48821TL	LIN-IC	AF PA, 1.8..4V, 2x40mW(3V/16Q), I2C volume	BGA-16	39	-	-	Nsc
GG3	LM4980SD	LIN-IC	AF PA, BTL, 1.5..3.6V, 2x42mW(5V/16Q), shutdown	DFN-10	37	-	-	Nsc
GG3	LM4982TL	LIN-IC	AF PA, 2.3..5.5V, 2x80mW(5V/16Q), I2C volume	BGA-16	39	-	-	Nsc
GG7	LM4935RL	LIN-IC	AF PA, class-D, 1.8..4.5V, 600+2x33+115mW(8/32Q), I2C, SPI	BGA-49	39	-	9j	Nsc
GG9	LM4934RL	LIN-IC	AF PA, 1.8..4.5V, 2x520+2x36+55mW(8/32Q), I2C, SPI	BGA-42	39	-	9j	Nsc
GH	LM4892IBP	LIN-IC	AF PA, BTL, 2.2..5.5V, 1.1W(5V/8Q), shutdown	BGA-8	39	-	9k	Nsc
GH	R3114K381C	Vdet-IC	3.8V±0.8%, -Reset PPO	DFN1010-4	48vd9	VD7	9a	Ric
GH	R3134K40EC	Vdet-IC	4.0V±1.8%, -Reset PPO, -MR	DFN1212-6	52z6	VD5	9a	Ric
GH4	LM4920TL	LIN-IC	AF PA, 2.2..5.5V, 2x80mW(5V/16Q), shutdown	BGA-16	39	-	9j	Nsc
GH1	LM49321RL	LIN-IC	AF PA, 1.8..4.5V, 520+2x36+55mW(8/32Q), I2C, I2S or SPI	BGA-36	39	-	9j	Nsc
GH1	LM4937TL	LIN-IC	AF PA, 1.8..4.5V, 520+2x36+55mW(8/32Q), I2C, I2S, SPI	BGA-36	39	-	9j	Nsc
GH2	LM4674ATL	LIN-IC	AF PA, BTL, class-D, 2.5..5.5V, 2x2.5W(5V/4Q), shutdown	BGA-16	39	AFP46	9j	Nsc
GH3	LM49370RL	LIN-IC	AF PA, BTL, class-D, 2.5..5.5V, 1.2W(4Q)+2x33mW(32Q), shutdown	BGA-49	39	-	-	Nsc
GH7	LM48820TM	LIN-IC	AF PA, 2.7..5V, 2x97mW(5V/16Q), shutdown	BGA-14	39	-	-	Nsc
GH9	LM4946TM	LIN-IC	AF PA, BTL, class-D, 2.5..5.5V, 540mW(4Q)+2x35mW(32Q), PWM	BGA-25	39	-	-	Nsc
GJ	R3114K391C	Vdet-IC	3.9V±0.8%, -Reset PPO	DFN1010-4	48vd9	VD7	9a	Ric



SMD code	Type	Function	Short description	Case	Pinout	Sch.	St.	Mnf.
GJ	R3134K41 EC	Vdet-IC	4.1V±1.8%, -Reset PPO, -MR	DFN1212-6	52z6	VD5	9a	Ric
GJ1	LM49250RL	LIN-IC	AF PA, BTL, class-D, 2.5..5.5V, 2x2.4W+2x41mW+170mW(4/32Q), I2C	BGA-36	39	-	9j	Nsc
GJ8	LM49350RL	LIN-IC	AF PA, BTL, class-D, 2.5..5.5V, 1.2W+2x58mW(4/32Q), I2S/PCM	BGA-36	39	-	-	Nsc
GK	LM4895IBP	LIN-IC	AF PA, BTL, 2.2..5.5V, 1W(5V/8Q), select shutdown	BGA-9	39	AFP54	-	Nsc
GK	R3114K401C	Vdet-IC	4.0V±0.8%, -Reset PPO	DFN1010-4	48vd9	VD7	9a	Ric
GK	R3134K42EC	Vdet-IC	4.2V±1.8%, -Reset PPO, -MR	DFN1212-6	52z6	VD5	9a	Ric
GK1	LM48822TL	LIN-IC	AF PA, 2.4..5.5V, 2x40mW(3V/16Q), I2C volume	BGA-16	39	-	-	Nsc
GK2	LM49120TL	LIN-IC	AF PA, BTL, 2.2..5.5V, 1.3W(8Q)+2x85mW(32Q), I2C volume	BGA-16	39	-	-	Nsc
GK4	LM48556TL	LIN-IC	AF PA, BTL, 2.7..5.5V, 15.7Vp-p, ceramic speaker, shutdown	BGA-12	39	-	9j	Nsc
GK6	LM48823TL	LIN-IC	AF PA, BTL, 2.7..5.5V, 15Vp-p, ceramic speaker, I2C volume	BGA-16	39	-	-	Nsc
GK7	LM49150TL	LIN-IC	AF PA, 2.5..5.5V, 1.25W+2x42mW(4/32Q), I2C	BGA-20	39	-	9j	Nsc
GL	LM4894IBP	LIN-IC	AF PA, BTL, 2.2..5.5V, 1W(5V/8Q), shutdown	BGA-9	39	AFP53	-	Nsc
GL	R3114K411C	Vdet-IC	4.1V±0.8%, -Reset PPO	DFN1010-4	48vd9	VD7	9a	Ric
GL	R3134K43EC	Vdet-IC	4.3V±1.8%, -Reset PPO, -MR	DFN1212-6	52z6	VD5	9a	Ric
GL2	LM48413TL	LIN-IC	AF PA, BTL, class-D, 2.5..5.5V, 2x2.3W(5V/4Q), shutdown, 3D	BGA-18	39	-	-	Nsc
GL3	LM49200TL	LIN-IC	AF PA, BTL, 2.5..5.5V, 2x1.25W+2x38mW(4/32Q), I2C	BGA-20	39	-	9j	Nsc
GL4	LM49101TM	LIN-IC	AF PA, BTL, 2.5..5.5V, 1.3W+2x45mW(4/32Q), I2C	BGA-25	39	-	-	Nsc
GL5	LM49352RL	LIN-IC	AF PA, BTL, class-D, 2.5..5.5V, 1.4W+2x69mW+58mW, I2S/PCM	BGA-36	39	-	-	Nsc
GL6	LM48824TM	LIN-IC	AF PA, class-G, 1.8..5.5V, 2x37mW(3V/16Q), I2C volume	BGA-16	39	-	-	Nsc
GL7	LM49151TL	LIN-IC	AF PA, class-D, 1.8..4.5V, 1.25W+2x42mW(8/32Q), I2C	BGA-20	39	-	-	Nsc
gM	XC7SET125GF	CMOS-Logic	Bus buffer gate with 3-state output	SOT891	52Log14	-	9a	Phi
gM	XC7SET125GM	CMOS-Logic	Bus buffer gate with 3-state output	SOT-886	57Log14	-	9a	Phi
GM	R3114K421C	Vdet-IC	4.2V±0.8%, -Reset PPO	DFN1010-4	48vd9	VD7	9a	Ric
GM	R3134K44EC	Vdet-IC	4.4V±1.8%, -Reset PPO, -MR	DFN1212-6	52z6	VD5	9a	Ric
GM2	LM48557TL	LIN-IC	AF PA, BTL, 2.6..5.5V, 15.6Vp-p, ceramic speaker, I2C control	BGA-16	39	-	-	Nsc
GN	LM4879IBP	LIN-IC	AF PA, BTL, 2.2..5V, 1.1W(5V/8Q), shutdown	BGA-9	39	AFP44	-	Nsc
GN	R3114K431C	Vdet-IC	4.3V±0.8%, -Reset PPO	DFN1010-4	48vd9	VD7	9a	Ric
GN	R3134K45EC	Vdet-IC	4.5V±1.8%, -Reset PPO, -MR	DFN1212-6	52z6	VD5	9a	Ric
GN	RT9198-30GQW	LVR-IC	LDO, 3.0V±1%, 300mA, +CE	WDFN-6	49	VR4	9a	Rct
GN7	LM49155TL	LIN-IC	AF PA, BTL, class-D, 2.5..5V, 2x1.35W(32Q)+2x19mW(32Q), I2C, ALC	BGA-36	39	-	-	Nsc
GN9	LM49251TL	LIN-IC	AF PA, BTL, 2.7..5.5V, class-D 2x1.37W(8Q)+2x20mW(32Q), I2C	BGA-30	39	-	9j	Nsc
G07	LM49153TM	LIN-IC	AF PA, BTL, 2.7..5.5V, class-D 1.35W(8Q)+2x25mW(32Q), I2C	BGA-25	39	-	9j	Nsc
GP	EMA1001IBPX	LIN-IC	AF PA, BTL, 2.2..5.5V, 1W(5V/8Q), shutdown	BGA-9	39	AFP44	9k	Emp
GP	LM4890IBL	LIN-IC	AF PA, BTL, 2.2..5.5V, 1.1W(5V/8Q), shutdown	BGA-9	39	AFP44	-	Nsc
GP	R3114K441C	Vdet-IC	4.4V±0.8%, -Reset PPO	DFN1010-4	48vd9	VD7	9a	Ric
GP	R3134K46EC	Vdet-IC	4.6V±1.8%, -Reset PPO, -MR	DFN1212-6	52z6	VD5	9a	Ric
GQ	LM4901IBL	LIN-IC	AF PA, BTL, 2.2..5.5V, 1.6W(5V/8Q), shutdown	BGA-9	39	-	-	Nsc
GQ	R3114K451C	Vdet-IC	4.5V±0.8%, -Reset PPO	DFN1010-4	48vd9	VD7	9a	Ric
GR	R3114K461C	Vdet-IC	4.6V±0.8%, -Reset PPO	DFN1010-4	48vd9	VD7	9a	Ric
GR	R3134K47EC	Vdet-IC	4.7V±1.8%, -Reset PPO, -MR	DFN1212-6	52z6	VD5	9a	Ric
GS	R3114K471C	Vdet-IC	4.7V±0.8%, -Reset PPO	DFN1010-4	48vd9	VD7	9a	Ric
GS	R3134K48EC	Vdet-IC	4.8V±1.8%, -Reset PPO, -MR	DFN1212-6	52z6	VD5	9a	Ric
GT	R3114K481C	Vdet-IC	4.8V±0.8%, -Reset PPO	DFN1010-4	48vd9	VD7	9a	Ric
GT	R3134K49EC	Vdet-IC	4.9V±1.8%, -Reset PPO, -MR	DFN1212-6	52z6	VD5	9a	Ric
GT33G	AIC1952-33GDA	LVR-IC	LDO, Dual out, V1=2.85V±2%, V2=2.85V±2%, 300mA, +CE	DFN-6L	52xv	VR19	9a	Aic
GT34G	AIC1952-34GDA	LVR-IC	LDO, Dual out, V1=2.85V±2%, V2=3.4V±2%, 300mA, +CE	DFN-6L	52xv	VR19	9a	Aic
GT35G	AIC1952-35GDA	LVR-IC	LDO, Dual out, V1=2.85V±2%, V2=3.5V±2%, 300mA, +CE	DFN-6L	52xv	VR19	9a	Aic
GT36G	AIC1952-36GDA	LVR-IC	LDO, Dual out, V1=2.85V±2%, V2=3.6V±2%, 300mA, +CE	DFN-6L	52xv	VR19	9a	Aic
GT37G	AIC1952-37GDA	LVR-IC	LDO, Dual out, V1=2.85V±2%, V2=3.7V±2%, 300mA, +CE	DFN-6L	52xv	VR19	9a	Aic
GT38G	AIC1952-38GDA	LVR-IC	LDO, Dual out, V1=2.85V±2%, V2=3.8V±2%, 300mA, +CE	DFN-6L	52xv	VR19	9a	Aic
GT3AG	AIC1952-3AGDA	LVR-IC	LDO, Dual out, V1=2.85V±2%, V2=0.8V±2%, 300mA, +CE	DFN-6L	52xv	VR19	9a	Aic
GT3BG	AIC1952-3BGDA	LVR-IC	LDO, Dual out, V1=2.85V±2%, V2=0.9V±2%, 300mA, +CE	DFN-6L	52xv	VR19	9a	Aic
GT3CG	AIC1952-3CGDA	LVR-IC	LDO, Dual out, V1=2.85V±2%, V2=1.0V±2%, 300mA, +CE	DFN-6L	52xv	VR19	9a	Aic
GT3DG	AIC1952-3DGDA	LVR-IC	LDO, Dual out, V1=2.85V±2%, V2=1.1V±2%, 300mA, +CE	DFN-6L	52xv	VR19	9a	Aic
GT3EG	AIC1952-3EGDA	LVR-IC	LDO, Dual out, V1=2.85V±2%, V2=1.2V±2%, 300mA, +CE	DFN-6L	52xv	VR19	9a	Aic
GT3FG	AIC1952-3FGDA	LVR-IC	LDO, Dual out, V1=2.85V±2%, V2=1.3V±2%, 300mA, +CE	DFN-6L	52xv	VR19	9a	Aic
GT3GG	AIC1952-3GGDA	LVR-IC	LDO, Dual out, V1=2.85V±2%, V2=1.4V±2%, 300mA, +CE	DFN-6L	52xv	VR19	9a	Aic
GT3HG	AIC1952-3HGDA	LVR-IC	LDO, Dual out, V1=2.85V±2%, V2=1.5V±2%, 300mA, +CE	DFN-6L	52xv	VR19	9a	Aic
GT3IG	AIC1952-3IGDA	LVR-IC	LDO, Dual out, V1=2.85V±2%, V2=1.6V±2%, 300mA, +CE	DFN-6L	52xv	VR19	9a	Aic
GT3JG	AIC1952-3JGDA	LVR-IC	LDO, Dual out, V1=2.85V±2%, V2=1.7V±2%, 300mA, +CE	DFN-6L	52xv	VR19	9a	Aic
GT3KG	AIC1952-3KGDA	LVR-IC	LDO, Dual out, V1=2.85V±2%, V2=1.8V±2%, 300mA, +CE	DFN-6L	52xv	VR19	9a	Aic
GT3LG	AIC1952-3LGDA	LVR-IC	LDO, Dual out, V1=2.85V±2%, V2=1.9V±2%, 300mA, +CE	DFN-6L	52xv	VR19	9a	Aic
GT3MG	AIC1952-3MGDA	LVR-IC	LDO, Dual out, V1=2.85V±2%, V2=2.0V±2%, 300mA, +CE	DFN-6L	52xv	VR19	9a	Aic
GT3NG	AIC1952-3NGDA	LVR-IC	LDO, Dual out, V1=2.85V±2%, V2=0.1V±2%, 300mA, +CE	DFN-6L	52xv	VR19	9a	Aic
GT3OG	AIC1952-3OGDA	LVR-IC	LDO, Dual out, V1=2.85V±2%, V2=2.2V±2%, 300mA, +CE	DFN-6L	52xv	VR19	9a	Aic
GT3PG	AIC1952-3PGDA	LVR-IC	LDO, Dual out, V1=2.85V±2%, V2=2.3V±2%, 300mA, +CE	DFN-6L	52xv	VR19	9a	Aic
GT3QG	AIC1952-3QGDA	LVR-IC	LDO, Dual out, V1=2.85V±2%, V2=2.4V±2%, 300mA, +CE	DFN-6L	52xv	VR19	9a	Aic
GT3RG	AIC1952-3RGDA	LVR-IC	LDO, Dual out, V1=2.85V±2%, V2=2.5V±2%, 300mA, +CE	DFN-6L	52xv	VR19	9a	Aic
GT3SG	AIC1952-3SGDA	LVR-IC	LDO, Dual out, V1=2.85V±2%, V2=2.6V±2%, 300mA, +CE	DFN-6L	52xv	VR19	9a	Aic
GT3TG	AIC1952-3TGDA	LVR-IC	LDO, Dual out, V1=2.85V±2%, V2=2.7V±2%, 300mA, +CE	DFN-6L	52xv	VR19	9a	Aic



SMD code	Type	Function	Short description	Case	Pinout	Sch.	St.	Mnf.
GTZIG	AIC1952-ZIGDA	LVR-IC	LDO, Dual out, V1=3.3V±2%, V2=1.6V±2%, 300mA, +CE	DFN-6L	52xv	VR19	9a	Aic
GTZJG	AIC1952-ZJGDA	LVR-IC	LDO, Dual out, V1=3.3V±2%, V2=1.7V±2%, 300mA, +CE	DFN-6L	52xv	VR19	9a	Aic
GTZKG	AIC1952-ZKGD	LVR-IC	LDO, Dual out, V1=3.3V±2%, V2=1.8V±2%, 300mA, +CE	DFN-6L	52xv	VR19	9a	Aic
GTZLG	AIC1952-ZLGD	LVR-IC	LDO, Dual out, V1=3.3V±2%, V2=1.9V±2%, 300mA, +CE	DFN-6L	52xv	VR19	9a	Aic
GTZMG	AIC1952-ZMGDA	LVR-IC	LDO, Dual out, V1=3.3V±2%, V2=2.0V±2%, 300mA, +CE	DFN-6L	52xv	VR19	9a	Aic
GTZNG	AIC1952-ZNGDA	LVR-IC	LDO, Dual out, V1=3.3V±2%, V2=2.1V±2%, 300mA, +CE	DFN-6L	52xv	VR19	9a	Aic
GTZOG	AIC1952-ZOGDA	LVR-IC	LDO, Dual out, V1=3.3V±2%, V2=2.2V±2%, 300mA, +CE	DFN-6L	52xv	VR19	9a	Aic
GTZPG	AIC1952-ZPGDA	LVR-IC	LDO, Dual out, V1=3.3V±2%, V2=2.3V±2%, 300mA, +CE	DFN-6L	52xv	VR19	9a	Aic
GTZQG	AIC1952-ZQGD	LVR-IC	LDO, Dual out, V1=3.3V±2%, V2=2.4V±2%, 300mA, +CE	DFN-6L	52xv	VR19	9a	Aic
GTZRG	AIC1952-ZRGDA	LVR-IC	LDO, Dual out, V1=3.3V±2%, V2=2.5V±2%, 300mA, +CE	DFN-6L	52xv	VR19	9a	Aic
GTZSG	AIC1952-ZSGDA	LVR-IC	LDO, Dual out, V1=3.3V±2%, V2=2.6V±2%, 300mA, +CE	DFN-6L	52xv	VR19	9a	Aic
GTZTG	AIC1952-ZTGD	LVR-IC	LDO, Dual out, V1=3.3V±2%, V2=2.7V±2%, 300mA, +CE	DFN-6L	52xv	VR19	9a	Aic
GTZUG	AIC1952-ZUGDA	LVR-IC	LDO, Dual out, V1=3.3V±2%, V2=2.8V±2%, 300mA, +CE	DFN-6L	52xv	VR19	9a	Aic
GTZVG	AIC1952-ZVGD	LVR-IC	LDO, Dual out, V1=3.3V±2%, V2=2.9V±2%, 300mA, +CE	DFN-6L	52xv	VR19	9a	Aic
GTZWG	AIC1952-ZWGD	LVR-IC	LDO, Dual out, V1=3.3V±2%, V2=3.0V±2%, 300mA, +CE	DFN-6L	52xv	VR19	9a	Aic
GTZXG	AIC1952-ZXGD	LVR-IC	LDO, Dual out, V1=3.3V±2%, V2=3.1V±2%, 300mA, +CE	DFN-6L	52xv	VR19	9a	Aic
GTZYG	AIC1952-ZYGD	LVR-IC	LDO, Dual out, V1=3.3V±2%, V2=3.2V±2%, 300mA, +CE	DFN-6L	52xv	VR19	9a	Aic
GTZZG	AIC1952-ZZGDA	LVR-IC	LDO, Dual out, V1=3.3V±2%, V2=3.3V±2%, 300mA, +CE	DFN-6L	52xv	VR19	9a	Aic
GU	R3114K491C	Vdet-IC	4.9V±0.8%, -Reset PPO	DFN1010-4	48vd9	VD7	9a	Ric
GU	R3134K50EC	Vdet-IC	5.0V±1.8%, -Reset PPO, -MR	DFN1212-6	52z6	VD5	9a	Ric
GU=	RT9104GQW	LIN-IC	AF PA, BTL, class-D, 2.5.5V, 2x3W(5V/4Q), shutdown, DC volume	QFN-16	38	-	-	Rct
GV	R3114K501C	Vdet-IC	5V±0.8%, -Reset PPO	DFN1010-4	48vd9	VD7	9a	Ric
GV	R3134K23EC2	Vdet-IC	2.32V±1.8%, -Reset PPO, -MR	DFN1212-6	52z6	VD5	9a	Ric
GW	R3134K26EC3	Vdet-IC	2.63V±1.8%, -Reset PPO, -MR	DFN1212-6	52z6	VD5	9a	Ric
GX	R3134K29EC3	Vdet-IC	2.93V±1.8%, -Reset PPO, -MR	DFN1212-6	52z6	VD5	9a	Ric
GY	R3134K30EC8	Vdet-IC	3.08V±1.8%, -Reset PPO, -MR	DFN1212-6	52z6	VD5	9a	Ric
GZ	R3134K43EC8	Vdet-IC	4.38V±1.8%, -Reset PPO, -MR	DFN1212-6	52z6	VD5	9a	Ric
H	HMPP-3860	PIN-diode	RF, Att, 50V±2%, 1A(1µs), <0.2pF, 220(1mA), <80ns	MP	37d	-	-	Agi
H0	R3118K261C	Vdet-IC	2.6V±1.5%, -Reset PPO, Sense	DFN1212-6	52z3	VD15	9a	Ric
H0	RP109L281D	LVR-IC	LDO, 2.8V±1%, 150mA, +CE, CL	DFN1010-4	48vm	VR4	9a	Ric
H0	XC6221B31B7R	LVR-IC	LDO, 3.15V±1%, 200mA, +CE, CL	USPN-4	58vm	VR4	9a	Tor
H0	XC6223A4019R-G	LVR-IC	LDO, 4.0V±1%, 300mA, +CE	USPQ-4B03	48vm	VR4	9a	Tor
H001	RP150K001A	LVR-IC	LDO, LN, Dual out, Vout1/Vout2=2.85V/2.85V±1%, 300mA, +CE	PLP2020-8	37yv	VR19	9b	Ric
H002	RP150K002A	LVR-IC	LDO, LN, Dual out, Vout1/Vout2=3V/3V±1%, 300mA, +CE	PLP2020-8	37yv	VR19	9b	Ric
H003	RP150K003A	LVR-IC	LDO, LN, Dual out, Vout1/Vout2=3.3V/3.3V±1%, 300mA, +CE	PLP2020-8	37yv	VR19	9b	Ric
H004	RP150K004A	LVR-IC	LDO, LN, Dual out, Vout1/Vout2=2.5V/1.8V±1%, 300mA, +CE	PLP2020-8	37yv	VR19	9b	Ric
H005	RP150K005A	LVR-IC	LDO, LN, Dual out, Vout1/Vout2=2.8V/2.6V±1%, 300mA, +CE	PLP2020-8	37yv	VR19	9b	Ric
H006	RP150K006A	LVR-IC	LDO, LN, Dual out, Vout1/Vout2=1.5V/2.8V±1%, 300mA, +CE	PLP2020-8	37yv	VR19	9b	Ric
H007	RP150K007A	LVR-IC	LDO, LN, Dual out, Vout1/Vout2=3.3V/1.8V±1%, 300mA, +CE	PLP2020-8	37yv	VR19	9b	Ric
H008	RP150K008A	LVR-IC	LDO, LN, Dual out, Vout1/Vout2=1.8V/2.8V±1%, 300mA, +CE	PLP2020-8	37yv	VR19	9b	Ric
H009	RP150K009A	LVR-IC	LDO, LN, Dual out, Vout1/Vout2=3.3V/2.8V±1%, 300mA, +CE	PLP2020-8	37yv	VR19	9b	Ric
H010	RP150K010A	LVR-IC	LDO, LN, Dual out, Vout1/Vout2=3.3V/3V±1%, 300mA, +CE	PLP2020-8	37yv	VR19	9b	Ric
H011	RP150K011A	LVR-IC	LDO, LN, Dual out, Vout1/Vout2=2.8V/2.8V±1%, 300mA, +CE	PLP2020-8	37yv	VR19	9b	Ric
H012	RP150K012A	LVR-IC	LDO, LN, Dual out, Vout1/Vout2=2.7V/3V±1%, 300mA, +CE	PLP2020-8	37yv	VR19	9b	Ric
H013	RP150K013A	LVR-IC	LDO, LN, Dual out, Vout1/Vout2=1.7V/1.8V±1%, 300mA, +CE	PLP2020-8	37yv	VR19	9b	Ric
H014	RP150K014A	LVR-IC	LDO, LN, Dual out, Vout1/Vout2=1.8V/1.8V±1%, 300mA, +CE	PLP2020-8	37yv	VR19	9b	Ric
H015	RP150K015A	LVR-IC	LDO, LN, Dual out, Vout1/Vout2=1.8V/2.6V±1%, 300mA, +CE	PLP2020-8	37yv	VR19	9b	Ric
H016	RP150K016A	LVR-IC	LDO, LN, Dual out, Vout1/Vout2=2.8V/3V±1%, 300mA, +CE	PLP2020-8	37yv	VR19	9b	Ric
H017	RP150K017A	LVR-IC	LDO, LN, Dual out, Vout1/Vout2=1.8V/3V±1%, 300mA, +CE	PLP2020-8	37yv	VR19	9b	Ric
H08	XC6220A081ER	LVR-IC	LDO, 0.8V±20mV, 1A, +CE	USP-6C	49vr	VR4	9a	Tor
H09	XC6220A091ER	LVR-IC	LDO, 0.9V±20mV, 1A	USP-6C	49vr	VR4	9a	Tor
H0A	XC6127N55A7R	Vdet-IC	5.5V±0.8%, -Reset ODO, -MR, Rt=50ms	USPN-4	58cc	VD4	9th	Tor
H0A	XC6220A101ER	LVR-IC	LDO, 1V±20mV, 1A, +CE	USP-6C	49vr	VR4	9a	Tor
H0B	XC6127N55B7R	Vdet-IC	5.5V±0.8%, -Reset ODO, -MR, Rt=100ms	USPN-4	58cc	VD4	9th	Tor
H0B	XC6220A111ER	LVR-IC	LDO, 1.1V±20mV, 1A, +CE	USP-6C	49vr	VR4	9a	Tor
H0C	XC6127N55C7R	Vdet-IC	5.5V±0.8%, -Reset ODO, -MR, Rt=200ms	USPN-4	58cc	VD4	9th	Tor
H0C	XC6220A121ER	LVR-IC	LDO, 1.2V±20mV, 1A, +CE	USP-6C	49vr	VR4	9a	Tor
H0D	XC6127N55D7R	Vdet-IC	5.5V±0.8%, -Reset ODO, -MR, Rt=400ms	USPN-4	58cc	VD4	9th	Tor
H0D	XC6220A131ER	LVR-IC	LDO, 1.3V±20mV, 1A, +CE	USP-6C	49vr	VR4	9a	Tor
H0E	XC6127N55E7R	Vdet-IC	5.5V±0.8%, -Reset ODO, -MR, Rt=800ms	USPN-4	58cc	VD4	9th	Tor
H0E	XC6220A141ER	LVR-IC	LDO, 1.4V±20mV, 1A, +CE	USP-6C	49vr	VR4	9a	Tor
H0F	XC6127N55F7R	Vdet-IC	5.5V±0.8%, +Reset ODO, -MR, Rt=50ms	USPN-4	58cc	VD4	9th	Tor
H0F	XC6220A151ER	LVR-IC	LDO, 1.5V±20mV, 1A, +CE	USP-6C	49vr	VR4	9a	Tor
H0H	XC6127N55G7R	Vdet-IC	5.5V±0.8%, +Reset ODO, -MR, Rt=100ms	USPN-4	58cc	VD4	9th	Tor
H0H	XC6220A161ER	LVR-IC	LDO, 1.6V±20mV, 1A, +CE	USP-6C	49vr	VR4	9a	Tor
H0K	XC6127N55H7R	Vdet-IC	5.5V±0.8%, +Reset ODO, -MR, Rt=200ms	USPN-4	58cc	VD4	9th	Tor
H0K	XC6220A171ER	LVR-IC	LDO, 1.7V±20mV, 1A, +CE	USP-6C	49vr	VR4	9a	Tor
H0L	XC6127N55J7R	Vdet-IC	5.5V±0.8%, +Reset ODO, -MR, Rt=400ms	USPN-4	58cc	VD4	9th	Tor
H0L	XC6220A181ER	LVR-IC	LDO, 1.8V±20mV, 1A, +CE	USP-6C	49vr	VR4	9a	Tor
H0M	XC6127N55K7R	Vdet-IC	5.5V±0.8%, +Reset ODO, -MR, Rt=800ms	USPN-4	58cc	VD4	9th	Tor



SMD code	Type	Function	Short description	Case	Pinout	Sch.	St.	Mnf.
H0M	XC6220A191ER	LVR-IC	LDO, 1.9V±20mV, 1A, +CE	USP-6C	49vr	VR4	9a	Tor
H0N	XC6220A201ER	LVR-IC	LDO, 2V±1%, 1A, +CE	USP-6C	49vr	VR4	9a	Tor
H0P	XC6220A211ER	LVR-IC	LDO, 2.1V±1%, 1A, +CE	USP-6C	49vr	VR4	9a	Tor
H0R	XC6220A221ER	LVR-IC	LDO, 2.2V±1%, 1A, +CE	USP-6C	49vr	VR4	9a	Tor
H0S	XC6220A231ER	LVR-IC	LDO, 2.3V±1%, 1A, +CE	USP-6C	49vr	VR4	9a	Tor
H0T	XC6220A241ER	LVR-IC	LDO, 2.4V±1%, 1A, +CE	USP-6C	49vr	VR4	9a	Tor
H0U	XC6220A251ER	LVR-IC	LDO, 2.5V±1%, 1A, +CE	USP-6C	49vr	VR4	9a	Tor
H0V	XC6220A261ER	LVR-IC	LDO, 2.6V±1%, 1A, +CE	USP-6C	49vr	VR4	9a	Tor
H0X	XC6220A271ER	LVR-IC	LDO, 2.7V±1%, 1A, +CE	USP-6C	49vr	VR4	9a	Tor
H0Y	XC6220A281ER	LVR-IC	LDO, 2.8V±1%, 1A, +CE	USP-6C	49vr	VR4	9a	Tor
H0Z	XC6220A291ER	LVR-IC	LDO, 2.9V±1%, 1A, +CE	USP-6C	49vr	VR4	9a	Tor
H1	LM4947TL	LIN-IC	AF PA, BTL, class-D, 2.7..5.5V, 500mW(80)+2x37mW(32Q), I2C	BGA-25	39	-	-	Nsc
H1	R3118K271C	Vdet-IC	2.7V±1.5%, -Reset PPO, Sense	DFN1212-6	52z3	VD15	9a	Ric
H1	RP109L291D	LVR-IC	LDO, 2.9V±1%, 150mA, +CE, CL	DFN1010-4	48vm	VR4	9a	Ric
H1	XC6221B332B7R	LVR-IC	LDO, 3.25V±1%, 200mA, +CE, CL	USPN-4	58vm	VR4	9a	Tor
H1	XC6223B4019R-G	LVR-IC	LDO, 4.0V±1%, 300mA, +CE, CL	USPQ-4B03	48vm	VR4	9a	Tor
H18	XC6220A08BER	LVR-IC	LDO, 0.85V±20mV, 1A, +CE	USP-6C	49vr	VR4	9a	Tor
H19	XC6220A09BER	LVR-IC	LDO, 0.95V±20mV, 1A, +CE	USP-6C	49vr	VR4	9a	Tor
H1A	XC6220A10BER	LVR-IC	LDO, 1.05V±20mV, 1A, +CE	USP-6C	49vr	VR4	9a	Tor
H1B	XC6220A11BER	LVR-IC	LDO, 1.15V±20mV, 1A, +CE	USP-6C	49vr	VR4	9a	Tor
H1C	XC6220A12BER	LVR-IC	LDO, 1.25V±20mV, 1A, +CE	USP-6C	49vr	VR4	9a	Tor
H1D	XC6220A13BER	LVR-IC	LDO, 1.35V±20mV, 1A, +CE	USP-6C	49vr	VR4	9a	Tor
H1E	XC6220A14BER	LVR-IC	LDO, 1.45V±20mV, 1A, +CE	USP-6C	49vr	VR4	9a	Tor
H1F	XC6220A15BER	LVR-IC	LDO, 1.55V±20mV, 1A, +CE	USP-6C	49vr	VR4	9a	Tor
H1H	XC6220A16BER	LVR-IC	LDO, 1.65V±20mV, 1A, +CE	USP-6C	49vr	VR4	9a	Tor
H1K	XC6220A17BER	LVR-IC	LDO, 1.75V±20mV, 1A, +CE	USP-6C	49vr	VR4	9a	Tor
H1L	XC6220A18BER	LVR-IC	LDO, 1.85V±20mV, 1A, +CE	USP-6C	49vr	VR4	9a	Tor
H1M	XC6220A19BER	LVR-IC	LDO, 1.95V±20mV, 1A, +CE	USP-6C	49vr	VR4	9a	Tor
H1N	XC6220A20BER	LVR-IC	LDO, 2.05V±1%, 1A, +CE	USP-6C	49vr	VR4	9a	Tor
H1P	XC6220A21BER	LVR-IC	LDO, 2.15V±1%, 1A, +CE	USP-6C	49vr	VR4	9a	Tor
H1R	XC6220A22BER	LVR-IC	LDO, 2.25V±1%, 1A, +CE	USP-6C	49vr	VR4	9a	Tor
H1S	XC6220A23BER	LVR-IC	LDO, 2.35V±1%, 1A, +CE	USP-6C	49vr	VR4	9a	Tor
H1T	XC6220A24BER	LVR-IC	LDO, 2.45V±1%, 1A, +CE	USP-6C	49vr	VR4	9a	Tor
H1U	XC6220A25BER	LVR-IC	LDO, 2.55V±1%, 1A, +CE	USP-6C	49vr	VR4	9a	Tor
H1V	XC6220A26BER	LVR-IC	LDO, 2.65V±1%, 1A, +CE	USP-6C	49vr	VR4	9a	Tor
H1X	XC6220A27BER	LVR-IC	LDO, 2.75V±1%, 1A, +CE	USP-6C	49vr	VR4	9a	Tor
H1Y	XC6220A28BER	LVR-IC	LDO, 2.85V±1%, 1A, +CE	USP-6C	49vr	VR4	9a	Tor
H1Z	XC6220A29BER	LVR-IC	LDO, 2.95V±1%, 1A, +CE	USP-6C	49vr	VR4	9a	Tor
H2	LM4985TM	LIN-IC	AF PA, 2.3..5.5V, 2x68mW(5V/16Q), I2C volume	BGA-12	39	-	-	Nsc
H2	R3118K281C	Vdet-IC	2.8V±1.5%, -Reset PPO, Sense	DFN1212-6	52z3	VD15	9a	Ric
H2	RP109L301D	LVR-IC	LDO, 3.0V±1%, 150mA, +CE, CL	DFN1010-4	48vm	VR4	9a	Ric
H2	XC6221B333B7R	LVR-IC	LDO, 3.35V±1%, 200mA, +CE, CL	USPN-4	58vm	VR4	9a	Tor
H2	XC6223C4019R-G	LVR-IC	LDO, 4.0V±1%, 300mA, +CE, PDR	USPQ-4B03	48vm	VR4	9a	Tor
H20	XC6220A301ER	LVR-IC	LDO, 3V±1%, 1A, +CE	USP-6C	49vr	VR4	9a	Tor
H21	XC6220A311ER	LVR-IC	LDO, 3.1V±1%, 1A, +CE	USP-6C	49vr	VR4	9a	Tor
H22	XC6220A321ER	LVR-IC	LDO, 3.2V±1%, 1A, +CE	USP-6C	49vr	VR4	9a	Tor
H23	XC6220A331ER	LVR-IC	LDO, 3.3V±1%, 1A, +CE	USP-6C	49vr	VR4	9a	Tor
H24	XC6220A341ER	LVR-IC	LDO, 3.4V±1%, 1A, +CE	USP-6C	49vr	VR4	9a	Tor
H25	XC6220A351ER	LVR-IC	LDO, 3.5V±1%, 1A, +CE	USP-6C	49vr	VR4	9a	Tor
H26	XC6220A361ER	LVR-IC	LDO, 3.6V±1%, 1A, +CE	USP-6C	49vr	VR4	9a	Tor
H27	XC6220A371ER	LVR-IC	LDO, 3.7V±1%, 1A, +CE	USP-6C	49vr	VR4	9a	Tor
H28	XC6220A381ER	LVR-IC	LDO, 3.8V±1%, 1A, +CE	USP-6C	49vr	VR4	9a	Tor
H29	XC6220A391ER	LVR-IC	LDO, 3.9V±1%, 1A, +CE	USP-6C	49vr	VR4	9a	Tor
H2A	XC6220A401ER	LVR-IC	LDO, 4V±1%, 1A, +CE	USP-6C	49vr	VR4	9a	Tor
H2B	XC6220A411ER	LVR-IC	LDO, 4.1V±1%, 1A, +CE	USP-6C	49vr	VR4	9a	Tor
H2C	XC6220A421ER	LVR-IC	LDO, 4.2V±1%, 1A, +CE	USP-6C	49vr	VR4	9a	Tor
H2D	XC6220A431ER	LVR-IC	LDO, 4.3V±1%, 1A, +CE	USP-6C	49vr	VR4	9a	Tor
H2E	XC6220A441ER	LVR-IC	LDO, 4.4V±1%, 1A, +CE	USP-6C	49vr	VR4	9a	Tor
H2F	XC6220A451ER	LVR-IC	LDO, 4.5V±1%, 1A, +CE	USP-6C	49vr	VR4	9a	Tor
H2H	XC6220A461ER	LVR-IC	LDO, 4.6V±1%, 1A, +CE	USP-6C	49vr	VR4	9a	Tor
H2K	XC6220A471ER	LVR-IC	LDO, 4.7V±1%, 1A, +CE	USP-6C	49vr	VR4	9a	Tor
H2L	XC6220A481ER	LVR-IC	LDO, 4.8V±1%, 1A, +CE	USP-6C	49vr	VR4	9a	Tor
H2M	XC6220A491ER	LVR-IC	LDO, 4.9V±1%, 1A, +CE	USP-6C	49vr	VR4	9a	Tor
H2N	XC6220A501ER	LVR-IC	LDO, 5V±1%, 1A, +CE	USP-6C	49vr	VR4	9a	Tor
H3	R3118K291C	Vdet-IC	2.9V±1.5%, -Reset PPO, Sense	DFN1212-6	52z3	VD15	9a	Ric
H3	RP109L311D	LVR-IC	LDO, 3.1V±1%, 150mA, +CE, CL	DFN1010-4	48vm	VR4	9a	Ric
H3	XC6221B334B7R	LVR-IC	LDO, 3.45V±1%, 200mA, +CE, CL	USPN-4	58vm	VR4	9a	Tor
H3	XC6223D4019R-G	LVR-IC	LDO, 4.0V±1%, 300mA, +CE, CL, PDR	USPQ-4B03	48vm	VR4	9a	Tor
H30	XC6220A30BER	LVR-IC	LDO, 3.05V±1%, 1A, +CE	USP-6C	49vr	VR4	9a	Tor
H31	XC6220A31BER	LVR-IC	LDO, 3.15V±1%, 1A, +CE	USP-6C	49vr	VR4	9a	Tor



SMD code	Type	Function	Short description	Case	Pinout	Sch.	St.	Mnf.
H32	XC6220A32BER	LVR-IC	LDO, 3.25V±1%, 1A, +CE	USP-6C	49vr	VR4	9a	Tor
H33	XC6220A33BER	LVR-IC	LDO, 3.35V±1%, 1A, +CE	USP-6C	49vr	VR4	9a	Tor
H34	XC6220A34BER	LVR-IC	LDO, 3.45V±1%, 1A, +CE	USP-6C	49vr	VR4	9a	Tor
H35	XC6220A35BER	LVR-IC	LDO, 3.55V±1%, 1A, +CE	USP-6C	49vr	VR4	9a	Tor
H36	XC6220A36BER	LVR-IC	LDO, 3.65V±1%, 1A, +CE	USP-6C	49vr	VR4	9a	Tor
H37	XC6220A37BER	LVR-IC	LDO, 3.75V±1%, 1A, +CE	USP-6C	49vr	VR4	9a	Tor
H38	XC6220A38BER	LVR-IC	LDO, 3.85V±1%, 1A, +CE	USP-6C	49vr	VR4	9a	Tor
H39	XC6220A39BER	LVR-IC	LDO, 3.95V±1%, 1A, +CE	USP-6C	49vr	VR4	9a	Tor
H3A	XC6220A40BER	LVR-IC	LDO, 4.05V±1%, 1A, +CE	USP-6C	49vr	VR4	9a	Tor
H3B	XC6220A41BER	LVR-IC	LDO, 4.15V±1%, 1A, +CE	USP-6C	49vr	VR4	9a	Tor
H3C	XC6220A42BER	LVR-IC	LDO, 4.25V±1%, 1A, +CE	USP-6C	49vr	VR4	9a	Tor
H3D	XC6220A43BER	LVR-IC	LDO, 4.35V±1%, 1A, +CE	USP-6C	49vr	VR4	9a	Tor
H3E	XC6220A44BER	LVR-IC	LDO, 4.45V±1%, 1A, +CE	USP-6C	49vr	VR4	9a	Tor
H3F	XC6220A45BER	LVR-IC	LDO, 4.55V±1%, 1A, +CE	USP-6C	49vr	VR4	9a	Tor
H3H	XC6220A46BER	LVR-IC	LDO, 4.65V±1%, 1A, +CE	USP-6C	49vr	VR4	9a	Tor
H3K	XC6220A47BER	LVR-IC	LDO, 4.75V±1%, 1A, +CE	USP-6C	49vr	VR4	9a	Tor
H3L	XC6220A48BER	LVR-IC	LDO, 4.85V±1%, 1A, +CE	USP-6C	49vr	VR4	9a	Tor
H3M	XC6220A49BER	LVR-IC	LDO, 4.95V±1%, 1A, +CE	USP-6C	49vr	VR4	9a	Tor
H4	R3118K301C	Vdel-IC	3.0V±1.5%, -Reset PPO, Sense	DFN1212-6	52z3	VD15	9a	Ric
H4	RP109L321D	LVR-IC	LDO, 3.2V±1%, 150mA, +CE, CL	DFN1010-4	48vm	VR4	9a	Ric
H4	XC6221B35B7R	LVR-IC	LDO, 3.55V±1%, 200mA, +CE, CL	USPN-4	58vm	VR4	9a	Tor
H4	XC6223E4019R-G	LVR-IC	LDO, 4.0V±1%, 300mA, +CE, ICP	USPQ-4B03	48vm	VR4	9a	Tor
H48	XC6220B081ER	LVR-IC	LDO, 0.8V±20mV, 1A, +CE, CL	USP-6C	49vr	VR4	9a	Tor
H49	XC6220B091ER	LVR-IC	LDO, 0.9V±20mV, 1A, +CE, CL	USP-6C	49vr	VR4	9a	Tor
H498RSQ	STH4988SQ	LIN-IC	AF PA, BTL, 2.4-5.5V, 2x2.1W(5V/8Ω), 3D, shutdown	QFN-24	38	-	-	Sit
H4A	XC6220B101ER	LVR-IC	LDO, 1V±20mV, 1A, +CE, CL	USP-6C	49vr	VR4	9a	Tor
H4B	XC6220B111ER	LVR-IC	LDO, 1.1V±20mV, 1A, +CE, CL	USP-6C	49vr	VR4	9a	Tor
H4C	XC6220B121ER	LVR-IC	LDO, 1.2V±20mV, 1A, +CE, CL	USP-6C	49vr	VR4	9a	Tor
H4D	XC6220B131ER	LVR-IC	LDO, 1.3V±20mV, 1A, +CE, CL	USP-6C	49vr	VR4	9a	Tor
H4E	XC6220B141ER	LVR-IC	LDO, 1.4V±20mV, 1A, +CE, CL	USP-6C	49vr	VR4	9a	Tor
H4F	XC6220B151ER	LVR-IC	LDO, 1.5V±20mV, 1A, +CE, CL	USP-6C	49vr	VR4	9a	Tor
H4H	XC6220B161ER	LVR-IC	LDO, 1.6V±20mV, 1A, +CE, CL	USP-6C	49vr	VR4	9a	Tor
H4K	XC6220B171ER	LVR-IC	LDO, 1.7V±20mV, 1A, +CE, CL	USP-6C	49vr	VR4	9a	Tor
H4L	XC6220B181ER	LVR-IC	LDO, 1.8V±20mV, 1A, +CE, CL	USP-6C	49vr	VR4	9a	Tor
H4M	XC6220B191ER	LVR-IC	LDO, 1.9V±20mV, 1A, +CE, CL	USP-6C	49vr	VR4	9a	Tor
H4N	XC6220B201ER	LVR-IC	LDO, 2V±1%, 1A, +CE, CL	USP-6C	49vr	VR4	9a	Tor
H4P	XC6220B211ER	LVR-IC	LDO, 2.1V±1%, 1A, +CE, CL	USP-6C	49vr	VR4	9a	Tor
H4R	XC6220B221ER	LVR-IC	LDO, 2.2V±1%, 1A, +CE, CL	USP-6C	49vr	VR4	9a	Tor
H4S	XC6220B231ER	LVR-IC	LDO, 2.3V±1%, 1A, +CE, CL	USP-6C	49vr	VR4	9a	Tor
H4T	XC6220B241ER	LVR-IC	LDO, 2.4V±1%, 1A, +CE, CL	USP-6C	49vr	VR4	9a	Tor
H4U	XC6220B251ER	LVR-IC	LDO, 2.5V±1%, 1A, +CE, CL	USP-6C	49vr	VR4	9a	Tor
H4V	XC6220B261ER	LVR-IC	LDO, 2.6V±1%, 1A, +CE, CL	USP-6C	49vr	VR4	9a	Tor
H4X	XC6220B271ER	LVR-IC	LDO, 2.7V±1%, 1A, +CE, CL	USP-6C	49vr	VR4	9a	Tor
H4Y	XC6220B281ER	LVR-IC	LDO, 2.8V±1%, 1A, +CE, CL	USP-6C	49vr	VR4	9a	Tor
H4Z	XC6220B291ER	LVR-IC	LDO, 2.9V±1%, 1A, +CE, CL	USP-6C	49vr	VR4	9a	Tor
H5	R3118K311C	Vdel-IC	3.1V±1.5%, -Reset PPO, Sense	DFN1212-6	52z3	VD15	9a	Ric
H5	RP109L331D	LVR-IC	LDO, 3.3V±1%, 150mA, +CE, CL	DFN1010-4	48vm	VR4	9a	Ric
H5	XC6221B36B7R	LVR-IC	LDO, 3.65V±1%, 200mA, +CE, CL	USPN-4	58vm	VR4	9a	Tor
H5	XC6223F4019R-G	LVR-IC	LDO, 4.0V±1%, 300mA, +CE, CL, ICP	USPQ-4B03	48vm	VR4	9a	Tor
H58	XC6220B08BER	LVR-IC	LDO, 0.85V±20mV, 1A, +CE, CL	USP-6C	49vr	VR4	9a	Tor
H59	XC6220B09BER	LVR-IC	LDO, 0.95V±20mV, 1A, +CE, CL	USP-6C	49vr	VR4	9a	Tor
H5A	XC6220B10BER	LVR-IC	LDO, 1.05V±20mV, 1A, +CE, CL	USP-6C	49vr	VR4	9a	Tor
H5B	XC6220B11BER	LVR-IC	LDO, 1.15V±20mV, 1A, +CE, CL	USP-6C	49vr	VR4	9a	Tor
H5C	XC6220B12BER	LVR-IC	LDO, 1.25V±20mV, 1A, +CE, CL	USP-6C	49vr	VR4	9a	Tor
H5D	XC6220B13BER	LVR-IC	LDO, 1.35V±20mV, 1A, +CE, CL	USP-6C	49vr	VR4	9a	Tor
H5E	XC6220B14BER	LVR-IC	LDO, 1.45V±20mV, 1A, +CE, CL	USP-6C	49vr	VR4	9a	Tor
H5F	XC6220B15BER	LVR-IC	LDO, 1.55V±20mV, 1A, +CE, CL	USP-6C	49vr	VR4	9a	Tor
H5H	XC6220B16BER	LVR-IC	LDO, 1.65V±20mV, 1A, +CE, CL	USP-6C	49vr	VR4	9a	Tor
H5K	XC6220B17BER	LVR-IC	LDO, 1.75V±20mV, 1A, +CE, CL	USP-6C	49vr	VR4	9a	Tor
H5L	XC6220B18BER	LVR-IC	LDO, 1.85V±20mV, 1A, +CE, CL	USP-6C	49vr	VR4	9a	Tor
H5M	XC6220B19BER	LVR-IC	LDO, 1.95V±20mV, 1A, +CE, CL	USP-6C	49vr	VR4	9a	Tor
H5N	XC6220B20BER	LVR-IC	LDO, 2.05V±1%, 1A, +CE, CL	USP-6C	49vr	VR4	9a	Tor
H5P	XC6220B21BER	LVR-IC	LDO, 2.15V±1%, 1A, +CE, CL	USP-6C	49vr	VR4	9a	Tor
H5R	XC6220B22BER	LVR-IC	LDO, 2.25V±1%, 1A, +CE, CL	USP-6C	49vr	VR4	9a	Tor
H5S	XC6220B23BER	LVR-IC	LDO, 2.35V±1%, 1A, +CE, CL	USP-6C	49vr	VR4	9a	Tor
H5T	XC6220B24BER	LVR-IC	LDO, 2.45V±1%, 1A, +CE, CL	USP-6C	49vr	VR4	9a	Tor
H5U	XC6220B25BER	LVR-IC	LDO, 2.55V±1%, 1A, +CE, CL	USP-6C	49vr	VR4	9a	Tor
H5V	XC6220B26BER	LVR-IC	LDO, 2.65V±1%, 1A, +CE, CL	USP-6C	49vr	VR4	9a	Tor
H5X	XC6220B27BER	LVR-IC	LDO, 2.75V±1%, 1A, +CE, CL	USP-6C	49vr	VR4	9a	Tor
H5Y	XC6220B28BER	LVR-IC	LDO, 2.85V±1%, 1A, +CE, CL	USP-6C	49vr	VR4	9a	Tor



SMD code	Type	Function	Short description	Case	Pinout	Sch.	St.	Mnf.
H5Z	XC6220B29BER	LVR-IC	LDO, 2.95V±1%, 1A, +CE, CL	USP-6C	49vr	VR4	9a	Tor
H6	LM4941TM	LIN-IC	AF PA, BTL, 2.4..5.5V, 1.25W(5V/8Ω), shutdown	BGA-9	39	-	-	Nsc
H6	R3118K321C	Vdet-IC	3.2V±1.5%, -Reset PPO, Sense	DFN1212-6	52z3	VD15	9a	Ric
H6	RP109L341D	LVR-IC	LDO, 3.4V±1%, 150mA, +CE, CL	DFN1010-4	48vm	VR4	9a	Ric
H6	XC6221B37B7R	LVR-IC	LDO, 3.75V±1%, 200mA, +CE, CL	USPN-4	58vm	VR4	9a	Tor
H6	XC6223G4019R-G	LVR-IC	LDO, 4.0V±1%, 300mA, +CE, PDR, ICP	USPQ-4B03	48vm	VR4	9a	Tor
H60	XC6220B301ER	LVR-IC	LDO, 3V±1%, 1A, +CE, CL	USP-6C	49vr	VR4	9a	Tor
H61	XC6220B311ER	LVR-IC	LDO, 3.1V±1%, 1A, +CE, CL	USP-6C	49vr	VR4	9a	Tor
H62	XC6220B321ER	LVR-IC	LDO, 3.2V±1%, 1, +CE, CL	USP-6C	49vr	VR4	9a	Tor
H63	XC6220B331ER	LVR-IC	LDO, 3.3V±1%, 1A, +CE, CL	USP-6C	49vr	VR4	9a	Tor
H64	XC6220B341ER	LVR-IC	LDO, 3.4V±1%, 1A, +CE, CL	USP-6C	49vr	VR4	9a	Tor
H65	XC6220B351ER	LVR-IC	LDO, 3.5V±1%, 1A, +CE, CL	USP-6C	49vr	VR4	9a	Tor
H66	XC6220B361ER	LVR-IC	LDO, 3.6V±1%, 1A, +CE, CL	USP-6C	49vr	VR4	9a	Tor
H67	XC6220B371ER	LVR-IC	LDO, 3.7V±1%, 1A, +CE, CL	USP-6C	49vr	VR4	9a	Tor
H68	XC6220B381ER	LVR-IC	LDO, 3.8V±1%, 1A, +CE, CL	USP-6C	49vr	VR4	9a	Tor
H69	XC6220B391ER	LVR-IC	LDO, 3.9V±1%, 1A, +CE, CL	USP-6C	49vr	VR4	9a	Tor
H6A	XC6220B401ER	LVR-IC	LDO, 4V±1%, 1A, +CE, CL	USP-6C	49vr	VR4	9a	Tor
H6B	XC6220B411ER	LVR-IC	LDO, 4.1V±1%, 1A, +CE, CL	USP-6C	49vr	VR4	9a	Tor
H6C	XC6220B421ER	LVR-IC	LDO, 4.2V±1%, 1A, +CE, CL	USP-6C	49vr	VR4	9a	Tor
H6D	XC6220B431ER	LVR-IC	LDO, 4.3V±1%, 1A, +CE, CL	USP-6C	49vr	VR4	9a	Tor
H6E	XC6220B441ER	LVR-IC	LDO, 4.4V±1%, 1A, +CE, CL	USP-6C	49vr	VR4	9a	Tor
H6F	XC6220B451ER	LVR-IC	LDO, 4.5V±1%, 1A, +CE, CL	USP-6C	49vr	VR4	9a	Tor
H6H	XC6220B461ER	LVR-IC	LDO, 4.6V±1%, 1A, +CE, CL	USP-6C	49vr	VR4	9a	Tor
H6K	XC6220B471ER	LVR-IC	LDO, 4.7V±1%, 1A, +CE, CL	USP-6C	49vr	VR4	9a	Tor
H6L	XC6220B481ER	LVR-IC	LDO, 4.8V±1%, 1A, +CE, CL	USP-6C	49vr	VR4	9a	Tor
H6M	XC6220B491ER	LVR-IC	LDO, 4.9V±1%, 1A, +CE, CL	USP-6C	49vr	VR4	9a	Tor
H6N	XC6220B501ER	LVR-IC	LDO, 5V±1%, 1A, +CE, CL	USP-6C	49vr	VR4	9a	Tor
H7	R3118K331C	Vdet-IC	3.3V±1.5%, -Reset PPO, Sense	DFN1212-6	52z3	VD15	9a	Ric
H7	RP109L351D	LVR-IC	LDO, 3.5V±1%, 150mA, +CE, CL	DFN1010-4	48vm	VR4	9a	Ric
H7	XC6221B38B7R	LVR-IC	LDO, 3.85V±1%, 200mA, +CE, CL	USPN-4	58vm	VR4	9a	Tor
H7	XC6223H4019R-G	LVR-IC	LDO, 4.0V±1%, 300mA, +CE, CL, PDR, ICP	USPQ-4B03	48vm	VR4	9a	Tor
H70	XC6220B30BER	LVR-IC	LDO, 3.05V±1%, 1A, +CE, CL	USP-6C	49vr	VR4	9a	Tor
H71	XC6220B31BER	LVR-IC	LDO, 3.15V±1%, 1A, +CE, CL	USP-6C	49vr	VR4	9a	Tor
H72	XC6220B32BER	LVR-IC	LDO, 3.25V±1%, 1A, +CE, CL	USP-6C	49vr	VR4	9a	Tor
H73	XC6220B33BER	LVR-IC	LDO, 3.35V±1%, 1A, +CE, CL	USP-6C	49vr	VR4	9a	Tor
H74	XC6220B34BER	LVR-IC	LDO, 3.45V±1%, 1A, +CE, CL	USP-6C	49vr	VR4	9a	Tor
H75	XC6220B35BER	LVR-IC	LDO, 3.55V±1%, 1A, +CE, CL	USP-6C	49vr	VR4	9a	Tor
H76	XC6220B36BER	LVR-IC	LDO, 3.65V±1%, 1A, +CE, CL	USP-6C	49vr	VR4	9a	Tor
H77	XC6220B37BER	LVR-IC	LDO, 3.75V±1%, 1A, +CE, CL	USP-6C	49vr	VR4	9a	Tor
H78	XC6220B38BER	LVR-IC	LDO, 3.85V±1%, 1A, +CE, CL	USP-6C	49vr	VR4	9a	Tor
H79	XC6220B39BER	LVR-IC	LDO, 3.95V±1%, 1A, +CE, CL	USP-6C	49vr	VR4	9a	Tor
H7A	XC6220B40BER	LVR-IC	LDO, 4.05V±1%, 1A, +CE, CL	USP-6C	49vr	VR4	9a	Tor
H7B	XC6220B41BER	LVR-IC	LDO, 4.15V±1%, 1A, +CE, CL	USP-6C	49vr	VR4	9a	Tor
H7C	XC6220B42BER	LVR-IC	LDO, 4.25V±1%, 1A, +CE, CL	USP-6C	49vr	VR4	9a	Tor
H7D	XC6220B43BER	LVR-IC	LDO, 4.35V±1%, 1A, +CE, CL	USP-6C	49vr	VR4	9a	Tor
H7E	XC6220B44BER	LVR-IC	LDO, 4.45V±1%, 1A, +CE, CL	USP-6C	49vr	VR4	9a	Tor
H7F	XC6220B45BER	LVR-IC	LDO, 4.55V±1%, 1A, +CE, CL	USP-6C	49vr	VR4	9a	Tor
H7H	XC6220B46BER	LVR-IC	LDO, 4.65V±1%, 1A, +CE, CL	USP-6C	49vr	VR4	9a	Tor
H7K	XC6220B47BER	LVR-IC	LDO, 4.75V±1%, 1A, +CE, CL	USP-6C	49vr	VR4	9a	Tor
H7L	XC6220B48BER	LVR-IC	LDO, 4.85V±1%, 1A, +CE, CL	USP-6C	49vr	VR4	9a	Tor
H7M	XC6220B49BER	LVR-IC	LDO, 4.95V±1%, 1A, +CE, CL	USP-6C	49vr	VR4	9a	Tor
H8	LM4675TL	LIN-IC	AF PA, BTL, class-D, 2.5..5.5V, 2.8W(5V/4Ω), shutdown	BGA-9	39	AFP45	-	Nsc
H8	R3118K341C	Vdet-IC	3.4V±1.5%, -Reset PPO, Sense	DFN1212-6	52z3	VD15	9a	Ric
H8	RP109L361D	LVR-IC	LDO, 3.6V±1%, 150mA, +CE, CL	DFN1010-4	48vm	VR4	9a	Ric
H8	XC6221B39B7R	LVR-IC	LDO, 3.95V±1%, 200mA, +CE, CL	USPN-4	58vm	VR4	9a	Tor
H88	XC6220C081ER	LVR-IC	LDO, 0.8V±20mV, 1A, +CE, PDR	USP-6C	49vr	VR4	9a	Tor
H89	XC6220C091ER	LVR-IC	LDO, 0.9V±20mV, 1A, +CE, PDR	USP-6C	49vr	VR4	9a	Tor
H8A	XC6220C101ER	LVR-IC	LDO, 1V±20mV, 1A, +CE, PDR	USP-6C	49vr	VR4	9a	Tor
H8B	XC6220C111ER	LVR-IC	LDO, 1.1V±20mV, 1A, +CE, PDR	USP-6C	49vr	VR4	9a	Tor
H8C	XC6220C121ER	LVR-IC	LDO, 1.2V±20mV, 1A, +CE, PDR	USP-6C	49vr	VR4	9a	Tor
H8D	XC6220C131ER	LVR-IC	LDO, 1.3V±20mV, 1A, +CE, PDR	USP-6C	49vr	VR4	9a	Tor
H8E	XC6220C141ER	LVR-IC	LDO, 1.4V±20mV, 1A, +CE, PDR	USP-6C	49vr	VR4	9a	Tor
H8F	XC6220C151ER	LVR-IC	LDO, 1.5V±20mV, 1A, +CE, PDR	USP-6C	49vr	VR4	9a	Tor
H8H	XC6220C161ER	LVR-IC	LDO, 1.6V±20mV, 1A, +CE, PDR	USP-6C	49vr	VR4	9a	Tor
H8K	XC6220C171ER	LVR-IC	LDO, 1.7V±20mV, 1A, +CE, PDR	USP-6C	49vr	VR4	9a	Tor
H8L	XC6220C181ER	LVR-IC	LDO, 1.8V±20mV, 1A, +CE, PDR	USP-6C	49vr	VR4	9a	Tor
H8M	XC6220C191ER	LVR-IC	LDO, 1.9V±20mV, 1A, +CE, PDR	USP-6C	49vr	VR4	9a	Tor
H8N	XC6220C201ER	LVR-IC	LDO, 2V±1%, 1A, +CE, PDR	USP-6C	49vr	VR4	9a	Tor
H8P	XC6220C211ER	LVR-IC	LDO, 2.1V±1%, 1A, +CE, PDR	USP-6C	49vr	VR4	9a	Tor
H8R	XC6220C221ER	LVR-IC	LDO, 2.2V±1%, 1A, +CE, PDR	USP-6C	49vr	VR4	9a	Tor



SMD code	Type	Function	Short description	Case	Pinout	Sch.	St.	Mnf.
H8S	XC6220C231ER	LVR-IC	LDO, 2.3V±1%, 1A, +CE, PDR	USP-6C	49vr	VR4	9a	Tor
H8T	XC6220C241ER	LVR-IC	LDO, 2.4V±1%, 1A, +CE, PDR	USP-6C	49vr	VR4	9a	Tor
H8U	XC6220C251ER	LVR-IC	LDO, 2.5V±1%, 1A, +CE, PDR	USP-6C	49vr	VR4	9a	Tor
H8V	XC6220C261ER	LVR-IC	LDO, 2.6V±1%, 1A, +CE, PDR	USP-6C	49vr	VR4	9a	Tor
H8X	XC6220C271ER	LVR-IC	LDO, 2.7V±1%, 1A, +CE, PDR	USP-6C	49vr	VR4	9a	Tor
H8Y	XC6220C281ER	LVR-IC	LDO, 2.8V±1%, 1A, +CE, PDR	USP-6C	49vr	VR4	9a	Tor
H8Z	XC6220C291ER	LVR-IC	LDO, 2.9V±1%, 1A, +CE, PDR	USP-6C	49vr	VR4	9a	Tor
H9	R3118K351C	Vdet-IC	3.5V±1.5%, -Reset PPO, Sense	DFN1212-6	52z3	VD15	9a	Ric
H9	RP109L121D5	LVR-IC	LDO, 1.25V±1%, 150mA, +CE, CL	DFN1010-4	48vm	VR4	9a	Ric
H9	RT9198-27GQW	LVR-IC	LDO, 2.7V±1%, 300mA, +CE	WDFN-6	49	VR1	9a	Rct
H9	XC6221B44B7R	LVR-IC	LDO, 4.45V±1%, 200mA, +CE, CL	USPN-4	58vm	VR4	9a	Tor
H98	XC6220C08BER	LVR-IC	LDO, 0.85V±20mV, 1A, +CE, PDR	USP-6C	49vr	VR4	9a	Tor
H99	XC6220C09BER	LVR-IC	LDO, 0.95V±20mV, 1A, +CE, PDR	USP-6C	49vr	VR4	9a	Tor
H9A	XC6220C10BER	LVR-IC	LDO, 1.05V±20mV, 1A, +CE, PDR	USP-6C	49vr	VR4	9a	Tor
H9B	XC6220C11BER	LVR-IC	LDO, 1.15V±20mV, 1A, +CE, PDR	USP-6C	49vr	VR4	9a	Tor
H9C	XC6220C12BER	LVR-IC	LDO, 1.25V±20mV, 1A, +CE, PDR	USP-6C	49vr	VR4	9a	Tor
H9D	XC6220C13BER	LVR-IC	LDO, 1.35V±20mV, 1A, +CE, PDR	USP-6C	49vr	VR4	9a	Tor
H9E	XC6220C14BER	LVR-IC	LDO, 1.45V±20mV, 1A, +CE, PDR	USP-6C	49vr	VR4	9a	Tor
H9F	XC6220C15BER	LVR-IC	LDO, 1.55V±20mV, 1A, +CE, PDR	USP-6C	49vr	VR4	9a	Tor
H9H	XC6220C16BER	LVR-IC	LDO, 1.65V±20mV, 1A, +CE, PDR	USP-6C	49vr	VR4	9a	Tor
H9K	XC6220C17BER	LVR-IC	LDO, 1.75V±20mV, 1A, +CE, PDR	USP-6C	49vr	VR4	9a	Tor
H9L	XC6220C18BER	LVR-IC	LDO, 1.85V±20mV, 1A, +CE, PDR	USP-6C	49vr	VR4	9a	Tor
H9M	XC6220C19BER	LVR-IC	LDO, 1.95V±20mV, 1A, +CE, PDR	USP-6C	49vr	VR4	9a	Tor
H9N	XC6220C20BER	LVR-IC	LDO, 2.05V±1%, 1A, +CE, PDR	USP-6C	49vr	VR4	9a	Tor
H9P	XC6220C21BER	LVR-IC	LDO, 2.15V±1%, 1A, +CE, PDR	USP-6C	49vr	VR4	9a	Tor
H9R	XC6220C22BER	LVR-IC	LDO, 2.25V±1%, 1A, +CE, PDR	USP-6C	49vr	VR4	9a	Tor
H9S	XC6220C23BER	LVR-IC	LDO, 2.35V±1%, 1A, +CE, PDR	USP-6C	49vr	VR4	9a	Tor
H9T	XC6220C24BER	LVR-IC	LDO, 2.45V±1%, 1A, +CE, PDR	USP-6C	49vr	VR4	9a	Tor
H9U	XC6220C25BER	LVR-IC	LDO, 2.55V±1%, 1A, +CE, PDR	USP-6C	49vr	VR4	9a	Tor
H9V	XC6220C26BER	LVR-IC	LDO, 2.65V±1%, 1A, +CE, PDR	USP-6C	49vr	VR4	9a	Tor
H9X	XC6220C27BER	LVR-IC	LDO, 2.75V±1%, 1A, +CE, PDR	USP-6C	49vr	VR4	9a	Tor
H9Y	XC6220C28BER	LVR-IC	LDO, 2.85V±1%, 1A, +CE, PDR	USP-6C	49vr	VR4	9a	Tor
H9Z	XC6220C29BER	LVR-IC	LDO, 2.95V±1%, 1A, +CE, PDR	USP-6C	49vr	VR4	9a	Tor
HA	R3116K071A	Vdet-IC	0.7V±0.8%, -Reset ODO	DFN1010-4	48rj	VD1	9a	Ric
HA	R3134K46C3E	Vdet-IC	4.63V±1.8%, -Reset PPO, -MR	DFN1212-6	52z6	VD5	9a	Ric
HA	RT9193-33GQW	LVR-IC	LDO, 3.3V±1%, 300mA, +CE	WDFN-6L	49ub	VR7	9a	Rct
HA0	XC6220C301ER	LVR-IC	LDO, 3V±1%, 1A, +CE, PDR	USP-6C	49vr	VR4	9a	Tor
HA1	XC6220C311ER	LVR-IC	LDO, 3.1V±1%, 1A, +CE, PDR	USP-6C	49vr	VR4	9a	Tor
HA2	XC6220C321ER	LVR-IC	LDO, 3.2V±1%, 1A, +CE, PDR	USP-6C	49vr	VR4	9a	Tor
HA3	XC6220C331ER	LVR-IC	LDO, 3.3V±1%, 1A, +CE, PDR	USP-6C	49vr	VR4	9a	Tor
HA4	XC6220C341ER	LVR-IC	LDO, 3.4V±1%, 1A, +CE, PDR	USP-6C	49vr	VR4	9a	Tor
HA5	XC6220C351ER	LVR-IC	LDO, 3.5V±1%, 1A, +CE, PDR	USP-6C	49vr	VR4	9a	Tor
HA6	XC6220C361ER	LVR-IC	LDO, 3.6V±1%, 1A, +CE, PDR	USP-6C	49vr	VR4	9a	Tor
HA7	XC6220C371ER	LVR-IC	LDO, 3.7V±1%, 1A, +CE, PDR	USP-6C	49vr	VR4	9a	Tor
HA8	XC6220C381ER	LVR-IC	LDO, 3.8V±1%, 1A, +CE, PDR	USP-6C	49vr	VR4	9a	Tor
HA9	XC6220C391ER	LVR-IC	LDO, 3.9V±1%, 1A, +CE, PDR	USP-6C	49vr	VR4	9a	Tor
HAA	XC6127N15A7R	Vdet-IC	1.5V±0.8%, -Reset ODO, -MR, Rt=50ms	USPN-4	58cc	VD4	9h	Tor
HAA	XC6220C401ER	LVR-IC	LDO, 4V±1%, 1A, +CE, PDR	USP-6C	49vr	VR4	9a	Tor
HAB	XC6127N15B7R	Vdet-IC	1.5V±0.8%, -Reset ODO, -MR, Rt=100ms	USPN-4	58cc	VD4	9h	Tor
HAB	XC6220C411ER	LVR-IC	LDO, 4.1V±1%, 1A, +CE, PDR	USP-6C	49vr	VR4	9a	Tor
HAC	XC6127N15C7R	Vdet-IC	1.5V±0.8%, -Reset ODO, -MR, Rt=200ms	USPN-4	58cc	VD4	9h	Tor
HAC	XC6220C421ER	LVR-IC	LDO, 4.2V±1%, 1A, +CE, PDR	USP-6C	49vr	VR4	9a	Tor
HAD	XC6127N15D7R	Vdet-IC	1.5V±0.8%, -Reset ODO, -MR, Rt=400ms	USPN-4	58cc	VD4	9h	Tor
HAD	XC6220C431ER	LVR-IC	LDO, 4.3V±1%, 1A, +CE, PDR	USP-6C	49vr	VR4	9a	Tor
HAE	XC6127N15E7R	Vdet-IC	1.5V±0.8%, -Reset ODO, -MR, Rt=800ms	USPN-4	58cc	VD4	9h	Tor
HAE	XC6220C441ER	LVR-IC	LDO, 4.4V±1%, 1A, +CE, PDR	USP-6C	49vr	VR4	9a	Tor
HAF	XC6127N15F7R	Vdet-IC	1.5V±0.8%, +Reset ODO, -MR, Rt=50ms	USPN-4	58cc	VD4	9h	Tor
HAF	XC6220C451ER	LVR-IC	LDO, 4.5V±1%, 1A, +CE, PDR	USP-6C	49vr	VR4	9a	Tor
HAH	XC6127N15G7R	Vdet-IC	1.5V±0.8%, +Reset ODO, -MR, Rt=100ms	USPN-4	58cc	VD4	9h	Tor
HAH	XC6220C461ER	LVR-IC	LDO, 4.6V±1%, 1A, +CE, PDR	USP-6C	49vr	VR4	9a	Tor
HAK	XC6127N15H7R	Vdet-IC	1.5V±0.8%, +Reset ODO, -MR, Rt=200ms	USPN-4	58cc	VD4	9h	Tor
HAK	XC6220C471ER	LVR-IC	LDO, 4.7V±1%, 1A, +CE, PDR	USP-6C	49vr	VR4	9a	Tor
HAL	XC6127N15J7R	Vdet-IC	1.5V±0.8%, +Reset ODO, -MR, Rt=400ms	USPN-4	58cc	VD4	9h	Tor
HAL	XC6220C481ER	LVR-IC	LDO, 4.8V±1%, 1A, +CE, PDR	USP-6C	49vr	VR4	9a	Tor
HAM	XC6127N15K7R	Vdet-IC	1.5V±0.8%, +Reset ODO, -MR, Rt=800ms	USPN-4	58cc	VD4	9h	Tor
HAM	XC6220C491ER	LVR-IC	LDO, 4.9V±1%, 1A, +CE, PDR	USP-6C	49vr	VR4	9a	Tor
HAN	XC6127N16A7R	Vdet-IC	1.6V±0.8%, -Reset ODO, -MR, Rt=50ms	USPN-4	58cc	VD4	9h	Tor
HAN	XC6220C501ER	LVR-IC	LDO, 5V±1%, 1A, +CE, PDR	USP-6C	49vr	VR4	9a	Tor
HAP	XC6127N16B7R	Vdet-IC	1.6V±0.8%, -Reset ODO, -MR, Rt=100ms	USPN-4	58cc	VD4	9h	Tor
HAR	XC6127N16C7R	Vdet-IC	1.6V±0.8%, -Reset ODO, -MR, Rt=200ms	USPN-4	58cc	VD4	9h	Tor



SMD code	Type	Function	Short description	Case	Pinout	Sch.	St.	Mnf.
HAS	XC6127N16D7R	Vdet-IC	1.6V±0.8%, -Reset ODO, -MR, Rt=400ms	USPN-4	58cc	VD4	9h	Tor
HAT	XC6127N16E7R	Vdet-IC	1.6V±0.8%, -Reset ODO, -MR, Rt=800ms	USPN-4	58cc	VD4	9h	Tor
HAU	XC6127N16F7R	Vdet-IC	1.6V±0.8%, +Reset ODO, -MR, Rt=50ms	USPN-4	58cc	VD4	9h	Tor
HAV	XC6127N16G7R	Vdet-IC	1.6V±0.8%, +Reset ODO, -MR, Rt=100ms	USPN-4	58cc	VD4	9h	Tor
HAX	XC6127N16H7R	Vdet-IC	1.6V±0.8%, +Reset ODO, -MR, Rt=200ms	USPN-4	58cc	VD4	9h	Tor
HAY	XC6127N16J7R	Vdet-IC	1.6V±0.8%, +Reset ODO, -MR, Rt=400ms	USPN-4	58cc	VD4	9h	Tor
HAZ	XC6127N16K7R	Vdet-IC	1.6V±0.8%, +Reset ODO, -MR, Rt=800ms	USPN-4	58cc	VD4	9h	Tor
HB	R3116K081A	Vdet-IC	0.8V±0.8%, -Reset ODO	DFN1010-4	48rj	VD1	9a	Ric
HB0	XC6220C30BER	LVR-IC	LDO, 3.05V±1%, 1A, +CE, PDR	USP-6C	49vr	VR4	9a	Tor
HB1	XC6220C31BER	LVR-IC	LDO, 3.15V±1%, 1A, +CE, PDR	USP-6C	49vr	VR4	9a	Tor
HB2	XC6220C32BER	LVR-IC	LDO, 3.25V±1%, 1A, +CE, PDR	USP-6C	49vr	VR4	9a	Tor
HB3	XC6220C33BER	LVR-IC	LDO, 3.35V±1%, 1A, +CE, PDR	USP-6C	49vr	VR4	9a	Tor
HB4	XC6220C34BER	LVR-IC	LDO, 3.45V±1%, 1A, +CE, PDR	USP-6C	49vr	VR4	9a	Tor
HB5	XC6220C35BER	LVR-IC	LDO, 3.55V±1%, 1A, +CE, PDR	USP-6C	49vr	VR4	9a	Tor
HB6	XC6220C36BER	LVR-IC	LDO, 3.65V±1%, 1A, +CE, PDR	USP-6C	49vr	VR4	9a	Tor
HB7	XC6220C37BER	LVR-IC	LDO, 3.75V±1%, 1A, +CE, PDR	USP-6C	49vr	VR4	9a	Tor
HB8	XC6220C38BER	LVR-IC	LDO, 3.85V±1%, 1A, +CE, PDR	USP-6C	49vr	VR4	9a	Tor
HB9	XC6220C39BER	LVR-IC	LDO, 3.95V±1%, 1A, +CE, PDR	USP-6C	49vr	VR4	9a	Tor
HBA	XC6127N17A7R	Vdet-IC	1.7V±0.8%, -Reset ODO, -MR, Rt=50ms	USPN-4	58cc	VD4	9h	Tor
HBA	XC6220C40BER	LVR-IC	LDO, 4.05V±1%, 1A, +CE, PDR	USP-6C	49vr	VR4	9a	Tor
HBB	XC6127N17B7R	Vdet-IC	1.7V±0.8%, -Reset ODO, -MR, Rt=100ms	USPN-4	58cc	VD4	9h	Tor
HBB	XC6220C41BER	LVR-IC	LDO, 4.15V±1%, 1A, +CE, PDR	USP-6C	49vr	VR4	9a	Tor
HBC	XC6127N17C7R	Vdet-IC	1.7V±0.8%, -Reset ODO, -MR, Rt=200ms	USPN-4	58cc	VD4	9h	Tor
HBC	XC6220C42BER	LVR-IC	LDO, 4.25V±1%, 1A, +CE, PDR	USP-6C	49vr	VR4	9a	Tor
HBD	XC6127N17D7R	Vdet-IC	1.7V±0.8%, -Reset ODO, -MR, Rt=400ms	USPN-4	58cc	VD4	9h	Tor
HBD	XC6220C43BER	LVR-IC	LDO, 4.35V±1%, 1A, +CE, PDR	USP-6C	49vr	VR4	9a	Tor
HBE	XC6127N17E7R	Vdet-IC	1.7V±0.8%, -Reset ODO, -MR, Rt=800ms	USPN-4	58cc	VD4	9h	Tor
HBE	XC6220C44BER	LVR-IC	LDO, 4.45V±1%, 1A, +CE, PDR	USP-6C	49vr	VR4	9a	Tor
HBF	XC6127N17F7R	Vdet-IC	1.7V±0.8%, +Reset ODO, -MR, Rt=50ms	USPN-4	58cc	VD4	9h	Tor
HBF	XC6220C45BER	LVR-IC	LDO, 4.55V±1%, 1A, +CE, PDR	USP-6C	49vr	VR4	9a	Tor
HBH	XC6127N17G7R	Vdet-IC	1.7V±0.8%, +Reset ODO, -MR, Rt=100ms	USPN-4	58cc	VD4	9h	Tor
HBH	XC6220C46BER	LVR-IC	LDO, 4.65V±1%, 1A, +CE, PDR	USP-6C	49vr	VR4	9a	Tor
HBK	XC6127N17H7R	Vdet-IC	1.7V±0.8%, +Reset ODO, -MR, Rt=200ms	USPN-4	58cc	VD4	9h	Tor
HBK	XC6220C47BER	LVR-IC	LDO, 4.75V±1%, 1A, +CE, PDR	USP-6C	49vr	VR4	9a	Tor
HBL	XC6127N17J7R	Vdet-IC	1.7V±0.8%, +Reset ODO, -MR, Rt=400ms	USPN-4	58cc	VD4	9h	Tor
HBL	XC6220C48BER	LVR-IC	LDO, 4.85V±1%, 1A, +CE, PDR	USP-6C	49vr	VR4	9a	Tor
HBM	XC6127N17K7R	Vdet-IC	1.7V±0.8%, +Reset ODO, -MR, Rt=800ms	USPN-4	58cc	VD4	9h	Tor
HBM	XC6220C49BER	LVR-IC	LDO, 4.95V±1%, 1A, +CE, PDR	USP-6C	49vr	VR4	9a	Tor
HBN	XC6127N18A7R	Vdet-IC	1.8V±0.8%, -Reset ODO, -MR, Rt=50ms	USPN-4	58cc	VD4	9h	Tor
HBP	XC6127N18B7R	Vdet-IC	1.8V±0.8%, -Reset ODO, -MR, Rt=100ms	USPN-4	58cc	VD4	9h	Tor
HBR	XC6127N18C7R	Vdet-IC	1.8V±0.8%, -Reset ODO, -MR, Rt=200ms	USPN-4	58cc	VD4	9h	Tor
HBS	XC6127N18D7R	Vdet-IC	1.8V±0.8%, -Reset ODO, -MR, Rt=400ms	USPN-4	58cc	VD4	9h	Tor
HBT	XC6127N18E7R	Vdet-IC	1.8V±0.8%, -Reset ODO, -MR, Rt=800ms	USPN-4	58cc	VD4	9h	Tor
HBU	XC6127N18F7R	Vdet-IC	1.8V±0.8%, +Reset ODO, -MR, Rt=50ms	USPN-4	58cc	VD4	9h	Tor
HBV	XC6127N18G7R	Vdet-IC	1.8V±0.8%, +Reset ODO, -MR, Rt=100ms	USPN-4	58cc	VD4	9h	Tor
HBX	XC6127N18H7R	Vdet-IC	1.8V±0.8%, +Reset ODO, -MR, Rt=200ms	USPN-4	58cc	VD4	9h	Tor
HBY	XC6127N18J7R	Vdet-IC	1.8V±0.8%, +Reset ODO, -MR, Rt=400ms	USPN-4	58cc	VD4	9h	Tor
HBZ	XC6127N18K7R	Vdet-IC	1.8V±0.8%, +Reset ODO, -MR, Rt=800ms	USPN-4	58cc	VD4	9h	Tor
HC	R3116K091A	Vdet-IC	0.9V±0.8%, -Reset ODO	DFN1010-4	48rj	VD1	9a	Ric
HC8	XC6220D081ER	LVR-IC	LDO, 0.8V±20mV, 1A, +CE, CL, PDR	USP-6C	49vr	VR4	9a	Tor
HC9	XC6220D091ER	LVR-IC	LDO, 0.9V±20mV, 1A, +CE, CL, PDR	USP-6C	49vr	VR4	9a	Tor
HCA	XC6127N19A7R	Vdet-IC	1.9V±0.8%, -Reset ODO, -MR, Rt=50ms	USPN-4	58cc	VD4	9h	Tor
HCA	XC6220D101ER	LVR-IC	LDO, 1V±20mV, 1A, +CE, CL, PDR	USP-6C	49vr	VR4	9a	Tor
HCB	XC6127N19B7R	Vdet-IC	1.9V±0.8%, -Reset ODO, -MR, Rt=100ms	USPN-4	58cc	VD4	9h	Tor
HCB	XC6220D111ER	LVR-IC	LDO, 1.1V±20mV, 1A, +CE, CL, PDR	USP-6C	49vr	VR4	9a	Tor
HCC	XC6127N19C7R	Vdet-IC	1.9V±0.8%, -Reset ODO, -MR, Rt=200ms	USPN-4	58cc	VD4	9h	Tor
HCC	XC6220D121ER	LVR-IC	LDO, 1.2V±20mV, 1A, +CE, CL, PDR	USP-6C	49vr	VR4	9a	Tor
HCD	XC6127N19D7R	Vdet-IC	1.9V±0.8%, -Reset ODO, -MR, Rt=400ms	USPN-4	58cc	VD4	9h	Tor
HCD	XC6220D131ER	LVR-IC	LDO, 1.3V±20mV, 1A, +CE, CL, PDR	USP-6C	49vr	VR4	9a	Tor
HCE	XC6127N19E7R	Vdet-IC	1.9V±0.8%, -Reset ODO, -MR, Rt=800ms	USPN-4	58cc	VD4	9h	Tor
HCE	XC6220D141ER	LVR-IC	LDO, 1.4V±20mV, 1A, +CE, CL, PDR	USP-6C	49vr	VR4	9a	Tor
HCF	XC6127N19F7R	Vdet-IC	1.9V±0.8%, +Reset ODO, -MR, Rt=50ms	USPN-4	58cc	VD4	9h	Tor
HCF	XC6220D151ER	LVR-IC	LDO, 1.5V±20mV, 1A, +CE, CL, PDR	USP-6C	49vr	VR4	9a	Tor
HCH	XC6127N19G7R	Vdet-IC	1.9V±0.8%, +Reset ODO, -MR, Rt=100ms	USPN-4	58cc	VD4	9h	Tor
HCH	XC6220D161ER	LVR-IC	LDO, 1.6V±20mV, 1A, +CE, CL, PDR	USP-6C	49vr	VR4	9a	Tor
HCK	XC6127N19H7R	Vdet-IC	1.9V±0.8%, +Reset ODO, -MR, Rt=200ms	USPN-4	58cc	VD4	9h	Tor
HCK	XC6220D171ER	LVR-IC	LDO, 1.7V±20mV, 1A, +CE, CL, PDR	USP-6C	49vr	VR4	9a	Tor
HCL	XC6127N19J7R	Vdet-IC	1.9V±0.8%, +Reset ODO, -MR, Rt=400ms	USPN-4	58cc	VD4	9h	Tor
HCL	XC6220D181ER	LVR-IC	LDO, 1.8V±20mV, 1A, +CE, CL, PDR	USP-6C	49vr	VR4	9a	Tor
HCM	XC6127N19K7R	Vdet-IC	1.9V±0.8%, +Reset ODO, -MR, Rt=800ms	USPN-4	58cc	VD4	9h	Tor



SMD code	Type	Function	Short description	Case	Pinout	Sch.	St.	Mnf.
HCM	XC6220D191ER	LVR-IC	LDO, 1.9V±20mV, 1A, +CE, CL, PDR	USP-6C	49vr	VR4	9a	Tor
HCN	XC6127N20A7R	Vdet-IC	2.0V±0.8%, -Reset ODO, -MR, Rt=50ms	USPN-4	58cc	VD4	9h	Tor
HCN	XC6220D201ER	LVR-IC	LDO, 2V±1%, 1A, +CE, CL, PDR	USP-6C	49vr	VR4	9a	Tor
HCP	XC6127N20B7R	Vdet-IC	2.0V±0.8%, -Reset ODO, -MR, Rt=100ms	USPN-4	58cc	VD4	9h	Tor
HCP	XC6220D211ER	LVR-IC	LDO, 2.1V±1%, 1A, +CE, CL, PDR	USP-6C	49vr	VR4	9a	Tor
HCR	XC6127N20C7R	Vdet-IC	2.0V±0.8%, -Reset ODO, -MR, Rt=200ms	USPN-4	58cc	VD4	9h	Tor
HCR	XC6220D221ER	LVR-IC	LDO, 2.2V±1%, 1A, +CE, CL, PDR	USP-6C	49vr	VR4	9a	Tor
HCS	XC6127N20D7R	Vdet-IC	2.0V±0.8%, -Reset ODO, -MR, Rt=400ms	USPN-4	58cc	VD4	9h	Tor
HCS	XC6220D231ER	LVR-IC	LDO, 2.3V±1%, 1A, +CE, CL, PDR	USP-6C	49vr	VR4	9a	Tor
HCT	XC6127N20E7R	Vdet-IC	2.0V±0.8%, -Reset ODO, -MR, Rt=800ms	USPN-4	58cc	VD4	9h	Tor
HCT	XC6220D241ER	LVR-IC	LDO, 2.4V±1%, 1A, +CE, CL, PDR	USP-6C	49vr	VR4	9a	Tor
HCU	XC6127N20F7R	Vdet-IC	2.0V±0.8%, +Reset ODO, -MR, Rt=50ms	USPN-4	58cc	VD4	9h	Tor
HCU	XC6220D251ER	LVR-IC	LDO, 2.5V±1%, 1A, +CE, CL, PDR	USP-6C	49vr	VR4	9a	Tor
HCV	XC6127N20G7R	Vdet-IC	2.0V±0.8%, +Reset ODO, -MR, Rt=100ms	USPN-4	58cc	VD4	9h	Tor
HCV	XC6220D261ER	LVR-IC	LDO, 2.6V±1%, 1A, +CE, CL, PDR	USP-6C	49vr	VR4	9a	Tor
HCX	XC6127N20H7R	Vdet-IC	2.0V±0.8%, +Reset ODO, -MR, Rt=200ms	USPN-4	58cc	VD4	9h	Tor
HCX	XC6220D271ER	LVR-IC	LDO, 2.7V±1%, 1A, +CE, CL, PDR	USP-6C	49vr	VR4	9a	Tor
HCY	XC6127N20J7R	Vdet-IC	2.0V±0.8%, +Reset ODO, -MR, Rt=400ms	USPN-4	58cc	VD4	9h	Tor
HCY	XC6220D281ER	LVR-IC	LDO, 2.8V±1%, 1A, +CE, CL, PDR	USP-6C	49vr	VR4	9a	Tor
HCZ	XC6127N20K7R	Vdet-IC	2.0V±0.8%, +Reset ODO, -MR, Rt=800ms	USPN-4	58cc	VD4	9h	Tor
HCZ	XC6220D291ER	LVR-IC	LDO, 2.9V±1%, 1A, +CE, CL, PDR	USP-6C	49vr	VR4	9a	Tor
HD	R3116K101A	Vdet-IC	1.0V±0.8%, -Reset ODO	DFN1010-4	48rj	VD1	9a	Ric
HD	RT9193-1HGQW	LVR-IC	LDO, 1.85V±1%, 300mA, +CE	WDFN-6L	49ub	VR7	9a	Ret
HD8	XC6220D08BER	LVR-IC	LDO, 0.85V±20mV, 1A, +CE, CL, PDR	USP-6C	49vr	VR4	9a	Tor
HD9	XC6220D09BER	LVR-IC	LDO, 0.95V±20mV, 1A, +CE, CL, PDR	USP-6C	49vr	VR4	9a	Tor
HDA	XC6127N21A7R	Vdet-IC	2.1V±0.8%, -Reset ODO, -MR, Rt=50ms	USPN-4	58cc	VD4	9h	Tor
HDA	XC6220D10BER	LVR-IC	LDO, 1.05V±20mV, 1A, +CE, CL, PDR	USP-6C	49vr	VR4	9a	Tor
HDB	XC6127N21B7R	Vdet-IC	2.1V±0.8%, -Reset ODO, -MR, Rt=100ms	USPN-4	58cc	VD4	9h	Tor
HDB	XC6220D11BER	LVR-IC	LDO, 1.15V±20mV, 1A, +CE, CL, PDR	USP-6C	49vr	VR4	9a	Tor
HDC	XC6127N21C7R	Vdet-IC	2.1V±0.8%, -Reset ODO, -MR, Rt=200ms	USPN-4	58cc	VD4	9h	Tor
HDC	XC6220D12BER	LVR-IC	LDO, 1.25V±20mV, 1A, +CE, CL, PDR	USP-6C	49vr	VR4	9a	Tor
HDD	XC6127N21D7R	Vdet-IC	2.1V±0.8%, -Reset ODO, -MR, Rt=400ms	USPN-4	58cc	VD4	9h	Tor
HDD	XC6220D13BER	LVR-IC	LDO, 1.35V±20mV, 1A, +CE, CL, PDR	USP-6C	49vr	VR4	9a	Tor
HDE	XC6127N21E7R	Vdet-IC	2.1V±0.8%, -Reset ODO, -MR, Rt=800ms	USPN-4	58cc	VD4	9h	Tor
HDE	XC6220D14BER	LVR-IC	LDO, 1.45V±20mV, 1A, +CE, CL, PDR	USP-6C	49vr	VR4	9a	Tor
HDF	XC6127N21F7R	Vdet-IC	2.1V±0.8%, +Reset ODO, -MR, Rt=50ms	USPN-4	58cc	VD4	9h	Tor
HDF	XC6220D15BER	LVR-IC	LDO, 1.55V±20mV, 1A, +CE, CL, PDR	USP-6C	49vr	VR4	9a	Tor
HDH	XC6127N21G7R	Vdet-IC	2.1V±0.8%, +Reset ODO, -MR, Rt=100ms	USPN-4	58cc	VD4	9h	Tor
HDH	XC6220D16BER	LVR-IC	LDO, 1.65V±20mV, 1A, +CE, CL, PDR	USP-6C	49vr	VR4	9a	Tor
HDK	XC6127N21H7R	Vdet-IC	2.1V±0.8%, +Reset ODO, -MR, Rt=200ms	USPN-4	58cc	VD4	9h	Tor
HDK	XC6220D17BER	LVR-IC	LDO, 1.75V±20mV, 1A, +CE, CL, PDR	USP-6C	49vr	VR4	9a	Tor
HDL	XC6127N21J7R	Vdet-IC	2.1V±0.8%, +Reset ODO, -MR, Rt=400ms	USPN-4	58cc	VD4	9h	Tor
HDL	XC6220D18BER	LVR-IC	LDO, 1.85V±20mV, 1A, +CE, CL, PDR	USP-6C	49vr	VR4	9a	Tor
HDM	XC6127N21K7R	Vdet-IC	2.1V±0.8%, +Reset ODO, -MR, Rt=800ms	USPN-4	58cc	VD4	9h	Tor
HDM	XC6220D19BER	LVR-IC	LDO, 1.95V±20mV, 1A, +CE, CL, PDR	USP-6C	49vr	VR4	9a	Tor
HDN	XC6127N22A7R	Vdet-IC	2.2V±0.8%, -Reset ODO, -MR, Rt=50ms	USPN-4	58cc	VD4	9h	Tor
HDN	XC6220D20BER	LVR-IC	LDO, 2.05V±1%, 1A, +CE, CL, PDR	USP-6C	49vr	VR4	9a	Tor
HDP	XC6127N22B7R	Vdet-IC	2.2V±0.8%, -Reset ODO, -MR, Rt=100ms	USPN-4	58cc	VD4	9h	Tor
HDP	XC6220D21BER	LVR-IC	LDO, 2.15V±1%, 1A, +CE, CL, PDR	USP-6C	49vr	VR4	9a	Tor
HDR	XC6127N22C7R	Vdet-IC	2.2V±0.8%, -Reset ODO, -MR, Rt=200ms	USPN-4	58cc	VD4	9h	Tor
HDR	XC6220D22BER	LVR-IC	LDO, 2.25V±1%, 1A, +CE, CL, PDR	USP-6C	49vr	VR4	9a	Tor
HDS	XC6127N22D7R	Vdet-IC	2.2V±0.8%, -Reset ODO, -MR, Rt=400ms	USPN-4	58cc	VD4	9h	Tor
HDS	XC6220D23BER	LVR-IC	LDO, 2.35V±1%, 1A, +CE, CL, PDR	USP-6C	49vr	VR4	9a	Tor
HDT	XC6127N22E7R	Vdet-IC	2.2V±0.8%, -Reset ODO, -MR, Rt=800ms	USPN-4	58cc	VD4	9h	Tor
HDT	XC6220D24BER	LVR-IC	LDO, 2.45V±1%, 1A, +CE, CL, PDR	USP-6C	49vr	VR4	9a	Tor
HDU	XC6127N22F7R	Vdet-IC	2.2V±0.8%, +Reset ODO, -MR, Rt=50ms	USPN-4	58cc	VD4	9h	Tor
HDU	XC6220D25BER	LVR-IC	LDO, 2.55V±1%, 1A, +CE, CL, PDR	USP-6C	49vr	VR4	9a	Tor
HDV	XC6127N22G7R	Vdet-IC	2.2V±0.8%, +Reset ODO, -MR, Rt=100ms	USPN-4	58cc	VD4	9h	Tor
HDV	XC6220D26BER	LVR-IC	LDO, 2.65V±1%, 1A, +CE, CL, PDR	USP-6C	49vr	VR4	9a	Tor
HDX	XC6127N22H7R	Vdet-IC	2.2V±0.8%, +Reset ODO, -MR, Rt=200ms	USPN-4	58cc	VD4	9h	Tor
HDX	XC6220D27BER	LVR-IC	LDO, 2.75V±1%, 1A, +CE, CL, PDR	USP-6C	49vr	VR4	9a	Tor
HDY	XC6127N22J7R	Vdet-IC	2.2V±0.8%, +Reset ODO, -MR, Rt=400ms	USPN-4	58cc	VD4	9h	Tor
HDY	XC6220D28BER	LVR-IC	LDO, 2.85V±1%, 1A, +CE, CL, PDR	USP-6C	49vr	VR4	9a	Tor
HDZ	XC6127N22K7R	Vdet-IC	2.2V±0.8%, +Reset ODO, -MR, Rt=800ms	USPN-4	58cc	VD4	9h	Tor
HDZ	XC6220D29BER	LVR-IC	LDO, 2.95V±1%, 1A, +CE, CL, PDR	USP-6C	49vr	VR4	9a	Tor
HE	R3116K111A	Vdet-IC	1.1V±0.8%, -Reset ODO	DFN1010-4	48rj	VD1	9a	Ric
HE	SN74AUP2G08RSE	CMOS-Logic	Dual 2-input AND gates	QFN-8	51L,og51	-	9a	Ti
HE0	XC6220D301ER	LVR-IC	LDO, 3V±1%, 1A, +CE, CL, PDR	USP-6C	49vr	VR4	9a	Tor
HE1	XC6220D311ER	LVR-IC	LDO, 3.1V±1%, 1A, +CE, CL, PDR	USP-6C	49vr	VR4	9a	Tor
HE2	XC6220D321ER	LVR-IC	LDO, 3.2V±1%, 1A, +CE, CL, PDR	USP-6C	49vr	VR4	9a	Tor



SMD code	Type	Function	Short description	Case	Pinout	Sch.	St.	Mnf.
HE3	XC6220D331ER	LVR-IC	LDO, 3.3V±1%, 1A, +CE, CL, PDR	USP-6C	49vr	VR4	9a	Tor
HE4	XC6220D341ER	LVR-IC	LDO, 3.4V±1%, 1A, +CE, CL, PDR	USP-6C	49vr	VR4	9a	Tor
HE5	XC6220D351ER	LVR-IC	LDO, 3.5V±1%, 1A, +CE, CL, PDR	USP-6C	49vr	VR4	9a	Tor
HE6	XC6220D361ER	LVR-IC	LDO, 3.6V±1%, 1A, +CE, CL, PDR	USP-6C	49vr	VR4	9a	Tor
HE7	XC6220D371ER	LVR-IC	LDO, 3.7V±1%, 1A, +CE, CL, PDR	USP-6C	49vr	VR4	9a	Tor
HE8	XC6220D381ER	LVR-IC	LDO, 3.8V±1%, 1A, +CE, CL, PDR	USP-6C	49vr	VR4	9a	Tor
HE9	XC6220D391ER	LVR-IC	LDO, 3.9V±1%, 1A, +CE, CL, PDR	USP-6C	49vr	VR4	9a	Tor
HEA	XC6127N23A7R	Vdet-IC	2.3V±0.8%, -Reset ODO, -MR, Rt=50ms	USPN-4	58cc	VD4	9h	Tor
HEA	XC6220D401ER	LVR-IC	LDO, 4V±1%, 1A, +CE, CL, PDR	USP-6C	49vr	VR4	9a	Tor
HEB	XC6127N23B7R	Vdet-IC	2.3V±0.8%, -Reset ODO, -MR, Rt=100ms	USPN-4	58cc	VD4	9h	Tor
HEB	XC6220D411ER	LVR-IC	LDO, 4.1V±1%, 1A, +CE, CL, PDR	USP-6C	49vr	VR4	9a	Tor
HEC	XC6127N23C7R	Vdet-IC	2.3V±0.8%, -Reset ODO, -MR, Rt=200ms	USPN-4	58cc	VD4	9h	Tor
HEC	XC6220D421ER	LVR-IC	LDO, 4.2V±1%, 1A, +CE, CL, PDR	USP-6C	49vr	VR4	9a	Tor
HED	XC6127N23D7R	Vdet-IC	2.3V±0.8%, -Reset ODO, -MR, Rt=400ms	USPN-4	58cc	VD4	9h	Tor
HED	XC6220D431ER	LVR-IC	LDO, 4.3V±1%, 1A, +CE, CL, PDR	USP-6C	49vr	VR4	9a	Tor
HEE	XC6127N23E7R	Vdet-IC	2.3V±0.8%, -Reset ODO, -MR, Rt=800ms	USPN-4	58cc	VD4	9h	Tor
HEE	XC6220D441ER	LVR-IC	LDO, 4.4V±1%, 1A, +CE, CL, PDR	USP-6C	49vr	VR4	9a	Tor
HEF	XC6127N23F7R	Vdet-IC	2.3V±0.8%, +Reset ODO, -MR, Rt=50ms	USPN-4	58cc	VD4	9h	Tor
HEF	XC6220D451ER	LVR-IC	LDO, 4.5V±1%, 1A, +CE, CL, PDR	USP-6C	49vr	VR4	9a	Tor
HEH	XC6127N23G7R	Vdet-IC	2.3V±0.8%, +Reset ODO, -MR, Rt=100ms	USPN-4	58cc	VD4	9h	Tor
HEH	XC6220D461ER	LVR-IC	LDO, 4.6V±1%, 1A, +CE, CL, PDR	USP-6C	49vr	VR4	9a	Tor
HEK	XC6127N23H7R	Vdet-IC	2.3V±0.8%, +Reset ODO, -MR, Rt=200ms	USPN-4	58cc	VD4	9h	Tor
HEK	XC6220D471ER	LVR-IC	LDO, 4.7V±1%, 1A, +CE, CL, PDR	USP-6C	49vr	VR4	9a	Tor
HEL	XC6127N23J7R	Vdet-IC	2.3V±0.8%, +Reset ODO, -MR, Rt=400ms	USPN-4	58cc	VD4	9h	Tor
HEL	XC6220D481ER	LVR-IC	LDO, 4.8V±1%, 1A, +CE, CL, PDR	USP-6C	49vr	VR4	9a	Tor
HEM	XC6127N23K7R	Vdet-IC	2.3V±0.8%, +Reset ODO, -MR, Rt=800ms	USPN-4	58cc	VD4	9h	Tor
HEM	XC6220D491ER	LVR-IC	LDO, 4.9V±1%, 1A, +CE, CL, PDR	USP-6C	49vr	VR4	9a	Tor
HEN	XC6127N24A7R	Vdet-IC	2.4V±0.8%, -Reset ODO, -MR, Rt=50ms	USPN-4	58cc	VD4	9h	Tor
HEN	XC6220D501ER	LVR-IC	LDO, 5V±1%, 1A, +CE, CL, PDR	USP-6C	49vr	VR4	9a	Tor
HEP	XC6127N24B7R	Vdet-IC	2.4V±0.8%, -Reset ODO, -MR, Rt=100ms	USPN-4	58cc	VD4	9h	Tor
HER	XC6127N24C7R	Vdet-IC	2.4V±0.8%, -Reset ODO, -MR, Rt=200ms	USPN-4	58cc	VD4	9h	Tor
HES	XC6127N24D7R	Vdet-IC	2.4V±0.8%, -Reset ODO, -MR, Rt=400ms	USPN-4	58cc	VD4	9h	Tor
HET	XC6127N24E7R	Vdet-IC	2.4V±0.8%, -Reset ODO, -MR, Rt=800ms	USPN-4	58cc	VD4	9h	Tor
HEU	XC6127N24F7R	Vdet-IC	2.4V±0.8%, +Reset ODO, -MR, Rt=50ms	USPN-4	58cc	VD4	9h	Tor
HEV	XC6127N24G7R	Vdet-IC	2.4V±0.8%, +Reset ODO, -MR, Rt=100ms	USPN-4	58cc	VD4	9h	Tor
HEX	XC6127N24H7R	Vdet-IC	2.4V±0.8%, +Reset ODO, -MR, Rt=200ms	USPN-4	58cc	VD4	9h	Tor
HEY	XC6127N24J7R	Vdet-IC	2.4V±0.8%, +Reset ODO, -MR, Rt=400ms	USPN-4	58cc	VD4	9h	Tor
HEZ	XC6127N24K7R	Vdet-IC	2.4V±0.8%, +Reset ODO, -MR, Rt=800ms	USPN-4	58cc	VD4	9h	Tor
HF	R3116K121A	Vdet-IC	1.2V±0.8%, -Reset ODO	DFN1010-4	48rj	VD1	9a	Ric
HF0	XC6220D30BER	LVR-IC	LDO, 3.05V±1%, 1A, +CE, CL, PDR	USP-6C	49vr	VR4	9a	Tor
HF1	XC6220D31BER	LVR-IC	LDO, 3.15V±1%, 1A, +CE, CL, PDR	USP-6C	49vr	VR4	9a	Tor
HF2	XC6220D32BER	LVR-IC	LDO, 3.25V±1%, 1A, +CE, CL, PDR	USP-6C	49vr	VR4	9a	Tor
HF3	XC6220D33BER	LVR-IC	LDO, 3.35V±1%, 1A, +CE, CL, PDR	USP-6C	49vr	VR4	9a	Tor
HF4	XC6220D34BER	LVR-IC	LDO, 3.45V±1%, 1A, +CE, CL, PDR	USP-6C	49vr	VR4	9a	Tor
HF5	XC6220D35BER	LVR-IC	LDO, 3.55V±1%, 1A, +CE, CL, PDR	USP-6C	49vr	VR4	9a	Tor
HF6	XC6220D36BER	LVR-IC	LDO, 3.65V±1%, 1A, +CE, CL, PDR	USP-6C	49vr	VR4	9a	Tor
HF7	XC6220D37BER	LVR-IC	LDO, 3.75V±1%, 1A, +CE, CL, PDR	USP-6C	49vr	VR4	9a	Tor
HF8	XC6220D38BER	LVR-IC	LDO, 3.85V±1%, 1A, +CE, CL, PDR	USP-6C	49vr	VR4	9a	Tor
HF9	XC6220D39BER	LVR-IC	LDO, 3.95V±1%, 1A, +CE, CL, PDR	USP-6C	49vr	VR4	9a	Tor
HFA	XC6127N25A7R	Vdet-IC	2.5V±0.8%, -Reset ODO, -MR, Rt=50ms	USPN-4	58cc	VD4	9h	Tor
HFA	XC6220D40BER	LVR-IC	LDO, 4.05V±1%, 1A, +CE, CL, PDR	USP-6C	49vr	VR4	9a	Tor
HFB	XC6127N25B7R	Vdet-IC	2.5V±0.8%, -Reset ODO, -MR, Rt=100ms	USPN-4	58cc	VD4	9h	Tor
HFB	XC6220D41BER	LVR-IC	LDO, 4.15V±1%, 1A, +CE, CL, PDR	USP-6C	49vr	VR4	9a	Tor
HFC	XC6127N25C7R	Vdet-IC	2.5V±0.8%, -Reset ODO, -MR, Rt=200ms	USPN-4	58cc	VD4	9h	Tor
HFC	XC6220D42BER	LVR-IC	LDO, 4.25V±1%, 1A, +CE, CL, PDR	USP-6C	49vr	VR4	9a	Tor
HFD	XC6127N25D7R	Vdet-IC	2.5V±0.8%, -Reset ODO, -MR, Rt=400ms	USPN-4	58cc	VD4	9h	Tor
HFD	XC6220D43BER	LVR-IC	LDO, 4.35V±1%, 1A, +CE, CL, PDR	USP-6C	49vr	VR4	9a	Tor
HFE	XC6127N25E7R	Vdet-IC	2.5V±0.8%, -Reset ODO, -MR, Rt=800ms	USPN-4	58cc	VD4	9h	Tor
HFE	XC6220D44BER	LVR-IC	LDO, 4.45V±1%, 1A, +CE, CL, PDR	USP-6C	49vr	VR4	9a	Tor
HFF	XC6127N25F7R	Vdet-IC	2.5V±0.8%, +Reset ODO, -MR, Rt=50ms	USPN-4	58cc	VD4	9h	Tor
HFF	XC6220D45BER	LVR-IC	LDO, 4.55V±1%, 1A, +CE, CL, PDR	USP-6C	49vr	VR4	9a	Tor
HFH	XC6127N25G7R	Vdet-IC	2.5V±0.8%, +Reset ODO, -MR, Rt=100ms	USPN-4	58cc	VD4	9h	Tor
HFH	XC6220D46BER	LVR-IC	LDO, 4.65V±1%, 1A, +CE, CL, PDR	USP-6C	49vr	VR4	9a	Tor
HFK	XC6127N25H7R	Vdet-IC	2.5V±0.8%, +Reset ODO, -MR, Rt=200ms	USPN-4	58cc	VD4	9h	Tor
HFK	XC6220D47BER	LVR-IC	LDO, 4.75V±1%, 1A, +CE, CL, PDR	USP-6C	49vr	VR4	9a	Tor
HFL	XC6127N25J7R	Vdet-IC	2.5V±0.8%, +Reset ODO, -MR, Rt=400ms	USPN-4	58cc	VD4	9h	Tor
HFL	XC6220D48BER	LVR-IC	LDO, 4.85V±1%, 1A, +CE, CL, PDR	USP-6C	49vr	VR4	9a	Tor
HFM	XC6127N25K7R	Vdet-IC	2.5V±0.8%, +Reset ODO, -MR, Rt=800ms	USPN-4	58cc	VD4	9h	Tor
HFM	XC6220D49BER	LVR-IC	LDO, 4.95V±1%, 1A, +CE, CL, PDR	USP-6C	49vr	VR4	9a	Tor
HFN	XC6127N26A7R	Vdet-IC	2.6V±0.8%, -Reset ODO, -MR, Rt=50ms	USPN-4	58cc	VD4	9h	Tor



SMD code	Type	Function	Short description	Case	Pinout	Sch.	St.	Mnf.
HFP	XC6127N26B7R	Vdet-IC	2.6V±0.8%, -Reset ODO, -MR, Rt=100ms	USPN-4	58cc	VD4	9h	Tor
HFR	XC6127N26C7R	Vdet-IC	2.6V±0.8%, -Reset ODO, -MR, Rt=200ms	USPN-4	58cc	VD4	9h	Tor
HFS	XC6127N26D7R	Vdet-IC	2.6V±0.8%, -Reset ODO, -MR, Rt=400ms	USPN-4	58cc	VD4	9h	Tor
HFT	XC6127N26E7R	Vdet-IC	2.6V±0.8%, -Reset ODO, -MR, Rt=800ms	USPN-4	58cc	VD4	9h	Tor
HFU	XC6127N26F7R	Vdet-IC	2.6V±0.8%, +Reset ODO, -MR, Rt=50ms	USPN-4	58cc	VD4	9h	Tor
HFV	XC6127N26G7R	Vdet-IC	2.6V±0.8%, +Reset ODO, -MR, Rt=100ms	USPN-4	58cc	VD4	9h	Tor
HFX	XC6127N26H7R	Vdet-IC	2.6V±0.8%, +Reset ODO, -MR, Rt=200ms	USPN-4	58cc	VD4	9h	Tor
HFY	XC6127N26J7R	Vdet-IC	2.6V±0.8%, +Reset ODO, -MR, Rt=400ms	USPN-4	58cc	VD4	9h	Tor
HFZ	XC6127N26K7R	Vdet-IC	2.6V±0.8%, +Reset ODO, -MR, Rt=800ms	USPN-4	58cc	VD4	9h	Tor
HG	R3116K131A	Vdet-IC	1.3V±0.8%, -Reset ODO	DFN1010-4	48rj	VD1	9a	Ric
HH	R3116K141A	Vdet-IC	1.4V±0.8%, -Reset ODO	DFN1010-4	48rj	VD1	9a	Ric
HHA	XC6127N27A7R	Vdet-IC	2.7V±0.8%, -Reset ODO, -MR, Rt=50ms	USPN-4	58cc	VD4	9h	Tor
HHB	XC6127N27B7R	Vdet-IC	2.7V±0.8%, -Reset ODO, -MR, Rt=100ms	USPN-4	58cc	VD4	9h	Tor
HHC	XC6127N27C7R	Vdet-IC	2.7V±0.8%, -Reset ODO, -MR, Rt=200ms	USPN-4	58cc	VD4	9h	Tor
HHD	XC6127N27D7R	Vdet-IC	2.7V±0.8%, -Reset ODO, -MR, Rt=400ms	USPN-4	58cc	VD4	9h	Tor
HHE	XC6127N27E7R	Vdet-IC	2.7V±0.8%, -Reset ODO, -MR, Rt=800ms	USPN-4	58cc	VD4	9h	Tor
HHF	XC6127N27F7R	Vdet-IC	2.7V±0.8%, +Reset ODO, -MR, Rt=50ms	USPN-4	58cc	VD4	9h	Tor
HHH	XC6127N27G7R	Vdet-IC	2.7V±0.8%, +Reset ODO, -MR, Rt=100ms	USPN-4	58cc	VD4	9h	Tor
HHK	XC6127N27H7R	Vdet-IC	2.7V±0.8%, +Reset ODO, -MR, Rt=200ms	USPN-4	58cc	VD4	9h	Tor
HHL	XC6127N27J7R	Vdet-IC	2.7V±0.8%, +Reset ODO, -MR, Rt=400ms	USPN-4	58cc	VD4	9h	Tor
HHM	XC6127N27K7R	Vdet-IC	2.7V±0.8%, +Reset ODO, -MR, Rt=800ms	USPN-4	58cc	VD4	9h	Tor
HHN	XC6127N28A7R	Vdet-IC	2.8V±0.8%, -Reset ODO, -MR, Rt=50ms	USPN-4	58cc	VD4	9h	Tor
HHP	XC6127N28B7R	Vdet-IC	2.8V±0.8%, -Reset ODO, -MR, Rt=100ms	USPN-4	58cc	VD4	9h	Tor
HHR	XC6127N28C7R	Vdet-IC	2.8V±0.8%, -Reset ODO, -MR, Rt=200ms	USPN-4	58cc	VD4	9h	Tor
HHS	XC6127N28D7R	Vdet-IC	2.8V±0.8%, -Reset ODO, -MR, Rt=400ms	USPN-4	58cc	VD4	9h	Tor
HHT	XC6127N28E7R	Vdet-IC	2.8V±0.8%, -Reset ODO, -MR, Rt=800ms	USPN-4	58cc	VD4	9h	Tor
HHU	XC6127N28F7R	Vdet-IC	2.8V±0.8%, +Reset ODO, -MR, Rt=50ms	USPN-4	58cc	VD4	9h	Tor
HHV	XC6127N28G7R	Vdet-IC	2.8V±0.8%, +Reset ODO, -MR, Rt=100ms	USPN-4	58cc	VD4	9h	Tor
HHX	XC6127N28H7R	Vdet-IC	2.8V±0.8%, +Reset ODO, -MR, Rt=200ms	USPN-4	58cc	VD4	9h	Tor
HHY	XC6127N28J7R	Vdet-IC	2.8V±0.8%, +Reset ODO, -MR, Rt=400ms	USPN-4	58cc	VD4	9h	Tor
HHZ	XC6127N28K7R	Vdet-IC	2.8V±0.8%, +Reset ODO, -MR, Rt=800ms	USPN-4	58cc	VD4	9h	Tor
HJ	R3116K151A	Vdet-IC	1.5V±0.8%, -Reset ODO	DFN1010-4	48rj	VD1	9a	Ric
HK	R3116K161A	Vdet-IC	1.6V±0.8%, -Reset ODO	DFN1010-4	48rj	VD1	9a	Ric
HKA	XC6127N29A7R	Vdet-IC	2.9V±0.8%, -Reset ODO, -MR, Rt=50ms	USPN-4	58cc	VD4	9h	Tor
HKB	XC6127N29B7R	Vdet-IC	2.9V±0.8%, -Reset ODO, -MR, Rt=100ms	USPN-4	58cc	VD4	9h	Tor
HKC	XC6127N29C7R	Vdet-IC	2.9V±0.8%, -Reset ODO, -MR, Rt=200ms	USPN-4	58cc	VD4	9h	Tor
HKD	XC6127N29D7R	Vdet-IC	2.9V±0.8%, -Reset ODO, -MR, Rt=400ms	USPN-4	58cc	VD4	9h	Tor
HKE	XC6127N29E7R	Vdet-IC	2.9V±0.8%, -Reset ODO, -MR, Rt=800ms	USPN-4	58cc	VD4	9h	Tor
HKF	XC6127N29F7R	Vdet-IC	2.9V±0.8%, +Reset ODO, -MR, Rt=50ms	USPN-4	58cc	VD4	9h	Tor
HKH	XC6127N29G7R	Vdet-IC	2.9V±0.8%, +Reset ODO, -MR, Rt=100ms	USPN-4	58cc	VD4	9h	Tor
HKK	XC6127N29H7R	Vdet-IC	2.9V±0.8%, +Reset ODO, -MR, Rt=200ms	USPN-4	58cc	VD4	9h	Tor
HKL	XC6127N29J7R	Vdet-IC	2.9V±0.8%, +Reset ODO, -MR, Rt=400ms	USPN-4	58cc	VD4	9h	Tor
HKM	XC6127N29K7R	Vdet-IC	2.9V±0.8%, +Reset ODO, -MR, Rt=800ms	USPN-4	58cc	VD4	9h	Tor
HKN	XC6127N30A7R	Vdet-IC	3.0V±0.8%, -Reset ODO, -MR, Rt=50ms	USPN-4	58cc	VD4	9h	Tor
HKP	XC6127N30B7R	Vdet-IC	3.0V±0.8%, -Reset ODO, -MR, Rt=100ms	USPN-4	58cc	VD4	9h	Tor
HKR	XC6127N30C7R	Vdet-IC	3.0V±0.8%, -Reset ODO, -MR, Rt=200ms	USPN-4	58cc	VD4	9h	Tor
HKS	XC6127N30D7R	Vdet-IC	3.0V±0.8%, -Reset ODO, -MR, Rt=400ms	USPN-4	58cc	VD4	9h	Tor
HKT	XC6127N30E7R	Vdet-IC	3.0V±0.8%, -Reset ODO, -MR, Rt=800ms	USPN-4	58cc	VD4	9h	Tor
HKU	XC6127N30F7R	Vdet-IC	3.0V±0.8%, +Reset ODO, -MR, Rt=50ms	USPN-4	58cc	VD4	9h	Tor
HKV	XC6127N30G7R	Vdet-IC	3.0V±0.8%, +Reset ODO, -MR, Rt=100ms	USPN-4	58cc	VD4	9h	Tor
HKX	XC6127N30H7R	Vdet-IC	3.0V±0.8%, +Reset ODO, -MR, Rt=200ms	USPN-4	58cc	VD4	9h	Tor
HKY	XC6127N30J7R	Vdet-IC	3.0V±0.8%, +Reset ODO, -MR, Rt=400ms	USPN-4	58cc	VD4	9h	Tor
HKZ	XC6127N30K7R	Vdet-IC	3.0V±0.8%, +Reset ODO, -MR, Rt=800ms	USPN-4	58cc	VD4	9h	Tor
HL	R3116K171A	Vdet-IC	1.7V±0.8%, -Reset ODO	DFN1010-4	48rj	VD1	9a	Ric
HLA	XC6127N31A7R	Vdet-IC	3.1V±0.8%, -Reset ODO, -MR, Rt=50ms	USPN-4	58cc	VD4	9h	Tor
HLB	XC6127N31B7R	Vdet-IC	3.1V±0.8%, -Reset ODO, -MR, Rt=100ms	USPN-4	58cc	VD4	9h	Tor
HLC	XC6127N31C7R	Vdet-IC	3.1V±0.8%, -Reset ODO, -MR, Rt=200ms	USPN-4	58cc	VD4	9h	Tor
HLD	XC6127N31D7R	Vdet-IC	3.1V±0.8%, -Reset ODO, -MR, Rt=400ms	USPN-4	58cc	VD4	9h	Tor
HLE	XC6127N31E7R	Vdet-IC	3.1V±0.8%, -Reset ODO, -MR, Rt=800ms	USPN-4	58cc	VD4	9h	Tor
HLF	XC6127N31F7R	Vdet-IC	3.1V±0.8%, +Reset ODO, -MR, Rt=50ms	USPN-4	58cc	VD4	9h	Tor
HLH	XC6127N31G7R	Vdet-IC	3.1V±0.8%, +Reset ODO, -MR, Rt=100ms	USPN-4	58cc	VD4	9h	Tor
HLK	XC6127N31H7R	Vdet-IC	3.1V±0.8%, +Reset ODO, -MR, Rt=200ms	USPN-4	58cc	VD4	9h	Tor
HLL	XC6127N31J7R	Vdet-IC	3.1V±0.8%, +Reset ODO, -MR, Rt=400ms	USPN-4	58cc	VD4	9h	Tor
HLM	XC6127N31K7R	Vdet-IC	3.1V±0.8%, +Reset ODO, -MR, Rt=800ms	USPN-4	58cc	VD4	9h	Tor
HLN	XC6127N32A7R	Vdet-IC	3.2V±0.8%, -Reset ODO, -MR, Rt=50ms	USPN-4	58cc	VD4	9h	Tor
HLP	XC6127N32B7R	Vdet-IC	3.2V±0.8%, -Reset ODO, -MR, Rt=100ms	USPN-4	58cc	VD4	9h	Tor
HLR	XC6127N32C7R	Vdet-IC	3.2V±0.8%, -Reset ODO, -MR, Rt=200ms	USPN-4	58cc	VD4	9h	Tor
HLS	XC6127N32D7R	Vdet-IC	3.2V±0.8%, -Reset ODO, -MR, Rt=400ms	USPN-4	58cc	VD4	9h	Tor
HLT	XC6127N32E7R	Vdet-IC	3.2V±0.8%, -Reset ODO, -MR, Rt=800ms	USPN-4	58cc	VD4	9h	Tor
HLU	XC6127N32F7R	Vdet-IC	3.2V±0.8%, +Reset ODO, -MR, Rt=50ms	USPN-4	58cc	VD4	9h	Tor



SMD code	Type	Function	Short description	Case	Pinout	Sch.	St.	Mnf.
HLV	XC6127N32G7R	Vdet-IC	3.2V±0.8%, +Reset ODO, -MR, Rt=100ms	USPN-4	58cc	VD4	9h	Tor
HLX	XC6127N32H7R	Vdet-IC	3.2V±0.8%, +Reset ODO, -MR, Rt=200ms	USPN-4	58cc	VD4	9h	Tor
HLY	XC6127N32J7R	Vdet-IC	3.2V±0.8%, +Reset ODO, -MR, Rt=400ms	USPN-4	58cc	VD4	9h	Tor
HLZ	XC6127N32K7R	Vdet-IC	3.2V±0.8%, +Reset ODO, -MR, Rt=800ms	USPN-4	58cc	VD4	9h	Tor
HMI	R3116K181A	Vdet-IC	1.8V±0.8%, -Reset ODO	DFN1010-4	48rj	VD1	9a	Ric
HIM	SN74AUP2G125RSE	CMOS-Logic	Dual bus buffer with 3-state output	QFN-8	51/Log54	-	9a	Ti
HMA	XC6127N33A7R	Vdet-IC	3.3V±0.8%, -Reset ODO, -MR, Rt=50ms	USPN-4	58cc	VD4	9h	Tor
HMB	XC6127N33B7R	Vdet-IC	3.3V±0.8%, -Reset ODO, -MR, Rt=100ms	USPN-4	58cc	VD4	9h	Tor
HMC	XC6127N33C7R	Vdet-IC	3.3V±0.8%, -Reset ODO, -MR, Rt=200ms	USPN-4	58cc	VD4	9h	Tor
HMD	XC6127N33D7R	Vdet-IC	3.3V±0.8%, -Reset ODO, -MR, Rt=400ms	USPN-4	58cc	VD4	9h	Tor
HME	XC6127N33E7R	Vdet-IC	3.3V±0.8%, -Reset ODO, -MR, Rt=800ms	USPN-4	58cc	VD4	9h	Tor
HMF	XC6127N33F7R	Vdet-IC	3.3V±0.8%, +Reset ODO, -MR, Rt=50ms	USPN-4	58cc	VD4	9h	Tor
HMH	XC6127N33G7R	Vdet-IC	3.3V±0.8%, +Reset ODO, -MR, Rt=100ms	USPN-4	58cc	VD4	9h	Tor
HMK	XC6127N33H7R	Vdet-IC	3.3V±0.8%, +Reset ODO, -MR, Rt=200ms	USPN-4	58cc	VD4	9h	Tor
HML	XC6127N33J7R	Vdet-IC	3.3V±0.8%, +Reset ODO, -MR, Rt=400ms	USPN-4	58cc	VD4	9h	Tor
HMM	XC6127N33K7R	Vdet-IC	3.3V±0.8%, +Reset ODO, -MR, Rt=800ms	USPN-4	58cc	VD4	9h	Tor
HMN	XC6127N33A7R	Vdet-IC	3.4V±0.8%, -Reset ODO, -MR, Rt=50ms	USPN-4	58cc	VD4	9h	Tor
HMP	XC6127N33B7R	Vdet-IC	3.4V±0.8%, -Reset ODO, -MR, Rt=100ms	USPN-4	58cc	VD4	9h	Tor
HMR	XC6127N33C7R	Vdet-IC	3.4V±0.8%, -Reset ODO, -MR, Rt=200ms	USPN-4	58cc	VD4	9h	Tor
HMS	XC6127N33D7R	Vdet-IC	3.4V±0.8%, -Reset ODO, -MR, Rt=400ms	USPN-4	58cc	VD4	9h	Tor
HMT	XC6127N33E7R	Vdet-IC	3.4V±0.8%, -Reset ODO, -MR, Rt=800ms	USPN-4	58cc	VD4	9h	Tor
HMU	XC6127N33F7R	Vdet-IC	3.4V±0.8%, +Reset ODO, -MR, Rt=50ms	USPN-4	58cc	VD4	9h	Tor
HMV	XC6127N33G7R	Vdet-IC	3.4V±0.8%, +Reset ODO, -MR, Rt=100ms	USPN-4	58cc	VD4	9h	Tor
HMX	XC6127N33H7R	Vdet-IC	3.4V±0.8%, +Reset ODO, -MR, Rt=200ms	USPN-4	58cc	VD4	9h	Tor
HMY	XC6127N33J7R	Vdet-IC	3.4V±0.8%, +Reset ODO, -MR, Rt=400ms	USPN-4	58cc	VD4	9h	Tor
HMZ	XC6127N33K7R	Vdet-IC	3.4V±0.8%, +Reset ODO, -MR, Rt=800ms	USPN-4	58cc	VD4	9h	Tor
HN	R3116K191A	Vdet-IC	1.9V±0.8%, -Reset ODO	DFN1010-4	48rj	VD1	9a	Ric
HN	SN74AUP2G126RSE	CMOS-Logic	Bus buffer gate with 3-state output	QFN-8	51/Log13	-	9d	Ti
HNA	XC6127N35A7R	Vdet-IC	3.5V±0.8%, -Reset ODO, -MR, Rt=50ms	USPN-4	58cc	VD4	9h	Tor
HNB	XC6127N35B7R	Vdet-IC	3.5V±0.8%, -Reset ODO, -MR, Rt=100ms	USPN-4	58cc	VD4	9h	Tor
HNC	XC6127N35C7R	Vdet-IC	3.5V±0.8%, -Reset ODO, -MR, Rt=200ms	USPN-4	58cc	VD4	9h	Tor
HND	XC6127N35D7R	Vdet-IC	3.5V±0.8%, -Reset ODO, -MR, Rt=400ms	USPN-4	58cc	VD4	9h	Tor
HNE	XC6127N35E7R	Vdet-IC	3.5V±0.8%, -Reset ODO, -MR, Rt=800ms	USPN-4	58cc	VD4	9h	Tor
HNF	XC6127N35F7R	Vdet-IC	3.5V±0.8%, +Reset ODO, -MR, Rt=50ms	USPN-4	58cc	VD4	9h	Tor
HNH	XC6127N35G7R	Vdet-IC	3.5V±0.8%, +Reset ODO, -MR, Rt=100ms	USPN-4	58cc	VD4	9h	Tor
HNK	XC6127N35H7R	Vdet-IC	3.5V±0.8%, +Reset ODO, -MR, Rt=200ms	USPN-4	58cc	VD4	9h	Tor
HNL	XC6127N35J7R	Vdet-IC	3.5V±0.8%, +Reset ODO, -MR, Rt=400ms	USPN-4	58cc	VD4	9h	Tor
HNM	XC6127N35K7R	Vdet-IC	3.5V±0.8%, +Reset ODO, -MR, Rt=800ms	USPN-4	58cc	VD4	9h	Tor
HNN	XC6127N36A7R	Vdet-IC	3.6V±0.8%, -Reset ODO, -MR, Rt=50ms	USPN-4	58cc	VD4	9h	Tor
HNP	XC6127N36B7R	Vdet-IC	3.6V±0.8%, -Reset ODO, -MR, Rt=100ms	USPN-4	58cc	VD4	9h	Tor
HNR	XC6127N36C7R	Vdet-IC	3.6V±0.8%, -Reset ODO, -MR, Rt=200ms	USPN-4	58cc	VD4	9h	Tor
HNS	XC6127N36D7R	Vdet-IC	3.6V±0.8%, -Reset ODO, -MR, Rt=400ms	USPN-4	58cc	VD4	9h	Tor
HNT	XC6127N36E7R	Vdet-IC	3.6V±0.8%, -Reset ODO, -MR, Rt=800ms	USPN-4	58cc	VD4	9h	Tor
HNU	XC6127N36F7R	Vdet-IC	3.6V±0.8%, +Reset ODO, -MR, Rt=50ms	USPN-4	58cc	VD4	9h	Tor
HNV	XC6127N36G7R	Vdet-IC	3.6V±0.8%, +Reset ODO, -MR, Rt=100ms	USPN-4	58cc	VD4	9h	Tor
HNX	XC6127N36H7R	Vdet-IC	3.6V±0.8%, +Reset ODO, -MR, Rt=200ms	USPN-4	58cc	VD4	9h	Tor
HNY	XC6127N36J7R	Vdet-IC	3.6V±0.8%, +Reset ODO, -MR, Rt=400ms	USPN-4	58cc	VD4	9h	Tor
HNZ	XC6127N36K7R	Vdet-IC	3.6V±0.8%, +Reset ODO, -MR, Rt=800ms	USPN-4	58cc	VD4	9h	Tor
HP	R3116K201A	Vdet-IC	2.0V±0.8%, -Reset ODO	DFN1010-4	48rj	VD1	9a	Ric
HPA	XC6127N37A7R	Vdet-IC	3.7V±0.8%, -Reset ODO, -MR, Rt=50ms	USPN-4	58cc	VD4	9h	Tor
HPB	XC6127N37B7R	Vdet-IC	3.7V±0.8%, -Reset ODO, -MR, Rt=100ms	USPN-4	58cc	VD4	9h	Tor
HPC	XC6127N37C7R	Vdet-IC	3.7V±0.8%, -Reset ODO, -MR, Rt=200ms	USPN-4	58cc	VD4	9h	Tor
HPD	XC6127N37D7R	Vdet-IC	3.7V±0.8%, -Reset ODO, -MR, Rt=400ms	USPN-4	58cc	VD4	9h	Tor
HPE	XC6127N37E7R	Vdet-IC	3.7V±0.8%, -Reset ODO, -MR, Rt=800ms	USPN-4	58cc	VD4	9h	Tor
HPF	XC6127N37F7R	Vdet-IC	3.7V±0.8%, +Reset ODO, -MR, Rt=50ms	USPN-4	58cc	VD4	9h	Tor
HPH	XC6127N37G7R	Vdet-IC	3.7V±0.8%, +Reset ODO, -MR, Rt=100ms	USPN-4	58cc	VD4	9h	Tor
HPK	XC6127N37H7R	Vdet-IC	3.7V±0.8%, +Reset ODO, -MR, Rt=200ms	USPN-4	58cc	VD4	9h	Tor
HPL	XC6127N37J7R	Vdet-IC	3.7V±0.8%, +Reset ODO, -MR, Rt=400ms	USPN-4	58cc	VD4	9h	Tor
HPM	XC6127N37K7R	Vdet-IC	3.7V±0.8%, +Reset ODO, -MR, Rt=800ms	USPN-4	58cc	VD4	9h	Tor
HPN	XC6127N38A7R	Vdet-IC	3.8V±0.8%, -Reset ODO, -MR, Rt=50ms	USPN-4	58cc	VD4	9h	Tor
PPP	XC6127N38B7R	Vdet-IC	3.8V±0.8%, -Reset ODO, -MR, Rt=100ms	USPN-4	58cc	VD4	9h	Tor
HPR	XC6127N38C7R	Vdet-IC	3.8V±0.8%, -Reset ODO, -MR, Rt=200ms	USPN-4	58cc	VD4	9h	Tor
HPS	XC6127N38D7R	Vdet-IC	3.8V±0.8%, -Reset ODO, -MR, Rt=400ms	USPN-4	58cc	VD4	9h	Tor
HPT	XC6127N38E7R	Vdet-IC	3.8V±0.8%, -Reset ODO, -MR, Rt=800ms	USPN-4	58cc	VD4	9h	Tor
HPU	XC6127N38F7R	Vdet-IC	3.8V±0.8%, +Reset ODO, -MR, Rt=50ms	USPN-4	58cc	VD4	9h	Tor
HPV	XC6127N38G7R	Vdet-IC	3.8V±0.8%, +Reset ODO, -MR, Rt=100ms	USPN-4	58cc	VD4	9h	Tor
HPX	XC6127N38H7R	Vdet-IC	3.8V±0.8%, +Reset ODO, -MR, Rt=200ms	USPN-4	58cc	VD4	9h	Tor
HPY	XC6127N38J7R	Vdet-IC	3.8V±0.8%, +Reset ODO, -MR, Rt=400ms	USPN-4	58cc	VD4	9h	Tor
HPZ	XC6127N38K7R	Vdet-IC	3.8V±0.8%, +Reset ODO, -MR, Rt=800ms	USPN-4	58cc	VD4	9h	Tor
HQ	R3116K211A	Vdet-IC	2.1V±0.8%, -Reset ODO	DFN1010-4	48rj	VD1	9a	Ric



SMD code	Type	Function	Short description	Case	Pinout	Sch.	St.	Mnf.
HUH	XC6127N45G7R	Vdet-IC	4.5V±0.8%, +Reset ODO, -MR, Rt=100ms	USPN-4	58cc	VD4	9h	Tor
HUK	XC6127N45H7R	Vdet-IC	4.5V±0.8%, +Reset ODO, -MR, Rt=200ms	USPN-4	58cc	VD4	9h	Tor
HUL	XC6127N45J7R	Vdet-IC	4.5V±0.8%, +Reset ODO, -MR, Rt=400ms	USPN-4	58cc	VD4	9h	Tor
HUM	XC6127N45K7R	Vdet-IC	4.5V±0.8%, +Reset ODO, -MR, Rt=800ms	USPN-4	58cc	VD4	9h	Tor
HUN	XC6127N46A7R	Vdet-IC	4.6V±0.8%, -Reset ODO, -MR, Rt=50ms	USPN-4	58cc	VD4	9h	Tor
HUP	XC6127N46B7R	Vdet-IC	4.6V±0.8%, -Reset ODO, -MR, Rt=100ms	USPN-4	58cc	VD4	9h	Tor
HUR	XC6127N46C7R	Vdet-IC	4.6V±0.8%, -Reset ODO, -MR, Rt=200ms	USPN-4	58cc	VD4	9h	Tor
HUS	XC6127N46D7R	Vdet-IC	4.6V±0.8%, -Reset ODO, -MR, Rt=400ms	USPN-4	58cc	VD4	9h	Tor
HUT	XC6127N46E7R	Vdet-IC	4.6V±0.8%, -Reset ODO, -MR, Rt=800ms	USPN-4	58cc	VD4	9h	Tor
HUU	XC6127N46F7R	Vdet-IC	4.6V±0.8%, +Reset ODO, -MR, Rt=50ms	USPN-4	58cc	VD4	9h	Tor
HUV	XC6127N46G7R	Vdet-IC	4.6V±0.8%, +Reset ODO, -MR, Rt=100ms	USPN-4	58cc	VD4	9h	Tor
HUX	XC6127N46H7R	Vdet-IC	4.6V±0.8%, +Reset ODO, -MR, Rt=200ms	USPN-4	58cc	VD4	9h	Tor
HUY	XC6127N46J7R	Vdet-IC	4.6V±0.8%, +Reset ODO, -MR, Rt=400ms	USPN-4	58cc	VD4	9h	Tor
HUZ	XC6127N46K7R	Vdet-IC	4.6V±0.8%, +Reset ODO, -MR, Rt=800ms	USPN-4	58cc	VD4	9h	Tor
HV	R3116K261A	Vdet-IC	2.6V±0.8%, -Reset ODO	DFN1010-4	48rj	VD1	9a	Ric
HVA	XC6127N47A7R	Vdet-IC	4.7V±0.8%, -Reset ODO, -MR, Rt=50ms	USPN-4	58cc	VD4	9h	Tor
HVB	XC6127N47B7R	Vdet-IC	4.7V±0.8%, -Reset ODO, -MR, Rt=100ms	USPN-4	58cc	VD4	9h	Tor
HVC	XC6127N47C7R	Vdet-IC	4.7V±0.8%, -Reset ODO, -MR, Rt=200ms	USPN-4	58cc	VD4	9h	Tor
HVD	XC6127N47D7R	Vdet-IC	4.7V±0.8%, -Reset ODO, -MR, Rt=400ms	USPN-4	58cc	VD4	9h	Tor
HVE	XC6127N47E7R	Vdet-IC	4.7V±0.8%, -Reset ODO, -MR, Rt=800ms	USPN-4	58cc	VD4	9h	Tor
HVF	XC6127N47F7R	Vdet-IC	4.7V±0.8%, +Reset ODO, -MR, Rt=50ms	USPN-4	58cc	VD4	9h	Tor
HVH	XC6127N47G7R	Vdet-IC	4.7V±0.8%, +Reset ODO, -MR, Rt=100ms	USPN-4	58cc	VD4	9h	Tor
HVK	XC6127N47H7R	Vdet-IC	4.7V±0.8%, +Reset ODO, -MR, Rt=200ms	USPN-4	58cc	VD4	9h	Tor
HVL	XC6127N47J7R	Vdet-IC	4.7V±0.8%, +Reset ODO, -MR, Rt=400ms	USPN-4	58cc	VD4	9h	Tor
HVM	XC6127N47K7R	Vdet-IC	4.7V±0.8%, +Reset ODO, -MR, Rt=800ms	USPN-4	58cc	VD4	9h	Tor
HVN	XC6127N48A7R	Vdet-IC	4.8V±0.8%, -Reset ODO, -MR, Rt=50ms	USPN-4	58cc	VD4	9h	Tor
HVP	XC6127N48B7R	Vdet-IC	4.8V±0.8%, -Reset ODO, -MR, Rt=100ms	USPN-4	58cc	VD4	9h	Tor
HVR	XC6127N48C7R	Vdet-IC	4.8V±0.8%, -Reset ODO, -MR, Rt=200ms	USPN-4	58cc	VD4	9h	Tor
HVS	XC6127N48D7R	Vdet-IC	4.8V±0.8%, -Reset ODO, -MR, Rt=400ms	USPN-4	58cc	VD4	9h	Tor
HVT	XC6127N48E7R	Vdet-IC	4.8V±0.8%, -Reset ODO, -MR, Rt=800ms	USPN-4	58cc	VD4	9h	Tor
HVU	XC6127N48F7R	Vdet-IC	4.8V±0.8%, +Reset ODO, -MR, Rt=50ms	USPN-4	58cc	VD4	9h	Tor
HVV	XC6127N48G7R	Vdet-IC	4.8V±0.8%, +Reset ODO, -MR, Rt=100ms	USPN-4	58cc	VD4	9h	Tor
HVX	XC6127N48H7R	Vdet-IC	4.8V±0.8%, +Reset ODO, -MR, Rt=200ms	USPN-4	58cc	VD4	9h	Tor
HVY	XC6127N48J7R	Vdet-IC	4.8V±0.8%, +Reset ODO, -MR, Rt=400ms	USPN-4	58cc	VD4	9h	Tor
HVZ	XC6127N48K7R	Vdet-IC	4.8V±0.8%, +Reset ODO, -MR, Rt=800ms	USPN-4	58cc	VD4	9h	Tor
HW	R3116K271A	Vdet-IC	2.7V±0.8%, -Reset ODO	DFN1010-4	48rj	VD1	9a	Ric
HX	R3116K281A	Vdet-IC	2.8V±0.8%, -Reset ODO	DFN1010-4	48rj	VD1	9a	Ric
HX	XC6221B45B7R	LVR-IC	LDO, 4.55V±1%, 200mA, +CE, CL	USPN-4	58vm	VR4	9a	Tor
HXA	XC6127N49A7R	Vdet-IC	4.9V±0.8%, -Reset ODO, -MR, Rt=50ms	USPN-4	58cc	VD4	9h	Tor
HXB	XC6127N49B7R	Vdet-IC	4.9V±0.8%, -Reset ODO, -MR, Rt=100ms	USPN-4	58cc	VD4	9h	Tor
HXC	XC6127N49C7R	Vdet-IC	4.9V±0.8%, -Reset ODO, -MR, Rt=200ms	USPN-4	58cc	VD4	9h	Tor
HXD	XC6127N49D7R	Vdet-IC	4.9V±0.8%, -Reset ODO, -MR, Rt=400ms	USPN-4	58cc	VD4	9h	Tor
HXE	XC6127N49E7R	Vdet-IC	4.9V±0.8%, -Reset ODO, -MR, Rt=800ms	USPN-4	58cc	VD4	9h	Tor
HXF	XC6127N49F7R	Vdet-IC	4.9V±0.8%, +Reset ODO, -MR, Rt=50ms	USPN-4	58cc	VD4	9h	Tor
HXH	XC6127N49G7R	Vdet-IC	4.9V±0.8%, +Reset ODO, -MR, Rt=100ms	USPN-4	58cc	VD4	9h	Tor
HXK	XC6127N49H7R	Vdet-IC	4.9V±0.8%, +Reset ODO, -MR, Rt=200ms	USPN-4	58cc	VD4	9h	Tor
HXL	XC6127N49J7R	Vdet-IC	4.9V±0.8%, +Reset ODO, -MR, Rt=400ms	USPN-4	58cc	VD4	9h	Tor
HXM	XC6127N49K7R	Vdet-IC	4.9V±0.8%, +Reset ODO, -MR, Rt=800ms	USPN-4	58cc	VD4	9h	Tor
HXN	XC6127N50A7R	Vdet-IC	5.0V±0.8%, -Reset ODO, -MR, Rt=50ms	USPN-4	58cc	VD4	9h	Tor
HXP	XC6127N50B7R	Vdet-IC	5.0V±0.8%, -Reset ODO, -MR, Rt=100ms	USPN-4	58cc	VD4	9h	Tor
HXR	XC6127N50C7R	Vdet-IC	5.0V±0.8%, -Reset ODO, -MR, Rt=200ms	USPN-4	58cc	VD4	9h	Tor
HXS	XC6127N50D7R	Vdet-IC	5.0V±0.8%, -Reset ODO, -MR, Rt=400ms	USPN-4	58cc	VD4	9h	Tor
HXT	XC6127N50E7R	Vdet-IC	5.0V±0.8%, -Reset ODO, -MR, Rt=800ms	USPN-4	58cc	VD4	9h	Tor
HXU	XC6127N50F7R	Vdet-IC	5.0V±0.8%, +Reset ODO, -MR, Rt=50ms	USPN-4	58cc	VD4	9h	Tor
HXV	XC6127N50G7R	Vdet-IC	5.0V±0.8%, +Reset ODO, -MR, Rt=100ms	USPN-4	58cc	VD4	9h	Tor
HXX	XC6127N50H7R	Vdet-IC	5.0V±0.8%, +Reset ODO, -MR, Rt=200ms	USPN-4	58cc	VD4	9h	Tor
HXY	XC6127N50J7R	Vdet-IC	5.0V±0.8%, +Reset ODO, -MR, Rt=400ms	USPN-4	58cc	VD4	9h	Tor
HXZ	XC6127N50K7R	Vdet-IC	5.0V±0.8%, +Reset ODO, -MR, Rt=800ms	USPN-4	58cc	VD4	9h	Tor
HY	R3116K291A	Vdet-IC	2.9V±0.8%, -Reset ODO	DFN1010-4	48rj	VD1	9a	Ric
HY	XC6221B46B7R	LVR-IC	LDO, 4.65V±1%, 200mA, +CE, CL	USPN-4	58vm	VR4	9a	Tor
HYA	XC6127N51A7R	Vdet-IC	5.1V±0.8%, -Reset ODO, -MR, Rt=50ms	USPN-4	58cc	VD4	9h	Tor
HYB	XC6127N51B7R	Vdet-IC	5.1V±0.8%, -Reset ODO, -MR, Rt=100ms	USPN-4	58cc	VD4	9h	Tor
HYC	XC6127N51C7R	Vdet-IC	5.1V±0.8%, -Reset ODO, -MR, Rt=200ms	USPN-4	58cc	VD4	9h	Tor
HYD	XC6127N51D7R	Vdet-IC	5.1V±0.8%, -Reset ODO, -MR, Rt=400ms	USPN-4	58cc	VD4	9h	Tor
HYE	XC6127N51E7R	Vdet-IC	5.1V±0.8%, -Reset ODO, -MR, Rt=800ms	USPN-4	58cc	VD4	9h	Tor
HYF	XC6127N51F7R	Vdet-IC	5.1V±0.8%, +Reset ODO, -MR, Rt=50ms	USPN-4	58cc	VD4	9h	Tor
HYH	XC6127N51G7R	Vdet-IC	5.1V±0.8%, +Reset ODO, -MR, Rt=100ms	USPN-4	58cc	VD4	9h	Tor
HYK	XC6127N51H7R	Vdet-IC	5.1V±0.8%, +Reset ODO, -MR, Rt=200ms	USPN-4	58cc	VD4	9h	Tor
HYL	XC6127N51J7R	Vdet-IC	5.1V±0.8%, +Reset ODO, -MR, Rt=400ms	USPN-4	58cc	VD4	9h	Tor
HYM	XC6127N51K7R	Vdet-IC	5.1V±0.8%, +Reset ODO, -MR, Rt=800ms	USPN-4	58cc	VD4	9h	Tor



SMD code	Type	Function	Short description	Case	Pinout	Sch.	St.	Mnf.
HYN	XC6127N52A7R	Vdet-IC	5.2V±0.8%, -Reset ODO, -MR, Rt=50ms	USPN-4	58cc	VD4	9h	Tor
HYP	XC6127N52B7R	Vdet-IC	5.2V±0.8%, -Reset ODO, -MR, Rt=100ms	USPN-4	58cc	VD4	9h	Tor
HYR	XC6127N52C7R	Vdet-IC	5.2V±0.8%, -Reset ODO, -MR, Rt=200ms	USPN-4	58cc	VD4	9h	Tor
HYS	XC6127N52D7R	Vdet-IC	5.2V±0.8%, -Reset ODO, -MR, Rt=400ms	USPN-4	58cc	VD4	9h	Tor
HYT	XC6127N52E7R	Vdet-IC	5.2V±0.8%, -Reset ODO, -MR, Rt=800ms	USPN-4	58cc	VD4	9h	Tor
HYU	XC6127N52F7R	Vdet-IC	5.2V±0.8%, +Reset ODO, -MR, Rt=50ms	USPN-4	58cc	VD4	9h	Tor
HYV	XC6127N52G7R	Vdet-IC	5.2V±0.8%, +Reset ODO, -MR, Rt=100ms	USPN-4	58cc	VD4	9h	Tor
HYX	XC6127N52H7R	Vdet-IC	5.2V±0.8%, +Reset ODO, -MR, Rt=200ms	USPN-4	58cc	VD4	9h	Tor
HYZ	XC6127N52J7R	Vdet-IC	5.2V±0.8%, +Reset ODO, -MR, Rt=400ms	USPN-4	58cc	VD4	9h	Tor
HYZ	XC6127N52K7R	Vdet-IC	5.2V±0.8%, +Reset ODO, -MR, Rt=800ms	USPN-4	58cc	VD4	9h	Tor
HZ	R3116K301A	Vdet-IC	3.0V±0.8%, -Reset ODO	DFN1010-4	48j	VD1	9a	Ric
HZ	XC6221B47B7R	LVR-IC	LDO, 4.75V±1%, 200mA, +CE, CL	USPN-4	58vm	VR4	9a	Tor
HZA	XC6127N53A7R	Vdet-IC	5.3V±0.8%, -Reset ODO, -MR, Rt=50ms	USPN-4	58cc	VD4	9h	Tor
HZB	XC6127N53B7R	Vdet-IC	5.3V±0.8%, -Reset ODO, -MR, Rt=100ms	USPN-4	58cc	VD4	9h	Tor
HZC	XC6127N53C7R	Vdet-IC	5.3V±0.8%, -Reset ODO, -MR, Rt=200ms	USPN-4	58cc	VD4	9h	Tor
HZD	XC6127N53D7R	Vdet-IC	5.3V±0.8%, -Reset ODO, -MR, Rt=400ms	USPN-4	58cc	VD4	9h	Tor
HZE	XC6127N53E7R	Vdet-IC	5.3V±0.8%, -Reset ODO, -MR, Rt=800ms	USPN-4	58cc	VD4	9h	Tor
HZF	XC6127N53F7R	Vdet-IC	5.3V±0.8%, +Reset ODO, -MR, Rt=50ms	USPN-4	58cc	VD4	9h	Tor
HZH	XC6127N53G7R	Vdet-IC	5.3V±0.8%, +Reset ODO, -MR, Rt=100ms	USPN-4	58cc	VD4	9h	Tor
HZK	XC6127N53H7R	Vdet-IC	5.3V±0.8%, +Reset ODO, -MR, Rt=200ms	USPN-4	58cc	VD4	9h	Tor
HZL	XC6127N53J7R	Vdet-IC	5.3V±0.8%, +Reset ODO, -MR, Rt=400ms	USPN-4	58cc	VD4	9h	Tor
HZM	XC6127N53K7R	Vdet-IC	5.3V±0.8%, +Reset ODO, -MR, Rt=800ms	USPN-4	58cc	VD4	9h	Tor
HZN	XC6127N54A7R	Vdet-IC	5.4V±0.8%, -Reset ODO, -MR, Rt=50ms	USPN-4	58cc	VD4	9h	Tor
HZP	XC6127N54B7R	Vdet-IC	5.4V±0.8%, -Reset ODO, -MR, Rt=100ms	USPN-4	58cc	VD4	9h	Tor
HZR	XC6127N54C7R	Vdet-IC	5.4V±0.8%, -Reset ODO, -MR, Rt=200ms	USPN-4	58cc	VD4	9h	Tor
HZS	XC6127N54D7R	Vdet-IC	5.4V±0.8%, -Reset ODO, -MR, Rt=400ms	USPN-4	58cc	VD4	9h	Tor
HZT	XC6127N54E7R	Vdet-IC	5.4V±0.8%, -Reset ODO, -MR, Rt=800ms	USPN-4	58cc	VD4	9h	Tor
HZU	XC6127N54F7R	Vdet-IC	5.4V±0.8%, +Reset ODO, -MR, Rt=50ms	USPN-4	58cc	VD4	9h	Tor
HZV	XC6127N54G7R	Vdet-IC	5.4V±0.8%, +Reset ODO, -MR, Rt=100ms	USPN-4	58cc	VD4	9h	Tor
HZX	XC6127N54H7R	Vdet-IC	5.4V±0.8%, +Reset ODO, -MR, Rt=200ms	USPN-4	58cc	VD4	9h	Tor
HZY	XC6127N54J7R	Vdet-IC	5.4V±0.8%, +Reset ODO, -MR, Rt=400ms	USPN-4	58cc	VD4	9h	Tor
HZZ	XC6127N54K7R	Vdet-IC	5.4V±0.8%, +Reset ODO, -MR, Rt=800ms	USPN-4	58cc	VD4	9h	Tor
I4	LM4855STL	LIN-IC	AF PA, BTL, 2.7..5.5V, 15.7Vp-p, ceramic speaker, shutdown	BGA-12	39	-	9n	Nsc
I5	LM48520TL	LIN-IC	AF PA, BTL, class-D, 2.6..5.5V, 2x1.1W(5V/8Ω), shutdown	BGA-25	39	-	-	Nsc
IGH3	LM4949TL	LIN-IC	AF PA, BTL, class-D, 2.6..5.5V, 2x2.5W(8Ω)+2x190mW(32Ω), I2C	BGA-25	39	-	-	Nsc
J	HMPS-2825	Si-diode	Dual, Schottky Barrier, RF, 15V±2%, 1A(1μs), <1pF	MP	37ct	-	-	Agi
J0	R3118K361C	Vdet-IC	3.6V±1.5%, -Reset PPO, Sense	DFN1212-6	52z3	VD15	9a	Ric
J0	RP109L181B5	LVR-IC	LDO, 1.85V±1%, 150mA, +CE	DFN1010-4	48vm	VR4	9a	Ric
J001	RP151K001A	LVR/Vdet-IC	LDO, Dual out, Vout1/Vout2=2.8V/2.8V±1%, 300mA, +CE, Vdet	DFN2020-8	75	-	9b	Ric
J002	RP151K002A	LVR/Vdet-IC	LDO, Dual out, Vout1/Vout2=2.8V/1.8V±1%, 300mA, +CE, Vdet	DFN2020-8	75	-	9b	Ric
J005	RP151K005A	LVR/Vdet-IC	LDO, Dual out, Vout1/Vout2=3.0V/2.8V±1%, 300mA, +CE, Vdet	DFN2020-8	75	-	9b	Ric
J006	RP151K006A	LVR/Vdet-IC	LDO, Dual out, Vout1/Vout2=1.5V/3.3V±1%, 300mA, +CE, Vdet	DFN2020-8	75	-	9b	Ric
J1	R3118K371C	Vdet-IC	3.7V±1.5%, -Reset PPO, Sense	DFN1212-6	52z3	VD15	9a	Ric
J1	RP109L281B5	LVR-IC	LDO, 2.85V±1%, 150mA, +CE	DFN1010-4	48vm	VR4	9a	Ric
J2	LM48411TL	LIN-IC	AF PA, BTL, class-D, 2.4..5.5V, 2x2.5W(5V/4Ω), shutdown	BGA-16	39	-	-	Nsc
J2	R3118K381C	Vdet-IC	3.8V±1.5%, -Reset PPO, Sense	DFN1212-6	52z3	VD15	9a	Ric
J2	RP109L341B5	LVR-IC	LDO, 3.45V±1%, 150mA, +CE	DFN1010-4	48vm	VR4	9a	Ric
J3	R3118K391C	Vdet-IC	3.9V±1.5%, -Reset PPO, Sense	DFN1212-6	52z3	VD15	9a	Ric
J4	R3118K401C	Vdet-IC	4.0V±1.5%, -Reset PPO, Sense	DFN1212-6	52z3	VD15	9a	Ric
J5	R3118K411C	Vdet-IC	4.1V±1.5%, -Reset PPO, Sense	DFN1212-6	52z3	VD15	9a	Ric
J6	R3118K421C	Vdet-IC	4.2V±1.5%, -Reset PPO, Sense	DFN1212-6	52z3	VD15	9a	Ric
J7	R3118K431C	Vdet-IC	4.3V±1.5%, -Reset PPO, Sense	DFN1212-6	52z3	VD15	9a	Ric
J8	R3118K441C	Vdet-IC	4.4V±1.5%, -Reset PPO, Sense	DFN1212-6	52z3	VD15	9a	Ric
J9	R3118K451C	Vdet-IC	4.5V±1.5%, -Reset PPO, Sense	DFN1212-6	52z3	VD15	9a	Ric
JA	R3116K311A	Vdet-IC	3.1V±0.8%, -Reset ODO	DFN1010-4	48j	VD1	9a	Ric
JA	RP107K101B	LVR-IC	LDO, 1.0V±1%, 200mA, +CE	DFN1212-6	52vr2	VR4	9a	Ric
JB	R3116K321A	Vdet-IC	3.2V±0.8%, -Reset ODO	DFN1010-4	48j	VD1	9a	Ric
JB	RP107K111B	LVR-IC	LDO, 1.1V±1%, 200mA, +CE	DFN1212-6	52vr2	VR4	9a	Ric
JC	R3116K331A	Vdet-IC	3.3V±0.8%, -Reset ODO	DFN1010-4	48j	VD1	9a	Ric
JC	RP107K121B	LVR-IC	LDO, 1.2V±1%, 200mA, +CE	DFN1212-6	52vr2	VR4	9a	Ric
JD	R3116K341A	Vdet-IC	3.4V±0.8%, -Reset ODO	DFN1010-4	48j	VD1	9a	Ric
JD	RP107K131B	LVR-IC	LDO, 1.3V±1%, 200mA, +CE	DFN1212-6	52vr2	VR4	9a	Ric
JE	R3116K351A	Vdet-IC	3.5V±0.8%, -Reset ODO	DFN1010-4	48j	VD1	9a	Ric
JE	RP107K141B	LVR-IC	LDO, 1.4V±1%, 200mA, +CE	DFN1212-6	52vr2	VR4	9a	Ric
JF	R3116K361A	Vdet-IC	3.6V±0.8%, -Reset ODO	DFN1010-4	48j	VD1	9a	Ric
JF	RP107K151B	LVR-IC	LDO, 1.5V±1%, 200mA, +CE	DFN1212-6	52vr2	VR4	9a	Ric
JG	R3116K371A	Vdet-IC	3.7V±0.8%, -Reset ODO	DFN1010-4	48j	VD1	9a	Ric
JG	RP107K161B	LVR-IC	LDO, 1.6V±1%, 200mA, +CE	DFN1212-6	52vr2	VR4	9a	Ric
JH	R3116K381A	Vdet-IC	3.8V±0.8%, -Reset ODO	DFN1010-4	48j	VD1	9a	Ric
JH	RP107K171B	LVR-IC	LDO, 1.7V±1%, 200mA, +CE	DFN1212-6	52vr2	VR4	9a	Ric



SMD code	Type	Function	Short description	Case	Pinout	Sch.	St.	Mnf.
JJ	R3116K391A	Vdet-IC	3.9V±0.8%, -Reset ODO	DFN1010-4	48rj	VD1	9a	Ric
JJ	RP107K181B	LVR-IC	LDO, 1.8V±1%, 200mA, +CE	DFN1212-6	52vr2	VR4	9a	Ric
JK	R3116K401A	Vdet-IC	4.0V±0.8%, -Reset ODO	DFN1010-4	48rj	VD1	9a	Ric
JK	RP107K191B	LVR-IC	LDO, 1.9V±1%, 200mA, +CE	DFN1212-6	52vr2	VR4	9a	Ric
JL	R3116K411A	Vdet-IC	4.1V±0.8%, -Reset ODO	DFN1010-4	48rj	VD1	9a	Ric
JL	RP107K201B	LVR-IC	LDO, 2.0V±1%, 200mA, +CE	DFN1212-6	52vr2	VR4	9a	Ric
JM	R3116K421A	Vdet-IC	4.2V±0.8%, -Reset ODO	DFN1010-4	48rj	VD1	9a	Ric
JM	RP107K211B	LVR-IC	LDO, 2.1V±1%, 200mA, +CE	DFN1212-6	52vr2	VR4	9a	Ric
JN	R3116K431A	Vdet-IC	4.3V±0.8%, -Reset ODO	DFN1010-4	48rj	VD1	9a	Ric
JN	RP107K221B	LVR-IC	LDO, 2.2V±1%, 200mA, +CE	DFN1212-6	52vr2	VR4	9a	Ric
JP	R3116K441A	Vdet-IC	4.4V±0.8%, -Reset ODO	DFN1010-4	48rj	VD1	9a	Ric
JP	RP107K231B	LVR-IC	LDO, 2.3V±1%, 200mA, +CE	DFN1212-6	52vr2	VR4	9a	Ric
JQ	R3116K451A	Vdet-IC	4.5V±0.8%, -Reset ODO	DFN1010-4	48rj	VD1	9a	Ric
JQ	RP107K241B	LVR-IC	LDO, 2.4V±1%, 200mA, +CE	DFN1212-6	52vr2	VR4	9a	Ric
JR	R3116K461A	Vdet-IC	4.6V±0.8%, -Reset ODO	DFN1010-4	48rj	VD1	9a	Ric
JR	RP107K251B	LVR-IC	LDO, 2.5V±1%, 200mA, +CE	DFN1212-6	52vr2	VR4	9a	Ric
JS	R3116K471A	Vdet-IC	4.7V±0.8%, -Reset ODO	DFN1010-4	48rj	VD1	9a	Ric
JS	RP107K261B	LVR-IC	LDO, 2.6V±1%, 200mA, +CE	DFN1212-6	52vr2	VR4	9a	Ric
JT	R3116K481A	Vdet-IC	4.8V±0.8%, -Reset ODO	DFN1010-4	48rj	VD1	9a	Ric
JT	RP107K271B	LVR-IC	LDO, 2.7V±1%, 200mA, +CE	DFN1212-6	52vr2	VR4	9a	Ric
JU	R3116K491A	Vdet-IC	4.9V±0.8%, -Reset ODO	DFN1010-4	48rj	VD1	9a	Ric
JU	RP107K281B	LVR-IC	LDO, 2.8V±1%, 200mA, +CE	DFN1212-6	52vr2	VR4	9a	Ric
JV	R3116K501A	Vdet-IC	5V±0.8%, -Reset ODO	DFN1010-4	48rj	VD1	9a	Ric
JV	RP107K291B	LVR-IC	LDO, 2.9V±1%, 200mA, +CE	DFN1212-6	52vr2	VR4	9a	Ric
JW	RP107K301B	LVR-IC	LDO, 3.0V±1%, 200mA, +CE	DFN1212-6	52vr2	VR4	9a	Ric
JX	RP107K311B	LVR-IC	LDO, 3.1V±1%, 200mA, +CE	DFN1212-6	52vr2	VR4	9a	Ric
JY	RP107K321B	LVR-IC	LDO, 3.2V±1%, 200mA, +CE	DFN1212-6	52vr2	VR4	9a	Ric
JZ	RP107K331B	LVR-IC	LDO, 3.3V±1%, 200mA, +CE	DFN1212-6	52vr2	VR4	9a	Ric
K	HMPS-2822	Si-diode	Dual, Schottky Barrier, RF, 15V±2%, 1A(1µs), <1pF	MP	37cs	-	-	Agi
K0	R3118K461C	Vdet-IC	4.6V±1.5%, -Reset PPO, Sense	DFN1212-6	52z3	VD15	9a	Ric
K0	RP109L181D5	LVR-IC	LDO, 1.85V±1%, 150mA, +CE, CL	DFN1010-4	48vm	VR4	9a	Ric
K0	TS2012EJT	LIN-IC	AF PA, BTL, class-D, 2.5..5.5V, 2x2.5W(5V/4Q), shutdown	BGA-16	39	AFP46	-	Ste
K0	TS2012FC	LIN-IC	AF PA, BTL, class-D, 2.5..5.5V, 2x2.5W(5V/4Q), shutdown	BGA-16	39	AFP46	-	Ste
K007	TS2007IQT	LIN-IC	AF PA, BTL, class-D, 2.4..5.5V, 2x3W(5V/4Q), shutdown	DFN-8	37	-	-	Ste
K1	HD74LVC1G98CLE	CMOS-Logic	Configurable multiple-function gate	WCSP-6	40/Log43	-	9d	Ren
K1	R3118K471C	Vdet-IC	4.7V±1.5%, -Reset PPO, Sense	DFN1212-6	52z3	VD15	9a	Ric
K1	RP109L281D5	LVR-IC	LDO, 2.85V±1%, 150mA, +CE, CL	DFN1010-4	48vm	VR4	9a	Ric
K12	TS2012IQT	LIN-IC	AF PA, BTL, class-D, 2.5..5.5V, 2x2.5W(5V/4Q), shutdown	QFN-20	38	-	-	Ste
K19A	TS419QT	LIN-IC	AF PA, BTL, 2..5.5V, 367mW(5V/16Q), shutdown	DFN-8	37	-	-	Ste
K19B	TS419-2QT	LIN-IC	AF PA, BTL, 2..5.5V, 367mW(5V/16Q), shutdown	DFN-8	37	AFP59	-	Ste
K19C	TS419-4QT	LIN-IC	AF PA, BTL, 2..5.5V, 367mW(5V/16Q), shutdown	DFN-8	37	AFP59	-	Ste
K19D	TS419-8QT	LIN-IC	AF PA, BTL, 2..5.5V, 367mW(5V/16Q), shutdown	DFN-8	37	AFP59	-	Ste
K1Y	RD74LVC1G98WPE	CMOS-Logic	Configurable multiple-function gate	WCSP-6	40/Log43	-	9d	Ren
K2	HD74LVC1G97CLE	CMOS-Logic	Configurable multiple-function gate	WCSP-6	40/Log41	-	9d	Ren
K2	R3118K481C	Vdet-IC	4.8V±1.5%, -Reset PPO, Sense	DFN1212-6	52z3	VD15	9a	Ric
K2	RP109L341D5	LVR-IC	LDO, 3.45V±1%, 150mA, +CE, CL	DFN1010-4	48vm	VR4	9a	Ric
K21	TS421QT	LIN-IC	AF PA, BTL, 2..5.5V, 367mW(5V/16Q), shutdown	DFN-8	37	-	-	Ste
K21A	TS421-2QT	LIN-IC	AF PA, BTL, 2..5.5V, 367mW(5V/16Q), shutdown	DFN-8	37	-	-	Ste
K21B	TS421-4QT	LIN-IC	AF PA, BTL, 2..5.5V, 367mW(5V/16Q), shutdown	DFN-8	37	-	-	Ste
K21C	TS421-8QT	LIN-IC	AF PA, BTL, 2..5.5V, 367mW(5V/16Q), shutdown	DFN-8	37	-	-	Ste
K2Y	RD74LVC1G97WPE	CMOS-Logic	Configurable multiple-function gate	WCSP-6	40/Log41	-	9d	Ren
K3	LM48861TM	LIN-IC	AF PA, 1.2..2.8V, 2x26mW(2V/16Q), I2C volume	BGA-12	39	-	-	Nsc
K3	R3118K491C	Vdet-IC	4.9V±1.5%, -Reset PPO, Sense	DFN1212-6	52z3	VD15	9a	Ric
K4	R3118K501C	Vdet-IC	5.0V±1.5%, -Reset PPO, Sense	DFN1212-6	52z3	VD15	9a	Ric
K5	74AVCH1T45GM	CMOS-Logic	Dual supply translating transceiver with 3-state output	SOT-886	57/Log70	-	9c	Phi
K61T	TS4961TIQT	LIN-IC	AF PA, BTL, class-D, 2.7..5.5V, 1.6W(5V/4Q), shutdown	QFN-16	38	-	9q	Ste
K7	TS2007EKJUT	LIN-IC	AF PA, BTL, class-D, 2.4..5.5V, 3W(5V/4Q), shutdown	BGA-9	39	AFP52	-	Ste
K7	TS2007FC	LIN-IC	AF PA, BTL, class-D, 2.4..5.5V, 3W(5V/4Q), shutdown	BGA-9	39	AFP52	-	Ste
K86A	TS486-IQT	LIN-IC	AF PA, 2.5..5V, 2x100mW(16Q), shutdown	DFN-8	37	AFP7	-	Ste
K86B	TS486-1IQT	LIN-IC	AF PA, 2.5..5V, 2x100mW(5V/16Q), shutdown	DFN-8	37	AFP25	-	Ste
K86C	TS486-2IQT	LIN-IC	AF PA, 2.5..5V, 2x100mW(5V/16Q), shutdown	DFN-8	37	AFP25	-	Ste
K86D	TS486-4IQT	LIN-IC	AF PA, 2.5..5V, 2x100mW(5V/16Q), shutdown	DFN-8	37	AFP25	-	Ste
K87A	TS487-IQT	LIN-IC	AF PA, 2.5..5V, 2x100mW(5V/16Q), shutdown	DFN-8	37	AFP16	-	Ste
K87B	TS487-1IQT	LIN-IC	AF PA, 2.5..5V, 2x100mW(5V/16Q), shutdown	DFN-8	37	AFP64	-	Ste
K87C	TS487-2IQT	LIN-IC	AF PA, 2.5..5V, 2x100mW(5V/16Q), shutdown	DFN-8	37	AFP64	-	Ste
K87D	TS487-4IQT	LIN-IC	AF PA, 2.5..5V, 2x100mW(5V/16Q), shutdown	DFN-8	37	AFP64	-	Ste
K88	TS488IQT	LIN-IC	AF PA, 2.5..5.5V, 2x120mW(16Q), shutdown	DFN-8	37	-	-	Ste
K89	TS489IQT	LIN-IC	AF PA, 2.5..5.5V, 2x120mW(16Q), shutdown	DFN-8	37	-	-	Ste
K8A	XC6108N08AGR	Vdet-IC	0.8V±2%, Hysteresis, -Reset ODO	USP-4	45ro	VD14	9b	Tor
K8B	XC6108N08BGR	Vdet-IC	0.8V±2%, -Reset ODO	USP-4	45ro	VD14	9b	Tor



SMD code	Type	Function	Short description	Case	Pinout	Sch.	St.	Mnf.
K8C	XC6108N08CGR	Vdet-IC	0.8V±2%, Hysteresis, -Reset ODO	USP-4	45rn	VD14	9b	Tor
K8D	XC6108N08DGR	Vdet-IC	0.8V±2%, -Reset ODO	USP-4	45rn	VD14	9b	Tor
K9	TS4999EIJT	LIN-IC	AF PA, BTL, 2.7..5.5V, 2x1W(5V/8Q), shutdown	BGA-18	39	-	9p	Ste
K909	TS4909IQT	LIN-IC	AF PA, 2.5..5.5V, 2x120mW(16Q), shutdown	DFN-10	37	-	-	Ste
K962	TS4962IQT	LIN-IC	AF PA, BTL, class-D, 2.4..5.5V, 2.4W(5V/4Q), shutdown	DFN-8	37	AFF24	-	Ste
K982	TS4982IQT	LIN-IC	AF PA, BTL, 2.7..5.5V, 2x2W(4Q)+2x125mW(16Q), shutdown	QFN-32	38	-	-	Ste
K984	TS4984IQT	LIN-IC	AF PA, BTL, 2.5..5.5V, 2x1W(5V/8Q), shutdown	QFN-16	38	-	-	Ste
K990	TS4990IQT	LIN-IC	AF PA, BTL, 2.5..5.5V, 1.2W(5V/8Q), shutdown	DFN-8	37	AFF12	-	Ste
K994	TS4994IQT	LIN-IC	AF PA, BTL, 2.5..5.5V, 1.2W(5V/8Q), select shutdown	DFN-10	37	AFF19	-	Ste
K9A	XC6108N09AGR	Vdet-IC	0.9V±2%, Hysteresis, -Reset ODO	USP-4	45ro	VD14	9b	Tor
K9B	XC6108N09BGR	Vdet-IC	0.9V±2%, -Reset ODO	USP-4	45ro	VD14	9b	Tor
K9C	XC6108N09CGR	Vdet-IC	0.9V±2%, Hysteresis, -Reset ODO	USP-4	45rn	VD14	9b	Tor
K9D	XC6108N09DGR	Vdet-IC	0.9V±2%, -Reset ODO	USP-4	45rn	VD14	9b	Tor
KA	R3116K071C	Vdet-IC	0.7V±0.8%, -Reset PPO	DFN1010-4	48rj	VD3	9a	Ric
KA	RP107K341B	LVR-IC	LDO, 3.4V±1%, 200mA, +CE	DFN1212-6	52vr2	VR4	9a	Ric
KA8	XC9235C08C4R-G	DC-DC-IC	PWM, st-dwn, 0.8V±2%, 600mA, 1.2MHz, Vin>2V, LSST, CL	USP-6EL	56dc5	DC1	9a	Tor
KA8	XC9235C08CER	DC-DC-IC	PWM, st-dwn, 0.8V±2%, 600mA, 1.2MHz, Vin>2V, LSST, CL	USP-6C	49dc5	DC1	9a	Tor
KA9	XC9235C09C4R-G	DC-DC-IC	PWM, st-dwn, 0.9V±2%, 600mA, 1.2MHz, Vin>2V, LSST, CL	USP-6EL	56dc5	DC1	9a	Tor
KA9	XC9235C09CER	DC-DC-IC	PWM, st-dwn, 0.9V±2%, 600mA, 1.2MHz, Vin>2V, LSST, CL	USP-6C	49dc5	DC1	9a	Tor
KAL	XC9235C0LC4R-G	DC-DC-IC	PWM, st-dwn, 0.85V±2%, 600mA, 1.2MHz, Vin>2V, LSST, CL	USP-6EL	56dc5	DC1	9a	Tor
KAL	XC9235C0LCER	DC-DC-IC	PWM, st-dwn, 0.85V±2%, 600mA, 1.2MHz, Vin>2V, LSST, CL	USP-6C	49dc5	DC1	9a	Tor
KAM	XC9235C0MC4R-G	DC-DC-IC	PWM, st-dwn, 0.95V±2%, 600mA, 1.2MHz, Vin>2V, LSST, CL	USP-6EL	56dc5	DC1	9a	Tor
KAM	XC9235C0MCER	DC-DC-IC	PWM, st-dwn, 0.95V±2%, 600mA, 1.2MHz, Vin>2V, LSST, CL	USP-6C	49dc5	DC1	9a	Tor
KB	R3116K081C	Vdet-IC	0.8V±0.8%, -Reset PPO	DFN1010-4	48rj	VD3	9a	Ric
KB	RP107K351B	LVR-IC	LDO, 3.5V±1%, 200mA, +CE	DFN1212-6	52vr2	VR4	9a	Ric
KB0	XC9235C10C4R-G	DC-DC-IC	PWM, st-dwn, 1.0V±2%, 600mA, 1.2MHz, Vin>2V, LSST, CL	USP-6EL	56dc5	DC1	9a	Tor
KB0	XC9235C10CER	DC-DC-IC	PWM, st-dwn, 1.0V±2%, 600mA, 1.2MHz, Vin>2V, LSST, CL	USP-6C	49dc5	DC1	9a	Tor
KB02A	XC9133B02AER	LDR-IC	PWM step-up, Adj. 2.5...17.5V.LED backlight driver	USP-6C	49dc6	LD3	9b	Tor
KB1	XC9235C11C4R-G	DC-DC-IC	PWM, st-dwn, 1.1V±2%, 600mA, 1.2MHz, Vin>2V, LSST, CL	USP-6EL	56dc5	DC1	9a	Tor
KB1	XC9235C11CER	DC-DC-IC	PWM, st-dwn, 1.1V±2%, 600mA, 1.2MHz, Vin>2V, LSST, CL	USP-6C	49dc5	DC1	9a	Tor
KB2	XC9235C12C4R-G	DC-DC-IC	PWM, st-dwn, 1.2V±2%, 600mA, 1.2MHz, Vin>2V, LSST, CL	USP-6EL	56dc5	DC1	9a	Tor
KB2	XC9235C12CER	DC-DC-IC	PWM, st-dwn, 1.2V±2%, 600mA, 1.2MHz, Vin>2V, LSST, CL	USP-6C	49dc5	DC1	9a	Tor
KB3	XC9235C13C4R-G	DC-DC-IC	PWM, st-dwn, 1.3V±2%, 600mA, 1.2MHz, Vin>2V, LSST, CL	USP-6EL	56dc5	DC1	9a	Tor
KB3	XC9235C13CER	DC-DC-IC	PWM, st-dwn, 1.3V±2%, 600mA, 1.2MHz, Vin>2V, LSST, CL	USP-6C	49dc5	DC1	9a	Tor
KB4	XC9235C14C4R-G	DC-DC-IC	PWM, st-dwn, 1.4V±2%, 600mA, 1.2MHz, Vin>2V, LSST, CL	USP-6EL	56dc5	DC1	9a	Tor
KB4	XC9235C14CER	DC-DC-IC	PWM, st-dwn, 1.4V±2%, 600mA, 1.2MHz, Vin>2V, LSST, CL	USP-6C	49dc5	DC1	9a	Tor
KB5	XC9235C15C4R-G	DC-DC-IC	PWM, st-dwn, 1.5V±2%, 600mA, 1.2MHz, Vin>2V, LSST, CL	USP-6EL	56dc5	DC1	9a	Tor
KB5	XC9235C15CER	DC-DC-IC	PWM, st-dwn, 1.5V±2%, 600mA, 1.2MHz, Vin>2V, LSST, CL	USP-6C	49dc5	DC1	9a	Tor
KB6	XC9235C16C4R-G	DC-DC-IC	PWM, st-dwn, 1.6V±2%, 600mA, 1.2MHz, Vin>2V, LSST, CL	USP-6EL	56dc5	DC1	9a	Tor
KB6	XC9235C16CER	DC-DC-IC	PWM, st-dwn, 1.6V±2%, 600mA, 1.2MHz, Vin>2V, LSST, CL	USP-6C	49dc5	DC1	9a	Tor
KB7	XC9235C17C4R-G	DC-DC-IC	PWM, st-dwn, 1.7V±2%, 600mA, 1.2MHz, Vin>2V, LSST, CL	USP-6EL	56dc5	DC1	9a	Tor
KB7	XC9235C17CER	DC-DC-IC	PWM, st-dwn, 1.7V±2%, 600mA, 1.2MHz, Vin>2V, LSST, CL	USP-6C	49dc5	DC1	9a	Tor
KB8	XC9235C18C4R-G	DC-DC-IC	PWM, st-dwn, 1.8V±2%, 600mA, 1.2MHz, Vin>2V, LSST, CL	USP-6EL	56dc5	DC1	9a	Tor
KB8	XC9235C18CER	DC-DC-IC	PWM, st-dwn, 1.8V±2%, 600mA, 1.2MHz, Vin>2V, LSST, CL	USP-6C	49dc5	DC1	9a	Tor
KB9	XC9235C19C4R-G	DC-DC-IC	PWM, st-dwn, 1.9V±2%, 600mA, 1.2MHz, Vin>2V, LSST, CL	USP-6EL	56dc5	DC1	9a	Tor
KB9	XC9235C19CER	DC-DC-IC	PWM, st-dwn, 1.9V±2%, 600mA, 1.2MHz, Vin>2V, LSST, CL	USP-6C	49dc5	DC1	9a	Tor
KBA	XC9235C1AC4R-G	DC-DC-IC	PWM, st-dwn, 1.05V±2%, 600mA, 1.2MHz, Vin>2V, LSST, CL	USP-6EL	56dc5	DC1	9a	Tor
KBA	XC9235C1ACER	DC-DC-IC	PWM, st-dwn, 1.05V±2%, 600mA, 1.2MHz, Vin>2V, LSST, CL	USP-6C	49dc5	DC1	9a	Tor
KBB	XC9235C1BC4R-G	DC-DC-IC	PWM, st-dwn, 1.15V±2%, 600mA, 1.2MHz, Vin>2V, LSST, CL	USP-6EL	56dc5	DC1	9a	Tor
KBB	XC9235C1BCER	DC-DC-IC	PWM, st-dwn, 1.15V±2%, 600mA, 1.2MHz, Vin>2V, LSST, CL	USP-6C	49dc5	DC1	9a	Tor
KBC	XC9235C1CC4R-G	DC-DC-IC	PWM, st-dwn, 1.25V±2%, 600mA, 1.2MHz, Vin>2V, LSST, CL	USP-6EL	56dc5	DC1	9a	Tor
KBC	XC9235C1CCER	DC-DC-IC	PWM, st-dwn, 1.25V±2%, 600mA, 1.2MHz, Vin>2V, LSST, CL	USP-6C	49dc5	DC1	9a	Tor
KBD	XC9235C1DC4R-G	DC-DC-IC	PWM, st-dwn, 1.35V±2%, 600mA, 1.2MHz, Vin>2V, LSST, CL	USP-6EL	56dc5	DC1	9a	Tor
KBD	XC9235C1DCER	DC-DC-IC	PWM, st-dwn, 1.35V±2%, 600mA, 1.2MHz, Vin>2V, LSST, CL	USP-6C	49dc5	DC1	9a	Tor
KBE	XC9235C1EC4R-G	DC-DC-IC	PWM, st-dwn, 1.45V±2%, 600mA, 1.2MHz, Vin>2V, LSST, CL	USP-6EL	56dc5	DC1	9a	Tor
KBE	XC9235C1ECER	DC-DC-IC	PWM, st-dwn, 1.45V±2%, 600mA, 1.2MHz, Vin>2V, LSST, CL	USP-6C	49dc5	DC1	9a	Tor
KBF	XC9235C1FC4R-G	DC-DC-IC	PWM, st-dwn, 1.55V±2%, 600mA, 1.2MHz, Vin>2V, LSST, CL	USP-6EL	56dc5	DC1	9a	Tor
KBF	XC9235C1FCER	DC-DC-IC	PWM, st-dwn, 1.55V±2%, 600mA, 1.2MHz, Vin>2V, LSST, CL	USP-6C	49dc5	DC1	9a	Tor
KBH	XC9235C1HC4R-G	DC-DC-IC	PWM, st-dwn, 1.65V±2%, 600mA, 1.2MHz, Vin>2V, LSST, CL	USP-6EL	56dc5	DC1	9a	Tor
KBH	XC9235C1HCER	DC-DC-IC	PWM, st-dwn, 1.65V±2%, 600mA, 1.2MHz, Vin>2V, LSST, CL	USP-6C	49dc5	DC1	9a	Tor
KBK	XC9235C1KC4R-G	DC-DC-IC	PWM, st-dwn, 1.75V±2%, 600mA, 1.2MHz, Vin>2V, LSST, CL	USP-6EL	56dc5	DC1	9a	Tor
KBK	XC9235C1KCER	DC-DC-IC	PWM, st-dwn, 1.75V±2%, 600mA, 1.2MHz, Vin>2V, LSST, CL	USP-6C	49dc5	DC1	9a	Tor
KBL	XC9235C1LC4R-G	DC-DC-IC	PWM, st-dwn, 1.85V±2%, 600mA, 1.2MHz, Vin>2V, LSST, CL	USP-6EL	56dc5	DC1	9a	Tor
KBL	XC9235C1LCER	DC-DC-IC	PWM, st-dwn, 1.85V±2%, 600mA, 1.2MHz, Vin>2V, LSST, CL	USP-6C	49dc5	DC1	9a	Tor
KBM	XC9235C1MC4R-G	DC-DC-IC	PWM, st-dwn, 1.95V±2%, 600mA, 1.2MHz, Vin>2V, LSST, CL	USP-6EL	56dc5	DC1	9a	Tor
KBM	XC9235C1MCER	DC-DC-IC	PWM, st-dwn, 1.95V±2%, 600mA, 1.2MHz, Vin>2V, LSST, CL	USP-6C	49dc5	DC1	9a	Tor
KC	R3116K091C	Vdet-IC	0.9V±0.8%, -Reset PPO	DFN1010-4	48rj	VD3	9a	Ric
KC	RP107K361B	LVR-IC	LDO, 3.6V±1%, 200mA, +CE	DFN1212-6	52vr2	VR4	9a	Ric
KC0	XC9235C20C4R-G	DC-DC-IC	PWM, st-dwn, 2.0V±2%, 600mA, 1.2MHz, Vin>2V, LSST, CL	USP-6EL	56dc5	DC1	9a	Tor
KC0	XC9235C20CER	DC-DC-IC	PWM, st-dwn, 2.0V±2%, 600mA, 1.2MHz, Vin>2V, LSST, CL	USP-6C	49dc5	DC1	9a	Tor



SMD code	Type	Function	Short description	Case	Pinout	Sch.	St.	Mnf.
KDF	XC9235C3FC4R-G	DC-DC-IC	PWM, st-dwn, 3.55V±2%, 600mA, 1.2MHz, Vin>2V, LSST, CL	USP-6EL	56dc5	DC1	9a	Tor
KDF	XC9235C3FCER	DC-DC-IC	PWM, st-dwn, 3.55V±2%, 600mA, 1.2MHz, Vin>2V, LSST, CL	USP-6C	49dc5	DC1	9a	Tor
KDH	XC9235C3HC4R-G	DC-DC-IC	PWM, st-dwn, 3.65V±2%, 600mA, 1.2MHz, Vin>2V, LSST, CL	USP-6EL	56dc5	DC1	9a	Tor
KDH	XC9235C3HCER	DC-DC-IC	PWM, st-dwn, 3.65V±2%, 600mA, 1.2MHz, Vin>2V, LSST, CL	USP-6C	49dc5	DC1	9a	Tor
KDK	XC9235C3KC4R-G	DC-DC-IC	PWM, st-dwn, 3.75V±2%, 600mA, 1.2MHz, Vin>2V, LSST, CL	USP-6EL	56dc5	DC1	9a	Tor
KDK	XC9235C3KCER	DC-DC-IC	PWM, st-dwn, 3.75V±2%, 600mA, 1.2MHz, Vin>2V, LSST, CL	USP-6C	49dc5	DC1	9a	Tor
KDL	XC9235C3LC4R-G	DC-DC-IC	PWM, st-dwn, 3.85V±2%, 600mA, 1.2MHz, Vin>2V, LSST, CL	USP-6EL	56dc5	DC1	9a	Tor
KDL	XC9235C3LCER	DC-DC-IC	PWM, st-dwn, 3.85V±2%, 600mA, 1.2MHz, Vin>2V, LSST, CL	USP-6C	49dc5	DC1	9a	Tor
KDM	XC9235C3MC4R-G	DC-DC-IC	PWM, st-dwn, 3.95V±2%, 600mA, 1.2MHz, Vin>2V, LSST, CL	USP-6EL	56dc5	DC1	9a	Tor
KDM	XC9235C3MCER	DC-DC-IC	PWM, st-dwn, 3.95V±2%, 600mA, 1.2MHz, Vin>2V, LSST, CL	USP-6C	49dc5	DC1	9a	Tor
KE	R3116K111C	Vdet-IC	1.1V±0.8%, -Reset PPO	DFN1010-4	48j	VD3	9a	Ric
KE	RD74LVC2G07WPE	CMOS-Logic	Triple noninverting buffers/drivers (ODO)	WCSP-8	50Lug73	-	9d	Ren
KE	RP107K381B	LVR-IC	LDO, 3.8V±1%, 200mA, +CE	DFN1212-6	52vr2	VR4	9a	Ric
KE0	XC9235C40C4R-G	DC-DC-IC	PWM, st-dwn, 4.0V±2%, 600mA, 1.2MHz, Vin>2V, LSST, CL	USP-6EL	56dc5	DC1	9a	Tor
KE0	XC9235C40CER	DC-DC-IC	PWM, st-dwn, 4.0V±2%, 600mA, 1.2MHz, Vin>2V, LSST, CL	USP-6C	49dc5	DC1	9a	Tor
KF	R3116K121C	Vdet-IC	1.2V±0.8%, -Reset PPO	DFN1010-4	48j	VD3	9a	Ric
KF	RP107K391B	LVR-IC	LDO, 3.9V±1%, 200mA, +CE	DFN1212-6	52vr2	VR4	9a	Ric
KF8	XC9235C08D4R-G	DC-DC-IC	PWM, st-dwn, 0.8V±2%, 600mA, 3MHz, Vin>2V, LSST, CL	USP-6EL	56dc5	DC1	9a	Tor
KF8	XC9235C08DER	DC-DC-IC	PWM, st-dwn, 0.8V±2%, 600mA, 3MHz, Vin>2V, LSST, CL	USP-6C	49dc5	DC1	9a	Tor
ƒF8	XCL205C084AR-G	DC/DC-IC	PWM st-dwn, 3MHz, 0.8V±2%, 600mA, -CE, CL, soft start	CL-2025	67dc7	DC9	9a	Tor
KF9	XC9235C09D4R-G	DC-DC-IC	PWM, st-dwn, 0.9V±2%, 600mA, 3MHz, Vin>2V, LSST, CL	USP-6EL	56dc5	DC1	9a	Tor
KF9	XC9235C09DER	DC-DC-IC	PWM, st-dwn, 0.9V±2%, 600mA, 3MHz, Vin>2V, LSST, CL	USP-6C	49dc5	DC1	9a	Tor
ƒF9	XCL205C094AR-G	DC/DC-IC	PWM st-dwn, 3MHz, 0.9V±2%, 600mA, -CE, CL, soft start	CL-2025	67dc7	DC9	9a	Tor
KFL	XC9235C0LD4R-G	DC-DC-IC	PWM, st-dwn, 0.85V±2%, 600mA, 3MHz, Vin>2V, LSST, CL	USP-6EL	56dc5	DC1	9a	Tor
KFL	XC9235C0LDER	DC-DC-IC	PWM, st-dwn, 0.85V±2%, 600mA, 3MHz, Vin>2V, LSST, CL	USP-6C	49dc5	DC1	9a	Tor
KFM	XC9235C0MD4R-G	DC-DC-IC	PWM, st-dwn, 0.95V±2%, 600mA, 3MHz, Vin>2V, LSST, CL	USP-6EL	56dc5	DC1	9a	Tor
KFM	XC9235C0MDER	DC-DC-IC	PWM, st-dwn, 0.95V±2%, 600mA, 3MHz, Vin>2V, LSST, CL	USP-6C	49dc5	DC1	9a	Tor
KG	R3116K131C	Vdet-IC	1.3V±0.8%, -Reset PPO	DFN1010-4	48j	VD3	9a	Ric
KG	RP107K401B	LVR-IC	LDO, 4.0V±1%, 200mA, +CE	DFN1212-6	52vr2	VR4	9a	Ric
KH	R3116K141C	Vdet-IC	1.4V±0.8%, -Reset PPO	DFN1010-4	48j	VD3	9a	Ric
KH	RP107K411B	LVR-IC	LDO, 4.1V±1%, 200mA, +CE	DFN1212-6	52vr2	VR4	9a	Ric
KH0	XC9235C10D4R-G	DC-DC-IC	PWM, st-dwn, 1.0V±2%, 600mA, 3MHz, Vin>2V, LSST, CL	USP-6EL	56dc5	DC1	9a	Tor
KH0	XC9235C10DER	DC-DC-IC	PWM, st-dwn, 1.0V±2%, 600mA, 3MHz, Vin>2V, LSST, CL	USP-6C	49dc5	DC1	9a	Tor
ƒH0	XCL205C104AR-G	DC/DC-IC	PWM st-dwn, 3MHz, 1.0V±2%, 600mA, -CE, CL, soft start	CL-2025	67dc7	DC9	9a	Tor
KH1	XC9235C11D4R-G	DC-DC-IC	PWM, st-dwn, 1.1V±2%, 600mA, 3MHz, Vin>2V, LSST, CL	USP-6EL	56dc5	DC1	9a	Tor
KH1	XC9235C11DER	DC-DC-IC	PWM, st-dwn, 1.1V±2%, 600mA, 3MHz, Vin>2V, LSST, CL	USP-6C	49dc5	DC1	9a	Tor
ƒH1	XCL205C114AR-G	DC/DC-IC	PWM st-dwn, 3MHz, 1.1V±2%, 600mA, -CE, CL, soft start	CL-2025	67dc7	DC9	9a	Tor
KH2	XC9235C12D4R-G	DC-DC-IC	PWM, st-dwn, 1.2V±2%, 600mA, 3MHz, Vin>2V, LSST, CL	USP-6EL	56dc5	DC1	9a	Tor
KH2	XC9235C12DER	DC-DC-IC	PWM, st-dwn, 1.2V±2%, 600mA, 3MHz, Vin>2V, LSST, CL	USP-6C	49dc5	DC1	9a	Tor
ƒH2	XCL205C124AR-G	DC/DC-IC	PWM st-dwn, 3MHz, 1.2V±2%, 600mA, -CE, CL, soft start	CL-2025	67dc7	DC9	9a	Tor
KH3	XC9235C13D4R-G	DC-DC-IC	PWM, st-dwn, 1.3V±2%, 600mA, 3MHz, Vin>2V, LSST, CL	USP-6EL	56dc5	DC1	9a	Tor
KH3	XC9235C13DER	DC-DC-IC	PWM, st-dwn, 1.3V±2%, 600mA, 3MHz, Vin>2V, LSST, CL	USP-6C	49dc5	DC1	9a	Tor
ƒH3	XCL205C134AR-G	DC/DC-IC	PWM st-dwn, 3MHz, 1.3V±2%, 600mA, -CE, CL, soft start	CL-2025	67dc7	DC9	9a	Tor
KH4	XC9235C14D4R-G	DC-DC-IC	PWM, st-dwn, 1.4V±2%, 600mA, 3MHz, Vin>2V, LSST, CL	USP-6EL	56dc5	DC1	9a	Tor
KH4	XC9235C14DER	DC-DC-IC	PWM, st-dwn, 1.4V±2%, 600mA, 3MHz, Vin>2V, LSST, CL	USP-6C	49dc5	DC1	9a	Tor
ƒH4	XCL205C144AR-G	DC/DC-IC	PWM st-dwn, 3MHz, 1.4V±2%, 600mA, -CE, CL, soft start	CL-2025	67dc7	DC9	9a	Tor
KH5	XC9235C15D4R-G	DC-DC-IC	PWM, st-dwn, 1.5V±2%, 600mA, 3MHz, Vin>2V, LSST, CL	USP-6EL	56dc5	DC1	9a	Tor
KH5	XC9235C15DER	DC-DC-IC	PWM, st-dwn, 1.5V±2%, 600mA, 3MHz, Vin>2V, LSST, CL	USP-6C	49dc5	DC1	9a	Tor
ƒH5	XCL205C154AR-G	DC/DC-IC	PWM st-dwn, 3MHz, 1.5V±2%, 600mA, -CE, CL, soft start	CL-2025	67dc7	DC9	9a	Tor
KH6	XC9235C16D4R-G	DC-DC-IC	PWM, st-dwn, 1.6V±2%, 600mA, 3MHz, Vin>2V, LSST, CL	USP-6EL	56dc5	DC1	9a	Tor
KH6	XC9235C16DER	DC-DC-IC	PWM, st-dwn, 1.6V±2%, 600mA, 3MHz, Vin>2V, LSST, CL	USP-6C	49dc5	DC1	9a	Tor
ƒH6	XCL205C164AR-G	DC/DC-IC	PWM st-dwn, 3MHz, 1.6V±2%, 600mA, -CE, CL, soft start	CL-2025	67dc7	DC9	9a	Tor
KH7	XC9235C17D4R-G	DC-DC-IC	PWM, st-dwn, 1.7V±2%, 600mA, 3MHz, Vin>2V, LSST, CL	USP-6EL	56dc5	DC1	9a	Tor
KH7	XC9235C17DER	DC-DC-IC	PWM, st-dwn, 1.7V±2%, 600mA, 3MHz, Vin>2V, LSST, CL	USP-6C	49dc5	DC1	9a	Tor
ƒH7	XCL205C174AR-G	DC/DC-IC	PWM st-dwn, 3MHz, 1.7V±2%, 600mA, -CE, CL, soft start	CL-2025	67dc7	DC9	9a	Tor
KH8	XC9235C18D4R-G	DC-DC-IC	PWM, st-dwn, 1.8V±2%, 600mA, 3MHz, Vin>2V, LSST, CL	USP-6EL	56dc5	DC1	9a	Tor
KH8	XC9235C18DER	DC-DC-IC	PWM, st-dwn, 1.8V±2%, 600mA, 3MHz, Vin>2V, LSST, CL	USP-6C	49dc5	DC1	9a	Tor
ƒH8	XCL205C184AR-G	DC/DC-IC	PWM st-dwn, 3MHz, 1.8V±2%, 600mA, -CE, CL, soft start	CL-2025	67dc7	DC9	9a	Tor
KH9	XC9235C19D4R-G	DC-DC-IC	PWM, st-dwn, 1.9V±2%, 600mA, 3MHz, Vin>2V, LSST, CL	USP-6EL	56dc5	DC1	9a	Tor
KH9	XC9235C19DER	DC-DC-IC	PWM, st-dwn, 1.9V±2%, 600mA, 3MHz, Vin>2V, LSST, CL	USP-6C	49dc5	DC1	9a	Tor
ƒH9	XCL205C194AR-G	DC/DC-IC	PWM st-dwn, 3MHz, 1.9V±2%, 600mA, -CE, CL, soft start	CL-2025	67dc7	DC9	9a	Tor
KHA	XC9235C1AD4R-G	DC-DC-IC	PWM, st-dwn, 1.05V±2%, 600mA, 3MHz, Vin>2V, LSST, CL	USP-6EL	56dc5	DC1	9a	Tor
KHA	XC9235C1ADER	DC-DC-IC	PWM, st-dwn, 1.05V±2%, 600mA, 3MHz, Vin>2V, LSST, CL	USP-6C	49dc5	DC1	9a	Tor
KHB	XC9235C1BD4R-G	DC-DC-IC	PWM, st-dwn, 1.15V±2%, 600mA, 3MHz, Vin>2V, LSST, CL	USP-6EL	56dc5	DC1	9a	Tor
KHB	XC9235C1BDER	DC-DC-IC	PWM, st-dwn, 1.15V±2%, 600mA, 3MHz, Vin>2V, LSST, CL	USP-6C	49dc5	DC1	9a	Tor
KHC	XC9235C1CD4R-G	DC-DC-IC	PWM, st-dwn, 1.25V±2%, 600mA, 3MHz, Vin>2V, LSST, CL	USP-6EL	56dc5	DC1	9a	Tor
KHC	XC9235C1CDER	DC-DC-IC	PWM, st-dwn, 1.25V±2%, 600mA, 3MHz, Vin>2V, LSST, CL	USP-6C	49dc5	DC1	9a	Tor
KHD	XC9235C1DD4R-G	DC-DC-IC	PWM, st-dwn, 1.35V±2%, 600mA, 3MHz, Vin>2V, LSST, CL	USP-6EL	56dc5	DC1	9a	Tor
KHD	XC9235C1DDER	DC-DC-IC	PWM, st-dwn, 1.35V±2%, 600mA, 3MHz, Vin>2V, LSST, CL	USP-6C	49dc5	DC1	9a	Tor
KHE	XC9235C1ED4R-G	DC-DC-IC	PWM, st-dwn, 1.45V±2%, 600mA, 3MHz, Vin>2V, LSST, CL	USP-6EL	56dc5	DC1	9a	Tor



SMD code	Type	Function	Short description	Case	Pinout	Sch.	St.	Mnf.
KHE	XC9235C1EDER	DC-DC-IC	PWM, st-dwn, 1.45V±2%, 600mA, 3MHz, Vin>2V, LSST, CL	USP-6C	49dc5	DC1	9a	Tor
KHF	XC9235C1FD4R-G	DC-DC-IC	PWM, st-dwn, 1.55V±2%, 600mA, 3MHz, Vin>2V, LSST, CL	USP-6EL	56dc5	DC1	9a	Tor
KHF	XC9235C1FDER	DC-DC-IC	PWM, st-dwn, 1.55V±2%, 600mA, 3MHz, Vin>2V, LSST, CL	USP-6C	49dc5	DC1	9a	Tor
KHH	XC9235C1HD4R-G	DC-DC-IC	PWM, st-dwn, 1.65V±2%, 600mA, 3MHz, Vin>2V, LSST, CL	USP-6EL	56dc5	DC1	9a	Tor
KHH	XC9235C1HDER	DC-DC-IC	PWM, st-dwn, 1.65V±2%, 600mA, 3MHz, Vin>2V, LSST, CL	USP-6C	49dc5	DC1	9a	Tor
KHK	XC9235C1KD4R-G	DC-DC-IC	PWM, st-dwn, 1.75V±2%, 600mA, 3MHz, Vin>2V, LSST, CL	USP-6EL	56dc5	DC1	9a	Tor
KHK	XC9235C1KDER	DC-DC-IC	PWM, st-dwn, 1.75V±2%, 600mA, 3MHz, Vin>2V, LSST, CL	USP-6C	49dc5	DC1	9a	Tor
KHL	XC9235C1LD4R-G	DC-DC-IC	PWM, st-dwn, 1.85V±2%, 600mA, 3MHz, Vin>2V, LSST, CL	USP-6EL	56dc5	DC1	9a	Tor
KHL	XC9235C1LDER	DC-DC-IC	PWM, st-dwn, 1.85V±2%, 600mA, 3MHz, Vin>2V, LSST, CL	USP-6C	49dc5	DC1	9a	Tor
KHM	XC9235C1MD4R-G	DC-DC-IC	PWM, st-dwn, 1.95V±2%, 600mA, 3MHz, Vin>2V, LSST, CL	USP-6EL	56dc5	DC1	9a	Tor
KHM	XC9235C1MDER	DC-DC-IC	PWM, st-dwn, 1.95V±2%, 600mA, 3MHz, Vin>2V, LSST, CL	USP-6C	49dc5	DC1	9a	Tor
KJ	R3116K151C	Vdel-IC	1.5V±0.8%, -Reset PPO	DFN1010-4	48hj	VD3	9a	Ric
KJ	RP107K421B	LVR-IC	LDO, 4.2V±1%, 200mA, +CE	DFN1212-6	52vr2	VR4	9a	Ric
KK	R3116K161C	Vdel-IC	1.6V±0.8%, -Reset PPO	DFN1010-4	48hj	VD3	9a	Ric
KK	RD74LVC2G17WPE	CMOS-Logic	Dual Schmitt-trigger buffers	WCSP-6	40Log27	-	9d	Ren
KK	RP107K121B5	LVR-IC	LDO, 1.25V±1%, 200mA, +CE	DFN1212-6	52vr2	VR4	9a	Ric
KK0	XC9235C20D4R-G	DC-DC-IC	PWM, st-dwn, 2.0V±2%, 600mA, 3MHz, Vin>2V, LSST, CL	USP-6EL	56dc5	DC1	9a	Tor
KK0	XC9235C20DER	DC-DC-IC	PWM, st-dwn, 2.0V±2%, 600mA, 3MHz, Vin>2V, LSST, CL	USP-6C	49dc5	DC1	9a	Tor
KK0	XCL205C204AR-G	DC/DC-IC	PWM st-dwn, 3MHz, 2.0V±2%, 600mA, -CE, CL, soft start	CL-2025	67dc7	DC9	9a	Tor
KK1	XC9235C21D4R-G	DC-DC-IC	PWM, st-dwn, 2.1V±2%, 600mA, 3MHz, Vin>2V, LSST, CL	USP-6EL	56dc5	DC1	9a	Tor
KK1	XC9235C21DER	DC-DC-IC	PWM, st-dwn, 2.1V±2%, 600mA, 3MHz, Vin>2V, LSST, CL	USP-6C	49dc5	DC1	9a	Tor
KK1	XCL205C214AR-G	DC/DC-IC	PWM st-dwn, 3MHz, 2.1V±2%, 600mA, -CE, CL, soft start	CL-2025	67dc7	DC9	9a	Tor
KK2	XC9235C22D4R-G	DC-DC-IC	PWM, st-dwn, 2.2V±2%, 600mA, 3MHz, Vin>2V, LSST, CL	USP-6EL	56dc5	DC1	9a	Tor
KK2	XC9235C22DER	DC-DC-IC	PWM, st-dwn, 2.2V±2%, 600mA, 3MHz, Vin>2V, LSST, CL	USP-6C	49dc5	DC1	9a	Tor
KK2	XCL205C224AR-G	DC/DC-IC	PWM st-dwn, 3MHz, 2.2V±2%, 600mA, -CE, CL, soft start	CL-2025	67dc7	DC9	9a	Tor
KK3	XC9235C23D4R-G	DC-DC-IC	PWM, st-dwn, 2.3V±2%, 600mA, 3MHz, Vin>2V, LSST, CL	USP-6EL	56dc5	DC1	9a	Tor
KK3	XC9235C23DER	DC-DC-IC	PWM, st-dwn, 2.3V±2%, 600mA, 3MHz, Vin>2V, LSST, CL	USP-6C	49dc5	DC1	9a	Tor
KK3	XCL205C234AR-G	DC/DC-IC	PWM st-dwn, 3MHz, 2.3V±2%, 600mA, -CE, CL, soft start	CL-2025	67dc7	DC9	9a	Tor
KK4	XC9235C24D4R-G	DC-DC-IC	PWM, st-dwn, 2.4V±2%, 600mA, 3MHz, Vin>2V, LSST, CL	USP-6EL	56dc5	DC1	9a	Tor
KK4	XC9235C24DER	DC-DC-IC	PWM, st-dwn, 2.4V±2%, 600mA, 3MHz, Vin>2V, LSST, CL	USP-6C	49dc5	DC1	9a	Tor
KK4	XCL205C244AR-G	DC/DC-IC	PWM st-dwn, 3MHz, 2.4V±2%, 600mA, -CE, CL, soft start	CL-2025	67dc7	DC9	9a	Tor
KK5	XC9235C25D4R-G	DC-DC-IC	PWM, st-dwn, 2.5V±2%, 600mA, 3MHz, Vin>2V, LSST, CL	USP-6EL	56dc5	DC1	9a	Tor
KK5	XC9235C25DER	DC-DC-IC	PWM, st-dwn, 2.5V±2%, 600mA, 3MHz, Vin>2V, LSST, CL	USP-6C	49dc5	DC1	9a	Tor
KK5	XCL205C254AR-G	DC/DC-IC	PWM st-dwn, 3MHz, 2.5V±2%, 600mA, -CE, CL, soft start	CL-2025	67dc7	DC9	9a	Tor
KK6	XC9235C26D4R-G	DC-DC-IC	PWM, st-dwn, 2.6V±2%, 600mA, 3MHz, Vin>2V, LSST, CL	USP-6EL	56dc5	DC1	9a	Tor
KK6	XC9235C26DER	DC-DC-IC	PWM, st-dwn, 2.6V±2%, 600mA, 3MHz, Vin>2V, LSST, CL	USP-6C	49dc5	DC1	9a	Tor
KK6	XCL205C264AR-G	DC/DC-IC	PWM st-dwn, 3MHz, 2.6V±2%, 600mA, -CE, CL, soft start	CL-2025	67dc7	DC9	9a	Tor
KK7	XC9235C27D4R-G	DC-DC-IC	PWM, st-dwn, 2.7V±2%, 600mA, 3MHz, Vin>2V, LSST, CL	USP-6EL	56dc5	DC1	9a	Tor
KK7	XC9235C27DER	DC-DC-IC	PWM, st-dwn, 2.7V±2%, 600mA, 3MHz, Vin>2V, LSST, CL	USP-6C	49dc5	DC1	9a	Tor
KK7	XCL205C274AR-G	DC/DC-IC	PWM st-dwn, 3MHz, 2.7V±2%, 600mA, -CE, CL, soft start	CL-2025	67dc7	DC9	9a	Tor
KK8	XC9235C28D4R-G	DC-DC-IC	PWM, st-dwn, 2.8V±2%, 600mA, 3MHz, Vin>2V, LSST, CL	USP-6EL	56dc5	DC1	9a	Tor
KK8	XC9235C28DER	DC-DC-IC	PWM, st-dwn, 2.8V±2%, 600mA, 3MHz, Vin>2V, LSST, CL	USP-6C	49dc5	DC1	9a	Tor
KK8	XCL205C284AR-G	DC/DC-IC	PWM st-dwn, 3MHz, 2.8V±2%, 600mA, -CE, CL, soft start	CL-2025	67dc7	DC9	9a	Tor
KK9	XC9235C29D4R-G	DC-DC-IC	PWM, st-dwn, 2.9V±2%, 600mA, 3MHz, Vin>2V, LSST, CL	USP-6EL	56dc5	DC1	9a	Tor
KK9	XC9235C29DER	DC-DC-IC	PWM, st-dwn, 2.9V±2%, 600mA, 3MHz, Vin>2V, LSST, CL	USP-6C	49dc5	DC1	9a	Tor
KK9	XCL205C294AR-G	DC/DC-IC	PWM st-dwn, 3MHz, 2.9V±2%, 600mA, -CE, CL, soft start	CL-2025	67dc7	DC9	9a	Tor
KKa	XC9235C2AD4R-G	DC-DC-IC	PWM, st-dwn, 2.05V±2%, 600mA, 3MHz, Vin>2V, LSST, CL	USP-6EL	56dc5	DC1	9a	Tor
KKa	XC9235C2ADER	DC-DC-IC	PWM, st-dwn, 2.05V±2%, 600mA, 3MHz, Vin>2V, LSST, CL	USP-6C	49dc5	DC1	9a	Tor
KKb	XC9235C2BD4R-G	DC-DC-IC	PWM, st-dwn, 2.15V±2%, 600mA, 3MHz, Vin>2V, LSST, CL	USP-6EL	56dc5	DC1	9a	Tor
KKb	XC9235C2BDER	DC-DC-IC	PWM, st-dwn, 2.15V±2%, 600mA, 3MHz, Vin>2V, LSST, CL	USP-6C	49dc5	DC1	9a	Tor
KKc	XC9235C2CD4R-G	DC-DC-IC	PWM, st-dwn, 2.25V±2%, 600mA, 3MHz, Vin>2V, LSST, CL	USP-6EL	56dc5	DC1	9a	Tor
KKc	XC9235C2CDER	DC-DC-IC	PWM, st-dwn, 2.25V±2%, 600mA, 3MHz, Vin>2V, LSST, CL	USP-6C	49dc5	DC1	9a	Tor
KKd	XC9235C2DD4R-G	DC-DC-IC	PWM, st-dwn, 2.35V±2%, 600mA, 3MHz, Vin>2V, LSST, CL	USP-6EL	56dc5	DC1	9a	Tor
KKd	XC9235C2DDER	DC-DC-IC	PWM, st-dwn, 2.35V±2%, 600mA, 3MHz, Vin>2V, LSST, CL	USP-6C	49dc5	DC1	9a	Tor
KKe	XC9235C2ED4R-G	DC-DC-IC	PWM, st-dwn, 2.45V±2%, 600mA, 3MHz, Vin>2V, LSST, CL	USP-6EL	56dc5	DC1	9a	Tor
KKe	XC9235C2EDER	DC-DC-IC	PWM, st-dwn, 2.45V±2%, 600mA, 3MHz, Vin>2V, LSST, CL	USP-6C	49dc5	DC1	9a	Tor
KKf	XC9235C2FD4R-G	DC-DC-IC	PWM, st-dwn, 2.55V±2%, 600mA, 3MHz, Vin>2V, LSST, CL	USP-6EL	56dc5	DC1	9a	Tor
KKf	XC9235C2FDER	DC-DC-IC	PWM, st-dwn, 2.55V±2%, 600mA, 3MHz, Vin>2V, LSST, CL	USP-6C	49dc5	DC1	9a	Tor
KKH	XC9235C2HD4R-G	DC-DC-IC	PWM, st-dwn, 2.65V±2%, 600mA, 3MHz, Vin>2V, LSST, CL	USP-6EL	56dc5	DC1	9a	Tor
KKH	XC9235C2HDER	DC-DC-IC	PWM, st-dwn, 2.65V±2%, 600mA, 3MHz, Vin>2V, LSST, CL	USP-6C	49dc5	DC1	9a	Tor
KKK	XC9235C2KD4R-G	DC-DC-IC	PWM, st-dwn, 2.75V±2%, 600mA, 3MHz, Vin>2V, LSST, CL	USP-6EL	56dc5	DC1	9a	Tor
KKK	XC9235C2KDER	DC-DC-IC	PWM, st-dwn, 2.75V±2%, 600mA, 3MHz, Vin>2V, LSST, CL	USP-6C	49dc5	DC1	9a	Tor
KKL	XC9235C2LD4R-G	DC-DC-IC	PWM, st-dwn, 2.85V±2%, 600mA, 3MHz, Vin>2V, LSST, CL	USP-6EL	56dc5	DC1	9a	Tor
KKL	XC9235C2LDER	DC-DC-IC	PWM, st-dwn, 2.85V±2%, 600mA, 3MHz, Vin>2V, LSST, CL	USP-6C	49dc5	DC1	9a	Tor
KKM	XC9235C2MD4R-G	DC-DC-IC	PWM, st-dwn, 2.95V±2%, 600mA, 3MHz, Vin>2V, LSST, CL	USP-6EL	56dc5	DC1	9a	Tor
KKM	XC9235C2MDER	DC-DC-IC	PWM, st-dwn, 2.95V±2%, 600mA, 3MHz, Vin>2V, LSST, CL	USP-6C	49dc5	DC1	9a	Tor
KL	R3116K171C	Vdel-IC	1.7V±0.8%, -Reset PPO	DFN1010-4	48hj	VD3	9a	Ric
KL	RP107K181B5	LVR-IC	LDO, 1.85V±1%, 200mA, +CE	DFN1212-6	52vr2	VR4	9a	Ric
KL0	XC9235C30D4R-G	DC-DC-IC	PWM, st-dwn, 3.0V±2%, 600mA, 3MHz, Vin>2V, LSST, CL	USP-6EL	56dc5	DC1	9a	Tor
KL0	XC9235C30DER	DC-DC-IC	PWM, st-dwn, 3.0V±2%, 600mA, 3MHz, Vin>2V, LSST, CL	USP-6C	49dc5	DC1	9a	Tor



SMD code	Type	Function	Short description	Case	Pinout	Sch.	St.	Mnf.
KL0	XCL205C304AR-G	DC/DC-IC	PWM st-dwn, 3MHz, 3.0V±2%, 600mA, -CE, CL, soft start	CL-2025	67dc7	DC9	9a	Tor
KL1	XC9235C3104R-G	DC-DC-IC	PWM, st-dwn, 3.1V±2%, 600mA, 3MHz, Vin>2V, LSST, CL	USP-6EL	56dc5	DC1	9a	Tor
KL1	XC9235C31DER	DC-DC-IC	PWM, st-dwn, 3.1V±2%, 600mA, 3MHz, Vin>2V, LSST, CL	USP-6C	49dc5	DC1	9a	Tor
KL1	XCL205C314AR-G	DC/DC-IC	PWM st-dwn, 3MHz, 3.1V±2%, 600mA, -CE, CL, soft start	CL-2025	67dc7	DC9	9a	Tor
KL2	XC9235C32D4R-G	DC-DC-IC	PWM, st-dwn, 3.2V±2%, 600mA, 3MHz, Vin>2V, LSST, CL	USP-6EL	56dc5	DC1	9a	Tor
KL2	XC9235C32DER	DC-DC-IC	PWM, st-dwn, 3.2V±2%, 600mA, 3MHz, Vin>2V, LSST, CL	USP-6C	49dc5	DC1	9a	Tor
KL2	XCL205C324AR-G	DC/DC-IC	PWM st-dwn, 3MHz, 3.2V±2%, 600mA, -CE, CL, soft start	CL-2025	67dc7	DC9	9a	Tor
KL3	XC9235C33D4R-G	DC-DC-IC	PWM, st-dwn, 3.3V±2%, 600mA, 3MHz, Vin>2V, LSST, CL	USP-6EL	56dc5	DC1	9a	Tor
KL3	XC9235C33DER	DC-DC-IC	PWM, st-dwn, 3.3V±2%, 600mA, 3MHz, Vin>2V, LSST, CL	USP-6C	49dc5	DC1	9a	Tor
KL3	XCL205C334AR-G	DC/DC-IC	PWM st-dwn, 3MHz, 3.3V±2%, 600mA, -CE, CL, soft start	CL-2025	67dc7	DC9	9a	Tor
KL4	XC9235C34D4R-G	DC-DC-IC	PWM, st-dwn, 3.4V±2%, 600mA, 3MHz, Vin>2V, LSST, CL	USP-6EL	56dc5	DC1	9a	Tor
KL4	XC9235C34DER	DC-DC-IC	PWM, st-dwn, 3.4V±2%, 600mA, 3MHz, Vin>2V, LSST, CL	USP-6C	49dc5	DC1	9a	Tor
KL4	XCL205C344AR-G	DC/DC-IC	PWM st-dwn, 3MHz, 3.4V±2%, 600mA, -CE, CL, soft start	CL-2025	67dc7	DC9	9a	Tor
KL5	XC9235C35D4R-G	DC-DC-IC	PWM, st-dwn, 3.5V±2%, 600mA, 3MHz, Vin>2V, LSST, CL	USP-6EL	56dc5	DC1	9a	Tor
KL5	XC9235C35DER	DC-DC-IC	PWM, st-dwn, 3.5V±2%, 600mA, 3MHz, Vin>2V, LSST, CL	USP-6C	49dc5	DC1	9a	Tor
KL5	XCL205C354AR-G	DC/DC-IC	PWM st-dwn, 3MHz, 3.5V±2%, 600mA, -CE, CL, soft start	CL-2025	67dc7	DC9	9a	Tor
KL6	XC9235C36D4R-G	DC-DC-IC	PWM, st-dwn, 3.6V±2%, 600mA, 3MHz, Vin>2V, LSST, CL	USP-6EL	56dc5	DC1	9a	Tor
KL6	XC9235C36DER	DC-DC-IC	PWM, st-dwn, 3.6V±2%, 600mA, 3MHz, Vin>2V, LSST, CL	USP-6C	49dc5	DC1	9a	Tor
KL6	XCL205C364AR-G	DC/DC-IC	PWM st-dwn, 3MHz, 3.6V±2%, 600mA, -CE, CL, soft start	CL-2025	67dc7	DC9	9a	Tor
KL7	XC9235C37D4R-G	DC-DC-IC	PWM, st-dwn, 3.7V±2%, 600mA, 3MHz, Vin>2V, LSST, CL	USP-6EL	56dc5	DC1	9a	Tor
KL7	XC9235C37DER	DC-DC-IC	PWM, st-dwn, 3.7V±2%, 600mA, 3MHz, Vin>2V, LSST, CL	USP-6C	49dc5	DC1	9a	Tor
KL7	XCL205C374AR-G	DC/DC-IC	PWM st-dwn, 3MHz, 3.7V±2%, 600mA, -CE, CL, soft start	CL-2025	67dc7	DC9	9a	Tor
KL8	XC9235C38D4R-G	DC-DC-IC	PWM, st-dwn, 3.8V±2%, 600mA, 3MHz, Vin>2V, LSST, CL	USP-6EL	56dc5	DC1	9a	Tor
KL8	XC9235C38DER	DC-DC-IC	PWM, st-dwn, 3.8V±2%, 600mA, 3MHz, Vin>2V, LSST, CL	USP-6C	49dc5	DC1	9a	Tor
KL8	XCL205C384AR-G	DC/DC-IC	PWM st-dwn, 3MHz, 3.8V±2%, 600mA, -CE, CL, soft start	CL-2025	67dc7	DC9	9a	Tor
KL9	XC9235C39D4R-G	DC-DC-IC	PWM, st-dwn, 3.9V±2%, 600mA, 3MHz, Vin>2V, LSST, CL	USP-6EL	56dc5	DC1	9a	Tor
KL9	XC9235C39DER	DC-DC-IC	PWM, st-dwn, 3.9V±2%, 600mA, 3MHz, Vin>2V, LSST, CL	USP-6C	49dc5	DC1	9a	Tor
KL9	XCL205C394AR-G	DC/DC-IC	PWM st-dwn, 3MHz, 3.9V±2%, 600mA, -CE, CL, soft start	CL-2025	67dc7	DC9	9a	Tor
KLA	XC9235C3AD4R-G	DC-DC-IC	PWM, st-dwn, 3.05V±2%, 600mA, 3MHz, Vin>2V, LSST, CL	USP-6EL	56dc5	DC1	9a	Tor
KLA	XC9235C3ADER	DC-DC-IC	PWM, st-dwn, 3.05V±2%, 600mA, 3MHz, Vin>2V, LSST, CL	USP-6C	49dc5	DC1	9a	Tor
KLB	XC9235C3BD4R-G	DC-DC-IC	PWM, st-dwn, 3.15V±2%, 600mA, 3MHz, Vin>2V, LSST, CL	USP-6EL	56dc5	DC1	9a	Tor
KLB	XC9235C3BDER	DC-DC-IC	PWM, st-dwn, 3.15V±2%, 600mA, 3MHz, Vin>2V, LSST, CL	USP-6C	49dc5	DC1	9a	Tor
KLC	XC9235C3CD4R-G	DC-DC-IC	PWM, st-dwn, 3.25V±2%, 600mA, 3MHz, Vin>2V, LSST, CL	USP-6EL	56dc5	DC1	9a	Tor
KLC	XC9235C3CDER	DC-DC-IC	PWM, st-dwn, 3.25V±2%, 600mA, 3MHz, Vin>2V, LSST, CL	USP-6C	49dc5	DC1	9a	Tor
KLD	XC9235C3DD4R-G	DC-DC-IC	PWM, st-dwn, 3.35V±2%, 600mA, 3MHz, Vin>2V, LSST, CL	USP-6EL	56dc5	DC1	9a	Tor
KLD	XC9235C3DDER	DC-DC-IC	PWM, st-dwn, 3.35V±2%, 600mA, 3MHz, Vin>2V, LSST, CL	USP-6C	49dc5	DC1	9a	Tor
KLE	XC9235C3ED4R-G	DC-DC-IC	PWM, st-dwn, 3.45V±2%, 600mA, 3MHz, Vin>2V, LSST, CL	USP-6EL	56dc5	DC1	9a	Tor
KLE	XC9235C3EDER	DC-DC-IC	PWM, st-dwn, 3.45V±2%, 600mA, 3MHz, Vin>2V, LSST, CL	USP-6C	49dc5	DC1	9a	Tor
KLF	XC9235C3FD4R-G	DC-DC-IC	PWM, st-dwn, 3.55V±2%, 600mA, 3MHz, Vin>2V, LSST, CL	USP-6EL	56dc5	DC1	9a	Tor
KLF	XC9235C3FDER	DC-DC-IC	PWM, st-dwn, 3.55V±2%, 600mA, 3MHz, Vin>2V, LSST, CL	USP-6C	49dc5	DC1	9a	Tor
KLH	XC9235C3HD4R-G	DC-DC-IC	PWM, st-dwn, 3.65V±2%, 600mA, 3MHz, Vin>2V, LSST, CL	USP-6EL	56dc5	DC1	9a	Tor
KLH	XC9235C3HDER	DC-DC-IC	PWM, st-dwn, 3.65V±2%, 600mA, 3MHz, Vin>2V, LSST, CL	USP-6C	49dc5	DC1	9a	Tor
KLK	XC9235C3KD4R-G	DC-DC-IC	PWM, st-dwn, 3.75V±2%, 600mA, 3MHz, Vin>2V, LSST, CL	USP-6EL	56dc5	DC1	9a	Tor
KLK	XC9235C3KDER	DC-DC-IC	PWM, st-dwn, 3.75V±2%, 600mA, 3MHz, Vin>2V, LSST, CL	USP-6C	49dc5	DC1	9a	Tor
KLL	XC9235C3LD4R-G	DC-DC-IC	PWM, st-dwn, 3.85V±2%, 600mA, 3MHz, Vin>2V, LSST, CL	USP-6EL	56dc5	DC1	9a	Tor
KLL	XC9235C3LDER	DC-DC-IC	PWM, st-dwn, 3.85V±2%, 600mA, 3MHz, Vin>2V, LSST, CL	USP-6C	49dc5	DC1	9a	Tor
KLM	XC9235C3MD4R-G	DC-DC-IC	PWM, st-dwn, 3.95V±2%, 600mA, 3MHz, Vin>2V, LSST, CL	USP-6EL	56dc5	DC1	9a	Tor
KLM	XC9235C3MDER	DC-DC-IC	PWM, st-dwn, 3.95V±2%, 600mA, 3MHz, Vin>2V, LSST, CL	USP-6C	49dc5	DC1	9a	Tor
KM	R3116K181C	Vdel-IC	1.8V±0.8%, -Reset PPO	DFN11010-4	48jr	VD3	9a	Ric
KM	RP107K281B5	LVR-IC	LDO, 2.85V±1%, 200mA, +CE	DFN1212-6	52vr2	VR4	9a	Ric
KM0	XC9235C40D4R-G	DC-DC-IC	PWM, st-dwn, 4.0V±2%, 600mA, 3MHz, Vin>2V, LSST, CL	USP-6EL	56dc5	DC1	9a	Tor
KM0	XC9235C40DER	DC-DC-IC	PWM, st-dwn, 4.0V±2%, 600mA, 3MHz, Vin>2V, LSST, CL	USP-6C	49dc5	DC1	9a	Tor
KM0	XCL205C404AR-G	DC/DC-IC	PWM st-dwn, 3MHz, 4.0V±2%, 600mA, -CE, CL, soft start	CL-2025	67dc7	DC9	9a	Tor
KN	R3116K191C	Vdel-IC	1.9V±0.8%, -Reset PPO	DFN11010-4	48jr	VD3	9a	Ric
KN21	XC62KN212D	LVR-IC	LDO, -2.1V±2%, 100mA, 100mW	USP-6B	49xt	VR2	9b	Tor
KN22	XC62KN222D	LVR-IC	LDO, -2.2V±2%, 100mA, 100mW	USP-6B	49xt	VR2	9b	Tor
KN23	XC62KN232D	LVR-IC	LDO, -2.3V±2%, 100mA, 100mW	USP-6B	49xt	VR2	9b	Tor
KN24	XC62KN242D	LVR-IC	LDO, -2.4V±2%, 100mA, 100mW	USP-6B	49xt	VR2	9b	Tor
KN25	XC62KN252D	LVR-IC	LDO, -2.5V±2%, 100mA, 100mW	USP-6B	49xt	VR2	9b	Tor
KN26	XC62KN262D	LVR-IC	LDO, -2.6V±2%, 100mA, 100mW	USP-6B	49xt	VR2	9b	Tor
KN27	XC62KN272D	LVR-IC	LDO, -2.7V±2%, 100mA, 100mW	USP-6B	49xt	VR2	9b	Tor
KN28	XC62KN282D	LVR-IC	LDO, -2.8V±2%, 100mA, 100mW	USP-6B	49xt	VR2	9b	Tor
KN29	XC62KN292D	LVR-IC	LDO, -2.9V±2%, 100mA, 100mW	USP-6B	49xt	VR2	9b	Tor
KN30	XC62KN302D	LVR-IC	LDO, -3V±2%, 100mA, 100mW	USP-6B	49xt	VR2	9b	Tor
KN31	XC62KN312D	LVR-IC	LDO, -3.1V±2%, 100mA, 100mW	USP-6B	49xt	VR2	9b	Tor
KN32	XC62KN322D	LVR-IC	LDO, -3.2V±2%, 100mA, 100mW	USP-6B	49xt	VR2	9b	Tor
KN33	XC62KN332D	LVR-IC	LDO, -3.3V±2%, 100mA, 100mW	USP-6B	49xt	VR2	9b	Tor
KN34	XC62KN342D	LVR-IC	LDO, -3.4V±2%, 100mA, 100mW	USP-6B	49xt	VR2	9b	Tor
KN35	XC62KN352D	LVR-IC	LDO, -3.5V±2%, 100mA, 100mW	USP-6B	49xt	VR2	9b	Tor
KN36	XC62KN362D	LVR-IC	LDO, -3.6V±2%, 100mA, 100mW	USP-6B	49xt	VR2	9b	Tor



SMD code	Type	Function	Short description	Case	Pinout	Sch.	St.	Mnf.
KN37	XC62KN372D	LVR-IC	LDO, -3.7V±2%, 100mA, 100mW	USP-6B	49xt	VR2	9b	Tor
KN38	XC62KN382D	LVR-IC	LDO, -3.8V±2%, 100mA, 100mW	USP-6B	49xt	VR2	9b	Tor
KN39	XC62KN392D	LVR-IC	LDO, -3.9V±2%, 100mA, 100mW	USP-6B	49xt	VR2	9b	Tor
KN40	XC62KN402D	LVR-IC	LDO, -4V±2%, 100mA, 100mW	USP-6B	49xt	VR2	9b	Tor
KN41	XC62KN412D	LVR-IC	LDO, -4.1V±2%, 100mA, 100mW	USP-6B	49xt	VR2	9b	Tor
KN42	XC62KN422D	LVR-IC	LDO, -4.2V±2%, 100mA, 100mW	USP-6B	49xt	VR2	9b	Tor
KN43	XC62KN432D	LVR-IC	LDO, -4.3V±2%, 100mA, 100mW	USP-6B	49xt	VR2	9b	Tor
KN44	XC62KN442D	LVR-IC	LDO, -4.4V±2%, 100mA, 100mW	USP-6B	49xt	VR2	9b	Tor
KN45	XC62KN452D	LVR-IC	LDO, -4.5V±2%, 100mA, 100mW	USP-6B	49xt	VR2	9b	Tor
KN46	XC62KN462D	LVR-IC	LDO, -4.6V±2%, 100mA, 100mW	USP-6B	49xt	VR2	9b	Tor
KN47	XC62KN472D	LVR-IC	LDO, -4.7V±2%, 100mA, 100mW	USP-6B	49xt	VR2	9b	Tor
KN48	XC62KN482D	LVR-IC	LDO, -4.8V±2%, 100mA, 100mW	USP-6B	49xt	VR2	9b	Tor
KN49	XC62KN492D	LVR-IC	LDO, -4.9V±2%, 100mA, 100mW	USP-6B	49xt	VR2	9b	Tor
KN50	XC62KN502D	LVR-IC	LDO, -5V±2%, 100mA, 100mW	USP-6B	49xt	VR2	9b	Tor
KN51	XC62KN512D	LVR-IC	LDO, -5.1V±2%, 100mA, 100mW	USP-6B	49xt	VR2	9b	Tor
KN52	XC62KN522D	LVR-IC	LDO, -5.2V±2%, 100mA, 100mW	USP-6B	49xt	VR2	9b	Tor
KN53	XC62KN532D	LVR-IC	LDO, -5.3V±2%, 100mA, 100mW	USP-6B	49xt	VR2	9b	Tor
KN54	XC62KN542D	LVR-IC	LDO, -5.4V±2%, 100mA, 100mW	USP-6B	49xt	VR2	9b	Tor
KN55	XC62KN552D	LVR-IC	LDO, -5.5V±2%, 100mA, 100mW	USP-6B	49xt	VR2	9b	Tor
KN56	XC62KN562D	LVR-IC	LDO, -5.6V±2%, 100mA, 100mW	USP-6B	49xt	VR2	9b	Tor
KN57	XC62KN572D	LVR-IC	LDO, -5.7V±2%, 100mA, 100mW	USP-6B	49xt	VR2	9b	Tor
KN58	XC62KN582D	LVR-IC	LDO, -5.8V±2%, 100mA, 100mW	USP-6B	49xt	VR2	9b	Tor
KN59	XC62KN592D	LVR-IC	LDO, -5.9V±2%, 100mA, 100mW	USP-6B	49xt	VR2	9b	Tor
KN60	XC62KN602D	LVR-IC	LDO, -6V±2%, 100mA, 100mW	USP-6B	49xt	VR2	9b	Tor
KN8	XC9235D08CER	DC-DC-IC	PWM, st-dwn, 0.8V±2%, 600mA, 1.2MHz, Vin>1.8V, LSST, CL	USP-6C	49da	DC16	9a	Tor
KN9	XC9235D09CER	DC-DC-IC	PWM, st-dwn, 0.9V±2%, 600mA, 1.2MHz, Vin>1.8V, LSST, CL	USP-6C	49da	DC16	9a	Tor
KNL	XC9235D0LCER	DC-DC-IC	PWM, st-dwn, 0.85V±2%, 600mA, 1.2MHz, Vin>1.8V, LSST, CL	USP-6C	49da	DC16	9a	Tor
KNM	XC9235D0MCER	DC-DC-IC	PWM, st-dwn, 0.95V±2%, 600mA, 1.2MHz, Vin>1.8V, LSST, CL	USP-6C	49da	DC16	9a	Tor
KP	HD74LVC1G53CLE	CMOS-Logic	2-channel analog multiplexer/demultiplexer	WCSP-5	46fLog38	-	9d	Ren
KP	HD74LVC1G53CPE	CMOS-Logic	2-channel analog multiplexer/demultiplexer	WCSP-5	46fLog38	-	9d	Ren
KP	R3116K201C	Vdet-IC	2.0V±0.8%, -Reset PPO	DFN1010-4	48j	VD3	9a	Ric
KP0	XC9235D10CER	DC-DC-IC	PWM, st-dwn, 1.0V±2%, 600mA, 1.2MHz, Vin>1.8V, LSST, CL	USP-6C	49da	DC16	9a	Tor
KP1	XC9235D11CER	DC-DC-IC	PWM, st-dwn, 1.1V±2%, 600mA, 1.2MHz, Vin>1.8V, LSST, CL	USP-6C	49da	DC16	9a	Tor
KP2	XC9235D12CER	DC-DC-IC	PWM, st-dwn, 1.2V±2%, 600mA, 1.2MHz, Vin>1.8V, LSST, CL	USP-6C	49da	DC16	9a	Tor
KP3	XC9235D13CER	DC-DC-IC	PWM, st-dwn, 1.3V±2%, 600mA, 1.2MHz, Vin>1.8V, LSST, CL	USP-6C	49da	DC16	9a	Tor
KP4	XC9235D14CER	DC-DC-IC	PWM, st-dwn, 1.4V±2%, 600mA, 1.2MHz, Vin>1.8V, LSST, CL	USP-6C	49da	DC16	9a	Tor
KP5	XC9235D15CER	DC-DC-IC	PWM, st-dwn, 1.5V±2%, 600mA, 1.2MHz, Vin>1.8V, LSST, CL	USP-6C	49da	DC16	9a	Tor
KP6	XC9235D16CER	DC-DC-IC	PWM, st-dwn, 1.6V±2%, 600mA, 1.2MHz, Vin>1.8V, LSST, CL	USP-6C	49da	DC16	9a	Tor
KP7	XC9235D17CER	DC-DC-IC	PWM, st-dwn, 1.7V±2%, 600mA, 1.2MHz, Vin>1.8V, LSST, CL	USP-6C	49da	DC16	9a	Tor
KP8	XC9235D18CER	DC-DC-IC	PWM, st-dwn, 1.8V±2%, 600mA, 1.2MHz, Vin>1.8V, LSST, CL	USP-6C	49da	DC16	9a	Tor
KP9	XC9235D19CER	DC-DC-IC	PWM, st-dwn, 1.9V±2%, 600mA, 1.2MHz, Vin>1.8V, LSST, CL	USP-6C	49da	DC16	9a	Tor
KPA	XC9235D1ACER	DC-DC-IC	PWM, st-dwn, 1.05V±2%, 600mA, 1.2MHz, Vin>1.8V, LSST, CL	USP-6C	49da	DC16	9a	Tor
KPB	XC9235D1BCER	DC-DC-IC	PWM, st-dwn, 1.15V±2%, 600mA, 1.2MHz, Vin>1.8V, LSST, CL	USP-6C	49da	DC16	9a	Tor
KPD	XC9235D1DCER	DC-DC-IC	PWM, st-dwn, 1.35V±2%, 600mA, 1.2MHz, Vin>1.8V, LSST, CL	USP-6C	49da	DC16	9a	Tor
KPE	XC9235D1ECER	DC-DC-IC	PWM, st-dwn, 1.45V±2%, 600mA, 1.2MHz, Vin>1.8V, LSST, CL	USP-6C	49da	DC16	9a	Tor
KPF	XC9235D1FCER	DC-DC-IC	PWM, st-dwn, 1.55V±2%, 600mA, 1.2MHz, Vin>1.8V, LSST, CL	USP-6C	49da	DC16	9a	Tor
KPH	XC9235D1HCER	DC-DC-IC	PWM, st-dwn, 1.65V±2%, 600mA, 1.2MHz, Vin>1.8V, LSST, CL	USP-6C	49da	DC16	9a	Tor
KPK	XC9235D1KCER	DC-DC-IC	PWM, st-dwn, 1.75V±2%, 600mA, 1.2MHz, Vin>1.8V, LSST, CL	USP-6C	49da	DC16	9a	Tor
KPL	XC9235D1LCER	DC-DC-IC	PWM, st-dwn, 1.85V±2%, 600mA, 1.2MHz, Vin>1.8V, LSST, CL	USP-6C	49da	DC16	9a	Tor
KPM	XC9235D1MCER	DC-DC-IC	PWM, st-dwn, 1.95V±2%, 600mA, 1.2MHz, Vin>1.8V, LSST, CL	USP-6C	49da	DC16	9a	Tor
KPV	XC9235D1CCER	DC-DC-IC	PWM, st-dwn, 1.25V±2%, 600mA, 1.2MHz, Vin>1.8V, LSST, CL	USP-6C	49da	DC16	9a	Tor
KQ	R3116K211C	Vdet-IC	2.1V±0.8%, -Reset PPO	DFN1010-4	48j	VD3	9a	Ric
KR	HD74LVC1G57CLE	CMOS-Logic	Configurable multiple-function gate	WCSP-5	46fLog36	-	9d	Ren
KR	R3116K221C	Vdet-IC	2.2V±0.8%, -Reset PPO	DFN1010-4	48j	VD3	9a	Ric
KR0	XC9235D20CER	DC-DC-IC	PWM, st-dwn, 2.0V±2%, 600mA, 1.2MHz, Vin>1.8V, LSST, CL	USP-6C	49da	DC16	9a	Tor
KR1	XC9235D21CER	DC-DC-IC	PWM, st-dwn, 2.1V±2%, 600mA, 1.2MHz, Vin>1.8V, LSST, CL	USP-6C	49da	DC16	9a	Tor
KR2	XC9235D22CER	DC-DC-IC	PWM, st-dwn, 2.2V±2%, 600mA, 1.2MHz, Vin>1.8V, LSST, CL	USP-6C	49da	DC16	9a	Tor
KR3	XC9235D23CER	DC-DC-IC	PWM, st-dwn, 2.3V±2%, 600mA, 1.2MHz, Vin>1.8V, LSST, CL	USP-6C	49da	DC16	9a	Tor
KR4	XC9235D24CER	DC-DC-IC	PWM, st-dwn, 2.4V±2%, 600mA, 1.2MHz, Vin>1.8V, LSST, CL	USP-6C	49da	DC16	9a	Tor
KR5	XC9235D25CER	DC-DC-IC	PWM, st-dwn, 2.5V±2%, 600mA, 1.2MHz, Vin>1.8V, LSST, CL	USP-6C	49da	DC16	9a	Tor
KR6	XC9235D26CER	DC-DC-IC	PWM, st-dwn, 2.6V±2%, 600mA, 1.2MHz, Vin>1.8V, LSST, CL	USP-6C	49da	DC16	9a	Tor
KR7	XC9235D27CER	DC-DC-IC	PWM, st-dwn, 2.7V±2%, 600mA, 1.2MHz, Vin>1.8V, LSST, CL	USP-6C	49da	DC16	9a	Tor
KR8	XC9235D28CER	DC-DC-IC	PWM, st-dwn, 2.8V±2%, 600mA, 1.2MHz, Vin>1.8V, LSST, CL	USP-6C	49da	DC16	9a	Tor
KR9	XC9235D29CER	DC-DC-IC	PWM, st-dwn, 2.9V±2%, 600mA, 1.2MHz, Vin>1.8V, LSST, CL	USP-6C	49da	DC16	9a	Tor
KRA	XC9235D2ACER	DC-DC-IC	PWM, st-dwn, 2.05V±2%, 600mA, 1.2MHz, Vin>1.8V, LSST, CL	USP-6C	49da	DC16	9a	Tor
KRB	XC9235D2BCER	DC-DC-IC	PWM, st-dwn, 2.15V±2%, 600mA, 1.2MHz, Vin>1.8V, LSST, CL	USP-6C	49da	DC16	9a	Tor
KRC	XC9235D2CCER	DC-DC-IC	PWM, st-dwn, 2.25V±2%, 600mA, 1.2MHz, Vin>1.8V, LSST, CL	USP-6C	49da	DC16	9a	Tor
KRD	XC9235D2DCER	DC-DC-IC	PWM, st-dwn, 2.35V±2%, 600mA, 1.2MHz, Vin>1.8V, LSST, CL	USP-6C	49da	DC16	9a	Tor
KRE	XC9235D2ECER	DC-DC-IC	PWM, st-dwn, 2.45V±2%, 600mA, 1.2MHz, Vin>1.8V, LSST, CL	USP-6C	49da	DC16	9a	Tor
KRF	XC9235D2FCER	DC-DC-IC	PWM, st-dwn, 2.55V±2%, 600mA, 1.2MHz, Vin>1.8V, LSST, CL	USP-6C	49da	DC16	9a	Tor



SMD code	Type	Function	Short description	Case	Pinout	Sch.	St.	Mnf.
KXD	XC9235D2DDER	DC-DC-IC	PWM, st-dwn, 2.35V±2%, 600mA, 3MHz, Vin>1.8V, LSST, CL	USP-6C	49da	DC16	9a	Tor
KXE	XC9235D2EDER	DC-DC-IC	PWM, st-dwn, 2.45V±2%, 600mA, 3MHz, Vin>1.8V, LSST, CL	USP-6C	49da	DC16	9a	Tor
KXF	XC9235D2FDER	DC-DC-IC	PWM, st-dwn, 2.55V±2%, 600mA, 3MHz, Vin>1.8V, LSST, CL	USP-6C	49da	DC16	9a	Tor
KXH	XC9235D2HDER	DC-DC-IC	PWM, st-dwn, 2.65V±2%, 600mA, 3MHz, Vin>1.8V, LSST, CL	USP-6C	49da	DC16	9a	Tor
KXK	XC9235D2KDER	DC-DC-IC	PWM, st-dwn, 2.75V±2%, 600mA, 3MHz, Vin>1.8V, LSST, CL	USP-6C	49da	DC16	9a	Tor
KXL	XC9235D2LDER	DC-DC-IC	PWM, st-dwn, 2.85V±2%, 600mA, 3MHz, Vin>1.8V, LSST, CL	USP-6C	49da	DC16	9a	Tor
KXM	XC9235D2MDER	DC-DC-IC	PWM, st-dwn, 2.95V±2%, 600mA, 3MHz, Vin>1.8V, LSST, CL	USP-6C	49da	DC16	9a	Tor
KY	R3116K291C	Vdet-IC	2.9V±0.8%, -Reset PPO	DFN1010-4	48rj	VD3	9a	Ric
KY0	XC9235D30DER	DC-DC-IC	PWM, st-dwn, 3.0V±2%, 600mA, 3MHz, Vin>1.8V, LSST, CL	USP-6C	49da	DC16	9a	Tor
KY1	XC9235D31DER	DC-DC-IC	PWM, st-dwn, 3.1V±2%, 600mA, 3MHz, Vin>1.8V, LSST, CL	USP-6C	49da	DC16	9a	Tor
KY2	XC9235D32DER	DC-DC-IC	PWM, st-dwn, 3.2V±2%, 600mA, 3MHz, Vin>1.8V, LSST, CL	USP-6C	49da	DC16	9a	Tor
KY3	XC9235D33DER	DC-DC-IC	PWM, st-dwn, 3.3V±2%, 600mA, 3MHz, Vin>1.8V, LSST, CL	USP-6C	49da	DC16	9a	Tor
KY4	XC9235D34DER	DC-DC-IC	PWM, st-dwn, 3.4V±2%, 600mA, 3MHz, Vin>1.8V, LSST, CL	USP-6C	49da	DC16	9a	Tor
KY5	XC9235D35DER	DC-DC-IC	PWM, st-dwn, 3.5V±2%, 600mA, 3MHz, Vin>1.8V, LSST, CL	USP-6C	49da	DC16	9a	Tor
KY6	XC9235D36DER	DC-DC-IC	PWM, st-dwn, 3.6V±2%, 600mA, 3MHz, Vin>1.8V, LSST, CL	USP-6C	49da	DC16	9a	Tor
KY7	XC9235D37DER	DC-DC-IC	PWM, st-dwn, 3.7V±2%, 600mA, 3MHz, Vin>1.8V, LSST, CL	USP-6C	49da	DC16	9a	Tor
KY8	XC9235D38DER	DC-DC-IC	PWM, st-dwn, 3.8V±2%, 600mA, 3MHz, Vin>1.8V, LSST, CL	USP-6C	49da	DC16	9a	Tor
KY9	XC9235D39DER	DC-DC-IC	PWM, st-dwn, 3.9V±2%, 600mA, 3MHz, Vin>1.8V, LSST, CL	USP-6C	49da	DC16	9a	Tor
KYA	XC9235D3ADER	DC-DC-IC	PWM, st-dwn, 3.05V±2%, 600mA, 3MHz, Vin>1.8V, LSST, CL	USP-6C	49da	DC16	9a	Tor
KYB	XC9235D3BDER	DC-DC-IC	PWM, st-dwn, 3.15V±2%, 600mA, 3MHz, Vin>1.8V, LSST, CL	USP-6C	49da	DC16	9a	Tor
KYC	XC9235D3CDER	DC-DC-IC	PWM, st-dwn, 3.25V±2%, 600mA, 3MHz, Vin>1.8V, LSST, CL	USP-6C	49da	DC16	9a	Tor
KYD	XC9235D3DDER	DC-DC-IC	PWM, st-dwn, 3.35V±2%, 600mA, 3MHz, Vin>1.8V, LSST, CL	USP-6C	49da	DC16	9a	Tor
KYE	XC9235D3EDER	DC-DC-IC	PWM, st-dwn, 3.45V±2%, 600mA, 3MHz, Vin>1.8V, LSST, CL	USP-6C	49da	DC16	9a	Tor
KYF	XC9235D3FDER	DC-DC-IC	PWM, st-dwn, 3.55V±2%, 600mA, 3MHz, Vin>1.8V, LSST, CL	USP-6C	49da	DC16	9a	Tor
KYH	XC9235D3HDER	DC-DC-IC	PWM, st-dwn, 3.65V±2%, 600mA, 3MHz, Vin>1.8V, LSST, CL	USP-6C	49da	DC16	9a	Tor
KYK	XC9235D3KDER	DC-DC-IC	PWM, st-dwn, 3.75V±2%, 600mA, 3MHz, Vin>1.8V, LSST, CL	USP-6C	49da	DC16	9a	Tor
KYL	XC9235D3LDER	DC-DC-IC	PWM, st-dwn, 3.85V±2%, 600mA, 3MHz, Vin>1.8V, LSST, CL	USP-6C	49da	DC16	9a	Tor
KYM	XC9235D3MDER	DC-DC-IC	PWM, st-dwn, 3.95V±2%, 600mA, 3MHz, Vin>1.8V, LSST, CL	USP-6C	49da	DC16	9a	Tor
KZ	R3116K301C	Vdet-IC	3.0V±0.8%, -Reset PPO	DFN1010-4	48rj	VD3	9a	Ric
KZ0	XC9235D40DER	DC-DC-IC	PWM, st-dwn, 4.0V±2%, 600mA, 3MHz, Vin>1.8V, LSST, CL	USP-6C	49da	DC16	9a	Tor
L	HMPS-2820	Si-diode	SBD, RF, 15V±2%, 1A(1µs), <1pF	MP	37d	-	-	Agi
LA09	XC6219A092DR	LVR-IC	LDO, 0.9V±2%, 150mA, +CE, PDR	USP-6B	49hq	VR4	9b	Tor
LA0M	XC6219A09ADR	LVR-IC	LDO, 0.95V±2%, 150mA, +CE, PDR	USP-6B	49hq	VR4	9b	Tor
LA10	XC6219A102DR	LVR-IC	LDO, 1V±2%, 150mA, +CE, PDR	USP-6B	49hq	VR4	9b	Tor
LA11	XC6219A112DR	LVR-IC	LDO, 1.1V±2%, 150mA, +CE, PDR	USP-6B	49hq	VR4	9b	Tor
LA12	XC6219A122DR	LVR-IC	LDO, 1.2V±2%, 150mA, +CE, PDR	USP-6B	49hq	VR4	9b	Tor
LA13	XC6219A132DR	LVR-IC	LDO, 1.3V±2%, 150mA, +CE, PDR	USP-6B	49hq	VR4	9b	Tor
LA14	XC6219A142DR	LVR-IC	LDO, 1.4V±2%, 150mA, +CE, PDR	USP-6B	49hq	VR4	9b	Tor
LA15	XC6219A152DR	LVR-IC	LDO, 1.5V±2%, 150mA, +CE, PDR	USP-6B	49hq	VR4	9b	Tor
LA16	XC6219A162DR	LVR-IC	LDO, 1.6V±2%, 150mA, +CE, PDR	USP-6B	49hq	VR4	9b	Tor
LA17	XC6219A172DR	LVR-IC	LDO, 1.7V±2%, 150mA, +CE, PDR	USP-6B	49hq	VR4	9b	Tor
LA18	XC6219A182DR	LVR-IC	LDO, 1.8V±2%, 240mA, +CE, PDR	USP-6B	49hq	VR4	9b	Tor
LA19	XC6219A192DR	LVR-IC	LDO, 1.9V±2%, 240mA, +CE, PDR	USP-6B	49hq	VR4	9b	Tor
LA1A	XC6219A10ADR	LVR-IC	LDO, 1.05V±2%, 150mA, +CE, PDR	USP-6B	49hq	VR4	9b	Tor
LA1B	XC6219A11ADR	LVR-IC	LDO, 1.15V±2%, 150mA, +CE, PDR	USP-6B	49hq	VR4	9b	Tor
LA1C	XC6219A12ADR	LVR-IC	LDO, 1.25V±2%, 150mA, +CE, PDR	USP-6B	49hq	VR4	9b	Tor
LA1D	XC6219A13ADR	LVR-IC	LDO, 1.35V±2%, 150mA, +CE, PDR	USP-6B	49hq	VR4	9b	Tor
LA1E	XC6219A14ADR	LVR-IC	LDO, 1.45V±2%, 150mA, +CE, PDR	USP-6B	49hq	VR4	9b	Tor
LA1F	XC6219A15ADR	LVR-IC	LDO, 1.55V±2%, 150mA, +CE, PDR	USP-6B	49hq	VR4	9b	Tor
LA1H	XC6219A16ADR	LVR-IC	LDO, 1.65V±2%, 150mA, +CE, PDR	USP-6B	49hq	VR4	9b	Tor
LA1K	XC6219A17ADR	LVR-IC	LDO, 1.75V±2%, 150mA, +CE, PDR	USP-6B	49hq	VR4	9b	Tor
LA1L	XC6219A18ADR	LVR-IC	LDO, 1.85V±2%, 240mA, +CE, PDR	USP-6B	49hq	VR4	9b	Tor
LA1M	XC6219A19ADR	LVR-IC	LDO, 1.95V±2%, 240mA, +CE, PDR	USP-6B	49hq	VR4	9b	Tor
LA20	XC6219A202DR	LVR-IC	LDO, 2V±2%, 240mA, +CE, PDR	USP-6B	49hq	VR4	9b	Tor
LA20A	XC6219A20ADR	LVR-IC	LDO, 2.05V±2%, 240mA, +CE, PDR	USP-6B	49hq	VR4	9b	Tor
LA21	XC6219A212DR	LVR-IC	LDO, 2.1V±2%, 240mA, +CE, PDR	USP-6B	49hq	VR4	9b	Tor
LA22	XC6219A222DR	LVR-IC	LDO, 2.2V±2%, 240mA, +CE, PDR	USP-6B	49hq	VR4	9b	Tor
LA23	XC6219A232DR	LVR-IC	LDO, 2.3V±2%, 240mA, +CE, PDR	USP-6B	49hq	VR4	9b	Tor
LA24	XC6219A242DR	LVR-IC	LDO, 2.4V±2%, 240mA, +CE, PDR	USP-6B	49hq	VR4	9b	Tor
LA25	XC6219A252DR	LVR-IC	LDO, 2.5V±2%, 240mA, +CE, PDR	USP-6B	49hq	VR4	9b	Tor
LA26	XC6219A262DR	LVR-IC	LDO, 2.6V±2%, 240mA, +CE, PDR	USP-6B	49hq	VR4	9b	Tor
LA27	XC6219A272DR	LVR-IC	LDO, 2.7V±2%, 240mA, +CE, PDR	USP-6B	49hq	VR4	9b	Tor
LA28	XC6219A282DR	LVR-IC	LDO, 2.8V±2%, 240mA, +CE, PDR	USP-6B	49hq	VR4	9b	Tor
LA29	XC6219A292DR	LVR-IC	LDO, 2.9V±2%, 240mA, +CE, PDR	USP-6B	49hq	VR4	9b	Tor
LA2B	XC6219A21ADR	LVR-IC	LDO, 2.15V±2%, 240mA, +CE, PDR	USP-6B	49hq	VR4	9b	Tor
LA2C	XC6219A22ADR	LVR-IC	LDO, 2.25V±2%, 240mA, +CE, PDR	USP-6B	49hq	VR4	9b	Tor
LA2D	XC6219A23ADR	LVR-IC	LDO, 2.35V±2%, 240mA, +CE, PDR	USP-6B	49hq	VR4	9b	Tor
LA2E	XC6219A24ADR	LVR-IC	LDO, 2.45V±2%, 240mA, +CE, PDR	USP-6B	49hq	VR4	9b	Tor
LA2F	XC6219A25ADR	LVR-IC	LDO, 2.55V±2%, 240mA, +CE, PDR	USP-6B	49hq	VR4	9b	Tor
LA2H	XC6219A26ADR	LVR-IC	LDO, 2.65V±2%, 240mA, +CE, PDR	USP-6B	49hq	VR4	9b	Tor



SMD code	Type	Function	Short description	Case	Pinout	Sch.	St.	Mnf.
L A2K	XC6219A27ADR	LVR-IC	LDO, 2.75V±2%, 240mA, +CE, PDR	USP-6B	49hq	VR4	9b	Tor
L A2L	XC6219A28ADR	LVR-IC	LDO, 2.85V±2%, 240mA, +CE, PDR	USP-6B	49hq	VR4	9b	Tor
L A2M	XC6219A29ADR	LVR-IC	LDO, 2.95V±2%, 240mA, +CE, PDR	USP-6B	49hq	VR4	9b	Tor
L A30	XC6219A302DR	LVR-IC	LDO, 3V±2%, 240mA, +CE, PDR	USP-6B	49hq	VR4	9b	Tor
L A31	XC6219A312DR	LVR-IC	LDO, 3.1V±2%, 240mA, +CE, PDR	USP-6B	49hq	VR4	9b	Tor
L A32	XC6219A322DR	LVR-IC	LDO, 3.2V±2%, 240mA, +CE, PDR	USP-6B	49hq	VR4	9b	Tor
L A33	XC6219A332DR	LVR-IC	LDO, 3.3V±2%, 240mA, +CE, PDR	USP-6B	49hq	VR4	9b	Tor
L A34	XC6219A342DR	LVR-IC	LDO, 3.4V±2%, 240mA, +CE, PDR	USP-6B	49hq	VR4	9b	Tor
L A35	XC6219A352DR	LVR-IC	LDO, 3.5V±2%, 240mA, +CE, PDR	USP-6B	49hq	VR4	9b	Tor
L A36	XC6219A362DR	LVR-IC	LDO, 3.6V±2%, 240mA, +CE, PDR	USP-6B	49hq	VR4	9b	Tor
L A37	XC6219A372DR	LVR-IC	LDO, 3.7V±2%, 240mA, +CE, PDR	USP-6B	49hq	VR4	9b	Tor
L A38	XC6219A382DR	LVR-IC	LDO, 3.8V±2%, 240mA, +CE, PDR	USP-6B	49hq	VR4	9b	Tor
L A39	XC6219A392DR	LVR-IC	LDO, 3.9V±2%, 240mA, +CE, PDR	USP-6B	49hq	VR4	9b	Tor
L A3A	XC6219A30ADR	LVR-IC	LDO, 3.05V±2%, 240mA, +CE, PDR	USP-6B	49hq	VR4	9b	Tor
L A3B	XC6219A31ADR	LVR-IC	LDO, 3.15V±2%, 240mA, +CE, PDR	USP-6B	49hq	VR4	9b	Tor
L A3C	XC6219A32ADR	LVR-IC	LDO, 3.25V±2%, 240mA, +CE, PDR	USP-6B	49hq	VR4	9b	Tor
L A3D	XC6219A33ADR	LVR-IC	LDO, 3.35V±2%, 240mA, +CE, PDR	USP-6B	49hq	VR4	9b	Tor
L A3E	XC6219A34ADR	LVR-IC	LDO, 3.45V±2%, 240mA, +CE, PDR	USP-6B	49hq	VR4	9b	Tor
L A3F	XC6219A35ADR	LVR-IC	LDO, 3.55V±2%, 240mA, +CE, PDR	USP-6B	49hq	VR4	9b	Tor
L A3H	XC6219A36ADR	LVR-IC	LDO, 3.65V±2%, 240mA, +CE, PDR	USP-6B	49hq	VR4	9b	Tor
L A3K	XC6219A37ADR	LVR-IC	LDO, 3.75V±2%, 240mA, +CE, PDR	USP-6B	49hq	VR4	9b	Tor
L A3L	XC6219A38ADR	LVR-IC	LDO, 3.85V±2%, 240mA, +CE, PDR	USP-6B	49hq	VR4	9b	Tor
L A3M	XC6219A39ADR	LVR-IC	LDO, 3.95V±2%, 240mA, +CE, PDR	USP-6B	49hq	VR4	9b	Tor
L A40	XC6219A402DR	LVR-IC	LDO, 4V±2%, 240mA, +CE, PDR	USP-6B	49hq	VR4	9b	Tor
L A41	XC6219A412DR	LVR-IC	LDO, 4.1V±2%, 240mA, +CE, PDR	USP-6B	49hq	VR4	9b	Tor
L A42	XC6219A422DR	LVR-IC	LDO, 4.2V±2%, 240mA, +CE, PDR	USP-6B	49hq	VR4	9b	Tor
L A43	XC6219A432DR	LVR-IC	LDO, 4.3V±2%, 240mA, +CE, PDR	USP-6B	49hq	VR4	9b	Tor
L A44	XC6219A442DR	LVR-IC	LDO, 4.4V±2%, 240mA, +CE, PDR	USP-6B	49hq	VR4	9b	Tor
L A45	XC6219A452DR	LVR-IC	LDO, 4.5V±2%, 240mA, +CE, PDR	USP-6B	49hq	VR4	9b	Tor
L A46	XC6219A462DR	LVR-IC	LDO, 4.6V±2%, 240mA, +CE, PDR	USP-6B	49hq	VR4	9b	Tor
L A47	XC6219A472DR	LVR-IC	LDO, 4.7V±2%, 240mA, +CE, PDR	USP-6B	49hq	VR4	9b	Tor
L A48	XC6219A482DR	LVR-IC	LDO, 4.8V±2%, 240mA, +CE, PDR	USP-6B	49hq	VR4	9b	Tor
L A49	XC6219A492DR	LVR-IC	LDO, 4.9V±2%, 240mA, +CE, PDR	USP-6B	49hq	VR4	9b	Tor
L A4A	XC6219A40ADR	LVR-IC	LDO, 4.05V±2%, 240mA, +CE, PDR	USP-6B	49hq	VR4	9b	Tor
L A4B	XC6219A41ADR	LVR-IC	LDO, 4.15V±2%, 240mA, +CE, PDR	USP-6B	49hq	VR4	9b	Tor
L A4C	XC6219A42ADR	LVR-IC	LDO, 4.25V±2%, 240mA, +CE, PDR	USP-6B	49hq	VR4	9b	Tor
L A4D	XC6219A43ADR	LVR-IC	LDO, 4.35V±2%, 240mA, +CE, PDR	USP-6B	49hq	VR4	9b	Tor
L A4E	XC6219A44ADR	LVR-IC	LDO, 4.45V±2%, 240mA, +CE, PDR	USP-6B	49hq	VR4	9b	Tor
L A4F	XC6219A45ADR	LVR-IC	LDO, 4.55V±2%, 240mA, +CE, PDR	USP-6B	49hq	VR4	9b	Tor
L A4H	XC6219A46ADR	LVR-IC	LDO, 4.65V±2%, 240mA, +CE, PDR	USP-6B	49hq	VR4	9b	Tor
L A4K	XC6219A47ADR	LVR-IC	LDO, 4.75V±2%, 240mA, +CE, PDR	USP-6B	49hq	VR4	9b	Tor
L A4L	XC6219A48ADR	LVR-IC	LDO, 4.85V±2%, 240mA, +CE, PDR	USP-6B	49hq	VR4	9b	Tor
L A4M	XC6219A49ADR	LVR-IC	LDO, 4.95V±2%, 240mA, +CE, PDR	USP-6B	49hq	VR4	9b	Tor
L A50	XC6219A502DR	LVR-IC	LDO, 5V±2%, 240mA, +CE, PDR	USP-6B	49hq	VR4	9b	Tor
L B09	XC6219B092DR	LVR-IC	LDO, 0.9V±2%, 150mA, +CE	USP-6B	49hq	VR4	9b	Tor
L B0M	XC6219B09ADR	LVR-IC	LDO, 0.95V±2%, 150mA, +CE	USP-6B	49hq	VR4	9b	Tor
L B10	XC6219B102DR	LVR-IC	LDO, 1V±2%, 150mA, +CE	USP-6B	49hq	VR4	9b	Tor
L B11	XC6219B112DR	LVR-IC	LDO, 1.1V±2%, 150mA, +CE	USP-6B	49hq	VR4	9b	Tor
L B12	XC6219B122DR	LVR-IC	LDO, 1.2V±2%, 150mA, +CE	USP-6B	49hq	VR4	9b	Tor
L B13	XC6219B132DR	LVR-IC	LDO, 1.3V±2%, 150mA, +CE	USP-6B	49hq	VR4	9b	Tor
L B14	XC6219B142DR	LVR-IC	LDO, 1.4V±2%, 150mA, +CE	USP-6B	49hq	VR4	9b	Tor
L B15	XC6219B152DR	LVR-IC	LDO, 1.5V±2%, 150mA, +CE	USP-6B	49hq	VR4	9b	Tor
L B16	XC6219B162DR	LVR-IC	LDO, 1.6V±2%, 150mA, +CE	USP-6B	49hq	VR4	9b	Tor
L B17	XC6219B172DR	LVR-IC	LDO, 1.7V±2%, 150mA, +CE	USP-6B	49hq	VR4	9b	Tor
L B18	XC6219B182DR	LVR-IC	LDO, 1.8V±2%, 240mA, +CE	USP-6B	49hq	VR4	9b	Tor
L B19	XC6219B192DR	LVR-IC	LDO, 1.9V±2%, 240mA, +CE	USP-6B	49hq	VR4	9b	Tor
L B1A	XC6219B10ADR	LVR-IC	LDO, 1.05V±2%, 150mA, +CE	USP-6B	49hq	VR4	9b	Tor
L B1B	XC6219B11ADR	LVR-IC	LDO, 1.15V±2%, 150mA, +CE	USP-6B	49hq	VR4	9b	Tor
L B1C	XC6219B12ADR	LVR-IC	LDO, 1.25V±2%, 150mA, +CE	USP-6B	49hq	VR4	9b	Tor
L B1D	XC6219B13ADR	LVR-IC	LDO, 1.35V±2%, 150mA, +CE	USP-6B	49hq	VR4	9b	Tor
L B1E	XC6219B14ADR	LVR-IC	LDO, 1.45V±2%, 150mA, +CE	USP-6B	49hq	VR4	9b	Tor
L B1F	XC6219B15ADR	LVR-IC	LDO, 1.55V±2%, 150mA, +CE	USP-6B	49hq	VR4	9b	Tor
L B1H	XC6219B16ADR	LVR-IC	LDO, 1.65V±2%, 150mA, +CE	USP-6B	49hq	VR4	9b	Tor
L B1K	XC6219B17ADR	LVR-IC	LDO, 1.75V±2%, 150mA, +CE	USP-6B	49hq	VR4	9b	Tor
L B1L	XC6219B18ADR	LVR-IC	LDO, 1.85V±2%, 240mA, +CE	USP-6B	49hq	VR4	9b	Tor
L B1M	XC6219B19ADR	LVR-IC	LDO, 1.95V±2%, 240mA, +CE	USP-6B	49hq	VR4	9b	Tor
L B20	XC6219B202DR	LVR-IC	LDO, 2V±2%, 240mA, +CE	USP-6B	49hq	VR4	9b	Tor
L B21	XC6219B212DR	LVR-IC	LDO, 2.1V±2%, 240mA, +CE	USP-6B	49hq	VR4	9b	Tor
L B22	XC6219B222DR	LVR-IC	LDO, 2.2V±2%, 240mA, +CE	USP-6B	49hq	VR4	9b	Tor
L B23	XC6219B232DR	LVR-IC	LDO, 2.3V±2%, 240mA, +CE	USP-6B	49hq	VR4	9b	Tor



SMD code	Type	Function	Short description	Case	Pinout	Sch.	St.	Mnf.
LB24	XC6219B242DR	LVR-IC	LDO, 2.4V±2%, 240mA, +CE	USP-6B	49hq	VR4	9b	Tor
LB25	XC6219B252DR	LVR-IC	LDO, 2.5V±2%, 240mA, +CE	USP-6B	49hq	VR4	9b	Tor
LB26	XC6219B262DR	LVR-IC	LDO, 2.6V±2%, 240mA, +CE	USP-6B	49hq	VR4	9b	Tor
LB27	XC6219B272DR	LVR-IC	LDO, 2.7V±2%, 240mA, +CE	USP-6B	49hq	VR4	9b	Tor
LB28	XC6219B282DR	LVR-IC	LDO, 2.8V±2%, 240mA, +CE	USP-6B	49hq	VR4	9b	Tor
LB29	XC6219B292DR	LVR-IC	LDO, 2.9V±2%, 240mA, +CE	USP-6B	49hq	VR4	9b	Tor
LB2A	XC6219B2A0ADR	LVR-IC	LDO, 2.05V±2%, 240mA, +CE	USP-6B	49hq	VR4	9b	Tor
LB2B	XC6219B21ADR	LVR-IC	LDO, 2.15V±2%, 240mA, +CE	USP-6B	49hq	VR4	9b	Tor
LB2C	XC6219B22ADR	LVR-IC	LDO, 2.25V±2%, 240mA, +CE	USP-6B	49hq	VR4	9b	Tor
LB2D	XC6219B23ADR	LVR-IC	LDO, 2.35V±2%, 240mA, +CE	USP-6B	49hq	VR4	9b	Tor
LB2E	XC6219B24ADR	LVR-IC	LDO, 2.45V±2%, 240mA, +CE	USP-6B	49hq	VR4	9b	Tor
LB2F	XC6219B25ADR	LVR-IC	LDO, 2.55V±2%, 240mA, +CE	USP-6B	49hq	VR4	9b	Tor
LB2H	XC6219B26ADR	LVR-IC	LDO, 2.65V±2%, 240mA, +CE	USP-6B	49hq	VR4	9b	Tor
LB2K	XC6219B27ADR	LVR-IC	LDO, 2.75V±2%, 240mA, +CE	USP-6B	49hq	VR4	9b	Tor
LB2L	XC6219B28ADR	LVR-IC	LDO, 2.85V±2%, 240mA, +CE	USP-6B	49hq	VR4	9b	Tor
LB2M	XC6219B29ADR	LVR-IC	LDO, 2.95V±2%, 240mA, +CE	USP-6B	49hq	VR4	9b	Tor
LB30	XC6219B302DR	LVR-IC	LDO, 3V±2%, 240mA, +CE	USP-6B	49hq	VR4	9b	Tor
LB31	XC6219B312DR	LVR-IC	LDO, 3.1V±2%, 240mA, +CE	USP-6B	49hq	VR4	9b	Tor
LB32	XC6219B322DR	LVR-IC	LDO, 3.2V±2%, 240mA, +CE	USP-6B	49hq	VR4	9b	Tor
LB33	XC6219B332DR	LVR-IC	LDO, 3.3V±2%, 240mA, +CE	USP-6B	49hq	VR4	9b	Tor
LB34	XC6219B342DR	LVR-IC	LDO, 3.4V±2%, 240mA, +CE	USP-6B	49hq	VR4	9b	Tor
LB35	XC6219B352DR	LVR-IC	LDO, 3.5V±2%, 240mA, +CE	USP-6B	49hq	VR4	9b	Tor
LB36	XC6219B362DR	LVR-IC	LDO, 3.6V±2%, 240mA, +CE	USP-6B	49hq	VR4	9b	Tor
LB37	XC6219B372DR	LVR-IC	LDO, 3.7V±2%, 240mA, +CE	USP-6B	49hq	VR4	9b	Tor
LB38	XC6219B382DR	LVR-IC	LDO, 3.8V±2%, 240mA, +CE	USP-6B	49hq	VR4	9b	Tor
LB39	XC6219B392DR	LVR-IC	LDO, 3.9V±2%, 240mA, +CE	USP-6B	49hq	VR4	9b	Tor
LB3A	XC6219B30ADR	LVR-IC	LDO, 3.05V±2%, 240mA, +CE	USP-6B	49hq	VR4	9b	Tor
LB3B	XC6219B31ADR	LVR-IC	LDO, 3.15V±2%, 240mA, +CE	USP-6B	49hq	VR4	9b	Tor
LB3C	XC6219B32ADR	LVR-IC	LDO, 3.25V±2%, 240mA, +CE	USP-6B	49hq	VR4	9b	Tor
LB3D	XC6219B33ADR	LVR-IC	LDO, 3.35V±2%, 240mA, +CE	USP-6B	49hq	VR4	9b	Tor
LB3E	XC6219B34ADR	LVR-IC	LDO, 3.45V±2%, 240mA, +CE	USP-6B	49hq	VR4	9b	Tor
LB3F	XC6219B35ADR	LVR-IC	LDO, 3.55V±2%, 240mA, +CE	USP-6B	49hq	VR4	9b	Tor
LB3H	XC6219B36ADR	LVR-IC	LDO, 3.65V±2%, 240mA, +CE	USP-6B	49hq	VR4	9b	Tor
LB3K	XC6219B37ADR	LVR-IC	LDO, 3.75V±2%, 240mA, +CE	USP-6B	49hq	VR4	9b	Tor
LB3L	XC6219B38ADR	LVR-IC	LDO, 3.85V±2%, 240mA, +CE	USP-6B	49hq	VR4	9b	Tor
LB3M	XC6219B39ADR	LVR-IC	LDO, 3.95V±2%, 240mA, +CE	USP-6B	49hq	VR4	9b	Tor
LB40	XC6219B402DR	LVR-IC	LDO, 4V±2%, 240mA, +CE	USP-6B	49hq	VR4	9b	Tor
LB41	XC6219B412DR	LVR-IC	LDO, 4.1V±2%, 240mA, +CE	USP-6B	49hq	VR4	9b	Tor
LB42	XC6219B422DR	LVR-IC	LDO, 4.2V±2%, 240mA, +CE	USP-6B	49hq	VR4	9b	Tor
LB43	XC6219B432DR	LVR-IC	LDO, 4.3V±2%, 240mA, +CE	USP-6B	49hq	VR4	9b	Tor
LB44	XC6219B442DR	LVR-IC	LDO, 4.4V±2%, 240mA, +CE	USP-6B	49hq	VR4	9b	Tor
LB45	XC6219B452DR	LVR-IC	LDO, 4.5V±2%, 240mA, +CE	USP-6B	49hq	VR4	9b	Tor
LB46	XC6219B462DR	LVR-IC	LDO, 4.6V±2%, 240mA, +CE	USP-6B	49hq	VR4	9b	Tor
LB47	XC6219B472DR	LVR-IC	LDO, 4.7V±2%, 240mA, +CE	USP-6B	49hq	VR4	9b	Tor
LB48	XC6219B482DR	LVR-IC	LDO, 4.8V±2%, 240mA, +CE	USP-6B	49hq	VR4	9b	Tor
LB49	XC6219B492DR	LVR-IC	LDO, 4.9V±2%, 240mA, +CE	USP-6B	49hq	VR4	9b	Tor
LB4A	XC6219B40ADR	LVR-IC	LDO, 4.05V±2%, 240mA, +CE	USP-6B	49hq	VR4	9b	Tor
LB4B	XC6219B41ADR	LVR-IC	LDO, 4.15V±2%, 240mA, +CE	USP-6B	49hq	VR4	9b	Tor
LB4C	XC6219B42ADR	LVR-IC	LDO, 4.25V±2%, 240mA, +CE	USP-6B	49hq	VR4	9b	Tor
LB4D	XC6219B43ADR	LVR-IC	LDO, 4.35V±2%, 240mA, +CE	USP-6B	49hq	VR4	9b	Tor
LB4E	XC6219B44ADR	LVR-IC	LDO, 4.45V±2%, 240mA, +CE	USP-6B	49hq	VR4	9b	Tor
LB4F	XC6219B45ADR	LVR-IC	LDO, 4.55V±2%, 240mA, +CE	USP-6B	49hq	VR4	9b	Tor
LB4H	XC6219B46ADR	LVR-IC	LDO, 4.65V±2%, 240mA, +CE	USP-6B	49hq	VR4	9b	Tor
LB4K	XC6219B47ADR	LVR-IC	LDO, 4.75V±2%, 240mA, +CE	USP-6B	49hq	VR4	9b	Tor
LB4L	XC6219B48ADR	LVR-IC	LDO, 4.85V±2%, 240mA, +CE	USP-6B	49hq	VR4	9b	Tor
LB4M	XC6219B49ADR	LVR-IC	LDO, 4.95V±2%, 240mA, +CE	USP-6B	49hq	VR4	9b	Tor
LB50	XC6219B502DR	LVR-IC	LDO, 5V±2%, 240mA, +CE	USP-6B	49hq	VR4	9b	Tor
LC09	XC6219C092DR	LVR-IC	LDO, 0.9V±2%, 150mA, -CE, PDR	USP-6B	49hq	VR4	9b	Tor
LC0M	XC6219C09ADR	LVR-IC	LDO, 0.95V±2%, 150mA, -CE, PDR	USP-6B	49hq	VR4	9b	Tor
LC10	XC6219C102DR	LVR-IC	LDO, 1V±2%, 150mA, -CE, PDR	USP-6B	49hq	VR4	9b	Tor
LC11	XC6219C112DR	LVR-IC	LDO, 1.1V±2%, 150mA, -CE, PDR	USP-6B	49hq	VR4	9b	Tor
LC12	XC6219C122DR	LVR-IC	LDO, 1.2V±2%, 150mA, -CE, PDR	USP-6B	49hq	VR4	9b	Tor
LC13	XC6219C132DR	LVR-IC	LDO, 1.3V±2%, 150mA, -CE, PDR	USP-6B	49hq	VR4	9b	Tor
LC14	XC6219C142DR	LVR-IC	LDO, 1.4V±2%, 150mA, -CE, PDR	USP-6B	49hq	VR4	9b	Tor
LC15	XC6219C152DR	LVR-IC	LDO, 1.5V±2%, 150mA, -CE, PDR	USP-6B	49hq	VR4	9b	Tor
LC16	XC6219C162DR	LVR-IC	LDO, 1.6V±2%, 150mA, -CE, PDR	USP-6B	49hq	VR4	9b	Tor
LC17	XC6219C172DR	LVR-IC	LDO, 1.7V±2%, 150mA, -CE, PDR	USP-6B	49hq	VR4	9b	Tor
LC18	XC6219C182DR	LVR-IC	LDO, 1.8V±2%, 240mA, -CE, PDR	USP-6B	49hq	VR4	9b	Tor
LC19	XC6219C192DR	LVR-IC	LDO, 1.9V±2%, 240mA, -CE, PDR	USP-6B	49hq	VR4	9b	Tor
LC1A	XC6219C10ADR	LVR-IC	LDO, 1.05V±2%, 150mA, -CE, PDR	USP-6B	49hq	VR4	9b	Tor



SMD code	Type	Function	Short description	Case	Pinout	Sch.	St.	Mnf.
L C1B	XC6219C11ADR	LVR-IC	LDO, 1.15V±2%, 150mA, -CE, PDR	USP-6B	49hq	VR4	9b	Tor
L C1C	XC6219C12ADR	LVR-IC	LDO, 1.25V±2%, 150mA, -CE, PDR	USP-6B	49hq	VR4	9b	Tor
L C1D	XC6219C13ADR	LVR-IC	LDO, 1.35V±2%, 150mA, -CE, PDR	USP-6B	49hq	VR4	9b	Tor
L C1E	XC6219C14ADR	LVR-IC	LDO, 1.45V±2%, 150mA, -CE, PDR	USP-6B	49hq	VR4	9b	Tor
L C1F	XC6219C15ADR	LVR-IC	LDO, 1.55V±2%, 150mA, -CE, PDR	USP-6B	49hq	VR4	9b	Tor
L C1H	XC6219C16ADR	LVR-IC	LDO, 1.65V±2%, 150mA, -CE, PDR	USP-6B	49hq	VR4	9b	Tor
L C1K	XC6219C17ADR	LVR-IC	LDO, 1.75V±2%, 150mA, -CE, PDR	USP-6B	49hq	VR4	9b	Tor
L C1L	XC6219C18ADR	LVR-IC	LDO, 1.85V±2%, 240mA, -CE, PDR	USP-6B	49hq	VR4	9b	Tor
L C1M	XC6219C19ADR	LVR-IC	LDO, 1.95V±2%, 240mA, -CE, PDR	USP-6B	49hq	VR4	9b	Tor
L C20	XC6219C202DR	LVR-IC	LDO, 2V±2%, 240mA, -CE, PDR	USP-6B	49hq	VR4	9b	Tor
L C21	XC6219C212DR	LVR-IC	LDO, 2.1V±2%, 240mA, -CE, PDR	USP-6B	49hq	VR4	9b	Tor
L C22	XC6219C222DR	LVR-IC	LDO, 2.2V±2%, 240mA, -CE, PDR	USP-6B	49hq	VR4	9b	Tor
L C23	XC6219C232DR	LVR-IC	LDO, 2.3V±2%, 240mA, -CE, PDR	USP-6B	49hq	VR4	9b	Tor
L C24	XC6219C242DR	LVR-IC	LDO, 2.4V±2%, 240mA, -CE, PDR	USP-6B	49hq	VR4	9b	Tor
L C25	XC6219C252DR	LVR-IC	LDO, 2.5V±2%, 240mA, -CE, PDR	USP-6B	49hq	VR4	9b	Tor
L C26	XC6219C262DR	LVR-IC	LDO, 2.6V±2%, 240mA, -CE, PDR	USP-6B	49hq	VR4	9b	Tor
L C27	XC6219C272DR	LVR-IC	LDO, 2.7V±2%, 240mA, -CE, PDR	USP-6B	49hq	VR4	9b	Tor
L C28	XC6219C282DR	LVR-IC	LDO, 2.8V±2%, 240mA, -CE, PDR	USP-6B	49hq	VR4	9b	Tor
L C29	XC6219C292DR	LVR-IC	LDO, 2.9V±2%, 240mA, -CE, PDR	USP-6B	49hq	VR4	9b	Tor
L C2A	XC6219C20ADR	LVR-IC	LDO, 2.05V±2%, 240mA, -CE, PDR	USP-6B	49hq	VR4	9b	Tor
L C2B	XC6219C21ADR	LVR-IC	LDO, 2.15V±2%, 240mA, -CE, PDR	USP-6B	49hq	VR4	9b	Tor
L C2C	XC6219C22ADR	LVR-IC	LDO, 2.25V±2%, 240mA, -CE, PDR	USP-6B	49hq	VR4	9b	Tor
L C2D	XC6219C23ADR	LVR-IC	LDO, 2.35V±2%, 240mA, -CE, PDR	USP-6B	49hq	VR4	9b	Tor
L C2E	XC6219C24ADR	LVR-IC	LDO, 2.45V±2%, 240mA, -CE, PDR	USP-6B	49hq	VR4	9b	Tor
L C2F	XC6219C25ADR	LVR-IC	LDO, 2.55V±2%, 240mA, -CE, PDR	USP-6B	49hq	VR4	9b	Tor
L C2H	XC6219C26ADR	LVR-IC	LDO, 2.65V±2%, 240mA, -CE, PDR	USP-6B	49hq	VR4	9b	Tor
L C2K	XC6219C27ADR	LVR-IC	LDO, 2.75V±2%, 240mA, -CE, PDR	USP-6B	49hq	VR4	9b	Tor
L C2L	XC6219C28ADR	LVR-IC	LDO, 2.85V±2%, 240mA, -CE, PDR	USP-6B	49hq	VR4	9b	Tor
L C2M	XC6219C29ADR	LVR-IC	LDO, 2.95V±2%, 240mA, -CE, PDR	USP-6B	49hq	VR4	9b	Tor
L C30	XC6219C302DR	LVR-IC	LDO, 3V±2%, 240mA, -CE, PDR	USP-6B	49hq	VR4	9b	Tor
L C31	XC6219C312DR	LVR-IC	LDO, 3.1V±2%, 240mA, -CE, PDR	USP-6B	49hq	VR4	9b	Tor
L C32	XC6219C322DR	LVR-IC	LDO, 3.2V±2%, 240mA, -CE, PDR	USP-6B	49hq	VR4	9b	Tor
L C33	XC6219C332DR	LVR-IC	LDO, 3.3V±2%, 240mA, -CE, PDR	USP-6B	49hq	VR4	9b	Tor
L C34	XC6219C342DR	LVR-IC	LDO, 3.4V±2%, 240mA, -CE, PDR	USP-6B	49hq	VR4	9b	Tor
L C35	XC6219C352DR	LVR-IC	LDO, 3.5V±2%, 240mA, -CE, PDR	USP-6B	49hq	VR4	9b	Tor
L C36	XC6219C362DR	LVR-IC	LDO, 3.6V±2%, 240mA, -CE, PDR	USP-6B	49hq	VR4	9b	Tor
L C37	XC6219C372DR	LVR-IC	LDO, 3.7V±2%, 240mA, -CE, PDR	USP-6B	49hq	VR4	9b	Tor
L C38	XC6219C382DR	LVR-IC	LDO, 3.8V±2%, 240mA, -CE, PDR	USP-6B	49hq	VR4	9b	Tor
L C39	XC6219C392DR	LVR-IC	LDO, 3.9V±2%, 240mA, -CE, PDR	USP-6B	49hq	VR4	9b	Tor
L C3A	XC6219C30ADR	LVR-IC	LDO, 3.05V±2%, 240mA, -CE, PDR	USP-6B	49hq	VR4	9b	Tor
L C3B	XC6219C31ADR	LVR-IC	LDO, 3.15V±2%, 240mA, -CE, PDR	USP-6B	49hq	VR4	9b	Tor
L C3C	XC6219C32ADR	LVR-IC	LDO, 3.25V±2%, 240mA, -CE, PDR	USP-6B	49hq	VR4	9b	Tor
L C3D	XC6219C33ADR	LVR-IC	LDO, 3.35V±2%, 240mA, -CE, PDR	USP-6B	49hq	VR4	9b	Tor
L C3E	XC6219C34ADR	LVR-IC	LDO, 3.45V±2%, 240mA, -CE, PDR	USP-6B	49hq	VR4	9b	Tor
L C3F	XC6219C35ADR	LVR-IC	LDO, 3.55V±2%, 240mA, -CE, PDR	USP-6B	49hq	VR4	9b	Tor
L C3H	XC6219C36ADR	LVR-IC	LDO, 3.65V±2%, 240mA, -CE, PDR	USP-6B	49hq	VR4	9b	Tor
L C3K	XC6219C37ADR	LVR-IC	LDO, 3.75V±2%, 240mA, -CE, PDR	USP-6B	49hq	VR4	9b	Tor
L C3L	XC6219C38ADR	LVR-IC	LDO, 3.85V±2%, 240mA, -CE, PDR	USP-6B	49hq	VR4	9b	Tor
L C3M	XC6219C39ADR	LVR-IC	LDO, 3.95V±2%, 240mA, -CE, PDR	USP-6B	49hq	VR4	9b	Tor
L C40	XC6219C402DR	LVR-IC	LDO, 4V±2%, 240mA, -CE, PDR	USP-6B	49hq	VR4	9b	Tor
L C41	XC6219C412DR	LVR-IC	LDO, 4.1V±2%, 240mA, -CE, PDR	USP-6B	49hq	VR4	9b	Tor
L C42	XC6219C422DR	LVR-IC	LDO, 4.2V±2%, 240mA, -CE, PDR	USP-6B	49hq	VR4	9b	Tor
L C43	XC6219C432DR	LVR-IC	LDO, 4.3V±2%, 240mA, -CE, PDR	USP-6B	49hq	VR4	9b	Tor
L C44	XC6219C442DR	LVR-IC	LDO, 4.4V±2%, 240mA, -CE, PDR	USP-6B	49hq	VR4	9b	Tor
L C45	XC6219C452DR	LVR-IC	LDO, 4.5V±2%, 240mA, -CE, PDR	USP-6B	49hq	VR4	9b	Tor
L C46	XC6219C462DR	LVR-IC	LDO, 4.6V±2%, 240mA, -CE, PDR	USP-6B	49hq	VR4	9b	Tor
L C47	XC6219C472DR	LVR-IC	LDO, 4.7V±2%, 240mA, -CE, PDR	USP-6B	49hq	VR4	9b	Tor
L C48	XC6219C482DR	LVR-IC	LDO, 4.8V±2%, 240mA, -CE, PDR	USP-6B	49hq	VR4	9b	Tor
L C49	XC6219C492DR	LVR-IC	LDO, 4.9V±2%, 240mA, -CE, PDR	USP-6B	49hq	VR4	9b	Tor
L C4A	XC6219C40ADR	LVR-IC	LDO, 4.05V±2%, 240mA, -CE, PDR	USP-6B	49hq	VR4	9b	Tor
L C4B	XC6219C41ADR	LVR-IC	LDO, 4.15V±2%, 240mA, -CE, PDR	USP-6B	49hq	VR4	9b	Tor
L C4C	XC6219C42ADR	LVR-IC	LDO, 4.25V±2%, 240mA, -CE, PDR	USP-6B	49hq	VR4	9b	Tor
L C4D	XC6219C43ADR	LVR-IC	LDO, 4.35V±2%, 240mA, -CE, PDR	USP-6B	49hq	VR4	9b	Tor
L C4E	XC6219C44ADR	LVR-IC	LDO, 4.45V±2%, 240mA, -CE, PDR	USP-6B	49hq	VR4	9b	Tor
L C4F	XC6219C45ADR	LVR-IC	LDO, 4.55V±2%, 240mA, -CE, PDR	USP-6B	49hq	VR4	9b	Tor
L C4H	XC6219C46ADR	LVR-IC	LDO, 4.65V±2%, 240mA, -CE, PDR	USP-6B	49hq	VR4	9b	Tor
L C4K	XC6219C47ADR	LVR-IC	LDO, 4.75V±2%, 240mA, -CE, PDR	USP-6B	49hq	VR4	9b	Tor
L C4L	XC6219C48ADR	LVR-IC	LDO, 4.85V±2%, 240mA, -CE, PDR	USP-6B	49hq	VR4	9b	Tor
L C4M	XC6219C49ADR	LVR-IC	LDO, 4.95V±2%, 240mA, -CE, PDR	USP-6B	49hq	VR4	9b	Tor
L C50	XC6219C502DR	LVR-IC	LDO, 5V±2%, 240mA, -CE, PDR	USP-6B	49hq	VR4	9b	Tor



SMD code	Type	Function	Short description	Case	Pinout	Sch.	St.	Mnf.
LD09	XC6219D092DR	LVR-IC	LDO, 0.9V±2%, 150mA, -CE	USP-6B	49hq	VR4	9b	Tor
LD0M	XC6219D09ADR	LVR-IC	LDO, 0.95V±2%, 150mA, -CE	USP-6B	49hq	VR4	9b	Tor
LD10	XC6219D102DR	LVR-IC	LDO, 1V±2%, 150mA, -CE	USP-6B	49hq	VR4	9b	Tor
LD11	XC6219D112DR	LVR-IC	LDO, 1.1V±2%, 150mA, -CE	USP-6B	49hq	VR4	9b	Tor
LD12	XC6219D122DR	LVR-IC	LDO, 1.2V±2%, 150mA, -CE	USP-6B	49hq	VR4	9b	Tor
LD13	XC6219D132DR	LVR-IC	LDO, 1.3V±2%, 150mA, -CE	USP-6B	49hq	VR4	9b	Tor
LD14	XC6219D142DR	LVR-IC	LDO, 1.4V±2%, 150mA, -CE	USP-6B	49hq	VR4	9b	Tor
LD15	XC6219D152DR	LVR-IC	LDO, 1.5V±2%, 150mA, -CE	USP-6B	49hq	VR4	9b	Tor
LD16	XC6219D162DR	LVR-IC	LDO, 1.6V±2%, 150mA, -CE	USP-6B	49hq	VR4	9b	Tor
LD17	XC6219D172DR	LVR-IC	LDO, 1.7V±2%, 150mA, -CE	USP-6B	49hq	VR4	9b	Tor
LD18	XC6219D182DR	LVR-IC	LDO, 1.8V±2%, 240mA, -CE	USP-6B	49hq	VR4	9b	Tor
LD19	XC6219D192DR	LVR-IC	LDO, 1.9V±2%, 240mA, -CE	USP-6B	49hq	VR4	9b	Tor
LD1A	XC6219D10ADR	LVR-IC	LDO, 1.05V±2%, 150mA, -CE	USP-6B	49hq	VR4	9b	Tor
LD1B	XC6219D11ADR	LVR-IC	LDO, 1.15V±2%, 150mA, -CE	USP-6B	49hq	VR4	9b	Tor
LD1C	XC6219D12ADR	LVR-IC	LDO, 1.25V±2%, 150mA, -CE	USP-6B	49hq	VR4	9b	Tor
LD1D	XC6219D13ADR	LVR-IC	LDO, 1.35V±2%, 150mA, -CE	USP-6B	49hq	VR4	9b	Tor
LD1E	XC6219D14ADR	LVR-IC	LDO, 1.45V±2%, 150mA, -CE	USP-6B	49hq	VR4	9b	Tor
LD1F	XC6219D15ADR	LVR-IC	LDO, 1.55V±2%, 150mA, -CE	USP-6B	49hq	VR4	9b	Tor
LD1H	XC6219D16ADR	LVR-IC	LDO, 1.65V±2%, 150mA, -CE	USP-6B	49hq	VR4	9b	Tor
LD1K	XC6219D17ADR	LVR-IC	LDO, 1.75V±2%, 150mA, -CE	USP-6B	49hq	VR4	9b	Tor
LD1L	XC6219D18ADR	LVR-IC	LDO, 1.85V±2%, 240mA, -CE	USP-6B	49hq	VR4	9b	Tor
LD1M	XC6219D19ADR	LVR-IC	LDO, 1.95V±2%, 240mA, -CE	USP-6B	49hq	VR4	9b	Tor
LD20	XC6219D202DR	LVR-IC	LDO, 2V±2%, 240mA, -CE	USP-6B	49hq	VR4	9b	Tor
LD21	XC6219D212DR	LVR-IC	LDO, 2.1V±2%, 240mA, -CE	USP-6B	49hq	VR4	9b	Tor
LD22	XC6219D222DR	LVR-IC	LDO, 2.2V±2%, 240mA, -CE	USP-6B	49hq	VR4	9b	Tor
LD23	XC6219D232DR	LVR-IC	LDO, 2.3V±2%, 240mA, -CE	USP-6B	49hq	VR4	9b	Tor
LD24	XC6219D242DR	LVR-IC	LDO, 2.4V±2%, 240mA, -CE	USP-6B	49hq	VR4	9b	Tor
LD25	XC6219D252DR	LVR-IC	LDO, 2.5V±2%, 240mA, -CE	USP-6B	49hq	VR4	9b	Tor
LD26	XC6219D262DR	LVR-IC	LDO, 2.6V±2%, 240mA, -CE	USP-6B	49hq	VR4	9b	Tor
LD27	XC6219D272DR	LVR-IC	LDO, 2.7V±2%, 240mA, -CE	USP-6B	49hq	VR4	9b	Tor
LD28	XC6219D282DR	LVR-IC	LDO, 2.8V±2%, 240mA, -CE	USP-6B	49hq	VR4	9b	Tor
LD29	XC6219D292DR	LVR-IC	LDO, 2.9V±2%, 240mA, -CE	USP-6B	49hq	VR4	9b	Tor
LD2A	XC6219D20ADR	LVR-IC	LDO, 2.05V±2%, 240mA, -CE	USP-6B	49hq	VR4	9b	Tor
LD2B	XC6219D21ADR	LVR-IC	LDO, 2.15V±2%, 240mA, -CE	USP-6B	49hq	VR4	9b	Tor
LD2C	XC6219D22ADR	LVR-IC	LDO, 2.25V±2%, 240mA, -CE	USP-6B	49hq	VR4	9b	Tor
LD2D	XC6219D23ADR	LVR-IC	LDO, 2.35V±2%, 240mA, -CE	USP-6B	49hq	VR4	9b	Tor
LD2E	XC6219D24ADR	LVR-IC	LDO, 2.45V±2%, 240mA, -CE	USP-6B	49hq	VR4	9b	Tor
LD2F	XC6219D25ADR	LVR-IC	LDO, 2.55V±2%, 240mA, -CE	USP-6B	49hq	VR4	9b	Tor
LD2H	XC6219D26ADR	LVR-IC	LDO, 2.65V±2%, 240mA, -CE	USP-6B	49hq	VR4	9b	Tor
LD2K	XC6219D27ADR	LVR-IC	LDO, 2.75V±2%, 240mA, -CE	USP-6B	49hq	VR4	9b	Tor
LD2L	XC6219D28ADR	LVR-IC	LDO, 2.85V±2%, 240mA, -CE	USP-6B	49hq	VR4	9b	Tor
LD2M	XC6219D29ADR	LVR-IC	LDO, 2.95V±2%, 240mA, -CE	USP-6B	49hq	VR4	9b	Tor
LD30	XC6219D302DR	LVR-IC	LDO, 3V±2%, 240mA, -CE	USP-6B	49hq	VR4	9b	Tor
LD31	XC6219D312DR	LVR-IC	LDO, 3.1V±2%, 240mA, -CE	USP-6B	49hq	VR4	9b	Tor
LD32	XC6219D322DR	LVR-IC	LDO, 3.2V±2%, 240mA, -CE	USP-6B	49hq	VR4	9b	Tor
LD33	XC6219D332DR	LVR-IC	LDO, 3.3V±2%, 240mA, -CE	USP-6B	49hq	VR4	9b	Tor
LD34	XC6219D342DR	LVR-IC	LDO, 3.4V±2%, 240mA, -CE	USP-6B	49hq	VR4	9b	Tor
LD35	XC6219D352DR	LVR-IC	LDO, 3.5V±2%, 240mA, -CE	USP-6B	49hq	VR4	9b	Tor
LD36	XC6219D362DR	LVR-IC	LDO, 3.6V±2%, 240mA, -CE	USP-6B	49hq	VR4	9b	Tor
LD37	XC6219D372DR	LVR-IC	LDO, 3.7V±2%, 240mA, -CE	USP-6B	49hq	VR4	9b	Tor
LD38	XC6219D382DR	LVR-IC	LDO, 3.8V±2%, 240mA, -CE	USP-6B	49hq	VR4	9b	Tor
LD39	XC6219D392DR	LVR-IC	LDO, 3.9V±2%, 240mA, -CE	USP-6B	49hq	VR4	9b	Tor
LD3A	XC6219D30ADR	LVR-IC	LDO, 3.05V±2%, 240mA, -CE	USP-6B	49hq	VR4	9b	Tor
LD3B	XC6219D31ADR	LVR-IC	LDO, 3.15V±2%, 240mA, -CE	USP-6B	49hq	VR4	9b	Tor
LD3C	XC6219D32ADR	LVR-IC	LDO, 3.25V±2%, 240mA, -CE	USP-6B	49hq	VR4	9b	Tor
LD3D	XC6219D33ADR	LVR-IC	LDO, 3.35V±2%, 240mA, -CE	USP-6B	49hq	VR4	9b	Tor
LD3E	XC6219D34ADR	LVR-IC	LDO, 3.45V±2%, 240mA, -CE	USP-6B	49hq	VR4	9b	Tor
LD3F	XC6219D35ADR	LVR-IC	LDO, 3.55V±2%, 240mA, -CE	USP-6B	49hq	VR4	9b	Tor
LD3H	XC6219D36ADR	LVR-IC	LDO, 3.65V±2%, 240mA, -CE	USP-6B	49hq	VR4	9b	Tor
LD3K	XC6219D37ADR	LVR-IC	LDO, 3.75V±2%, 240mA, -CE	USP-6B	49hq	VR4	9b	Tor
LD3L	XC6219D38ADR	LVR-IC	LDO, 3.85V±2%, 240mA, -CE	USP-6B	49hq	VR4	9b	Tor
LD3M	XC6219D39ADR	LVR-IC	LDO, 3.95V±2%, 240mA, -CE	USP-6B	49hq	VR4	9b	Tor
LD40	XC6219D402DR	LVR-IC	LDO, 4V±2%, 240mA, -CE	USP-6B	49hq	VR4	9b	Tor
LD41	XC6219D412DR	LVR-IC	LDO, 4.1V±2%, 240mA, -CE	USP-6B	49hq	VR4	9b	Tor
LD42	XC6219D422DR	LVR-IC	LDO, 4.2V±2%, 240mA, -CE	USP-6B	49hq	VR4	9b	Tor
LD43	XC6219D432DR	LVR-IC	LDO, 4.3V±2%, 240mA, -CE	USP-6B	49hq	VR4	9b	Tor
LD44	XC6219D442DR	LVR-IC	LDO, 4.4V±2%, 240mA, -CE	USP-6B	49hq	VR4	9b	Tor
LD45	XC6219D452DR	LVR-IC	LDO, 4.5V±2%, 240mA, -CE	USP-6B	49hq	VR4	9b	Tor
LD46	XC6219D462DR	LVR-IC	LDO, 4.6V±2%, 240mA, -CE	USP-6B	49hq	VR4	9b	Tor
LD47	XC6219D472DR	LVR-IC	LDO, 4.7V±2%, 240mA, -CE	USP-6B	49hq	VR4	9b	Tor



SMD code	Type	Function	Short description	Case	Pinout	Sch.	St.	Mnf.
L D48	XC6219D482DR	LVR-IC	LDO, 4.8V±2%, 240mA, -CE	USP-6B	49hq	VR4	9b	Tor
L D49	XC6219D492DR	LVR-IC	LDO, 4.9V±2%, 240mA, -CE	USP-6B	49hq	VR4	9b	Tor
L D4A	XC6219D40ADR	LVR-IC	LDO, 4.05V±2%, 240mA, -CE	USP-6B	49hq	VR4	9b	Tor
L D4B	XC6219D41ADR	LVR-IC	LDO, 4.15V±2%, 240mA, -CE	USP-6B	49hq	VR4	9b	Tor
L D4C	XC6219D42ADR	LVR-IC	LDO, 4.25V±2%, 240mA, -CE	USP-6B	49hq	VR4	9b	Tor
L D4D	XC6219D43ADR	LVR-IC	LDO, 4.35V±2%, 240mA, -CE	USP-6B	49hq	VR4	9b	Tor
L D4E	XC6219D44ADR	LVR-IC	LDO, 4.45V±2%, 240mA, -CE	USP-6B	49hq	VR4	9b	Tor
L D4F	XC6219D45ADR	LVR-IC	LDO, 4.55V±2%, 240mA, -CE	USP-6B	49hq	VR4	9b	Tor
L D4H	XC6219D46ADR	LVR-IC	LDO, 4.65V±2%, 240mA, -CE	USP-6B	49hq	VR4	9b	Tor
L D4K	XC6219D47ADR	LVR-IC	LDO, 4.75V±2%, 240mA, -CE	USP-6B	49hq	VR4	9b	Tor
L D4L	XC6219D48ADR	LVR-IC	LDO, 4.85V±2%, 240mA, -CE	USP-6B	49hq	VR4	9b	Tor
L D4M	XC6219D49ADR	LVR-IC	LDO, 4.95V±2%, 240mA, -CE	USP-6B	49hq	VR4	9b	Tor
L D50	XC6219D502DR	LVR-IC	LDO, 5V±2%, 240mA, -CE	USP-6B	49hq	VR4	9b	Tor
L0	R3117K073A	Vdet-IC	0.7V±15mV, -Reset ODO, Sense	DFN1010-4	48rq	VD11	9a	Ric
L0	RP114K081B	LVR-IC	LDO, 0.8V±1%, 300mA, +CE	DFN1010-4	48vm	VR4	9a	Ric
L085B	LP3990SDX-0.8	LVR-IC	0.8V±1.5%, 150mA, +CE	LLP-6	56va	VR4	9c	Nsc
L086B	LP3990SDX-1.2	LVR-IC	1.2V±1.5%, 150mA, +CE	LLP-6	56va	VR4	9c	Nsc
L087B	LP3990SDX-1.5	LVR-IC	1.5V±1.5%, 150mA, +CE	LLP-6	56va	VR4	9c	Nsc
L088B	LP3990SDX-1.8	LVR-IC	1.8V±1.5%, 150mA, +CE	LLP-6	56va	VR4	9c	Nsc
L090B	LP3990SDX-2.5	LVR-IC	2.5V±1.5%, 150mA, +CE	LLP-6	56va	VR4	9c	Nsc
L091B	LP3990SDX-2.8	LVR-IC	2.8V±1.5%, 150mA, +CE	LLP-6	56va	VR4	9c	Nsc
L0A	XC6108N10AGR	Vdet-IC	1.0V±2%, Hysteresis, -Reset ODO	USP-4	45ro	VD14	9b	Tor
L0B	XC6108N10BGR	Vdet-IC	1.0V±2%, -Reset ODO	USP-4	45ro	VD14	9b	Tor
L0C	XC6108N10CGR	Vdet-IC	1.0V±2%, Hysteresis, -Reset ODO	USP-4	45m	VD14	9b	Tor
L0D	XC6108N10DGR	Vdet-IC	1.0V±2%, -Reset ODO	USP-4	45m	VD14	9b	Tor
L1	R3117K083A	Vdet-IC	0.8V±15mV, -Reset ODO, Sense	DFN1010-4	48rq	VD11	9a	Ric
L1	RP114K091B	LVR-IC	LDO, 0.9V±1%, 300mA, +CE	DFN1010-4	48vm	VR4	9a	Ric
L12	LP5900SD-2.8	LVR-IC	2.8V±2%, 150mA, +CE, LN	LLP-6	56ep	VR4	9a	Nsc
L13	LP5900SD-2.5	LVR-IC	2.5V±2%, 150mA, +CE, LN	LLP-6	56ep	VR4	9a	Nsc
L14	LP5900SD-2.7	LVR-IC	2.7V±2%, 150mA, +CE, LN	LLP-6	56ep	VR4	9a	Nsc
L15	LP5900SD-1.5	LVR-IC	1.5V±2%, 150mA, +CE, LN	LLP-6	56ep	VR4	9a	Nsc
L150B	LP3990SDX-1.35	LVR-IC	1.35V±1.5%, 150mA, +CE	LLP-6	56va	VR4	9c	Nsc
L16	LP5900SD-3.3	LVR-IC	3.3V±2%, 150mA, +CE, LN	LLP-6	56ep	VR4	9a	Nsc
L17	LP5900SD-1.8	LVR-IC	1.8V±2%, 150mA, +CE, LN	LLP-6	56ep	VR4	9a	Nsc
L18	LP5900SD-2.0	LVR-IC	2.0V±2%, 150mA, +CE, LN	LLP-6	56ep	VR4	9a	Nsc
L19	LP5900SD-2.2	LVR-IC	2.2V±2%, 150mA, +CE, LN	LLP-6	56ep	VR4	9a	Nsc
L1A	XC6108N11AGR	Vdet-IC	1.1V±2%, Hysteresis, -Reset ODO	USP-4	45ro	VD14	9b	Tor
L1B	XC6108N11BGR	Vdet-IC	1.1V±2%, -Reset ODO	USP-4	45ro	VD14	9b	Tor
L1C	XC6108N11CGR	Vdet-IC	1.1V±2%, Hysteresis, -Reset ODO	USP-4	45m	VD14	9b	Tor
L1D	XC6108N11DGR	Vdet-IC	1.1V±2%, -Reset ODO	USP-4	45m	VD14	9b	Tor
L2	R3117K093A	Vdet-IC	0.9V±15mV, -Reset ODO, Sense	DFN1010-4	48rq	VD11	9a	Ric
L2	RP114K101B	LVR-IC	LDO, 1.0V±1%, 300mA, +CE	DFN1010-4	48vm	VR4	9a	Ric
L20	LP5900SD-3.0	LVR-IC	3.0V±2%, 150mA, +CE, LN	LLP-6	56ep	VR4	9a	Nsc
L2A	XC6108N12AGR	Vdet-IC	1.2V±2%, Hysteresis, -Reset ODO	USP-4	45ro	VD14	9b	Tor
L2B	XC6108N12BGR	Vdet-IC	1.2V±2%, -Reset ODO	USP-4	45ro	VD14	9b	Tor
L2C	XC6108N12CGR	Vdet-IC	1.2V±2%, Hysteresis, -Reset ODO	USP-4	45m	VD14	9b	Tor
L2D	XC6108N12DGR	Vdet-IC	1.2V±2%, -Reset ODO	USP-4	45m	VD14	9b	Tor
L3	R3117K103A	Vdet-IC	1.0V±15mV, -Reset ODO, Sense	DFN1010-4	48rq	VD11	9a	Ric
L3	RP114K111B	LVR-IC	LDO, 1.1V±1%, 300mA, +CE	DFN1010-4	48vm	VR4	9a	Ric
L3A	XC6108N13AGR	Vdet-IC	1.3V±2%, Hysteresis, -Reset ODO	USP-4	45ro	VD14	9b	Tor
L3B	XC6108N13BGR	Vdet-IC	1.3V±2%, -Reset ODO	USP-4	45ro	VD14	9b	Tor
L3C	XC6108N13CGR	Vdet-IC	1.3V±2%, Hysteresis, -Reset ODO	USP-4	45m	VD14	9b	Tor
L3D	XC6108N13DGR	Vdet-IC	1.3V±2%, -Reset ODO	USP-4	45m	VD14	9b	Tor
L4	R3117K113A	Vdet-IC	1.1V±15mV, -Reset ODO, Sense	DFN1010-4	48rq	VD11	9a	Ric
L4	RP114K121B	LVR-IC	LDO, 1.2V±1%, 300mA, +CE	DFN1010-4	48vm	VR4	9a	Ric
L4665	LM4665LD	LIN-IC	AF PA, BTL, class-D, 2.7..5.5V, 1W(5V/8Q), shutdown	DFN-10	37	AFP5	-	Nsc
L4666	LM4666SDA	LIN-IC	AF PA, BTL, class-D, 4.5..5.5V, 2x1.2W(5V/8Q), shutdown	DFN-16	37	-	-	Nsc
L4670	LM4670SD	LIN-IC	AF PA, BTL, class-D, 2.5..5.5V, 3W(5V/4Q), shutdown	DFN-8	37	-	-	Nsc
L4673	LM4673SD	LIN-IC	AF PA, BTL, class-D, 2.5..5.5V, 2.65W(5V/4Q), shutdown	DFN-8	37	AFP48	-	Nsc
L4675	LM4675SD	LIN-IC	AF PA, BTL, class-D, 2.5..5.5V, 2.8W(5V/4Q), shutdown	DFN-8	37	AFP48	-	Nsc
L4811	LM4811YD	LIN-IC	AF PA, 2.5.5V, 2x105mW(4V/16Q), shutdown	DFN-10	37	-	-	Nsc
I48410SQ	LM48410SQ	LIN-IC	AF PA, BTL, class-D, 2.5.5V, 2x2.3W(5V/4Q), shutdown, 3D	LQFP-24	38	-	-	Nsc
L4854LD	LM4854LD	LIN-IC	AF PA, BTL, 2.7..5.5V, 1.9W(4Q)+2x85mW(8Q), shutdown	DFN-14	37	-	-	Nsc
L4871	LM4871LD	LIN-IC	AF PA, BTL, 2.5.5V, 3W(5V/3Q), shutdown	DFN-8	37	AFP12	-	Nsc
L4883SQ	LM4883SQ	LIN-IC	AF PA, BTL, 2..5.5V, 2x2.1W(5V/4Q), shutdown	QFN-24	38	-	-	Nsc
L4888SQ	LM4888SQ	LIN-IC	AF PA, BTL, 2..5.5V, 2x2.1W(5V/8Q), 3D control	LQFN-24	38	-	-	Nsc
L4889	LM4889LD	LIN-IC	AF PA, BTL, 2.7..5.5V, 1W(5V/8Q), shutdown	DFN-10	37	AFP15	9j	Nsc
L4890	EMA1001BL	LIN-IC	AF PA, BTL, 2..5.5V, 1W(5V/8Q), shutdown	DFN-10	37	AFP15	9j	Emp
L4890	LM4890LD	LIN-IC	AF PA, BTL, 2.2..5.5V, 1.1W(5V/8Q), shutdown	DFN-10	37	AFP15	9j	Nsc
L4890	SH4890LD	LIN-IC	AF PA, BTL, 2.2..5.5V, 1W(5V/8Q), shutdown	DFN-10	37	AFP15	-	Sit



SMD code	Type	Function	Short description	Case	Pinout	Sch.	St.Mnf.
L4891	LM4891LD	LIN-IC	AF PA, BTL, 2.2..5.5V, 1.1W(5V/8Q), shutdown	DFN-10	37	AFP15	9j Nsc
L4892	LM4892LD	LIN-IC	AF PA, BTL, 2.2..5.5V, 1.1W(5V/8Q), shutdown	DFN-10	37	-	- Nsc
L4894	LM4894LD	LIN-IC	AF PA, BTL, 2.2..5.5V, 1W(5V/8Q), shutdown	DFN-10	37	AFP19	- Nsc
L4895	LM4895LD	LIN-IC	AF PA, BTL, 2.2..5.5V, 1W(5V/8Q), shutdown	DFN-10	37	AFP20	- Nsc
L4898	LM4898LD	LIN-IC	AF PA, BTL, 2.5..5.5V, 1W(5V/8Q), shutdown	DFN-10	37	AFP19	- Nsc
L4899	LM4899LD	LIN-IC	AF PA, BTL, 2.2..5.5V, 1W(5V/8Q), shutdown	DFN-10	37	AFP20	- Nsc
L4901	LM4901LD	LIN-IC	AF PA, BTL, 2.2..5.5V, 1.6W(5V/8Q), shutdown	DFN-10	37	AFP26	- Nsc
L4905	LM4905LD	LIN-IC	AF PA, BTL, 2.2..5.5V, 1W(5V/8Q), shutdown	DFN-8	37	AFP12	- Nsc
L4906	LM4906LD	LIN-IC	AF PA, BTL, 2.2..5.5V, 1W(5V/8Q), shutdown	DFN-10	37	-	- Nsc
L4911	LM4911LD	LIN-IC	AF PA, BTL, 2.2..5.5V, 2x40mW(5V/16Q), mute, shutdown	DFN-10	37	AFP30	- Nsc
L4916	LM4916LD	LIN-IC	AF PA, BTL, 2.2..5.5V, 85mW(3V/32Q), shutdown	DFN-10	37	AFP32	- Nsc
L4917	LM4917SD	LIN-IC	AF PA, 2.2..5.5V, 2x95mW(5V/16Q), shutdown	DFN-14	37	-	- Nsc
L4924	LM4924SD	LIN-IC	AF PA, BTL, 1.5..3.6V, 2x40mW(5V/16Q), mute, shutdown	DFN-10	37	AFP33	- Nsc
L4928	LM4928SD	LIN-IC	AF PA, BTL, 2.4..5.5V, 1.2W(5V/8Q), shutdown	DFN-14	37	-	- Nsc
L4940	LM4945OSQ	LIN-IC	AF PA, BTL, 2.7..5.5V, 2x1.2W(4Q)+2x34mW(8Q), I2S, I2C	LQFN-32	38	-	- Nsc
L4990	LM4990LD	LIN-IC	AF PA, BTL, 2.7..5.5V, 2W(5V/4Q), shutdown	DFN-10	37	AFP26	- Nsc
L4991	LM4991LD	LIN-IC	AF PA, BTL, 2.7..5.5V, 3W(5.5V/8Q), shutdown	DFN-8	37	AFP12	- Nsc
L4992	LM4992SD	LIN-IC	AF PA, BTL, 2.7..5.5V, 2x1W(5V/8Q), shutdown	DFN-14	37	-	- Nsc
L4995	LM4995SD	LIN-IC	AF PA, BTL, 2.4..5.5V, 1.3W(5V/8Q), shutdown	DFN-8	37	AFP12	- Nsc
L4A	XC6108N14AGR	Vdet-IC	1.4V±2%, Hysteresis, -Reset ODO	USP-4	45ro	VD14	9b Tor
L4B	XC6108N14BGR	Vdet-IC	1.4V±2%, -Reset ODO	USP-4	45ro	VD14	9b Tor
L4C	XC6108N14CGR	Vdet-IC	1.4V±2%, Hysteresis, -Reset ODO	USP-4	45m	VD14	9b Tor
L4D	XC6108N14DGR	Vdet-IC	1.4V±2%, -Reset ODO	USP-4	45m	VD14	9b Tor
L5	R3117K123A	Vdet-IC	1.2V±15mV, -Reset ODO, Sense	DFN1010-4	48rq	VD11	9a Ric
L5	RP114K131B	LVR-IC	LDO, 1.3V±1%, 300mA, +CE	DFN1010-4	48vm	VR4	9a Ric
L5A	XC6108N15AGR	Vdet-IC	1.5V±2%, Hysteresis, -Reset ODO	USP-4	45ro	VD14	9b Tor
L5B	XC6108N15BGR	Vdet-IC	1.5V±2%, -Reset ODO	USP-4	45ro	VD14	9b Tor
L5C	XC6108N15CGR	Vdet-IC	1.5V±2%, Hysteresis, -Reset ODO	USP-4	45m	VD14	9b Tor
L5D	XC6108N15DGR	Vdet-IC	1.5V±2%, -Reset ODO	USP-4	45m	VD14	9b Tor
L6	R3117K133A	Vdet-IC	1.3V±15mV, -Reset ODO, Sense	DFN1010-4	48rq	VD11	9a Ric
L6	RP114K141B	LVR-IC	LDO, 1.4V±1%, 300mA, +CE	DFN1010-4	48vm	VR4	9a Ric
L6A	XC6108N16AGR	Vdet-IC	1.6V±2%, Hysteresis, -Reset ODO	USP-4	45ro	VD14	9b Tor
L6B	XC6108N16BGR	Vdet-IC	1.6V±2%, -Reset ODO	USP-4	45ro	VD14	9b Tor
L6C	XC6108N16CGR	Vdet-IC	1.6V±2%, Hysteresis, -Reset ODO	USP-4	45m	VD14	9b Tor
L6D	XC6108N16DGR	Vdet-IC	1.6V±2%, -Reset ODO	USP-4	45m	VD14	9b Tor
L7	R3117K143A	Vdet-IC	1.4V±15mV, -Reset ODO, Sense	DFN1010-4	48rq	VD11	9a Ric
L7	RP114K151B	LVR-IC	LDO, 1.5V±1%, 300mA, +CE	DFN1010-4	48vm	VR4	9a Ric
L7990	SH4990LD	LIN-IC	AF PA, BTL, 2.2..5.5V, 2W(5V/4Q), select shutdown	DFN-10	37	AFP26	- Sit
L7A	XC6108N17AGR	Vdet-IC	1.7V±2%, Hysteresis, -Reset ODO	USP-4	45ro	VD14	9b Tor
L7B	XC6108N17BGR	Vdet-IC	1.7V±2%, -Reset ODO	USP-4	45ro	VD14	9b Tor
L7C	XC6108N17CGR	Vdet-IC	1.7V±2%, Hysteresis, -Reset ODO	USP-4	45m	VD14	9b Tor
L7D	XC6108N17DGR	Vdet-IC	1.7V±2%, -Reset ODO	USP-4	45m	VD14	9b Tor
L8	R3117K153A	Vdet-IC	1.5V±15mV, -Reset ODO, Sense	DFN1010-4	48rq	VD11	9a Ric
L8	RP114K161B	LVR-IC	LDO, 1.6V±1%, 300mA, +CE	DFN1010-4	48vm	VR4	9a Ric
L8A	XC6108N18AGR	Vdet-IC	1.8V±2%, Hysteresis, -Reset ODO	USP-4	45ro	VD14	9b Tor
L8A	XC6118C08AGR-G	Vdet-IC	0.8V±30mV, ±Reset PPO, Sense, hysteresis 5%, Cd	USP-4	45me	VD15	9a Tor
L8B	XC6108N18BGR	Vdet-IC	1.8V±2%, -Reset ODO	USP-4	45ro	VD14	9b Tor
L8B	XC6118C08BGR-G	Vdet-IC	0.8V±30mV, ±Reset PPO, Sense, hysteresis <1%, Cd	USP-4	45me	VD15	9a Tor
L8C	XC6108N18CGR	Vdet-IC	1.8V±2%, Hysteresis, -Reset ODO	USP-4	45m	VD14	9b Tor
L8C	XC6118C08CGR-G	Vdet-IC	0.8V±30mV, ±Reset PPO, Sense, hysteresis 5%	USP-4	45md	VD12	9a Tor
L8D	XC6108N18DGR	Vdet-IC	1.8V±2%, -Reset ODO	USP-4	45m	VD14	9b Tor
L8D	XC6118C08DGR-G	Vdet-IC	0.8V±30mV, ±Reset PPO, Sense, hysteresis <1%	USP-4	45md	VD12	9a Tor
L9	R3117K163A	Vdet-IC	1.6V±1%, -Reset ODO, Sense	DFN1010-4	48rq	VD11	9a Ric
L9	RP114K171B	LVR-IC	LDO, 1.7V±1%, 300mA, +CE	DFN1010-4	48vm	VR4	9a Ric
L9A	XC6108N19AGR	Vdet-IC	1.9V±2%, Hysteresis, -Reset ODO	USP-4	45ro	VD14	9b Tor
L9A	XC6118C09AGR-G	Vdet-IC	0.9V±30mV, ±Reset PPO, Sense, hysteresis 5%, Cd	USP-4	45me	VD15	9a Tor
L9B	XC6108N19BGR	Vdet-IC	1.9V±2%, -Reset ODO	USP-4	45ro	VD14	9b Tor
L9B	XC6118C09BGR-G	Vdet-IC	0.9V±30mV, ±Reset PPO, Sense, hysteresis <1%, Cd	USP-4	45me	VD15	9a Tor
L9C	XC6108N19CGR	Vdet-IC	1.9V±2%, Hysteresis, -Reset ODO	USP-4	45m	VD14	9b Tor
L9C	XC6118C09CGR-G	Vdet-IC	0.9V±30mV, ±Reset PPO, Sense, hysteresis 5%	USP-4	45md	VD12	9a Tor
L9D	XC6108N19DGR	Vdet-IC	1.9V±2%, -Reset ODO	USP-4	45m	VD14	9b Tor
L9D	XC6118C09DGR-G	Vdet-IC	0.9V±30mV, ±Reset PPO, Sense, hysteresis <1%	USP-4	45md	VD12	9a Tor
LA	R3116K311C	Vdet-IC	3.1V±0.8%, -Reset PPO	DFN1010-4	48j	VD3	9a Ric
LA	RP107K101D	LVR-IC	LDO, 1.0V±1%, 200mA, +CE, CL	DFN1212-6	52vr2	VR4	9a Ric
LA8	XC9236C08C4R-G	DC-DC-IC	PWM/PMF, st-dwn, 0.8V±2%, 600mA, 1.2MHz, Vin>2V, LSST, CL	USP-6EL	56dc5	DC1	9a Tor
LA8	XC9236C08CER	DC-DC-IC	PWM/PMF, st-dwn, 0.8V±2%, 600mA, 1.2MHz, Vin>2V, LSST, CL	USP-6C	49dc5	DC1	9a Tor
LA9	XC9236C09C4R-G	DC-DC-IC	PWM/PMF, st-dwn, 0.9V±2%, 600mA, 1.2MHz, Vin>2V, LSST, CL	USP-6EL	56dc5	DC1	9a Tor
LA9	XC9236C09CER	DC-DC-IC	PWM/PMF, st-dwn, 0.9V±2%, 600mA, 1.2MHz, Vin>2V, LSST, CL	USP-6C	49dc5	DC1	9a Tor
LAL	XC9236C0L4R-G	DC-DC-IC	PWM/PMF, st-dwn, 0.85V±2%, 600mA, 1.2MHz, Vin>2V, LSST, CL	USP-6EL	56dc5	DC1	9a Tor
LAL	XC9236C0L.CER	DC-DC-IC	PWM/PMF, st-dwn, 0.85V±2%, 600mA, 1.2MHz, Vin>2V, LSST, CL	USP-6C	49dc5	DC1	9a Tor



SMD code	Type	Function	Short description	Case	Pinout	Sch.	St.	Mnf.
LCC	XC9236C2CC4R-G	DC-DC-IC	PWM/PFM, st-dwn, 2.25V±2%, 600mA, 1.2MHz, Vin>2V, LSST, CL	USP-6EL	56dc5	DC1	9a	Tor
LCC	XC9236C2CCER	DC-DC-IC	PWM/PFM, st-dwn, 2.25V±2%, 600mA, 1.2MHz, Vin>2V, LSST, CL	USP-6C	49dc5	DC1	9a	Tor
LCD	XC9236C2DC4R-G	DC-DC-IC	PWM/PFM, st-dwn, 2.35V±2%, 600mA, 1.2MHz, Vin>2V, LSST, CL	USP-6EL	56dc5	DC1	9a	Tor
LCD	XC9236C2DCER	DC-DC-IC	PWM/PFM, st-dwn, 2.35V±2%, 600mA, 1.2MHz, Vin>2V, LSST, CL	USP-6C	49dc5	DC1	9a	Tor
LCE	XC9236C2EC4R-G	DC-DC-IC	PWM/PFM, st-dwn, 2.45V±2%, 600mA, 1.2MHz, Vin>2V, LSST, CL	USP-6EL	56dc5	DC1	9a	Tor
LCE	XC9236C2ECER	DC-DC-IC	PWM/PFM, st-dwn, 2.45V±2%, 600mA, 1.2MHz, Vin>2V, LSST, CL	USP-6C	49dc5	DC1	9a	Tor
LCF	XC9236C2FC4R-G	DC-DC-IC	PWM/PFM, st-dwn, 2.55V±2%, 600mA, 1.2MHz, Vin>2V, LSST, CL	USP-6EL	56dc5	DC1	9a	Tor
LCF	XC9236C2FCER	DC-DC-IC	PWM/PFM, st-dwn, 2.55V±2%, 600mA, 1.2MHz, Vin>2V, LSST, CL	USP-6C	49dc5	DC1	9a	Tor
LCH	XC9236C2HC4R-G	DC-DC-IC	PWM/PFM, st-dwn, 2.65V±2%, 600mA, 1.2MHz, Vin>2V, LSST, CL	USP-6EL	56dc5	DC1	9a	Tor
LCH	XC9236C2HCER	DC-DC-IC	PWM/PFM, st-dwn, 2.65V±2%, 600mA, 1.2MHz, Vin>2V, LSST, CL	USP-6C	49dc5	DC1	9a	Tor
LCK	XC9236C2KC4R-G	DC-DC-IC	PWM/PFM, st-dwn, 2.75V±2%, 600mA, 1.2MHz, Vin>2V, LSST, CL	USP-6EL	56dc5	DC1	9a	Tor
LCK	XC9236C2KCER	DC-DC-IC	PWM/PFM, st-dwn, 2.75V±2%, 600mA, 1.2MHz, Vin>2V, LSST, CL	USP-6C	49dc5	DC1	9a	Tor
LCL	XC9236C2LC4R-G	DC-DC-IC	PWM/PFM, st-dwn, 2.85V±2%, 600mA, 1.2MHz, Vin>2V, LSST, CL	USP-6EL	56dc5	DC1	9a	Tor
LCL	XC9236C2LCER	DC-DC-IC	PWM/PFM, st-dwn, 2.85V±2%, 600mA, 1.2MHz, Vin>2V, LSST, CL	USP-6C	49dc5	DC1	9a	Tor
LCM	XC9236C2MC4R-G	DC-DC-IC	PWM/PFM, st-dwn, 2.95V±2%, 600mA, 1.2MHz, Vin>2V, LSST, CL	USP-6EL	56dc5	DC1	9a	Tor
LCM	XC9236C2MCER	DC-DC-IC	PWM/PFM, st-dwn, 2.95V±2%, 600mA, 1.2MHz, Vin>2V, LSST, CL	USP-6C	49dc5	DC1	9a	Tor
LD	R3116K341C	Vdel-IC	3.4V±0.8%, -Reset PPO	DFN1010-4	48j	VD3	9a	Ric
LD	RP107K131D	LVR-IC	LDO, 1.3V±1%, 200mA, +CE, CL	DFN1212-6	52v2	VR4	9a	Ric
LD0	XC9236C30C4R-G	DC-DC-IC	PWM/PFM, st-dwn, 3.0V±2%, 600mA, 1.2MHz, Vin>2V, LSST, CL	USP-6EL	56dc5	DC1	9a	Tor
LD0	XC9236C30CER	DC-DC-IC	PWM/PFM, st-dwn, 3.0V±2%, 600mA, 1.2MHz, Vin>2V, LSST, CL	USP-6C	49dc5	DC1	9a	Tor
LD1	XC9236C31C4R-G	DC-DC-IC	PWM/PFM, st-dwn, 3.1V±2%, 600mA, 1.2MHz, Vin>2V, LSST, CL	USP-6EL	56dc5	DC1	9a	Tor
LD1	XC9236C31CER	DC-DC-IC	PWM/PFM, st-dwn, 3.1V±2%, 600mA, 1.2MHz, Vin>2V, LSST, CL	USP-6C	49dc5	DC1	9a	Tor
LD2	XC9236C32C4R-G	DC-DC-IC	PWM/PFM, st-dwn, 3.2V±2%, 600mA, 1.2MHz, Vin>2V, LSST, CL	USP-6EL	56dc5	DC1	9a	Tor
LD2	XC9236C32CER	DC-DC-IC	PWM/PFM, st-dwn, 3.2V±2%, 600mA, 1.2MHz, Vin>2V, LSST, CL	USP-6C	49dc5	DC1	9a	Tor
LD3	XC9236C33C4R-G	DC-DC-IC	PWM/PFM, st-dwn, 3.3V±2%, 600mA, 1.2MHz, Vin>2V, LSST, CL	USP-6EL	56dc5	DC1	9a	Tor
LD3	XC9236C33CER	DC-DC-IC	PWM/PFM, st-dwn, 3.3V±2%, 600mA, 1.2MHz, Vin>2V, LSST, CL	USP-6C	49dc5	DC1	9a	Tor
LD4	XC9236C34C4R-G	DC-DC-IC	PWM/PFM, st-dwn, 3.4V±2%, 600mA, 1.2MHz, Vin>2V, LSST, CL	USP-6EL	56dc5	DC1	9a	Tor
LD4	XC9236C34CER	DC-DC-IC	PWM/PFM, st-dwn, 3.4V±2%, 600mA, 1.2MHz, Vin>2V, LSST, CL	USP-6C	49dc5	DC1	9a	Tor
LD5	XC9236C35C4R-G	DC-DC-IC	PWM/PFM, st-dwn, 3.5V±2%, 600mA, 1.2MHz, Vin>2V, LSST, CL	USP-6EL	56dc5	DC1	9a	Tor
LD5	XC9236C35CER	DC-DC-IC	PWM/PFM, st-dwn, 3.5V±2%, 600mA, 1.2MHz, Vin>2V, LSST, CL	USP-6C	49dc5	DC1	9a	Tor
LD6	XC9236C36C4R-G	DC-DC-IC	PWM/PFM, st-dwn, 3.6V±2%, 600mA, 1.2MHz, Vin>2V, LSST, CL	USP-6EL	56dc5	DC1	9a	Tor
LD6	XC9236C36CER	DC-DC-IC	PWM/PFM, st-dwn, 3.6V±2%, 600mA, 1.2MHz, Vin>2V, LSST, CL	USP-6C	49dc5	DC1	9a	Tor
LD7	XC9236C37C4R-G	DC-DC-IC	PWM/PFM, st-dwn, 3.7V±2%, 600mA, 1.2MHz, Vin>2V, LSST, CL	USP-6EL	56dc5	DC1	9a	Tor
LD7	XC9236C37CER	DC-DC-IC	PWM/PFM, st-dwn, 3.7V±2%, 600mA, 1.2MHz, Vin>2V, LSST, CL	USP-6C	49dc5	DC1	9a	Tor
LD8	XC9236C38C4R-G	DC-DC-IC	PWM/PFM, st-dwn, 3.8V±2%, 600mA, 1.2MHz, Vin>2V, LSST, CL	USP-6EL	56dc5	DC1	9a	Tor
LD8	XC9236C38CER	DC-DC-IC	PWM/PFM, st-dwn, 3.8V±2%, 600mA, 1.2MHz, Vin>2V, LSST, CL	USP-6C	49dc5	DC1	9a	Tor
LD9	XC9236C39C4R-G	DC-DC-IC	PWM/PFM, st-dwn, 3.9V±2%, 600mA, 1.2MHz, Vin>2V, LSST, CL	USP-6EL	56dc5	DC1	9a	Tor
LD9	XC9236C39CER	DC-DC-IC	PWM/PFM, st-dwn, 3.9V±2%, 600mA, 1.2MHz, Vin>2V, LSST, CL	USP-6C	49dc5	DC1	9a	Tor
LDA	XC9236C3AC4R-G	DC-DC-IC	PWM/PFM, st-dwn, 3.05V±2%, 600mA, 1.2MHz, Vin>2V, LSST, CL	USP-6EL	56dc5	DC1	9a	Tor
LDA	XC9236C3ACER	DC-DC-IC	PWM/PFM, st-dwn, 3.05V±2%, 600mA, 1.2MHz, Vin>2V, LSST, CL	USP-6C	49dc5	DC1	9a	Tor
LDB	XC9236C3BC4R-G	DC-DC-IC	PWM/PFM, st-dwn, 3.15V±2%, 600mA, 1.2MHz, Vin>2V, LSST, CL	USP-6EL	56dc5	DC1	9a	Tor
LDB	XC9236C3BCER	DC-DC-IC	PWM/PFM, st-dwn, 3.15V±2%, 600mA, 1.2MHz, Vin>2V, LSST, CL	USP-6C	49dc5	DC1	9a	Tor
LDC	XC9236C3CC4R-G	DC-DC-IC	PWM/PFM, st-dwn, 3.25V±2%, 600mA, 1.2MHz, Vin>2V, LSST, CL	USP-6EL	56dc5	DC1	9a	Tor
LDC	XC9236C3CCER	DC-DC-IC	PWM/PFM, st-dwn, 3.25V±2%, 600mA, 1.2MHz, Vin>2V, LSST, CL	USP-6C	49dc5	DC1	9a	Tor
LDD	XC9236C3DC4R-G	DC-DC-IC	PWM/PFM, st-dwn, 3.35V±2%, 600mA, 1.2MHz, Vin>2V, LSST, CL	USP-6EL	56dc5	DC1	9a	Tor
LDD	XC9236C3DCER	DC-DC-IC	PWM/PFM, st-dwn, 3.35V±2%, 600mA, 1.2MHz, Vin>2V, LSST, CL	USP-6C	49dc5	DC1	9a	Tor
LDE	XC9236C3EC4R-G	DC-DC-IC	PWM/PFM, st-dwn, 3.45V±2%, 600mA, 1.2MHz, Vin>2V, LSST, CL	USP-6EL	56dc5	DC1	9a	Tor
LDE	XC9236C3ECER	DC-DC-IC	PWM/PFM, st-dwn, 3.45V±2%, 600mA, 1.2MHz, Vin>2V, LSST, CL	USP-6C	49dc5	DC1	9a	Tor
LDF	XC9236C3FC4R-G	DC-DC-IC	PWM/PFM, st-dwn, 3.55V±2%, 600mA, 1.2MHz, Vin>2V, LSST, CL	USP-6EL	56dc5	DC1	9a	Tor
LDF	XC9236C3FCER	DC-DC-IC	PWM/PFM, st-dwn, 3.55V±2%, 600mA, 1.2MHz, Vin>2V, LSST, CL	USP-6C	49dc5	DC1	9a	Tor
LDH	XC9236C3HC4R-G	DC-DC-IC	PWM/PFM, st-dwn, 3.65V±2%, 600mA, 1.2MHz, Vin>2V, LSST, CL	USP-6EL	56dc5	DC1	9a	Tor
LDH	XC9236C3HCER	DC-DC-IC	PWM/PFM, st-dwn, 3.65V±2%, 600mA, 1.2MHz, Vin>2V, LSST, CL	USP-6C	49dc5	DC1	9a	Tor
LDK	XC9236C3KC4R-G	DC-DC-IC	PWM/PFM, st-dwn, 3.75V±2%, 600mA, 1.2MHz, Vin>2V, LSST, CL	USP-6EL	56dc5	DC1	9a	Tor
LDK	XC9236C3KCER	DC-DC-IC	PWM/PFM, st-dwn, 3.75V±2%, 600mA, 1.2MHz, Vin>2V, LSST, CL	USP-6C	49dc5	DC1	9a	Tor
LDL	XC9236C3LC4R-G	DC-DC-IC	PWM/PFM, st-dwn, 3.85V±2%, 600mA, 1.2MHz, Vin>2V, LSST, CL	USP-6EL	56dc5	DC1	9a	Tor
LDL	XC9236C3LCER	DC-DC-IC	PWM/PFM, st-dwn, 3.85V±2%, 600mA, 1.2MHz, Vin>2V, LSST, CL	USP-6C	49dc5	DC1	9a	Tor
LDM	XC9236C3MC4R-G	DC-DC-IC	PWM/PFM, st-dwn, 3.95V±2%, 600mA, 1.2MHz, Vin>2V, LSST, CL	USP-6EL	56dc5	DC1	9a	Tor
LDM	XC9236C3MCER	DC-DC-IC	PWM/PFM, st-dwn, 3.95V±2%, 600mA, 1.2MHz, Vin>2V, LSST, CL	USP-6C	49dc5	DC1	9a	Tor
LE	R3116K351C	Vdel-IC	3.5V±0.8%, -Reset PPO	DFN1010-4	48j	VD3	9a	Ric
LE	RP107K141D	LVR-IC	LDO, 1.4V±1%, 200mA, +CE, CL	DFN1212-6	52v2	VR4	9a	Ric
LE0	XC9236C40C4R-G	DC-DC-IC	PWM/PFM, st-dwn, 4.0V±2%, 600mA, 1.2MHz, Vin>2V, LSST, CL	USP-6EL	56dc5	DC1	9a	Tor
LE0	XC9236C40CER	DC-DC-IC	PWM/PFM, st-dwn, 4.0V±2%, 600mA, 1.2MHz, Vin>2V, LSST, CL	USP-6C	49dc5	DC1	9a	Tor
LED	NCP500SN18T1	LVR-IC	LDO, LN, +CE, 1.8V±2.5%, 150mA	LLP-6	56ve	VR4	-	Ons
LEE	NCP500SN25T1	LVR-IC	LDO, LN, +CE, 2.5V±2.5%, 150mA	LLP-6	56ve	VR4	-	Ons
LEF	NCP500SN27T1	LVR-IC	LDO, LN, +CE, 2.7V±2.5%, 150mA	LLP-6	56ve	VR4	-	Ons
LEG	NCP500SN28T1	LVR-IC	LDO, LN, +CE, 2.8V±2.5%, 150mA	LLP-6	56ve	VR4	-	Ons
LEH	NCP500SN30T1	LVR-IC	LDO, LN, +CE, 3V±2.5%, 150mA	LLP-6	56ve	VR4	-	Ons
LEJ	NCP500SN33T1	LVR-IC	LDO, LN, +CE, 3.3V±2.5%, 150mA	LLP-6	56ve	VR4	-	Ons
LEK	NCP500SN50T1	LVR-IC	LDO, LN, +CE, 5V±2.5%, 150mA	LLP-6	56ve	VR4	-	Ons
LF	R3116K361C	Vdel-IC	3.6V±0.8%, -Reset PPO	DFN1010-4	48j	VD3	9a	Ric



SMD code	Type	Function	Short description	Case	Pinout	Sch.	St.	Mnf.
LF	RP107K151D	LVR-IC	LDO, 1.5V±1%, 200mA, +CE, CL	DFN1212-6	52vr2	VR4	9a	Ric
LF8	XC9236C08D4R-G	DC-DC-IC	PWM/PFM, st-dwn, 0.8V±2%, 600mA, 3MHz, Vin>2V, LSST, CL	USP-6EL	56dc5	DC1	9a	Tor
LF8	XC9236C08DER	DC-DC-IC	PWM/PFM, st-dwn, 0.8V±2%, 600mA, 3MHz, Vin>2V, LSST, CL	USP-6C	49dc5	DC1	9a	Tor
LF8	XCL206C084AR-G	DC/DC-IC	PWM/PFM st-dwn, 3MHz, 0.8V±2%, 600mA, CL, soft start	CL-2025	67dc7	DC9	9a	Tor
LF9	XC9236C09D4R-G	DC-DC-IC	PWM/PFM, st-dwn, 0.9V±2%, 600mA, 3MHz, Vin>2V, LSST, CL	USP-6EL	56dc5	DC1	9a	Tor
LF9	XC9236C09DER	DC-DC-IC	PWM/PFM, st-dwn, 0.9V±2%, 600mA, 3MHz, Vin>2V, LSST, CL	USP-6C	49dc5	DC1	9a	Tor
LF9	XCL206C094AR-G	DC/DC-IC	PWM/PFM st-dwn, 3MHz, 0.9V±2%, 600mA, CL, soft start	CL-2025	67dc7	DC9	9a	Tor
LFL	XC9236C0LD4R-G	DC-DC-IC	PWM/PFM, st-dwn, 0.85V±2%, 600mA, 3MHz, Vin>2V, LSST, CL	USP-6EL	56dc5	DC1	9a	Tor
LFL	XC9236C0LDER	DC-DC-IC	PWM/PFM, st-dwn, 0.85V±2%, 600mA, 3MHz, Vin>2V, LSST, CL	USP-6C	49dc5	DC1	9a	Tor
LFM	XC9236C0MD4R-G	DC-DC-IC	PWM/PFM, st-dwn, 0.95V±2%, 600mA, 3MHz, Vin>2V, LSST, CL	USP-6EL	56dc5	DC1	9a	Tor
LFM	XC9236C0MDER	DC-DC-IC	PWM/PFM, st-dwn, 0.95V±2%, 600mA, 3MHz, Vin>2V, LSST, CL	USP-6C	49dc5	DC1	9a	Tor
LG	R3116K371C	Vdet-IC	3.7V±0.8%, -Reset PPO	DFN1010-4	48j	VD3	9a	Ric
LG	RP107K161D	LVR-IC	LDO, 1.6V±1%, 200mA, +CE, CL	DFN1212-6	52vr2	VR4	9a	Ric
LH	R3116K381C	Vdet-IC	3.8V±0.8%, -Reset PPO	DFN1010-4	48j	VD3	9a	Ric
LH	RP107K171D	LVR-IC	LDO, 1.7V±1%, 200mA, +CE, CL	DFN1212-6	52vr2	VR4	9a	Ric
LH0	XC9236C10D4R-G	DC-DC-IC	PWM/PFM, st-dwn, 1.0V±2%, 600mA, 3MHz, Vin>2V, LSST, CL	USP-6EL	56dc5	DC1	9a	Tor
LH0	XC9236C10DER	DC-DC-IC	PWM/PFM, st-dwn, 1.0V±2%, 600mA, 3MHz, Vin>2V, LSST, CL	USP-6C	49dc5	DC1	9a	Tor
LH0	XCL206C104AR-G	DC/DC-IC	PWM/PFM st-dwn, 3MHz, 1.0V±2%, 600mA, CL, soft start	CL-2025	67dc7	DC9	9a	Tor
LH1	XC9236C11D4R-G	DC-DC-IC	PWM/PFM, st-dwn, 1.1V±2%, 600mA, 3MHz, Vin>2V, LSST, CL	USP-6EL	56dc5	DC1	9a	Tor
LH1	XC9236C11DER	DC-DC-IC	PWM/PFM, st-dwn, 1.1V±2%, 600mA, 3MHz, Vin>2V, LSST, CL	USP-6C	49dc5	DC1	9a	Tor
LH1	XCL206C114AR-G	DC/DC-IC	PWM/PFM st-dwn, 3MHz, 1.1V±2%, 600mA, CL, soft start	CL-2025	67dc7	DC9	9a	Tor
LH2	XC9236C12D4R-G	DC-DC-IC	PWM/PFM, st-dwn, 1.2V±2%, 600mA, 3MHz, Vin>2V, LSST, CL	USP-6EL	56dc5	DC1	9a	Tor
LH2	XC9236C12DER	DC-DC-IC	PWM/PFM, st-dwn, 1.2V±2%, 600mA, 3MHz, Vin>2V, LSST, CL	USP-6C	49dc5	DC1	9a	Tor
LH2	XCL206C124AR-G	DC/DC-IC	PWM/PFM st-dwn, 3MHz, 1.2V±2%, 600mA, CL, soft start	CL-2025	67dc7	DC9	9a	Tor
LH3	XC9236C13D4R-G	DC-DC-IC	PWM/PFM, st-dwn, 1.3V±2%, 600mA, 3MHz, Vin>2V, LSST, CL	USP-6EL	56dc5	DC1	9a	Tor
LH3	XC9236C13DER	DC-DC-IC	PWM/PFM, st-dwn, 1.3V±2%, 600mA, 3MHz, Vin>2V, LSST, CL	USP-6C	49dc5	DC1	9a	Tor
LH3	XCL206C134AR-G	DC/DC-IC	PWM/PFM st-dwn, 3MHz, 1.3V±2%, 600mA, CL, soft start	CL-2025	67dc7	DC9	9a	Tor
LH4	XC9236C14D4R-G	DC-DC-IC	PWM/PFM, st-dwn, 1.4V±2%, 600mA, 3MHz, Vin>2V, LSST, CL	USP-6EL	56dc5	DC1	9a	Tor
LH4	XC9236C14DER	DC-DC-IC	PWM/PFM, st-dwn, 1.4V±2%, 600mA, 3MHz, Vin>2V, LSST, CL	USP-6C	49dc5	DC1	9a	Tor
LH4	XCL206C144AR-G	DC/DC-IC	PWM/PFM st-dwn, 3MHz, 1.4V±2%, 600mA, CL, soft start	CL-2025	67dc7	DC9	9a	Tor
LH5	XC9236C15D4R-G	DC-DC-IC	PWM/PFM, st-dwn, 1.5V±2%, 600mA, 3MHz, Vin>2V, LSST, CL	USP-6EL	56dc5	DC1	9a	Tor
LH5	XC9236C15DER	DC-DC-IC	PWM/PFM, st-dwn, 1.5V±2%, 600mA, 3MHz, Vin>2V, LSST, CL	USP-6C	49dc5	DC1	9a	Tor
LH5	XCL206C154AR-G	DC/DC-IC	PWM/PFM st-dwn, 3MHz, 1.5V±2%, 600mA, CL, soft start	CL-2025	67dc7	DC9	9a	Tor
LH6	XC9236C16D4R-G	DC-DC-IC	PWM/PFM, st-dwn, 1.6V±2%, 600mA, 3MHz, Vin>2V, LSST, CL	USP-6EL	56dc5	DC1	9a	Tor
LH6	XC9236C16DER	DC-DC-IC	PWM/PFM, st-dwn, 1.6V±2%, 600mA, 3MHz, Vin>2V, LSST, CL	USP-6C	49dc5	DC1	9a	Tor
LH6	XCL206C164AR-G	DC/DC-IC	PWM/PFM st-dwn, 3MHz, 1.6V±2%, 600mA, CL, soft start	CL-2025	67dc7	DC9	9a	Tor
LH7	XC9236C17D4R-G	DC-DC-IC	PWM/PFM, st-dwn, 1.7V±2%, 600mA, 3MHz, Vin>2V, LSST, CL	USP-6EL	56dc5	DC1	9a	Tor
LH7	XC9236C17DER	DC-DC-IC	PWM/PFM, st-dwn, 1.7V±2%, 600mA, 3MHz, Vin>2V, LSST, CL	USP-6C	49dc5	DC1	9a	Tor
LH7	XCL206C174AR-G	DC/DC-IC	PWM/PFM st-dwn, 3MHz, 1.7V±2%, 600mA, CL, soft start	CL-2025	67dc7	DC9	9a	Tor
LH8	XC9236C18D4R-G	DC-DC-IC	PWM/PFM, st-dwn, 1.8V±2%, 600mA, 3MHz, Vin>2V, LSST, CL	USP-6EL	56dc5	DC1	9a	Tor
LH8	XC9236C18DER	DC-DC-IC	PWM/PFM, st-dwn, 1.8V±2%, 600mA, 3MHz, Vin>2V, LSST, CL	USP-6C	49dc5	DC1	9a	Tor
LH8	XCL206C184AR-G	DC/DC-IC	PWM/PFM st-dwn, 3MHz, 1.8V±2%, 600mA, CL, soft start	CL-2025	67dc7	DC9	9a	Tor
LH9	XC9236C19D4R-G	DC-DC-IC	PWM/PFM, st-dwn, 1.9V±2%, 600mA, 3MHz, Vin>2V, LSST, CL	USP-6EL	56dc5	DC1	9a	Tor
LH9	XC9236C19DER	DC-DC-IC	PWM/PFM, st-dwn, 1.9V±2%, 600mA, 3MHz, Vin>2V, LSST, CL	USP-6C	49dc5	DC1	9a	Tor
LH9	XCL206C194AR-G	DC/DC-IC	PWM/PFM st-dwn, 3MHz, 1.9V±2%, 600mA, CL, soft start	CL-2025	67dc7	DC9	9a	Tor
LHA	XC9236C1AD4R-G	DC-DC-IC	PWM/PFM, st-dwn, 1.05V±2%, 600mA, 3MHz, Vin>2V, LSST, CL	USP-6EL	56dc5	DC1	9a	Tor
LHA	XC9236C1ADER	DC-DC-IC	PWM/PFM, st-dwn, 1.05V±2%, 600mA, 3MHz, Vin>2V, LSST, CL	USP-6C	49dc5	DC1	9a	Tor
LHB	XC9236C1BD4R-G	DC-DC-IC	PWM/PFM, st-dwn, 1.15V±2%, 600mA, 3MHz, Vin>2V, LSST, CL	USP-6EL	56dc5	DC1	9a	Tor
LHB	XC9236C1BDER	DC-DC-IC	PWM/PFM, st-dwn, 1.15V±2%, 600mA, 3MHz, Vin>2V, LSST, CL	USP-6C	49dc5	DC1	9a	Tor
LHC	XC9236C1CD4R-G	DC-DC-IC	PWM/PFM, st-dwn, 1.25V±2%, 600mA, 3MHz, Vin>2V, LSST, CL	USP-6EL	56dc5	DC1	9a	Tor
LHC	XC9236C1CDER	DC-DC-IC	PWM/PFM, st-dwn, 1.25V±2%, 600mA, 3MHz, Vin>2V, LSST, CL	USP-6C	49dc5	DC1	9a	Tor
LHD	XC9236C1DD4R-G	DC-DC-IC	PWM/PFM, st-dwn, 1.35V±2%, 600mA, 3MHz, Vin>2V, LSST, CL	USP-6EL	56dc5	DC1	9a	Tor
LHD	XC9236C1DDER	DC-DC-IC	PWM/PFM, st-dwn, 1.35V±2%, 600mA, 3MHz, Vin>2V, LSST, CL	USP-6C	49dc5	DC1	9a	Tor
LHE	XC9236C1ED4R-G	DC-DC-IC	PWM/PFM, st-dwn, 1.45V±2%, 600mA, 3MHz, Vin>2V, LSST, CL	USP-6EL	56dc5	DC1	9a	Tor
LHE	XC9236C1EDER	DC-DC-IC	PWM/PFM, st-dwn, 1.45V±2%, 600mA, 3MHz, Vin>2V, LSST, CL	USP-6C	49dc5	DC1	9a	Tor
LHF	XC9236C1FD4R-G	DC-DC-IC	PWM/PFM, st-dwn, 1.55V±2%, 600mA, 3MHz, Vin>2V, LSST, CL	USP-6EL	56dc5	DC1	9a	Tor
LHF	XC9236C1FDER	DC-DC-IC	PWM/PFM, st-dwn, 1.55V±2%, 600mA, 3MHz, Vin>2V, LSST, CL	USP-6C	49dc5	DC1	9a	Tor
LHH	XC9236C1HD4R-G	DC-DC-IC	PWM/PFM, st-dwn, 1.65V±2%, 600mA, 3MHz, Vin>2V, LSST, CL	USP-6EL	56dc5	DC1	9a	Tor
LHH	XC9236C1HDER	DC-DC-IC	PWM/PFM, st-dwn, 1.65V±2%, 600mA, 3MHz, Vin>2V, LSST, CL	USP-6C	49dc5	DC1	9a	Tor
LHK	XC9236C1KD4R-G	DC-DC-IC	PWM/PFM, st-dwn, 1.75V±2%, 600mA, 3MHz, Vin>2V, LSST, CL	USP-6EL	56dc5	DC1	9a	Tor
LHK	XC9236C1KDER	DC-DC-IC	PWM/PFM, st-dwn, 1.75V±2%, 600mA, 3MHz, Vin>2V, LSST, CL	USP-6C	49dc5	DC1	9a	Tor
LHL	XC9236C1LD4R-G	DC-DC-IC	PWM/PFM, st-dwn, 1.85V±2%, 600mA, 3MHz, Vin>2V, LSST, CL	USP-6EL	56dc5	DC1	9a	Tor
LHL	XC9236C1LDER	DC-DC-IC	PWM/PFM, st-dwn, 1.85V±2%, 600mA, 3MHz, Vin>2V, LSST, CL	USP-6C	49dc5	DC1	9a	Tor
LHM	XC9236C1MD4R-G	DC-DC-IC	PWM/PFM, st-dwn, 1.95V±2%, 600mA, 3MHz, Vin>2V, LSST, CL	USP-6EL	56dc5	DC1	9a	Tor
LHM	XC9236C1MDER	DC-DC-IC	PWM/PFM, st-dwn, 1.95V±2%, 600mA, 3MHz, Vin>2V, LSST, CL	USP-6C	49dc5	DC1	9a	Tor
LJ	R3116K391C	Vdet-IC	3.9V±0.8%, -Reset PPO	DFN1010-4	48j	VD3	9a	Ric
LJ	RP107K181D	LVR-IC	LDO, 1.8V±1%, 200mA, +CE, CL	DFN1212-6	52vr2	VR4	9a	Ric
LK	R3116K401C	Vdet-IC	4.0V±0.8%, -Reset PPO	DFN1010-4	48j	VD3	9a	Ric
LK	RP107K191D	LVR-IC	LDO, 1.9V±1%, 200mA, +CE, CL	DFN1212-6	52vr2	VR4	9a	Ric
LK0	XC9236C20D4R-G	DC-DC-IC	PWM/PFM, st-dwn, 2.0V±2%, 600mA, 3MHz, Vin>2V, LSST, CL	USP-6EL	56dc5	DC1	9a	Tor



SMD code	Type	Function	Short description	Case	Pinout	Sch.	St.	Mnf.
LK0	XC9236C20DER	DC-DC-IC	PWM/PFM, st-dwn, 2.0V±2%, 600mA, 3MHz, Vin>2V, LSST, CL	USP-6C	49dc5	DC1	9a	Tor
LK0	XCL206C204AR-G	DC/DC-IC	PWM/PFM st-dwn, 3MHz, 2.0V±2%, 600mA, CL, soft start	CL-2025	67dc7	DC9	9a	Tor
LK1	XC9236C21D4R-G	DC-DC-IC	PWM/PFM, st-dwn, 2.1V±2%, 600mA, 3MHz, Vin>2V, LSST, CL	USP-6EL	56dc5	DC1	9a	Tor
LK1	XC9236C21DER	DC-DC-IC	PWM/PFM, st-dwn, 2.1V±2%, 600mA, 3MHz, Vin>2V, LSST, CL	USP-6C	49dc5	DC1	9a	Tor
LK1	XCL206C214AR-G	DC/DC-IC	PWM/PFM st-dwn, 3MHz, 2.1V±2%, 600mA, CL, soft start	CL-2025	67dc7	DC9	9a	Tor
LK2	XC9236C22D4R-G	DC-DC-IC	PWM/PFM, st-dwn, 2.2V±2%, 600mA, 3MHz, Vin>2V, LSST, CL	USP-6EL	56dc5	DC1	9a	Tor
LK2	XC9236C22DER	DC-DC-IC	PWM/PFM, st-dwn, 2.2V±2%, 600mA, 3MHz, Vin>2V, LSST, CL	USP-6C	49dc5	DC1	9a	Tor
LK2	XCL206C224AR-G	DC/DC-IC	PWM/PFM st-dwn, 3MHz, 2.2V±2%, 600mA, CL, soft start	CL-2025	67dc7	DC9	9a	Tor
LK3	XC9236C23D4R-G	DC-DC-IC	PWM/PFM, st-dwn, 2.3V±2%, 600mA, 3MHz, Vin>2V, LSST, CL	USP-6EL	56dc5	DC1	9a	Tor
LK3	XC9236C23DER	DC-DC-IC	PWM/PFM, st-dwn, 2.3V±2%, 600mA, 3MHz, Vin>2V, LSST, CL	USP-6C	49dc5	DC1	9a	Tor
LK3	XCL206C234AR-G	DC/DC-IC	PWM/PFM st-dwn, 3MHz, 2.3V±2%, 600mA, CL, soft start	CL-2025	67dc7	DC9	9a	Tor
LK4	XC9236C24D4R-G	DC-DC-IC	PWM/PFM, st-dwn, 2.4V±2%, 600mA, 3MHz, Vin>2V, LSST, CL	USP-6EL	56dc5	DC1	9a	Tor
LK4	XC9236C24DER	DC-DC-IC	PWM/PFM, st-dwn, 2.4V±2%, 600mA, 3MHz, Vin>2V, LSST, CL	USP-6C	49dc5	DC1	9a	Tor
LK4	XCL206C244AR-G	DC/DC-IC	PWM/PFM st-dwn, 3MHz, 2.4V±2%, 600mA, CL, soft start	CL-2025	67dc7	DC9	9a	Tor
LK5	XC9236C25D4R-G	DC-DC-IC	PWM/PFM, st-dwn, 2.5V±2%, 600mA, 3MHz, Vin>2V, LSST, CL	USP-6EL	56dc5	DC1	9a	Tor
LK5	XC9236C25DER	DC-DC-IC	PWM/PFM, st-dwn, 2.5V±2%, 600mA, 3MHz, Vin>2V, LSST, CL	USP-6C	49dc5	DC1	9a	Tor
LK5	XCL206C254AR-G	DC/DC-IC	PWM/PFM st-dwn, 3MHz, 2.5V±2%, 600mA, CL, soft start	CL-2025	67dc7	DC9	9a	Tor
LK6	XC9236C26D4R-G	DC-DC-IC	PWM/PFM, st-dwn, 2.6V±2%, 600mA, 3MHz, Vin>2V, LSST, CL	USP-6EL	56dc5	DC1	9a	Tor
LK6	XC9236C26DER	DC-DC-IC	PWM/PFM, st-dwn, 2.6V±2%, 600mA, 3MHz, Vin>2V, LSST, CL	USP-6C	49dc5	DC1	9a	Tor
LK6	XCL206C264AR-G	DC/DC-IC	PWM/PFM st-dwn, 3MHz, 2.6V±2%, 600mA, CL, soft start	CL-2025	67dc7	DC9	9a	Tor
LK7	XC9236C27D4R-G	DC-DC-IC	PWM/PFM, st-dwn, 2.7V±2%, 600mA, 3MHz, Vin>2V, LSST, CL	USP-6EL	56dc5	DC1	9a	Tor
LK7	XC9236C27DER	DC-DC-IC	PWM/PFM, st-dwn, 2.7V±2%, 600mA, 3MHz, Vin>2V, LSST, CL	USP-6C	49dc5	DC1	9a	Tor
LK7	XCL206C274AR-G	DC/DC-IC	PWM/PFM st-dwn, 3MHz, 2.7V±2%, 600mA, CL, soft start	CL-2025	67dc7	DC9	9a	Tor
LK8	XC9236C28D4R-G	DC-DC-IC	PWM/PFM, st-dwn, 2.8V±2%, 600mA, 3MHz, Vin>2V, LSST, CL	USP-6EL	56dc5	DC1	9a	Tor
LK8	XC9236C28DER	DC-DC-IC	PWM/PFM, st-dwn, 2.8V±2%, 600mA, 3MHz, Vin>2V, LSST, CL	USP-6C	49dc5	DC1	9a	Tor
LK8	XCL206C284AR-G	DC/DC-IC	PWM/PFM st-dwn, 3MHz, 2.8V±2%, 600mA, CL, soft start	CL-2025	67dc7	DC9	9a	Tor
LK9	XC9236C29D4R-G	DC-DC-IC	PWM/PFM, st-dwn, 2.9V±2%, 600mA, 3MHz, Vin>2V, LSST, CL	USP-6EL	56dc5	DC1	9a	Tor
LK9	XC9236C29DER	DC-DC-IC	PWM/PFM, st-dwn, 2.9V±2%, 600mA, 3MHz, Vin>2V, LSST, CL	USP-6C	49dc5	DC1	9a	Tor
LK9	XCL206C294AR-G	DC/DC-IC	PWM/PFM st-dwn, 3MHz, 2.9V±2%, 600mA, CL, soft start	CL-2025	67dc7	DC9	9a	Tor
LKA	XC9236C2AD4R-G	DC-DC-IC	PWM/PFM, st-dwn, 2.05V±2%, 600mA, 3MHz, Vin>2V, LSST, CL	USP-6EL	56dc5	DC1	9a	Tor
LKA	XC9236C2ADER	DC-DC-IC	PWM/PFM, st-dwn, 2.05V±2%, 600mA, 3MHz, Vin>2V, LSST, CL	USP-6C	49dc5	DC1	9a	Tor
LKB	XC9236C2BD4R-G	DC-DC-IC	PWM/PFM, st-dwn, 2.15V±2%, 600mA, 3MHz, Vin>2V, LSST, CL	USP-6EL	56dc5	DC1	9a	Tor
LKB	XC9236C2BDER	DC-DC-IC	PWM/PFM, st-dwn, 2.15V±2%, 600mA, 3MHz, Vin>2V, LSST, CL	USP-6C	49dc5	DC1	9a	Tor
LKC	XC9236C2CD4R-G	DC-DC-IC	PWM/PFM, st-dwn, 2.25V±2%, 600mA, 3MHz, Vin>2V, LSST, CL	USP-6EL	56dc5	DC1	9a	Tor
LKC	XC9236C2CDER	DC-DC-IC	PWM/PFM, st-dwn, 2.25V±2%, 600mA, 3MHz, Vin>2V, LSST, CL	USP-6C	49dc5	DC1	9a	Tor
LKD	XC9236C2DD4R-G	DC-DC-IC	PWM/PFM, st-dwn, 2.35V±2%, 600mA, 3MHz, Vin>2V, LSST, CL	USP-6EL	56dc5	DC1	9a	Tor
LKD	XC9236C2DDER	DC-DC-IC	PWM/PFM, st-dwn, 2.35V±2%, 600mA, 3MHz, Vin>2V, LSST, CL	USP-6C	49dc5	DC1	9a	Tor
LKE	XC9236C2ED4R-G	DC-DC-IC	PWM/PFM, st-dwn, 2.45V±2%, 600mA, 3MHz, Vin>2V, LSST, CL	USP-6EL	56dc5	DC1	9a	Tor
LKE	XC9236C2EDER	DC-DC-IC	PWM/PFM, st-dwn, 2.45V±2%, 600mA, 3MHz, Vin>2V, LSST, CL	USP-6C	49dc5	DC1	9a	Tor
LKF	XC9236C2FD4R-G	DC-DC-IC	PWM/PFM, st-dwn, 2.55V±2%, 600mA, 3MHz, Vin>2V, LSST, CL	USP-6EL	56dc5	DC1	9a	Tor
LKF	XC9236C2FDER	DC-DC-IC	PWM/PFM, st-dwn, 2.55V±2%, 600mA, 3MHz, Vin>2V, LSST, CL	USP-6C	49dc5	DC1	9a	Tor
LKH	XC9236C2HD4R-G	DC-DC-IC	PWM/PFM, st-dwn, 2.65V±2%, 600mA, 3MHz, Vin>2V, LSST, CL	USP-6EL	56dc5	DC1	9a	Tor
LKH	XC9236C2HDER	DC-DC-IC	PWM/PFM, st-dwn, 2.65V±2%, 600mA, 3MHz, Vin>2V, LSST, CL	USP-6C	49dc5	DC1	9a	Tor
LKK	XC9236C2KD4R-G	DC-DC-IC	PWM/PFM, st-dwn, 2.75V±2%, 600mA, 3MHz, Vin>2V, LSST, CL	USP-6EL	56dc5	DC1	9a	Tor
LKK	XC9236C2KDER	DC-DC-IC	PWM/PFM, st-dwn, 2.75V±2%, 600mA, 3MHz, Vin>2V, LSST, CL	USP-6C	49dc5	DC1	9a	Tor
LKL	XC9236C2LD4R-G	DC-DC-IC	PWM/PFM, st-dwn, 2.85V±2%, 600mA, 3MHz, Vin>2V, LSST, CL	USP-6EL	56dc5	DC1	9a	Tor
LKL	XC9236C2LDER	DC-DC-IC	PWM/PFM, st-dwn, 2.85V±2%, 600mA, 3MHz, Vin>2V, LSST, CL	USP-6C	49dc5	DC1	9a	Tor
LKM	XC9236C2MD4R-G	DC-DC-IC	PWM/PFM, st-dwn, 2.95V±2%, 600mA, 3MHz, Vin>2V, LSST, CL	USP-6EL	56dc5	DC1	9a	Tor
LKM	XC9236C2MDER	DC-DC-IC	PWM/PFM, st-dwn, 2.95V±2%, 600mA, 3MHz, Vin>2V, LSST, CL	USP-6C	49dc5	DC1	9a	Tor
LL	GS18010AQ	LIN-IC	AF PA, BTL, class-D, 2.5..5.5V, 2.5W(5V/4Ω), shutdown	DFN-8	37	AFP24	-	Go2
LL	GS18010AW	LIN-IC	AF PA, BTL, class-D, 2.5..5.5V, 2.5W(5V/4Ω), shutdown	BGA-9	39	AFP45	-	Go2
LL	R3116K411C	Vdet-IC	4.1V±0.8%, -Reset PPO	DFN1010-4	48j	VD3	9a	Ric
LL	RP107K201D	LVR-IC	LDO, 2.0V±1%, 200mA, +CE, CL	DFN1212-6	52v2r	VR4	9a	Ric
LL0	XC9236C30D4R-G	DC-DC-IC	PWM/PFM, st-dwn, 3.0V±2%, 600mA, 3MHz, Vin>2V, LSST, CL	USP-6EL	56dc5	DC1	9a	Tor
LL0	XC9236C30DER	DC-DC-IC	PWM/PFM, st-dwn, 3.0V±2%, 600mA, 3MHz, Vin>2V, LSST, CL	USP-6C	49dc5	DC1	9a	Tor
LL0	XCL206C304AR-G	DC/DC-IC	PWM/PFM st-dwn, 3MHz, 3.0V±2%, 600mA, CL, soft start	CL-2025	67dc7	DC9	9a	Tor
LL1	XC9236C31D4R-G	DC-DC-IC	PWM/PFM, st-dwn, 3.1V±2%, 600mA, 3MHz, Vin>2V, LSST, CL	USP-6EL	56dc5	DC1	9a	Tor
LL1	XC9236C31DER	DC-DC-IC	PWM/PFM, st-dwn, 3.1V±2%, 600mA, 3MHz, Vin>2V, LSST, CL	USP-6C	49dc5	DC1	9a	Tor
LL1	XCL206C314AR-G	DC/DC-IC	PWM/PFM st-dwn, 3MHz, 3.1V±2%, 600mA, CL, soft start	CL-2025	67dc7	DC9	9a	Tor
LL2	XC9236C32D4R-G	DC-DC-IC	PWM/PFM, st-dwn, 3.2V±2%, 600mA, 3MHz, Vin>2V, LSST, CL	USP-6EL	56dc5	DC1	9a	Tor
LL2	XC9236C32DER	DC-DC-IC	PWM/PFM, st-dwn, 3.2V±2%, 600mA, 3MHz, Vin>2V, LSST, CL	USP-6C	49dc5	DC1	9a	Tor
LL2	XCL206C324AR-G	DC/DC-IC	PWM/PFM st-dwn, 3MHz, 3.2V±2%, 600mA, CL, soft start	CL-2025	67dc7	DC9	9a	Tor
LL3	XC9236C33D4R-G	DC-DC-IC	PWM/PFM, st-dwn, 3.3V±2%, 600mA, 3MHz, Vin>2V, LSST, CL	USP-6EL	56dc5	DC1	9a	Tor
LL3	XC9236C33DER	DC-DC-IC	PWM/PFM, st-dwn, 3.3V±2%, 600mA, 3MHz, Vin>2V, LSST, CL	USP-6C	49dc5	DC1	9a	Tor
LL3	XCL206C334AR-G	DC/DC-IC	PWM/PFM st-dwn, 3MHz, 3.3V±2%, 600mA, CL, soft start	CL-2025	67dc7	DC9	9a	Tor
LL4	XC9236C34D4R-G	DC-DC-IC	PWM/PFM, st-dwn, 3.4V±2%, 600mA, 3MHz, Vin>2V, LSST, CL	USP-6EL	56dc5	DC1	9a	Tor
LL4	XC9236C34DER	DC-DC-IC	PWM/PFM, st-dwn, 3.4V±2%, 600mA, 3MHz, Vin>2V, LSST, CL	USP-6C	49dc5	DC1	9a	Tor
LL4	XCL206C344AR-G	DC/DC-IC	PWM/PFM st-dwn, 3MHz, 3.4V±2%, 600mA, CL, soft start	CL-2025	67dc7	DC9	9a	Tor
LL5	XC9236C35D4R-G	DC-DC-IC	PWM/PFM, st-dwn, 3.5V±2%, 600mA, 3MHz, Vin>2V, LSST, CL	USP-6EL	56dc5	DC1	9a	Tor
LL5	XC9236C35DER	DC-DC-IC	PWM/PFM, st-dwn, 3.5V±2%, 600mA, 3MHz, Vin>2V, LSST, CL	USP-6C	49dc5	DC1	9a	Tor



SMD code	Type	Function	Short description	Case	Pinout	Sch.	St.	Mnf.
LL5	XCL206C354AR-G	DC/DC-IC	PWM/PFM st-dwn, 3MHz, 3.5V±2%, 600mA, CL, soft start	CL-2025	67dc7	DC9	9a	Tor
LL6	XC9236C36DAR-G	DC-DC-IC	PWM/PFM, st-dwn, 3.6V±2%, 600mA, 3MHz, Vin>2V, LSST, CL	USP-6EL	56dc5	DC1	9a	Tor
LL6	XC9236C36DER	DC-DC-IC	PWM/PFM, st-dwn, 3.6V±2%, 600mA, 3MHz, Vin>2V, LSST, CL	USP-6C	49dc5	DC1	9a	Tor
LL6	XCL206C364AR-G	DC/DC-IC	PWM/PFM st-dwn, 3MHz, 3.6V±2%, 600mA, CL, soft start	CL-2025	67dc7	DC9	9a	Tor
LL7	XC9236C37DAR-G	DC-DC-IC	PWM/PFM, st-dwn, 3.7V±2%, 600mA, 3MHz, Vin>2V, LSST, CL	USP-6EL	56dc5	DC1	9a	Tor
LL7	XC9236C37DER	DC-DC-IC	PWM/PFM, st-dwn, 3.7V±2%, 600mA, 3MHz, Vin>2V, LSST, CL	USP-6C	49dc5	DC1	9a	Tor
LL7	XCL206C374AR-G	DC/DC-IC	PWM/PFM st-dwn, 3MHz, 3.7V±2%, 600mA, CL, soft start	CL-2025	67dc7	DC9	9a	Tor
LL8	XC9236C38DAR-G	DC-DC-IC	PWM/PFM, st-dwn, 3.8V±2%, 600mA, 3MHz, Vin>2V, LSST, CL	USP-6EL	56dc5	DC1	9a	Tor
LL8	XC9236C38DER	DC-DC-IC	PWM/PFM, st-dwn, 3.8V±2%, 600mA, 3MHz, Vin>2V, LSST, CL	USP-6C	49dc5	DC1	9a	Tor
LL8	XCL206C384AR-G	DC/DC-IC	PWM/PFM st-dwn, 3MHz, 3.8V±2%, 600mA, CL, soft start	CL-2025	67dc7	DC9	9a	Tor
LL9	XC9236C39DAR-G	DC-DC-IC	PWM/PFM, st-dwn, 3.9V±2%, 600mA, 3MHz, Vin>2V, LSST, CL	USP-6EL	56dc5	DC1	9a	Tor
LL9	XC9236C39DER	DC-DC-IC	PWM/PFM, st-dwn, 3.9V±2%, 600mA, 3MHz, Vin>2V, LSST, CL	USP-6C	49dc5	DC1	9a	Tor
LL9	XCL206C394AR-G	DC/DC-IC	PWM/PFM st-dwn, 3MHz, 3.9V±2%, 600mA, CL, soft start	CL-2025	67dc7	DC9	9a	Tor
LLA	XC9236C3ADAR-G	DC-DC-IC	PWM/PFM, st-dwn, 3.05V±2%, 600mA, 3MHz, Vin>2V, LSST, CL	USP-6EL	56dc5	DC1	9a	Tor
LLA	XC9236C3ADER	DC-DC-IC	PWM/PFM, st-dwn, 3.05V±2%, 600mA, 3MHz, Vin>2V, LSST, CL	USP-6C	49dc5	DC1	9a	Tor
LLB	XC9236C3BDAR-G	DC-DC-IC	PWM/PFM, st-dwn, 3.15V±2%, 600mA, 3MHz, Vin>2V, LSST, CL	USP-6EL	56dc5	DC1	9a	Tor
LLB	XC9236C3BDER	DC-DC-IC	PWM/PFM, st-dwn, 3.15V±2%, 600mA, 3MHz, Vin>2V, LSST, CL	USP-6C	49dc5	DC1	9a	Tor
LLC	XC9236C3CDAR-G	DC-DC-IC	PWM/PFM, st-dwn, 3.25V±2%, 600mA, 3MHz, Vin>2V, LSST, CL	USP-6EL	56dc5	DC1	9a	Tor
LLC	XC9236C3CDER	DC-DC-IC	PWM/PFM, st-dwn, 3.25V±2%, 600mA, 3MHz, Vin>2V, LSST, CL	USP-6C	49dc5	DC1	9a	Tor
LLD	XC9236C3DDAR-G	DC-DC-IC	PWM/PFM, st-dwn, 3.35V±2%, 600mA, 3MHz, Vin>2V, LSST, CL	USP-6EL	56dc5	DC1	9a	Tor
LLD	XC9236C3DDER	DC-DC-IC	PWM/PFM, st-dwn, 3.35V±2%, 600mA, 3MHz, Vin>2V, LSST, CL	USP-6C	49dc5	DC1	9a	Tor
LLE	XC9236C3EDAR-G	DC-DC-IC	PWM/PFM, st-dwn, 3.45V±2%, 600mA, 3MHz, Vin>2V, LSST, CL	USP-6EL	56dc5	DC1	9a	Tor
LLE	XC9236C3EDER	DC-DC-IC	PWM/PFM, st-dwn, 3.45V±2%, 600mA, 3MHz, Vin>2V, LSST, CL	USP-6C	49dc5	DC1	9a	Tor
LLF	XC9236C3FDAR-G	DC-DC-IC	PWM/PFM, st-dwn, 3.55V±2%, 600mA, 3MHz, Vin>2V, LSST, CL	USP-6EL	56dc5	DC1	9a	Tor
LLF	XC9236C3FDER	DC-DC-IC	PWM/PFM, st-dwn, 3.55V±2%, 600mA, 3MHz, Vin>2V, LSST, CL	USP-6C	49dc5	DC1	9a	Tor
LLH	XC9236C3HDAR-G	DC-DC-IC	PWM/PFM, st-dwn, 3.65V±2%, 600mA, 3MHz, Vin>2V, LSST, CL	USP-6EL	56dc5	DC1	9a	Tor
LLH	XC9236C3HDER	DC-DC-IC	PWM/PFM, st-dwn, 3.65V±2%, 600mA, 3MHz, Vin>2V, LSST, CL	USP-6C	49dc5	DC1	9a	Tor
LLK	XC9236C3KDAR-G	DC-DC-IC	PWM/PFM, st-dwn, 3.75V±2%, 600mA, 3MHz, Vin>2V, LSST, CL	USP-6EL	56dc5	DC1	9a	Tor
LLK	XC9236C3KDER	DC-DC-IC	PWM/PFM, st-dwn, 3.75V±2%, 600mA, 3MHz, Vin>2V, LSST, CL	USP-6C	49dc5	DC1	9a	Tor
LLL	XC9236C3LDAR-G	DC-DC-IC	PWM/PFM, st-dwn, 3.85V±2%, 600mA, 3MHz, Vin>2V, LSST, CL	USP-6EL	56dc5	DC1	9a	Tor
LLL	XC9236C3LDER	DC-DC-IC	PWM/PFM, st-dwn, 3.85V±2%, 600mA, 3MHz, Vin>2V, LSST, CL	USP-6C	49dc5	DC1	9a	Tor
LLM	XC9236C3MDAR-G	DC-DC-IC	PWM/PFM, st-dwn, 3.95V±2%, 600mA, 3MHz, Vin>2V, LSST, CL	USP-6EL	56dc5	DC1	9a	Tor
LLM	XC9236C3MDER	DC-DC-IC	PWM/PFM, st-dwn, 3.95V±2%, 600mA, 3MHz, Vin>2V, LSST, CL	USP-6C	49dc5	DC1	9a	Tor
LM	R3116K421C	Vdel-IC	4.2V±0.8%, -Reset PPO	DFN1010-4	48j	VD3	9a	Ric
LM	RP107K211D	LVR-IC	LDO, 2.1V±1%, 200mA, +CE, CL	DFN1212-6	52vr2	VR4	9a	Ric
LM0	XC9236C40DAR-G	DC-DC-IC	PWM/PFM, st-dwn, 4.0V±2%, 600mA, 3MHz, Vin>2V, LSST, CL	USP-6EL	56dc5	DC1	9a	Tor
LM0	XC9236C40DER	DC-DC-IC	PWM/PFM, st-dwn, 4.0V±2%, 600mA, 3MHz, Vin>2V, LSST, CL	USP-6C	49dc5	DC1	9a	Tor
LM0	XCL206C404AR-G	DC/DC-IC	PWM/PFM st-dwn, 3MHz, 4.0V±2%, 600mA, CL, soft start	CL-2025	67dc7	DC9	9a	Tor
LN	R3116K431C	Vdel-IC	4.3V±0.8%, -Reset PPO	DFN1010-4	48j	VD3	9a	Ric
LN	RP107K221D	LVR-IC	LDO, 2.2V±1%, 200mA, +CE, CL	DFN1212-6	52vr2	VR4	9a	Ric
LN8	XC9236D08CER	DC-DC-IC	PWM/PFM, st-dwn, 0.8V±2%, 600mA, 1.2MHz, Vin>1.8V, LSST, CL	USP-6C	49da	DC16	9a	Tor
LN9	XC9236D09CER	DC-DC-IC	PWM/PFM, st-dwn, 0.9V±2%, 600mA, 1.2MHz, Vin>1.8V, LSST, CL	USP-6C	49da	DC16	9a	Tor
LNL	XC9236D0LCER	DC-DC-IC	PWM/PFM, st-dwn, 0.85V±2%, 600mA, 1.2MHz, Vin>1.8V, LSST, CL	USP-6C	49da	DC16	9a	Tor
LNM	XC9236D0MCER	DC-DC-IC	PWM/PFM, st-dwn, 0.95V±2%, 600mA, 1.2MHz, Vin>1.8V, LSST, CL	USP-6C	49da	DC16	9a	Tor
LP	R3116K441C	Vdel-IC	4.4V±0.8%, -Reset PPO	DFN1010-4	48j	VD3	9a	Ric
LP	RP107K231D	LVR-IC	LDO, 2.3V±1%, 200mA, +CE, CL	DFN1212-6	52vr2	VR4	9a	Ric
LP0	XC9236D10CER	DC-DC-IC	PWM/PFM, st-dwn, 1.0V±2%, 600mA, 1.2MHz, Vin>1.8V, LSST, CL	USP-6C	49da	DC16	9a	Tor
LP1	XC9236D11CER	DC-DC-IC	PWM/PFM, st-dwn, 1.1V±2%, 600mA, 1.2MHz, Vin>1.8V, LSST, CL	USP-6C	49da	DC16	9a	Tor
LP2	XC9236D12CER	DC-DC-IC	PWM/PFM, st-dwn, 1.2V±2%, 600mA, 1.2MHz, Vin>1.8V, LSST, CL	USP-6C	49da	DC16	9a	Tor
LP3	XC9236D13CER	DC-DC-IC	PWM/PFM, st-dwn, 1.3V±2%, 600mA, 1.2MHz, Vin>1.8V, LSST, CL	USP-6C	49da	DC16	9a	Tor
LP4	XC9236D14CER	DC-DC-IC	PWM/PFM, st-dwn, 1.4V±2%, 600mA, 1.2MHz, Vin>1.8V, LSST, CL	USP-6C	49da	DC16	9a	Tor
LP5	XC9236D15CER	DC-DC-IC	PWM/PFM, st-dwn, 1.5V±2%, 600mA, 1.2MHz, Vin>1.8V, LSST, CL	USP-6C	49da	DC16	9a	Tor
LP6	XC9236D16CER	DC-DC-IC	PWM/PFM, st-dwn, 1.6V±2%, 600mA, 1.2MHz, Vin>1.8V, LSST, CL	USP-6C	49da	DC16	9a	Tor
LP7	XC9236D17CER	DC-DC-IC	PWM/PFM, st-dwn, 1.7V±2%, 600mA, 1.2MHz, Vin>1.8V, LSST, CL	USP-6C	49da	DC16	9a	Tor
LP8	XC9236D18CER	DC-DC-IC	PWM/PFM, st-dwn, 1.8V±2%, 600mA, 1.2MHz, Vin>1.8V, LSST, CL	USP-6C	49da	DC16	9a	Tor
LP9	XC9236D19CER	DC-DC-IC	PWM/PFM, st-dwn, 1.9V±2%, 600mA, 1.2MHz, Vin>1.8V, LSST, CL	USP-6C	49da	DC16	9a	Tor
LPA	XC9236D1ACER	DC-DC-IC	PWM/PFM, st-dwn, 1.05V±2%, 600mA, 1.2MHz, Vin>1.8V, LSST, CL	USP-6C	49da	DC16	9a	Tor
LPB	XC9236D1BCER	DC-DC-IC	PWM/PFM, st-dwn, 1.15V±2%, 600mA, 1.2MHz, Vin>1.8V, LSST, CL	USP-6C	49da	DC16	9a	Tor
LPC	XC9236D1CCER	DC-DC-IC	PWM/PFM, st-dwn, 1.25V±2%, 600mA, 1.2MHz, Vin>1.8V, LSST, CL	USP-6C	49da	DC16	9a	Tor
LPD	XC9236D1DCER	DC-DC-IC	PWM/PFM, st-dwn, 1.35V±2%, 600mA, 1.2MHz, Vin>1.8V, LSST, CL	USP-6C	49da	DC16	9a	Tor
LPE	XC9236D1ECER	DC-DC-IC	PWM/PFM, st-dwn, 1.45V±2%, 600mA, 1.2MHz, Vin>1.8V, LSST, CL	USP-6C	49da	DC16	9a	Tor
LPF	XC9236D1FCER	DC-DC-IC	PWM/PFM, st-dwn, 1.55V±2%, 600mA, 1.2MHz, Vin>1.8V, LSST, CL	USP-6C	49da	DC16	9a	Tor
LPH	XC9236D1HCER	DC-DC-IC	PWM/PFM, st-dwn, 1.65V±2%, 600mA, 1.2MHz, Vin>1.8V, LSST, CL	USP-6C	49da	DC16	9a	Tor
LPK	XC9236D1KCER	DC-DC-IC	PWM/PFM, st-dwn, 1.75V±2%, 600mA, 1.2MHz, Vin>1.8V, LSST, CL	USP-6C	49da	DC16	9a	Tor
LPL	XC9236D1LCER	DC-DC-IC	PWM/PFM, st-dwn, 1.85V±2%, 600mA, 1.2MHz, Vin>1.8V, LSST, CL	USP-6C	49da	DC16	9a	Tor
LPM	XC9236D1MCER	DC-DC-IC	PWM/PFM, st-dwn, 1.95V±2%, 600mA, 1.2MHz, Vin>1.8V, LSST, CL	USP-6C	49da	DC16	9a	Tor
LQ	R3116K451C	Vdel-IC	4.5V±0.8%, -Reset PPO	DFN1010-4	48j	VD3	9a	Ric
LQ	RP107K241D	LVR-IC	LDO, 2.4V±1%, 200mA, +CE, CL	DFN1212-6	52vr2	VR4	9a	Ric
LR	R3116K461C	Vdel-IC	4.6V±0.8%, -Reset PPO	DFN1010-4	48j	VD3	9a	Ric
LR	RP107K251D	LVR-IC	LDO, 2.5V±1%, 200mA, +CE, CL	DFN1212-6	52vr2	VR4	9a	Ric



SMD code	Type	Function	Short description	Case	Pinout	Sch.	St.	Mnf.
LVF	XC9236D1FDER	DC-DC-IC	PWM/PFM, st-dwn, 1.55V±2%, 600mA, 3MHz, Vin>1.8V, LSST, CL	USP-6C	49da	DC16	9a	Tor
LVH	XC9236D1HDER	DC-DC-IC	PWM/PFM, st-dwn, 1.65V±2%, 600mA, 3MHz, Vin>1.8V, LSST, CL	USP-6C	49da	DC16	9a	Tor
LVK	XC9236D1KDER	DC-DC-IC	PWM/PFM, st-dwn, 1.75V±2%, 600mA, 3MHz, Vin>1.8V, LSST, CL	USP-6C	49da	DC16	9a	Tor
LVL	XC9236D1LDER	DC-DC-IC	PWM/PFM, st-dwn, 1.85V±2%, 600mA, 3MHz, Vin>1.8V, LSST, CL	USP-6C	49da	DC16	9a	Tor
LVM	XC9236D1MDER	DC-DC-IC	PWM/PFM, st-dwn, 1.95V±2%, 600mA, 3MHz, Vin>1.8V, LSST, CL	USP-6C	49da	DC16	9a	Tor
LW	MAX8840ELT29+T	LVR-IC	LDO, 2.85V±2%, 150mA, +CE	DFN-6	52	VR7a	9t	Max
LW	RP107K301D	LVR-IC	LDO, 3.0V±1%, 200mA, +CE, CL	DFN1212-6	52vr2	VR4	9a	Ric
LX	MAX8840ELT19+T	LVR-IC	LDO, 1.9V±2%, 150mA, +CE	DFN-6	52	VR7a	9t	Max
LX	RP107K311D	LVR-IC	LDO, 3.1V±1%, 200mA, +CE, CL	DFN1212-6	52vr2	VR4	9a	Ric
LX0	XC9236D20DER	DC-DC-IC	PWM/PFM, st-dwn, 2.0V±2%, 600mA, 3MHz, Vin>1.8V, LSST, CL	USP-6C	49da	DC16	9a	Tor
LX1	XC9236D21DER	DC-DC-IC	PWM/PFM, st-dwn, 2.1V±2%, 600mA, 3MHz, Vin>1.8V, LSST, CL	USP-6C	49da	DC16	9a	Tor
LX2	XC9236D22DER	DC-DC-IC	PWM/PFM, st-dwn, 2.2V±2%, 600mA, 3MHz, Vin>1.8V, LSST, CL	USP-6C	49da	DC16	9a	Tor
LX3	XC9236D23DER	DC-DC-IC	PWM/PFM, st-dwn, 2.3V±2%, 600mA, 3MHz, Vin>1.8V, LSST, CL	USP-6C	49da	DC16	9a	Tor
LX4	XC9236D24DER	DC-DC-IC	PWM/PFM, st-dwn, 2.4V±2%, 600mA, 3MHz, Vin>1.8V, LSST, CL	USP-6C	49da	DC16	9a	Tor
LX5	XC9236D25DER	DC-DC-IC	PWM/PFM, st-dwn, 2.5V±2%, 600mA, 3MHz, Vin>1.8V, LSST, CL	USP-6C	49da	DC16	9a	Tor
LX6	XC9236D26DER	DC-DC-IC	PWM/PFM, st-dwn, 2.6V±2%, 600mA, 3MHz, Vin>1.8V, LSST, CL	USP-6C	49da	DC16	9a	Tor
LX7	XC9236D27DER	DC-DC-IC	PWM/PFM, st-dwn, 2.7V±2%, 600mA, 3MHz, Vin>1.8V, LSST, CL	USP-6C	49da	DC16	9a	Tor
LX8	XC9236D28DER	DC-DC-IC	PWM/PFM, st-dwn, 2.8V±2%, 600mA, 3MHz, Vin>1.8V, LSST, CL	USP-6C	49da	DC16	9a	Tor
LX9	XC9236D29DER	DC-DC-IC	PWM/PFM, st-dwn, 2.9V±2%, 600mA, 3MHz, Vin>1.8V, LSST, CL	USP-6C	49da	DC16	9a	Tor
LXA	XC9236D2ADER	DC-DC-IC	PWM/PFM, st-dwn, 2.05V±2%, 600mA, 3MHz, Vin>1.8V, LSST, CL	USP-6C	49da	DC16	9a	Tor
LXB	XC9236D2BDER	DC-DC-IC	PWM/PFM, st-dwn, 2.15V±2%, 600mA, 3MHz, Vin>1.8V, LSST, CL	USP-6C	49da	DC16	9a	Tor
LXC	XC9236D2CDER	DC-DC-IC	PWM/PFM, st-dwn, 2.25V±2%, 600mA, 3MHz, Vin>1.8V, LSST, CL	USP-6C	49da	DC16	9a	Tor
LXD	XC9236D2DDER	DC-DC-IC	PWM/PFM, st-dwn, 2.35V±2%, 600mA, 3MHz, Vin>1.8V, LSST, CL	USP-6C	49da	DC16	9a	Tor
LXE	XC9236D2EDER	DC-DC-IC	PWM/PFM, st-dwn, 2.45V±2%, 600mA, 3MHz, Vin>1.8V, LSST, CL	USP-6C	49da	DC16	9a	Tor
LXF	XC9236D2FDER	DC-DC-IC	PWM/PFM, st-dwn, 2.55V±2%, 600mA, 3MHz, Vin>1.8V, LSST, CL	USP-6C	49da	DC16	9a	Tor
LXH	XC9236D2HDER	DC-DC-IC	PWM/PFM, st-dwn, 2.65V±2%, 600mA, 3MHz, Vin>1.8V, LSST, CL	USP-6C	49da	DC16	9a	Tor
LXK	XC9236D2KDER	DC-DC-IC	PWM/PFM, st-dwn, 2.75V±2%, 600mA, 3MHz, Vin>1.8V, LSST, CL	USP-6C	49da	DC16	9a	Tor
LXL	XC9236D2LDER	DC-DC-IC	PWM/PFM, st-dwn, 2.85V±2%, 600mA, 3MHz, Vin>1.8V, LSST, CL	USP-6C	49da	DC16	9a	Tor
LXM	XC9236D2MDER	DC-DC-IC	PWM/PFM, st-dwn, 2.95V±2%, 600mA, 3MHz, Vin>1.8V, LSST, CL	USP-6C	49da	DC16	9a	Tor
LY	RP107K321D	LVR-IC	LDO, 3.2V±1%, 200mA, +CE, CL	DFN1212-6	52vr2	VR4	9a	Ric
LY0	XC9236D30DER	DC-DC-IC	PWM/PFM, st-dwn, 3.0V±2%, 600mA, 3MHz, Vin>1.8V, LSST, CL	USP-6C	49da	DC16	9a	Tor
LY1	XC9236D31DER	DC-DC-IC	PWM/PFM, st-dwn, 3.1V±2%, 600mA, 3MHz, Vin>1.8V, LSST, CL	USP-6C	49da	DC16	9a	Tor
LY2	XC9236D32DER	DC-DC-IC	PWM/PFM, st-dwn, 3.2V±2%, 600mA, 3MHz, Vin>1.8V, LSST, CL	USP-6C	49da	DC16	9a	Tor
LY3	XC9236D33DER	DC-DC-IC	PWM/PFM, st-dwn, 3.3V±2%, 600mA, 3MHz, Vin>1.8V, LSST, CL	USP-6C	49da	DC16	9a	Tor
LY4	XC9236D34DER	DC-DC-IC	PWM/PFM, st-dwn, 3.4V±2%, 600mA, 3MHz, Vin>1.8V, LSST, CL	USP-6C	49da	DC16	9a	Tor
LY5	XC9236D35DER	DC-DC-IC	PWM/PFM, st-dwn, 3.5V±2%, 600mA, 3MHz, Vin>1.8V, LSST, CL	USP-6C	49da	DC16	9a	Tor
LY6	XC9236D36DER	DC-DC-IC	PWM/PFM, st-dwn, 3.6V±2%, 600mA, 3MHz, Vin>1.8V, LSST, CL	USP-6C	49da	DC16	9a	Tor
LY7	XC9236D37DER	DC-DC-IC	PWM/PFM, st-dwn, 3.7V±2%, 600mA, 3MHz, Vin>1.8V, LSST, CL	USP-6C	49da	DC16	9a	Tor
LY8	XC9236D38DER	DC-DC-IC	PWM/PFM, st-dwn, 3.8V±2%, 600mA, 3MHz, Vin>1.8V, LSST, CL	USP-6C	49da	DC16	9a	Tor
LY9	XC9236D39DER	DC-DC-IC	PWM/PFM, st-dwn, 3.9V±2%, 600mA, 3MHz, Vin>1.8V, LSST, CL	USP-6C	49da	DC16	9a	Tor
LYA	XC9236D3ADER	DC-DC-IC	PWM/PFM, st-dwn, 3.05V±2%, 600mA, 3MHz, Vin>1.8V, LSST, CL	USP-6C	49da	DC16	9a	Tor
LYB	XC9236D3BDER	DC-DC-IC	PWM/PFM, st-dwn, 3.15V±2%, 600mA, 3MHz, Vin>1.8V, LSST, CL	USP-6C	49da	DC16	9a	Tor
LYC	XC9236D3CDER	DC-DC-IC	PWM/PFM, st-dwn, 3.25V±2%, 600mA, 3MHz, Vin>1.8V, LSST, CL	USP-6C	49da	DC16	9a	Tor
LYD	XC9236D3DDER	DC-DC-IC	PWM/PFM, st-dwn, 3.35V±2%, 600mA, 3MHz, Vin>1.8V, LSST, CL	USP-6C	49da	DC16	9a	Tor
LYE	XC9236D3EDER	DC-DC-IC	PWM/PFM, st-dwn, 3.45V±2%, 600mA, 3MHz, Vin>1.8V, LSST, CL	USP-6C	49da	DC16	9a	Tor
LYF	XC9236D3FDER	DC-DC-IC	PWM/PFM, st-dwn, 3.55V±2%, 600mA, 3MHz, Vin>1.8V, LSST, CL	USP-6C	49da	DC16	9a	Tor
LYH	XC9236D3HDER	DC-DC-IC	PWM/PFM, st-dwn, 3.65V±2%, 600mA, 3MHz, Vin>1.8V, LSST, CL	USP-6C	49da	DC16	9a	Tor
LYK	XC9236D3KDER	DC-DC-IC	PWM/PFM, st-dwn, 3.75V±2%, 600mA, 3MHz, Vin>1.8V, LSST, CL	USP-6C	49da	DC16	9a	Tor
LYL	XC9236D3LDER	DC-DC-IC	PWM/PFM, st-dwn, 3.85V±2%, 600mA, 3MHz, Vin>1.8V, LSST, CL	USP-6C	49da	DC16	9a	Tor
LYM	XC9236D3MDER	DC-DC-IC	PWM/PFM, st-dwn, 3.95V±2%, 600mA, 3MHz, Vin>1.8V, LSST, CL	USP-6C	49da	DC16	9a	Tor
LZ	MAX8840ELT30+T	LVR-IC	LDO, 3.0V±2%, 150mA, +CE	DFN-6	52	VR7a	9t	Max
LZ	RP107K331D	LVR-IC	LDO, 3.3V±1%, 200mA, +CE, CL	DFN1212-6	52vr2	VR4	9a	Ric
LZ0	XC9236D40DER	DC-DC-IC	PWM/PFM, st-dwn, 4.0V±2%, 600mA, 3MHz, Vin>1.8V, LSST, CL	USP-6C	49da	DC16	9a	Tor
M0	R3117K173A	Vdet-IC	1.7V±1%, -Reset ODO, Sense	DFN1010-4	48rq	VD11	9a	Ric
M0	RP114K181B	LVR-IC	LDO, 1.8V±1%, 300mA, +CE	DFN1010-4	48vm	VR4	9a	Ric
MOA	XC6108N20AGR	Vdet-IC	2.0V±2%, Hysteresis, -Reset ODO	USP-4	45ro	VD14	9b	Tor
MOA	XC6118C10AGR-G	Vdet-IC	1.0V±30mV, ±Reset PPO, Sense, hysteresis 5%, Cd	USP-4	45me	VD15	9a	Tor
MOB	XC6108N20BGR	Vdet-IC	2.0V±2%, -Reset ODO	USP-4	45ro	VD14	9b	Tor
MOB	XC6118C10BGR-G	Vdet-IC	1.0V±30mV, ±Reset PPO, Sense, hysteresis <1%, Cd	USP-4	45me	VD15	9a	Tor
MOC	XC6108N20CGR	Vdet-IC	2.0V±2%, Hysteresis, -Reset ODO	USP-4	45m	VD14	9b	Tor
MOC	XC6118C10CGR-G	Vdet-IC	1.0V±30mV, ±Reset PPO, Sense, hysteresis 5%	USP-4	45md	VD12	9a	Tor
MOD	XC6108N20DGR	Vdet-IC	2.0V±2%, -Reset ODO	USP-4	45m	VD14	9b	Tor
MOD	XC6118C10DGR-G	Vdet-IC	1.0V±30mV, ±Reset PPO, Sense, hysteresis <1%	USP-4	45md	VD12	9a	Tor
M1	R3117K183A	Vdet-IC	1.8V±1%, -Reset ODO, Sense	DFN1010-4	48rq	VD11	9a	Ric
M1	RP114K191B	LVR-IC	LDO, 1.9V±1%, 300mA, +CE	DFN1010-4	48vm	VR4	9a	Ric
M15B	R1163K151B	LVR-IC	LDO, 1.5V±2.5%, 150mA, +CE, AE(mode)	PLP1616-6	66vj	VR10	9b	Ric
M16B	R1163K161B	LVR-IC	LDO, 1.6V±2.5%, 150mA, +CE, AE(mode)	PLP1616-6	66vj	VR10	9b	Ric
M17B	R1163K171B	LVR-IC	LDO, 1.7V±2.5%, 150mA, +CE, AE(mode)	PLP1616-6	66vj	VR10	9b	Ric
M185	R1163K181B5	LVR-IC	LDO, 1.85V±2.5%, 150mA, +CE, AE(mode)	PLP1616-6	66vj	VR10	9b	Ric
M18B	R1163K181B	LVR-IC	LDO, 1.8V±2.5%, 150mA, +CE, AE(mode)	PLP1616-6	66vj	VR10	9b	Ric



SMD code	Type	Function	Short description	Case	Pinout	Sch.	St.Mnf.
M19B	R1163K191B	LVR-IC	LDO, 1.9V±2.5%, 150mA, +CE, AE(mode)	PLP1616-6	66vjj	VR10	9b Ric
M1A	XC6108N21AGR	Vdet-IC	2.1V±2%, Hysteresis, -Reset ODO	USP-4	45ro	VD14	9a Tor
M1A	XC6118C11AGR-G	Vdet-IC	1.1V±30mV, ±Reset PPO, Sense, hysteresis 5%, Cd	USP-4	45me	VD15	9a Tor
M1B	XC6108N21BGR	Vdet-IC	2.1V±2%, -Reset ODO	USP-4	45ro	VD14	9b Tor
M1B	XC6118C11BGR-G	Vdet-IC	1.1V±30mV, ±Reset PPO, Sense, hysteresis <1%, Cd	USP-4	45me	VD15	9a Tor
M1C	XC6108N21CGR	Vdet-IC	2.1V±2%, Hysteresis, -Reset ODO	USP-4	45ro	VD14	9b Tor
M1C	XC6118C11CGR-G	Vdet-IC	1.1V±30mV, ±Reset PPO, Sense, hysteresis 5%	USP-4	45md	VD12	9a Tor
M1D	XC6108N21DGR	Vdet-IC	2.1V±2%, -Reset ODO	USP-4	45rn	VD14	9b Tor
M1D	XC6118C11DGR-G	Vdet-IC	1.1V±30mV, ±Reset PPO, Sense, hysteresis <1%	USP-4	45md	VD12	9a Tor
M2	R3117K193A	Vdet-IC	1.9V±1%, -Reset ODO, Sense	DFN1010-4	48rq	VD11	9a Ric
M2	RP114K201B	LVR-IC	LDO, 2.0V±1%, 300mA, +CE	DFN1010-4	48vm	VR4	9a Ric
M20B	R1163K201B	LVR-IC	LDO, 2V±2.5%, 150mA, +CE, AE(mode)	PLP1616-6	66vjj	VR10	9b Ric
M21B	R1163K211B	LVR-IC	LDO, 2.1V±2.5%, 150mA, +CE, AE(mode)	PLP1616-6	66vjj	VR10	9b Ric
M22B	R1163K221B	LVR-IC	LDO, 2.2V±2.5%, 150mA, +CE, AE(mode)	PLP1616-6	66vjj	VR10	9b Ric
M23B	R1163K231B	LVR-IC	LDO, 2.3V±2.5%, 150mA, +CE, AE(mode)	PLP1616-6	66vjj	VR10	9b Ric
M24B	R1163K241B	LVR-IC	LDO, 2.4V±2.5%, 150mA, +CE, AE(mode)	PLP1616-6	66vjj	VR10	9b Ric
M25B	R1163K251B	LVR-IC	LDO, 2.5V±2.5%, 150mA, +CE, AE(mode)	PLP1616-6	66vjj	VR10	9b Ric
M26B	R1163K261B	LVR-IC	LDO, 2.6V±2.5%, 150mA, +CE, AE(mode)	PLP1616-6	66vjj	VR10	9b Ric
M27B	R1163K271B	LVR-IC	LDO, 2.7V±2.5%, 150mA, +CE, AE(mode)	PLP1616-6	66vjj	VR10	9b Ric
M28B	R1163K281B5	LVR-IC	LDO, 2.85V±2.5%, 150mA, +CE, AE(mode)	PLP1616-6	66vjj	VR10	9b Ric
M28B	R1163K281B	LVR-IC	LDO, 2.8V±2.5%, 150mA, +CE, AE(mode)	PLP1616-6	66vjj	VR10	9b Ric
M29B	R1163K291B	LVR-IC	LDO, 2.9V±2.5%, 150mA, +CE, AE(mode)	PLP1616-6	66vjj	VR10	9b Ric
M2A	XC6108N22AGR	Vdet-IC	2.2V±2%, Hysteresis, -Reset ODO	USP-4	45ro	VD14	9b Tor
M2A	XC6118C12AGR-G	Vdet-IC	1.2V±30mV, ±Reset PPO, Sense, hysteresis 5%, Cd	USP-4	45me	VD15	9a Tor
M2B	XC6108N22BGR	Vdet-IC	2.2V±2%, -Reset ODO	USP-4	45ro	VD14	9b Tor
M2B	XC6118C12BGR-G	Vdet-IC	1.2V±30mV, ±Reset PPO, Sense, hysteresis <1%, Cd	USP-4	45me	VD15	9a Tor
M2C	XC6108N22CGR	Vdet-IC	2.2V±2%, Hysteresis, -Reset ODO	USP-4	45rn	VD14	9b Tor
M2C	XC6118C12CGR-G	Vdet-IC	1.2V±30mV, ±Reset PPO, Sense, hysteresis 5%	USP-4	45md	VD12	9a Tor
M2D	XC6108N22DGR	Vdet-IC	2.2V±2%, -Reset ODO	USP-4	45rn	VD14	9b Tor
M2D	XC6118C12DGR-G	Vdet-IC	1.2V±30mV, ±Reset PPO, Sense, hysteresis <1%	USP-4	45md	VD12	9a Tor
M3	NX3L1T384GM	CMOS-Logic	Single-pole single-throw analog switch	SOT-886	57Log86	-	9c Phi
M3	R3117K203A	Vdet-IC	2.0V±1%, -Reset ODO, Sense	DFN1010-4	48rq	VD11	9a Ric
M3	RP114K211B	LVR-IC	LDO, 2.1V±1%, 300mA, +CE	DFN1010-4	48vm	VR4	9a Ric
M30B	R1163K301B	LVR-IC	LDO, 3V±2.5%, 150mA, +CE, AE(mode)	PLP1616-6	66vjj	VR10	9b Ric
M31B	R1163K311B	LVR-IC	LDO, 3.1V±2.5%, 150mA, +CE, AE(mode)	PLP1616-6	66vjj	VR10	9b Ric
M32B	R1163K321B	LVR-IC	LDO, 3.2V±2.5%, 150mA, +CE, AE(mode)	PLP1616-6	66vjj	VR10	9b Ric
M33B	R1163K331B	LVR-IC	LDO, 3.3V±2.5%, 150mA, +CE, AE(mode)	PLP1616-6	66vjj	VR10	9b Ric
M34B	R1163K341B	LVR-IC	LDO, 3.4V±2.5%, 150mA, +CE, AE(mode)	PLP1616-6	66vjj	VR10	9b Ric
M35B	R1163K351B	LVR-IC	LDO, 3.5V±2.5%, 150mA, +CE, AE(mode)	PLP1616-6	66vjj	VR10	9b Ric
M36B	R1163K361B	LVR-IC	LDO, 3.6V±2.5%, 150mA, +CE, AE(mode)	PLP1616-6	66vjj	VR10	9b Ric
M37B	R1163K371B	LVR-IC	LDO, 3.7V±2.5%, 150mA, +CE, AE(mode)	PLP1616-6	66vjj	VR10	9b Ric
M38B	R1163K381B	LVR-IC	LDO, 3.8V±2.5%, 150mA, +CE, AE(mode)	PLP1616-6	66vjj	VR10	9b Ric
M39B	R1163K391B	LVR-IC	LDO, 3.9V±2.5%, 150mA, +CE, AE(mode)	PLP1616-6	66vjj	VR10	9b Ric
M3A	XC6108N23AGR	Vdet-IC	2.3V±2%, Hysteresis, -Reset ODO	USP-4	45ro	VD14	9b Tor
M3A	XC6118C13AGR-G	Vdet-IC	1.3V±30mV, ±Reset PPO, Sense, hysteresis 5%, Cd	USP-4	45me	VD15	9a Tor
M3B	XC6108N23BGR	Vdet-IC	2.3V±2%, -Reset ODO	USP-4	45ro	VD14	9b Tor
M3B	XC6118C13BGR-G	Vdet-IC	1.3V±30mV, ±Reset PPO, Sense, hysteresis <1%, Cd	USP-4	45me	VD15	9a Tor
M3C	XC6108N23CGR	Vdet-IC	2.3V±2%, Hysteresis, -Reset ODO	USP-4	45ro	VD14	9b Tor
M3C	XC6118C13CGR-G	Vdet-IC	1.3V±30mV, ±Reset PPO, Sense, hysteresis 5%	USP-4	45md	VD12	9a Tor
M3D	XC6108N23DGR	Vdet-IC	2.3V±2%, -Reset ODO	USP-4	45rn	VD14	9b Tor
M3D	XC6118C13DGR-G	Vdet-IC	1.3V±30mV, ±Reset PPO, Sense, hysteresis <1%	USP-4	45md	VD12	9a Tor
M4	R3117K213A	Vdet-IC	2.1V±1%, -Reset ODO, Sense	DFN1010-4	48rq	VD11	9a Ric
M4	RP114K221B	LVR-IC	LDO, 2.2V±1%, 300mA, +CE	DFN1010-4	48vm	VR4	9a Ric
M40B	R1163K401B	LVR-IC	LDO, 4V±2.5%, 150mA, +CE, AE(mode)	PLP1616-6	66vjj	VR10	9b Ric
M4A	XC6108N24AGR	Vdet-IC	2.4V±2%, Hysteresis, -Reset ODO	USP-4	45ro	VD14	9b Tor
M4A	XC6118C14AGR-G	Vdet-IC	1.4V±30mV, ±Reset PPO, Sense, hysteresis 5%, Cd	USP-4	45me	VD15	9a Tor
M4B	XC6108N24BGR	Vdet-IC	2.4V±2%, -Reset ODO	USP-4	45ro	VD14	9b Tor
M4B	XC6118C14BGR-G	Vdet-IC	1.4V±30mV, ±Reset PPO, Sense, hysteresis <1%, Cd	USP-4	45me	VD15	9a Tor
M4C	XC6108N24CGR	Vdet-IC	2.4V±2%, Hysteresis, -Reset ODO	USP-4	45rn	VD14	9b Tor
M4C	XC6118C14CGR-G	Vdet-IC	1.4V±30mV, ±Reset PPO, Sense, hysteresis 5%	USP-4	45md	VD12	9a Tor
M4D	XC6108N24DGR	Vdet-IC	2.4V±2%, -Reset ODO	USP-4	45rn	VD14	9b Tor
M4D	XC6118C14DGR-G	Vdet-IC	1.4V±30mV, ±Reset PPO, Sense, hysteresis <1%	USP-4	45md	VD12	9a Tor
M5	R3117K223A	Vdet-IC	2.2V±1%, -Reset ODO, Sense	DFN1010-4	48rq	VD11	9a Ric
M5	RP114K231B	LVR-IC	LDO, 2.3V±1%, 300mA, +CE	DFN1010-4	48vm	VR4	9a Ric
M53	NX3L1T53GD	CMOS-Logic	Single-pole double-throw analog switch	SOT996-2	54Log58	-	9a Phi
M53	NX3L1T53GM	CMOS-Logic	Single-pole double-throw analog switch	SOT902-1	51Log58	-	9a Phi
M53	NX3L1T53GT	CMOS-Logic	Single-pole double-throw analog switch	SOT833-1	53Log58	-	9c Phi
M5A	XC6108N25AGR	Vdet-IC	2.5V±2%, Hysteresis, -Reset ODO	USP-4	45ro	VD14	9b Tor
M5A	XC6118C15AGR-G	Vdet-IC	1.5V±30mV, ±Reset PPO, Sense, hysteresis 5%, Cd	USP-4	45me	VD15	9a Tor
M5B	XC6108N25BGR	Vdet-IC	2.5V±2%, -Reset ODO	USP-4	45ro	VD14	9b Tor



SMD code	Type	Function	Short description	Case	Pinout	Sch.	St.	Mnf.
M5B	XC6118C15BGR-G	Vdet-IC	1.5V±30mV, ±Reset PPO, Sense, hysteresis <1%, Cd	USP-4	45me	VD15	9a	Tor
M5C	XC6108N25CGR	Vdet-IC	2.5V±2%, Hysteresis, -Reset ODO	USP-4	45m	VD14	9b	Tor
M5C	XC6118C15CGR-G	Vdet-IC	1.5V±30mV, ±Reset PPO, Sense, hysteresis 5%	USP-4	45md	VD12	9a	Tor
M5D	XC6108N25DGR	Vdet-IC	2.5V±2%, -Reset ODO	USP-4	45m	VD14	9b	Tor
M5D	XC6118C15DGR-G	Vdet-IC	1.5V±30mV, ±Reset PPO, Sense, hysteresis <1%	USP-4	45md	VD12	9a	Tor
M6	R3117K233A	Vdet-IC	2.3V±1%, -Reset ODO, Sense	DFN1010-4	48rq	VD11	9a	Ric
M6	RP114K241B	LVR-IC	LDO, 2.4V±1%, 300mA, +CE	DFN1010-4	48vm	VR4	9a	Ric
M6A	XC6108N26AGR	Vdet-IC	2.6V±2%, Hysteresis, -Reset ODO	USP-4	45ro	VD14	9b	Tor
M6A	XC6118C16AGR-G	Vdet-IC	1.6V±2%, ±Reset PPO, Sense, hysteresis 5%, Cd	USP-4	45me	VD15	9a	Tor
M6B	XC6108N26BGR	Vdet-IC	2.6V±2%, -Reset ODO	USP-4	45ro	VD14	9b	Tor
M6B	XC6118C16BGR-G	Vdet-IC	1.6V±2%, ±Reset PPO, Sense, hysteresis <1%, Cd	USP-4	45me	VD15	9a	Tor
M6C	XC6108N26CGR	Vdet-IC	2.6V±2%, Hysteresis, -Reset ODO	USP-4	45m	VD14	9b	Tor
M6C	XC6118C16CGR-G	Vdet-IC	1.6V±2%, ±Reset PPO, Sense, hysteresis 5%	USP-4	45md	VD12	9a	Tor
M6D	XC6108N26DGR	Vdet-IC	2.6V±2%, -Reset ODO	USP-4	45m	VD14	9b	Tor
M6D	XC6118C16DGR-G	Vdet-IC	1.6V±2%, ±Reset PPO, Sense, hysteresis <1%	USP-4	45md	VD12	9a	Tor
M7	R3117K243A	Vdet-IC	2.4V±1%, -Reset ODO, Sense	DFN1010-4	48rq	VD11	9a	Ric
M7	RP114K251B	LVR-IC	LDO, 2.5V±1%, 300mA, +CE	DFN1010-4	48vm	VR4	9a	Ric
M7A	XC6108N27AGR	Vdet-IC	2.7V±2%, Hysteresis, -Reset ODO	USP-4	45ro	VD14	9b	Tor
M7A	XC6118C17AGR-G	Vdet-IC	1.7V±2%, ±Reset PPO, Sense, hysteresis 5%, Cd	USP-4	45me	VD15	9a	Tor
M7B	XC6108N27BGR	Vdet-IC	2.7V±2%, -Reset ODO	USP-4	45ro	VD14	9b	Tor
M7B	XC6118C17BGR-G	Vdet-IC	1.7V±2%, ±Reset PPO, Sense, hysteresis <1%, Cd	USP-4	45me	VD15	9a	Tor
M7C	XC6108N27CGR	Vdet-IC	2.7V±2%, Hysteresis, -Reset ODO	USP-4	45m	VD14	9b	Tor
M7C	XC6118C17CGR-G	Vdet-IC	1.7V±2%, ±Reset PPO, Sense, hysteresis 5%	USP-4	45md	VD12	9a	Tor
M7D	XC6108N27DGR	Vdet-IC	2.7V±2%, -Reset ODO	USP-4	45m	VD14	9b	Tor
M7D	XC6118C17DGR-G	Vdet-IC	1.7V±2%, ±Reset PPO, Sense, hysteresis <1%	USP-4	45md	VD12	9a	Tor
M8	R3117K253A	Vdet-IC	2.5V±1%, -Reset ODO, Sense	DFN1010-4	48rq	VD11	9a	Ric
M8	RP114K261B	LVR-IC	LDO, 2.6V±1%, 300mA, +CE	DFN1010-4	48vm	VR4	9a	Ric
M8A	XC6108N28AGR	Vdet-IC	2.8V±2%, Hysteresis, -Reset ODO	USP-4	45ro	VD14	9b	Tor
M8A	XC6118C18AGR-G	Vdet-IC	1.8V±2%, ±Reset PPO, Sense, hysteresis 5%, Cd	USP-4	45me	VD15	9a	Tor
M8B	XC6108N28BGR	Vdet-IC	2.8V±2%, -Reset ODO	USP-4	45ro	VD14	9b	Tor
M8B	XC6118C18BGR-G	Vdet-IC	1.8V±2%, ±Reset PPO, Sense, hysteresis <1%, Cd	USP-4	45me	VD15	9a	Tor
M8C	XC6108N28CGR	Vdet-IC	2.8V±2%, Hysteresis, -Reset ODO	USP-4	45m	VD14	9b	Tor
M8C	XC6118C18CGR-G	Vdet-IC	1.8V±2%, ±Reset PPO, Sense, hysteresis 5%	USP-4	45md	VD12	9a	Tor
M8D	XC6108N28DGR	Vdet-IC	2.8V±2%, -Reset ODO	USP-4	45m	VD14	9b	Tor
M8D	XC6118C18DGR-G	Vdet-IC	1.8V±2%, ±Reset PPO, Sense, hysteresis <1%	USP-4	45md	VD12	9a	Tor
M9	R3117K263A	Vdet-IC	2.6V±1%, -Reset ODO, Sense	DFN1010-4	48rq	VD11	9a	Ric
M9	RP114K271B	LVR-IC	LDO, 2.7V±1%, 300mA, +CE	DFN1010-4	48vm	VR4	9a	Ric
M9A	XC6108N29AGR	Vdet-IC	2.9V±2%, Hysteresis, -Reset ODO	USP-4	45ro	VD14	9b	Tor
M9A	XC6118C19AGR-G	Vdet-IC	1.9V±2%, ±Reset PPO, Sense, hysteresis 5%, Cd	USP-4	45me	VD15	9a	Tor
M9B	XC6108N29BGR	Vdet-IC	2.9V±2%, -Reset ODO	USP-4	45ro	VD14	9b	Tor
M9B	XC6118C19BGR-G	Vdet-IC	1.9V±2%, ±Reset PPO, Sense, hysteresis <1%, Cd	USP-4	45me	VD15	9a	Tor
M9C	XC6108N29CGR	Vdet-IC	2.9V±2%, Hysteresis, -Reset ODO	USP-4	45m	VD14	9b	Tor
M9C	XC6118C19CGR-G	Vdet-IC	1.9V±2%, ±Reset PPO, Sense, hysteresis 5%	USP-4	45md	VD12	9a	Tor
M9D	XC6108N29DGR	Vdet-IC	2.9V±2%, -Reset ODO	USP-4	45m	VD14	9b	Tor
M9D	XC6118C19DGR-G	Vdet-IC	1.9V±2%, ±Reset PPO, Sense, hysteresis <1%	USP-4	45md	VD12	9a	Tor
MA	R1118K081B	LVR-IC	0.8V±1%, 150mA, +CE	DFN1612-4B	45vm	VR4	9a	Ric
MA	RP107K341D	LVR-IC	LDO, 3.4V±1%, 200mA, +CE, CL	DFN1212-6	52vr2	VR4	9a	Ric
MA8	XC9237C08C4R-G	DC-DC-IC	PWM-PWM/PPM, st-dwn, 0.8V±2%, 600mA, 1.2MHz, Vin>2V, LSST, CL	USP-6EL	56dc5	DC1	9a	Tor
MA8	XC9237C08CER	DC-DC-IC	PWM-PWM/PPM, st-dwn, 0.8V±2%, 600mA, 1.2MHz, Vin>2V, LSST, CL	USP-6C	49dc5	DC1	9a	Tor
MA9	XC9237C09C4R-G	DC-DC-IC	PWM-PWM/PPM, st-dwn, 0.9V±2%, 600mA, 1.2MHz, Vin>2V, LSST, CL	USP-6EL	56dc5	DC1	9a	Tor
MA9	XC9237C09CER	DC-DC-IC	PWM-PWM/PPM, st-dwn, 0.9V±2%, 600mA, 1.2MHz, Vin>2V, LSST, CL	USP-6C	49dc5	DC1	9a	Tor
MAG	NCP2890AFCT2	LIN-IC	AF PA, BTL, 2.2. 5.5V, 1W(5V/8Ω), shutdown	BGA-9	39	AFP44	9a	Ons
MAH-	NCP2890AFCT2G	LIN-IC	AF PA, BTL, 2.2. 5.5V, 1W(5V/8Ω), shutdown	BGA-9	39	AFP44	9a	Ons
MAI	NCP4894FCT1	LIN-IC	AF PA, BTL, 2.2. 5.5V, 1W(5V/8Ω), shutdown	BGA-9	39	AFP53	9a	Ons
MAL	XC9237C0LC4R-G	DC-DC-IC	PWM-PWM/PPM, st-dwn, 0.85V±2%, 600mA, 1.2MHz, Vin>2V, LSST, CL	USP-6EL	56dc5	DC1	9a	Tor
MAL	XC9237C0LCER	DC-DC-IC	PWM-PWM/PPM, st-dwn, 0.85V±2%, 600mA, 1.2MHz, Vin>2V, LSST, CL	USP-6C	49dc5	DC1	9a	Tor
MAM	NCP4896FCT1	LIN-IC	AF PA, BTL 2.2. 5.5V, 1W(5V/8Ω), shutdown	BGA-9	39	-	9a	Ons
MAM	XC9237C0MC4R-G	DC-DC-IC	PWM-PWM/PPM, st-dwn, 0.95V±2%, 600mA, 1.2MHz, Vin>2V, LSST, CL	USP-6EL	56dc5	DC1	9a	Tor
MAM	XC9237C0MCER	DC-DC-IC	PWM-PWM/PPM, st-dwn, 0.95V±2%, 600mA, 1.2MHz, Vin>2V, LSST, CL	USP-6C	49dc5	DC1	9a	Tor
MAM-	NCP4896FCT1G	LIN-IC	AF PA, BTL 2.2. 5.5V, 1W(5V/8Ω), shutdown	BGA-9	39	-	9a	Ons
MAQ	NCP2820FCT1	LIN-IC	AF PA, BTL, class-D, 2.2. 5.5V, 2.65W(5V/4Ω), shutdown	BGA-9	39	AFP45	9a	Ons
MAQ	NCP9004FCT1G	LIN-IC	AF PA, BTL, class-D, 2.2. 5.5V, 2.65W(5V/4Ω), shutdown	BGA-9	39	AFP45	9a	Ons
MAQ-	NCP2820FCT1G	LIN-IC	AF PA, BTL, class-D, 2.2. 5.5V, 2.65W(5V/4Ω), shutdown	BGA-9	39	AFP45	9a	Ons
MAQ-	NCP2820FCT2G	LIN-IC	AF PA, BTL, class-D, 2.2. 5.5V, 2.65W(5V/4Ω), shutdown	BGA-9	39	AFP45	9a	Ons
MAU	NCP2821FCT1G	LIN-IC	AF PA, BTL, class-D, 2.2. 5.5V, 2.65W(5V/4Ω), shutdown	BGA-9	39	AFP52	9a	Ons
MAX	NCP2892AFCT2G	LIN-IC	AF PA, BTL, 2.2. 5.5V, 1.3W(5V/8Ω), shutdown	BGA-9	39	AFP44	9a	Ons
MAZ	NCP2892BFCT2G	LIN-IC	AF PA, BTL, 2.2. 5.5V, 1.3W(5V/8Ω), shutdown	BGA-9	39	AFP44	9a	Ons
MAZ	NCP9002FCT2G	LIN-IC	AF PA, BTL, 2.2. 5.5V, 1.3W(5V/8Ω), shutdown	BGA-9	39	AFP44	9a	Ons
MB	R1118K091B	LVR-IC	0.9V±1%, 150mA, +CE	DFN1612-4B	45vm	VR4	9a	Ric
MB	RP107K351D	LVR-IC	LDO, 3.5V±1%, 200mA, +CE, CL	DFN1212-6	52vr2	VR4	9a	Ric



SMD code	Type	Function	Short description	Case	Pinout	Sch.	St.	Mnf.
MB0	XC9237C10C4R-G	DC-DC-IC	PWM-PWM/PPM, st-dwn, 1.0V±2%, 600mA, 1.2MHz, Vin>2V, LSST, CL	USP-6EL	56dc5	DC1	9a	Tor
MB0	XC9237C10CER	DC-DC-IC	PWM-PWM/PPM, st-dwn, 1.0V±2%, 600mA, 1.2MHz, Vin>2V, LSST, CL	USP-6C	49dc5	DC1	9a	Tor
MB1	XC9237C11C4R-G	DC-DC-IC	PWM-PWM/PPM, st-dwn, 1.1V±2%, 600mA, 1.2MHz, Vin>2V, LSST, CL	USP-6EL	56dc5	DC1	9a	Tor
MB1	XC9237C11CER	DC-DC-IC	PWM-PWM/PPM, st-dwn, 1.1V±2%, 600mA, 1.2MHz, Vin>2V, LSST, CL	USP-6C	49dc5	DC1	9a	Tor
MB2	XC9237C12C4R-G	DC-DC-IC	PWM-PWM/PPM, st-dwn, 1.2V±2%, 600mA, 1.2MHz, Vin>2V, LSST, CL	USP-6EL	56dc5	DC1	9a	Tor
MB2	XC9237C12CER	DC-DC-IC	PWM-PWM/PPM, st-dwn, 1.2V±2%, 600mA, 1.2MHz, Vin>2V, LSST, CL	USP-6C	49dc5	DC1	9a	Tor
MB3	XC9237C13C4R-G	DC-DC-IC	PWM-PWM/PPM, st-dwn, 1.3V±2%, 600mA, 1.2MHz, Vin>2V, LSST, CL	USP-6EL	56dc5	DC1	9a	Tor
MB3	XC9237C13CER	DC-DC-IC	PWM-PWM/PPM, st-dwn, 1.3V±2%, 600mA, 1.2MHz, Vin>2V, LSST, CL	USP-6C	49dc5	DC1	9a	Tor
MB4	XC9237C14C4R-G	DC-DC-IC	PWM-PWM/PPM, st-dwn, 1.4V±2%, 600mA, 1.2MHz, Vin>2V, LSST, CL	USP-6EL	56dc5	DC1	9a	Tor
MB4	XC9237C14CER	DC-DC-IC	PWM-PWM/PPM, st-dwn, 1.4V±2%, 600mA, 1.2MHz, Vin>2V, LSST, CL	USP-6C	49dc5	DC1	9a	Tor
MB5	XC9237C15C4R-G	DC-DC-IC	PWM-PWM/PPM, st-dwn, 1.5V±2%, 600mA, 1.2MHz, Vin>2V, LSST, CL	USP-6EL	56dc5	DC1	9a	Tor
MB5	XC9237C15CER	DC-DC-IC	PWM-PWM/PPM, st-dwn, 1.5V±2%, 600mA, 1.2MHz, Vin>2V, LSST, CL	USP-6C	49dc5	DC1	9a	Tor
MB6	XC9237C16C4R-G	DC-DC-IC	PWM-PWM/PPM, st-dwn, 1.6V±2%, 600mA, 1.2MHz, Vin>2V, LSST, CL	USP-6EL	56dc5	DC1	9a	Tor
MB6	XC9237C16CER	DC-DC-IC	PWM-PWM/PPM, st-dwn, 1.6V±2%, 600mA, 1.2MHz, Vin>2V, LSST, CL	USP-6C	49dc5	DC1	9a	Tor
MB7	XC9237C17C4R-G	DC-DC-IC	PWM-PWM/PPM, st-dwn, 1.7V±2%, 600mA, 1.2MHz, Vin>2V, LSST, CL	USP-6EL	56dc5	DC1	9a	Tor
MB7	XC9237C17CER	DC-DC-IC	PWM-PWM/PPM, st-dwn, 1.7V±2%, 600mA, 1.2MHz, Vin>2V, LSST, CL	USP-6C	49dc5	DC1	9a	Tor
MB8	XC9237C18C4R-G	DC-DC-IC	PWM-PWM/PPM, st-dwn, 1.8V±2%, 600mA, 1.2MHz, Vin>2V, LSST, CL	USP-6EL	56dc5	DC1	9a	Tor
MB8	XC9237C18CER	DC-DC-IC	PWM-PWM/PPM, st-dwn, 1.8V±2%, 600mA, 1.2MHz, Vin>2V, LSST, CL	USP-6C	49dc5	DC1	9a	Tor
MB9	XC9237C19C4R-G	DC-DC-IC	PWM-PWM/PPM, st-dwn, 1.9V±2%, 600mA, 1.2MHz, Vin>2V, LSST, CL	USP-6EL	56dc5	DC1	9a	Tor
MB9	XC9237C19CER	DC-DC-IC	PWM-PWM/PPM, st-dwn, 1.9V±2%, 600mA, 1.2MHz, Vin>2V, LSST, CL	USP-6C	49dc5	DC1	9a	Tor
MBA	NCP2990FCT2G	LIN-IC	AF PA, BTL, 2.2.5.5V, 1.3W(5V/8Q), shutdown	BGA-9	39	AFF44	9a	Ons
MBA	XC9237C1A4R-G	DC-DC-IC	PWM-PWM/PPM, st-dwn, 1.05V±2%, 600mA, 1.2MHz, Vin>2V, LSST, CL	USP-6EL	56dc5	DC1	9a	Tor
MBA	XC9237C1ACER	DC-DC-IC	PWM-PWM/PPM, st-dwn, 1.05V±2%, 600mA, 1.2MHz, Vin>2V, LSST, CL	USP-6C	49dc5	DC1	9a	Tor
MBB	XC9237C1B4R-G	DC-DC-IC	PWM-PWM/PPM, st-dwn, 1.15V±2%, 600mA, 1.2MHz, Vin>2V, LSST, CL	USP-6EL	56dc5	DC1	9a	Tor
MBB	XC9237C1BCER	DC-DC-IC	PWM-PWM/PPM, st-dwn, 1.15V±2%, 600mA, 1.2MHz, Vin>2V, LSST, CL	USP-6C	49dc5	DC1	9a	Tor
MBC	XC9237C1C4R-G	DC-DC-IC	PWM-PWM/PPM, st-dwn, 1.25V±2%, 600mA, 1.2MHz, Vin>2V, LSST, CL	USP-6EL	56dc5	DC1	9a	Tor
MBC	XC9237C1CCER	DC-DC-IC	PWM-PWM/PPM, st-dwn, 1.25V±2%, 600mA, 1.2MHz, Vin>2V, LSST, CL	USP-6C	49dc5	DC1	9a	Tor
MBD	XC9237C1D4R-G	DC-DC-IC	PWM-PWM/PPM, st-dwn, 1.35V±2%, 600mA, 1.2MHz, Vin>2V, LSST, CL	USP-6EL	56dc5	DC1	9a	Tor
MBD	XC9237C1DCER	DC-DC-IC	PWM-PWM/PPM, st-dwn, 1.35V±2%, 600mA, 1.2MHz, Vin>2V, LSST, CL	USP-6C	49dc5	DC1	9a	Tor
MBE	XC9237C1E4R-G	DC-DC-IC	PWM-PWM/PPM, st-dwn, 1.45V±2%, 600mA, 1.2MHz, Vin>2V, LSST, CL	USP-6EL	56dc5	DC1	9a	Tor
MBE	XC9237C1ECER	DC-DC-IC	PWM-PWM/PPM, st-dwn, 1.45V±2%, 600mA, 1.2MHz, Vin>2V, LSST, CL	USP-6C	49dc5	DC1	9a	Tor
MBF	XC9237C1F4R-G	DC-DC-IC	PWM-PWM/PPM, st-dwn, 1.55V±2%, 600mA, 1.2MHz, Vin>2V, LSST, CL	USP-6EL	56dc5	DC1	9a	Tor
MBF	XC9237C1FCER	DC-DC-IC	PWM-PWM/PPM, st-dwn, 1.55V±2%, 600mA, 1.2MHz, Vin>2V, LSST, CL	USP-6C	49dc5	DC1	9a	Tor
MBH	XC9237C1H4R-G	DC-DC-IC	PWM-PWM/PPM, st-dwn, 1.65V±2%, 600mA, 1.2MHz, Vin>2V, LSST, CL	USP-6EL	56dc5	DC1	9a	Tor
MBH	XC9237C1HCER	DC-DC-IC	PWM-PWM/PPM, st-dwn, 1.65V±2%, 600mA, 1.2MHz, Vin>2V, LSST, CL	USP-6C	49dc5	DC1	9a	Tor
MBK	XC9237C1K4R-G	DC-DC-IC	PWM-PWM/PPM, st-dwn, 1.75V±2%, 600mA, 1.2MHz, Vin>2V, LSST, CL	USP-6EL	56dc5	DC1	9a	Tor
MBK	XC9237C1KCER	DC-DC-IC	PWM-PWM/PPM, st-dwn, 1.75V±2%, 600mA, 1.2MHz, Vin>2V, LSST, CL	USP-6C	49dc5	DC1	9a	Tor
MBL	XC9237C1L4R-G	DC-DC-IC	PWM-PWM/PPM, st-dwn, 1.85V±2%, 600mA, 1.2MHz, Vin>2V, LSST, CL	USP-6EL	56dc5	DC1	9a	Tor
MBL	XC9237C1LCER	DC-DC-IC	PWM-PWM/PPM, st-dwn, 1.85V±2%, 600mA, 1.2MHz, Vin>2V, LSST, CL	USP-6C	49dc5	DC1	9a	Tor
MBM	XC9237C1M4R-G	DC-DC-IC	PWM-PWM/PPM, st-dwn, 1.95V±2%, 600mA, 1.2MHz, Vin>2V, LSST, CL	USP-6EL	56dc5	DC1	9a	Tor
MBM	XC9237C1MCER	DC-DC-IC	PWM-PWM/PPM, st-dwn, 1.95V±2%, 600mA, 1.2MHz, Vin>2V, LSST, CL	USP-6C	49dc5	DC1	9a	Tor
MBZ	NCV2890DMR2G	LIN-IC	AF PA, BTL 2.2.5.5V, 1W(5V/8Q), shutdown	DFN-8	37	AFF12	-	Ons
MC	R118K101B	LVR-IC	1V±1%, 150mA, +CE	DFN1612-4B	45vm	VR4	9a	Ric
MC	RP107K361D	LVR-IC	LDO, 3.6V±1%, 200mA, +CE, CL	DFN1212-6	52r2	VR4	9a	Ric
MC0	XC9237C20C4R-G	DC-DC-IC	PWM-PWM/PPM, st-dwn, 2.0V±2%, 600mA, 1.2MHz, Vin>2V, LSST, CL	USP-6EL	56dc5	DC1	9a	Tor
MC0	XC9237C20CER	DC-DC-IC	PWM-PWM/PPM, st-dwn, 2.0V±2%, 600mA, 1.2MHz, Vin>2V, LSST, CL	USP-6C	49dc5	DC1	9a	Tor
MC1	XC9237C21C4R-G	DC-DC-IC	PWM-PWM/PPM, st-dwn, 2.1V±2%, 600mA, 1.2MHz, Vin>2V, LSST, CL	USP-6EL	56dc5	DC1	9a	Tor
MC1	XC9237C21CER	DC-DC-IC	PWM-PWM/PPM, st-dwn, 2.1V±2%, 600mA, 1.2MHz, Vin>2V, LSST, CL	USP-6C	49dc5	DC1	9a	Tor
MC151	XC9110C151ER	DC/DC-IC	PFM step-up, 100kHz, 1.5V±2.5%, 400mA, +CE	USP-6C	49gd	DC3	9b	Tor
MC161	XC9110C161ER	DC/DC-IC	PFM step-up, 100kHz, 1.6V±2.5%, 400mA, +CE	USP-6C	49gd	DC3	9b	Tor
MC171	XC9110C171ER	DC/DC-IC	PFM step-up, 100kHz, 1.7V±2.5%, 400mA, +CE	USP-6C	49gd	DC3	9b	Tor
MC181	XC9110C181ER	DC/DC-IC	PFM step-up, 100kHz, 1.8V±2.5%, 400mA, +CE	USP-6C	49gd	DC3	9b	Tor
MC191	XC9110C191ER	DC/DC-IC	PFM step-up, 100kHz, 1.9V±2.5%, 400mA, +CE	USP-6C	49gd	DC3	9b	Tor
MC2	XC9237C22C4R-G	DC-DC-IC	PWM-PWM/PPM, st-dwn, 2.2V±2%, 600mA, 1.2MHz, Vin>2V, LSST, CL	USP-6EL	56dc5	DC1	9a	Tor
MC2	XC9237C22CER	DC-DC-IC	PWM-PWM/PPM, st-dwn, 2.2V±2%, 600mA, 1.2MHz, Vin>2V, LSST, CL	USP-6C	49dc5	DC1	9a	Tor
MC201	XC9110C201ER	DC/DC-IC	PFM step-up, 100kHz, 2.0V±2.5%, 400mA, +CE	USP-6C	49gd	DC3	9b	Tor
MC211	XC9110C211ER	DC/DC-IC	PFM step-up, 100kHz, 2.1V±2.5%, 400mA, +CE	USP-6C	49gd	DC3	9b	Tor
MC221	XC9110C221ER	DC/DC-IC	PFM step-up, 100kHz, 2.2V±2.5%, 400mA, +CE	USP-6C	49gd	DC3	9b	Tor
MC231	XC9110C231ER	DC/DC-IC	PFM step-up, 100kHz, 2.3V±2.5%, 400mA, +CE	USP-6C	49gd	DC3	9b	Tor
MC241	XC9110C241ER	DC/DC-IC	PFM step-up, 100kHz, 2.4V±2.5%, 400mA, +CE	USP-6C	49gd	DC3	9b	Tor
MC251	XC9110C251ER	DC/DC-IC	PFM step-up, 100kHz, 2.5V±2.5%, 400mA, +CE	USP-6C	49gd	DC3	9b	Tor
MC261	XC9110C261ER	DC/DC-IC	PFM step-up, 100kHz, 2.6V±2.5%, 400mA, +CE	USP-6C	49gd	DC3	9b	Tor
MC271	XC9110C271ER	DC/DC-IC	PFM step-up, 100kHz, 2.7V±2.5%, 400mA, +CE	USP-6C	49gd	DC3	9b	Tor
MC281	XC9110C281ER	DC/DC-IC	PFM step-up, 100kHz, 2.8V±2.5%, 400mA, +CE	USP-6C	49gd	DC3	9b	Tor
MC291	XC9110C291ER	DC/DC-IC	PFM step-up, 100kHz, 2.9V±2.5%, 400mA, +CE	USP-6C	49gd	DC3	9b	Tor
MC3	XC9237C23C4R-G	DC-DC-IC	PWM-PWM/PPM, st-dwn, 2.3V±2%, 600mA, 1.2MHz, Vin>2V, LSST, CL	USP-6EL	56dc5	DC1	9a	Tor
MC3	XC9237C23CER	DC-DC-IC	PWM-PWM/PPM, st-dwn, 2.3V±2%, 600mA, 1.2MHz, Vin>2V, LSST, CL	USP-6C	49dc5	DC1	9a	Tor
MC301	XC9110C301ER	DC/DC-IC	PFM step-up, 100kHz, 3.0V±2.5%, 400mA, +CE	USP-6C	49gd	DC3	9b	Tor
MC311	XC9110C311ER	DC/DC-IC	PFM step-up, 100kHz, 3.1V±2.5%, 400mA, +CE	USP-6C	49gd	DC3	9b	Tor
MC321	XC9110C321ER	DC/DC-IC	PFM step-up, 100kHz, 3.2V±2.5%, 400mA, +CE	USP-6C	49gd	DC3	9b	Tor



SMD code	Type	Function	Short description	Case	Pinout	Sch.	St.	Mnf.
MD691	XC9110D691ER	DC/DC-IC	PFM step-up, 100kHz, 6.9V±2.5%, 400mA, +CE	USP-6C	49gg	DC6	9b	Tor
MD7	XC9237C37C4R-G	DC-DC-IC	PWM-PWM/PPM, st-dwn, 3.7V±2%, 600mA, 1.2MHz, Vin>2V, LSST, CL	USP-6EL	56dc5	DC1	9a	Tor
MD7	XC9237C37CER	DC-DC-IC	PWM-PWM/PPM, st-dwn, 3.7V±2%, 600mA, 1.2MHz, Vin>2V, LSST, CL	USP-6C	49dc5	DC1	9a	Tor
MD701	XC9110D701ER	DC/DC-IC	PFM step-up, 100kHz, 7.0V±2.5%, 400mA, +CE	USP-6C	49gg	DC6	9b	Tor
MD8	XC9237C38C4R-G	DC-DC-IC	PWM-PWM/PPM, st-dwn, 3.8V±2%, 600mA, 1.2MHz, Vin>2V, LSST, CL	USP-6EL	56dc5	DC1	9a	Tor
MD8	XC9237C38CER	DC-DC-IC	PWM-PWM/PPM, st-dwn, 3.8V±2%, 600mA, 1.2MHz, Vin>2V, LSST, CL	USP-6C	49dc5	DC1	9a	Tor
MD9	XC9237C39C4R-G	DC-DC-IC	PWM-PWM/PPM, st-dwn, 3.9V±2%, 600mA, 1.2MHz, Vin>2V, LSST, CL	USP-6EL	56dc5	DC1	9a	Tor
MD9	XC9237C39CER	DC-DC-IC	PWM-PWM/PPM, st-dwn, 3.9V±2%, 600mA, 1.2MHz, Vin>2V, LSST, CL	USP-6C	49dc5	DC1	9a	Tor
MDA	XC9237C3A4R-G	DC-DC-IC	PWM-PWM/PPM, st-dwn, 3.05V±2%, 600mA, 1.2MHz, Vin>2V, LSST, CL	USP-6EL	56dc5	DC1	9a	Tor
MDA	XC9237C3ACER	DC-DC-IC	PWM-PWM/PPM, st-dwn, 3.05V±2%, 600mA, 1.2MHz, Vin>2V, LSST, CL	USP-6C	49dc5	DC1	9a	Tor
MDB	XC9237C3BC4R-G	DC-DC-IC	PWM-PWM/PPM, st-dwn, 3.15V±2%, 600mA, 1.2MHz, Vin>2V, LSST, CL	USP-6EL	56dc5	DC1	9a	Tor
MDB	XC9237C3BCER	DC-DC-IC	PWM-PWM/PPM, st-dwn, 3.15V±2%, 600mA, 1.2MHz, Vin>2V, LSST, CL	USP-6C	49dc5	DC1	9a	Tor
MDC	XC9237C3CC4R-G	DC-DC-IC	PWM-PWM/PPM, st-dwn, 3.25V±2%, 600mA, 1.2MHz, Vin>2V, LSST, CL	USP-6EL	56dc5	DC1	9a	Tor
MDC	XC9237C3CCER	DC-DC-IC	PWM-PWM/PPM, st-dwn, 3.25V±2%, 600mA, 1.2MHz, Vin>2V, LSST, CL	USP-6C	49dc5	DC1	9a	Tor
MDD	XC9237C3DC4R-G	DC-DC-IC	PWM-PWM/PPM, st-dwn, 3.35V±2%, 600mA, 1.2MHz, Vin>2V, LSST, CL	USP-6EL	56dc5	DC1	9a	Tor
MDD	XC9237C3DCER	DC-DC-IC	PWM-PWM/PPM, st-dwn, 3.35V±2%, 600mA, 1.2MHz, Vin>2V, LSST, CL	USP-6C	49dc5	DC1	9a	Tor
MDE	XC9237C3EC4R-G	DC-DC-IC	PWM-PWM/PPM, st-dwn, 3.45V±2%, 600mA, 1.2MHz, Vin>2V, LSST, CL	USP-6EL	56dc5	DC1	9a	Tor
MDE	XC9237C3ECER	DC-DC-IC	PWM-PWM/PPM, st-dwn, 3.45V±2%, 600mA, 1.2MHz, Vin>2V, LSST, CL	USP-6C	49dc5	DC1	9a	Tor
MDF	XC9237C3FC4R-G	DC-DC-IC	PWM-PWM/PPM, st-dwn, 3.55V±2%, 600mA, 1.2MHz, Vin>2V, LSST, CL	USP-6EL	56dc5	DC1	9a	Tor
MDF	XC9237C3FCER	DC-DC-IC	PWM-PWM/PPM, st-dwn, 3.55V±2%, 600mA, 1.2MHz, Vin>2V, LSST, CL	USP-6C	49dc5	DC1	9a	Tor
MDH	XC9237C3HC4R-G	DC-DC-IC	PWM-PWM/PPM, st-dwn, 3.65V±2%, 600mA, 1.2MHz, Vin>2V, LSST, CL	USP-6EL	56dc5	DC1	9a	Tor
MDH	XC9237C3HCER	DC-DC-IC	PWM-PWM/PPM, st-dwn, 3.65V±2%, 600mA, 1.2MHz, Vin>2V, LSST, CL	USP-6C	49dc5	DC1	9a	Tor
MDK	XC9237C3KC4R-G	DC-DC-IC	PWM-PWM/PPM, st-dwn, 3.75V±2%, 600mA, 1.2MHz, Vin>2V, LSST, CL	USP-6EL	56dc5	DC1	9a	Tor
MDK	XC9237C3KCER	DC-DC-IC	PWM-PWM/PPM, st-dwn, 3.75V±2%, 600mA, 1.2MHz, Vin>2V, LSST, CL	USP-6C	49dc5	DC1	9a	Tor
MDL	XC9237C3LC4R-G	DC-DC-IC	PWM-PWM/PPM, st-dwn, 3.85V±2%, 600mA, 1.2MHz, Vin>2V, LSST, CL	USP-6EL	56dc5	DC1	9a	Tor
MDL	XC9237C3LCER	DC-DC-IC	PWM-PWM/PPM, st-dwn, 3.85V±2%, 600mA, 1.2MHz, Vin>2V, LSST, CL	USP-6C	49dc5	DC1	9a	Tor
MDM	XC9237C3MC4R-G	DC-DC-IC	PWM-PWM/PPM, st-dwn, 3.95V±2%, 600mA, 1.2MHz, Vin>2V, LSST, CL	USP-6EL	56dc5	DC1	9a	Tor
MDM	XC9237C3MCER	DC-DC-IC	PWM-PWM/PPM, st-dwn, 3.95V±2%, 600mA, 1.2MHz, Vin>2V, LSST, CL	USP-6C	49dc5	DC1	9a	Tor
ME	R1118K121B	LVR-IC	1.2V±1%, 150mA, +CE	DFN1612-4B	45vm	VR4	9a	Ric
ME	RP107K381D	LVR-IC	LDO, 3.8V±1%, 200mA, +CE, CL	DFN1212-6	52v2r	VR4	9a	Ric
ME0	XC9237C40C4R-G	DC-DC-IC	PWM-PWM/PPM, st-dwn, 4.0V±2%, 600mA, 1.2MHz, Vin>2V, LSST, CL	USP-6EL	56dc5	DC1	9a	Tor
ME0	XC9237C40CER	DC-DC-IC	PWM-PWM/PPM, st-dwn, 4.0V±2%, 600mA, 1.2MHz, Vin>2V, LSST, CL	USP-6C	49dc5	DC1	9a	Tor
ME151	XC9110E151ER	DC/DC-IC	PFM step-up, 100kHz, 1.5V±2.5%, 400mA	USP-6C	49ge	DC4	9b	Tor
ME161	XC9110E161ER	DC/DC-IC	PFM step-up, 100kHz, 1.6V±2.5%, 400mA	USP-6C	49ge	DC4	9b	Tor
ME171	XC9110E171ER	DC/DC-IC	PFM step-up, 100kHz, 1.7V±2.5%, 400mA	USP-6C	49ge	DC4	9b	Tor
ME181	XC9110E181ER	DC/DC-IC	PFM step-up, 100kHz, 1.8V±2.5%, 400mA	USP-6C	49ge	DC4	9b	Tor
ME191	XC9110E191ER	DC/DC-IC	PFM step-up, 100kHz, 1.9V±2.5%, 400mA	USP-6C	49ge	DC4	9b	Tor
ME201	XC9110E201ER	DC/DC-IC	PFM step-up, 100kHz, 2.0V±2.5%, 400mA	USP-6C	49ge	DC4	9b	Tor
ME211	XC9110E211ER	DC/DC-IC	PFM step-up, 100kHz, 2.1V±2.5%, 400mA	USP-6C	49ge	DC4	9b	Tor
ME221	XC9110E221ER	DC/DC-IC	PFM step-up, 100kHz, 2.2V±2.5%, 400mA	USP-6C	49ge	DC4	9b	Tor
ME231	XC9110E231ER	DC/DC-IC	PFM step-up, 100kHz, 2.3V±2.5%, 400mA	USP-6C	49ge	DC4	9b	Tor
ME241	XC9110E241ER	DC/DC-IC	PFM step-up, 100kHz, 2.4V±2.5%, 400mA	USP-6C	49ge	DC4	9b	Tor
ME251	XC9110E251ER	DC/DC-IC	PFM step-up, 100kHz, 2.5V±2.5%, 400mA	USP-6C	49ge	DC4	9b	Tor
ME261	XC9110E261ER	DC/DC-IC	PFM step-up, 100kHz, 2.6V±2.5%, 400mA	USP-6C	49ge	DC4	9b	Tor
ME271	XC9110E271ER	DC/DC-IC	PFM step-up, 100kHz, 2.7V±2.5%, 400mA	USP-6C	49ge	DC4	9b	Tor
ME281	XC9110E281ER	DC/DC-IC	PFM step-up, 100kHz, 2.8V±2.5%, 400mA	USP-6C	49ge	DC4	9b	Tor
ME291	XC9110E291ER	DC/DC-IC	PFM step-up, 100kHz, 2.9V±2.5%, 400mA	USP-6C	49ge	DC4	9b	Tor
ME301	XC9110E301ER	DC/DC-IC	PFM step-up, 100kHz, 3.0V±2.5%, 400mA	USP-6C	49ge	DC4	9b	Tor
ME311	XC9110E311ER	DC/DC-IC	PFM step-up, 100kHz, 3.1V±2.5%, 400mA	USP-6C	49ge	DC4	9b	Tor
ME321	XC9110E321ER	DC/DC-IC	PFM step-up, 100kHz, 3.2V±2.5%, 400mA	USP-6C	49ge	DC4	9b	Tor
ME331	XC9110E331ER	DC/DC-IC	PFM step-up, 100kHz, 3.3V±2.5%, 400mA	USP-6C	49ge	DC4	9b	Tor
ME341	XC9110E341ER	DC/DC-IC	PFM step-up, 100kHz, 3.4V±2.5%, 400mA	USP-6C	49ge	DC4	9b	Tor
ME351	XC9110E351ER	DC/DC-IC	PFM step-up, 100kHz, 3.5V±2.5%, 400mA	USP-6C	49ge	DC4	9b	Tor
ME361	XC9110E361ER	DC/DC-IC	PFM step-up, 100kHz, 3.6V±2.5%, 400mA	USP-6C	49ge	DC4	9b	Tor
ME371	XC9110E371ER	DC/DC-IC	PFM step-up, 100kHz, 3.7V±2.5%, 400mA	USP-6C	49ge	DC4	9b	Tor
ME381	XC9110E381ER	DC/DC-IC	PFM step-up, 100kHz, 3.8V±2.5%, 400mA	USP-6C	49ge	DC4	9b	Tor
ME391	XC9110E391ER	DC/DC-IC	PFM step-up, 100kHz, 3.9V±2.5%, 400mA	USP-6C	49ge	DC4	9b	Tor
ME401	XC9110E401ER	DC/DC-IC	PFM step-up, 100kHz, 4.0V±2.5%, 400mA	USP-6C	49ge	DC4	9b	Tor
ME411	XC9110E411ER	DC/DC-IC	PFM step-up, 100kHz, 4.1V±2.5%, 400mA	USP-6C	49ge	DC4	9b	Tor
ME421	XC9110E421ER	DC/DC-IC	PFM step-up, 100kHz, 4.2V±2.5%, 400mA	USP-6C	49ge	DC4	9b	Tor
ME431	XC9110E431ER	DC/DC-IC	PFM step-up, 100kHz, 4.3V±2.5%, 400mA	USP-6C	49ge	DC4	9b	Tor
ME441	XC9110E441ER	DC/DC-IC	PFM step-up, 100kHz, 4.4V±2.5%, 400mA	USP-6C	49ge	DC4	9b	Tor
ME451	XC9110E451ER	DC/DC-IC	PFM step-up, 100kHz, 4.5V±2.5%, 400mA	USP-6C	49ge	DC4	9b	Tor
ME461	XC9110E461ER	DC/DC-IC	PFM step-up, 100kHz, 4.6V±2.5%, 400mA	USP-6C	49ge	DC4	9b	Tor
ME471	XC9110E471ER	DC/DC-IC	PFM step-up, 100kHz, 4.7V±2.5%, 400mA	USP-6C	49ge	DC4	9b	Tor
ME481	XC9110E481ER	DC/DC-IC	PFM step-up, 100kHz, 4.8V±2.5%, 400mA	USP-6C	49ge	DC4	9b	Tor
ME491	XC9110E491ER	DC/DC-IC	PFM step-up, 100kHz, 4.9V±2.5%, 400mA	USP-6C	49ge	DC4	9b	Tor
ME501	XC9110E501ER	DC/DC-IC	PFM step-up, 100kHz, 5.0V±2.5%, 400mA	USP-6C	49ge	DC4	9b	Tor
ME511	XC9110E511ER	DC/DC-IC	PFM step-up, 100kHz, 5.1V±2.5%, 400mA	USP-6C	49ge	DC4	9b	Tor
ME521	XC9110E521ER	DC/DC-IC	PFM step-up, 100kHz, 5.2V±2.5%, 400mA	USP-6C	49ge	DC4	9b	Tor



SMD code	Type	Function	Short description	Case	Pinout	Sch.	St.	Mnf.
ME531	XC9110E531ER	DC/DC-IC	PFM step-up, 100kHz, 5.3V±2.5%, 400mA	USP-6C	49ge	DC4	9b	Tor
ME541	XC9110E541ER	DC/DC-IC	PFM step-up, 100kHz, 5.4V±2.5%, 400mA	USP-6C	49ge	DC4	9b	Tor
ME551	XC9110E551ER	DC/DC-IC	PFM step-up, 100kHz, 5.5V±2.5%, 400mA	USP-6C	49ge	DC4	9b	Tor
ME561	XC9110E561ER	DC/DC-IC	PFM step-up, 100kHz, 5.6V±2.5%, 400mA	USP-6C	49ge	DC4	9b	Tor
ME571	XC9110E571ER	DC/DC-IC	PFM step-up, 100kHz, 5.7V±2.5%, 400mA	USP-6C	49ge	DC4	9b	Tor
ME581	XC9110E581ER	DC/DC-IC	PFM step-up, 100kHz, 5.8V±2.5%, 400mA	USP-6C	49ge	DC4	9b	Tor
ME591	XC9110E591ER	DC/DC-IC	PFM step-up, 100kHz, 5.9V±2.5%, 400mA	USP-6C	49ge	DC4	9b	Tor
ME601	XC9110E601ER	DC/DC-IC	PFM step-up, 100kHz, 6.0V±2.5%, 400mA	USP-6C	49ge	DC4	9b	Tor
ME611	XC9110E611ER	DC/DC-IC	PFM step-up, 100kHz, 6.1V±2.5%, 400mA	USP-6C	49ge	DC4	9b	Tor
ME621	XC9110E621ER	DC/DC-IC	PFM step-up, 100kHz, 6.2V±2.5%, 400mA	USP-6C	49ge	DC4	9b	Tor
ME631	XC9110E631ER	DC/DC-IC	PFM step-up, 100kHz, 6.3V±2.5%, 400mA	USP-6C	49ge	DC4	9b	Tor
ME641	XC9110E641ER	DC/DC-IC	PFM step-up, 100kHz, 6.4V±2.5%, 400mA	USP-6C	49ge	DC4	9b	Tor
ME651	XC9110E651ER	DC/DC-IC	PFM step-up, 100kHz, 6.5V±2.5%, 400mA	USP-6C	49ge	DC4	9b	Tor
ME661	XC9110E661ER	DC/DC-IC	PFM step-up, 100kHz, 6.6V±2.5%, 400mA	USP-6C	49ge	DC4	9b	Tor
ME671	XC9110E671ER	DC/DC-IC	PFM step-up, 100kHz, 6.7V±2.5%, 400mA	USP-6C	49ge	DC4	9b	Tor
ME681	XC9110E681ER	DC/DC-IC	PFM step-up, 100kHz, 6.8V±2.5%, 400mA	USP-6C	49ge	DC4	9b	Tor
ME691	XC9110E691ER	DC/DC-IC	PFM step-up, 100kHz, 6.9V±2.5%, 400mA	USP-6C	49ge	DC4	9b	Tor
ME701	XC9110E701ER	DC/DC-IC	PFM step-up, 100kHz, 7.0V±2.5%, 400mA	USP-6C	49ge	DC4	9b	Tor
MF	R1118K121B5	LVR-IC	1.25V±1%, 150mA, +CE	DFM1612-4B	45vm	VR4	9a	Ric
MF	RP107K391D	LVR-IC	LDO, 3.9V±1%, 200mA, +CE, CL	DFM1212-6	52vr2	VR4	9a	Ric
MF151	XC9110F151ER	DC/DC-IC	PFM step-up, 100kHz, 1.5V±2.5%, 400mA	USP-6C	49go	DC13	9b	Tor
MF161	XC9110F161ER	DC/DC-IC	PFM step-up, 100kHz, 1.6V±2.5%, 400mA	USP-6C	49go	DC13	9b	Tor
MF171	XC9110F171ER	DC/DC-IC	PFM step-up, 100kHz, 1.7V±2.5%, 400mA	USP-6C	49go	DC13	9b	Tor
MF181	XC9110F181ER	DC/DC-IC	PFM step-up, 100kHz, 1.8V±2.5%, 400mA	USP-6C	49go	DC13	9b	Tor
MF191	XC9110F191ER	DC/DC-IC	PFM step-up, 100kHz, 1.9V±2.5%, 400mA	USP-6C	49go	DC13	9b	Tor
MF201	XC9110F201ER	DC/DC-IC	PFM step-up, 100kHz, 2.0V±2.5%, 400mA	USP-6C	49go	DC13	9b	Tor
MF211	XC9110F211ER	DC/DC-IC	PFM step-up, 100kHz, 2.1V±2.5%, 400mA	USP-6C	49go	DC13	9b	Tor
MF221	XC9110F221ER	DC/DC-IC	PFM step-up, 100kHz, 2.2V±2.5%, 400mA	USP-6C	49go	DC13	9b	Tor
MF231	XC9110F231ER	DC/DC-IC	PFM step-up, 100kHz, 2.3V±2.5%, 400mA	USP-6C	49go	DC13	9b	Tor
MF241	XC9110F241ER	DC/DC-IC	PFM step-up, 100kHz, 2.4V±2.5%, 400mA	USP-6C	49go	DC13	9b	Tor
MF251	XC9110F251ER	DC/DC-IC	PFM step-up, 100kHz, 2.5V±2.5%, 400mA	USP-6C	49go	DC13	9b	Tor
MF261	XC9110F261ER	DC/DC-IC	PFM step-up, 100kHz, 2.6V±2.5%, 400mA	USP-6C	49go	DC13	9b	Tor
MF271	XC9110F271ER	DC/DC-IC	PFM step-up, 100kHz, 2.7V±2.5%, 400mA	USP-6C	49go	DC13	9b	Tor
MF281	XC9110F281ER	DC/DC-IC	PFM step-up, 100kHz, 2.8V±2.5%, 400mA	USP-6C	49go	DC13	9b	Tor
MF291	XC9110F291ER	DC/DC-IC	PFM step-up, 100kHz, 2.9V±2.5%, 400mA	USP-6C	49go	DC13	9b	Tor
MF301	XC9110F301ER	DC/DC-IC	PFM step-up, 100kHz, 3.0V±2.5%, 400mA	USP-6C	49go	DC13	9b	Tor
MF311	XC9110F311ER	DC/DC-IC	PFM step-up, 100kHz, 3.1V±2.5%, 400mA	USP-6C	49go	DC13	9b	Tor
MF321	XC9110F321ER	DC/DC-IC	PFM step-up, 100kHz, 3.2V±2.5%, 400mA	USP-6C	49go	DC13	9b	Tor
MF331	XC9110F331ER	DC/DC-IC	PFM step-up, 100kHz, 3.3V±2.5%, 400mA	USP-6C	49go	DC13	9b	Tor
MF341	XC9110F341ER	DC/DC-IC	PFM step-up, 100kHz, 3.4V±2.5%, 400mA	USP-6C	49go	DC13	9b	Tor
MF351	XC9110F351ER	DC/DC-IC	PFM step-up, 100kHz, 3.5V±2.5%, 400mA	USP-6C	49go	DC13	9b	Tor
MF361	XC9110F361ER	DC/DC-IC	PFM step-up, 100kHz, 3.6V±2.5%, 400mA	USP-6C	49go	DC13	9b	Tor
MF371	XC9110F371ER	DC/DC-IC	PFM step-up, 100kHz, 3.7V±2.5%, 400mA	USP-6C	49go	DC13	9b	Tor
MF381	XC9110F381ER	DC/DC-IC	PFM step-up, 100kHz, 3.8V±2.5%, 400mA	USP-6C	49go	DC13	9b	Tor
MF391	XC9110F391ER	DC/DC-IC	PFM step-up, 100kHz, 3.9V±2.5%, 400mA	USP-6C	49go	DC13	9b	Tor
MF401	XC9110F401ER	DC/DC-IC	PFM step-up, 100kHz, 4.0V±2.5%, 400mA	USP-6C	49go	DC13	9b	Tor
MF411	XC9110F411ER	DC/DC-IC	PFM step-up, 100kHz, 4.1V±2.5%, 400mA	USP-6C	49go	DC13	9b	Tor
MF421	XC9110F421ER	DC/DC-IC	PFM step-up, 100kHz, 4.2V±2.5%, 400mA	USP-6C	49go	DC13	9b	Tor
MF431	XC9110F431ER	DC/DC-IC	PFM step-up, 100kHz, 4.3V±2.5%, 400mA	USP-6C	49go	DC13	9b	Tor
MF441	XC9110F441ER	DC/DC-IC	PFM step-up, 100kHz, 4.4V±2.5%, 400mA	USP-6C	49go	DC13	9b	Tor
MF451	XC9110F451ER	DC/DC-IC	PFM step-up, 100kHz, 4.5V±2.5%, 400mA	USP-6C	49go	DC13	9b	Tor
MF461	XC9110F461ER	DC/DC-IC	PFM step-up, 100kHz, 4.6V±2.5%, 400mA	USP-6C	49go	DC13	9b	Tor
MF471	XC9110F471ER	DC/DC-IC	PFM step-up, 100kHz, 4.7V±2.5%, 400mA	USP-6C	49go	DC13	9b	Tor
MF481	XC9110F481ER	DC/DC-IC	PFM step-up, 100kHz, 4.8V±2.5%, 400mA	USP-6C	49go	DC13	9b	Tor
MF491	XC9110F491ER	DC/DC-IC	PFM step-up, 100kHz, 4.9V±2.5%, 400mA	USP-6C	49go	DC13	9b	Tor
MF501	XC9110F501ER	DC/DC-IC	PFM step-up, 100kHz, 5.0V±2.5%, 400mA	USP-6C	49go	DC13	9b	Tor
MF511	XC9110F511ER	DC/DC-IC	PFM step-up, 100kHz, 5.1V±2.5%, 400mA	USP-6C	49go	DC13	9b	Tor
MF521	XC9110F521ER	DC/DC-IC	PFM step-up, 100kHz, 5.2V±2.5%, 400mA	USP-6C	49go	DC13	9b	Tor
MF531	XC9110F531ER	DC/DC-IC	PFM step-up, 100kHz, 5.3V±2.5%, 400mA	USP-6C	49go	DC13	9b	Tor
MF541	XC9110F541ER	DC/DC-IC	PFM step-up, 100kHz, 5.4V±2.5%, 400mA	USP-6C	49go	DC13	9b	Tor
MF551	XC9110F551ER	DC/DC-IC	PFM step-up, 100kHz, 5.5V±2.5%, 400mA	USP-6C	49go	DC13	9b	Tor
MF561	XC9110F561ER	DC/DC-IC	PFM step-up, 100kHz, 5.6V±2.5%, 400mA	USP-6C	49go	DC13	9b	Tor
MF571	XC9110F571ER	DC/DC-IC	PFM step-up, 100kHz, 5.7V±2.5%, 400mA	USP-6C	49go	DC13	9b	Tor
MF581	XC9110F581ER	DC/DC-IC	PFM step-up, 100kHz, 5.8V±2.5%, 400mA	USP-6C	49go	DC13	9b	Tor
MF591	XC9110F591ER	DC/DC-IC	PFM step-up, 100kHz, 5.9V±2.5%, 400mA	USP-6C	49go	DC13	9b	Tor
MF601	XC9110F601ER	DC/DC-IC	PFM step-up, 100kHz, 6.0V±2.5%, 400mA	USP-6C	49go	DC13	9b	Tor
MF611	XC9110F611ER	DC/DC-IC	PFM step-up, 100kHz, 6.1V±2.5%, 400mA	USP-6C	49go	DC13	9b	Tor
MF621	XC9110F621ER	DC/DC-IC	PFM step-up, 100kHz, 6.2V±2.5%, 400mA	USP-6C	49go	DC13	9b	Tor
MF631	XC9110F631ER	DC/DC-IC	PFM step-up, 100kHz, 6.3V±2.5%, 400mA	USP-6C	49go	DC13	9b	Tor
MF641	XC9110F641ER	DC/DC-IC	PFM step-up, 100kHz, 6.4V±2.5%, 400mA	USP-6C	49go	DC13	9b	Tor



SMD code	Type	Function	Short description	Case	Pinout	Sch.	St.	Mnf.
MF651	XC9110F651ER	DC/DC-IC	PFM step-up, 100kHz, 6.5V±2.5%, 400mA	USP-6C	49go	DC13	9b	Tor
MF661	XC9110F661ER	DC/DC-IC	PFM step-up, 100kHz, 6.6V±2.5%, 400mA	USP-6C	49go	DC13	9b	Tor
MF671	XC9110F671ER	DC/DC-IC	PFM step-up, 100kHz, 6.7V±2.5%, 400mA	USP-6C	49go	DC13	9b	Tor
MF681	XC9110F681ER	DC/DC-IC	PFM step-up, 100kHz, 6.8V±2.5%, 400mA	USP-6C	49go	DC13	9b	Tor
MF691	XC9110F691ER	DC/DC-IC	PFM step-up, 100kHz, 6.9V±2.5%, 400mA	USP-6C	49go	DC13	9b	Tor
MF701	XC9110F701ER	DC/DC-IC	PFM step-up, 100kHz, 7.0V±2.5%, 400mA	USP-6C	49go	DC13	9b	Tor
MF8	XC9237C08D4R-G	DC-DC-IC	PWM-PWM/PPM, st-dwn, 0.8V±2%, 600mA, 3MHz, Vin>2V, LSST, CL	USP-6EL	56dc5	DC1	9a	Tor
MF8	XC9237C08DER	DC-DC-IC	PWM-PWM/PPM, st-dwn, 0.8V±2%, 600mA, 3MHz, Vin>2V, LSST, CL	USP-6C	49dc5	DC1	9a	Tor
MF8	XCL207C0844R-G	DC/DC-IC	PWM-PWM/PPM st-dwn, 3MHz, 0.8V±2%, 600mA, CL, soft start	CL-2025	67dc7	DC9	9a	Tor
MF9	XC9237C09D4R-G	DC-DC-IC	PWM-PWM/PPM, st-dwn, 0.9V±2%, 600mA, 3MHz, Vin>2V, LSST, CL	USP-6EL	56dc5	DC1	9a	Tor
MF9	XC9237C09DER	DC-DC-IC	PWM-PWM/PPM, st-dwn, 0.9V±2%, 600mA, 3MHz, Vin>2V, LSST, CL	USP-6C	49dc5	DC1	9a	Tor
MF9	XCL207C0944R-G	DC/DC-IC	PWM-PWM/PPM st-dwn, 3MHz, 0.9V±2%, 600mA, CL, soft start	CL-2025	67dc7	DC9	9a	Tor
MFL	XC9237C0LD4R-G	DC-DC-IC	PWM-PWM/PPM, st-dwn, 0.85V±2%, 600mA, 3MHz, Vin>2V, LSST, CL	USP-6EL	56dc5	DC1	9a	Tor
MFL	XC9237C0LDER	DC-DC-IC	PWM-PWM/PPM, st-dwn, 0.85V±2%, 600mA, 3MHz, Vin>2V, LSST, CL	USP-6C	49dc5	DC1	9a	Tor
MFMM	XC9237C0MD4R-G	DC-DC-IC	PWM-PWM/PPM, st-dwn, 0.95V±2%, 600mA, 3MHz, Vin>2V, LSST, CL	USP-6EL	56dc5	DC1	9a	Tor
MFMM	XC9237C0MDER	DC-DC-IC	PWM-PWM/PPM, st-dwn, 0.95V±2%, 600mA, 3MHz, Vin>2V, LSST, CL	USP-6C	49dc5	DC1	9a	Tor
MG	R1118K131B	LVR-IC	1.3V±1%, 150mA, +CE	DFM1612-4B	45vm	VR4	9a	Ric
MG	RP107K401D	LVR-IC	LDO, 4.0V±1%, 200mA, +CE, CL	DFM1212-6	52vr2	VR4	9a	Ric
MH	R1118K141B	LVR-IC	1.4V±1%, 150mA, +CE	DFM1612-4B	45vm	VR4	9a	Ric
MH	RP107K411D	LVR-IC	LDO, 4.1V±1%, 200mA, +CE, CL	DFM1212-6	52vr2	VR4	9a	Ric
MH0	XC9237C10D4R-G	DC-DC-IC	PWM-PWM/PPM, st-dwn, 1.0V±2%, 600mA, 3MHz, Vin>2V, LSST, CL	USP-6EL	56dc5	DC1	9a	Tor
MH0	XC9237C10DER	DC-DC-IC	PWM-PWM/PPM, st-dwn, 1.0V±2%, 600mA, 3MHz, Vin>2V, LSST, CL	USP-6C	49dc5	DC1	9a	Tor
MH0	XCL207C1044R-G	DC/DC-IC	PWM-PWM/PPM st-dwn, 3MHz, 1.0V±2%, 600mA, CL, soft start	CL-2025	67dc7	DC9	9a	Tor
MH1	XC9237C11D4R-G	DC-DC-IC	PWM-PWM/PPM, st-dwn, 1.1V±2%, 600mA, 3MHz, Vin>2V, LSST, CL	USP-6EL	56dc5	DC1	9a	Tor
MH1	XC9237C11DER	DC-DC-IC	PWM-PWM/PPM, st-dwn, 1.1V±2%, 600mA, 3MHz, Vin>2V, LSST, CL	USP-6C	49dc5	DC1	9a	Tor
MH1	XCL207C1144R-G	DC/DC-IC	PWM-PWM/PPM st-dwn, 3MHz, 1.1V±2%, 600mA, CL, soft start	CL-2025	67dc7	DC9	9a	Tor
MH2	XC9237C12D4R-G	DC-DC-IC	PWM-PWM/PPM, st-dwn, 1.2V±2%, 600mA, 3MHz, Vin>2V, LSST, CL	USP-6EL	56dc5	DC1	9a	Tor
MH2	XC9237C12DER	DC-DC-IC	PWM-PWM/PPM, st-dwn, 1.2V±2%, 600mA, 3MHz, Vin>2V, LSST, CL	USP-6C	49dc5	DC1	9a	Tor
MH2	XCL207C1244R-G	DC/DC-IC	PWM-PWM/PPM st-dwn, 3MHz, 1.2V±2%, 600mA, CL, soft start	CL-2025	67dc7	DC9	9a	Tor
MH3	XC9237C13D4R-G	DC-DC-IC	PWM-PWM/PPM, st-dwn, 1.3V±2%, 600mA, 3MHz, Vin>2V, LSST, CL	USP-6EL	56dc5	DC1	9a	Tor
MH3	XC9237C13DER	DC-DC-IC	PWM-PWM/PPM, st-dwn, 1.3V±2%, 600mA, 3MHz, Vin>2V, LSST, CL	USP-6C	49dc5	DC1	9a	Tor
MH3	XCL207C1344R-G	DC/DC-IC	PWM-PWM/PPM st-dwn, 3MHz, 1.3V±2%, 600mA, CL, soft start	CL-2025	67dc7	DC9	9a	Tor
MH4	XC9237C14D4R-G	DC-DC-IC	PWM-PWM/PPM, st-dwn, 1.4V±2%, 600mA, 3MHz, Vin>2V, LSST, CL	USP-6EL	56dc5	DC1	9a	Tor
MH4	XC9237C14DER	DC-DC-IC	PWM-PWM/PPM, st-dwn, 1.4V±2%, 600mA, 3MHz, Vin>2V, LSST, CL	USP-6C	49dc5	DC1	9a	Tor
MH4	XCL207C1444R-G	DC/DC-IC	PWM-PWM/PPM st-dwn, 3MHz, 1.4V±2%, 600mA, CL, soft start	CL-2025	67dc7	DC9	9a	Tor
MH5	XC9237C15D4R-G	DC-DC-IC	PWM-PWM/PPM, st-dwn, 1.5V±2%, 600mA, 3MHz, Vin>2V, LSST, CL	USP-6EL	56dc5	DC1	9a	Tor
MH5	XC9237C15DER	DC-DC-IC	PWM-PWM/PPM, st-dwn, 1.5V±2%, 600mA, 3MHz, Vin>2V, LSST, CL	USP-6C	49dc5	DC1	9a	Tor
MH5	XCL207C1544R-G	DC/DC-IC	PWM-PWM/PPM st-dwn, 3MHz, 1.5V±2%, 600mA, CL, soft start	CL-2025	67dc7	DC9	9a	Tor
MH6	XC9237C16D4R-G	DC-DC-IC	PWM-PWM/PPM, st-dwn, 1.6V±2%, 600mA, 3MHz, Vin>2V, LSST, CL	USP-6EL	56dc5	DC1	9a	Tor
MH6	XC9237C16DER	DC-DC-IC	PWM-PWM/PPM, st-dwn, 1.6V±2%, 600mA, 3MHz, Vin>2V, LSST, CL	USP-6C	49dc5	DC1	9a	Tor
MH6	XCL207C1644R-G	DC/DC-IC	PWM-PWM/PPM st-dwn, 3MHz, 1.6V±2%, 600mA, CL, soft start	CL-2025	67dc7	DC9	9a	Tor
MH7	XC9237C17D4R-G	DC-DC-IC	PWM-PWM/PPM, st-dwn, 1.7V±2%, 600mA, 3MHz, Vin>2V, LSST, CL	USP-6EL	56dc5	DC1	9a	Tor
MH7	XC9237C17DER	DC-DC-IC	PWM-PWM/PPM, st-dwn, 1.7V±2%, 600mA, 3MHz, Vin>2V, LSST, CL	USP-6C	49dc5	DC1	9a	Tor
MH7	XCL207C1744R-G	DC/DC-IC	PWM-PWM/PPM st-dwn, 3MHz, 1.7V±2%, 600mA, CL, soft start	CL-2025	67dc7	DC9	9a	Tor
MH8	XC9237C18D4R-G	DC-DC-IC	PWM-PWM/PPM, st-dwn, 1.8V±2%, 600mA, 3MHz, Vin>2V, LSST, CL	USP-6EL	56dc5	DC1	9a	Tor
MH8	XC9237C18DER	DC-DC-IC	PWM-PWM/PPM, st-dwn, 1.8V±2%, 600mA, 3MHz, Vin>2V, LSST, CL	USP-6C	49dc5	DC1	9a	Tor
MH8	XCL207C1844R-G	DC/DC-IC	PWM-PWM/PPM st-dwn, 3MHz, 1.8V±2%, 600mA, CL, soft start	CL-2025	67dc7	DC9	9a	Tor
MH9	XC9237C19D4R-G	DC-DC-IC	PWM-PWM/PPM, st-dwn, 1.9V±2%, 600mA, 3MHz, Vin>2V, LSST, CL	USP-6EL	56dc5	DC1	9a	Tor
MH9	XC9237C19DER	DC-DC-IC	PWM-PWM/PPM, st-dwn, 1.9V±2%, 600mA, 3MHz, Vin>2V, LSST, CL	USP-6C	49dc5	DC1	9a	Tor
MH9	XCL207C1944R-G	DC/DC-IC	PWM-PWM/PPM st-dwn, 3MHz, 1.9V±2%, 600mA, CL, soft start	CL-2025	67dc7	DC9	9a	Tor
MHA	XC9237C1AD4R-G	DC-DC-IC	PWM-PWM/PPM, st-dwn, 1.05V±2%, 600mA, 3MHz, Vin>2V, LSST, CL	USP-6EL	56dc5	DC1	9a	Tor
MHA	XC9237C1ADER	DC-DC-IC	PWM-PWM/PPM, st-dwn, 1.05V±2%, 600mA, 3MHz, Vin>2V, LSST, CL	USP-6C	49dc5	DC1	9a	Tor
MHB	XC9237C1BD4R-G	DC-DC-IC	PWM-PWM/PPM, st-dwn, 1.15V±2%, 600mA, 3MHz, Vin>2V, LSST, CL	USP-6EL	56dc5	DC1	9a	Tor
MHB	XC9237C1BDER	DC-DC-IC	PWM-PWM/PPM, st-dwn, 1.15V±2%, 600mA, 3MHz, Vin>2V, LSST, CL	USP-6C	49dc5	DC1	9a	Tor
MHC	XC9237C1CD4R-G	DC-DC-IC	PWM-PWM/PPM, st-dwn, 1.25V±2%, 600mA, 3MHz, Vin>2V, LSST, CL	USP-6EL	56dc5	DC1	9a	Tor
MHC	XC9237C1CDER	DC-DC-IC	PWM-PWM/PPM, st-dwn, 1.25V±2%, 600mA, 3MHz, Vin>2V, LSST, CL	USP-6C	49dc5	DC1	9a	Tor
MHD	XC9237C1DD4R-G	DC-DC-IC	PWM-PWM/PPM, st-dwn, 1.35V±2%, 600mA, 3MHz, Vin>2V, LSST, CL	USP-6EL	56dc5	DC1	9a	Tor
MHD	XC9237C1DDER	DC-DC-IC	PWM-PWM/PPM, st-dwn, 1.35V±2%, 600mA, 3MHz, Vin>2V, LSST, CL	USP-6C	49dc5	DC1	9a	Tor
MHE	XC9237C1ED4R-G	DC-DC-IC	PWM-PWM/PPM, st-dwn, 1.45V±2%, 600mA, 3MHz, Vin>2V, LSST, CL	USP-6EL	56dc5	DC1	9a	Tor
MHE	XC9237C1EDER	DC-DC-IC	PWM-PWM/PPM, st-dwn, 1.45V±2%, 600mA, 3MHz, Vin>2V, LSST, CL	USP-6C	49dc5	DC1	9a	Tor
MHF	XC9237C1FD4R-G	DC-DC-IC	PWM-PWM/PPM, st-dwn, 1.55V±2%, 600mA, 3MHz, Vin>2V, LSST, CL	USP-6EL	56dc5	DC1	9a	Tor
MHF	XC9237C1FDER	DC-DC-IC	PWM-PWM/PPM, st-dwn, 1.55V±2%, 600mA, 3MHz, Vin>2V, LSST, CL	USP-6C	49dc5	DC1	9a	Tor
MHH	XC9237C1HD4R-G	DC-DC-IC	PWM-PWM/PPM, st-dwn, 1.65V±2%, 600mA, 3MHz, Vin>2V, LSST, CL	USP-6EL	56dc5	DC1	9a	Tor
MHH	XC9237C1HDER	DC-DC-IC	PWM-PWM/PPM, st-dwn, 1.65V±2%, 600mA, 3MHz, Vin>2V, LSST, CL	USP-6C	49dc5	DC1	9a	Tor
MHK	XC9237C1KD4R-G	DC-DC-IC	PWM-PWM/PPM, st-dwn, 1.75V±2%, 600mA, 3MHz, Vin>2V, LSST, CL	USP-6EL	56dc5	DC1	9a	Tor
MHK	XC9237C1KDER	DC-DC-IC	PWM-PWM/PPM, st-dwn, 1.75V±2%, 600mA, 3MHz, Vin>2V, LSST, CL	USP-6C	49dc5	DC1	9a	Tor
MHL	XC9237C1LD4R-G	DC-DC-IC	PWM-PWM/PPM, st-dwn, 1.85V±2%, 600mA, 3MHz, Vin>2V, LSST, CL	USP-6EL	56dc5	DC1	9a	Tor
MHL	XC9237C1LDER	DC-DC-IC	PWM-PWM/PPM, st-dwn, 1.85V±2%, 600mA, 3MHz, Vin>2V, LSST, CL	USP-6C	49dc5	DC1	9a	Tor
MHM	XC9237C1MD4R-G	DC-DC-IC	PWM-PWM/PPM, st-dwn, 1.95V±2%, 600mA, 3MHz, Vin>2V, LSST, CL	USP-6EL	56dc5	DC1	9a	Tor
MHM	XC9237C1MDER	DC-DC-IC	PWM-PWM/PPM, st-dwn, 1.95V±2%, 600mA, 3MHz, Vin>2V, LSST, CL	USP-6C	49dc5	DC1	9a	Tor



SMD code	Type	Function	Short description	Case	Pinout	Sch.	St.Mnf.
MI	NX3L1T3157GM	CMOS-Logic	Single-pole double-throw analog switch	SOT-886	57L	Log38	- 9c Phi
MJ	NX3L1G3157GM	CMOS-Logic	Single-pole double-throw analog switch	SOT-886	57L	Log38	- 9c Phi
MJ	R1118K151B	LVR-IC	1.5V±1%, 150mA, +CE	DFN1612-4B	45vm	VR4	9a Ric
MJ	RP107K421D	LVR-IC	LDO, 4.2V±1%, 200mA, +CE, CL	DFN1212-6	52vr2	VR4	9a Ric
MK	MAX8840ELT26+T	LVR-IC	LDO, 2.6V±2%, 150mA, +CE	DFN-6	52	VR7a	9t Max
MK	R1118K161B	LVR-IC	1.6V±1%, 150mA, +CE	DFN1612-4B	45vm	VR4	9a Ric
MK	RP107K121D5	LVR-IC	LDO, 1.25V±1%, 200mA, +CE, CL	DFN1212-6	52vr2	VR4	9a Ric
MK0	XC9237C20D4R-G	DC-DC-IC	PWM-PWM/PPM, st-dwn, 2.0V±2%, 600mA, 3MHz, Vin>2V, LSST, CL	USP-6EL	56dc5	DC1	9a Tor
MK0	XC9237C20DER	DC-DC-IC	PWM-PWM/PPM, st-dwn, 2.0V±2%, 600mA, 3MHz, Vin>2V, LSST, CL	USP-6C	49dc5	DC1	9a Tor
M̄K0	XCL207C204AR-G	DC/DC-IC	PWM-PWM/PPM, st-dwn, 3MHz, 2.0V±2%, 600mA, CL, soft start	CL-2025	67dc7	DC9	9a Tor
MK1	XC9237C21D4R-G	DC-DC-IC	PWM-PWM/PPM, st-dwn, 2.1V±2%, 600mA, 3MHz, Vin>2V, LSST, CL	USP-6EL	56dc5	DC1	9a Tor
MK1	XC9237C21DER	DC-DC-IC	PWM-PWM/PPM, st-dwn, 2.1V±2%, 600mA, 3MHz, Vin>2V, LSST, CL	USP-6C	49dc5	DC1	9a Tor
M̄K1	XCL207C214AR-G	DC/DC-IC	PWM-PWM/PPM, st-dwn, 3MHz, 2.1V±2%, 600mA, CL, soft start	CL-2025	67dc7	DC9	9a Tor
MK2	XC9237C22D4R-G	DC-DC-IC	PWM-PWM/PPM, st-dwn, 2.2V±2%, 600mA, 3MHz, Vin>2V, LSST, CL	USP-6EL	56dc5	DC1	9a Tor
MK2	XC9237C22DER	DC-DC-IC	PWM-PWM/PPM, st-dwn, 2.2V±2%, 600mA, 3MHz, Vin>2V, LSST, CL	USP-6C	49dc5	DC1	9a Tor
M̄K2	XCL207C224AR-G	DC/DC-IC	PWM-PWM/PPM, st-dwn, 3MHz, 2.2V±2%, 600mA, CL, soft start	CL-2025	67dc7	DC9	9a Tor
MK3	XC9237C23D4R-G	DC-DC-IC	PWM-PWM/PPM, st-dwn, 2.3V±2%, 600mA, 3MHz, Vin>2V, LSST, CL	USP-6EL	56dc5	DC1	9a Tor
MK3	XC9237C23DER	DC-DC-IC	PWM-PWM/PPM, st-dwn, 2.3V±2%, 600mA, 3MHz, Vin>2V, LSST, CL	USP-6C	49dc5	DC1	9a Tor
M̄K3	XCL207C234AR-G	DC/DC-IC	PWM-PWM/PPM, st-dwn, 3MHz, 2.3V±2%, 600mA, CL, soft start	CL-2025	67dc7	DC9	9a Tor
MK4	XC9237C24D4R-G	DC-DC-IC	PWM-PWM/PPM, st-dwn, 2.4V±2%, 600mA, 3MHz, Vin>2V, LSST, CL	USP-6EL	56dc5	DC1	9a Tor
MK4	XC9237C24DER	DC-DC-IC	PWM-PWM/PPM, st-dwn, 2.4V±2%, 600mA, 3MHz, Vin>2V, LSST, CL	USP-6C	49dc5	DC1	9a Tor
M̄K4	XCL207C244AR-G	DC/DC-IC	PWM-PWM/PPM, st-dwn, 3MHz, 2.4V±2%, 600mA, CL, soft start	CL-2025	67dc7	DC9	9a Tor
MK5	XC9237C25D4R-G	DC-DC-IC	PWM-PWM/PPM, st-dwn, 2.5V±2%, 600mA, 3MHz, Vin>2V, LSST, CL	USP-6EL	56dc5	DC1	9a Tor
MK5	XC9237C25DER	DC-DC-IC	PWM-PWM/PPM, st-dwn, 2.5V±2%, 600mA, 3MHz, Vin>2V, LSST, CL	USP-6C	49dc5	DC1	9a Tor
M̄K5	XCL207C254AR-G	DC/DC-IC	PWM-PWM/PPM, st-dwn, 3MHz, 2.5V±2%, 600mA, CL, soft start	CL-2025	67dc7	DC9	9a Tor
MK6	XC9237C26D4R-G	DC-DC-IC	PWM-PWM/PPM, st-dwn, 2.6V±2%, 600mA, 3MHz, Vin>2V, LSST, CL	USP-6EL	56dc5	DC1	9a Tor
MK6	XC9237C26DER	DC-DC-IC	PWM-PWM/PPM, st-dwn, 2.6V±2%, 600mA, 3MHz, Vin>2V, LSST, CL	USP-6C	49dc5	DC1	9a Tor
M̄K6	XCL207C264AR-G	DC/DC-IC	PWM-PWM/PPM, st-dwn, 3MHz, 2.6V±2%, 600mA, CL, soft start	CL-2025	67dc7	DC9	9a Tor
MK7	XC9237C27D4R-G	DC-DC-IC	PWM-PWM/PPM, st-dwn, 2.7V±2%, 600mA, 3MHz, Vin>2V, LSST, CL	USP-6EL	56dc5	DC1	9a Tor
MK7	XC9237C27DER	DC-DC-IC	PWM-PWM/PPM, st-dwn, 2.7V±2%, 600mA, 3MHz, Vin>2V, LSST, CL	USP-6C	49dc5	DC1	9a Tor
M̄K7	XCL207C274AR-G	DC/DC-IC	PWM-PWM/PPM, st-dwn, 3MHz, 2.7V±2%, 600mA, CL, soft start	CL-2025	67dc7	DC9	9a Tor
MK8	XC9237C28D4R-G	DC-DC-IC	PWM-PWM/PPM, st-dwn, 2.8V±2%, 600mA, 3MHz, Vin>2V, LSST, CL	USP-6EL	56dc5	DC1	9a Tor
MK8	XC9237C28DER	DC-DC-IC	PWM-PWM/PPM, st-dwn, 2.8V±2%, 600mA, 3MHz, Vin>2V, LSST, CL	USP-6C	49dc5	DC1	9a Tor
M̄K8	XCL207C284AR-G	DC/DC-IC	PWM-PWM/PPM, st-dwn, 3MHz, 2.8V±2%, 600mA, CL, soft start	CL-2025	67dc7	DC9	9a Tor
MK9	XC9237C29D4R-G	DC-DC-IC	PWM-PWM/PPM, st-dwn, 2.9V±2%, 600mA, 3MHz, Vin>2V, LSST, CL	USP-6EL	56dc5	DC1	9a Tor
MK9	XC9237C29DER	DC-DC-IC	PWM-PWM/PPM, st-dwn, 2.9V±2%, 600mA, 3MHz, Vin>2V, LSST, CL	USP-6C	49dc5	DC1	9a Tor
M̄K9	XCL207C294AR-G	DC/DC-IC	PWM-PWM/PPM, st-dwn, 3MHz, 2.9V±2%, 600mA, CL, soft start	CL-2025	67dc7	DC9	9a Tor
MKA	XC9237C2AD4R-G	DC-DC-IC	PWM-PWM/PPM, st-dwn, 2.05V±2%, 600mA, 3MHz, Vin>2V, LSST, CL	USP-6EL	56dc5	DC1	9a Tor
MKA	XC9237C2ADER	DC-DC-IC	PWM-PWM/PPM, st-dwn, 2.05V±2%, 600mA, 3MHz, Vin>2V, LSST, CL	USP-6C	49dc5	DC1	9a Tor
MKB	XC9237C2BD4R-G	DC-DC-IC	PWM-PWM/PPM, st-dwn, 2.15V±2%, 600mA, 3MHz, Vin>2V, LSST, CL	USP-6EL	56dc5	DC1	9a Tor
MKB	XC9237C2BDER	DC-DC-IC	PWM-PWM/PPM, st-dwn, 2.15V±2%, 600mA, 3MHz, Vin>2V, LSST, CL	USP-6C	49dc5	DC1	9a Tor
MKC	XC9237C2CD4R-G	DC-DC-IC	PWM-PWM/PPM, st-dwn, 2.25V±2%, 600mA, 3MHz, Vin>2V, LSST, CL	USP-6EL	56dc5	DC1	9a Tor
MKC	XC9237C2CDER	DC-DC-IC	PWM-PWM/PPM, st-dwn, 2.25V±2%, 600mA, 3MHz, Vin>2V, LSST, CL	USP-6C	49dc5	DC1	9a Tor
MKD	XC9237C2DD4R-G	DC-DC-IC	PWM-PWM/PPM, st-dwn, 2.35V±2%, 600mA, 3MHz, Vin>2V, LSST, CL	USP-6EL	56dc5	DC1	9a Tor
MKD	XC9237C2DDER	DC-DC-IC	PWM-PWM/PPM, st-dwn, 2.35V±2%, 600mA, 3MHz, Vin>2V, LSST, CL	USP-6C	49dc5	DC1	9a Tor
MKE	XC9237C2ED4R-G	DC-DC-IC	PWM-PWM/PPM, st-dwn, 2.45V±2%, 600mA, 3MHz, Vin>2V, LSST, CL	USP-6EL	56dc5	DC1	9a Tor
MKE	XC9237C2EDER	DC-DC-IC	PWM-PWM/PPM, st-dwn, 2.45V±2%, 600mA, 3MHz, Vin>2V, LSST, CL	USP-6C	49dc5	DC1	9a Tor
MKF	XC9237C2FD4R-G	DC-DC-IC	PWM-PWM/PPM, st-dwn, 2.55V±2%, 600mA, 3MHz, Vin>2V, LSST, CL	USP-6EL	56dc5	DC1	9a Tor
MKF	XC9237C2FDER	DC-DC-IC	PWM-PWM/PPM, st-dwn, 2.55V±2%, 600mA, 3MHz, Vin>2V, LSST, CL	USP-6C	49dc5	DC1	9a Tor
MKH	XC9237C2HD4R-G	DC-DC-IC	PWM-PWM/PPM, st-dwn, 2.65V±2%, 600mA, 3MHz, Vin>2V, LSST, CL	USP-6EL	56dc5	DC1	9a Tor
MKH	XC9237C2HDER	DC-DC-IC	PWM-PWM/PPM, st-dwn, 2.65V±2%, 600mA, 3MHz, Vin>2V, LSST, CL	USP-6C	49dc5	DC1	9a Tor
MKK	XC9237C2KD4R-G	DC-DC-IC	PWM-PWM/PPM, st-dwn, 2.75V±2%, 600mA, 3MHz, Vin>2V, LSST, CL	USP-6EL	56dc5	DC1	9a Tor
MKK	XC9237C2KDER	DC-DC-IC	PWM-PWM/PPM, st-dwn, 2.75V±2%, 600mA, 3MHz, Vin>2V, LSST, CL	USP-6C	49dc5	DC1	9a Tor
MKL	XC9237C2LD4R-G	DC-DC-IC	PWM-PWM/PPM, st-dwn, 2.85V±2%, 600mA, 3MHz, Vin>2V, LSST, CL	USP-6EL	56dc5	DC1	9a Tor
MKL	XC9237C2LDER	DC-DC-IC	PWM-PWM/PPM, st-dwn, 2.85V±2%, 600mA, 3MHz, Vin>2V, LSST, CL	USP-6C	49dc5	DC1	9a Tor
MKM	XC9237C2MD4R-G	DC-DC-IC	PWM-PWM/PPM, st-dwn, 2.95V±2%, 600mA, 3MHz, Vin>2V, LSST, CL	USP-6EL	56dc5	DC1	9a Tor
MKM	XC9237C2MDER	DC-DC-IC	PWM-PWM/PPM, st-dwn, 2.95V±2%, 600mA, 3MHz, Vin>2V, LSST, CL	USP-6C	49dc5	DC1	9a Tor
ML	MAX8840ELT31+T	LVR-IC	LDO, 3.1V±2%, 150mA, +CE	DFN-6	52	VR7a	9t Max
ML	NX3L1G384GM	CMOS-Logic	Single-pole single-throw analog switch	SOT-886	57L	Log86	- 9c Phi
ML	R1118K171B	LVR-IC	1.7V±1%, 150mA, +CE	DFN1612-4B	45vm	VR4	9a Ric
ML	RP107K181D5	LVR-IC	LDO, 1.85V±1%, 200mA, +CE, CL	DFN1212-6	52vr2	VR4	9a Ric
ML0	XC9237C30D4R-G	DC-DC-IC	PWM-PWM/PPM, st-dwn, 3.0V±2%, 600mA, 3MHz, Vin>2V, LSST, CL	USP-6EL	56dc5	DC1	9a Tor
ML0	XC9237C30DER	DC-DC-IC	PWM-PWM/PPM, st-dwn, 3.0V±2%, 600mA, 3MHz, Vin>2V, LSST, CL	USP-6C	49dc5	DC1	9a Tor
M̄L0	XCL207C304AR-G	DC/DC-IC	PWM-PWM/PPM, st-dwn, 3MHz, 3.0V±2%, 600mA, CL, soft start	CL-2025	67dc7	DC9	9a Tor
ML1	XC9237C31D4R-G	DC-DC-IC	PWM-PWM/PPM, st-dwn, 3.1V±2%, 600mA, 3MHz, Vin>2V, LSST, CL	USP-6EL	56dc5	DC1	9a Tor
ML1	XC9237C31DER	DC-DC-IC	PWM-PWM/PPM, st-dwn, 3.1V±2%, 600mA, 3MHz, Vin>2V, LSST, CL	USP-6C	49dc5	DC1	9a Tor
M̄L1	XCL207C314AR-G	DC/DC-IC	PWM-PWM/PPM, st-dwn, 3MHz, 3.1V±2%, 600mA, CL, soft start	CL-2025	67dc7	DC9	9a Tor
ML2	NX3L2G384GM	CMOS-Logic	2-channel analog switch	SOT902-1	51L	Log68	- 9a Phi
ML2	NX3L2G384GT	CMOS-Logic	2-channel analog switch	SOT833-1	53L	Log68	- 9c Phi
ML2	XC9237C32D4R-G	DC-DC-IC	PWM-PWM/PPM, st-dwn, 3.2V±2%, 600mA, 3MHz, Vin>2V, LSST, CL	USP-6EL	56dc5	DC1	9a Tor



SMD code	Type	Function	Short description	Case	Pinout	Sch.	St.	Mnf.
ML2	XC9237C32DER	DC-DC-IC	PWM-PWM/PPM, st-dwn, 3.2V±2%, 600mA, 3MHz, Vin>2V, LSST, CL	USP-6C	49dc5	DC1	9a	Tor
ML2	XCL207C324AR-G	DC/DC-IC	PWM-PWM/PPM st-dwn, 3MHz, 3.2V±2%, 600mA, CL, soft start	CL-2025	67dc7	DC9	9a	Tor
ML3	XC9237C33D4R-G	DC-DC-IC	PWM-PWM/PPM, st-dwn, 3.3V±2%, 600mA, 3MHz, Vin>2V, LSST, CL	USP-6EL	56dc5	DC1	9a	Tor
ML3	XC9237C33DER	DC-DC-IC	PWM-PWM/PPM, st-dwn, 3.3V±2%, 600mA, 3MHz, Vin>2V, LSST, CL	USP-6C	49dc5	DC1	9a	Tor
ML3	XCL207C334AR-G	DC/DC-IC	PWM-PWM/PPM st-dwn, 3MHz, 3.3V±2%, 600mA, CL, soft start	CL-2025	67dc7	DC9	9a	Tor
ML4	XC9237C34D4R-G	DC-DC-IC	PWM-PWM/PPM, st-dwn, 3.4V±2%, 600mA, 3MHz, Vin>2V, LSST, CL	USP-6EL	56dc5	DC1	9a	Tor
ML4	XC9237C34DER	DC-DC-IC	PWM-PWM/PPM, st-dwn, 3.4V±2%, 600mA, 3MHz, Vin>2V, LSST, CL	USP-6C	49dc5	DC1	9a	Tor
ML4	XCL207C344AR-G	DC/DC-IC	PWM-PWM/PPM st-dwn, 3MHz, 3.4V±2%, 600mA, CL, soft start	CL-2025	67dc7	DC9	9a	Tor
ML5	XC9237C35D4R-G	DC-DC-IC	PWM-PWM/PPM, st-dwn, 3.5V±2%, 600mA, 3MHz, Vin>2V, LSST, CL	USP-6EL	56dc5	DC1	9a	Tor
ML5	XC9237C35DER	DC-DC-IC	PWM-PWM/PPM, st-dwn, 3.5V±2%, 600mA, 3MHz, Vin>2V, LSST, CL	USP-6C	49dc5	DC1	9a	Tor
ML5	XCL207C354AR-G	DC/DC-IC	PWM-PWM/PPM st-dwn, 3MHz, 3.5V±2%, 600mA, CL, soft start	CL-2025	67dc7	DC9	9a	Tor
ML6	XC9237C36D4R-G	DC-DC-IC	PWM-PWM/PPM, st-dwn, 3.6V±2%, 600mA, 3MHz, Vin>2V, LSST, CL	USP-6EL	56dc5	DC1	9a	Tor
ML6	XC9237C36DER	DC-DC-IC	PWM-PWM/PPM, st-dwn, 3.6V±2%, 600mA, 3MHz, Vin>2V, LSST, CL	USP-6C	49dc5	DC1	9a	Tor
ML6	XCL207C364AR-G	DC/DC-IC	PWM-PWM/PPM st-dwn, 3MHz, 3.6V±2%, 600mA, CL, soft start	CL-2025	67dc7	DC9	9a	Tor
ML7	XC9237C37D4R-G	DC-DC-IC	PWM-PWM/PPM, st-dwn, 3.7V±2%, 600mA, 3MHz, Vin>2V, LSST, CL	USP-6EL	56dc5	DC1	9a	Tor
ML7	XC9237C37DER	DC-DC-IC	PWM-PWM/PPM, st-dwn, 3.7V±2%, 600mA, 3MHz, Vin>2V, LSST, CL	USP-6C	49dc5	DC1	9a	Tor
ML7	XCL207C374AR-G	DC/DC-IC	PWM-PWM/PPM st-dwn, 3MHz, 3.7V±2%, 600mA, CL, soft start	CL-2025	67dc7	DC9	9a	Tor
ML8	XC9237C38D4R-G	DC-DC-IC	PWM-PWM/PPM, st-dwn, 3.8V±2%, 600mA, 3MHz, Vin>2V, LSST, CL	USP-6EL	56dc5	DC1	9a	Tor
ML8	XC9237C38DER	DC-DC-IC	PWM-PWM/PPM, st-dwn, 3.8V±2%, 600mA, 3MHz, Vin>2V, LSST, CL	USP-6C	49dc5	DC1	9a	Tor
ML8	XCL207C384AR-G	DC/DC-IC	PWM-PWM/PPM st-dwn, 3MHz, 3.8V±2%, 600mA, CL, soft start	CL-2025	67dc7	DC9	9a	Tor
ML9	XC9237C39D4R-G	DC-DC-IC	PWM-PWM/PPM, st-dwn, 3.9V±2%, 600mA, 3MHz, Vin>2V, LSST, CL	USP-6EL	56dc5	DC1	9a	Tor
ML9	XC9237C39DER	DC-DC-IC	PWM-PWM/PPM, st-dwn, 3.9V±2%, 600mA, 3MHz, Vin>2V, LSST, CL	USP-6C	49dc5	DC1	9a	Tor
ML9	XCL207C394AR-G	DC/DC-IC	PWM-PWM/PPM st-dwn, 3MHz, 3.9V±2%, 600mA, CL, soft start	CL-2025	67dc7	DC9	9a	Tor
MLA	XC9237C3AD4R-G	DC-DC-IC	PWM-PWM/PPM, st-dwn, 3.05V±2%, 600mA, 3MHz, Vin>2V, LSST, CL	USP-6EL	56dc5	DC1	9a	Tor
MLA	XC9237C3ADER	DC-DC-IC	PWM-PWM/PPM, st-dwn, 3.05V±2%, 600mA, 3MHz, Vin>2V, LSST, CL	USP-6C	49dc5	DC1	9a	Tor
MLB	XC9237C3BD4R-G	DC-DC-IC	PWM-PWM/PPM, st-dwn, 3.15V±2%, 600mA, 3MHz, Vin>2V, LSST, CL	USP-6EL	56dc5	DC1	9a	Tor
MLB	XC9237C3BDER	DC-DC-IC	PWM-PWM/PPM, st-dwn, 3.15V±2%, 600mA, 3MHz, Vin>2V, LSST, CL	USP-6C	49dc5	DC1	9a	Tor
MLC	XC9237C3CD4R-G	DC-DC-IC	PWM-PWM/PPM, st-dwn, 3.25V±2%, 600mA, 3MHz, Vin>2V, LSST, CL	USP-6EL	56dc5	DC1	9a	Tor
MLC	XC9237C3CDER	DC-DC-IC	PWM-PWM/PPM, st-dwn, 3.25V±2%, 600mA, 3MHz, Vin>2V, LSST, CL	USP-6C	49dc5	DC1	9a	Tor
MLD	XC9237C3DD4R-G	DC-DC-IC	PWM-PWM/PPM, st-dwn, 3.35V±2%, 600mA, 3MHz, Vin>2V, LSST, CL	USP-6EL	56dc5	DC1	9a	Tor
MLD	XC9237C3DDER	DC-DC-IC	PWM-PWM/PPM, st-dwn, 3.35V±2%, 600mA, 3MHz, Vin>2V, LSST, CL	USP-6C	49dc5	DC1	9a	Tor
MLE	XC9237C3ED4R-G	DC-DC-IC	PWM-PWM/PPM, st-dwn, 3.45V±2%, 600mA, 3MHz, Vin>2V, LSST, CL	USP-6EL	56dc5	DC1	9a	Tor
MLE	XC9237C3EDER	DC-DC-IC	PWM-PWM/PPM, st-dwn, 3.45V±2%, 600mA, 3MHz, Vin>2V, LSST, CL	USP-6C	49dc5	DC1	9a	Tor
MLF	XC9237C3FD4R-G	DC-DC-IC	PWM-PWM/PPM, st-dwn, 3.55V±2%, 600mA, 3MHz, Vin>2V, LSST, CL	USP-6EL	56dc5	DC1	9a	Tor
MLF	XC9237C3FDER	DC-DC-IC	PWM-PWM/PPM, st-dwn, 3.55V±2%, 600mA, 3MHz, Vin>2V, LSST, CL	USP-6C	49dc5	DC1	9a	Tor
MLH	XC9237C3HD4R-G	DC-DC-IC	PWM-PWM/PPM, st-dwn, 3.65V±2%, 600mA, 3MHz, Vin>2V, LSST, CL	USP-6EL	56dc5	DC1	9a	Tor
MLH	XC9237C3HDER	DC-DC-IC	PWM-PWM/PPM, st-dwn, 3.65V±2%, 600mA, 3MHz, Vin>2V, LSST, CL	USP-6C	49dc5	DC1	9a	Tor
MLK	XC9237C3KD4R-G	DC-DC-IC	PWM-PWM/PPM, st-dwn, 3.75V±2%, 600mA, 3MHz, Vin>2V, LSST, CL	USP-6EL	56dc5	DC1	9a	Tor
MLK	XC9237C3KDER	DC-DC-IC	PWM-PWM/PPM, st-dwn, 3.75V±2%, 600mA, 3MHz, Vin>2V, LSST, CL	USP-6C	49dc5	DC1	9a	Tor
MLL	XC9237C3LD4R-G	DC-DC-IC	PWM-PWM/PPM, st-dwn, 3.85V±2%, 600mA, 3MHz, Vin>2V, LSST, CL	USP-6EL	56dc5	DC1	9a	Tor
MLL	XC9237C3LDER	DC-DC-IC	PWM-PWM/PPM, st-dwn, 3.85V±2%, 600mA, 3MHz, Vin>2V, LSST, CL	USP-6C	49dc5	DC1	9a	Tor
MLM	XC9237C3MD4R-G	DC-DC-IC	PWM-PWM/PPM, st-dwn, 3.95V±2%, 600mA, 3MHz, Vin>2V, LSST, CL	USP-6EL	56dc5	DC1	9a	Tor
MLM	XC9237C3MDER	DC-DC-IC	PWM-PWM/PPM, st-dwn, 3.95V±2%, 600mA, 3MHz, Vin>2V, LSST, CL	USP-6C	49dc5	DC1	9a	Tor
MM	MAX8840ELT33+T	LVR-IC	LDO, 3.3V±2%, 150mA, +CE	DFN-6	52	VR7a	9t	Max
MM	R1118K181B	LVR-IC	1.8V±1%, 150mA, +CE	DFN1612-4B	45vm	VR4	9a	Ric
MM	RP107K281D5	LVR-IC	LDO, 2.85V±1%, 200mA, +CE, CL	DFN1212-6	52vr2	VR4	9a	Ric
MM0	XC9237C40D4R-G	DC-DC-IC	PWM-PWM/PPM, st-dwn, 4.0V±2%, 600mA, 3MHz, Vin>2V, LSST, CL	USP-6EL	56dc5	DC1	9a	Tor
MM0	XC9237C40DER	DC-DC-IC	PWM-PWM/PPM, st-dwn, 4.0V±2%, 600mA, 3MHz, Vin>2V, LSST, CL	USP-6C	49dc5	DC1	9a	Tor
MM0	XCL207C404AR-G	DC/DC-IC	PWM-PWM/PPM st-dwn, 3MHz, 4.0V±2%, 600mA, CL, soft start	CL-2025	67dc7	DC9	9a	Tor
MN	MAX8840ELT16+T	LVR-IC	LDO, 1.6V±2%, 150mA, +CE	DFN-6	52	VR7a	9t	Max
MN	R1118K181B5	LVR-IC	1.85V±1%, 150mA, +CE	DFN1612-4B	45vm	VR4	9a	Ric
MN8	XC9237D08CER	DC-DC-IC	PWM-PWM/PPM, st-dwn, 0.8V±2%, 600mA, 1.2MHz, Vin>1.8V, LSST, CL	USP-6C	49da	DC16	9a	Tor
MN9	XC9237D09CER	DC-DC-IC	PWM-PWM/PPM, st-dwn, 0.9V±2%, 600mA, 1.2MHz, Vin>1.8V, LSST, CL	USP-6C	49da	DC16	9a	Tor
MNL	XC9237D0LCER	DC-DC-IC	PWM-PWM/PPM, st-dwn, 0.85V±2%, 600mA, 1.2MHz, Vin>1.8V, LSST, CL	USP-6C	49da	DC16	9a	Tor
MNM	XC9237D0MCER	DC-DC-IC	PWM-PWM/PPM, st-dwn, 0.95V±2%, 600mA, 1.2MHz, Vin>1.8V, LSST, CL	USP-6C	49da	DC16	9a	Tor
MO	MAX8840ELT18+T	LVR-IC	LDO, 1.8V±2%, 150mA, +CE	DFN-6	52	VR7a	9t	Max
MP	MAX8840ELT25+T	LVR-IC	LDO, 2.5V±2%, 150mA, +CE	DFN-6	52	VR7a	9t	Max
MP	R1118K191B	LVR-IC	1.9V±1%, 150mA, +CE	DFN1612-4B	45vm	VR4	9a	Ric
MP0	XC9237D10CER	DC-DC-IC	PWM-PWM/PPM, st-dwn, 1.0V±2%, 600mA, 1.2MHz, Vin>1.8V, LSST, CL	USP-6C	49da	DC16	9a	Tor
MP1	XC9237D11CER	DC-DC-IC	PWM-PWM/PPM, st-dwn, 1.1V±2%, 600mA, 1.2MHz, Vin>1.8V, LSST, CL	USP-6C	49da	DC16	9a	Tor
MP2	XC9237D12CER	DC-DC-IC	PWM-PWM/PPM, st-dwn, 1.2V±2%, 600mA, 1.2MHz, Vin>1.8V, LSST, CL	USP-6C	49da	DC16	9a	Tor
MP3	XC9237D13CER	DC-DC-IC	PWM-PWM/PPM, st-dwn, 1.3V±2%, 600mA, 1.2MHz, Vin>1.8V, LSST, CL	USP-6C	49da	DC16	9a	Tor
MP4	XC9237D14CER	DC-DC-IC	PWM-PWM/PPM, st-dwn, 1.4V±2%, 600mA, 1.2MHz, Vin>1.8V, LSST, CL	USP-6C	49da	DC16	9a	Tor
MP5	XC9237D15CER	DC-DC-IC	PWM-PWM/PPM, st-dwn, 1.5V±2%, 600mA, 1.2MHz, Vin>1.8V, LSST, CL	USP-6C	49da	DC16	9a	Tor
MP6	XC9237D16CER	DC-DC-IC	PWM-PWM/PPM, st-dwn, 1.6V±2%, 600mA, 1.2MHz, Vin>1.8V, LSST, CL	USP-6C	49da	DC16	9a	Tor
MP7	XC9237D17CER	DC-DC-IC	PWM-PWM/PPM, st-dwn, 1.7V±2%, 600mA, 1.2MHz, Vin>1.8V, LSST, CL	USP-6C	49da	DC16	9a	Tor
MP8	XC9237D18CER	DC-DC-IC	PWM-PWM/PPM, st-dwn, 1.8V±2%, 600mA, 1.2MHz, Vin>1.8V, LSST, CL	USP-6C	49da	DC16	9a	Tor
MP9	XC9237D19CER	DC-DC-IC	PWM-PWM/PPM, st-dwn, 1.9V±2%, 600mA, 1.2MHz, Vin>1.8V, LSST, CL	USP-6C	49da	DC16	9a	Tor
MPA	XC9237D1ACER	DC-DC-IC	PWM-PWM/PPM, st-dwn, 1.05V±2%, 600mA, 1.2MHz, Vin>1.8V, LSST, CL	USP-6C	49da	DC16	9a	Tor
MPB	XC9237D1BCER	DC-DC-IC	PWM-PWM/PPM, st-dwn, 1.15V±2%, 600mA, 1.2MHz, Vin>1.8V, LSST, CL	USP-6C	49da	DC16	9a	Tor



SMD code	Type	Function	Short description	Case	Pinout	Sch.	St.	Mnf.
MPC	XC9237D1CCER	DC-DC-IC	PWM-PWM/PPM, st-dwn, 1.25V±2%, 600mA, 1.2MHz, Vin>1.8V, LSST, CL	USP-6C	49da	DC16	9a	Tor
MPD	XC9237D1DCER	DC-DC-IC	PWM-PWM/PPM, st-dwn, 1.35V±2%, 600mA, 1.2MHz, Vin>1.8V, LSST, CL	USP-6C	49da	DC16	9a	Tor
MPE	XC9237D1ECER	DC-DC-IC	PWM-PWM/PPM, st-dwn, 1.45V±2%, 600mA, 1.2MHz, Vin>1.8V, LSST, CL	USP-6C	49da	DC16	9a	Tor
MPF	XC9237D1FCER	DC-DC-IC	PWM-PWM/PPM, st-dwn, 1.55V±2%, 600mA, 1.2MHz, Vin>1.8V, LSST, CL	USP-6C	49da	DC16	9a	Tor
MPH	XC9237D1HCER	DC-DC-IC	PWM-PWM/PPM, st-dwn, 1.65V±2%, 600mA, 1.2MHz, Vin>1.8V, LSST, CL	USP-6C	49da	DC16	9a	Tor
MPK	XC9237D1KCER	DC-DC-IC	PWM-PWM/PPM, st-dwn, 1.75V±2%, 600mA, 1.2MHz, Vin>1.8V, LSST, CL	USP-6C	49da	DC16	9a	Tor
MPL	XC9237D1LCER	DC-DC-IC	PWM-PWM/PPM, st-dwn, 1.85V±2%, 600mA, 1.2MHz, Vin>1.8V, LSST, CL	USP-6C	49da	DC16	9a	Tor
MPM	XC9237D1MCER	DC-DC-IC	PWM-PWM/PPM, st-dwn, 1.95V±2%, 600mA, 1.2MHz, Vin>1.8V, LSST, CL	USP-6C	49da	DC16	9a	Tor
MQ	MAX8841ELT15+T	LVR-IC	LDO, 1.5V±2%, 150mA, +CE	DFN-6	52ys	VR4	9t	Max
MQ	R1118K201B	LVR-IC	2V±1%, 150mA, +CE	DFN1612-4B	45vm	VR4	9a	Ric
MR	MAX8841ELT18+T	LVR-IC	LDO, 1.8V±2%, 150mA, +CE	DFN-6	52ys	VR4	9t	Max
MR	R1118K211B	LVR-IC	2.1V±1%, 150mA, +CE	DFN1612-4B	45vm	VR4	9a	Ric
MR0	XC9237D20CER	DC-DC-IC	PWM-PWM/PPM, st-dwn, 2.0V±2%, 600mA, 1.2MHz, Vin>1.8V, LSST, CL	USP-6C	49da	DC16	9a	Tor
MR1	XC9237D21CER	DC-DC-IC	PWM-PWM/PPM, st-dwn, 2.1V±2%, 600mA, 1.2MHz, Vin>1.8V, LSST, CL	USP-6C	49da	DC16	9a	Tor
MR2	XC9237D22CER	DC-DC-IC	PWM-PWM/PPM, st-dwn, 2.2V±2%, 600mA, 1.2MHz, Vin>1.8V, LSST, CL	USP-6C	49da	DC16	9a	Tor
MR3	XC9237D23CER	DC-DC-IC	PWM-PWM/PPM, st-dwn, 2.3V±2%, 600mA, 1.2MHz, Vin>1.8V, LSST, CL	USP-6C	49da	DC16	9a	Tor
MR4	XC9237D24CER	DC-DC-IC	PWM-PWM/PPM, st-dwn, 2.4V±2%, 600mA, 1.2MHz, Vin>1.8V, LSST, CL	USP-6C	49da	DC16	9a	Tor
MR5	XC9237D25CER	DC-DC-IC	PWM-PWM/PPM, st-dwn, 2.5V±2%, 600mA, 1.2MHz, Vin>1.8V, LSST, CL	USP-6C	49da	DC16	9a	Tor
MR6	XC9237D26CER	DC-DC-IC	PWM-PWM/PPM, st-dwn, 2.6V±2%, 600mA, 1.2MHz, Vin>1.8V, LSST, CL	USP-6C	49da	DC16	9a	Tor
MR7	XC9237D27CER	DC-DC-IC	PWM-PWM/PPM, st-dwn, 2.7V±2%, 600mA, 1.2MHz, Vin>1.8V, LSST, CL	USP-6C	49da	DC16	9a	Tor
MR8	XC9237D28CER	DC-DC-IC	PWM-PWM/PPM, st-dwn, 2.8V±2%, 600mA, 1.2MHz, Vin>1.8V, LSST, CL	USP-6C	49da	DC16	9a	Tor
MR9	XC9237D29CER	DC-DC-IC	PWM-PWM/PPM, st-dwn, 2.9V±2%, 600mA, 1.2MHz, Vin>1.8V, LSST, CL	USP-6C	49da	DC16	9a	Tor
MRA	XC9237D2ACER	DC-DC-IC	PWM-PWM/PPM, st-dwn, 2.05V±2%, 600mA, 1.2MHz, Vin>1.8V, LSST, CL	USP-6C	49da	DC16	9a	Tor
MRA-	NCP2824FC	LIN-IC	AF PA, BTL, class-D, 2.5..5.5V, 2.4W(5V/4Q), shutdown	BGA-9	39	-	90	Ons
MRAG	NCP2824FC	LIN-IC	AF PA, BTL, class-D, 2.5..5.5V, 2.4W(5V/4Q), shutdown	BGA-9	39	-	90	Ons
MRB	XC9237D2BCER	DC-DC-IC	PWM-PWM/PPM, st-dwn, 2.15V±2%, 600mA, 1.2MHz, Vin>1.8V, LSST, CL	USP-6C	49da	DC16	9a	Tor
MRC	XC9237D2CCER	DC-DC-IC	PWM-PWM/PPM, st-dwn, 2.25V±2%, 600mA, 1.2MHz, Vin>1.8V, LSST, CL	USP-6C	49da	DC16	9a	Tor
MRD	XC9237D2DCER	DC-DC-IC	PWM-PWM/PPM, st-dwn, 2.35V±2%, 600mA, 1.2MHz, Vin>1.8V, LSST, CL	USP-6C	49da	DC16	9a	Tor
MRE	XC9237D2ECER	DC-DC-IC	PWM-PWM/PPM, st-dwn, 2.45V±2%, 600mA, 1.2MHz, Vin>1.8V, LSST, CL	USP-6C	49da	DC16	9a	Tor
MRF	XC9237D2FCER	DC-DC-IC	PWM-PWM/PPM, st-dwn, 2.55V±2%, 600mA, 1.2MHz, Vin>1.8V, LSST, CL	USP-6C	49da	DC16	9a	Tor
MRH	NCP2991FC	LIN-IC	AF PA, BTL 2.2..5.5V, 1.35W(5V/8Ω), shutdown	BGA-9	39	AFP44	90	Ons
MRH	XC9237D2HCER	DC-DC-IC	PWM-PWM/PPM, st-dwn, 2.65V±2%, 600mA, 1.2MHz, Vin>1.8V, LSST, CL	USP-6C	49da	DC16	9a	Tor
MRK	XC9237D2KCER	DC-DC-IC	PWM-PWM/PPM, st-dwn, 2.75V±2%, 600mA, 1.2MHz, Vin>1.8V, LSST, CL	USP-6C	49da	DC16	9a	Tor
MRL	XC9237D2LCER	DC-DC-IC	PWM-PWM/PPM, st-dwn, 2.85V±2%, 600mA, 1.2MHz, Vin>1.8V, LSST, CL	USP-6C	49da	DC16	9a	Tor
MRM	XC9237D2MCER	DC-DC-IC	PWM-PWM/PPM, st-dwn, 2.95V±2%, 600mA, 1.2MHz, Vin>1.8V, LSST, CL	USP-6C	49da	DC16	9a	Tor
MS	MAX8841ELT25+T	LVR-IC	LDO, 2.5V±2%, 150mA, +CE	DFN-6	52ys	VR4	9t	Max
MS	R1118K221B	LVR-IC	2.2V±1%, 150mA, +CE	DFN1612-4B	45vm	VR4	9a	Ric
MS0	XC9237D30CER	DC-DC-IC	PWM-PWM/PPM, st-dwn, 3.0V±2%, 600mA, 1.2MHz, Vin>1.8V, LSST, CL	USP-6C	49da	DC16	9a	Tor
MS1	XC9237D31CER	DC-DC-IC	PWM-PWM/PPM, st-dwn, 3.1V±2%, 600mA, 1.2MHz, Vin>1.8V, LSST, CL	USP-6C	49da	DC16	9a	Tor
MS2	XC9237D32CER	DC-DC-IC	PWM-PWM/PPM, st-dwn, 3.2V±2%, 600mA, 1.2MHz, Vin>1.8V, LSST, CL	USP-6C	49da	DC16	9a	Tor
MS3	XC9237D33CER	DC-DC-IC	PWM-PWM/PPM, st-dwn, 3.3V±2%, 600mA, 1.2MHz, Vin>1.8V, LSST, CL	USP-6C	49da	DC16	9a	Tor
MS4	XC9237D34CER	DC-DC-IC	PWM-PWM/PPM, st-dwn, 3.4V±2%, 600mA, 1.2MHz, Vin>1.8V, LSST, CL	USP-6C	49da	DC16	9a	Tor
MS5	XC9237D35CER	DC-DC-IC	PWM-PWM/PPM, st-dwn, 3.5V±2%, 600mA, 1.2MHz, Vin>1.8V, LSST, CL	USP-6C	49da	DC16	9a	Tor
MS6	XC9237D36CER	DC-DC-IC	PWM-PWM/PPM, st-dwn, 3.6V±2%, 600mA, 1.2MHz, Vin>1.8V, LSST, CL	USP-6C	49da	DC16	9a	Tor
MS7	XC9237D37CER	DC-DC-IC	PWM-PWM/PPM, st-dwn, 3.7V±2%, 600mA, 1.2MHz, Vin>1.8V, LSST, CL	USP-6C	49da	DC16	9a	Tor
MS8	XC9237D38CER	DC-DC-IC	PWM-PWM/PPM, st-dwn, 3.8V±2%, 600mA, 1.2MHz, Vin>1.8V, LSST, CL	USP-6C	49da	DC16	9a	Tor
MS9	XC9237D39CER	DC-DC-IC	PWM-PWM/PPM, st-dwn, 3.9V±2%, 600mA, 1.2MHz, Vin>1.8V, LSST, CL	USP-6C	49da	DC16	9a	Tor
MSA	XC9237D3ACER	DC-DC-IC	PWM-PWM/PPM, st-dwn, 3.05V±2%, 600mA, 1.2MHz, Vin>1.8V, LSST, CL	USP-6C	49da	DC16	9a	Tor
MSB	XC9237D3BCER	DC-DC-IC	PWM-PWM/PPM, st-dwn, 3.15V±2%, 600mA, 1.2MHz, Vin>1.8V, LSST, CL	USP-6C	49da	DC16	9a	Tor
MSC	XC9237D3CCER	DC-DC-IC	PWM-PWM/PPM, st-dwn, 3.25V±2%, 600mA, 1.2MHz, Vin>1.8V, LSST, CL	USP-6C	49da	DC16	9a	Tor
MSD	XC9237D3DCER	DC-DC-IC	PWM-PWM/PPM, st-dwn, 3.35V±2%, 600mA, 1.2MHz, Vin>1.8V, LSST, CL	USP-6C	49da	DC16	9a	Tor
MSE	XC9237D3ECER	DC-DC-IC	PWM-PWM/PPM, st-dwn, 3.45V±2%, 600mA, 1.2MHz, Vin>1.8V, LSST, CL	USP-6C	49da	DC16	9a	Tor
MSF	XC9237D3FCER	DC-DC-IC	PWM-PWM/PPM, st-dwn, 3.55V±2%, 600mA, 1.2MHz, Vin>1.8V, LSST, CL	USP-6C	49da	DC16	9a	Tor
MSH	XC9237D3HCER	DC-DC-IC	PWM-PWM/PPM, st-dwn, 3.65V±2%, 600mA, 1.2MHz, Vin>1.8V, LSST, CL	USP-6C	49da	DC16	9a	Tor
MSK	XC9237D3KCER	DC-DC-IC	PWM-PWM/PPM, st-dwn, 3.75V±2%, 600mA, 1.2MHz, Vin>1.8V, LSST, CL	USP-6C	49da	DC16	9a	Tor
MSL	XC9237D3LCER	DC-DC-IC	PWM-PWM/PPM, st-dwn, 3.85V±2%, 600mA, 1.2MHz, Vin>1.8V, LSST, CL	USP-6C	49da	DC16	9a	Tor
MSM	XC9237D3MCER	DC-DC-IC	PWM-PWM/PPM, st-dwn, 3.95V±2%, 600mA, 1.2MHz, Vin>1.8V, LSST, CL	USP-6C	49da	DC16	9a	Tor
MT	MAX8841ELT26+T	LVR-IC	LDO, 2.6V±2%, 150mA, +CE	DFN-6	52ys	VR4	9t	Max
MT	R1118K231B	LVR-IC	2.3V±1%, 150mA, +CE	DFN1612-4B	45vm	VR4	9a	Ric
MT0	XC9237D40CER	DC-DC-IC	PWM-PWM/PPM, st-dwn, 4.0V±2%, 600mA, 1.2MHz, Vin>1.8V, LSST, CL	USP-6C	49da	DC16	9a	Tor
MU	MAX8841ELT28+T	LVR-IC	LDO, 2.8V±2%, 150mA, +CE	DFN-6	52ys	VR4	9t	Max
MU	R1118K241B	LVR-IC	2.4V±1%, 150mA, +CE	DFN1612-4B	45vm	VR4	9a	Ric
MU8	XC9237D08DER	DC-DC-IC	PWM-PWM/PPM, st-dwn, 0.8V±2%, 600mA, 3MHz, Vin>1.8V, LSST, CL	USP-6C	49da	DC16	9a	Tor
MU9	XC9237D09DER	DC-DC-IC	PWM-PWM/PPM, st-dwn, 0.9V±2%, 600mA, 3MHz, Vin>1.8V, LSST, CL	USP-6C	49da	DC16	9a	Tor
MUL	XC9237D0LDER	DC-DC-IC	PWM-PWM/PPM, st-dwn, 0.85V±2%, 600mA, 3MHz, Vin>1.8V, LSST, CL	USP-6C	49da	DC16	9a	Tor
MUM	XC9237D0MDER	DC-DC-IC	PWM-PWM/PPM, st-dwn, 0.95V±2%, 600mA, 3MHz, Vin>1.8V, LSST, CL	USP-6C	49da	DC16	9a	Tor
MV	MAX8841ELT29+T	LVR-IC	LDO, 2.85V±2%, 150mA, +CE	DFN-6	52ys	VR4	9t	Max
MV	R1118K251B	LVR-IC	2.5V±1%, 150mA, +CE	DFN1612-4B	45vm	VR4	9a	Ric
MV0	XC9237D10DER	DC-DC-IC	PWM-PWM/PPM, st-dwn, 1.0V±2%, 600mA, 3MHz, Vin>1.8V, LSST, CL	USP-6C	49da	DC16	9a	Tor
MV1	XC9237D11DER	DC-DC-IC	PWM-PWM/PPM, st-dwn, 1.1V±2%, 600mA, 3MHz, Vin>1.8V, LSST, CL	USP-6C	49da	DC16	9a	Tor



SMD code	Type	Function	Short description	Case	Pinout	Sch.	St.	Mnf.
N0A	XC6118C20AGR-G	Vdet-IC	2.0V±2%, ±Reset PPO, Sense, hysteresis 5%, Cd	USP-4	45me	VD15	9a	Tor
N0B	XC6108N30BGR	Vdet-IC	3.0V±2%, -Reset ODO	USP-4	45ro	VD14	9b	Tor
N0B	XC6118C20BGR-G	Vdet-IC	2.0V±2%, ±Reset PPO, Sense, hysteresis <1%, Cd	USP-4	45me	VD15	9a	Tor
N0C	XC6108N30CGR	Vdet-IC	3.0V±2%, Hysteresis, -Reset ODO	USP-4	45rn	VD14	9b	Tor
N0C	XC6118C20CGR-G	Vdet-IC	2.0V±2%, ±Reset PPO, Sense, hysteresis 5%	USP-4	45md	VD12	9a	Tor
N0D	XC6108N30DGR	Vdet-IC	3.0V±2%, -Reset ODO	USP-4	45rn	VD14	9b	Tor
N0D	XC6118C20DGR-G	Vdet-IC	2.0V±2%, ±Reset PPO, Sense, hysteresis <1%	USP-4	45md	VD12	9a	Tor
N1	LM48311TL	LIN-IC	AF PA, BTL, class-D, 2.4. 5.5V, 2.6W(5V/4Q), shutdown	BGA-9	39	-	-	Nsc
N1	LM48312TLE	LIN-IC	AF PA, BTL, class-D, 2.4. 5.5V, 2.6W(5V/4Q), shutdown	BGA-9	39	-	-	Nsc
N1	R3117K283A	Vdet-IC	2.8V±1%, -Reset ODO, Sense	DFN1010-4	48rq	VD11	9a	Ric
N1	RP114K291B	LVR-IC	LDO, 2.9V±1%, 300mA, +CE	DFN1010-4	48vm	VR4	9a	Ric
N15D	R1163K151D	LVR-IC	LDO, 1.5V±2.5%, 150mA, +CE, CL, AE(mode)	PLP1616-6	66vj	VR10	9b	Ric
N16D	R1163K161D	LVR-IC	LDO, 1.6V±2.5%, 150mA, +CE, CL, AE(mode)	PLP1616-6	66vj	VR10	9b	Ric
N17D	R1163K171D	LVR-IC	LDO, 1.7V±2.5%, 150mA, +CE, CL, AE(mode)	PLP1616-6	66vj	VR10	9b	Ric
N185	R1163K181D5	LVR-IC	LDO, 1.85V±2.5%, 150mA, +CE, CL, AE(mode)	PLP1616-6	66vj	VR10	9b	Ric
N18D	R1163K181D	LVR-IC	LDO, 1.8V±2.5%, 150mA, +CE, CL, AE(mode)	PLP1616-6	66vj	VR10	9b	Ric
N19D	R1163K191D	LVR-IC	LDO, 1.9V±2.5%, 150mA, +CE, CL, AE(mode)	PLP1616-6	66vj	VR10	9b	Ric
N1A	XC6108N31AGR	Vdet-IC	3.1V±2%, Hysteresis, -Reset ODO	USP-4	45ro	VD14	9b	Tor
N1A	XC6118C21AGR-G	Vdet-IC	2.1V±2%, ±Reset PPO, Sense, hysteresis 5%, Cd	USP-4	45me	VD15	9a	Tor
N1B	XC6108N31BGR	Vdet-IC	3.1V±2%, -Reset ODO	USP-4	45ro	VD14	9b	Tor
N1B	XC6118C21BGR-G	Vdet-IC	2.1V±2%, ±Reset PPO, Sense, hysteresis <1%, Cd	USP-4	45me	VD15	9a	Tor
N1C	XC6108N31CGR	Vdet-IC	3.1V±2%, Hysteresis, -Reset ODO	USP-4	45rn	VD14	9b	Tor
N1C	XC6118C21CGR-G	Vdet-IC	2.1V±2%, ±Reset PPO, Sense, hysteresis 5%	USP-4	45md	VD12	9a	Tor
N1D	XC6108N31DGR	Vdet-IC	3.1V±2%, -Reset ODO	USP-4	45rn	VD14	9b	Tor
N1D	XC6118C21DGR-G	Vdet-IC	2.1V±2%, ±Reset PPO, Sense, hysteresis <1%	USP-4	45md	VD12	9a	Tor
N2	R3117K293A	Vdet-IC	2.9V±1%, -Reset ODO, Sense	DFN1010-4	48rq	VD11	9a	Ric
N2	RP114K301B	LVR-IC	LDO, 3.0V±1%, 300mA, +CE	DFN1010-4	48vm	VR4	9a	Ric
N20D	R1163K201D	LVR-IC	LDO, 2V±1.5%, 150mA, +CE, CL, AE(mode)	PLP1616-6	66vj	VR10	9b	Ric
N21D	R1163K211D	LVR-IC	LDO, 2.1V±2.5%, 150mA, +CE, CL, AE(mode)	PLP1616-6	66vj	VR10	9b	Ric
N2211	NGS2211MN	LIN-IC	AF PA, BTL 2.7..5.5V, 1.5W(5V/4Q), shutdown	DFN-8	37	AFP11	-	Oms
N22D	R1163K221D	LVR-IC	LDO, 2.2V±2.5%, 150mA, +CE, CL, AE(mode)	PLP1616-6	66vj	VR10	9b	Ric
N23D	R1163K231D	LVR-IC	LDO, 2.3V±2.5%, 150mA, +CE, CL, AE(mode)	PLP1616-6	66vj	VR10	9b	Ric
N24D	R1163K241D	LVR-IC	LDO, 2.4V±2.5%, 150mA, +CE, CL, AE(mode)	PLP1616-6	66vj	VR10	9b	Ric
N25D	R1163K251D	LVR-IC	LDO, 2.5V±2.5%, 150mA, +CE, CL, AE(mode)	PLP1616-6	66vj	VR10	9b	Ric
N26D	R1163K261D	LVR-IC	LDO, 2.6V±2.5%, 150mA, +CE, CL, AE(mode)	PLP1616-6	66vj	VR10	9b	Ric
N27D	R1163K271D	LVR-IC	LDO, 2.7V±2.5%, 150mA, +CE, CL, AE(mode)	PLP1616-6	66vj	VR10	9b	Ric
N285	R1163K281D5	LVR-IC	LDO, 2.85V±2.5%, 150mA, +CE, CL, AE(mode)	PLP1616-6	66vj	VR10	9b	Ric
N28D	R1163K281D	LVR-IC	LDO, 2.8V±2.5%, 150mA, +CE, CL, AE(mode)	PLP1616-6	66vj	VR10	9b	Ric
N29D	R1163K291D	LVR-IC	LDO, 2.9V±2.5%, 150mA, +CE, CL, AE(mode)	PLP1616-6	66vj	VR10	9b	Ric
N2A	XC6108N32AGR	Vdet-IC	3.2V±2%, Hysteresis, -Reset ODO	USP-4	45ro	VD14	9b	Tor
N2A	XC6118C22AGR-G	Vdet-IC	2.2V±2%, ±Reset PPO, Sense, hysteresis 5%, Cd	USP-4	45me	VD15	9a	Tor
N2B	XC6108N32BGR	Vdet-IC	3.2V±2%, -Reset ODO	USP-4	45ro	VD14	9b	Tor
N2B	XC6118C22BGR-G	Vdet-IC	2.2V±2%, ±Reset PPO, Sense, hysteresis <1%, Cd	USP-4	45me	VD15	9a	Tor
N2C	XC6108N32CGR	Vdet-IC	3.2V±2%, Hysteresis, -Reset ODO	USP-4	45rn	VD14	9b	Tor
N2C	XC6118C22CGR-G	Vdet-IC	2.2V±2%, ±Reset PPO, Sense, hysteresis 5%	USP-4	45md	VD12	9a	Tor
N2D	XC6108N32DGR	Vdet-IC	3.2V±2%, -Reset ODO	USP-4	45rn	VD14	9b	Tor
N2D	XC6118C22DGR-G	Vdet-IC	2.2V±2%, ±Reset PPO, Sense, hysteresis <1%	USP-4	45md	VD12	9a	Tor
N3	R3117K303A	Vdet-IC	3.0V±1%, -Reset ODO, Sense	DFN1010-4	48rq	VD11	9a	Ric
N3	RP114K311B	LVR-IC	LDO, 3.1V±1%, 300mA, +CE	DFN1010-4	48vm	VR4	9a	Ric
N30D	R1163K301D	LVR-IC	LDO, 3V±2.5%, 150mA, +CE, CL, AE(mode)	PLP1616-6	66vj	VR10	9b	Ric
N31D	R1163K311D	LVR-IC	LDO, 3.1V±2.5%, 150mA, +CE, CL, AE(mode)	PLP1616-6	66vj	VR10	9b	Ric
N32D	R1163K321D	LVR-IC	LDO, 3.2V±2.5%, 150mA, +CE, CL, AE(mode)	PLP1616-6	66vj	VR10	9b	Ric
N33D	R1163K331D	LVR-IC	LDO, 3.3V±2.5%, 150mA, +CE, CL, AE(mode)	PLP1616-6	66vj	VR10	9b	Ric
N34D	R1163K341D	LVR-IC	LDO, 3.4V±1.5%, 150mA, +CE, CL, AE(mode)	PLP1616-6	66vj	VR10	9b	Ric
N35D	R1163K351D	LVR-IC	LDO, 3.5V±2.5%, 150mA, +CE, CL, AE(mode)	PLP1616-6	66vj	VR10	9b	Ric
N36D	R1163K361D	LVR-IC	LDO, 3.6V±2.5%, 150mA, +CE, CL, AE(mode)	PLP1616-6	66vj	VR10	9b	Ric
N37D	R1163K371D	LVR-IC	LDO, 3.7V±2.5%, 150mA, +CE, CL, AE(mode)	PLP1616-6	66vj	VR10	9b	Ric
N38D	R1163K381D	LVR-IC	LDO, 3.8V±2.5%, 150mA, +CE, CL, AE(mode)	PLP1616-6	66vj	VR10	9b	Ric
N39D	R1163K391D	LVR-IC	LDO, 3.9V±2.5%, 150mA, +CE, CL, AE(mode)	PLP1616-6	66vj	VR10	9b	Ric
N3A	XC6108N33AGR	Vdet-IC	3.3V±2%, Hysteresis, -Reset ODO	USP-4	45ro	VD14	9b	Tor
N3A	XC6118C23AGR-G	Vdet-IC	2.3V±2%, ±Reset PPO, Sense, hysteresis 5%, Cd	USP-4	45me	VD15	9a	Tor
N3B	XC6108N33BGR	Vdet-IC	3.3V±2%, -Reset ODO	USP-4	45ro	VD14	9b	Tor
N3B	XC6118C23BGR-G	Vdet-IC	2.3V±2%, ±Reset PPO, Sense, hysteresis <1%, Cd	USP-4	45me	VD15	9a	Tor
N3C	XC6108N33CGR	Vdet-IC	3.3V±2%, Hysteresis, -Reset ODO	USP-4	45rn	VD14	9b	Tor
N3C	XC6118C23CGR-G	Vdet-IC	2.3V±2%, ±Reset PPO, Sense, hysteresis 5%	USP-4	45md	VD12	9a	Tor
N3D	XC6108N33DGR	Vdet-IC	3.3V±2%, -Reset ODO	USP-4	45rn	VD14	9b	Tor
N3D	XC6118C23DGR-G	Vdet-IC	2.3V±2%, ±Reset PPO, Sense, hysteresis <1%	USP-4	45md	VD12	9a	Tor
N4	R3117K313A	Vdet-IC	3.1V±1%, -Reset ODO, Sense	DFN1010-4	48rq	VD11	9a	Ric
N4	RP114K321B	LVR-IC	LDO, 3.2V±1%, 300mA, +CE	DFN1010-4	48vm	VR4	9a	Ric
N40D	R1163K401D	LVR-IC	LDO, 4V±2.5%, 150mA, +CE, CL, AE(mode)	PLP1616-6	66vj	VR10	9b	Ric



SMD code	Type	Function	Short description	Case	Pinout	Sch.	St.	Mnf.
N4A	XC6108N34AGR	Vdet-IC	3.4V±2%, Hysteresis, -Reset ODO	USP-4	45ro	VD14	9b	Tor
N4A	XC6118C24AGR-G	Vdet-IC	2.4V±2%, ±Reset PPO, Sense, hysteresis 5%, Cd	USP-4	45me	VD15	9a	Tor
N4B	XC6108N34BGR	Vdet-IC	3.4V±2%, -Reset ODO	USP-4	45ro	VD14	9b	Tor
N4B	XC6118C24BGR-G	Vdet-IC	2.4V±2%, ±Reset PPO, Sense, hysteresis <1%, Cd	USP-4	45me	VD15	9a	Tor
N4C	XC6108N34CGR	Vdet-IC	3.4V±2%, Hysteresis, -Reset ODO	USP-4	45m	VD14	9b	Tor
N4C	XC6118C24CGR-G	Vdet-IC	2.4V±2%, ±Reset PPO, Sense, hysteresis 5%	USP-4	45md	VD12	9a	Tor
N4D	XC6108N34DGR	Vdet-IC	3.4V±2%, -Reset ODO	USP-4	45m	VD14	9b	Tor
N4D	XC6118C24DGR-G	Vdet-IC	2.4V±2%, ±Reset PPO, Sense, hysteresis <1%	USP-4	45md	VD12	9a	Tor
N5	R3117K323A	Vdet-IC	3.2V±1%, -Reset ODO, Sense	DFN1010-4	48rq	VD11	9a	Ric
N5	RP114K331B	LVR-IC	LDO, 3.3V±1%, 300mA, +CE	DFN1010-4	48vm	VR4	9a	Ric
N5A	XC6108N35AGR	Vdet-IC	3.5V±2%, Hysteresis, -Reset ODO	USP-4	45ro	VD14	9b	Tor
N5A	XC6118C25AGR-G	Vdet-IC	2.5V±2%, ±Reset PPO, Sense, hysteresis 5%, Cd	USP-4	45me	VD15	9a	Tor
N5B	XC6108N35BGR	Vdet-IC	3.5V±2%, -Reset ODO	USP-4	45ro	VD14	9b	Tor
N5B	XC6118C25BGR-G	Vdet-IC	2.5V±2%, ±Reset PPO, Sense, hysteresis <1%, Cd	USP-4	45me	VD15	9a	Tor
N5C	XC6108N35CGR	Vdet-IC	3.5V±2%, Hysteresis, -Reset ODO	USP-4	45m	VD14	9b	Tor
N5C	XC6118C25CGR-G	Vdet-IC	2.5V±2%, ±Reset PPO, Sense, hysteresis 5%	USP-4	45md	VD12	9a	Tor
N5D	XC6108N35DGR	Vdet-IC	3.5V±2%, -Reset ODO	USP-4	45m	VD14	9b	Tor
N5D	XC6118C25DGR-G	Vdet-IC	2.5V±2%, ±Reset PPO, Sense, hysteresis <1%	USP-4	45md	VD12	9a	Tor
N6	R3117K333A	Vdet-IC	3.3V±1%, -Reset ODO, Sense	DFN1010-4	48rq	VD11	9a	Ric
N6	RP114K341B	LVR-IC	LDO, 3.4V±1%, 300mA, +CE	DFN1010-4	48vm	VR4	9a	Ric
N6A	XC6108N36AGR	Vdet-IC	3.6V±2%, Hysteresis, -Reset ODO	USP-4	45ro	VD14	9b	Tor
N6A	XC6118C26AGR-G	Vdet-IC	2.6V±2%, ±Reset PPO, Sense, hysteresis 5%, Cd	USP-4	45me	VD15	9a	Tor
N6B	XC6108N36BGR	Vdet-IC	3.6V±2%, -Reset ODO	USP-4	45ro	VD14	9b	Tor
N6B	XC6118C26BGR-G	Vdet-IC	2.6V±2%, ±Reset PPO, Sense, hysteresis <1%, Cd	USP-4	45me	VD15	9a	Tor
N6C	XC6108N36CGR	Vdet-IC	3.6V±2%, Hysteresis, -Reset ODO	USP-4	45m	VD14	9b	Tor
N6C	XC6118C26CGR-G	Vdet-IC	2.6V±2%, ±Reset PPO, Sense, hysteresis 5%	USP-4	45md	VD12	9a	Tor
N6D	XC6108N36DGR	Vdet-IC	3.6V±2%, -Reset ODO	USP-4	45m	VD14	9b	Tor
N6D	XC6118C26DGR-G	Vdet-IC	2.6V±2%, ±Reset PPO, Sense, hysteresis <1%	USP-4	45md	VD12	9a	Tor
N7	R3117K343A	Vdet-IC	3.4V±1%, -Reset ODO, Sense	DFN1010-4	48rq	VD11	9a	Ric
N7	RP114K351B	LVR-IC	LDO, 3.5V±1%, 300mA, +CE	DFN1010-4	48vm	VR4	9a	Ric
N7A	XC6108N37AGR	Vdet-IC	3.7V±2%, Hysteresis, -Reset ODO	USP-4	45ro	VD14	9b	Tor
N7A	XC6118C27AGR-G	Vdet-IC	2.7V±2%, ±Reset PPO, Sense, hysteresis 5%, Cd	USP-4	45me	VD15	9a	Tor
N7B	XC6108N37BGR	Vdet-IC	3.7V±2%, -Reset ODO	USP-4	45ro	VD14	9b	Tor
N7B	XC6118C27BGR-G	Vdet-IC	2.7V±2%, ±Reset PPO, Sense, hysteresis <1%, Cd	USP-4	45me	VD15	9a	Tor
N7C	XC6108N37CGR	Vdet-IC	3.7V±2%, Hysteresis, -Reset ODO	USP-4	45m	VD14	9b	Tor
N7C	XC6118C27CGR-G	Vdet-IC	2.7V±2%, ±Reset PPO, Sense, hysteresis 5%	USP-4	45md	VD12	9a	Tor
N7D	XC6108N37DGR	Vdet-IC	3.7V±2%, -Reset ODO	USP-4	45m	VD14	9b	Tor
N7D	XC6118C27DGR-G	Vdet-IC	2.7V±2%, ±Reset PPO, Sense, hysteresis <1%	USP-4	45md	VD12	9a	Tor
N8	R3117K353A	Vdet-IC	3.5V±1%, -Reset ODO, Sense	DFN1010-4	48rq	VD11	9a	Ric
N8	RP114K361B	LVR-IC	LDO, 3.6V±1%, 300mA, +CE	DFN1010-4	48vm	VR4	9a	Ric
N8A	XC6108N38AGR	Vdet-IC	3.8V±2%, Hysteresis, -Reset ODO	USP-4	45ro	VD14	9b	Tor
N8A	XC6118C28AGR-G	Vdet-IC	2.8V±2%, ±Reset PPO, Sense, hysteresis 5%, Cd	USP-4	45me	VD15	9a	Tor
N8B	XC6108N38BGR	Vdet-IC	3.8V±2%, -Reset ODO	USP-4	45ro	VD14	9b	Tor
N8B	XC6118C28BGR-G	Vdet-IC	2.8V±2%, ±Reset PPO, Sense, hysteresis <1%, Cd	USP-4	45me	VD15	9a	Tor
N8C	XC6108N38CGR	Vdet-IC	3.8V±2%, Hysteresis, -Reset ODO	USP-4	45m	VD14	9b	Tor
N8C	XC6118C28CGR-G	Vdet-IC	2.8V±2%, ±Reset PPO, Sense, hysteresis 5%	USP-4	45md	VD12	9a	Tor
N8D	XC6108N38DGR	Vdet-IC	3.8V±2%, -Reset ODO	USP-4	45m	VD14	9b	Tor
N8D	XC6118C28DGR-G	Vdet-IC	2.8V±2%, ±Reset PPO, Sense, hysteresis <1%	USP-4	45md	VD12	9a	Tor
N9	R3117K363A	Vdet-IC	3.6V±1%, -Reset ODO, Sense	DFN1010-4	48rq	VD11	9a	Ric
N9	RP114K121B5	LVR-IC	LDO, 1.25V±1%, 300mA, +CE	DFN1010-4	48vm	VR4	9a	Ric
N9A	XC6108N39AGR	Vdet-IC	3.9V±2%, Hysteresis, -Reset ODO	USP-4	45ro	VD14	9b	Tor
N9A	XC6118C29AGR-G	Vdet-IC	2.9V±2%, ±Reset PPO, Sense, hysteresis 5%, Cd	USP-4	45me	VD15	9a	Tor
N9B	XC6108N39BGR	Vdet-IC	3.9V±2%, -Reset ODO	USP-4	45ro	VD14	9b	Tor
N9B	XC6118C29BGR-G	Vdet-IC	2.9V±2%, ±Reset PPO, Sense, hysteresis <1%, Cd	USP-4	45me	VD15	9a	Tor
N9C	XC6108N39CGR	Vdet-IC	3.9V±2%, Hysteresis, -Reset ODO	USP-4	45m	VD14	9b	Tor
N9C	XC6118C29CGR-G	Vdet-IC	2.9V±2%, ±Reset PPO, Sense, hysteresis 5%	USP-4	45md	VD12	9a	Tor
N9D	XC6108N39DGR	Vdet-IC	3.9V±2%, -Reset ODO	USP-4	45m	VD14	9b	Tor
N9D	XC6118C29DGR-G	Vdet-IC	2.9V±2%, ±Reset PPO, Sense, hysteresis <1%	USP-4	45md	VD12	9a	Tor
NA	EUP7201-1.8/2.8U	LVR-IC	LDO, Dual out, Vout1/Vout2=1.8V/2.8V±2%, 150mA, +CE	USP-6	49xv	VR19	9m	Eut
NA	MAX8842ELT+T	LVR-IC	LDO, Adjustable 1.5..4.5V, 150mA, +CE	DFN-6	52	VR16	9t	Max
NA	R1118K291B	LVR-IC	LDO, 2.9V±1%, 150mA, +CE	DFN1612-6	45vm	VR4	9a	Ric
NA	RP106K071B	LVR-IC	LDO, 0.7V±0.8%, 400mA, +CE	DFN1212-6	52vr2	VR4	9a	Ric
NB	R1118K301B	LVR-IC	LDO, 3V±1%, 150mA, +CE	DFN1612-6	45vm	VR4	9a	Ric
NB	RP106K081B	LVR-IC	LDO, 0.8V±0.8%, 400mA, +CE	DFN1212-6	52vr2	VR4	9a	Ric
NC	EUP7201-1.5/2.8U	LVR-IC	LDO, Dual out, Vout1/Vout2=1.5V/2.8V±2%, 150mA, +CE	USP-6	49xv	VR19	9m	Eut
NC	R1118K311B	LVR-IC	LDO, 3.1V±1%, 150mA, +CE	DFN1612-6	45vm	VR4	9a	Ric
NC	RP106K091B	LVR-IC	LDO, 0.9V±0.8%, 400mA, +CE	DFN1212-6	52vr2	VR4	9a	Ric
NC151	XC9111C151ER	DC/DC-IC	PFM step-up, 100kHz, 1.5V±2.5%, 400mA, +CE	USP-6C	49gd	DC3	9b	Tor
NC161	XC9111C161ER	DC/DC-IC	PFM step-up, 100kHz, 1.6V±2.5%, 400mA, +CE	USP-6C	49gd	DC3	9b	Tor
NC171	XC9111C171ER	DC/DC-IC	PFM step-up, 100kHz, 1.7V±2.5%, 400mA, +CE	USP-6C	49gd	DC3	9b	Tor



SMD code	Type	Function	Short description	Case	Pinout	Sch.	St.	Mnf.
NCU	XC6222A251ER-G	LVR-IC	LDO, 2.5V±1%, 700mA, +CE	USP-6C	49hg	VR4	9a	Tor
NCV	XC6222A261ER-G	LVR-IC	LDO, 2.6V±1%, 700mA, +CE	USP-6C	49hg	VR4	9a	Tor
NCX	XC6222A271ER-G	LVR-IC	LDO, 2.7V±1%, 700mA, +CE	USP-6C	49hg	VR4	9a	Tor
NCY	XC6222A281ER-G	LVR-IC	LDO, 2.8V±1%, 700mA, +CE	USP-6C	49hg	VR4	9a	Tor
NCZ	XC6222A291ER-G	LVR-IC	LDO, 2.9V±1%, 700mA, +CE	USP-6C	49hg	VR4	9a	Tor
ND	EUP7201-2.5/2.8U	LVR-IC	LDO, Dual out, Vout1/Vout2=2.5V/2.8V±2%, 150mA, +CE	USP-6	49xv	VR19	9m	Eut
ND	R1106K321B	LVR-IC	3.2V±1%, 150mA, +CE	DFM1612-4B	45vm	VR4	9a	Ric
ND	RP106K101B	LVR-IC	LDO, 1.0V±0.8%, 400mA, +CE	DFM1212-6	52vr2	VR4	9a	Ric
ND151	XC9111D151ER	DC/DC-IC	PFM step-up, 100kHz, 1.5V±2.5%, 400mA, +CE	USP-6C	49gg	DC6	9b	Tor
ND161	XC9111D161ER	DC/DC-IC	PFM step-up, 100kHz, 1.6V±2.5%, 400mA, +CE	USP-6C	49gg	DC6	9b	Tor
ND171	XC9111D171ER	DC/DC-IC	PFM step-up, 100kHz, 1.7V±2.5%, 400mA, +CE	USP-6C	49gg	DC6	9b	Tor
ND181	XC9111D181ER	DC/DC-IC	PFM step-up, 100kHz, 1.8V±2.5%, 400mA, +CE	USP-6C	49gg	DC6	9b	Tor
ND191	XC9111D191ER	DC/DC-IC	PFM step-up, 100kHz, 1.9V±2.5%, 400mA, +CE	USP-6C	49gg	DC6	9b	Tor
ND201	XC9111D201ER	DC/DC-IC	PFM step-up, 100kHz, 2.0V±2.5%, 400mA, +CE	USP-6C	49gg	DC6	9b	Tor
ND211	XC9111D211ER	DC/DC-IC	PFM step-up, 100kHz, 2.1V±2.5%, 400mA, +CE	USP-6C	49gg	DC6	9b	Tor
ND221	XC9111D221ER	DC/DC-IC	PFM step-up, 100kHz, 2.2V±2.5%, 400mA, +CE	USP-6C	49gg	DC6	9b	Tor
ND231	XC9111D231ER	DC/DC-IC	PFM step-up, 100kHz, 2.3V±2.5%, 400mA, +CE	USP-6C	49gg	DC6	9b	Tor
ND241	XC9111D241ER	DC/DC-IC	PFM step-up, 100kHz, 2.4V±2.5%, 400mA, +CE	USP-6C	49gg	DC6	9b	Tor
ND251	XC9111D251ER	DC/DC-IC	PFM step-up, 100kHz, 2.5V±2.5%, 400mA, +CE	USP-6C	49gg	DC6	9b	Tor
ND261	XC9111D261ER	DC/DC-IC	PFM step-up, 100kHz, 2.6V±2.5%, 400mA, +CE	USP-6C	49gg	DC6	9b	Tor
ND271	XC9111D271ER	DC/DC-IC	PFM step-up, 100kHz, 2.7V±2.5%, 400mA, +CE	USP-6C	49gg	DC6	9b	Tor
ND281	XC9111D281ER	DC/DC-IC	PFM step-up, 100kHz, 2.8V±2.5%, 400mA, +CE	USP-6C	49gg	DC6	9b	Tor
ND291	XC9111D291ER	DC/DC-IC	PFM step-up, 100kHz, 2.9V±2.5%, 400mA, +CE	USP-6C	49gg	DC6	9b	Tor
ND301	XC9111D301ER	DC/DC-IC	PFM step-up, 100kHz, 3.0V±2.5%, 400mA, +CE	USP-6C	49gg	DC6	9b	Tor
ND311	XC9111D311ER	DC/DC-IC	PFM step-up, 100kHz, 3.1V±2.5%, 400mA, +CE	USP-6C	49gg	DC6	9b	Tor
ND321	XC9111D321ER	DC/DC-IC	PFM step-up, 100kHz, 3.2V±2.5%, 400mA, +CE	USP-6C	49gg	DC6	9b	Tor
ND331	XC9111D331ER	DC/DC-IC	PFM step-up, 100kHz, 3.3V±2.5%, 400mA, +CE	USP-6C	49gg	DC6	9b	Tor
ND341	XC9111D341ER	DC/DC-IC	PFM step-up, 100kHz, 3.4V±2.5%, 400mA, +CE	USP-6C	49gg	DC6	9b	Tor
ND351	XC9111D351ER	DC/DC-IC	PFM step-up, 100kHz, 3.5V±2.5%, 400mA, +CE	USP-6C	49gg	DC6	9b	Tor
ND361	XC9111D361ER	DC/DC-IC	PFM step-up, 100kHz, 3.6V±2.5%, 400mA, +CE	USP-6C	49gg	DC6	9b	Tor
ND371	XC9111D371ER	DC/DC-IC	PFM step-up, 100kHz, 3.7V±2.5%, 400mA, +CE	USP-6C	49gg	DC6	9b	Tor
ND381	XC9111D381ER	DC/DC-IC	PFM step-up, 100kHz, 3.8V±2.5%, 400mA, +CE	USP-6C	49gg	DC6	9b	Tor
ND391	XC9111D391ER	DC/DC-IC	PFM step-up, 100kHz, 3.9V±2.5%, 400mA, +CE	USP-6C	49gg	DC6	9b	Tor
ND401	XC9111D401ER	DC/DC-IC	PFM step-up, 100kHz, 4.0V±2.5%, 400mA, +CE	USP-6C	49gg	DC6	9b	Tor
ND411	XC9111D411ER	DC/DC-IC	PFM step-up, 100kHz, 4.1V±2.5%, 400mA, +CE	USP-6C	49gg	DC6	9b	Tor
ND421	XC9111D421ER	DC/DC-IC	PFM step-up, 100kHz, 4.2V±2.5%, 400mA, +CE	USP-6C	49gg	DC6	9b	Tor
ND431	XC9111D431ER	DC/DC-IC	PFM step-up, 100kHz, 4.3V±2.5%, 400mA, +CE	USP-6C	49gg	DC6	9b	Tor
ND441	XC9111D441ER	DC/DC-IC	PFM step-up, 100kHz, 4.4V±2.5%, 400mA, +CE	USP-6C	49gg	DC6	9b	Tor
ND451	XC9111D451ER	DC/DC-IC	PFM step-up, 100kHz, 4.5V±2.5%, 400mA, +CE	USP-6C	49gg	DC6	9b	Tor
ND461	XC9111D461ER	DC/DC-IC	PFM step-up, 100kHz, 4.6V±2.5%, 400mA, +CE	USP-6C	49gg	DC6	9b	Tor
ND471	XC9111D471ER	DC/DC-IC	PFM step-up, 100kHz, 4.7V±2.5%, 400mA, +CE	USP-6C	49gg	DC6	9b	Tor
ND481	XC9111D481ER	DC/DC-IC	PFM step-up, 100kHz, 4.8V±2.5%, 400mA, +CE	USP-6C	49gg	DC6	9b	Tor
ND491	XC9111D491ER	DC/DC-IC	PFM step-up, 100kHz, 4.9V±2.5%, 400mA, +CE	USP-6C	49gg	DC6	9b	Tor
ND501	XC9111D501ER	DC/DC-IC	PFM step-up, 100kHz, 5.0V±2.5%, 400mA, +CE	USP-6C	49gg	DC6	9b	Tor
ND511	XC9111D511ER	DC/DC-IC	PFM step-up, 100kHz, 5.1V±2.5%, 400mA, +CE	USP-6C	49gg	DC6	9b	Tor
ND521	XC9111D521ER	DC/DC-IC	PFM step-up, 100kHz, 5.2V±2.5%, 400mA, +CE	USP-6C	49gg	DC6	9b	Tor
ND531	XC9111D531ER	DC/DC-IC	PFM step-up, 100kHz, 5.3V±2.5%, 400mA, +CE	USP-6C	49gg	DC6	9b	Tor
ND541	XC9111D541ER	DC/DC-IC	PFM step-up, 100kHz, 5.4V±2.5%, 400mA, +CE	USP-6C	49gg	DC6	9b	Tor
ND551	XC9111D551ER	DC/DC-IC	PFM step-up, 100kHz, 5.5V±2.5%, 400mA, +CE	USP-6C	49gg	DC6	9b	Tor
ND561	XC9111D561ER	DC/DC-IC	PFM step-up, 100kHz, 5.6V±2.5%, 400mA, +CE	USP-6C	49gg	DC6	9b	Tor
ND571	XC9111D571ER	DC/DC-IC	PFM step-up, 100kHz, 5.7V±2.5%, 400mA, +CE	USP-6C	49gg	DC6	9b	Tor
ND581	XC9111D581ER	DC/DC-IC	PFM step-up, 100kHz, 5.8V±2.5%, 400mA, +CE	USP-6C	49gg	DC6	9b	Tor
ND591	XC9111D591ER	DC/DC-IC	PFM step-up, 100kHz, 5.9V±2.5%, 400mA, +CE	USP-6C	49gg	DC6	9b	Tor
ND601	XC9111D601ER	DC/DC-IC	PFM step-up, 100kHz, 6.0V±2.5%, 400mA, +CE	USP-6C	49gg	DC6	9b	Tor
ND611	XC9111D611ER	DC/DC-IC	PFM step-up, 100kHz, 6.1V±2.5%, 400mA, +CE	USP-6C	49gg	DC6	9b	Tor
ND621	XC9111D621ER	DC/DC-IC	PFM step-up, 100kHz, 6.2V±2.5%, 400mA, +CE	USP-6C	49gg	DC6	9b	Tor
ND631	XC9111D631ER	DC/DC-IC	PFM step-up, 100kHz, 6.3V±2.5%, 400mA, +CE	USP-6C	49gg	DC6	9b	Tor
ND641	XC9111D641ER	DC/DC-IC	PFM step-up, 100kHz, 6.4V±2.5%, 400mA, +CE	USP-6C	49gg	DC6	9b	Tor
ND651	XC9111D651ER	DC/DC-IC	PFM step-up, 100kHz, 6.5V±2.5%, 400mA, +CE	USP-6C	49gg	DC6	9b	Tor
ND661	XC9111D661ER	DC/DC-IC	PFM step-up, 100kHz, 6.6V±2.5%, 400mA, +CE	USP-6C	49gg	DC6	9b	Tor
ND671	XC9111D671ER	DC/DC-IC	PFM step-up, 100kHz, 6.7V±2.5%, 400mA, +CE	USP-6C	49gg	DC6	9b	Tor
ND681	XC9111D681ER	DC/DC-IC	PFM step-up, 100kHz, 6.8V±2.5%, 400mA, +CE	USP-6C	49gg	DC6	9b	Tor
ND691	XC9111D691ER	DC/DC-IC	PFM step-up, 100kHz, 6.9V±2.5%, 400mA, +CE	USP-6C	49gg	DC6	9b	Tor
ND701	XC9111D701ER	DC/DC-IC	PFM step-up, 100kHz, 7.0V±2.5%, 400mA, +CE	USP-6C	49gg	DC6	9b	Tor
ND8	XC6222A08BER-G	LVR-IC	LDO, 0.85V±20mV, 700mA, +CE	USP-6C	49hg	VR4	9a	Tor
ND9	XC6222A09BER-G	LVR-IC	LDO, 0.95V±20mV, 700mA, +CE	USP-6C	49hg	VR4	9a	Tor
NDA	XC6222A10BER-G	LVR-IC	LDO, 1.05V±20mV, 700mA, +CE	USP-6C	49hg	VR4	9a	Tor
NDB	XC6222A11BER-G	LVR-IC	LDO, 1.15V±20mV, 700mA, +CE	USP-6C	49hg	VR4	9a	Tor
NDC	XC6222A12BER-G	LVR-IC	LDO, 1.25V±20mV, 700mA, +CE	USP-6C	49hg	VR4	9a	Tor
NDD	XC6222A13BER-G	LVR-IC	LDO, 1.35V±20mV, 700mA, +CE	USP-6C	49hg	VR4	9a	Tor



SMD code	Type	Function	Short description	Case	Pinout	Sch.	St.	Mnf.
NDE	XC6222A14BER-G	LVR-IC	LDO, 1.45V±20mV, 700mA, +CE	USP-6C	49hg	VR4	9a	Tor
NDF	XC6222A15BER-G	LVR-IC	LDO, 1.55V±20mV, 700mA, +CE	USP-6C	49hg	VR4	9a	Tor
NDH	XC6222A16BER-G	LVR-IC	LDO, 1.65V±20mV, 700mA, +CE	USP-6C	49hg	VR4	9a	Tor
NDK	XC6222A17BER-G	LVR-IC	LDO, 1.75V±20mV, 700mA, +CE	USP-6C	49hg	VR4	9a	Tor
NDL	XC6222A18BER-G	LVR-IC	LDO, 1.85V±20mV, 700mA, +CE	USP-6C	49hg	VR4	9a	Tor
NDM	XC6222A19BER-G	LVR-IC	LDO, 1.95V±20mV, 700mA, +CE	USP-6C	49hg	VR4	9a	Tor
NDN	XC6222A20BER-G	LVR-IC	LDO, 2.05V±1%, 700mA, +CE	USP-6C	49hg	VR4	9a	Tor
NDP	XC6222A21BER-G	LVR-IC	LDO, 2.15V±1%, 700mA, +CE	USP-6C	49hg	VR4	9a	Tor
NDR	XC6222A22BER-G	LVR-IC	LDO, 2.25V±1%, 700mA, +CE	USP-6C	49hg	VR4	9a	Tor
NDS	XC6222A23BER-G	LVR-IC	LDO, 2.35V±1%, 700mA, +CE	USP-6C	49hg	VR4	9a	Tor
NDT	XC6222A24BER-G	LVR-IC	LDO, 2.45V±1%, 700mA, +CE	USP-6C	49hg	VR4	9a	Tor
NDU	XC6222A25BER-G	LVR-IC	LDO, 2.55V±1%, 700mA, +CE	USP-6C	49hg	VR4	9a	Tor
NDV	XC6222A26BER-G	LVR-IC	LDO, 2.65V±1%, 700mA, +CE	USP-6C	49hg	VR4	9a	Tor
NDX	XC6222A27BER-G	LVR-IC	LDO, 2.75V±1%, 700mA, +CE	USP-6C	49hg	VR4	9a	Tor
NDY	XC6222A28BER-G	LVR-IC	LDO, 2.85V±1%, 700mA, +CE	USP-6C	49hg	VR4	9a	Tor
NDZ	XC6222A29BER-G	LVR-IC	LDO, 2.95V±1%, 700mA, +CE	USP-6C	49hg	VR4	9a	Tor
NE	R118K331B	LVR-IC	3.3V±1%, 150mA, +CE	DFM1612-4B	45vm	VR4	9a	Ric
NE	RP106K111B	LVR-IC	LDO, 1.1V±0.8%, 400mA, +CE	DFM1212-6	52v2	VR4	9a	Ric
NE0	XC6222A301ER-G	LVR-IC	LDO, 3.0V±1%, 700mA, +CE	USP-6C	49hg	VR4	9a	Tor
NE1	XC6222A311ER-G	LVR-IC	LDO, 3.1V±1%, 700mA, +CE	USP-6C	49hg	VR4	9a	Tor
NE151	XC9111E151ER	DC/DC-IC	PFM step-up, 100kHz, 1.5V±2.5%, 400mA	USP-6C	49ge	DC4	9b	Tor
NE161	XC9111E161ER	DC/DC-IC	PFM step-up, 100kHz, 1.6V±2.5%, 400mA	USP-6C	49ge	DC4	9b	Tor
NE171	XC9111E171ER	DC/DC-IC	PFM step-up, 100kHz, 1.7V±2.5%, 400mA	USP-6C	49ge	DC4	9b	Tor
NE181	XC9111E181ER	DC/DC-IC	PFM step-up, 100kHz, 1.8V±2.5%, 400mA	USP-6C	49ge	DC4	9b	Tor
NE191	XC9111E191ER	DC/DC-IC	PFM step-up, 100kHz, 1.9V±2.5%, 400mA	USP-6C	49ge	DC4	9b	Tor
NE2	XC6222A321ER-G	LVR-IC	LDO, 3.2V±1%, 700mA, +CE	USP-6C	49hg	VR4	9a	Tor
NE201	XC9111E201ER	DC/DC-IC	PFM step-up, 100kHz, 2.0V±2.5%, 400mA	USP-6C	49ge	DC4	9b	Tor
NE211	XC9111E211ER	DC/DC-IC	PFM step-up, 100kHz, 2.1V±2.5%, 400mA	USP-6C	49ge	DC4	9b	Tor
NE221	XC9111E221ER	DC/DC-IC	PFM step-up, 100kHz, 2.2V±2.5%, 400mA	USP-6C	49ge	DC4	9b	Tor
NE231	XC9111E231ER	DC/DC-IC	PFM step-up, 100kHz, 2.3V±2.5%, 400mA	USP-6C	49ge	DC4	9b	Tor
NE241	XC9111E241ER	DC/DC-IC	PFM step-up, 100kHz, 2.4V±2.5%, 400mA	USP-6C	49ge	DC4	9b	Tor
NE251	XC9111E251ER	DC/DC-IC	PFM step-up, 100kHz, 2.5V±2.5%, 400mA	USP-6C	49ge	DC4	9b	Tor
NE261	XC9111E261ER	DC/DC-IC	PFM step-up, 100kHz, 2.6V±2.5%, 400mA	USP-6C	49ge	DC4	9b	Tor
NE271	XC9111E271ER	DC/DC-IC	PFM step-up, 100kHz, 2.7V±2.5%, 400mA	USP-6C	49ge	DC4	9b	Tor
NE281	XC9111E281ER	DC/DC-IC	PFM step-up, 100kHz, 2.8V±2.5%, 400mA	USP-6C	49ge	DC4	9b	Tor
NE291	XC9111E291ER	DC/DC-IC	PFM step-up, 100kHz, 2.9V±2.5%, 400mA	USP-6C	49ge	DC4	9b	Tor
NE3	XC6222A331ER-G	LVR-IC	LDO, 3.3V±1%, 700mA, +CE	USP-6C	49hg	VR4	9a	Tor
NE301	XC9111E301ER	DC/DC-IC	PFM step-up, 100kHz, 3.0V±2.5%, 400mA	USP-6C	49ge	DC4	9b	Tor
NE311	XC9111E311ER	DC/DC-IC	PFM step-up, 100kHz, 3.1V±2.5%, 400mA	USP-6C	49ge	DC4	9b	Tor
NE321	XC9111E321ER	DC/DC-IC	PFM step-up, 100kHz, 3.2V±2.5%, 400mA	USP-6C	49ge	DC4	9b	Tor
NE331	XC9111E331ER	DC/DC-IC	PFM step-up, 100kHz, 3.3V±2.5%, 400mA	USP-6C	49ge	DC4	9b	Tor
NE341	XC9111E341ER	DC/DC-IC	PFM step-up, 100kHz, 3.4V±2.5%, 400mA	USP-6C	49ge	DC4	9b	Tor
NE351	XC9111E351ER	DC/DC-IC	PFM step-up, 100kHz, 3.5V±2.5%, 400mA	USP-6C	49ge	DC4	9b	Tor
NE361	XC9111E361ER	DC/DC-IC	PFM step-up, 100kHz, 3.6V±2.5%, 400mA	USP-6C	49ge	DC4	9b	Tor
NE371	XC9111E371ER	DC/DC-IC	PFM step-up, 100kHz, 3.7V±2.5%, 400mA	USP-6C	49ge	DC4	9b	Tor
NE381	XC9111E381ER	DC/DC-IC	PFM step-up, 100kHz, 3.8V±2.5%, 400mA	USP-6C	49ge	DC4	9b	Tor
NE391	XC9111E391ER	DC/DC-IC	PFM step-up, 100kHz, 3.9V±2.5%, 400mA	USP-6C	49ge	DC4	9b	Tor
NE4	XC6222A341ER-G	LVR-IC	LDO, 3.4V±1%, 700mA, +CE	USP-6C	49hg	VR4	9a	Tor
NE401	XC9111E401ER	DC/DC-IC	PFM step-up, 100kHz, 4.0V±2.5%, 400mA	USP-6C	49ge	DC4	9b	Tor
NE411	XC9111E411ER	DC/DC-IC	PFM step-up, 100kHz, 4.1V±2.5%, 400mA	USP-6C	49ge	DC4	9b	Tor
NE421	XC9111E421ER	DC/DC-IC	PFM step-up, 100kHz, 4.2V±2.5%, 400mA	USP-6C	49ge	DC4	9b	Tor
NE431	XC9111E431ER	DC/DC-IC	PFM step-up, 100kHz, 4.3V±2.5%, 400mA	USP-6C	49ge	DC4	9b	Tor
NE441	XC9111E441ER	DC/DC-IC	PFM step-up, 100kHz, 4.4V±2.5%, 400mA	USP-6C	49ge	DC4	9b	Tor
NE451	XC9111E451ER	DC/DC-IC	PFM step-up, 100kHz, 4.5V±2.5%, 400mA	USP-6C	49ge	DC4	9b	Tor
NE461	XC9111E461ER	DC/DC-IC	PFM step-up, 100kHz, 4.6V±2.5%, 400mA	USP-6C	49ge	DC4	9b	Tor
NE471	XC9111E471ER	DC/DC-IC	PFM step-up, 100kHz, 4.7V±2.5%, 400mA	USP-6C	49ge	DC4	9b	Tor
NE481	XC9111E481ER	DC/DC-IC	PFM step-up, 100kHz, 4.8V±2.5%, 400mA	USP-6C	49ge	DC4	9b	Tor
NE491	XC9111E491ER	DC/DC-IC	PFM step-up, 100kHz, 4.9V±2.5%, 400mA	USP-6C	49ge	DC4	9b	Tor
NE5	XC6222A351ER-G	LVR-IC	LDO, 3.5V±1%, 700mA, +CE	USP-6C	49hg	VR4	9a	Tor
NE501	XC9111E501ER	DC/DC-IC	PFM step-up, 100kHz, 5.0V±2.5%, 400mA	USP-6C	49ge	DC4	9b	Tor
NE511	XC9111E511ER	DC/DC-IC	PFM step-up, 100kHz, 5.1V±2.5%, 400mA	USP-6C	49ge	DC4	9b	Tor
NE521	XC9111E521ER	DC/DC-IC	PFM step-up, 100kHz, 5.2V±2.5%, 400mA	USP-6C	49ge	DC4	9b	Tor
NE531	XC9111E531ER	DC/DC-IC	PFM step-up, 100kHz, 5.3V±2.5%, 400mA	USP-6C	49ge	DC4	9b	Tor
NE541	XC9111E541ER	DC/DC-IC	PFM step-up, 100kHz, 5.4V±2.5%, 400mA	USP-6C	49ge	DC4	9b	Tor
NE551	XC9111E551ER	DC/DC-IC	PFM step-up, 100kHz, 5.5V±2.5%, 400mA	USP-6C	49ge	DC4	9b	Tor
NE561	XC9111E561ER	DC/DC-IC	PFM step-up, 100kHz, 5.6V±2.5%, 400mA	USP-6C	49ge	DC4	9b	Tor
NE571	XC9111E571ER	DC/DC-IC	PFM step-up, 100kHz, 5.7V±2.5%, 400mA	USP-6C	49ge	DC4	9b	Tor
NE581	XC9111E581ER	DC/DC-IC	PFM step-up, 100kHz, 5.8V±2.5%, 400mA	USP-6C	49ge	DC4	9b	Tor
NE591	XC9111E591ER	DC/DC-IC	PFM step-up, 100kHz, 5.9V±2.5%, 400mA	USP-6C	49ge	DC4	9b	Tor
NE6	XC6222A361ER-G	LVR-IC	LDO, 3.6V±1%, 700mA, +CE	USP-6C	49hg	VR4	9a	Tor



SMD code	Type	Function	Short description	Case	Pinout	Sch.	St.	Mnf.
NE601	XC9111E601ER	DC/DC-IC	PFM step-up, 100kHz, 6.0V±2.5%, 400mA	USP-6C	49ge	DC4	9b	Tor
NE611	XC9111E611ER	DC/DC-IC	PFM step-up, 100kHz, 6.1V±2.5%, 400mA	USP-6C	49ge	DC4	9b	Tor
NE621	XC9111E621ER	DC/DC-IC	PFM step-up, 100kHz, 6.2V±2.5%, 400mA	USP-6C	49ge	DC4	9b	Tor
NE631	XC9111E631ER	DC/DC-IC	PFM step-up, 100kHz, 6.3V±2.5%, 400mA	USP-6C	49ge	DC4	9b	Tor
NE641	XC9111E641ER	DC/DC-IC	PFM step-up, 100kHz, 6.4V±2.5%, 400mA	USP-6C	49ge	DC4	9b	Tor
NE651	XC9111E651ER	DC/DC-IC	PFM step-up, 100kHz, 6.5V±2.5%, 400mA	USP-6C	49ge	DC4	9b	Tor
NE661	XC9111E661ER	DC/DC-IC	PFM step-up, 100kHz, 6.6V±2.5%, 400mA	USP-6C	49ge	DC4	9b	Tor
NE671	XC9111E671ER	DC/DC-IC	PFM step-up, 100kHz, 6.7V±2.5%, 400mA	USP-6C	49ge	DC4	9b	Tor
NE681	XC9111E681ER	DC/DC-IC	PFM step-up, 100kHz, 6.8V±2.5%, 400mA	USP-6C	49ge	DC4	9b	Tor
NE691	XC9111E691ER	DC/DC-IC	PFM step-up, 100kHz, 6.9V±2.5%, 400mA	USP-6C	49ge	DC4	9b	Tor
NE7	XC6222A371ER-G	LVR-IC	LDO, 3.7V±1%, 700mA, +CE	USP-6C	49hg	VR4	9a	Tor
NE701	XC9111E701ER	DC/DC-IC	PFM step-up, 100kHz, 7.0V±2.5%, 400mA	USP-6C	49ge	DC4	9b	Tor
NE8	XC6222A381ER-G	LVR-IC	LDO, 3.8V±1%, 700mA, +CE	USP-6C	49hg	VR4	9a	Tor
NE9	XC6222A391ER-G	LVR-IC	LDO, 3.9V±1%, 700mA, +CE	USP-6C	49hg	VR4	9a	Tor
NEA	XC6222A401ER-G	LVR-IC	LDO, 4.0V±1%, 700mA, +CE	USP-6C	49hg	VR4	9a	Tor
NEB	XC6222A411ER-G	LVR-IC	LDO, 4.1V±1%, 700mA, +CE	USP-6C	49hg	VR4	9a	Tor
NEC	XC6222A421ER-G	LVR-IC	LDO, 4.2V±1%, 700mA, +CE	USP-6C	49hg	VR4	9a	Tor
NED	XC6222A431ER-G	LVR-IC	LDO, 4.3V±1%, 700mA, +CE	USP-6C	49hg	VR4	9a	Tor
NEE	XC6222A441ER-G	LVR-IC	LDO, 4.4V±1%, 700mA, +CE	USP-6C	49hg	VR4	9a	Tor
NEF	XC6222A451ER-G	LVR-IC	LDO, 4.5V±1%, 700mA, +CE	USP-6C	49hg	VR4	9a	Tor
NEH	XC6222A461ER-G	LVR-IC	LDO, 4.6V±1%, 700mA, +CE	USP-6C	49hg	VR4	9a	Tor
NEK	XC6222A471ER-G	LVR-IC	LDO, 4.7V±1%, 700mA, +CE	USP-6C	49hg	VR4	9a	Tor
NEL	XC6222A481ER-G	LVR-IC	LDO, 4.8V±1%, 700mA, +CE	USP-6C	49hg	VR4	9a	Tor
NEM	XC6222A491ER-G	LVR-IC	LDO, 4.9V±1%, 700mA, +CE	USP-6C	49hg	VR4	9a	Tor
NEN	XC6222A501ER-G	LVR-IC	LDO, 5.0V±1%, 700mA, +CE	USP-6C	49hg	VR4	9a	Tor
NF	R1118K341B	LVR-IC	3.4V±1%, 150mA, +CE	DFN1612-4B	45vm	VR4	9a	Ric
NF	RP106K121B	LVR-IC	LDO, 1.2V±0.8%, 400mA, +CE	DFN1212-6	52vr2	VR4	9a	Ric
NF0	XC6222A30BER-G	LVR-IC	LDO, 3.05V±1%, 700mA, +CE	USP-6C	49hg	VR4	9a	Tor
NF1	XC6222A31BER-G	LVR-IC	LDO, 3.15V±1%, 700mA, +CE	USP-6C	49hg	VR4	9a	Tor
NF151	XC9111F151ER	DC/DC-IC	PFM step-up, 100kHz, 1.5V±2.5%, 400mA	USP-6C	49go	DC13	9b	Tor
NF161	XC9111F161ER	DC/DC-IC	PFM step-up, 100kHz, 1.6V±2.5%, 400mA	USP-6C	49go	DC13	9b	Tor
NF171	XC9111F171ER	DC/DC-IC	PFM step-up, 100kHz, 1.7V±2.5%, 400mA	USP-6C	49go	DC13	9b	Tor
NF181	XC9111F181ER	DC/DC-IC	PFM step-up, 100kHz, 1.8V±2.5%, 400mA	USP-6C	49go	DC13	9b	Tor
NF191	XC9111F191ER	DC/DC-IC	PFM step-up, 100kHz, 1.9V±2.5%, 400mA	USP-6C	49go	DC13	9b	Tor
NF2	XC6222A32BER-G	LVR-IC	LDO, 3.25V±1%, 700mA, +CE	USP-6C	49hg	VR4	9a	Tor
NF201	XC9111F201ER	DC/DC-IC	PFM step-up, 100kHz, 2.0V±2.5%, 400mA	USP-6C	49go	DC13	9b	Tor
NF211	XC9111F211ER	DC/DC-IC	PFM step-up, 100kHz, 2.1V±2.5%, 400mA	USP-6C	49go	DC13	9b	Tor
NF221	XC9111F221ER	DC/DC-IC	PFM step-up, 100kHz, 2.2V±2.5%, 400mA	USP-6C	49go	DC13	9b	Tor
NF231	XC9111F231ER	DC/DC-IC	PFM step-up, 100kHz, 2.3V±2.5%, 400mA	USP-6C	49go	DC13	9b	Tor
NF241	XC9111F241ER	DC/DC-IC	PFM step-up, 100kHz, 2.4V±2.5%, 400mA	USP-6C	49go	DC13	9b	Tor
NF251	XC9111F251ER	DC/DC-IC	PFM step-up, 100kHz, 2.5V±2.5%, 400mA	USP-6C	49go	DC13	9b	Tor
NF261	XC9111F261ER	DC/DC-IC	PFM step-up, 100kHz, 2.6V±2.5%, 400mA	USP-6C	49go	DC13	9b	Tor
NF271	XC9111F271ER	DC/DC-IC	PFM step-up, 100kHz, 2.7V±2.5%, 400mA	USP-6C	49go	DC13	9b	Tor
NF281	XC9111F281ER	DC/DC-IC	PFM step-up, 100kHz, 2.8V±2.5%, 400mA	USP-6C	49go	DC13	9b	Tor
NF291	XC9111F291ER	DC/DC-IC	PFM step-up, 100kHz, 2.9V±2.5%, 400mA	USP-6C	49go	DC13	9b	Tor
NF3	XC6222A33BER-G	LVR-IC	LDO, 3.35V±1%, 700mA, +CE	USP-6C	49hg	VR4	9a	Tor
NF301	XC9111F301ER	DC/DC-IC	PFM step-up, 100kHz, 3.0V±2.5%, 400mA	USP-6C	49go	DC13	9b	Tor
NF311	XC9111F311ER	DC/DC-IC	PFM step-up, 100kHz, 3.1V±2.5%, 400mA	USP-6C	49go	DC13	9b	Tor
NF321	XC9111F321ER	DC/DC-IC	PFM step-up, 100kHz, 3.2V±2.5%, 400mA	USP-6C	49go	DC13	9b	Tor
NF331	XC9111F331ER	DC/DC-IC	PFM step-up, 100kHz, 3.3V±2.5%, 400mA	USP-6C	49go	DC13	9b	Tor
NF341	XC9111F341ER	DC/DC-IC	PFM step-up, 100kHz, 3.4V±2.5%, 400mA	USP-6C	49go	DC13	9b	Tor
NF351	XC9111F351ER	DC/DC-IC	PFM step-up, 100kHz, 3.5V±2.5%, 400mA	USP-6C	49go	DC13	9b	Tor
NF361	XC9111F361ER	DC/DC-IC	PFM step-up, 100kHz, 3.6V±2.5%, 400mA	USP-6C	49go	DC13	9b	Tor
NF371	XC9111F371ER	DC/DC-IC	PFM step-up, 100kHz, 3.7V±2.5%, 400mA	USP-6C	49go	DC13	9b	Tor
NF381	XC9111F381ER	DC/DC-IC	PFM step-up, 100kHz, 3.8V±2.5%, 400mA	USP-6C	49go	DC13	9b	Tor
NF391	XC9111F391ER	DC/DC-IC	PFM step-up, 100kHz, 3.9V±2.5%, 400mA	USP-6C	49go	DC13	9b	Tor
NF4	XC6222A34BER-G	LVR-IC	LDO, 3.45V±1%, 700mA, +CE	USP-6C	49hg	VR4	9a	Tor
NF401	XC9111F401ER	DC/DC-IC	PFM step-up, 100kHz, 4.0V±2.5%, 400mA	USP-6C	49go	DC13	9b	Tor
NF411	XC9111F411ER	DC/DC-IC	PFM step-up, 100kHz, 4.1V±2.5%, 400mA	USP-6C	49go	DC13	9b	Tor
NF421	XC9111F421ER	DC/DC-IC	PFM step-up, 100kHz, 4.2V±2.5%, 400mA	USP-6C	49go	DC13	9b	Tor
NF431	XC9111F431ER	DC/DC-IC	PFM step-up, 100kHz, 4.3V±2.5%, 400mA	USP-6C	49go	DC13	9b	Tor
NF441	XC9111F441ER	DC/DC-IC	PFM step-up, 100kHz, 4.4V±2.5%, 400mA	USP-6C	49go	DC13	9b	Tor
NF451	XC9111F451ER	DC/DC-IC	PFM step-up, 100kHz, 4.5V±2.5%, 400mA	USP-6C	49go	DC13	9b	Tor
NF461	XC9111F461ER	DC/DC-IC	PFM step-up, 100kHz, 4.6V±2.5%, 400mA	USP-6C	49go	DC13	9b	Tor
NF471	XC9111F471ER	DC/DC-IC	PFM step-up, 100kHz, 4.7V±2.5%, 400mA	USP-6C	49go	DC13	9b	Tor
NF481	XC9111F481ER	DC/DC-IC	PFM step-up, 100kHz, 4.8V±2.5%, 400mA	USP-6C	49go	DC13	9b	Tor
NF491	XC9111F491ER	DC/DC-IC	PFM step-up, 100kHz, 4.9V±2.5%, 400mA	USP-6C	49go	DC13	9b	Tor
NF5	XC6222A35BER-G	LVR-IC	LDO, 3.55V±1%, 700mA, +CE	USP-6C	49hg	VR4	9a	Tor
NF501	XC9111F501ER	DC/DC-IC	PFM step-up, 100kHz, 5.0V±2.5%, 400mA	USP-6C	49go	DC13	9b	Tor
NF511	XC9111F511ER	DC/DC-IC	PFM step-up, 100kHz, 5.1V±2.5%, 400mA	USP-6C	49go	DC13	9b	Tor



SMD code	Type	Function	Short description	Case	Pinout	Sch.	St.	Mnf.
NF521	XC9111F521ER	DC/DC-IC	PFM step-up, 100kHz, 5.2V±2.5%, 400mA	USP-6C	49go	DC13	9b	Tor
NF531	XC9111F531ER	DC/DC-IC	PFM step-up, 100kHz, 5.3V±2.5%, 400mA	USP-6C	49go	DC13	9b	Tor
NF541	XC9111F541ER	DC/DC-IC	PFM step-up, 100kHz, 5.4V±2.5%, 400mA	USP-6C	49go	DC13	9b	Tor
NF551	XC9111F551ER	DC/DC-IC	PFM step-up, 100kHz, 5.5V±2.5%, 400mA	USP-6C	49go	DC13	9b	Tor
NF561	XC9111F561ER	DC/DC-IC	PFM step-up, 100kHz, 5.6V±2.5%, 400mA	USP-6C	49go	DC13	9b	Tor
NF571	XC9111F571ER	DC/DC-IC	PFM step-up, 100kHz, 5.7V±2.5%, 400mA	USP-6C	49go	DC13	9b	Tor
NF581	XC9111F581ER	DC/DC-IC	PFM step-up, 100kHz, 5.8V±2.5%, 400mA	USP-6C	49go	DC13	9b	Tor
NF591	XC9111F591ER	DC/DC-IC	PFM step-up, 100kHz, 5.9V±2.5%, 400mA	USP-6C	49go	DC13	9b	Tor
NF6	XC6222A36BER-G	LVR-IC	LDO, 3.65V±1%, 700mA, +CE	USP-6C	49hg	VR4	9a	Tor
NF601	XC9111F601ER	DC/DC-IC	PFM step-up, 100kHz, 6.0V±2.5%, 400mA	USP-6C	49go	DC13	9b	Tor
NF611	XC9111F611ER	DC/DC-IC	PFM step-up, 100kHz, 6.1V±2.5%, 400mA	USP-6C	49go	DC13	9b	Tor
NF621	XC9111F621ER	DC/DC-IC	PFM step-up, 100kHz, 6.2V±2.5%, 400mA	USP-6C	49go	DC13	9b	Tor
NF631	XC9111F631ER	DC/DC-IC	PFM step-up, 100kHz, 6.3V±2.5%, 400mA	USP-6C	49go	DC13	9b	Tor
NF641	XC9111F641ER	DC/DC-IC	PFM step-up, 100kHz, 6.4V±2.5%, 400mA	USP-6C	49go	DC13	9b	Tor
NF651	XC9111F651ER	DC/DC-IC	PFM step-up, 100kHz, 6.5V±2.5%, 400mA	USP-6C	49go	DC13	9b	Tor
NF661	XC9111F661ER	DC/DC-IC	PFM step-up, 100kHz, 6.6V±2.5%, 400mA	USP-6C	49go	DC13	9b	Tor
NF671	XC9111F671ER	DC/DC-IC	PFM step-up, 100kHz, 6.7V±2.5%, 400mA	USP-6C	49go	DC13	9b	Tor
NF681	XC9111F681ER	DC/DC-IC	PFM step-up, 100kHz, 6.8V±2.5%, 400mA	USP-6C	49go	DC13	9b	Tor
NF691	XC9111F691ER	DC/DC-IC	PFM step-up, 100kHz, 6.9V±2.5%, 400mA	USP-6C	49go	DC13	9b	Tor
NF7	XC6222A37BER-G	LVR-IC	LDO, 3.75V±1%, 700mA, +CE	USP-6C	49hg	VR4	9a	Tor
NF701	XC9111F701ER	DC/DC-IC	PFM step-up, 100kHz, 7.0V±2.5%, 400mA	USP-6C	49go	DC13	9b	Tor
NF8	XC6222A38BER-G	LVR-IC	LDO, 3.85V±1%, 700mA, +CE	USP-6C	49hg	VR4	9a	Tor
NF9	XC6222A39BER-G	LVR-IC	LDO, 3.95V±1%, 700mA, +CE	USP-6C	49hg	VR4	9a	Tor
NFA	XC6222A40BER-G	LVR-IC	LDO, 4.05V±1%, 700mA, +CE	USP-6C	49hg	VR4	9a	Tor
NFB	XC6222A41BER-G	LVR-IC	LDO, 4.15V±1%, 700mA, +CE	USP-6C	49hg	VR4	9a	Tor
NFC	XC6222A42BER-G	LVR-IC	LDO, 4.25V±1%, 700mA, +CE	USP-6C	49hg	VR4	9a	Tor
NFD	XC6222A43BER-G	LVR-IC	LDO, 4.35V±1%, 700mA, +CE	USP-6C	49hg	VR4	9a	Tor
NFE	XC6222A44BER-G	LVR-IC	LDO, 4.45V±1%, 700mA, +CE	USP-6C	49hg	VR4	9a	Tor
NFF	XC6222A45BER-G	LVR-IC	LDO, 4.55V±1%, 700mA, +CE	USP-6C	49hg	VR4	9a	Tor
NFH	XC6222A46BER-G	LVR-IC	LDO, 4.65V±1%, 700mA, +CE	USP-6C	49hg	VR4	9a	Tor
NFK	XC6222A47BER-G	LVR-IC	LDO, 4.75V±1%, 700mA, +CE	USP-6C	49hg	VR4	9a	Tor
NFL	XC6222A48BER-G	LVR-IC	LDO, 4.85V±1%, 700mA, +CE	USP-6C	49hg	VR4	9a	Tor
NFM	XC6222A49BER-G	LVR-IC	LDO, 4.95V±1%, 700mA, +CE	USP-6C	49hg	VR4	9a	Tor
NG	R1118K351B	LVR-IC	3.5V±1%, 150mA, +CE	DFN1612-4B	45vm	VR4	9a	Ric
NG	RP106K131B	LVR-IC	LDO, 1.3V±0.8%, 400mA, +CE	DFN1212-6	52vr2	VR4	9a	Ric
NH	EUP7201-1.8/3.3U	LVR-IC	LDO, Dual out, Vout1/Vout2=1.8V/3.3V±2%, 150mA, +CE	USP-6	49xv	VR19	9m	Eut
NH	R1118K361B	LVR-IC	3.6V±1%, 150mA, +CE	DFN1612-4B	45vm	VR4	9a	Ric
NH	RP106K141B	LVR-IC	LDO, 1.4V±0.8%, 400mA, +CE	DFN1212-6	52vr2	VR4	9a	Ric
NH8	XC6222B081ER-G	LVR-IC	LDO, 0.8V±20mV, 700mA, +CE, CL	USP-6C	49hg	VR4	9a	Tor
NH9	XC6222B091ER-G	LVR-IC	LDO, 0.9V±20mV, 700mA, +CE, CL	USP-6C	49hg	VR4	9a	Tor
NHA	XC6222B101ER-G	LVR-IC	LDO, 1.0V±20mV, 700mA, +CE, CL	USP-6C	49hg	VR4	9a	Tor
NHB	XC6222B111ER-G	LVR-IC	LDO, 1.1V±20mV, 700mA, +CE, CL	USP-6C	49hg	VR4	9a	Tor
NHC	XC6222B121ER-G	LVR-IC	LDO, 1.2V±20mV, 700mA, +CE, CL	USP-6C	49hg	VR4	9a	Tor
NHD	XC6222B131ER-G	LVR-IC	LDO, 1.3V±20mV, 700mA, +CE, CL	USP-6C	49hg	VR4	9a	Tor
NHE	XC6222B141ER-G	LVR-IC	LDO, 1.4V±20mV, 700mA, +CE, CL	USP-6C	49hg	VR4	9a	Tor
NHF	XC6222B151ER-G	LVR-IC	LDO, 1.5V±20mV, 700mA, +CE, CL	USP-6C	49hg	VR4	9a	Tor
NHH	XC6222B161ER-G	LVR-IC	LDO, 1.6V±20mV, 700mA, +CE, CL	USP-6C	49hg	VR4	9a	Tor
NHK	XC6222B171ER-G	LVR-IC	LDO, 1.7V±20mV, 700mA, +CE, CL	USP-6C	49hg	VR4	9a	Tor
NHL	XC6222B181ER-G	LVR-IC	LDO, 1.8V±20mV, 700mA, +CE, CL	USP-6C	49hg	VR4	9a	Tor
NHM	XC6222B191ER-G	LVR-IC	LDO, 1.9V±20mV, 700mA, +CE, CL	USP-6C	49hg	VR4	9a	Tor
NHN	XC6222B201ER-G	LVR-IC	LDO, 2.0V±20mV, 700mA, +CE, CL	USP-6C	49hg	VR4	9a	Tor
NHP	XC6222B211ER-G	LVR-IC	LDO, 2.1V±1%, 700mA, +CE, CL	USP-6C	49hg	VR4	9a	Tor
NHR	XC6222B221ER-G	LVR-IC	LDO, 2.2V±1%, 700mA, +CE, CL	USP-6C	49hg	VR4	9a	Tor
NHS	XC6222B231ER-G	LVR-IC	LDO, 2.3V±1%, 700mA, +CE, CL	USP-6C	49hg	VR4	9a	Tor
NHT	XC6222B241ER-G	LVR-IC	LDO, 2.4V±1%, 700mA, +CE, CL	USP-6C	49hg	VR4	9a	Tor
NHU	XC6222B251ER-G	LVR-IC	LDO, 2.5V±1%, 700mA, +CE, CL	USP-6C	49hg	VR4	9a	Tor
NHV	XC6222B261ER-G	LVR-IC	LDO, 2.6V±1%, 700mA, +CE, CL	USP-6C	49hg	VR4	9a	Tor
NHX	XC6222B271ER-G	LVR-IC	LDO, 2.7V±1%, 700mA, +CE, CL	USP-6C	49hg	VR4	9a	Tor
NHY	XC6222B281ER-G	LVR-IC	LDO, 2.8V±1%, 700mA, +CE, CL	USP-6C	49hg	VR4	9a	Tor
NHZ	XC6222B291ER-G	LVR-IC	LDO, 2.9V±1%, 700mA, +CE, CL	USP-6C	49hg	VR4	9a	Tor
NJ	EUP7201-3.3/3.3U	LVR-IC	LDO, Dual out, Vout1/Vout2=3.3V/3.3V±2%, 150mA, +CE	USP-6	49xv	VR19	9m	Eut
NJ	R1118K371B	LVR-IC	3.7V±1%, 150mA, +CE	DFN1612-4B	45vm	VR4	9a	Ric
NJ	RP106K151B	LVR-IC	LDO, 1.5V±0.8%, 400mA, +CE	DFN1212-6	52vr2	VR4	9a	Ric
NK	EUP7201-2.8/3.0U	LVR-IC	LDO, Dual out, Vout1/Vout2=2.8V/3.0V±2%, 150mA, +CE	USP-6	49xv	VR19	9m	Eut
NK	R1118K381B	LVR-IC	3.8V±1%, 150mA, +CE	DFN1612-4B	45vm	VR4	9a	Ric
NK	RP106K161B	LVR-IC	LDO, 1.6V±0.8%, 400mA, +CE	DFN1212-6	52vr2	VR4	9a	Ric
NK8	XC6222B08BER-G	LVR-IC	LDO, 0.85V±20mV, 700mA, +CE, CL	USP-6C	49hg	VR4	9a	Tor
NK9	XC6222B09BER-G	LVR-IC	LDO, 0.95V±20mV, 700mA, +CE, CL	USP-6C	49hg	VR4	9a	Tor
NKA	XC6222B10BER-G	LVR-IC	LDO, 1.05V±20mV, 700mA, +CE, CL	USP-6C	49hg	VR4	9a	Tor
NKB	XC6222B11BER-G	LVR-IC	LDO, 1.15V±20mV, 700mA, +CE, CL	USP-6C	49hg	VR4	9a	Tor



SMD
code

Type

Function

Short description

Case

Pinout Sch. St.Mnf.

SMD code	Type	Function	Short description	Case	Pinout	Sch.	St.Mnf.
NKC	XC6222B12BER-G	LVR-IC	LDO, 1.25V±20mV, 700mA, +CE, CL	USP-6C	49hg	VR4	9a Tor
NKD	XC6222B13BER-G	LVR-IC	LDO, 1.35V±20mV, 700mA, +CE, CL	USP-6C	49hg	VR4	9a Tor
NKE	XC6222B14BER-G	LVR-IC	LDO, 1.45V±20mV, 700mA, +CE, CL	USP-6C	49hg	VR4	9a Tor
NKF	XC6222B15BER-G	LVR-IC	LDO, 1.55V±20mV, 700mA, +CE, CL	USP-6C	49hg	VR4	9a Tor
NKH	XC6222B16BER-G	LVR-IC	LDO, 1.65V±20mV, 700mA, +CE, CL	USP-6C	49hg	VR4	9a Tor
NKK	XC6222B17BER-G	LVR-IC	LDO, 1.75V±20mV, 700mA, +CE, CL	USP-6C	49hg	VR4	9a Tor
NKL	XC6222B18BER-G	LVR-IC	LDO, 1.85V±20mV, 700mA, +CE, CL	USP-6C	49hg	VR4	9a Tor
NKM	XC6222B19BER-G	LVR-IC	LDO, 1.95V±20mV, 700mA, +CE, CL	USP-6C	49hg	VR4	9a Tor
NKN	XC6222B20BER-G	LVR-IC	LDO, 2.05V±1%, 700mA, +CE, CL	USP-6C	49hg	VR4	9a Tor
NKP	XC6222B21BER-G	LVR-IC	LDO, 2.15V±1%, 700mA, +CE, CL	USP-6C	49hg	VR4	9a Tor
NKR	XC6222B22BER-G	LVR-IC	LDO, 2.25V±1%, 700mA, +CE, CL	USP-6C	49hg	VR4	9a Tor
NKS	XC6222B23BER-G	LVR-IC	LDO, 2.35V±1%, 700mA, +CE, CL	USP-6C	49hg	VR4	9a Tor
NKT	XC6222B24BER-G	LVR-IC	LDO, 2.45V±1%, 700mA, +CE, CL	USP-6C	49hg	VR4	9a Tor
NKU	XC6222B25BER-G	LVR-IC	LDO, 2.55V±1%, 700mA, +CE, CL	USP-6C	49hg	VR4	9a Tor
NKV	XC6222B26BER-G	LVR-IC	LDO, 2.65V±1%, 700mA, +CE, CL	USP-6C	49hg	VR4	9a Tor
NKX	XC6222B27BER-G	LVR-IC	LDO, 2.75V±1%, 700mA, +CE, CL	USP-6C	49hg	VR4	9a Tor
NKY	XC6222B28BER-G	LVR-IC	LDO, 2.85V±1%, 700mA, +CE, CL	USP-6C	49hg	VR4	9a Tor
NKZ	XC6222B29BER-G	LVR-IC	LDO, 2.95V±1%, 700mA, +CE, CL	USP-6C	49hg	VR4	9a Tor
NL	EUP7201-2.8/3.3U	LVR-IC	LDO, Dual out, Vout1/Vout2=2.8V/3.3V±2%, 150mA, +CE	USP-6	49xv	VR19	9m Eut
NL	R118K391B	LVR-IC	3.9V±1%, 150mA, +CE	DFN1612-4B	45vm	VR4	9a Ric
NL	RP106K171B	LVR-IC	LDO, 1.7V±0.8%, 400mA, +CE	DFN1212-6	52vr2	VR4	9a Ric
NL0	XC6222B301ER-G	LVR-IC	LDO, 3.0V±1%, 700mA, +CE, CL	USP-6C	49hg	VR4	9a Tor
NL1	XC6222B311ER-G	LVR-IC	LDO, 3.1V±1%, 700mA, +CE, CL	USP-6C	49hg	VR4	9a Tor
NL2	XC6222B321ER-G	LVR-IC	LDO, 3.2V±1%, 700mA, +CE, CL	USP-6C	49hg	VR4	9a Tor
NL3	XC6222B331ER-G	LVR-IC	LDO, 3.3V±1%, 700mA, +CE, CL	USP-6C	49hg	VR4	9a Tor
NL4	XC6222B341ER-G	LVR-IC	LDO, 3.4V±1%, 700mA, +CE, CL	USP-6C	49hg	VR4	9a Tor
NL5	XC6222B351ER-G	LVR-IC	LDO, 3.5V±1%, 700mA, +CE, CL	USP-6C	49hg	VR4	9a Tor
NL6	XC6222B361ER-G	LVR-IC	LDO, 3.6V±1%, 700mA, +CE, CL	USP-6C	49hg	VR4	9a Tor
NL7	XC6222B371ER-G	LVR-IC	LDO, 3.7V±1%, 700mA, +CE, CL	USP-6C	49hg	VR4	9a Tor
NL8	XC6222B381ER-G	LVR-IC	LDO, 3.8V±1%, 700mA, +CE, CL	USP-6C	49hg	VR4	9a Tor
NL9	XC6222B391ER-G	LVR-IC	LDO, 3.9V±1%, 700mA, +CE, CL	USP-6C	49hg	VR4	9a Tor
NLA	XC6222B401ER-G	LVR-IC	LDO, 4.0V±1%, 700mA, +CE, CL	USP-6C	49hg	VR4	9a Tor
NLB	XC6222B411ER-G	LVR-IC	LDO, 4.1V±1%, 700mA, +CE, CL	USP-6C	49hg	VR4	9a Tor
NLC	XC6222B421ER-G	LVR-IC	LDO, 4.2V±1%, 700mA, +CE, CL	USP-6C	49hg	VR4	9a Tor
NLD	XC6222B431ER-G	LVR-IC	LDO, 4.3V±1%, 700mA, +CE, CL	USP-6C	49hg	VR4	9a Tor
NLE	XC6222B441ER-G	LVR-IC	LDO, 4.4V±1%, 700mA, +CE, CL	USP-6C	49hg	VR4	9a Tor
NLF	XC6222B451ER-G	LVR-IC	LDO, 4.5V±1%, 700mA, +CE, CL	USP-6C	49hg	VR4	9a Tor
NLH	XC6222B461ER-G	LVR-IC	LDO, 4.6V±1%, 700mA, +CE, CL	USP-6C	49hg	VR4	9a Tor
NLK	XC6222B471ER-G	LVR-IC	LDO, 4.7V±1%, 700mA, +CE, CL	USP-6C	49hg	VR4	9a Tor
NLL	XC6222B481ER-G	LVR-IC	LDO, 4.8V±1%, 700mA, +CE, CL	USP-6C	49hg	VR4	9a Tor
NLM	XC6222B491ER-G	LVR-IC	LDO, 4.9V±1%, 700mA, +CE, CL	USP-6C	49hg	VR4	9a Tor
NLN	XC6222B501ER-G	LVR-IC	LDO, 5.0V±1%, 700mA, +CE, CL	USP-6C	49hg	VR4	9a Tor
NM	EUP7201-2.8/2.8U	LVR-IC	LDO, Dual out, Vout1/Vout2=2.8V/2.8V±2%, 150mA, +CE	USP-6	49xv	VR19	9m Eut
NM	R118K401B	LVR-IC	4V±1%, 150mA, +CE	DFN1612-4B	45vm	VR4	9a Ric
NM	RP106K181B	LVR-IC	LDO, 1.8V±0.8%, 400mA, +CE	DFN1212-6	52vr2	VR4	9a Ric
NM0	XC6222B30BER-G	LVR-IC	LDO, 3.05V±1%, 700mA, +CE, CL	USP-6C	49hg	VR4	9a Tor
NM1	XC6222B31BER-G	LVR-IC	LDO, 3.15V±1%, 700mA, +CE, CL	USP-6C	49hg	VR4	9a Tor
NM2	XC6222B32BER-G	LVR-IC	LDO, 3.25V±1%, 700mA, +CE, CL	USP-6C	49hg	VR4	9a Tor
NM3	XC6222B33BER-G	LVR-IC	LDO, 3.35V±1%, 700mA, +CE, CL	USP-6C	49hg	VR4	9a Tor
NM4	XC6222B34BER-G	LVR-IC	LDO, 3.45V±1%, 700mA, +CE, CL	USP-6C	49hg	VR4	9a Tor
NM5	XC6222B35BER-G	LVR-IC	LDO, 3.55V±1%, 700mA, +CE, CL	USP-6C	49hg	VR4	9a Tor
NM6	XC6222B36BER-G	LVR-IC	LDO, 3.65V±1%, 700mA, +CE, CL	USP-6C	49hg	VR4	9a Tor
NM7	XC6222B37BER-G	LVR-IC	LDO, 3.75V±1%, 700mA, +CE, CL	USP-6C	49hg	VR4	9a Tor
NM8	XC6222B38BER-G	LVR-IC	LDO, 3.85V±1%, 700mA, +CE, CL	USP-6C	49hg	VR4	9a Tor
NM9	XC6222B39BER-G	LVR-IC	LDO, 3.95V±1%, 700mA, +CE, CL	USP-6C	49hg	VR4	9a Tor
NMA	XC6222B40BER-G	LVR-IC	LDO, 4.05V±1%, 700mA, +CE, CL	USP-6C	49hg	VR4	9a Tor
NMB	XC6222B41BER-G	LVR-IC	LDO, 4.15V±1%, 700mA, +CE, CL	USP-6C	49hg	VR4	9a Tor
NMC	XC6222B42BER-G	LVR-IC	LDO, 4.25V±1%, 700mA, +CE, CL	USP-6C	49hg	VR4	9a Tor
NMD	XC6222B43BER-G	LVR-IC	LDO, 4.35V±1%, 700mA, +CE, CL	USP-6C	49hg	VR4	9a Tor
NME	XC6222B44BER-G	LVR-IC	LDO, 4.45V±1%, 700mA, +CE, CL	USP-6C	49hg	VR4	9a Tor
NMF	XC6222B45BER-G	LVR-IC	LDO, 4.55V±1%, 700mA, +CE, CL	USP-6C	49hg	VR4	9a Tor
NMH	XC6222B46BER-G	LVR-IC	LDO, 4.65V±1%, 700mA, +CE, CL	USP-6C	49hg	VR4	9a Tor
NMK	XC6222B47BER-G	LVR-IC	LDO, 4.75V±1%, 700mA, +CE, CL	USP-6C	49hg	VR4	9a Tor
NML	XC6222B48BER-G	LVR-IC	LDO, 4.85V±1%, 700mA, +CE, CL	USP-6C	49hg	VR4	9a Tor
NMM	XC6222B49BER-G	LVR-IC	LDO, 4.95V±1%, 700mA, +CE, CL	USP-6C	49hg	VR4	9a Tor
NN	EUP7201-3.0/3.0U	LVR-IC	LDO, Dual out, Vout1/Vout2=3.0V/3.0V±2%, 150mA, +CE	USP-6	49xv	VR19	9m Eut
NN	R118K411B	LVR-IC	4.1V±1%, 150mA, +CE	DFN1612-4B	45vm	VR4	9a Ric
NN	RP106K101B5	LVR-IC	LDO, 1.05V±0.8%, 400mA, +CE	DFN1212-6	52vr2	VR4	9a Ric
NN8	XC6222C081ER-G	LVR-IC	LDO, 0.8V±20mV, 700mA, +CE, PDR	USP-6C	49hg	VR4	9a Tor
NN9	XC6222C091ER-G	LVR-IC	LDO, 0.9V±20mV, 700mA, +CE, PDR	USP-6C	49hg	VR4	9a Tor



SMD code	Type	Function	Short description	Case	Pinout	Sch.	St.	Mnf.
NNA	XC6222C101ER-G	LVR-IC	LDO, 1.0V±20mV, 700mA, +CE, PDR	USP-6C	49hg	VR4	9a	Tor
NNB	XC6222C111ER-G	LVR-IC	LDO, 1.1V±20mV, 700mA, +CE, PDR	USP-6C	49hg	VR4	9a	Tor
NNC	XC6222C121ER-G	LVR-IC	LDO, 1.2V±20mV, 700mA, +CE, PDR	USP-6C	49hg	VR4	9a	Tor
NND	XC6222C131ER-G	LVR-IC	LDO, 1.3V±20mV, 700mA, +CE, PDR	USP-6C	49hg	VR4	9a	Tor
NNE	XC6222C141ER-G	LVR-IC	LDO, 1.4V±20mV, 700mA, +CE, PDR	USP-6C	49hg	VR4	9a	Tor
NNF	XC6222C151ER-G	LVR-IC	LDO, 1.5V±20mV, 700mA, +CE, PDR	USP-6C	49hg	VR4	9a	Tor
NNH	XC6222C161ER-G	LVR-IC	LDO, 1.6V±20mV, 700mA, +CE, PDR	USP-6C	49hg	VR4	9a	Tor
NNK	XC6222C171ER-G	LVR-IC	LDO, 1.7V±20mV, 700mA, +CE, PDR	USP-6C	49hg	VR4	9a	Tor
NNL	XC6222C181ER-G	LVR-IC	LDO, 1.8V±20mV, 700mA, +CE, PDR	USP-6C	49hg	VR4	9a	Tor
NNM	XC6222C191ER-G	LVR-IC	LDO, 1.9V±20mV, 700mA, +CE, PDR	USP-6C	49hg	VR4	9a	Tor
NNN	XC6222C201ER-G	LVR-IC	LDO, 2.0V±20mV, 700mA, +CE, PDR	USP-6C	49hg	VR4	9a	Tor
NNP	XC6222C211ER-G	LVR-IC	LDO, 2.1V±1%, 700mA, +CE, PDR	USP-6C	49hg	VR4	9a	Tor
NNR	XC6222C221ER-G	LVR-IC	LDO, 2.2V±1%, 700mA, +CE, PDR	USP-6C	49hg	VR4	9a	Tor
NNS	XC6222C231ER-G	LVR-IC	LDO, 2.3V±1%, 700mA, +CE, PDR	USP-6C	49hg	VR4	9a	Tor
NNT	XC6222C241ER-G	LVR-IC	LDO, 2.4V±1%, 700mA, +CE, PDR	USP-6C	49hg	VR4	9a	Tor
NNU	XC6222C251ER-G	LVR-IC	LDO, 2.5V±1%, 700mA, +CE, PDR	USP-6C	49hg	VR4	9a	Tor
NNV	XC6222C261ER-G	LVR-IC	LDO, 2.6V±1%, 700mA, +CE, PDR	USP-6C	49hg	VR4	9a	Tor
NNX	XC6222C271ER-G	LVR-IC	LDO, 2.7V±1%, 700mA, +CE, PDR	USP-6C	49hg	VR4	9a	Tor
NNY	XC6222C281ER-G	LVR-IC	LDO, 2.8V±1%, 700mA, +CE, PDR	USP-6C	49hg	VR4	9a	Tor
NNZ	XC6222C291ER-G	LVR-IC	LDO, 2.9V±1%, 700mA, +CE, PDR	USP-6C	49hg	VR4	9a	Tor
NP	EUP7201-2.8/1.2U	LVR-IC	LDO, Dual out, Vout1/Vout2=2.8V/1.2V±2%, 150mA, +CE	USP-6	49xv	VR19	9m	Eut
NP	R1118K421B	LVR-IC	LDO, 4.2V±1%, 150mA, +CE	DFN1612-4B	45vm	VR4	9a	Ric
NP	RP106K121B5	LVR-IC	LDO, 1.25V±0.8%, 400mA, +CE	DFN1212-6	52vr2	VR4	9a	Ric
NP8	XC6222C08BER-G	LVR-IC	LDO, 0.85V±20mV, 700mA, +CE, PDR	USP-6C	49hg	VR4	9a	Tor
NP9	XC6222C09BER-G	LVR-IC	LDO, 0.95V±20mV, 700mA, +CE, PDR	USP-6C	49hg	VR4	9a	Tor
NPA	XC6222C10BER-G	LVR-IC	LDO, 1.05V±20mV, 700mA, +CE, PDR	USP-6C	49hg	VR4	9a	Tor
NPB	XC6222C11BER-G	LVR-IC	LDO, 1.15V±20mV, 700mA, +CE, PDR	USP-6C	49hg	VR4	9a	Tor
NPC	XC6222C12BER-G	LVR-IC	LDO, 1.25V±20mV, 700mA, +CE, PDR	USP-6C	49hg	VR4	9a	Tor
NPD	XC6222C13BER-G	LVR-IC	LDO, 1.35V±20mV, 700mA, +CE, PDR	USP-6C	49hg	VR4	9a	Tor
NPE	XC6222C14BER-G	LVR-IC	LDO, 1.45V±20mV, 700mA, +CE, PDR	USP-6C	49hg	VR4	9a	Tor
NPF	XC6222C15BER-G	LVR-IC	LDO, 1.55V±20mV, 700mA, +CE, PDR	USP-6C	49hg	VR4	9a	Tor
NPH	XC6222C16BER-G	LVR-IC	LDO, 1.65V±20mV, 700mA, +CE, PDR	USP-6C	49hg	VR4	9a	Tor
NPK	XC6222C17BER-G	LVR-IC	LDO, 1.75V±20mV, 700mA, +CE, PDR	USP-6C	49hg	VR4	9a	Tor
NPL	XC6222C18BER-G	LVR-IC	LDO, 1.85V±20mV, 700mA, +CE, PDR	USP-6C	49hg	VR4	9a	Tor
NPM	XC6222C19BER-G	LVR-IC	LDO, 1.95V±20mV, 700mA, +CE, PDR	USP-6C	49hg	VR4	9a	Tor
NPN	XC6222C20BER-G	LVR-IC	LDO, 2.05V±1%, 700mA, +CE, PDR	USP-6C	49hg	VR4	9a	Tor
NPP	XC6222C21BER-G	LVR-IC	LDO, 2.15V±1%, 700mA, +CE, PDR	USP-6C	49hg	VR4	9a	Tor
NPR	XC6222C22BER-G	LVR-IC	LDO, 2.25V±1%, 700mA, +CE, PDR	USP-6C	49hg	VR4	9a	Tor
NPS	XC6222C23BER-G	LVR-IC	LDO, 2.35V±1%, 700mA, +CE, PDR	USP-6C	49hg	VR4	9a	Tor
NPT	XC6222C24BER-G	LVR-IC	LDO, 2.45V±1%, 700mA, +CE, PDR	USP-6C	49hg	VR4	9a	Tor
NPV	XC6222C25BER-G	LVR-IC	LDO, 2.55V±1%, 700mA, +CE, PDR	USP-6C	49hg	VR4	9a	Tor
NPV	XC6222C26BER-G	LVR-IC	LDO, 2.65V±1%, 700mA, +CE, PDR	USP-6C	49hg	VR4	9a	Tor
NPX	XC6222C27BER-G	LVR-IC	LDO, 2.75V±1%, 700mA, +CE, PDR	USP-6C	49hg	VR4	9a	Tor
NPY	XC6222C28BER-G	LVR-IC	LDO, 2.85V±1%, 700mA, +CE, PDR	USP-6C	49hg	VR4	9a	Tor
NPZ	XC6222C29BER-G	LVR-IC	LDO, 2.95V±1%, 700mA, +CE, PDR	USP-6C	49hg	VR4	9a	Tor
NQ	RP106K181B5	LVR-IC	LDO, 1.85V±0.8%, 400mA, +CE	DFN1212-6	52vr2	VR4	9a	Ric
NR	RP106K111B5	LVR-IC	LDO, 1.15V±0.8%, 400mA, +CE	DFN1212-6	52vr2	VR4	9a	Ric
NR0	XC6222C301ER-G	LVR-IC	LDO, 3.0V±1%, 700mA, +CE, PDR	USP-6C	49hg	VR4	9a	Tor
NR1	XC6222C311ER-G	LVR-IC	LDO, 3.1V±1%, 700mA, +CE, PDR	USP-6C	49hg	VR4	9a	Tor
NR2	XC6222C321ER-G	LVR-IC	LDO, 3.2V±1%, 700mA, +CE, PDR	USP-6C	49hg	VR4	9a	Tor
NR3	XC6222C331ER-G	LVR-IC	LDO, 3.3V±1%, 700mA, +CE, PDR	USP-6C	49hg	VR4	9a	Tor
NR4	XC6222C341ER-G	LVR-IC	LDO, 3.4V±1%, 700mA, +CE, PDR	USP-6C	49hg	VR4	9a	Tor
NR5	XC6222C351ER-G	LVR-IC	LDO, 3.5V±1%, 700mA, +CE, PDR	USP-6C	49hg	VR4	9a	Tor
NR6	XC6222C361ER-G	LVR-IC	LDO, 3.6V±1%, 700mA, +CE, PDR	USP-6C	49hg	VR4	9a	Tor
NR7	XC6222C371ER-G	LVR-IC	LDO, 3.7V±1%, 700mA, +CE, PDR	USP-6C	49hg	VR4	9a	Tor
NR8	XC6222C381ER-G	LVR-IC	LDO, 3.8V±1%, 700mA, +CE, PDR	USP-6C	49hg	VR4	9a	Tor
NR9	XC6222C391ER-G	LVR-IC	LDO, 3.9V±1%, 700mA, +CE, PDR	USP-6C	49hg	VR4	9a	Tor
NRA	XC6222C401ER-G	LVR-IC	LDO, 4.0V±1%, 700mA, +CE, PDR	USP-6C	49hg	VR4	9a	Tor
NRB	XC6222C411ER-G	LVR-IC	LDO, 4.1V±1%, 700mA, +CE, PDR	USP-6C	49hg	VR4	9a	Tor
NRC	XC6222C421ER-G	LVR-IC	LDO, 4.2V±1%, 700mA, +CE, PDR	USP-6C	49hg	VR4	9a	Tor
NRD	XC6222C431ER-G	LVR-IC	LDO, 4.3V±1%, 700mA, +CE, PDR	USP-6C	49hg	VR4	9a	Tor
NRE	XC6222C441ER-G	LVR-IC	LDO, 4.4V±1%, 700mA, +CE, PDR	USP-6C	49hg	VR4	9a	Tor
NRF	XC6222C451ER-G	LVR-IC	LDO, 4.5V±1%, 700mA, +CE, PDR	USP-6C	49hg	VR4	9a	Tor
NRH	XC6222C461ER-G	LVR-IC	LDO, 4.6V±1%, 700mA, +CE, PDR	USP-6C	49hg	VR4	9a	Tor
NRK	XC6222C471ER-G	LVR-IC	LDO, 4.7V±1%, 700mA, +CE, PDR	USP-6C	49hg	VR4	9a	Tor
NRL	XC6222C481ER-G	LVR-IC	LDO, 4.8V±1%, 700mA, +CE, PDR	USP-6C	49hg	VR4	9a	Tor
NRM	XC6222C491ER-G	LVR-IC	LDO, 4.9V±1%, 700mA, +CE, PDR	USP-6C	49hg	VR4	9a	Tor
NRN	XC6222C501ER-G	LVR-IC	LDO, 5.0V±1%, 700mA, +CE, PDR	USP-6C	49hg	VR4	9a	Tor
NS0	XC6222C30BER-G	LVR-IC	LDO, 3.05V±1%, 700mA, +CE, PDR	USP-6C	49hg	VR4	9a	Tor
NS1	XC6222C31BER-G	LVR-IC	LDO, 3.15V±1%, 700mA, +CE, PDR	USP-6C	49hg	VR4	9a	Tor



SMD code	Type	Function	Short description	Case	Pinout	Sch.	St.	Mnf.
NS2	XC6222C32BER-G	LVR-IC	LDO, 3.25V±1%, 700mA, +CE, PDR	USP-6C	49hg	VR4	9a	Tor
NS3	XC6222C33BER-G	LVR-IC	LDO, 3.35V±1%, 700mA, +CE, PDR	USP-6C	49hg	VR4	9a	Tor
NS4	XC6222C34BER-G	LVR-IC	LDO, 3.45V±1%, 700mA, +CE, PDR	USP-6C	49hg	VR4	9a	Tor
NS5	XC6222C35BER-G	LVR-IC	LDO, 3.55V±1%, 700mA, +CE, PDR	USP-6C	49hg	VR4	9a	Tor
NS6	XC6222C36BER-G	LVR-IC	LDO, 3.65V±1%, 700mA, +CE, PDR	USP-6C	49hg	VR4	9a	Tor
NS7	XC6222C37BER-G	LVR-IC	LDO, 3.75V±1%, 700mA, +CE, PDR	USP-6C	49hg	VR4	9a	Tor
NS8	XC6222C38BER-G	LVR-IC	LDO, 3.85V±1%, 700mA, +CE, PDR	USP-6C	49hg	VR4	9a	Tor
NS9	XC6222C39BER-G	LVR-IC	LDO, 3.95V±1%, 700mA, +CE, PDR	USP-6C	49hg	VR4	9a	Tor
NSA	XC6222C40BER-G	LVR-IC	LDO, 4.05V±1%, 700mA, +CE, PDR	USP-6C	49hg	VR4	9a	Tor
NSB	XC6222C41BER-G	LVR-IC	LDO, 4.15V±1%, 700mA, +CE, PDR	USP-6C	49hg	VR4	9a	Tor
NSC	XC6222C42BER-G	LVR-IC	LDO, 4.25V±1%, 700mA, +CE, PDR	USP-6C	49hg	VR4	9a	Tor
NSD	XC6222C43BER-G	LVR-IC	LDO, 4.35V±1%, 700mA, +CE, PDR	USP-6C	49hg	VR4	9a	Tor
NSE	XC6222C44BER-G	LVR-IC	LDO, 4.45V±1%, 700mA, +CE, PDR	USP-6C	49hg	VR4	9a	Tor
NSF	XC6222C45BER-G	LVR-IC	LDO, 4.55V±1%, 700mA, +CE, PDR	USP-6C	49hg	VR4	9a	Tor
NSH	XC6222C46BER-G	LVR-IC	LDO, 4.65V±1%, 700mA, +CE, PDR	USP-6C	49hg	VR4	9a	Tor
NSK	XC6222C47BER-G	LVR-IC	LDO, 4.75V±1%, 700mA, +CE, PDR	USP-6C	49hg	VR4	9a	Tor
NSL	XC6222C48BER-G	LVR-IC	LDO, 4.85V±1%, 700mA, +CE, PDR	USP-6C	49hg	VR4	9a	Tor
NSM	XC6222C49BER-G	LVR-IC	LDO, 4.95V±1%, 700mA, +CE, PDR	USP-6C	49hg	VR4	9a	Tor
NSU	TPA2028D1YZF	LIN-IC	AF PA, BTL, class-D, 2.5..5.5V, 3W(5V/4Q), shutdown, 12C	BGA-9	39	-	-	Ti
NSV	TPA2026D2YZH	LIN-IC	AF PA, BTL, class-D, 2.5..5.5V, 3.2W(5V/4Q), shutdown, 12C	BGA-16	39	-	-	Ti
NT	EUP7201-3.0/3.3U	LVR-IC	LDO, Dual out, Vout1/Vout2=3.0V/3.3V±2%, 150mA, +CE	USP-6	49xv	VR19	9m	Eut
NT8	XC6222D081ER-G	LVR-IC	LDO, 0.8V±20mV, 700mA, +CE, PDR, CL	USP-6C	49hg	VR4	9a	Tor
NT9	XC6222D091ER-G	LVR-IC	LDO, 0.9V±20mV, 700mA, +CE, CL, PDR	USP-6C	49hg	VR4	9a	Tor
NTA	XC6222D101ER-G	LVR-IC	LDO, 1.0V±20mV, 700mA, +CE, PDR, CL	USP-6C	49hg	VR4	9a	Tor
NTB	XC6222D111ER-G	LVR-IC	LDO, 1.1V±20mV, 700mA, +CE, CL, PDR	USP-6C	49hg	VR4	9a	Tor
NTC	XC6222D121ER-G	LVR-IC	LDO, 1.2V±20mV, 700mA, +CE, CL, PDR	USP-6C	49hg	VR4	9a	Tor
NTD	XC6222D131ER-G	LVR-IC	LDO, 1.3V±20mV, 700mA, +CE, CL, PDR	USP-6C	49hg	VR4	9a	Tor
NTE	XC6222D141ER-G	LVR-IC	LDO, 1.4V±20mV, 700mA, +CE, CL, PDR	USP-6C	49hg	VR4	9a	Tor
NTF	XC6222D151ER-G	LVR-IC	LDO, 1.5V±20mV, 700mA, +CE, CL, PDR	USP-6C	49hg	VR4	9a	Tor
NTH	XC6222D161ER-G	LVR-IC	LDO, 1.6V±20mV, 700mA, +CE, CL, PDR	USP-6C	49hg	VR4	9a	Tor
NTK	XC6222D171ER-G	LVR-IC	LDO, 1.7V±20mV, 700mA, +CE, CL, PDR	USP-6C	49hg	VR4	9a	Tor
NTL	XC6222D181ER-G	LVR-IC	LDO, 1.8V±20mV, 700mA, +CE, CL, PDR	USP-6C	49hg	VR4	9a	Tor
NTM	XC6222D191ER-G	LVR-IC	LDO, 1.9V±20mV, 700mA, +CE, CL, PDR	USP-6C	49hg	VR4	9a	Tor
NTN	XC6222D201ER-G	LVR-IC	LDO, 2.0V±20mV, 700mA, +CE, CL, PDR	USP-6C	49hg	VR4	9a	Tor
NTP	XC6222D211ER-G	LVR-IC	LDO, 2.1V±1%, 700mA, +CE, CL, PDR	USP-6C	49hg	VR4	9a	Tor
NTR	XC6222D221ER-G	LVR-IC	LDO, 2.2V±1%, 700mA, +CE, CL, PDR	USP-6C	49hg	VR4	9a	Tor
NTS	XC6222D231ER-G	LVR-IC	LDO, 2.3V±1%, 700mA, +CE, CL, PDR	USP-6C	49hg	VR4	9a	Tor
NTT	XC6222D241ER-G	LVR-IC	LDO, 2.4V±1%, 700mA, +CE, CL, PDR	USP-6C	49hg	VR4	9a	Tor
NTU	XC6222D251ER-G	LVR-IC	LDO, 2.5V±1%, 700mA, +CE, CL, PDR	USP-6C	49hg	VR4	9a	Tor
NTV	XC6222D261ER-G	LVR-IC	LDO, 2.6V±1%, 700mA, +CE, CL, PDR	USP-6C	49hg	VR4	9a	Tor
NTX	XC6222D271ER-G	LVR-IC	LDO, 2.7V±1%, 700mA, +CE, CL, PDR	USP-6C	49hg	VR4	9a	Tor
NTY	XC6222D281ER-G	LVR-IC	LDO, 2.8V±1%, 700mA, +CE, CL, PDR	USP-6C	49hg	VR4	9a	Tor
NTZ	XC6222D291ER-G	LVR-IC	LDO, 2.9V±1%, 700mA, +CE, CL, PDR	USP-6C	49hg	VR4	9a	Tor
NU	EUP7201-1.8/2.6U	LVR-IC	LDO, Dual out, Vout1/Vout2=1.8V/2.6V±2%, 150mA, +CE	USP-6	49xv	VR19	9m	Eut
NU8	XC6222D08BER-G	LVR-IC	LDO, 0.85V±20mV, 700mA, +CE, PDR, CL	USP-6C	49hg	VR4	9a	Tor
NU9	XC6222D09BER-G	LVR-IC	LDO, 0.95V±20mV, 700mA, +CE, PDR, CL	USP-6C	49hg	VR4	9a	Tor
NUA	XC6222D10BER-G	LVR-IC	LDO, 1.05V±20mV, 700mA, +CE, PDR, CL	USP-6C	49hg	VR4	9a	Tor
NUB	XC6222D11BER-G	LVR-IC	LDO, 1.15V±20mV, 700mA, +CE, PDR, CL	USP-6C	49hg	VR4	9a	Tor
NUC	XC6222D12BER-G	LVR-IC	LDO, 1.25V±20mV, 700mA, +CE, CL, PDR	USP-6C	49hg	VR4	9a	Tor
NUD	XC6222D13BER-G	LVR-IC	LDO, 1.35V±20mV, 700mA, +CE, CL, PDR	USP-6C	49hg	VR4	9a	Tor
NUE	XC6222D14BER-G	LVR-IC	LDO, 1.45V±20mV, 700mA, +CE, CL, PDR	USP-6C	49hg	VR4	9a	Tor
NUF	XC6222D15BER-G	LVR-IC	LDO, 1.55V±20mV, 700mA, +CE, CL, PDR	USP-6C	49hg	VR4	9a	Tor
NUH	XC6222D16BER-G	LVR-IC	LDO, 1.65V±20mV, 700mA, +CE, CL, PDR	USP-6C	49hg	VR4	9a	Tor
NUK	XC6222D17BER-G	LVR-IC	LDO, 1.75V±20mV, 700mA, +CE, CL, PDR	USP-6C	49hg	VR4	9a	Tor
NUL	XC6222D18BER-G	LVR-IC	LDO, 1.85V±20mV, 700mA, +CE, CL, PDR	USP-6C	49hg	VR4	9a	Tor
NUM	XC6222D19BER-G	LVR-IC	LDO, 1.95V±20mV, 700mA, +CE, CL, PDR	USP-6C	49hg	VR4	9a	Tor
NUN	XC6222D20BER-G	LVR-IC	LDO, 2.05V±1%, 700mA, +CE, CL, PDR	USP-6C	49hg	VR4	9a	Tor
NUP	XC6222D21BER-G	LVR-IC	LDO, 2.15V±1%, 700mA, +CE, CL, PDR	USP-6C	49hg	VR4	9a	Tor
NUR	XC6222D22BER-G	LVR-IC	LDO, 2.25V±1%, 700mA, +CE, CL, PDR	USP-6C	49hg	VR4	9a	Tor
NUS	XC6222D23BER-G	LVR-IC	LDO, 2.35V±1%, 700mA, +CE, CL, PDR	USP-6C	49hg	VR4	9a	Tor
NUT	XC6222D24BER-G	LVR-IC	LDO, 2.45V±1%, 700mA, +CE, CL, PDR	USP-6C	49hg	VR4	9a	Tor
NUU	XC6222D25BER-G	LVR-IC	LDO, 2.55V±1%, 700mA, +CE, CL, PDR	USP-6C	49hg	VR4	9a	Tor
NUV	XC6222D26BER-G	LVR-IC	LDO, 2.65V±1%, 700mA, +CE, CL, PDR	USP-6C	49hg	VR4	9a	Tor
NUX	XC6222D27BER-G	LVR-IC	LDO, 2.75V±1%, 700mA, +CE, CL, PDR	USP-6C	49hg	VR4	9a	Tor
NUY	XC6222D28BER-G	LVR-IC	LDO, 2.85V±1%, 700mA, +CE, CL, PDR	USP-6C	49hg	VR4	9a	Tor
NUZ	XC6222D29BER-G	LVR-IC	LDO, 2.95V±1%, 700mA, +CE, CL, PDR	USP-6C	49hg	VR4	9a	Tor
NV0	XC6222D301ER-G	LVR-IC	LDO, 3.0V±1%, 700mA, +CE, CL, PDR	USP-6C	49hg	VR4	9a	Tor
NV1	XC6222D311ER-G	LVR-IC	LDO, 3.1V±1%, 700mA, +CE, CL, PDR	USP-6C	49hg	VR4	9a	Tor
NV2	XC6222D321ER-G	LVR-IC	LDO, 3.2V±1%, 700mA, +CE, CL, PDR	USP-6C	49hg	VR4	9a	Tor
NV3	XC6222D331ER-G	LVR-IC	LDO, 3.3V±1%, 700mA, +CE, CL, PDR	USP-6C	49hg	VR4	9a	Tor



SMD code	Type	Function	Short description	Case	Pinout	Sch.	St.	Mnf.
NV4	XC6222D341ER-G	LVR-IC	LDO, 3.4V±1%, 700mA, +CE, CL, PDR	USP-6C	49hg	VR4	9a	Tor
NV5	XC6222D351ER-G	LVR-IC	LDO, 3.5V±1%, 700mA, +CE, CL, PDR	USP-6C	49hg	VR4	9a	Tor
NV6	XC6222D361ER-G	LVR-IC	LDO, 3.6V±1%, 700mA, +CE, CL, PDR	USP-6C	49hg	VR4	9a	Tor
NV7	XC6222D371ER-G	LVR-IC	LDO, 3.7V±1%, 700mA, +CE, CL, PDR	USP-6C	49hg	VR4	9a	Tor
NV8	XC6222D381ER-G	LVR-IC	LDO, 3.8V±1%, 700mA, +CE, CL, PDR	USP-6C	49hg	VR4	9a	Tor
NV9	XC6222D391ER-G	LVR-IC	LDO, 3.9V±1%, 700mA, +CE, CL, PDR	USP-6C	49hg	VR4	9a	Tor
NVA	XC6222D401ER-G	LVR-IC	LDO, 4.0V±1%, 700mA, +CE, CL, PDR	USP-6C	49hg	VR4	9a	Tor
NVB	XC6222D411ER-G	LVR-IC	LDO, 4.1V±1%, 700mA, +CE, CL, PDR	USP-6C	49hg	VR4	9a	Tor
NVC	XC6222D421ER-G	LVR-IC	LDO, 4.2V±1%, 700mA, +CE, CL, PDR	USP-6C	49hg	VR4	9a	Tor
NVD	XC6222D431ER-G	LVR-IC	LDO, 4.3V±1%, 700mA, +CE, CL, PDR	USP-6C	49hg	VR4	9a	Tor
NVE	XC6222D441ER-G	LVR-IC	LDO, 4.4V±1%, 700mA, +CE, CL, PDR	USP-6C	49hg	VR4	9a	Tor
NVF	XC6222D451ER-G	LVR-IC	LDO, 4.5V±1%, 700mA, +CE, CL, PDR	USP-6C	49hg	VR4	9a	Tor
NVH	XC6222D461ER-G	LVR-IC	LDO, 4.6V±1%, 700mA, +CE, CL, PDR	USP-6C	49hg	VR4	9a	Tor
NVK	XC6222D471ER-G	LVR-IC	LDO, 4.7V±1%, 700mA, +CE, CL, PDR	USP-6C	49hg	VR4	9a	Tor
NVL	XC6222D481ER-G	LVR-IC	LDO, 4.8V±1%, 700mA, +CE, CL, PDR	USP-6C	49hg	VR4	9a	Tor
NVM	XC6222D491ER-G	LVR-IC	LDO, 4.9V±1%, 700mA, +CE, CL, PDR	USP-6C	49hg	VR4	9a	Tor
NVN	XC6222D501ER-G	LVR-IC	LDO, 5.0V±1%, 700mA, +CE, CL, PDR	USP-6C	49hg	VR4	9a	Tor
NX0	XC6222D30BER-G	LVR-IC	LDO, 3.05V±1%, 700mA, +CE, CL, PDR	USP-6C	49hg	VR4	9a	Tor
NX1	XC6222D31BER-G	LVR-IC	LDO, 3.15V±1%, 700mA, +CE, CL, PDR	USP-6C	49hg	VR4	9a	Tor
NX2	XC6222D32BER-G	LVR-IC	LDO, 3.25V±1%, 700mA, +CE, CL, PDR	USP-6C	49hg	VR4	9a	Tor
NX3	XC6222D33BER-G	LVR-IC	LDO, 3.35V±1%, 700mA, +CE, CL, PDR	USP-6C	49hg	VR4	9a	Tor
NX4	XC6222D34BER-G	LVR-IC	LDO, 3.45V±1%, 700mA, +CE, CL, PDR	USP-6C	49hg	VR4	9a	Tor
NX5	XC6222D35BER-G	LVR-IC	LDO, 3.55V±1%, 700mA, +CE, CL, PDR	USP-6C	49hg	VR4	9a	Tor
NX6	XC6222D36BER-G	LVR-IC	LDO, 3.65V±1%, 700mA, +CE, CL, PDR	USP-6C	49hg	VR4	9a	Tor
NX7	XC6222D37BER-G	LVR-IC	LDO, 3.75V±1%, 700mA, +CE, CL, PDR	USP-6C	49hg	VR4	9a	Tor
NX8	XC6222D38BER-G	LVR-IC	LDO, 3.85V±1%, 700mA, +CE, CL, PDR	USP-6C	49hg	VR4	9a	Tor
NX9	XC6222D39BER-G	LVR-IC	LDO, 3.95V±1%, 700mA, +CE, CL, PDR	USP-6C	49hg	VR4	9a	Tor
NXA	XC6222D40BER-G	LVR-IC	LDO, 4.05V±1%, 700mA, +CE, CL, PDR	USP-6C	49hg	VR4	9a	Tor
NXB	XC6222D41BER-G	LVR-IC	LDO, 4.15V±1%, 700mA, +CE, CL, PDR	USP-6C	49hg	VR4	9a	Tor
NXC	XC6222D42BER-G	LVR-IC	LDO, 4.25V±1%, 700mA, +CE, CL, PDR	USP-6C	49hg	VR4	9a	Tor
NXD	XC6222D43BER-G	LVR-IC	LDO, 4.35V±1%, 700mA, +CE, CL, PDR	USP-6C	49hg	VR4	9a	Tor
NXE	XC6222D44BER-G	LVR-IC	LDO, 4.45V±1%, 700mA, +CE, CL, PDR	USP-6C	49hg	VR4	9a	Tor
NXF	XC6222D45BER-G	LVR-IC	LDO, 4.55V±1%, 700mA, +CE, CL, PDR	USP-6C	49hg	VR4	9a	Tor
NXH	XC6222D46BER-G	LVR-IC	LDO, 4.65V±1%, 700mA, +CE, CL, PDR	USP-6C	49hg	VR4	9a	Tor
NXK	XC6222D47BER-G	LVR-IC	LDO, 4.75V±1%, 700mA, +CE, CL, PDR	USP-6C	49hg	VR4	9a	Tor
NXL	XC6222D48BER-G	LVR-IC	LDO, 4.85V±1%, 700mA, +CE, CL, PDR	USP-6C	49hg	VR4	9a	Tor
NXM	XC6222D49BER-G	LVR-IC	LDO, 4.95V±1%, 700mA, +CE, CL, PDR	USP-6C	49hg	VR4	9a	Tor
OBC	TPA2018D1YZF	LIN-IC	AF PA, BTL, class-D, 2.5. 5.5V, 3W(5V/4Q), shutdown, I2C	BGA-9	39	-	-	Ti
OCA	TPA2037D1YFF	LIN-IC	AF PA, BTL, class-D, 2.5. 5.5V, 3.25W(5V/4Q), shutdown	BGA-9	39	AFP45	-	Ti
OD	MAX8840ELT15+T	LVR-IC	LDO, 1.5V±2%, 150mA, +CE	DFN-6	52	VR7a	9t	Max
OEN	TPA2015D1YZH	LIN-IC	AF PA, BTL, class-D, 3.5. 5.5V, 2W(5V/8Q), shutdown	BGA-16	39	-	-	Ti
OEW	TPA2011D1YFF	LIN-IC	AF PA, BTL, class-D, 2.5. 5.5V, 3.2W(5V/4Q), shutdown	BGA-9	39	AFP45	-	Ti
OG	MAX8840ELT21+T	LVR-IC	LDO, 2.1V±2%, 150mA, +CE	DFN-6	52	VR7a	9t	Max
OR	MAX8840ELT45+T	LVR-IC	LDO, 4.5V±2%, 150mA, +CE	DFN-6	52	VR7a	9t	Max
OY	MAX8840ELT40+T	LVR-IC	LDO, 4.0V±2%, 150mA, +CE	DFN-6	52	VR7a	9t	Max
P*	SH4890IBL	LIN-IC	AF PA, BTL, 2.2. 5.5V, 1W(5V/8Q), shutdown	BGA-9	39	AFP44	-	Sit
P0	R3117K373A	Vdet-IC	3.7V±1%, -Reset ODO, Sense	DFN1010-4	48rq	VD11	9a	Ric
P0	RP114K181B5	LVR-IC	LDO, 1.85V±1%, 300mA, +CE	DFN1010-4	48vm	VR4	9a	Ric
P0	XC6221B4117R	LVR-IC	LDO, 4.1V±1%, 200mA, +CE, CL	USPN-4	58vm	VR4	9a	Tor
p00	74AUP2G00GM	CMOS-Logic	Dual 2-input NAND gates	SOT902-1	51/Log50	-	9a	Phi
p00	74AUP2G00GT	CMOS-Logic	Dual 2-input NAND gates	SOT833-1	53/Log50	-	9c	Phi
p02	74AUP2G02GM	CMOS-Logic	Dual 2-input NOR gates	SOT902-1	51/Log53	-	9a	Phi
p02	74AUP2G02GT	CMOS-Logic	Dual 2-input NOR gates	SOT833-1	53/Log53	-	9c	Phi
p08	74AUP2G08GM	CMOS-Logic	Dual 2-input AND gates	SOT902-1	51/Log51	-	9a	Phi
p08	74AUP2G08GT	CMOS-Logic	Dual 2-input AND gates	SOT833-1	53/Log51	-	9c	Phi
P0A	XC6108N40AGR	Vdet-IC	4.0V±2%, Hysteresis, -Reset ODO	USP-4	45ro	VD14	9b	Tor
P0A	XC6118C30AGR-G	Vdet-IC	3.0V±2%, ±Reset PPO, Sense, hysteresis 5%, Cd	USP-4	45me	VD15	9a	Tor
P0B	XC6108N40BGR	Vdet-IC	4.0V±2%, -Reset ODO	USP-4	45ro	VD14	9b	Tor
P0B	XC6118C30BGR-G	Vdet-IC	3.0V±2%, ±Reset PPO, Sense, hysteresis <1%, Cd	USP-4	45me	VD15	9a	Tor
P0C	XC6108N40CGR	Vdet-IC	4.0V±2%, Hysteresis, -Reset ODO	USP-4	45m	VD14	9b	Tor
P0C	XC6118C30CGR-G	Vdet-IC	3.0V±2%, ±Reset PPO, Sense, hysteresis 5%	USP-4	45md	VD12	9a	Tor
P0D	XC6108N40DGR	Vdet-IC	4.0V±2%, -Reset ODO	USP-4	45m	VD14	9b	Tor
P0D	XC6118C30DGR-G	Vdet-IC	3.0V±2%, ±Reset PPO, Sense, hysteresis <1%	USP-4	45md	VD12	9a	Tor
P1	R3117K383A	Vdet-IC	3.8V±1%, -Reset ODO, Sense	DFN1010-4	48rq	VD11	9a	Ric
P1	RP114K281B5	LVR-IC	LDO, 2.85V±1%, 300mA, +CE	DFN1010-4	48vm	VR4	9a	Ric
P1	XC6221B4217R	LVR-IC	LDO, 4.2V±1%, 200mA, +CE, CL	USPN-4	58vm	VR4	9a	Tor
P15E	R1163K151E	LVR-IC	LDO, 1.5V±2.5%, 150mA, +CE, AE(mode)	PLP1616-6	66vj	VR10	9b	Ric
P16E	R1163K161E	LVR-IC	LDO, 1.6V±2.5%, 150mA, +CE, AE(mode)	PLP1616-6	66vj	VR10	9b	Ric
P17E	R1163K171E	LVR-IC	LDO, 1.7V±2.5%, 150mA, +CE, AE(mode)	PLP1616-6	66vj	VR10	9b	Ric
P185	R1163K181E5	LVR-IC	LDO, 1.85V±2.5%, 150mA, +CE, AE(mode)	PLP1616-6	66vj	VR10	9b	Ric



SMD code	Type	Function	Short description	Case	Pinout	Sch.	St.	Mnf.
P18E	R1163K181E	LVR-IC	LDO, 1.8V±2.5%, 150mA, +CE, AE(mode)	PLP1616-6	66vj	VR10	9b	Ric
P19E	R1163K191E	LVR-IC	LDO, 1.9V±2.5%, 150mA, +CE, AE(mode)	PLP1616-6	66vj	VR10	9b	Ric
P1A	XC6108N41AGR	Vdet-IC	4.1V±2%, Hysteresis, -Reset ODO	USP-4	45ro	VD14	9b	Tor
P1A	XC6118C31AGR-G	Vdet-IC	3.1V±2%, ±Reset PPO, Sense, hysteresis 5%, Cd	USP-4	45me	VD15	9a	Tor
P1B	XC6108N41BGR	Vdet-IC	4.1V±2%, -Reset ODO	USP-4	45ro	VD14	9b	Tor
P1B	XC6118C31BGR-G	Vdet-IC	3.1V±2%, ±Reset PPO, Sense, hysteresis <1%, Cd	USP-4	45me	VD15	9a	Tor
P1C	XC6108N41CGR	Vdet-IC	4.1V±2%, Hysteresis, -Reset ODO	USP-4	45m	VD14	9b	Tor
P1C	XC6118C31CGR-G	Vdet-IC	3.1V±2%, ±Reset PPO, Sense, hysteresis 5%	USP-4	45md	VD12	9a	Tor
P1D	XC6108N41DGR	Vdet-IC	4.1V±2%, -Reset ODO	USP-4	45m	VD14	9b	Tor
P1D	XC6118C31DGR-G	Vdet-IC	3.1V±2%, ±Reset PPO, Sense, hysteresis <1%	USP-4	45md	VD12	9a	Tor
p2	74AUP1G240GF	CMOS-Logic	Bus buffer inverted with 3-state output	SOT891	52/Log22	-	9c	Phi
p2	74AUP1G240GM	CMOS-Logic	Bus buffer inverted with 3-state output	SOT-886	57/Log22	-	9c	Phi
P2	R3117K393A	Vdet-IC	3.9V±1%, -Reset ODO, Sense	DFN1010-4	48rq	VD11	9a	Ric
P2	RP114K341B5	LVR-IC	LDO, 3.45V±1%, 300mA, +CE	DFN1010-4	48vm	VR4	9a	Ric
P2	XC6221B4317R	LVR-IC	LDO, 4.3V±1%, 200mA, +CE, CL	USPN-4	58vm	VR4	9a	Tor
P20E	R1163K201E	LVR-IC	LDO, 2V±2.5%, 150mA, +CE, AE(mode)	PLP1616-6	66vj	VR10	9b	Ric
P21E	R1163K211E	LVR-IC	LDO, 2.1V±2.5%, 150mA, +CE, AE(mode)	PLP1616-6	66vj	VR10	9b	Ric
P22E	R1163K221E	LVR-IC	LDO, 2.2V±2.5%, 150mA, +CE, AE(mode)	PLP1616-6	66vj	VR10	9b	Ric
P23E	R1163K231E	LVR-IC	LDO, 2.3V±2.5%, 150mA, +CE, AE(mode)	PLP1616-6	66vj	VR10	9b	Ric
P24E	R1163K241E	LVR-IC	LDO, 2.4V±2.5%, 150mA, +CE, AE(mode)	PLP1616-6	66vj	VR10	9b	Ric
p25	74AUP2G125GM	CMOS-Logic	Dual bus buffer with 3-state output	SOT902-1	51/Log54	-	9a	Phi
p25	74AUP2G125GT	CMOS-Logic	Dual bus buffer with 3-state output	SOT833-1	53/Log54	-	9c	Phi
P25E	R1163K251E	LVR-IC	LDO, 2.5V±2.5%, 150mA, +CE, AE(mode)	PLP1616-6	66vj	VR10	9b	Ric
p26	74AUP2G126GM	CMOS-Logic	Dual bus buffer with 3-state output	SOT902-1	51/Log55	-	9a	Phi
p26	74AUP2G126GT	CMOS-Logic	Dual bus buffer with 3-state output	SOT833-1	53/Log55	-	9c	Phi
P26E	R1163K261E	LVR-IC	LDO, 2.6V±2.5%, 150mA, +CE, AE(mode)	PLP1616-6	66vj	VR10	9b	Ric
P27E	R1163K271E	LVR-IC	LDO, 2.7V±2.5%, 150mA, +CE, AE(mode)	PLP1616-6	66vj	VR10	9b	Ric
P28E	R1163K281E5	LVR-IC	LDO, 2.85V±2.5%, 150mA, +CE, AE(mode)	PLP1616-6	66vj	VR10	9b	Ric
P28E	R1163K281E	LVR-IC	LDO, 2.8V±2.5%, 150mA, +CE, AE(mode)	PLP1616-6	66vj	VR10	9b	Ric
P29E	R1163K291E	LVR-IC	LDO, 2.9V±2.5%, 150mA, +CE, AE(mode)	PLP1616-6	66vj	VR10	9b	Ric
P2A	XC6108N42AGR	Vdet-IC	4.2V±2%, Hysteresis, -Reset ODO	USP-4	45ro	VD14	9b	Tor
P2A	XC6118C32AGR-G	Vdet-IC	3.2V±2%, ±Reset PPO, Sense, hysteresis 5%, Cd	USP-4	45me	VD15	9a	Tor
P2B	XC6108N42BGR	Vdet-IC	4.2V±2%, -Reset ODO	USP-4	45ro	VD14	9b	Tor
P2B	XC6118C32BGR-G	Vdet-IC	3.2V±2%, ±Reset PPO, Sense, hysteresis <1%, Cd	USP-4	45me	VD15	9a	Tor
P2C	XC6108N42CGR	Vdet-IC	4.2V±2%, Hysteresis, -Reset ODO	USP-4	45m	VD14	9b	Tor
P2C	XC6118C32CGR-G	Vdet-IC	3.2V±2%, ±Reset PPO, Sense, hysteresis 5%	USP-4	45md	VD12	9a	Tor
P2D	XC6108N42DGR	Vdet-IC	4.2V±2%, -Reset ODO	USP-4	45m	VD14	9b	Tor
P2D	XC6118C32DGR-G	Vdet-IC	3.2V±2%, ±Reset PPO, Sense, hysteresis <1%	USP-4	45md	VD12	9a	Tor
P3	R3117K403A	Vdet-IC	4.0V±1%, -Reset ODO, Sense	DFN1010-4	48rq	VD11	9a	Ric
P3	XC6221B4417R	LVR-IC	LDO, 4.4V±1%, 200mA, +CE, CL	USPN-4	58vm	VR4	9a	Tor
P30E	R1163K301E	LVR-IC	LDO, 3V±2.5%, 150mA, +CE, AE(mode)	PLP1616-6	66vj	VR10	9b	Ric
P31E	R1163K311E	LVR-IC	LDO, 3.1V±2.5%, 150mA, +CE, AE(mode)	PLP1616-6	66vj	VR10	9b	Ric
p32	74AUP2G32GM	CMOS-Logic	Dual 2-input OR gates	SOT902-1	51/Log52	-	9a	Phi
p32	74AUP2G32GT	CMOS-Logic	Dual 2-input OR gates	SOT833-1	53/Log52	-	9c	Phi
P32E	R1163K321E	LVR-IC	LDO, 3.2V±2.5%, 150mA, +CE, AE(mode)	PLP1616-6	66vj	VR10	9b	Ric
P33E	R1163K331E	LVR-IC	LDO, 3.3V±2.5%, 150mA, +CE, AE(mode)	PLP1616-6	66vj	VR10	9b	Ric
P34E	R1163K341E	LVR-IC	LDO, 3.4V±2.5%, 150mA, +CE, AE(mode)	PLP1616-6	66vj	VR10	9b	Ric
P35E	R1163K351E	LVR-IC	LDO, 3.5V±2.5%, 150mA, +CE, AE(mode)	PLP1616-6	66vj	VR10	9b	Ric
P36E	R1163K361E	LVR-IC	LDO, 3.6V±2.5%, 150mA, +CE, AE(mode)	PLP1616-6	66vj	VR10	9b	Ric
P37E	R1163K371E	LVR-IC	LDO, 3.7V±2.5%, 150mA, +CE, AE(mode)	PLP1616-6	66vj	VR10	9b	Ric
P38E	R1163K381E	LVR-IC	LDO, 3.8V±2.5%, 150mA, +CE, AE(mode)	PLP1616-6	66vj	VR10	9b	Ric
P39E	R1163K391E	LVR-IC	LDO, 3.9V±2.5%, 150mA, +CE, AE(mode)	PLP1616-6	66vj	VR10	9b	Ric
P3A	XC6108N43AGR	Vdet-IC	4.3V±2%, Hysteresis, -Reset ODO	USP-4	45ro	VD14	9b	Tor
P3A	XC6118C33AGR-G	Vdet-IC	3.3V±2%, ±Reset PPO, Sense, hysteresis 5%, Cd	USP-4	45me	VD15	9a	Tor
P3B	XC6108N43BGR	Vdet-IC	4.3V±2%, -Reset ODO	USP-4	45ro	VD14	9b	Tor
P3B	XC6118C33BGR-G	Vdet-IC	3.3V±2%, ±Reset PPO, Sense, hysteresis <1%, Cd	USP-4	45me	VD15	9a	Tor
P3C	XC6108N43CGR	Vdet-IC	4.3V±2%, Hysteresis, -Reset ODO	USP-4	45m	VD14	9b	Tor
P3C	XC6118C33CGR-G	Vdet-IC	3.3V±2%, ±Reset PPO, Sense, hysteresis 5%	USP-4	45md	VD12	9a	Tor
P3D	XC6108N43DGR	Vdet-IC	4.3V±2%, -Reset ODO	USP-4	45m	VD14	9b	Tor
P3D	XC6118C33DGR-G	Vdet-IC	3.3V±2%, ±Reset PPO, Sense, hysteresis <1%	USP-4	45md	VD12	9a	Tor
p4	74AUP2G04GF	CMOS-Logic	Dual inverters	SOT891	52/Log24	-	9c	Phi
p4	74AUP2G04GM	CMOS-Logic	Dual inverters	SOT-886	57/Log24	-	9c	Phi
P4	R3117K413A	Vdet-IC	4.1V±1%, -Reset ODO, Sense	DFN1010-4	48rq	VD11	9a	Ric
P4	XC6221B4517R	LVR-IC	LDO, 4.5V±1%, 200mA, +CE, CL	USPN-4	58vm	VR4	9a	Tor
p40	74AUP2G240GM	CMOS-Logic	Dual bus buffer inverted with 3-state output	SOT902-1	51/Log67	-	9a	Phi
p40	74AUP2G240GT	CMOS-Logic	Dual bus buffer inverted with 3-state output	SOT833-1	53/Log67	-	9c	Phi
P40E	R1163K401E	LVR-IC	LDO, 4V±2.5%, 150mA, +CE, AE(mode)	PLP1616-6	66vj	VR10	9b	Ric
p41	74AUP2G241GM	CMOS-Logic	Dual bus buffer non-inverted with 3-state output	SOT902-1	51/Log60	-	9a	Phi
p41	74AUP2G241GT	CMOS-Logic	Dual bus buffer non-inverted with 3-state output	SOT833-1	53/Log60	-	9c	Phi
P4A	XC6108N44AGR	Vdet-IC	4.4V±2%, Hysteresis, -Reset ODO	USP-4	45ro	VD14	9b	Tor



SMD code	Type	Function	Short description	Case	Pinout	Sch.	St.	Mnf.
P4A	XC6118C34AGR-G	Vdet-IC	3.4V±2%, ±Reset PPO, Sense, hysteresis 5%, Cd	USP-4	45me	VD15	9a	Tor
P4B	XC6108N4BGR	Vdet-IC	4.4V±2%, -Reset ODO	USP-4	45ro	VD14	9b	Tor
P4B	XC6118C34BGR-G	Vdet-IC	3.4V±2%, ±Reset PPO, Sense, hysteresis <1%, Cd	USP-4	45me	VD15	9a	Tor
P4C	XC6108N4CGR	Vdet-IC	4.4V±2%, Hysteresis, -Reset ODO	USP-4	45rn	VD14	9b	Tor
P4C	XC6118C34CGR-G	Vdet-IC	3.4V±2%, ±Reset PPO, Sense, hysteresis 5%	USP-4	45md	VD12	9a	Tor
P4D	XC6108N4DGR	Vdet-IC	4.4V±2%, -Reset ODO	USP-4	45rn	VD14	9b	Tor
P4D	XC6118C34DGR-G	Vdet-IC	3.4V±2%, ±Reset PPO, Sense, hysteresis <1%	USP-4	45md	VD12	9a	Tor
p5	74AUP1T45GF	CMOS-Logic	Dual supply translating transceiver with 3-state output	SOT891	52Log70	-	9c	Phi
p5	74AUP1T45GM	CMOS-Logic	Dual supply translating transceiver with 3-state output	SOT-886	57Log70	-	9c	Phi
P5	R3117K423A	Vdet-IC	4.2V±1%, -Reset ODO, Sense	DFN1010-4	48rq	VD11	9a	Ric
P5	XC6221B4617R	LVR-IC	LDO, 4.6V±1%, 200mA, +CE, CL	USPN-4	58vm	VR4	9a	Tor
P5A	XC6108N45AGR	Vdet-IC	4.5V±2%, Hysteresis, -Reset ODO	USP-4	45ro	VD14	9b	Tor
P5A	XC6118C35AGR-G	Vdet-IC	3.5V±2%, ±Reset PPO, Sense, hysteresis 5%, Cd	USP-4	45me	VD15	9a	Tor
P5B	XC6108N45BGR	Vdet-IC	4.5V±2%, -Reset ODO	USP-4	45ro	VD14	9b	Tor
P5B	XC6118C35BGR-G	Vdet-IC	3.5V±2%, ±Reset PPO, Sense, hysteresis <1%, Cd	USP-4	45me	VD15	9a	Tor
P5C	XC6108N45CGR	Vdet-IC	4.5V±2%, Hysteresis, -Reset ODO	USP-4	45rn	VD14	9b	Tor
P5C	XC6118C35CGR-G	Vdet-IC	3.5V±2%, ±Reset PPO, Sense, hysteresis 5%	USP-4	45md	VD12	9a	Tor
P5D	XC6108N45DGR	Vdet-IC	4.5V±2%, -Reset ODO	USP-4	45rn	VD14	9b	Tor
P5D	XC6118C35DGR-G	Vdet-IC	3.5V±2%, ±Reset PPO, Sense, hysteresis <1%	USP-4	45md	VD12	9a	Tor
P6	R3117K433A	Vdet-IC	4.3V±1%, -Reset ODO, Sense	DFN1010-4	48rq	VD11	9a	Ric
P6	XC6221B4717R	LVR-IC	LDO, 4.7V±1%, 200mA, +CE, CL	USPN-4	58vm	VR4	9a	Tor
P6A	XC6108N46AGR	Vdet-IC	4.6V±2%, Hysteresis, -Reset ODO	USP-4	45ro	VD14	9b	Tor
P6A	XC6118C36AGR-G	Vdet-IC	3.6V±2%, ±Reset PPO, Sense, hysteresis 5%, Cd	USP-4	45me	VD15	9a	Tor
P6B	XC6108N46BGR	Vdet-IC	4.6V±2%, -Reset ODO	USP-4	45ro	VD14	9b	Tor
P6B	XC6118C36BGR-G	Vdet-IC	3.6V±2%, ±Reset PPO, Sense, hysteresis <1%, Cd	USP-4	45me	VD15	9a	Tor
P6C	XC6108N46CGR	Vdet-IC	4.6V±2%, Hysteresis, -Reset ODO	USP-4	45rn	VD14	9b	Tor
P6C	XC6118C36CGR-G	Vdet-IC	3.6V±2%, ±Reset PPO, Sense, hysteresis 5%	USP-4	45md	VD12	9a	Tor
P6D	XC6108N46DGR	Vdet-IC	4.6V±2%, -Reset ODO	USP-4	45rn	VD14	9b	Tor
P6D	XC6118C36DGR-G	Vdet-IC	3.6V±2%, ±Reset PPO, Sense, hysteresis <1%	USP-4	45md	VD12	9a	Tor
p7	74AUP2G07GF	CMOS-Logic	Dual noninverting buffers/drivers (ODO)	SOT891	52Log26	-	9c	Phi
p7	74AUP2G07GM	CMOS-Logic	Dual noninverting buffers/drivers (ODO)	SOT-886	57Log26	-	9c	Phi
P7	R3117K443A	Vdet-IC	4.4V±1%, -Reset ODO, Sense	DFN1010-4	48rq	VD11	9a	Ric
P7	XC6221B4817R	LVR-IC	LDO, 4.8V±1%, 200mA, +CE, CL	USPN-4	58vm	VR4	9a	Tor
p74	74AUP1G74GM	CMOS-Logic	Positive edge-triggered D-type flip-flop with set and reset	SOT902-1	51Log59	-	9a	Phi
p74	74AUP1G74GT	CMOS-Logic	Positive edge-triggered D-type flip-flop with set and reset	SOT833-1	53Log59	-	9c	Phi
p79	74AUP2G79GM	CMOS-Logic	Dual positive-edge triggered D-type flip-flop	SOT902-1	51Log63	-	9a	Phi
p79	74AUP2G79GT	CMOS-Logic	Dual positive-edge triggered D-type flip-flop	SOT833-1	53Log63	-	9c	Phi
P7A	XC6108N47AGR	Vdet-IC	4.7V±2%, Hysteresis, -Reset ODO	USP-4	45ro	VD14	9b	Tor
P7A	XC6118C37AGR-G	Vdet-IC	3.7V±2%, ±Reset PPO, Sense, hysteresis 5%, Cd	USP-4	45me	VD15	9a	Tor
P7B	XC6108N47BGR	Vdet-IC	4.7V±2%, -Reset ODO	USP-4	45ro	VD14	9b	Tor
P7B	XC6118C37BGR-G	Vdet-IC	3.7V±2%, ±Reset PPO, Sense, hysteresis <1%, Cd	USP-4	45me	VD15	9a	Tor
P7C	XC6108N47CGR	Vdet-IC	4.7V±2%, Hysteresis, -Reset ODO	USP-4	45rn	VD14	9b	Tor
P7C	XC6118C37CGR-G	Vdet-IC	3.7V±2%, ±Reset PPO, Sense, hysteresis 5%	USP-4	45md	VD12	9a	Tor
P7D	XC6108N47DGR	Vdet-IC	4.7V±2%, -Reset ODO	USP-4	45rn	VD14	9b	Tor
P7D	XC6118C37DGR-G	Vdet-IC	3.7V±2%, ±Reset PPO, Sense, hysteresis <1%	USP-4	45md	VD12	9a	Tor
P8	R3117K453A	Vdet-IC	4.5V±1%, -Reset ODO, Sense	DFN1010-4	48rq	VD11	9a	Ric
p80	74AUP2G80GM	CMOS-Logic	Dual positive-edge triggered D-type flip-flop	SOT902-1	51Log64	-	9a	Phi
p80	74AUP2G80GT	CMOS-Logic	Dual positive-edge triggered D-type flip-flop	SOT833-1	53Log64	-	9c	Phi
P8302A	PAM8302AAYC	LIN-IC	AF PA, BTL, class-D, 2.5..5.5V, 2.5W(5V/4Q), shutdown	DFN-8	37	AFF24	-	Pam
P8303A	PAM8303ABYC	LIN-IC	AF PA, BTL, class-D, 2.8..5.5V, 3W(5V/4Q), shutdown	DFN-8	37	AFF63	-	Pam
P8303C	PAM8303CBYC	LIN-IC	AF PA, BTL, class-D, 2.8..5.5V, 3W(5V/4Q), shutdown	DFN-8	37	AFF63	-	Pam
P8303D	PAM8303DBYC	LIN-IC	AF PA, BTL, class-D, 2.8..5.5V, 3W(5V/4Q), shutdown	DFN-8	37	AFF63	-	Pam
P8404	PAM8404KG	LIN-IC	AF PA, BTL, class-D, 2.5..5.5V, 2x3W(5V/4Q), shutdown	QFN-20	38	-	-	Pam
p86	74AUP2G86GM	CMOS-Logic	Dual 2-input EXCLUSIVE-OR gates	SOT902-1	51Log65	-	9a	Phi
p86	74AUP2G86GT	CMOS-Logic	Dual 2-input EXCLUSIVE-OR gates	SOT833-1	53Log65	-	9c	Phi
P8A	XC6108N48AGR	Vdet-IC	4.8V±2%, Hysteresis, -Reset ODO	USP-4	45ro	VD14	9b	Tor
P8A	XC6118C38AGR-G	Vdet-IC	3.8V±2%, ±Reset PPO, Sense, hysteresis 5%, Cd	USP-4	45me	VD15	9a	Tor
P8B	XC6108N48BGR	Vdet-IC	4.8V±2%, -Reset ODO	USP-4	45ro	VD14	9b	Tor
P8B	XC6118C38BGR-G	Vdet-IC	3.8V±2%, ±Reset PPO, Sense, hysteresis <1%, Cd	USP-4	45me	VD15	9a	Tor
P8C	XC6108N48CGR	Vdet-IC	4.8V±2%, Hysteresis, -Reset ODO	USP-4	45rn	VD14	9b	Tor
P8C	XC6118C38CGR-G	Vdet-IC	3.8V±2%, ±Reset PPO, Sense, hysteresis 5%	USP-4	45md	VD12	9a	Tor
P8D	XC6108N48DGR	Vdet-IC	4.8V±2%, -Reset ODO	USP-4	45rn	VD14	9b	Tor
P8D	XC6118C38DGR-G	Vdet-IC	3.8V±2%, ±Reset PPO, Sense, hysteresis <1%	USP-4	45md	VD12	9a	Tor
p89	74AUP1G09GF	CMOS-Logic	2-input AND gate (ODO)	SOT891	52Log9	-	9c	Phi
p9	74AUP1G09GM	CMOS-Logic	2-input AND gate (ODO)	SOT-886	57Log9	-	9c	Phi
P9	R3117K463A	Vdet-IC	4.6V±1%, -Reset ODO, Sense	DFN1010-4	48rq	VD11	9a	Ric
P9A	XC6108N49AGR	Vdet-IC	4.9V±2%, Hysteresis, -Reset ODO	USP-4	45ro	VD14	9b	Tor
P9A	XC6118C39AGR-G	Vdet-IC	3.9V±2%, ±Reset PPO, Sense, hysteresis 5%, Cd	USP-4	45me	VD15	9a	Tor
P9B	XC6108N49BGR	Vdet-IC	4.9V±2%, -Reset ODO	USP-4	45ro	VD14	9b	Tor
P9B	XC6118C39BGR-G	Vdet-IC	3.9V±2%, ±Reset PPO, Sense, hysteresis <1%, Cd	USP-4	45me	VD15	9a	Tor



SMD code	Type	Function	Short description	Case	Pinout	Sch.	St.	Mnf.
P9C	XC6108N49CGR	Vdet-IC	4.9V±2%, Hysteresis, -Reset ODO	USP-4	45m	VD14	9b	Tor
P9C	XC6118C39CGR-G	Vdet-IC	3.9V±2%, ±Reset PPO, Sense, hysteresis 5%	USP-4	45md	VD12	9a	Tor
P9D	XC6108N49DGR	Vdet-IC	4.9V±2%, -Reset ODO	USP-4	45m	VD14	9b	Tor
P9D	XC6118C39DGR-G	Vdet-IC	3.9V±2%, ±Reset PPO, Sense, hysteresis <1%	USP-4	45md	VD12	9a	Tor
pA	74AUP1G00GF	CMOS-Logic	2-input NAND gate	SOT891	52L	Log1	-	9c Phi
pA	74AUP1G00GM	CMOS-Logic	2-input NAND gate	SOT-886	57L	Log1	-	9c Phi
PA	EUA4890H	LIN-IC	AF PA, BTL, 3.5.5V, 1W(5V/8Ω), shutdown	BGA-9	39	AFP44	-	Eut
PA	R1118K081D	LVR-IC	0.8V±1%, 150mA, +CE, CL	DFN1612-4B	45vm	VR4	9a	Ric
PA	RP106K071D	LVR-IC	LDO, 0.7V±0.8%, 400mA, +CE, CL	DFN1212-6	52vr2	VR4	9a	Ric
PA096	XC9226A096D	DC/DC-IC	PWM/PFM step-down, 600kHz, 0.9V±1%, 600mA, +CE	USP-6B	49dc5	DC1	9b	Tor
PA09C	XC9226A09CD	DC/DC-IC	PWM/PFM step-down, 1.2MHz, 0.9V±1%, 600mA, +CE	USP-6B	49dc5	DC1	9b	Tor
PA0M6	XC9226A0M6D	DC/DC-IC	PWM/PFM step-down, 600kHz, 0.95V±1%, 600mA, +CE	USP-6B	49dc5	DC1	9b	Tor
PA0MC	XC9226A0MCD	DC/DC-IC	PWM/PFM step-down, 1.2MHz, 0.95V±1%, 600mA, +CE	USP-6B	49dc5	DC1	9b	Tor
PA106	XC9226A106D	DC/DC-IC	PWM/PFM step-down, 600kHz, 1.0V±1%, 600mA, +CE	USP-6B	49dc5	DC1	9b	Tor
PA10C	XC9226A10CD	DC/DC-IC	PWM/PFM step-down, 1.2MHz, 1.0V±1%, 600mA, +CE	USP-6B	49dc5	DC1	9b	Tor
PA116	XC9226A116D	DC/DC-IC	PWM/PFM step-down, 600kHz, 1.1V±1%, 600mA, +CE	USP-6B	49dc5	DC1	9b	Tor
PA11C	XC9226A11CD	DC/DC-IC	PWM/PFM step-down, 1.2MHz, 1.1V±1%, 600mA, +CE	USP-6B	49dc5	DC1	9b	Tor
PA126	XC9226A126D	DC/DC-IC	PWM/PFM step-down, 600kHz, 1.2V±1%, 600mA, +CE	USP-6B	49dc5	DC1	9b	Tor
PA12C	XC9226A12CD	DC/DC-IC	PWM/PFM step-down, 1.2MHz, 1.2V±1%, 600mA, +CE	USP-6B	49dc5	DC1	9b	Tor
PA136	XC9226A136D	DC/DC-IC	PWM/PFM step-down, 600kHz, 1.3V±1%, 600mA, +CE	USP-6B	49dc5	DC1	9b	Tor
PA13C	XC9226A13CD	DC/DC-IC	PWM/PFM step-down, 1.2MHz, 1.3V±1%, 600mA, +CE	USP-6B	49dc5	DC1	9b	Tor
PA146	XC9226A146D	DC/DC-IC	PWM/PFM step-down, 600kHz, 1.4V±1%, 600mA, +CE	USP-6B	49dc5	DC1	9b	Tor
PA14C	XC9226A14CD	DC/DC-IC	PWM/PFM step-down, 1.2MHz, 1.4V±1%, 600mA, +CE	USP-6B	49dc5	DC1	9b	Tor
PA156	XC9226A156D	DC/DC-IC	PWM/PFM step-down, 600kHz, 1.5V±1%, 600mA, +CE	USP-6B	49dc5	DC1	9b	Tor
PA15C	XC9226A15CD	DC/DC-IC	PWM/PFM step-down, 1.2MHz, 1.5V±1%, 600mA, +CE	USP-6B	49dc5	DC1	9b	Tor
PA166	XC9226A166D	DC/DC-IC	PWM/PFM step-down, 600kHz, 1.6V±1%, 600mA, +CE	USP-6B	49dc5	DC1	9b	Tor
PA16C	XC9226A16CD	DC/DC-IC	PWM/PFM step-down, 1.2MHz, 1.6V±1%, 600mA, +CE	USP-6B	49dc5	DC1	9b	Tor
PA176	XC9226A176D	DC/DC-IC	PWM/PFM step-down, 600kHz, 1.7V±1%, 600mA, +CE	USP-6B	49dc5	DC1	9b	Tor
PA17C	XC9226A17CD	DC/DC-IC	PWM/PFM step-down, 1.2MHz, 1.7V±1%, 600mA, +CE	USP-6B	49dc5	DC1	9b	Tor
PA186	XC9226A186D	DC/DC-IC	PWM/PFM step-down, 600kHz, 1.8V±1%, 600mA, +CE	USP-6B	49dc5	DC1	9b	Tor
PA18C	XC9226A18CD	DC/DC-IC	PWM/PFM step-down, 1.2MHz, 1.8V±1%, 600mA, +CE	USP-6B	49dc5	DC1	9b	Tor
PA196	XC9226A196D	DC/DC-IC	PWM/PFM step-down, 600kHz, 1.9V±1%, 600mA, +CE	USP-6B	49dc5	DC1	9b	Tor
PA19C	XC9226A19CD	DC/DC-IC	PWM/PFM step-down, 1.2MHz, 1.9V±1%, 600mA, +CE	USP-6B	49dc5	DC1	9b	Tor
PA1A6	XC9226A1A6D	DC/DC-IC	PWM/PFM step-down, 600kHz, 1.05V±1%, 600mA, +CE	USP-6B	49dc5	DC1	9b	Tor
PA1AC	XC9226A1ACD	DC/DC-IC	PWM/PFM step-down, 1.2MHz, 1.05V±1%, 600mA, +CE	USP-6B	49dc5	DC1	9b	Tor
PA1B6	XC9226A1B6D	DC/DC-IC	PWM/PFM step-down, 600kHz, 1.15V±1%, 600mA, +CE	USP-6B	49dc5	DC1	9b	Tor
PA1BC	XC9226A1BCD	DC/DC-IC	PWM/PFM step-down, 1.2MHz, 1.15V±1%, 600mA, +CE	USP-6B	49dc5	DC1	9b	Tor
PA1C6	XC9226A1C6D	DC/DC-IC	PWM/PFM step-down, 600kHz, 1.25V±1%, 600mA, +CE	USP-6B	49dc5	DC1	9b	Tor
PA1CC	XC9226A1CCD	DC/DC-IC	PWM/PFM step-down, 1.2MHz, 1.25V±1%, 600mA, +CE	USP-6B	49dc5	DC1	9b	Tor
PA1D6	XC9226A1D6D	DC/DC-IC	PWM/PFM step-down, 600kHz, 1.35V±1%, 600mA, +CE	USP-6B	49dc5	DC1	9b	Tor
PA1DC	XC9226A1DCD	DC/DC-IC	PWM/PFM step-down, 1.2MHz, 1.35V±1%, 600mA, +CE	USP-6B	49dc5	DC1	9b	Tor
PA1E6	XC9226A1E6D	DC/DC-IC	PWM/PFM step-down, 600kHz, 1.45V±1%, 600mA, +CE	USP-6B	49dc5	DC1	9b	Tor
PA1EC	XC9226A1ECD	DC/DC-IC	PWM/PFM step-down, 1.2MHz, 1.45V±1%, 600mA, +CE	USP-6B	49dc5	DC1	9b	Tor
PA1F6	XC9226A1F6D	DC/DC-IC	PWM/PFM step-down, 600kHz, 1.55V±1%, 600mA, +CE	USP-6B	49dc5	DC1	9b	Tor
PA1FC	XC9226A1FCD	DC/DC-IC	PWM/PFM step-down, 1.2MHz, 1.55V±1%, 600mA, +CE	USP-6B	49dc5	DC1	9b	Tor
PA1H6	XC9226A1H6D	DC/DC-IC	PWM/PFM step-down, 600kHz, 1.65V±1%, 600mA, +CE	USP-6B	49dc5	DC1	9b	Tor
PA1HC	XC9226A1HCD	DC/DC-IC	PWM/PFM step-down, 1.2MHz, 1.65V±1%, 600mA, +CE	USP-6B	49dc5	DC1	9b	Tor
PA1K6	XC9226A1K6D	DC/DC-IC	PWM/PFM step-down, 600kHz, 1.75V±1%, 600mA, +CE	USP-6B	49dc5	DC1	9b	Tor
PA1KC	XC9226A1KCD	DC/DC-IC	PWM/PFM step-down, 1.2MHz, 1.75V±1%, 600mA, +CE	USP-6B	49dc5	DC1	9b	Tor
PA1L6	XC9226A1L6D	DC/DC-IC	PWM/PFM step-down, 600kHz, 1.85V±1%, 600mA, +CE	USP-6B	49dc5	DC1	9b	Tor
PA1LC	XC9226A1LCD	DC/DC-IC	PWM/PFM step-down, 1.2MHz, 1.85V±1%, 600mA, +CE	USP-6B	49dc5	DC1	9b	Tor
PA1M6	XC9226A1M6D	DC/DC-IC	PWM/PFM step-down, 600kHz, 1.95V±1%, 600mA, +CE	USP-6B	49dc5	DC1	9b	Tor
PA1MC	XC9226A1MCD	DC/DC-IC	PWM/PFM step-down, 1.2MHz, 1.95V±1%, 600mA, +CE	USP-6B	49dc5	DC1	9b	Tor
PA206	XC9226A206D	DC/DC-IC	PWM/PFM step-down, 600kHz, 2.0V±1%, 600mA, +CE	USP-6B	49dc5	DC1	9b	Tor
PA20C	XC9226A20CD	DC/DC-IC	PWM/PFM step-down, 1.2MHz, 2.0V±1%, 600mA, +CE	USP-6B	49dc5	DC1	9b	Tor
PA216	XC9226A216D	DC/DC-IC	PWM/PFM step-down, 600kHz, 2.1V±1%, 600mA, +CE	USP-6B	49dc5	DC1	9b	Tor
PA21C	XC9226A21CD	DC/DC-IC	PWM/PFM step-down, 1.2MHz, 2.1V±1%, 600mA, +CE	USP-6B	49dc5	DC1	9b	Tor
PA226	XC9226A226D	DC/DC-IC	PWM/PFM step-down, 600kHz, 2.2V±1%, 600mA, +CE	USP-6B	49dc5	DC1	9b	Tor
PA22C	XC9226A22CD	DC/DC-IC	PWM/PFM step-down, 1.2MHz, 2.2V±1%, 600mA, +CE	USP-6B	49dc5	DC1	9b	Tor
PA236	XC9226A236D	DC/DC-IC	PWM/PFM step-down, 600kHz, 2.3V±1%, 600mA, +CE	USP-6B	49dc5	DC1	9b	Tor
PA23C	XC9226A23CD	DC/DC-IC	PWM/PFM step-down, 1.2MHz, 2.3V±1%, 600mA, +CE	USP-6B	49dc5	DC1	9b	Tor
PA246	XC9226A246D	DC/DC-IC	PWM/PFM step-down, 600kHz, 2.4V±1%, 600mA, +CE	USP-6B	49dc5	DC1	9b	Tor
PA24C	XC9226A24CD	DC/DC-IC	PWM/PFM step-down, 1.2MHz, 2.4V±1%, 600mA, +CE	USP-6B	49dc5	DC1	9b	Tor
PA256	XC9226A256D	DC/DC-IC	PWM/PFM step-down, 600kHz, 2.5V±1%, 600mA, +CE	USP-6B	49dc5	DC1	9b	Tor
PA25C	XC9226A25CD	DC/DC-IC	PWM/PFM step-down, 1.2MHz, 2.5V±1%, 600mA, +CE	USP-6B	49dc5	DC1	9b	Tor
PA266	XC9226A266D	DC/DC-IC	PWM/PFM step-down, 600kHz, 2.6V±1%, 600mA, +CE	USP-6B	49dc5	DC1	9b	Tor
PA26C	XC9226A26CD	DC/DC-IC	PWM/PFM step-down, 1.2MHz, 2.6V±1%, 600mA, +CE	USP-6B	49dc5	DC1	9b	Tor
PA276	XC9226A276D	DC/DC-IC	PWM/PFM step-down, 600kHz, 2.7V±1%, 600mA, +CE	USP-6B	49dc5	DC1	9b	Tor
PA27C	XC9226A27CD	DC/DC-IC	PWM/PFM step-down, 1.2MHz, 2.7V±1%, 600mA, +CE	USP-6B	49dc5	DC1	9b	Tor
PA286	XC9226A286D	DC/DC-IC	PWM/PFM step-down, 600kHz, 2.8V±1%, 600mA, +CE	USP-6B	49dc5	DC1	9b	Tor



SMD code	Type	Function	Short description	Case	Pinout	Sch.	St.	Mnf.
PA28C	XC9226A28CD	DC/DC-IC	PWM/PFM step-down, 1.2MHz, 2.8V±1%, 600mA, +CE	USP-6B	49dc5	DC1	9b	Tor
PA296	XC9226A296D	DC/DC-IC	PWM/PFM step-down, 600kHz, 2.9V±1%, 600mA, +CE	USP-6B	49dc5	DC1	9b	Tor
PA29C	XC9226A29CD	DC/DC-IC	PWM/PFM step-down, 1.2MHz, 2.9V±1%, 600mA, +CE	USP-6B	49dc5	DC1	9b	Tor
PA2A6	XC9226A2A6D	DC/DC-IC	PWM/PFM step-down, 600kHz, 2.05V±1%, 600mA, +CE	USP-6B	49dc5	DC1	9b	Tor
PA2AC	XC9226A2ACD	DC/DC-IC	PWM/PFM step-down, 1.2MHz, 2.05V±1%, 600mA, +CE	USP-6B	49dc5	DC1	9b	Tor
PA2B6	XC9226A2B6D	DC/DC-IC	PWM/PFM step-down, 600kHz, 2.15V±1%, 600mA, +CE	USP-6B	49dc5	DC1	9b	Tor
PA2BC	XC9226A2BCD	DC/DC-IC	PWM/PFM step-down, 1.2MHz, 2.15V±1%, 600mA, +CE	USP-6B	49dc5	DC1	9b	Tor
PA2C6	XC9226A2C6D	DC/DC-IC	PWM/PFM step-down, 600kHz, 2.25V±1%, 600mA, +CE	USP-6B	49dc5	DC1	9b	Tor
PA2CC	XC9226A2CCD	DC/DC-IC	PWM/PFM step-down, 1.2MHz, 2.25V±1%, 600mA, +CE	USP-6B	49dc5	DC1	9b	Tor
PA2D6	XC9226A2D6D	DC/DC-IC	PWM/PFM step-down, 600kHz, 2.35V±1%, 600mA, +CE	USP-6B	49dc5	DC1	9b	Tor
PA2DC	XC9226A2DCD	DC/DC-IC	PWM/PFM step-down, 1.2MHz, 2.35V±1%, 600mA, +CE	USP-6B	49dc5	DC1	9b	Tor
PA2E6	XC9226A2E6D	DC/DC-IC	PWM/PFM step-down, 600kHz, 2.45V±1%, 600mA, +CE	USP-6B	49dc5	DC1	9b	Tor
PA2EC	XC9226A2ECD	DC/DC-IC	PWM/PFM step-down, 1.2MHz, 2.45V±1%, 600mA, +CE	USP-6B	49dc5	DC1	9b	Tor
PA2F6	XC9226A2F6D	DC/DC-IC	PWM/PFM step-down, 600kHz, 2.55V±1%, 600mA, +CE	USP-6B	49dc5	DC1	9b	Tor
PA2FC	XC9226A2FCD	DC/DC-IC	PWM/PFM step-down, 1.2MHz, 2.55V±1%, 600mA, +CE	USP-6B	49dc5	DC1	9b	Tor
PA2H6	XC9226A2H6D	DC/DC-IC	PWM/PFM step-down, 600kHz, 2.65V±1%, 600mA, +CE	USP-6B	49dc5	DC1	9b	Tor
PA2HC	XC9226A2HCD	DC/DC-IC	PWM/PFM step-down, 1.2MHz, 2.65V±1%, 600mA, +CE	USP-6B	49dc5	DC1	9b	Tor
PA2K6	XC9226A2K6D	DC/DC-IC	PWM/PFM step-down, 600kHz, 2.75V±1%, 600mA, +CE	USP-6B	49dc5	DC1	9b	Tor
PA2KC	XC9226A2KCD	DC/DC-IC	PWM/PFM step-down, 1.2MHz, 2.75V±1%, 600mA, +CE	USP-6B	49dc5	DC1	9b	Tor
PA2L6	XC9226A2L6D	DC/DC-IC	PWM/PFM step-down, 600kHz, 2.85V±1%, 600mA, +CE	USP-6B	49dc5	DC1	9b	Tor
PA2LC	XC9226A2LCD	DC/DC-IC	PWM/PFM step-down, 1.2MHz, 2.85V±1%, 600mA, +CE	USP-6B	49dc5	DC1	9b	Tor
PA2M6	XC9226A2M6D	DC/DC-IC	PWM/PFM step-down, 600kHz, 2.95V±1%, 600mA, +CE	USP-6B	49dc5	DC1	9b	Tor
PA2MC	XC9226A2MCD	DC/DC-IC	PWM/PFM step-down, 1.2MHz, 2.95V±1%, 600mA, +CE	USP-6B	49dc5	DC1	9b	Tor
PA306	XC9226A306D	DC/DC-IC	PWM/PFM step-down, 600kHz, 3.0V±1%, 600mA, +CE	USP-6B	49dc5	DC1	9b	Tor
PA30C	XC9226A30CD	DC/DC-IC	PWM/PFM step-down, 1.2MHz, 3.0V±1%, 600mA, +CE	USP-6B	49dc5	DC1	9b	Tor
PA316	XC9226A316D	DC/DC-IC	PWM/PFM step-down, 600kHz, 3.1V±1%, 600mA, +CE	USP-6B	49dc5	DC1	9b	Tor
PA31C	XC9226A31CD	DC/DC-IC	PWM/PFM step-down, 1.2MHz, 3.1V±1%, 600mA, +CE	USP-6B	49dc5	DC1	9b	Tor
PA326	XC9226A326D	DC/DC-IC	PWM/PFM step-down, 600kHz, 3.2V±1%, 600mA, +CE	USP-6B	49dc5	DC1	9b	Tor
PA32C	XC9226A32CD	DC/DC-IC	PWM/PFM step-down, 1.2MHz, 3.2V±1%, 600mA, +CE	USP-6B	49dc5	DC1	9b	Tor
PA336	XC9226A336D	DC/DC-IC	PWM/PFM step-down, 600kHz, 3.3V±1%, 600mA, +CE	USP-6B	49dc5	DC1	9b	Tor
PA33C	XC9226A33CD	DC/DC-IC	PWM/PFM step-down, 1.2MHz, 3.3V±1%, 600mA, +CE	USP-6B	49dc5	DC1	9b	Tor
PA346	XC9226A346D	DC/DC-IC	PWM/PFM step-down, 600kHz, 3.4V±1%, 600mA, +CE	USP-6B	49dc5	DC1	9b	Tor
PA34C	XC9226A34CD	DC/DC-IC	PWM/PFM step-down, 1.2MHz, 3.4V±1%, 600mA, +CE	USP-6B	49dc5	DC1	9b	Tor
PA356	XC9226A356D	DC/DC-IC	PWM/PFM step-down, 600kHz, 3.5V±1%, 600mA, +CE	USP-6B	49dc5	DC1	9b	Tor
PA35C	XC9226A35CD	DC/DC-IC	PWM/PFM step-down, 1.2MHz, 3.5V±1%, 600mA, +CE	USP-6B	49dc5	DC1	9b	Tor
PA366	XC9226A366D	DC/DC-IC	PWM/PFM step-down, 600kHz, 3.6V±1%, 600mA, +CE	USP-6B	49dc5	DC1	9b	Tor
PA36C	XC9226A36CD	DC/DC-IC	PWM/PFM step-down, 1.2MHz, 3.6V±1%, 600mA, +CE	USP-6B	49dc5	DC1	9b	Tor
PA376	XC9226A376D	DC/DC-IC	PWM/PFM step-down, 600kHz, 3.7V±1%, 600mA, +CE	USP-6B	49dc5	DC1	9b	Tor
PA37C	XC9226A37CD	DC/DC-IC	PWM/PFM step-down, 1.2MHz, 3.7V±1%, 600mA, +CE	USP-6B	49dc5	DC1	9b	Tor
PA386	XC9226A386D	DC/DC-IC	PWM/PFM step-down, 600kHz, 3.8V±1%, 600mA, +CE	USP-6B	49dc5	DC1	9b	Tor
PA38C	XC9226A38CD	DC/DC-IC	PWM/PFM step-down, 1.2MHz, 3.8V±1%, 600mA, +CE	USP-6B	49dc5	DC1	9b	Tor
PA396	XC9226A396D	DC/DC-IC	PWM/PFM step-down, 600kHz, 3.9V±1%, 600mA, +CE	USP-6B	49dc5	DC1	9b	Tor
PA39C	XC9226A39CD	DC/DC-IC	PWM/PFM step-down, 1.2MHz, 3.9V±1%, 600mA, +CE	USP-6B	49dc5	DC1	9b	Tor
PA3A6	XC9226A3A6D	DC/DC-IC	PWM/PFM step-down, 600kHz, 3.05V±1%, 600mA, +CE	USP-6B	49dc5	DC1	9b	Tor
PA3AC	XC9226A3ACD	DC/DC-IC	PWM/PFM step-down, 1.2MHz, 3.05V±1%, 600mA, +CE	USP-6B	49dc5	DC1	9b	Tor
PA3B6	XC9226A3B6D	DC/DC-IC	PWM/PFM step-down, 600kHz, 3.15V±1%, 600mA, +CE	USP-6B	49dc5	DC1	9b	Tor
PA3BC	XC9226A3BCD	DC/DC-IC	PWM/PFM step-down, 1.2MHz, 3.15V±1%, 600mA, +CE	USP-6B	49dc5	DC1	9b	Tor
PA3C6	XC9226A3C6D	DC/DC-IC	PWM/PFM step-down, 600kHz, 3.25V±1%, 600mA, +CE	USP-6B	49dc5	DC1	9b	Tor
PA3CC	XC9226A3CCD	DC/DC-IC	PWM/PFM step-down, 1.2MHz, 3.25V±1%, 600mA, +CE	USP-6B	49dc5	DC1	9b	Tor
PA3D6	XC9226A3D6D	DC/DC-IC	PWM/PFM step-down, 600kHz, 3.35V±1%, 600mA, +CE	USP-6B	49dc5	DC1	9b	Tor
PA3DC	XC9226A3DCD	DC/DC-IC	PWM/PFM step-down, 1.2MHz, 3.35V±1%, 600mA, +CE	USP-6B	49dc5	DC1	9b	Tor
PA3E6	XC9226A3E6D	DC/DC-IC	PWM/PFM step-down, 600kHz, 3.45V±1%, 600mA, +CE	USP-6B	49dc5	DC1	9b	Tor
PA3EC	XC9226A3ECD	DC/DC-IC	PWM/PFM step-down, 1.2MHz, 3.45V±1%, 600mA, +CE	USP-6B	49dc5	DC1	9b	Tor
PA3F6	XC9226A3F6D	DC/DC-IC	PWM/PFM step-down, 600kHz, 3.55V±1%, 600mA, +CE	USP-6B	49dc5	DC1	9b	Tor
PA3FC	XC9226A3FCD	DC/DC-IC	PWM/PFM step-down, 1.2MHz, 3.55V±1%, 600mA, +CE	USP-6B	49dc5	DC1	9b	Tor
PA3H6	XC9226A3H6D	DC/DC-IC	PWM/PFM step-down, 600kHz, 3.65V±1%, 600mA, +CE	USP-6B	49dc5	DC1	9b	Tor
PA3HC	XC9226A3HCD	DC/DC-IC	PWM/PFM step-down, 1.2MHz, 3.65V±1%, 600mA, +CE	USP-6B	49dc5	DC1	9b	Tor
PA3K6	XC9226A3K6D	DC/DC-IC	PWM/PFM step-down, 600kHz, 3.85V±1%, 600mA, +CE	USP-6B	49dc5	DC1	9b	Tor
PA3KC	XC9226A3KCD	DC/DC-IC	PWM/PFM step-down, 1.2MHz, 3.75V±1%, 600mA, +CE	USP-6B	49dc5	DC1	9b	Tor
PA3L6	XC9226A3L6D	DC/DC-IC	PWM/PFM step-down, 600kHz, 3.85V±1%, 600mA, +CE	USP-6B	49dc5	DC1	9b	Tor
PA3LC	XC9226A3LCD	DC/DC-IC	PWM/PFM step-down, 1.2MHz, 3.85V±1%, 600mA, +CE	USP-6B	49dc5	DC1	9b	Tor
PA3M6	XC9226A3M6D	DC/DC-IC	PWM/PFM step-down, 600kHz, 3.95V±1%, 600mA, +CE	USP-6B	49dc5	DC1	9b	Tor
PA3MC	XC9226A3MCD	DC/DC-IC	PWM/PFM step-down, 1.2MHz, 3.95V±1%, 600mA, +CE	USP-6B	49dc5	DC1	9b	Tor
PA406	XC9226A406D	DC/DC-IC	PWM/PFM step-down, 600kHz, 4.0V±1%, 600mA, +CE	USP-6B	49dc5	DC1	9b	Tor
PA40C	XC9226A40CD	DC/DC-IC	PWM/PFM step-down, 1.2MHz, 4.0V±1%, 600mA, +CE	USP-6B	49dc5	DC1	9b	Tor
pB	74AUP1G02GF	CMOS-Logic	2-input NOR gate	SOT891	52LLog2	-	9c	Phi
pB	74AUP1G02GM	CMOS-Logic	2-input NOR gate	SOT-886	57LLog2	-	9c	Phi
PB	R1118K091D	LVR-IC	0.9V±1%, 150mA, +CE, CL	DFN1612-4B	45vm	VR4	9a	Ric
PB	RP106K081D	LVR-IC	LDO, 0.8V±0.8%, 400mA, +CE, CL	DFN1212-6	52v2r	VR4	9a	Ric
PB051	TPA2005D1GQY	LIN-IC	AF PA, BTL, class-D, 2.5..5.5V, 1.4W(5V/8Ω), shutdown	BGA-15	39	-	-	Ti



SMD code	Type	Function	Short description	Case	Pinout	Sch.	St.	Mnf.
PB2D6	XC9226B2D6D	DC/DC-IC	PWM/PFM step-down, 600kHz, 2.35V±1%, 600mA, -CE	USP-6B	49dc5	DC1	9b	Tor
PB2DC	XC9226B2DCD	DC/DC-IC	PWM/PFM step-down, 1.2MHz, 2.35V±1%, 600mA, -CE	USP-6B	49dc5	DC1	9b	Tor
PB2E6	XC9226B2E6D	DC/DC-IC	PWM/PFM step-down, 600kHz, 2.45V±1%, 600mA, -CE	USP-6B	49dc5	DC1	9b	Tor
PB2EC	XC9226B2ECD	DC/DC-IC	PWM/PFM step-down, 1.2MHz, 2.45V±1%, 600mA, -CE	USP-6B	49dc5	DC1	9b	Tor
PB2F6	XC9226B2F6D	DC/DC-IC	PWM/PFM step-down, 600kHz, 2.55V±1%, 600mA, -CE	USP-6B	49dc5	DC1	9b	Tor
PB2FC	XC9226B2FCD	DC/DC-IC	PWM/PFM step-down, 1.2MHz, 2.55V±1%, 600mA, -CE	USP-6B	49dc5	DC1	9b	Tor
PB2H6	XC9226B2H6D	DC/DC-IC	PWM/PFM step-down, 600kHz, 2.65V±1%, 600mA, -CE	USP-6B	49dc5	DC1	9b	Tor
PB2HC	XC9226B2HCD	DC/DC-IC	PWM/PFM step-down, 1.2MHz, 2.65V±1%, 600mA, -CE	USP-6B	49dc5	DC1	9b	Tor
PB2K6	XC9226B2K6D	DC/DC-IC	PWM/PFM step-down, 600kHz, 2.75V±1%, 600mA, -CE	USP-6B	49dc5	DC1	9b	Tor
PB2KC	XC9226B2KCD	DC/DC-IC	PWM/PFM step-down, 1.2MHz, 2.75V±1%, 600mA, -CE	USP-6B	49dc5	DC1	9b	Tor
PB2L6	XC9226B2L6D	DC/DC-IC	PWM/PFM step-down, 600kHz, 2.85V±1%, 600mA, -CE	USP-6B	49dc5	DC1	9b	Tor
PB2LC	XC9226B2LCD	DC/DC-IC	PWM/PFM step-down, 1.2MHz, 2.85V±1%, 600mA, -CE	USP-6B	49dc5	DC1	9b	Tor
PB2M6	XC9226B2M6D	DC/DC-IC	PWM/PFM step-down, 600kHz, 2.95V±1%, 600mA, -CE	USP-6B	49dc5	DC1	9b	Tor
PB2MC	XC9226B2MCD	DC/DC-IC	PWM/PFM step-down, 1.2MHz, 2.95V±1%, 600mA, -CE	USP-6B	49dc5	DC1	9b	Tor
PB306	XC9226B306D	DC/DC-IC	PWM/PFM step-down, 600kHz, 3.0V±1%, 600mA, -CE	USP-6B	49dc5	DC1	9b	Tor
PB30C	XC9226B30CD	DC/DC-IC	PWM/PFM step-down, 1.2MHz, 3.0V±1%, 600mA, -CE	USP-6B	49dc5	DC1	9b	Tor
PB316	XC9226B316D	DC/DC-IC	PWM/PFM step-down, 600kHz, 3.1V±1%, 600mA, -CE	USP-6B	49dc5	DC1	9b	Tor
PB31C	XC9226B31CD	DC/DC-IC	PWM/PFM step-down, 1.2MHz, 3.1V±1%, 600mA, -CE	USP-6B	49dc5	DC1	9b	Tor
PB326	XC9226B326D	DC/DC-IC	PWM/PFM step-down, 600kHz, 3.2V±1%, 600mA, -CE	USP-6B	49dc5	DC1	9b	Tor
PB32C	XC9226B32CD	DC/DC-IC	PWM/PFM step-down, 1.2MHz, 3.2V±1%, 600mA, -CE	USP-6B	49dc5	DC1	9b	Tor
PB336	XC9226B336D	DC/DC-IC	PWM/PFM step-down, 600kHz, 3.3V±1%, 600mA, -CE	USP-6B	49dc5	DC1	9b	Tor
PB33C	XC9226B33CD	DC/DC-IC	PWM/PFM step-down, 1.2MHz, 3.3V±1%, 600mA, -CE	USP-6B	49dc5	DC1	9b	Tor
PB346	XC9226B346D	DC/DC-IC	PWM/PFM step-down, 600kHz, 3.4V±1%, 600mA, -CE	USP-6B	49dc5	DC1	9b	Tor
PB34C	XC9226B34CD	DC/DC-IC	PWM/PFM step-down, 1.2MHz, 3.4V±1%, 600mA, -CE	USP-6B	49dc5	DC1	9b	Tor
PB356	XC9226B356D	DC/DC-IC	PWM/PFM step-down, 600kHz, 3.5V±1%, 600mA, -CE	USP-6B	49dc5	DC1	9b	Tor
PB35C	XC9226B35CD	DC/DC-IC	PWM/PFM step-down, 1.2MHz, 3.5V±1%, 600mA, -CE	USP-6B	49dc5	DC1	9b	Tor
PB366	XC9226B366D	DC/DC-IC	PWM/PFM step-down, 600kHz, 3.6V±1%, 600mA, -CE	USP-6B	49dc5	DC1	9b	Tor
PB36C	XC9226B36CD	DC/DC-IC	PWM/PFM step-down, 1.2MHz, 3.6V±1%, 600mA, -CE	USP-6B	49dc5	DC1	9b	Tor
PB376	XC9226B376D	DC/DC-IC	PWM/PFM step-down, 600kHz, 3.7V±1%, 600mA, -CE	USP-6B	49dc5	DC1	9b	Tor
PB37C	XC9226B37CD	DC/DC-IC	PWM/PFM step-down, 1.2MHz, 3.7V±1%, 600mA, -CE	USP-6B	49dc5	DC1	9b	Tor
PB386	XC9226B386D	DC/DC-IC	PWM/PFM step-down, 600kHz, 3.8V±1%, 600mA, -CE	USP-6B	49dc5	DC1	9b	Tor
PB38C	XC9226B38CD	DC/DC-IC	PWM/PFM step-down, 1.2MHz, 3.8V±1%, 600mA, -CE	USP-6B	49dc5	DC1	9b	Tor
PB396	XC9226B396D	DC/DC-IC	PWM/PFM step-down, 600kHz, 3.9V±1%, 600mA, -CE	USP-6B	49dc5	DC1	9b	Tor
PB39C	XC9226B39CD	DC/DC-IC	PWM/PFM step-down, 1.2MHz, 3.9V±1%, 600mA, -CE	USP-6B	49dc5	DC1	9b	Tor
PB3A6	XC9226B3A6D	DC/DC-IC	PWM/PFM step-down, 600kHz, 3.05V±1%, 600mA, -CE	USP-6B	49dc5	DC1	9b	Tor
PB3AC	XC9226B3ACD	DC/DC-IC	PWM/PFM step-down, 1.2MHz, 3.05V±1%, 600mA, -CE	USP-6B	49dc5	DC1	9b	Tor
PB3B6	XC9226B3B6D	DC/DC-IC	PWM/PFM step-down, 600kHz, 3.15V±1%, 600mA, -CE	USP-6B	49dc5	DC1	9b	Tor
PB3BC	XC9226B3BCD	DC/DC-IC	PWM/PFM step-down, 1.2MHz, 3.15V±1%, 600mA, -CE	USP-6B	49dc5	DC1	9b	Tor
PB3C6	XC9226B3C6D	DC/DC-IC	PWM/PFM step-down, 600kHz, 3.25V±1%, 600mA, -CE	USP-6B	49dc5	DC1	9b	Tor
PB3CC	XC9226B3CCD	DC/DC-IC	PWM/PFM step-down, 1.2MHz, 3.25V±1%, 600mA, -CE	USP-6B	49dc5	DC1	9b	Tor
PB3D6	XC9226B3D6D	DC/DC-IC	PWM/PFM step-down, 600kHz, 3.35V±1%, 600mA, -CE	USP-6B	49dc5	DC1	9b	Tor
PB3DC	XC9226B3DCD	DC/DC-IC	PWM/PFM step-down, 1.2MHz, 3.35V±1%, 600mA, -CE	USP-6B	49dc5	DC1	9b	Tor
PB3E6	XC9226B3E6D	DC/DC-IC	PWM/PFM step-down, 600kHz, 3.45V±1%, 600mA, -CE	USP-6B	49dc5	DC1	9b	Tor
PB3EC	XC9226B3ECD	DC/DC-IC	PWM/PFM step-down, 1.2MHz, 3.45V±1%, 600mA, -CE	USP-6B	49dc5	DC1	9b	Tor
PB3F6	XC9226B3F6D	DC/DC-IC	PWM/PFM step-down, 600kHz, 3.55V±1%, 600mA, -CE	USP-6B	49dc5	DC1	9b	Tor
PB3FC	XC9226B3FCD	DC/DC-IC	PWM/PFM step-down, 1.2MHz, 3.55V±1%, 600mA, -CE	USP-6B	49dc5	DC1	9b	Tor
PB3H6	XC9226B3H6D	DC/DC-IC	PWM/PFM step-down, 600kHz, 3.65V±1%, 600mA, -CE	USP-6B	49dc5	DC1	9b	Tor
PB3HC	XC9226B3HCD	DC/DC-IC	PWM/PFM step-down, 1.2MHz, 3.65V±1%, 600mA, -CE	USP-6B	49dc5	DC1	9b	Tor
PB3K6	XC9226B3K6D	DC/DC-IC	PWM/PFM step-down, 600kHz, 3.75V±1%, 600mA, -CE	USP-6B	49dc5	DC1	9b	Tor
PB3KC	XC9226B3KCD	DC/DC-IC	PWM/PFM step-down, 1.2MHz, 3.75V±1%, 600mA, -CE	USP-6B	49dc5	DC1	9b	Tor
PB3L6	XC9226B3L6D	DC/DC-IC	PWM/PFM step-down, 600kHz, 3.85V±1%, 600mA, -CE	USP-6B	49dc5	DC1	9b	Tor
PB3LC	XC9226B3LCD	DC/DC-IC	PWM/PFM step-down, 1.2MHz, 3.85V±1%, 600mA, -CE	USP-6B	49dc5	DC1	9b	Tor
PB3M6	XC9226B3M6D	DC/DC-IC	PWM/PFM step-down, 600kHz, 3.95V±1%, 600mA, -CE	USP-6B	49dc5	DC1	9b	Tor
PB3MC	XC9226B3MCD	DC/DC-IC	PWM/PFM step-down, 1.2MHz, 3.95V±1%, 600mA, -CE	USP-6B	49dc5	DC1	9b	Tor
PB406	XC9226B406D	DC/DC-IC	PWM/PFM step-down, 600kHz, 4.0V±1%, 600mA, -CE	USP-6B	49dc5	DC1	9b	Tor
PB40C	XC9226B40CD	DC/DC-IC	PWM/PFM step-down, 1.2MHz, 4.0V±1%, 600mA, -CE	USP-6B	49dc5	DC1	9b	Tor
pC	74AUP1G04GF	CMOS-Logic	Inverter	SOT891	52LLog6	-	9c	Phi
pC	74AUP1G04GM	CMOS-Logic	Inverter	SOT-886	57LLog6	-	9c	Phi
PC	R118K101D	LVR-IC	1V±1%, 150mA, +CE, CL	DFN1612-4B	45vm	VR4	9a	Ric
PC	RP106K091D	LVR-IC	LDO, 0.9V±0.8%, 400mA, +CE, CL	DFN1212-6	52v2r	VR4	9a	Ric
PC096	XC9226C096D	DC/DC-IC	PWM/PFM step-down, 600kHz, 0.9V±1%, 600mA, +CE, PDR	USP-6B	49dc5	DC1	9b	Tor
PC09C	XC9226C09CD	DC/DC-IC	PWM/PFM step-down, 1.2MHz, 0.9V±1%, 600mA, +CE, PDR	USP-6B	49dc5	DC1	9b	Tor
PC0M6	XC9226C0M6D	DC/DC-IC	PWM/PFM step-down, 600kHz, 0.95V±1%, 600mA, +CE, PDR	USP-6B	49dc5	DC1	9b	Tor
PC0MC	XC9226C0MCD	DC/DC-IC	PWM/PFM step-down, 1.2MHz, 0.95V±1%, 600mA, +CE, PDR	USP-6B	49dc5	DC1	9b	Tor
PC106	XC9226C106D	DC/DC-IC	PWM/PFM step-down, 600kHz, 1.0V±1%, 600mA, +CE, PDR	USP-6B	49dc5	DC1	9b	Tor
PC10C	XC9226C10CD	DC/DC-IC	PWM/PFM step-down, 1.2MHz, 1.0V±1%, 600mA, +CE, PDR	USP-6B	49dc5	DC1	9b	Tor
PC116	XC9226C116D	DC/DC-IC	PWM/PFM step-down, 600kHz, 1.1V±1%, 600mA, +CE, PDR	USP-6B	49dc5	DC1	9b	Tor
PC11C	XC9226C11CD	DC/DC-IC	PWM/PFM step-down, 1.2MHz, 1.1V±1%, 600mA, +CE, PDR	USP-6B	49dc5	DC1	9b	Tor
PC126	XC9226C126D	DC/DC-IC	PWM/PFM step-down, 600kHz, 1.2V±1%, 600mA, +CE, PDR	USP-6B	49dc5	DC1	9b	Tor
PC12C	XC9226C12CD	DC/DC-IC	PWM/PFM step-down, 1.2MHz, 1.2V±1%, 600mA, +CE, PDR	USP-6B	49dc5	DC1	9b	Tor



SMD code	Type	Function	Short description	Case	Pinout	Sch.	St.	Mnf.
PC2L6	XC9226C2L6D	DQ/DC-IC	PWM/PFM step-down, 600kHz, 2.85V±1%, 600mA, +CE, PDR	USP-6B	49dc5	DC1	9b	Tor
PC2LC	XC9226C2LC	DQ/DC-IC	PWM/PFM step-down, 1.2MHz, 2.85V±1%, 600mA, +CE, PDR	USP-6B	49dc5	DC1	9b	Tor
PC2M6	XC9226C2M6D	DQ/DC-IC	PWM/PFM step-down, 600kHz, 2.95V±1%, 600mA, +CE, PDR	USP-6B	49dc5	DC1	9b	Tor
PC2MC	XC9226C2MCD	DQ/DC-IC	PWM/PFM step-down, 1.2MHz, 2.95V±1%, 600mA, +CE, PDR	USP-6B	49dc5	DC1	9b	Tor
PC306	XC9226C306D	DQ/DC-IC	PWM/PFM step-down, 600kHz, 3.0V±1%, 600mA, +CE, PDR	USP-6B	49dc5	DC1	9b	Tor
PC30C	XC9226C30CD	DQ/DC-IC	PWM/PFM step-down, 1.2MHz, 3.0V±1%, 600mA, +CE, PDR	USP-6B	49dc5	DC1	9b	Tor
PC316	XC9226C316D	DQ/DC-IC	PWM/PFM step-down, 600kHz, 3.1V±1%, 600mA, +CE, PDR	USP-6B	49dc5	DC1	9b	Tor
PC31C	XC9226C31CD	DQ/DC-IC	PWM/PFM step-down, 1.2MHz, 3.1V±1%, 600mA, +CE, PDR	USP-6B	49dc5	DC1	9b	Tor
PC326	XC9226C326D	DQ/DC-IC	PWM/PFM step-down, 600kHz, 3.2V±1%, 600mA, +CE, PDR	USP-6B	49dc5	DC1	9b	Tor
PC32C	XC9226C32CD	DQ/DC-IC	PWM/PFM step-down, 1.2MHz, 3.2V±1%, 600mA, +CE, PDR	USP-6B	49dc5	DC1	9b	Tor
PC336	XC9226C336D	DQ/DC-IC	PWM/PFM step-down, 600kHz, 3.3V±1%, 600mA, +CE, PDR	USP-6B	49dc5	DC1	9b	Tor
PC33C	XC9226C33CD	DQ/DC-IC	PWM/PFM step-down, 1.2MHz, 3.3V±1%, 600mA, +CE, PDR	USP-6B	49dc5	DC1	9b	Tor
PC346	XC9226C346D	DQ/DC-IC	PWM/PFM step-down, 600kHz, 3.4V±1%, 600mA, +CE, PDR	USP-6B	49dc5	DC1	9b	Tor
PC34C	XC9226C34CD	DQ/DC-IC	PWM/PFM step-down, 1.2MHz, 3.4V±1%, 600mA, +CE, PDR	USP-6B	49dc5	DC1	9b	Tor
PC356	XC9226C356D	DQ/DC-IC	PWM/PFM step-down, 600kHz, 3.5V±1%, 600mA, +CE, PDR	USP-6B	49dc5	DC1	9b	Tor
PC35C	XC9226C35CD	DQ/DC-IC	PWM/PFM step-down, 1.2MHz, 3.5V±1%, 600mA, +CE, PDR	USP-6B	49dc5	DC1	9b	Tor
PC366	XC9226C366D	DQ/DC-IC	PWM/PFM step-down, 600kHz, 3.6V±1%, 600mA, +CE, PDR	USP-6B	49dc5	DC1	9b	Tor
PC36C	XC9226C36CD	DQ/DC-IC	PWM/PFM step-down, 1.2MHz, 3.6V±1%, 600mA, +CE, PDR	USP-6B	49dc5	DC1	9b	Tor
PC376	XC9226C376D	DQ/DC-IC	PWM/PFM step-down, 600kHz, 3.7V±1%, 600mA, +CE, PDR	USP-6B	49dc5	DC1	9b	Tor
PC37C	XC9226C37CD	DQ/DC-IC	PWM/PFM step-down, 1.2MHz, 3.7V±1%, 600mA, +CE, PDR	USP-6B	49dc5	DC1	9b	Tor
PC386	XC9226C386D	DQ/DC-IC	PWM/PFM step-down, 600kHz, 3.8V±1%, 600mA, +CE, PDR	USP-6B	49dc5	DC1	9b	Tor
PC38C	XC9226C38CD	DQ/DC-IC	PWM/PFM step-down, 1.2MHz, 3.8V±1%, 600mA, +CE, PDR	USP-6B	49dc5	DC1	9b	Tor
PC396	XC9226C396D	DQ/DC-IC	PWM/PFM step-down, 600kHz, 3.9V±1%, 600mA, +CE, PDR	USP-6B	49dc5	DC1	9b	Tor
PC39C	XC9226C39CD	DQ/DC-IC	PWM/PFM step-down, 1.2MHz, 3.9V±1%, 600mA, +CE, PDR	USP-6B	49dc5	DC1	9b	Tor
PC3A6	XC9226C3A6D	DQ/DC-IC	PWM/PFM step-down, 600kHz, 3.95V±1%, 600mA, +CE, PDR	USP-6B	49dc5	DC1	9b	Tor
PC3AC	XC9226C3ACD	DQ/DC-IC	PWM/PFM step-down, 1.2MHz, 3.95V±1%, 600mA, +CE, PDR	USP-6B	49dc5	DC1	9b	Tor
PC3B6	XC9226C3B6D	DQ/DC-IC	PWM/PFM step-down, 600kHz, 3.15V±1%, 600mA, +CE, PDR	USP-6B	49dc5	DC1	9b	Tor
PC3BC	XC9226C3BCD	DQ/DC-IC	PWM/PFM step-down, 1.2MHz, 3.15V±1%, 600mA, +CE, PDR	USP-6B	49dc5	DC1	9b	Tor
PC3C6	XC9226C3C6D	DQ/DC-IC	PWM/PFM step-down, 600kHz, 3.25V±1%, 600mA, +CE, PDR	USP-6B	49dc5	DC1	9b	Tor
PC3CC	XC9226C3CCD	DQ/DC-IC	PWM/PFM step-down, 1.2MHz, 3.25V±1%, 600mA, +CE, PDR	USP-6B	49dc5	DC1	9b	Tor
PC3D6	XC9226C3D6D	DQ/DC-IC	PWM/PFM step-down, 600kHz, 3.35V±1%, 600mA, +CE, PDR	USP-6B	49dc5	DC1	9b	Tor
PC3DC	XC9226C3DCD	DQ/DC-IC	PWM/PFM step-down, 1.2MHz, 3.35V±1%, 600mA, +CE, PDR	USP-6B	49dc5	DC1	9b	Tor
PC3E6	XC9226C3E6D	DQ/DC-IC	PWM/PFM step-down, 600kHz, 3.45V±1%, 600mA, +CE, PDR	USP-6B	49dc5	DC1	9b	Tor
PC3EC	XC9226C3ECD	DQ/DC-IC	PWM/PFM step-down, 1.2MHz, 3.45V±1%, 600mA, +CE, PDR	USP-6B	49dc5	DC1	9b	Tor
PC3F6	XC9226C3F6D	DQ/DC-IC	PWM/PFM step-down, 600kHz, 3.55V±1%, 600mA, +CE, PDR	USP-6B	49dc5	DC1	9b	Tor
PC3FC	XC9226C3FCD	DQ/DC-IC	PWM/PFM step-down, 1.2MHz, 3.55V±1%, 600mA, +CE, PDR	USP-6B	49dc5	DC1	9b	Tor
PC3H6	XC9226C3H6D	DQ/DC-IC	PWM/PFM step-down, 600kHz, 3.65V±1%, 600mA, +CE, PDR	USP-6B	49dc5	DC1	9b	Tor
PC3HC	XC9226C3HCD	DQ/DC-IC	PWM/PFM step-down, 1.2MHz, 3.65V±1%, 600mA, +CE, PDR	USP-6B	49dc5	DC1	9b	Tor
PC3K6	XC9226C3K6D	DQ/DC-IC	PWM/PFM step-down, 600kHz, 3.75V±1%, 600mA, +CE, PDR	USP-6B	49dc5	DC1	9b	Tor
PC3KC	XC9226C3KCD	DQ/DC-IC	PWM/PFM step-down, 1.2MHz, 3.75V±1%, 600mA, +CE, PDR	USP-6B	49dc5	DC1	9b	Tor
PC3L6	XC9226C3L6D	DQ/DC-IC	PWM/PFM step-down, 600kHz, 3.85V±1%, 600mA, +CE, PDR	USP-6B	49dc5	DC1	9b	Tor
PC3LC	XC9226C3LCD	DQ/DC-IC	PWM/PFM step-down, 1.2MHz, 3.85V±1%, 600mA, +CE, PDR	USP-6B	49dc5	DC1	9b	Tor
PC3M6	XC9226C3M6D	DQ/DC-IC	PWM/PFM step-down, 600kHz, 3.95V±1%, 600mA, +CE, PDR	USP-6B	49dc5	DC1	9b	Tor
PC3MC	XC9226C3MCD	DQ/DC-IC	PWM/PFM step-down, 1.2MHz, 3.95V±1%, 600mA, +CE, PDR	USP-6B	49dc5	DC1	9b	Tor
PC406	XC9226C406D	DQ/DC-IC	PWM/PFM step-down, 600kHz, 4.0V±1%, 600mA, +CE, PDR	USP-6B	49dc5	DC1	9b	Tor
PC40C	XC9226C40CD	DQ/DC-IC	PWM/PFM step-down, 1.2MHz, 4.0V±1%, 600mA, +CE, PDR	USP-6B	49dc5	DC1	9b	Tor
pD	74AUP1GU04GF	CMOS-Logic	Inverter	SOT891	52Llog6	-	9c	Phi
pD	74AUP1GU04GM	CMOS-Logic	Inverter	SOT-886	57Llog6	-	9c	Phi
PD	R118K111D	LVR-IC	1.1V±1%, 150mA, +CE, CL	DFN1612-4B	45vm	VR4	9a	Ric
PD	RP106K101D	LVR-IC	LDO, 1.0V±0.8%, 400mA, +CE, CL	DFN1212-6	52vr2	VR4	9a	Ric
PD096	XC9226D096D	DQ/DC-IC	PWM/PFM step-down, 600kHz, 0.9V±1%, 600mA, -CE, PDR	USP-6B	49dc5	DC1	9b	Tor
PD09C	XC9226D09CD	DQ/DC-IC	PWM/PFM step-down, 1.2MHz, 0.9V±1%, 600mA, -CE, PDR	USP-6B	49dc5	DC1	9b	Tor
PD0M6	XC9226D0M6D	DQ/DC-IC	PWM/PFM step-down, 600kHz, 0.95V±1%, 600mA, -CE, PDR	USP-6B	49dc5	DC1	9b	Tor
PD0MC	XC9226D0MCD	DQ/DC-IC	PWM/PFM step-down, 1.2MHz, 0.95V±1%, 600mA, -CE, PDR	USP-6B	49dc5	DC1	9b	Tor
PD106	XC9226D106D	DQ/DC-IC	PWM/PFM step-down, 600kHz, 1.0V±1%, 600mA, -CE, PDR	USP-6B	49dc5	DC1	9b	Tor
PD10C	XC9226D10CD	DQ/DC-IC	PWM/PFM step-down, 1.2MHz, 1.0V±1%, 600mA, -CE, PDR	USP-6B	49dc5	DC1	9b	Tor
PD116	XC9226D116D	DQ/DC-IC	PWM/PFM step-down, 600kHz, 1.1V±1%, 600mA, -CE, PDR	USP-6B	49dc5	DC1	9b	Tor
PD11C	XC9226D11CD	DQ/DC-IC	PWM/PFM step-down, 1.2MHz, 1.1V±1%, 600mA, -CE, PDR	USP-6B	49dc5	DC1	9b	Tor
PD126	XC9226D126D	DQ/DC-IC	PWM/PFM step-down, 600kHz, 1.2V±1%, 600mA, -CE, PDR	USP-6B	49dc5	DC1	9b	Tor
PD12C	XC9226D12CD	DQ/DC-IC	PWM/PFM step-down, 1.2MHz, 1.2V±1%, 600mA, -CE, PDR	USP-6B	49dc5	DC1	9b	Tor
PD136	XC9226D136D	DQ/DC-IC	PWM/PFM step-down, 600kHz, 1.3V±1%, 600mA, -CE, PDR	USP-6B	49dc5	DC1	9b	Tor
PD13C	XC9226D13CD	DQ/DC-IC	PWM/PFM step-down, 1.2MHz, 1.3V±1%, 600mA, -CE, PDR	USP-6B	49dc5	DC1	9b	Tor
PD146	XC9226D146D	DQ/DC-IC	PWM/PFM step-down, 600kHz, 1.4V±1%, 600mA, -CE, PDR	USP-6B	49dc5	DC1	9b	Tor
PD14C	XC9226D14CD	DQ/DC-IC	PWM/PFM step-down, 1.2MHz, 1.4V±1%, 600mA, -CE, PDR	USP-6B	49dc5	DC1	9b	Tor
PD156	XC9226D156D	DQ/DC-IC	PWM/PFM step-down, 600kHz, 1.5V±1%, 600mA, -CE, PDR	USP-6B	49dc5	DC1	9b	Tor
PD15C	XC9226D15CD	DQ/DC-IC	PWM/PFM step-down, 1.2MHz, 1.5V±1%, 600mA, -CE, PDR	USP-6B	49dc5	DC1	9b	Tor
PD166	XC9226D166D	DQ/DC-IC	PWM/PFM step-down, 600kHz, 1.6V±1%, 600mA, -CE, PDR	USP-6B	49dc5	DC1	9b	Tor
PD16C	XC9226D16CD	DQ/DC-IC	PWM/PFM step-down, 1.2MHz, 1.6V±1%, 600mA, -CE, PDR	USP-6B	49dc5	DC1	9b	Tor
PD176	XC9226D176D	DQ/DC-IC	PWM/PFM step-down, 600kHz, 1.7V±1%, 600mA, -CE, PDR	USP-6B	49dc5	DC1	9b	Tor
PD17C	XC9226D17CD	DQ/DC-IC	PWM/PFM step-down, 1.2MHz, 1.7V±1%, 600mA, -CE, PDR	USP-6B	49dc5	DC1	9b	Tor



SMD code	Type	Function	Short description	Case	Pinout	Sch.	St.	Mnf.
PD336	XC9226D336D	DC/DC-IC	PWM/PFM step-down, 600kHz, 3.3V±1%, 600mA, -CE, PDR	USP-6B	49dc5	DC1	9b	Tor
PD33C	XC9226D33CD	DC/DC-IC	PWM/PFM step-down, 1.2MHz, 3.3V±1%, 600mA, -CE, PDR	USP-6B	49dc5	DC1	9b	Tor
PD346	XC9226D346D	DC/DC-IC	PWM/PFM step-down, 600kHz, 3.4V±1%, 600mA, -CE, PDR	USP-6B	49dc5	DC1	9b	Tor
PD34C	XC9226D34CD	DC/DC-IC	PWM/PFM step-down, 1.2MHz, 3.4V±1%, 600mA, -CE, PDR	USP-6B	49dc5	DC1	9b	Tor
PD356	XC9226D356D	DC/DC-IC	PWM/PFM step-down, 600kHz, 3.5V±1%, 600mA, -CE, PDR	USP-6B	49dc5	DC1	9b	Tor
PD35C	XC9226D35CD	DC/DC-IC	PWM/PFM step-down, 1.2MHz, 3.5V±1%, 600mA, -CE, PDR	USP-6B	49dc5	DC1	9b	Tor
PD366	XC9226D366D	DC/DC-IC	PWM/PFM step-down, 600kHz, 3.6V±1%, 600mA, -CE, PDR	USP-6B	49dc5	DC1	9b	Tor
PD36C	XC9226D36CD	DC/DC-IC	PWM/PFM step-down, 1.2MHz, 3.6V±1%, 600mA, -CE, PDR	USP-6B	49dc5	DC1	9b	Tor
PD376	XC9226D376D	DC/DC-IC	PWM/PFM step-down, 600kHz, 3.7V±1%, 600mA, -CE, PDR	USP-6B	49dc5	DC1	9b	Tor
PD37C	XC9226D37CD	DC/DC-IC	PWM/PFM step-down, 1.2MHz, 3.7V±1%, 600mA, -CE, PDR	USP-6B	49dc5	DC1	9b	Tor
PD386	XC9226D386D	DC/DC-IC	PWM/PFM step-down, 600kHz, 3.8V±1%, 600mA, -CE, PDR	USP-6B	49dc5	DC1	9b	Tor
PD38C	XC9226D38CD	DC/DC-IC	PWM/PFM step-down, 1.2MHz, 3.8V±1%, 600mA, -CE, PDR	USP-6B	49dc5	DC1	9b	Tor
PD396	XC9226D396D	DC/DC-IC	PWM/PFM step-down, 600kHz, 3.9V±1%, 600mA, -CE, PDR	USP-6B	49dc5	DC1	9b	Tor
PD39C	XC9226D39CD	DC/DC-IC	PWM/PFM step-down, 1.2MHz, 3.9V±1%, 600mA, -CE, PDR	USP-6B	49dc5	DC1	9b	Tor
PD3A6	XC9226D3A6D	DC/DC-IC	PWM/PFM step-down, 600kHz, 3.05V±1%, 600mA, -CE, PDR	USP-6B	49dc5	DC1	9b	Tor
PD3AC	XC9226D3ACD	DC/DC-IC	PWM/PFM step-down, 1.2MHz, 3.05V±1%, 600mA, -CE, PDR	USP-6B	49dc5	DC1	9b	Tor
PD3B6	XC9226D3B6D	DC/DC-IC	PWM/PFM step-down, 600kHz, 3.15V±1%, 600mA, -CE, PDR	USP-6B	49dc5	DC1	9b	Tor
PD3BC	XC9226D3BCD	DC/DC-IC	PWM/PFM step-down, 1.2MHz, 3.15V±1%, 600mA, -CE, PDR	USP-6B	49dc5	DC1	9b	Tor
PD3C6	XC9226D3C6D	DC/DC-IC	PWM/PFM step-down, 600kHz, 3.25V±1%, 600mA, -CE, PDR	USP-6B	49dc5	DC1	9b	Tor
PD3CC	XC9226D3CCD	DC/DC-IC	PWM/PFM step-down, 1.2MHz, 3.25V±1%, 600mA, -CE, PDR	USP-6B	49dc5	DC1	9b	Tor
PD3D6	XC9226D3D6D	DC/DC-IC	PWM/PFM step-down, 600kHz, 3.35V±1%, 600mA, -CE, PDR	USP-6B	49dc5	DC1	9b	Tor
PD3DC	XC9226D3DCD	DC/DC-IC	PWM/PFM step-down, 1.2MHz, 3.35V±1%, 600mA, -CE, PDR	USP-6B	49dc5	DC1	9b	Tor
PD3E6	XC9226D3E6D	DC/DC-IC	PWM/PFM step-down, 600kHz, 3.45V±1%, 600mA, -CE, PDR	USP-6B	49dc5	DC1	9b	Tor
PD3EC	XC9226D3ECD	DC/DC-IC	PWM/PFM step-down, 1.2MHz, 3.45V±1%, 600mA, -CE, PDR	USP-6B	49dc5	DC1	9b	Tor
PD3F6	XC9226D3F6D	DC/DC-IC	PWM/PFM step-down, 600kHz, 3.55V±1%, 600mA, -CE, PDR	USP-6B	49dc5	DC1	9b	Tor
PD3FC	XC9226D3FCD	DC/DC-IC	PWM/PFM step-down, 1.2MHz, 3.55V±1%, 600mA, -CE, PDR	USP-6B	49dc5	DC1	9b	Tor
PD3H6	XC9226D3H6D	DC/DC-IC	PWM/PFM step-down, 600kHz, 3.65V±1%, 600mA, -CE, PDR	USP-6B	49dc5	DC1	9b	Tor
PD3HC	XC9226D3HCD	DC/DC-IC	PWM/PFM step-down, 1.2MHz, 3.65V±1%, 600mA, -CE, PDR	USP-6B	49dc5	DC1	9b	Tor
PD3K6	XC9226D3K6D	DC/DC-IC	PWM/PFM step-down, 600kHz, 3.75V±1%, 600mA, -CE, PDR	USP-6B	49dc5	DC1	9b	Tor
PD3KC	XC9226D3KCD	DC/DC-IC	PWM/PFM step-down, 1.2MHz, 3.75V±1%, 600mA, -CE, PDR	USP-6B	49dc5	DC1	9b	Tor
PD3L6	XC9226D3L6D	DC/DC-IC	PWM/PFM step-down, 600kHz, 3.85V±1%, 600mA, -CE, PDR	USP-6B	49dc5	DC1	9b	Tor
PD3LC	XC9226D3LCD	DC/DC-IC	PWM/PFM step-down, 1.2MHz, 3.85V±1%, 600mA, -CE, PDR	USP-6B	49dc5	DC1	9b	Tor
PD3M6	XC9226D3M6D	DC/DC-IC	PWM/PFM step-down, 600kHz, 3.95V±1%, 600mA, -CE, PDR	USP-6B	49dc5	DC1	9b	Tor
PD3MC	XC9226D3MCD	DC/DC-IC	PWM/PFM step-down, 1.2MHz, 3.95V±1%, 600mA, -CE, PDR	USP-6B	49dc5	DC1	9b	Tor
PD406	XC9226D406D	DC/DC-IC	PWM/PFM step-down, 600kHz, 4.0V±1%, 600mA, -CE, PDR	USP-6B	49dc5	DC1	9b	Tor
PD40C	XC9226D40CD	DC/DC-IC	PWM/PFM step-down, 1.2MHz, 4.0V±1%, 600mA, -CE, PDR	USP-6B	49dc5	DC1	9b	Tor
pE	74AUP1G08GF	CMOS-Logic	2-input AND gate	SOT891	52/Log3	-	9c	Phi
pE	74AUP1G08GM	CMOS-Logic	2-input AND gate	SOT-886	57/Log3	-	9c	Phi
PE	R1118K121D	LVR-IC	1.2V±1%, 150mA, +CE, CL	DFN1612-4B	45vm	VR4	9a	Ric
PE	RP106K111D	LVR-IC	LDO, 1.1V±0.8%, 400mA, +CE, CL	DFN1212-6	52vr2	VR4	9a	Ric
PE306	XC9226E306D	DC/DC-IC	PWM/PFM step-down, 600kHz, 3.0V±1%, 900mA, +CE	USP-6B	49dc5	DC1	9b	Tor
PE30C	XC9226E30CD	DC/DC-IC	PWM/PFM step-down, 1.2MHz, 3.0V±1%, 900mA, +CE	USP-6B	49dc5	DC1	9b	Tor
PE316	XC9226E316D	DC/DC-IC	PWM/PFM step-down, 600kHz, 3.1V±1%, 900mA, +CE	USP-6B	49dc5	DC1	9b	Tor
PE31C	XC9226E31CD	DC/DC-IC	PWM/PFM step-down, 1.2MHz, 3.1V±1%, 900mA, +CE	USP-6B	49dc5	DC1	9b	Tor
PE326	XC9226E326D	DC/DC-IC	PWM/PFM step-down, 600kHz, 3.2V±1%, 900mA, +CE	USP-6B	49dc5	DC1	9b	Tor
PE32C	XC9226E32CD	DC/DC-IC	PWM/PFM step-down, 1.2MHz, 3.2V±1%, 900mA, +CE	USP-6B	49dc5	DC1	9b	Tor
PE336	XC9226E336D	DC/DC-IC	PWM/PFM step-down, 600kHz, 3.3V±1%, 900mA, +CE	USP-6B	49dc5	DC1	9b	Tor
PE33C	XC9226E33CD	DC/DC-IC	PWM/PFM step-down, 1.2MHz, 3.3V±1%, 900mA, +CE	USP-6B	49dc5	DC1	9b	Tor
PE346	XC9226E346D	DC/DC-IC	PWM/PFM step-down, 600kHz, 3.4V±1%, 900mA, +CE	USP-6B	49dc5	DC1	9b	Tor
PE34C	XC9226E34CD	DC/DC-IC	PWM/PFM step-down, 1.2MHz, 3.4V±1%, 900mA, +CE	USP-6B	49dc5	DC1	9b	Tor
PE356	XC9226E356D	DC/DC-IC	PWM/PFM step-down, 600kHz, 3.5V±1%, 900mA, +CE	USP-6B	49dc5	DC1	9b	Tor
PE35C	XC9226E35CD	DC/DC-IC	PWM/PFM step-down, 1.2MHz, 3.5V±1%, 900mA, +CE	USP-6B	49dc5	DC1	9b	Tor
PE366	XC9226E366D	DC/DC-IC	PWM/PFM step-down, 600kHz, 3.6V±1%, 900mA, +CE	USP-6B	49dc5	DC1	9b	Tor
PE36C	XC9226E36CD	DC/DC-IC	PWM/PFM step-down, 1.2MHz, 3.6V±1%, 900mA, +CE	USP-6B	49dc5	DC1	9b	Tor
PE376	XC9226E376D	DC/DC-IC	PWM/PFM step-down, 600kHz, 3.7V±1%, 900mA, +CE	USP-6B	49dc5	DC1	9b	Tor
PE37C	XC9226E37CD	DC/DC-IC	PWM/PFM step-down, 1.2MHz, 3.7V±1%, 900mA, +CE	USP-6B	49dc5	DC1	9b	Tor
PE386	XC9226E386D	DC/DC-IC	PWM/PFM step-down, 600kHz, 3.8V±1%, 900mA, +CE	USP-6B	49dc5	DC1	9b	Tor
PE38C	XC9226E38CD	DC/DC-IC	PWM/PFM step-down, 1.2MHz, 3.8V±1%, 900mA, +CE	USP-6B	49dc5	DC1	9b	Tor
PE396	XC9226E396D	DC/DC-IC	PWM/PFM step-down, 600kHz, 3.9V±1%, 900mA, +CE	USP-6B	49dc5	DC1	9b	Tor
PE39C	XC9226E39CD	DC/DC-IC	PWM/PFM step-down, 1.2MHz, 3.9V±1%, 900mA, +CE	USP-6B	49dc5	DC1	9b	Tor
PE3A6	XC9226E3A6D	DC/DC-IC	PWM/PFM step-down, 600kHz, 3.05V±1%, 900mA, +CE	USP-6B	49dc5	DC1	9b	Tor
PE3AC	XC9226E3ACD	DC/DC-IC	PWM/PFM step-down, 1.2MHz, 3.05V±1%, 900mA, +CE	USP-6B	49dc5	DC1	9b	Tor
PE3B6	XC9226E3B6D	DC/DC-IC	PWM/PFM step-down, 600kHz, 3.15V±1%, 900mA, +CE	USP-6B	49dc5	DC1	9b	Tor
PE3BC	XC9226E3BCD	DC/DC-IC	PWM/PFM step-down, 1.2MHz, 3.15V±1%, 900mA, +CE	USP-6B	49dc5	DC1	9b	Tor
PE3C6	XC9226E3C6D	DC/DC-IC	PWM/PFM step-down, 600kHz, 3.25V±1%, 900mA, +CE	USP-6B	49dc5	DC1	9b	Tor
PE3CC	XC9226E3CCD	DC/DC-IC	PWM/PFM step-down, 1.2MHz, 3.25V±1%, 900mA, +CE	USP-6B	49dc5	DC1	9b	Tor
PE3D6	XC9226E3D6D	DC/DC-IC	PWM/PFM step-down, 600kHz, 3.35V±1%, 900mA, +CE	USP-6B	49dc5	DC1	9b	Tor
PE3DC	XC9226E3DCD	DC/DC-IC	PWM/PFM step-down, 1.2MHz, 3.35V±1%, 900mA, +CE	USP-6B	49dc5	DC1	9b	Tor
PE3E6	XC9226E3E6D	DC/DC-IC	PWM/PFM step-down, 600kHz, 3.45V±1%, 900mA, +CE	USP-6B	49dc5	DC1	9b	Tor
PE3EC	XC9226E3ECD	DC/DC-IC	PWM/PFM step-down, 1.2MHz, 3.45V±1%, 900mA, +CE	USP-6B	49dc5	DC1	9b	Tor



SMD code	Type	Function	Short description	Case	Pinout	Sch.	St.	Mnf.
PE3F6	XC9226E3F6D	DC/DC-IC	PWM/PFM step-down, 600kHz, 3.55V±1%, 900mA, +CE	USP-6B	49dc5	DC1	9b	Tor
PE3FC	XC9226E3FC	DC/DC-IC	PWM/PFM step-down, 1.2MHz, 3.55V±1%, 900mA, +CE	USP-6B	49dc5	DC1	9b	Tor
PE3H6	XC9226E3H6D	DC/DC-IC	PWM/PFM step-down, 600kHz, 3.65V±1%, 900mA, +CE	USP-6B	49dc5	DC1	9b	Tor
PE3HC	XC9226E3HCD	DC/DC-IC	PWM/PFM step-down, 1.2MHz, 3.65V±1%, 900mA, +CE	USP-6B	49dc5	DC1	9b	Tor
PE3K6	XC9226E3K6D	DC/DC-IC	PWM/PFM step-down, 600kHz, 3.75V±1%, 900mA, +CE	USP-6B	49dc5	DC1	9b	Tor
PE3KC	XC9226E3KCD	DC/DC-IC	PWM/PFM step-down, 1.2MHz, 3.75V±1%, 900mA, +CE	USP-6B	49dc5	DC1	9b	Tor
PE3L6	XC9226E3L6D	DC/DC-IC	PWM/PFM step-down, 600kHz, 3.85V±1%, 900mA, +CE	USP-6B	49dc5	DC1	9b	Tor
PE3LC	XC9226E3LCD	DC/DC-IC	PWM/PFM step-down, 1.2MHz, 3.85V±1%, 900mA, +CE	USP-6B	49dc5	DC1	9b	Tor
PE3M6	XC9226E3M6D	DC/DC-IC	PWM/PFM step-down, 600kHz, 3.95V±1%, 900mA, +CE	USP-6B	49dc5	DC1	9b	Tor
PE3MC	XC9226E3MCD	DC/DC-IC	PWM/PFM step-down, 1.2MHz, 3.95V±1%, 900mA, +CE	USP-6B	49dc5	DC1	9b	Tor
PE406	XC9226E406D	DC/DC-IC	PWM/PFM step-down, 600kHz, 4.0V±1%, 900mA, +CE	USP-6B	49dc5	DC1	9b	Tor
PE40C	XC9226E40CD	DC/DC-IC	PWM/PFM step-down, 1.2MHz, 4.0V±1%, 900mA, +CE	USP-6B	49dc5	DC1	9b	Tor
pF	74AUP1G14GF	CMOS-Logic	Inverting Schmitt-trigger	SOT891	52LLog7	-	9c	Phi
pF	74AUP1G14GM	CMOS-Logic	Inverting Schmitt-trigger	SOT-886	57LLog7	-	9c	Phi
PF	R1118K121D5	LVR-IC	1.25V±1%, 150mA, +CE, CL	DFM1612-4B	45vm	VR4	9a	Ric
PF	RP106K121D	LVR-IC	LDO, 1.2V±0.8%, 400mA, +CE, CL	DFN1212-6	52vr2	VR4	9a	Ric
PF306	XC9226F306D	DC/DC-IC	PWM/PFM step-down, 600kHz, 3.0V±1%, 900mA, -CE	USP-6B	49dc5	DC1	9b	Tor
PF30C	XC9226F30CD	DC/DC-IC	PWM/PFM step-down, 1.2MHz, 3.0V±1%, 900mA, -CE	USP-6B	49dc5	DC1	9b	Tor
PF316	XC9226F316D	DC/DC-IC	PWM/PFM step-down, 600kHz, 3.1V±1%, 900mA, -CE	USP-6B	49dc5	DC1	9b	Tor
PF31C	XC9226F31CD	DC/DC-IC	PWM/PFM step-down, 1.2MHz, 3.1V±1%, 900mA, -CE	USP-6B	49dc5	DC1	9b	Tor
PF326	XC9226F326D	DC/DC-IC	PWM/PFM step-down, 600kHz, 3.2V±1%, 900mA, -CE	USP-6B	49dc5	DC1	9b	Tor
PF32C	XC9226F32CD	DC/DC-IC	PWM/PFM step-down, 1.2MHz, 3.2V±1%, 900mA, -CE	USP-6B	49dc5	DC1	9b	Tor
PF336	XC9226F336D	DC/DC-IC	PWM/PFM step-down, 600kHz, 3.3V±1%, 900mA, -CE	USP-6B	49dc5	DC1	9b	Tor
PF33C	XC9226F33CD	DC/DC-IC	PWM/PFM step-down, 1.2MHz, 3.3V±1%, 900mA, -CE	USP-6B	49dc5	DC1	9b	Tor
PF346	XC9226F346D	DC/DC-IC	PWM/PFM step-down, 600kHz, 3.4V±1%, 900mA, -CE	USP-6B	49dc5	DC1	9b	Tor
PF34C	XC9226F34CD	DC/DC-IC	PWM/PFM step-down, 1.2MHz, 3.4V±1%, 900mA, -CE	USP-6B	49dc5	DC1	9b	Tor
PF356	XC9226F356D	DC/DC-IC	PWM/PFM step-down, 600kHz, 3.5V±1%, 900mA, -CE	USP-6B	49dc5	DC1	9b	Tor
PF35C	XC9226F35CD	DC/DC-IC	PWM/PFM step-down, 1.2MHz, 3.5V±1%, 900mA, -CE	USP-6B	49dc5	DC1	9b	Tor
PF366	XC9226F366D	DC/DC-IC	PWM/PFM step-down, 600kHz, 3.6V±1%, 900mA, -CE	USP-6B	49dc5	DC1	9b	Tor
PF36C	XC9226F36CD	DC/DC-IC	PWM/PFM step-down, 1.2MHz, 3.6V±1%, 900mA, -CE	USP-6B	49dc5	DC1	9b	Tor
PF376	XC9226F376D	DC/DC-IC	PWM/PFM step-down, 600kHz, 3.7V±1%, 900mA, -CE	USP-6B	49dc5	DC1	9b	Tor
PF37C	XC9226F37CD	DC/DC-IC	PWM/PFM step-down, 1.2MHz, 3.7V±1%, 900mA, -CE	USP-6B	49dc5	DC1	9b	Tor
PF386	XC9226F386D	DC/DC-IC	PWM/PFM step-down, 600kHz, 3.8V±1%, 900mA, -CE	USP-6B	49dc5	DC1	9b	Tor
PF38C	XC9226F38CD	DC/DC-IC	PWM/PFM step-down, 1.2MHz, 3.8V±1%, 900mA, -CE	USP-6B	49dc5	DC1	9b	Tor
PF396	XC9226F396D	DC/DC-IC	PWM/PFM step-down, 600kHz, 3.9V±1%, 900mA, -CE	USP-6B	49dc5	DC1	9b	Tor
PF39C	XC9226F39CD	DC/DC-IC	PWM/PFM step-down, 1.2MHz, 3.9V±1%, 900mA, -CE	USP-6B	49dc5	DC1	9b	Tor
PF3A6	XC9226F3A6D	DC/DC-IC	PWM/PFM step-down, 600kHz, 3.05V±1%, 900mA, -CE	USP-6B	49dc5	DC1	9b	Tor
PF3AC	XC9226F3ACD	DC/DC-IC	PWM/PFM step-down, 1.2MHz, 3.05V±1%, 900mA, -CE	USP-6B	49dc5	DC1	9b	Tor
PF3B6	XC9226F3B6D	DC/DC-IC	PWM/PFM step-down, 600kHz, 3.15V±1%, 900mA, -CE	USP-6B	49dc5	DC1	9b	Tor
PF3BC	XC9226F3BCD	DC/DC-IC	PWM/PFM step-down, 1.2MHz, 3.15V±1%, 900mA, -CE	USP-6B	49dc5	DC1	9b	Tor
PF3C6	XC9226F3C6D	DC/DC-IC	PWM/PFM step-down, 600kHz, 3.25V±1%, 900mA, -CE	USP-6B	49dc5	DC1	9b	Tor
PF3CC	XC9226F3CCD	DC/DC-IC	PWM/PFM step-down, 1.2MHz, 3.25V±1%, 900mA, -CE	USP-6B	49dc5	DC1	9b	Tor
PF3D6	XC9226F3D6D	DC/DC-IC	PWM/PFM step-down, 600kHz, 3.35V±1%, 900mA, -CE	USP-6B	49dc5	DC1	9b	Tor
PF3DC	XC9226F3DCD	DC/DC-IC	PWM/PFM step-down, 1.2MHz, 3.35V±1%, 900mA, -CE	USP-6B	49dc5	DC1	9b	Tor
PF3E6	XC9226F3E6D	DC/DC-IC	PWM/PFM step-down, 600kHz, 3.45V±1%, 900mA, -CE	USP-6B	49dc5	DC1	9b	Tor
PF3EC	XC9226F3ECD	DC/DC-IC	PWM/PFM step-down, 1.2MHz, 3.45V±1%, 900mA, -CE	USP-6B	49dc5	DC1	9b	Tor
PF3F6	XC9226F3F6D	DC/DC-IC	PWM/PFM step-down, 600kHz, 3.55V±1%, 900mA, -CE	USP-6B	49dc5	DC1	9b	Tor
PF3FC	XC9226F3FCD	DC/DC-IC	PWM/PFM step-down, 1.2MHz, 3.55V±1%, 900mA, -CE	USP-6B	49dc5	DC1	9b	Tor
PF3H6	XC9226F3H6D	DC/DC-IC	PWM/PFM step-down, 600kHz, 3.65V±1%, 900mA, -CE	USP-6B	49dc5	DC1	9b	Tor
PF3HC	XC9226F3HCD	DC/DC-IC	PWM/PFM step-down, 1.2MHz, 3.65V±1%, 900mA, -CE	USP-6B	49dc5	DC1	9b	Tor
PF3K6	XC9226F3K6D	DC/DC-IC	PWM/PFM step-down, 600kHz, 3.75V±1%, 900mA, -CE	USP-6B	49dc5	DC1	9b	Tor
PF3KC	XC9226F3KCD	DC/DC-IC	PWM/PFM step-down, 1.2MHz, 3.75V±1%, 900mA, -CE	USP-6B	49dc5	DC1	9b	Tor
PF3L6	XC9226F3L6D	DC/DC-IC	PWM/PFM step-down, 600kHz, 3.85V±1%, 900mA, -CE	USP-6B	49dc5	DC1	9b	Tor
PF3LC	XC9226F3LCD	DC/DC-IC	PWM/PFM step-down, 1.2MHz, 3.85V±1%, 900mA, -CE	USP-6B	49dc5	DC1	9b	Tor
PF3M6	XC9226F3M6D	DC/DC-IC	PWM/PFM step-down, 600kHz, 3.95V±1%, 900mA, -CE	USP-6B	49dc5	DC1	9b	Tor
PF3MC	XC9226F3MCD	DC/DC-IC	PWM/PFM step-down, 1.2MHz, 3.95V±1%, 900mA, -CE	USP-6B	49dc5	DC1	9b	Tor
PF406	XC9226F406D	DC/DC-IC	PWM/PFM step-down, 600kHz, 4.0V±1%, 900mA, -CE	USP-6B	49dc5	DC1	9b	Tor
PF40C	XC9226F40CD	DC/DC-IC	PWM/PFM step-down, 1.2MHz, 4.0V±1%, 900mA, -CE	USP-6B	49dc5	DC1	9b	Tor
pG	74AUP1G32GF	CMOS-Logic	2-input OR gate	SOT891	52LLog4	-	9c	Phi
pG	74AUP1G32GM	CMOS-Logic	2-input OR gate	SOT-886	57LLog4	-	9c	Phi
PG	R1118K131D	LVR-IC	1.3V±1%, 150mA, +CE, CL	DFM1612-4B	45vm	VR4	9a	Ric
PG	RP106K131D	LVR-IC	LDO, 1.3V±0.8%, 400mA, +CE, CL	DFN1212-6	52vr2	VR4	9a	Ric
pH	74AUP1G86GF	CMOS-Logic	2-input EXCLUSIVE-OR gate	SOT891	52LLog5	-	9c	Phi
pH	74AUP1G86GM	CMOS-Logic	2-input EXCLUSIVE-OR gate	SOT-886	57LLog5	-	9c	Phi
PH	R1118K141D	LVR-IC	1.4V±1%, 150mA, +CE, CL	DFM1612-4B	45vm	VR4	9a	Ric
PH	RP106K141D	LVR-IC	LDO, 1.4V±0.8%, 400mA, +CE, CL	DFN1212-6	52vr2	VR4	9a	Ric
PH306	XC9226H306D	DC/DC-IC	PWM/PFM step-down, 600kHz, 3.0V±1%, 900mA, -CE, PDR	USP-6B	49dc5	DC1	9b	Tor
PH30C	XC9226H30CD	DC/DC-IC	PWM/PFM step-down, 1.2MHz, 3.0V±1%, 900mA, -CE, PDR	USP-6B	49dc5	DC1	9b	Tor
PH316	XC9226H316D	DC/DC-IC	PWM/PFM step-down, 600kHz, 3.1V±1%, 900mA, -CE, PDR	USP-6B	49dc5	DC1	9b	Tor
PH31C	XC9226H31CD	DC/DC-IC	PWM/PFM step-down, 1.2MHz, 3.1V±1%, 900mA, -CE, PDR	USP-6B	49dc5	DC1	9b	Tor



SMD code	Type	Function	Short description	Case	Pinout	Sch.	St.	Mnf.
PH326	XC9226H326D	DC/DC-IC	PWM/PFM step-down, 600kHz, 3.2V±1%, 900mA, -CE, PDR	USP-6B	49dc5	DC1	9b	Tor
PH32C	XC9226H32CD	DC/DC-IC	PWM/PFM step-down, 1.2MHz, 3.2V±1%, 900mA, -CE, PDR	USP-6B	49dc5	DC1	9b	Tor
PH336	XC9226H336D	DC/DC-IC	PWM/PFM step-down, 600kHz, 3.3V±1%, 900mA, -CE, PDR	USP-6B	49dc5	DC1	9b	Tor
PH33C	XC9226H33CD	DC/DC-IC	PWM/PFM step-down, 1.2MHz, 3.3V±1%, 900mA, -CE, PDR	USP-6B	49dc5	DC1	9b	Tor
PH346	XC9226H346D	DC/DC-IC	PWM/PFM step-down, 600kHz, 3.4V±1%, 900mA, -CE, PDR	USP-6B	49dc5	DC1	9b	Tor
PH34C	XC9226H34CD	DC/DC-IC	PWM/PFM step-down, 1.2MHz, 3.4V±1%, 900mA, -CE, PDR	USP-6B	49dc5	DC1	9b	Tor
PH356	XC9226H356D	DC/DC-IC	PWM/PFM step-down, 600kHz, 3.5V±1%, 900mA, -CE, PDR	USP-6B	49dc5	DC1	9b	Tor
PH35C	XC9226H35CD	DC/DC-IC	PWM/PFM step-down, 1.2MHz, 3.5V±1%, 900mA, -CE, PDR	USP-6B	49dc5	DC1	9b	Tor
PH366	XC9226H366D	DC/DC-IC	PWM/PFM step-down, 600kHz, 3.6V±1%, 900mA, -CE, PDR	USP-6B	49dc5	DC1	9b	Tor
PH36C	XC9226H36CD	DC/DC-IC	PWM/PFM step-down, 1.2MHz, 3.6V±1%, 900mA, -CE, PDR	USP-6B	49dc5	DC1	9b	Tor
PH376	XC9226H376D	DC/DC-IC	PWM/PFM step-down, 600kHz, 3.7V±1%, 900mA, -CE, PDR	USP-6B	49dc5	DC1	9b	Tor
PH37C	XC9226H37CD	DC/DC-IC	PWM/PFM step-down, 1.2MHz, 3.7V±1%, 900mA, -CE, PDR	USP-6B	49dc5	DC1	9b	Tor
PH386	XC9226H386D	DC/DC-IC	PWM/PFM step-down, 600kHz, 3.8V±1%, 900mA, -CE, PDR	USP-6B	49dc5	DC1	9b	Tor
PH38C	XC9226H38CD	DC/DC-IC	PWM/PFM step-down, 1.2MHz, 3.8V±1%, 900mA, -CE, PDR	USP-6B	49dc5	DC1	9b	Tor
PH396	XC9226H396D	DC/DC-IC	PWM/PFM step-down, 600kHz, 3.9V±1%, 900mA, -CE, PDR	USP-6B	49dc5	DC1	9b	Tor
PH39C	XC9226H39CD	DC/DC-IC	PWM/PFM step-down, 1.2MHz, 3.9V±1%, 900mA, -CE, PDR	USP-6B	49dc5	DC1	9b	Tor
PH3A6	XC9226H3A6D	DC/DC-IC	PWM/PFM step-down, 600kHz, 3.05V±1%, 900mA, -CE, PDR	USP-6B	49dc5	DC1	9b	Tor
PH3AC	XC9226H3ACD	DC/DC-IC	PWM/PFM step-down, 1.2MHz, 3.05V±1%, 900mA, -CE, PDR	USP-6B	49dc5	DC1	9b	Tor
PH3B6	XC9226H3B6D	DC/DC-IC	PWM/PFM step-down, 600kHz, 3.15V±1%, 900mA, -CE, PDR	USP-6B	49dc5	DC1	9b	Tor
PH3BC	XC9226H3BCD	DC/DC-IC	PWM/PFM step-down, 1.2MHz, 3.15V±1%, 900mA, -CE, PDR	USP-6B	49dc5	DC1	9b	Tor
PH3C6	XC9226H3C6D	DC/DC-IC	PWM/PFM step-down, 600kHz, 3.25V±1%, 900mA, -CE, PDR	USP-6B	49dc5	DC1	9b	Tor
PH3CC	XC9226H3CCD	DC/DC-IC	PWM/PFM step-down, 1.2MHz, 3.25V±1%, 900mA, -CE, PDR	USP-6B	49dc5	DC1	9b	Tor
PH3D6	XC9226H3D6D	DC/DC-IC	PWM/PFM step-down, 600kHz, 3.35V±1%, 900mA, -CE, PDR	USP-6B	49dc5	DC1	9b	Tor
PH3DC	XC9226H3DCD	DC/DC-IC	PWM/PFM step-down, 1.2MHz, 3.35V±1%, 900mA, -CE, PDR	USP-6B	49dc5	DC1	9b	Tor
PH3E6	XC9226H3E6D	DC/DC-IC	PWM/PFM step-down, 600kHz, 3.45V±1%, 900mA, -CE, PDR	USP-6B	49dc5	DC1	9b	Tor
PH3EC	XC9226H3ECD	DC/DC-IC	PWM/PFM step-down, 1.2MHz, 3.45V±1%, 900mA, -CE, PDR	USP-6B	49dc5	DC1	9b	Tor
PH3F6	XC9226H3F6D	DC/DC-IC	PWM/PFM step-down, 600kHz, 3.55V±1%, 900mA, -CE, PDR	USP-6B	49dc5	DC1	9b	Tor
PH3FC	XC9226H3FCD	DC/DC-IC	PWM/PFM step-down, 1.2MHz, 3.55V±1%, 900mA, -CE, PDR	USP-6B	49dc5	DC1	9b	Tor
PH3H6	XC9226H3H6D	DC/DC-IC	PWM/PFM step-down, 600kHz, 3.65V±1%, 900mA, -CE, PDR	USP-6B	49dc5	DC1	9b	Tor
PH3HC	XC9226H3HCD	DC/DC-IC	PWM/PFM step-down, 1.2MHz, 3.65V±1%, 900mA, -CE, PDR	USP-6B	49dc5	DC1	9b	Tor
PH3K6	XC9226H3K6D	DC/DC-IC	PWM/PFM step-down, 600kHz, 3.75V±1%, 900mA, -CE, PDR	USP-6B	49dc5	DC1	9b	Tor
PH3KC	XC9226H3KCD	DC/DC-IC	PWM/PFM step-down, 1.2MHz, 3.75V±1%, 900mA, -CE, PDR	USP-6B	49dc5	DC1	9b	Tor
PH3L6	XC9226H3L6D	DC/DC-IC	PWM/PFM step-down, 600kHz, 3.85V±1%, 900mA, -CE, PDR	USP-6B	49dc5	DC1	9b	Tor
PH3LC	XC9226H3LCD	DC/DC-IC	PWM/PFM step-down, 1.2MHz, 3.85V±1%, 900mA, -CE, PDR	USP-6B	49dc5	DC1	9b	Tor
PH3M6	XC9226H3M6D	DC/DC-IC	PWM/PFM step-down, 600kHz, 3.95V±1%, 900mA, -CE, PDR	USP-6B	49dc5	DC1	9b	Tor
PH3MC	XC9226H3MCD	DC/DC-IC	PWM/PFM step-down, 1.2MHz, 3.95V±1%, 900mA, -CE, PDR	USP-6B	49dc5	DC1	9b	Tor
PH406	XC9226H406D	DC/DC-IC	PWM/PFM step-down, 600kHz, 4.0V±1%, 900mA, -CE, PDR	USP-6B	49dc5	DC1	9b	Tor
PH40C	XC9226H40CD	DC/DC-IC	PWM/PFM step-down, 1.2MHz, 4.0V±1%, 900mA, -CE, PDR	USP-6B	49dc5	DC1	9b	Tor
PHH	XC6602A111ER-G	LVR-IC	LDO, 1.1V±15mV, 1A, +CE, soft start	USP-6C	49gm	VR11	9a	Tor
pJ	74AUP1G17GF	CMOS-Logic	Schmitt-trigger	SOT891	52Log11	-	9c	Phi
pJ	74AUP1G17GM	CMOS-Logic	Schmitt-trigger	SOT-886	57Log11	-	9c	Phi
PJ	R1118K151D	LVR-IC	1.5V±1%, 150mA, +CE, CL	DFN1612-4B	45vm	VR4	9a	Ric
PJ	RP106K151D	LVR-IC	LDO, 1.5V±0.8%, 400mA, +CE, CL	DFN1212-6	52v2r	VR4	9a	Ric
pK	74AUP2G14GF	CMOS-Logic	Dual Schmitt-trigger inverter buffers	SOT891	52Log34	-	9c	Phi
pK	74AUP2G14GM	CMOS-Logic	Dual Schmitt-trigger inverter buffers	SOT-886	57Log34	-	9c	Phi
PK	R1118K161D	LVR-IC	1.6V±1%, 150mA, +CE, CL	DFN1612-4B	45vm	VR4	9a	Ric
PK	RP106K161D	LVR-IC	LDO, 1.6V±0.8%, 400mA, +CE, CL	DFN1212-6	52v2r	VR4	9a	Ric
PKK	XC6602A121ER-G	LVR-IC	LDO, 1.2V±20mV, 1A, +CE, soft start	USP-6C	49gm	VR11	9a	Tor
PL	R1118K171D	LVR-IC	1.7V±1%, 150mA, +CE, CL	DFN1612-4B	45vm	VR4	9a	Ric
PL	RP106K171D	LVR-IC	LDO, 1.7V±0.8%, 400mA, +CE, CL	DFN1212-6	52v2r	VR4	9a	Ric
PLL	XC6602A131ER-G	LVR-IC	LDO, 1.3V±20mV, 1A, +CE, soft start	USP-6C	49gm	VR11	9a	Tor
pM	74AUP1G125GF	CMOS-Logic	Bus buffer gate with 3-state output	SOT891	52Log14	-	9c	Phi
pM	74AUP1G125GM	CMOS-Logic	Bus buffer gate with 3-state output	SOT-886	57Log14	-	9c	Phi
PM	R1118K181D	LVR-IC	1.8V±1%, 150mA, +CE, CL	DFN1612-4B	45vm	VR4	9a	Ric
PM	RP106K181D	LVR-IC	LDO, 1.8V±0.8%, 400mA, +CE, CL	DFN1212-6	52v2r	VR4	9a	Ric
PMA	NCP2823BFC	LIN-IC	AF PA, BTL, class-D, 2.5..5.5V, 3W(5V/8Ω), shutdown	BGA-9	39	AFP45	9o	Oms
pN	74AUP1G126GF	CMOS-Logic	Bus buffer gate with 3-state output	SOT891	52Log13	-	9c	Phi
pN	74AUP1G126GM	CMOS-Logic	Bus buffer gate with 3-state output	SOT-886	57Log13	-	9c	Phi
PN	R1118K181D5	LVR-IC	1.85V±1%, 150mA, +CE, CL	DFN1612-4B	45vm	VR4	9a	Ric
PN	RP106K101D5	LVR-IC	LDO, 1.05V±0.8%, 400mA, +CE, CL	DFN1212-6	52v2r	VR4	9a	Ric
PN20A	XC31BPN20AD	Tdet-IC	Sensor (-30..+80°C); t=25°C- Vout=2V±3%	USP-6B	49xr	VR4	9b	Tor
PN21A	XC31BPN21AD	Tdet-IC	Sensor (-30..+80°C); t=25°C- Vout=2.1V±3%	USP-6B	49xr	VR4	9b	Tor
PN22A	XC31BPN22AD	Tdet-IC	Sensor (-30..+80°C); t=25°C- Vout=2.2V±3%	USP-6B	49xr	VR4	9b	Tor
PN23A	XC31BPN23AD	Tdet-IC	Sensor (-30..+80°C); t=25°C- Vout=2.3V±3%	USP-6B	49xr	VR4	9b	Tor
PN24A	XC31BPN24AD	Tdet-IC	Sensor (-30..+80°C); t=25°C- Vout=2.4V±3%	USP-6B	49xr	VR4	9b	Tor
PN25A	XC31BPN25AD	Tdet-IC	Sensor (-30..+80°C); t=25°C- Vout=2.5V±3%	USP-6B	49xr	VR4	9b	Tor
PN26A	XC31BPN26AD	Tdet-IC	Sensor (-30..+80°C); t=25°C- Vout=2.6V±3%	USP-6B	49xr	VR4	9b	Tor
PN27A	XC31BPN27AD	Tdet-IC	Sensor (-30..+80°C); t=25°C- Vout=2.7V±3%	USP-6B	49xr	VR4	9b	Tor
PN28A	XC31BPN28AD	Tdet-IC	Sensor (-30..+80°C); t=25°C- Vout=2.8V±3%	USP-6B	49xr	VR4	9b	Tor
PN29A	XC31BPN29AD	Tdet-IC	Sensor (-30..+80°C); t=25°C- Vout=2.9V±3%	USP-6B	49xr	VR4	9b	Tor



SMD code	Type	Function	Short description	Case	Pinout	Sch.	St.	Mnf.
PN30A	XC31BPN30AD	Tdet-IC	Sensor (-30...+80°C); t=25°C- Vout=3V±3%	USP-6B	49xr	VR4	9b	Tor
PN31A	XC31BPN31AD	Tdet-IC	Sensor (-30...+80°C); t=25°C- Vout=3.1V±3%	USP-6B	49xr	VR4	9b	Tor
PN32A	XC31BPN32AD	Tdet-IC	Sensor (-30...+80°C); t=25°C- Vout=3.1V±3%	USP-6B	49xr	VR4	9b	Tor
PN33A	XC31BPN33AD	Tdet-IC	Sensor (-30...+80°C); t=25°C- Vout=3.3V±3%	USP-6B	49xr	VR4	9b	Tor
PN34A	XC31BPN34AD	Tdet-IC	Sensor (-30...+80°C); t=25°C- Vout=3.4V±3%	USP-6B	49xr	VR4	9b	Tor
PN35A	XC31BPN35AD	Tdet-IC	Sensor (-30...+80°C); t=25°C- Vout=3.5V±3%	USP-6B	49xr	VR4	9b	Tor
PN36A	XC31BPN36AD	Tdet-IC	Sensor (-30...+80°C); t=25°C- Vout=3.6V±3%	USP-6B	49xr	VR4	9b	Tor
PN37A	XC31BPN37AD	Tdet-IC	Sensor (-30...+80°C); t=25°C- Vout=3.7V±3%	USP-6B	49xr	VR4	9b	Tor
PN38A	XC31BPN38AD	Tdet-IC	Sensor (-30...+80°C); t=25°C- Vout=3.8V±3%	USP-6B	49xr	VR4	9b	Tor
PN39A	XC31BPN39AD	Tdet-IC	Sensor (-30...+80°C); t=25°C- Vout=3.9V±3%	USP-6B	49xr	VR4	9b	Tor
PN40A	XC31BPN40AD	Tdet-IC	Sensor (-30...+80°C); t=25°C- Vout=4V±3%	USP-6B	49xr	VR4	9b	Tor
PN41A	XC31BPN41AD	Tdet-IC	Sensor (-30...+80°C); t=25°C- Vout=4.1V±3%	USP-6B	49xr	VR4	9b	Tor
PN42A	XC31BPN42AD	Tdet-IC	Sensor (-30...+80°C); t=25°C- Vout=4.2V±3%	USP-6B	49xr	VR4	9b	Tor
PN43A	XC31BPN43AD	Tdet-IC	Sensor (-30...+80°C); t=25°C- Vout=4.3V±3%	USP-6B	49xr	VR4	9b	Tor
PN44A	XC31BPN44AD	Tdet-IC	Sensor (-30...+80°C); t=25°C- Vout=4.4V±3%	USP-6B	49xr	VR4	9b	Tor
PN45A	XC31BPN45AD	Tdet-IC	Sensor (-30...+80°C); t=25°C- Vout=4.5V±3%	USP-6B	49xr	VR4	9b	Tor
PN46A	XC31BPN46AD	Tdet-IC	Sensor (-30...+80°C); t=25°C- Vout=4.6V±3%	USP-6B	49xr	VR4	9b	Tor
PN47A	XC31BPN47AD	Tdet-IC	Sensor (-30...+80°C); t=25°C- Vout=4.7V±3%	USP-6B	49xr	VR4	9b	Tor
PN48A	XC31BPN48AD	Tdet-IC	Sensor (-30...+80°C); t=25°C- Vout=4.8V±3%	USP-6B	49xr	VR4	9b	Tor
PN49A	XC31BPN49AD	Tdet-IC	Sensor (-30...+80°C); t=25°C- Vout=4.9V±3%	USP-6B	49xr	VR4	9b	Tor
PN50A	XC31BPN50AD	Tdet-IC	Sensor (-30...+80°C); t=25°C- Vout=5V±3%	USP-6B	49xr	VR4	9b	Tor
PN51A	XC31BPN51AD	Tdet-IC	Sensor (-30...+80°C); t=25°C- Vout=5.1V±3%	USP-6B	49xr	VR4	9b	Tor
PN52A	XC31BPN52AD	Tdet-IC	Sensor (-30...+80°C); t=25°C- Vout=5.2V±3%	USP-6B	49xr	VR4	9b	Tor
PN53A	XC31BPN53AD	Tdet-IC	Sensor (-30...+80°C); t=25°C- Vout=5.3V±3%	USP-6B	49xr	VR4	9b	Tor
PN54A	XC31BPN54AD	Tdet-IC	Sensor (-30...+80°C); t=25°C- Vout=5.4V±3%	USP-6B	49xr	VR4	9b	Tor
PN55A	XC31BPN55AD	Tdet-IC	Sensor (-30...+80°C); t=25°C- Vout=5.5V±3%	USP-6B	49xr	VR4	9b	Tor
PN56A	XC31BPN56AD	Tdet-IC	Sensor (-30...+80°C); t=25°C- Vout=5.6V±3%	USP-6B	49xr	VR4	9b	Tor
PN57A	XC31BPN57AD	Tdet-IC	Sensor (-30...+80°C); t=25°C- Vout=5.7V±3%	USP-6B	49xr	VR4	9b	Tor
PN58A	XC31BPN58AD	Tdet-IC	Sensor (-30...+80°C); t=25°C- Vout=5.8V±3%	USP-6B	49xr	VR4	9b	Tor
PN59A	XC31BPN59AD	Tdet-IC	Sensor (-30...+80°C); t=25°C- Vout=5.9V±3%	USP-6B	49xr	VR4	9b	Tor
PN60A	XC31BPN60AD	Tdet-IC	Sensor (-30...+80°C); t=25°C- Vout=6V±3%	USP-6B	49xr	VR4	9b	Tor
pP	74AUP1G79GF	CMOS-Logic	Positive edge-triggered D-type flip-flop	SOT891	52Log20	-	9c	Phi
pP	74AUP1G79GM	CMOS-Logic	Positive edge-triggered D-type flip-flop	SOT-886	57Log20	-	9c	Phi
PP	R1118K191D	LVR-IC	1.9V±1%, 150mA, +CE, CL	DFN1612-4B	45vm	VR4	9a	Ric
PP	RP106K121D5	LVR-IC	LDO, 1.25V±0.8%, 400mA, +CE, CL	DFN1212-6	52vr2	VR4	9a	Ric
pQ	74AUP1T34GF	CMOS-Logic	Dual supply translating buffer	SOT891	52Log78	-	9c	Phi
pQ	74AUP1T34GM	CMOS-Logic	Dual supply translating buffer	SOT-886	57Log78	-	9c	Phi
PQ	R1118K201D	LVR-IC	2V±1%, 150mA, +CE, CL	DFN1612-4B	45vm	VR4	9a	Ric
PQ	RP106K181D5	LVR-IC	LDO, 1.85V±0.8%, 400mA, +CE, CL	DFN1212-6	52vr2	VR4	9a	Ric
pR	74AUP1G06GF	CMOS-Logic	Inverter (ODO)	SOT891	52Log19	-	9c	Phi
pR	74AUP1G06GM	CMOS-Logic	Inverter (ODO)	SOT-886	57Log19	-	9c	Phi
PR	R1118K211D	LVR-IC	2.1V±1%, 150mA, +CE, CL	DFN1612-4B	45vm	VR4	9a	Ric
PR	RP106K111D5	LVR-IC	LDO, 1.15V±0.8%, 400mA, +CE, CL	DFN1212-6	52vr2	VR4	9a	Ric
pS	74AUP1G07GF	CMOS-Logic	Noninverting buffer/driver (ODO)	SOT891	52Log8	-	9c	Phi
pS	74AUP1G07GM	CMOS-Logic	Noninverting buffer/driver (ODO)	SOT-886	57Log8	-	9c	Phi
PS	R1118K221D	LVR-IC	2.2V±1%, 150mA, +CE, CL	DFN1612-4B	45vm	VR4	9a	Ric
pS8	74AUP1G885GD	CMOS-Logic	Dual function gate	SOT996-2	51Log61	-	9a	Phi
pS8	74AUP1G885GM	CMOS-Logic	Dual function gate	SOT902-1	51Log61	-	9a	Phi
pS8	74AUP1G885GT	CMOS-Logic	Dual function gate	SOT833-1	53Log61	-	9c	Phi
pT	74AUP1G80GF	CMOS-Logic	Positive edge-triggered D-type flip-flop	SOT891	52Log21	-	9c	Phi
pT	74AUP1G80GM	CMOS-Logic	Positive edge-triggered D-type flip-flop	SOT-886	57Log21	-	9c	Phi
PT	R1118K231D	LVR-IC	2.3V±1%, 150mA, +CE, CL	DFN1612-4B	45vm	VR4	9a	Ric
pU	74AUP1G11GF	CMOS-Logic	3-input AND gate	SOT891	52Log30	-	9c	Phi
pU	74AUP1G11GM	CMOS-Logic	3-input AND gate	SOT-886	57Log30	-	9c	Phi
PU	R1118K241D	LVR-IC	2.4V±1%, 150mA, +CE, CL	DFN1612-4B	45vm	VR4	9a	Ric
PV	R1118K251D	LVR-IC	2.5V±1%, 150mA, +CE, CL	DFN1612-4B	45vm	VR4	9a	Ric
pW	74AUP1G18GF	CMOS-Logic	Noninverting 1-of-2 demultiplexer with 3-state deselected output	SOT891	52Log44	-	9c	Phi
pW	74AUP1G18GM	CMOS-Logic	Noninverting 1-of-2 demultiplexer with 3-state deselected output	SOT-886	57Log44	-	9c	Phi
PW	R1118K261D	LVR-IC	2.6V±1%, 150mA, +CE, CL	DFN1612-4B	45vm	VR4	9a	Ric
PX	R1118K271D	LVR-IC	2.7V±1%, 150mA, +CE, CL	DFN1612-4B	45vm	VR4	9a	Ric
pY	74AUP1G19GF	CMOS-Logic	1-of-2 decoder/demultiplexer	SOT891	52Log47	-	9c	Phi
pY	74AUP1G19GM	CMOS-Logic	1-of-2 decoder/demultiplexer	SOT-886	57Log47	-	9c	Phi
PY	R1118K281D	LVR-IC	2.8V±1%, 150mA, +CE, CL	DFN1612-4B	45vm	VR4	9a	Ric
PZ	R1118K281D5	LVR-IC	2.85V±1%, 150mA, +CE, CL	DFN1612-4B	45vm	VR4	9a	Ric
PZ306	XC9226G306D	DC/DC-IC	PWM/PFM step-down, 600kHz, 3.0V±1%, 900mA, +CE, PDR	USP-6B	49dc5	DC1	9b	Tor
PZ30C	XC9226G306CD	DC/DC-IC	PWM/PFM step-down, 1.2MHz, 3.0V±1%, 900mA, +CE, PDR	USP-6B	49dc5	DC1	9b	Tor
PZ316	XC9226G316D	DC/DC-IC	PWM/PFM step-down, 600kHz, 3.1V±1%, 900mA, +CE, PDR	USP-6B	49dc5	DC1	9b	Tor
PZ31C	XC9226G316CD	DC/DC-IC	PWM/PFM step-down, 1.2MHz, 3.1V±1%, 900mA, +CE, PDR	USP-6B	49dc5	DC1	9b	Tor
PZ326	XC9226G326D	DC/DC-IC	PWM/PFM step-down, 600kHz, 3.2V±1%, 900mA, +CE, PDR	USP-6B	49dc5	DC1	9b	Tor
PZ32C	XC9226G326CD	DC/DC-IC	PWM/PFM step-down, 1.2MHz, 3.2V±1%, 900mA, +CE, PDR	USP-6B	49dc5	DC1	9b	Tor



SMD code	Type	Function	Short description	Case	Pinout	Sch.	St.	Mnf.
PZ336	XC9226G336D	DC/DC-IC	PWM/PFM step-down, 600kHz, 3.3V±1%, 900mA, +CE, PDR	USP-6B	49dc5	DC1	9b	Tor
PZ33C	XC9226G33CD	DC/DC-IC	PWM/PFM step-down, 1.2MHz, 3.3V±1%, 900mA, +CE, PDR	USP-6B	49dc5	DC1	9b	Tor
PZ346	XC9226G346D	DC/DC-IC	PWM/PFM step-down, 600kHz, 3.4V±1%, 900mA, +CE, PDR	USP-6B	49dc5	DC1	9b	Tor
PZ34C	XC9226G34CD	DC/DC-IC	PWM/PFM step-down, 1.2MHz, 3.4V±1%, 900mA, +CE, PDR	USP-6B	49dc5	DC1	9b	Tor
PZ356	XC9226G356D	DC/DC-IC	PWM/PFM step-down, 600kHz, 3.5V±1%, 900mA, +CE, PDR	USP-6B	49dc5	DC1	9b	Tor
PZ35C	XC9226G35CD	DC/DC-IC	PWM/PFM step-down, 1.2MHz, 3.5V±1%, 900mA, +CE, PDR	USP-6B	49dc5	DC1	9b	Tor
PZ366	XC9226G366D	DC/DC-IC	PWM/PFM step-down, 600kHz, 3.6V±1%, 900mA, +CE, PDR	USP-6B	49dc5	DC1	9b	Tor
PZ36C	XC9226G36CD	DC/DC-IC	PWM/PFM step-down, 1.2MHz, 3.6V±1%, 900mA, +CE, PDR	USP-6B	49dc5	DC1	9b	Tor
PZ376	XC9226G376D	DC/DC-IC	PWM/PFM step-down, 600kHz, 3.7V±1%, 900mA, +CE, PDR	USP-6B	49dc5	DC1	9b	Tor
PZ37C	XC9226G37CD	DC/DC-IC	PWM/PFM step-down, 1.2MHz, 3.7V±1%, 900mA, +CE, PDR	USP-6B	49dc5	DC1	9b	Tor
PZ386	XC9226G386D	DC/DC-IC	PWM/PFM step-down, 600kHz, 3.8V±1%, 900mA, +CE, PDR	USP-6B	49dc5	DC1	9b	Tor
PZ38C	XC9226G38CD	DC/DC-IC	PWM/PFM step-down, 1.2MHz, 3.8V±1%, 900mA, +CE, PDR	USP-6B	49dc5	DC1	9b	Tor
PZ396	XC9226G396D	DC/DC-IC	PWM/PFM step-down, 600kHz, 3.9V±1%, 900mA, +CE, PDR	USP-6B	49dc5	DC1	9b	Tor
PZ39C	XC9226G39CD	DC/DC-IC	PWM/PFM step-down, 1.2MHz, 3.9V±1%, 900mA, +CE, PDR	USP-6B	49dc5	DC1	9b	Tor
PZ3A6	XC9226G3A6D	DC/DC-IC	PWM/PFM step-down, 600kHz, 3.05V±1%, 900mA, +CE, PDR	USP-6B	49dc5	DC1	9b	Tor
PZ3AC	XC9226G3ACD	DC/DC-IC	PWM/PFM step-down, 1.2MHz, 3.05V±1%, 900mA, +CE, PDR	USP-6B	49dc5	DC1	9b	Tor
PZ3B6	XC9226G3B6D	DC/DC-IC	PWM/PFM step-down, 600kHz, 3.15V±1%, 900mA, +CE, PDR	USP-6B	49dc5	DC1	9b	Tor
PZ3BC	XC9226G3BCD	DC/DC-IC	PWM/PFM step-down, 1.2MHz, 3.15V±1%, 900mA, +CE, PDR	USP-6B	49dc5	DC1	9b	Tor
PZ3C6	XC9226G3C6D	DC/DC-IC	PWM/PFM step-down, 600kHz, 3.25V±1%, 900mA, +CE, PDR	USP-6B	49dc5	DC1	9b	Tor
PZ3CC	XC9226G3CCD	DC/DC-IC	PWM/PFM step-down, 1.2MHz, 3.25V±1%, 900mA, +CE, PDR	USP-6B	49dc5	DC1	9b	Tor
PZ3D6	XC9226G3D6D	DC/DC-IC	PWM/PFM step-down, 600kHz, 3.35V±1%, 900mA, +CE, PDR	USP-6B	49dc5	DC1	9b	Tor
PZ3DC	XC9226G3DCD	DC/DC-IC	PWM/PFM step-down, 1.2MHz, 3.35V±1%, 900mA, +CE, PDR	USP-6B	49dc5	DC1	9b	Tor
PZ3E6	XC9226G3E6D	DC/DC-IC	PWM/PFM step-down, 600kHz, 3.45V±1%, 900mA, +CE, PDR	USP-6B	49dc5	DC1	9b	Tor
PZ3EC	XC9226G3ECD	DC/DC-IC	PWM/PFM step-down, 1.2MHz, 3.45V±1%, 900mA, +CE, PDR	USP-6B	49dc5	DC1	9b	Tor
PZ3F6	XC9226G3F6D	DC/DC-IC	PWM/PFM step-down, 600kHz, 3.55V±1%, 900mA, +CE, PDR	USP-6B	49dc5	DC1	9b	Tor
PZ3FC	XC9226G3FCD	DC/DC-IC	PWM/PFM step-down, 1.2MHz, 3.55V±1%, 900mA, +CE, PDR	USP-6B	49dc5	DC1	9b	Tor
PZ3H6	XC9226G3H6D	DC/DC-IC	PWM/PFM step-down, 600kHz, 3.65V±1%, 900mA, +CE, PDR	USP-6B	49dc5	DC1	9b	Tor
PZ3HC	XC9226G3HCD	DC/DC-IC	PWM/PFM step-down, 1.2MHz, 3.65V±1%, 900mA, +CE, PDR	USP-6B	49dc5	DC1	9b	Tor
PZ3K6	XC9226G3K6D	DC/DC-IC	PWM/PFM step-down, 600kHz, 3.75V±1%, 900mA, +CE, PDR	USP-6B	49dc5	DC1	9b	Tor
PZ3KC	XC9226G3KCD	DC/DC-IC	PWM/PFM step-down, 1.2MHz, 3.75V±1%, 900mA, +CE, PDR	USP-6B	49dc5	DC1	9b	Tor
PZ3L6	XC9226G3L6D	DC/DC-IC	PWM/PFM step-down, 600kHz, 3.85V±1%, 900mA, +CE, PDR	USP-6B	49dc5	DC1	9b	Tor
PZ3LC	XC9226G3LCD	DC/DC-IC	PWM/PFM step-down, 1.2MHz, 3.85V±1%, 900mA, +CE, PDR	USP-6B	49dc5	DC1	9b	Tor
PZ3M6	XC9226G3M6D	DC/DC-IC	PWM/PFM step-down, 600kHz, 3.95V±1%, 900mA, +CE, PDR	USP-6B	49dc5	DC1	9b	Tor
PZ3MC	XC9226G3MCD	DC/DC-IC	PWM/PFM step-down, 1.2MHz, 3.95V±1%, 900mA, +CE, PDR	USP-6B	49dc5	DC1	9b	Tor
PZ406	XC9226G406D	DC/DC-IC	PWM/PFM step-down, 600kHz, 4.0V±1%, 900mA, +CE, PDR	USP-6B	49dc5	DC1	9b	Tor
PZ40C	XC9226G40CD	DC/DC-IC	PWM/PFM step-down, 1.2MHz, 4.0V±1%, 900mA, +CE, PDR	USP-6B	49dc5	DC1	9b	Tor
Q0	R3117K473A	Vdel-IC	4.7V±1%, -Reset ODO, Sense	DFN1010-4	48rq	VD11	9a	Ric
Q0	RP114K081D	LVR-IC	LDO, 0.8V±1%, 300mA, +CE, CL	DFN1010-4	48vm	VR4	9a	Ric
Q1	R3117K483A	Vdel-IC	4.8V±1%, -Reset ODO, Sense	DFN1010-4	48rq	VD11	9a	Ric
Q1	RP114K091D	LVR-IC	LDO, 0.9V±1%, 300mA, +CE, CL	DFN1010-4	48vm	VR4	9a	Ric
Q2	R3117K493A	Vdel-IC	4.9V±1%, -Reset ODO, Sense	DFN1010-4	48rq	VD11	9a	Ric
Q2	RP114K101D	LVR-IC	LDO, 1.0V±1%, 300mA, +CE, CL	DFN1010-4	48vm	VR4	9a	Ric
Q3	R3117K503A	Vdel-IC	5.0V±1%, -Reset ODO, Sense	DFN1010-4	48rq	VD11	9a	Ric
Q3	RP114K111D	LVR-IC	LDO, 1.1V±1%, 300mA, +CE, CL	DFN1010-4	48vm	VR4	9a	Ric
Q4	RP114K121D	LVR-IC	LDO, 1.2V±1%, 300mA, +CE, CL	DFN1010-4	48vm	VR4	9a	Ric
Q5	RP114K131D	LVR-IC	LDO, 1.3V±1%, 300mA, +CE, CL	DFN1010-4	48vm	VR4	9a	Ric
Q6	RP114K141D	LVR-IC	LDO, 1.4V±1%, 300mA, +CE, CL	DFN1010-4	48vm	VR4	9a	Ric
Q7	RP114K151D	LVR-IC	LDO, 1.5V±1%, 300mA, +CE, CL	DFN1010-4	48vm	VR4	9a	Ric
Q8	RP114K161D	LVR-IC	LDO, 1.6V±1%, 300mA, +CE, CL	DFN1010-4	48vm	VR4	9a	Ric
Q9	RP114K171D	LVR-IC	LDO, 1.7V±1%, 300mA, +CE, CL	DFN1010-4	48vm	VR4	9a	Ric
Q997	TS49971QT	LIN-IC	AF PA, BTL, 2.7..5.5V, 2x1W(5V/8Q), separate shutdown	QFN-16	38	-	-	Ste
QA	R1118K291D	LVR-IC	2.9V±1%, 150mA, +CE, CL	DFN1612-4B	45vm	VR4	9a	Ric
QA	RP152L001A	LVR-IC	LDO, Dual out, Vout1/Vout2=2.8V/2.8V±1%, 150mA, +CE	DFN1212-6	52x4	VR19	9a	Ric
QB	R1118K301D	LVR-IC	3V±1%, 150mA, +CE, CL	DFN1612-4B	45vm	VR4	9a	Ric
QB	RP152L002A	LVR-IC	LDO, Dual out, Vout1/Vout2=1.8V/2.8V±1%, 150mA, +CE	DFN1212-6	52x4	VR19	9a	Ric
QC	R1118K311D	LVR-IC	3.1V±1%, 150mA, +CE, CL	DFN1612-4B	45vm	VR4	9a	Ric
QC	RP152L003A	LVR-IC	LDO, Dual out, Vout1/Vout2=1.5V/2.8V±1%, 150mA, +CE	DFN1212-6	52x4	VR19	9a	Ric
QD	R1118K321D	LVR-IC	3.2V±1%, 150mA, +CE, CL	DFN1612-4B	45vm	VR4	9a	Ric
QD	RP152L004A	LVR-IC	LDO, Dual out, Vout1/Vout2=1.2V/1.8V±1%, 150mA, +CE	DFN1212-6	52x4	VR19	9a	Ric
QE	R1118K331D	LVR-IC	3.3V±1%, 150mA, +CE, CL	DFN1612-4B	45vm	VR4	9a	Ric
QE	RP152L005A	LVR-IC	LDO, Dual out, Vout1/Vout2=3.3V/1.2V±1%, 150mA, +CE	DFN1212-6	52x4	VR19	9a	Ric
QF	R1118K341D	LVR-IC	3.4V±1%, 150mA, +CE, CL	DFN1612-4B	45vm	VR4	9a	Ric
QF	RP152L006A	LVR-IC	LDO, Dual out, Vout1/Vout2=3.3V/1.8V±1%, 150mA, +CE	DFN1212-6	52x4	VR19	9a	Ric
QG	R1118K351D	LVR-IC	3.5V±1%, 150mA, +CE, CL	DFN1612-4B	45vm	VR4	9a	Ric
QG	RP152L007A	LVR-IC	LDO, Dual out, Vout1/Vout2=2.85V/2.85V±1%, 150mA, +CE	DFN1212-6	52x4	VR19	9a	Ric
QH	R1118K361D	LVR-IC	3.6V±1%, 150mA, +CE, CL	DFN1612-4B	45vm	VR4	9a	Ric
QH	RP152L008A	LVR-IC	LDO, Dual out, Vout1/Vout2=2.85V/2.6V±1%, 150mA, +CE	DFN1212-6	52x4	VR19	9a	Ric
QJ	R1118K371D	LVR-IC	3.7V±1%, 150mA, +CE, CL	DFN1612-4B	45vm	VR4	9a	Ric
QJ	RP152L009A	LVR-IC	LDO, Dual out, Vout1/Vout2=3.0V/2.8V±1%, 150mA, +CE	DFN1212-6	52x4	VR19	9a	Ric
QK	R1118K381D	LVR-IC	3.8V±1%, 150mA, +CE, CL	DFN1612-4B	45vm	VR4	9a	Ric



SMD code	Type	Function	Short description	Case	Pinout	Sch.	St.	Mnf.
QK	RP152L010A	LVR-IC	LDO, Dual out, Vout1/Vout2=3.0V/1.8V±1%, 150mA, +CE	DFN1212-6	52x4	VR19	9a	Ric
QL	R1118K391D	LVR-IC	3.9V±1%, 150mA, +CE, CL	DFN1612-4B	45vm	VR4	9a	Ric
QL	RP152L011A	LVR-IC	LDO, Dual out, Vout1/Vout2=1.8V/1.5V±1%, 150mA, +CE	DFN1212-6	52x4	VR19	9a	Ric
QM	R1118K401D	LVR-IC	4V±1%, 150mA, +CE, CL	DFN1612-4B	45vm	VR4	9a	Ric
QM	RP152L012A	LVR-IC	LDO, Dual out, Vout1/Vout2=2.8V/2.6V±1%, 150mA, +CE	DFN1212-6	52x4	VR19	9a	Ric
QN	R1118K411D	LVR-IC	4.1V±1%, 150mA, +CE, CL	DFN1612-4B	45vm	VR4	9a	Ric
QN	RP152L013A	LVR-IC	LDO, Dual out, Vout1/Vout2=3.3V/2.8V±1%, 150mA, +CE	DFN1212-6	52x4	VR19	9a	Ric
QP	R1118K421D	LVR-IC	4.2V±1%, 150mA, +CE, CL	DFN1612-4B	45vm	VR4	9a	Ric
QP	RP152L014A	LVR-IC	LDO, Dual out, Vout1/Vout2=3.3V/3.3V±1%, 150mA, +CE	DFN1212-6	52x4	VR19	9a	Ric
QQ	RP152L015A	LVR-IC	LDO, Dual out, Vout1/Vout2=1.5V/2.5V±1%, 150mA, +CE	DFN1212-6	52x4	VR19	9a	Ric
QR	RP152L016A	LVR-IC	LDO, Dual out, Vout1/Vout2=1.5V/3.0V±1%, 150mA, +CE	DFN1212-6	52x4	VR19	9a	Ric
QS	RP152L017A	LVR-IC	LDO, Dual out, Vout1/Vout2=2.5V/3.0V±1%, 150mA, +CE	DFN1212-6	52x4	VR19	9a	Ric
QT	RP152L018A	LVR-IC	LDO, Dual out, Vout1/Vout2=1.8V/1.8V±1%, 150mA, +CE	DFN1212-6	52x4	VR19	9a	Ric
QTA	NCP2823AF	LIN-IC	AF PA, BTL, class-D, 2.5...5.5V, 1.5W(5W/8Q), shutdown	BGA-9	39	AFP45	9o	Ons
QU	RP152L019A	LVR-IC	LDO, Dual out, Vout1/Vout2=1.5V/2.6V±1%, 150mA, +CE	DFN1212-6	52x4	VR19	9a	Ric
QV	RP152L020A	LVR-IC	LDO, Dual out, Vout1/Vout2=2.8V/1.8V±1%, 150mA, +CE	DFN1212-6	52x4	VR19	9a	Ric
QW	RP152L021A	LVR-IC	LDO, Dual out, Vout1/Vout2=1.2V/2.8V±1%, 150mA, +CE	DFN1212-6	52x4	VR19	9a	Ric
QX	RP152L022A	LVR-IC	LDO, Dual out, Vout1/Vout2=2.8V/1.2V±1%, 150mA, +CE	DFN1212-6	52x4	VR19	9a	Ric
QY	RP152L023A	LVR-IC	LDO, Dual out, Vout1/Vout2=2.5V/2.5V±1%, 150mA, +CE	DFN1212-6	52x4	VR19	9a	Ric
QZ	RP152L024A	LVR-IC	LDO, Dual out, Vout1/Vout2=3.3V/3.0V±1%, 150mA, +CE	DFN1212-6	52x4	VR19	9a	Ric
R0	R3117K073C	Vdet-IC	0.7V±15mV, -Reset PPO, Sense	DFN1010-4	48rq	VD12	9a	Ric
R0	RP114K181D	LVR-IC	LDO, 1.8V±1%, 300mA, +CE, CL	DFN1010-4	48vm	VR4	9a	Ric
R001	R5325K001A	LVR-IC	LDO, Dual out, V1=2V±1%, V2=2V±1%, 150mA, +CE	DFN1820-6	74ri	VR19	9b	Ric
R002	R5325K002A	LVR-IC	LDO, Dual out, V1=2.8V±1%, V2=2.8V±1%, 150mA, +CE	DFN1820-6	74ri	VR19	9b	Ric
R003	R5325K003A	LVR-IC	LDO, Dual out, V1=1.8V±1%, V2=3V±1%, 150mA, +CE	DFN1820-6	74ri	VR19	9b	Ric
R004	R5325K004A	LVR-IC	LDO, Dual out, V1=2.5V±1%, V2=3V±1%, 150mA, +CE	DFN1820-6	74ri	VR19	9b	Ric
R005	R5325K005A	LVR-IC	LDO, Dual out, V1=1.8V±1%, V2=2.5V±1%, 150mA, +CE	DFN1820-6	74ri	VR19	9b	Ric
R006	R5325K006A	LVR-IC	LDO, Dual out, V1=1.8V±1%, V2=3V±1%, 150mA, +CE	DFN1820-6	74ri	VR19	9b	Ric
R007	R5325K007A	LVR-IC	LDO, Dual out, V1=2.5V±1%, V2=2.8V±1%, 150mA, +CE	DFN1820-6	74ri	VR19	9b	Ric
R008	R5325K008A	LVR-IC	LDO, Dual out, V1=1.2V±1%, V2=1.2V±1%, 150mA, +CE	DFN1820-6	74ri	VR19	9b	Ric
R009	R5325K009A	LVR-IC	LDO, Dual out, V1=1.5V±1%, V2=1.6V±1%, 150mA, +CE	DFN1820-6	74ri	VR19	9b	Ric
R010	R5325K010A	LVR-IC	LDO, Dual out, V1=1.5V±1%, V2=2.8V±1%, 150mA, +CE	DFN1820-6	74ri	VR19	9b	Ric
R011	R5325K011A	LVR-IC	LDO, Dual out, V1=3V±1%, V2=3V±1%, 150mA, +CE	DFN1820-6	74ri	VR19	9b	Ric
R012	R5325K012A	LVR-IC	LDO, Dual out, V1=3.1V±1%, V2=3.1V±1%, 150mA, +CE	DFN1820-6	74ri	VR19	9b	Ric
R013	R5325K013A	LVR-IC	LDO, Dual out, V1=2.7V±1%, V2=1.8V±1%, 150mA, +CE	DFN1820-6	74ri	VR19	9b	Ric
R014	R5325K014A	LVR-IC	LDO, Dual out, V1=1.8V±1%, V2=2.6V±1%, 150mA, +CE	DFN1820-6	74ri	VR19	9b	Ric
R015	R5325K015A	LVR-IC	LDO, Dual out, V1=3.3V±1%, V2=3.3V±1%, 150mA, +CE	DFN1820-6	74ri	VR19	9b	Ric
R016	R5325K016A	LVR-IC	LDO, Dual out, V1=2.85V±1%, V2=2.85V±1%, 150mA, +CE	DFN1820-6	74ri	VR19	9b	Ric
R017	R5325K017A	LVR-IC	LDO, Dual out, V1=2.9V±1%, V2=2.9V±1%, 150mA, +CE	DFN1820-6	74ri	VR19	9b	Ric
R018	R5325K018A	LVR-IC	LDO, Dual out, V1=1.2V±1%, V2=2.6V±1%, 150mA, +CE	DFN1820-6	74ri	VR19	9b	Ric
R019	R5325K019A	LVR-IC	LDO, Dual out, V1=2.8V±1%, V2=2.9V±1%, 150mA, +CE	DFN1820-6	74ri	VR19	9b	Ric
R020	R5325K020A	LVR-IC	LDO, Dual out, V1=1.2V±1%, V2=1.8V±1%, 150mA, +CE	DFN1820-6	74ri	VR19	9b	Ric
R021	R5325K021A	LVR-IC	LDO, Dual out, V1=2.5V±1%, V2=1.2V±1%, 150mA, +CE	DFN1820-6	74ri	VR19	9b	Ric
R022	R5325K022A	LVR-IC	LDO, Dual out, V1=2.7V±1%, V2=2.85V±1%, 150mA, +CE	DFN1820-6	74ri	VR19	9b	Ric
R023	R5325K023A	LVR-IC	LDO, Dual out, V1=1.2V±1%, V2=2.7V±1%, 150mA, +CE	DFN1820-6	74ri	VR19	9b	Ric
R024	R5325K024A	LVR-IC	LDO, Dual out, V1=1.2V±1%, V2=3V±1%, 150mA, +CE	DFN1820-6	74ri	VR19	9b	Ric
R025	R5325K025A	LVR-IC	LDO, Dual out, V1=2.5V±1%, V2=2.9V±1%, 150mA, +CE	DFN1820-6	74ri	VR19	9b	Ric
R026	R5325K026A	LVR-IC	LDO, Dual out, V1=1.2V±1%, V2=1.2V±1%, 150mA, +CE	DFN1820-6	74ri	VR19	9b	Ric
R027	R5325K027A	LVR-IC	LDO, Dual out, V1=2.9V±1%, V2=1.8V±1%, 150mA, +CE	DFN1820-6	74ri	VR19	9b	Ric
R028	R5325K028A	LVR-IC	LDO, Dual out, V1=1.5V±1%, V2=1.8V±1%, 150mA, +CE	DFN1820-6	74ri	VR19	9b	Ric
R029	R5325K029A	LVR-IC	LDO, Dual out, V1=3.3V±1%, V2=3.3V±1%, 150mA, +CE	DFN1820-6	74ri	VR19	9b	Ric
R030	R5325K030A	LVR-IC	LDO, Dual out, V1=3.45±1%V, V2=2.3V±1%, 150mA, +CE	DFN1820-6	74ri	VR19	9b	Ric
R031	R5325K031A	LVR-IC	LDO, Dual out, V1=1.3V±1%, V2=1.8V±1%, 150mA, +CE	DFN1820-6	74ri	VR19	9b	Ric
R032	R5325K032A	LVR-IC	LDO, Dual out, V1=1.8V±1%, V2=1.8V±1%, 150mA, +CE	DFN1820-6	74ri	VR19	9b	Ric
R033	R5325K033A	LVR-IC	LDO, Dual out, V1=3.1V±1%, V2=3.0V±1%, 150mA, +CE	DFN1820-6	74ri	VR19	9b	Ric
R034	R5325K034A	LVR-IC	LDO, Dual out, V1=2.95V±1%, V2=2.75V±1%, 150mA, +CE	DFN1820-6	74ri	VR19	9b	Ric
R035	R5325K035A	LVR-IC	LDO, Dual out, V1=2.8V±1%, V2=2.85V±1%, 150mA, +CE	DFN1820-6	74ri	VR19	9b	Ric
ROA	XC6108N50AGR	Vdet-IC	5.0V±2%, Hysteresis, -Reset ODO	USP-4	45ro	VD14	9b	Tor
ROA	XC6118C40AGR-G	Vdet-IC	4.0V±2%, ±Reset PPO, Sense, hysteresis 5%, Cd	USP-4	45me	VD15	9a	Tor
ROB	XC6108N50BGR	Vdet-IC	5.0V±2%, -Reset ODO	USP-4	45ro	VD14	9b	Tor
ROB	XC6118C40BGR-G	Vdet-IC	4.0V±2%, ±Reset PPO, Sense, hysteresis <1%, Cd	USP-4	45me	VD15	9a	Tor
ROC	XC6108N50CGR	Vdet-IC	5.0V±2%, Hysteresis, -Reset ODO	USP-4	45m	VD14	9b	Tor
ROC	XC6118C40CGR-G	Vdet-IC	4.0V±2%, ±Reset PPO, Sense, hysteresis 5%	USP-4	45md	VD12	9a	Tor
ROD	XC6108N50DGR	Vdet-IC	5.0V±2%, -Reset ODO	USP-4	45m	VD14	9b	Tor
ROD	XC6118C40DGR-G	Vdet-IC	4.0V±2%, ±Reset PPO, Sense, hysteresis <1%	USP-4	45md	VD12	9a	Tor
R1	R3117K083C	Vdet-IC	0.8V±15mV, -Reset PPO, Sense	DFN1010-4	48rq	VD12	9a	Ric
R1	RP114K191D	LVR-IC	LDO, 1.9V±1%, 300mA, +CE, CL	DFN1010-4	48vm	VR4	9a	Ric
R1A	XC6118C41AGR-G	Vdet-IC	4.1V±2%, ±Reset PPO, Sense, hysteresis 5%, Cd	USP-4	45me	VD15	9a	Tor
R1B	XC6118C41BGR-G	Vdet-IC	4.1V±2%, ±Reset PPO, Sense, hysteresis <1%, Cd	USP-4	45me	VD15	9a	Tor
R1C	XC6118C41CGR-G	Vdet-IC	4.1V±2%, ±Reset PPO, Sense, hysteresis 5%	USP-4	45md	VD12	9a	Tor



SMD code	Type	Function	Short description	Case	Pinout	Sch.	St.	Mnf.
R1D	XC6118C41DGR-G	Vdet-IC	4.1V±2%, ±Reset PPO, Sense, hysteresis <1%	USP-4	45md	VD12	9a	Tor
R2	R3117K093C	Vdet-IC	0.9V±15mV, -Reset PPO, Sense	DFN1010-4	48rq	VD12	9a	Ric
R2	RP114K201D	LVR-IC	LDO, 2.0V±1%, 300mA, +CE, CL	DFN1010-4	48vm	VR4	9a	Ric
R2A	XC6118C42AGR-G	Vdet-IC	4.2V±2%, ±Reset PPO, Sense, hysteresis 5%, Cd	USP-4	45me	VD15	9a	Tor
R2B	XC6118C42BGR-G	Vdet-IC	4.2V±2%, ±Reset PPO, Sense, hysteresis <1%, Cd	USP-4	45me	VD15	9a	Tor
R2C	XC6118C42CGR-G	Vdet-IC	4.2V±2%, ±Reset PPO, Sense, hysteresis 5%	USP-4	45md	VD12	9a	Tor
R2D	XC6118C42DGR-G	Vdet-IC	4.2V±2%, ±Reset PPO, Sense, hysteresis <1%	USP-4	45md	VD12	9a	Tor
R3	R3117K103C	Vdet-IC	1.0V±15mV, -Reset PPO, Sense	DFN1010-4	48rq	VD12	9a	Ric
R3	RP114K211D	LVR-IC	LDO, 2.1V±1%, 300mA, +CE, CL	DFN1010-4	48vm	VR4	9a	Ric
R3A	XC6118C43AGR-G	Vdet-IC	4.3V±2%, ±Reset PPO, Sense, hysteresis 5%, Cd	USP-4	45me	VD15	9a	Tor
R3B	XC6118C43BGR-G	Vdet-IC	4.3V±2%, ±Reset PPO, Sense, hysteresis <1%, Cd	USP-4	45me	VD15	9a	Tor
R3C	XC6118C43CGR-G	Vdet-IC	4.3V±2%, ±Reset PPO, Sense, hysteresis 5%	USP-4	45md	VD12	9a	Tor
R3D	XC6118C43DGR-G	Vdet-IC	4.3V±2%, ±Reset PPO, Sense, hysteresis <1%	USP-4	45md	VD12	9a	Tor
R4	R3117K113C	Vdet-IC	1.1V±15mV, -Reset PPO, Sense	DFN1010-4	48rq	VD12	9a	Ric
R4	RP114K221D	LVR-IC	LDO, 2.2V±1%, 300mA, +CE, CL	DFN1010-4	48vm	VR4	9a	Ric
R4A	XC6118C44AGR-G	Vdet-IC	4.4V±2%, ±Reset PPO, Sense, hysteresis 5%, Cd	USP-4	45me	VD15	9a	Tor
R4B	XC6118C44BGR-G	Vdet-IC	4.4V±2%, ±Reset PPO, Sense, hysteresis <1%, Cd	USP-4	45me	VD15	9a	Tor
R4C	XC6118C44CGR-G	Vdet-IC	4.4V±2%, ±Reset PPO, Sense, hysteresis 5%	USP-4	45md	VD12	9a	Tor
R4D	XC6118C44DGR-G	Vdet-IC	4.4V±2%, ±Reset PPO, Sense, hysteresis <1%	USP-4	45md	VD12	9a	Tor
R5	R3117K123C	Vdet-IC	1.2V±15mV, -Reset PPO, Sense	DFN1010-4	48rq	VD12	9a	Ric
R5	RP114K231D	LVR-IC	LDO, 2.3V±1%, 300mA, +CE, CL	DFN1010-4	48vm	VR4	9a	Ric
R5A	XC6118C45AGR-G	Vdet-IC	4.5V±2%, ±Reset PPO, Sense, hysteresis 5%, Cd	USP-4	45me	VD15	9a	Tor
R5B	XC6118C45BGR-G	Vdet-IC	4.5V±2%, ±Reset PPO, Sense, hysteresis <1%, Cd	USP-4	45me	VD15	9a	Tor
R5C	XC6118C45CGR-G	Vdet-IC	4.5V±2%, ±Reset PPO, Sense, hysteresis 5%	USP-4	45md	VD12	9a	Tor
R5D	XC6118C45DGR-G	Vdet-IC	4.5V±2%, ±Reset PPO, Sense, hysteresis <1%	USP-4	45md	VD12	9a	Tor
R6	R3117K133C	Vdet-IC	1.3V±15mV, -Reset PPO, Sense	DFN1010-4	48rq	VD12	9a	Ric
R6	RP114K241D	LVR-IC	LDO, 2.4V±1%, 300mA, +CE, CL	DFN1010-4	48vm	VR4	9a	Ric
R6A	XC6118C46AGR-G	Vdet-IC	4.6V±2%, ±Reset PPO, Sense, hysteresis 5%, Cd	USP-4	45me	VD15	9a	Tor
R6B	XC6118C46BGR-G	Vdet-IC	4.6V±2%, ±Reset PPO, Sense, hysteresis <1%, Cd	USP-4	45me	VD15	9a	Tor
R6C	XC6118C46CGR-G	Vdet-IC	4.6V±2%, ±Reset PPO, Sense, hysteresis 5%	USP-4	45md	VD12	9a	Tor
R6D	XC6118C46DGR-G	Vdet-IC	4.6V±2%, ±Reset PPO, Sense, hysteresis <1%	USP-4	45md	VD12	9a	Tor
R7	R3117K143C	Vdet-IC	1.4V±15mV, -Reset PPO, Sense	DFN1010-4	48rq	VD12	9a	Ric
R7	RP114K251D	LVR-IC	LDO, 2.5V±1%, 300mA, +CE, CL	DFN1010-4	48vm	VR4	9a	Ric
R7A	XC6118C47AGR-G	Vdet-IC	4.7V±2%, ±Reset PPO, Sense, hysteresis 5%, Cd	USP-4	45me	VD15	9a	Tor
R7B	XC6118C47BGR-G	Vdet-IC	4.7V±2%, ±Reset PPO, Sense, hysteresis <1%, Cd	USP-4	45me	VD15	9a	Tor
R7C	XC6118C47CGR-G	Vdet-IC	4.7V±2%, ±Reset PPO, Sense, hysteresis 5%	USP-4	45md	VD12	9a	Tor
R7D	XC6118C47DGR-G	Vdet-IC	4.7V±2%, ±Reset PPO, Sense, hysteresis <1%	USP-4	45md	VD12	9a	Tor
R8	R3117K153C	Vdet-IC	1.5V±15mV, -Reset PPO, Sense	DFN1010-4	48rq	VD12	9a	Ric
R8	RP114K261D	LVR-IC	LDO, 2.6V±1%, 300mA, +CE, CL	DFN1010-4	48vm	VR4	9a	Ric
R8A	XC6118C48AGR-G	Vdet-IC	4.8V±2%, ±Reset PPO, Sense, hysteresis 5%, Cd	USP-4	45me	VD15	9a	Tor
R8B	XC6118C48BGR-G	Vdet-IC	4.8V±2%, ±Reset PPO, Sense, hysteresis <1%, Cd	USP-4	45me	VD15	9a	Tor
R8C	XC6118C48CGR-G	Vdet-IC	4.8V±2%, ±Reset PPO, Sense, hysteresis 5%	USP-4	45md	VD12	9a	Tor
R8D	XC6118C48DGR-G	Vdet-IC	4.8V±2%, ±Reset PPO, Sense, hysteresis <1%	USP-4	45md	VD12	9a	Tor
R9	R3117K163C	Vdet-IC	1.6V±1%, -Reset PPO, Sense	DFN1010-4	48rq	VD12	9a	Ric
R9	RP114K271D	LVR-IC	LDO, 2.7V±1%, 300mA, +CE, CL	DFN1010-4	48vm	VR4	9a	Ric
R9A	XC6118C49AGR-G	Vdet-IC	4.9V±2%, ±Reset PPO, Sense, hysteresis 5%, Cd	USP-4	45me	VD15	9a	Tor
R9B	XC6118C49BGR-G	Vdet-IC	4.9V±2%, ±Reset PPO, Sense, hysteresis <1%, Cd	USP-4	45me	VD15	9a	Tor
R9C	XC6118C49CGR-G	Vdet-IC	4.9V±2%, ±Reset PPO, Sense, hysteresis 5%	USP-4	45md	VD12	9a	Tor
R9D	XC6118C49DGR-G	Vdet-IC	4.9V±2%, ±Reset PPO, Sense, hysteresis <1%	USP-4	45md	VD12	9a	Tor
RA	EUA2010H	LIN-IC	AFF PA, BTL, class-D, 2.5..5.5V, 3W(5V/4Q), shutdown	BGA-9	39	AFP45	-	Eut
RA	RP130K121A	LVR-IC	LDO, LN, -CE, 1.2V±1%, 150mA	DFN1010-4	48vm	VR4	9a	Ric
RA	RP152L025A	LVR-IC	LDO, Dual out, Vout1/Vout2=3.0V/3.0V±1%, 150mA, +CE	DFN1212-6	52x4	VR19	9a	Ric
RA096	XC9227A096D	DC/DC-IC	PWM-PWM/PFM st-dwn, 600kHz, 0.9V±1%, 600mA, +CE	USP-6B	49dc5	DC1	9b	Tor
RA09C	XC9227A096D	DC/DC-IC	PWM-PWM/PFM st-dwn, 1.2MHz, 0.9V±1%, 600mA, +CE	USP-6B	49dc5	DC1	9b	Tor
RA0M6	XC9227A0M6D	DC/DC-IC	PWM-PWM/PFM st-dwn, 600kHz, 0.95V±1%, 600mA, +CE	USP-6B	49dc5	DC1	9b	Tor
RA0MC	XC9227A0M6D	DC/DC-IC	PWM-PWM/PFM st-dwn, 1.2MHz, 0.95V±1%, 600mA, +CE	USP-6B	49dc5	DC1	9b	Tor
RA106	XC9227A106D	DC/DC-IC	PWM-PWM/PFM st-dwn, 600kHz, 1.0V±1%, 600mA, +CE	USP-6B	49dc5	DC1	9b	Tor
RA10C	XC9227A106D	DC/DC-IC	PWM-PWM/PFM st-dwn, 1.2MHz, 1.0V±1%, 600mA, +CE	USP-6B	49dc5	DC1	9b	Tor
RA116	XC9227A116D	DC/DC-IC	PWM-PWM/PFM st-dwn, 600kHz, 1.1V±1%, 600mA, +CE	USP-6B	49dc5	DC1	9b	Tor
RA11C	XC9227A116D	DC/DC-IC	PWM-PWM/PFM st-dwn, 1.2MHz, 1.1V±1%, 600mA, +CE	USP-6B	49dc5	DC1	9b	Tor
RA126	XC9227A126D	DC/DC-IC	PWM-PWM/PFM st-dwn, 600kHz, 1.2V±1%, 600mA, +CE	USP-6B	49dc5	DC1	9b	Tor
RA12C	XC9227A126D	DC/DC-IC	PWM-PWM/PFM st-dwn, 1.2MHz, 1.2V±1%, 600mA, +CE	USP-6B	49dc5	DC1	9b	Tor
RA136	XC9227A136D	DC/DC-IC	PWM-PWM/PFM st-dwn, 600kHz, 1.3V±1%, 600mA, +CE	USP-6B	49dc5	DC1	9b	Tor
RA13C	XC9227A136D	DC/DC-IC	PWM-PWM/PFM st-dwn, 1.2MHz, 1.3V±1%, 600mA, +CE	USP-6B	49dc5	DC1	9b	Tor
RA146	XC9227A146D	DC/DC-IC	PWM-PWM/PFM st-dwn, 600kHz, 1.4V±1%, 600mA, +CE	USP-6B	49dc5	DC1	9b	Tor
RA14C	XC9227A146D	DC/DC-IC	PWM-PWM/PFM st-dwn, 1.2MHz, 1.4V±1%, 600mA, +CE	USP-6B	49dc5	DC1	9b	Tor
RA156	XC9227A156D	DC/DC-IC	PWM-PWM/PFM st-dwn, 600kHz, 1.5V±1%, 600mA, +CE	USP-6B	49dc5	DC1	9b	Tor
RA15C	XC9227A156D	DC/DC-IC	PWM-PWM/PFM st-dwn, 1.2MHz, 1.5V±1%, 600mA, +CE	USP-6B	49dc5	DC1	9b	Tor
RA166	XC9227A166D	DC/DC-IC	PWM-PWM/PFM st-dwn, 600kHz, 1.6V±1%, 600mA, +CE	USP-6B	49dc5	DC1	9b	Tor
RA16C	XC9227A166D	DC/DC-IC	PWM-PWM/PFM st-dwn, 1.2MHz, 1.6V±1%, 600mA, +CE	USP-6B	49dc5	DC1	9b	Tor



SMD code	Type	Function	Short description	Case	Pinout	Sch.	St.	Mnf.
RA326	XC9227A326D	DC/DC-IC	PWM-PWM/PPM st-dwn, 600kHz, 3.2V±1%, 600mA, +CE	USP-6B	49dc5	DC1	9b	Tor
RA32C	XC9227A32CD	DC/DC-IC	PWM-PWM/PPM st-dwn, 1.2MHz, 3.2V±1%, 600mA, +CE	USP-6B	49dc5	DC1	9b	Tor
RA336	XC9227A336D	DC/DC-IC	PWM-PWM/PPM st-dwn, 600kHz, 3.3V±1%, 600mA, +CE	USP-6B	49dc5	DC1	9b	Tor
RA33C	XC9227A33CD	DC/DC-IC	PWM-PWM/PPM st-dwn, 1.2MHz, 3.3V±1%, 600mA, +CE	USP-6B	49dc5	DC1	9b	Tor
RA346	XC9227A346D	DC/DC-IC	PWM-PWM/PPM st-dwn, 600kHz, 3.4V±1%, 600mA, +CE	USP-6B	49dc5	DC1	9b	Tor
RA34C	XC9227A34CD	DC/DC-IC	PWM-PWM/PPM st-dwn, 1.2MHz, 3.4V±1%, 600mA, +CE	USP-6B	49dc5	DC1	9b	Tor
RA356	XC9227A356D	DC/DC-IC	PWM-PWM/PPM st-dwn, 600kHz, 3.5V±1%, 600mA, +CE	USP-6B	49dc5	DC1	9b	Tor
RA35C	XC9227A35CD	DC/DC-IC	PWM-PWM/PPM st-dwn, 1.2MHz, 3.5V±1%, 600mA, +CE	USP-6B	49dc5	DC1	9b	Tor
RA366	XC9227A366D	DC/DC-IC	PWM-PWM/PPM st-dwn, 600kHz, 3.6V±1%, 600mA, +CE	USP-6B	49dc5	DC1	9b	Tor
RA36C	XC9227A36CD	DC/DC-IC	PWM-PWM/PPM st-dwn, 1.2MHz, 3.6V±1%, 600mA, +CE	USP-6B	49dc5	DC1	9b	Tor
RA376	XC9227A376D	DC/DC-IC	PWM-PWM/PPM st-dwn, 600kHz, 3.7V±1%, 600mA, +CE	USP-6B	49dc5	DC1	9b	Tor
RA37C	XC9227A37CD	DC/DC-IC	PWM-PWM/PPM st-dwn, 1.2MHz, 3.7V±1%, 600mA, +CE	USP-6B	49dc5	DC1	9b	Tor
RA386	XC9227A386D	DC/DC-IC	PWM-PWM/PPM st-dwn, 600kHz, 3.8V±1%, 600mA, +CE	USP-6B	49dc5	DC1	9b	Tor
RA38C	XC9227A38CD	DC/DC-IC	PWM-PWM/PPM st-dwn, 1.2MHz, 3.8V±1%, 600mA, +CE	USP-6B	49dc5	DC1	9b	Tor
RA396	XC9227A396D	DC/DC-IC	PWM-PWM/PPM st-dwn, 600kHz, 3.9V±1%, 600mA, +CE	USP-6B	49dc5	DC1	9b	Tor
RA39C	XC9227A39CD	DC/DC-IC	PWM-PWM/PPM st-dwn, 1.2MHz, 3.9V±1%, 600mA, +CE	USP-6B	49dc5	DC1	9b	Tor
RA3A6	XC9227A3A6D	DC/DC-IC	PWM-PWM/PPM st-dwn, 600kHz, 3.05V±1%, 600mA, +CE	USP-6B	49dc5	DC1	9b	Tor
RA3AC	XC9227A3ACD	DC/DC-IC	PWM-PWM/PPM st-dwn, 1.2MHz, 3.05V±1%, 600mA, +CE	USP-6B	49dc5	DC1	9b	Tor
RA3B6	XC9227A3B6D	DC/DC-IC	PWM-PWM/PPM st-dwn, 600kHz, 3.15V±1%, 600mA, +CE	USP-6B	49dc5	DC1	9b	Tor
RA3BC	XC9227A3BCD	DC/DC-IC	PWM-PWM/PPM st-dwn, 1.2MHz, 3.15V±1%, 600mA, +CE	USP-6B	49dc5	DC1	9b	Tor
RA3C6	XC9227A3C6D	DC/DC-IC	PWM-PWM/PPM st-dwn, 600kHz, 3.25V±1%, 600mA, +CE	USP-6B	49dc5	DC1	9b	Tor
RA3CC	XC9227A3CCD	DC/DC-IC	PWM-PWM/PPM st-dwn, 1.2MHz, 3.25V±1%, 600mA, +CE	USP-6B	49dc5	DC1	9b	Tor
RA3D6	XC9227A3D6D	DC/DC-IC	PWM-PWM/PPM st-dwn, 600kHz, 3.35V±1%, 600mA, +CE	USP-6B	49dc5	DC1	9b	Tor
RA3DC	XC9227A3DCD	DC/DC-IC	PWM-PWM/PPM st-dwn, 1.2MHz, 3.35V±1%, 600mA, +CE	USP-6B	49dc5	DC1	9b	Tor
RA3E6	XC9227A3E6D	DC/DC-IC	PWM-PWM/PPM st-dwn, 600kHz, 3.45V±1%, 600mA, +CE	USP-6B	49dc5	DC1	9b	Tor
RA3EC	XC9227A3ECD	DC/DC-IC	PWM-PWM/PPM st-dwn, 1.2MHz, 3.45V±1%, 600mA, +CE	USP-6B	49dc5	DC1	9b	Tor
RA3F6	XC9227A3F6D	DC/DC-IC	PWM-PWM/PPM st-dwn, 600kHz, 3.55V±1%, 600mA, +CE	USP-6B	49dc5	DC1	9b	Tor
RA3FC	XC9227A3FCD	DC/DC-IC	PWM-PWM/PPM st-dwn, 1.2MHz, 3.55V±1%, 600mA, +CE	USP-6B	49dc5	DC1	9b	Tor
RA3H6	XC9227A3H6D	DC/DC-IC	PWM-PWM/PPM st-dwn, 600kHz, 3.65V±1%, 600mA, +CE	USP-6B	49dc5	DC1	9b	Tor
RA3HC	XC9227A3HCD	DC/DC-IC	PWM-PWM/PPM st-dwn, 1.2MHz, 3.65V±1%, 600mA, +CE	USP-6B	49dc5	DC1	9b	Tor
RA3K6	XC9227A3K6D	DC/DC-IC	PWM-PWM/PPM st-dwn, 600kHz, 3.75V±1%, 600mA, +CE	USP-6B	49dc5	DC1	9b	Tor
RA3KC	XC9227A3KCD	DC/DC-IC	PWM-PWM/PPM st-dwn, 1.2MHz, 3.75V±1%, 600mA, +CE	USP-6B	49dc5	DC1	9b	Tor
RA3L6	XC9227A3L6D	DC/DC-IC	PWM-PWM/PPM st-dwn, 600kHz, 3.85V±1%, 600mA, +CE	USP-6B	49dc5	DC1	9b	Tor
RA3LC	XC9227A3LCD	DC/DC-IC	PWM-PWM/PPM st-dwn, 1.2MHz, 3.85V±1%, 600mA, +CE	USP-6B	49dc5	DC1	9b	Tor
RA3M6	XC9227A3M6D	DC/DC-IC	PWM-PWM/PPM st-dwn, 600kHz, 3.95V±1%, 600mA, +CE	USP-6B	49dc5	DC1	9b	Tor
RA3MC	XC9227A3MCD	DC/DC-IC	PWM-PWM/PPM st-dwn, 1.2MHz, 3.95V±1%, 600mA, +CE	USP-6B	49dc5	DC1	9b	Tor
RA406	XC9227A406D	DC/DC-IC	PWM-PWM/PPM st-dwn, 600kHz, 4.0V±1%, 600mA, +CE	USP-6B	49dc5	DC1	9b	Tor
RA40C	XC9227A40CD	DC/DC-IC	PWM-PWM/PPM st-dwn, 1.2MHz, 4.0V±1%, 600mA, +CE	USP-6B	49dc5	DC1	9b	Tor
RB	RP130K131A	LVR-IC	LDO, LN, -CE, 1.3V±1%, 150mA	DFN1010-4	48vm	VR4	9a	Ric
RB	RP15L2026A	LVR-IC	LDO, Dual out, Vout1/Vout2=2.8V/3.1V±1%, 150mA, +CE	DFN1212-6	52x4	VR19	9a	Ric
RB096	XC9227B096D	DC/DC-IC	PWM-PWM/PPM st-dwn, 600kHz, 0.95V±1%, 600mA, -CE	USP-6B	49dc5	DC1	9b	Tor
RB09C	XC9227B09CD	DC/DC-IC	PWM-PWM/PPM st-dwn, 1.2MHz, 0.9V±1%, 600mA, -CE	USP-6B	49dc5	DC1	9b	Tor
RB0M6	XC9227B0M6D	DC/DC-IC	PWM-PWM/PPM st-dwn, 600kHz, 0.95V±1%, 600mA, -CE	USP-6B	49dc5	DC1	9b	Tor
RB0MC	XC9227B0MCD	DC/DC-IC	PWM-PWM/PPM st-dwn, 1.2MHz, 0.95V±1%, 600mA, -CE	USP-6B	49dc5	DC1	9b	Tor
RB106	XC9227B106D	DC/DC-IC	PWM-PWM/PPM st-dwn, 600kHz, 1.0V±1%, 600mA, -CE	USP-6B	49dc5	DC1	9b	Tor
RB10C	XC9227B10CD	DC/DC-IC	PWM-PWM/PPM st-dwn, 1.2MHz, 1.0V±1%, 600mA, -CE	USP-6B	49dc5	DC1	9b	Tor
RB116	XC9227B116D	DC/DC-IC	PWM-PWM/PPM st-dwn, 600kHz, 1.1V±1%, 600mA, -CE	USP-6B	49dc5	DC1	9b	Tor
RB11C	XC9227B11CD	DC/DC-IC	PWM-PWM/PPM st-dwn, 1.2MHz, 1.1V±1%, 600mA, -CE	USP-6B	49dc5	DC1	9b	Tor
RB126	XC9227B126D	DC/DC-IC	PWM-PWM/PPM st-dwn, 600kHz, 1.2V±1%, 600mA, -CE	USP-6B	49dc5	DC1	9b	Tor
RB12C	XC9227B12CD	DC/DC-IC	PWM-PWM/PPM st-dwn, 1.2MHz, 1.2V±1%, 600mA, -CE	USP-6B	49dc5	DC1	9b	Tor
RB136	XC9227B136D	DC/DC-IC	PWM-PWM/PPM st-dwn, 600kHz, 1.3V±1%, 600mA, -CE	USP-6B	49dc5	DC1	9b	Tor
RB13C	XC9227B13CD	DC/DC-IC	PWM-PWM/PPM st-dwn, 1.2MHz, 1.3V±1%, 600mA, -CE	USP-6B	49dc5	DC1	9b	Tor
RB146	XC9227B146D	DC/DC-IC	PWM-PWM/PPM st-dwn, 600kHz, 1.4V±1%, 600mA, -CE	USP-6B	49dc5	DC1	9b	Tor
RB14C	XC9227B14CD	DC/DC-IC	PWM-PWM/PPM st-dwn, 1.2MHz, 1.4V±1%, 600mA, -CE	USP-6B	49dc5	DC1	9b	Tor
RB156	XC9227B156D	DC/DC-IC	PWM-PWM/PPM st-dwn, 600kHz, 1.5V±1%, 600mA, -CE	USP-6B	49dc5	DC1	9b	Tor
RB15C	XC9227B15CD	DC/DC-IC	PWM-PWM/PPM st-dwn, 1.2MHz, 1.5V±1%, 600mA, -CE	USP-6B	49dc5	DC1	9b	Tor
RB166	XC9227B166D	DC/DC-IC	PWM-PWM/PPM st-dwn, 600kHz, 1.6V±1%, 600mA, -CE	USP-6B	49dc5	DC1	9b	Tor
RB16C	XC9227B16CD	DC/DC-IC	PWM-PWM/PPM st-dwn, 1.2MHz, 1.6V±1%, 600mA, -CE	USP-6B	49dc5	DC1	9b	Tor
RB176	XC9227B176D	DC/DC-IC	PWM-PWM/PPM st-dwn, 600kHz, 1.7V±1%, 600mA, -CE	USP-6B	49dc5	DC1	9b	Tor
RB17C	XC9227B17CD	DC/DC-IC	PWM-PWM/PPM st-dwn, 1.2MHz, 1.7V±1%, 600mA, -CE	USP-6B	49dc5	DC1	9b	Tor
RB186	XC9227B186D	DC/DC-IC	PWM-PWM/PPM st-dwn, 600kHz, 1.8V±1%, 600mA, -CE	USP-6B	49dc5	DC1	9b	Tor
RB18C	XC9227B18CD	DC/DC-IC	PWM-PWM/PPM st-dwn, 1.2MHz, 1.8V±1%, 600mA, -CE	USP-6B	49dc5	DC1	9b	Tor
RB196	XC9227B196D	DC/DC-IC	PWM-PWM/PPM st-dwn, 600kHz, 1.9V±1%, 600mA, -CE	USP-6B	49dc5	DC1	9b	Tor
RB19C	XC9227B19CD	DC/DC-IC	PWM-PWM/PPM st-dwn, 1.2MHz, 1.9V±1%, 600mA, -CE	USP-6B	49dc5	DC1	9b	Tor
RB1A6	XC9227B1A6D	DC/DC-IC	PWM-PWM/PPM st-dwn, 600kHz, 1.05V±1%, 600mA, -CE	USP-6B	49dc5	DC1	9b	Tor
RB1AC	XC9227B1ACD	DC/DC-IC	PWM-PWM/PPM st-dwn, 1.2MHz, 1.05V±1%, 600mA, -CE	USP-6B	49dc5	DC1	9b	Tor
RB1B6	XC9227B1B6D	DC/DC-IC	PWM-PWM/PPM st-dwn, 600kHz, 1.15V±1%, 600mA, -CE	USP-6B	49dc5	DC1	9b	Tor
RB1BC	XC9227B1BCD	DC/DC-IC	PWM-PWM/PPM st-dwn, 1.2MHz, 1.15V±1%, 600mA, -CE	USP-6B	49dc5	DC1	9b	Tor
RB1C6	XC9227B1C6D	DC/DC-IC	PWM-PWM/PPM st-dwn, 600kHz, 1.25V±1%, 600mA, -CE	USP-6B	49dc5	DC1	9b	Tor
RB1CC	XC9227B1CCD	DC/DC-IC	PWM-PWM/PPM st-dwn, 1.2MHz, 1.25V±1%, 600mA, -CE	USP-6B	49dc5	DC1	9b	Tor



SMD code	Type	Function	Short description	Case	Pinout	Sch.	St.	Mnf.
RB386	XC9227B386D	DC/DC-IC	PWM-PWM/PPM st-dwn, 600kHz, 3.8V±1%, 600mA, -CE	USP-6B	49dc5	DC1	9b	Tor
RB38C	XC9227B38CD	DC/DC-IC	PWM-PWM/PPM st-dwn, 1.2MHz, 3.8V±1%, 600mA, -CE	USP-6B	49dc5	DC1	9b	Tor
RB396	XC9227B396D	DC/DC-IC	PWM-PWM/PPM st-dwn, 600kHz, 3.9V±1%, 600mA, -CE	USP-6B	49dc5	DC1	9b	Tor
RB39C	XC9227B39CD	DC/DC-IC	PWM-PWM/PPM st-dwn, 1.2MHz, 3.9V±1%, 600mA, -CE	USP-6B	49dc5	DC1	9b	Tor
RB3A6	XC9227B3A6D	DC/DC-IC	PWM-PWM/PPM st-dwn, 600kHz, 3.05V±1%, 600mA, -CE	USP-6B	49dc5	DC1	9b	Tor
RB3AC	XC9227B3ACD	DC/DC-IC	PWM-PWM/PPM st-dwn, 1.2MHz, 3.05V±1%, 600mA, -CE	USP-6B	49dc5	DC1	9b	Tor
RB3B6	XC9227B3B6D	DC/DC-IC	PWM-PWM/PPM st-dwn, 600kHz, 3.15V±1%, 600mA, -CE	USP-6B	49dc5	DC1	9b	Tor
RB3BC	XC9227B3BCD	DC/DC-IC	PWM-PWM/PPM st-dwn, 1.2MHz, 3.15V±1%, 600mA, -CE	USP-6B	49dc5	DC1	9b	Tor
RB3C6	XC9227B3C6D	DC/DC-IC	PWM-PWM/PPM st-dwn, 600kHz, 3.25V±1%, 600mA, -CE	USP-6B	49dc5	DC1	9b	Tor
RB3CC	XC9227B3CCD	DC/DC-IC	PWM-PWM/PPM st-dwn, 1.2MHz, 3.25V±1%, 600mA, -CE	USP-6B	49dc5	DC1	9b	Tor
RB3D6	XC9227B3D6D	DC/DC-IC	PWM-PWM/PPM st-dwn, 600kHz, 3.35V±1%, 600mA, -CE	USP-6B	49dc5	DC1	9b	Tor
RB3DC	XC9227B3DCD	DC/DC-IC	PWM-PWM/PPM st-dwn, 1.2MHz, 3.35V±1%, 600mA, -CE	USP-6B	49dc5	DC1	9b	Tor
RB3E6	XC9227B3E6D	DC/DC-IC	PWM-PWM/PPM st-dwn, 600kHz, 3.45V±1%, 600mA, -CE	USP-6B	49dc5	DC1	9b	Tor
RB3EC	XC9227B3ECD	DC/DC-IC	PWM-PWM/PPM st-dwn, 1.2MHz, 3.45V±1%, 600mA, -CE	USP-6B	49dc5	DC1	9b	Tor
RB3F6	XC9227B3F6D	DC/DC-IC	PWM-PWM/PPM st-dwn, 600kHz, 3.55V±1%, 600mA, -CE	USP-6B	49dc5	DC1	9b	Tor
RB3FC	XC9227B3FCD	DC/DC-IC	PWM-PWM/PPM st-dwn, 1.2MHz, 3.55V±1%, 600mA, -CE	USP-6B	49dc5	DC1	9b	Tor
RB3H6	XC9227B3H6D	DC/DC-IC	PWM-PWM/PPM st-dwn, 600kHz, 3.65V±1%, 600mA, -CE	USP-6B	49dc5	DC1	9b	Tor
RB3HC	XC9227B3HCD	DC/DC-IC	PWM-PWM/PPM st-dwn, 1.2MHz, 3.65V±1%, 600mA, -CE	USP-6B	49dc5	DC1	9b	Tor
RB3K6	XC9227B3K6D	DC/DC-IC	PWM-PWM/PPM st-dwn, 600kHz, 3.75V±1%, 600mA, -CE	USP-6B	49dc5	DC1	9b	Tor
RB3KC	XC9227B3KCD	DC/DC-IC	PWM-PWM/PPM st-dwn, 1.2MHz, 3.75V±1%, 600mA, -CE	USP-6B	49dc5	DC1	9b	Tor
RB3L6	XC9227B3L6D	DC/DC-IC	PWM-PWM/PPM st-dwn, 600kHz, 3.85V±1%, 600mA, -CE	USP-6B	49dc5	DC1	9b	Tor
RB3LC	XC9227B3LCD	DC/DC-IC	PWM-PWM/PPM st-dwn, 1.2MHz, 3.85V±1%, 600mA, -CE	USP-6B	49dc5	DC1	9b	Tor
RB3M6	XC9227B3M6D	DC/DC-IC	PWM-PWM/PPM st-dwn, 600kHz, 3.95V±1%, 600mA, -CE	USP-6B	49dc5	DC1	9b	Tor
RB3MC	XC9227B3MCD	DC/DC-IC	PWM-PWM/PPM st-dwn, 1.2MHz, 3.95V±1%, 600mA, -CE	USP-6B	49dc5	DC1	9b	Tor
RB406	XC9227B406D	DC/DC-IC	PWM-PWM/PPM st-dwn, 600kHz, 4.0V±1%, 600mA, -CE	USP-6B	49dc5	DC1	9b	Tor
RB40C	XC9227B40CD	DC/DC-IC	PWM-PWM/PPM st-dwn, 1.2MHz, 4.0V±1%, 600mA, -CE	USP-6B	49dc5	DC1	9b	Tor
RC	RP130K141A	LVR-IC	LDO, LN, -CE, 1.4V±1%, 150mA	DFN1010-4	48vm	VR4	9a	Ric
RC	RP15L027A	LVR-IC	LDO, Dual out, Vout1/Vout2=2.3V/2.8V±1%, 150mA, +CE	DFM1212-6	52x4	VR19	9a	Ric
RC096	XC9227C096D	DC/DC-IC	PWM-PWM/PPM st-dwn, 600kHz, 0.9V±1%, 600mA, +CE, PDR	USP-6B	49dc5	DC1	9b	Tor
RC09C	XC9227C09CD	DC/DC-IC	PWM-PWM/PPM st-dwn, 1.2MHz, 0.9V±1%, 600mA, +CE, PDR	USP-6B	49dc5	DC1	9b	Tor
RC0M6	XC9227C0M6D	DC/DC-IC	PWM-PWM/PPM st-dwn, 600kHz, 0.95V±1%, 600mA, +CE, PDR	USP-6B	49dc5	DC1	9b	Tor
RC0MC	XC9227C0MCD	DC/DC-IC	PWM-PWM/PPM st-dwn, 1.2MHz, 0.95V±1%, 600mA, +CE, PDR	USP-6B	49dc5	DC1	9b	Tor
RC106	XC9227C106D	DC/DC-IC	PWM-PWM/PPM st-dwn, 600kHz, 1.0V±1%, 600mA, +CE, PDR	USP-6B	49dc5	DC1	9b	Tor
RC10C	XC9227C10CD	DC/DC-IC	PWM-PWM/PPM st-dwn, 1.2MHz, 1.0V±1%, 600mA, +CE, PDR	USP-6B	49dc5	DC1	9b	Tor
RC116	XC9227C116D	DC/DC-IC	PWM-PWM/PPM st-dwn, 600kHz, 1.1V±1%, 600mA, +CE, PDR	USP-6B	49dc5	DC1	9b	Tor
RC11C	XC9227C11CD	DC/DC-IC	PWM-PWM/PPM st-dwn, 1.2MHz, 1.1V±1%, 600mA, +CE, PDR	USP-6B	49dc5	DC1	9b	Tor
RC126	XC9227C126D	DC/DC-IC	PWM-PWM/PPM st-dwn, 600kHz, 1.2V±1%, 600mA, +CE, PDR	USP-6B	49dc5	DC1	9b	Tor
RC12C	XC9227C12CD	DC/DC-IC	PWM-PWM/PPM st-dwn, 1.2MHz, 1.2V±1%, 600mA, +CE, PDR	USP-6B	49dc5	DC1	9b	Tor
RC136	XC9227C136D	DC/DC-IC	PWM-PWM/PPM st-dwn, 600kHz, 1.3V±1%, 600mA, +CE, PDR	USP-6B	49dc5	DC1	9b	Tor
RC13C	XC9227C13CD	DC/DC-IC	PWM-PWM/PPM st-dwn, 1.2MHz, 1.3V±1%, 600mA, +CE, PDR	USP-6B	49dc5	DC1	9b	Tor
RC146	XC9227C146D	DC/DC-IC	PWM-PWM/PPM st-dwn, 600kHz, 1.4V±1%, 600mA, +CE, PDR	USP-6B	49dc5	DC1	9b	Tor
RC14C	XC9227C14CD	DC/DC-IC	PWM-PWM/PPM st-dwn, 1.2MHz, 1.4V±1%, 600mA, +CE, PDR	USP-6B	49dc5	DC1	9b	Tor
RC156	XC9227C156D	DC/DC-IC	PWM-PWM/PPM st-dwn, 600kHz, 1.5V±1%, 600mA, +CE, PDR	USP-6B	49dc5	DC1	9b	Tor
RC15C	XC9227C15CD	DC/DC-IC	PWM-PWM/PPM st-dwn, 1.2MHz, 1.5V±1%, 600mA, +CE, PDR	USP-6B	49dc5	DC1	9b	Tor
RC166	XC9227C166D	DC/DC-IC	PWM-PWM/PPM st-dwn, 600kHz, 1.6V±1%, 600mA, +CE, PDR	USP-6B	49dc5	DC1	9b	Tor
RC16C	XC9227C16CD	DC/DC-IC	PWM-PWM/PPM st-dwn, 1.2MHz, 1.6V±1%, 600mA, +CE, PDR	USP-6B	49dc5	DC1	9b	Tor
RC176	XC9227C176D	DC/DC-IC	PWM-PWM/PPM st-dwn, 600kHz, 1.7V±1%, 600mA, +CE, PDR	USP-6B	49dc5	DC1	9b	Tor
RC17C	XC9227C17CD	DC/DC-IC	PWM-PWM/PPM st-dwn, 1.2MHz, 1.7V±1%, 600mA, +CE, PDR	USP-6B	49dc5	DC1	9b	Tor
RC186	XC9227C186D	DC/DC-IC	PWM-PWM/PPM st-dwn, 600kHz, 1.8V±1%, 600mA, +CE, PDR	USP-6B	49dc5	DC1	9b	Tor
RC18C	XC9227C18CD	DC/DC-IC	PWM-PWM/PPM st-dwn, 1.2MHz, 1.8V±1%, 600mA, +CE, PDR	USP-6B	49dc5	DC1	9b	Tor
RC196	XC9227C196D	DC/DC-IC	PWM-PWM/PPM st-dwn, 600kHz, 1.9V±1%, 600mA, +CE, PDR	USP-6B	49dc5	DC1	9b	Tor
RC19C	XC9227C19CD	DC/DC-IC	PWM-PWM/PPM st-dwn, 1.2MHz, 1.9V±1%, 600mA, +CE, PDR	USP-6B	49dc5	DC1	9b	Tor
RC1A6	XC9227C1A6D	DC/DC-IC	PWM-PWM/PPM st-dwn, 600kHz, 1.05V±1%, 600mA, +CE, PDR	USP-6B	49dc5	DC1	9b	Tor
RC1AC	XC9227C1ACD	DC/DC-IC	PWM-PWM/PPM st-dwn, 1.2MHz, 1.05V±1%, 600mA, +CE, PDR	USP-6B	49dc5	DC1	9b	Tor
RC1B6	XC9227C1B6D	DC/DC-IC	PWM-PWM/PPM st-dwn, 600kHz, 1.15V±1%, 600mA, +CE, PDR	USP-6B	49dc5	DC1	9b	Tor
RC1BC	XC9227C1BCD	DC/DC-IC	PWM-PWM/PPM st-dwn, 1.2MHz, 1.15V±1%, 600mA, +CE, PDR	USP-6B	49dc5	DC1	9b	Tor
RC1C6	XC9227C1C6D	DC/DC-IC	PWM-PWM/PPM st-dwn, 600kHz, 1.25V±1%, 600mA, +CE, PDR	USP-6B	49dc5	DC1	9b	Tor
RC1CC	XC9227C1CCD	DC/DC-IC	PWM-PWM/PPM st-dwn, 1.2MHz, 1.25V±1%, 600mA, +CE, PDR	USP-6B	49dc5	DC1	9b	Tor
RC1D6	XC9227C1D6D	DC/DC-IC	PWM-PWM/PPM st-dwn, 600kHz, 1.35V±1%, 600mA, +CE, PDR	USP-6B	49dc5	DC1	9b	Tor
RC1DC	XC9227C1DCD	DC/DC-IC	PWM-PWM/PPM st-dwn, 1.2MHz, 1.35V±1%, 600mA, +CE, PDR	USP-6B	49dc5	DC1	9b	Tor
RC1E6	XC9227C1E6D	DC/DC-IC	PWM-PWM/PPM st-dwn, 600kHz, 1.45V±1%, 600mA, +CE, PDR	USP-6B	49dc5	DC1	9b	Tor
RC1EC	XC9227C1ECD	DC/DC-IC	PWM-PWM/PPM st-dwn, 1.2MHz, 1.45V±1%, 600mA, +CE, PDR	USP-6B	49dc5	DC1	9b	Tor
RC1F6	XC9227C1F6D	DC/DC-IC	PWM-PWM/PPM st-dwn, 600kHz, 1.55V±1%, 600mA, +CE, PDR	USP-6B	49dc5	DC1	9b	Tor
RC1FC	XC9227C1FCD	DC/DC-IC	PWM-PWM/PPM st-dwn, 1.2MHz, 1.55V±1%, 600mA, +CE, PDR	USP-6B	49dc5	DC1	9b	Tor
RC1H6	XC9227C1H6D	DC/DC-IC	PWM-PWM/PPM st-dwn, 600kHz, 1.65V±1%, 600mA, +CE, PDR	USP-6B	49dc5	DC1	9b	Tor
RC1HC	XC9227C1HCD	DC/DC-IC	PWM-PWM/PPM st-dwn, 1.2MHz, 1.65V±1%, 600mA, +CE, PDR	USP-6B	49dc5	DC1	9b	Tor
RC1K6	XC9227C1K6D	DC/DC-IC	PWM-PWM/PPM st-dwn, 600kHz, 1.75V±1%, 600mA, +CE, PDR	USP-6B	49dc5	DC1	9b	Tor
RC1KC	XC9227C1KCD	DC/DC-IC	PWM-PWM/PPM st-dwn, 1.2MHz, 1.75V±1%, 600mA, +CE, PDR	USP-6B	49dc5	DC1	9b	Tor
RC1L6	XC9227C1L6D	DC/DC-IC	PWM-PWM/PPM st-dwn, 600kHz, 1.85V±1%, 600mA, +CE, PDR	USP-6B	49dc5	DC1	9b	Tor
RC1LC	XC9227C1LCD	DC/DC-IC	PWM-PWM/PPM st-dwn, 1.2MHz, 1.85V±1%, 600mA, +CE, PDR	USP-6B	49dc5	DC1	9b	Tor



SMD code	Type	Function	Short description	Case	Pinout	Sch.	St.	Mnf.
RC3E6	XC9227C3E6D	DC/DC-IC	PWM-PWM/PPM st-dwn, 600kHz, 3.45V±1%, 600mA, +CE, PDR	USP-6B	49dc5	DC1	9b	Tor
RC3EC	XC9227C3ECD	DC/DC-IC	PWM-PWM/PPM st-dwn, 1.2MHz, 3.45V±1%, 600mA, +CE, PDR	USP-6B	49dc5	DC1	9b	Tor
RC3F6	XC9227C3F6D	DC/DC-IC	PWM-PWM/PPM st-dwn, 600kHz, 3.55V±1%, 600mA, +CE, PDR	USP-6B	49dc5	DC1	9b	Tor
RC3FC	XC9227C3FCD	DC/DC-IC	PWM-PWM/PPM st-dwn, 1.2MHz, 3.55V±1%, 600mA, +CE, PDR	USP-6B	49dc5	DC1	9b	Tor
RC3H6	XC9227C3H6D	DC/DC-IC	PWM-PWM/PPM st-dwn, 600kHz, 3.65V±1%, 600mA, +CE, PDR	USP-6B	49dc5	DC1	9b	Tor
RC3HC	XC9227C3HCD	DC/DC-IC	PWM-PWM/PPM st-dwn, 1.2MHz, 3.65V±1%, 600mA, +CE, PDR	USP-6B	49dc5	DC1	9b	Tor
RC3K6	XC9227C3K6D	DC/DC-IC	PWM-PWM/PPM st-dwn, 600kHz, 3.75V±1%, 600mA, +CE, PDR	USP-6B	49dc5	DC1	9b	Tor
RC3KC	XC9227C3KCD	DC/DC-IC	PWM-PWM/PPM st-dwn, 1.2MHz, 3.75V±1%, 600mA, +CE, PDR	USP-6B	49dc5	DC1	9b	Tor
RC3L6	XC9227C3L6D	DC/DC-IC	PWM-PWM/PPM st-dwn, 600kHz, 3.85V±1%, 600mA, +CE, PDR	USP-6B	49dc5	DC1	9b	Tor
RC3LC	XC9227C3LCD	DC/DC-IC	PWM-PWM/PPM st-dwn, 1.2MHz, 3.85V±1%, 600mA, +CE, PDR	USP-6B	49dc5	DC1	9b	Tor
RC3M6	XC9227C3M6D	DC/DC-IC	PWM-PWM/PPM st-dwn, 600kHz, 3.95V±1%, 600mA, +CE, PDR	USP-6B	49dc5	DC1	9b	Tor
RC3MC	XC9227C3MCD	DC/DC-IC	PWM-PWM/PPM st-dwn, 1.2MHz, 3.95V±1%, 600mA, +CE, PDR	USP-6B	49dc5	DC1	9b	Tor
RC406	XC9227C406D	DC/DC-IC	PWM-PWM/PPM st-dwn, 600kHz, 4.0V±1%, 600mA, +CE, PDR	USP-6B	49dc5	DC1	9b	Tor
RC40C	XC9227C40CD	DC/DC-IC	PWM-PWM/PPM st-dwn, 1.2MHz, 4.0V±1%, 600mA, +CE, PDR	USP-6B	49dc5	DC1	9b	Tor
RD	RP130K151A	LVR-IC	LDO, LN, -CE, 1.5V±1%, 150mA	DFN1010-4	49dm5	VR4	9a	Ric
RD	RP15L208A	LVR-IC	LDO, Dual out, Vout1/Vout2=2.8V/1.0V±1%, 150mA, +CE	DFN1212-6	52x4	VR19	9a	Ric
RD096	XC9227D096D	DC/DC-IC	PWM-PWM/PPM st-dwn, 600kHz, 0.9V±1%, 600mA, -CE, PDR	USP-6B	49dc5	DC1	9b	Tor
RD09C	XC9227D09CD	DC/DC-IC	PWM-PWM/PPM st-dwn, 1.2MHz, 0.9V±1%, 600mA, -CE, PDR	USP-6B	49dc5	DC1	9b	Tor
RD0M6	XC9227D0M6D	DC/DC-IC	PWM-PWM/PPM st-dwn, 600kHz, 0.95V±1%, 600mA, -CE, PDR	USP-6B	49dc5	DC1	9b	Tor
RD0MC	XC9227D0MCD	DC/DC-IC	PWM-PWM/PPM st-dwn, 1.2MHz, 0.95V±1%, 600mA, -CE, PDR	USP-6B	49dc5	DC1	9b	Tor
RD106	XC9227D106D	DC/DC-IC	PWM-PWM/PPM st-dwn, 600kHz, 1.0V±1%, 600mA, -CE, PDR	USP-6B	49dc5	DC1	9b	Tor
RD10C	XC9227D10CD	DC/DC-IC	PWM-PWM/PPM st-dwn, 1.2MHz, 1.0V±1%, 600mA, -CE, PDR	USP-6B	49dc5	DC1	9b	Tor
RD116	XC9227D116D	DC/DC-IC	PWM-PWM/PPM st-dwn, 600kHz, 1.1V±1%, 600mA, -CE, PDR	USP-6B	49dc5	DC1	9b	Tor
RD11C	XC9227D11CD	DC/DC-IC	PWM-PWM/PPM st-dwn, 1.2MHz, 1.1V±1%, 600mA, -CE, PDR	USP-6B	49dc5	DC1	9b	Tor
RD126	XC9227D126D	DC/DC-IC	PWM-PWM/PPM st-dwn, 600kHz, 1.2V±1%, 600mA, -CE, PDR	USP-6B	49dc5	DC1	9b	Tor
RD12C	XC9227D12CD	DC/DC-IC	PWM-PWM/PPM st-dwn, 1.2MHz, 1.2V±1%, 600mA, -CE, PDR	USP-6B	49dc5	DC1	9b	Tor
RD136	XC9227D136D	DC/DC-IC	PWM-PWM/PPM st-dwn, 600kHz, 1.3V±1%, 600mA, -CE, PDR	USP-6B	49dc5	DC1	9b	Tor
RD13C	XC9227D13CD	DC/DC-IC	PWM-PWM/PPM st-dwn, 1.2MHz, 1.3V±1%, 600mA, -CE, PDR	USP-6B	49dc5	DC1	9b	Tor
RD146	XC9227D146D	DC/DC-IC	PWM-PWM/PPM st-dwn, 600kHz, 1.4V±1%, 600mA, -CE, PDR	USP-6B	49dc5	DC1	9b	Tor
RD14C	XC9227D14CD	DC/DC-IC	PWM-PWM/PPM st-dwn, 1.2MHz, 1.4V±1%, 600mA, -CE, PDR	USP-6B	49dc5	DC1	9b	Tor
RD156	XC9227D156D	DC/DC-IC	PWM-PWM/PPM st-dwn, 600kHz, 1.5V±1%, 600mA, -CE, PDR	USP-6B	49dc5	DC1	9b	Tor
RD15C	XC9227D15CD	DC/DC-IC	PWM-PWM/PPM st-dwn, 1.2MHz, 1.5V±1%, 600mA, -CE, PDR	USP-6B	49dc5	DC1	9b	Tor
RD166	XC9227D166D	DC/DC-IC	PWM-PWM/PPM st-dwn, 600kHz, 1.6V±1%, 600mA, -CE, PDR	USP-6B	49dc5	DC1	9b	Tor
RD16C	XC9227D16CD	DC/DC-IC	PWM-PWM/PPM st-dwn, 1.2MHz, 1.6V±1%, 600mA, -CE, PDR	USP-6B	49dc5	DC1	9b	Tor
RD176	XC9227D176D	DC/DC-IC	PWM-PWM/PPM st-dwn, 600kHz, 1.7V±1%, 600mA, -CE, PDR	USP-6B	49dc5	DC1	9b	Tor
RD17C	XC9227D17CD	DC/DC-IC	PWM-PWM/PPM st-dwn, 1.2MHz, 1.7V±1%, 600mA, -CE, PDR	USP-6B	49dc5	DC1	9b	Tor
RD186	XC9227D186D	DC/DC-IC	PWM-PWM/PPM st-dwn, 600kHz, 1.8V±1%, 600mA, -CE, PDR	USP-6B	49dc5	DC1	9b	Tor
RD18C	XC9227D18CD	DC/DC-IC	PWM-PWM/PPM st-dwn, 1.2MHz, 1.8V±1%, 600mA, -CE, PDR	USP-6B	49dc5	DC1	9b	Tor
RD196	XC9227D196D	DC/DC-IC	PWM-PWM/PPM st-dwn, 600kHz, 1.9V±1%, 600mA, -CE, PDR	USP-6B	49dc5	DC1	9b	Tor
RD19C	XC9227D19CD	DC/DC-IC	PWM-PWM/PPM st-dwn, 1.2MHz, 1.9V±1%, 600mA, -CE, PDR	USP-6B	49dc5	DC1	9b	Tor
RD1A6	XC9227D1A6D	DC/DC-IC	PWM-PWM/PPM st-dwn, 600kHz, 1.05V±1%, 600mA, -CE, PDR	USP-6B	49dc5	DC1	9b	Tor
RD1AC	XC9227D1ACD	DC/DC-IC	PWM-PWM/PPM st-dwn, 1.2MHz, 1.05V±1%, 600mA, -CE, PDR	USP-6B	49dc5	DC1	9b	Tor
RD1B6	XC9227D1B6D	DC/DC-IC	PWM-PWM/PPM st-dwn, 600kHz, 1.15V±1%, 600mA, -CE, PDR	USP-6B	49dc5	DC1	9b	Tor
RD1BC	XC9227D1BCD	DC/DC-IC	PWM-PWM/PPM st-dwn, 1.2MHz, 1.15V±1%, 600mA, -CE, PDR	USP-6B	49dc5	DC1	9b	Tor
RD1C6	XC9227D1C6D	DC/DC-IC	PWM-PWM/PPM st-dwn, 600kHz, 1.25V±1%, 600mA, -CE, PDR	USP-6B	49dc5	DC1	9b	Tor
RD1CC	XC9227D1CCD	DC/DC-IC	PWM-PWM/PPM st-dwn, 1.2MHz, 1.25V±1%, 600mA, -CE, PDR	USP-6B	49dc5	DC1	9b	Tor
RD1D6	XC9227D1D6D	DC/DC-IC	PWM-PWM/PPM st-dwn, 600kHz, 1.35V±1%, 600mA, -CE, PDR	USP-6B	49dc5	DC1	9b	Tor
RD1DC	XC9227D1DCD	DC/DC-IC	PWM-PWM/PPM st-dwn, 1.2MHz, 1.35V±1%, 600mA, -CE, PDR	USP-6B	49dc5	DC1	9b	Tor
RD1E6	XC9227D1E6D	DC/DC-IC	PWM-PWM/PPM st-dwn, 600kHz, 1.45V±1%, 600mA, -CE, PDR	USP-6B	49dc5	DC1	9b	Tor
RD1EC	XC9227D1ECD	DC/DC-IC	PWM-PWM/PPM st-dwn, 1.2MHz, 1.45V±1%, 600mA, -CE, PDR	USP-6B	49dc5	DC1	9b	Tor
RD1F6	XC9227D1F6D	DC/DC-IC	PWM-PWM/PPM st-dwn, 600kHz, 1.55V±1%, 600mA, -CE, PDR	USP-6B	49dc5	DC1	9b	Tor
RD1FC	XC9227D1FCD	DC/DC-IC	PWM-PWM/PPM st-dwn, 1.2MHz, 1.55V±1%, 600mA, -CE, PDR	USP-6B	49dc5	DC1	9b	Tor
RD1H6	XC9227D1H6D	DC/DC-IC	PWM-PWM/PPM st-dwn, 600kHz, 1.65V±1%, 600mA, -CE, PDR	USP-6B	49dc5	DC1	9b	Tor
RD1HC	XC9227D1HCD	DC/DC-IC	PWM-PWM/PPM st-dwn, 1.2MHz, 1.65V±1%, 600mA, -CE, PDR	USP-6B	49dc5	DC1	9b	Tor
RD1K6	XC9227D1K6D	DC/DC-IC	PWM-PWM/PPM st-dwn, 600kHz, 1.75V±1%, 600mA, -CE, PDR	USP-6B	49dc5	DC1	9b	Tor
RD1KC	XC9227D1KCD	DC/DC-IC	PWM-PWM/PPM st-dwn, 1.2MHz, 1.75V±1%, 600mA, -CE, PDR	USP-6B	49dc5	DC1	9b	Tor
RD1L6	XC9227D1L6D	DC/DC-IC	PWM-PWM/PPM st-dwn, 600kHz, 1.85V±1%, 600mA, -CE, PDR	USP-6B	49dc5	DC1	9b	Tor
RD1LC	XC9227D1LCD	DC/DC-IC	PWM-PWM/PPM st-dwn, 1.2MHz, 1.85V±1%, 600mA, -CE, PDR	USP-6B	49dc5	DC1	9b	Tor
RD1M6	XC9227D1M6D	DC/DC-IC	PWM-PWM/PPM st-dwn, 600kHz, 1.95V±1%, 600mA, -CE, PDR	USP-6B	49dc5	DC1	9b	Tor
RD1MC	XC9227D1MCD	DC/DC-IC	PWM-PWM/PPM st-dwn, 1.2MHz, 1.95V±1%, 600mA, -CE, PDR	USP-6B	49dc5	DC1	9b	Tor
RD206	XC9227D206D	DC/DC-IC	PWM-PWM/PPM st-dwn, 600kHz, 2.0V±1%, 600mA, -CE, PDR	USP-6B	49dc5	DC1	9b	Tor
RD20C	XC9227D20CD	DC/DC-IC	PWM-PWM/PPM st-dwn, 1.2MHz, 2.0V±1%, 600mA, -CE, PDR	USP-6B	49dc5	DC1	9b	Tor
RD216	XC9227D216D	DC/DC-IC	PWM-PWM/PPM st-dwn, 600kHz, 2.1V±1%, 600mA, -CE, PDR	USP-6B	49dc5	DC1	9b	Tor
RD21C	XC9227D21CD	DC/DC-IC	PWM-PWM/PPM st-dwn, 1.2MHz, 2.1V±1%, 600mA, -CE, PDR	USP-6B	49dc5	DC1	9b	Tor
RD226	XC9227D226D	DC/DC-IC	PWM-PWM/PPM st-dwn, 600kHz, 2.2V±1%, 600mA, -CE, PDR	USP-6B	49dc5	DC1	9b	Tor
RD22C	XC9227D22CD	DC/DC-IC	PWM-PWM/PPM st-dwn, 1.2MHz, 2.2V±1%, 600mA, -CE, PDR	USP-6B	49dc5	DC1	9b	Tor
RD236	XC9227D236D	DC/DC-IC	PWM-PWM/PPM st-dwn, 600kHz, 2.3V±1%, 600mA, -CE, PDR	USP-6B	49dc5	DC1	9b	Tor
RD23C	XC9227D23CD	DC/DC-IC	PWM-PWM/PPM st-dwn, 1.2MHz, 2.3V±1%, 600mA, -CE, PDR	USP-6B	49dc5	DC1	9b	Tor
RD246	XC9227D246D	DC/DC-IC	PWM-PWM/PPM st-dwn, 600kHz, 2.4V±1%, 600mA, -CE, PDR	USP-6B	49dc5	DC1	9b	Tor
RD24C	XC9227D24CD	DC/DC-IC	PWM-PWM/PPM st-dwn, 1.2MHz, 2.4V±1%, 600mA, -CE, PDR	USP-6B	49dc5	DC1	9b	Tor



SMD code	Type	Function	Short description	Case	Pinout	Sch.	St.	Mnf.
RL	RP130K211A	LVR-IC	LDO, LN, -CE, 2.1V±1%, 150mA	DFN1010-4	48vm	VR4	9a	Ric
RL	RP152L035A	LVR-IC	LDO, Dual out, Vout1/Vout2=2.5V/1.2V±1%, 150mA, +CE	DFN1212-6	52x4	VR19	9a	Ric
RM	RP130K221A	LVR-IC	LDO, LN, -CE, 2.2V±1%, 150mA	DFN1010-4	48vm	VR4	9a	Ric
RM	RP152L036A	LVR-IC	LDO, Dual out, Vout1/Vout2=1.2V/2.9V±1%, 150mA, +CE	DFN1212-6	52x4	VR19	9a	Ric
RN	RP130K231A	LVR-IC	LDO, LN, -CE, 2.3V±1%, 150mA	DFN1010-4	48vm	VR4	9a	Ric
RN	RP152L037A	LVR-IC	LDO, Dual out, Vout1/Vout2=3.3V/2.0V±1%, 150mA, +CE	DFN1212-6	52x4	VR19	9a	Ric
RP	RP130K241A	LVR-IC	LDO, LN, -CE, 2.4V±1%, 150mA	DFN1010-4	48vm	VR4	9a	Ric
RP	RP152L038A	LVR-IC	LDO, Dual out, Vout1/Vout2=1.2V/2.85V±1%, 150mA, +CE	DFN1212-6	52x4	VR19	9a	Ric
RQ	RP130K251A	LVR-IC	LDO, LN, -CE, 2.5V±1%, 150mA	DFN1010-4	48vm	VR4	9a	Ric
RQ	RP152L039A	LVR-IC	LDO, Dual out, Vout1/Vout2=2.1V/3.3V±1%, 150mA, +CE	DFN1212-6	52x4	VR19	9a	Ric
RR	RP130K261A	LVR-IC	LDO, LN, -CE, 2.6V±1%, 150mA	DFN1010-4	48vm	VR4	9a	Ric
RR	RP152L040A	LVR-IC	LDO, Dual out, Vout1/Vout2=2.8V/2.85V±1%, 150mA, +CE	DFN1212-6	52x4	VR19	9a	Ric
RS	RP130K271A	LVR-IC	LDO, LN, -CE, 2.7V±1%, 150mA	DFN1010-4	48vm	VR4	9a	Ric
RS	RP152L041A	LVR-IC	LDO, Dual out, Vout1/Vout2=1.8V/3.0V±1%, 150mA, +CE	DFN1212-6	52x4	VR19	9a	Ric
RT	RP130K281A	LVR-IC	LDO, LN, -CE, 2.8V±1%, 150mA	DFN1010-4	48vm	VR4	9a	Ric
RT	RP152L042A	LVR-IC	LDO, Dual out, Vout1/Vout2=1.2V/2.6V±1%, 150mA, +CE	DFN1212-6	52x4	VR19	9a	Ric
RU	RP130K281A5	LVR-IC	LDO, LN, -CE, 2.85V±1%, 150mA	DFN1010-4	48vm	VR4	9a	Ric
RU	RP152L043A	LVR-IC	LDO, Dual out, Vout1/Vout2=1.3V/2.8V±1%, 150mA, +CE	DFN1212-6	52x4	VR19	9a	Ric
RV	RP130K291A	LVR-IC	LDO, LN, -CE, 2.9V±1%, 150mA	DFN1010-4	48vm	VR4	9a	Ric
RV	RP152L044A	LVR-IC	LDO, Dual out, Vout1/Vout2=1.1V/1.5V±1%, 150mA, +CE	DFN1212-6	52x4	VR19	9a	Ric
RW	RP130K301A	LVR-IC	LDO, LN, -CE, 3V±1%, 150mA	DFN1010-4	48vm	VR4	9a	Ric
RW	RP152L045A	LVR-IC	LDO, Dual out, Vout1/Vout2=2.8V/3.3V±1%, 150mA, +CE	DFN1212-6	52x4	VR19	9a	Ric
RX	RP130K311A	LVR-IC	LDO, LN, -CE, 3.1V±1%, 150mA	DFN1010-4	48vm	VR4	9a	Ric
RX	RP152L046A	LVR-IC	LDO, Dual out, Vout1/Vout2=2.8V/3.0V±1%, 150mA, +CE	DFN1212-6	52x4	VR19	9a	Ric
RY	RP130K321A	LVR-IC	LDO, LN, -CE, 3.2V±1%, 150mA	DFN1010-4	48vm	VR4	9a	Ric
RY	RP152L047A	LVR-IC	LDO, Dual out, Vout1/Vout2=2.5V/2.8V±1%, 150mA, +CE	DFN1212-6	52x4	VR19	9a	Ric
RZ	RP130K331A	LVR-IC	LDO, LN, -CE, 3.3V±1%, 150mA	DFN1010-4	48vm	VR4	9a	Ric
RZ	RP152L048A	LVR-IC	LDO, Dual out, Vout1/Vout2=2.5V/3.2V±1%, 150mA, +CE	DFN1212-6	52x4	VR19	9a	Ric
RZ306	XC9227G306D	DC/DC-IC	PWM-PWM/PPM st-dwn, 600kHz, 3.0V±1%, 900mA, +CE, PDR	USP-6B	49dc5	DC1	9b	Tor
RZ30C	XC9227G30CD	DC/DC-IC	PWM-PWM/PPM st-dwn, 1.2MHz, 3.0V±1%, 900mA, +CE, PDR	USP-6B	49dc5	DC1	9b	Tor
RZ316	XC9227G316D	DC/DC-IC	PWM-PWM/PPM st-dwn, 600kHz, 3.1V±1%, 900mA, +CE, PDR	USP-6B	49dc5	DC1	9b	Tor
RZ31C	XC9227G31CD	DC/DC-IC	PWM-PWM/PPM st-dwn, 1.2MHz, 3.1V±1%, 900mA, +CE, PDR	USP-6B	49dc5	DC1	9b	Tor
RZ326	XC9227G326D	DC/DC-IC	PWM-PWM/PPM st-dwn, 600kHz, 3.2V±1%, 900mA, +CE, PDR	USP-6B	49dc5	DC1	9b	Tor
RZ32C	XC9227G32CD	DC/DC-IC	PWM-PWM/PPM st-dwn, 1.2MHz, 3.2V±1%, 900mA, +CE, PDR	USP-6B	49dc5	DC1	9b	Tor
RZ336	XC9227G336D	DC/DC-IC	PWM-PWM/PPM st-dwn, 600kHz, 3.3V±1%, 900mA, +CE, PDR	USP-6B	49dc5	DC1	9b	Tor
RZ33C	XC9227G33CD	DC/DC-IC	PWM-PWM/PPM st-dwn, 1.2MHz, 3.3V±1%, 900mA, +CE, PDR	USP-6B	49dc5	DC1	9b	Tor
RZ346	XC9227G346D	DC/DC-IC	PWM-PWM/PPM st-dwn, 600kHz, 3.4V±1%, 900mA, +CE, PDR	USP-6B	49dc5	DC1	9b	Tor
RZ34C	XC9227G34CD	DC/DC-IC	PWM-PWM/PPM st-dwn, 1.2MHz, 3.4V±1%, 900mA, +CE, PDR	USP-6B	49dc5	DC1	9b	Tor
RZ356	XC9227G356D	DC/DC-IC	PWM-PWM/PPM st-dwn, 600kHz, 3.5V±1%, 900mA, +CE, PDR	USP-6B	49dc5	DC1	9b	Tor
RZ35C	XC9227G35CD	DC/DC-IC	PWM-PWM/PPM st-dwn, 1.2MHz, 3.5V±1%, 900mA, +CE, PDR	USP-6B	49dc5	DC1	9b	Tor
RZ366	XC9227G366D	DC/DC-IC	PWM-PWM/PPM st-dwn, 600kHz, 3.6V±1%, 900mA, +CE, PDR	USP-6B	49dc5	DC1	9b	Tor
RZ36C	XC9227G36CD	DC/DC-IC	PWM-PWM/PPM st-dwn, 1.2MHz, 3.6V±1%, 900mA, +CE, PDR	USP-6B	49dc5	DC1	9b	Tor
RZ376	XC9227G376D	DC/DC-IC	PWM-PWM/PPM st-dwn, 600kHz, 3.7V±1%, 900mA, +CE, PDR	USP-6B	49dc5	DC1	9b	Tor
RZ37C	XC9227G37CD	DC/DC-IC	PWM-PWM/PPM st-dwn, 1.2MHz, 3.7V±1%, 900mA, +CE, PDR	USP-6B	49dc5	DC1	9b	Tor
RZ386	XC9227G386D	DC/DC-IC	PWM-PWM/PPM st-dwn, 600kHz, 3.8V±1%, 900mA, +CE, PDR	USP-6B	49dc5	DC1	9b	Tor
RZ38C	XC9227G38CD	DC/DC-IC	PWM-PWM/PPM st-dwn, 1.2MHz, 3.8V±1%, 900mA, +CE, PDR	USP-6B	49dc5	DC1	9b	Tor
RZ396	XC9227G396D	DC/DC-IC	PWM-PWM/PPM st-dwn, 600kHz, 3.9V±1%, 900mA, +CE, PDR	USP-6B	49dc5	DC1	9b	Tor
RZ39C	XC9227G39CD	DC/DC-IC	PWM-PWM/PPM st-dwn, 1.2MHz, 3.9V±1%, 900mA, +CE, PDR	USP-6B	49dc5	DC1	9b	Tor
RZ3A6	XC9227G3A6D	DC/DC-IC	PWM-PWM/PPM st-dwn, 600kHz, 3.05V±1%, 900mA, +CE, PDR	USP-6B	49dc5	DC1	9b	Tor
RZ3AC	XC9227G3ACD	DC/DC-IC	PWM-PWM/PPM st-dwn, 1.2MHz, 3.05V±1%, 900mA, +CE, PDR	USP-6B	49dc5	DC1	9b	Tor
RZ3B6	XC9227G3B6D	DC/DC-IC	PWM-PWM/PPM st-dwn, 600kHz, 3.15V±1%, 900mA, +CE, PDR	USP-6B	49dc5	DC1	9b	Tor
RZ3BC	XC9227G3BCD	DC/DC-IC	PWM-PWM/PPM st-dwn, 1.2MHz, 3.15V±1%, 900mA, +CE, PDR	USP-6B	49dc5	DC1	9b	Tor
RZ3C6	XC9227G3C6D	DC/DC-IC	PWM-PWM/PPM st-dwn, 600kHz, 3.25V±1%, 900mA, +CE, PDR	USP-6B	49dc5	DC1	9b	Tor
RZ3CC	XC9227G3CCD	DC/DC-IC	PWM-PWM/PPM st-dwn, 1.2MHz, 3.25V±1%, 900mA, +CE, PDR	USP-6B	49dc5	DC1	9b	Tor
RZ3D6	XC9227G3D6D	DC/DC-IC	PWM-PWM/PPM st-dwn, 600kHz, 3.35V±1%, 900mA, +CE, PDR	USP-6B	49dc5	DC1	9b	Tor
RZ3DC	XC9227G3DCD	DC/DC-IC	PWM-PWM/PPM st-dwn, 1.2MHz, 3.35V±1%, 900mA, +CE, PDR	USP-6B	49dc5	DC1	9b	Tor
RZ3E6	XC9227G3E6D	DC/DC-IC	PWM-PWM/PPM st-dwn, 600kHz, 3.45V±1%, 900mA, +CE, PDR	USP-6B	49dc5	DC1	9b	Tor
RZ3EC	XC9227G3ECD	DC/DC-IC	PWM-PWM/PPM st-dwn, 1.2MHz, 3.45V±1%, 900mA, +CE, PDR	USP-6B	49dc5	DC1	9b	Tor
RZ3F6	XC9227G3F6D	DC/DC-IC	PWM-PWM/PPM st-dwn, 600kHz, 3.55V±1%, 900mA, +CE, PDR	USP-6B	49dc5	DC1	9b	Tor
RZ3FC	XC9227G3FCD	DC/DC-IC	PWM-PWM/PPM st-dwn, 1.2MHz, 3.55V±1%, 900mA, +CE, PDR	USP-6B	49dc5	DC1	9b	Tor
RZ3H6	XC9227G3H6D	DC/DC-IC	PWM-PWM/PPM st-dwn, 600kHz, 3.65V±1%, 900mA, +CE, PDR	USP-6B	49dc5	DC1	9b	Tor
RZ3HC	XC9227G3HCD	DC/DC-IC	PWM-PWM/PPM st-dwn, 1.2MHz, 3.65V±1%, 900mA, +CE, PDR	USP-6B	49dc5	DC1	9b	Tor
RZ3K6	XC9227G3K6D	DC/DC-IC	PWM-PWM/PPM st-dwn, 600kHz, 3.75V±1%, 900mA, +CE, PDR	USP-6B	49dc5	DC1	9b	Tor
RZ3KC	XC9227G3KCD	DC/DC-IC	PWM-PWM/PPM st-dwn, 1.2MHz, 3.75V±1%, 900mA, +CE, PDR	USP-6B	49dc5	DC1	9b	Tor
RZ3L6	XC9227G3L6D	DC/DC-IC	PWM-PWM/PPM st-dwn, 600kHz, 3.85V±1%, 900mA, +CE, PDR	USP-6B	49dc5	DC1	9b	Tor
RZ3LC	XC9227G3LCD	DC/DC-IC	PWM-PWM/PPM st-dwn, 1.2MHz, 3.85V±1%, 900mA, +CE, PDR	USP-6B	49dc5	DC1	9b	Tor
RZ3M6	XC9227G3M6D	DC/DC-IC	PWM-PWM/PPM st-dwn, 600kHz, 3.95V±1%, 900mA, +CE, PDR	USP-6B	49dc5	DC1	9b	Tor
RZ3MC	XC9227G3MCD	DC/DC-IC	PWM-PWM/PPM st-dwn, 1.2MHz, 3.95V±1%, 900mA, +CE, PDR	USP-6B	49dc5	DC1	9b	Tor
RZ406	XC9227G406D	DC/DC-IC	PWM-PWM/PPM st-dwn, 600kHz, 4.0V±1%, 900mA, +CE, PDR	USP-6B	49dc5	DC1	9b	Tor
RZ40C	XC9227G40CD	DC/DC-IC	PWM-PWM/PPM st-dwn, 1.2MHz, 4.0V±1%, 900mA, +CE, PDR	USP-6B	49dc5	DC1	9b	Tor



SMD code	Type	Function	Short description	Case	Pinout	Sch.	St.	Mnf.
S0	R3117K173C	Vdet-IC	1.7V±1%, -Reset PPO, Sense	DFN1010-4	48rq	VD12	9a	Ric
S0	RP114K281D	LVR-IC	LDO, 2.8V±1%, 300mA, +CE, CL	DFN1010-4	48vm	VR4	9a	Ric
S012	R5220K012A	DC/DC-IC	PWM step-down, +CE, Vdc=1.2V, Vldo=1.1V	PLP2514-6	65dc3	DC8	9b	Ric
S022	R5220K022A	DC/DC-IC	PWM step-down, +CE, Vdc=1.5V, Vldo=1.1V	PLP2514-6	65dc3	DC8	9b	Ric
S032	R5220K032A	DC/DC-IC	PWM step-down, +CE, Vdc=1.3V, Vldo=1.05V	PLP2514-6	65dc3	DC8	9b	Ric
S042	R5220K042A	DC/DC-IC	PWM step-down, +CE, Vdc=1.3V, Vldo=1.1V	PLP2514-6	65dc3	DC8	9b	Ric
S0A	XC6118C50AGR-G	Vdet-IC	5.0V±2%, ±Reset PPO, Sense, hysteresis 5%, Cd	USP-4	45me	VD15	9a	Tor
S0B	XC6118C50BGR-G	Vdet-IC	5.0V±2%, ±Reset PPO, Sense, hysteresis <1%, Cd	USP-4	45me	VD15	9a	Tor
S0C	XC6118C50CGR-G	Vdet-IC	5.0V±2%, ±Reset PPO, Sense, hysteresis 5%	USP-4	45md	VD12	9a	Tor
S0D	XC6118C50DGR-G	Vdet-IC	5.0V±2%, ±Reset PPO, Sense, hysteresis <1%	USP-4	45md	VD12	9a	Tor
S1	R3117K183C	Vdet-IC	1.8V±1%, -Reset PPO, Sense	DFN1010-4	48rq	VD12	9a	Ric
S1	RP114K291D	LVR-IC	LDO, 2.9V±1%, 300mA, +CE, CL	DFN1010-4	48vm	VR4	9a	Ric
S101	R5220K101A	DC/DC-IC	PWM step-down, +CE, Vdc=Vldo=1V	PLP2514-6	65dc3	DC8	9b	Ric
S111	R5220K111A	DC/DC-IC	PWM step-down, +CE, Vdc=Vldo=1.1V	PLP2514-6	65dc3	DC8	9b	Ric
S121	R5220K121A	DC/DC-IC	PWM step-down, +CE, Vdc=Vldo=1.2V	PLP2514-6	65dc3	DC8	9b	Ric
S131	R5220K131A	DC/DC-IC	PWM step-down, +CE, Vdc=Vldo=1.3V	PLP2514-6	65dc3	DC8	9b	Ric
S141	R5220K141A	DC/DC-IC	PWM step-down, +CE, Vdc=Vldo=1.4V	PLP2514-6	65dc3	DC8	9b	Ric
S151	R5220K151A	DC/DC-IC	PWM step-down, +CE, Vdc=Vldo=1.5V	PLP2514-6	65dc3	DC8	9b	Ric
S161	R5220K161A	DC/DC-IC	PWM step-down, +CE, Vdc=Vldo=1.6V	PLP2514-6	65dc3	DC8	9b	Ric
S171	R5220K171A	DC/DC-IC	PWM step-down, +CE, Vdc=Vldo=1.7V	PLP2514-6	65dc3	DC8	9b	Ric
S181	R5220K181A	DC/DC-IC	PWM step-down, +CE, Vdc=Vldo=1.8V	PLP2514-6	65dc3	DC8	9b	Ric
S191	R5220K191A	DC/DC-IC	PWM step-down, +CE, Vdc=Vldo=1.9V	PLP2514-6	65dc3	DC8	9b	Ric
S2	R3117K193C	Vdet-IC	1.9V±1%, -Reset PPO, Sense	DFN1010-4	48rq	VD12	9a	Ric
S2	RP114K301D	LVR-IC	LDO, 3.0V±1%, 300mA, +CE, CL	DFN1010-4	48vm	VR4	9a	Ric
S201	R5220K201A	DC/DC-IC	PWM step-down, +CE, Vdc=Vldo=2V	PLP2514-6	65dc3	DC8	9b	Ric
S211	R5220K211A	DC/DC-IC	PWM step-down, +CE, Vdc=Vldo=2.1V	PLP2514-6	65dc3	DC8	9b	Ric
S221	R5220K221A	DC/DC-IC	PWM step-down, +CE, Vdc=Vldo=2.2V	PLP2514-6	65dc3	DC8	9b	Ric
S231	R5220K231A	DC/DC-IC	PWM step-down, +CE, Vdc=Vldo=2.3V	PLP2514-6	65dc3	DC8	9b	Ric
S241	R5220K241A	DC/DC-IC	PWM step-down, +CE, Vdc=Vldo=2.4V	PLP2514-6	65dc3	DC8	9b	Ric
S251	R5220K251A	DC/DC-IC	PWM step-down, +CE, Vdc=Vldo=2.5V	PLP2514-6	65dc3	DC8	9b	Ric
S261	R5220K261A	DC/DC-IC	PWM step-down, +CE, Vdc=Vldo=2.6V	PLP2514-6	65dc3	DC8	9b	Ric
S271	R5220K271A	DC/DC-IC	PWM step-down, +CE, Vdc=Vldo=2.7V	PLP2514-6	65dc3	DC8	9b	Ric
S281	R5220K281A	DC/DC-IC	PWM step-down, +CE, Vdc=Vldo=2.8V	PLP2514-6	65dc3	DC8	9b	Ric
S291	R5220K291A	DC/DC-IC	PWM step-down, +CE, Vdc=Vldo=2.9V	PLP2514-6	65dc3	DC8	9b	Ric
S3	R3117K203C	Vdet-IC	2.0V±1%, -Reset PPO, Sense	DFN1010-4	48rq	VD12	9a	Ric
S3	RP114K311D	LVR-IC	LDO, 3.1V±1%, 300mA, +CE, CL	DFN1010-4	48vm	VR4	9a	Ric
S301	R5220K301A	DC/DC-IC	PWM step-down, +CE, Vdc=Vldo=3V	PLP2514-6	65dc3	DC8	9b	Ric
S311	R5220K311A	DC/DC-IC	PWM step-down, +CE, Vdc=Vldo=3.1V	PLP2514-6	65dc3	DC8	9b	Ric
S321	R5220K321A	DC/DC-IC	PWM step-down, +CE, Vdc=Vldo=3.2V	PLP2514-6	65dc3	DC8	9b	Ric
S331	R5220K331A	DC/DC-IC	PWM step-down, +CE, Vdc=Vldo=3.3V	PLP2514-6	65dc3	DC8	9b	Ric
S4	R3117K213C	Vdet-IC	2.1V±1%, -Reset PPO, Sense	DFN1010-4	48rq	VD12	9a	Ric
S4	RP114K321D	LVR-IC	LDO, 3.2V±1%, 300mA, +CE, CL	DFN1010-4	48vm	VR4	9a	Ric
S5	R3117K223C	Vdet-IC	2.2V±1%, -Reset PPO, Sense	DFN1010-4	48rq	VD12	9a	Ric
S5	RP114K331D	LVR-IC	LDO, 3.3V±1%, 300mA, +CE, CL	DFN1010-4	48vm	VR4	9a	Ric
S6	R3117K233C	Vdet-IC	2.3V±1%, -Reset PPO, Sense	DFN1010-4	48rq	VD12	9a	Ric
S6	RP114K341D	LVR-IC	LDO, 3.4V±1%, 300mA, +CE, CL	DFN1010-4	48vm	VR4	9a	Ric
S7	R3117K243C	Vdet-IC	2.4V±1%, -Reset PPO, Sense	DFN1010-4	48rq	VD12	9a	Ric
S7	RP114K351D	LVR-IC	LDO, 3.5V±1%, 300mA, +CE, CL	DFN1010-4	48vm	VR4	9a	Ric
S8	R3117K253C	Vdet-IC	2.5V±1%, -Reset PPO, Sense	DFN1010-4	48rq	VD12	9a	Ric
S8	RP114K361D	LVR-IC	LDO, 3.6V±1%, 300mA, +CE, CL	DFN1010-4	48vm	VR4	9a	Ric
S9	R3117K263C	Vdet-IC	2.6V±1%, -Reset PPO, Sense	DFN1010-4	48rq	VD12	9a	Ric
S9	RP114K121D5	LVR-IC	LDO, 1.25V±1%, 300mA, +CE, CL	DFN1010-4	48vm	VR4	9a	Ric
SA	RP130K341A	LVR-IC	LDO, LN, -CE, 3.4V±1%, 150mA	DFN1010-4	48vm	VR4	9a	Ric
SA	RP152L001B	LVR-IC	LDO, Dual out, Vout1/Vout2=2.8V/2.8V±1%, 150mA, +CE, CL	DFN1212-6	52x4	VR19	9a	Ric
SB	RP130K351A	LVR-IC	LDO, LN, -CE, 3.5V±1%, 150mA	DFN1010-4	48vm	VR4	9a	Ric
SB	RP152L002B	LVR-IC	LDO, Dual out, Vout1/Vout2=1.8V/2.8V±1%, 150mA, +CE, CL	DFN1212-6	52x4	VR19	9a	Ric
SC	RP130K361A	LVR-IC	LDO, LN, -CE, 3.6V±1%, 150mA	DFN1010-4	48vm	VR4	9a	Ric
SC	RP152L003B	LVR-IC	LDO, Dual out, Vout1/Vout2=1.5V/2.8V±1%, 150mA, +CE, CL	DFN1212-6	52x4	VR19	9a	Ric
SD	RP130K371A	LVR-IC	LDO, LN, -CE, 3.7V±1%, 150mA	DFN1010-4	48vm	VR4	9a	Ric
SD	RP152L004B	LVR-IC	LDO, Dual out, Vout1/Vout2=1.2V/1.8V±1%, 150mA, +CE, CL	DFN1212-6	52x4	VR19	9a	Ric
SE	RP130K381A	LVR-IC	LDO, LN, -CE, 3.8V±1%, 150mA	DFN1010-4	48vm	VR4	9a	Ric
SE	RP152L005B	LVR-IC	LDO, Dual out, Vout1/Vout2=3.3V/1.2V±1%, 150mA, +CE, CL	DFN1212-6	52x4	VR19	9a	Ric
SF	RP130K391A	LVR-IC	LDO, LN, -CE, 3.9V±1%, 150mA	DFN1010-4	48vm	VR4	9a	Ric
SF	RP152L006B	LVR-IC	LDO, Dual out, Vout1/Vout2=3.3V/1.8V±1%, 150mA, +CE, CL	DFN1212-6	52x4	VR19	9a	Ric
SG	RP130K401A	LVR-IC	LDO, LN, -CE, 4V±1%, 150mA	DFN1010-4	48vm	VR4	9a	Ric
SG	RP152L007B	LVR-IC	LDO, Dual out, Vout1/Vout2=2.85V/2.85V±1%, 150mA, +CE, CL	DFN1212-6	52x4	VR19	9a	Ric
SH	RP130K411A	LVR-IC	LDO, LN, -CE, 4.1V±1%, 150mA	DFN1010-4	48vm	VR4	9a	Ric
SH	RP152L008B	LVR-IC	LDO, Dual out, Vout1/Vout2=2.85V/2.6V±1%, 150mA, +CE, CL	DFN1212-6	52x4	VR19	9a	Ric
SJ	RP130K421A	LVR-IC	LDO, LN, -CE, 4.2V±1%, 150mA	DFN1010-4	48vm	VR4	9a	Ric
SJ	RP152L009B	LVR-IC	LDO, Dual out, Vout1/Vout2=3.0V/2.8V±1%, 150mA, +CE, CL	DFN1212-6	52x4	VR19	9a	Ric



SMD
code

Type

Function

Short description

Case

Pinout Sch. St.Mnf.

SMD code	Type	Function	Short description	Case	Pinout	Sch.	St.Mnf.
SJA	MIC2288YML	DC/DC-IC	1.2MHz PWM Boost converter, 1A, Output OVP 34V	MLF-8	37bn	-	- Mcr
SJA	MIC2288BML	DC/DC-IC	1.2MHz PWM Boost converter, 1A, Output OVP 34V	MLF-8	37bn	-	- Mcr
SK	RP130K431A	LVR-IC	LDO, LN, -CE, 4.3V±1%, 150mA	DFN1010-4	48vm	VR4	9a Ric
SK	RP152L010B	LVR-IC	LDO, Dual out, Vout1/Vout2=3.0V/1.8V±1%, 150mA, +CE, CL	DFN1212-6	52x4	VR19	9a Ric
SL	RP130K441A	LVR-IC	LDO, LN, -CE, 4.4V±1%, 150mA	DFN1010-4	48vm	VR4	9a Ric
SL	RP152L011B	LVR-IC	LDO, Dual out, Vout1/Vout2=1.8V/1.5V±1%, 150mA, +CE, CL	DFN1212-6	52x4	VR19	9a Ric
SLA	MIC2287-15BML	DC/DC-IC	1.2MHz PWM Boost converter, Output OVP 15V	MLF-8	37bn	-	- Mcr
SEA	MIC2287-15YML	DC/DC-IC	1.2MHz PWM Boost converter, Output OVP 15V	MLF-8	37bn	-	- Mcr
SLB	MIC2287-24BML	DC/DC-IC	1.2MHz PWM Boost converter, Output OVP 24V	MLF-8	37bn	-	- Mcr
SLB	MIC2287-24YML	DC/DC-IC	1.2MHz PWM Boost converter, Output OVP 24V	MLF-8	37bn	-	- Mcr
SLC	MIC2287-34BML	DC/DC-IC	1.2MHz PWM Boost converter, Output OVP 34V	MLF-8	37bn	-	- Mcr
SLC	MIC2287-34YML	DC/DC-IC	1.2MHz PWM Boost converter, Output OVP 34V	MLF-8	37bn	-	- Mcr
SM	RP130K451A	LVR-IC	LDO, LN, -CE, 4.5V±1%, 150mA	DFN1010-4	48vm	VR4	9a Ric
SM	RP152L012B	LVR-IC	LDO, Dual out, Vout1/Vout2=2.8V/2.6V±1%, 150mA, +CE, CL	DFN1212-6	52x4	VR19	9a Ric
SN	RP130K461A	LVR-IC	LDO, LN, -CE, 4.6V±1%, 150mA	DFN1010-4	48vm	VR4	9a Ric
SN	RP152L013B	LVR-IC	LDO, Dual out, Vout1/Vout2=3.3V/2.8V±1%, 150mA, +CE, CL	DFN1212-6	52x4	VR19	9a Ric
SNA	MIC2289-15BML	LDR-IC	1.2 MHz PWM White LED driver, OVP 15V	DFN-8	37lc	LD1	9a Mcr
SNA	MIC2289-15YML	LDR-IC	1.2 MHz PWM White LED driver, OVP 15V	DFN-8	37lc	LD1	9a Mcr
SNB	MIC2289-24BML	LDR-IC	1.2 MHz PWM White LED driver, OVP 24V	DFN-8	37lc	LD1	9a Mcr
SNB	MIC2289-24YML	LDR-IC	1.2 MHz PWM White LED driver, OVP 24V	DFN-8	37lc	LD1	9a Mcr
SNC	MIC2289-34BML	LDR-IC	1.2 MHz PWM White LED driver, OVP 34V	DFN-8	37lc	LD1	9a Mcr
SNC	MIC2289-34YML	LDR-IC	1.2 MHz PWM White LED driver, OVP 34V	DFN-8	37lc	LD1	9a Mcr
SP	RP130K471A	LVR-IC	LDO, LN, -CE, 4.7V±1%, 150mA	DFN1010-4	48vm	VR4	9a Ric
SP	RP152L014B	LVR-IC	LDO, Dual out, Vout1/Vout2=3.3V/3.3V±1%, 150mA, +CE, CL	DFN1212-6	52x4	VR19	9a Ric
SQ	RP130K481A	LVR-IC	LDO, LN, -CE, 4.8V±1%, 150mA	DFN1010-4	48vm	VR4	9a Ric
SQ	RP152L015B	LVR-IC	LDO, Dual out, Vout1/Vout2=1.5V/2.5V±1%, 150mA, +CE, CL	DFN1212-6	52x4	VR19	9a Ric
SR	RP130K491A	LVR-IC	LDO, LN, -CE, 4.9V±1%, 150mA	DFN1010-4	48vm	VR4	9a Ric
SR	RP152L016B	LVR-IC	LDO, Dual out, Vout1/Vout2=1.5V/3.0V±1%, 150mA, +CE, CL	DFN1212-6	52x4	VR19	9a Ric
SS	RP130K501A	LVR-IC	LDO, LN, -CE, 5V±1%, 150mA	DFN1010-4	48vm	VR4	9a Ric
SS	RP152L017B	LVR-IC	LDO, Dual out, Vout1/Vout2=2.5V/3.0V±1%, 150mA, +CE, CL	DFN1212-6	52x4	VR19	9a Ric
ST	RP152L018B	LVR-IC	LDO, Dual out, Vout1/Vout2=1.8V/1.8V±1%, 150mA, +CE, CL	DFN1212-6	52x4	VR19	9a Ric
SU	RP152L019B	LVR-IC	LDO, Dual out, Vout1/Vout2=1.5V/2.6V±1%, 150mA, +CE, CL	DFN1212-6	52x4	VR19	9a Ric
SV	RP152L020B	LVR-IC	LDO, Dual out, Vout1/Vout2=2.8V/1.8V±1%, 150mA, +CE, CL	DFN1212-6	52x4	VR19	9a Ric
SW	RP152L021B	LVR-IC	LDO, Dual out, Vout1/Vout2=1.2V/2.8V±1%, 150mA, +CE, CL	DFN1212-6	52x4	VR19	9a Ric
SX	RP152L022B	LVR-IC	LDO, Dual out, Vout1/Vout2=2.8V/1.2V±1%, 150mA, +CE, CL	DFN1212-6	52x4	VR19	9a Ric
SY	RP152L023B	LVR-IC	LDO, Dual out, Vout1/Vout2=2.5V/2.5V±1%, 150mA, +CE, CL	DFN1212-6	52x4	VR19	9a Ric
SZ	RP152L024B	LVR-IC	LDO, Dual out, Vout1/Vout2=3.3V/3.0V±1%, 150mA, +CE, CL	DFN1212-6	52x4	VR19	9a Ric
T0	R3117K273C	Vdet-IC	2.7V±1%, -Reset PPO, Sense	DFN1010-4	48rq	VD12	9a Ric
T0	RP114K181D5	LVR-IC	LDO, 1.85V±1%, 300mA, +CE, CL	DFN1010-4	48vm	VR4	9a Ric
T02	R5220K012B	DC/DC-IC	PWM step-down, +CE, Vdc=1.2V, Vldo=1.1V	PLP2514-6	65dc3	DC8	9b Ric
T022	R5220K022B	DC/DC-IC	PWM step-down, +CE, Vdc=1.5V, Vldo=1.1V	PLP2514-6	65dc3	DC8	9b Ric
T032	R5220K032B	DC/DC-IC	PWM step-down, +CE, Vdc=1.3V, Vldo=1.05V	PLP2514-6	65dc3	DC8	9b Ric
T042	R5220K042B	DC/DC-IC	PWM step-down, +CE, Vdc=1.3V, Vldo=1.1V	PLP2514-6	65dc3	DC8	9b Ric
T1	R3117K283C	Vdet-IC	2.8V±1%, -Reset PPO, Sense	DFN1010-4	48rq	VD12	9a Ric
T1	RP114K281D5	LVR-IC	LDO, 2.85V±1%, 300mA, +CE, CL	DFN1010-4	48vm	VR4	9a Ric
T101	R5220K101B	DC/DC-IC	PWM step-down, +CE, Vdc=Vldo=1V	PLP2514-6	65dc3	DC8	9b Ric
T111	R5220K111B	DC/DC-IC	PWM step-down, +CE, Vdc=Vldo=1.1V	PLP2514-6	65dc3	DC8	9b Ric
T121	R5220K121B	DC/DC-IC	PWM step-down, +CE, Vdc=Vldo=1.2V	PLP2514-6	65dc3	DC8	9b Ric
T131	R5220K131B	DC/DC-IC	PWM step-down, +CE, Vdc=Vldo=1.3V	PLP2514-6	65dc3	DC8	9b Ric
T141	R5220K141B	DC/DC-IC	PWM step-down, +CE, Vdc=Vldo=1.4V	PLP2514-6	65dc3	DC8	9b Ric
T151	R5220K151B	DC/DC-IC	PWM step-down, +CE, Vdc=Vldo=1.5V	PLP2514-6	65dc3	DC8	9b Ric
T161	R5220K161B	DC/DC-IC	PWM step-down, +CE, Vdc=Vldo=1.6V	PLP2514-6	65dc3	DC8	9b Ric
T171	R5220K171B	DC/DC-IC	PWM step-down, +CE, Vdc=Vldo=1.7V	PLP2514-6	65dc3	DC8	9b Ric
T181	R5220K181B	DC/DC-IC	PWM step-down, +CE, Vdc=Vldo=1.8V	PLP2514-6	65dc3	DC8	9b Ric
T191	R5220K191B	DC/DC-IC	PWM step-down, +CE, Vdc=Vldo=1.9V	PLP2514-6	65dc3	DC8	9b Ric
T2	R3117K293C	Vdet-IC	2.9V±1%, -Reset PPO, Sense	DFN1010-4	48rq	VD12	9a Ric
T2	RP114K341D5	LVR-IC	LDO, 3.45V±1%, 300mA, +CE, CL	DFN1010-4	48vm	VR4	9a Ric
T201	R5220K201B	DC/DC-IC	PWM step-down, +CE, Vdc=Vldo=2V	PLP2514-6	65dc3	DC8	9b Ric
T211	R5220K211B	DC/DC-IC	PWM step-down, +CE, Vdc=Vldo=2.1V	PLP2514-6	65dc3	DC8	9b Ric
T221	R5220K221B	DC/DC-IC	PWM step-down, +CE, Vdc=Vldo=2.2V	PLP2514-6	65dc3	DC8	9b Ric
T231	R5220K231B	DC/DC-IC	PWM step-down, +CE, Vdc=Vldo=2.3V	PLP2514-6	65dc3	DC8	9b Ric
T241	R5220K241B	DC/DC-IC	PWM step-down, +CE, Vdc=Vldo=2.4V	PLP2514-6	65dc3	DC8	9b Ric
T251	R5220K251B	DC/DC-IC	PWM step-down, +CE, Vdc=Vldo=2.5V	PLP2514-6	65dc3	DC8	9b Ric
T261	R5220K261B	DC/DC-IC	PWM step-down, +CE, Vdc=Vldo=2.6V	PLP2514-6	65dc3	DC8	9b Ric
T271	R5220K271B	DC/DC-IC	PWM step-down, +CE, Vdc=Vldo=2.7V	PLP2514-6	65dc3	DC8	9b Ric
T281	R5220K281B	DC/DC-IC	PWM step-down, +CE, Vdc=Vldo=2.8V	PLP2514-6	65dc3	DC8	9b Ric
T291	R5220K291B	DC/DC-IC	PWM step-down, +CE, Vdc=Vldo=2.9V	PLP2514-6	65dc3	DC8	9b Ric
T3	R3117K303C	Vdet-IC	3.0V±1%, -Reset PPO, Sense	DFN1010-4	48rq	VD12	9a Ric
T301	R5220K301B	DC/DC-IC	PWM step-down, +CE, Vdc=Vldo=3V	PLP2514-6	65dc3	DC8	9b Ric
T311	R5220K311B	DC/DC-IC	PWM step-down, +CE, Vdc=Vldo=3.1V	PLP2514-6	65dc3	DC8	9b Ric



SMD code	Type	Function	Short description	Case	Pinout	Sch.	St.Mnf.
T321	R5220K321B	DC/DC-IC	PWM step-down, +CE, Vdc=Vldo=3.2V	PLP2514-6	65dc3	DC8	9b Ric
T331	R5220K331B	DC/DC-IC	PWM step-down, +CE, Vdc=Vldo=3.3V	PLP2514-6	65dc3	DC8	9b Ric
T4	R3117K313C	Vdet-IC	3.1V±1%, -Reset PPO, Sense	DFN1010-4	48rq	VD12	9a Ric
T5	R3117K323C	Vdet-IC	3.2V±1%, -Reset PPO, Sense	DFN1010-4	48rq	VD12	9a Ric
T6	R3117K333C	Vdet-IC	3.3V±1%, -Reset PPO, Sense	DFN1010-4	48rq	VD12	9a Ric
T7	R3117K343C	Vdet-IC	3.4V±1%, -Reset PPO, Sense	DFN1010-4	48rq	VD12	9a Ric
T8	PF2015UDF8B	ESD-Prot	4x EMI filtering TVS, 5V, 100MHz	UDFN-8B	37	-	9g Kec
T8	R3117K353C	Vdet-IC	3.5V±1%, -Reset PPO, Sense	DFN1010-4	48rq	VD12	9a Ric
T8A	XC6118N08AGR-G	Vdet-IC	0.8V±30mV, ±Reset ODO, Sense, hysteresis 5%, Cd	USP-4	45me	VD14	9a Tor
T8B	XC6118N08BGR-G	Vdet-IC	0.8V±30mV, ±Reset ODO, Sense, hysteresis <1%, Cd	USP-4	45me	VD14	9a Tor
T8C	XC6118N08CGR-G	Vdet-IC	0.8V±30mV, ±Reset ODO, Sense, hysteresis 5%	USP-4	45md	VD11	9a Tor
T8D	XC6118N08DGR-G	Vdet-IC	0.8V±30mV, ±Reset ODO, Sense, hysteresis <1%	USP-4	45md	VD11	9a Tor
T9	R3117K363C	Vdet-IC	3.6V±1%, -Reset PPO, Sense	DFN1010-4	48rq	VD12	9a Ric
T9A	XC6118N09AGR-G	Vdet-IC	0.9V±30mV, ±Reset ODO, Sense, hysteresis 5%, Cd	USP-4	45me	VD14	9a Tor
T9B	XC6118N09BGR-G	Vdet-IC	0.9V±30mV, ±Reset ODO, Sense, hysteresis <1%, Cd	USP-4	45me	VD14	9a Tor
T9C	XC6118N09CGR-G	Vdet-IC	0.9V±30mV, ±Reset ODO, Sense, hysteresis 5%	USP-4	45md	VD11	9a Tor
T9D	XC6118N09DGR-G	Vdet-IC	0.9V±30mV, ±Reset ODO, Sense, hysteresis <1%	USP-4	45md	VD11	9a Tor
TA	RP130K121B	LVR-IC	LDO, LN, +CE, 1.2V±1%, 150mA	DFN1010-4	48vm	VR4	9a Ric
TA	RP152L025B	LVR-IC	LDO, Dual out, Vout1/Vout2=3.0V/3.0V±1%, 150mA, +CE, CL	DFN1212-6	52x4	VR19	9a Ric
TB	RP130K131B	LVR-IC	LDO, LN, +CE, 1.3V±1%, 150mA	DFN1010-4	48vm	VR4	9a Ric
TB	RP152L026B	LVR-IC	LDO, Dual out, Vout1/Vout2=2.8V/3.1V±1%, 150mA, +CE, CL	DFN1212-6	52x4	VR19	9a Ric
TC	RP130K141B	LVR-IC	LDO, LN, +CE, 1.4V±1%, 150mA	DFN1010-4	48vm	VR4	9a Ric
TC	RP152L027B	LVR-IC	LDO, Dual out, Vout1/Vout2=2.3V/2.8V±1%, 150mA, +CE, CL	DFN1212-6	52x4	VR19	9a Ric
TD	RP130K151B	LVR-IC	LDO, LN, +CE, 1.5V±1%, 150mA	DFN1010-4	48vm	VR4	9a Ric
TD	RP152L028B	LVR-IC	LDO, Dual out, Vout1/Vout2=2.8V/1.0V±1%, 150mA, +CE, CL	DFN1212-6	52x4	VR19	9a Ric
TE	RP130K161B	LVR-IC	LDO, LN, +CE, 1.6V±1%, 150mA	DFN1010-4	48vm	VR4	9a Ric
TE	RP152L029B	LVR-IC	LDO, Dual out, Vout1/Vout2=1.5V/1.5V±1%, 150mA, +CE, CL	DFN1212-6	52x4	VR19	9a Ric
TF	RP130K171B	LVR-IC	LDO, LN, +CE, 1.7V±1%, 150mA	DFN1010-4	48vm	VR4	9a Ric
TF	RP152L030B	LVR-IC	LDO, Dual out, Vout1/Vout2=1.5V/3.3V±1%, 150mA, +CE, CL	DFN1212-6	52x4	VR19	9a Ric
TG	RP130K181B	LVR-IC	LDO, LN, +CE, 1.8V±1%, 150mA	DFN1010-4	48vm	VR4	9a Ric
TG	RP152L031B	LVR-IC	LDO, Dual out, Vout1/Vout2=1.8V/2.7V±1%, 150mA, +CE, CL	DFN1212-6	52x4	VR19	9a Ric
TH	RP130K181B5	LVR-IC	LDO, LN, +CE, 1.85V±1%, 150mA	DFN1010-4	48vm	VR4	9a Ric
TH	RP152L032B	LVR-IC	LDO, Dual out, Vout1/Vout2=1.2V/3.0V±1%, 150mA, +CE, CL	DFN1212-6	52x4	VR19	9a Ric
TJ	RP130K191B	LVR-IC	LDO, LN, +CE, 1.9V±1%, 150mA	DFN1010-4	48vm	VR4	9a Ric
TJ	RP152L033B	LVR-IC	LDO, Dual out, Vout1/Vout2=3.1V/3.1V±1%, 150mA, +CE, CL	DFN1212-6	52x4	VR19	9a Ric
TK	RP130K201B	LVR-IC	LDO, LN, +CE, 2.0V±1%, 150mA	DFN1010-4	48vm	VR4	9a Ric
TK	RP152L034B	LVR-IC	LDO, Dual out, Vout1/Vout2=1.8V/2.6V±1%, 150mA, +CE, CL	DFN1212-6	52x4	VR19	9a Ric
TL	RP130K211B	LVR-IC	LDO, LN, +CE, 2.1V±1%, 150mA	DFN1010-4	48vm	VR4	9a Ric
TL	RP152L035B	LVR-IC	LDO, Dual out, Vout1/Vout2=2.5V/1.2V±1%, 150mA, +CE, CL	DFN1212-6	52x4	VR19	9a Ric
TM	RP130K221B	LVR-IC	LDO, LN, +CE, 2.2V±1%, 150mA	DFN1010-4	48vm	VR4	9a Ric
TM	RP152L036B	LVR-IC	LDO, Dual out, Vout1/Vout2=1.2V/2.9V±1%, 150mA, +CE, CL	DFN1212-6	52x4	VR19	9a Ric
TN	RP130K231B	LVR-IC	LDO, LN, +CE, 2.3V±1%, 150mA	DFN1010-4	48vm	VR4	9a Ric
TN	RP152L037B	LVR-IC	LDO, Dual out, Vout1/Vout2=3.3V/2.0V±1%, 150mA, +CE, CL	DFN1212-6	52x4	VR19	9a Ric
TP	RP130K241B	LVR-IC	LDO, LN, +CE, 2.4V±1%, 150mA	DFN1010-4	48vm	VR4	9a Ric
TP	RP152L038B	LVR-IC	LDO, Dual out, Vout1/Vout2=1.2V/2.85V±1%, 150mA, +CE, CL	DFN1212-6	52x4	VR19	9a Ric
TQ	RP130K251B	LVR-IC	LDO, LN, +CE, 2.5V±1%, 150mA	DFN1010-4	48vm	VR4	9a Ric
TQ	RP152L039B	LVR-IC	LDO, Dual out, Vout1/Vout2=2.1V/3.3V±1%, 150mA, +CE, CL	DFN1212-6	52x4	VR19	9a Ric
TR	RP130K261B	LVR-IC	LDO, LN, +CE, 2.6V±1%, 150mA	DFN1010-4	48vm	VR4	9a Ric
TR	RP152L040B	LVR-IC	LDO, Dual out, Vout1/Vout2=2.8V/2.85V±1%, 150mA, +CE, CL	DFN1212-6	52x4	VR19	9a Ric
TR0	XC6902N091ER-G	LVR-IC	-0.9V±1.5%, 500mA, soft start	USP-6C	49ez	VR2	9a Tor
TR1	XC6902N101ER-G	LVR-IC	-1.0V±1.5%, 500mA, soft start	USP-6C	49ez	VR2	9a Tor
TR2	XC6902N111ER-G	LVR-IC	-1.1V±1.5%, 500mA, soft start	USP-6C	49ez	VR2	9a Tor
TR3	XC6902N121ER-G	LVR-IC	-1.2V±1.5%, 500mA, soft start	USP-6C	49ez	VR2	9a Tor
TR4	XC6902N131ER-G	LVR-IC	-1.3V±1.5%, 500mA, soft start	USP-6C	49ez	VR2	9a Tor
TR5	XC6902N141ER-G	LVR-IC	-1.4V±1.5%, 500mA, soft start	USP-6C	49ez	VR2	9a Tor
TR6	XC6902N151ER-G	LVR-IC	-1.5V±1.5%, 500mA, soft start	USP-6C	49ez	VR2	9a Tor
TR7	XC6902N161ER-G	LVR-IC	-1.6V±1.5%, 500mA, soft start	USP-6C	49ez	VR2	9a Tor
TR8	XC6902N171ER-G	LVR-IC	-1.7V±1.5%, 500mA, soft start	USP-6C	49ez	VR2	9a Tor
TR9	XC6902N181ER-G	LVR-IC	-1.8V±1.5%, 500mA, soft start	USP-6C	49ez	VR2	9a Tor
TRA	XC6902N191ER-G	LVR-IC	-1.9V±1.5%, 500mA, soft start	USP-6C	49ez	VR2	9a Tor
TRB	XC6902N201ER-G	LVR-IC	-2.0V±1.5%, 500mA, soft start	USP-6C	49ez	VR2	9a Tor
TRC	XC6902N211ER-G	LVR-IC	-2.1V±1.5%, 500mA, soft start	USP-6C	49ez	VR2	9a Tor
TRD	XC6902N221ER-G	LVR-IC	-2.2V±1.5%, 500mA, soft start	USP-6C	49ez	VR2	9a Tor
TRE	XC6902N231ER-G	LVR-IC	-2.3V±1.5%, 500mA, soft start	USP-6C	49ez	VR2	9a Tor
TRF	XC6902N241ER-G	LVR-IC	-2.4V±1.5%, 500mA, soft start	USP-6C	49ez	VR2	9a Tor
TRH	XC6902N251ER-G	LVR-IC	-2.5V±1.5%, 500mA, soft start	USP-6C	49ez	VR2	9a Tor
TRJ	XC6902N261ER-G	LVR-IC	-2.6V±1.5%, 500mA, soft start	USP-6C	49ez	VR2	9a Tor
TRL	XC6902N271ER-G	LVR-IC	-2.7V±1.5%, 500mA, soft start	USP-6C	49ez	VR2	9a Tor
TRM	XC6902N281ER-G	LVR-IC	-2.8V±1.5%, 500mA, soft start	USP-6C	49ez	VR2	9a Tor
TRN	XC6902N291ER-G	LVR-IC	-2.9V±1.5%, 500mA, soft start	USP-6C	49ez	VR2	9a Tor



SMD code	Type	Function	Short description	Case	Pinout	Sch.	St.	Mnf.
TRP	XC6902N301ER-G	LVR-IC	-3.0V±1.5%, 500mA, soft start	USP-6C	49ez	VR2	9a	Tor
TRR	XC6902N311ER-G	LVR-IC	-3.1V±1.5%, 500mA, soft start	USP-6C	49ez	VR2	9a	Tor
TRS	XC6902N321ER-G	LVR-IC	-3.2V±1.5%, 500mA, soft start	USP-6C	49ez	VR2	9a	Tor
TRT	XC6902N331ER-G	LVR-IC	-3.3V±1.5%, 500mA, soft start	USP-6C	49ez	VR2	9a	Tor
TRU	XC6902N341ER-G	LVR-IC	-3.4V±1.5%, 500mA, soft start	USP-6C	49ez	VR2	9a	Tor
TRV	XC6902N351ER-G	LVR-IC	-3.5V±1.5%, 500mA, soft start	USP-6C	49ez	VR2	9a	Tor
TRX	XC6902N361ER-G	LVR-IC	-3.6V±1.5%, 500mA, soft start	USP-6C	49ez	VR2	9a	Tor
TRY	XC6902N371ER-G	LVR-IC	-3.7V±1.5%, 500mA, soft start	USP-6C	49ez	VR2	9a	Tor
TRZ	XC6902N381ER-G	LVR-IC	-3.8V±1.5%, 500mA, soft start	USP-6C	49ez	VR2	9a	Tor
TS	RP130K271B	LVR-IC	LDO, LN, +CE, 2.7V±1%, 150mA	DFN1010-4	48vm	VR4	9a	Ric
TS	RP152L041B	LVR-IC	LDO, Dual out, Vout1/Vout2=1.8V/3.0V±1%, 150mA, +CE, CL	DFN1212-6	52x4	VR19	9a	Ric
TS0	XC6902N391ER-G	LVR-IC	-3.9V±1.5%, 500mA, soft start	USP-6C	49ez	VR2	9a	Tor
TS1	XC6902N401ER-G	LVR-IC	-4.0V±1.5%, 500mA, soft start	USP-6C	49ez	VR2	9a	Tor
TS2	XC6902N411ER-G	LVR-IC	-4.1V±1.5%, 500mA, soft start	USP-6C	49ez	VR2	9a	Tor
TS3	XC6902N421ER-G	LVR-IC	-4.2V±1.5%, 500mA, soft start	USP-6C	49ez	VR2	9a	Tor
TS4	XC6902N431ER-G	LVR-IC	-4.3V±1.5%, 500mA, soft start	USP-6C	49ez	VR2	9a	Tor
TS5	XC6902N441ER-G	LVR-IC	-4.4V±1.5%, 500mA, soft start	USP-6C	49ez	VR2	9a	Tor
TS6	XC6902N451ER-G	LVR-IC	-4.5V±1.5%, 500mA, soft start	USP-6C	49ez	VR2	9a	Tor
TS7	XC6902N461ER-G	LVR-IC	-4.6V±1.5%, 500mA, soft start	USP-6C	49ez	VR2	9a	Tor
TS8	XC6902N471ER-G	LVR-IC	-4.7V±1.5%, 500mA, soft start	USP-6C	49ez	VR2	9a	Tor
TS9	XC6902N481ER-G	LVR-IC	-4.8V±1.5%, 500mA, soft start	USP-6C	49ez	VR2	9a	Tor
TSA	XC6902N491ER-G	LVR-IC	-4.9V±1.5%, 500mA, soft start	USP-6C	49ez	VR2	9a	Tor
TSB	XC6902N501ER-G	LVR-IC	-5.0V±1.5%, 500mA, soft start	USP-6C	49ez	VR2	9a	Tor
TSC	XC6902N511ER-G	LVR-IC	-5.1V±1.5%, 500mA, soft start	USP-6C	49ez	VR2	9a	Tor
TSD	XC6902N521ER-G	LVR-IC	-5.2V±1.5%, 500mA, soft start	USP-6C	49ez	VR2	9a	Tor
TSE	XC6902N531ER-G	LVR-IC	-5.3V±1.5%, 500mA, soft start	USP-6C	49ez	VR2	9a	Tor
TSF	XC6902N541ER-G	LVR-IC	-5.4V±1.5%, 500mA, soft start	USP-6C	49ez	VR2	9a	Tor
TSH	XC6902N551ER-G	LVR-IC	-5.5V±1.5%, 500mA, soft start	USP-6C	49ez	VR2	9a	Tor
TSJ	XC6902N561ER-G	LVR-IC	-5.6V±1.5%, 500mA, soft start	USP-6C	49ez	VR2	9a	Tor
TSL	XC6902N571ER-G	LVR-IC	-5.7V±1.5%, 500mA, soft start	USP-6C	49ez	VR2	9a	Tor
TSM	XC6902N581ER-G	LVR-IC	-5.8V±1.5%, 500mA, soft start	USP-6C	49ez	VR2	9a	Tor
TSN	XC6902N591ER-G	LVR-IC	-5.9V±1.5%, 500mA, soft start	USP-6C	49ez	VR2	9a	Tor
TSP	XC6902N601ER-G	LVR-IC	-6.0V±1.5%, 500mA, soft start	USP-6C	49ez	VR2	9a	Tor
TSR	XC6902N611ER-G	LVR-IC	-6.1V±1.5%, 500mA, soft start	USP-6C	49ez	VR2	9a	Tor
TSS	XC6902N621ER-G	LVR-IC	-6.2V±1.5%, 500mA, soft start	USP-6C	49ez	VR2	9a	Tor
TST	XC6902N631ER-G	LVR-IC	-6.3V±1.5%, 500mA, soft start	USP-6C	49ez	VR2	9a	Tor
TSU	XC6902N641ER-G	LVR-IC	-6.4V±1.5%, 500mA, soft start	USP-6C	49ez	VR2	9a	Tor
TSV	XC6902N651ER-G	LVR-IC	-6.5V±1.5%, 500mA, soft start	USP-6C	49ez	VR2	9a	Tor
TSX	XC6902N661ER-G	LVR-IC	-6.6V±1.5%, 500mA, soft start	USP-6C	49ez	VR2	9a	Tor
TSY	XC6902N671ER-G	LVR-IC	-6.7V±1.5%, 500mA, soft start	USP-6C	49ez	VR2	9a	Tor
TSZ	XC6902N681ER-G	LVR-IC	-6.8V±1.5%, 500mA, soft start	USP-6C	49ez	VR2	9a	Tor
TT	RP130K281B	LVR-IC	LDO, LN, +CE, 2.8V±1%, 150mA	DFN1010-4	48vm	VR4	9a	Ric
TT	RP152L042B	LVR-IC	LDO, Dual out, Vout1/Vout2=1.2V/2.6V±1%, 150mA, +CE, CL	DFN1212-6	52x4	VR19	9a	Ric
TT0	XC6902N691ER-G	LVR-IC	-6.9V±1.5%, 500mA, soft start	USP-6C	49ez	VR2	9a	Tor
TT1	XC6902N701ER-G	LVR-IC	-7.0V±1.5%, 500mA, soft start	USP-6C	49ez	VR2	9a	Tor
TT2	XC6902N711ER-G	LVR-IC	-7.1V±1.5%, 500mA, soft start	USP-6C	49ez	VR2	9a	Tor
TT3	XC6902N721ER-G	LVR-IC	-7.2V±1.5%, 500mA, soft start	USP-6C	49ez	VR2	9a	Tor
TT4	XC6902N731ER-G	LVR-IC	-7.3V±1.5%, 500mA, soft start	USP-6C	49ez	VR2	9a	Tor
TT5	XC6902N741ER-G	LVR-IC	-7.4V±1.5%, 500mA, soft start	USP-6C	49ez	VR2	9a	Tor
TT6	XC6902N751ER-G	LVR-IC	-7.5V±1.5%, 500mA, soft start	USP-6C	49ez	VR2	9a	Tor
TT7	XC6902N761ER-G	LVR-IC	-7.6V±1.5%, 500mA, soft start	USP-6C	49ez	VR2	9a	Tor
TT8	XC6902N771ER-G	LVR-IC	-7.7V±1.5%, 500mA, soft start	USP-6C	49ez	VR2	9a	Tor
TT9	XC6902N781ER-G	LVR-IC	-7.8V±1.5%, 500mA, soft start	USP-6C	49ez	VR2	9a	Tor
TTA	XC6902N791ER-G	LVR-IC	-7.9V±1.5%, 500mA, soft start	USP-6C	49ez	VR2	9a	Tor
TTB	XC6902N801ER-G	LVR-IC	-8.0V±1.5%, 500mA, soft start	USP-6C	49ez	VR2	9a	Tor
TTC	XC6902N811ER-G	LVR-IC	-8.1V±1.5%, 500mA, soft start	USP-6C	49ez	VR2	9a	Tor
TTD	XC6902N821ER-G	LVR-IC	-8.2V±1.5%, 500mA, soft start	USP-6C	49ez	VR2	9a	Tor
TT E	XC6902N831ER-G	LVR-IC	-8.3V±1.5%, 500mA, soft start	USP-6C	49ez	VR2	9a	Tor
TT F	XC6902N841ER-G	LVR-IC	-8.4V±1.5%, 500mA, soft start	USP-6C	49ez	VR2	9a	Tor
TT H	XC6902N851ER-G	LVR-IC	-8.5V±1.5%, 500mA, soft start	USP-6C	49ez	VR2	9a	Tor
TT K	XC6902N861ER-G	LVR-IC	-8.6V±1.5%, 500mA, soft start	USP-6C	49ez	VR2	9a	Tor
TT L	XC6902N871ER-G	LVR-IC	-8.7V±1.5%, 500mA, soft start	USP-6C	49ez	VR2	9a	Tor
TT M	XC6902N881ER-G	LVR-IC	-8.8V±1.5%, 500mA, soft start	USP-6C	49ez	VR2	9a	Tor
TT N	XC6902N891ER-G	LVR-IC	-8.9V±1.5%, 500mA, soft start	USP-6C	49ez	VR2	9a	Tor
TT P	XC6902N901ER-G	LVR-IC	-9.0V±1.5%, 500mA, soft start	USP-6C	49ez	VR2	9a	Tor
TT R	XC6902N911ER-G	LVR-IC	-9.1V±1.5%, 500mA, soft start	USP-6C	49ez	VR2	9a	Tor
TT S	XC6902N921ER-G	LVR-IC	-9.2V±1.5%, 500mA, soft start	USP-6C	49ez	VR2	9a	Tor
TT T	XC6902N931ER-G	LVR-IC	-9.3V±1.5%, 500mA, soft start	USP-6C	49ez	VR2	9a	Tor
TT U	XC6902N941ER-G	LVR-IC	-9.4V±1.5%, 500mA, soft start	USP-6C	49ez	VR2	9a	Tor
TT V	XC6902N951ER-G	LVR-IC	-9.5V±1.5%, 500mA, soft start	USP-6C	49ez	VR2	9a	Tor



SMD code	Type	Function	Short description	Case	Pinout	Sch.	St.	Mnf.
TTX	XC6902N961ER-G	LVR-IC	-9.6V±1.5%, 500mA, soft start	USP-6C	49ez	VR2	9a	Tor
TTY	XC6902N971ER-G	LVR-IC	-9.7V±1.5%, 500mA, soft start	USP-6C	49ez	VR2	9a	Tor
TTZ	XC6902N981ER-G	LVR-IC	-9.8V±1.5%, 500mA, soft start	USP-6C	49ez	VR2	9a	Tor
TU	RP130K281B5	LVR-IC	LDO, LN, +CE, 2.85V±1%, 150mA	DFN1010-4	48vm	VR4	9a	Ric
TU	RP152L043B	LVR-IC	LDO, Dual out, Vout1/Vout2=1.3V/2.8V±1%, 150mA, +CE, CL	DFN1212-6	52x4	VR19	9a	Ric
TU0	XC6902N991ER-G	LVR-IC	-9.9V±1.5%, 500mA, soft start	USP-6C	49ez	VR2	9a	Tor
TU1	XC6902NA01ER-G	LVR-IC	-10.0V±1.5%, 500mA, soft start	USP-6C	49ez	VR2	9a	Tor
TU2	XC6902NA11ER-G	LVR-IC	-10.1V±1.5%, 500mA, soft start	USP-6C	49ez	VR2	9a	Tor
TU3	XC6902NA21ER-G	LVR-IC	-10.2V±1.5%, 500mA, soft start	USP-6C	49ez	VR2	9a	Tor
TU4	XC6902NA31ER-G	LVR-IC	-10.3V±1.5%, 500mA, soft start	USP-6C	49ez	VR2	9a	Tor
TU5	XC6902NA41ER-G	LVR-IC	-10.4V±1.5%, 500mA, soft start	USP-6C	49ez	VR2	9a	Tor
TU6	XC6902NA51ER-G	LVR-IC	-10.5V±1.5%, 500mA, soft start	USP-6C	49ez	VR2	9a	Tor
TU7	XC6902NA61ER-G	LVR-IC	-10.6V±1.5%, 500mA, soft start	USP-6C	49ez	VR2	9a	Tor
TU8	XC6902NA71ER-G	LVR-IC	-10.7V±1.5%, 500mA, soft start	USP-6C	49ez	VR2	9a	Tor
TU9	XC6902NA81ER-G	LVR-IC	-10.8V±1.5%, 500mA, soft start	USP-6C	49ez	VR2	9a	Tor
TUA	XC6902NA91ER-G	LVR-IC	-10.9V±1.5%, 500mA, soft start	USP-6C	49ez	VR2	9a	Tor
TUB	XC6902NB01ER-G	LVR-IC	-11.0V±1.5%, 500mA, soft start	USP-6C	49ez	VR2	9a	Tor
TUC	XC6902NB11ER-G	LVR-IC	-11.1V±1.5%, 500mA, soft start	USP-6C	49ez	VR2	9a	Tor
TUD	XC6902NB21ER-G	LVR-IC	-11.2V±1.5%, 500mA, soft start	USP-6C	49ez	VR2	9a	Tor
TUE	XC6902NB31ER-G	LVR-IC	-11.3V±1.5%, 500mA, soft start	USP-6C	49ez	VR2	9a	Tor
TUF	XC6902NB41ER-G	LVR-IC	-11.4V±1.5%, 500mA, soft start	USP-6C	49ez	VR2	9a	Tor
TUH	XC6902NB51ER-G	LVR-IC	-11.5V±1.5%, 500mA, soft start	USP-6C	49ez	VR2	9a	Tor
TUK	XC6902NB61ER-G	LVR-IC	-11.6V±1.5%, 500mA, soft start	USP-6C	49ez	VR2	9a	Tor
TUL	XC6902NB71ER-G	LVR-IC	-11.7V±1.5%, 500mA, soft start	USP-6C	49ez	VR2	9a	Tor
TUM	XC6902NB81ER-G	LVR-IC	-11.8V±1.5%, 500mA, soft start	USP-6C	49ez	VR2	9a	Tor
TUN	XC6902NB91ER-G	LVR-IC	-11.9V±1.5%, 500mA, soft start	USP-6C	49ez	VR2	9a	Tor
TUP	XC6902NC01ER-G	LVR-IC	-12.0V±1.5%, 500mA, soft start	USP-6C	49ez	VR2	9a	Tor
TV	RP130K291B	LVR-IC	LDO, LN, +CE, 2.9V±1%, 150mA	DFN1010-4	48vm	VR4	9a	Ric
TV	RP152L044B	LVR-IC	LDO, Dual out, Vout1/Vout2=1.1V/1.5V±1%, 150mA, +CE, CL	DFN1212-6	52x4	VR19	9a	Ric
TW	RP130K301B	LVR-IC	LDO, LN, +CE, 3V±1%, 150mA	DFN1010-4	48vm	VR4	9a	Ric
TW	RP152L045B	LVR-IC	LDO, Dual out, Vout1/Vout2=2.8V/3.3V±1%, 150mA, +CE, CL	DFN1212-6	52x4	VR19	9a	Ric
TX	RP130K311B	LVR-IC	LDO, LN, +CE, 3.1V±1%, 150mA	DFN1010-4	48vm	VR4	9a	Ric
TX	RP152L046B	LVR-IC	LDO, Dual out, Vout1/Vout2=2.8V/3.0V±1%, 150mA, +CE, CL	DFN1212-6	52x4	VR19	9a	Ric
TY	RP130K321B	LVR-IC	LDO, LN, +CE, 3.2V±1%, 150mA	DFN1010-4	48vm	VR4	9a	Ric
TY	RP152L047B	LVR-IC	LDO, Dual out, Vout1/Vout2=2.5V/2.8V±1%, 150mA, +CE, CL	DFN1212-6	52x4	VR19	9a	Ric
TZ	RP130K331B	LVR-IC	LDO, LN, +CE, 3.3V±1%, 150mA	DFN1010-4	48vm	VR4	9a	Ric
TZ	RP152L048B	LVR-IC	LDO, Dual out, Vout1/Vout2=2.5V/3.2V±1%, 150mA, +CE, CL	DFN1212-6	52x4	VR19	9a	Ric
U0	R3117K373C	Vdet-IC	3.7V±1%, -Reset PPO, Sense	DFN1010-4	48PQ	VD12	9a	Ric
U0	RP152L049A	LVR-IC	LDO, Dual out, Vout1/Vout2=1.5V/2.85V±1%, 150mA, +CE	DFN1212-6	52x4	VR19	9a	Ric
U001	R5326K001B	LVR-IC	LDO, Dual out, V1=2.2V±1%, V2=2.2V±1%, 150mA, +CE, CL	DFN1820-6	74r	VR19	9b	Ric
U002	R5326K002B	LVR-IC	LDO, Dual out, V1=2.8V±1%, V2=2.8V±1%, 150mA, +CE, CL	DFN1820-6	74r	VR19	9b	Ric
U003	R5326K003B	LVR-IC	LDO, Dual out, V1=1.8V±1%, V2=3V±1%, 150mA, +CE, CL	DFN1820-6	74r	VR19	9b	Ric
U004	R5326K004B	LVR-IC	LDO, Dual out, V1=2.5V±1%, V2=3V±1%, 150mA, +CE, CL	DFN1820-6	74r	VR19	9b	Ric
U005	R5326K005B	LVR-IC	LDO, Dual out, V1=1.8V±1%, V2=2.5V±1%, 150mA, +CE, CL	DFN1820-6	74r	VR19	9b	Ric
U006	R5326K006B	LVR-IC	LDO, Dual out, V1=1.8V±1%, V2=3.3V±1%, 150mA, +CE, CL	DFN1820-6	74r	VR19	9b	Ric
U007	R5326K007B	LVR-IC	LDO, Dual out, V1=2.5V±1%, V2=2.8V±1%, 150mA, +CE, CL	DFN1820-6	74r	VR19	9b	Ric
U008	R5326K008B	LVR-IC	LDO, Dual out, V1=1.2V±1%, V2=1.2V±1%, 150mA, +CE, CL	DFN1820-6	74r	VR19	9b	Ric
U009	R5326K009B	LVR-IC	LDO, Dual out, V1=1.5V±1%, V2=1.6V±1%, 150mA, +CE, CL	DFN1820-6	74r	VR19	9b	Ric
U010	R5326K010B	LVR-IC	LDO, Dual out, V1=1.5V±1%, V2=2.8V±1%, 150mA, +CE, CL	DFN1820-6	74r	VR19	9b	Ric
U011	R5326K011B	LVR-IC	LDO, Dual out, V1=3V±1%, V2=3V±1%, 150mA, +CE, CL	DFN1820-6	74r	VR19	9b	Ric
U012	R5326K012B	LVR-IC	LDO, Dual out, V1=3.1V±1%, V2=3.1V±1%, 150mA, +CE, CL	DFN1820-6	74r	VR19	9b	Ric
U013	R5326K013B	LVR-IC	LDO, Dual out, V1=2.7V±1%, V2=1.8V±1%, 150mA, +CE, CL	DFN1820-6	74r	VR19	9b	Ric
U014	R5326K014B	LVR-IC	LDO, Dual out, V1=1.8V±1%, V2=2.6V±1%, 150mA, +CE, CL	DFN1820-6	74r	VR19	9b	Ric
U015	R5326K015B	LVR-IC	LDO, Dual out, V1=3.3V±1%, V2=3.3V±1%, 150mA, +CE, CL	DFN1820-6	74r	VR19	9b	Ric
U016	R5326K016B	LVR-IC	LDO, Dual out, V1=2.85V±1%, V2=2.85V±1%, 150mA, +CE, CL	DFN1820-6	74r	VR19	9b	Ric
U017	R5326K017B	LVR-IC	LDO, Dual out, V1=1.1V±1%, V2=1.1V±1%, 150mA, +CE, CL	DFN1820-6	74r	VR19	9b	Ric
U018	R5326K018B	LVR-IC	LDO, Dual out, V1=1.2V±1%, V2=1.2V±1%, 150mA, +CE, CL	DFN1820-6	74r	VR19	9b	Ric
U019	R5326K019B	LVR-IC	LDO, Dual out, V1=1.2V±1%, V2=2.9V±1%, 150mA, +CE, CL	DFN1820-6	74r	VR19	9b	Ric
U020	R5326K020B	LVR-IC	LDO, Dual out, V1=2.8V±1%, V2=3.0V±1%, 150mA, +CE, CL	DFN1820-6	74r	VR19	9b	Ric
U021	R5326K021B	LVR-IC	LDO, Dual out, V1=1.5V±1%, V2=2.8V±1%, 150mA, +CE, CL	DFN1820-6	74r	VR19	9b	Ric
U022	R5326K022B	LVR-IC	LDO, Dual out, V1=1.8V±1%, V2=2.9V±1%, 150mA, +CE, CL	DFN1820-6	74r	VR19	9b	Ric
U023	R5326K023B	LVR-IC	LDO, Dual out, V1=4.2V±1%, V2=3.1V±1%, 150mA, +CE, CL	DFN1820-6	74r	VR19	9b	Ric
U024	R5326K024B	LVR-IC	LDO, Dual out, V1=1.5V±1%, V2=3.0V±1%, 150mA, +CE, CL	DFN1820-6	74r	VR19	9b	Ric
U025	R5326K025B	LVR-IC	LDO, Dual out, V1=1.8V±1%, V2=1.85V±1%, 150mA, +CE, CL	DFN1820-6	74r	VR19	9b	Ric
U026	R5326K026B	LVR-IC	LDO, Dual out, V1=1.8V±1%, V2=2.85V±1%, 150mA, +CE, CL	DFN1820-6	74r	VR19	9b	Ric
U0A	XC6118N10AGR-G	Vdet-IC	1.0V±30mV, ±Reset ODO, Sense, hysteresis 5%, Cd	USP-4	45me	VD14	9a	Tor
U0B	XC6118N10BGR-G	Vdet-IC	1.0V±30mV, ±Reset ODO, Sense, hysteresis <1%, Cd	USP-4	45me	VD14	9a	Tor
U0C	XC6118N10CGR-G	Vdet-IC	1.0V±30mV, ±Reset ODO, Sense, hysteresis 5%	USP-4	45md	VD11	9a	Tor
U0D	XC6118N10DGR-G	Vdet-IC	1.0V±30mV, ±Reset ODO, Sense, hysteresis <1%	USP-4	45md	VD11	9a	Tor
U1	R3117K383C	Vdet-IC	3.8V±1%, -Reset PPO, Sense	DFN1010-4	48rq	VD12	9a	Ric



SMD code	Type	Function	Short description	Case	Pinout	Sch.	St.	Mnf.
U1A	XC6118N11AGR-G	Vdet-IC	1.1V±30mV, ±Reset ODO, Sense, hysteresis 5%, Cd	USP-4	45me	VD14	9a	Tor
U1B	XC6118N11BGR-G	Vdet-IC	1.1V±30mV, ±Reset ODO, Sense, hysteresis <1%, Cd	USP-4	45me	VD14	9a	Tor
U1C	XC6118N11CGR-G	Vdet-IC	1.1V±30mV, ±Reset ODO, Sense, hysteresis 5%	USP-4	45md	VD11	9a	Tor
U1D	XC6118N11DGR-G	Vdet-IC	1.1V±30mV, ±Reset ODO, Sense, hysteresis <1%	USP-4	45md	VD11	9a	Tor
U2	R3117K393C	Vdet-IC	3.9V±1%, -Reset PPO, Sense	DFN1010-4	48rq	VD12	9a	Ric
U2A	XC6118N12AGR-G	Vdet-IC	1.2V±30mV, ±Reset ODO, Sense, hysteresis 5%, Cd	USP-4	45me	VD14	9a	Tor
U2B	XC6118N12BGR-G	Vdet-IC	1.2V±30mV, ±Reset ODO, Sense, hysteresis <1%, Cd	USP-4	45me	VD14	9a	Tor
U2C	XC6118N12CGR-G	Vdet-IC	1.2V±30mV, ±Reset ODO, Sense, hysteresis 5%	USP-4	45md	VD11	9a	Tor
U2D	XC6118N12DGR-G	Vdet-IC	1.2V±30mV, ±Reset ODO, Sense, hysteresis <1%	USP-4	45md	VD11	9a	Tor
U3	R3117K403C	Vdet-IC	4.0V±1%, -Reset PPO, Sense	DFN1010-4	48rq	VD12	9a	Ric
U3A	XC6118N13AGR-G	Vdet-IC	1.3V±30mV, ±Reset ODO, Sense, hysteresis 5%, Cd	USP-4	45me	VD14	9a	Tor
U3B	XC6118N13BGR-G	Vdet-IC	1.3V±30mV, ±Reset ODO, Sense, hysteresis <1%, Cd	USP-4	45me	VD14	9a	Tor
U3C	XC6118N13CGR-G	Vdet-IC	1.3V±30mV, ±Reset ODO, Sense, hysteresis 5%	USP-4	45md	VD11	9a	Tor
U3D	XC6118N13DGR-G	Vdet-IC	1.3V±30mV, ±Reset ODO, Sense, hysteresis <1%	USP-4	45md	VD11	9a	Tor
U4	R3117K413C	Vdet-IC	4.1V±1%, -Reset PPO, Sense	DFN1010-4	48rq	VD12	9a	Ric
U4A	XC6118N14AGR-G	Vdet-IC	1.4V±30mV, ±Reset ODO, Sense, hysteresis 5%, Cd	USP-4	45me	VD14	9a	Tor
U4B	XC6118N14BGR-G	Vdet-IC	1.4V±30mV, ±Reset ODO, Sense, hysteresis <1%, Cd	USP-4	45me	VD14	9a	Tor
U4C	XC6118N14CGR-G	Vdet-IC	1.4V±30mV, ±Reset ODO, Sense, hysteresis 5%	USP-4	45md	VD11	9a	Tor
U4D	XC6118N14DGR-G	Vdet-IC	1.4V±30mV, ±Reset ODO, Sense, hysteresis <1%	USP-4	45md	VD11	9a	Tor
U5	R3117K423C	Vdet-IC	4.2V±1%, -Reset PPO, Sense	DFN1010-4	48rq	VD12	9a	Ric
U5A	XC6118N15AGR-G	Vdet-IC	1.5V±30mV, ±Reset ODO, Sense, hysteresis 5%, Cd	USP-4	45me	VD14	9a	Tor
U5B	XC6118N15BGR-G	Vdet-IC	1.5V±30mV, ±Reset ODO, Sense, hysteresis <1%, Cd	USP-4	45me	VD14	9a	Tor
U5C	XC6118N15CGR-G	Vdet-IC	1.5V±30mV, ±Reset ODO, Sense, hysteresis 5%	USP-4	45md	VD11	9a	Tor
U5D	XC6118N15DGR-G	Vdet-IC	1.5V±30mV, ±Reset ODO, Sense, hysteresis <1%	USP-4	45md	VD11	9a	Tor
U6	R3117K433C	Vdet-IC	4.3V±1%, -Reset PPO, Sense	DFN1010-4	48rq	VD12	9a	Ric
U6A	XC6118N16AGR-G	Vdet-IC	1.6V±2%, ±Reset ODO, Sense, hysteresis 5%, Cd	USP-4	45me	VD14	9a	Tor
U6B	XC6118N16BGR-G	Vdet-IC	1.6V±2%, ±Reset ODO, Sense, hysteresis <1%, Cd	USP-4	45me	VD14	9a	Tor
U6C	XC6118N16CGR-G	Vdet-IC	1.6V±2%, ±Reset ODO, Sense, hysteresis 5%	USP-4	45md	VD11	9a	Tor
U6D	XC6118N16DGR-G	Vdet-IC	1.6V±2%, ±Reset ODO, Sense, hysteresis <1%	USP-4	45md	VD11	9a	Tor
U7	R3117K443C	Vdet-IC	4.4V±1%, -Reset PPO, Sense	DFN1010-4	48rq	VD12	9a	Ric
U7A	XC6118N17AGR-G	Vdet-IC	1.7V±2%, ±Reset ODO, Sense, hysteresis 5%, Cd	USP-4	45me	VD14	9a	Tor
U7B	XC6118N17BGR-G	Vdet-IC	1.7V±2%, ±Reset ODO, Sense, hysteresis <1%, Cd	USP-4	45me	VD14	9a	Tor
U7C	XC6118N17CGR-G	Vdet-IC	1.7V±2%, ±Reset ODO, Sense, hysteresis 5%	USP-4	45md	VD11	9a	Tor
U7D	XC6118N17DGR-G	Vdet-IC	1.7V±2%, ±Reset ODO, Sense, hysteresis <1%	USP-4	45md	VD11	9a	Tor
U8	R3117K453C	Vdet-IC	4.5V±1%, -Reset PPO, Sense	DFN1010-4	48rq	VD12	9a	Ric
U8A	XC6118N18AGR-G	Vdet-IC	1.8V±2%, ±Reset ODO, Sense, hysteresis 5%, Cd	USP-4	45me	VD14	9a	Tor
U8B	XC6118N18BGR-G	Vdet-IC	1.8V±2%, ±Reset ODO, Sense, hysteresis <1%, Cd	USP-4	45me	VD14	9a	Tor
U8C	XC6118N18CGR-G	Vdet-IC	1.8V±2%, ±Reset ODO, Sense, hysteresis 5%	USP-4	45md	VD11	9a	Tor
U8D	XC6118N18DGR-G	Vdet-IC	1.8V±2%, ±Reset ODO, Sense, hysteresis <1%	USP-4	45md	VD11	9a	Tor
U9	R3117K463C	Vdet-IC	4.6V±1%, -Reset PPO, Sense	DFN1010-4	48rq	VD12	9a	Ric
U9A	XC6118N19AGR-G	Vdet-IC	1.9V±2%, ±Reset ODO, Sense, hysteresis 5%, Cd	USP-4	45me	VD14	9a	Tor
U9B	XC6118N19BGR-G	Vdet-IC	1.9V±2%, ±Reset ODO, Sense, hysteresis <1%, Cd	USP-4	45me	VD14	9a	Tor
U9C	XC6118N19CGR-G	Vdet-IC	1.9V±2%, ±Reset ODO, Sense, hysteresis 5%	USP-4	45md	VD11	9a	Tor
U9D	XC6118N19DGR-G	Vdet-IC	1.9V±2%, ±Reset ODO, Sense, hysteresis <1%	USP-4	45md	VD11	9a	Tor
UA	RP130K341B	LVR-IC	LDO, LN, +CE, 3.4V±1%, 150mA	DFN1010-4	48vm	VR4	9a	Ric
UA	RP152L001C	LVR-IC	LDO, Dual out, Vout1/Vout2=2.8V/2.8V±1%, 150mA, +CE, CL	DFN1212-6	52x4	VR19	9a	Ric
UB	RP130K351B	LVR-IC	LDO, LN, +CE, 3.5V±1%, 150mA	DFN1010-4	48vm	VR4	9a	Ric
UB	RP152L002C	LVR-IC	LDO, Dual out, Vout1/Vout2=1.8V/2.8V±1%, 150mA, +CE, CL	DFN1212-6	52x4	VR19	9a	Ric
UC	RP130K361B	LVR-IC	LDO, LN, +CE, 3.6V±1%, 150mA	DFN1010-4	48vm	VR4	9a	Ric
UC	RP152L003C	LVR-IC	LDO, Dual out, Vout1/Vout2=1.5V/2.8V±1%, 150mA, +CE, CL	DFN1212-6	52x4	VR19	9a	Ric
UD	RP130K371B	LVR-IC	LDO, LN, +CE, 3.7V±1%, 150mA	DFN1010-4	48vm	VR4	9a	Ric
UD	RP152L004C	LVR-IC	LDO, Dual out, Vout1/Vout2=1.2V/1.8V±1%, 150mA, +CE, CL	DFN1212-6	52x4	VR19	9a	Ric
UE	RP130K381B	LVR-IC	LDO, LN, +CE, 3.8V±1%, 150mA	DFN1010-4	48vm	VR4	9a	Ric
UE	RP152L005C	LVR-IC	LDO, Dual out, Vout1/Vout2=3.3V/1.2V±1%, 150mA, +CE, CL	DFN1212-6	52x4	VR19	9a	Ric
UF	RP130K391B	LVR-IC	LDO, LN, +CE, 3.9V±1%, 150mA	DFN1010-4	48vm	VR4	9a	Ric
UF	RP152L006C	LVR-IC	LDO, Dual out, Vout1/Vout2=3.3V/1.8V±1%, 150mA, +CE, CL	DFN1212-6	52x4	VR19	9a	Ric
UG	RP130K401B	LVR-IC	LDO, LN, +CE, 4V±1%, 150mA	DFN1010-4	48vm	VR4	9a	Ric
UG	RP152L007C	LVR-IC	LDO, Dual out, Vout1/Vout2=2.85V/2.85V±1%, 150mA, +CE, CL	DFN1212-6	52x4	VR19	9a	Ric
UH	RP130K411B	LVR-IC	LDO, LN, +CE, 4.1V±1%, 150mA	DFN1010-4	48vm	VR4	9a	Ric
UH	RP152L008C	LVR-IC	LDO, Dual out, Vout1/Vout2=2.85V/2.6V±1%, 150mA, +CE, CL	DFN1212-6	52x4	VR19	9a	Ric
UJ	RP130K421B	LVR-IC	LDO, LN, +CE, 4.2V±1%, 150mA	DFN1010-4	48vm	VR4	9a	Ric
UJ	RP152L009C	LVR-IC	LDO, Dual out, Vout1/Vout2=3.0V/2.8V±1%, 150mA, +CE, CL	DFN1212-6	52x4	VR19	9a	Ric
UK	RP130K431B	LVR-IC	LDO, LN, +CE, 4.3V±1%, 150mA	DFN1010-4	48vm	VR4	9a	Ric
UK	RP152L010C	LVR-IC	LDO, Dual out, Vout1/Vout2=3.0V/1.8V±1%, 150mA, +CE, CL	DFN1212-6	52x4	VR19	9a	Ric
UL	RP130K441B	LVR-IC	LDO, LN, +CE, 4.4V±1%, 150mA	DFN1010-4	48vm	VR4	9a	Ric
UL	RP152L011C	LVR-IC	LDO, Dual out, Vout1/Vout2=1.8V/1.5V±1%, 150mA, +CE, CL	DFN1212-6	52x4	VR19	9a	Ric
UM	RP130K451B	LVR-IC	LDO, LN, +CE, 4.5V±1%, 150mA	DFN1010-4	48vm	VR4	9a	Ric
UM	RP152L012C	LVR-IC	LDO, Dual out, Vout1/Vout2=2.8V/2.6V±1%, 150mA, +CE, CL	DFN1212-6	52x4	VR19	9a	Ric
UN	RP130K461B	LVR-IC	LDO, LN, +CE, 4.6V±1%, 150mA	DFN1010-4	48vm	VR4	9a	Ric
UN	RP152L013C	LVR-IC	LDO, Dual out, Vout1/Vout2=3.3V/2.8V±1%, 150mA, +CE, CL	DFN1212-6	52x4	VR19	9a	Ric



SMD code	Type	Function	Short description	Case	Pinout	Sch.	St.	Mnf.
UP	RP130K471B	LVR-IC	LDO, LN, +CE, 4.7V±1%, 150mA	DFN1010-4	48vm	VR4	9a	Ric
UP	RP152L014C	LVR-IC	LDO, Dual out, Vout1/Vout2=3.3V/3.3V±1%, 150mA, +CE, CL	DFN1212-6	52x4	VR19	9a	Ric
UQ	RP130K481B	LVR-IC	LDO, LN, +CE, 4.8V±1%, 150mA	DFN1010-4	48vm	VR4	9a	Ric
UQ	RP152L015C	LVR-IC	LDO, Dual out, Vout1/Vout2=1.5V/2.5V±1%, 150mA, +CE, CL	DFN1212-6	52x4	VR19	9a	Ric
UR	RP130K491B	LVR-IC	LDO, LN, +CE, 4.9V±1%, 150mA	DFN1010-4	48vm	VR4	9a	Ric
UR	RP152L016C	LVR-IC	LDO, Dual out, Vout1/Vout2=1.5V/3.0V±1%, 150mA, +CE, CL	DFN1212-6	52x4	VR19	9a	Ric
US	RP130K501B	LVR-IC	LDO, LN, +CE, 5V±1%, 150mA	DFN1010-4	48vm	VR4	9a	Ric
US	RP152L017C	LVR-IC	LDO, Dual out, Vout1/Vout2=2.5V/3.0V±1%, 150mA, +CE, CL	DFN1212-6	52x4	VR19	9a	Ric
UT	RP152L018C	LVR-IC	LDO, Dual out, Vout1/Vout2=1.8V/1.8V±1%, 150mA, +CE, CL	DFN1212-6	52x4	VR19	9a	Ric
UU	RP152L019C	LVR-IC	LDO, Dual out, Vout1/Vout2=1.5V/2.6V±1%, 150mA, +CE, CL	DFN1212-6	52x4	VR19	9a	Ric
UV	RP152L020C	LVR-IC	LDO, Dual out, Vout1/Vout2=2.8V/1.8V±1%, 150mA, +CE, CL	DFN1212-6	52x4	VR19	9a	Ric
UW	RP152L021C	LVR-IC	LDO, Dual out, Vout1/Vout2=1.2V/2.8V±1%, 150mA, +CE, CL	DFN1212-6	52x4	VR19	9a	Ric
UX	RP152L022C	LVR-IC	LDO, Dual out, Vout1/Vout2=2.8V/1.2V±1%, 150mA, +CE, CL	DFN1212-6	52x4	VR19	9a	Ric
UX	XC6221B4917R	LVR-IC	LDO, 4.9V±1%, 200mA, +CE, CL	USPN-4	58vm	VR4	9a	Tor
UY	RP152L023C	LVR-IC	LDO, Dual out, Vout1/Vout2=2.5V/2.5V±1%, 150mA, +CE, CL	DFN1212-6	52x4	VR19	9a	Ric
UY	XC6221B5017R	LVR-IC	LDO, 5.0V±1%, 200mA, +CE, CL	USPN-4	58vm	VR4	9a	Tor
UZ	RP152L024C	LVR-IC	LDO, Dual out, Vout1/Vout2=3.3V/3.0V±1%, 150mA, +CE, CL	DFN1212-6	52x4	VR19	9a	Ric
V0	R3117K473C	Vdet-IC	4.7V±1%, -Reset PPO, Sense	DFN1010-4	48rq	VD12	9a	Ric
V0	RP152L049B	LVR-IC	LDO, Dual out, Vout1/Vout2=1.5V/2.85V±1%, 150mA, +CE, CL	DFN1212-6	52x4	VR19	9a	Ric
V001	R5326K001A	LVR-IC	LDO, Dual out, V1=2V±1%, V2=2V±1%, 150mA, +CE	DFN1820-6	74ri	VR19	9b	Ric
V002	R5326K002A	LVR-IC	LDO, Dual out, V1=2.8V±1%, V2=2.8V±1%, 150mA, +CE	DFN1820-6	74ri	VR19	9b	Ric
V003	R5326K003A	LVR-IC	LDO, Dual out, V1=1.8V±1%, V2=3V±1%, 150mA, +CE	DFN1820-6	74ri	VR19	9b	Ric
V004	R5326K004A	LVR-IC	LDO, Dual out, V1=2.5V±1%, V2=3V±1%, 150mA, +CE	DFN1820-6	74ri	VR19	9b	Ric
V005	R5326K005A	LVR-IC	LDO, Dual out, V1=1.8V±1%, V2=2.5V±1%, 150mA, +CE	DFN1820-6	74ri	VR19	9b	Ric
V006	R5326K006A	LVR-IC	LDO, Dual out, V1=1.8V±1%, V2=3.3V±1%, 150mA, +CE	DFN1820-6	74ri	VR19	9b	Ric
V007	R5326K007A	LVR-IC	LDO, Dual out, V1=2.5V±1%, V2=2.8V±1%, 150mA, +CE	DFN1820-6	74ri	VR19	9b	Ric
V008	R5326K008A	LVR-IC	LDO, Dual out, V1=1.2V±1%, V2=1.2V±1%, 150mA, +CE	DFN1820-6	74ri	VR19	9b	Ric
V009	R5326K009A	LVR-IC	LDO, Dual out, V1=1.5V±1%, V2=1.6V±1%, 150mA, +CE	DFN1820-6	74ri	VR19	9b	Ric
V010	R5326K010A	LVR-IC	LDO, Dual out, V1=1.5V±1%, V2=2.8V±1%, 150mA, +CE	DFN1820-6	74ri	VR19	9b	Ric
V011	R5326K011A	LVR-IC	LDO, Dual out, V1=3V±1%, V2=3V±1%, 150mA, +CE	DFN1820-6	74ri	VR19	9b	Ric
V012	R5326K012A	LVR-IC	LDO, Dual out, V1=3.1V±1%, V2=3.1V±1%, 150mA, +CE	DFN1820-6	74ri	VR19	9b	Ric
V013	R5326K013A	LVR-IC	LDO, Dual out, V1=2.7V±1%, V2=1.8V±1%, 150mA, +CE	DFN1820-6	74ri	VR19	9b	Ric
V014	R5326K014A	LVR-IC	LDO, Dual out, V1=1.8V±1%, V2=2.6V±1%, 150mA, +CE	DFN1820-6	74ri	VR19	9b	Ric
V015	R5326K015A	LVR-IC	LDO, Dual out, V1=3.3V±1%, V2=3.3V±1%, 150mA, +CE	DFN1820-6	74ri	VR19	9b	Ric
V016	R5326K016A	LVR-IC	LDO, Dual out, V1=2.85V±1%, V2=2.85V±1%, 150mA, +CE	DFN1820-6	74ri	VR19	9b	Ric
V017	R5326K017A	LVR-IC	LDO, Dual out, V1=1.1V±1%, V2=1.1V±1%, 150mA, +CE	DFN1820-6	74ri	VR19	9b	Ric
V018	R5326K018A	LVR-IC	LDO, Dual out, V1=1.2V±1%, V2=1.2V±1%, 150mA, +CE	DFN1820-6	74ri	VR19	9b	Ric
V019	R5326K019A	LVR-IC	LDO, Dual out, V1=1.2V±1%, V2=2.9V±1%, 150mA, +CE	DFN1820-6	74ri	VR19	9b	Ric
V020	R5326K020A	LVR-IC	LDO, Dual out, V1=2.8V±1%, V2=3.0V±1%, 150mA, +CE	DFN1820-6	74ri	VR19	9b	Ric
V021	R5326K021A	LVR-IC	LDO, Dual out, V1=1.5V±1%, V2=2.8V±1%, 150mA, +CE	DFN1820-6	74ri	VR19	9b	Ric
V022	R5326K022A	LVR-IC	LDO, Dual out, V1=1.8V±1%, V2=2.9V±1%, 150mA, +CE	DFN1820-6	74ri	VR19	9b	Ric
V023	R5326K023A	LVR-IC	LDO, Dual out, V1=4.2V±1%, V2=3.1V±1%, 150mA, +CE	DFN1820-6	74ri	VR19	9b	Ric
V024	R5326K024A	LVR-IC	LDO, Dual out, V1=1.5V±1%, V2=3.0V±1%, 150mA, +CE	DFN1820-6	74ri	VR19	9b	Ric
V025	R5326K025A	LVR-IC	LDO, Dual out, V1=1.8V±1%, V2=1.85V±1%, 150mA, +CE	DFN1820-6	74ri	VR19	9b	Ric
V026	R5326K026A	LVR-IC	LDO, Dual out, V1=1.8V±1%, V2=2.85V±1%, 150mA, +CE	DFN1820-6	74ri	VR19	9b	Ric
V04	74LVC3G04GD	CMOS-Logic	Triple inverters	SOT996-2	54Log56	-	9a	Phi
V04	74LVC3G04GM	CMOS-Logic	Triple inverters	SOT992-1	51Log56	-	9a	Phi
V04	74LVC3G04GT	CMOS-Logic	Triple inverters	SOT833-1	53Log56	-	9c	Phi
V06	74LVC3G06GD	CMOS-Logic	Triple inverters (ODO)	SOT996-2	54Log72	-	9a	Phi
V06	74LVC3G06GM	CMOS-Logic	Triple inverters (ODO)	SOT902-1	51Log72	-	9a	Phi
V06	74LVC3G06GT	CMOS-Logic	Triple inverters (ODO)	SOT833-1	53Log72	-	9c	Phi
V07	74LVC3G07GD	CMOS-Logic	Triple noninverting buffers/drivers (ODO)	SOT996-2	54Log73	-	9a	Phi
V07	74LVC3G07GM	CMOS-Logic	Triple noninverting buffers/drivers (ODO)	SOT902-1	51Log73	-	9a	Phi
V07	74LVC3G07GT	CMOS-Logic	Triple noninverting buffers/drivers (ODO)	SOT833-1	53Log73	-	9c	Phi
V0A	XC6118N20AGR-G	Vdet-IC	2.0V±2%, ±Reset ODO, Sense, hysteresis 5%, Cd	USP-4	45me	VD14	9a	Tor
V0B	XC6118N20BGR-G	Vdet-IC	2.0V±2%, ±Reset ODO, Sense, hysteresis <1%, Cd	USP-4	45me	VD14	9a	Tor
V0C	XC6118N20CGR-G	Vdet-IC	2.0V±2%, ±Reset ODO, Sense, hysteresis 5%	USP-4	45md	VD11	9a	Tor
V0D	XC6118N20DGR-G	Vdet-IC	2.0V±2%, ±Reset ODO, Sense, hysteresis <1%	USP-4	45md	VD11	9a	Tor
V1	R3117K483C	Vdet-IC	4.8V±1%, -Reset PPO, Sense	DFN1010-4	48rq	VD12	9a	Ric
V14	74LVC3G14GD	CMOS-Logic	Triple Schmitt-trigger inverters	SOT996-2	54Log57	-	9a	Phi
V14	74LVC3G14GM	CMOS-Logic	Triple Schmitt-trigger inverters	SOT902-1	51Log57	-	9a	Phi
V14	74LVC3G14GT	CMOS-Logic	Triple Schmitt-trigger inverters	SOT833-1	53Log57	-	9c	Phi
V17	74LVC3G17GD	CMOS-Logic	Triple non-inverting Schmitt-trigger	SOT996-2	54Log71	-	9a	Phi
V17	74LVC3G17GM	CMOS-Logic	Triple non-inverting Schmitt-trigger	SOT902-1	51Log71	-	9a	Phi
V17	74LVC3G17GT	CMOS-Logic	Triple non-inverting Schmitt-trigger	SOT833-1	53Log71	-	9c	Phi
V1A	XC6118N21AGR-G	Vdet-IC	2.1V±2%, ±Reset ODO, Sense, hysteresis 5%, Cd	USP-4	45me	VD14	9a	Tor
V1B	XC6118N21BGR-G	Vdet-IC	2.1V±2%, ±Reset ODO, Sense, hysteresis <1%, Cd	USP-4	45me	VD14	9a	Tor
V1C	XC6118N21CGR-G	Vdet-IC	2.1V±2%, ±Reset ODO, Sense, hysteresis 5%	USP-4	45md	VD11	9a	Tor
V1D	XC6118N21DGR-G	Vdet-IC	2.1V±2%, ±Reset ODO, Sense, hysteresis <1%	USP-4	45md	VD11	9a	Tor
V2	R3117K493C	Vdet-IC	4.9V±1%, -Reset PPO, Sense	DFN1010-4	48rq	VD12	9a	Ric



SMD code	Type	Function	Short description	Case	Pinout	Sch.	St.	Mnf.
V2A	XC6118N22AGR-G	Vdet-IC	2.2V±2%, ±Reset ODO, Sense, hysteresis 5%, Cd	USP-4	45me	VD14	9a	Tor
V2B	XC6118N22BGR-G	Vdet-IC	2.2V±2%, ±Reset ODO, Sense, hysteresis <1%, Cd	USP-4	45me	VD14	9a	Tor
V2C	XC6118N22CGR-G	Vdet-IC	2.2V±2%, ±Reset ODO, Sense, hysteresis 5%	USP-4	45md	VD11	9a	Tor
V2D	XC6118N22DGR-G	Vdet-IC	2.2V±2%, ±Reset ODO, Sense, hysteresis <1%	USP-4	45md	VD11	9a	Tor
V3	R3117K503C	Vdet-IC	5.0V±1%, -Reset PPO, Sense	DFN1010-4	48rq	VD12	9a	Ric
V34	74LVC3G34GD	CMOS-Logic	Triple non-inverter buffers	SOT996-2	54/Log69	-	9a	Phi
V34	74LVC3G34GM	CMOS-Logic	Triple non-inverter buffers	SOT902-1	51/Log69	-	9a	Phi
V34	74LVC3G34GT	CMOS-Logic	Triple non-inverter buffers	SOT833-1	53/Log69	-	9c	Phi
V3A	XC6118N23AGR-G	Vdet-IC	2.3V±2%, ±Reset ODO, Sense, hysteresis 5%, Cd	USP-4	45me	VD14	9a	Tor
V3B	XC6118N23BGR-G	Vdet-IC	2.3V±2%, ±Reset ODO, Sense, hysteresis <1%, Cd	USP-4	45me	VD14	9a	Tor
V3C	XC6118N23CGR-G	Vdet-IC	2.3V±2%, ±Reset ODO, Sense, hysteresis 5%	USP-4	45md	VD11	9a	Tor
V3D	XC6118N23DGR-G	Vdet-IC	2.3V±2%, ±Reset ODO, Sense, hysteresis <1%	USP-4	45md	VD11	9a	Tor
V4	74LVC2G04GM	CMOS-Logic	Dual inverters	SOT-886	57/Log24	-	9c	Phi
V4A	XC6118N24AGR-G	Vdet-IC	2.4V±2%, ±Reset ODO, Sense, hysteresis 5%, Cd	USP-4	45me	VD14	9a	Tor
V4B	XC6118N24BGR-G	Vdet-IC	2.4V±2%, ±Reset ODO, Sense, hysteresis <1%, Cd	USP-4	45me	VD14	9a	Tor
V4C	XC6118N24CGR-G	Vdet-IC	2.4V±2%, ±Reset ODO, Sense, hysteresis 5%	USP-4	45md	VD11	9a	Tor
V4D	XC6118N24DGR-G	Vdet-IC	2.4V±2%, ±Reset ODO, Sense, hysteresis <1%	USP-4	45md	VD11	9a	Tor
V5	74LVC1T45GF	CMOS-Logic	Dual supply translating transceiver with 3-state output	SOT891	52/Log70	-	9c	Phi
V5	74LVC1T45GM	CMOS-Logic	Dual supply translating transceiver with 3-state output	SOT-886	52/Log70	-	9c	Phi
V53	74LVC1G53GM	CMOS-Logic	2-channel analog multiplexer/demultiplexer	SOT902-1	51/Log58	-	9a	Phi
V53	74LVC1G53GT	CMOS-Logic	2-channel analog multiplexer/demultiplexer	SOT833-1	53/Log58	-	9c	Phi
V53	74LVC2G53GT	CMOS-Logic	2-channel analog multiplexer/demultiplexer	SOT833-1	53/Log58	-	9c	Phi
V5A	XC6118N25AGR-G	Vdet-IC	2.5V±2%, ±Reset ODO, Sense, hysteresis 5%, Cd	USP-4	45me	VD14	9a	Tor
V5B	XC6118N25BGR-G	Vdet-IC	2.5V±2%, ±Reset ODO, Sense, hysteresis <1%, Cd	USP-4	45me	VD14	9a	Tor
V5C	XC6118N25CGR-G	Vdet-IC	2.5V±2%, ±Reset ODO, Sense, hysteresis 5%	USP-4	45md	VD11	9a	Tor
V5D	XC6118N25DGR-G	Vdet-IC	2.5V±2%, ±Reset ODO, Sense, hysteresis <1%	USP-4	45md	VD11	9a	Tor
V6	74LVC2G06GM	CMOS-Logic	Dual inverter buffers/drivers (ODO)	SOT-886	57/Log25	-	9c	Phi
V66	74LVC2G66GM	CMOS-Logic	2-channel analog switch	SOT902-1	51/Log68	-	9a	Phi
V66	74LVC2G66GT	CMOS-Logic	2-channel analog switch	SOT833-1	53/Log68	-	9c	Phi
V6A	XC6118N26AGR-G	Vdet-IC	2.6V±2%, ±Reset ODO, Sense, hysteresis 5%, Cd	USP-4	45me	VD14	9a	Tor
V6B	XC6118N26BGR-G	Vdet-IC	2.6V±2%, ±Reset ODO, Sense, hysteresis <1%, Cd	USP-4	45me	VD14	9a	Tor
V6C	XC6118N26CGR-G	Vdet-IC	2.6V±2%, ±Reset ODO, Sense, hysteresis 5%	USP-4	45md	VD11	9a	Tor
V6D	XC6118N26DGR-G	Vdet-IC	2.6V±2%, ±Reset ODO, Sense, hysteresis <1%	USP-4	45md	VD11	9a	Tor
V7	74LVC2G07GM	CMOS-Logic	Dual noninverting buffers/drivers (ODO)	SOT-886	57/Log26	-	9c	Phi
V74	74LVC1G74GD	CMOS-Logic	Positive edge-triggered D-type flip-flop with set and reset	SOT996-2	54/Log59	-	9a	Phi
V74	74LVC1G74GM	CMOS-Logic	Positive edge-triggered D-type flip-flop with set and reset	SOT902-1	51/Log59	-	9a	Phi
V74	74LVC1G74GT	CMOS-Logic	Positive edge-triggered D-type flip-flop with set and reset	SOT833-1	53/Log59	-	9c	Phi
V74	74LVC2G74GT	CMOS-Logic	D-type flip-flop with preset and clear	SOT833-1	53/Log59	-	9c	Phi
V7A	XC6118N27AGR-G	Vdet-IC	2.7V±2%, ±Reset ODO, Sense, hysteresis 5%, Cd	USP-4	45me	VD14	9a	Tor
V7B	XC6118N27BGR-G	Vdet-IC	2.7V±2%, ±Reset ODO, Sense, hysteresis <1%, Cd	USP-4	45me	VD14	9a	Tor
V7C	XC6118N27CGR-G	Vdet-IC	2.7V±2%, ±Reset ODO, Sense, hysteresis 5%	USP-4	45md	VD11	9a	Tor
V7D	XC6118N27DGR-G	Vdet-IC	2.7V±2%, ±Reset ODO, Sense, hysteresis <1%	USP-4	45md	VD11	9a	Tor
V86	74LVC2G86GM	CMOS-Logic	Dual 2-input EXCLUSIVE-OR gates	SOT902-1	51/Log65	-	9a	Phi
V86	74LVC2G86GT	CMOS-Logic	Dual 2-input EXCLUSIVE-OR gates	SOT833-1	53/Log65	-	9c	Phi
V8A	XC6118N28AGR-G	Vdet-IC	2.8V±2%, ±Reset ODO, Sense, hysteresis 5%, Cd	USP-4	45me	VD14	9a	Tor
V8B	XC6118N28BGR-G	Vdet-IC	2.8V±2%, ±Reset ODO, Sense, hysteresis <1%, Cd	USP-4	45me	VD14	9a	Tor
V8C	XC6118N28CGR-G	Vdet-IC	2.8V±2%, ±Reset ODO, Sense, hysteresis 5%	USP-4	45md	VD11	9a	Tor
V8D	XC6118N28DGR-G	Vdet-IC	2.8V±2%, ±Reset ODO, Sense, hysteresis <1%	USP-4	45md	VD11	9a	Tor
V99	74LVC1G99GM	CMOS-Logic	Ultra-configurable multiple function gate with 3-state output	SOT902-1	51/Log84	-	9a	Phi
V99	74LVC1G99GT	CMOS-Logic	Ultra-configurable multiple function gate with 3-state output	SOT833-1	53/Log84	-	9c	Phi
V9A	XC6118N29AGR-G	Vdet-IC	2.9V±2%, ±Reset ODO, Sense, hysteresis 5%, Cd	USP-4	45me	VD14	9a	Tor
V9B	XC6118N29BGR-G	Vdet-IC	2.9V±2%, ±Reset ODO, Sense, hysteresis <1%, Cd	USP-4	45me	VD14	9a	Tor
V9C	XC6118N29CGR-G	Vdet-IC	2.9V±2%, ±Reset ODO, Sense, hysteresis 5%	USP-4	45md	VD11	9a	Tor
V9D	XC6118N29DGR-G	Vdet-IC	2.9V±2%, ±Reset ODO, Sense, hysteresis <1%	USP-4	45md	VD11	9a	Tor
VA	74LVC1G00GF	CMOS-Logic	2-input NAND gate	SOT891	52/Log1	-	9c	Phi
VA	74LVC1G00GM	CMOS-Logic	2-input NAND gate	SOT-886	57/Log1	-	9c	Phi
VA	RP130K121D	LVR-IC	LDO, LN, +CE, CL, 1.2V±1%, 150mA	DFN1010-4	48vm	VR4	9a	Ric
VA	RP152L025C	LVR-IC	LDO, Dual out, Vout1/Vout2=3.0V/3.0V±1%, 150mA, +CE, CL	DFN1212-6	52x4	VR19	9a	Ric
VB	74LVC1G02GF	CMOS-Logic	2-input NOR gate	SOT891	52/Log2	-	9c	Phi
VB	74LVC1G02GM	CMOS-Logic	2-input NOR gate	SOT-886	57/Log2	-	9c	Phi
VB	RP130K131D	LVR-IC	LDO, LN, +CE, CL, 1.3V±1%, 150mA	DFN1010-4	48vm	VR4	9a	Ric
VB	RP152L026C	LVR-IC	LDO, Dual out, Vout1/Vout2=2.8V/3.1V±1%, 150mA, +CE, CL	DFN1212-6	52x4	VR19	9a	Ric
VC	74LVC1G04GF	CMOS-Logic	Inverter	SOT891	52/Log6	-	9c	Phi
VC	74LVC1G04GM	CMOS-Logic	Inverter	SOT-886	57/Log6	-	9c	Phi
VC	RP130K141D	LVR-IC	LDO, LN, +CE, CL, 1.4V±1%, 150mA	DFN1010-4	48vm	VR4	9a	Ric
VC	RP152L027C	LVR-IC	LDO, Dual out, Vout1/Vout2=2.3V/2.8V±1%, 150mA, +CE, CL	DFN1212-6	52x4	VR19	9a	Ric
VD	74LVC1GU04GF	CMOS-Logic	Inverter	SOT891	52/Log6	-	9c	Phi
VD	74LVC1GU04GM	CMOS-Logic	Inverter	SOT-886	57/Log6	-	9c	Phi
VD	RP130K151D	LVR-IC	LDO, LN, +CE, CL, 1.5V±1%, 150mA	DFN1010-4	48vm	VR4	9a	Ric
VD	RP152L028C	LVR-IC	LDO, Dual out, Vout1/Vout2=2.8V/1.0V±1%, 150mA, +CE, CL	DFN1212-6	52x4	VR19	9a	Ric



SMD code	Type	Function	Short description	Case	Pinout	Sch.	St.	Mnf.
VE	74LVC1G08GF	CMOS-Logic	2-input AND gate	SOT891	52Log3	-	9c	Phi
VE	74LVC1G08GM	CMOS-Logic	2-input AND gate	SOT-886	57Log3	-	9c	Phi
VE	RP130K161D	LVR-IC	LDO, LN, +CE, CL, 1.6V±1%, 150mA	DFN1010-4	48vm	VR4	9a	Ric
VE	RP152L029C	LVR-IC	LDO, Dual out, Vout1/Vout2=1.5V/1.5V±1%, 150mA, +CE, CL	DFN1212-6	52x4	VR19	9a	Ric
VF	74LVC1G14GF	CMOS-Logic	Inverting Schmitt-trigger	SOT891	52Log7	-	9c	Phi
VF	74LVC1G14GM	CMOS-Logic	Inverting Schmitt-trigger	SOT-886	57Log7	-	9c	Phi
VF	RP130K171D	LVR-IC	LDO, LN, +CE, CL, 1.7V±1%, 150mA	DFN1010-4	48vm	VR4	9a	Ric
VF	RP152L030C	LVR-IC	LDO, Dual out, Vout1/Vout2=1.5V/3.3V±1%, 150mA, +CE, CL	DFN1212-6	52x4	VR19	9a	Ric
VG	74LVC1G32GF	CMOS-Logic	2-input OR gate	SOT891	52Log4	-	9c	Phi
VG	74LVC1G32GM	CMOS-Logic	2-input OR gate	SOT-886	57Log4	-	9c	Phi
VG	RP130K181D	LVR-IC	LDO, LN, +CE, CL, 1.8V±1%, 150mA	DFN1010-4	48vm	VR4	9a	Ric
VG	RP152L031C	LVR-IC	LDO, Dual out, Vout1/Vout2=1.8V/2.7V±1%, 150mA, +CE, CL	DFN1212-6	52x4	VR19	9a	Ric
VH	74LVC1G86GF	CMOS-Logic	2-input EXCLUSIVE-OR gate	SOT891	52Log5	-	9c	Phi
VH	74LVC1G86GM	CMOS-Logic	2-input EXCLUSIVE-OR gate	SOT-886	57Log5	-	9c	Phi
VH	RP130K181D5	LVR-IC	LDO, LN, +CE, CL, 1.85V±1%, 150mA	DFN1010-4	48vm	VR4	9a	Ric
VH	RP152L032C	LVR-IC	LDO, Dual out, Vout1/Vout2=1.2V/3.0V±1%, 150mA, +CE, CL	DFN1212-6	52x4	VR19	9a	Ric
VJ	74LVC1G17GF	CMOS-Logic	Schmitt-trigger	SOT891	52Log11	-	9c	Phi
VJ	74LVC1G17GM	CMOS-Logic	Schmitt-trigger	SOT-886	57Log11	-	9c	Phi
VJ	RP130K191D	LVR-IC	LDO, LN, +CE, CL, 1.9V±1%, 150mA	DFN1010-4	48vm	VR4	9a	Ric
VJ	RP152L033C	LVR-IC	LDO, Dual out, Vout1/Vout2=3.1V/3.1V±1%, 150mA, +CE, CL	DFN1212-6	52x4	VR19	9a	Ric
VK	74LVC2G14GM	CMOS-Logic	Dual Schmitt-trigger inverter buffers	SOT-886	57Log34	-	9c	Phi
VK	RP130K201D	LVR-IC	LDO, LN, +CE, CL, 2V±1%, 150mA	DFN1010-4	48vm	VR4	9a	Ric
VK	RP152L034C	LVR-IC	LDO, Dual out, Vout1/Vout2=1.8V/2.6V±1%, 150mA, +CE, CL	DFN1212-6	52x4	VR19	9a	Ric
VL	74LVC1G66GF	CMOS-Logic	Bilateral analogic switch	SOT891	52Log16	-	9c	Phi
VL	74LVC1G66GM	CMOS-Logic	Bilateral analogic switch	SOT-886	57Log16	-	9c	Phi
VL	RP130K211D	LVR-IC	LDO, LN, +CE, CL, 2.1V±1%, 150mA	DFN1010-4	48vm	VR4	9a	Ric
VL	RP152L035C	LVR-IC	LDO, Dual out, Vout1/Vout2=2.5V/1.2V±1%, 150mA, +CE, CL	DFN1212-6	52x4	VR19	9a	Ric
VM	74LVC1G125GF	CMOS-Logic	Bus buffer gate with 3-state output	SOT891	52Log14	-	9c	Phi
VM	74LVC1G125GM	CMOS-Logic	Bus buffer gate with 3-state output	SOT-886	57Log14	-	9c	Phi
VM	RP130K221D	LVR-IC	LDO, LN, +CE, CL, 2.2V±1%, 150mA	DFN1010-4	48vm	VR4	9a	Ric
VM	RP152L036C	LVR-IC	LDO, Dual out, Vout1/Vout2=1.2V/2.9V±1%, 150mA, +CE, CL	DFN1212-6	52x4	VR19	9a	Ric
VN	74LVC1G126GF	CMOS-Logic	Bus buffer gate with 3-state output	SOT891	52Log13	-	9c	Phi
VN	74LVC1G126GM	CMOS-Logic	Bus buffer gate with 3-state output	SOT-886	57Log13	-	9c	Phi
VN	RP130K231D	LVR-IC	LDO, LN, +CE, CL, 2.3V±1%, 150mA	DFN1010-4	48vm	VR4	9a	Ric
VN	RP152L037C	LVR-IC	LDO, Dual out, Vout1/Vout2=3.3V/2.0V±1%, 150mA, +CE, CL	DFN1212-6	52x4	VR19	9a	Ric
VP	74LVC1G79GF	CMOS-Logic	Positive edge-triggered D-type flip-flop	SOT891	52Log20	-	9c	Phi
VP	74LVC1G79GM	CMOS-Logic	Positive edge-triggered D-type flip-flop	SOT-886	57Log20	-	9c	Phi
VP	RP130K241D	LVR-IC	LDO, LN, +CE, CL, 2.4V±1%, 150mA	DFN1010-4	48vm	VR4	9a	Ric
VP	RP152L038C	LVR-IC	LDO, Dual out, Vout1/Vout2=1.2V/2.85V±1%, 150mA, +CE, CL	DFN1212-6	52x4	VR19	9a	Ric
VQ	RP130K251D	LVR-IC	LDO, LN, +CE, CL, 2.5V±1%, 150mA	DFN1010-4	48vm	VR4	9a	Ric
VQ	RP152L039C	LVR-IC	LDO, Dual out, Vout1/Vout2=2.1V/3.3V±1%, 150mA, +CE, CL	DFN1212-6	52x4	VR19	9a	Ric
VR	74LVC1G06GF	CMOS-Logic	Inverter (ODO)	SOT891	52Log19	-	9c	Phi
VR	74LVC1G06GM	CMOS-Logic	Inverter (ODO)	SOT-886	57Log19	-	9c	Phi
VR	RP130K261D	LVR-IC	LDO, LN, +CE, CL, 2.6V±1%, 150mA	DFN1010-4	48vm	VR4	9a	Ric
VR	RP152L040C	LVR-IC	LDO, Dual out, Vout1/Vout2=2.8V/2.85V±1%, 150mA, +CE, CL	DFN1212-6	52x4	VR19	9a	Ric
VS	74LVC1G07GF	CMOS-Logic	Noninverting buffer/driver (ODO)	SOT891	52Log8	-	9c	Phi
VS	74LVC1G07GM	CMOS-Logic	Noninverting buffer/driver (ODO)	SOT-886	57Log8	-	9c	Phi
VS	RP130K271D	LVR-IC	LDO, LN, +CE, CL, 2.7V±1%, 150mA	DFN1010-4	48vm	VR4	9a	Ric
VS	RP152L041C	LVR-IC	LDO, Dual out, Vout1/Vout2=1.8V/3.0V±1%, 150mA, +CE, CL	DFN1212-6	52x4	VR19	9a	Ric
VT	74LVC1G80GF	CMOS-Logic	Positive edge-triggered D-type flip-flop	SOT891	52Log21	-	9c	Phi
VT	74LVC1G80GM	CMOS-Logic	Positive edge-triggered D-type flip-flop	SOT-886	57Log21	-	9c	Phi
VT	RP130K281D	LVR-IC	LDO, LN, +CE, CL, 2.8V±1%, 150mA	DFN1010-4	48vm	VR4	9a	Ric
VT	RP152L042C	LVR-IC	LDO, Dual out, Vout1/Vout2=1.2V/2.6V±1%, 150mA, +CE, CL	DFN1212-6	52x4	VR19	9a	Ric
VU	74LVC1G11GF	CMOS-Logic	3-input AND gate	SOT891	52Log30	-	9c	Phi
VU	74LVC1G11GM	CMOS-Logic	3-input AND gate	SOT-886	57Log30	-	9c	Phi
VU	RP130K281D5	LVR-IC	LDO, LN, +CE, CL, 2.85V±1%, 150mA	DFN1010-4	48vm	VR4	9a	Ric
VU	RP152L043C	LVR-IC	LDO, Dual out, Vout1/Vout2=1.3V/2.8V±1%, 150mA, +CE, CL	DFN1212-6	52x4	VR19	9a	Ric
VU4	74LVC3GU04GM	CMOS-Logic	Triple inverters	SOT902-1	51Log56	-	9a	Phi
VU4	74LVC3GU04GT	CMOS-Logic	Triple inverters	SOT833-1	53Log56	-	9c	Phi
VV	74LVC2G17GM	CMOS-Logic	Dual Schmitt-trigger buffers	SOT-886	57Log27	-	9c	Phi
VV	RP130K291D	LVR-IC	LDO, LN, +CE, CL, 2.9V±1%, 150mA	DFN1010-4	48vm	VR4	9a	Ric
VV	RP152L044C	LVR-IC	LDO, Dual out, Vout1/Vout2=1.1V/1.5V±1%, 150mA, +CE, CL	DFN1212-6	52x4	VR19	9a	Ric
VW	RP130K301D	LVR-IC	LDO, LN, +CE, CL, 3V±1%, 150mA	DFN1010-4	48vm	VR4	9a	Ric
VW	RP152L045C	LVR-IC	LDO, Dual out, Vout1/Vout2=2.8V/3.3V±1%, 150mA, +CE, CL	DFN1212-6	52x4	VR19	9a	Ric
VX	RP130K311D	LVR-IC	LDO, LN, +CE, CL, 3.1V±1%, 150mA	DFN1010-4	48vm	VR4	9a	Ric
VX	RP152L046C	LVR-IC	LDO, Dual out, Vout1/Vout2=2.8V/3.0V±1%, 150mA, +CE, CL	DFN1212-6	52x4	VR19	9a	Ric
VY	74LVC1G19GF	CMOS-Logic	1-of-2 decoder/demultiplexer	SOT891	52Log47	-	9c	Phi
VY	74LVC1G19GM	CMOS-Logic	1-of-2 decoder/demultiplexer	SOT-886	57Log47	-	9c	Phi
VY	RP130K321D	LVR-IC	LDO, LN, +CE, CL, 3.2V±1%, 150mA	DFN1010-4	48vm	VR4	9a	Ric
VY	RP152L047C	LVR-IC	LDO, Dual out, Vout1/Vout2=2.5V/2.8V±1%, 150mA, +CE, CL	DFN1212-6	52x4	VR19	9a	Ric



SMD code	Type	Function	Short description	Case	Pinout	Sch.	St.Mnf.
VZ	RP130K331D	LVR-IC	LDO, LN, +CE, CL, 3.3V±1%, 150mA	DFN1010-4	48vm	VR4	9a Ric
VZ	RP152L048C	LVR-IC	LDO, Dual out, Vout1/Vout2=2.5V/3.2V±1%, 150mA, +CE, CL	DFN1212-6	52x4	VR19	9a Ric
W0	RP152L049C	LVR-IC	LDO, Dual out, Vout1/Vout2=1.5V/2.85V±1%, 150mA, +CE, CL	DFN1212-6	52x4	VR19	9a Ric
W001	R5328K001B	LVR-IC	LDO, Dual out, Vout1/Vout2=2.8V/2.8V±1%, 150mA, +CE, ECO	DFN2020-8	75	-	9b Ric
W002	R5328K002B	LVR-IC	LDO, Dual out, Vout1/Vout2=1.8V/3.0V±1%, 150mA, +CE, ECO	DFN2020-8	75	-	9b Ric
W003	R5328K003B	LVR-IC	LDO, Dual out, Vout1/Vout2=2.9V/2.9V±1%, 150mA, +CE, ECO	DFN2020-8	75	-	9b Ric
W004	R5328K004B	LVR-IC	LDO, Dual out, Vout1/Vout2=1.8V/2.8V±1%, 150mA, +CE, ECO	DFN2020-8	75	-	9b Ric
W005	R5328K005B	LVR-IC	LDO, Dual out, Vout1/Vout2=1.8V/2.5V±1%, 150mA, +CE, ECO	DFN2020-8	75	-	9b Ric
W006	R5328K006B	LVR-IC	LDO, Dual out, Vout1/Vout2=1.2V/1.8V±1%, 150mA, +CE, ECO	DFN2020-8	75	-	9b Ric
W007	R5328K007B	LVR-IC	LDO, Dual out, Vout1/Vout2=1.2V/2.9V±1%, 150mA, +CE, ECO	DFN2020-8	75	-	9b Ric
W008	R5328K008B	LVR-IC	LDO, Dual out, Vout1/Vout2=2.9V/2.6V±1%, 150mA, +CE, ECO	DFN2020-8	75	-	9b Ric
W009	R5328K009B	LVR-IC	LDO, Dual out, Vout1/Vout2=1.5V/3.0V±1%, 150mA, +CE, ECO	DFN2020-8	75	-	9b Ric
W010	R5328K010B	LVR-IC	LDO, Dual out, Vout1/Vout2=2.9V/3.0V±1%, 150mA, +CE, ECO	DFN2020-8	75	-	9b Ric
W011	R5328K011B	LVR-IC	LDO, Dual out, Vout1/Vout2=2.8V/3.0V±1%, 150mA, +CE, ECO	DFN2020-8	75	-	9b Ric
WA	EUA4890AH	LIN-IC	AF PA, BTL, 3..5.5V, 1W(5W/8Q), shutdown	BGA-9	39	AFP44	- Eut
WA	RP130K341D	LVR-IC	LDO, LN, +CE, CL, 3.4V±1%, 150mA	DFN1010-4	48vm	VR4	9a Ric
WA	RP201K081B	LVR-IC	LDO, 0.8V±1%, 150mA, +CE, AE(Mode)	DFN1212-6	52ht	VR12	9a Ric
WB	RP130K351D	LVR-IC	LDO, LN, +CE, CL, 3.5V±1%, 150mA	DFN1010-4	48vm	VR4	9a Ric
WB	RP201K091B	LVR-IC	LDO, 0.9V±1%, 150mA, +CE, AE(Mode)	DFN1212-6	52ht	VR12	9a Ric
WC	RP130K361D	LVR-IC	LDO, LN, +CE, CL, 3.6V±1%, 150mA	DFN1010-4	48vm	VR4	9a Ric
WC	RP201K101B	LVR-IC	LDO, 1.0V±1%, 150mA, +CE, AE(Mode)	DFN1212-6	52ht	VR12	9a Ric
WD	RP130K371D	LVR-IC	LDO, LN, +CE, CL, 3.7V±1%, 150mA	DFN1010-4	48vm	VR4	9a Ric
WD	RP201K111B	LVR-IC	LDO, 1.1V±1%, 150mA, +CE, AE(Mode)	DFN1212-6	52ht	VR12	9a Ric
WE	RP130K381D	LVR-IC	LDO, LN, +CE, CL, 3.8V±1%, 150mA	DFN1010-4	48vm	VR4	9a Ric
WE	RP201K121B	LVR-IC	LDO, 1.2V±1%, 150mA, +CE, AE(Mode)	DFN1212-6	52ht	VR12	9a Ric
WF	RP130K391D	LVR-IC	LDO, LN, +CE, CL, 3.9V±1%, 150mA	DFN1010-4	48vm	VR4	9a Ric
WF	RP201K131B	LVR-IC	LDO, 1.3V±1%, 150mA, +CE, AE(Mode)	DFN1212-6	52ht	VR12	9a Ric
WG	RP130K401D	LVR-IC	LDO, LN, +CE, CL, 4V±1%, 150mA	DFN1010-4	48vm	VR4	9a Ric
WG	RP201K141B	LVR-IC	LDO, 1.4V±1%, 150mA, +CE, AE(Mode)	DFN1212-6	52ht	VR12	9a Ric
WH	RP130K411D	LVR-IC	LDO, LN, +CE, CL, 4.1V±1%, 150mA	DFN1010-4	48vm	VR4	9a Ric
WH	RP201K151B	LVR-IC	LDO, 1.5V±1%, 150mA, +CE, AE(Mode)	DFN1212-6	52ht	VR12	9a Ric
WJ	RP130K421D	LVR-IC	LDO, LN, +CE, CL, 4.2V±1%, 150mA	DFN1010-4	48vm	VR4	9a Ric
WJ	RP201K161B	LVR-IC	LDO, 1.6V±1%, 150mA, +CE, AE(Mode)	DFN1212-6	52ht	VR12	9a Ric
WK	RP130K431D	LVR-IC	LDO, LN, +CE, CL, 4.3V±1%, 150mA	DFN1010-4	48vm	VR4	9a Ric
WK	RP201K171B	LVR-IC	LDO, 1.7V±1%, 150mA, +CE, AE(Mode)	DFN1212-6	52ht	VR12	9a Ric
WL	RP130K441D	LVR-IC	LDO, LN, +CE, CL, 4.4V±1%, 150mA	DFN1010-4	48vm	VR4	9a Ric
WL	RP201K181B	LVR-IC	LDO, 1.8V±1%, 150mA, +CE, AE(Mode)	DFN1212-6	52ht	VR12	9a Ric
WM	RP130K451D	LVR-IC	LDO, LN, +CE, CL, 4.5V±1%, 150mA	DFN1010-4	48vm	VR4	9a Ric
WM	RP201K191B	LVR-IC	LDO, 1.9V±1%, 150mA, +CE, AE(Mode)	DFN1212-6	52ht	VR12	9a Ric
WN	RP130K461D	LVR-IC	LDO, LN, +CE, CL, 4.6V±1%, 150mA	DFN1010-4	48vm	VR4	9a Ric
WN	RP201K201B	LVR-IC	LDO, 2.0V±1%, 150mA, +CE, AE(Mode)	DFN1212-6	52ht	VR12	9a Ric
WP	RP130K471D	LVR-IC	LDO, LN, +CE, CL, 4.7V±1%, 150mA	DFN1010-4	48vm	VR4	9a Ric
WP	RP201K211B	LVR-IC	LDO, 2.1V±1%, 150mA, +CE, AE(Mode)	DFN1212-6	52ht	VR12	9a Ric
WQ	RP130K481D	LVR-IC	LDO, LN, +CE, CL, 4.8V±1%, 150mA	DFN1010-4	48vm	VR4	9a Ric
WQ	RP201K221B	LVR-IC	LDO, 2.2V±1%, 150mA, +CE, AE(Mode)	DFN1212-6	52ht	VR12	9a Ric
WR	RP130K491D	LVR-IC	LDO, LN, +CE, CL, 4.9V±1%, 150mA	DFN1010-4	48vm	VR4	9a Ric
WR	RP201K231B	LVR-IC	LDO, 2.3V±1%, 150mA, +CE, AE(Mode)	DFN1212-6	52ht	VR12	9a Ric
WS	RP130K501D	LVR-IC	LDO, LN, +CE, CL, 5V±1%, 150mA	DFN1010-4	48vm	VR4	9a Ric
WS	RP201K241B	LVR-IC	LDO, 2.4V±1%, 150mA, +CE, AE(Mode)	DFN1212-6	52ht	VR12	9a Ric
WT	RP201K251B	LVR-IC	LDO, 2.5V±1%, 150mA, +CE, AE(Mode)	DFN1212-6	52ht	VR12	9a Ric
WU	RP201K261B	LVR-IC	LDO, 2.6V±1%, 150mA, +CE, AE(Mode)	DFN1212-6	52ht	VR12	9a Ric
WV	RP201K271B	LVR-IC	LDO, 2.7V±1%, 150mA, +CE, AE(Mode)	DFN1212-6	52ht	VR12	9a Ric
WW	RP201K281B	LVR-IC	LDO, 2.8V±1%, 150mA, +CE, AE(Mode)	DFN1212-6	52ht	VR12	9a Ric
WX	RP201K291B	LVR-IC	LDO, 2.9V±1%, 150mA, +CE, CL, AE(Mode)	DFN1212-6	52ht	VR12	9a Ric
WY	RP201K301B	LVR-IC	LDO, 3.0V±1%, 150mA, +CE, AE(Mode)	DFN1212-6	52ht	VR12	9a Ric
WZ	RP201K311B	LVR-IC	LDO, 3.1V±1%, 150mA, +CE, AE(Mode)	DFN1212-6	52ht	VR12	9a Ric
WZ-	RT9193T-25PB	LVR-IC	LDO, 2.5V±1%, 300mA, +CE	WDFN-6L	49ub	VR7	9a Ret
X001	R5328K001A	LVR-IC	LDO, Dual out, Vout1/Vout2=2.8V/2.8V±1%, 150mA, +CE, ECO	DFN2020-8	75	-	9b Ric
X002	R5328K002A	LVR-IC	LDO, Dual out, Vout1/Vout2=1.8V/3.0V±1%, 150mA, +CE, ECO	DFN2020-8	75	-	9b Ric
X003	R5328K003A	LVR-IC	LDO, Dual out, Vout1/Vout2=2.9V/2.9V±1%, 150mA, +CE, ECO	DFN2020-8	75	-	9b Ric
X004	R5328K004A	LVR-IC	LDO, Dual out, Vout1/Vout2=1.8V/2.8V±1%, 150mA, +CE, ECO	DFN2020-8	75	-	9b Ric
X005	R5328K005A	LVR-IC	LDO, Dual out, Vout1/Vout2=1.8V/2.5V±1%, 150mA, +CE, ECO	DFN2020-8	75	-	9b Ric
X006	R5328K006A	LVR-IC	LDO, Dual out, Vout1/Vout2=1.2V/1.8V±1%, 150mA, +CE, ECO	DFN2020-8	75	-	9b Ric
X007	R5328K007A	LVR-IC	LDO, Dual out, Vout1/Vout2=1.2V/2.9V±1%, 150mA, +CE, ECO	DFN2020-8	75	-	9b Ric
X008	R5328K008A	LVR-IC	LDO, Dual out, Vout1/Vout2=2.9V/2.6V±1%, 150mA, +CE, ECO	DFN2020-8	75	-	9b Ric
X009	R5328K009A	LVR-IC	LDO, Dual out, Vout1/Vout2=1.5V/3.0V±1%, 150mA, +CE, ECO	DFN2020-8	75	-	9b Ric
X010	R5328K010A	LVR-IC	LDO, Dual out, Vout1/Vout2=2.9V/3.0V±1%, 150mA, +CE, ECO	DFN2020-8	75	-	9b Ric
X011	R5328K011A	LVR-IC	LDO, Dual out, Vout1/Vout2=2.8V/3.0V±1%, 150mA, +CE, ECO	DFN2020-8	75	-	9b Ric
X0A	XC6118N30AGR-G	Vdet-IC	3.0V±2%, ±Reset ODO, Sense, hysteresis 5%, Cd	USP-4	45me	VD14	9a Tor
X0B	XC6118N30BGR-G	Vdet-IC	3.0V±2%, ±Reset ODO, Sense, hysteresis <1%, Cd	USP-4	45me	VD14	9a Tor



SMD code	Type	Function	Short description	Case	Pinout	Sch.	St.	Mnf.
X0C	XC6118N30CGR-G	Vdet-IC	3.0V±2%, ±Reset ODO, Sense, hysteresis 5%	USP-4	45md	VD11	9a	Tor
X0D	XC6118N30DGR-G	Vdet-IC	3.0V±2%, ±Reset ODO, Sense, hysteresis <1%	USP-4	45md	VD11	9a	Tor
X1A	XC6118N31AGR-G	Vdet-IC	3.1V±2%, ±Reset ODO, Sense, hysteresis 5%, Cd	USP-4	45me	VD14	9a	Tor
X1B	XC6118N31BGR-G	Vdet-IC	3.1V±2%, ±Reset ODO, Sense, hysteresis <1%, Cd	USP-4	45me	VD14	9a	Tor
X1C	XC6118N31CGR-G	Vdet-IC	3.1V±2%, ±Reset ODO, Sense, hysteresis 5%	USP-4	45md	VD11	9a	Tor
X1D	XC6118N31DGR-G	Vdet-IC	3.1V±2%, ±Reset ODO, Sense, hysteresis <1%	USP-4	45md	VD11	9a	Tor
X2A	XC6118N32AGR-G	Vdet-IC	3.2V±2%, ±Reset ODO, Sense, hysteresis 5%, Cd	USP-4	45me	VD14	9a	Tor
X2B	XC6118N32BGR-G	Vdet-IC	3.2V±2%, ±Reset ODO, Sense, hysteresis <1%, Cd	USP-4	45me	VD14	9a	Tor
X2C	XC6118N32CGR-G	Vdet-IC	3.2V±2%, ±Reset ODO, Sense, hysteresis 5%	USP-4	45md	VD11	9a	Tor
X2D	XC6118N32DGR-G	Vdet-IC	3.2V±2%, ±Reset ODO, Sense, hysteresis <1%	USP-4	45md	VD11	9a	Tor
X3A	XC6118N33AGR-G	Vdet-IC	3.3V±2%, ±Reset ODO, Sense, hysteresis 5%, Cd	USP-4	45me	VD14	9a	Tor
X3B	XC6118N33BGR-G	Vdet-IC	3.3V±2%, ±Reset ODO, Sense, hysteresis <1%, Cd	USP-4	45me	VD14	9a	Tor
X3C	XC6118N33CGR-G	Vdet-IC	3.3V±2%, ±Reset ODO, Sense, hysteresis 5%	USP-4	45md	VD11	9a	Tor
X3D	XC6118N33DGR-G	Vdet-IC	3.3V±2%, ±Reset ODO, Sense, hysteresis <1%	USP-4	45md	VD11	9a	Tor
X4A	XC6118N34AGR-G	Vdet-IC	3.4V±2%, ±Reset ODO, Sense, hysteresis 5%, Cd	USP-4	45me	VD14	9a	Tor
X4B	XC6118N34BGR-G	Vdet-IC	3.4V±2%, ±Reset ODO, Sense, hysteresis <1%, Cd	USP-4	45me	VD14	9a	Tor
X4C	XC6118N34CGR-G	Vdet-IC	3.4V±2%, ±Reset ODO, Sense, hysteresis 5%	USP-4	45md	VD11	9a	Tor
X4D	XC6118N34DGR-G	Vdet-IC	3.4V±2%, ±Reset ODO, Sense, hysteresis <1%	USP-4	45md	VD11	9a	Tor
X5	74LVCH1T45GF	CMOS-Logic	Dual supply translating transceiver with 3-state output	SOT891	52/Log70	-	9c	Phi
X5	74LVCH1T45GM	CMOS-Logic	Dual supply translating transceiver with 3-state output	SOT-886	52/Log70	-	9c	Phi
X5A	XC6118N35AGR-G	Vdet-IC	3.5V±2%, ±Reset ODO, Sense, hysteresis 5%, Cd	USP-4	45me	VD14	9a	Tor
X5B	XC6118N35BGR-G	Vdet-IC	3.5V±2%, ±Reset ODO, Sense, hysteresis <1%, Cd	USP-4	45me	VD14	9a	Tor
X5C	XC6118N35CGR-G	Vdet-IC	3.5V±2%, ±Reset ODO, Sense, hysteresis 5%	USP-4	45md	VD11	9a	Tor
X5D	XC6118N35DGR-G	Vdet-IC	3.5V±2%, ±Reset ODO, Sense, hysteresis <1%	USP-4	45md	VD11	9a	Tor
X6A	XC6118N36AGR-G	Vdet-IC	3.6V±2%, ±Reset ODO, Sense, hysteresis 5%, Cd	USP-4	45me	VD14	9a	Tor
X6B	XC6118N36BGR-G	Vdet-IC	3.6V±2%, ±Reset ODO, Sense, hysteresis <1%, Cd	USP-4	45me	VD14	9a	Tor
X6C	XC6118N36CGR-G	Vdet-IC	3.6V±2%, ±Reset ODO, Sense, hysteresis 5%	USP-4	45md	VD11	9a	Tor
X6D	XC6118N36DGR-G	Vdet-IC	3.6V±2%, ±Reset ODO, Sense, hysteresis <1%	USP-4	45md	VD11	9a	Tor
X7A	XC6118N37AGR-G	Vdet-IC	3.7V±2%, ±Reset ODO, Sense, hysteresis 5%, Cd	USP-4	45me	VD14	9a	Tor
X7B	XC6118N37BGR-G	Vdet-IC	3.7V±2%, ±Reset ODO, Sense, hysteresis <1%, Cd	USP-4	45me	VD14	9a	Tor
X7C	XC6118N37CGR-G	Vdet-IC	3.7V±2%, ±Reset ODO, Sense, hysteresis 5%	USP-4	45md	VD11	9a	Tor
X7D	XC6118N37DGR-G	Vdet-IC	3.7V±2%, ±Reset ODO, Sense, hysteresis <1%	USP-4	45md	VD11	9a	Tor
X8A	XC6118N38AGR-G	Vdet-IC	3.8V±2%, ±Reset ODO, Sense, hysteresis 5%, Cd	USP-4	45me	VD14	9a	Tor
X8B	XC6118N38BGR-G	Vdet-IC	3.8V±2%, ±Reset ODO, Sense, hysteresis <1%, Cd	USP-4	45me	VD14	9a	Tor
X8C	XC6118N38CGR-G	Vdet-IC	3.8V±2%, ±Reset ODO, Sense, hysteresis 5%	USP-4	45md	VD11	9a	Tor
X8D	XC6118N38DGR-G	Vdet-IC	3.8V±2%, ±Reset ODO, Sense, hysteresis <1%	USP-4	45md	VD11	9a	Tor
X9A	XC6118N39AGR-G	Vdet-IC	3.9V±2%, ±Reset ODO, Sense, hysteresis 5%, Cd	USP-4	45me	VD14	9a	Tor
X9B	XC6118N39BGR-G	Vdet-IC	3.9V±2%, ±Reset ODO, Sense, hysteresis <1%, Cd	USP-4	45me	VD14	9a	Tor
X9C	XC6118N39CGR-G	Vdet-IC	3.9V±2%, ±Reset ODO, Sense, hysteresis 5%	USP-4	45md	VD11	9a	Tor
X9D	XC6118N39DGR-G	Vdet-IC	3.9V±2%, ±Reset ODO, Sense, hysteresis <1%	USP-4	45md	VD11	9a	Tor
XA	RP201K321B	LVR-IC	LDO, 3.2V±1%, 150mA, +CE, AE(Mode)	DFN1212-6	52ht	VR12	9a	Ric
XB	RP201K331B	LVR-IC	LDO, 3.3V±1%, 150mA, +CE, AE(Mode)	DFN1212-6	52ht	VR12	9a	Ric
XC	RP201K341B	LVR-IC	LDO, 3.4V±1%, 150mA, +CE, AE(Mode)	DFN1212-6	52ht	VR12	9a	Ric
XD	RP201K351B	LVR-IC	LDO, 3.5V±1%, 150mA, +CE, AE(Mode)	DFN1212-6	52ht	VR12	9a	Ric
XE	RP201K361B	LVR-IC	LDO, 3.6V±1%, 150mA, +CE, AE(Mode)	DFN1212-6	52ht	VR12	9a	Ric
XF	RP201K371B	LVR-IC	LDO, 3.7V±1%, 150mA, +CE, AE(Mode)	DFN1212-6	52ht	VR12	9a	Ric
XG	RP201K381B	LVR-IC	LDO, 3.8V±1%, 150mA, +CE, AE(Mode)	DFN1212-6	52ht	VR12	9a	Ric
XH	RP201K391B	LVR-IC	LDO, 3.9V±1%, 150mA, +CE, AE(Mode)	DFN1212-6	52ht	VR12	9a	Ric
XJ	RP201K401B	LVR-IC	LDO, 4.0V±1%, 150mA, +CE, AE(Mode)	DFN1212-6	52ht	VR12	9a	Ric
XK	RP201K281B5	LVR-IC	LDO, 2.85V±1%, 150mA, +CE, AE(Mode)	DFN1212-6	52ht	VR12	9a	Ric
XXX	LM4946SQ	LIN-IC	AF PA, BTL, 2.7..5.5V, 540mW(4Q)+2x35mW(8Q), I2C	LQFN-24	38	-	-	Nsc
Y0A	XC6118N40AGR-G	Vdet-IC	4.0V±2%, ±Reset ODO, Sense, hysteresis 5%, Cd	USP-4	45me	VD14	9a	Tor
Y0B	XC6118N40BGR-G	Vdet-IC	4.0V±2%, ±Reset ODO, Sense, hysteresis <1%, Cd	USP-4	45me	VD14	9a	Tor
Y0C	XC6118N40CGR-G	Vdet-IC	4.0V±2%, ±Reset ODO, Sense, hysteresis 5%	USP-4	45md	VD11	9a	Tor
Y0D	XC6118N40DGR-G	Vdet-IC	4.0V±2%, ±Reset ODO, Sense, hysteresis <1%	USP-4	45md	VD11	9a	Tor
Y0P	SSM2315CBZ	LIN-IC	AF PA, BTL, class-D, 2.5..5.5V, 3W(5V/3Q), shutdown	BGA-9	39	AFP45	-	Ad
Y10	SSM2305CPZ	LIN-IC	AF PA, BTL, class-D, 2.5..5.5V, 2.8W(5V/4Q), shutdown	CP-8	37	AFP24	-	Ad
Y1A	XC6118N41AGR-G	Vdet-IC	4.1V±2%, ±Reset ODO, Sense, hysteresis 5%, Cd	USP-4	45me	VD14	9a	Tor
Y1B	XC6118N41BGR-G	Vdet-IC	4.1V±2%, ±Reset ODO, Sense, hysteresis <1%, Cd	USP-4	45me	VD14	9a	Tor
Y1C	XC6118N41CGR-G	Vdet-IC	4.1V±2%, ±Reset ODO, Sense, hysteresis 5%	USP-4	45md	VD11	9a	Tor
Y1D	XC6118N41DGR-G	Vdet-IC	4.1V±2%, ±Reset ODO, Sense, hysteresis <1%	USP-4	45md	VD11	9a	Tor
Y1L	SSM2335CBZ	LIN-IC	AF PA, BTL, class-D, 2.5..5.5V, 3W(5V/3Q), shutdown	BGA-9	39	AFP45	-	Ad
Y2A	XC6118N42AGR-G	Vdet-IC	4.2V±2%, ±Reset ODO, Sense, hysteresis 5%, Cd	USP-4	45me	VD14	9a	Tor
Y2B	XC6118N42BGR-G	Vdet-IC	4.2V±2%, ±Reset ODO, Sense, hysteresis <1%, Cd	USP-4	45me	VD14	9a	Tor
Y2C	XC6118N42CGR-G	Vdet-IC	4.2V±2%, ±Reset ODO, Sense, hysteresis 5%	USP-4	45md	VD11	9a	Tor
Y2D	XC6118N42DGR-G	Vdet-IC	4.2V±2%, ±Reset ODO, Sense, hysteresis <1%	USP-4	45md	VD11	9a	Tor
Y3A	XC6118N43AGR-G	Vdet-IC	4.3V±2%, ±Reset ODO, Sense, hysteresis 5%, Cd	USP-4	45me	VD14	9a	Tor
Y3B	XC6118N43BGR-G	Vdet-IC	4.3V±2%, ±Reset ODO, Sense, hysteresis <1%, Cd	USP-4	45me	VD14	9a	Tor
Y3C	XC6118N43CGR-G	Vdet-IC	4.3V±2%, ±Reset ODO, Sense, hysteresis 5%	USP-4	45md	VD11	9a	Tor
Y3D	XC6118N43DGR-G	Vdet-IC	4.3V±2%, ±Reset ODO, Sense, hysteresis <1%	USP-4	45md	VD11	9a	Tor



SMD code	Type	Function	Short description	Case	Pinout	Sch.	St.	Mnf.
Y4A	XC6118N44AGR-G	Vdet-IC	4.4V±2%, ±Reset ODO, Sense, hysteresis 5%, Cd	USP-4	45me	VD14	9a	Tor
Y4B	XC6118N44BGR-G	Vdet-IC	4.4V±2%, ±Reset ODO, Sense, hysteresis <1%, Cd	USP-4	45me	VD14	9a	Tor
Y4C	XC6118N44CGR-G	Vdet-IC	4.4V±2%, ±Reset ODO, Sense, hysteresis 5%	USP-4	45md	VD11	9a	Tor
Y4D	XC6118N44DGR-G	Vdet-IC	4.4V±2%, ±Reset ODO, Sense, hysteresis <1%	USP-4	45md	VD11	9a	Tor
Y5A	XC6118N45AGR-G	Vdet-IC	4.5V±2%, ±Reset ODO, Sense, hysteresis 5%, Cd	USP-4	45me	VD14	9a	Tor
Y5B	XC6118N45BGR-G	Vdet-IC	4.5V±2%, ±Reset ODO, Sense, hysteresis <1%, Cd	USP-4	45me	VD14	9a	Tor
Y5C	XC6118N45CGR-G	Vdet-IC	4.5V±2%, ±Reset ODO, Sense, hysteresis 5%	USP-4	45md	VD11	9a	Tor
Y5D	XC6118N45DGR-G	Vdet-IC	4.5V±2%, ±Reset ODO, Sense, hysteresis <1%	USP-4	45md	VD11	9a	Tor
Y6A	XC6118N46AGR-G	Vdet-IC	4.6V±2%, ±Reset ODO, Sense, hysteresis 5%, Cd	USP-4	45me	VD14	9a	Tor
Y6B	XC6118N46BGR-G	Vdet-IC	4.6V±2%, ±Reset ODO, Sense, hysteresis <1%, Cd	USP-4	45me	VD14	9a	Tor
Y6C	XC6118N46CGR-G	Vdet-IC	4.6V±2%, ±Reset ODO, Sense, hysteresis 5%	USP-4	45md	VD11	9a	Tor
Y6D	XC6118N46DGR-G	Vdet-IC	4.6V±2%, ±Reset ODO, Sense, hysteresis <1%	USP-4	45md	VD11	9a	Tor
Y7A	XC6118N47AGR-G	Vdet-IC	4.7V±2%, ±Reset ODO, Sense, hysteresis 5%, Cd	USP-4	45me	VD14	9a	Tor
Y7B	XC6118N47BGR-G	Vdet-IC	4.7V±2%, ±Reset ODO, Sense, hysteresis <1%, Cd	USP-4	45me	VD14	9a	Tor
Y7C	XC6118N47CGR-G	Vdet-IC	4.7V±2%, ±Reset ODO, Sense, hysteresis 5%	USP-4	45md	VD11	9a	Tor
Y7D	XC6118N47DGR-G	Vdet-IC	4.7V±2%, ±Reset ODO, Sense, hysteresis <1%	USP-4	45md	VD11	9a	Tor
Y8A	XC6118N48AGR-G	Vdet-IC	4.8V±2%, ±Reset ODO, Sense, hysteresis 5%, Cd	USP-4	45me	VD14	9a	Tor
Y8B	XC6118N48BGR-G	Vdet-IC	4.8V±2%, ±Reset ODO, Sense, hysteresis <1%, Cd	USP-4	45me	VD14	9a	Tor
Y8C	XC6118N48CGR-G	Vdet-IC	4.8V±2%, ±Reset ODO, Sense, hysteresis 5%	USP-4	45md	VD11	9a	Tor
Y8D	XC6118N48DGR-G	Vdet-IC	4.8V±2%, ±Reset ODO, Sense, hysteresis <1%	USP-4	45md	VD11	9a	Tor
Y9A	XC6118N49AGR-G	Vdet-IC	4.9V±2%, ±Reset ODO, Sense, hysteresis 5%, Cd	USP-4	45me	VD14	9a	Tor
Y9B	XC6118N49BGR-G	Vdet-IC	4.9V±2%, ±Reset ODO, Sense, hysteresis <1%, Cd	USP-4	45me	VD14	9a	Tor
Y9C	XC6118N49CGR-G	Vdet-IC	4.9V±2%, ±Reset ODO, Sense, hysteresis 5%	USP-4	45md	VD11	9a	Tor
Y9D	XC6118N49DGR-G	Vdet-IC	4.9V±2%, ±Reset ODO, Sense, hysteresis <1%	USP-4	45md	VD11	9a	Tor
YA	74LVC2G34GM	CMOS-Logic	Dual non-inverter buffers	SOT-886	57Log23	-	9c	Phi
YA	RP201K081D	LVR-IC	LDO, 0.8V±1%, 150mA, +CE, CL, AE(Mode)	DFN1212-6	52ht	VR12	9a	Ric
YB	74LVC1G38GF	CMOS-Logic	2-input NAND gate (ODO)	SOT891	52Log17	-	9c	Phi
YB	74LVC1G38GM	CMOS-Logic	2-input NAND gate (ODO)	SOT-886	57Log17	-	9c	Phi
YB	RP201K091D	LVR-IC	LDO, 0.9V±1%, 150mA, +CE, CL, AE(Mode)	DFN1212-6	52ht	VR12	9a	Ric
YC	74LVC1G57GF	CMOS-Logic	Configurable multiple-function gate	SOT891	52Log36	-	9c	Phi
YC	74LVC1G57GM	CMOS-Logic	Configurable multiple-function gate	SOT-886	57Log36	-	9c	Phi
YC	RP201K101D	LVR-IC	LDO, 1.0V±1%, 150mA, +CE, CL, AE(Mode)	DFN1212-6	52ht	VR12	9a	Ric
YD	74LVC2GU04GM	CMOS-Logic	Dual inverters	SOT-886	57Log24	-	9c	Phi
YD	RP201K111D	LVR-IC	LDO, 1.1V±1%, 150mA, +CE, CL, AE(Mode)	DFN1212-6	52ht	VR12	9a	Ric
YE	RP201K121D	LVR-IC	LDO, 1.2V±1%, 150mA, +CE, CL, AE(Mode)	DFN1212-6	52ht	VR12	9a	Ric
YF	RP201K131D	LVR-IC	LDO, 1.3V±1%, 150mA, +CE, CL, AE(Mode)	DFN1212-6	52ht	VR12	9a	Ric
YG	74LVC1G332GF	CMOS-Logic	3-input OR gate	SOT891	52Log32	-	9c	Phi
YG	74LVC1G332GM	CMOS-Logic	3-input OR gate	SOT-886	57Log32	-	9c	Phi
YG	RP201K141D	LVR-IC	LDO, 1.4V±1%, 150mA, +CE, CL, AE(Mode)	DFN1212-6	52ht	VR12	9a	Ric
YH	RP201K151D	LVR-IC	LDO, 1.5V±1%, 150mA, +CE, CL, AE(Mode)	DFN1212-6	52ht	VR12	9a	Ric
YJ	74LVC1G3157GF	CMOS-Logic	2-channel analog multiplexer/demultiplexer	SOT891	52Log38	-	9c	Phi
YJ	74LVC1G3157GM	CMOS-Logic	2-channel analog multiplexer/demultiplexer	SOT-886	57Log38	-	9c	Phi
YJ	RP201K161D	LVR-IC	LDO, 1.6V±1%, 150mA, +CE, CL, AE(Mode)	DFN1212-6	52ht	VR12	9a	Ric
YK	74LVC1G58GF	CMOS-Logic	Configurable multiple-function gate	SOT891	52Log37	-	9c	Phi
YK	74LVC1G58GM	CMOS-Logic	Configurable multiple-function gate	SOT-886	57Log37	-	9c	Phi
YK	RP201K171D	LVR-IC	LDO, 1.7V±1%, 150mA, +CE, CL, AE(Mode)	DFN1212-6	52ht	VR12	9a	Ric
YL	74LVC1G384GF	CMOS-Logic	Bilateral analogic switch	SOT891	52Log16	-	9c	Phi
YL	74LVC1G384GM	CMOS-Logic	Bilateral analogic switch	SOT-886	57Log16	-	9c	Phi
YL	RP201K181D	LVR-IC	LDO, 1.8V±1%, 150mA, +CE, CL, AE(Mode)	DFN1212-6	52ht	VR12	9a	Ric
YM	74LVC1G10GF	CMOS-Logic	3-input NAND gate	SOT891	52Log29	-	9c	Phi
YM	74LVC1G10GM	CMOS-Logic	3-input NAND gate	SOT-886	57Log29	-	9c	Phi
YM	RP201K191D	LVR-IC	LDO, 1.9V±1%, 150mA, +CE, CL, AE(Mode)	DFN1212-6	52ht	VR12	9a	Ric
YN	74LVC1G34GF	CMOS-Logic	Noninverting buffer	SOT891	52Log10	-	9c	Phi
YN	74LVC1G34GM	CMOS-Logic	Noninverting buffer	SOT-886	57Log10	-	9c	Phi
YN	RP201K201D	LVR-IC	LDO, 2.0V±1%, 150mA, +CE, CL, AE(Mode)	DFN1212-6	52ht	VR12	9a	Ric
YP	74LVC1G157GF	CMOS-Logic	2-input multiplexer	SOT891	52Log42	-	9c	Phi
YP	74LVC1G157GM	CMOS-Logic	2-input multiplexer	SOT-886	57Log42	-	9c	Phi
YP	RP201K211D	LVR-IC	LDO, 2.1V±1%, 150mA, +CE, CL, AE(Mode)	DFN1212-6	52ht	VR12	9a	Ric
YQ	RP201K221D	LVR-IC	LDO, 2.2V±1%, 150mA, +CE, CL, AE(Mode)	DFN1212-6	52ht	VR12	9a	Ric
YR	RP201K231D	LVR-IC	LDO, 2.3V±1%, 150mA, +CE, CL, AE(Mode)	DFN1212-6	52ht	VR12	9a	Ric
YS	RP201K241D	LVR-IC	LDO, 2.4V±1%, 150mA, +CE, CL, AE(Mode)	DFN1212-6	52ht	VR12	9a	Ric
YT	74LVC1G175GF	CMOS-Logic	Positive edge-triggered D-type flip-flop with reset	SOT891	52Log40	-	9c	Phi
YT	74LVC1G175GM	CMOS-Logic	Positive edge-triggered D-type flip-flop with reset	SOT-886	57Log40	-	9c	Phi
YT	RP201K251D	LVR-IC	LDO, 2.5V±1%, 150mA, +CE, CL, AE(Mode)	DFN1212-6	52ht	VR12	9a	Ric
YU	RP201K261D	LVR-IC	LDO, 2.6V±1%, 150mA, +CE, CL, AE(Mode)	DFN1212-6	52ht	VR12	9a	Ric
YV	RP201K271D	LVR-IC	LDO, 2.7V±1%, 150mA, +CE, CL, AE(Mode)	DFN1212-6	52ht	VR12	9a	Ric
YW	RP201K281D	LVR-IC	LDO, 2.8V±1%, 150mA, +CE, CL, AE(Mode)	DFN1212-6	52ht	VR12	9a	Ric
YX	RP201K291D	LVR-IC	LDO, 2.9V±1%, 150mA, +CE, CL, AE(Mode)	DFN1212-6	52ht	VR12	9a	Ric
YY	RP201K301D	LVR-IC	LDO, 3.0V±1%, 150mA, +CE, CL, AE(Mode)	DFN1212-6	52ht	VR12	9a	Ric
YZ	RP201K311D	LVR-IC	LDO, 3.1V±1%, 150mA, +CE, CL, AE(Mode)	DFN1212-6	52ht	VR12	9a	Ric



SMD code	Type	Function	Short description	Case	Pinout	Sch.	St.	Mnf.
Z0A	XC6118N50AGR-G	Vdet-IC	5.0V±2%, ±Reset ODO, Sense, hysteresis 5%, Cd	USP-4	45me	VD14	9a	Tor
Z0B	XC6118N50BGR-G	Vdet-IC	5.0V±2%, ±Reset ODO, Sense, hysteresis <1%, Cd	USP-4	45me	VD14	9a	Tor
Z0C	XC6118N50CGR-G	Vdet-IC	5.0V±2%, ±Reset ODO, Sense, hysteresis 5%	USP-4	45md	VD11	9a	Tor
Z0D	XC6118N50DGR-G	Vdet-IC	5.0V±2%, ±Reset ODO, Sense, hysteresis <1%	USP-4	45md	VD11	9a	Tor
ZA	RP201K321D	LVR-IC	LDO, 3.2V±1%, 150mA, +CE, CL, AE(Mode)	DFN1212-6	52ht	VR12	9a	Ric
ZA096	XC9225A096D	DC/DC-IC	PWM step-down, 600kHz, 0.9V±1%, 600mA, +CE	USP-6B	49dc5	DC1	9b	Tor
ZA09C	XC9225A09CD	DC/DC-IC	PWM step-down, 1.2MHz, 0.9V±1%, 600mA, +CE	USP-6B	49dc5	DC1	9b	Tor
ZA0M6	XC9225A0M6D	DC/DC-IC	PWM step-down, 600kHz, 0.95V±1%, 600mA, +CE	USP-6B	49dc5	DC1	9b	Tor
ZA0MC	XC9225A0MCD	DC/DC-IC	PWM step-down, 1.2MHz, 0.95V±1%, 600mA, +CE	USP-6B	49dc5	DC1	9b	Tor
ZA106	XC9225A106D	DC/DC-IC	PWM step-down, 600kHz, 1.0V±1%, 600mA, +CE	USP-6B	49dc5	DC1	9b	Tor
ZA10C	XC9225A10CD	DC/DC-IC	PWM step-down, 1.2MHz, 1.0V±1%, 600mA, +CE	USP-6B	49dc5	DC1	9b	Tor
ZA116	XC9225A116D	DC/DC-IC	PWM step-down, 600kHz, 1.1V±1%, 600mA, +CE	USP-6B	49dc5	DC1	9b	Tor
ZA11C	XC9225A11CD	DC/DC-IC	PWM step-down, 1.2MHz, 1.1V±1%, 600mA, +CE	USP-6B	49dc5	DC1	9b	Tor
ZA126	XC9225A126D	DC/DC-IC	PWM step-down, 600kHz, 1.2V±1%, 600mA, +CE	USP-6B	49dc5	DC1	9b	Tor
ZA12C	XC9225A12CD	DC/DC-IC	PWM step-down, 1.2MHz, 1.2V±1%, 600mA, +CE	USP-6B	49dc5	DC1	9b	Tor
ZA136	XC9225A136D	DC/DC-IC	PWM step-down, 600kHz, 1.3V±1%, 600mA, +CE	USP-6B	49dc5	DC1	9b	Tor
ZA13C	XC9225A13CD	DC/DC-IC	PWM step-down, 1.2MHz, 1.3V±1%, 600mA, +CE	USP-6B	49dc5	DC1	9b	Tor
ZA146	XC9225A146D	DC/DC-IC	PWM step-down, 600kHz, 1.4V±1%, 600mA, +CE	USP-6B	49dc5	DC1	9b	Tor
ZA14C	XC9225A14CD	DC/DC-IC	PWM step-down, 1.2MHz, 1.4V±1%, 600mA, +CE	USP-6B	49dc5	DC1	9b	Tor
ZA156	XC9225A156D	DC/DC-IC	PWM step-down, 600kHz, 1.5V±1%, 600mA, +CE	USP-6B	49dc5	DC1	9b	Tor
ZA15C	XC9225A15CD	DC/DC-IC	PWM step-down, 1.2MHz, 1.5V±1%, 600mA, +CE	USP-6B	49dc5	DC1	9b	Tor
ZA166	XC9225A166D	DC/DC-IC	PWM step-down, 600kHz, 1.6V±1%, 600mA, +CE	USP-6B	49dc5	DC1	9b	Tor
ZA16C	XC9225A16CD	DC/DC-IC	PWM step-down, 1.2MHz, 1.6V±1%, 600mA, +CE	USP-6B	49dc5	DC1	9b	Tor
ZA176	XC9225A176D	DC/DC-IC	PWM step-down, 600kHz, 1.7V±1%, 600mA, +CE	USP-6B	49dc5	DC1	9b	Tor
ZA17C	XC9225A17CD	DC/DC-IC	PWM step-down, 1.2MHz, 1.7V±1%, 600mA, +CE	USP-6B	49dc5	DC1	9b	Tor
ZA186	XC9225A186D	DC/DC-IC	PWM step-down, 600kHz, 1.8V±1%, 600mA, +CE	USP-6B	49dc5	DC1	9b	Tor
ZA18C	XC9225A18CD	DC/DC-IC	PWM step-down, 1.2MHz, 1.8V±1%, 600mA, +CE	USP-6B	49dc5	DC1	9b	Tor
ZA196	XC9225A196D	DC/DC-IC	PWM step-down, 600kHz, 1.9V±1%, 600mA, +CE	USP-6B	49dc5	DC1	9b	Tor
ZA19C	XC9225A19CD	DC/DC-IC	PWM step-down, 1.2MHz, 1.9V±1%, 600mA, +CE	USP-6B	49dc5	DC1	9b	Tor
ZA1A6	XC9225A1A6D	DC/DC-IC	PWM step-down, 600kHz, 1.05V±1%, 600mA, +CE	USP-6B	49dc5	DC1	9b	Tor
ZA1AC	XC9225A1ACD	DC/DC-IC	PWM step-down, 1.2MHz, 1.05V±1%, 600mA, +CE	USP-6B	49dc5	DC1	9b	Tor
ZA1B6	XC9225A1B6D	DC/DC-IC	PWM step-down, 600kHz, 1.15V±1%, 600mA, +CE	USP-6B	49dc5	DC1	9b	Tor
ZA1BC	XC9225A1BCD	DC/DC-IC	PWM step-down, 1.2MHz, 1.15V±1%, 600mA, +CE	USP-6B	49dc5	DC1	9b	Tor
ZA1C6	XC9225A1C6D	DC/DC-IC	PWM step-down, 600kHz, 1.25V±1%, 600mA, +CE	USP-6B	49dc5	DC1	9b	Tor
ZA1CC	XC9225A1CCD	DC/DC-IC	PWM step-down, 1.2MHz, 1.25V±1%, 600mA, +CE	USP-6B	49dc5	DC1	9b	Tor
ZA1D6	XC9225A1D6D	DC/DC-IC	PWM step-down, 600kHz, 1.35V±1%, 600mA, +CE	USP-6B	49dc5	DC1	9b	Tor
ZA1DC	XC9225A1DCD	DC/DC-IC	PWM step-down, 1.2MHz, 1.35V±1%, 600mA, +CE	USP-6B	49dc5	DC1	9b	Tor
ZA1E6	XC9225A1E6D	DC/DC-IC	PWM step-down, 600kHz, 1.45V±1%, 600mA, +CE	USP-6B	49dc5	DC1	9b	Tor
ZA1EC	XC9225A1ECD	DC/DC-IC	PWM step-down, 1.2MHz, 1.45V±1%, 600mA, +CE	USP-6B	49dc5	DC1	9b	Tor
ZA1F6	XC9225A1F6D	DC/DC-IC	PWM step-down, 600kHz, 1.55V±1%, 600mA, +CE	USP-6B	49dc5	DC1	9b	Tor
ZA1FC	XC9225A1FCD	DC/DC-IC	PWM step-down, 1.2MHz, 1.55V±1%, 600mA, +CE	USP-6B	49dc5	DC1	9b	Tor
ZA1H6	XC9225A1H6D	DC/DC-IC	PWM step-down, 600kHz, 1.65V±1%, 600mA, +CE	USP-6B	49dc5	DC1	9b	Tor
ZA1HC	XC9225A1HCD	DC/DC-IC	PWM step-down, 1.2MHz, 1.65V±1%, 600mA, +CE	USP-6B	49dc5	DC1	9b	Tor
ZA1K6	XC9225A1K6D	DC/DC-IC	PWM step-down, 600kHz, 1.75V±1%, 600mA, +CE	USP-6B	49dc5	DC1	9b	Tor
ZA1KC	XC9225A1KCD	DC/DC-IC	PWM step-down, 1.2MHz, 1.75V±1%, 600mA, +CE	USP-6B	49dc5	DC1	9b	Tor
ZA1L6	XC9225A1L6D	DC/DC-IC	PWM step-down, 600kHz, 1.85V±1%, 600mA, +CE	USP-6B	49dc5	DC1	9b	Tor
ZA1LC	XC9225A1LCD	DC/DC-IC	PWM step-down, 1.2MHz, 1.85V±1%, 600mA, +CE	USP-6B	49dc5	DC1	9b	Tor
ZA1M6	XC9225A1M6D	DC/DC-IC	PWM step-down, 600kHz, 1.95V±1%, 600mA, +CE	USP-6B	49dc5	DC1	9b	Tor
ZA1MC	XC9225A1MCD	DC/DC-IC	PWM step-down, 1.2MHz, 1.95V±1%, 600mA, +CE	USP-6B	49dc5	DC1	9b	Tor
ZA206	XC9225A206D	DC/DC-IC	PWM step-down, 600kHz, 2.0V±1%, 600mA, +CE	USP-6B	49dc5	DC1	9b	Tor
ZA20C	XC9225A20CD	DC/DC-IC	PWM step-down, 1.2MHz, 2.0V±1%, 600mA, +CE	USP-6B	49dc5	DC1	9b	Tor
ZA216	XC9225A216D	DC/DC-IC	PWM step-down, 600kHz, 2.1V±1%, 600mA, +CE	USP-6B	49dc5	DC1	9b	Tor
ZA21C	XC9225A21CD	DC/DC-IC	PWM step-down, 1.2MHz, 2.1V±1%, 600mA, +CE	USP-6B	49dc5	DC1	9b	Tor
ZA226	XC9225A226D	DC/DC-IC	PWM step-down, 600kHz, 2.2V±1%, 600mA, +CE	USP-6B	49dc5	DC1	9b	Tor
ZA22C	XC9225A22CD	DC/DC-IC	PWM step-down, 1.2MHz, 2.2V±1%, 600mA, +CE	USP-6B	49dc5	DC1	9b	Tor
ZA236	XC9225A236D	DC/DC-IC	PWM step-down, 600kHz, 2.3V±1%, 600mA, +CE	USP-6B	49dc5	DC1	9b	Tor
ZA23C	XC9225A23CD	DC/DC-IC	PWM step-down, 1.2MHz, 2.3V±1%, 600mA, +CE	USP-6B	49dc5	DC1	9b	Tor
ZA246	XC9225A246D	DC/DC-IC	PWM step-down, 600kHz, 2.4V±1%, 600mA, +CE	USP-6B	49dc5	DC1	9b	Tor
ZA24C	XC9225A24CD	DC/DC-IC	PWM step-down, 1.2MHz, 2.4V±1%, 600mA, +CE	USP-6B	49dc5	DC1	9b	Tor
ZA256	XC9225A256D	DC/DC-IC	PWM step-down, 600kHz, 2.5V±1%, 600mA, +CE	USP-6B	49dc5	DC1	9b	Tor
ZA25C	XC9225A25CD	DC/DC-IC	PWM step-down, 1.2MHz, 2.5V±1%, 600mA, +CE	USP-6B	49dc5	DC1	9b	Tor
ZA266	XC9225A266D	DC/DC-IC	PWM step-down, 600kHz, 2.6V±1%, 600mA, +CE	USP-6B	49dc5	DC1	9b	Tor
ZA26C	XC9225A26CD	DC/DC-IC	PWM step-down, 1.2MHz, 2.6V±1%, 600mA, +CE	USP-6B	49dc5	DC1	9b	Tor
ZA276	XC9225A276D	DC/DC-IC	PWM step-down, 600kHz, 2.7V±1%, 600mA, +CE	USP-6B	49dc5	DC1	9b	Tor
ZA27C	XC9225A27CD	DC/DC-IC	PWM step-down, 1.2MHz, 2.7V±1%, 600mA, +CE	USP-6B	49dc5	DC1	9b	Tor
ZA286	XC9225A286D	DC/DC-IC	PWM step-down, 600kHz, 2.8V±1%, 600mA, +CE	USP-6B	49dc5	DC1	9b	Tor
ZA28C	XC9225A28CD	DC/DC-IC	PWM step-down, 1.2MHz, 2.8V±1%, 600mA, +CE	USP-6B	49dc5	DC1	9b	Tor
ZA296	XC9225A296D	DC/DC-IC	PWM step-down, 600kHz, 2.9V±1%, 600mA, +CE	USP-6B	49dc5	DC1	9b	Tor
ZA29C	XC9225A29CD	DC/DC-IC	PWM step-down, 1.2MHz, 2.9V±1%, 600mA, +CE	USP-6B	49dc5	DC1	9b	Tor
ZA2A6	XC9225A2A6D	DC/DC-IC	PWM step-down, 600kHz, 2.05V±1%, 600mA, +CE	USP-6B	49dc5	DC1	9b	Tor



SMD code	Type	Function	Short description	Case	Pinout	Sch.	St.	Mnf.
ZB2K6	XC9225B2K6D	DC/DC-IC	PWM step-down, 600kHz, 2.75V±1%, 600mA, -CE	USP-6B	49dc5	DC1	9b	Tor
ZB2KC	XC9225B2KCD	DC/DC-IC	PWM step-down, 1.2MHz, 2.75V±1%, 600mA, -CE	USP-6B	49dc5	DC1	9b	Tor
ZB2L6	XC9225B2L6D	DC/DC-IC	PWM step-down, 600kHz, 2.85V±1%, 600mA, -CE	USP-6B	49dc5	DC1	9b	Tor
ZB2LC	XC9225B2LCD	DC/DC-IC	PWM step-down, 1.2MHz, 2.85V±1%, 600mA, -CE	USP-6B	49dc5	DC1	9b	Tor
ZB2M6	XC9225B2M6D	DC/DC-IC	PWM step-down, 600kHz, 2.95V±1%, 600mA, -CE	USP-6B	49dc5	DC1	9b	Tor
ZB2MC	XC9225B2MCD	DC/DC-IC	PWM step-down, 1.2MHz, 2.95V±1%, 600mA, -CE	USP-6B	49dc5	DC1	9b	Tor
ZB306	XC9225B306D	DC/DC-IC	PWM step-down, 600kHz, 3.0V±1%, 600mA, -CE	USP-6B	49dc5	DC1	9b	Tor
ZB30C	XC9225B30CD	DC/DC-IC	PWM step-down, 1.2MHz, 3.0V±1%, 600mA, -CE	USP-6B	49dc5	DC1	9b	Tor
ZB316	XC9225B316D	DC/DC-IC	PWM step-down, 600kHz, 3.1V±1%, 600mA, -CE	USP-6B	49dc5	DC1	9b	Tor
ZB31C	XC9225B31CD	DC/DC-IC	PWM step-down, 1.2MHz, 3.1V±1%, 600mA, -CE	USP-6B	49dc5	DC1	9b	Tor
ZB326	XC9225B326D	DC/DC-IC	PWM step-down, 600kHz, 3.2V±1%, 600mA, -CE	USP-6B	49dc5	DC1	9b	Tor
ZB32C	XC9225B32CD	DC/DC-IC	PWM step-down, 1.2MHz, 3.2V±1%, 600mA, -CE	USP-6B	49dc5	DC1	9b	Tor
ZB336	XC9225B336D	DC/DC-IC	PWM step-down, 600kHz, 3.3V±1%, 600mA, -CE	USP-6B	49dc5	DC1	9b	Tor
ZB33C	XC9225B33CD	DC/DC-IC	PWM step-down, 1.2MHz, 3.3V±1%, 600mA, -CE	USP-6B	49dc5	DC1	9b	Tor
ZB346	XC9225B346D	DC/DC-IC	PWM step-down, 600kHz, 3.4V±1%, 600mA, -CE	USP-6B	49dc5	DC1	9b	Tor
ZB34C	XC9225B34CD	DC/DC-IC	PWM step-down, 1.2MHz, 3.4V±1%, 600mA, -CE	USP-6B	49dc5	DC1	9b	Tor
ZB356	XC9225B356D	DC/DC-IC	PWM step-down, 600kHz, 3.5V±1%, 600mA, -CE	USP-6B	49dc5	DC1	9b	Tor
ZB35C	XC9225B35CD	DC/DC-IC	PWM step-down, 1.2MHz, 3.5V±1%, 600mA, -CE	USP-6B	49dc5	DC1	9b	Tor
ZB366	XC9225B366D	DC/DC-IC	PWM step-down, 600kHz, 3.6V±1%, 600mA, -CE	USP-6B	49dc5	DC1	9b	Tor
ZB36C	XC9225B36CD	DC/DC-IC	PWM step-down, 1.2MHz, 3.6V±1%, 600mA, -CE	USP-6B	49dc5	DC1	9b	Tor
ZB376	XC9225B376D	DC/DC-IC	PWM step-down, 600kHz, 3.7V±1%, 600mA, -CE	USP-6B	49dc5	DC1	9b	Tor
ZB37C	XC9225B37CD	DC/DC-IC	PWM step-down, 1.2MHz, 3.7V±1%, 600mA, -CE	USP-6B	49dc5	DC1	9b	Tor
ZB386	XC9225B386D	DC/DC-IC	PWM step-down, 600kHz, 3.8V±1%, 600mA, -CE	USP-6B	49dc5	DC1	9b	Tor
ZB38C	XC9225B38CD	DC/DC-IC	PWM step-down, 1.2MHz, 3.8V±1%, 600mA, -CE	USP-6B	49dc5	DC1	9b	Tor
ZB396	XC9225B396D	DC/DC-IC	PWM step-down, 600kHz, 3.9V±1%, 600mA, -CE	USP-6B	49dc5	DC1	9b	Tor
ZB39C	XC9225B39CD	DC/DC-IC	PWM step-down, 1.2MHz, 3.9V±1%, 600mA, -CE	USP-6B	49dc5	DC1	9b	Tor
ZB3A6	XC9225B3A6D	DC/DC-IC	PWM step-down, 600kHz, 3.05V±1%, 600mA, -CE	USP-6B	49dc5	DC1	9b	Tor
ZB3AC	XC9225B3ACD	DC/DC-IC	PWM step-down, 1.2MHz, 3.05V±1%, 600mA, -CE	USP-6B	49dc5	DC1	9b	Tor
ZB3B6	XC9225B3B6D	DC/DC-IC	PWM step-down, 600kHz, 3.15V±1%, 600mA, -CE	USP-6B	49dc5	DC1	9b	Tor
ZB3BC	XC9225B3BCD	DC/DC-IC	PWM step-down, 1.2MHz, 3.15V±1%, 600mA, -CE	USP-6B	49dc5	DC1	9b	Tor
ZB3C6	XC9225B3C6D	DC/DC-IC	PWM step-down, 600kHz, 3.25V±1%, 600mA, -CE	USP-6B	49dc5	DC1	9b	Tor
ZB3CC	XC9225B3CCD	DC/DC-IC	PWM step-down, 1.2MHz, 3.25V±1%, 600mA, -CE	USP-6B	49dc5	DC1	9b	Tor
ZB3D6	XC9225B3D6D	DC/DC-IC	PWM step-down, 600kHz, 3.35V±1%, 600mA, -CE	USP-6B	49dc5	DC1	9b	Tor
ZB3DC	XC9225B3DCD	DC/DC-IC	PWM step-down, 1.2MHz, 3.35V±1%, 600mA, -CE	USP-6B	49dc5	DC1	9b	Tor
ZB3E6	XC9225B3E6D	DC/DC-IC	PWM step-down, 600kHz, 3.45V±1%, 600mA, -CE	USP-6B	49dc5	DC1	9b	Tor
ZB3EC	XC9225B3ECD	DC/DC-IC	PWM step-down, 1.2MHz, 3.45V±1%, 600mA, -CE	USP-6B	49dc5	DC1	9b	Tor
ZB3F6	XC9225B3F6D	DC/DC-IC	PWM step-down, 600kHz, 3.55V±1%, 600mA, -CE	USP-6B	49dc5	DC1	9b	Tor
ZB3FC	XC9225B3FCD	DC/DC-IC	PWM step-down, 1.2MHz, 3.55V±1%, 600mA, -CE	USP-6B	49dc5	DC1	9b	Tor
ZB3H6	XC9225B3H6D	DC/DC-IC	PWM step-down, 600kHz, 3.65V±1%, 600mA, -CE	USP-6B	49dc5	DC1	9b	Tor
ZB3HC	XC9225B3HCD	DC/DC-IC	PWM step-down, 1.2MHz, 3.65V±1%, 600mA, -CE	USP-6B	49dc5	DC1	9b	Tor
ZB3K6	XC9225B3K6D	DC/DC-IC	PWM step-down, 600kHz, 3.75V±1%, 600mA, -CE	USP-6B	49dc5	DC1	9b	Tor
ZB3KC	XC9225B3KCD	DC/DC-IC	PWM step-down, 1.2MHz, 3.75V±1%, 600mA, -CE	USP-6B	49dc5	DC1	9b	Tor
ZB3L6	XC9225B3L6D	DC/DC-IC	PWM step-down, 600kHz, 3.85V±1%, 600mA, -CE	USP-6B	49dc5	DC1	9b	Tor
ZB3LC	XC9225B3LCD	DC/DC-IC	PWM step-down, 1.2MHz, 3.85V±1%, 600mA, -CE	USP-6B	49dc5	DC1	9b	Tor
ZB3M6	XC9225B3M6D	DC/DC-IC	PWM step-down, 600kHz, 3.95V±1%, 600mA, -CE	USP-6B	49dc5	DC1	9b	Tor
ZB3MC	XC9225B3MCD	DC/DC-IC	PWM step-down, 1.2MHz, 3.95V±1%, 600mA, -CE	USP-6B	49dc5	DC1	9b	Tor
ZB406	XC9225B406D	DC/DC-IC	PWM step-down, 600kHz, 4.0V±1%, 600mA, -CE	USP-6B	49dc5	DC1	9b	Tor
ZB40C	XC9225B40CD	DC/DC-IC	PWM step-down, 1.2MHz, 4.0V±1%, 600mA, -CE	USP-6B	49dc5	DC1	9b	Tor
ZB4M-	NCP2820MUTBG	LIN-IC	AF PA, BTL, class-D, 2.2-5.5V, 2.65W(4Q), shutdown	DFN-8	37	-	-	Ons
ZC	RP201K341D	LVR-IC	LDO, 3.4V±1%, 150mA, +CE, CL, AE(Mode)	DFN1212-6	52ht	VR12	9a	Ric
ZC096	XC9225C096D	DC/DC-IC	PWM step-down, 600kHz, 0.9V±1%, 600mA, +CE, PDR	USP-6B	49dc5	DC1	9b	Tor
ZC09C	XC9225C09CD	DC/DC-IC	PWM step-down, 1.2MHz, 0.9V±1%, 600mA, +CE, PDR	USP-6B	49dc5	DC1	9b	Tor
ZC0M6	XC9225C0M6D	DC/DC-IC	PWM step-down, 600kHz, 0.95V±1%, 600mA, +CE, PDR	USP-6B	49dc5	DC1	9b	Tor
ZC0MC	XC9225C0MCD	DC/DC-IC	PWM step-down, 1.2MHz, 0.95V±1%, 600mA, +CE, PDR	USP-6B	49dc5	DC1	9b	Tor
ZC106	XC9225C106D	DC/DC-IC	PWM step-down, 600kHz, 1.0V±1%, 600mA, +CE, PDR	USP-6B	49dc5	DC1	9b	Tor
ZC10C	XC9225C10CD	DC/DC-IC	PWM step-down, 1.2MHz, 1.0V±1%, 600mA, +CE, PDR	USP-6B	49dc5	DC1	9b	Tor
ZC116	XC9225C116D	DC/DC-IC	PWM step-down, 600kHz, 1.1V±1%, 600mA, +CE, PDR	USP-6B	49dc5	DC1	9b	Tor
ZC11C	XC9225C11CD	DC/DC-IC	PWM step-down, 1.2MHz, 1.1V±1%, 600mA, +CE, PDR	USP-6B	49dc5	DC1	9b	Tor
ZC126	XC9225C126D	DC/DC-IC	PWM step-down, 600kHz, 1.2V±1%, 600mA, +CE, PDR	USP-6B	49dc5	DC1	9b	Tor
ZC12C	XC9225C12CD	DC/DC-IC	PWM step-down, 1.2MHz, 1.2V±1%, 600mA, +CE, PDR	USP-6B	49dc5	DC1	9b	Tor
ZC136	XC9225C136D	DC/DC-IC	PWM step-down, 600kHz, 1.3V±1%, 600mA, +CE, PDR	USP-6B	49dc5	DC1	9b	Tor
ZC13C	XC9225C13CD	DC/DC-IC	PWM step-down, 1.2MHz, 1.3V±1%, 600mA, +CE, PDR	USP-6B	49dc5	DC1	9b	Tor
ZC146	XC9225C146D	DC/DC-IC	PWM step-down, 600kHz, 1.4V±1%, 600mA, +CE, PDR	USP-6B	49dc5	DC1	9b	Tor
ZC14C	XC9225C14CD	DC/DC-IC	PWM step-down, 1.2MHz, 1.4V±1%, 600mA, +CE, PDR	USP-6B	49dc5	DC1	9b	Tor
ZC156	XC9225C156D	DC/DC-IC	PWM step-down, 600kHz, 1.5V±1%, 600mA, +CE, PDR	USP-6B	49dc5	DC1	9b	Tor
ZC15C	XC9225C15CD	DC/DC-IC	PWM step-down, 1.2MHz, 1.5V±1%, 600mA, +CE, PDR	USP-6B	49dc5	DC1	9b	Tor
ZC166	XC9225C166D	DC/DC-IC	PWM step-down, 600kHz, 1.6V±1%, 600mA, +CE, PDR	USP-6B	49dc5	DC1	9b	Tor
ZC16C	XC9225C16CD	DC/DC-IC	PWM step-down, 1.2MHz, 1.6V±1%, 600mA, +CE, PDR	USP-6B	49dc5	DC1	9b	Tor
ZC176	XC9225C176D	DC/DC-IC	PWM step-down, 600kHz, 1.7V±1%, 600mA, +CE, PDR	USP-6B	49dc5	DC1	9b	Tor
ZC17C	XC9225C17CD	DC/DC-IC	PWM step-down, 1.2MHz, 1.7V±1%, 600mA, +CE, PDR	USP-6B	49dc5	DC1	9b	Tor



SMD code	Type	Function	Short description	Case	Pinout	Sch.	St.	Mnf.
ZC336	XC9225C336D	DC/DC-IC	PWM step-down, 600kHz, 3.3V±1%, 600mA, +CE, PDR	USP-6B	49dc5	DC1	9b	Tor
ZC33C	XC9225C33CD	DC/DC-IC	PWM step-down, 1.2MHz, 3.3V±1%, 600mA, +CE, PDR	USP-6B	49dc5	DC1	9b	Tor
ZC346	XC9225C346D	DC/DC-IC	PWM step-down, 600kHz, 3.4V±1%, 600mA, +CE, PDR	USP-6B	49dc5	DC1	9b	Tor
ZC34C	XC9225C34CD	DC/DC-IC	PWM step-down, 1.2MHz, 3.4V±1%, 600mA, +CE, PDR	USP-6B	49dc5	DC1	9b	Tor
ZC356	XC9225C356D	DC/DC-IC	PWM step-down, 600kHz, 3.5V±1%, 600mA, +CE, PDR	USP-6B	49dc5	DC1	9b	Tor
ZC35C	XC9225C35CD	DC/DC-IC	PWM step-down, 1.2MHz, 3.5V±1%, 600mA, +CE, PDR	USP-6B	49dc5	DC1	9b	Tor
ZC366	XC9225C366D	DC/DC-IC	PWM step-down, 600kHz, 3.6V±1%, 600mA, +CE, PDR	USP-6B	49dc5	DC1	9b	Tor
ZC36C	XC9225C36CD	DC/DC-IC	PWM step-down, 1.2MHz, 3.6V±1%, 600mA, +CE, PDR	USP-6B	49dc5	DC1	9b	Tor
ZC376	XC9225C376D	DC/DC-IC	PWM step-down, 600kHz, 3.7V±1%, 600mA, +CE, PDR	USP-6B	49dc5	DC1	9b	Tor
ZC37C	XC9225C37CD	DC/DC-IC	PWM step-down, 1.2MHz, 3.7V±1%, 600mA, +CE, PDR	USP-6B	49dc5	DC1	9b	Tor
ZC386	XC9225C386D	DC/DC-IC	PWM step-down, 600kHz, 3.8V±1%, 600mA, +CE, PDR	USP-6B	49dc5	DC1	9b	Tor
ZC38C	XC9225C38CD	DC/DC-IC	PWM step-down, 1.2MHz, 3.8V±1%, 600mA, +CE, PDR	USP-6B	49dc5	DC1	9b	Tor
ZC396	XC9225C396D	DC/DC-IC	PWM step-down, 600kHz, 3.9V±1%, 600mA, +CE, PDR	USP-6B	49dc5	DC1	9b	Tor
ZC39C	XC9225C39CD	DC/DC-IC	PWM step-down, 1.2MHz, 3.9V±1%, 600mA, +CE, PDR	USP-6B	49dc5	DC1	9b	Tor
ZC3A6	XC9225C3A6D	DC/DC-IC	PWM step-down, 600kHz, 3.05V±1%, 600mA, +CE, PDR	USP-6B	49dc5	DC1	9b	Tor
ZC3AC	XC9225C3ACD	DC/DC-IC	PWM step-down, 1.2MHz, 3.05V±1%, 600mA, +CE, PDR	USP-6B	49dc5	DC1	9b	Tor
ZC3B6	XC9225C3B6D	DC/DC-IC	PWM step-down, 600kHz, 3.15V±1%, 600mA, +CE, PDR	USP-6B	49dc5	DC1	9b	Tor
ZC3BC	XC9225C3BCD	DC/DC-IC	PWM step-down, 1.2MHz, 3.15V±1%, 600mA, +CE, PDR	USP-6B	49dc5	DC1	9b	Tor
ZC3C6	XC9225C3C6D	DC/DC-IC	PWM step-down, 600kHz, 3.25V±1%, 600mA, +CE, PDR	USP-6B	49dc5	DC1	9b	Tor
ZC3CC	XC9225C3CCD	DC/DC-IC	PWM step-down, 1.2MHz, 3.25V±1%, 600mA, +CE, PDR	USP-6B	49dc5	DC1	9b	Tor
ZC3D6	XC9225C3D6D	DC/DC-IC	PWM step-down, 600kHz, 3.35V±1%, 600mA, +CE, PDR	USP-6B	49dc5	DC1	9b	Tor
ZC3DC	XC9225C3DCD	DC/DC-IC	PWM step-down, 1.2MHz, 3.35V±1%, 600mA, +CE, PDR	USP-6B	49dc5	DC1	9b	Tor
ZC3E6	XC9225C3E6D	DC/DC-IC	PWM step-down, 600kHz, 3.45V±1%, 600mA, +CE, PDR	USP-6B	49dc5	DC1	9b	Tor
ZC3EC	XC9225C3ECD	DC/DC-IC	PWM step-down, 1.2MHz, 3.45V±1%, 600mA, +CE, PDR	USP-6B	49dc5	DC1	9b	Tor
ZC3F6	XC9225C3F6D	DC/DC-IC	PWM step-down, 600kHz, 3.55V±1%, 600mA, +CE, PDR	USP-6B	49dc5	DC1	9b	Tor
ZC3FC	XC9225C3FCD	DC/DC-IC	PWM step-down, 1.2MHz, 3.55V±1%, 600mA, +CE, PDR	USP-6B	49dc5	DC1	9b	Tor
ZC3H6	XC9225C3H6D	DC/DC-IC	PWM step-down, 600kHz, 3.65V±1%, 600mA, +CE, PDR	USP-6B	49dc5	DC1	9b	Tor
ZC3HC	XC9225C3HCD	DC/DC-IC	PWM step-down, 1.2MHz, 3.65V±1%, 600mA, +CE, PDR	USP-6B	49dc5	DC1	9b	Tor
ZC3K6	XC9225C3K6D	DC/DC-IC	PWM step-down, 600kHz, 3.75V±1%, 600mA, +CE, PDR	USP-6B	49dc5	DC1	9b	Tor
ZC3KC	XC9225C3KCD	DC/DC-IC	PWM step-down, 1.2MHz, 3.75V±1%, 600mA, +CE, PDR	USP-6B	49dc5	DC1	9b	Tor
ZC3L6	XC9225C3L6D	DC/DC-IC	PWM step-down, 600kHz, 3.85V±1%, 600mA, +CE, PDR	USP-6B	49dc5	DC1	9b	Tor
ZC3LC	XC9225C3LCD	DC/DC-IC	PWM step-down, 1.2MHz, 3.85V±1%, 600mA, +CE, PDR	USP-6B	49dc5	DC1	9b	Tor
ZC3M6	XC9225C3M6D	DC/DC-IC	PWM step-down, 600kHz, 3.95V±1%, 600mA, +CE, PDR	USP-6B	49dc5	DC1	9b	Tor
ZC3MC	XC9225C3MCD	DC/DC-IC	PWM step-down, 1.2MHz, 3.95V±1%, 600mA, +CE, PDR	USP-6B	49dc5	DC1	9b	Tor
ZC406	XC9225C406D	DC/DC-IC	PWM step-down, 600kHz, 4.0V±1%, 600mA, +CE, PDR	USP-6B	49dc5	DC1	9b	Tor
ZC40C	XC9225C40CD	DC/DC-IC	PWM step-down, 1.2MHz, 4.0V±1%, 600mA, +CE, PDR	USP-6B	49dc5	DC1	9b	Tor
ZD	RP201K351D	LVR-IC	LDO, 3.5V±1%, 150mA, +CE, CL, AE(Mode)	DFN1212-6	52ht	VR12	9a	Ric
ZD096	XC9225D096D	DC/DC-IC	PWM step-down, 600kHz, 0.9V±1%, 600mA, -CE, PDR	USP-6B	49dc5	DC1	9b	Tor
ZD09C	XC9225D09CD	DC/DC-IC	PWM step-down, 1.2MHz, 0.9V±1%, 600mA, -CE, PDR	USP-6B	49dc5	DC1	9b	Tor
ZD0M6	XC9225D0M6D	DC/DC-IC	PWM step-down, 600kHz, 0.95V±1%, 600mA, -CE, PDR	USP-6B	49dc5	DC1	9b	Tor
ZD0MC	XC9225D0MCD	DC/DC-IC	PWM step-down, 1.2MHz, 0.95V±1%, 600mA, -CE, PDR	USP-6B	49dc5	DC1	9b	Tor
ZD106	XC9225D106D	DC/DC-IC	PWM step-down, 600kHz, 1.0V±1%, 600mA, -CE, PDR	USP-6B	49dc5	DC1	9b	Tor
ZD10C	XC9225D10CD	DC/DC-IC	PWM step-down, 1.2MHz, 1.0V±1%, 600mA, -CE, PDR	USP-6B	49dc5	DC1	9b	Tor
ZD116	XC9225D116D	DC/DC-IC	PWM step-down, 600kHz, 1.1V±1%, 600mA, -CE, PDR	USP-6B	49dc5	DC1	9b	Tor
ZD11C	XC9225D11CD	DC/DC-IC	PWM step-down, 1.2MHz, 1.1V±1%, 600mA, -CE, PDR	USP-6B	49dc5	DC1	9b	Tor
ZD126	XC9225D126D	DC/DC-IC	PWM step-down, 600kHz, 1.2V±1%, 600mA, -CE, PDR	USP-6B	49dc5	DC1	9b	Tor
ZD12C	XC9225D12CD	DC/DC-IC	PWM step-down, 1.2MHz, 1.2V±1%, 600mA, -CE, PDR	USP-6B	49dc5	DC1	9b	Tor
ZD136	XC9225D136D	DC/DC-IC	PWM step-down, 600kHz, 1.3V±1%, 600mA, -CE, PDR	USP-6B	49dc5	DC1	9b	Tor
ZD13C	XC9225D13CD	DC/DC-IC	PWM step-down, 1.2MHz, 1.3V±1%, 600mA, -CE, PDR	USP-6B	49dc5	DC1	9b	Tor
ZD146	XC9225D146D	DC/DC-IC	PWM step-down, 600kHz, 1.4V±1%, 600mA, -CE, PDR	USP-6B	49dc5	DC1	9b	Tor
ZD14C	XC9225D14CD	DC/DC-IC	PWM step-down, 1.2MHz, 1.4V±1%, 600mA, -CE, PDR	USP-6B	49dc5	DC1	9b	Tor
ZD156	XC9225D156D	DC/DC-IC	PWM step-down, 600kHz, 1.5V±1%, 600mA, -CE, PDR	USP-6B	49dc5	DC1	9b	Tor
ZD15C	XC9225D15CD	DC/DC-IC	PWM step-down, 1.2MHz, 1.5V±1%, 600mA, -CE, PDR	USP-6B	49dc5	DC1	9b	Tor
ZD166	XC9225D166D	DC/DC-IC	PWM step-down, 600kHz, 1.6V±1%, 600mA, -CE, PDR	USP-6B	49dc5	DC1	9b	Tor
ZD16C	XC9225D16CD	DC/DC-IC	PWM step-down, 1.2MHz, 1.6V±1%, 600mA, -CE, PDR	USP-6B	49dc5	DC1	9b	Tor
ZD176	XC9225D176D	DC/DC-IC	PWM step-down, 600kHz, 1.7V±1%, 600mA, -CE, PDR	USP-6B	49dc5	DC1	9b	Tor
ZD17C	XC9225D17CD	DC/DC-IC	PWM step-down, 1.2MHz, 1.7V±1%, 600mA, -CE, PDR	USP-6B	49dc5	DC1	9b	Tor
ZD186	XC9225D186D	DC/DC-IC	PWM step-down, 600kHz, 1.8V±1%, 600mA, -CE, PDR	USP-6B	49dc5	DC1	9b	Tor
ZD18C	XC9225D18CD	DC/DC-IC	PWM step-down, 1.2MHz, 1.8V±1%, 600mA, -CE, PDR	USP-6B	49dc5	DC1	9b	Tor
ZD196	XC9225D196D	DC/DC-IC	PWM step-down, 600kHz, 1.9V±1%, 600mA, -CE, PDR	USP-6B	49dc5	DC1	9b	Tor
ZD19C	XC9225D19CD	DC/DC-IC	PWM step-down, 1.2MHz, 1.9V±1%, 600mA, -CE, PDR	USP-6B	49dc5	DC1	9b	Tor
ZD1A6	XC9225D1A6D	DC/DC-IC	PWM step-down, 600kHz, 1.05V±1%, 600mA, -CE, PDR	USP-6B	49dc5	DC1	9b	Tor
ZD1AC	XC9225D1ACD	DC/DC-IC	PWM step-down, 1.2MHz, 1.05V±1%, 600mA, -CE, PDR	USP-6B	49dc5	DC1	9b	Tor
ZD1B6	XC9225D1B6D	DC/DC-IC	PWM step-down, 600kHz, 1.15V±1%, 600mA, -CE, PDR	USP-6B	49dc5	DC1	9b	Tor
ZD1BC	XC9225D1BCD	DC/DC-IC	PWM step-down, 1.2MHz, 1.15V±1%, 600mA, -CE, PDR	USP-6B	49dc5	DC1	9b	Tor
ZD1C6	XC9225D1C6D	DC/DC-IC	PWM step-down, 600kHz, 1.25V±1%, 600mA, -CE, PDR	USP-6B	49dc5	DC1	9b	Tor
ZD1CC	XC9225D1CCD	DC/DC-IC	PWM step-down, 1.2MHz, 1.25V±1%, 600mA, -CE, PDR	USP-6B	49dc5	DC1	9b	Tor
ZD1D6	XC9225D1D6D	DC/DC-IC	PWM step-down, 600kHz, 1.35V±1%, 600mA, -CE, PDR	USP-6B	49dc5	DC1	9b	Tor
ZD1DC	XC9225D1DCD	DC/DC-IC	PWM step-down, 1.2MHz, 1.35V±1%, 600mA, -CE, PDR	USP-6B	49dc5	DC1	9b	Tor
ZD1E6	XC9225D1E6D	DC/DC-IC	PWM step-down, 600kHz, 1.45V±1%, 600mA, -CE, PDR	USP-6B	49dc5	DC1	9b	Tor



SMD code	Type	Function	Short description	Case	Pinout	Sch.	St.	Mnf.
ZD39C	XC9225D39CD	DC/DC-IC	PWM step-down, 1.2MHz, 3.9V±1%, 600mA, -CE, PDR	USP-6B	49dc5	DC1	9b	Tor
ZD3A6	XC9225D3A6D	DC/DC-IC	PWM step-down, 600kHz, 3.05V±1%, 600mA, -CE, PDR	USP-6B	49dc5	DC1	9b	Tor
ZD3AC	XC9225D3ACD	DC/DC-IC	PWM step-down, 1.2MHz, 3.05V±1%, 600mA, -CE, PDR	USP-6B	49dc5	DC1	9b	Tor
ZD3B6	XC9225D3B6D	DC/DC-IC	PWM step-down, 600kHz, 3.15V±1%, 600mA, -CE, PDR	USP-6B	49dc5	DC1	9b	Tor
ZD3BC	XC9225D3BCD	DC/DC-IC	PWM step-down, 1.2MHz, 3.15V±1%, 600mA, -CE, PDR	USP-6B	49dc5	DC1	9b	Tor
ZD3C6	XC9225D3C6D	DC/DC-IC	PWM step-down, 600kHz, 3.25V±1%, 600mA, -CE, PDR	USP-6B	49dc5	DC1	9b	Tor
ZD3CC	XC9225D3CCD	DC/DC-IC	PWM step-down, 1.2MHz, 3.25V±1%, 600mA, -CE, PDR	USP-6B	49dc5	DC1	9b	Tor
ZD3D6	XC9225D3D6D	DC/DC-IC	PWM step-down, 600kHz, 3.35V±1%, 600mA, -CE, PDR	USP-6B	49dc5	DC1	9b	Tor
ZD3DC	XC9225D3DCD	DC/DC-IC	PWM step-down, 1.2MHz, 3.35V±1%, 600mA, -CE, PDR	USP-6B	49dc5	DC1	9b	Tor
ZD3E6	XC9225D3E6D	DC/DC-IC	PWM step-down, 600kHz, 3.45V±1%, 600mA, -CE, PDR	USP-6B	49dc5	DC1	9b	Tor
ZD3EC	XC9225D3ECD	DC/DC-IC	PWM step-down, 1.2MHz, 3.45V±1%, 600mA, -CE, PDR	USP-6B	49dc5	DC1	9b	Tor
ZD3F6	XC9225D3F6D	DC/DC-IC	PWM step-down, 600kHz, 3.55V±1%, 600mA, -CE, PDR	USP-6B	49dc5	DC1	9b	Tor
ZD3FC	XC9225D3FCD	DC/DC-IC	PWM step-down, 1.2MHz, 3.55V±1%, 600mA, -CE, PDR	USP-6B	49dc5	DC1	9b	Tor
ZD3H6	XC9225D3H6D	DC/DC-IC	PWM step-down, 600kHz, 3.65V±1%, 600mA, -CE, PDR	USP-6B	49dc5	DC1	9b	Tor
ZD3HC	XC9225D3HCD	DC/DC-IC	PWM step-down, 1.2MHz, 3.65V±1%, 600mA, -CE, PDR	USP-6B	49dc5	DC1	9b	Tor
ZD3K6	XC9225D3K6D	DC/DC-IC	PWM step-down, 600kHz, 3.75V±1%, 600mA, -CE, PDR	USP-6B	49dc5	DC1	9b	Tor
ZD3KC	XC9225D3KCD	DC/DC-IC	PWM step-down, 1.2MHz, 3.75V±1%, 600mA, -CE, PDR	USP-6B	49dc5	DC1	9b	Tor
ZD3L6	XC9225D3L6D	DC/DC-IC	PWM step-down, 600kHz, 3.85V±1%, 600mA, -CE, PDR	USP-6B	49dc5	DC1	9b	Tor
ZD3LC	XC9225D3LCD	DC/DC-IC	PWM step-down, 1.2MHz, 3.85V±1%, 600mA, -CE, PDR	USP-6B	49dc5	DC1	9b	Tor
ZD3M6	XC9225D3M6D	DC/DC-IC	PWM step-down, 600kHz, 3.95V±1%, 600mA, -CE, PDR	USP-6B	49dc5	DC1	9b	Tor
ZD3MC	XC9225D3MCD	DC/DC-IC	PWM step-down, 1.2MHz, 3.95V±1%, 600mA, -CE, PDR	USP-6B	49dc5	DC1	9b	Tor
ZD406	XC9225D406D	DC/DC-IC	PWM step-down, 600kHz, 4.0V±1%, 600mA, -CE, PDR	USP-6B	49dc5	DC1	9b	Tor
ZD40C	XC9225D40CD	DC/DC-IC	PWM step-down, 1.2MHz, 4.0V±1%, 600mA, -CE, PDR	USP-6B	49dc5	DC1	9b	Tor
ZE	RP201K361D	LVR-IC	LDO, 3.6V±1%, 150mA, +CE, CL, AE(Mode)	DFN1212-6	52ht	VR12	9a	Ric
ZE306	XC9225E306D	DC/DC-IC	PWM step-down, 600kHz, 3.0V±1%, 900mA, +CE	USP-6B	49dc5	DC1	9b	Tor
ZE30C	XC9225E30CD	DC/DC-IC	PWM step-down, 1.2MHz, 3.0V±1%, 900mA, +CE	USP-6B	49dc5	DC1	9b	Tor
ZE316	XC9225E316D	DC/DC-IC	PWM step-down, 600kHz, 3.1V±1%, 900mA, +CE	USP-6B	49dc5	DC1	9b	Tor
ZE31C	XC9225E31CD	DC/DC-IC	PWM step-down, 1.2MHz, 3.1V±1%, 900mA, +CE	USP-6B	49dc5	DC1	9b	Tor
ZE326	XC9225E326D	DC/DC-IC	PWM step-down, 600kHz, 3.2V±1%, 900mA, +CE	USP-6B	49dc5	DC1	9b	Tor
ZE32C	XC9225E32CD	DC/DC-IC	PWM step-down, 1.2MHz, 3.2V±1%, 900mA, +CE	USP-6B	49dc5	DC1	9b	Tor
ZE336	XC9225E336D	DC/DC-IC	PWM step-down, 600kHz, 3.3V±1%, 900mA, +CE	USP-6B	49dc5	DC1	9b	Tor
ZE33C	XC9225E33CD	DC/DC-IC	PWM step-down, 1.2MHz, 3.3V±1%, 900mA, +CE	USP-6B	49dc5	DC1	9b	Tor
ZE346	XC9225E346D	DC/DC-IC	PWM step-down, 600kHz, 3.4V±1%, 900mA, +CE	USP-6B	49dc5	DC1	9b	Tor
ZE34C	XC9225E34CD	DC/DC-IC	PWM step-down, 1.2MHz, 3.4V±1%, 900mA, +CE	USP-6B	49dc5	DC1	9b	Tor
ZE356	XC9225E356D	DC/DC-IC	PWM step-down, 600kHz, 3.5V±1%, 900mA, +CE	USP-6B	49dc5	DC1	9b	Tor
ZE35C	XC9225E35CD	DC/DC-IC	PWM step-down, 1.2MHz, 3.5V±1%, 900mA, +CE	USP-6B	49dc5	DC1	9b	Tor
ZE366	XC9225E366D	DC/DC-IC	PWM step-down, 600kHz, 3.6V±1%, 900mA, +CE	USP-6B	49dc5	DC1	9b	Tor
ZE36C	XC9225E36CD	DC/DC-IC	PWM step-down, 1.2MHz, 3.6V±1%, 900mA, +CE	USP-6B	49dc5	DC1	9b	Tor
ZE376	XC9225E376D	DC/DC-IC	PWM step-down, 600kHz, 3.7V±1%, 900mA, +CE	USP-6B	49dc5	DC1	9b	Tor
ZE37C	XC9225E37CD	DC/DC-IC	PWM step-down, 1.2MHz, 3.7V±1%, 900mA, +CE	USP-6B	49dc5	DC1	9b	Tor
ZE386	XC9225E386D	DC/DC-IC	PWM step-down, 600kHz, 3.8V±1%, 900mA, +CE	USP-6B	49dc5	DC1	9b	Tor
ZE38C	XC9225E38CD	DC/DC-IC	PWM step-down, 1.2MHz, 3.8V±1%, 900mA, +CE	USP-6B	49dc5	DC1	9b	Tor
ZE396	XC9225E396D	DC/DC-IC	PWM step-down, 600kHz, 3.9V±1%, 900mA, +CE	USP-6B	49dc5	DC1	9b	Tor
ZE39C	XC9225E39CD	DC/DC-IC	PWM step-down, 1.2MHz, 3.9V±1%, 900mA, +CE	USP-6B	49dc5	DC1	9b	Tor
ZE3A6	XC9225E3A6D	DC/DC-IC	PWM step-down, 600kHz, 3.05V±1%, 900mA, +CE	USP-6B	49dc5	DC1	9b	Tor
ZE3AC	XC9225E3ACD	DC/DC-IC	PWM step-down, 1.2MHz, 3.05V±1%, 900mA, +CE	USP-6B	49dc5	DC1	9b	Tor
ZE3B6	XC9225E3B6D	DC/DC-IC	PWM step-down, 600kHz, 3.15V±1%, 900mA, +CE	USP-6B	49dc5	DC1	9b	Tor
ZE3BC	XC9225E3BCD	DC/DC-IC	PWM step-down, 1.2MHz, 3.15V±1%, 900mA, +CE	USP-6B	49dc5	DC1	9b	Tor
ZE3C6	XC9225E3C6D	DC/DC-IC	PWM step-down, 600kHz, 3.25V±1%, 900mA, +CE	USP-6B	49dc5	DC1	9b	Tor
ZE3CC	XC9225E3CCD	DC/DC-IC	PWM step-down, 1.2MHz, 3.25V±1%, 900mA, +CE	USP-6B	49dc5	DC1	9b	Tor
ZE3D6	XC9225E3D6D	DC/DC-IC	PWM step-down, 600kHz, 3.35V±1%, 900mA, +CE	USP-6B	49dc5	DC1	9b	Tor
ZE3DC	XC9225E3DCD	DC/DC-IC	PWM step-down, 1.2MHz, 3.35V±1%, 900mA, +CE	USP-6B	49dc5	DC1	9b	Tor
ZE3E6	XC9225E3E6D	DC/DC-IC	PWM step-down, 600kHz, 3.45V±1%, 900mA, +CE	USP-6B	49dc5	DC1	9b	Tor
ZE3EC	XC9225E3ECD	DC/DC-IC	PWM step-down, 1.2MHz, 3.45V±1%, 900mA, +CE	USP-6B	49dc5	DC1	9b	Tor
ZE3F6	XC9225E3F6D	DC/DC-IC	PWM step-down, 600kHz, 3.55V±1%, 900mA, +CE	USP-6B	49dc5	DC1	9b	Tor
ZE3FC	XC9225E3FCD	DC/DC-IC	PWM step-down, 1.2MHz, 3.55V±1%, 900mA, +CE	USP-6B	49dc5	DC1	9b	Tor
ZE3H6	XC9225E3H6D	DC/DC-IC	PWM step-down, 600kHz, 3.65V±1%, 900mA, +CE	USP-6B	49dc5	DC1	9b	Tor
ZE3HC	XC9225E3HCD	DC/DC-IC	PWM step-down, 1.2MHz, 3.65V±1%, 900mA, +CE	USP-6B	49dc5	DC1	9b	Tor
ZE3K6	XC9225E3K6D	DC/DC-IC	PWM step-down, 600kHz, 3.75V±1%, 900mA, +CE	USP-6B	49dc5	DC1	9b	Tor
ZE3KC	XC9225E3KCD	DC/DC-IC	PWM step-down, 1.2MHz, 3.75V±1%, 900mA, +CE	USP-6B	49dc5	DC1	9b	Tor
ZE3L6	XC9225E3L6D	DC/DC-IC	PWM step-down, 600kHz, 3.85V±1%, 900mA, +CE	USP-6B	49dc5	DC1	9b	Tor
ZE3LC	XC9225E3LCD	DC/DC-IC	PWM step-down, 1.2MHz, 3.85V±1%, 900mA, +CE	USP-6B	49dc5	DC1	9b	Tor
ZE3M6	XC9225E3M6D	DC/DC-IC	PWM step-down, 600kHz, 3.95V±1%, 900mA, +CE	USP-6B	49dc5	DC1	9b	Tor
ZE3MC	XC9225E3MCD	DC/DC-IC	PWM step-down, 1.2MHz, 3.95V±1%, 900mA, +CE	USP-6B	49dc5	DC1	9b	Tor
ZE406	XC9225E406D	DC/DC-IC	PWM step-down, 600kHz, 4.0V±1%, 900mA, +CE	USP-6B	49dc5	DC1	9b	Tor
ZE40C	XC9225E40CD	DC/DC-IC	PWM step-down, 1.2MHz, 4.0V±1%, 900mA, +CE	USP-6B	49dc5	DC1	9b	Tor
ZF	RP201K371D	LVR-IC	LDO, 3.7V±1%, 150mA, +CE, CL, AE(Mode)	DFN1212-6	52ht	VR12	9a	Ric
ZF306	XC9225F306D	DC/DC-IC	PWM step-down, 600kHz, 3.0V±1%, 900mA, -CE	USP-6B	49dc5	DC1	9b	Tor
ZF30C	XC9225F30CD	DC/DC-IC	PWM step-down, 1.2MHz, 3.0V±1%, 900mA, -CE	USP-6B	49dc5	DC1	9b	Tor
ZF316	XC9225F316D	DC/DC-IC	PWM step-down, 600kHz, 3.1V±1%, 900mA, -CE	USP-6B	49dc5	DC1	9b	Tor



SMD code	Type	Function	Short description	Case	Pinout	Sch.	St.	Mnf.
ZF31C	XC9225F31CD	DG/DC-IC	PWM step-down, 1.2MHz, 3.1V±1%, 900mA, -CE	USP-6B	49dc5	DC1	9b	Tor
ZF32E	XC9225F326D	DG/DC-IC	PWM step-down, 600kHz, 3.2V±1%, 900mA, -CE	USP-6B	49dc5	DC1	9b	Tor
ZF32C	XC9225F32CD	DG/DC-IC	PWM step-down, 1.2MHz, 3.2V±1%, 900mA, -CE	USP-6B	49dc5	DC1	9b	Tor
ZF33E	XC9225F336D	DG/DC-IC	PWM step-down, 600kHz, 3.3V±1%, 900mA, -CE	USP-6B	49dc5	DC1	9b	Tor
ZF33C	XC9225F33CD	DG/DC-IC	PWM step-down, 1.2MHz, 3.3V±1%, 900mA, -CE	USP-6B	49dc5	DC1	9b	Tor
ZF34E	XC9225F346D	DG/DC-IC	PWM step-down, 600kHz, 3.4V±1%, 900mA, -CE	USP-6B	49dc5	DC1	9b	Tor
ZF34C	XC9225F34CD	DG/DC-IC	PWM step-down, 1.2MHz, 3.4V±1%, 900mA, -CE	USP-6B	49dc5	DC1	9b	Tor
ZF35E	XC9225F356D	DG/DC-IC	PWM step-down, 600kHz, 3.5V±1%, 900mA, -CE	USP-6B	49dc5	DC1	9b	Tor
ZF35C	XC9225F35CD	DG/DC-IC	PWM step-down, 1.2MHz, 3.5V±1%, 900mA, -CE	USP-6B	49dc5	DC1	9b	Tor
ZF36E	XC9225F366D	DG/DC-IC	PWM step-down, 600kHz, 3.6V±1%, 900mA, -CE	USP-6B	49dc5	DC1	9b	Tor
ZF36C	XC9225F36CD	DG/DC-IC	PWM step-down, 1.2MHz, 3.6V±1%, 900mA, -CE	USP-6B	49dc5	DC1	9b	Tor
ZF37E	XC9225F376D	DG/DC-IC	PWM step-down, 600kHz, 3.7V±1%, 900mA, -CE	USP-6B	49dc5	DC1	9b	Tor
ZF37C	XC9225F37CD	DG/DC-IC	PWM step-down, 1.2MHz, 3.7V±1%, 900mA, -CE	USP-6B	49dc5	DC1	9b	Tor
ZF38E	XC9225F386D	DG/DC-IC	PWM step-down, 600kHz, 3.8V±1%, 900mA, -CE	USP-6B	49dc5	DC1	9b	Tor
ZF38C	XC9225F38CD	DG/DC-IC	PWM step-down, 1.2MHz, 3.8V±1%, 900mA, -CE	USP-6B	49dc5	DC1	9b	Tor
ZF39E	XC9225F396D	DG/DC-IC	PWM step-down, 600kHz, 3.9V±1%, 900mA, -CE	USP-6B	49dc5	DC1	9b	Tor
ZF39C	XC9225F39CD	DG/DC-IC	PWM step-down, 1.2MHz, 3.9V±1%, 900mA, -CE	USP-6B	49dc5	DC1	9b	Tor
ZF3A6	XC9225F3A6D	DG/DC-IC	PWM step-down, 600kHz, 3.05V±1%, 900mA, -CE	USP-6B	49dc5	DC1	9b	Tor
ZF3AC	XC9225F3ACD	DG/DC-IC	PWM step-down, 1.2MHz, 3.05V±1%, 900mA, -CE	USP-6B	49dc5	DC1	9b	Tor
ZF3B6	XC9225F3B6D	DG/DC-IC	PWM step-down, 600kHz, 3.15V±1%, 900mA, -CE	USP-6B	49dc5	DC1	9b	Tor
ZF3BC	XC9225F3BCD	DG/DC-IC	PWM step-down, 1.2MHz, 3.15V±1%, 900mA, -CE	USP-6B	49dc5	DC1	9b	Tor
ZF3C6	XC9225F3C6D	DG/DC-IC	PWM step-down, 600kHz, 3.25V±1%, 900mA, -CE	USP-6B	49dc5	DC1	9b	Tor
ZF3CC	XC9225F3CCD	DG/DC-IC	PWM step-down, 1.2MHz, 3.25V±1%, 900mA, -CE	USP-6B	49dc5	DC1	9b	Tor
ZF3D6	XC9225F3D6D	DG/DC-IC	PWM step-down, 600kHz, 3.35V±1%, 900mA, -CE	USP-6B	49dc5	DC1	9b	Tor
ZF3DC	XC9225F3DCD	DG/DC-IC	PWM step-down, 1.2MHz, 3.35V±1%, 900mA, -CE	USP-6B	49dc5	DC1	9b	Tor
ZF3E6	XC9225F3E6D	DG/DC-IC	PWM step-down, 600kHz, 3.45V±1%, 900mA, -CE	USP-6B	49dc5	DC1	9b	Tor
ZF3EC	XC9225F3ECD	DG/DC-IC	PWM step-down, 1.2MHz, 3.45V±1%, 900mA, -CE	USP-6B	49dc5	DC1	9b	Tor
ZF3F6	XC9225F3F6D	DG/DC-IC	PWM step-down, 600kHz, 3.55V±1%, 900mA, -CE	USP-6B	49dc5	DC1	9b	Tor
ZF3FC	XC9225F3FCD	DG/DC-IC	PWM step-down, 1.2MHz, 3.55V±1%, 900mA, -CE	USP-6B	49dc5	DC1	9b	Tor
ZF3H6	XC9225F3H6D	DG/DC-IC	PWM step-down, 600kHz, 3.65V±1%, 900mA, -CE	USP-6B	49dc5	DC1	9b	Tor
ZF3HC	XC9225F3HCD	DG/DC-IC	PWM step-down, 1.2MHz, 3.65V±1%, 900mA, -CE	USP-6B	49dc5	DC1	9b	Tor
ZF3K6	XC9225F3K6D	DG/DC-IC	PWM step-down, 600kHz, 3.75V±1%, 900mA, -CE	USP-6B	49dc5	DC1	9b	Tor
ZF3KC	XC9225F3KCD	DG/DC-IC	PWM step-down, 1.2MHz, 3.75V±1%, 900mA, -CE	USP-6B	49dc5	DC1	9b	Tor
ZF3L6	XC9225F3L6D	DG/DC-IC	PWM step-down, 600kHz, 3.85V±1%, 900mA, -CE	USP-6B	49dc5	DC1	9b	Tor
ZF3LC	XC9225F3LCD	DG/DC-IC	PWM step-down, 1.2MHz, 3.85V±1%, 900mA, -CE	USP-6B	49dc5	DC1	9b	Tor
ZF3M6	XC9225F3M6D	DG/DC-IC	PWM step-down, 600kHz, 3.95V±1%, 900mA, -CE	USP-6B	49dc5	DC1	9b	Tor
ZF3MC	XC9225F3MCD	DG/DC-IC	PWM step-down, 1.2MHz, 3.95V±1%, 900mA, -CE	USP-6B	49dc5	DC1	9b	Tor
ZF40E	XC9225F406D	DG/DC-IC	PWM step-down, 600kHz, 4.0V±1%, 900mA, -CE	USP-6B	49dc5	DC1	9b	Tor
ZF40C	XC9225F40CD	DG/DC-IC	PWM step-down, 1.2MHz, 4.0V±1%, 900mA, -CE	USP-6B	49dc5	DC1	9b	Tor
ZG	RP201K381D	LVR-IC	LDO, 3.8V±1%, 150mA, +CE, CL, AE(Mode)	DFM1212-6	52ht	VR12	9a	Ric
ZH	RP201K391D	LVR-IC	LDO, 3.9V±1%, 150mA, +CE, CL, AE(Mode)	DFM1212-6	52ht	VR12	9a	Ric
ZH30E	XC9225H306D	DG/DC-IC	PWM step-down, 600kHz, 3.0V±1%, 900mA, -CE, PDR	USP-6B	49dc5	DC1	9b	Tor
ZH30C	XC9225H30CD	DG/DC-IC	PWM step-down, 1.2MHz, 3.0V±1%, 900mA, -CE, PDR	USP-6B	49dc5	DC1	9b	Tor
ZH31E	XC9225H316D	DG/DC-IC	PWM step-down, 600kHz, 3.1V±1%, 900mA, -CE, PDR	USP-6B	49dc5	DC1	9b	Tor
ZH31C	XC9225H31CD	DG/DC-IC	PWM step-down, 1.2MHz, 3.1V±1%, 900mA, -CE, PDR	USP-6B	49dc5	DC1	9b	Tor
ZH32E	XC9225H326D	DG/DC-IC	PWM step-down, 600kHz, 3.2V±1%, 900mA, -CE, PDR	USP-6B	49dc5	DC1	9b	Tor
ZH32C	XC9225H32CD	DG/DC-IC	PWM step-down, 1.2MHz, 3.2V±1%, 900mA, -CE, PDR	USP-6B	49dc5	DC1	9b	Tor
ZH33E	XC9225H336D	DG/DC-IC	PWM step-down, 600kHz, 3.3V±1%, 900mA, -CE, PDR	USP-6B	49dc5	DC1	9b	Tor
ZH33C	XC9225H33CD	DG/DC-IC	PWM step-down, 1.2MHz, 3.3V±1%, 900mA, -CE, PDR	USP-6B	49dc5	DC1	9b	Tor
ZH34E	XC9225H346D	DG/DC-IC	PWM step-down, 600kHz, 3.4V±1%, 900mA, -CE, PDR	USP-6B	49dc5	DC1	9b	Tor
ZH34C	XC9225H34CD	DG/DC-IC	PWM step-down, 1.2MHz, 3.4V±1%, 900mA, -CE, PDR	USP-6B	49dc5	DC1	9b	Tor
ZH35E	XC9225H356D	DG/DC-IC	PWM step-down, 600kHz, 3.5V±1%, 900mA, -CE, PDR	USP-6B	49dc5	DC1	9b	Tor
ZH35C	XC9225H35CD	DG/DC-IC	PWM step-down, 1.2MHz, 3.5V±1%, 900mA, -CE, PDR	USP-6B	49dc5	DC1	9b	Tor
ZH36E	XC9225H366D	DG/DC-IC	PWM step-down, 600kHz, 3.6V±1%, 900mA, -CE, PDR	USP-6B	49dc5	DC1	9b	Tor
ZH36C	XC9225H36CD	DG/DC-IC	PWM step-down, 1.2MHz, 3.6V±1%, 900mA, -CE, PDR	USP-6B	49dc5	DC1	9b	Tor
ZH37E	XC9225H376D	DG/DC-IC	PWM step-down, 600kHz, 3.7V±1%, 900mA, -CE, PDR	USP-6B	49dc5	DC1	9b	Tor
ZH37C	XC9225H37CD	DG/DC-IC	PWM step-down, 1.2MHz, 3.7V±1%, 900mA, -CE, PDR	USP-6B	49dc5	DC1	9b	Tor
ZH38E	XC9225H386D	DG/DC-IC	PWM step-down, 600kHz, 3.8V±1%, 900mA, -CE, PDR	USP-6B	49dc5	DC1	9b	Tor
ZH38C	XC9225H38CD	DG/DC-IC	PWM step-down, 1.2MHz, 3.8V±1%, 900mA, -CE, PDR	USP-6B	49dc5	DC1	9b	Tor
ZH39E	XC9225H396D	DG/DC-IC	PWM step-down, 600kHz, 3.9V±1%, 900mA, -CE, PDR	USP-6B	49dc5	DC1	9b	Tor
ZH39C	XC9225H39CD	DG/DC-IC	PWM step-down, 1.2MHz, 3.9V±1%, 900mA, -CE, PDR	USP-6B	49dc5	DC1	9b	Tor
ZH3A6	XC9225H3A6D	DG/DC-IC	PWM step-down, 600kHz, 3.05V±1%, 900mA, -CE, PDR	USP-6B	49dc5	DC1	9b	Tor
ZH3AC	XC9225H3ACD	DG/DC-IC	PWM step-down, 1.2MHz, 3.05V±1%, 900mA, -CE, PDR	USP-6B	49dc5	DC1	9b	Tor
ZH3B6	XC9225H3B6D	DG/DC-IC	PWM step-down, 600kHz, 3.15V±1%, 900mA, -CE, PDR	USP-6B	49dc5	DC1	9b	Tor
ZH3BC	XC9225H3BCD	DG/DC-IC	PWM step-down, 1.2MHz, 3.15V±1%, 900mA, -CE, PDR	USP-6B	49dc5	DC1	9b	Tor
ZH3C6	XC9225H3C6D	DG/DC-IC	PWM step-down, 600kHz, 3.25V±1%, 900mA, -CE, PDR	USP-6B	49dc5	DC1	9b	Tor
ZH3CC	XC9225H3CCD	DG/DC-IC	PWM step-down, 1.2MHz, 3.25V±1%, 900mA, -CE, PDR	USP-6B	49dc5	DC1	9b	Tor
ZH3D6	XC9225H3D6D	DG/DC-IC	PWM step-down, 600kHz, 3.35V±1%, 900mA, -CE, PDR	USP-6B	49dc5	DC1	9b	Tor
ZH3DC	XC9225H3DCD	DG/DC-IC	PWM step-down, 1.2MHz, 3.35V±1%, 900mA, -CE, PDR	USP-6B	49dc5	DC1	9b	Tor
ZH3E6	XC9225H3E6D	DG/DC-IC	PWM step-down, 600kHz, 3.45V±1%, 900mA, -CE, PDR	USP-6B	49dc5	DC1	9b	Tor



SMD code	Type	Function	Short description	Case	Pinout	Sch.	St.	Mnf.
ZH3EC	XC9225H3ECD	DC/DC-IC	PWM step-down, 1.2MHz, 3.45V±1%, 900mA, -CE, PDR	USP-6B	49dc5	DC1	9b	Tor
ZH3F6	XC9225H3F6D	DC/DC-IC	PWM step-down, 600kHz, 3.55V±1%, 900mA, -CE, PDR	USP-6B	49dc5	DC1	9b	Tor
ZH3FC	XC9225H3FCD	DC/DC-IC	PWM step-down, 1.2MHz, 3.55V±1%, 900mA, -CE, PDR	USP-6B	49dc5	DC1	9b	Tor
ZH3H6	XC9225H3H6D	DC/DC-IC	PWM step-down, 600kHz, 3.65V±1%, 900mA, -CE, PDR	USP-6B	49dc5	DC1	9b	Tor
ZH3HC	XC9225H3HCD	DC/DC-IC	PWM step-down, 1.2MHz, 3.65V±1%, 900mA, -CE, PDR	USP-6B	49dc5	DC1	9b	Tor
ZH3K6	XC9225H3K6D	DC/DC-IC	PWM step-down, 600kHz, 3.75V±1%, 900mA, -CE, PDR	USP-6B	49dc5	DC1	9b	Tor
ZH3KC	XC9225H3KCD	DC/DC-IC	PWM step-down, 1.2MHz, 3.75V±1%, 900mA, -CE, PDR	USP-6B	49dc5	DC1	9b	Tor
ZH3L6	XC9225H3L6D	DC/DC-IC	PWM step-down, 600kHz, 3.85V±1%, 900mA, -CE, PDR	USP-6B	49dc5	DC1	9b	Tor
ZH3LC	XC9225H3LCD	DC/DC-IC	PWM step-down, 1.2MHz, 3.85V±1%, 900mA, -CE, PDR	USP-6B	49dc5	DC1	9b	Tor
ZH3M6	XC9225H3M6D	DC/DC-IC	PWM step-down, 600kHz, 3.95V±1%, 900mA, -CE, PDR	USP-6B	49dc5	DC1	9b	Tor
ZH3MC	XC9225H3MCD	DC/DC-IC	PWM step-down, 1.2MHz, 3.95V±1%, 900mA, -CE, PDR	USP-6B	49dc5	DC1	9b	Tor
ZH406	XC9225H406D	DC/DC-IC	PWM step-down, 600kHz, 4.0V±1%, 900mA, -CE, PDR	USP-6B	49dc5	DC1	9b	Tor
ZH40C	XC9225H40CD	DC/DC-IC	PWM step-down, 1.2MHz, 4.0V±1%, 900mA, -CE, PDR	USP-6B	49dc5	DC1	9b	Tor
ZJ	RP201K1401D	LVR-IC	LDO, 4.0V±1%, 150mA, +CE, CL, AE(Mode)	DFM1212-6	52ht	VR12	9a	Ric
ZK	RP201K281D5	LVR-IC	LDO, 2.85V±1%, 150mA, +CE, CL, AE(Mode)	DFM1212-6	52ht	VR12	9a	Ric
ZX	XC6221B48B7R	LVR-IC	LDO, 4.85V±1%, 200mA, +CE, CL	USPN-4	58vm	VR4	9a	Tor
ZY	XC6221B49B7R	LVR-IC	LDO, 4.95V±1%, 200mA, +CE, CL	USPN-4	58vm	VR4	9a	Tor
ZZ306	XC9225G306D	DC/DC-IC	PWM step-down, 600kHz, 3.0V±1%, 900mA, +CE, PDR	USP-6B	49dc5	DC1	9b	Tor
ZZ30C	XC9225G30CD	DC/DC-IC	PWM step-down, 1.2MHz, 3.0V±1%, 900mA, +CE, PDR	USP-6B	49dc5	DC1	9b	Tor
ZZ316	XC9225G316D	DC/DC-IC	PWM step-down, 600kHz, 3.1V±1%, 900mA, +CE, PDR	USP-6B	49dc5	DC1	9b	Tor
ZZ31C	XC9225G31CD	DC/DC-IC	PWM step-down, 1.2MHz, 3.1V±1%, 900mA, +CE, PDR	USP-6B	49dc5	DC1	9b	Tor
ZZ326	XC9225G326D	DC/DC-IC	PWM step-down, 600kHz, 3.2V±1%, 900mA, +CE, PDR	USP-6B	49dc5	DC1	9b	Tor
ZZ32C	XC9225G32CD	DC/DC-IC	PWM step-down, 1.2MHz, 3.2V±1%, 900mA, +CE, PDR	USP-6B	49dc5	DC1	9b	Tor
ZZ336	XC9225G336D	DC/DC-IC	PWM step-down, 600kHz, 3.3V±1%, 900mA, +CE, PDR	USP-6B	49dc5	DC1	9b	Tor
ZZ33C	XC9225G33CD	DC/DC-IC	PWM step-down, 1.2MHz, 3.3V±1%, 900mA, +CE, PDR	USP-6B	49dc5	DC1	9b	Tor
ZZ346	XC9225G346D	DC/DC-IC	PWM step-down, 600kHz, 3.4V±1%, 900mA, +CE, PDR	USP-6B	49dc5	DC1	9b	Tor
ZZ34C	XC9225G34CD	DC/DC-IC	PWM step-down, 1.2MHz, 3.4V±1%, 900mA, +CE, PDR	USP-6B	49dc5	DC1	9b	Tor
ZZ356	XC9225G356D	DC/DC-IC	PWM step-down, 600kHz, 3.5V±1%, 900mA, +CE, PDR	USP-6B	49dc5	DC1	9b	Tor
ZZ35C	XC9225G35CD	DC/DC-IC	PWM step-down, 1.2MHz, 3.5V±1%, 900mA, +CE, PDR	USP-6B	49dc5	DC1	9b	Tor
ZZ366	XC9225G366D	DC/DC-IC	PWM step-down, 600kHz, 3.6V±1%, 900mA, +CE, PDR	USP-6B	49dc5	DC1	9b	Tor
ZZ36C	XC9225G36CD	DC/DC-IC	PWM step-down, 1.2MHz, 3.6V±1%, 900mA, +CE, PDR	USP-6B	49dc5	DC1	9b	Tor
ZZ376	XC9225G376D	DC/DC-IC	PWM step-down, 600kHz, 3.7V±1%, 900mA, +CE, PDR	USP-6B	49dc5	DC1	9b	Tor
ZZ37C	XC9225G37CD	DC/DC-IC	PWM step-down, 1.2MHz, 3.7V±1%, 900mA, +CE, PDR	USP-6B	49dc5	DC1	9b	Tor
ZZ386	XC9225G386D	DC/DC-IC	PWM step-down, 600kHz, 3.8V±1%, 900mA, +CE, PDR	USP-6B	49dc5	DC1	9b	Tor
ZZ38C	XC9225G38CD	DC/DC-IC	PWM step-down, 1.2MHz, 3.8V±1%, 900mA, +CE, PDR	USP-6B	49dc5	DC1	9b	Tor
ZZ396	XC9225G396D	DC/DC-IC	PWM step-down, 600kHz, 3.9V±1%, 900mA, +CE, PDR	USP-6B	49dc5	DC1	9b	Tor
ZZ39C	XC9225G39CD	DC/DC-IC	PWM step-down, 1.2MHz, 3.9V±1%, 900mA, +CE, PDR	USP-6B	49dc5	DC1	9b	Tor
ZZ3A6	XC9225G3A6D	DC/DC-IC	PWM step-down, 600kHz, 3.05V±1%, 900mA, +CE, PDR	USP-6B	49dc5	DC1	9b	Tor
ZZ3AC	XC9225G3ACD	DC/DC-IC	PWM step-down, 1.2MHz, 3.05V±1%, 900mA, +CE, PDR	USP-6B	49dc5	DC1	9b	Tor
ZZ3B6	XC9225G3B6D	DC/DC-IC	PWM step-down, 600kHz, 3.15V±1%, 900mA, +CE, PDR	USP-6B	49dc5	DC1	9b	Tor
ZZ3BC	XC9225G3BCD	DC/DC-IC	PWM step-down, 1.2MHz, 3.15V±1%, 900mA, +CE, PDR	USP-6B	49dc5	DC1	9b	Tor
ZZ3C6	XC9225G3C6D	DC/DC-IC	PWM step-down, 600kHz, 3.25V±1%, 900mA, +CE, PDR	USP-6B	49dc5	DC1	9b	Tor
ZZ3CC	XC9225G3CCD	DC/DC-IC	PWM step-down, 1.2MHz, 3.25V±1%, 900mA, +CE, PDR	USP-6B	49dc5	DC1	9b	Tor
ZZ3D6	XC9225G3D6D	DC/DC-IC	PWM step-down, 600kHz, 3.35V±1%, 900mA, +CE, PDR	USP-6B	49dc5	DC1	9b	Tor
ZZ3DC	XC9225G3DCD	DC/DC-IC	PWM step-down, 1.2MHz, 3.35V±1%, 900mA, +CE, PDR	USP-6B	49dc5	DC1	9b	Tor
ZZ3E6	XC9225G3E6D	DC/DC-IC	PWM step-down, 600kHz, 3.45V±1%, 900mA, +CE, PDR	USP-6B	49dc5	DC1	9b	Tor
ZZ3EC	XC9225G3ECD	DC/DC-IC	PWM step-down, 1.2MHz, 3.45V±1%, 900mA, +CE, PDR	USP-6B	49dc5	DC1	9b	Tor
ZZ3F6	XC9225G3F6D	DC/DC-IC	PWM step-down, 600kHz, 3.55V±1%, 900mA, +CE, PDR	USP-6B	49dc5	DC1	9b	Tor
ZZ3FC	XC9225G3FCD	DC/DC-IC	PWM step-down, 1.2MHz, 3.55V±1%, 900mA, +CE, PDR	USP-6B	49dc5	DC1	9b	Tor
ZZ3H6	XC9225G3H6D	DC/DC-IC	PWM step-down, 600kHz, 3.65V±1%, 900mA, +CE, PDR	USP-6B	49dc5	DC1	9b	Tor
ZZ3HC	XC9225G3HCD	DC/DC-IC	PWM step-down, 1.2MHz, 3.65V±1%, 900mA, +CE, PDR	USP-6B	49dc5	DC1	9b	Tor
ZZ3K6	XC9225G3K6D	DC/DC-IC	PWM step-down, 600kHz, 3.75V±1%, 900mA, +CE, PDR	USP-6B	49dc5	DC1	9b	Tor
ZZ3KC	XC9225G3KCD	DC/DC-IC	PWM step-down, 1.2MHz, 3.75V±1%, 900mA, +CE, PDR	USP-6B	49dc5	DC1	9b	Tor
ZZ3L6	XC9225G3L6D	DC/DC-IC	PWM step-down, 600kHz, 3.85V±1%, 900mA, +CE, PDR	USP-6B	49dc5	DC1	9b	Tor
ZZ3LC	XC9225G3LCD	DC/DC-IC	PWM step-down, 1.2MHz, 3.85V±1%, 900mA, +CE, PDR	USP-6B	49dc5	DC1	9b	Tor
ZZ3M6	XC9225G3M6D	DC/DC-IC	PWM step-down, 600kHz, 3.95V±1%, 900mA, +CE, PDR	USP-6B	49dc5	DC1	9b	Tor
ZZ3MC	XC9225G3MCD	DC/DC-IC	PWM step-down, 1.2MHz, 3.95V±1%, 900mA, +CE, PDR	USP-6B	49dc5	DC1	9b	Tor
ZZ406	XC9225G406D	DC/DC-IC	PWM step-down, 600kHz, 4.0V±1%, 900mA, +CE, PDR	USP-6B	49dc5	DC1	9b	Tor
ZZ40C	XC9225G40CD	DC/DC-IC	PWM step-down, 1.2MHz, 4.0V±1%, 900mA, +CE, PDR	USP-6B	49dc5	DC1	9b	Tor



SECTION 11
D-PAK CASES SMD SEMICONDUCTOR COMPONENTS

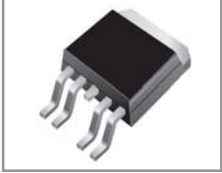

SMD code	Type	Function	Short description	Case	Pinout	Sch.	St.	Mnf.
100	XC6503P121JR-G	LVR-IC	LDO, 1.2V±20mV, 500mA	TO-252	68eu	VR1	10a	Tor
101	XC6503P131JR-G	LVR-IC	LDO, 1.3V±20mV, 500mA	TO-252	68eu	VR1	10a	Tor
102	XC6503P141JR-G	LVR-IC	LDO, 1.4V±20mV, 500mA	TO-252	68eu	VR1	10a	Tor
103	XC6503P151JR-G	LVR-IC	LDO, 1.5V±20mV, 500mA	TO-252	68eu	VR1	10a	Tor
104	XC6503P161JR-G	LVR-IC	LDO, 1.6V±20mV, 500mA	TO-252	68eu	VR1	10a	Tor
105	XC6503P171JR-G	LVR-IC	LDO, 1.7V±20mV, 500mA	TO-252	68eu	VR1	10a	Tor
106	XC6503P181JR-G	LVR-IC	LDO, 1.8V±20mV, 500mA	TO-252	68eu	VR1	10a	Tor
107	XC6503P191JR-G	LVR-IC	LDO, 1.9V±20mV, 500mA	TO-252	68eu	VR1	10a	Tor
108	XC6503P201JR-G	LVR-IC	LDO, 2.0V±1%, 500mA	TO-252	68eu	VR1	10a	Tor
109	XC6503P211JR-G	LVR-IC	LDO, 2.1V±1%, 500mA	TO-252	68eu	VR1	10a	Tor
10A	XC6503P221JR-G	LVR-IC	LDO, 2.2V±1%, 500mA	TO-252	68eu	VR1	10a	Tor
10B	XC6503P231JR-G	LVR-IC	LDO, 2.3V±1%, 500mA	TO-252	68eu	VR1	10a	Tor
10C	XC6503P241JR-G	LVR-IC	LDO, 2.4V±1%, 500mA	TO-252	68eu	VR1	10a	Tor
10D	XC6503P251JR-G	LVR-IC	LDO, 2.5V±1%, 500mA	TO-252	68eu	VR1	10a	Tor
10E	XC6503P261JR-G	LVR-IC	LDO, 2.6V±1%, 500mA	TO-252	68eu	VR1	10a	Tor
10F	XC6503P271JR-G	LVR-IC	LDO, 2.7V±1%, 500mA	TO-252	68eu	VR1	10a	Tor
10H	XC6503P281JR-G	LVR-IC	LDO, 2.8V±1%, 500mA	TO-252	68eu	VR1	10a	Tor
10K	XC6503P291JR-G	LVR-IC	LDO, 2.9V±1%, 500mA	TO-252	68eu	VR1	10a	Tor
10L	XC6503P301JR-G	LVR-IC	LDO, 3.0V±1%, 500mA	TO-252	68eu	VR1	10a	Tor
10M	XC6503P311JR-G	LVR-IC	LDO, 3.1V±1%, 500mA	TO-252	68eu	VR1	10a	Tor
10N	XC6503P321JR-G	LVR-IC	LDO, 3.2V±1%, 500mA	TO-252	68eu	VR1	10a	Tor
10N03LA	IPD10N03LA	n-MOSFET-e*	LogL, DC/DC-conv, 25V, 30A, 52W, Rds=10.4mΩ(10V), 6.3/18ns	TO-252-3-11	68fw	-	10b	Inf
10N03LA	IPF10N03LA	n-MOSFET-e*	LogL, DC/DC-conv, 25V, 30A, 52W, Rds=10.4mΩ(10V), 6.3/18ns	TO-252-3-23	68fw	-	10b	Inf
10N03LA	IPS10N03LA	n-MOSFET-e*	LogL, DC/DC-conv, 25V, 30A, 52W, Rds=10.4mΩ(10V), 6.3/18ns	TO-251-3-11	68fw	-	10b	Inf
10N03LA	IPU10N03LA	n-MOSFET-e*	LogL, DC/DC-conv, 25V, 30A, 52W, Rds=10.4mΩ(10V), 6.3/18ns	TO-251-3-1	68fw	-	10b	Inf
10P	XC6503P331JR-G	LVR-IC	LDO, 3.3V±1%, 500mA	TO-252	68eu	VR1	10a	Tor
10R	XC6503P341JR-G	LVR-IC	LDO, 3.4V±1%, 500mA	TO-252	68eu	VR1	10a	Tor
10S	XC6503P351JR-G	LVR-IC	LDO, 3.5V±1%, 500mA	TO-252	68eu	VR1	10a	Tor
10T	XC6503P361JR-G	LVR-IC	LDO, 3.6V±1%, 500mA	TO-252	68eu	VR1	10a	Tor
10U	XC6503P371JR-G	LVR-IC	LDO, 3.7V±1%, 500mA	TO-252	68eu	VR1	10a	Tor
10V	XC6503P381JR-G	LVR-IC	LDO, 3.8V±1%, 500mA	TO-252	68eu	VR1	10a	Tor
10X	XC6503P391JR-G	LVR-IC	LDO, 3.9V±1%, 500mA	TO-252	68eu	VR1	10a	Tor
10Y	XC6503P401JR-G	LVR-IC	LDO, 4.0V±1%, 500mA	TO-252	68eu	VR1	10a	Tor
10Z	XC6503P411JR-G	LVR-IC	LDO, 4.1V±1%, 500mA	TO-252	68eu	VR1	10a	Tor
110	XC6503P421JR-G	LVR-IC	LDO, 4.2V±1%, 500mA	TO-252	68eu	VR1	10a	Tor
111	XC6503P431JR-G	LVR-IC	LDO, 4.3V±1%, 500mA	TO-252	68eu	VR1	10a	Tor
112	XC6503P441JR-G	LVR-IC	LDO, 4.4V±1%, 500mA	TO-252	68eu	VR1	10a	Tor
113	XC6503P451JR-G	LVR-IC	LDO, 4.5V±1%, 500mA	TO-252	68eu	VR1	10a	Tor
114	XC6503P461JR-G	LVR-IC	LDO, 4.6V±1%, 500mA	TO-252	68eu	VR1	10a	Tor
115	XC6503P471JR-G	LVR-IC	LDO, 4.7V±1%, 500mA	TO-252	68eu	VR1	10a	Tor
116	XC6503P481JR-G	LVR-IC	LDO, 4.8V±1%, 500mA	TO-252	68eu	VR1	10a	Tor
117	XC6503P491JR-G	LVR-IC	LDO, 4.9V±1%, 500mA	TO-252	68eu	VR1	10a	Tor
118	XC6503P501JR-G	LVR-IC	LDO, 5.0V±1%, 500mA	TO-252	68eu	VR1	10a	Tor
1182	2SB1182PT	Si-pnp	AF, Sw, 32V, 2A, B=82..390, 100MHz	DPAK	68tb	-	10a	Chm
120	XC6503P12AJR-G	LVR-IC	LDO, 1.25V±20mV, 500mA	TO-252	68eu	VR1	10a	Tor
121	XC6503P13AJR-G	LVR-IC	LDO, 1.35V±20mV, 500mA	TO-252	68eu	VR1	10a	Tor
122	XC6503P14AJR-G	LVR-IC	LDO, 1.45V±20mV, 500mA	TO-252	68eu	VR1	10a	Tor
123	XC6503P15AJR-G	LVR-IC	LDO, 1.55V±20mV, 500mA	TO-252	68eu	VR1	10a	Tor
124	XC6503P16AJR-G	LVR-IC	LDO, 1.65V±20mV, 500mA	TO-252	68eu	VR1	10a	Tor
125	XC6503P17AJR-G	LVR-IC	LDO, 1.75V±20mV, 500mA	TO-252	68eu	VR1	10a	Tor
126	XC6503P18AJR-G	LVR-IC	LDO, 1.85V±20mV, 500mA	TO-252	68eu	VR1	10a	Tor
127	XC6503P19AJR-G	LVR-IC	LDO, 1.95V±20mV, 500mA	TO-252	68eu	VR1	10a	Tor
128	XC6503P20AJR-G	LVR-IC	LDO, 2.05V±1%, 500mA	TO-252	68eu	VR1	10a	Tor
129	XC6503P21AJR-G	LVR-IC	LDO, 2.15V±1%, 500mA	TO-252	68eu	VR1	10a	Tor
12A	XC6503P22AJR-G	LVR-IC	LDO, 2.25V±1%, 500mA	TO-252	68eu	VR1	10a	Tor
12B	XC6503P23AJR-G	LVR-IC	LDO, 2.35V±1%, 500mA	TO-252	68eu	VR1	10a	Tor
12C	XC6503P24AJR-G	LVR-IC	LDO, 2.45V±1%, 500mA	TO-252	68eu	VR1	10a	Tor
12D	XC6503P25AJR-G	LVR-IC	LDO, 2.55V±1%, 500mA	TO-252	68eu	VR1	10a	Tor
12E	XC6503P26AJR-G	LVR-IC	LDO, 2.65V±1%, 500mA	TO-252	68eu	VR1	10a	Tor
12F	XC6503P27AJR-G	LVR-IC	LDO, 2.75V±1%, 500mA	TO-252	68eu	VR1	10a	Tor
12H	XC6503P28AJR-G	LVR-IC	LDO, 2.85V±1%, 500mA	TO-252	68eu	VR1	10a	Tor
12K	XC6503P29AJR-G	LVR-IC	LDO, 2.95V±1%, 500mA	TO-252	68eu	VR1	10a	Tor
12L	XC6503P30AJR-G	LVR-IC	LDO, 3.05V±1%, 500mA	TO-252	68eu	VR1	10a	Tor
12M	XC6503P31AJR-G	LVR-IC	LDO, 3.15V±1%, 500mA	TO-252	68eu	VR1	10a	Tor
12N	XC6503P32AJR-G	LVR-IC	LDO, 3.25V±1%, 500mA	TO-252	68eu	VR1	10a	Tor
12P	XC6503P33AJR-G	LVR-IC	LDO, 3.35V±1%, 500mA	TO-252	68eu	VR1	10a	Tor
12R	XC6503P34AJR-G	LVR-IC	LDO, 3.45V±1%, 500mA	TO-252	68eu	VR1	10a	Tor
12S	XC6503P35AJR-G	LVR-IC	LDO, 3.55V±1%, 500mA	TO-252	68eu	VR1	10a	Tor
12T	XC6503P36AJR-G	LVR-IC	LDO, 3.65V±1%, 500mA	TO-252	68eu	VR1	10a	Tor
12U	XC6503P37AJR-G	LVR-IC	LDO, 3.75V±1%, 500mA	TO-252	68eu	VR1	10a	Tor



SMD code	Type	Function	Short description	Case	Pinout	Sch.	St.	Mnf.
12V	XC6503P38AJR-G	LVR-IC	LDO, 3.85V±1%, 500mA	TO-252	68eu	VR1	10a	Tor
12X	XC6503P39AJR-G	LVR-IC	LDO, 3.95V±1%, 500mA	TO-252	68eu	VR1	10a	Tor
12Y	XC6503P40AJR-G	LVR-IC	LDO, 4.05V±1%, 500mA	TO-252	68eu	VR1	10a	Tor
12Z	XC6503P41AJR-G	LVR-IC	LDO, 4.15V±1%, 500mA	TO-252	68eu	VR1	10a	Tor
130	XC6503P42AJR-G	LVR-IC	LDO, 4.25V±1%, 500mA	TO-252	68eu	VR1	10a	Tor
131	XC6503P43AJR-G	LVR-IC	LDO, 4.35V±1%, 500mA	TO-252	68eu	VR1	10a	Tor
132	XC6503P44AJR-G	LVR-IC	LDO, 4.45V±1%, 500mA	TO-252	68eu	VR1	10a	Tor
133	XC6503P45AJR-G	LVR-IC	LDO, 4.55V±1%, 500mA	TO-252	68eu	VR1	10a	Tor
134	XC6503P46AJR-G	LVR-IC	LDO, 4.65V±1%, 500mA	TO-252	68eu	VR1	10a	Tor
135	XC6503P47AJR-G	LVR-IC	LDO, 4.75V±1%, 500mA	TO-252	68eu	VR1	10a	Tor
136	XC6503P48AJR-G	LVR-IC	LDO, 4.85V±1%, 500mA	TO-252	68eu	VR1	10a	Tor
137	XC6503P49AJR-G	LVR-IC	LDO, 4.95V±1%, 500mA	TO-252	68eu	VR1	10a	Tor
1386	2SB1386PPT	Si-pnp	AF, Sw, 20V, 5A, B=82.390, 120MHz	DPAK	68tb	-	10a	Chm
2098	2SD2098PPT	Si-npn	AF, Sw, 20V, 5A, B=230.600, 150MHz	DPAK	68tb	-	10a	Chm
24M	XC6216D202JR	LVR-IC	2.0V±2%, 150mA	TO-252	68eu	VR1	10c	Tor
24N	XC6216D212JR	LVR-IC	2.1V±2%, 150mA	TO-252	68eu	VR1	10c	Tor
24P	XC6216D222JR	LVR-IC	2.2V±2%, 150mA	TO-252	68eu	VR1	10c	Tor
24R	XC6216D232JR	LVR-IC	2.3V±2%, 150mA	TO-252	68eu	VR1	10c	Tor
24S	XC6216D242JR	LVR-IC	2.4V±2%, 150mA	TO-252	68eu	VR1	10c	Tor
24T	XC6216D252JR	LVR-IC	2.5V±2%, 150mA	TO-252	68eu	VR1	10c	Tor
24U	XC6216D262JR	LVR-IC	2.6V±2%, 150mA	TO-252	68eu	VR1	10c	Tor
24V	XC6216D272JR	LVR-IC	2.7V±2%, 150mA	TO-252	68eu	VR1	10c	Tor
24X	XC6216D282JR	LVR-IC	2.8V±2%, 150mA	TO-252	68eu	VR1	10c	Tor
24Y	XC6216D292JR	LVR-IC	2.9V±2%, 150mA	TO-252	68eu	VR1	10c	Tor
24Z	XC6216D302JR	LVR-IC	3.0V±2%, 150mA	TO-252	68eu	VR1	10c	Tor
250	XC6216D312JR	LVR-IC	3.1V±2%, 150mA	TO-252	68eu	VR1	10c	Tor
251	XC6216D322JR	LVR-IC	3.2V±2%, 150mA	TO-252	68eu	VR1	10c	Tor
252	XC6216D332JR	LVR-IC	3.3V±2%, 150mA	TO-252	68eu	VR1	10c	Tor
253	XC6216D342JR	LVR-IC	3.4V±2%, 150mA	TO-252	68eu	VR1	10c	Tor
254	XC6216D352JR	LVR-IC	3.5V±2%, 150mA	TO-252	68eu	VR1	10c	Tor
255	XC6216D362JR	LVR-IC	3.6V±2%, 150mA	TO-252	68eu	VR1	10c	Tor
256	XC6216D372JR	LVR-IC	3.7V±2%, 150mA	TO-252	68eu	VR1	10c	Tor
257	XC6216D382JR	LVR-IC	3.8V±2%, 150mA	TO-252	68eu	VR1	10c	Tor
258	XC6216D392JR	LVR-IC	3.9V±2%, 150mA	TO-252	68eu	VR1	10c	Tor
259	XC6216D402JR	LVR-IC	4.0V±2%, 150mA	TO-252	68eu	VR1	10c	Tor
25A	XC6216D412JR	LVR-IC	4.1V±2%, 150mA	TO-252	68eu	VR1	10c	Tor
25B	XC6216D422JR	LVR-IC	4.2V±2%, 150mA	TO-252	68eu	VR1	10c	Tor
25C	XC6216D432JR	LVR-IC	4.3V±2%, 150mA	TO-252	68eu	VR1	10c	Tor
25D	XC6216D442JR	LVR-IC	4.4V±2%, 150mA	TO-252	68eu	VR1	10c	Tor
25E	XC6216D452JR	LVR-IC	4.5V±2%, 150mA	TO-252	68eu	VR1	10c	Tor
25F	XC6216D462JR	LVR-IC	4.6V±2%, 150mA	TO-252	68eu	VR1	10c	Tor
25H	XC6216D472JR	LVR-IC	4.7V±2%, 150mA	TO-252	68eu	VR1	10c	Tor
25K	XC6216D482JR	LVR-IC	4.8V±2%, 150mA	TO-252	68eu	VR1	10c	Tor
25L	XC6216D492JR	LVR-IC	4.9V±2%, 150mA	TO-252	68eu	VR1	10c	Tor
25M	XC6216D502JR	LVR-IC	5.0V±2%, 150mA	TO-252	68eu	VR1	10c	Tor
25N	XC6216D512JR	LVR-IC	5.1V±2%, 150mA	TO-252	68eu	VR1	10c	Tor
25P	XC6216D522JR	LVR-IC	5.2V±2%, 150mA	TO-252	68eu	VR1	10c	Tor
25R	XC6216D532JR	LVR-IC	5.3V±2%, 150mA	TO-252	68eu	VR1	10c	Tor
25S	XC6216D542JR	LVR-IC	5.4V±2%, 150mA	TO-252	68eu	VR1	10c	Tor
25T	XC6216D552JR	LVR-IC	5.5V±2%, 150mA	TO-252	68eu	VR1	10c	Tor
25U	XC6216D562JR	LVR-IC	5.6V±2%, 150mA	TO-252	68eu	VR1	10c	Tor
25V	XC6216D572JR	LVR-IC	5.7V±2%, 150mA	TO-252	68eu	VR1	10c	Tor
25X	XC6216D582JR	LVR-IC	5.8V±2%, 150mA	TO-252	68eu	VR1	10c	Tor
25Y	XC6216D592JR	LVR-IC	5.9V±2%, 150mA	TO-252	68eu	VR1	10c	Tor
25Z	XC6216D602JR	LVR-IC	6.0V±2%, 150mA	TO-252	68eu	VR1	10c	Tor
260	XC6216D612JR	LVR-IC	6.1V±2%, 150mA	TO-252	68eu	VR1	10c	Tor
261	XC6216D622JR	LVR-IC	6.2V±2%, 150mA	TO-252	68eu	VR1	10c	Tor
262	XC6216D632JR	LVR-IC	6.3V±2%, 150mA	TO-252	68eu	VR1	10c	Tor
263	XC6216D642JR	LVR-IC	6.4V±2%, 150mA	TO-252	68eu	VR1	10c	Tor
264	XC6216D652JR	LVR-IC	6.5V±2%, 150mA	TO-252	68eu	VR1	10c	Tor
265	XC6216D662JR	LVR-IC	6.6V±2%, 150mA	TO-252	68eu	VR1	10c	Tor
266	XC6216D672JR	LVR-IC	6.7V±2%, 150mA	TO-252	68eu	VR1	10c	Tor
267	XC6216D682JR	LVR-IC	6.8V±2%, 150mA	TO-252	68eu	VR1	10c	Tor
268	XC6216D692JR	LVR-IC	6.9V±2%, 150mA	TO-252	68eu	VR1	10c	Tor
269	XC6216D702JR	LVR-IC	7.0V±2%, 150mA	TO-252	68eu	VR1	10c	Tor
26A	XC6216D712JR	LVR-IC	7.1V±2%, 150mA	TO-252	68eu	VR1	10c	Tor
26B	XC6216D722JR	LVR-IC	7.2V±2%, 150mA	TO-252	68eu	VR1	10c	Tor
26C	XC6216D732JR	LVR-IC	7.3V±2%, 150mA	TO-252	68eu	VR1	10c	Tor
26D	XC6216D742JR	LVR-IC	7.4V±2%, 150mA	TO-252	68eu	VR1	10c	Tor
26E	XC6216D752JR	LVR-IC	7.5V±2%, 150mA	TO-252	68eu	VR1	10c	Tor



SMD code	Type	Function	Short description	Case	Pinout	Sch.	St.	Mnf.
26F	XC6216D762JR	LVR-IC	7.6V±2%, 150mA	TO-252	68eu	VR1	10c	Tor
26H	XC6216D772JR	LVR-IC	7.7V±2%, 150mA	TO-252	68eu	VR1	10c	Tor
26K	XC6216D782JR	LVR-IC	7.8V±2%, 150mA	TO-252	68eu	VR1	10c	Tor
26L	XC6216D792JR	LVR-IC	7.9V±2%, 150mA	TO-252	68eu	VR1	10c	Tor
26M	XC6216D802JR	LVR-IC	8.0V±2%, 150mA	TO-252	68eu	VR1	10c	Tor
26N	XC6216D812JR	LVR-IC	8.1V±2%, 150mA	TO-252	68eu	VR1	10c	Tor
26P	XC6216D822JR	LVR-IC	8.2V±2%, 150mA	TO-252	68eu	VR1	10c	Tor
26R	XC6216D832JR	LVR-IC	8.3V±2%, 150mA	TO-252	68eu	VR1	10c	Tor
26S	XC6216D842JR	LVR-IC	8.4V±2%, 150mA	TO-252	68eu	VR1	10c	Tor
26T	XC6216D852JR	LVR-IC	8.5V±2%, 150mA	TO-252	68eu	VR1	10c	Tor
26U	XC6216D862JR	LVR-IC	8.6V±2%, 150mA	TO-252	68eu	VR1	10c	Tor
26V	XC6216D872JR	LVR-IC	8.7V±2%, 150mA	TO-252	68eu	VR1	10c	Tor
26X	XC6216D882JR	LVR-IC	8.8V±2%, 150mA	TO-252	68eu	VR1	10c	Tor
26Y	XC6216D892JR	LVR-IC	8.9V±2%, 150mA	TO-252	68eu	VR1	10c	Tor
26Z	XC6216D902JR	LVR-IC	9.0V±2%, 150mA	TO-252	68eu	VR1	10c	Tor
270	XC6216D912JR	LVR-IC	9.1V±2%, 150mA	TO-252	68eu	VR1	10c	Tor
271	XC6216D922JR	LVR-IC	9.2V±2%, 150mA	TO-252	68eu	VR1	10c	Tor
272	XC6216D932JR	LVR-IC	9.3V±2%, 150mA	TO-252	68eu	VR1	10c	Tor
273	XC6216D942JR	LVR-IC	9.4V±2%, 150mA	TO-252	68eu	VR1	10c	Tor
274	XC6216D952JR	LVR-IC	9.5V±2%, 150mA	TO-252	68eu	VR1	10c	Tor
275	XC6216D962JR	LVR-IC	9.6V±2%, 150mA	TO-252	68eu	VR1	10c	Tor
276	XC6216D972JR	LVR-IC	9.7V±2%, 150mA	TO-252	68eu	VR1	10c	Tor
277	XC6216D982JR	LVR-IC	9.8V±2%, 150mA	TO-252	68eu	VR1	10c	Tor
278	XC6216D992JR	LVR-IC	9.9V±2%, 150mA	TO-252	68eu	VR1	10c	Tor
279	XC6216DA02JR	LVR-IC	10.0V±2%, 150mA	TO-252	68eu	VR1	10c	Tor
27A	XC6216DA12JR	LVR-IC	10.1V±2%, 150mA	TO-252	68eu	VR1	10c	Tor
27B	XC6216DA22JR	LVR-IC	10.2V±2%, 150mA	TO-252	68eu	VR1	10c	Tor
27C	XC6216DA32JR	LVR-IC	10.3V±2%, 150mA	TO-252	68eu	VR1	10c	Tor
27D	XC6216DA42JR	LVR-IC	10.4V±2%, 150mA	TO-252	68eu	VR1	10c	Tor
27E	XC6216DA52JR	LVR-IC	10.5V±2%, 150mA	TO-252	68eu	VR1	10c	Tor
27F	XC6216DA62JR	LVR-IC	10.6V±2%, 150mA	TO-252	68eu	VR1	10c	Tor
27H	XC6216DA72JR	LVR-IC	10.7V±2%, 150mA	TO-252	68eu	VR1	10c	Tor
27K	XC6216DA82JR	LVR-IC	10.8V±2%, 150mA	TO-252	68eu	VR1	10c	Tor
27L	XC6216DA92JR	LVR-IC	10.9V±2%, 150mA	TO-252	68eu	VR1	10c	Tor
27M	XC6216DB02JR	LVR-IC	11.0V±2%, 150mA	TO-252	68eu	VR1	10c	Tor
27N	XC6216DB12JR	LVR-IC	11.1V±2%, 150mA	TO-252	68eu	VR1	10c	Tor
27P	XC6216DB22JR	LVR-IC	11.2V±2%, 150mA	TO-252	68eu	VR1	10c	Tor
27R	XC6216DB32JR	LVR-IC	11.3V±2%, 150mA	TO-252	68eu	VR1	10c	Tor
27S	XC6216DB42JR	LVR-IC	11.4V±2%, 150mA	TO-252	68eu	VR1	10c	Tor
27T	XC6216DB52JR	LVR-IC	11.5V±2%, 150mA	TO-252	68eu	VR1	10c	Tor
27U	XC6216DB62JR	LVR-IC	11.6V±2%, 150mA	TO-252	68eu	VR1	10c	Tor
27V	XC6216DB72JR	LVR-IC	11.7V±2%, 150mA	TO-252	68eu	VR1	10c	Tor
27X	XC6216DB82JR	LVR-IC	11.8V±2%, 150mA	TO-252	68eu	VR1	10c	Tor
27Y	XC6216DB92JR	LVR-IC	11.9V±2%, 150mA	TO-252	68eu	VR1	10c	Tor
27Z	XC6216DC02JR	LVR-IC	12.0V±2%, 150mA	TO-252	68eu	VR1	10c	Tor
510	S5KP10	TVS	Vbr=11.1..13.6V, Vrw=10V, 266A, 5000W(1ms)	TO-263	68ap	-	10a	Eic
5100	S5KP100	TVS	Vbr=11.1..136V, Vrw=100V, 28A, 5000W(1ms)	TO-263	68ap	-	10a	Eic
5100A	S5KP100A	TVS	Vbr=11.1..123V, Vrw=100V, 31A, 5000W(1ms)	TO-263	68ap	-	10a	Eic
5100C	S5KP100C	TVS	Vbr=11.1..136V, Vrw=100V, 28A, 5000W(1ms), Bidirectional	TO-263	68ao	-	10a	Eic
5100CA	S5KP100CA	TVS	Vbr=11.1..123V, Vrw=100V, 31A, 5000W(1ms), Bidirectional	TO-263	68ao	-	10a	Eic
510A	S5KP10A	TVS	Vbr=11.1..12.3V, Vrw=10V, 294A, 5000W(1ms)	TO-263	68ap	-	10a	Eic
510C	S5KP10C	TVS	Vbr=11.1..13.6V, Vrw=10V, 266A, 5000W(1ms), Bidirectional	TO-263	68ao	-	10a	Eic
510CA	S5KP10CA	TVS	Vbr=11.1..12.3V, Vrw=10V, 294A, 5000W(1ms), Bidirectional	TO-263	68ao	-	10a	Eic
511	S5KP11	TVS	Vbr=12.2..14.9V, Vrw=11V, 249A, 5000W(1ms)	TO-263	68ap	-	10a	Eic
5110	S5KP110	TVS	Vbr=12.2..149V, Vrw=110V, 26A, 5000W(1ms)	TO-263	68ap	-	10a	Eic
5110A	S5KP110A	TVS	Vbr=12.2..135V, Vrw=110V, 28A, 5000W(1ms)	TO-263	68ap	-	10a	Eic
5110C	S5KP110C	TVS	Vbr=12.2..149V, Vrw=110V, 26A, 5000W(1ms), Bidirectional	TO-263	68ao	-	10a	Eic
5110CA	S5KP110CA	TVS	Vbr=12.2..135V, Vrw=110V, 28A, 5000W(1ms), Bidirectional	TO-263	68ao	-	10a	Eic
5113	CHT5113PPT	Si-npn	AF, Sw, 60V, 6A, B=120..300, 150MHz	DPAK	68tb	-	10a	Chm
511A	S5KP11A	TVS	Vbr=12.2..13.5V, Vrw=11V, 274A, 5000W(1ms)	TO-263	68ap	-	10a	Eic
511C	S5KP11C	TVS	Vbr=12.2..14.9V, Vrw=11V, 249A, 5000W(1ms), Bidirectional	TO-263	68ao	-	10a	Eic
511CA	S5KP11CA	TVS	Vbr=12.2..13.5V, Vrw=11V, 274A, 5000W(1ms), Bidirectional	TO-263	68ao	-	10a	Eic
512	S5KP12	TVS	Vbr=13.3..16.3V, Vrw=12V, 227A, 5000W(1ms)	TO-263	68ap	-	10a	Eic
5120	S5KP120	TVS	Vbr=133..163V, Vrw=120V, 24A, 5000W(1ms)	TO-263	68ap	-	10a	Eic
5120A	S5KP120A	TVS	Vbr=133..147V, Vrw=120V, 26A, 5000W(1ms)	TO-263	68ap	-	10a	Eic
5120C	S5KP120C	TVS	Vbr=133..163V, Vrw=120V, 24A, 5000W(1ms), Bidirectional	TO-263	68ao	-	10a	Eic
5120CA	S5KP120CA	TVS	Vbr=133..147V, Vrw=120V, 26A, 5000W(1ms), Bidirectional	TO-263	68ao	-	10a	Eic
512A	S5KP12A	TVS	Vbr=13.3..14.7V, Vrw=12V, 251A, 5000W(1ms)	TO-263	68ap	-	10a	Eic
512C	S5KP12C	TVS	Vbr=13.3..16.3V, Vrw=12V, 227A, 5000W(1ms), Bidirectional	TO-263	68ao	-	10a	Eic
512CA	S5KP12CA	TVS	Vbr=13.3..14.7V, Vrw=12V, 251A, 5000W(1ms), Bidirectional	TO-263	68ao	-	10a	Eic



SMD code	Type	Function	Short description	Case	Pinout Sch.	St.	Mnf.
513	S5KP13	TVS	Vbr=14.4..17.6V, Vrwm=13V, 210A, 5000W(1ms)	TO-263	68ap	-	10a Eic
513A	S5KP13A	TVS	Vbr=14.4..15.9V, Vrwm=13V, 232A, 5000W(1ms)	TO-263	68ap	-	10a Eic
513C	S5KP13C	TVS	Vbr=14.4..17.6V, Vrwm=13V, 210A, 5000W(1ms), Bidirectional	TO-263	68ao	-	10a Eic
513CA	S5KP13CA	TVS	Vbr=14.4..15.9V, Vrwm=13V, 232A, 5000W(1ms), Bidirectional	TO-263	68ao	-	10a Eic
514	S5KP14	TVS	Vbr=15.6..19.1V, Vrwm=14V, 194A, 5000W(1ms)	TO-263	68ap	-	10a Eic
514A	S5KP14A	TVS	Vbr=15.6..17.2V, Vrwm=14V, 215A, 5000W(1ms)	TO-263	68ap	-	10a Eic
514C	S5KP14C	TVS	Vbr=15.6..19.1V, Vrwm=14V, 194A, 5000W(1ms), Bidirectional	TO-263	68ao	-	10a Eic
514CA	S5KP14CA	TVS	Vbr=15.6..17.2V, Vrwm=14V, 215A, 5000W(1ms), Bidirectional	TO-263	68ao	-	10a Eic
515	S5KP15	TVS	Vbr=16.7..20.4V, Vrwm=15V, 188A, 5000W(1ms)	TO-263	68ap	-	10a Eic
5150	S5KP150	TVS	Vbr=16.7..20.4V, Vrwm=150V, 19A, 5000W(1ms)	TO-263	68ap	-	10a Eic
5150A	S5KP150A	TVS	Vbr=16.7..18.4V, Vrwm=150V, 21A, 5000W(1ms)	TO-263	68ap	-	10a Eic
5150C	S5KP150C	TVS	Vbr=16.7..20.4V, Vrwm=150V, 19A, 5000W(1ms), Bidirectional	TO-263	68ao	-	10a Eic
5150CA	S5KP150CA	TVS	Vbr=16.7..18.4V, Vrwm=150V, 21A, 5000W(1ms), Bidirectional	TO-263	68ao	-	10a Eic
515A	S5KP15A	TVS	Vbr=16.7..18.5V, Vrwm=15V, 206A, 5000W(1ms)	TO-263	68ap	-	10a Eic
515C	S5KP15C	TVS	Vbr=16.7..20.4V, Vrwm=15V, 188A, 5000W(1ms), Bidirectional	TO-263	68ao	-	10a Eic
515CA	S5KP15CA	TVS	Vbr=16.7..18.5V, Vrwm=15V, 206A, 5000W(1ms), Bidirectional	TO-263	68ao	-	10a Eic
516	S5KP16	TVS	Vbr=17.8..21.8V, Vrwm=16V, 176A, 5000W(1ms)	TO-263	68ap	-	10a Eic
5160	S5KP160	TVS	Vbr=17.8..21.7V, Vrwm=160V, 18A, 5000W(1ms)	TO-263	68ap	-	10a Eic
5160A	S5KP160A	TVS	Vbr=17.8..19.6V, Vrwm=160V, 19A, 5000W(1ms)	TO-263	68ap	-	10a Eic
5160C	S5KP160C	TVS	Vbr=17.8..21.7V, Vrwm=160V, 18A, 5000W(1ms), Bidirectional	TO-263	68ao	-	10a Eic
5160CA	S5KP160CA	TVS	Vbr=17.8..19.6V, Vrwm=160V, 19A, 5000W(1ms), Bidirectional	TO-263	68ao	-	10a Eic
516A	S5KP16A	TVS	Vbr=17.8..19.7V, Vrwm=16V, 192A, 5000W(1ms)	TO-263	68ap	-	10a Eic
516C	S5KP16C	TVS	Vbr=17.8..21.8V, Vrwm=16V, 176A, 5000W(1ms), Bidirectional	TO-263	68ao	-	10a Eic
516CA	S5KP16CA	TVS	Vbr=17.8..19.7V, Vrwm=16V, 192A, 5000W(1ms), Bidirectional	TO-263	68ao	-	10a Eic
517	S5KP17	TVS	Vbr=18.9..23.1V, Vrwm=17V, 164A, 5000W(1ms)	TO-263	68ap	-	10a Eic
5170	S5KP170	TVS	Vbr=18.9..23.1V, Vrwm=170V, 17A, 5000W(1ms)	TO-263	68ap	-	10a Eic
5170A	S5KP170A	TVS	Vbr=18.9..20.9V, Vrwm=170V, 18A, 5000W(1ms)	TO-263	68ap	-	10a Eic
5170C	S5KP170C	TVS	Vbr=18.9..23.1V, Vrwm=17V, 17A, 5000W(1ms), Bidirectional	TO-263	68ao	-	10a Eic
5170CA	S5KP170CA	TVS	Vbr=18.9..20.9V, Vrwm=17V, 18A, 5000W(1ms), Bidirectional	TO-263	68ao	-	10a Eic
517A	S5KP17A	TVS	Vbr=18.9..20.9V, Vrwm=17V, 181A, 5000W(1ms)	TO-263	68ap	-	10a Eic
517C	S5KP17C	TVS	Vbr=18.9..23.1V, Vrwm=17V, 164A, 5000W(1ms), Bidirectional	TO-263	68ao	-	10a Eic
517CA	S5KP17CA	TVS	Vbr=18.9..20.9V, Vrwm=17V, 181A, 5000W(1ms), Bidirectional	TO-263	68ao	-	10a Eic
518	S5KP18	TVS	Vbr=20.0..24.4V, Vrwm=18V, 155A, 5000W(1ms)	TO-263	68ap	-	10a Eic
5180	S5KP180	TVS	Vbr=20.0..24.4V, Vrwm=180V, 16A, 5000W(1ms)	TO-263	68ap	-	10a Eic
5180A	S5KP180A	TVS	Vbr=20.0..22.1V, Vrwm=180V, 17A, 5000W(1ms)	TO-263	68ap	-	10a Eic
5180C	S5KP180C	TVS	Vbr=20.0..24.4V, Vrwm=18V, 16A, 5000W(1ms), Bidirectional	TO-263	68ao	-	10a Eic
5180CA	S5KP180CA	TVS	Vbr=20.0..22.1V, Vrwm=18V, 17A, 5000W(1ms), Bidirectional	TO-263	68ao	-	10a Eic
518A	S5KP18A	TVS	Vbr=20.0..22.1V, Vrwm=18V, 172A, 5000W(1ms)	TO-263	68ap	-	10a Eic
518C	S5KP18C	TVS	Vbr=20.0..24.4V, Vrwm=18V, 155A, 5000W(1ms), Bidirectional	TO-263	68ao	-	10a Eic
518CA	S5KP18CA	TVS	Vbr=20.0..22.1V, Vrwm=18V, 172A, 5000W(1ms), Bidirectional	TO-263	68ao	-	10a Eic
520	S5KP20	TVS	Vbr=22.2..27.1V, Vrwm=20V, 139A, 5000W(1ms)	TO-263	68ap	-	10a Eic
520A	S5KP20A	TVS	Vbr=22.2..24.5V, Vrwm=20V, 154A, 5000W(1ms)	TO-263	68ap	-	10a Eic
520C	S5KP20C	TVS	Vbr=22.2..27.1V, Vrwm=20V, 139A, 5000W(1ms), Bidirectional	TO-263	68ao	-	10a Eic
520CA	S5KP20CA	TVS	Vbr=22.2..24.5V, Vrwm=20V, 154A, 5000W(1ms), Bidirectional	TO-263	68ao	-	10a Eic
522	S5KP22	TVS	Vbr=24.4..29.8V, Vrwm=22V, 127A, 5000W(1ms)	TO-263	68ap	-	10a Eic
522A	S5KP22A	TVS	Vbr=24.4..26.9V, Vrwm=22V, 141A, 5000W(1ms)	TO-263	68ap	-	10a Eic
522C	S5KP22C	TVS	Vbr=24.4..29.8V, Vrwm=22V, 127A, 5000W(1ms), Bidirectional	TO-263	68ao	-	10a Eic
522CA	S5KP22CA	TVS	Vbr=24.4..26.9V, Vrwm=22V, 141A, 5000W(1ms), Bidirectional	TO-263	68ao	-	10a Eic
524	S5KP24	TVS	Vbr=26.7..32.6V, Vrwm=24V, 116A, 5000W(1ms)	TO-263	68ap	-	10a Eic
524A	S5KP24A	TVS	Vbr=26.7..29.5V, Vrwm=24V, 128A, 5000W(1ms)	TO-263	68ap	-	10a Eic
524C	S5KP24C	TVS	Vbr=26.7..32.6V, Vrwm=24V, 116A, 5000W(1ms), Bidirectional	TO-263	68ao	-	10a Eic
524CA	S5KP24CA	TVS	Vbr=26.7..29.5V, Vrwm=24V, 128A, 5000W(1ms), Bidirectional	TO-263	68ao	-	10a Eic
526	S5KP26	TVS	Vbr=28.9..35.3V, Vrwm=26V, 107A, 5000W(1ms)	TO-263	68ap	-	10a Eic
526A	S5KP26A	TVS	Vbr=28.9..31.9V, Vrwm=26V, 119A, 5000W(1ms)	TO-263	68ap	-	10a Eic
526C	S5KP26C	TVS	Vbr=28.9..35.3V, Vrwm=26V, 107A, 5000W(1ms), Bidirectional	TO-263	68ao	-	10a Eic
526CA	S5KP26CA	TVS	Vbr=28.9..31.9V, Vrwm=26V, 119A, 5000W(1ms), Bidirectional	TO-263	68ao	-	10a Eic
528	S5KP28	TVS	Vbr=31.1..38.0V, Vrwm=28V, 99A, 5000W(1ms)	TO-263	68ap	-	10a Eic
528A	S5KP28A	TVS	Vbr=31.1..34.4V, Vrwm=28V, 110A, 5000W(1ms)	TO-263	68ap	-	10a Eic
528C	S5KP28C	TVS	Vbr=31.1..38.0V, Vrwm=28V, 99A, 5000W(1ms), Bidirectional	TO-263	68ao	-	10a Eic
528CA	S5KP28CA	TVS	Vbr=31.1..34.4V, Vrwm=28V, 110A, 5000W(1ms), Bidirectional	TO-263	68ao	-	10a Eic
530	S5KP30	TVS	Vbr=33.3..40.7V, Vrwm=30V, 93A, 5000W(1ms)	TO-263	68ap	-	10a Eic
530A	S5KP30A	TVS	Vbr=33.3..36.8V, Vrwm=30V, 103A, 5000W(1ms)	TO-263	68ap	-	10a Eic
530C	S5KP30C	TVS	Vbr=33.3..40.7V, Vrwm=30V, 93A, 5000W(1ms), Bidirectional	TO-263	68ao	-	10a Eic
530CA	S5KP30CA	TVS	Vbr=33.3..36.8V, Vrwm=30V, 103A, 5000W(1ms), Bidirectional	TO-263	68ao	-	10a Eic
533	S5KP33	TVS	Vbr=36.7..44.9V, Vrwm=33V, 85A, 5000W(1ms)	TO-263	68ap	-	10a Eic
533A	S5KP33A	TVS	Vbr=36.7..40.6V, Vrwm=33V, 94A, 5000W(1ms)	TO-263	68ap	-	10a Eic
533C	S5KP33C	TVS	Vbr=36.7..44.9V, Vrwm=33V, 85A, 5000W(1ms), Bidirectional	TO-263	68ao	-	10a Eic
533CA	S5KP33CA	TVS	Vbr=36.7..40.6V, Vrwm=33V, 94A, 5000W(1ms), Bidirectional	TO-263	68ao	-	10a Eic
536	S5KP36	TVS	Vbr=40.0..48.9V, Vrwm=36V, 78A, 5000W(1ms)	TO-263	68ap	-	10a Eic
536A	S5KP36A	TVS	Vbr=40.0..44.2V, Vrwm=36V, 86A, 5000W(1ms)	TO-263	68ap	-	10a Eic



SMD code	Type	Function	Short description	Case	Pinout Sch.	St.	Mnf.
536C	S5KP36C	TVS	Vbr=40.0.48.9V, Vrwm=36V, 78A, 5000W(1ms), Bidirectional	TO-263	68ao	-	10a Eic
536CA	S5KP36CA	TVS	Vbr=40.0.44.2V, Vrwm=36V, 86A, 5000W(1ms), Bidirectional	TO-263	68ao	-	10a Eic
540	S5KP40	TVS	Vbr=44.4.54.3V, Vrwm=40V, 70A, 5000W(1ms)	TO-263	68ap	-	10a Eic
540A	S5KP40A	TVS	Vbr=44.4.49.1V, Vrwm=40V, 78A, 5000W(1ms)	TO-263	68ap	-	10a Eic
540C	S5KP40C	TVS	Vbr=44.4.54.3V, Vrwm=40V, 70A, 5000W(1ms), Bidirectional	TO-263	68ao	-	10a Eic
540CA	S5KP40CA	TVS	Vbr=44.4.49.1V, Vrwm=40V, 78A, 5000W(1ms), Bidirectional	TO-263	68ao	-	10a Eic
543	S5KP43	TVS	Vbr=47.8.58.4V, Vrwm=43V, 65A, 5000W(1ms)	TO-263	68ap	-	10a Eic
543A	S5KP43A	TVS	Vbr=47.8.52.8V, Vrwm=43V, 72A, 5000W(1ms)	TO-263	68ap	-	10a Eic
543C	S5KP43C	TVS	Vbr=47.8.58.4V, Vrwm=43V, 65A, 5000W(1ms), Bidirectional	TO-263	68ao	-	10a Eic
543CA	S5KP43CA	TVS	Vbr=47.8.52.8V, Vrwm=43V, 72A, 5000W(1ms), Bidirectional	TO-263	68ao	-	10a Eic
545	S5KP45	TVS	Vbr=50.0.61.1V, Vrwm=45V, 62A, 5000W(1ms)	TO-263	68ap	-	10a Eic
545A	S5KP45A	TVS	Vbr=50.0.55.3V, Vrwm=45V, 69A, 5000W(1ms)	TO-263	68ap	-	10a Eic
545C	S5KP45C	TVS	Vbr=50.0.61.1V, Vrwm=45V, 62A, 5000W(1ms), Bidirectional	TO-263	68ao	-	10a Eic
545CA	S5KP45CA	TVS	Vbr=50.0.55.3V, Vrwm=45V, 69A, 5000W(1ms), Bidirectional	TO-263	68ao	-	10a Eic
548	S5KP48	TVS	Vbr=53.3.65.2V, Vrwm=48V, 58A, 5000W(1ms)	TO-263	68ap	-	10a Eic
548A	S5KP48A	TVS	Vbr=53.3.58.9V, Vrwm=48V, 65A, 5000W(1ms)	TO-263	68ap	-	10a Eic
548C	S5KP48C	TVS	Vbr=53.3.65.2V, Vrwm=48V, 58A, 5000W(1ms), Bidirectional	TO-263	68ao	-	10a Eic
548CA	S5KP48CA	TVS	Vbr=53.3.58.9V, Vrwm=48V, 65A, 5000W(1ms), Bidirectional	TO-263	68ao	-	10a Eic
55.0	S5KP5.0	TVS	Vbr=6.40.7.30V, Vrwm=5.0V, 520A, 5000W(1ms)	TO-263	68ap	-	10a Eic
55.0A	S5KP5.0A	TVS	Vbr=6.40.7.00V, Vrwm=5.0V, 543A, 5000W(1ms)	TO-263	68ap	-	10a Eic
55.0C	S5KP5.0C	TVS	Vbr=6.40.7.30V, Vrwm=5.0V, 520A, 5000W(1ms), Bidirectional	TO-263	68ao	-	10a Eic
55.0CA	S5KP5.0CA	TVS	Vbr=6.40.7.00V, Vrwm=5.0V, 543A, 5000W(1ms), Bidirectional	TO-263	68ao	-	10a Eic
551	S5KP51	TVS	Vbr=56.7.69.3V, Vrwm=51V, 55A, 5000W(1ms)	TO-263	68ap	-	10a Eic
551A	S5KP51A	TVS	Vbr=56.7.62.7V, Vrwm=51V, 61A, 5000W(1ms)	TO-263	68ap	-	10a Eic
551C	S5KP51C	TVS	Vbr=56.7.69.3V, Vrwm=51V, 55A, 5000W(1ms), Bidirectional	TO-263	68ao	-	10a Eic
551CA	S5KP51CA	TVS	Vbr=56.7.62.7V, Vrwm=51V, 61A, 5000W(1ms), Bidirectional	TO-263	68ao	-	10a Eic
554	S5KP54	TVS	Vbr=60.0.73.3V, Vrwm=54V, 52A, 5000W(1ms)	TO-263	68ap	-	10a Eic
554A	S5KP54A	TVS	Vbr=60.0.66.3V, Vrwm=54V, 57A, 5000W(1ms)	TO-263	68ap	-	10a Eic
554C	S5KP54C	TVS	Vbr=60.0.73.3V, Vrwm=54V, 52A, 5000W(1ms), Bidirectional	TO-263	68ao	-	10a Eic
554CA	S5KP54CA	TVS	Vbr=60.0.66.3V, Vrwm=54V, 57A, 5000W(1ms), Bidirectional	TO-263	68ao	-	10a Eic
556	S5KP56	TVS	Vbr=62.2.76.1V, Vrwm=56V, 50A, 5000W(1ms)	TO-263	68ap	-	10a Eic
556A	S5KP56A	TVS	Vbr=62.2.68.8V, Vrwm=56V, 55A, 5000W(1ms)	TO-263	68ap	-	10a Eic
556C	S5KP56C	TVS	Vbr=62.2.76.1V, Vrwm=56V, 50A, 5000W(1ms), Bidirectional	TO-263	68ao	-	10a Eic
556CA	S5KP56CA	TVS	Vbr=62.2.68.8V, Vrwm=56V, 55A, 5000W(1ms), Bidirectional	TO-263	68ao	-	10a Eic
558	S5KP58	TVS	Vbr=64.4.78.7V, Vrwm=58V, 49A, 5000W(1ms)	TO-263	68ap	-	10a Eic
558A	S5KP58A	TVS	Vbr=64.4.71.2V, Vrwm=58V, 53A, 5000W(1ms)	TO-263	68ap	-	10a Eic
558C	S5KP58C	TVS	Vbr=64.4.78.7V, Vrwm=58V, 49A, 5000W(1ms), Bidirectional	TO-263	68ao	-	10a Eic
558CA	S5KP58CA	TVS	Vbr=64.4.71.2V, Vrwm=58V, 53A, 5000W(1ms), Bidirectional	TO-263	68ao	-	10a Eic
56.0	S5KP6.0	TVS	Vbr=6.67.8.15V, Vrwm=6.0V, 439A, 5000W(1ms)	TO-263	68ap	-	10a Eic
56.0A	S5KP6.0A	TVS	Vbr=6.67.7.37V, Vrwm=6.0V, 485A, 5000W(1ms)	TO-263	68ap	-	10a Eic
56.0C	S5KP6.0C	TVS	Vbr=6.67.8.15V, Vrwm=6.0V, 439A, 5000W(1ms), Bidirectional	TO-263	68ao	-	10a Eic
56.0CA	S5KP6.0CA	TVS	Vbr=6.67.7.37V, Vrwm=6.0V, 485A, 5000W(1ms), Bidirectional	TO-263	68ao	-	10a Eic
56.5	S5KP6.5	TVS	Vbr=7.22.8.82V, Vrwm=6.5V, 407A, 5000W(1ms)	TO-263	68ap	-	10a Eic
56.5A	S5KP6.5A	TVS	Vbr=7.22.7.98V, Vrwm=6.5V, 447A, 5000W(1ms)	TO-263	68ap	-	10a Eic
56.5C	S5KP6.5C	TVS	Vbr=7.22.8.82V, Vrwm=6.5V, 407A, 5000W(1ms), Bidirectional	TO-263	68ao	-	10a Eic
56.5CA	S5KP6.5CA	TVS	Vbr=7.22.7.98V, Vrwm=6.5V, 447A, 5000W(1ms), Bidirectional	TO-263	68ao	-	10a Eic
560	S5KP60	TVS	Vbr=66.7.81.5V, Vrwm=60V, 47A, 5000W(1ms)	TO-263	68ap	-	10a Eic
560A	S5KP60A	TVS	Vbr=66.7.73.7V, Vrwm=60V, 52A, 5000W(1ms)	TO-263	68ap	-	10a Eic
560C	S5KP60C	TVS	Vbr=66.7.81.5V, Vrwm=60V, 47A, 5000W(1ms), Bidirectional	TO-263	68ao	-	10a Eic
560CA	S5KP60CA	TVS	Vbr=66.7.73.7V, Vrwm=60V, 52A, 5000W(1ms), Bidirectional	TO-263	68ao	-	10a Eic
564	S5KP64	TVS	Vbr=71.1.96.9V, Vrwm=64V, 44A, 5000W(1ms)	TO-263	68ap	-	10a Eic
564A	S5KP64A	TVS	Vbr=71.1.78.6V, Vrwm=64V, 49A, 5000W(1ms)	TO-263	68ap	-	10a Eic
564C	S5KP64C	TVS	Vbr=71.1.96.9V, Vrwm=64V, 44A, 5000W(1ms), Bidirectional	TO-263	68ao	-	10a Eic
564CA	S5KP64CA	TVS	Vbr=71.1.78.6V, Vrwm=64V, 49A, 5000W(1ms), Bidirectional	TO-263	68ao	-	10a Eic
57.0	S5KP7.0	TVS	Vbr=7.78.9.51V, Vrwm=7.0V, 378A, 5000W(1ms)	TO-263	68ap	-	10a Eic
57.0A	S5KP7.0A	TVS	Vbr=7.78.8.60V, Vrwm=7.0V, 417A, 5000W(1ms)	TO-263	68ap	-	10a Eic
57.0C	S5KP7.0C	TVS	Vbr=7.78.9.51V, Vrwm=7.0V, 378A, 5000W(1ms), Bidirectional	TO-263	68ao	-	10a Eic
57.0CA	S5KP7.0CA	TVS	Vbr=7.78.8.60V, Vrwm=7.0V, 417A, 5000W(1ms), Bidirectional	TO-263	68ao	-	10a Eic
57.5	S5KP7.5	TVS	Vbr=8.33.10.2V, Vrwm=7.5V, 350A, 5000W(1ms)	TO-263	68ap	-	10a Eic
57.5A	S5KP7.5A	TVS	Vbr=8.33.9.21V, Vrwm=7.5V, 388A, 5000W(1ms)	TO-263	68ap	-	10a Eic
57.5C	S5KP7.5C	TVS	Vbr=8.33.10.2V, Vrwm=7.5V, 350A, 5000W(1ms), Bidirectional	TO-263	68ao	-	10a Eic
57.5CA	S5KP7.5CA	TVS	Vbr=8.33.9.21V, Vrwm=7.5V, 388A, 5000W(1ms), Bidirectional	TO-263	68ao	-	10a Eic
570	S5KP70	TVS	Vbr=77.6.95.1V, Vrwm=70V, 40A, 5000W(1ms)	TO-263	68ap	-	10a Eic
570A	S5KP70A	TVS	Vbr=77.6.86.0V, Vrwm=70V, 44A, 5000W(1ms)	TO-263	68ap	-	10a Eic
570C	S5KP70C	TVS	Vbr=77.6.95.1V, Vrwm=70V, 40A, 5000W(1ms), Bidirectional	TO-263	68ao	-	10a Eic
570CA	S5KP70CA	TVS	Vbr=77.6.86.0V, Vrwm=70V, 44A, 5000W(1ms), Bidirectional	TO-263	68ao	-	10a Eic
575	S5KP75	TVS	Vbr=83.3.102V, Vrwm=75V, 37A, 5000W(1ms)	TO-263	68ap	-	10a Eic
575A	S5KP75A	TVS	Vbr=83.3.92.1V, Vrwm=75V, 41A, 5000W(1ms)	TO-263	68ap	-	10a Eic
575C	S5KP75C	TVS	Vbr=83.3.102V, Vrwm=75V, 37A, 5000W(1ms), Bidirectional	TO-263	68ao	-	10a Eic
575CA	S5KP75CA	TVS	Vbr=83.3.92.1V, Vrwm=75V, 41A, 5000W(1ms), Bidirectional	TO-263	68ao	-	10a Eic



SMD code	Type	Function	Short description	Case	Pinout Sch.	St.	Mnf.
578	S5KP78	TVS	Vbr=86.7..106V, Vrwm=78V, 36A, 5000W(1ms)	TO-263	68ap -	10a	Eic
578A	S5KP78A	TVS	Vbr=86.7..95.8V, Vrwm=78V, 40A, 5000W(1ms)	TO-263	68ap -	10a	Eic
578C	S5KP78C	TVS	Vbr=86.7..106V, Vrwm=78V, 36A, 5000W(1ms), Bidirectional	TO-263	68ao -	10a	Eic
578CA	S5KP78CA	TVS	Vbr=86.7..95.8V, Vrwm=78V, 40A, 5000W(1ms), Bidirectional	TO-263	68ao -	10a	Eic
58.0	S5KP8.0	TVS	Vbr=8.89..10.9V, Vrwm=8.0V, 333A, 5000W(1ms)	TO-263	68ap -	10a	Eic
58.0A	S5KP8.0A	TVS	Vbr=8.89..9.83V, Vrwm=8.0V, 367A, 5000W(1ms)	TO-263	68ap -	10a	Eic
58.0C	S5KP8.0C	TVS	Vbr=8.89..10.9V, Vrwm=8.0V, 333A, 5000W(1ms), Bidirectional	TO-263	68ao -	10a	Eic
58.0CA	S5KP8.0CA	TVS	Vbr=8.89..9.83V, Vrwm=8.0V, 367A, 5000W(1ms), Bidirectional	TO-263	68ao -	10a	Eic
58.5	S5KP8.5	TVS	Vbr=9.44..11.5V, Vrwm=8.5V, 314A, 5000W(1ms)	TO-263	68ap -	10a	Eic
58.5A	S5KP8.5A	TVS	Vbr=9.44..10.4V, Vrwm=8.5V, 347A, 5000W(1ms)	TO-263	68ap -	10a	Eic
58.5C	S5KP8.5C	TVS	Vbr=9.44..11.5V, Vrwm=8.5V, 314A, 5000W(1ms), Bidirectional	TO-263	68ao -	10a	Eic
58.5CA	S5KP8.5CA	TVS	Vbr=9.44..10.4V, Vrwm=8.5V, 347A, 5000W(1ms), Bidirectional	TO-263	68ao -	10a	Eic
585	S5KP85	TVS	Vbr=94.4..115V, Vrwm=85V, 33A, 5000W(1ms)	TO-263	68ap -	10a	Eic
585A	S5KP85A	TVS	Vbr=94.4..104V, Vrwm=85V, 36A, 5000W(1ms)	TO-263	68ap -	10a	Eic
585C	S5KP85C	TVS	Vbr=94.4..115V, Vrwm=85V, 33A, 5000W(1ms), Bidirectional	TO-263	68ao -	10a	Eic
585CA	S5KP85CA	TVS	Vbr=94.4..104V, Vrwm=85V, 36A, 5000W(1ms), Bidirectional	TO-263	68ao -	10a	Eic
59.0	S5KP9.0	TVS	Vbr=10.0..12.2V, Vrwm=9.0V, 295A, 5000W(1ms)	TO-263	68ap -	10a	Eic
59.0A	S5KP9.0A	TVS	Vbr=10.0..11.1V, Vrwm=9.0V, 325A, 5000W(1ms)	TO-263	68ap -	10a	Eic
59.0C	S5KP9.0C	TVS	Vbr=10.0..12.2V, Vrwm=9.0V, 295A, 5000W(1ms), Bidirectional	TO-263	68ao -	10a	Eic
59.0CA	S5KP9.0CA	TVS	Vbr=10.0..11.1V, Vrwm=9.0V, 325A, 5000W(1ms), Bidirectional	TO-263	68ao -	10a	Eic
590	S5KP90	TVS	Vbr=100..122V, Vrwm=90V, 31A, 5000W(1ms)	TO-263	68ap -	10a	Eic
590A	S5KP90A	TVS	Vbr=100..111V, Vrwm=90V, 34A, 5000W(1ms)	TO-263	68ap -	10a	Eic
590C	S5KP90C	TVS	Vbr=100..122V, Vrwm=90V, 31A, 5000W(1ms), Bidirectional	TO-263	68ao -	10a	Eic
590CA	S5KP90CA	TVS	Vbr=100..111V, Vrwm=90V, 34A, 5000W(1ms), Bidirectional	TO-263	68ao -	10a	Eic
71J181C	R1171J181C	LVR-IC	LDO, 1.8V±2%, 2A, -CE	TO-252-5	69x1 VR4	10d	Ric
71J181C5	R1171J181C5	LVR-IC	LDO, 1.8V±2%, 2A, -CE	TO-252-5	69x1 VR4	10d	Ric
71J181D	R1171J181D	LVR-IC	LDO, 1.8V±2%, 2A, +CE	TO-252-5	69x1 VR4	10d	Ric
71J181D5	R1171J181D5	LVR-IC	LDO, 1.85V±2%, 2A, +CE	TO-252-5	69x1 VR4	10d	Ric
71J191C	R1171J191C	LVR-IC	LDO, 1.9V±2%, 2A, -CE	TO-252-5	69x1 VR4	10d	Ric
71J191D	R1171J191D	LVR-IC	LDO, 1.9V±2%, 2A, +CE	TO-252-5	69x1 VR4	10d	Ric
71J201C	R1171J201C	LVR-IC	LDO, 2.0V±2%, 2A, -CE	TO-252-5	69x1 VR4	10d	Ric
71J201D	R1171J201D	LVR-IC	LDO, 2.0V±2%, 2A, +CE	TO-252-5	69x1 VR4	10d	Ric
71J211C	R1171J211C	LVR-IC	LDO, 2.1V±2%, 2A, -CE	TO-252-5	69x1 VR4	10d	Ric
71J211D	R1171J211D	LVR-IC	LDO, 2.1V±2%, 2A, +CE	TO-252-5	69x1 VR4	10d	Ric
71J221C	R1171J221C	LVR-IC	LDO, 2.2V±2%, 2A, -CE	TO-252-5	69x1 VR4	10d	Ric
71J221D	R1171J221D	LVR-IC	LDO, 2.2V±2%, 2A, +CE	TO-252-5	69x1 VR4	10d	Ric
71J231C	R1171J231C	LVR-IC	LDO, 2.3V±2%, 2A, -CE	TO-252-5	69x1 VR4	10d	Ric
71J231D	R1171J231D	LVR-IC	LDO, 2.3V±2%, 2A, +CE	TO-252-5	69x1 VR4	10d	Ric
71J241C	R1171J241C	LVR-IC	LDO, 2.4V±2%, 2A, -CE	TO-252-5	69x1 VR4	10d	Ric
71J241D	R1171J241D	LVR-IC	LDO, 2.4V±2%, 2A, +CE	TO-252-5	69x1 VR4	10d	Ric
71J251C	R1171J251C	LVR-IC	LDO, 2.5V±2%, 2A, -CE	TO-252-5	69x1 VR4	10d	Ric
71J251D	R1171J251D	LVR-IC	LDO, 2.5V±2%, 2A, +CE	TO-252-5	69x1 VR4	10d	Ric
71J261C	R1171J261C	LVR-IC	LDO, 2.6V±2%, 2A, -CE	TO-252-5	69x1 VR4	10d	Ric
71J261D	R1171J261D	LVR-IC	LDO, 2.6V±2%, 2A, +CE	TO-252-5	69x1 VR4	10d	Ric
71J271C	R1171J271C	LVR-IC	LDO, 2.7V±2%, 2A, -CE	TO-252-5	69x1 VR4	10d	Ric
71J271D	R1171J271D	LVR-IC	LDO, 2.7V±2%, 2A, +CE	TO-252-5	69x1 VR4	10d	Ric
71J281C	R1171J281C	LVR-IC	LDO, 2.8V±2%, 2A, -CE	TO-252-5	69x1 VR4	10d	Ric
71J281C5	R1171J281C5	LVR-IC	LDO, 2.85V±2%, 2A, -CE	TO-252-5	69x1 VR4	10d	Ric
71J281D	R1171J281D	LVR-IC	LDO, 2.8V±2%, 2A, +CE	TO-252-5	69x1 VR4	10d	Ric
71J281D5	R1171J281D5	LVR-IC	LDO, 2.85V±2%, 2A, +CE	TO-252-5	69x1 VR4	10d	Ric
71J291C	R1171J291C	LVR-IC	LDO, 2.9V±2%, 2A, -CE	TO-252-5	69x1 VR4	10d	Ric
71J291D	R1171J291D	LVR-IC	LDO, 2.9V±2%, 2A, +CE	TO-252-5	69x1 VR4	10d	Ric
71J301C	R1171J301C	LVR-IC	LDO, 3.0V±2%, 2A, -CE	TO-252-5	69x1 VR4	10d	Ric
71J301D	R1171J301D	LVR-IC	LDO, 3.0V±2%, 2A, +CE	TO-252-5	69x1 VR4	10d	Ric
71J311C	R1171J311C	LVR-IC	LDO, 3.1V±2%, 2A, -CE	TO-252-5	69x1 VR4	10d	Ric
71J311D	R1171J311D	LVR-IC	LDO, 3.1V±2%, 2A, +CE	TO-252-5	69x1 VR4	10d	Ric
71J321C	R1171J321C	LVR-IC	LDO, 3.2V±2%, 2A, -CE	TO-252-5	69x1 VR4	10d	Ric
71J321D	R1171J321D	LVR-IC	LDO, 3.2V±2%, 2A, +CE	TO-252-5	69x1 VR4	10d	Ric
71J331C	R1171J331C	LVR-IC	LDO, 3.3V±2%, 2A, -CE	TO-252-5	69x1 VR4	10d	Ric
71J331D	R1171J331D	LVR-IC	LDO, 3.3V±2%, 2A, +CE	TO-252-5	69x1 VR4	10d	Ric
71J341C	R1171J341C	LVR-IC	LDO, 3.4V±2%, 2A, -CE	TO-252-5	69x1 VR4	10d	Ric
71J341D	R1171J341D	LVR-IC	LDO, 3.4V±2%, 2A, +CE	TO-252-5	69x1 VR4	10d	Ric
71J351C	R1171J351C	LVR-IC	LDO, 3.5V±2%, 2A, -CE	TO-252-5	69x1 VR4	10d	Ric
71J351D	R1171J351D	LVR-IC	LDO, 3.5V±2%, 2A, +CE	TO-252-5	69x1 VR4	10d	Ric
71J361C	R1171J361C	LVR-IC	LDO, 3.6V±2%, 2A, -CE	TO-252-5	69x1 VR4	10d	Ric
71J361D	R1171J361D	LVR-IC	LDO, 3.6V±2%, 2A, +CE	TO-252-5	69x1 VR4	10d	Ric
71J371C	R1171J371C	LVR-IC	LDO, 3.7V±2%, 2A, -CE	TO-252-5	69x1 VR4	10d	Ric
71J371D	R1171J371D	LVR-IC	LDO, 3.7V±2%, 2A, +CE	TO-252-5	69x1 VR4	10d	Ric
71J381C	R1171J381C	LVR-IC	LDO, 3.8V±2%, 2A, -CE	TO-252-5	69x1 VR4	10d	Ric
71J381D	R1171J381D	LVR-IC	LDO, 3.8V±2%, 2A, +CE	TO-252-5	69x1 VR4	10d	Ric



SMD code	Type	Function	Short description	Case	Pinout Sch.	St.	Mnf.
71J391C	R1171J391C	LVR-IC	LDO, 3.9V±2%, 2A, -CE	TO-252-5	69x1 VR4	10d	Ric
71J391D	R1171J391D	LVR-IC	LDO, 3.9V±2%, 2A, +CE	TO-252-5	69x1 VR4	10d	Ric
71J401C	R1171J401C	LVR-IC	LDO, 4.0V±2%, 2A, -CE	TO-252-5	69x1 VR4	10d	Ric
71J401D	R1171J401D	LVR-IC	LDO, 4.0V±2%, 2A, +CE	TO-252-5	69x1 VR4	10d	Ric
71J411C	R1171J411C	LVR-IC	LDO, 4.1V±2%, 2A, -CE	TO-252-5	69x1 VR4	10d	Ric
71J411D	R1171J411D	LVR-IC	LDO, 4.1V±2%, 2A, +CE	TO-252-5	69x1 VR4	10d	Ric
71J421C	R1171J421C	LVR-IC	LDO, 4.2V±2%, 2A, -CE	TO-252-5	69x1 VR4	10d	Ric
71J421D	R1171J421D	LVR-IC	LDO, 4.2V±2%, 2A, +CE	TO-252-5	69x1 VR4	10d	Ric
71J431C	R1171J431C	LVR-IC	LDO, 4.3V±2%, 2A, -CE	TO-252-5	69x1 VR4	10d	Ric
71J431D	R1171J431D	LVR-IC	LDO, 4.3V±2%, 2A, +CE	TO-252-5	69x1 VR4	10d	Ric
71J441C	R1171J441C	LVR-IC	LDO, 4.4V±2%, 2A, -CE	TO-252-5	69x1 VR4	10d	Ric
71J441D	R1171J441D	LVR-IC	LDO, 4.4V±2%, 2A, +CE	TO-252-5	69x1 VR4	10d	Ric
71J451C	R1171J451C	LVR-IC	LDO, 4.5V±2%, 2A, -CE	TO-252-5	69x1 VR4	10d	Ric
71J451D	R1171J451D	LVR-IC	LDO, 4.5V±2%, 2A, +CE	TO-252-5	69x1 VR4	10d	Ric
71J461C	R1171J461C	LVR-IC	LDO, 4.6V±2%, 2A, -CE	TO-252-5	69x1 VR4	10d	Ric
71J461D	R1171J461D	LVR-IC	LDO, 4.6V±2%, 2A, +CE	TO-252-5	69x1 VR4	10d	Ric
71J471C	R1171J471C	LVR-IC	LDO, 4.7V±2%, 2A, -CE	TO-252-5	69x1 VR4	10d	Ric
71J471D	R1171J471D	LVR-IC	LDO, 4.7V±2%, 2A, +CE	TO-252-5	69x1 VR4	10d	Ric
71J481C	R1171J481C	LVR-IC	LDO, 4.8V±2%, 2A, -CE	TO-252-5	69x1 VR4	10d	Ric
71J481D	R1171J481D	LVR-IC	LDO, 4.8V±2%, 2A, +CE	TO-252-5	69x1 VR4	10d	Ric
71J491C	R1171J491C	LVR-IC	LDO, 4.9V±2%, 2A, -CE	TO-252-5	69x1 VR4	10d	Ric
71J491D	R1171J491D	LVR-IC	LDO, 4.9V±2%, 2A, +CE	TO-252-5	69x1 VR4	10d	Ric
71J501C	R1171J501C	LVR-IC	LDO, 5.0V±2%, 2A, -CE	TO-252-5	69x1 VR4	10d	Ric
71J501D	R1171J501D	LVR-IC	LDO, 5.0V±2%, 2A, +CE	TO-252-5	69x1 VR4	10d	Ric
772	CH772PT	Si-pnp	AF, Sw, 30V, 3A, B=100..500, 100MHz	DPAK	68Bb	-	10a Chm
84K	XC6701D18JR	LVR-IC	1.8V±2%, 150mA	TO-252	68eu VR1	10c	Tor
84L	XC6701D19JR	LVR-IC	1.9V±2%, 150mA	TO-252	68eu VR1	10c	Tor
84M	XC6701D20JR	LVR-IC	2.0V±2%, 150mA	TO-252	68eu VR1	10c	Tor
84N	XC6701D21JR	LVR-IC	2.1V±2%, 150mA	TO-252	68eu VR1	10c	Tor
84P	XC6701D22JR	LVR-IC	2.2V±2%, 150mA	TO-252	68eu VR1	10c	Tor
84R	XC6701D23JR	LVR-IC	2.3V±2%, 150mA	TO-252	68eu VR1	10c	Tor
84S	XC6701D24JR	LVR-IC	2.4V±2%, 150mA	TO-252	68eu VR1	10c	Tor
84T	XC6701D25JR	LVR-IC	2.5V±2%, 150mA	TO-252	68eu VR1	10c	Tor
84U	XC6701D26JR	LVR-IC	2.6V±2%, 150mA	TO-252	68eu VR1	10c	Tor
84V	XC6701D27JR	LVR-IC	2.7V±2%, 150mA	TO-252	68eu VR1	10c	Tor
84X	XC6701D28JR	LVR-IC	2.8V±2%, 150mA	TO-252	68eu VR1	10c	Tor
84Y	XC6701D29JR	LVR-IC	2.9V±2%, 150mA	TO-252	68eu VR1	10c	Tor
84Z	XC6701D30JR	LVR-IC	3.0V±2%, 150mA	TO-252	68eu VR1	10c	Tor
850	XC6701D31JR	LVR-IC	3.1V±2%, 150mA	TO-252	68eu VR1	10c	Tor
851	XC6701D32JR	LVR-IC	3.2V±2%, 150mA	TO-252	68eu VR1	10c	Tor
852	XC6701D33JR	LVR-IC	3.3V±2%, 150mA	TO-252	68eu VR1	10c	Tor
853	XC6701D34JR	LVR-IC	3.4V±2%, 150mA	TO-252	68eu VR1	10c	Tor
854	XC6701D35JR	LVR-IC	3.5V±2%, 150mA	TO-252	68eu VR1	10c	Tor
855	XC6701D36JR	LVR-IC	3.6V±2%, 150mA	TO-252	68eu VR1	10c	Tor
856	XC6701D37JR	LVR-IC	3.7V±2%, 150mA	TO-252	68eu VR1	10c	Tor
857	XC6701D38JR	LVR-IC	3.8V±2%, 150mA	TO-252	68eu VR1	10c	Tor
858	XC6701D39JR	LVR-IC	3.9V±2%, 150mA	TO-252	68eu VR1	10c	Tor
859	XC6701D40JR	LVR-IC	4.0V±2%, 150mA	TO-252	68eu VR1	10c	Tor
85A	XC6701D41JR	LVR-IC	4.1V±2%, 150mA	TO-252	68eu VR1	10c	Tor
85B	XC6701D42JR	LVR-IC	4.2V±2%, 150mA	TO-252	68eu VR1	10c	Tor
85C	XC6701D43JR	LVR-IC	4.3V±2%, 150mA	TO-252	68eu VR1	10c	Tor
85C	XC6701D58JR	LVR-IC	5.8V±2%, 150mA	TO-252	68eu VR1	10c	Tor
85D	XC6701D44JR	LVR-IC	4.4V±2%, 150mA	TO-252	68eu VR1	10c	Tor
85E	XC6701D45JR	LVR-IC	4.5V±2%, 150mA	TO-252	68eu VR1	10c	Tor
85F	XC6701D46JR	LVR-IC	4.6V±2%, 150mA	TO-252	68eu VR1	10c	Tor
85H	XC6701D47JR	LVR-IC	4.7V±2%, 150mA	TO-252	68eu VR1	10c	Tor
85K	XC6701D48JR	LVR-IC	4.8V±2%, 150mA	TO-252	68eu VR1	10c	Tor
85L	XC6701D49JR	LVR-IC	4.9V±2%, 150mA	TO-252	68eu VR1	10c	Tor
85M	XC6701D50JR	LVR-IC	5.0V±2%, 150mA	TO-252	68eu VR1	10c	Tor
85N	XC6701D51JR	LVR-IC	5.1V±2%, 150mA	TO-252	68eu VR1	10c	Tor
85P	XC6701D52JR	LVR-IC	5.2V±2%, 150mA	TO-252	68eu VR1	10c	Tor
85R	XC6701D53JR	LVR-IC	5.3V±2%, 150mA	TO-252	68eu VR1	10c	Tor
85S	XC6701D54JR	LVR-IC	5.4V±2%, 150mA	TO-252	68eu VR1	10c	Tor
85T	XC6701D55JR	LVR-IC	5.5V±2%, 150mA	TO-252	68eu VR1	10c	Tor
85U	XC6701D56JR	LVR-IC	5.6V±2%, 150mA	TO-252	68eu VR1	10c	Tor
85V	XC6701D57JR	LVR-IC	5.7V±2%, 150mA	TO-252	68eu VR1	10c	Tor
85Y	XC6701D59JR	LVR-IC	5.9V±2%, 150mA	TO-252	68eu VR1	10c	Tor
85Z	XC6701D60JR	LVR-IC	6.0V±2%, 150mA	TO-252	68eu VR1	10c	Tor
860	XC6701D61JR	LVR-IC	6.1V±2%, 150mA	TO-252	68eu VR1	10c	Tor
861	XC6701D62JR	LVR-IC	6.2V±2%, 150mA	TO-252	68eu VR1	10c	Tor



SMD code	Type	Function	Short description	Case	Pinout	Sch.	St.	Mnf.
862	XC6701D63JR	LVR-IC	6.3V±2%, 150mA	TO-252	68eu	VR1	10c	Tor
863	XC6701D64JR	LVR-IC	6.4V±2%, 150mA	TO-252	68eu	VR1	10c	Tor
864	XC6701D65JR	LVR-IC	6.5V±2%, 150mA	TO-252	68eu	VR1	10c	Tor
865	XC6701D66JR	LVR-IC	6.6V±2%, 150mA	TO-252	68eu	VR1	10c	Tor
866	XC6701D67JR	LVR-IC	6.7V±2%, 150mA	TO-252	68eu	VR1	10c	Tor
867	XC6701D68JR	LVR-IC	6.8V±2%, 150mA	TO-252	68eu	VR1	10c	Tor
868	XC6701D69JR	LVR-IC	6.9V±2%, 150mA	TO-252	68eu	VR1	10c	Tor
869	XC6701D70JR	LVR-IC	7.0V±2%, 150mA	TO-252	68eu	VR1	10c	Tor
86A	XC6701D71JR	LVR-IC	7.1V±2%, 150mA	TO-252	68eu	VR1	10c	Tor
86B	XC6701D72JR	LVR-IC	7.2V±2%, 150mA	TO-252	68eu	VR1	10c	Tor
86C	XC6701D73JR	LVR-IC	7.3V±2%, 150mA	TO-252	68eu	VR1	10c	Tor
86D	XC6701D74JR	LVR-IC	7.4V±2%, 150mA	TO-252	68eu	VR1	10c	Tor
86E	XC6701D75JR	LVR-IC	7.5V±2%, 150mA	TO-252	68eu	VR1	10c	Tor
86F	XC6701D76JR	LVR-IC	7.6V±2%, 150mA	TO-252	68eu	VR1	10c	Tor
86H	XC6701D77JR	LVR-IC	7.7V±2%, 150mA	TO-252	68eu	VR1	10c	Tor
86K	XC6701D78JR	LVR-IC	7.8V±2%, 150mA	TO-252	68eu	VR1	10c	Tor
86L	XC6701D79JR	LVR-IC	7.9V±2%, 150mA	TO-252	68eu	VR1	10c	Tor
86M	XC6701D80JR	LVR-IC	8.0V±2%, 150mA	TO-252	68eu	VR1	10c	Tor
86N	XC6701D81JR	LVR-IC	8.1V±2%, 150mA	TO-252	68eu	VR1	10c	Tor
86P	XC6701D82JR	LVR-IC	8.2V±2%, 150mA	TO-252	68eu	VR1	10c	Tor
86R	XC6701D83JR	LVR-IC	8.3V±2%, 150mA	TO-252	68eu	VR1	10c	Tor
86S	XC6701D84JR	LVR-IC	8.4V±2%, 150mA	TO-252	68eu	VR1	10c	Tor
86T	XC6701D85JR	LVR-IC	8.5V±2%, 150mA	TO-252	68eu	VR1	10c	Tor
86U	XC6701D86JR	LVR-IC	8.6V±2%, 150mA	TO-252	68eu	VR1	10c	Tor
86V	XC6701D87JR	LVR-IC	8.7V±2%, 150mA	TO-252	68eu	VR1	10c	Tor
86X	XC6701D88JR	LVR-IC	8.8V±2%, 150mA	TO-252	68eu	VR1	10c	Tor
86Y	XC6701D89JR	LVR-IC	8.9V±2%, 150mA	TO-252	68eu	VR1	10c	Tor
86Z	XC6701D90JR	LVR-IC	9.0V±2%, 150mA	TO-252	68eu	VR1	10c	Tor
870	XC6701D91JR	LVR-IC	9.1V±2%, 150mA	TO-252	68eu	VR1	10c	Tor
871	XC6701D92JR	LVR-IC	9.2V±2%, 150mA	TO-252	68eu	VR1	10c	Tor
872	XC6701D93JR	LVR-IC	9.3V±2%, 150mA	TO-252	68eu	VR1	10c	Tor
873	XC6701D94JR	LVR-IC	9.4V±2%, 150mA	TO-252	68eu	VR1	10c	Tor
874	XC6701D95JR	LVR-IC	9.5V±2%, 150mA	TO-252	68eu	VR1	10c	Tor
875	XC6701D96JR	LVR-IC	9.6V±2%, 150mA	TO-252	68eu	VR1	10c	Tor
876	XC6701D97JR	LVR-IC	9.7V±2%, 150mA	TO-252	68eu	VR1	10c	Tor
877	XC6701D98JR	LVR-IC	9.8V±2%, 150mA	TO-252	68eu	VR1	10c	Tor
878	XC6701D99JR	LVR-IC	9.9V±2%, 150mA	TO-252	68eu	VR1	10c	Tor
879	XC6701DA0JR	LVR-IC	10.0V±2%, 150mA	TO-252	68eu	VR1	10c	Tor
87A	XC6701DA1JR	LVR-IC	10.1V±2%, 150mA	TO-252	68eu	VR1	10c	Tor
87B	XC6701DA2JR	LVR-IC	10.2V±2%, 150mA	TO-252	68eu	VR1	10c	Tor
87C	XC6701DA3JR	LVR-IC	10.3V±2%, 150mA	TO-252	68eu	VR1	10c	Tor
87D	XC6701DA4JR	LVR-IC	10.4V±2%, 150mA	TO-252	68eu	VR1	10c	Tor
87E	XC6701DA5JR	LVR-IC	10.5V±2%, 150mA	TO-252	68eu	VR1	10c	Tor
87F	XC6701DA6JR	LVR-IC	10.6V±2%, 150mA	TO-252	68eu	VR1	10c	Tor
87H	XC6701DA7JR	LVR-IC	10.7V±2%, 150mA	TO-252	68eu	VR1	10c	Tor
87K	XC6701DA8JR	LVR-IC	10.8V±2%, 150mA	TO-252	68eu	VR1	10c	Tor
87L	XC6701DA9JR	LVR-IC	10.9V±2%, 150mA	TO-252	68eu	VR1	10c	Tor
87M	XC6701DB0JR	LVR-IC	11.0V±2%, 150mA	TO-252	68eu	VR1	10c	Tor
87N	XC6701DB1JR	LVR-IC	11.1V±2%, 150mA	TO-252	68eu	VR1	10c	Tor
87P	XC6701DB2JR	LVR-IC	11.2V±2%, 150mA	TO-252	68eu	VR1	10c	Tor
87R	XC6701DB3JR	LVR-IC	11.3V±2%, 150mA	TO-252	68eu	VR1	10c	Tor
87S	XC6701DB4JR	LVR-IC	11.4V±2%, 150mA	TO-252	68eu	VR1	10c	Tor
87T	XC6701DB5JR	LVR-IC	11.5V±2%, 150mA	TO-252	68eu	VR1	10c	Tor
87U	XC6701DB6JR	LVR-IC	11.6V±2%, 150mA	TO-252	68eu	VR1	10c	Tor
87V	XC6701DB7JR	LVR-IC	11.7V±2%, 150mA	TO-252	68eu	VR1	10c	Tor
87X	XC6701DB8JR	LVR-IC	11.8V±2%, 150mA	TO-252	68eu	VR1	10c	Tor
87Y	XC6701DB9JR	LVR-IC	11.9V±2%, 150mA	TO-252	68eu	VR1	10c	Tor
87Z	XC6701DC0JR	LVR-IC	12.0V±2%, 150mA	TO-252	68eu	VR1	10c	Tor
882	CH882PT	Si-npn	AF, Sw, 30V, 3A, B=100..500, 100MHz	DPAK	68tb	-	10a	Chm
8C0	XC6701DC1JR	LVR-IC	12.1V±2%, 150mA	TO-252	68eu	VR1	10c	Tor
8C1	XC6701DC2JR	LVR-IC	12.2V±2%, 150mA	TO-252	68eu	VR1	10c	Tor
8C2	XC6701DC3JR	LVR-IC	12.3V±2%, 150mA	TO-252	68eu	VR1	10c	Tor
8C3	XC6701DC4JR	LVR-IC	12.4V±2%, 150mA	TO-252	68eu	VR1	10c	Tor
8C4	XC6701DC5JR	LVR-IC	12.5V±2%, 150mA	TO-252	68eu	VR1	10c	Tor
8C5	XC6701DC6JR	LVR-IC	12.6V±2%, 150mA	TO-252	68eu	VR1	10c	Tor
8C6	XC6701DC7JR	LVR-IC	12.7V±2%, 150mA	TO-252	68eu	VR1	10c	Tor
8C7	XC6701DC8JR	LVR-IC	12.8V±2%, 150mA	TO-252	68eu	VR1	10c	Tor
8C8	XC6701DC9JR	LVR-IC	12.9V±2%, 150mA	TO-252	68eu	VR1	10c	Tor
8C9	XC6701DD0JR	LVR-IC	13.0V±2%, 150mA	TO-252	68eu	VR1	10c	Tor
8CA	XC6701DD1JR	LVR-IC	13.1V±2%, 150mA	TO-252	68eu	VR1	10c	Tor



SMD code	Type	Function	Short description	Case	Pinout	Sch.	St.	Mnf.
8CB	XC6701DD2JR	LVR-IC	13.2V±2%, 150mA	TO-252	68eu	VR1	10c	Tor
8CC	XC6701DD3JR	LVR-IC	13.3V±2%, 150mA	TO-252	68eu	VR1	10c	Tor
8CD	XC6701DD4JR	LVR-IC	13.4V±2%, 150mA	TO-252	68eu	VR1	10c	Tor
8CE	XC6701DD5JR	LVR-IC	13.5V±2%, 150mA	TO-252	68eu	VR1	10c	Tor
8CF	XC6701DD6JR	LVR-IC	13.6V±2%, 150mA	TO-252	68eu	VR1	10c	Tor
8CH	XC6701DD7JR	LVR-IC	13.7V±2%, 150mA	TO-252	68eu	VR1	10c	Tor
8CK	XC6701DD8JR	LVR-IC	13.8V±2%, 150mA	TO-252	68eu	VR1	10c	Tor
8CL	XC6701DD9JR	LVR-IC	13.9V±2%, 150mA	TO-252	68eu	VR1	10c	Tor
8CM	XC6701DE0JR	LVR-IC	14.0V±2%, 150mA	TO-252	68eu	VR1	10c	Tor
8CN	XC6701DE1JR	LVR-IC	14.1V±2%, 150mA	TO-252	68eu	VR1	10c	Tor
8CP	XC6701DE2JR	LVR-IC	14.2V±2%, 150mA	TO-252	68eu	VR1	10c	Tor
8CR	XC6701DE3JR	LVR-IC	14.3V±2%, 150mA	TO-252	68eu	VR1	10c	Tor
8CS	XC6701DE4JR	LVR-IC	14.4V±2%, 150mA	TO-252	68eu	VR1	10c	Tor
8CT	XC6701DE5JR	LVR-IC	14.5V±2%, 150mA	TO-252	68eu	VR1	10c	Tor
8CU	XC6701DE6JR	LVR-IC	14.6V±2%, 150mA	TO-252	68eu	VR1	10c	Tor
8CV	XC6701DE7JR	LVR-IC	14.7V±2%, 150mA	TO-252	68eu	VR1	10c	Tor
8CX	XC6701DE8JR	LVR-IC	14.8V±2%, 150mA	TO-252	68eu	VR1	10c	Tor
8CY	XC6701DE9JR	LVR-IC	14.9V±2%, 150mA	TO-252	68eu	VR1	10c	Tor
8CZ	XC6701DF0JR	LVR-IC	15.0V±2%, 150mA	TO-252	68eu	VR1	10c	Tor
8D0	XC6701DF1JR	LVR-IC	15.1V±2%, 150mA	TO-252	68eu	VR1	10c	Tor
8D1	XC6701DF2JR	LVR-IC	15.2V±2%, 150mA	TO-252	68eu	VR1	10c	Tor
8D2	XC6701DF3JR	LVR-IC	15.3V±2%, 150mA	TO-252	68eu	VR1	10c	Tor
8D3	XC6701DF4JR	LVR-IC	15.4V±2%, 150mA	TO-252	68eu	VR1	10c	Tor
8D4	XC6701DF5JR	LVR-IC	15.5V±2%, 150mA	TO-252	68eu	VR1	10c	Tor
8D5	XC6701DF6JR	LVR-IC	15.6V±2%, 150mA	TO-252	68eu	VR1	10c	Tor
8D6	XC6701DF7JR	LVR-IC	15.7V±2%, 150mA	TO-252	68eu	VR1	10c	Tor
8D7	XC6701DF8JR	LVR-IC	15.8V±2%, 150mA	TO-252	68eu	VR1	10c	Tor
8D8	XC6701DF9JR	LVR-IC	15.9V±2%, 150mA	TO-252	68eu	VR1	10c	Tor
8D9	XC6701DG0JR	LVR-IC	16.0V±2%, 150mA	TO-252	68eu	VR1	10c	Tor
8DA	XC6701DG1JR	LVR-IC	16.1V±2%, 150mA	TO-252	68eu	VR1	10c	Tor
8DB	XC6701DG2JR	LVR-IC	16.2V±2%, 150mA	TO-252	68eu	VR1	10c	Tor
8DC	XC6701DG3JR	LVR-IC	16.3V±2%, 150mA	TO-252	68eu	VR1	10c	Tor
8DD	XC6701DG4JR	LVR-IC	16.4V±2%, 150mA	TO-252	68eu	VR1	10c	Tor
8DE	XC6701DG5JR	LVR-IC	16.5V±2%, 150mA	TO-252	68eu	VR1	10c	Tor
8DF	XC6701DG6JR	LVR-IC	16.6V±2%, 150mA	TO-252	68eu	VR1	10c	Tor
8DH	XC6701DG7JR	LVR-IC	16.7V±2%, 150mA	TO-252	68eu	VR1	10c	Tor
8DK	XC6701DG8JR	LVR-IC	16.8V±2%, 150mA	TO-252	68eu	VR1	10c	Tor
8DL	XC6701DG9JR	LVR-IC	16.9V±2%, 150mA	TO-252	68eu	VR1	10c	Tor
8DM	XC6701DH0JR	LVR-IC	17.0V±2%, 150mA	TO-252	68eu	VR1	10c	Tor
8DN	XC6701DH1JR	LVR-IC	17.1V±2%, 150mA	TO-252	68eu	VR1	10c	Tor
8DP	XC6701DH2JR	LVR-IC	17.2V±2%, 150mA	TO-252	68eu	VR1	10c	Tor
8DR	XC6701DH3JR	LVR-IC	17.3V±2%, 150mA	TO-252	68eu	VR1	10c	Tor
8DS	XC6701DH4JR	LVR-IC	17.4V±2%, 150mA	TO-252	68eu	VR1	10c	Tor
8DT	XC6701DH5JR	LVR-IC	17.5V±2%, 150mA	TO-252	68eu	VR1	10c	Tor
8DU	XC6701DH6JR	LVR-IC	17.6V±2%, 150mA	TO-252	68eu	VR1	10c	Tor
8DV	XC6701DH7JR	LVR-IC	17.7V±2%, 150mA	TO-252	68eu	VR1	10c	Tor
8DX	XC6701DH8JR	LVR-IC	17.8V±2%, 150mA	TO-252	68eu	VR1	10c	Tor
8DY	XC6701DH9JR	LVR-IC	17.9V±2%, 150mA	TO-252	68eu	VR1	10c	Tor
8DZ	XC6701DJ0JR	LVR-IC	18.0V±2%, 150mA	TO-252	68eu	VR1	10c	Tor
A1J030B	R1501J030B	LVR-IC	LDO, 3.0V±2%, 1A, +CE	TO-252-5	69x2	VR4	10d	Ric
A1J031B	R1501J031B	LVR-IC	LDO, 3.1V±2%, 1A, +CE	TO-252-5	69x2	VR4	10d	Ric
A1J032B	R1501J032B	LVR-IC	LDO, 3.2V±2%, 1A, +CE	TO-252-5	69x2	VR4	10d	Ric
A1J033B	R1501J033B	LVR-IC	LDO, 3.3V±2%, 1A, +CE	TO-252-5	69x2	VR4	10d	Ric
A1J034B	R1501J034B	LVR-IC	LDO, 3.4V±2%, 1A, +CE	TO-252-5	69x2	VR4	10d	Ric
A1J035B	R1501J035B	LVR-IC	LDO, 3.5V±2%, 1A, +CE	TO-252-5	69x2	VR4	10d	Ric
A1J036B	R1501J036B	LVR-IC	LDO, 3.6V±2%, 1A, +CE	TO-252-5	69x2	VR4	10d	Ric
A1J037B	R1501J037B	LVR-IC	LDO, 3.7V±2%, 1A, +CE	TO-252-5	69x2	VR4	10d	Ric
A1J038B	R1501J038B	LVR-IC	LDO, 3.8V±2%, 1A, +CE	TO-252-5	69x2	VR4	10d	Ric
A1J039B	R1501J039B	LVR-IC	LDO, 3.9V±2%, 1A, +CE	TO-252-5	69x2	VR4	10d	Ric
A1J040B	R1501J040B	LVR-IC	LDO, 4.0V±2%, 1A, +CE	TO-252-5	69x2	VR4	10d	Ric
A1J041B	R1501J041B	LVR-IC	LDO, 4.1V±2%, 1A, +CE	TO-252-5	69x2	VR4	10d	Ric
A1J042B	R1501J042B	LVR-IC	LDO, 4.2V±2%, 1A, +CE	TO-252-5	69x2	VR4	10d	Ric
A1J043B	R1501J043B	LVR-IC	LDO, 4.3V±2%, 1A, +CE	TO-252-5	69x2	VR4	10d	Ric
A1J044B	R1501J044B	LVR-IC	LDO, 4.4V±2%, 1A, +CE	TO-252-5	69x2	VR4	10d	Ric
A1J045B	R1501J045B	LVR-IC	LDO, 4.5V±2%, 1A, +CE	TO-252-5	69x2	VR4	10d	Ric
A1J046B	R1501J046B	LVR-IC	LDO, 4.6V±2%, 1A, +CE	TO-252-5	69x2	VR4	10d	Ric
A1J047B	R1501J047B	LVR-IC	LDO, 4.7V±2%, 1A, +CE	TO-252-5	69x2	VR4	10d	Ric
A1J048B	R1501J048B	LVR-IC	LDO, 4.8V±2%, 1A, +CE	TO-252-5	69x2	VR4	10d	Ric
A1J049B	R1501J049B	LVR-IC	LDO, 4.9V±2%, 1A, +CE	TO-252-5	69x2	VR4	10d	Ric
A1J050B	R1501J050B	LVR-IC	LDO, 5.0V±2%, 1A, +CE	TO-252-5	69x2	VR4	10d	Ric



SMD code	Type	Function	Short description	Case	Pinout	Sch.	St.	Mnf.
A1J125B	R1501J125B	LVR-IC	LDO, 12.5V±2%, 1A, +CE	TO-252-5	69x2	VR4	10d	Ric
A1J130B	R1501J130B	LVR-IC	LDO, 13.0V±2%, 1A, +CE	TO-252-5	69x2	VR4	10d	Ric
A1J135B	R1501J135B	LVR-IC	LDO, 13.5V±2%, 1A, +CE	TO-252-5	69x2	VR4	10d	Ric
A1J140B	R1501J140B	LVR-IC	LDO, 14.0V±2%, 1A, +CE	TO-252-5	69x2	VR4	10d	Ric
A1J145B	R1501J145B	LVR-IC	LDO, 14.5V±2%, 1A, +CE	TO-252-5	69x2	VR4	10d	Ric
A1J150B	R1501J150B	LVR-IC	LDO, 15.0V±2%, 1A, +CE	TO-252-5	69x2	VR4	10d	Ric
A1J155B	R1501J155B	LVR-IC	LDO, 15.5V±2%, 1A, +CE	TO-252-5	69x2	VR4	10d	Ric
A1J160B	R1501J160B	LVR-IC	LDO, 16.0V±2%, 1A, +CE	TO-252-5	69x2	VR4	10d	Ric
A1J165B	R1501J165B	LVR-IC	LDO, 16.5V±2%, 1A, +CE	TO-252-5	69x2	VR4	10d	Ric
A1J170B	R1501J170B	LVR-IC	LDO, 17.0V±2%, 1A, +CE	TO-252-5	69x2	VR4	10d	Ric
A1J175B	R1501J175B	LVR-IC	LDO, 17.5V±2%, 1A, +CE	TO-252-5	69x2	VR4	10d	Ric
A1J180B	R1501J180B	LVR-IC	LDO, 18.0V±2%, 1A, +CE	TO-252-5	69x2	VR4	10d	Ric
A8827BB	AME8827-ACS330	LVR-IC	LDO, 3.3V±1.5%, 1A	TO-252	68eu	VR1	10a	Ame
A8827BG	AME8827-ACS250	LVR-IC	LDO, 2.5V±1.5%, 1A	TO-252	68eu	VR1	10a	Ame
A8827BI	AME8827-ACS180	LVR-IC	LDO, 1.8V±1.5%, 1A	TO-252	68eu	VR1	10a	Ame
A8827BK	AME8827-ACS120	LVR-IC	LDO, 1.2V±1.5%, 1A	TO-252	68eu	VR1	10a	Ame
B1035CL	MBRD1035CTL	Si-diode	Dual, SBR, 35V, 5A, Vf<0.47V(5A)	D-PAK	68bu	-	10a	Ons
B1545T	MBRB1545CT	Si-diode	Dual, SBR, 45V, 7.5A, Vf<0.57V(7.5A)	D2-PAK	68bu	-	10a	Ons
B1J020B	R1190J020B	LVR-IC	2.0V±1.5%, 1A, +CE	TO-252-5	69zv	VR7	10d	Ric
B1J020D	R1190J020D	LVR-IC	2.0V±1.5%, 1A, +CE, CL	TO-252-5	69zv	VR7	10d	Ric
B1J021B	R1190J021B	LVR-IC	2.1V±1.5%, 1A, +CE	TO-252-5	69zv	VR7	10d	Ric
B1J021D	R1190J021D	LVR-IC	2.1V±1.5%, 1A, +CE, CL	TO-252-5	69zv	VR7	10d	Ric
B1J022B	R1190J022B	LVR-IC	2.2V±1.5%, 1A, +CE	TO-252-5	69zv	VR7	10d	Ric
B1J022D	R1190J022D	LVR-IC	2.2V±1.5%, 1A, +CE, CL	TO-252-5	69zv	VR7	10d	Ric
B1J023B	R1190J023B	LVR-IC	2.3V±1.5%, 1A, +CE	TO-252-5	69zv	VR7	10d	Ric
B1J023D	R1190J023D	LVR-IC	2.3V±1.5%, 1A, +CE, CL	TO-252-5	69zv	VR7	10d	Ric
B1J024B	R1190J024B	LVR-IC	2.4V±1.5%, 1A, +CE	TO-252-5	69zv	VR7	10d	Ric
B1J024D	R1190J024D	LVR-IC	2.4V±1.5%, 1A, +CE, CL	TO-252-5	69zv	VR7	10d	Ric
B1J025B	R1190J025B	LVR-IC	2.5V±1.5%, 1A, +CE	TO-252-5	69zv	VR7	10d	Ric
B1J025D	R1190J025D	LVR-IC	2.5V±1.5%, 1A, +CE, CL	TO-252-5	69zv	VR7	10d	Ric
B1J026B	R1190J026B	LVR-IC	2.6V±1.5%, 1A, +CE	TO-252-5	69zv	VR7	10d	Ric
B1J026D	R1190J026D	LVR-IC	2.6V±1.5%, 1A, +CE, CL	TO-252-5	69zv	VR7	10d	Ric
B1J027B	R1190J027B	LVR-IC	2.7V±1.5%, 1A, +CE	TO-252-5	69zv	VR7	10d	Ric
B1J027D	R1190J027D	LVR-IC	2.7V±1.5%, 1A, +CE, CL	TO-252-5	69zv	VR7	10d	Ric
B1J028B	R1190J028B	LVR-IC	2.8V±1.5%, 1A, +CE	TO-252-5	69zv	VR7	10d	Ric
B1J028D	R1190J028D	LVR-IC	2.8V±1.5%, 1A, +CE, CL	TO-252-5	69zv	VR7	10d	Ric
B1J029B	R1190J029B	LVR-IC	2.9V±1.5%, 1A, +CE	TO-252-5	69zv	VR7	10d	Ric
B1J029D	R1190J029D	LVR-IC	2.9V±1.5%, 1A, +CE, CL	TO-252-5	69zv	VR7	10d	Ric
B1J030B	R1190J030B	LVR-IC	3.0V±1.5%, 1A, +CE	TO-252-5	69zv	VR7	10d	Ric
B1J030D	R1190J030D	LVR-IC	3.0V±1.5%, 1A, +CE, CL	TO-252-5	69zv	VR7	10d	Ric
B1J031B	R1190J031B	LVR-IC	3.1V±1.5%, 1A, +CE	TO-252-5	69zv	VR7	10d	Ric
B1J031D	R1190J031D	LVR-IC	3.1V±1.5%, 1A, +CE, CL	TO-252-5	69zv	VR7	10d	Ric
B1J032B	R1190J032B	LVR-IC	3.2V±1.5%, 1A, +CE	TO-252-5	69zv	VR7	10d	Ric
B1J032D	R1190J032D	LVR-IC	3.2V±1.5%, 1A, +CE, CL	TO-252-5	69zv	VR7	10d	Ric
B1J033B	R1190J033B	LVR-IC	3.3V±1.5%, 1A, +CE	TO-252-5	69zv	VR7	10d	Ric
B1J033D	R1190J033D	LVR-IC	3.3V±1.5%, 1A, +CE, CL	TO-252-5	69zv	VR7	10d	Ric
B1J034B	R1190J034B	LVR-IC	3.4V±1.5%, 1A, +CE	TO-252-5	69zv	VR7	10d	Ric
B1J034D	R1190J034D	LVR-IC	3.4V±1.5%, 1A, +CE, CL	TO-252-5	69zv	VR7	10d	Ric
B1J035B	R1190J035B	LVR-IC	3.5V±1.5%, 1A, +CE	TO-252-5	69zv	VR7	10d	Ric
B1J035D	R1190J035D	LVR-IC	3.5V±1.5%, 1A, +CE, CL	TO-252-5	69zv	VR7	10d	Ric
B1J036B	R1190J036B	LVR-IC	3.6V±1.5%, 1A, +CE	TO-252-5	69zv	VR7	10d	Ric
B1J036D	R1190J036D	LVR-IC	3.6V±1.5%, 1A, +CE, CL	TO-252-5	69zv	VR7	10d	Ric
B1J037B	R1190J037B	LVR-IC	3.7V±1.5%, 1A, +CE	TO-252-5	69zv	VR7	10d	Ric
B1J037D	R1190J037D	LVR-IC	3.7V±1.5%, 1A, +CE, CL	TO-252-5	69zv	VR7	10d	Ric
B1J038B	R1190J038B	LVR-IC	3.8V±1.5%, 1A, +CE	TO-252-5	69zv	VR7	10d	Ric
B1J038D	R1190J038D	LVR-IC	3.8V±1.5%, 1A, +CE, CL	TO-252-5	69zv	VR7	10d	Ric
B1J039B	R1190J039B	LVR-IC	3.9V±1.5%, 1A, +CE	TO-252-5	69zv	VR7	10d	Ric
B1J039D	R1190J039D	LVR-IC	3.9V±1.5%, 1A, +CE, CL	TO-252-5	69zv	VR7	10d	Ric
B1J040B	R1190J040B	LVR-IC	4.0V±1.5%, 1A, +CE	TO-252-5	69zv	VR7	10d	Ric
B1J040D	R1190J040D	LVR-IC	4.0V±1.5%, 1A, +CE, CL	TO-252-5	69zv	VR7	10d	Ric
B1J041B	R1190J041B	LVR-IC	4.1V±1.5%, 1A, +CE	TO-252-5	69zv	VR7	10d	Ric
B1J041D	R1190J041D	LVR-IC	4.1V±1.5%, 1A, +CE, CL	TO-252-5	69zv	VR7	10d	Ric
B1J042B	R1190J042B	LVR-IC	4.2V±1.5%, 1A, +CE	TO-252-5	69zv	VR7	10d	Ric
B1J042D	R1190J042D	LVR-IC	4.2V±1.5%, 1A, +CE, CL	TO-252-5	69zv	VR7	10d	Ric
B1J043B	R1190J043B	LVR-IC	4.3V±1.5%, 1A, +CE	TO-252-5	69zv	VR7	10d	Ric
B1J043D	R1190J043D	LVR-IC	4.3V±1.5%, 1A, +CE, CL	TO-252-5	69zv	VR7	10d	Ric
B1J044B	R1190J044B	LVR-IC	4.4V±1.5%, 1A, +CE	TO-252-5	69zv	VR7	10d	Ric
B1J044D	R1190J044D	LVR-IC	4.4V±1.5%, 1A, +CE, CL	TO-252-5	69zv	VR7	10d	Ric
B1J045B	R1190J045B	LVR-IC	4.5V±1.5%, 1A, +CE	TO-252-5	69zv	VR7	10d	Ric
B1J045D	R1190J045D	LVR-IC	4.5V±1.5%, 1A, +CE, CL	TO-252-5	69zv	VR7	10d	Ric



SMD code	Type	Function	Short description	Case	Pinout	Sch.	St.	Mnf.
B1J116B	R1190J116B	LVR-IC	11.6V±1.5%, 1A, +CE	TO-252-5	69zv	VR7	10d	Ric
B1J116D	R1190J116D	LVR-IC	11.6V±1.5%, 1A, +CE, CL	TO-252-5	69zv	VR7	10d	Ric
B1J117B	R1190J117B	LVR-IC	11.7V±1.5%, 1A, +CE	TO-252-5	69zv	VR7	10d	Ric
B1J117D	R1190J117D	LVR-IC	11.7V±1.5%, 1A, +CE, CL	TO-252-5	69zv	VR7	10d	Ric
B1J118B	R1190J118B	LVR-IC	11.8V±1.5%, 1A, +CE	TO-252-5	69zv	VR7	10d	Ric
B1J118D	R1190J118D	LVR-IC	11.8V±1.5%, 1A, +CE, CL	TO-252-5	69zv	VR7	10d	Ric
B1J119B	R1190J119B	LVR-IC	11.9V±1.5%, 1A, +CE	TO-252-5	69zv	VR7	10d	Ric
B1J119D	R1190J119D	LVR-IC	11.9V±1.5%, 1A, +CE, CL	TO-252-5	69zv	VR7	10d	Ric
B1J120B	R1190J120B	LVR-IC	12.0V±1.5%, 1A, +CE	TO-252-5	69zv	VR7	10d	Ric
B1J120D	R1190J120D	LVR-IC	12.0V±1.5%, 1A, +CE, CL	TO-252-5	69zv	VR7	10d	Ric
B20100	MBRE20100CT	Si-diode	Dual, SBR, 100V, 10A, Vf<0.75V(10A)	D2-PAK	68bu	-	10a	Ons
B2060T	MBRE2060CT	Si-diode	Dual, SBR, 60V, 10A, Vf<0.75V(10A)	D2-PAK	68bu	-	10a	Ons
B320	MBRD320	Si-diode	Rectifier, 20V, 3A, Vf<0.6V(3A)	D-PAK	68dz	-	10a	Ons
B330	MBRD330	Si-diode	Rectifier, 30V, 3A, Vf<0.6V(3A)	D-PAK	68dz	-	10a	Ons
B340	MBRD340	Si-diode	Rectifier, 40V, 3A, Vf<0.6V(3A)	D-PAK	68dz	-	10a	Ons
B350	MBRD350	Si-diode	Rectifier, 50V, 3A, Vf<0.6V(3A)	D-PAK	68dz	-	10a	Ons
B360	MBRD360	Si-diode	Rectifier, 60V, 3A, Vf<0.6V(3A)	D-PAK	68dz	-	10a	Ons
B620T	MBRD620CT	Si-diode	Dual, Rectifier, 20V, 3A, Vf<0.7V(3A)	D-PAK	68bu	-	10a	Ons
B630T	MBRD630CT	Si-diode	Dual, Rectifier, 30V, 3A, Vf<0.7V(3A)	D-PAK	68bu	-	10a	Ons
B640T	MBRD640CT	Si-diode	Dual, Rectifier, 40V, 3A, Vf<0.7V(3A)	D-PAK	68bu	-	10a	Ons
B650T	MBRD650CT	Si-diode	Dual, Rectifier, 50V, 3A, Vf<0.7V(3A)	D-PAK	68bu	-	10a	Ons
B660T	MBRD660CT	Si-diode	Dual, Rectifier, 60V, 3A, Vf<0.7V(3A)	D-PAK	68bu	-	10a	Ons
B835L	MBRD835L	Si-diode	SBR, 35V, 8A, Vf<0.51V(8A)	D-PAK	68dz	-	10a	Ons
C1J030B	R1500J030B	LVR-IC	LDO, 3.0V±2%, 500mA, +CE	TO-252-5	69x2	VR4	10d	Ric
C1J031B	R1500J031B	LVR-IC	LDO, 3.1V±2%, 500mA, +CE	TO-252-5	69x2	VR4	10d	Ric
C1J032B	R1500J032B	LVR-IC	LDO, 3.2V±2%, 500mA, +CE	TO-252-5	69x2	VR4	10d	Ric
C1J033B	R1500J033B	LVR-IC	LDO, 3.3V±2%, 500mA, +CE	TO-252-5	69x2	VR4	10d	Ric
C1J034B	R1500J034B	LVR-IC	LDO, 3.4V±2%, 500mA, +CE	TO-252-5	69x2	VR4	10d	Ric
C1J035B	R1500J035B	LVR-IC	LDO, 3.5V±2%, 500mA, +CE	TO-252-5	69x2	VR4	10d	Ric
C1J036B	R1500J036B	LVR-IC	LDO, 3.6V±2%, 500mA, +CE	TO-252-5	69x2	VR4	10d	Ric
C1J037B	R1500J037B	LVR-IC	LDO, 3.7V±2%, 500mA, +CE	TO-252-5	69x2	VR4	10d	Ric
C1J038B	R1500J038B	LVR-IC	LDO, 3.8V±2%, 500mA, +CE	TO-252-5	69x2	VR4	10d	Ric
C1J039B	R1500J039B	LVR-IC	LDO, 3.9V±2%, 500mA, +CE	TO-252-5	69x2	VR4	10d	Ric
C1J040B	R1500J040B	LVR-IC	LDO, 4.0V±2%, 500mA, +CE	TO-252-5	69x2	VR4	10d	Ric
C1J041B	R1500J041B	LVR-IC	LDO, 4.1V±2%, 500mA, +CE	TO-252-5	69x2	VR4	10d	Ric
C1J042B	R1500J042B	LVR-IC	LDO, 4.2V±2%, 500mA, +CE	TO-252-5	69x2	VR4	10d	Ric
C1J043B	R1500J043B	LVR-IC	LDO, 4.3V±2%, 500mA, +CE	TO-252-5	69x2	VR4	10d	Ric
C1J044B	R1500J044B	LVR-IC	LDO, 4.4V±2%, 500mA, +CE	TO-252-5	69x2	VR4	10d	Ric
C1J045B	R1500J045B	LVR-IC	LDO, 4.5V±2%, 500mA, +CE	TO-252-5	69x2	VR4	10d	Ric
C1J046B	R1500J046B	LVR-IC	LDO, 4.6V±2%, 500mA, +CE	TO-252-5	69x2	VR4	10d	Ric
C1J047B	R1500J047B	LVR-IC	LDO, 4.7V±2%, 500mA, +CE	TO-252-5	69x2	VR4	10d	Ric
C1J048B	R1500J048B	LVR-IC	LDO, 4.8V±2%, 500mA, +CE	TO-252-5	69x2	VR4	10d	Ric
C1J049B	R1500J049B	LVR-IC	LDO, 4.9V±2%, 500mA, +CE	TO-252-5	69x2	VR4	10d	Ric
C1J050B	R1500J050B	LVR-IC	LDO, 5.0V±2%, 500mA, +CE	TO-252-5	69x2	VR4	10d	Ric
C1J051B	R1500J051B	LVR-IC	LDO, 5.1V±2%, 500mA, +CE	TO-252-5	69x2	VR4	10d	Ric
C1J052B	R1500J052B	LVR-IC	LDO, 5.2V±2%, 500mA, +CE	TO-252-5	69x2	VR4	10d	Ric
C1J053B	R1500J053B	LVR-IC	LDO, 5.3V±2%, 500mA, +CE	TO-252-5	69x2	VR4	10d	Ric
C1J054B	R1500J054B	LVR-IC	LDO, 5.4V±2%, 500mA, +CE	TO-252-5	69x2	VR4	10d	Ric
C1J055B	R1500J055B	LVR-IC	LDO, 5.5V±2%, 500mA, +CE	TO-252-5	69x2	VR4	10d	Ric
C1J056B	R1500J056B	LVR-IC	LDO, 5.6V±2%, 500mA, +CE	TO-252-5	69x2	VR4	10d	Ric
C1J057B	R1500J057B	LVR-IC	LDO, 5.7V±2%, 500mA, +CE	TO-252-5	69x2	VR4	10d	Ric
C1J058B	R1500J058B	LVR-IC	LDO, 5.8V±2%, 500mA, +CE	TO-252-5	69x2	VR4	10d	Ric
C1J059B	R1500J059B	LVR-IC	LDO, 5.9V±2%, 500mA, +CE	TO-252-5	69x2	VR4	10d	Ric
C1J060B	R1500J060B	LVR-IC	LDO, 6.0V±2%, 500mA, +CE	TO-252-5	69x2	VR4	10d	Ric
C1J061B	R1500J061B	LVR-IC	LDO, 6.1V±2%, 500mA, +CE	TO-252-5	69x2	VR4	10d	Ric
C1J062B	R1500J062B	LVR-IC	LDO, 6.2V±2%, 500mA, +CE	TO-252-5	69x2	VR4	10d	Ric
C1J063B	R1500J063B	LVR-IC	LDO, 6.3V±2%, 500mA, +CE	TO-252-5	69x2	VR4	10d	Ric
C1J064B	R1500J064B	LVR-IC	LDO, 6.4V±2%, 500mA, +CE	TO-252-5	69x2	VR4	10d	Ric
C1J065B	R1500J065B	LVR-IC	LDO, 6.5V±2%, 500mA, +CE	TO-252-5	69x2	VR4	10d	Ric
C1J066B	R1500J066B	LVR-IC	LDO, 6.6V±2%, 500mA, +CE	TO-252-5	69x2	VR4	10d	Ric
C1J067B	R1500J067B	LVR-IC	LDO, 6.7V±2%, 500mA, +CE	TO-252-5	69x2	VR4	10d	Ric
C1J068B	R1500J068B	LVR-IC	LDO, 6.8V±2%, 500mA, +CE	TO-252-5	69x2	VR4	10d	Ric
C1J069B	R1500J069B	LVR-IC	LDO, 6.9V±2%, 500mA, +CE	TO-252-5	69x2	VR4	10d	Ric
C1J070B	R1500J070B	LVR-IC	LDO, 7.0V±2%, 500mA, +CE	TO-252-5	69x2	VR4	10d	Ric
C1J071B	R1500J071B	LVR-IC	LDO, 7.1V±2%, 500mA, +CE	TO-252-5	69x2	VR4	10d	Ric
C1J072B	R1500J072B	LVR-IC	LDO, 7.2V±2%, 500mA, +CE	TO-252-5	69x2	VR4	10d	Ric
C1J073B	R1500J073B	LVR-IC	LDO, 7.3V±2%, 500mA, +CE	TO-252-5	69x2	VR4	10d	Ric
C1J074B	R1500J074B	LVR-IC	LDO, 7.4V±2%, 500mA, +CE	TO-252-5	69x2	VR4	10d	Ric
C1J075B	R1500J075B	LVR-IC	LDO, 7.5V±2%, 500mA, +CE	TO-252-5	69x2	VR4	10d	Ric
C1J076B	R1500J076B	LVR-IC	LDO, 7.6V±2%, 500mA, +CE	TO-252-5	69x2	VR4	10d	Ric



SMD code	Type	Function	Short description	Case	Pinout	Sch.	St.	Mnf.
C1J077B	R1500J077B	LVR-IC	LDO, 7.7V±2%, 500mA, +CE	TO-252-5	69x2	VR4	10d	Ric
C1J078B	R1500J078B	LVR-IC	LDO, 7.8V±2%, 500mA, +CE	TO-252-5	69x2	VR4	10d	Ric
C1J079B	R1500J079B	LVR-IC	LDO, 7.9V±2%, 500mA, +CE	TO-252-5	69x2	VR4	10d	Ric
C1J080B	R1500J080B	LVR-IC	LDO, 8.0V±2%, 500mA, +CE	TO-252-5	69x2	VR4	10d	Ric
C1J081B	R1500J081B	LVR-IC	LDO, 8.1V±2%, 500mA, +CE	TO-252-5	69x2	VR4	10d	Ric
C1J082B	R1500J082B	LVR-IC	LDO, 8.2V±2%, 500mA, +CE	TO-252-5	69x2	VR4	10d	Ric
C1J083B	R1500J083B	LVR-IC	LDO, 8.3V±2%, 500mA, +CE	TO-252-5	69x2	VR4	10d	Ric
C1J084B	R1500J084B	LVR-IC	LDO, 8.4V±2%, 500mA, +CE	TO-252-5	69x2	VR4	10d	Ric
C1J085B	R1500J085B	LVR-IC	LDO, 8.5V±2%, 500mA, +CE	TO-252-5	69x2	VR4	10d	Ric
C1J086B	R1500J086B	LVR-IC	LDO, 8.6V±2%, 500mA, +CE	TO-252-5	69x2	VR4	10d	Ric
C1J087B	R1500J087B	LVR-IC	LDO, 8.7V±2%, 500mA, +CE	TO-252-5	69x2	VR4	10d	Ric
C1J088B	R1500J088B	LVR-IC	LDO, 8.8V±2%, 500mA, +CE	TO-252-5	69x2	VR4	10d	Ric
C1J089B	R1500J089B	LVR-IC	LDO, 8.9V±2%, 500mA, +CE	TO-252-5	69x2	VR4	10d	Ric
C1J090B	R1500J090B	LVR-IC	LDO, 9.0V±2%, 500mA, +CE	TO-252-5	69x2	VR4	10d	Ric
C1J091B	R1500J091B	LVR-IC	LDO, 9.1V±2%, 500mA, +CE	TO-252-5	69x2	VR4	10d	Ric
C1J092B	R1500J092B	LVR-IC	LDO, 9.2V±2%, 500mA, +CE	TO-252-5	69x2	VR4	10d	Ric
C1J093B	R1500J093B	LVR-IC	LDO, 9.3V±2%, 500mA, +CE	TO-252-5	69x2	VR4	10d	Ric
C1J094B	R1500J094B	LVR-IC	LDO, 9.4V±2%, 500mA, +CE	TO-252-5	69x2	VR4	10d	Ric
C1J095B	R1500J095B	LVR-IC	LDO, 9.5V±2%, 500mA, +CE	TO-252-5	69x2	VR4	10d	Ric
C1J096B	R1500J096B	LVR-IC	LDO, 9.6V±2%, 500mA, +CE	TO-252-5	69x2	VR4	10d	Ric
C1J097B	R1500J097B	LVR-IC	LDO, 9.7V±2%, 500mA, +CE	TO-252-5	69x2	VR4	10d	Ric
C1J098B	R1500J098B	LVR-IC	LDO, 9.8V±2%, 500mA, +CE	TO-252-5	69x2	VR4	10d	Ric
C1J099B	R1500J099B	LVR-IC	LDO, 9.9V±2%, 500mA, +CE	TO-252-5	69x2	VR4	10d	Ric
C1J100B	R1500J100B	LVR-IC	LDO, 10.0V±2%, 500mA, +CE	TO-252-5	69x2	VR4	10d	Ric
C1J101B	R1500J101B	LVR-IC	LDO, 10.1V±2%, 500mA, +CE	TO-252-5	69x2	VR4	10d	Ric
C1J102B	R1500J102B	LVR-IC	LDO, 10.2V±2%, 500mA, +CE	TO-252-5	69x2	VR4	10d	Ric
C1J103B	R1500J103B	LVR-IC	LDO, 10.3V±2%, 500mA, +CE	TO-252-5	69x2	VR4	10d	Ric
C1J104B	R1500J104B	LVR-IC	LDO, 10.4V±2%, 500mA, +CE	TO-252-5	69x2	VR4	10d	Ric
C1J105B	R1500J105B	LVR-IC	LDO, 10.5V±2%, 500mA, +CE	TO-252-5	69x2	VR4	10d	Ric
C1J106B	R1500J106B	LVR-IC	LDO, 10.6V±2%, 500mA, +CE	TO-252-5	69x2	VR4	10d	Ric
C1J107B	R1500J107B	LVR-IC	LDO, 10.7V±2%, 500mA, +CE	TO-252-5	69x2	VR4	10d	Ric
C1J108B	R1500J108B	LVR-IC	LDO, 10.8V±2%, 500mA, +CE	TO-252-5	69x2	VR4	10d	Ric
C1J109B	R1500J109B	LVR-IC	LDO, 10.9V±2%, 500mA, +CE	TO-252-5	69x2	VR4	10d	Ric
C1J110B	R1500J110B	LVR-IC	LDO, 11.0V±2%, 500mA, +CE	TO-252-5	69x2	VR4	10d	Ric
C1J111B	R1500J111B	LVR-IC	LDO, 11.1V±2%, 500mA, +CE	TO-252-5	69x2	VR4	10d	Ric
C1J112B	R1500J112B	LVR-IC	LDO, 11.2V±2%, 500mA, +CE	TO-252-5	69x2	VR4	10d	Ric
C1J113B	R1500J113B	LVR-IC	LDO, 11.3V±2%, 500mA, +CE	TO-252-5	69x2	VR4	10d	Ric
C1J114B	R1500J114B	LVR-IC	LDO, 11.4V±2%, 500mA, +CE	TO-252-5	69x2	VR4	10d	Ric
C1J115B	R1500J115B	LVR-IC	LDO, 11.5V±2%, 500mA, +CE	TO-252-5	69x2	VR4	10d	Ric
C1J116B	R1500J116B	LVR-IC	LDO, 11.6V±2%, 500mA, +CE	TO-252-5	69x2	VR4	10d	Ric
C1J117B	R1500J117B	LVR-IC	LDO, 11.7V±2%, 500mA, +CE	TO-252-5	69x2	VR4	10d	Ric
C1J118B	R1500J118B	LVR-IC	LDO, 11.8V±2%, 500mA, +CE	TO-252-5	69x2	VR4	10d	Ric
C1J119B	R1500J119B	LVR-IC	LDO, 11.9V±2%, 500mA, +CE	TO-252-5	69x2	VR4	10d	Ric
C1J120B	R1500J120B	LVR-IC	LDO, 12.0V±2%, 500mA, +CE	TO-252-5	69x2	VR4	10d	Ric
D1J081B	RP131J081B	LVR-IC	LDO, 0.8V±1%, 1A, +CE	TO-252-5	69x7	VR4	10d	Ric
D1J081D	RP131J081D	LVR-IC	LDO, 0.8V±1%, 1A, +CE, CL	TO-252-5	69x7	VR4	10d	Ric
D1J091B	RP131J091B	LVR-IC	LDO, 0.9V±1%, 1A, +CE	TO-252-5	69x7	VR4	10d	Ric
D1J091D	RP131J091D	LVR-IC	LDO, 0.9V±1%, 1A, +CE, CL	TO-252-5	69x7	VR4	10d	Ric
D1J101B	RP131J101B	LVR-IC	LDO, 1.0V±1%, 1A, +CE	TO-252-5	69x7	VR4	10d	Ric
D1J101B5	RP131J101B5	LVR-IC	LDO, 1.05V±1%, 1A, +CE	TO-252-5	69x7	VR4	10d	Ric
D1J101D	RP131J101D	LVR-IC	LDO, 1.0V±1%, 1A, +CE, CL	TO-252-5	69x7	VR4	10d	Ric
D1J101D5	RP131J101D5	LVR-IC	LDO, 1.05V±1%, 1A, +CE, CL	TO-252-5	69x7	VR4	10d	Ric
D1J111B	RP131J111B	LVR-IC	LDO, 1.1V±1%, 1A, +CE	TO-252-5	69x7	VR4	10d	Ric
D1J111D	RP131J111D	LVR-IC	LDO, 1.1V±1%, 1A, +CE, CL	TO-252-5	69x7	VR4	10d	Ric
D1J121B	RP131J121B	LVR-IC	LDO, 1.2V±1%, 1A, +CE	TO-252-5	69x7	VR4	10d	Ric
D1J121B5	RP131J121B5	LVR-IC	LDO, 1.25V±1%, 1A, +CE	TO-252-5	69x7	VR4	10d	Ric
D1J121D	RP131J121D	LVR-IC	LDO, 1.2V±1%, 1A, +CE, CL	TO-252-5	69x7	VR4	10d	Ric
D1J121D5	RP131J121D5	LVR-IC	LDO, 1.25V±1%, 1A, +CE, CL	TO-252-5	69x7	VR4	10d	Ric
D1J131B	RP131J131B	LVR-IC	LDO, 1.3V±1%, 1A, +CE	TO-252-5	69x7	VR4	10d	Ric
D1J131D	RP131J131D	LVR-IC	LDO, 1.3V±1%, 1A, +CE, CL	TO-252-5	69x7	VR4	10d	Ric
D1J141B	RP131J141B	LVR-IC	LDO, 1.4V±1%, 1A, +CE	TO-252-5	69x7	VR4	10d	Ric
D1J141D	RP131J141D	LVR-IC	LDO, 1.4V±1%, 1A, +CE, CL	TO-252-5	69x7	VR4	10d	Ric
D1J151B	RP131J151B	LVR-IC	LDO, 1.5V±1%, 1A, +CE	TO-252-5	69x7	VR4	10d	Ric
D1J151D	RP131J151D	LVR-IC	LDO, 1.5V±1%, 1A, +CE, CL	TO-252-5	69x7	VR4	10d	Ric
D1J161B	RP131J161B	LVR-IC	LDO, 1.6V±1%, 1A, +CE	TO-252-5	69x7	VR4	10d	Ric
D1J161D	RP131J161D	LVR-IC	LDO, 1.6V±1%, 1A, +CE, CL	TO-252-5	69x7	VR4	10d	Ric
D1J171B	RP131J171B	LVR-IC	LDO, 1.7V±1%, 1A, +CE	TO-252-5	69x7	VR4	10d	Ric
D1J171D	RP131J171D	LVR-IC	LDO, 1.7V±1%, 1A, +CE, CL	TO-252-5	69x7	VR4	10d	Ric
D1J181B	RP131J181B	LVR-IC	LDO, 1.8V±1%, 1A, +CE	TO-252-5	69x7	VR4	10d	Ric
D1J181B5	RP131J181B5	LVR-IC	LDO, 1.85V±1%, 1A, +CE	TO-252-5	69x7	VR4	10d	Ric



SMD code	Type	Function	Short description	Case	Pinout	Sch.	St.	Mnf.
D1J181D	RP131J181D	LVR-IC	LDO, 1.8V±1%, 1A, +CE, CL	TO-252-5	69x7	VR4	10d	Ric
D1J181D5	RP131J181D5	LVR-IC	LDO, 1.85V±1%, 1A, +CE, CL	TO-252-5	69x7	VR4	10d	Ric
D1J191B	RP131J191B	LVR-IC	LDO, 1.9V±1%, 1A, +CE	TO-252-5	69x7	VR4	10d	Ric
D1J191D	RP131J191D	LVR-IC	LDO, 1.9V±1%, 1A, +CE, CL	TO-252-5	69x7	VR4	10d	Ric
D1J201B	RP131J201B	LVR-IC	LDO, 2.0V±1%, 1A, +CE	TO-252-5	69x7	VR4	10d	Ric
D1J201D	RP131J201D	LVR-IC	LDO, 2.0V±1%, 1A, +CE, CL	TO-252-5	69x7	VR4	10d	Ric
D1J211B	RP131J211B	LVR-IC	LDO, 2.1V±1%, 1A, +CE	TO-252-5	69x7	VR4	10d	Ric
D1J211D	RP131J211D	LVR-IC	LDO, 2.1V±1%, 1A, +CE, CL	TO-252-5	69x7	VR4	10d	Ric
D1J221B	RP131J221B	LVR-IC	LDO, 2.2V±1%, 1A, +CE	TO-252-5	69x7	VR4	10d	Ric
D1J221D	RP131J221D	LVR-IC	LDO, 2.2V±1%, 1A, +CE, CL	TO-252-5	69x7	VR4	10d	Ric
D1J231B	RP131J231B	LVR-IC	LDO, 2.3V±1%, 1A, +CE	TO-252-5	69x7	VR4	10d	Ric
D1J231D	RP131J231D	LVR-IC	LDO, 2.3V±1%, 1A, +CE, CL	TO-252-5	69x7	VR4	10d	Ric
D1J241B	RP131J241B	LVR-IC	LDO, 2.4V±1%, 1A, +CE	TO-252-5	69x7	VR4	10d	Ric
D1J241D	RP131J241D	LVR-IC	LDO, 2.4V±1%, 1A, +CE, CL	TO-252-5	69x7	VR4	10d	Ric
D1J251B	RP131J251B	LVR-IC	LDO, 2.5V±1%, 1A, +CE	TO-252-5	69x7	VR4	10d	Ric
D1J251D	RP131J251D	LVR-IC	LDO, 2.5V±1%, 1A, +CE, CL	TO-252-5	69x7	VR4	10d	Ric
D1J261B	RP131J261B	LVR-IC	LDO, 2.6V±1%, 1A, +CE	TO-252-5	69x7	VR4	10d	Ric
D1J261D	RP131J261D	LVR-IC	LDO, 2.6V±1%, 1A, +CE, CL	TO-252-5	69x7	VR4	10d	Ric
D1J271B	RP131J271B	LVR-IC	LDO, 2.7V±1%, 1A, +CE	TO-252-5	69x7	VR4	10d	Ric
D1J271D	RP131J271D	LVR-IC	LDO, 2.7V±1%, 1A, +CE, CL	TO-252-5	69x7	VR4	10d	Ric
D1J281B	RP131J281B	LVR-IC	LDO, 2.8V±1%, 1A, +CE	TO-252-5	69x7	VR4	10d	Ric
D1J281B5	RP131J281B5	LVR-IC	LDO, 2.85V±1%, 1A, +CE	TO-252-5	69x7	VR4	10d	Ric
D1J281D	RP131J281D	LVR-IC	LDO, 2.8V±1%, 1A, +CE, CL	TO-252-5	69x7	VR4	10d	Ric
D1J281D5	RP131J281D5	LVR-IC	LDO, 2.85V±1%, 1A, +CE, CL	TO-252-5	69x7	VR4	10d	Ric
D1J291B	RP131J291B	LVR-IC	LDO, 2.9V±1%, 1A, +CE	TO-252-5	69x7	VR4	10d	Ric
D1J291D	RP131J291D	LVR-IC	LDO, 2.9V±1%, 1A, +CE, CL	TO-252-5	69x7	VR4	10d	Ric
D1J301B	RP131J301B	LVR-IC	LDO, 3.0V±1%, 1A, +CE	TO-252-5	69x7	VR4	10d	Ric
D1J301D	RP131J301D	LVR-IC	LDO, 3.0V±1%, 1A, +CE, CL	TO-252-5	69x7	VR4	10d	Ric
D1J311B	RP131J311B	LVR-IC	LDO, 3.1V±1%, 1A, +CE	TO-252-5	69x7	VR4	10d	Ric
D1J311D	RP131J311D	LVR-IC	LDO, 3.1V±1%, 1A, +CE, CL	TO-252-5	69x7	VR4	10d	Ric
D1J321B	RP131J321B	LVR-IC	LDO, 3.2V±1%, 1A, +CE	TO-252-5	69x7	VR4	10d	Ric
D1J321D	RP131J321D	LVR-IC	LDO, 3.2V±1%, 1A, +CE, CL	TO-252-5	69x7	VR4	10d	Ric
D1J331B	RP131J331B	LVR-IC	LDO, 3.3V±1%, 1A, +CE	TO-252-5	69x7	VR4	10d	Ric
D1J331D	RP131J331D	LVR-IC	LDO, 3.3V±1%, 1A, +CE, CL	TO-252-5	69x7	VR4	10d	Ric
D1J341B	RP131J341B	LVR-IC	LDO, 3.4V±1%, 1A, +CE	TO-252-5	69x7	VR4	10d	Ric
D1J341D	RP131J341D	LVR-IC	LDO, 3.4V±1%, 1A, +CE, CL	TO-252-5	69x7	VR4	10d	Ric
D1J351B	RP131J351B	LVR-IC	LDO, 3.5V±1%, 1A, +CE	TO-252-5	69x7	VR4	10d	Ric
D1J351D	RP131J351D	LVR-IC	LDO, 3.5V±1%, 1A, +CE, CL	TO-252-5	69x7	VR4	10d	Ric
D1J361B	RP131J361B	LVR-IC	LDO, 3.6V±1%, 1A, +CE	TO-252-5	69x7	VR4	10d	Ric
D1J361D	RP131J361D	LVR-IC	LDO, 3.6V±1%, 1A, +CE, CL	TO-252-5	69x7	VR4	10d	Ric
D1J371B	RP131J371B	LVR-IC	LDO, 3.7V±1%, 1A, +CE	TO-252-5	69x7	VR4	10d	Ric
D1J371D	RP131J371D	LVR-IC	LDO, 3.7V±1%, 1A, +CE, CL	TO-252-5	69x7	VR4	10d	Ric
D1J381B	RP131J381B	LVR-IC	LDO, 3.8V±1%, 1A, +CE	TO-252-5	69x7	VR4	10d	Ric
D1J381D	RP131J381D	LVR-IC	LDO, 3.8V±1%, 1A, +CE, CL	TO-252-5	69x7	VR4	10d	Ric
D1J391B	RP131J391B	LVR-IC	LDO, 3.9V±1%, 1A, +CE	TO-252-5	69x7	VR4	10d	Ric
D1J391D	RP131J391D	LVR-IC	LDO, 3.9V±1%, 1A, +CE, CL	TO-252-5	69x7	VR4	10d	Ric
D1J401B	RP131J401B	LVR-IC	LDO, 4.0V±1%, 1A, +CE	TO-252-5	69x7	VR4	10d	Ric
D1J401D	RP131J401D	LVR-IC	LDO, 4.0V±1%, 1A, +CE, CL	TO-252-5	69x7	VR4	10d	Ric
D1J411B	RP131J411B	LVR-IC	LDO, 4.1V±1%, 1A, +CE	TO-252-5	69x7	VR4	10d	Ric
D1J411D	RP131J411D	LVR-IC	LDO, 4.1V±1%, 1A, +CE, CL	TO-252-5	69x7	VR4	10d	Ric
D1J421B	RP131J421B	LVR-IC	LDO, 4.2V±1%, 1A, +CE	TO-252-5	69x7	VR4	10d	Ric
D1J421D	RP131J421D	LVR-IC	LDO, 4.2V±1%, 1A, +CE, CL	TO-252-5	69x7	VR4	10d	Ric
D1J431B	RP131J431B	LVR-IC	LDO, 4.3V±1%, 1A, +CE	TO-252-5	69x7	VR4	10d	Ric
D1J431D	RP131J431D	LVR-IC	LDO, 4.3V±1%, 1A, +CE, CL	TO-252-5	69x7	VR4	10d	Ric
D1J441B	RP131J441B	LVR-IC	LDO, 4.4V±1%, 1A, +CE	TO-252-5	69x7	VR4	10d	Ric
D1J441D	RP131J441D	LVR-IC	LDO, 4.4V±1%, 1A, +CE, CL	TO-252-5	69x7	VR4	10d	Ric
D1J451B	RP131J451B	LVR-IC	LDO, 4.5V±1%, 1A, +CE	TO-252-5	69x7	VR4	10d	Ric
D1J451D	RP131J451D	LVR-IC	LDO, 4.5V±1%, 1A, +CE, CL	TO-252-5	69x7	VR4	10d	Ric
D1J461B	RP131J461B	LVR-IC	LDO, 4.6V±1%, 1A, +CE	TO-252-5	69x7	VR4	10d	Ric
D1J461D	RP131J461D	LVR-IC	LDO, 4.6V±1%, 1A, +CE, CL	TO-252-5	69x7	VR4	10d	Ric
D1J471B	RP131J471B	LVR-IC	LDO, 4.7V±1%, 1A, +CE	TO-252-5	69x7	VR4	10d	Ric
D1J471D	RP131J471D	LVR-IC	LDO, 4.7V±1%, 1A, +CE, CL	TO-252-5	69x7	VR4	10d	Ric
D1J481B	RP131J481B	LVR-IC	LDO, 4.8V±1%, 1A, +CE	TO-252-5	69x7	VR4	10d	Ric
D1J481D	RP131J481D	LVR-IC	LDO, 4.8V±1%, 1A, +CE, CL	TO-252-5	69x7	VR4	10d	Ric
D1J491B	RP131J491B	LVR-IC	LDO, 4.9V±1%, 1A, +CE	TO-252-5	69x7	VR4	10d	Ric
D1J491D	RP131J491D	LVR-IC	LDO, 4.9V±1%, 1A, +CE, CL	TO-252-5	69x7	VR4	10d	Ric
D1J501B	RP131J501B	LVR-IC	LDO, 5.0V±1%, 1A, +CE	TO-252-5	69x7	VR4	10d	Ric
D1J501D	RP131J501D	LVR-IC	LDO, 5.0V±1%, 1A, +CE, CL	TO-252-5	69x7	VR4	10d	Ric
T200	CHT200PPT	Si-npn	AF, Sw, 25V, 5A, B=45..180, 65MHz	DPAK	68tb	-	10a	Chm
T210P	CHT210PPT	Si-npn	AF, Sw, 30V, 5A, B=45..180, 120MHz	DPAK	68tb	-	10a	Chm



SECTION 12
CONVENTIONAL CASE DRAWINGS

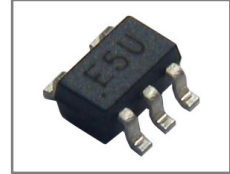

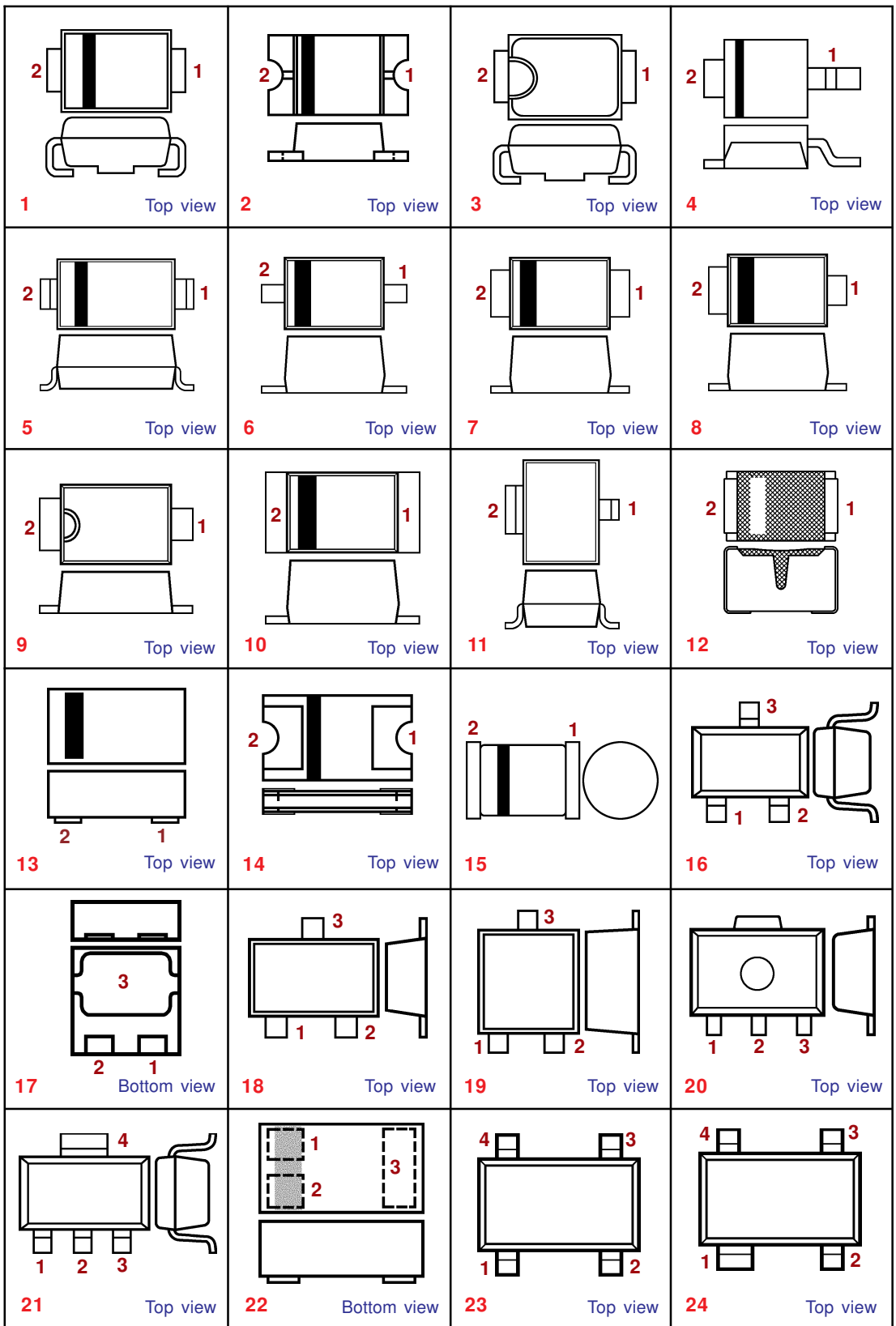

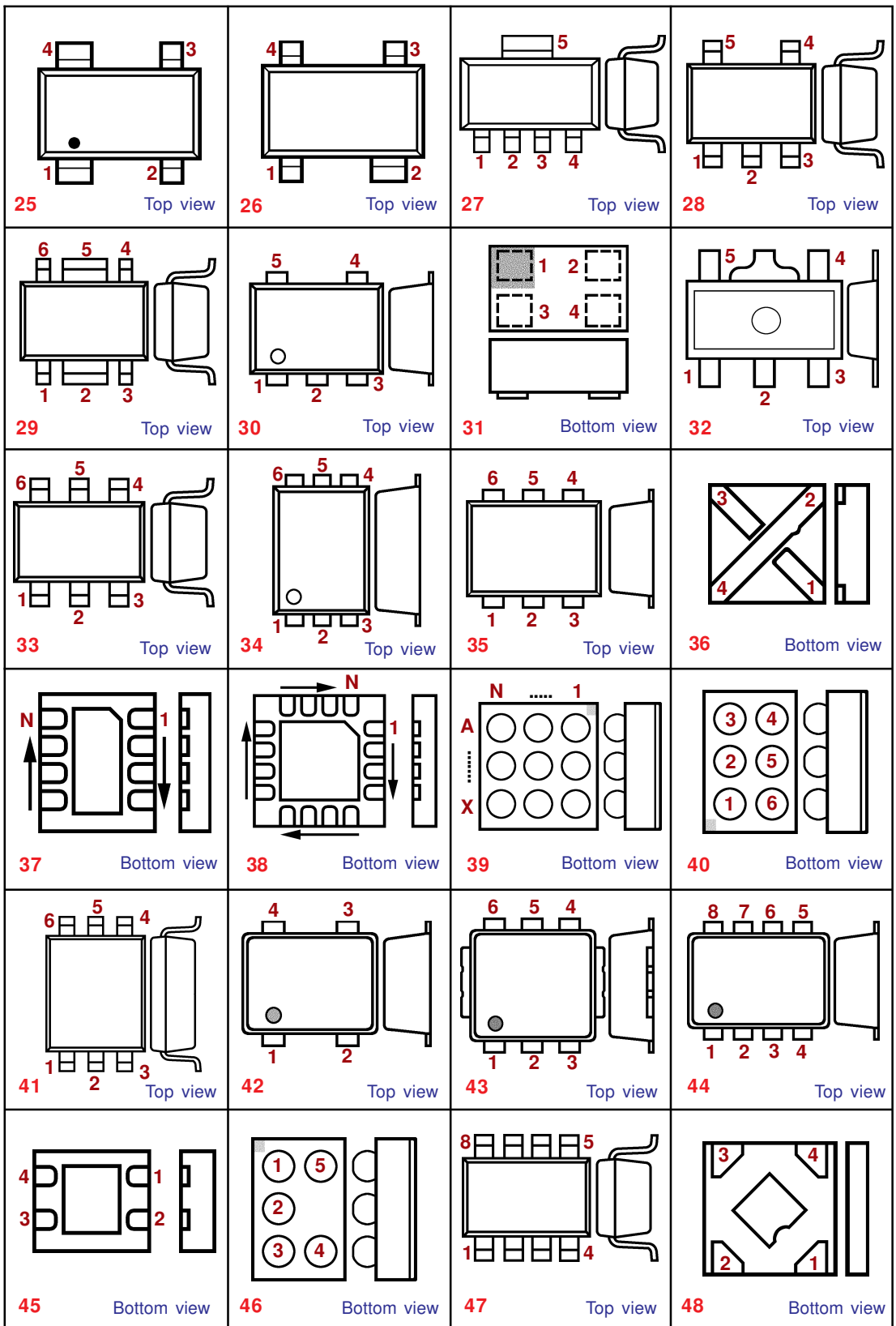

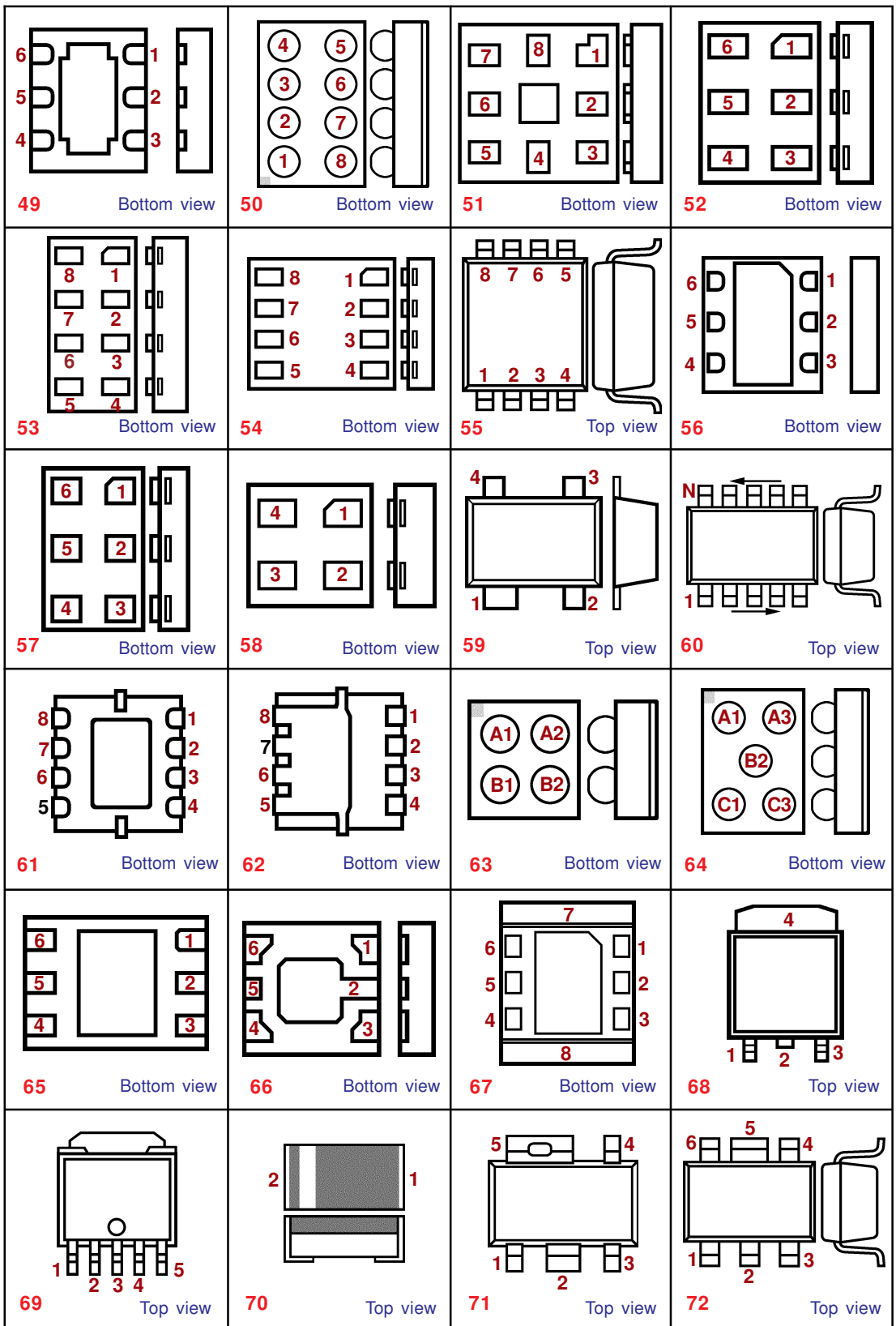

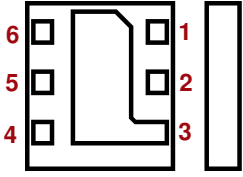
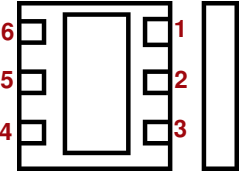
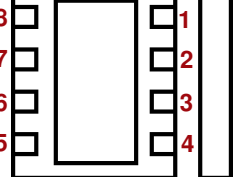
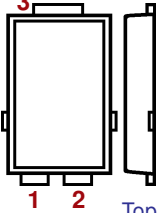
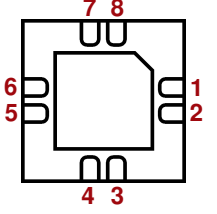
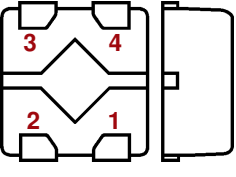
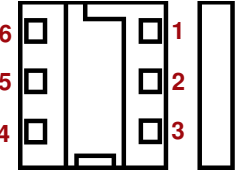
 <p>73 Bottom view</p>	 <p>74 Bottom view</p>	 <p>75 Bottom view</p>	 <p>76 1 2 3 Top view</p>
 <p>77 Bottom view</p>	 <p>78 Bottom view</p>	 <p>79 Bottom view</p>	

SECTION 13
CASES PIN ASSIGNMENTS / PINOUTS

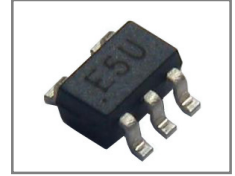

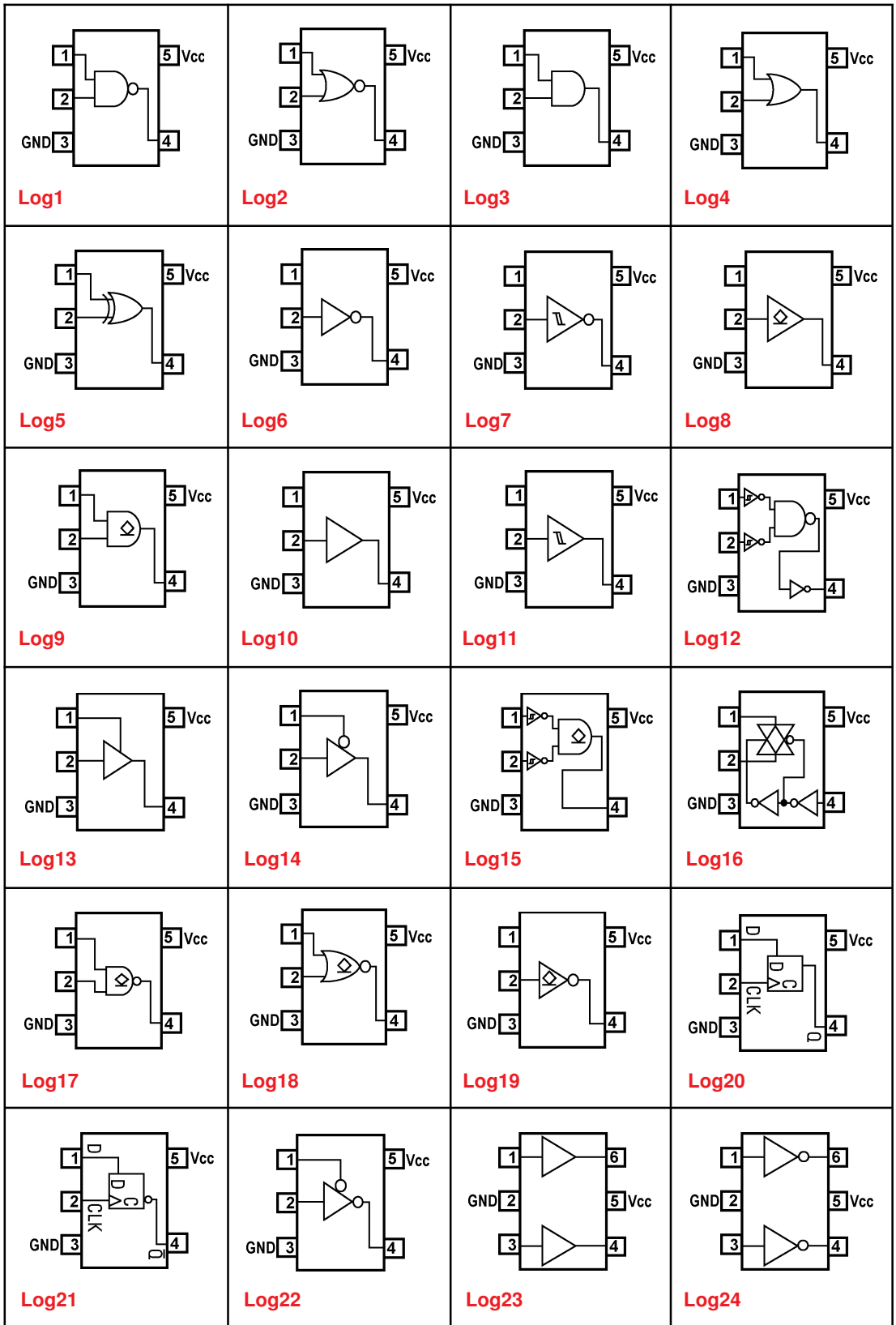

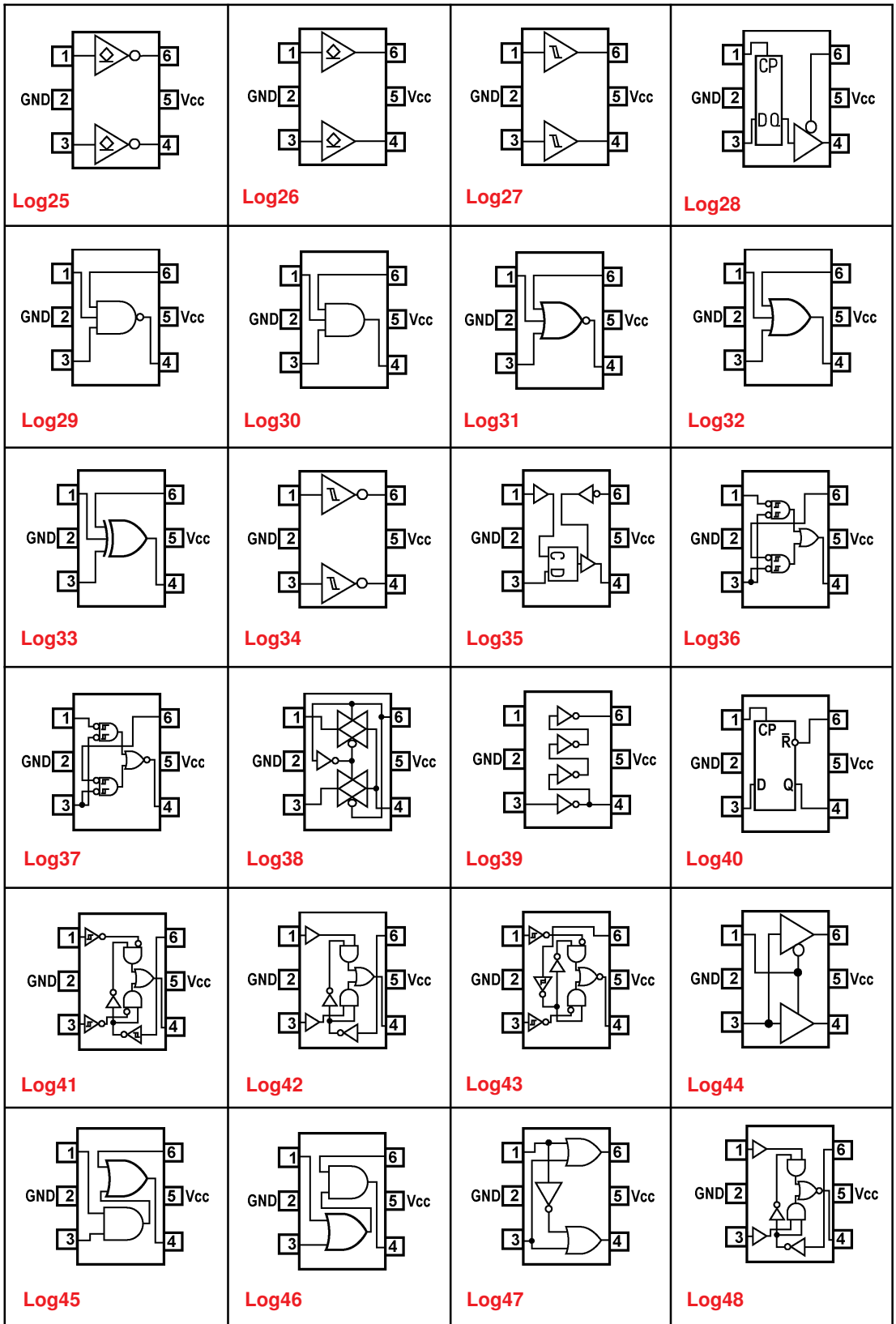

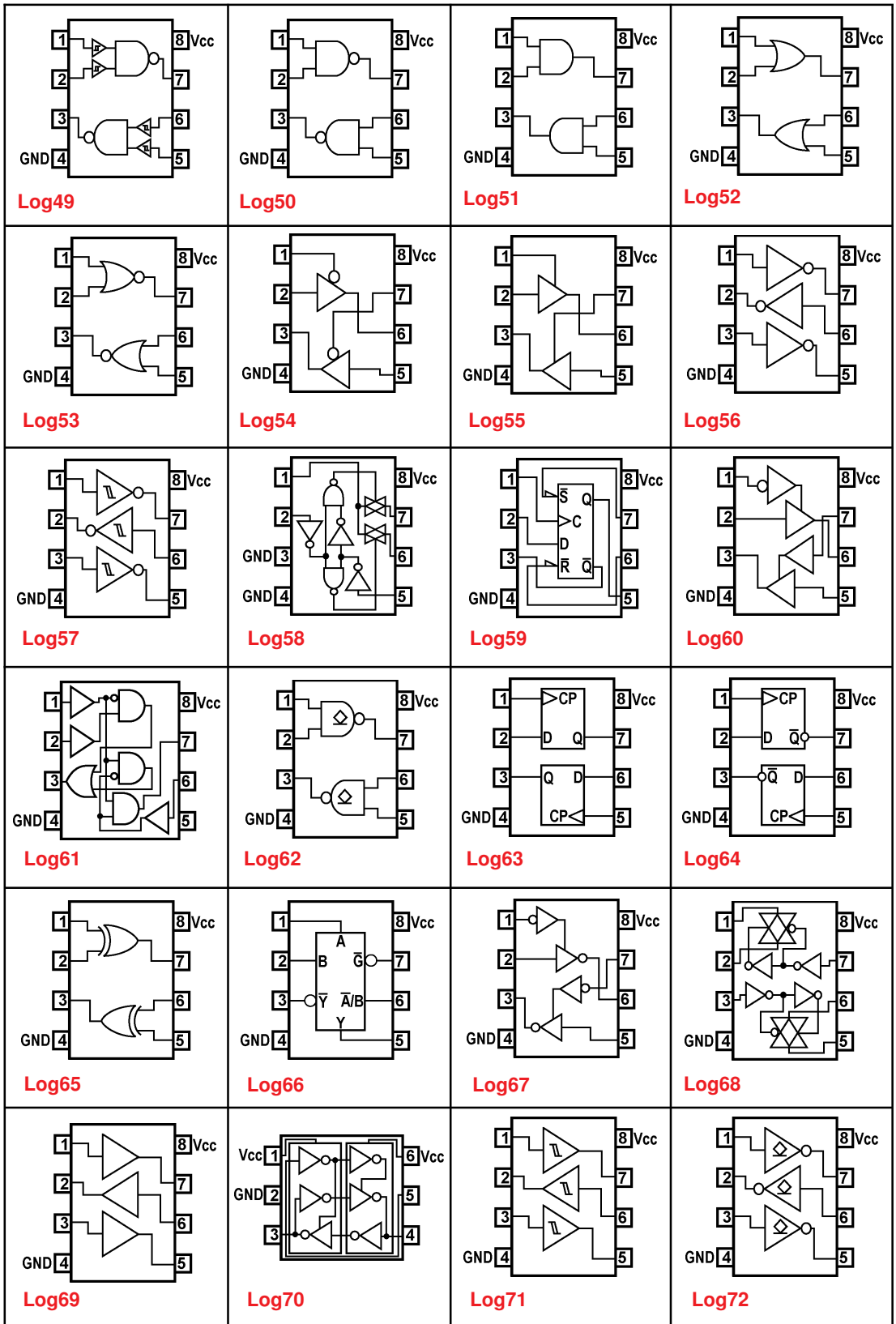

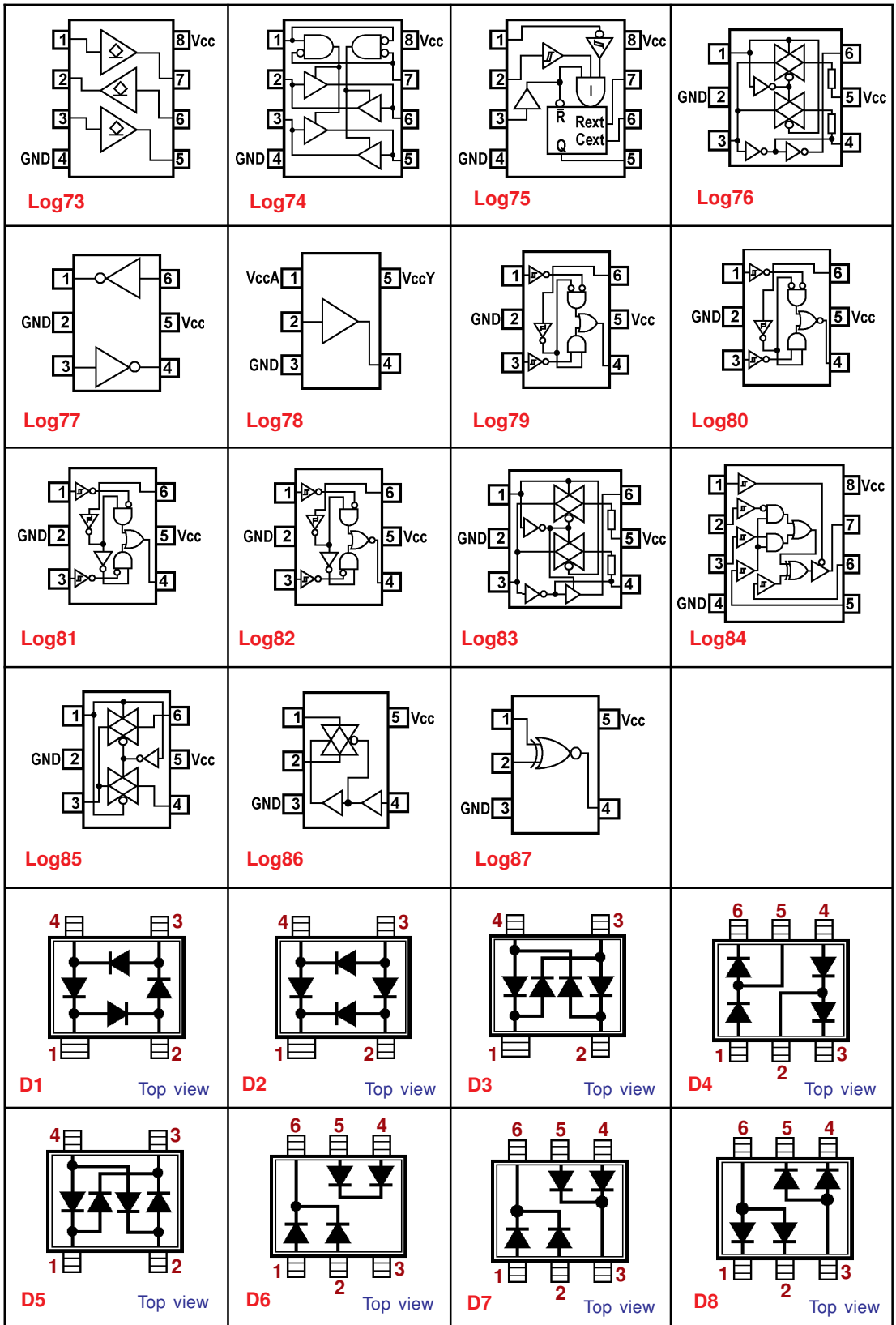

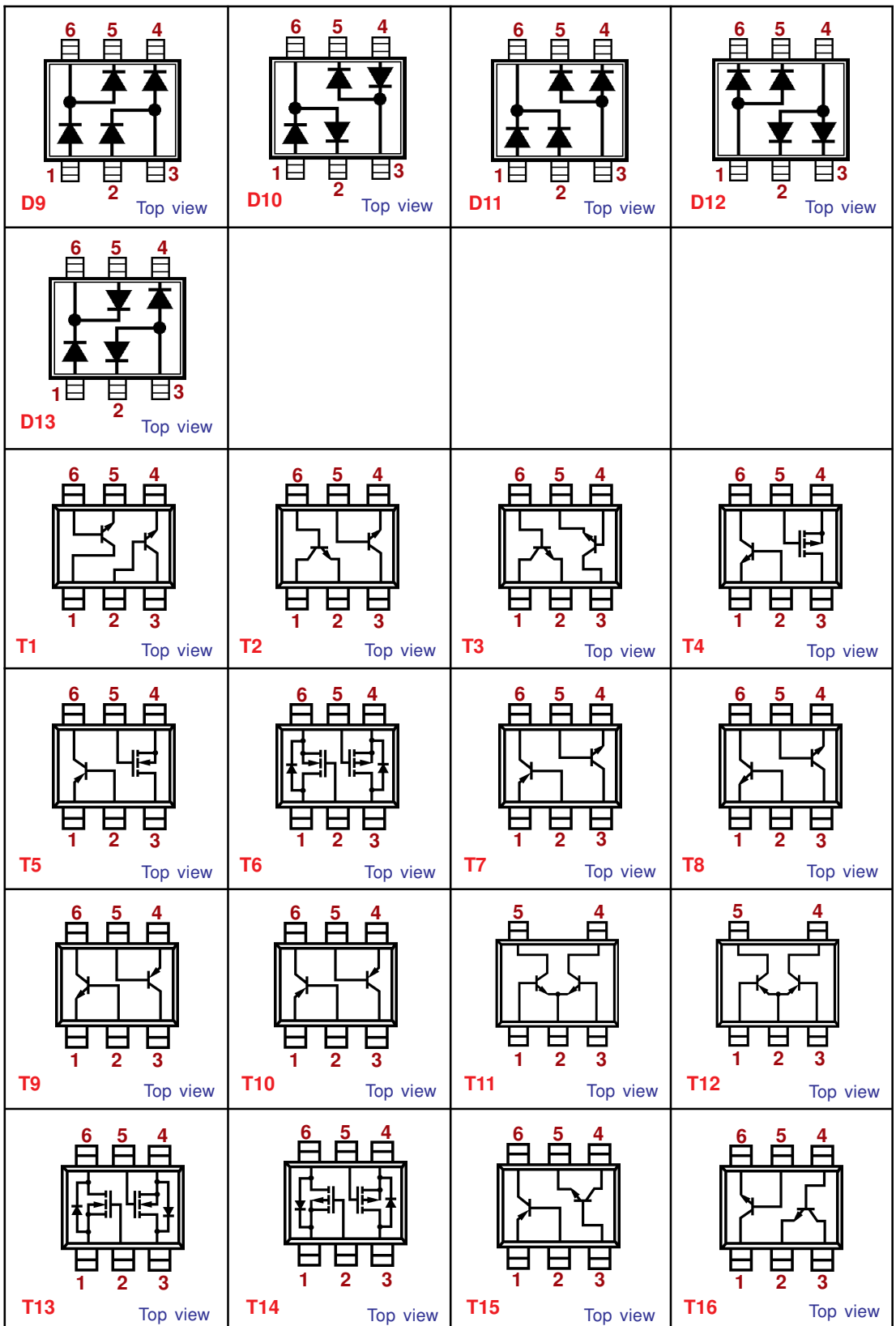

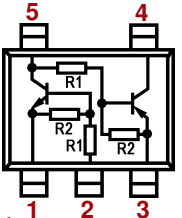
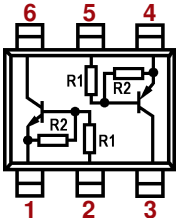
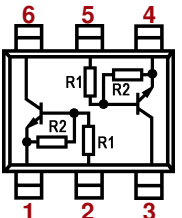
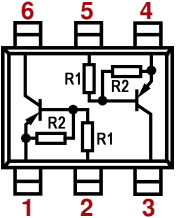
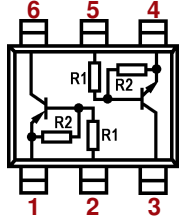
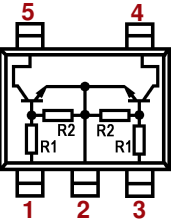
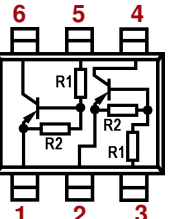
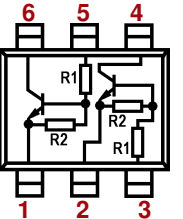
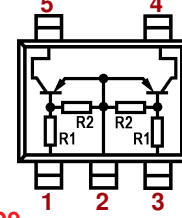
 <p>TD1 Top view</p>	 <p>TD2 Top view</p>	 <p>TD3 Top view</p>	 <p>TD4 Top view</p>
 <p>TD5 Top view</p>	 <p>TD6 Top view</p>	 <p>TD7 Top view</p>	 <p>TD8 Top view</p>
 <p>TD9 Top view</p>			

SECTION 14
PIN / TERMINAL FUNCTION (Table)



	PIN 1	PIN2	PIN3	PIN4	PIN5	PIN6	PIN7	PIN8
a1	GND	GND	Input	GND	GND	Vcc/Output	-	-
aa	Input	GND	Vcc/Output	GND	-	-	-	-
ab	Input	GND	GND	Output	GND	Vcc	-	-
ac	Vcc	GND	Input	GND	GND	Output	GND	GND
ad	Input	GND	Vcc	Output	GND	-	-	-
ae	Input	Vcc	GND	Output	GND	GND	-	-
af	N/C	Vinut	N/C	GND	N/C	Voutput	N/C	N/C
ag	Contact	Contact	N/C	-	-	-	-	-
ah	E	E	B	E	E	C	-	-
ai	GND		Vcc	Input	Output	-	-	-
aj	GND	Vcc/Vout	GND	Input	-	-	-	-
ak	N/C	Cathode	Anode	-	-	-	-	-
am	Vcc/Output	GND	Input	GND	-	-	-	-
an	Output	GND	Input	Vcc	GND	-	-	-
ao	Cathode(A)	N/C	Cathode(A)	Anode(K)	-	-	-	-
ap	Cathode	N/C	Cathode	Anode	-	-	-	-
ba	Cathode(A)	Cathode(A)	-	-	-	-	-	-
bb	Cathode1	Cathode2	Cathode3	Anode3	Anode2	Anode1	-	-
bc	Cathode1	Common A	Cathode2	Cathode3	Cathode4	-	-	-
bd	Cathode	Cathode	Anode	-	-	-	-	-
bf	Cathode1	Common A	Cathode2	Cathode3	Cathode4	Cathode5	-	-
bg	Cathode1	Cathode2	Anode2	N/C	Anode1	-	-	-
bh	Anode1	Common K	Anode2	Anode3	Anode4	-	-	-
bi	Anode	Cathode	Anode	Anode	Cathode	Anode	-	-
bm1	N/C	Cout	Dout	GND	V+	V-	-	-
bm2	V-	V+	GND	Dout	Cout	-	-	-
bn	OVP	Vinut	±CE	A GND	N/C	Feedback	SW	PGND
bp	Cathode	Cathode	Anode	Anode	Cathode	Cathode	-	-
bq	GND	Voutput	Lx	-	-	-	-	-
br	GND	Voutput	Ext	-	-	-	-	-
bs	Anode1	Common K	Anode2	Common K	-	-	-	-
bt	Cathode1	N/C	Cathode2	Common A	-	-	-	-
bu	Anode1	N/C	Anode2	Common K	-	-	-	-
bv	Anode1	N/C	Cathode2	K1/A2	-	-	-	-
bw	Anode1	Common K	Anode2	Anode3	Common K	Anode4	-	-
bx	Anode1	K1/A2	Cathode2	Cathode3	A3/K4	Anode4	-	-
by	Cathode1	A1/K2	Anode2	Cathode3	A3/K4	Anode4	-	-
bz	Cathode	Anode	Cathode	-	-	-	-	-
c	Cathode1	Common A	Cathode2	Cathode3	N/C	Cathode4	-	-
ca	Q	GND	+Input	-Input	Output	-	-	-
cb	Vcc	Shutdown	Input L	Output L	GND	Output R	Input R	Cext
cc	Reset	MR	GND	Vcc	-	-	-	-
cd	K1/A2/K3	Cathode2	Anode3	Anode1	-	-	-	-
ce	Cathode1	Cathode2	Anode2	Anode1	-	-	-	-
cf	GND	Vinput	Vinput	Vinput	Voutput	Voutput	Voutput	N/C
cg	GND	Voutput	Vinput	-	-	-	-	-
ch	Voutput	GND	Vinput	-	-	-	-	-
cj	Voutput	Vinput	GND	-	-	-	-	-
ck	Voutput	Adjust	Vinput	-	-	-	-	-
cm	Adjust	Vinput	Voutput	-	-	-	-	-
cn	Adjust	Voutput	Vinput	-	-	-	-	-
co	Reset	MR	Vcc	GND	-	-	-	-
cp	Reset	GND	MR	WDI	Vcc	-	-	-
cq	Reset	GND	MR1	Vcc	MR2	-	-	-
cr	Vcc	GND	MR	Reset	-	-	-	-
cs	Anode1	Cathode1	Anode2	K2	-	-	-	-
ct	Anode1	Cathode1	K2	Anode2	-	-	-	-
cu	Vinput	GND	CE	Shutdown	Voutput	-	-	-
cv	Voutput	Shutdown	CE	Vinput	-	-	-	-
cw	Shutdown	GND	CE	Vinput	Voutput	-	-	-
cx	Vinput	GND	CE	N/C	Voutput	-	-	-
cy	Adjust	Vinput	Voutput	Vinput	-	-	-	-

	PIN 1	PIN2	PIN3	PIN4	PIN5	PIN6	PIN7	PIN8
d	Anode	Cathode	-	-	-	-	-	-
cz	K1	Common Anode		K2	-	-	-	-
d	Anode	Cathode	-	-	-	-	-	-
d1	Anode1	Common K	Anode2	N/C	-	-	-	-
da	Lx	GND	Feedback	CE/MODE	GND	Vinput	-	-
db	Anode1	K1/A2	Cathode2	N/C	-	-	-	-
dc	Anode	N/C	Cathode	-	-	-	-	-
dc1	Voutput2	Vdout	Voutput1	Lx	GND	Vinput	-	-
dc2	Lx	GND	Voutput1	Vdout	Voutput2	Vinput	-	-
dc3	Lx	GND	Mode	OE	Voutput	Vinput	-	-
dc4	Vinput	GND	CE/MODE	Voutput	Lx	-	-	-
dc5	Lx	GND	Voutput	CE/MODE	GND	Vinput	-	-
dc6	Feedback	Switching	GND	Vinput	N/C	OE	-	-
dc7	Lx	GND	Voutput	CE/MODE	GND	Vinput	L1	L2
dc8	GND	Vinput	Ext	Voutput	OE	-	-	-
dc9	Vinput	GND	CE/MODE	Feedback	Lx	-	-	-
dd	Anode1	Anode2	Anode3	Cathode3	Cathode2	Cathode1	-	-
de	Anode1	N/C	Cathode2	Anode2	N/C	Cathode1	-	-
df	Cathode1	Cathode2	A1/2	-	-	-	-	-
dg	Anode1	Anode2	K1/K2	-	-	-	-	-
dh	Anode	Anode	Cathode	-	-	-	-	-
di	Anode	Cathode	N/C	-	-	-	-	-
dj	Anode1	K1/A2	Cathode2	-	-	-	-	-
dk	Cathode	Anode	N/C	-	-	-	-	-
dl	Anode1	Cathode2	K1/A2	-	-	-	-	-
dm	Anode	Cathode	Anode	-	-	-	-	-
dn	N/C	Anode1	Cathode1	N/C	Anode2	Cathode2	-	-
do	K1/K2	Anode3	A2/K3	Anode1	-	-	-	-
dp	A(K)	A(K)	A(K)	-	-	-	-	-
dq	Anode	N/C	Cathode	N/C	N/C	-	-	-
dr	N/C	Anode	Cathode	-	-	-	-	-
ds	Anode1	N/C	Anode2	Cathode2	Cathode1	-	-	-
dt	A(K)1	A(K)2	A(K)3	A(K)3	A(K)2	A(K)1	-	-
du	Adjust	Cathode	Anode	-	-	-	-	-
dv	Anode1	Anode2	Cathode2	Cathode1	-	-	-	-
d w	Anode1	N/C	Anode2	Cathode2	N/C	Cathode1	-	-
dx	Cathode1	Common A	Cathode2	Cathode3	Common A	Cathode4	-	-
dy	K1(A1)	K2(A2)	K3(A3)	K3(A3)	K2(A2)	K1(A1)	-	-
dz	Anode	N/C	Anode	Cathode	-	-	-	-
ea	Cathode1	Anode2	A1/K2	-	-	-	-	-
eb	Cathode	N/C	Anode	-	-	-	-	-
ec	Anode1	Anode2	Anode3	Common K	Common K	Common K	-	-
ed	N/C	A1/A2	N/C	Cathode1	N/C	Cathode2	-	-
ee	Voutput	Vinput	OE	GND	-	-	-	-
ef	Cathode1	A2	Cathode2	A1	-	-	-	-
eg	Reset	-HV	Vcc	GND	MR	-	-	-
eh	-HV	GND	Vcc	Reset	MR	-	-	-
ei	Vinput	GND	OE	Flag	Voutput	-	-	-
ej	Vinput	PGND	Vcc	OE	Vout/Feed	Mode	AGND	Lx
ek	Reset	GND	MR	Reset In	Vcc	-	-	-
el	PGND	Vinput	Vcc	OE	Vout/Feed	Test	AGND	Lx
em	Reset	GND	Reset In	OVR In	Vcc	-	-	-
en	N/C	Anode	Cathode	Cathode	-	-	-	-
ep	Voutput	N/C	GND	OE	N/C	Vinput	-	-
eq	Voutput	Voutput	N/C	N/C	GND	OE	Vinput	Vinput
er	Voutput	GND	N/C	OE	N/C	Vinput	-	-
es	Voutput	GND	Cd	OE	Vinput	-	-	-
et	Voutput	GND	Cd	OE	GND	Vinput	-	-
eu	Vinput	GND	Voutput	-	-	-	-	-
ev	Vinput	GND	Voutput	N/C	Vinput	N/C	-	-
e w	GND	Vinput	OE	N/C	Voutput	-	-	-
ex	N/C	Vinput	OE	GND	Voutput	-	-	-

	PIN 1	PIN2	PIN3	PIN4	PIN5	PIN6	PIN7	PIN8
ey	GND	±Reset	±MR	Vinput	-	-	-	-
ez	Voutput	N/C	Vinput	N/C	N/C	GND	-	-
f1	Gate1	Gate2	Drain	Source	-	-	-	-
f2	Gate	Drain	Source	Drain	-	-	-	-
fa	Source	Drain	Gate	-	-	-	-	-
fb	Gate1	S1/S2	Gate2	Drain2	Drain1	-	-	-
fc	Drain	Drain	Gate	Source	Drain	Drain	-	-
fd	Source	Drain	Gate1	Gate2	-	-	-	-
fe	Source1	Source2	Gate2	Drain2	Gate1	Drain1	-	-
fg	Source	Gate	Drain	-	-	-	-	-
fh	Gate	Source	Drain	-	-	-	-	-
fi	Gate	Drain	Source	-	-	-	-	-
fj	Drain	Source	Gate	-	-	-	-	-
fk	Drain	Gate	Source	-	-	-	-	-
fl	Sub	Source	Drain	Gate	-	-	-	-
fm	Drain	Source	Gate1	G2	-	-	-	-
fn	Drain	Source	Gate	N/C	-	-	-	-
fo	Source1	Gate1	Source2	Gate2	Drain2	Drain2	Drain1	Drain1
fp	Source	Drain	Source	Gate	-	-	-	-
fq	Gate	Source	Drain	Source	-	-	-	-
fr	N/C	Source	Source	Gate	Drain	Drain	Drain	Drain
fs	Source	Source	Source	Gate	Drain	Drain	Drain	Drain
ft	Gate	Prot Di	Source	Drain	-	-	-	-
fv	Gate	Drain	Source	Source	-	-	-	-
fw	Gate	N/C	Source	Drain	-	-	-	-
fx	SUB	Source	Drain	Gate	-	-	-	-
ga	Vinput	N/C	N/C	Lx	N/C	GND	-	-
gb	N/C	Voutput	CE	Lx	GND	-	-	-
gc	N/C	Vdd	Voutput	Lx	GND	-	-	-
gd	Voutput	N/C	CE	Lx	N/C	GND	-	-
ge	Vcc	N/C	Voutput	Lx	N/C	GND	-	-
gf	N/C	Voutput	Vinput	GND	CE	-	-	-
gg	Voutput	N/C	CE	Ext	N/C	GND	-	-
gh	Vinput	GND	Cd	Reset	-	-	-	-
gi	Voutput	GND	Lx	Vinput	GND	CE	-	-
gj	Vinput	Vbias	GND	CE	Voutput	-	-	-
gk	CE	Vbias	GND	Vinput	Voutput	-	-	-
gm	Vbias	GND	Vinput	Voutput	N/C	CE	-	-
gn	Vinput	CE	GND	Lx	N/C	Voutput	-	-
go	Vinput	N/C	Voutput	Ext	N/C	GND	-	-
gp	Vinput	N/C	GND	Lx	N/C	Voutput	-	-
gq	Voutput	GND	Lx	Vinput	CE	-	-	-
ha	Vcc	Output	GND	-	-	-	-	-
hb	Vcc	GND	T1 Input	CLK	DATA	INT/Output	-	-
hc	Vcc	GND	T1 Input	CLK	DATA	N/C	-	-
hd	N/C	GND	Vcc	SCLK	SDA	-	-	-
he	GND	GND	Hysteresis	Vcc	Tower	-	-	-
hf	GND	GND	Hysteresis	Vcc	Tunder	-	-	-
hg	Vinput	GND	CE	Reset	Voutput	-	-	-
hh	Vinput	GND	Sense	Reset	Voutput	-	-	-
hj	Vinput	GND	N/C	Reset	Voutput	-	-	-
hk	Vinput	GND	Voutput	Reset	CE	-	-	-
hl	Vinput	GND	Voutput	Reset	Sense	-	-	-
hm	Vinput	GND	Voutput	Reset	N/C	-	-	-
hn	Vinput	GND	Voutput	GND	-	-	-	-
ho	Vinput	+CE	-CE	N/C	Vadj	GND	Base	Voutput
hp	CE	N/C	GND	Voutput	N/C	Vinput	-	-
hq	Vinput	N/C	Voutput	N/C	GND	CE	-	-
hr	CE	N/C	Vinput	GND	Voutput	N/C	-	-
hs	Vinput	N/C	Voutput	N/C	GND	N/C	-	-
ht	AE(Mode)	GND	CE	Vinput	N/C	Voutput	-	-
hu	Voutput	N/C	CE	N/C	GND	Vinput	-	-

	PIN 1	PIN2	PIN3	PIN4	PIN5	PIN6	PIN7	PIN8
hv	AE(Mode)	GND	Vinput	Vinput	CE	-	-	-
hw	Vinput	GND	N/C	CE	Voutput	-	-	-
hx	GND	Reset	Cd	Vcc	-	-	-	-
hy	Vinput	CE	Voutput	GND	-	-	-	-
hz	Main1	Main2	Gate	Main2	-	-	-	-
la	+Vcc	GND	Output	Trigger	THR	-	-	-
lb	T/T	GND	CE	Vcc	Output	-	-	-
lc	Voutput	Vinput	CE	AGND	N/C	Feedback	Switch	P GND
ld	IN/OUT	GND	IN/OUT	CTRL	GND	Vcc	-	-
le	CE	OVP	Switch	Feedback	GND	Vinput	-	-
lf	CE	OVP	Vinput	Switch	GND	Feedback	-	-
ma	Reset	GND	MR	PFI	-PFO	Vcc	-	-
mb	ResetVcc	GND	MR	Sense	ResetSense	Vcc	-	-
mc	Reset	GND	MR	Sense	WDI	Vcc	-	-
md	Reset	N/C	Sense	Vcc	-	-	-	-
me	Reset	Cd	Sence	Vcc	-	-	-	-
mf	Reset	GND	Vcc	Sense	N/C	-	-	-
mg	Reset	GND	Vcc	Sense	Cd	-	-	-
opa	Output	-Vcc	+Input	-Input	+Vcc	-	-	-
opb	Output	+Vcc	+Input	-Input	-Vcc	-	-	-
opc	Output	-Vcc	+Input	-Input	+Vcc	Disable	-	-
opd	Output A	-Input A	+Input A	-Vcc	+Input B	-Input B	Output B +Vcc	-
ope	Offset	-Input	+Input	-Vcc	Offset	Output	+Vcc	N/C
opf	+Input	-Vcc	-Input	Output	+Vcc	-	-	-
ra	Anode	Reference	Cathode	-	-	-	-	-
rb	Reference	Anode	Cathode	-	-	-	-	-
rc	Cathode	Reference	Anode	-	-	-	-	-
rd	Reference	Cathode	Anode	-	-	-	-	-
re	N/C	N/C	Cathode	Reference A	-	-	-	-
rf	N/C	Anode	Cathode	Reference A	-	-	-	-
rg	Vout1	Vinput	Vout2	CE2	GND	CE1	-	-
rh	Vout1	Vinput	Vout2	GND	CE1	CE2	-	-
ri	Vout2	Vinput	Vout1	CE1	GND	CE2	-	-
rj	Reset	Cd	GND	Vcc	-	-	-	-
rk	Reset	GND	Vcc	Vreset	N/C	-	-	-
rm	Reset	GND	Vcc	Vreset	Cd	-	-	-
rn	Reset	N/C	Vreset	Vcc	PAD=GND	-	-	-
ro	Reset	Cd	Vreset	Vcc	PAD=GND	-	-	-
rp	Vcc	GND	Cd	Reset	-	-	-	-
rq	Reset	Sense	GND	Vcc	-	-	-	-
rr	Reset	Vcc	GND	N/C	Sense	-	-	-
rs	Vcc	N/C	GND	Sense	Reset	-	-	-
rt	N/C	Cathode	Anode	Cathode	-	-	-	-
ru	Reset	N/C	Vcc	N/C	GND	-	-	-
rv	Vcc	N/C	GND	Cd	Reset	-	-	-
rw	Voutput	Vinput	GND	N/C	-	-	-	-
rx	N/C	Vinput	Voutput	GND	Vinput	CE	-	-
rz	Voutput	Vinput	GND	CE	N/C	-	-	-
sa	N/C	GND	N/C	Voutput	Vinput	-	-	-
sb	GND	Voutput	Vinput	N/C	CE	-	-	-
sc	CE	Voutput	N/C	GND	Lx	-	-	-
sd	CE	Voutput	N/C	GND	Ext	-	-	-
se	Delay	Ampout	Vfeedback	Vinput	GND	Ext	-	-
sf	Delay	GND	Ext	Vinput	Vfeedback	Ampout	-	-
sg	Vinput	GND	±CE	Adjust	Voutput	-	-	-
sh	Voutput	Vinput	CE	GND	Ext	-	-	-
si	Delay	GND	Ext	Vinput	Feedback	CE	-	-
sj	Feedback	Vinput	CE	GND	Ext	-	-	-
sk	Voutput	Vinput	GND	Reset	CE	-	-	-
sl	Delay	CE	Vfeedback	Vinput	GND	Ext	-	-
sm	Voutput	Vinput	GND	Reset	Vsense	-	-	-
sn	Voutput	Vinput	GND	Reset	CD	-	-	-

	PIN 1	PIN2	PIN3	PIN4	PIN5	PIN6	PIN7	PIN8
so	Ext	Vinput	Delay	OE	GND	Voutput	-	-
sp	OE	GND	Vinput	Voutput	Cd	-	-	-
sq	Switch	GND	Feedback	OE	Vinput	-	-	-
sr	Reference	GND	-Shutdown	Lx	Output	-	-	-
ss	GND	Lx	Voutput	-	-	-	-	-
st	Feedback	GND	Reference	Output	LX	-	-	-
su	Feedback	GND	Reference	Lx	Output	Shutdown	-	-
sv	Switch	GND	Feedback	OE	OVP	Vinput	-	-
s w	GND	Ext	Voutput	-	-	-	-	-
sx	Voutput	Vinput	N/C	GND	Lx	-	-	-
sy	Voutput	Vinput	N/C	GND	Ext	-	-	-
sz	Voutput	Vinput	GND	N/C	N/C	-	-	-
t1	Base	Emitter	Collector	Emitter	-	-	-	-
t2	Base1	Emitter1	Collector2	Base2	Emitter2	Collector1	-	-
t3	Base1	Emitter2	Base2	Collector2	Emitter1	Collector1	-	-
t4	Collector	Collector	Base	Emitter	Collector	Collector	-	-
t5	B1/B2/C2	Collector1	Emitter1	Emitter2	-	-	-	-
t6	Collector	Base	Emitter	Emitter	-	-	-	-
t7	B	C	E	N/C	C	-	-	-
t8	Emitter	Base	Emitter	Collector	-	-	-	-
t9	Base	Collector	Base	Emitter	-	-	-	-
ta	Base	Emitter	Collector	-	-	-	-	-
tb	Base	Collector	Emitter	-	-	-	-	-
tc	Collector	Emitter	Base	Emitter	-	-	-	-
td	Base1	E1/E2	Base2	Collector2	Collector1	-	-	-
te	Emitter	Base	Collector	-	-	-	-	-
tf	Emitter1	Emitter2	Base2	Collector2	Base1	Collector1	-	-
tg	B	C	E	E	-	-	-	-
th	Emitter	C/Cathode	Anode	N/C	C/K	B	-	-
ti	Emitter1	C1/C2	Base2	Emitter2	C1/C2	B1	-	-
tj	Emitter1	Emitter2	Collector2	Base2	Base1	Collector1	-	-
tk	Collector	Emitter	Emitter	Base	Emitter	Emitter	-	-
tl	Collector1	Collector1	Collector2	Collector2	Emitter2	Base2	Emitter1	Base1
tm	Base	Collector	Emitter	Collector	-	-	-	-
tn	Cathode	Base	Emitter	C+A	-	-	-	-
to	Anode	Base	Emitter	C+K	-	-	-	-
tp	Emitter	Collector	Base	Collector	-	-	-	-
tq	N/C	Collector	Emitter	Base	-	-	-	-
tr	Emitter	Collector	Base	-	-	-	-	-
ts	Collector	Base	Emitter	-	-	-	-	-
tt	C(n)	B(n)/B(p)	C(P)	E(n)/E(p)	-	-	-	-
tu	Emitter	Collector	Emitter	Base	-	-	-	-
tv	E(n)	Base(p)	C(p)	E(p)	Base(n)	C(n)	-	-
t w	E(n)	Base(n)	E(p)	C(p)	B(p)C(n)	-	-	-
ty	Emitter1	B1/B2	Emitter2	Collector2	Collector1	-	-	-
tz	Anode	Base	Collector	Emitter	N/C	Cathode	-	-
ua	Reset	GND	Cd	GND	Vcc	-	-	-
ub	OE	GND	Vinput	Voutput	N/C	Cb	-	-
uc	GND	OE	Vinput	Voutput	-	-	-	-
ud	OE	GND	Voutput	Ext	Vinput	-	-	-
ue	OC	Feedback	CSP	Vinput	EXT	GND	Rosc	Shutdown
uf	GND	Output	Cap-	Shutdown	+Vcc	Cap+	-	-
ug	OC	Feedback	CSP	Vinput	EXT	GND	Rosc	Rduty
uh	Cd	Voutput1	Voutput2	Cd	CE1	GND	Vinput	CE1
ui	Cd	GND	Vcc1	Vcc	Reset	-	-	-
uj	Vinput	GND	OE	-Error	Cb	Voutput	-	-
uk	Voutput	GND	Vcc	OE	Feedback	-	-	-
ul	OE	GND	Feedback	Voutput	Vcc	-	-	-
um	N/C	GND	OE	Vinput	Voutput	-	-	-
un	OE	GND	Cb	Voutput	Vinput	-	-	-
uo	E	C	E	B	C	-	-	-
up	OE	GND	Cb	Voutput	N/C	Vinput	-	-

	PIN 1	PIN2	PIN3	PIN4	PIN5	PIN6	PIN7	PIN8
uq	Voutput	Vcc	GND	OE	Feedback	-	-	-
ur	Reset	GND	Cd	N/C	GND	Vcc	-	-
us	N/C	GND	N/C	Vinput	N/C	Voutput	-	-
ut	Vcc	GND	N/C	Reset	-	-	-	-
v1	OE	Vinput	Voutput	N/C	Vinput	GND	-	-
v2	N/C	Vinput	Voutput	N/C	Vinput	GND	-	-
va	Voutput	GND	N/C	N/C	OE	Vinput	-	-
vb	Voutput	GND	GND	N/C	N/C	GND	GND	Vinput
vc	OE	GND	N/C	Voutput	Vinput	-	-	-
vcd	+Vcc	GND	Cap-	GND	Output	Cap+	-	-
vce	Vreg	GND	Ext	Vcc	Select	-	-	-
vd	GND	Voutput	Ext	N/C	OE	-	-	-
vd1	Reset	GND	Vcc	N/C	N/C	-	-	-
vd2	GND	N/C	Reset	MR	Vcc	-	-	-
vd3	Reset/MR	GND	Reset	Cpor	Vcc	-	-	-
vd4	Reset/MR	GND	Reset	Vmon	Vcc	-	-	-
vd5	Reset/MR	GND	Reset	WDI	Vcc	-	-	-
vd6	Reset/MR	GND	Vmon	Cpor	Vcc	-	-	-
vd7	Reset/MR	GND	Vmon	WDI	Vcc	-	-	-
vd8	Reset	Vcc	GND	N/C	Vcc	N/C	-	-
vd9	Reset	N/C	GND	Vinput/Vcc-	-	-	-	-
vda	Reset	Vcc	GND	-	-	-	-	-
vdb	Reset	GND	Vcc	-	-	-	-	-
vdc	GND	Reset	Vcc	-	-	-	-	-
vdd	Vcc	GND	Reset	-	-	-	-	-
vde	GND	Vcc	Reset	-	-	-	-	-
vdf	GND	Vcc	Cd	Reset	-	-	-	-
vdg	GND	Vcc	Reset	N/C	N/C	-	-	-
vdh	GND	Reset	MR	Vcc	-	-	-	-
vdj	Reset	GND	N/C	Vcc	-	-	-	-
vdI	Reset	Vcc	N/C	GND	-	-	-	-
vdm	Reset	Vcc	GND	N/C	N/C	-	-	-
vdo	Reset	Vcc	GND	N/C	Cd	-	-	-
vdp	ER	GND	GND	Reset	Vcc	-	-	-
vdq	N/C	GND	GND	Reset	Vcc	-	-	-
vdr	N/C	GND	N/C	Reset	Vcc	-	-	-
vdv	Reset	GND	N/C	GND	Vcc	-	-	-
vdY	Vcc	Reset	GND	-	-	-	-	-
vdz	N/C	N/C	GND	Reset	Vcc	-	-	-
ve	OE	GND	Vinput	Voutput	GND	N/C	-	-
vf	OE	GND	Cb	Voutput	GND	Vinput	-	-
vg	Cd	GND	OE	Vinput	GND	Voutput	-	-
vh	+Vcc	GND	Cap-	Shutdown	Output	Cap+	-	-
vi	-Input	GND	N/C	Comp	Output	-	-	-
vj	Vinput	Voutput	GND	-	-	-	-	-
vk	Reset	SUB	N/C	Vcc	GND	-	-	-
vka	Reset	SUB	Ct	Vcc	GND	-	-	-
vkb	Vcc	GND	MR	Reset	GND	N/C	-	-
vl	GND	Vinput	Voutput	-	-	-	-	-
vm	Voutput	GND	OE	Vinput	-	-	-	-
vn	OE	GND	Voutput	Vinput	-	-	-	-
vp	GND	Vinput	Voutput	OE	-	-	-	-
vq	Vinput	GND	N/C	N/C	OE	Voutput	-	-
vr	Voutput	Voutput	OE	GND	Vinput	Vinput	-	-
vr1	Voutput	GND	Vinput	OE	Cd	-	-	-
vr2	N/C	GND	OE	Vinput	N/C	Voutput	-	-
vr3	OE	GND	Vinput	Voutput	N/C	-	-	-
vr4	Voutput	GND	N/C	OE	Vinput	-	-	-
vr5	Vinput	Voutput	Voutput	Cb	GND	OE	-	-
vr7	Cn	Delay	GND	Vinput	Voutput	Sense	Error	OE
vr8	Cn	Delay	GND	Vinput	Voutput	Adjust	Error	OE
vr9	Ext	GND	-Enable	Vinput	Voutput	-	-	-

	PIN 1	PIN2	PIN3	PIN4	PIN5	PIN6	PIN7	PIN8
vra	Vinput	GND	Voutput	N/C	GND	CE	-	-
vrb	Vinput	CE	GND	Voutput	-	-	-	-
vr c	Vinput	N/C	Voutput	AE(Mode)	GND	CE	-	-
vr d	Voutput	GND	Vinput	N/C	CE	-	-	-
vre	Ext	Vdet	Voutput	Cd	GND	Vinput	-	-
vrf	CE	GND	Vinput	Ext	Voutput	-	-	-
vr g	Voutput	GND	Vinput	Adjust	CE	-	-	-
vr h	CE	GND	Vinput	Voutput	GND	AE(Mode)	-	-
vri	Adjust	GND	CE	Vinput	Voutput	-	-	-
vr j	Voutput	GND	AE(Mode)	CE	N/C	Vinput	-	-
vr k	Voutput	GND	CE	N/C	GND	Vinput	-	-
vr m	Voutput	Voutput	Adjust	GND	CE	-	-	-
vr n	Voutput	Voutput	N/C	GND	CE	Vinput	-	-
vr p	Voutput	Vinput	Adjust	N/C	CE	-	-	-
vr q	Voutput	GND	CE	N/C	Vinput	-	-	-
vr r	Voutput	GND	CE	Adjust	Vinput	-	-	-
vr s	Adjust	Vinput	Vinput	Vinput	Voutput	Voutput	Voutput	N/C
vr t	GND	Vinput	Voutput	N/C	CE	-	-	-
vr u	CE	GND	Vinput	Cb	Voutput	-	-	-
vr v	CE	GND	Vinput	Voutput	AE(Mode)	-	-	-
vr x	Vinput	GND	CE	Cb	Voutput	-	-	-
vr y	CE	Vinput	Voutput	Sense	GND	-	-	-
vr z	CE	Vinput	Voutput	-Error	GND	-	-	-
vs	GND	Vinput	Voutput	N/C	-	-	-	-
vt	Voutput	GND	Vinput	CE	N/C	-	-	-
vta	Voutput	GND	Adjust	CE	GND	Vinput	-	-
vtb	Voutput	GND	N/C	CE	GND	Vinput	-	-
vt c	N/C	Vinput	N/C	Voutput	GND	Bp	CE	N/C
vu	GND	Vinput	Voutput	N/C	N/C	-	-	-
v w	GND	Vinput	Voutput	Ext	CE	-	-	-
vy	CE	GND	N/C	Vinput	Voutput	-	-	-
vz	Voutput	Vinput	GND	N/C	CE	-	-	-
w	Vinput	GND	CE	-Error	Voutput	-	-	-
wa	GND	Feedback	Tap	Vinput	Voutput	Sense	Error	CE
wb	GND	Voutput	Vinput	Voutput	-	-	-	-
wc	Adjust	Voutput	Vinput	Voutput	-	-	-	-
wd	Vinput	GND	Cb	Adjust	Voutput	-	-	-
we	CE	Cb	Vinput	Voutput	GND	GND	GND	GND
wf	Voutput	Voutput	GND	CE	Vinput	Vinput	-	-
wg	Voutput	GND	CE	GND	Vinput	-	-	-
wh	Voutput	GND	CE	GND	GND	Vinput	-	-
x1	Voutput	CE	GND	GND	Vinput	-	-	-
x2	Vinput	GND	GND	CE	Voutput	-	-	-
x3	Vinput	GND	GND	CE	GND	Voutput	-	-
x4	Voutput1	Voutput2	GND	CE2	Vinput	CE1	-	-
x5	CE1	Vinput	CE2	Voutput2	GND	Voutput1	-	-
x6	GND	Voutput1	Voutput2	GND	CE2	Vinput2	Vinput1	CE1
x7	Voutput	GND	GND	CE	Vinput	-	-	-
x9	Vinput	GND	CE	AE(Mode)	Voutput	-	-	-
xa	N/C	GND	CE	Voutput	Vinput	-	-	-
xb	Voutput	Sense	N/C	GND	CE	N/C	N/C	Vinput
xc	Voutput	Adjust	N/C	GND	CE	N/C	N/C	Vinput
xd	Reset	GND	MR	WD	Vcc	-	-	-
xf	Reset	GND	Reset	MR	Vcc	-	-	-
xg	Reset	GND	Reset	WD	Vcc	-	-	-
xh	WD	MR	N/C	Reset	GND	Vcc	-	-
xj	Dout	V-	Cout	Ct	Vcc	GND	-	-
xk	Dout	V-	Cout	DS	Vcc	GND	-	-
xm	CE	N/C	GND	Voutput	Vinput	-	-	-
xn	Reset	GND	Reset	Reset In	Vcc	-	-	-
xo	-Input	GND	Output	-Output	Vcc	Input	-	-
xp	-Input	GND	Output	Vcc	Vagc	Input	-	-

	PIN 1	PIN2	PIN3	PIN4	PIN5	PIN6	PIN7	PIN8
xq	WD	+Reset	N/C	Reset	GND	Vinput/Vcc	-	-
xr	Vinput	N/C	Voutput	OE	N/C	GND	-	-
xs	MR	Reset	N/C	Reset	GND	Vinput/Vcc	-	-
xt	N/C	Voutput	N/C	GND	N/C	Vinput	-	-
xu	CE	GND	Vinput	Voutput	N/C	N/C	-	-
xv	CE2	Vinput	CE1	GND	Voutput1	Voutput2	-	-
xx	AE(Mode)	GND	Voutput	Vinput	CE	-	-	-
y1	Voutput	GND	N/C	Vinput	-	-	-	-
y2	N/C	N/C	GND	Voutput	Vinput	-	-	-
y3	Cd	GND	GND	Voutput	Vinput	-	-	-
y4	N/C	N/C	GND	Vcc	Reset	-	-	-
ya	Voutput	GND	OE	Reset	Vinput	-	-	-
yb	Voutput	GND	Sense	Reset	Vinput	-	-	-
yc	Voutput	GND	Cd	Reset	Vinput	-	-	-
yd	Cd	GND	N/C	Reset	Vcc	-	-	-
ye	GND	Cd	Vcc	Reset	-	-	-	-
yf	CE1	GND	CE2	Voutput2	Vinput	Voutput1	-	-
yg	Reset	GND	MR1	Reset In	MR2	-	-	-
yh	CE	GND	Vbat	Vdrv	Vinput	Vsense	-	-
yj	Vinput	GND	OE	Feedback	SW/Voutput	-	-	-
yk	CE	GND	Feedback	Isense	Vinput	SW/Voutput	-	-
yl	Vinput	GND	Voutput	N/C	GND	N/C	-	-
ym	Vinput	GND	N/C	N/C	Voutput	-	-	-
yp	Vinput	GND	OE	GND	Voutput	-	-	-
yr	N/C	GND	Voutput	Vinput	-	-	-	-
ys	Vinput	GND	OE	N/C	N/C	Voutput	-	-
yt	Vinput	GND	N/C	GND	GND	Voutput	-	-
yu	N/C	GND	Reset	Vinput	-	-	-	-
yv	CE1	GND	CE1	N/C	N/C	Voutput2	Vinput	Voutput1
yw	B1	E	B2	-	-	-	-	-
yx	MR	GND	N/C	Reset	Vcc	-	-	-
z1	Vinput	GND	GND	Reset	Cd	-	-	-
z2	Vinput	GND	GND	Reset	Sense	-	-	-
z3	Sense	GND	Cd	Vinput	N/C	Reset	-	-
z4	Reset	Vcc	GND	Cd	Sense	-	-	-
z5	Reset	GND	Vcc	Cd	Sense	-	-	-
z6	Vinput	N/C	GND	Reset	GND	MR	-	-
z7	Reset	Vcc	GND	MR	Vcc	N/C	-	-
z8	Vcc	GND	MR	Reset	N/C	-	-	-
z9	Reset	Vcc	Cd	N/C	GND	-	-	-
za	Reset	Vcc	Cd	GND	N/C	-	-	-
zb	Voutput1	GND	CE1	CE2	Vinput	Voutput2	-	-
zc	Voutput2	GND	CE2	CE1	Vinput	Voutput1	-	-
zd	Vbias	GND	OE	Vinput	N/C	Voutput	-	-
ze	Vinput	GND	OE	Vbias	Voutput	-	-	-
zf	Vbias	GND	Voutput	Vinput	OE	-	-	-
zg	OE	N/C	Vinput	Voutput	N/C	GND	-	-
zh	Vinput	GND	OE	Ext	Voutput	-	-	-
zi	EL+	HV	EL-	Ind	GND	Vcc	-	-
zj	Vinput	CE1	CE2	CE3	GND	Voutput3	Voutput2	Voutput1
zk	OE	N/C	Voutput	Vinput	GND	Vbias	-	-
zl	OE	GND	Vbias	Vinput	Voutput	-	-	-
zm	Ext	Vinput	GND	OE	Voutput	-	-	-
zn	Ext	Vinput	GND	OE	Feedback	-	-	-
zo	GND	Vinput	Ext	Voutput	N/C	OE	-	-
zp	GND	Vinput	Ext	Feedback	N/C	OE	-	-
zq	Lx	GND	Voutput	CE/MODE	Vinput	-	-	-
zr	OE	GND	Vinput	Voutput	Lx	-	-	-
zs	N/C	GND	Vinput	Voutput	Lx	-	-	-
zt	Voutput	GND	OE	Cd	Vinput	-	-	-
zu	Voutput	GND	OE	Cd	GND	Vinput	-	-
zv	Cd	Vinput	GND	Voutput	OE	-	-	-

SECTION15
SMD-CODE MARKING STYLE



<p>1</p> <p>Color band (cathode) SMD code</p>	<p>1a</p> <p>Cathode band SMD code</p>	<p>1b</p> <p>Cathode band SMD code</p>	<p>1c</p> <p>Cathode band SMD code Lot number</p>
<p>1d</p> <p>Cathode band SMD code Data code (Y-Year, M-month)</p>	<p>1e</p> <p>SMD code</p>	<p>1f</p> <p>Cathode band SMD code Assembly location Wafer lot Data code (Y-Year, W-week)</p>	<p>1g</p> <p>Cathode band SMD code Data code</p>
<p>1h</p> <p>Cathode band Data code SMD code</p>	<p>1i</p> <p>SMD code Cathode band Data code (N-Year, M-month)</p>	<p>1j</p> <p>SMD code</p>	<p>1k</p> <p>Manufacturer logo Cathode band SMD code Data code (N-Year, M-month)</p>
<p>1l</p> <p>Manufacturer logo SMD code Data code (N-Year, M-month)</p>	<p>1m</p> <p>Manufacturer logo Cathode band SMD code Data code (N-Year, W-week)</p>	<p>1n</p> <p>Cathode band SMD code</p>	<p>1o</p> <p>Manufacturer logo Cathode band SMD code</p>
<p>1p</p> <p>Manufacturer logo SMD code</p>	<p>1q</p> <p>Manufacturer logo Cathode band SMD code Data code (Y-Year, W-week)</p>	<p>1r</p> <p>Manufacturer logo SMD code Data code (Y-Year, W-week)</p>	<p>1s</p> <p>Cathode band SMD code Data code (Y-Year, W-week)</p>
<p>1t</p> <p>Cathode band SMD code</p>	<p>1u</p> <p>Cathode band SMD code Data code</p>	<p>1v</p> <p>Cathode band SMD code</p>	<p>1w</p> <p>Manufacturer logo Cathode band SMD code</p>

<p>Manufacturer logo 1x</p> <p>SMD code Data code (N-Year, W-week)</p>	<p>Manufacturer logo 1y</p> <p>SMD code</p>	<p>Colour dot (year, week) 1z</p> <p>Cathode band SMD code</p>	
<p>2</p> <p>Cathode band SMD code (colored)</p>	<p>2a</p> <p>Cathode (Collector) (Drain) SMD code</p>	<p>2b</p> <p>Cathode (Collector) (Drain) SMD code</p>	<p>2c</p> <p>Cathode band SMD code</p>
<p>2d</p> <p>Cathode band SMD code</p>	<p>2e</p> <p>Cathode mark SMD code</p>	<p>2f</p> <p>Cathode band SMD code</p>	<p>2g</p> <p>Cathode band (same color as cathode band) SMD code (same color as cathode band)</p>
<p>2h</p> <p>Cathode band SMD code</p>	<p>2i</p> <p>Cathode (Collector) (Drain) SMD code</p>	<p>Manufacturer logo 2j</p> <p>Cathode band SMD code Week Year</p>	<p>Manufacturer logo 2k</p> <p>Cathode band SMD code Week Year</p>
<p>2m</p> <p>SMD code Cathode band</p>	<p>2n</p> <p>Week, year SMD code Cathode band</p>		
<p>3a</p> <p>SMD code</p>	<p>3b</p> <p>SMD code Data code (Y-Year, M-month)</p>	<p>3c</p> <p>SMD code Data code (Y-Year, M-month)</p>	<p>3d</p> <p>SMD code Lot number</p>

<p>3e</p> <p>SMD code Lot number</p>	<p>3f</p> <p>SMD code Lot number</p>	<p>3g</p> <p>Data code Manufacturer logo SMD code</p>	<p>3h</p> <p>Combination bar of production year Lot number SMD code Combination bar of production month</p>
<p>3i</p> <p>SMD code Colour dot (year, week)</p>	<p>3j</p> <p>SMD code Colour dot (year, week)</p>	<p>3k</p> <p>SMD code</p>	<p>3m</p> <p>SMD code Data code (W- Work Week)</p>
<p>3n</p> <p>SMD code Lot number Data code (W- Week) Assembly location</p>	<p>3o</p> <p>SMD code Data code</p>		
<p>4a</p> <p>SMD code Lot number</p>	<p>4b</p> <p>SMD code Data code (Y-Year, M-month)</p>	<p>4c</p> <p>SMD code Lot number</p>	<p>4d</p> <p>SMD code</p>
<p>4e</p> <p>SMD code Data code (Y-Year, M-month)</p>	<p>4f</p> <p>Lot number SMD code</p>	<p>4g</p> <p>SMD code</p>	<p>4h</p> <p>Lot number SMD code</p>
<p>4i</p> <p>SMD code Lot number</p>	<p>4j</p> <p>Combination bar of production year Lot number SMD code Combination bar of production month</p>	<p>4k</p> <p>SMD code Lot number</p>	<p>4m</p> <p>Manufacturer logo SMD code Data code (Y-Year, WW-week)</p>

<p>4n</p> <p>SMD code Data code (Y-Year, W-week)</p>	<p>4o</p> <p>SMD code Data code</p>	<p>4p</p> <p>SMD code Lot number</p>	<p>4q</p> <p>SMD code Data code (Y-Year, M-month)</p>
<p>4r</p> <p>SMD code</p>	<p>4s</p> <p>Data code (Y-Year, M-data code) Assembly Location</p> <p>SMD code Pb-Free</p>	<p>4t</p> <p>SMD code</p> <p>Assembly Location Work Week</p>	
<p>5a</p> <p>SMD code Lot number</p>	<p>5b</p> <p>SMD code</p>	<p>5c</p> <p>SMD code Lot number</p>	<p>5d</p> <p>SMD code Data code (Y-Year, W-week)</p>
<p>5e</p> <p>SMD code Lot number</p>	<p>5f</p> <p>Colour dot (year, week)</p> <p>SMD code Pin1 mark</p>	<p>5g</p> <p>SMD code Data code (Y-Year, W-week)</p>	<p>5h</p> <p>SMD code Data code</p>
<p>5i</p> <p>Assembly Location</p> <p>SMD code Data code</p>			
<p>6a</p> <p>SMD code</p>	<p>6b</p> <p>SMD code Data code</p>	<p>6c</p> <p>SMD code Lot number</p>	<p>6d</p> <p>Manufacturer logo</p> <p>SMD code Data code (WW-week)</p>

<p>6e</p> <p>SMD code Lot number</p>	<p>6f</p> <p>SMD code Lot number</p>	<p>6g</p> <p>SMD code Lot number</p>	<p>6h</p> <p>SMD code Lot number</p>
<p>6i</p> <p>Lot number SMD code</p>	<p>6j</p> <p>SMD code</p>	<p>6k</p> <p>SMD code Data code</p>	<p>6l</p> <p>SMD code Lot number</p>
<p>6m</p> <p>SMD code Lot number</p>	<p>6n</p> <p>SMD code Lot number</p>	<p>6p</p> <p>Combination bar of production year Lot number SMD code Combination bar of production month</p>	<p>6q</p> <p>SMD code Data code (Y-Year, W-week)</p>
<p>6r</p> <p>SMD code Lot number</p>	<p>6s</p> <p>SMD code Lot number</p>		
<p>Manufacturer logo 7a</p> <p>SMD code Data code (Y-Year, WW-week)</p>	<p>7b</p> <p>SMD code</p>	<p>7c</p> <p>SMD code Data code (Y-Year, M-month)</p>	<p>7d</p> <p>SMD code Lot number</p>
<p>7e</p> <p>SMD code Lot number</p>	<p>7f</p> <p>SMD code Lot number</p>	<p>7g</p> <p>SMD code Lot number</p>	<p>7h</p> <p>SMD code Lot number Manufacturer logo</p>

<p>7i</p> <p>SMD code Lot number</p>	<p>7j</p> <p>Lot number SMD code</p>	<p>7k</p> <p>SMD code Lot number</p>	<p>7l</p> <p>SMD code Data code (Y-Year, M-month)</p>
<p>7m</p> <p>SMD code Data code</p>	<p>7n</p> <p>SMD code Lot number</p>	<p>7o</p> <p>SMD code Data code (Y-Year, M-month)</p>	<p>7p</p> <p>Lot number Data code (Y-Year, M-month)</p>
<p>8a</p> <p>SMD code Lot number</p>	<p>8b</p> <p>SMD code Data code</p>	<p>8c</p> <p>SMD code Lot number</p>	<p>8d</p> <p>SMD code</p>
<p>8e</p> <p>SMD code Lot number Manufacturer logo</p>	<p>8f</p> <p>SMD code Lot number</p>	<p>8g</p> <p>SMD code Lot number Production year</p>	<p>8h</p> <p>SMD code Data code (Y-Year, W-week)</p>
<p>9a</p> <p>Pin1 mark Lot number SMD code</p>	<p>9b</p> <p>SMD code Lot number</p>	<p>9c</p> <p>Pin1 mark Lot number SMD code</p>	<p>9d</p> <p>Pin1 mark SMD code Data code (Y-Year, M-month)</p>
<p>9e</p> <p>Pin1 mark Lot number SMD code</p>	<p>9f</p> <p>Pin1 mark Lot number SMD code</p>	<p>9g</p> <p>Pin1 mark Lot number SMD code</p>	<p>9h</p> <p>Pin1 mark SMD code Lot number</p>

<p>Pin1 mark 9i</p> <p>SMD code (Y-Year, WW-week)</p>	<p>Data code 9j Die traceability</p> <p>Pin1 mark SMD code</p>	<p>Data code SMD code 9k</p> <p>Pin1 mark Die traceability</p>	<p>9m</p> <p>Pin1 mark SMD code</p>
<p>Die traceability 9n Data code Boomer family</p> <p>Pin1 mark SMD code</p>	<p>SMD code 9o</p> <p>Pin1 mark Data code (Y-Year, WW-week) Assembly location</p>	<p>Manufacturer logo 9p Pin1 mark Assembly code</p> <p>SMD code Data code (Y-Year, WW-week)</p>	<p>Manufacturer logo 9q Pin1 mark</p> <p>SMD code Data code (Y-Year, WW-week)</p>
<p>SMD code 9r</p> <p>Pin1 mark Lot number</p>	<p>SMD code 9s</p> <p>Pin1 mark Data code (Y-Year, WW-week)</p>	<p>Combination bar of production year 9t</p> <p>Pin1 mark SMD code Combination bar of production week</p>	
<p>10a</p> <p>SMD code Lot number</p>	<p>Manufacturer logo 10b</p> <p>SMD code Lot number</p>	<p>Manufacturer logo 10c</p> <p>SMD code Lot number</p>	<p>10d</p> <p>SMD code Lot number</p>
<p>Manufacturer logo 10e</p> <p>Data code SMD code</p>			

SECTION 16
SAMPLE SCHEMATIC DIAGRAMS

 **HOME**

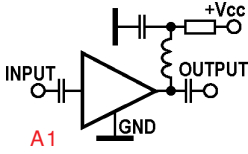

A1

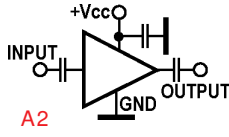

A2

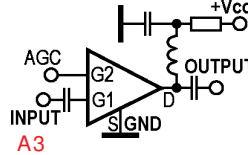

A3

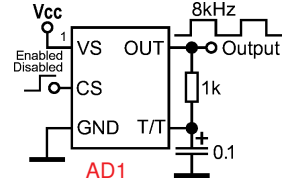

AD1

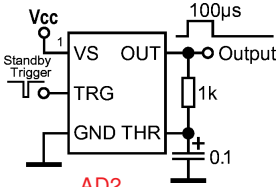

AD2

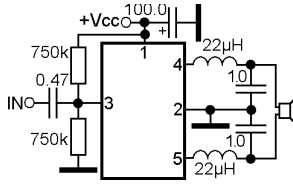

AFP1

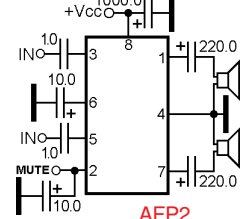

AFP2

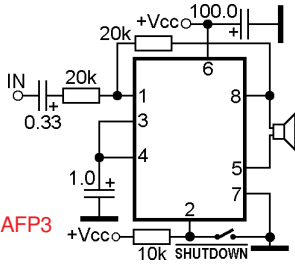

AFP3

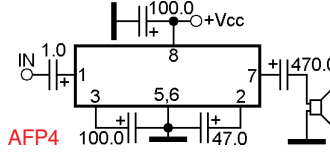

AFP4

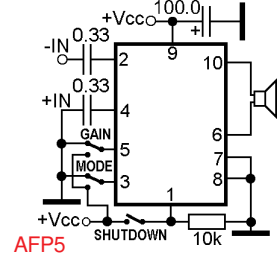

AFP5

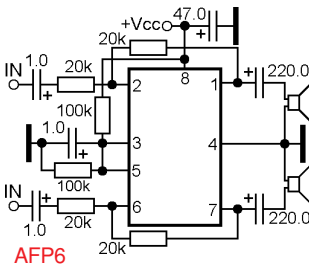

AFP6

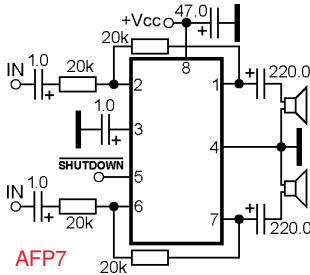

AFP7

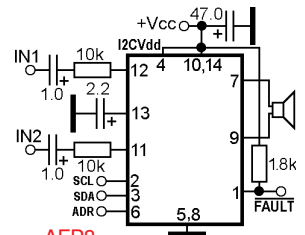

AFP8

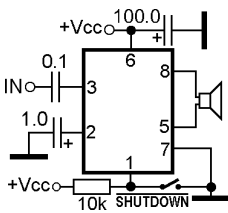

AFP9

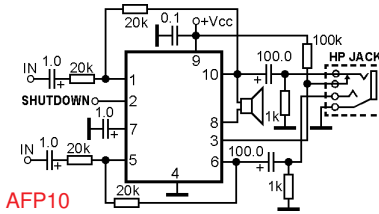

AFP10

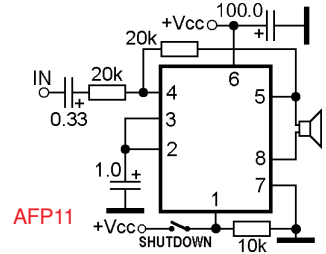

AFP11

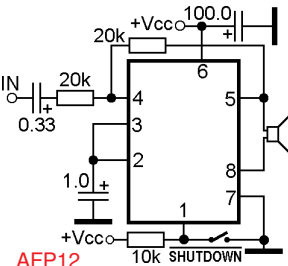

AFP12

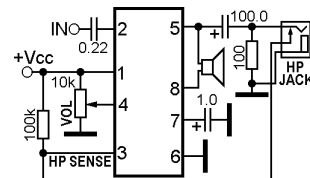

AFP13

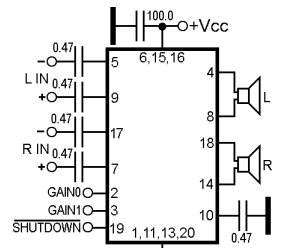

AFP14

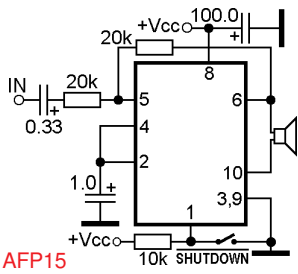

AFP15

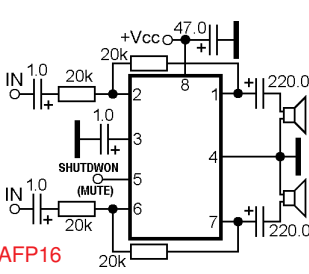

AFP16

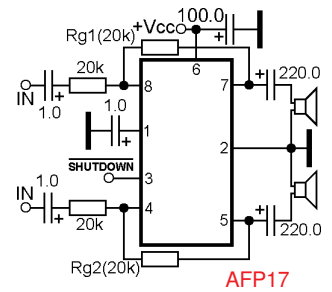

AFP17

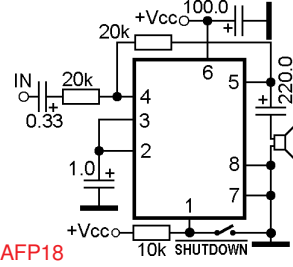

AFP18

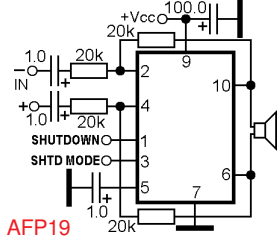

AFP19

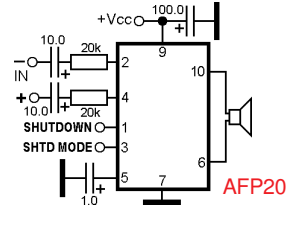

AFP20

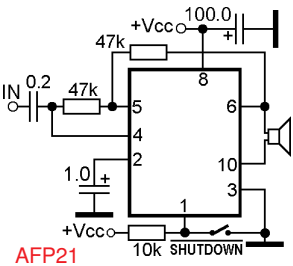

AFP21

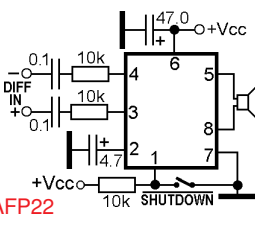

AFP22

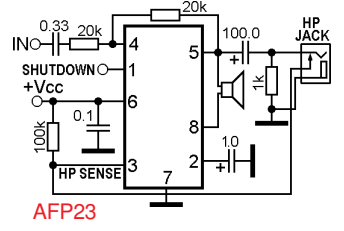

AFP23

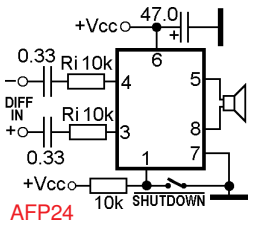

AFP24

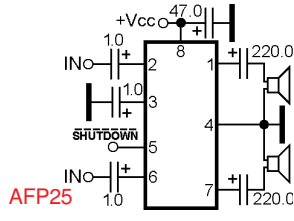

AFP25

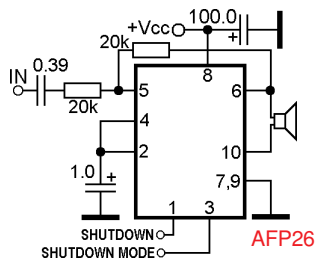

AFP26

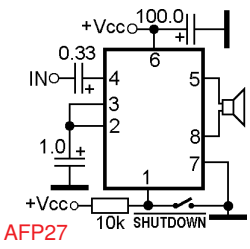

AFP27

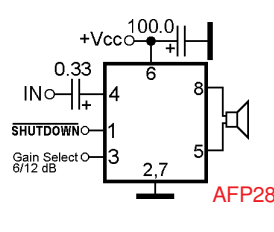

AFP28

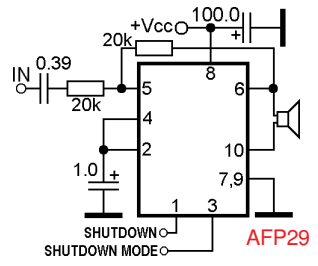

AFP29

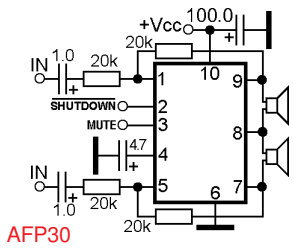

AFP30

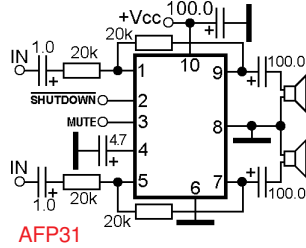

AFP31

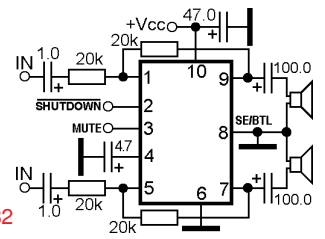

AFP32

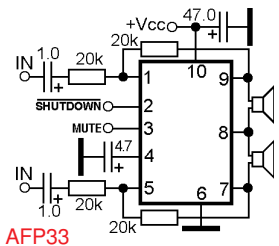

AFP33

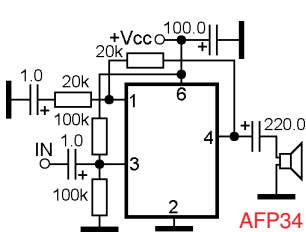

AFP34

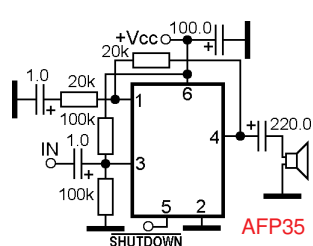

AFP35

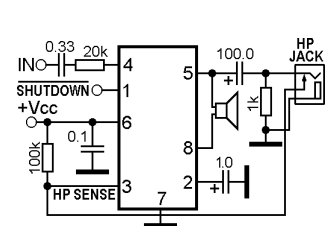

AFP36

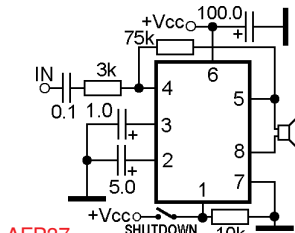

AFP37

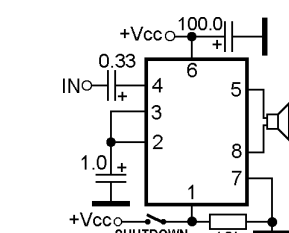

AFP38

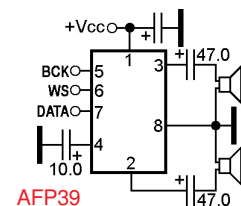

AFP39

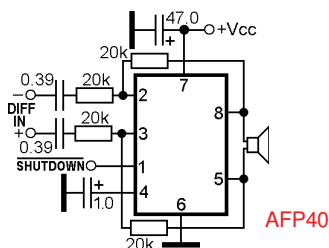

AFP40

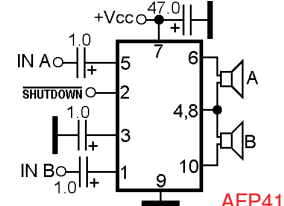

AFP41

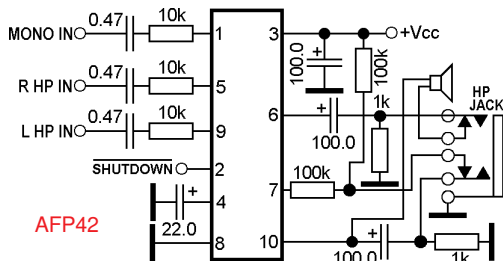

AFP42

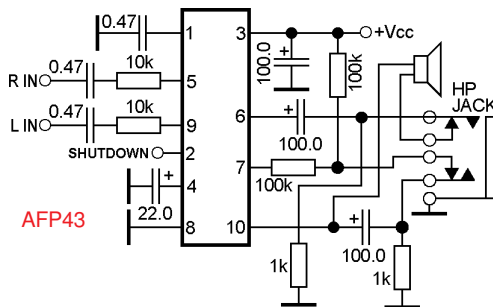

AFP43

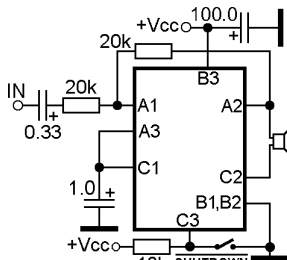

AFP44

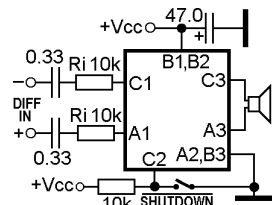

AFP45

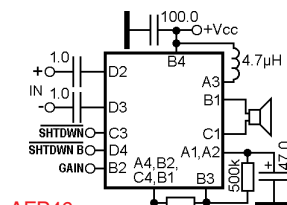

AFP46

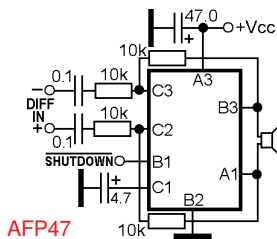

AFP47

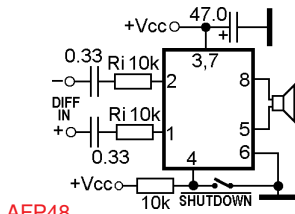

AFP48

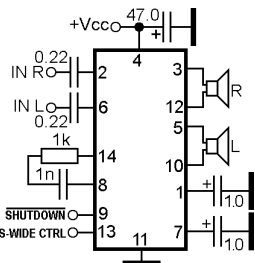

AFP49

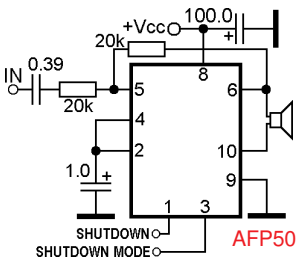

AFP50

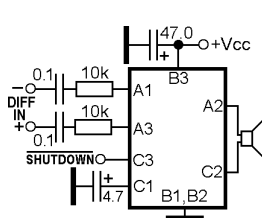

AFP51

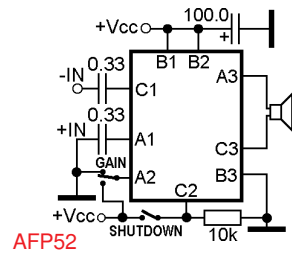

AFP52

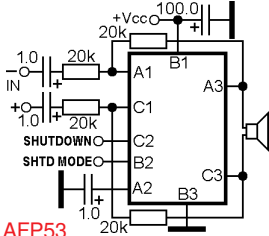

AFP53

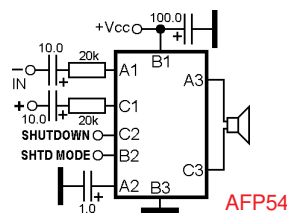

AFP54

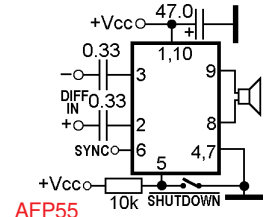

AFP55

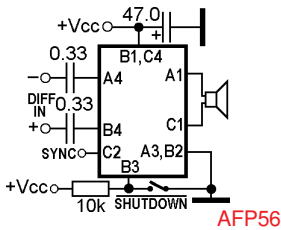

AFP56

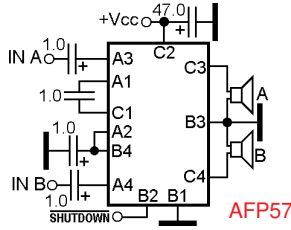

AFP57

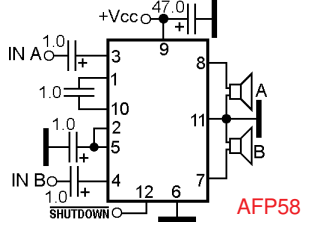

AFP58

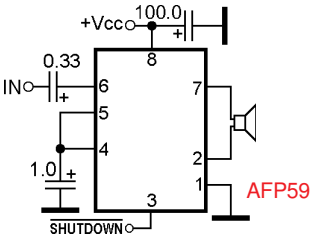

AFP59

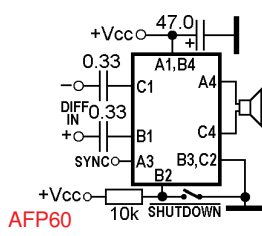

AFP60

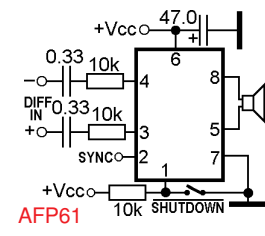

AFP61

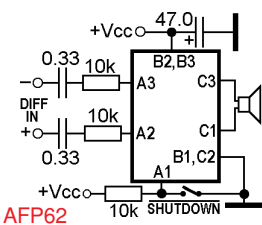

AFP62

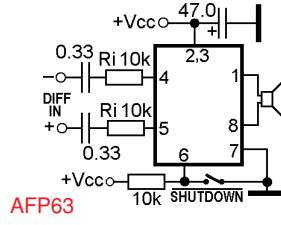

AFP63

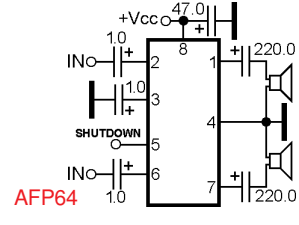

AFP64

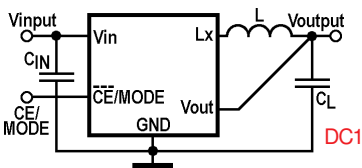

DC1

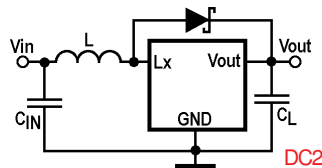

DC2

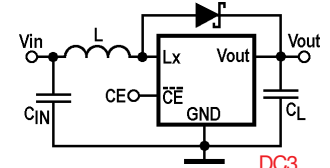

DC3

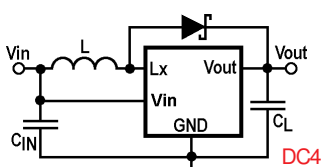

DC4

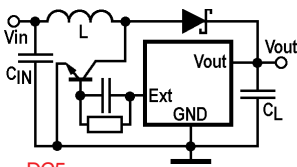

DC5

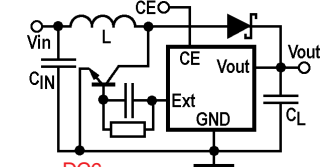

DC6

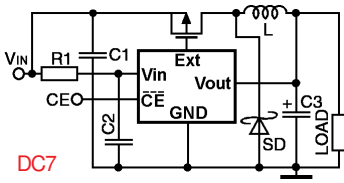

DC7

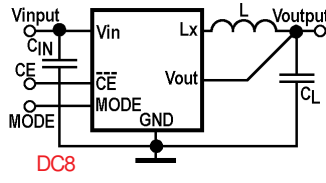

DC8

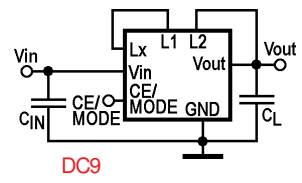

DC9

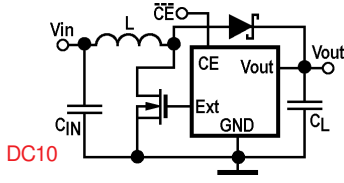

DC10

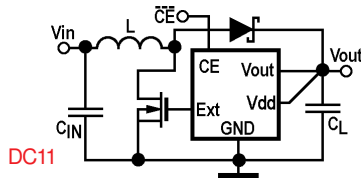

DC11

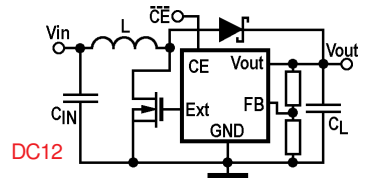

DC12

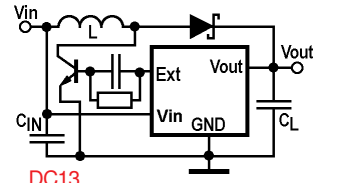

DC13

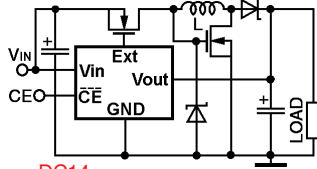

DC14

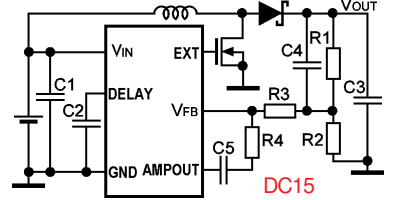

DC15

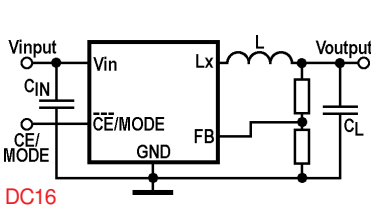

DC16

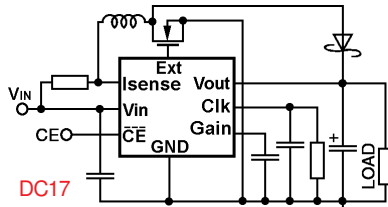

DC17

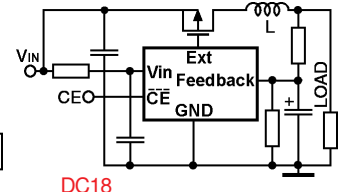

DC18

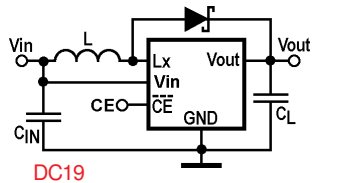

DC19

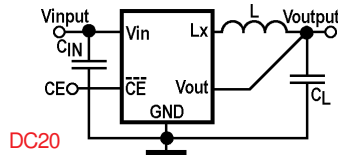

DC20

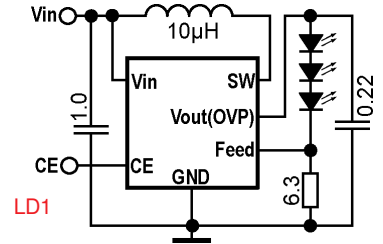

LD1

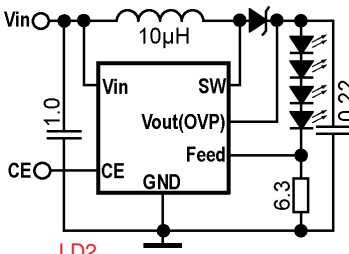

LD2

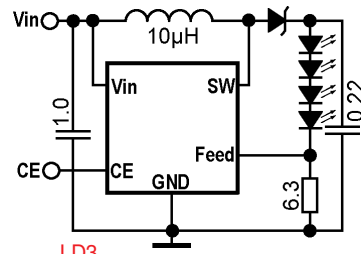

LD3

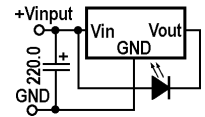

LD4

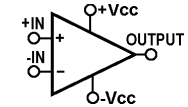

OP1

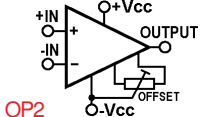

OP2

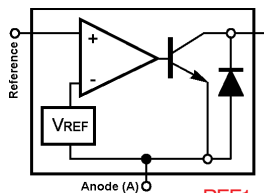

REF1

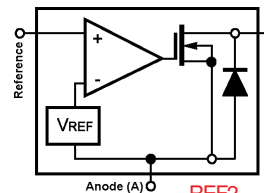

REF2

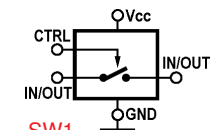

SW1

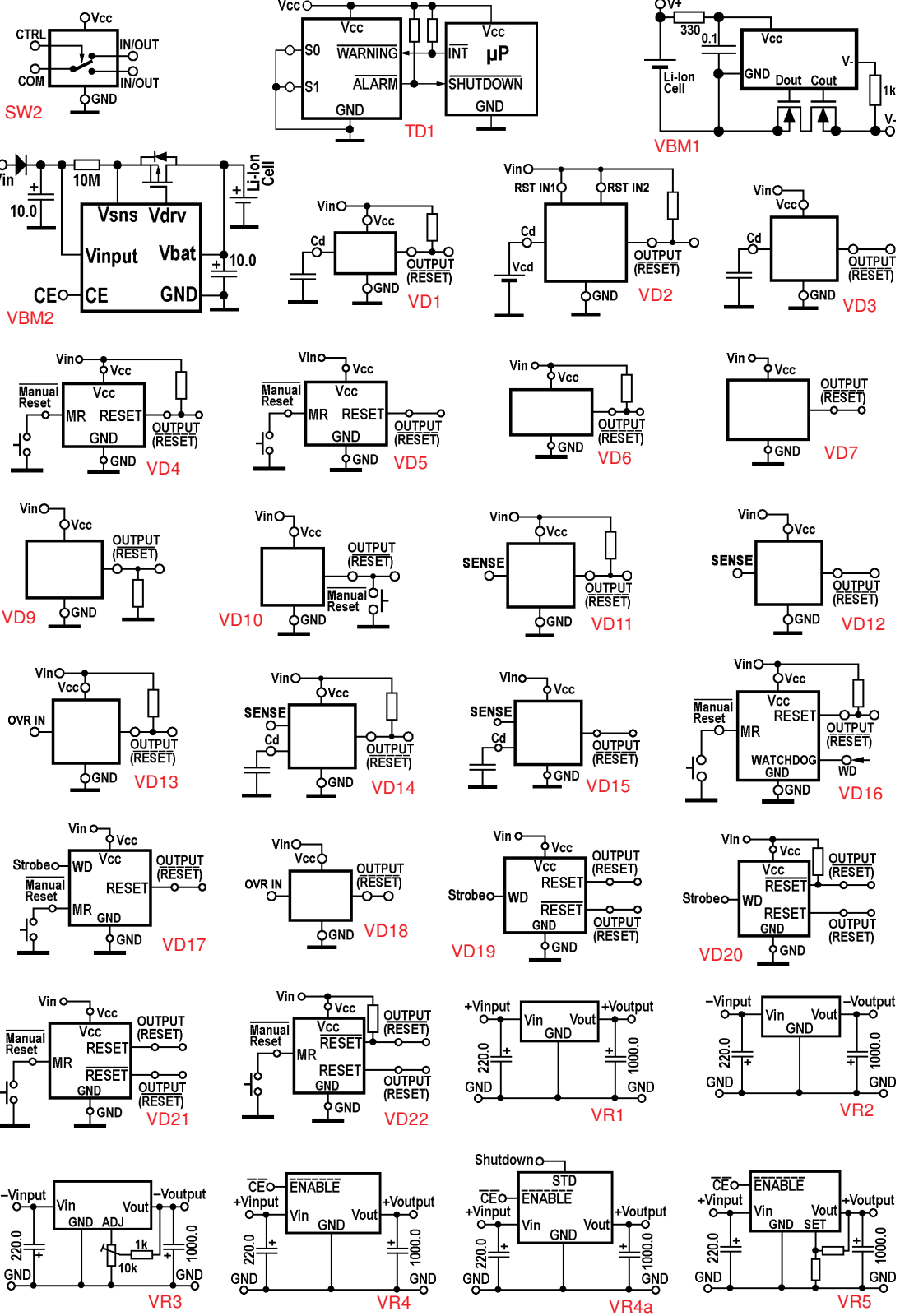

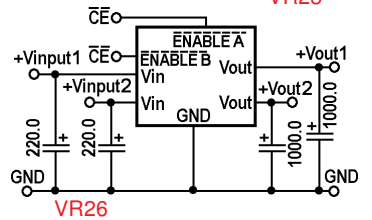
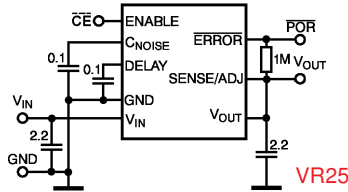
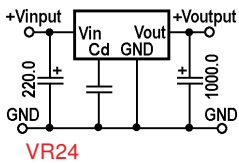
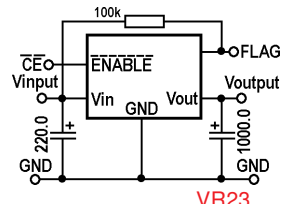
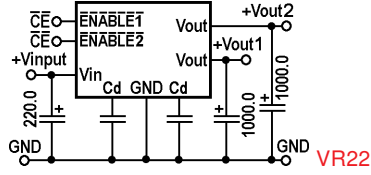
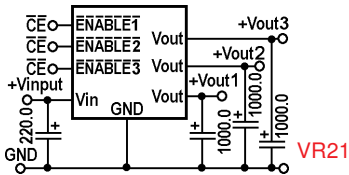
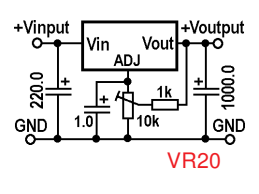
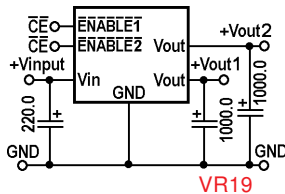
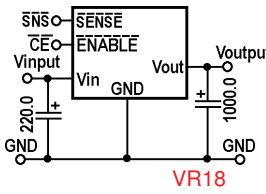
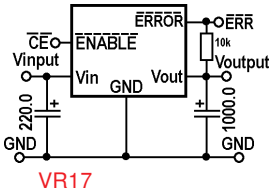
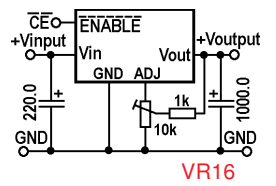
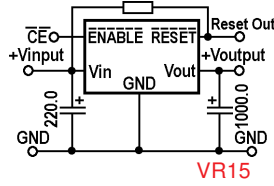
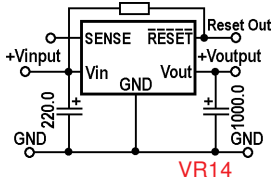
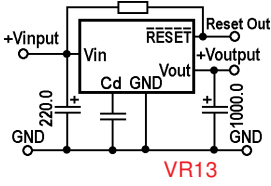
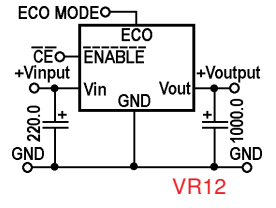
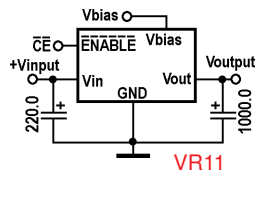
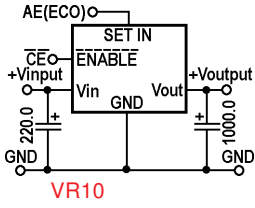
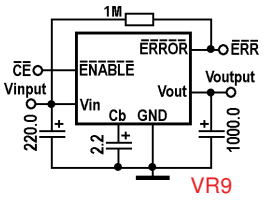
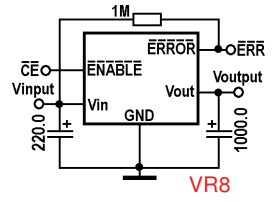
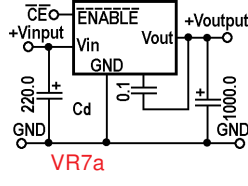
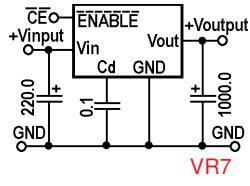
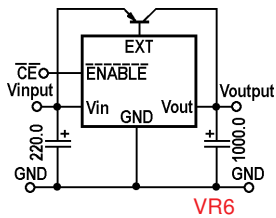



SECTION 17
LOGOS, CONTACT and WEB-ADDRESSES OF THE MANUFACTURERS

 **HOME**



Aat- Advanced Analog Technology

2F, No. 17, Gongye E. 2nd Rd., Science-Based Industrial Park, Hsinchu City 300, Taiwan
<http://www.aatech.com.tw/index.aspx>



Ad- Analog Devices

One Technology Way, Norwood, MA 02062, USA, Phone: 781/329-4700
<http://www.analog.com>



Adt- ADDtek

Taiwan-Taipei, Phone : +886-2-2570-0299, Fax : +886-2-2570-0196
<http://www.addmtek.com/Index.htm>



Agi- Agilent Technologies

395 Page Mill Rd. Palo Alto, CA 94306 USA, Phone: +1 (877) 424-4536
www.semiconductor.agilent.com



Aic- Analog Integrations Corporation

3A1, No.1, Li-Hsin Rd. I, Science Park, Hsinchu 300, Taiwan, R.O.C.
<http://www.analog.com.tw>



Ali- Alliance Semiconductor

12575 Augustine Drive, Santa Clara, CA 95054, USA, Phone: +1-408.855.4900
<http://www.alsc.com>



All- Allegro MicroSystems Inc.

115 Northeast Cutoff, Box 15036 Worcester, MA 01615, USA, Phone: +1-508-853-5000
<http://www.allegromicro.com>



Ame- AME, Inc.

2F, 189 Kang-Chien Road, Nei-Hu Dist. Taipei 114 Taiwan, R.O.C., Phone: 886 2 2627-8687
www.ame.com.tw



Ams- AMOS Technology Limited

Phone: (852) 2607- 4123
<http://www.amos-tech.com>



Ana- Anachip Corp.

2F, No.24-2, Industry E. Rd. IV, Science-Based Industrial Park, Hsinchu 300, Taiwan
www.anachip.com.tw



Anp- Anpec Electronics Corp.

5F, No. 2 Li-Hsin Road, SBIP, Hsin-Chu, Taiwan, R.O.C. Phone: 886-3-5642000
www.anpec.com.tw



Ant- Advanced Analogic Technologies, Inc.

830 E. Arques Avenue, Sunnyvale, CA 94085, USA, Phone: (408) 737-4600
<http://www.analogictech.com>



Aom- Alpha & Omega Semiconductor

495 Mercury Drive, Sunnyvale, CA 94085, USA, Phone: +1 (408) 830-9742
<http://www.aosmd.com/>



Aot- IRICO AOTOM (Hong Kong) Holdings Co., Ltd.

Unit 19,11/F.Asia Trade Centre No.79 LeiMuk Road.Kwai Chung.N.T
<http://www.aotom.com>



Ape- Advanced Power Electronics Corp.

12F-1, No.5, Taiyuan 1st ST., Zhubei City, Hsinchu Country, 30265, Taiwan, R.O.C.
<http://www.a-power.com.tw/index.aspx>



Ask- AKM Semiconductor Inc.

1731 Technology Drive Suite 500, San Jose, CA 95110, USA
<http://akm.com/index.asp>

**Asm- Austria microsystems AG**

Tobelbader Strasse 30, A-8141 Unterprenstatten, Phone:+43 3136 500-0
<http://www.austriamicrosystems.com>

**Atr- Aimtron**

2F, No.10, Prosperity RD. II, Science-Based Industrial Park, Hsinchu 300, Taiwan, R.O.C.
<http://www.aimtron.com.tw>

**Auk- AUK Semiconductor Corp.**

Shinheung-dong, Iksan, Jeollabuk-do, Korea, Phone: 063-835-7111
<http://www.auk.co.kr>

**Avi- Avic Electronics Corp.**

(There is no accesible padding information)
<http://www.avictek.com>

**Axl- AXelite Technology Co., Ltd**

7F-1, No.125, Lane 235, Baociao Rd., Sindian City, Taipei County 231, Taiwan (R.O.C.)
www.axelite.com.tw/

**Axp- Analog Express Corp.**

7F-3 No. 2, Fusing 4th Road, Cianjhen District, Kaohsiung, Taiwan
<http://www.analogexpress.com>

**Bb- Burr-Brown Corp.**

PO Box 11400, 6730 S. Tucson Blvd., Tucson, AZ 85706 USA, Phone: 520/746-7365
(acquired by Texas Instruments)
<http://www.burr-brown.com>

**Bcd- BCD Semiconductor Manufacturing Limited**

No. 1600, Zi Xing Road, Shanghai ZiZhu Science-based Industrial Park, 200241, P.R.C.
<http://www.bcdsemi.com/en/index.aspx>

**Bel- Bharat Electronics Ltd**

Bangalore, India
www.bel-india.com

**Brn- Bourns, Inc.**

Riverside, CA, USA, Phone: +951-781-5500 ext 2778
<http://www.bourns.com/>

**Bts- Bytesonic Corporation**

No.2 Fuqiang Road South (Highway No. 312), Changzhou City, Jiangsu, China
<http://www.bytesonic.com>

**Cal- Calogic, LLC**

237 Whitney Place, Fremont, CA, Phone: 510-656-2900
<http://www.calogic.net/>

**Can- Canaan Microelectronics Corp. Ltd.**

RM 1604, Hart Avenue Plaza, 5-9 Hart Avenue, Tsimshatsui, Kowloon, Hong Kong
<http://www.canaan-micro.com>

**Cdi- Continental Device India Limited**

C-120, Naraina Industrial Area, New Delhi 110028, India, Phone: 91-11-5796150-63
<http://www.cdil.com>

**Cel- California Eastern Laboratories**

4590 Patrick Henry Drive, Santa Clara, CA 95054-1817, USA, Phone: (408) 988-3500
<http://www.cel.com>

**Cen- Central Semiconductor Corp.**

1145 Adams Avenue, Hauppauge, NY 11788, USA, Phone: 516/435-1110
<http://www.centalsemi.com>

**Cer- Ceramite Technical Co., Ltd.**

1F, No.66-5, Sec.2, Nan-Kan Rd., Luchu, Taoyuan, Taiwan, R.O.C

<http://www.ceramite.com.tw>**Cha- Champion Microelectronic Corporation**

5F, No. 11, Park Avenue II, Hsinchu Science-based Industrial Park, Hsinchu city, Taiwan

<http://www.champion-micro.com>**Chm- Chenmko Enterprise Co., Ltd.**

5F-2, No.190, Sec 2, Chung Shing Rd., Hsin Tien City, Taipei Hsien, Taiwan

<http://www.chenmko.com/>**Cmc- Comchip Technology Corporation**

4115 Clipper Court, Fremont, CA 94538, USA, Phone: 510-657-8671

<http://www.comchip.com.tw/>**Cnc- Concord Semiconductor**

(acquired by Littelfuse, Inc)

<http://www.littelfuse.com>**Cpm- Chiphomer Technology Ltd.**

4F, Building D, 1618 Yishan Road Shanghai, 201103, P.R.C.

<http://www.chiphomer.com>**Crp- Crownpo Technology Inc.**

9F., No. 99, Sec. 5, Nanjing E. Rd., Taipei, Taiwan, R.O.C.

www.crownpo.com**Csm- Chengdu Sino Microelectronics**

2nd floor, Building D, Science & Technology Industrial Park, 11 Gaopeng Avenue, Chengdu High-Tech Zone, Chengdu City, Sichuan Province, P.R.China. Phone: +86-28-8517-7737

<http://www.csmisc.com>**Ctc- Compact Technology Corp.**

12F.-7, No.79,Sec. 1, Xintai 5th Rd., Xizhi City, County 221, Taiwan (R.O.C.)

<http://www.ctc-semicon.com/?action=index>**Cys- Cystech Electronics Corp.**

15F-7, No.716, Chung Cheng Rd. , Chung Ho City, Taipei Hsien, Taiwan, 235

<http://wwwt.cystekec.com/>**Cyt- Shenzhen CYT Opto-Electronic Technology Co.,Ltd.**

Shenzhen High-tech Zone in the Central District Science and Technology Software Park Road, Building 4 2nd Floor, West Wing

<http://www.szcyt.com/en-us/>**Dac- DACO Semiconductor Co., Ltd.**

No. 28-4, ChengTien Road, TuCheng City, Taipei Hsien, 236 Taiwan, R.O.C.

<http://www.dacosemi.com.tw>**Dal- Dallas Semiconductor Corporation**

4401 South Beltwood Parkway, Dallas TX 75244-3292, USA, Phone: 972-371-4448

(acquired by Maxim)

<http://www.dalsemi.com>**Dbp- DB Power Tech Inc.**

Phone: 031-227-3465

<http://www.dbpowertech.com/>**Di- Diodes Inc.**

3050 East Hillcrest Drive, Suite 200, Westlake Village, CA 91362, USA, Phone: 805/446-4800

<http://www.diodes.com>**Did- Diodesemi Technology Inc.**

4F, No.118, An-Ho Rd., Sec. 2, Taipei 10680, Taiwan

www.diodesemi.com

**Ecg- E C G**

A Philips (USA) subdivision. 1025 Westminster Drive, Williamsport, PA 17701 USA
<http://www.ecgproducts.com>

**Ecm- E-CMOS Corporation**

No 1, Creation Road II , Hsinchu Science Park, Taiwan (R.O.C.)
<http://www.ecmos.com.tw>

**Eic- EIC Semiconductor, Inc.**

12698 Schabarum Ave, Irwindale, CA 91706, USA, Phone: (626) 960-0877
<http://www.eicsemi.com>

**Elm- ELM Technology Corporation**

3F-30, Akagishitamachi, Shinjuku-ku tokyo, 162-0803 Japan
<http://www.elm-tech.com/>

**Em- EM Microelectronic-Marin SA**

CH - 2074 Marin, Switzerland, Phone: +41 - (0)32 75 55 111
<http://www.emmicroelectronic.com>

**Emp- Elite Semiconductor Memory Technology Inc.**

sales@elitemicropower.com Phone: 886-3-578-1970 ext 7111
<http://www.elitemicropower.com>

**Ers- Eris Technology Corporation**

6F., No.17, Lane 155, Sec.3, Bei-Shen Rd., Shen Keng Hsiang, Taipei, 22203, Taiwan
<http://www.eris.com.tw/>

**Etc- Electronic Technology Corp.**

402 Campus Drive, Huxley, IA50124, USA, Phone: (515) 597-7000
<http://www.etctechcorp.com>

**Eut- Eutech Microelectronics Inc.**

4F, 38-1, Ming Shen N. Rd. Sec. 1, Kuei-Shan, Taoyuan 333, Taiwan, R.O.C.
 Phone: 886-3-3164556
<http://www.eutechmicro.com>

**Exc- Excel Semiconductor Inc.**

No.8 YangMing Road, Suzhou, China Zip: 215021
www.excel-semi.com

**Ext- Extensive Technology Co., Ltd.**

11F, No. 79, Zhouzi St., Neihu District, Taipei City 11493, Taiwan
<http://www.extensivetech.com>

**F- Fairchild Semiconductor Corp.**

333 Western Avenue, South Portland ME 04106, USA, Phone: 207/775-8100
<http://www.fairchildsemi.com>

**Fag- Fagor Electronica**

Bd. San Andres, s/n - Apdo. 33-E 20500 Mondragon, Spain, Phone: +34 943-712-526
<http://www.fagorelectronica.es>

**Fee- Fagor Electronica**

Bd. San Andres, s/n - Apdo. 33-E 20500 Mondragon, Spain, Phone: +34 943-712-526
<http://feelingteam.com.tw>

**Fer- Ferranti Semiconductors**

Fields New Road, Chadderton, Oldham OL9 8NP, England, Phone: +44-1161-6240515
 (Bought by GPSI)

**Fis- First Silion Co., Ltd.**

802, Daeryung Techno Tower 3 Cha, Gasan-dong, Geumcheon-gu, Seoul, Korea
<http://www.firstsilicon.co.kr/>

**Fit- Fitipower Integrated Technology**

2 Floor, No.16, Kejhong Rd., Science-Based Industrial Park Jhunan Township, Miaoli County
35053, Taiwan, R.O.C
<http://eng.fitipower.com>

**Fji- Fuji Semiconductor**

Shinjuku Koyama Building, 30-3, Yoyogi 4-chome, Shibuya-ku, Tokyo 151, Japan
<http://www.fujielectric.co.jp>

**Fmd- Fremont Micro Devices Inc.**

16, 16/F, Blk B, Veristrong Industrial Centre, 34-36 Au Pui Wan Street, Shatin, Hong Kong
www.fremontmicro.com

**Frm- Formosa Microsemi Co., Ltd**

5F, No.208, Sec.3, Chung Yang Rd., Tucheng, Taipei Hsien Taiwan, R.O.C.
<http://www.formosams.com/>

**Gal- Galaxy Semiconductor Co., Ltd.**

No.168 West Hehai Road, Xinbei district, Changzhou, Jiangsu, China
www.galaxycn.com

**Gen- Gennum Corp.**

Box 489, Station A, 970 Fraser Drive, Burlington, Ontario, Canada, L7R 3Y3
<http://www.gennum.com>

**Glo- Globaltech Semiconductor**

4F., No.43-1, Lane11, Sec.6, Minquan E.Rd Neihu District Taipei City 114, Taiwan (R.O.C)
www.gs-power.com

**Gmt- Global Mixed-mode Technology Inc.**

5F, NO.700, Chung Cheng Road, Chung Ho City, Taipei Hsien, 235 Taiwan.
<http://www.gmt.com.tw/>

**Go2- Go2Silicon. Inc**

2880 Zanker Road, Suite 105, San Jose, CA 95134, USA, Phone: 408-435-1888
<http://www.go2silicon.com/>

**Gse- General Semiconductor**

10 Melville Park Road, Melville, NY 11747, USA, Phone: 516/847-3000 (Bought by Vishay)
<http://www.gensemi.com>

**Gtm- GTM Corporation**

9F, 320 Zhong Xiao E. Rd. Sec.4, Taipei, Taiwan 10694, Phone: +886-2-27415000
<http://www.gtm.com.tw/>

**Hit- Hitachi, Ltd.**

2000 Sierra Point Parkway, MS 080 Brisbane, CA 94005, USA, Phone: +1-800-285-1601
<http://www.hitachi.co.jp/products/power/pse/>

**Hrc- Jiaxing Heroic Electronic Technology Co., Ltd.**

3F, Block A, JRC Building, No.3339, Linggongtang Road, Jiaxing City, Zhejiang Province, China
<http://www.heroic.com.cn>

**Hsn- Hi-Sincerity Microelectronics Corp.**

3F., No. 72, Sec.2, Nanjing E. Rd., Taipei, Taiwan, R.O.C., Phone: +886-2-2521-2056
<http://www.hsmc.com.tw/>

**Htk- Holtek Semiconductor Inc.**

No.3, Creation Rd. II, Science Park, Hsinchu, Taiwan, Phone: 886-3-563-1999
<http://www.holtek.com.tw>



Htt- Hittite Microwave Corporation

2 Elizabeth Drive, Chelmsford, MA 01824, USA

<http://www.hittite.com/>



Icm- ICmic-UniKL Academy

ICmic UniKL Academy Sdn. Bhd. Unit C-G-02, SME Technopreneur Centre 2 2260 Jalan Usahawan 1 63000 Cyberjaya, Selangor, Malaysia.

<http://www.icmic-unikl.com/>



Idt- Integrated Device Technology

6024 Silver Creek Valley Road, San Jose, CA 95138, USA

<http://www.idt.com/>



Imp- IMP, Inc.

7 Keda Road, Hi-Tech Park, NingB, Zhejiang, China

<http://www.ds-imp.com.cn/>



Inf- Infineon Technologies AG

St.-Martin-Strasse 53, 81669 München, Germany, Phone: (+49) 911-252-930

<http://www.infineon.com>



Inr- International Rectifier

233 Kansas St., El Segundo, California 90245, USA, Phone: (310) 252-7105

<http://www.irf.com>



Ish- Isahaya Electronics Corporation

6-41 Tsukuba, Isahaya, Nagasaki, 854-0065 Japan, Phone: 0957-26-35920

<http://www.idc-com.co.jp/>



Isl- Intersil Inc.

10600 Ridgeview Ct. Cupertino, CA 95014, USA. Phone: 408-995-5000

<http://www.intersil.com>



Itt- ITT Intermetall

Hans-Bunte-Strasse 19, D-79108 Freiburg, Germany, Phone: +49-761-517-0

<http://www.itt-sc.de>



Jbs- Jian Hui Power Electronics Technology Co., Ltd.

12F, At Tower, No.180 Electric Rd., North Point, H.K.

<http://www.jbsemi.com>



Jce- Jiangsu Changjiang Electronics Technology Co., Ltd

275# Binjiang Rd. Middle Jiangyin, Jiangsu, China

<http://www.cj-elec.com>



Jgd- Jinan Gude Electronic Device

No.6, No.3 Road, Lichengyuan Area, Jinan Hi-tech Development Zone, Jinan, China

<http://www.jgd.com.cn/>



Kau- Kodenshi AUK

802-12, Sinheung-dong, Iksan, Korea (part of AUK company)

<http://www.kodenshi.co.kr>



Kd- KD Diotech

#3116 Ba-Dong, Jungang Circulation Complex, 1258, Guro-Dong, Guro-Gu, Seoul, Korea

<http://www.kdiode.com>



Kec- Korea Electronics Co. Ltd

9F Shamber Bldg, 45, 4-Ka Namadaemum-RO, Chung-Ku C.P.O. 4896 Seoul, Korea

<http://www.kec.co.kr>

**Kex- KEXIN Group**

Building C/5 Floor TianJi Plaza, TianAn Digital City, Shenzhen, China Phone:+86-755-83896222
www.kexin.com.cn

**Ktc- Kingbor Technology Co., Ltd**

(There is no accesible padding information)
<http://www.kingbor.com/>

**Lfr- Lucky Forest Corporation**

32659, Meizhen, Yong Ping Road, Taoyuan 549, Lane 2, China
<http://lucky.erufa.com>

**Lge- Luguang Electronic Technology Co., Ltd**

R13A07, B Block, Haisong Building, Terra 9rd, Chegongmiao, Futian District, Shenzhen, China
http://www.luguang.cn/web_en/index.html

**Lif- Littelfuse, Inc.**

8755 West Higgins Road Suite 500, Chicago, IL, 60631 USA
<http://www.littelfuse.com>

**Lin- LinFinity Microelectronics Inc.**

(Is now part of Microsemi)
<http://www.microsemi.com/>

**Lns- Linear Integrated System, Inc.**

4042 Clipper Court, Fremont, California, USA, 94538-6540
<http://www.linearsystems.com/>

**Lrc- Leshan Radio Company, Ltd.**

Leshan City Demos West Road, Sichuan, China, Phone: +86-833-2150303
<http://www.lrc-china.com>

**Ltc- Linear Technology Corporation**

1630 McCarthy Blvd., Milpitas, CA 95035-7417, USA, Phone: (408) 432-1900
<http://www.linear.com>

**Ltk- Lyontek Incorporation**

5F, No. 2, Industry E. Rd. IX, Science-Based Industrial Park, Hsinchu 300, Taiwan, R.O.C.
<http://www.lyontek.com.tw/>

**Mam- Matrix Microtech Corp.**

5F., No. 164, Jiankang Rd., Jhonghe City, Taipei County 235-85., Taiwan (R.O.C)
www.matrix-microtech.com.tw

**Mas- Micro Analog Systems Oy**

Kamreerintie 2, P.O.Box 51, FIN-02771 Espoo, Finland, Phone: (09) 80-521
<http://www.mas-oy.com>

**Max- Maxim Integrated Products**

120 San Gabriel Sunnyvale, CA 94086, USA, Phone: +1-800-998-8800
<http://www.maxim-ic.com>

**Mc- Mini-Circuits**

P.O. Box 350166, Brooklyn, New York 11235-0003, USA, Phone: (718) 934-4500
<http://www.minicircuits.com>

**Mcc- Microchip Technology Inc.**

2355 West Chandler Blvd. Chandler, AZ 85224-6199, USA, Phone: 480-792-7200
<http://www.microchip.com>

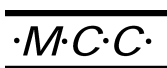
**Mco- Micro Commercial Components**

21201 Itasca Street Chatsworth, CA 91311, USA, Phone: (818) 701-4933
www.mccsemi.com



Mcr- Micrel Inc.

1849 Fortune Drive, San Jose, CA 95131, USA, Phone: + 1 (408) 944-0800
<http://www.micrel.com>



Mde- MDE Semiconductor, Inc.

78-150 Calle Tampico, Unit 210, La Quinta, CA, U.S.A. 92253 Phone: 800-831-4881
www.mdesemiconductor.com



Mei- MEI Semiconductor

(There is no accesible padding information)

<http://www.megastar.com/products/mei/semiconductors/index.aspx>



Mep- MegaPower Semiconductor Ltd

Room 806 Treasure Centre 42 Hung To Road Kwun Tong Kowloon Hong Kong
<http://www.megapower.com.cn>



Mic- Master Instrument Corporation of Shanghai

No.18-28 East GongJi Rd, LaoGang Chemical Industry Park, NanHui District, Shanghai, China
<http://www.cnmic.com>



Mit- Mitsubishi Electric Co. Ltd.

2-3 Marunouchi, 2-chome J 100 Chiyoda-Ku, Tokyo, Japan, Phone: +81-3-3218-2863
<http://www.mitsubishichips.com>



Mic- MiniLogic Device Corp.

Unit 508-9, IC Development Ctr., No. 6 Science Park West Ave., Hong Kong Science Park, Pak Shek Kok, Shatin, N.T., H.K., Phone: (852)2319-1080
<http://www.minilogic.com.hk/>



Mos- MOSA Electronics Corp.

13F-6, No.77, Sec.1, Hsin Tai Wu Road. Hsi-Chih City,Taipei Taiwan, R.O.C
<http://www.mosanalog.com/>



Mot- Motorola Inc.

6501 William Cannon Drive W Austin, TX 78735, USA, Phone: +1-512-891-2000
<http://www.motorola.com>



Msc- Microsemi Integrated Products Division

11861 Western Avenue, Garden Grove, CA. 92841, USA, Phone: 714-898-8121
<http://www.microsemi.com>



Mcp- Mospes Semiconductor Corp.

No. 76, Chung Shan rd., Hsin-Shin Hsiang, Taiwan, R.O.C., Phone: 886-6-5991621
<http://www.mospec.com.tw>



Nec- NEC Electronics Inc. (Nippon Electrical Company)

NEC Building 7-1, Shiba 5-chome, Minato-ku Tokyo, Japan, Phone: +81-3-3454-1111
<http://www.ic.nec.co.jp>



Nih- Nihon Inter Electronics Corporation

1204 Soya, Hadano-shi, Kanagawa 257-8511, Japan, Phone: +81-463-81-2709
<http://www.niec.co.jp>



Njr- New Japan Radio Co., Ltd.

Arco Tower 17F, 1-8-1, Shimomeguro, Meguro-ku, Tokyo 153, Japan
Phone: +81-3-5434-8335
<http://www.njr.com>



Nsc- National Semiconductor Corp.

North America PO Box 7643 Mount Prospect, IL 60056-7643, USA Phone: +1-800-628-7364, ext 305
<http://www.national.com>



Nte- NTE Electronics Inc.

44 Farrand Street, Bloomfield, NJ 07003, USA, Phone: 800-631-1250
<http://www.nteinc.com>



Nxp- NXP Semiconductors (Philips); NxC- NXP China; NXH- NXP Hong Kong;

NxM- NXP Malaysia

PO Box 80073, 5600 KA Eindhoven, Netherlands. Phone: +31 40 27 45678
<http://www.nxp.com>



Ons- ON Semiconductor

Japan Customer Focus Center 4-32-1 Nishi-Gotanda, Shinagawa-ku, Tokyo, Japan
<http://onsemi.com>



Org- Origin Semiconductor

1-18-18 Takada, Toshima-ku, Tokyo 171-8575, Phone: +81-3-3988-6369
<http://www.origin.co.jp>



Pam- Power Analog Microelectronics, Inc

Suite 201, Building #1, 33 Le Shan Road, Xuhui District, Shanghai, 200030, China,
<http://www.poweranalog.com/>



Pan- Panasonic (Matsushita) Electronics Corp.

1 Kotari-Yakemashi, Nagaokakyo, Kyoto 617, Japan, Phone: 075/921-8151
<http://www.mec.panasonic.co.jp>



Pcr- PulseCore Semiconductor

(Acquired by ON Semiconductor)
www.pulsecoresemi.com



Pct- Princeton Technology Corp.

2F, No. 233-1, Baociao Road, Sindian City, Taipei 23145, Taiwan, R.O.C.
<http://www.princeton.com.tw>



Per- Pericom Semiconductor Corporation

3545 North First St. San Jose, CA 95134, USA
<http://www.pericom.com/>



Phi- Philips GmbH; PhC- Philips China; PhH- Philips Hong Kong;

PhM- Philips, Malaysia (semiconductor manufacture is handed to NXP Semiconductor)

Hammerbrookstrasszlige 69 D-20097 Hamburg, Germany, Phone: +49-40-23536-0
<http://www.philips.com>



Pic- Paceleader Industrial

6F-8, No.2 Jian Ba Road, Chung Ho City, Taipei Hsien, Taiwan.
<http://www.paceleader.tw/>



Pjt- PanJIT Semiconductor

No. 21 Kang Shan Nort Road, Kang Shan Town, Kaohsihng Hsion 870, Taiwan R.O.C,
<http://www.panjit.com.tw>



Prt- Protek Devices

2929 South Fair Lane, Tempe, AZ 85282, USA
<http://www.protekdevices.com/>



Pti- Pericom Technology Inc.

Unit 1203,12/F Chevalier Commercial Centre,8 Wang Hoi Road, Kowloon Bay HK
www.pti-ic.com



Rct- Richtek Technology Corp.

5F, No. 20, Tai Yuen Street, Chupei City, Hsinchu, Taiwan 30288
<http://www.richtek.com/index.jsp>



Rec- Rectron China, Ltd.

82 Canton Road, 16th Floor. Tsimshatsui, Kowloon, Hong Kong, Phone: 852-2424-9127
<http://www.rectron.com>



Ren- Renesas (Hitachi and Mitsubishi) Ltd.

Nippon Bldg., 2-6-2, Ohte-machi, Chiyoda-ku, Tokyo 100-0004, Japan, Phone: 852-2424-9127
<http://www.renesas.eu/>



Rfe- RFE International, Inc.

1938 Blair Ave, Santa Ana, CA 92705, USA
<http://www.rfeinc.com/>



Rhm- Rohm Co., Ltd.

21 Saiin Mizosaki-cho, Ukyo-ku, Kyoto 615 Japan, Phone: +81-75-311-2121
<http://www.rohm.co.jp>



Ric- Ricoh Co., Ltd

13-1 Himemuro-cho, Ikeda City, Osaka 563-8501, Japan, Phone: +81-72-753-1111
<http://www.ricoh.com>



Sam- Samsung Electronics

8/10FL. Samsung Main Bld. 250, 2-KA, Taepyung-Ro Chung-Ku, Seoul, Korea, Box 8233
<http://www.korea.samsungsemi.com>



San- Sanyo Electric Co. Ltd

15-13-6 Chome Tokyo 113 Japan, Phone: +81-3-3835-1474
<http://semicon.sanyo.com>



Se- Si-En Technology

8F, No. 33, Lane 155, Sec. 3, Bei Shen Road, Shen Keng Hsiang, Taipei 222 Taiwan
<http://www.secosgmbh.com/>



Sec- Secos Corporation

8F, No. 33, Lane 155, Sec. 3, Bei Shen Road, Shen Keng Hsiang, Taipei 222 Taiwan
<http://www.secosgmbh.com/>



Sew- Seaward Electronics Inc.

Section B, 2nd Floor, #22 XinXi Road, ShangDi, HaiDian District, Beijing, China
www.seawardinc.com.cn



Sgm- SG Micro Limited

(There is no accesible padding information)
<http://www.sg-micro.com/f/index.aspx>



Shb- Shanghai Belling Co, Ltd.

810 YiShan Rd, Shanghai, PR China 200233. Phone:86-21-64850700
<http://www.belling.com.cn>



Shi- Shindengen Electric Mfg. Co. Ltd

Recruit Ikebukuro Bldg., 13-23 1Chome, Minami-Ikebukuro, Toshima-Ku, Tokyo 171, Japan
<http://www.shindengen.com>



Sie- Siemens AG

Postfach 2352 90713 Fuerth-Bislohe, Germany, Phone: +49-911-3001-220
<http://www.siemens.de>



Sii- Seiko Instruments Inc.

8, Nakase 1-chome, Mihama-ku, Chiba-shi, Chiba 261-8507, Japan
<http://www.sii.co.jp>



Sil- Silicon General Inc (Is now part of Microsemi)

<http://www.microsemi.com>



Sip- Sipex
(Is now part of Exar)
<http://www.sipex.com>



Sir- Sirenza Microdevices
522 Almanor Ave., Sunnyvale, CA 94085, USA
<http://www.sirenza.com>



Sit- Sitech Semiconductors Co., Limited
(There is no accesible padding information)
<http://www.sth-semico.com/en/index.asp>



Six- Siliconix GmbH
(Is now part of Vishay)
<http://www.siliconix.com>



Sib- Silicon Laboratories Inc.
400 West Cesar Chavez, Austin, TX 78701, USA
<http://www.silabs.com/Pages/default.aspx>



Sin- Hangzhou Silan Microelectronics Co., Ltd
No. 4 HuangGuShan Road, Hangzhou City, P.R.C
<http://www.silan.com.cn>



Sme- Semtech Electronics Ltd.
Room 2610,CCT Telecom Building,11 wo Shing Street, Fo Tan,Shatin, N.T., Hong Kong
<http://www.semtech.net.cn/>



Smt- Semtech Corporation
200 Flynn Road, Camarillo, CA 93012, USA, Phone: (805)498-2111
<http://www.semtech.com>



Soy- Sony Corporation
10-18 Takanawa 4 Chome, Minato-ku, Tokyo, 108 Japan, Phone: +81-3-448-3426
<http://www.sony.co.jp>



Ssc- Silicon Standard Corp.
2900 Gordon Ave., Ste.100, Santa Clara, CA 95051, USA
<http://www.siliconstandard.com/>



Sta- Stanson Technology Co., Ltd.
16F-3, No.421, Song Sung Rd., Taipei City, Taiwan
<http://www.stansontech.com/>



Ste- SGS-Thomson Microelectronics
Technoparc du Pays de Gex, 01630 Saint Genis Pouilly, France, Phone: +33-50402640
<http://www.st.com>



Stx- Supertex Inc.
1235 Bordeaux Dr. Sunnyvale, CA 94089, USA, Phone: +1-408-744-0100
<http://www.supertex.com>



Sup- SUPEC Electronics Corp.
A411, 328 Airport Road, Suzhou Industrial Park, Suzhou, P.R.China
www.supec.com.cn



Sur- Surge Components Inc.
11016 Grand Blvd., Deer Park, NY 11729, USA, Phone: (631) 595-1283
<http://www.surgecomponents.com>



Sus- SynSemi, Inc.
California, USA, Phone: (650) 560-0095
<http://www.synsemi.com/>



Syn- Sync Power Corp.
7F-2, No. 3-1, Park Street, Nankang District, (NKSP), Taipei, Taiwan, 115 , R.O.C
<http://www.syncpower.com/>



Tac- Tak Cheong Semiconductor Co., Ltd.
Rm. 220-222, Chiap Thong Building, 321 Tokwawan Road, Kln, H.K.
<http://www.takcheong.com/en/index.asp>



Tcs- TelCom Semiconductor
1300 Terra Bella Avenue, P.O. Box 7267, Mountain View, CA 94039-7267, USA
<http://www.telcom-semi.com>



Tfk- Temic Telefunken microelectronic GmbH
(Is not a current ICs manufacturer)
<http://www.temic.de>



Ti- Texas Instruments
13500 N Central Expwy PO Box 655474 Dallas, TX 72265, USA, Phone: 214/995-2011
<http://www.ti.com>



Tok- Toko America, Inc.
1250 Feehanville Drive Mt. Prospect, IL 60056, USA , Phone: (847) 297-0070
<http://www.tokoam.com>



Tor- Torex Semiconductor Ltd.
8F Sakuranihonbashi Bildg, 1-13-12 Nihonbashikayabacho Chuo-ku, Tokyo 103-0025 Japan
<http://www.torex.co.jp>



Tos- Toshiba Corporation
1-1 Shibaura 1-Chome J 105 Tokyo, Japan, Phone: +813-3457-3495
<http://www.toshiba.com>



Trs- Transys Electronics Ltd.
Birmingham, PO Box 11848 B46 1ZT, UK, Phone: 0121-776-6321
<http://www.transyselectronics.com>



Tsc- Taiwan Semiconductor Company, Ltd.
2F, 8 Alley 16, Lane 235, Pao Chiao Road, Hsin Tien, Taipei, Hsien, Taiwan ROC
<http://www.taiwansemi.com>



Ttr- TAITRON Components Incorporated
28040 West Harrison Parkway Valencia California 91355, USA
www.taitroncomponents.com



Utc- Unisonic Technologies Co., Ltd.
4F-2, No. 16, Lane 609, Sec. 5, Chung-shin Rd, San-Chung City, Taipei Hsien, Taiwan
<http://www.unisonic.com.tw>



Vs- Vishay Semiconductor GmbH
P.O.B. 3535, D-74025 Heilbronn, Germany, Phone: 49 (0)7131 67 2831
<http://www.vishay.com>



Wjc - WJ Communications, Inc.
401 River Oaks Parkway, San Jose, CA 95134, USA, Phone: 800-951-4401
<http://www.wj.com>



Wpl- World Products, LLC

19654 Eighth Street East, P.O. Box 517, Sonoma, CA 95476, USA
<http://www.worldproducts.com/>

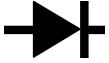

Wte- Won-Top Electronics Co., Ltd.

No. 44 Yu Kang North 3rd Road, Chine Chen Dist., Kaohsiung, Taiwan
<http://www.wontop.com>



Wtr- Weitron Technology Co., Ltd

No 11. Hsin-Sheng St., Hsin-Tien City, Taipei County, Taiwan
http://www.weitron.com.tw/e_main.html



Xpt- Tshen Zhen Xptek Technology Co., Ltd.

4 Bldg., Kejizhong Rd2, Software Park, Hi-tech District Shenzhen, China
<http://www.xptek.com.cn>



Ybn- Yobon Technologies, Inc.

4F.-1, No. 98, Mincyuan Rd., Sindian City, Taipei County 23143, Taiwan
<http://www.yobon.com.tw>



Zow- Zowie Technology Corporation

3F, No. 13, Fu Shin Rd., Hin Thin, Taipei, Taiwan, Phone: 885-2-22195533
<http://www.zowie.com.tw/>



Zx- Zetex plc.

Fields New Road, Chadderton, Oldham, OL9 8NP, UK, Phone: (44) 161 622 4422
(Is now part of Diodes Inc.)
<http://www.zetex.com>

SECTION18
ADDITIONAL SMD INFO

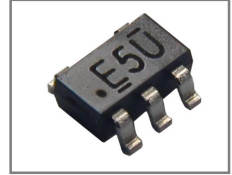

 **HOME**

On the cover of the electronic components besides SMD code, manufacturers can place additional information such as **internal production lot number**, **traceability code**, **data of production**, **assembly location** etc. The additional info is an arbitral position and arbitral content (depending of the manufacturer) and can be alphanumeric symbol (symbols) or graphic symbol.

Below we present some additional info from diverse manufacturers.

Lot number.

Manufacturer: **Elm (ELM Technology Corporation):**

Rules 1 (for ODO voltage detectors)

Symbol 1 - A to Z(I, O, X excepted)

Symbol 2 - 0 to 9

Rules 2 (for PPO voltage detectors)

Symbol 1 - 0 to 9

Symbol 2 - A to Z(I, O, X excepted)

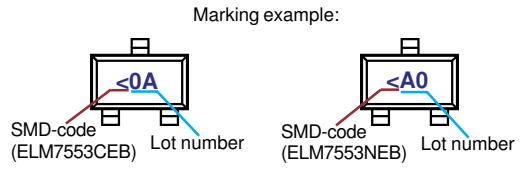

Manufacturer: **Tor (Torex Semiconductor LTD):**

01~09, 0A~0Z, 11~9Z, A1~A9, AA~AZ, B1~ZZ repeated, (G, I, J, O, Q, W excluded.) * No character inversion used.

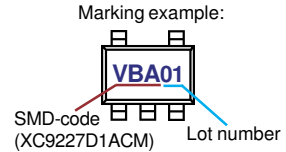

Data of production

Manufacturer: **Ape (Advanced Power Electronics Corp.)**

Code Year

- YY** 2004, 2008, 2012
- YY** 2003, 2007, 2011
- YY** 2002, 2006, 2010
- YY** 2001, 2005, 2009

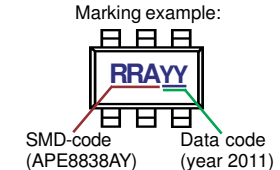

Manufacturer: **Axl (AXElite Technology Co., Ltd)**

Code Year Code Week

- 7** 2007 **A...Z** 1...26
- 8** 2008 **a...z** 27...52
- 9** 2009
- A** 2010
- B** 2011
- C** 2012

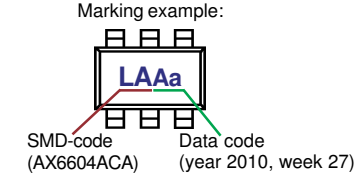

Manufacturer: **Inf (Infineon Technologies AG)**

Month	Y e a r											
	2003	2004	2005	2006	2007	2008	2009	2010	2011	2012	2013	2014
01	a	p	A	P	a	p	A	P	a	p	A	P
02	b	q	B	Q	b	q	B	Q	b	q	B	Q
03	c	r	C	R	c	r	C	R	c	r	C	R
04	d	s	D	S	d	s	D	S	d	s	D	S
05	e	t	E	T	e	t	E	T	e	t	E	T
06	f	u	F	U	f	u	F	U	f	u	F	U
07	g	v	G	V	g	v	G	V	g	v	G	V
08	h	x	H	X	h	x	H	X	h	x	H	X
09	j	y	J	Y	j	y	J	Y	j	y	J	Y
10	k	z	K	Z	k	z	K	Z	k	z	K	Z
11	l	2	L	4	l	2	L	4	l	2	L	4
12	n	3	N	5	n	3	N	5	n	3	N	5

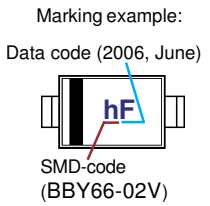

Manufacturer: **Kec (Korea Electronics Co. Ltd.)**

Year	Marking (Week)				Periode (Year)				
1 st Year (2006)	01	02	...	51	52	2006-2010-2014...			
2 nd Year (2007)	0A	0B	...	5A	5B	2007-2011-2015...			
4 rd Year (2008)	J1	J2	...	E1	E2	2008-2012-2016...			
4 th Year (2009)	JA	JB	...	EA	EB	2009-2013-2017...			

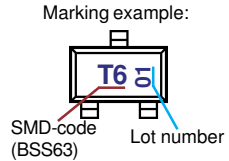

Manufacturer: **Pti (Pericom Tecnology Inc.)**

Year	W	Year	W	Year	W	Year	W	Year	W					
2005	P 1	A	2006	R 1	A	2007	T 1	A	2008	V 1	A	2009	X 1	A
2005	P 2	B	2006	R 2	B	2007	T 2	B	2008	V 2	B	2009	X 2	B
2005	P 3	C	2006	R 3	C	2007	T 3	C	2008	V 3	C	2009	X 3	C
2005	P 4	D	2006	R 4	D	2007	T 4	D	2008	V 4	D	2009	X 4	D
2005	P 5	E	2006	R 5	E	2007	T 5	E	2008	V 5	E	2009	X 5	E
2005	P 6	F	2006	R 6	F	2007	T 6	F	2008	V 6	F	2009	X 6	F

Year	W	Year	W	Year	W	Year	W	Year	W
2005	P 7 G	2006	R 7 G	2007	T 7 G	2008	V 7 G	2009	X 7 G
2005	P 8 H	2006	R 8 H	2007	T 8 H	2008	V 8 H	2009	X 8 H
2005	P 9 I	2006	R 9 I	2007	T 9 I	2008	V 9 I	2009	X 9 I
2005	P 10 J	2006	R 10 J	2007	T 10 J	2008	V 10 J	2009	X 10 J
2005	P 11 K	2006	R 11 K	2007	T 11 K	2008	V 11 K	2009	X 11 K
2005	P 12 L	2006	R 12 L	2007	T 12 L	2008	V 12 L	2009	X 12 L
2005	P 13 M	2006	R 13 M	2007	T 13 M	2008	V 13 M	2009	X 13 M
2005	P 14 N	2006	R 14 N	2007	T 14 N	2008	V 14 N	2009	X 14 N
2005	P 15 O	2006	R 15 O	2007	T 15 O	2008	V 15 O	2009	X 15 O
2005	P 16 P	2006	R 16 P	2007	T 16 P	2008	V 16 P	2009	X 16 P
2005	P 17 Q	2006	R 17 Q	2007	T 17 Q	2008	V 17 Q	2009	X 17 Q
2005	P 18 R	2006	R 18 R	2007	T 18 R	2008	V 18 R	2009	X 18 R
2005	P 19 S	2006	R 19 S	2007	T 19 S	2008	V 19 S	2009	X 19 S
2005	P 20 T	2006	R 20 T	2007	T 20 T	2008	V 20 T	2009	X 20 T
2005	P 21 U	2006	R 21 U	2007	T 21 U	2008	V 21 U	2009	X 21 U
2005	P 22 V	2006	R 22 V	2007	T 22 V	2008	V 22 V	2009	X 22 V
2005	P 23 W	2006	R 23 W	2007	T 23 W	2008	V 23 W	2009	X 23 W
2005	P 24 X	2006	R 24 X	2007	T 24 X	2008	V 24 X	2009	X 24 X
2005	P 25 Y	2006	R 25 Y	2007	T 25 Y	2008	V 25 Y	2009	X 25 Y
2005	P 26 Z	2006	R 26 Z	2007	T 26 Z	2008	V 26 Z	2009	X 26 Z
2005	Q 27 A	2006	S 27 A	2007	U 27 A	2008	W 27 A	2009	Y 27 A
2005	Q 28 B	2006	S 28 B	2007	U 28 B	2008	W 28 B	2009	Y 28 B
2005	Q 29 C	2006	S 29 C	2007	U 29 C	2008	W 29 C	2009	Y 29 C
2005	Q 30 D	2006	S 30 D	2007	U 30 D	2008	W 30 D	2009	Y 30 D
2005	Q 31 E	2006	S 31 E	2007	U 31 E	2008	W 31 E	2009	Y 31 E
2005	Q 32 F	2006	S 32 F	2007	U 32 F	2008	W 32 F	2009	Y 32 F
2005	Q 33 G	2006	S 33 G	2007	U 33 G	2008	W 33 G	2009	Y 33 G
2005	Q 34 H	2006	S 34 H	2007	U 34 H	2008	W 34 H	2009	Y 34 H
2005	Q 35 I	2006	S 35 I	2007	U 35 I	2008	W 35 I	2009	Y 35 I
2005	Q 36 J	2006	S 36 J	2007	U 36 J	2008	W 36 J	2009	Y 36 J
2005	Q 37 K	2006	S 37 K	2007	U 37 K	2008	W 37 K	2009	Y 37 K
2005	Q 38 L	2006	S 38 L	2007	U 38 L	2008	W 38 L	2009	Y 38 L
2005	Q 39 M	2006	S 39 M	2007	U 39 M	2008	W 39 M	2009	Y 39 M
2005	Q 40 N	2006	S 40 N	2007	U 40 N	2008	W 40 N	2009	Y 40 N
2005	Q 41 O	2006	S 41 O	2007	U 41 O	2008	W 41 O	2009	Y 41 O
2005	Q 42 P	2006	S 42 P	2007	U 42 P	2008	W 42 P	2009	Y 42 P
2005	Q 43 Q	2006	S 43 Q	2007	U 43 Q	2008	W 43 Q	2009	Y 43 Q
2005	Q 44 R	2006	S 44 R	2007	U 44 R	2008	W 44 R	2009	Y 44 R
2005	Q 45 S	2006	S 45 S	2007	U 45 S	2008	W 45 S	2009	Y 45 S
2005	Q 46 T	2006	S 46 T	2007	U 46 T	2008	W 46 T	2009	Y 46 T
2005	Q 47 U	2006	S 47 U	2007	U 47 U	2008	W 47 U	2009	Y 47 U
2005	Q 48 V	2006	S 48 V	2007	U 48 V	2008	W 48 V	2009	Y 48 V
2005	Q 49 W	2006	S 49 W	2007	U 49 W	2008	W 49 W	2009	Y 49 W
2005	Q 50 X	2006	S 50 X	2007	U 50 X	2008	W 50 X	2009	Y 50 X
2005	Q 51 Y	2006	S 51 Y	2007	U 51 Y	2008	W 51 Y	2009	Y 51 Y
2005	Q 52 Z	2006	S 52 Z	2007	U 52 Z	2008	W 52 Z	2009	Y 52 Z
2010	Z 1 A	2011	B 1 A	2012	D 1 A	2013	F 1 A	2014	H 1 A
2010	Z 2 B	2011	B 2 B	2012	D 2 B	2013	F 2 B	2014	H 2 B
2010	Z 3 C	2011	B 3 C	2012	D 3 C	2013	F 3 C	2014	H 3 C
2010	Z 4 D	2011	B 4 D	2012	D 4 D	2013	F 4 D	2014	H 4 D
2010	Z 5 E	2011	B 5 E	2012	D 5 E	2013	F 5 E	2014	H 5 E
2010	Z 6 F	2011	B 6 F	2012	D 6 F	2013	F 6 F	014	H 6 F
2010	Z 7 G	2011	B 7 G	2012	D 7 G	2013	F 7 G	2014	H 7 G
2010	Z 8 H	2011	B 8 H	2012	D 8 H	2013	F 8 H	2014	H 8 H
2010	Z 9 I	2011	B 9 I	2012	D 9 I	2013	F 9 I	2014	H 9 I
2010	Z 10 J	2011	B 10 J	2012	D 10 J	2013	F 10 J	2014	H 10 J
2010	Z 11 K	2011	B 11 K	2012	D 11 K	2013	F 11 K	2014	H 11 K
2010	Z 12 L	2011	B 12 L	2012	D 12 L	2013	F 12 L	2014	H 12 L
2010	Z 13 M	2011	B 13 M	2012	D 13 M	2013	F 13 M	2014	H 13 M
2010	Z 14 N	2011	B 14 N	2012	D 14 N	2013	F 14 N	2014	H 14 N
2010	Z 15 O	2011	B 15 O	2012	D 15 O	2013	F 15 O	2014	H 15 O
2010	Z 16 P	2011	B 16 P	2012	D 16 P	2013	F 16 P	2014	H 16 P
2010	Z 17 Q	2011	B 17 Q	2012	D 17 Q	2013	F 17 Q	2014	H 17 Q
2010	Z 18 R	2011	B 18 R	2012	D 18 R	2013	F 18 R	2014	H 18 R
2010	Z 19 S	2011	B 19 S	2012	D 19 S	2013	F 19 S	2014	H 19 S
2010	Z 20 T	2011	B 20 T	2012	D 20 T	2013	F 20 T	2014	H 20 T
2010	Z 21 U	2011	B 21 U	2012	D 21 U	2013	F 21 U	2014	H 21 U

Year	W	Year	W	Year	W	Year	W	Year	W					
2010	Z 22	V	2011	B 22	V	2012	D 22	V	2013	F 22	V	2014	H 22	V
2010	Z 23	W	2011	B 23	W	2012	D 23	W	2013	F 23	W	2014	H 23	W
2010	Z 24	X	2011	B 24	X	2012	D 24	X	2013	F 24	X	2014	H 24	X
2010	Z 25	Y	2011	B 25	Y	2012	D 25	Y	2013	F 25	Y	2014	H 25	Y
2010	Z 26	Z	2011	B 26	Z	2012	D 26	Z	2013	F 26	Z	2014	H 26	Z
2010	A 27	A	2011	C 27	A	2012	E 27	A	2013	G 27	A	2014	J 27	A
2010	A 28	B	2011	C 28	B	2012	E 28	B	2013	G 28	B	2014	J 28	B
2010	A 29	C	2011	C 29	C	2012	E 29	C	2013	G 29	C	2014	J 29	C
2010	A 30	D	2011	C 30	D	2012	E 30	D	2013	G 30	D	2014	J 30	D
2010	A 31	E	2011	C 31	E	2012	E 31	E	2013	G 31	E	2014	J 31	E
2010	A 32	F	2011	C 32	F	2012	E 32	F	2013	G 32	F	2014	J 32	F
2010	A 33	G	2011	C 33	G	2012	E 33	G	2013	G 33	G	2014	J 33	G
2010	A 34	H	2011	C 34	H	2012	E 34	H	2013	G 34	H	2014	J 34	H
2010	A 35	I	2011	C 35	I	2012	E 35	I	2013	G 35	I	2014	J 35	I
2010	A 36	J	2011	C 36	J	2012	E 36	J	2013	G 36	J	2014	J 36	J
2010	A 37	K	2011	C 37	K	2012	E 37	K	2013	G 37	K	2014	J 37	K
2010	A 38	L	2011	C 38	L	2012	E 38	L	2013	G 38	L	2014	J 38	L
2010	A 39	M	2011	C 39	M	2012	E 39	M	2013	G 39	M	2014	J 39	M
2010	A 40	N	2011	C 40	N	2012	E 40	N	2013	G 40	N	2014	J 40	N
2010	A 41	O	2011	C 41	O	2012	E 41	O	2013	G 41	O	2014	J 41	O
2010	A 42	P	2011	C 42	P	2012	E 42	P	2013	G 42	P	2014	J 42	P
2010	A 43	Q	2011	C 43	Q	2012	E 43	Q	2013	G 43	Q	2014	J 43	Q
2010	A 44	R	2011	C 44	R	2012	E 44	R	2013	G 44	R	2014	J 44	R
2010	A 45	S	2011	C 45	S	2012	E 45	S	2013	G 45	S	2014	J 45	S
2010	A 46	T	2011	C 46	T	2012	E 46	T	2013	G 46	T	2014	J 46	T
2010	A 47	U	2011	C 47	U	2012	E 47	U	2013	G 47	U	2014	J 47	U
2010	A 48	V	2011	C 48	V	2012	E 48	V	2013	G 48	V	2014	J 48	V
2010	A 49	W	2011	C 49	W	2012	E 49	W	2013	G 49	W	2014	J 49	W
2010	A 50	X	2011	C 50	X	2012	E 50	X	2013	G 50	X	2014	J 50	X
2010	A 51	Y	2011	C 51	Y	2012	E 51	Y	2013	G 51	Y	2014	J 51	Y
2010	A 52	Z	2011	C 52	Z	2012	E 52	Z	2013	G 52	Z	2014	J 52	Z

Marking example:

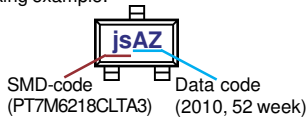

Manufacturer: **Sew** (Seaward Electronics Inc.)

Code	Year	Code	Week	
<u>5</u>	2001	A...Z	1...26	A dot on top right corner of case is for lead-free process.
<u>5</u>	2002	a...z	27...52	
<u>6</u>	2003			
<u>6</u>	2004			
<u>7</u>	2005			
<u>7</u>	2006			
<u>8</u>	2007			
<u>8</u>	2018			
<u>9</u>	2009			
<u>9</u>	2010			

Marking example:

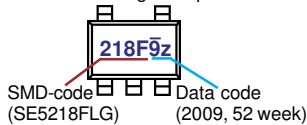

Manufacturer: **Ste** (SGS-Thomson Microelectronics)

Code	Week
A	01, 02
B	03, 04
C	05, 06
...	...
Z	51, 52, 53

Marking example:

